

AEDC-TR-79-22

Reference to
J. Jacobs

NOV 14 1979
JAN 24 1980
MAY 14 1980

C.6



Separated and Nonseparated Turbulent Flows about Axisymmetric Nozzle Afterbodies

Part II Detailed Flow Measurements

John A. Benek
ARO, Inc.

October 1979

Final Report for Period October 1, 1977 - December 1, 1978

Approved for public release, distribution unlimited

Property of U. S. Air Force
AEDC-TR-79-22
F6-20-79-0-017

**ARNOLD ENGINEERING DEVELOPMENT CENTER
ARNOLD AIR FORCE STATION, TENNESSEE
AIR FORCE SYSTEMS COMMAND
UNITED STATES AIR FORCE**

NOTICES

When U. S. Government drawings, specifications, or other data are used for any purpose other than a definitely related Government procurement operation, the Government thereby incurs no responsibility nor any obligation whatsoever, and the fact that the Government may have formulated, furnished, or in any way supplied the said drawings, specifications, or other data, is not to be regarded by implication or otherwise, or in any manner licensing the holder or any other person or corporation, or conveying any rights or permission to manufacture, use, or sell any patented invention that may in any way be related thereto.

Qualified users may obtain copies of this report from the Defense Documentation Center.

References to named commercial products in this report are not to be considered in any sense as an indorsement of the product by the United States Air Force or the Government.

This report has been reviewed by the Information Office (OI) and is releasable to the National Technical Information Service (NTIS). At NTIS, it will be available to the general public, including foreign nations.

APPROVAL STATEMENT

This report has been reviewed and approved.



ELTON R. THOMPSON
Project Manager
Directorate of Technology

Approved for publication:

FOR THE COMMANDER

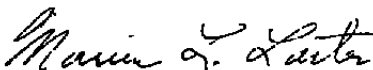

MARION L. LASTER
Director of Technology
Deputy for Operations

UNCLASSIFIED

REPORT DOCUMENTATION PAGE		READ INSTRUCTIONS BEFORE COMPLETING FORM															
1 REPORT NUMBER AEDC-TR-79-22	2 GOVT ACCESSION NO.	3 RECIPIENT'S CATALOG NUMBER															
4 TITLE (and Subtitle) SEPARATED AND NONSEPARATED TURBULENT FLOWS ABOUT AXISYMMETRIC NOZZLE AFTERBODIES, Part II - Detailed Flow Measurements		5 TYPE OF REPORT & PERIOD COVERED Final Report - October 1, 1977 - December 1, 1978															
		6 PERFORMING ORG REPORT NUMBER															
7. AUTHOR(s) John A. Benek, ARO, Inc., a Sverdrup Corporation Company		8 CONTRACT OR GRANT NUMBER(s)															
9 PERFORMING ORGANIZATION NAME AND ADDRESS Arnold Engineering Development Center/DOT Air Force Systems Command Arnold Air Force Station, Tennessee 37389		10 PROGRAM ELEMENT, PROJECT, TASK AREA & WORK UNIT NUMBERS Program Element 65807F															
11 CONTROLLING OFFICE NAME AND ADDRESS Arnold Engineering Development Center/DOS Air Force Systems Command Arnold Air Force Station, Tennessee 37389		12. REPORT DATE October 1979															
		13 NUMBER OF PAGES 213															
14 MONITORING AGENCY NAME & ADDRESS (if different from Controlling Office)		15. SECURITY CLASS. (of this report) UNCLASSIFIED															
		15a. DECLASSIFICATION/DOWNGRADING SCHEDULE N/A															
16 DISTRIBUTION STATEMENT (of this Report) Approved for public release; distribution unlimited.																	
17 DISTRIBUTION STATEMENT (of the abstract entered in Block 20, if different from Report)																	
18 SUPPLEMENTARY NOTES Available in DDC																	
19 KEY WORDS (Continue on reverse side if necessary and identify by block number) <table style="width: 100%; border: none;"> <tr> <td style="width: 33%;">cylindrical bodies</td> <td style="width: 33%;">plumes</td> <td style="width: 33%;">kinetic energy</td> </tr> <tr> <td>afterbodies</td> <td>simulators</td> <td>mean</td> </tr> <tr> <td>drag</td> <td>flow fields</td> <td>velocity</td> </tr> <tr> <td>boundary layer</td> <td>flow separation</td> <td>pressure distribution</td> </tr> <tr> <td>exhaust nozzles</td> <td>Reynolds number</td> <td>velocity vectors</td> </tr> </table>			cylindrical bodies	plumes	kinetic energy	afterbodies	simulators	mean	drag	flow fields	velocity	boundary layer	flow separation	pressure distribution	exhaust nozzles	Reynolds number	velocity vectors
cylindrical bodies	plumes	kinetic energy															
afterbodies	simulators	mean															
drag	flow fields	velocity															
boundary layer	flow separation	pressure distribution															
exhaust nozzles	Reynolds number	velocity vectors															
20 ABSTRACT (Continue on reverse side if necessary and identify by block number) Measurements of mean velocity, specific turbulent kinetic energy, and specific Reynolds shear were obtained at $M = 0.64$ and $Re_D = 2.886 \times 10^5$ in a symmetry plane of two axisymmetric, circular-arc, boattail geometries each of which had a solid plume simulator. The geometries were selected such that an attached- and a separated flow boundary layer would be obtained. Ancillary measurements, consisting of model surface and tunnel wall, axial, static pressure																	

UNCLASSIFIED

UNCLASSIFIED

20. ABSTRACT (Continued)

distributions, and velocity vectors near the tunnel wall provide a well-defined domain with which to validate numerical flow simulations. Tabulations of the data and coefficients of least-squares cubic spline fits to the data are presented.

UNCLASSIFIED

PREFACE

The work reported herein was conducted by the Arnold Engineering Development Center (AEDC), Air Force Systems Command (AFSC). The results presented were obtained by ARO, Inc., AEDC Division (a Sverdrup Corporation Company), contract operator of the AEDC, AFSC, Arnold Air Force Station, Tennessee. The work was conducted under ARO Project Number P32P-R4, and the data analysis was completed on 1 December 1978. The report was prepared under ARO Project Number P32G-23. The Air Force Project Manager of this work was E. R. Thompson, AEDC/DOT. The manuscript was submitted for publication on March 8, 1979.

CONTENTS

	<u>Page</u>
1.0 INTRODUCTION	5
2.0 APPARATUS	
2.1 Wind Tunnel	6
2.2 Models	6
2.3 Instrumentation	7
3.0 EXPERIMENTAL PROCEDURE	
3.1 Calibration	9
3.2 Data Reduction Equations	10
3.3 Measurement Uncertainties	12
4.0 RESULTS AND DISCUSSION	
4.1 Attached-Flow Model	13
4.2 Separated-Flow Model	15
4.3 Eddy Viscosity	16
5.0 CONCLUDING REMARKS	17
REFERENCES	17

ILLUSTRATIONS

Figure

1. Acoustic Research Tunnel (ART)	21
2. Tunnel Sidewall Configurations and Test Section Viewing Area	21
3. Attached-Flow Model	22
4. Separated-Flow Model	23
5. Model Installation in the ART	24
6. ART Laser Velocimeter System	26
7. Mean Velocity Vectors, Attached-Flow Model	27
8. Cusp Region of Attached-Flow Model	28
9. Mean Axial Velocity Component, Attached-Flow Model	29
10. Mean Radial Velocity Component, Attached-Flow Model	32
11. Specific Turbulent Kinetic Energy, Attached-Flow Model	35
12. Specific Reynolds Shear, Attached-Flow Model	38
13. Boundary Conditions for Attached Flow Field	41
14. Mean Velocity Vectors, Separated-Flow Model	42
15. Cusp Region of Separated-Flow Model	43

<u>Figure</u>	<u>Page</u>
16. Mean Axial Velocity Component, Separated-Flow Model	44
17. Mean Radial Velocity Component, Separated-Flow Model	47
18. Specific Turbulent Kinetic Energy, Separated-Flow Model	50
19. Specific Reynolds Shear, Separated-Flow Model	53
20. Boundary Conditions for Separated Flow Field	56
21. Eddy Viscosity, Attached-Flow Model	57
22. Eddy Viscosity, Separated-Flow Model	60

TABLES

1. Model Geometry	63
2. Measurement Uncertainties for $M_\infty = 0.64$	65
3. Forebody Pressure Distribution	66
4. Comparison of Boundary-Layer Parameters, Attached-Flow Model	67
5. Data Tabulation, Attached-Flow Model	68
6. Least-Squares Cubic Spline Coefficients, Attached-Flow Model	105
7. Comparison of Boundary-Layer Parameters, Attached-Flow Model	123
8. Data Tabulation, Separated-Flow Model	124
9. Least-Squares Cubic Spline Coefficients, Separated-Flow Model	156
10. Eddy Viscosity Tabulation, Attached-Flow Model	175
11. Eddy Viscosity Tabulation, Separated-Flow Model	192
 NOMENCLATURE	 210

1.0 INTRODUCTION

The importance of afterbody drag to overall aircraft performance is the focus of much attention. An extensive body of experimental data has been accumulated in an effort to determine important design parameters (see, e.g., Refs. 1-8). However, improvements in design techniques are dependent largely upon the ability to accurately compute the afterbody flow field. Such calculations are complicated by the presence of regions of separated flow. The development of suitable computational methods for separated flows is hindered by the paucity of high-quality experimental data. Such data are necessary to guide the development and subsequent validation of the calculations. Therefore, the acquisition of data suitable for use as a standard is of paramount importance.

The characteristics required of data that will be used to develop and validate separated-flow computations have been formulated by Gehart and Chima (Ref. 9) and by Aulehla (Ref. 10). These are (1) a simple geometry, (2) boundary-layer separation and reattachment caused by pressure gradients and not by sudden changes in geometry such as back steps, (3) extensive mapping of the velocity and pressure fields, and (4) well-defined boundary conditions. Two-dimensional data meeting these requirements have been reported by Simpson, et al. (Ref. 11) and by Albert, et al. (Ref. 12), but corresponding data for the axisymmetric case have not been found in the literature. Therefore, the present investigation was initiated expressly to acquire axisymmetric separated-flow data meeting these requirements.

Two axisymmetric, circular-arc, boattail nozzle geometries having identical solid plume simulators were selected to produce an attached and a separated flow field. The circular-arc boattail was chosen because this geometry has a convenient mathematical representation and is representative of practical geometries of interest. The solid plume simulator was employed to remove the complexities that would be introduced by a real jet exhaust with fluid entrainment. Similarly, a free-stream Mach number of 0.64, which yielded a forebody diameter Reynolds number of 2.886×10^5 , was selected to exclude complications arising from interactions with shock waves. The data include symmetry plane measurements of the mean velocity; specific turbulent kinetic energy; specific Reynolds shear; and model and tunnel wall, axial, static pressure distributions.

Additional experimental data, Part I of this work, covering these nozzle afterbody configurations for the Mach number range of $0.60 \leq M_\infty \leq 1.3$ and a unit Reynolds number range of $3.3 \times 10^6/m \leq Re_\infty \leq 13.2 \times 10^6/m$ ($1 \times 10^6/ft \leq Re_\infty \leq 4 \times 10^6/ft$) are contained in AEDC-TR-78-49.

2.0 APPARATUS

2.1 WIND TUNNEL

The Acoustic Research Tunnel (ART) is an atmospheric indraft, continuous-flow wind tunnel having a nominal 15- by 15- by 60-cm-long test section and a Mach number range of $0.2 \leq M \leq 1.06$ (see Ref. 13). Mach numbers above $M_{\infty} = 0.7$ are obtained through use of top and bottom porous walls and plenum suction. A schematic of the tunnel with significant dimensions is presented in Fig. 1.

A relatively low acoustic level is obtained in the test section by means of acoustic silencers (46-db maximum attenuation rating at 1.2 kHz) in the diffuser and plenum exhaust ducts, as well as vibration isolation expansion joints. Honeycomb and damping screens installed in the inlet section further reduce the acoustic and vortical background values. Because the exhaust machinery is remotely located with respect to the tunnel, fan noise is not transmitted back into the test section.

For this investigation the top and bottom test section walls were ventilated by a 6-percent porous array of 0.32-cm-diam holes that were inclined 30 deg to the free-stream velocity. These walls were covered with a fine-mesh, wire screen that reduced the acoustic level in the test section to 137.5 db at $M_{\infty} = 0.64$. The solid sidewalls were equipped with 20-cm-diam, optical-quality-glass windows mounted eccentrically with respect to the test section axis. A viewing area extending over approximately 32 cm was achieved by interchanging the sidewalls and rotating them 180 deg, as indicated in Fig. 2. The top wall was equipped with a row of static pressure orifices spaced at 1.3-cm intervals (see Figs. 3 and 4).

2.2 MODELS

Each of the models consisted of a 2.54-cm-diam cylindrical forebody, a circular-arc boattail, and a solid plume simulator (see Figs. 3 and 4). The plume simulator was composed of two parts—a contoured section and a cylindrical section. The contour corresponds to an inviscid jet boundary having a nozzle-to-free-stream static pressure ratio of 4.7 and a length-to-forebody-diameter ratio, \hat{L} of 0.63.* The cylindrical section smoothly joins the contour and has a closure ratio, \hat{d}_p , of 0.68. Two circular-arc geometries were chosen to produce an attached- and separated-flow case. The attached-flow boattail has a length, \hat{L} , of 1.77 and is illustrated in Fig. 3. The separated-flow model has a length, \hat{L} , of 0.8 and is represented in Fig. 4. Each model has

*All lengths are made dimensionless by the forebody diameter, 2.54 cm.

0.41-mm-diam pressure orifices distributed along an axis of symmetry. The orifice distribution for each model is indicated in Figs. 3 and 4. Table 1 contains a tabulation of the as-built coordinates and the analytic expression for the boattail geometry.

The models were mounted as tunnels centerline pipes as illustrated in Fig. 5. The models were supported in the tunnel stilling chamber and in the diffuser by a system of 0.51-mm-diam guy wires. The models were clamped rigidly to a strut support at the diffuser exit and were maintained in tension by a 6.8-kg mass and pulley system located in the stilling chamber. This mounting system was subsequently found to maintain the model on the tunnel centerline and to allow an axial shift of less than 25 microns during flow. The estimated maximum vibration amplitude normal to the tunnel centerline was less than 50 microns.

2.3 INSTRUMENTATION

2.3.1 Laser Velocimetry System

The presence of regions of reversed flow caused by separation required that a nonintrusive measurement technique be utilized to map the flow field. Therefore, a two-component, dual-scatter, Bragg-cell-type, laser velocimeter (LV) system collecting light in the forward-scatter mode was employed. Forward-scatter operation was selected because the intensity of light scattered in the direction of the incident light beam is greatest, thus making the system much more sensitive to smaller scatter sources. The moving fringe system established by the Bragg cell allowed the determination of both the magnitude and direction of the flow velocity. The optics were adjusted to yield an effective probe volume with diameter, $\hat{d}_v = 0.008$, and length, $\hat{l}_v = 0.045$. This probe volume was judged to be sufficiently "point like" relative to the model dimensions to yield accurate velocity measurements in a symmetry plane. For this investigation, the fringes were rotated 45 deg with respect to the tunnel centerline. A schematic of the LV system is given in Fig. 6, and a complete, detailed description is found in Ref. 14. Because the ART is an atmospheric indraft wind tunnel, sufficient particles were found to be present in the ambient air to provide high signal levels without seeding the tunnel airflow. The particles were mainly water droplets that formed during the expansion through the tunnel nozzle. By applying the procedure delineated by McGregor (Ref. 15) to representative flow conditions, specifically a Mach number of 0.64, total temperature of 300°K, total pressure of 9.768×10^6 pascals, and relative humidity of 90 percent, the particles were found to be approximately one micron in diameter. A Stokes flow analysis indicated that this size particle was sufficiently small to follow the flow accurately.

A 2.5-cm-thick aluminum plate is utilized as an optics platform to which the laser and associated optics are rigidly mounted. The optics platform is solidly mounted on a precision, three-component, machine tool bed that has a total positional uncertainty of 25 microns relative to an arbitrary reference point.

2.3.2 Pressures

The tunnel static and total pressures and the model static pressures were converted to a d-c electrical signal by one of two Scanivalve[®], Druck Model PDCR22, 0- to 10⁵-pascal pressure transducers. The tunnel reference pressure was converted to a d-c signal by a Kistler[®] Series 314, 0- to 10⁵-pascal transducer. The electrical signals were read on a Fluke[®] Model 8400 digital voltmeter and hand recorded.

A 0.64-cm-diam Bruel and Kjaer[®] condenser microphone was used to measure the tunnel root-mean-square sound pressure level, \tilde{P}_{rms} . The microphone was flush mounted to the tunnel sidewall, 47.6 cm ($\hat{X} \approx 22$) downstream from the test section entrance and 13.4 cm ($\hat{X} \approx -12$) downstream of the entrance with the sidewalls reversed. The average acoustic level was found to be 137.5 db.

2.3.3 Temperatures

The tunnel total temperature, T_T , was taken to be the arithmetic average of three measurements obtained from three copper-constantan thermocouples located in the stilling chamber. The tunnel sidewall temperature was measured at three axial locations by copper-constantan thermocouples. These thermocouples were embedded in the wall approximately 3 mm below the wetted surface through holes drilled into the wall from the plenum (no-flow) side. All temperatures were read on a Doric Thermocouple, Type J Indicator[®], which had an allowable input range of -70 to 868°C, and were hand recorded.

The measured values of the wall temperatures were observed to be equal to each other and within 0.2 percent of the adiabatic wall temperature, T_{aw} , determined from the ratio

$$T_{aw}/T_T = \left(1 + r \frac{\gamma - 1}{2} M_\infty^2\right) / \left(1 + \frac{\gamma - 1}{2} M_\infty^2\right) \quad (1)$$

where $\gamma = 1.4$ is the ratio of specific heats for air and $r = 0.88$ is the recovery factor for turbulent flow.

3.0 EXPERIMENTAL PROCEDURE

At the beginning of each test run, the free-stream velocity was computed from the total conditions. The tunnel flow was then established at $M = 0.64$. The probe volume

was then traversed to a point in the free stream, $\widehat{X} = -1.062$ and $\widehat{R} = 2.000$, and the value of the velocity measured. The average agreement between the computed and measured values was 0.6 percent over the course of the experiment.

3.1 CALIBRATION

3.1.1 Laser Velocimeter

Reduction of the LV data required that ϕ , the angle between the beams (see Fig. 6), be determined. This was done by projecting the beams onto a plane perpendicular to the line bisecting the angle ϕ . The distance between the projected beam centers, $\widehat{\xi}_A$, and the distance between the probe volume and projection plane, $\widehat{\xi}_B$, were measured. The angle ϕ was computed from

$$\tan \phi/2 = \widehat{\xi}_A / (2 \widehat{\xi}_B) \quad (2)$$

3.1.2 Traversing Mechanism

The traversing mechanism allows the probe volume to be moved in three dimensions with a positional accuracy of ± 25 microns relative to an arbitrary reference point. Thus, calibration of the traversing mechanism required that the probe volume be located at a known position with specified coordinates. The reference point for this investigation was the model junction (see Fig. 5a) that was assigned the coordinates

$$(\widehat{X}, \widehat{R}, \widehat{Z}) = (-1.062, 0.5, 0.0)$$

for both models. The model coordinate system is indicated in Figs. 3, 4, and 5a.

The probe volume was positioned at the reference point by the following procedure: the distance between the model centerline and tunnel sidewall was measured using a micrometer and calipers. A vertical 76-micron-diam wire mounted to a steel block was located on the model centerline by measurement from the sidewall. The probe volume was then traversed across the wire in the \widehat{Z} direction until a symmetrical diffraction pattern was obtained. This located the $\widehat{Z} = 0$ plane. The collector optics were then aligned on the wire and the wire and block removed from the tunnel. With the laser on a low power setting the probe volume was traversed along the model until it was observed to coincide with the model junction. This established the $\widehat{X} = -1.062$ plane. The probe volume was then moved to the model surface. This was accomplished by traversing the probe volume toward the model surface in the $\widehat{Z} = 0$ plane from a point off the model. When the edge of the probe volume touched the model surface, a diffraction pattern was observed. This established the $\widehat{R} = 0.5$ plane and therefore the reference point

$$(-1.062, 0.5, 0.0)$$

This procedure for locating the model surface was employed at every axial location where a profile was to be obtained.

3.1.3 Probe Volume

The dimensions of the probe volume were determined as follows: The probe volume was centered on a vertical wire of known diameter, \widehat{d}_w . The probe volume was then traversed axially in a horizontal plane toward the wire from a point nearby until a diffraction pattern was observed. At this point the edge of the probe volume was touching the wire. The \widehat{X} location of the center of the probe volume, \widehat{X}_1 , was recorded and the procedure repeated from the opposite side of the wire to obtain \widehat{X}_2 . The diameter of the probe volume was determined from

$$\widehat{d}_v = \left| \widehat{X}_2 - \widehat{X}_1 \right| - \widehat{d}_w \quad (3)$$

A similar procedure was employed in the \widehat{Z} direction to obtain the length of the probe volume from

$$\widehat{l}_v = \left| \widehat{Z}_2 - \widehat{Z}_1 \right| - \widehat{d}_w \quad (4)$$

Several such measurements were averaged to obtain the values $\widehat{d}_v = 0.008$ and $\widehat{l}_v = 0.045$.

3.1.4 Pressures

The microphone was calibrated *in situ* before each test period by application of a 140-db sound pressure level at a frequency of 1 kHz to the microphone diaphragm by means of a piston phone, having a certified accuracy of ± 0.5 db. The Scanivalve and Kistler transducers were also calibrated before each test period using the ART pressure calibration rig. The zero or no-load level was set by venting both sides of the transducer diaphragm to atmosphere. The span or maximum pressure value was set by exposing the reference side of the diaphragm to a vacuum of less than one micron of mercury and the measurement side to a known pressure.

3.2 DATA REDUCTION EQUATIONS

The primary data of this investigation were measurements of the velocity field. The instantaneous scatter source speed normal to the LV fringes was determined from

$$S_i = \frac{\lambda}{2 \sin \phi \cdot 2} \left(\frac{1}{r_1} - r_B \right) \quad (5)$$

where λ is the LV radiation frequency, ϕ is the angle between the beams, τ_i is the period measured by the LV electronics, and f_B is the Bragg-cell frequency. The mean speed was obtained statistically from a collection of N measurements by the relation

$$\langle S \rangle = \frac{1}{N} \sum_{i=1}^N S_i \quad (6)$$

and the variance by

$$s^2 = \frac{1}{N-1} \sum_{i=1}^N (S_i - \langle S \rangle)^2 \quad (7)$$

The value of N was 1,000 for these experiments. The fringes were rotated 45 deg with respect to the tunnel centerline. The velocity components, specific Reynolds shear, and specific turbulent kinetic energy can be obtained in the model coordinates (see Figs. 3 and 4) from the following relations (see, c.g., Refs. 16 and 17):

$$\langle U \rangle = (\langle S \rangle_1 + \langle S \rangle_2) / \sqrt{2} \quad (8)$$

$$\langle V \rangle = (\langle S \rangle_1 - \langle S \rangle_2) / \sqrt{2} \quad (9)$$

$$\langle u'v' \rangle = (s_1^2 - s_2^2) / 2 \quad (10)$$

$$\langle k \rangle = (\langle s_1^2 \rangle + \langle s_2^2 \rangle) / 2 = (\langle u'^2 \rangle + \langle v'^2 \rangle) \quad (11)$$

where the subscripts 1 and 2 indicate the two fringe systems. The dimensionless variables corresponding to the above quantities are:

$$\begin{aligned} \widehat{U} &= \langle U \rangle / \nu_\infty \\ \widehat{V} &= \langle V \rangle / \nu_\infty \\ \langle \widehat{u}'\widehat{v}' \rangle &= \langle u'v' \rangle / \nu_\infty^2 \\ \langle \widehat{k} \rangle &= \langle k \rangle / \nu_\infty^2 \end{aligned}$$

The Reynolds shear may be related to the gradients of the mean velocity vector by a scalar eddy viscosity:

$$\widehat{\tau} = \epsilon / \mu = -\rho \langle u'v' \rangle / \mu (\partial \langle U \rangle / \partial y) \quad (12)$$

where y is the spacial variable normal to the axis of symmetry. It is usual to include a term $\mu \partial \langle V \rangle / \partial X$ in the denominator, but this term has not been used because there was insufficient data to accurately determine the axial derivatives. The density, ρ , temperature, T , and viscosity, μ , were determined from

$$\widehat{\rho} = \rho / \rho_\infty = T_\infty / T = \left[\frac{T_{aw}}{T_\infty} - \left(\frac{T_{aw}}{T_\infty} - 1 \right) \left(\frac{\nu}{\nu_\infty} \right)^2 \right]^{-1} \quad (13)$$

where $\nu^2 = \langle u \rangle^2 + \langle v \rangle^2$, T_{aw} is the measured adiabatic wall temperature, and

$$\mu = 1.0869 \times 10^{-6} T^{3.2} (T + 110.33), \frac{\text{nt-sec}}{\text{m}^2} \quad (14)$$

where T is the local temperature and all temperatures are in degrees Kelvin. The subscript ∞ refers to the free-stream conditions.

The pressure readings from the tunnel wall and model surface are presented in the form of pressure coefficient, C_p ,

$$C_p = \frac{P - P_\infty}{q_\infty} \quad (15)$$

where P is the local pressure and

$$q_\infty = \frac{\gamma}{2} M_\infty^2 P_\infty \quad (16)$$

3.3 MEASUREMENT UNCERTAINTIES

Uncertainties (combinations of systematic and random errors) of the basic tunnel parameters shown in Table 2 were estimated from repeated calibration of the instrumentation and from the repeatability and uniformity of the test section flow during calibration. Uncertainties in the instrumentation systems were estimated from repeat calibration of the systems against secondary standards whose uncertainties are traceable to the National Bureau of Standards calibration equipment. The instrument uncertainties are combined using the Taylor series method of error propagation described in Ref. 18 to determine the uncertainties of the reduced parameters given in Table 2. The uncertainty in C_p is ± 0.017 at a Mach number of 0.64. However, the repeatability of C_p as determined by the root mean square of 12 to 15 separate measurements of C_p over the period of the test was nominally ± 0.005 . The repeatability of each static pressure lies within the symbols used to indicate the pressure data in the subsequent figures.

Uncertainties in the LV measurements are much more difficult to assess. These uncertainties depend upon the accuracy with which individual particle velocities are measured, the accuracy with which the particle follows the flow, and the number of samples collected for statistical analysis. Because of the complexities associated with estimates of the accuracy of individual particle velocity measurements, no definitive information is available. A Stokes flow analysis showed that particles in the one-micron range would follow the flow at the conditions of the test. The expected statistical uncertainties based on a 95-percent confidence level, Ref. 19, are given by

$$\Delta(\langle S \rangle) = 2\sigma / (\sqrt{NA}) \quad (17)$$

and

$$\Delta(s/\langle S \rangle) = 2\sqrt{(\beta - 1)/4 + (\sigma/\Lambda)^2} / \sqrt{N} \quad (18)$$

where s^2 is the measured variance and $\langle S \rangle$ is the measured mean value of any component of velocity in this case, σ^2 is the variance and Λ the mean of the true distribution of speeds, β is the kurtosis of the distribution defined such that β equals 3 for a Gaussian distribution. The number of samples, N , is equal to 1,000 for the present measurements. Because $\Delta(\langle S \rangle)$ depends upon the local turbulence, σ/Λ , $\Delta(\langle S \rangle)$ was found to be in the range of 4 to 5 percent near the model with nonseparated flow, 10 to 12 percent near the model with separated flow, and 0.25 to 0.55 percent in the free stream. Similarly, $\Delta(s/\langle S \rangle)$ was found to vary in the range from 4 to 6 percent throughout the nonseparated portion of the flow and between 10 to 13 percent in the separated region near the wall. The reader interested in LV measurement accuracies and problems associated with determination of measurement errors is directed to Cline and Bentley, Ref. 19, and Asher, et al. Ref. 20.

4.0 RESULTS AND DISCUSSION

Mean velocity vectors, specific turbulent kinetic energy, and specific Reynolds shear profiles were obtained in a plane of symmetry on both models at a Mach number of 0.64 and a forebody diameter Reynolds number of 2.886×10^5 . Profiles, defined by measurements at approximately 65 radii distributed between the model surface and the test section wall, were obtained at 12 axial locations on the attached-flow model ($\hat{L} = 1.77$) and at 13 axial locations on the separated-flow model ($\hat{L} = 0.8$). Supplementary partial profiles at approximately 40 radii distributed from the surface to a distance of one-half forebody diameter away from the model were also measured at 5 axial locations on each model. These latter profiles were concentrated in the "cusp" region formed by the junction of the boattail and solid plume simulator.

4.1 ATTACHED-FLOW MODEL

The measured mean flow vectors about the attached-flow, circular-arc, boattail geometry ($\hat{L} = 1.77$) are presented in Fig. 7. The distribution of measurement locations and the variation of the mean velocity field are indicated. All measurements in this and subsequent figures are made dimensionless by the mean free-stream speed, v_∞ . A more detailed depiction of the flow field in the cusp region is shown in Fig. 8. The fullness of the velocity distributions (Fig. 8a) decreases and then increases along the cusp in the direction of flow. This is consistent with the expected compression in the flow in this region of the model. Figures 8b and c illustrate the variation of the dimensionless specific

turbulent kinetic energy, \widehat{k} , and the specific Reynolds shear component, $\langle u'v' \rangle$. These figures indicate that a local maximum is formed in the profiles as the flow passes over the cusp.

The axial and radial components of the mean velocity, $\langle \widehat{U} \rangle$ and $\langle \widehat{V} \rangle$, are presented in Figs. 9 and 10, respectively. The turbulence quantities \widehat{k} and $\langle \widehat{u'v'} \rangle$ are displayed in Figs. 11 and 12. In order to assess the validity of the measurements, a comparison was made between the measured boundary-layer profile at $\widehat{X} = -4.062$ and one computed using the turbulent boundary-layer code described in Ref. 21. The measured model axial pressure distribution between the stilling chamber and $\widehat{X} = -4.062$, tabulated in Table 3, was used in the calculation. The resultant, calculated profile is depicted by the dashed line in Fig. 9. The boundary-layer integral properties, displacement thickness, δ^* , moment thickness, θ , and the local skin-friction coefficient, c_f , were estimated from the measured mean velocity profiles at $\widehat{X} = -4.062$ and -1.062 by means of a planar data reduction procedure also delineated in Ref. 21. The use of a planar analysis to estimate δ^* , θ , and c_f is appropriate because the boundary-layer thickness at these axial locations is small compared to the model radius. An additional check on the consistency of the data was made by estimating the value of c_f from the magnitude of the maximum specific Reynolds shear near the wall, $\langle u'v' \rangle|_{\max}$. The usual assumption for zero pressure gradient flows is that the total shear near the wall is constant:

$$\tau_w = \mu \frac{\partial \langle U \rangle}{\partial y} - \rho \langle u'v' \rangle$$

As the distance from the wall is increased, the turbulent shear, $\rho \langle u'v' \rangle$ becomes dominant. If this is assumed to occur in the wall region,

$$c_f = \frac{\tau_w}{q_\infty} \approx - \frac{\rho \langle u'v' \rangle_{\max}}{q_\infty} = 2 \langle u'v' \rangle_{\max}$$

where $\langle u'v' \rangle|_{\max}$ is used as the best approximation of the dominant wall region value of $\langle u'v' \rangle$. Results of both comparisons are tabulated in Table 4. In general, the agreement is quite good, with the largest disparity occurring between the computed and measured velocity profiles. This disagreement is not considered to be excessive since accurate initial conditions in the stilling chamber were not available.

Of interest in Fig. 10a is the negative value of $\langle \widehat{V} \rangle$ along the cylindrical portion of the forebody ($\widehat{X} < 0$). The expected orientation of $\langle \widehat{V} \rangle$ attributable to boundary-layer displacement effects is in the positive direction (i.e., away from the model). This disparity may be explained by noting that the magnitude of $\langle \widehat{V} \rangle$ is approximately 0.01 to 0.02, which is within the uncertainty of the measurements for the data of the figure.

The reversal of sign of $\langle \widehat{V} \rangle$, which can be observed in Figs. 10b and c for $\widehat{Y} < 0.15$, is consistent with the change in the slope of the body surface.

The measured boundary conditions are displayed in Fig. 13, which includes the model axial surface pressure coefficient, C_{p_M} ; the porous wall axial pressure distribution, C_{p_w} ; and the two mean velocity components $\langle \widehat{U}_w \rangle$ and $\langle \widehat{V}_w \rangle$ at $\widehat{R} = 2.5$. The wall velocity components vary because of the axial growth of the wall boundary layer, which is also influenced by the model flow field.

Tabulations of the data presented in Figs. 9 through 13 are given in Table 5. The profiles have also been fitted by a least-squares cubic spline as functions of the dimensionless radial distance from the model symmetry axis, \widehat{R} . Tabulations of the coefficients and their regions of validity are given in Table 6.

4.2 SEPARATED-FLOW MODEL

The measured, mean velocity field about the separated, circular-arc boattail geometry ($\widehat{L} = 0.8$) is shown in Fig. 14. The flow over the forebody is very similar to that of the attached-flow model (Fig. 7). An expansion of the cusp region is shown in Fig. 15. The reversed flow is clearly seen in Fig. 15a. The profiles of the turbulence quantities \widehat{k} and $\langle \widehat{u'v'} \rangle$ shown in Figs. 15b and c exhibit the local maximum observed to be developing in Figs. 8b and c. In addition, these profiles develop a second local maximum in the axial region near the cusp. A significant reduction in the turbulence quantities \widehat{k} and $\langle \widehat{u'v'} \rangle$ is shown in the reversed-flow region near the cusp. Figure 15c indicates a sign reversal in $\langle \widehat{u'v'} \rangle$ for the profile at the cusp, which may be due to measurement in accuracy.

The mean velocity components $\langle \widehat{U} \rangle$ and $\langle \widehat{V} \rangle$ and turbulence quantities \widehat{k} and $\langle \widehat{u'v'} \rangle$ are shown in Figs. 16 through 19. The region of reversed flow may be clearly seen in Figs. 16 and 17. Downstream of the cusp the profiles behave in a manner similar to that exhibited by the attached flow. However, the rate at which the profiles relax to parallel-flow shapes is slower for the separated case.

The mean velocity profile computed by the method of Ref. 21 at $\widehat{X} = -4.062$ is shown in Fig. 16 by the dashed line. The boundary-layer parameters, $\widehat{\delta}^*$, $\widehat{\theta}$, and C_f , were computed from the mean velocity profiles at $\widehat{X} = -4.062$, -1.062 , and -0.562 . The maximum magnitude of $\langle \widehat{u'v'} \rangle$ near the wall was used to compute a second estimate of C_f . The results of these calculations are presented in Table 7 and are in good agreement.

The measured boundary conditions, C_{pM} , C_{pw} , $\langle \hat{U}_w \rangle$, and $\langle \hat{V}_w \rangle$ are presented in Fig. 20. There is a slight difference in axial locations of the C_{pw} data between Figs. 13 and 20 that is due to a shift in the origin of \hat{X} relative to the tunnel wall between the two model installations. The disagreement in the repeat measurements of $\langle \hat{V}_w \rangle$ shown in Fig. 20 cannot be explained. A similar shift in $\langle \hat{U}_w \rangle$ would be observed if the scales were the same.

Tabulations of the measurements presented in Figs. 16 through 20 may be found in Table 8. The profiles have been fitted by a least-squares cubic spline as a function of \hat{R} . The polynomial coefficients and ranges of validity are given in Table 9.

4.3 EDDY VISCOSITY

Radial distributions of eddy viscosity were computed from the measured values of the mean velocity and specific Reynolds shear according to Eq. (12). The measurements were first fit with a least-squares cubic spline (see Tables 6 and 9), the derivative $\partial \langle U \rangle / \partial y$ evaluated, and ρ and μ computed from Eqs. (13) and (14). The resulting distributions are presented in Figs. 21 and 22 and tabulated in Tables 10 and 11 for the attached- and separated-flow models, respectively.

The most noticeable characteristic of the profiles is that they undulate. The undulations may be real. However, there are two factors that may artificially contribute to the waviness. First, data were not obtained at a sufficient number of radial points, particularly near the body, to allow accurate evaluation of the derivative $\partial \langle \hat{U} \rangle / \partial \hat{Y}$. Second, the statistical accuracy of the turbulence quantity $\langle \hat{u} \hat{v} \rangle$ (nominally, 8 to 10 percent) is not sufficient to resolve the difference between actual data trends and spurious data scatter. These factors combine to cause $\hat{\epsilon}$ to diverge when the mean velocity is essentially constant (e.g., as it approaches the free stream). That is, whenever $\partial \langle \hat{U} \rangle / \partial y \rightarrow 0$ faster than $\langle \hat{u} \hat{v} \rangle \rightarrow 0$, the ratio tends to diverge. This effect is evidenced in Figs. 21a and 22a.

It was noted in Section 3.2 that Eq. (12) defining $\hat{\epsilon}$ did not have a term $\partial \langle V \rangle / \partial X$ included in the denominator. This term, which is usually included in the definition of $\hat{\epsilon}$ for general coordinate systems (see, e.g., Ref. 22), was dropped from Eq. (12) because the axial separation of profiles precluded accurate evaluation of X derivatives and the statistical uncertainty of the measurements was too great to permit accurate evaluations of derivatives of $\langle V \rangle$.

5.0 CONCLUDING REMARKS

High-quality measurements of mean velocity, specific turbulent kinetic energy, and specific Reynolds shear have been made in a symmetry plane of two axisymmetric, circular-arc, boattail geometries, each having a solid plume simulator. The data were obtained at a Mach number of 0.64 and Reynolds number based on model maximum diameter of 2.886×10^5 using a laser velocimeter. Ancillary measurements of model surface and tunnel wall static pressures and velocity vectors in the neighborhood of the tunnel wall have also been made. These data were obtained to permit the direct comparison of mean-flow variables, such as velocities and pressures, with computations and to serve as a basis for the development of turbulence models applicable to complex flows, specifically, those with separation. The initial boundary-layer profiles of both models were found to be in reasonably good agreement with boundary-layer calculations made using the measured forebody pressure distribution. Estimates of forebody, local, skin-friction coefficients inferred from the mean velocity profile and from the specific Reynolds shear were found to be in good agreement.

Extensions of this work should be directed toward obtaining data that will better assist the development of turbulence models. This means making velocity measurements at smaller spatial intervals, particularly in the cusp regions. This will permit more accurate evaluation of derivatives and hence a better description of quantities currently used in computations, such as the eddy viscosity.

REFERENCES

1. Ruebush, D. E. "Effects of Fineness and Closure Ratios of Boattail Drag of Circular-Arc Afterbody Models with Jet Exhaust at Mach Numbers up to 1.3." NASA TN D-7163, May 1973.
2. Ruebush, D. E. "Experimental Study of the Effectiveness of Cylindrical Plume Simulators for Predicting Jet-On Boattail Drag at Mach Numbers up to 1.3." NASA TN D-7795, November 1974.
3. Berrier, B. L. "Effect of Empennage Interference on Single-Engine Afterbody/Nozzle Drag." AIAA Paper No. 75-1296, October 1975.
4. Compton, W. B., III. "Effect of Jet Exhaust Gas Properties on Exhaust Simulation and Afterbody Drag." NASA TR-R444, October 1975.
5. Laughrey, J. A. "Comparison of Testing Techniques for Isolated Axisymmetric Exhaust Nozzles in Transonic Flow." AIAA Paper No. 75-1292, October 1975.

6. Reubush, D. E. "The Effect of Reynolds Number on Boattail Drag." AIAA Paper No. 75-63, January 1975.
7. Robinson, C. E. and Price, E. A. "Effect of Reynolds Number on the Nozzle Afterbody Performance of the AGARD Nozzle Afterbody and the B-1 0.06-Scale Model at Transonic Mach Numbers." AIAA Paper No. 75-1321, October 1975.
8. Putnam, L. E. and Abeyounis, W. K. "Experimental and Theoretical Study of Flow Fields Surrounding Boattail Nozzles at Subsonic Speeds." AIAA Paper No. 76-675, July 1976.
9. Gerhart, P. M. and Chima, R. V. "Development of a Method for Predicting Subsonic Turbulent Separating Boundary Layers." Technical Report (AD-A051535), The University of Akron, Akron, Ohio, February 1978.
10. Aulehla, F. "Drag Measurement in Transonic Wind Tunnels." AGARD Paper No. 7, AGARD Specialists' Meeting on Aircraft Performance Prediction Methods, 11-13 October 1977.
11. Simpson, R., Strickland, J., and Barr, P. "Laser and Hot Film Anemometer Measurements in a Separating Turbulent Boundary Layer." Report WT-3, Southern Methodist University, 1974. Also see J. Fluid Mechanics, Vol. 79, No. 3, 1977.
12. Albert, I., Bacon, J., Masson, B., and Collins, D. "An Experimental Investigation of Turbulent Transonic Viscous-Inviscid Interaction." AIAA Journal, Vol. 11, No. 5, May 1973.
13. Dougherty, N. S., Jr., Anderson, C. R., and Parker, R. L., Jr. "An Experimental Investigation of Techniques to Suppress Edgetones from Perforated Wind Tunnel Walls." AEDC-TR-75-88 (AD-A013728), August 1975, also AIAA Paper No. 76-50. Presented at the AIAA 14th Aerospace Sciences Meeting, Washington, D.C., January 26-28, 1976.
14. Cline, V. A. "A Laser Velocimeter for the AEDC Acoustic Research Tunnel." AEDC-TR-77-53 (AD-A040903), June 1977.
15. McGregor, I. "The Vapor-Screen Method of Flow Visualization." Journal of Fluid Mechanics, Vol. 2, 1961, p. 481.
16. Seegmiller, H. L., Marvin, J. G., and Levy, L. L. "Steady and Unsteady Transonic Flow." AIAA Paper No. 78-160, presented at the AIAA 16th Aerospace Sciences Meeting, Huntsville, Alabama, January 16-18, 1978.

17. Nurick, A. "The Use of a Laser Doppler Anemometer in a High Speed Blowdown Wind Tunnel." Report No. ME1496. Council for Scientific and Industrial Research, Pretoria, South Africa, January 1977.
18. Abernethy, R. B. and Thompson, J. W., Jr. "Handbook - Uncertainty in Gas Turbine Measurements." AEDC-TR-73-5 (AD755356), February 1973.
19. Cline, V. A. and Bentley, H. T., III. "Application of a Dual Beam Laser Velocimeter to Turbulent Flow Measurements." AEDC-TR-74-56 (AD785352), September 1974.
20. Asher, J. A., Scott, P. F., and Wang, J. C. "Parameters Affecting Laser Velocimeter Turbulence Spectra Measurements." AEDC-TR-74-54 (AD786886), October 1974.
21. Whitfield, D. L. "Analytical, Numerical, and Experimental Results on Turbulent Boundary Layers." AEDC-TR-76-62 (AD-A027588), July 1976.
22. Deiwert, G. S. "Computation of Separated Transonic Turbulent Flows." AIAA Paper No. 75-829, June 1975.

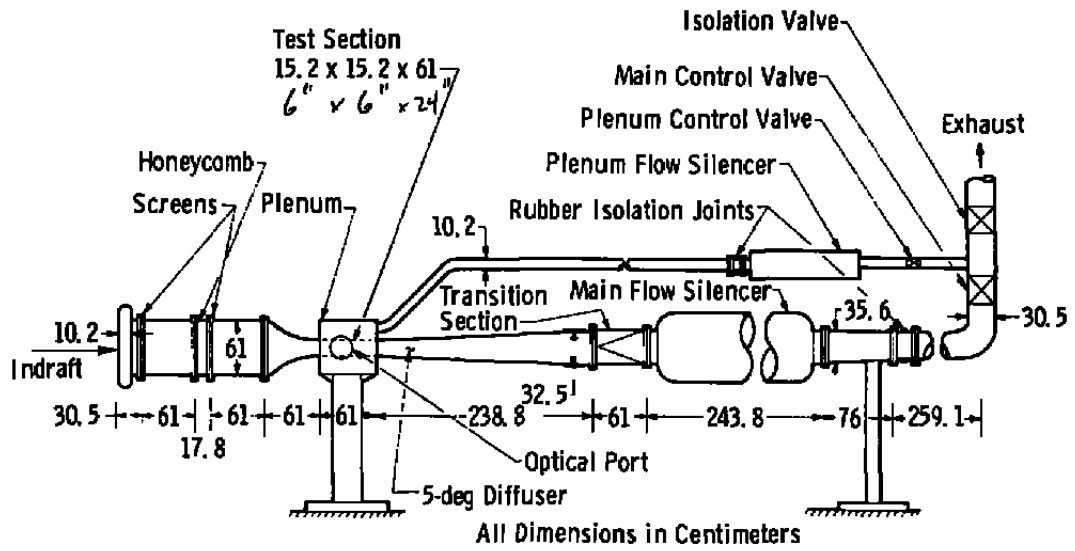

Figure 1. Acoustic research tunnel (ART).

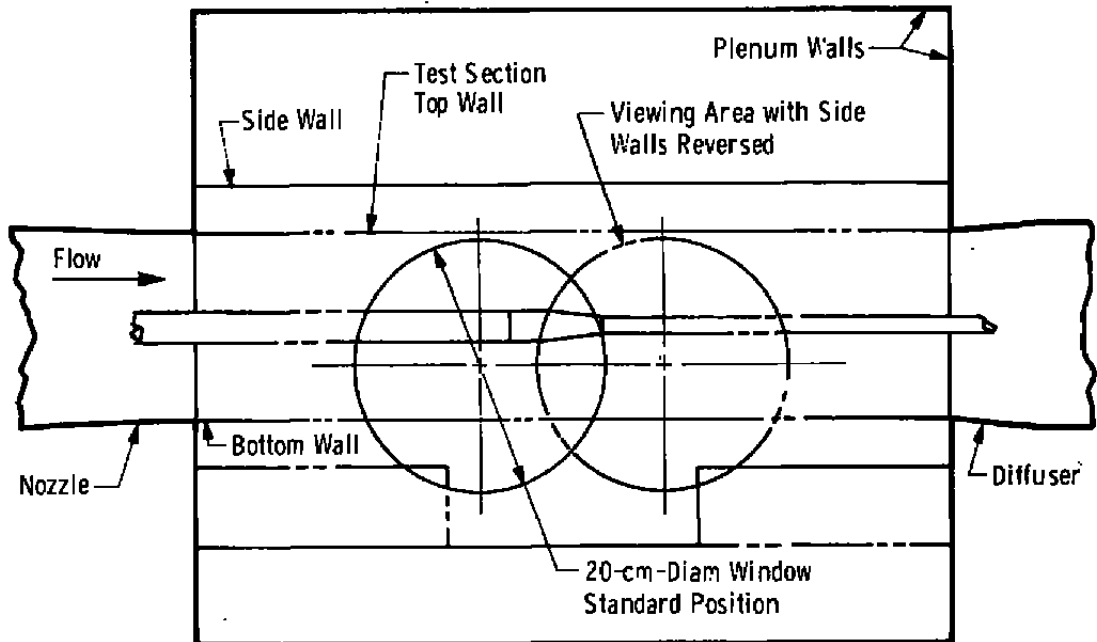

Figure 2. Tunnel sidewall configurations and test section viewing area.

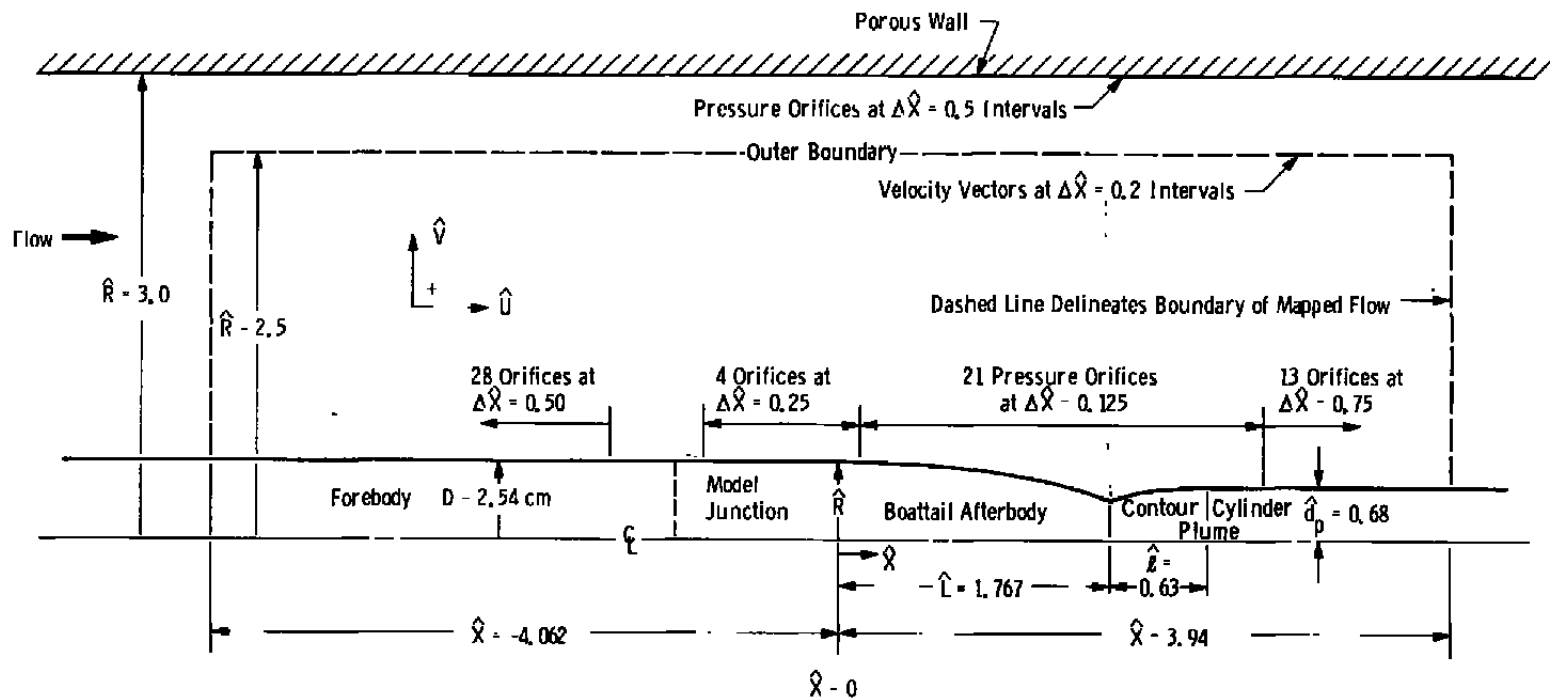

Figure 3. Attached-flow model.

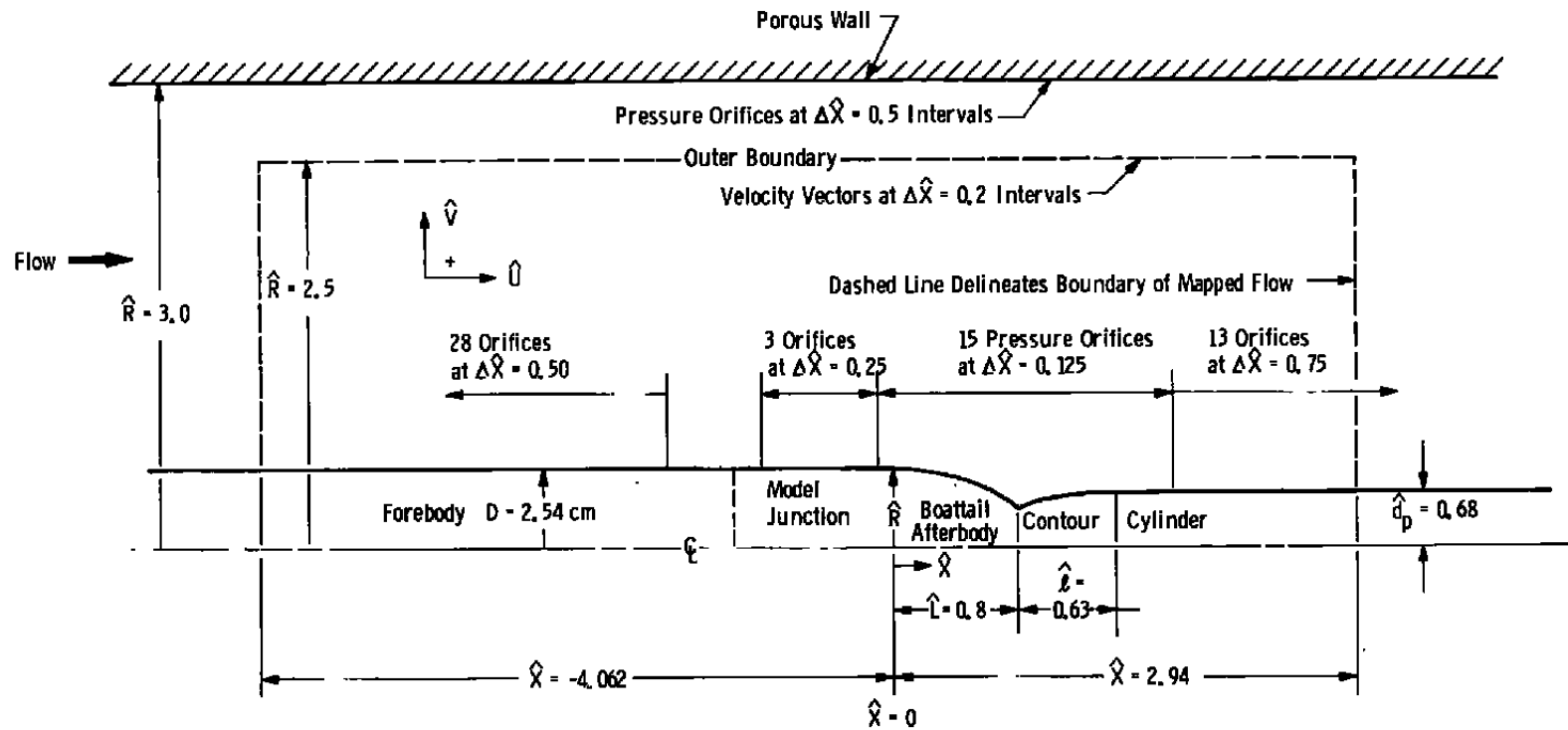

Figure 4. Separated-flow model.

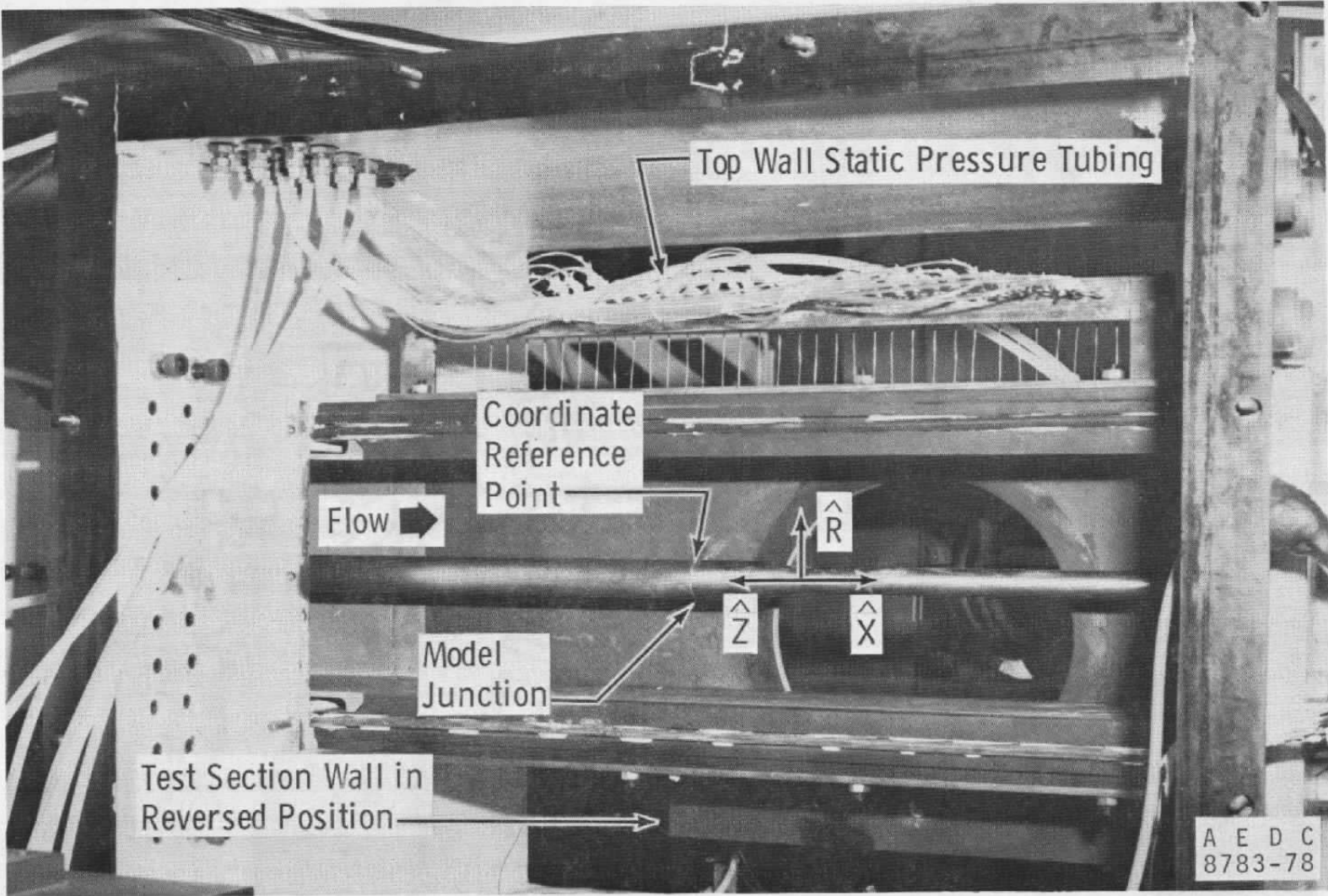

Figure 5. Model installation in the ART.

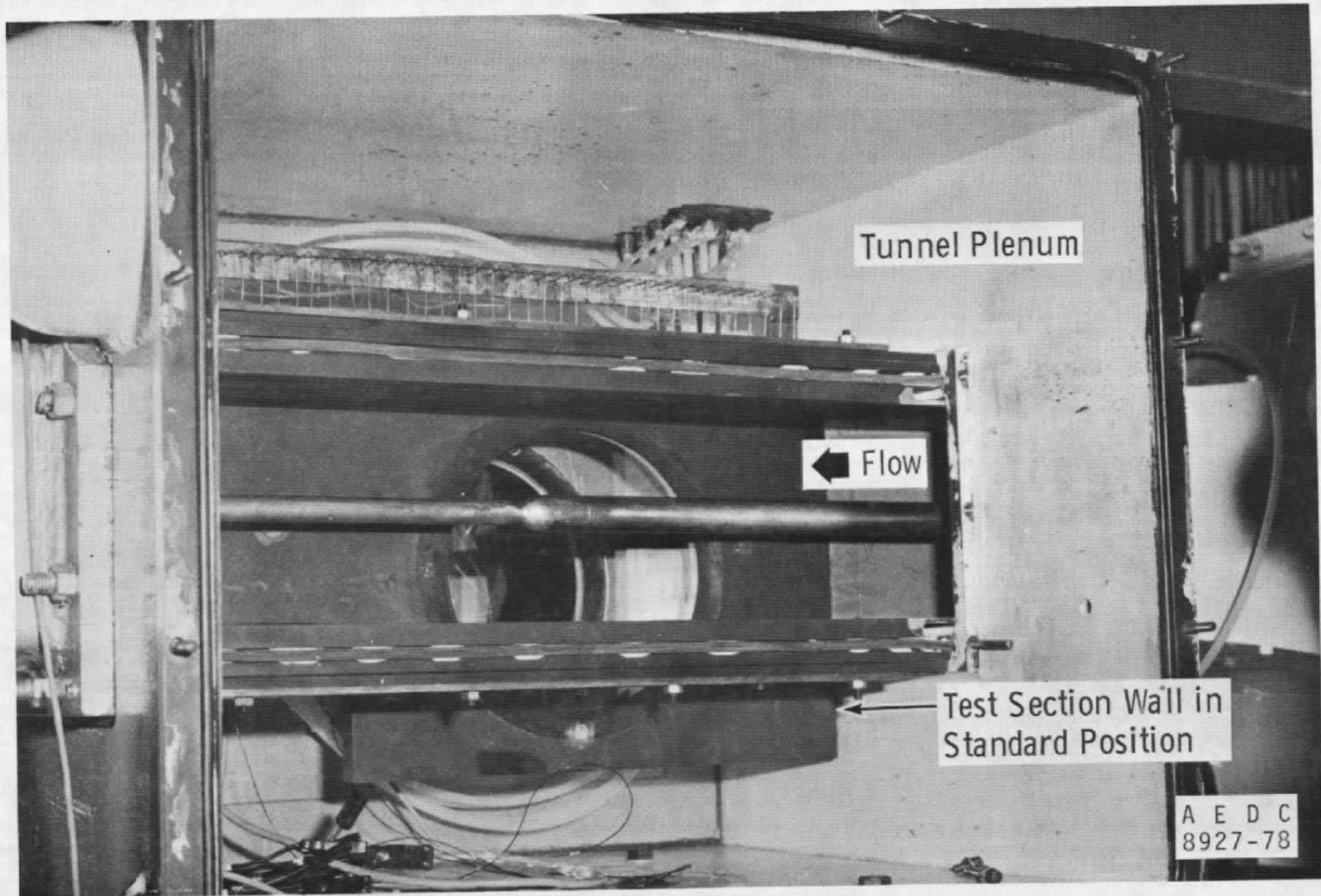

Figure 5. Concluded.

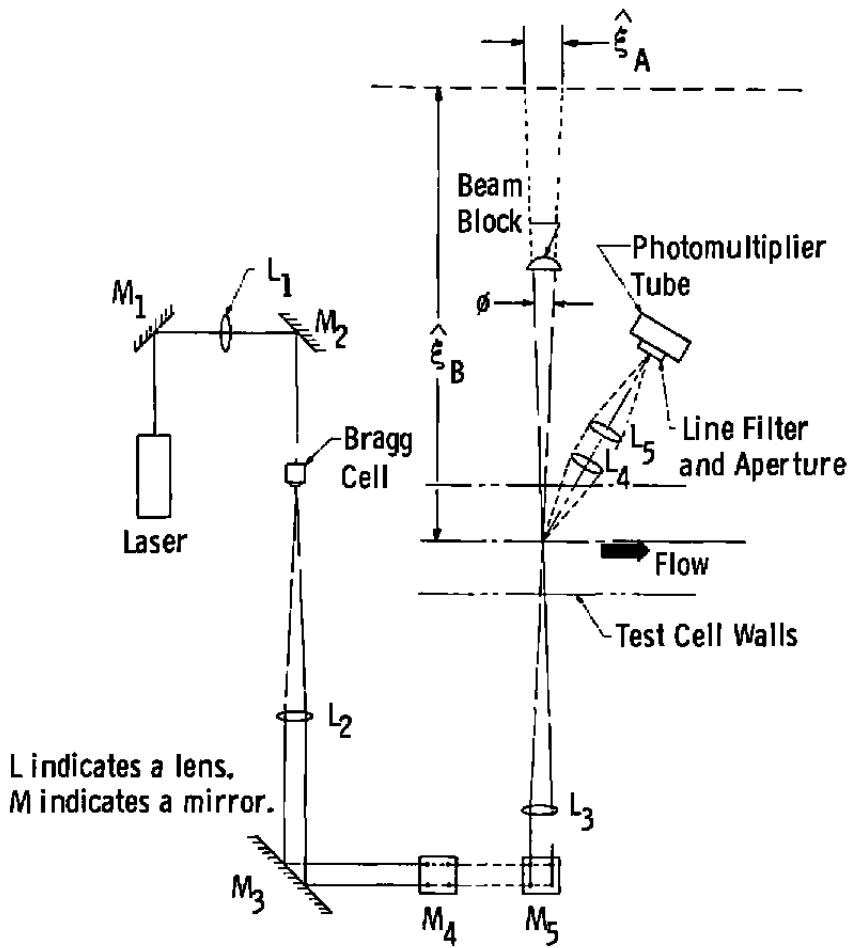

Figure 6. ART laser velocimeter system.

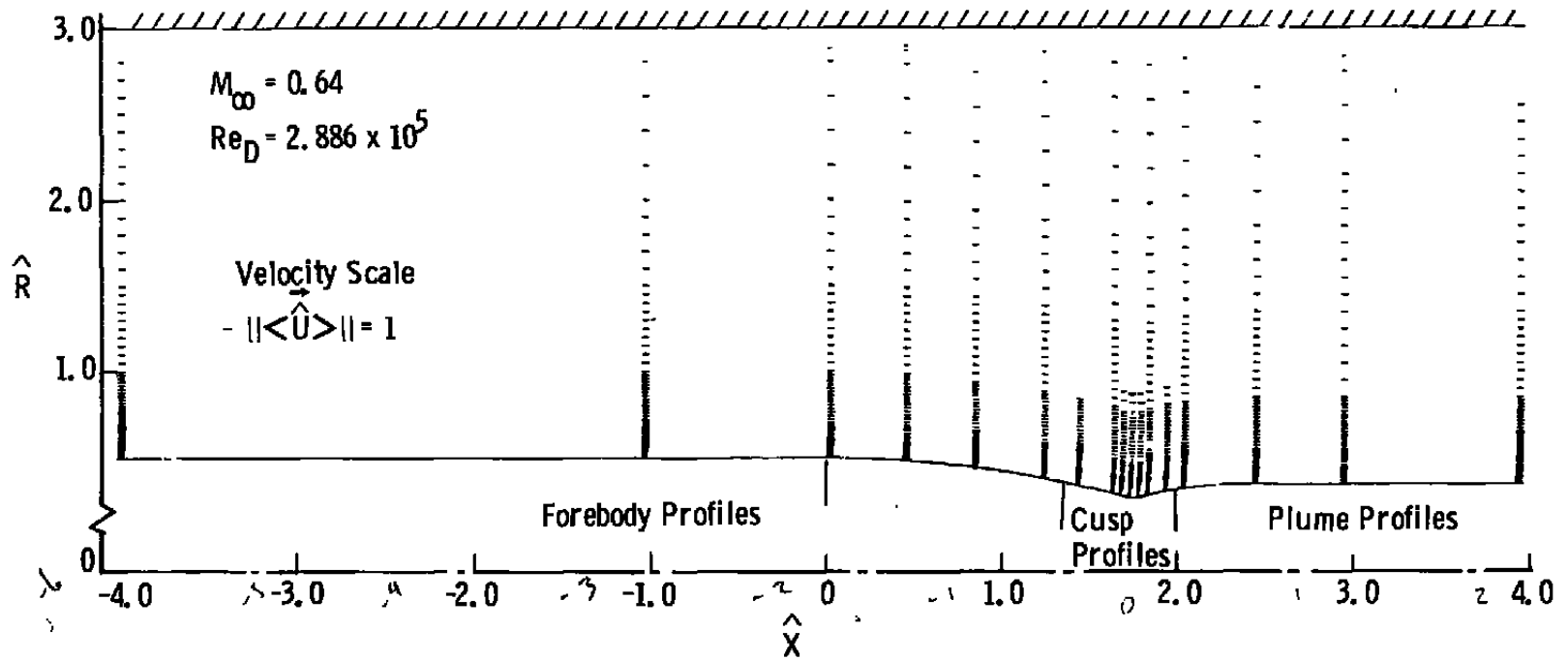
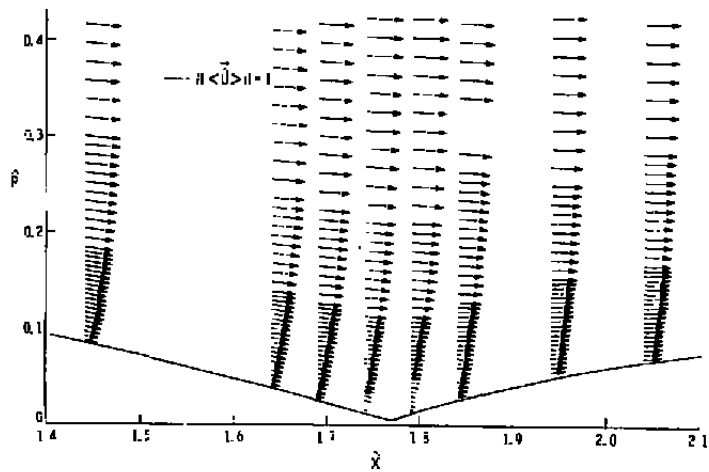
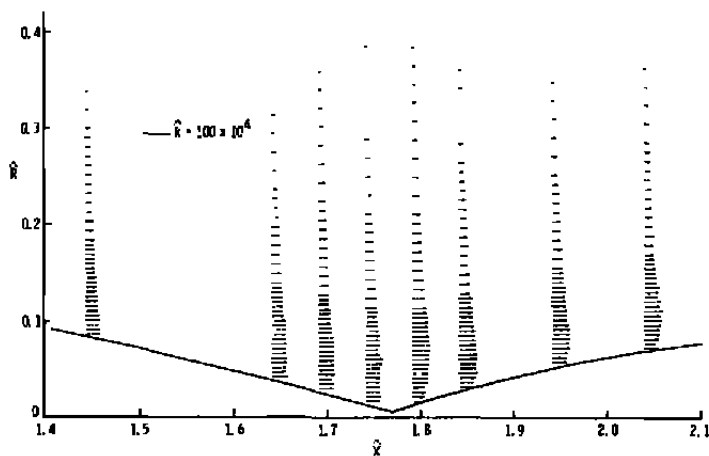

Figure 7. Mean velocity vectors, attached-flow model.



a. Mean velocity vectors



b. Specific turbulent kinetic energy

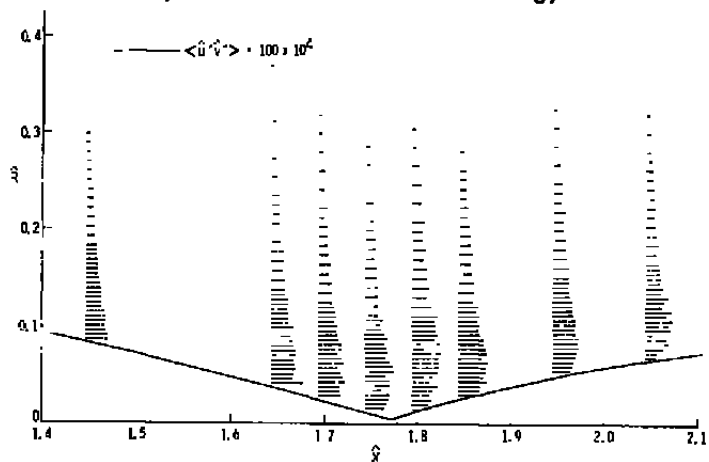

c. Specific Reynolds shear

Figure 8. Cusp region of attached-flow model.

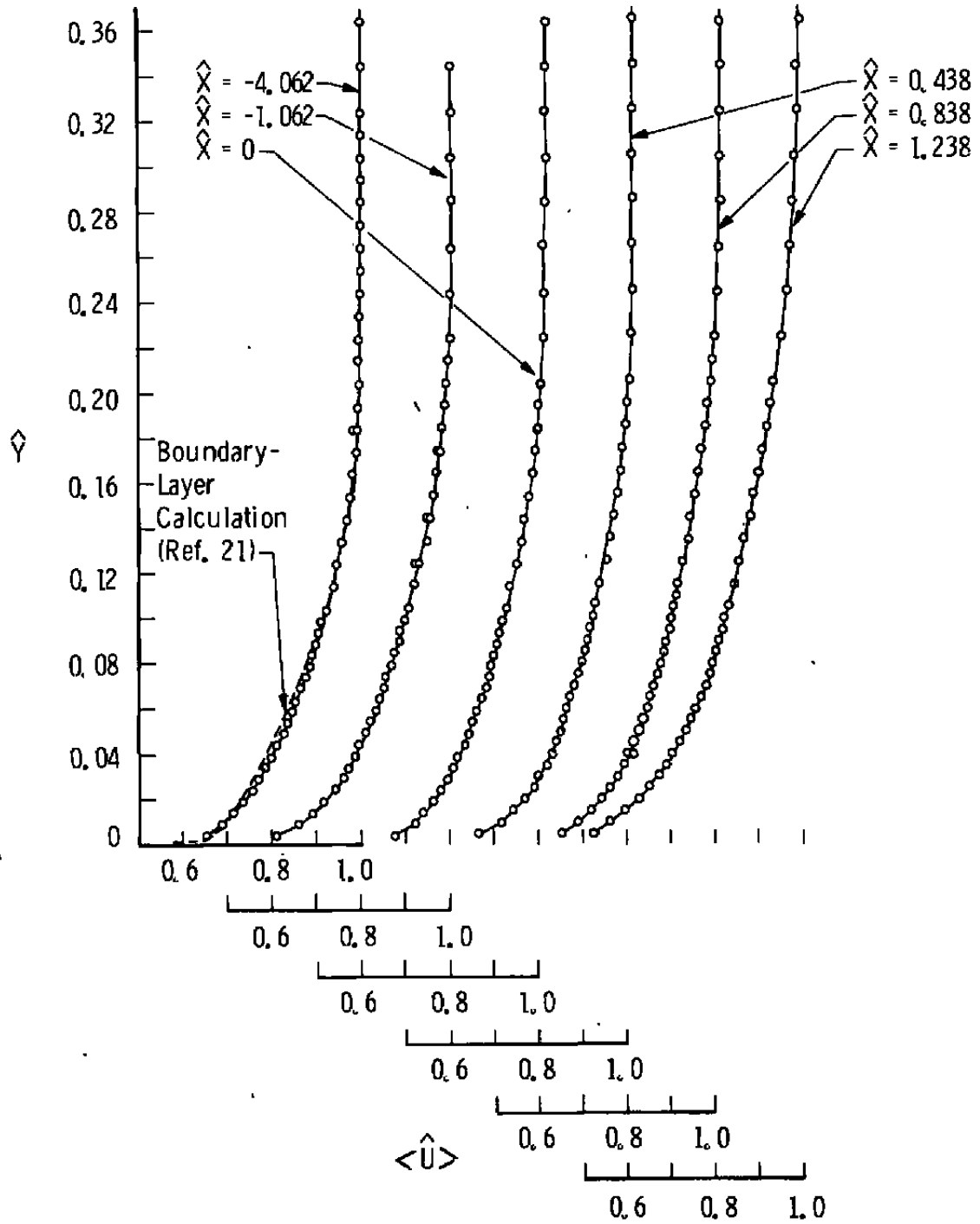

a. Forebody region

Figure 9. Mean axial velocity component, attached-flow model.

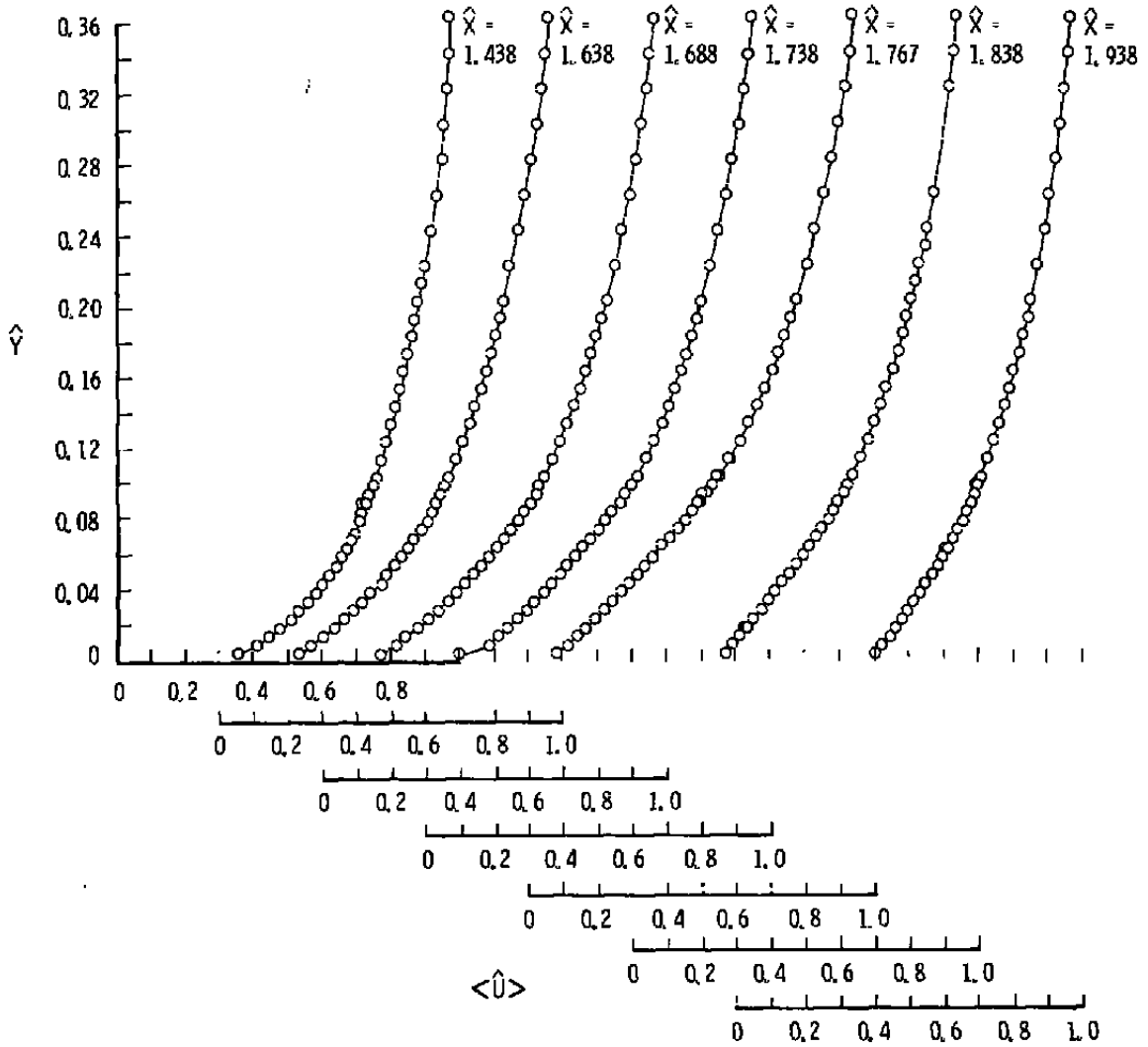

b. Cusp region
 Figure 9. Continued.

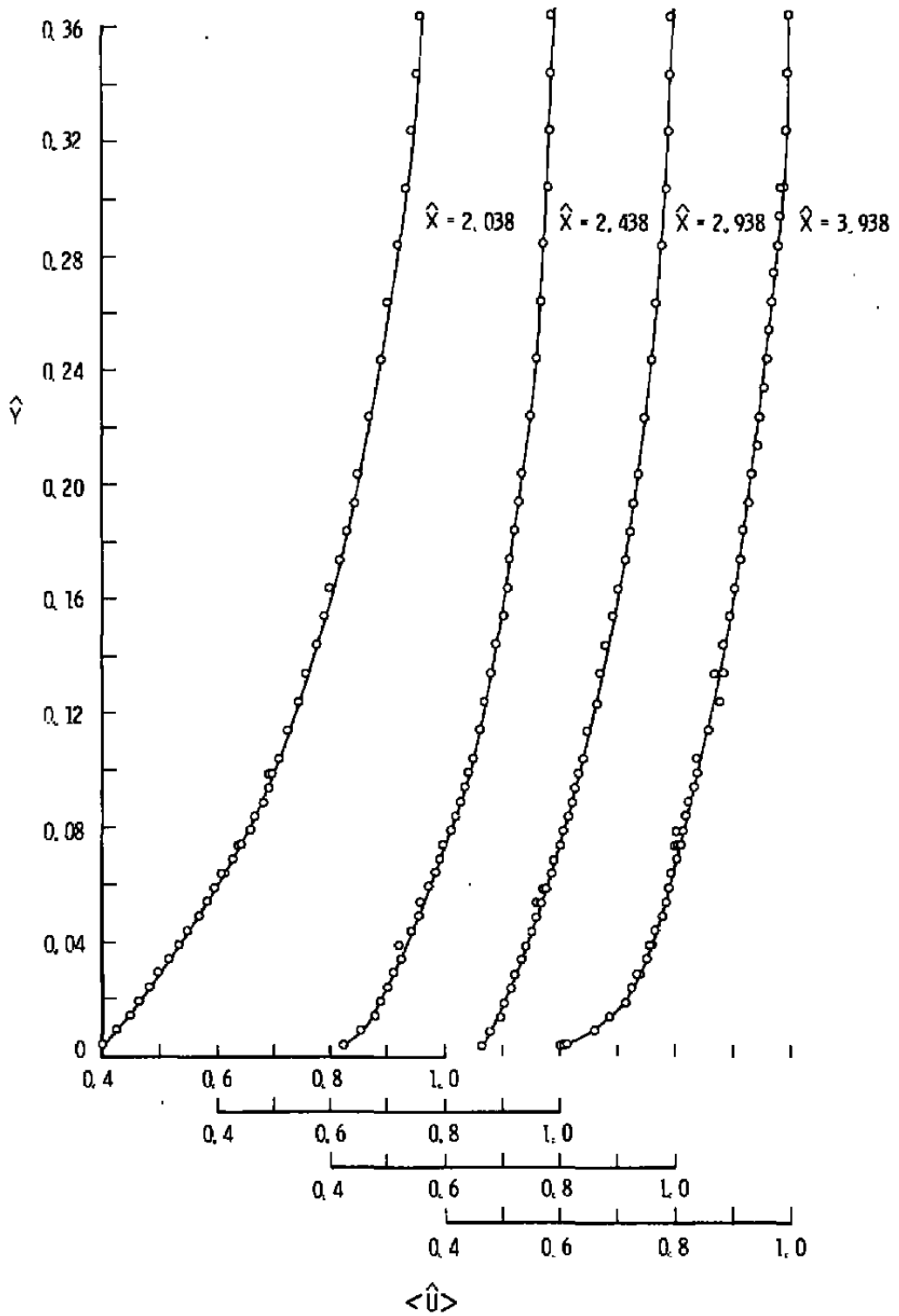

c. Plume region
 Figure 9. Concluded.

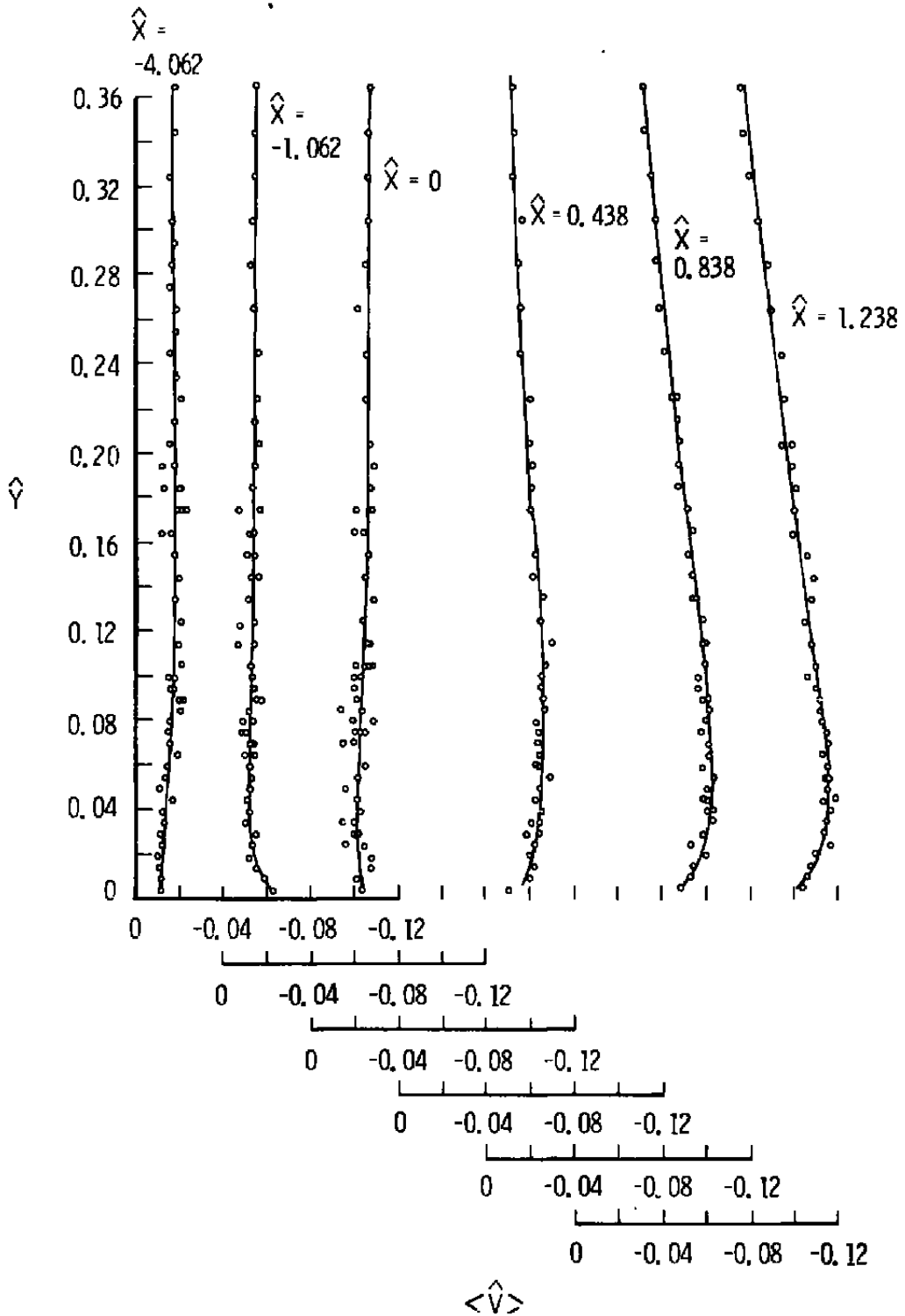

a. Forebody region

Figure 10. Mean radial velocity component, attached-flow model.

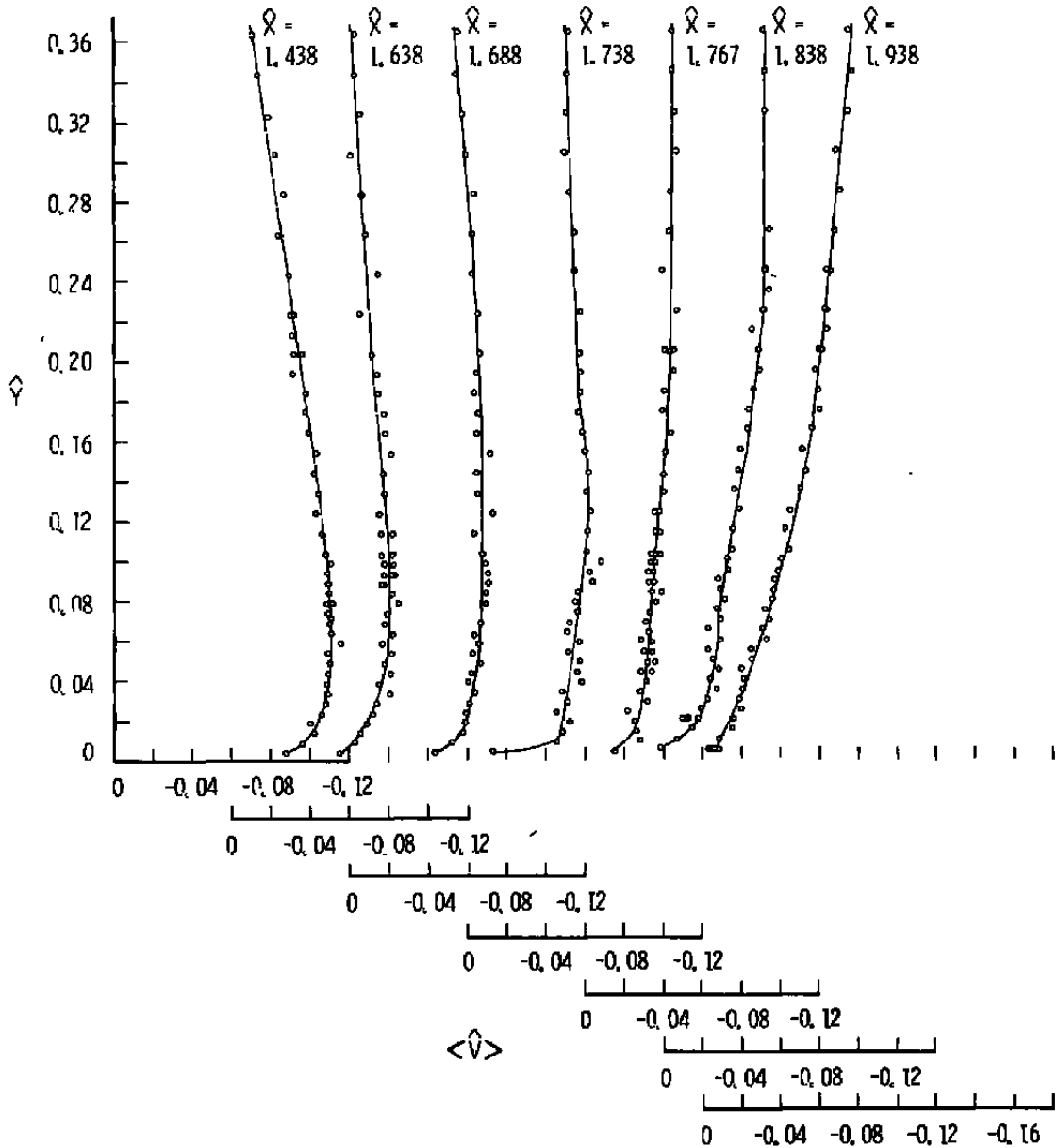

b. Cusp region
 Figure 10. Continued.

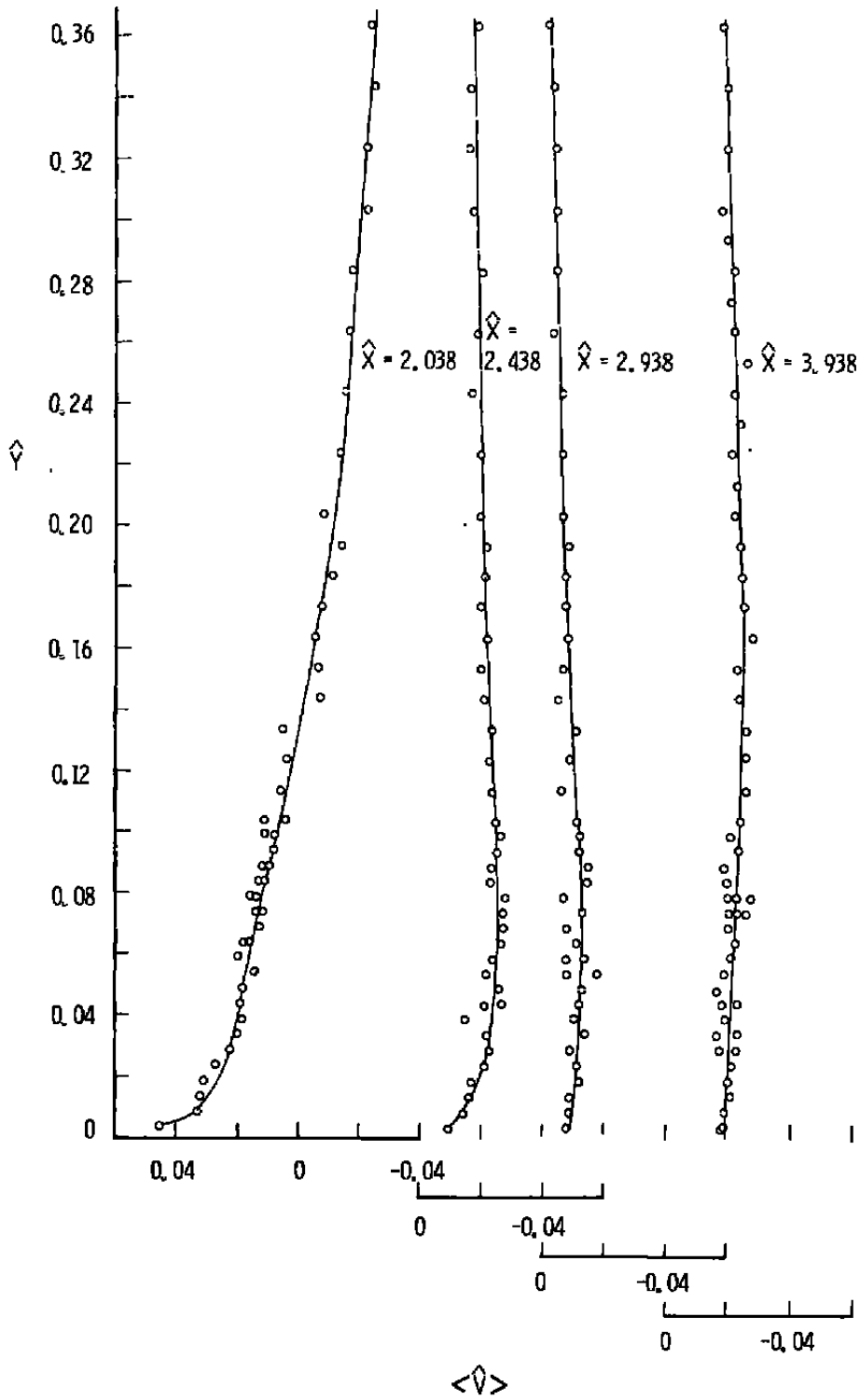

c. Plume region
Figure 10. Concluded.

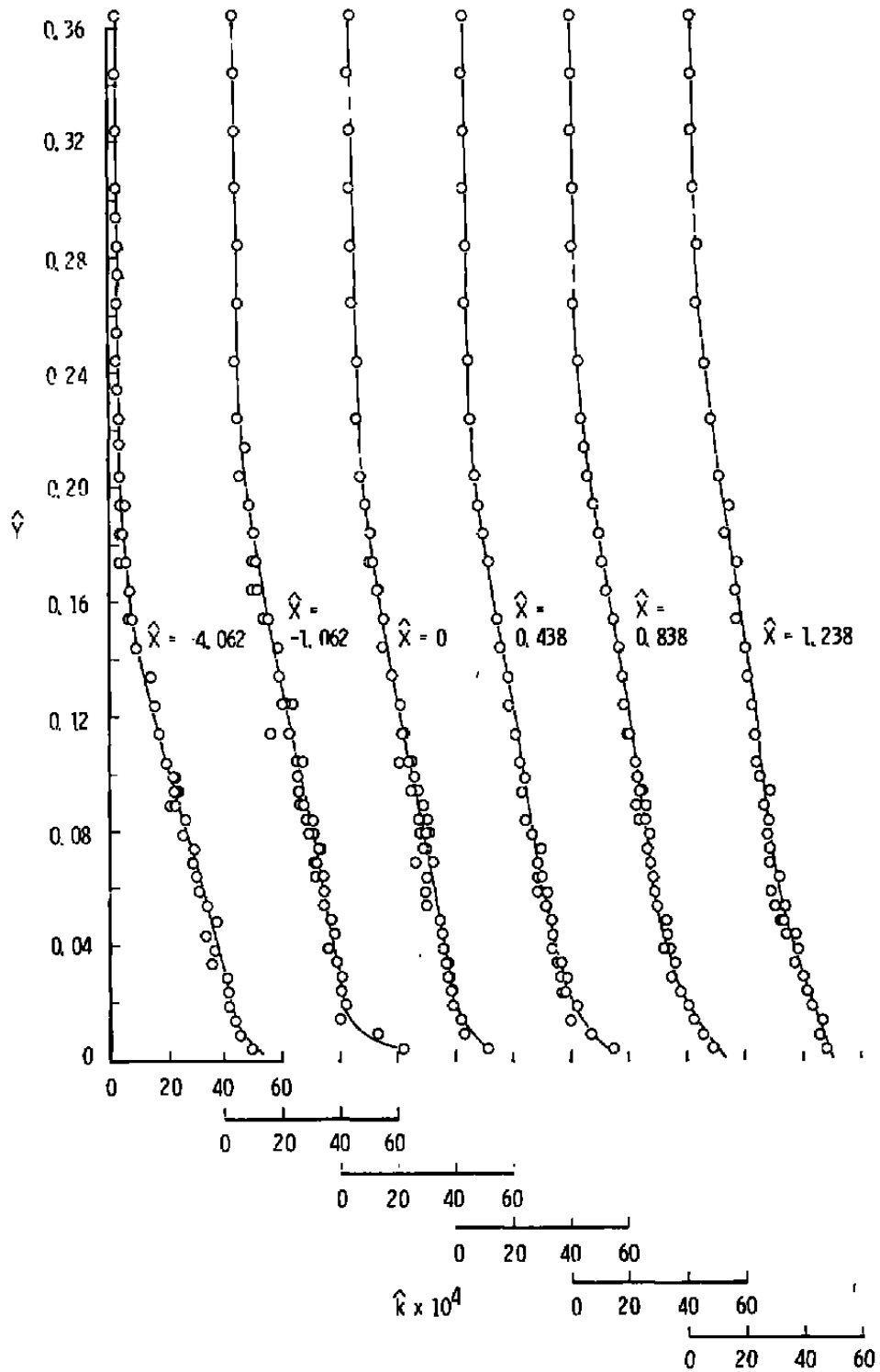

a. Forebody region

Figure 11. Specific turbulent kinetic energy, attached-flow model.

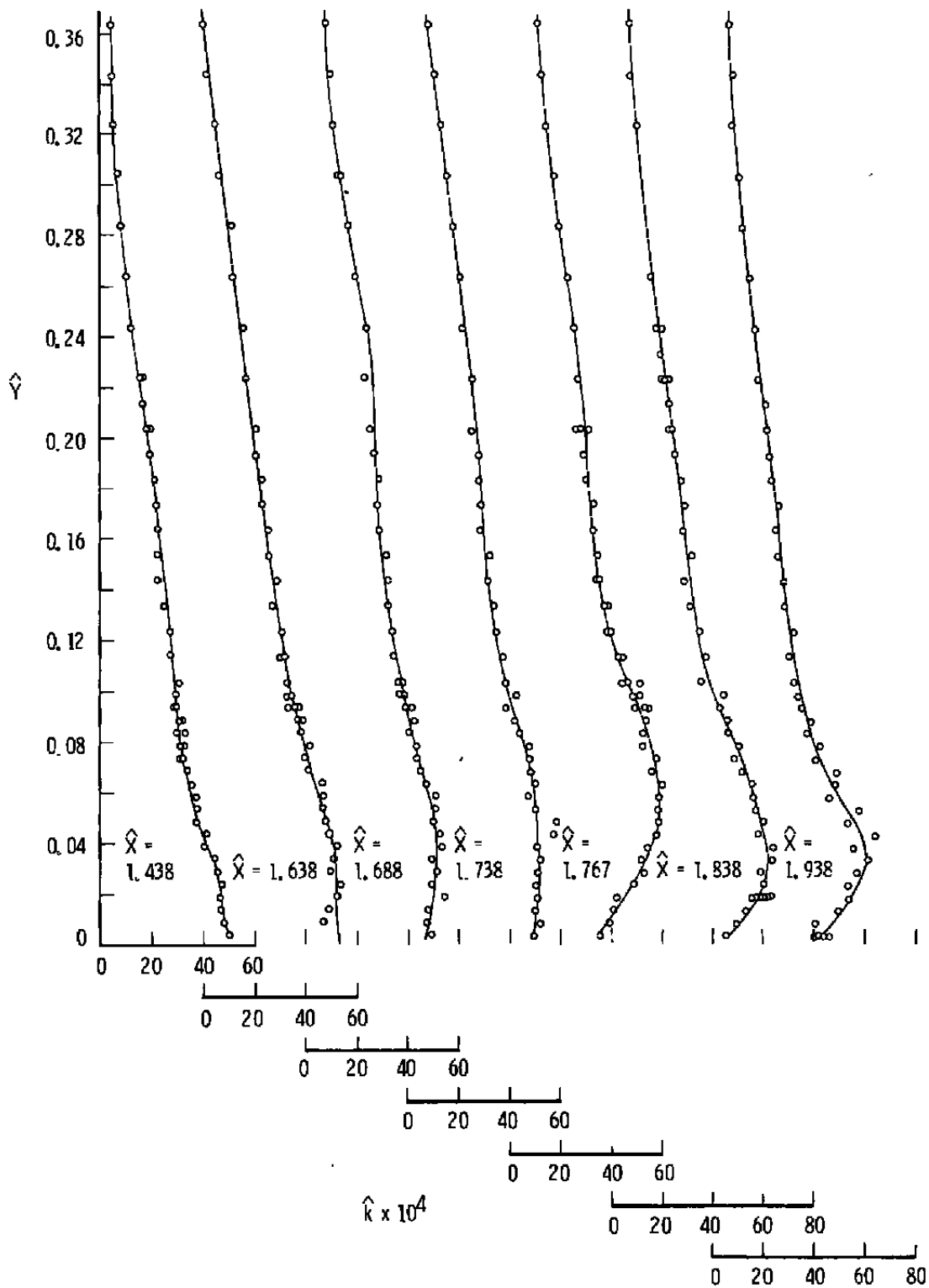

b. Cusp region
 Figure 11. Continued.

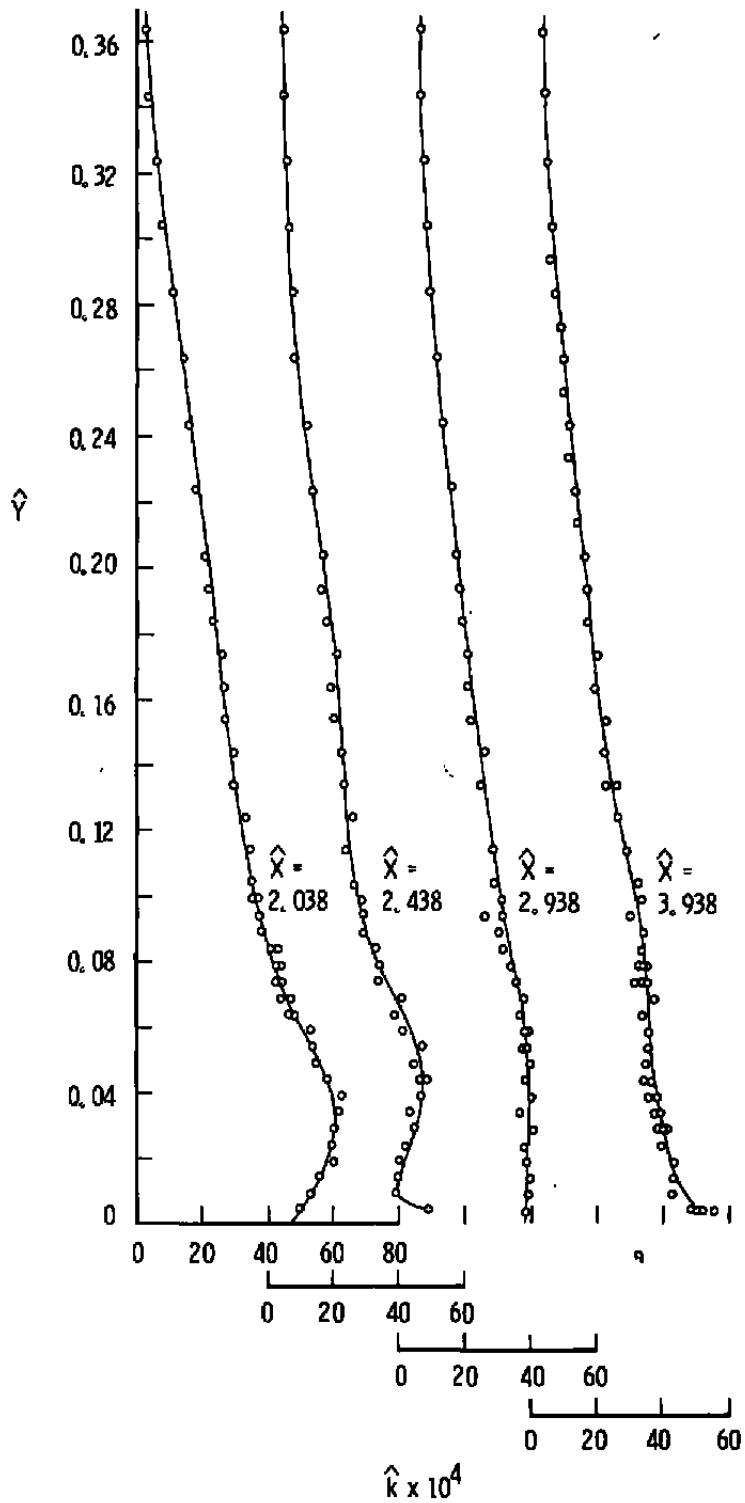

c. Plume region
 Figure 11. Concluded.

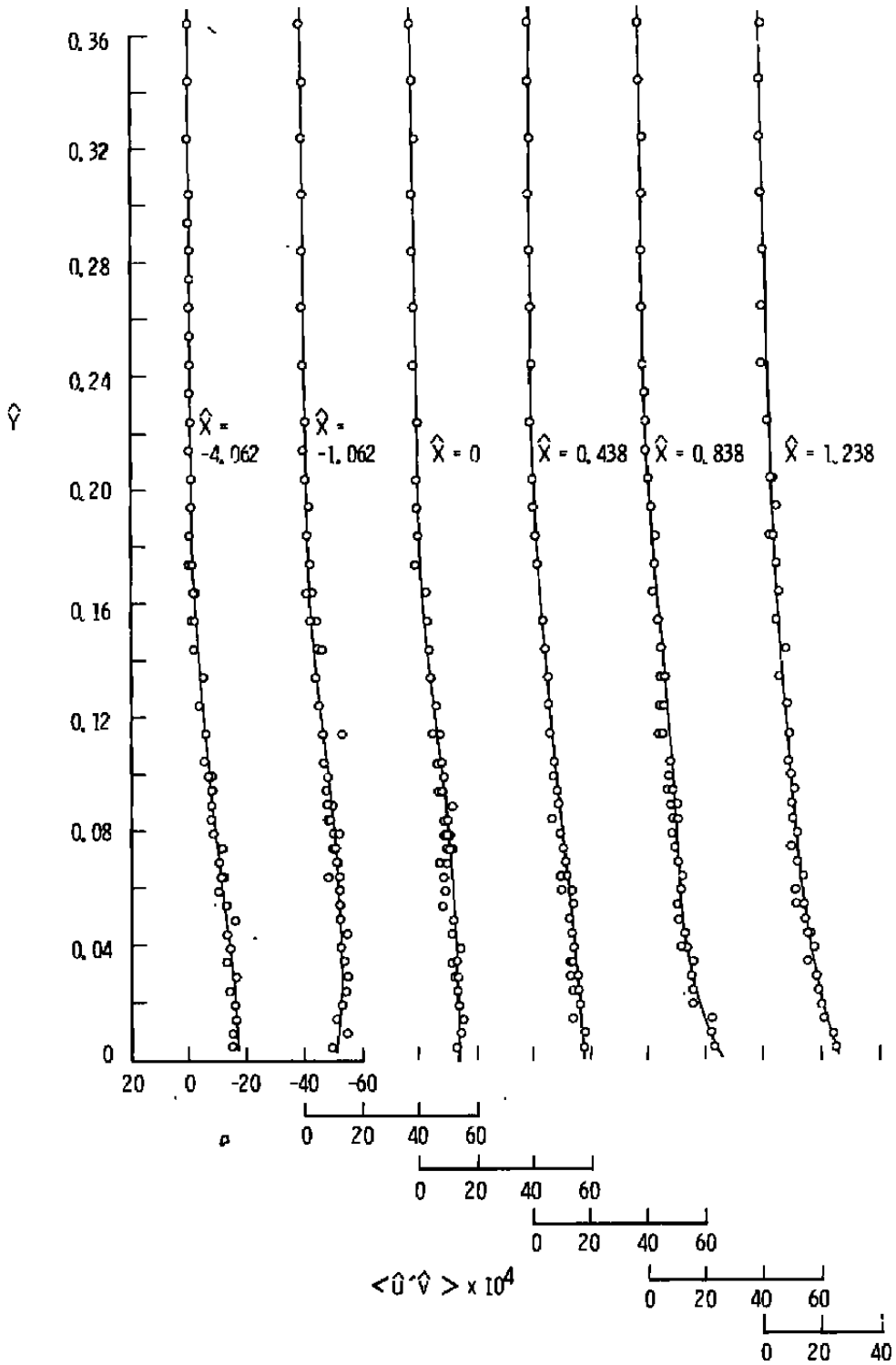

a. Forebody region

Figure 12. Specific Reynolds shear, attached-flow model.

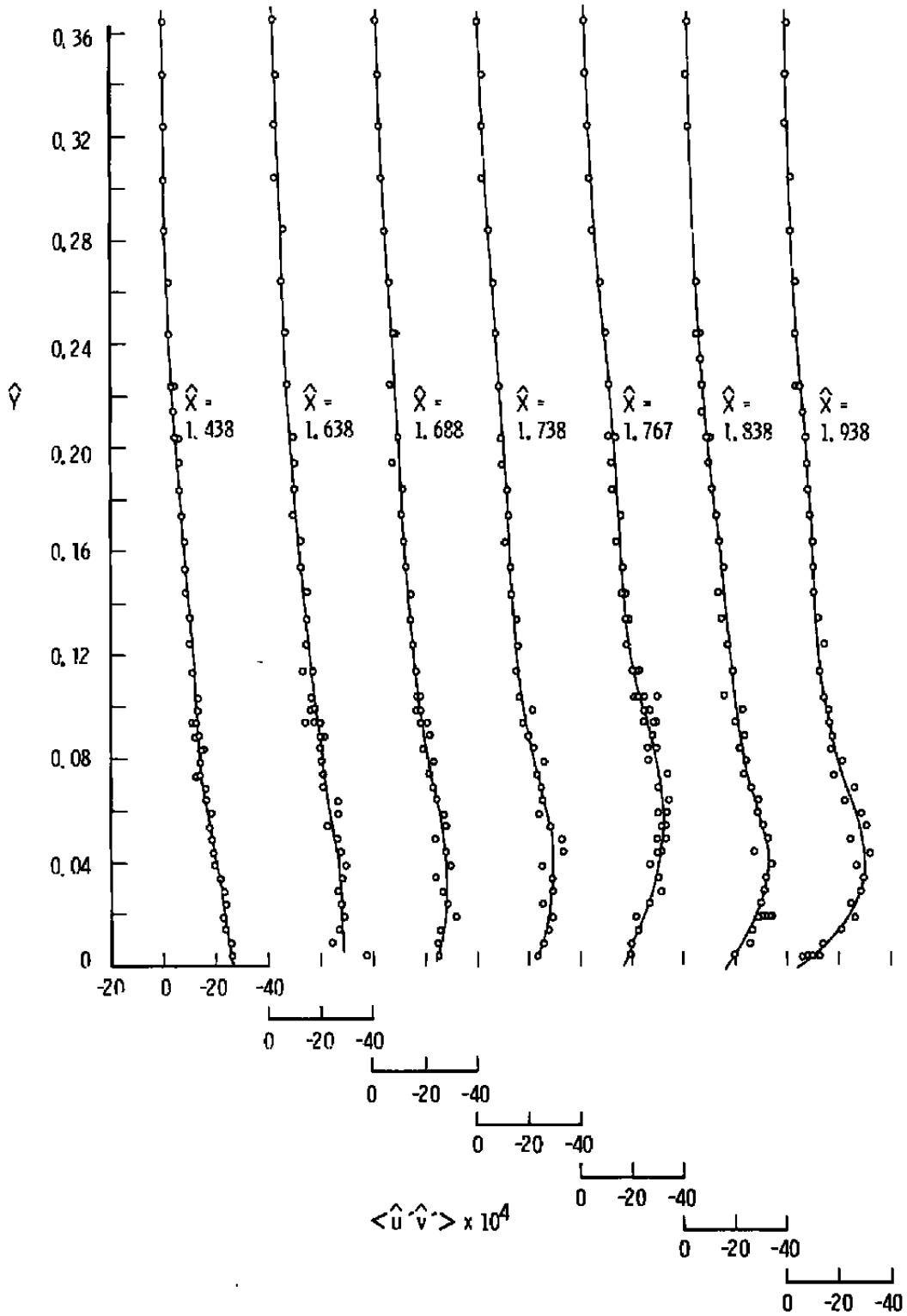

b. Cusp region
 Figure 12. Continued.

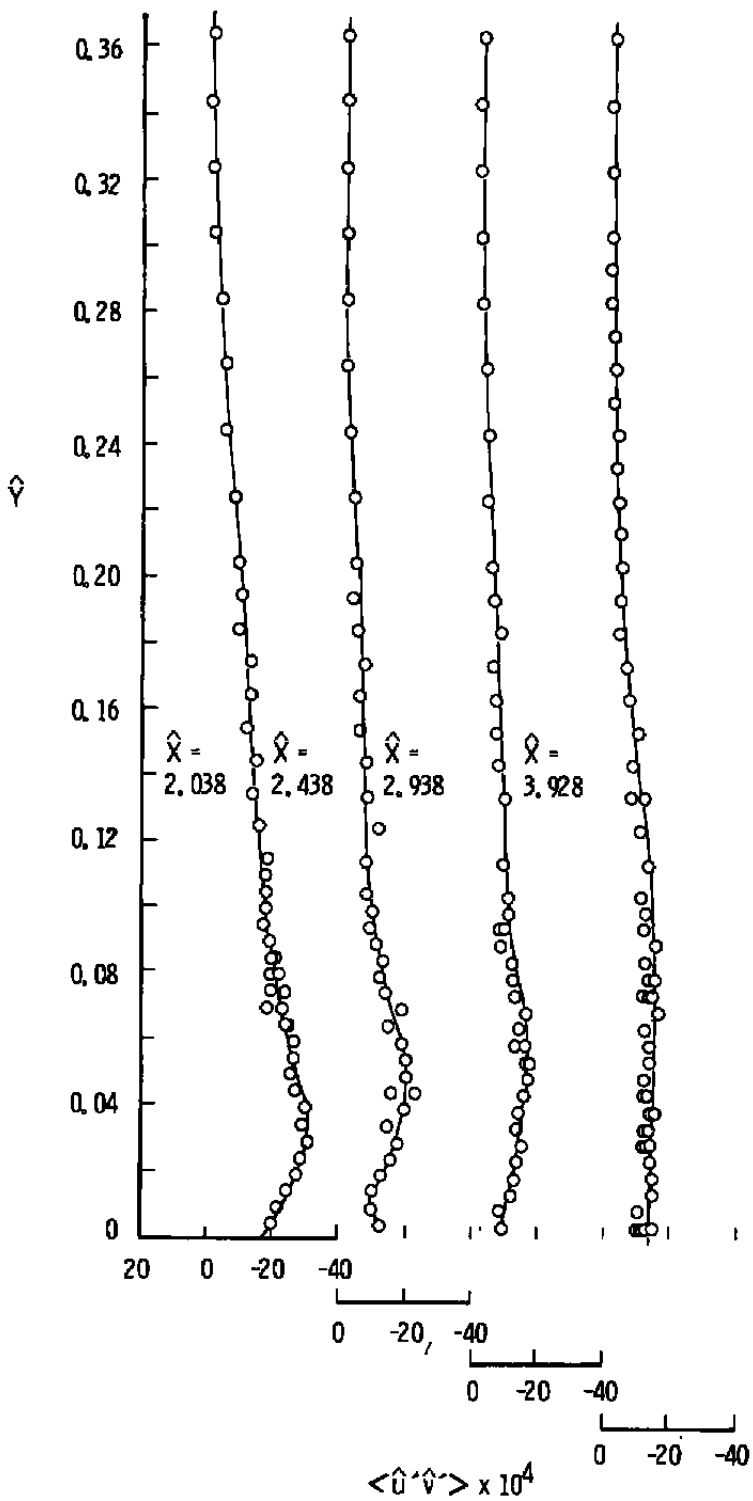

c. Plume region
 Figure 12. Concluded.

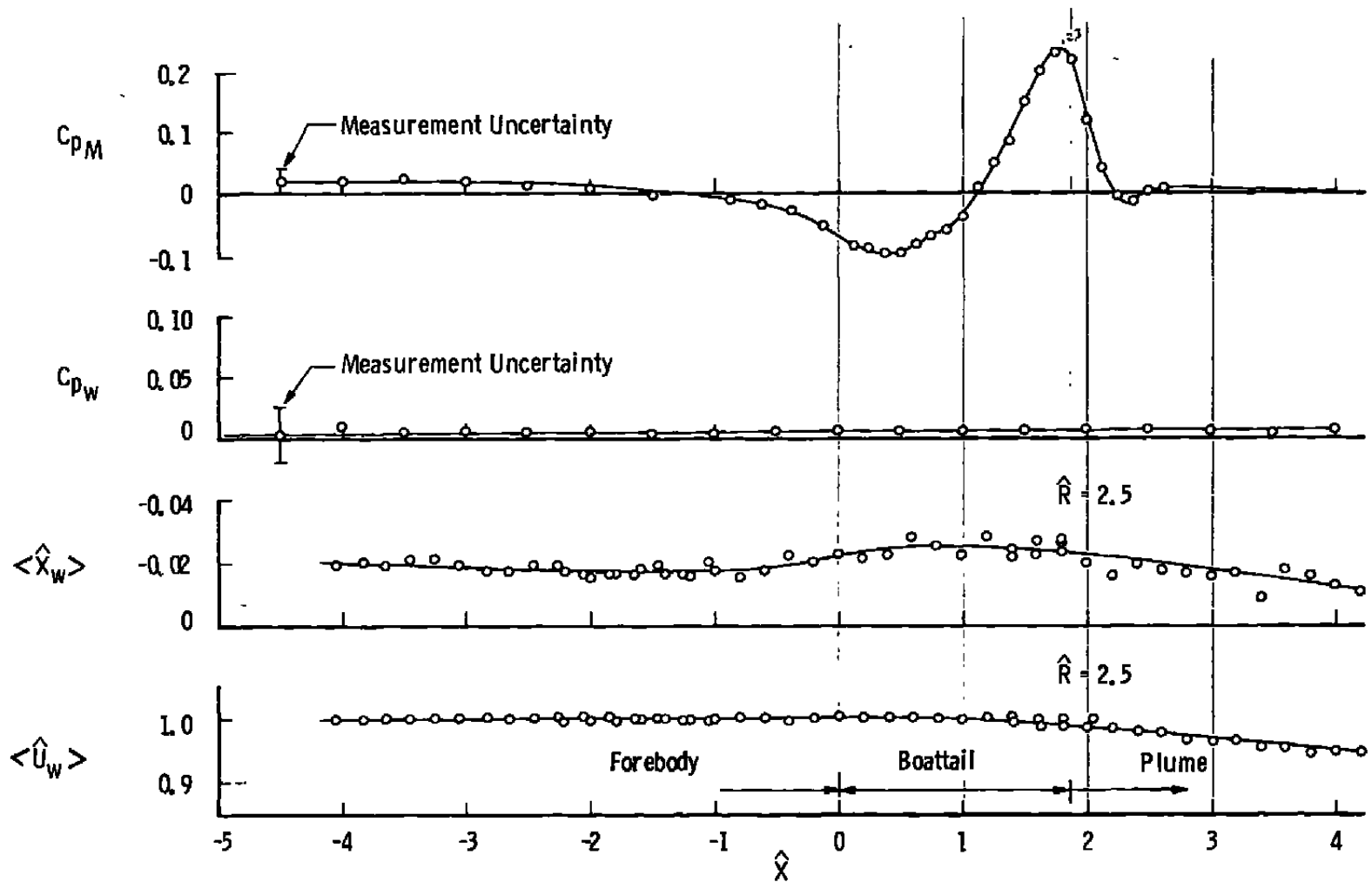

Figure 13. Boundary conditions for attached flow field.

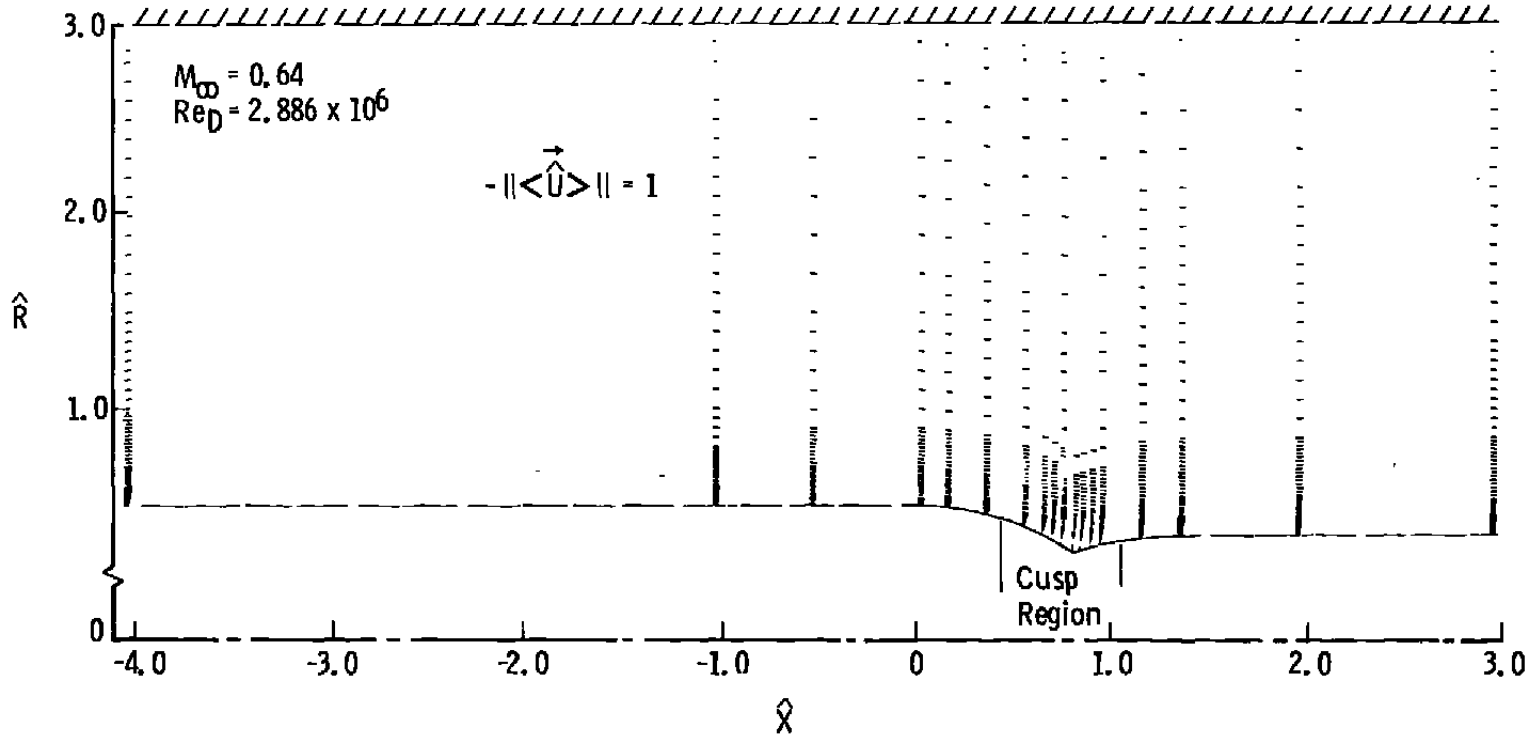
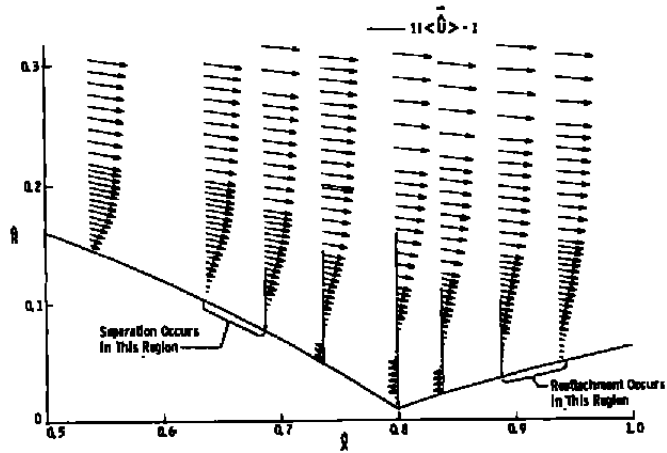
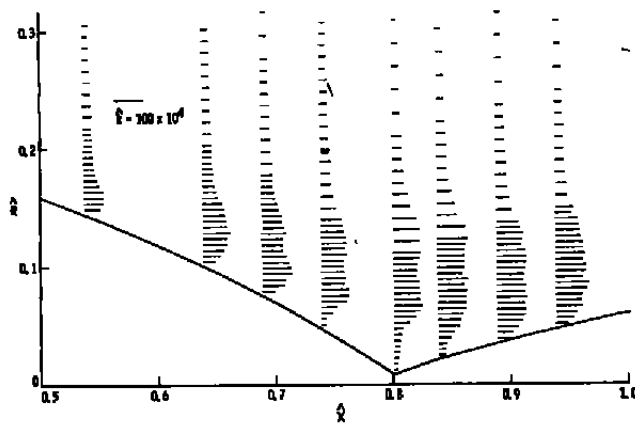

Figure 14. Mean velocity vectors, separated-flow model.



a. Mean velocity



b. Specific turbulent kinetic energy

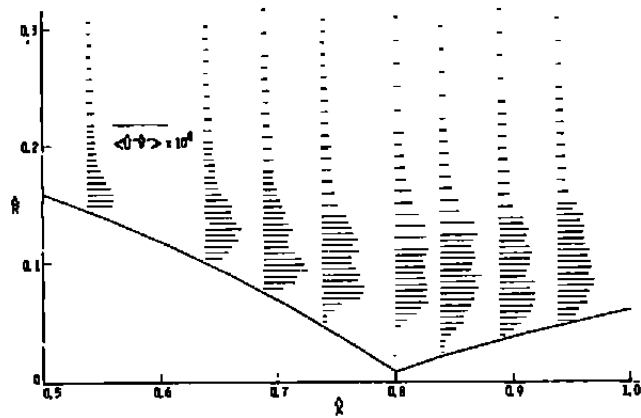

c. Specific Reynolds shear

Figure 15. Cusp region of separated-flow model.

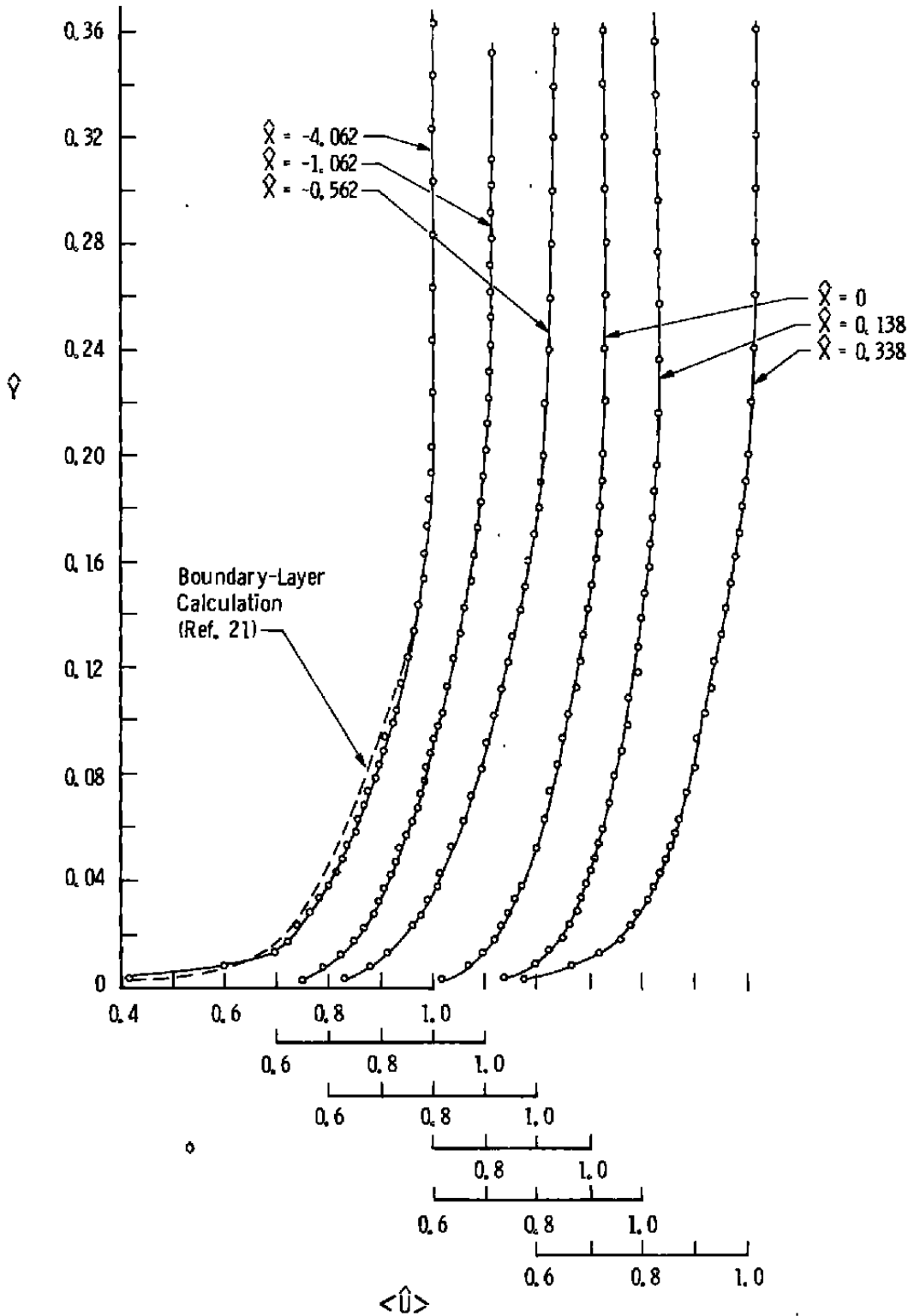

a. Forebody region

Figure 16. Mean axial velocity component, separated-flow model.

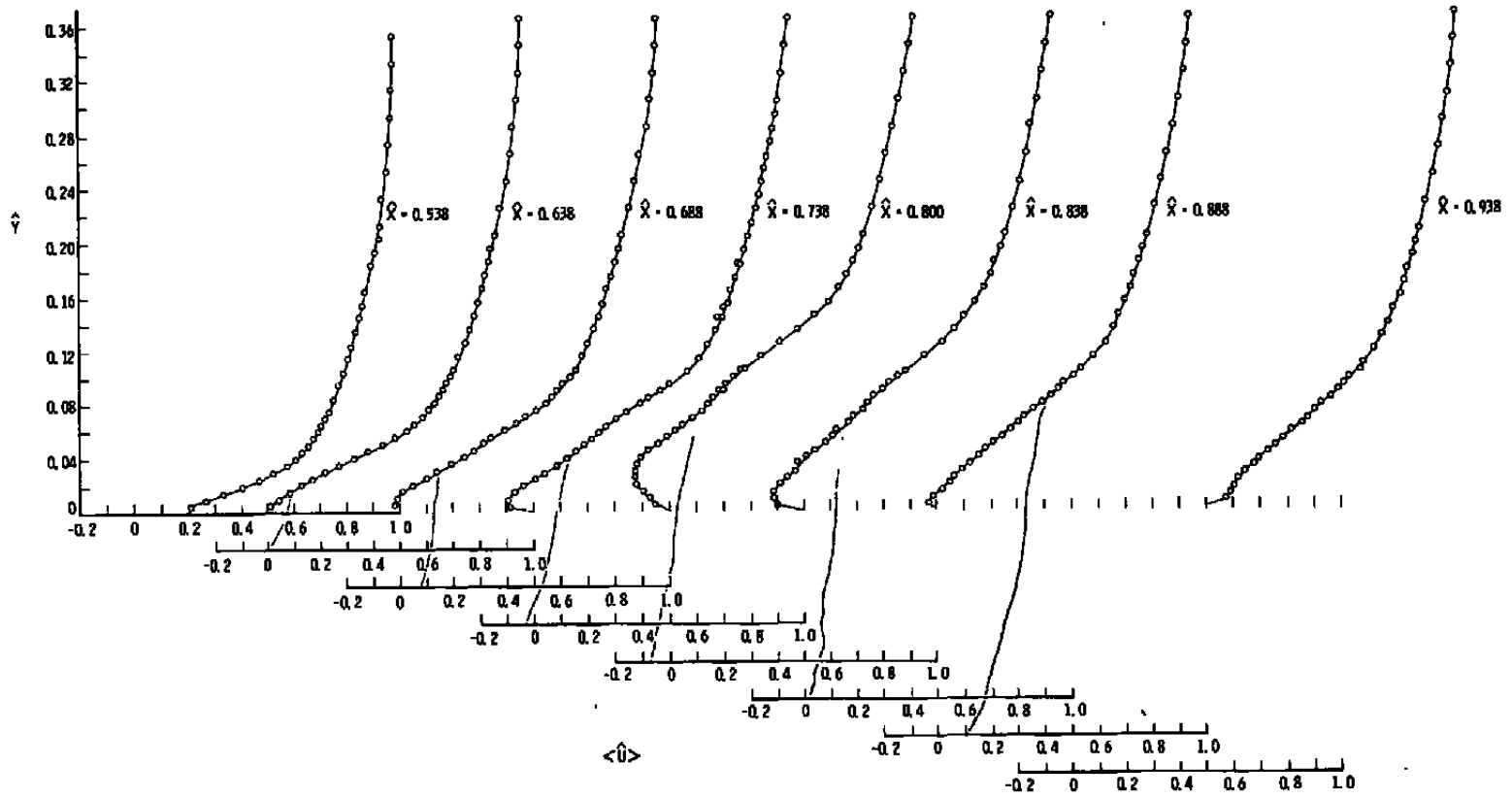

b. Cusp region
Figure 16. Continued.

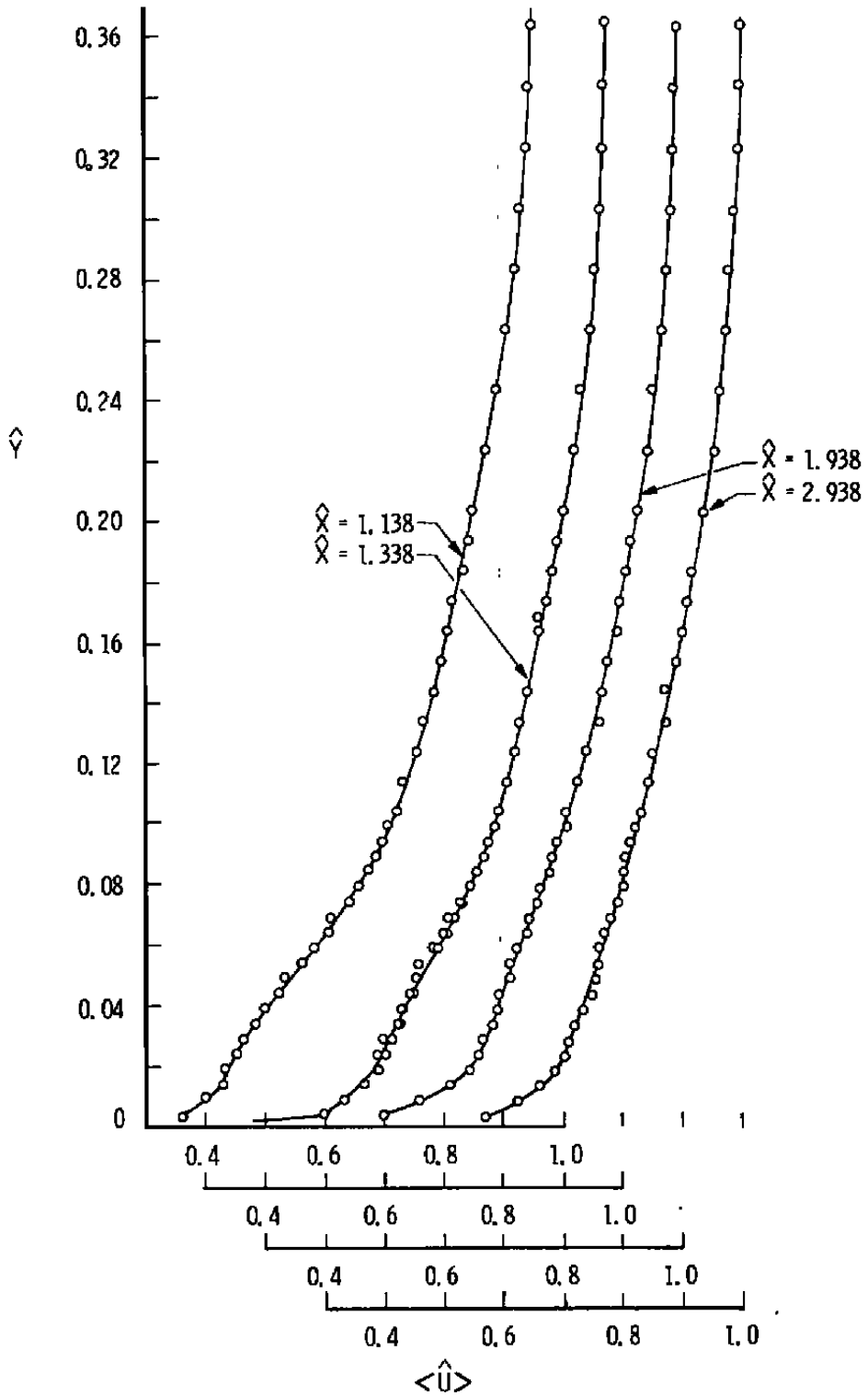

c. Plume region
 Figure 16. Concluded.

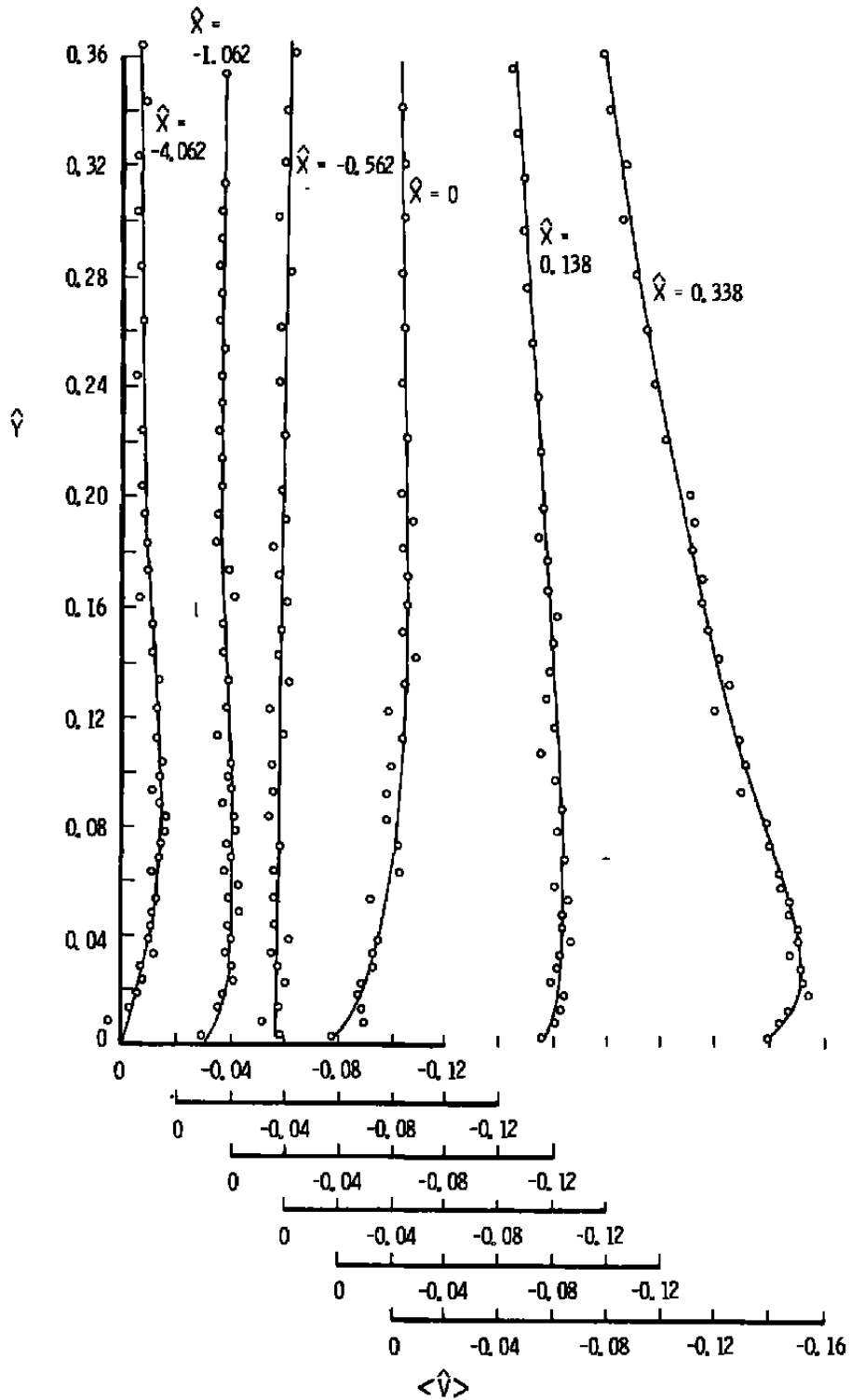

a. Forebody region

Figure 17. Mean radial velocity component, separated-flow model.

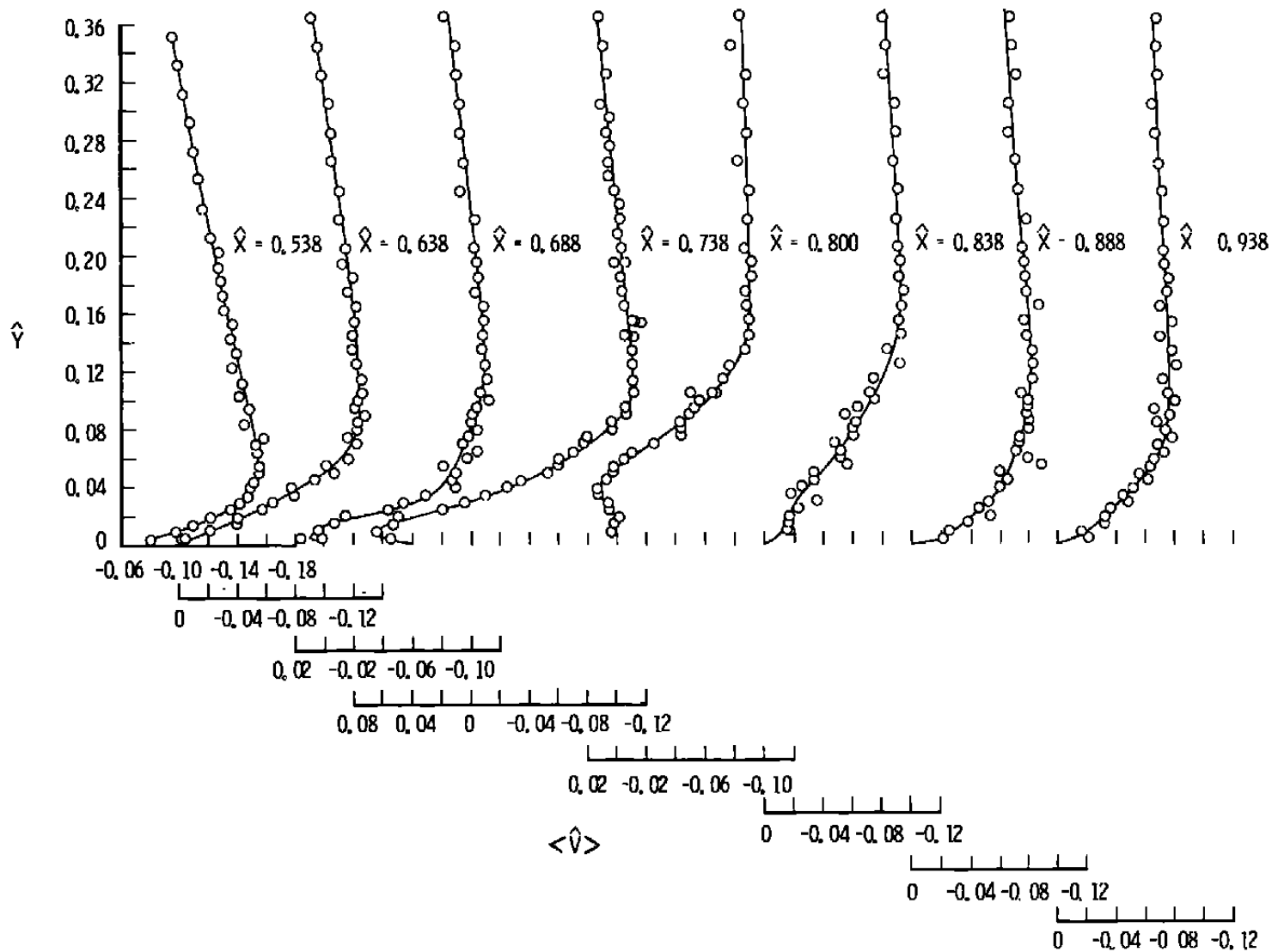

b. Cusp region
 Figure 17. Continued.

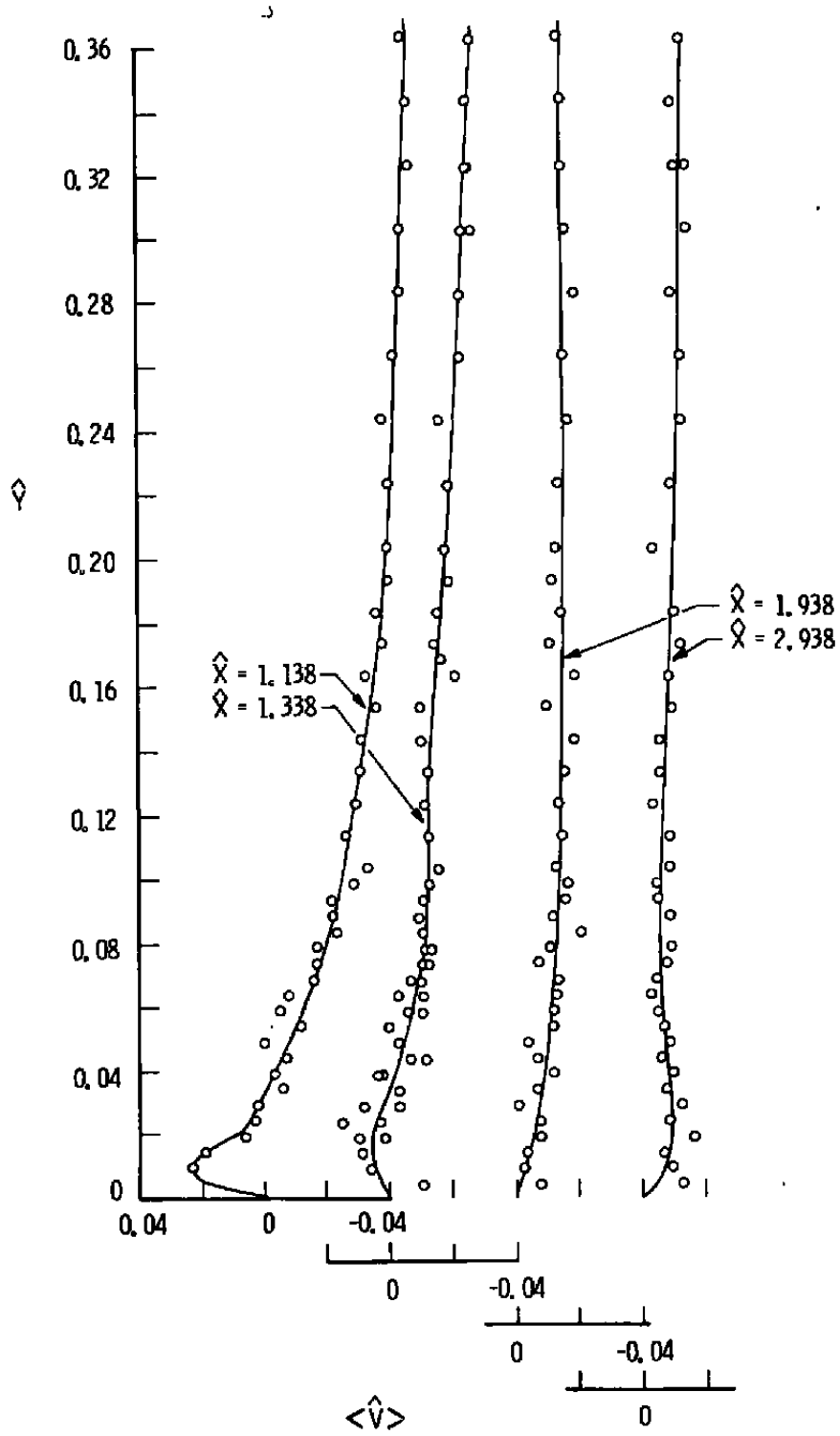

c. Plume region
 Figure 17. Concluded.

50

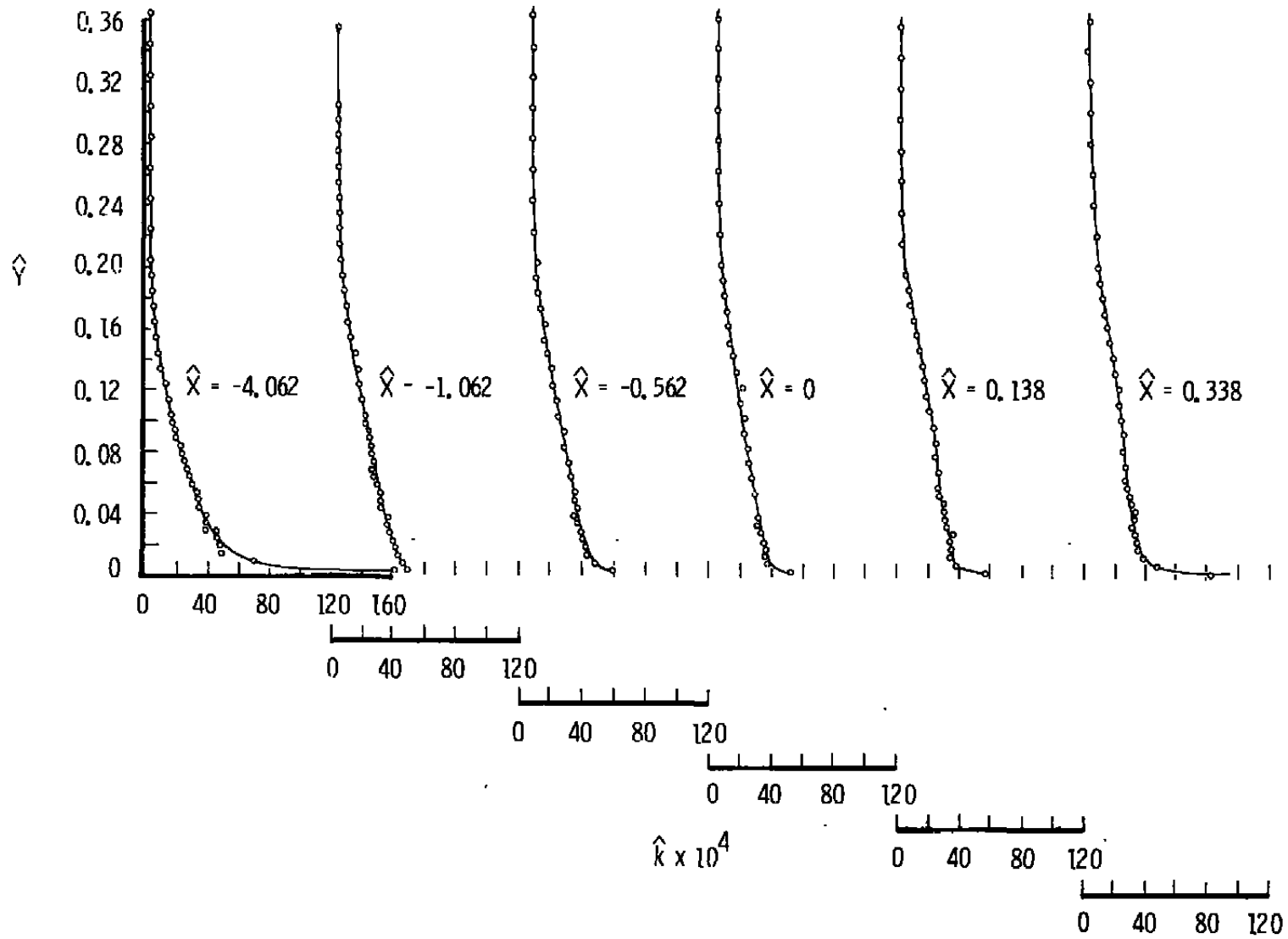

a. Forebody region

Figure 18. Specific turbulent kinetic energy, separated-flow model.

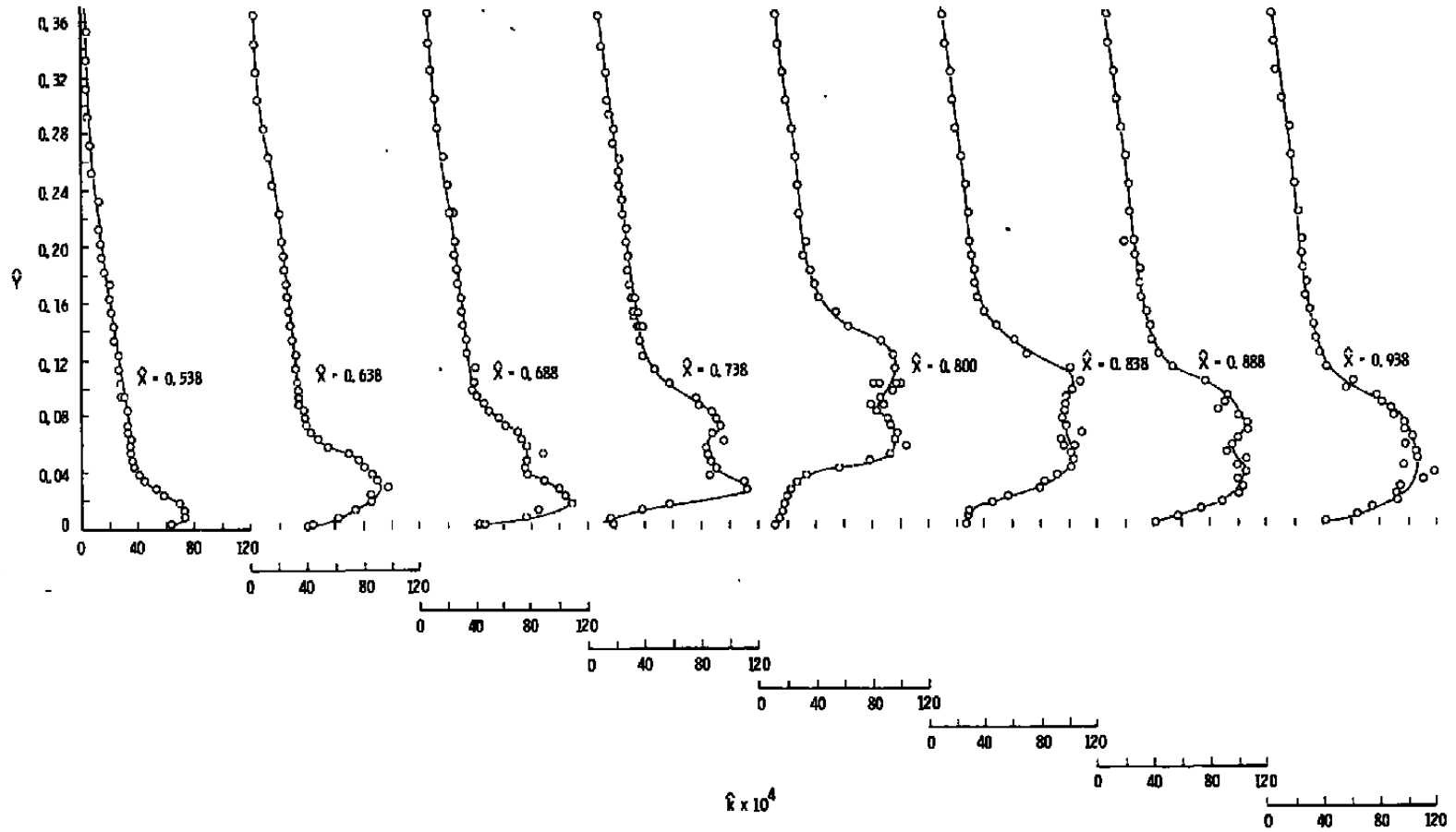

b. Cusp region
Figure 18. Continued.

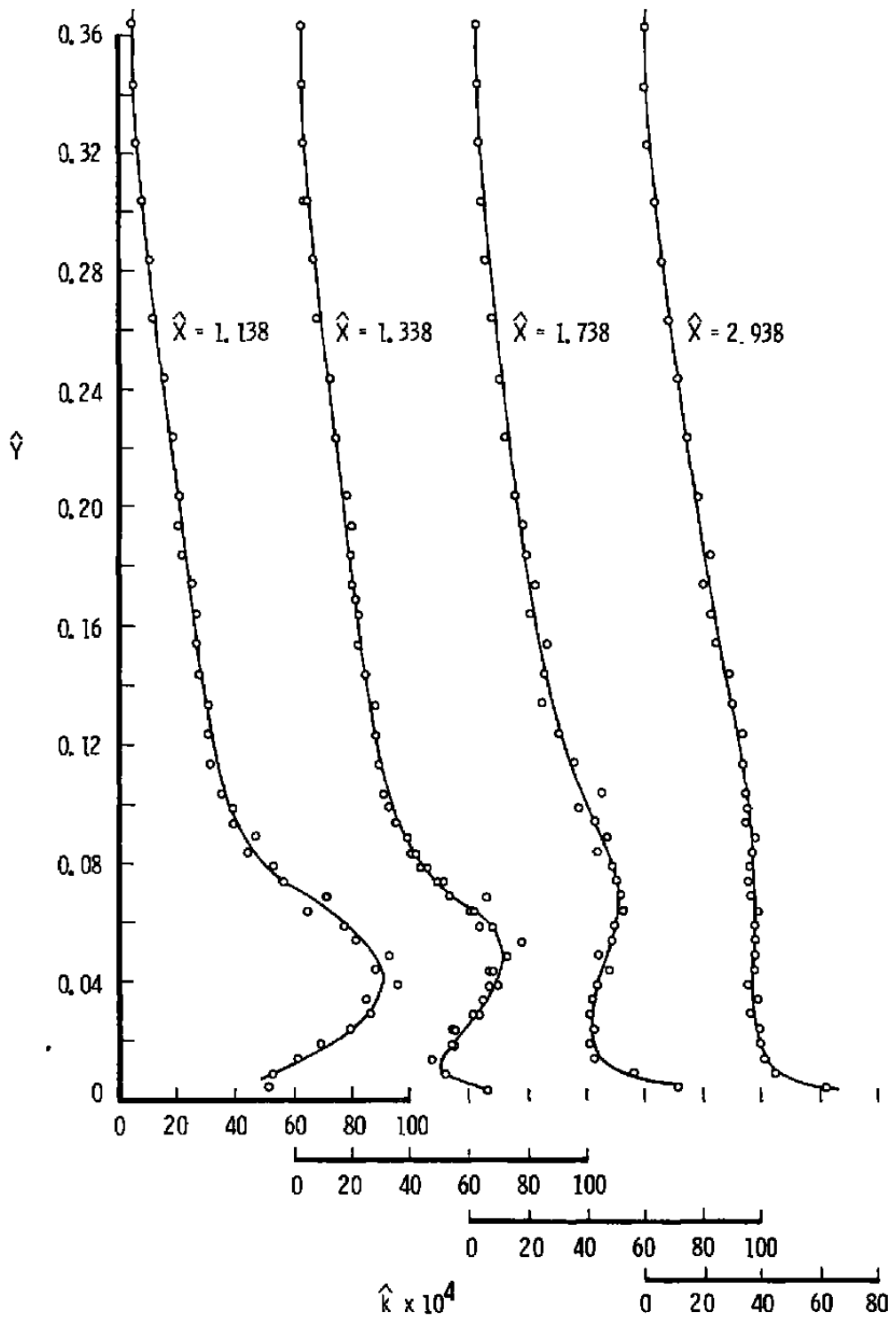

c. Plume region
 Figure 18. Concluded.

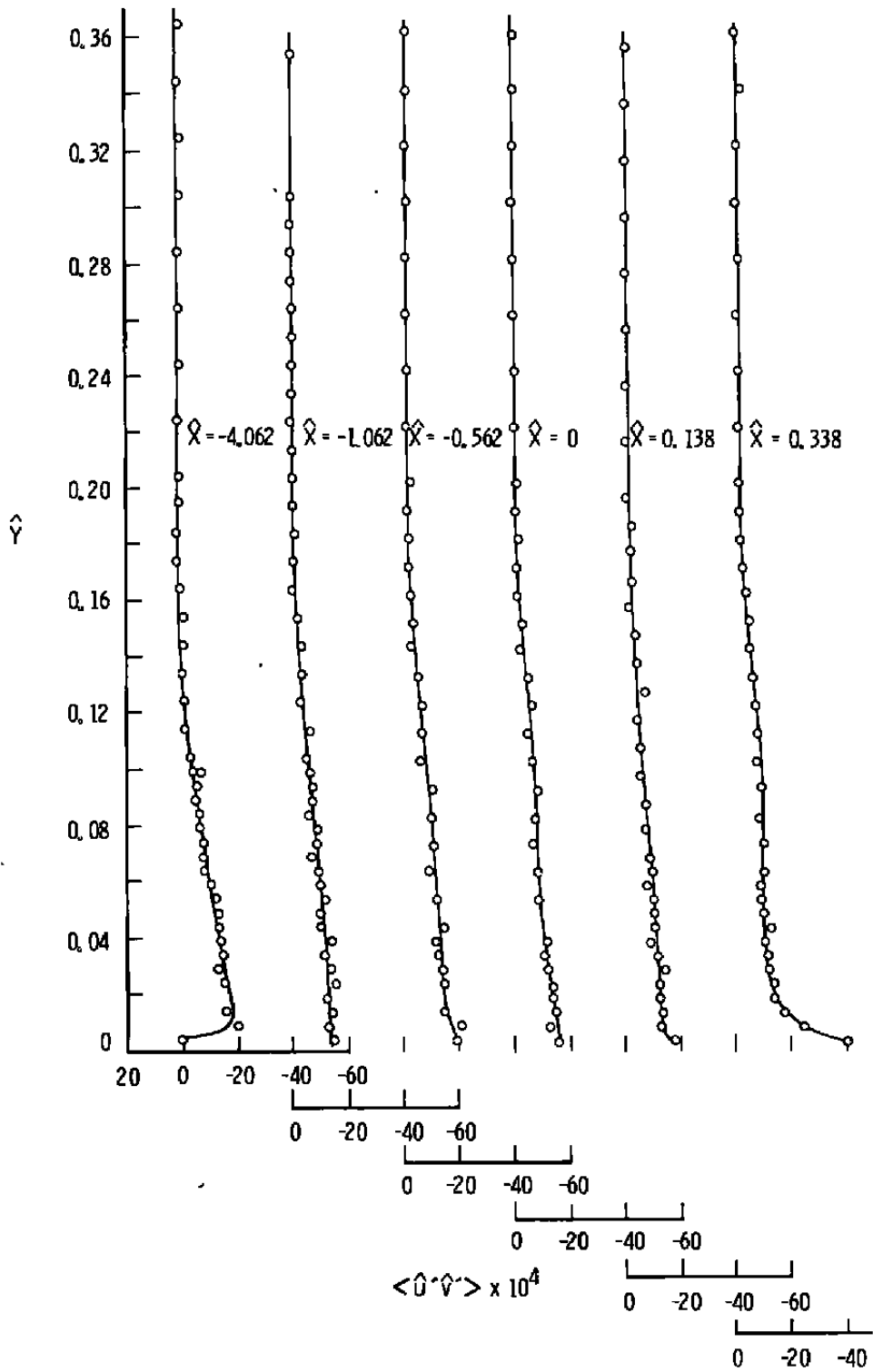

a. Forebody region

Figure 19. Specific Reynolds shear, separated-flow model.

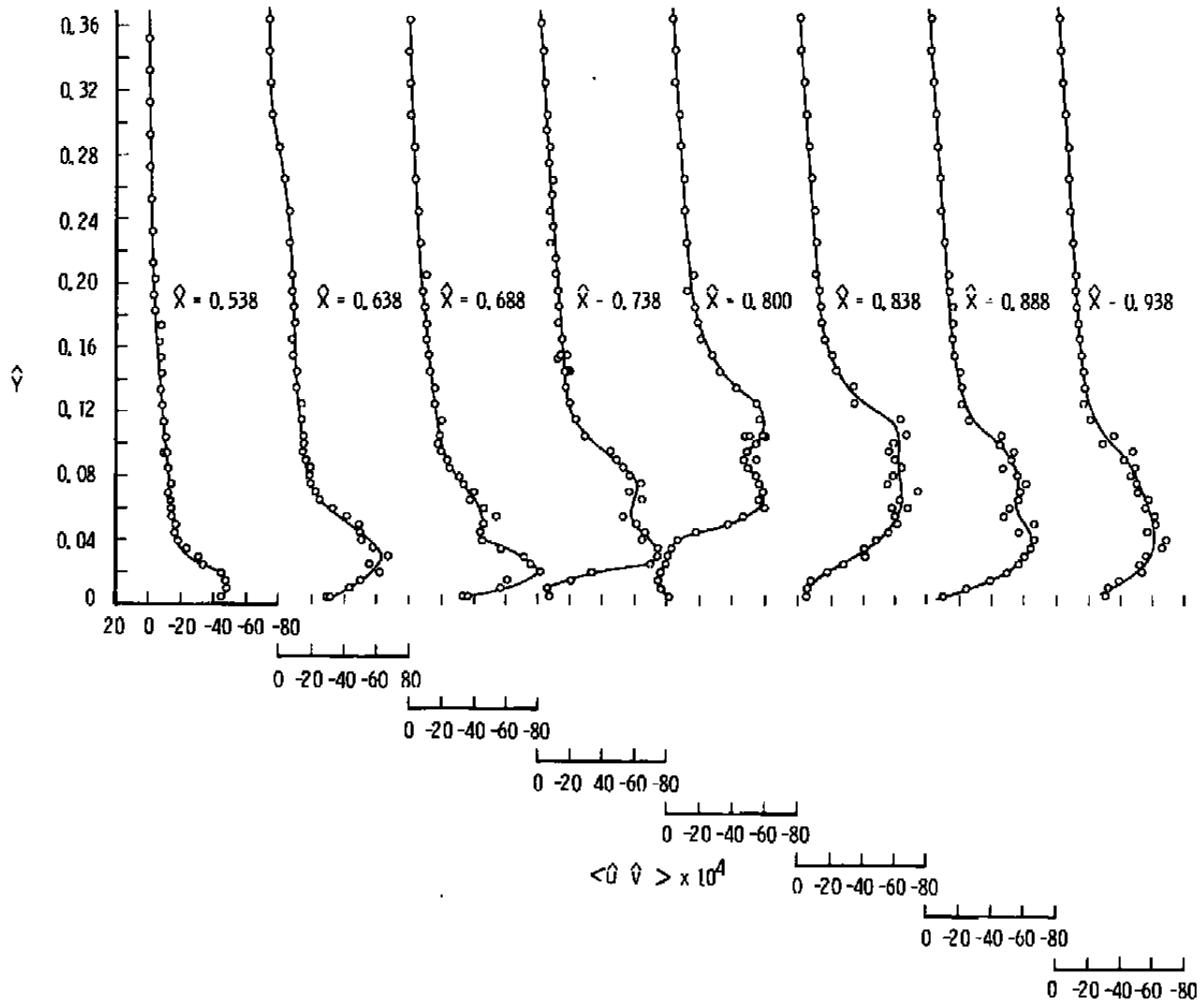

b. Cusp region
 Figure 19. Continued.

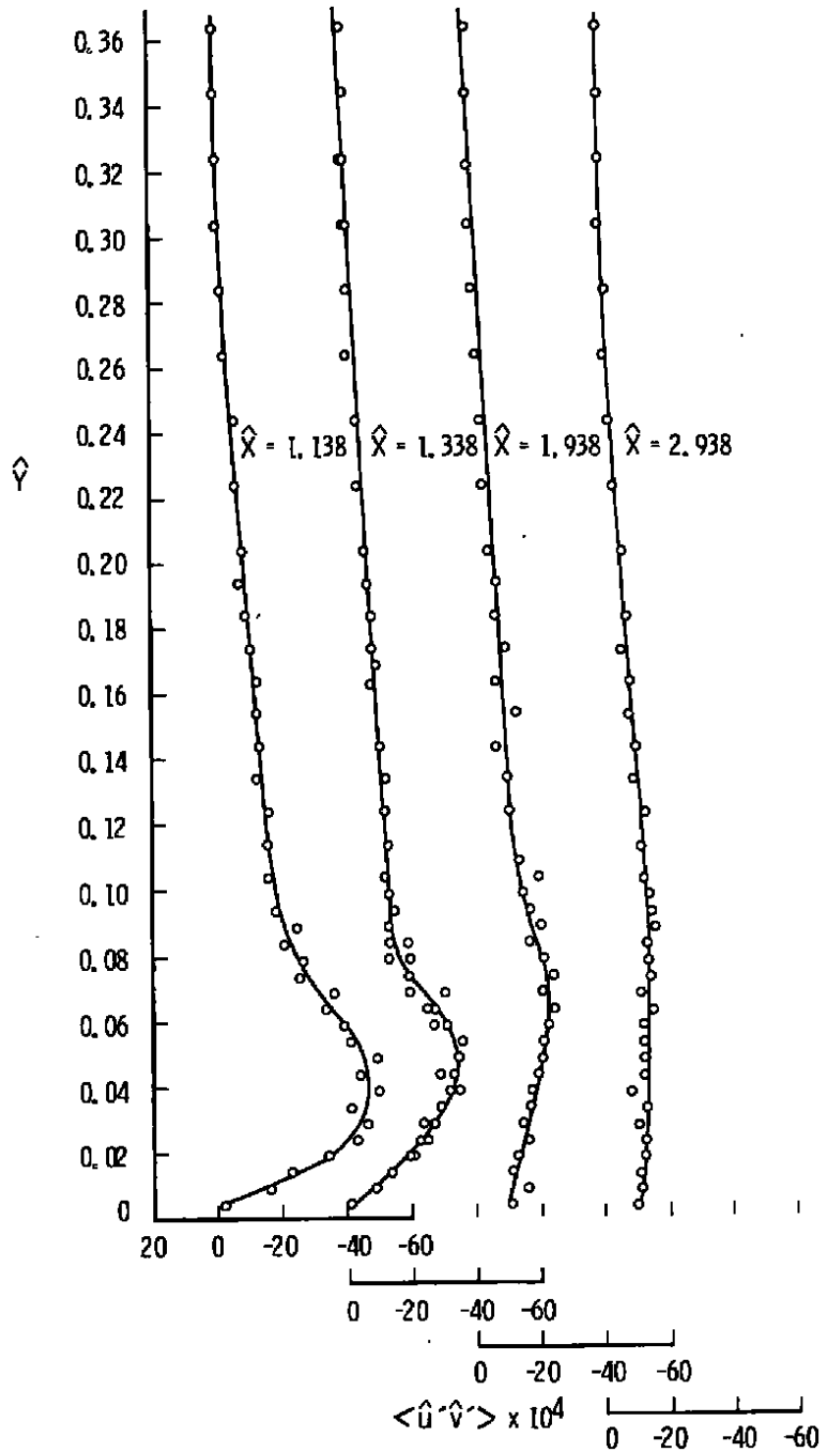

c. Plume region
 Figure 19. Concluded.

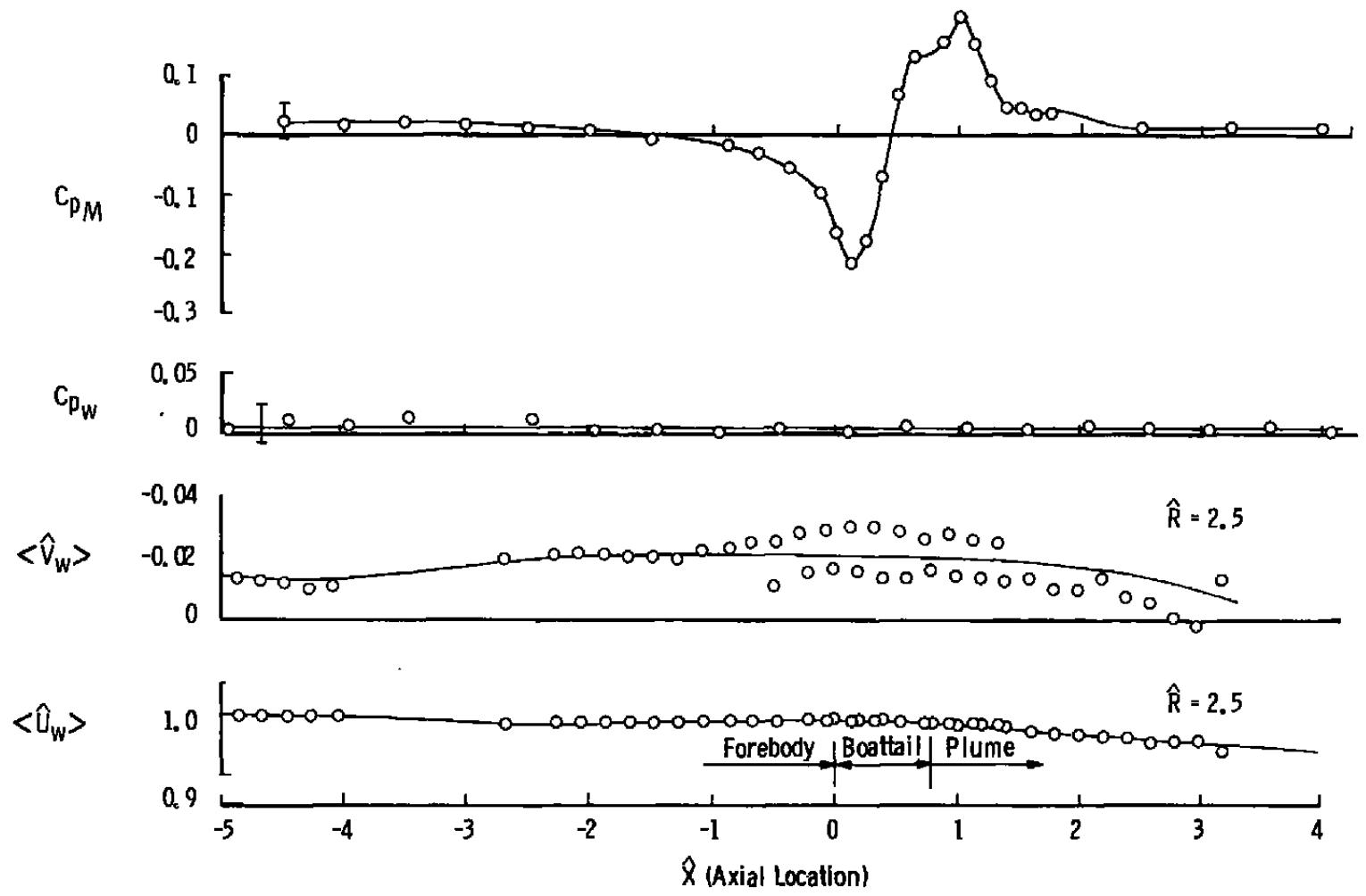
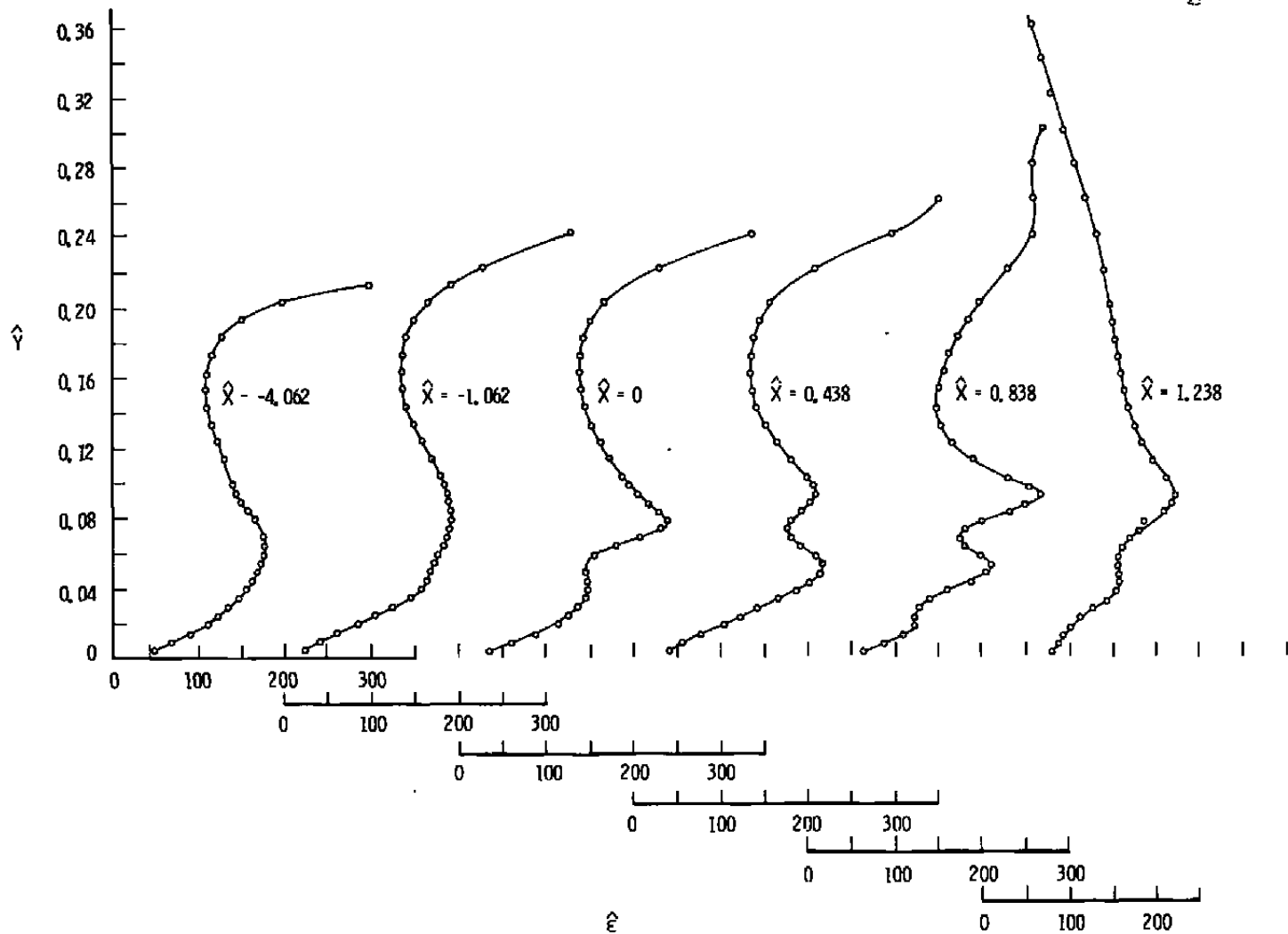
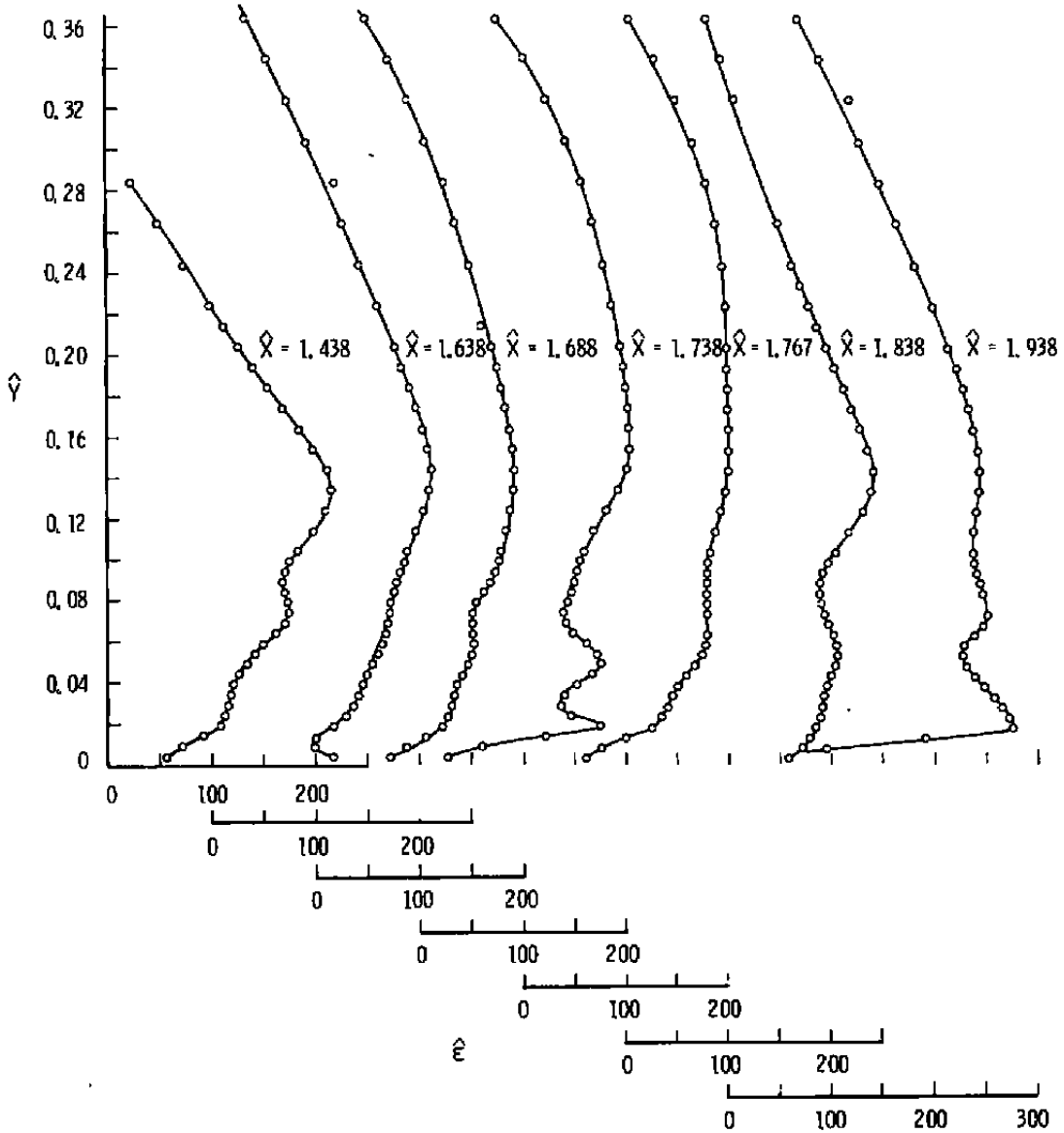

Figure 20. Boundary conditions for separated flow field.



a. Forebody region

Figure 21. Eddy viscosity, attached-flow model.



b. Cusp region
 Figure 21. Continued.

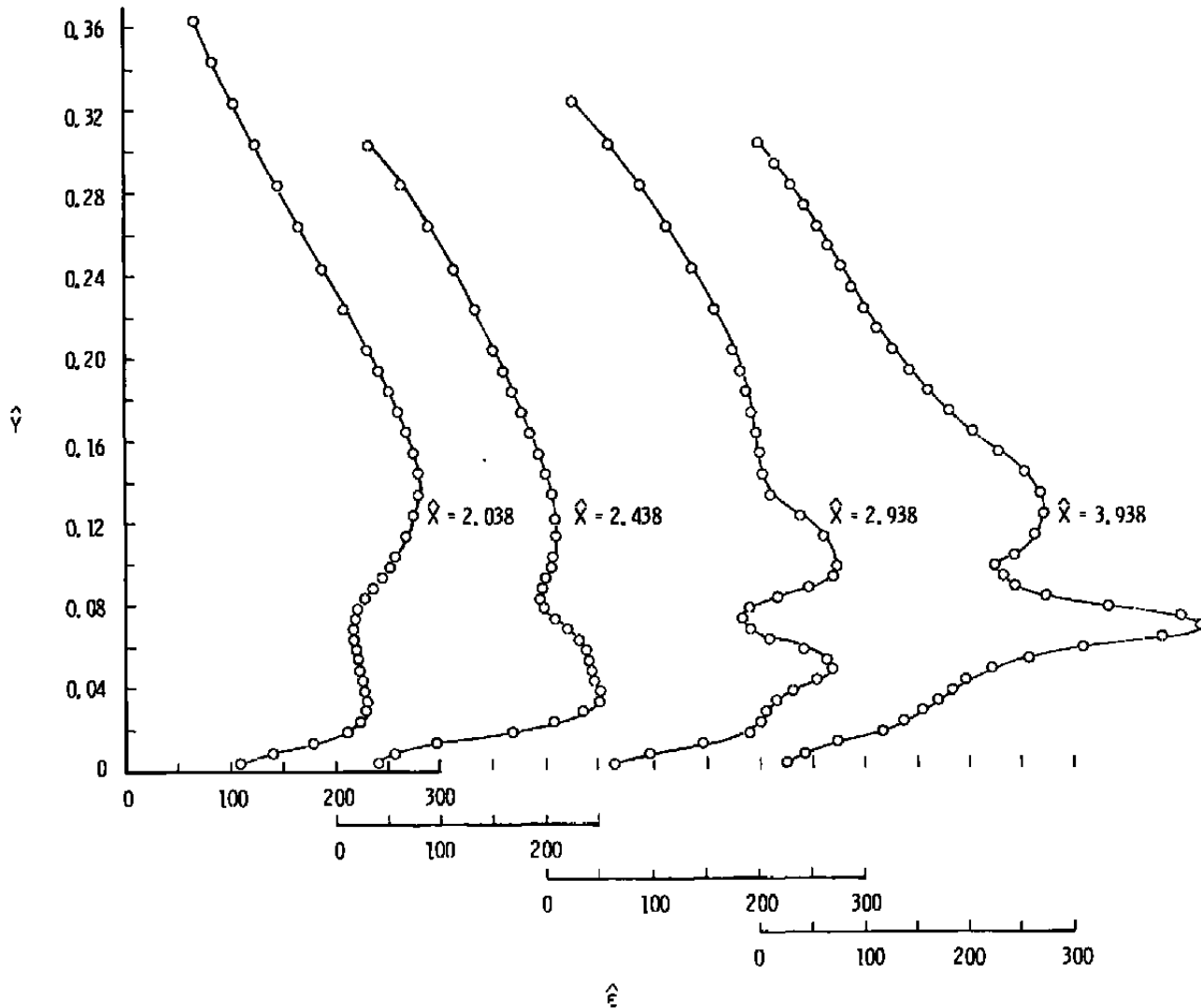

c. Plume region
Figure 21. Concluded.

60

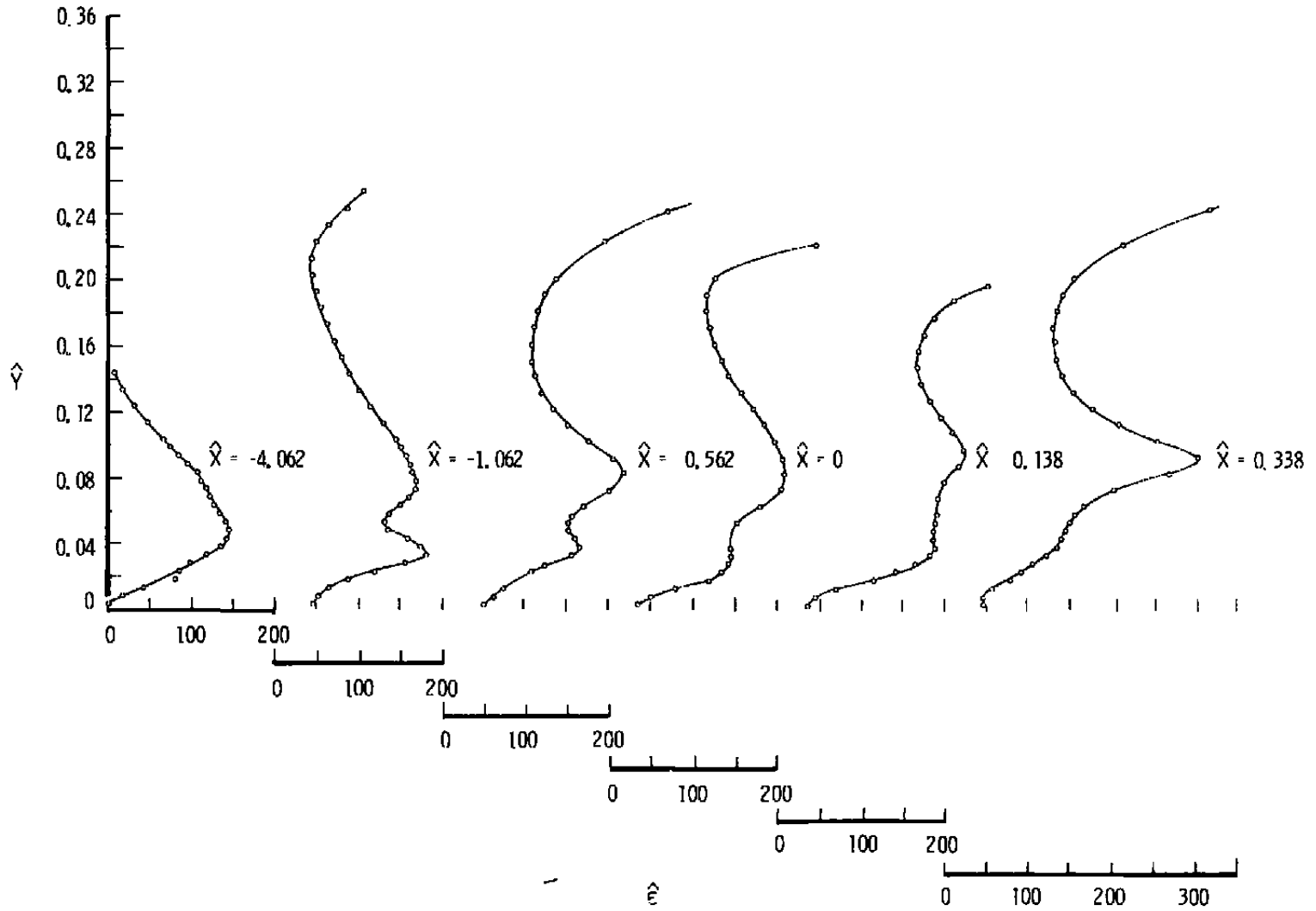

a. Forebody region

Figure 22. Eddy viscosity, separated-flow model.

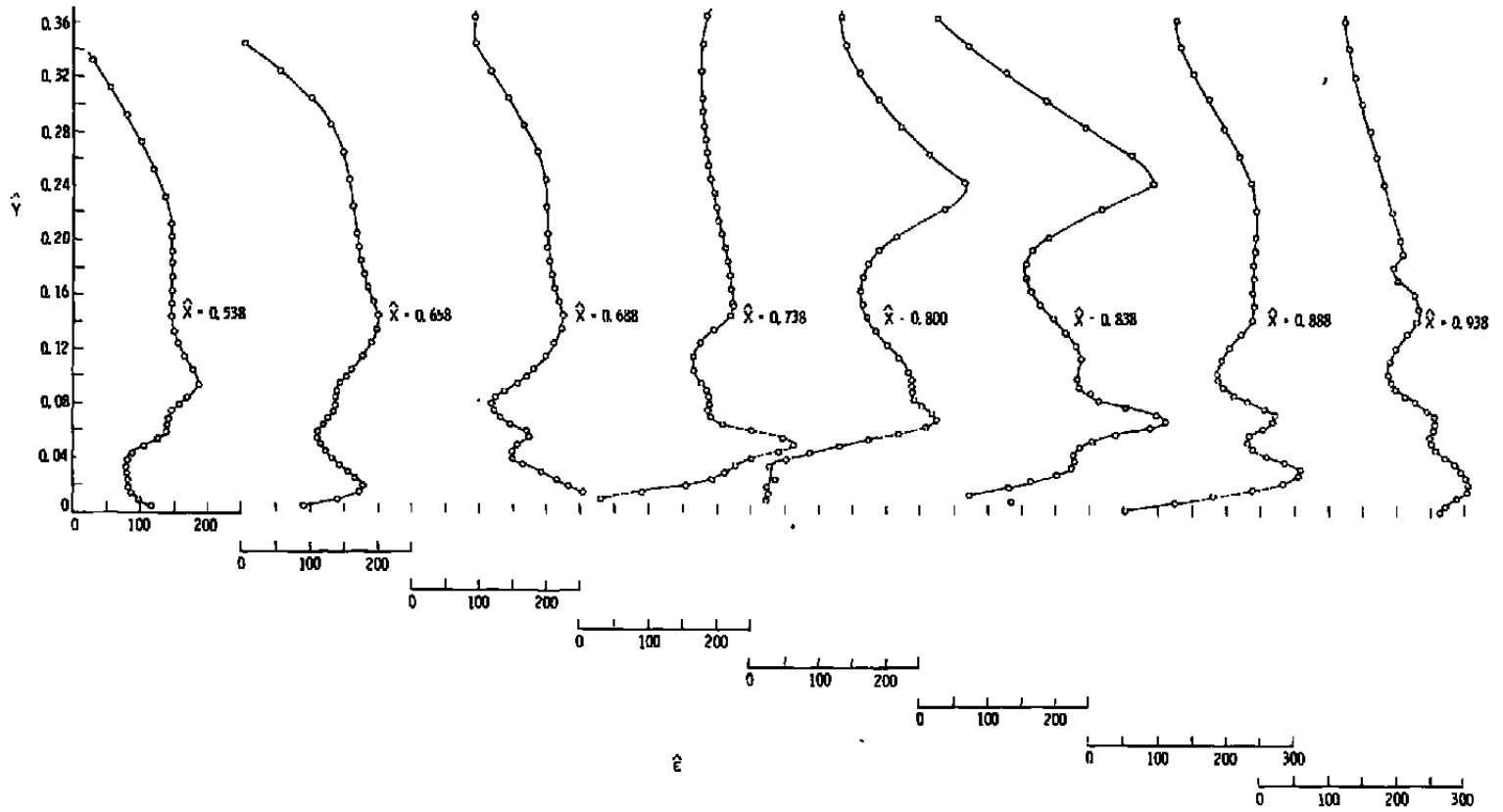

b. Cusp region
Figure 22. Continued.

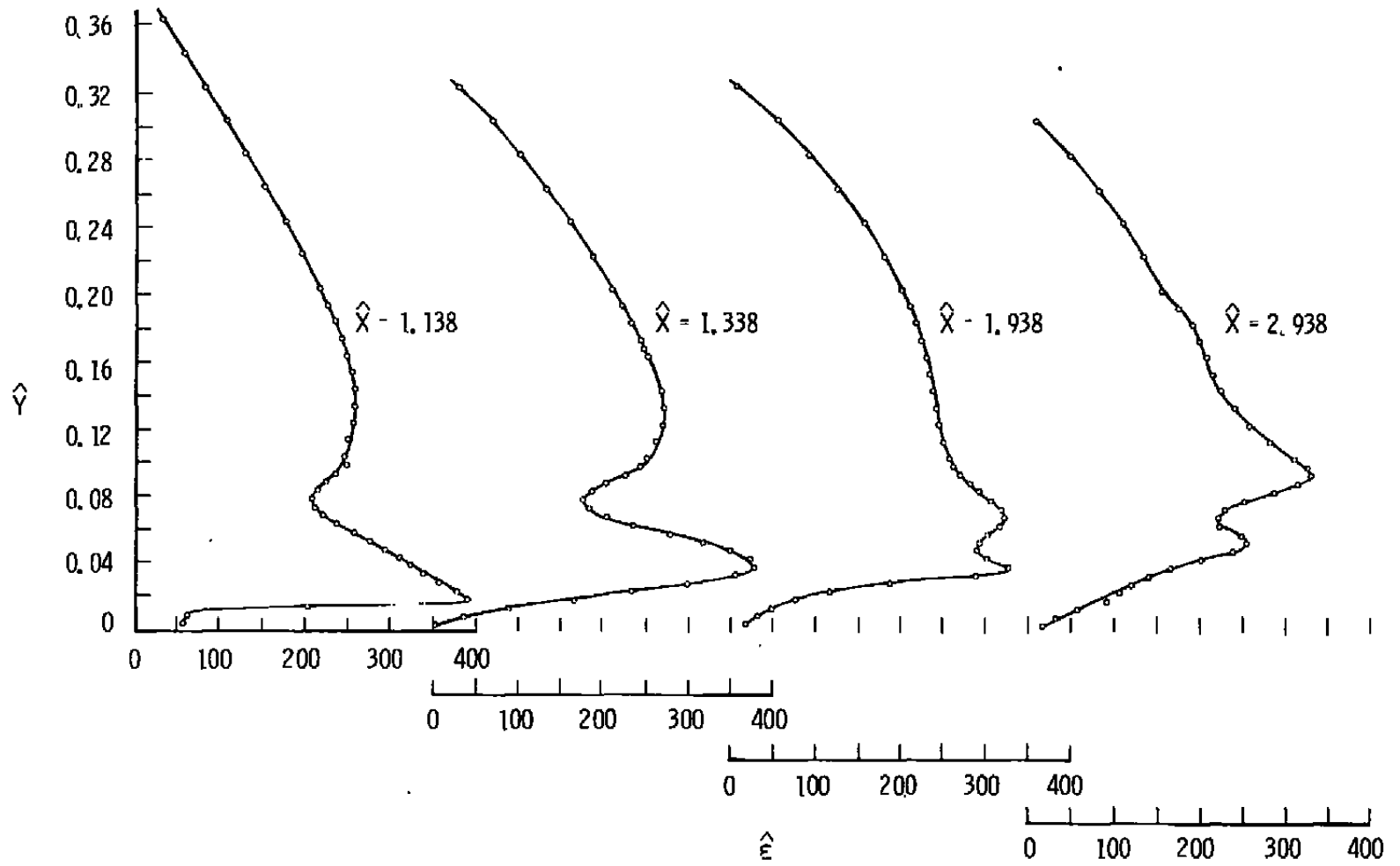

c. Plume region
Figure 22. Concluded.

Table 1. Model Geometry

As-Built Geometry				
Model Length, $\hat{L} = 1.77$			$\hat{L} = 0.8$	
Axial Position, \hat{X}	Radius, \hat{R}		Axial Position, \hat{X}	Radius, \hat{R}
0.0	0.5004		0.0	0.4998
0.126	0.4982		0.050	0.4985
0.278	0.4928		0.101	0.4953
0.431	0.4847		0.152	0.4903
0.583	0.4727		0.202	0.4840
0.735	0.4574		0.253	0.4758
0.887	0.4383		0.304	0.4665
1.039	0.4150		0.354	0.4533
1.191	0.3881		0.405	0.4388
1.343	0.3580		0.456	0.4225
1.495	0.3240		0.507	0.4038
1.648	0.2858		0.557	0.3833
1.767	0.2565		0.608	0.3602
1.803	0.2676		0.659	0.3351
1.841	0.2776		0.709	0.3079
1.879	0.2871		0.760	0.2775
1.920	0.2964		0.800	0.2561
1.961	0.3049		0.836	0.2671
2.004	0.3124		0.874	0.2774
2.048	0.3190		0.912	0.2870
2.093	0.3247		0.953	0.2962
2.140	0.3296		0.994	0.3045
2.188	0.3338		1.037	0.3119
2.237	0.3371		1.081	0.3186
2.288	0.3396		1.126	0.3246
2.341	0.3410		1.173	0.3295
2.395	0.3414		1.221	0.3337
			1.270	0.3371
			1.321	0.3394
			1.374	0.3408
			1.428	0.3411

Table 1. Concluded

I. C. The Circular-Arc Boattail Equation

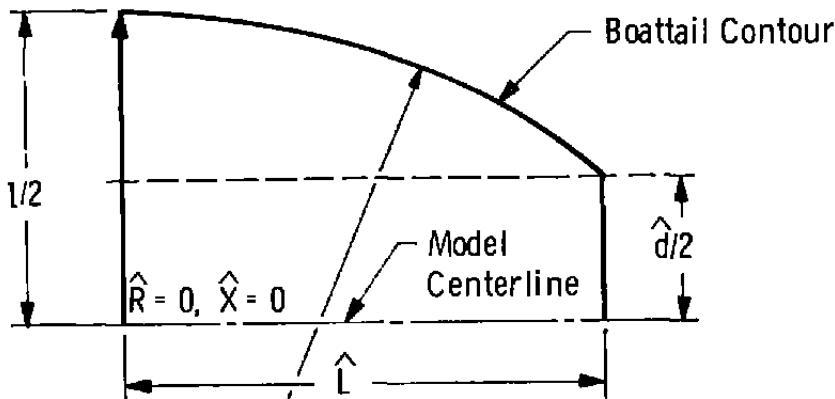

In Dimensionless Variables

$$\hat{R}_c = \left[\left(\frac{\hat{L}^2 + \Delta^2}{2\Delta} \right)^2 - \hat{X}^2 \right]^{1/2} - \left(\frac{\hat{L}^2 - \Delta^2}{2\Delta} \right) + \hat{d}/2 \quad (T1)$$

where

$$\Delta = \frac{1}{2} (1 - \hat{d})$$

Attached-Flow Model

$$\hat{L} = 1.77 \quad \hat{R} = \sqrt{42.26795952 - \hat{X}^2} - 6.001381355 \quad (T2)$$

Separated-Flow Model

$$\hat{L} = 1.77 \quad \hat{R} = \sqrt{2.040962102 - \hat{X}^2} - 0.928622449 \quad (T3)$$

Table 2. Measurement Uncertainties for $M_\infty = 0.64$

<u>Parameter</u>	<u>Uncertainty</u>
C_p	± 0.017
M_∞	± 0.0056
P_∞	± 300 pascals
q_∞	± 350 pascals

Table 3. Forebody Pressure Distribution

Axial Position, \hat{X}	C_{P_M}
-24.5	1.1066
-21.0	1.0110
-20.5	0.5811
-18.5	0.3983
-16.5	0.2820
-15.0	0.1686
-14.0	0.1337
-13.0	0.1020
-12.0	0.0831
-11.5	0.0827
-11.0	0.0763
-10.5	0.0790
-10.0	0.0735
-9.5	0.0616
-9.0	0.0661
-8.5	0.1272
-8.0	0.0547
-7.5	0.0446
-7.0	0.0418
-6.5	0.0326
-6.0	0.0014
-5.0	-0.0043
-4.5	0.0196
-4.0	0.0190

Table 4. Comparison of Boundary-Layer Parameters, Attached-Flow Model

Parameter	Calculation (Ref. 21)	From Mean Velocity Measurements (Ref. 21)	From Specific Reynolds Shear Measurement*
	$\widehat{X} = -4.062$		
$\widehat{\delta}^*$	0.0292 <i>A = 1.152</i>	0.0256 <i>A = 1.152</i>	---
$\widehat{\theta}$	0.0197	0.0173	---
c_f	0.00276	0.00300	0.00333
	$\widehat{X} = -1.062$		
$\widehat{\delta}^*$	---	0.0295	
$\widehat{\theta}$	---	0.0197	
c_f	---	0.00290	0.00313

* The coefficient of skin friction was computed from the specific Reynolds' Shear by

$$c_f = - \frac{\rho \langle u'v' \rangle_{\max}}{q_\infty} = -2 \widehat{\rho} |\langle \widehat{u}'\widehat{v}' \rangle|_{\max}$$

where ρ is given by Eq. (13).

Table 5. Data Tabulation, Attached-Flow Model

Model Surface				Tunnel Wall	
\hat{X}	C_{P_M}	\hat{X}	C_{P_M}	\hat{X}	C_{P_W}
		2.626	0.0053	-7.5	0.0
✓-5.0	-0.0043	3.376	0.0053	-6.0	0.0003
-4.5	0.0196	4.126	-0.0020	-5.5	0.0023
-4.0	0.0190	4.876	-0.0291	-5.0	---
✓-3.5	0.0236			-4.5	0.0025
-3.0	0.0181			-4.0	0.0100
-2.5	0.0118			-3.5	0.0075
-2.0	0.0080			-3.0	0.0118
-1.5	-0.0030			-2.5	0.0236
-0.874	-0.0126			-2.0	0.0118
-0.624	-0.0204			-1.5	0.0025
-0.374	-0.0289			-1.0	0.0023
-0.124	-0.0535			-0.5	0.0028
0.126	-0.0877			0.0	0.0045
0.251	-0.0910			0.5	0.0050
0.376	-0.0990			1.0	0.0040
0.501	-0.0983			1.5	0.0048
0.625	-0.0840			2.0	0.0055
0.751	-0.0716			2.5	0.0093
0.876	-0.0611			3.0	0.0049
1.001	-0.0282			3.5	0.0035
1.126	0.0073			4.0	0.0053
1.251	0.0810				
1.376	0.0832				
1.501	0.1440				
1.625	0.1943				
1.751	0.2256				
1.876	0.2128				
2.001	0.1158				
2.126	0.0399				
2.251	-0.0081				
2.376	-0.0153				
2.501	0.0030				

Table 5. Continued

Attached-Flow Model

$\hat{X} = -4.062$	$\hat{R}_{\text{surface}} = 0.500$	$v_{\infty} = 211 \text{ m/sec}$				
I	\hat{Y}	\hat{R}	$\langle \hat{U} \rangle$	$\langle \hat{V} \rangle$	$\hat{k} \times 10^4$	$\langle \hat{U} - \hat{V} \rangle$
1	0.004	0.504	0.653	-0.012	50.2	-15.2
2	0.009	0.509	0.690	-0.012	45.4	-15.3
3	0.014	0.514	0.714	-0.011	43.9	-16.9
4	0.019	0.519	0.739	-0.010	42.0	-16.5
5	0.024	0.524	0.757	-0.012	41.7	-14.7
6	0.029	0.529	0.773	-0.011	41.3	-17.2
7	0.034	0.534	0.785	-0.013	36.4	-13.7
8	0.039	0.539	0.800	-0.012	37.4	-14.7
9	0.044	0.544	0.814	-0.017	34.0	-14.0
10	0.049	0.549	0.829	-0.010	37.8	-16.4
11	0.054	0.554	0.838	-0.013	34.7	-13.3
12	0.059	0.559	0.849	-0.014	31.9	-10.4
13	0.064	0.564	0.852	-0.017	30.8	-13.3
14	0.064	0.564	0.854	-0.019	30.5	-11.7
15	0.069	0.569	0.865	-0.015	29.5	-10.8
16	0.074	0.574	0.878	-0.014	29.9	-12.3
17	0.079	0.579	0.887	-0.015	26.3	-8.8
18	0.084	0.584	0.892	-0.020	26.9	-8.1
19	0.089	0.589	0.899	-0.021	23.4	-8.3
20	0.089	0.589	0.903	-0.019	21.6	-8.5
21	0.094	0.594	0.901	-0.015	24.8	-8.5
22	0.094	0.594	0.905	-0.015	23.4	-8.3
23	0.094	0.594	0.907	-0.017	22.9	-8.8
24	0.099	0.599	0.915	-0.014	22.9	-8.8
25	0.099	0.599	0.914	-0.017	22.6	-7.5
26	0.104	0.604	0.925	-0.020	19.8	-5.7
27	0.114	0.614	0.940	-0.019	17.6	-6.5
28	0.124	0.624	0.947	-0.020	16.0	-4.0
29	0.134	0.634	0.959	-0.017	14.6	-5.4
30	0.144	0.644	0.969	-0.019	9.8	-2.2
31	0.154	0.654	0.978	-0.016	8.5	-2.5
32	0.154	0.654	0.976	-0.018	8.1	-2.0
33	0.164	0.664	0.983	-0.011	7.3	-3.8
34	0.164	0.664	0.981	-0.015	7.7	-2.4
35	0.174	0.674	0.988	-0.020	3.8	-0.3
36	0.174	0.674	0.989	-0.021	4.1	-0.6
37	0.174	0.674	0.992	-0.018	5.9	-1.7
38	0.184	0.684	0.992	-0.012	5.7	-2.7
39	0.184	0.684	0.989	-0.019	4.1	-0.6
40	0.184	0.684	0.991	-0.017	4.8	-1.3
41	0.194	0.694	0.993	-0.011	5.9	-1.7
42	0.194	0.694	0.995	-0.017	3.9	-1.4
43	0.204	0.704	0.998	-0.014	4.3	-1.8
44	0.214	0.714	0.994	-0.016	3.6	-1.1
45	0.224	0.724	0.997	-0.019	3.4	-1.3
46	0.234	0.734	0.999	-0.017	2.9	-1.2
47	0.244	0.744	0.998	-0.014	2.9	-1.2
48	0.254	0.754	0.998	-0.016	3.0	-1.7
49	0.264	0.764	0.999	-0.017	2.9	-1.2

Table 5. Continued

Attached-Flow Model

$\hat{X} = -4.062$	$\hat{R}_{\text{surface}} = 0.500$	$v_{\infty} = 211 \text{ m/sec}$				
I	\hat{Y}	\hat{R}	$\langle \hat{U} \rangle$	$\langle \hat{V} \rangle$	$\hat{k} \times 10^4$	$\langle \hat{U} \hat{V} \rangle$
50	0.274	0.774	0.998	-0.014	3.4	-1.3
51	0.284	0.784	0.997	-0.015	3.4	-1.3
52	0.294	0.794	1.000	-0.016	2.9	-1.2
53	0.304	0.804	1.003	-0.015	2.9	-1.2
54	0.324	0.824	0.998	-0.014	2.9	-1.2
55	0.344	0.844	1.002	-0.016	2.9	-1.2
56	0.364	0.864	0.998	-0.016	2.9	-1.2
57	0.384	0.884	0.998	-0.016	2.9	-1.2
58	0.404	0.904	1.001	-0.015	2.5	-0.7
59	0.424	0.924	1.002	-0.016	3.1	-1.0
60	0.444	0.944	0.997	-0.015	2.9	-1.2
61	0.464	0.964	1.002	-0.014	3.3	-0.3
62	0.484	0.984	1.000	-0.018	2.9	-1.2
63	0.504	1.004	0.997	-0.011	2.3	-0.7
64	0.554	1.054	0.997	-0.013	2.3	-0.7
65	0.604	1.104	0.999	-0.017	2.5	-0.9
66	0.654	1.154	0.998	-0.016	2.3	-0.7
67	0.704	1.204	0.999	-0.017	2.5	-0.9
68	0.754	1.254	0.999	-0.019	2.5	-0.9
69	0.804	1.304	1.002	-0.016	2.6	-0.9
70	0.854	1.354	0.999	-0.017	2.5	-0.5
71	0.904	1.404	0.997	-0.019	2.5	-0.9
72	0.954	1.454	0.999	-0.019	2.3	-0.7
73	1.004	1.504	0.999	-0.019	2.5	-0.9
74	1.104	1.604	0.995	-0.019	2.5	-0.9
75	1.204	1.704	1.000	-0.020	2.3	-0.7
76	1.304	1.804	0.997	-0.021	2.9	-1.2
77	1.404	1.904	1.000	-0.022	2.9	-1.2
78	1.504	2.004	0.995	-0.021	2.7	-1.4
79	1.604	2.104	1.000	-0.024	3.0	-0.5
80	1.704	2.204	0.996	-0.022	3.5	-0.5
81	1.804	2.304	0.996	-0.024	3.1	-1.0
82	1.904	2.404	0.996	-0.024	2.6	-0.9
83	2.004	2.504	0.998	-0.016	3.1	-1.0
84	2.104	2.604	0.995	-0.013	3.6	-1.1
85	2.204	2.704	0.995	-0.013	6.0	-0.7
86	2.304	2.804	0.862	0.002	58.4	21.7

Table 5. Continued
Attached-Flow Model

$\hat{X} = -1.062$	$\hat{R}_{\text{surface}} = 0.500$	$v_{\infty} = 212 \text{ m/sec}$				
I	\hat{Y}	\hat{R}	$\langle \hat{U} \rangle$	$\langle \hat{V} \rangle$	$\hat{k} \times 10^4$	$\langle \hat{U} - \hat{V} \rangle$
1	0.004	0.504	0.607	-0.023	61.9	-10.1
2	0.009	0.509	0.658	-0.019	51.9	-15.4
3	0.014	0.514	0.692	-0.015	40.0	-11.7
4	0.019	0.519	0.716	-0.012	42.1	-13.8
5	0.024	0.524	0.741	-0.013	40.6	-15.3
6	0.029	0.529	0.758	-0.015	40.6	-15.3
7	0.034	0.534	0.771	-0.010	38.9	-14.9
8	0.039	0.539	0.785	-0.012	36.1	-13.6
9	0.044	0.544	0.796	-0.011	38.2	-15.6
10	0.049	0.549	0.809	-0.012	36.9	-12.9
11	0.054	0.554	0.821	-0.013	34.4	-13.2
12	0.059	0.559	0.832	-0.012	34.4	-13.2
13	0.064	0.564	0.839	-0.009	34.4	-13.2
14	0.064	0.564	0.842	-0.014	31.3	-8.8
15	0.069	0.569	0.849	-0.013	31.9	-11.9
16	0.069	0.569	0.852	-0.012	31.2	-12.6
17	0.074	0.574	0.852	-0.008	32.5	-11.3
18	0.074	0.574	0.854	-0.010	33.4	-12.3
19	0.079	0.579	0.865	-0.013	30.6	-13.2
20	0.079	0.579	0.869	-0.009	29.3	-10.7
21	0.084	0.584	0.870	-0.016	28.4	-9.8
22	0.084	0.584	0.877	-0.012	30.6	-9.4
23	0.089	0.589	0.879	-0.016	27.5	-8.9
24	0.089	0.589	0.885	-0.018	25.8	-10.7
25	0.094	0.594	0.887	-0.014	26.1	-8.7
26	0.099	0.599	0.898	-0.013	25.5	-9.3
27	0.104	0.604	0.901	-0.012	27.3	-7.4
28	0.104	0.604	0.905	-0.012	25.2	-7.8
29	0.114	0.614	0.917	-0.014	22.5	-7.4
30	0.114	0.614	0.925	-0.006	15.8	-14.1
31	0.124	0.624	0.924	-0.007	23.5	-6.2
32	0.124	0.624	0.927	-0.014	20.2	-5.1
33	0.134	0.634	0.947	-0.011	18.9	-5.0
34	0.144	0.644	0.950	-0.012	18.4	-5.5
35	0.144	0.644	0.954	-0.016	18.6	-6.7
36	0.154	0.654	0.954	-0.010	15.3	-3.4
37	0.154	0.654	0.964	-0.014	13.4	-5.2
38	0.164	0.664	0.970	-0.012	9.7	-2.2
39	0.164	0.664	0.971	-0.013	11.3	-3.8
40	0.174	0.674	0.969	-0.007	10.7	-3.3
41	0.174	0.674	0.977	-0.017	10.2	-2.7
42	0.184	0.684	0.981	-0.013	10.1	-1.8
43	0.194	0.694	0.988	-0.014	8.1	-2.8
44	0.204	0.704	0.990	-0.016	5.1	-1.6
45	0.214	0.714	0.996	-0.014	6.7	-0.7
46	0.224	0.724	1.000	-0.015	4.5	-1.5
47	0.244	0.744	1.001	-0.016	3.4	-1.3
48	0.264	0.764	1.004	-0.013	4.7	-0.6
49	0.284	0.784	1.005	-0.012	4.4	-0.9

Table 5. Continued

Attached-Flow Model

$\hat{\chi} = -1.062$	$\hat{R}_{\text{surface}} = 0.500$	$v_{\infty} = 212 \text{ m/sec}$				
I	$\hat{\psi}$	\hat{R}	$\langle \hat{U} \rangle$	$\langle \hat{V} \rangle$	$\hat{k} \times 10^4$	$\langle \hat{U} \cdot \hat{V} \rangle$
50	0.304	0.804	1.000	-0.013	3.6	-1.1
51	0.324	0.824	1.003	-0.014	2.8	-0.7
52	0.344	0.844	1.003	-0.014	2.9	-1.2
53	0.364	0.864	1.004	-0.015	2.3	-0.7
54	0.384	0.884	1.002	-0.017	2.9	-1.2
55	0.404	0.904	1.003	-0.016	3.3	-0.8
56	0.424	0.924	1.004	-0.013	3.1	-1.0
57	0.444	0.944	1.003	-0.018	2.6	-0.9
58	0.464	0.964	1.005	-0.018	2.8	-0.7
59	0.484	0.984	1.004	-0.017	3.1	-1.0
60	0.504	1.004	1.002	-0.015	2.8	-0.7
61	0.554	1.054	1.004	-0.017	2.5	-0.5
62	0.604	1.104	1.004	-0.019	2.3	-0.7
63	0.654	1.154	1.002	-0.017	2.8	-0.7
64	0.704	1.204	1.003	-0.016	3.3	-0.8
65	0.754	1.254	1.004	-0.017	4.4	0.3
66	0.804	1.304	0.999	-0.018	3.8	0.3
67	0.854	1.354	1.002	-0.019	3.2	-0.3
68	0.904	1.404	1.000	-0.015	2.7	0.2
69	0.954	1.454	1.001	-0.016	3.5	-0.5
70	1.004	1.504	0.999	-0.014	3.1	-1.0
71	1.104	1.604	1.000	-0.017	3.5	0.0
72	1.204	1.704	0.999	-0.016	3.0	-0.5
73	1.304	1.804	0.996	-0.018	3.5	-0.5
74	1.404	1.904	1.000	-0.021	3.8	0.3
75	1.504	2.004	0.998	-0.017	3.5	-0.5
76	1.704	2.204	0.998	-0.019	3.1	-1.0
77	1.904	2.404	0.996	-0.020	3.6	-1.1
78	2.104	2.604	0.994	-0.014	5.3	-0.7
79	2.304	2.804	0.754	-0.004	111.3	41.7

Table 5. Continued

Attached-Flow Model

$\hat{x} = 0.0$	$\hat{R}_{\text{surface}} = 0.500$	$v_{\infty} = 212 \text{ m/sec}$				
I	\hat{Y}	\hat{R}	$\langle \hat{U} \rangle$	$\langle \hat{V} \rangle$	$\hat{k} \times 10^4$	$\langle \hat{U} \hat{V} \rangle$
1	0.004	0.504	0.673	-0.024	51.5	-13.3
2	0.009	0.509	0.721	-0.021	43.2	-14.9
3	0.014	0.514	0.740	-0.018	42.4	-15.6
4	0.019	0.519	0.765	-0.018	39.6	-14.2
5	0.024	0.524	0.774	-0.015	39.6	-14.2
6	0.024	0.524	0.781	-0.016	38.8	-14.9
7	0.029	0.529	0.797	-0.020	38.5	-13.2
8	0.029	0.529	0.797	-0.022	37.8	-13.9
9	0.034	0.534	0.810	-0.015	37.5	-12.2
10	0.034	0.534	0.813	-0.020	37.8	-13.9
11	0.039	0.539	0.921	-0.023	36.4	-15.3
12	0.044	0.544	0.835	-0.021	35.8	-11.9
13	0.049	0.549	0.842	-0.016	35.1	-12.6
14	0.054	0.554	0.852	-0.022	30.6	-9.4
15	0.059	0.559	0.863	-0.025	30.0	-10.1
16	0.064	0.564	0.874	-0.022	30.6	-9.4
17	0.069	0.569	0.883	-0.020	26.7	-8.1
18	0.069	0.569	0.889	-0.020	32.5	-11.3
19	0.074	0.574	0.885	-0.020	29.3	-10.7
20	0.074	0.574	0.890	-0.023	30.6	-13.2
21	0.074	0.574	0.892	-0.025	29.6	-12.2
22	0.079	0.579	0.893	-0.020	30.2	-11.6
23	0.079	0.579	0.894	-0.023	30.9	-11.0
24	0.079	0.579	0.890	-0.029	27.8	-10.4
25	0.084	0.584	0.901	-0.014	30.2	-11.6
26	0.084	0.584	0.901	-0.024	27.8	-10.4
27	0.089	0.589	0.908	-0.021	29.0	-12.8
28	0.094	0.594	0.913	-0.020	25.2	-7.8
29	0.094	0.594	0.915	-0.020	26.9	-9.5
30	0.099	0.599	0.919	-0.020	26.3	-10.1
31	0.099	0.599	0.922	-0.023	26.3	-10.1
32	0.104	0.604	0.928	-0.027	25.5	-9.3
33	0.104	0.604	0.929	-0.028	24.1	-9.0
34	0.104	0.604	0.932	-0.025	25.5	-9.3
35	0.104	0.604	0.937	-0.021	21.4	-8.5
36	0.114	0.614	0.943	-0.017	22.7	-8.7
37	0.114	0.614	0.946	-0.026	22.3	-6.0
38	0.124	0.624	0.954	-0.024	21.1	-7.2
39	0.134	0.634	0.965	-0.029	18.4	-5.5
40	0.144	0.644	0.971	-0.025	14.9	-4.9
41	0.154	0.654	0.984	-0.026	15.4	-4.5
42	0.164	0.664	0.986	-0.024	14.3	-4.3
43	0.164	0.664	0.990	-0.020	13.3	-4.1
44	0.174	0.674	0.993	-0.021	11.1	-2.9
45	0.174	0.674	0.999	-0.028	11.4	-0.5
46	0.184	0.684	1.002	-0.027	10.5	-1.4
47	0.194	0.694	1.004	-0.029	8.7	-1.3
48	0.204	0.704	1.010	-0.027	7.1	-1.1
49	0.224	0.724	1.016	-0.025	6.1	-1.4

Table 5. Continued
Attached-Flow Model

$\hat{X} = 0.0$	$\hat{R}_{\text{surface}} = 0.500$	$v_{\infty} = 212 \text{ m/sec}$				
I	\hat{Y}	\hat{R}	$\langle \hat{U} \rangle$	$\langle \hat{V} \rangle$	$\hat{k} \times 10^4$	$\langle \hat{U} \hat{V} \rangle$
50	0.244	0.744	1.018	-0.025	6.3	-0.4
51	0.264	0.764	1.016	-0.021	4.1	-1.2
52	0.284	0.784	1.016	-0.025	3.8	-0.8
53	0.304	0.804	1.021	-0.026	3.3	-0.8
54	0.324	0.824	1.019	-0.026	3.4	-1.3
55	0.344	0.844	1.017	-0.026	2.9	-1.2
56	0.364	0.864	1.020	-0.027	3.3	-0.8
57	0.384	0.884	1.021	-0.024	5.0	-0.3
58	0.404	0.904	1.017	-0.026	3.9	-0.8
59	0.424	0.924	1.019	-0.026	4.1	-0.6
60	0.444	0.944	1.014	-0.023	3.6	-1.1
61	0.464	0.964	1.015	-0.028	3.0	-0.5
62	0.484	0.984	1.015	-0.028	2.8	-0.7
63	0.504	1.004	1.017	-0.026	3.5	0.0
64	0.554	1.054	1.013	-0.024	3.1	-1.0
65	0.604	1.104	1.008	-0.023	2.1	-0.4
66	0.654	1.154	1.008	-0.025	2.1	-0.4
67	0.704	1.204	1.012	-0.027	2.6	-0.9
68	0.754	1.254	1.014	-0.027	2.8	-0.7
69	0.804	1.304	1.011	-0.028	2.4	-1.1
70	0.854	1.354	1.010	-0.027	2.5	-0.9
71	0.904	1.404	1.010	-0.025	3.3	-0.8
72	0.954	1.454	1.006	-0.021	3.2	-0.3
73	1.004	1.504	1.007	-0.024	2.8	-0.7
74	1.104	1.604	1.007	-0.028	2.6	-0.9
75	1.204	1.704	1.006	-0.029	2.7	-0.2
76	1.304	1.804	1.005	-0.031	2.6	-0.9
77	1.404	1.904	1.004	-0.032	2.3	-0.2
78	1.504	2.004	1.003	-0.031	2.5	-0.5
79	1.704	2.204	1.001	-0.028	3.2	0.3
80	1.904	2.404	0.998	-0.023	4.4	0.3
81	2.104	2.604	0.996	-0.020	6.7	0.7
82	2.304	2.804	0.731	-0.003	90.5	25.7
83	2.379	2.879	0.542	0.025	123.8	36.4

Table 5. Continued

Attached-Flow Model

$\hat{x} = 0.438$	$\hat{R}_{\text{surface}} = 0.485$	$v_{\infty} = 214 \text{ m/sec}$				
I	\hat{y}	\hat{R}	$\langle \hat{U} \rangle$	$\langle \hat{V} \rangle$	$\hat{k} \times 10^4$	$\langle \hat{U} - \hat{V} \rangle$
1	0.004	0.489	0.664	-0.051	55.3	-17.8
2	0.009	0.494	0.713	-0.060	47.6	-18.3
3	0.014	0.499	0.747	-0.062	40.6	-14.3
4	0.019	0.504	0.773	-0.060	42.7	-16.4
5	0.024	0.509	0.792	-0.063	38.1	-14.7
6	0.024	0.509	0.796	-0.062	38.5	-16.4
7	0.029	0.514	0.903	-0.059	37.1	-13.6
8	0.029	0.514	0.805	-0.065	39.1	-15.7
9	0.034	0.519	0.823	-0.061	37.1	-13.6
10	0.034	0.519	0.823	-0.065	36.4	-14.3
11	0.039	0.524	0.930	-0.066	34.1	-14.6
12	0.044	0.529	0.842	-0.062	34.7	-14.0
13	0.049	0.534	0.854	-0.064	33.7	-13.0
14	0.054	0.539	0.863	-0.069	32.5	-14.2
15	0.059	0.544	0.866	-0.064	28.9	-10.5
16	0.059	0.544	0.869	-0.063	32.5	-14.2
17	0.064	0.549	0.875	-0.065	30.6	-12.3
18	0.064	0.549	0.876	-0.064	29.4	-9.9
19	0.069	0.554	0.888	-0.064	29.1	-12.0
20	0.074	0.559	0.896	-0.064	30.3	-10.8
21	0.079	0.564	0.901	-0.063	27.3	-10.2
22	0.084	0.569	0.907	-0.067	25.4	-7.1
23	0.089	0.574	0.916	-0.066	26.4	-9.4
24	0.094	0.579	0.923	-0.065	23.6	-8.8
25	0.099	0.584	0.929	-0.065	24.9	-7.7
26	0.104	0.589	0.933	-0.067	22.8	-8.0
27	0.114	0.599	0.943	-0.070	21.3	-6.5
28	0.124	0.609	0.960	-0.065	18.8	-6.1
29	0.134	0.619	0.965	-0.066	18.8	-6.1
30	0.144	0.629	0.978	-0.061	15.7	-5.0
31	0.154	0.639	0.987	-0.062	15.1	-4.4
32	0.174	0.659	0.997	-0.060	12.3	-2.5
33	0.184	0.669	1.006	-0.061	10.4	-2.3
34	0.194	0.679	1.008	-0.061	8.6	-1.2
35	0.204	0.689	1.014	-0.059	7.4	-1.5
36	0.224	0.709	1.017	-0.060	5.9	-0.7
37	0.244	0.729	1.024	-0.055	5.3	-1.3
38	0.264	0.749	1.022	-0.055	4.3	-0.9
39	0.284	0.769	1.025	-0.054	4.0	-0.6
40	0.304	0.789	1.025	-0.056	3.7	-0.3
41	0.324	0.809	1.026	-0.051	3.7	-0.8
42	0.344	0.829	1.027	-0.052	3.2	-0.8
43	0.364	0.849	1.024	-0.051	3.4	-0.5
44	0.384	0.869	1.021	-0.048	3.4	-0.5
45	0.404	0.889	1.023	-0.048	3.4	-0.5
46	0.424	0.909	1.022	-0.047	3.4	-0.5
47	0.444	0.929	1.021	-0.046	3.4	-0.5
48	0.464	0.949	1.018	-0.047	3.7	-0.8
49	0.484	0.969	1.019	-0.044	3.4	-0.5

Table 5. Continued
Attached-Flow Model

$\hat{X} = 0.438$	$\hat{R}_{\text{surface}} = 0.485$	$v_{\infty} = 214 \text{ m/sec}$				
I	\hat{Y}	\hat{R}	$\langle \hat{U} \rangle$	$\langle \hat{V} \rangle$	$\hat{k} \times 10^4$	$\langle \hat{u} \hat{v} \rangle$
50	0.504	0.989	1.019	-0.044	3.4	-0.5
51	0.554	1.039	1.018	-0.043	3.4	-0.5
52	0.604	1.089	1.017	-0.042	3.7	-0.8
53	0.654	1.139	1.014	-0.039	3.4	-0.5
54	0.654	1.139	1.015	-0.040	3.2	-0.8
55	0.704	1.189	1.013	-0.038	3.4	-0.5
56	0.754	1.239	1.012	-0.039	3.4	-0.5
57	0.804	1.289	1.011	-0.040	3.4	-0.5
58	0.854	1.339	1.011	-0.036	3.7	-0.3
59	0.904	1.389	1.008	-0.035	3.7	-0.3
60	0.954	1.439	1.008	-0.035	3.2	-0.8
61	0.954	1.439	1.010	-0.033	3.4	-0.5
62	1.004	1.489	1.008	-0.035	4.0	-0.6
63	1.104	1.589	1.007	-0.032	4.3	-0.9
64	1.204	1.689	1.008	-0.031	3.7	-0.3
65	1.304	1.789	1.005	-0.034	4.0	-0.6
66	1.404	1.889	1.006	-0.031	4.0	-0.6
67	1.504	1.989	1.008	-0.031	4.1	-1.1
68	1.704	2.189	1.005	-0.030	4.0	-0.6
69	1.904	2.389	1.002	-0.029	4.0	-0.6
70	2.104	2.589	0.997	-0.020	7.7	-0.4
71	2.304	2.789	0.769	0.006	82.1	23.0
72	2.381	2.866	0.595	0.023	124.0	33.0
73	2.408	2.893	0.552	0.060	117.9	18.5

Table 5. Continued

Attached-Flow Model

$\hat{X} = 0.838$	$\hat{R}_{\text{surface}} = 0.433$	$v_{\infty} = 214 \text{ m/sec}$				
I	\hat{Y}	\hat{R}	$\langle \hat{U} \rangle$	$\langle \hat{V} \rangle$	$\hat{k} \times 10^4$	$\langle \hat{U} - \hat{V} \rangle$
1	0.004	0.437	0.651	-0.089	49.6	-23.4
2	0.009	0.442	0.691	-0.093	45.8	-22.4
3	0.014	0.447	0.720	-0.094	43.3	-22.6
4	0.019	0.452	0.748	-0.100	40.9	-16.1
5	0.024	0.457	0.761	-0.093	38.5	-16.4
6	0.029	0.462	0.781	-0.099	35.1	-15.6
7	0.034	0.467	0.796	-0.103	36.8	-16.0
8	0.039	0.472	0.809	-0.100	34.7	-14.0
9	0.039	0.472	0.818	-0.103	32.8	-12.0
10	0.044	0.477	0.816	-0.101	33.7	-13.0
11	0.044	0.477	0.818	-0.099	33.7	-13.0
12	0.049	0.482	0.832	-0.101	33.4	-11.4
13	0.054	0.487	0.839	-0.104	30.3	-10.8
14	0.059	0.492	0.847	-0.098	29.1	-12.0
15	0.064	0.497	0.854	-0.101	29.1	-12.0
16	0.069	0.502	0.862	-0.101	28.2	-11.1
17	0.074	0.507	0.871	-0.098	27.3	-10.2
18	0.079	0.512	0.878	-0.099	27.9	-9.6
19	0.084	0.517	0.888	-0.101	26.7	-10.8
20	0.084	0.517	0.889	-0.102	24.4	-9.7
21	0.089	0.522	0.889	-0.098	23.6	-8.8
22	0.089	0.522	0.890	-0.101	26.7	-10.8
23	0.094	0.527	0.897	-0.096	24.8	-7.7
24	0.094	0.527	0.897	-0.096	25.8	-9.9
25	0.099	0.532	0.903	-0.096	24.2	-8.3
26	0.104	0.537	0.908	-0.099	23.6	-8.8
27	0.114	0.547	0.918	-0.099	20.5	-5.7
28	0.114	0.547	0.921	-0.098	21.3	-6.5
29	0.124	0.557	0.932	-0.093	19.5	-6.8
30	0.124	0.557	0.929	-0.098	19.3	-5.6
31	0.134	0.567	0.940	-0.094	19.0	-7.3
32	0.134	0.567	0.941	-0.095	18.8	-6.1
33	0.144	0.577	0.945	-0.093	17.6	-5.9
34	0.144	0.577	0.948	-0.100	18.1	-5.4
35	0.154	0.587	0.957	-0.091	15.7	-5.0
36	0.164	0.597	0.967	-0.093	13.4	-3.6
37	0.174	0.607	0.975	-0.091	12.0	-3.9
38	0.184	0.617	0.980	-0.086	11.6	-4.3
39	0.194	0.627	0.983	-0.087	9.6	-3.1
40	0.204	0.637	0.993	-0.087	7.5	-2.3
41	0.214	0.647	0.996	-0.086	6.9	-2.2
42	0.224	0.657	1.003	-0.083	5.6	-1.7
43	0.224	0.657	1.002	-0.086	5.3	-1.3
44	0.244	0.677	1.006	-0.080	4.6	-0.6
45	0.264	0.697	1.011	-0.077	3.2	-0.8
46	0.284	0.717	1.012	-0.076	2.5	-0.4
47	0.304	0.737	1.014	-0.076	2.7	-0.7
48	0.324	0.757	1.010	-0.074	2.3	-0.6
49	0.344	0.777	1.009	-0.070	2.5	-0.4

Table 5. Continued

Attached-Flow Model

$\hat{X} = 0.838$	$\hat{R}_{\text{surface}} = 0.433$	$v_{\infty} = 214 \text{ m/sec}$				
I	\hat{Y}	\hat{R}	$\langle \hat{U} \rangle$	$\langle \hat{V} \rangle$	$\hat{k} \times 10^4$	$\langle \hat{U} - \hat{V} \rangle$
50	0.364	0.797	1.013	-0.070	2.3	-0.6
51	0.384	0.817	1.012	-0.065	2.3	-0.6
52	0.404	0.837	1.011	-0.062	2.5	-0.9
53	0.424	0.857	1.009	-0.062	2.3	-0.6
54	0.444	0.877	1.010	-0.061	2.3	-0.6
55	0.464	0.897	1.011	-0.058	2.0	-0.4
56	0.484	0.917	1.009	-0.058	2.0	-0.4
57	0.504	0.937	1.007	-0.056	2.0	-0.4
58	0.554	0.987	1.008	-0.053	1.7	-0.4
59	0.604	1.037	1.008	-0.051	1.9	-0.6
60	0.654	1.087	1.006	-0.049	2.0	-0.4
61	0.704	1.137	1.003	-0.046	1.8	-0.2
62	0.754	1.187	1.002	-0.045	1.8	-0.2
63	0.804	1.237	1.003	-0.044	1.9	-0.6
64	0.854	1.287	1.004	-0.045	2.2	-0.2
65	0.904	1.337	1.002	-0.043	2.0	-0.4
66	0.954	1.387	1.003	-0.040	2.0	-0.4
67	1.004	1.437	1.002	-0.039	2.1	-0.8
68	1.104	1.537	1.003	-0.040	1.9	-0.6
69	1.204	1.637	1.003	-0.038	2.0	-0.4
70	1.304	1.737	1.002	-0.037	2.3	-0.6
71	1.404	1.837	1.000	-0.031	2.5	-0.4
72	1.504	1.937	1.001	-0.032	2.7	-0.7
73	1.704	2.137	1.000	-0.033	2.7	-0.7
74	1.904	2.337	1.000	-0.031	2.9	-0.5
75	2.104	2.537	0.999	-0.026	4.9	-0.3
76	2.304	2.737	0.925	-0.003	67.2	18.5

Table 5. Continued

Attached-Flow Model

$\hat{\lambda} = 1.238$	$\hat{R}_{\text{surface}} = 0.380$	$v_{\infty} = 214 \text{ m/sec}$				
I	\hat{y}	\hat{R}	$\langle \hat{U} \rangle$	$\langle \hat{V} \rangle$	$\hat{k} \times 10^4$	$\langle \hat{U} - \hat{V} \rangle$
1	0.004	0.384	0.525	-0.104	48.2	-24.8
2	0.009	0.389	0.563	-0.106	46.3	-24.3
3	0.014	0.394	0.596	-0.107	47.3	-21.0
4	0.019	0.399	0.627	-0.110	43.5	-20.1
5	0.024	0.404	0.648	-0.117	42.4	-19.0
6	0.029	0.409	0.672	-0.114	40.5	-18.5
7	0.034	0.414	0.691	-0.115	37.4	-15.3
8	0.039	0.419	0.705	-0.117	38.9	-18.1
9	0.044	0.424	0.715	-0.113	35.1	-15.6
10	0.044	0.424	0.721	-0.119	37.9	-17.0
11	0.049	0.429	0.731	-0.115	34.1	-14.6
12	0.049	0.429	0.734	-0.114	33.5	-15.2
13	0.054	0.434	0.745	-0.115	34.7	-14.0
14	0.054	0.434	0.746	-0.116	31.2	-11.7
15	0.059	0.439	0.756	-0.116	29.7	-11.4
16	0.064	0.444	0.767	-0.113	32.5	-14.2
17	0.069	0.449	0.778	-0.116	29.1	-12.0
18	0.074	0.454	0.787	-0.115	29.4	-9.9
19	0.079	0.459	0.791	-0.113	29.1	-12.0
20	0.084	0.464	0.803	-0.112	28.9	-10.5
21	0.089	0.469	0.809	-0.112	27.3	-10.2
22	0.094	0.474	0.817	-0.110	29.7	-11.4
23	0.099	0.479	0.823	-0.106	25.8	-9.9
24	0.104	0.484	0.831	-0.110	25.0	-9.1
25	0.114	0.494	0.843	-0.108	24.4	-9.7
26	0.124	0.504	0.854	-0.105	23.6	-8.8
27	0.134	0.514	0.869	-0.108	21.8	-5.9
28	0.144	0.524	0.882	-0.109	21.0	-8.3
29	0.154	0.534	0.887	-0.106	18.1	-5.4
30	0.164	0.544	0.896	-0.099	17.6	-5.9
31	0.174	0.554	0.903	-0.100	18.1	-5.4
32	0.184	0.564	0.920	-0.101	13.9	-3.2
33	0.184	0.564	0.919	-0.104	14.0	-4.2
34	0.194	0.574	0.920	-0.099	15.3	-5.5
35	0.204	0.584	0.931	-0.094	12.0	-3.9
36	0.204	0.584	0.934	-0.099	11.9	-2.9
37	0.224	0.604	0.949	-0.095	9.1	-2.6
38	0.244	0.624	0.960	-0.094	6.9	-0.4
39	0.264	0.644	0.971	-0.089	4.3	-0.9
40	0.284	0.664	0.974	-0.088	3.5	-1.1
41	0.304	0.684	0.979	-0.083	2.9	-0.5
42	0.324	0.704	0.981	-0.079	2.2	-0.2
43	0.344	0.724	0.982	-0.076	2.5	-0.4
44	0.364	0.744	0.987	-0.075	2.0	-0.4
45	0.384	0.764	0.987	-0.073	1.9	-0.6
46	0.404	0.784	0.986	-0.069	1.8	-0.2
47	0.424	0.804	0.988	-0.069	2.0	-0.4
48	0.444	0.824	0.989	-0.066	1.9	-0.6
49	0.464	0.844	0.991	-0.064	1.8	-0.2

Table 5. Continued

Attached-Flow Model

$\hat{X} = 1.238$	$\hat{R}_{\text{surface}} = 0.380$	$v_{\infty} = 214 \text{ m/sec}$				
I	\hat{Y}	\hat{R}	$\langle \hat{U} \rangle$	$\langle \hat{V} \rangle$	$\hat{k} \times 10^4$	$\langle \hat{U} \hat{V} \rangle$
50	0.484	0.864	0.991	-0.062	1.9	-0.2
51	0.504	0.884	0.990	-0.061	1.7	-0.4
52	0.554	0.934	0.992	-0.057	1.7	-0.4
53	0.604	0.984	0.991	-0.054	1.7	-0.4
54	0.654	1.034	0.991	-0.052	1.7	-0.4
55	0.704	1.084	0.992	-0.049	1.9	-0.2
56	0.754	1.134	0.993	-0.044	1.7	-0.4
57	0.804	1.184	0.996	-0.045	1.7	-0.4
58	0.854	1.234	0.994	-0.043	1.7	-0.4
59	0.904	1.284	0.994	-0.043	1.9	-0.2
60	0.954	1.334	0.995	-0.042	1.7	-0.4
61	1.004	1.384	0.996	-0.041	1.9	-0.6
62	1.104	1.484	0.997	-0.036	1.9	-0.2
63	1.204	1.584	0.997	-0.036	1.9	-0.6
64	1.304	1.684	0.999	-0.034	1.7	-0.4
65	1.404	1.784	0.999	-0.034	1.7	-0.4
66	1.504	1.884	1.001	-0.032	1.9	-0.2
67	1.704	2.084	1.000	-0.033	1.9	-0.2
68	1.904	2.284	1.003	-0.030	2.0	-0.4
69	2.104	2.484	1.000	-0.025	2.7	-0.2
70	2.304	2.684	0.913	-0.005	36.1	6.8
71	2.477	2.857	0.513	0.039	119.2	30.8

Table 5. Continued

Attached-Flow Model

$\hat{X} = 1.438$ $\hat{R}_{\text{surface}} = 0.336$ $v_{\infty} = 213 \text{ m/sec}$						
I	\hat{Y}	\hat{R}	$\langle \hat{U} \rangle$	$\langle \hat{V} \rangle$	$\hat{k} \times 10^4$	$\langle \hat{U} \hat{V} \rangle$
1	0.004	0.340	0.358	-0.088	50.2	-26.4
2	0.009	0.345	0.413	-0.096	48.2	-25.8
3	0.014	0.350	0.447	-0.102	45.9	-23.4
4	0.019	0.355	0.476	-0.100	46.5	-22.7
5	0.024	0.350	0.512	-0.106	47.7	-23.9
6	0.029	0.365	0.533	-0.108	45.8	-23.4
7	0.034	0.370	0.559	-0.109	44.6	-22.2
8	0.039	0.375	0.587	-0.109	40.5	-19.5
9	0.044	0.380	0.601	-0.109	41.2	-18.8
10	0.049	0.385	0.623	-0.110	37.1	-18.6
11	0.054	0.390	0.641	-0.110	37.7	-17.9
12	0.059	0.395	0.655	-0.116	37.7	-17.9
13	0.064	0.400	0.670	-0.111	35.6	-15.8
14	0.069	0.405	0.686	-0.110	34.0	-15.4
15	0.074	0.410	0.697	-0.109	31.0	-12.5
16	0.074	0.410	0.697	-0.111	32.0	-13.5
17	0.079	0.415	0.709	-0.109	33.0	-14.4
18	0.079	0.415	0.708	-0.112	31.4	-14.1
19	0.084	0.420	0.713	-0.111	29.9	-13.7
20	0.084	0.420	0.718	-0.110	33.0	-14.4
21	0.089	0.425	0.716	-0.110	30.4	-13.1
22	0.089	0.425	0.727	-0.109	32.0	-13.5
23	0.089	0.425	0.729	-0.111	31.7	-11.9
24	0.094	0.430	0.736	-0.110	29.5	-12.2
25	0.094	0.430	0.739	-0.109	29.2	-10.7
26	0.099	0.435	0.750	-0.111	28.9	-12.8
27	0.104	0.440	0.759	-0.108	30.4	-13.1
28	0.114	0.450	0.770	-0.106	27.1	-11.0
29	0.124	0.460	0.785	-0.103	26.9	-9.5
30	0.134	0.470	0.798	-0.104	24.9	-9.8
31	0.144	0.480	0.812	-0.102	21.9	-7.9
32	0.154	0.490	0.826	-0.103	21.9	-7.9
33	0.164	0.500	0.834	-0.099	21.6	-7.9
34	0.174	0.510	0.846	-0.097	21.5	-6.6
35	0.184	0.520	0.859	-0.098	20.9	-5.8
36	0.194	0.530	0.866	-0.091	19.0	-6.2
37	0.204	0.540	0.871	-0.092	19.4	-4.4
38	0.204	0.540	0.877	-0.096	18.3	-5.5
39	0.214	0.550	0.888	-0.091	16.3	-3.5
40	0.224	0.560	0.897	-0.087	16.5	-4.6
41	0.224	0.560	0.898	-0.090	15.2	-3.3
42	0.224	0.560	0.902	-0.090	15.2	-3.3
43	0.244	0.580	0.911	-0.083	11.9	-2.0
44	0.244	0.580	0.915	-0.089	11.9	-1.0
45	0.264	0.600	0.929	-0.083	10.0	-1.8
46	0.284	0.620	0.944	-0.086	7.4	0.0
47	0.304	0.640	0.950	-0.082	6.0	0.7
48	0.324	0.660	0.957	-0.079	4.9	0.3
49	0.344	0.680	0.963	-0.073	4.3	0.3

Table 5. Continued

Attached-Flow Model

$\hat{k} = 1.438$		$\hat{R}_{\text{surface}} = 0.336$		$v_{\infty} = 213 \text{ m/sec}$			
I	$\hat{\psi}$	\hat{R}	$\langle \hat{U} \rangle$	$\langle \hat{V} \rangle$	$\hat{k} \times 10^4$	$\langle \hat{U} \cdot \hat{\psi} \rangle$	
50	0.364	0.700	0.965	-0.070	4.3	0.3	
51	0.384	0.720	0.970	-0.071	3.8	0.8	
52	0.404	0.740	0.971	-0.068	3.5	0.5	
53	0.424	0.760	0.971	-0.064	3.5	0.5	
54	0.444	0.780	0.975	-0.062	3.5	0.5	
55	0.464	0.800	0.977	-0.064	3.8	0.3	
56	0.484	0.820	0.978	-0.057	3.6	1.1	
57	0.504	0.840	0.977	-0.058	3.5	0.5	

Table 5. Continued

Attached-Flow Model

$\hat{X} = 1.638$	$\hat{R}_{\text{surface}} = 0.289$	$v_{\infty} = 213 \text{ m/sec}$				
I	\hat{Y}	\hat{R}	$\langle \hat{U} \rangle$	$\langle \hat{V} \rangle$	$\hat{k} \times 10^4$	$\langle \hat{U} - \hat{V} \rangle$
1	0.004	0.293	0.235	-0.055	58.1	-37.0
2	0.009	0.298	0.272	-0.063	47.0	-24.6
3	0.014	0.303	0.303	-0.066	49.5	-27.1
4	0.019	0.308	0.339	-0.069	52.7	-28.9
5	0.024	0.313	0.364	-0.072	54.2	-27.5
6	0.029	0.318	0.392	-0.074	50.2	-26.4
7	0.034	0.323	0.420	-0.081	50.7	-28.3
8	0.039	0.328	0.442	-0.075	52.7	-28.9
9	0.044	0.333	0.475	-0.081	49.5	-27.1
10	0.049	0.338	0.488	-0.078	48.2	-25.8
11	0.054	0.343	0.512	-0.082	47.2	-22.0
12	0.059	0.348	0.531	-0.077	47.6	-26.5
13	0.064	0.353	0.553	-0.082	47.6	-26.5
14	0.069	0.358	0.567	-0.078	41.6	-20.6
15	0.074	0.363	0.590	-0.079	39.9	-20.1
16	0.079	0.368	0.606	-0.085	42.3	-19.9
17	0.084	0.373	0.620	-0.082	38.8	-19.0
18	0.089	0.378	0.628	-0.078	38.2	-19.6
19	0.089	0.378	0.631	-0.077	39.9	-20.1
20	0.094	0.383	0.642	-0.078	38.2	-19.6
21	0.094	0.383	0.643	-0.083	34.2	-13.2
22	0.094	0.383	0.646	-0.082	37.3	-16.2
23	0.099	0.388	0.656	-0.078	35.0	-16.5
24	0.099	0.388	0.657	-0.083	34.0	-15.4
25	0.104	0.393	0.665	-0.077	34.0	-15.4
26	0.104	0.393	0.666	-0.082	34.0	-15.4
27	0.114	0.403	0.687	-0.076	32.8	-16.6
28	0.114	0.403	0.689	-0.082	31.0	-12.5
29	0.124	0.413	0.710	-0.075	32.0	-13.5
30	0.134	0.423	0.727	-0.078	27.9	-13.9
31	0.144	0.433	0.740	-0.077	29.8	-13.7
32	0.154	0.443	0.763	-0.081	27.1	-11.0
33	0.164	0.453	0.778	-0.078	26.5	-11.5
34	0.174	0.463	0.789	-0.077	24.5	-8.4
35	0.184	0.473	0.802	-0.074	24.0	-9.0
36	0.194	0.483	0.814	-0.074	22.1	-9.2
37	0.204	0.493	0.824	-0.071	22.6	-8.7
38	0.224	0.513	0.838	-0.065	17.9	-6.0
39	0.244	0.533	0.865	-0.074	17.6	-4.8
40	0.264	0.553	0.883	-0.068	13.6	-3.7
41	0.284	0.573	0.900	-0.066	13.2	-4.1
42	0.304	0.593	0.920	-0.070	8.2	-0.8
43	0.324	0.613	0.929	-0.065	7.0	-0.4
44	0.344	0.633	0.940	-0.062	4.4	-0.9
45	0.364	0.653	0.950	-0.062	3.0	0.0
46	0.384	0.673	0.952	-0.060	3.0	0.0
47	0.404	0.693	0.957	-0.057	2.5	0.0
48	0.424	0.713	0.958	-0.056	2.3	-0.2
49	0.444	0.733	0.962	-0.054	2.3	-0.2

Table 5. Continued
Attached-Flow Model

$\hat{x} = 1.638$		$\hat{R}_{\text{surface}} = 0.289$		$v_{\infty} = 213 \text{ m/sec}$			
I	\hat{Y}	\hat{R}	$\langle \hat{U} \rangle$	$\langle \hat{V} \rangle$	$\hat{k} \times 10^4$	$\langle \hat{U} - \hat{V} \rangle$	
50	0.464	0.753	0.963	-0.053	2.3	-0.2	
51	0.484	0.773	0.967	-0.052	2.1	0.0	
52	0.504	0.793	0.968	-0.051	2.1	0.0	
53	0.554	0.843	0.972	-0.049	1.9	-0.2	
54	0.604	0.893	0.973	-0.044	1.9	0.2	
55	0.654	0.943	0.978	-0.045	1.9	-0.2	
56	0.704	0.993	0.979	-0.042	2.3	0.2	
57	0.754	1.043	0.983	-0.040	2.1	0.0	
58	0.804	1.093	0.985	-0.042	2.3	0.2	
59	0.854	1.143	0.987	-0.040	2.1	0.4	
60	0.904	1.193	0.988	-0.039	2.1	0.0	
61	0.954	1.243	0.988	-0.039	2.1	0.0	
62	1.004	1.293	0.989	-0.040	2.1	0.0	
63	1.104	1.393	0.991	-0.033	2.1	0.0	
64	1.204	1.493	0.992	-0.032	2.1	0.0	
65	1.304	1.593	0.995	-0.035	2.1	0.0	
66	1.404	1.693	0.995	-0.033	2.1	0.0	
67	1.504	1.793	0.997	-0.031	2.3	-0.2	
68	1.704	1.993	1.000	-0.030	2.5	0.5	
69	1.904	2.193	1.001	-0.031	2.5	0.0	
70	2.104	2.393	1.003	-0.029	2.7	0.2	
71	2.304	2.593	0.976	-0.020	10.5	2.3	
72	2.504	2.793	0.719	0.007	95.6	26.4	

Table 5. Continued

Attached-Flow Model

$\hat{x} = 1.688$						
$\hat{R}_{\text{surface}} = 0.276$						
$v_{\infty} = 210 \text{ m/sec}$						
I	\hat{y}	\hat{R}	$\langle \hat{U} \rangle$	$\langle \hat{V} \rangle$	$\hat{k} \times 10^4$	$\langle \hat{U} \hat{V} \rangle$
1	0.004	0.280	0.172	-0.043	49.3	-26.4
2	0.009	0.285	0.216	-0.052	48.0	-25.1
3	0.014	0.290	0.245	-0.054	47.4	-25.0
4	0.019	0.295	0.279	-0.057	53.8	-32.3
5	0.024	0.300	0.308	-0.057	49.2	-29.0
6	0.029	0.305	0.337	-0.060	51.3	-27.0
7	0.034	0.310	0.367	-0.064	48.7	-24.4
8	0.039	0.315	0.390	-0.059	53.2	-30.3
9	0.044	0.320	0.414	-0.062	52.5	-28.3
10	0.049	0.325	0.438	-0.067	49.5	-23.7
11	0.054	0.330	0.460	-0.063	50.6	-27.7
12	0.059	0.335	0.482	-0.066	50.6	-27.7
13	0.064	0.340	0.510	-0.060	46.8	-23.9
14	0.069	0.345	0.524	-0.067	44.9	-23.4
15	0.074	0.350	0.546	-0.067	42.6	-21.0
16	0.079	0.355	0.566	-0.070	43.1	-22.9
17	0.084	0.360	0.578	-0.070	40.3	-18.8
18	0.089	0.365	0.600	-0.071	41.9	-21.7
19	0.094	0.370	0.612	-0.067	40.8	-20.5
20	0.094	0.370	0.618	-0.071	38.5	-18.3
21	0.099	0.375	0.623	-0.070	38.5	-18.3
22	0.099	0.375	0.629	-0.068	36.4	-16.2
23	0.104	0.380	0.636	-0.070	37.4	-17.2
24	0.104	0.380	0.640	-0.068	36.4	-16.2
25	0.114	0.390	0.658	-0.064	34.7	-15.8
26	0.124	0.400	0.686	-0.073	33.7	-14.8
27	0.134	0.410	0.705	-0.066	31.7	-12.8
28	0.144	0.420	0.725	-0.065	32.1	-14.4
29	0.154	0.430	0.746	-0.072	30.7	-11.8
30	0.164	0.440	0.760	-0.065	28.3	-10.6
31	0.174	0.450	0.771	-0.066	27.4	-9.7
32	0.184	0.460	0.787	-0.064	28.3	-10.6
33	0.194	0.470	0.801	-0.065	26.3	-7.4
34	0.204	0.480	0.819	-0.067	24.5	-9.2
35	0.224	0.500	0.841	-0.066	22.6	-6.1
36	0.244	0.520	0.860	-0.063	22.8	-7.5
37	0.244	0.520	0.861	-0.062	21.5	-7.3
38	0.264	0.540	0.883	-0.063	19.3	-5.0
39	0.284	0.560	0.902	-0.064	15.5	-3.4
40	0.304	0.580	0.915	-0.059	13.2	-2.1
41	0.304	0.580	0.919	-0.059	12.2	-2.0
42	0.324	0.600	0.931	-0.057	9.8	-1.4
43	0.344	0.620	0.940	-0.054	9.3	-0.9
44	0.364	0.640	0.951	-0.055	6.8	0.0
45	0.384	0.660	0.957	-0.054	6.8	0.0
46	0.404	0.680	0.960	-0.055	5.4	0.0
47	0.424	0.700	0.965	-0.052	5.1	-0.3
48	0.444	0.720	0.969	-0.050	4.1	0.0
49	0.464	0.740	0.974	-0.047	4.7	0.0

Table 5. Continued

Attached-Flow Model

$\hat{X} = 1.688$		$\hat{R}_{\text{surface}} = 0.276$		$v_{\infty} = 210 \text{ m/sec}$		
I	\hat{Y}	\hat{R}	$\langle \hat{U} \rangle$	$\langle \hat{V} \rangle$	$\hat{k} \times 10^4$	$\langle \hat{U} \hat{V} \rangle$
50	0.484	0.760	0.974	-0.049	3.9	-0.3
51	0.554	0.830	0.981	-0.044	4.4	0.3
52	0.604	0.890	0.982	-0.041	4.1	0.6

Table 5. Continued

Attached-Flow Model

$\hat{\lambda} = 1.738$	$\hat{R}_{\text{surface}} = 0.262$	$v_{\infty} = 210 \text{ m/sec}$				
I	\hat{Y}	\hat{R}	$\langle \hat{U} \rangle$	$\langle \hat{V} \rangle$	$\hat{k} \times 10^4$	$\langle \hat{U} \hat{V} \rangle$
1	0.004	0.266	0.097	-0.013	49.5	-23.7
2	0.009	0.271	0.186	-0.046	52.0	-26.2
3	0.014	0.276	0.211	-0.049	49.9	-28.3
4	0.019	0.281	0.237	-0.052	51.2	-29.6
5	0.024	0.286	0.265	-0.045	50.0	-25.7
6	0.029	0.291	0.293	-0.051	51.2	-29.6
7	0.034	0.296	0.313	-0.048	51.9	-29.0
8	0.039	0.301	0.342	-0.057	50.7	-25.0
9	0.044	0.306	0.363	-0.055	57.2	-34.3
10	0.049	0.311	0.389	-0.056	58.7	-32.9
11	0.054	0.316	0.404	-0.051	49.9	-28.3
12	0.059	0.321	0.432	-0.056	46.8	-23.9
13	0.064	0.326	0.453	-0.051	50.0	-25.7
14	0.069	0.331	0.477	-0.052	48.0	-25.1
15	0.074	0.336	0.498	-0.055	47.5	-23.2
16	0.079	0.341	0.516	-0.054	47.4	-25.8
17	0.084	0.346	0.536	-0.056	43.7	-22.2
18	0.089	0.351	0.564	-0.064	41.4	-19.9
19	0.094	0.356	0.573	-0.063	38.5	-18.3
20	0.099	0.361	0.593	-0.068	41.9	-21.7
21	0.104	0.366	0.610	-0.060	38.1	-16.6
22	0.114	0.376	0.634	-0.062	37.0	-15.5
23	0.124	0.386	0.657	-0.063	34.7	-15.8
24	0.134	0.396	0.682	-0.060	33.1	-15.4
25	0.144	0.406	0.697	-0.062	31.1	-13.4
26	0.154	0.416	0.718	-0.059	31.7	-12.8
27	0.164	0.426	0.733	-0.058	27.7	-11.2
28	0.174	0.436	0.749	-0.056	28.0	-12.7
29	0.184	0.446	0.769	-0.057	27.1	-11.8
30	0.194	0.456	0.783	-0.057	26.8	-10.3
31	0.204	0.466	0.794	-0.057	23.9	-9.7
32	0.224	0.486	0.818	-0.057	24.5	-9.2
33	0.244	0.506	0.842	-0.054	20.2	-7.1
34	0.264	0.526	0.864	-0.054	18.9	-6.8
35	0.284	0.546	0.879	-0.052	16.3	-5.2
36	0.304	0.566	0.903	-0.050	13.8	-2.7
37	0.324	0.586	0.912	-0.051	11.7	-2.5
38	0.344	0.606	0.927	-0.051	9.0	-2.2
39	0.364	0.626	0.938	-0.052	6.4	-0.4
40	0.384	0.646	0.946	-0.050	5.7	-0.3
41	0.404	0.666	0.945	-0.049	4.4	-0.3
42	0.404	0.666	0.950	-0.044	5.1	-0.3
43	0.424	0.686	0.950	-0.048	2.5	0.0
44	0.444	0.706	0.954	-0.044	2.8	0.7
45	0.464	0.726	0.960	-0.047	3.0	0.5
46	0.484	0.746	0.963	-0.042	3.6	0.5
47	0.504	0.766	0.966	-0.041	4.1	0.0
48	0.554	0.816	0.972	-0.041	3.8	-0.3
49	0.604	0.866	0.970	-0.041	3.6	0.0
50	0.604	0.866	0.973	-0.038	3.6	0.5

Table 5. Continued

Attached-Flow Model

$\hat{x} = 1.788$	$\hat{R}_{\text{surface}} = 0.261$	$v_{\infty} = 210 \text{ m/sec}$				
I	\hat{Y}	\hat{R}	$\langle \hat{U} \rangle$	$\langle \hat{V} \rangle$	$\hat{k} \times 10^4$	$\langle \hat{u} \hat{v} \rangle$
1	0.004	0.265	0.079	-0.015	35.6	-19.1
2	0.009	0.270	0.114	-0.028	39.6	-19.4
3	0.014	0.275	0.143	-0.026	41.3	-22.3
4	0.019	0.280	0.164	-0.025	41.9	-21.7
5	0.024	0.285	0.191	-0.021	49.3	-26.4
6	0.029	0.290	0.218	-0.030	52.5	-31.0
7	0.034	0.295	0.243	-0.028	51.9	-29.0
8	0.039	0.300	0.269	-0.031	54.0	-26.8
9	0.044	0.305	0.286	-0.034	58.0	-30.8
10	0.044	0.305	0.292	-0.028	56.7	-29.4
11	0.049	0.310	0.312	-0.035	54.6	-28.8
12	0.049	0.310	0.317	-0.032	58.7	-32.9
13	0.054	0.315	0.337	-0.030	58.0	-30.8
14	0.054	0.315	0.335	-0.034	58.7	-32.9
15	0.059	0.320	0.356	-0.028	58.7	-32.9
16	0.059	0.320	0.362	-0.034	58.9	-30.0
17	0.064	0.325	0.382	-0.032	60.1	-34.3
18	0.069	0.330	0.408	-0.031	55.9	-30.2
19	0.074	0.335	0.433	-0.033	57.9	-33.6
20	0.079	0.340	0.454	-0.036	52.0	-26.2
21	0.084	0.345	0.473	-0.034	53.9	-29.6
22	0.084	0.345	0.474	-0.039	52.0	-26.2
23	0.089	0.350	0.489	-0.032	53.3	-27.5
24	0.089	0.350	0.498	-0.035	53.3	-27.5
25	0.094	0.355	0.501	-0.034	54.6	-28.8
26	0.094	0.355	0.505	-0.032	52.6	-28.3
27	0.094	0.355	0.517	-0.035	48.7	-24.4
28	0.099	0.360	0.529	-0.033	51.3	-27.0
29	0.099	0.360	0.530	-0.036	48.0	-25.1
30	0.104	0.365	0.544	-0.034	51.2	-29.6
31	0.104	0.365	0.544	-0.038	46.1	-24.6
32	0.104	0.365	0.549	-0.036	44.4	-21.5
33	0.104	0.365	0.550	-0.037	46.1	-24.6
34	0.104	0.365	0.553	-0.038	43.7	-22.2
35	0.114	0.375	0.576	-0.035	44.4	-21.5
36	0.114	0.375	0.579	-0.038	43.1	-22.9
37	0.114	0.375	0.582	-0.035	43.2	-20.3
38	0.114	0.375	0.581	-0.038	42.6	-21.0
39	0.124	0.385	0.512	-0.036	38.5	-18.3
40	0.124	0.385	0.514	-0.038	39.2	-17.7
41	0.134	0.395	0.634	-0.039	36.8	-17.9
42	0.134	0.395	0.638	-0.039	37.9	-19.0
43	0.144	0.405	0.660	-0.039	34.7	-15.8
44	0.144	0.405	0.562	-0.039	35.1	-17.4
45	0.154	0.415	0.684	-0.040	34.1	-16.4
46	0.164	0.425	0.705	-0.043	32.7	-13.8
47	0.174	0.435	0.720	-0.039	32.5	-16.0
48	0.184	0.445	0.739	-0.040	30.1	-12.4
49	0.194	0.455	0.759	-0.045	28.6	-12.1

Table 5. Continued

Attached-Flow Model

$\hat{X} = 1.788$	$\hat{R}_{\text{surface}} = 0.261$	$v_{\infty} = 210 \text{ m/sec}$				
I	\hat{Y}	\hat{R}	$\langle \hat{U} \rangle$	$\langle \hat{V} \rangle$	$\hat{k} \times 10^4$	$\langle \hat{U} - \hat{V} \rangle$
50	0.204	0.465	0.771	-0.043	30.5	-14.0
51	0.204	0.465	0.774	-0.040	27.7	-11.2
52	0.204	0.465	0.775	-0.045	26.2	-10.9
53	0.224	0.495	0.805	-0.046	26.2	-10.9
54	0.244	0.505	0.826	-0.039	25.3	-10.0
55	0.264	0.525	0.852	-0.042	22.3	-8.1
56	0.284	0.545	0.876	-0.043	19.3	-5.0
57	0.304	0.565	0.895	-0.046	17.3	-4.2
58	0.324	0.585	0.915	-0.045	13.9	-3.8
59	0.344	0.605	0.929	-0.043	11.7	-2.5
60	0.364	0.625	0.934	-0.044	10.7	-1.4
61	0.384	0.645	0.946	-0.040	8.5	-1.7
62	0.404	0.665	0.952	-0.042	7.6	0.0
63	0.424	0.685	0.962	-0.041	6.8	0.0
64	0.444	0.705	0.964	-0.041	6.1	0.7
65	0.464	0.725	0.968	-0.039	5.1	0.3
66	0.484	0.745	0.971	-0.038	5.1	-0.3
67	0.504	0.765	0.974	-0.039	4.7	0.0
68	0.554	0.815	0.980	-0.037	4.1	0.0
69	0.604	0.865	0.984	-0.037	4.4	-0.3

Table 5. Continued

Attached-Flow Model

$\hat{\chi} = 1.838$						
$\hat{R}_{\text{surface}} = 0.276$						
$v_{\infty} = 211 \text{ m/sec}$						
I	\hat{Y}	\hat{R}	$\langle \hat{U} \rangle$	$\langle \hat{V} \rangle$	$\hat{k} \times 10^4$	$\langle \hat{U} \hat{V} \rangle$
1	0.004	0.280	0.273	0.021	45.4	-19.9
2	0.009	0.285	0.291	0.015	49.5	-25.5
3	0.014	0.290	0.311	0.005	53.5	-26.5
4	0.019	0.295	0.329	0.010	64.6	-34.6
5	0.019	0.295	0.327	0.004	56.2	-29.2
6	0.019	0.295	0.332	0.007	58.1	-32.6
7	0.019	0.295	0.333	0.008	59.1	-29.0
8	0.019	0.295	0.329	0.002	58.3	-29.8
9	0.019	0.295	0.330	0.001	62.4	-33.9
10	0.019	0.295	0.332	0.003	61.0	-32.5
11	0.019	0.295	0.334	0.005	59.6	-31.1
12	0.019	0.295	0.333	0.002	60.3	-33.3
13	0.024	0.300	0.352	0.001	60.4	-30.3
14	0.029	0.305	0.379	-0.003	59.6	-31.1
15	0.034	0.310	0.399	-0.007	64.0	-32.3
16	0.039	0.315	0.416	-0.004	64.5	-34.6
17	0.044	0.320	0.435	-0.008	57.7	-27.6
18	0.049	0.325	0.460	-0.005	60.3	-33.3
19	0.054	0.330	0.477	-0.003	56.8	-31.3
20	0.059	0.335	0.499	-0.009	56.2	-29.2
21	0.064	0.340	0.515	-0.003	56.2	-29.2
22	0.069	0.345	0.534	-0.009	51.5	-26.0
23	0.074	0.350	0.550	-0.007	49.0	-23.5
24	0.079	0.355	0.572	-0.012	50.3	-24.7
25	0.084	0.360	0.585	-0.009	45.9	-21.8
26	0.089	0.365	0.598	-0.008	45.7	-24.4
27	0.094	0.370	0.620	-0.013	42.9	-20.2
28	0.099	0.375	0.628	-0.013	44.5	-23.2
29	0.104	0.380	0.642	-0.015	36.1	-16.0
30	0.114	0.390	0.664	-0.015	37.5	-18.8
31	0.124	0.400	0.691	-0.019	34.8	-17.3
32	0.134	0.410	0.706	-0.016	31.2	-14.8
33	0.144	0.420	0.723	-0.018	28.7	-13.5
34	0.154	0.430	0.740	-0.019	32.2	-15.8
35	0.164	0.440	0.763	-0.022	28.1	-14.1
36	0.174	0.450	0.777	-0.023	29.3	-12.9
37	0.184	0.460	0.791	-0.026	27.4	-11.1
38	0.194	0.470	0.800	-0.029	25.1	-9.9
39	0.204	0.480	0.814	-0.027	23.2	-10.2
40	0.204	0.480	0.815	-0.028	23.7	-9.6
41	0.214	0.490	0.829	-0.024	22.6	-7.4
42	0.224	0.500	0.841	-0.031	21.3	-7.2
43	0.224	0.500	0.842	-0.030	20.3	-8.3
44	0.234	0.510	0.857	-0.033	18.8	-6.8
45	0.244	0.520	0.861	-0.031	20.0	-7.0
46	0.244	0.520	0.862	-0.032	17.9	-4.8
47	0.264	0.540	0.884	-0.033	15.1	-5.0
48	0.324	0.600	0.929	-0.031	9.8	-2.2
49	0.344	0.620	0.941	-0.031	7.2	-1.2

Table 5. Continued.

Attached-Flow Model

$\hat{x} = 1.838$	$\hat{R}_{\text{surface}} = 0.276$	$v_{\infty} = 211 \text{ m/sec}$				
I	\hat{Y}	\hat{R}	$\langle \hat{U} \rangle$	$\langle \hat{V} \rangle$	$\hat{k} \times 10^4$	$\langle \hat{U} \hat{V} \rangle$
50	0.364	0.640	0.948	-0.030	6.1	-1.4
51	0.384	0.660	0.955	-0.033	5.0	-0.3
52	0.404	0.680	0.959	-0.035	4.7	-0.6
53	0.424	0.700	0.963	-0.033	4.1	0.0
54	0.444	0.720	0.966	-0.031	4.1	-0.6
55	0.464	0.740	0.970	-0.031	4.4	-0.3
56	0.484	0.760	0.973	-0.032	3.9	-0.3
57	0.504	0.780	0.974	-0.029	4.1	0.0
58	0.554	0.830	0.977	-0.032	3.3	-0.3
59	0.604	0.880	0.981	-0.032	3.3	-0.3
60	0.654	0.930	0.982	-0.033	3.3	0.3
61	0.704	0.980	0.984	-0.031	3.0	-0.5
62	0.754	1.030	0.987	-0.032	3.3	-0.3
63	0.804	1.080	0.988	-0.031	3.0	-0.5
64	0.854	1.130	0.992	-0.031	3.0	-0.5
65	0.904	1.180	0.991	-0.032	3.0	-0.5
66	0.954	1.230	0.991	-0.032	3.0	-0.5
67	1.004	1.280	0.995	-0.032	3.3	-0.3
68	1.104	1.380	0.994	-0.031	3.5	-0.5
69	1.204	1.480	0.996	-0.031	3.3	-0.3
70	1.304	1.580	0.997	-0.030	3.3	-0.3
71	1.404	1.680	1.000	-0.031	3.3	-0.8
72	1.504	1.780	1.000	-0.029	3.3	-0.3
73	1.704	1.980	1.002	-0.029	3.3	-0.8
74	1.904	2.180	1.007	-0.030	3.5	-0.5
75	2.104	2.380	1.005	-0.030	4.1	-0.6
76	2.304	2.580	0.985	-0.019	11.5	-0.5
77	2.504	2.780	0.735	0.002	104.2	29.2

Table 5. Continued

Attached-Flow Model

$\hat{X} = 1.938$						
$\hat{R}_{\text{Surface}} = 0.302$						
$v_{\infty} = 214 \text{ m/sec}$						
I	\hat{Y}	\hat{R}	$\langle \hat{U} \rangle$	$\langle \hat{V} \rangle$	$\hat{k} \times 10^4$	$\langle \hat{U} \hat{V} \rangle$
1	0.004	0.306	0.406	0.045	49.9	-20.7
2	0.009	0.311	0.424	0.033	53.2	-22.3
3	0.014	0.316	0.449	0.032	55.7	-24.8
4	0.019	0.321	0.464	0.031	60.4	-27.9
5	0.024	0.326	0.482	0.027	59.6	-28.7
6	0.029	0.331	0.497	0.022	60.2	-30.9
7	0.034	0.336	0.516	0.020	61.7	-29.3
8	0.039	0.341	0.534	0.018	63.1	-30.7
9	0.044	0.346	0.549	0.019	58.3	-27.4
10	0.049	0.351	0.570	0.018	54.1	-26.4
11	0.054	0.356	0.584	0.014	53.4	-27.1
12	0.059	0.361	0.598	0.020	53.4	-27.1
13	0.064	0.366	0.608	0.018	46.3	-24.3
14	0.064	0.366	0.618	0.014	48.2	-24.8
15	0.069	0.371	0.629	0.013	44.2	-19.4
16	0.069	0.371	0.629	0.013	47.0	-23.6
17	0.074	0.376	0.638	0.014	44.5	-23.7
18	0.074	0.376	0.644	0.012	41.7	-19.6
19	0.079	0.381	0.657	0.016	44.0	-21.9
20	0.079	0.381	0.657	0.014	42.4	-19.0
21	0.084	0.386	0.667	0.014	42.8	-20.8
22	0.084	0.386	0.666	0.011	41.1	-20.3
23	0.089	0.391	0.682	0.009	37.5	-19.4
24	0.094	0.396	0.693	0.008	37.2	-17.7
25	0.099	0.401	0.694	0.011	36.5	-18.3
26	0.099	0.401	0.697	0.008	34.9	-17.8
27	0.104	0.406	0.712	0.011	34.9	-17.8
28	0.104	0.406	0.711	0.004	34.9	-17.8
29	0.114	0.416	0.725	0.006	34.3	-18.4
30	0.124	0.426	0.745	0.004	32.9	-15.8
31	0.134	0.436	0.758	0.005	28.8	-14.1
32	0.144	0.446	0.776	-0.007	29.8	-15.0
33	0.154	0.456	0.787	-0.006	27.0	-12.2
34	0.164	0.466	0.797	-0.005	26.5	-12.8
35	0.174	0.476	0.817	-0.007	26.0	-13.3
36	0.184	0.486	0.829	-0.011	23.1	-9.4
37	0.194	0.496	0.842	-0.014	22.1	-10.4
38	0.204	0.506	0.848	-0.008	21.3	-9.6
39	0.224	0.526	0.869	-0.013	18.0	-8.2
40	0.244	0.546	0.889	-0.015	15.7	-5.0
41	0.264	0.566	0.900	-0.016	14.2	-5.3
42	0.284	0.586	0.919	-0.017	11.1	-3.7
43	0.304	0.606	0.932	-0.022	7.4	-1.5
44	0.324	0.626	0.941	-0.022	6.3	-1.1
45	0.344	0.646	0.953	-0.024	4.0	-0.6
46	0.364	0.666	0.958	-0.023	3.2	-0.8
47	0.384	0.686	0.964	-0.025	3.2	-0.3
48	0.404	0.706	0.963	-0.026	2.7	-0.7
49	0.424	0.726	0.969	-0.024	2.5	-0.4

Table 5. Continued

Attached-Flow Model

$\hat{X} = 1.938$		$\hat{R}_{\text{surface}} = 0.302$		$v_{\infty} = 214 \text{ m/sec}$			
I	\hat{Y}	\hat{R}	$\langle \hat{U} \rangle$	$\langle \hat{V} \rangle$	$\hat{k} \times 10^4$	$\langle \hat{U} \hat{V} \rangle$	
50	0.444	0.746	0.969	-0.026	2.2	-0.2	
51	0.464	0.756	0.969	-0.024	2.0	-0.4	
52	0.484	0.786	0.974	-0.025	2.2	-0.2	
53	0.504	0.806	0.973	-0.024	2.0	0.0	
54	0.554	0.856	0.976	-0.025	2.0	-0.4	
55	0.604	0.906	0.980	-0.027	1.8	-0.2	

Table 5. Continued

Attached-Flow Model

$\hat{X} = 2.038$	$\hat{R}_{\text{surface}} = 0.316$	$v_{\infty} = 211 \text{ m/sec}$				
I	\hat{Y}	\hat{R}	$\langle \hat{U} \rangle$	$\langle \hat{V} \rangle$	$\hat{k} \times 10^4$	$\langle \hat{U} \hat{V} \rangle$
1	0.004	0.320	0.496	0.057	41.7	-8.3
2	0.004	0.320	0.497	0.056	41.9	-10.2
3	0.004	0.320	0.497	0.054	41.9	-10.2
4	0.004	0.320	0.501	0.056	45.9	-12.6
5	0.004	0.320	0.498	0.051	40.5	-5.5
6	0.004	0.320	0.502	0.055	43.8	-10.4
7	0.009	0.325	0.526	0.052	39.9	-14.3
8	0.014	0.330	0.542	0.044	49.3	-20.8
9	0.019	0.335	0.554	0.044	53.5	-26.5
10	0.024	0.340	0.566	0.040	53.0	-24.5
11	0.029	0.345	0.580	0.041	56.9	-28.4
12	0.034	0.350	0.598	0.039	61.2	-29.5
13	0.039	0.355	0.606	0.039	55.6	-27.1
14	0.044	0.360	0.626	0.040	64.0	-32.3
15	0.049	0.365	0.643	0.035	53.0	-24.5
16	0.054	0.370	0.659	0.035	57.5	-30.5
17	0.059	0.375	0.670	0.027	46.2	-19.2
18	0.064	0.380	0.686	0.029	47.8	-22.3
19	0.069	0.385	0.699	0.026	48.8	-26.2
20	0.074	0.390	0.707	0.028	40.6	-17.9
21	0.079	0.395	0.719	0.024	42.2	-20.8
22	0.084	0.400	0.734	0.023	37.1	-17.1
23	0.089	0.405	0.738	0.023	38.8	-17.5
24	0.094	0.410	0.750	0.021	35.4	-16.7
25	0.099	0.415	0.756	0.019	33.8	-16.3
26	0.104	0.420	0.771	0.015	31.8	-14.3
27	0.114	0.430	0.782	0.018	29.9	-12.3
28	0.124	0.440	0.797	0.015	31.8	-14.3
29	0.134	0.450	0.812	0.010	28.3	-12.0
30	0.144	0.460	0.828	0.007	28.0	-10.5
31	0.154	0.470	0.838	0.009	25.1	-9.9
32	0.164	0.480	0.851	0.004	24.6	-10.5
33	0.174	0.490	0.863	0.0	25.7	-9.3
34	0.184	0.500	0.871	0.001	22.9	-8.8
35	0.194	0.510	0.881	0.003	22.1	-8.0
36	0.204	0.520	0.887	-0.001	20.8	-7.8
37	0.204	0.520	0.889	-0.001	20.8	-7.8
38	0.204	0.520	0.890	0.0	20.8	-7.8
39	0.214	0.530	0.899	-0.003	20.5	-6.5
40	0.224	0.540	0.908	-0.002	17.3	-5.3
41	0.224	0.540	0.910	-0.004	17.2	-4.2
42	0.244	0.560	0.922	-0.003	16.0	-4.0
43	0.244	0.560	0.924	-0.005	16.0	-4.0
44	0.264	0.580	0.940	-0.007	13.8	-3.7
45	0.284	0.600	0.953	-0.010	11.1	-1.9
46	0.304	0.620	0.961	-0.008	9.9	-2.2
47	0.324	0.640	0.970	-0.014	6.4	0.4
48	0.344	0.660	0.972	-0.016	6.8	0.0
49	0.364	0.680	0.976	-0.014	5.1	-1.0

Table 5. Continued

Attached-Flow Model

$\hat{\chi} = 2.038$ $\hat{R}_{\text{surface}} = 0.316$ $v_{\infty} = 211 \text{ m/sec}$						
I	\hat{Y}	\hat{R}	$\langle \hat{U} \rangle$	$\langle \hat{V} \rangle$	$\hat{k} \times 10^4$	$\langle \hat{U} \hat{V} \rangle$
50	0.384	0.700	0.979	-0.015	5.0	0.3
51	0.404	0.720	0.983	-0.015	5.7	-1.0
52	0.424	0.740	0.982	-0.016	5.1	-1.0
53	0.444	0.760	0.983	-0.015	4.7	-0.6
54	0.464	0.780	0.987	-0.015	6.4	0.4
55	0.484	0.800	0.987	-0.017	4.8	-1.3
56	0.504	0.820	0.988	-0.020	5.0	0.3
57	0.554	0.870	0.990	-0.022	5.0	-0.3
58	0.604	0.920	0.993	-0.023	4.4	0.3
59	0.654	0.970	0.993	-0.023	5.3	0.0
60	0.704	1.020	0.994	-0.022	4.4	0.3
61	0.754	1.070	0.996	-0.027	3.8	0.3
62	0.804	1.120	0.994	-0.024	4.1	0.0
63	0.854	1.170	0.995	-0.023	4.1	0.0
64	0.904	1.220	0.997	-0.028	3.8	0.8
65	0.954	1.270	0.996	-0.029	3.5	0.8
66	1.004	1.320	1.000	-0.029	3.8	0.8
67	1.104	1.420	0.999	-0.028	3.5	0.5
68	1.204	1.520	1.003	-0.030	4.2	1.2
69	1.304	1.620	1.005	-0.030	4.1	0.6
70	1.404	1.720	1.004	-0.029	4.4	0.9
71	1.504	1.820	1.008	-0.031	4.4	0.3
72	1.704	2.020	1.005	-0.030	3.8	0.3
73	1.904	2.220	1.007	-0.032	3.8	0.3
74	2.104	2.420	1.005	-0.030	4.7	0.0
75	2.304	2.620	0.959	-0.018	23.6	4.9
76	2.504	2.820	0.657	0.010	104.6	32.1

Table 5. Continued
Attached-Flow Model

$\hat{X} = 2.438$	$\hat{R}_{\text{surface}} = 0.342$	$v_{\infty} = 212 \text{ m/sec}$				
I	\hat{V}	\hat{R}	$\langle \hat{U} \rangle$	$\langle \hat{V} \rangle$	$\hat{k} \times 10^4$	$\langle \hat{u} \hat{v} \rangle$
1	0.004	0.346	0.624	-0.009	49.5	-13.1
2	0.009	0.351	0.655	-0.014	39.0	-10.7
3	0.014	0.356	0.680	-0.016	40.0	-11.7
4	0.019	0.361	0.589	-0.017	40.3	-13.5
5	0.024	0.366	0.701	-0.021	41.8	-16.4
6	0.029	0.371	0.711	-0.023	44.7	-17.9
7	0.034	0.376	0.724	-0.022	43.2	-14.9
8	0.039	0.381	0.723	-0.015	47.0	-20.2
9	0.044	0.386	0.742	-0.021	48.7	-23.4
10	0.044	0.386	0.742	-0.027	46.3	-16.4
11	0.049	0.391	0.757	-0.026	44.4	-20.5
12	0.054	0.396	0.761	-0.022	47.0	-20.2
13	0.059	0.401	0.775	-0.024	41.5	-18.9
14	0.064	0.406	0.787	-0.026	38.9	-15.0
15	0.069	0.411	0.795	-0.027	41.5	-18.9
16	0.074	0.416	0.801	-0.027	33.8	-13.9
17	0.079	0.421	0.816	-0.028	33.5	-12.3
18	0.084	0.426	0.823	-0.023	32.8	-12.9
19	0.089	0.431	0.831	-0.023	29.4	-10.7
20	0.094	0.436	0.839	-0.025	29.1	-9.2
21	0.099	0.441	0.844	-0.026	28.5	-9.8
22	0.104	0.446	0.854	-0.025	26.7	-8.1
23	0.114	0.456	0.865	-0.024	23.9	-7.6
24	0.124	0.466	0.874	-0.023	25.8	-10.7
25	0.134	0.476	0.885	-0.024	23.3	-8.2
26	0.144	0.486	0.894	-0.021	22.5	-7.4
27	0.154	0.496	0.906	-0.020	20.2	-5.1
28	0.164	0.506	0.914	-0.022	19.0	-5.0
29	0.174	0.516	0.918	-0.020	20.4	-6.4
30	0.184	0.526	0.927	-0.021	18.3	-4.3
31	0.194	0.536	0.936	-0.022	15.8	-2.8
32	0.204	0.546	0.940	-0.020	16.4	-3.5
33	0.224	0.566	0.956	-0.020	13.1	-3.1
34	0.244	0.586	0.966	-0.017	11.5	-1.5
35	0.264	0.606	0.976	-0.019	7.5	0.0
36	0.284	0.626	0.981	-0.020	6.7	0.0
37	0.304	0.646	0.988	-0.017	6.0	0.0
38	0.324	0.666	0.991	-0.016	5.0	0.3
39	0.344	0.686	0.991	-0.016	4.1	0.6
40	0.364	0.706	0.994	-0.019	4.1	0.6
41	0.384	0.726	0.995	-0.016	3.2	0.3
42	0.404	0.746	0.994	-0.015	3.5	0.0
43	0.424	0.766	0.994	-0.017	3.5	0.5
44	0.444	0.786	0.996	-0.015	3.8	0.3
45	0.464	0.806	0.995	-0.016	3.9	0.3
46	0.484	0.826	0.996	-0.017	3.5	0.5
47	0.504	0.846	0.997	-0.016	3.5	0.0
48	0.554	0.896	0.996	-0.017	3.5	0.0
49	0.604	0.946	0.995	-0.018	3.0	0.0

Table 5. Continued

Attached-Flow Model

$\hat{X} = 2.438$	$\hat{R}_{\text{surface}} = 0.342$	$v_{\infty} = 212 \text{ m/sec}$				
I	\hat{Y}	\hat{R}	$\langle \hat{U} \rangle$	$\langle \hat{V} \rangle$	$\hat{k} \times 10^4$	$\langle \hat{U} \cdot \hat{V} \rangle$
50	0.654	0.996	0.997	-0.020	3.0	0.0
51	0.704	1.046	0.994	-0.017	3.0	0.5
52	0.754	1.096	0.993	-0.022	3.2	0.3
53	0.804	1.146	0.984	-0.025	3.2	0.3
54	0.854	1.196	0.996	-0.021	3.5	0.5
55	0.904	1.246	0.998	-0.019	3.5	0.0
56	0.954	1.296	0.998	-0.021	3.2	0.3
57	1.004	1.346	0.998	-0.021	3.2	-0.3
58	1.104	1.446	0.998	-0.021	3.9	0.3
59	1.204	1.546	0.999	-0.024	4.1	0.6
60	1.304	1.646	1.000	-0.023	3.8	-0.3
61	1.404	1.746	0.999	-0.022	3.9	-0.3
62	1.504	1.846	1.001	-0.024	3.8	-0.3
63	1.704	2.046	1.003	-0.024	4.4	0.3
64	1.904	2.246	1.002	-0.023	4.4	-0.3
65	2.104	2.446	1.002	-0.021	6.0	0.7
66	2.304	2.646	0.913	-0.013	39.0	10.7

Table 5. Continued
Attached-Flow Model

$\hat{x} = 2.938$	$\hat{R}_{\text{surface}} = 0.341$	$v_{\infty} = 211 \text{ m/sec}$				
I	\hat{Y}	\hat{R}	$\langle \hat{U} \rangle$	$\langle \hat{V} \rangle$	$\hat{k} \times 10^4$	$\langle \hat{u} \hat{v} \rangle$
1	0.004	0.345	0.667	-0.008	38.5	-9.8
2	0.009	0.350	0.678	-0.009	39.2	-9.0
3	0.014	0.355	0.697	-0.009	39.7	-12.6
4	0.019	0.360	0.704	-0.012	39.0	-13.3
5	0.024	0.365	0.715	-0.011	38.3	-14.1
6	0.029	0.370	0.721	-0.009	41.1	-15.5
7	0.034	0.375	0.728	-0.014	36.5	-13.7
8	0.039	0.380	0.741	-0.010	40.1	-14.4
9	0.044	0.385	0.751	-0.012	38.6	-15.8
10	0.049	0.390	0.760	-0.013	39.7	-16.9
11	0.054	0.395	0.759	-0.008	39.0	-17.6
12	0.054	0.395	0.769	-0.018	38.6	-15.8
13	0.059	0.400	0.774	-0.008	39.0	-13.3
14	0.059	0.400	0.778	-0.014	38.6	-15.8
15	0.064	0.405	0.787	-0.011	36.5	-13.7
16	0.069	0.410	0.790	-0.008	37.9	-16.5
17	0.074	0.415	0.801	-0.013	35.5	-12.7
18	0.079	0.420	0.805	-0.007	33.9	-12.4
19	0.084	0.425	0.815	-0.015	30.5	-11.8
20	0.089	0.430	0.822	-0.015	30.1	-8.6
21	0.094	0.435	0.827	-0.012	31.0	-9.5
22	0.094	0.435	0.865	-0.009	25.6	-7.9
23	0.099	0.440	0.831	-0.012	31.3	-11.1
24	0.104	0.445	0.840	-0.011	28.2	-10.6
25	0.114	0.455	0.847	-0.006	27.9	-9.0
26	0.134	0.475	0.871	-0.011	24.4	-9.1
27	0.144	0.485	0.879	-0.005	24.7	-7.1
28	0.154	0.495	0.892	-0.006	21.2	-5.9
29	0.164	0.505	0.900	-0.008	19.9	-5.7
30	0.174	0.515	0.914	-0.007	19.2	-5.0
31	0.184	0.525	0.920	-0.007	18.4	-7.3
32	0.194	0.535	0.927	-0.008	17.4	-5.4
33	0.204	0.545	0.935	-0.006	16.7	-4.7
34	0.224	0.565	0.947	-0.006	14.8	-2.8
35	0.244	0.585	0.958	-0.006	12.2	-3.0
36	0.264	0.605	0.967	-0.003	10.2	-1.8
37	0.284	0.625	0.976	-0.004	8.0	-0.4
38	0.304	0.645	0.984	-0.004	6.9	0.0
39	0.324	0.665	0.988	-0.004	5.7	0.3
40	0.344	0.685	0.991	-0.003	5.0	0.3
41	0.364	0.705	0.993	-0.001	4.7	0.0
42	0.384	0.725	0.996	-0.001	4.1	0.0
43	0.404	0.745	0.997	-0.004	3.8	0.3
44	0.424	0.765	0.996	-0.003	3.5	0.5
45	0.444	0.785	1.000	-0.003	3.5	0.5
46	0.464	0.805	0.999	-0.002	3.5	0.5
47	0.484	0.825	0.999	-0.004	3.9	0.8
48	0.504	0.845	0.997	-0.002	3.9	0.3
49	0.604	0.945	0.999	-0.002	3.3	0.3

Table 5. Continued

Attached-Flow Model

$\hat{X} = 2.938$ $\hat{R}_{\text{surface}} = 0.341$ $v_{\infty} = 211 \text{ m/sec}$						
I	\hat{Y}	\hat{R}	$\langle \hat{U} \rangle$	$\langle \hat{V} \rangle$	$\hat{k} \times 10^4$	$\langle \hat{U} \hat{V} \rangle$
50	0.704	1.045	1.000	-0.003	3.8	0.3
51	0.804	1.145	0.999	-0.004	3.8	0.3
52	0.904	1.245	1.001	-0.006	3.8	0.3
53	1.004	1.345	1.000	-0.005	4.1	0.6
54	1.104	1.445	1.002	-0.007	3.9	0.8
55	1.204	1.545	0.998	-0.007	3.5	0.0
56	1.304	1.645	1.001	-0.008	3.8	0.3
57	1.404	1.745	1.001	-0.008	3.6	0.5
58	1.504	1.845	1.001	-0.010	3.6	0.5
59	1.604	1.945	1.002	-0.009	3.5	0.0
60	1.704	2.045	1.001	-0.010	3.9	0.3
61	1.804	2.145	1.002	-0.009	3.5	0.0
62	2.004	2.345	1.001	-0.008	3.9	0.3
63	2.204	2.545	0.989	-0.005	8.1	2.0
64	2.404	2.745	0.800	0.012	75.0	24.7
65	2.491	2.832	0.663	0.014	105.6	35.2

Table 5. Continued

Attached-Flow Model

$\hat{X} = 3.938$	$\hat{R}_{\text{surface}} = 0.342$	$v_{\infty} = 212 \text{ m/sec}$				
I	\hat{Y}	\hat{R}	$\langle \hat{U} \rangle$	$\langle \hat{V} \rangle$	$\hat{k} \times 10^4$	$\langle \hat{U} \hat{V} \rangle$
1	0.004	0.346	0.606	-0.018	54.9	-14.8
2	0.004	0.346	0.609	-0.019	49.3	-11.0
3	0.004	0.346	0.610	-0.018	52.3	-10.4
4	0.004	0.346	0.614	-0.015	51.9	-15.4
5	0.004	0.346	0.611	-0.019	51.6	-13.3
6	0.004	0.346	0.616	-0.015	50.5	-12.2
7	0.009	0.351	0.661	-0.018	42.7	-11.2
8	0.014	0.356	0.687	-0.021	43.2	-14.9
9	0.019	0.361	0.714	-0.020	43.2	-14.9
10	0.024	0.366	0.725	-0.021	39.6	-14.2
11	0.029	0.371	0.734	-0.021	38.6	-13.2
12	0.029	0.371	0.734	-0.023	41.4	-14.6
13	0.029	0.371	0.742	-0.017	40.3	-13.5
14	0.034	0.376	0.751	-0.016	39.6	-14.2
15	0.034	0.376	0.752	-0.023	37.5	-12.2
16	0.039	0.381	0.758	-0.019	36.1	-13.6
17	0.039	0.381	0.764	-0.019	38.2	-15.7
18	0.044	0.386	0.769	-0.018	36.1	-13.6
19	0.044	0.386	0.766	-0.023	35.1	-12.6
20	0.049	0.391	0.781	-0.016	35.1	-12.6
21	0.054	0.396	0.786	-0.019	35.5	-14.3
22	0.059	0.401	0.793	-0.021	36.1	-13.6
23	0.064	0.406	0.796	-0.022	34.1	-11.6
24	0.069	0.411	0.806	-0.020	37.5	-16.3
25	0.074	0.416	0.800	-0.020	32.5	-11.3
26	0.074	0.416	0.807	-0.023	34.4	-13.2
27	0.074	0.416	0.814	-0.026	35.5	-14.3
28	0.079	0.421	0.804	-0.020	34.8	-14.9
29	0.079	0.421	0.815	-0.023	32.8	-12.9
30	0.079	0.421	0.816	-0.028	34.4	-13.2
31	0.084	0.426	0.820	-0.020	33.5	-12.3
32	0.089	0.431	0.825	-0.019	34.8	-14.9
33	0.094	0.436	0.836	-0.024	30.3	-11.6
34	0.099	0.441	0.841	-0.021	33.5	-12.3
35	0.104	0.446	0.840	-0.024	32.5	-11.3
36	0.114	0.456	0.861	-0.026	29.1	-12.8
37	0.124	0.466	0.873	-0.026	26.4	-10.1
38	0.134	0.476	0.883	-0.026	25.8	-10.7
39	0.134	0.476	0.887	-0.026	23.1	-6.8
40	0.144	0.486	0.887	-0.024	22.5	-7.4
41	0.154	0.496	0.898	-0.023	22.7	-8.7
42	0.164	0.506	0.906	-0.028	19.2	-6.2
43	0.174	0.516	0.915	-0.025	20.2	-5.1
44	0.184	0.526	0.923	-0.025	17.6	-3.6
45	0.194	0.536	0.932	-0.024	16.9	-3.0
46	0.204	0.546	0.936	-0.022	16.4	-3.5
47	0.214	0.556	0.945	-0.023	14.2	-3.2
48	0.224	0.566	0.949	-0.021	13.6	-2.6
49	0.234	0.576	0.958	-0.024	11.3	-1.5

Table 5. Continued.

Attached-Flow Model

$\hat{X} = 3.938$	$\hat{R}_{\text{surface}} = 0.342$	$v_{\infty} = 212 \text{ m/sec}$				
I	\hat{Y}	\hat{R}	$\langle \hat{U} \rangle$	$\langle \hat{V} \rangle$	$\hat{k} \times 10^4$	$\langle \hat{U} \hat{V} \rangle$
50	0.244	0.586	0.962	-0.022	12.0	-2.0
51	0.254	0.596	0.965	-0.026	10.5	-0.5
52	0.264	0.606	0.971	-0.022	10.0	-0.9
53	0.274	0.616	0.976	-0.021	9.5	-0.4
54	0.284	0.626	0.983	-0.022	7.9	0.4
55	0.294	0.636	0.995	-0.020	7.1	0.4
56	0.304	0.646	0.987	-0.018	7.5	0.0
57	0.324	0.666	0.997	-0.020	5.3	0.7
58	0.344	0.686	0.999	-0.020	4.7	0.6
59	0.364	0.706	1.001	-0.018	4.1	0.0
60	0.384	0.726	1.000	-0.017	4.1	0.6
61	0.404	0.746	1.002	-0.017	3.9	0.8
62	0.424	0.766	1.001	-0.018	3.8	0.8
63	0.444	0.786	1.004	-0.017	3.6	1.1
64	0.464	0.806	1.002	-0.019	3.5	0.5
65	0.484	0.826	1.004	-0.019	3.5	0.5
66	0.504	0.846	1.004	-0.017	3.9	0.8
67	0.554	0.896	1.005	-0.016	3.5	0.5
68	0.604	0.946	1.002	-0.019	3.5	1.1
69	0.654	0.996	1.004	-0.017	3.9	0.8
70	0.704	1.046	1.002	-0.019	3.3	0.8
71	0.754	1.096	1.002	-0.019	3.8	0.8
72	0.804	1.146	1.005	-0.018	3.9	0.8
73	0.854	1.196	1.003	-0.018	3.5	0.5
74	0.904	1.246	1.004	-0.021	3.3	0.8
75	0.954	1.296	1.003	-0.018	3.5	1.1
76	1.004	1.346	1.003	-0.018	3.9	0.8
77	1.104	1.446	1.002	-0.019	3.9	0.8
78	1.204	1.546	1.001	-0.020	3.9	0.8
79	1.304	1.646	1.000	-0.021	3.5	0.5
80	1.404	1.746	1.000	-0.021	3.5	1.1
81	1.504	1.846	1.002	-0.021	3.9	0.8
82	1.604	1.946	1.001	-0.022	3.3	0.8
83	1.704	2.046	1.001	-0.022	3.3	0.8
84	1.804	2.146	0.999	-0.020	3.3	0.8
85	1.904	2.246	0.998	-0.023	3.9	0.8
86	2.004	2.346	0.998	-0.021	3.9	0.8
87	2.104	2.446	0.995	-0.018	5.1	1.6
88	2.204	2.546	0.979	-0.010	9.2	1.7

Table 5. Continued

Attached-Flow Model

Porous Wall Boundary Conditions

	$\hat{R} = 2.500$	$\hat{Z} = 0.000$	$v_{\infty} = 212 \text{ m/sec}$		
I	\hat{X}	$\langle \hat{U} \rangle$	$\langle \hat{V} \rangle$	$\hat{k} \times 10^4$	$\langle \hat{U} \hat{V} \rangle$
1	-2.662	0.985	-0.020	2.3	0.7
2	-2.262	0.987	-0.022	3.2	0.3
3	-2.062	0.989	-0.022	4.4	0.3
4	-1.862	0.989	-0.022	4.4	-0.3
5	-1.662	0.988	-0.021	3.8	-0.3
6	-1.462	0.988	-0.021	4.4	-0.3
7	-1.262	0.989	-0.020	4.1	-0.6
8	-1.062	0.989	-0.024	3.5	-0.5
9	-1.062	0.992	-0.023	4.4	-0.3
10	-0.862	0.991	-0.024	3.5	-0.5
11	-0.662	0.991	-0.026	3.0	-0.5
12	-0.462	0.991	-0.026	3.5	-0.5
13	-0.262	0.991	-0.029	3.0	0.0
14	-0.062	0.992	-0.030	2.7	-0.2
15	0.138	0.991	-0.031	3.0	-0.5
16	0.338	0.989	-0.031	2.7	-0.2
17	0.538	0.990	-0.030	3.0	-0.5
18	0.738	0.988	-0.027	3.0	0.0
19	0.938	0.987	-0.029	3.0	0.0
20	1.138	0.988	-0.027	3.5	-0.5
21	1.338	0.985	-0.026	3.8	-0.3

Table 5. Continued

Attached-Flow Model

Porous Wall Boundary Conditions

	$\hat{R} = 2.500$	$\hat{Z} = 0.000$	$v_{\infty} = 211 \text{ m/sec}$		
I	\hat{X}	$\langle \hat{U} \rangle$	$\langle \hat{V} \rangle$	$\hat{k} \times 10^4$	$\langle \hat{U} \hat{V} \rangle$
1	-0.202	0.992	-0.016	5.1	1.0
2	-0.002	0.995	-0.017	7.2	1.2
3	0.198	0.994	-0.016	9.3	1.8
4	0.398	0.993	-0.013	10.6	1.4
5	0.598	0.990	-0.014	12.1	2.0
6	0.798	0.987	-0.011	12.6	2.6
7	0.798	0.985	-0.017	7.7	2.4
8	0.998	0.985	-0.015	6.8	0.8
9	1.198	0.980	-0.014	10.3	2.8
10	1.398	0.981	-0.013	8.9	2.1
11	1.598	0.972	-0.014	12.2	3.0
12	1.798	0.970	-0.010	13.2	3.1
13	1.998	0.968	-0.010	14.4	4.3
14	2.198	0.963	-0.014	17.8	7.7
15	2.398	0.963	-0.008	16.2	5.2
16	2.598	0.953	-0.006	22.6	7.4
17	2.798	0.956	-0.001	21.3	7.2
18	2.998	0.957	0.002	20.4	5.2
19	3.198	0.937	-0.014	32.4	13.6

Table 5. Concluded

Attached-Flow Model

Porous Wall Boundary Conditions

$\hat{R} = 2.500$ $\hat{Z} = 0.000$ $v_{\infty} = 211 \text{ m/sec}$					
I	\hat{X}	$\langle \hat{U} \rangle$	$\langle \hat{V} \rangle$	$\hat{k} \times 10^4$	$\langle u'v' \rangle$
1	-6.062	1.005	-0.007	0.7	-0.6
2	-5.862	1.004	-0.010	1.9	0.6
3	-5.662	1.004	-0.010	1.9	0.6
4	-5.462	1.003	-0.011	1.9	0.6
5	-5.262	1.003	-0.013	1.9	0.6
6	-5.062	0.997	-0.013	2.1	0.4
7	-4.862	0.997	-0.013	2.2	0.8
8	-4.662	0.999	-0.013	2.1	0.4
9	-4.462	0.998	-0.012	2.2	0.8
10	-4.262	1.000	-0.010	1.9	0.6
11	-4.062	0.999	-0.011	1.9	0.6

Table 6. Least-Squares Cubic Spline Coefficients, Attached-Flow Model

The fits are of the form

$$\langle \widehat{U}(\widehat{R}) \rangle = \sum_{i=0}^3 A_i \widehat{R}^i$$

Table 6. Continued

Attached-Flow Model

$$\hat{X} = -4.062 \quad \hat{R}_{\text{surface}} = 0.500$$

$\langle \hat{U} \rangle$ Coefficients				Interval Limit
A_3	A_2	A_1	A_0	\hat{R}_{max}
3.918E 03	-6.155E 03	3.227E 03	-5.639E 02	0.5200
4.282E 02	-7.117E 02	3.966E 02	-7.327E 01	0.5400
9.443E 01	-1.710E 02	1.046E 02	-2.070E 01	0.5600
1.602E 02	-2.814E 02	1.665E 02	-3.225E 01	0.5800
-6.899E 01	1.173E 02	-6.481E 01	1.246E 01	0.6000
-4.719E 00	1.644E 00	4.606E 00	-1.419E 00	0.6500
2.512E 01	-5.654E 01	4.243E 01	-9.614E 00	0.7500
2.864E-02	-8.592E-02	8.486E-02	9.718E-01	1.0000
-6.082E-04	1.824E-03	-2.893E-03	1.001E 00	2.5000

$\langle \hat{V} \rangle$ Coefficients				Interval Limit
A_3	A_2	A_1	A_0	\hat{R}_{max}
1.214E 02	-1.938E 02	1.031E 02	-1.826E 01	0.5200
7.625E 01	-1.234E 02	6.644E 01	-1.192E 01	0.5400
9.609E 00	-1.544E 01	8.148E 00	-1.425E 00	0.5600
-1.155E 00	2.647E 00	-1.978E 00	4.655E-01	0.5800
1.356E 01	-2.296E 01	1.288E 01	-2.406E 00	0.6000
-1.092E 01	2.111E 01	-1.357E 01	2.882E 00	0.6500
4.829E-01	-1.129E 00	8.864E-01	-2.494E-01	0.7500
4.799E-02	-1.504E-01	1.525E-01	-6.588E-02	1.0000
3.657E-03	-1.738E-02	1.953E-02	-2.155E-02	2.5000

\hat{k} Coefficients				Interval Limit
A_3	A_2	A_1	A_0	\hat{R}_{max}
-1.508E 02	2.346E 02	-1.216E 02	2.103E 01	0.5200
2.023E 01	-3.225E 01	1.711E 01	-3.016E 00	0.5400
-1.756E 01	2.896E 01	-1.594E 01	2.933E 00	0.5600
1.540E 01	-2.640E 01	1.506E 01	-2.854E 00	0.5800
-8.865E 00	1.582E 01	-9.427E 00	1.880E 00	0.6000
2.320E 00	-4.319E 00	2.653E 00	-5.363E-01	0.6500
-6.930E-01	1.557E 00	-1.166E 00	2.911E-01	0.7500
3.807E-03	-1.096E-02	1.027E-02	-2.843E-03	1.0000
-2.103E-04	1.093E-03	-1.781E-03	1.174E-03	2.5000

$\langle \hat{U} \cdot \hat{V} \rangle$ Coefficients				Interval Limit
A_3	A_2	A_1	A_0	\hat{R}_{max}
-5.340E 01	8.322E 01	-4.322E 01	7.481E 00	0.5200
4.689E 00	-7.403E 00	3.901E 00	-6.878E-01	0.5400
-1.593E 00	2.773E 00	-1.594E 00	3.014E-01	0.5600
-3.564E 00	6.085E 00	-3.449E 00	6.476E-01	0.5800
1.599E 00	-2.899E 00	1.762E 00	-3.598E-01	0.6000
-3.203E-01	5.564E-01	-3.111E-01	5.479E-02	0.6500
2.349E-01	-5.261E-01	3.926E-01	-9.767E-02	0.7500
-3.627E-03	1.049E-02	-9.911E-03	2.953E-03	1.0000
1.954E-04	-9.784E-04	1.557E-03	-8.699E-04	2.5000

Table 6. Continued

Attached-Flow Model

$$\hat{X} = -1.062 \quad \hat{R}_{\text{surface}} = 0.500$$

$\langle \hat{U} \rangle$ Coefficients				Interval Limit
A_3	A_2	A_1	A_0	\hat{R}_{max}
6.438E 03	-1.012E 04	5.309E 03	-9.281E 02	0.5200
1.108E 03	-1.807E 03	9.852E 02	-1.787E 02	0.5400
-4.130E 01	5.447E 01	-2.019E 01	2.308E 00	0.5600
1.697E 02	-3.000E 02	1.783E 02	-3.475E 01	0.5800
4.077E 01	-7.567E 01	4.821E 01	-9.592E 00	0.6000
-3.671E 01	6.379E 01	-3.547E 01	7.143E 00	0.6500
2.436E 01	-5.530E 01	4.194E 01	-9.629E 00	0.7500
6.621E-01	-1.973E 00	1.944E 00	3.704E-01	1.0000
-5.095E-03	2.902E-02	-5.746E-02	1.038E 00	2.5000

$\langle \hat{V} \rangle$ Coefficients				Interval Limit
A_3	A_2	A_1	A_0	\hat{R}_{max}
5.006E 02	-7.996E 02	4.258E 02	-7.558E 01	0.5200
4.762E 02	-7.617E 02	4.060E 02	-7.216E 01	0.5400
-3.818E 02	6.283E 02	-3.446E 02	6.295E 01	0.5600
3.978E 02	-6.814E 02	3.889E 02	-7.396E 01	0.5800
-2.267E 02	4.052E 02	-2.414E 02	4.789E 01	0.6000
2.054E 01	-3.978E 01	2.564E 01	-5.512E 00	0.6500
-8.887E-01	2.008E 00	-1.523E 00	3.729E-01	0.7500
7.149E-04	7.228E-03	-2.202E-02	-2.322E-03	1.0000
-5.575E-03	2.610E-02	-4.089E-02	3.967E-03	2.5000

\hat{k} Coefficients				Interval Limit
A_3	A_2	A_1	A_0	\hat{R}_{max}
-4.518E 02	7.047E 02	-3.665E 02	6.353E 01	0.5200
1.758E 00	-2.770E 00	1.437E 00	-2.412E-01	0.5400
-6.071E 00	9.914E 00	-5.413E 00	9.917E-01	0.5600
9.116E 00	-1.560E 01	8.876E 00	-1.676E 00	0.5800
-7.283E 00	1.293E 01	-7.674E 00	1.524E 00	0.6000
2.202E 00	-4.139E 00	2.569E 00	-5.245E-01	0.6500
-4.628E-01	1.057E 00	-8.082E-01	2.072E-01	0.7500
-2.199E-02	6.539E-02	-6.441E-02	2.129E-02	1.0000
2.538E-04	-1.346E-03	2.317E-03	-9.549E-04	2.5000

$\langle \hat{U} \hat{V} \rangle$ Coefficients				Interval Limit
A_3	A_2	A_1	A_0	\hat{R}_{max}
-6.569E 01	1.025E 02	-5.334E 01	9.250E 00	0.5200
6.392E 00	-9.925E 00	5.132E 00	-8.852E-01	0.5400
-9.053E 00	1.510E 01	-9.380E 00	1.547E 00	0.5600
5.102E-01	-9.697E-01	6.174E-01	-1.325E-01	0.5800
2.974E 00	-5.257E 00	3.104E 00	-6.133E-01	0.6000
-1.181E 00	2.223E 00	-1.384E 00	2.843E-01	0.6500
2.647E-01	-5.967E-01	4.488E-01	-1.128E-01	0.7500
1.470E-03	-4.485E-03	4.684E-03	-1.734E-03	1.0000
-2.963E-05	1.454E-05	1.846E-04	-2.344E-04	2.5000

Table 6. Continued

Attached-Flow Model

$$\hat{x} = 0.0 \quad \hat{R}_{\text{surface}} = 0.500$$

$\langle \hat{U} \rangle$ Coefficients				Interval Limit
A_3	A_2	A_1	A_0	\hat{R}_{max}
7.197E 03	-1.126E 04	5.880E 03	-1.023E 03	0.5200
4.658E 02	-7.639E 02	4.200E 02	-7.656E 01	0.5400
-2.929E 02	4.652E 02	-2.437E 02	4.291E 01	0.5600
5.759E 02	-9.945E 02	5.737E 02	-1.097E 02	0.5800
-2.067E 02	3.673E 02	-2.161E 02	4.302E 01	0.6000
-1.419E 01	2.079E 01	-8.221E 00	1.437E 00	0.6500
2.130E 01	-4.842E 01	3.677E 01	-8.310E 00	0.7500
7.095E-01	-2.090E 00	2.020E 00	3.767E-01	1.0000
-1.798E-02	9.233E-02	-1.628E-01	1.104E 00	2.5000

$\langle \hat{V} \rangle$ Coefficients				Interval Limit
A_3	A_2	A_1	A_0	\hat{R}_{max}
1.093E 03	-1.713E 03	8.951E 02	-1.559E 02	0.5200
1.315E 02	-2.134E 02	1.153E 02	-2.076E 01	0.5400
1.407E 02	-2.284E 02	1.234E 02	-2.221E 01	0.5600
-2.464E 02	4.219E 02	-2.408E 02	4.577E 01	0.5800
1.413E 02	-2.525E 02	1.504E 02	-2.986E 01	0.6000
-1.155E 01	2.251E 01	-1.463E 01	3.146E 00	0.6500
2.943E-01	-5.954E-01	3.901E-01	-1.080E-01	0.7500
-1.218E-01	3.410E-01	-3.121E-01	6.751E-02	1.0000
1.574E-02	-7.173E-02	1.006E-01	-7.005E-02	2.5000

\hat{k} Coefficients				Interval Limit
A_3	A_2	A_1	A_0	\hat{R}_{max}
-1.895E 02	2.961E 02	-1.542E 02	2.679E 01	0.5200
-2.481E 01	3.920E 01	-2.066E 01	3.635E 00	0.5400
3.915E 01	-6.442E 01	3.530E 01	-6.437E 00	0.5600
-3.633E 01	6.240E 01	-3.572E 01	6.819E 00	0.5800
1.384E 01	-2.491E 01	1.492E 01	-2.971E 00	0.6000
7.504E-01	-1.343E 00	7.776E-01	-1.425E-01	0.6500
-3.448E-01	7.924E-01	-6.106E-01	1.583E-01	0.7500
-2.278E-02	6.783E-02	-6.719E-02	2.243E-02	1.0000
3.511E-04	-1.562E-03	2.199E-03	-6.970E-04	2.5000

$\langle \hat{U} \cdot \hat{V} \rangle$ Coefficients				Interval Limit
A_3	A_2	A_1	A_0	\hat{R}_{max}
-1.360E 02	2.113E 02	-1.094E 02	1.886E 01	0.5200
3.169E 01	-5.038E 01	2.670E 01	-4.719E 00	0.5400
-3.877E 01	6.376E 01	-3.494E 01	6.376E 00	0.5600
3.867E 01	-6.632E 01	3.791E 01	-7.222E 00	0.5800
-1.693E 01	3.042E 01	-1.820E 01	3.626E 00	0.6000
-6.034E-02	4.717E-02	2.292E-02	-1.866E-02	0.6500
2.277E-01	-5.145E-01	3.880E-01	-9.776E-02	0.7500
2.978E-03	-8.879E-03	8.786E-03	-2.953E-03	1.0000
1.734E-05	4.625E-06	-9.786E-05	8.395E-06	2.5000

Table 6. Continued

Attached-Flow Model

$\hat{X} = 0.438$

$\hat{R}_{\text{surface}} = 0.485$

$\langle \hat{U} \rangle$ Coefficients				Interval Limit
A_3	A_2	A_1	A_0	\hat{R}_{max}
7.591E 03	-1.157E 04	5.886E 03	-9.975E 02	0.5050
8.320E 02	-1.333E 03	7.143E 02	-1.270E 02	0.5250
4.832E 02	-7.842E 02	4.259E 02	-7.656E 01	0.5450
-4.101E 02	6.764E 02	-3.701E 02	6.806E 01	0.5650
3.484E 02	-6.092E 02	3.563E 02	-6.874E 01	0.5850
-6.302E 01	1.128E 02	-6.609E 01	1.362E 01	0.6350
2.234E 01	-4.986E 01	3.717E 01	-8.238E 00	0.7350
8.626E-01	-2.496E 00	2.362E 00	2.904E-01	0.9850
-2.166E-02	1.169E-01	-2.117E-01	1.135E 00	2.5000

$\langle \hat{V} \rangle$ Coefficients				Interval Limit
A_3	A_2	A_1	A_0	\hat{R}_{max}
-4.139E 03	6.249E 03	-3.145E 03	5.276E 02	0.5050
5.197E 02	-8.082E 02	4.187E 02	-7.234E 01	0.5250
-2.005E 02	3.261E 02	-1.768E 02	3.187E 01	0.5450
-2.769E 01	4.358E 01	-2.279E 01	3.894E 00	0.5650
1.170E 02	-2.017E 02	1.158E 02	-2.221E 01	0.5850
-2.716E 01	5.133E 01	-3.223E 01	6.659E 00	0.6350
1.176E 00	-2.651E 00	2.048E 00	-5.969E-01	0.7350
3.280E-02	-1.297E-01	1.953E-01	-1.429E-01	0.9850
1.136E-02	-6.638E-02	1.329E-01	-1.224E-01	2.5000

\hat{k} Coefficients				Interval Limit
A_3	A_2	A_1	A_0	\hat{R}_{max}
-2.749E 02	4.164E 02	-2.103E 02	3.540E 01	0.5050
5.570E 00	-8.519E 00	4.316E 00	-7.205E-01	0.5250
-6.127E 00	9.905E 00	-5.356E 00	9.721E-01	0.5450
6.009E 00	-9.939E 00	5.459E 00	-9.926E-01	0.5650
-6.789E 00	1.175E 01	-6.797E 00	1.316E 00	0.5850
1.878E 00	-3.457E 00	2.100E 00	-4.194E-01	0.6350
-3.488E-01	7.858E-01	-5.935E-01	1.508E-01	0.7350
-2.268E-02	6.661E-02	-6.490E-02	2.129E-02	0.9850
1.769E-04	-9.353E-04	1.631E-03	-5.532E-04	2.5000

$\langle \hat{U} \hat{V} \rangle$ Coefficients				Interval Limit
A_3	A_2	A_1	A_0	\hat{R}_{max}
2.209E 01	-3.354E 01	1.699E 01	-2.871E 00	0.5050
8.757E-02	-2.103E-01	1.545E-01	-3.723E-02	0.5250
8.183E 00	-1.296E 01	6.849E 00	-1.209E 00	0.5450
-1.500E 01	2.495E 01	-1.381E 01	2.545E 00	0.5650
1.023E 01	-1.782E 01	1.035E 01	-2.006E 00	0.5850
-1.349E 00	2.500E 00	-1.535E 00	3.118E-01	0.6350
2.256E-01	-4.999E-01	3.699E-01	-9.148E-02	0.7350
3.422E-03	-1.009E-02	9.901E-03	-3.280E-03	0.9850
-4.143E-06	2.930E-05	-7.090E-05	-5.810E-06	2.5000

Table 6. Continued

Attached-Flow Model

$$\hat{\chi} = 0.838 \quad \hat{R}_{\text{surface}} = 0.433$$

 $\langle \hat{U} \rangle$ Coefficients

				Interval Limit
A_3	A_2	A_1	A_0	\hat{R}_{max}
5.757E 03	-7.865E 03	3.586E 03	-5.448E 02	0.4530
-8.120E 01	6.861E 01	-8.140E 00	-2.095E 00	0.4730
1.049E 03	-1.535E 03	7.505E 02	-1.217E 02	0.4930
-7.478E 02	1.122E 03	-5.597E 02	9.360E 01	0.5130
5.831E 02	-9.260E 02	4.911E 02	-8.608E 01	0.5330
-8.906E 01	1.489E 02	-8.181E 01	1.570E 01	0.5830
1.997E 01	-4.183E 01	2.937E 01	-5.904E 00	0.6830
1.291E 00	-3.556E 00	3.225E 00	4.851E-02	0.9330
-2.487E-02	1.269E-01	-2.118E-01	1.117E 00	2.5000

 $\langle \hat{V} \rangle$ Coefficients

				Interval Limit
A_3	A_2	A_1	A_0	\hat{R}_{max}
-1.463E 03	1.981E 03	-8.944E 02	1.345E 02	0.4530
3.395E 02	-4.689E 02	2.156E 02	-3.310E 01	0.4730
-2.634E 02	3.866E 02	-1.891E 02	3.070E 01	0.4930
6.784E 01	-1.033E 02	5.243E 01	-8.981E 00	0.5130
-1.444E 01	2.337E 01	-1.253E 01	2.127E 00	0.5330
1.017E 00	-1.345E 00	6.445E-01	-2.131E-01	0.5830
-2.234E 00	4.339E 00	-2.670E 00	4.309E-01	0.6830
2.438E-01	-7.368E-01	7.973E-01	-3.584E-01	0.9330
1.866E-02	-1.066E-01	2.094E-01	-1.755E-01	2.5000

 \hat{k} Coefficients

				Interval Limit
A_3	A_2	A_1	A_0	\hat{R}_{max}
4.559E 01	-6.036E 01	2.657E 01	-3.885E 00	0.4530
-3.142E 01	4.430E 01	-2.084E 01	3.274E 00	0.4730
9.379E 00	-1.360E 01	6.547E 00	-1.044E 00	0.4930
-1.633E 00	2.689E 00	-1.482E 00	2.757E-01	0.5130
-6.408E 00	1.004E 01	-5.252E 00	9.204E-01	0.5330
2.089E 00	-3.548E 00	1.989E 00	-3.662E-01	0.5830
-2.772E-01	5.903E-01	-4.235E-01	1.027E-01	0.6830
-3.050E-02	8.476E-02	-7.817E-02	2.408E-02	0.9330
3.163E-04	-1.495E-03	2.313E-03	-9.473E-04	2.5000

 $\langle \hat{U} \hat{V} \rangle$ Coefficients

				Interval Limit
A_3	A_2	A_1	A_0	\hat{R}_{max}
-1.292E 02	1.741E 02	-7.816E 01	1.169E 01	0.4530
2.386E 01	-3.392E 01	1.608E 01	-2.546E 00	0.4730
-2.398E 00	3.342E 00	-1.540E 00	2.331E-01	0.4930
6.548E 00	-9.889E 00	4.983E 00	-8.388E-01	0.5130
-3.917E 00	6.217E 00	-3.279E 00	5.740E-01	0.5330
1.076E-01	-2.185E-01	1.507E-01	-3.536E-02	0.5830
7.558E-02	-1.622E-01	1.180E-01	-2.902E-02	0.6830
1.051E-02	-2.923E-02	2.697E-02	-8.286E-03	0.9330
-8.338E-05	4.211E-04	-6.919E-04	3.160E-04	2.5000

Table 6. Continued

Attached-Flow Model

$\hat{X} = 1.238$

$\hat{R}_{\text{surface}} = 0.380$

 $\langle \hat{U} \rangle$ Coefficients

A_3	A_2	A_1	A_0	Interval Limit \hat{R}_{max}
3.842E 02	-5.528E 02	2.630E 02	-4.070E 01	0.4000
1.219E 03	-1.554E 03	6.635E 02	-9.410E 01	0.4200
2.177E 00	-2.144E 01	1.979E 01	-3.985E 00	0.4400
8.271E 01	-1.277E 02	6.657E 01	-1.084E 01	0.4600
2.438E 02	-3.500E 02	1.688E 02	-2.652E 01	0.4800
-4.003E 01	5.867E 01	-2.736E 01	4.864E 00	0.5300
1.076E 01	-2.209E 01	1.544E 01	-2.697E 00	0.6300
2.370E 00	-6.230E 00	5.455E 00	-5.994E-01	0.8800
-1.289E-02	6.020E-02	-8.001E-02	1.024E 00	2.5000

 $\langle \hat{V} \rangle$ Coefficients

A_3	A_2	A_1	A_0	Interval Limit \hat{R}_{max}
2.599E 03	-3.084E 03	1.219E 03	-1.606E 02	0.4000
-6.190E 02	7.774E 02	-3.254E 02	4.528E 01	0.4200
1.052E 02	-1.351E 02	5.783E 01	-8.367E 00	0.4400
-2.878E 01	4.178E 01	-2.000E 01	3.047E 00	0.4600
-7.899E 01	1.111E 02	-5.187E 01	7.934E 00	0.4800
2.537E 01	-3.921E 01	2.027E 01	-3.608E 00	0.5300
-4.707E 00	8.610E 00	-5.080E 00	8.697E-01	0.6300
2.841E-01	-8.220E-01	8.626E-01	-3.782E-01	0.8800
2.441E-02	-1.365E-01	2.593E-01	-2.012E-01	2.5000

 \hat{k} Coefficients

A_3	A_2	A_1	A_0	Interval Limit \hat{R}_{max}
8.916E 01	-1.062E 02	4.216E 01	-5.567E 00	0.4000
-1.886E 01	2.338E 01	-9.689E 00	1.346E 00	0.4200
2.125E 01	-2.716E 01	1.154E 01	-1.626E 00	0.4400
-1.819E 01	2.490E 01	-1.137E 01	1.734E 00	0.4600
2.295E 00	-3.371E 00	1.637E 00	-2.601E-01	0.4800
6.350E-01	-9.808E-01	4.894E-01	-7.652E-02	0.5300
2.601E-02	-1.247E-02	-2.375E-02	1.415E-02	0.6300
-4.999E-02	1.312E-01	-1.142E-01	3.315E-02	0.8800
3.618E-04	-1.764E-03	2.737E-03	-1.164E-03	2.5000

 $\langle \hat{U} - \hat{V} \rangle$ Coefficients

A_3	A_2	A_1	A_0	Interval Limit \hat{R}_{max}
-7.450E 01	8.793E 01	-3.455E 01	4.519E 00	0.4000
3.781E 01	-4.684E 01	1.935E 01	-2.669E 00	0.4200
-2.606E 01	3.363E 01	-1.444E 01	2.063E 00	0.4400
1.465E 01	-2.011E 01	9.201E 00	-1.405E 00	0.4600
-9.485E-01	1.421E 00	-7.021E-01	1.135E-01	0.4800
-6.120E-01	9.363E-01	-4.695E-01	7.629E-02	0.5300
8.575E-02	-1.731E-01	1.185E-01	-2.758E-02	0.6300
1.510E-02	-3.958E-02	3.438E-02	-9.917E-03	0.8800
-1.174E-04	6.029E-04	-9.722E-04	4.542E-04	2.5000

Table 6. Continued

Attached-Flow Model

$$\hat{X} = 1.438 \quad \hat{R}_{\text{surface}} = 0.336$$

$\langle \hat{U} \rangle$ Coefficients				Interval Limit
A_3	A_2	A_1	A_0	\hat{R}_{max}
7.401E 03	-7.930E 03	2.838E 03	-3.387E 02	0.3560
-2.107E 02	1.993E 02	-5.615E 01	4.718E 00	0.3760
3.954E 01	-8.295E 01	4.999E 01	-8.585E 00	0.3960
5.666E 02	-7.091E 02	2.980E 02	-4.132E 01	0.4160
-1.912E 02	2.367E 02	-9.549E 01	1.324E 01	0.4360
8.882E 01	-1.296E 02	6.422E 01	-9.968E 00	0.4860
-1.240E 01	1.794E 01	-7.507E 00	1.651E 00	0.5860
7.237E 00	-1.657E 01	1.272E 01	-2.300E 00	0.8360

$\langle \hat{V} \rangle$ Coefficients				Interval Limit
A_3	A_2	A_1	A_0	\hat{R}_{max}
-1.793E 03	1.924E 03	-6.889E 02	8.213E 01	0.3560
-1.484E 02	1.679E 02	-6.353E 01	7.922E 00	0.3760
1.083E 02	-1.216E 02	4.534E 01	-5.723E 00	0.3960
-1.532E 02	1.891E 02	-7.769E 01	1.052E 01	0.4160
6.965E 01	-8.905E 01	3.802E 01	-5.527E 00	0.4360
-1.538E 01	2.216E 01	-1.047E 01	1.520E 00	0.4860
5.778E-01	-1.106E 00	8.335E-01	-3.117E-01	0.5860
1.840E-01	-4.132E-01	4.277E-01	-2.324E-01	0.8360

\hat{k} Coefficients				Interval Limit
A_3	A_2	A_1	A_0	\hat{R}_{max}
-2.504E 02	2.648E 02	-9.335E 01	1.097E 01	0.3560
5.233E 01	-5.846E 01	2.173E 01	-2.683E 00	0.3760
-5.241E 00	6.476E 00	-2.685E 00	3.768E-01	0.3960
-4.765E 00	5.911E 00	-2.461E 00	3.472E-01	0.4160
3.563E 00	-4.483E 00	1.863E 00	-2.523E-01	0.4360
-1.654E 00	2.341E 00	-1.113E 00	1.800E-01	0.4860
3.898E-01	-6.385E-01	3.354E-01	-5.452E-02	0.5860
-4.963E-02	1.339E-01	-1.173E-01	3.390E-02	0.8360

$\langle \hat{U} \hat{V} \rangle$ Coefficients				Interval Limit
A_3	A_2	A_1	A_0	\hat{R}_{max}
1.141E 02	-1.208E 02	4.264E 01	-5.020E 00	0.3560
-2.112E 01	2.359E 01	-8.758E 00	1.079E 00	0.3760
3.348E 00	-4.013E 00	1.619E 00	-2.215E-01	0.3960
-2.438E 00	2.861E 00	-1.103E 00	1.378E-01	0.4160
2.504E 00	-3.307E 00	1.463E 00	-2.180E-01	0.4360
3.271E-01	-4.595E-01	2.215E-01	-3.758E-02	0.4860
-1.735E-01	2.703E-01	-1.330E-01	1.988E-02	0.5860
7.652E-02	-1.692E-01	1.245E-01	-3.043E-02	0.8360

Table 6. Continued

Attached-Flow Model

$\hat{X} = 1.638$

$\hat{R}_{\text{surface}} = 0.289$

 $\langle \hat{U} \rangle$ Coefficients

				Interval Limit
A_3	A_2	A_1	A_0	\hat{R}_{max}
1.463E 03	-1.383E 03	4.416E 02	-4.721E 01	0.3090
-2.631E 00	-2.434E 01	2.171E 01	-3.964E 00	0.3290
9.521E 01	-1.209E 02	5.348E 01	-7.448E 00	0.3490
-2.009E-01	-2.101E 01	1.861E 01	-3.392E 00	0.3690
1.283E 02	-1.633E 02	7.112E 01	-9.850E 00	0.3890
7.324E 01	-9.900E 01	4.611E 01	-6.607E 00	0.4390
-2.804E 00	1.147E 00	2.143E 00	-1.734E-01	0.5390
4.430E 00	-1.055E 01	8.448E 00	-1.306E 00	0.7890
2.102E-02	-1.143E-01	2.139E-01	8.594E-01	2.5000

 $\langle \hat{V} \rangle$ Coefficients

				Interval Limit
A_3	A_2	A_1	A_0	\hat{R}_{max}
-1.772E 03	1.639E 03	-5.061E 02	5.206E 01	0.3090
3.768E 02	-3.526E 02	1.094E 02	-1.134E 01	0.3290
-4.670E 02	4.802E 02	-1.646E 02	1.871E 01	0.3490
2.679E 02	-2.892E 02	1.040E 02	-1.253E 01	0.3690
-1.438E 02	1.665E 02	-6.418E 01	8.156E 00	0.3890
1.199E 01	-1.527E 01	6.527E 00	-1.013E 00	0.4390
-2.028E 00	3.184E 00	-1.576E 00	1.723E-01	0.5390
5.732E-02	-1.871E-01	2.417E-01	-1.542E-01	0.7890
1.697E-02	-9.163E-02	1.663E-01	-1.344E-01	2.5000

 \hat{k} Coefficients

				Interval Limit
A_3	A_2	A_1	A_0	\hat{R}_{max}
-6.127E 02	5.634E 02	-1.726E 02	1.763E 01	0.3090
8.781E 01	-8.594E 01	2.800E 01	-3.033E 00	0.3290
-1.967E 01	2.016E 01	-6.901E 00	7.945E-01	0.3490
5.860E 00	-6.579E 00	2.429E 00	-2.910E-01	0.3690
8.776E 00	-9.806E 00	3.620E 00	-4.375E-01	0.3890
-3.613E 00	4.652E 00	-2.004E 00	2.918E-01	0.4390
5.387E-01	-8.164E-01	3.966E-01	-5.949E-02	0.5390
-7.239E-02	1.717E-01	-1.360E-01	3.620E-02	0.7890
-1.476E-04	7.386E-04	-1.115E-03	7.151E-04	2.5000

 $\langle \hat{U} \hat{V} \rangle$ Coefficients

				Interval Limit
A_3	A_2	A_1	A_0	\hat{R}_{max}
5.530E 02	-5.095E 02	1.564E 02	-1.601E 01	0.3090
-6.108E 01	5.976E 01	-1.947E 01	2.110E 00	0.3290
1.887E 01	-1.915E 01	6.490E 00	-7.369E-01	0.3490
-1.553E 01	1.687E 01	-6.081E 00	7.255E-01	0.3690
2.859E 00	-3.490E 00	1.431E 00	-1.985E-01	0.3890
1.155E 00	-1.502E 00	6.578E-01	-9.822E-02	0.4390
-1.476E-01	2.133E-01	-9.514E-02	1.196E-02	0.5390
3.412E-02	-8.055E-02	6.325E-02	-1.649E-02	0.7890
-7.774E-05	3.928E-04	-6.156E-04	3.016E-04	2.5000

Table 6. Continued

Attached-Flow Model

$$\hat{X} = 1.688 \quad \hat{R}_{\text{surface}} = 0.276$$

$\langle \hat{U} \rangle$ Coefficients				Interval Limit
A_3	A_2	A_1	A_0	\hat{R}_{max}
3.513E 03	-3.135E 03	9.382E 02	-9.389E 01	0.2960
-2.326E 02	1.916E 02	-4.639E 01	3.262E 00	0.3160
3.899E 02	-3.985E 02	1.401E 02	-1.638E 01	0.3360
-4.731E 02	4.715E 02	-1.522E 02	1.636E 01	0.3560
3.405E 02	-3.975E 02	1.571E 02	-2.035E 01	0.3760
6.289E 01	-8.437E 01	3.938E 01	-5.594E 00	0.4260
2.317E 00	-6.957E 00	6.406E 00	-9.112E-01	0.5260
3.849E 00	-9.376E 00	7.678E 00	-1.134E 00	0.7760

$\langle \hat{V} \rangle$ Coefficients				Interval Limit
A_3	A_2	A_1	A_0	\hat{R}_{max}
-3.104E 03	2.745E 03	-8.097E 02	7.957E 01	0.2960
4.459E 02	-4.067E 02	1.233E 02	-1.249E 01	0.3160
-5.431E 02	5.308E 02	-1.729E 02	1.872E 01	0.3360
5.289E 02	-5.497E 02	1.901E 02	-2.195E 01	0.3560
-2.801E 02	3.143E 02	-1.175E 02	1.455E 01	0.3760
1.274E 01	-1.602E 01	6.737E 00	-1.014E 00	0.4260
-5.539E-01	9.649E-01	-5.004E-01	1.412E-02	0.5260
-2.433E-01	4.749E-01	-2.427E-01	-3.107E-02	0.7760

\hat{k} Coefficients ^S				Interval Limit
A_3	A_2	A_1	A_0	\hat{R}_{max}
-7.887E 01	6.956E 01	-2.043E 01	2.003E 00	0.2960
-3.283E 00	2.434E 00	-5.593E-01	4.244E-02	0.3160
4.847E 00	-5.273E 00	1.876E 00	-2.141E-01	0.3360
9.774E 00	-1.024E 01	3.545E 00	-4.010E-01	0.3560
8.163E-01	-6.726E-01	1.390E-01	3.170E-03	0.3760
-1.871E 00	2.359E 00	-1.001E 00	1.460E-01	0.4260
1.453E-01	-2.182E-01	9.700E-02	-9.859E-03	0.5260
4.500E-02	-5.987E-02	1.373E-02	4.740E-03	0.7760

$\langle \hat{U} \cdot \hat{V} \rangle$ Coefficients				Interval Limit
A_3	A_2	A_1	A_0	\hat{R}_{max}
1.419E 02	-1.237E 02	3.594E 01	-3.480E 00	0.2960
-5.129E 01	4.781E 01	-1.484E 01	1.531E 00	0.3160
2.705E 01	-2.645E 01	8.628E 00	-9.411E-01	0.3360
-1.797E 01	1.893E 01	-6.621E 00	7.667E-01	0.3560
2.069E 00	-2.476E 00	9.997E-01	-1.376E-01	0.3760
9.292E-01	-1.191E 00	5.164E-01	-7.700E-02	0.4260
-4.698E-02	5.690E-02	-1.502E-02	-1.537E-03	0.5260
1.026E-02	-3.343E-02	3.250E-02	-9.868E-03	0.7760

Table 6. Continued

Attached-Flow Model

$\hat{\chi} = 1.738$

$\hat{R}_{\text{surface}} = 0.262$

$\langle \hat{U} \rangle$ Coefficients				Interval Limit
A_3	A_2	A_1	A_0	\hat{R}_{max}
2.595E 04	-2.186E 04	6.139E 03	-5.749E 02	0.2820
-2.595E 03	2.296E 03	-6.719E 02	6.531E 01	0.3020
1.279E 03	-1.214E 03	3.880E 02	-4.139E 01	0.3220
-8.624E 02	8.551E 02	-2.781E 02	3.011E 01	0.3420
1.008E 02	-1.332E 02	5.991E 01	-8.421E 00	0.3620
1.358E 02	-1.712E 02	7.367E 01	-1.008E 01	0.4120
-5.971E-01	-2.623E 00	4.227E 00	-5.448E-01	0.5120
4.310E 00	-1.016E 01	8.085E 00	-1.203E 00	0.7620

$\langle \hat{V} \rangle$ Coefficients				Interval Limit
A_3	A_2	A_1	A_0	\hat{R}_{max}
-1.755E 04	1.474E 04	-4.127E 03	3.850E 02	0.2820
2.621E 03	-2.321E 03	6.844E 02	-6.726E 01	0.3020
-1.419E 03	1.339E 03	-4.210E 02	4.402E 01	0.3220
6.486E 02	-6.581E 02	2.222E 02	-2.501E 01	0.3420
-2.969E 01	3.780E 01	-1.582E 01	2.119E 00	0.3620
-4.307E 01	5.234E 01	-2.108E 01	2.754E 00	0.4120
3.350E 00	-5.038E 00	2.556E 00	-4.923E-01	0.5120
-1.669E-01	3.639E-01	-2.097E-01	-2.025E-02	0.7620

\hat{k} Coefficients				Interval Limit
A_3	A_2	A_1	A_0	\hat{R}_{max}
3.130E 02	-2.605E 02	7.224E 01	-6.669E 00	0.2820
-1.228E 02	1.082E 02	-3.174E 01	3.104E 00	0.3020
6.508E 01	-6.204E 01	1.968E 01	-2.072E 00	0.3220
-2.162E 01	2.172E 01	-7.291E 00	8.230E-01	0.3420
1.329E 01	-1.411E 01	4.960E 00	-5.736E-01	0.3620
-2.170E 00	2.684E 00	-1.118E 00	1.598E-01	0.4120
-1.630E-02	2.197E-02	-2.109E-02	9.201E-03	0.5120
8.690E-02	-1.365E-01	6.008E-02	-4.650E-03	0.7620

$\langle \hat{U} \cdot \hat{V} \rangle$ Coefficients				Interval Limit
A_3	A_2	A_1	A_0	\hat{R}_{max}
-3.174E 02	2.655E 02	-7.401E 01	6.873E 00	0.2820
8.878E 01	-7.812E 01	2.289E 01	-2.236E 00	0.3020
-5.141E 01	4.889E 01	-1.547E 01	1.626E 00	0.3220
2.061E 01	-2.068E 01	6.933E 00	-7.789E-01	0.3420
-1.330E 01	1.411E 01	-4.965E 00	5.775E-01	0.3620
2.386E 00	-2.927E 00	1.202E 00	-1.667E-01	0.4120
-1.147E-01	1.639E-01	-7.120E-02	8.186E-03	0.5120
-9.782E-03	2.857E-03	1.127E-02	-5.889E-03	0.7620

Table 6. Continued

Attached-Flow Model

$$\hat{x} = 1.788 \quad \hat{R}_{\text{surface}} = 0.261$$

$\langle \hat{U} \rangle$ Coefficients				Interval Limit
A_3	A_2	A_1	A_0	\hat{R}_{max}
4.199E 03	-3.529E 03	9.935E 02	-9.353E 01	0.2810
-4.109E 02	3.572E 02	-9.845E 01	8.754E 00	0.3010
2.478E 02	-2.377E 02	8.060E 01	-9.211E 00	0.3210
-2.755E 02	2.663E 02	-8.117E 01	8.098E 00	0.3410
-8.984E 01	7.631E 01	-1.640E 01	7.362E-01	0.3610
9.701E 01	-1.260E 02	5.665E 01	-8.054E 00	0.4110
9.722E 00	-1.842E 01	1.242E 01	-1.994E 00	0.5110
3.427E 00	-8.773E 00	7.489E 00	-1.154E 00	0.7610
1.003E 01	-2.385E 01	1.896E 01	-4.065E 00	2.5000

$\langle \hat{V} \rangle$ Coefficients				Interval Limit
A_3	A_2	A_1	A_0	\hat{R}_{max}
-7.666E 03	6.393E 03	-1.776E 03	1.645E 02	0.2810
1.740E 03	-1.537E 03	4.517E 02	-4.424E 01	0.3010
-8.297E 02	7.839E 02	-2.467E 02	2.585E 01	0.3210
3.536E 02	-3.556E 02	1.190E 02	-1.329E 01	0.3410
-1.226E 02	1.316E 02	-4.709E 01	5.590E 00	0.3610
1.255E 01	-1.485E 01	5.759E 00	-7.699E-01	0.4110
-1.556E 00	2.543E 00	-1.388E 00	2.092E-01	0.5110
-1.759E-01	4.279E-01	-3.072E-01	2.510E-02	0.7610
-2.562E 00	5.876E 00	-4.453E 00	1.077E 00	2.5000

\hat{k} Coefficients				Interval Limit
A_3	A_2	A_1	A_0	\hat{R}_{max}
-3.893E 01	3.250E 01	-8.978E 00	8.252E-01	0.2810
-1.468E 01	1.205E 01	-3.234E 00	2.871E-01	0.3010
1.235E 01	-1.236E 01	4.114E 00	-4.501E-01	0.3210
-8.196E 00	7.432E 00	-2.238E 00	2.296E-01	0.3410
2.237E 01	-2.384E 01	8.424E 00	-9.824E-01	0.3610
-2.087E 00	2.650E 00	-1.137E 00	1.682E-01	0.4110
-2.939E-01	4.388E-01	-2.285E-01	4.369E-02	0.5110
9.016E-02	-1.499E-01	7.231E-02	-7.548E-03	0.7610
-6.131E-01	1.456E 00	-1.149E 00	3.024E-01	2.5000

$\langle \hat{u} \cdot \hat{v} \rangle$ Coefficients				Interval Limit
A_3	A_2	A_1	A_0	\hat{R}_{max}
2.281E 02	-1.897E 02	5.252E 01	-4.844E 00	0.2810
-5.366E 01	4.784E 01	-1.423E 01	1.409E 00	0.3010
2.728E 01	-2.525E 01	7.774E 00	-7.990E-01	0.3210
-1.133E 01	1.193E 01	-4.162E 00	4.781E-01	0.3410
-9.616E 00	1.018E 01	-3.565E 00	4.103E-01	0.3610
1.288E 00	-1.630E 00	6.981E-01	-1.027E-01	0.4110
1.279E-01	-1.997E-01	1.103E-01	-2.216E-02	0.5110
-3.409E-02	4.872E-02	-1.657E-02	-5.426E-04	0.7610
3.824E-01	-9.022E-01	7.071E-01	-1.841E-01	2.5000

Table 6. Continued

Attached-Flow Model

$$\hat{X} = 1.838 \quad \hat{R}_{\text{surface}} = 0.316$$

$\langle \hat{U} \rangle$ Coefficients					Interval Limit
A_3	A_2	A_1	A_0	\hat{R}_{max}	
7.119E 03	-7.144E 03	2.392E 03	-2.667E 02	0.3360	
-3.875E 02	4.224E 02	-1.503E 02	1.806E 01	0.3560	
-6.048E 02	6.545E 02	-2.329E 02	2.786E 01	0.3760	
3.462E 02	-4.183E 02	1.705E 02	-2.269E 01	0.3960	
-1.905E 01	1.565E 01	-1.362E 00	-9.635E-03	0.4160	
3.576E 01	-5.275E 01	2.709E 01	-3.955E 00	0.4660	
3.774E-01	-3.290E 00	4.044E 00	-3.752E-01	0.5660	
3.535E 00	-8.652E 00	7.079E 00	-9.478E-01	0.8160	
-5.532E-03	1.573E-02	6.136E-03	9.761E-01	2.5000	

$\langle \hat{V} \rangle$ Coefficients					Interval Limit
A_3	A_2	A_1	A_0	\hat{R}_{max}	
1.436E 03	-1.404E 03	4.562E 02	-4.927E 01	0.3360	
-1.266E 03	1.320E 03	-4.589E 02	5.322E 01	0.3560	
8.751E 02	-9.662E 02	3.550E 02	-4.336E 01	0.3760	
-4.656E 02	5.461E 02	-2.137E 02	2.791E 01	0.3960	
1.370E 02	-1.698E 02	6.985E 01	-9.517E 00	0.4160	
-3.151E 00	5.128E 00	-2.920E 00	5.736E-01	0.4660	
-1.571E 00	2.920E 00	-1.891E 00	4.138E-01	0.5660	
-3.051E-01	7.697E-01	-6.740E-01	1.842E-01	0.8160	
-6.294E-03	3.817E-02	-7.710E-02	2.186E-02	2.5000	

\hat{k} Coefficients					Interval Limit
A_3	A_2	A_1	A_0	\hat{R}_{max}	
-2.296E 02	2.292E 02	-7.617E 01	8.433E 00	0.3360	
-8.730E 00	6.559E 00	-1.367E 00	5.504E-02	0.3560	
5.708E 01	-6.373E 01	2.366E 01	-2.914E 00	0.3760	
-7.105E 00	8.675E 00	-3.568E 00	4.977E-01	0.3960	
3.317E 00	-3.707E 00	1.335E 00	-1.495E-01	0.4160	
-3.410E 00	4.688E 00	-2.157E 00	3.348E-01	0.4660	
4.185E-01	-6.635E-01	3.370E-01	-5.261E-02	0.5660	
-6.286E-02	1.539E-01	-1.256E-01	3.467E-02	0.8160	
5.371E-05	-1.585E-04	5.512E-05	4.899E-04	2.5000	

$\langle \hat{U} \cdot \hat{V} \rangle$ Coefficients					Interval Limit
A_3	A_2	A_1	A_0	\hat{R}_{max}	
-4.199E 01	4.408E 01	-1.546E 01	1.808E 00	0.3360	
-3.949E 00	5.743E 00	-2.579E 00	3.652E-01	0.3560	
-3.359E 01	3.740E 01	-1.385E 01	1.703E 00	0.3760	
7.967E 00	-9.476E 00	3.778E 00	-5.065E-01	0.3960	
-3.113E 00	3.686E 00	-1.435E 00	1.815E-01	0.4160	
1.399E 00	-1.945E 00	9.076E-01	-1.433E-01	0.4660	
-1.104E-01	1.653E-01	-7.563E-02	9.439E-03	0.5660	
2.997E-02	-7.306E-02	5.931E-02	-1.602E-02	0.8160	
-1.766E-04	7.359E-04	-9.077E-04	3.598E-04	2.5000	

Table 6. Continued

Attached-Flow Model

$$\hat{X} = 1.838 \quad \hat{R}_{\text{surface}} = 0.276$$

$\langle \hat{U} \rangle$ Coefficients				Interval Limit
A_3	A_2	A_1	A_0	\hat{R}_{max}
-1.216E 03	1.087E 03	-3.196E 02	3.123E 01	0.2960
-3.807E 02	3.454E 02	-1.001E 02	9.565E 00	0.3160
1.449E 02	-1.528E 02	5.737E 01	-7.018E 00	0.3360
-1.202E 02	1.144E 02	-3.242E 01	3.039E 00	0.3560
-6.830E 01	5.894E 01	-1.267E 01	6.952E-01	0.3760
1.045E 02	-1.360E 02	6.062E 01	-8.491E 00	0.4260
-4.545E 00	3.385E 00	1.249E 00	-5.991E-02	0.5260
4.959E 00	-1.161E 01	9.137E 00	-1.443E 00	0.7760
2.244E-02	-1.200E-01	2.189E-01	8.638E-01	2.5000

$\langle \hat{V} \rangle$ Coefficients				Interval Limit
A_3	A_2	A_1	A_0	\hat{R}_{max}
-1.473E 03	1.311E 03	-3.895E 02	3.865E 01	0.2960
3.761E 02	-3.314E 02	9.659E 01	-9.309E 00	0.3160
-7.433E 02	7.298E 02	-2.387E 02	2.601E 01	0.3360
4.734E 02	-4.966E 02	1.733E 02	-2.014E 01	0.3560
-1.908E 02	2.128E 02	-7.922E 01	9.829E 00	0.3760
2.430E 01	-2.983E 01	1.202E 01	-1.606E 00	0.4260
-3.564E 00	5.774E 00	-3.149E 00	5.481E-01	0.5260
-2.016E-01	4.678E-01	-3.584E-01	5.869E-02	0.7760
3.111E-04	-2.294E-03	6.410E-03	-3.567E-02	2.5000

\hat{k} Coefficients				Interval Limit
A_3	A_2	A_1	A_0	\hat{R}_{max}
-1.122E 02	9.588E 01	-2.720E 01	2.567E 00	0.2960
5.392E 01	-5.167E 01	1.648E 01	-1.743E 00	0.3160
1.317E 01	-1.304E 01	4.271E 00	-4.568E-01	0.3360
-1.473E 01	1.509E 01	-5.181E 00	6.018E-01	0.3560
2.211E 01	-2.425E 01	8.825E 00	-1.060E 00	0.3760
-5.182E 00	6.526E 00	-2.748E 00	3.903E-01	0.4260
5.058E-01	-7.439E-01	3.486E-01	-4.949E-02	0.5260
-7.142E-02	1.669E-01	-1.305E-01	3.452E-02	0.7760
-2.271E-04	1.175E-03	-1.879E-03	1.248E-03	2.5000

$\langle \hat{U} \hat{V} \rangle$ Coefficients				Interval Limit
A_3	A_2	A_1	A_0	\hat{R}_{max}
-4.784E 01	4.455E 01	-1.382E 01	1.427E 00	0.2960
-3.719E 01	3.509E 01	-1.103E 01	1.150E 00	0.3160
1.474E 01	-1.414E 01	4.531E 00	-4.882E-01	0.3360
-1.979E 01	2.067E 01	-7.165E 00	8.218E-01	0.3560
5.996E 00	-6.873E 00	2.640E 00	-3.417E-01	0.3760
7.636E-01	-9.709E-01	4.209E-01	-6.355E-02	0.4260
-1.110E-01	1.467E-01	-5.528E-02	4.057E-03	0.5260
3.797E-02	-8.829E-02	6.833E-02	-1.762E-02	0.7760
-3.924E-05	1.981E-04	-3.376E-04	1.459E-04	2.5000

Table 6. Continued

Attached-Flow Model

$\hat{X} = 1.938$

$\hat{R}_{\text{surface}} = 0.302$

 $\langle \hat{U} \rangle$ Coefficients

				Interval Limit
A_3	A_2	A_1	A_0	\hat{R}_{max}
2.013E 03	-1.943E 03	6.283E 02	-6.765E 01	0.3220
-1.185E 02	1.165E 02	-3.468E 01	3.516E 00	0.3420
-1.126E 02	1.105E 02	-3.263E 01	3.282E 00	0.3620
-1.007E 02	9.748E 01	-2.793E 01	2.715E 00	0.3820
1.564E 02	-1.972E 02	8.463E 01	-1.162E 01	0.4020
3.980E 01	-5.651E 01	2.808E 01	-4.040E 00	0.4520
-1.563E 00	-4.222E-01	2.729E 00	-2.205E-01	0.5520
3.722E 00	-9.174E 00	7.560E 00	-1.109E 00	0.8020
5.875E 00	-1.435E 01	1.172E 01	-2.220E 00	2.5000

 $\langle \hat{V} \rangle$ Coefficients

				Interval Limit
A_3	A_2	A_1	A_0	\hat{R}_{max}
-3.704E 03	3.557E 03	-1.139E 03	1.216E 02	0.3220
7.588E 02	-7.546E 02	2.495E 02	-2.742E 01	0.3420
-5.742E 02	6.131E 02	-2.182E 02	2.591E 01	0.3620
2.269E 02	-2.569E 02	9.671E 01	-1.209E 01	0.3820
-8.425E 01	9.966E 01	-3.948E 01	5.247E 00	0.4020
2.235E 01	-2.890E 01	1.220E 01	-1.678E 00	0.4520
-4.408E 00	7.381E 00	-4.197E 00	7.929E-01	0.5520
3.463E-01	-4.914E-01	1.485E-01	-6.723E-03	0.8020
-7.961E 00	1.950E 01	-1.589E 01	4.278E 00	2.5000

 \hat{k} Coefficients

				Interval Limit
A_3	A_2	A_1	A_0	\hat{R}_{max}
-3.879E 00	2.471E 00	-3.460E-01	-9.322E-03	0.3220
-1.544E 01	1.364E 01	-3.941E 00	3.766E-01	0.3420
5.494E 01	-5.857E 01	2.075E 01	-2.438E 00	0.3620
-1.871E 01	2.141E 01	-8.200E 00	1.055E 00	0.3820
6.285E 00	-7.232E 00	2.742E 00	-3.382E-01	0.4020
-2.733E 00	3.643E 00	-1.630E 00	2.476E-01	0.4520
3.505E-01	-5.374E-01	2.596E-01	-3.705E-02	0.5520
-3.739E-02	1.049E-01	-9.498E-02	2.818E-02	0.8020
-2.677E-01	6.591E-01	-5.394E-01	1.470E-01	2.5000

 $\langle \hat{U} \hat{V} \rangle$ Coefficients

				Interval Limit
A_3	A_2	A_1	A_0	\hat{R}_{max}
1.511E 02	-1.432E 02	4.519E 01	-4.750E 00	0.3220
-4.249E 01	4.378E 01	-1.502E 01	1.713E 00	0.3420
5.104E-01	-3.414E-01	7.059E-02	-7.541E-03	0.3620
-1.188E 01	1.312E 01	-4.802E 00	5.804E-01	0.3820
8.208E 00	-9.907E 00	3.994E 00	-5.396E-01	0.4020
1.580E-01	-1.981E-01	9.091E-02	-1.659E-02	0.4520
-1.585E-01	2.310E-01	-1.031E-01	1.263E-02	0.5520
4.470E-02	-1.055E-01	8.269E-02	-2.155E-02	0.8020
1.514E-02	-3.437E-02	2.565E-02	-6.298E-03	2.5000

Table 6. Continued

Attached-Flow Model

$\hat{X} = 2.438$

$\hat{R}_{\text{surface}} = 0.342$

 $\langle \hat{U} \rangle$ Coefficients

				Interval Limit
A_3	A_2	A_1	A_0	\hat{R}_{max}
7.681E 03	-8.357E 03	3.033E 03	-3.665E 02	0.3620
4.912E 02	-5.494E 02	2.068E 02	-2.547E 01	0.3820
-3.669E 02	4.340E 02	-1.689E 02	2.237E 01	0.4020
-1.006E 02	1.128E 02	-3.976E 01	5.064E 00	0.4220
1.540E 02	-2.095E 02	9.624E 01	-1.407E 01	0.4420
1.481E 01	-2.491E 01	1.466E 01	-2.048E 00	0.4920
4.057E 00	-9.033E 00	6.853E 00	-7.668E-01	0.5920
2.500E 00	-6.268E 00	5.216E 00	-4.438E-01	0.8420
-2.021E-02	9.832E-02	-1.442E-01	1.061E 00	2.5000

 $\langle \hat{V} \rangle$ Coefficients

				Interval Limit
A_3	A_2	A_1	A_0	\hat{R}_{max}
4.816E 02	-4.981E 02	1.710E 02	-1.948E 01	0.3620
-6.253E 02	7.040E 02	-2.642E 02	3.303E 01	0.3820
3.899E 02	-4.594E 02	1.802E 02	-2.356E 01	0.4020
-1.734E 02	2.198E 02	-9.283E 01	1.303E 01	0.4220
-1.625E 01	2.091E 01	-8.897E 00	1.226E 00	0.4420
5.148E 00	-7.466E 00	3.645E 00	-6.220E-01	0.4920
-1.036E 00	1.662E 00	-8.459E-01	1.165E-01	0.5920
2.400E-01	-6.036E-01	4.957E-01	-1.502E-01	0.8420
1.531E-03	-1.365E-03	-1.143E-02	-7.902E-03	2.5000

 \hat{k} Coefficients

				Interval Limit
A_3	A_2	A_1	A_0	\hat{R}_{max}
-3.911E 02	4.246E 02	-1.536E 02	1.852E 01	0.3620
-2.655E 01	2.871E 01	-1.030E 01	1.231E 00	0.3820
1.592E 01	-1.996E 01	8.289E 00	-1.136E 00	0.4020
2.773E 01	-3.421E 01	1.402E 01	-1.904E 00	0.4220
-1.183E 01	1.587E 01	-7.119E 00	1.069E 00	0.4420
-1.467E 00	2.134E 00	-1.045E 00	1.744E-01	0.4920
2.361E-01	-3.798E-01	1.919E-01	-2.845E-02	0.5920
-5.335E-02	1.343E-01	-1.125E-01	3.161E-02	0.8420
2.325E-04	-1.022E-03	1.503E-03	-3.782E-04	2.5000

 $\langle \hat{U} \hat{V} \rangle$ Coefficients

				Interval Limit
A_3	A_2	A_1	A_0	\hat{R}_{max}
1.928E 02	-2.084E 02	7.505E 01	-9.005E 00	0.3620
-8.972E 00	1.071E 01	-4.265E 00	5.651E-01	0.3820
1.570E 01	-1.757E 01	6.536E 00	-8.102E-01	0.4020
-4.161E 01	5.155E 01	-2.125E 01	2.913E 00	0.4220
1.976E 01	-2.615E 01	1.154E 01	-1.699E 00	0.4420
-5.309E-01	7.580E-01	-3.534E-01	5.298E-02	0.4920
4.081E-02	-8.584E-02	6.179E-02	-1.511E-02	0.5920
1.812E-02	-4.553E-02	3.791E-02	-1.040E-02	0.8420
-6.712E-05	4.071E-04	-7.654E-04	4.514E-04	2.5000

Table 6. Continued

Attached-Flow Model

$\hat{\lambda} = 2.938$

$\hat{R}_{\text{surface}} = 0.341$

$\langle \hat{U} \rangle$ Coefficients				Interval Limit
A_3	A_2	A_1	A_0	\hat{R}_{max}
2.950E 03	-3.186E 03	1.149E 03	-1.376E 02	0.3610
-4.084E 02	4.508E 02	-1.639E 02	2.035E 01	0.3810
6.345E 02	-7.413E 02	2.902E 02	-3.733E 01	0.4010
-9.345E 02	1.146E 03	-4.667E 02	6.384E 01	0.4210
6.222E 02	-8.199E 02	3.611E 02	-5.232E 01	0.4410
-4.289E 01	6.006E 01	-2.697E 01	4.729E 00	0.4910
3.835E 00	-8.766E 00	6.824E 00	-8.019E-01	0.5910
2.645E 00	-6.656E 00	5.577E 00	-5.562E-01	0.8410
-7.914E-03	3.695E-02	-5.216E-02	1.022E 00	2.5000

$\langle \hat{V} \rangle$ Coefficients				Interval Limit
A_3	A_2	A_1	A_0	\hat{R}_{max}
-9.241E 02	9.903E 02	-3.537E 02	4.212E 01	0.3610
4.002E 02	-4.440E 02	1.640E 02	-2.019E 01	0.3810
-4.105E 02	4.826E 02	-1.890E 02	2.465E 01	0.4010
3.395E 02	-4.196E 02	1.728E 02	-2.371E 01	0.4210
-1.900E 02	2.491E 02	-1.088E 02	1.580E 01	0.4410
1.598E 01	-2.337E 01	1.141E 01	-1.868E 00	0.4910
-9.519E-01	1.577E 00	-8.378E-01	1.360E-01	0.5910
1.320E-01	-3.448E-01	2.979E-01	-8.774E-02	0.8410
7.215E-03	-3.010E-02	3.322E-02	-1.355E-02	2.5000

\hat{k} Coefficients				Interval Limit
A_3	A_2	A_1	A_0	\hat{R}_{max}
2.711E 01	-2.952E 01	1.071E 01	-1.292E 00	0.3610
1.153E 01	-1.266E 01	4.625E 00	-5.589E-01	0.3810
-3.352E 01	3.884E 01	-1.499E 01	1.933E 00	0.4010
3.839E 01	-4.767E 01	1.970E 01	-2.704E 00	0.4210
-1.319E 01	1.748E 01	-7.733E 00	1.145E 00	0.4410
-2.391E-01	3.416E-01	-1.747E-01	3.399E-02	0.4910
1.635E-01	-2.514E-01	1.165E-01	-1.366E-02	0.5910
-5.157E-02	1.299E-01	-1.089E-01	3.073E-02	0.8410
1.069E-04	-5.182E-04	7.921E-04	-5.663E-06	2.5000

$\langle \hat{U} \hat{V} \rangle$ Coefficients				Interval Limit
A_3	A_2	A_1	A_0	\hat{R}_{max}
9.773E 01	-1.043E 02	3.704E 01	-4.383E 00	0.3610
-3.582E 01	4.038E 01	-1.518E 01	1.900E 00	0.3810
3.098E 01	-3.597E 01	1.391E 01	-1.795E 00	0.4010
-3.530E 01	4.376E 01	-1.806E 01	2.479E 00	0.4210
1.436E 01	-1.896E 01	8.349E 00	-1.227E 00	0.4410
-2.691E-01	3.949E-01	-1.875E-01	2.802E-02	0.4910
-4.890E-02	7.051E-02	-2.829E-02	1.958E-03	0.5910
2.190E-02	-5.501E-02	4.589E-02	-1.266E-02	0.8410
-1.114E-04	5.304E-04	-8.167E-04	4.379E-04	2.5000

Table 6. Concluded

Attached-Flow Model

$$\hat{X} = 3.938 \quad \hat{R}_{\text{surface}} = 0.342$$

$\langle \hat{U} \rangle$ Coefficients				Interval Limit
A_3	A_2	A_1	A_0	\hat{R}_{max}
1.036E 04	-1.129E 04	4.105E 03	-4.973E 02	0.3620
4.202E 02	-4.974E 02	1.980E 02	-2.572E 01	0.3820
-1.608E 02	1.685E 02	-5.637E 01	6.672E 00	0.4020
8.643E 02	-1.068E 03	4.406E 02	-5.992E 01	0.4220
-6.205E 02	8.120E 02	-3.527E 02	5.166E 01	0.4420
6.294E 01	-9.430E 01	4.793E 01	-7.357E 00	0.4920
-2.295E 00	1.994E 00	5.565E+01	4.129E-01	0.5920
2.798E 00	-7.052E 00	5.912E 00	-6.439E-01	0.8420
-7.857E-03	3.621E-02	-5.620E-02	1.031E 00	2.5000

$\langle \hat{V} \rangle$ Coefficients				Interval Limit
A_3	A_2	A_1	A_0	\hat{R}_{max}
6.453E 02	-6.801E 02	2.387E 02	-2.790E 01	0.3620
-5.937E 02	6.654E 02	-2.484E 02	3.087E 01	0.3820
3.538E 02	-4.204E 02	1.663E 02	-2.194E 01	0.4020
-1.411E 02	1.765E 02	-7.358E 01	1.021E 01	0.4220
5.053E 01	-6.618E 01	2.881E 01	-4.194E 00	0.4420
-1.282E 00	2.523E 00	-1.553E 00	2.804E-01	0.4920
-2.643E 00	4.531E 00	-2.542E 00	4.425E-01	0.5920
2.005E-01	-5.182E-01	4.478E-01	-1.474E-01	0.8420
6.372E-03	-2.787E-02	3.497E-02	-3.155E-02	2.5000

\hat{k} Coefficients				Interval Limit
A_3	A_2	A_1	A_0	\hat{R}_{max}
-3.831E 02	4.135E 02	-1.488E 02	1.785E 01	0.3620
6.485E 01	-7.290E 01	2.729E 01	-3.395E 00	0.3820
-2.711E 01	3.249E 01	-1.298E 01	1.731E 00	0.4020
-2.434E 00	2.725E 00	-1.011E 00	1.276E-01	0.4220
6.208E 00	-8.215E 00	3.605E 00	-5.218E-01	0.4420
1.012E-01	-1.175E-01	2.669E-02	5.538E-03	0.4920
1.200E-02	1.417E-02	-3.810E-02	1.616E-02	0.5920
-4.765E-02	1.201E-01	-1.008E-01	2.854E-02	0.8420
1.477E-04	-6.332E-04	8.478E-04	6.078E-06	2.5000

$\langle \hat{U} \hat{V} \rangle$ Coefficients				Interval Limit
A_3	A_2	A_1	A_0	\hat{R}_{max}
5.186E 01	-5.532E 01	1.966E 01	-2.328E 00	0.3620
-2.452E 01	2.763E 01	-1.037E 01	1.296E 00	0.3820
1.068E 01	-1.271E 01	5.038E 00	-6.667E-01	0.4020
-2.231E 00	2.863E 00	-1.222E 00	1.720E-01	0.4220
1.896E 00	-2.363E 00	9.835E-01	-1.382E-01	0.4420
-1.453E 00	2.079E 00	-9.797E-01	1.511E-01	0.4920
1.785E-01	-3.294E-01	2.053E-01	-4.325E-02	0.5920
1.662E-02	-4.186E-02	3.505E-02	-9.659E-03	0.8420
-2.541E-05	1.755E-04	-3.430E-04	2.760E-04	2.5000

Table 7. Comparison of Boundary-Layer Parameters, Attached-Flow Model

Parameter	Calculation (Ref. 21)	Mean Velocity Measurement (Ref. 21)	Specific Reynolds Shear Measurement*
	$\widehat{X} = -4.062$		
$\widehat{\delta}^*$	0.0292	0.0264	---
$\widehat{\theta}$	0.0197	0.0173	---
c_f	0.00276	0.00295	0.00323
	$\widehat{X} = -1.062$		
$\widehat{\delta}^*$	---	0.0268	---
$\widehat{\theta}$	---	0.0185	---
c_f	---	0.00305	0.00302
	$\widehat{X} = -0.562$		
$\widehat{\delta}^*$		0.0272	---
$\widehat{\theta}$		0.0185	---
c_f		0.00300	0.00317

* The coefficient of skin friction was computed from the specific Reynolds' Shear by

$$c_f = - \frac{\rho \langle u'v' \rangle_{\max}}{q_\infty} = -2 \widehat{\rho} | \langle \widehat{u}'\widehat{v}' \rangle |_{\max}$$

where ρ is given by Eq. (13).

Table 8. Data Tabulation, Separated-Flow Model

Model Surface		Tunnel Wall	
\hat{X}	C_{P_M}	\hat{X}	C_{P_w}
-5.0	-0.0032	-6.94	0.0
-4.5	0.0222	-6.44	-0.0010
-4.0	0.0199	-5.94	0.0013
-3.5	0.0237	-5.44	---
-3.0	0.0177	-4.94	0.0038
-2.5	0.0135	-4.44	0.0125
-2.0	0.0094	-3.94	0.0084
-1.5	-0.0068	-3.44	0.0130
-0.874	-0.0155	-2.94	0.0248
-0.624	-0.0288	-2.44	0.0125
-0.374	-0.0535	-1.94	0.0035
-0.124	-0.0966	-1.44	0.0048
0.001	-0.1607	-0.94	0.0028
0.126	-0.2114	-0.44	0.0067
0.251	-0.1754	0.07	0.0065
0.376	-0.0693	0.57	0.0088
0.501	0.0671	1.07	0.0070
0.625	0.1281	1.57	0.0060
0.751	0.1343	2.07	0.0098
0.876	0.1540	2.57	0.0065
1.001	0.1979	3.07	0.0053
1.126	0.1520	3.57	0.0085
1.251	0.0907	4.07	0.0035
1.376	0.0453	4.57	0.0060
1.501	0.0472	5.07	0.0073
1.626	0.0353		
1.751	0.0429		
2.501	0.0139		
3.251	0.0148		
4.001	0.0145		
4.751	-0.0237		

Table 8. Continued

Separated-Flow Model

$\hat{x} = -4.062$		$\hat{R}_{\text{surface}} = 0.500$		$v_{\infty} = 211 \text{ m/sec}$		
I	\hat{y}	\hat{R}	$\langle \hat{U} \rangle$	$\langle \hat{V} \rangle$	$\hat{k} \times 10^4$	$\langle \hat{U} - \hat{V} \rangle$
1	0.004	0.504	0.418	-0.055	161.3	0.0
2	0.009	0.509	0.599	0.005	70.4	-20.4
3	0.014	0.514	0.669	-0.003	49.3	-16.0
4	0.019	0.519	0.721	-0.006	47.7	-17.6
5	0.024	0.524	0.741	-0.008	45.4	-15.3
6	0.029	0.529	0.764	-0.007	38.9	-13.3
7	0.034	0.534	0.782	-0.012	39.1	-15.1
8	0.039	0.539	0.800	-0.010	39.9	-14.3
9	0.044	0.544	0.815	-0.011	34.7	-13.3
10	0.049	0.549	0.826	-0.011	34.7	-13.3
11	0.054	0.554	0.836	-0.013	33.7	-12.3
12	0.059	0.559	0.854	-0.011	29.5	-10.8
13	0.064	0.564	0.858	-0.011	28.4	-8.4
14	0.069	0.569	0.870	-0.014	26.9	-8.1
15	0.074	0.574	0.874	-0.014	25.4	-7.9
16	0.079	0.579	0.890	-0.016	23.8	-6.3
17	0.084	0.584	0.898	-0.016	23.2	-6.9
18	0.089	0.589	0.908	-0.014	19.1	-5.0
19	0.094	0.594	0.909	-0.011	19.9	-5.7
20	0.099	0.599	0.925	-0.014	17.2	-4.2
21	0.104	0.604	0.930	-0.015	16.5	-3.5
22	0.114	0.614	0.940	-0.013	15.2	-1.1
23	0.124	0.624	0.952	-0.013	13.0	-1.0
24	0.134	0.634	0.963	-0.014	9.5	-0.4
25	0.144	0.644	0.973	-0.011	7.5	-0.8
26	0.154	0.654	0.981	-0.011	6.8	0.8
27	0.164	0.664	0.984	-0.006	6.0	0.7
28	0.174	0.674	0.989	-0.009	5.1	1.0
29	0.184	0.684	0.993	-0.009	4.5	1.5
30	0.194	0.694	0.996	-0.008	3.9	0.8
31	0.204	0.704	0.999	-0.007	2.8	0.7
32	0.224	0.724	1.001	-0.007	2.9	1.2
33	0.244	0.744	1.001	-0.005	2.3	0.7
34	0.264	0.764	1.001	-0.007	2.3	0.7
35	0.284	0.784	1.002	-0.006	3.5	1.1
36	0.304	0.804	1.001	-0.005	2.8	0.7
37	0.324	0.824	1.001	-0.005	2.3	0.7
38	0.344	0.844	0.998	-0.008	2.6	0.9
39	0.364	0.864	1.002	-0.006	2.3	0.7
40	0.384	0.884	1.002	-0.006	2.3	0.7
41	0.404	0.904	1.003	-0.007	2.2	0.8
42	0.424	0.924	1.002	-0.006	2.2	0.8
43	0.444	0.944	1.001	-0.007	1.7	0.4
44	0.464	0.964	1.002	-0.006	1.9	0.6
45	0.484	0.984	1.003	-0.007	1.8	0.8
46	0.504	1.004	1.000	-0.008	1.9	0.6
47	0.554	1.054	1.001	-0.009	1.9	0.6
48	0.604	1.104	1.000	-0.008	1.9	0.6
49	0.654	1.154	0.997	-0.009	1.9	0.6

Table 8. Continued

Separated-Flow Model

$\hat{x} = -4.062$ $\hat{R}_{\text{surface}} = 0.500$ $v_{\infty} = 211 \text{ m/sec}$						
I	\hat{y}	\hat{r}	$\langle \hat{u} \rangle$	$\langle \hat{v} \rangle$	$\hat{k} \times 10^4$	$\langle \hat{u} \hat{v} \rangle$
50	0.704	1.204	0.999	-0.009	1.9	0.6
51	0.754	1.254	0.999	-0.011	2.2	0.8
52	0.804	1.304	0.995	-0.013	1.8	0.8
53	0.854	1.354	0.995	-0.011	1.9	0.6
54	0.904	1.404	0.995	-0.011	2.2	0.8
55	0.954	1.454	0.995	-0.009	1.9	0.6
56	1.004	1.504	0.994	-0.012	2.0	1.0
57	1.104	1.604	0.994	-0.012	1.7	0.4
58	1.204	1.704	0.995	-0.011	1.9	0.6
59	1.304	1.804	0.995	-0.011	2.2	0.8
60	1.404	1.904	0.994	-0.014	1.9	0.6
61	1.504	2.004	0.993	-0.015	2.2	0.8
62	1.604	2.104	0.995	-0.015	2.3	0.7
63	1.704	2.204	0.995	-0.017	1.9	0.6
64	1.804	2.304	0.995	-0.017	2.2	0.8
65	1.904	2.404	0.995	-0.015	2.3	0.7
66	2.004	2.504	0.994	-0.010	2.3	0.7
67	2.104	2.604	0.995	-0.009	2.5	0.7
68	2.204	2.704	0.990	-0.008	4.8	1.3
69	2.304	2.804	0.902	0.006	34.1	10.0
70	2.365	2.865	0.795	0.021	63.3	24.8

Table 8. Continued

Separated-Flow Model

$\hat{\lambda} = -1.062$ $\hat{R}_{\text{surface}} = 0.500$ $v_{\infty} = 213 \text{ m/sec}$

I	\hat{Y}	\hat{R}	$\langle \hat{U} \rangle$	$\langle \hat{V} \rangle$	$\hat{k} \times 10^4$	$\langle \hat{U} \hat{V} \rangle$
1	0.004	0.504	0.653	-0.009	49.4	-14.9
2	0.009	0.509	0.689	-0.017	46.3	-13.5
3	0.014	0.514	0.726	-0.015	42.8	-14.8
4	0.019	0.519	0.750	-0.017	40.7	-12.6
5	0.024	0.524	0.768	-0.021	39.5	-15.9
6	0.029	0.529	0.786	-0.020	37.5	-13.8
7	0.034	0.534	0.794	-0.018	35.5	-11.8
8	0.039	0.539	0.804	-0.020	36.8	-14.5
9	0.044	0.544	0.817	-0.019	31.2	-10.3
10	0.049	0.549	0.827	-0.023	31.2	-10.3
11	0.054	0.554	0.835	-0.019	31.5	-11.8
12	0.059	0.559	0.847	-0.023	29.7	-10.0
13	0.064	0.564	0.858	-0.018	26.7	-9.5
14	0.069	0.569	0.869	-0.020	25.5	-7.2
15	0.074	0.574	0.871	-0.018	27.3	-8.9
16	0.079	0.579	0.879	-0.022	25.3	-9.2
17	0.084	0.584	0.884	-0.021	25.4	-5.7
18	0.089	0.589	0.892	-0.017	23.6	-7.6
19	0.094	0.594	0.899	-0.020	23.5	-7.6
20	0.099	0.599	0.906	-0.019	21.5	-6.6
21	0.104	0.604	0.915	-0.020	21.3	-5.2
22	0.114	0.614	0.922	-0.015	19.7	-6.9
23	0.124	0.624	0.933	-0.018	17.4	-3.6
24	0.134	0.634	0.947	-0.019	15.8	-3.9
25	0.144	0.644	0.955	-0.017	14.6	-3.8
26	0.154	0.654	0.967	-0.017	11.4	-2.4
27	0.164	0.664	0.973	-0.021	9.5	-0.4
28	0.174	0.674	0.977	-0.019	9.1	-0.9
29	0.184	0.684	0.984	-0.014	7.5	-1.6
30	0.194	0.694	0.987	-0.015	6.3	-0.4
31	0.204	0.704	0.992	-0.016	4.9	-0.3
32	0.214	0.714	0.994	-0.016	4.3	-0.3
33	0.224	0.724	0.997	-0.015	4.0	0.0
34	0.234	0.734	0.996	-0.016	4.0	-0.6
35	0.244	0.744	1.000	-0.016	4.0	-0.6
36	0.254	0.754	0.999	-0.017	3.5	-0.5
37	0.264	0.764	0.999	-0.015	3.5	-0.5
38	0.274	0.774	0.998	-0.016	3.2	-0.3
39	0.284	0.784	1.001	-0.015	3.0	0.0
40	0.294	0.794	1.000	-0.016	3.0	0.0
41	0.304	0.804	1.002	-0.016	3.2	-0.3
42	0.354	0.854	0.999	-0.017	2.7	-0.2
43	0.404	0.904	0.999	-0.015	2.7	-0.2
44	0.454	0.954	1.000	-0.016	3.0	0.0
45	0.504	1.004	1.000	-0.018	3.0	-0.5
46	0.604	1.104	0.998	-0.018	3.2	-0.3
47	0.704	1.204	0.997	-0.019	2.5	-0.5
48	0.804	1.304	0.998	-0.018	3.0	0.0
49	0.904	1.404	0.995	-0.018	3.0	-0.5

Table 8. Continued

Separated-Flow Model

$\hat{X} = -1.062$		$\hat{R}_{\text{surface}} = 0.500$		$v_{\infty} = 213 \text{ m/sec}$		
I	\hat{Y}	\hat{R}	$\langle \hat{U} \rangle$	$\langle \hat{V} \rangle$	$\hat{k} \times 10^4$	$\langle \hat{U} \hat{V} \rangle$
50	1.004	1.504	0.996	-0.018	3.2	-0.3
51	1.104	1.604	0.999	-0.019	3.0	0.0
52	1.204	1.704	0.996	-0.022	2.7	-0.2
53	1.304	1.804	0.994	-0.020	3.0	0.0
54	1.404	1.904	0.994	-0.022	3.2	-0.3
55	1.504	2.004	0.996	-0.026	3.0	-0.5
56	1.604	2.104	0.992	-0.028	3.5	-0.5
57	1.704	2.204	0.991	-0.025	3.5	0.0
58	1.804	2.304	0.992	-0.026	3.2	-0.3
59	1.904	2.404	0.992	-0.022	3.7	-0.3
60	2.004	2.504	0.995	-0.021	4.4	-0.9
61	2.104	2.604	0.986	-0.018	6.3	0.4
62	2.204	2.704	0.915	-0.004	32.4	7.3
63	2.304	2.804	0.728	-0.011	98.2	36.2
64	2.404	2.904	0.490	0.071	120.9	34.3

Table 8. Continued

Separated-Flow Model

$\hat{X} = -0.562$		$\hat{R}_{\text{surface}} = 0.500$		$v_{\infty} = 213 \text{ m/sec}$		
I	\hat{Y}	\hat{R}	$\langle \hat{U} \rangle$	$\langle \hat{V} \rangle$	$\hat{k} \times 10^4$	$\langle \hat{U} \hat{V} \rangle$
1	0.004	0.504	0.529	-0.019	59.2	-19.6
2	0.009	0.509	0.576	-0.012	47.8	-21.2
3	0.014	0.514	0.711	-0.018	42.9	-14.8
4	0.024	0.524	0.758	-0.021	40.3	-15.2
5	0.028	0.528	0.775	-0.018	39.2	-14.1
6	0.034	0.534	0.785	-0.015	36.5	-12.8
7	0.039	0.539	0.806	-0.022	33.8	-11.5
8	0.044	0.544	0.808	-0.016	36.8	-14.5
9	0.054	0.554	0.934	-0.016	34.9	-12.5
10	0.064	0.564	0.854	-0.016	31.9	-9.6
11	0.073	0.573	0.967	-0.018	30.5	-10.9
12	0.083	0.583	0.883	-0.014	27.5	-10.3
13	0.093	0.593	0.896	-0.015	27.5	-10.3
14	0.103	0.603	0.910	-0.015	23.4	-6.2
15	0.113	0.613	0.922	-0.019	22.8	-6.8
16	0.123	0.623	0.935	-0.014	19.7	-6.9
17	0.133	0.633	0.942	-0.021	19.5	-5.6
18	0.143	0.643	0.957	-0.017	16.8	-2.9
19	0.152	0.652	0.966	-0.018	14.6	-3.8
20	0.162	0.662	0.970	-0.020	14.5	-2.7
21	0.172	0.672	0.981	-0.017	11.9	-2.0
22	0.182	0.682	0.989	-0.015	9.6	-2.2
23	0.192	0.692	0.992	-0.020	8.7	-1.3
24	0.202	0.702	0.996	-0.018	9.2	-2.6
25	0.222	0.722	0.999	-0.019	6.7	-0.7
26	0.242	0.742	1.003	-0.017	5.6	-1.0
27	0.262	0.762	1.005	-0.017	4.9	-0.3
28	0.282	0.782	1.007	-0.021	4.5	-0.6
29	0.302	0.802	1.006	-0.016	4.4	-0.9
30	0.322	0.822	1.008	-0.018	4.3	-0.3
31	0.341	0.841	1.007	-0.019	4.4	-0.9
32	0.362	0.862	1.006	-0.022	3.7	-0.3
33	0.380	0.880	1.005	-0.019	4.4	-0.9
34	0.400	0.900	1.006	-0.018	3.5	-0.5
35	0.500	1.000	1.006	-0.020	3.2	-0.3
36	0.600	1.100	1.002	-0.022	3.5	-0.5
37	0.701	1.201	1.002	-0.022	3.0	-0.5
38	0.801	1.301	0.999	-0.021	3.5	0.0
39	0.901	1.401	1.000	-0.020	3.0	-0.5
40	1.001	1.501	0.999	-0.021	3.2	-0.3
41	1.201	1.701	0.998	-0.022	3.2	-0.8
42	1.401	1.901	0.991	-0.025	3.5	-0.5
43	1.601	2.101	0.994	-0.026	3.7	-0.3
44	1.801	2.301	0.995	-0.025	3.7	-0.3
45	2.001	2.501	0.995	-0.023	4.0	0.0
46	2.405	2.905	0.482	0.047	104.3	20.4

Table 8. Continued

Separated-Flow Model

$\hat{x} = 0.0$	$\hat{R}_{\text{surface}} = 0.500$	$v_{\infty} = 213 \text{ m/sec}$				
I	\hat{y}	\hat{R}	$\langle \hat{U} \rangle$	$\langle \hat{V} \rangle$	$\hat{k} \times 10^4$	$\langle \hat{U} \cdot \hat{V} \rangle$
1	0.004	0.504	0.717	-0.018	52.5	-16.4
2	0.009	0.509	0.767	-0.030	38.2	-13.1
3	0.014	0.514	0.795	-0.029	36.1	-15.1
4	0.019	0.519	0.818	-0.028	36.9	-14.5
5	0.023	0.523	0.831	-0.029	35.1	-14.1
6	0.029	0.529	0.843	-0.033	33.1	-12.1
7	0.034	0.534	0.857	-0.033	30.6	-10.9
8	0.039	0.539	0.870	-0.035	31.5	-11.8
9	0.054	0.554	0.897	-0.032	28.8	-9.1
10	0.064	0.564	0.913	-0.043	27.3	-8.9
11	0.074	0.574	0.922	-0.042	25.5	-7.2
12	0.083	0.583	0.937	-0.038	24.4	-8.4
13	0.093	0.593	0.946	-0.038	22.0	-9.2
14	0.103	0.603	0.956	-0.040	22.3	-7.3
15	0.113	0.613	0.973	-0.044	19.5	-5.6
16	0.123	0.623	0.979	-0.039	21.0	-7.1
17	0.133	0.633	0.986	-0.045	17.1	-5.3
18	0.143	0.643	0.994	-0.049	14.5	-2.7
19	0.152	0.652	1.003	-0.044	12.5	-3.5
20	0.162	0.662	1.011	-0.046	11.4	-1.4
21	0.172	0.672	1.015	-0.046	10.4	-1.4
22	0.182	0.682	1.015	-0.044	8.7	-2.1
23	0.192	0.692	1.021	-0.048	7.4	-0.8
24	0.202	0.702	1.023	-0.044	6.7	-1.5
25	0.222	0.722	1.028	-0.046	4.9	-0.3
26	0.242	0.742	1.025	-0.044	4.0	-0.6
27	0.262	0.762	1.026	-0.045	4.0	0.0
28	0.282	0.782	1.028	-0.044	3.7	-0.3
29	0.302	0.802	1.024	-0.045	3.7	0.3
30	0.322	0.822	1.022	-0.045	3.2	-0.3
31	0.342	0.842	1.021	-0.044	3.2	-0.3
32	0.362	0.862	1.021	-0.044	3.2	-0.3
33	0.382	0.882	1.018	-0.043	3.2	-0.3
34	0.402	0.902	1.018	-0.040	3.5	0.0
35	0.502	1.002	1.011	-0.037	3.0	0.0
36	0.602	1.102	1.006	-0.038	3.0	0.0
37	0.701	1.201	1.003	-0.037	3.0	0.0
38	0.801	1.301	1.000	-0.034	2.7	0.2
39	0.901	1.401	0.997	-0.031	2.7	-0.2
40	1.001	1.501	0.997	-0.033	2.7	-0.2
41	1.201	1.701	0.994	-0.028	2.7	-0.2
42	1.401	1.901	0.993	-0.031	2.3	-0.2
43	1.601	2.101	0.992	-0.032	3.0	-0.5
44	1.801	2.301	0.992	-0.030	3.0	0.0
45	2.001	2.501	0.990	-0.026	3.7	-0.3
46	2.201	2.701	0.994	-0.009	35.6	6.0
47	2.401	2.901	0.498	0.043	100.9	14.3

Table 8. Continued

Separated-Flow Model

$\hat{X} = 0.138$	$\hat{R}_{\text{surface}} = 0.492$	$v_{\infty} = 214 \text{ m/sec}$				
I	\hat{Y}	\hat{R}	$\langle \hat{U} \rangle$	$\langle \hat{V} \rangle$	$\hat{k} \times 10^4$	$\langle \hat{U} \hat{V} \rangle$
1	0.004	0.496	0.735	-0.076	57.5	-18.1
2	0.009	0.501	0.795	-0.081	38.9	-14.0
3	0.014	0.506	0.923	-0.083	34.9	-14.0
4	0.019	0.511	0.850	-0.084	34.5	-12.4
5	0.024	0.516	0.861	-0.079	34.5	-12.4
6	0.029	0.521	0.875	-0.081	36.5	-14.3
7	0.034	0.526	0.882	-0.082	31.3	-11.7
8	0.039	0.531	0.892	-0.086	31.7	-9.5
9	0.044	0.536	0.901	-0.083	30.4	-10.8
10	0.049	0.541	0.909	-0.083	30.4	-10.8
11	0.054	0.546	0.916	-0.085	27.3	-10.2
12	0.059	0.551	0.925	-0.080	26.2	-7.9
13	0.069	0.561	0.937	-0.084	26.5	-9.4
14	0.079	0.571	0.946	-0.081	24.9	-7.7
15	0.088	0.580	0.960	-0.083	24.9	-7.7
16	0.098	0.590	0.971	-0.080	23.9	-5.5
17	0.108	0.600	0.974	-0.075	20.6	-5.8
18	0.118	0.610	0.991	-0.080	18.6	-4.9
19	0.128	0.620	0.992	-0.077	17.4	-7.5
20	0.138	0.630	0.997	-0.078	16.3	-4.6
21	0.148	0.640	1.004	-0.079	14.5	-3.8
22	0.158	0.650	1.016	-0.081	12.3	-1.5
23	0.167	0.659	1.016	-0.077	10.9	-2.8
24	0.177	0.669	1.020	-0.077	8.7	-2.1
25	0.187	0.679	1.023	-0.074	8.0	-2.8
26	0.197	0.689	1.028	-0.075	5.6	-1.0
27	0.217	0.709	1.031	-0.074	3.5	-0.5
28	0.237	0.729	1.032	-0.073	2.9	-0.5
29	0.257	0.749	1.030	-0.071	2.7	-0.7
30	0.277	0.769	1.028	-0.069	2.5	-0.4
31	0.297	0.789	1.029	-0.068	1.9	-0.6
32	0.317	0.809	1.027	-0.068	2.1	-0.4
33	0.337	0.829	1.026	-0.065	2.1	-0.4
34	0.357	0.849	1.024	-0.063	2.1	-0.8
35	0.377	0.869	1.022	-0.063	1.9	-0.6
36	0.397	0.889	1.020	-0.063	1.5	-0.2
37	0.497	0.989	1.013	-0.055	1.5	-0.2
38	0.497	0.989	1.015	-0.057	1.3	-0.3
39	0.597	1.089	1.011	-0.055	1.5	0.2
40	0.697	1.189	1.005	-0.051	1.5	0.2
41	0.797	1.289	1.002	-0.044	1.6	0.0
42	0.896	1.388	0.999	-0.037	3.2	-0.8
43	0.997	1.489	0.998	-0.036	3.5	-0.5
44	1.096	1.588	0.997	-0.033	2.9	-0.5
45	1.196	1.688	0.996	-0.034	2.7	-0.7
46	1.396	1.888	0.994	-0.034	2.7	-0.7
47	1.596	2.088	0.995	-0.033	3.5	-0.5
48	1.796	2.288	0.990	-0.032	3.8	-0.8
49	1.996	2.488	0.992	-0.028	4.3	-0.9
50	2.196	2.688	0.920	-0.018	32.3	8.8
51	2.396	2.888	0.524	0.022	111.3	25.4

Table 8. Continued

Separated-Flow Model

$\hat{X} = 0.338$	$\hat{R}_{\text{surface}} = 0.463$	$v_{\infty} = 214 \text{ m/sec}$				
I	\hat{Y}	\hat{R}	$\langle \hat{U} \rangle$	$\langle \hat{V} \rangle$	$\hat{k} \times 10^4$	$\langle \hat{U} \hat{V} \rangle$
1	0.004	0.467	0.574	-0.140	83.4	-40.3
2	0.009	0.472	0.666	-0.144	48.4	-24.8
3	0.014	0.477	0.719	-0.148	39.6	-17.5
4	0.019	0.482	0.758	-0.155	34.8	-14.0
5	0.024	0.487	0.778	-0.153	34.8	-14.0
6	0.029	0.492	0.789	-0.152	32.9	-12.0
7	0.034	0.497	0.810	-0.148	31.3	-11.7
8	0.039	0.502	0.823	-0.151	32.6	-10.4
9	0.044	0.507	0.835	-0.151	33.8	-13.0
10	0.049	0.512	0.844	-0.148	31.0	-10.2
11	0.054	0.517	0.856	-0.148	30.1	-9.3
12	0.059	0.522	0.863	-0.145	28.5	-9.0
13	0.064	0.527	0.870	-0.144	27.3	-10.2
14	0.074	0.537	0.886	-0.140	27.3	-10.2
15	0.083	0.546	0.899	-0.139	25.6	-8.5
16	0.094	0.557	0.902	-0.130	26.5	-9.4
17	0.103	0.566	0.918	-0.131	24.8	-7.7
18	0.113	0.576	0.930	-0.129	22.9	-8.1
19	0.123	0.586	0.935	-0.120	23.4	-7.5
20	0.133	0.596	0.950	-0.125	20.0	-6.3
21	0.143	0.606	0.958	-0.121	19.9	-5.0
22	0.153	0.616	0.968	-0.117	16.9	-5.2
23	0.163	0.626	0.976	-0.115	15.6	-3.9
24	0.172	0.635	0.984	-0.115	13.3	-2.6
25	0.182	0.645	0.988	-0.111	12.9	-2.0
26	0.192	0.655	0.995	-0.112	10.8	-1.9
27	0.202	0.665	1.001	-0.110	9.4	-1.3
28	0.222	0.685	1.006	-0.101	8.6	-1.3
29	0.242	0.705	1.010	-0.097	6.7	-1.5
30	0.262	0.725	1.013	-0.094	5.9	-0.7
31	0.282	0.745	1.013	-0.090	4.4	-1.5
32	0.302	0.765	1.012	-0.085	4.6	-0.6
33	0.322	0.785	1.013	-0.086	4.3	-0.9
34	0.342	0.805	1.011	-0.080	2.7	-2.5
35	0.362	0.825	1.011	-0.078	4.6	0.0
36	0.382	0.845	1.012	-0.075	4.3	-0.3
37	0.402	0.865	1.010	-0.071	4.3	-0.3
38	0.502	0.965	1.007	-0.062	4.3	-0.3
39	0.602	1.065	1.002	-0.052	4.3	0.3
40	0.702	1.165	1.000	-0.050	3.7	-0.3
41	0.802	1.265	0.998	-0.044	4.3	0.3
42	0.901	1.364	0.997	-0.039	4.0	-0.6
43	1.001	1.464	0.996	-0.040	4.0	0.0
44	1.101	1.564	0.997	-0.037	3.7	-0.3
45	1.201	1.664	0.994	-0.034	3.7	-0.3
46	1.301	1.764	0.990	-0.034	4.0	-0.6
47	1.501	1.964	0.991	-0.033	3.7	-0.3
48	1.701	2.164	0.988	-0.034	3.5	-0.5
49	1.901	2.364	0.991	-0.029	3.5	-0.5

Table 8. Continued

Separated-Flow Model

$\hat{X} = 0.338$		$\hat{R}_{\text{surface}} = 0.463$		$v_{\infty} = 214 \text{ m/sec}$		
I	\hat{Y}	\hat{R}	$\langle \hat{U} \rangle$	$\langle \hat{V} \rangle$	$\hat{k} \times 10^4$	$\langle \hat{U} - \hat{V} \rangle$
50	2.101	2.564	0.989	-0.025	6.2	0.4
51	2.301	2.764	0.793	-0.016	79.1	26.3
52	2.404	2.867	0.565	0.0	125.3	39.4

Table 8. Continued

Separated-Flow Model

$\hat{X} = 0.538$		$\hat{R}_{\text{surface}} = 0.394$		$v_{\infty} = 214 \text{ m/sec}$		
I	\hat{Y}	\hat{R}	$\langle \hat{U} \rangle$	$\langle \hat{V} \rangle$	$\hat{k} \times 10^4$	$\langle \hat{U} \cdot \hat{V} \rangle$
1	0.004	0.398	0.211	-0.080	63.3	-45.0
2	0.009	0.403	0.267	-0.098	72.7	-47.8
3	0.014	0.408	0.336	-0.110	72.7	-47.8
4	0.019	0.413	0.409	-0.121	69.5	-44.7
5	0.024	0.418	0.472	-0.135	57.4	-33.9
6	0.029	0.423	0.524	-0.141	52.1	-31.2
7	0.034	0.428	0.579	-0.147	44.5	-23.8
8	0.039	0.433	0.611	-0.149	40.7	-18.6
9	0.044	0.438	0.634	-0.150	36.2	-16.7
10	0.049	0.443	0.661	-0.155	35.5	-17.3
11	0.054	0.448	0.677	-0.156	34.2	-14.6
12	0.059	0.453	0.697	-0.152	34.2	-14.6
13	0.064	0.458	0.707	-0.154	34.9	-14.0
14	0.069	0.463	0.724	-0.153	32.2	-12.7
15	0.074	0.468	0.738	-0.159	32.5	-14.3
16	0.084	0.478	0.756	-0.145	32.2	-12.7
17	0.094	0.488	0.771	-0.148	29.7	-11.4
18	0.094	0.488	0.775	-0.150	27.9	-9.6
19	0.103	0.497	0.791	-0.142	26.8	-10.8
20	0.113	0.507	0.810	-0.144	25.9	-10.0
21	0.123	0.517	0.825	-0.137	25.5	-8.5
22	0.133	0.527	0.840	-0.140	22.1	-7.3
23	0.143	0.537	0.855	-0.135	22.3	-8.6
24	0.153	0.547	0.867	-0.137	20.3	-7.6
25	0.163	0.557	0.876	-0.130	19.5	-6.8
26	0.173	0.567	0.890	-0.130	19.9	-8.1
27	0.182	0.576	0.899	-0.129	15.1	-4.4
28	0.192	0.586	0.916	-0.127	13.5	-3.6
29	0.202	0.596	0.920	-0.127	13.0	-4.1
30	0.212	0.606	0.931	-0.122	10.9	-2.8
31	0.232	0.626	0.941	-0.116	10.9	-2.8
32	0.252	0.646	0.960	-0.113	6.1	-2.1
33	0.272	0.666	0.967	-0.110	4.9	-0.9
34	0.292	0.686	0.975	-0.108	3.5	-0.5
35	0.312	0.706	0.978	-0.103	2.7	-0.2
36	0.332	0.726	0.982	-0.099	2.2	-0.2
37	0.352	0.746	0.982	-0.095	2.0	0.0
38	0.372	0.766	0.984	-0.093	2.2	-0.2
39	0.392	0.786	0.985	-0.090	1.5	0.0
40	0.412	0.806	0.986	-0.087	1.9	-0.2
41	0.512	0.906	0.986	-0.075	1.5	0.0
42	0.512	0.906	0.993	-0.068	1.8	0.2
43	0.612	1.006	0.988	-0.065	2.1	0.4
44	0.712	1.106	0.991	-0.057	2.9	0.0
45	0.812	1.206	0.991	-0.053	2.5	0.4
46	0.911	1.305	0.994	-0.044	5.9	0.7
47	1.011	1.405	0.993	-0.043	4.9	-0.9
48	1.111	1.505	0.992	-0.038	3.5	0.5
49	1.211	1.605	0.992	-0.036	5.2	0.7

Table 8. Continued

Separated-Flow Model

$\hat{X} = 0.538$		$\hat{R}_{\text{surface}} = 0.394$		$v_{\infty} = 214 \text{ m/sec}$		
I	$\hat{\psi}$	\hat{R}	$\langle \hat{U} \rangle$	$\langle \hat{V} \rangle$	$\hat{k} \times 10^4$	$\langle \hat{U} \hat{V} \rangle$
50	1.411	1.805	0.992	-0.034	3.2	0.3
51	1.611	2.005	0.994	-0.036	3.9	0.8
52	1.811	2.205	0.993	-0.033	5.5	0.3
53	2.011	2.405	0.990	-0.030	3.2	0.3
54	2.211	2.605	0.980	-0.024	9.4	1.3
55	2.411	2.805	0.710	-0.004	96.9	39.8
56	2.489	2.883	0.551	0.042	104.0	4.4

Table 8. Continued

Separated-Flow Model

$\hat{x} = 0.638$	$\hat{R}_{\text{surface}} = 0.348$	$v_{\infty} = 214 \text{ m/sec}$				
I	\hat{Y}	\hat{R}	$\langle \hat{U} \rangle$	$\langle \hat{V} \rangle$	$\hat{k} \times 10^4$	$\langle \hat{U} - \hat{V} \rangle$
1	0.004	0.352	0.011	-0.003	41.2	-29.5
2	0.004	0.352	0.011	-0.005	44.2	-31.5
3	0.009	0.357	0.049	-0.021	61.9	-43.6
4	0.014	0.362	0.089	-0.040	73.5	-50.1
5	0.019	0.367	0.129	-0.040	85.2	-51.7
6	0.024	0.372	0.174	-0.057	84.7	-55.4
7	0.029	0.377	0.221	-0.064	97.0	-67.7
8	0.034	0.382	0.272	-0.079	88.9	-58.0
9	0.039	0.387	0.329	-0.077	85.4	-51.3
10	0.044	0.392	0.379	-0.093	80.5	-49.6
11	0.049	0.397	0.439	-0.106	77.4	-49.5
12	0.054	0.402	0.482	-0.101	69.5	-41.8
13	0.059	0.407	0.527	-0.116	55.4	-33.2
14	0.064	0.412	0.558	-0.116	48.4	-24.8
15	0.069	0.417	0.588	-0.122	43.4	-22.6
16	0.074	0.422	0.512	-0.116	39.4	-19.9
17	0.079	0.427	0.632	-0.122	38.3	-18.8
18	0.084	0.432	0.551	-0.123	37.7	-19.4
19	0.089	0.437	0.664	-0.128	34.0	-16.9
20	0.094	0.442	0.676	-0.121	34.2	-14.6
21	0.099	0.447	0.694	-0.123	33.5	-15.3
22	0.104	0.452	0.705	-0.126	33.6	-15.3
23	0.114	0.462	0.731	-0.126	32.5	-14.3
24	0.124	0.472	0.751	-0.122	32.5	-14.3
25	0.134	0.482	0.766	-0.119	30.4	-10.8
26	0.144	0.492	0.784	-0.119	28.2	-11.1
27	0.154	0.502	0.799	-0.121	27.1	-8.8
28	0.164	0.512	0.816	-0.122	26.2	-7.9
29	0.174	0.522	0.828	-0.116	25.9	-10.0
30	0.184	0.532	0.844	-0.120	25.1	-9.1
31	0.194	0.542	0.849	-0.113	24.2	-8.3
32	0.204	0.552	0.865	-0.115	22.9	-8.1
33	0.224	0.572	0.884	-0.110	21.3	-6.5
34	0.244	0.592	0.908	-0.112	16.8	-4.1
35	0.264	0.612	0.926	-0.105	14.1	-4.2
36	0.284	0.632	0.935	-0.106	10.4	-2.3
37	0.304	0.652	0.949	-0.104	6.2	-0.4
38	0.324	0.672	0.956	-0.099	5.3	-1.3
39	0.344	0.692	0.960	-0.097	4.3	-0.3
40	0.364	0.712	0.962	-0.091	4.3	-0.3
41	0.384	0.732	0.969	-0.090	4.0	0.0
42	0.404	0.752	0.967	-0.088	3.2	-0.3
43	0.504	0.852	0.970	-0.073	2.2	-0.2

Table 8. Continued

Separated-Flow Model

$\hat{\lambda} = 0.688$	$\hat{R}_{\text{surface}} = 0.322$	$v_{\infty} = 212 \text{ m/sec}$				
I	\hat{Y}	\hat{R}	$\langle \hat{U} \rangle$	$\langle \hat{V} \rangle$	$\hat{k} \times 10^4$	$\langle \hat{U} \hat{V} \rangle$
1	0.004	0.326	-0.018	0.016	42.7	-34.4
2	0.004	0.326	-0.020	0.002	45.7	-36.6
3	0.009	0.331	-0.005	-0.005	75.6	-57.0
4	0.014	0.336	0.016	-0.006	85.1	-61.1
5	0.019	0.341	0.055	-0.014	108.9	-82.1
6	0.024	0.346	0.104	-0.043	103.8	-75.4
7	0.029	0.351	0.145	-0.053	100.0	-71.6
8	0.034	0.356	0.196	-0.068	88.9	-57.3
9	0.039	0.361	0.247	-0.089	77.2	-45.7
10	0.044	0.366	0.275	-0.086	75.6	-44.1
11	0.049	0.371	0.315	-0.089	76.4	-46.5
12	0.054	0.376	0.340	-0.081	87.9	-54.8
13	0.059	0.381	0.398	-0.097	76.4	-46.5
14	0.064	0.386	0.437	-0.103	72.6	-37.8
15	0.069	0.391	0.469	-0.093	70.2	-40.3
16	0.074	0.396	0.512	-0.099	61.3	-34.5
17	0.079	0.401	0.553	-0.103	55.7	-31.8
18	0.084	0.406	0.573	-0.099	49.3	-25.3
19	0.089	0.411	0.592	-0.100	45.5	-24.2
20	0.094	0.416	0.616	-0.103	40.2	-20.3
21	0.099	0.421	0.643	-0.112	37.3	-18.7
22	0.104	0.426	0.654	-0.105	38.4	-19.8
23	0.114	0.436	0.680	-0.110	39.5	-20.9
24	0.124	0.446	0.702	-0.108	33.0	-16.8
25	0.134	0.456	0.727	-0.106	33.0	-16.8
26	0.144	0.466	0.746	-0.107	30.5	-13.2
27	0.154	0.476	0.759	-0.108	29.1	-12.9
28	0.164	0.486	0.776	-0.108	28.8	-11.3
29	0.174	0.496	0.794	-0.102	26.7	-11.6
30	0.184	0.506	0.808	-0.104	26.4	-10.2
31	0.194	0.516	0.819	-0.103	24.1	-9.0
32	0.204	0.526	0.830	-0.101	24.8	-11.8
33	0.224	0.546	0.859	-0.100	20.2	-8.2
34	0.224	0.546	0.864	-0.101	22.8	-8.8
35	0.244	0.566	0.876	-0.091	19.4	-7.5
36	0.264	0.586	0.895	-0.093	16.1	-5.1
37	0.284	0.606	0.921	-0.091	12.5	-5.0
38	0.304	0.626	0.933	-0.091	9.7	-2.2
39	0.324	0.646	0.946	-0.089	7.2	-1.9
40	0.344	0.666	0.955	-0.088	5.1	-1.6
41	0.364	0.686	0.958	-0.080	5.5	-2.0
42	0.384	0.706	0.964	-0.078	4.1	-1.2
43	0.404	0.726	0.968	-0.076	4.1	-1.2
44	0.504	0.826	0.976	-0.064	3.6	-1.3

Table 8. Continued

Separated-Flow Model

$\hat{x} = 0.738$		$\hat{R}_{\text{surface}} = 0.293$		$v_{\infty} = 214 \text{ m/sec}$		
I	\hat{y}	\hat{R}	$\langle \hat{U} \rangle$	$\langle \hat{V} \rangle$	$\hat{k} \times 10^4$	$\langle \hat{U} - \hat{V} \rangle$
1	0.004	0.297	-0.090	0.055	17.4	-7.5
2	0.009	0.302	-0.094	0.064	16.0	-6.2
3	0.014	0.307	-0.069	0.054	38.2	-21.1
4	0.019	0.312	-0.040	0.052	57.4	-33.9
5	0.024	0.317	0.006	0.020	94.8	-69.9
6	0.029	0.322	0.043	0.005	101.8	-74.0
7	0.034	0.327	0.094	-0.009	100.4	-75.5
8	0.039	0.332	0.124	-0.025	85.6	-64.8
9	0.044	0.337	0.155	-0.034	90.5	-67.0
10	0.049	0.342	0.188	-0.052	85.9	-61.0
11	0.054	0.347	0.214	-0.060	83.8	-52.9
12	0.059	0.352	0.244	-0.060	83.0	-53.7
13	0.064	0.357	0.266	-0.069	96.0	-65.1
14	0.069	0.362	0.308	-0.076	87.2	-56.3
15	0.074	0.367	0.345	-0.079	93.4	-64.0
16	0.079	0.372	0.400	-0.096	89.7	-57.2
17	0.084	0.377	0.424	-0.096	87.1	-52.9
18	0.089	0.382	0.467	-0.106	78.1	-48.8
19	0.094	0.387	0.501	-0.106	75.7	-44.8
20	0.104	0.397	0.568	-0.112	56.9	-29.0
21	0.114	0.407	0.612	-0.110	47.1	-23.6
22	0.124	0.417	0.642	-0.110	37.7	-19.4
23	0.134	0.427	0.675	-0.110	35.6	-17.3
24	0.144	0.437	0.650	-0.096	38.3	-18.8
25	0.144	0.437	0.681	-0.102	34.6	-16.3
26	0.144	0.437	0.684	-0.101	35.0	-17.9
27	0.144	0.437	0.699	-0.108	34.0	-16.9
28	0.152	0.445	0.704	-0.117	31.3	-11.7
29	0.154	0.447	0.718	-0.111	35.0	-17.9
30	0.154	0.447	0.720	-0.113	31.6	-13.3
31	0.164	0.457	0.724	-0.105	32.6	-14.3
32	0.164	0.457	0.733	-0.104	30.4	-14.5
33	0.174	0.467	0.744	-0.103	29.1	-12.0
34	0.174	0.467	0.747	-0.104	28.6	-12.6
35	0.184	0.477	0.758	-0.103	27.7	-11.7
36	0.184	0.477	0.767	-0.104	27.1	-12.3
37	0.194	0.487	0.778	-0.099	27.7	-11.7
38	0.194	0.487	0.777	-0.106	28.6	-12.6
39	0.204	0.497	0.796	-0.104	26.8	-10.8
40	0.214	0.507	0.808	-0.100	26.9	-10.8
41	0.224	0.517	0.824	-0.102	23.4	-7.5
42	0.234	0.527	0.838	-0.102	23.7	-8.9
43	0.244	0.537	0.846	-0.098	21.3	-6.5
44	0.254	0.547	0.852	-0.094	21.0	-8.3
45	0.263	0.556	0.862	-0.094	21.9	-9.1
46	0.274	0.567	0.879	-0.095	17.1	-6.4
47	0.284	0.577	0.887	-0.093	17.8	-7.1
48	0.294	0.587	0.899	-0.095	14.7	-4.8
49	0.304	0.597	0.907	-0.089	12.8	-5.5

Table 8. Continued

Separated-Flow Model

$\hat{x} = 0.738$ $\hat{R}_{\text{surface}} = 0.293$ $v_{\infty} = 214 \text{ m/sec}$						
I	\hat{Y}	\hat{R}	$\langle \hat{U} \rangle$	$\langle \hat{V} \rangle$	$\hat{k} \times 10^4$	$\langle \hat{U} \hat{V} \rangle$
50	0.324	0.617	0.918	-0.093	12.0	-3.9
51	0.344	0.637	0.934	-0.091	8.9	-2.9
52	0.364	0.657	0.945	-0.088	6.0	-1.4
53	0.384	0.677	0.951	-0.086	5.0	-1.6
54	0.404	0.697	0.952	-0.081	5.3	-1.3
55	0.424	0.717	0.956	-0.079	5.0	-1.6
56	0.444	0.737	0.958	-0.077	4.1	-1.1
57	0.464	0.757	0.963	-0.074	4.3	-0.9
58	0.484	0.777	0.963	-0.072	4.3	-0.9
59	0.504	0.797	0.965	-0.068	4.1	-1.1
60	0.604	0.897	0.973	-0.062	4.0	-0.6
61	0.703	0.996	0.979	-0.053	4.1	-1.1
62	0.803	1.096	0.982	-0.046	4.7	-1.2
63	0.903	1.196	0.981	-0.045	4.9	-0.3
64	0.993	1.286	0.985	-0.043	5.5	-0.3
65	1.103	1.396	0.985	-0.037	5.5	0.3
66	1.303	1.596	0.989	-0.033	4.9	0.3
67	1.503	1.796	0.988	-0.032	4.9	-0.3
68	1.703	1.996	0.989	-0.031	4.7	-1.2
69	1.903	2.196	0.988	-0.028	4.9	-0.9
70	2.103	2.396	0.988	-0.028	4.9	-0.3
71	2.303	2.596	0.976	-0.022	10.3	-0.5
72	2.503	2.796	0.700	-0.022	101.9	38.2
73	2.554	2.847	0.584	-0.001	129.0	43.1

Table 8. Continued
Separated-Flow Model

$\hat{X} = 0.800$	$\hat{R}_{\text{surface}} = 0.254$	$v_{\infty} = 212 \text{ m/sec}$				
I	\hat{Y}	\hat{R}	$\langle \hat{U} \rangle$	$\langle \hat{V} \rangle$	$\hat{k} \times 10^4$	$\langle \hat{U} \cdot \hat{V} \rangle$
1	0.004	0.258	-0.055	0.024	11.5	-1.5
2	0.009	0.263	-0.071	0.004	15.3	3.4
3	0.014	0.268	-0.097	0.003	17.3	5.3
4	0.019	0.273	-0.128	-0.002	18.3	4.3
5	0.024	0.278	-0.127	0.005	20.5	0.7
6	0.029	0.283	-0.128	0.006	23.3	-0.7
7	0.034	0.288	-0.121	0.013	26.9	-3.0
8	0.039	0.293	-0.110	0.014	33.5	-6.6
9	0.044	0.298	-0.079	0.008	56.5	-18.1
10	0.049	0.303	-0.043	0.004	78.3	-38.2
11	0.054	0.308	-0.013	0.003	92.5	-46.8
12	0.059	0.313	0.016	-0.004	104.0	-60.1
13	0.064	0.318	0.049	-0.010	96.7	-56.6
14	0.069	0.323	0.087	-0.025	97.5	-59.3
15	0.074	0.328	0.121	-0.044	93.1	-56.6
16	0.079	0.333	0.141	-0.044	91.4	-54.8
17	0.084	0.338	0.161	-0.043	82.9	-49.7
18	0.089	0.343	0.187	-0.049	87.9	-54.8
19	0.089	0.343	0.204	-0.049	78.8	-47.3
20	0.094	0.348	0.207	-0.052	86.3	-49.7
21	0.099	0.353	0.239	-0.056	94.9	-54.8
22	0.104	0.358	0.266	-0.050	97.5	-59.3
23	0.104	0.358	0.277	-0.065	85.4	-50.6
24	0.104	0.358	0.281	-0.065	100.3	-60.2
25	0.104	0.358	0.280	-0.068	81.2	-48.1
26	0.114	0.368	0.339	-0.072	96.7	-56.6
27	0.124	0.378	0.412	-0.076	94.9	-54.8
28	0.134	0.388	0.477	-0.087	86.6	-42.7
29	0.144	0.398	0.542	-0.090	62.9	-32.9
30	0.154	0.408	0.592	-0.090	53.8	-28.4
31	0.164	0.418	0.635	-0.088	41.9	-20.7
32	0.174	0.428	0.660	-0.088	39.1	-19.1
33	0.184	0.438	0.685	-0.091	36.3	-17.6
34	0.194	0.448	0.709	-0.091	31.2	-12.6
35	0.204	0.458	0.722	-0.087	33.0	-16.8
36	0.224	0.478	0.758	-0.089	28.2	-11.9
37	0.244	0.498	0.786	-0.090	26.7	-11.6
38	0.264	0.518	0.808	-0.083	25.8	-10.7
39	0.284	0.538	0.836	-0.089	22.9	-8.8
40	0.304	0.558	0.861	-0.086	18.9	-7.9
41	0.324	0.578	0.879	-0.088	16.1	-5.1
42	0.344	0.598	0.899	-0.078	13.1	-5.6
43	0.364	0.618	0.915	-0.084	11.3	-3.8
44	0.384	0.638	0.927	-0.076	8.3	-3.6
45	0.404	0.658	0.939	-0.080	6.0	-0.7
46	0.504	0.758	0.959	-0.065	4.1	-1.2

Table 8. Continued

Separated-Flow Model

$\hat{x} = 0.838$		$\hat{R}_{\text{surface}} = 0.266$		$v_{\infty} = 214 \text{ m/sec}$		
I	\hat{y}	\hat{R}	$\langle \hat{U} \rangle$	$\langle \hat{V} \rangle$	$\hat{k} \times 10^4$	$\langle \hat{U} \hat{V} \rangle$
1	0.004	0.270	-0.111	-0.016	26.7	-5.9
2	0.009	0.275	-0.112	-0.015	28.2	-6.0
3	0.014	0.280	-0.107	-0.016	29.2	-8.4
4	0.019	0.285	-0.088	-0.017	45.8	-18.0
5	0.024	0.290	-0.057	-0.023	57.5	-28.3
6	0.029	0.295	-0.030	-0.036	79.1	-41.5
7	0.034	0.300	-0.024	-0.018	82.4	-41.3
8	0.039	0.305	0.013	-0.025	91.5	-48.5
9	0.044	0.310	0.044	-0.034	101.2	-56.3
10	0.049	0.315	0.084	-0.033	102.9	-61.8
11	0.054	0.320	0.109	-0.056	101.1	-59.9
12	0.059	0.325	0.127	-0.028	104.0	-68.1
13	0.064	0.330	0.170	-0.051	94.2	-63.3
14	0.069	0.335	0.185	-0.047	108.9	-74.7
15	0.059	0.325	0.124	-0.051	95.7	-58.2
16	0.074	0.340	0.224	-0.060	88.0	-55.5
17	0.079	0.345	0.242	-0.060	94.9	-59.0
18	0.084	0.350	0.263	-0.062	96.8	-64.3
19	0.089	0.355	0.298	-0.054	97.5	-59.9
20	0.094	0.360	0.317	-0.063	97.5	-56.4
21	0.099	0.365	0.353	-0.075	102.0	-59.0
22	0.104	0.370	0.384	-0.072	108.5	-67.3
23	0.114	0.380	0.457	-0.074	101.1	-63.5
24	0.124	0.390	0.527	-0.092	70.5	-34.8
25	0.134	0.400	0.573	-0.083	62.3	-34.5
26	0.144	0.410	0.613	-0.093	49.9	-23.4
27	0.154	0.420	0.647	-0.091	40.5	-21.0
28	0.164	0.430	0.680	-0.093	36.2	-16.7
29	0.174	0.440	0.706	-0.095	34.2	-14.6
30	0.184	0.450	0.718	-0.091	34.2	-14.6
31	0.194	0.460	0.741	-0.092	32.6	-14.3
32	0.204	0.470	0.755	-0.090	30.4	-10.8
33	0.224	0.490	0.782	-0.089	29.7	-11.4
34	0.244	0.510	0.815	-0.091	28.2	-11.1
35	0.264	0.530	0.838	-0.088	25.1	-9.1
36	0.284	0.550	0.844	-0.104	20.3	-7.6
37	0.304	0.570	0.879	-0.089	18.8	-6.1
38	0.324	0.590	0.897	-0.081	17.4	-4.7
39	0.344	0.610	0.915	-0.082	13.3	-2.6
40	0.364	0.630	0.927	-0.080	11.8	-2.0
41	0.384	0.650	0.937	-0.076	9.4	-1.3
42	0.404	0.670	0.943	-0.080	7.9	-1.2
43	0.504	0.770	0.965	-0.068	7.3	0.0

Table 8. Continued

Separated-Flow Model

$\hat{x} = 0.888$		$\hat{R}_{\text{surface}} = 0.280$		$v_{\infty} = 212 \text{ m/sec}$		
I	\hat{y}	\hat{R}	$\langle \hat{U} \rangle$	$\langle \hat{V} \rangle$	$\hat{k} \times 10^4$	$\langle \hat{U} \cdot \hat{V} \rangle$
1	0.004	0.284	-0.032	-0.021	41.7	-10.1
2	0.009	0.289	-0.015	-0.025	57.7	-24.5
3	0.014	0.294	0.021	-0.038	74.1	-39.3
4	0.019	0.299	0.053	-0.053	89.7	-49.6
5	0.024	0.304	0.067	-0.045	100.3	-56.5
6	0.029	0.309	0.092	-0.053	104.0	-60.1
7	0.034	0.314	0.126	-0.057	100.3	-63.8
8	0.039	0.319	0.154	-0.060	105.9	-65.7
9	0.044	0.324	0.178	-0.066	100.3	-56.5
10	0.049	0.329	0.207	-0.060	105.9	-65.7
11	0.054	0.334	0.249	-0.089	92.5	-46.8
12	0.059	0.339	0.273	-0.079	96.0	-50.2
13	0.064	0.344	0.299	-0.071	100.3	-56.5
14	0.069	0.349	0.320	-0.073	106.9	-57.2
15	0.074	0.354	0.350	-0.073	106.8	-61.0
16	0.079	0.359	0.392	-0.080	101.3	-55.5
17	0.084	0.364	0.420	-0.080	86.4	-46.2
18	0.089	0.369	0.446	-0.079	91.4	-51.3
19	0.094	0.374	0.470	-0.079	93.2	-53.0
20	0.099	0.379	0.503	-0.079	84.7	-44.6
21	0.104	0.384	0.531	-0.075	78.0	-44.9
22	0.114	0.394	0.583	-0.082	54.0	-25.6
23	0.124	0.404	0.631	-0.083	44.5	-20.5
24	0.134	0.414	0.657	-0.082	39.5	-20.9
25	0.144	0.424	0.678	-0.079	38.4	-19.8
26	0.154	0.434	0.698	-0.077	36.3	-17.6
27	0.164	0.444	0.720	-0.087	32.6	-15.2
28	0.174	0.454	0.733	-0.079	32.0	-15.7
29	0.184	0.464	0.750	-0.078	32.0	-15.7
30	0.194	0.474	0.765	-0.077	28.5	-13.4
31	0.204	0.484	0.779	-0.076	28.5	-13.4
32	0.224	0.504	0.810	-0.079	24.4	-10.4
33	0.244	0.524	0.835	-0.073	24.7	-8.5
34	0.264	0.544	0.851	-0.071	22.0	-8.0
35	0.284	0.564	0.875	-0.067	19.2	-6.2
36	0.304	0.584	0.896	-0.067	16.1	-5.1
37	0.324	0.604	0.911	-0.072	14.2	-3.2
38	0.344	0.624	0.924	-0.069	10.1	-1.8
39	0.364	0.644	0.933	-0.068	10.2	-2.7
40	0.384	0.664	0.914	-0.079	7.1	-1.2
41	0.384	0.664	0.942	-0.068	6.9	-1.5
42	0.404	0.684	0.948	-0.068	6.0	-0.7
43	0.504	0.784	0.961	-0.061	5.0	-0.3

Table 8. Continued
Separated-Flow Model

$\hat{\chi} = 0.938$		$\hat{R}_{\text{surface}} = 0.292$		$v_{\infty} = 214 \text{ m/sec}$		
I	\hat{Y}	\hat{R}	$\langle \hat{U} \rangle$	$\langle \hat{V} \rangle$	$\hat{k} \times 10^4$	$\langle \hat{U} \hat{V} \rangle$
1	0.004	0.296	0.076	-0.021	42.5	-30.7
2	0.009	0.301	0.091	-0.016	64.7	-32.1
3	0.014	0.306	0.109	-0.032	75.1	-39.3
4	0.019	0.311	0.122	-0.033	93.1	-53.8
5	0.024	0.316	0.149	-0.036	92.3	-51.1
6	0.029	0.321	0.177	-0.048	94.9	-55.5
7	0.034	0.326	0.193	-0.045	110.4	-65.5
8	0.039	0.331	0.230	-0.052	119.1	-68.3
9	0.044	0.336	0.257	-0.062	97.5	-56.4
10	0.049	0.341	0.288	-0.056	106.6	-61.7
11	0.054	0.346	0.311	-0.063	107.6	-60.8
12	0.059	0.351	0.353	-0.065	98.5	-55.4
13	0.064	0.356	0.377	-0.073	104.0	-57.1
14	0.069	0.361	0.401	-0.069	96.9	-50.0
15	0.074	0.366	0.427	-0.078	97.9	-49.0
16	0.079	0.371	0.461	-0.074	90.8	-45.9
17	0.084	0.376	0.487	-0.068	84.6	-48.8
18	0.089	0.381	0.509	-0.078	82.4	-41.3
19	0.094	0.386	0.529	-0.066	79.7	-47.2
20	0.099	0.391	0.572	-0.080	57.5	-28.3
21	0.104	0.396	0.582	-0.076	62.3	-34.5
22	0.114	0.406	0.622	-0.072	43.5	-20.1
23	0.124	0.416	0.651	-0.081	39.2	-15.7
24	0.134	0.426	0.673	-0.078	36.2	-16.7
25	0.144	0.436	0.695	-0.070	34.6	-16.3
26	0.154	0.446	0.719	-0.078	32.0	-14.9
27	0.164	0.456	0.731	-0.070	29.5	-13.5
28	0.174	0.466	0.746	-0.075	30.1	-13.0
29	0.184	0.476	0.765	-0.076	27.7	-11.7
30	0.194	0.486	0.780	-0.073	26.9	-10.8
31	0.204	0.496	0.796	-0.072	26.8	-10.8
32	0.224	0.516	0.819	-0.073	24.5	-9.7
33	0.244	0.536	0.844	-0.072	22.1	-7.3
34	0.264	0.556	0.863	-0.069	19.3	-5.6
35	0.284	0.576	0.880	-0.066	18.8	-6.1
36	0.304	0.596	0.899	-0.065	13.6	-4.7
37	0.324	0.616	0.916	-0.069	9.5	-2.2
38	0.344	0.636	0.925	-0.068	8.2	-1.6
39	0.364	0.656	0.933	-0.068	7.0	-0.4
40	0.384	0.676	0.942	-0.065	5.9	0.0
41	0.404	0.696	0.946	-0.065	5.2	-0.7
42	0.504	0.796	0.957	-0.057	3.7	-0.3
43	0.604	0.896	0.964	-0.052	2.9	-0.5
44	0.703	0.995	0.967	-0.049	3.2	-0.3
45	0.903	1.195	0.974	-0.042	2.5	0.0
46	1.003	1.295	0.979	-0.041	2.9	0.0
47	1.103	1.395	0.981	-0.037	3.2	0.3
48	1.403	1.695	0.983	-0.035	2.7	-0.2
49	1.603	1.895	0.985	-0.033	3.7	-0.3

Table 8. Continued
 Separated-Flow Model

$\hat{X} = 0.938$	$\hat{R}_{\text{surface}} = 0.292$	$v_{\infty} = 214 \text{ m/sec}$				
I	\hat{Y}	\hat{R}	$\langle \hat{U} \rangle$	$\langle \hat{V} \rangle$	$\hat{k} \times 10^4$	$\langle \hat{U} \hat{V} \rangle$
50	1.803	2.095	0.986	-0.034	4.9	0.3
51	2.003	2.295	0.992	-0.030	4.9	0.3
52	2.403	2.695	0.988	-0.021	44.3	15.0
53	2.520	2.812	0.556	-0.045	107.1	36.3

Table 8. Continued
Separated-Flow Model

$\hat{X} = 1.138$ $\hat{R}_{\text{surface}} = 0.325$ $v_{\infty} = 212 \text{ m/sec}$						
I	\hat{Y}	\hat{R}	$\langle \hat{U} \rangle$	$\langle \hat{V} \rangle$	$\hat{k} \times 10^4$	$\langle \hat{U} \hat{V} \rangle$
1	0.004	0.329	0.362	0.018	51.8	-2.1
2	0.009	0.334	0.400	0.023	53.1	-16.6
3	0.014	0.339	0.429	0.019	61.5	-23.3
4	0.019	0.344	0.434	0.006	69.5	-34.8
5	0.024	0.349	0.453	0.003	79.7	-43.2
6	0.029	0.354	0.464	0.002	86.4	-46.2
7	0.034	0.359	0.485	-0.006	85.0	-41.1
8	0.039	0.364	0.500	-0.003	96.0	-50.2
9	0.044	0.369	0.524	-0.007	88.2	-44.4
10	0.049	0.374	0.535	0.0	93.3	-49.5
11	0.054	0.379	0.564	-0.012	81.5	-41.4
12	0.059	0.384	0.583	-0.005	77.4	-39.1
13	0.064	0.389	0.607	-0.008	65.1	-33.6
14	0.069	0.394	0.613	-0.016	71.1	-36.3
15	0.074	0.399	0.642	-0.017	56.9	-25.4
16	0.079	0.404	0.657	-0.017	53.3	-26.4
17	0.084	0.409	0.675	-0.023	44.5	-20.5
18	0.089	0.414	0.686	-0.022	47.3	-24.8
19	0.094	0.419	0.698	-0.022	39.7	-18.5
20	0.099	0.424	0.706	-0.029	39.7	-18.5
21	0.104	0.429	0.723	-0.033	35.9	-15.9
22	0.114	0.439	0.731	-0.026	32.0	-15.7
23	0.124	0.449	0.754	-0.030	31.4	-16.3
24	0.134	0.459	0.767	-0.031	31.2	-12.6
25	0.144	0.469	0.786	-0.031	28.5	-13.4
26	0.154	0.479	0.797	-0.036	27.6	-12.5
27	0.164	0.489	0.808	-0.033	27.6	-12.5
28	0.174	0.499	0.817	-0.038	25.3	-10.7
29	0.184	0.509	0.934	-0.036	22.2	-9.3
30	0.194	0.519	0.842	-0.040	21.2	-7.2
31	0.204	0.529	0.850	-0.040	21.4	-8.5
32	0.224	0.549	0.872	-0.040	19.2	-6.2
33	0.244	0.569	0.889	-0.038	16.9	-5.8
34	0.264	0.589	0.905	-0.042	12.1	-3.0
35	0.284	0.609	0.921	-0.044	11.0	-1.9
36	0.304	0.629	0.931	-0.044	8.7	-0.4
37	0.324	0.649	0.941	-0.047	6.7	-0.7
38	0.344	0.669	0.946	-0.046	5.3	0.0
39	0.364	0.689	0.950	-0.044	5.3	0.0
40	0.384	0.709	0.952	-0.044	4.7	0.0
41	0.404	0.729	0.955	-0.043	4.1	-0.6
42	0.424	0.749	0.957	-0.045	3.9	-0.8
43	0.444	0.769	0.950	-0.046	3.5	-0.5
44	0.464	0.789	0.960	-0.042	1.9	-0.2
45	0.484	0.809	0.962	-0.042	2.1	-0.4
46	0.504	0.829	0.963	-0.041	2.1	-0.4
47	0.604	0.929	0.966	-0.042	2.1	-0.4
48	0.704	1.029	0.972	-0.040	2.3	-0.2
49	0.804	1.129	0.976	-0.038	1.9	-0.2

Table 8. Continued

Separated-Flow Model

$\hat{\chi} = 1.138$		$\hat{R}_{\text{surface}} = 0.325$		$v_{\infty} = 212 \text{ m/sec}$		
I	$\hat{\psi}$	\hat{R}	$\langle \hat{U} \rangle$	$\langle \hat{V} \rangle$	$\hat{k} \times 10^4$	$\langle \hat{U} \cdot \hat{\psi} \rangle$
50	0.904	1.229	0.979	-0.037	2.3	-0.2
51	1.004	1.329	0.979	-0.033	2.3	0.2
52	1.104	1.429	0.983	-0.033	2.3	-0.2
53	1.204	1.529	0.984	-0.032	2.3	-0.2
54	1.304	1.629	0.983	-0.031	2.1	0.0
55	1.404	1.729	0.983	-0.031	2.5	0.0
56	1.504	1.829	0.984	-0.030	2.3	-0.2
57	1.604	1.929	0.983	-0.029	3.0	-0.5
58	1.704	2.029	0.984	-0.032	2.3	-0.2
59	1.804	2.129	0.986	-0.032	2.7	-0.2
60	2.004	2.329	0.987	-0.024	3.5	-0.5
61	2.204	2.529	0.985	-0.020	6.0	-0.7
62	2.404	2.729	0.920	-0.012	68.4	24.6

Table 8. Continued

Separated-Flow Model

$\hat{X} = 1.338$		$\hat{R}_{\text{surface}} = 0.341$		$v_{\infty} = 211 \text{ m/sec}$		
I	\hat{Y}	\hat{R}	$\langle \hat{U} \rangle$	$\langle \hat{V} \rangle$	$\hat{k} \times 10^4$	$\langle \hat{U} \hat{V} \rangle$
1	0.004	0.345	0.497	-0.011	66.5	-1.2
2	0.009	0.350	0.531	0.006	51.5	-9.3
3	0.014	0.355	0.562	0.009	47.0	-13.7
4	0.019	0.360	0.580	0.010	54.2	-20.8
5	0.019	0.360	0.589	0.001	55.0	-20.0
6	0.024	0.365	0.587	0.015	55.1	-25.0
7	0.024	0.365	0.597	-0.003	54.6	-22.9
8	0.029	0.370	0.594	0.008	63.8	-27.0
9	0.029	0.370	0.509	-0.003	61.0	-24.3
10	0.034	0.375	0.620	-0.003	64.3	-29.3
11	0.034	0.375	0.624	-0.005	64.3	-29.3
12	0.039	0.380	0.627	0.004	70.0	-35.0
13	0.039	0.380	0.631	0.002	67.1	-32.1
14	0.044	0.385	0.541	-0.004	68.5	-33.5
15	0.044	0.385	0.647	-0.012	67.4	-28.9
16	0.049	0.390	0.650	-0.003	73.3	-34.7
17	0.054	0.395	0.655	0.0	78.1	-36.0
18	0.059	0.400	0.579	-0.011	63.8	-27.0
19	0.059	0.400	0.686	-0.006	68.0	-31.2
20	0.064	0.405	0.695	-0.003	60.2	-25.2
21	0.064	0.405	0.705	-0.011	61.5	-26.5
22	0.069	0.410	0.703	-0.011	65.7	-30.7
23	0.069	0.410	0.713	-0.007	52.9	-19.6
24	0.074	0.415	0.724	-0.013	50.9	-19.2
25	0.074	0.415	0.730	-0.011	48.7	-18.8
26	0.079	0.420	0.741	-0.012	45.4	-19.9
27	0.079	0.420	0.743	-0.014	43.2	-13.1
28	0.084	0.425	0.748	-0.011	40.5	-13.6
29	0.084	0.425	0.752	-0.011	41.7	-19.0
30	0.089	0.430	0.763	-0.010	38.8	-13.3
31	0.094	0.435	0.771	-0.011	35.0	-15.0
32	0.099	0.440	0.781	-0.013	32.4	-13.6
33	0.104	0.445	0.788	-0.016	30.5	-11.7
34	0.114	0.455	0.801	-0.013	29.3	-12.9
35	0.124	0.465	0.817	-0.012	28.3	-12.0
36	0.134	0.475	0.824	-0.013	27.8	-12.6
37	0.144	0.485	0.938	-0.011	24.6	-10.5
38	0.164	0.505	0.960	-0.021	22.1	-8.0
39	0.169	0.510	0.852	-0.017	21.8	-9.8
40	0.174	0.515	0.869	-0.015	19.8	-8.8
41	0.184	0.525	0.876	-0.016	19.8	-8.8
42	0.194	0.535	0.985	-0.019	20.0	-7.0
43	0.204	0.545	0.896	-0.018	18.0	-6.0
44	0.224	0.565	0.913	-0.019	14.4	-4.3
45	0.244	0.585	0.926	-0.017	12.3	-4.0
46	0.264	0.605	0.942	-0.023	7.5	-0.8
47	0.284	0.625	0.948	-0.023	6.4	-1.1
48	0.304	0.645	0.955	-0.024	4.4	-0.9
49	0.304	0.645	0.958	-0.028	4.1	0.0

Table 8. Continued

Separated-Flow Model

$\hat{x} = 1.338$	$\hat{R}_{\text{surface}} = 0.341$	$v_{\infty} = 211 \text{ m/sec}$				
I	\hat{y}	\hat{R}	$\langle \hat{U} \rangle$	$\langle \hat{V} \rangle$	$\hat{k} \times 10^4$	$\langle \hat{U} \hat{V} \rangle$
50	0.324	0.665	0.961	-0.027	3.5	0.0
51	0.324	0.665	0.962	-0.026	3.0	0.5
52	0.344	0.685	0.965	-0.026	2.3	-0.2
53	0.364	0.705	0.969	-0.028	2.1	0.4
54	0.384	0.725	0.971	-0.026	1.7	0.0
55	0.404	0.745	0.970	-0.027	2.1	0.4
56	0.424	0.765	0.971	-0.028	1.9	0.2
57	0.444	0.785	0.971	-0.028	1.9	0.6
58	0.464	0.805	0.972	-0.027	1.9	0.2
59	0.484	0.825	0.973	-0.028	1.9	0.2
60	0.504	0.845	0.974	-0.027	1.7	0.4
61	0.604	0.945	0.978	-0.024	1.9	0.6
62	0.704	1.045	0.981	-0.026	1.9	0.6
63	0.804	1.145	0.984	-0.027	1.5	0.5
64	0.904	1.245	0.987	-0.026	1.7	0.4
65	1.004	1.345	0.987	-0.023	1.6	0.5
66	1.104	1.445	0.988	-0.022	1.7	0.4
67	1.204	1.545	0.990	-0.022	1.7	0.4
68	1.304	1.645	0.991	-0.021	1.7	0.4
69	1.404	1.745	0.991	-0.023	1.6	0.5
70	1.504	1.845	0.992	-0.020	2.5	0.5
71	1.604	1.945	0.993	-0.021	2.9	0.7
72	1.704	2.045	0.995	-0.021	4.1	0.0
73	1.804	2.145	0.997	-0.019	3.9	0.8
74	2.004	2.345	0.997	-0.019	4.1	0.6
75	2.204	2.545	0.993	-0.017	5.7	1.0
76	2.404	2.745	0.912	-0.010	68.4	22.4
77	2.568	2.909	0.497	0.062	105.4	27.9

Table 8. Continued

Separated-Flow Model

$\hat{x} = 1.938$

$\hat{R}_{\text{surface}} = 0.341$

$v_{\infty} = 211 \text{ m/sec}$

I	\hat{y}	\hat{R}	$\langle \hat{U} \rangle$	$\langle \hat{V} \rangle$	$\hat{k} \times 10^4$	$\langle \hat{U} - \hat{V} \rangle$
1	0.004	0.345	0.496	-0.008	71.7	-11.0
2	0.009	0.350	0.556	-0.003	56.4	-16.1
3	0.014	0.355	0.608	-0.004	42.9	-11.3
4	0.019	0.360	0.639	-0.008	41.4	-12.8
5	0.024	0.365	0.655	-0.008	42.8	-15.8
6	0.029	0.370	0.662	-0.001	41.7	-14.7
7	0.034	0.375	0.679	-0.007	42.0	-16.5
8	0.039	0.380	0.688	-0.012	43.9	-16.9
9	0.044	0.385	0.689	-0.007	48.1	-19.6
10	0.049	0.390	0.706	-0.004	44.7	-20.6
11	0.054	0.395	0.706	-0.012	49.3	-20.8
12	0.059	0.400	0.719	-0.012	49.8	-22.8
13	0.064	0.405	0.736	-0.013	53.0	-24.5
14	0.069	0.410	0.739	-0.014	52.1	-20.4
15	0.074	0.415	0.753	-0.008	51.0	-24.0
16	0.079	0.420	0.756	-0.011	49.3	-20.8
17	0.084	0.425	0.772	-0.020	43.9	-16.9
18	0.089	0.430	0.778	-0.012	47.3	-20.3
19	0.094	0.435	0.784	-0.016	43.1	-17.6
20	0.099	0.440	0.801	-0.017	37.4	-14.7
21	0.104	0.445	0.801	-0.013	45.4	-19.9
22	0.114	0.455	0.820	-0.015	36.4	-13.7
23	0.124	0.465	0.835	-0.014	31.1	-11.1
24	0.134	0.475	0.855	-0.016	25.1	-9.9
25	0.144	0.485	0.859	-0.018	26.0	-7.3
26	0.154	0.495	0.870	-0.010	27.2	-13.1
27	0.164	0.505	0.886	-0.018	21.3	-7.2
28	0.174	0.515	0.889	-0.011	23.2	-10.2
29	0.184	0.525	0.899	-0.015	20.0	-7.0
30	0.194	0.535	0.908	-0.012	18.9	-6.8
31	0.204	0.545	0.920	-0.013	16.2	-5.2
32	0.224	0.565	0.937	-0.014	13.2	-3.1
33	0.244	0.585	0.944	-0.017	11.2	-2.9
34	0.264	0.605	0.959	-0.016	8.4	-1.7
35	0.284	0.625	0.968	-0.018	6.0	0.0
36	0.304	0.645	0.974	-0.016	5.0	0.3
37	0.324	0.665	0.979	-0.015	3.9	0.3
38	0.344	0.685	0.981	-0.015	3.3	0.8
39	0.364	0.705	0.986	-0.014	3.0	0.5
40	0.384	0.725	0.984	-0.016	3.3	0.3
41	0.404	0.745	0.985	-0.015	3.3	0.3
42	0.424	0.765	0.986	-0.016	2.5	0.5
43	0.444	0.785	0.986	-0.016	2.3	0.7
44	0.464	0.805	0.988	-0.014	2.3	0.7
45	0.484	0.825	0.988	-0.014	2.3	0.7
46	0.504	0.845	0.989	-0.015	3.3	0.3
47	0.504	0.845	0.989	-0.017	2.9	1.2
48	0.604	0.945	0.988	-0.014	3.0	0.5
49	0.704	1.045	0.989	-0.017	2.5	0.5

Table 8. Continued

Separated-Flow Model

$\hat{X} = 1.938$		$\hat{R}_{\text{surface}} = 0.341$		$v_{\infty} = 211 \text{ m/sec}$		
I	\hat{Y}	\hat{R}	$\langle \hat{U} \rangle$	$\langle \hat{V} \rangle$	$\hat{k} \times 10^4$	$\langle \hat{U} \hat{V} \rangle$
50	0.804	1.145	0.989	-0.015	2.2	0.8
51	0.904	1.245	0.990	-0.016	2.3	0.7
52	1.004	1.345	0.993	-0.015	2.3	0.7
53	1.104	1.445	0.991	-0.015	1.9	0.6
54	1.204	1.545	0.992	-0.014	2.2	0.8
55	1.304	1.645	0.993	-0.015	1.9	0.6
56	1.404	1.745	0.991	-0.015	1.9	0.6
57	1.504	1.845	0.998	-0.014	5.0	0.3
58	1.604	1.945	0.994	-0.016	4.7	0.6
59	1.704	2.045	0.996	-0.018	3.5	0.5
60	1.804	2.145	0.996	-0.016	3.0	0.5
61	2.004	2.345	0.996	-0.018	3.0	0.5
62	2.204	2.545	0.993	-0.015	5.4	0.7
63	2.404	2.745	0.904	-0.002	70.7	28.5
64	2.565	2.906	0.472	0.047	122.0	39.3

Table 8. Continued

Separated-Flow Model

$\hat{X} = 2.938$ $\hat{R}_{\text{surface}} = 0.341$ $v_{\infty} = 211 \text{ m/sec}$						
I	\hat{Y}	\hat{R}	$\langle \hat{U} \rangle$	$\langle \hat{V} \rangle$	$\hat{k} \times 10^4$	$\langle \hat{U} \hat{V} \rangle$
1	0.004	0.345	0.564	-0.013	62.3	-10.2
2	0.009	0.350	0.621	-0.010	44.8	-11.5
3	0.014	0.355	0.656	-0.007	41.1	-11.0
4	0.019	0.360	0.683	-0.017	39.5	-12.5
5	0.024	0.365	0.697	-0.009	39.5	-12.5
6	0.029	0.370	0.705	-0.001	35.8	-10.3
7	0.034	0.375	0.716	-0.008	38.9	-13.3
8	0.039	0.380	0.731	-0.010	35.5	-8.5
9	0.044	0.385	0.743	-0.006	37.9	-12.3
10	0.049	0.390	0.748	-0.009	37.8	-12.3
11	0.054	0.395	0.754	-0.007	37.8	-12.3
12	0.059	0.400	0.754	-0.005	37.8	-12.3
13	0.064	0.405	0.764	-0.003	39.1	-15.1
14	0.069	0.410	0.775	-0.005	36.8	-11.2
15	0.074	0.415	0.788	-0.008	35.7	-14.3
16	0.079	0.420	0.796	-0.010	36.4	-13.7
17	0.084	0.425	0.795	-0.007	37.1	-13.0
18	0.089	0.430	0.800	-0.008	38.4	-15.8
19	0.094	0.435	0.809	-0.005	35.0	-15.0
20	0.099	0.440	0.818	-0.005	35.7	-14.3
21	0.104	0.445	0.826	-0.009	35.3	-12.7
22	0.114	0.455	0.838	-0.009	34.4	-11.7
23	0.124	0.465	0.843	-0.004	34.7	-13.3
24	0.134	0.475	0.868	-0.016	30.9	-9.5
25	0.144	0.485	0.866	-0.006	30.2	-10.2
26	0.154	0.495	0.886	-0.010	25.4	-7.9
27	0.164	0.505	0.893	-0.009	24.0	-7.7
28	0.174	0.515	0.903	-0.013	21.1	-5.9
29	0.184	0.525	0.911	-0.011	24.0	-7.7
30	0.204	0.545	0.931	-0.004	19.8	-5.7
31	0.224	0.565	0.949	-0.010	16.5	-3.5
32	0.244	0.585	0.958	-0.013	13.1	-2.1
33	0.264	0.605	0.967	-0.013	10.6	-0.5
34	0.284	0.625	0.974	-0.010	8.4	-1.7
35	0.304	0.645	0.981	-0.015	6.0	0.7
36	0.324	0.665	0.989	-0.011	4.4	0.3
37	0.344	0.685	0.990	-0.010	3.5	0.5
38	0.364	0.705	0.995	-0.013	3.5	0.5
39	0.384	0.725	0.996	-0.010	3.3	0.3
40	0.404	0.745	0.996	-0.010	2.5	0.5
41	0.424	0.765	0.996	-0.010	1.9	0.6
42	0.444	0.785	0.996	-0.012	2.1	0.4
43	0.464	0.805	0.997	-0.011	2.3	0.7
44	0.484	0.825	0.996	-0.012	2.5	0.5
45	0.504	0.845	0.997	-0.009	3.8	0.3
46	0.554	0.895	0.998	-0.012	3.0	0.5
47	0.604	0.945	0.996	-0.010	3.0	0.5
48	0.654	0.995	0.995	-0.013	3.0	0.0
49	0.704	1.045	0.995	-0.013	3.0	0.5

Table 8. Continued
Separated-Flow Model

$\hat{X} = 2.938$ $\hat{R}_{\text{surface}} = 0.341$ $v_{\infty} = 211 \text{ m/sec}$						
I	$\hat{\psi}$	\hat{R}	$\langle \hat{U} \rangle$	$\langle \hat{V} \rangle$	$\hat{k} \times 10^4$	$\langle \hat{U} \hat{V} \rangle$
50	0.754	1.095	0.996	-0.012	2.9	0.2
51	0.804	1.145	0.995	-0.013	2.5	0.0
52	0.854	1.195	0.995	-0.013	2.3	0.2
53	0.904	1.245	0.996	-0.014	1.9	0.6
54	0.954	1.295	0.996	-0.014	2.1	0.4
55	1.004	1.345	0.993	-0.013	1.7	0.4
56	1.104	1.445	0.995	-0.013	1.9	0.6
57	1.204	1.545	0.996	-0.012	1.9	0.6
58	1.304	1.645	0.996	-0.014	1.9	0.6
59	1.404	1.745	0.995	-0.013	2.3	0.7
60	1.504	1.845	0.995	-0.015	2.5	0.5
61	1.604	1.945	0.997	-0.015	3.0	0.5
62	1.704	2.045	0.999	-0.015	4.4	0.9
63	1.804	2.145	0.997	-0.015	3.8	0.8
64	1.904	2.245	0.998	-0.016	3.3	0.3
65	2.004	2.345	0.997	-0.013	3.5	0.5
66	2.104	2.445	0.997	-0.011	4.4	0.9
67	2.204	2.545	0.983	-0.007	8.8	1.3
68	2.304	2.645	0.903	-0.013	41.3	17.2
69	2.404	2.745	0.772	0.002	76.1	26.0
70	2.504	2.845	0.606	0.010	108.0	35.5

Table 8. Continued

Attached-Flow Model

Porous Wall Boundary Conditions

$\hat{R} = 2.500$

$\hat{Z} = 0.000$

$v_w = 212$

I	\hat{X}	\hat{U}	\hat{V}	$\hat{k} \times 10^4$	$\langle \hat{uv} \rangle$
1	-2.200	0.995	-0.017	5.3	0.7
2	-2.000	0.995	-0.015	5.0	1.0
3	-1.800	0.996	-0.016	5.0	1.0
4	-1.600	0.999	-0.018	4.1	0.0
5	-1.400	0.999	-0.016	5.6	0.3
6	-1.200	0.998	-0.015	3.8	0.3
7	-1.000	0.998	-0.017	3.8	-0.8
8	-0.800	1.000	-0.015	4.4	-0.3
9	-0.600	1.000	-0.017	5.0	1.0
10	-0.400	0.996	-0.022	3.8	-0.3
11	-0.200	0.999	-0.020	4.1	0.0
12	0.000	1.001	-0.022	4.1	-0.6
13	0.200	1.000	-0.021	5.0	0.3
14	0.400	0.999	-0.022	5.0	-0.3
15	0.600	0.999	-0.028	4.1	-0.6
16	0.800	0.998	-0.025	3.8	0.3
17	1.000	0.996	-0.022	4.1	0.0
18	1.200	0.999	-0.028	5.0	-1.0
19	1.400	1.001	-0.024	5.6	-0.3
20	1.600	0.994	-0.022	3.8	-0.3
21	1.800	0.989	-0.027	4.7	-0.0
22	1.800	0.994	-0.026	6.3	-0.4

Table 8. Continued

Attached-Flow Model

Porous Wall Boundary Conditions

$\hat{R} = 2.500$

$\hat{Z} = 0.000$

$v_{\infty} = 211$

I	\hat{X}	\hat{U}	\hat{V}	$\hat{k} \times 10^4$	$\langle \hat{U}\hat{V} \rangle$
1	-4.062	0.997	-0.019	2.9	-1.2
2	-3.862	0.998	-0.020	3.1	-1.0
3	-3.662	0.999	-0.019	2.9	-1.2
4	-3.462	1.001	-0.021	2.8	-0.7
5	-3.262	0.999	-0.021	2.6	-0.9
6	-3.062	1.001	-0.019	3.1	-1.0
7	-2.862	1.001	-0.017	3.1	-1.0
8	-2.662	0.999	-0.017	3.4	-1.3
9	-2.462	1.001	-0.019	3.3	-0.8
10	-2.262	1.003	-0.019	3.3	-0.8
11	-2.062	1.002	-0.016	3.1	-1.0
12	-1.862	1.002	-0.016	3.3	-0.8
13	-1.662	1.000	-0.016	3.0	-0.5
14	-1.462	1.001	-0.019	3.3	-0.3
15	-1.262	0.996	-0.016	3.5	-0.5
16	-1.062	0.994	-0.020	3.3	0.8

Table 8. Concluded

Attached-Flow Model

Porous Wall Boundary Conditions

$\hat{R} = 2.500$

$\hat{Z} = 0.000$

$v_{\infty} = 212$

I	\hat{X}	\hat{U}	\hat{V}	$\hat{k} \times 10^4$	$\langle \hat{U}\hat{V} \rangle$
1	0.338	0.990	-0.021	10.0	0.9
2	0.538	0.985	-0.026	11.0	1.9
3	0.738	0.984	-0.023	12.9	4.6
4	1.138	0.980	-0.015	14.1	2.2
5	1.138	0.984	-0.019	12.0	1.0
6	1.338	0.976	-0.019	15.8	2.8
7	1.538	0.972	-0.017	18.8	3.7
8	1.738	0.963	-0.016	19.4	3.2
9	1.938	0.960	-0.015	22.0	3.4
10	2.138	0.959	-0.016	22.1	4.7
11	2.338	0.949	-0.008	26.9	3.0
12	2.538	0.950	-0.017	28.2	8.3
13	2.738	0.941	-0.015	30.2	6.3
14	2.938	0.946	-0.012	27.2	6.0
15	3.138	0.944	-0.010	28.4	3.1
16	3.338	0.928	-0.026	32.8	12.9
17	3.538	0.936	-0.014	27.0	9.6
18	3.938	0.927	-0.007	24.5	7.0

**Table 9. Least-Squares Cubic Spline Coefficients,
Separated-Flow Model**

The fits are of the form

$$\langle \widehat{U}(\widehat{R}) \rangle = \sum_{i=0}^3 A_i \widehat{R}^i$$

Table 9. Continued

Separated-Flow Model

$$\hat{X} = -4.062 \quad \hat{R}_{\text{surface}} = 0.500$$

$\langle \hat{U} \rangle$ Coefficients				Interval Limit
A_3	A_2	A_1	A_0	\hat{R}_{max}
4.535E 04	-7.085E 04	3.690E 04	-6.407E 03	0.5200
1.323E 03	-2.169E 03	1.188E 03	-2.165E 02	0.5400
1.993E 02	-3.479E 02	2.043E 02	-3.945E 01	0.5600
1.400E 02	-2.482E 02	1.485E 02	-2.903E 01	0.5800
-7.697E 01	1.292E 02	-7.044E 01	1.330E 01	0.6000
1.820E 01	-4.210E 01	3.235E 01	-7.263E 00	0.6500
2.156E 01	-4.865E 01	3.661E 01	-8.186E 00	0.7500
1.898E-01	-5.628E-01	5.424E-01	8.310E-01	1.0000
5.181E-04	5.126E-03	-2.549E-02	1.020E 00	2.5000

$\langle \hat{V} \rangle$ Coefficients				Interval Limit
A_3	A_2	A_1	A_0	\hat{R}_{max}
2.367E 04	-3.683E 04	1.910E 04	-3.301E 03	0.5200
-1.979E 03	3.188E 03	-1.712E 03	3.063E 02	0.5400
3.772E 02	-6.291E 02	3.496E 02	-6.473E 01	0.5600
-4.600E 01	8.181E 01	-4.852E 01	9.581E 00	0.5800
4.728E-01	9.547E-01	-1.624E 00	5.140E-01	0.6000
-1.651E 01	3.152E 01	-1.997E 01	4.182E 00	0.6500
1.893E 00	-4.362E 00	3.360E 00	-8.717E-01	0.7500
1.490E-01	-4.382E-01	4.174E-01	-1.359E-01	1.0000
-3.858E-03	2.052E-02	-4.126E-02	1.697E-02	2.5000

\hat{k} Coefficients				Interval Limit
A_3	A_2	A_1	A_0	\hat{R}_{max}
-3.123E 03	4.867E 03	-2.529E 03	4.380E 02	0.5200
8.349E 01	-1.344E 02	7.208E 01	-1.287E 01	0.5400
-1.831E 01	3.051E 01	-1.698E 01	3.158E 00	0.5600
9.496E 00	-1.621E 01	9.183E 00	-1.725E 00	0.5800
-4.085E 00	7.426E 00	-4.523E 00	9.250E-01	0.6000
4.491E-01	-7.364E-01	3.738E-01	-5.442E-02	0.6500
-4.637E-01	1.044E 00	-7.832E-01	1.963E-01	0.7500
-1.226E-05	3.054E-04	-7.226E-04	6.381E-04	1.0000
-1.131E-04	6.080E-04	-1.025E-03	7.389E-04	2.5000

$\langle \hat{U} \hat{V} \rangle$ Coefficients				Interval Limit
A_3	A_2	A_1	A_0	\hat{R}_{max}
-8.424E 02	1.310E 03	-6.789E 02	1.173E 02	0.5200
9.946E 01	-1.594E 02	8.516E 01	-1.517E 01	0.5400
-4.073E 01	6.769E 01	-3.747E 01	6.909E 00	0.5600
1.594E 01	-2.751E 01	1.584E 01	-3.043E 00	0.5800
-6.842E 00	1.213E 01	-7.155E 00	1.403E 00	0.6000
9.399E-01	-1.875E 00	1.249E 00	-2.781E-01	0.6500
1.466E-01	-3.277E-01	2.437E-01	-6.019E-02	0.7500
-2.852E-03	8.511E-03	-8.439E-03	2.843E-03	1.0000
1.959E-05	-1.026E-04	1.753E-04	-2.857E-05	2.5000

Table 9. Continued

Separated-Flow Model

$$\hat{\chi} = -1.062 \quad \hat{R}_{\text{surface}} = 0.500$$

$\langle \hat{U} \rangle$ Coefficients

A_3	A_2	A_1	A_0	Interval Limit \hat{R}_{max}
1.345E 02	-3.454E 02	2.543E 02	-5.702E 01	0.5200
2.687E 03	-4.327E 03	2.325E 03	-4.159E 02	0.5400
-9.168E 02	1.511E 03	-8.276E 02	1.515E 02	0.5600
4.343E 02	-7.590E 02	4.434E 02	-8.572E 01	0.5800
6.779E 01	-1.213E 02	7.359E 01	-1.422E 01	0.6000
-5.687E 01	1.031E 02	-6.104E 01	1.270E 01	0.6500
2.490E 01	-5.637E 01	4.260E 01	-9.752E 00	0.7500
4.859E-01	-1.440E 00	1.407E 00	5.474E-01	1.0000
-8.516E-03	4.339E-02	-7.639E-02	1.042E 00	2.5000

$\langle \hat{V} \rangle$ Coefficients

A_3	A_2	A_1	A_0	Interval Limit \hat{R}_{max}
-1.577E 03	2.461E 03	-1.280E 03	2.220E 02	0.5200
2.027E 01	-3.044E 01	1.509E 01	-2.486E 00	0.5400
-1.887E 01	3.295E 01	-1.914E 01	3.675E 00	0.5600
-2.724E 01	4.701E 01	-2.701E 01	5.145E 00	0.5800
9.540E 00	-1.698E 01	1.010E 01	-2.030E 00	0.6000
-3.291E 00	6.121E 00	-3.756E 00	7.415E-01	0.6500
1.003E 00	-2.253E 00	1.687E 00	-4.378E-01	0.7500
-2.354E-02	5.673E-02	-4.480E-02	-4.725E-03	1.0000
7.864E-03	-3.749E-02	4.942E-02	-3.613E-02	2.5000

\hat{k} Coefficients

A_3	A_2	A_1	A_0	Interval Limit \hat{R}_{max}
-3.504E 01	5.527E 01	-2.909E 01	5.114E 00	0.5200
-1.312E 01	2.106E 01	-1.130E 01	2.031E 00	0.5400
1.030E 01	-1.687E 01	9.181E 00	-1.657E 00	0.5600
-5.469E 00	9.620E 00	-5.654E 00	1.113E 00	0.5800
-5.567E 00	9.791E 00	-5.753E 00	1.132E 00	0.6000
2.599E 00	-4.906E 00	3.065E 00	-6.320E-01	0.6500
-5.018E-01	1.139E 00	-8.643E-01	2.194E-01	0.7500
-1.428E-02	4.234E-02	-4.157E-02	1.377E-02	1.0000
2.504E-04	-1.242E-03	2.014E-03	-7.612E-04	2.5000

$\langle \hat{U} \hat{V} \rangle$ Coefficients

A_3	A_2	A_1	A_0	Interval Limit \hat{R}_{max}
1.029E 02	-1.593E 02	8.220E 01	-1.414E 01	0.5200
-2.481E 01	3.992E 01	-2.139E 01	3.818E 00	0.5400
5.432E 00	-9.070E 00	5.059E 00	-9.436E-01	0.5600
-4.340E 00	7.347E 00	-4.134E 00	7.725E-01	0.5800
5.083E 00	-9.049E 00	5.375E 00	-1.066E 00	0.6000
-1.162E 00	2.192E 00	-1.370E 00	2.829E-01	0.6500
2.497E-01	-5.611E-01	4.202E-01	-1.049E-01	0.7500
-1.069E-03	3.154E-03	-3.066E-03	9.539E-04	1.0000
2.188E-05	-1.192E-04	2.063E-04	-1.370E-04	2.5000

Table 9. Continued

Separated-Flow Modelⁱ

$$\hat{X} = -0.562 \quad \hat{R}_{\text{surface}} = 0.500$$

 $\langle \hat{U} \rangle$ Coefficients

				Interval Limit
A_3	A_2	A_1	A_0	\hat{R}_{max}
3.628E 03	-5.775E 03	3.068E 03	-5.430E 02	0.5200
2.030E 03	-3.283E 03	1.772E 03	-3.184E 02	0.5400
-4.631E 02	7.564E 02	-4.095E 02	7.430E 01	0.5600
2.623E 02	-4.624E 02	2.730E 02	-5.310E 01	0.5800
1.240E 02	-2.217E 02	1.334E 02	-2.611E 01	0.6000
-6.491E 01	1.183E 02	-7.062E 01	1.470E 01	0.6500
2.602E 01	-5.898E 01	4.464E 01	-1.028E 01	0.7500
5.838E-01	-1.740E 00	1.707E 00	4.548E-01	1.0000
-1.156E-03	1.488E-02	-4.786E-02	1.040E 00	2.5000

 $\langle \hat{V} \rangle$ Coefficients

				Interval Limit
A_3	A_2	A_1	A_0	\hat{R}_{max}
4.091E 03	-6.338E 03	3.273E 03	-5.633E 02	0.5200
-9.852E 02	1.580E 03	-8.445E 02	1.504E 02	0.5400
4.292E 02	-7.113E 02	3.929E 02	-7.234E 01	0.5600
-3.126E 02	5.350E 02	-3.051E 02	5.795E 01	0.5800
1.789E 02	-3.203E 02	1.910E 02	-3.797E 01	0.6000
-1.217E 01	2.370E 01	-1.539E 01	3.314E 00	0.6500
1.251E-01	-2.742E-01	1.932E-01	-6.207E-02	0.7500
-8.122E-03	2.547E-02	-3.149E-02	-5.887E-03	1.0000
-7.458E-04	3.343E-03	-9.365E-03	-1.326E-02	2.5000

 \hat{k} Coefficients

				Interval Limit
A_3	A_2	A_1	A_0	\hat{R}_{max}
-4.170E 02	6.497E 02	-3.374E 02	5.841E 01	0.5200
3.359E 01	-5.331E 01	2.817E 01	-4.953E 00	0.5400
-3.479E 01	5.746E 01	-3.165E 01	5.814E 00	0.5600
2.586E 01	-4.443E 01	2.541E 01	-4.837E 00	0.5800
-1.286E 01	2.295E 01	-1.367E 01	2.719E 00	0.6000
2.252E 00	-4.251E 00	2.653E 00	-5.455E-01	0.6500
-4.191E-01	9.572E-01	-7.320E-01	1.880E-01	0.7500
-1.906E-02	5.704E-02	-5.686E-02	1.920E-02	1.0000
1.000E-04	-4.304E-04	6.108E-04	4.346E-05	2.5000

 $\langle \hat{u} \hat{v} \rangle$ Coefficients

				Interval Limit
A_3	A_2	A_1	A_0	\hat{R}_{max}
-1.081E 02	1.667E 02	-8.560E 01	1.465E 01	0.5200
4.673E 01	-7.488E 01	4.000E 01	-7.125E 00	0.5400
-2.486E 01	4.109E 01	-2.262E 01	4.147E 00	0.5600
1.965E 01	-3.369E 01	1.926E 01	-3.670E 00	0.5800
-9.432E 00	1.691E 01	-1.009E 01	2.004E 00	0.6000
6.194E-02	-1.792E-01	1.611E-01	-4.635E-02	0.6500
1.882E-01	-4.254E-01	3.211E-01	-8.102E-02	0.7500
2.498E-03	-7.615E-03	7.766E-03	-2.686E-03	1.0000
8.396E-05	-3.740E-04	5.246E-04	-2.727E-04	2.5000

Table 9. Continued

Separated-Flow Model

$$\hat{X} = 0.0 \quad \hat{R}_{\text{surface}} = 0.500$$

$\langle \hat{U} \rangle$ Coefficients				Interval Limit
A_3	A_2	A_1	A_0	\hat{R}_{max}
1.062E 04	-1.660E 04	8.656E 03	-1.504E 03	0.5200
4.115E 02	-6.805E 02	3.770E 02	-6.908E 01	0.5400
-4.813E 01	6.415E 01	-2.509E 01	3.294E 00	0.5600
2.744E 02	-4.776E 02	2.783E 02	-5.334E 01	0.5800
-1.148E 01	1.972E 01	-1.016E 01	2.431E 00	0.6000
-4.067E 01	7.226E 01	-4.169E 01	8.735E 00	0.6500
2.267E 01	-5.124E 01	3.859E 01	-8.659E 00	0.7500
4.056E-01	-1.150E 00	1.023E 00	7.340E-01	1.0000
-2.510E-02	1.421E-01	-2.694E-01	1.165E 00	2.5000

$\langle \hat{V} \rangle$ Coefficients				Interval Limit
A_3	A_2	A_1	A_0	\hat{R}_{max}
-4.442E 03	6.905E 03	-3.578E 03	6.180E 02	0.5200
4.933E 02	-7.935E 02	4.251E 02	-7.588E 01	0.5400
-1.509E 01	3.016E 01	-1.968E 01	4.172E 00	0.5600
-1.165E 02	2.006E 02	-1.151E 02	2.199E 01	0.5800
3.734E 01	-6.715E 01	4.017E 01	-8.035E 00	0.6000
3.982E 00	-7.111E 00	4.149E 00	-8.301E-01	0.6500
-2.086E 00	4.721E 00	-3.542E 00	8.362E-01	0.7500
-5.813E-02	1.582E-01	-1.202E-01	-1.925E-02	1.0000
3.319E-03	-2.619E-02	6.417E-02	-8.070E-02	2.5000

\hat{k} Coefficients				Interval Limit
A_3	A_2	A_1	A_0	\hat{R}_{max}
-6.238E 02	9.698E 02	-5.026E 02	8.681E 01	0.5200
8.849E 01	-1.414E 02	7.527E 01	-1.335E 01	0.5400
-5.381E 01	8.913E 01	-4.921E 01	9.061E 00	0.5600
3.696E 01	-6.336E 01	3.618E 01	-6.880E 00	0.5800
-2.282E 01	4.066E 01	-2.415E 01	4.784E 00	0.6000
3.910E 00	-7.460E 00	4.722E 00	-9.901E-01	0.6500
-5.108E-01	1.160E 00	-8.808E-01	2.239E-01	0.7500
-1.501E-02	4.461E-02	-4.406E-02	1.475E-02	1.0000
2.649E-04	-1.220E-03	1.771E-03	-5.279E-04	2.5000

$\langle \hat{U} \hat{V} \rangle$ Coefficients				Interval Limit
A_3	A_2	A_1	A_0	\hat{R}_{max}
1.100E 02	-1.703E 02	8.791E 01	-1.513E 01	0.5200
-2.971E 01	4.760E 01	-2.540E 01	4.513E 00	0.5400
5.469E 00	-9.389E 00	5.374E 00	-1.027E 00	0.5600
4.446E 00	-7.670E 00	4.412E 00	-8.468E-01	0.5800
1.346E 00	-2.277E 00	1.284E 00	-2.421E-01	0.6000
-1.533E 00	2.906E 00	-1.826E 00	3.799E-01	0.6500
2.781E-01	-6.259E-01	4.697E-01	-1.175E-01	0.7500
-2.012E-04	3.395E-04	-9.712E-06	-1.294E-04	1.0000
1.621E-04	-7.503E-04	1.080E-03	-4.927E-04	2.5000

Table 9. Continued

Separated-Flow Model

$\hat{\lambda} = 0.138$

$\hat{R}_{\text{surface}} = 0.492$

 $\langle \hat{U} \rangle$ Coefficients

				Interval Limit
A_3	A_2	A_1	A_0	\hat{R}_{max}
1.186E 04	-1.828E 04	9.399E 03	-1.610E 03	0.5120
1.014E 03	-1.624E 03	8.686E 02	-1.543E 02	0.5320
-3.797E 00	1.587E-01	4.706E 00	-1.082E 00	0.5520
-7.096E 01	1.114E 02	-5.669E 01	1.021E 01	0.5720
1.821E 02	-3.228E 02	1.917E 02	-3.714E 01	0.5920
-4.386E 01	7.844E 01	-4.587E 01	9.736E 00	0.6420
1.937E 01	-4.335E 01	3.231E 01	-6.996E 00	0.7420
3.954E-01	-1.113E 00	9.779E-01	7.543E-01	0.9920
-2.233E-02	1.305E-01	-2.554E-01	1.162E 00	2.5000

 $\langle \hat{V} \rangle$ Coefficients

				Interval Limit
A_3	A_2	A_1	A_0	\hat{R}_{max}
-4.378E 03	6.690E 03	-3.407E 03	5.783E 02	0.5120
8.928E 02	-1.406E 03	7.381E 02	-1.292E 02	0.5320
-4.652E 02	7.611E 02	-4.149E 02	7.530E 01	0.5520
2.781E 02	-4.697E 02	2.644E 02	-4.970E 01	0.5720
-1.738E 02	3.057E 02	-1.791E 02	3.486E 01	0.5920
2.399E 01	-4.558E 01	2.887E 01	-6.175E 00	0.6420
-2.300E 00	5.065E 00	-3.643E 00	7.826E-01	0.7420
2.512E-02	-1.113E-01	1.979E-01	-1.674E-01	0.9920
9.284E-03	-6.414E-02	1.511E-01	-1.519E-01	2.5000

 $\langle \hat{k} \rangle$ Coefficients

				Interval Limit
A_3	A_2	A_1	A_0	\hat{R}_{max}
-8.274E 02	1.268E 03	-6.475E 02	1.102E 02	0.5120
5.970E 01	-9.482E 01	5.016E 01	-8.837E 00	0.5320
-7.950E-01	1.736E 00	-1.203E 00	2.717E-01	0.5520
-8.653E 00	1.475E 01	-8.386E 00	1.593E 00	0.5720
-2.509E 00	4.206E 00	-2.356E 00	4.435E-01	0.5920
2.635E 00	-4.930E 00	3.053E 00	-6.237E-01	0.6420
-4.280E-01	9.691E-01	-7.346E-01	1.868E-01	0.7420
-2.231E-02	6.594E-02	-6.451E-02	2.103E-02	0.9920
1.963E-04	-1.045E-03	1.937E-03	-9.438E-04	2.5000

 $\langle \hat{U} \hat{V} \rangle$ Coefficients

				Interval Limit
A_3	A_2	A_1	A_0	\hat{R}_{max}
1.964E 02	-3.005E 02	1.532E 02	-2.605E 01	0.5120
-2.877E 01	4.539E 01	-2.385E 01	4.175E 00	0.5320
1.325E 01	-2.167E 01	1.182E 01	-2.152E 00	0.5520
-9.347E 00	1.575E 01	-8.833E 00	1.649E 00	0.5720
6.812E 00	-1.198E 01	7.028E 00	-1.375E 00	0.5920
-1.160E 00	2.177E 00	-1.354E 00	2.788E-01	0.6420
1.831E-01	-4.100E-01	3.065E-01	-7.663E-02	0.7420
2.907E-03	-8.789E-03	8.867E-03	-3.005E-03	0.9920
6.788E-05	-3.390E-04	4.851E-04	-2.329E-04	2.5000

Table 9. Continued

Separated-Flow Model

$$\hat{x} = 0.338 \quad \hat{R}_{\text{surface}} = 0.463$$

$\langle \hat{U} \rangle$ Coefficients				Interval Limit
A_3	A_2	A_1	A_0	\hat{R}_{max}
2.030E 04	-2.951E 04	1.431E 04	-2.313E 03	0.4830
1.465E 03	-2.228E 03	1.131E 03	-1.910E 02	0.5030
3.890E 01	-7.514E 01	4.841E 01	-9.463E 00	0.5230
-6.500E 01	8.787E 01	-3.685E 01	5.400E 00	0.5430
4.587E 02	-7.652E 02	4.264E 02	-7.844E 01	0.5630
-1.183E 02	2.093E 02	-1.223E 02	2.452E 01	0.6130
2.539E 01	-5.493E 01	3.969E 01	-8.576E 00	0.7130
8.676E-01	-2.465E 00	2.289E 00	3.144E-01	0.9630
-1.439E-02	8.346E-02	-1.646E-01	1.102E 00	2.5000

$\langle \hat{V} \rangle$ Coefficients				Interval Limit
A_3	A_2	A_1	A_0	\hat{R}_{max}
5.105E 02	-7.019E 02	3.204E 02	-4.870E 01	0.4830
-7.735E 02	1.159E 03	-5.782E 02	9.598E 01	0.5030
2.892E 02	-4.451E 02	2.285E 02	-3.927E 01	0.5230
-1.624E 02	2.636E 02	-1.421E 02	2.534E 01	0.5430
-3.943E 01	6.323E 01	-3.337E 01	5.651E 00	0.5630
2.680E 01	-4.864E 01	2.961E 01	-6.169E 00	0.6130
-3.678E 00	7.417E 00	-4.748E 00	8.520E-01	0.7130
4.841E-01	-1.486E 00	1.599E 00	-6.566E-01	0.9630
3.138E-02	-1.780E-01	3.395E-01	-2.522E-01	2.5000

\hat{k} Coefficients				Interval Limit
A_3	A_2	A_1	A_0	\hat{R}_{max}
-1.134E 03	1.643E 03	-7.935E 02	1.278E 02	0.4830
-9.973E 00	1.461E 01	-7.140E 00	1.168E 00	0.5030
1.079E 01	-1.672E 01	8.619E 00	-1.474E 00	0.5230
3.816E 00	-5.782E 00	2.897E 00	-4.769E-01	0.5430
-1.390E 01	2.308E 01	-1.277E 01	2.360E 00	0.5630
3.469E 00	-6.259E 00	3.743E 00	-7.401E-01	0.6130
-3.291E-01	7.261E-01	-5.385E-01	1.348E-01	0.7130
-3.078E-02	8.807E-02	-8.357E-02	2.665E-02	0.9630
3.781E-04	-1.933E-03	3.109E-03	-1.177E-03	2.5000

$\langle \hat{U} \hat{V} \rangle$ Coefficients				Interval Limit
A_3	A_2	A_1	A_0	\hat{R}_{max}
4.561E 02	-6.621E 02	3.204E 02	-5.168E 01	0.4830
2.212E 01	-3.322E 01	1.664E 01	-2.780E 00	0.5030
-7.436E 00	1.138E 01	-5.799E 00	9.820E 00	0.5230
5.167E 00	-8.391E 00	4.543E 00	-8.208E-01	0.5430
2.401E 00	-3.886E 00	2.097E 00	-3.781E-01	0.5630
-1.678E 00	3.004E 00	-1.782E 00	3.499E-01	0.6130
2.698E-01	-5.781E-01	4.134E-01	-9.878E-02	0.7130
7.017E-04	-2.440E-03	2.947E-03	-1.233E-03	0.9630
1.881E-04	-9.562E-04	1.519E-03	-7.746E-04	2.5000

Table 9. Continued

Separated-Flow Model

$\hat{x} = 0.538$

$\hat{R}_{\text{surface}} = 0.394$

$\langle \hat{U} \rangle$ Coefficients				Interval Limit
A_3	A_2	A_1	A_0	\hat{R}_{max}
-1.309E 04	1.605E 04	-6.546E 03	8.883E 02	0.4140
7.955E 02	-1.193E 03	5.918E 02	-9.664E 01	0.4340
2.492E 03	-3.401E 03	1.550E 03	-2.353E 02	0.4540
-3.744E 02	5.025E 02	-2.219E 02	3.289E 01	0.4740
5.421E 02	-8.007E 02	3.958E 02	-6.471E 01	0.4940
-6.365E 01	9.701E 01	-4.763E 01	8.316E 00	0.5440
1.592E 01	-3.285E 01	2.301E 01	-4.495E 00	0.6440
2.839E 00	-7.583E 00	6.739E 00	-1.001E 00	0.8940
-1.628E-02	7.550E-02	-1.081E-01	1.039E 00	2.5000

$\langle \hat{V} \rangle$ Coefficients				Interval Limit
A_3	A_2	A_1	A_0	\hat{R}_{max}
8.309E 02	-9.736E 02	3.768E 02	-4.819E 01	0.4140
-6.281E 02	8.385E 02	-3.734E 02	5.534E 01	0.4340
-2.145E 02	3.000E 02	-1.397E 02	2.152E 01	0.4540
-4.072E 01	6.329E 01	-3.227E 01	5.263E 00	0.4740
-1.495E 02	2.180E 02	-1.056E 02	1.685E 01	0.4940
2.884E 01	-4.633E 01	2.497E 01	-4.652E 00	0.5440
-3.507E 00	6.466E 00	-3.750E 00	5.561E-01	0.6440
2.744E-01	-8.400E-01	9.548E-01	-4.539E-01	0.8940
3.341E-02	-1.936E-01	3.769E-01	-2.817E-01	2.5000

\hat{k} Coefficients				Interval Limit
A_3	A_2	A_1	A_0	\hat{R}_{max}
6.062E 02	-7.536E 02	3.121E 02	-4.307E 01	0.4140
8.645E 01	-1.081E 02	4.489E 01	-6.187E 00	0.4340
-8.801E 01	1.191E 02	-5.369E 01	8.075E 00	0.4540
1.556E 01	-2.200E 01	1.035E 01	-1.618E 00	0.4740
-2.048E 00	3.038E 00	-1.517E 00	2.578E-01	0.4940
3.456E-02	-4.928E-02	8.017E-03	6.721E-03	0.5440
1.243E-01	-1.957E-01	8.767E-02	-7.722E-03	0.6440
-6.074E-02	1.618E-01	-1.425E-01	4.169E-02	0.8940
3.690E-04	-2.138E-03	3.990E-03	-1.969E-03	2.5000

$\langle \hat{U} \cdot \hat{V} \rangle$ Coefficients				Interval Limit
A_3	A_2	A_1	A_0	\hat{R}_{max}
-3.073E 02	3.830E 02	-1.590E 02	2.198E 01	0.4140
-8.781E 01	1.104E 02	-4.610E 01	6.399E 00	0.4340
7.893E 01	-1.067E 02	4.812E 01	-7.231E 00	0.4540
-1.836E 01	2.578E 01	-1.205E 01	1.873E 00	0.4740
5.968E 00	-8.821E 00	4.352E 00	-7.179E-01	0.4940
-2.798E-01	4.388E-01	-2.223E-01	3.538E-02	0.5440
8.758E-03	-3.208E-02	3.389E-02	-1.107E-02	0.6440
2.082E-02	-5.537E-02	4.889E-02	-1.429E-02	0.8940
-2.122E-04	1.022E-03	-1.528E-03	7.325E-04	2.5000

Table 9. Continued

Separated-Flow Model

$\hat{X} = 0.638$

$\hat{R}_{\text{surface}} = 0.348$

 $\langle \hat{U} \rangle$ Coefficients

	A_3	A_2	A_1	A_0	Interval Limit \hat{R}_{max}
	4.732E 03	-5.110E 03	1.847E 03	-2.234E 02	0.3680
	-1.908E 03	2.221E 03	-8.507E 02	1.075E 02	0.3880
	-2.818E 03	3.280E 03	-1.262E 03	1.607E 02	0.4080
	2.392E 03	-3.098E 03	1.340E 03	-1.932E 02	0.4280
	9.805E 01	-1.517E 02	7.950E 01	-1.330E 01	0.4480
	1.137E 02	-1.727E 02	8.893E 01	-1.470E 01	0.4980
	-3.409E 00	2.264E 00	1.789E 00	-2.381E-01	0.5980
	4.689E 00	-1.226E 01	1.048E 01	-1.970E 00	0.8480

 $\langle \hat{V} \rangle$ Coefficients

	A_3	A_2	A_1	A_0	Interval Limit \hat{R}_{max}
	-4.550E 03	5.010E 03	-1.840E 03	2.255E 02	0.3680
	4.511E 02	-5.117E 02	1.916E 02	-2.372E 01	0.3880
	3.083E 02	-3.455E 02	1.271E 02	-1.538E 01	0.4080
	-4.545E 02	5.882E 02	-2.539E 02	3.643E 01	0.4280
	-2.860E 01	4.133E 01	-1.983E 01	3.035E 00	0.4480
	-2.107E 01	3.121E 01	-1.529E 01	2.358E 00	0.4980
	1.954E 00	-3.186E 00	1.836E 00	-4.856E-01	0.5980
	-1.092E 00	2.279E 00	-1.432E 00	1.658E-01	0.8480

 \hat{k} Coefficients

	A_3	A_2	A_1	A_0	Interval Limit \hat{R}_{max}
	2.068E 02	-2.337E 02	8.812E 01	-1.108E 01	0.3680
	-7.618E 00	2.985E 00	1.021E 00	-3.917E-01	0.3880
	1.569E 02	-1.885E 02	7.532E 01	-1.000E 01	0.4080
	-2.763E 01	3.734E 01	-1.683E 01	2.531E 00	0.4280
	-3.274E 01	4.392E 01	-1.964E 01	2.932E 00	0.4480
	5.791E-01	-8.696E-01	4.239E-01	-6.405E-02	0.4980
	-7.384E-02	1.059E-01	-6.198E-02	1.659E-02	0.5980
	4.669E-01	-8.642E-01	5.182E-01	-9.905E-02	0.8480

 $\langle \hat{u} \hat{v} \rangle$ Coefficients

	A_3	A_2	A_1	A_0	Interval Limit \hat{R}_{max}
	-4.556E 01	5.603E 01	-2.280E 01	3.068E 00	0.3680
	-5.134E 01	6.241E 01	-2.515E 01	3.356E 00	0.3880
	-7.891E 01	9.451E 01	-3.760E 01	4.967E 00	0.4080
	1.057E 01	-1.503E 01	7.086E 00	-1.111E 00	0.4280
	2.549E 01	-3.418E 01	1.528E 01	-2.281E 00	0.4480
	-8.437E-01	1.213E 00	-5.722E-01	8.715E-02	0.4980
	2.059E-01	-3.547E-01	2.087E-01	-4.248E-02	0.5980
	-2.130E-01	3.968E-01	-2.407E-01	4.710E-02	0.8480

Table 9. Continued

Separated-Flow Model

$\hat{x} = 0.688$

$\hat{R}_{\text{surface}} = 0.322$

$\langle \hat{U} \rangle$ Coefficients				Interval Limit
A_3	A_2	A_1	A_0	\hat{R}_{max}
-8.615E 03	8.906E 03	-3.060E 03	3.495E 02	0.3420
-2.479E 03	2.610E 03	-9.069E 02	1.041E 02	0.3620
2.287E 03	-2.566E 03	9.669E 02	-1.220E 02	0.3820
-3.099E 03	3.607E 03	-1.391E 03	1.782E 02	0.4020
1.762E 03	-2.256E 03	9.659E 02	-1.376E 02	0.4220
1.389E 02	-2.010E 02	9.863E 01	-1.562E 01	0.4720
5.326E 00	-1.185E 01	9.324E 00	-1.567E 00	0.5720
-2.663E 00	1.862E 00	1.482E 00	-7.235E-02	0.8220
$\langle \hat{V} \rangle$ Coefficients				Interval Limit
A_3	A_2	A_1	A_0	\hat{R}_{max}
3.783E 02	-4.357E 02	1.623E 02	-1.971E 01	0.3420
2.565E 03	-2.680E 03	9.298E 02	-1.072E 02	0.3620
-2.171E 03	2.464E 03	-9.323E 02	1.175E 02	0.3820
5.481E 02	-6.521E 02	2.581E 02	-3.409E 01	0.4020
-8.663E 01	1.134E 02	-4.963E 01	7.145E 00	0.4220
-1.774E 01	2.623E 01	-1.282E 01	1.968E 00	0.4720
-5.985E 00	9.580E 00	-4.967E 00	7.322E-01	0.5720
4.831E 00	-8.981E 00	5.650E 00	-1.292E 00	0.8220
\hat{k} Coefficients				Interval Limit
A_3	A_2	A_1	A_0	\hat{R}_{max}
-2.707E 02	2.550E 02	-7.934E 01	8.149E 00	0.3420
5.989E 02	-6.372E 02	2.258E 02	-2.664E 01	0.3620
-3.819E 02	4.280E 02	-1.598E 02	1.989E 01	0.3820
2.451E 02	-2.906E 02	1.147E 02	-1.506E 01	0.4020
-7.885E 01	1.001E 02	-4.237E 01	5.987E 00	0.4220
-1.490E 00	2.144E 00	-1.041E 00	1.736E-01	0.4720
-2.429E-01	3.780E-01	-2.078E-01	4.242E-02	0.5720
4.692E-01	-8.439E-01	4.912E-01	-9.085E-02	0.8220
$\langle \hat{U} \hat{V} \rangle$ Coefficients				Interval Limit
A_3	A_2	A_1	A_0	\hat{R}_{max}
4.749E 02	-4.663E 02	1.523E 02	-1.654E 01	0.3420
-5.579E 02	5.934E 02	-2.101E 02	2.478E 01	0.3620
3.343E 02	-3.755E 02	1.406E 02	-1.755E 01	0.3820
-1.933E 02	2.291E 02	-9.037E 01	1.186E 01	0.4020
6.919E 01	-8.751E 01	3.690E 01	-5.191E 00	0.4220
-1.215E 00	1.629E 00	-7.140E-01	1.004E-01	0.4720
3.975E-01	-6.540E-01	3.637E-01	-6.912E-02	0.5720
-2.824E-01	5.128E-01	-3.038E-01	5.813E-02	0.8220

Table 9. Continued

Separated-Flow Model

$\hat{x} = 0.738$ $\hat{R}_{\text{surface}} = 0.293$

$\langle \hat{U} \rangle$ Coefficients

A_3	A_2	A_1	A_0	Interval Limit \hat{R}_{max}
-9.990E 03	9.477E 03	-2.989E 03	3.133E 02	0.3130
-4.253E 03	4.090E 03	-1.302E 03	1.374E 02	0.3330
4.858E 03	-5.012E 03	1.728E 03	-1.991E 02	0.3530
-2.897E 03	3.201E 03	-1.171E 03	1.421E 02	0.3730
-5.704E 02	5.976E 02	-1.997E 02	2.133E 01	0.3930
4.804E 02	-6.413E 02	2.872E 02	-4.245E 01	0.4430
-4.852E 00	3.615E 00	1.527E 00	-2.629E-01	0.5430
5.628E 00	-1.346E 01	1.080E 01	-1.941E 00	0.7930
2.106E-02	-1.187E-01	2.194E-01	8.551E-01	2.5000

$\langle \hat{V} \rangle$ Coefficients

A_3	A_2	A_1	A_0	Interval Limit \hat{R}_{max}
6.401E 03	-6.063E 03	1.911E 03	-2.004E 02	0.3130
2.426E 03	-2.331E 03	7.428E 02	-7.849E 01	0.3330
-2.045E 03	2.135E 03	-7.443E 02	8.658E 01	0.3530
1.174E 03	-1.274E 03	4.590E 02	-5.500E 01	0.3730
-5.294E 02	6.324E 02	-2.520E 02	3.340E 01	0.3930
-5.753E 01	7.604E 01	-3.338E 01	4.758E 00	0.4430
1.792E 00	-2.800E 00	1.548E 00	-3.990E-01	0.5430
-2.749E-01	5.667E-01	-2.805E-01	-6.804E-02	0.7930
2.637E-02	-1.499E-01	2.878E-01	-2.183E-01	2.5000

\hat{k} Coefficients

A_3	A_2	A_1	A_0	Interval Limit \hat{R}_{max}
-2.786E 03	2.581E 03	-7.967E 02	8.190E 01	0.3130
6.371E 02	-6.325E 02	2.092E 02	-2.305E 01	0.3330
-2.129E 01	2.513E 01	-9.761E 00	1.258E 00	0.3530
-1.709E 02	1.836E 02	-6.571E 01	7.841E 00	0.3730
1.775E 02	-2.062E 02	7.971E 01	-1.024E 01	0.3930
-2.084E 01	2.759E 01	-1.218E 01	1.798E 00	0.4430
5.313E-01	-8.121E-01	3.973E-01	-5.945E-02	0.5430
-6.898E-02	1.658E-01	-1.336E-01	3.665E-02	0.7930
-7.168E-04	3.361E-03	-4.864E-03	2.614E-03	2.5000

$\langle \hat{U} \cdot \hat{V} \rangle$ Coefficients

A_3	A_2	A_1	A_0	Interval Limit \hat{R}_{max}
2.274E 03	-2.109E 03	6.517E 02	-6.706E 01	0.3130
-4.398E 02	4.389E 02	-1.459E 02	1.616E 01	0.3330
-5.065E 01	5.019E 01	-1.649E 01	1.790E 00	0.3530
1.508E 02	-1.631E 02	5.882E 01	-7.071E 00	0.3730
-1.302E 02	1.513E 02	-5.846E 01	7.510E 00	0.3930
1.502E 01	-1.993E 01	8.818E 00	-1.303E 00	0.4430
-2.011E-01	3.015E-01	-1.426E-01	1.997E-02	0.5430
3.401E-02	-8.140E-02	6.531E-02	-1.767E-02	0.7930
1.694E-04	-8.883E-04	1.463E-03	-7.928E-04	2.5000

Table 9. Continued

Separated-Flow Model

$\hat{\alpha} = 0.800$

$\hat{R}_{\text{surface}} = 0.254$

$\langle \hat{U} \rangle$ Coefficients				Interval Limit
A_3	A_2	A_1	A_0	\hat{R}_{max}
8.791E 03	-7.000E 03	1.853E 03	-1.632E 02	0.2740
-1.075E 03	1.110E 03	-3.689E 02	3.977E 01	0.2940
-3.901E 03	3.602E 03	-1.102E 03	1.116E 02	0.3140
1.329E 03	-1.325E 03	4.453E 02	-5.034E 01	0.3340
3.537E 02	-3.471E 02	1.188E 02	-1.399E 01	0.3540
-4.967E 02	5.560E 02	-2.009E 02	2.374E 01	0.4040
1.704E 02	-2.525E 02	1.257E 02	-2.025E 01	0.5040
-3.830E 01	6.307E 01	-3.333E 01	6.471E 00	0.7540
$\langle \hat{V} \rangle$ Coefficients				Interval Limit
A_3	A_2	A_1	A_0	\hat{R}_{max}
-6.037E 03	4.995E 03	-1.377E 03	1.264E 02	0.2740
-1.713E 03	1.440E 03	-4.029E 02	3.749E 01	0.2940
1.084E 03	-1.026E 03	3.223E 02	-3.357E 01	0.3140
4.561E 02	-4.350E 02	1.366E 02	-1.414E 01	0.3340
-2.811E 02	3.037E 02	-1.101E 02	1.333E 01	0.3540
-3.123E 00	8.462E 00	-5.586E 00	9.953E-01	0.4040
-1.918E 01	2.793E 01	-1.345E 01	2.054E 00	0.5040
6.032E 00	-1.020E 01	5.765E 00	-1.174E 00	0.7540
\hat{k} Coefficients				Interval Limit
A_3	A_2	A_1	A_0	\hat{R}_{max}
2.345E 02	-1.907E 02	5.172E 01	-4.674E 00	0.2740
1.623E 02	-1.314E 02	3.547E 01	-3.190E 00	0.2940
-5.499E 02	4.968E 02	-1.492E 02	1.491E 01	0.3140
5.548E 02	-5.438E 02	1.775E 02	-1.929E 01	0.3340
-2.779E 02	2.905E 02	-1.011E 02	1.174E 01	0.3540
3.855E 01	-4.555E 01	1.783E 01	-2.303E 00	0.4040
-4.455E 00	6.567E 00	-3.230E 00	5.327E-01	0.5040
7.757E-01	-1.342E 00	7.562E-01	-1.369E-01	0.7540
$\langle \hat{U} \hat{V} \rangle$ Coefficients				Interval Limit
A_3	A_2	A_1	A_0	\hat{R}_{max}
4.072E 02	-3.320E 02	9.020E 01	-8.164E 00	0.2740
-2.245E 02	1.872E 02	-5.207E 01	4.829E 00	0.2940
4.267E 02	-3.871E 02	1.168E 02	-1.172E 01	0.3140
-3.574E 02	3.515E 02	-1.151E 02	1.256E 01	0.3340
1.541E 02	-1.610E 02	5.604E 01	-6.502E 00	0.3540
-2.255E 01	2.659E 01	-1.037E 01	1.336E 00	0.4040
2.820E 00	-4.164E 00	2.050E 00	-3.375E-01	0.5040
-4.669E-01	8.065E-01	-4.554E-01	8.330E-02	0.7540

Table 9. Continued

Separated-Flow Model

$\hat{X} = 0.838$

$\hat{R}_{\text{surface}} = 0.266$

$\langle \hat{U} \rangle$ Coefficients				Interval Limit
A_3	A_2	A_1	A_0	\hat{R}_{max}
-1.086E 04	9.307E 03	-2.654E 03	2.517E 02	0.2860
1.456E 03	-1.261E 03	3.687E 02	-3.643E 01	0.3060
-2.773E 03	2.621E 03	-8.193E 02	8.474E 01	0.3260
3.034E 03	-3.059E 03	1.032E 03	-1.165E 02	0.3460
-2.002E 03	2.169E 03	-7.764E 02	9.215E 01	0.3660
-5.658E 00	-2.315E 01	2.592E 01	-5.738E 00	0.4160
1.120E 02	-1.700E 02	8.699E 01	-1.421E 01	0.5160
-3.113E 01	5.158E 01	-2.732E 01	5.455E 00	0.7660
$\langle \hat{V} \rangle$ Coefficients				Interval Limit
A_3	A_2	A_1	A_0	\hat{R}_{max}
5.284E 03	-4.478E 03	1.264E 03	-1.188E 02	0.2860
-1.705E 03	1.519E 03	-4.511E 02	4.466E 01	0.3060
1.384E 03	-1.317E 03	4.166E 02	-4.385E 01	0.3260
-1.007E 03	1.022E 03	-3.460E 02	3.902E 01	0.3460
5.800E 02	-6.257E 02	2.242E 02	-2.673E 01	0.3660
-6.669E 01	8.441E 01	-3.574E 01	4.972E 00	0.4160
-1.392E 00	2.920E 00	-1.841E 00	2.716E-01	0.5160
-3.282E 00	5.844E 00	-3.350E 00	5.312E-01	0.7660
\hat{k} Coefficients				Interval Limit
A_3	A_2	A_1	A_0	\hat{R}_{max}
-5.689E 02	4.887E 02	-1.396E 02	1.328E 01	0.2860
-1.530E 02	1.319E 02	-3.759E 01	3.551E 00	0.3060
1.556E 02	-1.514E 02	4.908E 01	-5.290E 00	0.3260
8.805E 00	-7.857E 00	2.286E 00	-2.052E-01	0.3460
-7.109E 01	7.507E 01	-2.641E 01	3.104E 00	0.3660
2.927E 01	-3.512E 01	1.392E 01	-1.816E 00	0.4160
-5.975E 00	8.865E 00	-4.375E 00	7.210E-01	0.5160
1.962E 00	-3.423E 00	1.965E 00	-3.696E-01	0.7660
$\langle \hat{U} \cdot \hat{V} \rangle$ Coefficients				Interval Limit
A_3	A_2	A_1	A_0	\hat{R}_{max}
5.701E 02	-4.864E 02	1.381E 02	-1.306E 01	0.2860
-1.621E 01	1.664E 01	-5.737E 00	6.568E-01	0.3060
1.617E 01	-1.308E 01	3.359E 00	-2.710E-01	0.3260
-6.348E 01	6.481E 01	-2.203E 01	2.488E 00	0.3460
4.618E 01	-4.902E 01	1.735E 01	-2.054E 00	0.3660
-1.744E 01	2.084E 01	-8.219E 00	1.065E 00	0.4160
3.901E 00	-5.793E 00	2.861E 00	-4.709E-01	0.5160
-1.299E 00	2.257E 00	-1.293E 00	2.436E-01	0.7660

Table 9. Continued

Separated-Flow Model

$$\hat{\chi} = 0.888 \quad \hat{R}_{\text{surface}} = 0.280$$

\hat{U} Coefficients					Interval Limit
A_3	A_2	A_1	A_0	\hat{R}_{max}	
-1.544E 03	1.365E 03	-3.966E 02	3.791E 01	0.3000	0.3000
1.204E 03	-1.108E 03	3.453E 02	-3.629E 01	0.3200	0.3200
-1.508E 03	1.572E 03	-5.124E 02	5.520E 01	0.3400	0.3400
1.816E 03	-1.900E 03	6.682E 02	-7.860E 01	0.3600	0.3600
-2.143E 03	2.376E 03	-8.711E 02	1.061E 02	0.3800	0.3800
3.987E 02	-5.222E 02	2.300E 02	-3.336E 01	0.4300	0.4300
1.986E 01	-3.347E 01	1.986E 01	-3.239E 00	0.5300	0.5300
-7.470E 00	9.975E 00	-3.168E 00	8.287E-01	0.7800	0.7800
\hat{V} Coefficients					Interval Limit
A_3	A_2	A_1	A_0	\hat{R}_{max}	
5.120E 02	-4.239E 02	1.149E 02	-1.020E 01	0.3000	0.3000
-8.996E 02	8.465E 02	-2.662E 02	2.791E 01	0.3200	0.3200
8.684E 02	-8.507E 02	2.769E 02	-3.002E 01	0.3400	0.3400
-7.944E 02	8.453E 02	-2.997E 02	3.534E 01	0.3600	0.3600
2.514E 02	-2.841E 02	1.069E 02	-1.346E 01	0.3800	0.3800
-7.367E 00	1.087E 01	-5.226E 00	7.413E-01	0.4300	0.4300
-7.480E 00	1.101E 01	-5.288E 00	7.502E-01	0.5300	0.5300
2.368E 00	-4.642E 00	3.010E 00	-7.158E-01	0.7800	0.7800
\hat{k} Coefficients					Interval Limit
A_3	A_2	A_1	A_0	\hat{R}_{max}	
-4.091E 02	3.557E 02	-1.028E 02	9.870E 00	0.3000	0.3000
1.983E 02	-1.909E 02	6.120E 01	-6.528E 00	0.3200	0.3200
6.507E 01	-6.299E 01	2.029E 01	-2.163E 00	0.3400	0.3400
-1.737E 02	1.806E 02	-6.253E 01	7.222E 00	0.3600	0.3600
1.512E 02	-1.704E 02	6.382E 01	-7.940E 00	0.3800	0.3800
-1.121E 01	1.481E 01	-6.554E 00	9.744E-01	0.4300	0.4300
-1.579E 00	2.392E 00	-1.214E 00	2.090E-01	0.5300	0.5300
6.607E-01	-1.168E 00	6.729E-01	-1.244E-01	0.7800	0.7800
$\hat{U} \cdot \hat{V}$ Coefficients					Interval Limit
A_3	A_2	A_1	A_0	\hat{R}_{max}	
4.348E 01	-3.270E 01	7.716E 00	-5.505E-01	0.3000	0.3000
-4.615E 01	4.796E 01	-1.648E 01	1.870E 00	0.3200	0.3200
-1.458E 02	1.436E 02	-4.710E 01	5.135E 00	0.3400	0.3400
1.790E 02	-1.876E 02	6.553E 01	-7.629E 00	0.3600	0.3600
-1.201E 02	1.353E 02	-5.074E 01	6.322E 00	0.3800	0.3800
9.656E 00	-1.257E 01	5.466E 00	-7.966E-01	0.4300	0.4300
4.292E-01	-6.626E-01	3.477E-01	-6.293E-02	0.5300	0.5300
-2.112E-01	3.556E-01	-1.920E-01	3.241E-02	0.7800	0.7800

Table 9. Continued

Separated-Flow Model

$\hat{X} = 0.938$

$\hat{R}_{\text{surface}} = 0.292$

 $\langle \hat{U} \rangle$ Coefficients

				Interval Limit
A_3	A_2	A_1	A_0	\hat{R}_{max}
8.111E 02	-7.006E 02	2.045E 02	-2.010E 01	0.3120
-5.484E 02	5.719E 02	-1.925E 02	2.119E 01	0.3320
-9.303E 02	9.523E 02	-3.188E 02	3.516E 01	0.3520
7.039E 02	-7.734E 02	2.886E 02	-3.611E 01	0.3720
-1.085E 03	1.223E 03	-4.542E 02	5.600E 01	0.3920
3.330E 02	-4.446E 02	1.997E 02	-2.944E 01	0.4420
-3.058E 00	9.819E-01	2.719E 00	-4.230E-01	0.5420
5.226E 00	-1.249E 01	1.002E 01	-1.742E 00	0.7920
2.558E-02	-1.320E-01	2.338E-01	8.414E-01	2.5000

 $\langle \hat{V} \rangle$ Coefficients

				Interval Limit
A_3	A_2	A_1	A_0	\hat{R}_{max}
3.914E 03	-3.623E 03	1.117E 03	-1.146E 02	0.3120
-8.461E 02	8.319E 02	-2.734E 02	2.997E 01	0.3320
5.584E 02	-5.670E 02	1.911E 02	-2.143E 01	0.3520
-4.189E 02	4.650E 02	-1.722E 02	2.119E 01	0.3720
9.419E 01	-1.076E 02	4.082E 01	-5.219E 00	0.3920
-2.293E 01	3.016E 01	-1.317E 01	1.835E 00	0.4420
1.123E 00	-1.731E 00	9.239E-01	-2.417E-01	0.5420
-1.809E-01	3.899E-01	-2.254E-01	-3.409E-02	0.7920
1.153E-02	-6.729E-02	1.367E-01	-1.297E-01	2.5000

 \hat{k} Coefficients

				Interval Limit
A_3	A_2	A_1	A_0	\hat{R}_{max}
4.670E 02	-4.362E 02	1.372E 02	-1.433E 01	0.3120
-7.805E 01	7.194E 01	-2.194E 01	2.223E 00	0.3320
1.459E 02	-1.511E 02	5.212E 01	-5.973E 00	0.3520
-1.448E 02	1.559E 02	-5.596E 01	6.707E 00	0.3720
1.440E 02	-1.664E 02	6.395E 01	-8.161E 00	0.3920
-1.991E 01	2.632E 01	-1.161E 01	1.712E 00	0.4420
4.150E-01	-6.265E-01	2.995E-01	-4.244E-02	0.5420
-6.157E-02	1.484E-01	-1.205E-01	3.344E-02	0.7920
-7.897E-04	3.969E-03	-6.167E-03	3.247E-03	2.5000

 $\langle \hat{U} \hat{V} \rangle$ Coefficients

				Interval Limit
A_3	A_2	A_1	A_0	\hat{R}_{max}
2.778E 02	-2.569E 02	7.903E 01	-8.093E 00	0.3120
1.779E 01	-1.352E 01	3.100E 00	-1.963E-01	0.3320
-1.110E 02	1.147E 02	-3.947E 01	4.515E 00	0.3520
9.393E 01	-1.016E 02	3.669E 01	-4.421E 00	0.3720
-7.901E 01	9.135E 01	-3.511E 01	4.482E 00	0.3920
1.052E 01	-1.393E 01	6.162E 00	-9.110E-01	0.4420
-1.322E-01	1.878E-01	-8.001E-02	8.579E-03	0.5420
3.565E-02	-8.509E-02	6.790E-02	-1.814E-02	0.7920
1.828E-04	-8.177E-04	1.162E-03	-5.249E-04	2.5000

Table 9. Continued

Separated-Flow Model

$\hat{X} = 1.138$

$\hat{R}_{\text{surface}} = 0.325$

 $\langle \hat{U} \rangle$ Coefficients

A_3	A_2	A_1	A_0	Interval Limit \hat{R}_{max}
1.354E 04	-1.395E 04	4.794E 03	-5.491E 02	0.3450
-8.021E 02	8.907E 02	-3.257E 02	3.975E 01	0.3650
-2.296E 02	2.637E 02	-9.692E 01	1.191E 01	0.3850
-7.322E 02	8.442E 02	-3.204E 02	4.059E 01	0.4050
5.770E 02	-7.464E 02	3.238E 02	-4.638E 01	0.4250
5.145E 01	-7.634E 01	3.903E 01	-6.036E 00	0.4750
7.897E-01	-4.152E 00	4.737E 00	-6.071E-01	0.5750
3.686E 00	-9.148E 00	7.610E 00	-1.158E 01	0.8250
4.799E-03	-3.712E-02	9.329E-02	9.093E-01	2.5000

 $\langle \hat{V} \rangle$ Coefficients

A_3	A_2	A_1	A_0	Interval Limit \hat{R}_{max}
7.997E 03	-8.204E 03	2.803E 03	-3.191E 02	0.3450
-1.202E 03	1.317E 03	-4.811E 02	5.859E 01	0.3650
-3.241E 02	3.557E 02	-1.302E 02	1.590E 01	0.3850
5.576E 02	-6.627E 02	2.618E 02	-3.442E 01	0.4050
-2.194E 02	2.814E 02	-1.205E 02	1.720E 01	0.4250
-1.067E 01	1.530E 01	-7.410E 00	1.179E 00	0.4750
8.730E-01	-1.158E 00	4.065E-01	-5.859E-02	0.5750
-4.870E-01	1.188E 00	-9.424E-01	2.000E-01	0.8250
5.670E-03	-3.127E-02	6.356E-02	-7.669E-02	2.5000

 \hat{k} Coefficients

A_3	A_2	A_1	A_0	Interval Limit \hat{R}_{max}
-3.544E 02	3.642E 02	-1.246E 02	1.419E 01	0.3450
-5.813E 01	5.754E 01	-1.877E 01	2.021E 00	0.3650
9.486E 01	-1.100E 02	4.238E 01	-5.419E 00	0.3850
3.922E 01	-4.572E 01	1.763E 01	-2.243E 00	0.4050
-1.926E 01	2.533E 01	-1.114E 01	1.641E 00	0.4250
-5.766E 00	8.129E 00	-3.829E 00	6.056E-01	0.4750
4.616E-01	-7.451E-01	3.857E-01	-6.177E-02	0.5750
-6.754E-02	1.677E-01	-1.391E-01	3.882E-02	0.8250
-1.572E-04	8.811E-04	-1.484E-03	9.827E-04	2.5000

 $\langle \hat{U} - \hat{V} \rangle$ Coefficients

A_3	A_2	A_1	A_0	Interval Limit \hat{R}_{max}
5.631E 01	-5.291E 01	1.626E 01	-1.628E 00	0.3450
-5.597E 01	6.330E 01	-2.383E 01	2.982E 00	0.3650
-1.669E 01	2.030E 01	-8.136E 00	1.073E 00	0.3850
-4.495E 01	5.293E 01	-2.070E 01	2.685E 00	0.4050
2.482E 01	-3.184E 01	1.363E 01	-1.950E 00	0.4250
1.318E 00	-1.874E 00	8.964E-01	-1.455E-01	0.4750
-1.068E-01	1.570E-01	-6.828E-02	7.216E-03	0.5750
3.725E-02	-9.154E-02	7.463E-02	-2.017E-02	0.8250
-3.060E-04	1.412E-03	-2.058E-03	9.141E-04	2.5000

Table 9. Continued

Separated-Flow Model

$\hat{X} = 1.338$

$\hat{R}_{\text{surface}} = 0.341$

$\langle \hat{U} \rangle$ Coefficients

A_3	A_2	A_1	A_0	Interval Limit \hat{R}_{max}
6.958E 03	-7.582E 03	2.757E 03	-3.339E 02	0.3611
9.477E 02	-1.071E 03	4.058E 02	-5.091E 01	0.3811
1.702E 02	-1.823E 02	6.706E 01	-7.872E 00	0.4011
-1.144E 03	1.399E 03	-5.671E 02	7.691E 01	0.4211
6.791E 02	-9.040E 02	4.026E 02	-5.920E 01	0.4411
1.780E 01	-2.889E 01	1.659E 01	-2.442E 00	0.4911
1.094E 00	-4.281E 00	4.501E 00	-4.633E-01	0.5911
3.153E 00	-7.933E 00	6.660E 00	-8.886E-01	0.8411
-1.300E-02	5.596E-02	-5.963E-02	9.953E-01	2.5000

$\langle \hat{V} \rangle$ Coefficients

A_3	A_2	A_1	A_0	Interval Limit \hat{R}_{max}
7.354E 03	-7.955E 03	2.868E 03	-3.446E 02	0.3611
-6.978E 01	8.670E 01	-3.597E 01	4.975E 00	0.3811
-1.976E 02	2.329E 02	-9.167E 01	1.205E 01	0.4011
2.393E 02	-2.929E 02	1.192E 02	-1.614E 01	0.4211
-1.773E 02	2.335E 02	-1.024E 02	1.497E 01	0.4411
6.450E 00	-9.752E 00	4.845E 00	-8.060E-01	0.4911
1.749E 00	-2.825E 00	1.443E 00	-2.492E-01	0.5911
-3.656E-01	9.237E-01	-7.729E-01	1.875E-01	0.8411
-9.059E-04	3.510E-03	1.042E-03	-2.953E-02	2.5000

\hat{k} Coefficients

A_3	A_2	A_1	A_0	Interval Limit \hat{R}_{max}
-7.131E 02	7.721E 02	-2.785E 02	3.349E 01	0.3611
-2.735E 01	2.919E 01	-1.028E 01	1.201E 00	0.3811
-3.677E 01	3.996E 01	-1.439E 01	1.722E 00	0.4011
1.261E 02	-1.560E 02	6.422E 01	-8.787E 00	0.4211
-4.859E 01	6.466E 01	-2.871E 01	4.256E 00	0.4411
-2.757E 00	4.012E 00	-1.958E 00	3.229E-01	0.4911
3.395E-01	-5.507E-01	2.829E-01	-4.391E-02	0.5911
-6.946E-02	1.745E-01	-1.457E-01	4.055E-02	0.8411
4.109E-04	-1.781E-03	2.565E-03	-1.023E-03	2.5000

$\langle \hat{U} \cdot \hat{V} \rangle$ Coefficients

A_3	A_2	A_1	A_0	Interval Limit \hat{R}_{max}
-1.431E 02	1.553E 02	-5.624E 01	6.798E 00	0.3611
3.358E 01	-3.613E 01	1.287E 01	-1.522E 00	0.3811
-6.480E 00	9.680E 00	-4.583E 00	6.960E-01	0.4011
-7.046E 01	8.666E 01	-3.546E 01	4.824E 00	0.4211
4.137E 01	-5.461E 01	2.403E 01	-3.526E 00	0.4411
-9.538E-01	1.400E 00	-6.764E-01	1.065E-01	0.4911
-5.984E-02	8.269E-02	-2.962E-02	6.572E-04	0.5911
3.191E-02	-8.001E-02	6.655E-02	-1.829E-02	0.8411
-2.128E-04	1.048E-03	-1.621E-03	8.220E-04	2.5000

Table 9. Continued

Separated-Flow Model

$\hat{X} = 1.938$

$\hat{R}_{\text{surface}} = 0.341$

$\langle \hat{U} \rangle$ Coefficients				Interval Limit
A_3	A_2	A_1	A_0	\hat{R}_{max}
7.985E 03	-8.820E 03	3.251E 03	-3.991E 02	0.3611
3.366E 03	-3.817E 03	1.444E 03	-1.816E 02	0.3811
-6.284E 02	7.498E 02	-2.961E 02	3.944E 01	0.4011
1.006E 02	-1.274E 02	5.570E 01	-7.604E 00	0.4211
-1.152E 02	1.452E 02	-5.910E 01	8.510E 00	0.4411
2.163E 01	-3.593E 01	2.079E 01	-3.237E 00	0.4911
6.353E 00	-1.343E 01	9.738E 00	-1.427E 00	0.5911
2.927E 00	-7.354E 00	6.148E 00	-7.198E-01	0.8411
-1.464E-02	6.931E-02	-9.716E-02	1.031E 00	2.5000
$\langle \hat{V} \rangle$ Coefficients				Interval Limit
A_3	A_2	A_1	A_0	\hat{R}_{max}
2.454E 03	-2.641E 03	9.469E 02	-1.131E 02	0.3611
-4.862E 02	5.446E 02	-2.034E 02	2.531E 01	0.3811
2.915E 02	-3.444E 02	1.354E 02	-1.773E 01	0.4011
-1.133E 02	1.426E 02	-5.992E 01	8.389E 00	0.4211
4.588E 01	-5.850E 01	2.478E 01	-3.500E 00	0.4411
-1.833E 01	2.646E 01	-1.270E 01	2.010E 00	0.4911
2.042E 00	-3.548E 00	2.039E 00	-4.021E-01	0.5911
-9.955E-02	2.497E-01	-2.063E-01	4.023E-02	0.8411
-8.616E-04	6.906E-04	3.149E-03	-1.849E-02	2.5000
\hat{k} Coefficients				Interval Limit
A_3	A_2	A_1	A_0	\hat{R}_{max}
-5.340E 02	5.805E 02	-2.104E 02	2.542E 01	0.3611
-2.202E 01	2.586E 01	-1.008E 01	1.309E 00	0.3811
-3.793E 01	4.405E 01	-1.701E 01	2.190E 00	0.4011
1.177E 01	-1.576E 01	6.975E 00	-1.017E 00	0.4211
2.089E 01	-2.727E 01	1.182E 01	-1.698E 00	0.4411
-2.018E 00	3.041E 00	-1.547E 00	2.682E-01	0.4911
-8.406E-02	1.909E-01	-1.478E-01	3.909E-02	0.5911
-5.590E-02	1.410E-01	-1.183E-01	3.327E-02	0.8411
4.192E-05	-2.044E-04	4.079E-04	-1.211E-05	2.5000
$\langle \hat{U} \hat{V} \rangle$ Coefficients				Interval Limit
A_3	A_2	A_1	A_0	\hat{R}_{max}
-1.155E 02	1.238E 02	-4.425E 01	5.269E 00	0.3611
2.015E 01	-2.312E 01	8.815E 00	-1.118E 00	0.3811
2.234E 01	-2.563E 01	9.770E 00	-1.239E 00	0.4011
-1.774E 01	2.260E 01	-9.573E 00	1.347E 00	0.4211
-6.670E 00	8.614E 00	-3.685E 00	5.204E-01	0.4411
1.295E 00	-1.926E 00	9.640E-01	-1.632E-01	0.4911
-1.074E-02	-2.586E-03	1.930E-02	-8.550E-03	0.5911
2.950E-02	-7.395E-02	6.148E-02	-1.686E-02	0.8411
-2.214E-04	1.060E-03	-1.612E-03	8.269E-04	2.5000

Table 9. Concluded

Separated-Flow Model

$\hat{X} = 2.938$

$\hat{R}_{\text{surface}} = 0.341$

\hat{U} Coefficients				Interval Limit
A_3	A_2	A_1	A_0	\hat{R}_{max}
1.317E 04	-1.431E 04	5.186E 03	-6.262E 02	0.3611
1.106E 02	-1.623E 02	7.725E 01	-1.126E 01	0.3811
9.605E 02	-1.134E 03	4.476E 02	-5.830E 01	0.4011
-6.953E 02	8.584E 02	-3.516E 02	4.855E 01	0.4211
4.015E 02	-5.271E 02	2.319E 02	-3.335E 01	0.4411
-5.676E 01	7.923E 01	-3.559E 01	5.975E 00	0.4911
7.569E 00	-1.554E 01	1.095E 01	-1.644E 00	0.5911
2.863E 00	-7.197E 00	6.014E 00	-6.720E-01	0.8411
-9.883E-03	5.128E-02	-8.285E-02	1.037E 00	2.5000
\hat{V} Coefficients				Interval Limit
A_3	A_2	A_1	A_0	\hat{R}_{max}
-7.330E 01	7.308E 01	-2.397E 01	2.569E 00	0.3611
1.763E 02	-1.973E 02	7.365E 01	-9.181E 00	0.3811
-2.070E 02	2.409E 02	-9.335E 01	1.203E 01	0.4011
2.006E 02	-2.496E 02	1.034E 02	-1.427E 01	0.4211
-7.832E 01	1.028E 02	-4.499E 01	6.557E 00	0.4411
7.669E 00	-1.098E 01	5.200E 00	-8.228E-01	0.4911
-9.837E-01	1.765E 00	-1.060E 00	2.021E-01	0.5911
-3.626E-02	8.495E-02	-6.723E-02	6.389E-03	0.8411
4.381E-03	-1.760E-02	1.902E-02	-1.779E-02	2.5000
\hat{k} Coefficients				Interval Limit
A_3	A_2	A_1	A_0	\hat{R}_{max}
-6.036E 02	6.528E 02	-2.354E 02	2.829E 01	0.3611
3.447E 01	-3.839E 01	1.424E 01	-1.754E 00	0.3811
-3.067E 01	3.609E 01	-1.415E 01	1.851E 00	0.4011
2.017E 01	-2.508E 01	1.039E 01	-1.429E 00	0.4211
-1.194E 01	1.548E 01	-6.692E 00	9.684E-01	0.4411
2.348E 00	-3.426E 00	1.647E 00	-2.577E-01	0.4911
5.194E-02	-4.409E-02	-1.415E-02	1.423E-02	0.5911
-6.436E-02	1.622E-01	-1.361E-01	3.825E-02	0.8411
1.735E-04	-6.947E-04	9.114E-04	-1.477E-04	2.5000
$\hat{U}\hat{V}$ Coefficients				Interval Limit
A_3	A_2	A_1	A_0	\hat{R}_{max}
2.584E 00	-2.111E 00	5.136E-01	-3.306E-02	0.3611
-2.307E 01	2.568E 01	-9.522E 00	1.175E 00	0.3811
1.476E 01	-1.757E 01	6.961E 00	-9.190E-01	0.4011
7.753E-01	-7.435E-01	2.117E-01	-1.661E-02	0.4211
-1.614E 00	2.275E 00	-1.060E 00	1.618E-01	0.4411
-1.214E 00	1.746E 00	-8.260E-01	1.275E-01	0.4911
8.330E-02	-1.658E-01	1.128E-01	-2.619E-02	0.5911
2.469E-02	-6.187E-02	5.140E-02	-1.409E-02	0.8411
-1.776E-04	8.891E-04	-1.382E-03	7.071E-04	2.5000

Table 10. Eddy Viscosity Tabulation, Attached-Flow Model

Attached-Flow Model

$\hat{x} = -4.062$ $\hat{R}_{\text{surface}} = 0.500$ $v_{\infty} = 211 \text{ m/sec}$

I	\hat{y}	$\hat{\epsilon}$	I	\hat{y}	$\hat{\epsilon}$
1	0.004	4.889E 01	51	0.284	1.149E 04
2	0.009	6.742E 01	52	0.294	1.327E 04
3	0.014	9.131E 01	53	0.304	1.547E 04
4	0.019	1.117E 02	54	0.324	2.180E 04
5	0.024	1.234E 02	55	0.344	3.369E 04
6	0.029	1.350E 02	56	0.364	5.594E 04
7	0.034	1.471E 02	57	0.384	3.779E 05
8	0.039	1.564E 02	58	0.404	-1.205E 05
9	0.044	1.632E 02	59	0.424	-5.553E 04
10	0.049	1.693E 02	60	0.444	-3.845E 04
11	0.054	1.737E 02	61	0.464	-3.093E 04
12	0.059	1.765E 02	62	0.484	-2.714E 04
13	0.064	1.775E 02	63	0.504	-2.555E 04
14	0.064	1.775E 02	64	0.554	-2.323E 04
15	0.069	1.757E 02	65	0.604	-2.122E 04
16	0.074	1.714E 02	66	0.654	-1.954E 04
17	0.079	1.542E 02	67	0.704	-1.817E 04
18	0.084	1.565E 02	68	0.754	-1.707E 04
19	0.089	1.504E 02	69	0.804	-1.621E 04
20	0.089	1.504E 02	70	0.854	-1.555E 04
21	0.094	1.449E 02	71	0.904	-1.504E 04
22	0.094	1.449E 02	72	0.954	-1.464E 04
23	0.094	1.449E 02	73	1.004	-1.432E 04
24	0.099	1.409E 02	74	1.104	-1.377E 04
25	0.099	1.409E 02	75	1.204	-1.321E 04
26	0.104	1.375E 02	76	1.304	-1.253E 04
27	0.114	1.302E 02	77	1.404	-1.160E 04
28	0.124	1.230E 02	78	1.504	-1.049E 04
29	0.134	1.166E 02	79	1.604	-9.164E 03
30	0.144	1.113E 02	80	1.704	-7.643E 03
31	0.154	1.090E 02	81	1.804	-5.943E 03
32	0.154	1.090E 02	82	1.904	-4.085E 03
33	0.164	1.098E 02			
34	0.164	1.098E 02			
35	0.174	1.147E 02			
36	0.174	1.147E 02			
37	0.174	1.147E 02			
38	0.184	1.266E 02			
39	0.184	1.266E 02			
40	0.184	1.266E 02			
41	0.194	1.497E 02			
42	0.194	1.497E 02			
43	0.204	1.978E 02			
44	0.214	2.984E 02			
45	0.224	5.249E 02			
46	0.234	1.241E 03			
47	0.244	4.287E 03			
48	0.254	7.725E 03			
49	0.264	8.806E 03			
50	0.274	1.006E 04			

Table 10. Continued

Attached-Flow Model

$\hat{X} = -1.062$

$\hat{R}_{\text{surface}} = 0.500$

$v_{\infty} = 212 \text{ m/sec}$

I	\hat{Y}	\hat{Z}	I	\hat{Y}	\hat{Z}
1	0.004	2.449E 01	51	0.324	5.675E 02
2	0.009	4.099E 01	52	0.344	3.984E 02
3	0.014	6.162E 01	53	0.364	1.359E 03
4	0.019	8.515E 01	54	0.384	2.692E 03
5	0.024	1.050E 02	55	0.404	2.145E 04
6	0.029	1.248E 02	56	0.424	-4.181E 03
7	0.034	1.453E 02	57	0.444	-2.090E 03
8	0.039	1.580E 02	58	0.464	-1.535E 03
9	0.044	1.633E 02	59	0.484	-1.322E 03
10	0.049	1.677E 02	60	0.504	-1.274E 03
11	0.054	1.716E 02	61	0.554	-1.270E 03
12	0.059	1.760E 02	62	0.604	-1.267E 03
13	0.064	1.818E 02	63	0.654	-1.266E 03
14	0.064	1.818E 02	64	0.704	-1.267E 03
15	0.069	1.862E 02	65	0.754	-1.273E 03
16	0.069	1.862E 02	66	0.804	-1.285E 03
17	0.074	1.891E 02	67	0.854	-1.310E 03
18	0.074	1.891E 02	68	0.904	-1.349E 03
19	0.079	1.901E 02	69	0.954	-1.409E 03
20	0.079	1.901E 02	70	1.004	-1.498E 03
21	0.084	1.895E 02	71	1.104	-1.807E 03
22	0.084	1.895E 02	72	1.204	-2.367E 03
23	0.089	1.885E 02	73	1.304	-3.219E 03
24	0.089	1.885E 02	74	1.404	-4.215E 03
25	0.094	1.864E 02	75	1.504	-5.045E 03
26	0.099	1.832E 02	76	1.704	-5.622E 03
27	0.104	1.789E 02	77	1.904	-5.426E 03
28	0.104	1.789E 02			
29	0.114	1.686E 02			
30	0.114	1.686E 02			
31	0.124	1.578E 02			
32	0.124	1.578E 02			
33	0.134	1.479E 02			
34	0.144	1.394E 02			
35	0.144	1.394E 02			
36	0.154	1.351E 02			
37	0.154	1.351E 02			
38	0.164	1.335E 02			
39	0.164	1.335E 02			
40	0.174	1.342E 02			
41	0.174	1.342E 02			
42	0.184	1.386E 02			
43	0.194	1.475E 02			
44	0.204	1.640E 02			
45	0.214	1.903E 02			
46	0.224	2.273E 02			
47	0.244	3.267E 02			
48	0.264	3.797E 02			
49	0.284	4.402E 02			
50	0.304	5.283E 02			

Table 10. Continued

Attached-Flow Model

 $\hat{x} = 0.0$ $\hat{R}_{\text{surface}} = 0.500$ $v_{\infty} = 212 \text{ m/sec}$

I	\hat{Y}	\hat{z}	I	\hat{Y}	\hat{z}
1	0.004	3.546E 01	51	0.264	4.014E 02
2	0.009	5.982E 01	52	0.284	4.953E 02
3	0.014	8.848E 01	53	0.304	5.684E 02
4	0.019	1.148E 02	54	0.324	1.071E 03
5	0.024	1.244E 02	55	0.344	2.611E 03
6	0.024	1.244E 02	56	0.364	-5.901E 03
7	0.029	1.346E 02	57	0.384	-1.589E 03
8	0.029	1.346E 02	58	0.404	-3.739E 02
9	0.034	1.447E 02	59	0.424	-7.479E 02
10	0.034	1.447E 02	60	0.444	-5.433E 02
11	0.039	1.492E 02	61	0.464	-5.997E 02
12	0.044	1.477E 02	62	0.484	-5.925E 02
13	0.049	1.453E 02	63	0.504	-5.179E 02
14	0.054	1.463E 02	64	0.554	-7.159E 02
15	0.059	1.554E 02	65	0.604	-9.310E 02
16	0.064	1.801E 02	66	0.654	-9.666E 02
17	0.069	2.083E 02	67	0.704	-1.127E 03
18	0.069	2.083E 02	68	0.754	-1.318E 03
19	0.074	2.312E 02	69	0.804	-1.544E 03
20	0.074	2.312E 02	70	0.854	-1.810E 03
21	0.074	2.312E 02	71	0.904	-2.122E 03
22	0.079	2.388E 02	72	0.954	-2.475E 03
23	0.079	2.388E 02	73	1.004	-2.859E 03
24	0.079	2.388E 02	74	1.104	-3.545E 03
25	0.084	2.291E 02	75	1.204	-3.650E 03
26	0.084	2.291E 02	76	1.304	-2.886E 03
27	0.089	2.176E 02	77	1.404	-1.799E 03
28	0.094	2.050E 02	78	1.504	-9.212E 02
29	0.094	2.050E 02	79	1.704	1.357E 01
30	0.099	1.952E 02	80	1.904	3.855E 02
31	0.099	1.952E 02			
32	0.104	1.879E 02			
33	0.104	1.879E 02			
34	0.104	1.879E 02			
35	0.104	1.879E 02			
36	0.114	1.736E 02			
37	0.114	1.736E 02			
38	0.124	1.611E 02			
39	0.134	1.510E 02			
40	0.144	1.431E 02			
41	0.154	1.390E 02			
42	0.164	1.372E 02			
43	0.164	1.372E 02			
44	0.174	1.378E 02			
45	0.174	1.378E 02			
46	0.184	1.417E 02			
47	0.194	1.501E 02			
48	0.204	1.660E 02			
49	0.224	2.285E 02			
50	0.244	3.340E 02			

Table 10. Continued

Attached-Flow Model

 $\hat{X} = 0.438$ $\hat{R}_{\text{surface}} = 0.485$ $v_{\infty} = 214 \text{ m/sec}$

I	\hat{Y}	\hat{E}	I	\hat{Y}	\hat{E}
1	0.004	4.028E 01	51	0.554	-3.944E 02
2	0.009	5.494E 01	52	0.604	-4.593E 02
3	0.014	7.647E 01	53	0.654	-5.392E 02
4	0.019	1.036E 02	54	0.654	-5.392E 02
5	0.024	1.216E 02	55	0.704	-5.377E 02
6	0.024	1.216E 02	56	0.754	-7.619E 02
7	0.029	1.412E 02	57	0.804	-9.211E 02
8	0.029	1.412E 02	58	0.854	-1.130E 03
9	0.034	1.647E 02	59	0.904	-1.409E 03
10	0.034	1.647E 02	60	0.954	-1.794E 03
11	0.039	1.852E 02	61	0.954	-1.794E 03
12	0.044	2.012E 02	62	1.004	-2.340E 03
13	0.049	2.131E 02	63	1.104	-4.343E 03
14	0.054	2.153E 02	64	1.204	-8.997E 03
15	0.059	2.070E 02	65	1.304	-1.497E 04
16	0.059	2.070E 02	66	1.404	-1.062E 04
17	0.064	1.907E 02	67	1.504	-5.215E 03
18	0.064	1.907E 02	68	1.704	-1.684E 03
19	0.069	1.802E 02	69	1.904	-7.872E 02
20	0.074	1.752E 02			
21	0.079	1.786E 02			
22	0.084	1.902E 02			
23	0.089	2.009E 02			
24	0.094	2.075E 02			
25	0.099	2.053E 02			
26	0.104	1.965E 02			
27	0.114	1.783E 02			
28	0.124	1.620E 02			
29	0.134	1.486E 02			
30	0.144	1.380E 02			
31	0.154	1.333E 02			
32	0.174	1.315E 02			
33	0.184	1.346E 02			
34	0.194	1.419E 02			
35	0.204	1.546E 02			
36	0.224	2.063E 02			
37	0.244	2.922E 02			
38	0.264	3.483E 02			
39	0.284	4.319E 02			
40	0.304	6.024E 02			
41	0.324	1.098E 03			
42	0.344	7.468E 03			
43	0.364	-1.544E 03			
44	0.384	-7.179E 02			
45	0.404	-4.946E 02			
46	0.424	-3.970E 02			
47	0.444	-3.490E 02			
48	0.464	-3.290E 02			
49	0.484	-3.269E 02			
50	0.504	-3.409E 02			

Table 10. Continued

Attached-Flow Model

$\hat{x} = 0.838$

$\hat{R}_{\text{surface}} = 0.433$

$v_{\infty} = 214 \text{ m/sec}$

I	\hat{Y}	$\hat{\epsilon}$	I	\hat{Y}	$\hat{\epsilon}$
1	0.004	6.445E 01	51	0.384	-3.864E 03
2	0.009	8.742E 01	52	0.404	-5.123E 02
3	0.014	1.090E 02	53	0.424	-2.773E 02
4	0.019	1.219E 02	54	0.444	-2.135E 02
5	0.024	1.223E 02	55	0.464	-1.973E 02
6	0.029	1.271E 02	56	0.484	-2.043E 02
7	0.034	1.390E 02	57	0.504	-2.301E 02
8	0.039	1.579E 02	58	0.554	-3.155E 02
9	0.039	1.579E 02	59	0.604	-4.203E 02
10	0.044	1.826E 02	60	0.654	-5.525E 02
11	0.044	1.826E 02	61	0.704	-7.241E 02
12	0.049	2.038E 02	62	0.754	-9.582E 02
13	0.054	2.090E 02	63	0.804	-1.298E 03
14	0.059	1.967E 02	64	0.854	-1.834E 03
15	0.064	1.763E 02	65	0.904	-2.802E 03
16	0.069	1.714E 02	66	0.954	-5.035E 03
17	0.074	1.767E 02	67	1.004	-1.517E 04
18	0.079	1.973E 02	68	1.104	7.578E 03
19	0.084	2.301E 02	69	1.204	4.092E 03
20	0.084	2.301E 02	70	1.304	3.755E 03
21	0.089	2.562E 02	71	1.404	5.348E 03
22	0.089	2.562E 02	72	1.504	-1.154E 06
23	0.094	2.665E 02	73	1.704	-1.539E 03
24	0.094	2.665E 02	74	1.904	-7.271E 02
25	0.099	2.523E 02			
26	0.104	2.263E 02			
27	0.114	1.870E 02			
28	0.114	1.870E 02			
29	0.124	1.631E 02			
30	0.124	1.631E 02			
31	0.134	1.495E 02			
32	0.134	1.495E 02			
33	0.144	1.437E 02			
34	0.144	1.437E 02			
35	0.154	1.463E 02			
36	0.164	1.520E 02			
37	0.174	1.593E 02			
38	0.184	1.686E 02			
39	0.194	1.795E 02			
40	0.204	1.935E 02			
41	0.214	2.090E 02			
42	0.224	2.266E 02			
43	0.224	2.266E 02			
44	0.244	2.538E 02			
45	0.264	2.527E 02			
46	0.284	2.536E 02			
47	0.304	2.637E 02			
48	0.324	2.935E 02			
49	0.344	3.712E 02			
50	0.364	6.521E 02			

Table 10. Continued

Attached-Flow Model

 $\hat{X} = 1.238$ $\hat{R}_{\text{surface}} = 0.380$ $v_{\infty} = 214 \text{ m/sec}$

I	\hat{Y}	\hat{z}	I	\hat{Y}	\hat{z}
1	0.004	7.908E 01	51	0.504	-1.152E 03
2	0.009	8.600E 01	52	0.554	-5.205E 03
3	0.014	9.214E 01	53	0.604	3.787E 03
4	0.019	1.005E 02	54	0.654	3.340E 03
5	0.024	1.125E 02	55	0.704	2.329E 03
6	0.029	1.271E 02	56	0.754	1.881E 03
7	0.034	1.435E 02	57	0.804	1.617E 03
8	0.039	1.537E 02	58	0.854	1.435E 03
9	0.044	1.561E 02	59	0.904	1.300E 03
10	0.044	1.561E 02	60	0.954	1.191E 03
11	0.049	1.559E 02	61	1.004	1.100E 03
12	0.049	1.559E 02	62	1.104	9.527E 02
13	0.054	1.550E 02	63	1.204	8.375E 02
14	0.054	1.550E 02	64	1.304	7.481E 02
15	0.059	1.555E 02	65	1.404	6.879E 02
16	0.064	1.504E 02	66	1.504	6.765E 02
17	0.069	1.690E 02	67	1.704	1.540E 03
18	0.074	1.805E 02	68	1.904	-3.455E 02
19	0.079	1.959E 02	69	2.104	-5.890E 02
20	0.084	2.095E 02			
21	0.089	2.184E 02			
22	0.094	2.227E 02			
23	0.099	2.194E 02			
24	0.104	2.117E 02			
25	0.114	1.967E 02			
26	0.124	1.838E 02			
27	0.134	1.735E 02			
28	0.144	1.657E 02			
29	0.154	1.612E 02			
30	0.164	1.579E 02			
31	0.174	1.545E 02			
32	0.184	1.512E 02			
33	0.184	1.512E 02			
34	0.194	1.482E 02			
35	0.204	1.450E 02			
36	0.204	1.450E 02			
37	0.224	1.382E 02			
38	0.244	1.291E 02			
39	0.254	1.163E 02			
40	0.254	1.034E 02			
41	0.304	9.048E 01			
42	0.324	7.734E 01			
43	0.344	6.484E 01			
44	0.354	5.308E 01			
45	0.384	4.305E 01			
46	0.404	3.803E 01			
47	0.424	4.551E 01			
48	0.444	1.094E 02			
49	0.454	6.743E 02			
50	0.454	-1.117E 03			

Table 10. Continued

Attached-Flow Model

 $\hat{X} = 1.438$ $\hat{R}_{\text{surface}} = 0.336$ $v_{\infty} = 213 \text{ m/sec}$

I	\hat{Y}	\hat{E}	I	\hat{Y}	\hat{E}
1	0.004	5.707E 01	51	0.384	-1.500E 02
2	0.009	7.192E 01	52	0.404	-1.883E 02
3	0.014	9.166E 01	53	0.424	-2.057E 02
4	0.019	1.093E 02	54	0.444	-1.939E 02
5	0.024	1.134E 02	55	0.464	-1.745E 02
6	0.029	1.161E 02	56	0.484	-1.659E 02
7	0.034	1.188E 02	57	0.504	-1.385E 00
8	0.039	1.221E 02			
9	0.044	1.268E 02			
10	0.049	1.336E 02			
11	0.054	1.416E 02			
12	0.059	1.514E 02			
13	0.064	1.535E 02			
14	0.069	1.721E 02			
15	0.074	1.764E 02			
16	0.074	1.765E 02			
17	0.079	1.752E 02			
18	0.079	1.752E 02			
19	0.084	1.709E 02			
20	0.084	1.709E 02			
21	0.089	1.695E 02			
22	0.089	1.695E 02			
23	0.089	1.695E 02			
24	0.094	1.712E 02			
25	0.094	1.712E 02			
26	0.099	1.758E 02			
27	0.104	1.835E 02			
28	0.114	1.987E 02			
29	0.124	2.107E 02			
30	0.134	2.163E 02			
31	0.144	2.128E 02			
32	0.154	1.993E 02			
33	0.164	1.847E 02			
34	0.174	1.696E 02			
35	0.184	1.550E 02			
36	0.194	1.411E 02			
37	0.204	1.268E 02			
38	0.204	1.268E 02			
39	0.214	1.129E 02			
40	0.224	9.984E 01			
41	0.224	9.984E 01			
42	0.224	9.984E 01			
43	0.244	7.410E 01			
44	0.244	7.410E 01			
45	0.264	4.919E 01			
46	0.284	2.365E 01			
47	0.304	-3.949E 00			
48	0.324	-3.483E 01			
49	0.344	-6.857E 01			
50	0.364	-1.070E 02			

Table 10. Continued

Attached-Flow Model

 $\hat{\lambda} = 1.638$ $\hat{R}_{\text{surface}} = 0.289$ $v_{\infty} = 213 \text{ m/sec}$

I	$\hat{\psi}$	$\hat{\epsilon}$	I	$\hat{\psi}$	$\hat{\epsilon}$
1	0.004	1.184E 02	51	0.484	-9.912E 01
2	0.009	9.941E 01	52	0.504	-9.581E 01
3	0.014	1.020E 02	53	0.554	-5.600E 01
4	0.019	1.177E 02	54	0.604	-4.639E 01
5	0.024	1.297E 02	55	0.654	-2.697E 01
6	0.029	1.371E 02	56	0.704	-9.304E 00
7	0.034	1.422E 02	57	0.754	9.772E 00
8	0.039	1.458E 02	58	0.804	2.664E 01
9	0.044	1.501E 02	59	0.854	4.199E 01
10	0.049	1.559E 02	60	0.904	5.522E 01
11	0.054	1.615E 02	61	0.954	6.553E 01
12	0.059	1.662E 02	62	1.004	7.182E 01
13	0.064	1.695E 02	63	1.104	5.579E 01
14	0.069	1.713E 02	64	1.204	1.819E 01
15	0.074	1.726E 02	65	1.304	-9.905E 01
16	0.079	1.742E 02	66	1.404	-3.040E 02
17	0.084	1.767E 02	67	1.504	-5.439E 02
18	0.089	1.796E 02	68	1.704	-5.521E 02
19	0.089	1.795E 02	69	1.904	-3.798E 02
20	0.094	1.832E 02	70	2.104	-1.275E 02
21	0.094	1.832E 02			
22	0.094	1.832E 02			
23	0.099	1.864E 02			
24	0.099	1.865E 02			
25	0.104	1.900E 02			
26	0.104	1.900E 02			
27	0.114	1.978E 02			
28	0.114	1.978E 02			
29	0.124	2.056E 02			
30	0.134	2.114E 02			
31	0.144	2.137E 02			
32	0.154	2.103E 02			
33	0.164	2.052E 02			
34	0.174	1.991E 02			
35	0.184	1.924E 02			
36	0.194	1.854E 02			
37	0.204	1.775E 02			
38	0.224	1.611E 02			
39	0.244	1.442E 02			
40	0.264	1.274E 02			
41	0.284	1.105E 02			
42	0.304	9.309E 01			
43	0.324	7.439E 01			
44	0.344	5.524E 01			
45	0.354	3.492E 01			
46	0.394	1.292E 01			
47	0.404	-9.870E 00			
48	0.424	-3.383E 01			
49	0.444	-5.808E 01			
50	0.464	-7.325E 01			

Table 10. Continued

Attached-Flow Model

 $\hat{x} = 1.688$ $\hat{R}_{\text{surface}} = 0.276$ $v_{\infty} = 209 \text{ m/sec}$

I	\hat{y}	\hat{z}		I	\hat{y}	\hat{z}
1	0.004	7.312E 01		51	0.554	1.444E 02
2	0.009	8.814E 01		52	0.604	-4.170E 02
3	0.014	1.065E 02				
4	0.019	1.230E 02				
5	0.024	1.291E 02				
6	0.029	1.324E 02				
7	0.034	1.350E 02				
8	0.039	1.382E 02				
9	0.044	1.433E 02				
10	0.049	1.490E 02				
11	0.054	1.531E 02				
12	0.059	1.546E 02				
13	0.064	1.533E 02				
14	0.069	1.526E 02				
15	0.074	1.534E 02				
16	0.079	1.573E 02				
17	0.084	1.638E 02				
18	0.089	1.699E 02				
19	0.094	1.755E 02				
20	0.094	1.755E 02				
21	0.099	1.789E 02				
22	0.099	1.789E 02				
23	0.104	1.809E 02				
24	0.104	1.809E 02				
25	0.114	1.851E 02				
26	0.124	1.895E 02				
27	0.134	1.928E 02				
28	0.144	1.940E 02				
29	0.154	1.919E 02				
30	0.164	1.889E 02				
31	0.174	1.852E 02				
32	0.184	1.812E 02				
33	0.194	1.770E 02				
34	0.204	1.721E 02				
35	0.224	1.617E 02				
36	0.244	1.500E 02				
37	0.244	1.500E 02				
38	0.264	1.371E 02				
39	0.284	1.233E 02				
40	0.304	1.080E 02				
41	0.304	1.080E 02				
42	0.324	9.070E 01				
43	0.344	7.197E 01				
44	0.364	5.103E 01				
45	0.384	2.733E 01				
46	0.404	1.985E 00				
47	0.424	-2.500E 01				
48	0.444	-5.182E 01				
49	0.464	-7.178E 01				
50	0.484	-7.406E 01				

Table 10. Continued

Attached-Flow Model

 $\hat{X} = 1.738$ $\hat{R}_{\text{surface}} = 0.262$ $v_{\infty} = 209 \text{ m/sec}$

I	\hat{Y}	\hat{E}	I	\hat{Y}	\hat{E}
1	0.004	2.852E 01			
2	0.009	6.149E 01			
3	0.014	1.222E 02			
4	0.019	1.773E 02			
5	0.024	1.477E 02			
6	0.029	1.382E 02			
7	0.034	1.415E 02			
8	0.039	1.537E 02			
9	0.044	1.695E 02			
10	0.049	1.771E 02			
11	0.054	1.739E 02			
12	0.059	1.631E 02			
13	0.064	1.496E 02			
14	0.069	1.433E 02			
15	0.074	1.415E 02			
16	0.079	1.439E 02			
17	0.084	1.481E 02			
18	0.089	1.514E 02			
19	0.094	1.544E 02			
20	0.099	1.572E 02			
21	0.104	1.606E 02			
22	0.114	1.704E 02			
23	0.124	1.925E 02			
24	0.134	1.943E 02			
25	0.144	2.032E 02			
26	0.154	2.049E 02			
27	0.164	2.043E 02			
28	0.174	2.031E 02			
29	0.184	2.011E 02			
30	0.194	1.987E 02			
31	0.204	1.956E 02			
32	0.224	1.881E 02			
33	0.244	1.791E 02			
34	0.264	1.689E 02			
35	0.284	1.567E 02			
36	0.304	1.416E 02			
37	0.324	1.229E 02			
38	0.344	1.006E 02			
39	0.364	7.380E 01			
40	0.384	4.117E 01			
41	0.404	4.147E 00			
42	0.404	4.147E 00			
43	0.424	-3.710E 01			
44	0.444	-7.925E 01			
45	0.464	-1.109E 02			
46	0.484	-1.157E 02			
47	0.504	-6.991E 01			
48	0.554	2.324E 02			
49	0.604	1.593E 03			
50	0.604	1.593E 03			

Table 10. Continued

Attached-Flow Model

 $\hat{X} = 1.788$ $\hat{R}_{\text{surface}} = 0.261$ $v_{\infty} = 209 \text{ m/sec}$

I	\hat{Y}	\hat{z}	I	\hat{Y}	\hat{z}
1	0.004	6.283E 01	51	0.204	1.980E 02
2	0.009	7.789E 01	52	0.204	1.980E 02
3	0.014	1.022E 02	53	0.224	1.965E 02
4	0.019	1.268E 02	54	0.244	1.932E 02
5	0.024	1.364E 02	55	0.264	1.861E 02
6	0.029	1.423E 02	56	0.284	1.764E 02
7	0.034	1.474E 02	57	0.304	1.634E 02
8	0.039	1.531E 02	58	0.324	1.464E 02
9	0.044	1.509E 02	59	0.344	1.257E 02
10	0.044	1.509E 02	60	0.364	1.003E 02
11	0.049	1.695E 02	61	0.384	5.899E 01
12	0.049	1.695E 02	62	0.404	3.289E 01
13	0.054	1.760E 02	63	0.424	-9.824E 00
14	0.054	1.760E 02	64	0.444	-5.555E 01
15	0.059	1.799E 02	65	0.464	-1.005E 02
16	0.059	1.799E 02	66	0.484	-1.312E 02
17	0.064	1.810E 02	67	0.504	-1.062E 02
18	0.069	1.811E 02	68	0.554	2.849E 02
19	0.074	1.808E 02	69	0.604	2.631E 01
20	0.079	1.805E 02			
21	0.084	1.805E 02			
22	0.084	1.805E 02			
23	0.089	1.803E 02			
24	0.089	1.803E 02			
25	0.094	1.803E 02			
26	0.094	1.803E 02			
27	0.094	1.803E 02			
28	0.099	1.812E 02			
29	0.099	1.812E 02			
30	0.104	1.831E 02			
31	0.104	1.831E 02			
32	0.104	1.831E 02			
33	0.104	1.831E 02			
34	0.104	1.831E 02			
35	0.114	1.879E 02			
36	0.114	1.879E 02			
37	0.114	1.879E 02			
38	0.114	1.879E 02			
39	0.124	1.932E 02			
40	0.124	1.932E 02			
41	0.134	1.979E 02			
42	0.134	1.979E 02			
43	0.144	2.007E 02			
44	0.144	2.007E 02			
45	0.154	2.005E 02			
46	0.164	1.997E 02			
47	0.174	1.991E 02			
48	0.184	1.987E 02			
49	0.194	1.983E 02			
50	0.204	1.980E 02			

Table 10. Continued

Attached-Flow Model

 $\hat{X} = 1.838$ $\hat{R}_{\text{surface}} = 0.276$ $v_{\infty} = 211 \text{ m/sec}$

I	\hat{Y}	\hat{Z}	I	\hat{Y}	\hat{Z}
1	0.004	1.605E 02	51	0.384	5.037E 01
2	0.009	1.741E 02	52	0.404	4.872E 01
3	0.014	1.810E 02	53	0.424	3.973E 01
4	0.019	1.864E 02	54	0.444	3.544E 01
5	0.019	1.864E 02	55	0.464	3.844E 01
6	0.019	1.864E 02	56	0.484	4.903E 01
7	0.019	1.864E 02	57	0.504	5.112E 01
8	0.019	1.864E 02	58	0.554	9.771E 01
9	0.019	1.864E 02	59	0.604	1.172E 02
10	0.019	1.864E 02	60	0.654	1.504E 02
11	0.019	1.864E 02	61	0.704	1.874E 02
12	0.019	1.864E 02	62	0.754	2.300E 02
13	0.024	1.907E 02	63	0.804	2.785E 02
14	0.029	1.928E 02	64	0.854	3.350E 02
15	0.034	1.944E 02	65	0.904	4.013E 02
16	0.039	1.971E 02	66	0.954	4.799E 02
17	0.044	2.013E 02	67	1.004	5.743E 02
18	0.049	2.052E 02	68	1.104	9.285E 02
19	0.054	2.070E 02	69	1.204	1.211E 03
20	0.059	2.064E 02	70	1.304	1.764E 03
21	0.064	2.026E 02	71	1.404	2.417E 03
22	0.069	1.981E 02	72	1.504	2.780E 03
23	0.074	1.937E 02	73	1.704	1.897E 03
24	0.079	1.899E 02	74	1.904	1.015E 03
25	0.084	1.886E 02	75	2.104	5.409E 02
26	0.089	1.893E 02			
27	0.094	1.924E 02			
28	0.099	1.973E 02			
29	0.104	2.036E 02			
30	0.114	2.173E 02			
31	0.124	2.295E 02			
32	0.134	2.378E 02			
33	0.144	2.400E 02			
34	0.154	2.341E 02			
35	0.164	2.264E 02			
36	0.174	2.181E 02			
37	0.184	2.097E 02			
38	0.194	2.014E 02			
39	0.204	1.927E 02			
40	0.204	1.927E 02			
41	0.214	1.841E 02			
42	0.224	1.759E 02			
43	0.224	1.759E 02			
44	0.234	1.675E 02			
45	0.244	1.600E 02			
46	0.244	1.600E 02			
47	0.264	1.454E 02			
48	0.324	1.021E 02			
49	0.344	8.780E 01			
50	0.364	7.383E 01			

Table 10. Continued

Attached-Flow Model

 $\hat{x} = 1.938$ $\hat{R}_{\text{surface}} = 0.302$ $v_{\infty} = 214 \text{ m/sec}$

I	\hat{y}	\hat{z}	I	\hat{y}	\hat{z}
1	0.004	1.094E 02	51	0.464	9.693E 01
2	0.009	1.401E 02	52	0.484	1.958E 02
3	0.014	1.775E 02	53	0.504	3.551E 02
4	0.019	2.109E 02	54	0.554	1.960E 02
5	0.024	2.237E 02	55	0.604	3.367E 01
6	0.029	2.290E 02			
7	0.034	2.297E 02			
8	0.039	2.277E 02			
9	0.044	2.255E 02			
10	0.049	2.233E 02			
11	0.054	2.216E 02			
12	0.059	2.200E 02			
13	0.064	2.184E 02			
14	0.064	2.184E 02			
15	0.069	2.175E 02			
16	0.069	2.175E 02			
17	0.074	2.182E 02			
18	0.074	2.182E 02			
19	0.079	2.219E 02			
20	0.079	2.219E 02			
21	0.084	2.287E 02			
22	0.084	2.287E 02			
23	0.089	2.363E 02			
24	0.094	2.449E 02			
25	0.099	2.519E 02			
26	0.099	2.519E 02			
27	0.104	2.575E 02			
28	0.104	2.575E 02			
29	0.114	2.680E 02			
30	0.124	2.760E 02			
31	0.134	2.804E 02			
32	0.144	2.803E 02			
33	0.154	2.751E 02			
34	0.164	2.682E 02			
35	0.174	2.600E 02			
36	0.184	2.510E 02			
37	0.194	2.417E 02			
38	0.204	2.312E 02			
39	0.224	2.095E 02			
40	0.244	1.871E 02			
41	0.264	1.653E 02			
42	0.284	1.443E 02			
43	0.304	1.234E 02			
44	0.324	1.027E 02			
45	0.344	8.347E 01			
46	0.364	6.572E 01			
47	0.384	5.041E 01			
48	0.404	4.017E 01			
49	0.424	3.825E 01			
50	0.444	5.256E 01			

Table 10. Continued

Attached-Flow Model

$\hat{X} = 2.038$

$\hat{R}_{\text{surface}} = 0.316$

$v_{\infty} = 211 \text{ m/sec}$

I	\hat{Y}	\hat{z}	I	\hat{Y}	\hat{z}
1	0.004	3.663E 01	51	0.404	1.215E 01
2	0.004	3.663E 01	52	0.424	-2.139E 01
3	0.004	3.663E 01	53	0.444	-5.485E 01
4	0.004	3.663E 01	54	0.464	-1.187E 02
5	0.004	3.663E 01	55	0.484	-1.719E 02
6	0.004	3.663E 01	56	0.504	-1.789E 02
7	0.009	9.702E 01	57	0.554	-1.484E 02
8	0.014	1.927E 02	58	0.604	-1.375E 02
9	0.019	2.774E 02	59	0.654	-1.442E 02
10	0.024	2.742E 02	60	0.704	-1.667E 02
11	0.029	2.674E 02	61	0.754	-2.037E 02
12	0.034	2.588E 02	62	0.804	-2.540E 02
13	0.039	2.497E 02	63	0.854	-3.170E 02
14	0.044	2.404E 02	64	0.904	-3.920E 02
15	0.049	2.324E 02	65	0.954	-4.790E 02
16	0.054	2.287E 02	66	1.004	-5.779E 02
17	0.059	2.309E 02	67	1.104	-3.135E 02
18	0.064	2.400E 02	68	1.204	-1.109E 03
19	0.069	2.475E 02	69	1.304	-1.482E 03
20	0.074	2.523E 02	70	1.404	-1.987E 03
21	0.079	2.524E 02	71	1.504	-2.759E 03
22	0.084	2.484E 02	72	1.704	-1.070E 04
23	0.089	2.447E 02	73	1.904	1.944E 03
24	0.094	2.413E 02	74	2.104	-5.532E 02
25	0.099	2.393E 02			
26	0.104	2.386E 02			
27	0.114	2.384E 02			
28	0.124	2.403E 02			
29	0.134	2.432E 02			
30	0.144	2.441E 02			
31	0.154	2.416E 02			
32	0.164	2.377E 02			
33	0.174	2.328E 02			
34	0.184	2.270E 02			
35	0.194	2.207E 02			
36	0.204	2.133E 02			
37	0.204	2.133E 02			
38	0.204	2.133E 02			
39	0.214	2.054E 02			
40	0.224	1.974E 02			
41	0.224	1.974E 02			
42	0.244	1.801E 02			
43	0.244	1.801E 02			
44	0.264	1.625E 02			
45	0.284	1.448E 02			
46	0.304	1.264E 02			
47	0.324	1.068E 02			
48	0.344	8.651E 01			
49	0.364	6.459E 01			
50	0.384	3.985E 01			

Table 10. Continued

Attached-Flow Model

 $\hat{X} = 2.438$ $\hat{R}_{\text{surface}} = 0.342$ $v_{\infty} = 212 \text{ m/sec}$

I	\hat{Y}	\hat{z}	I	\hat{Y}	\hat{z}
1	0.004	4.059E 01	51	0.704	1.141E 03
2	0.009	5.551E 01	52	0.754	2.452E 03
3	0.014	9.652E 01	53	0.804	-1.505E 03
4	0.019	1.694E 02	54	0.854	-2.322E 02
5	0.024	2.079E 02	55	0.904	7.231E 00
6	0.029	2.350E 02	56	0.954	7.715E 01
7	0.034	2.511E 02	57	1.004	1.365E 02
8	0.039	2.524E 02	58	1.104	1.549E 02
9	0.044	2.470E 02	59	1.204	1.355E 02
10	0.044	2.470E 02	60	1.304	9.297E 01
11	0.049	2.437E 02	61	1.404	2.597E 01
12	0.054	2.417E 02	62	1.504	-9.145E 01
13	0.059	2.390E 02	63	1.704	-7.802E 02
14	0.064	2.324E 02	64	1.904	9.695E 02
15	0.069	2.214E 02	65	2.104	3.603E 02
16	0.074	2.092E 02			
17	0.079	1.987E 02			
18	0.084	1.954E 02			
19	0.089	1.967E 02			
20	0.094	2.012E 02			
21	0.099	2.055E 02			
22	0.104	2.090E 02			
23	0.114	2.107E 02			
24	0.124	2.105E 02			
25	0.134	2.074E 02			
26	0.144	2.015E 02			
27	0.154	1.939E 02			
28	0.164	1.861E 02			
29	0.174	1.778E 02			
30	0.184	1.693E 02			
31	0.194	1.611E 02			
32	0.204	1.521E 02			
33	0.224	1.337E 02			
34	0.244	1.133E 02			
35	0.264	8.973E 01			
36	0.284	6.377E 01			
37	0.304	3.337E 01			
38	0.324	-4.524E 00			
39	0.344	-5.264E 01			
40	0.364	-1.213E 02			
41	0.384	-2.361E 02			
42	0.404	-4.671E 02			
43	0.424	-1.289E 03			
44	0.444	5.646E 03			
45	0.464	1.194E 03			
46	0.484	8.039E 02			
47	0.504	7.391E 02			
48	0.554	7.598E 02			
49	0.504	8.030E 02			
50	0.554	8.966E 02			

Table 10. Continued
Attached-Flow Model

$\hat{X} = 2.938$

$\hat{R}_{\text{surface}} = 0.341$

$v_{\infty} = 210 \text{ m/sec}$

I	\hat{Y}	$\hat{\epsilon}$	I	\hat{Y}	$\hat{\epsilon}$
1	0.004	6.586E 01	51	0.804	-5.682E 03
2	0.009	9.863E 01	52	0.904	-2.672E 03
3	0.014	1.481E 02	53	1.004	-1.873E 03
4	0.019	1.933E 02	54	1.104	-1.663E 03
5	0.024	2.024E 02	55	1.204	-1.591E 03
6	0.029	2.085E 02	56	1.304	-1.890E 03
7	0.034	2.178E 02	57	1.404	-2.301E 03
8	0.039	2.341E 02	58	1.504	-3.165E 03
9	0.044	2.574E 02	59	1.604	-5.952E 03
10	0.049	2.713E 02	60	1.704	2.959E 04
11	0.054	2.670E 02	61	1.804	2.717E 03
12	0.054	2.670E 02	62	2.004	9.655E 01
13	0.059	2.444E 02			
14	0.059	2.444E 02			
15	0.064	2.121E 02			
16	0.069	1.935E 02			
17	0.074	1.857E 02			
18	0.079	1.934E 02			
19	0.084	2.198E 02			
20	0.089	2.485E 02			
21	0.094	2.732E 02			
22	0.094	2.732E 02			
23	0.099	2.769E 02			
24	0.104	2.544E 02			
25	0.114	2.420E 02			
26	0.134	2.142E 02			
27	0.144	2.065E 02			
28	0.154	2.030E 02			
29	0.154	1.998E 02			
30	0.174	1.957E 02			
31	0.184	1.906E 02			
32	0.194	1.849E 02			
33	0.204	1.779E 02			
34	0.224	1.514E 02			
35	0.244	1.411E 02			
36	0.264	1.175E 02			
37	0.284	9.202E 01			
38	0.304	6.319E 01			
39	0.324	2.884E 01			
40	0.344	-1.199E 01			
41	0.364	-6.524E 01			
42	0.384	-1.424E 02			
43	0.404	-2.531E 02			
44	0.424	-4.972E 02			
45	0.444	-1.163E 03			
46	0.454	-7.711E 03			
47	0.484	3.441E 03			
48	0.504	2.556E 03			
49	0.504	3.734E 03			
50	0.704	1.224E 04			

Table 10. Continued

Attached-Flow Model

$\hat{X} = 3.938$

$\hat{R}_{\text{surface}} = 0.342$

$v_{\infty} = 212 \text{ m/sec}$

I	\hat{Y}	\hat{E}	I	\hat{Y}	\hat{E}
1	0.004	2.754E 01	51	0.254	7.023E 01
2	0.004	2.754E 01	52	0.264	5.885E 01
3	0.004	2.754E 01	53	0.274	4.675E 01
4	0.004	2.754E 01	54	0.284	3.424E 01
5	0.004	2.754E 01	55	0.294	1.991E 01
6	0.004	2.754E 01	56	0.304	4.295E 00
7	0.009	4.455E 01	57	0.324	-3.201E 01
8	0.014	7.552E 01	58	0.344	-7.897E 01
9	0.019	1.195E 02	59	0.364	-1.463E 02
10	0.024	1.393E 02	60	0.384	-2.479E 02
11	0.029	1.557E 02	61	0.404	-4.249E 02
12	0.029	1.557E 02	62	0.424	-9.261E 02
13	0.029	1.557E 02	63	0.444	-2.272E 03
14	0.034	1.717E 02	64	0.464	1.392E 04
15	0.034	1.717E 02	65	0.484	2.744E 03
16	0.039	1.847E 02	66	0.504	2.347E 03
17	0.039	1.847E 02	67	0.554	2.571E 03
18	0.044	1.988E 02	68	0.604	2.855E 03
19	0.044	1.988E 02	69	0.654	3.224E 03
20	0.049	2.237E 02	70	0.704	3.704E 03
21	0.054	2.588E 02	71	0.754	4.340E 03
22	0.059	3.108E 02	72	0.804	5.201E 03
23	0.064	3.857E 02	73	0.854	6.395E 03
24	0.069	4.227E 02	74	0.904	9.090E 03
25	0.074	4.041E 02	75	0.954	1.055E 04
26	0.074	4.041E 02	76	1.004	1.415E 04
27	0.074	4.041E 02	77	1.104	2.625E 04
28	0.079	3.356E 02	78	1.204	3.535E 04
29	0.079	3.356E 02	79	1.304	2.455E 04
30	0.079	3.356E 02	80	1.404	1.370E 04
31	0.084	2.756E 02	81	1.504	9.214E 03
32	0.089	2.464E 02	82	1.604	5.450E 03
33	0.094	2.337E 02	83	1.704	3.919E 03
34	0.099	2.355E 02	84	1.804	2.990E 03
35	0.104	2.462E 02	85	1.904	2.381E 03
36	0.114	2.645E 02	86	2.004	1.959E 03
37	0.124	2.735E 02	87	2.104	1.649E 03
38	0.134	2.710E 02			
39	0.134	2.710E 02			
40	0.144	2.556E 02			
41	0.154	2.300E 02			
42	0.154	2.058E 02			
43	0.174	1.831E 02			
44	0.184	1.629E 02			
45	0.194	1.457E 02			
46	0.204	1.296E 02			
47	0.214	1.154E 02			
48	0.224	1.031E 02			
49	0.234	9.138E 01			
50	0.244	8.050E 01			

Table 11. Eddy Viscosity Tabulation, Separated-Flow Model

Separated-Flow Model

$\hat{x} = -4.062$ $\hat{R}_{\text{surface}} = 0.500$ $v_{\infty} = 211 \text{ m/sec}$

I	\hat{Y}	\hat{z}	I	\hat{Y}	\hat{z}
1	0.004	9.234E-01	51	0.754	1.933E 03
2	0.009	1.751E 01	52	0.804	2.091E 03
3	0.014	4.284E 01	53	0.854	2.273E 03
4	0.019	7.892E 01	54	0.904	2.485E 03
5	0.024	8.541E 01	55	0.954	2.739E 03
6	0.029	9.768E 01	56	1.004	3.049E 03
7	0.034	1.176E 02	57	1.104	3.950E 03
8	0.039	1.350E 02	58	1.204	5.653E 03
9	0.044	1.432E 02	59	1.304	1.017E 04
10	0.049	1.444E 02	60	1.404	5.764E 04
11	0.054	1.400E 02	61	1.504	-1.519E 04
12	0.059	1.329E 02	62	1.604	-6.657E 03
13	0.064	1.259E 02	63	1.704	-4.268E 03
14	0.069	1.211E 02	64	1.804	-3.163E 03
15	0.074	1.168E 02	65	1.904	-2.545E 03
16	0.079	1.106E 02			
17	0.084	1.025E 02			
18	0.089	9.357E 01			
19	0.094	8.303E 01			
20	0.099	7.335E 01			
21	0.104	6.443E 01			
22	0.114	4.662E 01			
23	0.124	3.038E 01			
24	0.134	1.578E 01			
25	0.144	7.334E-01			
26	0.154	-1.537E 01			
27	0.164	-3.365E 01			
28	0.174	-5.734E 01			
29	0.184	-8.777E 01			
30	0.194	-1.275E 02			
31	0.204	-1.989E 02			
32	0.224	-4.486E 02			
33	0.244	-1.272E 03			
34	0.264	-1.777E 03			
35	0.284	-2.411E 03			
36	0.304	-3.970E 03			
37	0.324	-1.296E 04			
38	0.344	1.065E 04			
39	0.364	3.876E 03			
40	0.384	2.444E 03			
41	0.404	1.873E 03			
42	0.424	1.580E 03			
43	0.444	1.421E 03			
44	0.464	1.345E 03			
45	0.484	1.323E 03			
46	0.504	1.347E 03			
47	0.554	1.445E 03			
48	0.504	1.552E 03			
49	0.554	1.566E 03			
50	0.704	1.792E 03			

Table 11. Continued

Separated-Flow Model

$\hat{x} = -1.062$

$\hat{R}_{\text{surface}} = 0.500$

$v_{\infty} = 213 \text{ m/sec}$

I	\hat{Y}	\hat{z}	I	\hat{Y}	\hat{z}
1	0.004	4.613E 01	51	1.104	-2.218E 03
2	0.009	5.148E 01	52	1.204	-2.494E 03
3	0.014	6.359E 01	53	1.304	-2.351E 03
4	0.019	8.708E 01	54	1.404	-1.931E 03
5	0.024	1.196E 02	55	1.504	-1.484E 03
6	0.029	1.549E 02	56	1.604	-1.119E 03
7	0.034	1.811E 02	57	1.704	-9.437E 02
8	0.039	1.731E 02	58	1.804	-5.385E 02
9	0.044	1.486E 02	59	1.904	-4.825E 02
10	0.049	1.351E 02			
11	0.054	1.320E 02			
12	0.059	1.372E 02			
13	0.064	1.508E 02			
14	0.069	1.614E 02			
15	0.074	1.678E 02			
16	0.079	1.685E 02			
17	0.084	1.648E 02			
18	0.089	1.611E 02			
19	0.094	1.563E 02			
20	0.099	1.504E 02			
21	0.104	1.434E 02			
22	0.114	1.283E 02			
23	0.124	1.136E 02			
24	0.134	1.002E 02			
25	0.144	8.767E 01			
26	0.154	7.808E 01			
27	0.164	6.981E 01			
28	0.174	6.157E 01			
29	0.184	5.418E 01			
30	0.194	4.828E 01			
31	0.204	4.423E 01			
32	0.214	4.391E 01			
33	0.224	4.939E 01			
34	0.234	6.416E 01			
35	0.244	8.706E 01			
36	0.254	1.057E 02			
37	0.264	1.247E 02			
38	0.274	1.468E 02			
39	0.284	1.721E 02			
40	0.294	2.045E 02			
41	0.304	2.446E 02			
42	0.354	8.279E 02			
43	0.404	-1.756E 03			
44	0.454	-6.240E 02			
45	0.504	-5.373E 02			
46	0.504	-6.187E 02			
47	0.704	-7.504E 02			
48	0.804	-9.593E 02			
49	0.904	-1.280E 03			
50	1.004	-1.727E 03			

Table 11. Continued

Separated-Flow Model

 $\hat{X} = -0.562$ $\hat{R}_{\text{surface}} = 0.500$ $v_{\infty} = 213 \text{ m/sec}$

I	\hat{Y}	\hat{Z}	I	\hat{Y}	\hat{Z}
1	0.004	4.951E 01			
2	0.009	6.169E 01			
3	0.014	7.393E 01			
4	0.024	1.060E 02			
5	0.028	1.235E 02			
6	0.034	1.551E 02			
7	0.039	1.650E 02			
8	0.044	1.588E 02			
9	0.054	1.513E 02			
10	0.064	1.686E 02			
11	0.073	2.005E 02			
12	0.083	2.167E 02			
13	0.093	2.043E 02			
14	0.103	1.756E 02			
15	0.113	1.500E 02			
16	0.123	1.317E 02			
17	0.133	1.187E 02			
18	0.143	1.102E 02			
19	0.152	1.074E 02			
20	0.162	1.075E 02			
21	0.172	1.095E 02			
22	0.182	1.141E 02			
23	0.192	1.227E 02			
24	0.202	1.374E 02			
25	0.222	1.954E 02			
26	0.242	2.969E 02			
27	0.262	3.428E 02			
28	0.282	3.881E 02			
29	0.302	4.609E 02			
30	0.322	5.898E 02			
31	0.341	8.572E 02			
32	0.362	1.685E 03			
33	0.380	1.343E 04			
34	0.400	-2.087E 03			
35	0.500	-5.116E 02			
36	0.600	-5.451E 02			
37	0.701	-6.187E 02			
38	0.801	-7.375E 02			
39	0.901	-9.108E 02			
40	1.001	-1.153E 03			
41	1.201	-1.952E 03			
42	1.401	-3.780E 03			
43	1.601	-1.877E 04			
44	1.801	2.937E 03			
45	0.504	-5.373E 02			
46	0.604	-6.187E 02			
47	0.704	-7.504E 02			
48	0.804	-9.593E 02			
49	0.904	-1.280E 03			
50	1.004	-1.727E 03			

Table 11. Continued

Separated-Flow Model

$\hat{x} = 0.0$			$\hat{R}_{\text{surface}} = 0.500$			$v_{\infty} = 213 \text{ m/sec}$		
I	\hat{y}	\hat{z}	I	\hat{y}	\hat{z}	I	\hat{y}	\hat{z}
1	0.004	3.480E 01						
2	0.009	5.025E 01						
3	0.014	7.982E 01						
4	0.019	1.185E 02						
5	0.023	1.334E 02						
6	0.029	1.419E 02						
7	0.034	1.448E 02						
8	0.039	1.434E 02						
9	0.054	1.511E 02						
10	0.054	1.781E 02						
11	0.074	2.031E 02						
12	0.083	2.078E 02						
13	0.093	2.040E 02						
14	0.103	1.955E 02						
15	0.113	1.829E 02						
16	0.123	1.689E 02						
17	0.133	1.545E 02						
18	0.143	1.405E 02						
19	0.152	1.310E 02						
20	0.162	1.239E 02						
21	0.172	1.178E 02						
22	0.182	1.145E 02						
23	0.192	1.153E 02						
24	0.202	1.249E 02						
25	0.222	2.450E 02						
26	0.242	-1.012E 03						
27	0.262	-3.574E 02						
28	0.282	-2.348E 02						
29	0.302	-1.685E 02						
30	0.322	-1.256E 02						
31	0.342	-9.563E 01						
32	0.362	-7.529E 01						
33	0.382	-5.839E 01						
34	0.402	-4.512E 01						
35	0.502	-3.239E 00						
36	0.602	2.026E 01						
37	0.701	2.420E 01						
38	0.801	-5.409E 00						
39	0.901	-9.776E 01						
40	1.001	-3.189E 02						
41	1.201	-2.159E 03						
42	1.401	-8.783E 03						
43	1.501	-1.993E 03						
44	1.601	-1.050E 02						
45	0.504	-5.373E 02						
46	0.504	-6.187E 02						
47	0.704	-7.504E 02						
48	0.804	-9.593E 02						
49	0.904	-1.280E 03						
50	1.004	-1.727E 03						

Table 11. Continued

Separated-Flow Model

$\hat{x} = 0.138$

$\hat{R}_{\text{surface}} = 0.492$

$v_{\infty} = 214 \text{ m/sec}$

I	\hat{Y}	\hat{z}	I	\hat{Y}	\hat{z}
1	0.004	3.452E 01			
2	0.009	4.430E 01			
3	0.014	6.466E 01			
4	0.019	1.130E 02			
5	0.024	1.399E 02			
6	0.029	1.630E 02			
7	0.034	1.814E 02			
8	0.039	1.870E 02			
9	0.044	1.846E 02			
10	0.049	1.850E 02			
11	0.054	1.871E 02			
12	0.059	1.892E 02			
13	0.069	1.904E 02			
14	0.079	1.974E 02			
15	0.088	2.161E 02			
16	0.098	2.213E 02			
17	0.108	2.080E 02			
18	0.118	1.941E 02			
19	0.128	1.809E 02			
20	0.138	1.706E 02			
21	0.148	1.655E 02			
22	0.158	1.677E 02			
23	0.167	1.740E 02			
24	0.177	1.861E 02			
25	0.187	2.095E 02			
26	0.197	2.507E 02			
27	0.217	5.325E 02			
28	0.237	-5.113E 03			
29	0.257	-8.928E 02			
30	0.277	-5.572E 02			
31	0.297	-3.805E 02			
32	0.317	-2.773E 02			
33	0.337	-2.111E 02			
34	0.357	-1.563E 02			
35	0.377	-1.364E 02			
36	0.397	-1.157E 02			
37	0.497	-8.881E 01			
38	0.497	-8.881E 01			
39	0.597	-1.096E 02			
40	0.597	-1.559E 02			
41	0.797	-2.449E 02			
42	0.896	-4.074E 02			
43	0.997	-7.200E 02			
44	1.096	-1.329E 03			
45	1.196	-2.665E 03			
46	1.396	-1.272E 04			
47	1.596	-8.753E 03			
48	1.796	-2.699E 03			
49	1.996	-1.097E 03			
50	1.004	-1.727E 03			

Table 11. Continued

Separated-Flow Model

 $\hat{X} = 0.338$ $\hat{R}_{\text{surface}} = 0.463$ $v_{\infty} = 214$ m/sec

I	\hat{Y}	\hat{Z}	I	\hat{Y}	\hat{Z}
1	0.004	4.550E 01			
2	0.009	4.637E 01			
3	0.014	5.643E 01			
4	0.019	7.900E 01			
5	0.024	9.094E 01			
6	0.029	1.051E 02			
7	0.034	1.223E 02			
8	0.039	1.342E 02			
9	0.044	1.392E 02			
10	0.049	1.441E 02			
11	0.054	1.492E 02			
12	0.059	1.556E 02			
13	0.064	1.661E 02			
14	0.074	2.016E 02			
15	0.083	2.683E 02			
16	0.094	3.034E 02			
17	0.103	2.534E 02			
18	0.113	2.075E 02			
19	0.123	1.750E 02			
20	0.133	1.526E 02			
21	0.143	1.379E 02			
22	0.153	1.315E 02			
23	0.163	1.295E 02			
24	0.172	1.295E 02			
25	0.182	1.328E 02			
26	0.192	1.402E 02			
27	0.202	1.539E 02			
28	0.222	2.125E 02			
29	0.242	3.170E 02			
30	0.262	3.881E 02			
31	0.282	4.814E 02			
32	0.302	6.474E 02			
33	0.322	1.029E 03			
34	0.342	2.959E 03			
35	0.362	-3.379E 03			
36	0.382	-1.020E 03			
37	0.402	-5.900E 02			
38	0.502	-2.029E 02			
39	0.602	-1.180E 02			
40	0.702	-5.751E 01			
41	0.802	-3.637E 01			
42	0.901	-8.005E 01			
43	1.001	-2.366E 02			
44	1.101	-5.913E 02			
45	1.201	-1.285E 03			
46	1.301	-2.468E 03			
47	1.501	-4.797E 03			
48	1.701	-3.086E 03			
49	1.901	-1.098E 03			
50	1.004	-1.727E 03			

Table 11. Continued

Separated-Flow Model

$\hat{X} = 0.538$

$\hat{R}_{\text{surface}} = 0.394$

$v_{\infty} = 214 \text{ m/sec}$

I	\hat{Y}	\hat{Z}	I	\hat{Y}	\hat{Z}
1	0.004	1.164E 02	51	1.611	1.149E 04
2	0.009	9.648E 01	52	1.811	1.270E 03
3	0.014	8.580E 01	53	2.011	1.535E 02
4	0.019	8.068E 01			
5	0.024	8.094E 01			
6	0.029	4.013E 01			
7	0.034	7.906E 01			
8	0.039	8.057E 01			
9	0.044	8.834E 01			
10	0.049	1.046E 02			
11	0.054	1.239E 02			
12	0.059	1.375E 02			
13	0.064	1.402E 02			
14	0.069	1.423E 02			
15	0.074	1.461E 02			
16	0.084	1.586E 02			
17	0.094	1.967E 02			
18	0.094	1.867E 02			
19	0.103	1.783E 02			
20	0.113	1.650E 02			
21	0.123	1.554E 02			
22	0.133	1.488E 02			
23	0.143	1.451E 02			
24	0.153	1.451E 02			
25	0.163	1.459E 02			
26	0.173	1.465E 02			
27	0.182	1.467E 02			
28	0.192	1.463E 02			
29	0.202	1.452E 02			
30	0.212	1.432E 02			
31	0.232	1.351E 02			
32	0.252	1.194E 02			
33	0.272	9.960E 01			
34	0.292	7.806E 01			
35	0.312	5.363E 01			
36	0.332	2.576E 01			
37	0.352	-8.150E 00			
38	0.372	-5.336E 01			
39	0.392	-1.188E 02			
40	0.412	-2.336E 02			
41	0.512	7.309E 02			
42	0.512	7.309E 02			
43	0.612	6.690E 02			
44	0.712	1.745E 03			
45	0.812	-2.920E 02			
46	0.911	-3.143E 02			
47	1.011	-5.059E 02			
48	1.111	-7.799E 02			
49	1.211	-1.161E 03			
50	1.411	-2.944E 03			

Table 11. Continued

Separated-Flow Model

 $\hat{x} = 0.638$ $\hat{R}_{\text{surface}} = 0.348$ $v_{\infty} = 214$ m/sec

I	\hat{y}	\hat{z}	I	\hat{y}	\hat{z}
1	0.004	9.164E 01			
2	0.004	9.164E 01			
3	0.009	1.419E 02			
4	0.014	1.731E 02			
5	0.019	1.788E 02			
6	0.024	1.674E 02			
7	0.029	1.563E 02			
8	0.034	1.445E 02			
9	0.039	1.339E 02			
10	0.044	1.243E 02			
11	0.049	1.159E 02			
12	0.054	1.113E 02			
13	0.059	1.118E 02			
14	0.064	1.198E 02			
15	0.069	1.283E 02			
16	0.074	1.357E 02			
17	0.079	1.389E 02			
18	0.084	1.378E 02			
19	0.089	1.402E 02			
20	0.094	1.464E 02			
21	0.099	1.542E 02			
22	0.104	1.622E 02			
23	0.114	1.783E 02			
24	0.124	1.913E 02			
25	0.134	1.990E 02			
26	0.144	2.000E 02			
27	0.154	1.936E 02			
28	0.164	1.869E 02			
29	0.174	1.811E 02			
30	0.184	1.764E 02			
31	0.194	1.727E 02			
32	0.204	1.697E 02			
33	0.224	1.651E 02			
34	0.244	1.605E 02			
35	0.264	1.514E 02			
36	0.284	1.329E 02			
37	0.304	1.024E 02			
38	0.324	6.040E 01			
39	0.344	7.133E 01			
40	0.364	-5.165E 01			
41	0.384	-5.043E 01			
42	0.404	-1.370E 03			
43	0.504	4.977E-01			
44	0.712	1.745E 03			
45	0.812	-2.920E 02			
46	0.911	-3.143E 02			
47	1.011	-5.059E 02			
48	1.111	-7.799E 02			
49	1.211	-1.161E 03			
50	1.411	-2.944E 03			

Table 11. Continued

Separated-Flow Model

$\hat{X} = 0.688$

$\hat{R}_{\text{surface}} = 0.322$

$v_{\infty} = 212 \text{ m/sec}$

I	\hat{Y}	\hat{z}	I	\hat{Y}	\hat{z}
1	0.004	-1.044E 04			
2	0.004	-1.044E 04			
3	0.009	3.395E 02			
4	0.014	2.541E 02			
5	0.019	2.315E 02			
6	0.024	2.164E 02			
7	0.029	1.928E 02			
8	0.034	1.659E 02			
9	0.039	1.495E 02			
10	0.044	1.484E 02			
11	0.049	1.561E 02			
12	0.054	1.627E 02			
13	0.059	1.602E 02			
14	0.064	1.455E 02			
15	0.069	1.321E 02			
16	0.074	1.215E 02			
17	0.079	1.173E 02			
18	0.084	1.245E 02			
19	0.089	1.372E 02			
20	0.094	1.556E 02			
21	0.099	1.709E 02			
22	0.104	1.799E 02			
23	0.114	1.974E 02			
24	0.124	2.120E 02			
25	0.134	2.215E 02			
26	0.144	2.237E 02			
27	0.154	2.180E 02			
28	0.164	2.121E 02			
29	0.174	2.075E 02			
30	0.184	2.043E 02			
31	0.194	2.023E 02			
32	0.204	2.011E 02			
33	0.224	1.995E 02			
34	0.224	1.995E 02			
35	0.244	1.955E 02			
36	0.264	1.841E 02			
37	0.264	1.657E 02			
38	0.304	1.415E 02			
39	0.324	1.155E 02			
40	0.344	9.298E 01			
41	0.364	9.154E 01			
42	0.384	2.107E 02			
43	0.404	-2.221E 03			
44	0.504	9.095E-01			
45	0.812	-2.920E 02			
46	0.911	-3.143E 02			
47	1.011	-5.059E 02			
48	1.111	-7.799E 02			
49	1.211	-1.161E 03			
50	1.411	-2.944E 03			

Table 11. Continued

Separated-Flow Model

$\hat{X} = 0.738$

$\hat{R}_{\text{surface}} = 0.293$

$v_{\infty} = 214 \text{ m/sec}$

I	\hat{Y}	\hat{Z}	I	\hat{Y}	\hat{Z}
1	0.004	-8.129E 01	51	0.344	1.737E 02
2	0.009	2.851E 01	52	0.364	1.797E 02
3	0.014	8.985E 01	53	0.384	1.915E 02
4	0.019	1.536E 02	54	0.404	2.121E 02
5	0.024	1.923E 02	55	0.424	2.460E 02
6	0.029	2.110E 02	56	0.444	2.958E 02
7	0.034	2.263E 02	57	0.464	3.602E 02
8	0.039	2.503E 02	58	0.484	4.211E 02
9	0.044	2.900E 02	59	0.504	4.320E 02
10	0.049	3.113E 02	60	0.604	3.687E 02
11	0.054	2.937E 02	61	0.703	3.147E 02
12	0.059	2.502E 02	62	0.803	2.772E 02
13	0.064	2.075E 02	63	0.903	2.710E 02
14	0.069	1.907E 02	64	0.993	3.197E 02
15	0.074	1.863E 02	65	1.103	3.508E 02
16	0.079	1.868E 02	66	1.303	5.654E 03
17	0.084	1.872E 02	67	1.503	-4.469E 03
18	0.089	1.829E 02	68	1.703	-5.762E 03
19	0.094	1.752E 02	69	1.903	7.545E 03
20	0.104	1.645E 02	70	2.103	1.258E 03
21	0.114	1.633E 02			
22	0.124	1.732E 02			
23	0.134	1.936E 02			
24	0.144	2.165E 02			
25	0.144	2.165E 02			
26	0.144	2.165E 02			
27	0.144	2.165E 02			
28	0.152	2.210E 02			
29	0.154	2.206E 02			
30	0.154	2.206E 02			
31	0.164	2.185E 02			
32	0.164	2.185E 02			
33	0.174	2.155E 02			
34	0.174	2.155E 02			
35	0.184	2.119E 02			
36	0.184	2.119E 02			
37	0.194	2.081E 02			
38	0.194	2.081E 02			
39	0.204	2.036E 02			
40	0.214	1.991E 02			
41	0.224	1.946E 02			
42	0.234	1.902E 02			
43	0.244	1.863E 02			
44	0.254	1.834E 02			
45	0.263	1.808E 02			
46	0.274	1.783E 02			
47	0.284	1.762E 02			
48	0.294	1.744E 02			
49	0.304	1.731E 02			
50	0.324	1.720E 02			

Table 11. Continued

Separated-Flow Model

 $\hat{X} = 0.800$ $\hat{R}_{\text{surface}} = 0.254$ $v_{\infty} = 212 \text{ m/sec}$

I	\hat{Y}	\hat{z}	I	\hat{Y}	\hat{z}
1	0.004	-1.273E 01			
2	0.009	2.266E 01			
3	0.014	2.626E 01			
4	0.019	2.334E 01			
5	0.024	3.521E 01			
6	0.029	-1.298E 01			
7	0.034	2.626E 01			
8	0.039	5.234E 01			
9	0.044	8.566E 01			
10	0.049	1.293E 02			
11	0.054	1.725E 02			
12	0.059	2.165E 02			
13	0.064	2.582E 02			
14	0.069	2.724E 02			
15	0.074	2.670E 02			
16	0.079	2.499E 02			
17	0.084	2.383E 02			
18	0.089	2.357E 02			
19	0.089	2.357E 02			
20	0.094	2.367E 02			
21	0.099	2.359E 02			
22	0.104	2.311E 02			
23	0.104	2.311E 02			
24	0.104	2.311E 02			
25	0.104	2.311E 02			
26	0.114	2.160E 02			
27	0.124	1.982E 02			
28	0.134	1.812E 02			
29	0.144	1.665E 02			
30	0.154	1.602E 02			
31	0.164	1.586E 02			
32	0.174	1.511E 02			
33	0.184	1.592E 02			
34	0.194	1.843E 02			
35	0.204	2.096E 02			
36	0.224	2.805E 02			
37	0.244	3.110E 02			
38	0.264	2.569E 02			
39	0.284	2.141E 02			
40	0.304	1.797E 02			
41	0.324	1.525E 02			
42	0.344	1.320E 02			
43	0.364	1.236E 02			
44	0.384	1.554E 02			
45	0.404	-7.742E 02			
46	0.504	2.262E-01			
47	0.284	1.762E 02			
48	0.294	1.744E 02			
49	0.304	1.731E 02			
50	0.324	1.720E 02			

Table 11. Continued

Separated-Flow Model

 $\hat{X} = 0.838$ $\hat{R}_{\text{surface}} = 0.266$ $v_{\infty} = 214 \text{ m/sec}$

I	\hat{Y}	\hat{Z}	I	\hat{Y}	\hat{Z}
1	0.004	-4.848E 01			
2	0.009	1.316E 02			
3	0.014	7.142E 01			
4	0.019	1.105E 02			
5	0.024	1.635E 02			
6	0.029	2.017E 02			
7	0.034	2.239E 02			
8	0.039	2.274E 02			
9	0.044	2.256E 02			
10	0.049	2.349E 02			
11	0.054	2.544E 02			
12	0.059	2.885E 02			
13	0.059	2.885E 02			
14	0.064	3.393E 02			
15	0.069	3.607E 02			
16	0.074	3.472E 02			
17	0.079	3.024E 02			
18	0.084	2.509E 02			
19	0.089	2.398E 02			
20	0.094	2.301E 02			
21	0.099	2.300E 02			
22	0.104	2.342E 02			
23	0.114	2.355E 02			
24	0.124	2.270E 02			
25	0.134	2.116E 02			
26	0.144	1.912E 02			
27	0.154	1.724E 02			
28	0.164	1.586E 02			
29	0.174	1.503E 02			
30	0.184	1.505E 02			
31	0.194	1.608E 02			
32	0.204	1.845E 02			
33	0.224	2.612E 02			
34	0.244	3.160E 02			
35	0.264	2.849E 02			
36	0.284	2.361E 02			
37	0.304	1.792E 02			
38	0.324	1.205E 02			
39	0.344	6.333E 01			
40	0.364	1.592E 01			
41	0.384	4.013E 01			
42	0.404	-5.767E 02			
43	0.504	-3.113E-08			
44	0.384	1.654E 02			
45	0.404	-7.742E 02			
46	0.504	2.262E-01			
47	0.284	1.762E 02			
48	0.294	1.744E 02			
49	0.304	1.731E 02			
50	0.324	1.720E 02			

Table 11. Continued

Separated-Flow Model

 $\hat{X} = 0.888$ $\hat{R}_{\text{surface}} = 0.280$ $v_{\infty} = 212 \text{ m/sec}$

I	\hat{Y}	\hat{Z}	I	\hat{Y}	\hat{Z}
1	0.004	5.141E 01			
2	0.009	1.228E 02			
3	0.014	1.800E 02			
4	0.019	2.365E 02			
5	0.024	2.811E 02			
6	0.029	3.043E 02			
7	0.034	3.048E 02			
8	0.039	2.853E 02			
9	0.044	2.588E 02			
10	0.049	2.379E 02			
11	0.054	2.287E 02			
12	0.059	2.327E 02			
13	0.054	2.523E 02			
14	0.069	2.673E 02			
15	0.074	2.705E 02			
16	0.079	2.547E 02			
17	0.084	2.292E 02			
18	0.089	2.090E 02			
19	0.094	1.927E 02			
20	0.099	1.851E 02			
21	0.104	1.847E 02			
22	0.114	1.894E 02			
23	0.124	2.013E 02			
24	0.134	2.181E 02			
25	0.144	2.341E 02			
26	0.154	2.363E 02			
27	0.164	2.353E 02			
28	0.174	2.351E 02			
29	0.184	2.356E 02			
30	0.194	2.366E 02			
31	0.204	2.377E 02			
32	0.224	2.377E 02			
33	0.244	2.299E 02			
34	0.264	2.115E 02			
35	0.284	1.900E 02			
36	0.304	1.665E 02			
37	0.324	1.435E 02			
38	0.344	1.239E 02			
39	0.364	1.157E 02			
40	0.384	1.627E 02			
41	0.384	1.627E 02			
42	0.404	-1.352E 04			
43	0.504	1.451E-01			
44	0.384	1.654E 02			
45	0.404	-7.742E 02			
46	0.504	2.262E-01			
47	0.284	1.762E 02			
48	0.294	1.744E 02			
49	0.304	1.731E 02			
50	0.324	1.720E 02			

Table 11. Continued

Separated-Flow Model

 $\hat{X} = 0.938$ $\hat{R}_{\text{surface}} = 0.292$ $v_{\infty} = 214 \text{ m/sec}$

I	\hat{Y}	\hat{z}	I	\hat{Y}	\hat{z}
1	0.004	2.544E 02	51	2.003	-4.099E 02
2	0.009	2.720E 02			
3	0.014	2.903E 02			
4	0.019	3.035E 02			
5	0.024	3.039E 02			
6	0.029	3.008E 02			
7	0.034	2.938E 02			
8	0.039	2.839E 02			
9	0.044	2.714E 02			
10	0.049	2.583E 02			
11	0.054	2.495E 02			
12	0.059	2.470E 02			
13	0.064	2.517E 02			
14	0.069	2.551E 02			
15	0.074	2.538E 02			
16	0.079	2.433E 02			
17	0.084	2.263E 02			
18	0.089	2.103E 02			
19	0.094	1.960E 02			
20	0.099	1.875E 02			
21	0.104	1.851E 02			
22	0.114	1.860E 02			
23	0.124	1.959E 02			
24	0.134	2.121E 02			
25	0.144	2.274E 02			
26	0.154	2.273E 02			
27	0.164	2.226E 02			
28	0.174	2.172E 02			
29	0.184	2.114E 02			
30	0.194	2.055E 02			
31	0.204	1.990E 02			
32	0.224	1.862E 02			
33	0.244	1.736E 02			
34	0.264	1.627E 02			
35	0.284	1.522E 02			
36	0.304	1.416E 02			
37	0.324	1.315E 02			
38	0.344	1.223E 02			
39	0.364	1.137E 02			
40	0.384	1.067E 02			
41	0.404	1.016E 02			
42	0.504	1.030E 02			
43	0.504	4.309E 01			
44	0.703	-1.121E 01			
45	0.903	-8.236E 01			
46	1.003	-7.882E 01			
47	1.103	-2.193E 01			
48	1.403	6.166E 02			
49	1.503	4.879E 02			
50	1.803	-2.949E 01			

Table 11. Continued

Separated-Flow Model

 $\hat{X} = 1.138$ $\hat{R}_{\text{surface}} = 0.325$ $v_{\infty} = 212 \text{ m/sec}$

I	\hat{Y}	\hat{Z}	I	\hat{Y}	\hat{Z}
1	0.004	5.940E 00	51	1.004	5.435E 02
2	0.009	6.414E 01	52	1.104	5.224E 02
3	0.014	2.047E 02	53	1.204	5.343E 02
4	0.019	3.924E 02	54	1.304	3.765E 02
5	0.024	3.779E 02	55	1.404	1.570E 02
6	0.029	3.585E 02	56	1.504	-5.253E 01
7	0.034	3.396E 02	57	1.604	-1.784E 02
8	0.039	3.250E 02	58	1.704	5.354E 02
9	0.044	3.122E 02	59	1.804	1.157E 04
10	0.049	2.954E 02	60	2.004	-1.615E 04
11	0.054	2.778E 02			
12	0.059	2.589E 02			
13	0.064	2.379E 02			
14	0.069	2.223E 02			
15	0.074	2.120E 02			
16	0.079	2.097E 02			
17	0.084	2.174E 02			
18	0.089	2.274E 02			
19	0.094	2.385E 02			
20	0.099	2.449E 02			
21	0.104	2.466E 02			
22	0.114	2.509E 02			
23	0.124	2.556E 02			
24	0.134	2.592E 02			
25	0.144	2.600E 02			
26	0.154	2.557E 02			
27	0.164	2.498E 02			
28	0.174	2.427E 02			
29	0.184	2.349E 02			
30	0.194	2.266E 02			
31	0.204	2.172E 02			
32	0.224	1.972E 02			
33	0.244	1.757E 02			
34	0.264	1.534E 02			
35	0.284	1.310E 02			
36	0.304	1.078E 02			
37	0.324	8.314E 01			
38	0.344	5.812E 01			
39	0.364	3.191E 01			
40	0.384	4.049E 00			
41	0.404	-2.388E 01			
42	0.424	-5.147E 01			
43	0.444	-7.543E 01			
44	0.464	-8.635E 01			
45	0.484	-7.209E 01			
46	0.504	-3.057E 01			
47	0.604	1.887E 02			
48	0.704	3.707E 02			
49	0.804	5.111E 02			
50	0.904	6.043E 02			

Table 11. Continued

Separated-Flow Model

 $\hat{X} = 1.338$ $\hat{R}_{\text{surface}} = 0.341$ $v_{\infty} = 212 \text{ m/sec}$

I	\hat{Y}	\hat{z}	I	\hat{Y}	\hat{z}
1	0.004	2.995E 00	51	0.324	3.047E 01
2	0.009	3.738E 01	52	0.344	-1.454E 01
3	0.014	9.054E 01	53	0.363	-7.039E 01
4	0.019	1.697E 02	54	0.384	-1.455E 02
5	0.019	1.697E 02	55	0.404	-2.500E 02
6	0.024	2.355E 02	56	0.423	-4.159E 02
7	0.024	2.355E 02	57	0.444	-7.223E 02
8	0.029	3.000E 02	58	0.464	-1.342E 03
9	0.029	3.000E 02	59	0.483	-2.559E 03
10	0.034	3.560E 02	60	0.504	-2.893E 03
11	0.034	3.560E 02	61	0.604	-1.160E 03
12	0.039	3.785E 02	62	0.704	-5.617E 02
13	0.039	3.785E 02	63	0.804	-3.230E 02
14	0.044	3.721E 02	64	0.904	-2.479E 02
15	0.044	3.721E 02	65	1.004	-2.643E 02
16	0.049	3.491E 02	66	1.104	-3.423E 02
17	0.054	3.169E 02	67	1.204	-4.699E 02
18	0.059	2.782E 02	68	1.304	-5.472E 02
19	0.059	2.782E 02	69	1.404	-9.879E 02
20	0.064	2.351E 02	70	1.504	-1.233E 03
21	0.064	2.351E 02	71	1.604	-1.809E 03
22	0.069	2.053E 02	72	1.704	-3.175E 03
23	0.069	2.053E 02	73	1.804	-1.841E 04
24	0.074	1.855E 02	74	2.004	9.204E 02
25	0.074	1.855E 02			
26	0.079	1.779E 02			
27	0.079	1.779E 02			
28	0.084	1.878E 02			
29	0.084	1.878E 02			
30	0.089	2.051E 02			
31	0.094	2.284E 02			
32	0.099	2.454E 02			
33	0.104	2.529E 02			
34	0.114	2.643E 02			
35	0.124	2.704E 02			
36	0.134	2.716E 02			
37	0.144	2.681E 02			
38	0.164	2.529E 02			
39	0.169	2.482E 02			
40	0.174	2.436E 02			
41	0.184	2.337E 02			
42	0.194	2.235E 02			
43	0.204	2.120E 02			
44	0.224	1.879E 02			
45	0.243	1.616E 02			
46	0.264	1.332E 02			
47	0.284	1.031E 02			
48	0.303	6.954E 01			
49	0.303	6.954E 01			
50	0.324	3.047E 01			

Table 11. Continued

Separated-Flow Model

$\hat{x} = 1.938$

$\hat{R}_{\text{surface}} = 0.341$

$v_{\infty} = 212 \text{ m/sec}$

I	\hat{Y}	\hat{z}	I	\hat{Y}	\hat{z}
1	0.004	1.928E 01	51	0.904	-1.417E 03
2	0.009	3.184E 01	52	1.004	-1.117E 03
3	0.014	4.912E 01	53	1.104	-1.093E 03
4	0.019	7.812E 01	54	1.204	-1.203E 03
5	0.024	1.199E 02	55	1.304	-1.405E 03
6	0.029	1.897E 02	56	1.404	-1.729E 03
7	0.034	2.900E 02	57	1.504	-2.259E 03
8	0.039	3.283E 02	58	1.604	-3.342E 03
9	0.044	3.020E 02	59	1.704	-7.629E 03
10	0.049	2.918E 02	60	1.804	9.685E 03
11	0.054	2.943E 02	61	2.004	4.703E 02
12	0.059	3.042E 02			
13	0.064	3.176E 02			
14	0.069	3.214E 02			
15	0.074	3.175E 02			
16	0.079	3.063E 02			
17	0.084	2.928E 02			
18	0.089	2.810E 02			
19	0.094	2.702E 02			
20	0.099	2.630E 02			
21	0.104	2.583E 02			
22	0.114	2.508E 02			
23	0.124	2.457E 02			
24	0.134	2.424E 02			
25	0.144	2.393E 02			
26	0.154	2.351E 02			
27	0.164	2.301E 02			
28	0.174	2.240E 02			
29	0.184	2.172E 02			
30	0.194	2.097E 02			
31	0.204	2.009E 02			
32	0.224	1.802E 02			
33	0.243	1.546E 02			
34	0.264	1.237E 02			
35	0.284	8.997E 01			
36	0.303	5.123E 01			
37	0.324	4.280E 00			
38	0.344	-5.290E 01			
39	0.363	-1.295E 02			
40	0.384	-2.448E 02			
41	0.404	-4.353E 02			
42	0.423	-8.432E 02			
43	0.444	-2.368E 03			
44	0.464	1.219E 04			
45	0.483	2.636E 03			
46	0.504	2.233E 03			
47	0.504	2.233E 03			
48	0.504	3.408E 03			
49	0.704	5.452E 04			
50	0.904	-2.807E 03			

Table 11. Concluded

Separated-Flow Model

$\hat{X} = 2.938$

$\hat{R}_{\text{surface}} = 0.341$

$v_{\infty} = 212 \text{ m/sec}$

I	\hat{Y}	\hat{Z}	I	\hat{Y}	\hat{Z}
1	0.004	1.830E 01	51	0.804	1.600E 03
2	0.009	3.238E 01	52	0.854	2.440E 03
3	0.014	5.764E 01	53	0.904	5.659E 03
4	0.019	9.400E 01	54	0.954	-2.713E 04
5	0.024	1.082E 02	55	1.004	-4.880E 03
6	0.029	1.219E 02	56	1.104	-2.579E 03
7	0.034	1.410E 02	57	1.204	-2.344E 03
8	0.039	1.669E 02	58	1.304	-2.515E 03
9	0.044	2.026E 02	59	1.404	-2.925E 03
10	0.049	2.399E 02	60	1.504	-3.624E 03
11	0.054	2.567E 02	61	1.604	-4.897E 03
12	0.059	2.485E 02	62	1.704	-3.009E 03
13	0.064	2.278E 02	63	1.804	-3.224E 04
14	0.069	2.232E 02	64	1.904	1.075E 04
15	0.074	2.305E 02	65	2.004	3.485E 03
16	0.079	2.539E 02	66	2.104	1.455E 03
17	0.084	2.985E 02			
18	0.089	3.164E 02			
19	0.094	3.319E 02			
20	0.099	3.280E 02			
21	0.104	3.122E 02			
22	0.114	2.824E 02			
23	0.124	2.582E 02			
24	0.134	2.395E 02			
25	0.144	2.248E 02			
26	0.154	2.157E 02			
27	0.164	2.082E 02			
28	0.174	2.001E 02			
29	0.184	1.918E 02			
30	0.204	1.748E 02			
31	0.224	1.561E 02			
32	0.243	1.345E 02			
33	0.264	1.085E 02			
34	0.284	8.023E 01			
35	0.303	4.772E 01			
36	0.324	8.294E 00			
37	0.344	-3.991E 01			
38	0.353	-1.052E 02			
39	0.384	-2.055E 02			
40	0.404	-3.802E 02			
41	0.423	-8.016E 02			
42	0.444	-3.487E 03			
43	0.464	2.742E 03			
44	0.483	1.297E 03			
45	0.504	1.114E 03			
46	0.554	1.073E 03			
47	0.503	1.052E 03			
48	0.554	1.060E 03			
49	0.704	1.118E 03			
50	0.754	1.265E 03			

NOMENCLATURE

C_p	Pressure coefficient. Eq. (15)
C_{pM}	Model Pressure coefficient
C_{pw}	Tunnel wall pressure coefficient
c_f	Local skin-friction coefficient, τ_w/q_∞
D	Forebody diameter = 2.54 cm
\hat{d}	Boattail closure ratio, see Table 1
\hat{d}_p	Ratio of cylindrical plume diameter to forebody diameter, see Figs. 3 and 4
\hat{d}_v	Ratio of laser velocimeter probe volume diameter to forebody diameter, Eq. (3)
\hat{d}_w	Ratio of wire diameter to forebody diameter used to determine \hat{d}_v and $\hat{\ell}_v$, Eqs. (3) and (4)
f_B	Bragg-cell frequency, Hz
\hat{k}	Ratio of specific turbulent kinetic energy to square of the free-stream speed, Eq. (11)
\hat{L}	Ratio of boattail length to forebody diameter
$\hat{\ell}$	Ratio of length of contoured portion of the solid plume simulator to forebody diameter
$\hat{\ell}_v$	Ratio of laser velocimeter length to forebody diameter
M	Mach number
N	Total number of velocity measurements used to obtain statistical properties of flow. $N = 1,000$
P	Static pressure, pascals
\tilde{P}_{rms}	Root-mean-square acoustic level, db
q	Dynamic pressure, pascals

\widehat{R}	Ratio of radial distance measured from model symmetry axis to forebody diameter
ReD	Forebody diameter Reynolds number, $\rho_{\infty} v_{\infty} D / \mu_{\infty}$
\widehat{R}_{max}	Maximum value of R for which a given set of spline coefficients is valid
r	Recovery factor, $r = 0.88$
S	Instantaneous scatter source speed, Eq. (5)
s	Square root of variance or standard deviation of a set of instantaneous velocity measurements
T	Static temperature, °K
T_{aw}	Adiabatic wall temperature, Eq. (1), °K
T_T	Tunnel total temperature, °K
$\langle \widehat{U} \rangle$	Ratio of the mean axial velocity component to the free-stream speed, see Figs. 3 and 4
$\langle \widehat{U}_w \rangle$	Ratio of the tunnel wall axial velocity component at $\widehat{R} = 2.5$ to the free-stream speed
u'	Ratio of the fluctuating part of axial velocity component to the free-stream speed
$\langle \widehat{u}' \widehat{v}' \rangle$	Ratio of specific Reynolds shear to the square of the free-stream speed, Eq. (12)
$\langle \widehat{V} \rangle$	Ratio of the mean radial velocity component to the free-stream speed, see Figs. 3 and 4
$\langle \widehat{V}_w \rangle$	Ratio of the tunnel wall radial velocity component to the free-stream speed
\widehat{v}'	Ratio of the fluctuating part of the radial velocity component to the free-stream speed
\widehat{X}	Ratio of the axial coordinate measured from the beginning of the boattail to the forebody diameter

\widehat{Y}	Ratio of the radial coordinate (colinear with \widehat{R} but measured from the model surface) to the forebody diameter
\widehat{Z}	Ratio of the radial coordinate perpendicular to the $\widehat{X}\text{-}\widehat{R}$ plane to the forebody diameter, see Fig. 5a
β	Kurtosis, see Eq. (18)
γ	Ratio of specific heats
$\widehat{\delta}^*$	Ratio of displacement thickness to forebody diameter, $\widehat{\delta}^* = \int_0^\infty (1 - \widehat{\rho}\langle\widehat{U}\rangle) d\widehat{Y}$
Δ	Statistical uncertainty operator. see Eqs. (17) and (18)
$\widehat{\epsilon}$	Ratio of eddy viscosity to molecular viscosity, Eq. (12)
$\widehat{\theta}$	Ratio of momentum thickness to forebody diameter, $\widehat{\theta} = \int_0^\infty \widehat{\rho}\langle\widehat{U}\rangle (1 - \langle\widehat{U}\rangle) d\widehat{Y}$
Λ	True mean value of speed. see Eqs. (17) and (18)
λ	Laser wavelength
μ	Molecular viscosity, Eq. (14), (nt-sec)/m ²
ν	Magnitude of velocity vector, $\sqrt{\langle\widehat{U}\rangle^2 + \langle\widehat{V}\rangle^2}$, m/sec
ν_∞	Free-stream speed, m/sec
ξ_A, ξ_B	Distances used to calibrate the laser velocimeter in units of forebody diameters
$\widehat{\rho}$	Ratio of density to free-stream density, Eq. (3)
σ	True value of standard deviation of a set of velocity measurements, see Eqs. (17) and (18)
τ	Scatter source period measured by laser velocimeter electronics
τ_w	Local value of wall shear
ϕ	Angle of intersection of laser velocimeter beams, see Fig. 16

SUBSCRIPTS

- ∞ Indicates quantity is evaluated at free-stream conditions
- $\langle \cdot \rangle$ Indicates statistical average, see Eq. (6)