

AD-775 835

POSITIVE-ENGAGEMENT CLUTCH

Charles J. Wirth

Kaman Aerospace Corporation

Prepared for:

Army Air Mobility Research and Development
Laboratory

December 1973

DISTRIBUTED BY:

NTIS

**National Technical Information Service
U. S. DEPARTMENT OF COMMERCE
5285 Port Royal Road, Springfield Va. 22151**

DISCLAIMERS

The findings in this report are not to be construed as an official Department of the Army position unless so designated by other authorized documents.

When Government drawings, specifications, or other data are used for any purpose other than in connection with a definitely related Government procurement operation, the United States Government thereby incurs no responsibility nor any obligation whatsoever; and the fact that the Government may have formulated, furnished, or in any way supplied the said drawings, specifications, or other data is not to be regarded by implication or otherwise as in any manner licensing the holder or any other person or corporation, or conveying any rights or permission, to manufacture, use, or sell any patented invention that may in any way be related thereto.

Trade names cited in this report do not constitute an official endorsement or approval of the use of such commercial hardware or software.

DISPOSITION INSTRUCTIONS

Destroy this report when no longer needed. Do not return it to the originator.

ACCESSION for	
NTIS	White Section <input checked="" type="checkbox"/>
DTIC	Self Section <input type="checkbox"/>
UNANNOUNCED	<input type="checkbox"/>
JUSTIFICATION.....	
BY.....	
DISTRIBUTION/AVAILABILITY CODES	
Dist.	AVAIL. and/or SPECIAL
A	



DEPARTMENT OF THE ARMY
U. S. ARMY AIR MOBILITY RESEARCH & DEVELOPMENT LABORATORY
EUSTIS DIRECTORATE
FORT EUSTIS, VIRGINIA 23604

The research described herein was conducted by Kaman Aerospace Corporation under the terms of Contract DAAJ02-72-C-0055. The work was performed under the technical management of Mr. D. P. Lubrano, Technology Applications Division, Eustis Directorate.

V/STOL drive systems must incorporate an overrunning (freewheel) clutch unit so that in the event of engine malfunction, the aircraft can safely autorotate or, in the case of multiengines, proceed on single-engine operation. Current clutches are based on friction operating mechanisms with inherent limitations in capacity and wear. The objective of this program was to evaluate a positive engagement clutch operating at 11,500 rpm and 40,000 in.-lb. maximum continuous torque.

Appropriate technical personnel of this Directorate have reviewed this report and concur with the conclusions contained herein.

Task 1G162207AA7201
Contract DAAJ02-72-C-0055
USAAMRDL Technical Report 73-96
December 1973

POSITIVE-ENGAGEMENT CLUTCH

Final Report

Kaman Engineering Report R-1180

By

Charles J. Wirth

Prepared by

Kaman Aerospace Corporation
Bloomfield, Connecticut

for

EUSTIS DIRECTORATE
U.S. ARMY AIR MOBILITY RESEARCH AND DEVELOPMENT LABORATORY
FORT EUSTIS, VIRGINIA

ii.

Approved for public release;
distribution unlimited.

Unclassified
Security Classification

AD775 835

DOCUMENT CONTROL DATA - R & D		
<i>(Security classification of title, body of abstract and indexing annotation must be entered when the overall report is classified)</i>		
1. ORIGINATING ACTIVITY (Corporate author) Kaman Aerospace Corporation Old Windsor Road Bloomfield, Connecticut		2a. REPORT SECURITY CLASSIFICATION Unclassified
		2b. GROUP
3. REPORT TITLE POSITIVE-ENGAGEMENT CLUTCH		
4. DESCRIPTIVE NOTES (Type of report and inclusive dates) Final Technical Report		
5. AUTHOR(S) (First name, middle initial, last name) Charles J. Wirth		
6. REPORT DATE December 1973	7a. TOTAL NO. OF PAGES 90	7b. NO. OF REFS 2
8a. CONTRACT OR GRANT NO. DAAJ02-72-C-0055	9a. ORIGINATOR'S REPORT NUMBER(S) USAAMRDL Technical Report 73-96	
b. PROJECT NO. c. Task IG162207AA7201	9b. OTHER REPORT NO(S) (Any other numbers that may be assigned this report) Kaman Engineering Report R-1180	
d.		
10. DISTRIBUTION STATEMENT Approved for public release; distribution unlimited.		
11. SUPPLEMENTARY NOTES		12. SPONSORING MILITARY ACTIVITY Eustis Directorate U.S. Army Air Mobility R&D Laboratory Fort Eustis, Virginia
13. ABSTRACT Overrunning clutches are universally used in helicopter drive systems to couple the engine and rotor in powered flight while permitting rotor autorotation with the engine stopped. The clutches in current use depend on friction for power transmission, and suffer from structural inefficiency which imposes a weight penalty and centrifugal influences which restrict operating speed. The positive-engagement overrunning clutch described herein offers the possibility of better structural efficiency and lifting of the overrunning speed limitation. This clutch transmits power through splines, and suffers no detriment to overrunning operation from centrifugal force. A positive-engagement clutch was designed to meet the operating and space requirements of the HLH helicopter, and a test program was conducted to explore the operating characteristics of the clutch. Feasibility was demonstrated through static torque tests, running engagements and disengagements, and sustained overrunning. Full-scale operational tests are recommended.		

Reproduced by
NATIONAL TECHNICAL
INFORMATION SERVICE
U S Department of Commerce
Springfield VA 22151

92

DD FORM 1473 1 NOV 66 REPLACES DD FORM 1473, 1 JAN 64, WHICH IS OBSOLETE FOR ARMY USE.

Unclassified
Security Classification

Unclassified

Security Classification

14	KEY WORDS	LINK A		LINK B		LINK C	
		ROLE	WT	ROLE	WT	ROLE	WT
	Overrunning Clutch Positive-Engagement Clutch Positive-Drive Self-Synchronizing						
	<i>ia</i>						

Unclassified

Security Classification

SUMMARY

The purpose of this program was to design, fabricate, and test a positive-engagement clutch consistent with the requirements of the HLH main engine overrunning clutch.

A concept was developed using a face spline to connect driving and driven members. A pawl and ratchet system provides proper synchronization and indexing for smooth engagement, and a spiral spline is used as the means of engagement/disengagement actuation.

The test program included static testing to design torque, overrunning tests including a lubrication requirements survey, and operating-speed engagement tests.

The test program successfully demonstrated the ability of the clutch to engage, transmit torque, and disengage, statically and at speeds to 11,000 RPM. Testing also showed that the clutch is capable of long-term overrunning with oil flows down to .5 GPM.

The test program has not explored the durability of the clutch for long-term full power engaged running, or for exposure to high-acceleration-impact engagements. It is recommended that exploration of these operational areas be the subject of future testing.

FOREWORD

The U.S. Army Air Mobility Research and Development Laboratory (USAAMRDL) supervises research programs aimed at advancing helicopter power transmission systems. Overrunning clutches have been identified as a subsystem requiring improvement. The positive-engagement clutch is a type of overrunning clutch with wide application in marine and power generation drive systems. The positive-engagement clutch appears to have great advantages when proportioned for helicopter power transmissions. Accordingly, the positive-engagement clutch has been investigated under USAAMRDL Contract DAAJ02-72-C-0055, Task 1G162207AA7201. Technical direction was provided by Mr. Dominick P. Lubrano, Aerospace Engineer, Eustis Directorate, USAAMRDL.

This report covers some design considerations, analyses, and bench tests of the positive-engagement clutch. The curvic coupling portions of the test clutch were designed and manufactured with the cooperation of Gleason Works, Rochester, New York. The program reported herein was accomplished during the period from 10 April 1972 to 3 June 1973. The work was conducted at Kaman Aerospace Corporation, Bloomfield, Connecticut, under the technical supervision of Mr. Charles J. Wirth, Project Engineer. Overall cognizance of the program was maintained by Mr. Robert Bossler, Jr., Chief of Mechanical Systems Research.

Preceding page blank

TABLE OF CONTENTS

	<u>Page</u>
SUMMARY	iii
FOREWORD	v
LIST OF ILLUSTRATIONS	ix
LIST OF TABLES	xi
LIST OF SYMBOLS	xii
INTRODUCTION	1
DESCRIPTION OF OPERATION	3
PERFORMANCE REQUIREMENTS	5
HLH CLUTCH - GENERAL ARRANGEMENT	7
DESIGN AND ANALYSIS	9
LOAD PATH ANALYSIS	9
ENGAGEMENT SYSTEM ANALYSIS	17
CLUTCH CRITICAL SPEED	21
TEST PROGRAM	23
INTRODUCTION	23
TEST SPECIMEN	23
STATIC TEST	29
LUBRICATION REQUIREMENTS TESTS.	32
PAWL SYSTEM EVALUATION	35
OVERRUNNING ENDURANCE TEST	43
RUNNING ENGAGEMENTS	47
ANALYSIS OF HARDWARE AFTER TEST	51
CONCLUSIONS	53
RECOMMENDATIONS	55

Preceding page blank

	<u>Page</u>
APPENDIXES	
I. DIMENSIONAL DEFINITION OF FACE SPLINE	56
II. ANALYSIS OF PAWL SYSTEM	58
III. CRITICAL SPEED ANALYSIS	61
IV. RAW TEST DATA	64
DISTRIBUTION	78

LIST OF ILLUSTRATIONS

<u>Figure</u>		<u>Page</u>
1	Functional Diagram of Clutch	4
2	Engagement Sequence	5
3	Positive-Engagement Clutch in HLH Drive System	7
4	Thrust Path in Clutch	16
5	Differential Speed and Ratchet Tooth Exciting Frequency Vs Time	18
6	Hydrodynamic Moment About Pivot	22
7	Assembly - Test Specimen Clutch.	25
8	Test Clutch Shown Engaged	26
9	Test Clutch Shown Disengaged	26
10	Clutch Assembly Showing Spiral Spline	27
11	Synchronizer Subassembly	27
12	Clutch Installed in Static Test Fixture	28
13	Clutch Deflections Vs Torque	30
14	Dynamic Test Facility	33
15	Pawl System Evaluation Test Arrangement	36
16	Extraneous Spring Motion	38
17	Comparison of Original and Revised Ratchet Profiles	40
18	Comparison of Pawl Systems	42
19	Onset of Pawl Planing Vs Lubricating Oil Flow	45
20	Oil Temperature Increase - Full Overrun	46
21	Oil Temperature Increase - Half-Speed Overrun.	46

LIST OF ILLUSTRATIONS (Continued)

<u>Figure</u>		<u>Page</u>
22	Clutch Engagement at 4,020 RPM	48
23	Clutch Engagement at 2,010 RPM	48
24	Clutch Engagement at 8,160 RPM	49
25	Clutch Engagement at 6,120 RPM	49
26	Clutch Engagement at 10,100 RPM	50
27	Clutch Engagement at 10,920 RPM	50
28A	Microphotograph of Unworn Surface of Pawl . .	52
28B	Microphotograph of Worn Surface of Pawl . . .	52

LIST OF TABLES

<u>Table</u>		<u>Page</u>
I	Identification of Clutch Parts	6
II	Test Specimen Materials List	24
III	Clutch Geometry	24
IV	Face Spline Dimensions	57
V	Critical Whirl Speeds for HLH Clutch	62
VI	Calculated Values of Mass, EI and Mass Moment of Inertia	63

LIST OF SYMBOLS

A	=	addendum
C _P	=	specific heat = .46 Btu/lb F ⁰
C _F	=	coefficient of friction
D _F	=	pitch dia, face spline - in.
D _S	=	pitch dia., helical spline - in.
F _A	=	axial load generated in clutch - lb
F _T	=	pawl tip force, radial - lb
f _n	=	pawl natural frequency - Hz
f _t	=	ratchet tooth exciting frequency - Hz
g	=	acceleration due to gravity = 386.4 in./sec ²
J	=	polar mass moment of inertia - lb/in.sec ²
K	=	radius of gyration - in.
K _S	=	spring rate - lb-in./rad
L	=	length of engagement of spiral spline - in.
P _S	=	pawl spring force - lb
m	=	spring moment - in.-lb
N	=	number of teeth
N _i	=	input RPM
N _D	=	output RPM
n	=	spring deflection - turns
Q	=	clutch torque - in.-lb
q	=	oil flow - GPM
S	=	lateral travel of synchronizer - in.
t	=	temperature - °F

LIST OF SYMBOLS (Continued)

- T = time - sec
R = ratchet teeth number
 α = pressure angle, face spline - deg
 β = helix angle, spiral spline - deg
 θ = torsional deflection, input to output - deg

INTRODUCTION

In many drive systems, overrunning clutches are used as an automatic means of transmitting engine power into a drive train when that engine develops power, while permitting engine decoupling at times when engine power ceases and the driven member continues to run. Overrunning clutches are universally used in helicopters to permit autorotation with a dead engine or to permit an engine shutdown in a multiengine installation.

The most common types of overrunning clutches in current use are sprag or ramp roller clutches, which depend on friction to transmit torque between the input and output members. While these clutches are entirely satisfactory in many applications at moderate power levels, their inherent structural inefficiency severely penalizes the high torque applications in size and weight demanded. Their use at high speed is also limited, since centrifugal effects in the sprags and rollers interfere with proper release and accelerate wear.

A type of overrunning clutch is in present use in very heavy machine and marine drive applications, based on the principle of carrying the drive load through engaged spline teeth. Synchronization required to produce engagement at matched speed is provided by a ratchet and pawl system, while a spiral spline provides the transfer motion needed to engage the splines. While these clutches in their present form are completely outsized and unsuitable for aircraft use, the basic principles are validly applicable to overrunning clutches of any size, and they offer advantages which appear to be particularly attractive in the realm of high-powered aircraft drive systems.

A positive drive clutch, wherein the teeth on one member engage mating teeth on the other, transmits torque directly through surface compression, bending and shear. Since there is no dependence on friction, or the huge normal loads required to develop that friction, structural efficiency is greatly improved, and size and weight savings can be realized. This benefit increases as torque levels increase.

By elimination of a friction-dependent engagement system, concern over centrifugal modification of that friction is eliminated, along with the need to remove the heat generated by that friction. This benefit becomes more important with increasing operating speeds.

Sprag and ramp roller clutches depend upon shallow-angle cams which develop huge radial forces and which permit very small

radial motions. This characteristic demands very stiff, close-tolerance races and severely limits allowable wear. By elimination of small wedging angle cams, required stiffness, manufacturing tolerances, and wear allowance are all significantly liberalized. This results in fabrication benefits, extends useful life, and improves repairability of the positive-engagement clutch.

This program demonstrated the feasibility of creating an over-running clutch of the positive-engagement type specifically suited to an aircraft application. This experimental clutch was competitive in weight and size to the sprag type clutch developed for this same application. Further, testing of the experimental model of the positive-engagement clutch demonstrated satisfactory operation and the potential for a very long life without dependence on the large oil flow demanded by comparable sprag and ramp roller clutches.

The space and performance requirements for the HLH main engine overrunning clutch form the basis for the design and test criteria used in this program.

This report describes the original clutch concept, the design approach used, and the test program to which the clutch was subjected.

DESCRIPTION OF OPERATION

Figure 1 illustrates operation of the clutch, which is pictured as being disengaged. In the position shown, the output is free to rotate in the overrunning direction while the input remains stationary. The face splines clear each other, and the ratchet ramps slide freely over the pawls.

If the input is rotated in a clockwise direction relative to the output, the pawls will be brought into contact with the ratchet teeth, holding the synchronizer rotationally fixed to the output member with the face splines disengaged but poised in the proper engagement position. Further rotation of the input member clockwise has the same effect as turning a screw inside a nut; the synchronizer is moved axially into engagement with the output member by the action of its spiral splined connection to the input.

The clutch will transmit torque in this condition, once the face spline is fully engaged, with the torque being passed from the input to the synchronizer through the spiral spline, and torque passing from synchronizer to output member through the face spline.

The thrust component derived in the spiral spline holds the face spline in intimate contact as long as direction of torque is positive (input moment clockwise, output drag moment counterclockwise). On reversal of this torque direction, the spiral spline thrust reverses and the synchronizer face spline is immediately propelled out of engagement.

Two features of the clutch concept intended to significantly enhance its ability to operate at high speed and power levels are worthy of mention:

- o As shown in Figure 2, the face spline tooth alignment at the instant of contact is on the load bearing side, and occurs when the depth of tooth engagement is only one-third to one-half of final engagement. The slight rotation that results as the splines fully engage backs the pawls away from the ratchet to assure that no driving torque is imposed on them.
- o At any appreciable overrunning speed, the pawls become hydrostatically supported by the oil annulus inside the ratchet. This eliminates metal-to-metal wear of the pawls and ratchet.

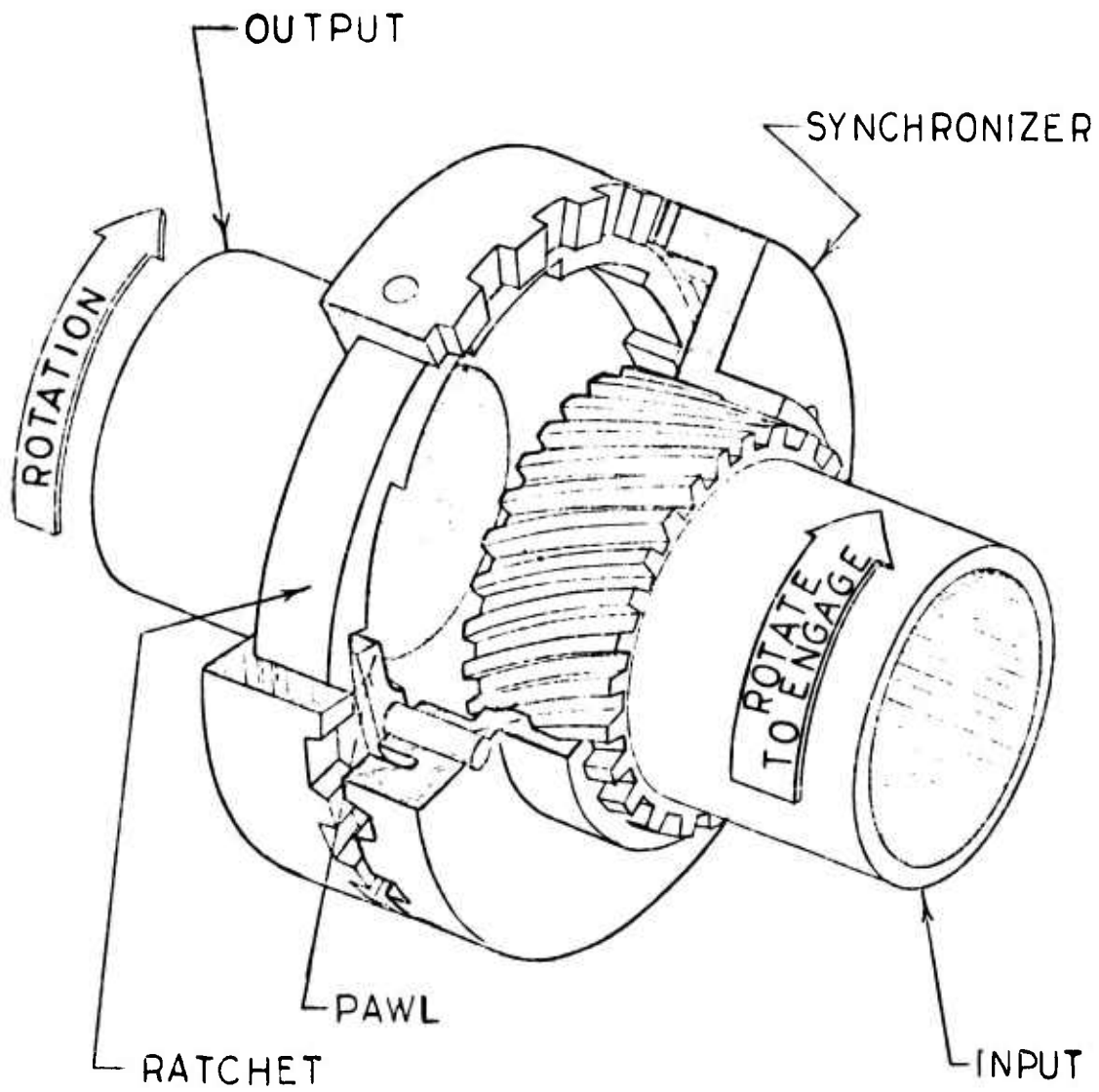

Figure 1. Functional Diagram of Clutch.

PERFORMANCE REQUIREMENTS

The specific requirements chosen for this feasibility evaluation are the operating requirements, available space, and interface arrangements of the HLH main engine overrunning clutch.

Performance requirements are as follows:

Operating interval is 2000 hours
Maximum continuous torque is 45,550 inch-pounds
Peak torque (limit) is 80,000 inch-pounds
Ultimate torque is 120,000 inch-pounds
Operating speed is 11,500 RPM
Lubricant is MIL-L-7808 or MIL-L-23699
Oil inlet temperature is 195°F
Oil inlet pressure not to exceed 100 psig

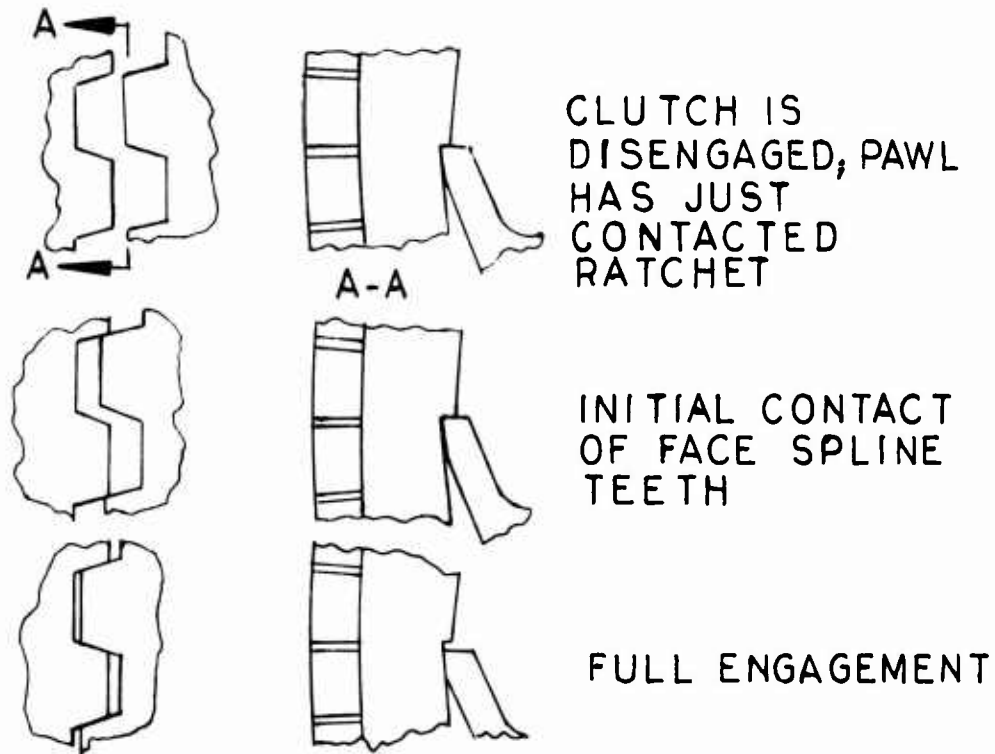

Figure 2. Engagement Sequence.

HLH CLUTCH - GENERAL ARRANGEMENT

Figure 3 shows a general arrangement of the clutch designed to meet these requirements, superimposed on a view of the surrounding HLH parts (shown in phantom). The clutch assembly is designed for installation as a complete bench-assembled unit. The input member (1) supports and retains the output member (9) on a set of bearings. All induced loads are completely balanced within the clutch, with no thrust or side reactions being fed to the mounting bearings as a result of transmitted torque.

TABLE I. IDENTIFICATION OF CLUTCH PARTS		
NO.	QTY/CLUTCH	PART NAME
1	1	Input Shaft
2		Spiral Spline Between Input Shaft and Synchronizer
3	1	Pawl Carrier
4	6	Pawl
5	6	Pawl Return Spring
6	1	Ratchet
7	1	Synchronizer
8		Face Spline Between Synchronizer and Output Shaft
9	1	Output Shaft
10	1	Oil Retainer
11		Ratchet Tooth

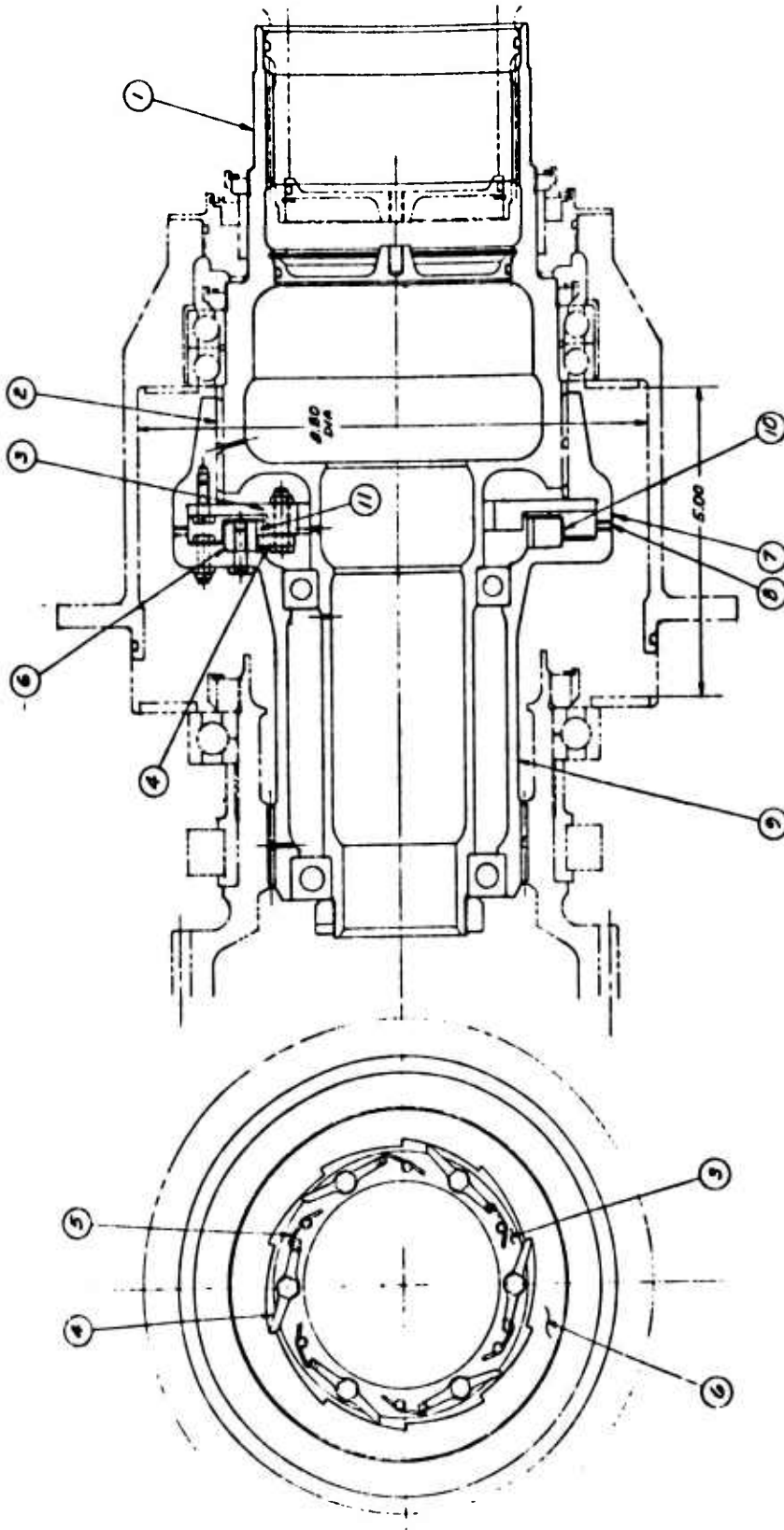

Figure 3. Positive-Engagement Clutch in HLH Drive System.

Since this design concept is unique, with no similar or preceding design to follow as a guide, it was necessary to develop a rational design approach. Refinements in this design approach will evolve with subsequent new designs. The approach that was used is believed to be valid and adequate.

DESIGN AND ANALYSIS

The sequence of examination followed in development of design definition falls into three broad categories:

- o Load-path analysis - design to maintain proper engagement, to transmit torque, and to withstand induced internal loads.
- o Engagement-system analysis - design the pawl system for positive engagement at synchronous speed, and long life at overrunning speed.
- o Critical-speed analysis - design to assure that critical speed of the clutch package is always higher than 115% operating speed.

Basic clutch parameters, established for convenience of fit, ease of manufacture, and based on preliminary analysis, are as follows:

1. Pawls to be arranged in 3 pairs, 6 total.
2. Ratchet to have 10 teeth, giving 30 different pawl and ratchet engagement positions.
3. Face spline to be curvic type, 30 teeth to match the 30 ratchet positions.
4. Pawl clearance with clutch engaged = .010 in. minimum.
5. Pitch diameter of spiral spline = 5.900 in.

LOAD-PATH ANALYSIS

Face Spline Design

Mating face spline halves on the output member and synchronizer make up the basic driving connection between input and output halves of the clutch.

During the engagement process, tooth contact must be avoided until one member has sufficiently penetrated the other to provide adequate load-bearing area of the contacting surfaces (see Figure 2). In the fully engaged position, the synchronizer must have rotated back far enough to pull the pawl tips back from the ratchet teeth.

Strength of the face spline must be adequate to carry the normal load without galling and the ultimate load without failure.

Pressure angle of the face spline teeth must exceed 10° , to avoid sticking in engagement, and yet the angle must not be so large that excessive separating forces are generated.

The face spline chosen for use in this clutch is the curvic type, introduced by the Gleason Works. In this type of spline, precise fit, interchangeability, and good tooth strength can be achieved at reasonable cost. Design guidance is offered, both in handbook form and in the form of expert analytical review of a proposed spline design, by Gleason.

4340 steel, heat treated to 150,000 psi, was chosen as the material to be used in the load-path members. This material is readily available, is tough, and has good dimensional stability. A variety of surface treatments are available to enhance wear resistance and reduce fretting tendencies. In this initial design, the chosen surface treatment for the splined areas was silver plating to inhibit fretting.

Using the design procedure given in the Gleason design handbook*, face spline diameter and tooth proportions appropriate to continuous torque of 45,550 inch-pounds were derived. The face spline definition thus derived is as follows:

Spline outside diameter	- 7.56 inches
diametral pitch	- 3.970 inches
whole depth	- .222 inch
addendum	- .098 inch
dedendum	- .123 inch
tip-to-root clearance	- .025 inch

Derivation of the face spline pressure angle was based on a need to keep the angle small to minimize separating force, while providing sufficient tooth slope to assure proper engagement and pawl load relief in the presence of wear and adverse tolerances.

*"Curvic Coupling Design", Copyright 1964, Gleason Works, Rochester, N.Y.

It was assumed to be desirable that tooth contact on engagement not occur with less than one-third of tooth overlap. This dictates that in the remaining two-thirds tooth penetration, tolerances, wear, and desired pawl setback be accommodated.

$$2/3 \text{ of tooth overlap} = 2/3 (2) (.098) = .130$$

Total tolerance - pawl length ($\pm .002$)	.004
Total tolerance - ratchet tooth position ($\pm .002$)	.004
Total tolerance - pawl to spline tooth	.004
Total tolerance - ratchet tooth to spline tooth	.003
Pawl & ratchet wear -	.008
Minimum pawl setback -	<u>.010</u>
Total	.033

$$T_{AN} \alpha = \frac{.033}{.130} = .250$$

$$\text{Face spline pressure angle} - 14.2^\circ = 15^\circ$$

The face spline data thus derived was submitted to the Gleason Works for their review, comment, and tooling recommendations. Their response indicates that the face spline should perform satisfactorily (see Appendix I).

The separating force generated by the spline teeth, and the force which must be overcome to drive the teeth into engagement while carrying torque, can be calculated by assuming a coefficient of friction between the spline teeth. For this analysis, a coefficient of .05 was used.

$$\text{Axial force required to engage} = \frac{Q}{(.5)D_F} \tan \alpha + \frac{Q C_F}{.5 D_F \cos \alpha}$$

$$\text{Axial force required to maintain engagement} = \frac{Q}{(.5)D_F} \tan \alpha + \frac{Q C_F}{.5 D_F \cos \alpha}$$

where Q = Clutch torque

D_F = Diameter of face spline = 7.56 in.

α = Face spline pressure angle = 15°

C_F = Coefficient of friction; assume $C_F = .05$

Axial force to engage = $.085 Q$

Axial force to maintain engagement = $.057 Q$

In practice, it is necessary to provide an excess of axial pre-load beyond the minimum required for engagement so that good clamp-up of the face spline is maintained. This clamping effect brings more teeth into engagement and minimizes the working which may occur at tooth contact surfaces in response to cyclic torque variations.

As recommended by Gleason Works, a clamping force to torque ratio of .18 lb/lb-in. was used (see Appendix I). This is approximately double the axial force required to bring the teeth into engagement, and it assures that full tooth contact will be maintained under all driving conditions.

Spiral Spline

The spiral spline between the input member and synchronizer transmits driving torque and at the same time generates the axial force required to hold the face spline members in intimate engagement.

The spline diameter, tooth size, and length of engagement must be chosen to carry the clutch torque adequately, and the helix angle must be chosen to achieve the proper proportion between axial load and torque.

A standard SAE spline tooth form, fillet root side fit, of moderate pitch was tentatively chosen for the spiral spline, with availability of tooling to be considered in the final choice.

Tentative spline parameters chosen for convenience of arrangement, which will be checked for adequacy, are:

D_S = Spline pitch diameter = 5.900 in.
 Diametral pitch = 10/20
 Number of teeth = 59
 Pressure angle = 30°
 Minimum engaged length = 1.6 in.

The axial force requirement determines the helix angle to be used in the spiral spline as follows:

$$\text{Axial Force} = (\text{Tooth Load}) (\tan \beta) - (\text{Tooth Load}) (C_F) (\cos 30^\circ)$$

where $\text{Tooth Load} = \frac{Q}{1/2 D_S}$

β = Helix angle

Q = Clutch torque

C_F = Coefficient of friction - .05

$$\text{Axial Force} = \frac{Q}{1/2 D_S} (\tan \beta) - \frac{Q}{1/2 D_S} (.05) (\cos 30^\circ)$$

Letting the axial force = .18Q as recommended by Gleason and solving for β , we get

$$\begin{aligned} \beta &= \tan^{-1} \frac{.18Q(1/2 D_S)}{Q} + .05 (\cos 30^\circ) = \tan^{-1} .565 \\ &= 29^\circ 28' \end{aligned}$$

Tooling was available to produce a helix angle of $29^\circ 52' 8''$, so this was used.

Surface stress in the spline, based on projected area and on the assumption of 25% tooth contact, is found as follows:

$$\text{Surface Stress} = (\text{Tooth Load}) \frac{1}{.25 (N) (L) (2A)}$$

N = Number of spline teeth = 59

L = Length of engagement = 1.6 in.

A = Addendum = .1 in.

$$\text{Surface stress} = \frac{Q}{2.59 \times .25 \times 59 \times 1.6 \times .1} = .164Q$$

Surface stress at continuous load = 7452 psi

Surface stress limit load = 13,120 psi

Surface stress ultimate load = 19,680 psi

Experience has shown that surface stresses of this magnitude are not excessive, and the spline is judged to be adequate.

Thrust Path

The axial load exerted by the spiral spline must be reacted, either within the clutch itself or by the input and output support bearings in the HLH transmission. Since the load is high enough to severely tax those bearings, this clutch is designed to completely react the axial load internally.

As Figure 4 indicates, input and output members are supported by a duplex bearing pair (A & B) which is preloaded by an 80-pound spring to eliminate radial play and to enhance smooth running.

When the clutch engages and axial forces far in excess of the spring preload are generated, the input (which is slip fitted into the bearings) moves to the right until the thrust collar "C" contacts the outer race of bearing A. All thrust loads then follow the path indicated in the sketch, with none of the load taken through the bearings.

An added feature of the bearing mounting scheme is the removal of preload from bearing "B" in the engaged condition. This increases the radial clearance in the bearing so that it does not fight the powerful tendency of the face spline to center the members on its own axis, which may deviate slightly from the bearing center (by virtue of manufacturing tolerances).

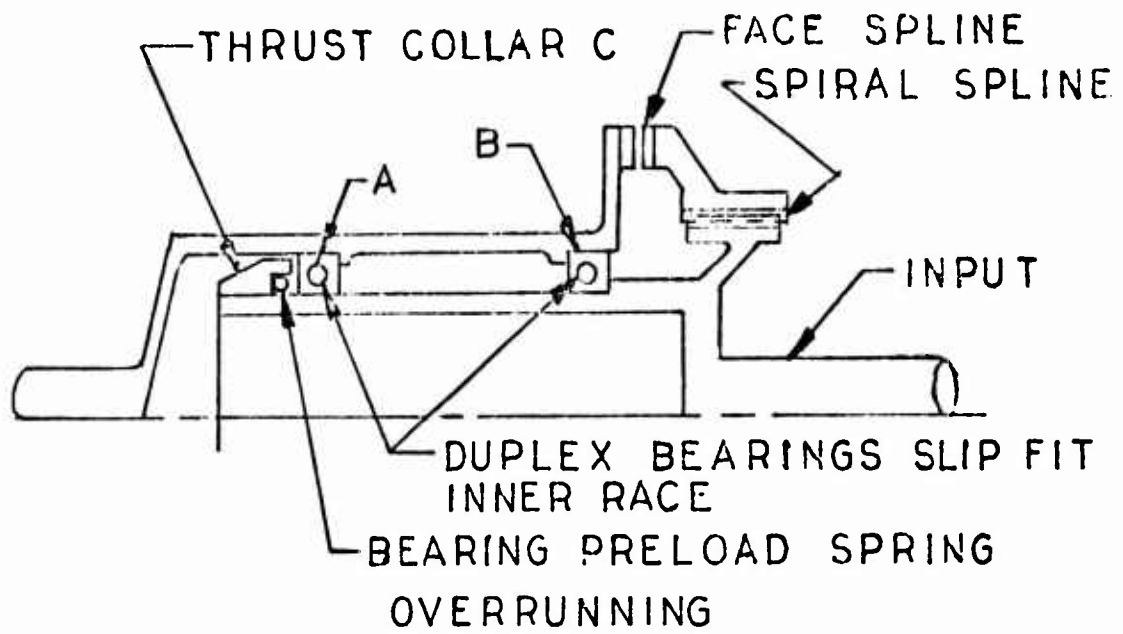

 MATERIAL IN COMPRESSION

 MATERIAL IN TENSION

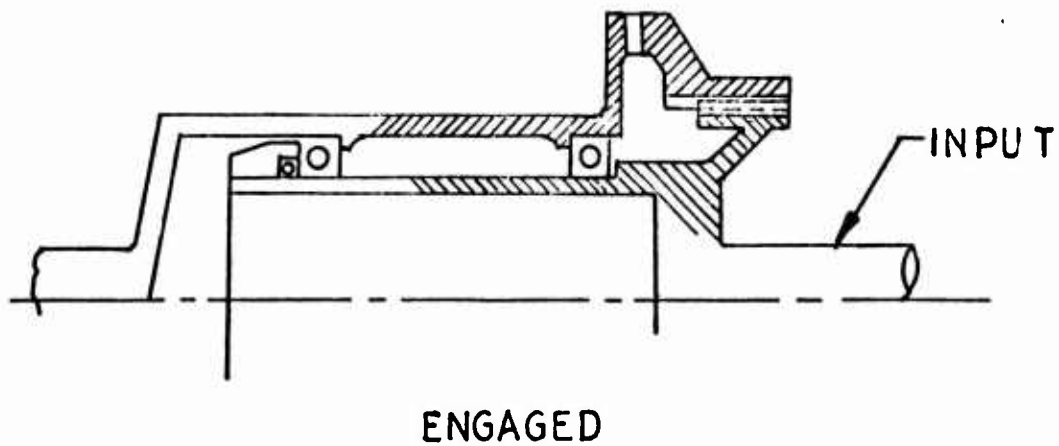

Figure 4. Thrust Path in Clutch.

ENGAGEMENT SYSTEM ANALYSIS

Pawl System

The pawl system of the positive engagement clutch provides the means for sensing the proper instant to initiate engagement and for operating the synchronizer to complete the engagement. It is essential that the engagement operation commence as soon as input speed has overtaken output speed and the face spline teeth are in alignment.

In the subject clutch, positive pawl system operation is assured by prevention of random pawl bounce during the time interval immediately preceding engagement.

The second element in assurance of reliable pawl system operation involves design to minimize wear and fatigue of the pawl-ratchet system in long-term overrunning. By promoting pawl hydroplaning at all continuous overrunning conditions, metal-to-metal wear between pawls and ratchet teeth can be avoided and return spring cyclic motion minimized.

Figure 5 is a plot of pawl action versus differential input to output speed. By assuming uniform acceleration of the input from 0 to full speed in 5 seconds, a scale of time to go to synchronous speed can be added to the abscissa; and by knowing the number of teeth in the ratchet, ratchet tooth exciting frequency can be added to the ordinate.

As the plot indicates, pawl system behavior passes through three distinct phases as differential speed changes:

- o Pawl hydroplaning, wherein differential speed between the pawls and the oil annulus carried in the ratchet is sufficient to support the pawl hydrodynamically.
- o Resonant behavior, where the speed differential will no longer support hydroplaning, so that the pawls become propelled by the ratchet teeth. When the ratchet pulses occur at a frequency which the pawls are unable to follow, then the pawls will tend to bounce at their natural frequency.
- o Coherent pawl and ratchet interaction occurs when the click frequency becomes less than the pawl natural frequency and each pawl falls into each ratchet pocket as it comes by.

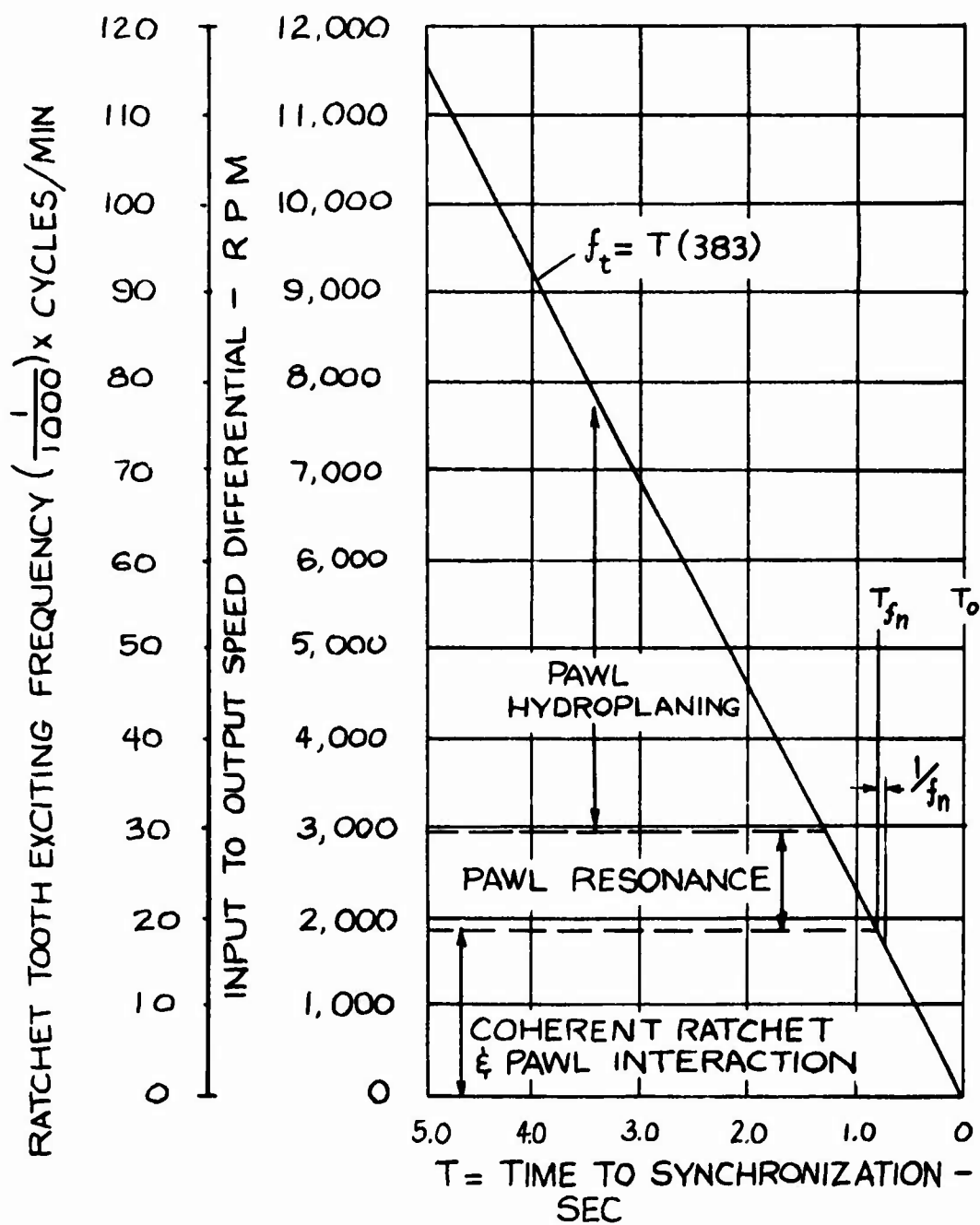

Figure 5. Differential Speed and Ratchet Tooth Exciting Frequency Vs Time.

The main thrust of pawl system design is to exercise control over the extent of these zones to promote reliable operation and long life.

Determination of Ability of Pawl to Engage Ratchet in the Available Time

In the HLH drive system, it is possible for the speed differential between input and output to change rapidly as an engine accelerates up to engagement speed. It is assumed that this acceleration rate can be as high as 0 to 11,500 RPM in 5 seconds.

The plot given in Figure 5 shows that the input to output speed differential diminishes as the instant of synchronization (T_0) approaches. The rate of change of differential speed is

$$\frac{11,500 \text{ RPM}}{5 \text{ sec}} = 2300 \frac{\text{RPM}}{\text{sec}}$$

Converting to rev/sec², we get $\frac{2300}{60} = 38.3 \text{ rev/sec}^2$.

Since there are 10 teeth in the ratchet, the rate of change of ratchet tooth exciting frequency = (10)(38.3)Hz.

And $f_t = 383 T$ (1)

where f_t = Ratchet tooth exciting frequency

T = Time remaining to synchronization

Working back from the instant of synchronization (T_0), we can say that the last resonant pawl cycle must be completed at T_0 or sooner. It can also be seen that the last opportunity for the start of that resonant cycle occurred when the ratchet tooth exciting frequency just equaled the pawl natural frequency ($T = T_{f_n}$).

The period of time for one resonant cycle = $\frac{1}{f_n}$

where f_n = Pawl natural frequency

From (1), the time preceding T_0 for f_t to equal f_n is

$$T_{f_n} = \frac{f_n}{383}$$

As a minimum let $\frac{1}{f_n} = \frac{f_n}{383}$.

Therefore, $f_n = \sqrt{383} = 19.57 \text{ Hz}$

For a rotationally vibrating system,

$$f_n = \frac{1}{2\pi} \sqrt{\frac{K_s}{J}}$$

where K_s = Spring rate of pawl return spring, lb-in./rad

J = Pawl polar mass moment of inertia = $\frac{(W)}{g}K^2$ lb-in. sec²

W = Pawl weight, lb

K = Pawl radius of gyration, in.

g = Acceleration of gravity = 386.4 in./sec²

From Appendix II, we find that pawl weight is approximately .0159 lb, $J = 7.795 \times 10^{-6}$ lb-in. sec².

if $f_n = 19.57 \text{ Hz}$,

$$19.57 = \frac{1}{2\pi} \sqrt{\frac{K_s}{7.795 \times 10^{-6}}}$$

$K_s = .113 \text{ lb-in./rad}$ or $.712 \text{ lb-in./turn}$

Note that this is a minimum; any spring rate exceeding this value is satisfactory.

Other considerations in the design of the pawl return spring, such as available space, installation tolerances, desirable stress levels, and desirable pawl preload, all lead to a practical range of spring rate of from 4 to 6 inch-pounds per turn. Pawl natural frequencies of 50 Hz are therefore assured.

Determination of Pawl Hydroplaning

It is desired that the pawls be supported entirely by hydrodynamic planing for all continuous overrunning conditions. Hydrodynamic planing requires that the pawl skating on the oil film develop a lift moment greater than opposing moments. The pawl moment which must be overcome by the hydrodynamic moment consists of the return spring torque and the centrifugally magnified pawl nose heaviness. Expected values for these moments are:

Spring torque = .5 to 1.0 lb-in.

Centrifugal moment = .5 lb-in. at 6000 RPM

Total moment to be reacted by planing = 1.0 to 1.5 lb-in.

Analytical determination of pawl planing torque is a difficult, uncertain process, with little background data available on the scale of clutch parts. An analysis was made using methods and data presented by Hoerner*, pages 11-20 and 7-18, and the results of that analysis are given in Figure 6. Analysis indicated that half-speed overrunning (with the input at 6000 RPM and the output at 11,500 RPM) generated the lowest hydrodynamic pawl lift, and this condition is represented by Figure 6. Testing has shown, however, that the analysis has underestimated planing ability by several hundred percent.

While Figure 6 indicates marginal planing with .19 wide pawls at 5500 RPM differential, testing shows planing down to 2500 RPM differential.

CLUTCH CRITICAL SPEED

Assurance was required that the subject clutch have a critical speed well above its operating speed of 11,500 RPM. Appendix III contains a summary of that analysis, the results of which are presented here.

Critical speed as calculated -
clutch disengaged = 56,200 RPM

Critical speed assuming bearing
spring rate 1/2 calculated = 49,000 RPM

No critical speed problem was encountered during testing, nor should any be encountered in operation with this clutch.

*Sighard Hoerner, "Fluid Dynamics Drag", 1958.

RELATIVE SPEED 550 RPM
OIL S.G. .875

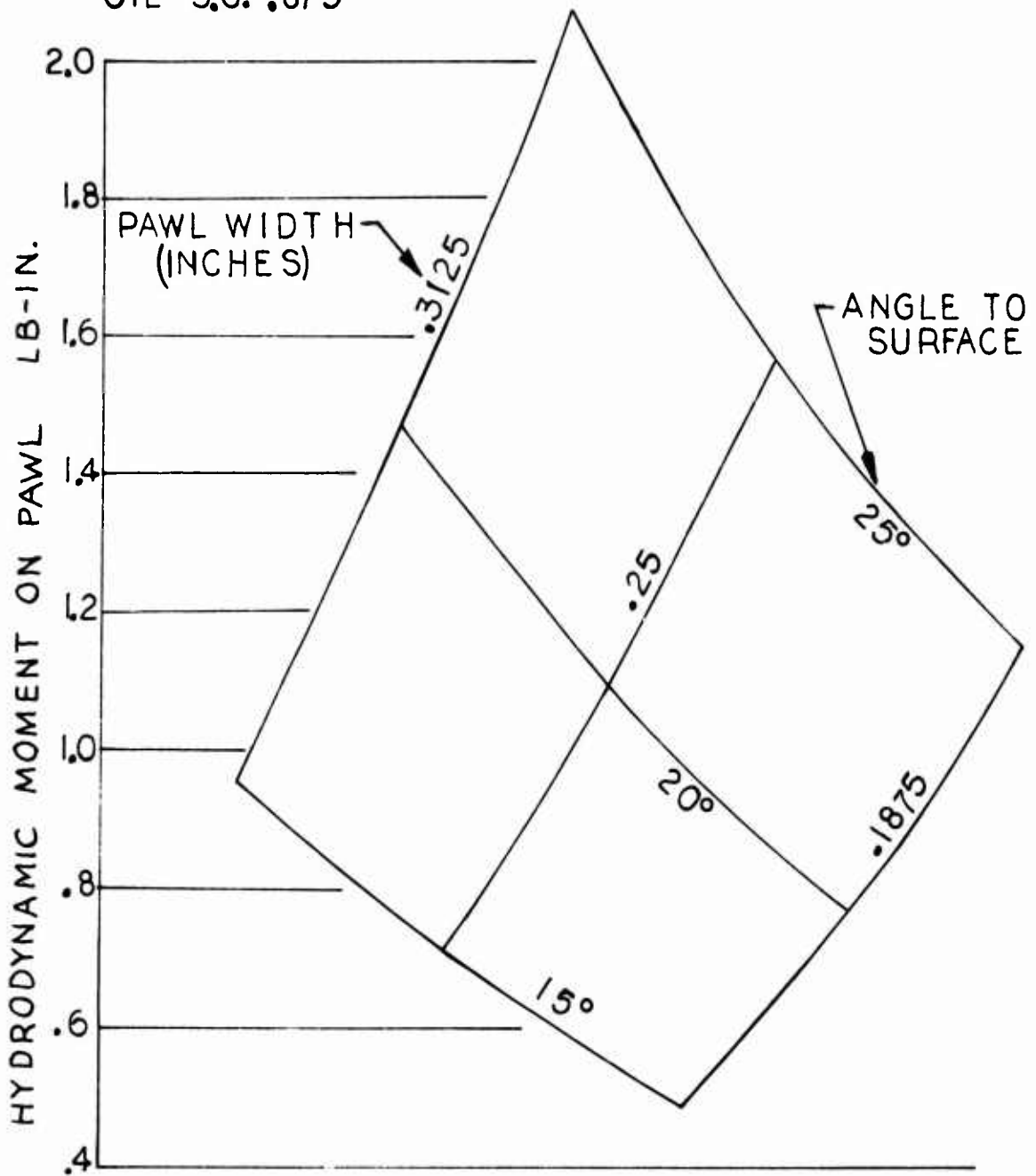

Figure 6. Hydrodynamic Moment About Pivot.

RELATIVE SPEED 550 RPM
OIL S.G. .875

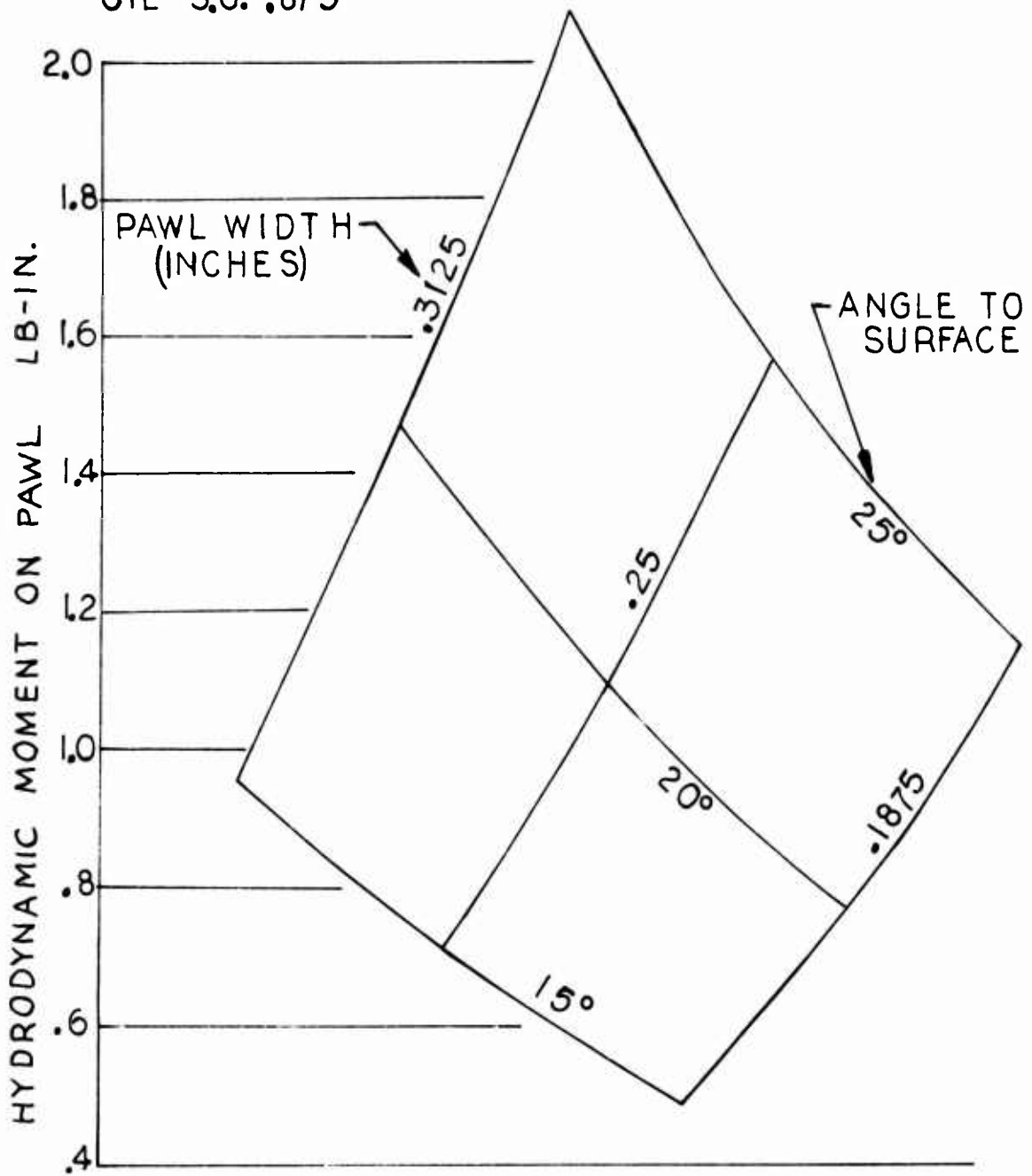

Figure 6. Hydrodynamic Moment About Pivot.

TEST PROGRAM

INTRODUCTION

In order to investigate the feasibility of the positive engagement clutch and to evaluate its applicability to the HLH, a clutch was built, a test plan was developed, and tests were conducted. The characteristics which this program intended to explore were the ability to engage, transmit torque, disengage, and overrun; and the heat generation, lubrication requirements, and durability in the overrunning mode. Testing included both static and dynamic tests, and observations of deflections, temperatures, vibrations, noise, speed, and wear.

TEST SPECIMEN

Figure 7 shows an assembly drawing of the test specimen clutch and its test housing. This clutch is similar to the proposed HLH clutch shown on Figure 3 in all significant aspects of design, material, heat treatment, and method of manufacture. The design and analysis referred to in the preceding section were applied to this test specimen. Outside of the clutch itself, input and output adapter shafts have been added to the clutch to facilitate design of the drive system used in the dynamic test.

TABLE II. TEST SPECIMEN MATERIALS LIST			
PART NO.	PART NAME	MATERIAL	HEAT TREAT
SK-22-9	Input Shaft	4340 STL	150,000 psi min.
SK-22-13	Adapter-Helical Spline	4340 STL	150,000 psi min.
SK-22-12	Synchronizer	4340 STL	150,000 psi min.
SK-22-15	Output Shaft	4340 STL	150,000 psi min.
SK-22-18	Thrust Collar	4130 STL	Condition N
SK-22-16	Ratchet	4340 STL	Salt Bath Nitride per AMS 2755
SK-22-22	Pawl	4340 STL	Salt Bath Nitride per AMS 2755
SK-22-24	Pawl Return Spring	Music Wire	
SK-22-23	Bushing-Pawl Pivot	4340 STL	Salt Bath Nitride per AMS 2755
SK-22-14	Carrier	4130 STL	180,000 psi

TABLE III. CLUTCH GEOMETRY	
Face Spline	- 7.56-in. O. diameter, 30 teeth, 15° PA Curvic
Helical Spline	- 5.900-in. pitch diameter, 59 teeth, 10/20 pitch, 30° Helix
Ratchet	- 10 teeth
No. of Pawls	- 6 (3 pairs)

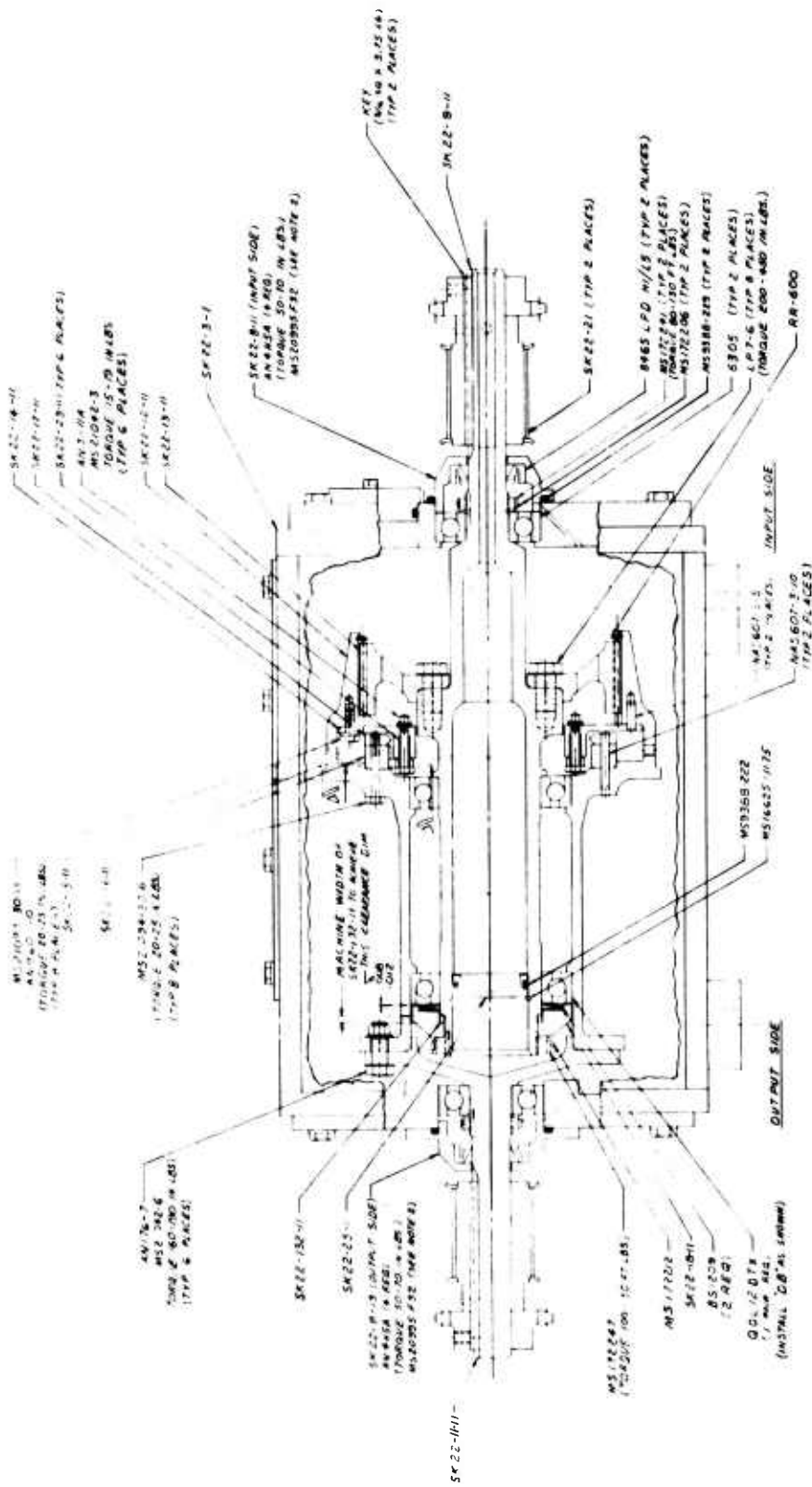

Figure 7. Assembly - Test Specimen Clutch.

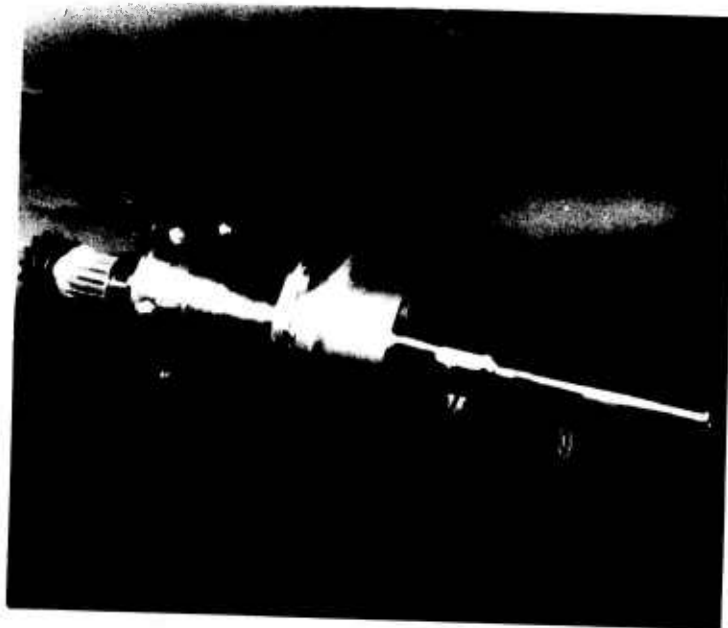

Figure 8. Test Clutch Shown Engaged.

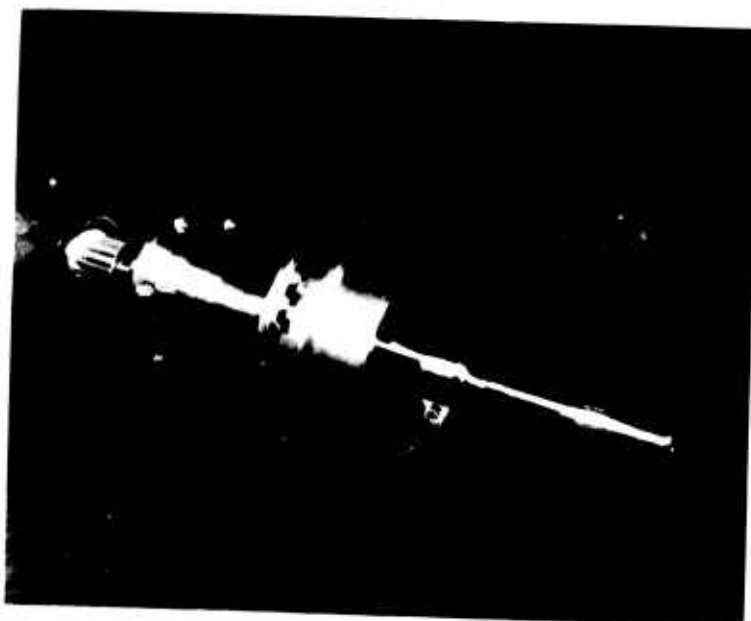

Figure 9. Test Clutch Shown Disengaged.

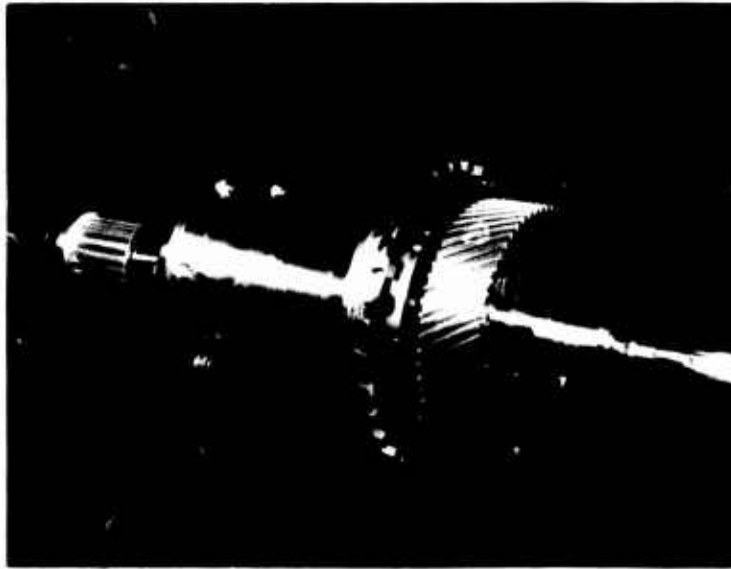

Figure 10. Clutch Assembly
Showing Spiral Spline.

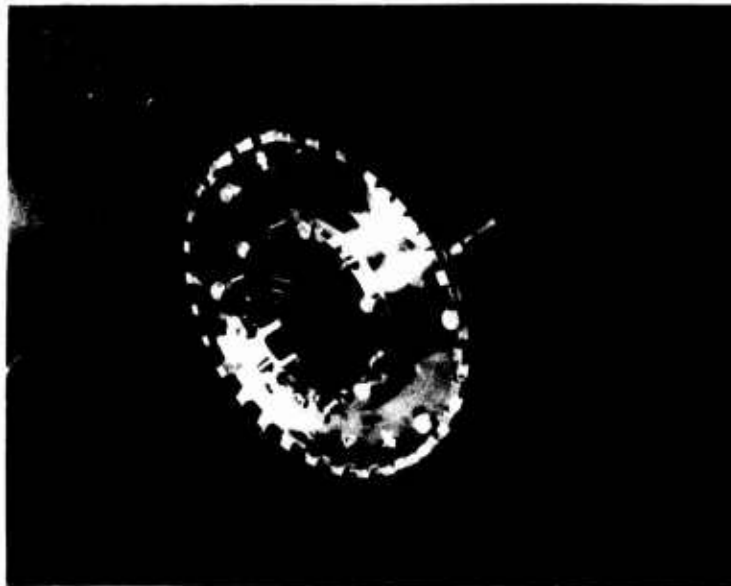

Figure 11. Synchronizer Subassembly.



Figure 12. Clutch Installed in Static Test Fixture.

STATIC TEST

This first test to which the clutch was exposed investigated the ability of the clutch to engage, transmit torque and disengage. Effort required to actuate the clutch and deflections under load were measured.

Test Rig

Figure 12 shows the clutch installed in the static test fixture with the loading beam in place and load cylinders connected.

In this test setup, the output member was bolted directly to massive structure. The loading beam was rigidly fastened to the input member, and hydraulic cylinders were coupled to the ends of the loading beam by calibrated load links.

Large loads were applied by pressurizing the two hydraulic cylinders simultaneously, providing a pure couple. For application of the small actuating loads, a torque wrench was applied to a hexagonal fitting in the center of the load beam.

Load was monitored by torque wrench readings or by readout from the strain-gaged cylinder links. Clutch rotation was measured by the dial indicators on the load beam, axial displacement by measuring the gap between the load beam and synchronizer.

Test Plan

The test plan called for four load cycles, starting with the clutch disengaged, proceeding through engagement, load application in 10,000 inch-pound increments to 40,000 inch-pounds, relief of the load, and disengagement. Loads and deflections were monitored for all steps.

Test Results

Results of the testing showed that torque required to engage the clutch ranged from 40 to 80 inch-pounds, if engaged very slowly, while 20 inch-pounds would actuate the engagement if completed in a continuous motion. Disengagement torque was 10 inch-pounds, with no sign that the clutch tended to be locked in engagement after application of full load. Engagements were tried in all ratchet positions, with no significant differences noted. There was no tendency to bind.

The results of the load cycles are shown on Figure 13. Runs 2, 3 and 4 show good repetition; but it is evident that Run 1 took up some slack in the test rig, accounting for the fact that the

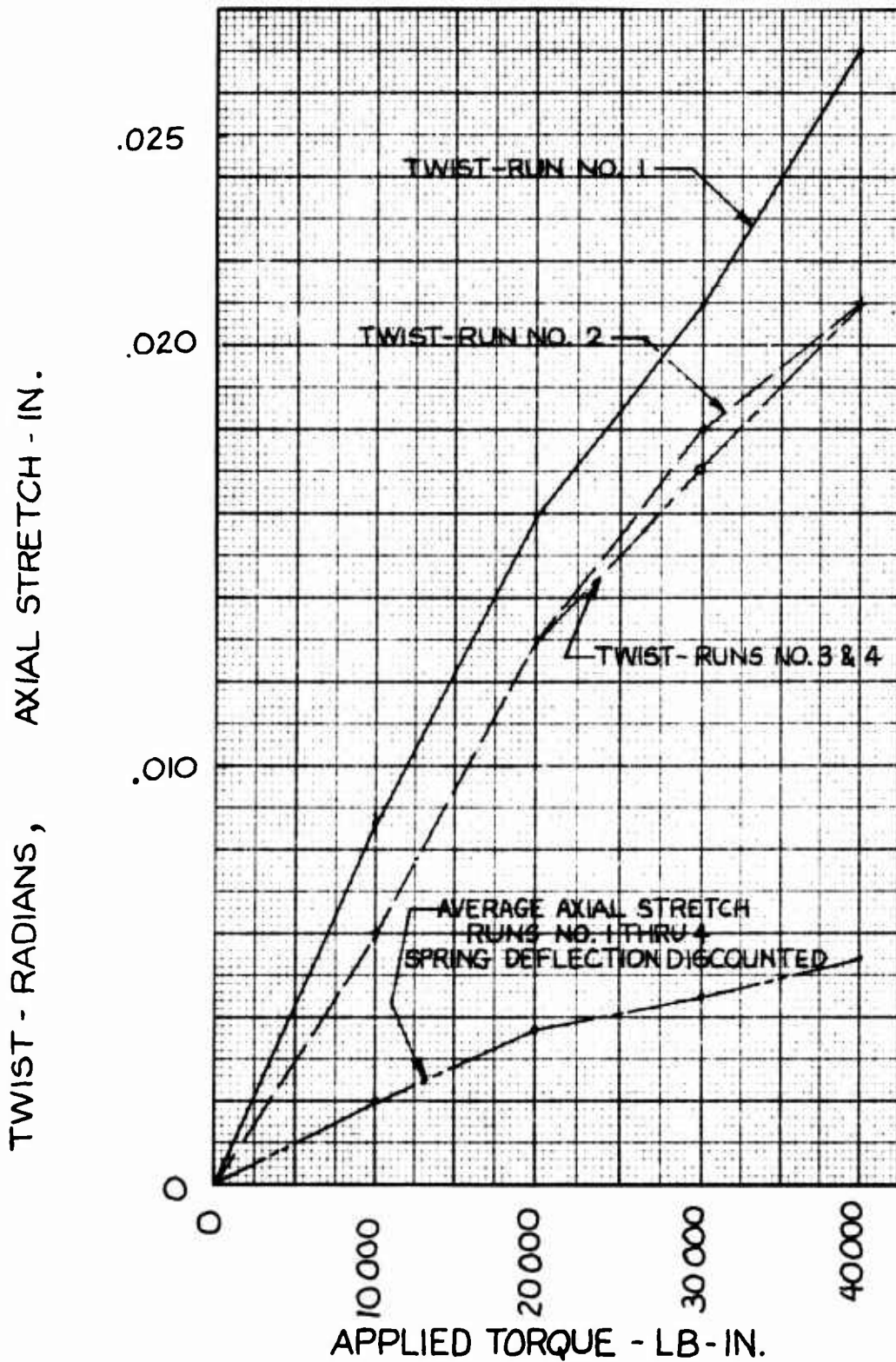

Figure 13. Clutch Deflections Versus Torque.

plot of Run No. 1 deflections is displaced from the remaining plots.

Clutch torsional deflection is shown to be fairly linear, with a slight tendency to stiffen up after 20,000 inch-pounds, probably as more spline teeth are made to share the load. Torsional deflection at design torque of 40,000 inch-pounds is 1.2° .

As the clutch is engaged, and load applied, there is an initial axial offset of .010 inch, due to compression of the bearing preload springs until thrust is taken by the internal thrust collar. Figure 13 reflects the net elastic deflection of the primary structural members of the clutch. Axial deflection of the clutch is shown to be .006 inch at design torque.

An effort was made to investigate load sharing of the pawls by bluing the tips and examining for rub-off after engagement, but this method was not considered reliable. As an alternative test method, one pawl was removed from a pair, and engagements were attempted. It was found that attempted single pawl engagements could not be made with a smooth slow torque application, as internal binding led to a "stick-slip" type action. Since the double pawl engagements were entirely free of binding, it was judged that both pawls were sharing the load.

Discussion

The static test program demonstrated that the positive engagement clutch will engage, maintain engagement when subjected to operating torque, and disengage without binding, as torque is reversed.

In performing these operations, the clutch did not exhibit any tendencies which would be detrimental to use as an overrunning clutch in the HLH drive system.

Torsional stiffness of the clutch shows that deflection at design torque is only 1.2° , which is less than half the deflection which would be expected with a sprag or ramp roller clutch. This could be an important factor in avoidance of torsional natural frequencies in the drive train.

The loads required for clutch actuation are repeatable, and very small in terms of engine torque (less than .25%). This indicates that engagements and disengagements should be smooth and very responsive.

The face spline pressure angle and spiral spline helix angle are considered to be satisfactory.

LUBRICATION REQUIREMENTS TESTS

Introduction

This series of tests was intended to explore the lubrication needs of the positive engagement clutch, particularly during overrunning.

As in other overrunning clutches, a supply of oil is required to carry away heat of friction and to sustain an oil film separating the overrunning parts and their raceway. Excessive oil flow can be detrimental because of additional heat generated by oil churning, while insufficient oil flow can greatly accelerate part wear. Determination of a flow range which avoids those extremes is essential to the proper integration of this clutch into a power transmission system.

In the course of design, the proper oil flow for the subject clutch was estimated to be 1.5 gallons per minute for either MIL-L-7808 or MIL-L-23699 oil. The test scheme was to operate throughout the overrunning speed spectrum at that flow, and at 50% above and below that flow. The heat generated during those runs was to be monitored, and through observation of vibration, noise and wear, pawl operation was to be assessed.

Test Rig

For this, and other dynamic tests, a rig was built with the capability of spinning input and output at independent, variable speeds. The test rig is shown in Figure 14.

Input and output are each driven by a 5-HP varidrive, coupled to the clutch by a flat cog belt system with 3:1 step up in speed.

The clutch test housing can be seen mounted on the table between the varidrives.

Lubricating oil supply (MIL-L-23699) is fed into the center of the input shaft through a standpipe. The oil supply tank is equipped with a thermostatically controlled immersion heater so that inlet oil temperature can be raised to 195° F, valving is furnished to control oil flow, and a flowmeter is provided to measure that flow.

Other instrumentation is provided to monitor the following:

Inlet oil temperature
Outlet oil temperature

Input Varidrive ↗

Output Varidrive ↗

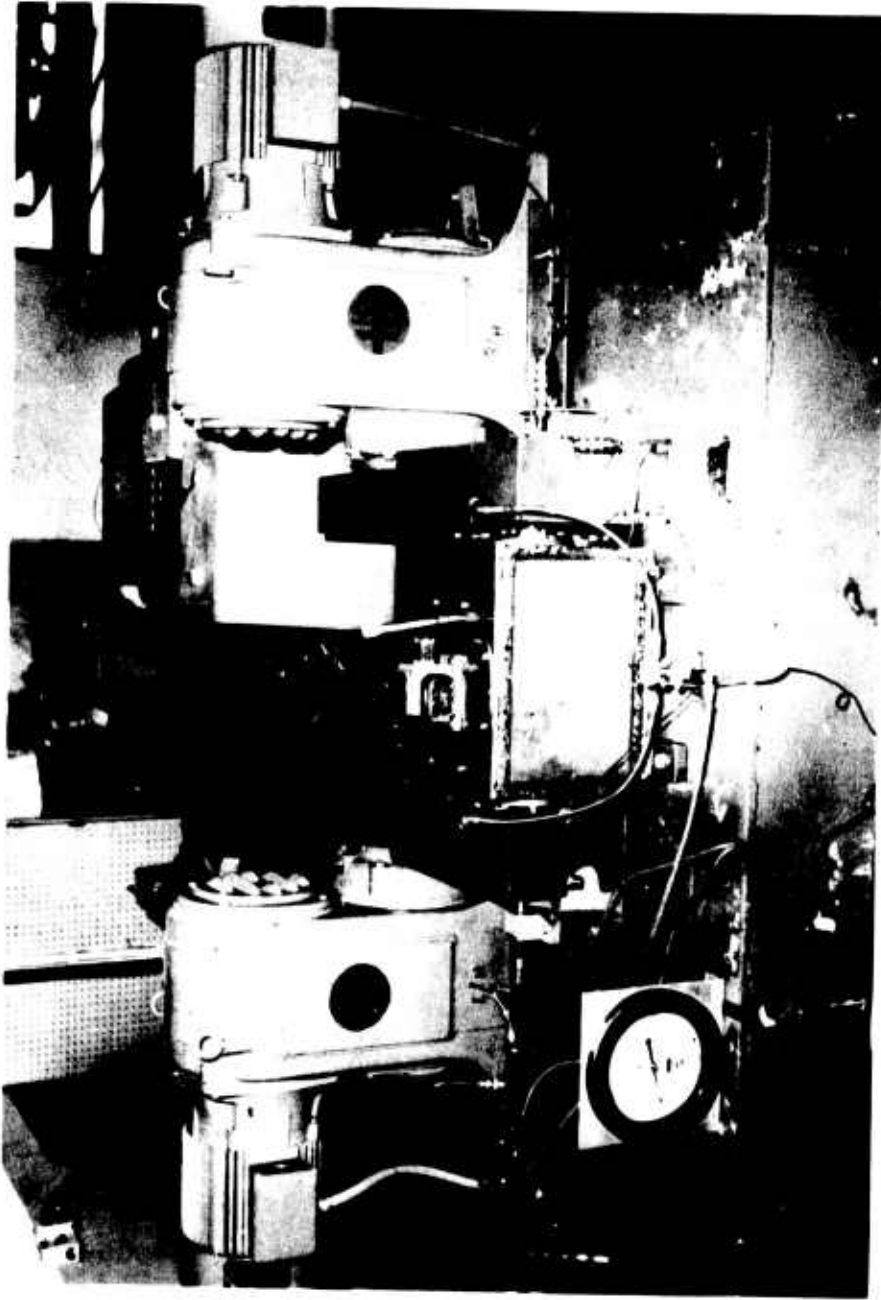

↖ Clutch Housing

Figure 14. Dynamic Test Facility.

Temperature of carrier bearings
Vibration amplitude of clutch housing in three axes
Oil pressure

Test Plan

The test plan closely followed the usual procedure for evaluating lubrication requirements for other clutches. The clutch was to be overrun through the full-speed spectrum at design oil flow to find the point of maximum heat generation. The clutch would then be run at that speed at flows 50% above and below the design flow to determine the effect of flow variation on heat generated. Observations were also to be maintained on vibration, noise, and wear, as possible indicators of detrimental effects due to the oil flow variations.

Clutch drag at the various oil flows was also to be measured and recorded.

In order to separate the pawl system heat, noise and vibration effects from those generated in the clutch support bearings or in the rig, the tests were to be run first with no pawl system installed, then repeated with the full clutch assembly.

Test Results

In conducting the planned tests, it was found that heat generation attributed to clutch operation was slight. The absence of significant heat generation diminishes the importance of identifying the exact relationships between heating and variables such as oil flow or speed. The raw test data is given in Appendix IV, and reveals temperature rises which are typically 7° to 12°F. Attempts to plot most of this information resulted in erratic curves. Several important conclusions can be drawn, however, from the data:

- o Heat generation during overrunning of the positive engagement clutch is slight.
- o Heat generation is not significantly responsive to oil flow variations in the .75 to 2.25 GPM range.
- o Heat generation is not significantly responsive to overrunning speed variations.

Measurement of clutch drag revealed a linear relationship between overrunning RPM and drag. The values were fairly small, reaching a peak of under 20 inch-pounds.

Power absorption represented by this drag amounts to about 3.0 HP.

Discussion

Evidence gathered in this test indicates that the heat removal criterion which establishes the oil flow requirements for sprag and roller clutches is not an appropriate concern in the positive engagement clutch. The lowest flow tested, .75 GPM, showed no indication of producing a trend to higher heat generation.

PAWL SYSTEM EVALUATION

Introduction

During the overrunning which was done as part of the lubrication requirements test, there was evidence that the pawl system was not operating in a manner conducive to long life. There were no indications that pawl hydroplaning occurred at any speed, and a number of failures were encountered in the pawl return spring system.

The methods of observation available in the lubrication requirements test arrangement were not useful for study of pawl system operation, or disclosure of problems, since the pawl system was completely surrounded by other clutch parts and hidden from view.

This test series was undertaken to permit study of pawl system operation, identification of problems, and development of corrections. It was intended, through this test program, to refine the pawl system so that operation in accordance with design intent could be realized.

Discussion of Failures

In the course of lubrication requirements testing, several episodes of failures had occurred involving the pawl return springs. The failure pattern appeared to involve nearly coincident breakage of several springs or spring attachments through high stress, low cycle fatigue. It was suspected that some unanticipated action of the pawl or spring was generated under particular overrunning conditions, leading to these failures. Identification of those particular conditions, or even the exact time of failure, could not be deduced from the observations made during the lubrication requirements testing.

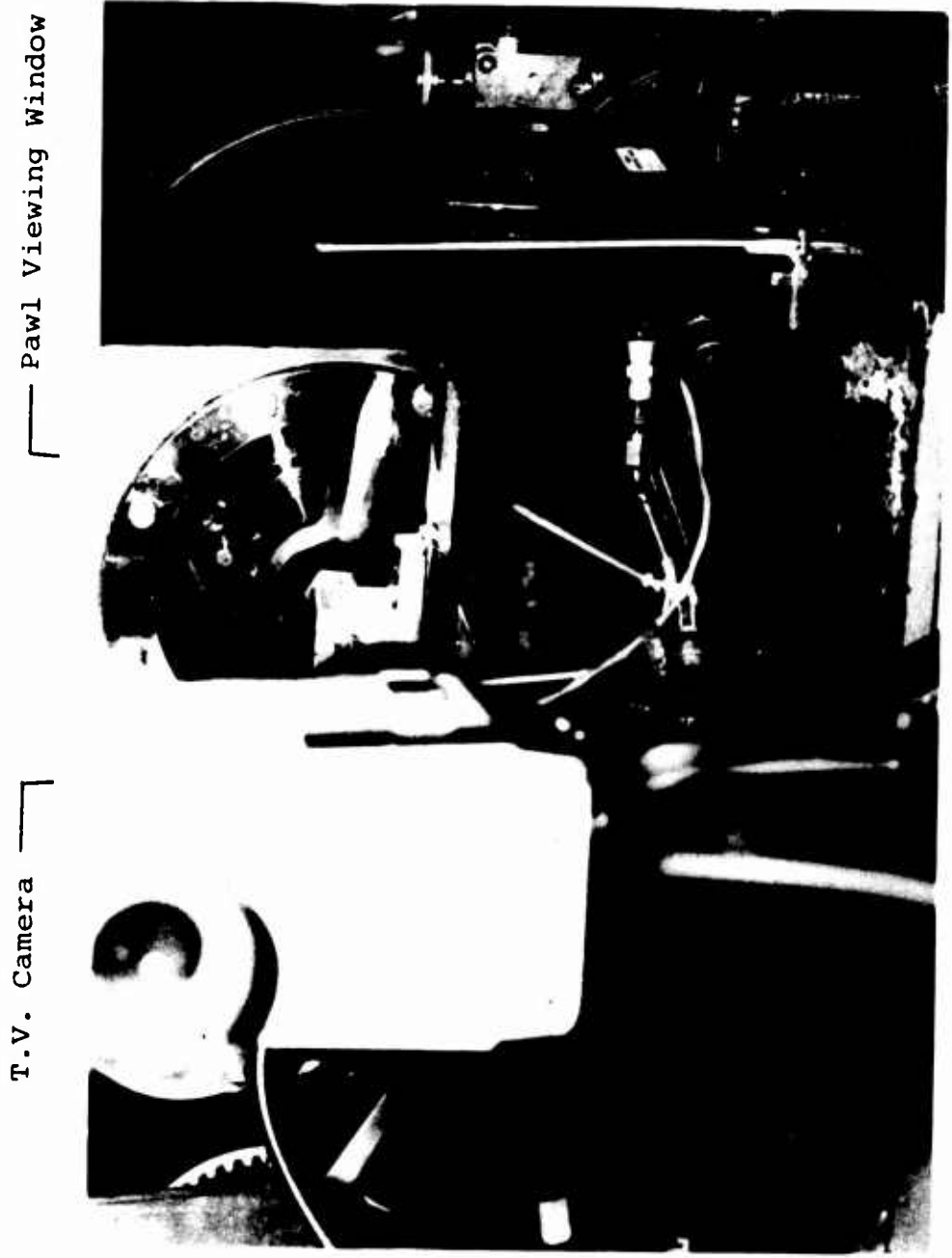

Figure 15. Pawl System Evaluation Test Arrangement.

Test Rig

Figure 15 shows the clutch test rig as set up for the pawl system evaluation tests. In this test arrangement, a single pawl and return spring are mounted to a fixed support in such a way that they can be readily viewed as the output member and ratchet are overrun at any selected speed. A video-tape recording system was incorporated into the test setup to supplement direct visual observation. All events were recorded on tape for subsequent replay at reduced or stopped speed.

The lubrication system remained unchanged from the previous (lubrication requirements) test, allowing control and measurement of oil flow and temperature.

Stroboscopic illumination was used throughout the test, so that pawl system operation could be closely observed.

This test arrangement provided a means to gain direct, intimate knowledge of the pawl system action. In the full clutch assembly tests, the pawl system was completely enclosed, and only indirect methods of observation were feasible.

Test Plan

The plan for this portion of the test program was to study the behavior of the pawl system throughout the full overrunning speed range. Through this study, the unanticipated, failure generating behavior could be identified, and corrective action evaluated.

Specifically, the plan was to operate the pawl system which had been subject to failure in the lubrication requirements test through the full overrunning speed range. By means of direct visual observation of the stroboscopically illuminated pawl system, and aided by video tape records of pawl operation, it was intended to study the conditions which had contributed to the previous failures. Particular attention was to be directed to the spring motion, pawl motion, and interaction between the pawl and ratchet. Alertness to extraneous spring motion and erratic or violent pawl action was to be maintained.

The next planned test phase was the evaluation of the effect of changes which could readily be made. Changes slated for trial were to include spring and spring support variations, pawl stop cushions and ratchet profile variation. The same methods of observation were to be used, and operation through the full overrunning speed spectrum surveyed.

A final evaluation was to be based on a pawl system incorporating the revisions deemed necessary and desirable on the basis of the first two test phases. Pawl system function throughout the overrunning speed range was to be examined and compared to the type of operation intended by design. To be acceptable, pawl hydroplaning would be required as the mode of pawl operation for all overrunning speeds in excess of 6000 RPM. Determination of the lubricating flow range to support acceptable pawl operation was a goal of this test phase.

Test Results

The initial test in the pawl system evaluation series called for operation with the pawl, spring, and ratchet which was run in the lubrication test series. The pawl return springs in this configuration had been subject to very early failure in previous testing, and observation of the operation leading to these failures was desired.

The plan for this test called for running the output (and ratchet) in increasing 1000 RPM increments, starting at 2000 RPM which was the rig minimum speed.

A considerable amount of extraneous spring motion was observed in this running, in the form of lateral movement of the spring tail in the pawl slot and squirming of the body of the spring on its arbor (see Figure 16).

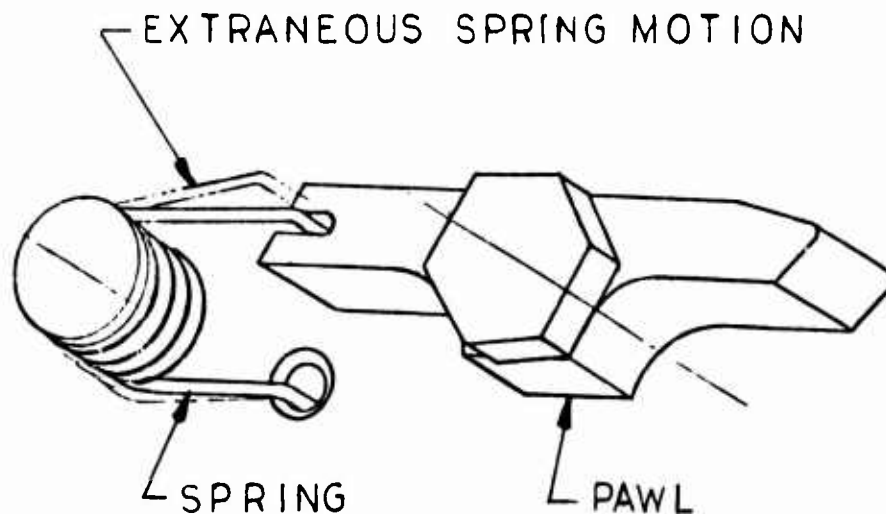

Figure 16. Extraneous Spring Motion.

This spring squirming increased with overrunning speed, and while increasing from 7000 to 8000 RPM, the spring lateral deflection allowed the spring tail to disengage from the pawl.

It is felt that the unwanted, extraneous spring motion which was observed increased cyclic stresses within the spring-wire severely. This higher stress level is the probable reason failures previously encountered in this spring.

The corrective measure taken to reduce this unwanted spring working was the addition of a thin, .500-inch-diameter washer under the .375-inch arbor flange. This provided more lateral support for the spring tail and a better endwise fit for the spring body.

This configuration was run and observed at 1000 RPM increasing increments of ratchet speed, with the spring motion found to be much better, and the squirming eliminated. As speed was increased, the pawl motion became increasingly violent, with no indication of support through hydroplaning. A travel stop is provided for the pawl in the form of a .190-inch-diameter roll pin, and the pawl rebounded against this pin quite hard. At 8000 RPM, the stop pin broke off.

It was evident from the observations made to this point in the test program that the pawl motions being achieved, particularly at overrunning speeds over 2500 to 3000 RPM, were not conducive to long life of the pawl system components.

It was considered vital to pawl system survival that hydroplaning action be established at least by 5500 RPM, since long term overrunning operation at that differential is viewed as probable.

It was thought that a probable reason for the failure to hydroplane was that the ratchet tooth peaks were protruding through the surface of the oil annulus inside the ratchet. The pawls striking these tooth peaks would be flipped outwardly, against the stops, and then rebound back against the ratchet. It can be visualized that this type of motion could build up to increasing violence with successive cycles.

A ratchet with revised profile was chosen as the subject for the next test. Figure 17 compares the original ratchet tooth profile with this revised one.

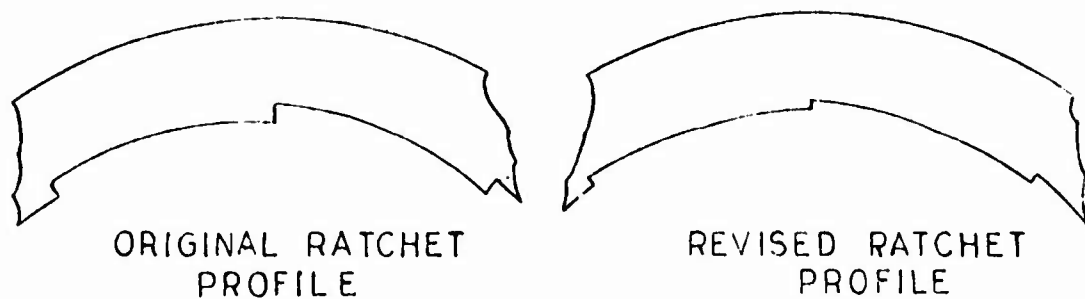

Figure 17. Comparison of Original and Revised Ratchet Profiles.

This configuration was tested, as were the previous ones, in 1000 RPM increasing increments of ratchet speeds.

The pawl was found to run with significantly less violence at speeds to 6000 RPM, and at all speeds above 6000 RPM hydroplaning action took over. During hydroplaning, the pawl motion stopped completely as the pawl rode smoothly on the surface of the oil film within the ratchet. It was clear that pawl system wear and distress would be reduced practically to the point of nonexistence in this mode of operation.

Testing next focused on pawl system durability in the non-planing mode. Since observation had indicated an increase in pawl motion up to transition to hydroplaning, this same configuration was continuously overrun at 5000 RPM. Thirty-five minutes of running were accomplished before the stop pin again broke.

Interim Conclusions

On the basis of pawl system observations up to this point, a number of conclusions were formed:

- o The spring distress encountered in the lubrication tests was probably due to extraneous spring motion.

Stabilization of the spring to eliminate squirming and design to preclude lateral bending are required to assure reliable spring performance.

- o Pawl planing is an achievable overrunning mode, offering operation free from fatigue and wear-producing pawl motion. If the differential overrunning speed required for planing could be reduced below the smallest continuous differential speed expected in normal transmission system operation, the result would be almost unlimited overrunning endurance.

Final Pawl System Revision

Based on the previous test observations and conclusions, a final pawl system configuration was assembled and tested.

Figure 18 shows this final pawl system in contrast to the system which ran in the lubrication tests. The improvements are as follows:

- o The spring was designed with straight tangs rather than bent, a closer fit was provided between the spring and arbor, and the spring action was reversed so that increasing load tended to wind up the spring rather than unwind it. The spring preload was also reduced, since this new spring would be centrifugally augmented rather than diminished, which was previously the case.
- o The ratchet with revised profile which was used in the previous test was assembled in this configuration.

This configuration displayed a smooth pawl action with considerably less violent bouncing than any previous configuration.

A careful survey was made of pawl cycling rate versus overrunning RPM, with the finding that the pawl responded to each ratchet tooth up to an overrunning speed of 1850 RPM (pawl frequency of 308 Hz).

Pawl motion above 1850 RPM was not precisely repetitive, but was not violent, with only occasional moves against the stop pin.

Hydroplaning of the pawl commenced at 3000 RPM overrunning speed, at an oil flow of .25 GPM, and persisted at all higher speeds.

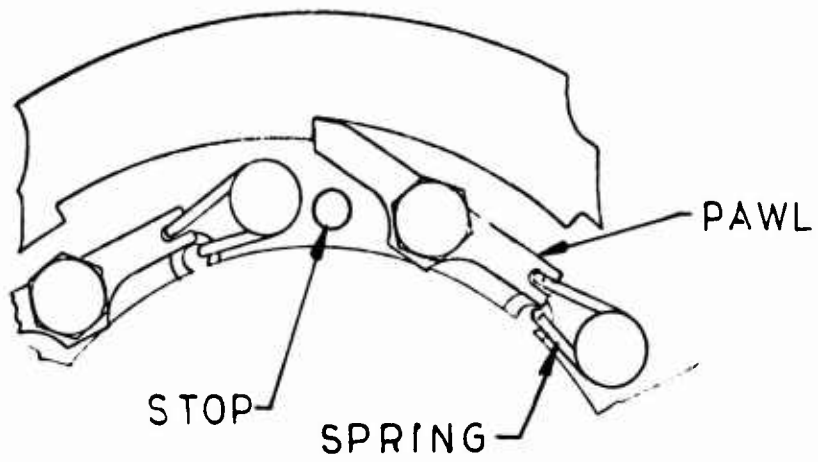

PAWL SYSTEM USED IN
LUBRICATION REQUIREMENT TEST

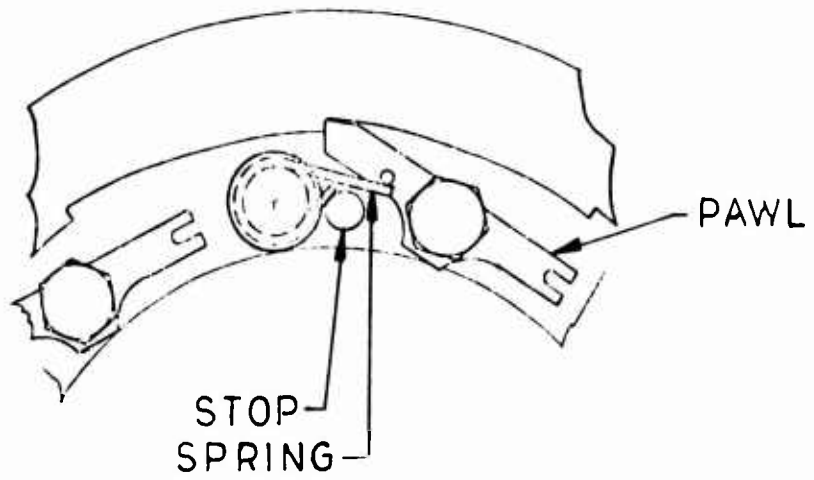

FINAL PAWL SYSTEM

Figure 18. Comparison of Pawl Systems.

Both visual and audible clues to the degree of violence of pawl motion indicated a significant reduction in comparison to the previous configuration. The clutch overran quietly, and contact with the stop pin was infrequent and light.

Since the maximum activity level of the pawl appeared to take place at 1850 RPM (the point where pawl natural frequency and excitation frequency coincide), it was decided to overrun for 2 hours at this speed with an oil flow of .75 GPM. It should be noted that this condition would only occur as a transient condition in normal operation.

Following the 2-hour run, the parts were examined and exhibited only superficial wear of the pawl and ratchet.

Conclusions

The pawl system performance as revealed in this single-pawl test setup was adequate and in accord with design intent.

A question of transferability of these results to a full six-pawl clutch required that this system be evaluated in a complete clutch assembly, with both input and output rotating.

OVERRUNNING ENDURANCE TEST

Introduction

Testing to this point had proven the ability of the positive engagement clutch to engage, carry torque and disengage. Lubrication tests revealed that oil flow requirements were modest, and at least at flows down to .75 GPM there were no indications that lubrication was marginal. Difficulties within the pawl system (spring failures, inability to hydroplane) had been corrected by the system adjustments derived in the pawl system evaluation. An important question remaining concerned the ability of the positive engagement clutch to overrun and engage as required throughout the operational speed range.

Overrunning demonstrations would be required in addition to those accomplished in the pawl system evaluation, because several operational factors could not be explored in that test.

- o The ability to maintain an oil annulus while planing six pawls would probably differ from the single-pawl situation.

- o Dynamic engagements, the primary task for this clutch, remained untried.

Test Rig

The test setup used in the lubrication tests was again used for this overrunning endurance test (see Figure 14). Instrumentation included 3 axis vibration pickups, pulse type input and output revolution counters, inlet and outlet oil thermocouples, and lubricating oil flowmeter.

Test Specimen

The full clutch as shown in Figure 7 was assembled, incorporating the ratchet and pawl system design which was used in the final pawl system evaluation test.

Test Plan

In an attempt to simulate actual operation, the test plan called for overrunning the output at high speed with the input stationary for a continuous 2-hour period. The clutch was then to be inspected, reassembled and overrun with the input at 6000 RPM for 2 hours. Following this overrunning, engagements and disengagements would be made at 2000 RPM increasing speed increments.

In the course of running this complete clutch, a test was also planned to measure the effect of oil flow variation on the hydroplaning transition point.

Test Results

The full clutch assembly was found to operate with the pawls hydroplaning at differential speeds ranging from 2500 RPM to 4000 RPM, depending on lubricating oil flow. A curve of the point of onset of hydroplaning is shown on Figure 19.

If pawl hydroplaning is used as a basis for establishment of lubricating oil flow, then a nominal flow in the .75 to 1.0 GPM range is seen as a good choice. Adequate margin thereby remains for a 50% diminution of flow with no detriment expected. Accordingly, the subsequent tests of overrunning and engagements were made with lubrication flow adjusted to 1 GPM.

The first 2-hour overrun was made with the input held stationary and the output running at 10,700 RPM. Inlet and outlet oil temperatures are plotted in Figure 20, showing a differential of about 25° F. It should be noted that the total

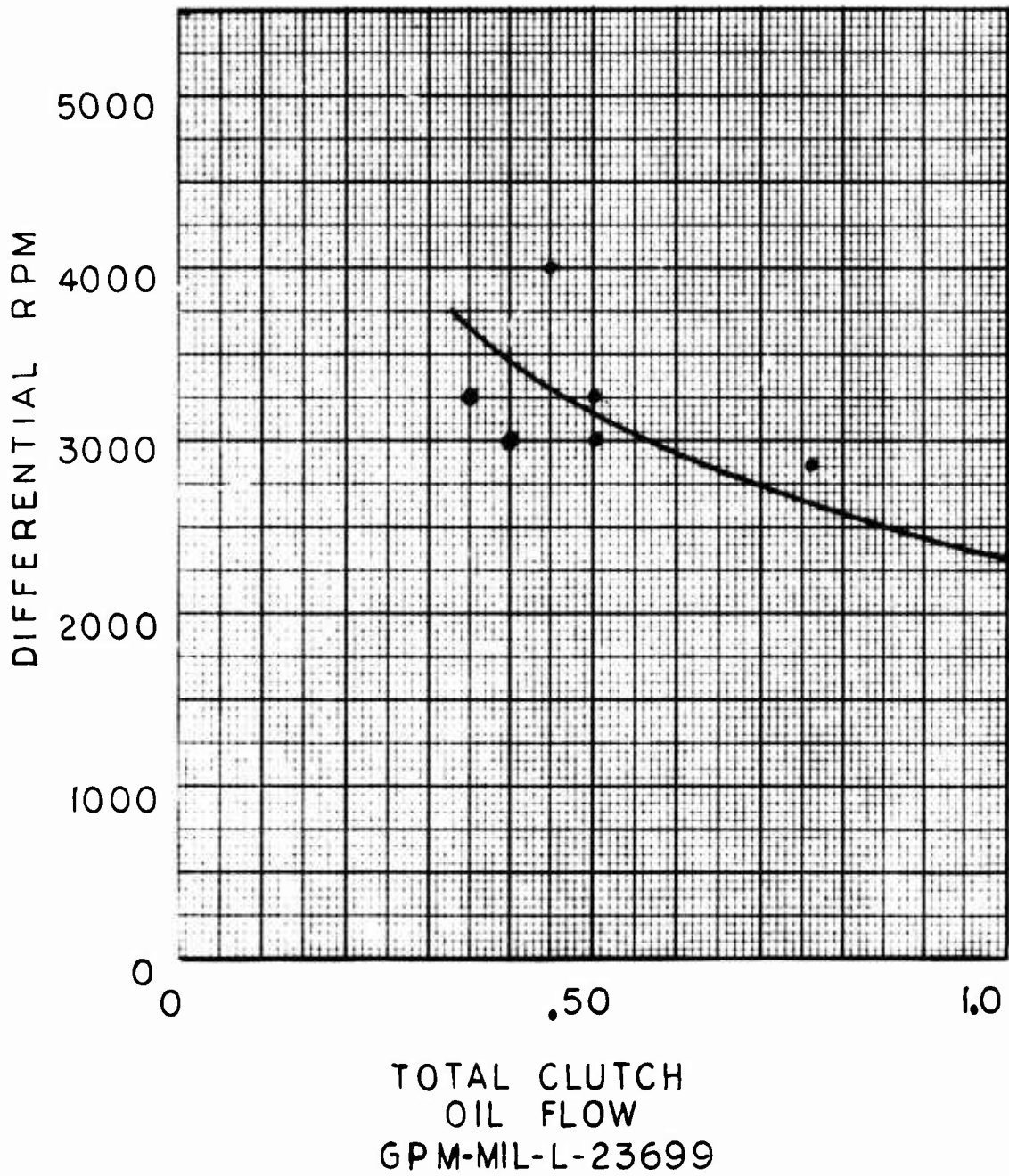

Figure 19. Onset of Pawl Planing Vs Lubricating Oil Flow.

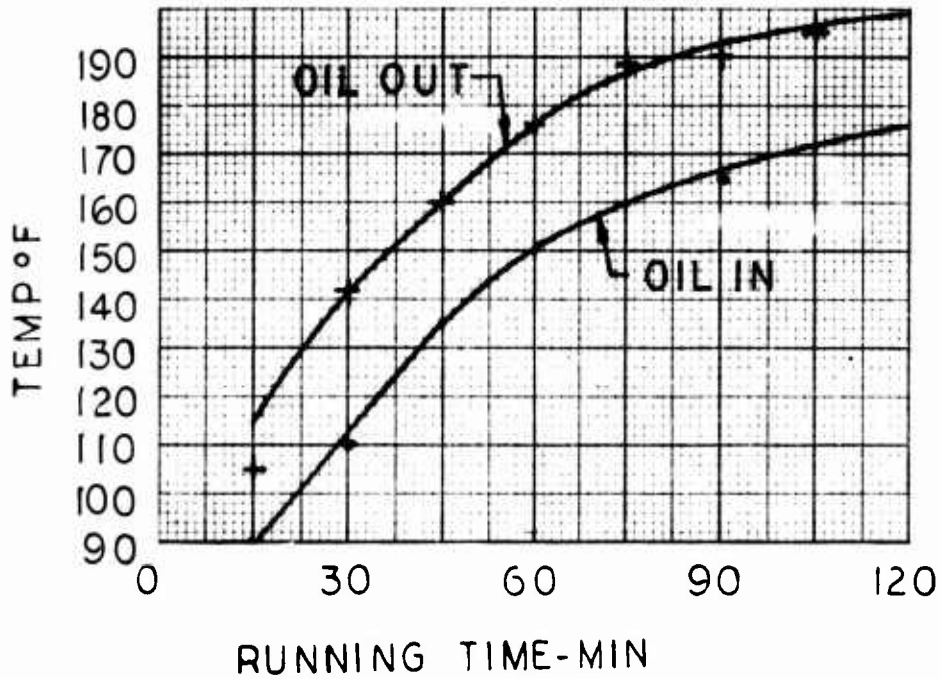

Figure 20. Oil Temp. Increase - Full Overrun
(Output - 10,500 RPM; Input - 0 RPM).

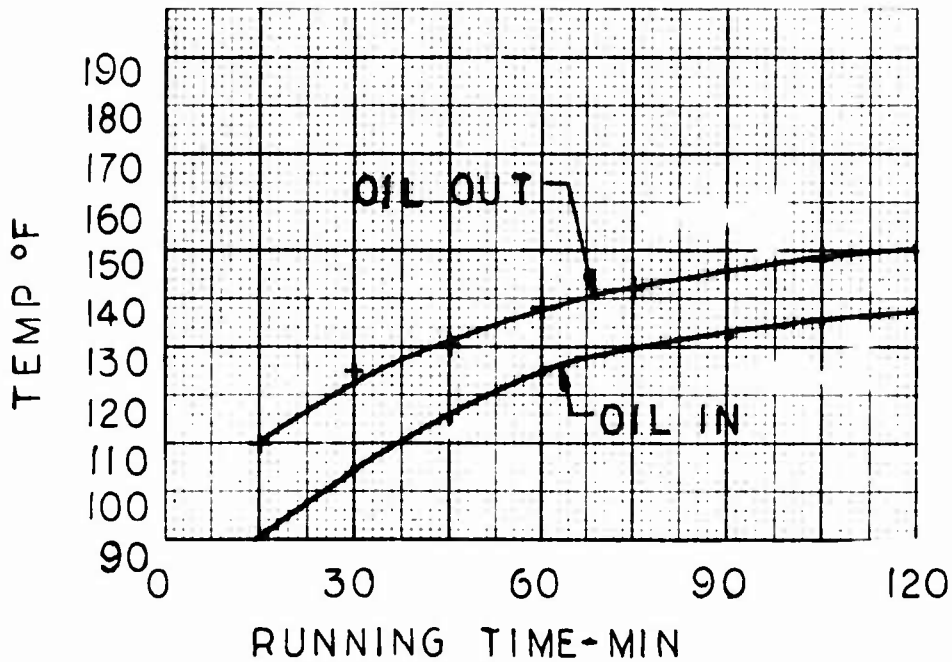

Figure 21. Oil Temp. Increase - Half-Speed Overrun
(Output - 10,500 RPM; Input - 6,000 RPM).

oil system duty included supply for pawl hydroplaning, and lubricating two overrunning clutch bearings, two rig bearings, and rig seals.

Disassembly of the clutch after this run disclosed no appreciable wear of the pawls and ratchet, and no indication of distress in any clutch part.

The clutch was reassembled and overrun with the output at 10,700 RPM and the input at 6000 RPM. Oil flow was again held at 1 GPM, and temperatures were noted every 15 minutes. Figure 21, which is a plot of the temperature differential between inlet and outlet, shows this differential to be about 15° F.

RUNNING ENGAGEMENTS

Without change to the test setup, a series of clutch engagements and disengagements was made, in accordance with the following procedure:

With the input stationary, oil flow at 1 GPM, output speed was adjusted to the desired engagement speed. The input shaft was then energized at its minimum speed and the input speed rapidly increased to produce an engagement. Traces of input and output speed were made as engagement was approached through the engagement event. Input speed was then readjusted to its minimum and shut down.

The sequence was repeated, producing engagements at 2000, 4000, 6000, 8000, 10,000 and 10,700 RPM. The engagements and disengagements were positive, smooth, and without harmful incident. These engagements are plotted on Figures 22 through 27.

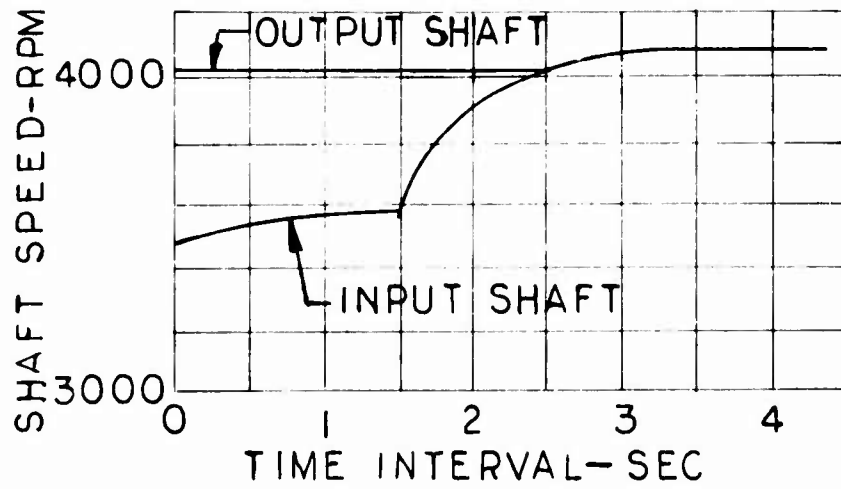

Figure 22. Clutch Engagement at 4020 RPM.

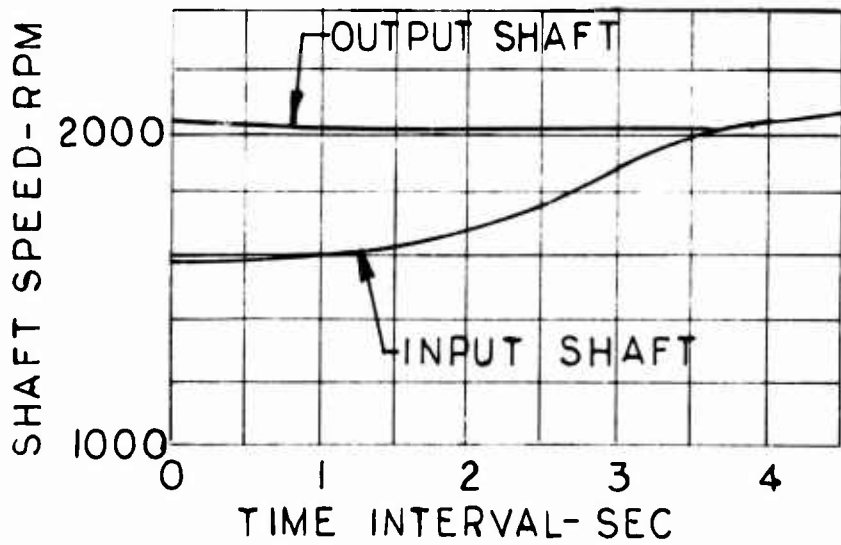

Figure 23. Clutch Engagement at 2010 RPM.

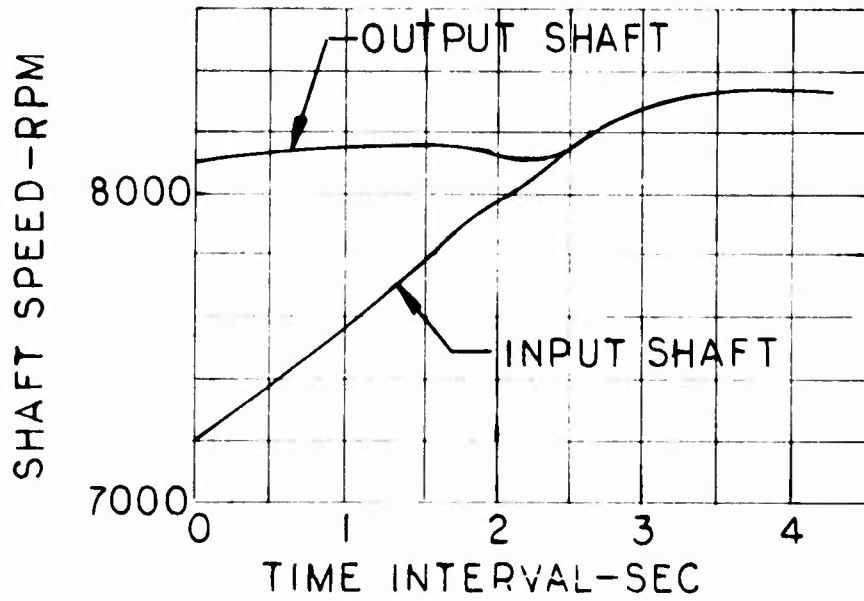

Figure 24. Clutch Engagements at 8160 RPM.

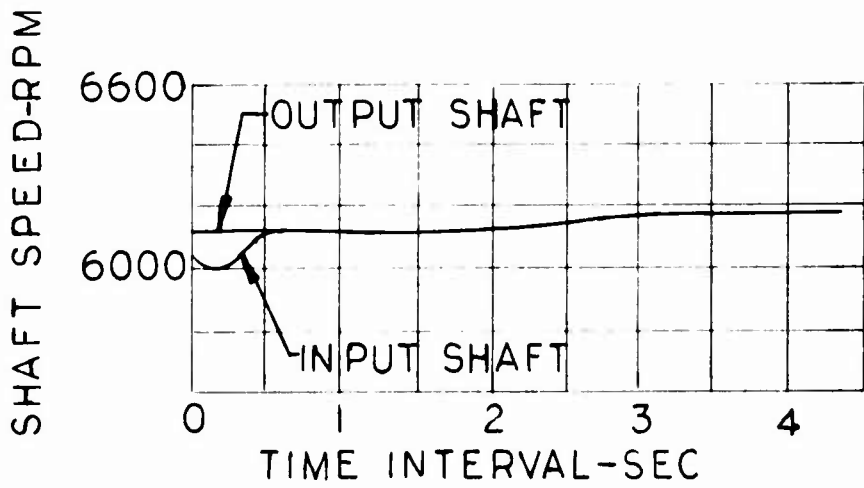

Figure 25, Clutch Engagement at 6120 RPM.

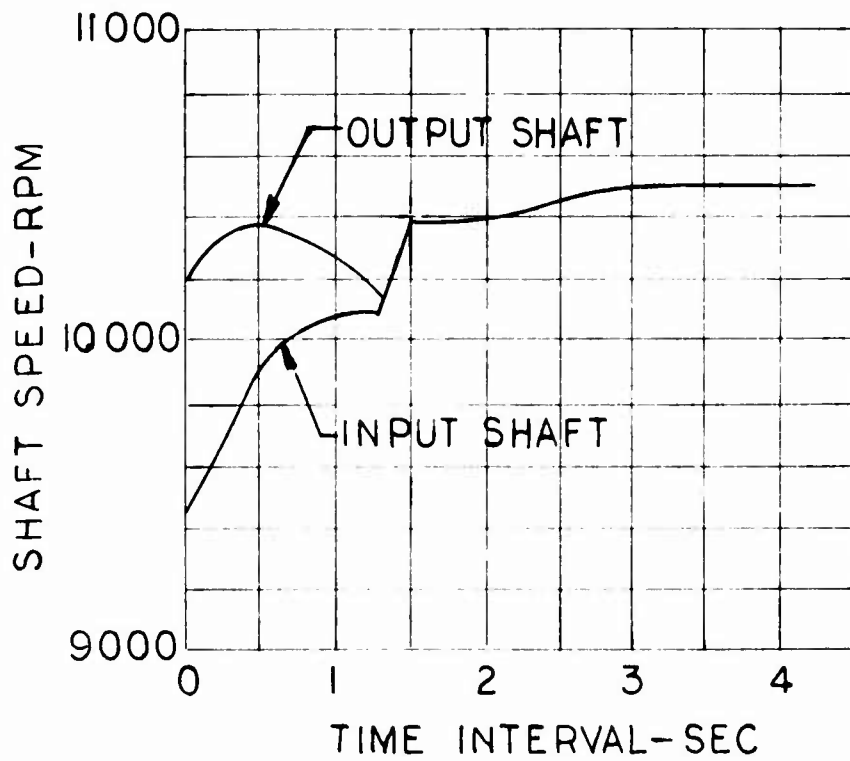

Figure 26. Clutch Engagement at 10,100 RPM.

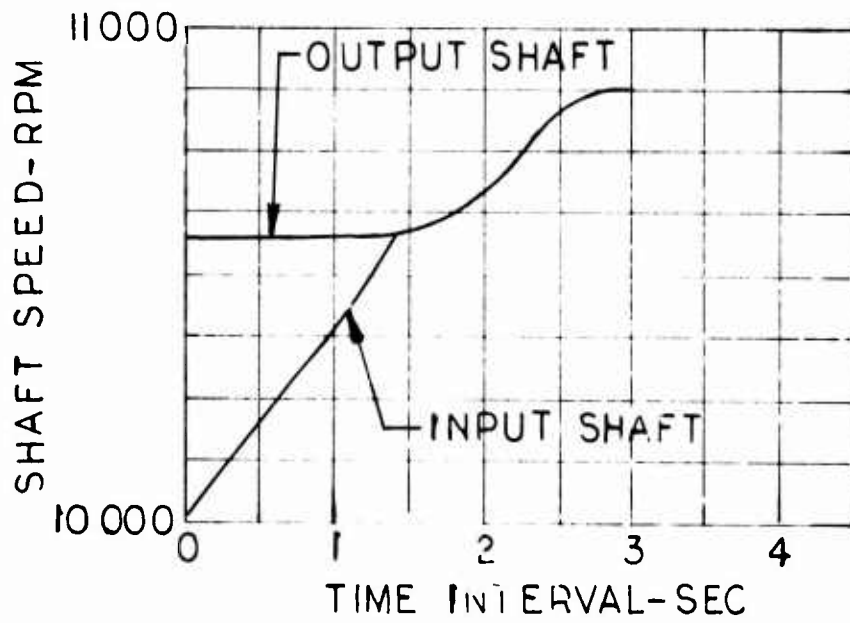

Figure 27. Clutch Engagement at 10,920 RPM.

ANALYSIS OF HARDWARE AFTER TEST

Following the tests the clutch was disassembled and detail parts were examined. Very little wear was observed in the pawl and ratchet system, and no wear was detected in the remaining parts, including bearings, face spline and helical spline.

The internal ratchet surfaces showed no more than light polishing in the track of the overrunning pawls, with the pawls themselves exhibiting somewhat heavier surface polishing. A single pawl, typical of all six, was cross sectioned and subjected to microscopic study for determination of wear.

Figure 28A is a microphotograph of an unworn section of the pawl surface, while Figure 28B shows a similar view of the worn portion of the same pawl. Material of this part is 4340 steel with a core hardness of Rc 32, case hardened (Tuftrided) by a salt bath nitride treatment. Figure 28A reveals a white surface layer which is .00016 to .00024 inch thick, which is typical of the condition expected as a result of the heat treatment. Micro hardness checks reveal hardened material below the white layer to a depth of .005 to .006 inch, with a gradual decrease to core hardness beneath this level. This case-hardened area is visible in the microphotograph as a layer of finer grained material.

The microphotograph of the worn area (Figure 28B) shows remaining vestiges of the white layer, so that the material removed through wear can be estimated as less than .0002 inch. This wear amounts to approximately 3% of the depth of relatively hard case material which would continue to support operation with little increase in wear rate.

All clutch parts remained in good condition following the test program, with no evidence of material distress and only slight wear of the pawls. Since the test experience leading to this wear consisted of 4 hours of hydroplaning overrunning together with approximately 1/2 hour of nonhydroplaning overrunning, a prediction of overrunning life capability on the order of 150 hours can be made. This is recognized as a somewhat tenuous prediction, but in view of the readily available design alternatives for wear enhancement which could be employed if needed, it is regarded as completely feasible.

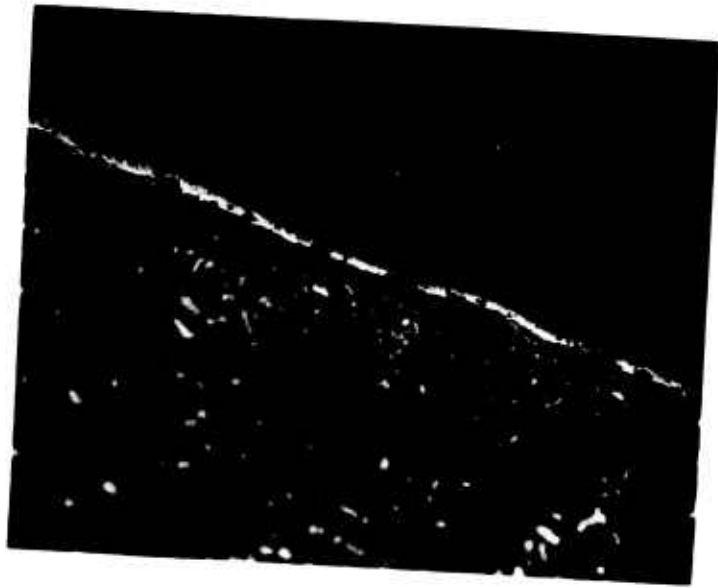

Figure 28A. Microphotograph of Unworn Surface of Pawl. (500X)

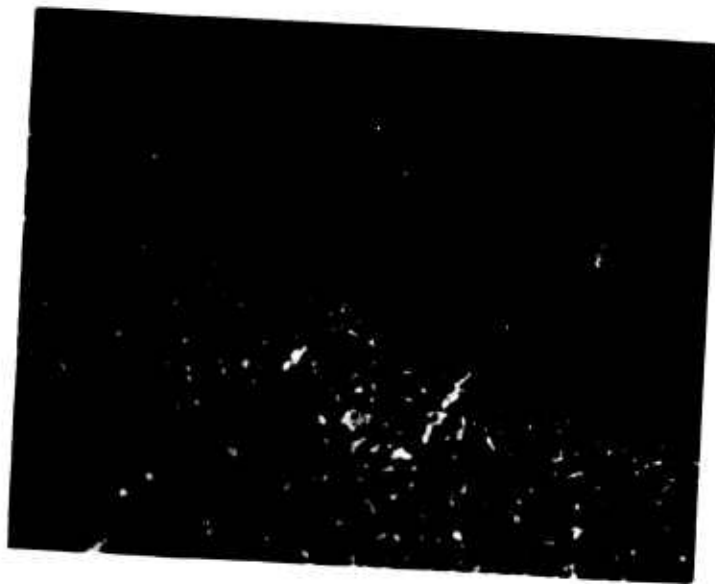

Figure 28B. Microphotograph of Worn Surface of Pawl. (500X)

CONCLUSIONS

Static testing of the positive-engagement clutch demonstrated the following:

1. The clutch engaged smoothly and properly with no more than 80 inch-pounds of torque required.
2. The engaged clutch transmitted 40,000 inch-pounds of torque with no distress to any clutch part and no tendency to disengage. Torsional deflection was 1.2^o, and axial deflection was .006 inch.
3. Disengagement was accomplished with the application of 10 inch-pounds reverse torque, with no binding resulting from the preceding application of full design torque.

Lubrication requirements testing showed that heat generated by the clutch while overrunning was slight, and that cooling requirements would not be the criteria to use in determining the optimum oil flow. This testing also revealed weaknesses in the pawl system design, as evidenced by pawl return spring failures.

Pawl system evaluation tests showed that:

1. With relatively small adjustments to the original pawl system design, overrunning modes leading to reliable operation and long life could be achieved.
2. Pawl hydroplaning is a remarkable overrunning mode, wherein the pawl is immobile. There is no metal-to-metal wear and no cyclic loading of the return spring.
3. Pawl motion below hydroplaning speed is not distressful; and at differential speeds of less than 1850 RPM, the pawl motion faithfully responds to each ratchet tooth.

The overrunning endurance test of the complete clutch demonstrated that:

1. Overrunning at both full and half differential speed produced very low wear rates, indicating the feasibility of overrunning life of 150 hours or greater.

2. Lubricating oil flow of 1 GPM was satisfactory, with satisfactory operation demonstrated over the range from .50 to 2.0 GPM.

The engagement tests showed that the clutch does engage when input speed coincides with output speed, and the clutch disengages when the input is slowed; these operations are accomplished smoothly and without incident.

RECOMMENDATIONS

The reported program has successfully met the initial goal of designing, fabricating, and testing a positive engagement clutch to HLH scale. Engagement, torque transmission, disengagement, and overrunning have all been demonstrated. Some aspects of operation which the clutch would face in actual use have not been probed, however: long-time driving endurance with fluctuating torque loads such as occur in helicopter drive trains and exposure to high-impact engagements. The high-impact engagement represents an emergency situation in which the clutch must survive engagement at maximum engine acceleration.

It is recommended that the existing clutch, which remains in good, operable condition, be submitted to an extended program which would explore both of the aforementioned operational aspects, and then proceed to an ultimate torque test.

The endurance test could be run in the static torque test rig through incorporation of a high-frequency cyclic load source (shaker). In this way, various cyclic torques could be superimposed on a schedule of steady driving torques for extended periods of time.

A dynamic rig modification could be made to provide momentum, spring rate, and acceleration equivalent to the HLH engine input system, so that high impact engagement effects can be probed.

Testing to ultimate torque can be accomplished in the present static torque test rig.

In view of the potential benefits which would follow from development of the positive engagement clutch, it is urged that the above recommendations be implemented.

APPENDIX I
DIMENSIONAL DEFINITION OF FACE SPLINE

The CURVIC Coupling Dimension Sheet No. 563.168 gives the set-up instructions and finished part dimensions which Gleason Works recommends for the positive-engagement clutch face splines. These recommendations were adhered to in fabrication of the subject test clutch.

Spline stresses calculated by Gleason Works for loads of 85,000 lb-in. and 120,000 lb-in. are as given below. These calculated stresses assume that the clamping force is 1.5 times the separating force.

Torque Load	85,000 lb-in.	120,000 lb-in.
Shear Stress (psi).	8,100	11,420
Surface Stress (psi).	20,600	29,000
Equivalent Surface Stress (psi)	36,050	50,800
Recommended Clamping Force (lb)	15,450	21,800

Gleason Works recommended allowable limits for 150,000 psi ultimate tensile strength steel are 15,000 psi shear and 40,000 psi surface stress for applications involving both bending and torsion. The recommended limit for the equivalent surface stress is 145,000 psi. The calculated stresses are well within these recommended limits.

TABLE IV. FACE SPLINE DIMENSIONS

Dimensional Sheet No. 563.168		Form A	6/05/72
Number of Teeth	30	Outside Diameter	7.557"
Diametral Pitch	3.970	Outside Circular Thickness	.398"
Total Face Width	.250"	Face Angle of Blank	90°
Pressure Angle	15°	Root Angle	90°
Circular Pitch	.791"	Gable Angle Theoretical	0°20'
Whole Depth	.222"	Gable Height Theoretical	.001"
Clearance	.025"	Backlash	.000"
Chamfer Depth	.023"	Design Desired	Std
Addendum	.098"	Final Design	Std
Dedendum	.123"	Tooth Proportions	Givn
		Manufacturing Method	Grnd
		<u>Concave</u>	<u>Convex</u>
Point Diameter - Wheel		11.186"	11.318"
Actual Point Width		.228"	.232"
Mutilation Point Width		.293"	.299"
Outer Slot Width		.327"	.332"
Limit Slot Width		.327"	.306"
Limit Slot Width Cone Dist		3.779"	3.529"
Inner Slot Width		.301"	.306"
End Angle		0°20'	0°20'
Dresser Block Angle		32°0'	32°0'
Pressure Angle - Wheel		15°0'	15°0'
Clearance Pressure Angle		17°0'	17°0'
Maximum Radius - Interference		.065"	.065"
Edge Radius - Wheel		.065"	.065"
Radius to Point of Tangency Std		3.654"	
Layout Radius - Wheel		5.626"	5.626"
Layout Radial - Wheel		6.708"	6.708"
Separating Force Factor K1		.0733	
Shear Stress Factor K2		.0954	
Surface Stress Factor K3		.2422	
Bolt Load Stress Factor K4		3.3020	

**APPENDIX II
ANALYSIS OF PAWL SYSTEM**

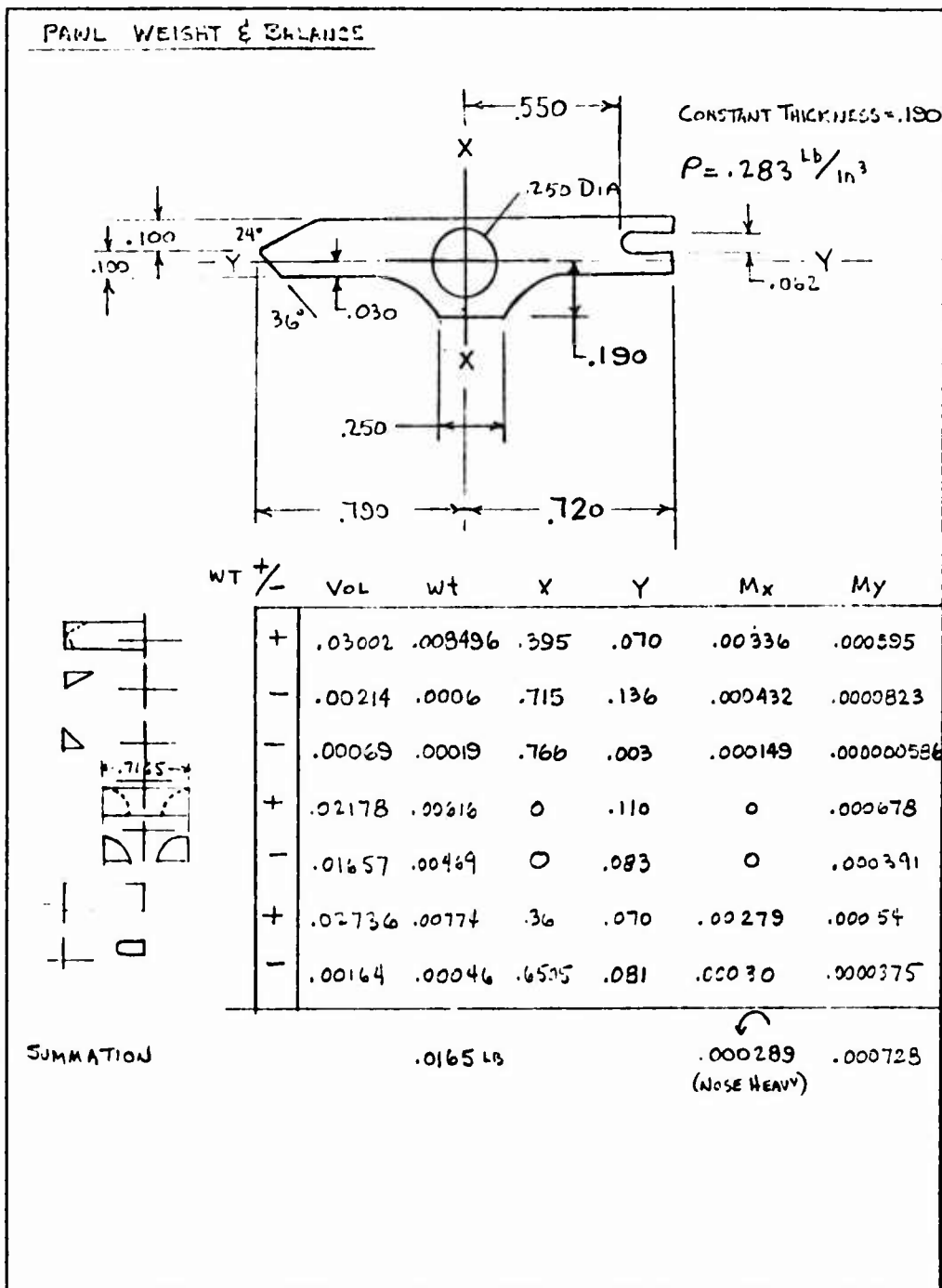

REVISED:

PAWL INERTIA:

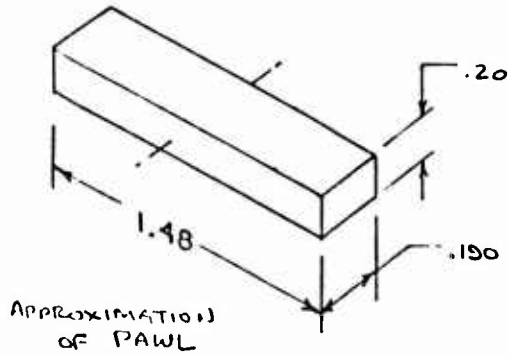

$$W = .0165 \text{ Lb}$$

$$K = \sqrt{I/A}$$

$$I = \frac{bd^3}{12} = \frac{(20)(1.48)^3}{12} = .054$$

$$A = 1.48 \times .20 = .296$$

$$\therefore K = \sqrt{\frac{.054}{.296}} = .427$$

$$J = \left(\frac{W}{g}\right) K^2 = \frac{.0165}{386.4} (.192) = .000007795$$

PAWL NATURAL FREQUENCY:

$$f_n = \frac{1}{2\pi} \sqrt{\frac{K_s}{J}}$$

$$K_s = \text{SPRING RATE OF PAWL RETURN SPRING} = \frac{\text{TORQUE (LB INS)}}{\text{DEFLECTION (RADIAN)}}$$

$$\frac{M}{T} = 3.38 \frac{\text{LB INS}}{\text{TURN}}, \text{ OR } 3.38 \frac{\text{LB INS}}{2\pi \text{ RAD.}}$$

$$K_s = \frac{3.38}{2\pi} = .538 \text{ LB INS/RAD}$$

$$f_n = \frac{1}{2\pi} \sqrt{\frac{.538}{.0000078}} = 41.80 \text{ Hz}$$

(OK, MIN. ACCEPTABLE = 20 Hz)

REVISED:

PAWL RETURN SPRING

$d = .039'' = \text{WIRE DIA}$
 $d^3 = .0000593, d^4 = .0000023$
 $D = .393'' = \text{MEAN DIA}$
 $N = 4.6 = \text{No. of Turns}$

$$\frac{M}{T} = \frac{E d^4}{10.2 D N} = \frac{\text{INCH LBS}}{\text{FULL TURN DEFL.}}$$

$$\frac{M}{T} = \frac{30 \times 10^6 \times 2.3 \times 10^{-6}}{10.2 \times .426 \times 4.7} = 3.38 \frac{\text{IN LBS}}{\text{TURN}}$$

By LAYOUT, WORKING DEFLECTION = .111 TURNS - .194 TURNS

$M = .375 \text{ TO } .486 \text{ IN}$

$$\text{BENDING STRESS} = \frac{32 M}{\pi d^3} = \frac{32 \times .486}{\pi \times 5.934 \times 10^{-5}} = 83,480 \text{ psi}$$

REVISED

APPENDIX III
CRITICAL SPEED ANALYSIS

SUMMARY

A cursory analysis of the Kaman designed HLH clutch (P-2087) indicates that its critical whirl speed is well above its proposed operating speed of 20,000 RPM.

DISCUSSION

A preliminary model of a HLH clutch is in the design stage and it was desired to ascertain if this design configuration would operate in the region of the critical whirl speed.

An analysis was performed utilizing an existing digital computer program (ZGIC). The clutch assembly was simulated by a series of 15 lumped masses. The structural inertia (EI) and mass moment of inertia (polar) were calculated for use in the program. Additional calculations were performed to determine the spring rate of the support bearing. The effect of spring rate and structural inertia on the whirl frequency was ascertained for various combinations. The results are listed in Table V, and it can be noted that the calculated speeds are well above the operating frequency of 20,000 RPM.

Table VI contains the physical characteristics calculated for the clutch assembly and are included for reference.

TABLE V. CRITICAL WHIRL SPEEDS FOR HLH CLUTCH			
CASE	SPRING RATE AT SUPPORTS	EI DISTRIBUTION	CRITICAL SPEED (RPM)
1	Infinite	Calculated	66,270
2	Calculated	Calculated	56,200
3	½ Calculated	Calculated	49,000
4	Twice Calculated	Calculated	60,900
5	Calculated	½ Calculated	43,080
6	Calculated	½ Calculated Between Supports	53,700

Operating RPM: 20,000

Calculated Spring Rate of Bearing: 5.4×10^6 lb/in.

See Table VI for Calculated EI Distribution.

TABLE VI. CALCULATED VALUES OF MASS,
EI AND MASS MOMENT OF INERTIA

GENERAL INFLUENCE COEF
12/66

HLH CLUTCH CHECK OF WHIRL FREQ CALCULATED SPRING RATE 5

OUT DATA STA. INS	EI	K LB/IN	C IN-LB/RAD	M SLIGS	I SLIG IN S ²
0.0	1.72650 06	0.0	0.0	8.78000-04	4.27700-05
2.530	1.72650 06	0.0	0.0	1.37000-03	7.09000-05
* 4.375	2.66150 06	5.40000 06	0.0	3.76000-04	2.23000-05
5.100	4.08160 08	0.0	0.0	1.69100-03	1.24430-03
5.500	3.40960 09	0.0	0.0	8.71000-03	1.31930-02
6.220	7.84000 08	0.0	0.0	5.19000-03	1.74600-03
6.900	5.33000 08	0.0	0.0	5.06000-03	1.74600-03
8.920	4.31000 08	0.0	0.0	1.17200-02	2.45000-03
10.950	6.91000 08	0.0	0.0	8.57800-03	3.70700-03
11.650	9.24000 09	0.0	0.0	1.50780-02	4.11790-02
12.240	5.74700 09	0.0	0.0	1.06720-02	7.12100-03
13.220	4.60000 09	0.0	0.0	3.51620-02	3.01410-02
15.370	2.67000 07	0.0	0.0	4.21300-03	6.58000-04
* 17.120	2.21600 06	5.40000 06	0.0	3.05600-04	1.41000-05
19.000	1.14800 06	0.0	0.0	8.32000-04	4.09000-05

* DENOTES $\frac{1}{2}$ OF SUPPORT BEARING

* MATERIAL STEEL E = 30X10⁶

**APPENDIX IV
RAW TEST DATA**

PMIC TEST RIG CHECK

1. OIL FLOW VS PRESS:

PRESS	FLOW @ 175°F	FLOW @ 200°F
	GPM	GPM
20	1.35	1.30
30	1.65	1.57
40	1.88	1.86
50	2.15	2.11
60	2.33	2.32
70	2.50	2.49
80	2.65	2.55

2. BASE LINE VIBRATION CHECK:

RPM	VERT.	HOB.	FORE & AFT	
1450	.0001	.0000	.0002	
2000	.00015	↑ ↓	.00025	
3000	.00022		.0003	
4000	.00025		.00075	
5000	.00036		.0003	
6000	.00043		.00058	
7000	.00068		.00026	
8000	.0016		.0012	
9000	.0009		.0014	
10000	.0007		.0010	
11000	.00055		.0005	
12000	.00045		.0000	.00055

REVISED:

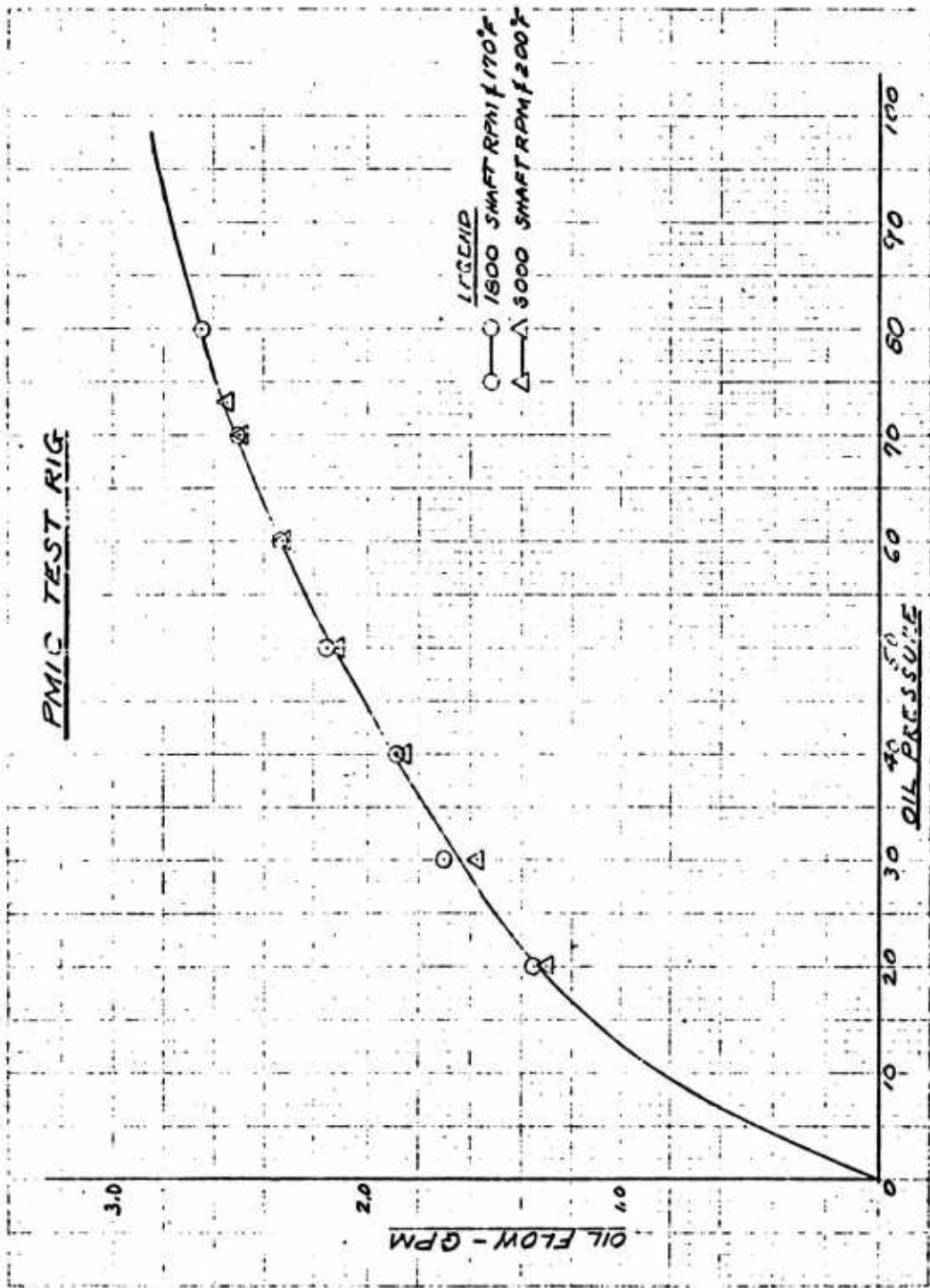

POSITIVE ENGAGEMENT CLUTCH
STATIC TEST DATA

					SHT 1
					Run No STRECH RUN
GAP A	TORQUE TO ENGAGE	APPLIED TORQUE LOAD	DIAL INDICATOR # 1	DIAL INDICATOR # 2	TORQUE TO TOOTH DISENGAGE CLICE
.2630		—	.880	.880	
.2645		2500	.860	.862	
.2669	60/80	10000	.791	.791	10 LB IN
.2685	LB IN	20000	.575	.545	
.2702		30000	.368	.420	
.2720		40000	.231	.305	
		0	.461	.534	

					Run No 1
GAP A	TORQUE TO ENGAGE	APPLIED TORQUE LOAD	DIAL INDICATOR # 1	DIAL INDICATOR # 2	TORQUE TO TOOTH DISENGAGE CLICE
.2490		—	.559	.643	
.2608		10000	.451	.535	
.2639		20000	.359	.445	
.2639		30000	.305	.391	
.2670	40 LB IN	40000	.230	.320	10 LB IN
.2650		0	.476	.567	

SOLDER
(SHT)
(SHT)
.0484
.0336

POSITIVE ENGAGEMENT CIRCUIT
STATIC TEST DATA

SHT 2
Run No 2

GAP A	TORQUE TO ENGAGE	APPLIED TORQUE LOAD	DIAL INDICATOR # 1	DIAL INDICATOR # 2	TORQUE TO TOOTH DISENGAGE CL'CE
.2670		0	.480	.580	
.2696		10000	.411	.511	
.2710		20000	.320	.424	
.2716		30000	.266	.372	
.2698	40 LB IN	40000	.230	.331	10 LB IN
.2664		0	.473	.573	

SOLDEN (TOOTH SPACE)
.0470

Run No 3

GAP A	TORQUE TO ENGAGE	APPLIED TORQUE LOAD	DIAL INDICATOR # 1	DIAL INDICATOR # 2	TORQUE TO TOOTH DISENGAGE CL'CE
.2666		—	.460	.560	
.2675		10000	.392	.495	
.2690		20000	.305	.407	
.2706		30000	.257	.355	
.2706	10 LB IN	40000	.203	.312	10 LB IN
.2700		0	.450	.550	

SOLDEN (TOOTH SPACE)
.046
.033

POSITIVE ENGAGEMENT CLUTCH

STATIC TEST DATA

SHT 3
Run No 4

GAP A	TORQUE TO ENGAGE	APPLIED TORQUE LOAD	DIAL INDICATOR # 1	DIAL INDICATOR # 2	TORQUE TO BOTH DISENGAGE CLIP
.2658		0	.470	.580	
.2660		10 000	.398	.515	
.2670		20 000	.310	.431	
.2680	70 LB IN	30 000	.254	.378	10 LB IN
.2708		40 000	.212	.337	
.2650		0	.450	.561	

SUCCESS (TORQUE SOURCE)

.046

.0326

Run No

GAP A	TORQUE TO ENGAGE	APPLIED TORQUE LOAD	DIAL INDICATOR # 1	DIAL INDICATOR # 2	TORQUE TO BOTH DISENGAGE CLIP

NO SYNCHRONIZER OR PAULS POSITIVE ENGAGEMENT CLUTCH TEST N12 C-461

TIME	OIL TEMP		ENG. TEMP		OIL FLOW		INPUT RPM	OUTPUT RPM	VENT	VIBRATION HOR	FOUR POINT	OIL PRESS
	IN	OUT	INPUT	OUTPUT	IN	OUT						
	TEST ENG. E. ROEHL		OPERATOR		ROOM TEMP 75°							
1045	160	160	165	175	57	2.25	2000	10500	.001	.0008	.0102	58
1050	165	177	170	179	53	2.25	4000	"	.001	.001	.0002	55
1055	168	169	168	180	53	2.25	4000	"	.001	.001	.0002	60
1100	174	174	175	180	53	2.25	8000	"	.0018	.0009	.0001	60
1105	175	175	178	186	53	2.25	10000	"	.0014	.0009	.0006	60
1110	175	185	181	185	53	2.25	10500	"	.0014	.0008	.001	58
1323	150	158	155	162	56.5	1.5	2000	"	.0015	.001	.0008	32
1329	152	162	155	168	56.5	1.5	4000	"	.0015	.001	.0008	30
1335	154	165	160	168	57.8	1.5	6000	"	.0013	.001	.0008	28
1340	155	165	162	171	57.8	1.5	8000	"	.0020	.001	.0008	30
1345	155	168	165	173	57.8	1.5	10000	"	.0015	.001	.0015	28
1350	156	168	168	175	57.8	1.5	10500	"	.0015	.001	.0015	28
1405	160	165	155	160	57.8	1.5	2000	"	.0010	.0007	.0005	11
1410	159	168	165	173	57.8	1.5	4000	"	.0009	.0009	.0003	8
1415	158	167	164	172	57.8	1.5	6000	"	.001	.0007	.0003	6
1420	155	163	161	168	57.8	1.5	8000	"	.0018	.0009	.0002	6
1425	153	160	160	166	57.8	1.5	10000	"	.0019	.0013	.0003	7
1430	151	158	158	166	57.8	1.5	10500	"	.001	.001	.0003	10

TEST TIME		SPURR		OIL TEMP		BKG. TEMP		OPERATOR		BEDROD		ROOM TEMP		DATE 1-26-73		SHT. 2	
TIME	IN	OUT	IN	OUT	IN	OUT	IN	OUT				VENT	HOR	VERT	FOUR	SEPT	OIL PRESS
1230	155	150	—	—	—	—	.75	0/1050	10,500								13.0
1355	158	155	—	—	—	—	2.25	0/8750	10,500								01.0
	ACCELERATION RUNS - INPUT RELEASED & ALLOWED TO ACCELERATE IN RESPONSE TO INTERNAL DRAG. TAKE HISTORY OF INPUT RPM WAS RECORDED.																
	MEASUREMENT OF DRAG REQ'D TO HOLD INPUT STATIONARY.																
160°F	13.5	W LBS	1.5	0	10,500												35
160	14.0	" "	2.25	0	10,500												62
155	8.5	" "	.75	0	10,500												12

COMPLETE CLUTCH POSITIVE ENGAGEMENT CLUTCH TEST N2 C-461

TIME	OIL TEMP		ROOM TEMP		VARIATION HOR	FOUR FACT	OIL PRESS
	IN	OUT	IN	OUT			
1252	202	210	200	215	.0013	.0001	53
1302	192	203	200	187	.0013	.0001	53
1308	197	203	198	192	.0013	.0001	57
1313	193	198	198	167	.0013	.0001	57
1323	205	212	210	215	.0012	.0001	58
1328	203	215	212	212	.0014	.0001	58
1330	BLEW CIRCUIT BREAKER ON #1 VARI. DRIVE. THIS BROKEN ON PAUL'S DISASSEMBLY REVEALED STAINING						

COMPLETE CLUTCH POSITIVE ENGAGEMENT CLUTCH										TEST N2 C-461	
TEST EJS.		SPURR		OPERATOR BEDFORD		ROOM TEMP 70°F		DATE 2-2-73		SHT. 4	
TIME	OIL TEMP		Eng. TEMP		OIL FLOW	INPUT RPM	OUTPUT RPM	VIBRATION		FASE	OIL PRESS
	IN	OUT	INPUT	OUTPUT				VERT	HQA		
1020	195	195	145	155	2.25	0	10 400	.0012	.0012	.0001	18.0
1027	208	210	192	200	2.25	2000	10 520	.0012	.0012	.0001	46.0
1033	204	209	205	205	2.25	4000	10 500	.0012	.0012	.0001	42.0
1037	203	208	203	207	2.25	6000	10 500	.0012	.001	.0001	42.0
1039		SHUT	DOWN								
1103	198	204	187	193	2.25	2000	10 500	.0011	.0009	.0008	44
1108	197	204	188	193	2.25	2000	10 500	.0011	.0009	.0008	45
1223		SHUT	DOWN								
1228	202	204	205	206	2.25	2000	10 500	.0011	.0009	.0009	45
1233	202	211	205	206	2.25	2000	10 500	.0011	.0009	.0009	45
1238	202	210	200	200	2.00	2000	10 500	.0011	.0009	.0009	32
1243	199	209	204	204	2.00	2000	10 500	.0011	.0009	.0009	32
1248	197	207	199	199	1.50	2000	10 500	.0011	.0009	.0009	22
1253	195	205	198	200	1.50	2000	10 500	.0011	.0009	.0009	22
1258	193	203	193	193	1.20	2000	10 500	.0011	.0009	.0009	13.5
1303	191	199	192	192	1.20	2000	10 500	.0011	.0009	.0009	13.5
1308	192	198	192	192	1.20	2000	10 500	.0011	.0009	.0009	14.0
1313	190	195	192	193	.75	2000	10 500	.0011	.0009	.0009	7.0
1318	200	203	194	199	.75	2000	10 500	.0011	.0009	.0009	7.0
		SHUT	DOWN								
			No ERATIC NOISE OBSERVED								

ZIG MEASUREMENTS POSITIVE ENGAGEMENT CLUTCH COMPRESS CLUTCH TEST N12 C-461

TIME	OIL TEMP		TORQUE HOLD		BKG. TEMP		OPERATOR		BEDFORD		ROOM TEMP 72°F			OIL PRESS
	IN	OUT	IN LB	OUT LB	IN LB	OUT LB	OIL FLOW	INPUT RPM	OUTPUT RPM	VERT	HOR	FASE	SAFT	
0930	190°F		3				2.25	0	2000					
			6				"	0	4000					
			8				"	0	6000					
0937	STOP		18				"	0	10350					
0952	190°F		2.5	11 LB			1.75	0	2900					
			5.5	"			"	0	4000					
			9.0	"			"	0	6000					
			11.5	"			"	0	8000					
0957	STOP		12.5	"			"	0	10500					
				ON SHUT DOWN			CLUTCH WOULD NOT OVERRUN.							FOUND 5 FASE SPRINGS BROKEN

POSITIVE ENGAGEMENT CLUTCH										TEST N ^o C-461		
TIME	TEST EJC.		SPARKS		OPERATOR		BEDFORD		ROOM TEMP		DATE	SHT.
	OIL IN	OIL OUT	IN	OUT	IN	OUT	IN	OUT	VERT	HOR	2-20	6
			Avg. Temp		OIL FLOW		INPUT RPM	OUTPUT RPM	VIBRATION		OIL PRESS	
			INPUT	OUTPUT	INPUT	OUTPUT			VERT	HOR	DATE	NO
			CLUTCH WITH NEW SPRINGS (SK 23-26)		NEW SPRINGS (SK 23-26)				PINKS (SK 23-25)			
10.57			6.5	IN 13	1.5		0	1464				
			6.5	" "	1.5		0	2000				
			8.0	" "	1.5		0	4500				
			14.0	" "	1.5		0	6000				
			18.5	" "	1.5		0	8000				
			15.5	" "	1.5		0	10,500				
11.00			TEAR DOWN REVEALED		5 BROKEN SPRINGS							

SINGLE PAWL SETUP		POSITIVE ENGAGEMENT CLUTCH				TEST NO. C-461					
TIME	OIL TEMP		ENG. TEMP		OIL FLOW	INPUT RPM	OUTPUT RPM	ROOM TEMP		DATE 5-2-73	SHT. 7
	IN	OUT	INPUT	OUTPUT				VERT	HORIZ		
1004	DETERMINE PAWL PLANNING.				.225	V5 OIL 0	FLOW 1833	(PLANNING JUST BEGINS)			
					.420	0	1750				
					.900	0	1500				
						0	1250	NO PLANNING			
1010	START ENDURANCE				.4	0	1250				
1045	STOP TEST. SHEARED STOP PIN										

FULL CLUTCH.		POSITIVE ENGAGEMENT CLUTCH								TEST NO. C-461	
TEST ENG. SPURER		ROOM TEMP		OPERATOR WASHBURN		DATE 5-29-73		SHT. 8			
TIME	OIL TEMP		BEG. TEMP		OIL FLOW	INVT RPM	OUTVT RPM	VIBRATION		OIL PRESS	
	IN	OUT	INVT	OUTVT				VERT	HOR		PMSE
12:15			ATTEMPT 2HR		1.5	0	2200	ONSET OF PAWL RATCHING		20	
12:27					1.5	0	10700			20	
12:40	82°F	115°F	95°F	130°F	1.0	0	10700			13	
13:00	110	143	135	150	1.0	0	10700			13	
13:15	135	160	155	164	"	"	"			12	
13:30	150	175	170	177	"	"	"			11	
13:45	160	188	182	188	"	"	"			10	
14:00	155	190	190	190	"	"	"			10	
14:15	173	196	196	196	"	"	"			10	
			COMPLETE - O.K.								
			RUN								
			NORMAL								
			SHUT DOWN								

FULL CLUTCH										POSITIVE ENGAGEMENT CLUTCH									
TEST ENG. SPURR					OPERATOR WASHBURN					ROOM TEMP					DATE 6-1-72 SMT. 9				
TIME	OIL TEMP		ENG. TEMP		OIL FLOW	INPUT RPM	OUTPUT RPM	VIBRATION		OIL PRES									
	IN	OUT	INPUT	OUTPUT				VERT	HOR										
8:45	95°F	85°F	95°F	110°F	1.0	6000	10500			13									
9:00	90°F	110	112	130	"	"	"			"									
9:15	105	125	125	140	"	"	"			"									
9:30	115	130	130	145	"	"	"			"									
9:45	125	138	138	152	"	"	"			"									
10:00	150	143	144	155	"	"	"			"									
10:15	133	145	148	157	"	"	"			"									
10:30	136	149	150	160	"	"	"			"									
10:45	159	150	150	162	"	"	"			"									
CHECK ON SET OF PLANNING										NORMAL SHUT DOWN - ALL O.K.									
	107°F				1.0	0	2324			13									
	"				.9	0	2848			9									
	"				.5	0	3500			5.5									
	"				.5	0	3000			5.5									
	"				.42	0	4000			5.0									
	190°F				.41	0	3000			4.5									
	"				.3	0	3500			3.5									