

20030225012

AD-A252 961
[Barcode]

ESL-TR-89-39
VOL III - PART 3

C

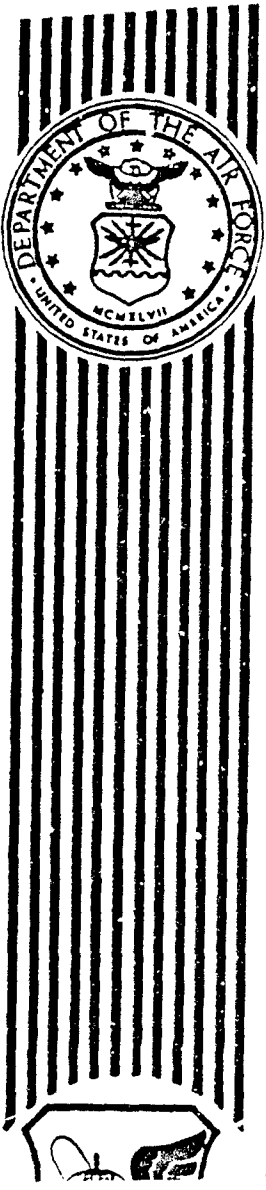

**FULL-SCALE INCINERATION SYSTEM
DEMONSTRATION VERIFICATION TEST
BURNS AT THE NAVAL BATTALION CON-
STRUCTION CENTER, GULFPORT, MIS-
SISSIPPI - VOL III: TREATABILITY TESTS
PART 3**

D. J. HALEY, R. W. THOMAS, D. B. DERRINGTON, JR.

EG&G IDAHO, INC.
P. O. BOX 1625
IDAHO FALLS ID 83415

JULY 1991

FINAL REPORT

SEPTEMBER 1986 - FEBRUARY 1989

APPROVED FOR PUBLIC RELEASE: DISTRIBUTION
UNLIMITED

DTIC
ELECTE
S. D
JUL 15 1992

[Barcode]
92-18819
[Barcode]

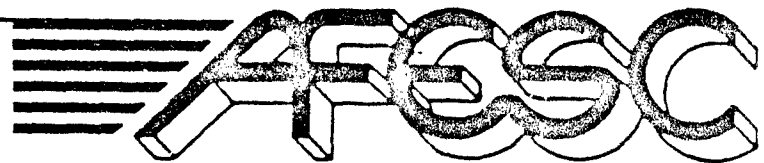

AIR FORCE ENGINEERING & SERVICES CENTER
ENGINEERING & SERVICES LABORATORY
TYNDALL AIR FORCE BASE, FLORIDA 32403

NOTICE

The following commercial products (requiring Trademark®) are mentioned in this report. If it becomes necessary to reproduce any segment of this document containing any of these names, this notice must be included as part of that reproduction.

Eagle One®
Lotus®
Ziploc®

XAD®
Molylub®
Gunnite®

PROMIS®

Mention of the products listed above does not constitute Air Force or EG&G, Idaho, Inc. endorsement or rejection of this product, and use of information contained herein for advertising purposes without obtaining clearance according to existing contractual agreement is prohibited.

DISCLAIMER

This book was prepared as an account of work sponsored by an agency of the United States Government. Neither the United States Government nor any agency thereof, nor any of their employees, makes any warranty, express or implied, or assumes any legal liability or responsibility for the accuracy, completeness, or usefulness of any information, apparatus, product or process disclosed, or represents that its use would not infringe privately owned rights. References herein to any specific commercial product, process, or service by trade name, trademark, manufacturer, or otherwise, does not necessarily constitute or imply its endorsement, recommendation, or favoring by the United States Government or any agency thereof. The views and opinions of authors expressed herein do not necessarily state or reflect those of the United States Government or any agency thereof.

DISCLAIMER NOTICE

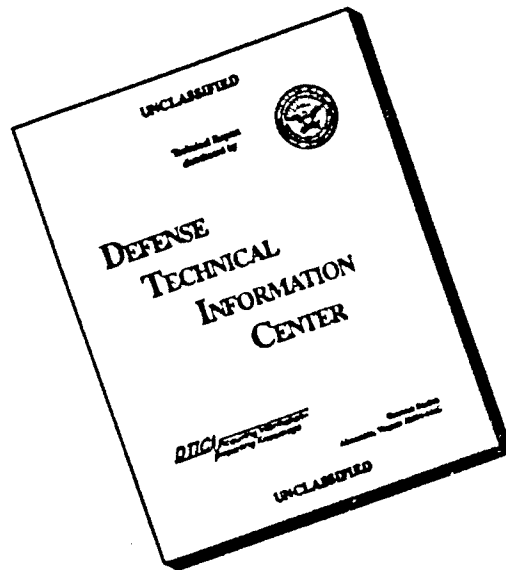

THIS DOCUMENT IS BEST QUALITY AVAILABLE. THE COPY FURNISHED TO DTIC CONTAINED A SIGNIFICANT NUMBER OF PAGES WHICH DO NOT REPRODUCE LEGIBLY.

UNCLASSIFIED

SECURITY CLASSIFICATION OF THIS PAGE

REPORT DOCUMENTATION PAGE				Form Approved OMB No. 0704-0188	
1a. REPORT SECURITY CLASSIFICATION			1b. RESTRICTIVE MARKINGS		
2a. SECURITY CLASSIFICATION AUTHORITY		3. DISTRIBUTION/AVAILABILITY OF REPORT			
2b. DECLASSIFICATION/DOWNGRADING SCHEDULE		Approved for Public Release Distribution Unlimited			
4. PERFORMING ORGANIZATION REPORT NUMBER(S)			5. MONITORING ORGANIZATION REPORT NUMBER(S)		
			ESL-TR-89-39, Vol III - Part 3		
6a. NAME OF PERFORMING ORGANIZATION		6b. OFFICE SYMBOL (if applicable)	7a. NAME OF MONITORING ORGANIZATION		
EG&G Idaho, Inc.					
6c. ADDRESS (City, State, and ZIP Code)			7b. ADDRESS (City, State, and ZIP Code)		
P. O. Box 1625 Idaho Falls, ID 83415					
8a. NAME OF FUNDING SPONSORING ORGANIZATION		8b. OFFICE SYMBOL (if applicable)	9. PROCUREMENT INSTRUMENT IDENTIFICATION NUMBER		
HQ AFESC		RDVW			
8c. ADDRESS (City, State, and ZIP Code)			10. SOURCE OF FUNDING NUMBERS		
HQ AFESC/RDVW Tyndall AFB FL 32403-6001			PROGRAM ELEMENT NO	PROJECT NO.	TASK NO.
					OFFICE UNIT ACCESSION NO
11. TITLE (Include Security Classification)					
Full-Scale Incineration System Demonstration Verification Test Burns at the Naval Battalion Construction Center, Gulfport, Mississippi: Treatability Tests, Part 3					
12. PERSONAL AUTHOR(S)					
D.J. Haley, R.W. Thomas, D.B. Derrington, Jr.					
13a. TYPE OF REPORT		13b. TIME COVERED		14. DATE OF REPORT (Year, Month, Day)	15. PAGE COUNT
Final		FROM Sep 86 TO Dec 86		July 1991	252
16. SUPPLEMENTARY NOTES					
COSATI CODES			18. SUBJECT TERMS (Continue on reverse if necessary and identify by block number)		
FIELD	GROUP	SUB GROUP	Herbicide Orange		
			Dioxin		
			Incineration		
19. ABSTRACT (Continue on reverse if necessary and identify by block number)					
This technical report is divided into eight volumes. This portion of the report comprises Volume II, which is further subdivided into 5 parts, including the appendixes. This volume describes the verification test burns conducted on a 100 ton/day mobile incinerator that was used to process soil contamination with the constituents of Herbicide Orange, namely 2,4,5-T, 2,4-D, and trace quantities of dioxin. The demonstration was conducted at the Naval Construction Battalion Center in Gulfport, Mississippi. This volume provides specific details concerning the planning efforts and data results from the test burns. Project managers and field engineers responsible for planning and implementation of hazardous waste remedial actions should find the information contained herein very useful.					
20. DISTRIBUTION/AVAILABILITY OF ABSTRACT			21. ABSTRACT SECURITY CLASSIFICATION		
<input checked="" type="checkbox"/> UNCLASSIFIED/UNLIMITED <input type="checkbox"/> SAME AS RPT <input type="checkbox"/> DTIC USERS			Unclassified		
22a. NAME OF RESPONSIBLE INDIVIDUAL			22b. TELEPHONE (Include Area Code)	22c. OFFICE SYMBOL	
MICHAEL L. SHELLEY, Major, USAF			(904) 283-6009	BDV	

DD Form 1473, JUN 86

Previous editions are obsolete

SECURITY CLASSIFICATION OF THIS PAGE

(The reverse of this page is blank.)

PREFACE

This report was prepared by EG&G Idaho, Inc., P. O. Box 1625, Idaho Falls, ID 83415, under Job Order Number (JON) 2103 9027, for the Air Force Engineering and Services Center, Engineering and Services Laboratory, Tyndall Air Force Base, Florida 32403-6001.

This report summarizes work done between September 1986 and December 1986. Major Terry Stoddart and Major Michael L. Shelley were the AFESC/RDVS Project Officers.

The information contained in this volume describes the events, the planning efforts, and the data results of a test burn conducted on a 100 ton/day mobile incinerator that was used to process soil contaminated with constituents of herbicide orange. This volume is subdivided into five parts; Part 1 contains the final report on the verification test burns, Parts 2 through 5 contain the appendixes. Volumes I and III through VIII describe the incinerator operations, the soil excavation activities, and the additional testing required by the Environmental Protection Agency.

This report has been reviewed by the Public Affairs Office (PA) and is releasable to the general public, including foreign nationals.

This report has been reviewed and is approved for publication.

MICHAEL L. SHELLEY, Maj, USAF, BSC
Chief, Environmental Actions R&D

FRANK P. GALLAGHER III, Col, USAF
Director, Engineering and Services
Laboratory

NEIL J. LAMB, Lt Col, USAF, BSC
Chief, Environics Division

LIST OF APPENDIXES

Appendix	Title	Page
K	VERSAR'S SAMPLING PLAN FOR MWP-2000 VERIFICATION TEST BURNS AT NCBC.....	495
L	ANALYSIS RESULTS FOR WATER SAMPLES FROM NCBC WATER SUPPLY WELLS.	601
M	PLOTS OF SIGNIFICANT INCINERATOR OPERATING PARAMETERS DURING DAYS OF TEST BURNS.....	605
N	ENSCO HEALTH AND SAFETY DATA REPORT FOR THE NCBC VERIFICATION TEST BURN OPERATION.....	633
O	CONSTRUCTION SITE CERTIFICATION.....	639
P	MODIFIED METHOD 5 AND VOST STACK SAMPLING FIELD TEST DATA FOR MWP-2000 INCINERATOR SYSTEM VERIFICATION TEST BURNS AT NCBC.....	645
Q	ITAS STANDARD OPERATING PROCEDURES FOR DIOXIN AND FURAN ANALYSIS.....	697
R	U.S. EPA CLP REQUIRED DETECTION LIMITS.....	733
S	NARRATIVE AND SIGNIFICANT DATA SHEETS FROM ITAS DIOXIN/FURAN ANALYTICAL REPORT.....	737

Accession For	
NTIS GRA&I	<input checked="" type="checkbox"/>
DTIC TAB	<input type="checkbox"/>
Unannounced	<input type="checkbox"/>
Justification	
By _____	
Distribution/	
Availability Codes	
Dist	Avail and/or Special
A-1	

v
(The reverse of this page is blank.)



APPENDIX K

VERSAR'S SAMPLING PLAN FOR MWP-2000
VERIFICATION TEST BURNS AT NCBC

The document contained in this appendix is the detailed sampling plan used during the verification test burn conducted at NCBC. This document was reproduced from the best available copy. Due to poor original legibility, the legibility of the microfiche editions is also poor. Persons requiring the information contained in this appendix may write to the technical libraries listed below to obtain photocopied versions of the appendix. A nominal charge will be levied to cover reproduction and archival costs. Please be prepared to provide the following information:

Report Title: Full-Scale Incineration System Demonstration
Verification Test Burns at the Naval Construction
Battalion Center, Gulfport, Mississippi:
Treatability Tests

Report Number: ELS-TR-88-61, Volume: II, Part: 3, Appendix: K

Send inquiries to: Technical Library
Engineering and Services Laboratory
Tyndall Air Force Base, FL 32403

or Technical Library
Idaho National Engineering Laboratory
EG&G Idaho, Inc.
P.O. Box 1625
Idaho Falls, ID 83415-2300

The documents contained in this appendix were published according to their own internal style, which deviates from the Air Force Engineering Services Center format. They have, therefore, been published without editing.

SAMPLING PLAN
VERIFICATION BURN SAMPLING OF ENSCO'S MWP-2000 INCINERATOR
DURING THE TREATMENT OF SOIL CONTAINING
2,3,7,8-TCDD AT NCBC GULFPORT, MS

Prepared For:

EG&G Idaho Inc.
1955 Fremont Avenue
Idaho Falls, Idaho 83415

Prepared By:

Versar Inc.
6850 Versar Center
Springfield, Virginia 22151

November 7, 1986

TABLE OF CONTENTS

Section	Page
1. Introduction	1
2. Facility Description	2
3. Sampling Approach	5
3.1 Sampling Locations	5
3.2 Sampling Collection Procedures	5
3.3 Sample Frequency and Schedule	9
3.4 Sample Containerization, Preservation, and Holding Times	9
3.5 Sample Tracking and Management	11
3.6 Field Blanks	11
3.7 Sample Shipment	14
4. Air Monitoring	15
4.1 Introduction	15
4.2 Soil Excavation Activities	15
4.3 Incinerator Operation	16
4.4 Analysis	17
5. Safety Considerations During Sampling	18
REFERENCES	19
Attachment I: Quality Assurance Project Plan	
Attachment II: EG&G RFP for Analysis of Samples	
Attachment III: Description of Model PS-1 PUF Sampler	

LIST OF TABLES

Table 3-1 Sampling Frequency and Schedule	10
---	----

LIST OF FIGURES

Figure 2-1 Schematic Flow Diagram of MNP-2000	3
Figure 3-1 Sampling Locations for ENSCO MWP-2000 Incinerator	6
Figure 3-2 Versar Sample Label	12
Figure 3-3 Versar Chain of Custody Form	13

1. INTRODUCTION

During the week of November 17, 1986, 2,3,7,8-TCDD contaminated soil will be treated in ENSCO's MWP-2000 incinerator which will be located onsite at the Naval Construction Battalion Center (NCBC) in Gulfport, MS. The verification burn will consist of five separate tests, which will be performed over a period of approximately three days. Test one will be performed at a soil feed rate of three tons per hour during the first day of testing. Tests two and three, which will be performed during the second day of testing, will be performed at a soil feed rate of 4 tons per hour and the final two tests will be performed on day three at a soil feed rate of 5 tons per hour.

The results of ENSCO's verification burn will be characterized through samples obtained by Versar Inc. which will be analyzed by an independent laboratory. This sampling plan describes the samples to be taken, their location, collection method and frequency of collection.

Before sampling is initiated, the incinerator will be operated for a length of time necessary to establish steady state operating conditions. Steady state conditions are presented in the verification burn plan.

The sections that follow describe the incinerator to be sampled, the sampling approach, and the safety precautions to be exercised during sample collection and analysis.

2. FACILITY DESCRIPTION

The incinerator to be sampled is ENSCO's Mobil Waste Processor-2000 unit, which is a transportable rotary kiln incinerator. Figure 2.1 is a schematic flow diagram of the MWP-2000. The unit consists of a soil preparation and handling system, a rotary kiln, a secondary combustion chamber, and an air pollution control system.

After the soil has been excavated, it will be placed in soil handling bins which have a capacity of approximately 20 cubic yards. The soil is then transferred, as required, to the soil feed conveyor which feeds the soil hopper. An in-line weight scale is used to determine the quantity of soil fed to the system.

The soil is then fed to the kiln where it is exposed to temperatures in the near 1700°F range. Combustion of natural gas is used to maintain the temperature in the kiln. The soil and exhaust gases exit from the kiln and the treated soil falls into the ash sump. An ash drag is used to remove the soil from the ash sump and transport it to an ash bin.

As the exhaust gases exit the kiln, they pass through a cyclone for the removal of fine particulate and are then introduced into the secondary combustion chamber where the temperature of the gas is raised to nominally 2200°F. The gas enters a waste heat boiler downstream of the secondary combustion chamber where steam is generated for use in the facility.

Prior to entering a scrubber, the gas is water quenched to reduce the temperature of the gases so that the fiberglass reinforced plastic (RFP) scrubber is not damaged. The scrubber uses water as a scrubbing media to remove any fine particulate and acid gases that may be present. The gas then exists the process through a demister and on through the stack.

A detailed description of the operating parameters for the incinerator is contained in the Verification Burn Plan.

3. SAMPLING APPROACH

3.1 Sampling Locations

To evaluate the effectiveness of ENSCO's incinerator for treating soil containing 2,3,7,8-TCDD and other chlorinated organics, Versar will collect the following samples:

- Feedstock soil (untreated soil)
- Treated soil
- Stack gas
- Neutralization tank (after carbon adsorption)
- Boiler water blowdown
- Blanks

Feedstock soil samples will be obtained from the conveyor before the soil is transferred to the hopper. The treated soil sample will be obtained at the exit of the rotary kiln (see Figure 3.1). The treated soil will be sampled before it drops into the ash drag sump. Stack gas samples will be obtained on the stack via two 4 inch flanges which are located 90° apart approximately 6 feet before the top of the stack. The stack is constructed of fiberglass reinforced plastic and is 36 inches in diameter. The boiler blowdown sample will be obtained from a sample port located on the waste heat boiler. The neutralization tank sample will be obtained from a sample tap immediately after the water exits carbon adsorption. The blank water sample will be obtained from a supply water tap.

3.2 Sampling Collection Procedures

3.2.1 Feedstock Soil

Samples of feedstock soil will be collected from the conveyor as the soil is transferred to the hopper. Grab samples will be obtained every

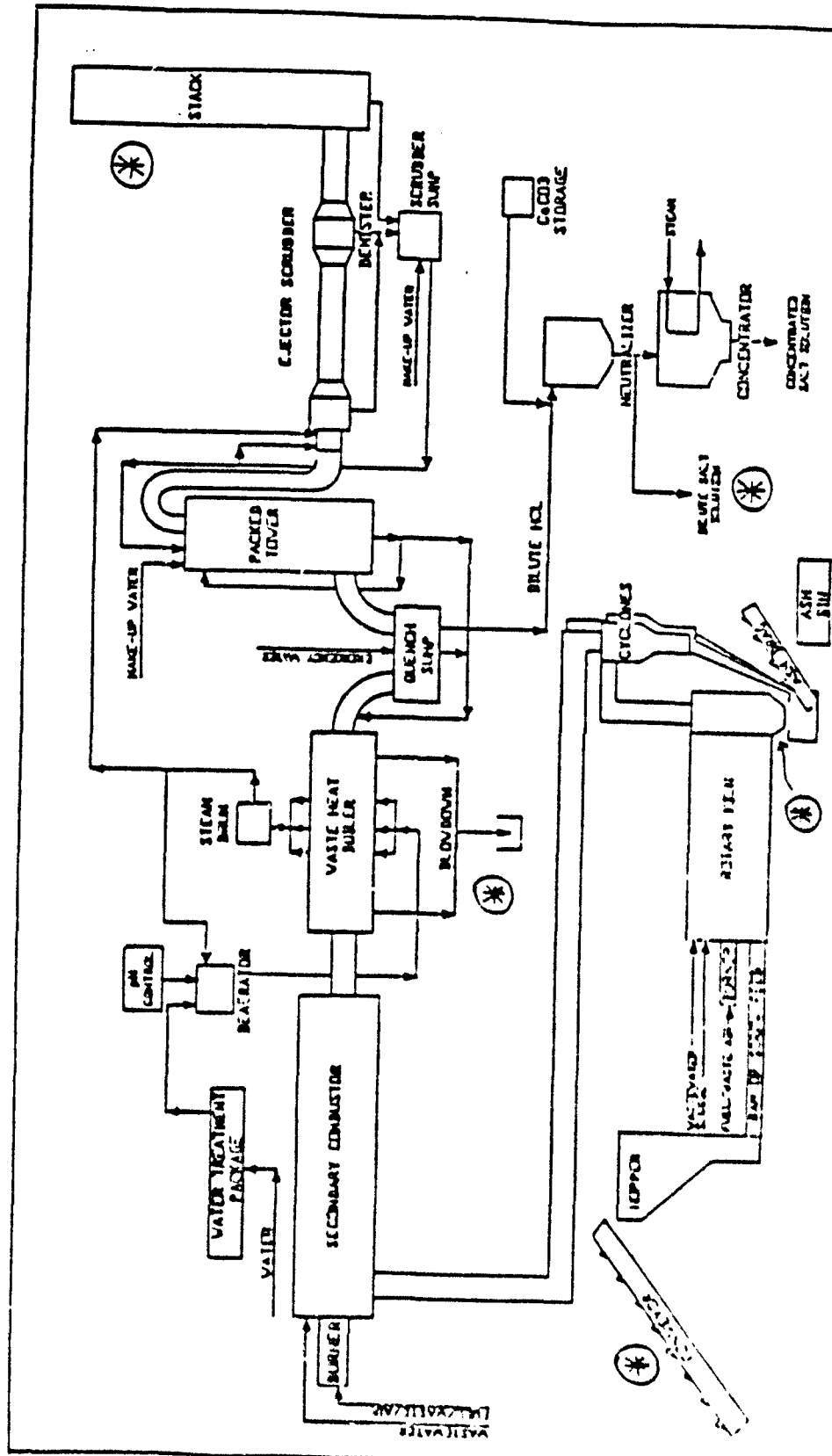

Sampling Locations for FNSD Inclinorator

Figure 3.1

A - Sampling Locations

30 minutes during the test, starting about 20 to 30 minutes (depending on soil feed rate) prior to initiation of the test (to take into account the residence time of the soil in the hopper). A representative composite sample will be prepared by homogenizing equal portions of each grab sample taken. Individual grab samples will also be used for analysis so that variability (i.e., homogeneity of sample) can be established. Collected samples will be placed in clean aluminum trays, composited if necessary, mixed, and put in appropriate sample jars.

3.2.2 Treated Soil

Grab samples of the treated soil will be obtained using a 1 inch diameter pipe to draw samples of the soil as it exits the kiln, but before it falls into the ash drag sump. Sample collection will begin 30 to 60 minutes (depending on soil feed rate) after the test has begun. A representative composite sample will be prepared by homogenizing the grab samples taken after they have been allowed to cool. Individual grab samples will also be used for analysis so that variability (i.e., homogeneity of sample) can be established. Collected samples will be placed in clean aluminum trays, composited if necessary, mixed, and put in appropriate sample jars.

3.2.3 Stack Gas

Stack gas samples will be obtained using an EPA Modified Method 5 and VOST stack gas sampling trains. The standard operating procedures, quality assurance activities, and data reporting elements for the MM5 and VOST test are clearly defined in the Quality Assurance Project Plan which is contained in Attachment I.

3.2.4 Boiler Blowdown

Boiler blowdown samples will be obtained via a sample port located on the waste heat boiler. Prior to sample collection, the port will be emptied of any potentially stagnate liquid. Each equal volume grab sample will be obtained by partially filling a glass beaker in which the samples will be composited. At all times, the beaker will be covered with clean aluminum foil to prevent cross contamination. After the last grab sample has been obtained, the sample bottle will be filled and sealed.

3.2.5 Neutralization Tank

Neutralization tank samples will be collected via a sample port located immediately after carbon adsorption treatment but before the POTW holding tanks. Prior to sample collection the port will be emptied of any potentially stagnate liquid. Equal volumes of each grab sample will be obtained by partially filling a glass beaker in which the samples will be composited. At all times, the beaker will be covered with clean aluminum foil to prevent cross contamination. After the last grab sample has been obtained, a sample bottle will be filled and sealed.

3.2.6 Blank

A background water sample will be obtained from a water tap used to provide feed water to incinerator operations. The individual sample bottles will be filled directly from the water tap in the field. The protocol for obtaining the blank gas sample is detailed in the QAPP.

3.3 Sampling Frequency and Schedule

The frequency of sample collection and the anticipated schedule is summarized in Table 3.1. Feedstock soil samples will be collected from the conveyor before the soil is transferred into the hopper. Grab samples will be obtained every 30 minutes beginning approximately 30 to 50 minutes prior to initiation of the test. The sampling delay will depend on the feed rate of the soil. This will account for the residence time of the soil in the hopper/screw feeder before it enters the kiln. Soil sampling will be performed over a three hour period for each test.

Treated soil sample aliquots will be obtained every 30 minutes so that individual grab samples and a composite sample can be obtained for each test. Depending on the feed rate of the soil, the sampling will be delayed after the beginning of the test.

Boiler blowdown and neutralization tank samples will be taken by collecting equal volume sample aliquots at the beginning, middle (i.e., 90 minutes after the test has started), and end of the test and composited to form a single sample. The blank water sample will be obtained prior to the tests.

3.4 Sample Containerization, Preservation, and Holding Times

All samples collected will be placed in containers and preserved (with ice or "blue ice") and will be analyzed within the time constraints consistent with procedures as summarized in EPA 600/4-79-020 Methods For Chemical Analysis of Water and Wastes (March 1983 Version) or as

0244F

Table 3.1 Sampling Frequency and Schedule

Sample Description	Sample Type	Number of Samples	Frequency
Feedstock soil	grab	30	6 per test
	composite grab	5	1 per test
Treated soil	grab	30	6 per test
	composite grab	5	1 per test
Stack gas	VOST ¹	15	1 for each test
	Modified Method 5 ¹	30	1 for each test
Boiler blowdown	composite grab	5	1 per test
Neutralization tank	composite grab	5	1 per test
Blank	-	as required	as required

¹Each HNS train will produce the following samples: 1) filter, 2) XAD module, 3) probe rinse, 4) back half/coil rinse, 5) condensate, and 6) impinger solution. Each VOST will produce the following samples: 1) Tenax #1, 2) condensate, and 3) Tenax/charcoal #2.

indicated in specific SW-846 Analytical Methods. The specific method and number of blanks are defined in Attachment II which is the request for proposal for the laboratory that will perform all analyses on samples.

3.5 Sample Tracking and Management

All sample containers will be labelled with the upper portion of Versar's standard 3 part label (see Figure 3.2). The duplicate label will be affixed to containers in which the sample jars are packaged. The lower portion of the sample label will be placed into the field log book as a cross check mechanism on sample identification. All samples will be tracked using Versar's standard chain of custody form (see Figure 3.3). Custody of the samples will begin at the time of sample collection and will be maintained by the sampling team supervisor until samples are relinquished for shipment to the laboratory performing the final analysis.

3.6 Field Blank

Selected parameter bottles will be filled with HPLC grade water and preserved in accordance with outlined procedures at a location near the treatment facility where the actual field samples are prepared. These samples will be submitted to the laboratory along with the final batch of field samples for analysis. The field blank samples will serve to document any contamination caused by the site conditions. Blank sample and required sample splits will be performed as is required in Attachment II.

3.7 Sample Shipment

All samples collected at the facility and shipped to the laboratory will be packaged and shipped in accordance with applicable DOT regulations. All shipments to the laboratory will be via Federal Express in order to meet time constraints.

4. AIR MONITORING

4.1 Introduction

Ambient air sampling during all activities associated with ENSCO's test burn will be performed using model PS-1 PUF samplers (see Attachment III for a detailed description of the PS-1 ambient air sampler). These monitors are capable of detecting both fugitive particulate matter and organic vapors. As is described in Attachment III, these samplers are equipped with a dual chamber sampling module which contains both filtering systems. The upper chamber supports the airborne particulate filter media in a 4 inch circular filter holder. The lower chamber encapsulates a glass cartridge which contains PolyUrethane Foam (PUF) for vapor entrapment. During sampling, a flow rate of 6-10 cfm will be maintained.

4.2 Soil Excavation Activities

Ambient air monitoring will be performed during all soil excavation activities. Three particulate samples will be taken with monitors at the following locations:

- One monitor located directly upwind, offsite from excavation activities.
- One monitor located onsite, approximately 75 feet downwind from excavation activities.
- One monitor located offsite, directly downwind from excavation activities.

Samples will be obtained daily using all three monitors. As a background sample, the onsite monitor will be ran for a length of time equal to the sampling time during the activity (i.e., at the end of each day, the onsite monitor will be reloaded and begin running for a length of time equal to the length of that day's operation). Therefore, for each day of excavation, a total of four particulate samples will be obtained. The placement of each monitor will be reviewed before each day's activities by checking wind direction and verifying soil excavation location. Wind direction will be checked at least every two hours to ensure that the monitors are properly located. If the monitor's location is not within $\pm 30^\circ$ of the wind direction, the monitor will be relocated.

During one day's activity during soil excavation, a personnel monitor will be attached to one of the personnel most likely to experience exposure to airborne particulate resulting from excavation activities.

4.3 Incinerator Operation

The placement and operation of ambient air monitors during incineration activities will be much the same as during soil excavation activities. The primary difference will be that the ambient air monitor will be equipped to collect both particulate and organic vapors. Three samples will be taken with monitors at the following locations:

- One monitor located directly upwind, offsite from incineration operations.
- One monitor located onsite, approximately 75 feet from incinerator operations.
- One monitor located offsite, directly downwind from incineration operations.

Samples will be obtained during each test using all three monitors. As a background sample, the onsite monitor will be ran for a length of time equal to the sampling time during each test. Therefore, for each test, a total of four particulate and organic vapor samples will be obtained. The placement of each monitor will be reviewed before each day's tests by checking wind direction with respect to the location of the incinerator.

During one day's activity during incineration, a personnel monitor will be attached to one of the personnel most likely to experience exposure to airborne particulate or vapor.

4.4 Analysis

Analysis of both particulate and vapor samples collected by ambient air monitors and personnel samplers will be performed using the appropriate method as is described in Attachment II.

5. SAFETY CONSIDERATIONS DURING SAMPLING ACTIVITIES

Versar personnel will strictly follow all of the safety procedures in effect at NCBC. All Versar field personnel will be equipped with hard hats, safety shoes, safety glasses, chemical goggles, long sleeve coveralls, and gloves. While sampling activities are being performed in exclusion areas, all personnel will be equipped with Level "C" personnel protection. Field team personnel will not smoke, consume food or carry any ignition sources while onsite except in areas designated suitable for such purposes. Field personnel will not operate any valves or switches, unless under the direct supervision of ENSCO or EG&G personnel or with clearly stated permission. All field team personnel will wear identification badges and carry identification cards at all times.

REFERENCES

1. U.S. EPA. 1982. U.S. Environmental Protection Agency, Office of Solid Waste and Emergency Response. Test Methods for Evaluating Solid Waste: Physical/Chemical Methods. SW-846, Washington, D.C.

Attachment I

QUALITY ASSURANCE PROJECT PLAN (QAPP)
VERIFICATION BURN SAMPLING OF ENSCO'S MWP-2000 INCINERATOR
DURING THE TREATMENT OF SOIL CONTAINING
2, 3, 7, 8-TCDD AT NCBC GULFPORT, MS

Prepared For:

EG&G Idaho Inc.
1955 Fremont Ave.
Idaho Falls, Idaho 83415

Prepared By:

Versar, Inc.
6850 Versar Center
Springfield, Virginia 22151

November 7, 1986

This Quality Assurance Project Plan for conducting an emission test of ENSCO's MWP-2000 Incinerator at NCBC in Gulfport, MS has been reviewed and approved by:

Darrell B. Derrington, Jr., P.E.
Versar Program Manager

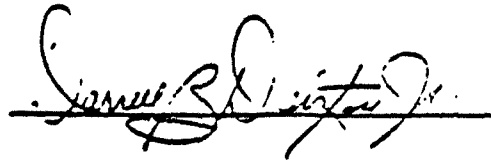

Art Jung
Versar Quality Assurance Officer



Captain Terry Stoddart
USAF Program Officer



Harry Williams
EG&G Program Manager



This QAPP has been prepared based on the guidelines contained in Interim Guidelines And Specifications For Preparing Quality Assurance Project Plans, P883-170514, and as such, contains all sixteen elements which should be included in an EPA approved QAPP.

TABLE OF CONTENTS

<u>Section</u>	<u>Page</u>
1.0 Project Description	1-1
2.0 Project Organization and Responsibility.....	2-1
3.0 Quality Assurance Objectives	3-1
3.1 Precision	3-1
3.2 Accuracy	3-1
3.3 Completeness	3-1
3.4 Representativeness	3-3
3.4.1 Feedstock Soil and Treated Soil Samples	3-3
3.4.2 Neutralization Tank Water and Boiler Blowdown Samples	3-4
3.4.3 Stack Emissions	3-4
3.5 Comparability	3-5
4.0 Sampling Procedures	4-1
4.1 Incinerator Operating Parameters	4-1
4.2 Feedstock Soil	4-1
4.3 Treated Soil	4-1
4.4 Stack Gas	4-1
4.4.1 Continuous Monitoring	4-1
4.4.2 Modified Method 5/Volatile Organic Sampling Train	4-2
4.4.3 Sample Preservation and Transport	4-5
5.0 Sample Custody	5-1
6.0 Calibration Procedures and Frequency	6-1
6.1 Sampling Equipment	6-1
6.1.1 Modified Method 5 Equipment	6-1
6.1.2 VOST Equipment	6-1
6.1.3 Continuous Monitors	6-1
7.0 Analytical Procedures	7-1

TABLE OF CONTENTS (continued)

List to Tables

Table 1-1	Sampling of ENSCO's MWP-2000 Incinerator	1-3
Table 3-1	Summary of Quality Assurance Objectives	3-2
Table 6-1	Calibration of Sampling Apparatus	6-2
Table 9-1	Summary of Internal Quality Control Checks	9-1

List of Figures

Figure 2-1	Corporate Organization Chart	2-2
Figure 2-2	Project Organization Chart	2-3

1.0 PROJECT DESCRIPTION

This Quality Assurance Project Plan (QAPP) presents, in specific terms, the policies, organization, objectives, functional activities and specific quality assurance (QA) and quality control (QC) activities which will be used to achieve data quality for this sampling project. The objective of this project is to collect samples during the operation of ENSCO's MWP-2000 Incinerator while it is processing soil which contains 2,3,7,8-TCDD, and other chlorinated organics as well, at the Naval Construction Battalion Center (NCBC) in Gulfport, MS. The samples, which will be obtained by Versar, Inc., will be sent to an independent laboratory for final analysis. The QA/QC activities associated with the analytical portion of this program are contained in the Verification Burn Plan and are not addressed in this QAPP.

The United States Air Force (USAF) intends to restore the site at NCBC, which was previously used to store Herbicide Orange, to beneficial use through the research and test evaluation of a thermal technology. As a result of storing Herbicide Orange on the site, the soil has become contaminated with 2,3,7,8-TCDD, and other chlorinated organics, which were contained in the Herbicide Orange. The site clean up focuses on the use of a mobile rotary kiln which will thermally destroy all organics in the soil during treatment. Before the Air Force can perform the R&D permitted activity, the rotary kiln must be tested and sampled during actual operation. The sampling during this test, which is referred to as the Verification Burn, is the primary focus of this QAPP.

The technology to be sampled is ENSCO's MWP-2000 (Mobile Waste Processor) incinerator which has been set-up onsite at NCBC. This activity is under a RD&D permit from Region IV EPA. Because this incinerator has previously demonstrated an ability to destroy similar wastes (i.e., heavily chlorinated organic compounds in soil), the Verification Burn is not intended to establish a Destruction and Removal Efficiency (DRE), but to verify that the unit is properly operating. In addition, the NCBC soil has a relatively low concentration of TCDD (i.e., the highest onsite value of TCDD is 948 ppb) which would make DRE testing very difficult. The DRE test burn was performed at 75 percent of designed capacity (3 tons per hour). As part of the RD&D activity, a total of five different tests will be performed on the incinerator to establish the most efficient operation. During each test the samples summarized in Table 1-1 will be obtained. The Verification Burn will consist of five separate tests which will be performed during the week of November 17, 1986. The first test will be conducted at a soil feed rate of 3 tons per hour. Tests two and three will be conducted at a soil feed rate of 4 tons per hour and the final two tests will be conducted at a soil feed rate of 5 tons per hour. Approximately three to five days will be required to complete all tests.

To insure that the incinerator is not experiencing any transient operation, sampling during the Verification Burn will not begin until steady state operation has been established which is defined in the Verification Burn Plan. It is anticipated that approximately five hours

Table 1-1. Sampling of ENSCO's MWP-2000 Incinerator

Sample	Sampling method	Analysis parameters	No. of runs	Total no. samples for analysis
A. Operating parameters	Record plant instrument readings as per Verification Burn Plan	Feedrate; incinerator temperature; incinerator pressure	5	-
B. Feedstock soil	Grab samples taken every 1/2 hr over a 3-hr period. Each sample split to obtain individual grab and composite	Dioxin, etc. as per Verification Burn Plan	5	35
C. Treated soil	Grab samples taken every 1/2 hr over a 3-hr period. Each sample split to obtain individual grab and composite	Dioxin, etc. as per Verification Burn Plan	5	35
D. Stack gas	Continuous monitoring over 3-hr period (ORSAT verification at least 3 times for each test)	CO ₂ , CO, O ₂ , total HC	5	15
	Modified Method 5	Dioxin, etc. as per Verification Burn Plan	5	30 ¹
	Volatile Organic Sampling Train (VOST)	Dioxin, etc. as per Verification Burn Plan	5	15 ²
E. Boiler blowdown	Grab samples taken 3 times during 3-hr test period and composited into one sample	As per Verification Burn Plan	5	5

Table 1-1. (Continued)

Sample	Sampling method	Analysis parameters	No. of runs	Total no. samples for analysis
F. Neutralization tank	Grab samples taken 3 times during 3-hr test period and composited into one sample	As per Verification Burn Plan	5	5
G. Blank	Grab sample from water tap	As per Verification Burn Plan	-	1
	Reagent blanks (reagents used in stack gas testing)	Not to be analyzed unless required	-	9

¹For each mms train, the following samples will be obtained: 1) Filter, 2) XAD Module, 3) Probe rinse, 4) Back half/coil rinse, 5) Condensate and 6) Impinger Solution.

²For each VOST, the following samples will be obtained: 1) Tenax #1, 2) Condensate and 3) Tenax/Charcoal #2.

of operation will be required to reach steady state operation at a soil feed rate of three tons per hour. Less time may be needed at higher soil feed rates since the incinerator will not have to be brought up to temperature from a cold start condition.

The sections that follow contain all of the information required in a QAPP as dictated by Interim Guidelines and Specifications for Preparing Quality Assurance Project Plans. As noted previously, this QAPP addresses the elements associated with sampling of ENSCO's incinerator. The detail for the QAPP with regard to analysis is contained in the Verification Burn Plan.

2.0 PROJECT ORGANIZATION AND RESPONSIBILITY

This project will be performed by the Environmental Operations and Technical Operations Groups of Versar Inc. Versar will provide overall sampling project management, sampling, and various site support services. Program management will originate within Versar's Environmental Operations, sampling support will come from Versar's Technical Operations. A corporate organization chart is shown in Figure 2-1.

The project organization chart is shown in Figure 2-2. Mrs. Gayaneh Contos, Vice-President of Environmental Operations, will have overall corporate responsibility for the project. She will have the authority to delegate resources needed for quick-response tasks and will also monitor the financial status of the project. Mr. Arthur Jung, Versar's Corporate Quality Assurance Officer, will provide QA/QC guidance for work performed under this project.

The Versar Project Manager is Mr. Darrell B. Derrington, Jr., a Senior Environmental Engineer with experience in program management, and direct experience in dioxin-related work. Mr. Derrington reports directly to Mrs. Contos. He will have day-to-day project responsibility and will interact directly with EG&G.

As Quality Assurance Officer, Mr. Jung's responsibilities will include:

- Assure management that the facilities, equipment, personnel, methods, records, and controls are consistent with project objectives/requirements.

VERSAR, INC.

Section No.: 2.0
 Revision No.: 0
 Date: 11/7/86
 Page: 2 of 4

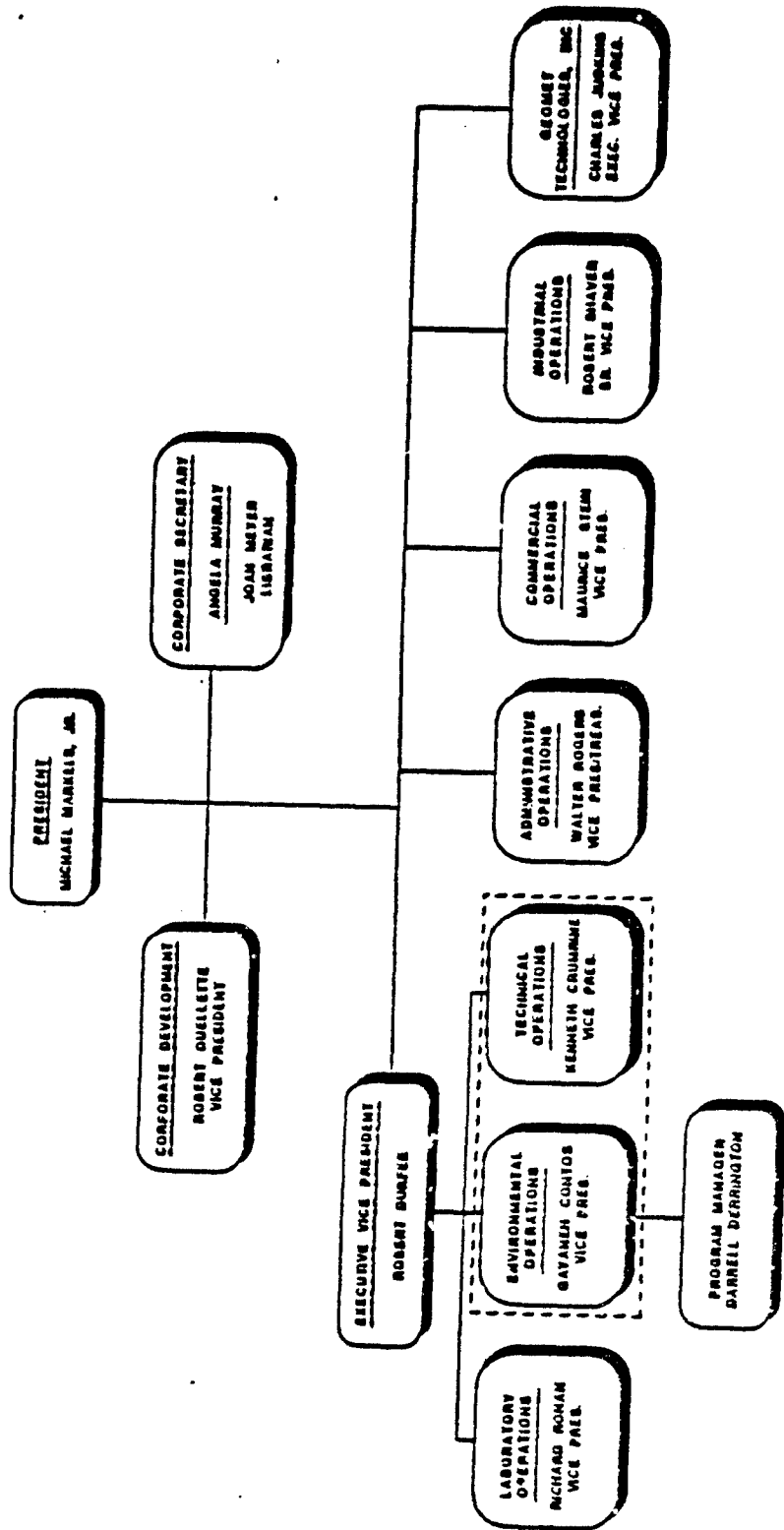

FIGURE 2-1. CORPORATE ORGANIZATION CHART

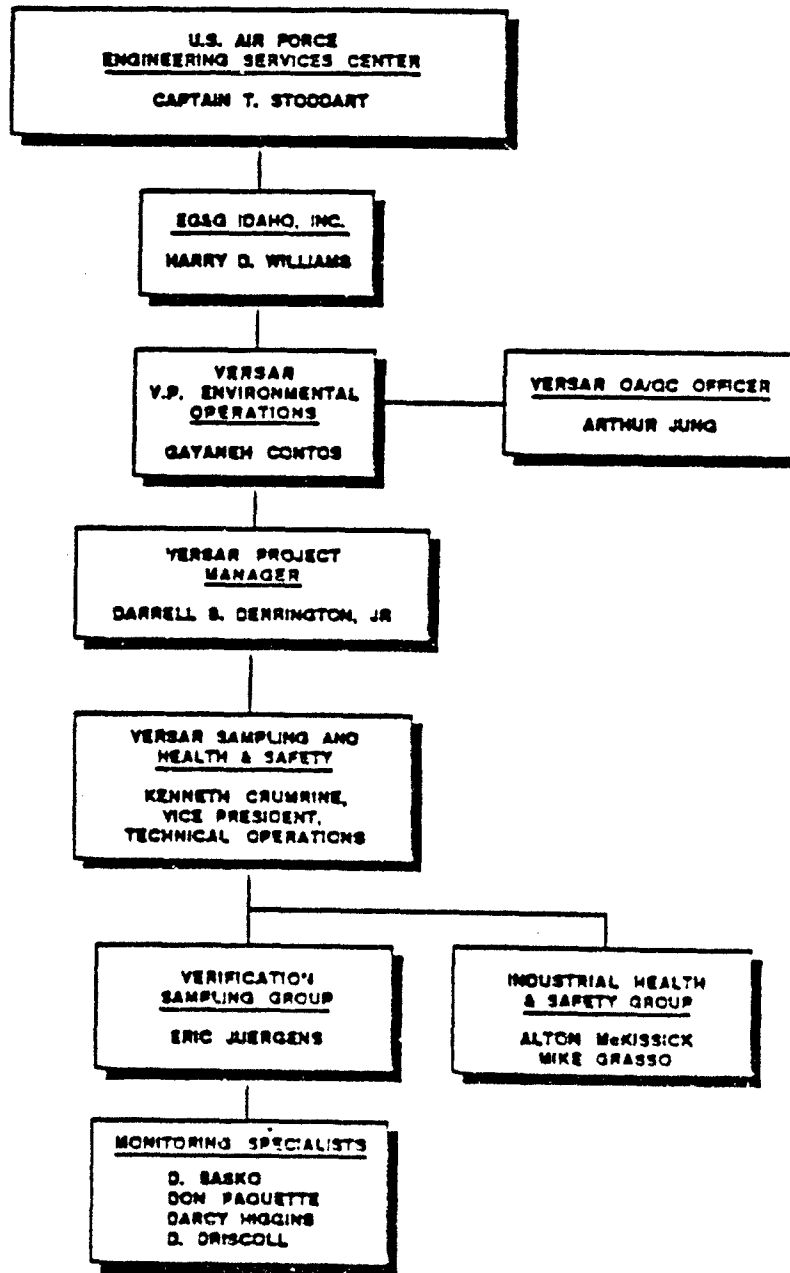

FIGURE 2-2. PROJECT ORGANIZATION CHART

- Assure that all QA policies and procedures are available and understood.
- Conduct or supervise audits.
- Summarize audit results.
- Request corrective action by way of reports to management.

Mr. Eric Juergens will be the Field Sampling Quality Control

Coordinator and will be responsible for:

- Examining data books, calibration and field records, forms, and any other hard copy information.
- Document deviations from all sampling protocols (dioxin, particulate/HCl, gaseous monitoring, ash).
- Report audit findings to the QAM.

Mr. Dave Basko will serve as the Field Sampling Task Leader and perform the following functions:

- Be responsible for staff training and documentation.
- Enforce equipment calibration and maintenance procedures.
- Take corrective action for any problems and communicate action in writing to the QAM, and QCC, the Project Leader, and department management.
- Be responsible for sample traceability.
- Be responsible for document control.
- Be responsible for sample data traceability.
- Ensure that all deviations from protocol are documented and reported to the Project Leader.
- Ensure that all data transferred to the Project Leader is complete and in the proper format.

3.0 QUALITY ASSURANCE OBJECTIVES

The quality assurance objectives for this project will be to provide reliable sample data for documenting 2, 3, 7, 8-TCDD (hereafter referred to as dioxin), and other chlorinated organic compounds as specified in the Verification Burn Plan, in the feedstock soil, treated soil, boiler water blowdown, neutralization tank water and stack gases for ENSCO's Incinerator while processing soil at NCBC. Specific objectives for precision, accuracy and completeness, as only applicable to sampling activities, are presented in Table 3-1. Quality assurance objectives applicable to the analysis of samples collected at NCBC will be presented in the Verification Burn Plan. The overall goal for the sample acquisition process is that 90 percent of all quality assurance measurements for precision and accuracy meet the QA objectives.

3.1 Precision

Precision will be assessed according to the specific procedures established in Section 12. Precision will be measured as range percents for small ($n \leq 8$) sample sets and as a percent relative standard deviation for large ($n > 8$) sample sets.

3.2 Accuracy

Accuracy will be assessed according to the specific procedures established in Section 12.

3.3 Completeness

As indicated in Table 3-1, all sample data collected will be recoverable and verifiable from the data records. As each test is being

Table 3-1. Summary of Quality Assurance Objectives¹

Measurement parameter	Precision ² (range percent; percent RDS)	Accuracy ³ (percent)	Completeness (percent)
1. Gas meter volume ⁴	-	± 5	100
2. Stack temperature sensor ⁴	-	± 1.5	100
3. HC1 ⁵	-	-	100
4. CO, CO ₂ , O ₂ ⁵	10	10	90
5. Total hydrocarbons ⁵	10	10	90

¹Specific quality assurance objectives are contained in the Verification Burn Plan.

²Procedures for assessing precision are presented in Section 12.1.

³Procedures for assessing accuracy are presented in Section 12.2.

⁴Quality Assurance Handbook for Air Pollution Measurement Systems, Volume II, Stationary Source Specific Methods, US EPA ORD, January 1984.

⁵Protocol as per Section 6.

performed, sampling activities will be monitored to insure that all essential data is collected. If necessary, test runs will be repeated to collect required data that may have not been collected in normal sampling routines.

3.4 Representiveness

3.4.1 Feedstock Soil and Treated Soil Samples

It is estimated that approximately three hours will be required to complete each verification burn test. To obtain representative samples of the feedstock and treated soil during this time period, each will be sampled at one-half hour intervals. Sampling of feedstock soil will begin 25, 20 and 15 minutes before the test when the soil feed flow rate is 3, 4, and 5 tons per hour, respectively. Sampling will continue for three hours. Each one-half hour increment samples of feedstock and treated soil will be split into two aliquots, one retained as a discrete incremental sample and the other combined to prepare a separate composite of the feedstock and treated soil. Starting feedstock soil sampling before the actual test begins is intended to take into the account the residence time of the soil in the feed hopper system (which is a function of soil feed rate).

Because the residence time of the soil in the rotary kiln is 60, 50 and 40 minutes at soil feed rates of 3, 4, and 5 tons per hour respectively, sampling of treated soil will be delayed a similar amount of time after initiation of each test.

Residence times for soil in the feed hopper and kiln will be verified in clean soil tests prior to the Verification Burn. If adjustments are needed, they will be made accordingly.

3.4.2 Neutralization Tank Water and Boiler Blowdown Samples

Equal volume grab samples of neutralization tank and boiler blowdown water will be obtained and composited for each test. Each will be sampled three times during the three hour test period at equal time intervals. Each grab sample will be taken directly from a sample tap located on the respective tanks. Before obtaining each sample, the sample tap will be flushed of any potentially stagnate liquid.

3.4.3 Stack Emissions

To obtain a representative sample, the particulate and gaseous stack emissions will be collected using a sampling probe (attached to a modified method 5 sampling train) which will traverse the stack according to procedures established in Reference Method 2. Isokinetic sampling will be established by sampling at flow rates equal to the stack gas velocity along specific points inside the stack in two dimensions, 90° apart. The total stack sampling time will be 60 minutes which will require about three hours to perform.

Gases or vapor phase constituents in the flue gas are assumed to be homogeneously distributed in the stack and not stratified and therefore may be representatively collected from a single point in the stack. Gases (CO, CO₂, O₂) will be monitored continuously during each test

run and samples for the analysis of vapor phase constituents (VOST) will be collected alongside each modified method 5 run.

3.5 Comparability

All sample data will be presented in comparable units as follows:

<u>Measurement</u>	<u>Units</u>
Gas volumes	dry standard cubic meter (dscm)
Gaseous constituents	weight percent
Total hydrocarbons	ppm as propane
Stack temperature	average °F
Stack velocity	average ft/sec at stack exit
Stack flow	average dscm/minute

4.0 SAMPLING PROCEDURES

4.1 Incinerator Operating Parameters

All pertinent incinerator operating parameters will be recorded by ENSCO and EG&G as is outlined in the Verification Burn Plan.

4.2 Feedstock Soil

Grab samples of feedstock soil will be obtained from the soil conveyer using clean sample spoons. Each grab sample will be placed in a clean aluminum tray, homogenized and split to make 2 aliquots. One aliquot will be bottled as an individual grab sample. The other aliquot will be mixed with other equal-volume grab aliquots to form a composite aliquots for each test.

4.3 Treated Soil

Grab samples of treated soil will be obtained by inserting a clean one inch diameter pipe into the soil stream at the end of the kiln. A partial vacuum from a small pump will be used to fill the pipe with soil which will then be placed in a clean metal tray for cooling. After the soil has cooled, samples will be split and maintained in the same manner as the feedstock soil.

4.4 Stack Gas

4.4.1 Continuous Monitoring

Stack effluent gases (CO, CO₂, and O₂) will be continuously monitored during each 3-hour test period using ENSCO's on-line instrumentation as is described in the Verification Burn Plan. To verify proper operation of ENSCO's gas monitoring equipment, Versar will perform

discrete tests at the stack using an ORSAT-type apparatus to determine CO, CO₂ and O₂ flue gas concentrations. These data points will then be correlated to ENSCO's continuous readings. During each 3 hour test period, a total of 3 discrete analyses will be performed. Continuous monitoring for total hydrocarbons will also be performed over the three hour test period.

4.4.2 Modified Method 5 and VOST

During each test a MMS and VOST sampling train will be used to sample for potential Principal Organic Hazardous Constituents (POHC's) and Products of Incomplete Combustion (PIC's). The MMS and VOST sampling trains will be identical for each test and their configurations are shown in Figures 4-1 and 4-2 for MMS and VOST respectively.

The MMS sampling trains and their operation will be in accordance with MMA's procedures (reference 5). An alkaline solution (KOH) will be used in the second impinger to trap acid vapors and to quantify for HCl. One of the requirements of the method is that no grease be used for sealing joints in the train. Viton® O-rings will be used to seal all joints prior to and including the first impinger.

The sampling location and the number of traverse points for MMS sampling will be determined after the presurvey according to procedures established in EPA Reference Method 1 (40 CFR 60, Appendix A). Assuming that the stack diameter is 36 inches and the sampling ports are less than eight stack diameters downstream of any flow disturbance; eight sampling point locations will be established on two perpendicular stack cross sections. Stack gas moisture and velocity will be determined concurrent

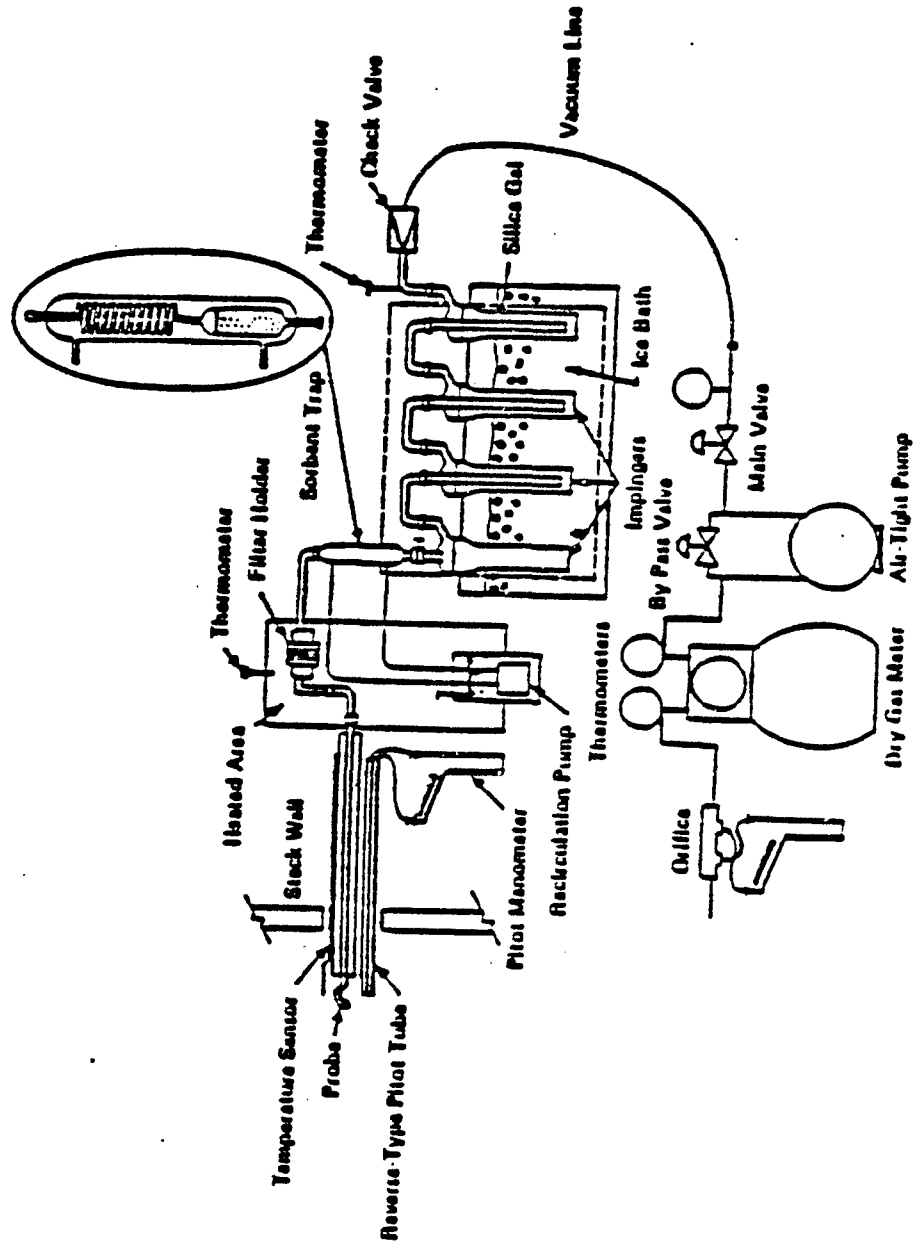

Figure 4-1. Modified Method 5 Sampling Train (1975)

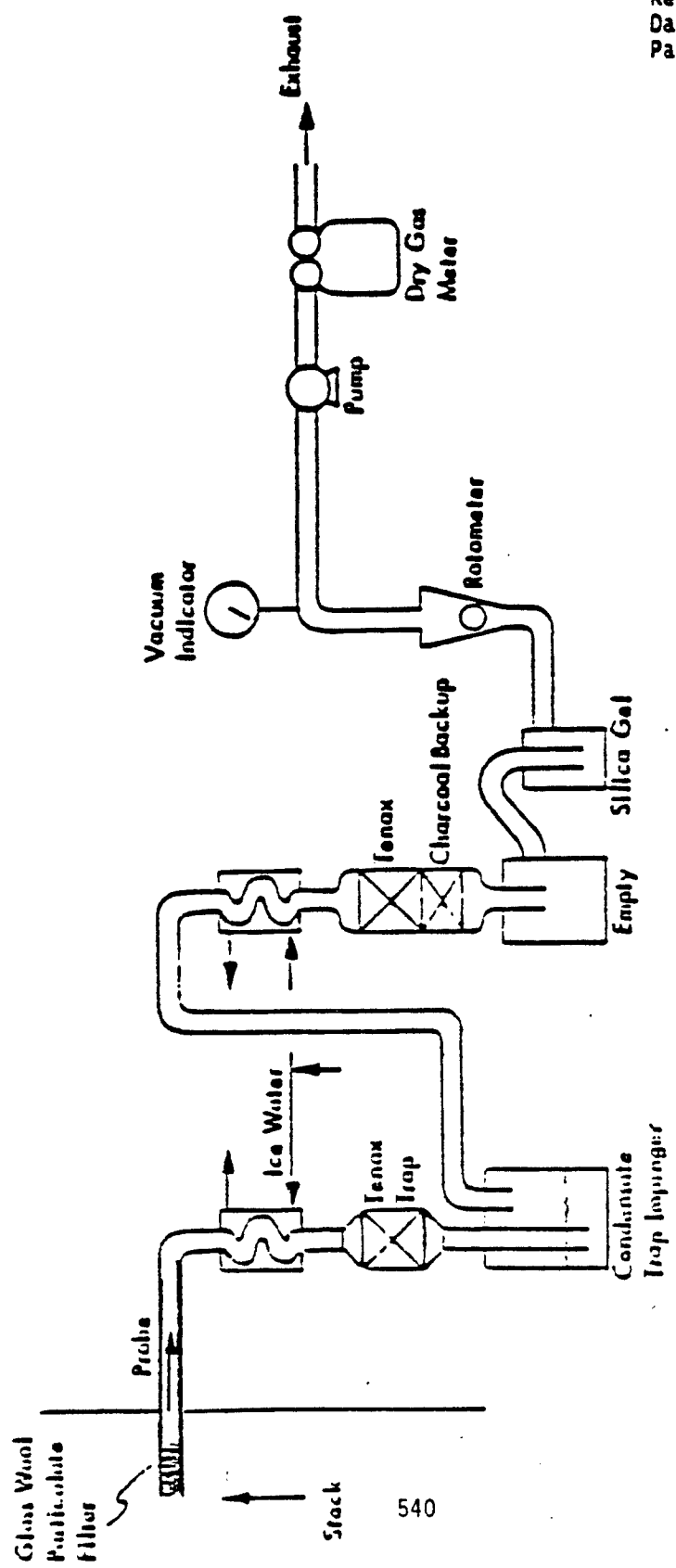

Figure 4-2. Volatile Organic Sampling Train (VOST)

with the MMS sampling using the procedures established in EPA reference Method 4 (40 CFR 60, Appendix A). Stack gas molecular weight will be determined concurrently with the MMS sampling using procedures established in Reference Method 3 (40 CFR 60, Appendix A).

The VOST sampling train basically consists of a system designed to draw sample gas at a flow rate of 1 liter/minute through two traps in series for a period of one hour. The first trap will contain Tenax and is preceded by a gas cooler/condenser which is followed by an impinger for condensate collection. The second trap contains a section of Tenax and a section of charcoal just downstream of the impinger. The purpose of the second trap is to collect very volatile POHC's (e.g., vinyl chloride) which will break through a Tenax trap.

4.4.3 Sample Preservation and Transport

Feedstock and treated soil samples will be bottled in appropriate containers and packaged in DOT approved containers for shipment. All aqueous samples and samples from MMS sampling will be properly bottled and packed in ice inside of coolers for shipment. Samples from VOST activities will be properly bottled and placed in coolers with dry ice for shipment. All shipping will strictly adhere to DOT approved procedures.

5.0 SAMPLE CUSTODY

Labelling and identification of all samples collected will be done using Versar's three part label which is shown in Figure 5-1. Both upper portions and the single lower portion have pre-printed numbers that become the field sample number. The upper portions will be completed and affixed to the sample bottle; the lower portion will be entered into the field notebook with pertinent information entered along side. All duplicate samples (or any number of replicates) will have the same field sample numbers assigned to corresponding parameters. In some case, this may require use of handwritten labels in addition to the pre-printed labels. The exception to replicate label numbering will be in the case of "blind" duplicates for QA/QC purposes; each sample will then be labeled and documented separately.

Sample custody will begin, in all cases, at the time of sample collection by placing the sample into an iced cooler, or appropriate container, in the possession of the designated field sample custodian. A line item on the field chain of custody form (Figure 5-2) will immediately be filled out and initialed by the field sample custodian. The following procedures will be followed when completing the chain of custody form:

PROJECT NO. Enter the complete project number; enter the analytical subtask number (usually an odd number) not the sampling subtask number.

PROJECT NAME Enter the project name as it is listed on the Contract Status Summary Sheets distributed periodically throughout Versar.

Versar INC.

VERSAR INC.		}	AFFIXED TO SAMPLE CONTAINER
13050	PARAMETER		
VERSAR INC.		}	AFFIXED TO DUPLICATE SAMPLE (E.G., VOA SAMPLES)
13050	DUPLICATE		
VERSAR INC.		}	ENTERED IN FIELD NOTEBOOK AS PERMANENT SAMPLE IDENTIFICATION
13050	PARAMETER		
TAG#			
PLANT			
SAMPLE LOCATION			
MATRIX			
SAMPLING COMMENTS			
SIGNATURE		TIME/DATE	

Figure 5-1. Versar's Three Part Sample Label.

- SAMPLERS Enter signature and print name of person or person(s) who participated in the collection of the samples listed, and who should be contacted should questions arise during sample log-in. If the field sample custodian is not listed as a sampler, receipt documentation should be indicated.
- FIELD SAMPLE NUMBER This box does not generally apply to MAD procedures and should be left blank.
- DATE Enter date of sample collection. If sample is a composite indicate both start and finish date.
- TIME Enter time of actual sample collection. If sample is a composite indicate both start and finish time.
- COMP./GRAB Indicate by a check the type of sample.
- STATION LOCATION Enter a description of location as well as any location code that had been assigned.
- NUMBER OF CONTAINERS Enter the actual number of sample bottles to be submitted to the laboratory.
- PARAMETERS List parameters to be analyzed; if abbreviations or parameter categories (e.g., ICP metals) are used further details must be given when logging in samples.

For each line entry indicate the last two digits in the sample number. Enter first three sample number digits in remarks section as shown in Figure 5-2.
- INDUSTRIAL HYGIENE SAMPLE Circle the appropriate box to indicate type of sample.

Upon completion of all line items, or upon sample pick-up, the custodian will sign, date and list time, and will confirm completeness of all descriptive information contained on the form. Each individual who subsequently assumes responsibility for the sample will sign the chain of custody form and the reason for assuming custody. The field chain of

Section No.: 5.0
Revision No.: 0
Date: 11/7/86
Page: 5 of 5

custody form terminates upon laboratory receipt of samples. The field sample custodian should obtain the pink copy of the chain of custody form for program files.

SECTION 6.0

CALIBRATION PROCEDURES AND FREQUENCY

6.1 Sampling Equipment

6.1.1 Modified Method 5 Equipment

Table 6-1 summarizes the sampling apparatus to be calibrated, the acceptance criteria, the method, and the frequency of calibration.

Prior to the test the gas metering device is calibrated against a positive displacement wet test meter. The calibration factor is rechecked after the test.

Temperature sensors are calibrated against an ASTM mercury-in-glass thermometer, and/or are calibrated in an ice bath and a boiling water bath.

The aneroid barometer is checked against a mercury column barometer.

The pitot tubes are constructed according to the design criteria of Reference Method 2. In addition, the S-type pitot tubes are calibrated against a standard pitot tube in a wind tunnel, if the specified design criteria are not met.

6.1.2 VOST Equipment

Prior to the test the gas metering device is calibrated against a positive displacement wet test meter. The calibration factor is rechecked after the test.

6.1.3 Continuous Monitors

The calibration criteria for ENSCO's continuous gas monitoring equipment is contained in the Verification Burn Plan.

Table 6-1. Calibration of Sampling Apparatus

Parameter	Calibration technique	Reference standard	Acceptance limit	Calibration frequency	Reference procedure
1. Probe nozzle	Measure diameter to nearest 0.001 in.	Micrometer	Mean of three measurements; difference between high and low ± 0.1	Prior to test	BMS
2. Gas meter volume	Compare to wet test	Wet test meter	Record calibration factor	Prior to test	
3. Gas meter temperature	Compare to mercury-in-glass thermometer	ASIM Thermometer	$\pm 1.5^\circ\text{F}$	Prior to test	BMS
4. Stack temperature sensor	Compare to mercury-in-glass thermometer	ASIM Thermometer	$\pm 1.5\%$	Prior to test	BMS
5. Final impinger temperature sensor	Compare to mercury-in-glass thermometer	ASIM Thermometer	$\pm 1.5^\circ\text{F}$	Prior to test	---
6. Filter temperature sensor	Compare to mercury-in-glass thermometer	ASIM Thermometer	$\pm 5^\circ\text{F}$	Prior to test	BMS
7. Aneroid barometer	Compare to mercury barometer	Mercury column barometer	± 2.5	Prior to test	BMS
8. S-type pitot tube	Design/wind tunnel	Design/standard pitot	Meets BMS criteria	Prior to test	BMS

^aQuality Assurance Handbook for Air Pollution Measurement Systems, Volume III: Stationary Source Specific Methods.

SECTION 7.0

ANALYTICAL PROCEDURES

Analysis of all samples collected will be as specified in EG&G's RFP
(see Attachment II) for analytical services.

SECTION 8.0

DATA REDUCTION, VALIDATION AND REPORTING

8.1 Data Reduction

Versar will summarize all intermediate calculations and values used in obtaining all samples in a report which will be given to EG&G. EG&G will be responsible for all data reduction, validation and reporting of analytical results as is described in the Verification Burn Plan.

All continuous monitoring data, including calibrations, will be recorded on ENSCO's strip chart recorders. The data will also be logged directly into ENSCO's on-line computer. The computer records the readings on a hard disk as well as with a diskette backup.

8.2 Data Validation

The criteria used to validate the integrity of the analytical results is contained in the Verification Burn Plan.

The principal criteria that will be used to validate the integrity of the gaseous data emissions measured by the continuous monitors will be discrete analyses using ORSAT-type measurements which will be taken directly at the stack. These values will be correlated with the gaseous emissions readings and any discrepancies will be recorded.

The principal criteria that will be used to validate the integrity of the stack field data which is essential to calculate emission levels (dioxin, particulate, HCl) will be the following:

- (1) Examination of all field data forms by the Quality Assurance Officer.

- (2) Verification of calculations for one test run by an independent, second reviewer.
- (3) Reporting of all associated blank, standards and calibration data along with reported results.

8.3 Data Reporting

Versar will submit all required sampling data to EG&G as is required for development of analytical results. The following data, as needed, will be provided:

- (a) MMS and VOST field data forms.
- (b) MMS and VOST equipment calibration data
- (c) Calibration data of ENSCO's continuous gas monitoring system along with correlations at stack using ORSAT-type tests
- (d) QA summary report.

9.0 INTERNAL QUALITY CONTROL

Table 9-1 summarizes the internal quality control checks which will be used during this study; the frequency of each control check is presented. The following paragraphs briefly explain the control checks.

9.1 Reagent Blanks

Reagent blanks of acetone and hexane representing the probe rinsing media tested will be tested for solids. At least one method blank of benzene used for extraction of ash samples will be tested for dioxin. Since a field blank is used, reagent blanks of acetone, hexane, KOH XAD-2, TENAX, and filters will be retained and analyzed for dioxin only if a problem with a particular sample occurs. However, one filter from each lot and aliquot of XAD from each extracted batch will each be screened for contamination prior to use.

9.2 Field Blanks

At least one field blank for the MMS train and VOST will be provided for analysis.

9.3 Zero/Span Gases

Certified (by manufacturer, $\pm 2\%$ accuracy) cylinder gases will be utilized to zero and span all continuous emissions monitors prior to the verification burn as is described in the Verification Burn Plan.

9.4 Calibration Standards

The Orsat-type analyzer will be checked by measuring the oxygen content of ambient air.

Table 9-1. Summary of Internal Quality Control Checks

Quality Control Check	Dioxin in feed water	Dioxin in stack	Particulate	Orsat	CT	Stack gaseous emissions ^a
1. Reagent blanks						
Acetone		1 ^b	1			
Hexane		1 ^b	1			
Benzene (method blank)		1 ^b				
XAD-2		2 ^c				
Tenay						
Filter		2 ^c				
KOH						
2. Field blanks						
HMS						
- Probable wash			1			
- Particulate filter		1				
- XAD-2		1				
- Condenser		1				
- Impinger					1	
VOST						
- Probable wash		1				
- Tenay		1				
- Condenser		1				
- Tenax/Charcoal		1				
3. Background Sample						
	1		1			
4. Zero/span gases						
						Before tests
5. Calibration standard						
				3 per run		1 per compound
6. Replicate(duplicate runs)						
		2 ^d				
6. Spikes ^e						
		as required				

^aCO, CO₂, O₂, THC by continuous monitor.

^bRetained for analysis, if necessary.

^cOne blank screened prior to test; one blank taken in field and retained for analysis, if necessary.

^dReplicates obtained during soil feed rates of 4 and 5 tons per hour.

^eAnalytical requirement specified in the Verification Burn Plan.

Section No.: 9.0
Revision No.: 0
Date: 11/7/86
Page: 3 of 3

For the continuous gas monitor, instrument calibration will be checked using the ORSAT-type analyzer at the stack.

9.5 Replicates

Replicate stack gas emission samples will be obtained when the incinerator is operating at soil field rates of four and five tons per hour (i.e., tests 2 and 3 at 4tph; and 4 and 5 at 5tph).

10.0 QUALITY ASSURANCE AUDITS

10.1 Field Programs System Audit

After sampling is completed, the Field Programs QCC will inspect calibration and maintenance records, field data forms and records, and the calculation of results. EG&G will review actual laboratory practices during sample analysis. Deviations from protocol and all results of the audit will be reported to the QAM. Note that a systems audit during actual field sampling will not be conducted.

10.2 QAM Audits

The QAM will verify that all applicable QA/QC procedures are followed, including (1) calibration and maintenance of equipment, (2) staff credentials and/or supervision, (3) documentation practices, (4) data traceability, and (5) sample and document controls. The QAM will also review QC data and QCC inspections and audits. The results of all inspections and audits will be summarized and reported, along with any corrective action requests, to project and EG&G management.

11.0 PREVENTIVE MAINTENANCE

Maintenance of the equipment for soil and water is limited to inspection and cleaning prior to each use. Other sampling equipment is checked prior to each use with appropriate check standards; equipment which is found to be defective is repaired or replaced immediately.

To minimize any potential sampling delays associated with stack gas testing, Versar will use five separate sets of MMS and VOST glassware, plus a redundant train for each which can be used to replace broken parts. In addition, two monorails will be used to expedite changing the probe from one side of the stack to the other.

12. SPECIFIC ASSESSMENT PROCEDURES

12.1 Precision

For data sets with a small number of points ($2 \leq n \leq 8$), the estimate of precision will be expressed as range percent (RZ):

$$RZ = \frac{C_1 - C_2}{\bar{C}} \times 100 \quad (12-1)$$

where: C_1 = highest value determined

C_2 = lowest value determined

\bar{C} = mean value of the set

and

$$\bar{C} = \sum_{i=1}^n \frac{C_i}{n} \quad (12-2)$$

where: C_i = i th determination

n = number of determinations

For one or two values below the detection limit (BDL):

BDL = DL/2; where DL = detection limit.

For large data sets ($n > 8$), the estimate of precision will be expressed as percent relative standard deviation (ZRSD):

$$SD = \frac{\sum_{i=1}^n (C_i - \bar{C})^2}{n-1} \quad (12-3)$$

$$ZRSD = \frac{100\% \times SD}{\bar{C}} \quad (12-4)$$

The following paragraphs briefly describe how precision will be determined for each measurement parameter.

12.1.1 Dioxin in Feedstock Soil

For each feedstock soil sample set analyzed in duplicate or triplicate, the precision (RZ) for each analyte will be calculated using EQ. 12-1. Then, for each analyte, the arithmetic mean of all the precision values of the individual sample sets will be calculated and reported as the overall precision. Three sample sets should be available for calculating precision. Since this assessment involves the use of chemical analysis data and not exclusively field sampling measurements, details will be provided in the Verification Burn Plan.

12.1.2 Dioxin in Treated Soil

Same as 12.1.1

12.1.3 Dioxin in Stack Emissions

The actual MMS and VOST field samples will not be analyzed in replicate. However, during this study sorbent media (XAD and Tenax) blanks and filter blanks will be spiked with dioxin and internal standards (surrogate) and then analyzed. The results from the dioxin analysis of these spiked samples will be used to estimate precision for the determination of dioxin in stack emissions. The precision estimate will be calculated using Eqs. 12-1 and 12-2. Two spiked filter measurements and two spiked sorbent measurements will be available to calculate precision.

12.1.4 Gaseous Emissions (CO, CO₂, O₂, SO, NO_x, THC)

For each instrument, an estimate of precision will be calculated from the high span measurements. All values of the span gas measured before, during, and after each run over the entire period will be used to calculate precision. Equations 12-3 and 12-4 will be used for calculating the precision; a minimum of 12 measurement values for each monitor are expected.

12.2 Accuracy

Accuracy will be determined from the performance samples (i.e., standards supplied as blind audits by the QCC and the independent laboratory) as percent accuracy (AZ). Accuracy will be determined as percent recovery (RZ) of native analytes from samples spiked with native analytes prior to sample preparation. The formulas are given below. For performance samples

$$AZ = \sum_{i=1}^n \frac{\text{Amount found}}{\text{True value}} \times \frac{100}{n} \quad (12-5)$$

For samples spiked with native analyte

$$RZ = \sum_{i=1}^n \frac{\text{Amount found} - \text{native amount prior to spiking}}{\text{Amount spiked}} \times \frac{100}{n} \quad (12-6)$$

12.2.1 Method for Dioxin

The accuracy of the instrumental procedure will be estimated from the performance samples supplied by EC&G. Accuracy will be calculated according to Eq. 12-5. At least one performance sample will be analyzed. Since this control measure involves chemical analysis data and

not the field sampling procedures, additional detail may be found in the Verification Burn Plan.

12.2.2 Dioxin in Feedstock Soil

Overall accuracy of the contractor's analytical procedures for determining dioxin in ash samples will be assessed by performance on a feedstock soil audit sample provided by an independent laboratory. The performance sample will be analyzed at least once and accuracy will be calculated using Eq. 12-5.

12.2.3 Dioxin in Treated Soil

Same as 12.2.2.

12.2.4 Dioxin in Stack Emissions

Accuracy will be assessed as percent recovery of native analyte spiked onto the sorbent media (XAD, Tenax) and filters. The estimate of accuracy will be calculated according to Eq. 12-6. At least two sorbent resin modules and at least two filters will be spiked in this manner.

12.2.5 Particulate, Cl^- in Stack Emissions

Accuracy will not be assessed.

12.2.6 Gaseous Emissions (CO , CO_2 , O_2 , SO_2 , NO_x , THC)

For each instrument, accuracy will be determined from measurement of the zero, mid, and high span cylinder gases. All measured values of the zero, mid-level, and high-level span gas will be used to calculate instrument accuracy according to Eq. 12-5. A minimum of 24 measurement values for each monitor are expected.

13.0 CORRECTIVE ACTION

Whoever observes sampling data problems will immediately notify the Task Leader. If the Task Leader discovers or is notified of sampling data problems, he will decide on the severity of the problem and take the appropriate action:

- Minimal data loss: The problem/corrective action taken will be documented; no further action is necessary.
- Moderate data loss: A problem memo will be prepared and sent to the QCC, and QAM, the Project Leader; a collective decision on the appropriate action will then be made.
- Severe data loss: A problem memo shall be prepared and sent to the QCC, the Project Leader, EG&G, and the QAM. The USAF Project Manager will be consulted before a collective decision on the appropriate action is made..

The Task Leader implements the corrective action, documents the problem and action taken, then prepares and sends a problem/action-taken memo to the QCC, and QAM, the Project Leader, and EG&G.

If, in any case, sampling data is lost, the Task Leader will investigate the problem, then perform one or more of the following actions:

- If the problem is limited in scope, the problem/action-taken is documented, the Task Leader then prepares and send a problem/action-taken memo to the QAM, the Project Leader, and EG&G.
- If a large quantity of data are affected, the problem/action-taken memo to the QAM, the Project Leader, EG&G, and the USAF Project Officer.

In general, if QA problems are encountered, The Task Leader shall identify technical problems and:

Section No.: 13.0
Revision No.: 0
Date: 11/7/86
Page: 2 of 2

- Prepare and send a problem memo to the QAM, the Project Leader, and EG&G; if the problems are significant, the action is determined collectively.
- The action taken is documented.

14.0 QUALITY ASSURANCE REPORTS TO MANAGEMENT

The QAM, in cooperation with the Project Leader, Analytical Task Leader, and Field Sampling Task Leader will identify critical areas of the project which will be subject to inspection; the inspection will include a review, where applicable, of:

- Staff qualifications
- Sampling equipment calibration and maintenance records
- Performance audits
- Systems audits
- Sample control
- Document-control
- Sampling data entry, including error handling, corrections, and additions
- Sampling data traceability and completeness
- Sampling data calculation and validation
- Internal QC data
- External QA data
- Assessment of sampling data accuracy, precision, and completeness.

The results of inspections/audits will be reported by the QAM to the Project Leader and EG&G management; summaries will be included in the final report.

15.0 REFERENCES

1. Quality Assurance Handbook for Air Pollution Measurement Systems. Volume III Stationary Source Specific Methods. EPA-600/4--77-0276.
2. Interim Guidelines and Specifications for Preparing Quality Assurance Project Plans. PB83-170514, Feb. 1983, QAMS-005/80.
3. Methods for Chemical Analysis of Water and Wastes, EPA-600/4-79-020, Revised March 1983.
4. Test Methods For Evaluating Solid Waste, SW-846, Third Edition, September 1986.
5. Sampling and Analysis Methods for Hazardous Waste Combustion. EPA-600/8-84-002.

Attachment II

REQUEST FOR PROPOSAL NO. C86-131150 FOR CHEMICAL ANALYSIS OF
VERIFICATION SAMPLES FROM SOIL INCINERATION



October 15, 1986

To: Attached List

REQUEST FOR PROPOSAL NO. C86-131150 FOR CHEMICAL ANALYSES OF VERIFICATION
SAMPLES FROM SOIL INCINERATION - RS-116-86

This is a Request for Proposal for analyses of soil, gas, and water samples involved with the incineration of 2,3,7,8-tetrachlorodibenzo-para-dioxin (TCDD) contaminated soil. A detailed description of the work to be provided is contained in Attachment 1, Scope of Work.

Samples are tentatively scheduled to be available for analyses November 19, 1986, through November 24, 1986.

The following mandatory requirements must be met by a proposer to be considered responsive to this Request for Proposal. If a proposer cannot meet the mandatory requirements or does not address each mandatory requirement, the proposal will be considered unacceptable and will not be evaluated further. You are requested to submit adequate information demonstrating that you meet these mandatory requirements.

1. The response must include a summary of the proposer's past experience in analyses (as identified in Attachment A to the Scope of Work) of soil, gas, and water samples resulting from thermal treatment of soil. Demonstrate past experience to show rapid turnaround of at least four weeks (receipt of final results).
2. At least one reference of a previous similar project must be provided. The reference should include the name of the project officer, telephone number, and a general statement of analyses performed.
3. The response must include the resumes of personnel who are experienced in analyses as cited in Item 1, above.

Request for Proposal
October 15, 1986
RS-116-86
Page 2

4. The response should indicate that the proposer is experienced in analyses utilizing high resolution GC/MS equipment and that such equipment is available for performance of the dioxin/furan analyses.
5. The response must describe the facilities and instrumentation that will be used for the required analyses. The response must include a contingency plan to be utilized if instrumentation failure occurs.
6. The response must indicate that the proposer has the capability to start analyses of samples November 19, 1986, meet the turnaround time of analyses as required, and complete the final report by December 24, 1986, as delineated in the attached Scope of Work. The anticipated period of performance will be from November 7, 1986, through December 24, 1986.

This procurement will be awarded to the most responsive, responsible proposer who meets the mandatory requirements noted above and submits the lowest price on the enclosed pricing schedule (Attachment 2).

It is anticipated that the work will be performed under a fixed-price-per-unit subcontract. A blank copy of a standard fixed-price subcontract used by EG&G Idaho is attached for your review (Attachment 3). The terms and conditions found in STC-EG&G-183, "Standard Terms and Conditions for Purchase Orders and Subcontracts," Rev. 5-82, shall apply except for the following clauses and those which are self-deleting:

Part I

- Clause 5 Changes
- Clause 6 Extras
- Clause 7 Variation in Quantity
- Clause 13 Warranties
- Clause 14 Delivery
- Clause 15 Consignment and Marking Instructions
- Clause 16 Inspection
- Clause 18 Payments
- Clause 20 Engineering and Operations Data Requirements
- Clause 25 Classification
- Clause 37 Required Source for Jewel Bearings
- Clause 41 Termination for Convenience

Part II

- Clause 1 Progress Payments
- Clause 3 Warranty
- Clause 4 Manufacturing Schedules

Request for Proposal
October 15, 1986
RS-116-86
Page 3

Clause 7 Basis of Award
Clause 8 Supplier Data Instructions and Documentation Submittals
Clause 16 Patent Indemnity

Article 10, Patent Rights, contained in the subcontract, will also be deleted.

The following articles will be included in the resultant subcontract:

Review and Approval of Procedures

The action of Contractor in reviewing and/or approving Subcontractor's analysis procedures and/or safety procedures shall not affect or relieve Subcontractor from such responsibility as Subcontractor otherwise has with respect to the adequacy or correctness of such analysis and/or safety procedures used by the Subcontractor in the performance of work under this subcontract.

Key Personnel

The Subcontractor agrees that personnel performing this Scope of Work will be those personnel for whom resumes were provided in the Subcontractor's proposal. Any changes to key personnel must be approved in advance by the Contractor.

Incentive

For delivery of the final report within three weeks after Subcontractor's receipt of the last set of samples, the Subcontractor will be paid an incentive of an additional ten percent of the cost of validated samples which are included in the final report. If a sample cannot be validated, there will be no incentive paid for that sample.

Liquidated Damages

The parties mutually agree that the expected actual damages to EG&G Idaho for failure to make delivery within 30 days after Subcontractor's receipt of the last set of samples will be \$2,792.00 per day. Therefore, liquidated damages of \$2,792.00 per day will be deducted from the subcontract price, up to a maximum amount of 50 percent of the total subcontract price, for failure to deliver the final report within 30 days after Subcontractor's receipt of the last set of samples.

Your proposal should include a statement that such a subcontract would be acceptable, or specify any exceptions.

In addition to your technical proposal, the following information must be provided:

Request for Proposal
October 15, 1986
RS-116-86
Page 4

1. A disclosure statement regarding Organizational Conflicts of Interest (see Standard Terms and Conditions, Part II, Clause 26).

Failure to provide a disclosure statement may result in disqualification of your proposal.

2. A completed Representations and Certifications form (see Attachment 4).

Your proposal must be submitted to EG&G Idaho by October 30, 1986, addressed as follows:

R. Simmons
Subcontract Administrator
EG&G Idaho, Inc.
1955 Fremont Avenue
P. O. Box 1625
Idaho Falls, ID 83415

Proposals shall be submitted as follows:

1. Five copies of the mandatory requirements shall be submitted with all required data excluding price.
2. Five copies of the price proposal shall be submitted on the enclosed pricing schedule in a sealed envelope plainly marked:

"PRICE PROPOSAL - C86-131150"

EG&G Idaho, Inc., reserves the right to reject a proposal that is not considered responsive to the Request for Proposal and to reject any and all proposals as the best interest of the Government may require.

Proposers are advised that, although negotiations may follow receipt of proposals, award may be made without discussion on proposals received. Therefore, proposals should be submitted initially on the most favorable terms of price and completeness.

Please advise EG&G Idaho if you do not intend to submit a proposal.

If you have any questions pertaining to this Request for Proposal, contact me at (208) 526-1661.

Very truly yours,

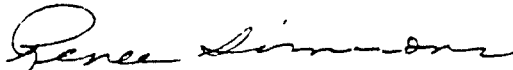

R. Simmons
Subcontract Administrator

km

Attachments:
As Stated

569

SCOPE OF WORK
FOR CHEMICAL ANALYSIS OF VERIFICATION
SAMPLES FROM SOIL INCINERATION

1.0 OBJECTIVE

The objective of this work is:

Analysis: The subcontractor shall analyze samples of soil, gas, and water involved with the incineration of 2,3,7,8-tetrachlorodibenzo-para-dioxin (TCDD) contaminated soil. The samples will involve treated/untreated soil, stack gas, scrubber water, and boiler blowdown water. The analyses involved are presented in Attachment A. The compounds listed are under EPA review, but assessment is that changes to the list will be minimal.

2.0 BACKGROUND

From approximately 1965 to 1977, containers of Herbicide Orange were stored on an open-air site at the Naval Construction Battalion Center (NCBC) in Gulfport, Mississippi. During this time some of the herbicide leaked on the ground leaving TCDD, 2,4-D, & 2,4,5-T as contaminants in the soil. The soil is cement-stabilized sandy loam, established in the 1940's. Over the years, small amounts of asphalt, road tar, and road mix (gravel soil) have been placed on the site. These placements are spotty (less than 10 percent surface area); however, the asphalt could potentially be an analytical interference. Therefore, extended cleanup procedures should be utilized. Some oyster shell and pea gravel are also present.

High volume air samples will be taken during the course of the incineration program to determine if the operation is releasing dioxin-contaminated particulates into the air.

3.0 REQUIREMENTS

3.1 Analytical Procedures

The subcontractor shall perform analyses for all components listed in Attachment A according to the stated protocols. The intent of this task is to address not only regulatory requirements but also to provide data at the lowest detection level achievable while using recognized procedures.

For dioxin/furan analysis, the subcontractor shall utilize SW846-8290 and the U.S. EPA Contract Laboratory Program (CLP) IFB dioxin procedure to the extent possible. It is anticipated that modifications to the CLP procedure will be necessary, primarily in the extraction portion of the procedure. It is also anticipated that the concentrations of the spiking solutions and calibration solutions specified in the CLP procedure may have to be modified to more accurately reflect the analytical concentration range of interest. All quality assurance/quality control (QA/QC) measures specified in SW846 or the CLP procedure will be adhered to for all analyses. Modifications to the procedures made to perform the requested analyses will be submitted to EG&G Idaho for comment and/or approval prior to implementation.

3.2 Sample Types

The following samples types will be submitted to the subcontractor for analysis. These samples will be obtained by a separate subcontractor.

3.2.1 Soil Samples The subcontractor shall determine the amount of Attachment A compounds (if any) present in soil samples obtained by the field sampling team. These soil samples will consist of composite aliquots from soil handling equipment as obtained using EPA sampling protocol. The subcontractor will receive a minimum of ten (10) samples and a maximum of twenty (20) samples total which will include both treated and untreated soils. A detection limit of 0.01 ppb 2,3,7,8-TCDF is required, or as stated in Attachment A. It should be noted that a number

of the untreated soil samples may contain small quantities of asphalt, which may necessitate extra cleanup. Also, these analyses will require high resolution GC/high resolution MS equipment for the CLP procedure. Method SW846-8280 is to also be performed.

3.2.2 Aqueous Samples The subcontractor shall determine the amount of Attachment A compounds present (if any) in aqueous samples (scrubber, neutralization and boiler blowdown) obtained by the field sampling team. Each sample will consist of a minimum of two (2) liters. The subcontractor will receive a minimum of ten (10) and a maximum of twenty (20) aqueous samples. A detection limit of 0.01 ppb is required for 2,3,7,8-TCDD, or as stated in Attachment A. In addition, pH, TOC, BOD, COD, dissolved solids, and ammonia are to be determined.

3.2.3 High Volume Air Samples The subcontractor shall determine the amount of dioxin/furan present (if any) in particulate acquired on filters collected using high volume air samples. The subcontractor will receive a minimum of five (5) and a maximum of ten (10) samples. A detection limit of 1.0 nanograms per filter is required. It is anticipated that soxhlet extraction using toluene or benzene will be required for the filters.

3.2.4 Stack Gas Samples The subcontractor shall provide analysis of Attachment A compounds in stack gas samples collected by the field sampling team. Samples will be obtained by standard M5, MM5, and VOST trains. Three trial burns will be performed resulting in five (5) complete sets of gas samples.

3.3 Analytical Standards

The subcontractor will supply all necessary analytical standards for this program. For example, with TCDD, these standards include $^{13}\text{C}_{12}$ - 2,3,7,8-TCDD, $^{37}\text{C}_{14}$ - 2,3,7,8-TCDD, 2,3,7,8-TCDD, and the performance check solution used to demonstrate the isomer specificity of

the gas chromatography column. All standards may be obtained from commercial sources. All standards will be verified for concentration using U.S. EPA and National Bureau of Standards reference standards. A list of all standards to be utilized and the results of the verification will be provided to EG&G Idaho.

3.4 Turnaround Time

Samples will be delivered to the subcontractor either by overnight express service or by EG&G Idaho personnel or their designees. It will be necessary to have rapid turnaround of analytical results. The samples will arrive over approximately seven days. In addition to meeting protocol requirements, the subcontractor will perform analyses and provide EG&G Idaho immediate results to facilitate review and validation. A final report, including a complete compilation of all data, will be provided to EG&G Idaho within 30 days of receiving the last sample.

3.5 EG&G Idaho Representation in Laboratory

Due to the rapid turnaround time required, the subcontractor will be required to allow an EG&G Idaho representative to review data in the subcontractor's laboratory. The data review procedure will not interfere with the analysis of the samples.

3.6 Disposal of Samples

Upon direction from EG&G Idaho and following submission of the final report, it will be the subcontractor's responsibility to dispose of any unused portions of samples. The disposal must conform to the appropriate Government regulations.

3.7 Public Relations

Neither the subcontractor nor any personnel in the employ of the subcontractor shall release any information concerning this project to the public or the media. All requests for information are to be directed to

the on-site EG&G Idaho representative. That representative will refer all requests to Mr. Peter Mygatt, Director, Office of External Affairs, DOE-ID. Mr. Mygatt will coordinate all releases with the USAF.

4.0 QUALITY ASSURANCE/QUALITY CONTROL PLAN

The subcontractor shall submit a Quality Assurance/Quality Control Plan which covers all the activities of this Scope of Work. The procedures to be followed for the chain of custody of all samples shall be clearly presented. The procedures in this QA/QC Plan, once approved by EG&G Idaho, shall be followed in the execution of this work.

5.0 DELIVERABLES

5.1 Final Report

The subcontractor shall provide to EG&G a final report summarizing the results of all the analyses including QA/QC samples. This final report will follow the CLP reporting format where possible and shall include the CLP required deliverables. The remaining data summation will be provided in tabular form. The final report will be due 30 days after receiving the last set of samples. Data summaries should be provided in hard copy and also on floppy discs in dBASE III format. The hard copy should be unbound and suitable for reproduction.

5.2 Interim Reports

The subcontractor will not be required to prepare interim reports; however, as data is available it is to be presented to the EG&G Idaho representative, who will provide daily reports via personal computer to EG&G Idaho project management.

5.3 Laboratory Notebooks

The subcontractor shall include, as an appendix to the final report, copies of the laboratory notebook pages pertaining to all aspects of this program.

5.4 Presentation of Results

The subcontractor will be present for presentation and discussion of the results to the U.S. Air Force, State officials, EPA Regional officials, and EPA-HQ. The subcontractor should assume a one-week effort for personnel to travel from Gulfport to Jackson, Mississippi; to Atlanta, Georgia; and to Washington, D. C. The subcontractor must include personnel knowledgeable in organics, metals, and dioxins/furans.

DIOXINS/FURANS BY LOW RESOLUTION GC/MS

Constituent	Analytical Method	Reference	Detection Limit µg/kg (ppb)
Antimony	CLP	1	600
Arsenic	CLP	1	200
Barium	CLP	1	400
Benzidine([1,1'-biphenyl]-4,4' diamine)	SW 846/CLP	4	2,600
Benzo[a]anthracene (1,2 benzanthracene)	8310	3	2.0
Benzo[b]fluoranthene (2,3-benzofluoranthene)	8310	3	2.0
Benzo[a]pyrene (3,4-benzopyrene)	8310	3	2.0
Beryllium	CLP	1	200
Bis(2-chloroethoxy)methane (ethane,[methylenebis (oxy)]bis[2-chloro-])	CLP	2	330
Bis(2-chloroisopropyl) ether (propane,2,2'-oxybis[2-chloro-])	CLP	2	330
Cadmium	CLP	1	1,000
Chlorinated benzenes, N.O.S.			
1,2,4,5-Tetrachlorobenzene >	SW 846/CLP	4	330
1,2,3,5-Tetrachlorobenzene >			
Chlorinated phenol, N.O.S.			
2,4-Dichlorophenol	CLP	2	330
2,6-Dichlorophenol	SW 846/CLP	4	330
2,5-Dichlorophenol	SW 846/CLP	4	330
2,3,4-Dichlorophenol	SW 846/CLP	4	330
2,3,4-Trichlorophenol	SW 846/CLP	4	330
2,4,5-Trichlorophenol	CLP	2	1,600
2,4,6-Trichlorophenol	CLP	2	330
2,3,4,5-Tetrachlorophenol >	SW 846/CLP	4	330
2,3,4,6-Tetrachlorophenol >			
Chromium (Total)	CLP	1	2,000
Chromium (Hexavalent)	SW 846	3	400
Chrysene (1,2-benzphenanthrene)	8310	3	1.0
Copper	CLP	1	2,000
Coal tars			
Creosote (creosote, wood) >	Analyzed as methyl phenols and PAH's (CLP/8310)		
Cresols (cresylic acid) (phenol, methyl-)	CLP	2	330
Dibenz[a,h]anthracene (1,2,5,6-dibenzanthracene)	8310	3	1.0
3,3'-Dichlorobenzidine ([1,1'-biphenyl]-4,4'-diamine,3,3'-dichloro-)	CLP	2	660
2,4-Dichlorophenoxyacetic acid (2,4-D), salts and esters (acetic acid,2,4-dichlorophenoxy-, salts and esters)	8150	3	20.
4,6-Dinitro-o-cresol and salts (phenol, 2,4-dinitro-6-methyl-, and salts)	CLP	2	1,600
2,4-Dinitrophenol (phenol,2,4-dinitro)	CLP	2	1,600
2,4-Dinitrotoluene (benzene,1-methyl-2,4-dinitro-)	CLP	2	330

DIOXINS/FURANS BY LOW RESOLUTION GC/MS (continued)

<u>Constituent</u>	<u>Analytical Method</u>	<u>Reference</u>	<u>Detection Limit ug/kg (ppb)</u>
2,6-Dinitrotoluene (benzene,1-methyl-2,6-dinitro-)	CLP	2	330
Fluoranthene (benzo[j,k]fluorene)	8310	3	2.0
Hexachlorodibenzo-p-dioxins	8280	3	0.1-0.3
Hexachlorodibenzofurans	8280	3	0.1-0.3
Hydroxydimethylarsine oxide (cacodylic acid)		(As Arsenic)	
Indeno(1,2,3-cd)pyrene(1,10-1,2-phenylene) pyrene	8310	3	3.0
Lead	CLP	1	200
Mercury	CLP	1	20
Nickel	CLP	1	4,000
4-Nitrophenol (phenol,4-nitro-)	CLP	2	1,600
N-Nitrosodimethylamine (dimethylnitrosamine)	SW 846/CLP	4	330
Pentachlorodibenzo-p-dioxins	8280	3	0.1-0.3
Pentachlorodibenzofurans	8280	3	0.1-0.3
Pentachlorophenol	CLP	2	1,600
nol (benzene,hydroxy)	CLP	2	330
ychlorinated biphenyl, N.O.S.	CLP	2	100-210
Selenium	CLP	1	200
Silver	CLP	1	1,000
2,3,7,8-Tetrachlorodibenzo-p-dioxin (TCDD) (Dibenzo-p-dioxin,2,3,7,8-tetrachloro-furan)	8280	3	0.1-0.3
Tetrachlorodibenzo-p-dioxins	8280	3	0.1-0.3
Tetrachlorodibenzofurans	8280	3	0.1-0.3
Thallium	CLP	1	200
Toxaphene (camphene,octachloro-)	CLP	2	210
2,4,5-Trichlorophenoxyacetic acid (2,4,5-T) (Acetic acid,2,4,5-trichlorophenoxy-)	8150	3	2.0
Vanadium	CLP	1	2,000
Zinc	CLP	1	1,000
pH	9040	3	Standard Unit:
Cyanide	9010	3	500
Sulfide	9030	3	200
EP Toxicity Extraction	1310	3	-
Corrosivity (as pH)	9040	3	Standard Unit:
Total Cyanides	9010	3	10

REFERENCES

- (1) U.S. Environmental Protection Agency (EPA), 1987, "Chemical Analytical Services for Multi-Media Multi-Concentration Metals and Inorganics", Statement of Work 7/87, WA-87-K026, U.S. EPA, Washington, D.C.
- (2) U.S. Environmental Protection Agency (EPA), 1987, "Chemical Analytical Services for Multi-Media Multi-Concentration Organics, GC/MS Techniques", Statement of Work, 7/87, WA-87-K236, U.S. EPA, Washington, D.C.
- (3) U.S. Environmental Protection Agency (EPA), April 1984, "Test Methods for Evaluating Solid Waste, Physical/Chemical Methods", SW-846, Revised Second Edition.
- (4) These compounds are not a part of the CLP list. The method will include Reference 2 protocol with modifications from Reference 3.

DIOXINS/FURANS BY HIGH RESOLUTION GC/MS

Constituent	Analytical Method	Reference	Detection Limit ug/kg (ppb)
Antimony	CLP	1	600
Arsenic	CLP	1	200
Barium	CLP	1	400
Benzidine([1,1'-biphenyl]-4,4' diamine)	SW 846/CLP	4	2,600
Benzo[a]anthracene (1,2 benzanthracene)	8310	3	2.0
Benzo[b]fluoranthene (2,3-benzofluoranthene)	8310	3	2.0
Benzo[a]pyrene (3,4-benzopyrene)	8310	3	2.0
Beryllium	CLP	1	200
Bis(2-chloroethoxy)methane (ethane,[methylenebis (oxy)]bis[2-chloro-])	CLP	2	330
Bis(2-chloroisopropyl) ether (propane,2,2'-oxybis[2-chloro-])	CLP	2	330
Cadmium	CLP	1	1,000
Chlorinated benzenes, N.O.S.			
1,2,4,5-Tetrachlorobenzene >	SW 846/CLP	4	330
1,2,3,5-Tetrachlorobenzene >			
Chlorinated phenol, N.O.S.			
2,4-Dichlorophenol	CLP	2	330
2,6-Dichlorophenol	SW 846/CLP	4	330
2,5-Dichlorophenol	SW 846/CLP	4	330
2,4-Dichlorophenol	SW 846/CLP	4	330
2,3,4-Trichlorophenol	SW 846/CLP	4	330
2,4,5-Trichlorophenol	CLP	2	1,600
2,4,6-Trichlorophenol	CLP	2	330
2,3,4,5-Tetrachlorophenol >	SW 846/CLP	4	330
2,3,4,6-Tetrachlorophenol >			
Chromium (Total)	CLP	1	2,000
Chromium (Hexavalent)	SW 846	3	400
Chrysene (1,2-benzphenanthrene)	8310	3	1.0
Copper	CLP	1	2,000
Coal tars			
Creosote (creosote, wood) >	Analyzed as methyl phenols and PAH's (CLP/8310)		
Cresols (cresylic acid) (phenol, methyl-)	CLP	2	330
Dibenz[a,h]anthracene (1,2,5,6-dibenzanthracene)	8310	3	1.0
3,3'-Dichlorobenzidine ([1,1'-biphenyl]-4,4'-diamine,3,3'-dichloro-)	CLP	2	660
2,4-Dichlorophenoxyacetic acid (2,4-D), salts and esters (acetic acid,2,4-dichlorophenoxy-, salts and esters)	8150	3	20.
4,6-Dinitro-o-cresol and salts (phenol, 2,4-dinitro-6-methyl-, and salts)	CLP	2	1,600
2,4-Dinitrophenol (phenol,2,4-dinitro)	CLP	2	1,600
2,4-Dinitrotoluene (benzene,1-methyl-2,4-dinitro-)	CLP	2	330

DIOXINS/FURANS BY HIGH RESOLUTION GC/MS (continued)

<u>Constituent</u>	<u>Analytical Method</u>	<u>Reference</u>	<u>Detection Limit ug/kg (ppb)</u>
2,6-Dinitrotoluene (benzene,1-methyl-2,6-dinitro-)	CLP	2	330
Fluoranthene (benzo[j,k]fluorene)	8310	3	2.0
Hexachlorodibenzo-p-dioxins	8280	3	5-30 ppt
Hexachlorodibenzofurans	8280	3	5-30 ppt
Hydroxydimethylarsine oxide (cacodylic acid)		(As Arsenic)	
Indeno(1,2,3-cd)pyrene(1,10-1,2-phenylene) pyrene	8310	3	3.0
Lead	CLP	1	200
Mercury	CLP	1	20
Nickel	CLP	1	4,000
1-Nitrophenol (phenol,4-nitro-)	CLP	2	1,600
N-Nitrosodimethylamine (dimethylnitrosamine)	SW 846/CLP	4	330
Pentachlorodibenzo-p-dioxins	8280	3	5-30 ppt
Pentachlorodibenzofurans	8280	3	5-30 ppt
Pentachlorophenol	CLP	2	1,600
anol (benzene,hydroxy)	CLP	2	330
ychlorinated biphenyl, N.O.S.	CLP	2	100-210
Selenium	CLP	1	200
Silver	CLP	1	1.000
2,3,7,8-Tetrachlorodibenzo-p-dioxin (TCDD) (Dibenzo-p-dioxin,2,3,7,8-tetrachloro- u an)	8280	3	5-20 ppt
Tetrachlorodibenzo-p-dioxins	8280	3	5-30 ppt
Tetrachlorodibenzofurans	8280	3	5-30 ppt
Tellurium	CLP	2	0
x phene (camphene,octachloro-)	CLP	2	210
,4,5-Trichlorophenoxyacetic acid (2,4, -T, (Acetic acid,2,4,5-trichlorophenoxy-)	8150	3	2.
radium	CLP	1	2,00
nc	CL	1	1,000
ph	9040		standard units
Cyanide	010	3	500
Sulfide	9030	3	200
P Toxicity Extraction	10	3	-
Corrosivity (as pH)	9140	3	Standard Unit
Total Cyanides	5010	3	10

REFERENCES

- (1) U.S. Environmental Protection Agency (EPA), 1987, "Chemical Analytical Services for Multi-Media Multi-Concentration Metals and Inorganics", Statement of Work 7/87, WA-87-K026, U.S. EPA, Washington, D.C.
- (2) U.S. Environmental Protection Agency (EPA), 1987, "Chemical Analytical Services for Multi-Media Multi-Concentration Organics, GC/MS Techniques", Statement of Work, 7/87, WA-87-K236, U.S. EPA, Washington, D.C.
- (3) U.S. Environmental Protection Agency (EPA), April 1984, "Test Methods for Evaluating Solid Waste, Physical/Chemical Methods", SW-846, Revised Second Edition.
- (4) These compounds are not a part of the CLP list. The method will include Reference protocol with modifications from Reference 3.

DIOXINS/FURANS BY LOW RESOLUTION GC/MS

Constituent	Analytical Method	Reference	Detection Limit µg/kg (ppb)
Antimony	CLP	1	600
Arsenic	CLP	1	200
Barium	CLP	1	400
Benzidine([1,1'-biphenyl]-4,4' diamine)	SW 846/CLP	4	2,600
Benzo[a]anthracene (1,2 benzanthracene)	8310	3	2.0
Benzo[b]fluoranthene (2,3-benzofluoranthene)	8310	3	2.0
Benzo[a]pyrene (3,4-benzopyrene)	8310	3	2.0
Beryllium	CLP	1	200
Bis(2-chloroethoxy)methane (ethane,[methylenebis (oxy)]bis[2-chloro-])	CLP	2	330
Bis(2-chloroisopropyl) ether (propane,2,2'-oxybis[2-chloro-])	CLP	2	330
Cadmium	CLP	1	1,000
Chlorinated benzenes, N.O.S.			
1,2,4,5-Tetrachlorobenzene >	SW 846/CLP	4	330
1,2,3,5-Tetrachlorobenzene >			
Chlorinated phenol, N.O.S.			
2,4-Dichlorophenol	CLP	2	330
2,5-Dichlorophenol	SW 846/CLP	4	330
2,5-Dichlorophenol	SW 846/CLP	4	330
1,4-Dichlorophenol	SW 846/CLP	4	330
2,3,4-Trichlorophenol	SW 846/CLP	4	330
2,4,5-Trichlorophenol	CLP	2	1,600
2,4,6-Trichlorophenol	CLP	2	330
2,3,4,5-Tetrachlorophenol >	SW 846/CLP	4	330
2,3,4,6-Tetrachlorophenol >			
Chromium (Total)	CLP	1	2,000
Chromium (Hexavalent)	SW 846	3	400
Chrysene (1,2-benzphenanthrene)	8310	3	1.0
Copper	CLP	1	2,000
Coal tars	Analyzed as methyl phenols and PAH's (CLP/8310)		
Creosote (creosole, wood) >			
Cresols (creylin acid) (phenol, methyl-)	CLP	2	330
benzo[a,h]anthracene (1,2,5,6-dibenzanthracene)	8310	3	1.0
3,3'-Dichlorobenzidine ([1,1'-biphenyl]-4,4'-diamine,3,3'-dichloro-)	CLP	2	660
2,4-dichlorophenoxyacetic acid (2,4-D), salts and esters (acetic acid,2,4-dichlorophenoxy-, salts and esters)	8150	3	20.
4,6-Dinitro-o-cresol and salts (phenol, 2,4-dinitro-6-methyl-, and salts)	CLP	2	1,600
2,4-Dinitrophenol (phenol,2,4-dinitro)	CLP	2	1,600
2,4-Dinitrotoluene (benzene,1-methyl-2,4-dinitro-)	CLP	2	330

DIOXINS/FURANS BY LOW RESOLUTION GC/MS (continued)

<u>Constituent</u>	<u>Analytical Method</u>	<u>Reference</u>	<u>Detection Limit ug/kg (ppb)</u>
2,6-Dinitrotoluene (benzene,1-methyl-2,6-dinitro-)	CLP	2	330
Fluoranthene (benzo[j,k]fluorene)	8310	3	2.0
Hexachlorodibenzo-p-dioxins	8280	3	0.1-0.3
Hexachlorodibenzofurans	8280	3	0.1-0.3
Hydroxydimethylarsine oxide (cacodylic acid)		(As Arsenic)	
Indeno(1,2,3-cd)pyrene(1,10-1,2-phenylene) pyrene	8310	3	3.0
Lead	CLP	1	200
Mercury	CLP	1	20
Nickel	CLP	1	4,000
4-Nitrophenol (phenol,4-nitro-)	CLP	2	1,600
N-Nitrosodimethylamine (dimethylnitrosamine)	SW 846/CLP	4	330
Pentachlorodibenzo-p-dioxins	8280	3	0.1-0.3
Pentachlorodibenzofurans	8280	3	0.1-0.3
Pentachlorophenol	CLP	2	1,600
Phenol (benzene,hydroxy)	CLP	2	330
Polychlorinated biphenyl, N.O.S.	CLP	2	100-210
Selenium	CLP	1	200
Silver	CLP	1	1,000
2,3,7,8-Tetrachlorodibenzo-p-dioxin (TCDD) (Dibenzo-p-dioxin,2,3,7,8-tetrachloro-furan)	8280	3	0.1-0.3
Tetrachlorodibenzo-p-dioxins	8280	3	0.1-0.3
Tetrachlorodibenzofurans	8280	3	0.1-0.3
Thallium	CLP	1	200
Toxaphene (camphene,octachloro-)	CLP	2	210
2,4,5-Trichlorophenoxyacetic acid (2,4,5-T) (Acetic acid,2,4,5-trichlorophenoxy-)	8150	3	2.0
Vanadium	CLP	1	2,000
Zinc	CLP	1	1,000
pH	9040	3	Standard Unit
Cyanide	9010	3	500
Sulfide	9030	3	200
EP Toxicity Extraction	1310	3	-
Corrosivity (as pH)	9040	3	Standard Unit
Total Cyanides	9010	3	10

REFERENCES

- (1) U.S. Environmental Protection Agency (EPA), 1987, "Chemical Analytical Services for Multi-Media Multi-Concentration Metals and Inorganics", Statement of Work 7/87, WA-87-K026, U.S. EPA, Washington, D.C.
- (2) U.S. Environmental Protection Agency (EPA), 1987, "Chemical Analytical Services for Multi-Media Multi-Concentration Organics, GC/MS Techniques", Statement of Work, 7/87, WA-87-K236, U.S. EPA, Washington, D.C.
- (3) U.S. Environmental Protection Agency (EPA), April 1984, "Test Methods for Evaluating Solid Waste, Physical/Chemical Methods", SW-846, Revised Second Edition.
- (4) These compounds are not a part of the CLP list. The method will include Reference 2 protocol with modifications from Reference 3.

DIOXINS/FURANS BY HIGH RESOLUTION GC/MS

Constituent	Analytical Method	Reference	Detection Limit µg/kg (ppb)
Antimony	CLP	1	600
Arsenic	CLP	1	200
Barium	CLP	1	400
Benzidine([1,1'-biphenyl]-4,4' diamine)	SW 846/CLP	4	2,600
Benzo[a]anthracene (1,2 benzanthracene)	8310	3	2.0
Benzo[b]fluoranthene (2,3-benzofluoranthene)	8310	3	2.0
Benzo[a]pyrene (3,4-benzopyrene)	8310	3	2.0
Beryllium	CLP	1	200
Bis(2-chloroethoxy)methane (ethane,[methylenebis (oxy)]bis[2-chloro-])	CLP	2	330
Bis(2-chloroisopropyl) ether (propane,2,2'-oxybis[2-chloro-])	CLP	2	330
Cadmium	CLP	1	1,000
Chlorinated benzenes, N.O.S.			
1,2,4,5-Tetrachlorobenzene >	SW 846/CLP	4	330
1,2,3,5-Tetrachlorobenzene >			
Chlorinated phenol, N.O.S.			
2,4-Dichlorophenol	CLP	2	330
2,6-Dichlorophenol	SW 846/CLP	4	330
2,5-Dichlorophenol	SW 846/CLP	4	330
3,4-Dichlorophenol	SW 846/CLP	4	330
2,3,4-Trichlorophenol	SW 846/CLP	4	330
2,4,5-Trichlorophenol	CLP	2	1,600
2,4,6-Trichlorophenol	CLP	2	330
2,3,4,5-Tetrachlorophenol >	SW 846/CLP	4	330
2,3,4,6-Tetrachlorophenol >			
Chromium (Total)	CLP	1	2,000
Chromium (Hexavalent)	SW 846	3	400
Chrysene (1,2-benzphenanthrene)	8310	3	1.0
Copper	CLP	1	2,000
Coal tars			
Creosote (creosote, wood) >	Analyzed as methyl phenols and PAH's (CLP/8310)		
Cresols (cresylic acid) (phenol, methyl-)	CLP	2	330
Dibenz[a,h]anthracene (1,2,5,6-dibenzanthracene)	8310	3	1.0
3,3'-Dichlorobenzidine ([1,1'-biphenyl]-4,4'-diamine,3,3'-dichloro-)	CLP	2	660
2,4-Dichlorophenoxyacetic acid (2,4-D), salts and esters (acetic acid,2,4-dichlorophenoxy-, salts and esters)	8150	3	20.
4,6-Dinitro-o-cresol and salts (phenol, 2,4-dinitro-6-methyl-, and salts)	CLP	2	1,600
2,4-Dinitrophenol (phenol,2,4-dinitro)	CLP	2	1,600
2,4-Dinitrotoluene (benzene,1-methyl-2,4-dinitro-)	CLP	2	330

DIOXINS/FURANS BY HIGH RESOLUTION GC/MS (continued)

<u>Constituent</u>	<u>Analytical Method</u>	<u>Reference</u>	<u>Detection Limit µg/kg (ppb)</u>
2,6-Dinitrotoluene (benzene,1-methyl-2,6-dinitro-)	CLP	2	330
Fluoranthene (benzo[j,k]fluorene)	8310	3	2.0
Hexachlorodibenzo-p-dioxins	8280	3	5-30 ppt
Hexachlorodibenzofurans	8280	3	5-30 ppt
Hydroxydimethylarsine oxide (cacodylic acid)		(As Arsenic)	
Indeno(1,2,3-cd)pyrene(1,10-1,2-phenylene) pyrene	8310	3	3.0
Lead	CLP	1	200
Mercury	CLP	1	20
Nickel	CLP	1	4,000
4-Nitrophenol (phenol,4-nitro-)	CLP	2	1,600
N-Nitrosodimethylamine (dimethylnitrosamine)	SW 846/CLP	4	330
Pentachlorodibenzo-p-dioxins	8280	3	5-30 ppt
Pentachlorodibenzofurans	8280	3	5-30 ppt
Pentachlorophenol	CLP	2	1,600
Phenol (benzene,hydroxy)	CLP	2	330
Polychlorinated biphenyl, N.O.S.	CLP	2	100-210
Selenium	CLP	1	200
Silver	CLP	1	1,000
2,3,7,8-Tetrachlorodibenzo-p-dioxin (TCDD) (Dibenzo-p-dioxin,2,3,7,8-tetrachloro-furan)	8280	3	5-20 ppt
Tetrachlorodibenzo-p-dioxins	8280	3	5-30 ppt
Tetrachlorodibenzofurans	8280	3	5-30 ppt
Thallium	CLP	1	200
Toxaphene (camphene,octachloro-)	CLP	2	210
2,4,5-Trichlorophenoxyacetic acid (2,4,5-T) (Acetic acid,2,4,5-trichlorophenoxy-)	8150	3	2.0
Vanadium	CLP	1	2,000
Zinc	CLP	1	1,000
pH	9040	3	Standard Units
Cyanide	9010	3	500
Sulfide	9030	3	200
EP Toxicity Extraction	1310	3	-
Corrosivity (as pH)	9040	3	Standard Units
Total Cyanides	9010	3	10

REFERENCES

- (1) U.S. Environmental Protection Agency (EPA), 1987, "Chemical Analytical Services for Multi-Media Multi-Concentration Metals and Inorganics", Statement of Work 7/87, WA-87-K026, U.S. EPA, Washington, D.C.
- (2) U.S. Environmental Protection Agency (EPA), 1987, "Chemical Analytical Services for Multi-Media Multi-Concentration Organics, GC/MS Techniques", Statement of Work, 7/87, WA-87-K236, U.S. EPA, Washington, D.C.
- (3) U.S. Environmental Protection Agency (EPA), April 1984, "Test Methods for Evaluating Solid Waste, Physical/Chemical Methods", SW-846, Revised Second Edition.
- (4) These compounds are not a part of the CLP list. The method will include Reference 2 protocol with modifications from Reference 3.

Attachment III

OPERATING INSTRUCTIONS AND DESCRIPTION OF MODEL PS-1 PUF SAMPLER

OPERATING INSTRUCTIONS

MODEL PS-1

A. UNIT PREPARATION.

1. Remove the PS-1 Puf Sampler from the shipping carton.
2. Locate the shelter lid and install on the aluminum shelter as follows:
 - a. Align the hinges of the lid to the rear of the shelter and fasten with four (4) 10-24 x 1/2" pan head screws.
 - b. Secure the front catch, (see figure A), to the shelter front using two (2) 10-24 x 1/2" flat head screws.
 - c. Secure the rear catch to the shelter back panel using one (1) 10-24 x 1/2" pan head screw.
 - d. Secure the rear lid hasp to the shelter lid using two (2) 10-24 x 1/2" pan head screws. (note: These three catches may need readjustment to operate the shelter lid properly.)
 - e. Adjust the front and rear catches to be sure that the lid slot lowers over the front catch when closing the lid and aligns with the rear catch when the lid is in the open position.
 - f. The lid can now be secured in an open or closed position with the aluminum strip or a padlock.
3. Find one (1) sampling module in the packing container and install on the inlet port. The inlet port has a 1/2" threaded male fitting. Place the module over the male fitting and screw it on until snug.
4. Pull the exhaust hose from out of the shelter bottom and extend it away from the shelter on the ground.
5. Open the shelter door and timer.
6. Prepare the timer for the desired start and stop times.

B. Unit Calibration.

1. Calibration of the Puf Sampler is performed without a foam slug or filter paper in the sampling module. However the empty glass cartridge must remain in the module to insure a good seal through the module.
2. Install the GMW-40 Calibrator on top of the 4" filter holder.

Operating Instructions
Model PS-1
Page 2

3. Connect an 8" water manometer to the Calibrator.
4. Open the ball valve fully.
5. Turn the system on by tripping the manual switch on the timer. Allow a few minutes for warm-up.
6. Adjust the voltage control screw to obtain a reading of 70 inches on the dial gage, (Magnehelic Gage).
7. With 70 inches on the dial gage as your first calibration point, record it and the manometer reading on the data sheet.
8. Close the ball valve slightly to readjust the dial gage down to 60 inches. Record this figure and manometer reading on the data sheet.
9. Using the above procedure, adjust the ball valve for readings at 50, 40, and 30 inches and record on the data sheet.
10. Using these two sets of readings, plot a curve on the data sheet. This curve will be used for determining the actual flow rate in the field.
11. Readjust the voltage control fully clockwise to it's maximum setting. Open ball valve fully.

C. Unit Operation.

1. The Puf Sampler may be operated at ground level or on roof tops. In urban or congested areas, it is recommended that the sampler be placed on the roof of a single story building. The sampler should be located in an unobstructed area, at least two meters from any obstacle to air flow. The exhaust hose should be stretched out in a down wind direction if possible.
2. The sampler should be operated for 24 hours in order to obtain average daily levels of airborne pesticides.
3. On and off times and weather conditions during sampling periods should be recorded. Air concentrations may fluctuate with time of day, temperature, humidity, wind direction and velocity and other climatological conditions.
4. Air flow readings should be taken (dial gage) at the beginning and end of each sampling period. Differences between the beginning and ending flow rates should be averaged out to obtain an overall flow rate. (The Puf Sampler can be fitted with a gas meter which would give a direct reading of the total flow.)
5. Blower motor brushes should be inspected frequently and replaced before expending.

6. An electrical source of 110 volts, 15 amps is required.

D. Descriptions of Sampling Media (Sorbents)

1. Two types of sampling media are recommended for use with the Puf Sampler: polyurethane foams and granular solid sorbents. Foams may be used separately or in combination with granular solids. The sorbent may be extracted and reused (after drying) without unloading the cartridge.
2. Polyurethane Foam (PUF):
 - a. Use polyether-type polyurethane foam (density No. 3014, 0.0225 grams/cm³, or equivalent). This is the type of foam generally used for furniture upholstery, pillows, and mattresses. (General Metal Works' part number PS1-16 is recommended. It is a 3" PUF plug. Also available are two and one inch pieces.) This type of foam is white and yellows on exposure to light.
3. Granular Solids:
 - a. Porous (macroreticular) chromatography sorbents recommended. Pore sizes and mesh sizes must be selected to permit air flow rates of at least 200 liters/minute. Approximately 25 cm³ of sorbent is recommended. The granular solids may be sandwiched between two layers of foam to prevent loss during sampling and extraction.

E. Sampling Module.

1. Release the three (3) swing bolts on the 4" filter holder (FH-2104) and remove the hold down ring.
2. Install a clean 102mm dia. glass fiber filter (GMW-0232) on the support screen and secure it with the hold down ring and swing bolts.
3. Unscrew together the 4" filter holder and the sampling module cap leaving the module tube in place with the glass cartridge exposed.
4. Load the glass cartridge with foam and or foam/granular solids and replace in the module tube. Fasten the glass cartridge with the module cap and 4" filter holder assembly while making sure that the module assembly, 4" filter holder and all fittings are snug and not over-tighten.

5. The glass cartridge and glass fiber filter should be removed from the sampler with forceps and clean gloved hands and immediately placed in a sealed container for transport to the laboratory. Similar care should be taken to prevent contamination of the filter paper and vapor trap (foam) when loading the sampler.
6. It is recommended to have two (2) sampling modules for each sampling system so that filter and foam exchange can take place in the laboratory.

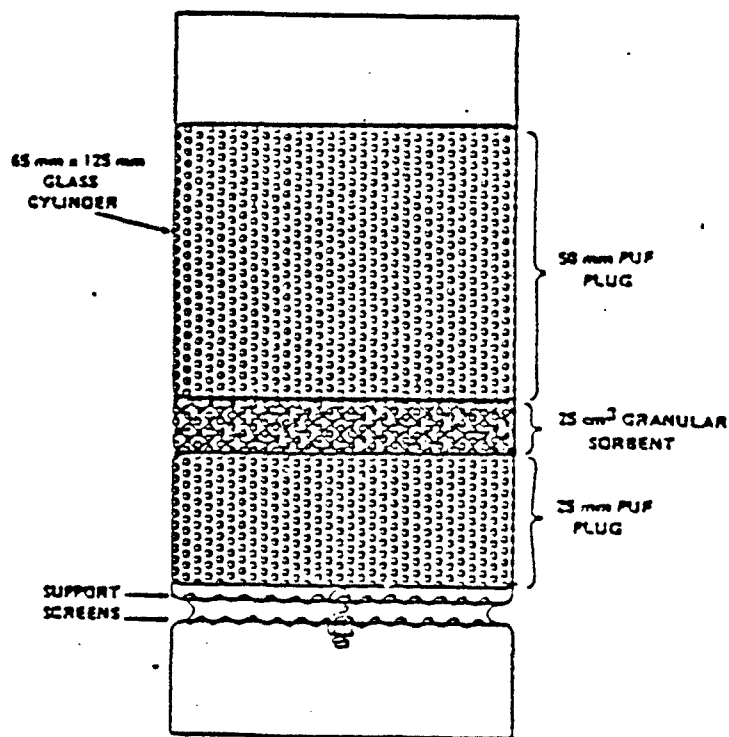

DUAL SORBENT VAPOR TRAP

MODEL PS-1 PUF SAMPLER

effective Feb 84

replacement parts

PS1-1	-----	Dual sampling module with FH-2104 4" filter holder, less glass cartridge.
PS1-2	-----	4" round Filter Holder (FH-2104)
PS1-3	-----	Silicone gasket (top module)
PS1-4	-----	Glass Cartridge w/ support screens
PS1-5	-----	Silicone gasket (bottom module)
PS1-6	-----	Voltage Variator/Elapsed Timer
PS1-7	-----	Seven Day Skip Timer (GMW-70)
PS1-8	-----	Magnehelic Gage 0-100"
PS1-9	-----	Flow Venturi
PS1-10	-----	Flow Valve
PS1-11	-----	Blower Motor Assembly
PS1-12	-----	Motor Cushion
PS1-13	-----	Replacement Motor only
PS1-14	-----	Replacement Motor Brushes (B-1)
PS1-15	-----	Exhaust Hose , 10ft.length
PS1-16	-----	PUF (polyurethane foam) plug 3"
PS1-17	-----	PUF (polyurethane foam) plug 2"
PS1-18	-----	PUF (polyurethane foam) plug 1"
PS1-19	-----	Aluminum Outdoor Shelter Complete
PS1-20	-----	Male Adapter for bottom of module
PS1-21	-----	Flanged coupler for Male Adapter

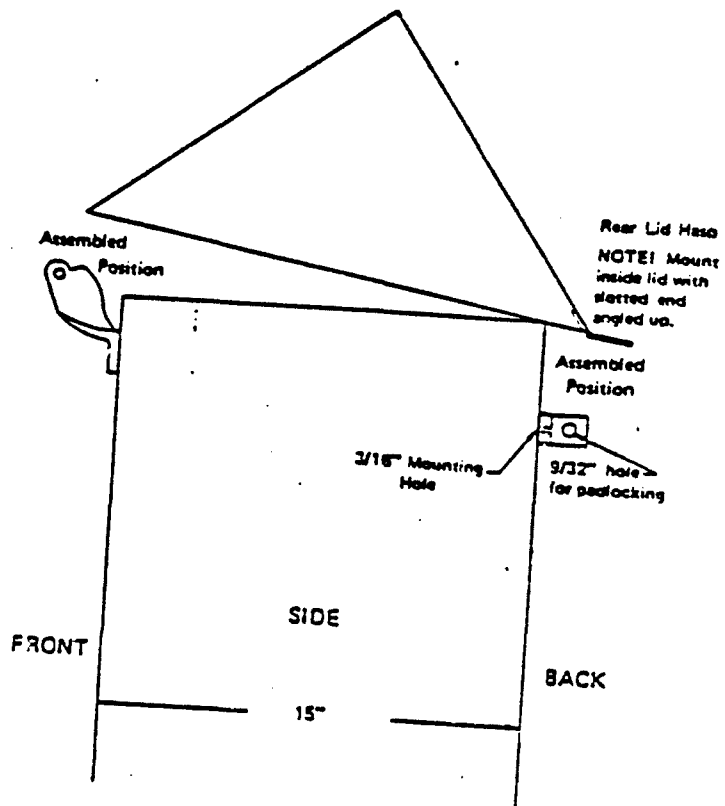

FIGURE A

MOTOR BRUSH SEATING PROCEDURE

On reassembly and handling, the lead wires must be kept away from rotating parts and motor frame.

To achieve best performance, the new brushes should be seated on the commutator before full voltage is applied.

After brush change apply approximately 50% voltage for thirty minutes to accomplish this seating. The motor will return to full performance after thirty to forty-five minutes running at full voltage.

(Caution) - Direct application of full voltage after changing brush will cause arcing, commutator pitting, and reduce overall life.

Use of the Model GMW - 900 Voltage Variator provides the reduced voltage needed for brush seating.

If reduced voltage is unavailable, connect two motors of similar rating in series for thirty minutes to accomplish the brush seating.

WARNING - **THE BRUSHES SHOULD BE CHANGED BEFORE**
THE BRUSH SHUNT TOUCHES THE COMMUTATOR.

SPECIAL NOTE: When ordering GMW Replacement Motor Brushes, compare brush configuration carefully!

3-1 Brush Sets used on 115750 motors furnished after January 1978

8-3 Brush Sets used on 115250 motors furnished prior to January 1978 only.

Motor Brush "U" clip connectors used with 8-3 brush sets only.

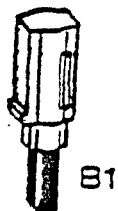

CALIBRATION DATA SHEET
HIGH VOLUME AIR SAMPLER CALIBRATION

Unit No.: _____

Date:

By:

Temp.:

Az. Press:

Remarks:

Indicated	True H ₂ O	Actual cfm

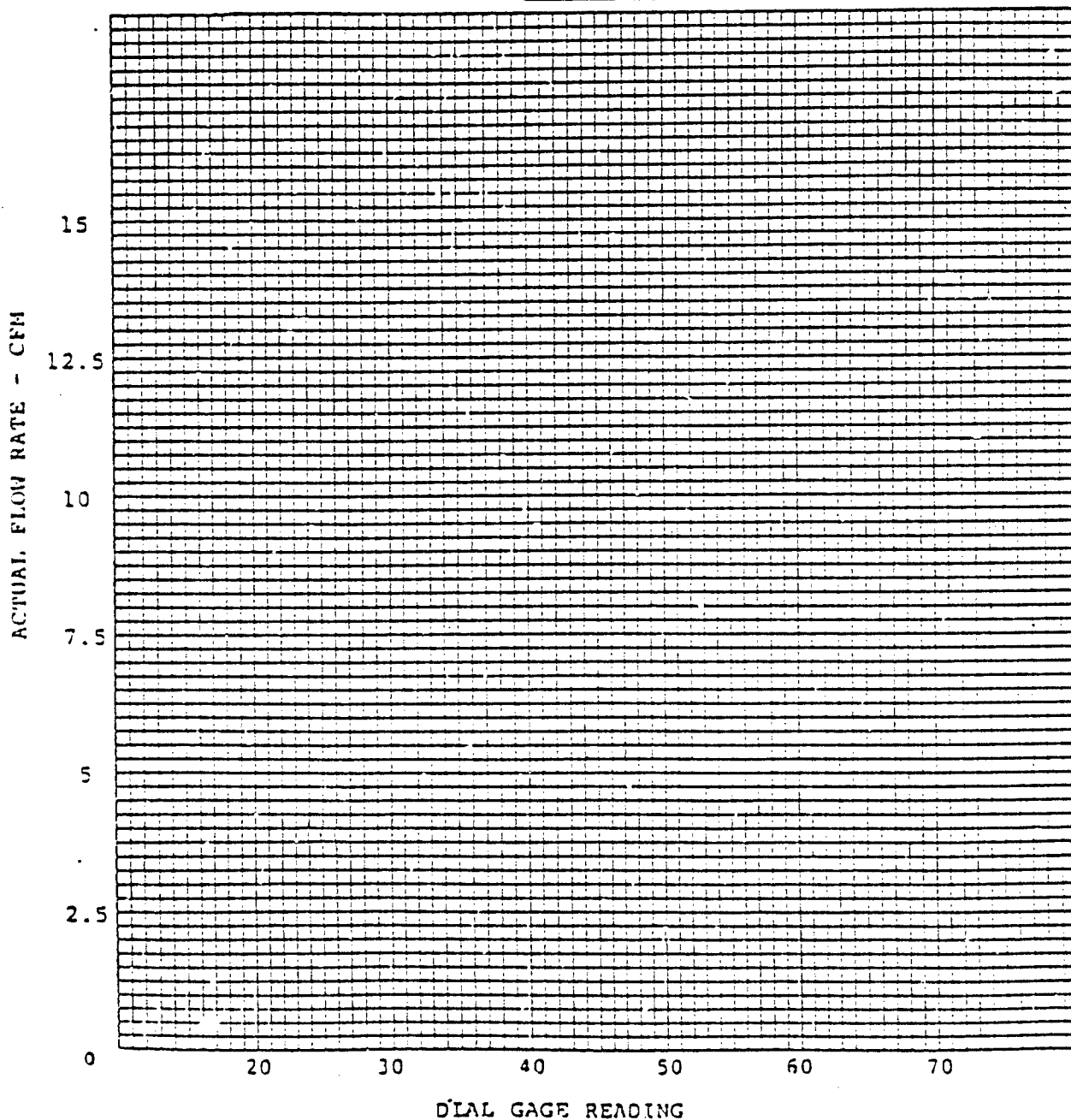



MODEL PS-1 PUF SAMPLER

Pesticide Particulate and Vapor Collection System

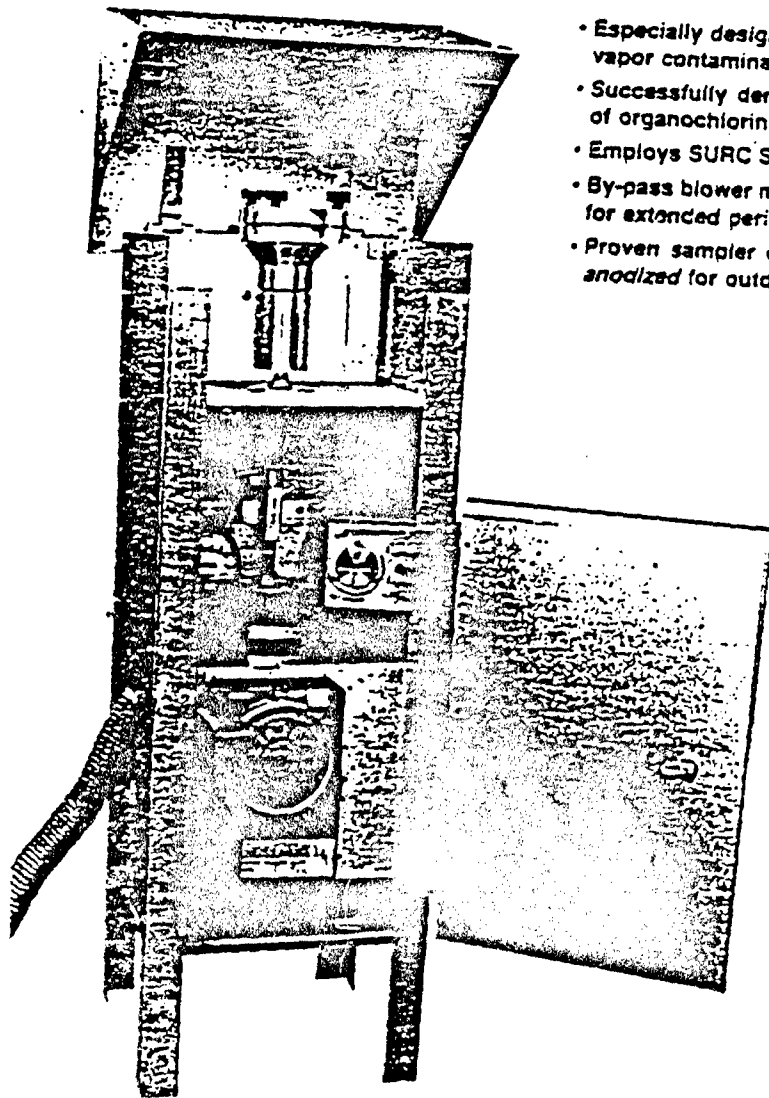

- Especially designed for sampling airborne particulates and vapor contamination from pesticide compounds.
- Successfully demonstrated to efficiently collect a number of organochlorine and organophosphate pesticides.
- Employs SURC Sampler concepts.
- By-pass blower motor design permits continuous sampling for extended periods at rates to 280 liters per minute.
- Proven sampler components housed in aluminum shelter anodized for outdoor service.

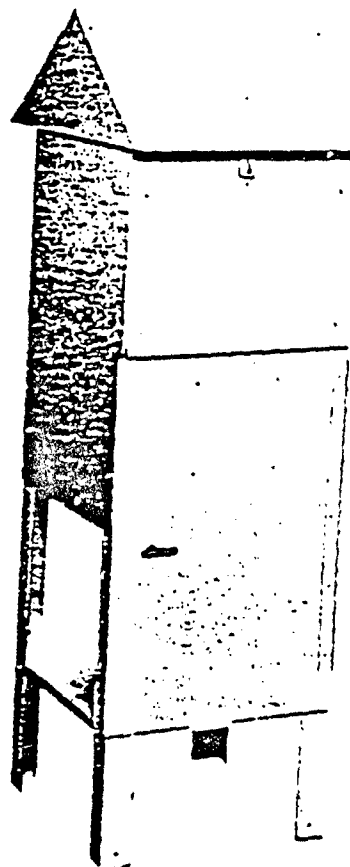

General Metal Works' PUF (PolyUrethane Foam) Sampler is a complete air sampling system designed to simultaneously collect suspended airborne particulates as well as trap airborne pesticide vapors at flow rates up to 280 liters per minute. Based on early SURC sampler collection concepts, the Model PS-1 features the latest in technological advances for accurately measur-

ing airborne particulates and vapors.

The GMW PUF Sampler is equipped with a by-pass blower motor arranged with an independent cooling fan. This feature permits the motor to operate at low sampling flow rates for periods of long duration without motor failure from overheating.

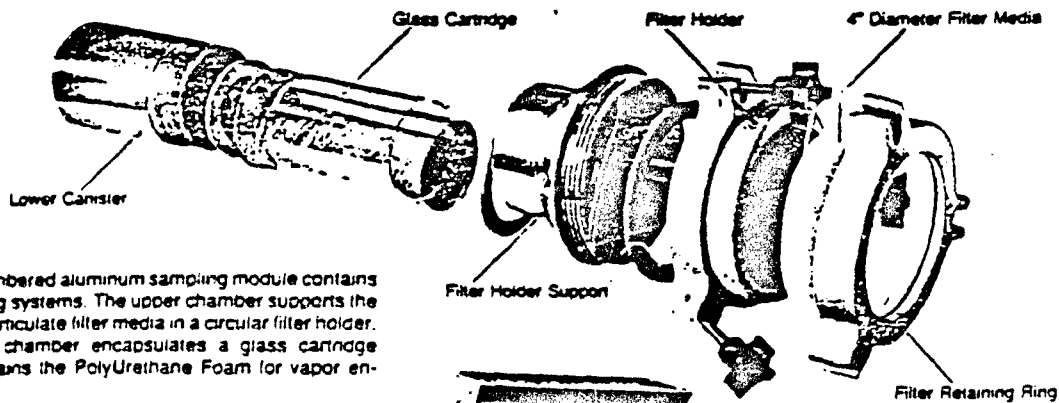

A dual chambered aluminum sampling module contains both filtering systems. The upper chamber supports the airborne particulate filter media in a circular filter holder. The lower chamber encapsulates a glass cartridge which contains the PolyUrethane Foam for vapor entrapment.

A wide variety of sorbents can be used in a manner that permits their continual use. Polyurethane foam or wet/dry granular solid media can be used individually or in combination.

The dual chambered sampling module is designed for easy access to both upper and lower media. Swing-away bolts simplify changing the 4" diameter particulate filter media. The threaded lower canister is removed with the cartridge intact for immediate exchange. Filter support screens and module components are equipped with gaskets providing a leak proof seal during the sampling process.

Air flow rates are infinitely variable up to 280 liters per minute. The voltage variator adjusting screw alters the blower motor speed to achieve the flow rate desired. The air flow rate is measured through the flow venturi utilizing a 0-100" Magnetic Gage. Periodic calibration is necessary to maintain on-site sampling accuracy.

A 7-day skip timer is included as standard and permits weekly scheduling with individual settings for each day and 14 trippers to turn the sampler on and off as desired. Any day or days may be omitted. Day and night periods are distinctly marked. Other timers and timer/programmers are available optionally to suit any sampling requirement.

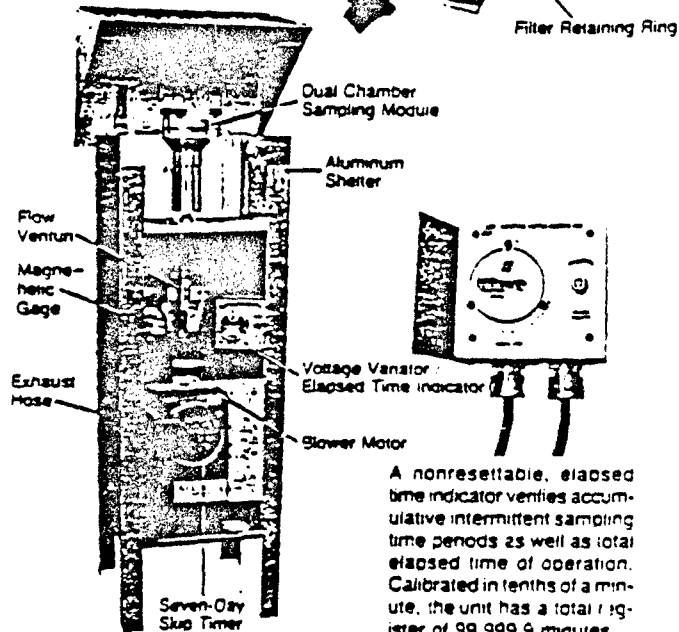

A nonresettable, elapsed time indicator verifies accumulative intermittent sampling time periods as well as total elapsed time of operation. Calibrated in tenths of a minute, the unit has a total register of 99,999.9 minutes.

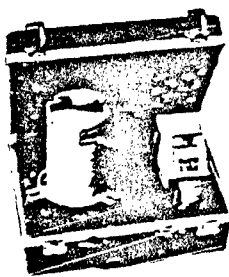

Priced separately, the calibration kit includes a manometer, calibrator and calibration curve nested in a carrying case. The calibrator attaches directly to the top of the filter holder eliminating the need to disassemble the sampling unit. It affords precise calibration of the sampler and is especially recommended for calibrating the Model PS-1 PUF Sampler.

The GMW Model PS-1 PUF Sampler is shipped completely wired and assembled, ready for operation. All components are housed within the anodized aluminum shelter for maximum protection.

SPECIFICATIONS:

- Ampereage - 6.0
- Wattage - 960
- Max. Flow Rate - 280 liters per minute
- Power Source - 115V, 1 phase, 60 Hertz (other electrical characteristics available on request)
- Net Weight - 55 lbs.
- Shipping Weight - 75 lbs.

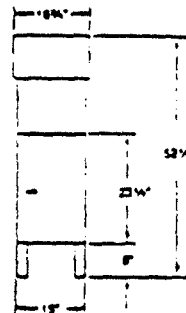

Outside Ohio call toll free 1-800-543-7412



GENERAL METAL WORKS INC.

A Subsidiary of Anderson Samplers, Inc.
145 South Miami Ave. / Village of Clevel. Ohio 45002 / Tel. 513-941-2229

APPENDIX L
ANALYSIS RESULTS FOR WATER SAMPLES FROM
NCBC WATER SUPPLY WELLS

The documents contained in this appendix were published according to their own internal style, which deviates from the Air Force Engineering Services Center format. They have, therefore, been published without editing.

601

(The reverse of this page is blank.)

REPORT

WELL WATER ANALYSIS FOR SILICA

POTABLE WATER SUPPLY WELL, NCBC, GULFPORT, MS

08 NOVEMBER, 1986

The ENSCO mobile incinerator, currently located at NCBC, requires low silica water to facilitate waste heat boiler operation. To determine if suitable well water was available at NCBC samples were collected from all five potable water supply wells. Samples were collected after purging each well for at least 3 minutes. The samples were collected in clean plastic sample bottles with plastic lids. Additionally, a sample was collected from the water distribution system located at the incinerator site. Samples were stored at ambient temperature and shipped to Tyndall AFB, FL for silica analysis.

Samples were analyzed by the colorimetric procedure listed in Standard Methods. Results of the lab analyses are listed below:

WELL NO.	DATE OF ANALYSIS	Si mg/l
1.	7 Nov 86	34.44
2.	7 Nov 86	30.17
3.	7 Nov 86	22.65
4.	7 Nov 86	39.08
5.	7 Nov 86	48.06
SYSTEM	7 Nov 86	41.07

These data indicate that the silica levels in the potable water are unacceptable high for use in the waste heat boiler. Other water sources or treatment methods must be considered.

Terry L. Stoddart, Capt, USAF, BSC
Project Officer

APPENDIX M
PLOTS OF SIGNIFICANT INCINERATOR OPERATING PARAMETERS
DURING DAYS OF TEST BURNS

The graphs contained in this appendix are operational data collected from the incinerator data acquisition system.

The documents contained in this appendix were published according to their own internal style, which deviates from the Air Force Engineering Services Center format. They have, therefore, been published without editing.

SOIL FEED RATE TEST #1

THREE POINT AVERAGE 12/6/86

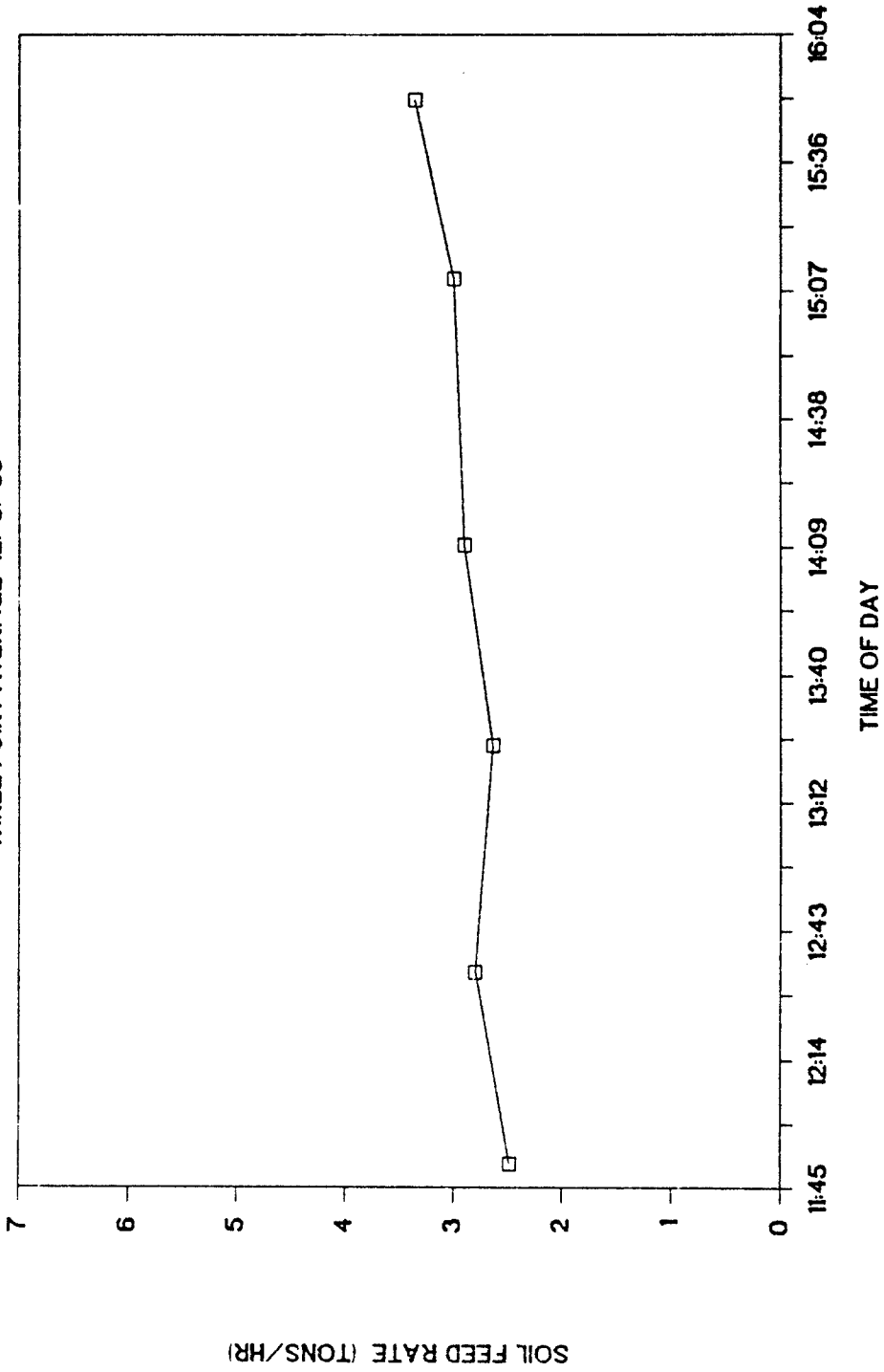

SOIL FEED RATE TEST #2

THREE POINT AVERAGE

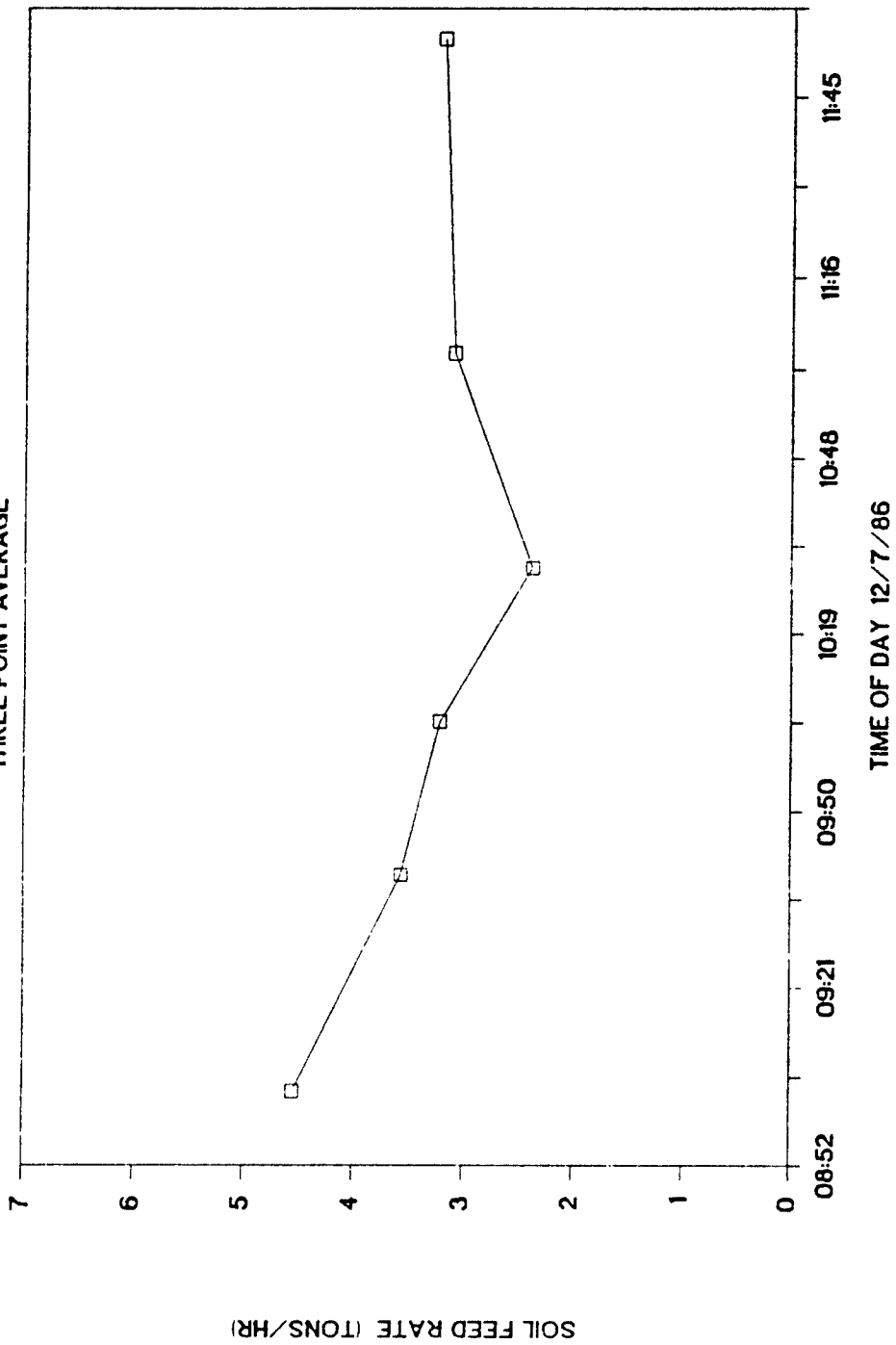

SOIL FEED RATE TEST #3

THREE POINT AVERAGE

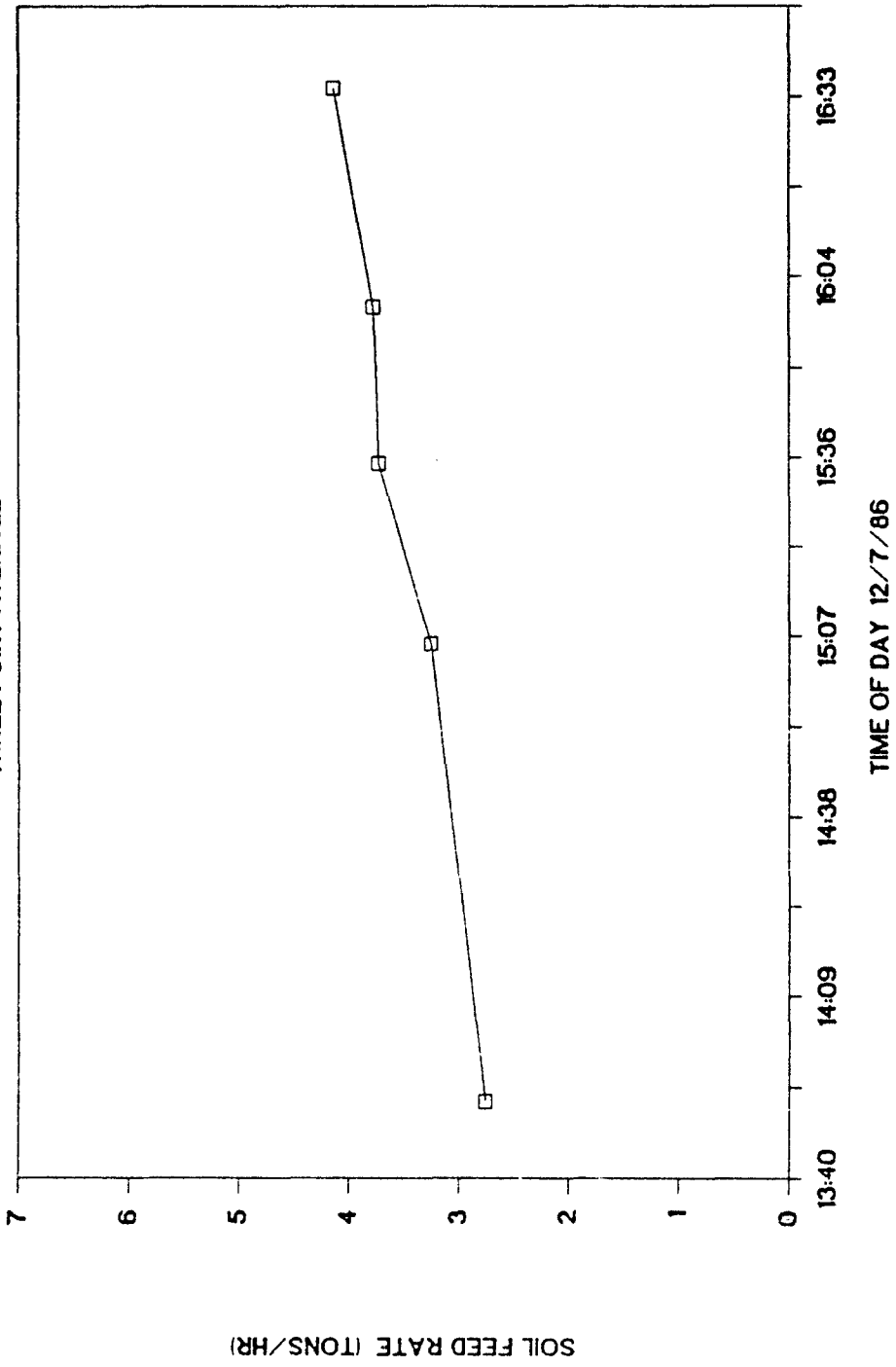

SOIL FEED RATE TEST #5

THREE POINT AVERAGE

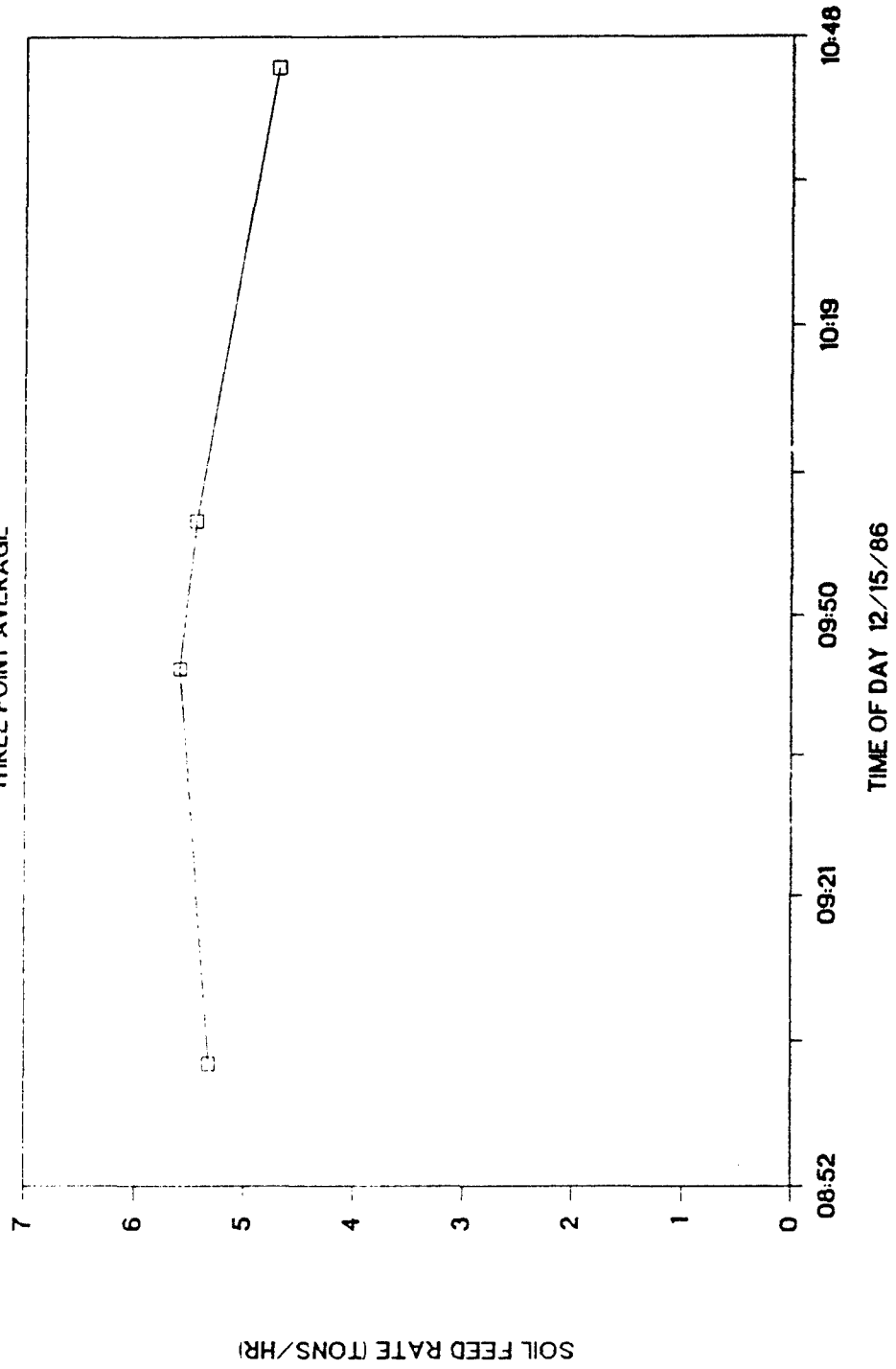

SOIL FEED RATE TEST #6

THREE POINT AVERAGE

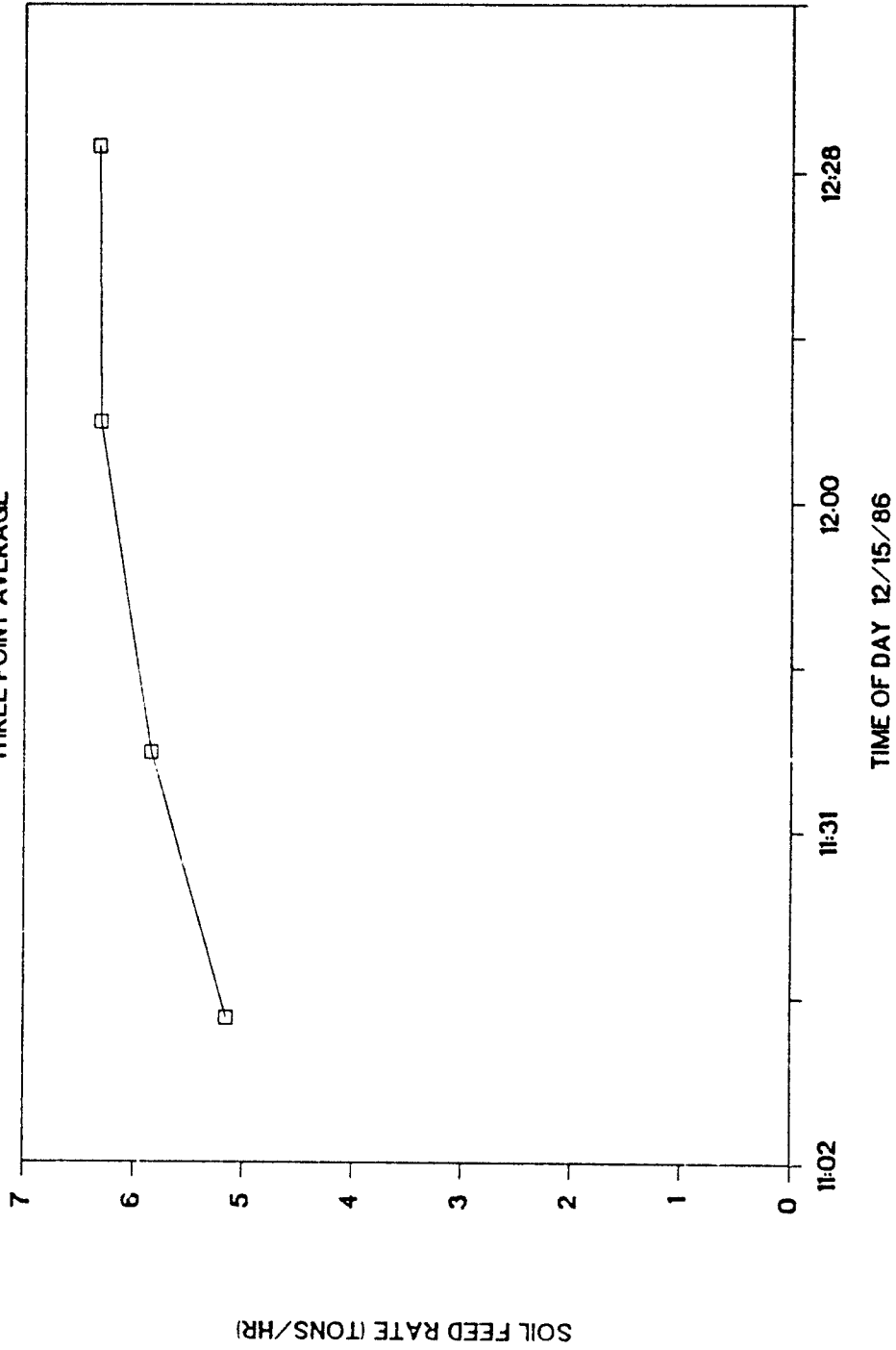

COMBUSTION EFFICIENCY 12/6/86

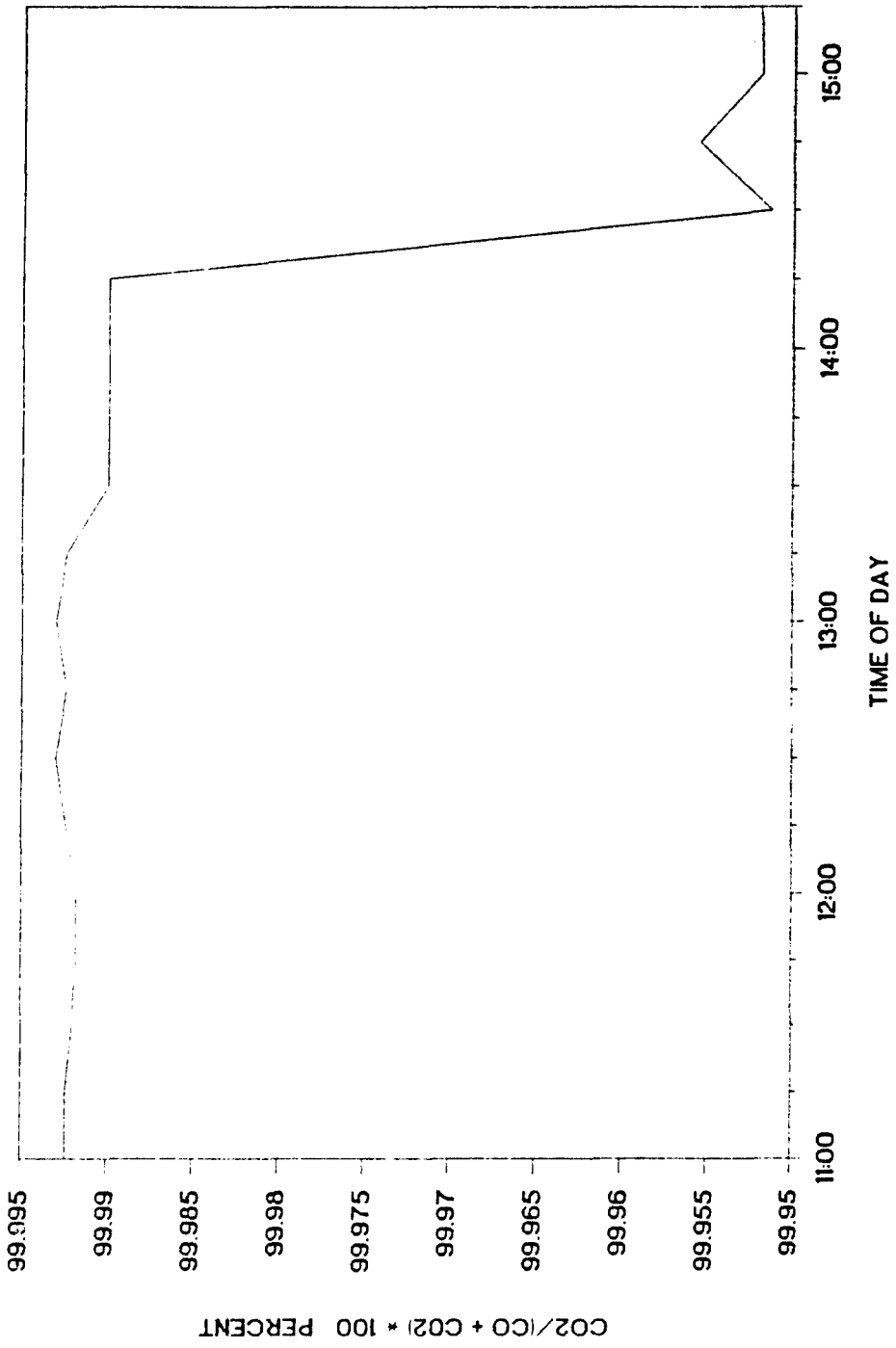

COMBUSTION EFFICIENCY 12/7/86

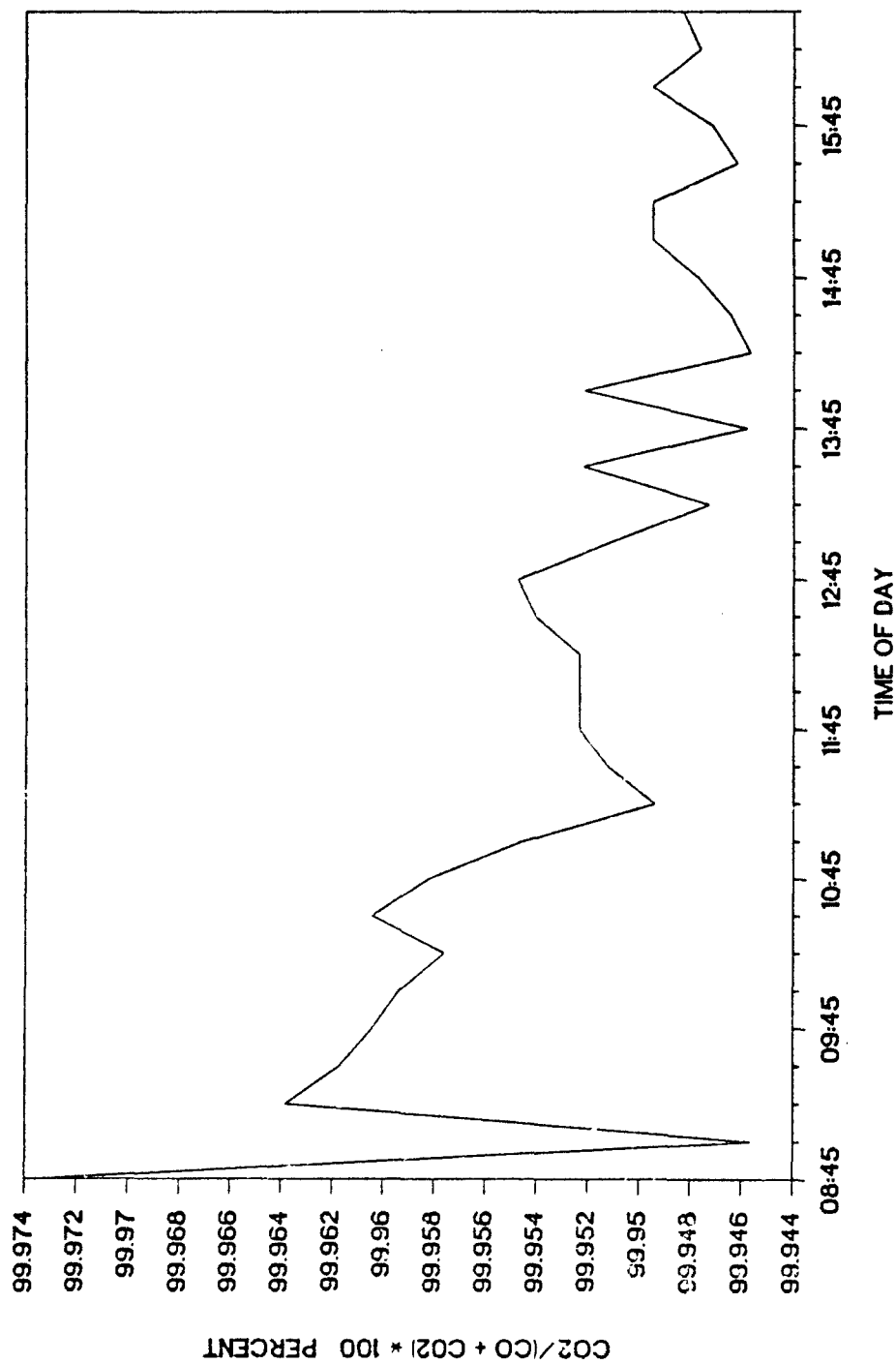

COMBUSTION EFFICIENCY 12/15/86

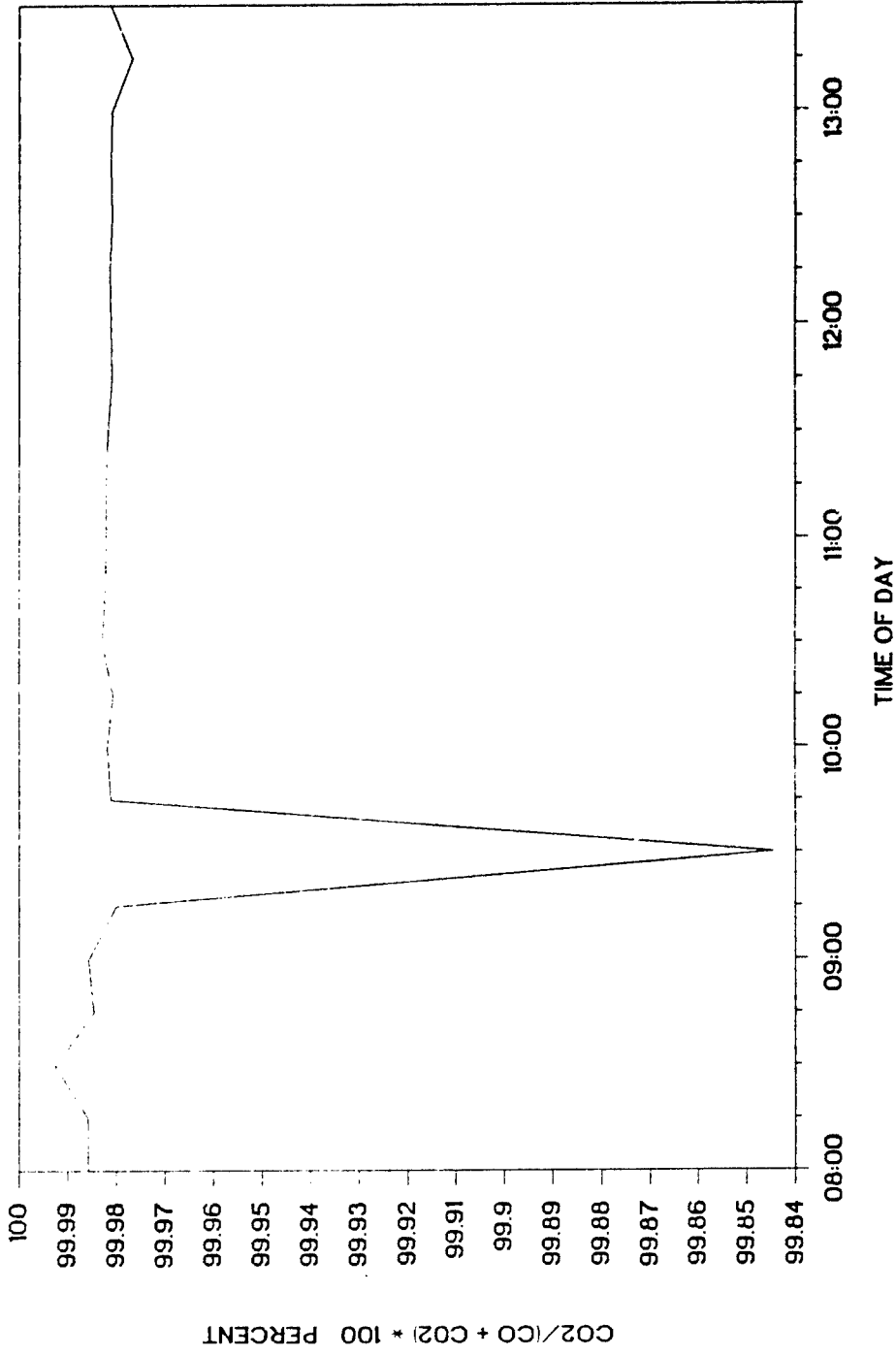

KILN DRAFT 12/6/86

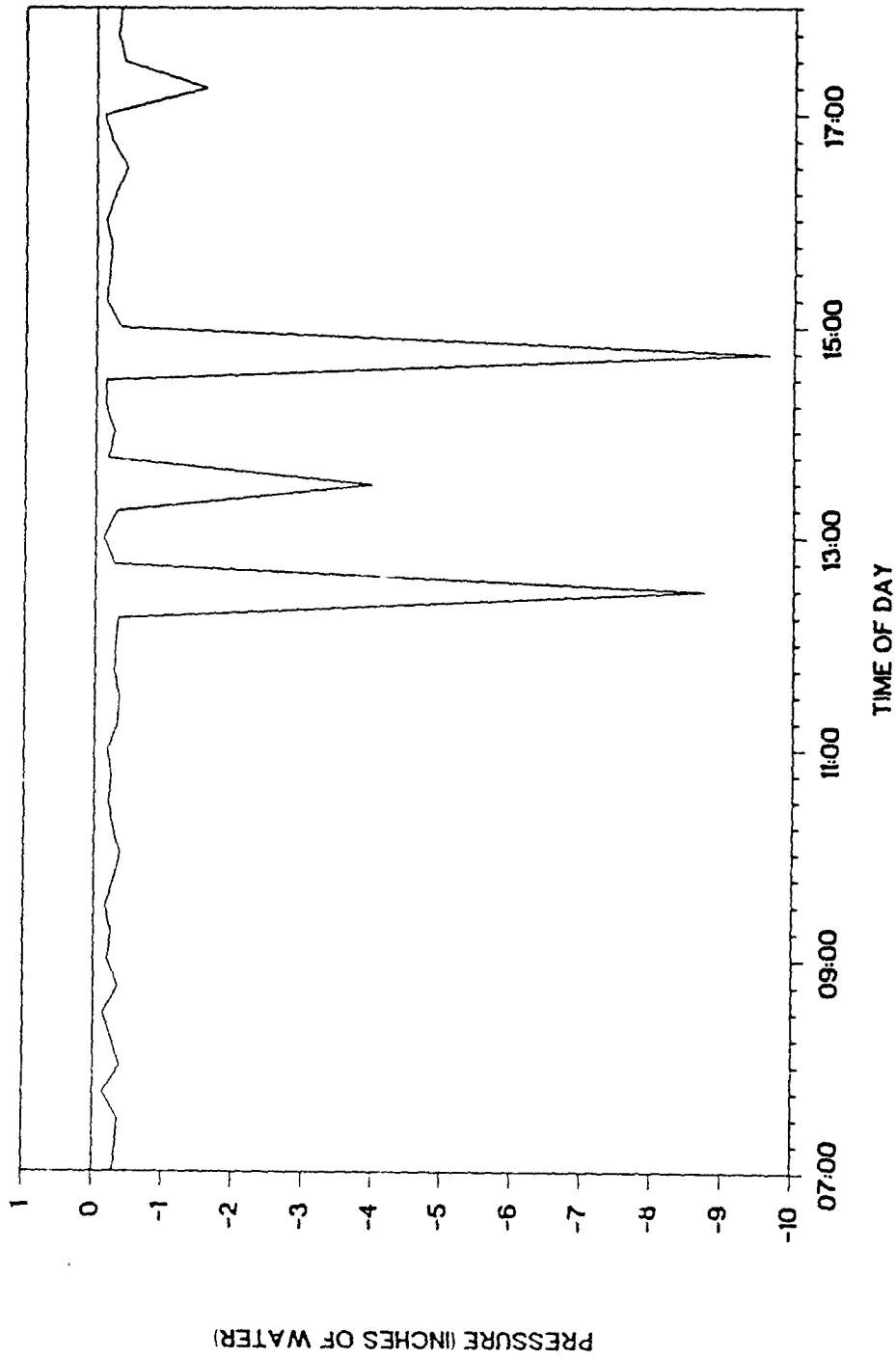

KILN DRAFT 12/7/86

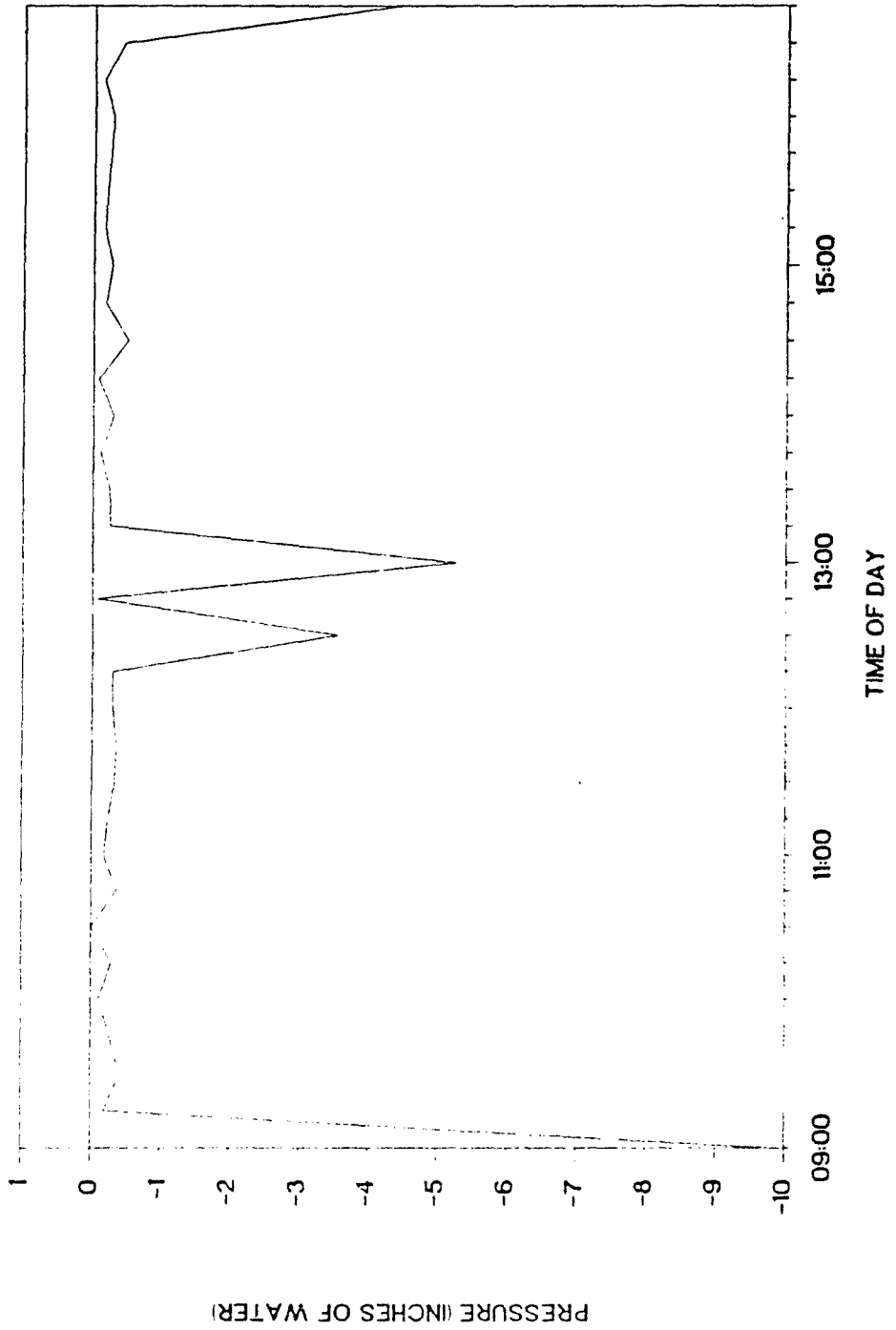

KILN DRAFT 12/15/86

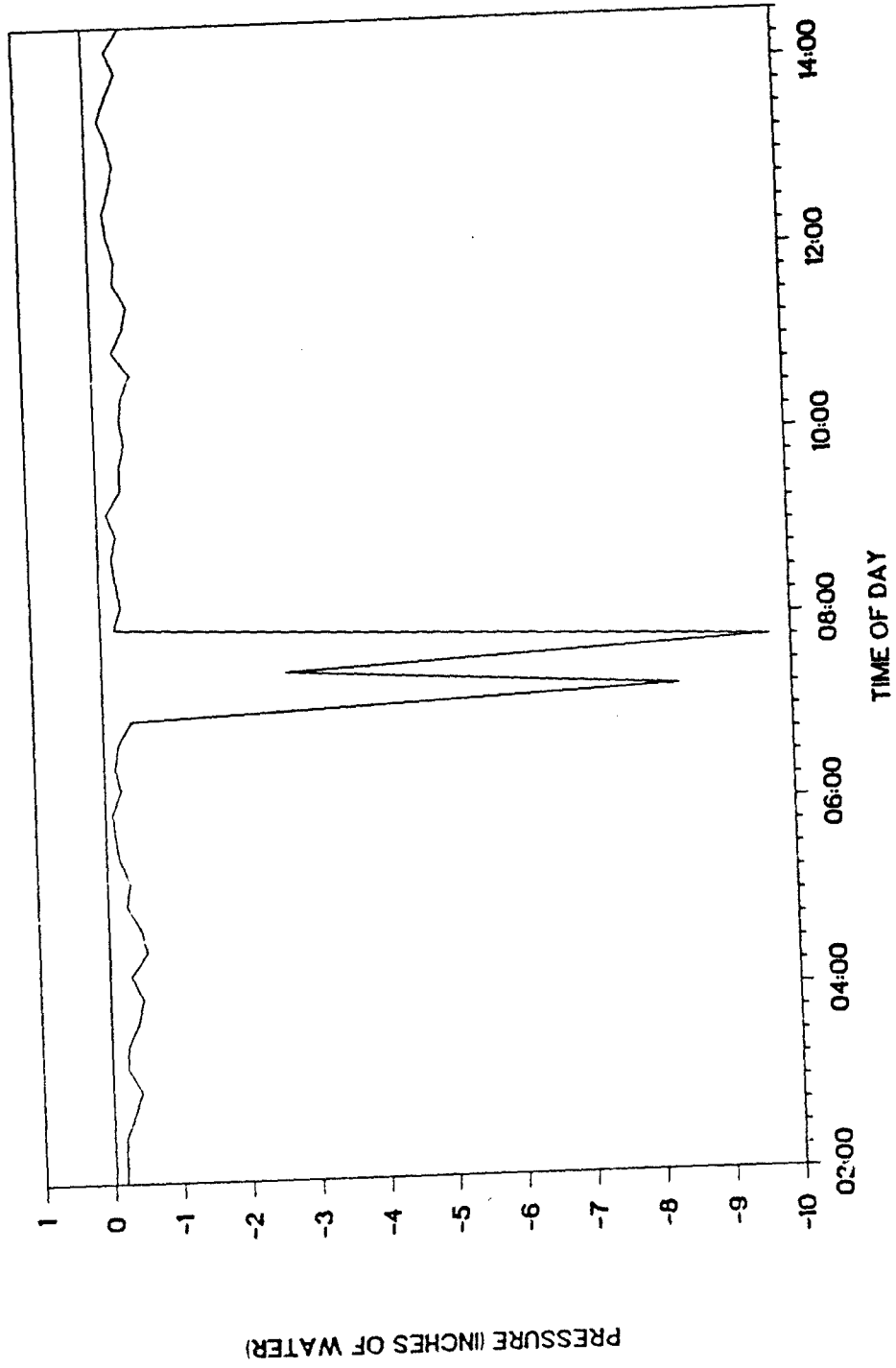

KILN TEMPERATURE 12/6/86

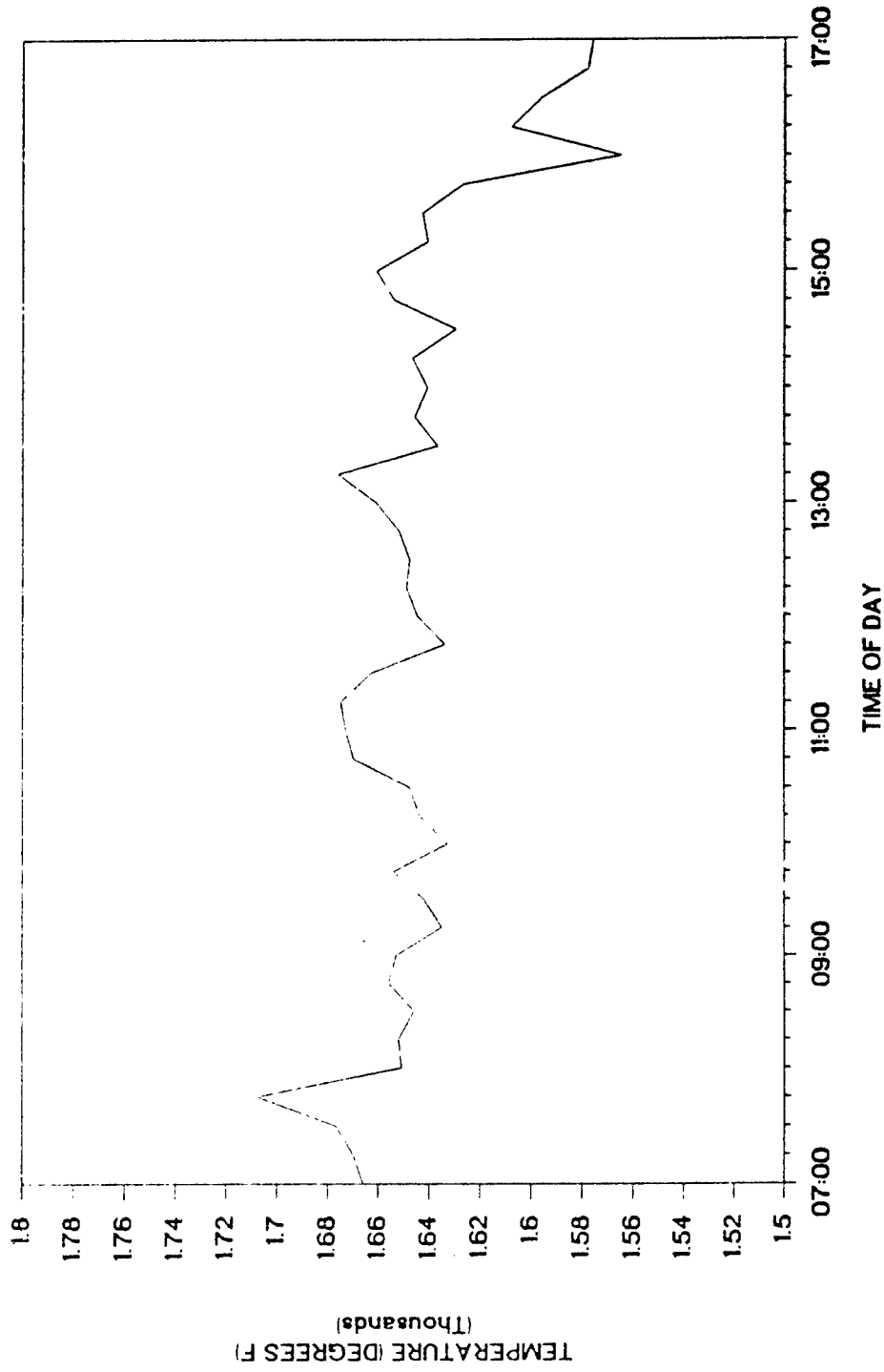

KILN TEMPERATURE 12/7/86

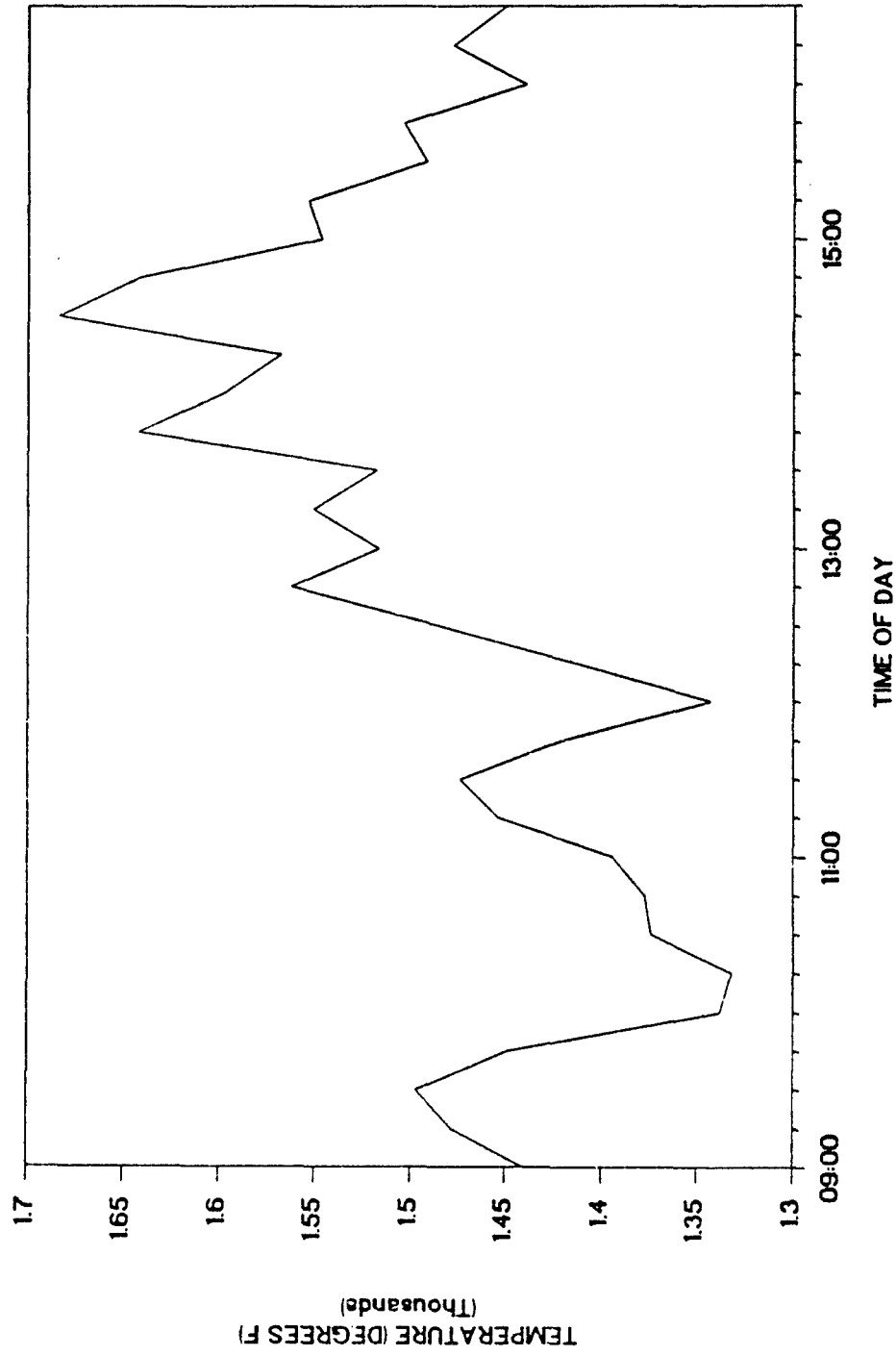

KILN TEMPERATURE 12/15/86

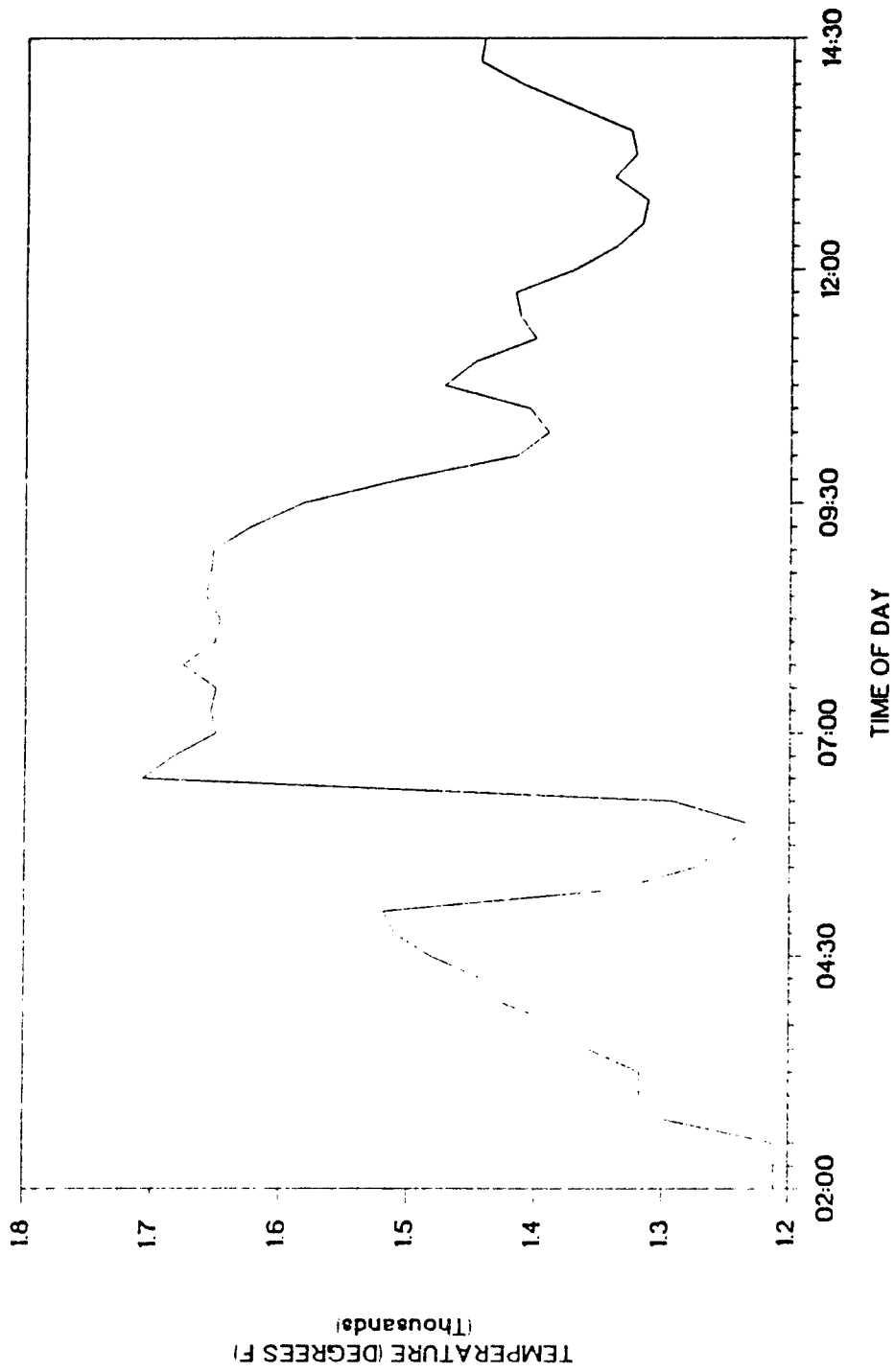

SCC TEMPERATURE 12/6/86

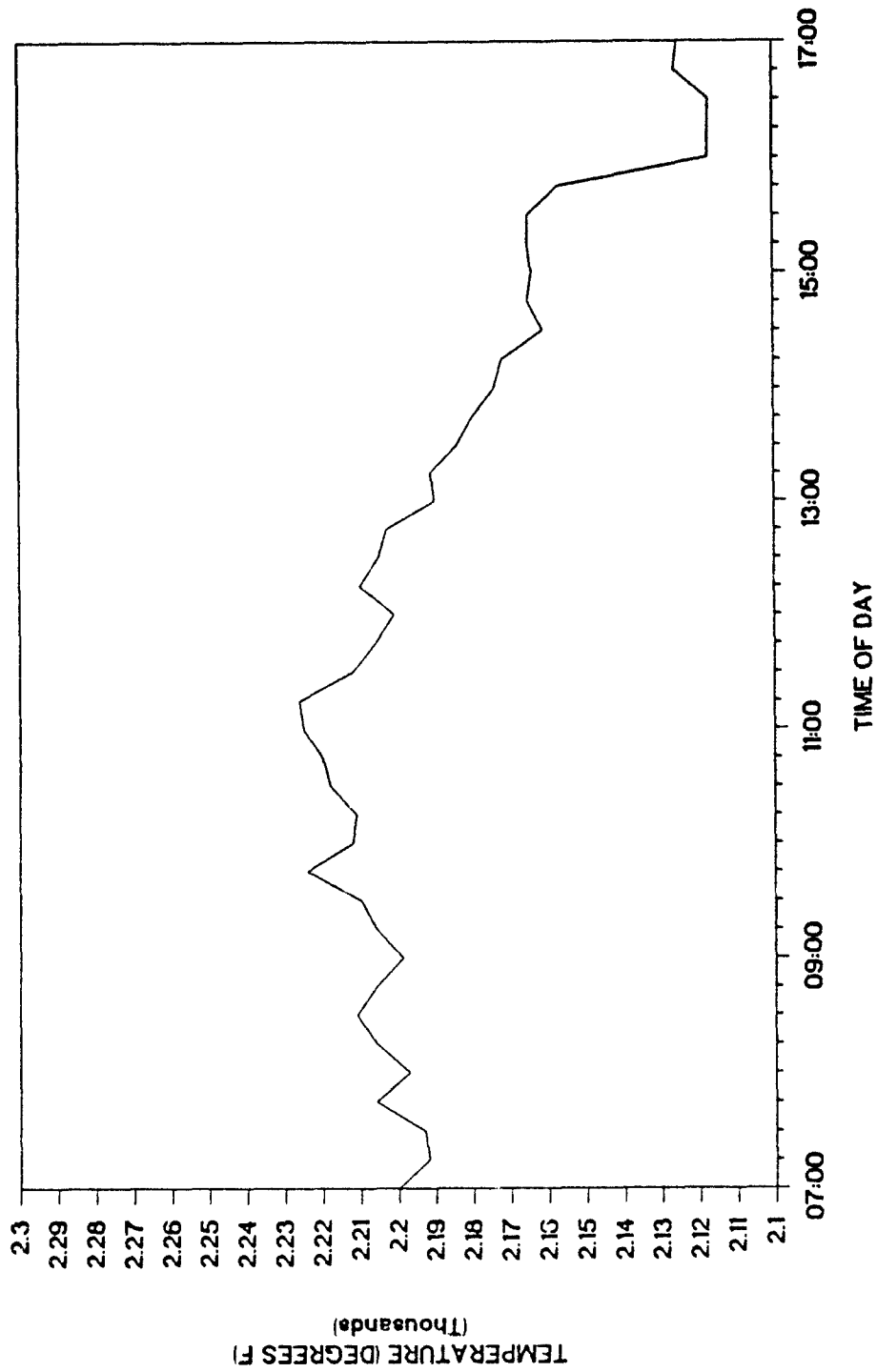

SCC TEMPERATURE 12/7/86

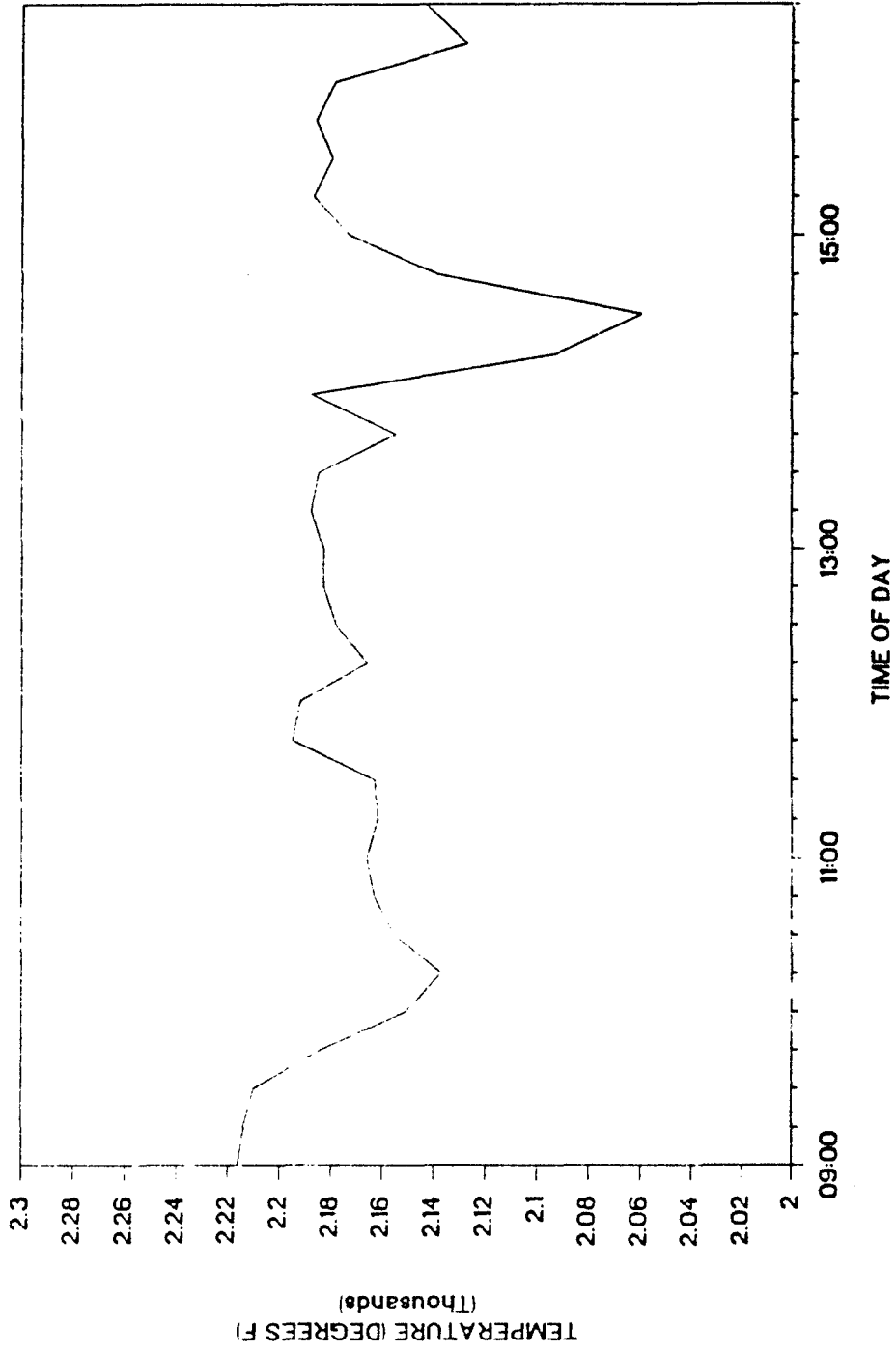

SCC TEMPERATURE 12/15/86

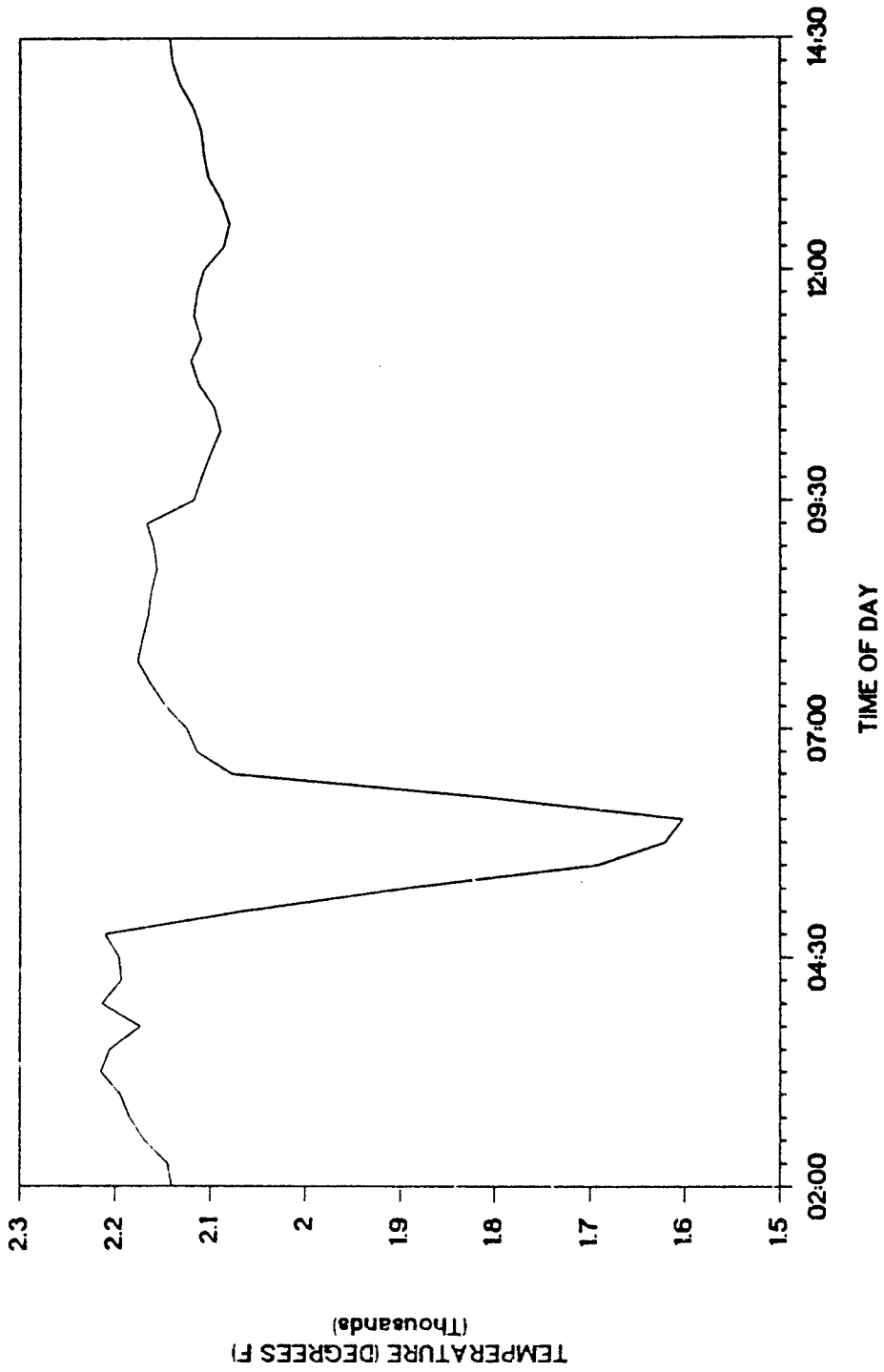

STACK OXYGEN CONCENTRATION 12/6/86

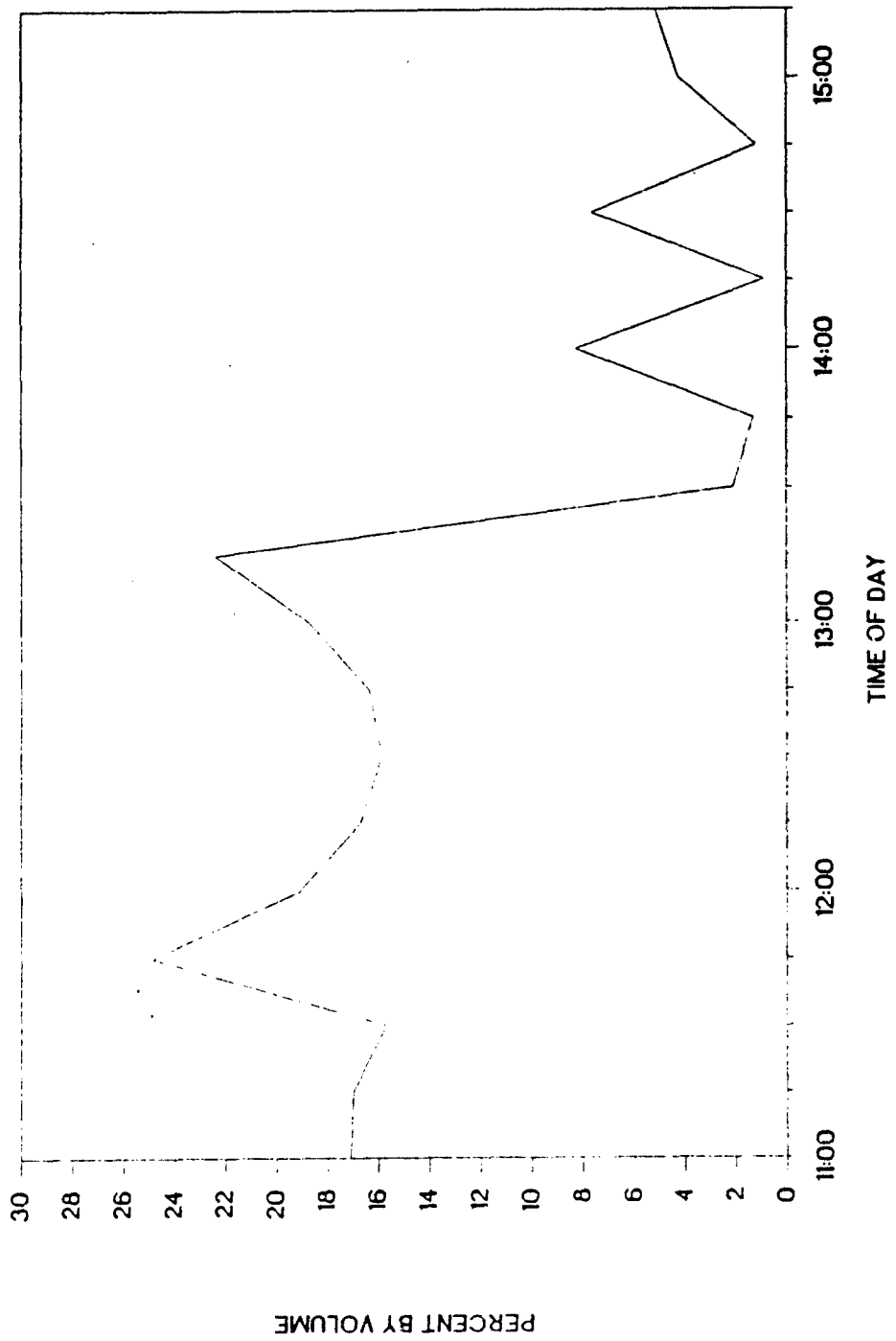

STACK OXYGEN CONCENTRATION 12/7/86

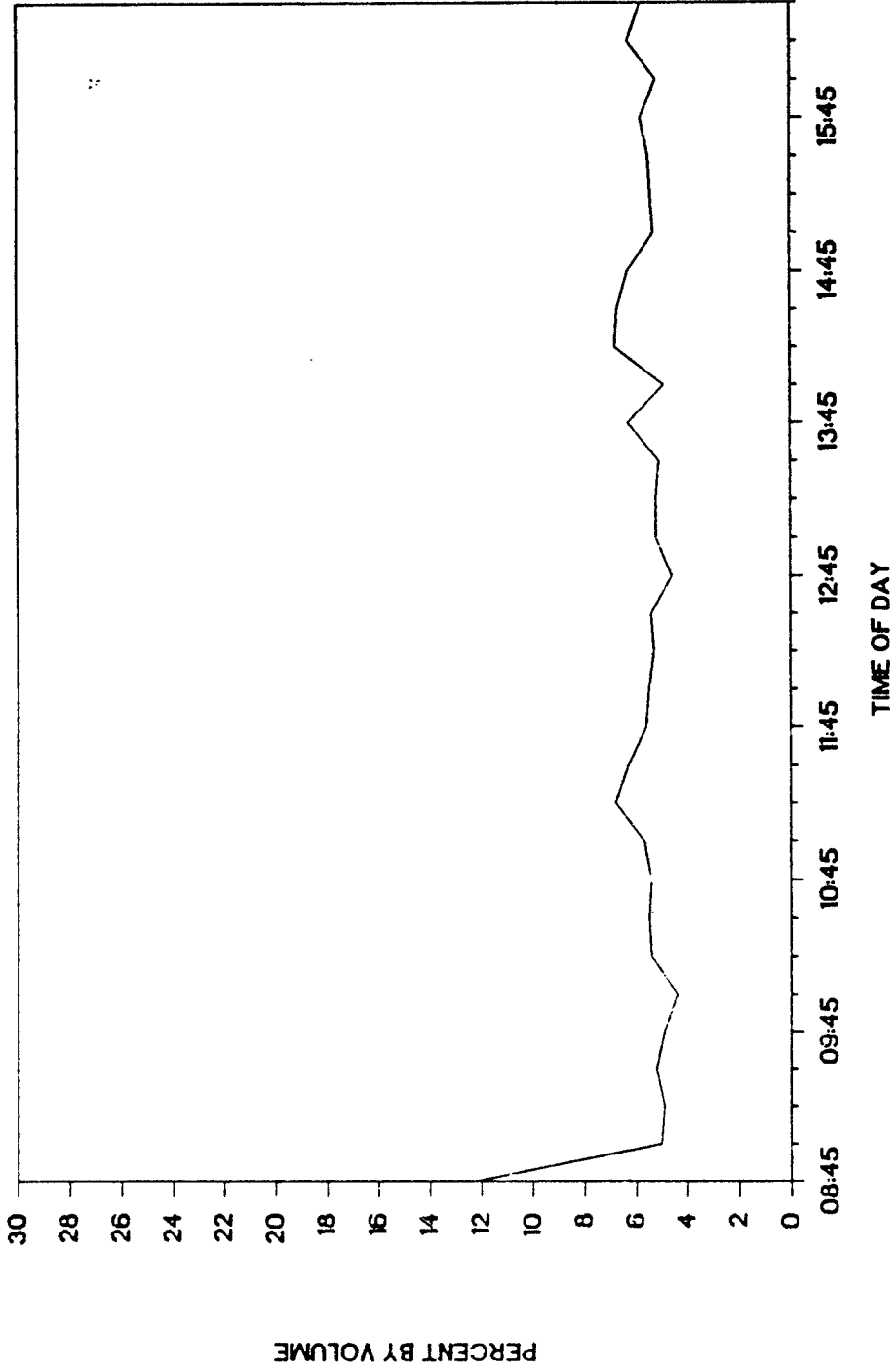

STACK OXYGEN CONCENTRATION 12/15/86

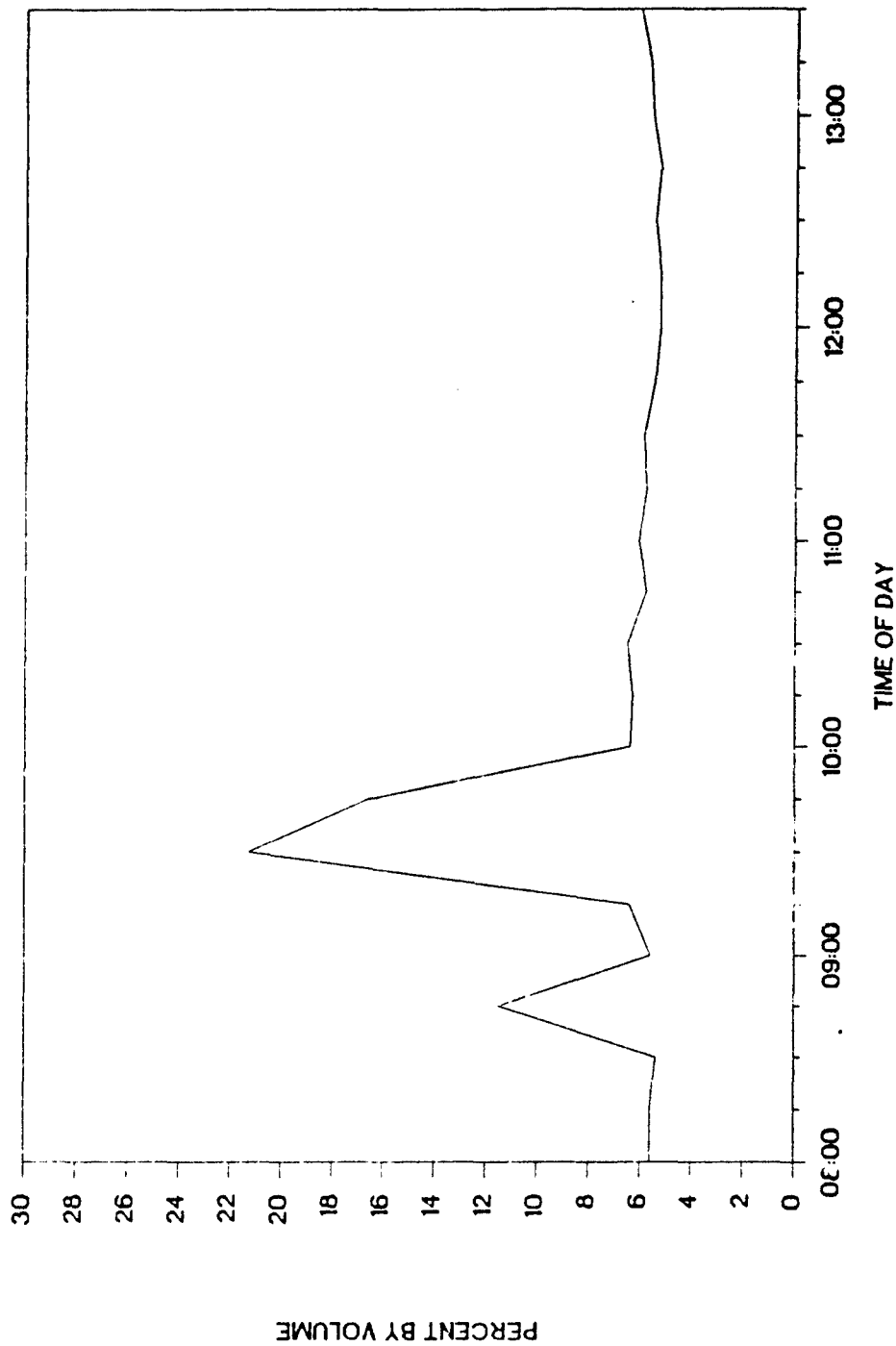

Stack CO Concentration 12/6/87

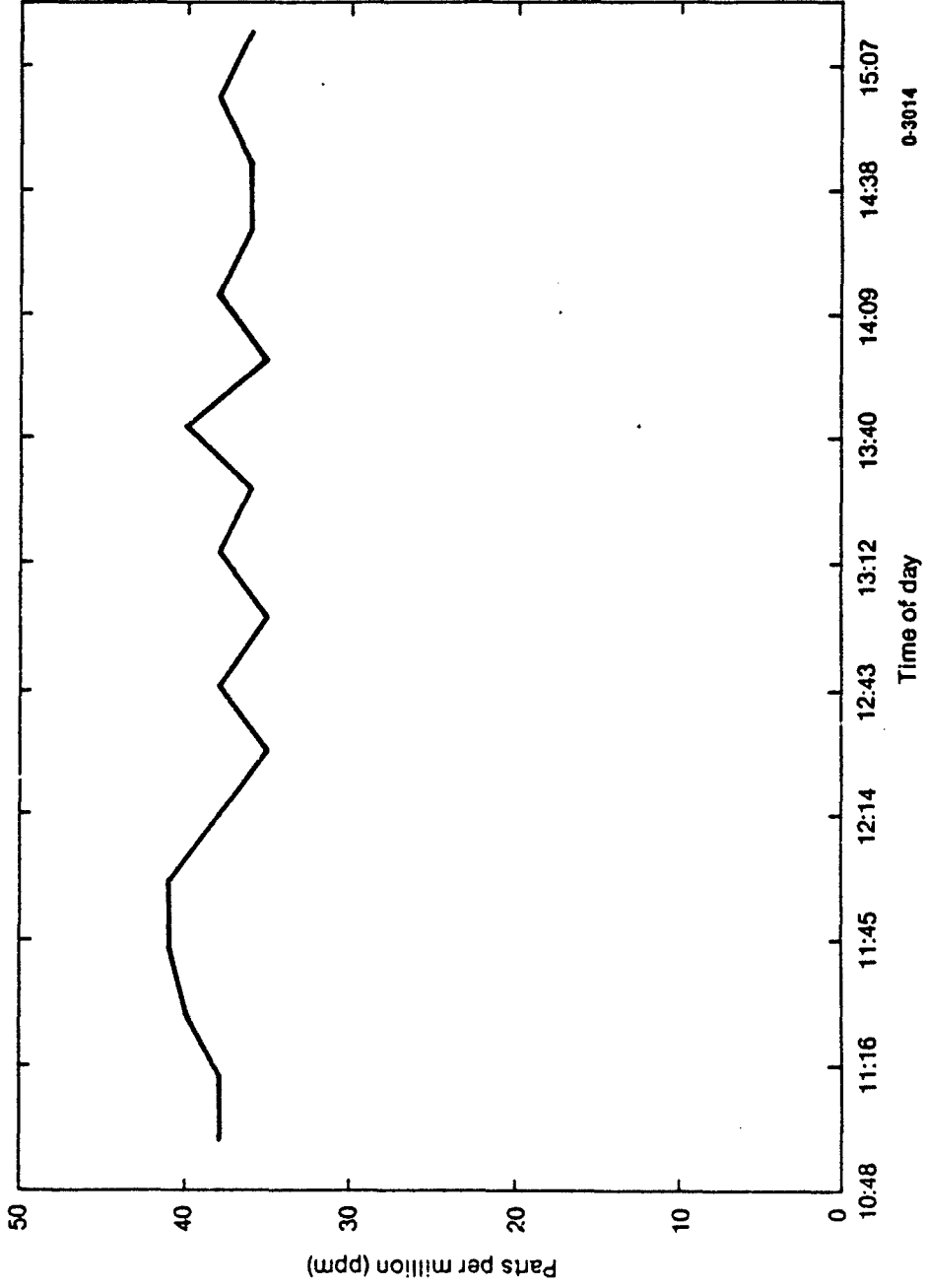

Stack CO Concentration 12/7/87

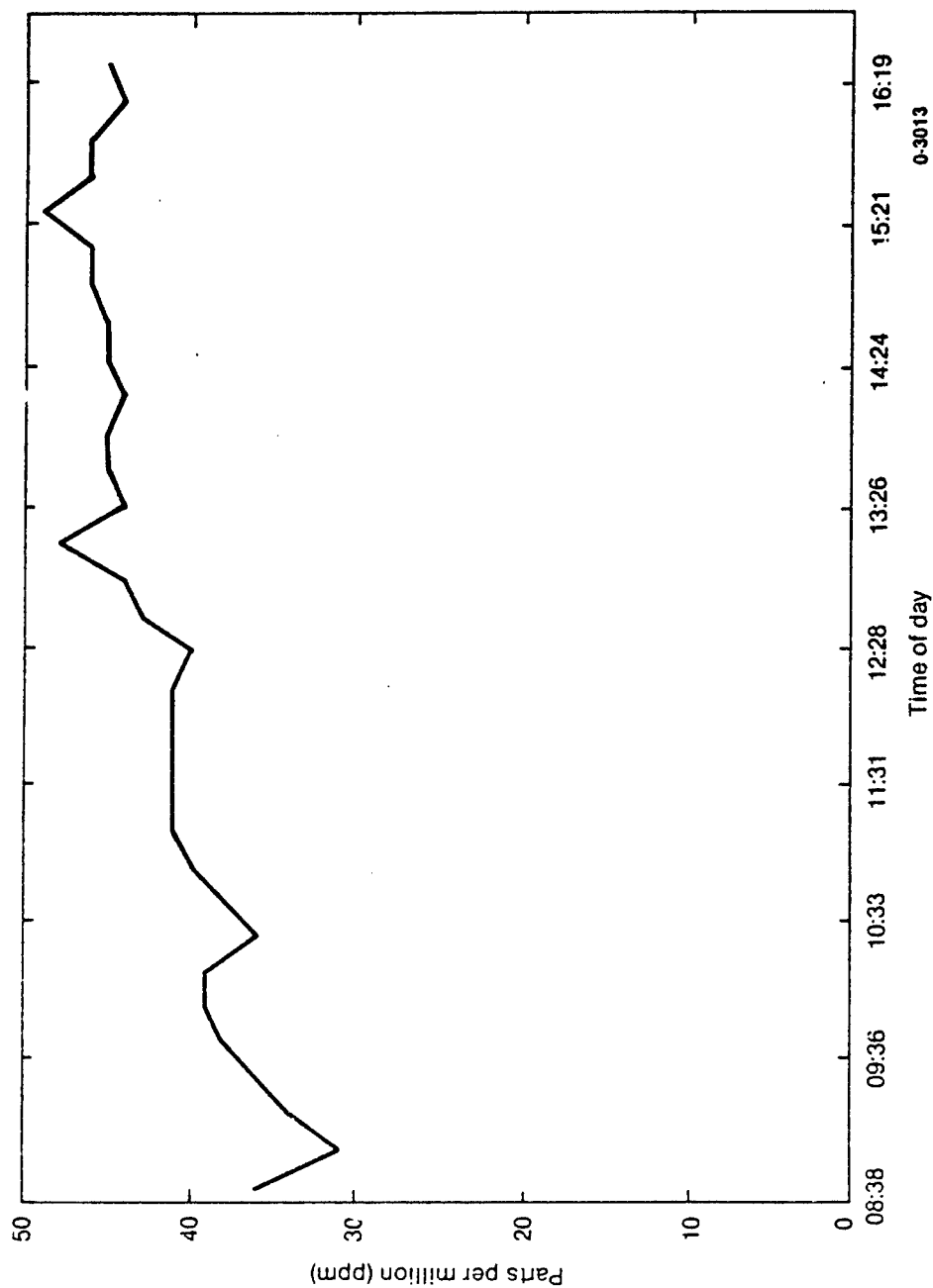

Stack CO Concentration 12/15/87

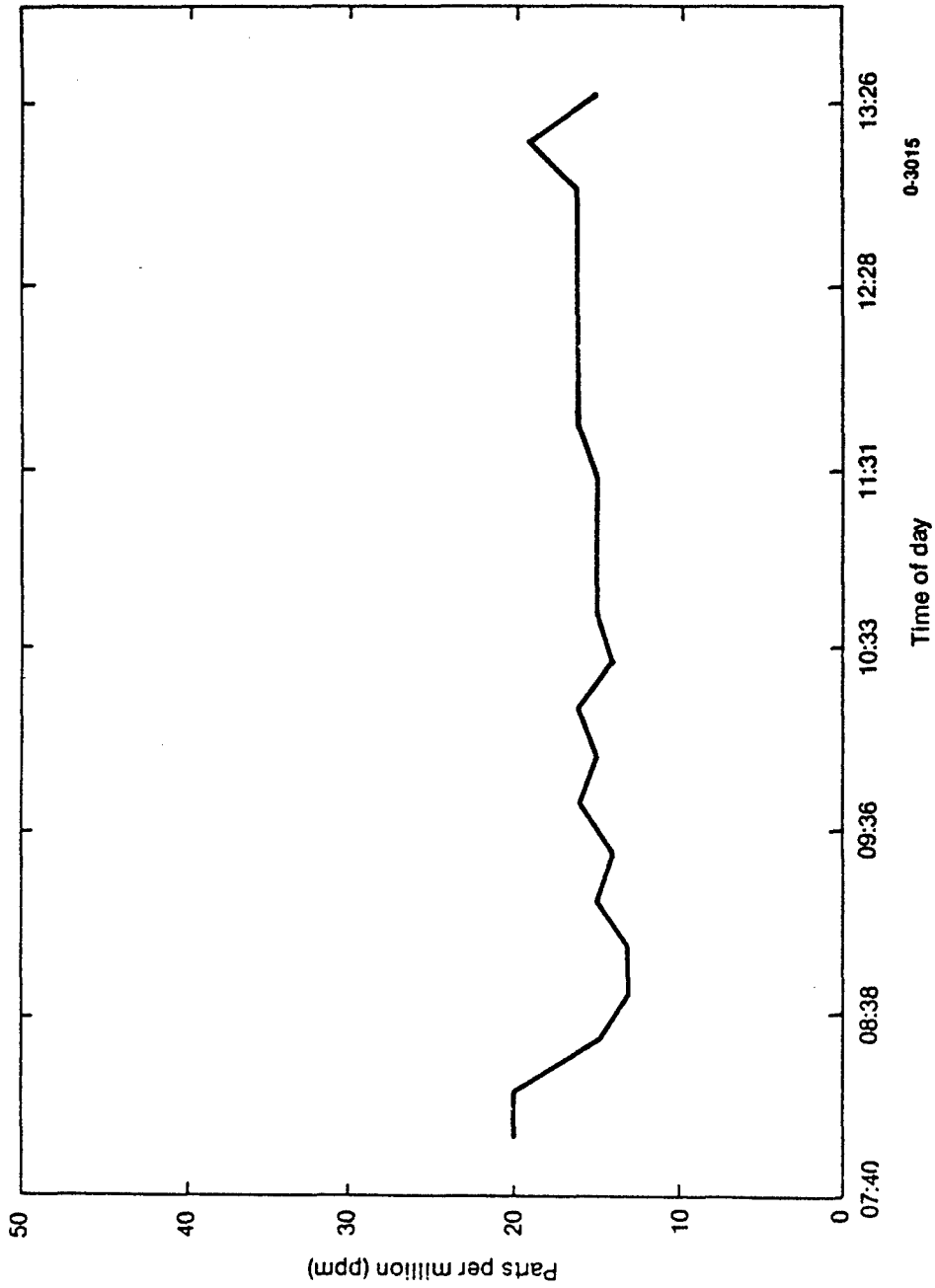

SCC DRAFT 12/6/86

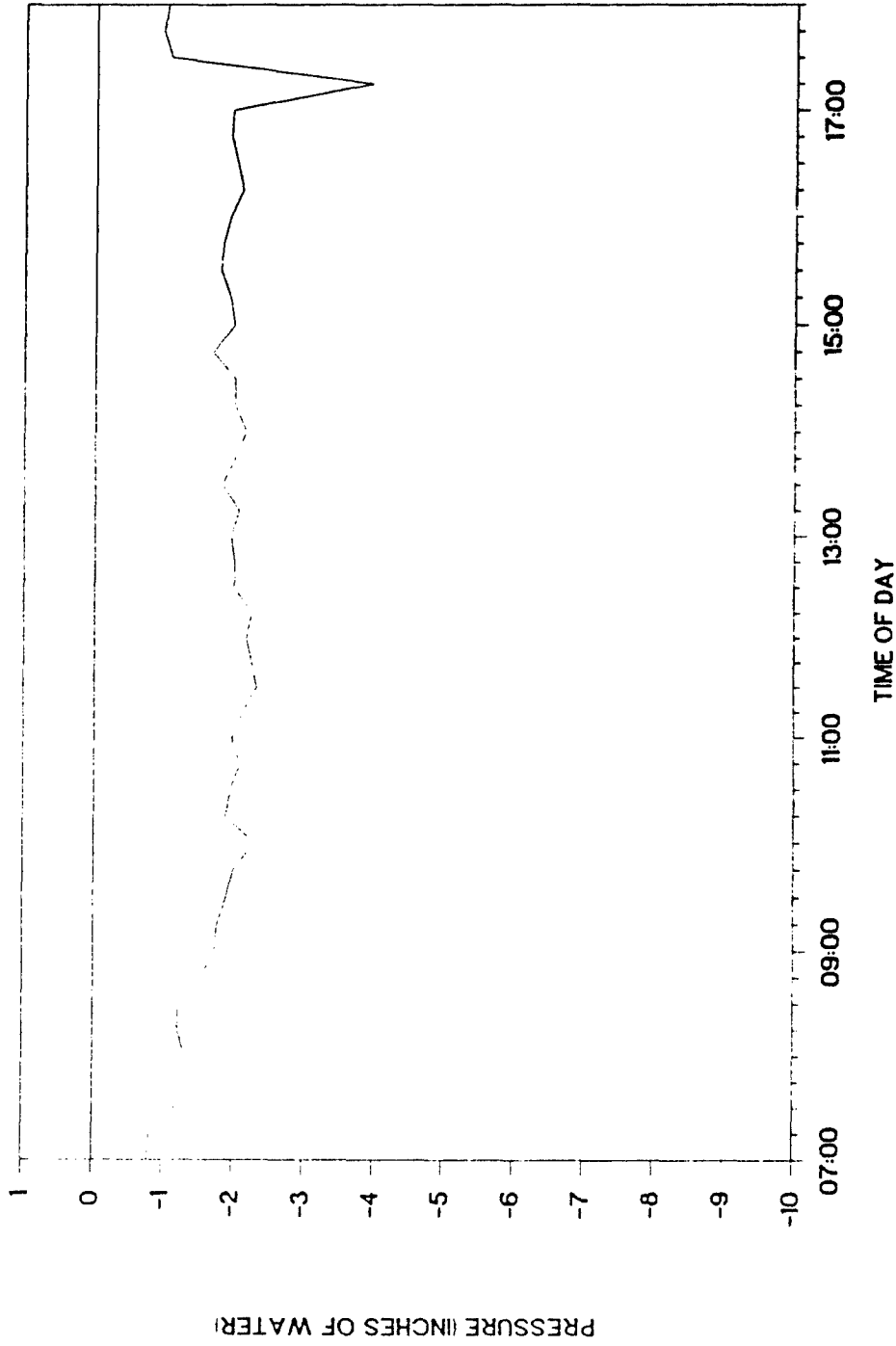

SCC DRAFT 12/7/86

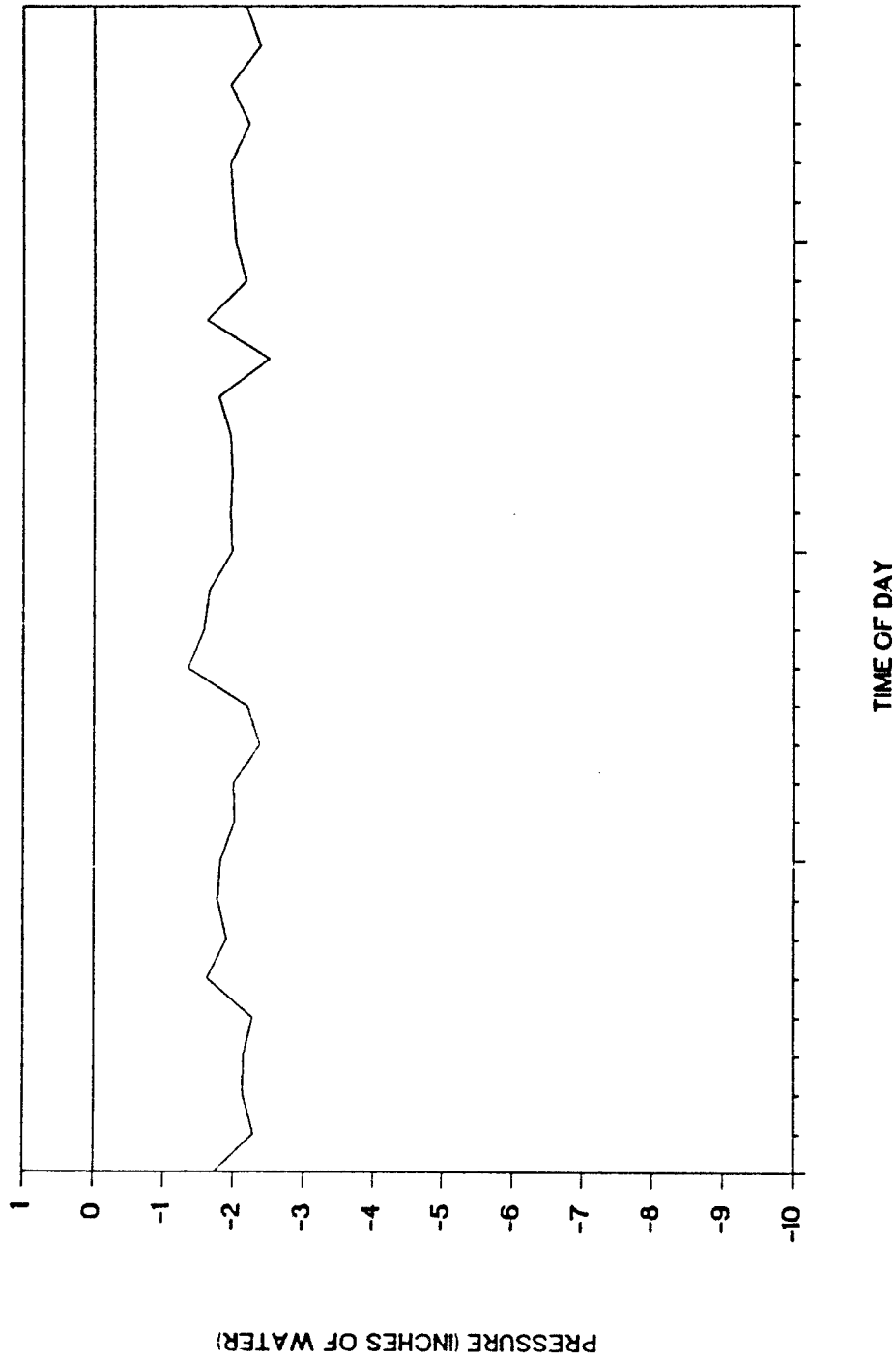

SCC DRAFT 12/15/86

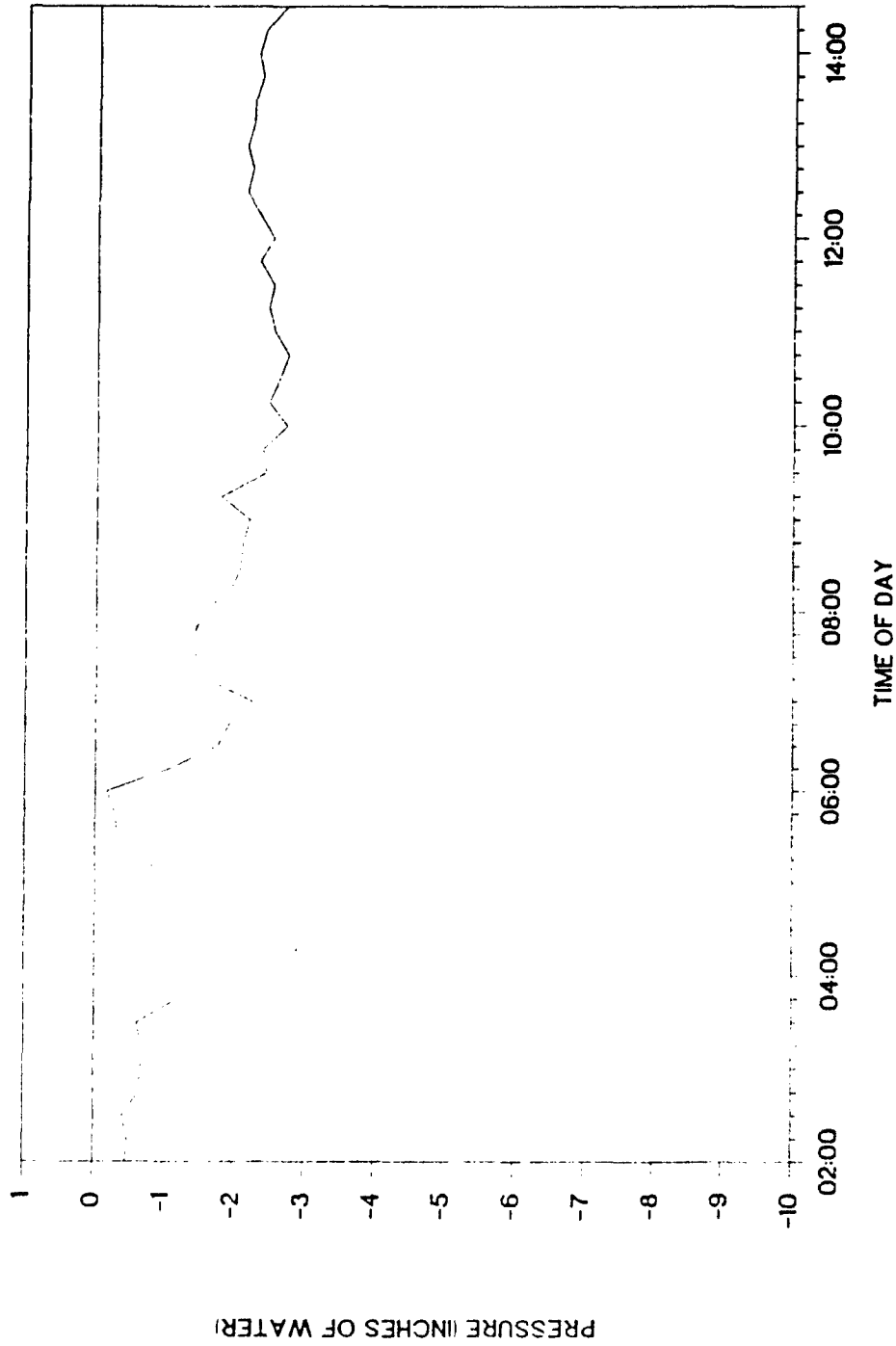

APPENDIX N
ENSCO HEALTH AND SAFETY DATA REPORT FOR
THE NCBC VERIFICATION TEST BURN OPERATION

The document contained in this appendix is the health and safety data report submitted by the Ensco safety officer. This appendix includes only the summary information, the enclosures referenced in this appendix are unavailable.

The documents contained in this appendix were published according to their own internal style, which deviates from the Air Force Engineering Services Center format. They have, therefore, been published without editing.

June 12, 1987

EG&G Idaho, Inc.
P.O. Box 1625
Idaho Falls, Id. 83415

Att: Dan Haley

Re: Summary of collected health and safety data for
the December test burn. Code Orange Project

Dear Dan,

Please find the enclosed data I generated during the period of the first test burn from 11-16-86 to 12-30-86, along with my field data sheets, daily and weekly reports.

Sincerely,

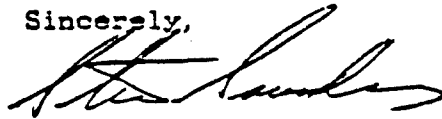

Steve Saunders
Health and Safety Officer
Ensco Environmental Services

attachments:

Data

- Enclosure 1 Weekly safety reports for weeks ending November 16 through December 21, 1986
- Enclosure 2 Daily safety log sheets for November 16-25, 1986, and December 2-16, 1986
- Enclosure 3 Field sampling data sheets for November 15-20 and 22-24, 1986, and December 2-7, 9, 11, and 12, 1986
- Enclosure 4 Air sampling data sheets for December 4-7, 1986
- Enclosure 5 Chain-of-custody record

Comments

On November 15, 1986, I began to collect background data for dust migration on a regular basis. Up to the first day of soil disturbance in the contaminated area, dust levels showed 0-0.05 mg/m³. 0.02 mg/m³ is commonly found in areas with no activity and will be held as the typical background dust concentration.

On December 4, 1986, excavation of contaminated grids commenced. I used a preweighed filter cassette and air sample pump to monitor the breathing zone of the excavator operator as well as the direct reading monitor, all around the excavation area. Results of the direct reading monitor showed 0.01 mg/m³ to 0.016 mg/m³, indicating 0.006 mg/m³ above background readings for that day. Results on filter cassette received on December 27 showed 0.0325 µg/L of dust in the vehicle cab.

On December 5, a filter cassette was run in the same manner as previous day with similar low results.

On December 6, the first day of the contaminated soil test burn, I did area monitoring in a downwind area of the weigh hopper. I used a preweighed cassette and an XAD tube in the same location. Complete site monitoring was also performed with the direct reading instrument. Direct readings showed 0.01 mg/m^3 downwind of active weight hopper. The filter cassette showed less than $0.007 \text{ } \mu\text{g/L}$ and the XAD tube showed $<5.3 \text{ ng/m}^3$ dioxin. Sample results for December 7 showed to be consistent with this day's readings.

In consideration of these test results it does look like a lesser level of protection would provide an adequate safety factor for future site work. But I feel that there are other variables that must be taken into consideration for future protection requirements. For example, the winter months on the Gulf Coast are relatively wet months, and when protecting for a dust hazard, soil moisture is of high concern. Active site work in the dryer summer months could result in higher dust readings. Soil conditions may also vary in different areas of the contaminated site providing for higher dust concentration. For these reasons, I feel it is premature to consider revising levels of protection standards for the future, considering only the data collected to this point and prefer to evaluate protection levels on a task performance and daily basis.

With this in mind, I would like to recommend that the level of protection in the plant area be reduced to level "D" during normal burning activities. This would be only on a daily basis. Continuous monitoring would be mandatory to evaluate weather and dust conditions for the work period and to evaluate potential exposure risk for each task performed. In this manner we could reduce potential for heat stress, and increase work performance without increasing employee exposure risk. All work in current contaminated areas will continue as level "C" PAPR.

I would like the opportunity to discuss this with you when you return to the plant. Please call if you have any questions.

APPENDIX O
CONSTRUCTION SITE CERTIFICATION

This appendix contains the report issued by a professional engineer certifying that the incinerator was built as specified in the EPA permit conditions. Only the letter is included because the material contained in the attachment referenced in the letter is the same as the information contained in Part 2, Appendix F.

The documents contained in this appendix were published according to their own internal style, which deviates from the Air Force Engineering Services Center format. They have, therefore, been published without editing.

December 2, 1986

Mr. Dan Haley
EG&G Idaho Inc.
1955 Fremont Avenue
Idaho Falls, Idaho 83415

Dear Mr. Haley;

One of the requirements for the USEPA RD&D Permit (Permit No. MS2 170 022 626), which allows the United States Air Force to test incineration of dioxin contaminated soils at the Naval Construction Battalion Center in Gulfport, MS, is that a registered professional engineer certify that the test equipment to be used has been erected in accordance with permit conditions. I have reviewed the system as is described in the referenced permit and examined the equipment erected at NCBC. The results of my review are summarized in the following.

Attachment I is a portion of the RD&D permit which describes ENSCO's mobile incinerator as is proposed for testing at NCBC. Based on my examination of the equipment erected by ENSCO at NCBC, I have prepared a schematic flow diagram of the system as it was configured on December 2, 1986 which is shown in Figure No. 1. A comparison of the system described in Attachment I and the system I have described in Figure No. 1 reveals the following minor differences:

- o The Effluent Reservoir and Effluent Concentrator are not used in the current NCBC configuration.
- o As salt loading in the Effluent Neutralization Tank increases, the supernatant is discharged through carbon beds and held in holding tanks prior to discharge to the POTW.
- o Solids accumulating in the Effluent Neutralization Tank will be discharged to a settling tank and the supernatant from the settling tank will be routed back to the Effluent Neutralization Tank. As of December 2, 1986, the line to return the supernatant from the settling tank had not been installed.
- o To control particulate fouling in the boiler, a water spray was installed in the flue gas stream, just prior to the waste heat boiler.
- o Other minor differences are shown in Figure No. 1.

Apart from the above minor changes, I certify that ENSCO has erected their MWP-2000 mobile incinerator in accordance with the permit conditions which are contained in Attachment I of this letter.

Sincerely,



Darrell B. Derrington, Jr.
Professional Engineer, Texas Certificate Number 55152

cc: Major Terry Stoddart, USAF/ESC
Harry Williams, EG&G

Attachment 1

Attachment 1 to this appendix described the MWP-2000 incineration process. The description is the same as that given in Part 2, Appendix F, and therefore has been omitted from Appendix O.

APPENDIX P

MODIFIED METHOD 5 AND VOST STACK SAMPLING
FIELD TEST DATA FOR MWP-2000 INCINERATOR SYSTEM
VERIFICATION TEST BURNS AT NCBC

The document contained in this appendix is the detailed data obtained from the stack sampling crew during the verification test burn at NCBC. This document was reproduced from the best available copy. Due to very poor original legibility, the legibility of the microfiche editions is also poor. Persons requiring the information contained in this appendix may write to the technical libraries listed below to obtain photocopied versions of the appendix. A nominal charge will be levied to cover reproduction and archival costs. Please be prepared to provide the following information:

Report Title: Full-Scale Incineration System Demonstration
Verification Test Burns at the Naval Construction
battalion Center, Gulfport, Mississippi:

Report Number: ELS-TR-88-61, Volume: II, Part: 3, Appendix: P

Send inquiries to:

Technical Library
Engineering and Services Laboratory
Tyndall Air Force Base, FL 32403

or

Technical Library
Idaho National Engineering Laboratory
EG&G Idaho, Inc.
P.O. Box 1625
Idaho Falls, ID 83415-2300

The documents contained in this appendix were published according to their own internal style, which deviates from the Air Force Engineering Services Center format. They have, therefore, been published without editing.

TABLE 5.1
FIELD DATA FOR TEST 1

MODIFIED METHOD 5 AND VOST TEST DATA SUMMARY

1. NCRC - GULFPORT
2. TEST RUN DESIGNATION - TEST 1
3. TEST DATE - 36-Dec-66

DATA DESCRIPTION	ID	MODIFIED METHOD 5		VOST	
		Value	Units	Value	Units
4. Time					
Start	Time(s)	1339	hrs	1348	hrs
Finish	Time(P)	1455	hrs	1528	hrs
Duration	T	68	min	68	min
5. Total Number of Sampling Points	NP	12		2	
6. Meter Calibration Factor	Y	0.994		NA	
7. Orifice Calibration Factor	Ka	1.613		NA	
8. Nozzle Specifications					
Diameter	Dn	0.375	in	6	mm
Area	An	7.67E-04	ft ²	NA	
9. Pitot Tube Coefficient	Cp	0.281		NA	
10. Average Orifice Pressure Drop	Havg	2.229	in H ₂ O	NA	
11. Volume of Dry Gas Sampled	Vm	51.976	ft ³	54.818	liter
12. Average Gas Meter Temperature	Ta	559.5	R	325.1	K
13. Barometric Pressure	Pb	28.46	in Hg	773.7	mm Hg
14. Static Stack Pressure	Pg	-8.42	in H ₂ O	-18.7	mm H ₂ O
15. Absolute Stack Pressure	Ps	28.43	in Hg	772.9	mm Hg
16. Volume of Gas Sampled (Standard)	Vstd	49.865	SCF	58.225	liter
17. Volume of Water Collected in Impingers and Silica Gel	Vic	663	ml	NA	
18. Volume of Water Collected Based on Saturated Conditions	Vic'	1822	ml	NA	
19. Volume Water Vapor Condensed in Impingers	Vwc	28.75	SCF	NA	
20. Volume Water Vapor Condensed in Silica Gel	Vwsg	1.47	SCF	NA	

TABLE 5.1 (continued)

21. Percent Moisture by Volume	Bm	38.585			
22. Percent Moisture by Saturation	Bm'	49.115			
23. Mole Fraction of Dry Gas	Fm	0.5989			
24. Gas Analysis					
Average CO ₂ by Volume	CO ₂	9.33	%		NO
Average O ₂ by Volume	O ₂	6.13	%		NO
Average CO by Volume	CO	2.89	%		NO
Average N ₂ by Volume	N ₂	84.59	%		NO
25. Dry Molecular Weight of Stack Gas	M _d	29.75	lb/lb-mole		NO
26. Molecular Weight at Stack Conditions	M _s	23.58	lb/lb-mole		NO
27. Average Stack Temperature	T _s	644	R	337.4	K
28. Average Stack Gas Velocity	V _s	55.59	ft/sec	17.29	m/sec
29. Stack Area	A _s	786.9	sq-in	2.456	sq-m
30. Actual Stack Gas Flowrate	Q _s	999,281	ACFM	28,319	SCMH
31. Dry Stack Gas Flowrate (Standard)	Q _{sstd}	424,753	SCFM	12,329	SCMH
32. Iso - Kinetic Rate		73.6	%		NO
33. Weight of Filterable Particulates	M _w	24.1	mg		NO
34a. Particulate Concentration (at standard conditions)	C _s	1.37E-09	lb/DSEF		NO
		0.48	mg/DSEF		NO
		2.087	gr/DSEF		NO
		17.263	mg/DSEF		NO
34b. Particulate Concentration (corrected to 5% oxygen)	C _{s@O2}	1.37E-09	lb/DSEF		NO
		2.49	mg/DSEF		NO
		2.288	gr/DSEF		NO
		17.219	mg/DSEF		NO
34c. Particulate Concentration (corrected to 12% carbon dioxide)	C _{s@CO2}	1.35E-09	lb/DSEF		NO
		0.62	mg/DSEF		NO
		2.219	gr/DSEF		NO
		21.244	mg/DSEF		NO
35. Pollutant Mass Rate	PMR	4.52E-04	lbs/hr		NO
		285.3	g/hr		NO
		3168	gr/hr		NO

Best Available Copy

Best Available Copy

TABLE 5.1 (continued)

METER BOX CALIBRATION

04-Dec-66

Baro. Pressure 28.21 Meter Box No. 2577/679

Used for: TEST 1

Orifice			Temperature				Dry Gas Meter		
Ratio	Gas Volume		Reference	Inlet	Outlet	Avg	Time		
Setting	Reference	Sampler	(ts)	(tdi)	(tso)	(td)	(@)	(H ₂ O)	(H ₂ O)
(in H ₂ O)	(ft ³)	(ft ³)	(F)	(F)	(F)	(F)	(min)	(Yr)	(in H ₂ O)
0.5	4.310	5.075	70	82	71	76.5	11.43	0.978162	1.468641
1	5.385	5.237	70	88	74	81	8.65	0.973166	1.612856
2	10.310	10.420	70	102	78	90	12.25	0.992874	1.605399
4	10.380	10.257	70	107	82	94.5	8.76	1.010000	1.629942
6	10.307	10.212	71	110	84	84	7.17	0.989466	1.673253
8	10.310	10.144	70	110	86	98	6.27	1.019079	1.637394

Avg (----) 0.993633 1.612565

CALIBRATION OF "S" TYPE PITOT TUBE

04-Dec-66

Used for: TEST 1

Pitot Tube	Sta Pitot Tube (P)	"S"-Type Pitot Tube		Sta Pitot (Co)	Pitot Tube ID. I & Y
		Pitot Tube (P)	(Co)		
Test 1	X	0.55	0.79	0.834	Sta Pitot (Co) 0.99
Test 2	X	0.57	0.80	0.797	
Test 3	X	0.58	0.92	0.786	Bar. Pressure 28.46
Test 4	X	0.58	0.92	0.786	
Avg (Co) for Probe X (---)				0.801	Gas Temp (F) 176
Test 1	Y	NOT	NOT	ERR	
Test 2	Y	IN	IN	ERR	
Test 3	Y	USE	USE	ERR	
Test 4	Y			ERR	
Avg (Co) for Probe Y (---)				ERR	

Best Available Copy

TABLE 5.1 (continued)

INITIAL STACK TEST DATA		Report Date:
(fill-in data marked by arrows)		05-Jan-67
1 →	Facility	NCBC
2 →	Location	Gulfport, Mississippi
3 →	Operator & Test Personnel	Jung Jurgens, Grasso Sasio Bacia
4 →	Test Date	06-Dec-66
5 →	Run Number	TEST 1
6 →	Stack Dia (in.)	30
	Stack Area (in ²) (A)	706.85834706
7 →	Sample Box Number	01
8 →	Meter Box Number	01
9	Orifice Calibration (Ka)	1.6126639758
10	Gas Meter Cal. Factor (Y)	0.9936583473
11	Pitot Constant (Probe X) (Ca)	2.8006011727
	Pitot Constant (Probe Y) (Cb)	ERR
12 →	Air Temperature (F)	60
13 →	Meter Temperature (Tm) (Fahrenheit)	66
14 →	Prelim. Stack Temp. (Ts) (Fahrenheit)	176
15 →	Barometric Pressure (Pb) (in. of Hg)	30.46
16	Moisture, Assumed (Bws)	0.491152916
17	Mol. Weight, Dry (Md)	29.68
18	Mol. Weight, Stack (Ms)	23.04352292
19 →	Meter Pressure (Pm) (in. of H ₂ O)	32.46
20 →	Stack Pressure, Static (Psg) (in. of H ₂ O)	-2.42

Best Available Copy

TABLE 5.1 (continued)

MOISTURE AND MOLECULAR WEIGHT DETERMINATION

(fill-in data at each arrow)

Test Dates	86-Jan-36
Report Date:	85-Jan-37
Stack Temp., Dry Bulb (F)	→ 179
Stack Temp., Wet Bulb (F)	→ 179
Barometric Pressure (in of Hg)	→ 30.46
Saturated H ₂ O Vapor Pressure at Wet Bulb Temperature (From Vapor Pressure Chart)	→ 14.36
Vapor Pressure of H ₂ O at Stack Conditions	14.35
Moisture Content in Stack, (lbs)	0.4911359 49.11%
CO ₂ in % (Orsat of Fryite)	→ 9
O ₂ in % (Orsat of Fryite)	→ 6
N ₂ in % (Orsat of Fryite)	→ 85
CO in % (Orsat of Fryite)	→ 0
Dry Molecular Weight, (M _d)	29.68
Wet Molecular Weight, (M _w)	23.25

Best Available Copy

TABLE 5.1 (continued)

21	Stack Pressure, Absolute (Ps) (in. of Hg)		38.43
22	K Factor (H = K x P)	00	4.5899622599
23	→ Reference P (in. of H ₂ O)	(Avg)	8.357
24	Nozzle Dia (Calculated)		8.3788928196
25	→ Nozzle Dia (Actual)	(Dn)	8.375
25	Nozzle Area (ft ²)	(An)	8.8887663994
27	→ Nozzle Number		81
28	→ Leak Rate (@15in Vacuum)		
	Initial (ft ³ /min)		8.381
	Final (ft ³ /min)		8.386
29a	→ Filter Weights (grams)	No. Final Initial Diff.	5-7 8.6255 8.6014 8.0241
29b	→	No. Final Initial Diff.	Not Used _____ _____ ERR
30a	→ VOST Sorbent	Temp T/Char	17939 17948
30b	→ VOST Sorbent	Temp T/Char	17941 17942
30c	→ VOST Sorbent	Temp T/Char	17943 17944
31a	→ Moisture-impinger #1	ml	316
31b	→ Moisture-impinger #2	ml	16
31c	→ Moisture-impinger #3	ml	9
31d	→ Moisture-Silica Gel	Final Initial Diff.	242.1833 210.3 31.1833
31e	→ Moisture-Total (excluding NaOH) Moisture-Saturation	(ml) (ml) (ml)	863.1833 663.1833 1922
31	→ Sample Container(s) No.	_____ _____ _____	

Best Available

TABLE 5.1 (continued)

No	→	Remarks
		184 ml of NaOH carryover to impinger #1.
		<hr/> <p>Liquid was lost due to overflow in impinger #1. Since flue gas stream was saturated, actual of moisture collected should have been 1822 ml.</p> <hr/>

TABLE 5.1 (continued)

STACK TEST DATA TEST 1 06-Jan-56

Report Date: 05-Jan-57

Traverse Point Number	Time (min)	Clock Time (24 hr)	Gas Meter Reading (Vol) (ft ³)	Pitot Pressure (P) (in H ₂ O)	Orifice Meter Pressure, (H) (in of H ₂ O)		Temperature (F)		Vacuum (in Hg)	Oven Drying Temp. (F)		Stack Temp. (Ts) (F)		CO ₂ (%)	O ₂ (%)
					Desire	Actual	Inlet	Outlet		Temp.	Temp.	(Ts)	(F)		
1	7	Start	1239	244.185	0.66	1.83	1.4	83	71	13		59	182		1
2	8	5	1344	259.4	0.67	1.88	2.35	100	74				183		2
3	9	10	1349	254.9	0.77	1.53	2.3	109	79	22			183	10	6
4	10	15	1254	259.9	0.68	4.84	2.7	116	82	22.5			183		4
5	11	20	1259	254.3	0.91	4.18	2.6	120	86	23	22	91	183		6
6	12	25	1425	259.6	0.88	4.24	2.45	125	90	23	240	85	183	9.5	6
7	1	30	1425	272.945	0.58	2.66	1.6	98	90	24	240	78	184		7
8	2	35	1431	275.3	0.59	2.71	1.75	110	92	24	240	78	184		8
9	3	40	1435	280.7	0.7	1.21	1.7	114	92	24	240	74	184		9
10	4	45	1441	284.5	0.86	1.35	1.7	120	94	24	243	41	184	2.5	10
11	5	50	1446	288.4	0.92	4.22	1.55	122	96	24	270	88	184	9	11
12	6	55	1451	292.5	0.87	1.99	1.55	124	100	24			183		12
13	6	58	1455	295.161		0.20							183	9	7

Sampling Duration (min) — 60

Gas Sample Vol (ft³) (Vol) — 51.376

	Pitot Pressure (in H ₂ O) (P)	Orifice Meter Pressure, (in of H ₂ O) (H)	Dry Gas Meter Temp. (F) (T _{in})	Vacuum (in Hg) (in Hg)	Oven Temp. (F) (F)	Drying Temp. (F) (F)	Stack Temp. (Ts) (F) (F)	CO ₂ (%) (X)	O ₂ (%) (X)
Average	0.774	2.029	99.3	22.50	244.3	72.3	183.0	9.4	5.1
Minimum	0.558	1.550	71.3	13.00	222.3	41.3	182.3	3.3	5.3
Maximum	0.929	1.400	125.3	24.00	270.3	91.3	184.3	12.3	7.3

Best Available Copy

TABLE 5.1 (continued)

MODIFIED METHOD 3 CALCULATED DATA

TEST 1 Test Date: 06-Jan-36
Report Date: 05-Jan-37

Average Pitot Pressure (Avg) (in H ₂ O)	Average Stack Temp. (T _s) (R)	Average Orifice Pressure (Avg) (in H ₂ O)	Average Meter Temp. (T _m) (R)	Average Stack Gas Velocity (vs) (ft/sec)	Volume of Gas Sampled at STP (V _{stc}) (dscf)	Vol. Flowrate at Stack (Q _s) (ACFH)	Vol. Flowrate at STP (Q _{stc}) (SCFH)	ISO-Kinetic (%)
0.560	642.3	1.48	537.3	NA	NA	NA	NA	NA
0.663	642.3	1.13	542.3	22.13	6.168	9.25E+05	3.34E+05	129.33
0.738	642.7	1.22	546.3	21.782	10.224	9.53E+05	4.34E+05	101.54
0.745	642.3	2.94	549.3	21.47	15.284	9.81E+05	4.17E+05	97.23
0.773	642.3	2.37	553.3	25.725	19.298	1.20E+06	4.25E+05	91.75
0.793	642.3	2.38	554.7	27.223	24.623	1.31E+06	4.31E+05	91.33
0.784	643.3	2.53	554.6	26.212	27.264	9.92E+05	4.22E+05	85.29
0.743	643.1	2.23	554.4	25.418	31.545	9.77E+05	4.16E+05	83.23
0.733	643.2	2.43	555.2	24.223	22.222	9.76E+05	4.15E+05	31.54
0.732	643.3	2.36	557.3	24.697	28.342	9.84E+05	4.19E+05	79.31
0.763	643.4	2.29	558.4	26.279	42.512	9.94E+05	4.22E+05	78.49
0.774	643.3	2.23	559.3	26.228	46.449	1.00E+06	4.23E+05	77.81
0.774	643.3	2.23	559.3	26.227	49.265	1.00E+06	4.23E+05	76.46

Best Available Copy

TABLE 5.1 (continued)

WOST TEST DATA TEST 1 06-Dec-36

Report Date: 05-Jan-37

Sample Time (min)	Clock Time (24 hr)	Gas		Rota- meter Setting	Vacuum (in Hg)	Meter Temp. (C)	Probe Temp. (C)	Meter Temp. (F)	Probe Temp. (F)
		Meter Reading (liter)	meter						
1	Start	1348	8978.5	75	22	53	153	127.4	327.4
2	5	1353	8975.5	76	22	51	153	123.3	311
3	10	1358	8979.9	78	21	49	155	129.2	312.3
4	15	1403	8984.4	75	23	50	159	122	318.2
5	20	1417	8988.65	77	17	51	153	123.3	256
6	25	1422	8993.7	80	7	51	125	123.3	257
7	31	1427	8999.5	80	7	53	159	127.4	322
8	35	1432	9002.7	62	15	53	155	127.4	311
9	40	1508	9006.31	80	6	54	159	129.2	318.2
10	45	1505	9011.7	80	11	53	155	127.4	311
11	50	1519	9015.2	75	13	53	155	127.4	311
12	55	1515	9023.3	80	14	54	155	129.2	312.3
13	60	1529	9025.31						

Gas Sample Volume
(liter) ——— 54.31

Sampling Duration (min) —	60	Rota- meter Setting	Vacuum (in Hg)	Meter Temp. (C)	Probe Temp. (C)	Meter Temp. (F)	Probe Temp. (F)
		75.5	14.3	52.1	153.7	125.3	323.2
		62	6	49	125	129.2	257
		80	33	54	159	129.2	318.2

Best Available Copy

TABLE 5.2
FIELD DATA FOR TEST 2

MODIFIED METHOD 5 AND VOST TEST DATA SUMMARY

1. NCSB - GULFPORT
2. TEST RUN DESIGNATION - TEST 2
3. TEST DATE - 07-Dec-56

DATA DESCRIPTION	ID	MODIFIED METHOD 5		VOST	
		Value	Units	Value	Units
4. Time					
Start	Time(s)	945	hrs	953	hrs
Finish	Time(F)	1190	hrs	1060	hrs
Duration	T	60	min	60	min
5. Total Number of Sampling Points	NP	12		2	
6. Meter Calibration Factor	Y	0.394		NA	
7. Orifice Calibration Factor	Ka	1.513		NA	
8. Nozzle Specifications					
Diameter	Dn	0.25	in	0	
Area	Kn	1.41E-04	ft ²	NA	
9. Pitot Tube Coefficient	Co	0.381		NA	
10. Average Orifice Pressure Drop	Havg	0.373	in H ₂ O	NA	
11. Volume of Dry Gas Sampled	Vd	33.287	ft ³	33.278	liter
12. Average Gas Meter Temperature	Tg	333.3	R	332.7	K
13. Barometric Pressure	Pb	30.22	in Hg	762.4	mm Hg
14. Static Stack Pressure	Pg	-1.33	in H ₂ O	-3.7	mm H ₂ O
15. Absolute Stack Pressure	Ps	30.22	in Hg	767.5	mm Hg
16. Volume of Gas Sampled (Standard)	Vstd	33.743	SCF	39.399	liter
17. Volume of Water Collected in Isingers and Silica Gel	Vlc	692	ml	NA	
18. Volume of Water Collected Based on Saturated Conditions	Vlc'	643	ml	NA	
19. Volume Water Vapor Condensed in Isingers	Vwc	32.15	SCF	NA	
20. Volume Water Vapor Condensed in Silica Gel	Vwag	2.45	SCF	NA	

TABLE 5.2 (continued)

21. Percent Moisture by Volume	B _v	49.12%			
22. Percent Moisture by Saturation	B _w '	47.27%			
23. Mole Fraction of Dry Gas	F _{nd}	0.5275			
24. Gas Analysis					
Average CO ₂ by Volume	CO ₂	9.38	%		
Average O ₂ by Volume	O ₂	5.47	%		
Average CO by Volume	CO	0.38	%		
Average H ₂ by Volume	H ₂	0.01	%		
25. Dry Molecular Weight of Stack Gas	M _d	29.56	lb/lb-mole		
26. Molecular Weight at Stack Conditions	M _s	24.15	lb/lb-mole		
27. Average Stack Temperature	T _s	646.3	R	339.3	K
28. Average Stack Gas Velocity	V _s	61.34	ft/sec	18.71	m/sec
29. Stack Area	A _s	706.3	sq-ft	6.456	sq-m
30. Actual Stack Gas Flowrate	Q _s	1,882,279	ACFM	38,628	SCM
31. Dry Stack Gas Flowrate (Standard)	Q _{sstd}	472,561	SCFM	13,286	SCM
32. Iso - Kinetic Rate		182.8	%		
33. Weight of Filterable Particulates	W _p	48.8	mg		
34a. Particulate Concentration (at standard conditions)	C _s	2.57E-09	lb/DSCF		
		1.21	mg/DSCF		
		0.019	gr/DSCF		
		42.594	mg/DSCM		
34b. Particulate Concentration (corrected to 6% oxygen)	C _{s(x)O₂}	2.57E-09	lb/DSCF		
		1.17	mg/DSCF		
		0.013	gr/DSCF		
		41.219	mg/DSCM		
34c. Particulate Concentration (corrected to 12% carbon dioxide)	C _{s(12)CO₂}	3.05E-09	lb/DSCF		
		1.51	mg/DSCF		
		0.025	gr/DSCF		
		55.325	mg/DSCM		
35. Pollutant Mass Rate	PMR	1.25E-03	lbs/hr		
		571.5	g/hr		
		8818	gr/hr		

TABLE 5.2 (continued)

METER BOX CALIBRATION

04-Jan-66

Baro. Pressure 33.21 Meter Box No. 2577/679

Used for: TEST 2

Orifice No.	Gas Volume		Temperature				Time (min)	(Ha)		
	Setting (in H ₂ O)	Reference (Vr) (ft ³)	Sampler (Vd) (ft ³)	Reference (tw) (F)	Inlet (toi) (F)	Outlet (too) (F)			Avg (td) (F)	
2.5	4.310	5.375	70	82	71	75.5	11.43	0.978162	1.468641	
1	5.395	5.257	70	80	74	81	8.65	0.973166	1.619855	
2	10.310	10.420	70	102	78	90	12.25	0.992074	1.625209	
4	10.300	10.257	70	107	82	94.5	8.76	1.010600	1.629942	
5	10.307	10.212	71	110	84	84	7.17	0.989466	1.673253	
0	10.310	10.144	70	110	86	90	6.27	1.019079	1.657994	
Avg								→	0.995658	1.612563

CALIBRATION OF "S" TYPE PIIOT TUBE

04-Jan-66

Used for: TEST 3

Test	Pilot Tube	Std	"S"-Type	(Co)	Pilot Tube ID. I & Y
		Pilot Tube (P)	Pilot Tube (P)		
Test 1	X	0.55	0.73	0.834	Std Pilot (Co) 0.99
Test 2	X	0.57	0.88	0.797	
Test 3	X	0.59	0.92	0.786	Bar. Pressure 33.46
Test 4	X	0.53	0.92	0.786	
Avg (Co) for Probe X →				0.681	Gas Temp (F) 175
Test 1	Y	NOT	NOT	ERR	
Test 2	Y	IN	IN	ERR	
Test 3	Y	USE	USE	ERR	
Test 4	Y			ERR	
Avg (Co) for Probe Y →				ERR	

Best Available Copy

TABLE 5.2 (continued)

MOISTURE AND MOLECULAR WEIGHT DETERMINATION

(fill-in data at each arrow)

Test Date:	07-Dec-66
Report Date:	25-Jan-67
Stack Temp., Dry Bulb (F)	177
Stack Temp., Wet Bulb (F)	177
Barometric Pressure (in of Hg)	30.25
Saturated H ₂ O Vapor Pressure at Wet Bulb Temperature (From Vapor Pressure Chart)	14.2
Vapor Pressure of H ₂ O at Stack Conditions	14.2
Moisture Content in Stack, (Bwt)	0.4767372 47.27%
CO ₂ in % (Orsat of Dryite)	3
O ₂ in % (Orsat of Dryite)	5.5
N ₂ in % (Orsat of Dryite)	85.3
CO in % (Orsat of Dryite)	3
Dry Molecular Weight, (M _d)	29.66
Wet Molecular Weight, (M _w)	24.15

TABLE 5.2 (continued)

INITIAL STACK TEST DATA		Report Date:
(fill-in data marked by arrows)		25-Jan-67
1 →	Facility	NEEC
2 →	Location	Gulfport, Mississippi
3 →	Operator & Test Personnel	Jung Jurgens Basko Bueia
4 →	Test Date	27-Dec-66
5 →	Run Number	TEST 2
6 →	Stack Dia (in.)	38
	Stack Area (in ²) (A)	786.35934736
7 →	Sample Box Number	01
8 →	Meter Box Number	01
9	Orifice Calibration (Ha)	1.5125639753
10	Gas Meter Cal. Factor (Y)	0.9936533473
11	Pitot Constant (Probe X) (Ca)	0.2006011727
	Pitot Constant (Probe Y) (Cb)	ERR
12 →	Air Temperature (F)	60
13 →	Meter Temperature (Tm) (Fahrenheit)	100
14 →	Prelim. Stack Temp. (Ts) (Fahrenheit)	178
15 →	Barometric Pressure (Pb) (in. of Hg)	30.25
16	Moisture, Assumed (Bwa)	0.4727272727
17	Mol. Weight, Dry (Md)	29.66
18	Mol. Weight, Stack (Ms)	24.148
19 →	Meter Pressure (Pm) (in. of Hg)	30.25
20 →	Stack Pressure, Static (Pg) (in. of H ₂ O)	-4.33

TABLE 5.2 (continued)

21	Stack Pressure, Absolute (Pa) (in. of Hg)		38.22
22	K Factor ($H = K \times P$)	(K)	1.2237721994
23	→ Reference P (in. of H ₂ O)	(Avg)	0.774
24	Nozzle Dia (Calculated)		0.2965436825
25	→ Nozzle Dia (Actual)	(Dn)	0.25
26	Nozzle Area (ft ²)	(An)	0.0083488846
27	→ Nozzle Number		42
28	→ Leak Rate (at 15 in Vacuum)		
	Initial (ft ³ /min)		0.383
	Final (ft ³ /min)		0.384
29a	→ Filter Weights	No.	S-5
	(grams)	Final	0.6427
		Initial	0.6319
		Diff.	0.0108
29b	→	No.	Not Used
		Final	
		Initial	
		Diff.	ERR
30a	→ VOST Tenax	Tenax	14793
		T/Char	14795
30b	→ VOST Tenax	Tenax	14794
		T/Char	14797
30c	→ VOST Tenax	Tenax	14795
		T/Char	14799
31a	→ Moisture-Isofinger #1	xi	356
31b	→ Moisture-Isofinger #2	xi	47
31c	→ Moisture-Isofinger #3	xi	0
31d	→ Moisture-Silica Gel	Final	213.1485
		Initial	283.6696
		Diff.	9.4789
31e	→ Moisture-Total	(ml)	992.4789
	(excluding NaOH)	(ml)	692.4789
	Moisture-Saturation	(ml)	643
31	→ Sample Container(s) No.		

TABLE 5.2 (continued)

SI	→	Remarks
		Insinger 81 includes carryover of 253 21 from insinger 42 (NaOH).

Best Available Copy

TABLE 5.2 (continued)

STACK TEST DATA TEST 2 27-Dec-66

Report Date: 25-Jan-67

Traverse Point Number	Time (min)	Clock Time (24 hr)	Gas Meter Reading (Vol) (ft ³)	Pitot Pressure (P) (in H ₂ O)	Orifice Meter Pressure, (H) (in of H ₂ O)		Temperature Dry Gas Meter (F)		Vacuum (in Hg)	Oven Temp. (F)	Inging Temp. (F)	Stack Temp. (Ts) (F)	CO ₂ (%)	O ₂ (%)	
					Desire	Actual	Inlet	Outlet							
1	7	Start	945	295.365	0.71	0.73	0.76	73	70	5	210	60	183.2	8.5	4.5
2	8	5	950	299	0.83	0.85	0.89	86	71	5	210	58	183.2		
3	9	10	955	301.33	0.88	0.90	0.94	95	74	5.2	240	58	183.2		
4	10	15	1000	305	0.88	0.90	0.94	105	80	5.2	250	58	183.2	10	4.3
5	11	20	1006	308.5	0.92	0.94	0.99	110	84	5.2	270	58	185.3		
6	12	25	1010	310.5	0.97	0.99	0.93	112	86	5.3	275	60	185		
7	1	30	1020	313.49	0.73	0.75	0.78	95	90	5.3	250	62	183.2		7
8	2	35	1037	317.3	0.86	0.88	0.92	110	93	6	250	58	183.2		
9	3	40	1040	319	0.94	0.95	1.02	112	94	5.5	210	60	183.2		
10	4	45	1045	322	1.2	1.23	1.3	117	96	7.7	210	60	183.2		
11	5	50	1050	325.2	1.1	1.13	1.15	120	98	7.2	270	60	183.2	9.5	
12	6	55	1055	329.3	0.97	0.99	1.05	122	100	5.5	250	58	183.2	8	
13	5	50	1100	331.332		0.90							185.3		

Sampling Duration (hr) — 60

Gas Sample Vol (ft³) (Vol) — 35,357

	Pitot Pressure (in H ₂ O) (P)	Orifice Meter Pressure, (in of H ₂ O) (H)	Dry Gas Meter Temp. (F) (T _{av})	Vacuum (in Hg)	Oven Temp. (F)	Inging Temp. (F)	Stack Temp. (Ts) (F)	CO ₂ (%)	O ₂ (%)
Average	0.998	0.973	95.3	5.18	242.1	59.3	183.3	9.0	5.5
Minimum	0.710	0.750	70.3	5.00	210.3	58.3	183.2	3.0	4.3
Maximum	1.300	1.300	122.3	7.70	270.3	62.3	185.3	10.3	7.3

Best Available Copy

TABLE 5.2 (continued)

MODIFIED METHOD 5 CALCULATED DATA

TEST 2

Test Date: 07-Dec-86

Report Date: 05-Jan-87

	Average Pitot Pressure (Pavg) (in H2O)	Average Stack Temp. (Ts) (R)	Average Orifice Pressure (Pavg) (in H2O)	Average Meter Temp. (Tm) (R)	Average Stack Gas Velocity (vs) (ft/sec)	Volume of Gas Sampled at STP (Vstd) (scf)	Vol. Flowrate at Stack (Qs) (ACFH)	Vol. Flowrate at STP (Qstd) (SCFH)	Iso- Kinetic (%)
1	0.710	643.2	0.76	534.0	NA	NA	NA	NA	NA
2	0.770	643.2	0.83	536.3	56.083	2.611	9.96E+05	4.36E+05	107.62
3	0.807	643.2	0.86	539.0	57.710	3.387	1.32E+06	4.46E+05	105.67
4	0.825	643.2	0.88	542.4	58.062	4.468	1.83E+06	4.51E+05	109.78
5	0.844	643.3	0.89	545.3	59.863	11.703	1.34E+06	4.56E+05	115.00
6	0.848	644.1	0.91	547.6	59.223	13.814	1.85E+06	4.57E+05	106.48
7	0.831	644.0	0.89	548.4	58.624	16.595	1.34E+06	4.52E+05	106.43
8	0.835	643.9	0.89	548.3	58.745	28.225	1.34E+06	4.52E+05	111.83
9	0.847	643.8	0.91	551.4	59.151	21.312	1.85E+06	4.57E+05	104.55
10	0.862	643.7	0.95	553.0	60.378	24.528	1.87E+06	4.66E+05	104.59
11	0.882	643.7	0.97	554.4	61.842	27.642	1.88E+06	4.71E+05	105.16
12	0.888	643.7	0.97	555.3	61.232	31.815	1.88E+06	4.73E+05	106.38
13	0.888	643.9	0.97	555.3	61.243	33.743	1.88E+06	4.73E+05	106.58

Best Available Copy

TABLE 5.2 (continued)

VOST TEST DATA TEST 2 07-Dec-66

Report Date: 05-Jan-67

Sampling Time (min)	Clock Time (24 hr)	Gas		Rota-meter Setting	Vacuum (in Hg)	Meter	Probe	Stack	Meter	Probe	Stack
		Meter Reading (liter)				Temp. #5 (C)	Temp. #1 (C)	Temp. #2 (C)	Temp. #5 (F)	Temp. #1 (F)	Temp. #2 (F)
1	Start	933	9125.33	30	7	62	137	84	143.5	278.5	183.2
2	5	938	9138.35	20	10	63	148	84	145.4	298.4	183.2
3	10	943	9124.3	30	11	64	147	84	147.2	295.5	183.2
4	15	948	9133.41	30	10	66	148	84	152.2	298.4	183.2
5	20	1003	9144.25	30	12	67	147	86	152.5	295.5	186.3
6	25	1008	9149.11	30	22	67	157	85	152.5	314.5	185
7	31	1013	9154.35	30	24	68	178	84	154.4	333	183.2
8	35	1028	9153.35	30	20	69	155	84	155.2	297.4	183.2
9	40	1040	9163.34	30	10	68	137	84	154.4	278.5	183.2
10	45	1045	9162.25	35	14	68	137	84	154.4	278.5	183.2
11	50	1050	9172.25	35	12	69	137	84	155.2	278.5	183.2
12	55	1055	9178.25	35	14	69	137	84	155.2	278.5	183.2
13	59	1060	9185.35	35		54	145	86	129.2	293	186.3

Gas Sample Volume (liter) → 59.27

Sampling Duration (min) → 59

	Rota-meter Setting	Vacuum (in Hg)	Meter Temp. (C)	Probe Temp. (C)	Stack Temp. (C)	Meter Temp. (F)	Probe Temp. (F)	Stack Temp. (F)
Average	31.5	13.3	65.7	146.2	84.4	152.2	295.1	183.3
Minimum	30	7	54	137	84	129.2	278.5	183.2
Maximum	35	24	69	178	86	155.2	333	186.3

Best Available Copy

TABLE 5.3
FIELD DATA FOR TEST 3

MODIFIED METHOD 5 AND VOST TEST DATA SUMMARY

NCSC - GULFPORT

TEST RUN DESIGNATION - TEST 3

TEST DATE - 07-Dec-36

DATA DESCRIPTION	ID	MODIFIED METHOD 5		VOST	
		Value	Units	Value	Units
Time					
Start	Time(s)	1455	hrs	1551	hrs
Finish	Time(f)	1620	hrs	1725	hrs
Duration	T	60	min	60	min
Total Number of Sampling Points	NP	12		2	
Meter Calibration Factor	Y	0.994		NA	
Orifice Calibration Factor	Ha	1.513		NA	
Nozzle Specifications					
Diameter	Dn	0.25	in	6	mm
Area	An	3.41E-4	ft ²	NA	
Pitot Tube Coefficient	Cp	0.981		NA	
Average Orifice Pressure Drop	Havg	0.252	in H ₂ O	NA	
Volume of Dry Gas Sampled	Vd	58.959	ft ³	58.659	liter
Average Gas Meter Temperature	Ta	558.0	R	331.0	K
Barometric Pressure	Pb	30.25	in Hg	768.4	mm Hg
Static Stack Pressure	Pg	-0.38	in H ₂ O	-9.7	mm H ₂ O
Absolute Stack Pressure	Ps	30.22	in Hg	767.6	mm Hg
Volume of Gas Sampled (Standard)	Vstd	34.141	SCF	58.735	liter
Volume of Water Collected in Impingers and Silica Gel	Vlc	679	ml	NA	
Volume of Water Collected Based on Saturated Conditions	Vlc'	678	ml	NA	
Volume Water Vapor Condensed in Impingers	Vwc	31.44	SCF	NA	
Volume Water Vapor Condensed in Silica Gel	Vwcg	0.54	SCF	NA	

TABLE 5.3

21. Percent Moisture by Volume	W _v	48.37%			
Percent Moisture by Saturation	W _s	48.25%			
22. Mole Fraction of Dry Gas	F _{dg}	0.5167			
24. Gas Analysis					
Average CO ₂ by Volume	CO ₂	9.23	%		
Average O ₂ by Volume	O ₂	4.59	%		
Average CO by Volume	CO	0.38	%		
Average H ₂ by Volume	H ₂	26.53	%		
25. Dry Molecular Weight of Stack Gas	M _d	29.65	lb/lb-mole		
26. Molecular Weight at Stack Conditions	M _s	24.82	lb/lb-mole		
27. Average Stack Temperature	T _s	644	R	357.4	K
28. Average Stack Gas Velocity	V _s	68.78	ft/sec	18.54	m/sec
29. Stack Area	A _s	706.3	sq-ft	64.55	sq-m
30. Actual Stack Gas Flowrate	Q _s	1,372,648	ACFM	33,777	SCFM
31. Dry Stack Gas Flowrate (Standard)	Q _{sstd}	468,749	SCFM	13,348	SCFM
32. Iso - Kinetic Rate		197.7	%		
33. Weight of Filterable Particulates	W _p	23.4	mg		
34a. Particulate Concentration (at standard conditions)	C _s	2.39E-09	lb/DSCF		
		1.24	mg/DSCF		
		0.815	gr/DSCF		
		25.612	mg/DSCM		
34b. Particulate Concentration (corrected to 5% oxygen)	C _{s(5%O2)}	2.38E-09	lb/DSCF		
		1.24	mg/DSCF		
		0.815	gr/DSCF		
		25.254	mg/DSCM		
34c. Particulate Concentration (corrected to 12% carbon dioxide)	C _{s(12%CO2)}	2.39E-09	lb/DSCF		
		1.24	mg/DSCF		
		0.821	gr/DSCF		
		47.722	mg/DSCM		
35. Pollutant Mass Rate	PMR	1.25E-03	lbs/hr		
		477.7	g/hr		
		7372	gr/hr		

Post AVI... COPY

TABLE 5.3 (continued)

METER BOX CALIBRATION

04-Dec-56

Pressure 38.21 Meter Box No. 2577/679

Used for: TEST 3

Orifice Manno. Setting (in H ₂ O)	Gas Volume		Temperature				Avg (F)	Time (min)	(H _a) (in H ₂ O)
	Reference (V _r) (ft ³)	Sampler (V _d) (ft ³)	Reference (t _r) (F)	Inlet (t _{di}) (F)	Outlet (t _{do}) (F)	Dry Gas Meter (t _d) (F)			
0.5	4.318	5.375	78	82	71	76.5	11.43	2.978162	1.4866+1
1	5.385	5.257	78	88	74	81	8.63	2.973166	1.619855
2	10.310	10.428	78	102	78	98	12.25	2.992974	1.625289
4	18.388	18.257	78	107	82	94.5	8.76	1.810800	1.629942
6	18.387	18.212	71	118	84	84	7.17	2.989466	1.573253
8	10.310	10.144	78	118	86	98	6.27	1.819879	1.657994

Avg → 2.993653 1.512563

CALIBRATION OF "S" TYPE PITOT TUBE

04-Dec-56

Used for: TEST 3

Pitot Tube	Std Pitot Tube (P)	"S"-Type Pitot Tube (P)		(Co)	Pitot Tube ID. X & Y
Test 1	X	0.56	0.79	0.354	Std Pitot (Co) 0.29
Test 2	X	0.57	0.88	0.797	
Test 3	X	0.58	0.92	0.786	Bar. Pressure 38.21
Test 4	X	0.58	0.92	0.786	
Avg (Co) for Probe X →				0.381	Gas Temp (F) 176
Test 1	Y	NOT	NOT	ERR	Avg (Co) for Probe Y → ERR
Test 2	Y	IN	IN	ERR	
Test 3	Y	USE	USE	ERR	
Test 4	Y			ERR	

Best Available Copy

TABLE 5.3 (continued)

MOISTURE AND MOLECULAR WEIGHT DETERMINATION

(fill-in data at each arrow)

Test Date:	97-Dec-66
Report Date:	85-Jan-67
Stack Temp., Dry Bulb (F)	→ 178
Stack Temp., Wet Bulb (F)	→ 178
Barometric Pressure (in of Hg)	→ 30.25
Saturated H ₂ O Vapor Pressure at Wet Bulb Temperature (From Vapor Pressure Chart)	→ 14.62
Vapor Pressure of H ₂ O at Stack Conditions	14.62
Moisture Content in Stack, (Bws)	0.4833857 48.33%
CO ₂ in % (Orsat of Fryite)	→ 9.2
O ₂ in % (Orsat of Fryite)	→ 4.5
N ₂ in % (Orsat of Fryite)	→ 26.3
CO in % (Orsat of Fryite)	→ 0
Dry Molecular Weight, (M _d)	29.63
Wet Molecular Weight, (M _w)	24.32

DO NOT ATTEMPT TO COPY

TABLE 5.3 (continued)

INITIAL STACK TEST DATA

Report Date:

85-Jan-87

(fill-in data marked by arrows)

1 →	Facility		NEEC
2 →	Location		Gulfport, Mississippi
3 →	Operator & Test Personnel		Jung Juergens, Grasso Basko Buelia
4 →	Test Date		87-Dec-36
5 →	Run Number		TEST 3
6 →	Stack Dia. (in.)		38
	Stack Area (in ²)	(A)	706.85834706
7 →	Sample Box Number		#1
8 →	Meter Box Number		#1
9	Orifice Calibration	(Ka)	1.6135639753
10	Gas Meter Cal. Factor	(Y)	0.9936533475
11	Pitot Constant (Probe X)	(Ca)	0.2006311727
	Pitot Constant (Probe Y)	(Cb)	ERR
12 →	Air Temperature (F)		63
13 →	Meter Temperature (Fahrenheit)	(Tm)	188
14 →	Prelim. Stack Temp. (Fahrenheit)	(Ts)	178
15 →	Barometric Pressure (in. of Hg)	(Pb)	30.25
16	Moisture, Assumed	(Bwa)	0.483257851
17	Mol. Weight, Dry	(Md)	29.532
18	Mol. Weight, Stack	(Ms)	24.028529992
19 →	Meter Pressure (in. of Hg)	(Pm)	30.25
20 →	Stack Pressure, Static (in. of H ₂ O)	(Pg)	-1.38 671

East Avenues

TABLE 5.3 (continued)

21	Stack Pressure, Absolute (Ps) (in. of Hg)		32.22
22	K Factor (H = K x P)	(K)	2.388232637
22 →	Reference P (in. of H ₂ O)	(Pavg)	2.998
24	Nozzle Dia (Calculated)		0.2978466681
25 →	Nozzle Dia (Actual)	(Dn)	2.25
25	Nozzle Area (ft ²)	(An)	0.2982488846
27 →	Nozzle Number		#2
28 →	Leak Rate (815in Vacuum)		
	Initial (ft ³ /min)		0.382
	Final (ft ³ /min)		2.294
29a →	Filter Weights (grams)	No. Final Initial Diff.	5-1 0.5373 0.5919 2.2334
29b →		No. Final Initial Diff.	Not Used _____ _____ ERR
30a →	VOST Tenax	Tenax T/Char	14729 14685
30b →	VOST Tenax	Tenax T/Char	14688 14683
30c →	VOST Tenax	Tenax T/Char	14681 14684
31a →	Moisture-Isoinger #1	zi	666
31b →	Moisture-Isoinger #2	zi	308
31c →	Moisture-Isoinger #3	zi	3
31d →	Moisture-Silica Gel	Final Initial Diff.	231.238 219.7664 11.4716
31e →	Moisture-Total (excluding NaOH)	(ml) (ml)	979.4716 679.4716
	Moisture-Saturation	(ml)	678
31 →	Sample Container(s) No.		_____ _____ _____

DO NOT WRITE IN THESE SPACES

TABLE 5.3 (continued)

W 1

Remarks

TABLE 5.3 (continued)

STACK TEST DATA TEST 3 07-Dec-66

Report Date: 25-Jan-67

Traverse Point Number	Clock Time (min)	Clock Time (24 hr)	Gas Meter Reading (Vol) (ft ³)	Pitot Pressure (P) (in H ₂ O)	Orifice Meter Pressure, (H) (in of H ₂ O)		Temperature Dry Gas Meter (F)		Vacuum (in Hg)	Oven Temp. (F)	Imping Temp. (F)	Stack Temp. (Ts) (F)	CO ₂ (%)	O ₂ (%)	
					Desire	Actual	Inlet	Outlet							
1	7	Start	1495	334.354	0.72	0.71	0.77	82	80	6.7	250	55	181		
2	8	5	1501	337.3	0.76	0.75	0.81	94	81	6.9	270	53	181		
3	9	10	1505	339.6	0.75	0.74	1.02	99	83	8.5	250	54	181	8	4.5
4	10	15	1510	342.3	0.7	0.69	0.95	107	85	8.2	250	59	181		
5	11	20	1515	345.6	0.9	0.89	0.95	110	88	8.2	250	62	181		
6	12	25	1520	348.4	0.93	0.92	1	115	90	8.3	250	68	181	9.5	
7	1	30	1525	351.215	0.79	0.78	0.85	101	92	7.1	250	62	181	9.5	
8	2	35	1530	354.3	0.79	0.78	0.85	109	94	7.2	270	54	181		
9	3	40	1535	357.7	0.97	0.96	0.93	114	95	7.3	250	55	181		
10	4	45	1540	359.4	1.08	1.07	1.15	117	95	9	250	53	181	9.5	
11	5	50	1545	363.5	1.05	1.04	1.12	120	98	9.3	295	60	184		
12	6	55	1550	357.2	0.94	0.93	1	122	100	8.5	295	60	183	9.5	
13	6	60	1555	370.219		0.90		119	100				183		

Flowing Duration
min — 60

Gas Sample Vol (ft³) (Vol) — 35,355

	Pitot Pressure (in H ₂ O) (P)	Orifice Meter Pressure, (H) (in of H ₂ O)	Dry Gas Meter Temp. (F) (T _{av})	Vacuum (in Hg)	Oven Temp. (F)	Imping Temp. (F)	Stack Temp. (Ts) (F)	CO ₂ (%)	O ₂ (%)
Average	0.899	0.852	93.3	8.02	253.3	53.4	181.5	9.3	4.5
Minimum	0.720	0.770	80.3	6.79	250.3	53.0	181.3	8.3	4.5
Maximum	1.080	1.153	122.3	9.30	295.3	60.3	184.3	9.5	4.5

TABLE 5.3 (continued)

MODIFIED METHOD 5 CALCULATED DATA				TEST 3	Test Date: 07-Dec-86	Report Date: 05-Jan-87			
Average Pitot Pressure (Pavg) (in H ₂ O)	Average Stack Temp. (Ts) (R)	Average Orifice Pressure (Pavg) (in H ₂ O)	Average Meter Temp. (Tm) (R)	Average Stack Gas Velocity (vs) (ft/sec)	Volume of Gas Sampled at STP (Vm(std)) (dscf)	Vol. Flowrate at Stack (Qs) (ACFH)	Vol. Flowrate at STP (Qstd) (SCFH)	Iso-Kinetic (%)	
1	0.720	641.0	0.77	541.0	NA	NA	NA	NA	
2	0.740	641.0	0.79	544.3	55.025	3.452	3.78E-05	4.23E-05	141.38
3	0.810	641.0	0.87	546.5	57.283	5.188	1.02E-06	4.40E-05	104.53
4	0.833	641.0	0.89	548.3	58.661	8.254	1.04E-06	4.46E-05	109.42
5	0.846	641.0	0.89	550.3	59.155	10.933	1.05E-06	4.49E-05	107.71
6	0.860	641.0	0.92	552.3	59.643	13.536	1.05E-06	4.51E-05	106.57
7	0.850	641.0	0.91	553.4	59.295	16.348	1.05E-06	4.50E-05	110.21
8	0.843	641.0	0.89	554.4	59.333	19.682	1.04E-06	4.48E-05	109.52
9	0.846	641.0	0.91	555.5	59.140	22.417	1.05E-06	4.49E-05	108.59
10	0.863	641.0	0.93	556.7	59.954	24.932	1.06E-06	4.52E-05	107.53
11	0.865	641.0	0.95	557.3	60.532	27.955	1.07E-06	4.50E-05	107.75
12	0.890	641.0	0.95	558.3	60.694	31.020	1.07E-06	4.51E-05	109.35
13	0.850	641.0	0.95	559.7	60.659	34.141	1.07E-06	4.51E-05	109.53

TABLE 5.3 (continued)

VOST TEST DATA TEST 3 97-Dec-66

Report Date: 05-Jan-67

Sampling Time (min)	Clock Time (24 hr)	Gas Meter Reading (liter)	Rota-meter Setting	Vacuum (in Hg)	Meter	Probe	Stack	Meter	Probe	Stack	
					Temp. #5 (C)	Temp. #1 (C)	Temp. #2 (C)	Temp. #5 (F)	Temp. #1 (F)	Temp. #2 (F)	
1	Start	1531	9230.55	85	12	65	154	84	149	389.2	183.2
2	5	1535	9235.55	85	16	65	156	85	131	312.3	185
3	10	1531	9218.45	85	16	55	155	85	132.3	312.3	185
4	15	1536	9215.45	85	16	55	157	85	132.3	314.5	185
5	20	1516	9229.45	85	19	57	157	84	134.5	314.5	183.2
6	25	1525	9227.55	84	21	58	155	84	135.4	312.3	183.2
7	31	1530	9229.55	88	21	58	155	84	135.4	312.3	183.2
8	37	1535	9224.55	88	23	59	154	85	138.2	389.2	185
9	43	1540	9233.54	85	22	60	143	84	140	289.4	183.2
10	45	1650	9245.5	85	22	60	144	85	140	291.2	185
11	50	1655	9249.55	84	23	60	145	85	140	293	185
12	55	1700	9254.51	78	23	52	149	86	128.5	388.2	185.3
13	58	1705	9257.0					86	12	32	185.3

Sample Volume (liter) ——— 55.55

Sampling Duration (min) ——— 58

	Rota-meter Setting	Vacuum (in Hg)	Meter Temp. (C)	Probe Temp. (C)	Stack Temp. (C)	Meter Temp. (F)	Probe Temp. (F)	Stack Temp. (F)
Average	82.4	19.5	55.0	152.0	84.3	128.4	385.0	184.5
Minimum	78	12	52	143	84	32	32	183.2
Maximum	85	23	58	157	86	149	314.5	185.3

TABLE 5.5
FIELD DATA FOR TEST 5

MODIFIED METHOD 5 AND VOST TEST DATA SUMMARY

1. NCSC - GULFPORT
2. TEST RUN DESIGNATION - TEST 5
3. TEST DATE - 15-Dec-66

<u>DATA DESCRIPTION</u>	<u>ID</u>	<u>MODIFIED METHOD 5</u>		<u>VOST</u>	
		<u>Value</u>	<u>Units</u>	<u>Value</u>	<u>Units</u>
4. Time					
Start	Time(s)	920	hrs	920	hrs
Finish	Time(f)	1030	hrs	1030	hrs
Duration	T	60	min	60	min
5. Total Number of Sampling Points	NP	12		2	
6. Meter Calibration Factor	Y	2.394		NA	
7. Orifice Calibration Factor	Ha	1.613		NA	
8. Nozzle Specifications					
Diameter	Dn	0.25	in	6	mm
Area	An	2.41E-04	ft ²	NA	
Pitot Tube Coefficient	Co	0.881		NA	
10. Average Orifice Pressure Drop	Havg	0.829	in H ₂ O	NA	
11. Volume of Dry Gas Sampled	Vd	31.725	ft ³	48.310	liter
12. Average Gas Meter Temperature	Ta	553.7	R	293.3	K
13. Barometric Pressure	Pb	30.35	in Hg	768.6	mm Hg
14. Static Stack Pressure	Pg	0.55	in H ₂ O	14.2	mm H ₂ O
15. Absolute Stack Pressure	Ps	30.38	in Hg	769.6	mm Hg
16. Volume of Gas Sampled (Standard)	Vstd	38.452	SCF	48.835	liter
17. Volume of Water Collected in Impingers and Silica Gel	Vic	839	ml	NA	
18. Volume of Water Collected Based on Saturated Conditions.	Vic'	837	ml	NA	
19. Volume Water Vapor Condensed in Impingers	Vwc	39.87	SCF	NA	
Volume Water Vapor Condensed in Silica Gel	Vwsg	8.43	SCF	NA	

TABLE 5.5 (continued)

21. Percent Moisture by Volume	Dw	55.46%		NA
Percent Moisture by Saturation	Dw'	55.41%		
22. Mole Fraction of Dry Gas	Fed	0.4359		NA
24. Gas Analysis				
Average CO ₂ by Volume	CO ₂	7.58	%	NA
Average O ₂ by Volume	O ₂	6.58	%	NA
Average CO by Volume	CO	2.38	%	NA
Average H ₂ by Volume	H ₂	65.38	%	NA
25. Dry Molecular Weight of Stack Gas	Md	29.48	lb/lb-mole	NA
26. Molecular Weight at Stack Conditions	Ms	23.38	lb/lb-mole	NA
27. Average Stack Temperature	Ts	648.6	R	369.3 K
28. Average Stack Gas Velocity	Vs	68.78	ft/sec	20.99 m/sec
29. Stack Area	As	786.9	sq-in	0.455 sq-m
30. Actual Stack Gas Flowrate	Qs	1,214,117	scfh	34,384 scmh
31. Dry Stack Gas Flowrate (Standard)	Qsstd	437,146	scfh	12,338 scmh
32. Iso - Kinetic Rate		181.0	%	NA
Weight of Filterable Particulates	Wp	41.2	mg	NA
34a. Particulate Concentration (at standard conditions)	Cs	2.38E-09	lb/DSCF	NA
		1.25	mg/DSCF	NA
		3.321	gr/DSCF	NA
		47.773	mg/DSCM	NA
34b. Particulate Concentration (corrected to 6% oxygen)	Cs6%O2	2.11E-09	lb/DSCF	NA
		1.41	mg/DSCF	NA
		3.822	gr/DSCF	NA
		49.778	mg/DSCM	NA
34c. Particulate Concentration (corrected to 12% carbon dioxide)	Cs12%CO2	4.71E-09	lb/DSCF	NA
		2.14	mg/DSCF	NA
		6.833	gr/DSCF	NA
		75.431	mg/DSCM	NA
35. Pollutant Mass Rate	MR	1.38E-03	lbs/hr	NA
		591.4	g/hr	NA
		9126	gr/hr	NA

TABLE 5.5 (continued)

METER BOX CALIBRATION

04-Dec-56

Pressure 38.21 Meter Box No. 2577/679

Used for: TEST 5

Orifice Mand.	Gas Volume		Temperature				Avg	Time		
	Reference	Standard	Reference	Inlet	Outlet	Dry Gas Meter				
(H)	(V _g)	(V _d)	(t _w)	(t _{d1})	(t _{d2})	(t _d)	(θ)	(min)	(H _g)	(in H ₂ O)
(in H ₂ O)	(ft ³)	(ft ³)	(F)	(F)	(F)	(F)				
0.5	4.910	5.375	70	82	71	76.5	11.43	0.378162	1.488641	
1	5.385	5.257	70	88	74	81	8.53	0.373156	1.519855	
2	10.310	10.420	70	102	78	90	12.25	0.992874	1.645209	
4	10.308	10.257	70	107	82	94.5	8.76	1.010000	1.629042	
6	10.007	10.212	71	110	84	84	7.17	0.989466	1.675253	
8	10.310	10.144	70	110	66	90	6.27	1.019879	1.557994	

Avg → 0.993538 1.612663

CALIBRATION OF "S" TYPE PITOT TUBE

04-Dec-56

Used for: TEST 5

Pitot Tube	Std Pitot Tube (P)	"S"-Type Pitot Tube (P)		(C _g)	Pitot Tube ID. X & Y	Std Pitot (C _g)
Test 1	X	0.55	0.79	0.334		0.39
Test 2	X	0.57	0.38	0.797		
Test 3	X	0.53	0.32	0.766		Bar. Pressure
Test 4	X	0.55	0.32	0.726		38.46
Avg (C _g) for Probe X →				0.681	Gas Temp (F)	176
Test 1	Y	NOT	NOT	ERR		
Test 2	Y	IN	IN	ERR		
Test 3	Y	USE	USE	ERR		
Test 4	Y			ERR		
Avg (C _g) for Probe Y →				ERR		

East Avon's Copy

TABLE 5.5 (continued)

INITIAL STACK TEST DATA		Report Date:
(fill-in data marked by arrows)		05-Jan-67
1 →	Facility	MCSC
2 →	Location	Gulfport, Mississippi
3 →	Operator & Test Personnel	Jung Juergens, Sasko Sasko Sueia
4 →	Test Date	15-Dec-66
5 →	Run Number	TEST 5
6 →	Stack Dia (in.)	30
	Stack Area (in ²) (A)	706.35334706
7 →	Sample Box Number	#1
8 →	Meter Box Number	#1
9	Orifice Calibration (Ha)	1.6125639753
10	Gas Meter Cal. Factor (Y)	0.9936533475
11	Pitot Constant (Probe X) (Ca)	0.8006811727
	Pitot Constant (Probe Y) (Cb)	ERR
12 →	Air Temperature (F)	60
13 →	Meter Temperature (Tm) (Fahrenheit)	34
14 →	Prelim. Stack Temp. (Ts) (Fahrenheit)	184
15 →	Barometric Pressure (Pb) (in. of Hg)	30.25
16	Moisture, Assumed (Bwa)	0.554118377
17	Mol. Weight, Dry (Md)	29.52
18	Mol. Weight, Stack (Ms)	23.321446846
19 →	Meter Pressure (Pm) (in. of Hg)	30.25
20 →	Stack Pressure, Static (Pg) (in. of H ₂ O)	0.55

TABLE 5.5 (continued)

21	Stack Pressure, Absolute (Ps) (in. of Hg)		32.38
22	K Factor ($H = K \times P$)	(K)	0.717388853
23	Reference P (in. of H ₂ O)	(P _{avg})	1.2167
24	Nozzle Dia (Calculated)		0.2993916636
25	Nozzle Dia (Actual)	(D _n)	0.25
25	Nozzle Area (ft ²)	(A _n)	0.0003488846
27	Nozzle Number		42
28	Leak Rate (@15in Vacuum)		
	Initial (ft ³ /min)		0.082
	Final (ft ³ /min)		0.091
29a	Filter Weights (grams)	No. Final Initial Diff.	5 - 8 0.6465 0.6853 0.0388
29b		No. Final Initial Diff.	NA _____ _____ ERR
29c	VOST Tenax	Tenax T/Char	_____ _____
29d	VOST Tenax	Tenax T/Char	_____ _____
29e	VOST Tenax	Tenax T/Char	_____ _____
31a	Moisture-Indicator #1	ni	838
31b	Moisture-Indicator #2	ni	388
31c	Moisture-Indicator #3	ni	8
31d	Moisture-Silica Gel	Final Initial Diff.	238.3 139.44 9.86
31e	Moisture-Total (excluding NaOH) Moisture-Saturation	(ml) (ml) (ml)	1133.06 837.06 837
31	Sample Containers) No.		_____ _____ _____

TABLE 5.5 (continued)

W → Remarks

TABLE 5.5 (continued)

STACK TEST DATA TEST 5 15-Dec-66

Report Date: 25-Jan-67

Traverse Point Number	Clock Time (min)	Clock Time (24 hr)	Gas Meter Reading (Vol) (ft ³)	Pitot Pressure (P) (in H ₂ O)	Orifice Meter Pressure, (H) (in of H ₂ O)		Temperature Dry Gas Meter (F)		Vacuum (in Hg)	Oven Temp. (F)	Leading Temp. (F)	Stack Temp. (Ts) (F)	CO ₂ (%)	O ₂ (%)	
					Desire	Actual	Inlet	Outlet							
1	7	Start	928	425.324	2.34	2.67	0.72	78	78	7.7	218	44	187	8.3	6.3
2	8	5	935	427.3	1.1	2.79	2.34	34	71	9	208	42	185	7.3	5.5
3	9	10	938	410	1.15	2.33	2.38	32	74	9.5	240	44	189	7.5	6.5
4	10	15	935	413.1	1.2	2.36	2.31	180	77	3.3	228	44	187		
5	11	20	940	415.3	1.25	2.38	2.35	187	81	10.5	228	46	189		
6	12	25	945	418.7	1.2	2.36	2.31	118	84	10.2	228	48	189		
7	1	30	1000	421.5	0.92	2.66	2.7	99	89	8	228	50	187		
8	2	35	1005	424.4	0.93	2.67	2.71	106	91	8.4	228	52	189	7.5	7.3
9	3	40	1010	425.5	0.94	2.67	2.72	106	92	8.5	228	53	187		
10	4	45	1015	429.1	1.08	2.77	2.82	113	93	9.5	240	52	187		
11	5	50	1020	431.3	1.3	2.33	2.39	118	96	11.2	228	52	187	8.3	7.3
12	6	55	1025	434.3	1.32	2.73	2.78	128	98	9	228	54	187		
13	6	58	1030	437.55		2.88							189		

ling Duration (min) → 60

as Sample Vol (ft³) (Vol) → 31.725

	Pitot Pressure (in H ₂ O) (P)	Orifice Meter Pressure, (H) (in of H ₂ O)	Dry Gas Meter Temp. (F) (T _{av})	Vacuum (in Hg)	Oven Temp. (F)	Leading Temp. (F)	Stack Temp. (Ts) (F)	CO ₂ (%)	O ₂ (%)
Average	1.286	2.328	93.7	9.28	231.7	48.3	187.4	7.6	6.6
Minimum	0.920	2.700	78.3	7.78	208.3	42.3	185.3	7.3	6.5
Maximum	1.390	2.950	128.3	11.28	250.3	58.3	198.5	8.3	7.3

TABLE 5.5 (continued)

MODIFIED METHOD 5 CALCULATED DATA

TEST 3

Test Date: 15-Dec-86

Report Date: 05-Jan-87

	Average Pitot Pressure (Avg) (in H ₂ O)	Average Stack Temp. (Ts) (R)	Average Orifice Pressure (Avg) (in H ₂ O)	Average Meter Temp. (Tm) (R)	Average Stack Gas Velocity (vs) (ft/sec)	Volume of Gas Sampled at STP (Vm(std)) (dscf)	Vol. Flowrate at Stack (Qs) (ACFH)	Vol. Flowrate at STP (Qstd) (SCFH)	Isokinetic (%)
1	0.340	646.3	0.72	534.8	NA	NA	NA	NA	NA
2	1.020	645.9	0.78	533.3	66.515	2.059	1.19E+06	4.24E+05	83.94
3	1.263	646.8	0.81	533.2	67.950	4.124	1.29E+06	4.33E+05	83.25
4	1.398	646.3	0.84	540.3	69.044	7.151	1.22E+06	4.40E+05	95.43
5	1.128	647.2	0.86	543.4	70.816	9.855	1.24E+06	4.46E+05	97.38
6	1.140	647.4	0.87	545.7	70.400	12.542	1.24E+06	4.46E+05	99.19
7	1.109	647.3	0.84	546.3	69.418	15.235	1.22E+06	4.42E+05	100.15
8	1.286	647.3	0.83	548.3	68.725	18.285	1.21E+06	4.37E+05	101.51
9	1.373	647.4	0.82	549.5	68.285	20.394	1.21E+06	4.34E+05	99.23
10	1.371	647.3	0.82	548.3	68.233	22.456	1.21E+06	4.34E+05	99.66
11	1.392	647.3	0.83	549.3	68.991	25.392	1.22E+06	4.38E+05	99.18
12	1.386	647.3	0.83	549.7	68.639	27.312	1.21E+06	4.37E+05	99.64
13	1.386	647.4	0.83	549.7	68.785	28.452	1.21E+06	4.37E+05	100.03

TABLE 5.5 (continued)

VOST TEST DATA TEST 5 15-Dec-86

Report Date: 25-Jan-87

Sampling Time (min)	Clock Time (24 hr)	Gas Meter Reading (liter)	Rotameter Setting	Vacuum (in hg)	Meter Temp. #5 (C)	Probe Temp. #1 (C)	Stack Temp. #2 (C)	Meter Temp. #5 (F)	Probe Temp. #1 (F)	Stack Temp. #2 (F)
1	Start	325	66	15		145	86	32	293	187
2	5	938	64	28	18	149	85	64	308	185
3	18	935	64	21	18	154	87	64	309	189
4	15	948	64	21	19	153	86	66	307	187
5	38	1000	66	12	19	148	87	66	299	189
6	28	1005	62	12.5	21	152	87	70	306	189
7	31	1010	25	13	21	153	86	70	307	187
8	24	1015	65	12.5	28	155	87	68	313	189
9	48	1030	45	24	21	151	86	70	304	187
10	45	1035	48	24	21	151	86	70	304	187
11	53	1040	48	25	22	152	86	72	306	187
12	58	1045	48	28	22	154	86	72	309	187
13	58	1050	48.41		22	151	87	72	304	189

Gas Sample Volume (liter) ——— 48.31

Sampling Duration (min) ——— 53

	Rotameter Setting	Vacuum (in hg)	Meter Temp. (C)	Probe Temp. (C)	Stack Temp. (C)	Meter Temp. (F)	Probe Temp. (F)	Stack Temp. (F)
Average	70.1	18.0	23.0	151.6	86.0	65.3	304.6	187.4
Minimum	48	12	18	145	85	62	293	185
Maximum	66	24	22	155	87	71.6	312.3	188.6

TABLE 5.6
FIELD DATA FOR TEST 6

MODIFIED METHOD 5 AND VOST TEST DATA SUMMARY

1. MISC - SULFUR
2. TEST RUN DESIGNATION - TEST 6
3. TEST DATE - 15-Dec-86

DATA DESCRIPTION	ID	MODIFIED METHOD 5		VOST	
		Value	Units	Value	Units
4. Time					
Start	Time(s)	1145	hrs	1150	hrs
Finish	Time(f)	1255	hrs	1313	hrs
Duration	T	60	min	60	min
5. Total Number of Sampling Points	NP	12		2	
6. Meter Calibration Factor	Y	0.994		NA	
7. Orifice Calibration Factor	Ha	1.613		NA	
8. Nozzle Specifications					
Diameter	Dn	0.25	in	6	mm
Area	An	3.41E-04	ft ²	NA	
9. Pitot Tube Coefficient	Cp	0.881		NA	
10. Average Orifice Pressure Drop	Havg	1.393	in H ₂ O	NA	
11. Volume of Dry Gas Sampled	Vg	38.528	ft ³	64.468	liter
12. Average Gas Meter Temperature	Ta	553.0	R	295.0	K
13. Barometric Pressure	Pb	30.25	in Hg	762.6	mm Hg
14. Static Stack Pressure	Pg	0.52	in H ₂ O	13.2	mm H ₂ O
15. Absolute Stack Pressure	Ps	30.73	in Hg	769.6	mm Hg
16. Volume of Gas Sampled (Standard)	Vstd	35.225	SCF	64.725	liter
17. Volume of Water Collected in Impingers and Silica Gel	Vlc	1815	ml	NA	
18. Volume of Water Collected Based on Saturated Conditions	Vlc'	1846	ml	NA	
19. Volume Water Vapor Condensed in Impingers	Vwc	47.21	SCF	NA	
20. Volume Water Vapor Condensed in Silica Gel	Vwsg	0.57	SCF	NA	

TABEL 5.6 (continued)

21. Percent Moisture by Volume	Dw	56.39%		NA
Percent Moisture by Saturation	Dw'	57.63%		
22. Mole Fraction of Dry Gas	F _{dg}	0.4237		NA
24. Gas Analysis				
Average CO ₂ by Volume	CO ₂	8.38	%	NA
Average O ₂ by Volume	O ₂	5.39	%	NA
Average CO by Volume	CO	0.30	%	NA
Average N ₂ by Volume	N ₂	86.10	%	NA
25. Dry Molecular Weight of Stack Gas	M _d	29.52	lb/lb-mole	NA
26. Molecular Weight at Stack Conditions	M _s	22.38	lb/lb-mole	NA
27. Average Stack Temperature	T _s	642.5	R	369.3 K
28. Average Stack Gas Velocity	V _s	83.49	ft/sec	25.53 m/sec
29. Stack Area	A _s	786.7	sq-in	0.456 sq-m
30. Actual Stack Gas Flowrate	Q _s	1,475,353	ACFH	41,782 ACFM
31. Dry Stack Gas Flowrate (Standard)	Q _{sstd}	515,251	SCFH	14,592 SCFM
32. Iso - Kinetic Rate		181.7	%	NA
Weight of Filterable Particulates	M _p	44.1	g	NA
34a. Particulate Concentration (at standard conditions)	C _s	2.57E-09	lb/DSCF	NA
		1.02	mg/DSCF	NA
		0.319	g/DSCF	NA
		43.318	mg/DSCM	NA
34b. Particulate Concentration (corrected to 5% oxygen)	C _{s5%}	2.57E-09	lb/DSCF	NA
		1.02	mg/DSCF	NA
		0.319	g/DSCF	NA
		42.724	mg/DSCM	NA
34c. Particulate Concentration (corrected to 12% carbon dioxide)	C _{s12%}	4.35E-09	lb/DSCF	NA
		1.33	mg/DSCF	NA
		0.423	g/DSCF	NA
		64.515	mg/DSCM	NA
35. Pollutant Mass Rate	PMR	1.38E-03	lbs/hr	NA
		627.6	g/hr	NA
		9684	g/hr	NA

TABLE 5.6 (continued)

METER BOX CALIBRATION

84-Jan-36

Pressure 38.21 Meter Box No. 2577/679

Used for: TEST 5

Orifice Mano.	Gas Volume		Temperature				Avg (td)	Time (θ)	(Hu)
	Setting (H)	Reference (Vu)	Sander (Vd)	Reference (tw)	Inlet (tdi)	Outlet (tdo)			
(in H2O)	(ft3)	(ft3)	(F)	(F)	(F)	(F)	(min)	(Hu)	(in H2O)
0.5	4.310	5.375	70	82	71	75.3	11.43	0.978162	1.488641
1	5.385	5.237	70	88	74	81	8.63	0.973156	1.619856
2	10.310	10.420	70	102	78	90	12.35	0.992074	1.595299
4	10.300	10.257	70	107	82	94.5	8.76	1.010000	1.629042
6	10.007	10.212	71	110	84	84	7.17	0.989466	1.673255
8	10.310	10.144	70	110	86	98	6.27	1.019079	1.657994
Avg →								0.995638	1.612565

CALIBRATION OF "S" TYPE PITOT TUBE

84-Dec-36

Used for: TEST 6

Pitot Tube	Std Pitot Tube (P)	"S"-Type Pitot Tube (P)		(Co)	Pitot Tube ID. X & Y
		(P)	(P)		
Test 1	X	0.55	0.79	0.354	Std Pitot (Co) 0.99
Test 2	X	0.57	0.38	0.797	
Test 3	X	0.53	0.32	0.780	
Test 4	X	0.53	0.32	0.786	
Avg (Co) for Probe X →				0.881	Gas Tube (F) 176
Test 1	Y	NOT	NOT	ERR	
Test 2	Y	IN	IN	ERR	
Test 3	Y	USE	USE	ERR	
Test 4	Y			ERR	
Avg (Co) for Probe Y →				ERR	

TABLE 5.6 (continued)

MOISTURE AND MOLECULAR WEIGHT DETERMINATION

(fill-in data at each arrow)

Test Date:	15-Dec-66
Report Date:	85-Jan-67
Stack Temp., Dry Bulb (F)	→ 186
Stack Temp., Wet Bulb (F)	→ 186
Barometric Pressure (in of Hg)	→ 30.15
Saturated H ₂ O Vapor Pressure at Wet Bulb Temperature (From Vapor Pressure Chart)	→ 17.44
Vapor Pressure of H ₂ O at Stack Conditions	17.44
Moisture Content in Stack, (Bws)	0.5763304 57.63%
CO ₂ in % (Orsat of Fryite)	→ 7.6
O ₂ in % (Orsat of Fryite)	→ 6.6
N ₂ in % (Orsat of Fryite)	→ 85.8
CO in % (Orsat of Fryite)	→ 0
Dry Molecular Weight, (M _d)	29.4
Wet Molecular Weight, (M _w)	22.36

TABLE 5.6 (continued)

INITIAL STACK TEST DATA Report Date:
 (fill-in data marked by arrows) 65-Jan-37

1 →	Facility		NCSB
2 →	Location		Gulfport, Mississippi
3 →	Operator & Test Personnel		Jung Juergens, Basco Basco Buelz
4 →	Test Date		15-Dec-66
5 →	Run Number		TEST 6
6 →	Stack Dia (in.)		39
	Stack Area (in ²)	(A)	786.25334786
7 →	Sample Box Number		01
8 →	Meter Box Number		01
9	Orifice Calibration	(Ka)	1.5125639733
10	Gas Meter Cal. Factor	(Y)	0.9916533473
11	Pitot Constant (Probe X) (Co)		0.9006011727
	Pitot Constant (Probe Y) (Co)		ERR
12 →	Air Temperature (F)		60
13 →	Meter Temperature (Fahrenheit)	(Tm)	100
14 →	Press. Stack Temp. (Fahrenheit)	(Ts)	187
15 →	Barometric Pressure (in. of Hg)	(Pb)	29.25
16	Moisture, Assumed	(Bwa)	0.5763334005
17	Mol. Weight, Dry	(Md)	29.46
18	Mol. Weight, Stack	(Ms)	22.363333152
19 →	Meter Pressure (in. of Hg)	(Pm)	29.25
20 →	Stack Pressure, Static (in. of H ₂ O)	(Pg)	2.22

TABLE 5.6 (continued)

21	Stack Pressure, Absolute (Ps) (in. of Hg)		28.38
22	K Factor (H = K x P) (K)		2.58592375
23 →	Reference P (Avg) (in. of H ₂ O)		1.29
24	Nozzle Dia (Calculated)		0.338821088
25 →	Nozzle Dia (Actual) (In)		2.25
26	Nozzle Area (ft ²) (An)		0.000346846
27 →	Nozzle Number		12
28 →	Leak Rate (@15in Vacuum)		
	Initial (ft ³ /min)		2.381
	Final (ft ³ /min)		2.385
29a →	Filter Weights (grams)	No. S - 3	
		Final	2.5429
		Initial	2.5988
		Diff.	2.3441
29b →		No. NA	
		Final	
		Initial	
		Diff.	ERR
30a →	VOST Tenax	Tenax	
		T/Char	
30b →	VOST Tenax	Tenax	
		T/Char	
30c →	VOST Tenax	Tenax	
		T/Char	
31a →	Moisture-Impinger #1	ml	1838
31b →	Moisture-Impinger #2	ml	253
31c →	Moisture-Impinger #3	ml	0
31d →	Moisture-Silica Gel	Final	199.31
		Initial	186.3621
		Diff.	12.1479
31e →	Moisture-Total (excluding NaOH)	(ml)	1315.1479
	Moisture-Saturation	(ml)	1815.1479
			1846
31 →	Sample Container(s) No.		

TABLE 5.6 (continued)

STACK TEST DATA TEST 5 15-Dec-36

Report Date: 25-Jan-37

Traverse Point Number	Time (min)	Clock Time (24 hr)	Gas Meter Reading (Vol) (ft ³)	Pitot Pressure (P) (in H ₂ O)	Orifice Meter Pressure, (H)		Temperature Dry Gas Meter (F)		Vacuum (in Hg)	Oven Temp. (F)	Inlet Temp. (F)	Stack Temp. (T _s) (F)	CO ₂ (%)	O ₂ (%)	
					Desire	Actual	Inlet	Outlet							
1	7	Start	1145	437.387	1.4	0.96	0.96	99	86	6.6	225	59	189	7.5	6.2
2	8	5	1159	448.6	1.45	0.99	1	97	87	7.1	228	48	189		
3	9	10	1155	443.9	1.5	1.18	1.1	106	89	7.5	229	48	189	8.3	5.3
4	10	15	1200	447	1.52	1.11	1.12	111	90	8	259	59	189		
5	11	20	1200	450.4	1.55	1.12	1.14	116	92	8.2	259	59	189	8.5	5.3
6	12	25	1210	451.5	1.5	1.10	1.1	119	95	8.2	240	53	189		
7	1	30	1225	455.3	1.55	0.93	0.93	104	95	6.7	230	48	189	8.3	5.3
8	2	35	1230	462.2	1.5	1.10	1.1	113	97	7.5	259	49	189		
9	3	40	1235	462.3	1.5	1.10	1.1	116	98	7.3	230	48	189		
10	4	45	1240	466.0	1.7	1.17	1.16	120	100	8.1	240	59	189		
11	5	50	1245	469.4	1.75	1.20	1.2	123	101	8.4	259	54	189	8.3	5.3
12	5	55	1250	473	1.75	1.20	1.2	124	102	1.3	229	50	189		
13	5	59	1255	476.215		0.90							189		

Sampling Duration
(min) — 60

Gas Sample Vol (ft³) (Vol) — 38.328

	Pitot Pressure (in H ₂ O) (P)	Orifice Meter Pressure, (in of H ₂ O) (H)	Dry Gas Meter Temp. (F) (T _{dg})	Vacuum (in Hg)	Oven Temp. (F)	Inlet Temp. (F)	Stack Temp. (T _s) (F)	CO ₂ (%)	O ₂ (%)
Average	1.539	1.093	103.3	7.75	257.1	51.3	188.5	8.3	5.3
Minimum	1.250	0.930	96.3	6.60	229.3	48.3	183.5	8.3	5.3
Maximum	1.750	1.200	124.3	8.60	258.3	58.3	188.5	8.5	5.3

Best Available Copy

TABLE 5.6 (continued)

MODIFIED METHOD 3 CALCULATED DATA				TEST 6	Test Date: 15-Dec-86	Report Date: 05-Jan-87			
Average Pitot Pressure (Avg) (in H ₂ O)	Average Stack Temp. (T _s) (R)	Average Orifice Pressure (Avg) (in H ₂ O)	Average Meter Temp. (T _m) (R)	Average Stack Gas Velocity (vs) (ft/sec)	Volume of Gas Sampled at STP (V _m (std)) (dscf)	Vol. Flowrate at Stack (Q _s) (ACFH)	Vol. Flowrate at STP (Q _{st}) (SCFH)	Iso-Kinetic (%)	
1	1.400	648.6	0.35	548.3	NA	NA	NA	NA	
2	1.425	648.6	0.38	552.3	79.358	2.523	1.40E+06	4.38E+05	92.33
3	1.483	648.6	1.32	552.5	88.668	3.787	1.43E+06	4.96E+05	101.53
4	1.518	648.6	1.35	554.5	81.584	8.739	1.44E+06	5.34E+05	101.46
5	1.544	648.6	1.36	555.4	82.393	11.959	1.45E+06	5.38E+05	103.54
6	1.553	648.6	1.37	558.2	82.541	14.873	1.46E+06	5.89E+05	102.51
7	1.524	648.6	1.35	558.4	81.766	18.810	1.44E+06	5.87E+05	102.41
8	1.534	648.6	1.36	559.3	82.819	21.216	1.45E+06	5.86E+05	104.29
9	1.541	648.6	1.36	558.1	82.216	23.747	1.45E+06	5.87E+05	102.35
10	1.557	648.6	1.37	561.1	82.639	25.328	1.46E+06	5.18E+05	102.67
11	1.573	648.6	1.38	562.1	83.183	29.815	1.47E+06	5.15E+05	102.13
12	1.539	648.6	1.39	553.3	83.488	33.168	1.48E+06	5.17E+05	103.39
13	1.539	648.6	1.39	553.3	83.488	36.185	1.48E+06	5.17E+05	102.39

DO NOT ALTER OR DESTROY THIS RECORD

TABLE 5.6 (continued)

VOST TEST DATA TEST 5 15-Dec-86

Report Date: 25-Jan-87

Sampling Time (min)	Clock Time (24 hr)	Gas Meter Reading (liter)	Rota-meter Setting	Vacuum (in Hg)	Meter	Probe	Stack	Meter	Probe	Stack	
					Temp. #5 (C)	Temp. #1 (C)	Temp. #2 (C)	Temp. #5 (F)	Temp. #1 (F)	Temp. #2 (F)	
1	Start	1159	52.54	85	12	21	157	87	78	315	189
2	5	1158	58.52	85	13	21	160	87	78	320	189
3	10	1200	62.31	93	13	22	160	87	72	320	189
4	15	1235	67.45	93	13	22	160	87	72	320	189
5	20	1222	73	93	18	22	161	87	72	322	189
6	25	1227	78.5	93	18	22	159	87	72	318	189
7	31	1232	84.31	93	18	22	155	87	72	311	189
8	35	1237	89.7	93	18	22	153	87	73	316	189
9	40	1253	95.15	98	11	23	158	87	73	322	189
10	45	1259	100.5	93	12	23	155	87	73	315	189
11	50	1303	106.2	95	13	23	154	87	73	320	189
12	55	1308	111.5	93	12	23	155	87	73	311	189
13	60	1313	117			23	155	87	73	311	189

Sample Volume (liter) → 64.46

Sampling Duration (min) → 60

	Rota-meter Setting	Vacuum (in Hg)	Meter Temp. (C)	Probe Temp. (C)	Stack Temp. (C)	Meter Temp. (F)	Probe Temp. (F)	Stack Temp. (F)
Average	91.7	11.5	22.0	155.3	87.3	72.2	314.5	188.5
Minimum	85	18	21	150	87	69.3	322	188.5
Maximum	95	13	23	161	87	73.4	321.3	188.5

APPENDIX Q

ITAS STANDARD OPERATING PROCEDURES FOR DIOXIN AND FURAN ANALYSIS

The documents contained in this appendix are the detailed operating procedures used by the analytical laboratory during their analysis of the samples collected during the Verification Test Burns at NCBC. This document was reproduced from the best available copy. Due to poor legibility, the legibility of the microfiche editions is also poor. Persons requiring the information contained in this appendix may write to the technical libraries listed below to obtain photocopied versions of the appendix. A nominal charge will be levied to cover reproduction and archival costs. Please be prepared to provide the following information:

Report Title: Full-Scale Incineration System Demonstration
Verification Test Burns at the Naval Construction
battalion Center, Gulfport, Mississippi:

Report Number: els-tr-88-61, Volume: II, Part: 3, Appendix: P

Send inquiries to:

Technical Library
Engineering and Services Laboratory
Tyndall Air Force Base, FL 32403

or

Technical Library
Idaho National Engineering Laboratory
EG&G Idaho, Inc.
P.O. Box 1625
Idaho Falls, ID 83415-2300

The documents contained in this appendix were published according to their own internal style, which deviates from the Air Force Engineering Services Center format. They have, therefore, been published without editing.

APPENDIX Q

CONTENTS

Exhibit 1	SOP EM.1 Extraction Method for Soils and Sediments	700
Exhibit 2	SOP EM.2 Extraction Method for Soils and Sediments (Soxhlet Method)	704
Exhibit 3	SOP EM.4 Extraction Method for Water	707
Exhibit 4	SOP EM.4 Extraction Method for Industrial Hygiene Samples (to Include Ambient Air, XAD, Florist, Silica Gel, and Resin Traps)	711
Exhibit 5	SOP IP.4 2,3,7,8-TCDD Analysis Procedures by Multiple Ion Detection (MID) High Resolution Gas Chromatography/High Resolution Mass Spectrometry (HGGC/HRMS)	714
Exhibit 6	SOP IP.5 Total PCDD and PCDF Congener (Cl ₄ - Cl ₈) Analysis Procedures by Multiple Ion Detection (MID) High Resolution Gas Chromatography (High Resolution Mass Spectrometry (HRGC/HRMS)	721

Appendix Q, Exhibit 1

 STANDARD OPERATING PROCEDURE	SOP No.: <u>EM.1</u>
	Date Revised: <u>1-15-86</u>
Title: <u>Extraction Method for Soils and Sediments</u>	Revision No.: <u>2</u>
	Approval: <u><i>[Signature]</i></u>
	Page <u>1</u> of <u>4</u>

1.0 Summary of Method

1.1 Soil and sediment samples are jar extracted with a methanol/hexane mixture after initial spiking with $^{37}\text{Cl}_{14}$ -2,3,7,8-TCDD and $^{13}\text{C}_{12}$ -2,3,7,8-TCDD. Extracts are filtered and concentrated in preparation for selected cleanup steps.

2.0 Reagents

2.1 Spiking standard solutions; for isomer specific analysis samples will be spiked with $^{13}\text{C}_{12}$ -2,3,7,8-TCDD internal standard at a concentration of 500 ng/ml and $^{37}\text{Cl}_{14}$ -2,3,7,8-TCDD surrogate standard at a concentration of 100 ng/ml, both in the same iso-octane solution. For total dioxin/furan analysis the sample will be spiked with the isomer specific spike plus a solution which contains ^{13}C -labeled Penta CDD, Penta CDF, Hexa CDD, Hexa CDF, Hepta CDD, Hepta CDF, Octa CDD, and Octa CDF, at a concentration of 500 ng/ml and all in the same iso-octane solution.

2.2 Sodium sulfate; ACS, granular, anhydrous.

2.3 Acetone; technical grade.

2.4 Methylene chloride; pesticide quality or equivalent.

2.5 Hexane; pesticide quality or equivalent.

2.6 Methanol; pesticide quality or equivalent.

2.7 Toluene; pesticide quality or equivalent.

3.0 Cautions

3.1 Samples received for this preparation procedure are of unknown composition but may be potentially carcinogenic, mutagenic, toxic or in other ways hazardous.

Regional Office

7 Carboron • 312 Directors Drive • Knoxville, Tennessee 37921 • 615-690-3211

3.2 It is mandatory that the initial weighing of the samples, addition of isotopically labeled 2,3,7,8-TCDD, and mixing of the sample be performed inside the designated dioxin hood in the high hazard laboratory.

3.3 Personnel involved in this sample preparation procedure should be thoroughly familiar with laboratory SOPs on the processing of high hazard samples.

4.0 Glassware

4.1 All glassware used in extraction and cleanup procedures is solvent rinsed before use. The solvents used are acetone, toluene, methylene chloride, and hexane (in this order). Allow to air dry in a hood.

5.0 Equipment and Materials

5.1 Electrical platform shakers

5.2 240 ml amber-colored glass jars with teflon-lined screw caps

5.3 Three ball macro Snyder column

5.4 500 ml evaporative flask

5.5 10 ml graduated concentrator tube

5.6 N-EVAP - concentration device

5.7 Glass funnels, short stem

5.8 Filter paper, Whatman No. 4 or equivalent

5.9 Analytical balance

5.10 Stainless steel spatulas

5.11 Glass helices; 1/16 inch

6.0 Sample Extraction

6.1 Prepare designated dioxin hood as instructed in laboratory SOP for processing high hazard samples. This includes obtaining, preparing, and labeling the requisite number of 240 ml amber-colored glass jars.

6.2 Transfer 10 grams of the soil or sediment (wet weight) to a tared 240 ml jar. (\pm 0.5 grams weighed to 3 significant figures).

- 6.3 Spike the sample with 100 μ l of spiking solution, adding the solution at several sites over the surface of the sample.
- 6.4 Add 20 grams of sodium sulfate. Stir the mixture thoroughly with a stainless steel spatula. Note: Extremely wet samples may require centrifuging to remove water before addition of sodium sulfate. The liquid will be analyzed as a water sample (see water method).
- 6.5 Allow the mixture to stand for 2 hours, mix thoroughly with spatula and allow the mixture to stand for an additional 5 hours. At the end of this time, mix the sample again, ensuring that no lumps are present.
- 6.6 Add 20 ml of methanol, stir and add 150 ml of hexane.
- 6.7 Place the extraction jar in the platform shaker and shake for at least 3 hours.
- 6.8 After the 3 hour shaking period, remove jars and allow the solids to settle before proceeding.
- 6.9 Into the top of a 500 ml KD flask fitted with a 10 ml graduated concentrator tube, insert a glass funnel containing Whatman No. 4 filter paper (or equivalent) rinsed with hexane.
- 6.10 Carefully decant the extract from the jar through the glass funnel.
- 6.11 Rinse the inside of the jar and contents with hexane thoroughly at least 3 times and add these rinsings into the glass funnel.
- 6.12 After completing the 3 rinsings and allowing these to filter through the glass funnel, pour 10-15 ml of hexane into the funnel and allow this to filter through.
- 6.13 Remove glass funnel from top of KD flask and add $\frac{1}{2}$ inch of glass helices. Insert a three ball macro Snyder column in top of KD flask.
- 6.14 Concentrate the extract volume to approximately 3 ml using steam.
- 6.15 Remove the concentration tube from bottom of KD flask. Rinse inside of KD flask with small amounts of hexane and allow this to run into concentrator tube.
- 6.16 Reduce solvent volume to approximately 1 ml with N-EVAP concentration device and proceed to appropriate cleanup procedure.

7.0 Cleanup of Glassware

After use, glassware is solvent rinsed with toluene and methylene chloride. Wash with detergent and rinse with copious amounts of tap water and several portions of distilled water. Place glassware in oven and heat to 350°C for 30 minutes. Remove from oven when cool and store in clean environment.

Appendix Q, Exhibit 2

 STANDARD OPERATING PROCEDURE	SOP No.: <u>EM.2</u>
	Date Revised: <u>1-15-86</u>
Title: Extraction Method for Soil and Sediment (Soxhlet Extraction)	Revision No.: <u>2</u>
	Approval: <u>LAPocratiky</u>
	Page <u>1</u> of <u>3</u>

1.0 Summary

- 1.1 Soil and sediment samples are extracted with benzene using a soxhlet extraction method after first spiking with the appropriate spiking standard solution. Extracts are then concentrated in preparation for selected cleanup steps.

2.0 Reagents

- 2.1 Spiking standard solutions; for isomer specific analysis, samples will be spiked with $^{12}C_{12}$ -2,3,7,8-TCDD internal standard at a concentration of 500 ng/ml and $^{37}Cl_4$ -2,3,7,8-TCDD surrogate standard at a concentration of 100 ng/ml, both in the same isooctane solution. For total dioxin/furan analysis the sample will be spiked with the isomer specific spike plus a solution which contains ^{13}C - labeled Penta CDD, Penta CDF, Hexa CDD, Hexa CDF, Hepta CDD, Hepta CDF, Octa CDD and Octa CDF each at a concentration of 500 ng/ml and all in the same isooctane solution.
- 2.2 Benzene; pesticide quality or equivalent.
- 2.3 Acetone; technical grade.
- 2.4 Toluene; pesticide quality or equivalent.
- 2.5 Methylene chloride; pesticide quality or equivalent.
- 2.6 Hexane; pesticide quality or equivalent.
- 2.7 Silica gel; type 60, EM reagent, 70-220 mesh, or equivalent.

3.0 Cautions

- 3.1 Samples received for this preparation procedure are of unknown composition but may be potentially carcinogenic, mutagenic, toxic or in other ways hazardous.

Regional Office

ITT Corporation • 312 Directors Drive • Knoxville, Tennessee 37923 • 615-690-1011

3.2 It is mandatory that the initial weighing of the samples, addition of isotopically labeled 2,3,7,8-TCDD and mixing of the sample, be performed inside the designated dioxin hood in the high hazard laboratory.

3.3 Personnel involved in this sample preparation procedure should be thoroughly familiar with laboratory SOPs on the processing of high hazard samples.

4.0 Glassware

4.1 All glassware used in extraction and cleanup procedures is solvent rinsed before use. The solvents used are acetone, toluene, methylene chloride and hexane (in this order). Allow to air dry in a hood.

5.0 Materials and Equipment

5.1 Analytical balance.

5.2 Stainless steel spatulas.

5.3 Heating mantle with temperature control.

5.4 Glass soxhlet system with glass thimble.

5.5 Three ball macro Snyder column.

5.6 500 ml evaporative flask, round bottom.

5.7 Boiling beads; 6 mm glass.

5.8 Glass wool.

5.9 Teflon sleeves.

6.0 Method

6.1 Prepare designated dioxin hood as instructed in laboratory SOP for processing high hazard samples. Obtain, prepare and label the requisite number of soxhlet systems.

6.2 Place 1-1 inch silica gel in glass thimble. Add 10 grams of the sample on top of silica gel.

6.3 Spike sample with 100 ul of the appropriate standard solution(s) and add a small amount of glass wool to the top of the extraction thimble.

6.4 Place extraction thimble in the glass soxhlet extractor.

- 6.5 Pour approximately 350 ml benzene into 500 ml round bottom flask. Place flask in the heating mantle. Add 15-20 boiling beads.
 - 6.6 Assemble soxhlet system and use a teflon sleeve on the flask joint. Secure to lab supports.
 - 6.7 Adjust temperature of heating mantle to approximately 80°C. Bring benzene to a rolling boil. There should be a steady drip from the condensers.
 - 6.8 Soxhlet extract in the above manner for 16 hours.
 - 6.9 Turn off heating mantle and allow to cool.
 - 6.10 Remove condensers and allow the soxhlet extractor chamber to empty, then remove the soxhlet extractor from 500 ml round bottom flask.
 - 6.11 Insert 3 ball macro Snyder column into the top of the 500 ml round bottom flask.
 - 6.12 Place 500 ml flask back into heating mantle and reduce extract volume of approximately 3 ml.
 - 6.13 Transfer extract into 20 ml scintillation vial, rinsing the 500 ml flask three times with small amounts of benzene. Add rinsings to 20 ml scintillation vial.
 - 6.14 Place 20 ml vials into the N-EVAP concentration device and reduce volume to approximately 1 ml.
 - 6.15 Proceed to appropriate cleanup procedure(s).
- 7.0 Cleanup of Glassware
- 7.1 After use, glassware is solvent rinsed with toluene and methylene chloride. Wash with detergent and rinse with copious amounts of tap water and several portions of distilled water. Place glassware in oven and heat to 350°C for 30 minutes. Remove from oven when cool and store in clean environment.

Appendix Q, Exhibit 3



STANDARD
OPERATING
PROCEDURE

Title: Extraction Method
for Water

SOP No.: E4.4

Date Revised: 1-15-86

Revision No.: 2

Approval: J.A. Polinsky

Page 1 of 4

1.0 Summary of Method

- 1.1 A one liter water sample (smaller amounts may be used) is extracted with methylene chloride using a separatory funnel technique. After sample is solvent exchanged to hexane and concentrated, selected cleanup steps are performed.

2.0 Reagents

- 2.1 Spiking standard solutions; for isomer specific analysis samples will be spiked with $^{13}\text{C}_{12}$ -2,3,7,8-TCDD internal standard at a concentration of 500 ng/ml and $^{37}\text{Cl}_4$ -2,3,7,8-TCDD surrogate standard at a concentration of 100 ng/ml both in the same iso-octane solution. For total dioxin/furan analysis the sample will be spiked with the isomer specific spike plus a solution which contains C-labeled Penta CDD, Penta CDF, Hexa CDD, Hexa CDF, Hepta CDD, Hepta CDF, Octa CDD, and Octa CDF, at a concentration of 500 ng/ml and all in the same iso-octane solution.
- 2.2 Acetone; technical grade and pesticide grade or equivalent.
- 2.3 Toluene; pesticide quality or equivalent.
- 2.4 Methylene chloride; pesticide quality or equivalent.
- 2.5 Hexane; pesticide quality or equivalent.
- 2.5 Sodium sulfate; ACS, granular, anhydrous.

3.0 Cautions

- 3.1 Samples received for this preparation procedure are of unknown composition but may be potentially carcinogenic, mutagenic, toxic or in other ways hazardous.

Regional Office

IT Corporation • 312 Directors Drive • Knoxville, Tennessee 37923 • 615-690-0211

- 3.2 It is mandatory that the initial preparation of the samples, addition of isotopically labeled 2,3,7,8-TCDD and mixing of the sample, be performed inside the designated dioxin hood in the high hazard laboratory.
- 3.3 Personnel involved in this sample preparation procedure should be thoroughly familiar with laboratory SOPs on the processing of high hazard samples.

4.0 Glassware

- 4.1 All glassware used in extraction and cleanup procedures is solvent rinsed before use. The solvents used are acetone, toluene, methylene chloride and hexane (in this order). Allow to air dry in a hood.

5.0 Equipment and Materials

- 5.1 Separatory funnels, (2000 ml) with teflon stopcocks and glass stoppers.
- 5.2 500 ml evaporative flask.
- 5.3 10 ml graduated concentrator tube.
- 5.4 Three ball macro Snyder column.
- 5.5 Steam bath, with concentric ring covers.
- 5.6 N-EVAP - concentration device.
- 5.7 Glass funnels, short stem.
- 5.8 Glass wool.
- 5.9 100 ml graduated cylinders.
- 5.10 Helices; 1/16 inch, glass.

6.0 Sample Extraction

- 6.1 Prepare designated dioxin hood as instructed in laboratory SOP for processing high hazard samples.
- 6.2 Attach separatory funnels, one for each sample, to lab supports in hood.
- 6.3 Attach 500 ml evaporation flasks, fitted with 10 ml graduated concentrator tubes, to lab supports in hood directly under the separatory funnel.
- 6.4 Add 1/2 inch of helices to 10 ml concentrator tube.

- 6.5 Plug the glass funnels with glass wool and set them in the top of the 500 ml evaporation flask. Pour sodium sulfate into the glass funnels to within $\frac{1}{4}$ to 1 inch from the top. Wet sodium sulfate with methylene chloride.
- 6.6 Measure 1000 ml of water into the graduated cylinders and pour this into the separatory funnel.
- 6.7 Add 100 μ l of spiking solution containing appropriate labeled materials.
- 6.8 Rinse graduated cylinder and sample bottle (if empty) with 60 ml methylene chloride and add to separatory funnel. Extract sample by shaking the funnel for 2 minutes. Caution: Vent separatory funnel frequently during this extraction.
- 6.9 If an emulsion forms, phase separation should be attempted using glass stirring rod.
- 6.10 Allow the methylene chloride extract to filter through sodium sulfate-filled funnels into the KD flask.
- 6.11 Repeat steps 6.8 through 6.10 two more times.
- 6.12 After the third methylene chloride extract has filtered through the sodium sulfate, pour in an additional 15-20 ml methylene chloride and let this filter through into KD flask.
- 6.13 Remove separatory funnels from lab supports and discard water.
- 6.14 Remove funnels from KD flask and insert the three ball macro Snyder columns into the top of KD flask.
- 6.15 Concentrate extract volume to approximately 3 ml using steam bath. Remove KD apparatus from steam bath and allow it to cool for 10 minutes.
- 6.16 Add 50 ml hexane to KD flask and again concentrate extract volume to approximately 3 ml using steam bath.
- 6.17 Remove concentrator tubes from KD flask. Rinse KD flask with small amounts of hexane and allow this to drain into concentrator tube.
- 6.18 Place concentrator tubes in N-EVAP concentration device and reduce volume to approximately 1 ml.
- 6.19 Proceed to required cleanup procedure.

7.0 Cleanup of Glassware

7.1 After use glassware is solvent rinsed with toluene and methylene chloride. Wash with detergent and rinse with copious amounts of tap water and several portions of distilled water. Place glassware in oven and heat to 350°C for 30 minutes. Remove from oven when cool and store in clean environment.

Appendix Q, Exhibit 4



STANDARD
OPERATING
PROCEDURE

SOP No.: EM.9

Date Revised: 1-15-86

Revision No.: 2

Approval: JA Poczorsky

Page 1 of 3

Title: Extraction Method for
Industrial Hygiene Samples
(To Include Ambient Air,
XAD, Florisil, Silica Gel
and Resin Traps)

1.0 Summary

- 1.1 Industrial hygiene samples are extracted by soxhlet extraction. Samples are spiked according to client request for analysts. After extraction and cleanup, samples are analyzed by GC/MS.

2.0 Reagents

- 2.1 Spiking standard solutions; for isomer specific analysis, samples will be spiked with $^{13}\text{C}_{12-2,3,7,8}$ -TCDD internal standard at a concentration of 500 ng/ml and $^{37}\text{Cl}_{4-2,3,7,8}$ -TCDD surrogate standard at a concentration of 100 ng/ml, both in the same isooctane solution. For total dioxin/furan analysis the sample will be spiked with the isomer specific spike plus a solution which contains ^{13}C - labeled Penta CDD, Penta CDF, Hexa CDD, Hexa CDF, Hepta CDD, Hepta CDF, Octa CDD and Octa CDF each at a concentration of 500 ng/ml and all in the same isooctane solution.
- 2.2 Silica gel, type 60, EM reagent, 70-230 mesh, or equivalent.
- 2.3 Acetone; technical grade.
- 2.4 Toluene; pesticide quality or equivalent.
- 2.5 Methylene chloride; pesticide quality or equivalent.
- 2.6 Hexane; pesticide quality or equivalent.
- 2.7 Benzene; pesticide quality or equivalent.

3.0 Cautions

- 3.1 Samples received for this preparation procedure are of unknown composition but may be potentially carcinogenic, mutagenic, toxic or in other ways hazardous.

Regional Office

IT Corporation • 312 Directors Drive • Radcliff, Tennessee 37923 • 615-690-3211

- 3.2 It is mandatory that the initial weighing of the samples, addition of isotopically labeled 2,3,7,8-TCDD, and mixing of the sample be performed inside the designated dioxin hood in the high hazard laboratory.
- 3.3 Personnel involved in this sample preparation procedure should be thoroughly familiar with laboratory SOPs on the processing of high hazard samples.

4.0 Glassware

- 4.1 All glassware used in extraction and cleanup procedures is solvent rinsed before use. The solvents used are acetone, toluene, methylene chloride and hexane (in this order). Allow to air dry in a hood.

5.0 Materials and Equipment

- 5.1 Glass soxhlet system with glass thimbles.
- 5.2 Heating mantles with temperature control.
- 5.3 Three ball macro Snyder column
- 5.4 500-ml evaporative flask, round bottom.
- 5.5 Glass wool.
- 5.6 Boiling beads; 6 mm glass
- 5.7 20 ml scintillation vial.
- 5.8 N-EVAP; concentration device.
- 5.9 Teflon sleeves.

6.0 Method

- 6.1 Prepare dioxin hood as instructed in laboratory SOP for processing high hazard sample. This includes obtaining, preparing and labeling the requisite number of soxhlet systems.
- 6.2 Place 4-1 inch silica gel in a glass extraction thimble (one per sample).
- 6.3 Carefully transfer each puff or front section of resin into an extraction thimble. The backup section of the resin traps are to be held until after analysis. If there is no dioxin found in the front section, the backup section can be discarded. However, if dioxin is found, the backup section must be analyzed to check for breakthrough.

- 6.4 Spike sample with 100 μ l of the appropriate standard solution(s). Add a small amount of glass wool to the top of the extraction thimble.
- 6.5 Pour approximately 350 ml benzene into 500 ml round bottom flask. Place flask in the heating mantle. Add 15-20 boiling beads.
- 6.6 Place extraction thimble in the glass soxhlet extractor.
- 6.7 Assemble soxhlet system and use a teflon sleeve on the flask joint. Secure to lab supports.
- 6.8 Adjust temperature of heating mantle to approximately 80°C. Bring benzene to a rolling boil. There should be a steady drip from the condenser.
- 6.9 Soxhlet extract in the above manner for 16 hours.
- 6.10 Turn off heating mantle and allow to cool.
- 6.11 Remove condensers and allow the soxhlet extractor chamber to empty, then remove the soxhlet extractor from 500 ml round bottom flask.
- 6.12 Insert three ball macro Snyder column into the top of 500 ml round bottom flask.
- 6.13 Prewet the Snyder column with methylene chloride. Place 500 ml flask back into heating mantle and reduce extract volume to approximately 3 ml.
- 6.14 Transfer extract into 20 ml scintillation vial, rinsing the 500 ml flask three times with small amounts of benzene. Add rinsing to 20 ml scintillation vial.
- 6.15 Place 20 ml vials into the N-EVAP concentration device and reduce volume to approximately 1 ml.
- 6.16 Proceed to appropriate cleanup procedure(s).

7.0 Cleanup of Glassware

- 7.1 After use, glassware is solvent rinsed with toluene and methylene chloride. Wash with detergent and rinse with copious amounts of tap water and several portions of distilled water. Place glassware in oven and heat to 350°C for 30 minutes. Remove from oven when cool and store in clean environment.

Exhibit 5

	INTERNATIONAL TECHNOLOGY CORPORATION	SOP No.: <u>12.4</u>
STANDARD OPERATING PROCEDURE		Date Revised: <u>11-12-86</u>
Title: 2,3,7,8-TCDD Analysis Procedures by Multiple Ion Detection (MID) High Resolution Gas Chromatography/High Resolution Mass Spectrometry (HRGC/HRMS)		Revision No.: <u>0</u>
		Approval: <u>[Signature]</u>
		Page <u>1</u> of <u>7</u>

1.0 Introduction

1.1 This is a qualitative and quantitative (high resolution) GC/(high resolution) MS analysis specific for the 2,3,7,8 isomer of tetrachloro-dibenzo-p-dioxin using selected ion monitoring. A sample is spiked with isotopically labeled $^{13}C_{12}$ -2,3,7,8-TCDD as internal standard and with $^{37}Cl_4$ -2,3,7,8-TCDD as surrogate. Quantitation is based on the response of native TCDD relative to the internal standard. Performance is based on surrogate standard results. Percent recovery of the IS/SURR mixture is based on the GC/MS internal standard.

2.0 Safety

2.1 Samples are sent to IT Corporation from suspected or known hazardous waste sites. Samples are to be handled from receipt to storage by qualified personnel only. Analysts must have a working knowledge of safety protocols and be adept at safety procedures. GC/MS instruments must be equipped with vapor contamination traps on the capillary split and sweep vents and on the rough pump effluent lines prior to use (see Safety SOP).

3.0 Set-Up and Installation

3.1 Install a 60 meter, 0.25 mm ID, fused silica SP2331, 0.20 micron film thickness capillary column. Set the head pressure to approximately 20 to 25 psi and the split and sweep flows to 30 ml/min and 8 ml/min respectively.

3.2 Create a reasonable 10,000 resolution tune, for m/z 331 for PFK. Adjust the zero according to the instrument manufacturers suggested settings. Set the preamp sensitivity to 10^{-6} amps/volts. Calibrate the instrument before every sample.

3.3 Establish the following MID descriptors:

3.4 Set the GC conditions as follows:

Injection Port Temp	250°C
Separator Temp	250°C
Initial Temp	70°C
Initial Time	4 min
Ramp Rate 1	20°C/min
Temp 2	200°C
Hold Time 2	0 min
Ramp Rate 2	4°C/min
Temp 3	250°C
Hold Time 3	5 min*
Split/Sweep	85 sec

*Hold for at least 2 min beyond the retention time of the last isomer of TCDD in the performance mixture.

4.0 Analysis

4.1 General Description

4.1.1 A five point calibration consisting of a 5 pg/ul, a 10 pg/ul, a 50 pg/ul, a 100 pg/ul, and a 500 pg/ul standard must be run in triplicate and a linear response curve generated before samples are analyzed. The 10 pg/ul standard is analyzed at the beginning of each eight hour shift to verify system performance and conformity to the multi-point calibration. Samples are received in 50 ul volumes and require no further preparation by the GC/MS laboratory.

4.1.2 COMPOSITION OF CONCENTRATION CALIBRATION SOLUTIONS

<u>Solution No.</u>	<u>Concentration of 2,3,7,8-TCDD/TCDF</u>			
	<u>Isotopically Labeled</u>			<u>Unlabeled</u>
	<u>$^{13}C_{12}$</u>	<u>$^{37}Cl_4$</u>	<u>^{13}C-TCDF</u>	<u>2,3,7,8-TCDD</u>
1	10 pg/ul	10 pg/ul	10 pg/ul	5 pg/ul
2	10 pg/ul	10 pg/ul	10 pg/ul	10 pg/ul
3	10 pg/ul	10 pg/ul	10 pg/ul	50 pg/ul
4	10 pg/ul	10 pg/ul	10 pg/ul	100 pg/ul
5	10 pg/ul	10 pg/ul	10 pg/ul	500 pg/ul

4.2 Procedures for GC/MS Analysis Initial Calibration

4.2.1 The GC conditions for all standards, samples, and the column performance mixture are as stated in Section 3.4.

4.2.2 Tune and calibrate the instrument as in step 3.2.

4.2.3 Acquire the seven isomer EPA test mix. If no isomers are co-eluting with 2,3,7,8-TCDD, proceed with 4.2.4. If co-elution does occur, the conditions must be modified or the column must be changed.

4.2.3.1 Determine and document acceptable system performance with the following criteria:

- A. Five data points for each GC peak are acquired.
- B. GC column performance -- The valley between 2,3,7,8-TCDD and the peaks representing all other TCDD isomers must be resolved with a valley $\leq 25\%$. Valley % = $x/y \times 100$ when y is peak height of 2,3,7,8-TCDD and x is baseline to valley height.
- C. Ratio of integrated ion current for m/z 320 to m/z 322 for 2,3,7,8-TCDD must be ≥ 0.67 and ≤ 0.87 .
- D. Ratio of integrated ion current for m/z 322 to m/z 334 for $^{13}\text{C}_{12}$ -2,3,7,8-TCDD must be ≥ 0.67 and ≤ 0.87 .
- E. Response factor for $^{37}\text{Cl}_4$ -2,3,7,8-TCDD relative to $^{13}\text{C}_{12}$ -2,3,7,8-TCDD must be within $\pm 10\%$ of the mean value established by triplicate analyses of the concentration calibration solutions (section 4.1.2).

4.2.3.2 Remedial action must be taken if all of the criteria are not met.

4.2.4 Using the same GC conditions that produced acceptable results with the performance solution, analyze 2 μl of each of the five concentration calibration solutions in section 4.1.2.

4.2.4.1 Repeat section 4.2.4 two times to produce triplicate data sets for each solution.

4.2.5 Calculate the response factor for $^{37}\text{Cl}_4$ -2,3,7,8-TCDD and for unlabeled 2,3,7,8-TCDD relative to $^{13}\text{C}_{12}$ -2,3,7,8-TCDD:

$$\text{RF} = \frac{A_x \cdot Q_{13}}{A_{13} \cdot Q_x}$$

where A_x = integrated ion abundance (corrected for native contribution) of m/z 328 for $^{37}\text{Cl}_4$ -2,3,7,8-TCDD or the sum of integrated ion abundances of m/z 320 and m/z 322 for unlabeled 2,3,7,8-TCDD.

A_{13} = the sum of integrated abundances of m/z 322 and m/z 334 for $^{13}\text{C}_{12}$ -2,3,7,8-TCDD.

Q_{13} = quantity of $^{13}\text{C}_{12}$ -2,3,7,8-TCDD.

Q_x = quantity of unlabeled 2,3,7,8-TCDD or $^{37}\text{Cl}_4$ -2,3,7,8-TCDD-injected.

RF is a unitless number; units used to express quantities must be equivalent.

- 4.2.6 For both $^{37}\text{Cl}_4$ -2,3,7,8-TCDD and unlabeled 2,3,7,8-TCDD, calculate the mean RF and its relative standard deviation (RSD) from triplicate analyses of each of the five concentration calibration solutions. Variation of the RF calculated for each compound at each concentration level must not exceed 10% RSD. If the five mean RFs for each compound do not differ by more than $\pm 10\%$, the RF can be considered to be independent of analyte quantity for the calibration concentration range, and the mean of the five mean RFs shall be used for concentration calculations.
- 4.2.7 Fill out all necessary paperwork for the standard calibration QA/QC (see Data and Records Management section for paperwork).
- 4.2.8 Plot the response factor vs concentration for the five point calibration curve for QA/QC reporting.
- 4.3 Calibration before the start of each eight hour shift.
- 4.3.1 Inject 2 μl of the concentration calibration solution No. 3 (10 $\text{pg}/\mu\text{l}$) to determine and document acceptable performance for:
- 4.3.2.1 MS sensitivity - signal-to-noise (S/N) ratio of ≥ 2.5 for m/z 257 and > 10 for m/z 322 for unlabeled 2,3,7,8-TCDD. The ratio of integrated ion current for m/z 257 to m/z 322 should be ≥ 0.20 and ≤ 0.45 . The ratio of integrated ion current for m/z 320 to m/z 322 must be > 0.67 and < 0.87 .
- 4.3.2.2 Measured response factor for unlabeled 2,3,7,8-TCDD relative to $^{13}\text{C}_{12}$ -2,3,7,8-TCDD is within $\pm 10\%$ of the mean values established (Section 4.2) by triplicate analyses of the concentration calibration solutions.
- 4.3.2.3 If both these criteria are met, fill out the bottom portion of the daily shift standard form. If the RF ratios are within 10% of the calibration average, samples may then be analyzed. DO NOT UPDATE the shift standard to the response list. Use R;S;T only. If the 10% criteria are not met, reanalyze the shift standard. If still out of bounds, a new multipoint must be run. Multipoints may continue to be used for as long as the shift standards conform to this criteria. Xerox a copy of the daily shift standard form for inclusion with the shift standard packages and an extra copy to be placed in the instrument logbook so that subsequent shift standard entries may be made on the same form.

4.3.2.4 Acquire sample analyses. Samples may be analyzed following a successful shift standard analysis. Performance standards must be rerun within every eight hours. The injection procedure must be carefully adhered to avoid cross contamination. If the background of a sample analysis remains high towards the end of an acquisition, the column should be baked out for an extra period of time to avoid possible chromatographic carryover into the next sample injection. Septa should be changed after approximately 40 injections. Capillary injection port liners should be cleaned or exchanged with every other septum change. Good sense and experience prevail.

4.4 For all injections, a hot needle injection technique is used.

4.4.1 Injection Technique (Hot Needle) - The syringe must be thoroughly cleaned between injections to avoid cross-contamination. Remove the plunger between injections and wipe it thoroughly with a Kimwipe. Rinse the syringe with ten to fifteen full syringe volumes of hexane solvent wash. Replace the solvent wash with pesticide quality hexane daily. Work the plunger up and down in the syringe barrel to reduce excess hexane wash. There should be approximately 0.5 μ l of solvent left in the syringe barrel following this final rinse.

4.4.2 Draw back the plunger so that there are about 2 μ l of air in the barrel. Draw 2.0 μ l of sample into the needle. Usually to get a total of 2 μ l of sample, it is necessary to pull the plunger back approximately 1.2 μ l. The sample should be drawn up into the barrel and the amount confirmed to be 2 μ l. If it is not, the sample should be expelled and process repeated.

4.4.3 After getting 2.0 μ l of sample into the barrel, insert the needle into the injector port and wait 6 seconds. Rapidly make the injection.

4.4.4 After making the injection, remove the needle as quickly as possible. As soon as the injection is made, start the GC.

4.5 Identification criteria for native 2,3,7,8-TCDD.

4.5.1 Retention time (at maximum peak height) of the sample component must be within 3 seconds of the retention time of the $^{12}\text{C}_{12}$ -2,3,7,8-TCDD. Retention times are required for all chromatograms, but scan numbers are optional. These parameters should be printed next to the appropriate peak.

- 4.5.2 The integrated ion currents detected for m/z 257, 320, and 322 must maximize simultaneously. If there are peaks that will affect the maximization of quantitation of peaks of interest, attempts should be made to narrow the scan window to eliminate the interfering peaks. This should be reported on a separate chromatogram.
- 4.5.3 Relative abundance of m/z 257 to m/z 322 should be $\geq 20\%$ and $\leq 45\%$.
- 4.5.4 Abundance of integrated ion counts detected for m/z 320 must be $\geq 75\%$ and $\leq 87\%$ of integrated ion counts detected for m/z 322.

5.0 Deliverables

5.1. Each sample "package" must include the following:

- a) RIC
- b) Complete quantitation report. (input area and scan no. manually if missed)
- c) EICP of m/e 332; m/e 334; m/e 328
- d) EICP of 320; 322; and 257
- e) Quan (320; 322; 257; 5 scans) The center of the 5 scan window is the retention time of $^{13}\text{C}_{12-2,3,7,8}\text{-TCDD}$
- f) EICP of m/e 316; m/e 318
- g) A standard package including all of (a) through (f) plus an attached copy of the TCDD calibration summary

5.1.1 See Data and Records Management section for batch report deliverables.

 INTERNATIONAL TECHNOLOGY CORPORATION STANDARD OPERATING PROCEDURE	SOP No.: <u>IP.5</u> Date Revised: <u>11-12-86</u> Revision No.: <u>0</u>
Title: Total PCDD and PCDF Congener (Cl ₄ -Cl ₈) Analysis Procedures by Multiple Ion Detection (MID) High Resolution Gas Chromatography/High Resolution Mass Spectrometry (HRGC/HRMS)	Approval: <u>L.A. P. [Signature]</u> Page <u>1</u> of <u>12</u>

1.0 Introduction

1.1 Based on the request for high resolution mass spectrometry of different congeners of dioxin and furan from tetra through octachloro, a modification of the procedures for the RCRA method 8280 must be employed to include analysis for the following:

- Total tetrachlorodibenzofuran (TCDF)
- Total pentachlorodibenzofuran (PeCDF)
- Total hexachlorodibenzofuran (H₆CDF)
- Total heptachlorodibenzofuran (H₇CDF)
- Total octachlorodibenzofuran (OCDF)
- Total tetrachlorodibenzodioxin (TCDD)
- Total pentachlorodibenzodioxin (PeCDD)
- Total hexachlorodibenzodioxin (H₆CDD)
- Total heptachlorodibenzodioxin (H₇CDD)
- Total octachlorodibenzodioxin (OCDD)

The analytical approach employed by ITAS for the determination of total dioxin and dibenzofuran is considered semi-quantitative due to the lack of availability of all dioxin and dibenzofuran isomers. The standard analyzed each shift will consist of:

<u>Dioxins</u>	<u>Dibenzofurans</u>
¹³ C-2,3,7,8-TCDD	¹³ C-2,3,7,8-TCDF
³⁷ Cl-2,3,7,8-TCDD	¹³ C-1,2,3,7,8-PeCDF
¹³ C-1,2,3,7,8-PeCDD	¹³ C-1,2,3,4,7,8-HxCDF
¹³ C-1,2,3,4,7,8-HxCDD	¹³ C-1,2,3,4,6,7,8-HpCDF
¹³ C-1,2,3,4,6,7,8-HpCDD	2,3,7,8-TCDF
¹³ C-OCDD	1,2,3,7,8-PeCDF
2,3,7,8-TCDD	1,2,3,4,7,8-HxCDF
1,2,3,7,8-PeCDD	1,2,3,4,6,7,8-H ₇ CDF
1,2,3,4,7,8-HxCDD	OCDF
1,2,3,4,6,7,8-H ₇ CDD	
OCDD	

Regional Office

312 Directors Drive • Knoxville, Tennessee 37923 • 615-690-3211

1.2 In order to effectively scan for all of the required masses and maintain adequate sensitivity, four groups within each run must be monitored. Group #1 will consist of all the tetra dioxin and furan isomers, including their ^{13}C -labeled congeners, as well as penta dioxin and furan isomers, and their ^{13}C -labeled congeners. Group #2 consists of penta native and ^{13}C -labeled furan and dioxin. In addition to the penta isomers, the hexa isomers are monitored for both dioxin and furan (native and ^{13}C -labeled). Group #3, in the same manner, monitors the hexa and hepta compounds as does Group #4, monitoring for hepta and octa isomers. Groups monitor for those isomers which overlap; for example, some tetra isomers elute after the earlier penta isomers.

1.3 Performance of the system is based on surrogate standard results for every sample.

2.0 Safety

2.1 Samples are sent to IT Corporation from suspected or known hazardous waste sites. Samples are to be handled from receipt to storage by qualified personnel only. Analysts must have a working knowledge of safety protocols and be adept at safety procedures. GC/MS instruments must be equipped with vapor contamination traps on the capillary split and sweep vents and on the rough pump effluent lines prior to use.

3.0 Set-Up and Installation

3.1 Install a fused silica DB-5 column (film thickness, 0.25 μm ; column dimensions, 30 meter x 0.253 mm). Set the head pressure to approximately 20 psi and the split and sweep flows to 30 ml/min and 0.02 ml/min respectively.

3.2 Create a reasonable tune with PFK for demonstrative 10,000 resolving power or better for mass 331. Adjust the zero according to the instrument manufacturers suggested settings. The sensitivity of the preamp is set at 10^{-6} amps/volts. Calibration of the instrument is performed before each run. Hard copies of calibrations will be included as deliverables.

3.3 Establish group descriptors using the following parameters:

Total Scan Time: 1.03 seconds per Group
Cali Mass Range: Depends on Group range.

GROUP #1 (TETRA/PENTA WINDOW)

PARAMETERS FOR SELECTIVE ION RECORDING [G01 KVE](SECTOR)

DATA	Reference filename	IAV	Maximum volts	10000
REF	Instrument	IHR	Maximum mass at IAV	2032
INS	Customer account	GTH	Time 0:03:30 0:20:00 Mode E1+1 Gas	
ACN	Accelerating volts	CIH	M(amu)	S(ms)P(ms)
ACV	Instrument resolution		303.9016	35 0 337.8625 35 8
HES	# Samples		305.8987	35 8 339.8967 35 8
SNP	# Injections		307.8957	35 8 341.8568 35 8
INJ	# Groups		315.9419	35 8 349.9029 35 8
GRP	# Calibration scans		317.9389	35 8 351.9000 35 8
CLS	Cal. scan time(s)		319.8965	35 8 353.8576 35 8
CST	Cal. tolerance (ppm)		321.8935	35 8 355.8546 35 8
CTL	Cal. examination		323.8906	35 8 357.8517 35 8
CEX	Peak examination		327.8847	35 8 367.8949 35 8
PEX	Lock span (peak widths)		330.9792	35 8 369.8919 35 8
LMS	Lock step (peak widths)		330.9792	35 8 373.8400 35 8
LST	Fast lock on		331.9368	35 8 407.8010 35 8
FLO			333.9338	35 8

TXI Sample #1: Sample Text

GROUP #2 (PENTA/HEXA WINDOW)

PARAMETERS FOR SELECTIVE ION RECORDING [G/2 KVE](SECTOR)

DATA	Reference filename	PFK	IAV	Maximum volts	10000
REF	Instrument	1:70-250S	IHR	Maximum mass at IAV	2032
INS	Customer account	IT	GTH	Time 0:20:10 0:24:00 Mode EI+I Gas	
ACH	Accelerating volts	8000	CIH	M(amu)	S(ms)D(ms)
RES	Instrument resolution	10000		337.8625	35 8 300.9760 35 8
SHP	# Samples	1		339.0597	35 8 300.9760 35 8
THJ	# Injections	1		341.8568	35 8 305.0610 35 8
GRP	# Groups	4		349.9029	35 8 387.8186 35 8
CIS	# Calibration scans	2		351.9000	35 8 307.8580 35 8
GSI	Cal. scan time(s)	10		353.8576	35 8 389.8156 35 8
GTL	Cal. tolerance (ppm)	50		355.8546	35 8 391.8127 35 8
CEX	Cal. examination	Y		357.8517	35 8 401.8559 35 8
PEX	Peak examination	Y		367.8949	35 8 403.8529 35 8
LMS	Lock span (peak widths)	2.0		369.8919	35 8 407.8010 35 8
LST	Lock step (peak widths)	0.02		371.8237	35 8 443.7590 35 8
FLO	Fast lock on	Y		373.8207	35 8
				375.8178	35 8

TXI Sample #1: Sample Text

GROUP #3 (HEXA/HEPTA WINDOW)

PARAMETERS FOR SELECTIVE ION RECORDING [G#3 KVE](SECTOR)

REF	DATA filename	IAV	Maximum volts	10000
INS	Reference filename	IHR	Maximum mass at IAV	2032
ACN	Instrument	GTN	Time 0:24:10 0:27:30 Mode EI+I Gas	
ACV	Customer account	CIIN	M(amu) S(ms) D(ms) H(amu) S(ms) D(ms)	
RES	Accelerating volts		371.8237 35 8 407.7818 35 8	
SNP	Instrument resolution		373.8207 35 8 409.7788 35 8	
INJ	# Samples		375.8178 35 8 419.8220 35 8	
GRP	# Injections		380.9760 35 8 421.7796 35 8	
CLS	# Groups		380.9760 35 8 421.8191 35 8	
GST	# Calibration scans		385.8610 35 8 423.7767 35 8	
CTL	Cal. scan time(s)		387.0186 35 8 425.7737 35 8	
CEX	Cal. tolerance (ppm)		387.0580 35 8 435.8169 35 8	
PEX	Cal. examination		389.8156 35 8 437.8140 35 8	
LHS	Peak examination		391.8127 35 8 443.7590 35 8	
LST	Lock span (peak widths)		401.8559 35 8 477.7200 35 8	
FLO	Lock step (peak widths)		403.0529 35 8	
	Fast lock on		405.7817 35 8	

TXT Sample #1: Sample Text

GROUP 1A (HEPTA/OCTA WINDOW)

PARAMETERS FOR SELECTIVE ION RECORDING [G/A KVE](SECTOR)

DAY	Data filename	IAV	Maximum volts	10000
REF	Reference filename	IHR	Maximum mass at IAV	2032
INS	Instrument	GTN	Time 0:27:40 0:45:00 Mode E+I Gas	
ACH	Customer account	CHI	H(amu)	S(ms)(ms)
ACV	Accelerating volts		392.9760	35 8
RES	Instrument resolution		392.9760	35 8
SHP	# Samples		405.7047	35 8
IHJ	# Injections		407.7018	35 8
GUP	# Groups		409.7708	35 8
CLS	# Calibration scans		419.8220	35 8
CST	Cal. scan time(s)		421.7796	35 8
CTL	Cal. tolerance (ppm)		421.8191	35 8
CEX	Cal. examination		423.7767	35 8
PEX	Peak examination		425.7737	35 8
LHS	lock span (peak widths)		435.8169	35 8
LST	lock step (peak widths)		437.8140	35 8
FLO	Fast lock on		439.7457	35 8

TXI Sample #1: Sample Text

3.4 Set the GC conditions as follows:

Injector Port Temp	300°C
Separator Temp	300°C
Initial Temperature 1 (deg.C)	70
Time 1 (mins)	1.00
Rate 1 (deg. C/min)	15.0
Temperature 2 (deg.C)	200
Time 2 (mins)	0.00
Rate 2 (deg.C/min)	3.0
Temperature 3 (deg.C)	280
Time 3 (mins)	8.00
Capillary split/sweep	90 sec.
Solvent Delay	3.5 min.

4.0 Analysis

4.1 General Description

4.1.1 A five point calibration consisting of a 1 pg/ul, 5 pg/ul, 10 pg/ul, 50 pg/ul, and 100 pg/ul standard must be run in triplicate and a linear response curve generated before samples are analyzed. The 10 pg/ul standard is analyzed at the beginning of each eight hour shift to verify system performance and conformity to the multipoint calibration. Samples are received in 50 ul volumes and require no further preparation by the GC/MS laboratory.

4.1.2 The concentrations of all components of the total standard are as follows:

CONGENER	I	II	III	IV	V
1,2,3,7,8-TCDD	10.0 pg/ul	10.0 pg/ul	10.0 pg/ul	10.0 pg/ul	10.0 pg/ul
3,7,8-TCDF	10.0 pg/ul	10.0 pg/ul	10.0 pg/ul	10.0 pg/ul	10.0 pg/ul
1,2,3,7,8-TCDF	10.0 pg/ul	10.0 pg/ul	10.0 pg/ul	10.0 pg/ul	10.0 pg/ul
1,2,3,4,7-PeCDD	10.0 pg/ul	10.0 pg/ul	10.0 pg/ul	10.0 pg/ul	10.0 pg/ul
1,2,3,7,8-PeCDF	10.0 pg/ul	10.0 pg/ul	10.0 pg/ul	10.0 pg/ul	10.0 pg/ul
1,2,3,4,7,8-HxCDD	10.0 pg/ul	10.0 pg/ul	10.0 pg/ul	10.0 pg/ul	10.0 pg/ul
1,2,3,4,7,8-HxCDF	10.0 pg/ul	10.0 pg/ul	10.0 pg/ul	10.0 pg/ul	10.0 pg/ul
1,2,3,4,6,7,8-HpCDD	10.0 pg/ul	10.0 pg/ul	10.0 pg/ul	10.0 pg/ul	10.0 pg/ul
1,2,3,4,6,7,8-HpCDF	10.0 pg/ul	10.0 pg/ul	10.0 pg/ul	10.0 pg/ul	10.0 pg/ul
1,2,3,7,8-OCDD	10.0 pg/ul	10.0 pg/ul	10.0 pg/ul	10.0 pg/ul	10.0 pg/ul
2,3,7,8-TCDD	5.0 pg/ul	10.0 pg/ul	50.0 pg/ul	100.0 pg/ul	500.0 pg/ul
2,3,7,8-TCDF	5.0 pg/ul	10.0 pg/ul	50.0 pg/ul	100.0 pg/ul	500.0 pg/ul
1,2,3,4,7-PeCDD	5.0 pg/ul	10.0 pg/ul	50.0 pg/ul	100.0 pg/ul	500.0 pg/ul
1,2,3,7,8-PeCDF	5.0 pg/ul	10.0 pg/ul	50.0 pg/ul	100.0 pg/ul	500.0 pg/ul
1,2,3,4,7,8-HxCDF	5.0 pg/ul	10.0 pg/ul	50.0 pg/ul	100.0 pg/ul	500.0 pg/ul
1,2,3,4,7,8-HxCDD	5.0 pg/ul	10.0 pg/ul	50.0 pg/ul	100.0 pg/ul	500.0 pg/ul
1,2,3,4,6,7,8-HpCDF	5.0 pg/ul	10.0 pg/ul	50.0 pg/ul	100.0 pg/ul	500.0 pg/ul
1,2,3,4,6,7,8-HpCDD	5.0 pg/ul	10.0 pg/ul	50.0 pg/ul	100.0 pg/ul	500.0 pg/ul
OCDD	5.0 pg/ul	10.0 pg/ul	50.0 pg/ul	100.0 pg/ul	500.0 pg/ul
OCDF	5.0 pg/ul	10.0 pg/ul	50.0 pg/ul	100.0 pg/ul	500.0 pg/ul

4.2 Procedures for GC/MS Analysis Initial Calibration

4.2.1 The GC conditions for all standards, samples and the column performance mixture are as stated in Section 3.4.

4.2.2 Tune and calibrate the instrument as in step 3.2.

4.2.3 Analyze 2 μ l of each of the five concentration calibration solutions in section 4.1.2 for dioxins and furans.

4.2.3.1 Repeat section 4.2.3 two times to produce triplicate data sets for each solution.

4.2.4 Calculate response factors for each compound in the standard relative to its respective ^{13}C congener.

Calculate all of the labeled materials versus ^{13}C -TCDD.

$$\text{RF} = \frac{A_x \cdot Q_{is}}{A_{is} \cdot Q_x}$$

Where A_x = integrated ion abundance (corrected for native contribution) of m/e 328 for $^{37}\text{Cl}_4$ -2,3,7,8-TCDD or the sum of integrated ion abundances of characteristic ions for the unlabeled congeners.

A_{is} = the sum of integrated ion abundances of characteristic ions for the labeled congeners.

Q_{is} = quantity of labeled congeners.

Q_x = quantity of the unlabeled dioxin or furan congener or $^{37}\text{Cl}_4$ -2,3,7,8-TCDD injected.

RF is a unitless number; units used to express quantities must be equivalent.

4.2.5 For both $^{37}\text{Cl}_4$ -2,3,7,8-TCDD and unlabeled dioxin or furan congeners, calculate the mean RF and its relative standard deviation (RSD) from triplicate analyses of each of the five concentration calibration solutions. Variation of the RF calculated for each compound at each concentration level must meet the following criteria:

37Cl₄-2,3,7,8-TCDD

TCDD and TCDF

not to exceed 10% RSD

PeCDD through OCDD

PeCDF through OCDF

not to exceed 30% RSD

If the three mean RFs for each compound do not differ by more than the amount specified above, the RF can be considered to be independent of analyte quantity for the calibration concentration range, and the mean of the three mean RFs shall be used for concentration calculations.

- 4.2.6 Fill out all necessary paperwork for the standard for the standard calibration Q¹/QC (see Data and Records Management section for paperwork).
- 4.2.7 Plot the response factor vs. concentration for the five point calibration curve for QA/QC reporting.
- 4.3 Calibration before the start of each eight hour shift
 - 4.3.1 Inject 2 µl of the concentration calibration solution #2 (10 pg/µl) to determine and document acceptable performance.
 - 4.3.1.1 MS sensitivity - signal-to-noise (S/N) ratio of > 10 for all characteristic ions.
 - 4.3.1.2 Measured response factor for unlabeled dioxin and furan congeners relative to the appropriately labeled ¹³C-compound is within prescribed limits of the mean values established (Section 4.2) by triplicate analyses of the concentration calibration solutions.
 - 4.3.1.3 If both these criteria are met, samples may then be analyzed. DO NOT UPDATE the shift standard to the response list. If the criteria are not met, reanalyze the shift standard. If still out of bounds, a new multipoint must be run. Multipoints may continue to be used for as long as the shift standards conform to this criteria.

- 4.3.1.4 Acquire sample analyses. Samples may be analyzed following a successful shift standard analysis. Standards must be rerun within every eight hours. The injection procedure must be carefully adhered in order to avoid cross contamination. If the background of a sample analysis remains high towards the end of an acquisition, the column should be baked out for an extra period of time to avoid possible chromatographic carryover into the next sample injection.
- 4.3.1.5 Septa should be changed after approximately 40 injections. Capillary injection port liners should be cleaned or exchanged with every other septum change. Good sense and experience prevail.
- 4.3.2 At eight hours from the injection of the standard (4.3.1), the tune is over.
- 4.4 For all injections, a hot needle injection technique is used.
- 4.4.1 Injection Technique (Hot Needle) - The syringe must be thoroughly cleaned between injections to avoid cross contamination. Remove the plunger between injections and wipe it thoroughly with a Kimwipe. Rinse the syringe with ten to fifteen full syringe volumes of hexane solvent wash. Replace the solvent wash with pesticide quality hexane daily. Work the plunger up and down in the syringe barrel to reduce excess hexane wash. There should be approximately 0.5 ul of solvent left in the syringe barrel following this final rinse.
- 4.4.2 Draw back the plunger so that there are about 2 ul of air in the barrel. Draw 2.0 ul of sample into the needle. Usually to get a total of 2 ul of sample, it is necessary to pull the plunger back approximately 1.2 ul. The sample should be drawn up into the barrel and the amount confirmed to be 2 ul. If it is not, the sample should be expelled and process repeated.
- 4.4.3 After drawing 2.0 ul of sample into the barrel press start on GC (shuts off purge for 90 seconds and begins GC/MS program). Insert the needle into the injection port, wait 10 seconds, and rapidly make the injection.
- 4.4.4 After making the injection, remove the needle as quickly as possible (2 seconds).

4.5 Identification Criteria

- 4.5.1 Integrated ion currents detected for all three characteristic ions for each class of compounds must maximize simultaneously.
- 4.5.2 The integrated ion current for all ions of interest must be at least 2.5 times signal to noise of background.
- 4.5.3 The integrated ion ratios of the three characteristic ions of each analyte group must be within $\pm 20\%$ of the theoretical ratio of the compound.

5.0 SEE DATA AND RECORDS MANAGEMENT SECTION FOR EXAMPLES OF ALL PAPERWORK NECESSARY FOR COMPLETE REPORTING OF GC/MS DATA

APPENDIX R
U.S. EPA CLP REQUIRED DETECTION LIMITS

The document contained in this appendix was published according to their own internal style, which deviates from the Air Force Engineering Services Center format. They have, therefore, been published without editing.

USEPA CLP REQUIRED DETECTION LIMITS

CONSTITUENT	DETECTION LIMIT	CONSTITUENT	DETECTION LIMIT
METALS			
ARSENIC	10 ppb	POLYNUCLEAR AROMATIC HYDROCARBONS	
BARIUM	200 ppb	BENZO(a)ANTHRACENE	10 ppb
CADMIUM	5 ppb	BENZO(a)PYRENE	10 ppb
CHROMIUM	10 ppb	BENZO(b)FLUORANTHENE	10 ppb
LEAD	5 ppb	CHRYSENE	10 ppb
MERCURY	0.20 ppb	DIBENZO(a,h)ANTHRACENE	10 ppb
NICKEL	40 ppb	FLUORANTHENE	2.2 ppb
SELENIUM	5 ppb	INDENO(1,2,3-cd)PYRENE	10 ppb
SILVER	10 ppb	PESTICIDE/PCB/HERBICIDE	
BASE NEUTRAL/ACIDS			
BENZIDINE	44 ppb	TOXAPHENE	1 ppb
BIS(2-CHLOROETHOXY)METHANE	10 ppb	PCB 1016	0.5 ppb
BIS(2-CHLOROISOPROPYL)ETHER	20 ppb	PCB 1221	0.5 ppb
3,3'-DICHLOROBENZIDINE	10 ppb	PCB 1232	0.5 ppb
2,4-DICHLOROPHENOL	ppb	PCB 1242	0.5 ppb
2,5-DICHLOROPHENOL	ppb	PCB 1248	0.5 ppb
2,6-DICHLOROPHENOL	ppb	PCB 1254	1.0 ppb
3,4-DICHLOROPHENOL	ppb	PCB 1260	1.0 ppb
4,6-DINITRO-O-CRESOL	ppb	2,4-D	1 ppb
2,4-DINITROPHENOL	50 ppb	2,4,5-T	0.1 ppb
2,4-DINITROTOLUENE	10 ppb	VOLATILE ORGANIC SAMPLING TRAIN (2)	
2-METHYLPHENOL	10 ppb	METHYLENE CHLORIDE	5 ppb
3-METHYLPHENOL	ppb	ACETONE	10 ppb
4-METHYLPHENOL	10 ppb	CARBON DISULFIDE	5 ppb
4-NITROPHENOL	50 ppb	CHLOROFORM	5 ppb
N-NITROSDIMETHYLAMINE	10 ppb	2-BUTANONE	10 ppb
PHENOL	2.2 ppb	1,1,1-TRICHLOROETHAN	5 ppb
1,2,3,5-TETRACHLOROBENZINE	ppb	CARBON TETRACHLORIDE	5 ppb
1,2,4,5-TETRACHLOROBENZINE	ppb	BROMODICHLOROMETHANE	5 ppb
2,3,4,5-TETRACHLOROPHENOL	ppb	DIBROMODICHLOROMETHANE	5 ppb
2,3,4,6-TETRACHLOROPHENOL	ppb	BENZENE	5 ppb
2,3,4-TRICHLOROPHENOL	ppb	TETRACHLOROCETHANE	5 ppb
2,4,5-TRICHLOROPHENOL	50 ppb	TOLUENE	5 ppb
2,4,6-TRICHLOROPHENOL	10 ppb	ETHYLBENZENE	5 ppb
DIOXINS/FURANS		STYRENE	5 ppb
2378 TCDD	0.076 ppt (1)	TOTAL XYLENE	5 ppb
2378 TCDF	0.120 ppt	CHLORIDES	
TCDD	0.056 ppt		0.2 ppb
PeCDD	0.059 ppt	SULFIDES	
HxCDD	0.040 ppt		1.0 ppm
MpCDD	0.016 ppt	BCD	
OCDD	0.068 ppt		1 ppb
TCDF	0.120 ppt	CCD	
PeCDF	0.140 ppt		1 ppb
HxCDF	0.025 ppt		
MpCDF	0.026 ppt		
OCDF	0.007 ppt		

(1) Actual Max. Lab Detection Limits

(2) In Extract

APPENDIX S
NARRATIVE AND SIGNIFICANT DATA SHEETS FROM
ITAS DIOXIN/FURAN ANALYTICAL REPORT

The documents contained in this appendix were published according to their own internal style, which deviates from the Air Force Engineering Services Center format. They have, therefore, been published without editing.

APPENDIX S

CONTENTS

Exhibits 1	Summary of Methods and Results	740
Exhibits 2	Sample of Cross Reference Index	746
Exhibits 3	Calibration Summary Tables for LRMS Analysis	747
Exhibits 4	Calibration Summary Tables for HRMS Analysis	750
Exhibits 5	Isomer Specific Data	755
Exhibits 6	Congener Totals Data	763
Exhibits 7	QA/QC Summary	769

EG&G

Summary of Method

One (1) XAD blank, eight (8) water samples, eleven (11) soil samples, and five (5) MM5 composites were received 12/10/86 for the analysis of both isomer specific 2,3,7,8-TCDD/TCDF and total dioxin and total dibenzofuran congeners from Cl₄-Cl₈. The samples and a blank were spiked with an internal standard/surrogate mixture containing either 50 ng ¹³C-2,3,7,8-TCDD, 10 ng ³⁷Cl-2,3,7,8-TCDD, 50 ng ¹³C-PeCDD, ¹³C-PeCDF, ¹³C-HpCDD and ¹³C-OCDD (LRMS) or 0.50 ng ¹³C-2,3,7,8-TCDD, ³⁷Cl-2,3,7,8-TCDD, ¹³C-TCDF, ¹³C-PeCDD, ¹³C-PeCDF, ¹³C-HxCDD, ¹³C-HxCDF, ¹³C-HpCDD, ¹³C-HpCDF and ¹³C-OCDD (HRMS). The samples were extracted and cleaned up using the EPA reference method described in "RCRA Method SW 8280," revised September 1986. Extracts were analyzed by either HRGC/LRMS or HRGC/HRMS operating in the selected ion monitoring mode for enhanced sensitivity. Table 1 (Appendix A) is a cross reference list of all samples in this project.

Sample Preparation

Soil, Soxhlet - An aliquot of each soil and a sodium sulfate blank (10g for LRMS or 25g for HRMS) were weighed into separate soxhlet thimbles. The samples and blanks were spiked with the internal standard/surrogate mixture and allowed to stand overnight for equilibration followed by a soxhlet extraction with benzene for sixteen hours. The resulting extracts were filtered into a KD flask and the volume reduced to approximately 10 ml.

Water - Approximately 1000 ml of each sample and 1000 ml distilled water (the blank) were transferred into individual separatory funnels. The samples were spiked with the internal standard/surrogate mixture, and then triple-extracted with CH₂Cl₂. The resulting extracts were filtered into a KD flask and the volume reduced to approximately 10 ml.

MM5 - Train Samples -

a) XAD-Tubes + Particulate Filters

Each sample (the XAD tubes and the corresponding particulate filters) and a blank (10 g silica gel) were transferred into separate glass soxhlet thimbles.

The samples and blank were spiked with the internal standard/surrogate mixture and allowed to stand overnight for equilibration, followed by a 16 hour soxhlet extraction with benzene. The resulting extracts were combined with the other components of the train (b) prior to cleanup.

b) MM5-Condensate + Water Impingers + Probe Rinse

The entire combined volume from each sample and 1000 ml distilled water (the blank) were transferred into individual separatory funnels, and triple-extracted with CH_2Cl_2 . The resulting extracts along with the corresponding acetone and hexane probe rinse samples were filtered into a KD flask and the volume reduced to approximately 10 ml. These extracts were combined with the corresponding XAD extracts from above. Table 1, Appendix A lists the samples combined for each MM5 train sample.

Sample Cleanup

To aid in the removal of chemical interferences, the samples and blank were cleaned up using dual column chromatography consisting of an acid-modified silica gel column followed by a neutral alumina column. Detailed descriptions of these cleanup techniques can be found in the EPA reference stated in the summary section. Final extracts were concentrated to near dryness and raised to 50 μl with either isooctane for HRMS or 11 ng ^{13}C -2,3,7,8-TCDF for LRMS.

GC/MS Analysis (LRMS)

Isomer Specific TCDD/TCDF - The sample extracts were analyzed using HRGC/LRMS scanning in the selected ion monitoring mode for enhanced sensitivity. The column used for this isomer specific analysis was a 60 m SP 2331 fused silica column. Before acquisition of the samples, a seven isomer performance mixture containing the six most closely eluting TCDD isomers was run. In addition, a five-point calibration plot was run in triplicate. The mean response factors obtained from the fifteen point calibrations were used for all subsequent calculations (Table 2, Appendix B). The shift standard, analyzed on the same day as the samples, produced a response factor within 10% of the fifteen point calibration (Table 3, Appendix C).

Isomer specific 2,3,7,8-TCDF cannot be demonstrated because there is no similar

column performance mixture for the furans; however, Rappe has shown that the SP 2331 column is an isomer specific column for 2,3,7,8-TCDF. The reported value for 2,3,7,8-TCDF is considered the highest amount of 2,3,7,8-TCDF present. While this column may not provide complete separation of 2,3,7,8-TCDF from the other 37 TCDF isomers, the level of confidence is far greater than with the DB-5 column and is considered to be state of the art.

Total Dioxin and Furan - The samples and blank were analyzed for total dioxin and furan congeners from Cl₄-Cl₈. The analytical approach employed by ITAS for the determination of total dioxins and furans is considered semi-quantitative due to the lack of availability of all dioxin and furan isomer standards. The standard analyzed each shift consisted of:

<u>Dioxins</u>	<u>Dibenzofurans</u>
¹³ C-2,3,7,8-TCDD	¹³ C-2,3,7,8-TCDF
³⁷ Cl-2,3,7,8-TCDD	¹³ C-1,2,3,7,8-PeCDF
¹³ C-1,2,3,7,8-PeCDD	2,3,7,8-TCDF
¹³ C-1,2,3,4,6,7,8-HpCDD	1,2,3,7,8-PeCDF
¹³ C-OCDD	1,2,3,4,7,8-HxCDF
2,3,7,8-TCDD	1,2,3,4,6,7,8-HpCDF
1,2,3,4-TCDD	OCDF
1,2,3,7,8-PeCDD	
1,2,3,4,7,8-HxCDD	
1,2,3,4,6,7,8-HpCDD	
OCDD	

Response factors were calculated for each compound in the standard relative to ¹³C-TCDD; the same response was assumed applicable to all isomers in each congener group. A three point calibration plot was run in triplicate. The mean response factors obtained from the nine point calibration were used for all subsequent calculations (Table 4, Appendix D). The shift standard analyzed on the same day as the samples produced a response factor within 30% of the multipoint. ³⁷Cl-TCDD, ¹³C-PeCDD, ¹³C-PeCDF, ¹³C-HpCDD and ¹³C-OCDD were used to calculate the accuracy of the method.

The extracts were analyzed using HRGC/LRMS, scanning in the selected ion monitoring mode for enhanced sensitivity. The column used for the analysis

was a 30 m DB-5 fused silica column. In order to achieve adequate sensitivity, the samples were analyzed twice each: the first time for dioxins and the second time for furans.

GC/MS Analysis (HRMS)

Isomer Specific TCDD/TCDF - The sample extracts were analyzed using HRGC/HRMS scanning in the selected ion monitoring mode for enhanced sensitivity. The column used for this isomer specific analysis was a 60 m SP 2331 fused silica column. Before acquisition of the samples, a seven isomer performance mixture containing the six most closely eluting TCDD isomers was run. In addition, a five-point calibration plot was run in triplicate. The mean response factors obtained from the fifteen point calibrations were used for all subsequent calculations (Table 5, Appendix E). The shift standard, analyzed on the same day as the samples, produced a response factor within 10% of the fifteen point calibration (Tables 6,7,8; Appendix F).

Isomer specific 2,3,7,8-TCDF cannot be demonstrated because there is no similar column performance mixture for the furans; however, Rappe has shown that the SP 2331 column is an isomer specific column for 2,3,7,8-TCDF. The reported value for 2,3,7,8-TCDF is considered the highest amount of 2,3,7,8-TCDF present. While this column may not provide complete separation of 2,3,7,8-TCDF from the other 37 TCDF isomers, the level of confidence is far greater than with the DB-5 column and is considered state of the art.

Total Dioxin and Furan - The samples and blank were analyzed for total dioxin and furan congeners from Cl₄-Cl₈. The analytical approach employed by ITAS for the determination of total dioxins and furans is considered semi-quantitative due to the lack of availability of all dioxin and furan isomer standards. The standard analyzed each shift consisted of:

2,3,7,8-TCDD	¹³ C-2,3,7,8-TCDD
2,3,7,8-TCDF	³⁷ Cl-2,3,7,8-TCDD
1,2,3,7,8-PeCDD	¹³ C-2,3,7,8-TCDF
1,2,3,7,8-PeCDF	¹³ C-1,2,3,7,8-PeCDD
1,2,3,4,7,8-HxCDD	¹³ C-1,2,3,7,8-PeCDF
1,2,3,4,7,8-HxCDF	¹³ C-1,2,3,4,7,8-HxCDD
1,2,3,4,6,7,8-HpCDF	¹³ C-1,2,3,4,7,8-HxCDF
1,2,3,4,6,7,8-HpCDD	¹³ C-1,2,3,4,6,7,8-HpCDD
OCDD	¹³ C-1,2,3,4,6,7,8-HpCDF
OCDF	¹³ C-OCDD

Response factors were calculated for each compound in the standard relative to the corresponding ¹³C isomer from each congener group; the same response was assumed applicable to all isomers in each congener group. A five point calibration plot was run in triplicate. The mean response factors obtained from the fifteen point calibration were used for all subsequent calculations (Table 9, Appendix G). The shift standard analyzed on the same day as the samples produced a response factor within 30% of the multipoint. ³⁷Cl-TCDD was used to calculate the accuracy of the method.

The extracts were analyzed using HRGC/HRMS scanning in the selected ion monitoring mode for enhanced sensitivity. The column used for the analysis was a 30 m DB-5 fused silica column.

GC/MS Results

Isomer Specific TCDD/TCDF - The results of the isomer specific analyses, shown in Tables 10-13, Appendix H, are reported in either ppb, ppt or ng/sample. A detection limit is calculated from 2.5 times the signal in the area of the elution of ¹³C-TCDD (¹³C-TCDF) whenever a sample contains no detectable TCDD (TCDF).

Totals - The results of the totals, shown in Tables 14 and 15, Appendix I, are reported in either ppb, ppt or ng/sample, with the total amount of each congener calculated. When more than one isomer of a congener of dioxin or furan is found, all of the isomers are added together to produce a total congener result. Detection limits are calculated from 2.5 times signal to

noise when a "not detected" (ND) is reported. The detection limits are listed in parentheses.

QA/QC

Tables 16 and 17, Appendix J, list the results of the QA/QC samples. Samples which do not meet the IT QA/QC specifications are noted on the tables.

Appendix 3, Exhibit 2
TABLE 1 CROSS REFERENCE LIST
EG&G

Exhibit 2
1 0007

<u>IT SAMPLE #</u>	<u>CLIENT SAMPLE #</u>	<u>MATRIX</u>
AA5825	ENT-B	HRMS - Water
AA5826	ENT-1	HRMS - Water
AA5827	ENT-2	HRMS - Water
AA6450	ENT-5	HRMS - Water
AA6456	ENT-6	HRMS - Water
AA6459	POTW	HRMS - Water
AA6463	CW	HRMS - Water
AA6469	WB-1	HRMS - Water
AA5880	FS-1	LRMS - Soils
AA5881	FS-2	LRMS - Soils
AA5882	FS-3	LRMS - Soils
AA6408	FS-6	LRMS - Soils
AA6410	FS-5	LRMS - Soils
AA5883	AD-1	HRMS - Soils
AA5884	AD-2	HRMS - Soils
AA5885	AD-3	HRMS - Soils
AA6409	AD-6	HRMS - Soils
AA6411	AD-5	HRMS - Soils
AA6444	SB-1	HRMS - Soils
AA5844	VB-1-Filter ^a	HRMS-MV5 Composites
AA5845	VB-2-Filter ^b	HRMS-MV5 Composites
AA5846	VB-3-Filter ^c	HRMS-MV5 Composites
AA6512	VB-5-Filter ^d	HRMS-MV5 Composites
AA6513	VB-6-Filter ^e	HRMS-MV5 Composites
AA6487	XAD Blank	HRMS XAD Blank

^aComposite of these samples VB-1-F; VB-1-XAD; VB-1-PW; VB-1-C.

^bComposite of these samples VB-2-F; VB-2-XAD; VB-2-PW; VB-2-C.

^cComposite of these samples VB-3-3F; VB-3-XAD; VB-3-PW; VB-3-C.

^dComposite of these samples VB-5-F; VB-5-XAD; VB-5-PW; VB-5-C.

^eComposite of these samples VB-6-F; VB-6-XAD; VB-6-PW; VB-6-C.

TABLE 2
INITIAL CALIBRATION SUMMARY (LRMS)
TCDD/TCDF

Date	Instr. ID	Sol. ID	Measured RF		Surrogate		Mean RF Used		
			Native TCDD	Native TCDF	37Cl-TCDD	37Cl-TCDF	Native TCDD	Native TCDF	Surrogate 37Cl-TCDD
11-24-86	TR061124PE1	CC1	0.99	2.13	1.58	1.08	2.18	1.65	
11-24-86	TR061124PE1	CC1	1.02	2.35	1.60	1.08	2.18	1.65	
11-24-86	TR061124PE1	CC1	0.98	2.14	1.57	1.08	2.18	1.65	
11-22-86	TR061122PE2	CC2	1.11	2.36	1.69	1.08	2.18	1.65	
11-22-86	TR061122PE2	CC2	1.13	2.29	1.74	1.08	2.18	1.65	
11-22-86	TR061122PE2	CC2	1.12	2.17	1.69	1.08	2.18	1.65	
11-22-86	TR061122PE3	CC3	1.10	2.13	1.68	1.08	2.18	1.65	
11-22-86	TR061122PE3	CC3	1.10	2.12	1.68	1.08	2.18	1.65	
11-22-86	TR061122PE3	CC3	1.09	2.09	1.66	1.08	2.18	1.65	
11-22-86	TR061122PE4	CC4	1.08	--	--	1.08	2.18	1.65	
11-22-86	TR061122PE4	CC4	1.09	--	--	1.08	2.18	1.65	
11-22-86	TR061122PE4	CC4	1.08	--	--	1.08	2.18	1.65	
11-22-86	TR061122PE5	CC5	1.07	--	--	1.08	2.18	1.65	
11-22-86	TR061122PE5	CC5	1.08	--	--	1.08	2.18	1.65	
11-22-86	TR061122PE5	CC5	1.09	--	--	1.08	2.18	1.65	
					$\bar{Y} =$	1.00	2.18	1.65	
					$\pm 1SD =$	4.25	4.10	3.50	

Solution ID Codes:

- CC1 = Concentration calibration solution #1 = 0.2 ng/μl
- CC2 = Concentration calibration solution #2 = 1.0 ng/μl
- CC3 = Concentration calibration solution #3 = 5.0 ng/μl
- CC4 = Concentration calibration solution #4 = 20.0 ng/μl
- CC5 = Concentration calibration solution #5 = 40.0 ng/μl

TABLE 3
CONTINUING CALIBRATION SUMMARY (LRMS)

EE&G

Date	Instr. ID	Sol. ID	Measured RF		Mean RF Used		TCDD Isomer Resolution Pct. Valley (Applies For PC Only)
			Native TCDD	Native TCDF	Native TCDD	Native TCDF	
12/20/86	4500	PC					14%
12/20/86	4500	CC2	1.06	1.88	1.08	2.18	
12/20/86	4500	PC			1.55	1.65	8%
12/24/86	4500	PC					11%
12/24/86	4506	CC2	1.08	2.07	1.60	2.18	
12/24/86	4500	PC			1.08	1.65	10%

Solution ID Codes:

- PC = Performance check solution
- CC1 = Concentration calibration solution #1 = 0.2 ng/µl
- CC2 = Concentration calibration solution #2 = 1.0 ng/µl
- CC3 = Concentration calibration solution #3 = 5.0 ng/µl
- CC4 = Concentration calibration solution #4 = 20.0 ng/µl
- CC5 = Concentration calibration solution #5 = 40.0 ng/µl

1 0009

TABLE 4
PCDD/PCDF INITIAL CALIBRATION SUMMARY (LRMS)

EG&G

CONGENER	CAL SOLUTION #1			CAL SOLUTION #2			CAL SOLUTION #3			\bar{X}	% RSD
	1.40	1.53	1.64	1.60	1.46	1.47	1.55	1.41	1.70		
3,4,7,8-TCDD (% acc)	0.62	0.59	0.65	0.69	0.66	0.68	0.62	0.65	0.59	1.53	6.7
1,2,3,7,8-PeCDD (% acc)	1.52	1.48	1.54	1.03	0.52	0.52	0.50	0.46	0.61	0.64	5.6
1,2,3,6,7,8-HxCDD (% acc)	0.45	0.43	0.41	0.37	0.41	0.39	0.36	0.38	1.15	1.21	12.2
1,2,3,4,7,8-HxCDD (% acc)	0.61	0.58	0.54	0.47	0.50	0.46	0.40	0.45	0.49	0.41	10.1
TCDD	1.10	1.24	1.34	1.11	1.02	0.99	1.05	0.95	0.58	0.51	13.9
PeCDD	0.82	0.75	0.75	0.65	0.69	0.64	0.56	0.53	0.69	1.12	11.8
HxCDD	1.07	0.99	0.95	0.69	0.75	0.74	0.68	0.66	0.86	0.67	13.8
HpCDD	0.93	0.86	0.81	0.63	0.68	0.65	0.60	0.61	0.76	0.82	18.4
OCDD	0.63	0.56	0.59	0.44	0.48	0.44	0.38	0.42	0.54	0.73	16.3
TCDF	1.97	1.87	2.03	1.63	1.98	1.62	1.41	1.77	1.81	0.50	17.1
PeCDF	1.18	1.10	1.32	1.00	1.14	1.06	0.83	0.92	1.13	1.79	11.3
HxCDF	1.10	1.14	1.32	1.05	1.11	1.02	0.91	0.95	0.98	1.08	13.4
HpCDF	1.00	0.95	1.09	0.89	0.94	0.88	0.79	0.78	0.86	1.07	11.5
OCDF	1.01	1.03	1.18	0.98	0.97	0.90	0.71	0.78	0.91	0.91	10.8
										0.94	14.7

Solution ID Codes:

- CC1 = Concentration calibration solution #1 = 0.2 ng/ul
- CC2 = Concentration calibration solution #2 = 1.0 ng/ul
- CC3 = Concentration calibration solution #3 = 5.0 ng/ul

1 0010

TABLE 5. INITIAL CALIBRATION SUMMARY
HIGH RESOLUTION

EG&G

TCDD/TCDF

Date	Instr. ID	Sol. ID	Measured RF		Mean RF Used		Surrogate 37Cl-TCDD	Surrogate 37Cl-TCDD
			Native TCDD	Native TCDF	Native TCDD	Native TCDF		
1/13/87	70-250S	CC1	1.16	0.877	1.18	0.833	1.64	1.84
1/13/87	70-250S	CC1	1.12	0.783	1.18	0.833	1.60	1.84
1/14/87	70-250S	CC1	1.14	0.882	1.18	0.833	1.75	1.84
1/13/87	70-250S	CC2	1.27	1.01	1.18	0.833	1.81	1.84
1/14/87	70-250S	CC2	1.18	0.835	1.18	0.833	1.89	1.84
1/13/87	70-250S	CC2	1.17	0.827	1.18	0.833	1.79	1.84
1/13/87	70-250S	CC3	1.18	0.738	1.18	0.833	1.78	1.84
1/13/87	70-250S	CC3	1.22	0.796	1.18	0.833	1.81	1.84
1/13/87	70-250S	CC3	1.10	0.780	1.18	0.833	1.70	1.84
1/13/87	70-250S	CC4	1.19	0.801	1.18	0.833	1.82	1.84
1/13/87	70-250S	CC4	1.16	0.801	1.18	0.833	1.82	1.84
1/13/87	70-250S	CC4	1.30	0.814	1.18	0.833	1.95	1.84
1/13/87	70-250S	CC5	1.14	0.832	1.18	0.833	2.04	1.84
1/13/87	70-250S	CC5	1.24	0.871	1.18	0.833	2.06	1.84
1/13/87	70-250S	CC5	1.26	0.853	1.18	0.833	2.07	1.84

Solution ID Codes:

- CC1 = Concentration calibration solution #1 = 5 pg/μl
- CC2 = Concentration calibration solution #2 = 10 pg/μl
- CC3 = Concentration calibration solution #3 = 50 pg/μl
- CC4 = Concentration calibration solution #4 = 100 pg/μl
- CC5 = Concentration calibration solution #5 = 500 pg/μl

TABLE 6.
CONTINUING CALIBRATION SUMMARY
SOILS
EG&G

Date	Instr. ID	Sol. ID	Measured RF		Native TCDD	Mean RF Used	Surrogate ³⁷ Cl-TCDD	Surrogate ³⁷ Cl-TCDD	TCDD Isomer Resolution Pct. Valley (Applies For PC Only)
			Native TCDD	Native TCDF					
1/14/87	70-250S	PC							
1/14/87	70-250S	CC2	1.20	0.788	1.18	0.833	1.84	1.84	3.09%
1/14/87	70-250S	PC							
1/14/87	70-250S	CC2	1.10	0.881	1.10	0.833	1.84	1.84	3.6%
1/14/87	70-250S	PC							
									3.9%

Solution ID Codes :
 PC = Performance check solution
 CC1 = Concentration calibration solution #1 = 5 pg/ul
 CC2 = Concentration calibration solution #2 = 10 pg/ul
 CC3 = Concentration calibration solution #3 = 50 pg/ul
 CC4 = Concentration calibration solution #4 = 100 pg/ul
 CC5 = Concentration calibration solution #5 = 500 pg/ul

TABLE 7.
CONTINUING CALIBRATION SUMMARY (HRMS)
WATERS
EG&G

Date	Instr. ID	Sol. ID	Measured RF		Mean RF Used		TCDD Isomer Resolution Pct. Valley (Applies For PC Only)
			Native TCDD	Native TCDF	Native TCDD	Native TCDF	
1/15/87	70-250S	PC					
1/15/87	70-250S	CC2	1.23	0.813	1.18	0.833	5.7%
1/15/87	70-250S	PC					
1/15/87	70-250S	CC2	1.20	0.860	1.18	0.833	6.8%
1/15/87	70-250S	PC					
							2.1%

Solution ID Codes :

- PC = Performance Check solution
- CC1 = Concentration calibration solution #1 = 5 pg/ul
- CC2 = Concentration calibration solution #2 = 10 pg/ul
- CC3 = Concentration calibration solution #3 = 50 pg/ul
- CC4 = Concentration calibration solution #4 = 100 pg/ul
- CC5 = Concentration calibration solution #5 = 500 pg/ul

1 0013

CONTINUING CALIBRATION SUMMARY (HRMS)

MM 5

EG&G

Date	Instr. ID	Sol. ID	Measured RF		Mean RF Used		TCDD Isomer Resolution Pct. Valley (Applies For PC Only)
			Native TCDD	Native TCDF	Native TCDD	Native TCDF	
1/14/87	70-250S	PC					
1/14/87	70-250S	CC2	1.20	0.788	1.18	0.833	3.1%
1/14/87	70-250S	PC					
1/14/87	70-250S	CC2	1.1C	0.881	1.18	0.833	3.6%
1/14/87	70-250S	PC					

Solution ID Codes :

- PC = Performance check solution
- CC1 = Concentration calibration solution #1 = 5 pg/ul
- CC2 = Concentration Calibration solution #2 = 10 pg/ul
- CC3 = Concentration calibration solution #3 = 50 pg/ul
- CC4 = Concentration calibration solution #4 = 100 pg/ul
- CC5 = Concentration calibration solution #5 = 500 pg/ul

1 0014

1 0015

Table 9
 BHCC/BIHCS
 INDD/ICDD INITIAL CALIBRATION SUMMARY

CONGENER	CAL SOLUTION #1		CAL SOLUTION #2		CAL SOLUTION #3		CAL SOLUTION #4			CAL SOLUTION #5		X̄	RSD			
	1.71	1.72	1.75	1.80	1.74	1.81	1.80	1.71	1.66	1.64	1.72			1.64	1.69	1.76
37Cl-TCDF (X sec)	1.11	1.02	1.03	1.10	1.06	1.09	1.11	1.07	0.96	0.83	1.02	1.03	1.04	1.03	1.72	3.2%
TCDD	0.46	0.76	0.81	0.79	0.84	0.81	0.81	0.80	0.70	0.72	0.80	0.80	0.84	0.80	1.03	6.7%
PeCDF	1.45	1.13	1.26	1.33	1.25	1.32	1.34	1.37	1.30	1.09	1.22	1.32	1.30	1.30	0.774	12.5%
HxCDD	2.24	1.97	2.14	2.18	2.06	2.07	2.08	2.23	2.10	2.16	2.14	2.10	2.10	2.28	1.30	7.8%
OCDD	1.98	2.15	2.14	2.04	1.73	2.10	2.18	1.94	1.74	1.47	1.96	1.59	1.63	1.82	2.14	4.1%
TCDF	0.66	0.72	0.62	0.62	0.61	0.63	0.63	0.62	0.63	0.61	0.60	0.65	0.65	0.65	1.89	11.7%
PeCDF	0.66	0.69	0.67	0.67	0.65	0.64	0.67	0.66	0.65	0.64	0.64	0.77	0.75	0.77	0.636	4.5%
HxCDF	1.26	1.12	1.24	1.23	1.17	1.17	1.19	1.20	1.17	1.19	1.15	1.28	1.28	1.28	0.679	6.7%
HpCDF	1.50	1.54	1.52	1.64	1.47	1.50	1.58	1.67	1.47	1.37	1.52	1.65	1.61	1.64	1.21	3.9%
OCDF	8.91	6.30	7.80	8.25	8.07	8.89	9.87	7.78	6.69	4.78	7.33	7.22	7.16	7.60	7.59	15.9%

Solution ID Codes:

- CC1 = Concentration calibration solution #1 = 5 pg/ul
- CC2 = Concentration calibration solution #2 = 10 pg/ul
- CC3 = Concentration calibration solution #3 = 50 pg/ul
- CC4 = Concentration calibration solution #4 = 100 pg/ul
- CC5 = Concentration calibration solution #5 = 500 pg/ul

Appendix S, Exhibit 5

Table 10
2,3,7,8-TCDD

Lab: IAS-Knoxville
Case No.: EGU
Batch/Shipmt No. 780, 794

Report Date: 04/27/91
Column: 04/27/91

Sample Number	Extra Cleanup	Aliquot Vol. (g)	p,p'-TCDD		GC/MS Analysis		Rel. Ion Abund. 320/322	322	320	Relative Ion Abundance	PPB* Surrogate Res. % Acc'y.	322	320	Relative Ion Abundance	(15 % Rec.) Comments			
			Meas.	DL	Instr.	Date										Time	320/322	322
FS-1	Yes	10	32.0	-	4500	12/20/86	10:20	0.80	0.80	198	99	2659010	3366530	1029500	286115	388464	484704	83
FS-2	Yes	10	54.0	-	4500	12/20/86	10:59	0.79	0.80	200	100	4441050	5621140	1683770	274946	369184	463088	92
FS-3	Yes	10	34.0	-	5500	12/20/86	11:56	0.79	0.80	204	102	2743290	3487750	1053670	269794	355406	446032	86
FS-5	Yes	10	50.0	-	4500	12/24/86	09:36	0.78	0.81	178	89	4142270	5284650	1512470	256694	390720	482480	85
RB 790	Yes	10	MD	0.030	4500	12/20/86	09:40	0.78	0.81	174	87	4029240	5141230	1483740	266273	414800	512840	84
RB 794	Yes	10	MD	0.086	4500	12/24/86	07:21	-	0.81	168	84	-	-	-	347968	483040	596787	86
															266512	431248	530432	86

* Corrected for contribution by native TCDD; 0.9% of m/z 322 subtracted
 RB - Reagent Blank
 P - Partial Scan/Confirmatory Analysis
 M - Native TCDD Spike
 D - Duplicate/Fortified Field Blank
 FB - Field Blank
 ND - Not Detected
 DL - Detection Limits
 BS - Blank Spike
 *ppb/l final extract (200 ppb/l x 50 ul extract = 10ng spike on 10g soil or 1 ppb spike)

1 0016

TABLE 10 (continued)

2,3,7,8-TCDF

Lab: IAS-Knoxville
 Case No.: EG6
 Batch/Shipment No. 790, 794

Report Date: 6/21/83
 Column: 60A SP2311

Sample Number	Extra Cleanup	Allquot Met. Wt. (g)	PPB TCDF Res.	Instr. ID	GC/MS Analysis		Rel. Ion Abund. 307/306	PPB Surrogate Res. % ACCY.	Relative Ion Abundance			(IS & Re. Comm)			
					Date	Time			304	306	312				
FS-1	Yes	10	0.15	4500	12/20/86	10:20	0.79	199	25824	31680	3456	266115	388466	484704	93
FS-2	Yes	10	0.16	4500	12/20/86	10:59	0.71	200	23328	33008	3776	278946	369184	463088	92
FS-3	Yes	10	0.20	4500	12/20/86	11:36	-	204	-	-	-	269794	353606	446072	86
FS-5	Yes	10	0.14	4500	12/24/86	09:36	0.82	178	24960	30448	10600	256694	390720	482486	85
BB 790	Yes	10	0.11	4500	12/24/86	10:31	0.75	174	19520	26080	2528	266273	414400	512640	89
BB 796	Yes	10	0.071	4500	12/20/86	09:40	-	195	-	-	-	347968	483040	596187	86
			0.16	4500	12/24/86	07:21	0.81	168	-	-	-	266512	431248	530432	90

† Corrected for contribution by native TCDF; 0.9% of m/z 322 subtracted

- RB - Reagent Blank
- P - Partial Scan/Confirmatory Analysis
- M - Native TCDF Spike
- D - Duplicate/Fortified Field Blank
- FB - Field Blank
- ND - Not Detected
- DL - Detection Limits
- BS - Blank Spike

*pg/l final extract (200 pg/l x 50 ul) extract = 10ng spike on 10g soil or 1 ppb spike

1 0017

TABLE 11

2,3,7,8-TCDD

Lab: IAS-Knoxville
 Case No.: 1020
 Batch/shipment No. 802

Report Date: 6/04/97
 Column: 60M 327JH

Sample Number	Extra Cleanup	Allquot Met Wt. (g)	PPT TCDD Meas. DL	Instr.	Date	Time	Rel. Ion Abund.		PPB Surrogate Meas. % Acc'y.	Relative Ion Abundance				
							327/327	327/334		327	327	328	332	334
AD-1	Yes	25	ND	70-2505	01/14/87	15:36	-	0.86	8.38	84	-	122.54	36.72	42.74
AD-2	Yes	25	ND	70-2505	01/14/87	16:16	-	0.82	9.61	96	-	132.54	33.70	41.22
AD-3	Yes	25	ND	70-2505	01/14/87	16:58	-	0.80	9.43	94	-	185.69	47.88	59.99
AD-6	Yes	25	ND	70-2505	01/14/87	18:15	-	0.78	10.24	102	-	162.78	38.01	48.42
AD-5	Yes	25	ND	70-2505	01/14/87	17:14	-	0.83	8.64	86	-	140.54	40.13	48.19
BS-1	Yes	25	ND	70-2505	01/14/87	18:51	-	0.78	8.47	85	-	189.61	49.94	71.65
AD-5-0	Yes	25	55.50	70-2505	01/14/87	21:01	-	0.78	10.09	101	-	124.75	29.41	37.75
AD-5-N	Yes	25	ND	70-2505	01/14/87	21:37	0.83	0.88	9.24	92	120.68	146.09	171.55	138.59
NB-802	Yes	25	ND	70-2505	01/14/87	14:06	-	0.76	9.78	98	-	132.07	31.59	41.76

* Corrected for contribution by native TCDD; 0.9% of m/z 327 subtracted
 RB - Reagent Blank
 P - Partial Scan/Confirmatory Analysis
 N - Native TCDD Spike
 D - Duplicate/fortified Field Blank
 FB - Field Blank
 ND - Not Detected
 DL - Detection Limits
 BS - Blank Spike
 *pg/ul final extract (10 pg/ul x 50 ul extract = 0.50ng spike on 25g soil or 0.02 ppb spike)

TABLE 11 (continued)

2,3,7,8-TCDF

Sample Number	Extra Cleanup	Aliquot Met Wt. (g)	PPI ICDF Reqs.	ICDF DE	Instr.	GC/MS Analysis		Rel. Ion Abund. 304/305	Rel. Ion Abund. 315/318	Ppm Surrogate Reqs. X Acc. Y.	Relative Ion Abundance				
						Date	Time				304	305	312	317	318
AD-1	Yes	25	NO	2.2	70-2505	01/14/87	15:36	-	-	-	14.62	16.50	122.54	36.72	42.74
AD-2	Yes	25	4.9	-	70-2505	01/14/87	16:16	0.89	0.88	8.38	25.95	31.61	132.54	31.70	41.22
AD-3	Yes	25	5.4	-	70-2505	01/14/87	16:16	0.82	0.83	9.61	14.65	19.45	165.69	47.98	59.99
AD-6	Yes	25	3.8	-	70-2505	01/14/87	18:15	0.75	0.80	10.24	8.34	10.6	162.78	38.01	48.42
AD-5	Yes	25	2.1	-	70-2505	01/14/87	17:34	0.79	0.87	8.64	5.86	7.72	140.54	40.13	48.19
BS-1	Yes	25	1.5	-	70-2505	01/14/87	18:51	0.76	0.85	8.47	5.86	7.72	189.61	49.96	71.65
AD-5-0	Yes	25	2.4	-	70-2505	01/14/87	21:01	0.82	0.83	10.09	6.32	7.73	124.75	29.41	37.75
AD-5-N	Yes	25	56.31	-	70-2505	01/14/87	21:37	0.79	0.82	9.24	165.85	208.85	138.59	38.07	43.40
HB-802	Yes	25	NO	4.3	70-2505	01/14/87	14:06	-	0.79	9.78	-	-	132.07	31.59	41.76

Lab: IAS-Knoxville
Case No.: 604
Batch/Shipement No. 527331

Report Date:
Column: 604 527331

* Corrected for contribution by native TCDF; 0.9% of m/z 322 subtracted
 RB - Reagent Blank
 P - Partial Scan/Confirmatory Analysis
 N - Native TCDF Spike
 D - Duplicate/Fortified Field Blank
 FB - Field Blank
 ND - Not Detected
 DL - Detection Limits
 BS - Blank Spike

*pg/ul final extract (10 pg/ul x 50 ul) extract = 0.50ng spike on 25g soil or 0.02 pph spike)

1 0019

TABLE 12. 2,3,7,8-TCDD RESULTS
EG&G

Lab: IAS-Knoxville
Case No.: LUG
Batch/Shipmt No. 788, 796

Report Date: 6/21/77
Column: 60M SP2311

Sample Number	Extra Cleanup	Aliquot Net Wt. (g)	PPF ICDD Mgst. DL	Instr. ID	GC/MS Analysis		Time	Rel. Ion Abund. 312/322	PPM Surrogate Meas. % Acc. Y.	Relative Ion Abundance 328e		
					Date	Time				370	322	257
ENT-4	Yes	900 ml	0.020	70-2505	01/15/87	12:07	0.83	9.40	96	264.62	64.11	81.09
ENT-1	Yes	990 ml	0.027	70-2505	01/15/87	12:45	0.79	9.45	94	323.57	82.42	103.73
ENT-2	Yes	850 ml	0.032	70-2505	01/15/87	01:30	0.73	98.6	99	321.03	78.23	96.71
ENT-5	Yes	1000 ml	0.020	70-2505	01/15/87	15:18	0.84	9.18	92	196.56	52.95	63.38
ENT-6	Yes	1000 ml	0.050	70-2505	01/15/87	20:39	0.79	7.90	79	100.22	30.39	34.54
POTM	Yes	1000 ml	0.076	70-2505	01/15/87	21:13	0.70	9.45	94	65.41	15.60	22.00
CV	Yes	1000 ml	0.036	70-2505	01/15/87	21:46	0.90	10.45	104	349.79	96.91	106.78
WB-1	Yes	1000 ml	0.035	70-2505	01/15/87	23:39	0.80	11.05	110	123.05	26.95	35.57
ENT-2-0	Yes	815 ml	0.059	70-2505	01/15/87	10:55	0.85	9.53	95	328.44	86.31	100.98
ENT-2-N	Yes	810 ml	-	70-2505	01/15/87	10:20	0.77	0.78	9.69	437.47	107.56	137.83
WB-1-D	Yes	1000 ml	0.011	70-2505	01/16/87	00:17	0.86	8.73	87	126.60	36.63	42.20
WB-1-R	Yes	1000 ml	-	70-2505	01/16/87	00:54	0.83	11.45	114	129.04	28.12	33.11
RB-788	Yes	1000 ml	0.064	70-2505	01/15/87	11:30	0.85	10.41	104	364.87	87.38	103.06
RB-796	Yes	1000 ml	0.054	70-2505	01/15/87	23:06	0.86	9.05	90	215.96	55.48	69.84

* Corrected for contribution by native TCDD; 0.9% of m/z 322 subtracted

RB - Reagent Blank
P - Partial Scan/Confirmatory Analysis
N - Native TCDD Spike
D - Duplicate/Fortified Field Blank

FB - Field Blank
ND - Not Detected
DL - Detection Limits
BS - Blank Spike

*pg/ml final extract (10 pg/ml X 50 ul extract = 0.50mg spike on 25g soil or 0.02 ppb spike)

1 0020

TABLE 13. 2,3,7,8-TCDD RESULTS
EG&G

Lab: ITAS-Equestling
Case No.: 1212
Batch/shipment No. 791

Sample Number	Extra Cleanup	Aliquot Vol. (μl)	ng/TCDD Resid. DC	Instr. ID	GC/MS Analysis		Time	Rel. Ion Abund. 370/377	377/378	370	377	378	Relative Ion Abundance	PPMS Surrogate Resid. % CC Y.
					Date	Time								
VB-1-fb	Yes	120	0.31	70-2505	01/15/87	22:26	-	0.81	-	-	-	-	183.93	46.17
VB-2-fc	Yes	120	0.25	70-2505	01/15/87	23:26	-	0.89	-	-	-	-	118.26	29.06
VB-3-fd	Yes	120	0.22	70-2505	01/15/87	00:02	-	0.71	-	-	-	-	128.46	34.00
VB-5-fe	Yes	120	0.22	70-2505	01/15/87	00:37	-	0.87	-	-	-	-	121.53	31.58
VB-6-ff	Yes	120	0.28	70-2505	01/15/87	01:13	-	0.72	-	-	-	-	107.04	21.39
120-blank	Yes	120	0.24	70-2505	01/15/87	01:45	-	0.84	-	-	-	-	130.60	32.48
RB-791	Yes	120	0.54	70-2505	01/15/87	14:05	-	0.68	-	-	-	-	154.72	42.85

Report Date: 6/24/87
Column: 60M SP2311

a Corrected for contribution by native TCDD; 0.9% of m/z 322 subtracted
 b Composite of these samples: VB-1-f; VB-1-LAD; VB-1-PW; VB-1-C
 c Composite of these samples: VB-2-f; VB-2-LAD; VB-2-PW; VB-2-C
 d Composite of these samples: VB-3-f; VB-3-LAD; VB-3-PW; VB-3-C
 e Composite of these samples: VB-5-f; VB-5-LAD; VB-5-PW; VB-5-C
 f Composite of these samples: VB-6-f; VB-6-LAD; VB-6-PW; VB-6-C
 RB - Reagent Blank
 P - Partial Scan/Confirmatory Analysis
 M - Native TCDD Spike
 D - Duplicate/Fortified Field Blank
 FB - Field Blank
 ND - Not Detected
 DL - Detection Limits
 BS - Blank Spike

*pg/ul final extract (10 pg/ul x 50 ul extract = 0.50ng spike on 25g soil or 0.02 ppb spike)

1 0022

TABLE 13. 2,3,7,8-TCDF RESULTS (Continued)

EG&G

Lab: 11AS-Enoaville
 Case No.: 1122
 Batch/Shipmt No. 791

Report Date: 6/24/73
 Column: 60A SP2311

Sample Number	Extra Cleanup	Alliquot Wet Wt. (g)	ng/TCDF Res.	GC/MS Analysis Instr. ID	Date	Time	Rel. Ion Abund.		PMB Surrogate Meas. % Acc'y.	Relative Ion Abundance				
							303/305	318/319		304	306	241	312	314
VB-1-fb	Yes	1.00	0.32	70-2505	01/15/87	22:26	0.79	0.66	87	3.57	3.36	163.93	46.17	56.71
VB-2-fc	Yes	1.00	0.32	70-2505	01/15/87	23:26	0.90	10.14	101	-	-	118.26	29.88	31.52
VB-3-fd	Yes	1.00	1.4	70-2505	01/15/87	03:02	0.82	10.60	108	-	-	128.46	34.00	37.73
VB-5-fe	Yes	1.00	0.69	70-2505	01/15/87	03:37	0.82	9.70	97	-	-	121.53	31.58	36.46
VB-6-ff	Yes	1.00	1.2	70-2505	01/15/87	01:13	0.86	11.48	114	10.67	12.96	107.84	21.39	29.64
1A0-81ana	Yes	1.00	0.34	70-2505	01/15/87	01:45	0.82	10.08	101	-	-	130.60	32.48	37.75
RB-791	Yes	1.00	0.67	70-2505	01/15/87	14:05	0.85	9.17	92	-	-	134.72	42.85	48.89

a Corrected for contribution by native TCDF; 0.9% of w/z 322 subtracted
 b Composite of these samples: VB-1-f; VB-1-1A0; VB-1-PB; VB-1-C
 c Composite of these samples: VB-2-f; VB-2-1A0; VB-2-PB; VB-2-C
 d Composite of these samples: VB-3-f; VB-3-1A0; VB-3-PB; VB-3-C
 e Composite of these samples: VB-5-f; VB-5-1A0; VB-5-PB; VB-5-C
 f Composite of these samples: VB-6-f; VB-6-1A0; VB-6-PB; VB-6-C
 VB - Reagent Blank
 P - Partial Scan/Confirmatory Analysis
 B - Native TCDF Spike
 D - Duplicate/fortified field blank
 FB - Field Blank
 ND - Not Detected
 DL - Detection Limit
 BS - Blank Spike

*99% final extract (10 µg/ml ± 50 µl extract = 0.50mg spike on 25g soil or 0.02 ppb spike)

1 0023

TABLE 14 PCDD/PCDF DATA SUMMARY
LOW RESOLUTION
EPA

CONGENER	FS1 AA5880 ^a	FS2 AA5881 ^a	FS3 AA5882 ^a	RB Blk790 ^a	FS5 AA6410 ^a	FS6 AA6408 ^a	RB Blk794 ^a
3TC1-TCDD (% acc)	114%	102%	116%	104%	89%	88%	93%
13C-TCDD (% rec)	91%	99%	87%	71%	64%	49%	69%
13PeCDD (% acc)	52%	55%	100%	122%	100%	133%	112%
13C-PeCDF (% acc)	93%	100%	142%	160%	114%	166%	106%
13C-HpCDD (% acc)	54%	58%	84%	110%	99%	121%	130%
13C-OCDD (% acc)	61%	68%	80%	91%	120%	90%	116%
TCDD	32.1	54.2	38.0	ND(0.053)	45.8	60.6	ND(0.024)
PeCDD	ND(0.15)	ND(0.28)	ND(0.28)	ND(0.10)	ND(0.21)	ND(0.28)	ND(0.073)
HxCDD	ND(0.058)	ND(0.10)	ND(0.18)	ND(0.044)	ND(0.91)	ND(0.085)	ND(0.072)
HpCDD	ND(0.10)	ND(0.14)	ND(0.25)	ND(0.034)	ND(0.14)	ND(0.10)	ND(0.10)
OCDD	0.70	0.64	0.72	ND(0.054)	0.80	1.2	ND(0.12)
TCDF	0.45	0.49	0.58	ND(0.082)	0.66	1.2	ND(0.026)
PeCDF	ND(0.23)	ND(0.15)	ND(0.14)	ND(0.16)	ND(0.12)	ND(0.96)	ND(0.036)
HxCDF	ND(0.081)	ND(0.060)	ND(0.019)	ND(0.14)	ND(0.050)	ND(0.050)	ND(0.022)
HpCDF	ND(0.070)	ND(0.10)	ND(0.052)	ND(0.072)	ND(0.22)	ND(0.097)	ND(0.020)
OCDF	ND(0.060)	ND(0.066)	ND(0.067)	ND(0.22)	ND(0.16)	ND(0.066)	ND(0.19)

^a Reported in ppb - analyzed by HRGC/IRMS.

1 0024

TABLE 15. PCDD/PCDF DATA SUMMARY
HIGH RESOLUTION
HGGC

COMPOUND	EPT-B AA5823 ^a	EPT-1 AA5826 ^a	EPT-2 AA5827 ^a	EPT-2Dup AA5827 ^a	EPT-2Spk AA5827 ^a	RB BTk780 ^a	EPT-5 AA6150 ^a
3(1)-TCDF (% acc)	91%	101%	126%	90%	99%	94%	93%
TCDF	ND(0.056)	ND(0.013)	ND(0.031)	ND(0.014)	1.35	ND(0.0051)	ND(0.0080)
PeCDF	ND(0.047)	ND(0.0036)	ND(0.041)	ND(0.0034)	0.017	ND(0.0067)	ND(0.026)
HxCDF	ND(0.040)	ND(0.023)	ND(0.0032)	ND(0.0064)	0.99	ND(0.015)	ND(0.0080)
HpCDF	ND(0.011)	ND(0.0034)	0.0953	ND(0.0052)	0.017	ND(0.0048)	0.018
OxCDF	0.81	ND(0.068)	0.060	0.044	0.75	ND(0.054)	0.075
TCDF	ND(0.12)	ND(0.012)	ND(0.017)	ND(0.024)	1.4	ND(0.0097)	ND(0.018)
PeCDF	ND(0.14)	ND(0.0034)	ND(0.0011)	ND(0.0022)	ND(0.0052)	ND(0.0038)	ND(0.0085)
HxCDF	ND(0.0053)	ND(0.0025)	ND(0.0028)	ND(0.0011)	1.1	ND(0.0014)	ND(0.013)
HpCDF	ND(0.0057)	ND(0.0049)	ND(0.0016)	ND(0.0039)	ND(0.010)	ND(0.0063)	ND(0.0073)
OxCDF	ND(0.0024)	0.0015	ND(0.00049)	ND(0.0022)	0.66	ND(0.0024)	ND(0.0073)

^aReported in ppt - analyzed by HGGC/HHRS.

^bReported in ng/sample - analyzed by HGGC/HHRS.

1 0025

TABLE 15. PCDD/PCDF DATA SUMMARY (Continued)
HIGH RESOLUTION
EPA

CONGENER	ENVI-6 AA6456 ^a	POW A6459 ^a	CW AA6463 ^a	WB-1 AA6469 ^a	WB-1 Dup AA6469D ^a	WB-1 Spike AA6469S ^a	RB B1K796
3TC1-TCDD (% acc)	79%	101%	95%	95%	93%	94%	103%
TCDD	ND(0.019)	ND(0.026)	ND(0.0066)	ND(0.014)	ND(0.010)	1.3	ND(0.016)
PeCDF	ND(0.0056)	ND(0.013)	ND(0.059)	ND(0.052)	ND(0.015)	ND(0.030)	ND(0.021)
HxCDF	ND(0.042)	ND(0.038)	ND(0.023)	ND(0.020)	ND(0.12)	0.90	ND(0.012)
HpCDF	0.087	0.079	0.14	ND(0.016)	0.014	0.013	ND(0.0021)
OCDF	0.78	0.52	0.092	0.071	0.078	0.85	0.066
TCDF	ND(0.045)	ND(0.075)	ND(0.010)	ND(0.012)	ND(0.014)	1.4	ND(0.025)
PeCDF	ND(0.0035)	ND(0.0068)	ND(0.0045)	ND(0.019)	ND(0.0090)	ND(0.016)	ND(0.088)
HxCDF	0.013	ND(0.025)	ND(0.0088)	ND(0.0064)	ND(0.0086)	1.0	ND(0.0031)
HpCDF	ND(0.0080)	ND(0.024)	ND(0.0061)	ND(0.0062)	ND(0.011)	ND(0.026)	ND(0.0078)
OCDF	0.012	0.010	0.036	ND(0.0016)	ND(0.0070)	0.76	ND(0.0026)

^aReported in ppt - analyzed by HIGC/HHMS.

^bReported in ng/sample - analyzed by HIGC/HHMS.

1 0026

TABLE 15. PCDD/PCDF DATA SUMMARY (Continued)

HIGH RESOLUTION
HIGG

CONGENER	AD-1 AA5883 ^a	AD-2 AA5884 ^a	AD-3 AA5885 ^a	AD-5 AA6411 ^a	AD-6 AA6409 ^a	BS-1 AA6414 ^a	AD-5 Dup AA6411D ^a
3(2,1-TCDD (% acc))	89%	96%	94%	107%	105%	98%	99%
TCDD	ND(0.48)	ND(1.5)	ND(0.89)	ND(2.2)	ND(2.5)	ND(0.59)	ND(2.5)
PeCDF	ND(1.8)	ND(2.9)	ND(0.28)	ND(0.35)	ND(1.5)	ND(0.62)	ND(0.26)
HxCDF	ND(5.4)	ND(1.4)	ND(2.2)	ND(0.14)	ND(0.76)	ND(1.6)	ND(1.4)
HpCDF	ND(0.45)	0.39	ND(1.7)	0.58	0.92	0.70	0.68
OCDF	2.4	4.37	19.3	22.7	11.6	6.6	5.5
TCDF	ND(0.85)	12.9	16.0	6.7	10.8	ND(0.97)	7.6
PeCDF	ND(0.18)	ND(0.69)	ND(1.29)	ND(0.48)	ND(0.89)	ND(0.042)	ND(1.6)
HxCDF	ND(0.31)	ND(0.57)	ND(0.68)	ND(0.65)	ND(0.53)	ND(0.50)	ND(0.62)
HpCDF	ND(1.1)	ND(0.62)	ND(0.50)	0.65	ND(1.9)	ND(0.37)	ND(0.53)
OCDF	ND(0.24)	ND(0.12)	ND(0.27)	ND(0.28)	ND(0.23)	ND(0.12)	ND(0.34)

^a Reported in ppt - analyzed by HIGG/HRES.

^b Reported in ng/sample - analyzed by HIGG/HRES.

1 0027

TABLE 15. PCDD/PCDF DATA SUMMARY (Continued)
HIGH RESOLUTION
HRGC

CONGENER	AD-5 Spk AA64115 ^a	RB B1K802 ^a	VB-1 Comp. AA5844 ^b	VB-2 Comp. AA5845 ^b	VB-3 Comp. AA5846 ^b	VB-5 Comp. AA6512 ^b	VB-6 Comp. AA6513 ^b
³⁷ Cl-TCDD (% acc)	103%	84%	100%	113%	97%	97%	101%
TCDD	51.6	ND(0.82)	ND(0.21)	ND(0.13)	ND(0.03)	ND(0.020)	ND(0.22)
PeCDD	ND(1.2)	ND(4.6)	ND(0.22)	ND(0.051)	ND(0.46)	ND(0.25)	ND(0.17)
HxCDD	31.9	ND(0.035)	ND(0.16)	ND(0.033)	ND(0.10)	ND(0.028)	ND(0.020)
HpCDD	0.55	ND(0.35)	0.11	ND(0.13)	ND(0.095)	0.17	0.12
OCDD	29.2	3.0	0.85	0.82	ND(0.81)	0.66	1.1
TCDF	46.8	ND(0.93)	ND(0.24)	ND(0.13)	1.5	ND(0.48)	5.4
PeCDF	ND(2.2)	ND(0.12)	ND(0.027)	ND(0.039)	ND(0.0060)	ND(0.11)	ND(0.15)
HxCDF	38.9	ND(0.20)	ND(0.050)	ND(0.034)	ND(0.36)	ND(0.080)	ND(0.069)
HpCDF	ND(0.52)	ND(0.32)	ND(0.091)	ND(0.11)	ND(0.26)	ND(0.16)	ND(0.11)
OCDF	27.9	ND(0.051)	0.027	ND(0.047)	ND(0.51)	ND(0.054)	0.39

^aReported in ppt - analyzed by HRGC/HRMS.

^bReported in ng/sample - analyzed by HRGC/HRMS.

1 0028

TABLE 15. PCDD/PCDF DATA SUMMARY (Continued)
HIGH RESOLUTION
HRC

CONGENER	XAD-BLK A6487 ^b	RB B1K791 ^b
³⁷ Cl-TCDD (% acc)	99%	98%
TCDD	ND(0.16)	ND(0.27)
PeCDD	ND(0.19)	ND(1.0)
HxCDD	ND(0.13)	ND(0.13)
HpCDD	ND(0.16)	ND(0.075)
OxCDD	0.89	0.61
TCDF	0.14	ND(0.018)
PeCDF	ND(0.050)	ND(0.064)
HxCDF	ND(0.10)	ND(0.025)
HpCDF	ND(0.060)	ND(0.051)
OCDF	ND(0.029)	0.060

^a Reported in ppt - analyzed by HRGC/HRMS.

^b Reported in ng/sample - analyzed by HRGC/HRMS.

1 G029

TABLE 1b. QA/QC REPORT

LIMS
EG&G

Surrogate Percent Accuracy	37Cl-PCDE	13C-PCDD	13C-PCDF	13C-HpCDD	13C-OCDD
Number of Data Points =	7	7	7	7	7
Mean Percent Accuracy =	100.0%	96.3%	125%	93.7%	89.4%
Range =	88-116%	52-133%	93-166% ^a	54-130%	61-120%
EPA Range =	60-140%	40-160%	40-160%	40-160%	40-160%

^aOne Sample (PS-6) was outside the IT QA/QC limit. These limits are established by IT and are not EPA ranges.

TABLE 17. QA/QC REPORT (HEMS)
EG&G

1 0031

Surrogate Percent Accuracy 37Cl-TCDD
 Number of Data Points = 30
 Mean Percent Accuracy = 97.8%
 Range = 79-126%
 EPA Range = 60-140%

Sample ID [ENT 2]

Precision of Duplicates HxCDD OCDD
 Original Value (b) = 0.0053 0.060
 Duplicate Value (a) = 0.0052 0.044
 Precision = $\frac{a-b}{a+b} \times 100\% =$ 1.9% 30.8%
 EPA Range = $\pm 50\%$

Accuracy of Spike TCDD HxCDD OCDD TCDF HxCDF OCDF
 Original Value (a) = ND ND 0.060 ND ND ND
 Spike Value (b) = 1.35 0.99 0.75 1.40 1.1 0.66
 Spike Level (c) = 1.0 1.0 1.0 1.0 1.0 1.0
 Accuracy = $\frac{b}{a+c} \times 100\% =$ 135% 99% 70.8% 140% 110% 65%
 EPA Range = 60-140%

Sample ID [WB1]^a

Precision of Duplicates OCDD
 Original Value (b) = 0.071
 Duplicate Value (a) = 0.078
 Precision $\frac{a-b}{a+b} \times 100\% =$ 9.3%
 EPA Range = $\pm 50\%$

Accuracy of Spike TCDD HxCDD OCDD TCDF HxCDF OCDF
 Original Value (a) = ND ND 0.071 ND ND ND
 Spike Value (b) = 1.3 0.90 0.85 1.4 1.0 0.76
 Spike Level (c) = 1.0 1.0 1.0 1.0 1.0 1.0
 Accuracy = $\frac{b}{a+c} \times 100\% =$ 130% 90% 79% 140% 100% 76%
 EPA Range. 60-140%
 770

TABLE 17. QA/QC REPORT (HEMS) (Continued)

EG&G

Sample ID [AD-5]^b

Precision of Duplicates	<u>HpCDD</u>	<u>OCDD</u>	<u>TCDF</u>
Original Value (b) =	0.58	22.7	6.7
Duplicate Value (a) =	0.68	5.5	7.6
Precision = $\frac{a-b}{\frac{a+b}{2}} \times 100\%$ =	15.9%	122% ^c	12.6%

EPA Range = $\pm 50\%$

Accuracy of Spike	<u>TCDD</u>	<u>HxCDD</u>	<u>OCDD</u>	<u>TCDF</u>	<u>HxCDF</u>	<u>OCE</u>
Original Value (a) =	ND	ND	22.7	6.7	ND	ND
Spike Value (b) =	51.6	31.9	29.2	46.8	38.9	7.
Spike Level (c) =	40.0	40.0	40.0	40.0	40.0	40.
Accuracy = $\frac{b-c}{a} \times 100\%$ =	129%	80%	47%	100%	97%	69%

EPA Range = 60-140%

OCDD found in duplicate and spike below the "ND" level found in original.

TCDF found in original at a level near the "ND" levels found in the duplicate and spike.

OCDD was found in some of our laboratory blanks. This contamination may be the cause of the low level of precision on this sample.

(The reverse of this page is blank.)