

Brasiltec

www.BRASILTEC.ind.br

High performance general purpose AC drive user manual

Safety Precautions



Warning

“ Warning ” Indicates that if you do not follow the regulations, it may result in death or serious bodily injury



Danger

“ Danger ” Indicates that if you do not follow the regulations, it will result in death or serious bodily injury

Security statement

- 1) When installing, operating, and maintaining the product, please read and follow these safety precautions first.
- 2) In order to ensure the safety of people and equipment, please follow all safety precautions described on the product and in the manual when installing, operating and maintaining the product.
- 3) The "Caution", "Warning" and "Danger" items in the manual do not represent all the safety items that should be followed, but only as a supplement to all the safety precautions.
- 4) This product should be used in an environment that meets the design specifications, otherwise it may cause malfunctions, and malfunctions or component damage caused by non-compliance with relevant regulations are not within the scope of product quality assurance.
- 5) Our company will not bear any legal responsibility for personal safety accidents and property losses caused by illegal operation of the product.

1. Purpose



Danger

This series is suitable for controlling the variable speed operation of three-phase AC motors, and cannot be used for single-phase motors or other purposes, otherwise it may cause inverter failure or fire.

This series of inverters cannot be simply applied to occasions directly related to personal safety, such as medical devices.

2. Goods Inspection

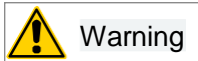

Warning

When unpacking, it is found that the product and its accessories are damaged, rusted, signs of use, etc., please do not install!

When unpacking, if water is found inside the product, parts missing, or parts damaged, please don't install it!

Please check the packing list, if you find that the packing list does not match the product name, please do not install it!

3. Safe operation



Warning

It is strictly forbidden for non-professionals to install, connect, maintain, inspect or replace parts of the product!

The installation, wiring, maintenance, inspection or component replacement of this product can only be carried out by professionals who have received relevant training in electrical equipment and have sufficient electrical knowledge.

The installer must be familiar with the product installation requirements and related technical information.

When it is necessary to install equipment with strong electromagnetic interference such as a transformer, please install a shielding protection device to avoid malfunction of this product!

4. Operation and maintenance



Danger

When the function of automatic fault reset or restart after power failure is set, safety isolation measures should be taken for the mechanical equipment, otherwise it may cause equipment damage and personal safety accidents.

After the inverter is connected to the power supply, even if it is in the stop state, the terminals of the inverter are still live and cannot be touched, otherwise there is a danger of electric shock.

In the occasions where there is power frequency and variable frequency switching, the two contactors that control the power frequency and variable frequency should be interlocked, otherwise the inverter will be damaged.

Wait at least 5 minutes after power off to ensure that the electrolytic capacitor of the main circuit is fully released, otherwise there is a danger of electric shock.

Product Information

1. Inverter checking

Before leaving the factory, each inverter has undergone strict quality control and strengthened anti-collision packaging. After unpacking, please check the following items:

- Check whether the inverter has been damaged during transportation
- Check whether there are instructions in the packing box (with certificate of conformity attached)
- Check the nameplate of the inverter and confirm that it is the model of the product you ordered
- If you have ordered the optional accessories of the inverter, please check to confirm

1-1 Specification model, technical specification

Functions	Description	
Highest frequency	Vector control: 0 ~ 300Hz V/F control: 0 ~ 500Hz (general purpose); 0 ~ 3200Hz (high frequency)	
Carrier frequency	0.5kHz ~ 16kHz The carrier frequency can be automatically adjusted according to the load characteristics.	
Input frequency resolution	Digital setting: 0.01Hz Analog setting: highest frequency●0.025%	
control method	Open loop vector control (SVC) Closed loop vector control (FVC) V/F control	
Starting torque	0.5Hz/150% (SVC); 0Hz/180% (FVC)	
Speed range	1:100 (SVC) 1:1000 (FVC)	1:100 (SVC) 1:1000 (FVC)
Stable speed accuracy	±0.5% (SVC) ±0.02% (FVC)	±0.5% (SVC) ±0.02% (FVC)
Torque control accuracy	±5% (FVC)	
Overload capacity	G type machine: 150% rated current 60s; 180% rated current 3s.	
Torque boost	P type machine: 120% rated current 60s; 150% rated current 3s.	
V/F curve	Automatic torque boost; manual torque boost 0.1%~30.0%	
V/F separation	Three methods: linear type; multi-point type; N-th power V/F curve	
Acceleration and deceleration curve	Linear or S-curve acceleration and deceleration mode. Four kinds of acceleration and deceleration time 0.0~6500.0s	
DC braking	DC braking frequency: 0.00Hz~maximum frequency braking time: 0.0s~36.0s	
Jog control	Braking current value: 0.0%~100.0%	
PLC, multi-speed operation	Jog frequency range: 0.00Hz ~ 50.00Hz. Jog acceleration/deceleration time is 0.0s ~ 6500.0s.	
Built-in PID	Through the built-in simple PLC or control terminal to achieve up to 16-speed operation	
Automatic voltage adjustment (AVR)	It is convenient to realize the process control closed-loop control system	
Over voltage and over current stall speed control	When the grid voltage changes, it can automatically keep the output voltage constant	
Fast current limiting function	Minimize over-current faults to protect the normal operation of the inverter	
Torque limit and control	The "shovel" feature automatically limits the torque during operation to prevent frequent over-current trips; closed-loop vector mode can realize torque control	
Functions	Description	

Mainly functions	Outstanding performance	Realize asynchronous motor and synchronous motor control with high-performance current vector control technology
	Stop momentarily	When instantaneous power failure occurs, the load feedback energy is used to compensate for the voltage drop, and maintain the inverter to continue running for a short period of time
	Fast current limit	Avoid frequent over-current faults of the inverter
	Virtual IO	Five groups of virtual input and output can realize simple logic control
	Timing control	Timing control function: set time range 0.0Min~6500.0Min
	Multi-motor switching	Two sets of motor parameters can realize switching control of two motors
	Multi-threaded bus support	Support a variety of field buses: R S-4 8 5, C A N I n k, CANopen, etc.
	Motor overheat protection	Extended analog input A I 3 Motor temperature sensor input PT100, PT1000

	Multi-encoder support	Support differential, open collector, UVW, resolver, sine and cosine encoders
	Command source	Operation panel setting, control terminal setting, communication setting and there are many ways to switch
	Frequency source	10 kinds of frequency sources: digital setting, analog voltage setting, analog current setting, pulse setting, serial port setting. Can be switched in a variety of ways
Running	Auxiliary frequency source	10 kinds of auxiliary frequency sources. Flexible realization of auxiliary frequency fine-tuning and frequency synthesis
	Input terminal	standard: 6 digital input terminals, one of which supports high-speed pulse input up to 100kHz 2 analog input terminals, 1 only supports 0~10V voltage input, 1 supports 0~10V voltage input or 4~20mA current input Expansion: 3 digital input terminals 1 analog input terminal, support -10~10V voltage input (PT100\PT1000)
	Output terminal	standard: 1 high-speed pulse output terminal (open-collector type is optional), supports 0~100kHz square wave signal output 1 digital output terminal 1 relay output terminal 1 analog output terminal, support 0~20mA current output or 0~10V voltage output Expansion: 1 digital output terminal 1 relay output terminal 1 analog output terminal, support 0~20mA current output or 0~10V voltage output
Key and display	LED display	Display parameters, status information, fault information, etc.
	Key lock and function selection	Realize partial or full lock of keys, define the range of some keys
	Protective function	Power-on motor short circuit detection, input and output phase loss protection, overcurrent protection, overvoltage protection, undervoltage protection, overheat protection, overload protection, etc.
Environment	Use place	Indoor, not exposed to direct sunlight, free of dust, corrosive gas, flammable gas, oil mist, water vapor, dripping water or salt, etc., the altitude is less than 1000m
	Ambient temperature	-10℃~+50℃ (Ambient temperature is 40℃~50℃, please use with derating)
	Humidity vibration	Humidity is less than 95%RH, no condensation, vibration is less than 5.9m/s ² (0.6g)
	storage temperature	-20℃~+60℃

2.1,Schematic diagram of main circuit terminals

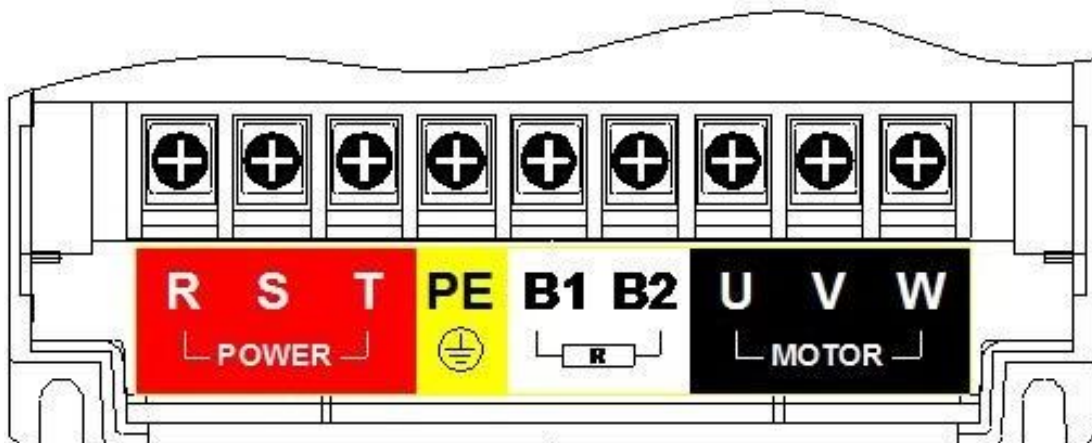

2.2 Main circuit power input terminal

Terminal	Terminal Name			Terminal function description
	22KW and below	30-37KW	45KW and above	
R S T	Main circuit power input terminal			AC 380V 3 phase input terminal
L N				AC 220V 1 phase input terminal
U V W	Inverter output terminal			Connect with 3 phase AC motor
P	no this terminal	no this terminal	DC reactor terminal 1	B1,B2 connect with braking resistor terminal,(+),(-) connect with braking unit terminal,P,(+) connect with DC reactor,need to remove the Short link between P and (+)when do connection
(+) or B1	Braking resistor terminal 1	/	DC reactor terminal 2	
		Braking Unit terminal 1		
(-)	no this terminal	Braking Unit terminal 2		
B2	Braking resistor terminal 2	no this terminal		
PE	Ground Terminal			make sure terminal do ground

2.3 Control circuit power input terminal

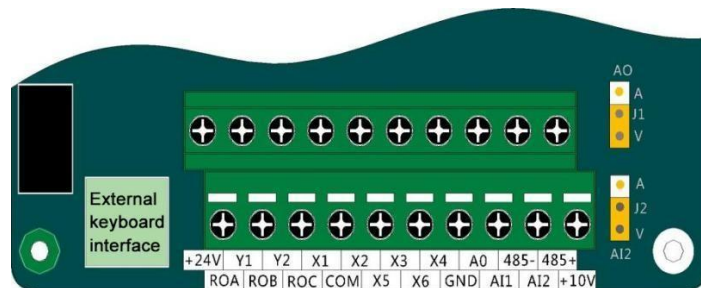

Type	Terminal	Terminal Name	Description and default
Multi-input terminal	X1	Multi-function input terminal 1	Default: forward
	X2	Multi-function input terminal 2	Default: reverse
	X3	Multi-function input terminal 3	Default: No function
	X4	Multi-function input terminal 4	Default: No function
	X5	Multi-function input terminal 5	Default: No function
	X6	Multi-function input terminal 6	Default: No function, can be used as high-speed pulse input
	COM	Common terminal	Multi-function input common terminal, +24V power reference ground
Analog input	AI1	Analog input 1	0~10V input
	AI2	Analog input 2	0~10V/0~20mA input (J2 jumper is optional)
	+10V	Power supply for analog quantity setting	+10V DC 10mA (potentiometer 3~5K)
	GND	Analog reference ground	Analog input and output reference ground
Multi-function output	Y1	Multi-function output terminal 1	Default: running status
	Y2	Multi-function output terminal 2	Default: no output, can be used as high-speed pulse output
	ROA	Relay output	Default: inverter fault output
	ROB	ROA-ROB normally closed	
ROC	ROA-ROC normally open		
Analog output	AO		0~10V/0~20mA output (J1 jumper is optional)
Input	+24V		GND is the reference ground
Communication	485+	Analog output terminal	+24V DC 100mA COM is the power ground.
	485-	+24V power supply	

3. Standard wiring

Single phase 220V
inverter input connect with
L N

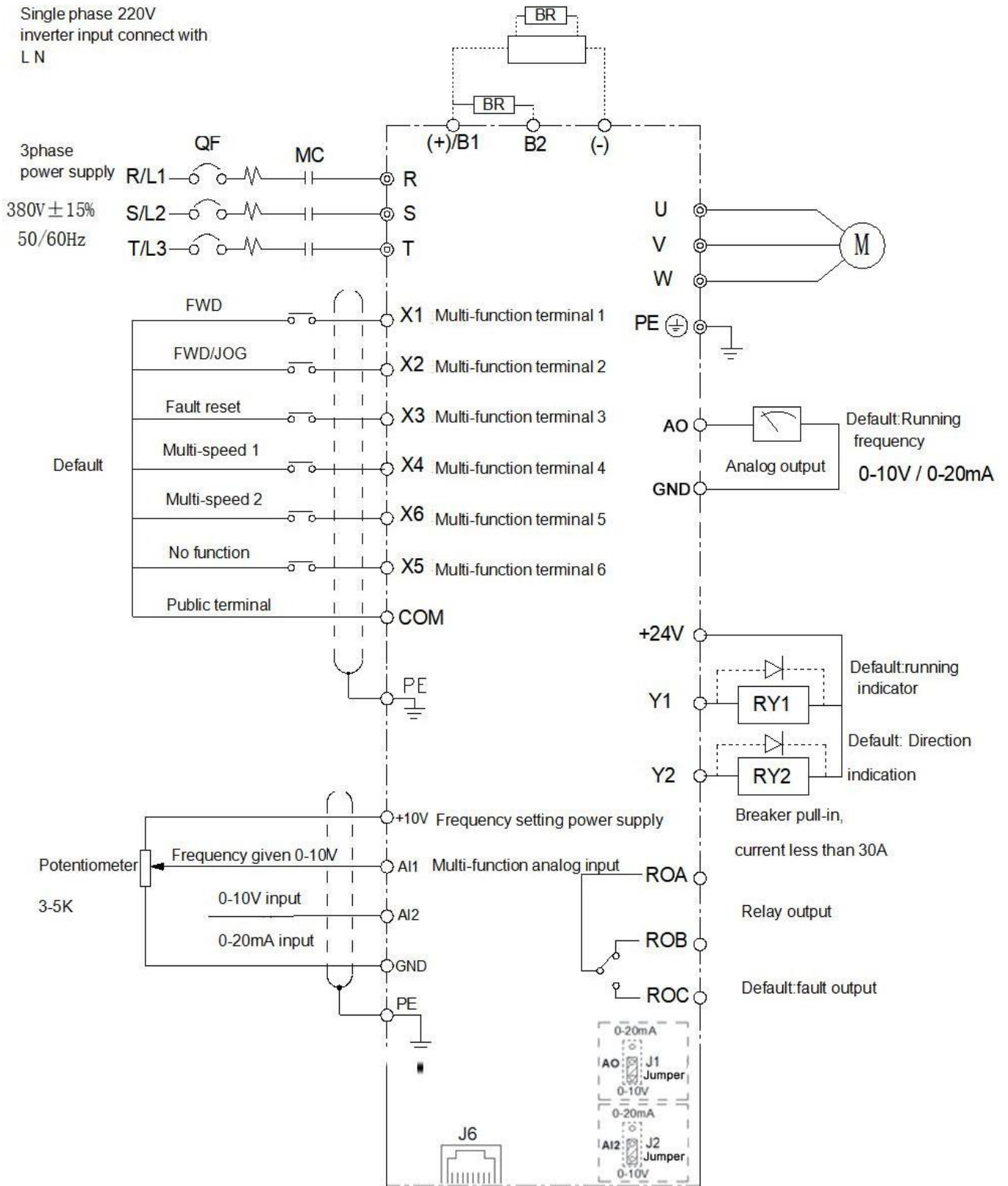

4. Basic operation and trial run

4.1 Keypad description

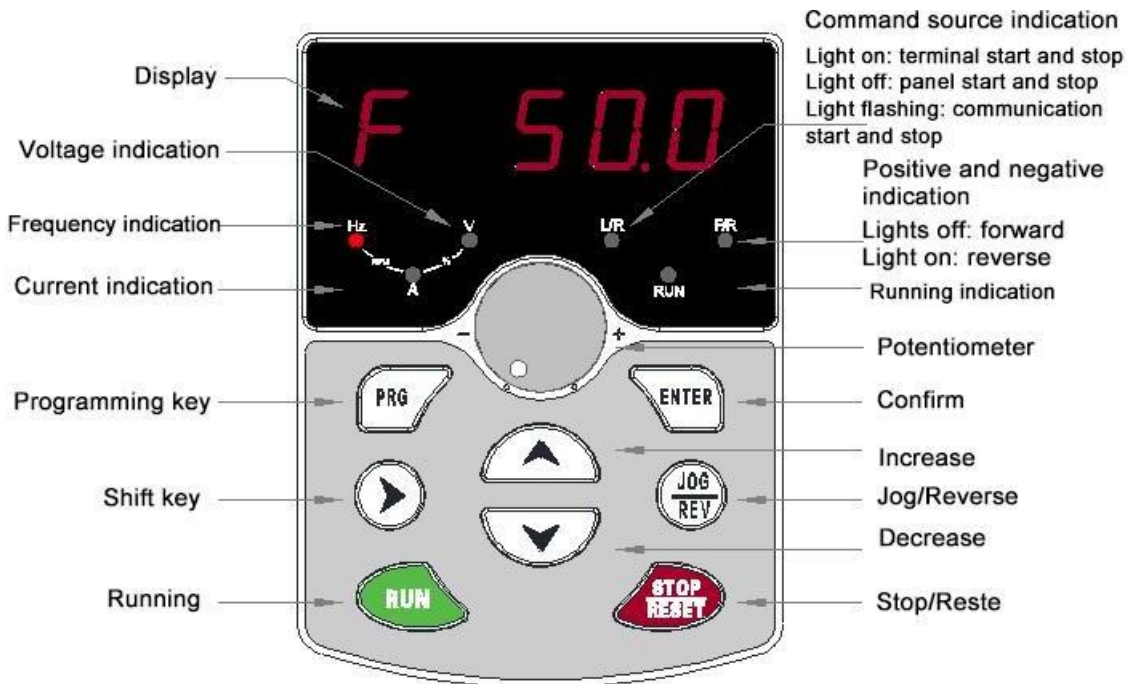

4.2 Keypad indicator light description

Indicator status		Status Description
RUN		Light off: stop
		Light on: Running
L/R		Light off:Keypad control
		Light on:Terminal control
		Flashing:Communication control
F/R		Light off:Forward running
		Light on:Reverse
 Unit indicator		Light on:shows frequency
		Light on:shows current
		Light on:shows voltage
		Hz/A light on:show motor running RPM
		A/V light on:shows percentage

a) 1. Keyboard instructions

Button function description

Button	Name	Function
PRG	Programming key	Enter or exit the first level menu.
ENTER	Enter	Enter the menu screen step by step and confirm the setting parameters.
▲	Increment key	Increment of data or function code.
▼	Decrement key	Decrement of data or function codes.
➤	Shift key	In the stop display interface and the running display interface, the display parameters can be selected cyclically; when modifying the parameters, the modification position of the parameters can be selected.
RUN	Run key	In keyboard operation mode, it is used for running operation.
STOP/RESET	Stop/reset	In the running state, pressing this key can be used to stop the running operation; in the fault alarm state, it can be used to reset the operation; the characteristics of this key are restricted by the function code P7-02.
JOG/REV	Multi-function selection key	According to P7-01 for function switching selection, it can quickly switch the command source and direction.

b) Function code modification instructions

The operation panel of the inverter adopts a three-level menu structure for parameter setting and other operations. The three-level menus are: function parameter group (first-level menu) → function code (second-level menu) → function code setting value (third-level menu). The operation flow is shown in the figure below.

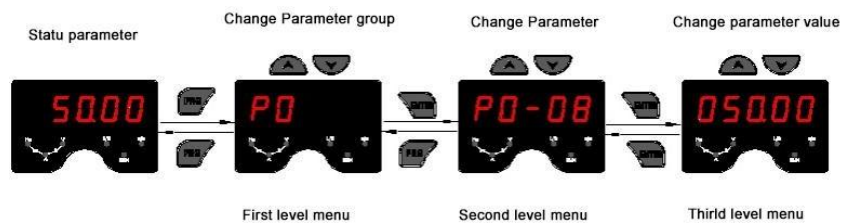

Note: When operating in the third-level menu, you can press PRG or ENTER to return to the second-level menu. The difference between the two is: press the ENTER key to save the set parameters and return to the secondary menu and automatically transfer to the next function code; while pressing the PRG key will directly return to the secondary menu without storing the parameters, and return to the current function code .

Example: An example of changing the function code P3-02 from 10.00Hz to 15.00Hz. (Black characters indicate flashing bits)

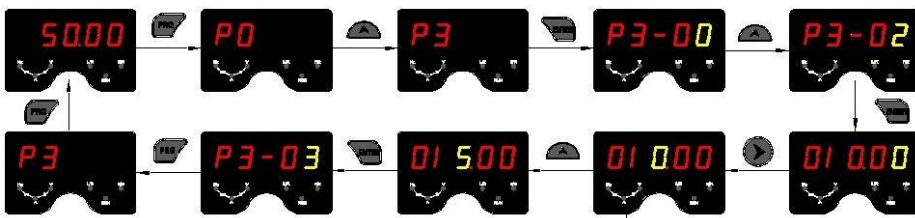

In the third level menu, if the parameter has no flashing bit, it means that the function code cannot be modified. The possible reasons are:

- 1) This function code is an unmodifiable parameter. Such as actual test parameters, running record parameters, etc.
- 2) This function code cannot be modified in the running state, and can be modified only after stopping.

Function parameter

PP-00 is set to a non-zero value, that is, the parameter protection password is set. The parameter menu must be entered after the password is entered correctly. To cancel the password, set PP-00 to 0.

“☆”: Indicates that this parameter can be changed while the inverter is running or stopped.

“★”: Indicates that this parameter cannot be changed while the inverter is running.

“●”: Indicates that this parameter is only the actual detected record value and cannot be changed.

5-1 Basic function parameter

P0 Basic function parameter				
Function code	Parameter Name	Setting Range	Default	Property
P0-00	GP type	1: G (Constant torque load model) 2: P (Fan, pump type load model)	1	★
P0-01	Speed control mode selection	0: Speed sensorless vector control (SVC) 1 : Speed sensor vector control (FVC) 2: V/F control	2	★
P0-02	Run command source selection	0: Operation panel command channel (LED close) 1: Terminal command channel (LED open) 2: Communication command channel (LED Flashing)	0	☆
P0-03	Main frequency source X selection	0: Digital setting (UP/DOWN) non-record at power failure 1: Digital setting (UP/DOWN) record at power failure 2: AI1 3: AI2 4: panel potentiometer 5: Pulse setting (X6) 6: Multi-segment instruction 7: Simple PLC 8: PID 9: Communication given	1	★
P0-04	Auxiliary frequency source Y selection	Same as P0-03 (main frequency source X selection)	0	★
P0-05	Frequency offset of auxiliary frequency source for X operation	0: relative to the maximum frequency 1: relative to the frequency source X	0	☆
P0-06	Frequency offset of auxiliary frequency source for Y operation	0%~150%	100%	☆
P0-07	Frequency source overlay selection	Unit position: frequency source selection 0: main frequency source X 1: primary and secondary operations (the operation relationship is determined by ten bits) 2: Main frequency source X and auxiliary frequency source Y are switched 3: Main frequency source X and main and auxiliary operation result switching 4: Auxiliary frequency source Y and main and auxiliary operation result switching Ten digits: frequency source primary and secondary operation relationship 0: main + auxiliary 1: main - auxiliary 2: the maximum of the two 3: the minimum of the two	00	☆
P0-08	Preset frequency	0.00Hz~Maximum frequency (P0-10)	50.00Hz	☆
P0-09	Running direction	0: Consistent direction 1: Opposite direction	0	☆
P0-10	Maximum frequency	50.00Hz~600.00Hz	50.00Hz	★
P0-11	Upper frequency source	0: Set by P0-12 1: AI1 2: AI2 3: AI3 4: Pulse setting 5: Communication given	0	★
P0-12	Source of frequency upper limit	Lower limit frequency P0-14~Maximum frequency P0-10	50.00Hz	☆
P0-13	Frequency upper limit offset	0.00Hz~Maximum frequency P0-10	0.00Hz	☆
P0-14	Frequency lower limit	0.00Hz~Upper limit frequency P0-12	0.00Hz	☆
P0-15	Carrier frequency	0.5kHz~16.0kHz	depending	☆
P0-16	Carrier frequency is adjusted with temperature	0: no 1: yes	0	☆
P0-17	acceleration time 1	0.00s~65000s	depending	☆
P0-18	deceleration time 1	0.00s~65000s	depending	☆

P0-19	Acceleration/deceleration unit	0: 1S 1: 0.1S 2: 0.01S	1	★
P0-21	Frequency offset of auxiliary frequency source for X and Y operation	0.00Hz~Maximum frequency P0-10	0.00Hz	☆
P0-22	Frequency command resolution	1: 0.1Hz 2: 0.01Hz	2	★
P0-23	Digital setting frequency shutdown memory selection	0: non-record 1: record	1	☆
P0-24	Motor parameter group selection	0: motor parameter1 1: motor parameter 2	0	★
P0-25	Acceleration/deceleration time reference frequency	0: Maximum frequency (P0-10) 1: Setting frequency 2: 100Hz	0	★
P0-26	Runtime frequency command UP/DOWN benchmark	0: running frequency 1: setting frequency	0	★
P0-27	Command source bundle frequency source	Single digit: operation panel command binding frequency source selection 0: No binding 1: Digital setting frequency 2: AI1 3: AI2 4: AI3 5: Pulse X6 6: Multi-speed 7: Simple PLC 8: PID 9: Communication given Tens place: terminal command binding frequency source selection Hundreds place: communication command binding frequency source selection Thousands: automatic operation binding frequency source selection	0000	☆

P1 motor parameter

Function code	Parameter Name	Setting Range	Default	Property
P1-00	Motor type selection	0: Ordinary asynchronous motor 1: Variable frequency asynchronous motor	0	★
P1-01	Motor rated power	0.1kW~1000.0kW	depending	★
P1-02	Motor rated voltage	1V~2000V	depending	★
P1-03	Motor rated current	0.1A~6553.5A	depending	★
P1-04	Motor rated frequency	0.01Hz~Maximum frequency	depending	★
P1-05	Motor rated speed	1rpm~65535rpm	depending	★
P1-06	Asynchronous motor stator resistance	0.001Ω~65.535Ω	auto tuning	★
P1-07	Synchronous motor stator resistance	0.001Ω~65.535Ω	auto tuning	★
P1-08	Leakage inductive reactance(asynchronous motor)	0.01mH~655.35mH	auto tuning	★
P1-09	Mutual inductive reactance(asynchronous motor)	0.1mH~6553.5mH	auto tuning	★
P1-10	No-load current (asynchronous motor)	0.01A~P1-03	auto tuning	★
P1-27	Encoder line number	1~65535	1024	★
P1-28	Encoder type	0: ABZ Incremental encoder 1: UVW Incremental encoder 2: Resolver	0	★
P1-30	A/B phase sequence of ABZ incremental encoder	0: forward 1:reserve		
P1-31	Encoder mounting angle	0.0 ~ 359.9°	0	★
P1-32	UVW incremental encoder	0: forward 1:reserve	0.0°	☆
P1-33	UVW Encoder offset angle	0.0 ~ 359.9°	0	★
P1-34	Rotary transformer pole pair	1~65535	1	★
P1-36	Speed feedback PG disconnection detection time	0.0: no act 0.1s~10.0s	0.0s	★
P1-37	Tuning selection	0:no act 1: Static tuning 2: Complete tuning 3: Static full tuning	0	★

Group P2 Motor vector control parameter

Motor code	Parameter Name	Setting Range	Default	Property
------------	----------------	---------------	---------	----------

P2-00	Speed loop proportional gain 1	1~100	30	☆
P2-01	Speed loop integration time 1	0.01s~10.00s	0.50s	☆
P2-02	Switching frequency 1	0.00~P2-05	5.00Hz	☆
P2-03	Speed loop proportional gain 2	1~100	20	☆
P2-04	Speed loop integration time 2	0.01s~10.00s	1.00s	☆
P2-05	Switching frequency 2	P2-02~Maximum frequency	10.00Hz	☆
P2-06	Vector control slip gain	50%~200%	100%	☆
P2-07	Speed loop filter time constant	0.000s~0.100s	0.055s	☆
P2-08	Vector controlled overexcitation gain	0~200	64	☆
P2-09	Torque upper limit source in speed control mode	0: function code P2-10 set 1: AI1 2: AI2 3: AI3 4: Pulse setting 5: Communication given6: MIN (AI1,AI2) 7: MAX (AI1,AI2) 1-7 option correspond to P2-10	0	☆
P2-10	Torque upper limit in speed control mode	0.0%~200.0%	160.0%	☆
P2-13	Excitation adjustment proportional gain	0~60000	2000	☆
P2-14	Excitation regulation integral gain	0~60000	1300	☆
P2-15	Torque adjustment proportional gain	0~60000	2000	☆
P2-16	Torque adjustment integral gain	0~60000	1300	☆
P2-17	Speed loop integral separation	0: Invalid 1: Valid	0	☆
P2-20	Maximum output voltage coefficient	100%~110%	105%	★
P2-21	Weak magnetic zone maximum torque factor	50%~200%	100%	☆
P3 Group V/FControl parameters				
Function code	Parameter Name	Setting Range	Default	Property
P3-00	VF Curve setting	0: Linear V/F 1 : V/F 2: Square V/F 3: 1.2-power V/F4: 1.4-power V/F6: 1.6-power 8: 1.8-power V/F9: Reserved 10: V/F complete separation 11: V/F half separation	0	★
P3-01	Torque boost	0.0% (Auto) 0.1%~30.0%	Model dependent	☆
P3-02	Torque boost cutoff frequency	0.00Hz~Maximum frequency	50.00Hz	★
P3-03	Multi-point VF frequency point 1	0.00Hz~P3-05	0.00Hz	★
P3-04	Multi-pointVF voltage 1	0.0%~100.0%	0.0%	★
P3-05	Multi-pointVF frequency 2	P3-03~P3-07	0.00Hz	★
P3-06	Multi-pointVF voltage 2	0.0%~100.0%	0.0%	★
P3-07	Multi-pointVF frequency3	P3-05~Motor rated frequency (P1-04)	0.00Hz	★
P3-08	Multi-pointVF voltage 3	0.0%~100.0%	0.0%	★
P3-09	VF Slip compensation gain	0.0%~200.0%	0.0%	☆
P3-10	VF Overexcitation gain	0~200	120	☆
P3-11	VF Oscillation suppression gain	0~100	40	☆
P3-12	Oscillation suppression mode selection	0~4	3	★
P3-13	Voltage source for V/F separation	0: Digital setting(d3-12) 1: AI1 2: AI2 3: AI3 4: Pulse setting(HDI) 5: Multi-function 6: Simple PLC 7: PID 8: Communication setting Note:100.0% corresponds to the rated motor voltage	0	☆

P3-14	Voltage digital setting for V/F separation	0 V ~ rated motor voltage	0V	☆
P3-15	Voltage rise time of V/F separation	0.0s~1000.0s	0.0s	☆
P3-16	V/F Separate voltage deceleration time	0.0s ~ 1000.0s note: Indicates the time from 0V changes to the rated voltage of the motor	0.0s	☆
P3-17	V/F Separate shutdown mode selection	0: frequency / voltage is independently reduced to 0 1: After the voltage is reduced to 0, the frequency is reduced again.	0	☆
P3-18	Overcurrent stall operating current	50~200%	150%	★
P3-19	Over-current suppression	0 Invalid、1 Valid	1	★
P3-20	Over current stall gain	0~100	20	☆
P3-21	Double speed overrun speed action current compensation coefficient	50~200%	50%	★
P3-22	Overvoltage stall operating voltage	200.0V~2000.0V	Model dependent 220V: 380V 380V: 760V 480V: 850V 690V: 1250V 1140V: 1900V	★
P3-23	Overvoltage stall enable	0 Invalid、1 Valid	1	★
P3-24	Overvoltage stall suppression frequency gain	0~100	30	☆
P3-25	Overvoltage stall suppression voltage gain	0~100	30	☆
P3-26	Overvoltage stall maximum rising frequency limit	0~50Hz	5Hz	★
P3-27	Slip compensation time constant	0.1~10.0s	0.5	☆
P3-34	Water supply mode selection	0: Turn off the water supply mode 1: Turn on the water supply mode	0	★
P3-35	Pressure gauge range	Range: 0.00~5.00Mpa Set according to the actual pressure gauge range	1.00MPa	☆
P3-36	Target pressure	Range: 0.00~P3-35 target pressure value (Mpa)	0.50MPa	☆
P3-37	Sleep frequency	Range: 0.00~upper limit frequency P0-10	25.00HZ	☆
P3-38	Sleep delay	Range: 0.0~3600.0s	0.0S	☆
P3-39	Percentage of wake-up stress	When the feedback pressure is greater than the target pressure and the operating frequency is less than P3-38 sleep delay, it will enter the sleep state	80.00%	☆
P3-40	Wake-up delay	Range: 0.0~100%, percentage of target pressure P3-36	0.0s	☆

Group P4 Input terminal

function code	Parameter Name	Setting Range	Default	Property
P4-00	X1 Terminal function selection	0: No function	1	★
P4-01	X2 Terminal function selection	1: Forward running	2	★
P4-02	X3 Terminal function selection	2: Reverse running	0	★
P4-03	X4 Terminal function selection	3: Three-line running	0	★
P4-04	X6 Terminal function selection	4: Forward turning	0	★
P4-05	X5 Terminal function selection	5: Reverse jog	0	★
P4-06	X7 Terminal function selection	6: Terminal UP	0	★
P4-07	X8 Terminal function selection	7: Terminal DOWN	0	★
		8: Free stop	0	★
		9: Fault reset	0	★
		10: Run pause	0	★
P4-08	X9 Terminal function selection	11: External fault normally open input		
		12: Multi-speed 1		
		13: Multi-speed 2		
		14: Multi-speed 3		
		15: Multi-speed 4		
		16: Acceleration/deceleration time selection 1		
		17: Acceleration/deceleration time selection 2 18: Frequency source switching		
		19: Keyboard UP/DOWN setting is cleared (terminal/keyboard)	0	★
		20: Run command switch		
		21: Acceleration/deceleration prohibition		
		22: PID pause		
		23: PLC reset		
		24: swing frequency pause		
		25: counter input		
		26: Counter reset		
		27: Length count input		
		28: Length reset		
		29: Torque control prohibited		

		30: Pulse frequency input 32: Immediate DC braking 33: External fault normally closed input 34: If this terminal is valid, frequency modification is allowed; if the terminal status is invalid, frequency modification is prohibited. 35: PID action direction is reversed 36: External parking terminal 1 37: Control command switch 2 38: PID integration pause 39: Frequency source X and preset frequency switching 40: Frequency source Y and preset frequency switching 43: PID parameter switching 44: User-defined fault 1 45: User-defined fault 2 46: Speed/torque control switching 47: Emergency stop 48: External parking terminal 2 49: Deceleration DC braking 50: This running time is cleared. 51: Two-wire/three-wire switching 52: Reverse rotation is prohibited		
P4-10	Input terminal filter time	0.000s~1.000s	0.10s	☆
P4-11	Terminal command mode	0: two-wire type 1: two-wire type 2 2: Three-wire type 1 3: Three-wire type 2	0	★
P4-12	Terminal UP/DOWN rate of change	0.001Hz/s~65.535Hz/s	1.00Hz/s	☆
P4-13	AI Curve 1 minimum input	0.00V~P4-15	0.00V	☆
P4-14	AI Curve 1 minimum input corresponding value	-100.0%~+100.0%	0.0%	☆
P4-15	AI Curve 1 maximum input	P4-13~+10.00V	10.00V	☆
P4-16	AI Curve 1 maximum input corresponding value	-100.0%~+100.0%	100.0%	☆
P4-17	AI1 Filtering time	0.00s~10.00s	0.10s	☆
P4-18	AI Curve 2 minimum input	0.00V~P4-20	0.00V	☆
P4-19	AI Curve 2 minimum input corresponding value	-100.0%~+100.0%	0.0%	☆
P4-20	AI Curve 2 maximum input	P4-18~+10.00V	10.00V	☆
P4-21	AI Curve 2 maximum input corresponding value	-100.0%~+100.0%	100.0%	☆
P4-22	AI2 Filtering time	0.00s~10.00s	0.10s	☆
P4-23	AI Curve 3 minimum input	-10.00V~P4-25	0V	☆
P4-24	AI Curve 3 minimum input corresponding value	-100.0%~+100.0%	0%	☆
P4-25	AI Curve 3 maximum input	P4-23~+10.00V	10.00V	☆
P4-26	AI Curve 1 maximum input corresponding value	-100.0%~+100.0%	100.0%	☆
P4-27	AI3 Filtering time	0.00s~10.00s	0.10s	☆
P4-28	Pulse minimum input	0.00kHz~P4-30	0.00kHz	☆
P4-29	Pulse minimum input corresponding value	-100.0%~100.0%	0.0%	☆
P4-30	Pulse maximum input	P4-28~100.00kHz	50.00kHz	☆
P4-31	Pulse maximum input corresponding value	-100.0%~100.0%	100.0%	☆
P4-32	Pulse input filtering time	0.00s~10.00s	0.10s	☆
P4-33	AI Curve selection	Unit: AI1 curve selection 1: curve 1 (2 points, P4-13 to P4-16) 2: Curve 2 (2 points, P4-18 to P4-21) 3: Curve 3 (2 points, P4-23 to P4-26) 4: Curve 4 (4 points, A6-00 to A6-07) 5: Curve 5 (4 points, A6-08 to A6-15) Ten: AI2 curve selection, ibid. Hundreds: AI3 curve selection, ibid.	H.321	☆
P4-34	AI Below the minimum input setting selection	Unit digit: AI1 is lower than the minimum input setting selection 0: corresponding to the minimum input setting 1:0.0% Ten digits: AI2 is lower than the minimum input setting selection, the same as above hundreds: AI3 is lower than the minimum input setting selection, the same as above	H.000	☆
P4-35	Input terminal X1 delay time	0.0s~3600.0s	0.0s	★
P4-36	Input terminal X2 delay time	0.0s~3600.0s	0.0s	★
P4-37	Input terminal X3 delay time	0.0s~3600.0s	0.0s	★
P4-38	Input terminal valid mode selection 1	Unit's digit: X1 Ten's digit: X2	00000	★

		Hundred's digit: X3 Thousands digit: X4 million: X6 0: The X terminal is connected to COM and the disconnection is invalid. 1: X terminal and COM connection are invalid, the disconnection is valid.		
P4-39	Input terminal valid mode selection 2	Unit's: X5 Ten's : X7 Hundred's : X8 Thousand's: X9 0: The X terminal is connected to COM and the disconnection is invalid. 1: X terminal and COM connection are invalid, the disconnection is valid.	00000	★

P5 Group Output terminal

function code	Parameter Name	Setting Range	Default	Property
P5-00	Y2 Output mode selection	0: Pulse output 1: Switch output	1	☆
P5-01	Y2 Switch output function selection	0: No function 1: The inverter is running 2: Fault shutdown output 3: Frequency level detection FDT1 4: Frequency arrival 5: Zero speed operation 6: Motor overload pre-alarm 7: Inverter overload pre-alarm 8: Set the value to arrive 9: Specify the value to arrive 10: Length reached 11: PLC cycle completed 12: Accumulated running time reaches	0	☆
P5-02	Relay output function selection	13: Frequency limit 14: Torque limit 15: Ready to run 16: AI1>AI2 17: Upper limit frequency arrival 18: Lower limit frequency arrives (no output when stopped) 19: Undervoltage status output 20: Communication setting 23: 2 in zero speed operation (also output when stopping) 24: Accumulated power-on time arrives 25: Frequency level detection FDT2 26: Frequency 1 reaches output 27: Frequency 2 reaches output 28: Current 1 reaches the output 29: Current 2 reaches the output 30: Timing arrives at output	2	☆
P5-03	Relay output function selection 2(Optional)	31: AI1 input exceeds limit 32: Offload 33: Reverse running 34: Zero current state	0	☆
P5-04	Y1 switch output function selection	35: Module temperature reached 36: Output current overrun 37: Lower limit frequency arrives (stop output also) 38: Fault warning output (continue to run)	1	☆
P5-05	Y3 switch output function selection (optional)	39: Motor overheat pre-alarm 40: This running time arrives	4	☆
P5-06	Y2 Pulse output function selection	0: running frequency 1: setting frequency 2: Output current 3: Output torque (absolute value) 4: Output power 5: Output voltage	0	☆
P5-07	AO Output function selection	6: Pulse input (100.0% corresponds to 100.0kHz) 7: AI1 8: AI2 9: AI3 (extended) 10: length	0	☆
P5-08	AO2 Output function selection (optional)	11: Record the value 12: Communication settings 13: Motor speed 14: Output current (Output current 55KW and below 100% corresponds to 100.0A, 75KW and above 100% corresponds to 1000.0A) 15: Output voltage (According to the bus voltage 1000.0V corresponding to 100%)	1	☆
P5-09	Y2 Pulse output Maximum frequency	0.01kHz~100.00kHz	50.00kHz	☆
P5-10	AO Zero offset coefficient	-100.0%~+100.0%	0.0%	☆

P5-11	AO Gain	-10.00~+10.00	1.00	☆
P5-12	Extended AO2 zero bias coefficient	-100.0%~+100.0%	0.0%	☆
P5-13	Extended AO2 gain	-10.00~+10.00	1.00	☆
P5-17	Y2 output delay time	0.0s~3600.0s	0.0s	☆
P5-18	Relay output delay time	0.0s~3600.0s	0.0s	☆
P5-19	Relay 2 delay time	0.0s~3600.0s	0.0s	☆
P5-20	Y1 Output delay time	0.0s~3600.0s	0.0s	☆
P5-21	Y3 Delay time (expansion)	0.0s~3600.0s	0.0s	☆
P5-22	Output terminal valid state selection	Unit's: Y2 Ten's: Relay Hundred's: Relay 2Thousand's : Y1 Ten thousand's digit: Y3 0: The output terminal is connected to COM and the disconnection is invalid. 1: The output terminal is not connected to COM, and the disconnection is valid.	00000	☆

P6 Group Start and stop control

function	Parameter Name	Setting Range	Default	Property
P6-00	Startup mode	0: Direct start 1: Speed tracking restart 2: Pre-excitation start (AC asynchronous machine)	0	☆
P6-01	Speed tracking method	0: Start from stop frequency 1: Start at zero speed 2: Starting with Maximum frequency	0	★
P6-02	Speed tracking	1~100	20	☆
P6-03	Starting frequency	0.00Hz~10.00Hz	0.00Hz	☆
P6-04	Start frequency hold time	0.0s~100.0s	0.0s	★
P6-05	Start DC braking current	0%~100%	50%	★
P6-06	Start DC braking time	0.0s~100.0s	0.0s	★
P6-07	Acceleration and deceleration	0: Linear acceleration/deceleration 1: S-curve acceleration/deceleration A 2: S curve acceleration and deceleration B	0	★
P6-08	S curve starting time ratio	0.0%~ (100.0%-P6-09)	30.0%	★
P6-09	S curve stop time ratio	0.0%~ (100.0%-P6-08)	30.0%	★
P6-10	Stop mode	0: slow down stop 1: free stop	0	☆
P6-11	Stop DC braking start frequency	0.00Hz~Maximum frequency	0.00Hz	☆
P6-12	DC brake waiting time	0.0s~100.0s	0.0s	☆
P6-13	DC braking current at stop	0%~100%	50%	☆
P6-14	DC braking time at stop	0.0s~100.0s	0.2s	☆
P6-15	Brake usage rate	0%~100%	100%	☆
P6-18	Speed tracking current	30%~200%	Model dependent	★
P6-21	Demagnetization time	0.0~5.0s	Model dependent	★
P6-23	AVR function	0: Not effective 1: Only deceleration effective 2: Fully effective	2	☆

P7 Group Keypad and display

function code	Parameter Name	Setting Range	Default	Property
P7-01	JOG/REV button	0: JOG/REV key is invalid 1: Keyboard command and terminal (communication) command switching 2: Forward and reverse switching 3: Forward rotation 4: Reverse jog	0	★
P7-02	Function selection	0: Only the button command under the keyboard command is valid. 1: Button stop is valid under any circumstances	1	☆
P7-03	STOP/RESET button	0000~FFFF Bit0: Operating frequency 1 (Hz) Bit1: Setting frequency (Hz) Bit2: Bus voltage (V) Bit3: Output voltage (V) Bit4: Output current (A) Bit5: Output power (kW) Bit6: Output torque (%) Bit7: Input status Bit8: Output Status Bit9: AI1 Voltage (V) Bit10: AI2 voltage (V) Bit11: AI3 voltage (V) Bit12: Count value Bit13: Length value Bit14: Load speed display Bit15: PID setting	1F	☆
P7-04	LED operation display parameter 2	0000~FFFF Bit0: PID feedback Bit1: PLC stage Bit2: Pulse input frequency (kHz) Bit3: Operating frequency 2 (Hz) Bit4: remaining running time Bit5: AI1 pre-correction voltage (V) Bit6: AI2 pre-correction voltage (V) Bit7: AI3 pre-correction voltage (V) Bit8: Line speed Bit9: Current power-on time (Hour)	0	☆

		Bit10: Current running time (Min) Bit11: PULSE input pulse frequency (Hz) Bit12: Communication setting value Bit13: Encoder feedback speed (Hz) Bit14: Main frequency X Display (Hz) Bit15: Auxiliary frequency Y display (Hz)		
P7-05	LED stop display parameters	0000~FFFF Bit00: Set frequency (Hz) Bit01: Bus voltage (V) Bit02: X input status Bit03: Output status Bit04: AI1 voltage (V) Bit05: AI2 voltage (V) Bit06: AI3 voltage (V) Bit07: count value Bit08: Length value Bit09: PLC stage Bit10: Load speed Bit11: PID setting Bit12: PULSE input pulse frequency (kHz)	33	☆
P7-06	Load speed display factor	0.0001~6.5000	1.0000	☆
P7-07	Module heat sink temperature	0.0°C~100.0°C	-	●
P7-08	Product ID	-	-	●
P7-09	Cumulative running time	0h~65535h	-	●
P7-10	Product ID	-	-	●
P7-11	Software version number	-	-	●
P7-12	Load speed display	0: 0 decimal place 1:1 decimal place 2: 2 decimal places 3: 3 decimal places	1	☆
P7-13	Decimal point	0~65535h	-	●
P7-14	Cumulative power-on time	0~65535 degree	-	●

P8 Group Auxiliary Functions

function code	Parameter Name	Setting Range	Default	Property
P8-00	Jog running frequency	0.00Hz~Maximum frequency	2.00Hz	☆
P8-01	Jog acceleration time	0.0s~6500.0s	20.0s	☆
P8-02	Jog deceleration time	0.0s~6500.0s	20.0s	☆
P8-03	Acceleration time 2	0.0s~6500.0s	Model dependent	☆
P8-04	Deceleration time 2	0.0s~6500.0s	Model dependent	☆
P8-05	Acceleration time 3	0.0s~6500.0s	Model dependent	☆
P8-06	Deceleration time 3	0.0s~6500.0s	Model dependent	☆
P8-07	Acceleration time 4	0.0s~6500.0s	Model dependent	☆
P8-08	Deceleration time 4	0.0s~6500.0s	Model dependent	☆
P8-09	Jump frequency 1	0.00Hz~Maximum frequency	0.00Hz	☆
P8-10	Jump frequency 2	0.00Hz~Maximum frequency	0.00Hz	☆
P8-11	Jump frequency amplitude	0.00Hz~Maximum frequency	0.01Hz	☆
P8-12	Positive reversal dead time	0.0s~3000.0s	0.0s	☆
P8-13	Reverse control enable	0: Allow 1: Prohibit	0	☆
P8-14	The set frequency is lower than the lower limit frequency.	0: Run at the following frequency limit 1: stop 2: Zero speed operation	0	☆
P8-15	Droop control	0.00Hz~10.00Hz	0.00Hz	☆
P8-16	Set the cumulative power-on arrival time	0h~65000h	0h	☆
P8-17	Set cumulative run arrival time	0h~65000h	0h	☆
P8-18	Start protection selection	0: no protection 1: protection	0	☆
P8-19	Frequency detection value FDT1	0.00Hz~Maximum frequency	50.00Hz	☆
P8-20	Frequency detection hysteresis value (FDT1)	0.0%~100.0% (FDT1)	5.0%	☆
P8-21	Frequency arrival detection width	0.0%~100.0% (Maximum frequency)	0.0%	☆

P8-22	Whether the jump frequency is effective during acceleration and deceleration	0: Invalid 1: Valid	0	☆
P8-25	Acceleration time 1 and acceleration time 2 switch frequency points	0.00Hz~Maximum frequency	0.00Hz	☆
P8-26	Deceleration time 1 and deceleration time 2 switch frequency points	0.00Hz~Maximum frequency	0.00Hz	☆
P8-27	Terminal jog priority	0: Invalid 1: Valid	1	☆
P8-28	Frequency detection value FDT2	0.00Hz~Maximum frequency	50.00Hz	☆
P8-29	Frequency detection hysteresis value (FDT2)	0.0%~100.0% (FDT2)	5.0%	☆
P8-30	Arbitrary arrival frequency detection value 1	0.00Hz~Maximum frequency	50.00Hz	☆
P8-31	Arbitrary arrival frequency detection width 1	0.0%~100.0% (Maximum frequency)	0.0%	☆
P8-32	Arbitrary arrival frequency detection value 2	0.00Hz~Maximum frequency	50.00Hz	☆
P8-33	Arbitrary arrival frequency detection width 2	0.0%~100.0% (Maximum frequency)	0.0%	☆
P8-34	Zero current detection level	0.0%~300.0% 100.0% Corresponding motor rated current	5.0%	☆
P8-35	Zero current detection delay time	0.01s~600.00s	0.10s	☆
P8-36	Output current limit	0.0% (Not detecting) 0.1%~300.0% (Motor rated current)	200.0%	☆
P8-37	Output current overrun detection delay time	0.00s~600.00s	0.00s	☆
P8-38	Arbitrary arrival current 1	0.0%~300.0% (Motor rated current)	100.0%	☆
P8-39	Arbitrary current 1 width	0.0%~300.0% (Motor rated current)	0.0%	☆
P8-40	Arbitrary arrival current 2	0.0%~300.0% (Motor rated current)	100.0%	☆
P8-41	Arbitrary current 2 width	0.0%~300.0% (Motor rated current)	0.0%	☆
P8-42	Timing function selection	0:Invalid 1:Valid	0	★
P8-43	Timing run time selection	0: P8-44 setting 1: AI1 2: AI2 3: AI3 Analog input range corresponding P8-44	0	★
P8-44	Timed running time	0.0Min~6500.0Min	0.0Min	★
P8-45	AI1 input voltage protection value lower limit	0.00V~P8-46	3.10V	☆
P8-46	AI1 input voltage protection value upper limit	P8-45~10.00V	6.80V	☆
P8-47	Module temperature reached	0℃~100℃	75℃	☆
P8-48	Cooling fan control	0: The fan is running during operation 1: The fan is always running	0	☆
P8-49	Wake-up frequency	Sleep frequency (P8-51) ~Maximum frequency (P0-10)	0.00Hz	☆
P8-50	Wake-up delay time	0.0s~6500.0s	0.0s	☆
P8-51	Sleep frequency	0.00Hz~Wake-up frequency (P8-49)	0.00Hz	☆
P8-52	Sleep delay time	0.0s~6500.0s	0.0s	☆
P8-53	This run arrival time setting	0.0Min~6500.0Min	0.0Min	★
P8-54	Output power correction factor	0.00% ~ 200.0%	100.0%	☆
P9 Group Failure and protection				
function code	Parameter Name	Setting Range	Default	Property
P9-00	Motor overload protection option	0: Not allow 1: Allow	1	☆

P9-01	Motor overload protection gain	0.20~10.00	1.00	☆
P9-02	Motor overload warning coefficient	50%~100%	80%	☆
P9-03	Overvoltage stall gain	0~100	30	☆
P9-04	Overvoltage stall protection voltage	650~800	760V	☆
P9-05	Over-current stall suppression gain	0~100,same as P3-20	20	☆
P9-06	Over-current stall action current	50% ~ 200%, same as P3-18	150%	☆
P9-07	Power-on short circuit protection option	0: Invalid 1: Valid	1	☆
P9-08	Brake unit action starting voltage	200.0~2000.0V 220V: 360V 380V: 690V	690V	☆
P9-09	Number of automatic resets	0~20	0	☆
P9-10	Fault DO action selection during automatic fault reset	0: no act 1: act	0	☆
P9-11	Fault auto reset interval	0.1s~100.0s	1.0s	☆
P9-12	Input phase loss / contactor suction protection option	Unit's: Input phase loss protection option Ten's: Contactor suction protection option 0: Disable 1: Allow	11	☆
P9-13	Output phase loss protection option	0: Disable 1: Allow	1	☆
P9-14	First failure type	0: no fault 2: accelerated overcurrent 3: Deceleration over current 4: Constant speed over current 5: Accelerated overvoltage 6: Deceleration overvoltage 7: Constant speed overvoltage 8: Buffer resistor overload 9: Under voltage 10: Inverter overload 11: Motor overload 12: Input phase loss	—	●
P9-15	Second failure type	13: Output phase loss 14: Module overheating 15: External fault 16: Communication error 17: Contactor abnormality 18: Abnormal current detection 19: Tuning error 20: PG card is abnormal 21: Parameter read and write error 22: Inverter hardware is abnormal 23: Motor short circuit to ground 24: Reserved	—	●
P9-16	Third (most recent) fault type	26: Run time arrives 27: User Defined Fault 1 28: User-defined fault 2 29: Power on time arrives 30: Offload 31: Loss of PID feedback at runtime 40: Fast current limit timeout 41: Switching motor during operation 42: Speed deviation is too large 43: Motor overspeed 45: Motor overheating 51: Initial position error	—	●
P9-17	Frequency at the third failure	—	—	●
P9-18	Current at the third fault	—	—	●
P9-19	Bus voltage at the third fault	—	—	●

P9-20	Third fault input terminal status	—	—	●
P9-21	Third fault output terminal status	—	—	●
P9-22	Inverter status at the third fault	—	—	●
P9-23	Power-on time during the third fault	—	—	●
P9-24	Run time at the third fault	—	—	●
P9-27	Frequency at the second failure	—	—	●
P9-28	Current at the second fault	—	—	●
P9-29	Bus voltage at the second fault	—	—	●
P9-30	Second fault input terminal status	—	—	●
P9-31	Second fault output terminal status	—	—	●
P9-32	Inverter status at the second fault	—	—	●
P9-33	Power-on time during the second fault	—	—	●
P9-34	Run time at the second fault	—	—	●
P9-37	Frequency at the first failure	—	—	●
P9-38	Current at the first fault	—	—	●
P9-39	Bus voltage at the first fault	—	—	●
P9-40	First fault input terminal status	—	—	●
P9-41	First fault output terminal status	—	—	●
P9-42	Inverter status at the first fault	—	—	●
P9-43	Power-on time at the first failure	—	—	●
P9-44	Run time at the first failure	—	—	●
P9-47	Fault protection action selection 1	Unit's: Motor overload (Err 11) 0: free stop 1: Stop by stop mode 2: Keep running Ten's: Input phase loss (Err12) as above Hundred's : Output phase loss (Err13) as above Thousand's: External fault (Err15) is the same as above Ten Thousand's digits: communication abnormality (Err16) is the same as above	00000	☆
P9-48	Fault protection action selection 2	Unit's digit: Encoder/PG card incorrect (Err20) 0: free stop 1: Stop by stop mode 2: keep running Ten's digit: function code reading and writing incorrect (Err21) 0: free stop 1: stop by stop mode Thousand's digit: motor too hot (Err25) same as P9-47 Ten Thousand's digit: Run time arrives (Err26) with P9-47	00000	☆
P9-49	Fault protection action selection 3	Unit's: Custom Fault 1 (Err27) Same as P9-47 Ten's : Custom Fault 1 (Err27) Same as P9-47 Hundred's : Power-on time arrives (Err29) with P9-47 Thousand's: Offload (Err30) 0: Free parking 1: slow down parking 2: Deceleration to 7% of the rated frequency, automatically return to the set frequency when no load is lost Ten Thousand's digit: PID feedback loss (Err31) with P9-47	00000	☆
P9-50	Fault protection action selection 4	Unit's: Speed deviation is too large (Err42) with P9-47 Ten's: Motor overspeed (Err43) with P9-47 Hundred's: Initial position error (Err51) Same as P9-47 Thousand's: Speed feedback error (Err52) with P9-47	00000	☆

P9-54	Continue to run frequency selection when fault occurs	0: Run at the current operating frequency 1: run at the set frequency 2: Run at the upper limit frequency 3: Run at the following frequency limit 4: Run at abnormal standby frequency	0	☆
P9-55	Abnormal backup frequency	60.0%~100.0% (100.0% correspond Maximum frequencyP0-10)	100.0%	☆
P9-56	Motor temperature sensor type	0: No temperature sensor 1 : PT100 2: PT1000	0	☆
P9-57	Motor overheat protection threshold	0°C~200°C	110°C	☆
P9-58	Motor overheat pre-alarm threshold	0°C~200°C	90°C	☆
P9-59	Instantaneous power failure action selection	0: Invalid 1: deceleration 2: Deceleration stop	0	☆
P9-60	Instantaneous stop action pause judgment voltage	80.0~100.0%	85.0%	☆
P9-61	Instantaneous power failure voltage rise judgment time	0.00s~100.00s	0.50s	☆
P9-62	Instantaneous power failure action judgment voltage	60.0%~100.0% (Standard bus voltage)	80.0%	☆
P9-63	Drop protection option	0: Invalid 1: Valid	0	☆
P9-64	Drop detection level	0.0~100.0%	10.0%	☆
P9-65	Drop detection time	0.0~60.0s	1.0s	☆
P9-67	Overspeed detection value	0.0%~50.0% (Maximum frequency)	20.0%	☆
P9-68	Overspeed detection time	0.0s~60.0s	5.0s	☆
P9-69	Speed deviation excessive detection value	0.0%~50.0% (Maximum frequency)	20.0%	☆
P9-70	Speed deviation too large detection time	0.0s~60.0s	5.0s	☆
P9-71	Instantaneous stop non-stop gain Kp	0~100	40	☆
P9-72	Instantaneous stop non-stop integral coefficient Ki	0~100	30	☆
P9-73	Instantaneous stop and stop motion deceleration time	0~300.0s	20.0s	★

PA Group PID function

function code	Parameter Name	Setting Range	Default	Property
PA-00	PID given source	0: PA-01 set 1: AI1 2: AI2 3: AI3 (panel potentiometer) 4: Pulse setting 5: Communication given 6: Multi-speed given	0	☆
PA-01	PID value given	0.0%~100.0%	50.0%	☆
PA-02	PID feedback source	0: AI1 1: AI2 2: AI3/ Panel potentiometer 3: AI1-AI2 4: Pulse setting (X6) 5: Communication given 6: AI1+AI2 7: MAX (AI1 , AI2) 8: MIN (AI1 , AI2)	0	☆
PA-03	PID action direction	0: Positive action 1: Negative	0	☆
PA-04	PID given feedback range	0~65535	1000	☆
PA-05	Proportional gain Kp1	0.0~100.0	40.0	☆
PA-06	Integration time Ti1	0.01s~10.00s	1.00s	☆
PA-07	Derivative time Td1	0.000s~10.000s	0.000s	☆

PA-08	PID reverse cutoff frequency	0.00~Maximum frequency	2.00Hz	☆
PA-09	PID deviation limit	0.0%~100.0%	0.0%	☆
PA-10	PID differential limiting	0.00%~100.00%	0.10%	☆
PA-11	PID given change time	0.00~650.00s	0.00s	☆
PA-12	PID feedback filter time	0.00~60.00s	0.00s	☆
PA-13	PID output filtering time	0.00~60.00s	0.00s	☆
PA-15	Proportional gain Kp2	0.0~100.0	20.0	☆
PA-16	Integration time Ti2	0.01s~10.00s	2.00s	☆
PA-17	Derivative time Td2	0.000s~10.000s	0.000s	☆
PA-18	PID parameter switching condition	0: Do not switch 1: Switch through the input terminal 2: Automatic switching according to deviation	0	☆
PA-19	PID parameter switching deviation 1	0.0%~PA-20	20.0%	☆
PA-20	PID parameter switching deviation 2	PA-19~100.0%	80.0%	☆
PA-21	PID initial value	0.0%~100.0%	60%	☆
PA-22	PID initial value hold time	0.00~650.00s	5s	☆
PA-25	PID integral attribute	Unit's: Integral separation 0: Invalid 1: Valid Ten's: Whether to stop integration after output to the limit 0: Continue to integrate 1: Stop the points	00	☆
PA-26	PID feedback loss detection value	0.0%: no judge feedback loss 0.1%~100.0%	0.0%	☆
PA-27	PID feedback loss detection time	0.0s~20.0s	0.0s	☆
PA-28	PID shutdown operation	0: stop does not operate 1: stop operation	1	☆
Pb Group Swing frequency, fixed length and counting				
function code	Parameter Name	Setting Range	Default	Property
Pb-00	Swing frequency setting method	0: Relative to the center frequency 1: Relative to the Maximum frequency	0	☆
Pb-01	Swing frequency range	0.0%~100.0%	0.0%	☆
Pb-02	Kick frequency amplitude	0.0%~50.0%	0.0%	☆
Pb-03	Wobble cycle	0.1s~3000.0s	10.0s	☆
Pb-04	Swing frequency triangle wave rise time	0.1%~100.0%	50.0%	☆
Pb-05	Set length	0m~65535m	1000m	☆
Pb-06	Actual length	0m~65535m	0m	☆
Pb-07	Pulse number per meter	0.1~6553.5	100.0	☆
Pb-08	Set count value	1~65535	1000	☆
Pb-09	Specified count value	1~65535	1000	☆
PC Group Multi-segment instruction, simple PLC				
function code	Parameter	Setting Range	Default	Property
PC-00	Multi-segment instruction 0	0.0Hz ~ ±P0-10	0.0Hz	☆
PC-01	Multi-segment instruction 1	0.0Hz ~ ±P0-10	0.0Hz	☆
PC-02	Multi-segment instruction 2	0.0Hz ~ ±P0-10	0.0Hz	☆
PC-03	Multi-segment instruction 3	0.0Hz ~ ±P0-10	0.0Hz	☆
PC-04	Multi-segment instruction 4	0.0Hz ~ ±P0-10	0.0Hz	☆

PC-05	Multi-segment instruction 5	0.0Hz ~ ±P0-10	0.0Hz	☆
PC-06	Multi-segment instruction 6	0.0Hz ~ ±P0-10	0.0Hz	☆
PC-07	Multi-segment instruction 7	0.0Hz ~ ±P0-10	0.0Hz	☆
PC-08	Multi-segment instruction 8	0.0Hz ~ ±P0-10	0.0Hz	☆
PC-09	Multi-segment instruction 9	0.0Hz ~ ±P0-10	0.0Hz	☆
PC-10	Multi-segment instruction 10	0.0Hz ~ ±P0-10	0.0Hz	☆
PC-11	Multi-segment instruction 11	0.0Hz ~ ±P0-10	0.0Hz	☆
PC-12	Multi-segment instruction 12	0.0Hz ~ ±P0-10	0.0Hz	☆
PC-13	Multi-segment instruction 13	0.0Hz ~ ±P0-10	0.0Hz	☆
PC-14	Multi-segment instruction 14	0.0Hz ~ ±P0-10	0.0Hz	☆
PC-15	Multi-segment instruction 15	0.0Hz ~ ±P0-10	0.0Hz	☆
PC-16	Simple PLC operation mode	0: Single run end shutdown 1: Keep the final value at the end of a single run 2: Always cycle	0	☆
PC-17	Simple PLC power-down memory selection	Unit's: Power-down memory selection 0: No power loss, no memory 1: Power failure memory Ten's : Stop memory selection 0: Stop without memory 1: Stop memory	00	☆
PC-18	0th run time	0.0s (h) ~6553.5s (h)	0.0s(h)	☆
PC-19	The 0th section acceleration and deceleration time selection	0~3	0	☆
PC-20	First run time	0.0s (h) ~6553.5s (h)	0.0s(h)	☆
PC-21	The first stage acceleration and deceleration time selection	0~3	0	☆
PC-22	2nd run time	0.0s (h) ~6553.5s (h)	0.0s(h)	☆
PC-23	The second stage acceleration and deceleration time selection	0~3	0	☆
PC-24	Third run time	0.0s (h) ~6553.5s (h)	0.0s(h)	☆
PC-25	The third stage acceleration and deceleration time selection	0~3	0	☆
PC-26	Stage 4 run time	0.0s (h) ~6553.5s (h)	0.0s(h)	☆
PC-27	Section 4 acceleration and deceleration time selection	0~3	0	☆
PC-28	5th run time	0.0s (h) ~6553.5s (h)	0.0s(h)	☆
PC-29	Section 5 acceleration and deceleration time selection	0~3	0	☆
PC-30	Run time of paragraph 6	0.0s (h) ~6553.5s (h)	0.0s(h)	☆
PC-31	Section 6 acceleration and deceleration time selection	0~3	0	☆
PC-32	Run time of paragraph 7	0.0s (h) ~6553.5s (h)	0.0s(h)	☆
PC-33	Section 7 acceleration and deceleration time selection	0~3	0	☆
PC-34	8th run time	0.0s (h) ~6553.5s (h)	0.0s(h)	☆
PC-35	Section 8 acceleration and deceleration time selection	0~3	0	☆
PC-36	9th run time	0.0s (h) ~6553.5s (h)	0.0s(h)	☆

PC-37	The 9th paragraph acceleration and deceleration time selection	0~3	0	☆
PC-38	Run time of paragraph 10	0.0s (h) ~6553.5s (h)	0.0s(h)	☆
PC-39	Section 10 acceleration and deceleration time selection	0~3	0	☆
PC-40	Run time in paragraph 11	0.0s (h) ~6553.5s (h)	0.0s(h)	☆
PC-41	The 11th paragraph acceleration and deceleration time selection	0~3	0	☆
PC-42	Run time in paragraph 12	0.0s (h) ~6553.5s (h)	0.0s(h)	☆
PC-43	The 12th paragraph acceleration and deceleration time selection	0~3	0	☆
PC-44	Run time of paragraph 13	0.0s (h) ~6553.5s (h)	0.0s(h)	☆
PC-45	The 13th paragraph acceleration and deceleration time selection	0~3	0	☆
PC-46	Run time in paragraph 14	0.0s (h) ~6553.5s (h)	0.0s(h)	☆
PC-47	The 14th paragraph acceleration and deceleration time selection	0~3	0	☆
PC-48	Run time in paragraph 15	0.0s (h) ~6553.5s (h)	0.0s(h)	☆
PC-49	The 15th paragraph acceleration and deceleration time selection	0~3	0	☆
PC-50	Simple PLC runtime unit	0: s (second) 1: h (hour)	0	☆
PC-51	Multi-segment instruction 0 given mode	0: given by PC-00 1: given by AI1 2: AI2 given 3: AI3 given (panel potentiometer) 4: Pulse given 5: PID given 6: PO-08 can be modified by UP/DOWN	0	☆

Pd Group Communication parameter

function code	Parameter	Setting Range	Default	Property
Pd-00	Baud rate	Unit's: MODBUS 0: 300BPS 1: 600BPS 2: 1200BPS 3: 2400BPS 4: 4800BPS 5: 9600BPS 6: 19200BPS 7: 38400BPS 8: 57600BPS 9: 115200BPS Ten's: Profibus-DP 0: 115200BPs 1: 208300BPs 2: 256000BPs 3: 512000Bps Thousand's : CANlink Baud rate (Hundred's : Reserved) 0: 20 1: 50 2: 100 3: 125 4: 250 5: 500 6: 1M	5005	☆
Pd-01	Data Format	0: no checking (8-N-2) 1 : even checking (8-E-1) 2 : odd checking (8-O-1) 3 : 8-N-1	0	☆
Pd-02	Local address	1~247, 0 Broadcast address	001	☆
Pd-03	Response delay	0ms~20ms	02	☆
Pd-04	Communication timeout	0.0 (Invalid) , 0.1s~60.0s	0.0	☆
Pd-05	Data transfer format selection	Unit's: 0: Non-standard MODBUS protocol 1: Standard MODBUS protocol	31	☆
Pd-06	Communication read current resolution	0: 0.01A 1: 0.1A	0	☆
Pd-08	Canlink communication timeout	0.0s: Invalid 0.1~60.0s	0.0	☆

PE Group Customized function code

function code	Parameter Name	Setting Range	Default	Property
---------------	----------------	---------------	---------	----------

PE-00	User function code 0	P0-00 ~ PP-xx A0-00 ~ Ax-xx U0-xx ~ U0-xx U3-00~U3-xx	U3-17	☆
PE-01	User function code 1		U3-16	☆
PE-02	User function code 2		P0.00	☆
Reserved	Reserved		Reserved	☆
PE-28	User function code 28		P0.00	☆
PE-29	User function code 29		P0.00	☆

PP Group function code management

function code	Parameter Name	Setting Range	Default	Property
PP-00	user password	0~65535	0	☆
PP-01	Parameter initialization	0: no operation 1: Restore factory value, excluding motor parameters 2: Clear record information 3: Restore factory values, including motor parameters 4: Backup user current parameters 501: Restore user backup parameters	0	★
PP-02	Function parameter group display selection	Unit's digit: U group display 0: not displayed 1: display Ten's digit: A group display 0: not displayed 1: display	11	★
PP-03	Personality parameter group display selection	Unit's digit: User customization 0: Do not display 1: Display Ten's digit: User change 0: Do not display 1: Display	00	☆
PP-04	Function code	0: Can be modified 1: Cannot be modified	0	☆

A0 Group Torque control parameter

function code	Parameter Name	Setting Range	Default	Property
A0-00	Speed/torque control selection	0: speed control 1: torque control	0	★
A0-01		0: Digital setting (A0-03) 1: AI1 2: AI2 3: AI3 4: Pulse setting 5: Communication reference 6: MIN (AI1, AI2) 7: MAX (AI1, AI2) (1-7 options full scale, Corresponding to A0-03 number setting)	0	★
A0-03	Torque setting source selection in torque control mode	-200.0%~200.0%	150.0%	☆
A0-05	Torque digital setting	0.00Hz~Maximum frequency	50.00Hz	☆
A0-06	Torque control forward maximum frequency	0.00Hz~Maximum frequency	50.00Hz	☆
A0-07	Torque control reverse maximum frequency	0.00s~65000s	0.00s	☆
A0-08	Torque control acceleration time	0.00s~65000s	0.00s	☆

A5 Group Control optimization parameter

function code	Parameter Name	Setting Range	Default	Property
---------------	----------------	---------------	---------	----------

A5-00	DPWM switching upper limit frequency	5.00Hz ~ Maximum frequency	8.00Hz	☆
A5-01	PWM modulation method	0: Asynchronous modulation 1: Synchronous modulation	0	☆
A5-02	Dead zone compensation mode selection	0: No compensation 1: Compensation mode 1 2: Compensation mode 2	1	☆
A5-03	Random PWM depth	0: Invalid 1~10: Random PWM depth	0	☆
A5-04	Fast current limiting	0: Invalid 1: Valid	1	☆
A5-05	Current detection compensation	0~100	5	☆
A5-06	Under voltage setting	60.0%~140.0%	100.0%	☆
A5-07	SVC optimization mode selection	0: Not optimized 1: Optimized mode 1 2: Optimized mode 2	1	☆
A5-08	Dead time adjustment	100%~200%	150%	★
A5-09	Overvoltage setting	200.0V ~ 2200.0V	Model dependent	★

A6 Group AI Curve setting

function code	Parameter Name	Setting Range	Default	Property
A6-00	AI curve 4 minimum input	-10.00V ~ A6-02	0.00V	☆
A6-01	AI curve 4 minimum input correspondence setting	-100.0% ~ +100.0%	0.0%	☆
A6-02	AI curve 4 inflection point 1 input	A6-00 ~ A6-04	3.00V	☆
A6-03	AI curve 4 inflection point 1 input corresponding setting	-100.0% ~ +100.0%	30.0%	☆
A6-04	AI curve 4 inflection point 2 input	A6-02 ~ A6-06	6.00V	☆
A6-05	AI curve 4 inflection point 2 input corresponding setting	-100.0% ~ +100.0%	60.0%	☆
A6-06	AI curve 4 maximum input	A6-06 ~ +10.00V	10.00V	☆
A6-07	AI curve 4 maximum input corresponding setting	-100.0% ~ +100.0%	100.0%	☆
A6-08	AI curve 5 minimum input	-10.00V ~ A6-10	-10.00V	☆
A6-09	AI curve 5 minimum input corresponding setting	-100.0% ~ +100.0%	-100.0%	☆
A6-10	AI curve 5 inflection point 1 input	A6-08 ~ A6-12	-3.00V	☆
A6-11	AI curve 5 inflection point 1 input corresponding setting	-100.0% ~ +100.0%	-30.0%	☆
A6-12	AI curve 5 inflection point 2 input	A6-10 ~ A6-14	3.00V	☆
A6-13	AI curve 5 inflection point 2 input corresponding setting	-100.0% ~ +100.0%	30.0%	☆
A6-14	AI curve 5 maximum input	A6-12 ~ +10.00V	10.00V	☆

A6-15	AI curve 5 maximum input corresponding setting	-100.0% ~ +100.0%	100.0%	☆
A6-24	AI1 sets the jump point	-100.0% ~ 100.0%	0.0%	☆
A6-25	AI1 sets the jump range	0.0% ~ 100.0%	0.5%	☆
A6-26	AI2 sets the jump point	-100.0% ~ 100.0%	0.0%	☆
A6-27	AI2 sets the jump range	0.0% ~ 100.0%	0.5%	☆
A6-28	AI3 sets the jump point	-100.0% ~ 100.0%	0.0%	☆
A6-29	AI3 sets the jump range	0.0% ~ 100.0%	0.5%	☆

AC Group AIAO checking

function code	Parameter Name	Setting Range	Default	Property
AC-00	AI1 measured voltage 1	0.500V ~ 4.000V	factory reset	☆
AC-01	AI1 display voltage 1	0.500V ~ 4.000V	factory reset	☆
AC-02	AI1 measured voltage 2	6.000V ~ 9.999V	factory reset	☆
AC-03	AI1 display voltage 2	6.000V ~ 9.999V	factory reset	☆
AC-04	AI2 measured voltage 1	0.500V ~ 4.000V	factory reset	☆
AC-05	AI2 display voltage 1	0.500V ~ 4.000V	factory reset	☆
AC-06	AI2 measured voltage 2	6.000V ~ 9.999V	factory reset	☆
AC-07	AI2 display voltage 2	6.000V ~ 9.999V	factory reset	☆
AC-08	AI3 measured voltage 1	-9.999V ~ 10.000V	factory reset	☆
AC-09	AI3 display voltage 1	-9.999V ~ 10.000V	factory reset	☆
AC-10	AI3 measured voltage 2	-9.999V ~ 10.000V	factory reset	☆
AC-11	AI3 display voltage 2	-9.999V ~ 10.000V	factory reset	☆
AC-12	AO1 target voltage 1	0.500V ~ 4.000V	factory reset	☆
AC-13	AO1 measured voltage 1	0.500V ~ 4.000V	factory reset	☆
AC-14	AO1 target voltage 2	6.000V ~ 9.999V	factory reset	☆
AC-15	AO1 measured voltage 2	6.000V ~ 9.999V	factory reset	☆
AC-16	AO2 target voltage 1	0.500V ~ 4.000V	factory reset	☆
AC-17	AO2 measured voltage 1	0.500V ~ 4.000V	factory reset	☆
AC-18	AO2 target voltage 2	6.000V ~ 9.999V	factory reset	☆
AC-19	AO2 measured voltage 2	6.000V ~ 9.999V	factory reset	☆

5-2 Monitoring parameter

U0 Group Basic monitoring parameter				
function code	Parameter name	Display range	Instruction	Communication address
U0-00	Operating frequency	0.01~320.00Hz	Display operating frequency and set frequency (Hz)	7000H
U0-01	Setting frequency			7001H
U0-02	bus voltage	0.0~3000.0V	Display bus voltage (V)	7002H
U0-03	The output voltage	0~1140V	Display inverter output voltage (V)	7003H
U0-04	Output current	0.0~6553.5A	Display inverter output current (A)	7004H
U0-05	Output Power	0~32767kW	Display inverter output power (kW)	7005H
U0-06	Output torque	-200.0~200.0%	Display inverter output torque during operation	7006H
U0-07	Input terminal status	0~32767	Input status: X1~X9 corresponds to Bit0~Bit8	7007H
U0-08	Output terminal status	0~1023	Output terminal status: Y2, relay,	7008H
U0-09	AI1 voltage	0.01V	Y1 corresponds to Bit0, Bit1, Bit3	7009H

U0-10	AI2 voltage	0.01V	Display input AI1 voltage (V)	700AH
U0-11	AI3 voltage	0.01V	Display input AI2 voltage (V)	700BH
U0-12	Count value	0~65535	Display input AI3 voltage (V)	700CH
U0-13	Length value	0~65535	Display count value	700DH
U0-14	Load speed display	0~65535	Display length value	700EH
U0-15	PID setting	0~65535	Display load speed	700FH
U0-16	PID feedback value	0~65535	Display PID settings	7010H
U0-17	PLC stage	0~16	Display PLC operation phase	7011H
U0-18	Input pulse frequency	0.00~10.00kHz	Display X6 input pulse frequency (kHz)	7012H
U0-19	Feedback speed	-320.0~+320.0	Display the actual output frequency of the inverter Hz	7013H
U0-20	Remaining running time	0.0~6500.0 Minutes	Show remaining runtime	7014H
U0-21	AI1 pre-correction voltage	0.01~10.20V	Display AI1 pre-correction voltage	7015H
U0-22	AI2 pre-correction voltage	0.01~10.20V	Display AI2 pre-correction voltage	7016H
U0-23	AI3 pre-correction voltage	0.01~10.20V	Display AI3 pre-correction voltage	7017H
U0-24	Line speed	0~65535m/Min	The number of pulses per minute and	7018H
U0-25	Current power-on time	1Min	PB-07, calculate the line speed value	7019H
U0-26	Current running time	0.1Min	Display current cumulative power-on time	701AH
U0-27	Input pulse frequency	1Hz	Display PULSE input pulse frequency	701BH
U0-28	Communication setting	0.01%	Display communication settings	701CH
U0-29	Encoder feedback speed	0.01Hz	Display encoder feedback speed	701DH
U0-30	Main frequency X	0.01Hz	Display main frequency X display	701EH
U0-31	Auxiliary frequency Y	0.01Hz	Display auxiliary frequency Y display	701FH
U0-32	View memory address values	1	Display to view any memory address value	7020H
U0-33	Synchronous machine rotor position	0.0°	Display synchronous machine rotor position	7021H
U0-34	Motor temperature value	1 °C	Display motor temperature value	7022H
U0-35	Target torque	0.1%	Display target torque (%)	7023H
U0-36	Rotational position	1	Display the position of the rotation	7024H
U0-37	Power factor angle	0.1	Display power factor angle	7025H
U0-38	ABZ position	0.0	Show ABZ position	7026H
U0-39	VF separation target voltage	1V	Display VF separation target voltage	7027H
U0-40	VF separation output voltage	1V	Display VF separate output voltage	7028H
U0-41	Input status visual display	1	Display input status visual display	7029H
U0-42	Output status visual display	1	Display output status visual display	702AH

U0-43	Input status visual display 1	1	Display input status visual display 1	702BH
U0-44	Input status visual display 2	1	Display input status visual display 2	702CH
U0-45	accident details	0	Display fault information	702DH
U0-58	Z signal counter	-	1	703AH
U0-59	Set frequency (%)	-	0.01%	703BH
U0-60	Operating frequency (%)	-	0.01%	703CH
U0-61	Inverter status	-	1	703DH
U0-62	Current fault code	-	1	703EH
U0-64	Number of slaves	-	1	7040H
U0-65	Torque limit	-	0.01%	7041H
U0-73	Motor serial number	-	0: motor 1 1: motor 2	7046H
U0-74	Actual output torque of the motor	-	-300-300%	7047H

Inverter braking resistor selection table

AC drive power	Braking Unit	Recommended resistance power	Minimum resistance value	QTY
0.75kW-220V	Built-in Braking unit as standard	80W	$\geq 80\Omega$	1
1.5kW-220V		200W	$\geq 55\Omega$	1
2.2kW-220V		200W	$\geq 35\Omega$	1
3.7kW-220V		300W	$\geq 25\Omega$	1
0.75kW-380V		150W	$\geq 300\Omega$	1
1.5kW-380V		150W	$\geq 220\Omega$	1
2.2kW-380V		250W	$\geq 200\Omega$	1
3.7kW-380V		400W	$\geq 130\Omega$	1
5.5kW-380V		500W	$\geq 90\Omega$	1
7.5kW-380V		800W	$\geq 65\Omega$	1
11kW-380V		1kW	$\geq 43\Omega$	1
15kW-380V		1.3kW	$\geq 32\Omega$	1
18.5kW-380V		1.5kW	$\geq 25\Omega$	1
22kW-380V		1.5kW	$\geq 22\Omega$	1
30kW and above		External		

Note: There is high voltage and high temperature on the surface of the braking resistor when it is working. Please consider the safety and flammability of the surrounding environment when installing.

The connection of multiple braking resistors is parallel. Please consult the brake manufacturer for specific information on the selection of external brake units and resistors.

Chapter 6 Parameter Instruction

P0 Group Basic function group

P0-00	GP Type display	1:G type (constant torque load type) 2: P type (fan, pump type load type)	Default: 1
--------------	------------------------	------------------------------------------------------------------------------	------------



This parameter is only for the user to view the factory model and cannot be changed.

- 1: Constant torque load for specified rated parameters
- 2: Variable torque load (fan, pump load) for specified rated parameters

P0-01	Speed control mode selection	0: No speed sensor vector control (SVC) 1: Speed sensor vector control (FVC) 2: V/F control	Default: 0
--------------	-------------------------------------	---------------------------------------------------------------------------------------------------	------------

0: No speed sensor vector control, open loop vector control, suitable for normal high performance control applications, one inverter can only drive one motor. Such as machine tools, centrifuges, wire drawing machines, injection molding machines and other loads.

1: There is speed sensor vector control, closed loop vector control, the motor end must be equipped with an encoder, the inverter must be equipped with the same type of PG card as the encoder. Suitable for high precision speed control or torque control applications. Only one motor can be driven by one inverter. Such as high-speed paper machinery, lifting machinery, elevators and other loads.

2: V/F control, suitable for occasions where the load requirements are not high, or when one inverter drives multiple motors, such as fans and pumps. It can be used in the case where one inverter drives multiple motors.

Note:The motor parameter identification process must be performed when selecting the vector control mode. Only accurate motor parameters can take advantage of the vector control method to achieve better performance.

P0-02	Run command source selection	0: Operation panel command channel (LED off) 1: terminal command channel (LED is lit) 2: Communication command channel (LED flashing)	Default: 0
--------------	-------------------------------------	---------------------------------------------------------------------------------------------------------------------------------------------	------------



Select the inverter running control command mode, the running command includes start, stop, forward and reverse, jog, etc. .

0: The operation panel command is controlled by the RUN, STOP and other buttons on the operation panel.

1: Terminal command channel ("L/R" is on), which is controlled by the multi-function input terminal.

2: Communication command channel ("L/R" flashing), the host computer controls the running command through communication mode.

P0-03	Main frequency source X selection	0: Digital setting (UP/DOWN) does not record when power is off 1: Digital setting (UP/DOWN) power-down record 2: AI1 3: AI2 4: panel potentiometer 5: Pulse setting (X6) 6: Multi-segment instruction 7: Simple PLC 8: PID 9: Communication given	Default: 0
--------------	------------------------------------------	------------------------------------------------------------------------------------------------------------------------------------------------------------------------------------------------------------------------------------------------------------	------------



Select the input channel of the main frequency of the inverter .

0: Digital setting (no memory is lost), the main frequency is set by parameter P0-08.

The set frequency value of the inverter can be modified by the ▲ and ▼ keys (terminal UP/DOWN) of the keyboard.

When the inverter is powered off and powered up again, the set frequency is restored to the set value of parameter P0-08.

1: Digital setting (power-down memory), the main frequency is set by parameter P0-08.

The set frequency value of the inverter can be modified by the ▲ and ▼ keys (terminal UP/DOWN) of the keyboard.

When the inverter is powered off and powered up again, the set frequency memory is the set frequency at the last power-down time.

(P0-23 is the setting frequency stop memory selection. When the inverter stops, the frequency change amount is memorized or cleared. P0-23 is related to the shutdown, not related to the power-down memory, so pay attention to the application.)

2: Analog AI1 setting, the main frequency is determined by inputting 0V~10V from AI1 terminal.

3: Analog AI2 setting, the main frequency is determined by AI2 input 0V ~ 10V or 4mA ~ 20mA

Control board J2 jumper selects whether AI2 is voltage input U or current input I (20mA corresponds to 10V)

The input voltage value of AI1 and AI2 and the corresponding relationship with the target frequency can be set by P4-13~27.

4: Panel potentiometer setting, the main frequency is set by the panel potentiometer.

5: The main frequency is given by the terminal pulse signal. The pulse signal specifications are: voltage range 9V ~ 30V, frequency range 0kHz ~ 100kHz. The pulse signal can only be input from terminal X6. (See P4-28~P4-31)

6: Multi-segment command, the main frequency can be composed of four multi-segment terminals with different state combinations corresponding to 16 kinds of set frequency values.

Set PC group function code corresponding to 16 multi-segment instructions, multi-segment command terminal function is set in P4 group

7: The simple PLC main frequency is given by the PLC, and the PLC running frequency and running time are set in the PC group.

8: PID, the main frequency is given by the output controlled by the process PID. Generally used for closed-loop control in the field, such as constant pressure closed-loop control, constant tension closed-loop control, etc., it is necessary to set the PA group PID function parameters.

9: Communication given (optional), the main frequency is given by the host computer through communication.

P0-04	Auxiliary frequency source Y selection	Same as P0-03 (main frequency source X selection)	Default: 0
--------------	-----------------------------------------------	---------------------------------------------------	------------



When the auxiliary frequency source Y is used as an independent frequency reference channel (X to Y switching), its usage is the same as that of the main frequency source X P0-03. Note when the auxiliary frequency source is used as the superimposed reference (the composite frequency of the main frequency source X and the auxiliary source Y is given):

- 1) When the auxiliary frequency source Y is digitally given, P0-08 does not work. The user adjusts the frequency based on the ▲, ▼ keys of the keyboard or the UP and DOWN of the terminal directly on the basis of the main given frequency.
- 2) When the auxiliary frequency source is analog input AI1, AI2 or pulse input timing, the frequency range is set by P0-05 and P0-06.
- 3) The selection of auxiliary frequency source Y and main frequency source X cannot be set to the same channel, that is, P0-03 and P0-04 should not be set to the same value, otherwise it will cause confusion.。

P0-05	Auxiliary source Y range selection when superimposing	0: relative to the maximum frequency 1: relative to the frequency source X	Default: 0
P0-06	Auxiliary frequency source Y range when superimposed	0%~150%	Default: 100%



When the frequency source is selected as frequency superposition (P0-07 is set to 1, 3 or 4), it is used to determine the adjustment range of the auxiliary frequency source.。

Note: If P0-05 is selected to be relative to the main frequency source X, the range of the auxiliary frequency source will change as the main frequency X changes. 。

P0-07	Frequency source overlay selection	Unit position: frequency source selection 0: main frequency source X 1: primary and secondary operations (the operation relationship is determined by ten bits) 2: Main frequency source X and auxiliary frequency source Y are switched 3: Main frequency source X and main and auxiliary operation result switching 4: Auxiliary frequency source Y and main and auxiliary operation result switching Ten digits: frequency source primary and secondary operation relationship 0: main + auxiliary 1: main - auxiliary 2: the maximum of the two 3: the minimum of the two	Default: 00
--------------	-------------------------------------------	-------------------------------------------------------------------------------------------------------------------------------------------------------------------------------------------------------------------------------------------------------------------------------------------------------------------------------------------------------------------------------------------------------------------------------------------------------------------------------------------------------------------------------------------------------------------------------------------------------------	-------------



The frequency reference channel is selected by this parameter. Frequency reference is realized by the combination of the main frequency source X and the auxiliary frequency source Y.

Unit's digit: Frequency source selection:

0: The main frequency source X frequency X is the target frequency.

1: Main and auxiliary operation results The main and auxiliary operation results are used as the target frequency, and the main and auxiliary operation relationships are described in the "ten place".

2: Main frequency source X and auxiliary frequency source Y are switched. When input terminal function P4-00~09 is set to 18

Input terminal (frequency source switching) is invalid: main frequency X is the target frequency;

The input terminal (frequency source switching) is valid: the auxiliary frequency Y is the target frequency.

3: Main frequency source X and main and auxiliary operation result switching When input terminal function P4-00~09 is set to 18

Input terminal (frequency source switching) is invalid: main frequency source X is the target frequency;

The input terminal (frequency source switching) is valid: the result of the main and auxiliary operations is used as the target frequency.

4: Auxiliary frequency source Y and main and auxiliary operation result switching When input terminal function P4-00~09 is set to 18

Invalid input terminal: auxiliary frequency Y as the target frequency;

The input terminal is valid: the result of the main and auxiliary operations is used as the target frequency.

Ten digits: frequency source primary and secondary operation relationship:

0: Main frequency source X + auxiliary frequency source Y is used as the target frequency. Achieve frequency superposition given function.

1: Main frequency source X-auxiliary frequency source Y is used as the target frequency.

2: Take the maximum of the absolute value of the main frequency X and the auxiliary

frequency Y as the target frequency.

- 3: Taking the absolute value of the main frequency X and the auxiliary frequency Y as the minimum target frequency.

When the frequency source is selected as the main and auxiliary operation, the offset frequency is set by P0-21, and the offset frequency is superimposed on the result of the main and auxiliary operations.

P0-08	Preset frequency	0.00Hz~Maximum frequency (P0-10)	Default: 50.00Hz
--------------	-------------------------	----------------------------------	------------------



When the frequency source is selected as digital setting or terminal UP/DOWN, the function code value is the initial value of the frequency digital setting of the inverter. ◦

P0-09	Running direction	0: the direction is the same 1: the opposite direction	Default: 0
--------------	--------------------------	--------------------------------------------------------	------------



It is used to change the running direction of the motor, which is equivalent to adjusting any two lines of motor U, V, W to change the direction of the motor.

Note: After the parameters are initialized, the motor running direction will return to the original state. For the occasion where it is strictly prohibited to change the motor steering, use it with caution. ◦

P0-10	Maximum frequency	50.00Hz~600.00Hz	Default: 50.00Hz
--------------	--------------------------	------------------	------------------



It is used to set the corresponding value of 100.0% for analog input, pulse input, multi-segment command, etc. as the frequency source. ◦

When P0-22=1, the frequency resolution is 0.1Hz, and the setting range of P0-10 is 50.0Hz~3200.0Hz;

When P0-22=2, the frequency resolution is 0.01Hz, and the setting range of P0-10 is 50.0Hz~600.0Hz. ◦

P0-11	Upper frequency source	0: Set by P0-12 1: AI1 2: AI2 3: AI3 4: Pulse setting 5: Communication given	Default: 0
--------------	-------------------------------	------------------------------------------------------------------------------	------------



Define the source of the upper limit frequency. When the upper limit frequency is set with the analog input, 100% of the analog input setting corresponds to P0-12. ◦

(For example, when the torque control mode is adopted in the winding control site, the upper limit frequency can be set by analog to avoid the "speeding" phenomenon of material disconnection. When the inverter runs to the upper limit frequency value, the inverter keeps running at the upper limit frequency. ◦)

P0-12	Upper limit frequency	Lower limit frequency P0-14 ~ maximum frequency P0-10	Default: 50.00Hz
P0-13	Upper frequency offset	0.00Hz to maximum frequency P0-10	Default: 0.00Hz



When the upper limit frequency is analog or pulse setting, P0-13 is used as the offset of the set value, and the offset frequency is superimposed with the upper limit frequency value set by P0-11 as the set value of the final upper limit frequency. ◦

P0-14	Lower limit frequency	0.00Hz~Upper limit frequency P0-12	Default: 0.00Hz
--------------	------------------------------	------------------------------------	-----------------



When the running frequency is lower than the lower limit frequency, the inverter can choose to stop, run at the lower limit frequency or run at zero speed, set by P8-14 .

P0-15	Carrier frequency	0.5kHz~16.0kHz	depending
--------------	--------------------------	----------------	-----------



This function is used to adjust the carrier frequency to reduce motor noise, avoid mechanical resonance points, and reduce ground leakage current and interference. When the carrier frequency is low, the output current higher harmonic component increases, the motor loss increases, and the motor temperature rise increases. When the carrier frequency is high, the motor loss is reduced, the motor temperature rise is reduced, but the temperature rise of the inverter is increased, and the interference is increased.

Adjusting the carrier frequency will affect the following performance:

Carrier frequency	Motor noise	Output current wave	Motor temperature rise	Inverter temperature rise	Leakage current	External radiation interference
Low	Big	Bad	High	Low	Small	Small
High	Small	Good	Low	High	Big	Big

The frequency setting of the carrier frequency is different for inverters with different powers. If the carrier frequency is set higher than Default, the temperature rise of the inverter radiator will increase. At this time, the user needs to derate the inverter, otherwise the inverter has the danger of overheating alarm .

P0-16	Carrier frequency is Adjusted with temperature	0: no 1: yes	Default: 1
--------------	-------------------------------------------------------	-------------------	------------



When the inverter detects that its own temperature is high, it automatically reduces the carrier frequency to reduce the temperature rise of the inverter. When the temperature is low, the carrier frequency is gradually restored to the set value. This function can reduce the chance of the inverter overheating alarm .

P0-17	Acceleration time 1	0.00s~65000s	depending
P0-18	Deceleration time 1	0.00s~65000s	depending



Acceleration time refers to the time required for the inverter to accelerate from zero frequency to the acceleration/deceleration reference frequency (P0-25), see t1 in Figure 6-1.

Deceleration time refers to the time required for the inverter to decelerate to the zero frequency from the acceleration/deceleration reference frequency (P0-25), see t2 in Figure 6-1.

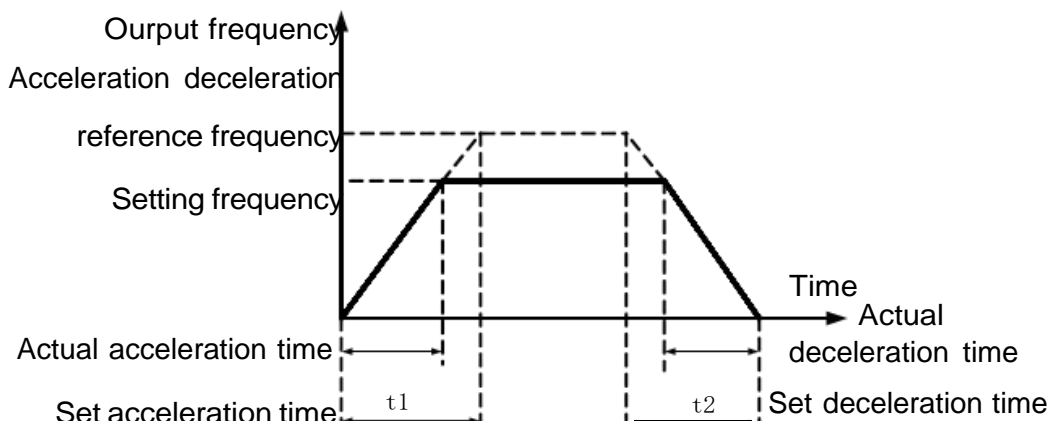

6-1 Acceleration and deceleration time

The inverter provides 4 sets of acceleration/deceleration time (P8-03~P8-08), and the user can switch from the input terminal.

P0-19	Acceleration/deceleration unit	0: 1s 1: 0.1s 2: 0.01s	Default: 1
--------------	---------------------------------------	------------------------------	------------



Used to set 3 acceleration and deceleration time units, which are 1 second, 0.1 second and 0.01 second respectively. ◦

Note: After modifying this parameter, the decimal places displayed in each acceleration/deceleration time will change, and the corresponding acceleration/deceleration time will also change. ◦

P0-21	Auxiliary frequency source offset Frequency when superimposing	0.00Hz~Maximum frequency P0-10	Default: 0.00Hz
--------------	---------------------------------------------------------------------------	--------------------------------	-----------------



When the frequency source is used as the main auxiliary operation, P0-21 is used as the offset frequency, and the result of the main and auxiliary operations is superimposed as the final frequency setting value, so that the frequency setting can be more flexible. ◦

P0-22	Frequency command resolution	1: 0.1Hz 2: 0.01Hz	Default: 2
--------------	-------------------------------------	-----------------------	------------



This parameter is used to determine the resolution of all frequency-dependent function codes.

When the frequency resolution is 0.1Hz, the maximum output frequency can reach 3200Hz.

When the frequency resolution is 0.01 Hz, the maximum output frequency is 600.00 Hz. ◦

Note: When modifying the function parameters, the decimal places of all frequency-related parameters will change and the corresponding frequency values will also change.

P0-23	Digital setting frequency shutdown memory selection	0: no record 1: record	Default: 0
--------------	--------------------------------------------------------------------	-----------------------------	------------



0: It means that after the inverter stops, the digital set frequency value will return to the value of P0-08. The frequency modified by the keyboard ▲, ▼ key or terminal UP, DOWN will be cleared.

1: means that after the inverter stops, the digital set frequency retains the set frequency of the last stop time, and the frequency modified by the keyboard ▲, ▼ key or terminal UP, DOWN remains valid.

P0-24	Motor parameter group selection	0: Motor parameter group 1 1: Motor parameter group 2	Default: 0
--------------	--------------------------------------------	----------------------------------------------------------	------------



The inverter drives the application of 2 motors in time division. The 2 motors can set the motor nameplate parameters, independent parameter tuning, select different control modes, and independently set parameters related to running performance. Motor parameter group 1 The corresponding function parameter group is F1 group and F2 group, and motor parameter group 2 corresponds to function parameter group A2 group. The user can select the current motor parameter group via the F0-24 function code, or switch the motor parameters via the digital input terminal DI.

When the function code selection conflicts with the terminal selection, the terminal selection is subject to.

P0-25	Acceleration/deceleration time reference frequency	0: Maximum frequency (P0-10) 1: Set frequency 2: 100Hz	Default: 0
--------------	---------------------------------------------------------------	-----------------------------------------------------------	------------



Acceleration/deceleration time refers to the acceleration/deceleration time from zero frequency to the frequency set by P0-25. See Figure 6-1.

When P0-25 is selected as 1, the acceleration/deceleration time will change with the change of the set frequency.

P0-26	Runtime frequency command UP/DOWN reference	0: running frequency 1: setting frequency	Default: 0
--------------	------------------------------------------------------------	-------------------------------------------	------------



This parameter is valid only when the frequency source is digitally set.

When used to determine the ▲, ▼ key or terminal UP/DOWN action of the keyboard, the target frequency is increased or decreased based on the operating frequency, or is increased or decreased based on the set frequency.

The difference between the two settings is obvious when the inverter is in the acceleration/deceleration process, that is, if the running frequency of the inverter is different from the set frequency, the different choices of the parameters are very different.

P0-27	Command source bundle frequency source	Single digit: operation panel command binding frequency source selection 0: No binding 1: Digital setting frequency 2: AI1 3: AI2 4: AI3 5: Pulse X6 6: Multi-speed 7: Simple PLC 8: PID 9: Communication given Tens: terminal command binding frequency source selection Hundreds: Communication command binding frequency source selection Thousands: automatic running binding frequency source selection	Default: 0000
--------------	-----------------------------------------------	--------------------------------------------------------------------------------------------------------------------------------------------------------------------------------------------------------------------------------------------------------------------------------------------------------------------------------------------------------------------------------------------------------------------------------------	---------------



Define the bundle combination between the three running command channels and the nine frequency references to facilitate synchronous switching.

The above frequency given channel has the same meaning as the main frequency source X selects P0-03. Different running command channels can bundle the same frequency given channel. When the command source has a bundled frequency source, the frequency source set by P0-03~P0-07 is no longer active during the valid period of the command source.

P1 Group First motor parameter

P1-00	Motor type selection	0: General asynchronous motor 1: variable frequency asynchronous motor	Default: 0
P1-01	Motor rated power	0.1kW~1000.0kW	depending
P1-02	Motor rated voltage	1V~2000V	depending
P1-03	Motor rated current	0.1A~6553.5A	depend
P1-04	Motor rated frequency	0.01Hz~Maximum frequency	depend
P1-05	Motor rated speed	1rpm~65535rpm	depend



The above function code is the motor parameter, and the relevant parameters are accurately set according to the motor nameplate.

In order to obtain better VF or vector control performance, motor parameter tuning is required, and the accuracy of the adjustment result is closely related to the correct setting of the motor nameplate parameters.

P1-06	Asynchronous motor stator resistance	0.001Ω~65.535Ω	Tuning parameter
P1-07	Asynchronous motor rotor resistance	0.001Ω~65.535Ω	Tuning parameter

P1-08	Asynchronous motor leakage inductance	0.01mH~655.35mH	Tuning parameter
P1-09	Asynchronous motor mutual inductance	0.1mH~6553.5mH	Tuning parameter
P1-10	Asynchronous motor no-load current	0.01A~P1-03	Tuning parameter



P1-06~P1-10 are the parameters of the asynchronous motor. These parameters are generally not on the motor nameplate and need to be automatically tuned by the inverter. Among them, "asynchronous motor static tuning" can only obtain three parameters P1-06~P1-08, and "integrated tuning of asynchronous motor" can obtain encoder phase sequence and current loop PI in addition to all five parameters here. Parameters, etc.

When changing the rated power of the motor (P1-01) or the rated voltage of the motor (P1-02), the inverter will automatically modify the P1-06~P1-10 parameter values and restore these five parameters to the common standard Y series motor parameters. If the asynchronous motor cannot be tuned at the site, you can enter the corresponding function code according to the parameters provided by the motor manufacturer.

P1-27	Encoder line number	1~65535	Default: 1024
--------------	----------------------------	---------	---------------



Set the number of pulses per revolution of the ABZ incremental encoder. In the speed sensor vector control mode, the encoder pulse number must be set correctly, otherwise the motor will not operate normally.

P1-30	ABZ incremental encoder AB phase sequence	0: forward 1: reverse	Default: 0
--------------	--------------------------------------------------	-----------------------	------------



This function code is used to set the phase sequence of the ABZ incremental encoder AB signal.

When the asynchronous motor is fully tuned, the AB phase sequence of the ABZ encoder can be obtained.

P1-31	Encoder mounting angle	0.0 ~ 359.9°	Default: 0.0°
P1-32	UVW encoder UYW phase sequence	0: positive 1: reverse	Default: 0
P1-33	UVW encoder offset angle	0.0 ~ 359.9°	Default: 0.0°
P1-34	Rotary transformer pole pair	1~65535	Default: 1



The resolver is extremely logarithmic. When using this encoder, the polar logarithm parameter must be set correctly.

P1-36	Speed feedback PG disconnection detection time	0.0: No action 0.1s~10.0s	Default: 0
--------------	-------------------------------------------------------	------------------------------	------------



It is used to set the detection time of the encoder disconnection fault. When set to 0.0s, the inverter does not detect the encoder disconnection fault. When the inverter detects a disconnection fault and the duration exceeds the set time of P1-36, the inverter alarms ERR20.

P1-37	Tuning selection	0: No operation 1: Static tuning 2: Complete tuning 3: Static full tuning	Default: 0
--------------	-------------------------	---------------------------------------------------------------------------	------------



0: No operation, ie tuning is prohibited.

1: Static tuning, suitable for asynchronous motors and where the load is not easy to disengage and cannot be fully tuned.

Asynchronous machine static tuning (P1-00~P1-05 must be set correctly) can get three parameters P1-06~P1-08.

Action Description: Set the function code to 1, then press the RUN button, the inverter will perform static tuning.

2: Complete tuning To ensure the dynamic control performance of the frequency converter, please select the full tuning.

Before the asynchronous machine is fully tuned, the motor must be disconnected from the load to keep the motor in no-load state. The parameters P1-00~P1-05 must be correctly set. (The encoder pulse number P1-27 must be set under the closed-loop control with PG card.).

The inverter can obtain five motor parameters P1-06~P1-10, AB phase sequence P1-30 (with PG card) of the encoder, and vector control current loop PI parameters P2-13~P2-16.

Action Description: Set the function code to 2, then press the RUN button, the inverter will perform a complete tuning.

3: Applicable to the case of no encoder, self-learning of the motor parameters under the static state of the motor (the motor may still have slight jitter at this time, need to pay attention to safety)

Action description: Set the function code to 3, then press RUN key, the inverter will perform no-load tuning. Note: Tuning supports motor tuning in keyboard operation mode, terminal mode and communication mode.

P2 Group Vector control parameter

P2 Group function code is valid only for vector control and invalid for VF control. .

P2-00	Speed loop proportional gain 1	1~100	Default: 30
P2-01	Speed loop integration time 1	0.01s~10.00s	Default: 0.50s
P2-02	Switching frequency 1	0.00~P2-05	Default: 5.00Hz
P2-03	Speed loop proportional gain 2	1~100	Default: 20

P2-04	Speed loop integration time 2	0.01s~10.00s	Default: 1.00s
P2-05	Switching frequency 2	P2-02~Maximum frequency	Default: 10.00Hz



The inverter runs at different frequencies and can select different speed loop PI parameters. When the running frequency is less than the switching frequency 1 (P2-02), the speed loop PI adjustment parameters are P2-00 and P2-01. When the running frequency is greater than the switching frequency 2, the speed loop PI adjustment parameters are P2-03 and P2-04. Switching the speed loop PI parameter between frequency 1 and switching frequency 2, linearly switching between two sets of PI parameters, as shown in Figure 6-2.:

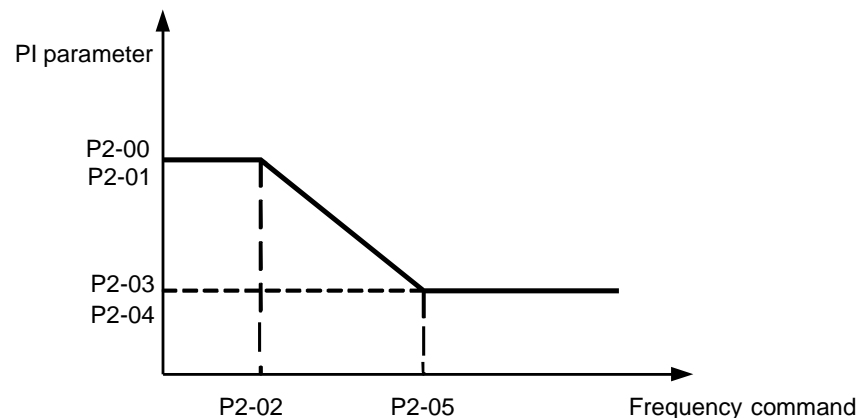

6-2 PI Parameter diagram

The speed dynamic response characteristic of the vector control can be adjusted by setting the proportionality factor and the integration time of the speed regulator.

Increasing the proportional gain and reducing the integration time can speed up the dynamic response of the speed loop. However, if the proportional gain is too large or the integration time is too small, the system can oscillate. The recommended adjustment method is:

If the factory parameters do not meet the requirements, fine-tune the Default parameter, first increase the proportional gain to ensure that the system does not oscillate; then reduce the integration time, so that the system has faster response characteristics, overshoot and smaller.

Note: If the PI parameters are not set properly, the speed overshoot may be too large.

An overvoltage fault occurs even when the overshoot falls back.

P2-06	Vector control slip gain	50%~200%	Default: 100%
--------------	---------------------------------	----------	---------------



For speed sensorless vector control, this parameter is increased when the speed is lower when the motor is loaded, and vice versa.

For speed sensor vector control, this parameter can adjust the output current of the inverter under the same load.

For speed sensor vector control, this parameter can adjust the output current of the inverter under the same load.

P2-07	Speed loop filter time constant	0.000s~0.100s	Default: 0.000s
--------------	----------------------------------------	---------------	-----------------



In vector control mode, the output of the speed loop regulator is the torque current command, which is used to filter the torque command. This parameter generally does not need to be adjusted. When the speed fluctuates greatly, the filtering time can be appropriately increased. If the motor oscillates, the parameter should be appropriately reduced. The speed loop filter time constant is small, the inverter output torque may fluctuate greatly, but the speed response is fast.

P2-08	Vector controlled overexcitation gain	0~200	Default: 64
--------------	----------------------------------------------	-------	-------------



During deceleration, the overexcitation control can suppress the rise of the bus voltage and avoid overvoltage faults. The larger the overexcitation gain, the stronger the suppression effect.

In the case where the inverter is easy to overvoltage alarm during the deceleration process, it is necessary to increase the overexcitation gain. However, the overexcitation gain is too large, which tends to cause an increase in the output current, which needs to be weighed in the application.

For applications where the inertia is small, there is no voltage rise during motor deceleration. It is recommended to set the overexcitation gain to 0. For those with braking resistors, it is also recommended to set the overexcitation gain to 0.

P2-09	Torque upper limit source in speed control mode	0: Function code P2-10 setting 1: AI1 2: AI2 3: AI3 4: Pulse setting 5: Communication setting 6: MIN (AI1, AI2) 7: MAX (AI1, AI2) The full scale of the 1-7 option corresponds to P2-10	Default: 0
P2-10	Torque upper limit in speed control mode	0.0%~200.0%	Default: 150.0%



In the speed control mode, the maximum value of the inverter output torque is controlled by the torque upper limit source.

P2-09 is used to select the setting source of the upper torque limit. When it is set by analog quantity, pulse and communication, the corresponding setting of 100% corresponds to P2-10, and 100% of P2-10 is the rated torque of the inverter.

P2-13	Excitation adjustment proportional gain	0~60000	Default: 2000
P2-14	Excitation regulation integral gain	0~60000	Default: 1300
P2-15	Torque adjustment proportional gain	0~60000	Default: 2000
P2-16	Torque adjustment integral gain	0~60000	Default: 1300

 The vector control current loop PI adjusts the parameter, which is automatically obtained after the asynchronous machine is fully tuned, and generally does not need to be modified.

Need to be reminded that the integral regulator of the current loop does not use the integration time as the dimension, but directly sets the integral gain. The current loop PI gain setting is too large, which may cause the entire control loop to oscillate, so when the current oscillation or torque fluctuation is large, the PI proportional gain or integral gain can be manually reduced.

P2-20	Maximum output voltage coefficient	100%~110%	Default: 105%
--------------	-------------------------------------------	-----------	---------------

 The maximum output voltage coefficient indicates the boosting capacity of the maximum output voltage of the inverter. Increasing the F2-20 can increase the maximum load capacity of the weak field of the motor, but the increase of the motor current ripple will increase the heat generated by the motor; otherwise, the maximum band of the weak field of the motor The load capacity will decrease, but the motor current ripple will decrease, which will reduce the heat generated by the motor. Generally no adjustment required.

P2-21	Weak magnetic Zone maximum torque factor	50%~200%	Default: 100%
--------------	-------------------------------------------------	----------	---------------

 This parameter only takes effect when the motor is running above the rated frequency. When the motor needs to accelerate to 2 times the rated motor frequency and the actual acceleration time is longer, reduce F2-21 appropriately; when the motor runs at 2 times the rated frequency and the speed drops greatly, increase F2-21 appropriately. Generally no need to change.

P3 Group V/F control parameter

This group of function codes is valid only for V/F control and invalid for vector control. V/F control is suitable for general-purpose loads such as fans and pumps, or an inverter with multiple motors, or applications with large differences in inverter power and motor power. .

P3-00	VF Curve setting	0: Straight line V/F 1: Multi-point V/F 2: square V/F 3: 1.2 power V/F 4: 1.4 power V/F 6: 1.6 power V/F 8: 1.8 power V/F 9: reserved 10: V/F complete separation mode 11: V/F semi-separation mode	Default: 0
--------------	-------------------------	--------------------------------------------------------------------------------------------------------------------------------------------------------------------------------------------------------------------	------------

 0: Straight line V/F. Suitable for ordinary constant torque loads.
1: Multi-point V/F. Suitable for loads such as dehydrators and centrifuges. Set the P3-03~P3-08 parameters to get any V/F curve.
2: square V/F. Suitable for centrifugal loads such as fans and pumps.
3~8: V/F relationship between straight line V/F and square V/F.
10: V/F complete separation mode. At this time, the output frequency of the inverter is independent of the output voltage, the output frequency is determined by the frequency source, and the output voltage is determined by P3-13. Generally used in induction heating, inverter power, torque motors and other occasions.

11: V/F semi-separation mode. In this mode, V is proportional to F, but the proportional relationship can be set by P3-13, and the relationship between V and F is also related to the rated voltage and rated frequency of the motor of P1 group.

Assuming that the voltage source input is X (X is 0~100%), the relationship between the inverter output voltage V and the frequency F is: $V/F=2 * X * (\text{motor rated voltage}) / (\text{motor rated frequency})$

P3-01	Torque boost	0.0% (Auto) 0.1%~30.0%	depend
P3-02	Torque boost cutoff frequency	0.00Hz~Maximum frequency	Default: 50.00Hz



In order to compensate for the low-frequency torque characteristics of the V/F control, some boost compensation is applied to the output voltage of the inverter at low frequencies. However, the torque boost setting is too large, the motor is prone to overheating, and the inverter is prone to overcurrent.

It is recommended to increase this parameter when the load is heavy and the motor starting torque is insufficient. The torque boost can be reduced when the load is light.

When the torque boost is set to 0.0, the inverter is automatically torque boosted. At this time, the inverter automatically calculates the required torque boost value according to parameters such as the stator resistance of the motor.

Torque boost cutoff frequency: Under this frequency, the torque boost is valid. If the set frequency is exceeded, the torque boost will be invalid, as shown in Figure 6-3

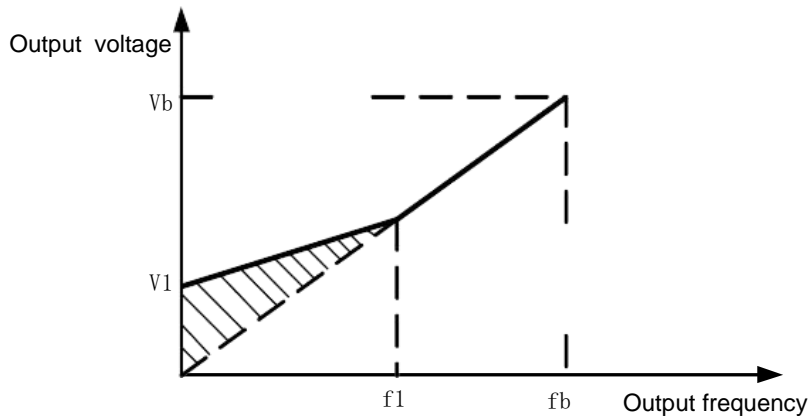

V1: Manual torque boost voltage

Vb: Maximum output voltage

f1: manual torque boost cutoff frequency

fb: Rated operating frequency

6-3 Manual torque boost

P3-03	Multi-point VF frequency point 1	0.00Hz~P3-05	Default: 0.00Hz
P3-04	Multi-point VF voltage point 1	0.0%~100.0%	Default: 0.0%

P3-05	Multi-point VF frequency point 2	P3-03~P3-07	Default: 0.00Hz
P3-06	Multi-point VF voltage point 2	0.0%~100.0%	Default: 0.0%
P3-07	Multi-point VF frequency point 3	P3-05~motor rated frequency (P1-04)	Default: 0.00Hz
P3-08	Multi-point VF voltage point 3	0.0%~100.0%	Default: 0.0%



P3-03~P3-08 Six parameters define multi-segment V/F curves .

The multi-point V/F curve should be set according to the load characteristics of the motor.

It should be noted that the relationship between the three voltage points and the frequency point must satisfy: $V1 < V2 < V3$, $F1 < F2 < F3$. Figure 6-4 shows the setting of the multi-point VF curve.

If the voltage is set too high at low frequencies, the motor may overheat or even burn out. The inverter may over-current or over-current protection. .

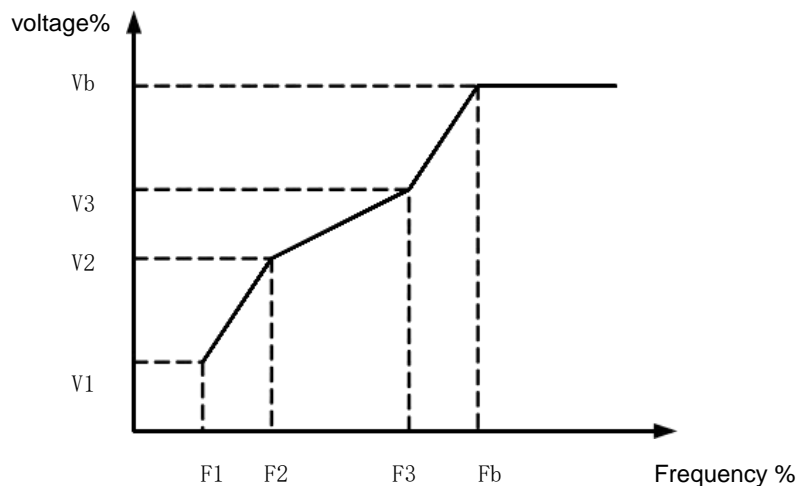

V1-V3: Multi-speed V/F section 1-3 voltage percentage

F1-F3: Multi-speed V/F section 1-3 frequency percentage Vb:

Motor rated voltage

Fb: Motor rated running frequency

6-4 Multi-point V/F curve setting diagram

P3-09	VF slip compensation gain	0.0%~200.0%	Default: 0.0%
--------------	----------------------------------	-------------	---------------



The VF slip compensation can compensate the motor speed deviation generated by the asynchronous motor when the load increases, so that the motor speed can be basically stabilized when the load changes. The VF slip compensation gain is set to 100.0%, which means that the motor's rated slip is the motor's rated slip when the rated load is applied, and the motor's rated slip is obtained. The inverter is calculated by the rated frequency and rated speed of the P1 motor.

When adjusting the VF slip compensation gain, the motor speed is basically the same

as the target speed under the rated load. When the motor speed is different from the target value, the gain needs to be fine-tuned appropriately.

P3-10	VF Overexcitation gain	0~200	Default: 64
--------------	-------------------------------	-------	-------------



During the deceleration, the overexcitation control can suppress the rise of the bus voltage and avoid overvoltage faults. The larger the overexcitation gain, the stronger the suppression effect.

In the case where the inverter is easy to overvoltage alarm during the deceleration process, it is necessary to increase the overexcitation gain. However, the overexcitation gain is too large, which tends to cause an increase in the output current, which needs to be weighed in the application.

For applications where the inertia is small, there is no voltage rise during motor deceleration. It is recommended to set the overexcitation gain to 0. For those with braking resistors, it is also recommended to set the overexcitation gain to 0.

P3-11	VF Oscillation suppression gain	0~100	depend
--------------	----------------------------------------	-------	--------



The selection method of the gain is as small as possible under the premise of effectively suppressing the oscillation, so as to avoid adversely affecting the operation of the VF. Select this gain to be 0 when there is no oscillation in the motor. Only when the motor oscillates obviously, the gain needs to be appropriately increased. The larger the gain, the more obvious the suppression of the oscillation. When using the suppression oscillation function, the motor rated current and no-load current parameters are required to be accurate, otherwise the VF oscillation suppression effect is not good.

P3-13	VF separated voltage source	0: Digital setting (P3-14) 1: AI1 2: AI2 3: AI3 4: Pulse setting (X6) 5: Multi-speed 6: Simple PLC 7: PID 8: Communication reference (100.0% corresponds to rated voltage)	Default: 0
P3-14	VF separation voltage digital setting	0V ~ motor rated voltage	Default: 0V



VF separation is generally used in induction heating, inverter power supply and torque motor control.

When VF separation control is selected, the output voltage can be set by function code P3-14, or it can be from analog quantity, multi-segment instruction, PLC, PID or communication reference. When using non-digital setting, 100% of each setting corresponds to the rated voltage of the motor. When the percentage of the output setting such as analog quantity is negative, the set absolute value is used as the effective setting value.

0: Digital setting (P3-14) The voltage is set directly by P3-14.

1: AI1 2: AI2 3: The AI3 voltage is determined by the analog input terminal.

4: Pulse setting The voltage reference is given by the terminal pulse.

5: Multi-segment command When the voltage source is a multi-segment command, set

the P4 group and PC group parameters to determine the output voltage.

6: When the simple PLC voltage source is a simple PLC, you need to set the PC group parameters to determine the given output voltage.

7: PID: The output voltage is generated according to the PID closed loop. For details, see the introduction of the PA group PID.

8: Communication reference The voltage is given by the host computer through communication.

When the above voltage source is selected from 1 to 8, 0 to 100% corresponds to the output voltage 0V to the motor rated voltage.

P3-15	VF separation voltage acceleration time	0.0s~1000.0s	Default: 0.0s
P3-16	VF separation voltage deceleration time	0.0s~1000.0s	Default: 0.0s



The VF separation rise time refers to the time required for the output voltage to change from 0V to the rated voltage of the motor. As shown in Figure 6-5:

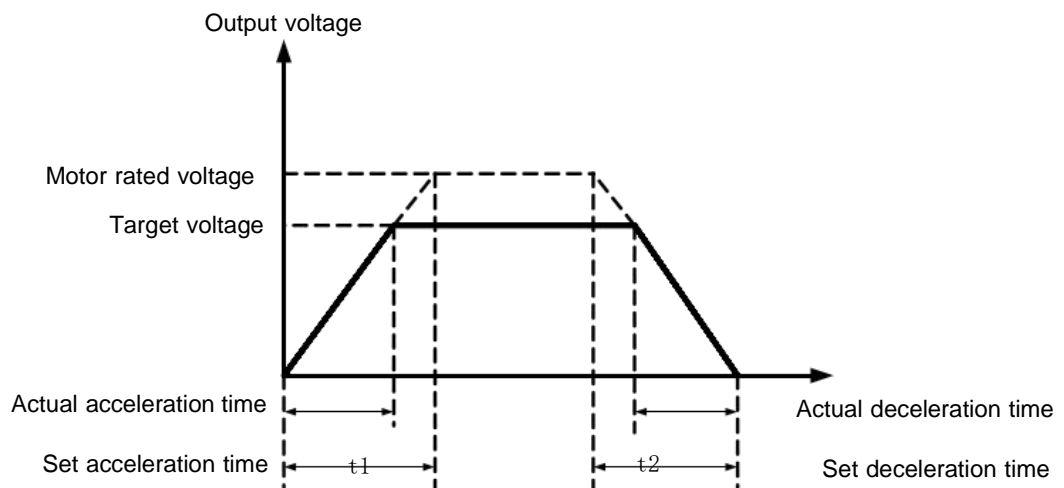

6-5 V/F Separation diagram

P3-17	VF shutdown selection	Separate mode 0: frequency / voltage is independently reduced to 0 1: After the voltage is reduced to 0, the frequency is reduced again.	Default: 0
--------------	------------------------------	-------------------------------------------------------------------------------------------------------------------------------------------------------	------------



0: The frequency/voltage is independently reduced to 0; the V/F separated output voltage is decremented to 0V according to the voltage fall time (F3-15); the V/F separated output frequency is simultaneously decremented to 0Hz according to the deceleration time (F0-18)..

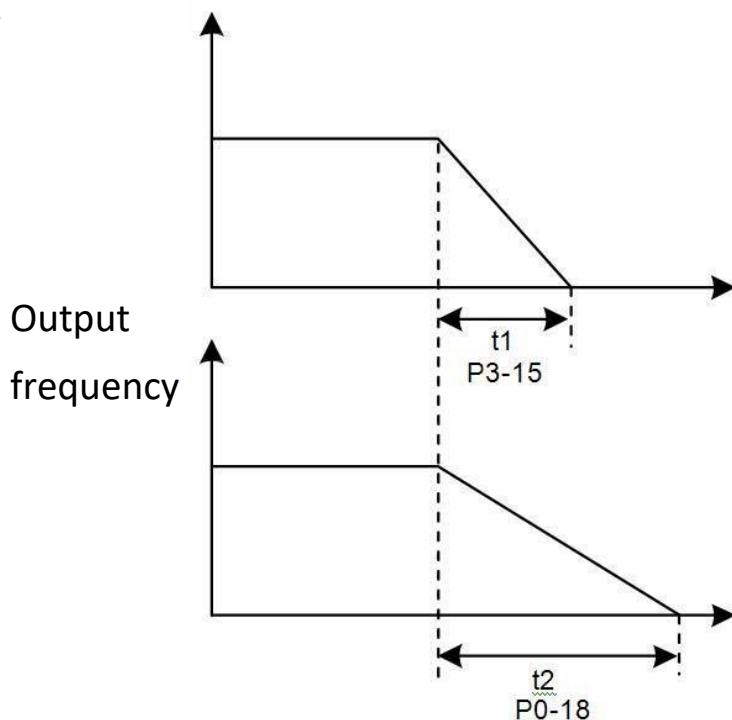

6-6 V/F Separate output voltage / frequency independently reduced to 0 1:

After the voltage is reduced to 0, the frequency is further reduced; the V/F separated output voltage is first decremented to 0V according to the voltage falling time (F3-15), and then the frequency is decremented to 0Hz according to the deceleration time (F0-18)..

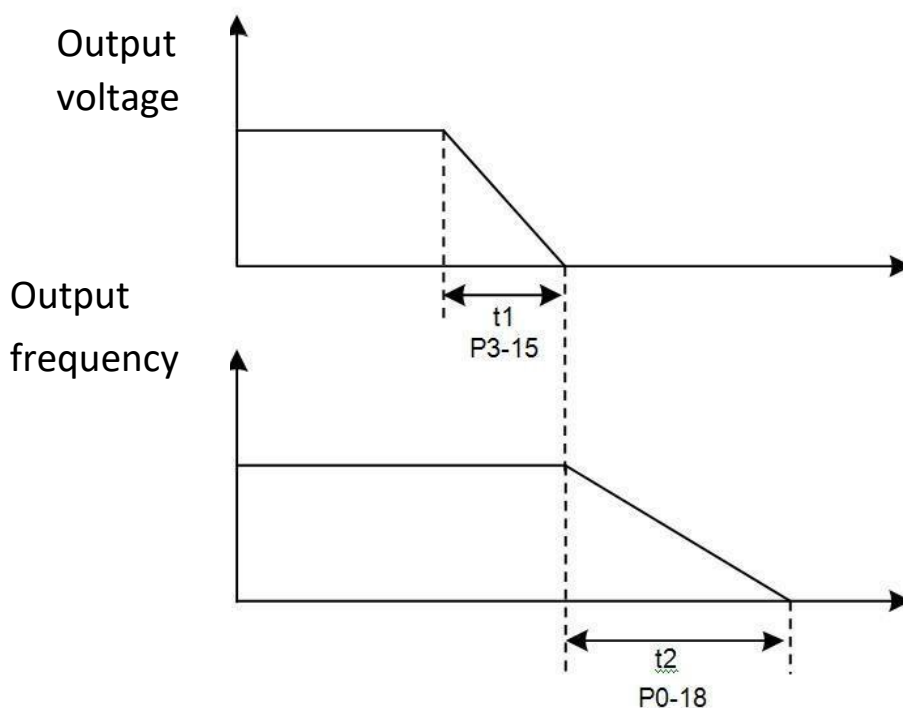

Inverter output current (torque) limit In the acceleration, constant speed, deceleration process, if the current exceeds the over current loss current point (150%), the overcurrent speed will work.

When the current exceeds the over-discharge speed point, the output frequency begins to decrease. Until the current returns below the over-discharge speed point, the frequency begins to accelerate upward to the target frequency. The actual acceleration time is automatically lengthened. If the actual acceleration time does not meet the requirements, it may be appropriate. Increase "F1-21 over-current operating current".

P3-18	Overcurrent current	50~200%	Default: 150%
P3-19	Over-speed suppression	0 is invalid, 1 is valid	Default: 1
P3-20	Over-speed rejection gain	0~100	Default: 20
P3-21	Double speed overrun speed action current compensation coefficient	50~200%	Default: 50%



In the high frequency region, the motor drive current is small, and the speed of the motor drops greatly with respect to the same stall current below the rated frequency. In order to improve the operating characteristics of the motor, the stall operating current above the rated frequency can be reduced, in some centrifuges. When the operating frequency is high, requiring several times of weak magnetic field and large load inertia, this method has a good effect on the acceleration performance.

Transition stall current exceeding the rated frequency = $(f_s/f_n) * k * \text{LimitCur}$;

f_s is the running frequency, f_n is the rated motor frequency, k is F3-21 "double speed over loss speed action current compensation coefficient", LimitCur is F3-18 "overcurrent speed action current";

Overcurrent loss current 150% means 1.5 times the rated current of the inverter;

For high-power motors, the carrier frequency is below 2 kHz. Due to the increase of the ripple current, the wave-by-wave current-limit response starts before the over-speed prevention action, and the torque is insufficient. In this case, reduce the over-speed prevention operation current.

- Inverter bus voltage limit (and brake resistor turn-on voltage setting)

If the bus voltage exceeds the overvoltage stall point of 760V, indicating that the electromechanical system is already in the power generation state (motor speed > output frequency), the overvoltage stall will work, adjust the output frequency (consuming more feedback than the feedback), the actual deceleration time will be automatic Stretching, avoiding trip protection, if the actual deceleration time can not meet the requirements, you can increase the overexcitation gain appropriately.

P3-22	Overvoltage stall operating voltage	200.0V~2000.0V	Default: depending
P3-23	Overvoltage stall enable	0 is invalid, 1 is valid	Default: 0
P3-24	Overvoltage stall suppression frequency gain	0~100	Default: 30
P3-25	Overvoltage stall suppression voltage gain	0~100	Default: 30
P3-27	Slip compensation time constant	0.1~10.0s	Default: 0.5

The smaller the response time value of the slip compensation is set, the faster the response speed is.

P4-00	X1 terminal function selection	Default: 1 (forward running)
P4-01	X2 terminal function selection	Default: 4 (forward jog)
P4-02	X3 terminal function selection	Default: 9 (fault reset)
P4-03	X4 terminal function selection	Default: 12 (multi-speed 1)
P4-04	X6 terminal function selection	Default: 13 (multi-speed 2)
P4-05	X5 terminal function selection	Default: 0
P4-06	X7 terminal function selection	Default: 0
P4-07	X8 terminal function selection	Default: 0
P4-08	X9 terminal function selection	Default: 0



These parameters are used to set the function of the digital multi-function input terminal. The functions that can be selected are shown in the table below.:

Setting value	Function	Instruction
0	No function	The unused terminals can be set to "No function" to prevent malfunction.
1	Forward running (X1)	The inverter is controlled to rotate forward and reverse

2	Reverse run (X2)	by external terminals.
3	Three-wire running terminal	Through this terminal as a three-wire running terminal, see P4-11 for details.
4	Forward turn	Control the forward and reverse jog operation of the inverter through external terminals.
5	Reverse jog	Jog running frequency, jog acceleration/deceleration time see P8-00~P8-02
6	Terminal UP	The frequency is incremented or decremented when the frequency is given by the external terminal. When the frequency source is set to digital setting, the set frequency can be adjusted up and down.
7	Terminal DOWN	
8	Free parking	The inverter blocks the output, and the motor's stopping process is not controlled by the inverter. This mode has the same meaning as the free parking described in P6-10.
9	Fault reset	The fault is reset via the terminal. Same as the RESET button on the keyboard.
10	Run pause	Inverter decelerates to stop, but all operating parameters are memorized. Such as PLC parameters, swing frequency parameters, PID parameters. After the terminal signal disappears, the inverter returns to the operating state before stopping.
11	External fault normally open input	When the signal is activated, the fault ERR15 is reported and the fault is processed according to the setting of P9-47.
12	Multi-speed terminal 1	The 16-segment speed or 16 other commands can be set by combining the 16 states of the four terminals. See Table 1 for details.
13	Multi-speed terminal 2	
14	Multi-speed terminal 3	
15	Multi-speed terminal 4	
16	Acceleration/deceleration time selection 1	Through the combination of the four states of the two terminals, four kinds of acceleration/deceleration time are selected. For details, see Appendix 2.
17	Acceleration/deceleration time selection 2	
18	Frequency source switching	This terminal is used to switch the main frequency between the two frequency sources. See P0-07 for details.
19	UP/DOWN setting remove (terminal, keyboard)	When the frequency is given as the digital frequency, this terminal can remove the frequency value changed by the terminal UP/DOWN or the keyboard UP/DOWN, so that the given frequency returns to the value set by P0-08.
20	Run command switch	This terminal can be used to switch between terminal control

	terminal	(P0-02=1) and keyboard control. This terminal can be used for communication control (P0-02=2) and keyboard control switching.
21	Acceleration and deceleration prohibited	Ensure that the inverter is not affected by external signals (except for shutdown commands), Maintain the current output frequency.
22	PID pause	The PID temporarily fails, the inverter maintains the current output frequency, and no PID adjustment is performed.
23	PLC status reset	When the PLC runs paused, this terminal can be restored to the initial state of the PLC.
24	Swing frequency pause	The frequency converter outputs at the center frequency. The swing frequency function is suspended.
25	Counter input	Count the input terminals of the pulse.
26	Counter reset	The counter status is cleared.
27	Length count input	Input terminal for length counting.
28	Length reset	Zero length
29	Torque control prohibited	The inverter is prohibited from performing torque control, and the inverter enters the speed control mode.
30	Pulse frequency input	X6 functions as a PULSE pulse input terminal (only X6 is active).
32	Immediate DC braking	When the terminal is valid, the inverter directly switches to the DC braking state.
33	External fault normally closed input	When the external fault normally closed signal is sent, the inverter reports ERR15 fault and stops.
34	Frequency modification prohibited	When the terminal function is valid, the inverter does not respond to the frequency change.
35	PID action direction is reversed	When the terminal is valid, the direction of the PID action is opposite to the direction set by PA-03.
36	External parking terminal 1	When the keyboard is controlled, the terminal can be stopped, which is equivalent to the STOP button function on the keyboard.
37	Control command switching	Used for switching between terminal control and

	terminal 2	communication control. If the command source is selected as the terminal control, the system switches to communication control when the terminal is valid; vice versa.
38	PID integration pause	When the terminal is valid, the integral adjustment function of the PID is suspended, but the proportional adjustment and differential adjustment functions of the PID are still valid.
39	Frequency source X and preset frequency switching	When the terminal is valid, the frequency source X is replaced by the preset frequency (P0-08).
40	Frequency source Y and preset frequency switching	When the terminal is valid, the frequency source Y is replaced by the preset frequency (P0-08).
43	PID parameter switching	When the terminal is invalid, the PID parameter uses PA-05~PA-07; when the terminal is valid, PA-15~PA-17 is used; (PA-18=1)
44	User-defined fault 1	When the user-defined faults 1 and 2 are valid, the inverter will alarm ERR27 and ERR28 respectively, and the inverter will select the action mode selected by P9-49 according to the fault protection action.
45	User-defined fault 2	
46	Speed control / torque control switching	The inverter is switched between torque control and speed control mode. When the terminal is invalid, the inverter runs in the control mode defined by A0-00. When the terminal is valid, it switches to the other mode.
47	emergency stop	When the terminal is valid, the inverter stops at the fastest speed, and the current is at the set current limit during the stop. This function is used when the inverter needs to stop as soon as possible in an emergency state.
48	External parking terminal 2	In any control mode (panel control, terminal control, communication control), this terminal can be used to decelerate the inverter, and the deceleration time is fixed at deceleration time 4.
49	Deceleration DC braking	When valid, the inverter decelerates to the braking start frequency and then DC braking.
50	This run time is cleared	When the terminal is valid, the timing of the inverter running this time is cleared. This function needs to be used together with the timing operation (P8-42) and the current running time arrival (P8-53).

51	Two-wire/three-wire switching	Used to switch between two-wire and three-wire control. If F4-11 is two-wire type 1, the function is switched to three-wire type 1 when the terminal function is valid. So on and so forth.
52	Reverse reversal	This terminal is valid and the inverter is prohibited from being reversed. Same function as F8-13.

Table1 Multi-segment instruction function description

The four multi-segment command terminals can be combined into 16 states, and each of the 16 states correspond to 16 command set values. As shown in Table 1:

K4	K3	K2	K1	Instruction setting	Corresponding parameter
OFF	OFF	OFF	OFF	Multi-segment instruction 0	PC-00
OFF	OFF	OFF	ON	Multi-segment instruction 1	PC-01
OFF	OFF	ON	OFF	Multi-segment instruction 2	PC-02
OFF	OFF	ON	ON	Multi-segment instruction 3	PC-03
OFF	ON	OFF	OFF	Multi-segment instruction 4	PC-04
OFF	ON	OFF	ON	Multi-segment instruction 5	PC-05
OFF	ON	ON	OFF	Multi-segment instruction 6	PC-06
OFF	ON	ON	ON	Multi-segment instruction 7	PC-07
ON	OFF	OFF	OFF	Multi-segment instruction 8	PC-08
ON	OFF	OFF	ON	Multi-segment instruction 9	PC-09
ON	OFF	ON	OFF	Multi-segment instruction 10	PC-10
ON	OFF	ON	ON	Multi-segment instruction 11	PC-11
ON	ON	OFF	OFF	Multi-segment instruction 12	PC-12
ON	ON	OFF	ON	Multi-segment instruction 13	PC-13
ON	ON	ON	OFF	Multi-segment instruction 14	PC-14
ON	ON	ON	ON	Multi-segment instruction 15	PC-15

When the frequency source is selected as multi-speed, 100.0% of function code PC-00~PC-15 corresponds to Maximum frequency P0-10. In addition to being a multi-speed function, the multi-segment command can also be used as a given source of PID or as a voltage source for VF separation control to meet the need to switch between different given

values.

Schedule 2 Acceleration/deceleration time selection terminal function description

Terminal 2	Terminal 1	Acceleration or deceleration time selection	Corresponding parameter
OFF	OFF	Acceleration time 1	P0-17、P0-18
OFF	ON	Acceleration time 2	P8-03、P8-04
ON	OFF	Acceleration time 3	P8-05、P8-06
ON	ON	Acceleration time 4	P8-07、P8-08

P4-10 Input terminal filter time 0.000s~1.000s Default: 0.010s



Set the software filter time for the terminal status. If the input terminal is susceptible to interference and cause malfunction, increase this parameter to enhance the anti-interference ability. However, this parameter increase will cause the X terminal to respond slowly.

P4-11 Terminal command mode 0: two-wire type 1: two-wire type 2
2: Three-wire type 1 3: Three-wire type 2 Default: 0



This parameter defines four different ways to control the operation of the drive via external terminals.

0: Two-wire mode 1: The positive and negative running of the motor is determined by terminals X1 and X2.

Terminal function settings are as follows:

Terminal	Function code	Setting value	Description
Terminal	P4-11	0	Two-line type 1
X1	P4-00	1	Forward running (X1)
X2	P4-01	2	Reverse run (X2)

K1	K2	Run
1	0	Forward
0	1	Reverse
1	1	stop
0	0	stop

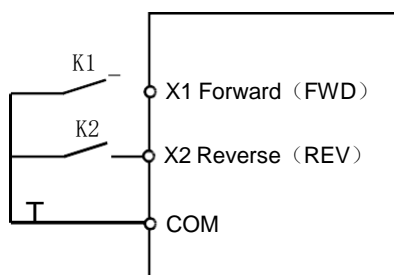

Figure 6-6 Two-wire mode 1

1: Two-wire mode 2, in this mode, the X1 terminal function is the operation enable terminal, and the X2 terminal function determines the running direction. The terminal function settings are as follows:

Terminal	Function code	Setting value	description
----------	---------------	---------------	-------------

Terminal command mode	P4-11	1	Two-line 2
X1	P4-00	1	Run enable
X2	P4-01	2	Positive and negative

K1	K2	Run
1	0	Forward
1	1	Reverse
0	0	stop
0	1	stop

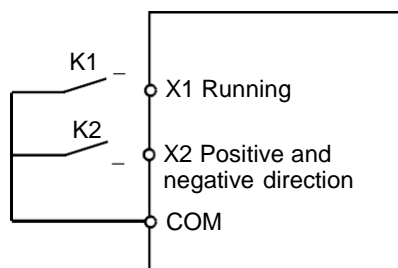

Figure 6-7 Two-wire mode 2

2: Three-wire control mode 1, this mode X3 is the enable terminal, and the direction is controlled by X1 and X2 respectively. Terminal function settings are as follows:

Terminal	Function code	Setting value	Description
Terminal command mode	P4-11	2	Three-wire type 1
X1	P4-00	1	Forward running (X1)
X2	P4-01	2	Reverse run (X2)
X3	P4-02	3	Three-wire operation

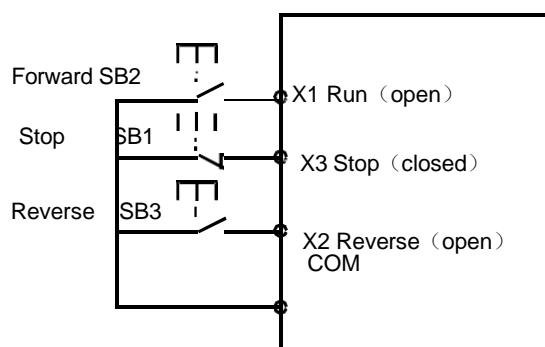

Figure 6-8 Three-wire control mode 1

As shown in the figure above, in the control mode, when the SB1 button is closed, press the SB2 button to turn the inverter forward. Press the SB3 button to reverse the inverter. When the SB1 button is turned off, the inverter stops. During normal start-up and operation, it is necessary to keep the SB1 button closed. The commands of the SB2 and SB3 buttons are valid at the end of the closing action. The running status of the inverter is based on the last button action of the three buttons.

3: Three-wire control mode 2, the X3 enable terminal of this mode, the running

command is given by X1, and the direction is determined by the state of X2.

Terminal function settings are as follows:

Terminal	Function code	Setting value	Description
Terminal command mode	P4-11	3	Three-wire type 2
X1	P4-00	1	Run enable
X2	P4-01	2	Positive and negative
X3	P4-02	3	Three-wire operation

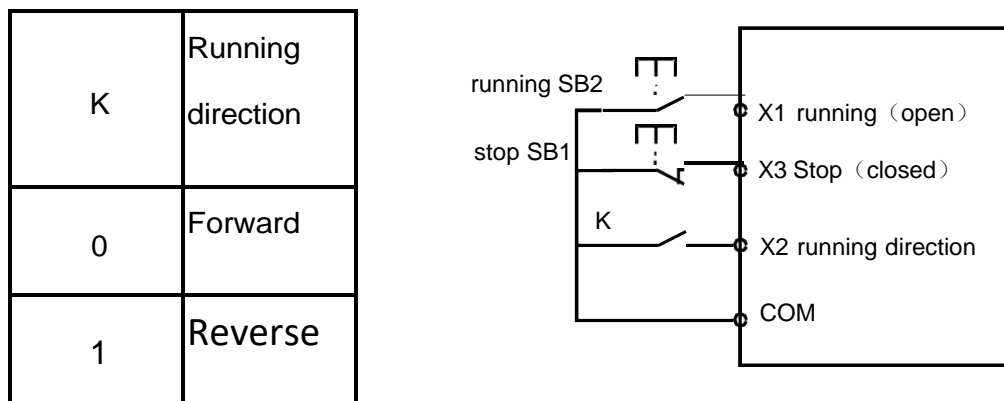

Figure 6-9 Three-wire control mode 2

As shown in the above figure, in the control mode, when the SB1 button is closed, press the SB2 button to run the inverter, K disconnects the inverter from forward rotation, K closes the inverter to reverse; when the SB1 button is disconnected, the inverter stops. During normal start-up and operation, the SB1 button must be closed and the SB2 button command will take effect at the end of the closing action.

P4-12	P4-12 terminal UP/DOWN change rate	0.001Hz/s~65.535Hz/s	Default: 1.00Hz/s
--------------	-------------------------------------------	----------------------	-------------------



It is used to set the speed at which the terminal UP/DOWN changes when the set frequency is adjusted, that is, the amount of change in frequency per second.

When P0-22 (frequency point) is 2, the value ranges from 0.001 Hz/s to 65.535 Hz/s.

When P0-22 (frequency decimal point) is 1, the value ranges from 0.01 Hz/s to 655.35 Hz/s.

P4-13	AI curve 1 minimum input	0.00V~P4-15	Default: 0.00V
P4-14	AI curve 1 minimum input corresponding value	-100.0%~+100.0%	Default: 0.0%
P4-15	AI curve 1 maximum input	P4-13~+10.00V	Default: 10.00V
P4-16	AI curve 1 maximum input corresponding value	-100.0%~+100.0%	Default: 100.0%
P4-17	AI1 filtering time	0.00s~10.00s	Default: 0.10s



The above function code is used to set the relationship between the analog input voltage and the set value it represents.

When the analog input voltage is greater than the set maximum input (P4-15), the analog voltage is calculated as the maximum input; when the analog input voltage is less than the set minimum input (P4-13), then P4 The -34 setting is calculated with a minimum input or 0.0%.

When the analog input is a current input, the 1mA current is equivalent to 0.5V.

AI1 input filtering time is used to set the software filtering time of AI1. When the field analog quantity is easily disturbed, please increase the filtering time so that the detected analog quantity tends to be stable, but the larger the filtering time is, the analog quantity detection is. The slower the response.

In different applications, the nominal value corresponding to 100.0% of the analog setting is different. For details, please refer to the description of each part. The following illustrations are for two typical settings:

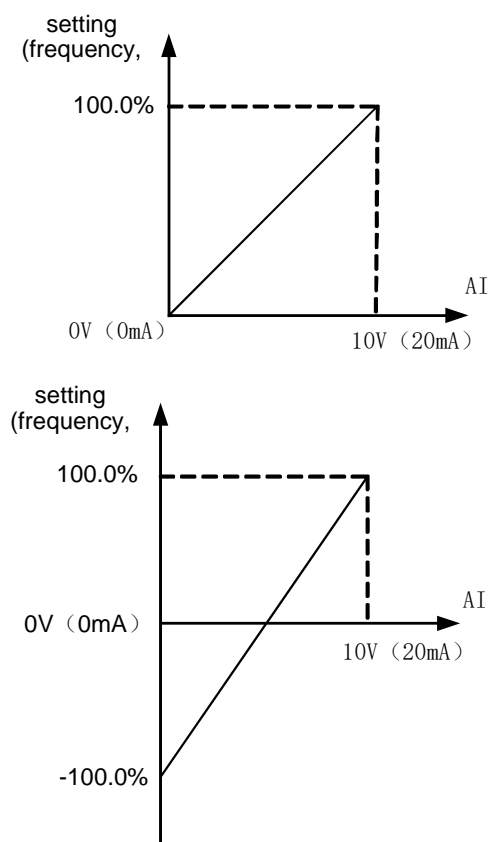

Figure 6-10 Correspondence between analog reference and set amount

P4-18	AI curve 2 minimum input	0.00V~P4-20	Default: 0.00V
P4-19	AI curve 2 minimum input corresponding value	-100.0%~+100.0%	Default: 0.0%
P4-20	AI curve 2 maximum input	P4-18~+10.00V	Default: 10.00V

P4-21	AI curve 2 maximum input corresponding value	-100.0%~+100.0%	Default: 100.0%
P4-22	AI2 filtering time	0.00s~10.00s	Default: 0.10s



For the function and usage of curve 2, please refer to the description of curve 1.

P4-23	AI curve 3 minimum input	-10.00V~P4-25	Default: -10.00V
P4-24	AI curve 3 minimum input corresponding value	-100.0%~+100.0%	Default: -100.0%
P4-25	AI curve 3 maximum input	P4-23~+10.00V	Default: 10.00V
P4-26	AI curve 3 maximum input corresponding value	-100.0%~+100.0%	Default: 100.0%
P4-27	AI3 filtering time	0.00s~10.00s	Default: 0.10s



For the function and usage of curve 3, please refer to the description of curve 1.

P4-28	Pulse minimum input	0.00kHz~P4-30	Default: 0.00kHz
P4-29	Pulse minimum input corresponding value	-100.0%~100.0%	Default: 0.0%
P4-30	Pulse maximum input	P4-28~100.00kHz	Default: 50.00kHz
P4-31	Pulse maximum input corresponding value	-100.0%~100.0%	Default: 100.0%
P4-32	Pulse input filtering time	0.00s~10.00s	Default: 0.10s



This group of function codes is used to set the relationship between the multi-function terminal X6 pulse input frequency and the corresponding setting.

The pulse frequency is only valid at the X6 terminal. The application of this group of functions is similar to curve 1, please refer to the description of curve 1.

P4-33	AI curve selection	Unit: AI1 curve selection 1: curve 1 (2 points, P4-13 to P4-16) 2: Curve 2 (2 points, P4-18 to P4-21) 3: Curve 3 (2 points, P4-23 to P4-26) 4: Curve 4 (4 points, A6-00 to A6-07) 5: Curve 5 (4 points, A6-08 to A6-15) Ten: AI2 curve selection, ibid. Hundreds: AI3 curve selection, ibid.	Default: 321
--------------	--------------------	-------------------------------------------------------------------------------------------------------------------------------------------------------------------------------------------------------------------------------------------------------------------------------------------------------------------	--------------



The unit's digit, ten's digit, and hundred's digit of the function code are used to select

the setting curves corresponding to AI1, AI2, and AI3, respectively.

Three analog inputs can be selected from any of the three curves. Curve 1, curve 2, and curve 3 are 2-point curves, which are set in the P4 group function code.

P4-34	AI is below the minimum input setting selection	Unit digit: AI1 is lower than the minimum input setting selection 0: corresponding to the minimum input setting 1:0.0% Ten digits: AI2 is lower than the minimum input setting selection, the same as hundreds: AI3 is lower than the minimum input setting selection, <i>ibid.</i>	Default: 000
--------------	--------------------------------------------------------	-------------------------------------------------------------------------------------------------------------------------------------------------------------------------------------------------------------------------------------------------------------------------------------------	--------------



The function code is used when the voltage of the analog input is less than the set "minimum input", and the corresponding setting of the analog quantity, the ones, tens, and hundred digits of the function code respectively correspond to the analog input AI1, AI2, AI3.

If 0 is selected, when the AI input is lower than the minimum input, the corresponding setting of the analog quantity is the minimum input corresponding setting (P4-14, P4-19, P4-24). If the selection is 1, the analog input is set to 0.0% when the AI input is lower than the minimum input.

P4-35	Input terminal X1 delay time	0.0s~3600.0s	Default: 0.0s
P4-36	Input terminal X2 delay time	0.0s~3600.0s	Default: 0.0s
P4-37	Input terminal X3 delay time	0.0s~3600.0s	Default: 0.0s



It is used to set the delay time for the inverter to change the state of the input terminal. Currently only X1, X2, and X3 have the function of setting the delay time.

P4-38	Input terminal valid mode selection 1	Unit digit: X1 Ten's digit: X2 Hundred's digit: X3 Thousand's digit: X4 Million's digit: X6 0: The X terminal is connected to COM and the disconnection is invalid. 1: X terminal and COM connection are invalid, the disconnection is valid.	Default: 00000
--------------	----------------------------------------------	-----------------------------------------------------------------------------------------------------------------------------------------------------------------------------------------------------------------------------------------------------------------	-------------------

P4-39	Input terminal valid mode selection 2	Unit's digit: X5 Ten's digit: X7 Hundred's digit: X8 Thousand's digit: X9	Default: 00000
		0: The X terminal is connected to COM and the disconnection is invalid. 1: X terminal and COM connection are invalid, the disconnection is valid.	



Used to set the active status mode of the digital input terminal.

0: Positive logic, the corresponding terminal is valid when connected to COM, and the disconnection is invalid.

1: Inverse logic, the corresponding terminal is invalid when connected to COM, and the disconnection is valid.

P5 Group Output terminal



The inverter comes standard with one multi-function analog output terminal, one multi-function digital output terminal, one multi-function relay output terminal, and one FM terminal (optional as a high-speed pulse output terminal, or as a collector open circuit) Switch output). If the above output terminal does not meet the field application, you need to select the multi-function input and output expansion card.

P5-00	Y2 output mode selection	0: Pulse output 1: Switch output	Default: 0
--------------	---------------------------------	-----------------------------------------	------------



The Y2 terminal is a programmable multiplexing terminal that can be used as a high-speed pulse output terminal or as an open collector output terminal. As a pulse output, the maximum frequency of the pulse is 100 kHz, see P5-06.

P5-01	Y2 switching output function selection	Default: 0 has no function
P5-02	Relay output function selection	Default: 2 fault output
P5-03	Relay output 2 selection (extended)	Default: 0 has no function
P5-04	Y1 switch output function selection	Default: 1 inverter running signal output
P5-05	Y3 switching output selection (extended)	Default: 4 frequency arrival signal output



The above function code is used to select the function of 5 digital outputs. The function of the multi-function output terminal is as follows:

Setting value	Function	Instructions
---------------	----------	--------------

0	No function	Output terminal has no function
1	Inverter running	When the inverter is running (can be 0Hz), it outputs ON signal.
2	Fault output (stop)	When the inverter fails and the fault stops, the ON signal is output.
3	Frequency level detection FDT1	Please refer to the description of function codes P8-19 and P8-20.
4	Frequency arrival	Please refer to the description of function code P8-21.
5	Zero speed operation (not output when stopped)	When the inverter runs and the output frequency is 0, the ON signal is output. This signal is OFF when the drive is in the stop state.
6	Motor overload pre-alarm	Before the motor overload protection action, the ON signal is output after the overload pre-alarm threshold is exceeded. Refer to P9-00~P9-02 for motor overload setting.
7	Inverter overload pre-alarm	The ON signal is output 10 s before the inverter overload protection occurs.
8	Set the count value to arrive	When the count value reaches the value set by PB-08, the ON signal is output.
9	Specify the count value to arrive	When the count value reaches the value set by PB-09, the ON signal is output.
10	Length reached	When the actual length of the detection exceeds that set by PB-05, an ON signal is output.
11	PLC cycle completed	The PLC runs a cycle and outputs a pulse signal with a width of 250ms.
12	Cumulative running time arrives	When the cumulative running time of the inverter exceeds the setting of P8-17, the output ON signal
13	Frequency limit	When the set frequency exceeds the upper limit frequency or the lower limit frequency, and the inverter output frequency also reaches the upper limit frequency or the lower limit frequency, the ON signal is output.
14	Torque limit	When the inverter is in the speed control mode, when the output torque reaches the torque limit value, the inverter is in the stall protection state and outputs the ON signal.

15	Ready to run	When the inverter is stable after power-on, and the inverter does not detect any fault information, the inverter will output an ON signal when it is in the operable state.
16	AI1>AI2	When the value of the input AI1 is greater than the input value of AI2, an ON signal is output.
17	Upper limit frequency arrival	When the running frequency reaches the upper limit frequency, an ON signal is output.
18	The lower limit frequency arrives (no output when stopped)	When the running frequency reaches the lower limit frequency, the ON signal is output. This signal is OFF in the stop state.
19	Undervoltage status output	When the inverter is under voltage, it outputs ON signal.
20	Communication setting	Please refer to the communication protocol.
23	2 at zero speed (also output when stopped)	When the inverter output frequency is 0, the ON signal is output. This signal is also ON in the stop state.
24	Cumulative power-on time arrives	The inverter's accumulated power-on time P7-13 exceeds the P8-16 set time output ON signal.
25	Frequency level detection FDT2 output	Please refer to the description of function codes P8-28 and P8-29.
26	Frequency 1 reaches the output	Please refer to the description of function codes P8-30 and P8-31.
27	Frequency 2 reaches the output	Please refer to the description of function codes P8-32 and P8-33.
28	Current 1 reaches the output	Please refer to the description of function code P8-38, P8-39.
29	Current 2 reaches the output	Please refer to the description of function codes P8-40 and P8-41.
30	Timing arrival output	When the timing function (P8-42) is valid, the inverter will output the ON signal after the current running time reaches the set timing time.

31	AI1 input overrun	When the value of analog input AI1 is greater than P8-46 (AI1 input protection upper limit) or less than P8-45 (AI1 input protection lower limit), the ON signal is output.
32	Dropped	When the inverter is in the off state, it outputs an ON signal.
33	Reverse running	When the inverter is in reverse operation, it outputs ON signal.
34	Zero current state	Please refer to the description of function code P8-28, P8-29
35	Module temperature reached	When the inverter module heatsink temperature (P7-07) reaches the set module temperature arrival value (P8-47), the ON signal is output.
36	Software current overrun	Please refer to the description of function code P8-36, P8-37.
37	Lower limit frequency arrival (stop output also)	When the running frequency reaches the lower limit frequency, the ON signal is output. This signal is also ON during the stop state.
38	Alarm output	When the inverter fails and the fault handling mode is continued, the ON signal is output.
39	Motor over temperature alarm	When the motor temperature reaches P9-58, the output ON signal
40	This running time arrives	When the inverter runs for longer than P8-53, it outputs ON signal.

P5-06	Y2 pulse output function selection	Default: 0 running frequency
P5-07	AO output function selection	Default: 0 running frequency
P5-08	AO2 output function selection (extension)	Default: 1 set frequency



The Y2 terminal output pulse frequency range is 0.01 kHz ~ P5-09 (between 0.01 and 100.00 kHz).

The analog output AO1 and AO2 output range is 0V ~ 10V, or 0mA ~ 20mA. The range of pulse output or analog output, and the calibration relationship of the corresponding function are shown in the following table:

Set value	Function	Function corresponding to pulse or analog output 0.0%~100.0%
-----------	----------	-----------------------------------------------------------------

0	Operating frequency	0 to the maximum output frequency
1	Setting frequency	0 to the maximum output frequency
2	Output current	0 to 2 times the rated current of the motor
3	Output torque	0 to 2 times rated motor torque
4	Output Power	0 to 2 times rated power
5	The output voltage	0 to 1.2 times the rated voltage of the inverter
6	PULSE pulse input	0.01kHz~100.00kHz
7	AI1	0V~10V
8	AI2	0V~10V (or 0~20mA)
9	AI3	0V~10V
10	Length	0 to the maximum set length
11	Count value	0 to the maximum count value
12	Communication setting	0.0% to 100.0%
13	Motor speed	0 to the maximum output frequency corresponding to the speed
14	Output current	0.0A~1000.0A
15	The output voltage	0.0V~1000.0V

P5-09	Y2 pulse output	0.01kHz~100.00kHz	Default: 50.00kHz
	Maximum frequency		



When the Y2 terminal is selected as the pulse output, the function code is used to select the Maximum frequency value of the output pulse. ◦

P5-10	AO zero offset coefficient	-100.0%~+100.0%	Default: 0.0%
P5-11	AO gain	-10.00~+10.00	Default: 1.00
P5-12	Extended AO2 zero bias coefficient	-100.0%~+100.0%	Default: 0.0%
P5-13	Extended AO2 gain	-10.00~+10.00	Default: 1.00



The above function code is used to correct the zero drift of the analog output and the deviation of the output amplitude. It can also be used to customize the required AO output curve. If the zero offset is represented by "b", the gain is represented by k, the actual output is represented by Y, and the standard output is represented by X, the actual output is: $Y = kX + b$. Among them, the zero offset coefficient of AO1 and AO2 corresponds to 10V (or 20mA), and the standard output refers to the output of 0V~10V (or 0mA~20mA) corresponding to the analog output without zero offset and gain correction.

For example, if the analog output is the running frequency, it is desirable to output 8V when the frequency is 0, and output 3V when the frequency is Maximum frequency, then the gain should be set to "-0.50" and the zero offset should be set to "80%".

P5-17	Y2 output delay time	0.0s~3600.0s	Default: 0.0s
P5-18	Relay output delay time	0.0s~3600.0s	Default: 0.0s
P5-19	Relay 2 delay time	0.0s~3600.0s	Default: 0.0s
P5-20	Y1 output delay time	0.0s~3600.0s	Default: 0.0s
P5-21	Y3 delay time (extended)	0.0s~3600.0s	Default: 0.0s



change

Set the delay time of the output terminal from the state change to the actual output

P5-22	Output terminal valid state selection	Unit's digit: Y2 Ten's digit: Relay Hundred's digit: Relay 2 Thousand's digit: Y1 million: Y3 0: The output terminal is connected to COM and the disconnection is invalid. 1: The output terminal is not connected to COM, and the disconnection is valid.	Default: 00000
--------------	----------------------------------------------	---------------------------------------------------------------------------------------------------------------------------------------------------------------------------------------------------------------------------------------------------------------------	----------------



Define the valid state selection for the multi-function output terminal.

0: Positive logic, the digital output terminal and the corresponding common terminal are connected to the active state, and the disconnection is in the invalid state;

1: Inverse logic, the digital output terminal and the corresponding common terminal are connected to an inactive state, and the disconnection is in an active state.

P6 Group Start and stop control

P6-00	Start model	0: Direct start 1: Speed tracking restart 2: Pre-excitation start (AC asynchronous machine)	Default: 0
--------------	--------------------	------------------------------------------------------------------------------------------------	------------



0: Direct start If the DC braking time is 0, the inverter will start running at the start frequency. If the DC braking time is not 0, the DC braking is performed first, and then

the starting frequency is started. Suitable for small inertia loads.

- 1: Speed tracking restart The inverter first judges the speed and direction of the motor, and then starts with the tracked motor frequency, and implements a smooth and non-impact start for the rotating motor. Instantaneous power failure restart for large inertia loads. In order to ensure the performance of the speed tracking restart, it is necessary to accurately set the parameters of the motor P1 group.
- 2: Asynchronous machine pre-excitation start Used to establish the magnetic field before the motor runs. Pre-excitation current and pre-excitation time are described in function code P6-05 and P6-06. If the pre-excitation time is set to 0, the inverter cancels the pre-excitation process and starts from the start frequency. If the pre-excitation time is not 0, the pre-excitation is restarted first, which can improve the dynamic response performance of the motor.

P6-01	Speed tracking method	0: Start from stop frequency 1: Start at zero speed	Default: 0
		2: Starting with Maximum frequency	



In order to better complete the speed tracking process, select the way the inverter tracks the motor speed:

0: Track down from the frequency at power failure. This method is usually used.

1: Tracking starts from 0 frequency, and is used when the power failure time is long and then restarted.

2: Track down from the Maximum frequency, generally used for generating loads.

P6-02	Speed tracking	1~100	Default: 20
--------------	-----------------------	-------	-------------



Select the speed of the speed tracking. The larger the parameter, the faster the tracking speed. However, setting too large may cause the tracking effect to be unreliable.

P6-03	Starting frequency	0.00Hz~10.00Hz	Default: 0.00Hz
P6-04	Start frequency hold time	0.0s~100.0s	Default: 0.0s



To ensure motor torque at start-up, set the appropriate starting frequency. In order to fully establish the magnetic flux when the motor is started, the starting frequency needs to be maintained for a certain period of time.

The starting frequency P6-03 is not limited by the lower limit frequency. However, when the set target frequency is less than the start frequency, the inverter does not start and is in the standby state.

The start frequency hold time does not work during the forward and reverse switching. The start frequency hold time is not included in the acceleration time, but is included in the run time of the simple PLC.

P6-05	Start DC braking current	0%~100%	Default: 0%
P6-06	DC braking time	0.0s~100.0s	Default: 0.0s



Start DC braking, which is generally used to stop the running motor and then start. The pre-excitation is used to first activate the asynchronous motor to establish a magnetic field and then increase the response speed.

Starting DC braking is only effective when the startup mode is direct startup. At this time, the inverter first performs DC braking according to the set starting DC braking current, and then starts running after the DC braking time is started. If the DC braking time is set to 0, it will start directly without DC braking. The greater the DC braking current, the greater the braking force.

If the starting mode is asynchronous machine pre-excitation start, the inverter first establishes the magnetic field according to the preset pre-excitation current, and then starts running after the set pre-excitation time. If the pre-excitation time is set to 0, it will start directly without the pre-excitation process.

Start DC braking current / pre-excitation current, which is a percentage of the rated current of the inverter.

P6-07	Acceleration and deceleration	0: Linear acceleration and deceleration 1: S curve acceleration and deceleration A 2: S curve acceleration and deceleration B	Default: 0
--------------	--------------------------------------	-------------------------------------------------------------------------------------------------------------------------------------	------------



Select the way the frequency change of the inverter during start and stop. 0:

Linear acceleration/deceleration The output frequency is incremented or decremented by a straight line. Choose from 4 acceleration and deceleration times.

1: S curve acceleration and deceleration A

The output frequency is incremented or decremented according to the S curve. The S-curve is used in places where gentle start or stop is required, such as elevators, conveyor belts, etc. The function codes P6-08 and P6-09 respectively define the time ratio of the start and end segments of the S-curve acceleration/deceleration.

2: S curve acceleration and deceleration B

In the S-curve acceleration/deceleration B, the motor rated frequency f_b is always the inflection point of the S-curve. As shown in Figure 6-12. It is generally used in applications where fast acceleration and deceleration are required in high-speed areas above the rated frequency.

When the set frequency is above the rated frequency, the acceleration and deceleration time is

$$t = \frac{f - f_b}{T} \left(\frac{f - f_b}{f_b} \right)^2$$

Where f is the set frequency, the rated frequency of the f_b motor, and T is the time from the 0 frequency acceleration to the nominal frequency f_b .

P6-08	S curve starting time ratio	0.0%~ (100.0%-P6-09)	Default: 30.0%
P6-09	S curve end period time ratio	0.0%~ (100.0%-P6-08)	Default: 30.0%



The function codes P6-08 and P6-09 respectively define the ratio of the initial segment and the end segment time of the S-curve acceleration/deceleration A. The two function codes should satisfy: $P6-08 + P6-09 \leq 100.0\%$.

In Figure 6-11, t_1 is the time defined by parameter P6-08, and the slope of the output frequency change gradually increases during this period. T_2 is the time defined by parameter P6-09, during which the slope of the output frequency change gradually changes

to zero. During the time between t_1 and t_2 , the slope of the output frequency change is fixed, that is, the interval is linearly accelerated or decelerated.

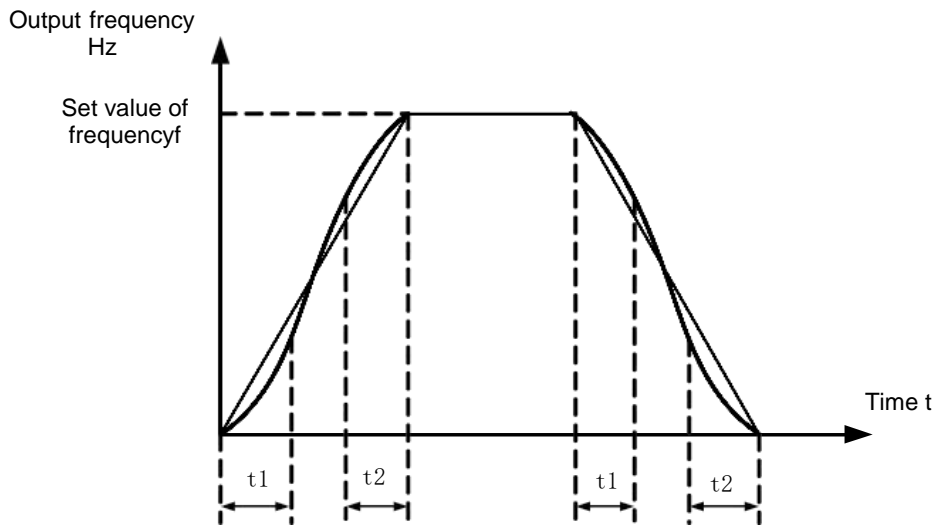

Figure 6-11 Schematic diagram of S-curve acceleration/deceleration A

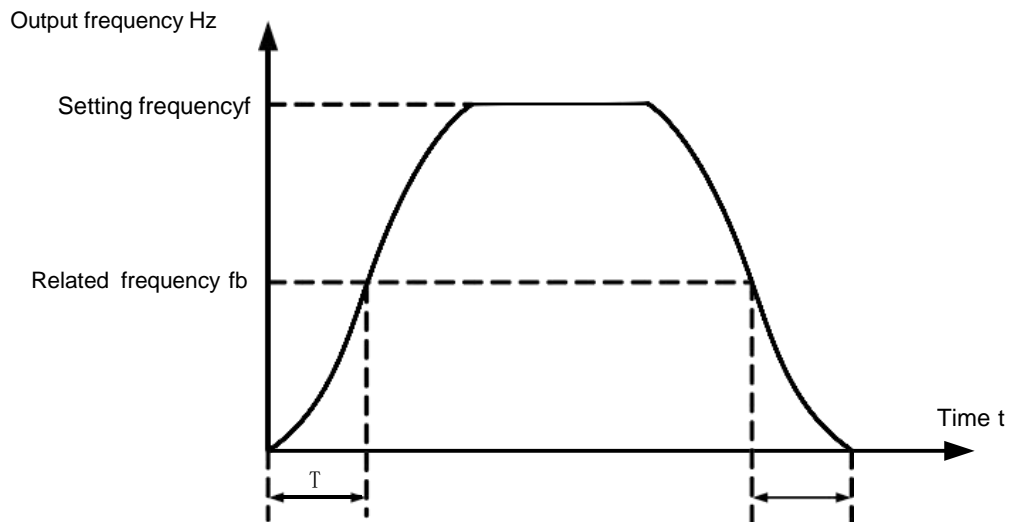

Figure 6-12 Schematic diagram of S-curve acceleration and deceleration B 0:

P6-10	Stop mode	0: Slow down parking 1: free parking	Default: 0
--------------	------------------	--------------------------------------	------------



Deceleration stop After the stop command is valid, the inverter reduces the output frequency according to the deceleration time, and the frequency drops to 0 and then stops.

1: Free stop After the stop command is valid, the inverter will immediately terminate the output. At this time, the motor will stop freely according to the mechanical inertia.

P6-11	Stop DC braking start frequency	0.00Hz~Maximum frequency	Default: 0.00Hz
--------------	---------------------------------	--------------------------	-----------------

P6-12	DC brake waiting time	0.0s~100.0s	Default: 0.0s
--------------	-----------------------	-------------	---------------

P6-13	DC braking current at stop	0%~100%	Default: 0%
P6-14	DC braking time at stop	0.0s~100.0s	Default: 0.0s



DC braking start frequency at stop: When the inverter stops, when the running frequency decreases to this frequency, DC braking starts.

DC brake waiting time at stop: After the running frequency is reduced to the stop DC braking start frequency, the inverter stops output for a period of time before starting the DC braking process. Used to prevent malfunctions such as overcurrent that may be caused by DC braking at higher speeds.

DC braking current at stop: refers to the output current during DC braking, as a percentage of the rated motor current. The larger the value, the stronger the DC braking effect, but the greater the heat generated by the motor and the inverter.

DC braking time at stop: The time during which the DC braking amount is maintained. This value is 0 and the DC braking process is cancelled. The DC braking process of the shutdown is shown in the schematic diagram of Figure 6-13.

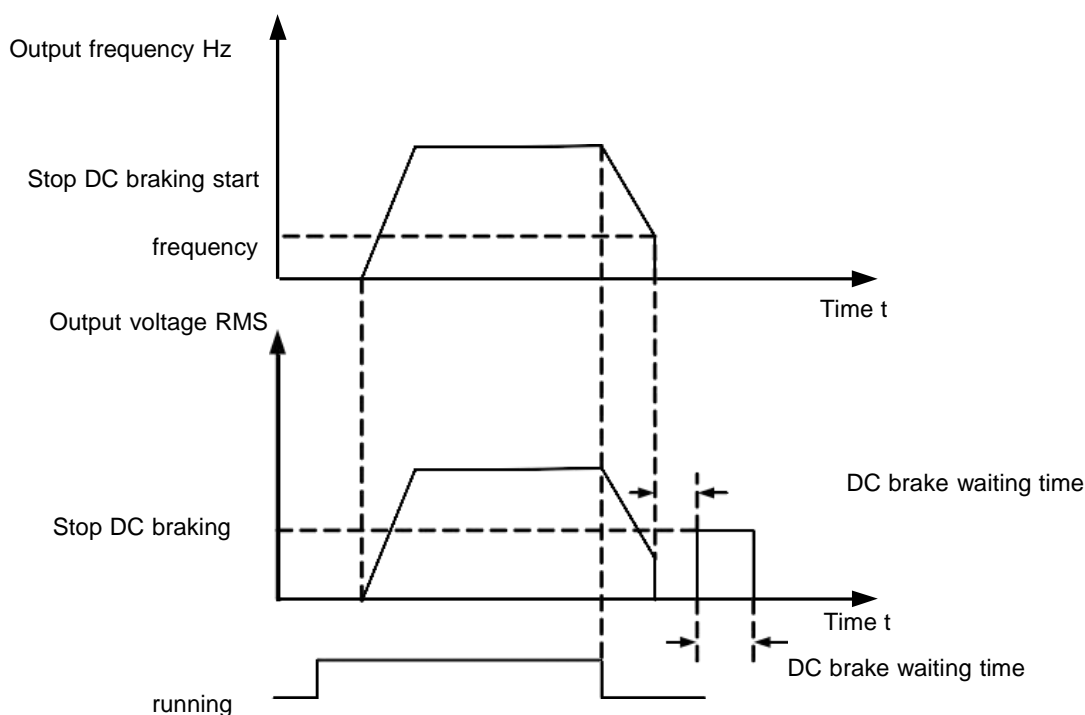

Figure 6-13 Schematic diagram of DC braking at stop

P6-15	Brake usage rate	0%~100%	Default: 100%
--------------	-------------------------	---------	---------------



Only valid for inverters with built-in brake unit. It is used to adjust the duty ratio of the brake unit. When the brake usage rate is high, the duty ratio of the brake unit is high and the braking effect is strong. However, the voltage of the inverter bus voltage fluctuates greatly during the braking process.

P6-18	Speed tracking current	30%~200%	Default: depending
--------------	-------------------------------	----------	--------------------



The maximum current limit of the speed tracking process is within the range of the “speed tracking current” setting. If the set value is too small, the effect of the speed tracking will be worse.

P6-21	Demagnetization time	0.0~5.0s	Default: depending
--------------	-----------------------------	----------	-----------------------



The demagnetization time is the minimum interval between stop and start. This function code will only take effect after the speed tracking function is turned on. If the setting value is too small, it will cause overvoltage fault.

P7-01	JOG/REV key function selection	0: F/R key is invalid 1: Keyboard command and terminal (communication) command switching 2: Forward and reverse switching 3: Forward rotation 4: Reverse jog	Default: 0
--------------	---------------------------------------	---------------------------------------------------------------------------------------------------------------------------------------------------------------------------------------------------	------------

JOG/REV The key is a multi-function key, and the function of the JOG/REV key can be set by this function code. This button can be used to switch between stop and run.

0: This button has no function.

1: Keyboard command and remote operation switch. Refers to the switching of the command source, that is, the current command source and keyboard control (local operation) switching. If the current command source is keyboard control, this key function is invalid.

2: Forward/reverse switching the direction of the frequency command is switched by the JOG/REV button. This function is only available when the command source is the operator panel command channel.

3: Forward jog through the keyboard JOG / REV button to achieve forward rotation

4: Reverse jog through the keyboard JOG/REV button to achieve reverse jog

P7-02	STOP/RESET key Function selection	0: Only the keyboard command is valid under the keyboard command 1: In any case, the key stop is valid	Default : 1
--------------	------------------------------------------	-------------------------------------------------------------------------------------------------------------------------	----------------

P7-03

LED running display 1

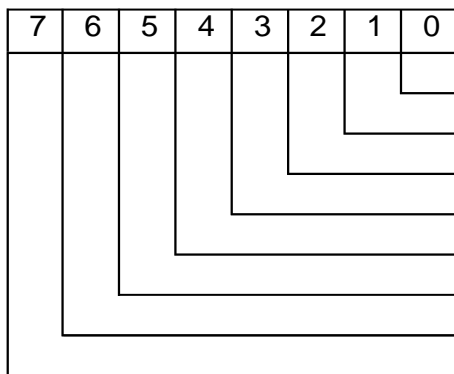

- Running frequency
- Set frequency
- Bus voltage
- Output voltage
- Output current
- Output power
- Output torque
- Output statu

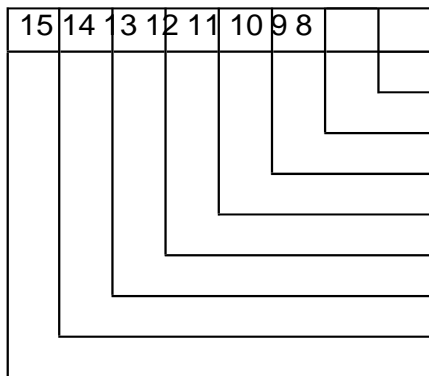

- Output staute
- AI1 voltage
- AI2 voltage
- AI3 voltage
- Count value
- Length value
- Over load speed display
- PID set

If you need to display the above parameters during operation, set the corresponding position to 1, and convert this binary number to hexadecimal and then set it to P7-03.

Default : 1F

P7-04

LED operation Display parameter 2

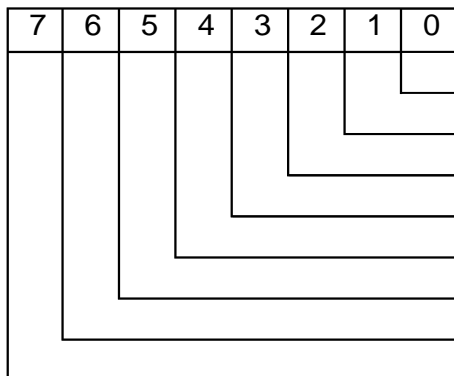

- PID feedback
- PLC stage
- Inpuse input frequency
- Running frequency 2
- Remaining running time
- AI 1 default voltage
- AI 2 default voltage
- AI 3 default voltage

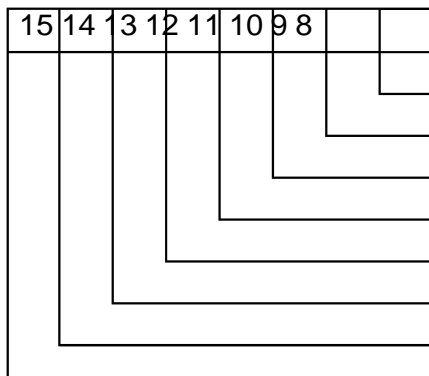

- Line speed
- Current power-on time
- Inpuse input Current running time Pulse Input
- Communication setting
- PG card speed feedback
- Main frequency X display
- Auxiliary frequency Y display

If you need to display the above parameters during operation, set the same as P7-03.

Default : 0

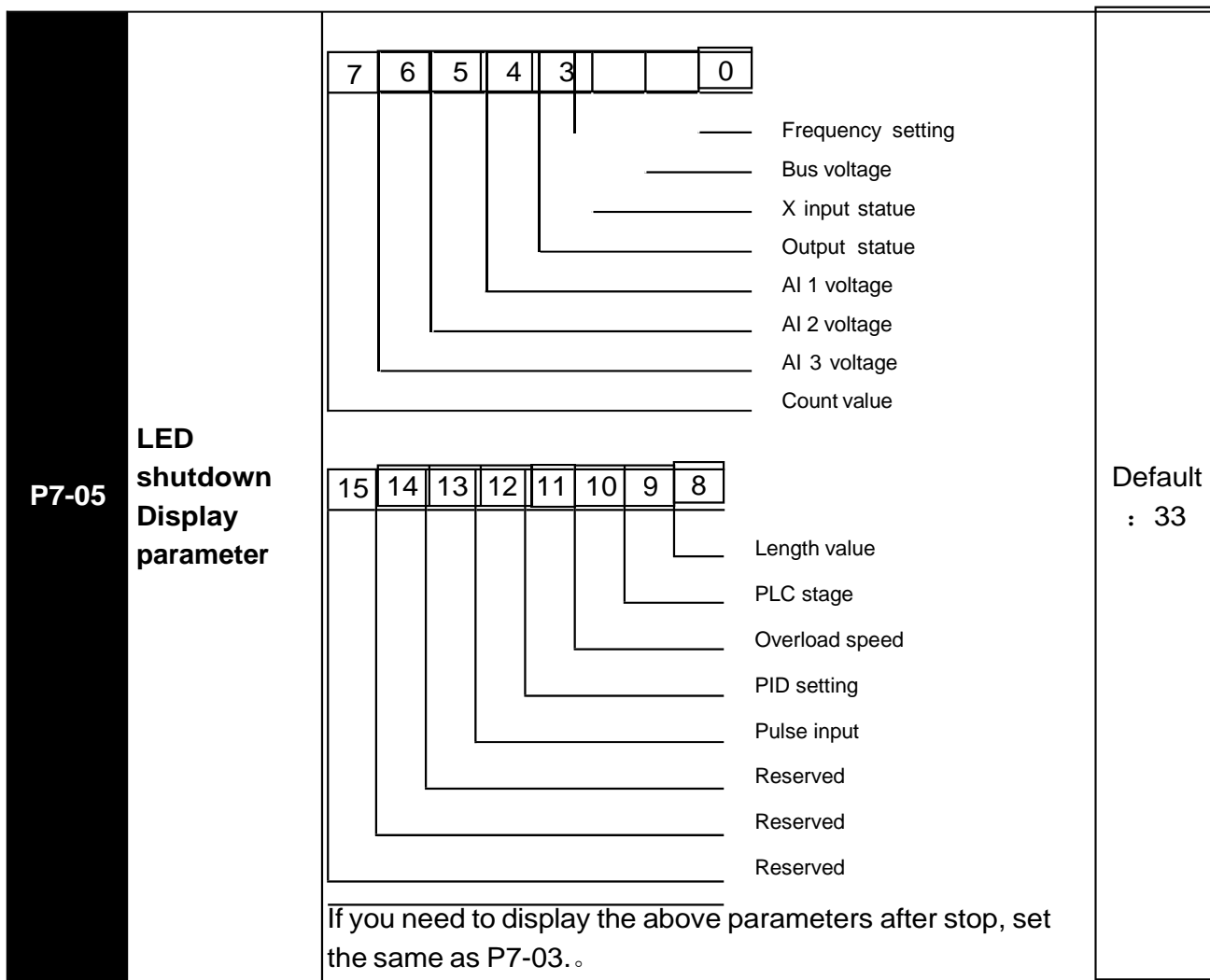

Display parameters are used to set the parameters that can be viewed when the inverter is running or stopped.

The maximum number of status parameters that can be viewed is 32. According to the P8-03~P7-05 parameter values, the status parameters to be displayed are selected. The display order starts from the lowest bit of P7-03.

P7-06	Load speed display factor	0.0001~6.5000	Default: 1.0000
--------------	----------------------------------	----------------------	-----------------

When the load speed needs to be displayed, the corresponding relationship between the inverter output frequency and the load speed is adjusted by this parameter. Refer to the description of P7-12 for the specific correspondence.

P7-07	Module heat sink temperature	0.0°C~100.0°C	-
--------------	-------------------------------------	----------------------	---

The temperature of the inverter module IGBT is displayed. Different models of inverter module IGBT over-temperature protection values are different

P7-09	Cumulative running time	0h~65535h	-
--------------	--------------------------------	------------------	---

Displays the cumulative running time of the drive. When the running time reaches the setting P8-17, the terminal (12) outputs an ON signal.

P7-10	Product ID	-	-
P7-11	Software version number	-	-
P7-12	Load speed display	0: 0 decimal place 1:1 decimal place 2: 2 decimal places 3: 3 decimal places	Default: 1



Used to set the number of decimal places for the load speed display. The following example illustrates how the load speed is calculated:

If the load speed display coefficient P7-06 is 2.000, the load speed decimal point P7-12 is 2 (2 decimal places), when the inverter running frequency is 40.00Hz, the load speed is: $40.00 \times 2.000 = 80.00$ (2 decimal places) display)

If the inverter is in the stop state, the load speed is displayed as the speed corresponding to the set frequency, that is, “set the load speed”. Taking the set frequency 50.00Hz as an example, the load speed in the stop state is: $50.00 \times 2.000 = 100.00$ (2 decimal places are displayed)

P7-13	Cumulative power-on time	0h~65535h	-
--------------	--------------------------	-----------	---



The cumulative power-on time of the inverter from the factory is displayed. When this time reaches the set power-on time (P8-17), the output terminal (24) outputs an ON signal.

P7-14	Cumulative power consumption	0kW~65535	-
--------------	------------------------------	-----------	---



Displays the cumulative power consumption of the inverter

P8 Group Accessibility

P8-00	Jog running frequency	0.00Hz~Maximum frequency	Default: 2.00Hz
P8-01	Jog acceleration time	0.0s~6500.0s	Default: 20.0s
P8-02	Jog deceleration time	0.0s~6500.0s	Default: 20.0s



Define the given frequency and acceleration/deceleration time of the inverter when jogging. When jog running, the start mode is fixed to the direct start mode (P6-00=0), and the stop mode is fixed to the deceleration stop (P6-10=0).

P8-03	Acceleration time 2	0.0s~6500.0s	depend
P8-04	Deceleration time 2	0.0s~6500.0s	depend
P8-05	Acceleration time 3	0.0s~6500.0s	depend
P8-06	Deceleration time 3	0.0s~6500.0s	depend
P8-07	Acceleration time 4	0.0s~6500.0s	depend

P8-08	Deceleration time 4	0.0s~6500.0s	depend
--------------	---------------------	--------------	--------



The inverter provides 4 sets of acceleration and deceleration time, which are P0-17\P0-18 and the above three groups of acceleration and deceleration time.

The definitions of the four groups of acceleration and deceleration are exactly the same. Please refer to the descriptions of P0-17 and P0-18. Through the different combinations of multi-function input terminals, you can switch between 4 groups of acceleration/deceleration time, see P4-01~P4-05.

P8-09	Jump frequency 1	0.00Hz~Maximum frequency	Default: 0.00Hz
P8-10	Jump frequency 2	0.00Hz~Maximum frequency	Default: 0.00Hz
P8-11	Jump frequency amplitude	0.00Hz~Maximum frequency	Default: 0.01Hz



When the set frequency is within the skip frequency range, the actual operating frequency will run at a skip frequency that is closer to the set frequency. By setting the skip frequency, the inverter can be avoided from the mechanical resonance point of the load.

Two skip frequency points can be set. If both skip frequencies are set to 0, the skip frequency function is canceled. The principle of the hopping frequency and the hopping frequency amplitude is shown in Figure 6-14.

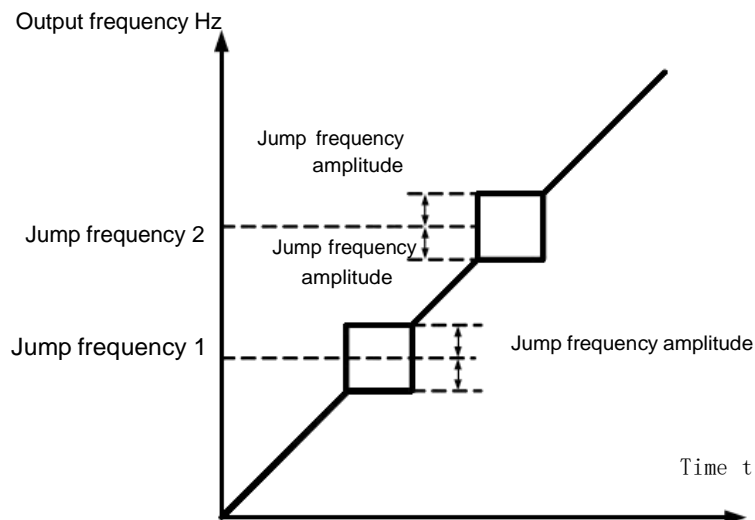

Figure 6-14 Schematic diagram of the hopping frequency

P8-12	Positive reversal dead time	0.0s~3000.0s	Default: 0.0s
--------------	------------------------------------	--------------	---------------



Set the transition time at the output 0Hz during the forward/reverse transition of the inverter, as shown in Figure 6-15:

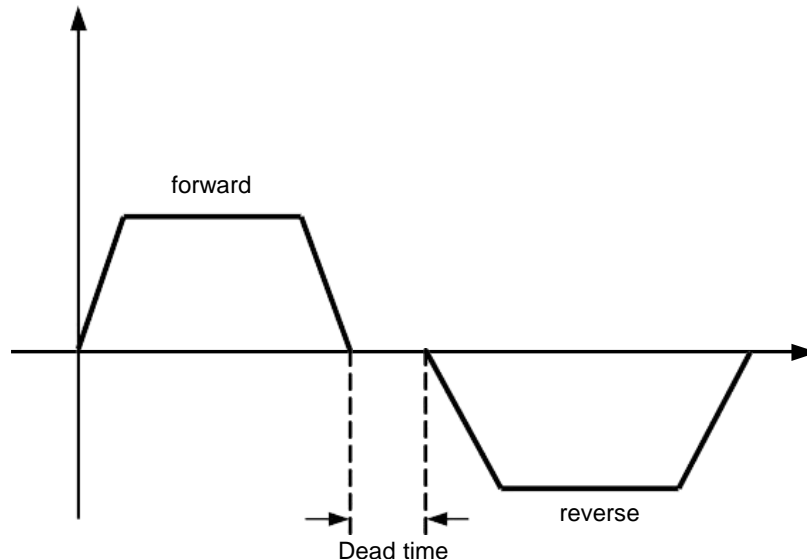

Figure 6-15 Schematic diagram of the positive and negative dead time

Output frequency Hz

P8-13	Reverse control enable	0: Allow 1: Prohibit	Default: 0
--------------	-------------------------------	----------------------	------------



Use this parameter to set whether the inverter is allowed to run in the reverse state. If the motor is not allowed to reverse, set P8-13=1.

P8-14	The set frequency is lower than the lower limit frequency.	0: Run at the following frequency limit 1: Stop 2: Zero speed operation	Default: 0
--------------	-------------------------------------------------------------------	-------------------------------------------------------------------------------	------------



When the set frequency is lower than the lower limit frequency, the running status of the inverter can be selected by this parameter.

P8-15	Droop control	0.00Hz~10.00Hz	Default: 0.00Hz
--------------	----------------------	----------------	-----------------



This function is generally used for load distribution when multiple motors are dragging the same load.

The droop control means that as the load increases, the output frequency of the inverter decreases, so that when multiple motors are dragged by the same load, the output frequency of the motor in the load drops more, thereby reducing the load of the motor and realizing the operation of multiple motors. The load is even.

This parameter refers to the frequency drop value of the output when the inverter outputs the rated load.

P8-16	Set the cumulative power-on arrival time	0h~65000h	Default: 0h
--------------	-------------------------------------------------	-----------	-------------



When the accumulated power-on time P7-13 reaches the power-on time set by P8-16, the inverter multi-function outputs ON signal.

P8-17	Set cumulative run arrival time	0h~65000h	Default: 0h
--------------	----------------------------------------	-----------	-------------



Used to set the running time of the inverter. When the accumulated running time P7-09 reaches this set running time, the inverter multi-function outputs ON signal.

P8-18	Start protection selection	0: Not protected 1: protected	Default: 0
--------------	-----------------------------------	-------------------------------	------------



This parameter relates to the safety protection function of the frequency converter. If the parameter is set to 1, if the running command of the inverter is valid (for example, the terminal running command is closed before power-on), the inverter does not respond to the running command, and the running command must be removed once. After the running command is valid again. The inverter responds.

In addition, if the parameter is set to 1, if the running command of the inverter fault reset time is valid, the inverter does not respond to the running command, and the running command must be removed before the running protection state can be eliminated.

Setting this parameter to 1 can prevent the danger caused by the motor responding to the running command when power is turned on or when the fault is reset without knowing it.

P8-19	Frequency detection value FDT1	0.00Hz~Maximum frequency	Default: 50.00Hz
P8-20	Frequency detection hysteresis value FDT1	0.0%~100.0% (FDT1 Level)	Default: 5.0%

When the running frequency is higher than the frequency detection value, the inverter multi-function outputs ON signal, and after the frequency is lower than the detection value, the output ON signal is canceled.

The above parameters are used to set the detection value of the output frequency and the hysteresis value of the output action release. Where P8-20 is the percentage of the hysteresis frequency relative to the frequency detection value P8-19. Figure 6-16 shows the function of the FDT function

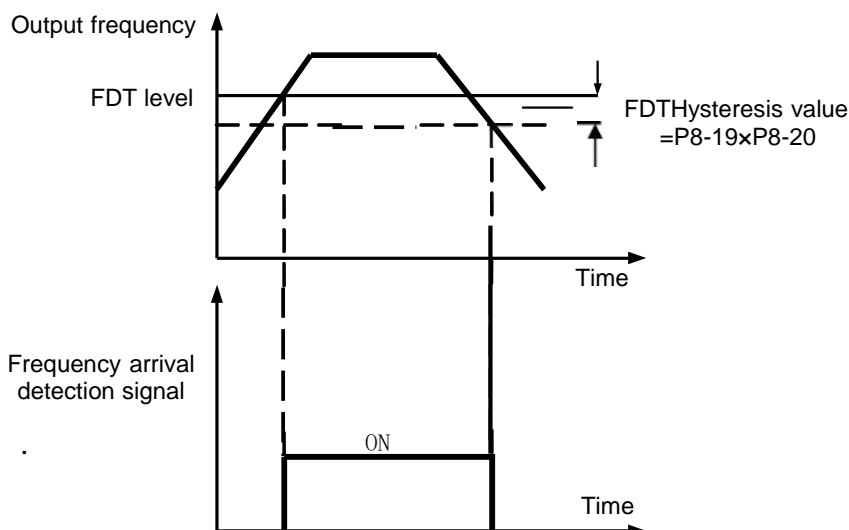

Figure 6-16 FDT level diagram

P8-21	Frequency arrival detection width	0.0%~100.0% (Maximum frequency)	Default: 0.0%
--------------	------------------------------------------	----------------------------------	---------------



When the running frequency of the inverter is within a certain range of the target frequency, the inverter multi-function outputs ON signal.

This parameter is used to set the detection range of the frequency arrival, which is a percentage relative to the Maximum frequency.

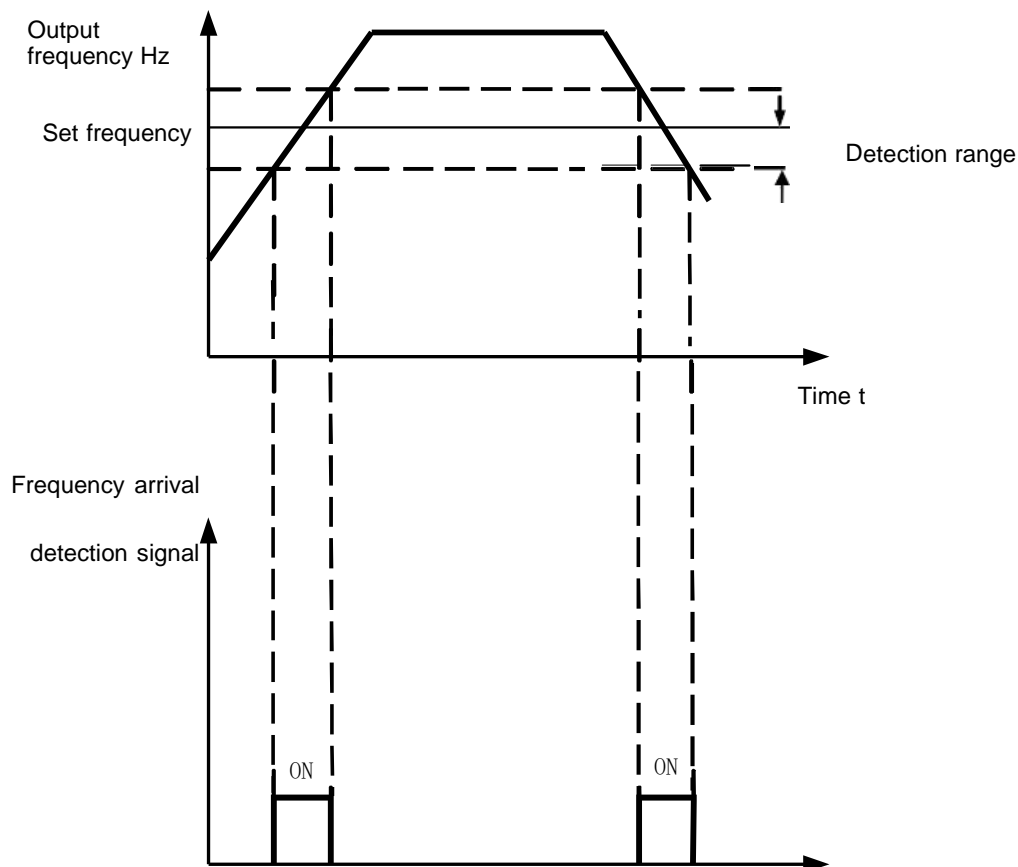

Figure 6-17 Schematic diagram of frequency arrival detection amplitude

P8-22	Whether the jump frequency is effective during acceleration and deceleration	0: invalid 1: valid	Default: 0
--------------	-------------------------------------------------------------------------------------	---------------------	------------



This function code is used to set whether the skip frequency is valid during acceleration and deceleration.

When set to valid, when the running frequency is in the skip frequency range, the actual running frequency will skip the set skip frequency boundary. Figure 6-18 shows the effective hopping frequency during acceleration and deceleration.

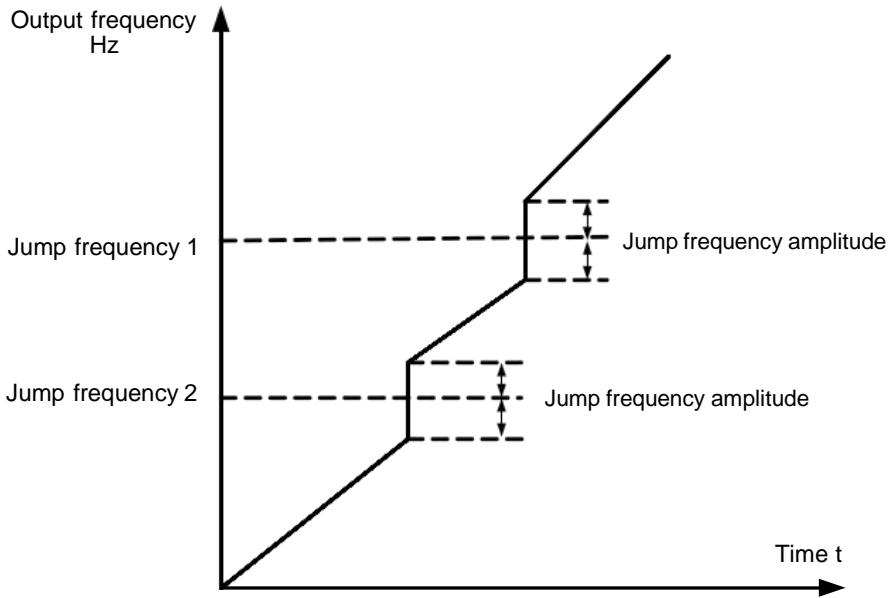

Figure 6-18 Schematic diagram of the hopping frequency during acceleration and deceleration

Fi

P8-25	Acceleration time 1 and acceleration time 2 switch frequency points	0.00Hz~Maximum frequency	Default: 0.00Hz
P8-26	Deceleration time 1 and deceleration time 2 switch frequency points	0.00Hz~Maximum frequency	Default: 0.00Hz



This function is effective when the acceleration/deceleration time is not selected by switching the input terminal. It is used to select different acceleration/deceleration time according to the operating frequency range without passing through the input terminal during the running of the inverter.

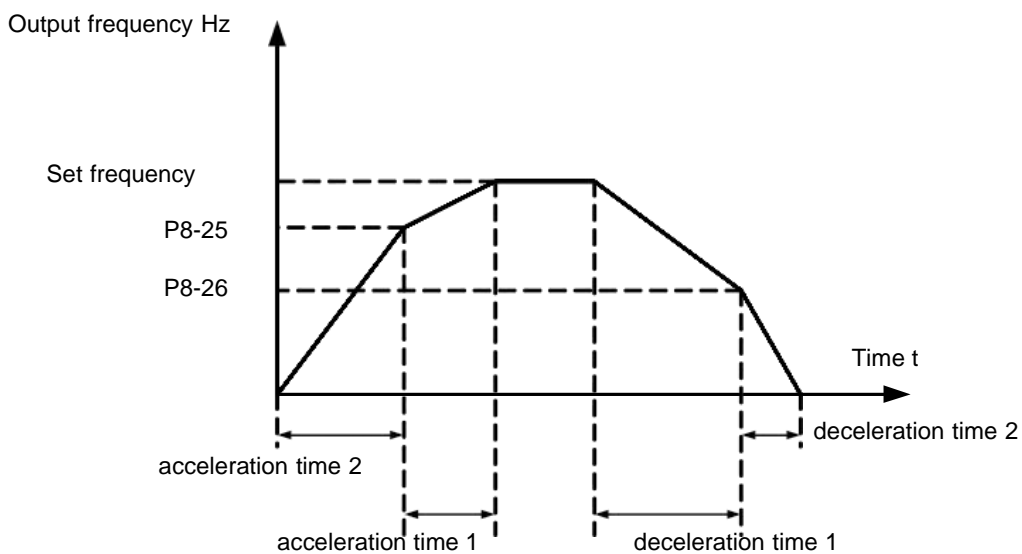

Figure 6-19 Schematic diagram of acceleration/deceleration time switching

Figure 6-19 shows the switching of acceleration/deceleration time. During the acceleration process, if the running frequency is less than P8-25, the acceleration time 2 is selected;

if the running frequency is greater than P8-25, the acceleration time 1 is selected. During deceleration, if the running frequency is greater than P8-26, the deceleration time 1 is selected. If the running frequency is less than P8-26, the deceleration time 2 is selected.

P8-27	Terminal jog priority	0: Invalid 1: Valid	Default: 0
--------------	------------------------------	---------------------	------------



This parameter is used to set whether the terminal jog function has the highest priority. When the terminal jog priority is valid, if the terminal jog command appears during operation, the inverter switches to the terminal jog operation state.

P8-28	Frequency detection value FDT2	0.00Hz~Maximum frequency	Default: 0.00Hz
P8-29	Frequency detection hysteresis value (FDT2)	0.0%~100.0% (FDT2 level)	Default: 5.0%



This frequency detection function is identical to the function of FDT1. Please refer to the description of function codes P8-19 and P8-20.

P8-30	Arbitrary arrival frequency detection value 1	0.00Hz~Maximum frequency	Default: 50.00Hz
P8-31	Arbitrary arrival frequency detection width 1	0.0%~100.0% (Maximum frequency)	Default: 0.0%
P8-32	Arbitrary arrival frequency detection value 2	0.00Hz~Maximum frequency	Default: 50.00Hz
P8-33	Arbitrary arrival frequency detection width 2	0.0%~100.0% (Maximum frequency)	Default: 0.0%



When the output frequency of the inverter is within the positive and negative detection range of any arrival frequency detection value, the ON signal is output. Figure 6-20 shows a schematic of this function.

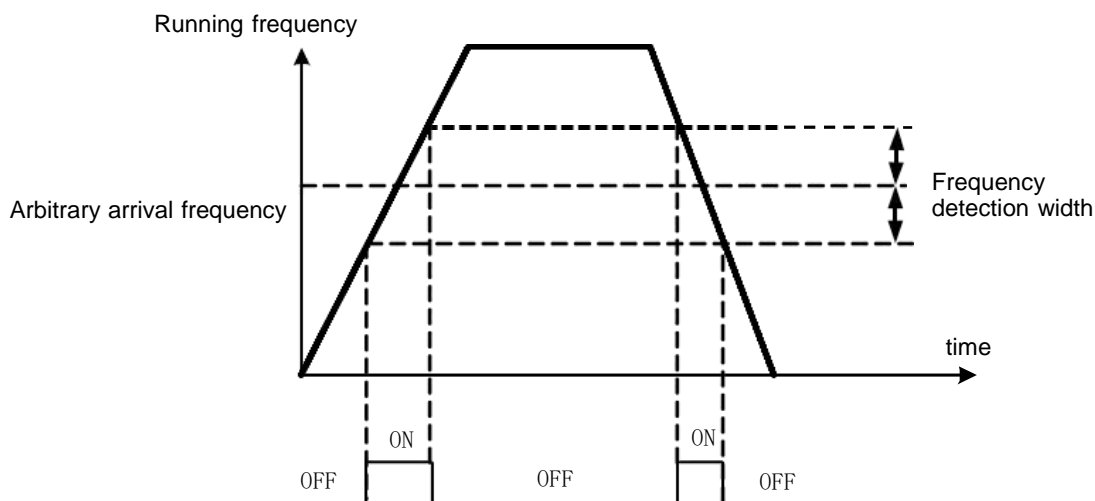

Figure 6-20 Schematic diagram of arbitrary arrival frequency detection

P8-34	Zero current detection level	0.0%~300.0% 100.0% corresponds to the rated current of the motor	Default: 5.0%
P8-35	Zero current detection delay time	0.01s~600.00s	Default: 0.10s

When the output current of the inverter is less than or equal to the zero current detection level and the duration exceeds the zero current detection delay time, the inverter outputs ON signal. Figure 6-21 Schematic diagram of zero current detection.

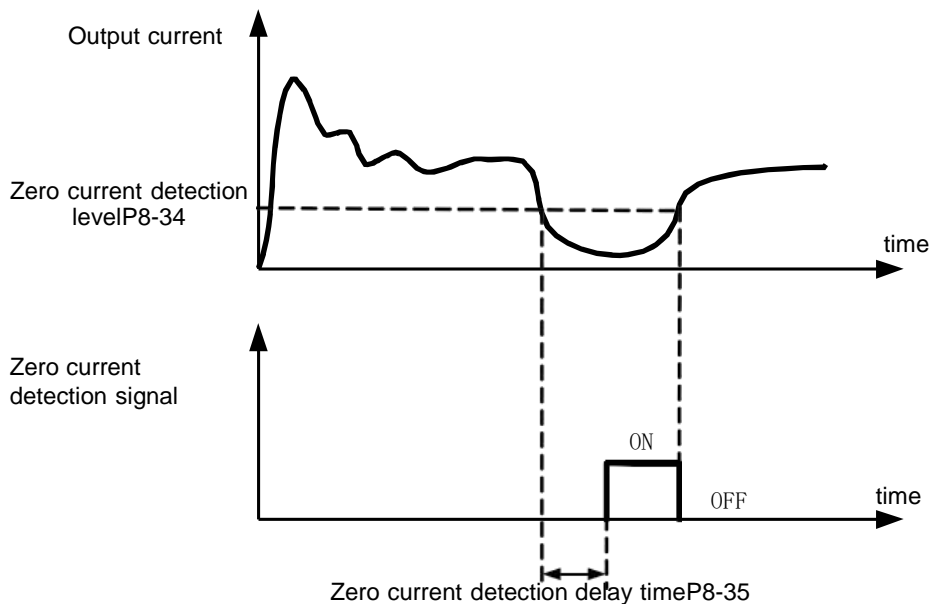

Figure 6-21 Schematic diagram of zero current detection

P8-36	Output current limit	0.0 % (not detected) 0.1 %~300.0% motor rated current	Default: 200.0%
P8-37	Output current overrun detection delay time	0.00s~600.00s	Default: 0.00



When the output current of the inverter is greater than or exceeds the detection point and the duration exceeds the software over-current detection delay time, the inverter outputs an ON signal. Figure 6-22 shows the output current over-limit function.

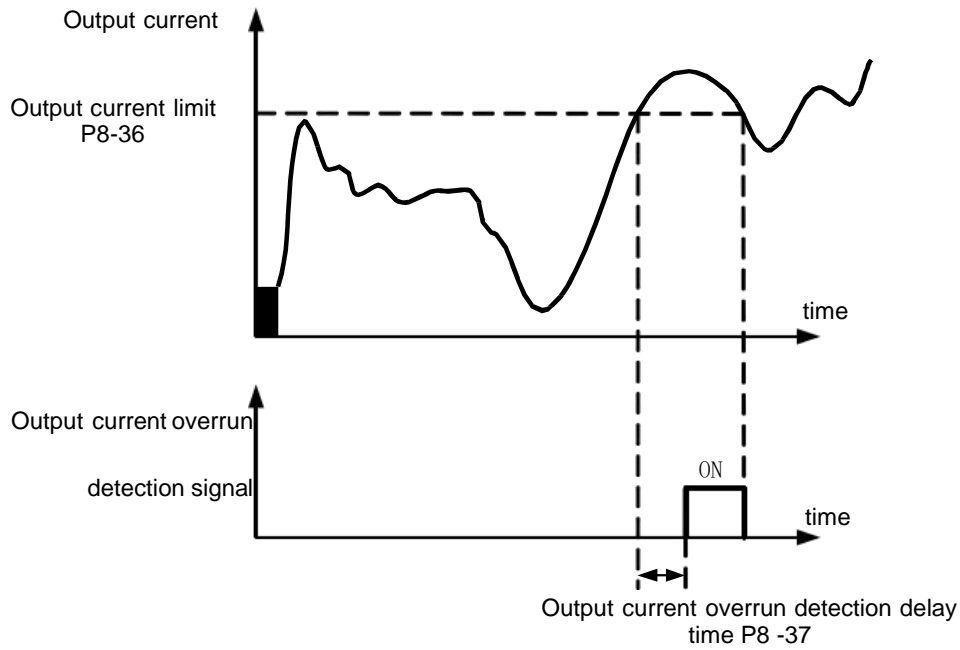

Figure 6-22 Schematic diagram of output current overrun detection

P8-38	Arbitrary arrival current 1	0.0% to 300.0% (rated motor current)	Default: 100.0%
P8-39	Arbitrary current 1 width	0.0% to 300.0% (rated motor current)	Default: 0.0%
P8-40	Arbitrary arrival current 2	0.0% to 300.0% (rated motor current)	Default: 100.0%
P8-41	Arbitrary current 2 width	0.0% to 300.0% (rated motor current)	Default: 0.0%



When the output current of the inverter is within the positive and negative detection width of any set current, the inverter outputs an ON signal.

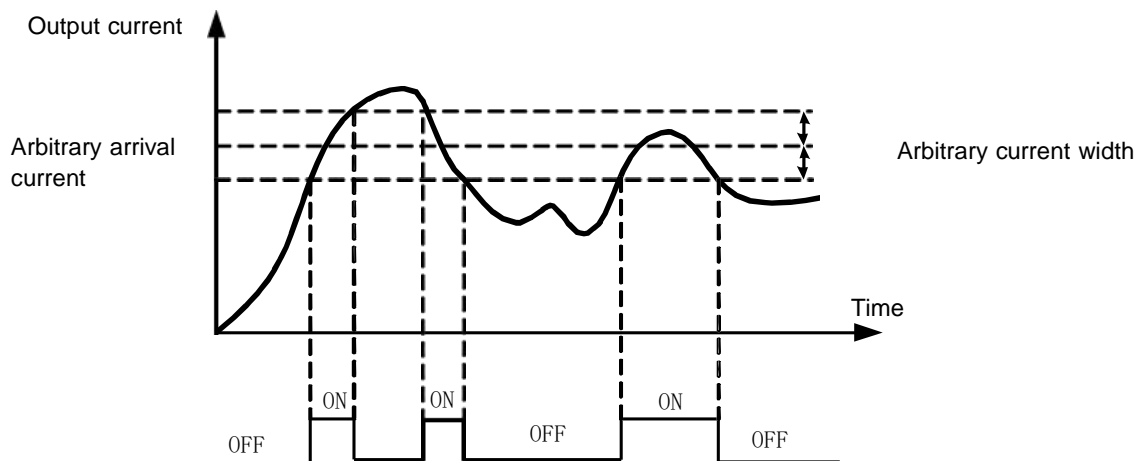

Figure 6-23 Schematic diagram of arbitrary arrival current detection

P8-42	Timing function selection	0: Invalid 1: Valid	Default: 0
P8-43	Timing run time selection	0: P8-44 set up 1: AI1 2: AI2 3: AI3 Analog input range corresponds to P8-44	Default: 0
P8-44	Timed running time	0.0Min~6500.0Min	Default: 0.0



This group of parameters is used to complete the timing operation of the inverter.

When the P8-42 timing function selection is valid, the inverter will start timing when it starts.

After the set timing running time, the inverter will automatically stop and output the ON signal. Each time the inverter starts, it starts from 0, and the remaining running time can be viewed through U0-20. The scheduled running time is set by P8-43 and P8-44, and the time unit is minute.

P8-45	AI1 input voltage protection value lower limit	0.00V~P8-46	Default: 3.10V
P8-46	AI1 input voltage protection value upper limit	P8-45~10.00V	Default: 6.80V



When the value of analog input AI1 is greater than P8-46 or less than P8-45, the inverter multi-function output "AI1 input overrun" ON signal is used to indicate whether the input voltage of AI1 is within the set range.

P8-47	Module temperature reached	0°C~100°C	Default: 75°C
--------------	-----------------------------------	-----------	---------------



When the temperature of the inverter radiator reaches this temperature, the inverter multi-function outputs "module temperature reached" ON signal.

P8-48	Cooling fan control	0: The fan is running during operation 1: The fan is always running	Default: 0
--------------	----------------------------	------------------------------------------------------------------------	------------



Used to select the action mode of the cooling fan,

0: The fan runs in the running state. If the radiator temperature is higher than 40 degrees in the stop state, the fan will run. When the radiator is below 40 degrees in the stop state, the fan will not run.

1: The fan keeps running after power-on.

P8-49	Wake-up frequency	Sleep frequency (P8-51) ~ Maximum frequency (P0-10)	Default: 0.00Hz
P8-50	Wake-up delay time	0.0s~6500.0s	Default: 0.0s
P8-51	Sleep frequency	0.00Hz to wake-up frequency (P8-49)	Default: 0.00Hz

P8-52	Sleep delay time	0.0s~6500.0s	Default: 0.0s
--------------	------------------	--------------	---------------



This set of parameters is used to implement sleep and wake-up functions in water supply applications.

During the running of the inverter, when the set frequency is less than or equal to the sleep frequency of P8-51, after the delay time of P8-52, the inverter enters the sleep state and stops automatically.

If the inverter is in the sleep state and the current running command is valid, when the set frequency is greater than or equal to the P8-49 wake-up frequency, after the delay time of the time P8-50, the inverter starts to start.

In general, please set the wake-up frequency to be greater than or equal to the sleep frequency. When the wake-up frequency and sleep frequency are both set to 0.00 Hz, the sleep and wake-up functions are invalid.

When the sleep function is enabled, if the frequency source uses the PID, whether the sleep state PID is calculated or not is affected by the function code PA-28. At this time, the PID stop operation (PA-28=1) must be selected.

P8-53	This run arrival time setting	0.0Min~6500.0Min	Default: 0.0
--------------	--------------------------------------	------------------	--------------



When the running time of this startup reaches this time, the inverter outputs the "this running time arrives" ON signal.

P8-54	Output power correction factor	0.00% ~ 200.0%	Default: 100.0%
--------------	---------------------------------------	----------------	-----------------



When the output power (U0-05) does not correspond to the expected value, the output power can be linearly corrected by this value.

P9-00	Motor overload protection option	0: Prohibited 1: allowed	Default: 1
P9-01	Motor overload protection gain	0.20~10.00	Default: 1.00



0: There is no motor overload protection function, there is a danger of motor overheating damage. It is recommended to heat the relay on the motor;

1: At this time, the inverter judges whether the motor is overloaded according to the inverse time curve of the motor overload protection. The shortest time to report motor overload is 2 minutes. If you need to adjust the motor overload current and time, please set P9-01.

(Be careful to confirm whether the rated current of the motor is correct before setting.) Reduce the value of P9-01 to make the motor protection advance. The user needs to correctly set the value of P9-01 according to the actual overload capacity of the motor. The motor is overheated and the inverter is not alarming!

P9-02	Motor overload warning coefficient	50%~100%	Default: 80%
--------------	-------------------------------------------	----------	--------------



This function is used to output an early warning signal to the control system before motor overload fault protection. This early warning coefficient is used to determine how much early warning is given before motor overload protection. The larger the value, the smaller the early warning amount. When the cumulative output current of the inverter is greater than the inverse of the overload inverse time curve and P9-02, the inverter outputs the “motor overload pre-alarm” ON signal.

P9-07	Power-on short circuit protection option	0: Invalid 1: Valid	Default: 1
--------------	-------------------------------------------------	---------------------	------------



The inverter can be selected to detect whether the motor is shorted to ground when it is powered on.

If this function is enabled, the UVW terminal of the inverter will have a voltage output for a period of time after power-on.

P9-08	Brake unit action starting voltage	200.0~2000.0V	Default: depend
--------------	-------------------------------------------	---------------	-----------------



The starting voltage V_{break} of the built-in braking unit action, the setting of this voltage value is as follows:

$$800 \geq V_{break} \geq (1.414V_s + 30)$$

V_s - Input AC power supply voltage of the inverter Note: Improper setting of this voltage may cause the built-in brake unit to operate abnormally!

P9-09	Number of automatic resets	0~20	Default: 0
--------------	-----------------------------------	------	------------



When the inverter selects fault automatic reset, the number of automatic resets can be set. After the number of times, the inverter outputs a fault status.

P9-10	Fault output action selection during automatic fault reset	0: No action 1: action	Default: 0
--------------	-------------------------------------------------------------------	---------------------------	------------



When the fault automatic reset function is set in the inverter, the fault output is activated during the automatic fault reset.

P9-11	Fault auto reset interval	0.1s~100.0s	Default: 1.0s
--------------	----------------------------------	-------------	---------------



The waiting time from the inverter fault alarm to the automatic fault reset.
The waiting time from the inverter fault alarm to the automatic fault reset.

P9-12	Input phase loss protection option	0: Prohibited 1: allowed	Default: 1
--------------	-------------------------------------------	--------------------------	------------



Choose whether to protect the input phase loss.
The inverter has the input phase loss protection function from the 18.5kW G type machine and above. The power of the 18.5kW P type machine has no input phase loss protection function regardless of whether P9-12 is set to 0 or 1

P9-13	Output phase loss protection option	0: Prohibited 1: allowed	Default: 1
--------------	--------------------------------------------	--------------------------	------------

Choose whether to protect the output phase loss.

P9-14	First failure type		—
P9-15	Second failure type		—
P9-16	Third failure type (last time)		—

Record the last three fault types of the inverter, 0 is no fault. For the possible causes and solutions of each fault code, please refer to Chapter 7 for related instructions. .

P9-17	Frequency at the third failure	Frequency at the most recent failure																				
P9-18	Current at the third fault	Current at the last fault																				
P9-19	Bus voltage at the third fault	Bus voltage at the most recent fault																				
P9-20	Third fault input terminal status	The status of the digital input terminals in the most recent fault, in the order:																				
		<table border="1"> <tr> <td>BIT9</td><td>BIT8</td><td>BIT7</td><td>BIT6</td><td>BIT5</td><td>BIT4</td><td>BIT3</td><td>BIT2</td><td>BIT1</td><td>BIT0</td> </tr> <tr> <td>X10</td><td>X9</td><td>X8</td><td>X7</td><td>X5</td><td>X6</td><td>X4</td><td>X3</td><td>X2</td><td>X1</td> </tr> </table>	BIT9	BIT8	BIT7	BIT6	BIT5	BIT4	BIT3	BIT2	BIT1	BIT0	X10	X9	X8	X7	X5	X6	X4	X3	X2	X1
		BIT9	BIT8	BIT7	BIT6	BIT5	BIT4	BIT3	BIT2	BIT1	BIT0											
X10	X9	X8	X7	X5	X6	X4	X3	X2	X1													
When the input terminal is ON, its corresponding secondary position is 1, and OFF is 0. The status of all inputs is converted to decimal display.																						
P9-21	Third fault output terminal status	The status of all output terminals in the most recent fault, in the order:																				
		<table border="1"> <tr> <td>BIT4</td><td>BIT3</td><td>BIT2</td><td>BIT1</td><td>BIT0</td> </tr> <tr> <td>Y3</td><td>Y1</td><td>REL2</td><td>REL1</td><td>Y2</td> </tr> </table>	BIT4	BIT3	BIT2	BIT1	BIT0	Y3	Y1	REL2	REL1	Y2										
		BIT4	BIT3	BIT2	BIT1	BIT0																
Y3	Y1	REL2	REL1	Y2																		
When the output terminal is ON, its corresponding secondary position is 1, and OFF is 0. The status of all outputs is converted to decimal display.																						
P9-22	Inverter status at the third fault	—																				
P9-23	Power-on time during the third fault	The current power-on time at the last fault																				
P9-24	Run time at the third fault	The current running time of the most recent failure																				

P9-27	Frequency at the second failure	Same as P9-17~P9-24
P9-28	Current at the second fault	
P9-29	Bus voltage at the second fault	
P9-30	Second fault input terminal status	
P9-31	Second fault output terminal status	
P9-32	Inverter status at the second fault	
P9-33	Power-on time during the second fault	
P9-34	Run time at the second fault	
P9-37	Frequency at the first failure	Same as P9-17~P9-24
P9-38	Current at the first fault	
P9-39	Bus voltage at the first fault	
P9-40	First fault input terminal status	
P9-41	First fault output terminal status	
P9-42	Inverter status at the first fault	
P9-43	Power-on time at the first failure	
P9-44	Run time at the first failure	

P9-47	Fault protection action selection 1	Unit's digit: Motor overload (Err11) 0: Free stop 1: Stop by stop mode 2: continue to run Ten's digit: input phase loss (Err12) as above Hundred's digit: output phase loss (Err13) as above Thousand's digit: external fault (Err15) as above 10,000 digits: communication abnormality (Err16) is the same as above	Default: 00000
P9-48	Fault protection action selection 2	Unit's digit: Encoder/PG card exception (Err20) 0: Free stop 1: Stop by stop mode 2: continue to run Ten's digit: function code read and write exception (Err21) 0: Free stop 1: Stop by stop mode Thousand's digit: Motor overheating (Err25) with P9-47 10,000: Run time arrives (Err26) with P9-47	Default: 00000
P9-49	Fault protection action selection 3	Unit's digit: Custom Fault 1 (Err27) Same as P9-47 Ten's digit: Custom Fault 2 (Err28) Same as P9-47 Hundred's digit: Power-on time arrives (Err29) with P9-47 Thousand's digit: Drop (Err30) 0: Free parking 1: slow down parking 2: Deceleration to 7% of the rated frequency, automatically return to the set frequency when no load is lost 10,000 digits: PID feedback loss (Err31) with P9-47	Default: 00000
P9-50	Fault protection action selection 4	Unit's digit: speed deviation is too large (Err42) with P9-47 Ten's digit: Motor overspeed (Err43) with P9-47 Hundred's digit: initial position error (Err51) with P9-47 Thousand's digit: speed feedback error (Err52) with P9-47	Default: 00000



When "Freewheeling" is selected, the inverter displays Err** and stops directly.
When "Stop in stop mode" is selected: The inverter displays A** and stops according to the stop mode. After the stop, Err** is displayed. When "Continuous operation" is selected: The inverter continues to run and displays A**, and the running frequency is set by P9-54.

P9-54	Continue to run frequency selection when fault occurs	0: Run at the current operating frequency 1: run at the set frequency 2: Run at the upper limit frequency 3: Run at the following frequency limit 4: Run at abnormal standby frequency	Default: 0
P9-55	Abnormal backup frequency	60.0%~100.0% (100.0% Maximum frequencyP0-10)	Default: 100.0%



When a fault occurs during the operation of the inverter and the fault is handled in the continuous mode, the inverter displays A** and operates at the frequency determined by P9-54.

When the abnormal standby frequency is selected, the value set by P9-55 is the percentage relative to the Maximum frequency.

P9-59	Instantaneous power failure action selection	0: Invalid 1: Deceleration 2: Deceleration stop	Default: 0
P9-60	Reserved	P9-62~100.0%	Default: 100.0%
P9-61	Instantaneous power failure voltage rise judgment time	0.00s~100.00s	Default: 0.50s
P9-62	Instantaneous power failure action judgment voltage	60.0%~100.0%(standard bus voltage)	Default: 80.0%



This function means that when the instantaneous power failure or sudden voltage drop occurs, the inverter compensates the DC bus voltage of the inverter by reducing the output speed and reducing the output voltage of the inverter to maintain the inverter running.

If P9-59=1, the inverter will decelerate when the power is suddenly lost or the voltage suddenly drops. When the bus voltage returns to normal, the inverter will accelerate to the set frequency. The basis for judging that the bus voltage returns to normal is that the bus voltage is normal and the duration exceeds the set time of P9-61. If P9-59=2, the inverter decelerates until the shutdown occurs in the event of an instantaneous power failure or sudden voltage drop

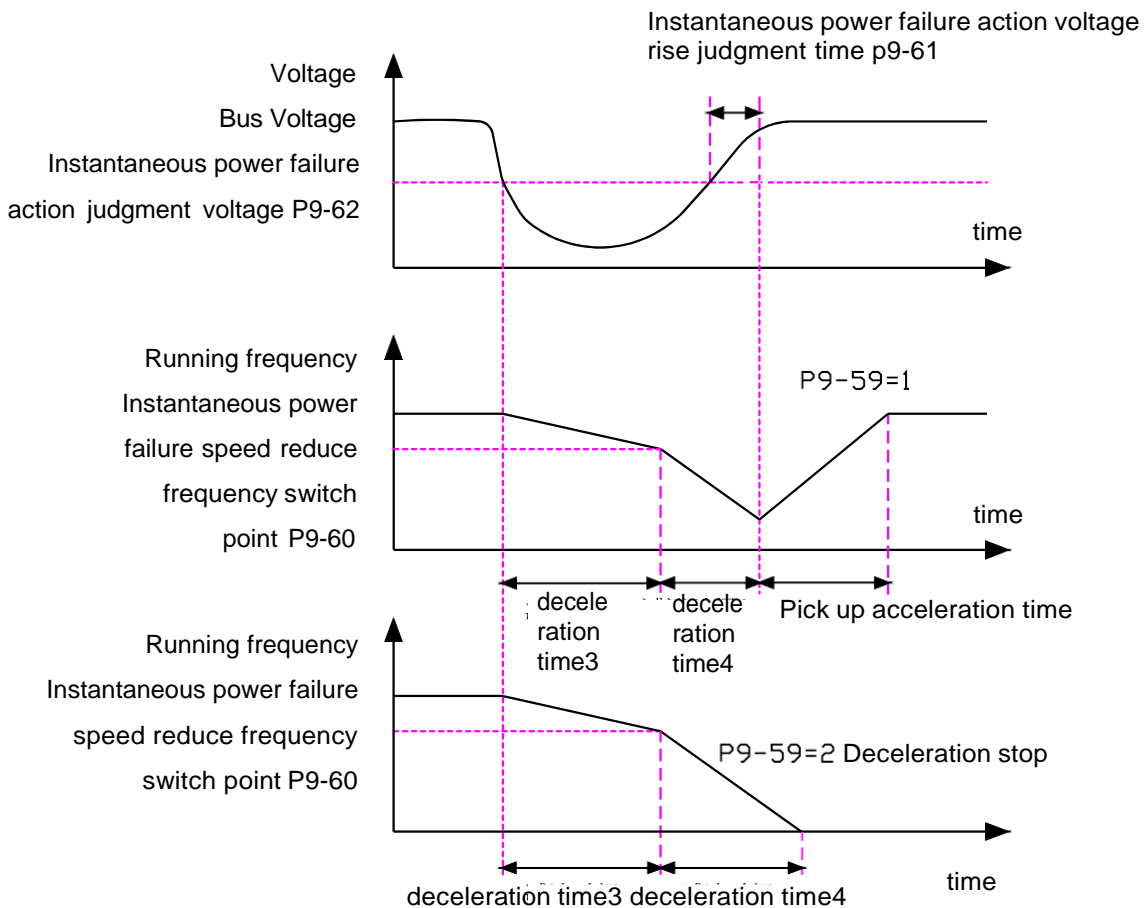

Figure 6-24 Schematic diagram of instantaneous power failure

P9-63	Drop protection option	0: Invalid 1: Valid	Default: 0
P9-64	Drop detection level	0.0~100.0%	Default: 10.0%
P9-65	Drop detection time	0.0~60.0s	Default: 1.0s



If the load-shedding protection function is valid, when the inverter output current is less than the load-detection detection level P9-64 and the duration is greater than the load-off detection time P9-65, the inverter output frequency is automatically reduced to 7% of the rated frequency. During load-shed protection, if the load recovers, the drive automatically returns to operating at the set frequency.

P9-67	Overspeed detection value	0.0%~50.0% (Maximum frequency)	Default: 20.0%
P9-68	Overspeed detection time	0.0s~60.0s	Default: 5.0s



This function is only available when the drive is running with speed sensor vector control. When the inverter detects that the actual speed of the motor exceeds the set frequency, the excess value is greater than the overspeed detection value P9-67, and the duration is longer than the overspeed detection time P9-68, the inverter fault alarm Err43, and according to the fault protection action mode deal with.

P9-69	Speed deviation excessive detection value	0.0%~50.0% (Maximum frequency)	Default: 20.0%
P9-70	Speed deviation too large detection time	0.0s~60.0s	Default: 0.0s

 This function is only available when the drive is running with speed sensor vector control. When the inverter detects that the actual speed of the motor deviates from the set frequency, the deviation amount is greater than the speed deviation excessive detection value P9-69, and the duration is greater than the speed deviation excessive detection time P9-70, the inverter fault alarm Err42, And according to the fault protection action mode.

When the speed deviation is too large and the detection time is 0.0s, the speed deviation excessive fault detection is canceled.

P9-71	Instantaneous stop non-stop gain Kp	0~100	Default: 40
P9-72	Instantaneous stop non-stop integral coefficient Ki	0~100	Default: 30
P9-73	Instantaneous stop and stop motion deceleration time	0~300.0s	Default: 20.0s

(1) When the bus voltage is constant, when the grid resumes power supply, the inverter output frequency continues to run to the target frequency. When the grid is restored, the inverter will continue to decelerate to 0Hz and stop until the inverter issues the start command again.

(2) The purpose of instantaneous stop is to ensure that when the power supply of the power grid is abnormal, the motor can be decelerated and stopped normally, so that the motor can be started immediately after the grid is restored to normal power supply, and will not suddenly owe because the motor is not properly powered by the grid. In the high inertia system, the motor can stop for a long time. When the power supply is normal, the motor can easily cause the inverter to overload or over-current faults because the motor is rotating at high speed.

PA group process control PID function

PID control is a common method of process control. By proportional, integral and differential calculation of the difference between the controlled feedback signal and the target signal, the output frequency of the inverter is adjusted to form a closed-loop system, so that the controlled quantity is stable. Target value.

It is suitable for process control situations such as flow control, pressure control and temperature control. Figure 6-25 shows the control principle block diagram of process PID

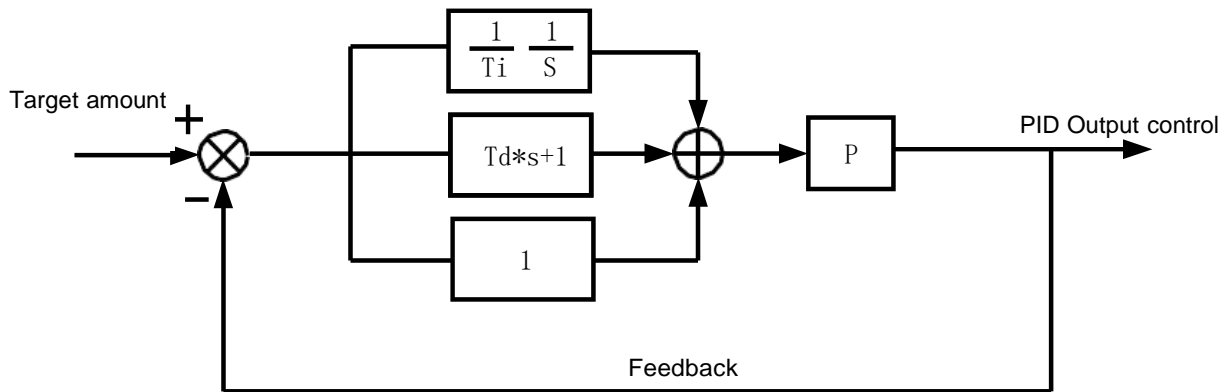

Figure 6-25 Process PID block diagram

PA-00	PID given source	0: PA-01 setting 1: AI1 2: AI2 3: AI3 (panel potentiometer) 4: Pulse setting 5: Communication given 6: Multi-speed given	Default: 0
PA-01	PID value given	0.0%~100.0%	Default: 50.0%



This parameter is used to select the target channel for the process PID. The set target amount of the process PID is a relative value, and the setting range is 0.0% to 100.0%. The feedback amount of the same PID is also the relative amount, and the role of the PID is to make the two relative quantities the same.

PA-02	PID feedback source	0: AI1 1: AI2 2: AI3/panel potentiometer 3: AI1-AI2 4: Pulse setting (X6) 5: Communication given 6: AI1+AI2 7:MAX(AI1 , AI2) 8:MIN(AI1 , AI2)	Default: 0
--------------	---------------------	-----------------------------------------------------------------------------------------------------------------------------------------------------	------------



This parameter is used to select the feedback signal channel of the process PID. The feedback amount of the process PID is also a relative value, and the setting range is 0.0% to 100.0%.

PA-03	PID action direction	0: Positive action 1: reaction	Default: 0
--------------	----------------------	--------------------------------	------------



Positive action: When the PID feedback signal is less than the given amount, the inverter output frequency rises. Such as winding tension control occasions.

Reaction: When the feedback signal of the PID is less than the given amount, the output frequency of the inverter decreases. Such as unwinding tension control occasions.

This function is affected by the reverse direction of the multi-function terminal PID (function 35), so you need to pay attention to it during use.

PA-04	PID given feedback range	0~65535	Default: 1000
--------------	--------------------------	---------	---------------



The PID given feedback range is a dimensionless unit for the PID given display U0-15 and the PID feedback display U0-16. The relative value of the given feedback of the PID is 100.0%, corresponding to the given feedback range PA-04. For example, if PA-04 is set to 2000, when the PID is given 100.0%, the PID given display U0-15 is 2000.

PA-05	Proportional gain Kp1	0.0~100.0	Default: 20.0
PA-06	Integration time Ti1	0.01s~10.00s	Default: 2.00s
PA-07	Derivative time Td1	0.000s~10.000s	Default: 0.000s



Proportional gain Kp1:

Determine the adjustment strength of the entire PID regulator, the larger the Kp1, the greater the adjustment intensity. The parameter 100.0 indicates that when the deviation between the PID feedback amount and the given amount is 100.0%, the adjustment range of the PID regulator to the output frequency command is the Maximum frequency.

Integration time Ti1: Determines the strength of the PID regulator integral adjustment. The shorter the integration time, the greater the adjustment intensity. The integration time means that when the deviation between the PID feedback amount and the given amount is 100.0%, the integral regulator continuously adjusts through the time, and the adjustment amount reaches the Maximum frequency.

Derivative time Td1: Determines the strength of the PID regulator's adjustment to the rate of change of the deviation. The longer the differentiation time, the greater the adjustment intensity. The derivative time means that when the feedback amount changes by 100.0% during this time, the adjustment amount of the differential regulator is the Maximum frequency.

PA-08	PID reverse cutoff frequency	0.00~Maximum frequency	Default: 2.00Hz
--------------	-------------------------------------	------------------------	-----------------

In some cases, only when the PID output frequency is negative (ie, the inverter is reversed), it is possible for the PID to control the given amount and the feedback amount to the same state, but the excessive reverse frequency is not allowed for some occasions. PA-08 is used to determine the upper limit of the inversion frequency.

PA-09	PID deviation limit	0.0%~100.0%	Default: 0.0%
--------------	----------------------------	-------------	---------------

When the deviation between the PID given amount and the feedback amount is smaller than PA-09, the PID stops the adjustment action. In this way, the output frequency is stable when the deviation from the feedback is small, which is effective for some closed-loop control applications.

PA-10	PID differential limiting	0.00%~100.00%	Default: 0.10%
--------------	----------------------------------	---------------	----------------

In the PID regulator, the function of the differential is relatively sensitive, and it is easy to cause the system to oscillate. For this reason, the role of the PID differential is generally limited to a small range, and the PA-10 is used to set the range of the PID differential output.

PA-11	PID given change time	0.00~650.00s	Default: 0.00s
--------------	------------------------------	--------------	----------------

PID given change time, refers to the time required for the PID reference value to change from 0.0% to 100.0%.

When the PID given changes, the PID set value changes linearly according to the given change time, which reduces the adverse effect of the given sudden change on the system.

PA-12	PID feedback filter time	0.00~60.00s	Default: 0.00s
PA-13	PID output filtering time	0.00~60.00s	Default: 0.00s

PA-12 is used to filter the amount of PID feedback. This filtering helps to reduce the influence of feedback on the feedback, but it will bring the response performance of the process closed-loop system.

PA-13 is used to filter the PID output frequency, which will attenuate the sudden change of the inverter output frequency, but it will also bring the response performance of the process closed-loop system.

PA-15	Proportional gain Kp2	0.0~100.0	Default: 20.0
PA-16	Integration time Ti2	0.01s~10.00s	Default: 2.00s
PA-17	Derivative time Td2	0.000s~10.000s	Default: 0.000s
PA-18	PID parameter switching condition	0: Do not switch 1: Switch through the input terminal 2: Automatic switching according to deviation	Default: 0
PA-19	PID parameter switching deviation 1	0.0%~PA-20	Default: 20.0%
PA-20	PID parameter switching deviation 2	PA-19~100.0%	Default: 80.0%



In some applications, a set of PID parameters cannot meet the requirements of the entire running process, and different PID parameters need to be used in different situations. This set of function codes is used for switching between two sets of PID parameters. The setting of the regulator parameters PA-15~PA-17 is similar to the parameters PA-05~PA-07.

The two sets of PID parameters can be switched by the multi-function X terminal, or can be automatically switched according to the deviation of the PID.

When the multi-function X terminal is selected for switching, the multi-function terminal function selection should be set to 43 (PID parameter switching terminal). When the terminal is invalid, select parameter group 1 (PA-05~PA-07). When the terminal is valid, select the parameter group 2 (PA-15~PA-17).

When automatic switching is selected, the absolute value of the deviation between the given and feedback is less than the PID parameter switching deviation 1 PA-19, and the PID parameter selects parameter group 1. When the absolute value of the deviation between the given and the feedback is greater than the PID switching deviation 2 PA-20, the PID parameter selection selects parameter group 2. When the deviation between the given and feedback is between the switching deviation 1 and the switching deviation 2, the PID parameter is the linear interpolation value of the two sets of PID parameters, as shown in Figure 6-26.

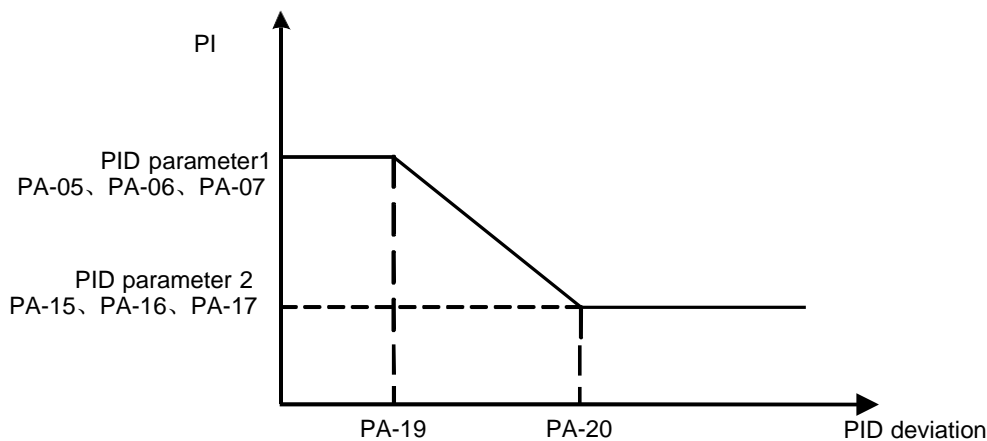

Figure 6-26 PID parameter switching

PA-21	PID initial value	0.0%~100.0%	Default: 0.0%
	PA-22	PID initial value hold time	0.00~650.00s Default: 0.00s

When the inverter starts, the PID output is fixed to the PID initial value PA-21. After the PID initial value hold time PA-22, the PID starts the closed-loop adjustment operation. Figure 6-27 shows the function of the PID initial value.

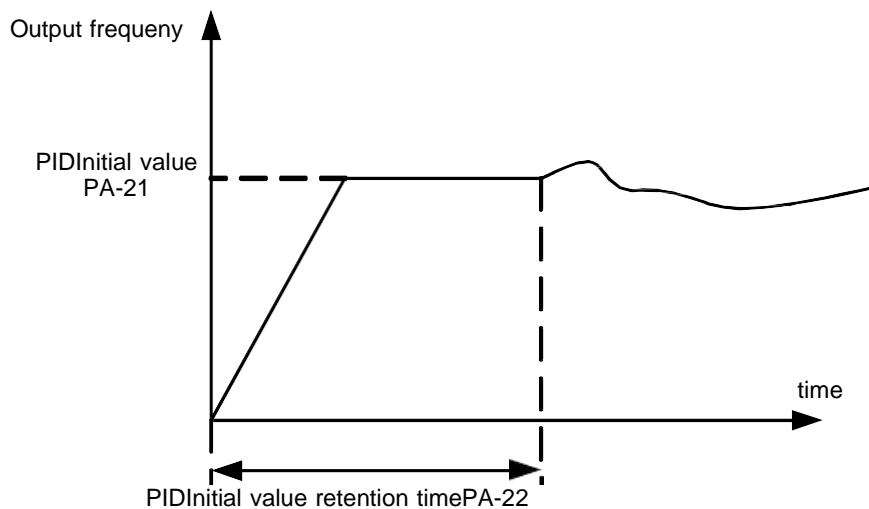

Figure 6-27 Schematic diagram of PID initial value function

This function is used to limit the difference between PID output two beats (2ms/beat), so as to suppress the PID output from changing too fast, and the inverter operation tends to be stable.

PA-25	PID integral attribute	Unit's digit: Integral separation 0: Invalid 1: Valid	Default: 00
		Ten's digit: Whether to stop the integration after outputting the limit 0: Continue to integrate 1: Stop the points	



Integral separation:

If the integral separation is set to be effective, when the multi-function digital X-integration pause (function 22) is valid, the integral PID integration of the PID stops the calculation, and at this time, the PID only proportional and differential action is effective. When the integral separation selection is invalid, the integral separation is invalid regardless of whether the multi-function digital X is valid or not.

Whether to stop integration after output to the limit: After the PID operation output reaches the maximum or minimum value, you can choose whether to stop the integral action. If you choose to stop the integration, then the PID integration stops counting, which may help reduce the overshoot of the PID.

PA-26	PID feedback loss detection value	0.0%: Do not judge feedback loss 0.1%~100.0%	Default: 0.0%
PA-27	PID feedback loss detection time	0.0s~20.0s	Default: 0.0s



This function code is used to judge whether the PID feedback is lost. When the PID feedback amount is less than the feedback loss detection value PA-26 and the duration exceeds the PID feedback loss detection time PA-27, the inverter alarms the fault Err31 and processes according to the selected fault processing mode.

PA-28	PID shutdown operation	0: No operation at stop 1: Operation at stop	Default: 0
--------------	-------------------------------	----------------------------------------------	------------



It is used to select whether the PID continues to operate under the PID stop state. In general applications, the PID should stop computing in the shutdown state.

PB Group Swing frequency, fixed length and counting

The swing frequency function is suitable for textile, chemical fiber and other industries, as well as occasions requiring traverse and winding functions. The swing frequency function refers to the inverter output frequency, which swings up and down with the set frequency as the center, and the running frequency is in the time axis.

As shown in Figure 6-28, the swing amplitude is set by PB-00 and PB-01. When PB-01 is set to 0, the swing is 0. At this time, the swing frequency does not work.

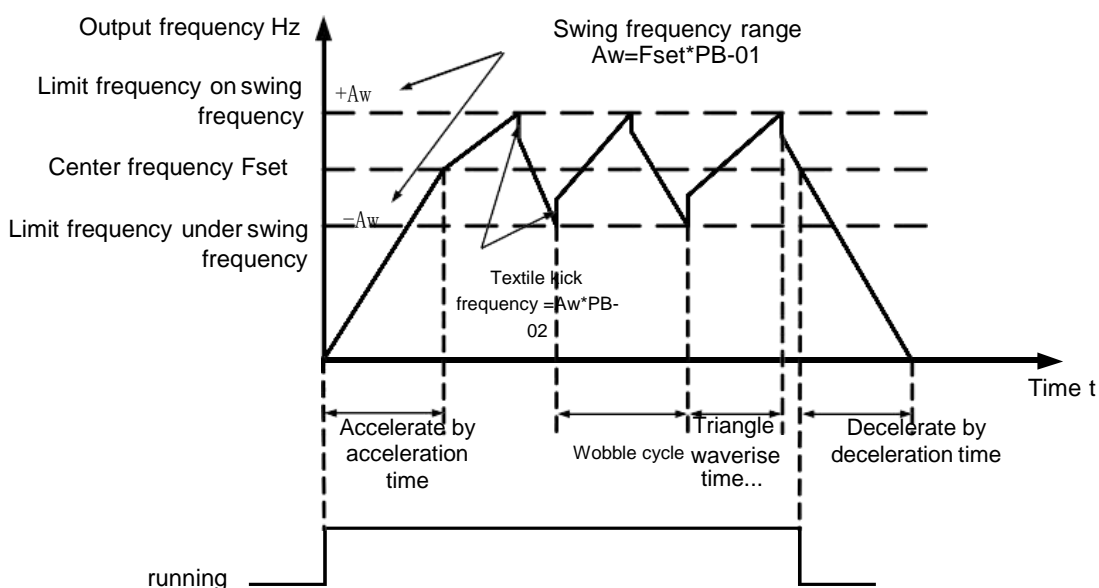

Figure 6-28 Schematic diagram of swing frequency operation

Pb-00	Swing frequency setting method	0: Relative to the center frequency 1: relative to Maximum frequency	Default: 0
--------------	---------------------------------------	----------------------------------------------------------------------	------------



This parameter is used to determine the reference amount of the swing.

0: Relative to the center frequency (P0-07 frequency source), it is a variable swing system. The swing varies with the center frequency (set frequency). 1: Relative to the Maximum frequency (P0-10), for a fixed swing system, the swing is fixed.

Pb-01	Swing frequency range	0.0%~100.0%	Default: 0.0%
Pb-02	Kick frequency amplitude	0.0%~50.0%	Default: 0.0%



This parameter is used to determine the value of the swing value and the kick frequency. When the swing is set relative to the center frequency (PB-00 = 0), the swing $AW = \text{frequency source P0-07} \times \text{swing amplitude PB-01}$. When setting the swing relative to the Maximum frequency (PB-00 = 1), the swing $AW = \text{Maximum frequency P0 - 10} \times \text{swing amplitude PB-01}$.

The amplitude of the kick frequency is the percentage of the frequency of the kick frequency relative to the swing when the swing frequency is running, that is, the burst frequency = swing $AW \times \text{kick frequency amplitude PB-02}$. If the swing is selected relative to the center frequency (PB-00 = 0), the burst frequency is the change value. If the swing is selected relative to the Maximum frequency (PB-00 = 1), the burst frequency is a fixed value.

The swing frequency is limited by the upper and lower frequencies.

Pb-03	Wobble cycle	0.1s~3000.0s	Default: 10.0s
Pb-04	Swing frequency triangle wave rise time	0.1%~100.0%	Default: 50.0%



Wobble cycle: The time value of a complete wobble cycle.

The triangular wave rise time coefficient PB-04 is the time percentage of the triangular wave rise time relative to the swing frequency period PB-03. Triangle wave rise time = swing frequency period PB-03 \times triangle wave rise time coefficient PB-04, in seconds. Triangle wave fall time = swing frequency period PB-03 \times (1 - triangular wave rise time coefficient PB-04), in seconds.

Pb-05	Set length	0m~65535m	Default: 1000m
Pb-06	Actual length	0m~65535m	Default: 0m
Pb-07	Pulse number per meter	0.1~6553.5	Default: 100.0



The above function code is used for fixed length control.

The length information is collected by the multi-function input terminal, and the number of pulses sampled by the terminal is divided by the number of pulses per meter PB-07, and the actual length PB-06 can be calculated. When the actual length is greater than the set length PB-05, the output length reaches the ON signal.

During the fixed length control, the length reset operation can be performed through the input terminal (28).

In the application, the corresponding input terminal function needs to be set to "length count input" (27). When the pulse frequency is high, the X6 port must be used.

Pb-08	Set count value	1~65535	Default: 1000
Pb-09	Specified count value	1~65535	Default: 1000



The count value needs to be collected through the multi-function digital input terminal. In the application, the corresponding input terminal function needs to be set to "counterinput" (function 25). When the pulse frequency is high, the X6 port must be used.

When the count value reaches the set count value PB-08, the multi-function digital output "sets the count value reached" ON signal, and then the counter stops counting.

When the count value reaches the specified count value PB-09, the multi-function digital output "specified count value reaches" ON signal, at which time the counter continues to count until the "set count value" is stopped.

The specified count value PB-09 should not be greater than the set count value PB-08. Figure 6-29 is a schematic diagram of setting the arrival of the count value and the arrival of the specified count value.

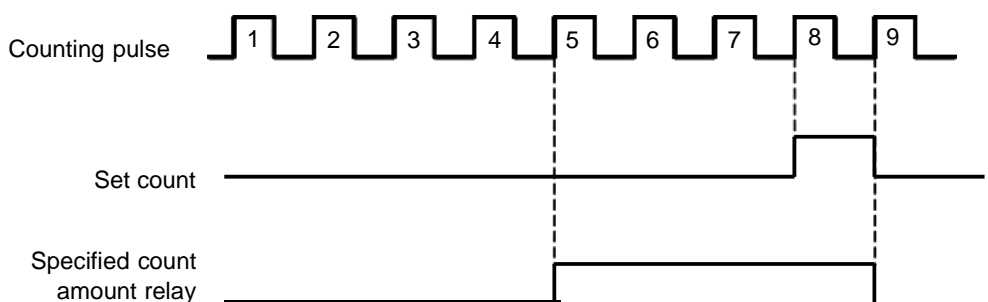

Figure 6-29 Setting the count value given and the specified count value

PC 组 Multi-segment instruction and simple PLC function

The multi-stage command of the inverter has more functions than the normal multi-speed. In addition to the multi-speed function, it can also be used as a voltage source for VF separation and a given source for the process PID. To this end, the dimensions of the multi-segment instructions are relative values.

PC-00	Multi-segment instruction 0	-100.0%~100.0%	Default: 0.0%
--------------	-----------------------------	----------------	---------------

PC-01	Multi-segment instruction 1	-100.0%~100.0%	Default: 0.0%
PC-02	Multi-segment instruction 2	-100.0%~100.0%	Default: 0.0%
PC-03	Multi-segment instruction 3	-100.0%~100.0%	Default: 0.0%
PC-04	Multi-segment instruction 4	-100.0%~100.0%	Default: 0.0%
PC-05	Multi-segment instruction 5	-100.0%~100.0%	Default: 0.0%
PC-06	Multi-segment instruction 6	-100.0%~100.0%	Default: 0.0%
PC-07	Multi-segment instruction 7	-100.0%~100.0%	Default: 0.0%
PC-08	Multi-segment instruction 8	-100.0%~100.0%	Default: 0.0%
PC-09	Multi-segment instruction 9	-100.0%~100.0%	Default: 0.0%
PC-10	Multi-segment instruction 10	-100.0%~100.0%	Default: 0.0%
PC-11	Multi-segment instruction 11	-100.0%~100.0%	Default: 0.0%
PC-12	Multi-segment instruction 12	-100.0%~100.0%	Default: 0.0%
PC-13	Multi-segment instruction 13	-100.0%~100.0%	Default: 0.0%
PC-14	Multi-segment instruction 14	-100.0%~100.0%	Default: 0.0%
PC-15	Multi-segment instruction 15	-100.0%~100.0%	Default: 0.0%



Multi-segment instructions can be used in three situations: as a frequency source, as a VF-separated voltage source, as a set source for the process PID. In three applications, the dimension of the multi-segment instruction is relative, ranging from -100.0% to

100.0%. When used as a frequency source, it is a percentage of the relative frequency; when the VF is separated from the voltage source, it is relative to the rated voltage of the motor. Percentage; since the PID given is originally a relative value, the multi-segment instruction does not require a dimension conversion as a PID setting source.

The multi-segment instruction needs to be switched according to the different states of the multi-function digital X. For details, please refer to the relevant description of the P4 group.

PC-16	Simple PLC operation mode	0: Single run end shutdown	Default: 0
		1: Keep the final value at the end of a single run 2: Always cycle	



The simple PLC function has two functions: as a frequency source or as a voltage source for VF separation.

When the simple PLC is used as the frequency source, the positive and negative of PC-00~PC-15 determine the running direction. If it is negative, it means the inverter runs in the opposite direction.

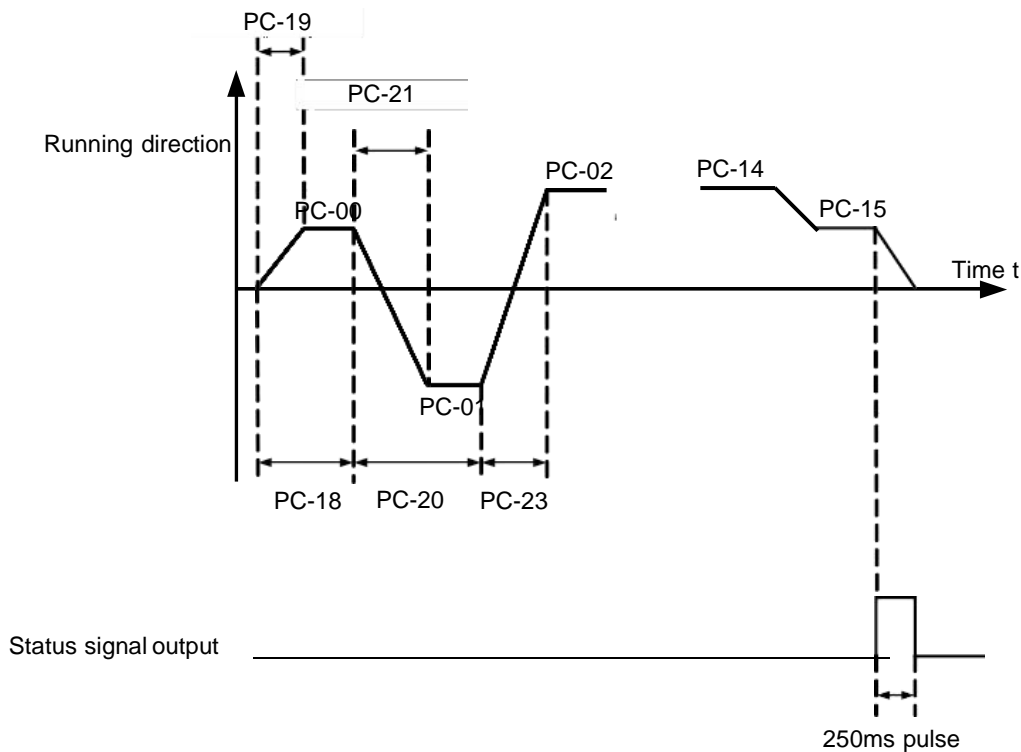

Figure 6-30 Simple PLC schematic

As a frequency source, the PLC has three modes of operation. When the VF is separated as a voltage source, these three modes are not available. among them:

0: Single run end shutdown

After the inverter completes a single cycle, it will stop automatically and need to give the running command again to start.

1: After the single run ends, the final value is maintained. After the inverter completes a single cycle,

Automatically maintain the running frequency and direction of the last segment.

2: Always cycle the inverter after completing a cycle, it will automatically start the next cycle until it stops when there is a stop command.

PC-17	Simple PLC power-down memory selection	Unit's digit: Power-down memory selection 0: No power loss, no memory 1: Power failure memory Ten's digit: stop memory selection 0: Stop without memory 1: Stop memory	Default: 00
--------------	-----------------------------------------------	---------------------------------------------------------------------------------------------------------------------------------------------------------------------------------	-------------



PLC power-down memory refers to the operating phase and operating frequency of the PLC before the power-down, and continues to run from the memory phase the next time the power is turned on. If you choose not to remember, the PLC process will be restarted every time you power up.

The PLC stop memory records the previous PLC running phase and running frequency when it stops, and continues to run from the memory phase in the next run. If you choose not to remember, the PLC process will be restarted each time you start.

PC-18	0th run time	0.0s (h) ~6553.5s (h)	Default: 0.0s(h)
PC-19	The 0th section acceleration and deceleration time selection	0~3	Default: 0
PC-20	First run time	0.0s (h) ~6553.5s (h)	Default: 0.0s(h)
PC-21	The first stage acceleration and deceleration time selection	0~3	Default: 0
PC-22	2nd run time	0.0s (h) ~6553.5s (h)	Default: 0.0s(h)
PC-23	The second stage acceleration and deceleration time selection	0~3	Default: 0
PC-24	Third run time	0.0s (h) ~6553.5s (h)	Default: 0.0s(h)
PC-25	The third stage acceleration and deceleration time selection	0~3	Default: 0
PC-26	Stage 4 run time	0.0s (h) ~6553.5s (h)	Default: 0.0s(h)

PC-27	Section 4 acceleration and deceleration time selection	0~3	Default: 0
PC-28	5th run time	0.0s (h) ~6553.5s (h)	Default: 0.0s(h)
PC-29	Section 5 acceleration and deceleration time selection	0~3	Default: 0
PC-30	Run time of paragraph 6	0.0s (h) ~6553.5s (h)	Default: 0.0s(h)
PC-31	Section 6 acceleration and deceleration time selection	0~3	Default: 0
PC-32	Run time of paragraph 7	0.0s (h) ~6553.5s (h)	Default: 0.0s(h)
PC-33	Section 7 acceleration and deceleration time selection	0~3	Default: 0
PC-34	8th run time	0.0s (h) ~6553.5s (h)	Default: 0.0s(h)
PC-35	Section 8 acceleration and deceleration time selection	0~3	Default: 0
PC-36	9th run time	0.0s (h) ~6553.5s (h)	Default: 0.0s(h)
PC-37	The 9th paragraph acceleration and deceleration time selection	0~3	Default: 0
PC-38	Run time of paragraph 10	0.0s (h) ~6553.5s (h)	Default: 0.0s(h)
PC-39	Section 10 acceleration and deceleration time selection	0~3	Default: 0
PC-40	Run time in paragraph 11	0.0s (h) ~6553.5s (h)	Default: 0.0s(h)

PC-41	The 11th paragraph acceleration and deceleration time selection	0~3	Default: 0
PC-42	Run time in paragraph 12	0.0s (h) ~6553.5s (h)	Default: 0.0s(h)
PC-43	The 12th paragraph acceleration and deceleration time selection	0~3	Default: 0
PC-44	Run time of paragraph 13	0.0s (h) ~6553.5s (h)	Default: 0.0s(h)
PC-45	The 13th paragraph acceleration and deceleration time selection	0~3	Default: 0
PC-46	Run time in paragraph 14	0.0s (h) ~6553.5s (h)	Default: 0.0s(h)
PC-47	The 14th paragraph acceleration and deceleration time selection	0~3	Default: 0
PC-48	Run time in paragraph 15	0.0s (h) ~6553.5s (h)	Default: 0.0s(h)
PC-49	The 15th paragraph acceleration and deceleration time selection	0~3	Default: 0
PC-50	Simple PLC runtime unit	0: s (seconds) 1: h (hours)	Default: 0
PC-51	Multi-segment instruction 0 given mode	0: Given by PC-00 1: given by AI1 2: AI2 given 3: panel potentiometer 4: PULSE pulse 5: PID given 6: P0-08 can be modified by UP/DOWN	Default: 0



This parameter determines the given channel of the multi-segment instruction 0. In addition to the PC-00, the multi-segment instruction 0 has a variety of other options to facilitate switching between multiple short instructions and other given modes. When a multi-segment command is used as a frequency source or a simple PLC as a frequency source, switching between the two frequency sources can be easily realized.

PP 组 user password

PP-00	user password	0~65535	Default: 0
--------------	----------------------	---------	------------



PP-00 sets any non-zero number, then the password protection function takes effect. The next time you enter the menu, you must enter the password correctly. Otherwise, you cannot view and modify the function parameters. Please remember the user password you set.

If PP-00 is set to 00000, the set user password will be cleared, and the password protection function will be invalid.

PP-01	Parameter initialization	0: No operation 1: Restore Default, excluding motor parameters 2: Clear record information 4: Backup user current parameters 501: Restore user backup parameters without operation 1: Restore Default, excluding motor parameters 2: Clear record information 4: Backup user current parameters 501: Restore user backup parameters	Default: 0
--------------	---------------------------------	-------------------------------------------------------------------------------------------------------------------------------------------------------------------------------------------------------------------------------------------------------------------------------------------------------------------------------------------------------------	------------



1、Restore factory settings, excluding motor parameters:

After setting PP-01 to 1, most of the inverter's function parameters are restored to the factory default parameters, but the motor parameters, frequency command decimal point (P0-22), fault record information, cumulative running time (P7-09), cumulative power-on Time (P7-13) and accumulated power consumption (P7-14) are not restored.

2. Clear the record information: clear the inverter fault record, accumulated operation/power-on time (P7-09/P7-13), and accumulated power consumption (P7-14).

4. Backup user current parameters: Back up the current setting values of all function parameters to facilitate the customer to recover after the parameter adjustment is disordered.

501. Restore user backup parameters: restore the user parameters that were backed up before, that is, restore the backup parameters by setting PP-01 to 4.

PP-02	Function parameter group display selection	Function parameter group display selection	Default: 11
PP-04	Function code modification attribute	0: Can be modified 1: not modifiable	Default: 0



Whether the user can set the function code parameter can be modified to prevent the risk of the function parameter being mistakenly changed.

When the function code is set to 0, all function codes can be modified; when set to 1, all function codes can only be viewed and cannot be modified.

A0-00	Speed/torque control selection	0: Speed control 1: torque control	Default: 0
--------------	---------------------------------------	------------------------------------	------------



Used to select the inverter control mode: speed control or torque control. The multi-function input terminals of the inverter are equipped with torque control inhibition (function 29) and speed control/torque control switching (function 46).

When the speed control/torque control switching terminal is invalid, the control mode is determined by A0-00. If the terminal is valid, the value corresponding to A0-00 is inverted. In any case, when the torque control inhibit terminal is valid, the inverter is fixed to the speed control mode.

A0-01	Torque setting source selection in torque control mode	0: Digital setting (A0-03) 1: AI1 2: AI2 3: AI3 4: Pulse setting 5: Communication reference 6: MIN (AI1, AI2) 7: MAX (AI1, AI2) 1-7 option full scale, corresponding to A0-03 digital setting	Default: 0
A0-03	Torque digital setting	-200.0%~200.0%	Default: 150.0%



A0-01 is used to select the torque setting source mode. The torque setting uses a relative value, and 100.0% corresponds to the rated torque of the inverter.

When the torque is set to 1~7 mode, 100% of communication, analog input and pulse input correspond to the percentage of A0-03.0-01

A0-05	Torque control forward maximum frequency	0.00Hz~Maximum frequency	Default: 50.00Hz
A0-06	Torque control reverse maximum frequency	0.00Hz~Maximum frequency	Default: 50.00Hz



It is used to set the forward or reverse maximum running frequency of the inverter under the torque control mode.

When the inverter torque is controlled, if the load torque is less than the motor output torque, the motor speed will continue to rise. To prevent accidents such as flying in the mechanical system, the maximum motor speed during torque control must be limited.

A0-07	Torque control acceleration time	0.00s~65000s	Default: 0.00s
A0-08	Torque control deceleration time	0.00s~65000s	Default: 0.00s



In the torque control mode, the difference between the motor output torque and the load torque determines the speed change rate of the motor and the load, so the motor speed may change rapidly, causing problems such as excessive noise or mechanical stress. By setting the torque control acceleration/deceleration time, the motor speed can be changed gently.

However, for situations where fast torque response is required, the torque control acceleration/deceleration time must be set to 0.00 s.

A5 组 Control optimization parameter

A5-00	DPWM switching upper limit frequency	0.00Hz~15.00Hz	Default: 12.00
--------------	---------------------------------------------	----------------	----------------



Only valid for VF control. The wave-forming mode of the asynchronous machine VF is

determined. Below this value is the 7-segment continuous modulation mode, and the opposite is the 5-segment intermittent modulation mode.

In the case of 7-segment continuous modulation, the switching loss of the inverter is large, but the current ripple is small; in the 5-segment intermittent debugging mode, the switching loss is small and the current ripple is large; but at high frequencies, it may cause The instability of the motor operation generally does not need to be modified.

Please refer to function code P3-11 for VF operation instability. For function loss and temperature rise, please refer to function code P0-15.

A5-01	PWMModulation	0 :Asynchronous modulation 1: synchronous modulation	Default: 0
--------------	----------------------	---------------------------------------------------------	------------



Only valid for VF control. Synchronous modulation means that the carrier frequency changes linearly with the output frequency conversion, ensuring that the ratio(carrier ratio) of the two is constant, and is generally used when the output frequency is high, which is beneficial to the output voltage quality.

At lower output frequencies (below 100 Hz), synchronous modulation is generally not required because the ratio of carrier frequency to output frequency is higher at this time, and the advantage of asynchronous modulation is more obvious.

When the running frequency is higher than 85 Hz, the synchronous modulation takes effect, and the frequency is fixed below the asynchronous modulation mode.

A5-02	Dead zone compensation mode selection	0: No compensation 1: Compensation mode 1 2: Compensation mode 2	Default: 1
--------------	----------------------------------------------	---------------------------------------------------------------------	------------



This parameter generally does not need to be modified. Only when there is a special requirement for the quality of the output voltage waveform, or when the motor has an abnormality such as oscillation, it is necessary to try to switch to select different compensation modes. Compensation mode 2 is recommended for high power.

A5-03	Random PWM depth	0: Invalid 1~10: Random PWM Depth	Default: 0
--------------	-------------------------	-----------------------------------	------------

By setting a random PWM, the monotonous and harsh motor sound can be softened and it can help reduce external electromagnetic interference. When the random PWM depth is set to 0, the random PWM is invalid. Adjusting the random PWM different depths will give different effects.

A5-04	Fast current limiting	0: Invalid 1: Valid	Default: 1
--------------	------------------------------	---------------------	------------



Enable the fast current limiting function to minimize the overcurrent fault of the inverter and ensure the uninterrupted operation of the inverter. If the inverter continues to be in the fast current limit state for a long time, the inverter may be damaged by overheating, etc. This situation is not allowed.

Therefore, when the inverter is quickly limited for a long time, it will alarm Err40, indicating that the inverter is overloaded and needs to stop.

A5-05	Current detection compensation	0~100	Default: 5
--------------	---------------------------------------	-------	------------



It is used to set the current detection compensation of the inverter. If the setting is too large, the control performance may be degraded. Generally do not need to be modified.

A5-06	Under voltage setting	60.0%~140.0%	Default: 100.0%
--------------	------------------------------	--------------	-----------------



It is used to set the voltage value of the inverter undervoltage fault Err09. The inverter with different voltage levels is 100.0%, corresponding to different voltage points:

Single phase / three phase 220V: 200V

Three phase 380V: 350V

Three phase 480V: 450V

Three phase 690V: 650V

A5-07	SVC optimization mode selection	0: Not optimized 1: Optimized mode 1 2: Optimized mode 2	Default: 1
--------------	----------------------------------------	----------------------------------------------------------	------------



Optimization Mode 1: Used when there is a higher torque control linearity requirement.
Optimization Mode 2: Use when there is a requirement for higher speed stability.

A5-08	Dead time adjustment	100%~200%	Default: 150%
--------------	-----------------------------	-----------	---------------

Set for 1140V voltage level. Adjusting this value can improve the effective voltage usage. If the adjustment is too small, the system may be unstable. User modification is not recommended

A5-09	Overvoltage setting	200.0V ~ 2200.0V	Default: depend
--------------	----------------------------	------------------	-----------------



Used to set the voltage value of the inverter overvoltage fault. The different voltage levels are respectively:

Voltage Level	Overpressure point Default
Single phase 220V	400.0V
Three phase 220V	400.0V
Three phase 380V	810.0V
Three phase 480V	890.0V
Three phase 690V	1300.0V
Three phase 1140V	2000.0V

Default is also the upper limit of the internal overvoltage protection of the inverter. This parameter setting takes effect only when the A5-09 setting value is less than the respective voltage level Default. Above Default, the Default is the standard.

A6 group AI curve setting

A6-00	AI curve 4 minimum input	-10.00V ~ A6-02	Default: 0.00V
A6-01	AI curve 4 minimum input correspondence setting	-100.0% ~ +100.0%	Default: 0.0%
A6-02	AI curve 4 inflection point 1 input	A6-00 ~ A6-04	Default: 3.00V

A6-03	AI curve 4 inflection point 1 input corresponding setting	-100.0% ~ +100.0%	Default: 30%
A6-04	AI curve 4 inflection point 2 input	A6-02 ~ A6-06	Default: 6.00V
A6-05	AI curve 4 inflection point 2 input corresponding setting	-100.0% ~ +100.0%	Default: 60%
A6-06	AI curve 4 maximum input	A6-06 ~ +10.00V	Default: 10.00V
A6-07	AI curve 4 maximum input corresponding setting	-100.0% ~ +100.0%	Default: 100%
A6-08	AI curve 5 minimum input	-10.00V ~ A6-10	Default: -10.00V
A6-09	AI curve 5 minimum input corresponding setting	-100.0% ~ +100.0%	Default: -100.0%
A6-10	AI curve 5 inflection point 1 input	A6-08 ~ A6-12	Default: -3.00V
A6-11	AI curve 5 inflection point 1 input corresponding setting	-100.0% ~ +100.0%	Default: -30.0%
A6-12	AI curve 5 inflection point 2 input	A6-10 ~ A6-14	Default: 3.00V
A6-13	AI curve 5 inflection point 2 input corresponding setting	-100.0% ~ +100.0%	Default: 30.0%
A6-14	AI curve 5 maximum input	A6-12 ~ +10.00V	Default: 10.00V
A6-15	AI curve 5 maximum input corresponding setting	-100.0% ~ +100.0%	Default: 100.0%

The functions of curves 4 and 5 are similar to those of curve 1 curve 3, but curve 1 is a straight line, while curve 4 and curve 5 are 4-point curves, which allows for a more flexible

correspondence. The figure below is a schematic diagram of curve 4 curve 5. 4

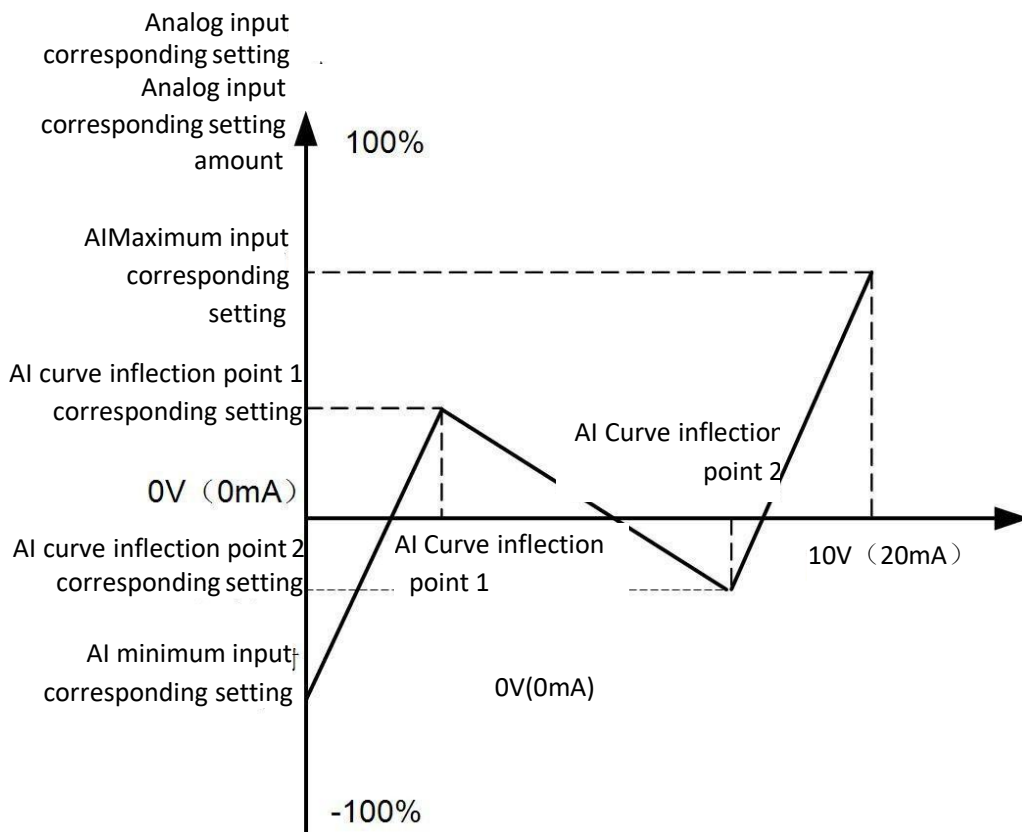

Figure 6-31 Schematic diagram of curve 4 and curve 5

Note that when setting curve 4 and curve 5, the minimum input voltage of the curve, the inflection point 1 voltage, the inflection point 2 voltage, and the maximum voltage must be increased in turn. AI curve selection F4-33 is used to determine how the analog inputs AI1~AI3 are selected among the 5 curves.

A6-24	AI1 sets the jump point	-100.0% ~ 100.0%	Default: 0.0%
A6-25	AI1 sets the jump range	0.0% ~ 100.0%	Default: 0.5%
A6-26	AI2 sets the jump point	-100.0% ~ 100.0%	Default: 0.0%
A6-27	AI2 sets the jump range	0.0% ~ 100.0%	Default: 0.5%
A6-28	AI3 sets the jump point	-100.0% ~ 100.0%	Default: 0.0%
A6-29	AI3 sets the jump range	0.0% ~ 100.0%	Default: 0.5%



The inverter analog input AI1~AI3 has the set value jump function. The jump function is to fix the analog amount corresponding set value to the value of the jump point when the analog amount is set to change in the upper and lower sections of the jump point.

E.g:

The voltage of analog input AI1 fluctuates around 5.00V, the fluctuation range is 4.90V~5.10V, the minimum input of AI1 is 0.00V corresponding to 0.0%, and the maximum input of 10.00V corresponds to 100.%, then the detected AI1 is set at 49.0. Fluctuations between %~51.0%.

Set AI1 to set jump point A6-24 to 50.0%, and set AI1 to set jump width A6-25 to 1.0%. When AI1 is input, after hopping function processing, the corresponding AI1 input corresponding setting is fixed to 50.0%. AI1 is transformed into a stable input that eliminates fluctuations.

AC group AIAO Correction

AC-00	AI1 measured voltage 1	0.500V ~ 4.000V	factory reset
AC-01	AI1 display voltage 1	0.500V ~ 4.000V	factory reset
AC-02	AI1 measured voltage 2	6.000V ~ 9.999V	factory reset
AC-03	AI1 display voltage 2	6.000V ~ 9.999V	factory reset
AC-04	AI2 measured voltage 1	0.500V ~ 4.000V	factory reset
AC-05	AI2 display voltage 1	0.500V ~ 4.000V	factory reset
AC-06	AI2 measured voltage 2	6.000V ~ 9.999V	factory reset
AC-07	AI2 display voltage 2	6.000V ~ 9.999V	factory reset
AC-08	AI3 measured voltage 1	-9.999V ~ 10.000V	factory reset
AC-09	AI3 display voltage 1	-9.999V ~ 10.000V	factory reset
AC-10	AI3 measured voltage 2	-9.999V ~ 10.000V	factory reset
AC-11	AI3 display voltage 2	-9.999V ~ 10.000V	factory reset

This set of function codes is used to correct the analog input AI to eliminate the effects of zero offset and gain on the AI input. The function parameters of this group have been corrected at the factory. When the default is restored, it will be restored to the factory-corrected value. Generally no correction is required at the application site.

The measured voltage refers to the actual voltage measured by a measuring instrument such as a multimeter. The display voltage refers to the voltage display value sampled by the inverter. See the U0 group AI correction voltage (U0-21, U0-22, U0-23) display.

During calibration, input two voltage values for each AI input port, and respectively input the value measured by the multimeter and the value read by the U0 group into the above function code, the inverter will automatically perform the zero offset of the AI. Correction of the gain.

For the case where the user's given voltage does not match the actual sampling voltage of the inverter, the field calibration method can be used to make the sampling value of the inverter

consistent with the expected set value. Take AI1 as an example. The field calibration method is as follows:

Given AI1 voltage signal (about 2V)

Actual measurement of AI1 voltage value, stored in function parameter AC-00 View U0-21 display value, stored in function parameter AC-01;

Given AI1 voltage signal (about 8V)

Actual measurement of AI1 voltage value, stored in function parameters AC-02

View U0-21 display value, save function parameters AC-03

When AI2 and AI3 are corrected, the actual sampling voltage viewing positions are U0-22 and U0-23 respectively.

For AI1 and AI2, it is recommended to use 2V and 8V as the calibration point pair AI3. It is recommended to sample -8V and 8V as the correction point.

AC-12	AO1 target voltage 1	0.500V ~ 4.000V	factory reset
AC-13	AO1 measured voltage 1	0.500V ~ 4.000V	factory reset
AC-14	AO1 target voltage 2	6.000V ~ 9.999V	factory reset
AC-15	AO1 measured voltage 2	6.000V ~ 9.999V	factory reset
AC-16	AO2 target voltage 1	0.500V ~ 4.000V	factory reset
AC-17	AO2 measured voltage 1	0.500V ~ 4.000V	factory reset
AC-18	AO2 target voltage 2	6.000V ~ 9.999V	factory reset
AC-19	AO2 measured voltage 2	6.000V ~ 9.999V	factory reset
AC-20	AI2 measured current 1	0.000mA ~ 20.000mA	factory reset
AC-21	AI2 sampling current 1	0.000mA ~ 20.000mA	factory reset
AC-22	AI2 measured current 2	0.000mA ~ 20.000mA	factory reset
AC-23	AI2 sampling current 2	0.000mA ~ 20.000mA	factory reset
AC-24	AO1 ideal current 1	0.000mA ~ 20.000mA	factory reset
AC-25	AO1 measured current 1	0.000mA ~ 20.000mA	factory reset

AC-26	AO1 ideal current 2	0.000mA ~ 20.000mA	factory reset
AC-27	AO1 measured current 2	0.000mA ~ 20.000mA	factory reset

This set of function codes is used to correct the analog output AO.

The function parameters of this group have been corrected at the factory. When the default is restored, it will be restored to the factory-corrected value. Generally no correction is required at the application site.

The target voltage is the theoretical output voltage value of the inverter. The measured voltage refers to the actual output voltage measured by an instrument such as a multimeter.

Fault alarm and Solutions

When the inverter fails during operation, the inverter will immediately protect the motor from output, and the inverter fault relay contact will act and display the fault code on the inverter display panel. Before seeking service, users can perform self-checking according to the tips in this section to analyze the cause of the fault. If the fault cannot be solved, please seek technical support from our company or product agent.

Fault name	display	Troubleshoot the cause	solutions
Inverter unit protection	Err01	<ol style="list-style-type: none"> 1, the inverter output circuit is short circuit 2. The motor and inverter are too long. 3, the module is overheated 4, the internal wiring of the inverter is loose 5. The main control board or driver board is abnormal. 6, the inverter module is abnormal 	<ol style="list-style-type: none"> 1, eliminate peripheral faults 2, install reactor or output filter 3. Check if the air duct is blocked and the fan is normal. 4, plug in all the cables 5, seeking technical support 6, seeking technical support
Accelerating overcurrent	Err02	<ol style="list-style-type: none"> 1. There is grounding or short circuit in the output circuit of the inverter. 2. The control mode is vector and there is no parameter identification. 3, the acceleration time is too short 4. Manual torque boost or V/F curve is not suitable 5, the voltage is low 6. Start the motor that is rotating 7. Sudden load during acceleration 8, the frequency converter selection is too small 	<ol style="list-style-type: none"> 1, eliminate peripheral faults 2. Perform motor parameter identification 3, increase the acceleration time 4, adjust the manual lift or V / F curve 5, adjust the voltage to the normal range 6, select the speed tracking start or wait for the motor to stop and then start 7, cancel the sudden load 8, select the inverter with a larger power level
Deceleration over current	Err03	<ol style="list-style-type: none"> 1. There is grounding or short circuit in the output circuit of the inverter. 2. The control mode is vector and there is no parameter identification. 3, the deceleration time is too short 4, the voltage is low 5, sudden load during deceleration 6, no brake unit and brake resistor installed 	<ol style="list-style-type: none"> 1, eliminate peripheral faults 2. Perform motor parameter identification 3, increase the deceleration time 4, adjust the voltage to the normal range 5, cancel the sudden load 6, install the brake unit and resistor
Constant speed over current	Err04	<ol style="list-style-type: none"> 1. There is grounding or short circuit in the output circuit of the inverter. 2. The control mode is vector and there is no parameter identification. 3, the voltage is low 4. Is there a sudden load during operation? 5, the frequency converter selection is too small 	<ol style="list-style-type: none"> 1, eliminate peripheral faults 2. Perform motor parameter identification 3. Adjust the voltage to the normal range 4, cancel the sudden load 5, select the inverter with a larger power level
Accelerated over voltage	Err05	<ol style="list-style-type: none"> 1, the input voltage is too high 2. There is an external force drag motor running during the acceleration process. 3, the acceleration time is too short 4, no brake unit and brake resistor installed 	<ol style="list-style-type: none"> 1. Adjust the voltage to the normal range 2, cancel the additional power or install braking resistor 3, increase the acceleration time 4, install the brake unit and resistor
Deceleration over voltage	Err06	<ol style="list-style-type: none"> 1, the input voltage is too high 2. There is external force drag motor running during deceleration 3, the deceleration time is too short 4, no brake unit and brake resistor installed 	<ol style="list-style-type: none"> 1. Adjust the voltage to the normal range 2, cancel the additional power or install braking resistor 3, increase the deceleration time 4, install the brake unit and resistor
Constant speed over voltage	Err07	<ol style="list-style-type: none"> 1, the input voltage is too high 2. There is an external force drag motor running during the running process. 	<ol style="list-style-type: none"> 1. Adjust the voltage to the normal range 2, cancel the additional power or install braking resistor
Control power	Err08	<ol style="list-style-type: none"> 1. The input voltage is not within the range specified 	<ol style="list-style-type: none"> 1. Adjust the voltage to the

failure		by the specification.	specification
Under voltage fault	Err09	1, instantaneous power outage 2. The input voltage of the inverter is not within the scope of the specification. 3, the bus voltage is not normal 4, rectifier bridge and buffer resistor are not normal 5, the driver board or control board is abnormal	1, reset failure 2. Adjust the voltage to the normal range 3. Ask for technical support 4, Ask for technical support 5, Ask for technical support
Inverter overload	Err10	1. Is the load too large or the motor is blocked? 2, the inverter selection is too small	1. Reduce the load and check the motor and mechanical conditions. 2, select the inverter with a larger power level
Motor overload	Err11	1. Is the motor protection parameter P9-01 suitable? 2. Is the load too large or the motor stalls? 3, the frequency converter selection is too small	1, set this parameter correctly 2. Reduce the load and check the motor and mechanical conditions 3. Select a frequency converter with a larger power level
Input phase loss	Err12	1, three-phase input power is not normal 2. The drive board or lightning protection board is abnormal.	1. Troubleshooting the peripheral lines 2, seeking technical support
Output phase loss	Err13	1. The lead of the inverter to the motor is not normal. 2. The three-phase output is unbalanced when the motor is running. 3. The driver board or module is abnormal.	1, eliminate peripheral faults 2. Check if the three phases of the motor are normal. 3. Seek technical support
Module overheating	Err14	1, the ambient temperature is too high 2. Air duct blockage or fan damage 3, module thermistor is damaged 4, the inverter module is damaged	1, reduce the ambient temperature 2, clean the air duct or replace the fan 3, replace the thermistor 4. Replace the inverter module
External device failure	Err15	Check external terminal input fault signal	Reset operation
communication fail	Err16	1, the host computer is not working properly 2, the communication line is not normal 3. The communication parameter PD group setting is incorrect.	1. Check the wiring of the upper computer 2, check the communication cable 3, correctly set the communication parameters
Contact failure	Err17	1. The driver board and power supply are abnormal. 2, the contactor is not normal 3, three-phase input power shortage	1. Replace the driver board or power board 2, replace the contactor 3, check the three-phase input power
Current detection fault	Err18	1, check the Hall device is abnormal 2, the driver board is abnormal	1, replace the Hall device 2, replace the driver board
Motor tuning failure	Err19	1. The motor parameters are not set according to the nameplate. 2. The parameter identification process times out.	1. Set the motor parameters correctly according to the nameplate 2. Check the inverter to the motor lead
Code disk failure	Err20	1, the encoder model does not match 2, the encoder connection error 3, the encoder or PG card is damaged	1, correctly set the encoder type 2, eliminate line faults 3. Replace the encoder or PG card
EEPROM read and write failure	Err21	1, EEPROM chip damage	1. Replace the main control board
Inverter hardware failure	Err22	Overvoltage or overcurrent	According to overvoltage or overcurrent fault handling
Short circuit to ground	Err23	Motor short to ground	Replace cable or motor
Accumulated running time to failure	Err26	Cumulative running time reaches the set value	Parameter initialization clear record information

User-defined fault 1	Err27	Check the signal of the terminal input custom fault 1	Reset operation
User-defined fault 2	Err28	Check the signal of the terminal input custom fault 2	Reset operation
Accumulated power-on time to failure	Err29	Cumulative power-on time reaches the set value	Parameter initialization clear record information
Download fault	Err30	The inverter running current is less than P9-64	Check if the load is out of range or whether the P9-64 and P9-65 settings are in accordance with the actual working conditions.
Runtime PID feedback loss failure	Err31	PID feedback is less than PA-26 set value	Check the PID feedback signal or set PA-26 to a suitable value
Wave-by-wave current limiting fault	Err40	1. Is the load too large or the motor is blocked? 2, the inverter selection is too small	1. Reduce the load and check the motor and mechanical conditions. 2. Select the inverter with higher power level.
Switching motor failure during operation	Err41	Change the current motor selection through the terminal while the inverter is running	After the inverter stops, the motor is switched.
Speed deviation is too large	Err42	1. Encoder parameter setting is incorrect 2, no parameter identification 3. The parameters P9-69 and P9-60 are unreasonable.	1, set the encoder parameters correctly 2. Perform motor parameter identification 3. Set the detection parameters according to the actual conditions.
Motor overspeed failure	Err43	1. Encoder parameter setting is incorrect 2, no parameter identification 3. The parameters P9-69 and P9-60 are unreasonable.	1, set the encoder parameters correctly 2. Perform motor parameter identification 3. Set the detection parameters reasonably
Motor over temperature fault	Err45	1, the temperature sensor wiring is loose 2, the motor temperature is too high	1, detecting temperature sensor wiring 2. Reduce the carrier frequency or take other heat dissipation measures to dissipate the motor
Initial position error	Err51	The motor parameters are too different from the actual deviation	Check if the motor parameters are correct and pay attention to whether the rated current is set too small.

Common faults and solution

The following fault conditions may be encountered during the use of the inverter. Please refer to the following method for simple fault analysis

Table 8-1 Common faults and solutions

No.	Fault phenomenon	Possible Causes	solutions
1	No display after power on	The grid voltage is not or too low; The switching power supply on the inverter drive board is faulty; The control board is disconnected from the driving board and the keyboard; The internal components of the inverter are damaged.	Check the input power or bus voltage; Re-insert 8-core and 34-core cable; Seek factory services;
2	Power on display FZKJ	Poor contact between the drive board and the control board; The relevant device on the control board is damaged; The motor or motor line is shorted to ground; Hall failure or grid voltage is too low;	Re-insert 8-core and 34-core cable; Seek factory services;
3	Power on display "Err23" alarm	The motor or output line is shorted to ground; The inverter is damaged;	Use a shaker to measure the insulation of the motor and the output line; seek factory service;
4	The power-on inverter is normal, and it displays "FZKJ" after running and stops immediately.	The fan is damaged or blocked; The peripheral control terminal wiring has a short circuit; The internal components of the inverter are damaged.	Replace the fan; Eliminate external short circuit faults; Seek factory services;
5	Frequently reported Err14 module overheat fault	The carrier frequency setting is too high. The fan is damaged or the air duct is blocked. Inverter internal device damage	Reduce the carrier frequency (P0-15). Replace the fan and clean the air duct. Seek factory to replace.
6	The motor does not rotate after the inverter is running.	Motor and motor line; Inverter parameter setting error (motor parameter); Poor contact between the driver board and the control board;	Reconfirm the connection between the inverter and the motor; Replace the motor or remove mechanical problems; Check and reset the motor parameters;
7	The input terminal is invalid.	The parameter setting is incorrect; External signal error; Control board failure;	Check and reset the P4 group parameters; Reconnect the external signal line; Seek factory services;
8	When closed loop vector control, the motor speed cannot be increased.	Encoder failure; The encoder is connected to the wrong line or has poor contact; PG card or drive board failure;	Replace the code wheel and reconfirm the wiring; replace the PG card; Seeking service;
9	The inverter frequently reports over current and over voltage faults.	Motor parameter setting is incorrect; The acceleration and deceleration time is not suitable Load fluctuations;	Reset motor parameters or motor tuning; Set the appropriate acceleration and deceleration time; Seek factory services;
10	Power up (or run) to report Err17	The soft start contactor is not attracted; Phase loss of three-phase input power supply;	Check if the contactor cable is loose; Check if the contactor is faulty; Check if the 24V power supply of the contactor is normal.;
11	Power on display 888888	The relevant device on the control board is damaged;	Replace the control panel;

