

DENSO

# SPARK PLUGS CATALOGUE

# 2023

Data up to  
October,  
2022



Search for a Part Number

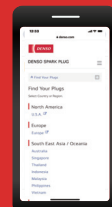

Most  
up-to-date  
info.

# Find Your Plugs on Website

Latest News, Products Info., Supports



Most up-to-date info. is available for you

Updated

Part Number Search

Regional Search Links

Latest News

Products Information

Basic Knowledge

Installation Tech

FAQs, Supports

Motor Sports News



DENSO spark plugs 



DENSO Spark Plugs Website

<https://www.denso.com/global/en/products-and-services/automotive-service-parts-and-accessories/plug/>

# INDEX

WARNINGS AND PRECAUTIONS	2
TT PLUGS	6
IRIDIUM POWER	16
IRIDIUM TOUGH	19
IRIDIUM RACING	20
AUSTRALIA	24
CHINA	73
INDIA	102
INDONESIA	107
KOREA	116
MALAYSIA	121
PHILIPPINES	131
SAUDI ARABIA	142
SINGAPORE	145
TAIWAN	162
THAILAND	180
VIETNAM	188
JAPAN	193
EUROPE & USA	263
CROSS REFERENCE	317
PART NUMBER	347



## Be Sure to Read Through These Warnings and Precautions

IN NO EVENT SHALL DENSO BE LIABLE FOR ANY LOSSES, EXPENSES OR DAMAGES WHATSOEVER RESULTING FROM ANY OF THE FOLLOWINGS;

- FAILURE TO COMPLY WITH THE WARNING OR PRECAUTIONS DESCRIBED IN THIS CATALOGUE AND WEBSITE,
- ANY USES OTHER THAN THE APPLICABLE USE DESCRIBED IN THIS CATALOGUE AND WEBSITE, and
- ANY TROUBLE NOT ATTRIBUTABLE TO DENSO SPARK PLUGS.

※"Spark plugs" means any type of DENSO's spark plugs, including but not limited to Iridium Power, Iridium TT, Iridium Racing, Iridium Plus, Iridium Saver, Iridium Tough, Iridium Long Life, Double Platinum, U-Groove, Resistor, Standard, Nickel TT, Platinum TT, Two-Tops.



### WARNING (Prohibited Usage)

Be sure to turn off the engine and disconnect the battery or power source before replacing or adjusting the plugs. Failure to heed this warning may result in a fire, an electric shock and/or bodily harm.

- Never use DENSO spark plugs in the engines for any aircraft, including airplanes, helicopters, gliders and drones. The DENSO spark plugs sold are not designed and manufactured for any aircraft: use may result in a plane crash or other accidents due to engine malfunction.
- Never use DENSO spark plugs, listed in this catalogue or website, in the engines for generator and gas heat pump air conditioning system or co-generation, except DENSO spark plugs specially designed for such use. The DENSO spark plugs we sell are not designed and manufactured for such use, so that such use may result in accidents, including power generation stop or heat generation stop. A separate catalogue for DENSO spark plugs specifically designed for co-generation is available for limited regions. Please contact your DENSO representative for more information.
- Never use DENSO spark plugs for gas burner ignition. The DENSO spark plugs we sell are not designed and manufactured for such use, so that such use may result in ignition failure or equipment damage due to overheating.
- Use genuine spark plugs for special applications such as ambulances, police cars, emergency vehicles, and others.



### Spark Plug Handling Precautions

- Carefully read the instructions and precautions on the package, catalogue and website.
- Do not drop spark plugs. This may cause the spark plug to crack internally or the gap to be narrowed, preventing it from functioning correctly.



### Precautions for Tuning and Modified Vehicles

- DENSO will not bear any responsibility whatsoever for any trouble arising from mechanically or electronically modified engines or vehicles.
- It is the user's judgement and responsibility to check the specifications required for modified engines or any engines or vehicles those are not listed in DENSO spark plugs catalogue and website, which includes and not limited to, gapping, heat ranges, reach, projection, and/or clearances with valves and/or pistons.



### Catalogue & Website Precautions

- Precautions for cross reference and product tables listing other manufacturer's spark plugs:
  - ◆ Use for reference only. Table does not guarantee the performance of spark plugs when installed in the vehicles even plug was specified in cross references. Always check the applications section for DENSO recommended spark plugs.
  - ◆ The spark plug specifications (construction, material, etc.) differ by manufacturers.
  - ◆ Select a suitable type of spark plug from the vehicle application table. If not listed on the table, please check with your regional DENSO Representative.
- The contents of the catalogue and website are updated on a regular basis, however, the information and data may change after updating or publishing. Please note that this catalogue and website does not include models that will be release after last updating or publishing.
- Consumption tax and installation fees are not included in the price of the product.
- Some spark plugs on this catalogue and website are manufacturer's genuine parts and reference only. Those cannot be sold directly from DENSO. Please contact your regional DENSO representative for further assistance.
- The appearance and specifications of the product are subject to change without prior notice.
- The images of spark plugs indicated in the catalogue and website are conceptual diagrams, and sometimes differ from the actual products.
- Data given in this catalogue are those as of October 2022. The information and data may change after updating or publishing. Please note that this catalogue does not include models that will be release after that.



# Precautions for Selecting Spark Plugs

Select appropriate spark plugs with the correct dimensions and heat range by checking vehicle manual, maintenance manual and this catalogue's or websites' application table.

## Spark Plug Selection Know-How

### Normal Vehicle

- Use standard heat range plugs. However, if you often drive at low speeds or short distances and the carbon fouling recurs, you might be able to avoid carbon fouling by selecting a low heat range spark plug.
- Do not use a non-register type spark plug for a model specified a register type spark plug (spark plug with resistance). Noise associated by spark discharge may cause engine trouble.
- If the extended type spark plugs (J, QJ, KJ, PKJ, SKJ, VKJ, TJ, etc.) are installed to any other designated engine, it will interfere with valves and pistons and may damage the engine and plug.

### Select the Optimum Heat Range

Heat Range	Applications
31	Prevent plug overheating
27	
24	
22	
20	Prevent carbon fouling/oil fouling

Low ← Tuning Level → High

### Tuning or Modified Vehicle

- If the engine is modified, or if the tuning or modified vehicle uses an aftermarket muffler, ignition coil, plug cord, turbo installation, electronic ignition system, NOS (\*), etc., the heat range of the spark plug must be increased according to the level of tuning. If the spark plug is not selected correctly, the vehicle may be damaged by carbon fouling, oil fouling or pre-ignition (the natural phenomenon of spontaneous combustion occurring faster than spark plug ignition), etc.
- (\*) NOS: a device that increases engine power by injecting nitrous oxide with gasoline into the air intake
- Select the heat range at your own discretion and responsibility when using the spark plugs in a tuning or modified vehicle.

### When Using Iridium Racing Plugs

- Iridium Racing plugs are intended for racing and also for tuning up. Select the heat range of the spark plugs according to the tuning level, based on the heat range of the standard spark plugs or Iridium Power plugs.
- Generally, a plug that protrudes into the combustion chamber has superior ignition performance, resulting in improved engine performance. On the other hand, this type of plug is more susceptible to exposure to hot combustion gases and the longer ground electrode makes it less heat-resistant and durable. Therefore, the higher the level of tuning, the greater the need to use a type with recessed electrodes.
- Generally, the higher the level of tuning, the greater the need for high-heat range spark plugs.
- Use of Iridium Racing plug is at your own discretion and responsibility.

## Use of Spark Plug with Terminal Nut

Using a spark plug with a terminal nut with the terminal nut loose may cause engine malfunction. When using a spark plug with a part number marked "R" alongside "Terminal Shape" or "NUT" and a terminal nut attached, securely tighten the nut by using pliers or the like. For spark plugs with part numbers marked "RC" alongside "Terminal Shape" or "NUT," the terminal nut is caulked and does not loosen under normal use. However, it may loosen in rare occasions when the engine and or plug cord vibrates intensely. If such a situation is expected, inspect the nut regularly and if it is loose, tighten it again securely.

#### S: Solid (Integrated Type)

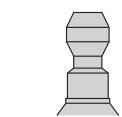

The terminal nut cannot be removed.

#### R: Nut Type (Not Caulked)



The terminal nut can be easily removed

#### RC: Nut Type (Caulked)



The terminal nut can be removed by using pliers or the like.

#### T: Screw Type



No terminal nut.



# Precautions for Installing Spark Plugs

## Recommended Torque and Tightening Angle

It is necessary to install the plugs in the engine using the correct torque.

- Too low torque: may cause damage to the engine and the plugs due to leakage of combustion gas or vibration.
- Too high torque: may cause airtight leakage or break of the mounting screws due to the caulking of the insulator and housing become loosened.

Thread Size	Applicable Models	Recommended Torque	Recommended Tightening Angle	
			New Plug	Previously Used
M 8	All Types	8 -10N·m	About 1/3 turn	About 1/12 turn
M10	Types other than the ones shown below	10-15N·m	About 1/3 turn	About 1/12 turn
M10	UFE, IUH, VUH, VNH Types	10-15N·m	About 2/3 turn	About 1/12 turn
M10	Stainless Gasket Type <sup>(*)1</sup>	10-15N·m	About 3/4 turn	About 1/12 turn
M12	All Types	15-20N·m	About 1/3 turn	About 1/12 turn
M14	Types other than the ones shown below	20-30N·m	About 1/2 turn	About 1/12 turn
M14	Stainless Gasket Type <sup>(*)2</sup>	20-30N·m	About 2/3 turn	About 1/12 turn
M18	All Types	30-40N·m	About 1/4 turn	About 1/12 turn
M14 <sub>Taper seat</sub>	All Types	10-20N·m	About 1/16 turn	About 1/16 turn
M14 <sub>(Gas)</sub>	If the cylinder head material is cast iron	20N·m	-	-
M14 <sub>(Gas)</sub>	If the cylinder head material is aluminum	17.5N·m	-	-
M18 <sub>(Gas)</sub>	If the cylinder head material is cast iron	30N·m	-	-

(\*)1 VUH27ES, U24FER9S

(\*)2 IK16G, IK20G, IK22G, K20PR-U8S, K20PR-U9S, KJ20DR-M11S, PK22PR-L11S, SK20PR-N9S, SK22PR-M11S, SKJ20DR-M11S, VK16G, VK20G, VK22G

## Spark Plugs Installation



Always refer to the vehicle manufacturer's repair manual for specific installation procedures.

Do not apply screw thread lubricant to the spark plug since it may make you over tighten the spark plug and cause the screw to break.

However, screw thread lubricant is already applied to some plugs for LPG engines. In such case, tighten the plug according to the maintenance manual.

1

Check the gasket ring.



When cleaning the mounting seat on the engine side, be sure that oil, dust and foreign objects in the vicinity of the cylinder head do not fall into the engine.

2

Hold the spark plug vertically to plug hole and lightly tighten it by hand or by using a plug wrench.



Use plug wrench that fits to the plug's hexagonal housing

3

Using a plug wrench, tighten the plug to the recommended torque or the recommended tightening angle.

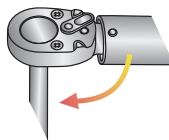

Be careful not to hold the wrench obliquely.



Tighten the plug to the recommended torque or the recommended tightening angle.

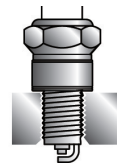

## Insulator Cracking

The spark plugs of recent engines are installed in deep plug holes, and it is difficult to notice the tilted wrench when installing and removing the spark plugs. However, if you turn the wrench in this condition, the head of the insulator may become stuck. By applying excessive force, resulting in cracking.

\*The mode of occurrence differs depending on the difference in the structure and the dimensions of the plug hole by vehicle and the type of wrench.

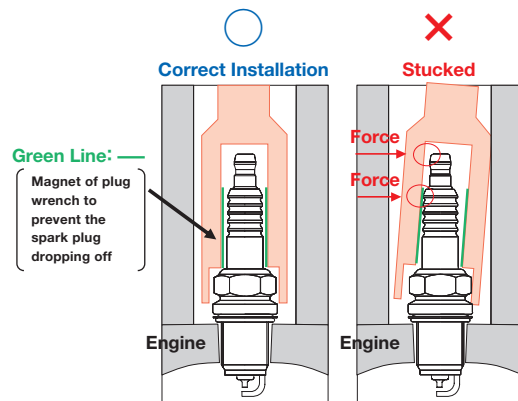



## Spark Plug Replacement Timing

The electrode progressively wears, causing the spark gap to increase, along with the increasing number of spark discharges. When the gap exceeds a certain limit, the sparking performance deteriorates, which may prevent stable ignition of the gas mixture. When this happens, the horsepower of the engine falls, the fuel economy deteriorates and also the quality of the exhaust gas is adversely affected, so it is necessary to replace the plugs.

The table below shows our recommended plug replacement timing as a rough guide to the economic life of the plugs. The economic life may be reduced depending upon the vehicle running condition and the sparking characteristics\*\*.

	IRIDIUM POWER Ni-TT Plugs Conventional Plugs	IRIDIUM TOUGH IRIDIUM PLUS Platinum Plugs
Automobile	15,000 ~ 20,000km	~ 100,000km *
Motorcycle	3,000 ~ 5,000km (No settings for Ni-TT Plugs)	No Settings

\* The small engine vehicle, a tuned vehicle or a vehicle that uses a simultaneous ignition coil is often used at high speed. This may cause the life of the plugs to be reduced.

\*\*Factors which shorten life

- Running condition: High-speed driving, high-load driving, hill climbing, extended idling (taxi), etc.
- Ignition characteristics: Simultaneous ignition, positive discharge, use of high-energy coil, etc.

## Simultaneous Ignition System

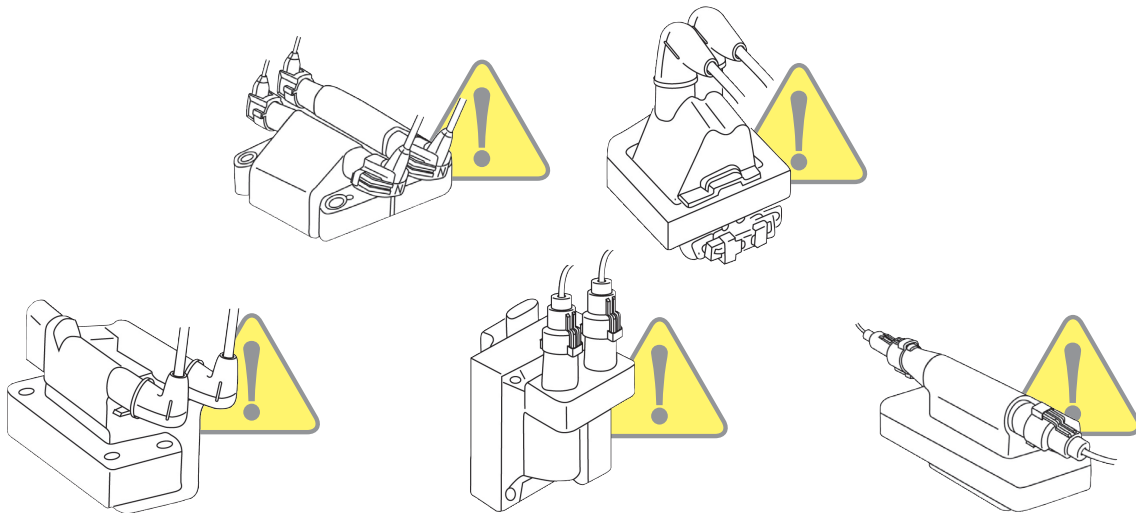

A simultaneous ignition system is an ignition system in which two plug cords are connected from one coil, as shown in the figure. Generally, a single coil provides high voltage to a single spark plug, and negative (-) discharge is used so that it reduces electrode wear and tear. Simultaneous ignition systems, on the other hand, a single coil provides voltage to two spark plugs, which are negative (-) and positive (+) discharge. It resulting the generation of waste fire that is not related to combustion, which causes electrode wear and tear, especially in positive (+) discharges.





## ⚠ Adjustment of the Plug Gap



- If the center electrode becomes rounded or the ground electrode wears unevenly, replace the spark plug with a new one.
- Do not adjust the gap of a spark plug that has a fine electrode, such as a platinum plug or an iridium plug. It may result in damage of the center electrode.



# Cross Reference

NGK Ni/Pt/Ir	NGK TYPE				DENSO
Ni	B5EB11	W16TT	PW16TT	IW16TT	W16EKR-S11
	B6EB	W20TT	PW20TT	IW20TT	W20EKR-S11
	B6EB11	W20TT	PW20TT	IW20TT	W20EKR-S11
	B6EB-L11	W20TT	PW20TT	IW20TT	W20EKR-S11
	B6EFS	T20TT	PT20TT	IT20TT	T20EP-U
	B7EB	W22TT	—	—	W22EKR-S11
	B7EB11	W22TT	—	—	W22EKR-S11
	BCP4ES	Q16TT	PQ16TT	IQ16TT	Q14R-U11
	BCP4ES11	Q16TT	PQ16TT	IQ16TT	Q14R-U11
	BCP5E	Q16TT	PQ16TT	IQ16TT	Q16P-U11
	BCP5E11	Q16TT	PQ16TT	IQ16TT	Q16P-U11
	BCP5ES	Q16TT	PQ16TT	IQ16TT	Q16-U
	BCP5ES11	Q16TT	PQ16TT	IQ16TT	Q16-U11
	BCP5ET	K20TT	PK20TT	IK20TT	K20PBR
	BCP5EY11	Q16TT	PQ16TT	IQ16TT	Q16-U11
	BCP6E	Q20TT	PQ20TT	IQ20TT	Q20P-U
	BCP6E11	Q20TT	PQ20TT	IQ20TT	Q20P-U11
	BCP6ES	Q20TT	PQ20TT	IQ20TT	Q20-U
	BCP6ES11	Q20TT	PQ20TT	IQ20TT	Q20-U11
	BCP6ET	K20TT	PK20TT	IK20TT	K20PBR
	BCP6EY11	Q20TT	PQ20TT	IQ20TT	Q20-U11
	BCPR4ES11	Q16TT	PQ16TT	IQ16TT	Q14R-U11
	BCPR4EY11	Q16TT	PQ16TT	IQ16TT	Q14R-U11
	BCPR5E	Q16TT	PQ16TT	IQ16TT	Q16PR-U
	BCPR5E11	Q16TT	PQ16TT	IQ16TT	Q16PR-U11
	BCPR5ES	Q16TT	PQ16TT	IQ16TT	Q16PR-U
	BCPR5ES11	Q16TT	PQ16TT	IQ16TT	Q16PR-U11
	BCPR5ET	K20TT	PK20TT	IK20TT	K20PBR
	BCPR5EY	—	PQ16TT	IQ16TT	Q16R-U
	BCPR5EY11	Q16TT	PQ16TT	IQ16TT	Q16R-U11
	BCPR5EY-N11	Q16TT	PQ16TT	IQ16TT	Q16PR-U11
	BCPR5EY-N11	Q16TT	PQ16TT	IQ16TT	Q16R-U11
	BCPR6E	Q20TT	PQ20TT	IQ20TT	Q20PR-U
	BCPR6E11	Q20TT	PQ20TT	IQ20TT	Q20PR-U11
	BCPR6ES	Q20TT	PQ20TT	IQ20TT	Q20PR-U
	BCPR6ES11	Q20TT	PQ20TT	IQ20TT	Q20PR-U11
	BCPR6ET	K20TT	PK20TT	IK20TT	K20PBR
	BCPR6EY	Q20TT	PQ20TT	IQ20TT	Q20R-U
	BCPR6EY11	Q20TT	PQ20TT	IQ20TT	Q20R-U11
	BCPR6EY-N11	Q20TT	PQ20TT	IQ20TT	Q20PR-U11
	BCPR6EY-N11	Q20TT	PQ20TT	IQ20TT	Q20R-U11
	BK5E	K16TT	PK16TT	IK16TT	K16P-U
	BK5E11	K16TT	PK16TT	IK16TT	K16P-U11
	BK6E	K20TT	PK20TT	IK20TT	K20P-U
	BK6E11	K20TT	PK20TT	IK20TT	K20PR-U11
	BKR4ESA11	—	PK16TT	IK16TT	—
	BKR5E	K16TT	PK16TT	IK16TT	K16PR-U
	BKR5E11	K16TT	PK16TT	IK16TT	K16PR-U11
	BKR5E11	K16TT	PK16TT	IK16TT	K16PR-U11
	BKR5E-E	K16TT	PK16TT	IK16TT	K16PR-UR
BKR5EK	K20TT	PK20TT	IK20TT	K20TXR	
BKR5EKB11	K16TT	PK16TT	IK16TT	K16TR11	
BKR5EKC	K16TT	PK16TT	IK16TT	K16TNR-S9	
BKR5EKU	K20TT	PK20TT	IK20TT	K20TXR	
BKR5EKUP	K20TT	PK20TT	IK20TT	K20TXR	
BKR5EN	K16TT	PK16TT	IK16TT	K16PR-U	



NGK Ni/Pt/Ir	NGK TYPE				DENSO
Ni	BKR5EN11	K16TT	PK16TT	IK16TT	K16PR-L11
	BKR5ES	K16TT	PK16TT	IK16TT	K16PR-U
	BKR5ES-11	K16TT	PK16TT	IK16TT	K16PR-U11
	BKR5ESA-11	K16TT	PK16TT	IK16TT	K16PR-U11
	BKR5EY	K16TT	PK16TT	IK16TT	K16R-U
	BKR5EY11	K16TT	PK16TT	IK16TT	K16R-U11
	BKR5EYA	K16TT	PK16TT	IK16TT	K16R-U
	BKR5EYA11	K16TT	PK16TT	IK16TT	K16R-U11
	BKR5EZ	K16TT	PK16TT	IK16TT	K16PR-U
	BKR6E	K20TT	PK20TT	IK20TT	K20PR-U
	BKR6E	K20TT	PK20TT	IK20TT	K20PR-U
	BKR6E11	K20TT	PK20TT	IK20TT	K20PR-U11
	BKR6E-E	K20TT	PK20TT	IK20TT	K20PR-UR
	BKR6EK	K20TT	PK20TT	IK20TT	K20TXR
	BKR6EKB11	K20TT	PK20TT	IK20TT	K20TR11
	BKR6EKC	K20TT	PK20TT	IK20TT	K20TNR
	BKR6EKC-N11	K20TT	PK20TT	IK20TT	K20TNR
	BKR6EKE	K20TT	PK20TT	IK20TT	K20TXR
	BKR6EKU	K20TT	PK20TT	IK20TT	K20TXR
	BKR6EKUB	K20TT	PK20TT	IK20TT	K20TXR
	BKR6EKUE	K20TT	PK20TT	IK20TT	K20TXR
	BKR6EN	K20TT	PK20TT	IK20TT	K20PR-U
	BKR6EN11	K20TT	PK20TT	IK20TT	K20PR-L11
	BKR6EQU	K20TT	PK20TT	IK20TT	K20TXR
	BKR6EQUA	K20TT	PK20TT	IK20TT	K20TXR
	BKR6EQUB	K20TT	PK20TT	IK20TT	K20TXR
	BKR6EQUPE	K20TT	PK20TT	IK20TT	K20TXR
	BKR6EQUPA	K20TT	PK20TT	IK20TT	K20TXR
	BKR6ES	K20TT	PK20TT	IK20TT	K20PR-U
	BKR6ES11	K20TT	PK20TT	IK20TT	K20PR-U11
	BKR6ESZ-10	K20TT	PK20TT	IK20TT	K20PR-U11
	BKR6ETA10	K20TT	PK20TT	IK20TT	K20PBR
	BKR6ETUB	K20TT	PK20TT	IK20TT	K20PBR-S10
	BKR6EY	K20TT	PK20TT	IK20TT	K20R-U
	BKR6EY11	K20TT	PK20TT	IK20TT	K20R-U11
	BKR6EYA	K20TT	PK20TT	IK20TT	K20R-U
	BKR6EYA11	K20TT	PK20TT	IK20TT	K20R-U11
	BKR6EZ	K20TT	PK20TT	IK20TT	K20PR-U
	BKR6EZB	K20TT	PK20TT	IK20TT	K20PR-U
	BKUR5EK9	K16TT	PK16TT	IK16TT	K16TNR-S9
	BKUR5ET	K16TT	PK16TT	IK16TT	K16TNR-S9
	BKUR5ET10	K16TT	PK16TT	IK16TT	K16TNR-S9
	BKUR5ETC10	K16TT	PK16TT	IK16TT	K16TNR-S9
	BKUR5ETZ10	K16TT	PK16TT	IK16TT	K16TNR-S9
	BKUR6E	K20TT	PK20TT	IK20TT	K20PR-SU9
	BKUR6EK	K20TT	PK20TT	IK20TT	K20TNR-S
	BKUR6EK9	K20TT	PK20TT	IK20TT	K20TNR-S9
	BKUR6ET	K20TT	PK20TT	IK20TT	K20PBR-S10
	BKUR6ET10	K20TT	PK20TT	IK20TT	K20PBR-S10
	BKUR6ETB	K20TT	PK20TT	IK20TT	K20PBR-S10
BP4E	W16TT	PW16TT	IW16TT	W14EX-U	
BP4EA11	W16TT	PW16TT	IW16TT	W14EX-U11	
BP4EFS	T16TT	PT16TT	IT16TT	T16EPR-U	
BP4ES	W16TT	PW16TT	IW16TT	W14EP-U	
BP4ES	W16TT	PW16TT	IW16TT	W14EX-U	
BP4ES11	W16TT	PW16TT	IW16TT	W14EX-U11	









NGK Ni/Pt/Ir	NGK TYPE				DENSO
Ni	BP4ES-L11	W16TT	PW16TT	IW16TT	W14EX-U11
	BP4EY	W16TT	PW16TT	IW16TT	W14EX-U
	BP4EY11	W16TT	PW16TT	IW16TT	W14EX-U11
	BP4FS	—	PTF16TT	ITF16TT	T14PR-U
	BP5E	W16TT	PW16TT	IW16TT	W16EP-U
	BP5EA	W16TT	PW16TT	IW16TT	W14EX-U
	BP5EA11	W16TT	PW16TT	IW16TT	W14EX-U11
	BP5EA-L	W16TT	PW16TT	IW16TT	W16EX-U
	BP5EA-L11	W16TT	PW16TT	IW16TT	W16EX-U11
	BP5EFS	T16TT	PT16TT	IT16TT	T16EPR-U
	BP5EFS-13	T16TT	PT16TT	IT16TT	T16EPR-U15
	BP5EK-A	W16TT	PW16TT	IW16TT	W16ET-S
	BP5EKN	W16TT	PW16TT	IW16TT	W16ET-S
	BP5ES	W16TT	PW16TT	IW16TT	W16EP-U
	BP5ES	W16TT	PW16TT	IW16TT	W16EX-U
	BP5ES11	W16TT	PW16TT	IW16TT	W16EP11
	BP5ES11	W16TT	PW16TT	IW16TT	W16EP-U11
	BP5ES11	W16TT	PW16TT	IW16TT	W16EX-U11
	BP5ES13	W16TT	PW16TT	IW16TT	W16EX-U13
	BP5ES-A	W16TT	PW16TT	IW16TT	W16EP-U
	BP5ES-A	W16TT	PW16TT	IW16TT	W16EX-U
	BP5ESZ	W16TT	PW16TT	IW16TT	W16EP-U
	BP5ET	W16TT	PW16TT	IW16TT	W16EPB10
	BP5ET10	W16TT	PW16TT	IW16TT	W16EPB10
	BP5EY	W16TT	PW16TT	IW16TT	W16EX-U
	BP5EY11	W16TT	PW16TT	IW16TT	W16EX-U11
	BP5FS	—	PTF16TT	ITF16TT	T16P-U
	BP6E	W20TT	PW20TT	IW20TT	W20EP-U
	BP6EA	W20TT	PW20TT	IW20TT	W20EX-U
	BP6EA11	W20TT	PW20TT	IW20TT	W20EX-U11
	BP6EFS	T20TT	PT20TT	IT20TT	T20EP-U
	BP6EFS-13	T20TT	PT20TT	IT20TT	T20EP-U15
	BP6EK	W20TT	PW20TT	IW20TT	W20ETR-L
	BP6EK	W20TT	PW20TT	IW20TT	W20ET-S
	BP6EK-A	W20TT	PW20TT	IW20TT	W20ET-S
	BP6EKN	W20TT	PW20TT	IW20TT	W20ETR-L
	BP6EK-N	W20TT	PW20TT	IW20TT	W20ET-S
	BP6ES	W20TT	PW20TT	IW20TT	W20EP
	BP6ES	W20TT	PW20TT	IW20TT	W20EP-U
	BP6ES	W20TT	PW20TT	IW20TT	W20EX-U
	BP6ES11	W20TT	PW20TT	IW20TT	W20EP11
	BP6ES11	W20TT	PW20TT	IW20TT	W20EPR-U11
	BP6ES11	W20TT	PW20TT	IW20TT	W20EX-U11
	BP6ES13	W20TT	PW20TT	IW20TT	W20EX-U13
	BP6ESZ	W20TT	PW20TT	IW20TT	W20EP-U
	BP6ET	W20TT	PW20TT	IW20TT	W20EPB
	BP6EY	W20TT	PW20TT	IW20TT	W20EX-U
	BP6EY11	W20TT	PW20TT	IW20TT	W20EX-U11
	BP6FS	—	PTF20TT	ITF20TT	T20P-U
	BP6HS	WF20TT	—	—	W20FP-U
BP6HS10	WF20TT	—	—	W20FP-U10	
BP6HSA	WF20TT	—	—	W20FR-L	
BP7E	W22TT	—	—	W22EP-U	
BP7EK-N	W22TT	—	—	W22ETR-L	
BP7ES	W22TT	—	—	W22EP-U	
BP7ES11	W22TT	—	—	W22EP11	



NGK Ni/Pt/Ir	NGK TYPE				DENSO
Ni	BP7ES11	W22TT	—	—	W22EP-U11
	BP7ET	W22TT	—	—	W22EPB
	BP7EY	W22TT	—	—	W22EP-U
	BPR4EFS	—	PT16TT	IT16TT	—
	BPR4ES	W16TT	PW16TT	IW16TT	W14EPR-U
	BPR4ES	W16TT	PW16TT	IW16TT	W14EXR-U
	BPR4ES11	W16TT	PW16TT	IW16TT	W14EXR-U11
	BPR4ES13	W16TT	PW16TT	IW16TT	W14EXR-U13
	BPR4ES-L11	W16TT	PW16TT	IW16TT	W14EXR-U11
	BPR4EY	W16TT	PW16TT	IW16TT	W14EXR-U
	BPR4EY11	W16TT	PW16TT	IW16TT	W14EXR-U11
	BPR4FS	—	PTF16TT	ITF16TT	T14PR-U
	BPR4FS11	—	PTF16TT	ITF16TT	T14PR-U15
	BPR4FS15	—	PTF16TT	ITF16TT	T14PR-U15
	BPR5E	W16TT	PW16TT	IW16TT	W16EPR-U
	BPR5E11	W16TT	PW16TT	IW16TT	W16EPR-U11
	BPR5EA	W16TT	PW16TT	IW16TT	W14EXR-U
	BPR5EA-11	W16TT	PW16TT	IW16TT	W14EXR-U11
	BPR5EA-L	W16TT	PW16TT	IW16TT	W16EXR-U
	BPR5EA-L11	W16TT	PW16TT	IW16TT	W16EXR-U11
	BPR5EF	T16TT	PT16TT	IT16TT	T16EPR-U
	BPR5EFS	T16TT	PT16TT	IT16TT	T16EPR-U
	BPR5EFS13	T16TT	PT16TT	IT16TT	T16EPR-U15
	BPR5EK-A	W16TT	PW16TT	IW16TT	W16ETR-S
	BPR5EKU	W16TT	PW16TT	IW16TT	W16ETR-S
	BPR5ES	W16TT	PW16TT	IW16TT	W16EPR-U
	BPR5ES	W16TT	PW16TT	IW16TT	W16EXR-U
	BPR5ES11	W16TT	PW16TT	IW16TT	W16EPR11
	BPR5ES11	W16TT	PW16TT	IW16TT	W16EXR-U11
	BPR5ES13	W16TT	PW16TT	IW16TT	W16EXR-U13
	BPR5ES-A	W16TT	PW16TT	IW16TT	W16EXR-U
	BPR5EY	W16TT	PW16TT	IW16TT	W16EXR-U
	BPR5EY11	W16TT	PW16TT	IW16TT	W16EXR-U11
	BPR5FS	—	PTF16TT	ITF16TT	T16PR-U
	BPR5FS11	—	PTF16TT	ITF16TT	T16PR-U11
	BPR5FS15	—	PTF16TT	ITF16TT	T16PR-U15
	BPR6E	W20TT	PW20TT	IW20TT	W20EPR-U
	BPR6EFS	T20TT	PT20TT	IT20TT	T20EPR-U
	BPR6EFS13	T20TT	PT20TT	IT20TT	T20EPR-U15
	BPR6EFS15	T20TT	PT20TT	IT20TT	T20EPR-U15
	BPR6EKA	W20TT	PW20TT	IW20TT	W20ET-S
	BPR6EK-N	W20TT	PW20TT	IW20TT	W20ETR-L
	BPR6ES	W20TT	PW20TT	IW20TT	W20EPR-U
	BPR6ES	W20TT	PW20TT	IW20TT	W20EXR-U
	BPR6ES11	W20TT	PW20TT	IW20TT	W20EPR11
	BPR6ES11	W20TT	PW20TT	IW20TT	W20EPR-U11
	BPR6ES11	W20TT	PW20TT	IW20TT	W20EXR-U11
	BPR6ES-13	W20TT	PW20TT	IW20TT	W20EXR-U13
	BPR6EY	W20TT	PW20TT	IW20TT	W20EXR-U
	BPR6EY11	W20TT	PW20TT	IW20TT	W20EXR-U11
BPR6EYZ	W20TT	PW20TT	IW20TT	W20EXR-U	
BPR6FS	—	PTF20TT	ITF20TT	T20PR-U	
BPR6HS	WF20TT	—	—	W20FPR-U	
BPR6HS10	WF20TT	—	—	W20FPR-U10	
BPR6HSA	WF20TT	—	—	W20FR-L	
BPR7E	W22TT	—	—	W22EPR-U	

# Cross Reference



NGK Ni/Pt/Ir	NGK TYPE				DENSO
	BPR7EK-N	W22TT	—	—	W22ETR-L8
	BPR7ES	W22TT	—	—	W22EPR-U
	BPR7ES11	W22TT	—	—	W22EPR-U11
	BPR7EY	W22TT	—	—	W22EPR-U
	BPR7EY-11	W22TT	—	—	W22EPR-U11
	BR5EF	T16TT	PT16TT	IT16TT	T16EPR-U
	BR6EB11	W20TT	PW20TT	IW20TT	W20EKR-S11
	BR6EBL	W20TT	PW20TT	IW20TT	W20EKR-S11
	BR6EB-L11	W20TT	PW20TT	IW20TT	W20EKR-S11
	BR6HSA	WF20TT	—	—	W20FR-L
	BU6EA11	W20TT	PW20TT	IW20TT	W20EP-S11
	BU6EFSZ	T20TT	PT20TT	IT20TT	T20EP-U
	BU7EA11	W22TT	—	—	W22EP-S11
	BUR5EB11	W16TT	PW16TT	IW16TT	W16EKR-S11
	BUR5ET	W20TT	PW20TT	IW20TT	W20EPBR-S
	BUR5ET10	W20TT	PW20TT	IW20TT	W20EPBR-S
	BUR5ETB-10	W20TT	PW20TT	IW20TT	W20EPBR-S
	BUR6EA11	W20TT	PW20TT	IW20TT	W20EPR-S11
	BUR6EB11	W20TT	PW20TT	IW20TT	W20EKR-S11
	BUR6EFSZ	T20TT	PT20TT	IT20TT	T20EPR-U
	BUR6ET	W20TT	PW20TT	IW20TT	W20EPBR-S
	BUR7EA11	W22TT	—	—	W22EP-S11
	DCP7E	XU22TT	—	—	XU22EP-U
	DCPR7E	XU22TT	—	—	XU22EPR-U
	DCPR7EA9	XU22TT	—	—	XU22PR9
	DCPR7E-N	XU22TT	—	—	XU22EPR-U
	DCPR7E-N10	XU22TT	—	—	XU22EPR-U
Ni	FR4	K16TT	PK16TT	IK16TT	K16PR-U
	FR45	K16TT	PK16TT	IK16TT	K16PR-U11
	FR5	K20TT	PK20TT	IK20TT	K20PR-U
	FR5-1	K20TT	PK20TT	IK20TT	KJ20CR-L11
	FR5EI	K16TT	PK16TT	IK16TT	K16PSR-B8
	GR4	W16TT	PW16TT	IW16TT	W14EXR-U
	GR45	W16TT	PW16TT	IW16TT	W14EXR-U11
	GR5	W16TT	PW16TT	IW16TT	W16EXR-U
	LFR5A11	KH16TT	PKH16TT	IKH16TT	K16HPR-U11
	LFR5B	KH16TT	PKH16TT	IKH16TT	K16HPR-U11
	LFR6A11	KH20TT	PKH20TT	IKH20TT	K20HR-U11
	LFR6C11	KH20TT	PKH20TT	IKH20TT	K20HR-U11
	LKR6C	XUH20TTI	—	—	XU20HR9
	LKR6D10E	XUH20TTI	—	—	XU20HR9
	LKR7B	XUH22TT	—	—	XU22HDR9
	LKR7B9	XUH22TT	—	—	XU22HDR9
	LKR7C	XUH22TT	—	—	XU22HR9
	LZFR5C11	KH16TT	PKH16TT	IKH16TT	K16HPR-U11
	LZFR5C11G	KH16TT	PKH16TT	IKH16TT	K16HPR-U11
	LZFR6B10E	KH20TT	PKH20TT	IKH20TT	—
	LZKR6B10E	XUH20TTI	—	—	—
	LZKR6B-E	XUH20TTI	—	—	—
	LZTR4A11	—	—	ITL16TT	—
	LZTR4AGP	—	—	ITL16TT	—
	LZTR4AIX13	—	—	ITL16TT	ITL16
	R5673-6	—	PTF20TT	ITF20TT	ITF20
	R5674-6	—	PTF20TT	ITF20TT	ITF20
	SR5	T20TT	PT20TT	IT20TT	T20NR-U11
	TR4	T16TT	PT16TT	IT16TT	T16EPR-U



NGK Ni/Pt/Ir	NGK TYPE				DENSO	
	TR4-2	T16TT	PT16TT	IT16TT	T16EPR-U	
	TR5	T20TT	PT20TT	IT20TT	T20EPR-U	
	TR5-1	T20TT	PT20TT	IT20TT	T20EPR-U	
	TR55	T20TT	PT20TT	IT20TT	T20EPR-U15	
	TR5A10	TV16TT	PTV16TT	ITV16TT	T16VR-U10	
	TR5A13	TV16TT	PTV16TT	ITV16TT	T16VR-U10	
	TR5B13	TV16TT	PTV16TT	ITV16TT	T16VR-U10	
	TR6	T20TT	PT20TT	IT20TT	T20EPR-U	
	TR6B10	—	PTV20TT	ITV20TT	—	
	TR6B13	—	PTV20TT	ITV20TT	—	
	UR4	—	PTF16TT	ITF16TT	T16PR-U	
	UR40	—	PTF16TT	ITF16TT	T16PR-U15	
	UR45	—	PTF16TT	ITF16TT	T16PR-U15	
	UR5	—	PTF20TT	ITF20TT	T20PR-U	
	UR5	—	PTF20TT	ITF20TT	T20PR-U11	
	UR55	—	PTF20TT	ITF20TT	T20PR-U15	
	ZF6A11	Q20TT	PQ20TT	IQ20TT	QJ20CR11	
	ZFR5A11	Q16TT	PQ16TT	IQ16TT	QJ16CR11	
	ZFR5C11G	K16TT	PK16TT	IK16TT	KJ16CR-L11	
Ni	ZFR5F	K16TT	PK16TT	IK16TT	KJ16CR	
	ZFR5F11	K16TT	PK16TT	IK16TT	KJ16CR-L11	
	ZFR5F11	K16TT	PK16TT	IK16TT	KJ16CR11	
	ZFR5F11	K16TT	PK16TT	IK16TT	KJ16CR-U11	
	ZFR5J11	K16TT	PK16TT	IK16TT	KJ16CR-L11	
	ZFR5N11	K16TT	PK16TT	IK16TT	KJ16CR-L11	
	ZFR6A11	Q20TT	PQ20TT	IQ20TT	QJ20CR11	
	ZFR6F11	K20TT	PK20TT	IK20TT	KJ20CR-L11	
	ZFR6F11	K20TT	PK20TT	IK20TT	KJ20CR11	
	ZFR6F11	K20TT	PK20TT	IK20TT	KJ20CR-U11	
	ZFR6J11	K20TT	PK20TT	IK20TT	KJ20CR-L11	
	ZFR6K11	K20TT	PK20TT	IK20TT	KJ20DR-M11	
	ZFR6S-Q	K20TT	PK20TT	IK20TT	K20PBR-S10	
	ZFR6U11	K20TT	PK20TT	IK20TT	KJ20CR-L11	
	ZFR6U9	K20TT	PK20TT	IK20TT	KJ20CR-11	
	ZG5A	W16TT	PW16TT	IW16TT	J16CR-U	
	ZGR5A	W16TT	PW16TT	IW16TT	J16CR-U	
	ZGR5C	W16TT	PW16TT	IW16TT	J16CR-U	
	ZGR5E	W16TT	PW16TT	IW16TT	J16CR-U	
	ZKR7A	XU22TT	—	—	XU22EPR-U	
	Pt	BCP5EV	—	PQ16TT	IQ16TT	—
		BCP5EV11	—	PQ16TT	IQ16TT	—
BCP5EVX		—	PQ16TT	IQ16TT	—	
BCP5EVX11		—	PQ16TT	IQ16TT	—	
BCP6EV		—	PQ20TT	IQ20TT	—	
BCP6EV11		—	PQ20TT	IQ20TT	—	
BCP6EVX		—	PQ20TT	IQ20TT	—	
BCP6EVX11		—	PQ20TT	IQ20TT	—	
BCPR5EP11		—	PQ16TT	IQ16TT	PQ16R	
BCPR5EP13		—	PQ16TT	IQ16TT	PQ16R13	
BCPR5EP8		—	PQ16TT	IQ16TT	PQ16R8	
BCPR5EP-N11		—	PQ16TT	IQ16TT	PQ16R-P11	
BCPR5EV		—	PQ16TT	IQ16TT	—	
BCPR5EV11		—	PQ16TT	IQ16TT	—	
BCPR5EVX		—	PQ16TT	IQ16TT	—	
BCPR5EVX11		—	PQ16TT	IQ16TT	—	
BCPR6EP11		—	PQ20TT	IQ20TT	PQ20R	



NGK Ni/Pt/Ir	NGK TYPE				DENSO
Pt	BCPR6EP13	—	PQ20TT	IQ20TT	PQ20R13
	BCPR6EP8	—	PQ20TT	IQ20TT	PQ20R8
	BCPR6EP-N11	—	PQ20TT	IQ20TT	PQ20R-P11
	BCPR6EP-N8	—	PQ20TT	IQ20TT	PQ20R-P8
	BCPR6EV	—	PQ20TT	IQ20TT	—
	BCPR6EV11	—	PQ20TT	IQ20TT	—
	BCPR6EVX	—	PQ20TT	IQ20TT	—
	BCPR6EVX11	—	PQ20TT	IQ20TT	—
	BKR5EGP	—	PK16TT	IK16TT	IK16
	BKR5EKP11	—	PK16TT	IK16TT	PK16TR11
	BKR5EKP13	—	PK16TT	IK16TT	PK16TR13
	BKR5EP11	—	PK16TT	IK16TT	PK16R11
	BKR5EP8	—	PK16TT	IK16TT	PK16R8
	BKR5EQUPA	—	—	IK16TT	—
	BKR5EVX	—	PK16TT	IK16TT	—
	BKR5EVX11	—	PK16TT	IK16TT	—
	BKR5EVXA	—	PK16TT	IK16TT	—
	BKR5EVXA11	—	PK16TT	IK16TT	—
	BKR5EVXA13	—	PK16TT	IK16TT	—
	BKR6EGP	—	PK20TT	IK20TT	IK20
	BKR6EKPA	—	PK20TT	IK20TT	PK20TR11
	BKR6EKP11	—	PK20TT	IK20TT	PK20TR11
	BKR6EP11	—	PK20TT	IK20TT	PK20R11
	BKR6EP13	—	PK20TT	IK20TT	PK20R13
	BKR6EP8	—	PK20TT	IK20TT	PK20R8
	BKR6EP8	—	—	IK20TT	VK20T
	BKR6EP-N8	—	PK20TT	IK20TT	PK20R-P8
	BKR6EVX11	—	PK20TT	IK20TT	—
	BKR6EVXA11	—	PK20TT	IK20TT	—
	BP5EV	—	PW16TT	IW16TT	—
	BP5EVX	—	PW16TT	IW16TT	—
	BP5EVX11	—	PW16TT	IW16TT	—
	BP6EV	—	PW20TT	IW20TT	—
	BP6EVX	—	PW20TT	IW20TT	—
	BP6EVX11	—	PW20TT	IW20TT	—
	BPR5EFVX	—	PT16TT	IT16TT	IT16
	BPR5EGP	—	PW16TT	IW16TT	IW16
	BPR5EP11	—	PW20TT	IW20TT	P16R
	BPR5EP11	—	PW16TT	IW16TT	P16R
	BPR5EP13	—	PW16TT	IW16TT	P16R13
	BPR5EV	—	PW16TT	IW16TT	—
	BPR5EVX	—	PW16TT	IW16TT	—
	BPR5EVX11	—	PW16TT	IW16TT	—
	BPR6EGP	—	PW20TT	IW20TT	IW20
	BPR6EP11	—	PW20TT	IW20TT	VW20
	BPR6EP8	—	PW20TT	IW20TT	VW20
	BPR6EP8	—	PW20TT	IW20TT	VW20T
	BPR6EV	—	IW20TT	IW20TT	IW20
	BPR6EVX	—	IW20TT	IW20TT	IW20
	BPR6EVX11	—	IW20TT	IW20TT	IW20
FR4BP11	—	PK16TT	IK16TT	IK16	
FR5BP11	—	PK16TT	IK16TT	IK16	
FR5CP	—	PK16TT	IK16TT	IK16	
FR6BP11	—	PK20TT	IK20TT	IK20	
LFR5AP11	—	PKH16TT	IKH16TT	IKH16	
LFR5AQP	—	PKH16TT	IKH16TT	IKH16	



NGK Ni/Pt/Ir	NGK TYPE				DENSO
Pt	LFR5BP11	—	PKH16TT	IKH16TT	IKH16
	LFR5P11	—	PKH16TT	IKH16TT	IKH16
	LFR6AP11	—	PKH20TT	IKH20TT	IKH20
	LFR6AP9	—	PKH20TT	IKH20TT	IKH20
	LFR6AQP	—	PKH20TT	IKH20TT	IKH20
	LFR6BP11	—	PKH20TT	IKH20TT	IKH20
	LTR6AP11	—	PTV20TT	ITV20TT	ITV20
	PFR5A11	—	PQ16TT	IQ16TT	PQ16R
	PFR5B	—	PK16TT	IK16TT	PK16R8
	PFR5B11	—	PK16TT	IK16TT	PK16PR(-L)11
	PFR5B11B	—	PK16TT	IK16TT	PK16R11
	PFR5B11C	—	PK16TT	IK16TT	PK16R11
	PFR5B9	—	PK16TT	IK16TT	PK16R8
	PFR5B-D	—	PK20TT	IK20TT	PK16R8
	PFR5C11	—	PK16TT	IK16TT	PK16R11
	PFR5F11	—	PQ16TT	IQ16TT	PQ16R
	PFR5G11	—	PK16TT	IK16TT	PK16PR(-L)11
	PFR5G11-E	—	PK16TT	IK16TT	PK16PR(-L)11
	PFR5G13-E	—	PK16TT	IK16TT	PK16PR-L11
	PFR5J11	—	PK16TT	IK16TT	PK16PR-P11
	PFR5K11	—	PQ16TT	IQ16TT	PQ16R
	PFR5L11	—	PK16TT	IK16TT	PK16PR(-L)11
	PFR5L13	—	PK16TT	IK16TT	VK16
	PFR5N11	—	PK16TT	IK16TT	PK16PR(-L)11
	PFR5P	—	PK16TT	IK16TT	PK16R8
	PFR5P11	—	PK16TT	IK16TT	PK16PR(-L)11
	PFR5R11	—	PK16TT	IK16TT	PK16PR(-L)11
	PFR6A11	—	PQ20TT	IQ20TT	PQ20R
	PFR6B	—	PK20TT	IK20TT	PK20PR-P8
	PFR6B11	—	PK20TT	IK20TT	PK20PR11
	PFR6B11B	—	PK20TT	IK20TT	PK20R11
	PFR6B9	—	PK20TT	IK20TT	PK20PR-P8
	PFR6B-D	—	PK20TT	IK20TT	PK20R8
	PFR6C11	—	PK20TT	IK20TT	PK20R11
	PFR6E	—	PK20TT	IK20TT	PK20PR-P8
	PFR6G11	—	PK20TT	IK20TT	PK20PR11
	PFR6G11	—	PK20TT	IK20TT	PK20PR-L11
	PFR6G11-E	—	PK20TT	IK20TT	PK20PR11
	PFR6G11-E	—	PK20TT	IK20TT	PK20PR-L11
	PFR6G13	—	PK20TT	IK20TT	PK20PR-L13
	PFR6G13E	—	PK20TT	IK20TT	PK20PR-L13
	PFR6H10	—	PQ20TT	IQ20TT	PQ20R
	PFR6J	—	PK20TT	IK20TT	PK20PR-P8
	PFR6J11	—	PK20TT	IK20TT	PK20PR-P11
	PFR6J13	—	PK20TT	IK20TT	PK20PR-L13
	PFR6K11	—	PQ20TT	IQ20TT	PQ20R
	PFR6L13	—	PK20TT	IK20TT	PK20PR-L13
	PFR6N11	—	PK20TT	IK20TT	PK20PR-L11
	PFR6P11	—	PK20TT	IK20TT	PK20PR(-L)11
	PFR6R11	—	PK20TT	IK20TT	PK20PR-L11
PFR6T10	—	PK20TT	IK20TT	PK20PR-L11	
PFR6T10G	—	PK20TT	IK20TT	PK20PR-L11	
PFR6T-G	—	PK20TT	IK20TT	PK20PR-P8	
PFR6U11G	—	PK20TT	IK20TT	PK20PR-L11	
PFR6V10D	—	PK20TT	IK20TT	VK20T	
PFR6X11	—	PK20TT	IK20TT	PK20PR-L11	

# Cross Reference

NGK Ni/Pt/Ir	NGK TYPE				DENSO
	PGR5A	—	PW16TT	IW16TT	P16PR8
	PGR5A11	—	PW16TT	IW16TT	P16PR11
	PGR6A	—	PW20TT	IW20TT	P20PR8
	PGR6A	—	PW20TT	IW20TT	P20R8
	PGR6A	—	PW20TT	IW20TT	P20PR8
	PGR6A	—	PW20TT	IW20TT	P20R8
	PGR6A11	—	PW20TT	IW20TT	VW20
	PGR6A-D	—	PW20TT	IW20TT	VW20
	PGR6B	—	PW20TT	IW20TT	VW20
	PLFR4A11	—	PKH16TT	IKH16TT	VKH16
	PLFR5A11	—	PKH16TT	IKH16TT	VKH16
	PLFR5A11D	—	PKH16TT	IKH16TT	VKH16
	PLFR6A11	—	PKH20TT	IKH20TT	VKH20
	PLFR6A9	—	PKH20TT	IKH20TT	VKH20
	PLTR6A10G	—	PTV20TT	ITV20TT	ITV20
	PLZFR5B-13G	—	PKH16TT	IKH16TT	VKH16
	PLZFR6A-11S	—	PKH20TT	IKH20TT	VKH20
	PLZKAR6A11	—	—	IXEH20TT	FXE20HR11
	PLZTR5A13	—	—	ITL16TT	—
	PTR4B15	—	PT16TT	IT16TT	PT16EPR-L13
	PTR4G15	—	PT16TT	IT16TT	PT16EPR-L13
	PTR5A10	—	PTV16TT	ITV16TT	PT16VR10
	PTR5A13	—	PTV16TT	ITV16TT	PT16VR13
	PTR5C13	—	PT16TT	IT16TT	PT16EPR-L13
	PTR6D13G	—	PT20TT	IT20TT	VT20
	PTR6E13	—	PT20TT	IT20TT	VT20
	PTR6F13	—	PT20TT	IT20TT	VT20
Pt	PZFR5E11	—	PK16TT	IK16TT	SKJ16CR-L11
	PZFR5F	—	PK16TT	IK16TT	PKJ16CR8
	PZFR5F11	—	PK16TT	IK16TT	SKJ16CR-L11
	PZFR5F13	—	PK16TT	IK16TT	PKJ16CR-L13
	PZFR5J11	—	PK16TT	IK16TT	SKJ16CR-L11
	PZFR6E11	—	PK20TT	IK20TT	PKJ20CR-L11
	PZFR6F11	—	PK20TT	IK20TT	PKJ20CR-L11
	PZFR6J11	—	PK20TT	IK20TT	PKJ20CR-L11
	PZTR5A15	—	PT16TT	IT16TT	PT16EPR-L13
	TR4VX	—	PT16TT	IT16TT	IT16
	TR5-1VX	—	PT20TT	IT20TT	IT20
	TR55-1VX	—	PT20TT	IT20TT	IT20
	TR55VX	—	PT20TT	IT20TT	IT20
	TR5BP12	—	PTV16TT	ITV16TT	ITV16
	TR5VX	—	PT20TT	IT20TT	IT20
	TR6AP13	—	PT20TT	IT20TT	IT20
	TR6AP13E	—	PT20TT	IT20TT	IT20
	TR6GP	—	PT20TT	IT20TT	IT20
	UR45VX	—	PTF16TT	ITF16TT	ITF16
	UR4VX	—	PTF16TT	ITF16TT	ITF16
	UR55VX	—	PTF20TT	ITF20TT	—
	UR5VX	—	PTF20TT	ITF20TT	—
	UR6VX	—	PTF20TT	ITF20TT	—
	YR55VX	—	PTF20TT	ITF20TT	—
	YR5VX	—	PTF20TT	ITF20TT	—
	ZFR5AP	—	PK16TT	IK16TT	IK16
	ZFR5FGP	—	PK16TT	IK16TT	IK16
	ZFR5LP13G	—	PK16TT	IK16TT	—
Ir	BCPR5EIX11	—	—	IQ16TT	IQ16

NGK Ni/Pt/Ir	NGK TYPE				DENSO
	BCPR5EIX11P	—	—	IQ16TT	VQ16
	BCPR6EIX11	—	—	IQ20TT	IQ20
	BCPR6EIX11P	—	—	IQ20TT	VQ20
	BKR4EIX	—	—	IK16TT	IK16
	BKR5EIX	—	—	IK16TT	IK16
	BKR5EIX11	—	—	IK16TT	IK16
	BKR5EIX11P	—	—	IK16TT	VK16
	BKR5EIXP	—	—	IK16TT	VK16
	BKR6EIX	—	—	IK20TT	IK20
	BKR6EIX	—	—	IK20TT	VK20T
	BKR6EIX11	—	—	IK20TT	IK20
	BKR6EIX11P	—	—	IK20TT	VK20
	BPR5EFIX13P	—	—	IT16TT	VT16
	BPR5EIX	—	—	IW16TT	IW16
	BPR5EIX11	—	—	IW16TT	IW16
	BPR5EIX11-P	—	—	IW16TT	VW16
	BPR5EIX-P	—	—	IW16TT	VW16
	BPR6EFIX10	—	—	IT20TT	IT20
	BPR6EFIX13P	—	—	IT20TT	VT20
	BPR6EIX	—	—	IW20TT	IW20
	BPR6EIX(LPG)	—	—	IW20TT	VW20T
	BPR6EIX11	—	—	IW20TT	IW20
	BPR6EIX11-P	—	—	IW20TT	VW20
	BPR6EIX-P	—	—	IW20TT	VW20
	DF5A11A	—	—	IK16TT	FK16PR11
	DF5B11A	—	—	IKH16TT	FK16HR11
	DF6H11A	—	—	IXEH20ETT	FXE20HE11
	DF6H11A	—	—	IXEH20ETT	VFXEH20E
	DF6H11B	—	—	IXEH20TT	FXE20HR11
	DF6H11B	—	—	IXEH20TT	VFXEH20
	DF7H11B	—	—	IXEH22TT	FXE22HR11
	DF7H11B	—	—	IXEH22TT	VFXEH22
	DFH6B11A	—	—	IKBH20TT	FK20HBR11
	DFH6B11A	—	—	IKBH20TT	VFKBH20
	DILFR5A	—	—	IK16TT	—
	DILFR5A11	—	—	IK16TT	FK16HR11
	DILFR5A11D	—	—	IK16TT	FK16HR11
	DILFR5E11	—	—	IK16TT	FK16HR11
	DILFR6D11	—	—	IK20TT	FK20HR11
	DILFR6F11G	—	—	IK20TT	—
	DILFR6J11	—	—	IK20TT	—
	DILKAR6A11	—	—	IXEH20TT	FXE20HR11
	DILKAR7B11	—	—	IXEH22TT	—
	DILKAR7F8	—	—	IXEH22TT	FC20HPR8
	DILZKAR6A11	—	—	IXEH20ETT	FXE20HE11
	DILZKR7B11	—	—	IXEH22TT	—
	GR4IX	—	—	IW16TT	IW16
	GR5AI10	—	—	IW16TT	IW16
	GR5IX	—	—	IW16TT	IW16
	HAMP-FR5C11G	—	—	IK16TT	HAMP-IK16F
	HAMP-FR6C11G	—	—	IK20TT	HAMP-IK20F
	HAMP-FR6D11G	—	—	IQ20TT	HAMP-IQ20F
	HAMP-ZFR5F11G	—	—	IK16TT	HAMP-IK16FJ
	HAMP-ZFR6F11G	—	—	IK20TT	HAMP-IK20FJ
	HAMP-ZFR6K11G	—	—	IK20TT	HAMP-IKD20F
	IFR5A11	—	—	IK16TT	SK16R11

NGK Ni/Pt/Ir	NGK TYPE				DENSO
Ir	IFR5A-8N	—	—	<b>IK20TT</b>	<b>SK16R-P8</b>
	IFR5D10	—	—	<b>IK16TT</b>	<b>VK16</b>
	IFR5E11	—	—	<b>IK16TT</b>	<b>SK16PR-A11</b>
	IFR5G11	—	—	<b>IK16TT</b>	<b>SK16PR-L11</b>
	IFR5G11K	—	—	<b>IK16TT</b>	<b>SK16PR-L11</b>
	IFR5J11	—	—	<b>IK16TT</b>	<b>VK16</b>
	IFR5L11	—	—	<b>IK16TT</b>	<b>VK16PRZ11</b>
	IFR5N	—	—	<b>IK16TT</b>	<b>VK16</b>
	IFR5N10	—	—	<b>IK16TT</b>	<b>VK16</b>
	IFR6A11	—	—	<b>IK20TT</b>	<b>SK20R11</b>
	IFR6C	—	—	<b>IK20TT</b>	<b>SK20PR-L9</b>
	IFR6D10	—	—	<b>IK20TT</b>	<b>VK20</b>
	IFR6E11	—	—	<b>IK20TT</b>	<b>VK20</b>
	IFR6J11	—	—	<b>IK20TT</b>	<b>SVK20RZ11</b>
	IFR6L11	—	—	<b>IK20TT</b>	<b>VK20PRZ11</b>
	IFR6T11	—	—	<b>IK20TT</b>	<b>SK20R11</b>
	IGR5B10-D	—	—	<b>IW16TT</b>	<b>VW16</b>
	IGR6A11	—	—	<b>IW20TT</b>	<b>VW20</b>
	IGR6B10-D	—	—	<b>IW20TT</b>	<b>VW20T</b>
	ILFR5C11	—	—	<b>IKH16TT</b>	<b>SK16HR11</b>
	ILFR6A	—	—	<b>IKH20TT</b>	<b>VKH20</b>
	ILFR6B	—	—	<b>IKH20TT</b>	<b>VKH20</b>
	ILFR6C	—	—	<b>IKH20TT</b>	<b>VKH20</b>
	ILFR6C11	—	—	<b>IKH20TT</b>	<b>SK20HR11</b>
	ILFR6D11	—	—	<b>IK20TT</b>	<b>FK20HR11</b>
	ILFR6G	—	—	<b>IKH20TT</b>	<b>VKH20</b>
	ILFR6J11K	—	—	<b>IKH20TT</b>	<b>SK20HPR-L11</b>
	ILKAR6C10	—	—	<b>IXEH20TT</b>	<b>VFXEH20</b>
	ILKAR7B11	—	—	<b>IXEH22TT</b>	<b>SC20HR11</b>
	ILKAR7L11	—	—	<b>IXEH22TT</b>	<b>ZC20HPR11</b>
	ILTR5A13G	—	—	<b>ITV16TT</b>	—
	ILTR5B11	—	—	<b>ITL16TT</b>	—
	ILTR5C11	—	—	<b>ITL16TT</b>	—
	ILTR5D	—	—	<b>ITV16TT</b>	—
	ILTR5E11	—	—	<b>ITV16TT</b>	—
	ILTR6A13G	—	—	<b>ITV20TT</b>	—
	ILTR6A8G	—	—	<b>ITV20TT</b>	—
	ILTR6E11	—	—	<b>ITV20TT</b>	—
	ILZFR5B	—	—	<b>IKH16TT</b>	<b>VKH16</b>
	ILZFR6A11	—	—	<b>IKH20TT</b>	<b>VKH20</b>
	ILZFR6C11K	—	—	<b>IKH20TT</b>	<b>VKH20</b>
	ILZFR6D11	—	—	<b>IKH20TT</b>	<b>VKH20</b>
	ILZKAR7A	—	—	<b>IXEH22TT</b>	—
	ILZKAR7A10	—	—	<b>IXEH22TT</b>	<b>FXE22HR11</b>
	ILZKAR7B11	—	—	<b>IXEH22TT</b>	—
	ITR4A15	—	—	<b>IT16TT</b>	<b>VT16</b>
	ITR5F13	—	—	<b>IT16TT</b>	<b>VT16</b>
	ITR6F13	—	—	<b>IT20TT</b>	<b>VT20</b>
	IZFR5F11	—	—	<b>IK16TT</b>	<b>SKJ16CR-L11</b>
	IZFR5K11	—	—	<b>IK16TT</b>	<b>SKJ16DR-M11</b>
IZFR5L11	—	—	<b>IK16TT</b>	<b>SKJ16CR-L11</b>	
IZFR6F11	—	—	<b>IK20TT</b>	<b>VKJ20RZ-M11</b>	
IZFR6H11	—	—	<b>IK20TT</b>	<b>VK20</b>	
IZFR6K11	—	—	<b>IK20TT</b>	<b>SKJ20DR-M11</b>	
IZFR6K13	—	—	<b>IK20TT</b>	<b>SKJ20DR-M13</b>	
LFR5AIX11	—	—	<b>IKH16TT</b>	<b>IKH16</b>	

NGK Ni/Pt/Ir	NGK TYPE				DENSO
Ir	LFR5AIX11P	—	—	<b>IKH16TT</b>	<b>VKH16</b>
	LFR5ARX-11P	—	—	<b>IKH16TT</b>	<b>VFKH16</b>
	LFR6AIX11	—	—	<b>IKH20TT</b>	<b>IKH20</b>
	LFR6AIX11P	—	—	<b>IKH20TT</b>	<b>VKH20</b>
	LFR6AIX-LPG	—	—	<b>IKH20TT</b>	<b>VKH20T</b>
	LKAR6AIX13P	—	—	<b>IXEH20TT</b>	<b>ZXE20HR13</b>
	LTR5BI-13	—	—	<b>ITV16TT</b>	—
	LTR5IX11	—	—	<b>ITV16TT</b>	<b>ITV16</b>
	LTR6AI-9	—	—	<b>ITV20TT</b>	<b>ITV20</b>
	LTR6BI-13	—	—	<b>ITV20TT</b>	—
	LTR6BI-9	—	—	<b>ITV20TT</b>	—
	LTR6BP13	—	—	<b>ITV20TT</b>	<b>ITV20</b>
	LTR6IX11	—	—	<b>ITV20TT</b>	<b>ITV20</b>
	LZFR6AI	—	—	<b>IKH20TT</b>	<b>IKH20</b>
	LZKAR6AP11	—	—	<b>IXEH20TT</b>	<b>FXE20HR11</b>
	SIFR6A11	—	—	<b>IK20TT</b>	<b>VK20</b>
	SILFR6A11	—	—	<b>IKH20TT</b>	<b>VKH20</b>
	SILFR6C11	—	—	<b>IKH20TT</b>	<b>VKH20</b>
	SILTR6A7G	—	—	<b>ITV20TT</b>	—
	SILZKAR7B11	—	—	<b>IXEH22TT</b>	—
	TR4IX	—	—	<b>IT16TT</b>	<b>IT16</b>
	TR5-11X	—	—	<b>IT20TT</b>	<b>IT20</b>
	TR55IX	—	—	<b>IT20TT</b>	<b>IT20</b>
	TR5IX	—	—	<b>IT20TT</b>	<b>IT20</b>
	TR6IX	—	—	<b>IT20TT</b>	<b>IT20</b>
	UR45IX	—	—	<b>ITF16TT</b>	<b>ITF16</b>
	UR4IX	—	—	<b>ITF16TT</b>	<b>ITF16</b>
	UR55IX	—	—	<b>ITF20TT</b>	<b>ITF20</b>
	UR5IX	—	—	<b>ITF20TT</b>	<b>ITF20</b>
	UR6IX	—	—	<b>ITF20TT</b>	<b>ITF20</b>
	YR55IX	—	—	<b>ITF20TT</b>	<b>ITF20</b>
	YR5IX	—	—	<b>ITF20TT</b>	<b>ITF20</b>
	ZFR5FIX11	—	—	<b>IK16TT</b>	<b>IK16</b>
	ZFR5FIX11P	—	—	<b>IK16TT</b>	<b>VK16</b>
	ZFR6FIX11	—	—	<b>IK20TT</b>	<b>IK20</b>
	ZFR6FIX11P	—	—	<b>IK20TT</b>	<b>VK20</b>
	LPG1	—	—	<b>IK20TT</b>	—
	LPG1	—	—	<b>IK20TT</b>	—
	LPG2	—	—	<b>IW20TT</b>	—
	LPG2	—	—	<b>IW20TT</b>	—
	LPG3	—	—	<b>IQ20TT</b>	—
	LPG4	—	—	<b>ITV16TT</b>	—
	LPG5	—	—	<b>IT20TT</b>	—
	LPG6	—	—	<b>IK20TT</b>	—
	LPG7	—	—	<b>IKH20TT</b>	—

# Specifications

TYPE	DIA (mm)	REACH (mm)	HEX (mm)	GAP	PROJECTION (mm)	SPARK POSITION (mm)	TERMINAL SHAPE	RESISTOR (kΩ)	TT PLUG DENSO P/N
<b>K16TT</b>	14	19	16	1.0	1.5	3	S	5	267700-7431
<b>K20TT</b>	14	19	16	1.0	1.5	3	S	5	267700-7441
<b>KH16TT</b>	12	26.5	16	1.0	1.5	3	S	5	267700-7451
<b>KH20TT</b>	14	26.5	16	1.0	1.5	3	S	5	267700-7460
<b>Q16TT</b>	14	19	16	1.0	1.5	3	S	5	267700-7471
<b>Q20TT</b>	14	19	16	1.0	1.5	3	S	5	267700-7481
<b>W16TT</b>	14	19	20.6	0.8	1.5	3	RC	5	267700-6301
<b>W20TT</b>	14	19	20.6	0.8	1.5	3	RC	5	267700-6311
<b>W22TT</b>	14	19	20.6	0.8	1.5	3	RC	5	267700-7510
<b>WF20TT</b>	14	12.7	20.6	0.8	1.5	3	RC	5	267700-7500
<b>T16TT</b>	14	17.5	16	1.0	1.5	3	S	5	267700-7820
<b>T20TT</b>	14	17.5	16	1.0	1.5	3	S	5	267700-7830
<b>TV16TT</b>	14	25	16	1.0	1.5	3	S	5	267700-7490
<b>XU22TT</b>	12	19	16	0.8	1.3	2.8	S	5	267700-7080
<b>XUH22TT</b>	12	26.5	16	0.8	1.5	3	S	5	267700-7090
<b>XUH20TTI</b>	12	26.5	16	0.8	1.5	4	S	5	267700-8290



# Specifications

Type	DIA (mm)	REACH (mm)	HEX (mm)	GAP (mm)	PROJECTION (mm)	SPARK POSITION (mm)	GROUND ELECTRODE HEIGHT (mm)	TERMINAL SHAPE	RESISTOR (kΩ)	No.	DENSO P/N
<b>PK16TT</b>	14	19	16	1	1.5	3	6.3	Solid	5	PT03	267700-6320
<b>PK20TT</b>	14	19	16	1	1.5	3	6.3	Solid	5	PT04	267700-6330
<b>PK22TT</b>	14	19	16	1	1.5	3	6.3	Solid	5	PT14	267700-7790
<b>PKH16TT</b>	14	26.5	16	1	1.5	3	6.3	Solid	5	PT05	267700-6340
<b>PKH20TT</b>	14	26.5	16	1	1.5	3	6.3	Solid	5	PT06	267700-6350
<b>PQ16TT</b>	14	19	16	1	1.5	3	6.3	Solid	5	PT07	267700-6360
<b>PQ20TT</b>	14	19	16	1	1.5	3	6.3	Solid	5	PT08	267700-6370
<b>PW16TT</b>	14	19	20.6	1	1.5	3	6.3	Solid	5	PT01	267700-6380
<b>PW20TT</b>	14	19	20.6	1	1.5	3	6.3	Solid	5	PT02	267700-6390
<b>PT16TT</b>	14	17.5	16	1	1.5	3	6.3	Solid	5	PT11	267700-7200
<b>PT20TT</b>	14	17.5	16	1	1.5	3	6.3	Solid	5	PT12	267700-7210
<b>PTF16TT</b>	14	11.2	16	1	1.5	3	6.3	Solid	5	PT09	267700-7240
<b>PTF20TT</b>	14	11.2	16	1	1.5	3	6.3	Solid	5	PT10	267700-7250
<b>PTV16TT</b>	14	25	16	1	1.5	3	6.3	Solid	5	PT13	267700-7220

# IRIDIUM TT Specifications

Type	Spec	DIA (mm)	REACH (mm)	HEX (mm)	GAP (mm)	PROJECTION (mm)	SPARK POSITION (mm)	GROUND ELECTRODE HEIGHT (mm)	TERMINAL SHAPE	RESISTOR (k $\Omega$ )	No.	DENSO P/N
<b>IK16TT</b>	ISO	14	19	16	1	1.5	3	6.2	Solid	5	IT01	267700-8450
<b>IK20TT</b>	ISO	14	19	16	1	1.5	3	6.2	Solid	5	IT02	267700-8530
<b>IKH16TT</b>	ISO	14	26.5	16	1	1.5	3	6.2	Solid	5	IT03	267700-8460
<b>IKH20TT</b>	ISO	14	26.5	16	1	1.5	3	6.2	Solid	5	IT04	267700-8470
<b>IKBH20TT</b>	NEW 3 ELECTRODE	14	26.5	16	1	2.5	4	7.2	Solid	5	IT05	267700-8480
<b>IQ16TT</b>	JIS	14	19	16	1	1.5	3	6.2	Solid	5	IT06	267700-8190
<b>IQ20TT</b>	JIS	14	19	16	1	1.5	3	6.2	Solid	5	IT07	267700-8200
<b>IW16TT</b>		14	19	20.6	1	1.5	3	6.2	Solid	5	IT08	267700-8210
<b>IW20TT</b>		14	19	20.6	1	1.5	3	6.2	Solid	5	IT09	267700-8220
<b>IXEH20ETT</b>	SHROUD 2mm	12	26.5	14	1	2.5 (+shroud 2mm)	4 (+shroud 2mm)	7.1 (+shroud 2mm)	Solid	5	IT10	267700-8490
<b>IXEH20TT</b>		12	26.5	14	1	2.5	4	7.1	Solid	5	IT11	267700-8500
<b>IXEH22TT</b>		12	26.5	14	1	2.5	4	7.1	Solid	5	IT12	267700-8510
<b>IT16TT</b>	TAPER SEAT	14	17.5	16	1	1.5	3	6.2	Solid	5	IT13	267700-8230
<b>IT20TT</b>	TAPER SEAT	14	17.5	16	1	1.5	3	6.2	Solid	5	IT14	267700-8520
<b>ITF16TT</b>	TAPER SEAT	14	11.2	16	1	1.5	3	6.2	Solid	5	IT15	267700-8260
<b>ITF20TT</b>	TAPER SEAT	14	11.2	16	1	1.5	3	6.2	Solid	5	IT16	267700-8270
<b>ITL16TT</b>	TAPER SEAT (INSULATOR Length 56mm)	14	25	16	1	1.5	3	6.2	Solid	5	IT17	267700-8280
<b>ITV16TT</b>	TAPER SEAT (INSULATOR Length 50mm)	14	25	16	1	1.5	3	6.2	Solid	5	IT18	267700-8240
<b>ITV20TT</b>	TAPER SEAT (INSULATOR Length 50mm)	14	25	16	1	1.5	3	6.2	Solid	5	IT19	267700-8250

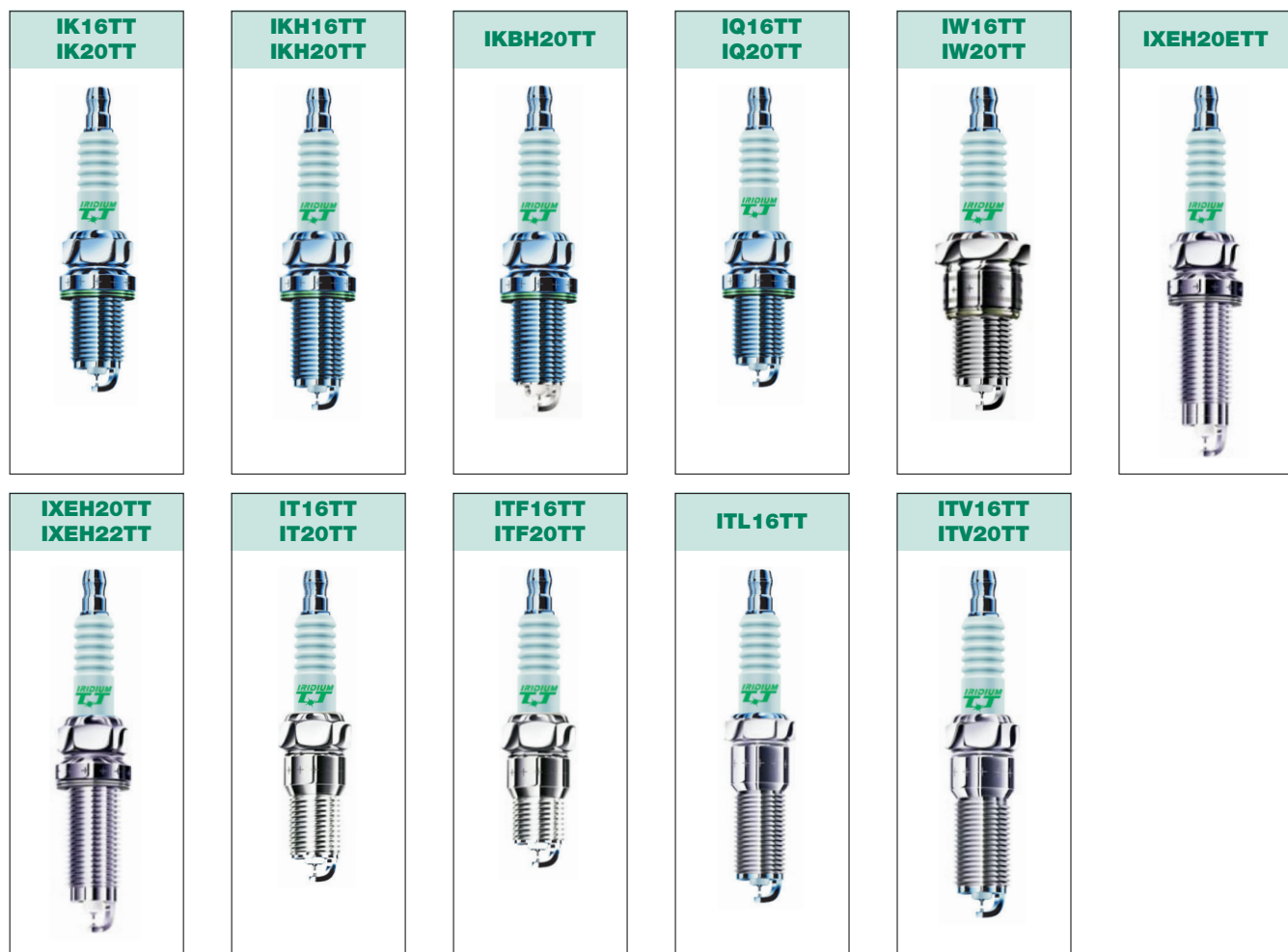



# MEMO

A series of horizontal dashed lines for writing.

# IRIDIUMPOWER® Specifications

TYPE	APPLICATION	SPEC	DIA. (mm)	REACH (mm)	HEX (mm)	GAP (mm)	PROJECTION (mm)	SPARK POSITION (mm)	GROUND ELECTRODE HEIGHT (mm)	TERMINAL SHAPE	RESISTOR (kΩ)	No.	IRIDIUM POWER	IRIDIUM POWER
													ONE PC BOX	2pcs BLISTER PACK
													DENSO P/N	DENSO P/N
<b>IQ16</b>	Automobile	Old JIS (Installing height=K type+2mm)	14	19	16	1.1	1.5	3.0	5.5	S	5	I01	067700-8701	100676-3380
<b>IQ20</b>	Automobile	Old JIS (Installing height=K type+2mm)	14	19	16	1.1	1.5	3.0	5.5	S	5	I02	067700-8711	100676-3390
<b>IQ22</b>	Automobile	Old JIS (Installing height=K type+2mm)	14	19	16	0.8	1.5	3.0	5.2	S	5	I13	067700-8481	100676-3480
<b>IQ24</b>	Automobile	Old JIS (Installing height=K type+2mm)	14	19	16	0.8	1.5	3.0	5.2	S	5	I14	067700-8491	100676-3490
<b>IQ27</b>	Automobile	Old JIS (Installing height=K type+2mm)	14	19	16	0.8	1.5	3.0	5.2	S	5	I15	067700-8502	
<b>IQ31</b>	Automobile	Old JIS (Installing height=K type+2mm)	14	19	16	0.8	-0.5	1.0	3.2	S	5	I23	067700-9231	
<b>IQ34</b>	Automobile	Old JIS (Installing height=K type+2mm)	14	19	16	0.8	-0.5	1.0	3.2	S	5	I24	067700-9601	
<b>IK16</b>	Automobile		14	19	16	1.1	1.5	3.0	5.5	S	5	I03	067700-8681	100676-3360
<b>IK20</b>	Automobile		14	19	16	1.1	1.5	3.0	5.5	S	5	I04	067700-8691	100676-3370
<b>IK22</b>	Automobile		14	19	16	0.8	1.5	3.0	5.2	S	5	I10	067700-8431	100676-3450
<b>IK24</b>	Automobile		14	19	16	0.8	1.5	3.0	5.2	S	5	I11	067700-8461	100676-3460
<b>IK27</b>	Automobile		14	19	16	0.8	1.5	3.0	5.2	S	5	I12	067700-8472	100676-3470
<b>IK31</b>	Automobile		14	19	16	0.8	-0.5	1.0	3.2	S	5	I21	067700-9221	
<b>IK34</b>	Automobile		14	19	16	0.8	-0.5	1.0	3.2	S	5	I22	067700-9591	
<b>IK16G</b>	Automobile	SUS Gasket	14	19	16	1.1	1.5	3.0	5.5	S	5	I51	267700-5611	
<b>IK20G</b>	Automobile	SUS Gasket	14	19	16	1.1	1.5	3.0	5.5	S	5	I52	267700-5621	
<b>IK22G</b>	Automobile	SUS Gasket	14	19	16	0.8	1.5	3.0	5.2	S	5	I48	267700-5661	100676-5350
<b>IK16L</b>	Automobile	EXTENDED	14	19	16	1.1	2.5	5.0	7.8	RC	5	I57	267700-5121	
<b>IK20L</b>	Automobile	EXTENDED	14	19	16	1.1	2.5	5.0	7.8	RC	5	I58	267700-5131	
<b>IKH16</b>	Automobile		14	26.5	16	1.1	1.5	3.0	5.5	S	5	I43	267700-3661	100676-5160
<b>IKH20</b>	Automobile		14	26.5	16	1.1	1.5	3.0	5.5	S	5	I44	267700-3671	100676-5140
<b>IKH22</b>	Automobile		14	26.5	16	0.8	1.5	3.0	5.2	S	5	I45	267700-2651	100676-5170
<b>IKH24</b>	Automobile		14	26.5	16	0.8	1.5	3.0	5.2	S	5	I46	267700-4281	100676-5180
<b>IKH27</b>	Automobile		14	26.5	16	0.8	1.5	3.0	5.2	S	5	I47	267700-4291	
<b>IW16</b>	Automobile		14	19	20.6	1.1	1.5	3.0	5.5	RC	5	I05	067700-8651	100676-3400
<b>IW20</b>	Automobile		14	19	20.6	1.1	1.5	3.0	5.5	RC	5	I06	067700-8661	100676-3410
<b>IW22</b>	Automobile		14	19	20.6	0.8	1.5	3.0	5.2	RC	5	I07	067700-8671	100676-3420
<b>IW24</b>	Motorcycle		14	19	20.6	0.7	-0.5	1.5	3.6	RC	5	I16	067700-8891	
<b>IW27</b>	Motorcycle		14	19	20.6	0.7	-0.5	1.5	3.6	RC	5	I17	067700-8901	
<b>IW29</b>	Racing Kart		14	19	20.6	0.7	-0.5	1.5	3.6	RC	5	I18	067700-8911	
<b>IW31</b>	Racing Kart		14	19	20.6	0.7	-0.5	1.5	3.6	RC	5	I19	067700-8921	
<b>IW34</b>	Racing Kart		14	19	20.6	0.7	-0.5	1.5	3.6	RC	5	I20	067700-8931	
<b>IWM24</b>	Motorcycle	Compact insulator head	14	19	20.6	0.8	-1.5	0.5	2.7	S	5	I91	267700-2891	
<b>IWM27</b>	Motorcycle	Compact insulator head	14	19	20.6	0.8	-1.5	0.5	2.7	S	5	I92	267700-2901	
<b>IWM31</b>	Motorcycle	Compact insulator head	14	19	20.6	0.8	-1.5	0.5	2.7	S	5	I93	267700-2911	
<b>IWF16</b>	Motorcycle		14	12.7	20.6	0.8	1.5	3.0	5.2	R	5	I59	267700-5001	
<b>IWF20</b>	Motorcycle		14	12.7	20.6	0.8	1.5	3.0	5.2	R	5	I78	267700-5011	
<b>IWF22</b>	Motorcycle		14	12.7	20.6	0.8	-0.5	1.5	3.7	R	5	I79	067700-9411	
<b>IWF24</b>	Motorcycle		14	12.7	20.6	0.8	-0.5	1.5	3.7	R	5	I80	067700-9421	
<b>IWF27</b>	Motorcycle		14	12.7	20.6	0.8	-0.5	1.5	3.7	R	5	I81	067700-9431	
<b>ITV16</b>	Automobile	Taper Seat(Insulator Length 50mm)	14	25	16	1.1	1.5	3.0	5.5	S	5	I38	267700-3701	100676-5200
<b>ITV20</b>	Automobile	Taper Seat(Insulator Length 50mm)	14	25	16	1.1	1.5	3.0	5.5	S	5	I39	267700-3711	100676-5210
<b>ITV22</b>	Automobile	Taper Seat(Insulator Length 50mm)	14	25	16	0.8	1.5	3.0	5.2	S	5	I40	267700-2501	
<b>ITV24</b>	Automobile	Taper Seat(Insulator Length 50mm)	14	25	16	0.8	-0.5	1.0	3.2	S	5	I41	267700-2511	
<b>ITV27</b>	Automobile	Taper Seat(Insulator Length 50mm)	14	25	16	0.8	-0.5	1.0	3.2	S	5	I42	267700-2521	
<b>ITL16</b>	Automobile	Taper Seat(Insulator Length 56mm)	14	25	16	1.1	1.5	3.0	5.5	S	5	I49	267700-4981	
<b>ITL20</b>	Automobile	Taper Seat(Insulator Length 56mm)	14	25	16	1.1	1.5	3.0	5.5	S	5	I50	267700-4991	
<b>IT16</b>	Automobile	TAPER SEAT	14	17.5	16	1.1	1.5	3.0	5.5	S	5	I25	267700-0611	100676-3610
<b>IT20</b>	Automobile	TAPER SEAT	14	17.5	16	1.1	1.5	3.0	5.5	S	5	I26	267700-0621	100676-3620
<b>IT22</b>	Automobile	TAPER SEAT	14	17.5	16	0.8	1.5	3.0	5.2	S	5	I27	267700-0631	
<b>IT24</b>	Automobile	TAPER SEAT	14	17.5	16	0.8	-0.5	1.0	3.2	S	5	I28	267700-0641	
<b>IT27</b>	Automobile	TAPER SEAT	14	17.5	16	0.8	-0.5	1.0	3.2	S	5	I29	267700-0651	
<b>ITF16</b>	Automobile	TAPER SEAT	14	11.2	16	1.1	1.5	3.0	5.5	S	5	I30	267700-0661	
<b>ITF20</b>	Automobile	TAPER SEAT	14	11.2	16	1.1	1.5	3.0	5.5	S	5	I31	267700-0671	
<b>ITF22</b>	Automobile	TAPER SEAT	14	11.2	16	0.8	1.5	3.0	5.2	S	5	I32	267700-0681	
<b>ITF24</b>	Automobile	TAPER SEAT	14	11.2	16	0.8	-0.5	1.0	3.2	S	5	I33	267700-0691	
<b>ITF27</b>	Automobile	TAPER SEAT	14	11.2	16	0.8	-0.5	1.0	3.2	S	5	I34	267700-0701	
<b>IXU22</b>	Automobile		12	19	16	0.9	1.3	2.8	5.0	RC	5	I08	067700-8722	100676-3430
<b>IXU24</b>	Automobile		12	19	16	0.9	1.3	2.8	5.0	RC	5	I09	067700-8732	100676-3440
<b>IXU27</b>	Motorcycle		12	19	16	0.9	1.3	2.8	5.0	RC	5	I37	067700-8602	100676-3820
<b>IXU22I</b>	Automobile		12	19	16	0.9	1.3	3.5	5.7	S	5	I51	267700-8431	
<b>IXUH22</b>	Automobile		12	26.5	16	0.9	1.5	3.0	5.2	S	5	I53	267700-6451	
<b>IXUH20I</b>	Automobile		12	26.5	16	0.9	1.5	4.0	6.2	S	5	I54	267700-8171	
<b>IXUH22I</b>	Automobile		12	26.5	16	0.9	1.5	4.0	6.2	S	5	I56	267700-7371	

TYPE	APPLICATION	SPEC	DIA.	REACH	HEX	GAP	PROJECTION	SPARK POSITION	GROUND ELECTRODE HEIGHT	TERMINAL SHAPE	RESISTOR (Ω)	No.	IRIDIUM POWER	IRIDIUM POWER
													ONE PC BOX	2pcs BLISTER PACK
													DENSO P/N	DENSO P/N
<b>IX22</b>	Motorcycle		12	19	18	0.8	0.6	2.0	4.1	R	5	I71	067700-9351	
<b>IX24</b>	Motorcycle		12	19	18	0.8	0.6	2.0	4.1	R	5	I72	067700-9361	
<b>IX27</b>	Motorcycle		12	19	18	0.8	0.6	2.0	4.1	R	5	I73	067700-9371	
<b>IX22B</b>	Motorcycle		12	19	18	0.9	1.5	2.8	5.0	R	5	I75	067700-9381	
<b>IX24B</b>	Motorcycle		12	19	18	0.9	1.5	2.8	5.0	R	5	I76	067700-9391	
<b>IX27B</b>	Motorcycle		12	19	18	0.9	1.5	2.8	5.0	R	5	I77	067700-9401	
<b>IXG24</b>	Motorcycle	SHROUD	12	21.8	18	0.7	0.7	2.0	4.1	R	5	I94	267700-2921	
<b>IXG27</b>	Motorcycle	SHROUD	12	21.8	18	0.7	0.7	2.0	4.1	R	5	I95	267700-2931	
<b>IU20</b>	Motorcycle		10	19	16	0.9	-0.5	0.7	2.6	R	5	I60	267700-5021	
<b>IU22</b>	Motorcycle		10	19	16	0.9	-0.5	0.7	2.6	R	5	I61	067700-9262	
<b>IU24</b>	Motorcycle		10	19	16	0.9	-0.5	0.7	2.6	R	5	I62	067700-9272	
<b>IU27</b>	Motorcycle		10	19	16	0.9	-0.5	0.7	2.6	R	5	I63	067700-9282	
<b>IU31</b>	Motorcycle		10	19	16	0.9	-0.5	0.7	2.6	R	5	I64	067700-9292	
<b>IU24A</b>	Motorcycle	SLANT GROUND ELECTRODE	10	19	16	0.9	-0.5	1.0	2.9	R	5	I65	067700-9302	
<b>IU27A</b>	Motorcycle	SLANT GROUND ELECTRODE	10	19	16	0.9	-0.5	1.0	2.9	R	5	I66	067700-9312	
<b>IU31A</b>	Motorcycle	SLANT GROUND ELECTRODE	10	19	16	0.9	-0.5	1.0	2.9	R	5	I67	067700-9321	
<b>IU22D</b>	Motorcycle	NON U-GROOVE	10	19	16	0.9	0.5	2.0	4.0	T	5	-	267700-0830	
<b>IU24D</b>	Motorcycle	NON U-GROOVE	10	19	16	0.9	0.5	2.0	4.0	T	5	I103	267700-0840	
<b>IU27D</b>	Motorcycle	NON U-GROOVE	10	19	16	0.9	0.5	2.0	4.0	T	5	I90	267700-0850	
<b>IUH24</b>	Motorcycle	HALF THREAD	10	19	16	0.9	0.6	2.0	3.9	R	5	I68	067700-9331	
<b>IUH27</b>	Motorcycle	HALF THREAD	10	19	16	0.9	0.6	2.0	3.9	R	5	I69	067700-9341	
<b>IUF22</b>	Motorcycle		10	12.7	16	0.8	0.6	2.0	3.8	R	5	I83	067700-9481	
<b>IUF24</b>	Motorcycle		10	12.7	16	0.8	0.6	2.0	3.8	R	5	I84	067700-9491	
<b>IUF27A</b>	Motorcycle	SLANT GROUND ELECTRODE	10	12.7	16	0.9	-0.5	1.0	2.9	R	5	I85	067700-9701	
<b>IUF31A</b>	Motorcycle	SLANT GROUND ELECTRODE	10	12.7	16	0.9	-0.5	1.0	2.9	R	5	I86	067700-9711	
<b>IY24</b>	Motorcycle	HALF THREAD	8	19	13	0.7	0.6	1.4	2.9	R	5	I100	267700-4491	
<b>IY27</b>	Motorcycle	HALF THREAD	8	19	13	0.7	0.6	1.4	2.9	R	5	I101	267700-4501	
<b>IY31</b>	Motorcycle	HALF THREAD	8	19	13	0.7	-0.5	0.5	2.0	R	5	I102	267700-4511	

### 0.4mm diameter IRIDIUM PLUG

TYPE	APPLICATION	SPEC	DIA.	REACH	HEX	GAP	PROJECTION	SPARK POSITION	GROUND ELECTRODE HEIGHT	TERMINAL SHAPE	RESISTOR (Ω)	No.	IRIDIUM	IRIDIUM
													ONE PC BOX	2pcs BLISTER PACK
													DENSO P/N	DENSO P/N
<b>IK24C11</b>	Motorcycle		14	19	16	1.1	1.5	3.0	5.7	S	5	I35	067700-9550	
<b>IK27C11</b>	Motorcycle		14	19	16	1.1	0.5	2.0	4.7	S	5	I36	067700-9520	
<b>IXU22C</b>	Automobile	NON U-GROOVE	12	19	16	0.8	1.3	2.8	4.9	S	5	-	267700-5170	
<b>IXU22HPR</b>	Automobile	NON U-GROOVE	12	26.5	16	0.8	1.5	3.0	5.1	S	5	I74	267700-7170	
<b>IU31D</b>	Motorcycle	NON U-GROOVE	10	19	16	0.9	-0.5	1.0	3.0	T	5	-	267700-0860	
<b>IUH24D</b>	Motorcycle	HALF THREAD	10	19	16	0.9	0.6	2.0	4.0	T	5	I87	067700-9560	
<b>IUH27D</b>	Motorcycle	HALF THREAD	10	19	16	0.9	0.6	2.0	4.0	T	5	I88	067700-9570	
<b>IUF14-UB</b>	MARINE		10	12.7	16	0.7	0.6	1.6	3.3	S	5	I89	267700-0540	
<b>VK16PR-Z11</b>	Motorcycle	GROUND ELEC. Pt.&TAPERCUT	14	19	16	1.1	1.5	3.0	5.7	S	5	V28	267700-1840	
<b>VK20PR-Z11</b>	Motorcycle	GROUND ELEC. Pt.&TAPERCUT	14	19	16	1.1	1.5	3.0	5.7	S	5	V15	267700-1850	
<b>VK22PR-Z11</b>	Motorcycle	GROUND ELEC. Pt.&TAPERCUT	14	19	16	1.1	1.5	3.0	5.7	S	5	V29	267700-1860	
<b>VK24PR-Z11</b>	Motorcycle	GROUND ELEC. Pt.&TAPERCUT	14	19	16	1.1	1.5	3.0	5.7	S	5	V16	267700-1870	
<b>VK27PR-Z11</b>	Motorcycle	GROUND ELEC. Pt.&TAPERCUT	14	19	16	1.1	0.5	2.0	4.7	S	5	V30	267700-2050	
<b>VKJ20RZ-M11</b>	Motorcycle	GROUND ELEC. Pt.&TAPERCUT	14	19	16	1.1	3.0	5.0	7.7	S	5	V33	267700-1970	
<b>SVK20RZ8</b>	Automobile	GROUND ELEC. Pt.&TAPERCUT	14	19	16	0.8	1.5	3.5	5.7	S	5	S18	067700-9740	
<b>SVK20RZ11</b>	Automobile	GROUND ELEC. Pt.&TAPERCUT	14	19	16	1.1	1.5	3.5	6.0	S	5	S52	067700-8620	
<b>VX20BC</b>	Motorcycle	GROUND ELEC. Pt.	12	19	18	0.9	1.5	2.8	5.0	T	5	V34	067700-9830	
<b>VX22BC</b>	Motorcycle	GROUND ELEC. Pt.	12	19	18	0.9	1.5	2.8	5.0	T	5	V14	067700-9720	
<b>VUH24D</b>	Motorcycle	HALF THREAD,Ground Elec. Pt.&TAPERCUT	10	19	16	0.9	0.6	2.0	4.0	T	5	V26	267700-2011	
<b>VUH27D</b>	Motorcycle	HALF THREAD,Ground Elec. Pt.&TAPERCUT	10	19	16	0.9	0.6	2.0	4.0	T	5	V27	267700-1931	
<b>VUH24ES</b>	Motorcycle	HALF THREAD,Ground Elec. Pt.&TAPERCUT,SUS GASKET	10	19	16	0.9	0.6	2.0	4.0	T	5	V57	267700-6130	
<b>VUH27ES</b>	Motorcycle	HALF THREAD,Ground Elec. Pt.&TAPERCUT,SUS GASKET	10	19	16	0.9	0.6	2.0	4.0	T	5	V42	267700-4770	
<b>VNH24Z</b>	Motorcycle	HALF THREAD,Ground Elec. Pt.&TAPERCUT	10	19	16	0.9	0.6	2.0	4.0	S	5	V32	267700-2060	
<b>VNH27Z</b>	Motorcycle	HALF THREAD,Ground Elec. Pt.&TAPERCUT	10	19	16	0.9	0.6	2.0	4.0	S	5	V31	267700-2070	
<b>VNH27ZB</b>	Motorcycle	HALF THREAD,Ground Elec. Pt.&TAPERCUT	10	19	16	0.9	0.6	2.0	4.0	S	5	-	267700-1920	

Spark gap example ..... For a 1.1 mm gap, set from 1.0 to 1.1 mm.  
 Insulator projection ..... Length from edge of side housing to top of insulator.  
 Spark position ..... The plus (+) direction is the distance from the edge to the piston head.  
 Ground electrode height ..... Length from edge of side housing to top of center electrode.  
 The plus (+) direction is the distance from the edge to the piston head.  
 The plus (+) direction is the distance from the edge to the piston head.  
 Terminal shapes ..... S: solid terminal, R: removable, RC: crimped nut, T: threaded  
 Note: Please purchase plugs equipped as original parts at stores that sell original parts.

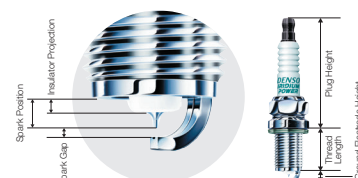

# MEMO

A series of horizontal dashed lines for writing.

# IRIDIUM TOUGH® Specifications

TYPE	APPLICATION	SPEC	DIA. (mm)	REACH (mm)	HEX (mm)	GAP (mm)	PROJECTION (mm)	SPARK POSITION (mm)	GROUND ELECTRODE HEIGHT (mm)	TERMINAL SHAPE	RESISTOR (kΩ)	No.	IRIDIUM TOUGH® ONE PC BOX	IRIDIUM TOUGH® 2pcs BLISTER PACK
													DENSO P/N	DENSO P/N
VQ16	Automobile	JIS	14	19	16	1.1	1.5	3.0	5.7	S	5	V01	267700-0741	100676-3740
VQ20	Automobile	JIS	14	19	16	1.1	1.5	3.0	5.7	S	5	V02	267700-0751	100676-3750
VQ22	Automobile	JIS	14	19	16	0.8	1.5	3.0	5.4	S	5	V13	267700-0761	100676-3760
VK16	Automobile	ISO	14	19	16	1.1	1.5	3.0	5.7	S	5	V03	267700-0711	100676-3710
VK20	Automobile	ISO	14	19	16	1.1	1.5	3.0	5.7	S	5	V04	267700-0721	100676-3720
VK22	Automobile	ISO	14	19	16	0.8	1.5	3.0	5.4	S	5	V10	267700-0731	100676-3730
VK16G	Automobile	SUS GASKET	14	19	16	1.1	1.5	3.0	5.7	S	5	V40	267700-5631	
VK20G	Automobile	SUS GASKET	14	19	16	1.1	1.5	3.0	5.7	S	5	V41	267700-5641	
VK22G	Automobile	SUS GASKET	14	19	16	0.8	1.5	3.0	5.4	S	5	V36	267700-5671	100676-5340
VK20Y	Automobile		14	19	16	0.8	1.5	3.0	5.4	S	5	V20	267700-3721	100676-3950
VKA16	Automobile	NEW 3 ELECTRODE SHROUD	14	22	16	1.1	2.5	4.0	6.5	S	5	V22	267700-5031	100676-5360
VKA20	Automobile	NEW 3 ELECTRODE SHROUD	14	22	16	1.1	2.5	4.0	6.5	S	5	V23	267700-5041	100676-5370
VKB16	Automobile	NEW 3 ELECTRODE	14	19	16	1.1	2.5	4.0	6.5	S	5	V24	267700-5051	100676-5380
VKB20	Automobile	NEW 3 ELECTRODE	14	19	16	1.1	2.5	4.0	6.5	S	5	V25	267700-5061	100676-5390
VFK16	Automobile	DOUBLE NEEDLE Ir & Pt ELEC.	14	19	16	1.1	1.5	3.0	6.5	S	5	V47	267700-9151	
VFK20F	Automobile	DOUBLE NEEDLE Ir & Pt ELEC. COPPER CORE GROUND ELEC.	14	19	16	1.1	1.5	3.0	6.5	S	5	V48	267700-9161	
VFKB16	Automobile	NEW 3 ELECTRODE, DOUBLE NEEDLE IRIIDIUM, PLATINUM	14	19	16	0.8	2.5	4.0	7.0	S	5	V64	267700-9271	
VFKH16	Automobile	DOUBLE NEEDLE Ir & Pt ELEC.	14	26.5	16	0.8	2.5	4.0	7.3	S	5	V54	267700-7411	
VFKH20	Automobile	DOUBLE NEEDLE Ir & Pt ELEC.	14	26.5	16	0.8	2.5	4.0	7.3	S	5	V55	267700-7421	
VFKBH20	Automobile	NEW 3 ELECTRODE, DOUBLE NEEDLE IRIIDIUM, PLATINUM	14	26.5	16	0.8	2.5	4.0	7.1	S	5	V43	267700-7661	
VKH16	Automobile		14	26.5	16	1.1	1.5	3.0	5.7	S	5	V17	267700-3681	100676-5250
VKH20	Automobile		14	26.5	16	1.1	1.5	3.0	5.7	S	5	V18	267700-3691	100676-5150
VKH20Y	Automobile		14	26.5	16	0.8	1.5	3.0	5.4	S	5	V39	267700-4541	100676-5260
VKH22	Automobile		14	26.5	16	0.8	1.5	3.0	5.4	S	5	V19	267700-2681	100676-5270
VW16	Automobile		14	19	20.6	1.1	1.5	3.0	5.5	S	5	V05	267700-0771	100676-3770
VW20	Automobile		14	19	20.6	1.1	1.5	3.0	5.5	S	5	V06	267700-0781	100676-3780
VW22	Automobile		14	19	20.6	0.8	1.5	3.0	5.2	S	5	V07	267700-0791	100676-3790
VT16	Automobile	TAPER SEAT	14	17.5	16	1.1	1.5	3.0	5.5	S	5	V21	267700-2811	100676-5280
VT20	Automobile	TAPER SEAT	14	17.5	16	1.1	1.5	3.0	5.5	S	5	V38	267700-4481	100676-5290
VXU20	Automobile		12	19	16	1.1	1.5	3.0	5.4	S	5	V49	267700-9141	
VXU22	Automobile		12	19	16	0.9	1.3	2.8	5.0	RC	5	V08	267700-0801	100676-3800
VXU24	Automobile		12	19	16	0.9	1.3	2.8	5.0	RC	5	V09	267700-0811	100676-3810
VXU22I	Automobile		12	19	16	0.9	1.3	3.5	5.7	S	5	V51	267700-8441	
VXUH22	Automobile		12	26.5	16	0.9	1.5	3.0	5.2	S	5	V11	267700-6461	
VXUH20I	Automobile		12	26.5	16	0.9	1.5	4.0	6.2	S	5	V50	267700-8161	
VXUH22I	Automobile		12	26.5	16	0.9	1.5	4.0	6.2	S	5	V56	267700-7381	
VXUHC22G	Automobile	SUS GASKET SHROUD	12	28	16	0.8	2.0	3.5	5.6	S	5	V52	267700-8671	
VFXUHC22FG	Automobile	DOUBLE NEEDLE Ir & Pt ELEC, SUS GASKET SHROUD	12	28	16	1.1	2.0	3.5	5.7	S	5	V53	267700-8681	
VCH16	Automobile		12	26.5	14	1.1	2.5	4.0	6.4	S	5	V58	267700-9211	
VCH20	Automobile		12	26.5	14	1.1	2.5	4.0	6.4	S	5	V37	267700-7671	
VFCH16	Automobile	DOUBLE NEEDLE Ir & Pt ELECTRODE	12	26.5	14	0.8	2.5	4.0	6.8	S	5	V65	267700-9281	
VDCH22F	Automobile	DOUBLE NEEDLE Ir & Pt ELECTRODE	12	26.5	14	0.9	3	3.0	6.0	S	5	V63	267700-9291	
VDKH22F	Automobile	DOUBLE NEEDLE Ir & Pt ELECTRODE	14	26.5		0.9	3	3.0	6.3	S	5	V62	267700-8751	
VXEBH27	Automobile	NEW 3 & COPPER CORE GROUND ELEC.	12	26.5	14	0.8	2	3.5	5.6	S	5	V86	267700-9171	
VXEHC24G	Automobile	SUS GASKET SHROUD 1.5mm	12	28	14	0.8	2	3.0	5.7	S	5	V60	267700-9231	
VFXEH20E	Automobile	DOUBLE NEEDLE Ir & Pt ELECTRODE, SHROUD 2mm	12	28.5	14	1.1	2.5	4.0	7.2	S	5	V44	267700-7631	
VFXEH22	Automobile	DOUBLE NEEDLE Ir & Pt ELECTRODE	12	26.5	14	1.1	2.5	4.0	7.2	S	5	V46	267700-7651	
VFXEH20	Automobile	DOUBLE NEEDLE Ir & Pt ELECTRODE	12	26.5	14	1.1	2.5	4.0	7.2	S	5	V45	267700-7641	
VFXEHC22G	Automobile	DOUBLE NEEDLE Ir & Pt ELECTRODE, SHROUD 1.5mm	12	28	14	0.8	2	3.5	6.4	S	5	V59	267700-9221	
VSUEH22	Automobile	M10x26.5	10	26.5	14	0.7	3	1.5	4.8	S	5	V61	267700-9241	

Spark gap example .....For a 1.1 mm gap, set from 1.0 to 1.1 mm.

Insulator projection.....Length from edge of side housing to top of insulator. The plus (+) direction is the distance from the edge to the piston head.

Spark position .....Length from edge of side housing to top of center electrode. The plus (+) direction is the distance from the edge to the piston head.

Ground electrode height.....Length from edge of side housing to top of ground electrode. The plus (+) direction is the distance from the edge to the piston head.

Terminal shapes.....S: solid terminal, R: removable, RC: crimped nut, T: threaded

# IRIDIUM RACING® Specifications

TYPE	APPLICATION	SPEC	DIA. (mm)	REACH (mm)	HEX (mm)	GAP (mm)	PROJECTION (mm)	SPARK POSITION (mm)	GROUND ELECTRODE HEIGHT (mm)	TERMINAL SHAPE	RESISTOR (K)	No.	IRIDIUM RACING ONE PC BOX
													DENSO P/N
<b>IK01-24</b>	Automobile	ISO(SLANT ELEC.)	14	19	16	0.7	-1.0	0.5	2.0	S	5	R01	267700-1311
<b>IK01-27</b>	Automobile	ISO(SLANT ELEC.)	14	19	16	0.7	-1.0	0.5	2.0	S	5	R02	267700-1321
<b>IK01-31</b>	Automobile	ISO(SLANT ELEC.)	14	19	16	0.7	-1.0	0.5	2.0	S	5	R03	267700-1331
<b>IK01-34</b>	Automobile	ISO(SLANT ELEC.)	14	19	16	0.7	-1.0	0.5	2.0	S	5	R42	267700-1341
<b>IK02-24</b>	Automobile	ISO(STRAIGHT ELEC.)	14	19	16	0.7	-2.3	-0.8	0.7	S	5	R04	267700-1361
<b>IK02-27</b>	Automobile	ISO(STRAIGHT ELEC.)	14	19	16	0.7	-2.3	-0.8	0.7	S	5	R05	267700-1371
<b>IK02-31</b>	Automobile	ISO(STRAIGHT ELEC.)	14	19	16	0.7	-2.3	-0.8	0.7	S	5	R06	267700-1381
<b>IKH01-24</b>	Automobile	LONG REACH	14	26.5	16	0.7	-1.0	0.5	2.0	S	5	R49	267700-4451
<b>IKH01-27</b>	Automobile	LONG REACH	14	26.5	16	0.7	-1.0	0.5	2.0	S	5	R50	267700-4461
<b>IKH01-31</b>	Automobile	LONG REACH	14	26.5	16	0.7	-1.0	0.5	2.0	S	5	R51	267700-4471
<b>IQ01-24</b>	Automobile	SLANT ELEC.	14	19	16	0.7	-1.0	0.5	2.0	S	5	R07	267700-1411
<b>IQ01-27</b>	Automobile	SLANT ELEC.	14	19	16	0.7	-1.0	0.5	2.0	S	5	R08	267700-1421
<b>IQ01-31</b>	Automobile	SLANT ELEC.	14	19	16	0.7	-1.0	0.5	2.0	S	5	R09	267700-1431
<b>IQ01-34</b>	Automobile	SLANT ELEC.	14	19	16	0.7	-1.0	0.5	2.0	S	5	R43	267700-1441
<b>IQ02-24</b>	Automobile	STRAIGHT ELEC.	14	19	16	0.7	-2.3	-0.8	0.7	S	5	R10	267700-1461
<b>IQ02-27</b>	Automobile	STRAIGHT ELEC.	14	19	16	0.7	-2.3	-0.8	0.7	S	5	R11	267700-1471
<b>IQ02-31</b>	Automobile	STRAIGHT ELEC.	14	19	16	0.7	-2.3	-0.8	0.7	S	5	R12	267700-1481
<b>IW01-24</b>	Motorcycle	W-E	14	19	20.6	0.6	-1.5	0.0	1.6	RC	5	R13	267700-1111
<b>IW01-27</b>	Motorcycle	W-E	14	19	20.6	0.6	-1.5	0.0	1.6	RC	5	R14	267700-1121
<b>IW01-29</b>	Racing Kart	W-E	14	19	20.6	0.6	-1.5	0.0	1.6	RC	5	R15	267700-1131
<b>IW01-31</b>	Racing Kart	W-E	14	19	20.6	0.6	-1.5	0.0	1.6	RC	5	R16	267700-1141
<b>IW01-32</b>	Racing Kart	W-E	14	19	20.6	0.6	-1.5	0.0	1.6	RC	5	R17	267700-1151
<b>IW01-34</b>	Racing Kart	W-E	14	19	20.6	0.6	-1.5	0.0	1.6	RC	5	R18	267700-1161
<b>IW06-27</b>	Automobile	W-E NON RESISTOR	14	19	20.6	0.6	-1.5	0.0	1.6	S	0	R44	067600-1811
<b>IW06-31</b>	Automobile	W-E NON RESISTOR	14	19	20.6	0.6	-1.5	0.0	1.6	S	0	R45	067600-1821
<b>IW06-34</b>	Automobile	W-E NON RESISTOR	14	19	20.6	0.6	-1.5	0.0	1.6	S	0	R46	067600-1831
<b>IRE01-27</b>	Rotary Engine	ROTARY ENGINE	14	21.5	20.6	0.7	-2.2	-0.7	0.8	S	5	R19	267700-1521
<b>IRE01-31</b>	Rotary Engine	ROTARY ENGINE	14	21.5	20.6	0.7	-2.2	-0.7	0.8	S	5	R20	267700-1531
<b>IRE01-32</b>	Rotary Engine	ROTARY ENGINE	14	21.5	20.6	0.7	-2.2	-0.7	0.8	S	5	R21	267700-1541
<b>IRE01-34</b>	Rotary Engine	ROTARY ENGINE	14	21.5	20.6	0.7	-2.2	-0.7	0.8	S	5	R22	267700-1551
<b>IRE01-35</b>	Rotary Engine	ROTARY ENGINE	14	21.5	20.6	0.7	-2.2	-0.7	0.8	S	5	R41	267700-1561
<b>IRL01-27</b>	Rotary Engine	ROTARY RX8(LEADING)	14	21	20.6	1.1	-2.5	-0.5	1.6	S	5	R54	267700-4821
<b>IRL01-31</b>	Rotary Engine	ROTARY RX8(LEADING)	14	21	20.6	1.1	-2.5	-0.5	1.6	S	5	R55	267700-4831
<b>IRT01-31</b>	Rotary Engine	ROTARY RX8(TRAILING)	14	19	20.6	1.1	-2.5	-0.5	1.6	S	5	R52	267700-4841
<b>IRT01-34</b>	Rotary Engine	ROTARY RX8(TRAILING)	14	19	20.6	1.1	-2.5	-0.5	1.6	S	5	R53	267700-4851
<b>IA01-31</b>	Motorcycle	WITH DETONATION COUNTER	14	22	16	0.6	-1.0	0.5	1.9	S	5	R23	267700-1261
<b>IA01-32</b>	Motorcycle	WITH DETONATION COUNTER	14	22	16	0.6	-1.0	0.5	1.9	S	5	R24	267700-1271
<b>IA01-34</b>	Motorcycle	WITH DETONATION COUNTER	14	22	16	0.6	-1.0	0.5	1.9	S	5	R25	267700-1281
<b>IAE01-32</b>	Motorcycle	W/OUT DETONATION COUNTER	14	19	16	0.6	-1.3	0.5	2.1	S	5	R47	267700-2941
<b>IAE01-34</b>	Motorcycle	W/OUT DETONATION COUNTER	14	19	16	0.6	-1.3	0.5	2.1	S	5	R48	267700-2951
<b>IWM01-29</b>	Motorcycle	W-EM	14	19	20.6	0.6	-1.5	0.0	1.6	S	5	R26	267700-1211
<b>IWM01-31</b>	Motorcycle	W-EM	14	19	20.6	0.6	-1.5	0.0	1.6	S	5	R27	267700-1221
<b>IWM01-32</b>	Motorcycle	W-EM	14	19	20.6	0.6	-1.5	0.0	1.6	S	5	R28	267700-1231
<b>IWM01-34</b>	Motorcycle	W-EM	14	19	20.6	0.6	-1.5	0.0	1.6	S	5	R29	267700-1241
<b>IXU01-24</b>	Motorcycle	XU-E	12	19	16	0.6	-1.5	0.0	1.4	R	5	R30	267700-1061
<b>IXU01-27</b>	Motorcycle	XU-E	12	19	16	0.6	-1.5	0.0	1.4	R	5	R31	267700-1071
<b>IXU01-31</b>	Motorcycle	XU-E	12	19	16	0.6	-1.5	0.0	1.4	R	5	R32	267700-1081
<b>IXU01-34</b>	Motorcycle	XU-E	12	19	16	0.6	-1.5	0.0	1.4	R	5	R33	267700-1091
<b>IU01-24</b>	Motorcycle	U-E	10	19	16	0.6	-1.8	-0.3	1.2	R	5	R34	267700-1011
<b>IU01-27</b>	Motorcycle	U-E	10	19	16	0.6	-1.8	-0.3	1.2	R	5	R35	267700-1021
<b>IU01-31</b>	Motorcycle	U-E	10	19	16	0.6	-1.8	-0.3	1.2	R	5	R36	267700-1031
<b>IU01-34</b>	Motorcycle	U-E	10	19	16	0.6	-1.8	-0.3	1.2	R	5	R37	267700-1041
<b>*RU01-27</b>	Motorcycle	U-E(SURFACE)	10	19	16	1.1	-0.2	0.0	0.0	R	5	R38	267700-1571
<b>*RU01-31</b>	Motorcycle	U-E(SURFACE)	10	19	16	1.1	-0.2	0.0	0.0	R	5	R39	267700-1581
<b>*RU01-34</b>	Motorcycle	U-E(SURFACE)	10	19	16	1.1	-0.2	0.0	0.0	R	5	R40	267700-1591

\* These plugs do not have iridium electrodes.

Spark gap example ..... For a 1.1 mm gap, set from 1.0 to 1.1 mm.

Insulator projection ..... Length from edge of side housing to top of insulator. The plus (+) direction is the distance from the edge to the piston head.

Spark position ..... Length from edge of side housing to top of center electrode. The plus (+) direction is the distance from the edge to the piston head.

Ground electrode height ..... Length from edge of side housing to top of ground electrode. The plus (+) direction is the distance from the edge to the piston head.

Terminal shapes ..... S: solid terminal, R: removable, RC: crimped nut, T: threaded

# IRIDIUM RACING® CROSS REFERENCE

DENSO			NGK					
IRIDIUM POWER	IRIDIUM RACING	FIGURE	DIA. (mm)	REACH (mm)	HEX (mm)	RESISTOR	FIGURE	TYPE
IW□		4 D	14	19	20.6		BP-E	R4304A-□
	IW01/IW06-□(Note 1)	4 A	14	19	20.6		B-E	B□EGP
IW□		4 D	14	19	20.6		B-E	B□EGV
IW□		4 D	14	19	20.6		B-E	R4118S-□
	IW01/IW06-□(Note 1)	4 A	14	19	20.6		B-E	R4630A-□
	IW01/IW06-□(Note 1)	4 A	14	19	20.6	R	B-E	R6252K-□
	IW01/IW06-□(Note 1)	4 A	14	19	20.6	R	B-E	R6918B-□
	IW01/IW06-□(Note 1)	4 A	14	19	20.6	R	B-E	R6918C-□
IW□		4 D	14	19	20.6	R	B-E	R6021E-□
	IW01/IW06-□(Note 1)	4 A	14	19	20.6	R	B-E	R6385-□P
	IW01/IW06-□(Note 1)	4 A	14	19	20.6	R	B-E	R7376-□(Ir)
			14	19	20.6		B-E SEMISURFACE	R5649-□
			14	19	20.6	R	B-E SEMISURFACE	R6712-□
	IWM01-□	5 A	14	19	20.6		B-E COMPACT	R5184-□
			14	19	20.6	R	B-E COMPACT	R5300A-□
			14	19	20.6	R	B-E COMPACT	R5300N-□
			14	19	20.6	R	B-E COMPACT	R5540F-□
	IWM01-□	5 A	14	19	20.6	R	B-E COMPACT	R6179A-□P
			14	22	20.6	R	B-E COMPACT	R6179C-□PA
			14	22	20.6	R	B-E	R7376B(Ir)
	IA01-□	8 A	14	22	16	R	BC-E COMPACT	R6120A-□
	IA01-□	8 A	14	22	16	R	BC-E COMPACT	R7282A-□(Ir)
	IAE01-□	9 A	14	19	16	R	BC-E COMPACT	R6120-□
	IAE01-□(Note 2)	9 A	14	19	16	R	BC-E COMPACT	R6120C-□
	IAE01-□(Note 2)	9 A	14	19	16	R	BC-E COMPACT	R6120M-□
	IAE01-□	9 A	14	19	16	R	BC-E COMPACT	R7282-□(Ir)
	IAE01-□(Note 2)	9 A	14	19	16	R	BC-E COMPACT	R7282C-□(Ir)
	IAE01-□(Note 2)	9 A	14	19	16	R	BC-E COMPACT	R7282M-□(Ir)
IK□		6 D	14	19	16	R	BK-E ISO	R6888A-□
IK□		6 D	14	19	16		BK-E ISO	R7112-□
IK□		6 D	14	19	16	R	BK-E ISO	R7113-□
IK□		6 D	14	19	16	R	BK-E ISO	R7433-□(Ir)
IK□		6 D	14	19	16		BK-E ISO	R7114-□
IK□		6 D	14	19	16	R	BK-E ISO	R7115-□
	IK01-□	6 A	14	19	16		BK-E ISO	R7116-□
	IK01-□	6 A	14	19	16	R	BK-E ISO	R7117-□
	IK02-□	6 B	14	19	16		BK-E ISO	R7118-□
	IK02-□	6 B	14	19	16	R	BK-E ISO	R7119-□
	IK01-□	6 A	14	19	16	R	BK-E ISO	R7434-□(Ir)
	IK02-□	6 B	14	19	16	R	BK-E ISO	R7279-□(Ir)
			14	19	16	R	BK-E SEMISURFACE	R6601-□
			14	19	16		BK-E SEMISURFACE	R6711-□
IQ□		7 D	14	19	16	R	BCP-E	R7435-□(Ir)
IQ□		7 D	14	19	16		BCP-E	R7232-□
IQ□		7 D	14	19	16	R	BCP-E	R7233-□
IQ□		7 D	14	19	16		BC-E	R7234-□
IQ□		7 D	14	19	16	R	BC-E	R7235-□
	IQ01-□	7 A	14	19	16		BC-E	R7236-□
	IQ01-□	7 A	14	19	16	R	BC-E	R7237-□
	IQ02-□	7 B	14	19	16		BC-E	R7238-□
	IQ02-□	7 B	14	19	16	R	BC-E	R7239-□
	IQ01-□	7 A	14	19	16	R	BC-E	R7436-□(Ir)
			14	19	16		BC-E SEMISURFACE	R5883-□
			14	19	16	R	BC-E SEMISURFACE	R6690-□
IKH□		10 D	14	26.5	16	R	LFR	R7437-□(Ir)
	IKH01-□	10 A	14	26.5	16	R	LFR	R7438-□(Ir)
IWF□		— D	14	12.7	20.6		B-H	R5525-□
			14	12.7	20.6		B-H	R5530-□
	IRE01-□	3 B	14	21.5	20.6	R	ROTARY	R6725-□
	IRE01-□	3 B	14	21.5	20.6	R	ROTARY	R7420-□(Ir)
			14	21.5	20.6		ROTARY, SURFACE	T813J-N13
	IRL01-□	11 A	14	21	20.6	R	ROTARY RX-8(L)	R7440A-□L(Ir)
	IRT01-□	12 A	14	19	20.6	R	ROTARY RX-8(T)	R7440B-□T(Ir)
	IXU01-□(Note 3)	2 A	12	19	18		D-E	R216-□
IX□(Note 3)	IXU01-□(Note 3)	2 D, 2 A	12	19	18		D-E	R217-□
			12	21	18		D-Z	R2188-□
			12	19	16	R	DC-E SEMISURFACE	R2349-□
			12	19	16	R	DC-E	R2525-□
			12	19	16		DC-E SEMISURFACE	R2430-□
	IU01-□	1 A	10	19	16		C-E	R016-□
IU□A		1 E	10	19	16		C-E	R017-□
	IU01-□	1 A	10	19	16		C-E	R0373A-□(Ir)
			10	19	16		C-E SEMISURFACE	R0045G-□
	RU01-□	1 C	10	19	16		C-E SEMISURFACE	R0045J-□
	RU01-□	1 C	10	19	16	R	C-E SEMISURFACE	R0045Q-□
	IU01-□	1 A	10	19	16	R	C-EH HALF THREAD	R0379A-10(Ir), R0409B-□
IUF□(A)		— D, — E	10	12.7	16		C-H	R0161-□
IY□		— D	8	19	12.7	R	E-EH SEMISURFACE	R847-□

## Overall shape

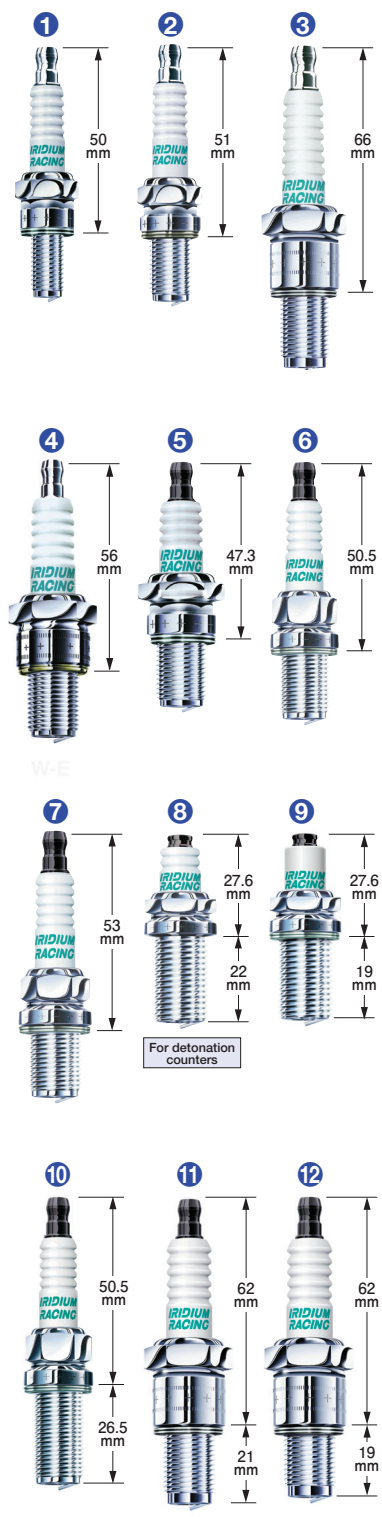

## Electrode shape

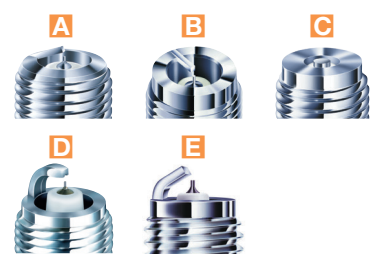

(Note 1) IW06 is a non resistor type  
 (Note 2) Remove the gasket with nippers before use  
 (Note 3) IX □ B and IX □ is different from IXU01-□ only in the hex size (18 mm or 16 mm), and are otherwise interchangeable in terms of installation.  
 (□) show the heat range.



# WARNING!

Counterfeit auto parts are illegal!

¡Falsificar las piezas de automóviles es un acto ilegal!

伪造汽车零部件是违法的!

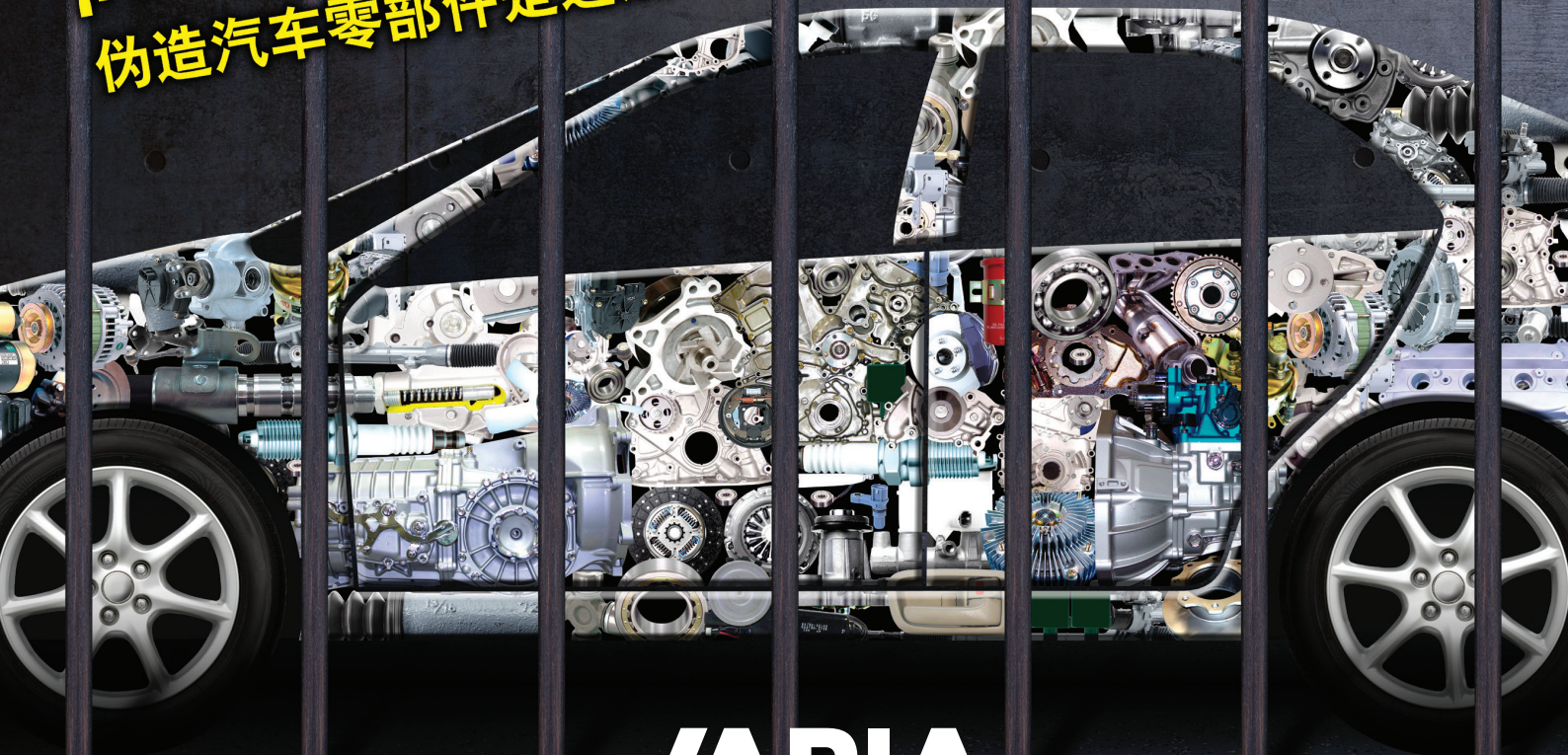

## JAPIA

Japan Auto Parts Industries Association

If you find any counterfeit parts, please contact us at "[info@japia.or.jp](mailto:info@japia.or.jp)"





# Comparison Between Genuine DENSO and Fake Spark Plugs

## Appearance

Compare a potential counterfeit and a genuine DENSO Spark Plug side by side.



**Insulator**  
Counterfeit spark plugs have an irregular insulator shape. The shape should be uniform.



**Ground electrode**  
The width of the ground electrode is usually inconsistent on counterfeit products.



**Material**  
A scratch test can reveal the cheap materials used in counterfeit products.



**Ground electrode chip**  
Counterfeit spark plugs are prone to have cheaper or fake material coatings.



**Center electrode**  
Look out for poor quality welding.



**Branding**  
Counterfeit spark plugs lack precision when embossing the DENSO logo and often display spelling mistakes.

## Problems Caused by Fake Spark Plugs

### Problem 1

Fuel economy is diminished.



Inconsistent sparking causes incomplete combustion. Unburned fuel forms a black sooty deposit on the spark plug, eventually leading to poor fuel economy and poor start up of the engine.

### Problem 2

Engine power drops on uphill roads and highways.



Poor heat dissipation due to the lack of a copper-core center electrode causes pre-ignition. As a result, engine power drops under highway driving or uphill driving conditions.

### Problem 3

The plug melts down.



Continued usage of an overheated plug will damage the electrodes.

## Why Power Drops and Melting Occurs

### DENSO

DENSO plug contains copper core

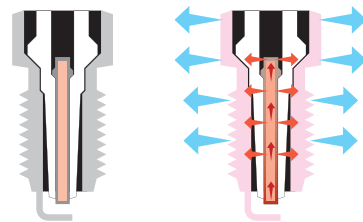

### Quick heat dissipation.

Copper is an excellent heat conductor. High temperature heat is quickly dissipated away from the center-electrode to prevent melt down.

(See below)

### Fake

Fake plug is iron only

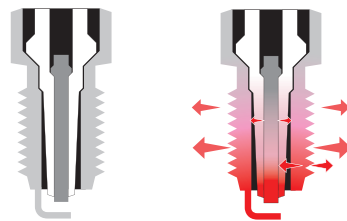

### Slow heat dissipation.

Absence of a copper-core center electrode results in poor heat dissipation capability. Prolonged use causes power loss due to excessive heat buildup. This results in melt down of the ground electrode, eventually leading to serious engine damage.

Finally ...





# AUSTRALIA CAR

▶ Spark plug color codes: ■ for Iridium Tough and Iridium Plugs and Iridium TT, ■ for Iridium Power, ■ for Iridium Racing and Two Tops Plugs, ■ for Platinum Plugs and Platinum TT, and black for general spark plugs.

Model	Engine Size	Engine Code	Specification	Year	DENSO				QTY			
<b>AUSTRALIA</b>												
<b>ABARTH</b>												
500 / 595 / 695	1.4L 4Cyl 16V	312 A1.000		2008-2016	IXU27	-	-	IXU27	4			
		312A1,312A3		2014-	IXU27	-	-	IXU27	4			
500C / 595C / 695C	1.4L 4Cyl 16V	312A1,312A3		2014-	IXU27	-	-	IXU27	4			
<b>CHINA</b>												
<b>ALFA ROMEO</b>												
147	1.6L 4Cyl 16V	AR 32104	T.SPARK	2001-2010	PK20TR11+IU22	-	IK20TT+IU22	IK20+IU22	VK20+IU22	8		
		AR 37203	T.SPARK ECO	2001-2010	PK20TR11+IU22	-	IK20TT+IU22	IK20+IU22	VK20+IU22	8		
	2.0L 4Cyl 16V	AR 32310	T.SPARK	2001-2010	IK20 / IU22	K20TT / -	IK20TT / -	IK20 / IU22	VK20 / -	8		
	3.2L 6Cyl 24V	932 A.000	GTA	2003-2010	IK20TT	K20TT	IK20TT	-	VK20Y	6		
156	2.0L 4Cyl 16V	AR32301,AR32310	T.SPARK	1997-2002	IK20 / IU22	K20TT / -	IK20TT / -	IK20 / IU22	VK20 / -	8		
		937 A1.000	JTS	2002-2006	IK20	K20TT	IK20TT	IK20	VK20	4		
	2.5L 6Cyl 24V	AR 32401	24V	1997-2002	K20PBR-S10	K20TT	IK20TT	IK20	VK20	6		
159	1.7L 4Cyl 16V	AR 32405	24V	2000-2005	IK20TT	K20TT	IK20TT	-	VK20Y	6		
		939 B1.000	TBi	2009-2012	IXEH22TT	-	IXEH22TT	-	VCH20	4		
166	2.2L 4Cyl 16V	939 A5.000	JTS	2005-2011	IK16	K16TT	IK16TT	IK16	VK16	4		
		939 A.000	JTS	2005-2011	IK16	K16TT	IK16TT	IK16	VK16	6		
		3.2L 6Cyl 24V	939 A.000	JTS	2005-2011	IK16	K16TT	IK16TT	IK16	VK16	6	
1750-2000	3.0L 6Cyl 24V	AR34301,AR34302	24V	1998-2007	IK20TT	K20TT	IK20TT	-	VK20Y	6		
		AR 36101	24V	2000-2007	IK20TT	K20TT	IK20TT	-	VK20Y	6		
4C	1.8L 4Cyl 8V	AR 00548	1750	1968-1972	W22ES-U	-	-	-	4			
		AR 10520	2000	1971-1975	W22ES-U	-	-	-	4			
MALAYSIA	1.7L 4Cyl 16V	960 A1.000	960	2013-	IXEH22TT	-	IXEH22TT	-	VCH20	4		
		ALFETTA	2.0L 4Cyl 8V	AR 01623	116	1977-1980	W22ES-U	-	-	4		
		BRERA	2.2L 4Cyl 16V	939 A5.000	JTS	2006-2011	IK16	K16TT	IK16TT	IK16	VK16	4
			3.2L 6Cyl 24V	939 A.000	JTS	2006-2011	IK16	K16TT	IK16TT	IK16	VK16	6
PHILIPPINES	1.4L 4Cyl 16V	940 A2.000	TB	2010-	IXU27	-	-	IXU27	4			
		198A4,940B7	TB	2013-2014	IXU27	-	-	IXU27	4			
	1.7L 4Cyl 16V	940 A1.000	TBi	2010-2016	IXEH22TT	-	IXEH22TT	-	VCH20	4		
		960A1,940B2	TBi	2013-	IXEH22TT	-	IXEH22TT	-	VCH20	4		
1.8L 4Cyl 8V	AR 01678	116	1979-1985	W22ES-U	-	-	-	4				
SAUDI ARABIA	2.0L 4Cyl 16V	932A2,937A1	JTS	2003-2010	IK20	K20TT	IK20TT	IK20	VK20	4		
		936 A.000	GTA	2003-2010	IK20TT	K20TT	IK20TT	-	VK20Y	6		
SINGAPORE	2.0L 4Cyl 16V	AR16201,AR32310	T.SPARK 16V	1995-2005	IK20 / IU22	K20TT / -	IK20TT / -	IK20 / IU22	VK20 / -	8		
		AR 32301	T.SPARK 16V	1997-2003	IK20TT+IU22	-	IK20TT+IU22	IK20+IU22	VK20+IU22	8		
	3.0L 6Cyl 24V	AR 16102	24V	1996-2000	IK20TT	K20TT	IK20TT	-	VK20Y	6		
		AR 16105	24V	2000-2005	IK20TT	K20TT	IK20TT	-	VK20Y	6		
TAIWAN	1.4L 4Cyl 16V	198 A4.000	TJet	2008-2010	IXU27	-	-	IXU27	4			
		199 A8.000	TJet	2008-2011	IXU27	-	-	IXU27	4			
	940 A2.000	MultiAir	2009-2015	IXU27	-	-	IXU27	-	4			
		955A2,955A7	Turbo MultiAir	2009-2015	IXU27	-	-	IXU27	-	4		
THAILAND	2.0L 4Cyl 16V	AR16201,AR32310	T.SPARK 16V	1995-2005	IK20 / IU22	K20TT / -	IK20TT / -	IK20 / IU22	VK20 / -	8		
		AR 32301	T.SPARK 16V	1998-2000	IK20TT+IU22	-	IK20TT+IU22	IK20+IU22	VK20+IU22	8		
	2.2L 4Cyl 16V	939 A5.000	JTS	2006-2011	IK16	K16TT	IK16TT	IK16	VK16	4		
3.0L 6Cyl 24V	AR 16102	24V	1999-2003	IK20TT	K20TT	IK20TT	-	VK20Y	6			
<b>Vietnam</b>												
<b>ASTON MARTIN</b>												
DB9	5.9L 12Cyl 48V	AM3		2004-2012	IT20	T20TT	IT20TT	IT20	-	12		
		AM3	V12	2004-2016	IT20	T20TT	IT20TT	IT20	-	12		
DBS	4.0L 6Cyl 12V	AJ6		1966-1972	W20EP-U	W20TT	IW20TT	IW20	VW20T	6		
		40HA3		1968-1972	IW16	W16TT	IW16TT	IW16	-	8		
<b>Vietnam</b>												
<b>AUDI</b>												
80	1.8L 4Cyl 8V	SD	B3,89,89Q,8A	1986-1990	W20EPBR-S	W20TT	IW20TT	IW20	-	4		
		JN,PM,NE,JV	B3,89,89Q,8A	1986-1991	W20EPB	W20TT	IW20TT	IW20	-	4		
	2.0L 4Cyl 8V	ABT	B4,8C2	1991-1994	W20EPBR-S	W20TT	IW20TT	IW20	-	4		
		ABK	B4,8C2	1991-1994	W20EPBR-S	W20TT	IW20TT	IW20	VW20T	4		
	2.6L 6Cyl 12V	ABC	B4,8C2	1992-1994	K20PBR-S10	K20TT	IK20TT	IK20	VK20	6		
	100	2.1L 5Cyl 10V	WB	C2,43	1977-1982	W20EP-U	W20TT	IW20TT	IW20	-	5	
WC			C2,43	1977-1982	W20EP-U	W20TT	IW20TT	IW20	-	5		
2.2L 5Cyl 20V		AAN	C4,4A2, S4 Turbo	1991-1994	VK22	-	-	IK22	VK22	5		
		NF	C3,44Q,44	1986-1990	IW16	W16TT	IW16TT	IW16	-	5		
2.3L 5Cyl 10V		AAR	C4,4A2	1990-1994	IW16	W16TT	IW16TT	IW16	-	5		
2.6L 6Cyl 12V	ABC	C4,4A2	1992-1994	K20PBR-S10	K20TT	IK20TT	IK20	VK20	6			
	2.8L 6Cyl 12V	AAH	C4,4A2	1990-1994	K20PBR-S10	K20TT	IK20TT	IK20	VK20	6		
A1	1.4L 4Cyl 16V	CAXA,CNVA	8XK,8X1	2010-2015	IK20L	-	-	IK20L	-	4		
		CAXA,CNVA	8XA,8XF	2011-2015	IK20L	-	-	IK20L	-	4		
		CAVG,CTHG,CTJA	8XA,8XF	2011-2015	VKA20	-	-	-	VKA20	4		
		CAVG,CTHG,CTJA	8XK,8X1	2011-2015	VKA20	-	-	-	VKA20	4		
1.8L 4Cyl 16V	DAJB	8XA,8XF	2015-2018	VKH22	-	-	IKH22	VKH22	4			
	1.4L 4Cyl 16V	CMSA,CAXC	8PA	2007-2013	IK20L	-	-	IK20L	-	4		
CPTA		8VF,8VA	2013-2014	IK20L	-	-	IK20L	-	4			









# AUSTRALIA CAR

▶ Spark plug color codes: ■ for Iridium Tough and Iridium Plugs and Iridium TT, ■ for Iridium Power, ■ for Iridium Racing and Two Tops Plugs, ■ for Platinum Plugs and Platinum TT, and black for general spark plugs.

Model	Engine Size	Engine Code	Specification	Year	DENSO					QTY	
AUSTRALIA CHINA INDIA INDONESIA KOREA MALAYSIA PHILIPPINES SAUDIARABIA SINGAPORE TAIWAN THAILAND VIETNAM JAPAN EUROPE & USA CROSS REFERENCE NUMBER	AUDI A4	APS,ARJ,AGA,ALF,AML	B5,8D2	1997-2000	K20TXR	K20TT	IK20TT	IK20	VK20	6	
		APS,ARJ,AGA,ALF,AML	B5,8D5	1997-2001	K20TXR	K20TT	IK20TT	IK20	VK20	6	
		BDV	B6,8E2	2001-2004	K20TXR	K20TT	IK20TT	IK20	VK20	6	
		AMM	B6,8E5	2001-2004	K20TXR	K20TT	IK20TT	IK20	VK20	6	
		BDV	B6,8E5	2001-2004	K20TXR	K20TT	IK20TT	IK20	VK20	6	
		BDV	B6,8H7,B7,8HE	2002-2005	K20TXR	K20TT	IK20TT	IK20	VK20	6	
		ABC	B5,8D2	1995-2000	K20PBR-S10	K20TT	IK20TT	IK20	VK20	6	
		ABC	B5,8D5	1995-2001	K20PBR-S10	K20TT	IK20TT	IK20	VK20	6	
		AZR,ASJ	RS4 B5,8D5	2000-2001	VK22	-	-	IK22	VK22	6	
		ATQ,ACK,AMX,APR,AHA,ALG,AQD	B5,8D2	1996-2001	K20TXR	K20TT	IK20TT	IK20	VK20	6	
		S4 B8,8K2	2008-2015	IK24	-	-	IK24	-	6		
		S4 B8,8K5	2008-2015	IK24	-	-	IK24	-	6		
		ASN	B6,8E2	2000-2004	K20TXR	K20TT	IK20TT	IK20	VK20	6	
		BBJ	B6,8E2	2001-2004	K20TXR	K20TT	IK20TT	IK20	VK20	6	
		ASN	B6,8E5	2001-2004	K20TXR	K20TT	IK20TT	IK20	VK20	6	
		ASN	B6,8H7,B7,8HE	2002-2005	K20TXR	K20TT	IK20TT	IK20	VK20	6	
		BBJ	B7,8EC	2004-2006	K20TXR	K20TT	IK20TT	IK20	VK20	6	
		AUK	B7,8EC	2005-2008	IK22	-	-	IK22	VK22	6	
		AUK	B6,8H7,B7,8HE	2006-2009	IK22	-	-	IK22	VK22	6	
		CALA	B8,8K2	2007-2012	IK20TT	K20TT	IK20TT	IK20	VK20	6	
		BNS	RS4 B7,8EC	2005-2008	IK22	-	-	IK22	VK22	8	
		BNS	RS4 B7,8ED	2005-2008	IK22	-	-	IK22	VK22	8	
		BNS	RS4 B6,8H7,B7,8HE	2006-2009	IK22	-	-	IK22	VK22	8	
		BBK	S4 B6,8E2	2003-2004	K20TXR	K20TT	IK20TT	IK20	VK20	8	
		BBK	S4 B6,8E5	2003-2004	K20TXR	K20TT	IK20TT	IK20	VK20	8	
		BBK	S4 B7,8ED	2004-2008	K20TXR	K20TT	IK20TT	IK20	VK20	8	
		BBK,BHF	S4 B6,8H7,B7,8HE	2004-2009	K20TXR	K20TT	IK20TT	IK20	VK20	8	
		A5	CABD,CJEB	8T3	2007-2017	VKH22	-	-	IKH22	VKH22	4
			CJEB	8F7	2011-2016	VKH22	-	-	IKH22	VKH22	4
			CJEB	8TA	2011-2017	VKH22	-	-	IKH22	VKH22	4
			CDNB	8T3	2008-2012	IK22	-	-	IK22	VK22	4
			CDNC	8T3	2008-2013	IK22	-	-	IK22	VK22	4
			CDNC,CPMA,CAEB	8T3	2008-2017	IK22	-	-	IK22	VK22	4
			CDNB,CAEA	8F7	2009-2012	IK22	-	-	IK22	VK22	4
			CDNC,CAEB	8F7	2009-2014	IK22	-	-	IK22	VK22	4
			CDNB	8TA	2009-2014	IK22	-	-	IK22	VK22	4
			CDNC,CPMA,CAEB	8F7	2009-2017	IK22	-	-	IK22	VK22	4
			CDNC	8TA	2009-2017	IK22	-	-	IK22	VK22	4
			CNCD	8F7	2013-2016	VKH22	-	-	IKH22	VKH22	4
			CNCD	8TA	2013-2016	VKH22	-	-	IKH22	VKH22	4
			S5 8F7	2009-2017	IK24	-	-	IK24	-	6	
			CTDA,CGWC,CAKA,CREC	S5 8TA	2010-2017	IK24	-	-	IK24	-	6
CMUA,CRED	8F7		2011-2017	IK24	-	-	IK24	-	6		
CMUA,CRED,CHMB	8T3		2011-2017	IK24	-	-	IK24	-	6		
CALA	8T3		2007-2012	IK20TT	K20TT	IK20TT	IK20	VK20	6		
CALA	8F7		2009-2012	IK20TT	K20TT	IK20TT	IK20	VK20	6		
A6	CAUA		S5 8T3	2007-2012	VKB20	-	-	-	VKB20	8	
	BPJ	C6,4F2	2005-2011	IK22	-	-	IK22	VK22	4		
	BPJ	C6,4F5	2005-2011	IK22	-	-	IK22	VK22	4		
	CDNB	C7,4GC,4G2	2011-2018	IK22	-	-	IK22	VK22	4		
	CDNB	C7,4GD,4G5	2011-2018	IK22	-	-	IK22	VK22	4		
	BDW	C6,4F2	2004-2008	IK20TT	K20TT	IK20TT	IK20	VK20	6		
	APS,ARJ,AGA,ALF,AML	C5,4B2	1997-2005	K20TXR	K20TT	IK20TT	IK20	VK20	6		
	BDV	C5,4B2	2001-2005	K20TXR	K20TT	IK20TT	IK20	VK20	6		
	ABC	C4,4A2	1994-1997	K20PBR-S10	K20TT	IK20TT	IK20	VK20	6		
	ABC	C4,4A5	1994-1997	K20PBR-S10	K20TT	IK20TT	IK20	VK20	6		
	ARE,BES	C5,4B2	2001-2005	IK20TT	K20TT	IK20TT	-	VK20Y	6		
	CCEA	C6,4F2	2008-2011	IK20TT	K20TT	IK20TT	IK20	VK20	6		
	CHVA	C7,4GC,4G2	2010-2015	IK20TT	K20TT	IK20TT	IK20	VK20	6		
	ACK	C4,4A2	1995-1997	K20TXR	K20TT	IK20TT	IK20	VK20	6		
	ACK,AMX,APR,ALG,AQD	C5,4B2	1997-2005	K20TXR	K20TT	IK20TT	IK20	VK20	6		
	ATQ,ACK,AMX,APR,ALG,AQD	C5,4B2	1997-2005	K20TXR	K20TT	IK20TT	IK20	VK20	6		
	ATQ,ACK,AMX,APR,ALG,AQD	C5,4B5	1997-2005	K20TXR	K20TT	IK20TT	IK20	VK20	6		
	CAJA	C6,4F2	2008-2011	IK24	-	-	IK24	-	6		
CGXB,CTUA,CGWD	C7,4GC,4G2	2011-2018	IK24	-	-	IK24	-	6			
ASN	C5,4B2	2001-2005	K20TXR	K20TT	IK20TT	IK20	VK20	6			
BBJ	C6,4F2	2004-2006	K20TXR	K20TT	IK20TT	IK20	VK20	6			

Model	Engine Size	Engine Code	Specification	Year	DENSO					QTY	
<b>AUDI</b>											
<b>A6</b>	3.0L 6Cyl 30V	BBJ	C6,4F5	2005-2006	K20TXR	K20TT	IK20TT	IK20	VK20	6	AUSTRALIA CHINA INDIA INDONESIA KOREA MALAYSIA PHILIPPINES SAUDIARABIA SINGAPORE TAIWAN THAILAND VIETNAM JAPAN EUROPE & USA CROSS PART REFERENCE NUMBER
		AUK	C6,4F2	2004-2008	IK22	-	-	IK22	VK22	6	
	3.1L 6Cyl 24V	AUK,BKH	C6,4F2	2004-2009	IK22	-	-	IK22	VK22	6	
		AUK,BKH	C6,4F5	2005-2008	IK22	-	-	IK22	VK22	6	
	4.2L 8Cyl 40V	ART,AWN,ASG,ARS	C5,4B2	1998-2005	K20TXR	K20TT	IK20TT	IK20	VK20	8	
		ASG,ARS	C5,4B5	1998-2005	K20TXR	K20TT	IK20TT	IK20	VK20	8	
		BCY	RS6 C5,4B2	2002-2005	VK22	-	-	IK22	VK22	8	
		BAT,BNK	C6,4F2	2004-2006	K20TXR	K20TT	IK20TT	IK20	VK20	8	
		BAT	C6,4F5	2005-2006	K20TXR	K20TT	IK20TT	IK20	VK20	8	
	5.0L 10Cyl 40V	BUH	RS6 C6,4F5	2008-2010	IK20TT	K20TT	IK20TT	-	VK20Y	10	
5.2L 10Cyl 40V	BXA	S6 C6,4F2	2006-2011	VKB20	-	-	-	VKB20	10		
<b>A6 Allroad</b>	4.2L 8Cyl 32V	BVJ	C6,4FH	2006-2010	VKB20	-	-	-	VKB20	8	
<b>A7</b>	3.0L 6Cyl 24V	CHMA,CGWB	4GA,4GF	2010-2012	IK24	-	-	IK24	-	6	
<b>A8</b>	3.1L 6Cyl 24V	BPK	4E8,4E2	2005-2010	IK22	-	-	IK22	VK22	6	
	3.7L 8Cyl 40V	BFL	4E8,4E2	2002-2006	K20TXR	K20TT	IK20TT	IK20	VK20	8	
		AKG,ABZ	4D2,4D8	1994-2000	T20EPR-U	T20TT	IT20TT	IT20	-	8	
	4.2L 8Cyl 32V	CDRA	4H2,4HL,4H8,4HC	2009-2012	VKB20	-	-	-	VKB20	8	
		AQF,AUX,AUW	4D2,4D8	1998-2005	K20TXR	K20TT	IK20TT	IK20	VK20	8	
	4.2L 8Cyl 40V	BFM	4E8,4E2	2002-2010	K20TXR	K20TT	IK20TT	IK20	VK20	8	
<b>ALLROAD</b>											
	2.7L 6Cyl 30V	ARE,BES	C5,4BH	2000-2005	IK20TT	K20TT	IK20TT	-	VK20Y	6	
	4.2L 8Cyl 40V	BAS	C5,4BH	2002-2005	K20TXR	K20TT	IK20TT	IK20	VK20	8	
<b>CABRIOLET</b>											
	2.6L 6Cyl 12V	ABC	8G7,B4	1993-2000	K20PBR-S10	K20TT	IK20TT	IK20	VK20	6	
<b>Q3</b>	2.0L 4Cyl 16V	CCZC	8UG,8UB	2011-2015	IK22	-	-	IK22	VK22	4	
		CPSA	8UG,8UB	2011-2015	IK22	-	-	IK22	VK22	4	
		CULB	8UG,8UB	2014-2018	VKH22	-	-	IKH22	VKH22	4	
<b>Q5</b>	2.0L 4Cyl 16V	CDNC,CAEB	8RB	2008-2012	IK22	-	-	IK22	VK22	4	
		CNCD	8RB	2012-2017	VKH22	-	-	IKH22	VKH22	4	
	3.0L 6Cyl 24V	CTUC,CTVA	8RB	2012-2017	IK24	-	-	IK24	-	6	
	3.2L 6Cyl 24V	CALB	8RB	2008-2012	IK20TT	K20TT	IK20TT	IK20	VK20	6	
<b>Q7</b>	3.0L 6Cyl 24V	CJT,CTWA,CJWB,CNAA	4LB	2010-2015	IK24	-	-	IK24	-	6	
	4.2L 8Cyl 32V	BAR	4LB	2006-2010	VKB20	-	-	-	VKB20	8	
<b>R8</b>	4.2L 8Cyl 32V	BYH	423422	2007-2010	IK22	-	-	IK22	VK22	8	
<b>TT</b>											
	1.8L 4Cyl 16V	CDA A	8J3	2008-2014	IK22	-	-	IK22	VK22	4	
		AJQ,APP,AUQ,ATC	8N3	1998-2006	IK20TT	K20TT	IK20TT	-	VK20Y	4	
	1.8L 4Cyl 20V	APX,BEA,BAM	8N3	1998-2006	IK20TT	K20TT	IK20TT	-	VK20Y	4	
		AJQ,APP,AUQ,ATC	8N9	1999-2006	IK20TT	K20TT	IK20TT	-	VK20Y	4	
		APX,BEA,BAM	8N9	1999-2006	IK20TT	K20TT	IK20TT	-	VK20Y	4	
	2.0L 4Cyl 16V	BWA	8J3	2006-2010	IK22	-	-	IK22	VK22	4	
		BWA	8J9	2007-2010	IK22	-	-	IK22	VK22	4	
		CDLB	TTS 8J3	2008-2014	IK22	-	-	IK22	VK22	4	
		CDLB	TTS 8J9	2008-2014	IK22	-	-	IK22	VK22	4	
		CESA	8J3	2010-2014	IK22	-	-	IK22	VK22	4	
		CESA,CETA	8J3	2010-2014	IK22	-	-	IK22	VK22	4	
		CESA	8J9	2010-2014	IK22	-	-	IK22	VK22	4	
		CHHC	FV3,FVP	2014-	VKH22	-	-	IKH22	VKH22	4	
		CHHC	FV9,FVR	2014-	VKH22	-	-	IKH22	VKH22	4	
	CJXF	TTS FV3,FVP	2015-	VKH22	-	-	IKH22	VKH22	4		
	2.5L 5Cyl 20V	CEPA	RS 8J3	2009-2014	VKH22	-	-	IKH22	VKH22	5	
	3.2L 6Cyl 24V	BHE	VR6 8N3	2003-2006	IK20TT	K20TT	IK20TT	-	VK20Y	6	
<b>AUSTIN</b>											
<b>MINI</b>											
	0.8L 4Cyl 8V	BMC Serie A	850	1959-1986	W20EP-U	W20TT	IW20TT	IW20	-	4	
		99 H	1000	1967-1984	W20EP-U	W20TT	IW20TT	IW20	-	4	
			1000	1967-1984	W20EP-U	W20TT	IW20TT	IW20	-	4	
<b>BEDFORD</b>											
<b>CF</b>											
	2.0L 4Cyl 8V	20 N	CF97	1985-1987	T20P-U	-	ITF20TT	ITF20	-	4	
	2.3L 4Cyl 8V	23 L	CF97	1980-1983	T20P-U	-	ITF20TT	ITF20	-	4	
<b>BENTLEY</b>											
<b>CONTINENTAL</b>											
	6.7L 8Cyl 16V	L 410 M1T3	T Mulliner	1999-2002	IK16	K16TT	IK16TT	IK16	VK16	8	
<b>BMW</b>											
<b>1</b>	1.6L 4Cyl 16V	N45 B16 A	116 i E87	2004-2011	K20TXR	K20TT	IK20TT	IK20	VK20	4	
		N13 B16 A	116 i F20	2011-2015	IXUH22	-	-	IXUH22	VXUH22	4	
		N13 B16 A	118 i F20	2011-2015	IXUH22	-	-	IXUH22	VXUH22	4	
		N13 B16 A	120 i F20	2015-2016	VXUH22	-	-	IXUH22	VXUH22	4	
	2.0L 4Cyl 16V	N46 B20 B	118 i E87	2004-2011	IK20TT	K20TT	IK20TT	IK20	VK20	4	
		N46 B20	120 i E87	2004-2011	IK20TT	K20TT	IK20TT	IK20	VK20	4	
	3.0L 6Cyl 24V	N52 B30	130 i E87	2005-2007	IKH20TT	-	IKH20TT	IKH20	VKH20	6	
		N52 B30	125 i E88	2007-2013	IKH20TT	-	IKH20TT	IKH20	VKH20	6	

DENSO	9	14	16	20	22	24	27	29	31	32	34	35	DENSO	9	14	16	20	22	24	27	31	32	DENSO	9	14	16	20	22	24	27	31	
NGK	2	4	5	6	7	8	9	9.5	10	10.5	11	11.5	CHAMPION	18	16,14	12,11	10,9	8,7	6,6,3,61	4,59	57	55	53	BOSCH	10	9	8	7,6	5	4	3	2







# AUSTRALIA CAR

▶ Spark plug color codes: ■ for Iridium Tough and Iridium Plugs and Iridium TT, ■ for Iridium Power, ■ for Iridium Racing and Two Tops Plugs, ■ for Platinum Plugs and Platinum TT, and black for general spark plugs.

Model	Engine Size	Engine Code	Specification	Year	DENSO					QTY
<b>AUSTRALIA</b>										
<b>BMW</b>										
Z4	3.0L 6Cyl 24V	N52B30	E85	2006-2008	IKH20TT	-	IKH20TT	IKH20	VKH20	6
		N52 B30 A	E86	2006-2008	IKH20TT	KH20TT	IKH20TT	IKH20	VKH20	6
	3.2L 6Cyl 24V	N52 B30	sDrive 30 i E89	2009-2011	IKH20TT	KH20TT	IKH20TT	IKH20	VKH20	6
		S54 B32 (326S4)	M E85	2006-2008	IXU24	-	-	IXU24	-	6
<b>CHINA</b>										
<b>CADILLAC</b>										
CTS	3.6L 6Cyl 24V	LLT	VVTi	2008-2012	ITV20	-	ITV20TT	ITV20	-	6
DEVILLE	4.9L 8Cyl 16V	L26(299CUV8)		1993-1995	T20EPR-U15	T20TT	IT20TT	IT20	-	8
SEVILLE	4.1L 8Cyl 16V	LT8		1982-1985	T20EPR-U15	T20TT	IT20TT	IT20	-	8
<b>INDIA</b>										
<b>CHERY</b>										
J11	2.0L 4Cyl 16V	SQR484F		2006-2009	IK22	-	-	IK22	VK22	4
<b>INDONESIA</b>										
<b>CHEVROLET</b>										
CAMARO	3.4L 6Cyl 12V	L32		1992-1998	T20PR-U	-	ITF20TT	ITF20	-	6
CORVETTE	5.4L 8Cyl 16V		C2	1962-1967	W16PR-U	-	-	-	-	8
	7.0L 8Cyl 16V		C2	1964-1967	W16EPR-U	W16TT	IW16TT	IW16	VW16	8
SILVERADO 1500	5.3L 8Cyl 16V	LM7	Hybrid	2003-2007	IT16TT	-	IT16TT	IT16	VT16	8
<b>KOREA</b>										
<b>CHRYSLER</b>										
300C	3.5L 6Cyl 24V	EGG	LE,LX	2004-2012	IK16	K16TT	IK16TT	IK16	VK16	6
	3.6L 6Cyl 24V	ERB		2011-	VXUHC22G	-	-	-	VXUHC22G	6
	5.7L 8Cyl 16V	EZB,EZD,EZH	LE,LX	2004-2010	ITL16	-	ITL16TT	ITL16	-	8
	6.1L 8Cyl 16V	ESF	SRT8 LE,LX	2005-2012	ITL16	-	ITL16TT	ITL16	-	16
CROSSFIRE	3.2L 6Cyl 18V	EGX		2003-2008	IK20TT	K20TT	IK20TT	IK20	VK20	12
		EGZ	SRT-6	2004-2007	IK20TT	K20TT	IK20TT	IK20	VK20	12
GRAND VOYAGER	3.8L 6Cyl 12V	EGL	RT	2007-2011	ITL16	-	ITL16TT	ITL16	-	6
NEON	2.0L 4Cyl 16V	420H	PL	1994-1999	K20PR-U	K20TT	IK20TT	IK20	VK20	4
		ECB,420H		1999-2006	K20PR-U	K20TT	IK20TT	IK20	VK20	4
PT CRUISER	1.6L 4Cyl 16V	EJD	PT_	2001-2010	K20R-U	K20TT	IK20TT	IK20	VK20	4
	2.0L 4Cyl 16V	ECC	PT	2000-2004	ITL16	-	ITL16TT	ITL16	-	4
	2.4L 4Cyl 16V	EDZ		2004-2008	ITL16	-	ITL16TT	ITL16	-	4
SEBRING	2.4L 4Cyl 16V	ED3,EDG	VVT JS	2007-2010	KJ16CR-L11	K16TT	IK16TT	IK16L	-	4
		2.7L 6Cyl 24V	EER	JS	2007-2010	ITL16TT	-	ITL16TT	ITL16	-
VALIANT	3.5L 6Cyl 12V		VH	1971-1974	W16EP-U	W16TT	IW16TT	IW16	VW16	6
			VG	1970-1972	W16EP-U	W16TT	IW16TT	IW16	VW16	6
	4.0L 6Cyl 12V		CL	1977-1982	W16EP-U	W16TT	IW16TT	IW16	VW16	6
			CM	1978-1982	W16EPR-U	W16TT	IW16TT	IW16	-	6
			CM	1978-1982	W16EP-U	W16TT	IW16TT	IW16	VW16	6
5.2L 8Cyl 16V		CL	1976-1981	W16EP-U	W16TT	IW16TT	IW16	VW16	8	
VOYAGER	3.3L 6Cyl 12V	R00	GS	1995-2001	IW16TT	-	IW16TT	IW16	VW16	6
		EGA	RS,RG	2000-2008	ITL16	-	ITL16TT	ITL16	-	6
		EGA,EGM	RS,RG	2000-2008	ITL16	-	ITL16TT	ITL16	-	6
<b>TAIWAN</b>										
<b>THAILAND</b>										
<b>CITROEN</b>										
BERLINGO	1.4L 4Cyl 8V	TU3JP,TU3A	M	1996-2011	K20PR-U	K20TT	IK20TT	IK20	VK20	4
	1.6L 4Cyl 16V	NFR (TU5JP4B)	B9	2008-2014	K20HR-U11	KH20TT	IKH20TT	IKH20	VKH20	4
BERLINGO MULTISPACE	1.6L 4Cyl 16V	NFR (TU5JP4B)	B9	2008-2014	K20HR-U11	KH20TT	IKH20TT	IKH20	VKH20	4
BX	1.6L 4Cyl 8V	XU52C	XB	1982-1992	T20EP-U	T20TT	IT20TT	IT20	-	4
C2	1.6L 4Cyl 16V	NFS (TU5JP4S)	VTS JM	2004-2009	K20HR-U11	KH20TT	IKH20TT	IKH20	VKH20	4
C3	1.4L 4Cyl 8V	TU3JP,TU3A	FC	2002-2010	K20PR-U	K20TT	IK20TT	IK20	VK20	4
		TU3A,TU3AE5	SC_	2009-2011	K20PR-U	K20TT	IK20TT	IK20	VK20	4
	1.6L 4Cyl 16V	NFU (TU5JP4)	FC	2002-2010	K20HR-U11	KH20TT	IKH20TT	IKH20	VKH20	4
C4	1.6L 4Cyl 16V	5FS (EP6C)	VTi 120 A3	2009-2014	VXUH22	-	-	IXUH22	VXUH22	4
		NFU (TU5JP4)	LC	2004-2011	K20HR-U11	KH20TT	IKH20TT	IKH20	VKH20	4
		5FV (EP6CDT)	THP 155 B7	2009-2013	VXUH22	-	-	IXUH22	VXUH22	4
C4 Grand Picasso	2.0L 4Cyl 16V	5FS (EP6C)	VTi 120 B7	2009-2015	VXUH22	-	-	IXUH22	VXUH22	4
		RFJ (EW10A)	LC	2004-2011	K16HPR-U11	KH16TT	IKH16TT	IKH16	VKH16	4
C4 Picasso	2.0L 4Cyl 16V	RFJ (EW10A)	16V UA	2006-2013	K16HPR-U11	KH16TT	IKH16TT	IKH16	VKH16	4
C5	2.0L 4Cyl 16V	5GZ (EP6FDT)	THP 165	2014-	VXUH22	-	-	IXUH22	VXUH22	4
		RFJ (EW10A)	16V UD	2007-2013	K16HPR-U11	KH16TT	IKH16TT	IKH16	VKH16	4
		RFN (EW10J4)	DC	2001-2004	K16HPR-U11	KH16TT	IKH16TT	IKH16	VKH16	4
		RFN (EW10J4)	DE	2001-2004	K16HPR-U11	KH16TT	IKH16TT	IKH16	VKH16	4
		RFJ (EW10A)	RC	2004-2008	K20HR-U11	KH20TT	IKH20TT	IKH20	VKH20	4
DS3	1.6L 4Cyl 16V	RFJ (EW10A)	RE	2004-2016	K16HPR-U11	KH16TT	IKH16TT	IKH16	VKH16	4
		RFJ (EW10A)	RD	2008-2008	K16HPR-U11	KH16TT	IKH16TT	IKH16	VKH16	4
		XFX (ES9J4S)	DC	2001-2004	IKH16TT	-	IKH16TT	IKH16	VKH16	6
DS3	1.6L 4Cyl 16V	5FR(EP6DT),5FV(EP6CDT)	THP 155	2010-2015	VXUH22	-	-	IXUH22	VXUH22	4
		5FS (EP6C)	VTi 120	2010-2015	VXUH22	-	-	IXUH22	VXUH22	4







# AUSTRALIA CAR

▶ Spark plug color codes: ■ for Iridium Tough and Iridium Plugs and Iridium TT, ■ for Iridium Power, ■ for Iridium Racing and Two Tops Plugs, ■ for Platinum Plugs and Platinum TT, and black for general spark plugs.

Model	Engine Size	Engine Code	Specification	Year	DENSO					QTY
<b>AUSTRALIA</b>										
<b>DODGE</b>										
CALIBER	2.0L 4Cyl 16V	ECN		2006-2012	KJ16CR-L11	K16TT	IK16TT	IK16	VK16	4
JOURNEY	2.7L 6Cyl 24V	EER	JC	2009-2011	ITL16	-	ITL16TT	ITL16	-	6
	3.6L 6Cyl 24V	ERB	JC	2012-2015	VXUHC22G	-	-	-	VXUHC22G	6
<b>CHINA</b>										
<b>NITRO</b>										
EUNOS	3.7L 6Cyl 12V	EKG		2007-2012	IK20TT	K20TT	IK20TT	IK20	VK20	6
<b>INDIA</b>										
<b>500</b>										
	2.0L 6Cyl 24V	KF27		1992-1999	K20PR-U11	K20TT	IK20TT	IK20	VK20	6
<b>800</b>										
	2.3L 6Cyl 24V	KJY5	Miller TA,E65	1993-1996	IK16TT	K16TT	IK16TT	IK16	VK16	6
	2.5L 6Cyl 24V	KL-ZE	TA,E65	1994-1998	KJ16CR-L11	K16TT	IK16TT	IK16L	-	6
<b>INDONESIA</b>										
<b>FERRARI</b>										
<b>360</b>										
		F 131 B40	Modena F131	1999-2005	IU24	-	-	IU24	-	8
	3.6L 8Cyl 40V	F 131 B40	F131	2000-2005	IU24	-	-	IU24	-	8
		F 131 B44	Modena F131	2002-2005	IU24	-	-	IU24	-	8
<b>456 GT/GTA</b>										
	5.5L 12Cyl 48V	F 116 B 00		1993-2004	IXU27	-	-	IXU27	-	12
<b>599 GTB/GTO</b>										
	6.0L 12Cyl 48V	F134FB61	GTB	2006-2011	IU24	-	-	IU24	-	12
<b>KOREA</b>										
<b>F355</b>										
	3.5L 8Cyl 40V	F 129B/40		1995-2000	IU22	-	-	IU22	-	8
<b>F430</b>										
	4.3L 8Cyl 32V	F 131 B47		2007-2009	IU24	-	-	IU24	-	8
<b>FIAT</b>										
<b>125</b>										
	1.6L 4Cyl 8V	125 A.000	125	1967-1974	W20EP-U	W20TT	IW20TT	IW20	VW20T	4
		125 B.000	125	1968-1973	W22EP-U	W22TT	-	IW22	VW22	4
<b>127</b>										
	0.9L 4Cyl 8V	100 GL.048	127	1971-1983	W20EP-U	W20TT	IW20TT	IW20	VW20T	4
<b>128</b>										
	1.3L 4Cyl 8V	128 A1.000	Sport 128	1974-1984	W20EP-U	W20TT	IW20TT	IW20	-	4
<b>500</b>										
	0.5L 2Cyl 4V	110F.000		1965-1975	W20FP-U	WF20TT	-	IWF20	-	2
	0.6L 2Cyl 4V			1968-1976	W22FP-U	-	-	IWF22	-	2
	1.2L 4Cyl 8V	169 A4.000	312	2007-	XU22EPR-U	XU22TT	-	IXU22	VXU22	4
	1.4L 4Cyl 16V	169 A3.000	312	2007-2017	XU22EPR-U	XU22TT	-	IXU22	VXU22	4
<b>600</b>										
	0.6L 4Cyl 8V			1955-1961	W20FP-U	WF20TT	-	IWF20	-	4
<b>500 C</b>										
	1.4L 4Cyl 16V	169 A3.000	312	2009-2017	XU22EPR-U	XU22TT	-	IXU22	VXU22	4
<b>CROMA</b>										
	2.0L 4Cyl 8V	154C3.046,834B.146	2000 i.e. 154	1987-1996	W22EPR-U	W22TT	-	IW22	VW22	4
<b>DOBLO</b>										
	1.4L 4Cyl 16V	843 A1.000	263	2010-2018	XU22EPR-U	XU22TT	-	IXU22	VXU22	4
<b>FREEMONT</b>										
	2.4L 4Cyl 16V	ED3,EDG	345	2011-2016	IK16TT	K16TT	IK16TT	IK16	VK16	4
<b>PANDA</b>										
	1.2L 4Cyl 8V	169 A4.000	150	2012-2015	XU22EPR-U	XU22TT	-	IXU22	VXU22	4
<b>PUNTO</b>										
	1.1L 4Cyl 8V	176A6,176B2	55 176_	1993-1999	K20PR-U	K20TT	IK20TT	IK20	VK20	4
	1.2L 4Cyl 8V	188 A4.000	60 188_	1999-2010	K16PR-U	K16TT	IK16TT	IK16	VK16	4
	1.4L 4Cyl 8V	350 A1.000	199	2005-2015	XU22EPR-U	XU22TT	-	IXU22	VXU22	4
<b>RITMO</b>										
	1.4L 4Cyl 16V	198 A1.000	T-Jet 198	2007-2014	IXU27	-	-	IXU27	-	4
<b>STILO</b>										
	2.4L 5Cyl 20V	192 A2.000	20V 192_	2001-2007	K20TNR	K20TT	IK20TT	IK20	VK20	5
<b>X 1/9</b>										
	1.3L 4Cyl 8V	128 AS.000	128	1975-1978	W20EPR-U	W20TT	IW20TT	IW20	VW20T	4
<b>FORD</b>										
<b>CAPRI</b>										
	1.6L 4Cyl 16V	B6 (DOHC 16 V)	SA,SB,SC,SE,	1989-1994	K16PR-U11	K16TT	IK16TT	IK16	VK16	4
		B6T	Turbo SA,SB,SC,SE,	1989-1994	K20PR-U11	K20TT	IK20TT	IK20	VK20	4
			1600 GT ECJ	1969-1972	W20EXR-U	W20TT	IW20TT	IW20	-	4
	1.6L 4Cyl 8V			1969-1974	W20EXR-U	W20TT	IW20TT	IW20	-	4
		B6 (8 V)	8V SA	1989-1990	W16EXR-U11	W16TT	IW16TT	IW16	VW16	4
	2.0L 6Cyl 12V	NYL,NWN	GECP	1976-1977	W20EPR-U	W20TT	IW20TT	IW20	-	6
		NYL	GECP	1978-1982	MA20P-U	-	-	-	-	6
<b>VIETNAM</b>										
<b>CORSAIR</b>										
	2.0L 4Cyl 8V	CA20E	UA (Twin spark)	1989-1992	K20PR-U11 / K16PR-U11	K20TT / K16TT	IK20TT / IK16TT	IK20 / IK16	VK20 / VK16	4 each
	2.4L 4Cyl 12V	KA24E	UA	1989-1992	K16GPR-U11	-	-	-	-	4
<b>THAILAND</b>										
<b>CORTINA</b>										
	2.0L 4Cyl 8V		TD	1974-1977	MA20P-U	-	-	-	-	4
			TE,TF	1977-1982	MA20P-U	-	-	-	-	4
<b>JAPAN</b>										
	3.3L 6Cyl 12V	200ci	200ci TE,TF (Alloy head)	1980-1982	W16EPR-U	W16TT	IW16TT	IW16	-	6
		200ci	200ci TE,TF (IRON HEAD)	1980-1982	T16P-U	-	ITF16TT	ITF16	-	6
	4.1L 6Cyl 12V	250ci	250ci TD	1974-1977	MA16PR-U	-	-	-	-	6
		250ci	250ci TE,TF (Alloy head)	1980-1982	W16EPR-U	W16TT	IW16TT	IW16	-	6
<b>EUROPE &amp; USA</b>										
<b>COUGAR</b>										
	2.5L 6Cyl 24V	LCBC	SX,SW	1999-2003	IT16TT	-	IT16TT	IT16	VT16	6
<b>COURIER</b>										
	2.0L 4Cyl 8V	FE	PC	1985-1992	W16EPR-U	W16TT	IW16TT	IW16	VW16	4
	2.2L 4Cyl 12V	F2 (12 V)	PC	1989-1993	W16EPR-U	W16TT	IW16TT	IW16	VW16	4
		G6	PC	1990-1996	K16PR-U11	K16TT	IK16TT	IK16	VK16	4
		G6	PD	1996-1999	KJ16CR-L11	K16TT	IK16TT	IK16	VK16	4
	2.6L 4Cyl 12V	G6	PE	1999-2002	KJ16CR-L11	K16TT	IK16TT	IK16L	-	4
		G6	PG	2002-2004	KJ16CR-L11	K16TT	IK16TT	IK16L	-	4
		G6	PH	2004-2006	KJ16CR-L11	K16TT	IK16TT	IK16	VK16	4
		G6	PH	2004-2006	KJ16CR-L11	K16TT	IK16TT	IK16L	-	4
	2.6L 4Cyl 8V	4G54	PC	1987-1992	W20EXR-U	W20TT	IW20TT	IW20	-	4
	4.0L 6Cyl 12V	1V	PH	2005-2006	IT16	-	IT16TT	IT16	VT16	6
<b>CROSS REFERENCE NUMBER</b>										
<b>ECONOVAN</b>										
	1.8L 4Cyl 8V	F8 (8 V)		1984-1997	W16EPR-U	W16TT	IW16TT	IW16	VW16	4
		F8 (8 V)	JH	2003-2006	W16EPR-U	W16TT	IW16TT	IW16	VW16	4





# AUSTRALIA CAR

▶ Spark plug color codes: ■ for Iridium Tough and Iridium Plugs and Iridium TT, ■ for Iridium Power, ■ for Iridium Racing and Two Tops Plugs, ■ for Platinum Plugs and Platinum TT, and black for general spark plugs.

Model	Engine Size	Engine Code	Specification	Year	DENSO					QTY	
AUSTRALIA	FORD FALCON		EB	1992-1993	J16AR-U11	-	-	-	-	6	
			EB	1992-1993	J16AR-U11	-	-	-	-	6	
CHINA		4.0L 6Cyl 12V	XR6 MPFi EB	1992-1993	W20EXR-U11	W20TT	IW20TT	IW20	-	6	
				ED	1993-1994	J16AR-U11	-	-	-	-	6
				XR6 ED	1993-1994	W20EXR-U11	W20TT	IW20TT	IW20	-	6
INDIA			XG	1993-1996	J16AR-U11	-	-	-	-	6	
				XR6 Efi XG	1993-1996	W20EXR-U11	W20TT	IW20TT	IW20	-	6
INDONESIA			YTR	1994-1996	W16EXR-U11	W16TT	IW16TT	IW16	VW16	6	
				XR6 EF	1994-1996	W20EXR-U11	W20TT	IW20TT	IW20	-	6
KOREA				1995-1996	W16EXR-U11	W16TT	IW16TT	IW16	VW16	6	
				YTR	1996-1998	W16EXR-U11	W16TT	IW16TT	IW16	VW16	6
MALAYSIA			YTR	1996-1998	W20EXR-U11	W20TT	IW20TT	IW20	-	6	
				XH	1996-1999	W16EXR-U11	W16TT	IW16TT	IW16	VW16	6
PHILIPPINES			XR6 Efi XH	1996-1999	W20EXR-U11	W20TT	IW20TT	IW20	-	6	
				YTR	1998-2000	W20EXR-U11	W20TT	IW20TT	IW20	-	6
SAUDIARABIA			YTR	1998-2000	W20EXR-U11	W20TT	IW20TT	IW20	-	6	
				LPG AU	1998-2000	W20EXR-U11	W20TT	IW20TT	IW20	-	6
SINGAPORE				1998-2001	W20EXR-U11	W20TT	IW20TT	IW20	-	6	
				XR6 AU II, AU II	2000-2002	W16EXR-U11	W16TT	IW16TT	IW16	VW16	6
TAIWAN			YTR	2001-2002	W16EXR-U11	W16TT	IW16TT	IW16	VW16	6	
				LPG AU	2001-2002	W16EXR-U11	W16TT	IW16TT	IW16	VW16	6
THAILAND			BARRA 182	(Inc XR6) BA	2002-2005	IK16	K16TT	IK16TT	IK16	VK16	6
				BARRA 182	BA	2002-2005	IK16	K16TT	IK16TT	IK16	VK16
VIETNAM			BARRA 156	BA E-Gas (-10/04)/(10/04-)	2002-2005	IK16TT / IK20TT	K16TT / K20TT	IK16TT / IK20TT	IK16 / IK20	VK16 / VK20	6
				BARRA 240T	XR6 Turbo BA	2002-2005	IK16	K16TT	IK16TT	IK16	VK16
JAPAN			BARRA 190	(Inc XR6) BF	2005-2008	IK20TT	K20TT	IK20TT	IK20	VK20	6
				BARRA 190	BF	2005-2008	IK20TT	K20TT	IK20TT	IK20	VK20
EUROPE & USA			BARRA 156	LPG BF	2005-2008	VK20Y	K20TT	IK20TT	-	VK20Y	6
				BARRA 190	XR6 BF	2005-2008	IK20TT	K20TT	IK20TT	IK20	VK20
CROSS REFERENCE NUMBER			BARRA 245T	XR6 Turbo BF	2005-2008	VK20Y	K20TT	IK20TT	-	VK20Y	6
				BARRA 195	FG	2008-2014	IK20TT	K20TT	IK20TT	IK20	VK20
PART NUMBER			BARRA 195	G6/XR6 FG	2008-2014	IK20TT	K20TT	IK20TT	IK20	VK20	6
				BARRA 156	LPG FG	2008-2014	VK20Y	K20TT	IK20TT	-	VK20Y
			BARRA 195	R6(Inc XR6) FG	2008-2014	IK20TT	K20TT	IK20TT	IK20	VK20	6
				BARRA 270T	Turbo (Inc XR6) FG	2008-2014	IK20TT	K20TT	IK20TT	-	VK20Y
			BARRA 270T	Turbo G6/XR6 FG	2008-2014	IK20TT	K20TT	IK20TT	-	VK20Y	6
				BARRA 270T	Turbo XR6/G6 FG	2008-2014	IK20TT	K20TT	IK20TT	-	VK20Y
			BARRA 270T	Turbo XR6/G6 FG	2008-2014	IK20TT	K20TT	IK20TT	-	VK20Y	6
				BARRA 195	EcoLPI G6/XR6/G6E FG	2010-2014	IK20TT	K20TT	IK20TT	IK20	VK20
			BARRA 198	LPi G6	2011-2014	IK20TT	K20TT	IK20TT	IK20	VK20	6
				BARRA 195	XR6 FG X	2014-2016	IK20TT	K20TT	IK20TT	IK20	VK20
			BARRA 270T	XR6 Turbo FG X	2014-2016	IK20TT	K20TT	IK20TT	-	VK20Y	6
				BARRA 270T	XR6 Turbo FG X	2014-2016	IK20TT	K20TT	IK20TT	-	VK20Y
			BARRA 195	XR6, G6E FG X	2014-2016	IK20TT	K20TT	IK20TT	IK20	VK20	6
					XR6, Sprint FG X	2016-2016	IK20TT	K20TT	IK20TT	IK20	VK20
			250ci	250ci XY	1970-1972	MA16PR-U	-	-	-	-	6
				250ci	250ci XA,XB,XC (Xflow head)	1972-1979	MA16PR-U	-	-	-	-
			250ci	XD (Xflow/Alloy head)	1979-1982	MA16PR-U / W16EPR-U	- / W16TT	- / IW16TT	- / IW16	- / -	6
				250ci	250ci XD (Xflow/Alloy head)	1979-1982	MA16PR-U / W16EPR-U	- / W16TT	- / IW16TT	- / IW16	- / -
			250ci	XE (Alloy head)	1982-1984	W16EPR-U	W16TT	IW16TT	IW16	-	6
				250ci	250ci XE (Alloy head)	1982-1984	W16EPR-U	W16TT	IW16TT	IW16	VW16
			250ci	250ci XE (Alloy head)	1982-1984	W16EPR-U	W16TT	IW16TT	IW16	VW16	6
				250ci	XF (Alloy head)	1984-1988	J16AR-U11	-	-	-	-
			250ci	XF (Alloy head)	1984-1993	J16AR-U11	-	-	-	-	6
				302ci XW	1969-1970	MA20P-U	-	-	-	-	8
			302ci XY	1970-1972	T20P-U	-	-	ITF20TT	ITF20	-	8
				302ci (XA, XB / XC)	1972-1979	T20P-U / T16P-U	-	-	ITF20TT / ITF16TT	ITF20 / ITF16	-
			302ci XD	1979-1982	T16P-U	-	-	ITF16TT	ITF16	-	8
				302ci XE	1982-1983	T16P-U	-	-	ITF16TT	ITF16	-
			GT EB	1992-1993	T20EPR-U	T20TT	IT20TT	IT20	-	8	
				MNG	XR8 XH	1996-1997	T16PR-U15	-	ITF16TT	ITF16	-
			MNG	EL	1996-1998	T16PR-U15	-	ITF16TT	ITF16	-	8
				V GT EL	1996-1998	T20PR-U	-	ITF20TT	ITF20	-	8
				XR8 EL	1996-1998	T20PR-U	-	ITF20TT	ITF20	-	8
				XR8 XH	1997-1999	T16PR-U15	-	ITF16TT	ITF16	-	8
			MNJ	AU	1998-2002	IT20	-	IT20TT	IT20	VT20	8
				XR8 AU	1998-2002	IT20	T20TT	IT20TT	IT20	VT20	8
			Boss 335	XR8 FG X	2014-2016	ITV22	-	-	ITV22	-	8
				XR8, Sprint FG X	2016-2016	ITV22	-	-	ITV22	-	8















# AUSTRALIA CAR

▶ Spark plug color codes: ■ for Iridium Tough and Iridium Plugs and Iridium TT, ■ for Iridium Power, ■ for Iridium Racing and Two Tops Plugs, ■ for Platinum Plugs and Platinum TT, and black for general spark plugs.

Model	Engine Size	Engine Code	Specification	Year	DENSO					QTY
<b>HOLDEN</b>										
<b>RODEO</b>	3.5L 6Cyl 24V	6VE1	RA	2003-2005	IK16TT	K16TT	IK16TT	IK16	VK16	6
	3.6L 6Cyl 24V	LCA (H9)	RA	2006-2008	ITV20	-	ITV20TT	ITV20	-	6
<b>SCURRY</b>	1.0L 4Cyl 8V	F10A	NB	1985-1987	W20EP-U	W20TT	IW20TT	IW20	VW20T	4
<b>SHUTTLE</b>	2.0L 4Cyl 8V	4ZC1	WFR	1983-1991	W20EP-U	W20TT	IW20TT	IW20	-	4
<b>STATESMAN</b>	3.6L 6Cyl 24V	LY7	WM	2006-2010	ITV20	-	ITV20TT	ITV20	-	6
		L27	VQ	1990-1991	T16EPR-U15	T16TT	IT16TT	IT16	VT16	6
		L27	VQ II	1991-1993	T20EPR-U15	T20TT	IT20TT	IT20	VT20	6
		L27	VR	1994-1995	T20EPR-U15	T20TT	IT20TT	IT20	VT20	6
		L36, LN3	VS	1995-1998	T20EPR-U15	T20TT	IT20TT	IT20	VT20	6
	3.8L 6Cyl 12V	L67	Supercharged VS	1996-1999	T20EPR-U15	T20TT	IT20TT	IT20	VT20	6
		L36(231CUV6)	WH	1999-2003	T20EPR-U15	T20TT	IT20TT	IT20	VT20	6
		L67	Supercharged WH	2001-2003	T20EPR-U15	T20TT	IT20TT	IT20	VT20	6
		L67	Supercharged WK	2003-2004	T20EPR-U15	T20TT	IT20TT	IT20	VT20	6
		L36(231CUV6)	WK	2003-2004	T20EPR-U15	T20TT	IT20TT	IT20	VT20	6
		GMH 308 (Red)	VQ	1990-1994	T20EPR-U	T20TT	IT20TT	IT20	VT20	8
	5.0L 8Cyl 16V		VR	1994-1995	T20EPR-U	T20TT	IT20TT	IT20	-	8
			VS	1995-1999	T20EPR-U	T20TT	IT20TT	IT20	VT20	8
	5.7L 8Cyl 16V	LS1	WH	1999-2003	IT16TT	-	IT16TT	IT16	VT16	8
	6.0L 8Cyl 16V	L76	WM	2006-2010	IT16TT	-	IT16TT	IT16	VT16	8
	L76, LS2	WM	2006-2010	IT16TT	-	IT16TT	IT16	VT16	8	
<b>TIGRA</b>	1.8L 4Cyl 16V	Z 18 XE	XC	2005-2007	K20TXR	K20TT	IK20TT	IK20	VK20	4
<b>TORANA</b>	2.8L 6Cyl 12V	GMH 173 (Red)	LX	1975-1978	T16P-U	-	ITF16TT	ITF16	-	6
	3.3L 6Cyl 12V	GMH 202 (Red)	LX	1975-1978	T16P-U	-	ITF16TT	ITF16	-	6
	4.1L 8Cyl 16V	GMH 253 (Red)	LH	1974-1976	T16P-U	-	ITF16TT	ITF16	-	8
		GMH 253 (Red)	LX	1975-1978	T16P-U	-	ITF16TT	ITF16	-	8
	5.0L 8Cyl 16V		LH	1974-1976	T20P-U	-	ITF20TT	ITF20	-	8
		LX	1975-1978	T20P-U	-	ITF20TT	ITF20	-	8	
<b>TRAX</b>	1.4L 4Cyl 16V	A 14 NET	TJ	2014-	VK22	-	-	IK22	VK22	4
	1.8L 4Cyl 16V	2H0	TJ	2013-	KJ20CR-L11	K20TT	IK20TT	IK20L	VK20	4
<b>VECTRA</b>		C 20 SEL	JR	1997-1998	K20TXR	K20TT	IK20TT	IK20	VK20	4
	2.0L 4Cyl 16V	X20XEV, C20SEL	JR	1997-1998	K20TXR	K20TT	IK20TT	IK20	VK20	4
		C 20 SEL	JS	1998-2000	K20TXR	K20TT	IK20TT	IK20	VK20	4
	2.2L 4Cyl 16V	C 22 SEL	JS	1998-2003	K20TXR	K20TT	IK20TT	IK20	VK20	4
		Z 22 SE	ZC	2002-2006	ITV20	-	ITV20TT	ITV20	-	4
	2.5L 6Cyl 24V	X 25 XE	JR	1997-1998	K20TXR	K20TT	IK20TT	IK20	VK20	6
		X 25 XE	JS	1998-2002	K20TXR	K20TT	IK20TT	IK20	VK20	6
	2.6L 6Cyl 24V	Y 26 SE	JS	2000-2002	K20TXR	K20TT	IK20TT	IK20	VK20	6
	3.2L 6Cyl 24V	Z 32 SE	ZC	2002-2006	K20TXR	K20TT	IK20TT	IK20	VK20	6
<b>VIVA</b>	1.8L 4Cyl 16V	F18D3	JF	2005-2009	K20PBR-S10	K20TT	IK20TT	IK20	VK20	4
<b>WB</b>	3.3L 6Cyl 12V	GMH 202 (Blue)		1980-1985	T20EPR-U15	T20TT	IT20TT	IT20	VT20	6
	4.1L 8Cyl 16V	GMH 253 (Blue)		1980-1985	T16PR-U15	-	ITF16TT	ITF16	-	8
	5.0L 8Cyl 16V	GMH 308 (Blue)		1984-1985	T16PR-U15	-	ITF16TT	ITF16	-	8
<b>ZAFIRA</b>	2.2L 4Cyl 16V	Z 22 SE	TT	2001-2006	ITV20	-	ITV20TT	ITV20	-	4
<b>HONDA</b>										
<b>ACCORD</b>	1.6L 4Cyl 8V	EL, EG	L/EX SJ, SY	1978-1983	W16EXR-U	W16TT	IW16TT	IW16	-	4
	1.8L 4Cyl 12V	ET1	EX AD	1983-1985	W20EX-U11	W20TT	IW20TT	IW20	-	4
	2.0L 4Cyl 12V	A20A2	EX CA	1985-1989	W20EXR-U11	W20TT	IW20TT	IW20	-	4
		A20A3	EXi CA	1987-1989	W20EXR-U11	W20TT	IW20TT	IW20	-	4
		F22A9, F22A6	CB	1989-1993	KJ16CR-L11	K16TT	IK16TT	IK16	VK16	4
		F22A6	CB, CC	1992-1993	KJ16CR-L11	K16TT	IK16TT	IK16	VK16	4
	2.2L 4Cyl 16V	F22B3	EXi CD	1993-1997	KJ16CR-L11	K16TT	IK16TT	IK16	VK16	4
		F22B1	Vti CD	1993-1997	KJ16CR-L11	K16TT	IK16TT	IK16	VK16	4
		F22B1	CE	1995-1996	KJ16CR-L11	K16TT	IK16TT	IK16L	-	4
	2.3L 4Cyl 16V	F23A1	VTEC CE	1997-1998	KJ16CR-L11	K16TT	IK16TT	IK16	VK16	4
		F23A1	CG	1997-1999	KJ16CR-L11	K16TT	IK16TT	IK16	VK16	4
		K24A4, K24A2	Vtec E CM	2002-2005	KJ20DR-M11	K20TT	IK20TT	IK20	VK20	4
	2.4L 4Cyl 16V	K24A4	Vtec E CM	2006-2008	KJ20DR-M11	K20TT	IK20TT	IK20	VK20	4
		K24Z2	CP	2008-2013	VXUHC22G	-	-	-	VXUHC22G	4
		K24W	CR, CU	2013-2019	IXEH22TT	-	IXEH22TT	-	VCH20	4
3.0L 6Cyl 24V	J30A1	Vtec CK	1997-2003	KJ16CR-L11	K16TT	IK16TT	IK16	VK16	6	
	J30A4	CM	2003-2007	KJ20DR-M11	K20TT	IK20TT	IK20	VK20	6	
3.5L 6Cyl 24V	J35Z2	V 6 CP	2007-2012	VXUHC22G	-	-	IXUH22I	VXUH22I	6	
	J35Z2	CR, CU	2013-	VXUHC22G	-	-	IXUH22I	VXUH22I	6	
<b>ACCORD EURO</b>	2.4L 4Cyl 16V	K24A3, K24A	CL	2003-2008	IK20TT	K20TT	IK20TT	IK20	VK20	4
		K24Z3	CU	2008-2015	VXUHC22G	-	-	-	VXUHC22G	4
<b>CITY</b>	1.5L 4Cyl 16V	L15A7	i-VTEC GM26	2009-2014	IK20TT	K20TT	IK20TT	IK20	VK20	4
		L15A7, L15Z1	i-VTEC GM65	2014-	IK20TT	K20TT	IK20TT	IK20	VK20	4













# AUSTRALIA CAR

▶ Spark plug color codes: ■ for Iridium Tough and Iridium Plugs and Iridium TT, ■ for Iridium Power, ■ for Iridium Racing and Two Tops Plugs, ■ for Platinum Plugs and Platinum TT, and black for general spark plugs.

	Model	Engine Size	Engine Code	Specification	Year	DENSO			IRIDIUM POWER	IRIDIUM TOUGH	QTY	
AUSTRALIA	<b>LANCIA</b>											
	FLAMINIA	2.8L 6Cyl 12V			1963-1967	W22ES-U	-	-	-	-	6	
AUSTRALIA	<b>LAND ROVER</b>											
	88/109	2.3L 4Cyl 8V	11H,10 H	LR	1961-1986	W20ESR-U	-	-	-	-	4	
CHINA	DISCOVERY	2.0L 4Cyl 16V	20 T4H	LJ	1989-1998	K20PR-U	K20TT	IK20TT	IK20	VK20	4	
		3.5L 8Cyl 16V	22 D	LJ	1989-1994	W16EPR-U	W16TT	IW16TT	IW16	VW16	8	
		3.9L 8Cyl 16V	36 D,35 D	LJ	1993-1998	W20EPR-U	W20TT	IW20TT	IW20	-	8	
INDIA	FREELANDER	4.4L 8Cyl 32V	448PN	L319	2004-2009	K20TXR	K20TT	IK20TT	IK20	VK20	8	
		5.0L 8Cyl 32V	508PN	L319	2009-2013	IK20TT	K20TT	IK20TT	IK20	VK20	8	
		1.8L 4Cyl 16V	18 K4F	16V L314	1998-2006	IK20TT	K20TT	IK20TT	IK20	VK20	4	
INDONESIA	FREELANDER 2	2.5L 6Cyl 24V	25 K4F	L314	2000-2006	IK20TT	K20TT	IK20TT	IK20	VK20	6	
		3.2L 6Cyl 24V	B 6324 S	L359	2006-2014	VKH20Y	-	IKH20TT	-	VKH20Y	6	
		3.5L 8Cyl 16V	11 D		1969-1991	W16EXR-U	W16TT	IW16TT	IW16	VW16	8	
KOREA	RANGE ROVER	3.5L 8Cyl 16V	11 D	Vogue	1981-1990	W16EXR-U	W16TT	IW16TT	IW16	VW16	8	
		4.2L 8Cyl 32V	428PS	L322	2005-2012	IK16TT	K16TT	IK16TT	IK16	VK16	8	
		4.4L 8Cyl 32V	M62 B44	L322	2002-2005	K20TXR	K20TT	IK20TT	IK20	VK20	8	
MALAYSIA	RANGE ROVER SPORT	4.6L 8Cyl 16V	46 D	P38A	1994-2002	W20EXR-U	W20TT	IW20TT	IW20	-	8	
		4.4L 8Cyl 32V	448PN	L320	2005-2013	IK16TT	K16TT	IK16TT	IK16	VK16	8	
		4.4L 8Cyl 32V	448PN	L320	2005-2013	IK16TT	K16TT	IK16TT	IK16	VK16	8	
PHILIPPINES	<b>LEXUS</b>											
	CT	1.8L 4Cyl 16V	2ZR-FXE	200h ZWA10	2010-	SC16HR11	-	IXEH20TT	-	VCH16	4	
	ES	2.5L 4Cyl 16V	2AR-FXE	300h AVV60	2012-2018	FK16HR-A8	-	IKH16TT	-	VFKH16	4	
		3.0L 6Cyl 24V	3VZ-FE	300 VCV10	1991-1997	IK20TT	K20TT	IK20TT	IK20	VK20	6	
			1MZ-FE	MCV_,VZV_	1996-2006	IK20	K20TT	IK20TT	IK20	VK20	6	
	1MZ-FE		MCV20	1998-2001	IK20	K20TT	IK20TT	IK20	VK20	6		
	GS	3.5L 6Cyl 24V	1MZ-FE	MCV30	2001-2008	IK20	K20TT	IK20TT	IK20	VK20	6	
		2.5L 6Cyl 24V	2GR-FE	350 GSV60	2012-2018	IKH20TT	-	IKH20TT	-	VFKH20	6	
		2.5L 6Cyl 24V	4GR-FSE	250 GRL11	2012-2015	IKBH20TT	-	IKBH20TT	-	VFKBH20	6	
	SINGAPORE	IS	3.0L 6Cyl 24V	2JZ-GE	300 JZS147	1993-1997	PK16R11	-	IK16TT	IK16	VK16	6
			3.0L 6Cyl 24V	2JZ-GE	300 JZS160	1997-2004	IK20TT	K20TT	IK20TT	IK20	VK20	6
			3.0L 6Cyl 24V	3GR-FSE	300 GRS190	2005-2011	IKBH20TT	-	IKBH20TT	-	VFKBH20	6
TAIWAN	IS	3.5L 6Cyl 24V	2GR-FSE	450h_S19_	2006-2011	IKBH20TT	-	IKBH20TT	-	VFKBH20	6	
		3.5L 6Cyl 24V	2GR-FSE	450h GWS191	2006-2011	IKBH20TT	-	IKBH20TT	-	VFKBH20	6	
		3.5L 6Cyl 24V	2GR-FSE	350 GRL10	2012-	IKBH20TT	-	IKBH20TT	-	VFKBH20	6	
THAILAND	IS	4.3L 8Cyl 32V	3UZ-FE	430 UZS190	2005-2011	IK20TT	K20TT	IK20TT	IK20	VK20	8	
		4.6L 8Cyl 32V	1UR-FSE	460 URS190	2007-2011	IKBH20TT	-	IKBH20TT	-	VFKBH20	8	
		2.0L 4Cyl 16V	8AR-FTS	200t ASE30	2015-	VDKH22F	-	-	-	VDKH22F	4	
VIETNAM	IS	2.0L 6Cyl 24V	1G-FE	200 GXE10	1999-2005	IK20TT	K20TT	IK20TT	IK20	VK20	6	
		2.5L 6Cyl 24V	4GR-FSE	250 GSE20	2005-2013	IKBH20TT	-	IKBH20TT	-	VFKBH20	6	
		2.5L 6Cyl 24V	4GR-FSE	250 GSE30	2013-2015	IKBH20TT	-	IKBH20TT	-	VFKBH20	6	
JAPAN	IS C	3.0L 6Cyl 24V	2JZ-GE	300 JCE10	2001-2005	IK20TT	K20TT	IK20TT	IK20	VK20	6	
		3.5L 6Cyl 24V	2GR-FSE	350 GSE21	2008-2013	IKBH20TT	-	IKBH20TT	-	VFKBH20	6	
		3.5L 6Cyl 24V	2GR-FSE	350 GSE30	2013-	IKBH20TT	-	IKBH20TT	-	VFKBH20	6	
EUROPE & USA	LX	5.0L 8Cyl 32V	2UR-GSE	IS F USE20	2007-2013	IKBH20TT	-	IKBH20TT	-	VFKBH20	8	
		2.5L 6Cyl 24V	4GR-FSE	250 GSE20	2009-2015	IKBH20TT	-	IKBH20TT	-	VFKBH20	6	
		4.0L 8Cyl 32V	1UZ-FE	400 UCF10	1989-1995	IK20TT	K20TT	IK20TT	IK20	VK20	8	
CROSS REFERENCE NUMBER	RX	4.0L 8Cyl 32V	1UZ-FE	400 UCF20	1994-2000	IK20TT	K20TT	IK20TT	-	VK20Y	8	
		4.3L 8Cyl 32V	3UZ-FE	430 UCF30	2000-2006	IK20TT	K20TT	IK20TT	IK20	VK20	8	
		4.6L 8Cyl 32V	1UR-FSE	460 UCF40	2006-2017	IKBH20TT	-	IKBH20TT	-	VFKBH20	8	
PART NUMBER	RX	4.7L 8Cyl 32V	2UZ-FE	470 UZJ100	1998-2008	IK20TT	K20TT	IK20TT	IK20	VK20	8	
		5.7L 8Cyl 32V	3UR-FE	570 URJ201	2007-	IKH20TT	-	IKH20TT	IKH20	VKH20	8	
		2.0L 4Cyl 16V	8AR-FTS	200t AGZ10	2014-	VDKH22F	-	-	-	VDKH22F	4	
PART NUMBER	RX	2.0L 4Cyl 16V	8AR-FTS	200t AGZ15	2014-	VDKH22F	-	-	-	VDKH22F	4	
		2.5L 4Cyl 16V	8AR-FTS	300 AGZ10	2017-	VDKH22F	-	-	-	VDKH22F	4	
		2.5L 4Cyl 16V	2AR-FXE	300h AYZ10	2014-	FK16HR-A8	-	IKH16TT	-	VFKH16	4	
PART NUMBER	RX	2.5L 4Cyl 16V	2AR-FXE	300h AYZ15	2014-	FK16HR-A8	-	IKH16TT	-	VFKH16	4	
		2.0L 4Cyl 16V	8AR-FTS	200t ASC10	2015-	VDKH22F	-	-	-	VDKH22F	4	
		3.5L 6Cyl 24V	2GR-FSE	350 GSC10	2014-	IKBH20TT	-	IKBH20TT	-	VFKBH20	6	
PART NUMBER	RX	2.0L 4Cyl 16V	8AR-FTS	200t AGL20	2015-2017	VDKH22F	-	-	-	VDKH22F	4	
		2.0L 4Cyl 16V	8AR-FTS	300 AGL20	2017-	VDKH22F	-	-	-	VDKH22F	4	







# AUSTRALIA CAR

▶ Spark plug color codes: ■ for Iridium Tough and Iridium Plugs and Iridium TT, ■ for Iridium Power, ■ for Iridium Racing and Two Tops Plugs, ■ for Platinum Plugs and Platinum TT, and black for general spark plugs.

Model	Engine Size	Engine Code	Specification	Year	DENSO					QTY	
AUSTRALIA	<b>MAZDA</b>										
	323	1.6L 4Cyl 8V	B61V	BG	1989-1991	W16EPR-U11	W16TT	IW16TT	IW16	-	4
				BP52	BG	1989-1994	K20PR-U11	K20TT	IK20TT	IK20	VK20
	1.8L 4Cyl 16V	BP (DOHC)	GT BG	1989-1994	K20PR-U11	K20TT	IK20TT	IK20	VK20	4	
CHINA	626	1.8L 4Cyl 16V	FP	GE	1992-1997	K16PR-U11	K16TT	IK16TT	IK16	VK16	4
			FP01LP	GE	1994-1997	K20PR-U11	K20TT	IK20TT	IK20	VK20	4
			FS	GE	1991-1997	K16PR-U11	K16TT	IK16TT	IK16	VK16	4
INDIA	2.0L 4Cyl 16V	FS	GF	1997-2002	KJ16CR-L11	K16TT	IK16TT	IK16	VK16	4	
		FS	GW	1998-2002	KJ16CR-L11	K16TT	IK16TT	IK16L	-	4	
		HE3,MA,M	CB	1979-1982	W16EPR-U	W16TT	IW16TT	IW16	VW16	4	
INDONESIA	2.0L 4Cyl 8V	FE (8V)	GC	1983-1987	W16EPR-U	W16TT	IW16TT	IW16	VW16	4	
		FET	Turbo GC	1986-1987	W20EPR-U11	W20TT	IW20TT	IW20	-	4	
		F2T	Turbo GD (-12/89) / (01/90-)	1987-1991	IQ20 / IK20L	Q20TT / K20TT	IQ20TT / IK20TT	IQ20 / IK20L	- / -	4	
INDONESIA	2.2L 4Cyl 12V	F2	GD	1988-1992	KJ20CR-L11	K20TT	IK20TT	IK20	VK20	4	
		KL	GE	1992-1997	KJ16CR-L11	K16TT	IK16TT	IK16	VK16	6	
KOREA	929	3.0L 6Cyl 18V	JE	HC	1987-1991	K20PR-U11 / KJ20CR-L11	K20TT / K20TT	IK20TT / IK20TT	IK20 / IK20	VK20 / VK20	6
			JE3	HC	1987-1991	K20PR-U11	K20TT	IK20TT	IK20	VK20	6
KOREA	121 METRO	1.3L 4Cyl 16V	B3 (16V)	16V DW	1996-2000	K16PR-U11	K16TT	IK16TT	IK16	VK16	4
			B3 ME	DW	1998-2003	K16PR-U11	K16TT	IK16TT	IK16	VK16	4
MALAYSIA	323 ASTINA	1.3L 4Cyl 16V	B3 (16V)	BA	1994-1998	K16PR-U11	K16TT	IK16TT	IK16	VK16	4
			Z5-DE	BA	1994-1998	K16PR-U11	K16TT	IK16TT	IK16	VK16	4
		1.5L 4Cyl 16V	B6	BG	1991-1994	K16PR-U11	K16TT	IK16TT	IK16	VK16	4
			B6E	BG	1989-1991	K20PR-U11	K20TT	IK20TT	IK20	VK20	4
		1.8L 4Cyl 16V	BP31	BG	1989-1993	K20PR-U	K20TT	IK20TT	IK20	VK20	4
			BP	BG	1989-1994	K16PR-U11	K16TT	IK16TT	IK16	VK16	4
			BP (DOHC)	GT BG	1989-1994	K16PR-U11	K16TT	IK16TT	IK16	VK16	4
			BP (DOHC)	BA	1994-1998	K16PR-U11	K16TT	IK16TT	IK16	VK16	4
			BP (DOHC)	BA	1994-1998	K16PR-U11	K16TT	IK16TT	IK16	VK16	4
			BP-ZE	BA	1994-1998	K16PR-U11	K16TT	IK16TT	IK16	VK16	4
2.0L 6Cyl 24V	BP (DOHC)	Astina BJ	1998-2004	K16PR-U11	K16TT	IK16TT	IK16	VK16	4		
	KF	BA	1994-1998	K20PR-U11	K20TT	IK20TT	IK20	VK20	6		
323 P	1.3L 4Cyl 16V	B3 (16V)	BA	1996-1998	K20PR-U11	K20TT	IK20TT	IK20	VK20	4	
		Z5-DE	BA	1996-1998	K20PR-U11	K20TT	IK20TT	IK20	VK20	4	
323 PROTEGE	1.3L 4Cyl 16V	B3 (16V)	BA	1994-1998	K16PR-U11	K16TT	IK16TT	IK16	VK16	4	
		Z5-DE	BA	1994-1998	K16PR-U11	K16TT	IK16TT	IK16	VK16	4	
	1.5L 4Cyl 16V	Z5-DE	BA	1994-1998	K16PR-U11	K16TT	IK16TT	IK16	VK16	4	
		Z5-DE	BA	1994-1998	K16PR-U11	K16TT	IK16TT	IK16	VK16	4	
1.6L 4Cyl 16V	BA	1994-1998	KJ16CR-L11	K16TT	IK16TT	IK16	VK16	4			
	BP (DOHC)	BA	1994-1998	K16PR-U11	K16TT	IK16TT	IK16	VK16	4		
TAIWAN	BONGO FRIENDEE B-SERIE BRAVO	2.5L 6Cyl 24V	J5DE	SG	1995-2001	K16PR-U11	K16TT	IK16TT	IK16	VK16	6
			G6	UF	1990-1999	KJ16CR-L11	K16TT	IK16TT	IK16L	-	4
			G6	UN	1999-2006	KJ16CR-L11	K16TT	IK16TT	IK16	VK16	4
THAILAND	2.6L 4Cyl 8V	G6Y1	UN	1999-2006	KJ16CR-L11	K16TT	IK16TT	IK16	VK16	4	
		4G54	UF	1987-1991	W16EP-U	W16TT	IW16TT	IW16	VW16	4	
		G54B	UF	1987-1991	W16EP-U	W16TT	IW16TT	IW16	VW16	4	
		4G54	UF	1987-1991	W16EP-U	W16TT	IW16TT	IW16	VW16	4	
		1V	MJ	2005-2006	IT16	T16TT	IT16TT	IT16	VT16	6	
VIETNAM	CAPELLA	2.0L 4Cyl 12V	1V	MJ	2005-2006	IT16	T16TT	IT16TT	IT16	VT16	6
			1V	MJ	2005-2006	IT16	T16TT	IT16TT	IT16	VT16	6
JAPAN	CX-3	2.0L 4Cyl 16V	FE (12V)	GV	1987-1990	K20PR-U	K20TT	IK20TT	IK20	VK20	4
			FE (16V)	GV	1988-1992	K20PR-U11	K20TT	IK20TT	IK20	VK20	4
			FE (8V)	GV	1988-1997	K20PR-U	K20TT	IK20TT	IK20	VK20	4
			F2	GV	1988-1997	KJ20CR-L11	K20TT	IK20TT	IK20	VK20	4
EUROPE & USA	CX-5	2.0L 4Cyl 16V	PEX0	SKYACTIV-G DK	2015-	IXEH22TT	-	IXEH22TT	-	VCH20	4
			PEX3,PEXT,PEXB	SKYACTIV-G DK	2015-	IXEH22TT	-	IXEH22TT	-	VFXEH22	4
			PEXB	SKYACTIV-G DK	2018-	IXEH22TT	-	IXEH22TT	-	VFXEH22	4
		2.5L 4Cyl 16V	PEY5,PEY4	KE,KF	2012-2017	IXEH22TT	-	IXEH22TT	-	VCH20	4
			PE-VPS	KF	2016-	IXEH22TT	-	IXEH22TT	-	VCH20	4
			PYY1	KE,KF	2013-2017	IXEH22TT	-	IXEH22TT	-	VCH20	4
CX-7	2.5L 4Cyl 16V	PY-Y8,PY-ZA	KF	2016-	IXEH22TT	-	IXEH22TT	-	VCH20	4	
		PYZ4	KF	2018-	IXEH22TT	-	IXEH22TT	-	VFXEH22	4	
CROSS REFERENCE NUMBER	CX-9	2.3L 4Cyl 16V	L3-VDT	MZR DISI Turbo ER	2006-2014	ITV20	-	ITV20TT	ITV20	-	4
			L5-VE	MZR ER	2009-2013	ITV16	-	ITV16TT	ITV16	-	4
		2.5L 4Cyl 16V	PYZ4	TC	2016-	IXEH22TT	-	IXEH22TT	-	VFXEH22	4
CAY1,CAY5,CAY6	TB		2007-2016	ITV20	-	ITV20TT	ITV20	-	6		
PART NUMBER	E-SERIE	1.8L 4Cyl 8V	CAY1,CAY5,CAY6,CA	TB	2007-2016	ITV20	-	ITV20TT	ITV20	-	6
			FE (8V)	E1800i SG,SK	2003-2006	K16PR-U11	K16TT	IK16TT	IK16	VK16	4
		2.0L 4Cyl 8V	FE (8V)	E2000 SR2	1984-1990	W16EP-U	W16TT	IW16TT	IW16	VW16	4
FE,FE60,FE61	E2000 SR2		1991-2003	W16EP-U	W16TT	IW16TT	IW16	VW16	4		
		FE (8V)	E2000 SG,SK	2004-2006	K16PR-U11	K16TT	IK16TT	IK16	VK16	4	









# AUSTRALIA CAR

▶ Spark plug color codes: ■ for Iridium Tough and Iridium Plugs and Iridium TT, ■ for Iridium Power, ■ for Iridium Racing and Two Tops Plugs, ■ for Platinum Plugs and Platinum TT, and black for general spark plugs.

Model	Engine Size	Engine Code	Specification	Year	DENSO					QTY
<b>MERCEDES</b>										
<b>M-CLASS</b>										
AUSTRALIA	5.0L 8Cyl 24V	M 113.964	ML 500 W164	2005-2011	IK16TT	K16TT	IK16TT	IK16	VK16	16
	5.4L 8Cyl 24V	M 113.981	ML 55 AMG W163	2000-2005	IK16TT	K16TT	IK16TT	IK16	VK16	16
CHINA	5.5L 8Cyl 32V	M 273.963	ML 500 W164	2005-2011	VXUH22I	-	-	IXUH22I	VXUH22I	16
		M 157.982	ML 63 AMG W166	2011-2015	VXUH22I	-	-	IXUH22I	VXUH22I	16
INDIA	6.2L 8Cyl 32V	M 156.980	ML 63 AMG W164	2006-2011	IXEH22TT	-	IXEH22T	-	VFXEH22	8
	5.0L 8Cyl 24V	M 113.971	R 500 W251,V251	2005-2014	IK16TT	K16TT	IK16TT	IK16	VK16	8
INDONESIA	5.5L 8Cyl 32V	M 273.963	R 500 W251,V251	2007-2014	VXUH22I	-	-	IXUH22I	VXUH22I	8
	2.7L 6Cyl 12V	M 110.922	280 S W116	1972-1980	W20EX-U	W20TT	IW20TT	IW20	-	6
KOREA		M110.989,M110.987	280 SE, SEL W126	1979-1986	W20EP-U	W20TT	IW20TT	IW20	-	6
	2.8L 6Cyl 24V	M 104.944	300 SE W140	1993-1998	IQ20	Q20TT	IQ20TT	IQ20	-	6
MALAYSIA		M 104.944	S 280 W140	1993-1998	IQ20	Q20TT	IQ20TT	IQ20	-	6
	3.0L 6Cyl 12V	M 103.981	300 SE, SEL W126	1985-1991	T20EP-U	T20TT	IT20TT	IT20	VT20	6
PHILIPPINES	3.2L 6Cyl 18V	M 112.944	S 320 W220	1998-2005	IK16TT	K16TT	IK16TT	IK16	VK16	6
	3.2L 6Cyl 24V	M104.990,M104.994	300 SE, SEL/S320 W140	1991-1998	IQ20	Q20TT	IQ20TT	IQ20	VQ20	6
SAUDI ARABIA	3.5L 6Cyl 24V	M 272.965	S 350 W221	2005-2013	VXUH22I	-	-	IXUH22I	VXUH22I	12
	3.7L 6Cyl 18V	M 112.972	S 350 W220	2002-2005	IK16TT	K16TT	IK16TT	IK16	VK16	12
SINGAPORE	4.3L 8Cyl 24V	M 113.941	S 430 W220	1998-2005	IK16TT	K16TT	IK16TT	IK16	VK16	8
	4.7L 8Cyl 32V	M 273.922	S 450 W221	2005-2013	IXUH22I	-	-	IXUH22I	VXUH22I	8
TAIWAN	5.0L 8Cyl 24V	M113.960,M113.966	S 500 W220	1998-2005	IK16TT	K16TT	IK16TT	IK16	VK16	16
		M 113.960	CL 500 C215	1999-2006	IK16TT	K16TT	IK16TT	IK16	VK16	8
THAILAND	5.0L 8Cyl 32V	M119.980,M119.970	500 SEC / CL 500 C140	1992-1999	IQ20	Q20TT	IQ20TT	IQ20	VQ20	8
		M119.980,M119.970	S 500 W140	1993-1998	IQ20	Q20TT	IQ20TT	IQ20	-	8
VIETNAM	5.5L 12Cyl 36V	M 275.950	S 600 W220	2002-2005	VK20Y	K20TT	IK20TT	-	VK20Y	24
	5.5L 8Cyl 32V	M 273.961	CL 500 C216	2006-2013	VXUH22I	-	-	IXUH22I	VXUH22I	8
JAPAN	5.8L 12Cyl 36V	M 137.970	S 600 W220	2000-2005	IK20TT	K20TT	IK20TT	IK20	VK20	12
	6.0L 12Cyl 36V	M 275.982	S 65 AMG W221	2005-2013	IK20TT	-	IK20TT	-	VK20Y	24
EUROPE & USA	6.2L 8Cyl 32V	M 156.984	CL 63 AMG C216	2006-2013	IXEH22TT	-	IXEH22T	-	VFXEH22	8
		M 156.984	S 63 AMG W221	2006-2013	IXEH22TT	-	IXEH22T	-	VFXEH22	8
<b>SEDAN</b>										
EUROPE & USA	2.3L 4Cyl 8V	M 102.980	230 E W123	1980-1985	T20EP-U	T20TT	IT20TT	IT20	VT20	4
		M 102.982	230 E W124	1985-1993	T20EP-U	T20TT	IT20TT	IT20	VT20	4
EUROPE & USA		M 102.982	230 E Cat W124	1989-1993	T20EP-U	T20TT	IT20TT	IT20	VT20	4
	2.5L 6Cyl 12V	M 123.921	250 W123	1976-1979	W20EP-U	W20TT	IW20TT	IW20	VW20T	6
EUROPE & USA	2.6L 6Cyl 12V	M 103.940	260 E W124	1985-1992	T20EP-U	T20TT	IT20TT	IT20	VT20	6
	2.8L 6Cyl 24V	M 104.942	280 E W124	1992-1993	Q20-U	Q20TT	IQ20TT	IQ20	VQ20	6
EUROPE & USA	3.0L 6Cyl 12V	M 103.983	300 E W124	1985-1992	T16EPR-U	T16TT	IT16TT	IT16	VT16	6
	3.2L 6Cyl 24V	M 104.992	320 E W124	1992-1993	IQ20	Q20TT	IQ20TT	IQ20	-	6
<b>SL</b>										
EUROPE & USA	3.5L 6Cyl 24V	M 272.966	350 R230	2006-2012	VXUH22I	-	-	IXUH22I	VXUH22I	6
	3.7L 6Cyl 18V	M 112.973	350 R230	2003-2012	IK16TT	K16TT	IK16TT	IK16	VK16	12
EUROPE & USA	5.0L 8Cyl 24V	M 113.963	500 R230	2001-2012	IK16TT	K16TT	IK16TT	IK16	VK16	8
		M119.960,M119.972	500 SL R129	1989-1992	IQ20	Q20TT	IQ20TT	IQ20	VQ20	8
EUROPE & USA		M119.982,M119.972	500 R129	1992-2001	IQ20	Q20TT	IQ20TT	IQ20	VQ20	8
	5.4L 8Cyl 24V	M 113.992	55 AMG Kompressor R230	2002-2012	IKH20TT	-	IKH20TT	IKH20	VKH20	16
EUROPE & USA	5.5L 8Cyl 32V	M 273.965	500 R230	2006-2012	VXUH22I	-	-	IXUH22I	VXUH22I	16
	1.8L 4Cyl 16V	M 271.954	200 Kompressor R171	2008-2011	VXUH22	-	-	IXUH22	VXUH22	4
EUROPE & USA		M271.860,M271.861	250 R172	2011-	VXUH22	-	-	IXUH22	VXUH22	4
	2.0L 4Cyl 16V	M 111.946	200 R170	1996-2000	K16TT	K16TT	IK16TT	IK16	VK16	4
EUROPE & USA		M 111.958	200 Kompressor R170	2000-2004	IK20TT	K20TT	IK20TT	IK20	VK20	4
	2.3L 4Cyl 16V	M 111.973	230 Kompressor R170	1996-2000	K20PBR-S10	K20TT	IK20TT	IK20	VK20	4
EUROPE & USA		M 111.983	230 Kompressor R170	2000-2004	IK20TT	K20TT	IK20TT	IK20	VK20	4
	3.0L 6Cyl 24V	M 272.942	280 R171	2005-2011	VXUH22I	-	-	IXUH22I	VXUH22I	6
EUROPE & USA	3.2L 6Cyl 18V	M 112.947	320 R170	2000-2004	IK16TT	K16TT	IK16TT	IK16	VK16	12
	3.5L 6Cyl 24V	M 272.963	350 R171	2004-2011	VXUH22I	-	-	IXUH22I	VXUH22I	6
EUROPE & USA		M 272.969	350 R171	2008-2011	VXUH22I	-	-	IXUH22	VXUH22	6
	5.4L 8Cyl 24V	M 113.989	55 AMG R171	2004-2011	IK20TT	K20TT	IK20TT	IK20	VK20	16
<b>VITO</b>										
2.0L 4Cyl 16V	M111.948,M111.950	113 638		1996-2003	K16TT	K16TT	IK16TT	IK16	VK16	4
<b>MIDGET</b>										
1.1L 4Cyl 8V	10CG			1964-1966	W16EP-U	W16TT	IW16TT	IW16	VW16	4
1.3L 4Cyl 8V	12 H			1967-1974	W20EP-U	W20TT	IW20TT	IW20	-	4























# AUSTRALIA CAR

▶ Spark plug color codes: ■ for Iridium Tough and Iridium Plugs and Iridium TT, ■ for Iridium Power, ■ for Iridium Racing and Two Tops Plugs, ■ for Platinum Plugs and Platinum TT, and black for general spark plugs.

Model	Engine Size	Engine Code	Specification	Year	DENSO					QTY		
<b>SKODA</b>												
YETI	1.8L 4Cyl 16V	CDA	5L	2009-2017	IK22	-	-	IK22	VK22	4		
		CDAB	5L	2009-2017	VK22	-	-	IK22	VK22	4		
<b>SMART</b>												
FORFOUR	1.3L 4Cyl 16V	M 135.930	454	2004-2006	K20HR-U11	KH20TT	IKH20TT	IKH20	VKH20	4		
FORTWO	1.0L 3Cyl 12V	M 132.930	Turbo 451	2007-2013	XUH22TT	XUH22TT	-	IXUH22	VXUH22	3		
		M 132.910	451	2007-2015	XUH22TT	XUH22TT	-	IXUH22	VXUH22	3		
<b>SSANGYONG</b>												
ACTYON	2.3L 4Cyl 16V	G23D		2006-2008	K16PR-U	K16TT	IK16TT	IK16	VK16	4		
KORANDO	2.0L 4Cyl 16V	G20	CK	2012-2016	VXUHC22G	-	-	-	VXUHC22G	4		
MUSSO	3.2L 6Cyl 24V	M 104.992	FJ	1996-2004	K16PR-U	K16TT	IK16TT	IK16	VK16	6		
REXTON	3.2L 6Cyl 24V	G32D	RX320 GAB	2002-2006	K16PR-U	K16TT	IK16TT	IK16	VK16	6		
<b>SUBARU</b>												
BRUMBY	1.8L 4Cyl 8V	EA81	AS	1981-1986	W20EP-U	W20TT	IW20TT	IW20	-	4		
BRZ	2.0L 4Cyl 16V	FA20D	Z1	2012-2016	VXEZH27	-	-	-	VXEZH27	4		
			Z1	2016-	VXEZH27	-	-	-	VXEZH27	4		
FORESTER	2.0L 4Cyl 16V	EJ202	SF,SF5	1997-2002	K20PR-U11	K20TT	IK20TT	IK20	VK20	4		
		EJ205	S Turbo SF,SF5	1998-2002	IK20TT	K20TT	IK20TT	-	VK20Y	4		
		EJ201	SG	2002-2008	K20PR-U11	K20TT	IK20TT	IK20	VK20	4		
		EJ205	S Turbo SG	2002-2008	IK20TT	K20TT	IK20TT	-	VK20Y	4		
		FB20	SJ	2013-2018	IXEH22TT	-	IXEH22TT	-	VFXEH22	4		
IMPREZA	2.5L 4Cyl 16V	EJ251	SG	2002-2005	K20PR-U11	K20TT	IK20TT	IK20	VK20	4		
		EJ25	RX Nato SG,SG9	2002-2008	K20PR-U11	K20TT	IK20TT	IK20	VK20	4		
		EJ25	SG,SG9	2003-2005	K20PR-U11	K20TT	IK20TT	IK20	VK20	4		
		EJ255	SG,SG9	2005-2008	IKH20TT	-	IKH20TT	IKH20	VKH20	4		
		EJ25D	SG,SG9	2005-2008	K20PR-U11	K20TT	IK20TT	IK20	VK20	4		
		EJ255	SH,SH9	2008-2013	K20PR-U11	K20TT	IK20TT	IK20	VK20	4		
		EJ25	SH,SH9	2009-2013	K20PR-U11	K20TT	IK20TT	IK20	VK20	4		
		FB25	SH	2011-2013	IXEH22TT	-	IXEH22TT	-	VFXEH22	4		
		EJ255	Turbo SH,SH9	2011-2013	VKH20Y	-	IKH20TT	-	VKH20Y	4		
		FB25	SJ,SJ9	2012-2018	IXEH22TT	-	IXEH22TT	-	VFXEH22	4		
IMPREZA	1.6L 4Cyl 16V	EJ16	GC,GC3	1992-2000	K20PR-U11	K20TT	IK20TT	IK20	VK20	4		
		EJ161,EJ16E	GFC	1996-2000	K20PR-U11	K20TT	IK20TT	IK20	VK20	4		
		EJ161	GC,GC3	1997-2000	K20PR-U11	K20TT	IK20TT	IK20	VK20	4		
		EJ161	GF,GF3	1997-2000	K20PR-U11	K20TT	IK20TT	IK20	VK20	4		
		EJ161	GFC	1998-2000	K20PR-U11	K20TT	IK20TT	IK20	VK20	4		
		EJ161	GG	2000-2006	K20PR-U11	K20TT	IK20TT	IK20	VK20	4		
		EJ161	GD	2000-2009	K20PR-U11	K20TT	IK20TT	IK20	VK20	4		
		EJ18E,EJ18	1.8L 4Cyl 16V	GC,GC6		1992-2000	K20PR-U11	K20TT	IK20TT	IK20	VK20	4
				GF,GF6		1992-2000	K20PR-U11	K20TT	IK20TT	IK20	VK20	4
		EJ20 (Turbo)	1.8L 4Cyl 16V	WRX GC,GC8		1992-2000	IK20TT	K20TT	IK20TT	-	VK20Y	4
WRX GF,GF8				1994-2000	IK20TT	K20TT	IK20TT	-	VK20Y	4		
EJ20E,EJ201	GC,GC7	1995-2000	K20PR-U11	K20TT	IK20TT	IK20	VK20	4				
EJ20E,EJ201	GF,GF8	1995-2000	K20PR-U11	K20TT	IK20TT	IK20	VK20	4				
EJ20E	GFC	1995-2000	K20PR-U11	K20TT	IK20TT	IK20	VK20	4				
EJ20E	GF	1996-1998	K20PR-U11	K20TT	IK20TT	IK20	VK20	4				
EJ20E	GC,GC7	1996-1998	K20PR-U11	K20TT	IK20TT	IK20	VK20	4				
EJ205P	GC,GC8	1998-2000	IK20TT	K20TT	IK20TT	-	VK20Y	4				
EJ205P	GFC	1998-2000	IK20TT	K20TT	IK20TT	-	VK20Y	4				
EJ201	GC	1998-2000	K20PR-U11	K20TT	IK20TT	IK20	VK20	4				
EJ201	GC,GC8	1998-2000	K20PR-U11	K20TT	IK20TT	IK20	VK20	4				
EJ205	WRX GC,GC8	1998-2000	IK20TT	K20TT	IK20TT	-	VK20Y	4				
EJ205	WRX GF,GF8	1998-2000	IK20TT	K20TT	IK20TT	-	VK20Y	4				
EJ201	2.0L 4Cyl 16V	GD,GD9		1999-2009	K20PR-U11	K20TT	IK20TT	IK20	VK20	4		
		WRX GG,GGA		2000-2005	IK20TT	K20TT	IK20TT	-	VK20Y	4		
EJ205	WRX Turbo GD,GDA	2000-2005	IK20TT	K20TT	IK20TT	-	VK20Y	4				
EJ201	GG	2000-2007	K20PR-U11	K20TT	IK20TT	IK20	VK20	4				
EJ205	GD	2001-2002	K20PR-U11	K20TT	IK20TT	IK20	VK20	4				
EJ207	WRX STi GD,GDB	2001-2005	IK20TT	K20TT	IK20TT	-	VK20Y	4				
EJ205	WRX GD,GDA	2002-2005	IK20TT	K20TT	IK20TT	-	VK20Y	4				
EJ205	WRX Turbo GG	2002-2006	IK20TT	K20TT	IK20TT	IK20	VK20	4				
EJ205	WRX Turbo GD	2002-2007	IK20TT	K20TT	IK20TT	IK20	VK20	4				
EJ205	WRX GG	2005-2006	IK20TT	K20TT	IK20TT	-	VK20Y	4				
EJ207	GD,GDB	2005-2007	IK20TT	K20TT	IK20TT	-	VK20Y	4				
EJ204	GG,GG9	2005-2007	IKH20TT	-	IKH20TT	IKH20	VKH20	4				
EJ204	R GD,GD9	2005-2007	IKH20TT	-	IKH20TT	IKH20	VKH20	4				
EJ204	R GE,GH,GR,GH7	2008-2012	IKH20TT	-	IKH20TT	IKH20	VKH20	4				
EJ204	GR,GE7	2008-2016	IKH20TT	-	IKH20TT	IKH20	VKH20	4				





Model	Engine Size	Engine Code	Specification	Year	DENSO	TJ	IRIDIUM	IRIDIUM POWER	IRIDIUM TOUGH	QTY	
<b>SUBARU IMPREZA</b>	2.0L 4Cyl 16V	FB20B	GJ,GJ7	2011-2016	IXEH22TT	-	IXEH22TT	-	VFXEH22	4	AUSTRALIA CHINA INDIA INDONESIA KOREA MALAYSIA PHILIPPINES SAUDARABIA SINGAPORE TAIWAN THAILAND VIETNAM JAPAN EUROPE & USA CROSS REFERENCE PART NUMBER
		FB20	GP,GP7	2012-2016	IXEH22TT	-	IXEH22TT	-	VFXEH22	4	
	2.5L 4Cyl 16V	EJ251	GD	2001-2005	K20PR-U11	K20TT	IK20TT	IK20	VK20	4	
		EJ251	GD,GDE	2001-2005	K20PR-U11	K20TT	IK20TT	IK20	VK20	4	
		EJ25	GDA,GGA	2002-2005	K20PR-U11	K20TT	IK20TT	IK20	VK20	4	
		EJ257	WRX STi GD,GDF	2005-2007	VKH20Y	-	IKH20TT	-	VKH20Y	4	
		EJ257	GG	2005-2008	IKH20TT	-	IKH20TT	-	VKH20Y	4	
		EJ255	WRX GD,GDG	2005-2008	VKH20Y	-	IKH20TT	-	VKH20Y	4	
		EJ255	WRX GG,GGG	2005-2008	IKH20TT	-	IKH20TT	-	VKH20Y	4	
		EJ255	GE,GH,GR,GHE	2007-2011	VKH20Y	-	IKH20TT	-	VKH20Y	4	
		EJ257	WRX / WRX STi GE,GH,GR,GRF	2008-2013	VKH20Y	-	IKH20TT	-	VKH20Y	4	
		EJ255	WRX SE GR,GVE	2009-2016	VKH20Y	-	IKH20TT	-	VKH20Y	4	
		EJ255	WRX SE GE,GH,GR,G3	2010-2013	VKH20Y	-	IKH20TT	-	VKH20Y	4	
		EJ257	WRX / WRX STi GR,GVF	2011-2013	VKH20Y	-	IKH20TT	-	VKH20Y	4	
		<b>LEONE LIBERTY</b>	1.8L 4Cyl 8V	EA82T	1800	1986-1990	W20EPR-U11	W20TT	IW20TT	IW20	
1.6L 4Cyl 16V	EJ16		BC	1989-1993	K20PR-U11	K20TT	IK20TT	IK20	VK20	4	
<b>LIBERTY</b>	2.0L 4Cyl 16V	EJ20-GN	RS BC,BC5	1991-1994	IK20TT	K20TT	IK20TT	-	VK20Y	4	
		EJ20-GN	RS BF,BF5	1991-1994	IK20TT	K20TT	IK20TT	-	VK20Y	4	
		EJ201	BE,BE5	1998-2003	K20PR-U11	K20TT	IK20TT	IK20	VK20	4	
		EJ201	BH,BH5	1998-2003	K20PR-U11	K20TT	IK20TT	IK20	VK20	4	
		EJ206	RSK BE	2001-2002	K20PR-U11	K20TT	IK20TT	IK20	VK20	4	
		EJ208	BE,BE5	2002-2003	K20PR-U11	K20TT	IK20TT	IK20	VK20	4	
		EJ202	BL,BL5	2003-2005	IK16TT	K16TT	IK16TT	IK16	VK16	4	
		EJ202	B13,BP,BP5	2003-2006	IK16TT	K16TT	IK16TT	IK16	VK16	4	
		EJ20 (Turbo)	Turbo BL,BL5	2003-2006	IKH20TT	-	IKH20TT	IKH20	VKH20	4	
		EJ20X,EJ204	B13,BP,BP5	2005-2007	IK16TT	K16TT	IK16TT	IK16	VK16	4	
	EJ20X,EJ204	BL	2005-2009	IKH20TT	-	IKH20TT	IKH20	VKH20	4		
	2.2L 4Cyl 16V	EJ22	BF,BF6	1989-1994	K20PR-U11	K20TT	IK20TT	IK20	VK20	4	
		EJ22 EMPI	GS Rally, Heritage BC	1989-1994	K20PR-U11	K20TT	IK20TT	IK20	VK20	4	
		EJ22 EMPI	GX BF,BFB	1989-1994	K20PR-U11	K20TT	IK20TT	IK20	VK20	4	
		EJ22	LX BC,BC6	1989-1994	K20PR-U11	K20TT	IK20TT	IK20	VK20	4	
		EJ22	BG,BG6/BG7	1994-1996	K20PR-U11	K20TT	IK20TT	IK20	VK20	4	
		EJ22 EMPI	BG,BG7	1994-1996	K20PR-U11	K20TT	IK20TT	IK20	VK20	4	
		EJ22 EMPI	GX, LX, Heritage BD,BD7	1994-1999	K20PR-U11	K20TT	IK20TT	IK20	VK20	4	
		EJ25	BD,BD9	1996-1998	K20PR-U11	K20TT	IK20TT	IK20	VK20	4	
		EJ25D	BG,BG9	1996-1998	K20PR-U11	K20TT	IK20TT	IK20	VK20	4	
		EJ25	BE,BE9	1998-2003	K20PR-U11	K20TT	IK20TT	IK20	VK20	4	
	2.5L 4Cyl 16V	EJ25	BH,BH9	1998-2003	K20PR-U11	K20TT	IK20TT	IK20	VK20	4	
		EJ25	B13,BP,BP9	2003-2006	IK16TT	K16TT	IK16TT	IK16	VK16	4	
		EJ25	BL,BL9	2003-2007	IK16TT	K16TT	IK16TT	IK16	VK16	4	
		EJ25DET	B13,BP,BP9	2006-2009	VKH20Y	-	IKH20TT	-	VKH20Y	4	
		EJ25DET	BL,BL9	2006-2009	VKH20Y	-	IKH20TT	-	VKH20Y	4	
		EJ25DET	STI B13,BP,BP9	2006-2009	VKH20Y	-	IKH20TT	-	VKH20Y	4	
		EJ255,EJ25DET	STI BL,BL9	2006-2009	VKH20Y	-	IKH20TT	-	VKH20Y	4	
		EJ25	BL,BL9	2007-2009	IK16TT	K16TT	IK16TT	IK16	VK16	4	
		EJ25	BP,BP9	2008-2009	IK16TT	K16TT	IK16TT	IK16	VK16	4	
		EJ253	BM,BM9	2009-2014	IK20TT	K20TT	IK20TT	IK20	VK20	4	
		EJ253	BR,BR9	2009-2014	IK20TT	K20TT	IK20TT	IK20	VK20	4	
		EJ255	GT BM,BM9	2010-2014	VKH20Y	-	IKH20TT	-	VKH20Y	4	
		EJ255	GT BR,BR9	2010-2014	VKH20Y	-	IKH20TT	-	VKH20Y	4	
	3.0L 6Cyl 24V	FB25	BM	2012-2014	IXEH22TT	-	IXEH22TT	-	VFXEH22	4	
		FB25	BR,BRM	2012-2014	IXEH22TT	-	IXEH22TT	-	VFXEH22	4	
		FB25	BM,BN9	2013-2017	IXEH22TT	-	IXEH22TT	-	VFXEH22	4	
		FB25	BN,BN9	2015-	IXEH22TT	-	IXEH22TT	-	VFXEH22	4	
		EZ30	R B13,BP,BPE	2004-2007	IKH20TT	-	IKH20TT	IKH20	VKH20	6	
		EZ30	R BL,BLE	2004-2007	IKH20TT	-	IKH20TT	IKH20	VKH20	6	
		3.6L 6Cyl 24V	EZ36D	BM,BMF	2009-2014	IKH20TT	-	IKH20TT	IKH20	VKH20	6
	EZ36D		BN,BNF	2015-	IKH20TT	KH20TT	IKH20TT	IKH20	VKH20	6	
<b>OUTBACK</b>	2.0L 4Cyl 16V	EJ202	BL,BP	2003-2005	IK16TT	K16TT	IK16TT	IK16	VK16	4	
		EJ25D	BG,BG9	1996-1999	K20PR-U11	K20TT	IK20TT	IK20	VK20	4	
		EJ25	BH,BH9	2000-2003	K20PR-U11	K20TT	IK20TT	IK20	VK20	4	
	2.5L 4Cyl 16V	EJ25D	BP,BP9	2003-2009	IK16TT	K16TT	IK16TT	IK16	VK16	4	
		EJ251	BP,BP9	2008-2009	IK16TT	K16TT	IK16TT	IK16	VK16	4	
		EJ253	BR,BR9	2009-2015	IK20TT	K20TT	IK20TT	IK20	VK20	4	
		FB25	BR	2013-2015	IXEH22TT	-	IXEH22TT	-	VFXEH22	4	
		FB25	BS,BS9	2014-	IXEH22TT	-	IXEH22TT	-	VFXEH22	4	
		EZ30	H6 BH,BHE	2000-2003	IKH20TT	-	IKH20TT	IKH20	VKH20	6	

DENSO	9	14	16	20	22	24	27	29	31	32	34	35	DENSO	9	14	16	20	22	24	27	31	32	DENSO	9	14	16	20	22	24	27	31	
NGK	2	4	5	6	7	8	9	9.5	10	10.5	11	11.5	CHAMPION	18	16,14	12,11	10,9	8,7	6,6.3,6.1	4,59	57	55	53	BOSCH	10	9	8	7,6	5	4	3	2















# AUSTRALIA CAR

▶ Spark plug color codes: ■ for Iridium Tough and Iridium Plugs and Iridium TT, ■ for Iridium Power, ■ for Iridium Racing and Two Tops Plugs, ■ for Platinum Plugs and Platinum TT, and black for general spark plugs.

COUNTRY	Model	Engine Size	Engine Code	Specification	Year	DENSO	TJ		IRIDIUM		QTY	
							Iridium	Tough	Power	Tough		
<b>VOLVO</b>												
AUSTRALIA	S80	2.9L 6Cyl 24V	B 6294 T	T6 184	2001-2006	IK20TT	K20TT	IK20TT	-	VK20Y	6	
		3.2L 6Cyl 24V	B 6324 S	124	2007-2010	VKH20Y	-	-	-	VKH20Y	6	
		4.4L 8Cyl 32V	B 8444 S	124	2006-2012	IK20TT	K20TT	IK20TT	IK20	VK20	8	
CHINA	S90	2.9L 6Cyl 24V	B 6304 S2	964	1997-1998	Q20PR-U	Q20TT	IQ20TT	IQ20	VQ20	6	
		V40	1.8L 4Cyl 16V	B 4184 S2	645	1999-2004	K20PBR-S10	K20TT	IK20TT	IK20	VK20	4
	B4204S,B4204S2		645	1995-2004	K20PBR-S10	K20TT	IK20TT	IK20	VK20	4		
	B 4204 S		645	1995-1999	K20PBR-S10	K20TT	IK20TT	IK20	VK20	4		
	B 4204 T		645	1997-2000	IK20TT	K20TT	IK20TT	-	VK20Y	4		
	1.9L 4Cyl 16V		B4194T,B4194T2	T4 645	1997-2000	IK20TT	K20TT	IK20TT	-	VK20Y	4	
			B 4204 T2	645	1999-2004	IK20TT	K20TT	IK20TT	-	VK20Y	4	
			B 4204 T5	T4 645	2000-2004	IK20TT	K20TT	IK20TT	-	VK20Y	4	
		B 4204 T3	645	2001-2004	IK20TT	K20TT	IK20TT	-	VK20Y	4		
INDONESIA	V50	2.4L 5Cyl 20V	B 5244 S4	545	2004-2010	K20HR-U11	KH20TT	IKH20TT	IKH20	VKH20	5	
			B 5244 S5	545	2004-2010	K20HR-U11	KH20TT	IKH20TT	IKH20	VKH20	5	
			B 5254 T3	T5 545	2004-2007	VKH20Y	-	-	-	VKH20Y	5	
KOREA	V70	2.5L 5Cyl 20V	B 5254 T7	T5 545	2007-2010	VKH20Y	-	-	-	VKH20Y	5	
		2.3L 5Cyl 20V	B 5234 T3	T5 285	1999-2008	IK20	K20TT	IK20TT	IK20	VK20	5	
			B 5252 FS	875, 876	1995-2000	K20PBR-S10	K20TT	IK20TT	IK20	VK20	5	
MALAYSIA	V90	B5244S,B5254S,B5254FS	875, 876	1995-2000	K20PBR-S10	K20TT	IK20TT	IK20	VK20	5		
		B5254T,B5244T	Turbo 875, 876	1996-2000	IK22	-	-	IK22	VK22	5		
		2.4L 5Cyl 20V	B5244S	875, 876	1999-2000	K20PBR-S10	K20TT	IK20TT	IK20	VK20	5	
			B 5244 T3	285	1999-2008	IK20TT	K20TT	IK20TT	-	VK20Y	5	
PHILIPPINES	V90	B 5244 S	285	2000-2008	K20PBR-S10	K20TT	IK20TT	IK20	VK20	5		
		B 5244 S2	285	2000-2008	K20PBR-S10	K20TT	IK20TT	IK20	VK20	5		
		3.0L 6Cyl 24V	B 6304 T2	T6 135	2007-2010	VKH20Y	-	IKH20TT	-	VKH20Y	6	
SAUDI ARABIA	XC60	2.9L 6Cyl 24V	B 6304 S2	965	1997-1998	Q20PR-U	Q20TT	IQ20TT	IQ20	VQ20	6	
			B6304GS,B6304FS	965	1997-1998	Q20PR-U	Q20TT	IQ20TT	IQ20	VQ20	6	
		3.0L 6Cyl 24V	B 6304 T2	T6 DZ	2008-2010	VKH20Y	-	IKH20TT	-	VKH20Y	6	
B 6304 T4	T6 DZ		2010-2017	IKH20TT	-	IKH20TT	-	VFKH20	6			
SINGAPORE	XC70	3.2L 6Cyl 24V	B 6324 S5	DZ	2010-2015	IKH20TT	-	IKH20TT	-	VFKH20	6	
		XC70 CROSS COUNTRY	3.2L 6Cyl 24V	B 6324 S	BZ	2007-2011	VKH20Y	-	IKH20TT	-	VKH20Y	6
			2.4L 5Cyl 20V	B 5244 T3	295	2000-2002	IK20TT	K20TT	IK20TT	-	VK20Y	5
TAIWAN	XC90	2.5L 5Cyl 20V	B 5254 T2	295	2002-2007	IK20	K20TT	IK20TT	IK20	VK20	5	
		2.5L 5Cyl 20V	B 5254 T2	275	2002-2014	IK20	K20TT	IK20TT	IK20	VK20	5	
		2.9L 6Cyl 24V	B 6294 T	T6 275	2002-2006	IK20	K20TT	IK20TT	IK20	VK20	6	
VIETNAM	AMAROK	3.2L 6Cyl 24V	B 6324 S5	275	2006-2010	VKH20Y	-	IKH20TT	-	VKH20Y	6	
		2.9L 6Cyl 24V	B 6324 S	275	2010-2012	IKH20TT	-	IKH20TT	-	VFKH20	6	
			B 6324 S5	275	2010-2012	IKH20TT	-	IKH20TT	-	VFKH20	6	
THAILAND	BEETLE	4.4L 8Cyl 32V	B 8444 S	275	2005-2010	IK20TT	K20TT	IK20TT	IK20	VK20	8	
		VW										
JAPAN	BORAROK	2.0L 4Cyl 16V	CFPA	S7A,2HA,2HB,S6B,S7B,S1B	2010-2016	IK22	-	-	IK22	VK22	4	
		CFPA	S1B,S6B,S7B	2011-2016	IK22	-	-	IK22	VK22	4		
EUROPE & USA	CADDY	1.2L 4Cyl 8V	M51		1954-1965	W16FS-U	-	-	-	-	4	
		D	1200	1960-1985	W16FS-U	-	-	-	-	-	4	
		1.3L 4Cyl 8V	AC	1302	1970-1975	W16FS-U	-	-	-	-	4	
		1.4L 4Cyl 16V	CNWA,CTKA,CAVD,CTHD	5C2,5C1	2011-2016	IK20TT	K20TT	IK20TT	-	VK20Y	4	
VIETNAM	BORA	1.5L 4Cyl 8V	H	1500	1966-1973	W16FS-U	-	-	-	-	4	
			AD,AJ,AS	1303 LS,S	1972-1979	W16FS-U	-	-	-	-	4	
		1.6L 4Cyl 8V	BFS,AYD	1C1,9C1	2000-2010	K20PBR-S10	K20TT	IK20TT	IK20	VK20	4	
JAPAN	BORAROK		BFS	1Y7	2003-2010	K20PBR-S10	K20TT	IK20TT	IK20	VK20	4	
		1.8L 4Cyl 20V	AGU,APH,AVC,AWU,AWW,BKF	1C1,9C1	1999-2010	IK20TT	K20TT	IK20TT	-	VK20Y	4	
		2.0L 4Cyl 8V		1C1,9C1	1998-2010	VKA16	-	-	-	VKA16	4	
EUROPE & USA	CADDY		AZJ,BEV,BDC,BGD	1Y7	2002-2010	VKA16	-	-	-	VKA16	4	
		1.6L 4Cyl 8V	APF,AEH,AKL	1J2	1998-2005	K20PBR-S10	K20TT	IK20TT	IK20	VK20	4	
		2.0L 4Cyl 8V	AQY,APK,AZH,AZJ,BBW,AZG	1J2	1998-2013	K20PBR-S10	K20TT	IK20TT	IK20	VK20	4	
EUROPE & USA	GOLF	2.3L 5Cyl 10V	AGZ	1J2	1998-2005	K20TXR	K20TT	IK20TT	IK20	VK20	5	
		2.3L 5Cyl 20V	AQN	1J2	2000-2005	VKA16	-	-	-	VKA16	5	
		1.6L 4Cyl 8V	BGU,BSE,BSF	2CB,2CJ,2KB,2KJ	2004-2015	K20PBR-S10	K20TT	IK20TT	IK20	VK20	4	
BGU,BSE,BSF	2KA,2CA,2CH,2KH		2004-2015	K20PBR-S10	K20TT	IK20TT	IK20	VK20	4			
EUROPE & USA	EOS	2.0L 4Cyl 16V	CAWB,CCZA,BWA	1F7,1F8	2006-2015	IK22	-	-	IK22	VK22	4	
		CCZB	1F7,1F8	2009-2015	IK22	-	-	IK22	VK22	4		
EUROPE & USA	GOLF	1.1L 4Cyl 8V	FA,GG	MKI, 17	1974-1983	W20EP-U	W20TT	IW20TT	IW20	-	4	
			AXP,BCA,APE,AHW,AKQ	1J1	1997-2004	K20PBR-S10	K20TT	IK20TT	IK20	VK20	4	
			AXP,BCA,APE,AHW,AKQ	1J5	1999-2006	K20PBR-S10	K20TT	IK20TT	IK20	VK20	4	
		1.4L 4Cyl 16V	BKG,BLN	1K1	2003-2006	K20PBR-S10	K20TT	IK20TT	IK20	VK20	4	
			BLG	MKV, 1K1	2005-2008	IK20L	-	-	IK20L	-	4	
			CAXA	MKV, 5K1	2008-2012	IK20L	-	-	IK20L	-	4	
CROSS REFERENCE PART NUMBER		CNWA,CAVD,CTHD	MKV, 5K1	2008-2012	IK20TT	K20TT	IK20TT	-	VK20Y	4		







# AUSTRALIA CAR

▶ Spark plug color codes: for Iridium Tough and Iridium Plugs and Iridium TT, for Iridium Power, for Iridium Racing and Two Tops Plugs, for Platinum Plugs and Platinum TT, and black for general spark plugs.

Model	Engine Size	Engine Code	Specification	Year	DENSO					QTY				
<b>VW</b>														
<b>POLO</b>	1.6L 4Cyl 16V	<b>BTS</b>	9N	2006-2009	<b>VKA20</b>	-	-	-	<b>VKA20</b>	4				
		<b>AEA,AEE</b>	75 6N1	1994-1999	<b>W20EPBR-S</b>	<b>W20TT</b>	<b>IW20TT</b>	<b>IW20</b>	-	4				
	1.6L 4Cyl 8V	<b>BCD</b>	Classic 9N	2004-2006	<b>VKA20</b>	-	-	<b>IK20L</b>	<b>VKA20</b>	4				
<b>CHINA</b>	1.8L 4Cyl 16V	<b>DAJA,DAJB</b>	GTI 6R1,6C1	2014-	<b>VKH22</b>	-	-	<b>IKH22</b>	<b>VKH22</b>	4				
	1.8L 4Cyl 20V	<b>BJX</b>	GTI 9N	2005-2009	<b>IK20TT</b>	<b>K20TT</b>	<b>IK20TT</b>	-	<b>VK20Y</b>	4				
<b>INDIA</b>	<b>SCIROCCO</b>	2.0L 4Cyl 16V	<b>CDLC</b>	R 138137	2009-2017	<b>IK22</b>	-	-	<b>IK22</b>	<b>VK22</b>	4			
<b>INDONESIA</b>	<b>TIGUAN</b>	1.4L 4Cyl 16V	<b>CAVD,CTHD</b>	5N	2011-2018	<b>IK20TT</b>	<b>K20TT</b>	<b>IK20TT</b>	-	<b>VK20Y</b>	4			
			<b>CCTA,CAWB,CCZA</b>	5N	2007-2018	<b>IK22</b>	-	-	<b>IK22</b>	<b>VK22</b>	4			
			<b>CCZC,CAWA</b>	5N	2007-2018	<b>IK22</b>	-	-	<b>IK22</b>	<b>VK22</b>	4			
		2.0L 4Cyl 16V	<b>CCZB</b>	5N	2011-2018	<b>IK22</b>	-	-	<b>IK22</b>	<b>VK22</b>	4			
			<b>CCZD</b>	5N	2011-2018	<b>IK22</b>	-	-	<b>IK22</b>	<b>VK22</b>	4			
			<b>CHHB</b>	AD1,BT1	2016-	<b>VKH22</b>	-	-	<b>IKH22</b>	<b>VKH22</b>	4			
<b>CZPA</b>	AD1,BT1	2016-	<b>VKH22</b>	-	-	<b>IKH22</b>	<b>VKH22</b>	4						
<b>TOUAREG</b>	4.2L 8Cyl 40V	<b>AXQ</b>	7L6,7LA,7L7	2002-2006	<b>K20TXR</b>	<b>K20TT</b>	<b>IK20TT</b>	<b>IK20</b>	<b>VK20</b>	8				
<b>TOURAN</b>	2.0L 4Cyl 16V	<b>BLX,BLY,BVY,BVZ,BLR,AXW</b>	1T1,1T2	2003-2007	<b>VKA16</b>	-	-	-	<b>VKA16</b>	4				
<b>KOREA</b>	<b>TRANSPORTER</b>	1.9L 4Cyl 8V	<b>DH</b>		1983-1985	<b>W20ES-U</b>	-	-	-	4				
			<b>AAC</b>	70A,70H,7DA,7DH	1990-2003	<b>W20EPBR-S</b>	<b>W20TT</b>	<b>IW20TT</b>	<b>IW20</b>	-	4			
		2.0L 4Cyl 8V	<b>AAC</b>	70E,70L,70M,7DE,7DL,7DM	1990-2003	<b>W20EPBR-S</b>	<b>W20TT</b>	<b>IW20TT</b>	<b>IW20</b>	-	4			
			<b>AAC</b>	7DB,70XC,7DK,70XB,7DW	1990-2003	<b>W20EPBR-S</b>	<b>W20TT</b>	<b>IW20TT</b>	<b>IW20</b>	-	4			
			<b>AXA</b>	7EA,7EH,7HA,7HH	2003-2015	<b>K20PBR-S10</b>	<b>K20TT</b>	<b>IK20TT</b>	<b>IK20</b>	<b>VK20</b>	4			
<b>MALAYSIA</b>	<b>PHILIPPINES</b>	2.1L 4Cyl 8V	<b>MV</b>		1985-1992	<b>W20ES-U</b>	-	-	-	4				
			<b>AEU,AAF,AEN,ACU</b>	70A,70H,7DA,7DH	1990-2003	<b>W20EPBR-S</b>	<b>W20TT</b>	<b>IW20TT</b>	<b>IW20</b>	-	5			
			<b>AEU,AAF,AEN,ACU</b>	70E,70L,70M,7DE,7DL,7DM	1990-2003	<b>W20EPBR-S</b>	<b>W20TT</b>	<b>IW20TT</b>	<b>IW20</b>	<b>VW20T</b>	5			
			<b>AEU,AAF,AEN,ACU</b>	7DB,70XC,7DK,70XB,7DW	1990-2003	<b>W20EPBR-S</b>	<b>W20TT</b>	<b>IW20TT</b>	<b>IW20</b>	<b>VW20T</b>	5			
			2.5L 5Cyl 10V	<b>AEU,AAF,ACU</b>	70E,70L,70M,7DE,7DL,7DM	1992-2001	<b>W20EPBR-S</b>	<b>W20TT</b>	<b>IW20TT</b>	<b>IW20</b>	-	5		
				<b>AET,APL,AVT</b>	70A,70H,7DA,7DH	1995-2003	<b>W20EPBR-S</b>	<b>W20TT</b>	<b>IW20TT</b>	<b>IW20</b>	<b>VW20T</b>	5		
				<b>AET,APL,AVT</b>	70E,70L,70M,7DE,7DL,7DM	1995-2003	<b>W20EPBR-S</b>	<b>W20TT</b>	<b>IW20TT</b>	<b>IW20</b>	<b>VW20T</b>	5		
				<b>AET,APL,AVT</b>	7DB,70XC,7DK,70XB,7DW	1995-2003	<b>W20EPBR-S</b>	<b>W20TT</b>	<b>IW20TT</b>	<b>IW20</b>	-	5		
			<b>SAUDIARABIA</b>	<b>SINGAPORE</b>	2.8L 6Cyl 24V	<b>AXK,AMV</b>	VR6 7DB,70XC,7DK,70XB,7DW	2000-2003	<b>IK16TT</b>	<b>K16TT</b>	<b>IK16TT</b>	<b>IK16L</b>	-	6
						<b>Type 3</b>	<b>K</b>	31	1961-1973	<b>W20FS-U</b>	<b>WF20TT</b>	-	<b>IWF20</b>	-
<b>K</b>	L 31	1968-1973					<b>W20FS-U</b>	-	-	<b>IWF20</b>	-	4		
<b>VIETNAM</b>	<b>JAPAN</b>	1.6L 4Cyl 8V	<b>T,U</b>	31	1965-1973	<b>W16FS-U</b>	-	-	-	4				
			<b>VENTO</b>	1.8L 4Cyl 8V	<b>ADZ,ABS</b>	1H2	1991-1998	<b>W20EPB</b>	<b>W20TT</b>	<b>IW20TT</b>	<b>IW20</b>	-	4	



车种	YEAR	车型	发动机型式	DENSO	IRIDIUM	IRIDIUM	PLATINUM	TT	
华晨汽车									
中华	2.0L	4G63S4M	K16PR-U11	IK16	IK16TT	PK16TT	K16TT		
	2.4L	4G63S4M	K16PR-U11	IK16	IK16TT	PK16TT	K16TT		
	1.5L	BM15L	K20HR-U11	IKH20	IKH20TT	PKH20TT	KH20TT		
	1.5T	BM15T	K20HR-U11	IKH20	IKH20TT	PKH20TT	KH20TT		
	1.6L	4A92S	K20HR-U11	IKH20	IKH20TT	PKH20TT	KH20TT		
尊驰	1.8L	4G93	K20PR-U11	IK20	IK20TT	PK20TT	K20TT		
	1.8T	BL18T	K22PR-U	IK22	-	PK22TT	-		
	2.0L	4G63S4M	K16PR-U11	IK16	IK16TT	PK16TT	K16TT		
	2.4L	4G63S4M	K16PR-U11	IK16	IK16TT	PK16TT	K16TT		
骏捷	1.6L	4G18	K16PR-U11	IK16	IK16TT	PK16TT	K16TT		
	1.8L	4G93	K20PR-U11	IK20	IK20TT	PK20TT	K20TT		
	1.8T	BL18T	K22PR-U	IK22	-	PK22TT	-		
	2.0L	4G63S4M	K16PR-U11	IK16	IK16TT	PK16TT	K16TT		
	1.6L	BL16L	K16PR-U11	IK16	IK16TT	PK16TT	K16TT		
	1.8L	BL18L	K20PR-U11	IK20	IK20TT	PK20TT	K20TT		
	1.8T	BL18L	K22PR-U	IK22	-	PK22TT	-		
	1.5L	4A15	XU22EPR-U	IXU22	-	-	XU22TT		
骏捷CROSS	1.6L	4G18S	K16PR-U11	IK16	IK16TT	PK16TT	K16TT		
骏捷	1.5L	4A91S	K16PR-U11	IK16	IK16TT	PK16TT	K16TT		
骏捷FRV	1.3L	4G13S	K16PR-U11	IK16	IK16TT	PK16TT	K16TT		
	1.3L	4A13	XU22EPR-U	IXU22	-	-	XU22TT		
	1.5L	4A91S	K16PR-U11	IK16	IK16TT	PK16TT	K16TT		
	1.6L	4G18S	K16PR-U11	IK16	IK16TT	PK16TT	K16TT		
骏捷FSV	1.5L	4A15	XU22EPR-U	IXU22	-	-	XU22TT		
	1.5L	4A91S	K16PR-U11	IK16	IK16TT	PK16TT	K16TT		
	1.6L	4G18S	K16PR-U11	IK16	IK16TT	PK16TT	K16TT		
骏捷Wagon	1.8L	4G93	K20PR-U11	IK20	IK20TT	PK20TT	K20TT		
	1.8T	BL18T	K22PR-U	IK22	-	PK22TT	-		
	2.0L	4G63S4M	K16PR-U11	IK16	IK16TT	PK16TT	K16TT		
	2.0L	BL20L	K16PR-U11	IK16	IK16TT	PK16TT	K16TT		
酷宝	1.8MT	4G93	K20PR-U11	IK20	IK20TT	PK20TT	K20TT		
	1.8T	BL18T	K22PR-U	IK22	-	PK22TT	-		
阁瑞斯	2.0L	4G20D4L	K16PR-U11	IK16	IK16TT	PK16TT	K16TT		
	2.4L	4RB2	K20PR-U	IK20	IK20TT	PK20TT	K20TT		
	2.7L	2TR	K16R-U	IK16	IK16TT	PK16TT	K16TT		
比亚迪									
F0	1.0L3	BYD371DA	K20HR-U11	IKH20	IKH20TT	PKH20TT	KH20TT		
F3	1.5L	三菱4G15S	K16PR-U11	IK16	IK16TT	PK16TT	K16TT		
	1.5L	BYD473QE	K20PR-U	IK20	IK20TT	PK20TT	K20TT		
	1.5T	BYD476ZQA	K20PR-U11	IK20	IK20TT	PK20TT	K20TT		
	1.6L	DA4G18	K16PR-U11	IK16	IK16TT	PK16TT	K16TT		
	1.8L	BYD483QA	K16PR-U11	IK16	IK16TT	PK16TT	K16TT		
	1.0L DM	371QA	K20HR-U11	IKH20	IKH20TT	PKH20TT	KH20TT		
F3R	1.5L	4G15S	K16PR-U11	IK16	IK16TT	PK16TT	K16TT		
	1.5L	BYD473QB	K20PR-U	IK20	IK20TT	PK20TT	K20TT		
	1.6L	DA4G18	K16PR-U11	IK16	IK16TT	PK16TT	K16TT		
G3	1.5L	4G15S	K16PR-U11	IK16	IK16TT	PK16TT	K16TT		
	1.8L	483QA	K16PR-U11	IK16	IK16TT	PK16TT	K16TT		
	1.5L	473QE	K20PR-U	IK20	IK20TT	PK20TT	K20TT		
G3R	1.5L	473QD	K20PR-U	IK20	IK20TT	PK20TT	K20TT		
	1.8L	483QA	K16PR-U11	IK16	IK16TT	PK16TT	K16TT		
L3	1.8L	BYD483QA	K16PR-U11	IK16	IK16TT	PK16TT	K16TT		
	1.5L	473QB/QE	K20PR-U	IK20	IK20TT	PK20TT	K20TT		
速锐	1.5L	BYD473QE	K20PR-U	IK20	IK20TT	PK20TT	K20TT		
	1.5T	BYD476ZQA	K20PR-U11	IK20	IK20TT	PK20TT	K20TT		
思锐	1.5T	BYD476ZQA	K20PR-U11	IK20	IK20TT	PK20TT	K20TT		
G5	1.5T	476ZQA	K20PR-U11	IK20	IK20TT	PK20TT	K20TT		
F6	1.8L	BYD483QA	K16PR-U11	IK16	IK16TT	PK16TT	K16TT		
	2.0L	BYD483QB	K16PR-U11	IK16	IK16TT	PK16TT	K16TT		
	2.4L	4G69S4M	KJ20CR-L11	IK20L	IK20TT	PK20TT	K20TT		
M6	2.0L	BYD483QB	K16PR-U11	IK16	IK16TT	PK16TT	K16TT		
	2.4L	4G69S4M	KJ20CR-L11	IK20L	IK20TT	PK20TT	K20TT		
	2.4L	BYD488QA	K16PR-U11	IK16	IK16TT	PK16TT	K16TT		
G6	1.5T	BYD476ZQA	K20PR-U11	IK20	IK20TT	PK20TT	K20TT		
	2.0L	BYD483QB	K20PR-U11	IK20	IK20TT	PK20TT	K20TT		
S6	1.5T	BYD476ZQA	K20PR-U11	IK20	IK20TT	PK20TT	K20TT		
	2.0L	BYD483QB	K16PR-U11	IK16	IK16TT	PK16TT	K16TT		

AUSTRALIA  
CHINA  
INDIA  
INDONESIA  
KOREA  
MALAYSIA  
PHILIPPINES  
SAUDIARABIA  
SINGAPORE  
TAIWAN  
THAILAND  
VIETNAM  
JAPAN  
EUROPE  
& USA  
CROSS  
REFERENCE  
PART  
NUMBER

DENSO	9	14	16	20	22	24	27	29	31	32	34	35	DENSO	9	14	16	20	22	24	27	29	31	32	DENSO	9	14	16	20	22	24	27	31
NGK	2	4	5	6	7	8	9	9.5	10	10.5	11	11.5	CHAMPION	18	16,14	12,11	10,9	8,7	6,63,61	4,59	57	55	53	BOSCH	10	9	8	7,6	5	4	3	2



	车种	YEAR	车型	发动机型式	DENSO	IRIDIUM			
AUSTRALIA	比亚迪								
	S6	2.4L	4G69	KJ20CR-L11	<b>IK20L</b>	<b>IK20TT</b>	<b>PK20TT</b>	<b>K20TT</b>	
CHINA	S7	2.4L	BYD488QB	K16PR-U11	<b>IK16</b>	<b>IK16TT</b>	<b>PK16TT</b>	<b>K16TT</b>	
	S8	1.5T	BYD476ZQA	K20PR-U11	<b>IK20</b>	<b>IK20TT</b>	<b>PK20TT</b>	<b>K20TT</b>	
INDIA	秦	2.0T	BYD487ZQA	K20HR-U11	<b>IKH20</b>	<b>IKH20TT</b>	<b>PKH20TT</b>	<b>KH20TT</b>	
	唐	2.0L	BYD483QB	K16PR-U11	<b>IK16</b>	<b>IK16TT</b>	<b>PK16TT</b>	<b>K16TT</b>	
INDONESIA	宋	1.5T	BYD476ZQA	K20PR-U11	<b>IK20</b>	<b>IK20TT</b>	<b>PK20TT</b>	<b>K20TT</b>	
	元	2.0T	BYD487QA	K20HR-U11	<b>IKH20</b>	<b>IKH20TT</b>	<b>PKH20TT</b>	<b>KH20TT</b>	
INDONESIA	昌河汽车								
	北斗星	1.5L	BYD473QE	K20PR-U	<b>IK20</b>	<b>IK20TT</b>	<b>PK20TT</b>	<b>K20TT</b>	
KOREA	浪迪	1.5T	BYD476ZQA	K20PR-U11	<b>IK20</b>	<b>IK20TT</b>	<b>PK20TT</b>	<b>K20TT</b>	
	利亚纳	1.0L	DA465Q	W16EX-U	<b>IW16</b>	<b>IW16TT</b>	<b>PW16TT</b>	-	
MALAYSIA	利亚纳A6	1.1L	DA465Q	W16EX-U	<b>IW16</b>	<b>IW16TT</b>	<b>PW16TT</b>	-	
	派喜	1.4L	K14B	XU22EPR-U	<b>IXU22</b>	-	-	<b>XU22TT</b>	
PHILIPPINES	爱迪尔	1.0L	K10A	XU22EPR-U	<b>IXU22</b>	-	-	<b>XU22TT</b>	
	福瑞达	1.2L	K12A	XU22EPR-U	<b>IXU22</b>	-	-	<b>XU22TT</b>	
SAUDIARABIA	利亚纳	1.4L	K14B-C	XU22EPR-U	<b>IXU22</b>	-	-	<b>XU22TT</b>	
	利亚纳A6	1.4L	K14B-G	XU22EPR-U	<b>IXU22</b>	-	-	<b>XU22TT</b>	
SINGAPORE	派喜	1.6L	M16A	K20PR-U11	<b>IK20</b>	<b>IK20TT</b>	<b>PK20TT</b>	<b>K20TT</b>	
	爱迪尔	1.4L	K14B-B	XU22EPR-U	<b>IXU22</b>	-	-	<b>XU22TT</b>	
TAIWAN	福瑞达	1.05L	DA465Q	W20EXR-U11	<b>IW20</b>	<b>IW20TT</b>	<b>PW20TT</b>	-	
	长安铃木	1.0L	DA465Q-2	W20EXR-U11	<b>IW20</b>	<b>IW20TT</b>	<b>PW20TT</b>	-	
THAILAND	奥拓	1.4L	K14B	XU22EPR-U	<b>IXU22</b>	-	-	<b>XU22TT</b>	
	羚羊	1.0L	DA465QAF1	W20EXR-U11	<b>IW20</b>	<b>IW20TT</b>	<b>PW20TT</b>	-	
VIETNAM	羚羊	1.1L	DA465QE-1A/FU	W20EXR-U11	<b>IW20</b>	<b>IW20TT</b>	<b>PW20TT</b>	-	
	天语SX4	1.5L	BJ415B	K20PR-U	<b>IK20</b>	<b>IK20TT</b>	<b>PK20TT</b>	<b>K20TT</b>	
VIETNAM	进口铃木								
	吉姆尼	1.0L	JL368Q3	W16EX-U	<b>IW16</b>	<b>IW16TT</b>	<b>PW16TT</b>	-	
VIETNAM	维特拉	1.0L	K10B	XU22EPR-U	<b>IXU22</b>	-	-	<b>XU22TT</b>	
	凯泽西	1.0L	JL472Q1	W16EXR-U	<b>IW16</b>	<b>IW16TT</b>	<b>PW16TT</b>	-	
VIETNAM	速翼特Swift sport	1.3L	JL474Q1	K16R-U	<b>IK16</b>	<b>IK16TT</b>	<b>PK16TT</b>	<b>K16TT</b>	
	长安汽车/CHANGAN	1.3L	G13B	K20PR-U	<b>IK20</b>	<b>IK20TT</b>	<b>PK20TT</b>	<b>K20TT</b>	
EUROPE & USA	长安之星	1.6L	M16A	K20PR-U11	<b>IK20</b>	<b>IK20TT</b>	<b>PK20TT</b>	<b>K20TT</b>	
	长安之星2	1.8L	M18A	K20PR-U11	<b>IK20</b>	<b>IK20TT</b>	<b>PK20TT</b>	<b>K20TT</b>	
EUROPE & USA	长安之星9	1.6L	CAS16	K16HPR-U11	<b>IKH16</b>	<b>IKH16TT</b>	<b>PKH16TT</b>	<b>KH16TT</b>	
	长安星光	1.6L	G-INNOTEK	K16HPR-U11	<b>IKH16</b>	<b>IKH16TT</b>	<b>PKH16TT</b>	<b>KH16TT</b>	
EUROPE & USA	长安睿行	1.3L	G13B	K20PR-U	<b>IK20</b>	<b>IK20TT</b>	<b>PK20TT</b>	<b>K20TT</b>	
	奔奔	1.5L	M15A	K20PR-U11	<b>IK20</b>	<b>IK20TT</b>	<b>PK20TT</b>	<b>K20TT</b>	
EUROPE & USA	长安之星	1.0L	JL465QE	W20EXR-U	<b>IW20</b>	<b>IW20TT</b>	<b>PW20TT</b>	-	
	长安之星2	1.3L	JL465QK/JL474QH	K20PR-U	<b>IK20</b>	<b>IK20TT</b>	<b>PK20TT</b>	<b>K20TT</b>	
EUROPE & USA	长安之星9	1.0L	JL466Q8	W20EXR-U	<b>IW20</b>	<b>IW20TT</b>	<b>PW20TT</b>	-	
	长安星光	1.3L	JL465QK/JL474QH	K20PR-U	<b>IK20</b>	<b>IK20TT</b>	<b>PK20TT</b>	<b>K20TT</b>	
EUROPE & USA	长安睿行	1.5L	4G15S	K16PR-U11	<b>IK16</b>	<b>IK16TT</b>	<b>PK16TT</b>	<b>K16TT</b>	
	奔奔	1.3L	JL474Q7	K20PR-U	<b>IK20</b>	<b>IK20TT</b>	<b>PK20TT</b>	<b>K20TT</b>	
EUROPE & USA	长安睿行	1.0L	MPI	W20EXR-U	<b>IW20</b>	<b>IW20TT</b>	<b>PW20TT</b>	-	
	奔奔	1.5L	4G15S	K16PR-U11	<b>IK16</b>	<b>IK16TT</b>	<b>PK16TT</b>	<b>K16TT</b>	
EUROPE & USA	长安睿行	1.0L	JL466Q2	K20PR-U	<b>IK20</b>	<b>IK20TT</b>	<b>PK20TT</b>	<b>K20TT</b>	
	奔奔	1.3L	JL474Q2	K20PR-U	<b>IK20</b>	<b>IK20TT</b>	<b>PK20TT</b>	<b>K20TT</b>	
EUROPE & USA	长安睿行	1.0L	C10	XU22EPR-U	<b>IXU22</b>	-	-	<b>XU22TT</b>	
	奔奔	1.4L	JL473Q1	XU22EPR-U	<b>IXU22</b>	-	-	<b>XU22TT</b>	
EUROPE & USA	长安睿行	1.4L	JL473Q1	XU22EPR-U	<b>IXU22</b>	-	-	<b>XU22TT</b>	
	奔奔	1.3L	JL474QL	K20PR-U11	<b>IK20</b>	<b>IK20TT</b>	<b>PK20TT</b>	<b>K20TT</b>	
EUROPE & USA	长安睿行	1.4L	JL473Q1	XU22EPR-U	<b>IXU22</b>	-	-	<b>XU22TT</b>	
	奔奔	1.6L	JL475QK	K20PR-U11	<b>IK20</b>	<b>IK20TT</b>	<b>PK20TT</b>	<b>K20TT</b>	





	车种	YEAR	车型	发动机型式	DENSO	IRIDIUM				
AUSTRALIA	奇瑞汽车									
	瑞麒G5		2.0TCI	SQR484B	K20PR-U	<b>IK20</b>	<b>IK20TT</b>	<b>PK20TT</b>	<b>K20TT</b>	
	瑞麒G6		2.0TSI	SQRE4T20	K22PR-U	<b>IK22</b>	-	<b>PK22TT</b>	-	
CHINA	威麟V5		3.0L	V6	K20PR-U	<b>IK20</b>	<b>IK20TT</b>	<b>PK20TT</b>	<b>K20TT</b>	
			1.8L	SQR481FC	K20PR-U	<b>IK20</b>	<b>IK20TT</b>	<b>PK20TT</b>	<b>K20TT</b>	
			1.9T	SQR484F	-	-	-	-	-	
INDIA	威麟H5		2.0L	SQR484F	K20PR-U	<b>IK20</b>	<b>IK20TT</b>	<b>PK20TT</b>	<b>K20TT</b>	
			2.0T	SQR484B	K22PR-U	<b>IK22</b>	-	<b>PK22TT</b>	-	
			2.0T	SQR481A	K22PR-U	<b>IK22</b>	-	<b>PK22TT</b>	-	
INDONESIA	瑞麒M5		1.3L	SQR473F	K20PR-U	<b>IK20</b>	<b>IK20TT</b>	<b>PK20TT</b>	<b>K20TT</b>	
			1.0L	SQR472FB	K20PR-U	<b>IK20</b>	<b>IK20TT</b>	<b>PK20TT</b>	<b>K20TT</b>	
			1.3L	SQR473F	K20PR-U	<b>IK20</b>	<b>IK20TT</b>	<b>PK20TT</b>	<b>K20TT</b>	
KOREA	瑞麒X1		1.3L	SQR473F	K20PR-U	<b>IK20</b>	<b>IK20TT</b>	<b>PK20TT</b>	<b>K20TT</b>	
		观致汽车/QOROS								
			1.6T L4	SQRE4T16	-	<b>IXUH22</b>	-	-	<b>XUH22TT</b>	
MALAYSIA	观致3 SUV		1.6T	SQRE4T16	-	<b>IXUH22</b>	-	-	<b>XUH22TT</b>	
			1.6T	SQRE4T16	-	<b>IXUH22</b>	-	-	<b>XUH22TT</b>	
			1.6T	SQRE4T16	-	<b>IXUH22</b>	-	-	<b>XUH22TT</b>	
PHILIPPINES	东风风行		2.0L	4G63	K16R-U	<b>IK16L</b>	<b>IK16TT</b>	<b>PK16TT</b>	<b>K16TT</b>	
			2.0L	东风EQ491	MA20PR-U	-	-	-	-	
			2.4L	4G64	K16PR-U	<b>IK16L</b>	<b>IK16TT</b>	<b>PK16TT</b>	<b>K16TT</b>	
SAUDIARABIA	景逸		1.5L	4A91S	K20HR-U11	<b>IKH20</b>	<b>IKH20TT</b>	<b>PKH20TT</b>	<b>KH20TT</b>	
			1.8L	4G93	K20PR-U	<b>IK20</b>	<b>IK20TT</b>	<b>PK20TT</b>	<b>K20TT</b>	
			1.8L	4G93M	K20PR-U	<b>IK20</b>	<b>IK20TT</b>	<b>PK20TT</b>	<b>K20TT</b>	
SINGAPORE	菱智		1.8T	18K4G	K22PR-U	<b>IK22</b>	-	<b>PK22TT</b>	-	
			1.6L	4A92	K20HR-U11	<b>IKH20</b>	<b>IKH20TT</b>	<b>PKH20TT</b>	<b>KH20TT</b>	
			2.0L	4G63	K16R-U	<b>IK16</b>	<b>IK16TT</b>	<b>PK16TT</b>	<b>K16TT</b>	
TAIWAN	东风风神		2.4L	4G64	K16R-U	<b>IK16</b>	<b>IK16TT</b>	<b>PK16TT</b>	<b>K16TT</b>	
			2.0L	4G94	K16R-U	<b>IK16</b>	<b>IK16TT</b>	<b>PK16TT</b>	<b>K16TT</b>	
			2.4L	4G69	K16R-U	<b>IK16</b>	<b>IK16TT</b>	<b>PK16TT</b>	<b>K16TT</b>	
THAILAND	风神S30		1.6L	TU5JP4	K16HPR-U11	<b>IKH16</b>	<b>IKH16TT</b>	<b>PKH16TT</b>	<b>KH16TT</b>	
			1.6L	TU5JP4	K16HPR-U11	<b>IKH16</b>	<b>IKH16TT</b>	<b>PKH16TT</b>	<b>KH16TT</b>	
			1.6L	HR16DE	XE20HR-U9	-	<b>IXEH20ETT</b>	-	-	
VIETNAM	风神H30		1.6L	HR16DE	XE20HR-U9	-	<b>IXEH20ETT</b>	-	-	
			2.0L	MR20DE	XE20HR-U9	-	<b>IXEH20ETT</b>	-	-	
			2.0L	RFN 10LH3X	K16HPR-U11	<b>IKH16</b>	<b>IKH16TT</b>	<b>PKH16TT</b>	<b>KH16TT</b>	
JAPAN	风神A60		2.3L	3FY 10XP01	K16HPR-U11	<b>IKH16</b>	<b>IKH16TT</b>	<b>PKH16TT</b>	<b>KH16TT</b>	
		东风雪铁龙								
			1.6L	TU5JPK	K20HR-U11	<b>IKH20</b>	<b>IKH20TT</b>	<b>PKH20TT</b>	<b>KH20TT</b>	
EUROPE & USA	富康ZX		1.4L	TU3JPK	K20PR-U	<b>IK20</b>	<b>IK20TT</b>	<b>PK20TT</b>	<b>K20TT</b>	
			1.6L	N6A 10FX3A	K20HR-U11	<b>IKH20</b>	<b>IKH20TT</b>	<b>PKH20TT</b>	<b>KH20TT</b>	
			1.6L	TU5JP/K	K20HR-U11	<b>IKH20</b>	<b>IKH20TT</b>	<b>PKH20TT</b>	<b>KH20TT</b>	
CROSS REFERENCE	爱丽舍		1.6L	TU3	K20HR-U11	<b>IKH20</b>	<b>IKH20TT</b>	<b>PKH20TT</b>	<b>KH20TT</b>	
			1.4L	TU5JP4	K20PR-U	<b>IK20</b>	<b>IK20TT</b>	<b>PK20TT</b>	<b>K20TT</b>	
			1.6L	N6A 10 xA3A	K20HR-U11	<b>IKH20</b>	<b>IKH20TT</b>	<b>PKH20TT</b>	<b>KH20TT</b>	
PART NUMBER	全新爱丽舍		1.6L	EC5	K20HR-U11	<b>IKH20</b>	<b>IKH20TT</b>	<b>PKH20TT</b>	<b>KH20TT</b>	
			1.6L	TU5JP4/L4	K20HR-U11	<b>IKH20</b>	<b>IKH20TT</b>	<b>PKH20TT</b>	<b>KH20TT</b>	
			2.0L	EW10J4	K16HPR-U11	<b>IKH16</b>	<b>IKH16TT</b>	<b>PKH16TT</b>	<b>KH16TT</b>	
PART NUMBER	毕加索		1.6L	TU5JP4	K20HR-U11	<b>IKH20</b>	<b>IKH20TT</b>	<b>PKH20TT</b>	<b>KH20TT</b>	
			2.0L	EW10J4	K16HPR-U11	<b>IKH16</b>	<b>IKH16TT</b>	<b>PKH16TT</b>	<b>KH16TT</b>	
			1.6L	TU5JP4	K20HR-U11	<b>IKH20</b>	<b>IKH20TT</b>	<b>PKH20TT</b>	<b>KH20TT</b>	
PART NUMBER	赛纳		2.0L	EW10J4	K16HPR-U11	<b>IKH16</b>	<b>IKH16TT</b>	<b>PKH16TT</b>	<b>KH16TT</b>	
			1.4L	TU3AF	K20PR-U	<b>IK20</b>	<b>IK20TT</b>	<b>PK20TT</b>	<b>K20TT</b>	
			1.6L	TU5JP4	K20HR-U11	<b>IKH20</b>	<b>IKH20TT</b>	<b>PKH20TT</b>	<b>KH20TT</b>	
PART NUMBER	C3-XR		1.6L	K20HR-U11	<b>IKH20</b>	<b>IKH20TT</b>	<b>PKH20TT</b>	<b>KH20TT</b>		
			1.6L	L4	K20HR-U11	<b>IKH20</b>	<b>IKH20TT</b>	<b>PKH20TT</b>	<b>KH20TT</b>	
			1.6THP	EP6CDTM进口	-	<b>IXUH22</b>	-	-	<b>XUH22TT</b>	
PART NUMBER	C4L		1.6THP	EP6FDTM国产	-	<b>IXUH22</b>	-	-	<b>XUH22TT</b>	
			1.8L	K20HR-U11	<b>IKH20</b>	<b>IKH20TT</b>	<b>PKH20TT</b>	<b>KH20TT</b>		
			1.8L	EC8	K20HR-U11	<b>IKH20</b>	<b>IKH20TT</b>	<b>PKH20TT</b>	<b>KH20TT</b>	
PART NUMBER	世嘉		1.6L	N6A	K20HR-U11	<b>IKH20</b>	<b>IKH20TT</b>	<b>PKH20TT</b>	<b>KH20TT</b>	
			2.0L	RFN 10LH3X	K16HPR-U11	<b>IKH16</b>	<b>IKH16TT</b>	<b>PKH16TT</b>	<b>KH16TT</b>	
			1.6L	N6A 10 xA3A	K20HR-U11	<b>IKH20</b>	<b>IKH20TT</b>	<b>PKH20TT</b>	<b>KH20TT</b>	
PART NUMBER	C4世嘉		1.6L	NFP	K20HR-U11	<b>IKH20</b>	<b>IKH20TT</b>	<b>PKH20TT</b>	<b>KH20TT</b>	
			2.0L	EW10A	K16HPR-U11	<b>IKH16</b>	<b>IKH16TT</b>	<b>PKH16TT</b>	<b>KH16TT</b>	
			1.6L	K20HR-U11	<b>IKH20</b>	<b>IKH20TT</b>	<b>PKH20TT</b>	<b>KH20TT</b>		
PART NUMBER	凯旋		2.0L	RFN 10LH3X	K16HPR-U11	<b>IKH16</b>	<b>IKH16TT</b>	<b>PKH16TT</b>	<b>KH16TT</b>	
			2.0L	RFN 10LH3X	K16HPR-U11	<b>IKH16</b>	<b>IKH16TT</b>	<b>PKH16TT</b>	<b>KH16TT</b>	
			2.3L	3FY 10XP01	K16HPR-U11	<b>IKH16</b>	<b>IKH16TT</b>	<b>PKH16TT</b>	<b>KH16TT</b>	



车种	YEAR	车型	发动机型式	DENSO	IRIDIUM	IRIDIUM	PLATINUM	TT	
东风雪铁龙									
C5	3.0L	10FJ5P XFV	K16HPR-U11	<b>IKH16</b>	<b>IKH16TT</b>	<b>PKH16TT</b>	<b>KH16TT</b>		
进口雪铁龙									
C4毕加索	2.0L	RFJ	K16HPR-U11	<b>IKH16</b>	<b>IKH16TT</b>	<b>PKH16TT</b>	<b>KH16TT</b>		
C4	2.0L		K16HPR-U11	<b>IKH16</b>	<b>IKH16TT</b>	<b>PKH16TT</b>	<b>KH16TT</b>		
C6	3.0L	XFV	K16HPR-U11	<b>IKH16</b>	<b>IKH16TT</b>	<b>PKH16TT</b>	<b>KH16TT</b>		
东风标致									
307	1.6L	TU5JP4	K20HR-U11	<b>IKH20</b>	<b>IKH20TT</b>	<b>PKH20TT</b>	<b>KH20TT</b>		
	1.6L	N6A 10XA3A	K20HR-U11	<b>IKH20</b>	<b>IKH20TT</b>	<b>PKH20TT</b>	<b>KH20TT</b>		
	1.6L	EC5	K20HR-U11	<b>IKH20</b>	<b>IKH20TT</b>	<b>PKH20TT</b>	<b>KH20TT</b>		
	1.6L	N6A 10XA3A PSA	K20HR-U11	<b>IKH20</b>	<b>IKH20TT</b>	<b>PKH20TT</b>	<b>KH20TT</b>		
	2.0L	EW10J4 99kw	K16HPR-U11	<b>IKH16</b>	<b>IKH16TT</b>	<b>PKH16TT</b>	<b>KH16TT</b>		
	2.0L	EW10J4 108kw	K16HPR-U11	<b>IKH16</b>	<b>IKH16TT</b>	<b>PKH16TT</b>	<b>KH16TT</b>		
	2.0L	RFN 10LH3X	K16HPR-U11	<b>IKH16</b>	<b>IKH16TT</b>	<b>PKH16TT</b>	<b>KH16TT</b>		
206	1.4L	TU3AF	K20PR-U	<b>IK20</b>	<b>IK20TT</b>	<b>PK20TT</b>	<b>K20TT</b>		
	1.6L	TU5JP4	K20HR-U11	<b>IKH20</b>	<b>IKH20TT</b>	<b>PKH20TT</b>	<b>KH20TT</b>		
207	1.4L	TU3AF	K20PR-U	<b>IK20</b>	<b>IK20TT</b>	<b>PK20TT</b>	<b>K20TT</b>		
	1.6L	TU5JP4	K20HR-U11	<b>IKH20</b>	<b>IKH20TT</b>	<b>PKH20TT</b>	<b>KH20TT</b>		
老款308	1.6L	N6A 10XA3A	K20HR-U11	<b>IKH20</b>	<b>IKH20TT</b>	<b>PKH20TT</b>	<b>KH20TT</b>		
	2.0L	RFN 10LH3X	K16HPR-U11	<b>IKH16</b>	<b>IKH16TT</b>	<b>PKH16TT</b>	<b>KH16TT</b>		
新款308	1.6L	NFP	K20HR-U11	<b>IKH20</b>	<b>IKH20TT</b>	<b>PKH20TT</b>	<b>KH20TT</b>		
	2.0L	RFN 10LH3X	K16HPR-U11	<b>IKH16</b>	<b>IKH16TT</b>	<b>PKH16TT</b>	<b>KH16TT</b>		
308S	1.6L	EC5	K20HR-U11	<b>IKH20</b>	<b>IKH20TT</b>	<b>PKH20TT</b>	<b>KH20TT</b>		
	1.6T	EP6	-	<b>IXUH22</b>	-	-	<b>XUH22TT</b>		
老款408	1.6L	N6A 10XA3A	K20HR-U11	<b>IKH20</b>	<b>IKH20TT</b>	<b>PKH20TT</b>	<b>KH20TT</b>		
	2.0L	EW10A	K16HPR-U11	<b>IKH16</b>	<b>IKH16TT</b>	<b>PKH16TT</b>	<b>KH16TT</b>		
新款408	1.6L	NFP	K20HR-U11	<b>IKH20</b>	<b>IKH20TT</b>	<b>PKH20TT</b>	<b>KH20TT</b>		
	2.0L	RFN 10LH3X	K16HPR-U11	<b>IKH16</b>	<b>IKH16TT</b>	<b>PKH16TT</b>	<b>KH16TT</b>		
	1.6T	EP6FDTM国产	-	<b>IXUH22</b>	-	-	<b>XUH22TT</b>		
	1.8L	EC8	K20HR-U11	<b>IKH20</b>	<b>IKH20TT</b>	<b>PKH20TT</b>	<b>KH20TT</b>		
508	2.0L	RFN 10LH3X	K16HPR-U11	<b>IKH16</b>	<b>IKH16TT</b>	<b>PKH16TT</b>	<b>KH16TT</b>		
	2.3L	3FY 10XP01	K16HPR-U11	<b>IKH16</b>	<b>IKH16TT</b>	<b>PKH16TT</b>	<b>KH16TT</b>		
	1.6T	-	-	<b>IXUH22</b>	-	-	<b>XUH22TT</b>		
	1.8T	-	-	<b>IXUH22</b>	-	-	<b>XUH22TT</b>		
	2.0L	EW10A	K16HPR-U11	<b>IKH16</b>	<b>IKH16TT</b>	<b>PKH16TT</b>	<b>KH16TT</b>		
2008	1.6THP	-	-	<b>IXUH22</b>	-	-	<b>XUH22TT</b>		
3008	1.6T	EP6CDTM进口	-	<b>IXUH22</b>	-	-	<b>XUH22TT</b>		
	1.6T	EP6FDTM国产	-	<b>IXUH22</b>	-	-	<b>XUH22TT</b>		
	2.0L	RFN 10LH3X	K16HPR-U11	<b>IKH16</b>	<b>IKH16TT</b>	<b>PKH16TT</b>	<b>KH16TT</b>		
进口标致									
206CC	1.6L	KFX(TU3JP4)	K20HR-U11	<b>IKH20</b>	<b>IKH20TT</b>	<b>PKH20TT</b>	<b>KH20TT</b>		
207CC	1.6T	EP6DT	-	<b>IXUH22</b>	-	-	<b>XUH22TT</b>		
	1.6L	EP6C	K20HR-U11	<b>IKH20</b>	<b>IKH20TT</b>	<b>PKH20TT</b>	<b>KH20TT</b>		
308CC308SW	1.6T	EP6DT	-	<b>IXUH22</b>	-	-	<b>XUH22TT</b>		
	1.6T	EP6CDTM	-	<b>IXUH22</b>	-	-	<b>XUH22TT</b>		
进口3008	1.6THP	EP6CDT	-	<b>IXUH22</b>	-	-	<b>XUH22TT</b>		
进口4008	2.0L	4B11	K16HPR-U11	<b>IKH16</b>	<b>IKH16TT</b>	<b>PKH16TT</b>	<b>KH16TT</b>		
进口RCZ	1.6T	EP6CDT	-	<b>IXUH22</b>	-	-	<b>XUH22TT</b>		
一汽奥迪									
奥迪 A6L AUDI A6L	2.8L V6	CCEA	-	<b>VKB20</b>	-	-	-		
	2.8L V6	BDX	K20R-U	<b>IK20</b>	<b>IK20TT</b>	<b>PK20TT</b>	<b>K20TT</b>		
	2006.05-	4.2L V8	BVJ	-	<b>VKB20</b>	-	-		
		3.2L V6	AUK	-	<b>IK22</b>	-	-		
	2005-	4.2L V8	BVJ	-	<b>VKB20</b>	-	-		
	2.4L V6	BDW	K20R-U	<b>IK20</b>	<b>IK20TT</b>	<b>PK20TT</b>	<b>K20TT</b>		
奥迪 A6 AUDI A6	2.8L V6	APS/ATX	K20TXR	<b>IK20</b>	<b>IK20TT</b>	<b>PK20TT</b>	<b>K20TT</b>		
	2.4L V6	APS/ATX	K20TXR	<b>IK20</b>	<b>IK20TT</b>	<b>PK20TT</b>	<b>K20TT</b>		
	2004-	1.8T	AWL	<b>PK20PR-P8</b>	<b>IK20</b>	<b>IK20TT</b>	<b>PK20TT</b>	<b>K20TT</b>	
	1999-	1.8T	AWL	<b>PK20PR-P8</b>	<b>IK20</b>	<b>IK20TT</b>	<b>PK20TT</b>	<b>K20TT</b>	
	1.8L	ANQ	K20PBR-S10	<b>IK20</b>	<b>IK20TT</b>	<b>PK20TT</b>	<b>K20TT</b>		
奥迪 A4 AUDI A4	2.0T	BWE	<b>PK20PR-P8</b>	<b>IK20</b>	<b>IK20TT</b>	<b>PK20TT</b>	<b>K20TT</b>		
	3.0L V6	BBJ	K20TXR	<b>IK20</b>	<b>IK20TT</b>	<b>PK20TT</b>	<b>K20TT</b>		
	2.4L V6	BDV	K20TXR	<b>IK20</b>	<b>IK20TT</b>	<b>PK20TT</b>	<b>K20TT</b>		
	1.8T	BFB	<b>PK20PR-P8</b>	<b>IK20</b>	<b>IK20TT</b>	<b>PK20TT</b>	<b>K20TT</b>		
奥迪									
Q7	4.2L	BAR	-	<b>VKB20</b>	-	-	-		
	3.6L	BHK	-	<b>IXUH221</b>	-	-	<b>XUH22TT</b>		
A8	6.0L	BHT	-	<b>IXUH221</b>	-	-	<b>XUH22TT</b>		

AUSTRALIA  
CHINA  
INDIA  
INDONESIA  
KOREA  
MALAYSIA  
PHILIPPINES  
SAUDIARABIA  
SINGAPORE  
TAIWAN  
THAILAND  
VIETNAM  
JAPAN  
EUROPE & USA  
CROSS REFERENCE  
PART NUMBER

DENSO	9	14	16	20	22	24	27	29	31	32	34	35	DENSO	9	14	16	20	22	24	27	29	31	32	DENSO	9	14	16	20	22	24	27	31
NGK	2	4	5	6	7	8	9	9.5	10	10.5	11	11.5	CHAMPION	18	16,14	12,11	10,9	8,7	6,63,61	4,59	57	55	53	BOSCH	10	9	8	7,6	5	4	3	2



车种	YEAR	车型	发动机型式	DENSO	IRIDIUM				
AUSTRALIA	奥迪								
	A8	4.2L	BJV	-	VKB20	-	-	-	
		4.2L	BFM	K20TXR	IK20	IK20TT	PK20TT	K20TT	
3.2L		BPK	PKJ20CR-L11	IK20L	IK20TT	PK20TT	K20TT		
CHINA	一汽大众								
	捷达	1.6L	ATK\AHP	K20PR-U	IK20	IK20TT	PK20TT	K20TT	
1.6L		ABX/ACR	K20PR-U	IK20	IK20TT	PK20TT	K20TT		
INDIA		1.6L		K20TXR	IK20	IK20TT	PK20TT	K20TT	
		1.4TSI		K20TXR	IK20	IK20TT	PK20TT	K20TT	
		1.8TSI		-	IK22	-	PK22TT	-	
		1.4L	EA211	XU22EPR-U	IXU22	-	-	XU22TT	
		1.6L	EA211	XU22EPR-U	IXU22	-	-	XU22TT	
INDONESIA	宝来	1.6L	L4	K20PBR-S10	IK20	IK20TT	PK20TT	K20TT	
		1.8L	BAF	K20PR-U	IK20	IK20TT	PK20TT	K20TT	
		1.8T	L4	K22PR-U	IK22	-	PK22TT	-	
KOREA		1.6L	SMFi	K20PBR-S10	IK20	IK20TT	PK20TT	K20TT	
		1.8L	SMFi	K20PR-U	IK20	IK20TT	PK20TT	K20TT	
		2.0L	L4	K20PR-U	IK20L	IK20TT	PK20TT	K20TT	
MALAYSIA	高尔夫4	1.4TSI	EA111	K20R-U	IK20	IK20TT	PK20TT	K20TT	
		1.6L	EA111	KJ20DR-M11	IK20L	IK20TT	PK20TT	K20TT	
		1.6L	SEFI 2V	K20PBR-S10	IK20	IK20TT	PK20TT	K20TT	
PHILIPPINES	高尔夫6	1.8L5V	SEFI	K20PBR-S10	IK20	IK20TT	PK20TT	K20TT	
		2.0L	SEFI	K20PR-U	IK20	IK20TT	PK20TT	K20TT	
		2.0L	EA113	K20PR-U	IK20	IK20TT	PK20TT	K20TT	
SAUDIARABIA	高尔夫7	1.4TSI	CFB	K20TXR	IK20	IK20TT	PK20TT	K20TT	
		1.6L	EA111	KJ20DR-M11	IK20L	IK20TT	PK20TT	K20TT	
		2.0TSI	CCZB	-	IK24	-	-	-	
		2.0TSI	CDLC,CDLA	-	IK24	-	-	-	
		2013-	2.0TSI 进口	CJXB,CJXD,CJXC	-	IKH24	-	-	-
SINGAPORE	开迪	1.6L	BRY	KJ20DR-M11	IK20L	IK20TT	PK20TT	K20TT	
		1.4TSI	EA111	K20R-U	IK20	IK20TT	PK20TT	K20TT	
		1.6L	EA113	K20PR-U	IK20	IK20TT	PK20TT	K20TT	
		1.8T	BPL	K20R-U	IK20	IK20TT	PK20TT	K20TT	
		2.0L	L4	KJ20DR-M11	IK20L	IK20TT	PK20TT	K20TT	
TAIWAN	速腾1代	1.8TSI	EA888	VK22	IK22	-	PK22TT	-	
		2.0TSI	EA888	VK24PR-Z11	IK24	-	-	-	
		1.4TSI	EA111	KJ20DR-M11	IK20L	IK20TT	PK20TT	K20TT	
		1.6L	EA111	KJ20DR-M11	IK20L	IK20TT	PK20TT	K20TT	
		1.4T 230TSI 96kw	EA211	XU22EPR-U	IXU22	-	-	XU22TT	
THAILAND	速腾2.5代小改引擎升级	1.4T 280TSI 110kw	EA211	XU22EPR-U	IXU22	-	-	XU22TT	
		1.6L 81kw	EA211	XU22EPR-U	IXU22	-	-	XU22TT	
		2007-2011	1.4TSI	EA111/CFB	K20TXR	IK20	IK20TT	PK20TT	K20TT
VIETNAM	迈腾 (底盘B6)	2007-2011	1.8TSI	EA888/BYJ	VK22	IK22	-	PK22TT	-
		2007-2011	2.0TSI	EA888/CBL	VK24PR-Z11	IK24	-	-	-
		2007-2011	2.0L	BJZ	KJ16CR-L11	IK16L	IK16TT	PK16TT	K16TT
		2007-2011	1.4TSI	EA111	K20TXR	IK20	IK20TT	PK20TT	K20TT
JAPAN	迈腾 (底盘B7L)	1.8TSI	EA888	VK22	IK22	-	PK22TT	-	
		2.0TSI	EA888	VK24PR-Z11	IK24	-	-	-	
		3.0FSI V6	CNGA	KJ16CR-L11	IK16L	IK16TT	PK16TT	K16TT	
		1.8TSI	EA888	-	IK22	-	PK22TT	-	
EUROPE & USA	CC	2.0TSI	EA888	-	IK24	-	-	-	
		3.0FSI V6	CNGA	KJ16CR-L11	IK16L	IK16TT	PK16TT	K16TT	
		进口大众							
CROSS REFERENCE	途锐	4.2L	BAR	VKB20	VKB20	-	-	-	
		3.2L	BRJ	XU22EPR-U	IXU22	-	-	XU22TT	
		6.0L	BAN,BAP,BRN	PKJ20CR-L11	IK20L	IK20TT	PK20TT	K20TT	
PART NUMBER	辉腾	4.2L	BGH	K20TXR	IK20	IK20TT	PK20TT	K20TT	
		3.2L	BRK	XU22EPR-U	IXU22	-	-	XU22TT	
		3.2L	FSI	XU22EPR-U	IXU22	-	-	XU22TT	
PART NUMBER	迈腾	3.2L	FSI	XU22EPR-U	IXU22	-	-	XU22TT	
		尚酷3代 (底盘1K8)	1.4TSI	CAXA, CMSB	K22PR-U	IK22	-	PK22TT	-
			1.4TSI 双涡轮	CAVD,CNWA,CTHD,CTKA	K22PR-U	IK22	-	PK22TT	-
			2.0TSI	CAWB	VK24PR-Z11	IK24	-	-	-
2.0TSI GTI	CCZB		VK24PR-Z11	IK24	-	-	-		







车种	YEAR	车型	发动机型式	DENSO	IRIDIUM				
<b>一汽马自达</b>									
CX-5		2.0L	PE	ZC20HPR11		IXEH22TT	-	-	
MX-5		2.0L	LFN 118kw	-	ITV16	ITV16TT	PTV16TT	TV16TT	
睿翼		2.0L	LF 108kw	-	ITV16	ITV16TT	PTV16TT	TV16TT	
		2.5L L4	L5 124kw	-	ITV16	ITV16TT	PTV16TT	TV16TT	
阿特兹ATENZA		2.0L	PE 116kw	ZC20HPR11	-	IXEH22TT	-	-	
		2.5L L4	PY 141kw	ZC20HPR11	-	IXEH22TT	-	-	
CX-4		2.0L		VFXEH20	-	IXEH20TT	-	-	
		2.5L L4		ZC20HPR11	-	IXEH22TT	-	-	
CX-7		2.5L L4	L5 120kw	ZC20HPR11	-	IXEH22TT	-	-	
<b>长安马自达</b>									
马自达3		2.0L	LF	T20EPR-U	IT20	IT20TT	PT20TT	-	
		1.6L	Z6V 79kw	K16PR-U11	IK16	IK16TT	PK16TT	K16TT	
		2.0L	LF 110kw	-	ITV16	ITV16TT	PTV16TT	TV16TT	
马自达3星骋		1.6L	Z6 79kw	K16PR-U11	IK16	IK16TT	PK16TT	K16TT	
		2.0L	LF 110kw	-	ITV16	ITV16TT	PTV16TT	TV16TT	
昂克赛拉Axela		1.5L	Dual S-VT 86kw	ZC20HPR11	-	IXEH22TT	-	-	
		2.0L	PY 116kw	ZC20HPR11	-	IXEH22TT	-	-	
马自达2/劲翔		1.3L	ZJ-VR	K16PR-U11	IK16	IK16TT	PK16TT	K16TT	
		1.5L	ZY-VE	K16PR-U11	IK16	IK16TT	PK16TT	K16TT	
CX-5		2.0L	PE 114kw	-	-	IXEH20ETT	-	-	
		2.5L	PY 144kw	-	-	IXEH20ETT	-	-	
<b>一汽奔腾</b>									
奔腾		1.6L	BWH	K20PR-U	IK20	IK20TT	PK20TT	K20TT	
		1.8L	CA4GD5	-	ITV20	ITV20TT	PTV20TT	-	
		1.8L	CA4GC	-	ITV20	ITV20TT	PTV20TT	-	
		2.0L	LFX	-	ITV16	ITV16TT	PTV16TT	TV16TT	
		2.3L	L3-VE	-	ITV16	ITV16TT	PTV16TT	TV16TT	
		1.8T	CA4GC18T	-	ITV20	ITV20TT	PTV20TT	-	
		2.0L	CA4GD1	-	ITV20	ITV20TT	PTV20TT	-	
		2.3L	CA4GD3	-	ITV16	ITV16TT	PTV16TT	-	
		2.0T	CA4GC20T	-	ITV20	ITV20TT	PTV20TT	-	
	<b>一汽红旗</b>								
红旗新明仕		1.8L	QG18DE	K16PR-U11	IK16	IK16TT	PK16TT	K16TT	
		1.8L	CA4GE/74	K16PR-U11	IK16	IK16TT	PK16TT	K16TT	
红旗世纪星		1.8L	QG18DE	K16PR-U11	IK16	IK16TT	PK16TT	K16TT	
		2.4L	APS	K20TXR	IK20	IK20TT	PK20TT	K20TT	
		2.0L	VG20E	Q16PR-U11	IQ16	IQ16TT	PQ16TT	Q16TT	
红旗明仕		1.8L/2.0L/2.2L	CA4GE/74	K16PR-U11	IK16	IK16TT	PK16TT	K16TT	
		1.8L/2.0L/2.2L	CA488-3B2	W20EPB	IW20	IW20TT	PW20TT	-	
		1.8L/2.0L/2.2L	CA488-3	W20EPB	IW20	IW20TT	PW20TT	-	
		2.0L	VG20E	Q16PR-U11	IQ16	IQ16TT	PQ16TT	Q16TT	
		1.8L	AHP	W20EPB	IW20	IW20TT	PW20TT	-	
<b>一汽吉林</b>									
森雅		1.3L	K3-VE3	XU22EPR-U	IXU22	-	-	XU22TT	
		1.5L	3SZ-VE2	XU22EPR-U	IXU22	-	-	XU22TT	
森雅 M80		1.3L	K3-VE3	XU22EPR-U	IXU22	-	-	XU22TT	
		1.5L	3SZ-VE2	XU22EPR-U	IXU22	-	-	XU22TT	
<b>一汽丰田</b>									
威驰	2003-2007	1.3L	8A-FE	-	IK16	IK16TT	PK16TT	K16TT	
	2003-2007	1.5L	5A-FE	-	IK16	IK16TT	PK16TT	K16TT	
	2003-2007	1.3L	2SZ-FE	XU22EPR-U	IXU22	-	-	XU22TT	
	2003-2007	1.5L	3SZ-FE	XU22EPR-U	IXU22	-	-	XU22TT	
	2008-2013	1.3L	2NZ-FE	-	IXU22	-	-	XU22TT	
	2008-2013	1.6L	1ZR-FE	SC20HR11	VCH20	IXEH22TT	-	-	
	2014-2016	1.3L	4NR-FE	SC20HR11	VCH20	IXEH22TT	-	-	
	2014-2016	1.5L	5NR-FE	SC20HR11	VCH20	IXEH22TT	-	-	
	2017-	1.5L	5NR-FE	FC16HR-Q8					
威驰 FS	2014-	1.5L	7NR-FE	FC16HR-Q8					
致炫	2017-	1.5L	7NR-FE	FC16HR-Q8					
花冠		1.8L	1ZZ-FE	-	IK16	IK16TT	PK16TT	K16TT	
		1.6L	1ZR-FE	SC20HR11	VCH20	IXEH22TT	-	-	
卡罗拉		1.6L	1ZR-FE	SC20HR11	VCH20	IXEH22TT	-	-	
		1.8L	2ZR-FE	SC20HR11	VCH20	IXEH22TT	-	-	
		2.0L	3ZR-FE	SC20HR11	VCH20	IXEH22TT	-	-	
		1.2T	9NR-FTS	-	-	IXEH22TT	-	-	
		1.8L	8ZR-FXE	SC20HR11	VCH20	IXEH22TT	-	-	
奕泽		2.0L	M20AFKS	FC20HR-Q8	VFCH20	IXEH22TT	-	-	

AUSTRALIA  
 CHINA  
 INDIA  
 INDONESIA  
 KOREA  
 MALAYSIA  
 PHILIPPINES  
 SAUDI ARABIA  
 SINGAPORE  
 TAIWAN  
 THAILAND  
 VIETNAM  
 JAPAN  
 EUROPE & USA  
 CROSS REFERENCE NUMBER  
 PART

DENSO	9	14	16	20	22	24	27	29	31	32	34	35	DENSO	9	14	16	20	22	24	27	29	31	32	DENSO	9	14	16	20	22	24	27	31
NGK	2	4	5	6	7	8	9	9.5	10	10.5	11	11.5	CHAMPION	18	16,14	12,11	10,9	8,7	6,63,61	4,59	57	55	53	BOSCH	10	9	8	7,6	5	4	3	2



车种	YEAR	车型	发动机型式	DENSO	IRIDIUM					
AUSTRALIA	一汽丰田									
	锐志	3.0L	3GR-FE	FK20HR11	VFKH20	IKH20TT	PKH20TT	KH20TT		
2.5L		5GR-FE	FK20HR11	VFKH20	IKH20TT	PKH20TT	KH20TT			
CHINA	皇冠	2.5L	5GR-FE	FK20HR11	VFKH20	IKH20TT	PKH20TT	KH20TT		
		3.0L	3GR-FE	FK20HR11	VFKH20	IKH20TT	PKH20TT	KH20TT		
		4.3L	3UZ-FE	SK20HR11	IKH20	IKH20TT	PKH20TT	KH20TT		
INDIA	普锐斯	2.0T	8AR-FTS	-	IKH22	-	-	KH20TT		
		1.5L	1NE-FXE	K16R-U11	IK16	IK16TT	PK16TT	K16TT		
INDONESIA	RVA4	1.8L	5ZR-FXE	SC16HR11	-	IXEH20TT	-	-		
		2.0L	1AZ-FE	SK20R11	IK20	IK20TT	PK20TT	K20TT		
		2.4L	2AZ-FE	SK20R11	IK20	IK20TT	PK20TT	K20TT		
INDONESIA	RVA4(荣放)	2.0L	6ZR-FE	SC20HR11	VCH20	IXEH22TT	-	-		
		2.5L L4	5AR-FE	SK16HR11	-	IKH16TT	-	KH20TT		
INDONESIA	RVA4(荣放)Hybrid	2.0L	M20AFKS	FC20HR-Q8	VFCH20	IXEH22TT	-	-		
		2.5L	A25AFKS	FC16HR-Q8						
KOREA	亚洲龙	2.5L	A25AFKS	FC16HR-Q8						
		2.5L	A25AFKS	FC16HR-Q8						
MALAYSIA	普拉多/霸道国产PRADO	2700L4	2TR-FE	K20HR-U11	IKH20	IKH20TT	PKH20TT	KH20TT		
		3500V6	7GR-FKS	K20HR-U11	IKH20	IKH20TT	PKH20TT	KH20TT		
		4000V6	1GR-FE	K20HR-U11	IKH20	IKH20TT	PKH20TT	KH20TT		
		4.0L V6	1GR-FE	SK20R11	IK20	IK20TT	PK20TT	K20TT		
PHILIPPINES	陆地巡洋舰/兰德酷路泽 LandCruiser	4.5L V6	1FZ-FE	K16TR11	IK16	IK16TT	PK16TT	K16TT		
		4.6L V8	1UR-FE	K20HR-U11	IKH20	IKH20TT	PKH20TT	KH20TT		
		4.7L V8	2UZ-FE	SK20R11	IK20	IK20TT	PK20TT	K20TT		
SAUDIARABIA	6代凯美瑞	广汽丰田								
		2.0L	1AZ-FE	SK20R11	IK20	IK20TT	PK20TT	K20TT		
		2.4L	2AZ-FE	SK20R11	IK20	IK20TT	PK20TT	K20TT		
		7代凯美瑞	2.0L	1AZ-FE	SK20R11	IK20	IK20TT	PK20TT	K20TT	
		2.5L	5AR-FE	SK16HR11	-	IKH16TT	-	KH16TT		
		2.5L 混动	4AR-FXE	FK16HR-A8	-	IKH16TT	-	KH16TT		
SINGAPORE	7.5代中改款凯美瑞	2.0L	6AR-FSE	FK16HBR-J8	-	IKH16TT	-	KH16TT		
		2.5L	5AR-FE	SK16HR11	-	IKH16TT	-	KH16TT		
		2.5L 混动	4AR-FXE	FK16HR-A8	-	IKH16TT	-	KH16TT		
TAIWAN	八代凯美瑞	2.0L	M20C	FC20HR-Q8	-	-	-	-		
		2.5L	A25AFKS	FC16HR-Q8	VFCH16	IXEH20TT	-	-		
VIETNAM	雅力士Yaris	1.3L	2NZ	SK16R11	IK16	IK16TT	PK16TT	K16TT		
		1.6L	4ZR	XU22EPR-U	IXU22	-	-	XU22TT		
THAILAND	致炫Yaris L	1.6L	1ZR	SC20HR11	VCH20	IXEH22TT	-	-		
		1.3L	6NR-FE	SC20HR11	VCH20	IXEH22TT	-	-		
		1.5L	7NR-FE	SC20HR11	VCH20	IXEH22TT	-	-		
VIETNAM	雷凌Levin	1.6L	1ZR;4ZR	SC20HR11	VCH20	IXEH22TT	-	-		
		1.8L	2ZR,7ZR	SC20HR11	VCH20	IXEH22TT	-	-		
		1.8L	8ZR-FXE	FC16HR-CY9						
JAPAN	汉兰达	2.7L L4	1AR-FE	SK16HR11	IKH16	IKH16TT	PKH16TT	KH16TT		
		2.7L L4	3AR-FE	SK16HR11	IKH16	IKH16TT	PKH16TT	KH16TT		
		3.5L V6	2GR-FE	FK20HR11	IKH20	IKH20TT	PKH20TT	KH20TT		
		2.0T	8AR-FTS	-	IKH22	-	-	-		
EUROPE & USA	威兰达	2.0L	M20C	FC20HR-Q8						
		2.5L	A25BFXS	FC16HR-Q8						
EUROPE & USA	威兰达Hybrid	2.5L	A25BFXS	FC16HR-Q8						
		逸致EZ	1.6L	1ZR-FE	SC20HR11	VCH20	IXEH22TT	-	-	
		1.8L	2ZR-FE	SC20HR11	VCH20	IXEH22TT	-	-		
EUROPE & USA	CH-R	2.0L	3ZR-FE	SC20HR11	VCH20	IXEH22TT	-	-		
		2.0L	M20AFKS	FC20HR-Q8	VFCH20	IXEH22TT	-	-		
		天津一汽								
CROSS REFERENCE NUMBER	PART NUMBER	夏利	1.1L	TJ378	W16EXR-U11	IW16	IW16TT	PW16TT	-	
			1.0L	TJ378	W16EXR-U11	IW16	IW16TT	PW16TT	-	
			1.3L	8A-FE	K16R-U	IK16	IK16TT	PK16TT	K16TT	
			1.0L	CA3GA2+	K20R-U	IK20	IK20TT	PK20TT	K20TT	
			1.3L	CA4GA1	K20R-U	IK20	IK20TT	PK20TT	K20TT	
			1.4L	CA3GA2	K20R-U	IK20	IK20TT	PK20TT	K20TT	
			1.0L	3GA2	K20R-U	IK20	IK20TT	PK20TT	K20TT	
			1.0L	TJ376QE	W16EXR-U11	IW16	IW16TT	PW16TT	-	
			1.1L	TJ378QE	K20R-U	IK20	IK20TT	PK20TT	K20TT	
EUROPE & USA	威姿	1.4L	4GBI	K20R-U	IK20	IK20TT	PK20TT	K20TT		
		1.0L	CA3GA2	K20R-U	IK20	IK20TT	PK20TT	K20TT		





车种	YEAR	车型	发动机型式	DENSO	IRIDIUM				
AUSTRALIA	长安福特								
	福克斯	2005-2008	1.8L	Duratec-HE	T20EPR-U	IT20	IT20TT	PT20TT	T20TT
		2005-2008	2.0L	Duratec-HE	T20EPR-U	IT20	IT20TT	PT20TT	T20TT
CHINA	2009-2010	1.8L	Duratec-HE	T20EPR-U	IT20	IT20TT	PT20TT	T20TT	
	2009-2010	2.0L	Duratec-HE	T20EPR-U	IT20	IT20TT	PT20TT	T20TT	
	2011-	1.8L	CAF483Q0	T20EPR-U	IT20	IT20TT	PT20TT	T20TT	
	2011-	2.0L	CAF488Q1	T20EPR-U	IT20	IT20TT	PT20TT	T20TT	
	2012-2014	1.6L	Ti-VCT C6	-	ITV20	ITV20TT	PTV20TT	-	
	2012-2014	1.8L经典版	CAF483Q0	T20EPR-U	IT20	IT20TT	PT20TT	T20TT	
INDIA	2012-2014	2.0L	GDI	-	ITV20	ITV20TT	PTV20TT	-	
	2012-2014	2.0T	-	-	ITV22	-	-	-	
	蒙迪欧	2003-2007	2.0L	CAF488Q1	T20EPR-U	IT20	IT20TT	PT20TT	T20TT
		2003-2007	2.5V6	CAF488Q0	T20EPR-U	IT20	IT20TT	PT20TT	T20TT
INDONESIA	2013-	2.0T	GTDi240	-	ITV22	-	-	-	
	致胜	2.0L	CAF488Q2	-	ITV20	ITV20TT	PTV20TT	-	
		2.3L	L3	-	ITV20	ITV20TT	PTV20TT	-	
KOREA	2.0T	Ecoboost	-	ITV22	-	-	-		
	翼搏	1.5L	CAF479Q0	-	ITV20	ITV20TT	PTV20TT	-	
	翼虎	1.6T	GTDiQ2	-	ITV22	-	-	-	
MALAYSIA	2.0T	CAF488WQ2	-	ITV22	-	-	-		
	S-MAX	2.3L	Duratec-HE	-	ITV20	ITV20TT	PTV20TT	-	
	锐界	2.0T	-	-	ITV22	-	-	-	
PHILIPPINES	3.5L	-	-	ITV22	-	-	-		
	吉利汽车								
	美日	1.3L	MR479Q	K16R-U11	IK16	IK16TT	PK16TT	K16TT	
1.3L		8A-FE	K16R-U11	IK16	IK16TT	PK16TT	K16TT		
自由舰	1.5L	MR479QA	K20PR-U	IK20	IK20TT	PK20TT	K20TT		
	1.3L	MR749Q	K16R-U	IK16	IK16TT	PK16TT	K16TT		
豪情	1.6L	MR481QA	K20PR-U	IK20	IK20TT	PK20TT	K20TT		
	1.3L	8A-FE	K16R-U11	IK16	IK16TT	PK16TT	K16TT		
	1.0L	JL376QE	W16EXR-U	IW16	IW16TT	PW16TT	-		
优利欧	1.3L	MR479Q	K16R-U11	IK16	IK16TT	PK16TT	K16TT		
	1.3L	MR479Q	K16R-U11	IK16	IK16TT	PK16TT	K16TT		
	1.0L	JL376QE	W16EXR-U	IW16	IW16TT	PW16TT	-		
远景	1.8L	JL4G18	K20PR-U	IK20	IK20TT	PK20TT	K20TT		
	1.5L	JL4G15D	K20PR-U	IK20	IK20TT	PK20TT	K20TT		
	1.5L	JL4G15D	K20PR-U	IK20	IK20TT	PK20TT	K20TT		
海景	1.8L	JL4G18	K20PR-U	IK20	IK20TT	PK20TT	K20TT		
	金刚	1.5L	MR479QA	K20PR-U	IK20	IK20TT	PK20TT	K20TT	
		1.6L	MR481QA	K20PR-U	IK20	IK20TT	PK20TT	K20TT	
1.8L		MR481QA	K20PR-U	IK20	IK20TT	PK20TT	K20TT		
金鹰	1.5L	JLB-4G15	K20PR-U	IK20	IK20TT	PK20TT	K20TT		
	1.5L	MR479QN	K20PR-U	IK20	IK20TT	PK20TT	K20TT		
	1.5L	MR479QA	K20PR-U	IK20	IK20TT	PK20TT	K20TT		
美人豹	1.3L	MR479Q	K20PR-U	IK20	IK20TT	PK20TT	K20TT		
	1.5L	MR479QA	K20PR-U	IK20	IK20TT	PK20TT	K20TT		
	1.8L	MR481QA	K20PR-U	IK20	IK20TT	PK20TT	K20TT		
熊猫	1.3L	MR479QA	K20PR-U	IK20	IK20TT	PK20TT	K20TT		
	1.0L	JL3G10	K20HR-U11	IKH20	IKH20TT	PKH20TT	KH20TT		
	1.5L	L4	K16PR-U	IK16	IK16TT	PK16TT	K16TT		
全球鹰	1.3L	MR479Q	K20PR-U	IK20	IK20TT	PK20TT	K20TT		
	1.5L	MR479QN	K20PR-U	IK20	IK20TT	PK20TT	K20TT		
	1.8L	JL4G18	K20PR-U	IK20	IK20TT	PK20TT	K20TT		
	2.0L	JL δ-4G20	K20HR-U11	IKH20	IKH20TT	PKH20TT	KH20TT		
	2.0L	JLD-4G20	K20PR-U	IK20	IK20TT	PK20TT	K20TT		
JAPAN	2.4L	JLD-4G24	K20PR-U	IK20	IK20TT	PK20TT	K20TT		
	吉利帝豪								
	经典帝豪EC7	1.5L	JL γ-4G15	K20HR-U11	IKH20	IKH20TT	PKH20TT	KH20TT	
1.5L		JL4G15	K20PR-U	IK20	IK20TT	PK20TT	K20TT		
1.8L L4		JL4G18	K20PR-U	IK20	IK20TT	PK20TT	K20TT		
新帝豪	1.8L	JL γ-4G18	K20HR-U11	IKH20	IKH20TT	PKH20TT	KH20TT		
	1.5L	JL4G15	K20PR-U	IK20	IK20TT	PK20TT	K20TT		
	2.0L	JL δ-4G20	K20HR-U11	IKH20	IKH20TT	PKH20TT	KH20TT		
帝豪EC8	2.0L	4G63S4N	K20HR-U11	IKH20	IKH20TT	PKH20TT	KH20TT		
	2.4L	JL δ-4G24	K20HR-U11	IKH20	IKH20TT	PKH20TT	KH20TT		
博瑞GC9	2.4L L4	JLD-4G24	K20PR-U	IK20	IK20TT	PK20TT	K20TT		
博越	2.0L L4	JLD-4G20	K20PR-U	IK20	IK20TT	PK20TT	K20TT		



车种	YEAR	车型	发动机型式	DENSO	IRIDIUM	IRIDIUM	PLATINUM	TT
<b>吉利英伦</b>								
SC3		1.3L	MR479Q	K20PR-U	IK20	IK20TT	PK20TT	K20TT
英伦C5		1.5L	JLB-4G15	K20PR-U	IK20	IK20TT	PK20TT	K20TT
SC5-RV		1.5L	MR479QA	K20PR-U	IK20	IK20TT	PK20TT	K20TT
SC6		1.5L	MR479QN	K20PR-U	IK20	IK20TT	PK20TT	K20TT
GC7		1.5L	JL4G15D	K20PR-U	IK20	IK20TT	PK20TT	K20TT
		1.5L	JLγ4G15	K20HR-U11	IKH20	IKH20TT	PKH20TT	KH20TT
		1.8L	JL4G18	K20PR-U	IK20	IK20TT	PK20TT	K20TT
SX7		1.8L	JLγ4G18	K20HR-U11	IKH20	IKH20TT	PKH20TT	KH20TT
		1.8L	JL4G18	K20PR-U	IK20	IK20TT	PK20TT	K20TT
		2.0L	JLD-4G20	K20PR-U	IK20	IK20TT	PK20TT	K20TT
	2.4L	JLD-4G24	K20PR-U	IK20	IK20TT	PK20TT	K20TT	
TX4英伦出租车		2.4L	4G69S4N	K16PR-U11	IK16	IK16TT	PK16TT	K16TT
<b>华普汽车</b>								
海域		1.3L	HJL479Q	-	IK16	IK16TT	PK16TT	K16TT
		1.5L	JL479Q	-	IK16	IK16TT	PK16TT	K16TT
海迅		1.5L	JL481Q	-	IK16	IK16TT	PK16TT	K16TT
海尚		海尚	JL481Q	-	IK16	IK16TT	PK16TT	K16TT
海锋		海锋	JL479Q4	-	IK16	IK16TT	PK16TT	K16TT
海悦		海悦	JL479QA	-	IK16	IK16TT	PK16TT	K16TT
海景		海景	JL4G18	-	IK16	IK16TT	PK16TT	K16TT
<b>上海通用</b>								
赛欧		1.6L	SOHC L01	W20EXR-U	IW20	IW20TT	PW20TT	-
凯越	2004-2007	1.6L	F16D3D	K20PR-U11	IK20	IK20TT	PK20TT	K20TT
	2004-2007	1.8L	T18SED	K20PR-U11	IK20	IK20TT	PK20TT	K20TT
	2004-2007	1.6L	F16D3	K20PR-U11	IK20	IK20TT	PK20TT	K20TT
新凯越	2008-2015	1.6L	F16D3	K20PR-U11	IK20	IK20TT	PK20TT	K20TT
	2008-2015	1.8L	T18SED	K20PR-U11	IK20	IK20TT	PK20TT	K20TT
	2008-2015	1.5L	L2B	XU22EPR-U	IXU22	-	-	XU22TT
老君威	2002-2007	2.0L	L34	K20PR-U11	IK20	IK20TT	PK20TT	K20TT
	2002-2007	2.5L	LB8	T16EPR-U	IT16	IT16TT	PT16TT	T16TT
	2002-2007	3.0L	LW9	T16EPR-U	IT16	IT16TT	PT16TT	T16TT
新君威	2009-2015	2.0L	ECO TEC	-	ITV16	ITV16TT	PTV16TT	TV16TT
	2009-2015	2.4L	ECO TEC	-	ITV16	ITV16TT	PTV16TT	TV16TT
	2009-2015	1.6T	Turbo	KJ20CR-L11	IK20L	IK20TT	PK20TT	K20TT
	2009-2015	2.0T	Turbo DI	-	ITV20	ITV20TT	PTV20TT	-
老君越	2006-2008	2.4L	LE5	-	ITV16	ITV16TT	PTV16TT	TV16TT
	2006-2008	3.0L	LZD	-	ITV16	ITV16TT	PTV16TT	TV16TT
新君越	2009-2014	2.4L	ECOTEC	-	ITV16	ITV16TT	PTV16TT	TV16TT
	2009-2014	3.0L	SIDI	-	ITV16	ITV16TT	PTV16TT	TV16TT
	2009-2014	2.0T	Turbo DI	-	ITV20	ITV20TT	PTV20TT	-
	2016-	2.0T L4	-	-	ITV20	ITV20TT	-	-
老GL8	2001-2005	2.5L	V6	T16EPR-U	IT16	IT16TT	PT16TT	T16TT
	2001-2005	3.0L	LW9	T16EPR-U	IT16	IT16TT	PT16TT	T16TT
GL8陆尊		2.5L	LB8	T16EPR-U	IT16	IT16TT	PT16TT	T16TT
		3.0L	LZC	T16EPR-U	IT16	IT16TT	PT16TT	T16TT
GL8天尊		2.4L	LE5	-	ITV16	ITV16TT	PTV16TT	TV16TT
		3.0L	LFW	-	ITV16	ITV16TT	PTV16TT	TV16TT
英朗		1.6L	ECOTEC	KJ20CR-L11	IK20L	IK20TT	PK20TT	K20TT
		1.6T	Turbo	KJ20CR-L11	IK20L	IK20TT	PK20TT	K20TT
		1.8L	D-VVT Eco	KJ20CR-L11	IK20L	IK20TT	PK20TT	K20TT
		1.4T	-	-	-	IXEH22TT	-	-
昂科拉		1.5L	-	-	IXUH22	-	-	XUH22TT
		1.4T	A14NET(LUJ)	-	IK22	-	PK22TT	-
		1.4TGL	LFF	-	IK22	-	PK22TT	-
昂科威		2.0T	LTG	-	ITV20	ITV20TT	PTV20TT	-
昂科雷		3.6L V6	LLT	-	ITV20	ITV20TT	PTV20TT	-
荣御		2.8L V6	Alloytec	-	ITV20	ITV20TT	PTV20TT	-
		3.6L V6	Alloytec	-	ITV20	ITV20TT	PTV20TT	-
林荫大道		2.8L V6	AlloyTec	-	ITV20	ITV20TT	PTV20TT	-
		3.6L V6	AlloyTec	-	ITV20	ITV20TT	PTV20TT	-
		3.0L V6	AlloyTec	-	ITV20	ITV20TT	PTV20TT	-
<b>进口凯迪拉克/CADILLAC</b>								
进口ATS		2.0T	LTG	-	ITV20	ITV20TT	PTV20TT	-
进口CTS 1代		2.8L V6	LP1	-	ITV20	ITV20TT	PTV20TT	-
		3.6L V6	LY7	-	ITV20	ITV20TT	PTV20TT	-
进口CTS 2代		2.8L V6	LY7	-	ITV20	ITV20TT	PTV20TT	-
		3.6L V6	LY7	-	ITV20	ITV20TT	PTV20TT	-

AUSTRALIA  
CHINA  
INDIA  
INDONESIA  
KOREA  
MALAYSIA  
PHILIPPINES  
SAUDIARABIA  
SINGAPORE  
TAIWAN  
THAILAND  
VIETNAM  
JAPAN  
EUROPE  
& USA  
CROSS  
REFERENCE  
PART  
NUMBER

DENSO	9	14	16	20	24	27	29	31	32	34	35	DENSO	9	14	16	20	22	24	27	29	31	32	DENSO	9	14	16	20	22	24	27	31	
NGK	2	4	5	6	7	8	9	9.5	10	10.5	11	11.5	CHAMPION	18	16,14	12,11	10,9	8,7	6,63,61	4,59	57	55	53	BOSCH	10	9	8	7,6	5	4	3	2



车种	YEAR	车型	发动机型式	DENSO	IRIDIUM				
AUSTRALIA	进口凯迪拉克/CADILLAC								
	进口CTS 2代	3.0L V6	SIDI	-	ITV20	ITV20TT	PTV20TT	-	
		6.2T V8	LSV V8-378	-	IT20	IT20TT	PT20TT	T20TT	
	2.0T L4	LTG	-	ITV20	ITV20TT	PTV20TT	-		
CHINA	XLR	4.6L V8	LH2	T16EPR-U	IT16	IT16TT	PT16TT	-	
	SRX 1代	3.6L V6	LY7	-	ITV20	ITV20TT	PTV20TT	-	
		4.6L V8	LH2	T16EPR-U	IT16	IT16TT	PT16TT	T16TT	
INDIA	SRX 2代	3.0L V6 198kw	LF1	-	ITV20	ITV20TT	PTV20TT	-	
		3.0L V6 199kw	LFW	-	ITV20	ITV20TT	PTV20TT	-	
		3.6L	LY7	-	ITV20	ITV20TT	PTV20TT	-	
	凯雷德Escalade	6.2LV8	VORTEC IV L92	-	IT20	IT20TT	PT20TT	T20TT	
6.0L V8 Hybrid		Vortec6000	-	IT16	IT16TT	PT16TT	T16TT		
INDONESIA	上汽通用凯迪拉克/CADILLAC								
	国产CTS 1代	2.8L V6	LP1	-	ITV20	ITV20TT	PTV20TT	-	
		3.6L V6	LY7	-	ITV20	ITV20TT	PTV20TT	-	
国产SLS赛威	2.8L V6		-	ITV20	ITV20TT	PTV20TT	-		
	3.0L V6	SIDI	-	ITV20	ITV20TT	PTV20TT	-		
KOREA		3.6L V6	LY7	-	ITV20	ITV20TT	PTV20TT	-	
		4.6L V8	D-VVT ETC	T16EPR-U	IT16	IT16TT	PT16TT	T16TT	
	国产ATS-L	2.0T	LNF	-	ITV20	ITV20TT	PTV20TT	-	
		2.0T	LTG 169kw	-	ITV20	ITV20TT	PTV20TT	-	
MALAYSIA	国产XTS	2.0T	LTG 205kw	-	ITV20	ITV20TT	PTV20TT	-	
		2.0T	LTG	-	ITV20	ITV20TT	PTV20TT	-	
	国产CT6	3.6L V6	LY7	-	ITV20	ITV20TT	PTV20TT	-	
PHILIPPINES	悍马/Hummer								
	悍马H3Hummer	3.5L L5	L52	-	ITV16	ITV16TT	PTV16TT	TV16TT	
		3.7L L5		-	ITV16	ITV16TT	PTV16TT	TV16TT	
		5.3L V8		-	IT16	IT16TT	PT16TT	T16TT	
	悍马H2Hummer	6.0L V8	Vortec6000	-	IT16	IT16TT	PT16TT	T16TT	
6.2L V8		VORTEC IV L92	-	IT16	IT16TT	PT16TT	T16TT		
SAUDIARABIA	上海通用雪佛兰								
	赛欧	1.6L	L4	W20EXR-U	IW20	IW20TT	PW20TT	-	
		1.2L	LMU	XU22EPR-U	IXU22	-	-	XU22TT	
		1.4L	LCU	XU22EPR-U	IXU22	-	-	XU22TT	
	赛欧3	1.3L	LEW	-	IXUH22	-	-	XUH22TT	
		1.5L	L2B	-	IXUH22	-	-	XUH22TT	
	TAIWAN	爱唯欧	1.4L	LCU	XU22EPR-U	IXU22	-	-	XU22TT
1.6L			Ecotec	KJ20CR-L11	IK20L	IK20TT	PK20TT	K20TT	
乐骋		1.4L	L95	K20PR-U11	IK20	IK20TT	PK20TT	K20TT	
	1.6L	L95	K20PR-U11	IK20	IK20TT	PK20TT	K20TT		
	1.2L	B12	XU22EPR-U	IXU22	-	-	XU22TT		
THAILAND	乐风	1.4L	L95	K20PR-U11	IK20	IK20TT	PK20TT	K20TT	
		1.6L	F16D3	K20PR-U11	IK20	IK20TT	PK20TT	K20TT	
	1.2L	B12	XU22EPR-U	IXU22	-	-	XU22TT		
	乐风RV	1.5L	L2B	-	IXUH22	-	-	XUH22TT	
VIETNAM	老景程	2.0L	T20SED	K20TNR	IK20	IK20TT	PK20TT	K20TT	
		2.0L	L34	K20TNR	IK20	IK20TT	PK20TT	K20TT	
	景程改款	1.8L	2H0	K20TNR	IK20L	IK20TT	PK20TT	K20TT	
		1.6L	LDE	KJ20CR-L11	IK20L	IK20TT	PK20TT	K20TT	
		1.8L	2H0	KJ20CR-L11	IK20L	IK20TT	PK20TT	K20TT	
JAPAN	科鲁兹 1代	1.6L	LDE	KJ20CR-L11	IK20L	IK20TT	PK20TT	K20TT	
		1.6T	LLU	KJ20CR-L11	IK20L	IK20TT	PK20TT	K20TT	
	科鲁兹 1代小改	1.6L	LDE	KJ20CR-L11	IK20L	IK20TT	PK20TT	K20TT	
EUROPE & USA	创酷	1.6T	LLU	KJ20CR-L11	IK20L	IK20TT	PK20TT	K20TT	
		1.4T	Ecotec	-	-	IXEH22TT	-	-	
		2.0L	LTD	-	ITV16	ITV16TT	PTV16TT	TV16TT	
	迈锐宝 1代	2.4L	LAF	-	ITV16	ITV16TT	PTV16TT	TV16TT	
		1.6T	LLU	KJ20CR-L11	IK20L	IK20TT	PK20TT	K20TT	
		2.0L	LTD	-	ITV16	ITV16TT	PTV16TT	TV16TT	
		2.4L	LAF	-	ITV16	ITV16TT	PTV16TT	TV16TT	
CROSS REFERENCE NUMBER	进口雪佛兰								
	科帕奇	2.4L	L4 DOHC	K20TNR	IK20	IK20TT	PK20TT	K20TT	
		3.2L	HFV6	K20TNR	IK20	IK20TT	PK20TT	K20TT	
3.2L		V6	K20TNR	IK20	IK20TT	PK20TT	K20TT		
PART NUMBER	科迈罗	3.6L	LLT	-	ITV20	ITV20TT	PTV20TT	-	
		3.2L	LU1	K20TNR	IK20	IK20TT	PK20TT	K20TT	



车种	YEAR	车型	发动机型式	DENSO	IRIDIUM			
进口雪佛兰								
科迈罗		3.6L限量版		-	<b>ITV20</b>	<b>ITV20TT</b>	<b>PTV20TT</b>	-
上汽通用五菱								
五菱之光		1.3L	LJ474QE2	K20PR-U	<b>IK20</b>	<b>IK20TT</b>	<b>PK20TT</b>	<b>K20TT</b>
		1.1L	LJ465QE5	W20EXR-U	<b>IW20</b>	<b>IW20TT</b>	<b>PW20TT</b>	-
乐驰SPARK		0.8L	F8CV	W16EXR-U11	<b>IW16</b>	<b>IW16TT</b>	<b>PW16TT</b>	-
		1.0L	B10S1	W16EXR-U11	<b>IW16</b>	<b>IW16TT</b>	<b>PW16TT</b>	-
		1.0L	LMU	XU22EPR-U	<b>IXU22</b>	-	-	<b>XU22TT</b>
		1.2L	LMU	XU22EPR-U	<b>IXU22</b>	-	-	<b>XU22TT</b>
		1.5L	L2C	XU22EPR-U	<b>IXU22</b>	-	-	<b>XU22TT</b>
五菱宏光		1.2L	LMU	XU22EPR-U	<b>IXU22</b>	-	-	<b>XU22TT</b>
		1.4L	LCU	XU22EPR-U	<b>IXU22</b>	-	-	<b>XU22TT</b>
五菱鸿途		1.1L	LXA	W20EXR-U11	<b>IW20</b>	<b>IW20TT</b>	<b>PW20TT</b>	-
		1.2L	LAQ	XU22EPR-U	<b>IXU22</b>	-	-	<b>XU22TT</b>
五菱荣光		1.2L	LAQ	XU22EPR-U	<b>IXU22</b>	-	-	<b>XU22TT</b>
		1.5L	L2C	XU22EPR-U	<b>IXU22</b>	-	-	<b>XU22TT</b>
上汽荣威/名爵汽车								
荣威950		2.0L		-	<b>ITV16</b>	<b>ITV16TT</b>	<b>PTV16TT</b>	<b>TV16TT</b>
		2.4L		-	<b>ITV16</b>	<b>ITV16TT</b>	<b>PTV16TT</b>	<b>TV16TT</b>
		3.0L		-	<b>ITV16</b>	<b>ITV16TT</b>	<b>PTV16TT</b>	<b>TV16TT</b>
荣威750		1.8T	Kavachi	K22PR-U	<b>IK22</b>	-	<b>PK22TT</b>	-
		2.5 V6		K20R-U	<b>IK20</b>	<b>IK20TT</b>	<b>PK20TT</b>	<b>K20TT</b>
荣威550		1.8L	L4	K20R-U	<b>IK20</b>	<b>IK20TT</b>	<b>PK20TT</b>	<b>K20TT</b>
		1.8T	18K4G	K22PR-U	<b>IK22</b>	-	<b>PK22TT</b>	-
荣威350		1.5L	15S4U	K20R-U	<b>IK20</b>	<b>IK20TT</b>	<b>PK20TT</b>	<b>K20TT</b>
荣威W5		1.8T		K22PR-U	<b>IK22</b>	-	<b>PK22TT</b>	-
名爵3MG3		1.4L	L4	K20R-U	<b>IK20</b>	<b>IK20TT</b>	<b>PK20TT</b>	<b>K20TT</b>
		1.8L	L4	K20R-U	<b>IK20</b>	<b>IK20TT</b>	<b>PK20TT</b>	<b>K20TT</b>
		1.3L	13S4F	K20R-U	<b>IK20</b>	<b>IK20TT</b>	<b>PK20TT</b>	<b>K20TT</b>
		1.5L	15S4U	K20R-U	<b>IK20</b>	<b>IK20TT</b>	<b>PK20TT</b>	<b>K20TT</b>
名爵5MG5		1.5L	15N4S4	K20R-U	<b>IK20</b>	<b>IK20TT</b>	<b>PK20TT</b>	<b>K20TT</b>
		1.5T	15S4G	K22PR-U	<b>IK22</b>	-	<b>PK22TT</b>	-
		1.8L	18K4C	K20R-U	<b>IK20</b>	<b>IK20TT</b>	<b>PK20TT</b>	<b>K20TT</b>
名爵6MG6		1.8T	L4	K22PR-U	<b>IK22</b>	-	<b>PK22TT</b>	-
		1.8L	DVVT	K20R-U	<b>IK20</b>	<b>IK20TT</b>	<b>PK20TT</b>	<b>K20TT</b>
名爵7MG7		1.8T	18N4T1	K22PR-U	<b>IK22</b>	-	<b>PK22TT</b>	-
		2.5L	V6	K20R-U	<b>IK20</b>	<b>IK20TT</b>	<b>PK20TT</b>	<b>K20TT</b>
MG TF		1.8L	L4	K20R-U	<b>IK20</b>	<b>IK20TT</b>	<b>PK20TT</b>	<b>K20TT</b>
长城汽车								
赛弗		2.2L	491QE	W16EXR-U	<b>IW16</b>	<b>IW16TT</b>	<b>PW16TT</b>	-
赛骏		2.2L	491QE	W16EXR-U	<b>IW16</b>	<b>IW16TT</b>	<b>PW16TT</b>	-
赛影		2.2L	GW491QE	W16EXR-U	<b>IW16</b>	<b>IW16TT</b>	<b>PW16TT</b>	-
哈弗M1		1.3L	GW4G13(VVT)	K16PR-U11	<b>IK16</b>	<b>IK16TT</b>	<b>PK16TT</b>	<b>K16TT</b>
哈弗M2		1.5L	GW4G15(VVT)	K16PR-U11	<b>IK16</b>	<b>IK16TT</b>	<b>PK16TT</b>	<b>K16TT</b>
哈弗M4		1.5L	GW4G15(VVT)	K16PR-U11	<b>IK16</b>	<b>IK16TT</b>	<b>PK16TT</b>	<b>K16TT</b>
哈弗H1		1.5L	GW4G15	K16PR-U11	<b>IK16</b>	<b>IK16TT</b>	<b>PK16TT</b>	<b>K16TT</b>
哈弗H2		1.5T	GW4G15B	K22PR-U	<b>IK22</b>	-	<b>PK22TT</b>	-
哈弗H3		2.0L	4G63S4M	K16PR-U11	<b>IK16</b>	<b>IK16TT</b>	<b>PK16TT</b>	<b>K16TT</b>
		2.4L	4G69S4M	K16PR-U11	<b>IK16</b>	<b>IK16TT</b>	<b>PK16TT</b>	<b>K16TT</b>
哈弗H5		2.0L	4G63S4M	K16PR-U11	<b>IK16</b>	<b>IK16TT</b>	<b>PK16TT</b>	<b>K16TT</b>
		2.4L	4G69S4N	K16PR-U11	<b>IK16</b>	<b>IK16TT</b>	<b>PK16TT</b>	<b>K16TT</b>
哈弗H6		1.5T		K22PR-U	<b>IK22</b>	-	<b>PK22TT</b>	-
		2.0L	4G63S4M	K16R-U11	<b>IK16</b>	<b>IK16TT</b>	<b>PK16TT</b>	<b>K16TT</b>
		2.4L	4G69S4M	K20HR-U11	<b>IKH20</b>	<b>IKH20TT</b>	<b>PKH20TT</b>	<b>KH20TT</b>
精灵		1.3L	GW4G13(VVT)	K16PR-U11	<b>IK16</b>	<b>IK16TT</b>	<b>PK16TT</b>	<b>K16TT</b>
		1.3L	GW413EF	K16PR-U11	<b>IK16</b>	<b>IK16TT</b>	<b>PK16TT</b>	<b>K16TT</b>
炫丽		1.3L	GW4G13(VVT)	K16PR-U11	<b>IK16</b>	<b>IK16TT</b>	<b>PK16TT</b>	<b>K16TT</b>
		1.5L	GW4G15(VVT)	K16PR-U11	<b>IK16</b>	<b>IK16TT</b>	<b>PK16TT</b>	<b>K16TT</b>
酷熊		1.5L	GW4G15(VVT)	K16PR-U11	<b>IK16</b>	<b>IK16TT</b>	<b>PK16TT</b>	<b>K16TT</b>
腾翼		2.4L	4G69	K20HR-U11	<b>IKH20</b>	<b>IKH20TT</b>	<b>PKH20TT</b>	<b>KH20TT</b>
		2.0L	4G63	K20HR-U11	<b>IKH20</b>	<b>IKH20TT</b>	<b>PKH20TT</b>	<b>KH20TT</b>
		1.5T	GW4G15T	K22PR-U	<b>IK22</b>	-	<b>PK22TT</b>	-
		1.5L	GW4G15(VVT)	K16PR-U11	<b>IK16</b>	<b>IK16TT</b>	<b>PK16TT</b>	<b>K16TT</b>
凌傲		1.3L	GW4G13(VVT)	K16PR-U11	<b>IK16</b>	<b>IK16TT</b>	<b>PK16TT</b>	<b>K16TT</b>
		1.5L	GW4G15(VVT)	K16PR-U11	<b>IK16</b>	<b>IK16TT</b>	<b>PK16TT</b>	<b>K16TT</b>
嘉誉		2.0L	4G69	K20HR-U11	<b>IKH20</b>	<b>IKH20TT</b>	<b>PKH20TT</b>	<b>KH20TT</b>
		2.4L	4G64	K16PR-U11	<b>IK16</b>	<b>IK16TT</b>	<b>PK16TT</b>	<b>K16TT</b>

AUSTRALIA  
CHINA  
INDIA  
INDONESIA  
KOREA  
MALAYSIA  
PHILIPPINES  
SAUDIARABIA  
SINGAPORE  
TAIWAN  
THAILAND  
VIETNAM  
JAPAN  
EUROPE  
& USA  
CROSS  
REFERENCE  
NUMBER  
PART



车种	YEAR	车型	发动机型式	DENSO	IRIDIUM				
AUSTRALIA	哈飞								
	中意	1.1L	DA465Q	W16EXR-U	IW16	IW16TT	PW16TT	-	
CHINA	民意	1.0L	DA465Q	W16EXR-U	IW16	IW16TT	PW16TT	-	
	赛马	1.3L	DA471Q	K16PR-U11	IK16	IK16TT	PK16TT	K16TT	
INDIA	赛豹	1.5L	4G15S	K16PR-U11	IK16	IK16TT	PK16TT	K16TT	
		1.6L	DA476Q	K16PR-U11	IK16	IK16TT	PK16TT	K16TT	
		1.6L	DA4G18	K16PR-U11	IK16	IK16TT	PK16TT	K16TT	
		2.0L	4G94	K16PR-U11	IK16	IK16TT	PK16TT	K16TT	
INDONESIA	路宝	1.6L	DA476Q	K16PR-U11	IK16	IK16TT	PK16TT	K16TT	
		1.8L	4G93	K16PR-U11	IK16	IK16TT	PK16TT	K16TT	
		1.0L	DAK10A	K16PR-U11	IK16	IK16TT	PK16TT	K16TT	
KOREA	福美来	1.1L	DA468Q	XU22EPR-U	IXU22	-	-	XU22TT	
		1.3L	DA471QL	K16PR-U11	IK16	IK16TT	PK16TT	K16TT	
		1.0L	DA465Q-2	W20EXR-U	IW20	IW20TT	PW20TT	-	
MALAYSIA	海南马自达/海马汽车	1.6L	ZM-II	KJ20CR-L11	IK20L	IK20TT	PK20TT	K20TT	
		1.6L	TRITEC	K20PR-U11	IK20	IK20TT	PK20TT	K20TT	
		1.8L	HM483Q	K16PR-U11	IK16	IK16TT	PK16TT	K16TT	
		1.6L	HA-VVT-1.6	K16PR-U11	IK16	IK16TT	PK16TT	K16TT	
PHILIPPINES	福美来M5	1.6L	HM474Q-C	K20PR-U11	IK20	IK20TT	PK20TT	K20TT	
		1.6L	4G18	K16PR-U11	IK16	IK16TT	PK16TT	K16TT	
		1.8L	483Q	K16PR-U11	IK16	IK16TT	PK16TT	K16TT	
SAUDI ARABIA	海福星	1.5L	4A91S	K20HR-U11	IKH20	IKH20TT	PKH20TT	KH20TT	
		1.3L	4A90S	K20HR-U11	IKH20	IKH20TT	PKH20TT	KH20TT	
		1.3L	HM474Q-BAJ	K20PR-U11	IK20	IK20TT	PK20TT	K20TT	
		1.5L	4A91S	K20HR-U11	IKH20	IKH20TT	PKH20TT	KH20TT	
SINGAPORE	海马2	1.5L	HM474Q	K20PR-U11	IK20	IK20TT	PK20TT	K20TT	
		1.6L	HM483Q	K16PR-U11	IK16	IK16TT	PK16TT	K16TT	
		1.6L	479Q-A	KJ20CR-L11	IK20L	IK20TT	PK20TT	K20TT	
TAIWAN	海马3	1.6L	TRITEC	K20PR-U11	IK20	IK20TT	PK20TT	K20TT	
		2.0L	HM484Q	KJ20CR-L11	IK20L	IK20TT	PK20TT	K20TT	
		1.8L	HM483Q	K16PR-U11	IK16	IK16TT	PK16TT	K16TT	
		1.6L	HA-VVT-1.6	K16PR-U11	IK16	IK16TT	PK16TT	K16TT	
VIETNAM	丘比特	1.3L	4A90S	K16PR-U11	IK16	IK16TT	PK16TT	K16TT	
		1.3L	HA-1.3	K16PR-U11	IK16	IK16TT	PK16TT	K16TT	
		1.5L	4A91S	K20HR-U11	IKH20	IKH20TT	PKH20TT	KH20TT	
JAPAN	欢动	1.6L	HA-VVT-1.6	K16PR-U11	IK16	IK16TT	PK16TT	K16TT	
		1.8L	HM483Q	K16PR-U11	IK16	IK16TT	PK16TT	K16TT	
		1.5L	4A91S	K20HR-U11	IKH20	IKH20TT	PKH20TT	KH20TT	
EUROPE & USA	骑士	1.5L	4A91S	K20HR-U11	IKH20	IKH20TT	PKH20TT	KH20TT	
		2.0L	484Q	K16PR-U11	IK16	IK16TT	PK16TT	K16TT	
		1.8L	HM483Q	K16PR-U11	IK16	IK16TT	PK16TT	K16TT	
THAILAND	海马3	1.8L	HM483Q	K16PR-U11	IK16	IK16TT	PK16TT	K16TT	
		广州本田							
		飞度	1.3L三厢	L13A3	K20PR-U11	IK20	IK20TT	PK20TT	K20TT
		1.5L三厢	L15A1	KJ20CR-L11	IK20L	IK20TT	PK20TT	K20TT	
VIETNAM	飞度	1.3L二厢	L13A3	K20PR-U11	IK20	IK20TT	PK20TT	K20TT	
		1.5L二厢	L15A1	KJ20CR-L11	IK20L	IK20TT	PK20TT	K20TT	
		1.3L	L13Z1	SKJ20DR-M13	IK20L	IK20TT	PK20TT	K20TT	
		1.5L	L15A7	SKJ20DR-M13	IK20L	IK20TT	PK20TT	K20TT	
JAPAN	思迪	1.5L	L15B2	-	-	IXEH22TT	-	-	
		1.5L	L15B3	DXE22HCR11S	-	IXEH22TT	-	-	
		1.3L	L13A3	K20PR-U11	IK20	IK20TT	PK20TT	K20TT	
EUROPE & USA	锋范	1.5L	L15A1	SKJ20DR-M13	IK20L	IK20TT	PK20TT	K20TT	
		1.5L	L15A7	SKJ20DR-M13	IK20L	IK20TT	PK20TT	K20TT	
		1.8L	R18A1	SKJ20DR-M11S	IK20G	IK20TT	PK20TT	K20TT	
		1.5L	L15B2	DXE22HCR11S	-	IXEH22TT	-	-	
EUROPE & USA	理念	1.3L	L13A3	K20PR-U11	IK20	IK20TT	PK20TT	K20TT	
		1.5L	L15A1	SKJ20DR-M13	IK20L	IK20TT	PK20TT	K20TT	
		1.8L	R18Z5	-	IXUH22	-	-	XUH22TT	
EUROPE & USA	缤智	1.5L	L15B2	DXE22HCR11S	-	IXEH22TT	-	-	
		1.8L	R18Z7	-	IXUH22	-	-	XUH22TT	
		2.0L	K20A7	KJ16CR-L11	IK16L	IK16TT	PK16TT	K16TT	
		2.3L CG5	F23A1	KJ16CR-L11	IK16L	IK16TT	PK16TT	K16TT	
EUROPE & USA	六代雅阁	30.L CG1	J30A4	KJ16CR-L11	IK16L	IK16TT	PK16TT	K16TT	
		2.0L	K20A7	KJ20DR-M11	IK20L	IK20TT	PK20TT	K20TT	
		2.4L	K24Z2/K24A8	KJ20DR-M11	IK20L	IK20TT	PK20TT	K20TT	
		3.0L	J30A4	KJ20DR-M11	IK20L	IK20TT	PK20TT	K20TT	
EUROPE & USA	七代雅阁	2.0L	K20A7	KJ20DR-M11	IK20L	IK20TT	PK20TT	K20TT	
		2.0L	R20A3	KJ20CR-L11	IK20L	IK20TT	PK20TT	K20TT	
EUROPE & USA	八代雅阁	2.4L	K24Z2	SXU22HCR11	IXUH22	-	-	XUH22TT	

车种	YEAR	车型	发动机型式	DENSO	IRIDIUM			
<b>广州本田</b>								
八代雅阁	3.5L	J35Z2		SC20HR11	VCH20	IXEH22TT	-	-
九代雅阁	2.0L	R20Z4		-	IXUH22	-	-	XUH22TT
	2.4L	K24W5		-	-	IXEH22TT	-	-
	3.0L	J30A5		-	IXUH22	-	-	XUH22TT
十代雅阁	1.5T			-	-	-	-	
奥德赛2代	2.3L	F23Z4		KJ16CR-L11	IK16L	IK16TT	PK16TT	K16TT
	3.0L	F23Z4		KJ16CR-L11	IK16L	IK16TT	PK16TT	K16TT
奥德赛3代	2.4L	K24A6		SKJ20DR-M11S	IK20L	IK20TT	PK20TT	K20TT
奥德赛4代	2.4L	K24A2		SXU22HCR11	IXUH22	-	-	XUH22TT
奥德赛5代	2.4L	K24W5		DXE22HQRD11S	-	IXEH22TT	-	-
歌诗图	2.4L	K24Y3		SXU22HCR11S	IXUH22	-	-	XUH22TT
	3.0L	J30A7		-	IXUH22	-	-	XUH22TT
	3.5L	J35Z2		SXU22HCR11	IXUH22	-	-	XUH22TT
<b>东风本田</b>								
八代思域	1.3L Hybrid	LDA2		SK20HR11	VKH20	IKH20TT	PKH20TT	KH20TT
	1.8L	R18A1		SKJ20DR-M11S	IK20G	IK20TT	-	K20TT
九代思域	1.8L	R18Z2		-	IXUH22	-	-	XUH22TT
	2.0L	R20A6		-	IXUH22	-	-	XUH22TT
	2.0L Hybrid	R20A6		-	IXUH22	-	-	XUH22TT
九代中改款思域(9.5代)	1.8L	R18Z2		-	IXUH22	-	-	XUH22TT
	2.4L	K24Z7		SXU22HCR11S	IXUH22	-	-	XUH22TT
十代思域	1.5T	L15B8		-	-	-	-	
思铭	1.8L	R18A1		K20PR-U11	IK20G	IK20TT	-	-
杰德	1.8L	R18Z6		-	IXUH22	-	-	XUH22TT
哥瑞 Greiz	1.5L	L15B5 地球梦引擎		DXE22HCR11S	-	IXEH22TT	-	-
CR-V 1代	2.0L	RD5		KJ20DR-M11	IK20L	IK20TT	PK20TT	K20TT
	2.4L	RD5		KJ20DR-M11	IK20L	IK20TT	PK20TT	K20TT
CR-V 2代	2.0L	K20A1		SKJ20DR-M11S	IK20L	IK20TT	PK20TT	K20TT
	2.4L	K24Z1		SKJ20DR-M11S	IK20L	IK20TT	PK20TT	K20TT
	2.0L	i-VTEC		K20PR-U11	IK20G	IK20TT	-	-
	2.4L	i-VTEC		K20PR-U11	IK20G	IK20TT	-	-
CR-V 3代	2.0L	R20A7		SXU22HCR11S	IXUH22	-	-	XUH22TT
	2.4L	K24Z8		SXU22HCR11S	IXUH22	-	-	XUH22TT
	2.4L	K24V6 地球梦引擎		DXE22HQRD11S	-	IXEH22TT	-	-
CR-V 5代	1.5T	L15BL		-	-	-	-	
XR-V	1.5L	L15B5		DXE22HCR11S	-	IXEH22TT	-	-
	1.8L	R18ZA		-	IXUH22	-	-	XUH22TT
思铂睿	2.0L	R20A4		K20PR-U11	IK20G	IK20TT	-	-
	2.0L	R20Z8		-	IXUH22	-	-	XUH22TT
	2.4L	K24Z5		SXU22HCR11	IXUH22	-	-	XUH22TT
	2.4L	K24V4		DXE22HQRD11S	-	IXEH22TT	-	-
艾力绅	2.4L	K24Z5		SXU22HCR11S	IXUH22	-	-	XUH22TT
<b>北京汽车</b>								
E系列	1.3L	4A90M		K20HR-U11	IKH20	IKH20TT	PKH20TT	KH20TT
	1.5L	4A91S		K20HR-U11	IKH20	IKH20TT	PKH20TT	KH20TT
<b>北京现代</b>								
索纳塔EF	2.0L	G4GC		K16PR-U11	IK16	IK16TT	PK16TT	K16TT
	2.5L	G6BV		K16PR-U11	IK16	IK16TT	PK16TT	K16TT
	2.7L	G6BA		K16PR-U11	IK16	IK16TT	PK16TT	K16TT
索纳塔八	2.0L	G4KD		K16HPR-U11	IKH16	IKH16TT	PKH16TT	KH16TT
	2.4L	G4KE		K16HPR-U11	IKH16	IKH16TT	PKH16TT	KH16TT
	2.0L	G4NA		-	IXUH22	-	-	XUH22TT
索纳塔九	1.6T 双离合	γ G4FJ		-	IXUH22	-	-	XUH22TT
	2.0L	G4KD		-	IXUH22	-	-	XUH22TT
	2.4L	G4KJ		-	IXUH22	-	-	XUH22TT
伊兰特	1.6L	G4ED		K20PR-U11	IK20	IK20TT	PK20TT	K20TT
	1.8L	G4GB		K16PR-U11	IK16	IK16TT	PK16TT	K16TT
	1.6L	G4FG		-	IXUH22	-	-	XUH22TT
	1.8L	G4NB		-	IXUH22	-	-	XUH22TT
悦动	1.6L	a-CVVT/G4ED		K16PR-U11	IK16	IK16TT	PK16TT	K16TT
	1.8L	β-DOHC/G4GB		K16PR-U11	IK16	IK16TT	PK16TT	K16TT
	1.6L	γ-CVVT/G4FC		-	IXUH22	-	-	XUH22TT
御翔	2.0L	G4KA		K16PR-U11	IK16	IK16TT	PK16TT	K16TT
	2.4L	G4KC/G4KE		K16PR-U11	IK16	IK16TT	PK16TT	K16TT
领翔	2.0L	G4KD		K16HPR-U11	IKH16	IKH16TT	PKH16TT	KH16TT
	2.4L	G4KE		K16HPR-U11	IKH16	IKH16TT	PKH16TT	KH16TT
名驭	1.8L	G4GB		K16PR-U11	IK16	IK16TT	PK16TT	K16TT

AUSTRALIA  
CHINA  
INDIA  
INDONESIA  
KOREA  
MALAYSIA  
PHILIPPINES  
SAUDIARABIA  
SINGAPORE  
TAIWAN  
THAILAND  
VIETNAM  
JAPAN  
EUROPE & USA  
CROSS REFERENCE NUMBER  
PART

DENSO	9	14	16	20	22	24	27	29	31	32	34	35	DENSO	9	14	16	20	22	24	27	31	32	DENSO	9	14	16	20	22	24	27	31	
NGK	2	4	5	6	7	8	9	9.5	10	10.5	11	11.5	CHAMPION	18	16,14	12,11	10,9	8,7	6,63,61	4,59	57	55	53	BOSCH	10	9	8	7,6	5	4	3	2



车种	YEAR	车型	发动机型式	DENSO	IRIDIUM			
AUSTRALIA	北京现代							
	名驭	2.0L	G4GC	K16PR-U11	<b>IK16</b>	<b>IK16TT</b>	<b>PK16TT</b>	<b>K16TT</b>
	名图MISTRA	1.8L	G4NB	-	<b>IXUH22</b>	-	-	<b>XUH22TT</b>
CHINA	雅绅特							
		1.4L	G4EE	K16PR-U11	<b>IK16</b>	<b>IK16TT</b>	<b>PK16TT</b>	<b>K16TT</b>
		1.6L	G4ED(CVVT)	K16PR-U11	<b>IK16</b>	<b>IK16TT</b>	<b>PK16TT</b>	<b>K16TT</b>
	瑞纳	1.4L	G4FA	-	<b>IXUH22</b>	-	-	<b>XUH22TT</b>
INDIA	瑞奕							
		1.4L		-	<b>IXUH22</b>	-	-	<b>XUH22TT</b>
		1.6L		-	<b>IXUH22</b>	-	-	<b>XUH22TT</b>
	朗动	1.6L	G4FG	-	<b>IXUH22</b>	-	-	<b>XUH22TT</b>
INDONESIA	i30							
		1.6L	G4FC, γ-CVVT	-	<b>IXUH22</b>	-	-	<b>XUH22TT</b>
		2.0L	G4GC, β-CVVT	-	<b>IXUH22</b>	-	-	<b>XUH22TT</b>
	ix25	1.6L	G4FG	-	<b>IXUH22</b>	-	-	<b>XUH22TT</b>
KOREA	ix35 1代							
		2.0L	G4KD	K16HPR-U11	<b>IKH16</b>	<b>IKH16TT</b>	<b>PKH16TT</b>	<b>KH16TT</b>
		2.4L	G4KC	K16HPR-U11	<b>IKH16</b>	<b>IKH16TT</b>	<b>PKH16TT</b>	<b>KH16TT</b>
	ix35 2代	2.0L	G4NA	-	<b>IXUH22</b>	-	-	<b>XUH22TT</b>
MALAYSIA	途胜1代							
		2.0L	G4GC	K16PR-U11	<b>IK16</b>	<b>IK16TT</b>	<b>PK16TT</b>	<b>K16TT</b>
		2.7L	G6BA	K16PR-U11	<b>IK16</b>	<b>IK16TT</b>	<b>PK16TT</b>	<b>K16TT</b>
	途胜3代	1.6T DCT	1.6 Gamma T-Gdi	-	<b>IXUH22</b>	-	-	<b>XUH22TT</b>
PHILIPPINES	国产新胜达Santa							
		2.0L	2.0 Nu Gdi	-	<b>IXUH22</b>	-	-	<b>XUH22TT</b>
		2.0T	G4KH	-	<b>IXUH22</b>	-	-	<b>XUH22TT</b>
		2.4L	G4KJ	-	<b>IXUH22</b>	-	-	<b>XUH22TT</b>
SAUDIARABIA	华泰汽车							
	圣达菲							
		2.7L	G6BA	K16PR-U11	<b>IK16</b>	<b>IK16TT</b>	<b>PK16TT</b>	<b>K16TT</b>
		1.8T	18K4G	K22PR-U	<b>IK22</b>	-	<b>PK22TT</b>	-
SINGAPORE	特拉卡							
		2.0L	4G63S4M	K20PR-U11	<b>IK20</b>	<b>IK20TT</b>	<b>PK20TT</b>	<b>K20TT</b>
		2.4L	4G64	K16PR-U11	<b>IK16</b>	<b>IK16TT</b>	<b>PK16TT</b>	<b>K16TT</b>
	进口现代							
TAIWAN	酷派							
		2.0L	G4GC	K16PR-U11	<b>IK16</b>	<b>IK16TT</b>	<b>PK16TT</b>	<b>K16TT</b>
		2.0L	DOHC	K16PR-U11	<b>IK16</b>	<b>IK16TT</b>	<b>PK16TT</b>	<b>K16TT</b>
		2.7 V6	G6BA	K16PR-U11	<b>IK16</b>	<b>IK16TT</b>	<b>PK16TT</b>	<b>K16TT</b>
	劳恩斯酷派	2.0T	G4KF	-	<b>IKH24</b>	-	-	-
		3.8L	D-CVVT	-	<b>IKH22</b>	-	-	-
	胜达	2.7L	G6EA	K16HPR-U11	<b>IKH16</b>	<b>IKH16TT</b>	<b>PKH16TT</b>	<b>KH16TT</b>
THAILAND	飞思Veloster							
		1.6L		-	-	-	-	-
	美佳MATRIX	1.6L L4	G4ED	K16PR-U11	<b>IK16</b>	<b>IK16TT</b>	<b>PK16TT</b>	<b>K16TT</b>
		1.8L L4	G6GB	K16PR-U11	<b>IK16</b>	<b>IK16TT</b>	<b>PK16TT</b>	<b>K16TT</b>
	维拉克斯	3.8L V6	G6DA	K16PR-U11	<b>IK16</b>	<b>IK16TT</b>	<b>PK16TT</b>	<b>K16TT</b>
	雅科仕Equus	3.8GDi V6	G6CU	K16PR-U11	<b>IK16</b>	<b>IK16TT</b>	<b>PK16TT</b>	<b>K16TT</b>
VIETNAM	雅科仕							
		3.5L	G6CU	K16PR-U11	<b>IK16</b>	<b>IK16TT</b>	<b>PK16TT</b>	<b>K16TT</b>
		4.5L		K16PR-U11	<b>IK16</b>	<b>IK16TT</b>	<b>PK16TT</b>	<b>K16TT</b>
		3.8L	V6 λ	K16PR-U11	<b>IK16</b>	<b>IK16TT</b>	<b>PK16TT</b>	<b>K16TT</b>
		4.6L	V8 τ	K16PR-U11	<b>IK16</b>	<b>IK16TT</b>	<b>PK16TT</b>	<b>K16TT</b>
	雅尊	2.4L		K16PR-U11	<b>IK16</b>	<b>IK16TT</b>	<b>PK16TT</b>	<b>K16TT</b>
		2.7L	G6EA	K16PR-U11	<b>IK16</b>	<b>IK16TT</b>	<b>PK16TT</b>	<b>K16TT</b>
EUROPE & USA	东风悦达起亚							
	千里马							
		1.3L	LS SOHC	K16PR-U11	<b>IK16</b>	<b>IK16TT</b>	<b>PK16TT</b>	<b>K16TT</b>
		1.6L	LS SOHC	K16PR-U11	<b>IK16</b>	<b>IK16TT</b>	<b>PK16TT</b>	<b>K16TT</b>
	锐欧	1.4L	DOHC	K16PR-U11	<b>IK16</b>	<b>IK16TT</b>	<b>PK16TT</b>	<b>K16TT</b>
		1.6L	CVVT	K20PR-U11	<b>IK20</b>	<b>IK20TT</b>	<b>PK20TT</b>	<b>K20TT</b>
	赛拉图	1.6L	CVVT L4	K20PR-U11	<b>IK20</b>	<b>IK20TT</b>	<b>PK20TT</b>	<b>K20TT</b>
CROSS REFERENCE NUMBER	远舰							
		1.8L	CVVT L4	K16PR-U11	<b>IK16</b>	<b>IK16TT</b>	<b>PK16TT</b>	<b>K16TT</b>
		1.6L	DOHC L4	K20PR-U11	<b>IK20</b>	<b>IK20TT</b>	<b>PK20TT</b>	<b>K20TT</b>
		1.8L	G4GB	K16PR-U11	<b>IK16</b>	<b>IK16TT</b>	<b>PK16TT</b>	<b>K16TT</b>
		2.0L	DOHC L4	K16PR-U11	<b>IK16</b>	<b>IK16TT</b>	<b>PK16TT</b>	<b>K16TT</b>
	嘉华	3.5L	G6CU	K16PR-U11	<b>IK16</b>	<b>IK16TT</b>	<b>PK16TT</b>	<b>K16TT</b>
PART NUMBER	福瑞迪							
		2.7L	DOHC	K16PR-U11	<b>IK16</b>	<b>IK16TT</b>	<b>PK16TT</b>	<b>K16TT</b>
	1.6L	1.6 γ	-	<b>IXUH22</b>	-	-	-	



车种	YEAR	车型	发动机型式	DENSO	IRIDIUM	IRIDIUM	PLATINUM	TT	
东风悦达起亚									
福瑞迪	2.0L	CVT	-	-	IXUH22	-	-	-	XUH22TT
	1.6L	G4FC	-	-	IXUH22	-	-	-	XUH22TT
秀尔	1.6L	G4FC	-	-	IXUH22	-	-	-	XUH22TT
	2.0L	G4GC	K16PR-U11	IK16	IK16TT	PK16TT	-	-	K16TT
K2	1.4L	G4FA	-	-	IXUH22	-	-	-	XUH22TT
	1.6L	G4FC	-	-	IXUH22	-	-	-	XUH22TT
K3	1.6L	G4FG	-	-	IXUH22	-	-	-	XUH22TT
	1.8L	G4NB	-	-	IXUH22	-	-	-	XUH22TT
K3S	1.6L	G4FG	-	-	IXUH22	-	-	-	XUH22TT
K4	1.6T	-	-	-	IXUH22	-	-	-	XUH22TT
	1.8L	-	-	-	IXUH22	-	-	-	XUH22TT
	2.0L	-	-	-	IXUH22	-	-	-	XUH22TT
K5 1代	2.0L	G4KD 121kw	K16HPR-U11	IKH16	IKH16TT	PKH16TT	-	-	KH16TT
	2.4L	G4KE	K16HPR-U11	IKH16	IKH16TT	PKH16TT	-	-	KH16TT
K5 1.5代小改款	2.0L	G4NA 119kw	-	-	IXUH22	-	-	-	XUH22TT
	2.0T	-	-	-	IXUH22	-	-	-	XUH22TT
	2.4L	G4KE	-	-	IXUH22	-	-	-	XUH22TT
K5 2代	1.6T	-	-	-	IXUH22	-	-	-	XUH22TT
	2.0L	-	-	-	IXUH22	-	-	-	XUH22TT
	2.0T	-	-	-	IXUH22	-	-	-	XUH22TT
狮跑	2.0L	G4GC	K16PR-U11	IK16	IK16TT	PK16TT	-	-	K16TT
	2.7L	G6BA	K16PR-U11	IK16	IK16TT	PK16TT	-	-	K16TT
智跑	2.0L	G4KD	K16HPR-U11	IKH16	IKH16TT	PKH16TT	-	-	KH16TT
	2.4L	G4KE	K16HPR-U11	IKH16	IKH16TT	PKH16TT	-	-	KH16TT
	2.0L	G4NA	-	-	IXUH22	-	-	-	XUH22TT
	2.0L	G4KD	-	-	IXUH22	-	-	-	XUH22TT
	2.4L	G4KE	-	-	IXUH22	-	-	-	XUH22TT
进口起亚									
新佳乐	2.0L	G4KA	-	-	IK16	IK16TT	PK16TT	-	K16TT
欧菲莱斯	2.7L	G6EA	K16PR-U11	IK16	IK16TT	PK16TT	-	-	K16TT
	3.8L	G6DA	K16PR-U11	IK16	IK16TT	PK16TT	-	-	K16TT
索兰托	2.4L	G4KE	K16HPR-U11	IKH16	IKH16TT	PKH16TT	-	-	KH16TT
	2.4L	G4JS	-	-	IXUH22	-	-	-	XUH22TT
	2.4L	-	-	-	IXUH22	-	-	-	XUH22TT
霸锐	3.8L	G6DA	-	-	IXUH22	-	-	-	XUH22TT
江淮汽车									
悦悦	1.0L	DAK10A	XU22EPR-U	IXU22	-	-	-	-	XU22TT
	1.3L	4GB1	K20PR-U	IK20	IK20TT	PK20TT	-	-	K20TT
同悦	1.3L	4G13	K16PR-U	IK16	IK16TT	PK16TT	-	-	K16TT
	1.5L	4G15	K16PR-U	IK16	IK16TT	PK16TT	-	-	K16TT
	1.5L	4GB2	-	-	IXUH22	-	-	-	XUH22TT
和悦	1.5L	4G15S	K20PR-U	IK20	IK20TT	PK20TT	-	-	K20TT
	1.5L	4GB2	K20HR-U11	IKH20	IKH20TT	PKH20TT	-	-	KH20TT
	1.8L	4G93D	K20PR-U	IK20	IK20TT	PK20TT	-	-	K20TT
宾悦	2.0L	HFC4GA3	K16PR-U11	IK16	IK16TT	PK16TT	-	-	K16TT
	2.4L	HFC4GA1	W16EXR-U11	IW16	IW16TT	PW16TT	-	-	-
瑞风	2.4L	HFC4GA1	W16EXR-U11	IW16	IW16TT	PW16TT	-	-	-
	2.0L	HFC4GA3	K16PR-U11	IK16	IK16TT	PK16TT	-	-	K16TT
	2.0T	HFC4GA3-1B	K22PR-U	IK22	-	PK22TT	-	-	-
瑞鹰	2.0L	HFC4GA3-1	K16PR-U11	IK16	IK16TT	PK16TT	-	-	K16TT
	2.4L	HFC4GA1-1	W16EXR-U11	IW16	IW16TT	PW16TT	-	-	-
青年莲花									
竞速	1.6L	S4PH	T20EPR-U	IT20	IT20TT	PT20TT	-	-	T20TT
竞悦	1.6L	S4PH	T20EPR-U	IT20	IT20TT	PT20TT	-	-	T20TT
L3	1.5L	4G15M	T20EPR-U	IT20	IT20TT	PT20TT	-	-	T20TT
	1.6L	S4PH	T20EPR-U	IT20	IT20TT	PT20TT	-	-	T20TT
L5	1.6L	S4PH	T20EPR-U	IT20	IT20TT	PT20TT	-	-	T20TT
	1.8L	4G93M	T20EPR-U	IT20	IT20TT	PT20TT	-	-	T20TT
力帆汽车									
320	1.3L	LF479Q3	K20PR-U11	IK20	IK20TT	PK20TT	-	-	K20TT
520	1.3L	LF479Q3	K20PR-U11	IK20	IK20TT	PK20TT	-	-	K20TT
	1.6L	LF481Q3	K20PR-U11	IK20	IK20TT	PK20TT	-	-	K20TT
	1.6L	TRITEC	KJ16CR-L11	IK16L	IK16TT	PK16TT	-	-	K16TT
620	1.6L	TRITEC	KJ16CR-L11	IK16L	IK16TT	PK16TT	-	-	K16TT
	1.6L	LF481Q3	K20PR-U11	IK20	IK20TT	PK20TT	-	-	K20TT
	1.5L	LF497Q2	K20PR-U11	IK20	IK20TT	PK20TT	-	-	K20TT
720	1.8L	LFB479Q	K20PR-U11	IK20	IK20TT	PK20TT	-	-	K20TT

AUSTRALIA  
CHINA  
INDIA  
INDONESIA  
KOREA  
MALAYSIA  
PHILIPPINES  
SAUDIARABIA  
SINGAPORE  
TAIWAN  
THAILAND  
VIETNAM  
JAPAN  
EUROPE & USA  
CROSS REFERENCE NUMBER  
PART

DENSO	9	14	16	20	22	24	27	29	31	32	34	35	DENSO	9	14	16	20	22	24	27	29	31	32	DENSO	9	14	16	20	22	24	27	31
NGK	2	4	5	6	7	8	9	9.5	10	10.5	11	11.5	CHAMPION	18	16,14	12,11	10,9	8,7	6,63,61	4,59	57	55	53	BOSCH	10	9	8	7,6	5	4	3	2



车种	YEAR	车型	发动机型式	DENSO	IRIDIUM				
AUSTRALIA	力帆汽车								
	X60	1.8L	LFB479Q	K20PR-U11	<b>IK20</b>	<b>IK20TT</b>	<b>PK20TT</b>	<b>K20TT</b>	
CHINA	江铃汽车								
	风尚	1.5L	JL475Q7	K20PR-U	<b>IK20</b>	<b>IK20TT</b>	<b>PK20TT</b>	<b>K20TT</b>	
INDIA	陆风	1.6L	JL475Q1	K20PR-U	<b>IK20</b>	<b>IK20TT</b>	<b>PK20TT</b>	<b>K20TT</b>	
		1.8L	4G93D	K20R-U	<b>IK20</b>	<b>IK20TT</b>	<b>PK20TT</b>	<b>K20TT</b>	
		2.0L	JL486Q	K16R-U	<b>IK16</b>	<b>IK16TT</b>	<b>PK16TT</b>	<b>K16TT</b>	
		1.6L	JL475Q1	K20PR-U	<b>IK20</b>	<b>IK20TT</b>	<b>PK20TT</b>	<b>K20TT</b>	
INDONESIA	庆铃	1.5L	JL475Q8	K20PR-U	<b>IK20</b>	<b>IK20TT</b>	<b>PK20TT</b>	<b>K20TT</b>	
		2.0L	4G63S4M	K20PR-U	<b>IK20</b>	<b>IK20TT</b>	<b>PK20TT</b>	<b>K20TT</b>	
		2.4L	4G64S4M	K20HR-U11	<b>IKH20</b>	<b>IKH20TT</b>	<b>PKH20TT</b>	<b>KH20TT</b>	
KOREA	国产克莱斯勒	2.4L	4G69	K20HR-U11	<b>IKH20</b>	<b>IKH20TT</b>	<b>PKH20TT</b>	<b>KH20TT</b>	
		3.2L	6VD1	K20PR-U	<b>IK20</b>	<b>IK20TT</b>	<b>PK20TT</b>	<b>K20TT</b>	
		2.5L	4ZE1-MPI	K20PR-U	<b>IK20</b>	<b>IK20TT</b>	<b>PK20TT</b>	<b>K20TT</b>	
MALAYSIA	切诺基	2.6L		K20PR-U	<b>IK20</b>	<b>IK20TT</b>	<b>PK20TT</b>	<b>K20TT</b>	
		2.7L 6V	EER	-	<b>ITL20</b>	-	-	-	
		3.5L 6V	EGG	-	<b>IK16</b>	<b>IK16TT</b>	<b>PK16TT</b>	<b>K16TT</b>	
		5.7L 8V	EZB	-	<b>ITL20</b>	-	-	-	
PHILIPPINES	进口克莱斯勒	2.0L	ECN	K20HR-U11	<b>IKH20</b>	<b>IKH20TT</b>	<b>PKH20TT</b>	<b>KH20TT</b>	
		2.4L	ED3	K20HR-U11	<b>IKH20</b>	<b>IKH20TT</b>	<b>PKH20TT</b>	<b>KH20TT</b>	
		2.7L	EER	K20HR-U11	<b>IKH20</b>	<b>IKH20TT</b>	<b>PKH20TT</b>	<b>KH20TT</b>	
		3.3L	EGA	-	<b>ITL20</b>	-	-	-	
SAUDIARABIA	道奇	2.4L L4	4G64	KJ16CR-L11	<b>IK16L</b>	<b>IK16TT</b>	<b>PK16TT</b>	<b>K16TT</b>	
		2.5L L4	C498QA1	KJ16CR-L11	<b>IK16L</b>	<b>IK16TT</b>	<b>PK16TT</b>	<b>K16TT</b>	
		4.0L V6	C698QA1	KJ16CR-L11	<b>IK16L</b>	<b>IK16TT</b>	<b>PK16TT</b>	<b>K16TT</b>	
		4.7L V8	C8V93Q	KJ16CR-L11	<b>IK16L</b>	<b>IK16TT</b>	<b>PK16TT</b>	<b>K16TT</b>	
SINGAPORE	JEEP 吉普	2.4L 16V	EDZ	-	<b>ITL20</b>	-	-	-	
		2.4 GT Turbo	EDV/EDT	-	<b>ITL20</b>	-	-	-	
		2.7L V6	EER	-	<b>ITL20</b>	-	-	-	
		2.4L		KJ16CR-L11	<b>IK16L</b>	<b>IK16TT</b>	<b>PK16TT</b>	<b>K16TT</b>	
TAIWAN	新款指南者 Compass	3.6L		-	<b>IKH22</b>	-	-	-	
		2.0L 16V CVT	ECN	-	<b>IK20L</b>	<b>IK20TT</b>	-	<b>K20TT</b>	
		4.7L V8	EV	KJ16CR-L11	<b>IK16L</b>	<b>IK16TT</b>	<b>PK16TT</b>	<b>K16TT</b>	
		5.7L V8	EZ	-	<b>ITL20</b>	-	-	-	
THAILAND	牧马人3代	2.0L	A	KJ20CR-L11	<b>IK20L</b>	<b>IK20TT</b>	-	<b>K20TT</b>	
		2.4L	B	KJ20CR-L11	<b>IK20L</b>	<b>IK20TT</b>	-	<b>K20TT</b>	
		2.0L	A	KJ20CR-L11	<b>IK20L</b>	<b>IK20TT</b>	-	<b>K20TT</b>	
		2.4L	B	KJ20CR-L11	<b>IK20L</b>	<b>IK20TT</b>	-	<b>K20TT</b>	
VIETNAM	大切诺基 2代	2.0L	16V	KJ20CR-L11	<b>IK20L</b>	<b>IK20TT</b>	-	<b>K20TT</b>	
		2.4L	16V	KJ20CR-L11	<b>IK20L</b>	<b>IK20TT</b>	-	<b>K20TT</b>	
		3.6L	V6	-	<b>IXUH22</b>	-	-	<b>XUH22TT</b>	
		1999-2005	3.8L	V6	-	<b>ITL20</b>	-	-	-
JAPAN	东南汽车	1999-2005	4.0L	WJ WG	KJ16CR-L11	<b>IK16L</b>	<b>IK16TT</b>	<b>PK16TT</b>	<b>K16TT</b>
		1999-2005	4.7L V8	WJ WG	-	<b>IK20</b>	<b>IK20TT</b>	<b>PK20TT</b>	<b>K20TT</b>
		1999-2005	4.7L V8 H.O.	WJ WG	-	<b>IK20</b>	<b>IK20TT</b>	<b>PK20TT</b>	<b>K20TT</b>
		2005-2010	4.7L V8 H.O.	EVA-231	-	<b>ITL20</b>	-	-	-
EUROPE & USA	得利卡	2005-2010	5.7L V8 HEMI	EZD,EZH	-	<b>ITL20</b>	-	-	
		2005-2010	6.1L V8 HEMI-SRT8	ESF	-	<b>ITL20</b>	-	-	
		2010-	5.7L V8	HEMI	K20HR-U11	<b>IKH20</b>	<b>IKH20TT</b>	<b>PKH20TT</b>	<b>KH20TT</b>
		2010-	6.4L V8	SRT	-	<b>ITL20</b>	-	-	
CROSS REFERENCE NUMBER	菱绅	2.0L\2.4L	4G63S4M	K16PR-U11	<b>IK16</b>	<b>IK16TT</b>	<b>PK16TT</b>	<b>K16TT</b>	
		2.0L	东风EQ491	MA20PR-U	-	-	-	-	
		2.0L\2.4L	4G63S4M	K16R-U11	<b>IK16</b>	<b>IK16TT</b>	<b>PK16TT</b>	<b>K16TT</b>	
		2.0L	东风EQ491	MA20PR-U	-	-	-	-	
PART NUMBER	东南三菱	1.3L	L4	K16PR-U11	<b>IK16</b>	<b>IK16TT</b>	<b>PK16TT</b>	<b>K16TT</b>	
		1.6L	L4	K16PR-U11	<b>IK16</b>	<b>IK16TT</b>	<b>PK16TT</b>	<b>K16TT</b>	
		1.6L	DA4G18	K16PR-U11	<b>IK16</b>	<b>IK16TT</b>	<b>PK16TT</b>	<b>K16TT</b>	
		1.6L	4G64	K16PR-U11	<b>IK16</b>	<b>IK16TT</b>	<b>PK16TT</b>	<b>K16TT</b>	
PART NUMBER	蓝瑟/LANCER	1.5L	4G15M	K20R-U	<b>IK20</b>	<b>IK20TT</b>	<b>PK20TT</b>	<b>K20TT</b>	
		1.5L	4A91	K16HPR-U11	<b>IKH16</b>	<b>IKH16TT</b>	<b>PKH16TT</b>	<b>KH16TT</b>	
		2.4L	4G64S4M	K16PR-U11	<b>IK16</b>	<b>IK16TT</b>	<b>PK16TT</b>	<b>K16TT</b>	
		2.4L	4G69	K16PR-U11	<b>IK16</b>	<b>IK16TT</b>	<b>PK16TT</b>	<b>K16TT</b>	



车种	YEAR	车型	发动机型式	DENSO	IRIDIUM			
<b>东南三菱</b>								
翼神	1.6L	4A92	K20HR-U11	<b>IKH20</b>	<b>IKH20TT</b>	<b>PKH20TT</b>	<b>KH20TT</b>	
	1.8L	4B10	K20R-U	<b>IK20</b>	<b>IK20TT</b>	<b>PK20TT</b>	<b>K20TT</b>	
	2.0L	4B11	K20R-U	<b>IK20</b>	<b>IK20TT</b>	<b>PK20TT</b>	<b>K20TT</b>	
	2.0T		-	<b>IKH24</b>	-	-	-	
戈蓝	2.0L	4G63S4N	K20PR-U11	<b>IK20</b>	<b>IK20TT</b>	<b>PK20TT</b>	<b>K20TT</b>	
	2.4L	4G69S4N	K20HR-U11	<b>IKH20</b>	<b>IKH20TT</b>	<b>PKH20TT</b>	<b>KH20TT</b>	
君阁	2.0L	4G63S4N	K20HR-U11	<b>IKH20</b>	<b>IKH20TT</b>	<b>PKH20TT</b>	<b>KH20TT</b>	
东南劲炫	2.0L	4B11	K20R-U	<b>IK20</b>	<b>IK20TT</b>	<b>PK20TT</b>	<b>K20TT</b>	
<b>广汽三菱</b>								
劲炫ASX	1.6L	4A92	K20HR-U11	<b>IKH20</b>	<b>IKH20TT</b>	<b>PKH20TT</b>	<b>KH20TT</b>	
	2.0L	4B11	K20R-U	<b>IK20</b>	<b>IK20TT</b>	<b>PK20TT</b>	<b>K20TT</b>	
帕杰罗V73/V77	3.0L	6G72 133kw	K20PR-U11	<b>IK20</b>	<b>IK20TT</b>	<b>PK20TT</b>	<b>K20TT</b>	
	3.8L	6G75	K20R-U	<b>IK20</b>	<b>IK20TT</b>	<b>PK20TT</b>	<b>K20TT</b>	
帕杰罗劲畅	2.4L	4G64S4M	K16PR-U11	<b>IK16</b>	<b>IK16TT</b>	<b>PK16TT</b>	<b>K16TT</b>	
	3.0L	6B31	-	<b>IXUH22</b>	-	-	<b>XUH22TT</b>	
<b>长丰三菱猎豹</b>								
猎豹	3.0L V6	6G72	W16ERP11	<b>IW16</b>	<b>IW16TT</b>	<b>PW16TT</b>	-	
	2.4L	4G64S4M	K16PR-U11	<b>IK16</b>	<b>IK16TT</b>	<b>PK16TT</b>	<b>K16TT</b>	
	2.0L	4G94	K20PR-U11	<b>IK20</b>	<b>IK20TT</b>	<b>PK20TT</b>	<b>K20TT</b>	
飞腾	1.5L	4G15	-	<b>IXUH22</b>	-	-	<b>XUH22TT</b>	
	2.0L	4G94	K20PR-U11	<b>IK20</b>	<b>IK20TT</b>	<b>PK20TT</b>	<b>K20TT</b>	
<b>北汽三菱</b>								
速跑	2.4L	4G64S4M	K16PR-U11	<b>IK16</b>	<b>IK16TT</b>	<b>PK16TT</b>	<b>K16TT</b>	
	3.0L	6G72	K16PR-U11	<b>IK16</b>	<b>IK16TT</b>	<b>PK16TT</b>	<b>K16TT</b>	
欧蓝德	2.4L	4G64	K16R-U11	<b>IK16</b>	<b>IK16TT</b>	<b>PK16TT</b>	<b>K16TT</b>	
	2.4L	4G69	K20HR-U11	<b>IKH20</b>	<b>IKH20TT</b>	<b>PKH20TT</b>	<b>KH20TT</b>	
	3.0L	6B31(MIVEC)	-	<b>IXUH22</b>	-	-	<b>XUH22TT</b>	
<b>三菱/MISTUBISHI</b>								
帕杰罗Pajero	3.0L	6G72	K16PR-U11	<b>IK16</b>	<b>IK16TT</b>	<b>PK16TT</b>	<b>K16TT</b>	
	2.4L	4G64	K16PR-U11	<b>IK16</b>	<b>IK16TT</b>	<b>PK16TT</b>	<b>K16TT</b>	
	3.0L	6G74	K16PR-U11	<b>IK16</b>	<b>IK16TT</b>	<b>PK16TT</b>	<b>K16TT</b>	
	3.0L	6G73	K16PR-U11	<b>IK16</b>	<b>IK16TT</b>	<b>PK16TT</b>	<b>K16TT</b>	
	3.8L	6G75	-	<b>IK20</b>	<b>IK20TT</b>	<b>PK20TT</b>	<b>K20TT</b>	
欧蓝德EXOutlander	2.0L	4B11	K20R-U	<b>IK20</b>	<b>IK20TT</b>	<b>PK20TT</b>	<b>K20TT</b>	
	3.0L	1113L	-	<b>IXUH22</b>	-	-	<b>XUH22TT</b>	
	3.0L	6B31	-	<b>IXUH22</b>	-	-	<b>XUH22TT</b>	
格蓝迪Grandis	2.4L	4G64	K16R-U	<b>IK16</b>	<b>IK16TT</b>	<b>PK16TT</b>	<b>K16TT</b>	
	2.4L	4G69	K20HR-U11	<b>IKH20</b>	<b>IKH20TT</b>	<b>PKH20TT</b>	<b>KH20TT</b>	
<b>东风日产</b>								
蓝鸟	U13	SR20DE	W16EXR-U	<b>IW16</b>	<b>IW16TT</b>	<b>PW16TT</b>	-	
	2.0L	SR20DE	W16EXR-U	<b>IW16</b>	<b>IW16TT</b>	<b>PW16TT</b>	-	
	2.0L	Z18S/Z18E	W16EXR-U	<b>IW16</b>	<b>IW16TT</b>	<b>PW16TT</b>	-	
阳光	2.0L	SR20DE	K16PR-U	<b>IK16</b>	<b>IK16TT</b>	<b>PK16TT</b>	<b>K16TT</b>	
骐达/颐达	1.5L	HR15DE	<b>FXE20HR11</b>	-	<b>IXEH20TT</b>	-	-	
	1.6L	HR16DE	<b>FXE20HR11</b>	-	<b>IXEH20TT</b>	-	-	
骊威	1.6T	MR16DDT	-	-	<b>IXEH22TT</b>	-	-	
	1.6L	HR16DE	<b>XE20HR-U9</b>	-	<b>IXEH20ETT</b>	-	-	
轩逸	1.8L	MR18DE	<b>XE20HR-U9</b>	-	<b>IXEH20ETT</b>	-	-	
	2.0L	MR20	<b>FXE20HR11</b>	-	<b>IXEH20TT</b>	-	-	
骏逸	1.6L	HR16	<b>FXE20HR11</b>	-	<b>IXEH20TT</b>	-	-	
	1.8L	MR18	<b>XE20HR-U9</b>	-	<b>IXEH20ETT</b>	-	-	
一代天籁 J31	2.3L	VQ23DE	K16HPR-U11	<b>IKH16</b>	<b>IKH16TT</b>	<b>PKH16TT</b>	<b>KH16TT</b>	
	3.5L	VQ35DE	K16HPR-U11	<b>IKH16</b>	<b>IKH16TT</b>	<b>PKH16TT</b>	<b>KH16TT</b>	
	2.0L	QR20	K16HPR-U11	<b>IKH16</b>	<b>IKH16TT</b>	<b>PKH16TT</b>	<b>KH16TT</b>	
二代天籁 J32	2.0L	MR20DE	-	-	<b>IXEH22TT</b>	-	-	
	2.5L	VQ25DE	-	-	<b>IXEH22TT</b>	-	-	
	3.5L	VQ35DE	-	-	<b>IXEH22TT</b>	-	-	
新世代天籁L33	2.0L	MR20DE	<b>FXE20HR11</b>	<b>VFXEH20</b>	<b>IXEH20TT</b>	-	-	
	2.5L	QR25DE	<b>FXE20HR11</b>	<b>VFXEH20</b>	<b>IXEH20TT</b>	-	-	
七代天籁	2.0L	MR20	<b>DXE22H11C</b>	-	-	-	-	
	2.0T	MR20	<b>DXE22H11C</b>	-	-	-	-	
老逍客	1.6L	HR16DE	<b>FXE20HR11</b>	<b>VFXEH20</b>	<b>IXEH20TT</b>	-	-	
	2.0L	MR20DE	<b>FXE20HR11</b>	<b>VFXEH20</b>	<b>IXEH20TT</b>	-	-	
新逍客	2.0L	MR20DD	<b>DXE22H11C</b>	-	<b>IXEH22TT</b>	-	-	
	2.0L	MR20DE	<b>FXE22HR11</b>	<b>VFXEH22</b>	<b>IXEH22TT</b>	-	-	
老奇骏	2.5L	QR25DE	<b>FXE22HR11</b>	<b>VFXEH22</b>	<b>IXEH22TT</b>	-	-	
	2.0L	MR20	<b>XE20HR-U9</b>	-	<b>IXEH20ETT</b>	-	-	



AUSTRALIA  
CHINA  
INDIA  
INDONESIA  
KOREA  
MALAYSIA  
PHILIPPINES  
SAUDIARABIA  
SINGAPORE  
TAIWAN  
THAILAND  
VIETNAM  
JAPAN  
EUROPE  
& USA  
CROSS  
REFERENCE  
NUMBER  
PART

DENSO	9	14	16	20	22	24	27	29	31	32	34	35	DENSO	9	14	16	20	22	24	27	29	31	32	DENSO	9	14	16	20	22	24	27	31
NGK	2	4	5	6	7	8	9	9.5	10	10.5	11	11.5	CHAMPION	18	16,14	12,11	10,9	8,7	6,63,61	4,59	57	55	53	BOSCH	10	9	8	7,6	5	4	3	2



	车种	YEAR	车型	发动机型式	DENSO	IRIDIUM			
AUSTRALIA	东风日产								
	老奇骏		2.5L	QR25	XE20HR-U9	-	IXEH20ETT	-	-
	新奇骏		2.0L	MR20dd	DXE22H11C	-	IXEH22TT	-	-
CHINA	玛驰		1.5L	HR15DE	FXE20HR11	VFXEH20	IXEH20TT	-	-
	郑州日产								
	帕拉丁		2.4L	KA24	K16PR-U	IK16	IK16TT	PK16TT	K16TT
INDIA	皮卡		2.4L	KA24	W16EXR-U	IW16	IW16TT	PW16TT	-
	御轩		2.5L/2.0L	QR25N/10LH3X	K16HPR-U11	IKH16	IKH16TT	PKH16TT	KH16TT
	NV200		1.6L	HR16	XE20HR-U9	-	IXEH20ETT	-	-
	进口日产								
INDONESIA	西玛		4.5L	VK45DE	K16HPR-U11	IKH16	IKH16TT	PKH16TT	KH16TT
	风雅		3.5L	VQ35DE	K16HPR-U11	IKH16	IKH16TT	PKH16TT	KH16TT
	途乐			TB42E	W16EPR-U	IW16	IW16TT	PW16TT	-
	水星			VG30E	W16EXR-U	IW16	IW16TT	PW16TT	-
KOREA	楼兰MURANO		3.5L	VQ35DE	-	-	IXEH22TT	-	-
			2.5L	QR25	XE20HR-U9	-	IXEH20ETT	-	-
			2.5T	QR25	-	-	IXEH22TT	-	-
	雷诺/Renault								
MALAYSIA	风朗		2.0L	M4R714	XE20HR-U9	-	IXEH20ETT	-	-
	纬度LATITUDE		2.0L	M4R746	XE20HR-U9	-	IXEH20ETT	-	-
			2.5L		XE20HR-U9	-	IXEH20ETT	-	-
PHILIPPINES	梅甘娜3代MEGANE		2.0L	F4R	K20PR-U	IK20	IK20TT	PK20TT	K20TT
			2.0T	F4R870	K20R-U	IK20	IK20TT	PK20TT	K20TT
	拉古娜LAGUNA		2.0L	F4R	K20PR-U	IK20	IK20TT	PK20TT	K20TT
SAUDIARABIA			2.0T	F4RJ813	K20R-U	IK20	IK20TT	PK20TT	K20TT
	风景		2.0L	F4R	K20PR-U	IK20	IK20TT	PK20TT	K20TT
	科雷傲KOLEOS		2.5L	2TRA7	FXE20HR11	VFXEH20	IXEH20TT	-	-
			2.0L		XE20HR-U9	-	IXEH20ETT	-	-
SINGAPORE	塔利斯曼Talisman		2.5L	VQ25DE	XE20HR-U9	-	IXEH20ETT	-	-
			3.5L	VQ35DE	XE20HR-U9	-	IXEH20ETT	-	-
	纳智捷(东风裕隆)								
TAIWAN	纳5		1.8T	G18TG	FXE24HR11	-	-	-	-
			2.0T	G20TE	K20PR-U11	IK20	IK20TT	PK20TT	K20TT
			2.0T	G20TG	FXE24HR11	-	-	-	-
	优6		1.8T	G18TE	K20PR-U11	IK20	IK20TT	PK20TT	K20TT
			1.8T	GPK 138kw	FXE24HR11	-	-	-	-
			2.0T	G20TE	K20PR-U11	IK20	IK20TT	PK20TT	K20TT
THAILAND	大7 SUV		2.0T	G20TE 120kw	K20PR-U11	IK20	IK20TT	PK20TT	K20TT
			2.2T	G22TG 131kw	K20PR-U11	IK20	IK20TT	PK20TT	K20TT
			2.2T	G22TG 138kw	K20PR-U11	IK20	IK20TT	PK20TT	K20TT
			2.2T	G22TG 148kw	K20PR-U11	IK20	IK20TT	PK20TT	K20TT
VIETNAM	大7 MPV		2.0T	G20TE 125kw	K20PR-U11	IK20	IK20TT	PK20TT	K20TT
			MPV 2.0T L4	GPK 138kw	FXE24HR11	-	-	-	-
			MPV 2.2T L4	G22TG 148kw	K20PR-U11	IK20	IK20TT	PK20TT	K20TT
JAPAN	CEO		MASTER CEO 2.2T	G22TG 131kw	K20PR-U11	IK20	IK20TT	PK20TT	K20TT
	广汽传祺								
	传祺GA3		1.6L	4B16K1	K20R-U	IK20	IK20TT	PK20TT	K20TT
	传祺GA3S		1.6L	4B16K1	K20R-U	IK20	IK20TT	PK20TT	K20TT
EUROPE & USA	传祺GA5		2.0L	4B20K2	K20R-U	IK20	IK20TT	PK20TT	K20TT
			1.8L	4B18K1	K20R-U	IK20	IK20TT	PK20TT	K20TT
			1.8T	4B18M1	SXU22HCR11	IXUH22	-	-	XUH22TT
			1.6T	4B16M1	SXU22HCR11	IXUH22	-	-	XUH22TT
	传祺GA6		1.6T	4B16M1	SXU22HCR11	IXUH22	-	-	XUH22TT
CROSS REFERENCE NUMBER	传祺GS5		1.8T	4B18M1	SXU22HCR11	IXUH22	-	-	XUH22TT
			2.0L	4B20K2	K20R-U	IK20	IK20TT	PK20TT	K20TT
			1.8T	4B18M1	SXU22HCR11	IXUH22	-	-	XUH22TT
PART NUMBER	双环汽车								
	来宝SRV		2.0L	EQ491i	W16EXR-U	IW16	IW16TT	PW16TT	-
			2.0L	4G63	-	IK16	IK16TT	PK16TT	K16TT
			2.2L	JM491Q-ME	W16EXR-U	IW16	IW16TT	PW16TT	-
			2.4L	4G64	-	IK16	IK16TT	PK16TT	K16TT
	SCEO		2.4L	4G64	-	IK16	IK16TT	PK16TT	K16TT
	小贵族		1.0L	DA468QA	XU22EPR-U	IXU22	-	-	XU22TT
			1.1L	DA468QA	XU22EPR-U	IXU22	-	-	XU22TT



车种	YEAR	车型	发动机型式	DENSO	IRIDIUM			
<b>永源汽车</b>								
飞碟UFO	1.6L	4G18S	K16PR-U11	IK16	IK16TT	PK16TT	K16TT	
	2.0L	4G63S4M	K16PR-U11	IK16	IK16TT	PK16TT	K16TT	
	2.4L	4G64S4M	K16PR-U11	IK16	IK16TT	PK16TT	K16TT	
<b>众泰汽车</b>								
Z200	1.5L	4A91S	K20HR-U11	IKH20	IKH20TT	PKH20TT	KH20TT	
	1.3L	4A90M	K16PR-U11	IK16	IK16TT	PK16TT	K16TT	
M300	1.6L	4G18	K20PR-U11	IK20	IK20TT	PK20TT	K20TT	
5008	1.3L	4G13S1	K20PR-U11	IK20	IK20TT	PK20TT	K20TT	
	1.5L	4G15	K20PR-U11	IK20	IK20TT	PK20TT	K20TT	
2008	1.3L	4G13	K16PR-U11	IK16	IK16TT	PK16TT	K16TT	
	1.5L	4G15S	K16PR-U11	IK16	IK16TT	PK16TT	K16TT	
	1.6L	4G18	K16PR-U11	IK16	IK16TT	PK16TT	K16TT	
朗悦	1.6L	4G18	K20PR-U11	IK20	IK20TT	PK20TT	K20TT	
朗俊	1.3L	4G13S1	K20PR-U11	IK20	IK20TT	PK20TT	K20TT	
朗朗	1.3L	4A90M	K16PR-U11	IK16	IK16TT	PK16TT	K16TT	
	1.5L	4A91S	K20HR-U11	IKH20	IKH20TT	PKH20TT	KH20TT	
<b>福田汽车</b>								
迷迪	1.3L	4G13S	K16PR-U11	IK16	IK16TT	PK16TT	K16TT	
	1.6L	4G18S	K16PR-U11	IK16	IK16TT	PK16TT	K16TT	
<b>雷克萨斯/LEXUS</b>								
CT	1.8T	2ZR-FXE	-	-	IXEH20ETT	-	-	
	F-Sport	2ZR-FXE	-	-	IXEH20ETT	-	-	
ES300	1996-2008	ES300	-	IQ20	IQ20TT	PQ20TT	Q20TT	
	2009-	2.4L	2AZ-FE	-	IK20	IK20TT	PK20TT	K20TT
	2009-	3.5L	2GR-FE	-	IKH20	IKH20TT	-	KH20TT
GS 2代	GS300 T3	2JZ-GE	-	IK20	IK20TT	PK20TT	K20TT	
	GS300	2JZ-GE	SK20R11	IK20	IK20TT	PK20TT	K20TT	
	GS430 V8	3UZ-FE	SK20R11	IK20	IK20TT	PK20TT	K20TT	
GS 3代	GS300	3GR-FSE	-	IKH20	IKH20TT	-	KH20TT	
	GS430 4.3L V8	3UZ-FE	-	IKH20	IKH20TT	-	KH20TT	
	GS450h 3.5L V6	2GR-FSE	-	IKH20	IKH20TT	-	KH20TT	
	GS460	1UR-FSE	-	IKH20	IKH20TT	-	KH20TT	
GS 4代	GS250 2.5L V6	4GR-FSE	-	IKH20	IKH20TT	-	KH20TT	
	GS300h 2.5L V6	2AR-FSE	-	IKH20	IKH20TT	-	KH20TT	
	GS350	2GR-FSE	FK20HBR11	IKH20	IKBH20TT	-	KH20TT	
	GS450h 3.5L V6	2GR-FXE	FK20HBR11	IKH20	IKBH20TT	-	KH20TT	
GX	GX 460	1UR-FE	-	IKH20	IKH20TT	-	KH20TT	
IS 1代	2001-2005	IS200 2.0L	1G-FE	-	IK20	IK20TT	PK20TT	K20TT
	2001-2005	IS200 Compressor	1GE-FEC	-	IK20	IK20TT	PK20TT	K20TT
	2001-2005	IS300	2JZ-GE	-	IK20	IK20TT	PK20TT	K20TT
IS 2代	IS250 2.5L V6	4GR-FSE	FK20HBR11	IKH20	IKBH20TT	-	KH20TT	
IS 3代	2013-	IS250 2.5L V6	4GR-FSE	FK20HBR11	IKH20	IKBH20TT	-	KH20TT
	2013-	IS300h 2.5L V6	2AR-FSE	-	IKH20	IKH20TT	-	KH20TT
LS 3代	2003-	LS430 4.3L	3UZ-FE	-	IK20	IK20TT	-	K20TT
LS 4代	2006-	LS460 4.6L V8	1UR-FSE	-	IKH20	IKH20TT	-	KH20TT
	2006-	LS460 AWD 4.6L V8	1UR-FSE	-	IKH20	IKH20TT	-	KH20TT
	2006-	LS600h 5.0L V8	2UR-FSE	-	IKH20	IKH20TT	-	KH20TT
LX470	LX470 4.7L V8	2UZ-FE	-	IK20	IK20TT	-	K20TT	
LX570	LX570 5.7L V8	3UZ-FE	-	IKH20	IKH20TT	-	KH20TT	
RX 2代	2003-2008	RX300 3.0 V6	1MZ-FE	-	IK20	IK20TT	-	K20TT
	2003-2008	RX350 3.5 V6	2GR-FE	-	IKH20	IKH20TT	-	KH20TT
	2003-2008	RX400h 3.3L V6	3MZ-FE	-	IK20	IK20TT	PK20TT	K20TT
RX 3代	2009-	RX270 2.7L	1AR-FE	-	IKH20	IKH20TT	-	KH20TT
	2009-	RX350 3.5 V6	2GR-FXE	-	IKH20	IKH20TT	-	KH20TT
	2009-	RX350h	2GR-FXE	-	IKH20	IKH20TT	-	KH20TT
	2009-	RX450h (Hybrid)	2GR-FXE	-	IKH20	IKH20TT	-	KH20TT
SC430	2009-	SC430 4.3L V8	3UZ-FE	-	IK20	IK20TT	-	K20TT
<b>英菲尼迪/INFINITI</b>								
G	G35 3.5L V6	VQ35DE/VQ35HR	FK16HR11	IKH16	IKH16TT	PKH16TT	KH16TT	
	G35 3.5L V6 双进气	VQ35DE/VQ35HR	FXE22HR11	-	IXEH22TT	-	-	
	G25 2.5L V6 双进气	VQ25HR	FXE22HR11	-	IXEH22TT	-	-	
	G37 3.7L V6 双进气	VQ37HR	FXE24HR11	-	-	-	-	
	M	M25 2.5L V6	VQ25HR	-	-	IXEH22TT	-	-
M25L 2.5L V6	VQ25HR	-	-	IXEH22TT	-	-		
M35 3.5L V6 双进气	VQ35DE	-	IKH16	IKH16TT	PKH16TT	KH16TT		
M35 3.7L V6 双进气	VQ35DE	FXE24HR11	-	-	-	-		
M35L 3.7L V6 双进气	VQ35DE	FXE24HR11	-	-	-	-		

AUSTRALIA  
CHINA  
INDIA  
INDONESIA  
KOREA  
MALAYSIA  
PHILIPPINES  
SAUDIARABIA  
SINGAPORE  
TAIWAN  
THAILAND  
VIETNAM  
JAPAN  
EUROPE  
& USA  
CROSS  
REFERENCE  
NUMBER  
PART

DENSO	9	14	16	20	22	24	27	29	31	32	34	35	DENSO	9	14	16	20	22	24	27	29	31	32	DENSO	9	14	16	20	22	24	27	31
NGK	2	4	5	6	7	8	9	9.5	10	10.5	11	11.5	CHAMPION	18	16,14	12,11	10,9	8,7	6,63,61	4,59	57	55	53	BOSCH	10	9	8	7,6	5	4	3	2



车种	YEAR	车型	发动机型式	DENSO	IRIDIUM			
<b>AUSTRALIA</b>								
英菲尼迪/INFINITI								
M		M37 3.7L V6 双进气	VQ37HR	FXE24HR11	-	-	-	-
EX		EX25 2.5L V6 双进气	VQ25HR	-	-	IXEH22TT	-	-
<b>CHINA</b>								
FX		EX35 3.5L V6 双进气	VQ35HR	FXE24HR11	-	-	-	-
		FX37 3.7L 双进气	VQ37VHR	FXE24HR11	-	-	-	-
		FX35 3.5L 双进气	VQ35DE	-	IKH16	IKH16TT	PKH16TT	KH16TT
		FX37 3.7L 双进气	VQ37HR	FXE24HR11	-	-	-	-
		FX45 4.5L 双进气	VK45DE	-	IKH16	IKH16TT	PKH16TT	KH16TT
		FX50 5.0L 双进气	VK50VE	FXE24HR11	-	-	-	-
JX		JX35 3.5L V6	VQ35 204kw	FXE24HR11	-	-	-	-
进口QX50(原FX)		QX50 2.5L V6	VQ25HR	FXE22HR11	-	IXEH22TT	-	-
		QX50 3.7L V6	VQ37VHR	FXE24HR11	-	-	-	-
进口Q50		Q50 3.5L V6	VQ35HR 235kw	FXE24HR11	-	-	-	-
		Q50 3.7L V6	VQ37HR	FXE24HR11	-	-	-	-
Q60 敞篷		Q60 3.7L V6	VQ37VHR 258kw	FXE24HR11	-	-	-	-
Q60S 硬顶		Q60S 3.7L V6	VQ37VHR 258kw	FXE24HR11	-	-	-	-
进口Q70L		Q70L 2.5L V6	VQ25HR	FXE22HR11	-	IXEH22TT	-	-
		Q70L 3.5L V6	VQ35HR	FXE24HR11	-	-	-	-
QX50		QX50 2.5L V6	VQ25HR 173kw	FXE22HR11	-	IXEH22TT	-	-
		QX50 3.7L V6	VQ37VHR 258kw	FXE24HR11	-	-	-	-
QX60/JX35		QX60 3.5L V6	VQ35	FXE24HR11	-	-	-	-
QX70		QX70 3.5L V6	VQ35	FXE24HR11	-	-	-	-
		QX70 3.7L V6	VQ37	FXE24HR11	-	-	-	-
		QX70 5.0L V8	VK50	FXE22HR11	-	IXEH22TT	-	-
QX56		QX56 5.6L V8	VK56 324kw	FXE22HR11	-	IXEH22TT	-	-
QX80		QX80 5.6L V8	VK56 324kw	FXE22HR11	-	IXEH22TT	-	-
		QX80 5.6L V8	VK56 293kw	FXE22HR11	-	IXEH22TT	-	-
东风英菲尼迪/INFINITI								
国产QX50		QX50 2.5L V6	VQ25HR 173kw	FXE22HR11	-	IXEH22TT	-	-
日产/NISSAN								
风度Cefiro		A31/32	VQ30DE	PK16PR(-L)11	IK16	IK16TT	PK16TT	K16TT
		A32	VQ20DE	VFK16	IK16	IK16TT	PK16TT	K16TT
		A33	VQ30DE	VFK16	IK16	IK16TT	PK16TT	K16TT
公爵王Cedric		S30	VG30S	VFK20F	IK20	IK20TT	PK20TT	K20TT
		SY31	VG20S/VG30S	VFK20F	IK20	IK20TT	PK20TT	K20TT
		WY3C	VG30S	VFK20F	IK20	IK20TT	PK20TT	K20TT
西玛Cima		VK45DE 4.5L	VK45DE	VFKH16	IKH16	IKH16TT	PKH16TT	KH16TT
斯巴鲁/SUBARU								
森林人SF 97-02		SF 2.0	EJ20	VK20Y	IK20	-	PK20TT	-
		SF 2.0 S-Turbo	EJ20G	VK20Y	IK20	-	PK20TT	-
森林人SG 02-07		SG 2.0L	EJ20	PK16PR(-L)11	IK16	IK16TT	PK16TT	K16TT
		SG 2.5T	EJ25	-	IKH20	IKH20TT	PKH20TT	KH20TT
		SG 2.5T	EJ25	VKH22	IKH22	-	-	-
森林人SH 08-10		SH 2.0L	EJ20	-	IK20	IK20TT	PK20TT	K20TT
		SH 2.5L	EJ25	VKH20	IKH20	IKH20TT	PKH20TT	KH20TT
		SH 2.5T	EJ25	VKH20Y	IKH20	IKH20TT	-	KH20TT
森林人SI 11-		SI 2.0L	FB20	-	-	IXEH22TT	-	-
		SI 2.5L	FB25	-	-	IXEH22TT	-	-
森林人SJ 13-		SJ 2.0L	FB20	-	-	IXEH22TT	-	-
		SJ 2.5L	FB25	-	-	IXEH22TT	-	-
翼豹2代  -07		2.0 WRX	EJ20T	-	IK22	-	PK22TT	-
翼豹3代		2.0L	EJ20	-	IKH20	IKH20TT	PKH20TT	KH20TT
翼豹3代 08-		2.5T	H4	-	IKH20	IKH20TT	-	KH20TT
翼豹4代 13-		2.0R	FB20	-	-	IXEH22TT	-	-
力狮III 98-04		2.0i	EJ20-E	-	IK22	-	PK22TT	-
		2.5i	EJ25D	-	IK22	-	PK22TT	-
力狮III Legacy 03-09		2.0i 16V	EJ20	-	IK22	-	PK22TT	-
		2.5i 16V	EJ25	-	IK22	-	PK22TT	-
		3.0i 24V	EZ30	-	IKH20	IKH20TT	PKH20TT	KH20TT
力狮 IV	2009-	2.0i	EJ20	-	IKH20	IKH20TT	PKH20TT	KH20TT
	2009-	2.5i	EJ25	-	IKH20	IKH20TT	PKH20TT	KH20TT
	2009-	2.5GT	EJ255	-	IKH20	IKH20TT	-	KH20TT
力狮 V	2012-	2.0i	FA20	-	-	IXEH22TT	-	-
	2012-	2.5i	FB25	VFXEH22	-	IXEH22TT	-	-
傲虎II	2004-2009	2.5L	EJ25	PK16PR(-L)11	IK16	IK16TT	PK16TT	K16TT
	2004-2009	3.0L 36V	EZ30	-	IKH20	IKH20TT	PKH20TT	KH20TT
傲虎III	2009-2014	2.5i	EJ25	-	IKH20	IKH20TT	PKH20TT	KH20TT
驰鹏Tribeca		3.0L 24V	EZ30	-	IKH20	IKH20TT	PKH20TT	KH20TT



车种	YEAR	车型	发动机型式	DENSO	IRIDIUM	IRIDIUM	PLATINUM	TT	
斯巴鲁/SUBARU									
驰鹏Tribeca		3.6R V6	EZ36	-	IKH20	IKH20TT	PKH20TT	KH20TT	
驰鹏		2.5T	EJ25	VKH20Y	-	IKH20TT	PKH20TT	KH20TT	
XV	2012-	XV 2.0i	FB20	VFXEH22	-	IXEH22TT	-	-	
BRZ	2012-	2.0i 16V	FA20	VXEBH27	-	-	-	-	
宝马									
X5		4.8IS	N62 B48	-	IK20	IK20TT	PK20TT	K20TT	
		4.4i	N62 B44	K20TXR	IK20	IK20TT	PK20TT	K20TT	
		3.0i	M62 B30	K20TXR	IK20	IK20TT	PK20TT	K20TT	
X3		3.0L	M54 B30	K20TXR	IK20	IK20TT	PK20TT	K20TT	
		2.5L	M54 B25	K20TXR	IK20	IK20TT	PK20TT	K20TT	
7系		750LI	N62 B50	-	IK20	IK20TT	PK20TT	K20TT	
		740LI	N62 B40	-	IK20	IK20TT	PK20TT	K20TT	
740i		4.0L	448S	K20TXR	IK20	IK20TT	PK20TT	K20TT	
530i		3.0L	308S	K20TXR	IK20	IK20TT	PK20TT	K20TT	
528i		2.8L	286S	K20TXR	IK20	IK20TT	PK20TT	K20TT	
320i		2.0L	206S	K20TXR	IK20	IK20TT	PK20TT	K20TT	
华晨宝马									
宝马5系		2.0L	N52	K20TXR	IK20	IK20TT	PK20TT	K20TT	
		3.0L(L6)	N54	K20TXR	IK20	IK20TT	PK20TT	K20TT	
		2.5L(L6)	M54	K20TXR	IK20	IK20TT	PK20TT	K20TT	
		2.2L(L6)	M54	K20TXR	IK20	IK20TT	PK20TT	K20TT	
宝马3系		2.5L(L6)	N52	K20TXR	IK20	IK20TT	PK20TT	K20TT	
		2.5L(L6)	M54	K20TXR	IK20	IK20TT	PK20TT	K20TT	
		2.0L	N46	-	IK20	IK20TT	PK20TT	K20TT	
MINI									
Mini Onell .Clubman .Countryman	2007-	1.6	N16 B16A	-	IXUH22	-	-	XUH22TT	
Mini Cooper II , Cabrio,clubman, Countrman,Roadster	2006-	1.6	N12 B16A	-	IXUH22	-	-	XUH22TT	
	2006-	1.6	N16 B16A	-	IXUH22	-	-	XUH22TT	
	2006-	1.6 John Cooper	N14 B16	-	IXUH22	-	-	XUH22TT	
	2006-	1.6 S Turbo	N14 B16A	-	IXUH22	-	-	XUH22TT	
	2006-	1.6 S Turbo	N18 B16A	-	IXUH22	-	-	XUH22TT	
奔驰									
SLK230 GF-170447		2.3L	170	K16TNR-S9	IK16	IK16TT	PK16TT	K16TT	
S600 E-140076		6.0L	M120	W16EPR-U	IW16	IW16TT	PW16TT	-	
S600		6.0L	M275	-	VK20Y	IK20TT	-	-	
S500		5.0L	M273	-	IXUH22	-	-	XUH22TT	
S350		3.5L	M272	-	IXUH22	-	-	XUH22TT	
MB100 M161E2.3		2.3L	M161	W20EPR-U	IW20	IW20TT	PW20TT	-	
北京奔驰									
奔驰 C280 BENS		3.0L V6	M272	-	IXUH22	-	-	XUH22TT	
奔驰 C230 BENS		2.5L V6	M272	-	IXUH22	-	-	XUH22TT	
奔驰 C200K BENS		1.8T	M271	-	IKH20	IKH20TT	PKH20TT	-	
C180K		1.6T	-	-	IXUH22	-	-	XUH22TT	
E500		5.0L V8	M11	PK16PR(-L)11	IK16	IK16TT	PK16TT	-	
E350		3.5L V6	M272	-	IXUH22	-	-	XUH22TT	
E280		3.0L V6	M272 940	-	IXUH22	-	-	XUH22TT	
E230		2.5L V6	-	-	IXUH22	-	-	XUH22TT	
E200K		1.8L	-	K20HR-U11	IKH20	IKH20TT	PKH20TT	KH20TT	
GLK300		3.0L	-	IXUH22	-	-	-	-	
SMART									
SMART Fortwo	2007-	1.0	M 132	-	IXUH22	-	-	XUH22TT	
	2007-	1.0 Turbo	M 132	-	IXUH22	-	-	XUH22TT	
	2007-	1.0 Brabus Turbo	M 132	-	IXUH22	-	-	XUH22TT	
	2007-	1.0 Brabus ultimate 120	M 132	-	IXUH22	-	-	XUH22TT	
保时捷									
卡宴		3.6L	M55	-	VXUH22I	-	-	-	
		3.2L	BFD	-	IXU22	-	-	-	
帕纳梅拉Panamera	2009-	3.0T S Hybrid	MCG.EA/FA	-	IK20L	IK20TT	PK20TT	K20TT	
沃尔沃汽车									
进口C30	2010-2013	进口C30 2.0i	B 4204 S3 / B 4204 S4	-	IT20	IT20TT	PT20TT	T20TT	
	2008-2010	进口C30 2.4i	B 5254 T3	-	IKH20	IKH20TT	PKH20TT	KH20TT	
长安S40 II	2009-2012	S40 2.0i	B 4204 S3	-	IT20	IT20TT	PT20TT	T20TT	
	2006-2007	S40 2.4i	B 5244 S5	-	IKH20	IKH20TT	PKH20TT	KH20TT	
长安S40 II 04-	2006-2009	S40 2.5 T5	B 5254 T3	-	IKH20	IKH20TT	PKH20TT	KH20TT	
进口S60 II	2012-2013	S60 1.6 T4	B 4164 T	-	ITV20	ITV20TT	PTV20TT	-	
	2011-2013	S60 2.0 T	B 4204 T6 福特引擎	-	ITV20	ITV20TT	PTV20TT	-	
	2012-	S60 2.0 T5	B 4204 T7 福特引擎	-	ITV20	ITV20TT	PTV20TT	-	

AUSTRALIA  
CHINA  
INDIA  
INDONESIA  
KOREA  
MALAYSIA  
PHILIPPINES  
SAUDIARABIA  
SINGAPORE  
TAIWAN  
THAILAND  
VIETNAM  
JAPAN  
EUROPE  
& USA  
CROSS  
REFERENCE  
NUMBER  
PART

DENSO	9	14	16	20	24	27	29	31	32	34	35	DENSO	9	14	16	20	22	24	27	31	32	DENSO	9	14	16	20	22	24	27	31		
NGK	2	4	5	6	7	8	9	9.5	10	10.5	11	11.5	CHAMPION	18	16,14	12,11	10,9	8,7	6,63,61	4,59	57	55	53	BOSCH	10	9	8	7,6	5	4	3	2



车种	YEAR	车型	发动机型式	DENSO	IRIDIUM						
AUSTRALIA	沃尔沃汽车										
	进口S60 II	2013-	S60 2.0 T5	B 4204 T 沃尔沃引擎	-	ITV20	ITV20TT	PTV20TT	-		
		2013-2014	S60 2.0 T5	B 4204 T9 沃尔沃引擎	-	ITV20	ITV20TT	PTV20TT	-		
	2014-2015	S60 2.0 T6	B 4204 T11	-	ITV20	ITV20TT	PTV20TT	-			
CHINA	进口V60	2011-2015	S60 3.0 T6	B 6304 T4	-	IKH20	IKH20TT	PKH20TT	KH20TT		
		2013-2014	V60 2.0 T5	B 4204 T9 沃尔沃引擎	-	ITV20	ITV20TT	PTV20TT	-		
		2014-2015	V60 2.0 T6	B 4204 T11 福特引擎	-	ITV20	ITV20TT	PTV20TT	-		
	2012-2015	V60 3.0 T6	B 6304 T4	-	IKH20	IKH20TT	PKH20TT	KH20TT			
INDIA	亚太XC40	2019-	XC40 2.0 T4	B4204T47;B4204T51	ZXE24HLR7	-	-	-	-		
	2020-	XC40 2.0 T5	B4204T14	ZXE24HLR7	-	-	-	-			
	亚太S90	2016-	S90 2.0T T4	B 4204 T44;B 4204 T31	ZXE24HLR7	-	-	-	-		
	2016-	S90 2.0T T5	B 4204 T23	ZXE24HLR7	-	-	-	-			
INDONESIA	亚太S90(Plug-In Hybrid)	2018-	S90 2.0T	B4204T35	ZXE24HLR7	-	-	-	-		
	亚太S60L	2014-2015	S60L 2.0 T	B 4204 T 沃尔沃引擎	-	ITV20	ITV20TT	PTV20TT	-		
	2014-2015	S60L 2.0 T5	B 4204 T9 沃尔沃引擎	-	ITV20	ITV20TT	PTV20TT	-			
	2015-2019	S60L 2.0T T5	B4204T12;B 4204 T11	ZXE24HLR7	-	-	-	-			
	2015-2019	S60L 2.0T T4	B 4204 T19	ZXE24HLR7	-	-	-	-			
KOREA		2015-	S60L 2.0T6 E驱混动	B 4204 T32	ZXE24HLR7	-	-	-	-		
	2016-	S60L 2.0T4	B4204T19	ZXE24HLR7	-	-	-	-			
	2016-	S60L 2.0 T5	B 4204 T11	ZXE24HLR7	-	-	-	-			
	亚太XC60	2014-	XC60 2.0T	B 4204 T11	ZXE24HLR7	-	-	-			
MALAYSIA	亚太XC60(Plug-In Hybrid)	2018-	XC60 2.0T	B4204T35;ERAD2	ZXE24HLR7	-	-	-			
	S80	1998-2005	2.4 20V	B 5244 S	-	IK20	IK20TT	-	K20TT		
		1998-2005	2.5 T	B 5254 T2	-	IK20	IK20TT	-	K20TT		
		1998-2005	2.9 T6	B6294 T	-	IK20	IK20TT	-	K20TT		
		1998-2005	3.0 T6	B 6304 T2	-	IK20	IK20TT	-	K20TT		
PHILIPPINES	长安S80LII	2011-2012	S80L 2.0 T	B 4204 T6 4缸	-	IKH20	IKH20TT	-	KH20TT		
		2014-	S80L 2.0 T5	B 4204 T9 沃尔沃引擎 5缸	-	IKH20	IKH20TT	-	KH20TT		
		2009-2010	S80L 2.5 T	B 5254 T6, B 5254 T8	-	IKH20	IKH20TT	-	KH20TT		
		2009-2015	S80L 3.0 T6	B 6304 T2	-	IKH20	IKH20TT	-	KH20TT		
		2006-2008	进口S80 4.4i	B 8444 S	-	IK20	IK20TT	-	K20TT		
SAUDIARABIA	进口V40 II	2015-	V40 1.6 T4	D 4164 T	-	ITV20	ITV20TT	PTV20TT	-		
			V40 2.0 T4 /Cross	B5204 T8	-	ITV20	ITV20TT	PTV20TT	-		
		2013-2015	V40 2.0 T5 /Cross	B5204 T9	-	ITV20	ITV20TT	PTV20TT	-		
		2016-	V40 2.0T	B4204T19	-	ITV20	ITV20TT	PTV20TT	-		
		2016-	V40 2.0 T4	B4204T19	-	ITV20	ITV20TT	PTV20TT	-		
SINGAPORE	进口XC60	2011-	XC60 2.0 T	B 4204 T6 沃尔沃引擎	-	ITV20	ITV20TT	PTV20TT	-		
		2012-2015	XC60 2.0 T5	B 4204 T7 福特引擎	-	ITV20	ITV20TT	PTV20TT	-		
		2014-2015	XC60 2.0 T5	B 4204 T11 沃尔沃引擎	-	ITV20	ITV20TT	PTV20TT	-		
		2009-2010	XC60 3.0 T6	B 6304 T2	-	IKH20	IKH20TT	-	KH20TT		
		2010-2015	XC60 3.0 T6	B 6304 T4	-	IKH20	IKH20TT	-	KH20TT		
TAIWAN	XC90/XC90 Sport		2.5 T	D 5244 T11	-	IK20	IK20TT	-	K20TT		
			3.2	B 6324 S	-	IKH20	IKH20TT	-	KH20TT		
			3.2 AWD	-	-	IKH20	IKH20TT	-	KH20TT		
			4.4 V8	B 8444 S	-	IK20	IK20TT	-	K20TT		
THAILAND	捷豹/JAGUAR										
	S-Type(CCX)	1999-2008	3.0 V6	AJ-V6	-	IT20	IT20TT	PT20TT	T20TT		
	1999-2008	4.0 V8	AJ-28	-	IK16	IK16TT	PK16TT	K16TT			
	1999-2008	4.2 V8	AJ-V8	-	IT20	IT20TT	PT20TT	T20TT			
	1999-2008	4.2 V8 R	AJ34 SC	-	IT20	IT20TT	PT20TT	T20TT			
VIETNAM	X-Type(CF1)	2001-2009	2.0 V6	AJ20	-	IT20	IT20TT	PT20TT	T20TT		
		2001-2009	2.5 V6	AJ25	-	IT20	IT20TT	PT20TT	T20TT		
		2001-2009	3.0 V6	AJ30	-	IT20	IT20TT	PT20TT	T20TT		
		2013-	XF 2.0T	204PT	-	ITV22	-	-	-		
JAPAN	捷豹XF	2008-2012	XF 3.0 V6	AJ-V6	-	IT20	IT20TT	PT20TT	T20TT		
		2013-	XF 3.0T V6 SC	-	IT20	IT20TT	PT20TT	T20TT			
		2009-2010	XF 4.2T V8	AJ34 KG	-	IK16	IK16TT	PK16TT	K16TT		
		2009-	XF 5.0 V8	HP385	-	IK16	IK16TT	PK16TT	K16TT		
		2009-	XFR 5.0T V8	HP510	-	IK16	IK16TT	PK16TT	K16TT		
		EUROPE & USA	XJ/XJR(X300)	1994-2003	XJ6 3.2 V6	9JPGRB	-	IK20	IK20TT	PK20TT	K20TT
				1994-2003	XJ8 3.2 V8	AJ-V8	-	IK20	IK20TT	PK20TT	K20TT
1994-2003	XJ8 4.0			AJ27	-	IK20	IK20TT	PK20TT	K20TT		
1994-2003	XJR8 4.0T			AJ27 SC	-	IK20	IK20TT	PK20TT	K20TT		
CROSS REFERENCE NUMBER	XJ/XJR (X350)	2003-2010	XJ6 3.0 V6	AJ-V6	-	IT20	IT20TT	PT20TT	T20TT		
		2003-2010	XJ8 3.5 V8	AJV8	-	IK16	IK16TT	PK16TT	K16TT		
		2003-2010	XJ8 4.2 V8	AJ34	-	IK16	IK16TT	PK16TT	K16TT		
		2003-2010	XJ8 4.2T V8	AJ34	-	IK20	IK20TT	PK20TT	K20TT		
		2003-2010	XJ8 4.2T V8	-	-	IK20	IK20TT	PK20TT	K20TT		
		2003-2010	XJ8 4.2T V8	-	-	IK20	IK20TT	PK20TT	K20TT		

车种	YEAR	车型	发动机型式	DENSO	IRIDIUM			
<b>捷豹/JAGUAR</b>								
XJ/XJR(X351)	2013-	XJL 2.0T	HP241	-	ITV22	-	-	-
	2010-	XJL 3.0L V6		-	IT20	IT20TT	PT20TT	T20TT
	2013-	XJL 3.0T		-	IT20	IT20TT	PT20TT	T20TT
	2010-	XJL 5.0L V8	AJ-V8 Gen III	-	IK16	IK16TT	PK16TT	K16TT
		XJL 5.0T V8		-	IK20	IK20TT	PK20TT	K20TT
捷豹XK J43	2006-2014	XK8 4.2L	219KW	-	IK16	IK16TT	PK16TT	K16TT
	2006-2014	XKR 4.2T	306/313KW	-	IK20	IK20TT	PK20TT	K20TT
	2006-2014	XK 5.0L	283KW	-	IK16	IK16TT	PK16TT	K16TT
	2006-2014	XKR 5.0T	375/405KW	-	IK20	IK20TT	PK20TT	K20TT
<b>路虎</b>								
发现者2	1998-2004	4.0 V8		-	IK20G	IK20TT	PK20TT	K20TT
发现者3	2004-2009	4.0 V6	161KW	-	IT20	IT20TT	PT20TT	T20TT
	2004-2009	4.0 V6	406PN 156KW	-	IK20G	IK20TT	PK20TT	K20TT
	2004-2009	4.4 V8	AJ34,L319	-	IK16	IK16TT	PK16TT	K16TT
发现者4	2009-	4.0 V6	406PN	-	IK20G	IK20TT	PK20TT	K20TT
	2009-	5.0 V8	AJ133	-	IK20	IK20TT	PK20TT	K20TT
神行者1	1998-	1.8i	18 K4F	-	IK20	IK20TT	PK20TT	K20TT
	1998-	1.8i 16V	18 K4F	-	IK20	IK20TT	PK20TT	K20TT
	1998-	2.5 V6	25 K4F	-	IK20	IK20TT	PK20TT	K20TT
神行者2	2007-	2.0T Si4	204PT	-	ITV22	-	-	-
	2007-	3.2	B 6324 S	-	-	IKH20TT	-	KH20TT
揽胜2	1994-2002	4.0	42D(185) - E97	-	IK20G	IK20TT	PK20TT	K20TT
	1994-2002	4.6	46D(224)	W16EXR-U	IW16	IW16TT	PW16TT	-
揽胜3	2002-2012	4.2 V8	AJ34	-	IK16	IK16TT	PK16TT	K16TT
	2002-2012	4.4 V8	M 62 B44	K20TXR	IK20	IK20TT	PK20TT	K20TT
	2002-2012	4.4 V8	AJ34	-	IK16	IK16TT	PK16TT	K16TT
	2002-2012	5.0 V8		-	-	IXEH22TT	-	-
揽胜4	2014-2016	3.0T V6	306PS	-	-	IXEH22TT	-	-
	2013-	5.0L V8	508PS	-	-	IXEH22TT	-	-
	2013-2016	5.0T V8	508PS	-	-	IXEH22TT	-	-
揽胜运动版1	2006-	4.2T V8	AJ34	-	IK16	IK16TT	PK16TT	K16TT
	2005-	4.4L V8	AJ34	-	IK16	IK16TT	PK16TT	K16TT
	2010-2011	5.0L V8	HP375	-	-	IXEH22TT	-	-
	2010-2011	5.0T V8 375KW	HP510	-	-	IXEH22TT	-	-
揽胜运动版2	2016-	2.0T		-	ITV22	-	-	-
	2014-2016	3.0T V6	30HD0D	-	-	IXEH22TT	-	-
	2016-	3.0T V6		-	-	IXEH22TT	-	-
	2014-2015	5.0T V8		-	-	IXEH22TT	-	-
揽胜极光	2016-	5.0T V8 SVR		-	-	IXEH22TT	-	-
<b>玛莎拉蒂</b>								
Ghibli吉博力	2014-	吉博力 3.0T	M156	-	-	-	-	-
	2014-	吉博力S 3.0T	M156	-	-	-	-	-
总裁Quattroporte	2008-2010	总裁 4.2L	M139, V8	-	IU24	-	-	-
	2013-2015	总裁 3.0T	M156C	-	IU24	-	-	-
GT	2009-	GT 4.2L	M139P, V8	-	IU24	-	-	-

- 注：  
 1、在安装火花塞时请确认与原车火花塞尺寸一致；  
 2、在安装时请严格按照火花塞标准力矩安装；  
 3、如出现点火不良可根据具体情况适当调节火花塞间隙；  
 4、奔驰新款双点火发动机不适合使用铱金火花塞；  
 5、火花塞热值可根据环境、季节、驾驶习惯、发动机改装、涡轮增压等适当提高一级热值；  
 6、高协调性发动机请直接使用长寿命火花塞。

AUSTRALIA  
 CHINA  
 INDIA  
 INDONESIA  
 KOREA  
 MALAYSIA  
 PHILIPPINES  
 SAUDIARABIA  
 SINGAPORE  
 TAIWAN  
 THAILAND  
 VIETNAM  
 JAPAN  
 EUROPE  
 & USA  
 CROSS  
 REFERENCE  
 NUMBER  
**99**



▶ Spark plug color codes: ■ for Iridium Tough and Iridium Plugs and Iridium TT, ■ for Iridium Power, ■ for Iridium Racing and Two Tops Plugs, ■ for Platinum Plugs and Platinum TT, and black for general spark plugs.

AUSTRALIA	车种	CC	DENSO	IRIDIUM POWER	IRIDIUM RACING
	Piaggio 霸伏				
			W20FP-U	IWF20	-
	Tomos				
			W20FP-U	IWF20	-
CHINA	天津富士达				
	CB125	125	X24EP-U/U9	IX24B	IXU01-□
	金城				
	AJ50	50	W20FP-U	IWF20	-
INDIA	JC70	70	U22FS-U	IUF22	-
	JC90-B	90	U22FS-U	IUF22	-
	AX100	100	W20EP-U	IW20	IW01-□
	FD100	100	U22FS-U	IUF22	-
INDONESIA	JC100	100	W20FP-U	IWF20	-
	JC150	150	U22FS-U	IUF22	-
INDONESIA	金鸟				
	TN36L		W20FP-U	IWF20	-
KOREA	木兰				
	AG50	50	W20FP-U	IWF20	-
	建设摩托				
	QMS50QW-A	50	W20FP-U	IWF20	-
MALAYSIA	JS50	50	W20FP-U	IWF20	-
	JY55	55	W20FP-U	IWF20	-
PHILIPPINES	JS60	60	W20FP-U	IWF20	-
	CY80	80	W20FP-U	IWF20	-
SAUDI ARABIA	JS90	90	U22FS-U	IUF22	-
	JS100	100	U22FS-U	IUF22	-
SINGAPORE	JS125	125	X24EP-U/U9	IX24B	IXU01-□
	SR125	125	X24EP-U/U9	IX24B	IXU01-□
TAIWAN	JY150	150	X24EP-U/U9	IX24B	IXU01-□
	SR150	150	X24EP-U/U9	IX24B	IXU01-□
THAILAND	建设雅马哈				
	SRZ150	150	X24EP-U/U9	IX24B	IXU01-□
VIETNAM	YBR125(天剑)	125	U22FS-U	IUF22	-
	SR150(劲豹)	150	X24ES-U	IX24	IXU01-□
	SRZ150(劲飙)	150	X24ES-U	IX24	IXU01-□
	SRV200(劲龙)		X24ES-U	IX24	IXU01-□
	JYM250		X24ES-U	IX24	IXU01-□
	YA90		W22FP-U	IWF22	-
VIETNAM	ZY100T-3(丽鹰100)		U20FS-U	IUF22	-
	幸福摩托				
	XF50Q	50	W20FP-U	IWF20	-
	XF90T	90	W20FP-U	IWF20	-
	XF125	125	X24EP-U/U9	IX24B	IXU01-□
	XF150	150	X24EP-U/U9	IX24B	IXU01-□
VIETNAM	广州五羊				
	WH100T-H(喜悦100)	100	U22FS-U	IUF22	-
	SCR110(佳御)	110	U22FS-U	IUF22	-
	优悦	110	U22FS-U	IUF22	-
JAPAN	WH125(锋芒125)	125	X24EP-U/U9	IX24B	IXU01-□
	WH125(追梦125)	125	X24EP-U/U9	IX24B	IXU01-□
	WH125(CG125)	125	X24EP-U/U9	IX24B	IXU01-□
	WH125-F	125	X24EP-U/U9	IX24B	IXU01-□
	WH125-H(新概念)	125	X24EP-U/U9	IX24B	IXU01-□
	WH125T(追梦125)	125	X24EP-U/U9	IX24B	IXU01-□
	GZ125	125	X24EP-U/U9	IX24B	IXU01-□
	WY125	125	X24EP-U/U9	IX24B	IXU01-□
EUROPE & USA	三阳 DUKE				
	50 丕L5H	50	W20FP-U	IWF20	-
REFERENCE NUMBER	125-5P(A125)	125	U22FS-U	IUF22	-
	125RD/RS	125	X24EP-U/U9	IX24B	IXU01-□
CROSS REFERENCE NUMBER	重庆力帆				
	LF125	125	U22FS-U	IUF22	-
	LF125T	125	U22FS-U	IUF22	-
	LX125	125	X24EP-U/U9	IX24B	IXU01-□
PART NUMBER	新大洲				
	XDZ35LL	35	W20FP-U	IWF20	-
	XDZ50	50	W20FP-U	IWF20	-
	XDZ 丕80T	80	W20FP-U	IWF20	-

车种	CC	DENSO	IRIDIUM POWER	IRIDIUM RACING
新大洲				
XDZ 丕90T	90	W20FP-U	IWF20	-
XDZ125	125	U22FS-U	IUF22	-
新大洲本田				
SDH100-21(太阳风)	100	U20FS-U	IUF22	-
SDH100-41(威武)	100	U20FS-U	IUF22	-
SDH100-42(威胜)	100	U22FS-U	IUF22	-
SDH125T-2D	125	U22FS-U	IUF22	-
SDH125T-8D(白马王子)	125	U22FS-U	IUF22	-
SDH125T-21(新生代)	125	U22FS-U	IUF22	-
SDH125T-22(E彩)	125	U22FS-U	IUF22	-
SDH125T-7B(新火鹰)	125	U22FS-U	IUF22	-
SDH125-2(新概念)	125	U20ESR-N	IU20	-
SDH125(万里行)	125	X24EP-U/U9	IX24B	IXU01-□
SDH125-39(新锋锐)	125	X24EP-U/U9	IX24B	IXU01-□
SDH125-7(神雕)	125	X24EP-U/U9	IX24B	IXU01-□
SDH125-42(威猛)	125	X24EP-U/U9	IX24B	IXU01-□
DNH125-46(锐箭)	125	X24EP-U/U9	IX24B	IXU01-□
SDH125-38(超影)	125	X24ES-U	IX24	IXU01-□
SDH125-40(稳重)	125	X24ES-U	IX24	IXU01-□
SDH100-6G(火龙驹)	100	U20FS-U	IUF22	-
SDH150(战鹰)	150	U24ES-N	IU24	IU01-□
常州光阳				
CK100T-A	100	U22FS-U	IUF22	-
南方				
NF50Q	50	W20FP-U	IWF20	-
NF55	55	W20FP-U	IWF20	-
NF90	90	W20FP-U	IWF20	-
NF125	125	W20FP-U	IWF20	-
捷达				
JD90	90	U22FS-U	IUF22	-
JD125	125	X24EP-U/U9	IX24B	IXU01-□
春兰				
CL125	125	U22FS-U	IUF22	-
光阳				
FREEWAY50	50	W20FP-U	IWF20	-
CB125	125	X24EP-U/U9	IX24B	IXU01-□
EY6125	125	X24EP-U/U9	IX24B	IXU01-□
光阳豪迈				
125(GY6)	125	U20FS-U	IUF22	-
光阳名流				
CH100	100	U20FS-U	IUF22	-
北方易初				
DY50	50	W20FP-U	IWF20	-
DY70	70	U22FS-U	IUF22	-
DY90	90	U22FS-U	IUF22	-
DY100	100	U22FS-U	IUF22	-
本田 HONDA				
NJ50	50	W20FP-U	IWF20	-
PA50	50	W20FP-U	IWF20	-
PC50	50	U22FS-U	IUF22	-
SK50	50	W20FP-U	IWF20	-
SZ50	50	W20FP-U	IWF20	-
XL50	50	U22FS-U	IUF22	-
NH60	60	W20FP-U	IWF20	-
AT70	70	U22FS-U	IUF22	-
C70	70	U22FS-U	IUF22	-
CA70	70	U22FS-U	IUF22	-
CD70	70	U22FS-U	IUF22	-
CL70	70	U22FS-U	IUF22	-
CM70	70	U22FS-U	IUF22	-
CD90	90	U22FS-U	IUF22	-
CD90D	90	U22FS-U	IUF22	-
H100S	100	W20FP-U	IWF20	-
WIN100	100	U22FS-U	IUF22	-
XL100S	100	U22FS-U	IUF22	-
CB125T	125	U22FS-U	IUF22	-
CHA125	125	U22FS-U	IUF22	-



车种	CC	DENSO	IRIDIUM POWER	IRIDIUM RACING
<b>本田 HONDA</b>				
CJ125	125	U22FS-U	IUF22	-
CM125	125	U22FS-U	IUF22	-
<b>宗申</b>				
ZS125	125	X24EP-U/U9	IX24B	IXU01-□
ZS125T	125	U24ES-N	IU24	IU01-□
ZS100	100	U22FS-U	IUF22	-
<b>嘉陵</b>				
CJ50	50	W20FP-U	IWF20	-
JH70	70	U22FS-U	IUF22	-
JH90	90	U22FS-U	IUF22	-
JH125	125	X24EP-U/U9	IX24B	IXU01-□
JH145	145	X24EP-U/U9	IX24B	IXU01-□
JH150	150	X24ES-U	IX24	IXU01-□
JH600	400	-	IU24	IU01-□
<b>嘉陵本田</b>				
CB125T	125	U22FS-U	IUF22	-
CB125X(锐影)	125	U20FS-U	IUF22	-
CH125(大鲨)	125	X22EP-U9	IX22B	IXU01-□
CG125	125	X24EP-U/U9	IX24B	IXU01-□
CM125	125	U20FS-U	IUF22	-
<b>雅马哈 YAMAHA</b>				
CY50	50	W20FP-U	IWF20	-
V50	50	W20FP-U	IWF20	-
YA50	50	W20FP-U	IWF20	-
YB50	50	W20FP-U	IWF20	-
T80	80	U22FS-U	IUF22	-
YA90	90	W20FP-U	IWF20	-
DX100	100	W20FP-U	IWF20	-
YB100	100	W20FP-U	IWF20	-
YFM100T	100	U22FS-U	IUF22	-
C125B	125	U22FS-U	IUF22	-
CX125	125	U22FS-U	IUF22	-
XC125U/W	125	U22FS-U	IUF22	-
<b>兰翔</b>				
LX50T	50	W20FP-U	IWF20	-
<b>凯基助动车</b>				
KJ50ZL	50	W20FP-U	IWF20	-
<b>济南轻骑</b>				
T151FMI	100	U22ES-N	IU22	IU01-□
K157FMI	125	X24ES-U	IX24	IXU01-□
157FMI	125	X24ES-U	IX24	IXU01-□
QM125	125	X24EP-U/U9	IX24B	IXU01-□
QM125T	125	X24EP-U/U9	IX24B	IXU01-□
<b>轻骑铃木</b>				
AG50	50	W20FP-U	IWF20	-
QM50Q-2B	50	W20FP-U	IWF20	-
ST50	50	W20FP-U	IWF20	-
TB50	50	W20FP-U	IWF20	-
K90	90	W20FP-U	IWF20	-
QS90	90	W20FP-U	IWF20	-
QM100	100	W20FP-U	IWF20	-

车种	CC	DENSO	IRIDIUM POWER	IRIDIUM RACING
<b>轻骑铃木</b>				
QS100	100	W20FP-U	IWF20	-
QX100	100	W20EP-U	IW20	IW01-□
QS110(赛驰)	110	U20FS-U	IUF22	-
QS125(悠E)	125	U20ESR-N	IU20	IU01-□
GS125(铃木王)	125	U22ES-N	IU22	IU01-□
GSX125-3/3A(骏威)	125	U22ES-N	IU22	IU01-□
QS125(风飙)	125	U24ES-N	IU24	IU01-□
GT125(骏驰)	125	U20FS-U	IUF22	-
QS125T-2(丽彩)	125	U20ESR-N	IU20	-
QS150(超人)	150	U20ESR-N	IU20	IU01-□
GZ150(新风暴)	150	U22ES-N	IU22	IU01-□
GSX150(骏威)	150	U22ES-N	IU22	IU01-□
<b>钱江</b>				
QJ125	125	X24EP-U/U9	IX24B	IXU01-□
<b>铃木刃</b>				
A50	50	W20FP-U	IWF20	-
AG50	50	W20FP-U	IWF20	-
A80	80	W20FP-U	IWF20	-
K90	90	W20FP-U	IWF20	-
A100	100	W20FP-U	IWF20	-
AG100	100	W20FP-U	IWF20	-
AX100	100	W20FP-U	IWF20	-
DR100	100	X24EP-U/U9	IX24B	IXU01-□
RC100	100	W20FP-U	IWF20	-
SP100	100	X24EP-U/U9	IX24B	IXU01-□
DF125	125	X24EP-U/U9	IX24B	IXU01-□
DR125	125	X24EP-U/U9	IX24B	IXU01-□
GN125	125	X24EP-U/U9	IX24B	IXU01-□
GS125	125	X24EP-U/U9	IX24B	IXU01-□
S125	125	W20FP-U	IWF20	-
SP125	125	X24EP-U/U9	IX24B	IXU01-□
<b>长春铃木</b>				
AR100	100	W20EP-U	IW20	IW01-□
AX100	100	W20EP-U	IW20	IW01-□
<b>隆鑫摩托</b>				
HY50QT	50	W14FP-UL	-	-
LX90	90	U22FS-U	IUF22	-
LX125	125	X24ES-U	IX24	IXU01-□
CY80	80	W22EP-U	IW22	-
AX100	100	W20EP-U	IW20	IW01-□
<b>望江摩托</b>				
WJ100	100	U22FS-U	IUF22	-
WJ125	125	X24ES-U	IX24	IXU01-□
<b>大江摩托</b>				
DJ100	100	U22FS-U	IUF22	-
DJ125	125	X24ES-U	IX24	IXU01-□
DJ150	150	X24ES-U	IX24	IXU01-□
<b>银刚科技</b>				
YG100	100	U22FS-U	IUF22	-
YG125	125	X24ES-U	IX24	IXU01-□
YG150	150	X24ES-U	IX24	IXU01-□

AUSTRALIA  
 CHINA  
 INDIA  
 INDONESIA  
 KOREA  
 MALAYSIA  
 PHILIPPINES  
 SAUDI ARABIA  
 SINGAPORE  
 TAIWAN  
 THAILAND  
 VIETNAM  
 JAPAN  
 EUROPE & USA  
 CROSS REFERENCE NUMBER  
 PART

DENSO	9	14	16	20	22	24	27	29	31	32	34	35
NGK	2	4	5	6	7	8	9	9.5	10	10.5	11	11.5

DENSO	9	14	16	20	22	24	27	29	31	32
CHAMPION	18	16,14	12,11	10,9	8,7	6,63,61	4,59	57	55	53

DENSO	9	14	16	20	22	24	27	31
BOSCH	10	9	8	7,6	5	4	3	2



	MODEL	YEAR	DENSO		
AUSTRALIA	<b>BMW</b>				
	740i, 740Li, 320i		-	-	IK20
CHINA	<b>DAEWOO MOTORS</b>				
	MATIZ		-	W16TT	-
INDIA	<b>FIAT INDIA AUTOMOBILES LTD</b>				
	ADVENTURE, PALIO (1.6i), SIENA (1.6i)		-	K16TT	IK16
INDONESIA	LINEA (1.4L), GRANDE PUNTO (1.2L/1.4L), PUNTO EVO, PALIO (1.2i), STILE (1.1i), SPORT, SIENA (1.2i)		XU22EPR-U	XU22TT	IXU22
	UNO (1.0i/1.2)		K20PR-U	K20TT	IK20
INDONESIA	<b>FORD INDIA PVT. LTD</b>				
	FIESTA (1.4/1.6/CLASSIC), FUSION (1.6), IKON (1.6i 8V), FIGO		T16VR-U10	TV16TT	ITV16
INDONESIA	IKON (1.3i)		T20EPR-U	T20TT	IT20
	<b>GENERAL MOTORS INDIA PVT. LTD</b>				
KOREA	ASTRA (1.6i), CORSA (1.6i), SPARK (1.0), UVA (1.2)		-	W16TT	-
	AVEO (1.4/1.6), OPTRA (1.6)		-	K20TT	IK20
KOREA	BEAT		XU22EPR-U	XU22TT	IXU22
	CORSA (1.4i), SWING (1.4), SAIL (1.4)		-	W20TT	IW20
MALAYSIA	OPTRA (1.8)		K20PR-U	K20TT	IK20
	<b>HINDUSTAN MOTORS LTD</b>				
MALAYSIA	AMBASSADOR (1.5/1.8)		-	W16TT	-
	<b>HONDA CARS INDIA LTD</b>				
PHILIPPINES	ACCORD	2003-	-	K16TT	IK16
	ACCORD (2.4i/3.0i)	2003-	-	K20TT	IK20
SAUDI ARABIA	AMAZE		K20PR-U11	-	-
	AMAZE (ALL MODELS)	2018-	K20PR-U11	-	-
SINGAPORE	BRIO		-	K20TT	IK20
	CITY (1.3/1.5)		-	K20TT	IK20
TAIWAN		2008-	-	K20TT	IK20
		2010-	-	K20TT	IK20
THAILAND		-2008	K20PR-U11	-	-
	CIVIC (1.6/1.8i/2.0i)		-	K20TT	IK20
VIETNAM	CR-V		-	K20TT	IK20
	JAZZ (1.2L)	2018-	K20PR-U11	-	-
VIETNAM	JAZZ (ALL MODELS)		-	K20TT	IK20
	WR-V	2018-	K20PR-U11	-	-
VIETNAM	WR-V EDGE	2018-	-	K20TT	IK20
	<b>HYUNDAI MOTOR INDIA LTD</b>				
VIETNAM	(2nd GENERATION) - GRAND i10, XCENT, i20 NEW (SPORTS & ACTIVE), i20 ELITE		-	-	IXUH22
	ACCENT (1.5i/1.6i)		K16PR-U11	K16TT	IK16
VIETNAM	CRETA (1.6L)	2015-2018	XU20HR9	XUH20TTI	IXUH20I
	ELANTRA		K16PR-U11	K16TT	IK16
VIETNAM	EON	2014-	XU20HR9	XUH20TTI	IXUH20I
		-2014	-	XUH20TTI	-
VIETNAM		-2013	K16PR-U11	K16TT	IK16
	GETZ (1.3i)		K16PR-U11	K16TT	IK16
VIETNAM	GRAND i10		-	XUH20TTI	-
	i10	2008-2013	XU20HR9	XUH20TTI	IXUH20I
VIETNAM	i10 (1.1L)		K16PR-U11	K16TT	IK16
	i10/i20 (KAPPA ENGINE)		-	XUH20TTI	-
VIETNAM	i20	2008-2014	XU20HR9	XUH20TTI	IXUH20I
	i20 ELITE		-	XUH20TTI	-
VIETNAM	SANTRO (1.1i)		K16PR-U11	K16TT	IK16
	SONATA (2.0/2.4/GOLD)		-	W20TT	IW20
VIETNAM	SONATA (2.4)		K16PR-U11	K16TT	IK16
	VERNA (1.6)		K16PR-U11	K16TT	IK16
VIETNAM	VERNA FLUIDIC (1.4L/1.6L)	2011-2017	XU20HR9	XUH20TTI	IXUH20I
	XCENT		-	XUH20TTI	-
VIETNAM	<b>LAND ROVER</b>				
	DISCOVERY III 4.4 4x4	2004-2009	-	-	IK16
VIETNAM	DISCOVERY IV 5.0 V8 4x4	2009-	-	-	IK20
	RANGE ROVER SPORT 4.2 4x4/4.4 4x4	2005-	-	-	IK16
VIETNAM	<b>MARUTI SUZUKI INDIA LTD</b>				
	ALL CARB. MODEL		-	W16TT	-
VIETNAM	ALTO	2010-	XU20EPR-U	-	-





MODEL	YEAR	DENSO			
<b>MARUTI SUZUKI INDIA LTD</b>					
ALTO 800, ALTO (0.8i 12V), ALTO (1.1i 16V), CAR 800 (12V), WAGON R (1.1i), ZEN ESTILO		XU22EPR-U	XU22TT	IXU22	AUSTRALIA
ALTO K10		-	XU22TT	IXU22	CHINA
A-STAR		-	XU22TT	IXU22	
	2008-2013	XU20EPR-U	-	-	INDIA
BALENO	2015-	XU20HR9	XUH20TTI	IXUH20I	
BREZZA	2020-	XU20EPR-U	-	-	INDONESIA
CELERIO		-	XU22TT	IXU22	
	2013-	XU20EPR-U	-	-	KOREA
CELERIO X	2017-	-	XU22TT	IXU22	
		XU20EPR-U	-	-	MALAYSIA
CIAZ	-2018	-	XU22TT	IXU22	
		XU20HR9	XUH20TTI	IXUH20I	PHILIPPINES
CIAZ F/L	2018-	XU20EPR-U	-	-	
DZIRE	2010-2015	XU20EPR-U	-	-	SAUDI ARABIA
ERTIGA	2012-	XU20EPR-U	-	-	
ERTIGA (K SERIES)		-	XU22TT	IXU22	SINGAPORE
ESTEEM (1.3 Carb.)		W20EPR-U	W20TT	IW20	
ESTILO	2009-2013	XU20EPR-U	-	-	TAIWAN
ESTILO (K SERIES)		-	XU22TT	IXU22	
GRAND VITARA (1.6/2.0/2.7)		-	K20TT	IK20	THAILAND
GYPSY (1.3 Carb.), ZEN (1.0 Carb.), CAR 800 (Carb.), OMNI (0.8 Carb.), OMNI (0.8 MPFI), CAR 1000 (Carb.)		W16EPR-U	W16TT	-	
IGNIS	2016-2020	XU20HR9	XUH20TTI	IXUH20I	VIETNAM
RITZ		-	XU22TT	IXU22	
		XU20EPR-U	-	-	JAPAN
S-CROSS	2020-	XU20EPR-U	-	-	
S-PRESSO	2019-	XU20EPR-U	-	-	EUROPE & USA
STINGRAY	2013-2017	XU20EPR-U	-	-	
	2014	-	XU22TT	IXU22	CROSS REFERENCE
SWIFT	2010-2014	XU20EPR-U	-	-	
	2014-	XU20HR9	XUH20TTI	IXUH20I	PART NUMBER
	2018-	XU20HR9	XUH20TTI	IXUH20I	
	2015	-	XU22TT	IXU22	PART NUMBER
SWIFT DZIRE	2015-2017	XU20HR9	XUH20TTI	IXUH20I	
	2017-	XU20HR9	XUH20TTI	IXUH20I	PART NUMBER
VERSA (1.3i), GYPSY KING (1.3i), SX4, SWIFT (1.3i), BALENO (1.6 BS II & III), ZEN (1.0i 16V), ESTEEM (1.3 MPFI), EECO		K20PR-U	K20TT	IK20	
	2010-	XU20EPR-U	-	-	PART NUMBER
WAGON R	2019-	XU20HR9	XUH20TTI	IXUH20I	
		-	XU22TT	IXU22	PART NUMBER
WAGON R (K SERIES)		-	XU22TT	IXU22	
WAGON R STINGRAY		-	XU22TT	IXU22	PART NUMBER
XL6	2019-	XU20EPR-U	-	-	
<b>DAEWOO MOTORS</b>					
CEDIA (2.0)		K16PR-U11	K16TT	IK16	PART NUMBER
LANCER (1.5/1.8)		-	W16TT	-	
<b>HYUNDAI MOTOR COMPANY</b>					
KWID		-	-	IXU22	PART NUMBER
SUPERB (2.8 AZM), OCTAVIA (1.8/2.0)		-	K20TT	IK20	
<b>MAZDA MOTOR CORP.</b>					
INDICA (1.4/1.4i/XETA), INDIGO (1.4i/MARINA/XL), NANO		K20PR-U	K20TT	IK20	PART NUMBER
INDICA VISTA, INDIGO MANZA		XU22EPR-U	XU22TT	IXU22	
NANO GENX		-	-	IK16	PART NUMBER
ZEST, BOLT, TIAGO (1.2L), TIGOR (1.2L)		-	-	IXUH22	
<b>TOYOTA MOTOR CORP.</b>					
COROLLA		-	K16TT	IK16	PART NUMBER
ETIOS (1.2/1.5), ETIOS LIVA (1.2/1.5)		-	KH20TT	-	
ETIOS (1.5), ETIOS LIVA (1.2)		K16HR-U11	-	-	PART NUMBER
INNOVA	2015-	K20HR-U11	KH20TT	-	
QUALIS		-	W16TT	-	PART NUMBER

DENSO	9	14	16	20	22	24	27	29	31	32	34	35
NGK	2	4	5	6	7	8	9	9.5	10	10.5	11	11.5

DENSO	9	14	16	20	22	24	27	29	31	32
CHAMPION	18	16,14	12,11	10,9	8,7	6,63,61	4,59	57	55	53

DENSO	9	14	16	20	22	24	27	31
BOSCH	10	9	8	7,6	5	4	3	2



	MODEL	YEAR	DENSO	IRIDIUM POWER
AUSTRALIA	<b>BAJAJ</b>			
	AVENGER		267700-0840	IU24D
	AVENGER CRUISE/STREET - 220 (LEFT/RIGHT SIDE)		267700-0840	IU24D
CHINA	BOXER (AT/CT)		067700-9481	IUF22
	BYK		067700-9481	IUF22
	CALIBER (ALL MODELS)		067700-9481	IUF22
INDIA	CHAMPION		067700-9481	IUF22
	CNG 3 WHEELER OLD		267700-5011	IWF20
	CT 100DX		067700-9481	IUF22
	DISCOVER 100/125/150 DTSI (ALL NEW MODELS)		067700-9481	IUF22
	DISCOVER 100M		067700-9481	IUF22
INDONESIA	DISCOVER 115		067700-9481	IUF22
	DISCOVER 125 DTSI (OLD MODELS)		267700-0840	IU24D
	DISCOVER 135 DTSI		267700-0840	IU24D
	DOMINAR 400 (LEFT/RIGHT SIDE)		267700-0840	IU24D
KOREA	ELIMINATOR		267700-0840	IU24D
	FUSION		067700-9481	IUF22
	LEGEND NXT		067700-9481	IUF22
MALAYSIA	M80-4S		067700-9481	IUF22
	PLATINA 100CC		067700-9481	IUF22
	PLATINA 125 CC		267700-0840	IU24D
PHILIPPINES	PULSAR 135 CC DTSI		067700-9481	IUF22
	PULSAR 135 LS (LEFT/RIGHT SIDE)		067700-9481	IUF22
	PULSAR 150/180/200		267700-0840	IU24D
	PULSAR 200 NS (LEFT/RIGHT SIDE)		267700-0840	IU24D
SAUDI ARABIA	PULSAR 220/220F (LEFT/RIGHT SIDE)		267700-0840	IU24D
	PULSAR AS 200 (LEFT/RIGHT SIDE)		267700-0840	IU24D
	PULSAR RS200 (LEFT/RIGHT SIDE)		267700-0840	IU24D
SINGAPORE	V BIKE V12/15 (125/150 CC) (LEFT/RIGHT SIDE)		067700-9481	IUF22
	WIND		067700-9481	IUF22
	XCD 125/135 DTSI		267700-0840	IU24D
TAIWAN	<b>BENELLI</b>			
	TNT 25 (250CC)		067700-9272	IU24
	TNT 300CC		067700-9272	IU24
THAILAND	<b>ENFIELD</b>			
	BS - 4 - 500CC (THUNDERBIRD, CLASSIC, BULLET)		067700-8651	IW16
	BULLET LB 350 MACHISMO		067700-8671	IW22
	BULLET LB 500 MACHISMO		067700-8901	IW27
VIETNAM	BULLET STD 350		267700-5011	IWF20
	CONTINENTAL GT (535CC)		067700-8651	IW16
	CONTINENTAL GT TWIN (650CC)		067700-9262	IU22
	HIMALAYAN 411CC (BS III & IV)		067700-9262	IU22
JAPAN	INTERCEPTOR TWIN (650 CC)		067700-9262	IU22
	UCE TWIN SPARK PLUG 350CC (THUNDERBIRD, CLASSIC, BULLET)		067700-8651	IW16
			267700-0830	IU22D
EUROPE & USA	<b>HERO</b>			
	ACHIEVER 150		267700-0840	IU24D
	AMBITION		067700-9391	IX24B
	CBZ- STAR		067700-9391	IX24B
	CBZ XTREME		267700-0840	IU24D
JAPAN	CBZ-GOLD		067700-9391	IX24B
	CD (ALL MODELS)		067700-9481	IUF22
	DUET		067700-9481	IUF22
	ENDURO (XT200)	2018.10-	267700-0840	IU24D
EUROPE & USA	GLAMOUR		267700-5021	IU20
	GLAMOUR 125 FI		267700-5021	IU20
	HF DAWN		067700-9481	IUF22
	HF-DELUXE		067700-9481	IUF22
EUROPE & USA	HF-DELUXE ECO		067700-9481	IUF22
	HUNK		267700-0840	IU24D
	IGNITOR		267700-5021	IU20
	IMPULSE		267700-0840	IU24D
EUROPE & USA	JOY		067700-9481	IUF22
	KARIZMA		067700-9391	IX24B
	KARIZMA-ZMR		067700-9391	IX24B
	MAESTRO (SCOOTER)		267700-0830	IU22D
EUROPE & USA	MAESTRO EDGE		067700-9481	IUF22
	PASSION (ALL MODELS)		067700-9481	IUF22



MODEL	YEAR	DENSO	IRIDIUM POWER	
<b>HERO</b>				AUSTRALIA
PASSION PRO X		267700-0830	IU22D	
PLEASURE		067700-9481	IUF22	
SPLENDOR (ALL MODELS)		067700-9481	IUF22	
SPLENDOR I SMART 110		067700-9481	IUF22	
STREET		067700-9481	IUF22	
STREET SMART		067700-9481	IUF22	
SUPER SPLENDOR		267700-5021	IU20	
XPULSE 200 CC	2019.05-	267700-0840	IU24D	INDIA
XTREME		267700-0840	IU24D	
XTREME (XT200FI)		267700-0840	IU24D	
XTREME 200R	2018.10-	267700-0840	IU24D	
XTREME SPORT		267700-0840	IU24D	INDONESIA
<b>HONDA</b>				
ACTIVA	2009.03-2013.01	267700-0830	IU22D	KOREA
	-2009.02	067700-9481	IUF22	
AVIATOR		067700-9481	IUF22	MALAYSIA
	2009.03-	267700-0830	IU22D	
CB HORNET 160R		267700-0840	IU24D	PHILIPPINES
CB SHINE 125		267700-0830	IU22D	
CB SHINE SP 125		267700-0830	IU22D	SAUDI ARABIA
CB TRIGGER		267700-0840	IU24D	
CB TWISTER		267700-0830	IU22D	SINGAPORE
CB UNICORN (160CC)		267700-0840	IU24D	
CB UNICORN 150		267700-0840	IU24D	TAIWAN
CBF STUNNER		267700-0830	IU22D	
CBR125R		067700-9272	IU24	THAILAND
CBR150R		067700-9272	IU24	
DIO	2012.04-2013.12	267700-0830	IU22D	VIETNAM
	-2012.03	067700-9481	IUF22	
DREAM CD 110		267700-0830	IU22D	JAPAN
DREAM NEO		267700-0830	IU22D	
DREAM YUGA		267700-0830	IU22D	EUROPE & USA
ETERNO		067700-9481	IUF22	
LIVO 110 CC		267700-0830	IU22D	CROSS REFERENCE
SHINE		267700-0830	IU22D	
SP 125 HET (BS-VI)		267700-0840	IU24D	PART NUMBER
UNICORN		267700-0840	IU24D	
UNICORN DAZZLER		267700-0840	IU24D	
X-BLADE		267700-0840	IU24D	
<b>KAWASAKI</b>				
KX 250F	2009.05-2010	067700-9272	IU24	
NINJA 250/R		067700-9272	IU24	
Z250		067700-9272	IU24	
<b>KINETIC</b>				
BOSS		067700-9481	IUF22	
GF (ALL MODELS)		067700-9262	IU22	
NOVA (ALL MODELS)		067700-9481	IUF22	
VELOCITY		067700-9481	IUF22	
<b>LML</b>				
BEAMER		067700-9272	IU24	
FREEDOM		067700-9272	IU24	
GRAPTOR		067700-9272	IU24	
SCOOTERS		067700-8651	IW16	
<b>M&amp;M</b>				
CENTURO NXT		067700-9481	IUF22	
CENTURO ROCKSTAR		067700-9481	IUF22	
DURO		067700-9481	IUF22	
FLYTE		067700-9481	IUF22	
PANTERO		067700-9481	IUF22	
RODEO		067700-9481	IUF22	
<b>SUZUKI</b>				
ACCESS 125 (OLD)		067700-9481	IUF22	
GIXXER 155CC (STANDARD SPARK PLUG)		267700-0830	IU22D	
SWISH 125		067700-9481	IUF22	
<b>TVS</b>				
APACHE RTR 160/180/180 ABS		067700-9262	IU22	
CENTRA		067700-9262	IU22	



	MODEL	YEAR	DENSO	IRIDIUM POWER
AUSTRALIA	TVS			
	FIERO (ALL MODELS)		067700-9262	IU22
	FLAME		067700-9262	IU22
CHINA	JUPITER		267700-0840	IU24D
	PEP PLUS		067700-9481	IUF22
INDIA	PHEONIX		267700-0840	IU24D
	RTR 180 ABS		067700-9262	IU22
	SAMURAI		067700-9411	IWF22
INDONESIA	SCOOTY 2-STROKE		067700-9411	IWF22
	SCOOTY PEP		067700-9481	IUF22
	SCOOTY STEAK		067700-9481	IUF22
MALAYSIA	SHAOLIN		067700-9411	IWF22
	SHOGUN		067700-9411	IWF22
	SPORT		067700-9481	IUF22
KOREA	STAR CITY		067700-9481	IUF22
	STAR CITY 110 CC		267700-0830	IU22D
	STAR CITY PLUS		267700-0840	IU24D
PHILIPPINES	VICTOR 110		067700-9481	IUF22
	VICTOR EDGE 125		067700-9262	IU22
	VICTOR GLX 125		067700-9262	IU22
SAUDI ARABIA	WEGO 110		267700-0840	IU24D
	XL 100 (ALL VARIANT)		267700-0840	IU24D
	ZEST 110		267700-0840	IU24D
SINGAPORE	<b>YAMAHA</b>			
	ALPHA	-2015.02	067700-9481	IUF22
	CRUX (ALL MODELS)		067700-9381	IX22B
TAIWAN	ENTICER		067700-9481	IUF22
	FAZER-FI		067700-9481	IUF22
	FZ 16 (150CC)		267700-0840	IU24D
THAILAND	FZ S		267700-0840	IU24D
	FZ V3.0 (BS-VI), FZS-FI V3.0 (BS-VI)		267700-0840	IU24D
	FZ-FI		267700-0840	IU24D
VIETNAM	FZ-S FI 150cc	2018.08-	267700-0840	IU24D
	G5		067700-9381	IX22B
	GLADIATOR		067700-9481	IUF22
JAPAN	LIBERO (ALL MODELS)		067700-9381	IX22B
	RAY		067700-9481	IUF22
	RAY-Z		067700-9481	IUF22
EUROPE & USA	RX100		067700-9411	IWF22
	RX135		067700-9411	IWF22
	RX-Z		067700-9411	IWF22
CROSS REFERENCE	SALUTO 125CC		267700-0830	IU22D
	SALUTO RX 110CC	2016.04-	067700-9481	IUF22
	SS 125		067700-9481	IUF22
PART NUMBER	SZ-RR 2.0		267700-0840	IU24D
	SZ-S		267700-0840	IU24D
	YBR 110		067700-9481	IUF22
	YBX		067700-9481	IUF22
	YD		067700-9481	IUF22
	YZF R15		067700-9272	IU24
	YZF R15 2.0		067700-9272	IU24
	YZF R3A		067700-9272	IU24



MODEL	YEAR	ENGINE	DENSO	IRIDIUM ★	TJ	IRIDIUM POWER	IRIDIUM TOUGH	
<b>AMC</b>								
CJ5, CJ6, CJ7		J5R-800	J16HR-U10	-	-	-	-	AUSTRALIA
<b>AUDI</b>								
A3, A4, A5, A6, A8		ABC	K20PBR-S10	IK20TT	K20TT	IK20	VK20	CHINA
Q5			K20PBR-S10	IK20TT	K20TT	IK20	VK20	
TT			K20PBR-S10	IK20TT	K20TT	IK20	VK20	INDIA
<b>BMW</b>								
325			W16EXR-U	IW16TT	W16TT	IW16	VW16	INDONESIA
523	1987-1992		W16EXR-U	IW16TT	W16TT	IW16	VW16	
318i	1984-1985		W16EXR-U	IW16TT	W16TT	IW16	VW16	
325i	1991-1999		K20TXR	IK20TT	K20TT	IK20	VK20	KOREA
	1993-2005		K20TXR	IK20TT	K20TT	IK20	VK20	
328i	2006-		K20HR-U11	IKH20TT	KH20TT	IKH20	VKH20	INDONESIA
			K20HR-U11	IKH20TT	KH20TT	IKH20	VKH20	
520i	2007-2009		K20TXR	IK20TT	K20TT	IK20	VK20	KOREA
	1996-2000		K20HR-U11	IKH20TT	KH20TT	IKH20	VKH20	
520i, 523i			K20TXR	IK20TT	K20TT	IK20	VK20	KOREA
730i V8, 740i V8, 740iL V8			K20TXR	IK20TT	K20TT	IK20	VK20	
<b>CHEVROLET</b>								
AVEO 1.5L		E-TEC II	W20EXR-U	IW20TT	W20TT	IW20	VW20	MALAYSIA
CAPTIVA		ECOTEC	W20EXR-U	IW20TT	W20TT	IW20	VW20	
KALOS		F14D3	K20PR-U11	IK20TT	K20TT	IK20	VK20	PHILIPPINES
SPARK 1.8L		S-TEC II	W16EXR-U	IW16TT	W16TT	IW16	VW16	
		LS-TECH	XU22PR9	-	XU22TT	IXU22	VXU22	
SPIN			XU22PR9	-	XU22TT	IXU22	VXU22	SINGAPORE
TAVERA 2.2L, NEW BLAZER 2.2L			K16PR-U	IK16TT	K16TT	IK16	VK16	
ZAFIRA 1.8L			K16PR-U	IK16TT	K16TT	IK16	VK16	SAUDI ARABIA
<b>CHRYSLER</b>								
CHEROKEE 2.5L		KENOSHA	KJ16CR-L11	IK16TT	K16TT	IK16L	-	TAIWAN
CHEROKEE COUNTRY		KENOSHA	KJ16CR-L11	IK16TT	K16TT	IK16L	-	
CHEROKEE LIMITED (+) (XJ)		KENOSHA	KJ16CR-L11	IK16TT	K16TT	IK16L	-	
CHEROKEE SPORT		KENOSHA	KJ16CR-L11	IK16TT	K16TT	IK16L	-	
GRAND CHEROKEE (ZJ)		KENOSHA	KJ16CR-L11	IK16TT	K16TT	IK16L	-	
WRANGLER (YJ)		KENOSHA	KJ16CR-L11	IK16TT	K16TT	IK16L	-	
<b>CITROEN</b>								
BX 19 GTi			Q20P-U	IQ20TT	Q20TT	IQ20	VQ20	VIETNAM
CX Pallas, DYANE, PFAF			W20FP-U	-	WF20TT	IWF20	-	
GS, GS Pallas, CHIC			W20EX-U	IW20TT	W20TT	IW20	VW20	
VAN CLUB 1220, COTTAGE			W20EX-U	IW20TT	W20TT	IW20	VW20	
<b>DAEWOO</b>								
ESPIRO, NEXIA, MATIZ			W16EXR-U	IW16TT	W16TT	IW16	VW16	THAILAND
<b>DAIHATSU</b>								
AYLA		1KR-FE	XU20HR9	-	XUH20TTI	IXUH20I	VXUH20I	VIETNAM
CERIA		ED-10	W20EX-U	IW20TT	W20TT	IW20	VW20	
CHARADE 1.0 CX		CB-23	W16EX-U	IW16TT	W16TT	IW16	VW16	VIETNAM
CHARADE 1.0, XG		CB-41	W16EX-U	IW16TT	W16TT	IW16	VW16	
CHARADE TURBO 1.0		CB-60	W16EX-U	IW16TT	W16TT	IW16	VW16	
CHARMANT		4A	W16EX-U	IW16TT	W16TT	IW16	VW16	VIETNAM
CLASSY, WINNER		HL-C	K20PR-U11	IK20TT	K20TT	IK20	VK20	
ESPASS 1.5 (EFI)		HC-E	K20TNR-S	IK20TT	K20TT	IK20	VK20	VIETNAM
ESPASS 1.6		HD	K20P-U	IK20TT	K20TT	IK20	VK20	
FELLOW MAX		ZM	W20EP-U	IW20TT	W20TT	IW20	VW20	VIETNAM
FEROZA, TARUNA		HD-C	K20PR-U11	IK20TT	K20TT	IK20	VK20	
GRAND MAX		K3/3SZ	XU22PR9	-	XU22TT	IXU22	VXU22	VIETNAM
HIJET 1000, ZEBRA 1.0		CB-41	W16EX-U	IW16TT	W16TT	IW16	VW16	
HIJET 55 WIDE		AB-20	W16EX-U	IW16TT	W16TT	IW16	VW16	VIETNAM
HIJET S38P		ZM	W20EP-U	IW20TT	W20TT	IW20	VW20	
LUXIO		3SZ	XU22PR9	-	XU22TT	IXU22	VXU22	VIETNAM
SIRION			K20PR-U11	IK20TT	K20TT	IK20	VK20	
TARUNA (EFI)		AD-E	K20TNR-S	IK20TT	K20TT	IK20	VK20	VIETNAM
TERIOS			XU22PR9	-	XU22TT	IXU22	VXU22	
XENIA 1.0		EJ-DE	K16PR-U11	IK16TT	K16TT	IK16	VK16	VIETNAM
XENIA VVTi			XU22PR9	-	XU22TT	IXU22	VXU22	
XENIA<NEW>			SC16HR11	IXEH20TT	-	-	VCH16	VIETNAM
YRV		K3-VE	K20R-U11	IK20TT	K20TT	IK20	VK20	
ZEBRA 1.3, ESPASS 1.3		HC	K20P-U	IK20TT	K20TT	IK20	VK20	JAPAN

DENSO	9	14	16	20	22	24	27	29	31	32	34	35
NGK	2	4	5	6	7	8	9	9.5	10	10.5	11	11.5

DENSO	9	14	16	20	22	24	27	29	31	32
CHAMPION	18	16,14	12,11	10,9	8,7	6,63,61	4,59	57	55	53

DENSO	9	14	16	20	22	24	27	31
BOSCH	10	9	8	7,6	5	4	3	2

AUSTRALIA  
 CHINA  
 INDIA  
 INDONESIA  
 KOREA  
 MALAYSIA  
 PHILIPPINES  
 SAUDI ARABIA  
 SINGAPORE  
 TAIWAN  
 THAILAND  
 VIETNAM  
 JAPAN  
 EUROPE  
 & USA  
 CROSS  
 REFERENCE  
 PART  
 NUMBER



	MODEL	YEAR	ENGINE	DENSO	IRIDIUM TIGHT	IRIDIUM RACING	IRIDIUM POWER	IRIDIUM TOUGH
<b>AUSTRALIA</b>								
<b>FORD</b>								
	CHALLENGE/BRILLIANT 2.0L		FS	K16PR-U	IK16TT	K16TT	IK16	VK16
	ESCAPE 2.0L			PT16VR10	ITV16TT	-	ITV16	-
<b>CHINA</b>								
	EVEREST			T20EPR-U15	IT20TT	T20TT	IT20	VT20
	FIESTA			T20EPR-U15	IT20TT	T20TT	IT20	VT20
<b>INDIA</b>								
	FOCUS			-	IT20TT	-	IT20	VT20
	LASER 1.3L		E3	W20EP-U	IW20TT	W20TT	IW20	VW20
	LASER 1.5L		E5	W20EP-U	IW20TT	W20TT	IW20	VW20
	LASER CHAM 1.8L		BP	K20PR-U	IK20TT	K20TT	IK20	VK20
	LASER GALA 1.6L		B6	K20PR-U	IK20TT	K20TT	IK20	VK20
	LASER GHIA 1.6L <NEW>		B6	K16PR-U	IK16TT	K16TT	IK16	VK16
	LASER GHIA 1.8L <NEW>		BP	K16PR-U	IK16TT	K16TT	IK16	VK16
<b>INDONESIA</b>								
	LASER SONIC 1.3L		B3	K20PR-U	IK20TT	K20TT	IK20	VK20
	LINX 1.8L			K20PR-U11	IK20TT	K20TT	IK20	VK20
	RANGER			T20EPR-U15	IT20TT	T20TT	IT20	VT20
	TELSTAR GRAND		FE	Q20PR-U	IQ20TT	Q20TT	IQ20	VQ20
	TELSTAR THUNDER		FE	Q20PR-U	IQ20TT	Q20TT	IQ20	VQ20
<b>KOREA</b>								
<b>HOLDEN</b>								
	CALLAIS			Q20P-U	IQ20TT	Q20TT	IQ20	VQ20
	GEMINI, CAMIRA, TORANA 1.3L			W20EX-U	IW20TT	W20TT	IW20	VW20
<b>MALAYSIA</b>								
<b>HONDA</b>								
	ACCORD		NP2	-	IXEH22TT	-	-	VCH20
	ACCORD 3.5			SXU22HCR11S	-	-	-	-
	ACCORD CIELO		SV4	KJ20CR-L11	IK20TT	K20TT	IK20L	-
	ACCORD ELEGEND		JHM	W20EXR-U11	IW20TT	W20TT	IW20	VW20
	ACCORD EXECUTIVE 1.6L		SA6	W20EXR-U11	IW20TT	W20TT	IW20	VW20
	ACCORD MAESTRO		SM4	KJ16CR-L11	IK16TT	K16TT	IK16L	-
	ACCORD PRESTIGE		SE3	W20EXR-U11	IW20TT	W20TT	IW20	VW20
	ACCORD VTI		SB6	KJ20CR-L11	IK20TT	K20TT	IK20L	-
	ALL NEW ACCORD		L15BG	SXU22HCR11S	-	-	-	-
	ALL NEW BRIO		L12	K20PR-U11	IK20TT	K20TT	IK20	VK20
	BRIO/BRIO SATYA		L13A/L12B	K20PR-U11	IK20TT	K20TT	IK20	VK20
	CITY		SX8	K16PR-U11	IK16TT	K16TT	IK16	VK16
	CITY <NEW>			K20PR-U11	IK20TT	K20TT	IK20	VK20
	CIVIC EXCELLENT 1.3L, 1.5L		JHM	W20EXR-U11	IW20TT	W20TT	IW20	VW20
	CIVIC FACELIFT 2.0			K20PR-U	IK20TT	K20TT	IK20	VK20
	CIVIC FERIO, JM		SO4	K16PR-U11	IK16TT	K16TT	IK16	VK16
	CIVIC GENIO, ESTILO		SR3/SR4	K20PR-U11	IK20TT	K20TT	IK20	VK20
	CIVIC GRAND		SH3/SH4	K16PR-U11	IK16TT	K16TT	IK16	VK16
	CIVIC Type R		K20C1	SKJ20DR-M11	IK20TT	-	IK20L	-
	CIVIC WONDER		SB3/SB4	W20EXR-U11	IW20TT	W20TT	IW20	VW20
	CRV			SKJ20DR-M11	IK20TT	-	IK20L	-
	FIT			K20PR-U11	IK20TT	K20TT	IK20	VK20
	FREED			K20PR-U11	IK20TT	K20TT	IK20	VK20
	HRV 1.5		D15A	K20PR-U11	IK20TT	K20TT	IK20	VK20
	HRV 1.8		D18A	SXU22HCR11S	-	-	-	-
	JAZZ			K20PR-U11	IK20TT	K20TT	IK20	VK20
	JAZZ RS			SKJ20DR-M11	IK20TT	-	IK20L	-
	MOBILIO		L15A1	K20PR-U11	IK20TT	K20TT	IK20	VK20
	NEW CIVIC Hatchback RS		L15B	K20PR-U11	IK20TT	K20TT	IK20	VK20
	NEW CIVIC Turbo		L15B7	K20PR-U11	IK20TT	K20TT	IK20	VK20
	ODDYSSEY			KJ16CR-L11	IK16TT	K16TT	IK16L	-
	STREAM 1.7			KJ20CR-L11	IK20TT	K20TT	IK20L	-
	STREAM 2.0			KJ20DR-M11	IK20TT	K20TT	IK20L	-
<b>HYUNDAI</b>								
	ACCENT 1.5			K16R-U11	IK16TT	K16TT	IK16	VK16
	ACCENT, CAKRA			Q20PR-U	IQ20TT	Q20TT	IQ20	VQ20
	ATOZ			K20PR-U	IK20TT	K20TT	IK16	VK16
	AVEGA			K16PR-U11	IK16TT	K16TT	IK16	VK16
	AVEGA <GRAND>			-	-	-	IXUH22I	VXUH22I
	COUPE 1.5i			K20PR-U11	IK20TT	K20TT	IK20	VK20
	ELANTRA, NENGGALA			W20EPR-U	IW20TT	W20TT	IW20	VW20
	EXEL 1.5i			K20PR-U11	IK20TT	K20TT	IK20	VK20
	GETZ			K16PR-U11	IK16TT	K16TT	IK16	VK16
	MATRIX			K16R-U11	IK16TT	K16TT	IK16	VK16
	MATRIX 1600cc			K20PR-U	IK20TT	K20TT	IK20	VK20
	SANTA FE			PK16PR-L11	IK16TT	-	IK16	VK16
	SONATA			W20EPR-U11	IW20TT	W20TT	IW20	VW20



MODEL	YEAR	ENGINE	DENSO	IRIDIUM U	TJ	IRIDIUM POWER	IRIDIUM TOUGH	
<b>HYUNDAI</b>								
TRAJET 2.0			W20EXR-U	IW20TT	W20TT	IW20	VW20	AUSTRALIA
TUCSON			K16PR-U11	IK16TT	K16TT	IK16	VK16	
VERNA			K16PR-U11	IK16TT	K16TT	IK16	VK16	
<b>ISUZU</b>								
TROOPER 3,2L			K20PR-U11	IK20TT	K20TT	IK20	VK20	CHINA
TROOPER 3,5L			PK16PR11	IK16TT	-	IK16	VK16	
<b>KIA</b>								
CARENS 1.8/2.0 (DOHC)			K20PR-U	IK20TT	K20TT	IK20	VK20	INDIA
CARNIVAL GSL 2.5 (DOHC)			K20PR-U11	IK20TT	K20TT	IK20	VK20	
CARNIVAL LPG 2.5 (DOHC)			K20PR-U	IK20TT	K20TT	IK20	VK20	
PICANTO (NEW)			XU20HR9	-	XUH20TTI	IXUH20I	VXUH20I	
PICANTO 1.0			K16PR-U	IK16TT	K16TT	IK16	VK16	INDONESIA
RIO 1.5, SHUMA 1.8, SPECTRA 1.8			K20PR-U	IK20TT	K20TT	IK20	VK20	
SEDONA 2.5			K16PR-U11	IK16TT	K16TT	IK16	VK16	
SEDONA 2.9			K16PR-U11	IK16TT	K16TT	IK16	VK16	
SORENTO			K16PR-U11	IK16TT	K16TT	IK16	VK16	KOREA
SPORTAGE 2.0 (DOHC)			K20PR-U11	IK20TT	K20TT	IK20	VK20	
SPORTAGE 2.0 (SOHC)			K16PR-U	IK16TT	K16TT	IK16	VK16	
VISTO			K16PR-U11	IK16TT	K16TT	IK16	VK16	
<b>LAND-ROVER</b>								
DEFENDER 3.9L			W16EPR-U	IW16TT	W16TT	IW16	VW16	MALAYSIA
DISCOVERY 3.9L			W16EPR-U	IW16TT	W16TT	IW16	VW16	
FREE LANDER 1.8L			W16EPR-U	IW16TT	W16TT	IW16	VW16	
RANGE ROVER 4.0L, 4.6L <NEW>			W16EPR-U	IW16TT	W16TT	IW16	VW16	PHILIPPINES
RANGE ROVER CLASSIC 3.9L			W16EPR-U	IW16TT	W16TT	IW16	VW16	
<b>MAZDA</b>								
626	1987-	FE	Q20PR-U	IQ20TT	Q20TT	IQ20	VQ20	SAUDI ARABIA
323 ELITE		E3	W16EX-U	IW16TT	W16TT	IW16	VW16	
323 INTERPLAY		B6N	K16PR-U	IK16TT	K16TT	IK16	VK16	
626 CAPELLA	1989-	FE	Q20PR-U	IQ20TT	Q20TT	IQ20	VQ20	
626 COUPE MX6		FE	Q20PR-U	IQ20TT	Q20TT	IQ20	VQ20	
808, 616, 929			W16EX-U	IW16TT	W16TT	IW16	VW16	
ASTINA (DOHC)		BP	K16PR-U11	IK16TT	K16TT	IK16	VK16	SINGAPORE
B600			W20EP-U	IW20TT	W20TT	IW20	VW20	
BIANTE		LF-VD	-	ITV16TT	-	ITV16	-	
BT-50		MZ-DE	-	ITV20TT	-	ITV20	-	
CRONOS 2.0L		FSN	K16PR-U11	IK16TT	K16TT	IK16	VK16	TAIWAN
CRONOS 2.5L		KL	K16PR-U11	IK16TT	K16TT	IK16	VK16	
CX-7		MZR 2.3	-	ITV20TT	-	ITV20	-	
CX-9		MZI 3.7	-	ITV20TT	-	ITV20	-	
E 2000		FE	Q20PR-U	IQ20TT	Q20TT	IQ20	VQ20	THAILAND
FAMILIA		BPD	K16PR-U11	IK16TT	K16TT	IK16	VK16	
H 1000, 2000, 3000			W16EX-U	IW16TT	W16TT	IW16	VW16	
LANTIS		BPG	K16PR-U11	IK16TT	K16TT	IK16	VK16	VIETNAM
MAZDA 2			PT16EPR-L13	IT16TT	-	IT16	VT16	
	2009-	MZR 1.5	K16PR-U11	IK16TT	K16TT	IK16	VK16	
MAZDA 6			PT16EPR-L13	IT16TT	-	IT16	VT16	
MAZDA 8		L3VE	-	ITV16TT	-	ITV16	-	
MR 90, VAN TREND		UCN	W16EX-U	IW16TT	W16TT	IW16	VW16	
RX-8		RENESIS	-	-	-	IRL01-27	-	
VX-1		K14B	XU20EPR-U	-	-	IXU20	VXU20	
<b>MERCEDES BENZ</b>								
180, 190		M 102	W16EP-U	IW16TT	W16TT	IW16	VW16	JAPAN
200 (W123)		M 102	W20EP-U	IW20TT	W20TT	IW20	VW20	
200, 230		M 115	W16EX-U	IW16TT	W16TT	IW16	VW16	
200E (W124)		M 103	T20EP-U	IT20TT	T20TT	IT20	VT20	EUROPE
230 (W123)		M 102	W20EP-U	IW20TT	W20TT	IW20	VW20	
230 S		M 115	W20EX-U	IW20TT	W20TT	IW20	VW20	
230E (W124)		M 103	T20EP-U	IT20TT	T20TT	IT20	VT20	CROSS
250, 250 S		M 123	W20EX-U	IW20TT	W20TT	IW20	VW20	
280 (W123)		M 110	W20EP-U	IW20TT	W20TT	IW20	VW20	
280, 280 S, 280 E		M 110	W20EP-U	IW20TT	W20TT	IW20	VW20	
280E (W123)		M 102	W20EP-U	IW20TT	W20TT	IW20	VW20	PART
300 SEL		M 104	K20P-U	IK20TT	K20TT	IK20	VK20	
300E (W124)		M 103	T20EP-U	IT20TT	T20TT	IT20	VT20	NUMBER
C180, C200, C230		M 111	Q16P-U11	IQ16TT	Q16TT	IQ16	VQ16	
E220, E230 (W210)		M 111	Q16P-U11	IQ16TT	Q16TT	IQ16	VQ16	

DENSO	9	14	16	20	22	24	27	29	31	32	DENSO	9	14	16	20	22	24	27	29	31	32	DENSO	9	14	16	20	22	24	27	31		
NGK	2	4	5	6	7	8	9	9.5	10	10.5	11	11.5	CHAMPION	18	16,14	12,11	10,9	8,7	6,63,61	4,59	57	55	53	BOSCH	10	9	8	7,6	5	4	3	2



	MODEL	YEAR	ENGINE	DENSO	IRIDIUM TT	IRIDIUM RACING	IRIDIUM POWER	IRIDIUM TOUGH
AUSTRALIA	<b>MERCEDES BENZ</b>							
	E320 (W124), S320		M 104	Q16P-U11	IQ16TT	Q16TT	IQ16	VQ16
	E320 (W210)		M 104	Q16P-U11	IQ16TT	Q16TT	IQ16	VQ16
	JEEP 280 GE		M 110	W20EP-U	IW20TT	W20TT	IW20	VW20
CHINA	JEEP 300 GE		M 104	Q16P-U11	IQ16TT	Q16TT	IQ16	VQ16
	<b>MITSUBISHI</b>							
	COLT L300		4G32	W20EP-U	IW20TT	W20TT	IW20	VW20
	COLT T120 SS		4G17	W20EP-U	IW20TT	W20TT	IW20	VW20
INDIA	DAN GAN 1.5L		4G15	W22EP-U	-	W22TT	IW22	VW22
	DAN GAN 1.5L SOHC		4G15	W22EP-U	-	W22TT	IW22	VW22
	DAN GAN 1.6L DOHC		4G61	W20EP-U	IW20TT	W20TT	IW20	VW20
	DAN GAN 1.8L DOHC		4G67	W16EP-U	IW16TT	W16TT	IW16	VW16
INDONESIA	ECLIPSE CROSS		4B40	-	-	-	-	-
	ETERNA 2.0L	1987-	4G63	W20EP-U	IW20TT	W20TT	IW20	VW20
	ETERNA 2.0L DOHC		4G63	W22EP-U	-	W22TT	IW22	VW22
	ETERNA 2.0L SOHC		4G63	W20EP-U	IW20TT	W20TT	IW20	VW20
KOREA	GALANT II 1.8L		4G37	K20P-U	IK20TT	K20TT	IK20	VK20
	GALANT SIGMA 1.6L YC		4G32	W20EP-U	IW20TT	W20TT	IW20	VW20
	GALANT SIGMA 1.6L YD		4G32	W20EP-U	IW20TT	W20TT	IW20	VW20
	GALANT SIGMA 2.0L YC		4G52	W20EP-U	IW20TT	W20TT	IW20	VW20
	GALANT SIGMA 2.0L YD		4G63	W20EP-U	IW20TT	W20TT	IW20	VW20
MALAYSIA	GALANT ST 2.5L		6A13	K20PR-U	IK20TT	K20TT	IK20	VK20
	GALANT V6 2.0L		6A12	K16P-U	IK16TT	K16TT	IK16	VK16
	GALANT VR 2.0L		4G63	K20PR-U	IK20TT	K20TT	IK20	VK20
PHILIPPINES	GRANDIS		4G69	IKH20	IKH20TT	-	IKH20	VKH20
	JET STAR		U21	W16EX-U	IW16TT	W16TT	IW16	VW16
	KUDA 1.6L		4G18	W16EP-U	IW16TT	W16TT	IW16	VW16
	LANCER EX 2.0 GT <NEW>			PQ16R	IQ16TT	-	IQ16	VQ16
	LANCER GLX, SEI 1.6L		4G92	W20EP-U	IW20TT	W20TT	IW20	VW20
	LANCER LA 1.4L		4G33	W20EP-U	IW20TT	W20TT	IW20	VW20
	LANCER LA 1.6L		3G32	W20EP-U	IW20TT	W20TT	IW20	VW20
	LANCER SL 1.4L		4G33	W20EP-U	IW20TT	W20TT	IW20	VW20
	LE-DAN GAN 1.5L SOHC		4G15	K16P-U	IK16TT	K16TT	IK16	VK16
	LE-DAN GAN 1.6L SOHC		4G92	K20P-U	IK20TT	K20TT	IK20	VK20
	LE-DAN GAN 1.8L DOHC		4G93	W16EP-U	IW16TT	W16TT	IW16	VW16
	MAVEN		4G15	K20PR-U	IK20TT	K20TT	IK20	VK20
	SINGAPORE	MIRAGE		3A92	K16PR-U	IK16TT	K16TT	IK16
OUTLANDER				FXE20HR11	IXEH20TT	-	-	VFXEH20
OUTLANDER SPORT			4B11	K20P-U	IK20TT	K20TT	IK20	VK20
PAJERO			4G72	W20EP-U	IW20TT	W20TT	IW20	VW20
TAIWAN	XPANDER		4A91	K16HPR-U11	IKH16TT	KH16TT	IKH16	VKH16
	XPANDER CROSS		4A91	K16HPR-U11	IKH16TT	KH16TT	IKH16	VKH16
THAILAND	<b>NISSAN</b>							
	ALL NEW LIVINA		4A91	K16HPR-U11	IKH16TT	KH16TT	IKH16	VKH16
	ALL NEW SERENA		M20	FXE20HE11	IXEH20TT	-	-	-
	CEFIRO		RB20E	Q20PR-U11	IQ20TT	Q20TT	IQ20	VQ20
	DATSUN GO/GO+		HR12DE	FXE20HR11	IXEH20TT	-	-	VFXEH20
VIETNAM	EVALIA			FXE20HR11	IXEH20TT	-	-	VFXEH20
	GENESIS		GA16CE	Q20PR-U	IQ20TT	Q20TT	IQ20	VQ20
	INFINITY		VQ30	K20PR-U	IK20TT	K20TT	IK20	VK20
	JUKE, EVALIA		HR15DE	FXE20HR11	IXEH20TT	-	-	VFXEH20
JAPAN	LAUREL		L 20 B	W20EP-U	IW20TT	W20TT	IW20	VW20
	LIVINA, GRAND LIVINA, LIVINA X-GEAR		HR15DE	FXE20HR11	IXEH20TT	-	-	VFXEH20
	MARCH		HR12DE	VFXEH20	IXEH20TT	-	-	VFXEH20
	MURANO, ELGRAND		VQ35DE	VKH16	IKH16TT	-	IKH16	VKH16
& EUROPE	N 1400, 120 J, 160 J, 180 B			W16EX-U	IW16TT	W16TT	IW16	VW16
	N 260C, 280C, 1600 (SSS)			W20EX-U	IW20TT	W20TT	IW20	VW20
	PATROL (4 Sil.-Carburator)		TB42S	W20EP-U	IW20TT	W20TT	IW20	VW20
	PATROL (6 Sil.-Injection)		TB24	W20EP-U	IW20TT	W20TT	IW20	VW20
	PICK UP 800, 1500, 1600 SENA			W16EX-U	IW16TT	W16TT	IW16	VW16
CROSS REFERENCE	SENTRA		E16	W20EP-U	IW20TT	W20TT	IW20	VW20
			GA16S	Q20P-U11	IQ20TT	Q20TT	IQ20	VQ20
	SENTRA COUPE		CA16DE	Q20PR-U11	IQ20TT	Q20TT	IQ20	VQ20
	SERENA 2.0L		5R20	Q20PR-U	IQ20TT	Q20TT	IQ20	VQ20
	STANZA 1.6L		CA 16	W16EP-U	IW16TT	W16TT	IW16	VW16
PART NUMBER	TEANA <NEW>		VQ25DE	FXE20HR11	IXEH20TT	-	-	VFXEH20
	TERRANO		Z24	W20EP-U	IW20TT	W20TT	IW20	VW20
	X-TRAIL		MR20DD	FXE20HR11	IXEH20TT	-	-	VFXEH20





MODEL	YEAR	ENGINE	DENSO	IRIDIUM U	TJ	IRIDIUM POWER	IRIDIUM TOUGH	
<b>NISSAN</b>								
X-TRAIL <NEW>		QR25DE	K16HPR-U11	IKH16TT	KH16TT	IKH16	VKH16	AUSTRALIA
X-TRAIL 2.5		QR25DE	K16HPR-U11	IKH16TT	KH16TT	IKH16	VKH16	
<b>OPEL</b>								
ADMIRAL			W20FP-U <sub>s</sub>	-	WF20TT	IWF20	-	CHINA
BLAZER 2.2i DOHC		SEC/DOHC	K20TXR	IK20TT	K20TT	IK20	VK20	
BLAZER 2.2i SOHC		NEC/SOHC	K20TXR	IK20TT	K20TT	IK20	VK20	
KADETT 1.3L			W16EX-U	IW16TT	W16TT	IW16	VW16	
KAPTAIN			W20FP-U <sub>s</sub>	-	WF20TT	IWF20	-	INDIA
OPTIMA CDX, CDX A 1.8i, CLUB		SE OHC II	W16EPR-U	IW16TT	W16TT	IW16	VW16	
OPTIMA GLS 1.8i		SE OHC II	W16EPR-U	IW16TT	W16TT	IW16	VW16	
OPTIMA SPORT 1.8L		SE OHC II	W16EPR-U	IW16TT	W16TT	IW16	VW16	
OPTIMA SPORT 2.0L		NE OHC II	K20TXR	IK20TT	K20TT	IK20	VK20	INDONESIA
REKORD E 1.7L			W20FP-U <sub>s</sub>	-	WF20TT	IWF20	-	
REKORD E 1.9L			W20FP-U <sub>s</sub>	-	WF20TT	IWF20	-	
TROOPER HIGH ROOF		ZDI/SOHC	W20EX-U	IW20TT	W20TT	IW20	VW20	
VECTRA CD 2.0i		NE OHC II	K20TXR	IK20TT	K20TT	IK20	VK20	
<b>PEUGEOT</b>								
306		XU7	K20TXR	IK20TT	K20TT	IK20	VK20	KOREA
406		XU10	K20TXR	IK20TT	K20TT	IK20	VK20	
604			T20EP-U	IT20TT	T20TT	IT20	VT20	
605		XU10	K20TXR	IK20TT	K20TT	IK20	VK20	MALAYSIA
807			K16HPR-U11	IKH16TT	KH16TT	IKH16	VKH16	
304 S	1975-	XL5	W24EP-U	-	-	IW24	VW24	PHILIPPINES
307 1.6 XS			K20HR-U11	IKH20TT	KH20TT	IKH20	VKH20	
404 Carburator			W20EP-U	IW20TT	W20TT	IW20	VW20	
405 SR		XU92C	Q22PR-U	-	-	IQ22	VQ22	SAUDI ARABIA
405 Sri		XU9J2	Q22PR-U	-	-	IQ22	VQ22	
504 Carburator		XLJ	W20EP-U	IW20TT	W20TT	IW20	VW20	SINGAPORE
505 GR <OLD>		Xni	W20EP-U	IW20TT	W20TT	IW20	VW20	
505 GTI		2DJ5	T20EP-U	IT20TT	T20TT	IT20	VT20	
506 GR <NEW>		XNiA	W20EP-U	IW20TT	W20TT	IW20	VW20	TAIWAN
<b>RENAULT</b>								
12 TL/SL, 15 TL			W20EP-U	IW20TT	W20TT	IW20	VW20	THAILAND
16 TL, 18 TL, 21 TL			W20EP-U	IW20TT	W20TT	IW20	VW20	
CLIO 1.4, SCENIC 1.9			K20PR-U	IK20TT	K20TT	IK20	VK20	VIETNAM
KANGOO 1.4			K16PR-U	IK16TT	K16TT	IK16	VK16	
<b>SSANGYONG</b>								
SG 320		M104	Q16P-U11	IQ16TT	Q16TT	IQ16	VQ16	JAPAN
<b>SUZUKI</b>								
APV, APV ARENA			K20PR-U	IK20TT	K20TT	IK20	VK20	EUROPE & USA
BALENO, AERIO		G16A	K20PR-U11	IK20TT	K20TT	IK20	VK20	
CARRY 1.3 FUTURA		G13C	W16EX-U	IW16TT	W16TT	IW16	VW16	CROSS REFERENCE NUMBER
CARRY 1.6 FUTURA		G16C	W16EX-U	IW16TT	W16TT	IW16	VW16	
CARRY ST 100		F10A	W16EX-U	IW16TT	W16TT	IW16	VW16	
CARRY ST 20		LJ50	W16FP-U <sub>s</sub>	-	-	IWF16	-	PART
ERTIGA		K14B	XU20EPR-U	-	-	IXU20	VXU20	
ESCUDO, SIDE KICK		G16A	W20EX-U	IW20TT	W20TT	IW20	VW20	
ESTEEM 1.3 (SOHC)		G13B	W20EP-U	IW20TT	W20TT	IW20	VW20	
ESTEEM 1.6 GT (SOHC)		G13A	K20P-U	IK20TT	K20TT	IK20	VK20	
FORSA AMENITY SF 413		G13C	W20EP-U	IW20TT	W20TT	IW20	VW20	
FORSA SA 410		F10A	W16EX-U	IW16TT	W16TT	IW16	VW16	
GRAND ESCUDO		J20A	K20PR-U11	IK20TT	K20TT	IK20	VK20	
GRAND VITARA			K20PR-U11	IK20TT	K20TT	IK20	VK20	
JIMNY		F8A	W16EX-U	IW16TT	W16TT	IW16	VW16	
KARIMUN		F10A	W16EX-U	IW16TT	W16TT	IW16	VW16	
KARIMUN ESTILO			XU22PR9	-	XU22TT	IXU22	VXU22	
KARIMUN WAGON R			-	-	-	IXU22	VXU22	
SUPER JIMNY, KATANA SJ 410V, GX		F10A	W16EX-U	IW16TT	W16TT	IW16	VW16	
SWIFT <NEW>			-	-	-	IXU22	VXU22	
SWIFT SA 310		G10	W16EX-U	IW16TT	W16TT	IW16	VW16	
SX4			K20PR-U11	IK20TT	K20TT	IK20	VK20	
VITARA SE 416		G16A	W20EX-U	IW20TT	W20TT	IW20	VW20	
WAGON R		K10B	XU20EPR-U	-	-	IXU20	VXU20	
XL-7			K20PR-U11	IK20TT	K20TT	IK20	VK20	
<b>TIMOR-KIA</b>								
CARNIVAL			K20PR-U11	IK20TT	K20TT	IK20	VK20	
S515		B5	W16EPR-U11	IW16TT	W16TT	IW16	VW16	

DENSO	9	14	16	20	22	24	27	29	31	32	34	35
NGK	2	4	5	6	7	8	9	9.5	10	10.5	11	11.5

DENSO	9	14	16	20	22	24	27	29	31	32
CHAMPION	18	16,14	12,11	10,9	8,7	6,63,61	4,59	57	55	53

DENSO	9	14	16	20	22	24	27	31
BOSCH	10	9	8	7,6	5	4	3	2



	MODEL	YEAR	ENGINE	DENSO					
AUSTRALIA	<b>TIMOR-KIA</b>								
	S515i		B5	K16PR-U11	IK16TT	K16TT	IK16	VK16	
	<b>TOYOTA</b>								
	AGYA		1KR-FE	XU20HR9	-	XUH20TTI	IXUH20I	VXUH20I	
CHINA	ALL NEW ALTIS		2ZR-FE	SC20HR11	IXEH22TT	-	-	VCH20	
	ALL NEW C-HR		2ZR-FBE	SC20HR11	IXEH22TT	-	-	VCH20	
	ALL NEW YARIS		2NR-FE	K16R-U	IK16TT	K16TT	IK16	VK16	
INDIA	ALPHARD 3.0		1MZ-FE	SK20R11	IK20TT	-	IK20	VK20	
	ALPHARD 3.5 <NEW>		2GR-FE	FK20HR11	IKH20TT	-	-	VFKH20	
	ALTIS		ZZ	K16R-U11	IK16TT	K16TT	IK16	VK16	
INDONESIA	AVANZA		NR	XU22PR9	-	XU22TT	IXU22	VXU22	
	AVANZA 1.3		K3-DE	K20PR-U	IK20TT	K20TT	IK20	VK20	
	AVANZA VVTI			XU22PR9	-	XU22TT	IXU22	VXU22	
KOREA	AVANZA<NEW>			SC16HR11	IXEH20TT	-	-	VCH16	
	CAMRY GLX 2.2L		5S-FE	K20TR11	IK20TT	K20TT	IK20	VK20	
	CAMRY GRAND 3.0L		1MZ-FE	K20TR11	IK20TT	K20TT	IK20	VK20	
MALAYSIA	CAMRY<NEW>		2AR-FE	SK20R11	IK20TT	-	IK20	VK20	
	COROLLA AE 101/111		4A-FE	K16R-U11	IK16TT	K16TT	IK16	VK16	
	COROLLA AE 112		7A	K20R-U	IK20TT	K20TT	IK20	VK20	
PHILIPPINES	COROLLA AE 80		2A	W16EX-U	IW16TT	W16TT	IW16	VW16	
	COROLLA AE 92		4A	Q16R-U	IQ16TT	Q16TT	IQ16	VQ16	
	COROLLA AE 92 GTI		4A-FE	K16R-U11	IK16TT	K16TT	IK16	VK16	
SAUDI ARABIA	COROLLA EE 80/90/100		2E	W20EXR-U	IW20TT	W20TT	IW20	VW20	
	CORONA AT 151		4A	W16EX-U	IW16TT	W16TT	IW16	VW16	
	CORONA AT 171		4A	Q16R-U	IQ16TT	Q16TT	IQ16	VQ16	
SINGAPORE	CORONA AT 190		4A	K16R-U11	IK16TT	K16TT	IK16	VK16	
	CORONA RX 60		21R	W16EXR-U	IW16TT	W16TT	IW16	VW16	
	CORONA ST 191		3S-FE	K20R-U11	IK20TT	K20TT	IK20	VK20	
TAIWAN	CRESSIDA GX 71		1G	W20EXR-U	IW20TT	W20TT	IW20	VW20	
	CROWN GS 131		1G-E	K20R-U11	IK20TT	K20TT	IK20	VK20	
	CROWN JZS 133		2G-FE	K20R-U	IK20TT	K20TT	IK20	VK20	
THAILAND	CROWN MS 111/122		5M	W16EXR-U	IW16TT	W16TT	IW16	VW16	
	ETIOS			K16HR-U11	IKH16TT	KH16TT	IKH16	VKH16	
	FORTUNER 2.7		3-2TR-FE	SK20HR11	IKH20TT	-	IKH20	VKH20	
VIETNAM	INNOVA			K20HR-U11	IKH20TT	KH20TT	IKH20	VKH20	
	KIJANG 2.0 L		1RZ-E	W16EXR-U	IW16TT	W16TT	IW16	VW16	
	KIJANG KF 20		4K	W16EX-U	IW16TT	W16TT	IW16	VW16	
JAPAN	KIJANG KF 21		5K	W16EX-U	IW16TT	W16TT	IW16	VW16	
	KIJANG KF 40/50		5K	W16EX-U	IW16TT	W16TT	IW16	VW16	
	KIJANG KF 42/52		7K	W16EX-U	IW16TT	W16TT	IW16	VW16	
EUROPE & USA	KIJANG KF 60/70/80		7K	W16EX-U	IW16TT	W16TT	IW16	VW16	
	KIJANG KF 72/82 (Carburator)		7K	W16EX-U	IW16TT	W16TT	IW16	VW16	
	KIJANG KF 72/82 (EFI)		7K-E	W16EXR-U11	IW16TT	W16TT	IW16	VW16	
CROSS REFERENCE NUMBER	LAND CRUISER FJ 40		2F	W14EX-U	IW16TT	W16TT	IW16	VW16	
	New AGYA		3NR-VE	XU20HR9	-	XUH20TTI	IXUH20I	VXUH20I	
	New COROLLA ALTIS		KE10	K20TXR	IK20TT	K20TT	IK20	VK20	
PART	PREVIA			PK20R11	IK20TT	-	IK20	VK20	
	RAV4 2.4, ALPHARD 2.4		2AZ-FE	K20R-U11	IK20TT	K20TT	IK20	VK20	
	RUSH		3SZ	XU22PR9	-	XU22TT	IXU22	VXU22	
PART	SOLUNA		5A-FE	K16R-U11	IK16TT	K16TT	IK16	VK16	
	STARLET EP 70/80		1E	W16EXR-U	IW16TT	W16TT	IW16	VW16	
	STARLET EP 71/81		2E	W20EXR-U	IW20TT	W20TT	IW20	VW20	
PART	TOYOTA 86			ZXE27HBR8	-	-	-	-	
	VELLFIRE 2.4 <NEW>		2AZ-FE	SK16R11	IK16TT	-	IK16	VK16	
	VIOS / ALL NEW VIOS		1NZ-FE	K16R-U	IK16TT	K16TT	IK16	VK16	
PART	YARIS / ALL NEW YARIS		1NZ-FE	K16R-U	IK16TT	K16TT	IK16	VK16	
	<b>VOLKSWAGEN</b>								
	BEETLE, COMBI, MITRA			W16FP-U	-	-	IWF16	-	
PART	CARAVELLE GL 2.5		AAF, ACU	W20EPBR-S	IW20TT	-	IW20	VW20	
	CARAVELLE GL 2.8		AET	W20EPBR-S	IW20TT	-	IW20	VW20	
	GOLF S/LS, PASSAT			W20EX-U	IW20TT	W20TT	IW20	VW20	
PART	SAFARI, GURSEL			W16FP-U	-	-	IWF16	-	
	V 1200, V 1300, V 1500			W16FP-U	-	-	IWF16	-	
	V 1302, V 1303			W16FP-U	-	-	IWF16	-	
PART	<b>VOLVO</b>								
	240, 245		B230E	W16EPR-U	IW16TT	W16TT	IW16	VW16	
	340 GL, 244 PL/GL		B23A	W16EPR-U	IW16TT	W16TT	IW16	VW16	
PART	740 GLE		B230E	W16EPR-U	IW16TT	W16TT	IW16	VW16	



MODEL	YEAR	ENGINE	DENSO				
<b>VOLVO</b>							
740 TI		B230GT	W20EPR-U	IW20TT	W20TT	IW20	VW20
850 GTL, S70 GTL		B5254S	Q20PR-U	IQ20TT	Q20TT	IQ20	VQ20
960 2.3 TURBO		B230GT	W20EPR-U	IW20TT	W20TT	IW20	VW20
960 3.0/EXECUTIVE		B6304G	W20EPR-U	IW20TT	W20TT	IW20	VW20
S70 T5		B5254T	Q22PR-U	-	-	IQ22	VQ22
V70		B5254S	Q20PR-U	IQ20TT	Q20TT	IQ20	VQ20

AUSTRALIA  
CHINA

# INDONESIA | MOTORCYCLE



MODEL	YEAR	DENSO		
<b>BAJAJ</b>				
ASTREA GRAND, WIN, SUPRA SERIES		U22FS-U	IUF22	-
BEAT (KVY)		U24EPR9	IU24	IU01-□
BEAT NEW Fi		U27EPR9	IU27	IU01-□
BLADE (KWB), BLADE NEW (K07A)		U20EPR9S	IU20	IU01-□
C700M, C800M, ASTREA 800, C700		U20FS-U	IUF22	-
PULSAR 180 DTSi		U27ESR-N	IU27	IU01-□
PULSAR 200 DTS-Fi		U27ESR-N	IU27	IU01-□
PULSAR 220 DTS-i		U24ESR-N	IU24	IU01-□
PULSAR XCD 125		U27ESR-N	IU27	IU01-□
<b>HONDA</b>				
BeAT		U24EPR-9	IU24	IU01-□
BeAT Street		U24ESR-N	IU24	IU01-□
C800, ASTREA STAR, ASTREA PRIMA		U22FS-U	IUF22	-
C90, S90Z		X20FS-U	-	-
CB 150 Verza, CB150 R		U27EPR-9	IU27	IU01-□
CB125S, CG125, CB200, MINICAR		X22EP-U	IX22B	IXU01-□
CB150		U27EPR9	IU27	IU01-□
CBR 150 (K15A), CBR 150 Fi		U27EPR9	IU27	IU01-□
CBR 150R		U24ESR-N	IU24	IU01-□
CBR 250		-	IU24	-
CBR 250RR		-	IU24	IU01-□
CITY SPORT 1		U24ESR-N	IU24	IU01-□
CRF 150L, CRF 250RALLY		U24FER9	IUH24	IU01-□
Genio		-	IU24	IU01-□
GL 100, GL MAX, GL PRO (CDI), CBX 650		X24EP-U9	IX24B	IXU01-□
GL MAX NEO TECH, KCJA (TIGER)		X24EP-U9	IX24B	IXU01-□
GL MAX, GL PRO (PLATINA)		X24EP-U	IX24B	IXU01-□
GL100K, GL125, XL125R, CB750K		X24EP-U	IX24B	IXU01-□
KARINA 125, KARISMA 125		U20EPR9	IU20	IU01-□
MEGA PRO (KYE A)		U24EPR9	IU24	IU01-□
MEGA PRO Fi		U27EPR9	IU27	IU01-□
MEGA PRO, GL PRO NEO TECH		X24EP-U9	IX24B	IXU01-□
Monkey		U20FSR-U	IUF22	-
NSR 150		W24ES-U	IW24	IW01-□
PCX		U22EPR9	IU22	IU01-□
REVO		U22FS-U	IUF22	-
REVO ABSOLUT, REVO MATIC, REVO NEW		U20EPR9S	IU20	IU01-□
REVO X		U20EPR9S	IU20	IU01-□
S110, CG110, CB100, CB125		X22EP-U	IX22B	IXU01-□
SCOOPY		U24EPR9	IU24	IU01-□
SCOOPY Fi		U27EPR9	IU27	IU01-□
SONIC 125		U24ESR-N	IU24	IU01-□
SONIC 150		U27EPR9	IU27	IU01-□
SPACY Fi		U27EPR9	IU27	IU01-□
SPACY, SPACY HELM IN		U24EPR9	IU24	IU01-□
SUPRA X 125, SUPRA X PGMFI		U20EPR9	IU20	IU01-□
SUPRA X HELM IN 125, HELM IN 125Fi		U20EPR9	IU20	IU01-□
TA 200 (PHANTOM)		X24EPR-U9	IX24B	IXU01-□
VARIO (KVB)		U22FER9	IUH24	IU01-□
VARIO 110, 150		U27EPR9	IU27	IU01-□
VARIO PGMFI 125 NEW		U22EPR9	IU22	IU01-□
VERZA		U27EPR9	IU27	IU01-□
<b>KANZEN</b>				
K-CROSS 125		X24EP-U9	IX24B	IXU01-□
SCUDETO 125		U22FS-U	IUF22	-

INDIA  
INDONESIA  
KOREA  
MALAYSIA  
PHILIPPINES  
SAUDI ARABIA  
SINGAPORE  
TAIWAN  
THAILAND  
VIETNAM  
JAPAN  
EUROPE & USA  
CROSS REFERENCE  
PART NUMBER

DENSO	9	14	16	20	22	24	27	29	31	32	35	DENSO	9	14	16	20	22	24	27	29	31	32	DENSO	9	14	16	20	22	24	27	31	
NGK	2	4	5	6	7	8	9	9.5	10	10.5	11	11.5	CHAMPION	18	16,14	12,11	10,9	8,7	6,63,61	4,59	57	55	53	BOSCH	10	9	8	7,6	5	4	3	2



	MODEL	YEAR	DENSO	IRIDIUM POWER	IRIDIUM RACING
AUSTRALIA	<b>KANZEN</b>				
	SPECTRA 110, PESONA 5		U16FS-U	-	-
	<b>KAWASAKI</b>				
CHINA	BLITZ 125, EDGE		U20FS-U	IUF22	-
	ELIMINATOR 175		U24ESR-N	IU24	IU01-□
	KAZE 110		U20FS-U	IUF22	-
	KLX 150S, KLX 250S, D TRACKER		U22FSR-U	IUF22	-
INDIA	MERCY 200		W22EP-U	IW22	IW01-□
	NINJA 150		W24ES-U	IW24	IW01-□
	NINJA 250		U24ESR-N	IU24	IU01-□
	NINJA RR 150		W27ES-U	IW27	IW01-□
	NINJA ZX-10R		U27ESR-N	IU27	IU01-□
INDONESIA	NINJA ZX-6R ABS		U27ESR-N	IU27	IU01-□
	W175TR		-	IU24	IU01-□
	ZONE R, ZX 130, ATHLETE		U20FS-U	IUF22	-
KOREA	<b>KYMCO</b>				
	EASY 100		U22FS-U	IUF22	-
	FREE MX, LX		U22FSR-U	IUF22	-
	LIBERO 110		U22FS-U	IUF22	-
MALAYSIA	METICA 125		U22FSR-U	IUF22	-
	SPIKE 120		U22FS-U	IUF22	-
	TREND 125		U22FSR-U	IUF22	-
PHILIPPINES	VISA		U22FS-U	IUF22	-
	<b>SUZUKI</b>				
SAUDI ARABIA	ADDRESS FI, PLAYFUL		U20FSR-U	IUF22	-
	ARASHI		U20FS-U	IUF22	-
	BYSON		U24EPR9	IU24	IU01-□
	COOL (110)		W24ES-U	IW24	IW01-□
	CORSA, PK125		W20FP-U <sub>s</sub>	IWF20	-
	CRYPTON		U22FS-U	IUF22	-
	DNA 180		U27ESR-N	IU27	IU01-□
	EXCLUSIVE 150, EXCEL 150		W14EX-U	IW16	IW01-□
	F1ZR, SIGMA		W22FP-U <sub>s</sub> 10	IWF22	-
	FINO		U22FS-U	IUF22	-
SINGAPORE	FINO FI		U20FSR-U	IUF22	-
	FORCE		U20FSR-U	IUF22	-
	FXR150		U24ESR-N	IU24	IU01-□
	GLIDE		W22FPR-U	IWF22	-
	GSX150 BANDIT		U24EPR-9	IU24	IU01-□
TAIWAN	GSX750		X24EP-U	IX24B	IXU01-□
	GSX-R150		U24EPR-9	IU24	IU01-□
	GSX-S150		U24EPR-9	IU24	IU01-□
	GT250		W22EP-U	IW22	IW01-□
THAILAND	GT380		W22EP-U	IW22	IW01-□
	HAYATE		U20FS-U	IUF22	-
	JUPITER		U22FS-U	IUF22	-
	JUPITER MX		U24EPR9	IU24	IU01-□
VIETNAM	JUPITER MX-KING		U24ESR-N	IU24	IU01-□
	JUPITER Z1 Fi		U20FSR-U	IUF22	-
	L2S, XT80, L2 Super		W22FP-U <sub>s</sub>	IWF22	-
	LEXAM		U20FS-U	IUF22	-
	MAJESTY		U22ES-N	IU22	IU01-□
JAPAN	MIO Fi, MIO SOUL Fi, MIO J, MIO GT		U20FSR-U	IUF22	-
	MIO, MIO SOUL, MIO SPORTY		U22FS-U	IUF22	-
	NEO 110CC		U22ESR-N	IU22	IU01-□
	NEO X3i		U22ESR-N	IU22	IU01-□
EUROPE & USA	NEX		U20FS-U	IUF22	-
	NEX FI, NEX AT NEW		U22EPR9	IU22	IU01-□
	NEX II ELEGANT PREMIUM		U22EPR-9	IU22	IU01-□
	NEX II FANCY DYNAMIC, CROSS		U22EPR-9	IU22	IU01-□
CROSS REFERENCE	N-MAX		U24EPR9	IU24	IU01-□
	NOUVO		U22FSR-U	IUF22	-
	P150X, P150S, PX150E		W9FP-UL	-	-
	PT100TS, SUPER, SPRINT		W9FP-UL	-	-
PART NUMBER	PX150XE, PX150SE, P200XE, EXCEL		W14EX-U	IW16	IW01-□
	RAIDER (125)		U24ES-N	IU24	IU01-□
	RC100, CRYSTAL RC80/100DK		W22FP-U <sub>s</sub>	IWF22	-
	RC110 CDN/CSD, TRS, TRZ		W24FP-U <sub>s</sub>	IWF24	-



MODEL	YEAR	DENSO	IRIDIUM POWER	IRIDIUM RACING	
<b>SUZUKI</b>					
RGR, Satria RU120		W24ES-U	IW24	IW01-□	AUSTRALIA
RX-K	1996-	W24FPR-U10	IWF24	-	CHINA
RX-Z, RZ-R		W24ES-U	IW24	IW01-□	INDIA
Satria F 150, NEW Satria		U24ESR-N	IU24	IU01-□	INDONESIA
SCORPIO Z <NEW>		X24ES-U	IX24	-	KOREA
SCORPIO, SCORPIO Z		X24EP-U	IX24B	IXU01-□	MALAYSIA
SHOGUN FD110		U20FS-U	IUF22	-	PHILIPPINES
SHOGUN Hyper Injection Fi <NEW>		U20FS-U	IUF22	-	SAUDI ARABIA
SHOGUN SC231 (125), SHOGUN AXELO		U20FS-U	IUF22	-	SINGAPORE
SKYWAVE 125		U20FSR-U	IUF22	-	TAIWAN
SMASH (110), SMASH <NEW>		U20FS-U	IUF22	-	THAILAND
SPIN, SKYDRIVE		U20FS-U	IUF22	-	VIETNAM
THUNDER EN125		U24ESR-N	IU24	IU01-□	JAPAN
THUNDER GSX250		X24ES-U	IX24	IXU01-□	EUROPE & USA
TITAN		U20FS-U	IUF22	-	CROSS REFERENCE
TITAN NEXT		U24EPR9	IU24	IU01-□	PART NUMBER
TOUCHS		W24ESR-U	IW24	IW01-□	
TS100		W22EP-U	IW22	IW01-□	
TS125	1978-	W22EP-U	IW22	IW01-□	
V100(3AY) ALVA IIR, V110(3XA) FORCE 1		W22FP-U510	IWF22	-	
VEGA		U22FS-U	IUF22	-	
VEGA ZR		U20FS-U	IUF22	-	
VIXION, VIXION NEW		U24ESR-N	IU24	IU01-□	
X9 180		U27ESR-N	IU27	IU01-□	
XEON, XEON Fi		U22ESR-N	IU22	IU01-□	
Y125Z, TIARA		W24ES-U	IW24	IW01-□	
YT 115, RX-S, RX-K		W24FP-U510	IWF24	-	





DENSO	9	14	16	20	22	24	27	29	31	32	34	35
NGK	2	4	5	6	7	8	9	9.5	10	10.5	11	11.5

DENSO	9	14	16	20	22	24	27	29	31	32
CHAMPION	18	16,14	12,11	10,9	8,7	6,63,61	4,59	57	55	53

DENSO	9	14	16	20	22	24	27	31
BOSCH	10	9	8	7,6	5	4	3	2



	MODEL	YEAR	DENSO				
AUSTRALIA	<b>GM Daewoo</b>						
	ACADIA		PK20PR-P11	IK20TT	-	IK20	VK20
CHINA	ALPHEON		-	ITV16	-	ITV16	-
	AVEO (1.6)		-	IK20TT	-	IK20	VK20
INDIA	BROUGHAM DOHC (2.0)		-	IK20TT	-	IK20	VK20
	BROUGHAM SOHC (2.0)		W20EPR-U	IW20TT	W20TT	IW20	VW20
INDONESIA	CALOS SOHC (1.2)		W16EPR-U11	IW16TT	W16TT	IW16	VW16
	CALOS SOHC (1.5)		W20EPR-U	IW20TT	W20TT	IW20	VW20
INDONESIA	CIERO DOHC (1.5)		K20PR-U11	IK20TT	K20TT	IK20	VK20
	CIERO SOHC		W20EPR-U	IW20TT	W20TT	IW20	VW20
INDONESIA	DAMAS		W16EPR-U	IW16TT	W16TT	IW16	VW16
	ESPERO DOHC (1.5)		K20PR-U11	IK20TT	K20TT	IK20	VK20
INDONESIA	ESPERO SOHC (1.5/1.8)		W20EPR-U	IW20TT	W20TT	IW20	VW20
	ESPERO TAXI		W20EPR-U	IW20TT	-	-	VW20T
KOREA	G2X (2.0)		-	ITV16	-	ITV16	-
	GENTRA DOHC (1.6)		K20PR-U11	IK20TT	K20TT	IK20	VK20
KOREA	GENTRA SOHC (1.5)		W20EPR-U	IW20TT	W20TT	IW20	VW20
	GENTRA X (1.2)		XU22EPR-U	-	XU22TT	IXU22	VXU22
MALAYSIA	LABO		W16EPR-U	IW16TT	W16TT	IW16	VW16
	LACETTI Premiere DOHC (1.6)		-	IK20TT	-	IK20	VK20
MALAYSIA	LACETTI DOHC (1.5/1.6/1.8)		K20PR-U11	IK20TT	K20TT	IK20	VK20
	LANOS I, II DOHC (1.5)		K20PR-U11	IK20TT	K20TT	IK20	VK20
PHILIPPINES	LANOS I, II SOHC (1.5)		W20EPR-U	IW20TT	W20TT	IW20	VW20
	LEMANS DOHC		K20PR-U11	IK20TT	K20TT	IK20	VK20
PHILIPPINES	LEMANS SOHC		W20EPR-U	IW20TT	W20TT	IW20	VW20
	MALIBU (2.0) & LPG		-	ITV16	-	ITV16	-
SAUDI ARABIA	MALIBU (2.4)		-	ITV16	-	ITV16	-
	MATIZ I, II <ALL NEW>		W16EXR-U11	IW16TT	W16TT	IW16	VW16
SINGAPORE	MATIZ CREATIVE DOHC (1.0)		-	-	-	IXU22	VXU22
	NUBIRA I, II DOHC (1.5/1.8)		K20PR-U11	IK20TT	K20TT	IK20	VK20
SINGAPORE	NUBIRA I, II SOHC		W20EPR-U	IW20TT	W20TT	IW20	VW20
	ORLANDO LPG		-	ITV16	-	ITV16	-
TAIWAN	PRINCE DOHC (1.8/2.0)		-	IK20TT	-	IK20	VK20
	PRINCE SOHC (1.8/2.0)		-	IW20TT	-	IW20	VW20
TAIWAN	PRINCE TAXI		W20EPR-U	IW20TT	-	-	VW20T
	SPAGON DOHC (1.8)		K20PR-U11	IK20TT	K20TT	IK20	VK20
THAILAND	STATESMAN DOHV (V6 2.8/3.6)		-	ITV16	-	ITV16	-
	TICO		W16EXR-U11	IW16TT	W16TT	IW16	VW16
VIETNAM	TOSCA DOHC (1.8)		K20PR-U11	IK20TT	K20TT	IK20	VK20
	TOSCA DOHC (L6 2.0/2.5)		K20PR-U11	IK20TT	K20TT	IK20	VK20
VIETNAM	VERITAS		-	ITV16	-	ITV16	-
	<b>HYUNDAI</b>						
VIETNAM	ACCENT		K16PR-U11	IK16TT	K16TT	IK16	VK16
	ACCENT GDI		-	-	-	IXUH22I	VXUH22I
VIETNAM	ATOS (0.8)		K16PR-U11	IK16TT	K16TT	IK16	VK16
	ATOS LPG (0.8)		K20PR-U	IK20TT	-	-	VK20T
VIETNAM	ATOS TCI (0.8)		K20PR-U11	IK20TT	K20TT	IK20	VK20
	AVANTE		K16PR-U11	IK16TT	K16TT	IK16	VK16
VIETNAM	AVANTE HYBRID (1.6)	2010-	-	-	-	IXUH22	VXUH22
	AVANTE HD DOHC (1.6/2.0)		KJ16CR-U11	IK16TT	K16TT	IK16L	VK16
VIETNAM		2009.01-	-	-	-	IXUH22	VXUH22
	AVANTE MD GDI (1.6)	2011-	-	-	-	IXUH22	VXUH22
JAPAN	AVANTE TOURING		K16PR-U11	IK16TT	K16TT	IK16	VK16
	AVANTE XD DOHC (1.6)		K16PR-U11	IK16TT	K16TT	IK16	VK16
JAPAN	CLICK (1.3/1.5)		K16PR-U11	IK16TT	K16TT	IK16	VK16
	DYNASTY DOHC (V6 3.0/3.5)		PK16PR-P11	IK16TT	-	IK16	VK16
EUROPE & USA	DYNASTY LIMOUSINE		PK16PR-P11	IK16TT	-	IK16	VK16
	EF SONATA Beta Engine (1.8/2.0) <NEW>		K16PR-U11	IK16TT	K16TT	IK16	VK16
EUROPE & USA	EF SONATA Beta Engine (1.8/2.0/2.5)		-	IK16TT	-	IK16	VK16
	EF SONATA Sirius Engine (1.8/2.0)		-	IW20TT	-	IW20	VW20
EUROPE & USA	EF SONATA Sirius Engine DOHC (2) <NEW>		K16PR-U11	IK16TT	K20TT	IK20	VK20
	EF SONATA DOHC LPG (2.0)		K20PR-U	IK20TT	-	-	VK20T
EUROPE & USA	EF SONATA TAXI <NEW>	2002.09-	PK20PR8	IK20TT	-	-	VK20T
	ELANTRA		W20EP-U11	IW20TT	W20TT	IW20	VW20
EUROPE & USA	EQUUS (V6 3.0/3.5)		PK16PR-P11	IK16TT	-	IK16	VK16
	EQUUS DOHC (3.3/3.8)		VK16	IK16TT	-	IK16	VK16
EUROPE & USA	EQUUS DOHC GDI (V8 4.5)		-	-	-	-	VKB16
	EQUUS DOHC MPI (V8 4.5)		PK16PR-P11	IK16TT	-	IK16	VK16





MODEL	YEAR	DENSO					
<b>HYUNDAI</b>							
EQUUS GDI		-	-	-	IXUH22I	VXUH22I	AUSTRALIA
EXCEL / EXCEL <NEW>		W20EP-U11	IW20TT	W20TT	IW20	VW20	CHINA
EXCEL VAN		W20EP-U11	IW20TT	W20TT	IW20	VW20	
GALLOPER SOHC (3.0)		W16EPR-U11	IW16TT	W16TT	IW16	VW16	INDIA
GALLOPER SOHC LPG (3.0)		W16EPR-U	IW16TT	-	-	VW20T	
GENESIS (3.3/3.8)		VK16	IK16TT	-	IK16	VK16	INDONESIA
	2010-	-	-	-	IXUH22	VXUH22	
	2014-	-	-	-	IXUH22	VXUH22	KOREA
GENESIS COUPE (3.8)		-	-	-	IXUH22	VXUH22	
GENESIS COUPE TURBO (2.0)		-	-	-	IKH22	VKH20Y	MALAYSIA
GENESIS GDI		-	-	-	IXUH22I	VXUH22I	
GRACE		W20EP-U11	IW20TT	W20TT	IW20	VW20	PHILIPPINES
GRACE LPG		W20EPR-U	IW20TT	-	-	VW20T	
GRANDEUR (2.0) <NEW>		W20EP-U11	IW20TT	W20TT	IW20	VW20	SAUDI ARABIA
GRANDEUR (2.4)		W20EP-U11	IW20TT	W20TT	IW20	VW20	
GRANDEUR DOHC (3.3)		-	IK16TT	-	IK16	VK16	SINGAPORE
GRANDEUR DOHC (V6 2.5/3.0/3.5)		PK16PR-P11	IK16TT	-	IK16	VK16	
GRANDEUR HG (2.4)		-	-	-	IXUH22I	VXUH22I	TAIWAN
GRANDEUR HG (3.0/3.3)		-	-	-	IXUH22I	VXUH22I	
GRANDEUR SOHC (3.0)		W16EPR-U11	IW16TT	W16TT	IW16	VW16	THAILAND
GRANDEUR TAXI (2.0)		W20EP-U	IW20TT	-	-	VW20T	
GRANDEUR TAXI (2.4) <NEW>		W20EPR-U	IW20TT	-	-	VW20T	VIETNAM
GRANDEUR TAXI (3.0) <NEW>		W16EPR-U	IW16TT	-	-	VW20T	
GRANDEUR TG (2.4/3.3/3.8)		VK16	IK16TT	-	IK16	VK16	JAPAN
GRANDEUR TG (2.7)		-	IKH16TT	-	IKH16	VKH16	
GRANDEUR XG DOHC (V6 2.0/2.5/3.0)		PK16PR-P11	IK16TT	-	IK16	VK16	EUROPE & USA
I-30	2012-	-	-	-	IXUH22I	VXUH22I	
I-30 (1.6/2.0)		KJ16CR-U11	IK16TT	K16TT	IK16L	VK16	CROSS REFERENCE NUMBER
	2009-2nd Half	-	-	-	IXUH22	VXUH22	
I-40		-	-	-	IXUH22I	VXUH22I	PART
LAVITA		K16PR-U11	IK16TT	K16TT	IK16	VK16	
LF SONATA (2.0 / 2.4)		-	-	-	IXUH22I	VXUH22I	
LIBERO SOHC LPG (3.0)		W16EPR-U	IW16TT	-	-	VW20T	
MARCIA (2.0)		W20EP-U11	IW20TT	W20TT	IW20	VW20	
MARCIA (2.5)		-	IK16TT	-	IK16	VK16	
NF SONATA DOHC (2.0/2.4)		K16PR-U11	IK16TT	K16TT	IK16	VK16	
NF SONATA DOHC (3.3)		IK16	IK16TT	-	IK16	VK16	
NF SONATA TRANSFORM		-	IKH16TT	-	IKH16	VKH16	
PORTER LPG		W20EPR-U	IW20TT	-	-	VW20T	
PRESTO		W20EPR-U	IW20TT	W20TT	IW20	VW20	
SANTAFE DOHC (2.0)		W20EPR-U11	IW20TT	W20TT	IW20	VW20	
SANTAFE DOHC (V6 2.7)		PK16PR-P11	IK16TT	-	IK16	VK16	
SANTAFE LPG (V6 2.7)		K20PR-U	IK20TT	-	-	VK20T	
SANTAMO		W20EP-U11	IW20TT	W20TT	IW20	VW20	
SANTAMO LPG		W20EPR-U	IW20TT	-	-	VW20T	
SCOOP N/A		K16PR-U11	IK16TT	K16TT	IK16	VK16	
SCOOP TURBO		K20PR-U	IK20TT	K20TT	IK20	VK20	
SONATA I, II, III		W20EP-U11	IW20TT	W20TT	IW20	VW20	
SONATA TAXI		W20EP-U	IW20TT	-	-	VW20T	
SONATA TAXI <NEW>		W20EPR-U	IW20TT	-	-	VW20T	
STAREX		W20EP-U11	IW20TT	W20TT	IW20	VW20	
STAREX LPG		W20EPR-U	IW20TT	-	-	VW20T	
STAREX SOHC LPG (3.0)		W16EPR-U	IW16TT	-	-	VW20T	
STELLA		W16EPR-U	IW16TT	W16TT	IW16	VW16	
STELLA TAXI LPG		W20EPR-U	IW20TT	-	-	VW20T	
TARJET XG DOHC (2.0)		-	IK20TT	-	IK20	VK20	
TERRACAN (V6 3.5)		K16PR-U11	IK16TT	K16TT	IK16	VK16	
TIBURON		K16PR-U11	IK16TT	K16TT	IK16	VK16	
TRAJET XG (V6 2.7)		PK16PR-P11	IK16TT	-	IK16	VK16	
TRAJET XG LPG (V6 2.7)		K20PR-U	IK20TT	-	-	VK20T	
TUCSON (2.0)		-	IK16TT	-	IK16	VK16	
TUCSON IX (2.0)		-	IKH16TT	-	IKH16	VKH16	
TUSCANI		K16PR-U11	IK16TT	K16TT	IK16	VK16	
VELOSTER & TURBO		-	-	-	IXUH22I	VXUH22I	
VERACRUZ GASOLINE (3.8)		PK16PR-P11	IK16TT	-	IK16	VK16	
VERNA / VERNA <NEW>		K16PR-U11	IK16TT	K16TT	IK16	VK16	
YF SONATA	2012-	-	-	-	IXUH22I	VXUH22I	

DENSO	9	14	16	20	22	24	27	29	31	32	34	35	DENSO	9	14	16	20	22	24	27	31	32	DENSO	9	14	16	20	22	24	27	31	
NGK	2	4	5	6	7	8	9	9.5	10	10.5	11	11.5	CHAMPION	18	16,14	12,11	10,9	8,7	6,6,6,1	4,59	57	55	53	BOSCH	10	9	8	7,6	5	4	3	2



	MODEL	YEAR	DENSO				
AUSTRALIA	<b>HYUNDAI</b>						
	YF SONATA LPI (2.0)	2010-	-	IK20TT	-	-	VK20T
	YF SONATA (2.0)	2010-	-	IKH16TT	-	IKH16	VKH16
	<b>KIA</b>						
CHINA	AVELLA (1.3)		W16EX-U11	IW16TT	W16TT	IW16	VW16
	AVELLA DELTA (1.3)		W16EX-U11	IW16TT	W16TT	IW16	VW16
	AVELLA DELTA SOHC (1.5)		W16EPR-U11	IW16TT	W16TT	IW16	VW16
INDIA	AVELLA DOHC (1.5)		K20PR-U11	IK20TT	K20TT	IK20	VK20
	AVELLA SOHC (1.5)		W16EP-U11	IW16TT	W16TT	IW16	VW16
	CAPITAL GLX/SLX		W16EP-U11	IW16TT	W16TT	IW16	VW16
	CAPITAL DOHC (1.5)		Q20P-U11	IQ20TT	Q20TT	IQ20	VQ20
INDONESIA	CAPITAL SOHC (1.8)		W16EPR-U	IW16TT	W16TT	IW16	VW16
	CAPITAL TAXI LPG		W20EP-U	IW20TT	-	-	VW20T
KOREA	CARENS <NEW>		-	IK20TT	-	-	VK20T
	CARENS DOHC (1.8)		K20PR-U	IK20TT	K20TT	IK20	VK20
	CARENS DOHC LPG (1.8/2.0)		K20PR-U	IK20TT	-	-	VK20T
MALAYSIA	CARNIVAL I, II DOHC LPG (2.5)		K20PR-U	IK20TT	-	-	VK20T
	CARNIVAL GSL DOHC (2.5)		PK20PR-P11	IK20TT	-	IK20	VK20
PHILIPPINES	CARSTAR		W20EP-U11	IW20TT	W20TT	IW20	VW20
	CARSTAR LPG		W20EPR-U	IW20TT	-	-	VW20T
SAUDI ARABIA	CERATO DOHC (1.5)		K16PR-U11	IK16TT	K16TT	IK16	VK16
	CERATO DOHC (1.6)		K16PR-U11	IK16TT	K16TT	IK16	VK16
SINGAPORE	CERATO DOHC (2.0)		K16PR-U11	IK16TT	K16TT	IK16	VK16
	CONCORD DOHC (2.0)		Q20P-U11	IQ20TT	Q20TT	IQ20	VQ20
TAIWAN	CONCORD SOHC (1.8)		W20EP-U	IW20TT	W20TT	IW20	VW20
	CONCORD SOHC (2.0)		W16EPR-U	IW16TT	W16TT	IW16	VW16
THAILAND	CONCORD TAXI DOHC (2.0)		W20EP-U	IW20TT	-	-	VW20T
	CREDOS DOHC (1.8)		K16PR-U	IK16TT	K16TT	IK16	VK16
VIETNAM	CREDOS DOHC (2.0)		K20PR-U11	IK20TT	K20TT	IK20	VK20
	CREDOS SOHC (2.0)		W16EPR-U	IW16TT	W16TT	IW16	VW16
JAPAN	CREDOS TAXI DOHC (1.8/2.0)		K20PR-U	IK20TT	-	-	VK20T
	ELAN		K20PR-U	IK20TT	K20TT	IK20	VK20
EUROPE & USA	ENTERPRISE (2.5/3.0/3.6)		KJ16CR-U11	IK16TT	K16TT	IK16L	VK16
	FORTE GDI (1.6)	2010-	-	-	-	IXUH22	VXUH22
TAIWAN	FORTE HYBRID LPI	2009-	-	-	-	IXUH22	VXUH22
	FORTE (1.6)		-	IKH16TT	-	IKH16	VKH16
THAILAND	FORTE (2.0)	2010-	-	-	-	IXUH22	VXUH22
	GRAND CARNIVAL LPG		-	IKH16TT	-	IKH16	VKH16
VIETNAM	K3 GDI/COUPE/COUPE TURBO		-	IKH20TT	-	-	VKH20T
	K5 (2.0)	2011-	-	IKH16TT	-	IKH16	VKH16
JAPAN	K5 GDI	2012-	-	-	-	IXUH22I	VXUH22I
	K5 LPI (2.0)	2011-	-	IK20TT	-	-	VK20T
THAILAND	K7 (2.7)		-	IKH16TT	-	IKH16	VKH16
	K7 GDI		-	-	-	IXUH22I	VXUH22I
VIETNAM	K7 LPI (2.7)		-	-	-	IKH22	VKH20T
	K9 GDI		-	-	-	IXUH22I	VXUH22I
EUROPE & USA	LOTZE INNOVATION	-2010	-	IKH16TT	-	IKH16	VKH16
	LOTZE (1.8/2.0/2.4)		K16PR-U11	IK16TT	K16TT	IK16	VK16
TAIWAN	LOTZE ADVANCE Theta1 Engine		-	IK16TT	-	IK16	VK16
	LOTZE ADVANCE Theta2 Engine		-	IKH16TT	-	IKH16	VKH16
JAPAN	MOHAVE		-	-	-	IXUH22	VXUH22
	MORNING (1.0) <NEW>	2010-	-	IK16TT	-	IK16	VK16
EUROPE & USA	MORNING <ALL NEW>	2010-	-	IK20TT	-	-	VK20T
	MORNING SOHC (1.0)		-	-	-	IXUH22I	VXUH22I
TAIWAN	OPIRUS (2.7/3.0/3.3/3.5/3.8)		K16PR-U11	IK16TT	K16TT	IK16	VK16
	OPIRUS LPG		PK16PR-P11	IK16TT	-	IK16	VK16
EUROPE & USA			-	IK20TT	-	-	VK20T
		2006-	-	-	-	IKH22	VKH20T
EUROPE & USA	OPTIMA Beta Engine DOHC (1.8/2.0)		K16PR-U11	IK16TT	K16TT	IK16	VK16
	OPTIMA Sirius Engine DOHC (1.8/2.0)		W20EPR-U11	IW20TT	W20TT	IW20	VW20
EUROPE & USA	OPTIMA TAXI DOHC (2.0) Beta Engine		K20PR-U	IK20TT	-	-	VK20T
	PARKTOWN DOHC (1.8)		K16PR-U	IK16TT	K16TT	IK16	VK16
EUROPE & USA	POTENTIA DOHC (2.0)		K20PR-U11	IK20TT	K20TT	IK20	VK20
	POTENTIA DOHC (2.2)		KJ20CR-U11	IK20TT	K20TT	IK20L	VK20
EUROPE & USA	POTENTIA DOHC (V6 3.0)		KJ16CR-U11	IK16TT	K16TT	IK16L	VK16
	POTENTIA TAXI DOHC (2.0)		K20PR-U	IK20TT	-	-	VK20T
EUROPE & USA	PRIDE		W16EP-U11	IW16TT	W16TT	IW16	VW16







MODEL	YEAR	DENSO				
<b>KIA</b>						
PRIDE DOHC (1.4) <NEW>		K16PR-U11	IK16TT	K16TT	IK16	VK16
PRIDE DOHC (1.6) <NEW>		K16PR-U11	IK16TT	K16TT	IK16	VK16
PRIDE GDI <ALL NEW>		-	-	-	IXUH22I	VXUH22I
<b>RAY</b>						
		-	-	-	IXUH22I	VXUH22I
<b>RIO DOHC (1.5/1.6)</b>						
		K20PR-U	IK20TT	K20TT	IK20	VK20
<b>RIO SOHC (1.3/1.5)</b>						
		W16EXR-U	IW16TT	W16TT	IW16	VW16
<b>ROCSTAR SOHC (1.8)</b>						
		W20EP-U	IW20TT	W20TT	IW20	VW20
<b>SEPHIA I DOHC (1.5)</b>						
		K20PR-U11	IK20TT	K20TT	IK20	VK20
<b>SEPHIA I SOHC (1.5)</b>						
		W16EP-U11	IW16TT	W16TT	IW16	VW16
<b>SEPHIA II (1.8)</b>						
		K20PR-U	IK20TT	K20TT	IK20	VK20
<b>SEPHIA II DOHC (1.5)</b>						
		K20PR-U11	IK20TT	K20TT	IK20	VK20
<b>SEPHIA II SOHC (1.5)</b>						
		W16EXR-U	IW16TT	W16TT	IW16	VW16
<b>SEPHIAREO DOHC</b>						
		K20PR-U11	IK20TT	K20TT	IK20	VK20
<b>SEPHIAREO SOHC (1.5)</b>						
		W16EP-U11	IW16TT	W16TT	IW16	VW16
<b>SHUMA DOHC (1.5)</b>						
		K20PR-U11	IK20TT	K20TT	IK20	VK20
<b>SHUMA SOHC (1.5)</b>						
		W16EXR-U	IW16TT	W16TT	IW16	VW16
<b>SORENTO DOHC (V6 3.5)</b>						
		-	IK16TT	-	IK16	VK16
<b>SOUL (1.6)</b>						
		-	IK16TT	-	IK16	VK16
		-	-	-	IXUH22	VXUH22
<b>SOUL (2.0)</b>						
		-	IK16TT	-	IK16	VK16
<b>SPECTRA DOHC (1.5/1.8)</b>						
		K20PR-U	IK20TT	K20TT	IK20	VK20
<b>SPECTRA SOHC (1.5)</b>						
		W16EXR-U	IW16TT	W16TT	IW16	VW16
<b>SPECTRAWING DOHC (1.5/1.8)</b>						
		K20PR-U	IK20TT	K20TT	IK20	VK20
<b>SPORTAGE DOHC (2.0)</b>						
		K20PR-U11	IK20TT	K20TT	IK20	VK20
<b>SPORTAGE R GDI TURBO</b>						
		-	-	-	IXUH22I	VXUH22I
<b>SPORTAGE R Theta2</b>						
		-	IKH16TT	-	IKH16	VKH16
<b>SPORTAGE SOHC (2.0)</b>						
		K16PR-U	IK16TT	K16TT	IK16	VK16
<b>TOWNER VAN/TRUCK/MINI BUS</b>						
		W16EX-U	IW16TT	W16TT	IW16	VW16
<b>TOWNER LPG</b>						
		W20EX-U	IW20TT	-	-	VW20T
<b>VESTA LPG</b>						
		W20EP-U	IW20TT	-	-	VW20T
<b>VISTO</b>						
		K16PR-U11	IK16TT	K16TT	IK16	VK16
<b>WIDEBONGO LPG</b>						
		W20EP-U	IW20TT	-	-	VW20T
<b>Renault Samsung</b>						
<b>ALL NEW SM5 LPLI</b>						
		-	IXEH22TT	-	-	VFXEH22
<b>ALL NEW SM7 (2.5/3.5)</b>						
		-	-	-	-	VFXEH22
<b>QM5 (2.5)</b>						
		FXE20HR11	IXEH20TT	-	-	VFXEH20
<b>SM3 (1.6) &lt;NEW&gt;</b>						
		IKH16	IKH16TT	-	IKH16	VKH16
<b>SM3(1.5/1.6)</b>						
		K16PR-U11	IK16TT	K16TT	IK16	VK16
<b>SM3(1.6) &lt;NEW&gt;</b>						
	2010-	FXE20HR11	IXEH20TT	-	-	VFXEH20
<b>SM5 (2.0/2.5) &lt;ALL NEW&gt;</b>						
		FXE20HR11	IXEH20TT	-	-	VFXEH20
<b>SM5 &lt;NEW&gt;</b>						
		K16PR-U11	IK16TT	K16TT	IK16	VK16
<b>SM5 Impression &lt;NEW&gt;</b>						
		FXE20HR11	IXEH20TT	-	-	VFXEH20
<b>SM5 LPG &lt;NEW&gt;</b>						
		K20PR-U	IK20TT	-	-	VK20T
<b>SM5 TAXI</b>						
		K20PR-U	IK20TT	-	-	VK20T
<b>SM520/SM520V</b>						
		K16PR-U11	IK16TT	K16TT	IK16	VK16
<b>SM525/SM525V</b>						
		K16PR-U11	IK16TT	K16TT	IK16	VK16
<b>SM7 &lt;ALL NEW&gt;</b>						
		FXE22HR11	IXEH22TT	-	-	VFXEH22
<b>SM7 DOHC (V6 2.3)</b>						
		VKH16	IKH16TT	-	IKH16	VKH16
<b>SM7 DOHC (V6 3.5)</b>						
		VKH16	IKH16TT	-	IKH16	VKH16
<b>SM7 New Art</b>						
		-	IKH16TT	-	IKH16	VKH16
<b>SSANGYONG</b>						
<b>Chairman (2.3/2.8/3.2)</b>						
		-	IK16TT	-	IK16	VK16
<b>Chairman Limousine</b>						
		-	IK16TT	-	IK16	VK16
<b>Chairman W (3.6/5.0)</b>						
		-	IK16TT	-	IK16	VK16
<b>Chairman W Limousine (3.6/5.0)</b>						
		-	IK16TT	-	IK16	VK16
<b>ISTANA LPG</b>						
		K20PR-U	IK20TT	-	-	VK20T
<b>KORANDO</b>						
		K16PR-U	IK16TT	K16TT	IK16	VK16
<b>MUSSO</b>						
		K16PR-U	IK16TT	K16TT	IK16	VK16
<b>TIVOLI</b>						
		-	-	-	IXUH22I	VXUH22I

AUSTRALIA  
CHINA  
INDIA  
INDONESIA  
KOREA  
MALAYSIA  
PHILIPPINES  
SAUDI ARABIA  
SINGAPORE  
TAIWAN  
THAILAND  
VIETNAM  
JAPAN  
EUROPE & USA  
CROSS REFERENCE NUMBER  
PART



	MODEL	DENSO	IRIDIUM POWER	IRIDIUM RACING
AUSTRALIA	<b>Asea</b>			
	CULTIVATOR	W14FP-UL	IWF16	-
CHINA	<b>DaeDong</b>			
	BINDER (HE50A)	W14F-U	-	-
INDIA	CULTIVATOR (5HV)	W20FP-U	IWF20	-
	ENGINE (FARM) (G5L)	W14P-U	-	-
	POWER TILLER (K6,K10)	W14P-U	-	-
INDONESIA	RICE TRANSPLANTER (NS402B,S402B)	W14F-U	-	-
	<b>DaeHeung</b>			
	SPRAYER (TA-40)	W22S-U	-	-
INDONESIA	WATER PUMP (GASOLINE)	W20FS-U	IWF22	-
	WATER PUMP (KEROSINE)	W14F-U	-	-
KOREA	WEEDER	W14M-U	-	-
	<b>DaeLim</b>			
MALAYSIA	ATS	W24FS-U	IWF24	-
	BESBI	U20FS-U	IUF22	-
PHILIPPINES	CT100	U22FS-U	IUF22	-
	FORTE/NEO FORTE	U24FE9	IUH24	IU01-□
SAUDI ARABIA	FREEWAY 250	X24ES-U	IX24	IXU01-□
	FREEWING 125/150	U24FE9	IUH24	IU01-□
SINGAPORE	GW90(Super Lead)	W20FS-U	IWF22	-
	ROADWIN 125/150	U24FE9	IUH24	IU01-□
TAIWAN	SH100(DELPHINO)	W24FS-U	IWF24	-
	TACT	W24FS-U	IWF24	-
THAILAND	TACT/LEAD 50	W20FP-U	IWF20	-
	<b>HyoSung</b>			
VIETNAM	AG100(ADDRESS)	W22FP-U	IWF22	-
	COMET 125/250/650	U24ES-N	IU24	IU01-□
EUROPE & USA	EXIV	U24ES-N	IU24	IU01-□
	EZ100(JEPA)	W22FP-U	IWF22	-
JAPAN	GA125(CRUISE)	X24ES-U	IX24	IXU01-□
	GA125F(CRUISE II)	U24FE9	IUH24	IU01-□
EUROPE & USA	GD125R(EXIV)	U24ESR-N	IU24	IU01-□
	GPS125(GRANDPRIX)	X24ES-U	IX24	IXU01-□
EUROPE & USA	GV125	U24ESR-N	IU24	IU01-□
	MIRAGE 125/250/650	U24ES-N	IU24	IU01-□
EUROPE & USA	SB50(SUPERCAP)	W20FP-U	IWF20	-
	SD50(Sence)	W20FP-U	IWF20	-
EUROPE & USA	SD90	W22FP-U	IWF22	-
	SF50(PRIMA)	W24FS-U	IWF24	-
EUROPE & USA	TROY	U24ES-N	IU24	IU01-□
	<b>KeYang</b>			
EUROPE & USA	ENGINE	W20M-U	-	-
	WEEDER	W20M-U	-	-

MAKER	YEAR	DENSO					
<b>ALFA ROMEO</b>							
145 , 146	1997-	PK20TR11+IU22	IK20TT+N/A	-	IK20+IU22	VK20+IU22	AUSTRALIA
147 2.0 Twin Spark	2000-	PK20TR11+IU22	IK20TT+N/A	-	IK20+IU22	VK20+IU22	
147 GTA 3.2	2002-	PK20PR-P8	IK20TT	-	IK20	VK20Y	CHINA
149 1.4 Turbo MultiAir	2010-	IXU27	-	-	IXU27	-	
156 2.0 (16V)	1997-2001	K20PR-U	IK20TT	K20TT	IK20	VK20	INDIA
156 GTA 3.2	2002-	VK22	-	-	IK22	VK22	
156 JTS 2.0	2001-	K20PR-U	IK20TT	K20TT	IK20	VK20	INDONESIA
159 2.0 (16V) Twin Spark	1997-2001	PK20TR11+IU22	IK20TT+N/A	-	IK20+IU22	VK20+IU22	
159 2.2	2008-	-	IK16TT	-	IK16	VK16	KOREA
159 GTA 3.2	2002-	PK20PR-P8	IK20TT	-	IK20	VK20Y	
159 JTS 2.0	2001-	PK20TR11	IK20TT	-	IK20	VK20	INDONESIA
164 3.0 V6 24V, Q4	1997-2001	PK20PR-P8	IK20TT	-	IK20	VK20Y	
166 2.0 (16V) Twin Spark	1998-2002	PK20TR11+IU22	IK20TT+N/A	-	IK20+IU22	VK20+IU22	INDONESIA
Brera 2.2, Spider 2.2	2006-	-	IK16TT	-	IK16	VK16	
GT 2.0, GTV 2.0, (JTS) 16V	2003-	PK20TR11	IK20TT	-	IK20	VK20	KOREA
Mito 1.4 MultiAir (105CV)	2009-	XU22EPR-U	-	XU22TT	IXU22	VXU22	
Mito 1.4 Turbo MultiAir (135 CV, 170 CV)	2009-	IXU27	-	-	IXU27	-	
Spider 1.8, 2.0 (16V) Twin Spark	1998-2002	PK20TR11+IU22	IK20TT+N/A	-	IK20+IU22	VK20+IU22	INDONESIA
Spider 2.0, 16v (JTS)	2003-	PK20TR11	IK20TT	-	IK20	VK20	
Spider 3.0, 3.2 V6 (24V)	2003-	PK20PR-P8	IK20TT	-	IK20	VK20Y	
<b>AUDI</b>							
A3 (8P1) 2.0	2004-	VK20	IK20TT	-	IK20	VK20	MALAYSIA
A4 1.6, 1.8	1998-	K20PBR-S10	IK20TT	K20TT	IK20	VK20	
A4 1.6, 1.8 (Turbo)	1998-	PK20PR-P8	IK20TT	-	-	VK20Y	PHILIPPINES
A4 1.8T, 2.0T	2006-	VK20	IK20TT	-	IK20	VK20	
A5 1.8T(CABD, CDHB)	2007-	VK22	-	-	IK22	VK22	SAUDI ARABIA
A5 4.2 (CAUA)	2007-	VKB20	-	-	-	VKB20	
A6 1.8 (AJL, AFY, AJB, AQF, ARH)	1998-	K20PBR-S10	IK20TT	K20TT	IK20	VK20	SINGAPORE
A6 2.0, 3.0	2005-	VK20	IK20TT	-	IK20	VK20	
A6 2.8, 3.0L (ACK, AEJ, AGE, AHA, APR)	1997-	K20TXR	IK20TT	K20TT	IK20	VK20	TAIWAN
A8 L3.0 (ASN, BBJ)	2001-	K20TXR	IK20TT	K20TT	IK20	VK20	
Q5 2.0 TFSI (CDNA, CDNB, CDNC, CAEB)	2008-	VK20	IK20TT	-	IK20	VK20	VIETNAM
Q7 4.2 (BAR)	2006-	VKB20	-	-	-	VKB20	
Quattro 80, 90, 100	1990-1999	W20EPB	IW20TT	W20TT	IW20	VW20	JAPAN
R8 4.2 V8, 5.2 V10	2007-2012	VK22	-	-	IK22	VK22	
S3 2.0 (CDL)	2009-	VK22	-	-	IK22	VK22	EUROPE & USA
TT/TTs Coupe 1.8 Turbo	1998-	PK20PR-P8	IK20TT	-	-	VK20Y	
TT/TTs Coupe 2.0 (CDMA, CESA, CETA)	2010-	VK22	-	-	IK22	VK22	CROSS REFERENCE NUMBER
<b>BMW</b>							
116i (B16)	2004-	K20TXR	IK20TT	K20TT	IK20	VK20	
3 Series - E36	1991-1998	K20TXR	IK20TT	K20TT	IK20	VK20	
3 Series - E46	1998-2005	K20TXR	IK20TT	K20TT	IK20	VK20	
3 Series - E90, E91	2005-	VK20	IK20TT	-	IK20	VK20	
5 Series - E34, E39	1995-2003	K20TXR	IK20TT	K20TT	IK20	VK20	
5 Series - E60 (523i, 525i, 530i)	2005-	-	IKH20TT	-	IKH20	VKH20	
5 Series - E60, E61	2003-	K20TXR	IK20TT	K20TT	IK20	VK20	
6 Series - E63	2004-	K20TXR	IK20TT	K20TT	IK20	VK20	
7 Series - E32	2001-	K20TXR	IK20TT	K20TT	IK20	VK20	
7 Series - E38	1994-2001	K20TXR	IK20TT	K20TT	IK20	VK20	
7 Series - E65, E66	2001-	K20TXR	IK20TT	K20TT	IK20	VK20	
X5 3.0 - E53	1999-	K20TXR	IK20TT	K20TT	IK20	VK20	
Z3 - E367, E368	1994-2002	K20TXR	IK20TT	K20TT	IK20	VK20	
Z3 - M43, M44, M45	1995-	K20TXR	IK20TT	K20TT	IK20	VK20	
Z4 - E85 (N46 B20)	2004-	VK20	IK20TT	-	IK20	VK20	
Z4 - M54	2003-	K20TXR	IK20TT	K20TT	IK20	VK20	
Z8 - E52	2003-	K20TXR	IK20TT	K20TT	IK20	VK20	
<b>CHERY</b>							
A160 1.6	2004-	K20PR-U	IK20TT	K20TT	IK20	VK20	
Easter 2.4	2003-2006	K20PR-U11	IK20TT	K20TT	IK20	VK20	
QQ 0.8	2003-	K20PR-U	IK20TT	K20TT	IK20	VK20	
Tiggo 1.6	2009-	K20PR-U	IK20TT	K20TT	IK20	VK20	
<b>CHEVROLET</b>							
Aveo 1.5	2004-	W20EPR-U	IW20TT	W20TT	IW20	VW20	
Captiva SUV 2.4	2006-	K20TXR	IK20TT	K20TT	IK20	VK20	
Epica 2.0	2009-	K20TXR	IK20TT	K20TT	IK20	VK20	
Nabira 1.8	2004-	K20TXR	IK20TT	K20TT	IK20	VK20	
Nabira 2.2	2004-	ITV20	ITV20TT	-	ITV20	-	

DENSO	9	14	16	20	22	24	27	29	31	32	34	35	DENSO	9	14	16	20	22	24	27	29	31	32	DENSO	9	14	16	20	22	24	27	31
NGK	2	4	5	6	7	8	9	9.5	10	10.5	11	11.5	CHAMPION	18	16,14	12,11	10,9	8,7	6,63,61	4,59	57	55	53	BOSCH	10	9	8	7,6	5	4	3	2



MAKER	YEAR	DENSO				
<b>AUSTRALIA</b>						
<b>CHEVROLET</b>						
Optra 1.6, 5	2004-	K20PR-U11	IK20TT	K20TT	IK20	VK20
Optra 1.8	2004-	K20TXR	IK20TT	K20TT	IK20	VK20
Spark 0.8	2005-	W16EPR11	IW16TT	W16TT	IW16	VW16
<b>CHINA</b>						
<b>CITREON</b>						
Belingo II 1.4	1996-	K20PR-U11	IK20TT	K20TT	IK20	VK20
C2, C3 1.6	2003-	K16HPR-U11	IKH16TT	KH16TT	IKH16	VKH16
C4, Coupe 1.6	2004-	K16HPR-U11	IKH16TT	KH16TT	IKH16	VKH16
C5 1.8, 2.0 16V	2002-	K16HPR-U11	IKH16TT	KH16TT	IKH16	VKH16
C8 2.0i 16V	2002-	K16HPR-U11	IKH16TT	KH16TT	IKH16	VKH16
Evasion 2.0	1994-2002	K20TXR	IK20TT	K20TT	IK20	VK20
Xsara Picasso	2005-	K16HPR-U11	IKH16TT	KH16TT	IKH16	VKH16
<b>INDONESIA</b>						
Xsara Picasso 1.6, 1.8, 2.0	1997-	K20TXR	IK20TT	K20TT	IK20	VK20
ZX 1.9i, 2.0i	1992-1997	K20PR-U	IK20TT	K20TT	IK20	VK20
<b>INDONESIA</b>						
<b>DAIHATSU</b>						
Esperi	1996-	W16EX-U	IW16TT	W16TT	IW16	VW16
Ferosa / Ascend	1992-1997	K20PR-U11	IK20TT	K20TT	IK20	VK20
GrandMax	2010-	XU22PR9	-	XU22TT	IXU22	VXU22
Hijet City Van II	2000-	K20P-U	IK20TT	K20TT	IK20	VK20
<b>KOREA</b>						
<b>FIAT</b>						
Coupe 2.0V Turbo	1997-	K20TXR	IK20TT	K20TT	IK20	VK20
Grande Punto 1.4	2006-	XU22EPR-U	-	XU22TT	IXU22	VXU22
Multipla 1.6	1999-2005	K20TXR	IK20TT	K20TT	IK20	VK20
Punto 1.3 (Speedgear)	2000-	K20PR-U	IK20TT	K20TT	IK20	VK20
Stilo 1.6, 1.8, 2.4	2001-	K20PR-U	IK20TT	K20TT	IK20	VK20
Ulysse 2.0 (A)16v, Emotion	1997-	K20PR-U	IK20TT	K20TT	IK20	VK20
<b>PHILIPPINES</b>						
<b>FORD</b>						
Econovan 2.0 (V193)	2003-	K16PR-U11	IK16TT	K16TT	IK16	VK16
Econovan, Spectron VAN	1997-2002	W16EX-U	IW16TT	W16TT	IW16	VW16
Escape 2.3 L	2001-	VT20	IT20TT	-	IT20	VT20
Fiesta 1.4, 1.6	2010-	ITV22	-	-	ITV22	-
Focus 1.8, 2.0L ZETEC, Escape 2.0	2002-	PT16VR13	ITV16TT	-	ITV16	-
Focus I 1.8 (ZETEC)	1998-2005	ITV16	ITV16TT	-	ITV16	-
Focus II 2.0	2005-	PT16EPR-L13	IT16TT	-	IT16	VT16
Focus III 2.0	2007-	VT20	IT20TT	-	IT20	VT20
Lynx 1.6, RS 2.0, Ranger 2.0	1998-	KJ16CR11	IK16TT	K16TT	IK16L	VK16
Mondeo 2.0 EcoBoost	2010-	ITV20	ITV20TT	-	ITV20	-
Ranger 2.0	2000-	T16EPR-U	IT16TT	T16TT	IT16	VT16
S-Max 2.0 EcoBoost	2010-	ITV20	ITV20TT	-	ITV20	-
Telstar 1.8, 2.0	1992-1997	K20PR-U11	IK20TT	K20TT	IK20	VK20
<b>TAIWAN</b>						
<b>HONDA</b>						
Accord 2.0 i-VTEC	2008-2013	IK20G	IK20TT	-	IK20G	VK20G
	2013-	SXU22HCR11S	-	-	-	VXUHC22G
Accord 2.0 Vti	2005-2008	KJ20DR-M11	IK20TT	K20TT	IK20L	VK20
Accord 2.0, 2.2	2001-2005	KJ20CR11	IK20TT	K20TT	IK20L	VK20
Accord 2.4 i-VTEC	2005-2008	KJ20DR-M11	IK20TT	K20TT	IK20L	VK20
	2008-2013	-	-	-	-	VXUHC22G
	2013-	VCH20	-	-	-	VCH20
Accord 3.0 V6	2005-	KJ20DR-M11	IK20TT	K20TT	IK20L	VK20
BRV 1.5 i-VTEC	2015-	VFK20F	IK20TT	-	-	VFK20F
City 1.3, 1.5 Type Z	1998-2001	K20PR-U11	IK20TT	K20TT	IK20	VK20
City 1.5 i-DSI	2003-2009	K20PR-U11	IK20TT	K20TT	IK20	VK20
City 1.5 i-VTEC	2009-2013	SKJ20DR-M13	IK20TT	-	IK20L	VK20
	2013-	VFK20F	IK20TT	-	-	VFK20F
City 1.5 i-Vtec Hybrid i-DCD	2017-	-	IXEH22TT	-	-	VFXEHC22G
City 1.5 VTEC	2005-	SKJ20DR-M13	IK20TT	-	IK20L	VK20
Civic (1.7, 2.0 VTEC)	2000-2005	KJ20CR-L11	IK20TT	K20TT	IK20L	VK20
Civic 1.3i Hybrid	2006-	SK20HPR-L11	IKH20TT	-	IKH20	VKH20
Civic 1.5 Turbo	2016-	-	-	-	-	VXEHC24G
Civic 1.5, 1.6	1992-1995	K20PR-U11	IK20TT	K20TT	IK20	VK20
Civic 1.8 Earth Dream	2016-	SXU22HCR11S	-	-	-	VXUHC22G
Civic 1.8, 2.0 i-VTEC (Earth Dream)	2013-	SXU22HCR11S	-	-	-	VXUHC22G
Civic Type R 2.0 FD2R	2008-2011	SK22PR-M11S	-	-	IK22G	VK22G
Civic Type R 2.0 FK2, FK8	2016-	SXU22HCR11S	-	-	-	VXUHC22G
Civic UH 1.8, 2.0 i-VTEC	2006-2012	SKJ20DR-M11	IK20TT	-	IK20L	VK20
CRV 1.5 Turbo	2017-	-	-	-	-	VXEHC24G
CRV 1st Gen 2.0 16V	1997-2001	KJ20CR-L11	IK20TT	K20TT	IK20L	VK20
CRV 2.0/2.4	2013-2017	SXU22HCR11S	-	-	-	VXUHC22G







MAKER	YEAR	DENSO	IRIDIUM U	TJ	IRIDIUM POWER	IRIDIUM TOUGH
<b>HONDA</b>						
CRV 2nd Gen 2.0 i-VTEC	2002-2006	KJ20DR-M11	IK20TT	K20TT	IK20L	VK20
CRV 3rd Gen 2.0 i-VTEC	2007-2012	IK20G	IK20TT	-	IK20G	VK20G
CRZ 1.5i Hybrid	2010-	SKJ20DR-M13	IK20TT	-	IK20L	VK20
Freed 1.5 i-VTEC	2010-	SKJ20DR-M13	IK20TT	-	IK20L	VK20
HRV 1.8	2010-	SXU22HCR11S	-	-	-	VXUHC22G
Insight 1.3i Hybrid	2009-	VFKH20	IKH20TT	-	-	VFKH20
Jazz 1.3i Hybrid	2010-2013	VFKH20	IKH20TT	-	-	VFKH20
Jazz 1.5 I-DSI, 1.4 i-DSI	2002-	K20PR-U11	IK20TT	K20TT	IK20	VK20
Jazz 1.5 i-VTEC	2008-	SKJ20DR-M13	IK20TT	-	IK20L	VK20
	2014-	VFK20F	IK20TT	-	-	VFK20F
Jazz 1.5 i-Vtec Hybrid i-DCD	2017-	-	IXEH22TT	-	-	VFXEHC22G
Jazz 1.5 VTEC	2005-2008	SKJ20DR-M13	IK20TT	-	IK20L	VK20
Odyssey 2.4L i-VTEC	2005-	SKJ20DR-M11	IK20TT	-	IK20L	VK20
Stream 1st Gen 1.7, 2.0	2001-2007	KJ20DR-M11	IK20TT	K20TT	IK20L	VK20
Stream 2nd Gen 1.8	2007-	VK20	IK20TT	-	IK20	VK20
<b>HYUNDAI INOKOM</b>						
Accent 1.5	1999-2006	K20PR-U11	IK20TT	K20TT	IK20	VK20
Accent 1.6	2006-	K16PR-U11	IK16TT	K16TT	IK16	VK16
Atos 1.1	1997-	K16PR-U	IK16TT	K16TT	IK16	VK16
Coupe 2.0i	2001-	K16PR-U11	IK16TT	K16TT	IK16	VK16
Elantra 1.6, 1.8	2001-2006	K20PR-U	IK20TT	K20TT	IK20	VK20
Elantra 2.0	2007-	K20PR-U11	IK20TT	K20TT	IK20	VK20
Getz 1.3, 1.6	2002-	K16PR-U	IK16TT	K16TT	IK16	VK16
Grandeur XG 3.0, 250 V6	2001-	PK16PR-L11	IK16TT	-	IK16	VK16
i10 1.1	2008-	K20PR-U11	IK20TT	K20TT	IK20	VK20
i30 1.6	2007-	K20PR-U11	IK20TT	K20TT	IK20	VK20
i40 2.0 GDI VF	2011-	-	-	-	-	-
Matrix 1.6	2001-	K16PR-U11	IK16TT	K16TT	IK16	VK16
NF 2.4	2005-	K16PR-U11	IK16TT	K16TT	IK16	VK16
NF 2.7	2005-	PK16PR-L11	IK16TT	-	IK16	VK16
Permas Van 2.0	-	W16EX/P-U	IW16TT	W16TT	IW16	VW16
Permas Van 2.2	-	T16EPR-U	IT16TT	T16TT	IT16	VT16
Santa FE 2.4	2001-2006	P16PR11	IW16TT	-	IW16	VW16
Sonata (NF) 2.4	2006	K16PR-U11	IK16TT	K16TT	IK16	VK16
Sonata (NF) 2.7	2005	VK20	IK20TT	-	IK20	VK20
Sonata 2.0, 2.4	2010	W20EXR-U	IW20TT	W20TT	IW20	VW20
Trajet 2.0GL / GLS	2000	W20EXR-U11	IW20TT	W20TT	IW20	VW20
Tucson 2.0	2005	K16PR-U11	IK16TT	K16TT	IK16	VK16
Tucson 2.0/ 2.4	2011	K16HPR-U11	IKH16TT	KH16TT	IKH16	VKH16
<b>ISUZU</b>						
Pick-Up	-	K20PR-U11	IK20TT	K20TT	IK20	VK20
Trooper V6 24V	1995	K20PR-U11	IK20TT	K20TT	IK20	VK20
Van	-	K20PR-U11	IK20TT	K20TT	IK20	VK20
<b>JAGUAR</b>						
XJ8 4.2 SE, XJR8	1997-2003	K20PR-U	IK20TT	K20TT	IK20	VK20
X-Type 3.0 SE (AJ-V6)	2001	K20PR-U	IK20TT	K20TT	IK20	VK20
<b>JEEP CHEROKEE</b>						
Jeep 2.5L	1994	K16PR-U	IK16TT	K16TT	IK16	VK16
Jeep 4	1994	K20PR-U	IK20TT	K20TT	IK20	VK20
<b>LAND ROVER</b>						
Range Rover 4.4 V8	2002-2005	K20TXR	IK20TT	K20TT	IK20	VK20
<b>LEXUS</b>						
IS/GS 250	2006-2016	FK20HBR11	IKBH20TT	-	-	VFKBH20
IS/GS/RX/NX 200t	2015	-	-	-	-	VDKH22F
LS460L	2007	FK20HBR11	IKBH20TT	-	-	VFKBH20
LX570	2016	-	IKH20TT	-	IKH20	VKH20
RX350	2007	FK20HR11	IKH20TT	-	-	VFKH20
RX450h	2009	-	IKBH20TT	-	-	VFKBH20
<b>LOTUS</b>						
Elise 1.8	1995	VK20	IK20TT	-	IK20	VK20
Europa Special	-	W22EP-U	-	-	IW22	VW22
<b>MAZDA</b>						
323 Astina	1995	K20PR-U11	IK20TT	K20TT	IK20	VK20
Bongo Van	-	W16EP-U/W16EX-U	IW16TT	W16TT	IW16	VW16
CX-3 2.0 SkyActiv	2015	VCH20	IXEH22TT	-	-	VCH20
CX-30	2019	ZC20HPR11	-	-	-	VCH20
CX-5 2.0, 2.5 Sky Activ	2012	VCH20	IXEH22TT	-	-	VCH20

AUSTRALIA  
CHINA  
INDIA  
INDONESIA  
KOREA  
MALAYSIA  
PHILIPPINES  
SAUDI ARABIA  
SINGAPORE  
TAIWAN  
THAILAND  
VIETNAM  
JAPAN  
EUROPE & USA  
CROSS REFERENCE NUMBER PART

DENSO	9	14	16	20	22	24	27	29	31	32	34	35	DENSO	9	14	16	20	22	24	27	31	32	DENSO	9	14	16	20	22	24	27	31	
NGK	2	4	5	6	7	8	9	9.5	10	10.5	11	11.5	CHAMPION	18	16,14	12,11	10,9	8,7	6,63,61	4,59	57	55	53	BOSCH	10	9	8	7,6	5	4	3	2



MAKER	YEAR	DENSO				
<b>AUSTRALIA</b>						
<b>MAZDA</b>						
CX-5 2.0, 2.5 Sky Activ	2018	ZC20HPR11	-	-	-	VCH20
CX-7 2.3	2009	ITV20	ITV20TT	-	ITV20	-
CX-8	2018	ZC20HPR11	-	-	-	VCH20
<b>CHINA</b>						
Lantis 1.6, 626 2.0	1995	K20PR-U11	IK20TT	K20TT	IK20	VK20
Mazda 2 1.5	2010	VK16	IK16TT	-	IK16	VK16
Mazda 2 1.5 (ZY-VE)	2009-2014	K16PR-U11	IK16TT	K16TT	IK16	VK16
Mazda 2 1.5 SkyActiv	2015	VCH20	IXEH22TT	-	-	VCH20
<b>INDIA</b>						
Mazda 3 1.5, 2.0	2019	ZC20HPR11	-	-	-	VCH20
Mazda 3 1.6	2009	VK16	IK16TT	-	IK16	VK16
Mazda 3 2.0	2004	VT16	IT16TT	-	IT16	VT16
Mazda 3 2.0 SkyActiv	2014	VCH20	IXEH22TT	-	-	VCH20
<b>INDONESIA</b>						
Mazda 5 2.0 MPV	2006	VT20	IT20TT	-	IT20	VT20
Mazda 6 2.0	2004	-	ITV16TT	-	ITV16	-
Mazda 6 2.0, 2.5 SkyActiv	2013	VCH20	IXEH22TT	-	-	VCH20
Premacy 1.8L	1999	K16PR-U11	IK16TT	K16TT	IK16	VK16
<b>MERCEDES BENZ</b>						
190E, 200, 230, 300 (123, 124, 126 Model)	-	T20EP-U	IT20TT	T20TT	IT20	VT20
B200T 2.0 (M266)	2005	VK20	IK20TT	-	IK20	VK20
C Class 180K 1.8 (M271) (W203)	2002-2007	VXUH22	-	-	IXUH22	VXUH22
C Class 200, 220 (M111)	1998	K16P-U	IK16TT	K16TT	IK16	VK16
<b>MALAYSIA</b>						
C Class 200K, E200K 2.0 (M111) (W203) (W210)	2000-2002	VK20	IK20TT	-	IK20	VK20
C Class 230K 2.3 (M271) (W203)	2004-2005	VKH20	IKH20TT	-	IKH20	VKH20
C-180K, C200K, E200K, (M271, M203)	2002	VKH20	IKH20TT	-	IKH20	VKH20
E200, E230, E240 (M111, M104, M119)	1996	K16PR-U	IK16TT	K16TT	IK16	VK16
<b>PHILIPPINES</b>						
E200, E230, S280, S320L (M111)	1998	K16TNR-S9	IK16TT	K16TT	IK16	VK16
E200K 2.0 (M271) (W211)	2002-2006	VKH20	IKH20TT	-	IKH20	VKH20
E240K, S280 (W211)	2004	PK16PR(-L)11	IK16TT	-	IK16	VK16
S320 (W220), 350L (V220)	2003	PK16PR(-L)11	IK16TT	-	IK16	VK16
<b>SAUDI ARABIA</b>						
SLK200, SLK350	2006	PK16PR(-L)11	IK16TT	-	IK16	VK16
<b>MINI</b>						
Cooper 1.6	2002	K20TXR	IK20TT	K20TT	IK20	VK20
Cooper S 1.6	2002	K20TXR	IK20TT	K20TT	IK20	VK20
Mini Cooper, One 1.6	2002	K20TXR	IK20TT	K20TT	IK20	VK20
<b>SINGAPORE</b>						
<b>TAIWAN</b>						
<b>THAILAND</b>						
<b>VIETNAM</b>						
<b>NAZA / KIA</b>						
Bestari 206 1.4	2006	K20TXR	IK20TT	K20TT	IK20	VK20
Carens 1.8	2001	K20PR-U11	IK20TT	K20TT	IK20	VK20
Carnival V6 2.5	2001-2006	PK20PR-L11	IK20TT	-	IK20	VK20
Cerato K3 1.6	2013	-	-	-	IXUH20I	VXUH20I
Cerato K3 2.0	2013	K16HPR-U11	IKH16TT	KH16TT	IKH16	VKH16
Citra 2.0	2002	K20PR-U11	IK20TT	K20TT	IK20	VK20
<b>&amp; USA</b>						
Citra II Rondo 2.0	2008	K20PR-U11	IK20TT	K20TT	IK20	VK20
Forte 1.6	2010	-	-	-	IXUH22I	VXUH22I
Forte 2.0	2010	K16HPR-U11	IKH16TT	KH16TT	IKH16	VKH16
Forte Koup 2.0i CVVT	2010	K16HPR-U11	IKH16TT	KH16TT	IKH16	VKH16
<b>CROSS REFERENCE NUMBER</b>						
K5 2.0	2011	-	-	-	-	-
Optima 2.0	2003	K20PR-U11	IK20TT	K20TT	IK20	VK20
Picanto 1.1	2004	K16PR-U11	IK16TT	K16TT	IK16	VK16
Picanto 1.2	2011	-	-	-	IXUH20I	VXUH20I
Ria 2.5 V6	2001-2006	PK20PR-L11	IK20TT	-	IK20	VK20
Rio 1.4	2003	K16PR-U11	IK16TT	K16TT	IK16	VK16
Rio/ Rio Sedan 1.4	2011	-	-	-	IXUH20I	VXUH20I
Sephia 1.5 / 1.6	2001	K20PR-U11	IK20TT	K20TT	IK20	VK20

MAKER	YEAR	DENSO					
<b>NAZA / KIA</b>							
Sorento V6 3.5	2002	K20PR-U11	IK20TT	K20TT	IK20	VK20	AUSTRALIA
Sorento XM	2009	K16HPR-U11	IKH16TT	KH16TT	IKH16	VKH16	CHINA
Spectra 1.6	2001	K20PR-U11	IK20TT	K20TT	IK20	VK20	INDIA
Spectra 5	-	K20PR-U11	IK20TT	K20TT	IK20	VK20	INDONESIA
Sportage 2.0 4x4	2010	K16HPR-U11	IKH16TT	KH16TT	IKH16	VKH16	KOREA
Sportage R	-	K20PR-U11	IK20TT	K20TT	IK20	VK20	MALAYSIA
Suria	-	K16PR-U	IK16TT	K16TT	IK16	VK16	PHILIPPINES
Sutera 1.1	2006	PK16PR-L11	IK16TT	-	IK16	VK16	SAUDI ARABIA
<b>NISSAN</b>							
350Z	2003	VKH16	IKH16TT	-	IKH16	VKH16	SINGAPORE
AD Resort 1.6SLX	1990-1997	K20PR-U	IK20TT	K20TT	IK20	VK20	TAIWAN
Almera 1.5	2013	FXE20HR11	IXEH20TT	-	-	VFXEH20	THAILAND
Altima 2.0, BLUEBIRD 2.0	2000	Q20PR-U	IQ20TT	Q20TT	IQ20	VQ20	VIETNAM
Bluebird 2.0	2000	K20PR-U	IK20TT	K20TT	IK20	VK20	JAPAN
Cefiro 2.0i V6 24V (A33)	2000	VK20	IK20TT	-	IK20	VK20	EUROPE
Cefiro 2.0i, 3.0i	1997-2001	PK20PR11	IK20TT	-	IK20	VK20	USA
Grand Livina 1.6, 1.8	2007	FXE20HR11	IXEH20TT	-	-	VFXEH20	CROSS
Latio 1.6, 1.8	2007	FXE20HR11	IXEH20TT	-	-	VFXEH20	REFERENCE
Livina X-GEAR	2011	FXE20HR11	IXEH20TT	-	-	VFXEH20	NUMBER
March Micra 1.0	2000	W16EX-U	IW16TT	W16TT	IW16	VW16	
March Micra 1.4 <NEW>	2002	VKH20	IKH20TT	-	IKH20	VKH20	
Murano 2.5	2004-2009	K16HPR-U11	IKH16TT	KH16TT	IKH16	VKH16	
Sentra 1.5, 1.6i (N13)	1988-1991	Q20-U	IQ20TT	Q20TT	IQ20	VQ20	
Sentra 1.6 (B13)	1991-1995	K16PR-U	IK16TT	K16TT	IK16	VK16	
Sentra 1.6 (B14)	1995-2001	K16PR-U11	IK16TT	K16TT	IK16	VK16	
Sentra 1.6, 1.8 (N16)	2000	K16PR-U	IK16TT	K16TT	IK16	VK16	
Serena 1.6, 2.0i	2001	K16PR-U11	IK16TT	K16TT	IK16	VK16	
Skyline 2.5GTR R34 (RB26DETT)	2001	VQ22	-	-	IQ22	VQ22	
Sunny 1.6i	1986	W16EX-U11	IW16TT	W16TT	IW16	VW16	
Sunny 120Y (B11), 130Y (B12)	1994	W16EX-U	IW16TT	W16TT	IW16	VW16	
SYLPHY 2.0	2008	FXE20HR11	IXEH20TT	-	-	VFXEH20	
Teana 2.0	2011	FXE20HR11	IXEH20TT	-	-	VFXEH20	
Teana 2.5 V6	2011	FXE20HR11	IXEH20TT	-	-	VFXEH20	
Terrano	1986-1995	W16EX-U	IW16TT	W16TT	IW16	VW16	
Vanette C20, C22	1993	W16EX-U	IW16TT	W16TT	IW16	VW16	
X-Trail 2.0	2015	-	IXEH20TT	-	-	VFXEH20	
X-Trail 2.0, 2.5	2003-2014	K16HPR-U11	IKH16TT	KH16TT	IKH16	VKH16	
<b>OPEL</b>							
Astra 1.6i	1993	K16PR-U	IK16TT	K16TT	IK16	VK16	
Astra 2.0i, GSi 16V	1995	K20PR-U	IK20TT	K20TT	IK20	VK20	
Frontera 4WD 2.2 ECOTEC	1995	K16PR-U	IK16TT	K16TT	IK16	VK16	
Vectra 1.8, 2.0i ECOTEC	1995	K20PR-U	IK20TT	K20TT	IK20	VK20	
<b>PERODUA</b>							
Alza 1.5	2010	XU22PR9	-	XU22TT	IXU22	VXU22	
Aruz 1.5	2018	SC16HR11	-	-	-	VCH16	
Ativa 1.0	2021	-	-	-	-	-	
Axia 1.0	2014	XU20HR9	-	-	IXUH20I	VXUH20I	
Bezza 1.0	2016	XU20HR9	-	-	IXUH20I	VXUH20I	
Bezza 1.3	2016	SC16HR11	IXEH20TT	-	-	VCH16	
Kancil 850Ezi	2000	K16PR-U11	IK16TT	K16TT	IK16	VK16	
Kancil EX, GX, EZ660	2009	W16EX-U	IW16TT	W16TT	IW16	VW16	
Kancil EX, GX, EZ850	1994	W20EX-U	IW20TT	W20TT	IW20	VW20	
Kelisa , Kenari , Myvi 1.0	1998	K16PR-U11	IK16TT	K16TT	IK16	VK16	
Kembara 1.3	1996	K20TNR-S	IK20TT	K20TT	IK20	VK20	
Myvi 1.3 (Old), Kembara DVVT	2005-2006	K20R-U11	IK20TT	K20TT	IK20	VK20	
Myvi 1.3 Lagi Best, Icon	2007-2017	XU22PR9	-	XU22TT	IXU22	VXU22	
Nautica 1.5	2007	XU22EPR-U	-	XU22TT	IXU22	VXU22	
New Myvi 1.3, 1.5	2017	SC16HR11	IXEH20TT	-	-	VCH16	
Rusa 1.3 , 1.6	2000	K20P-U	IK20TT	K20TT	IK20	VK20	
ViVa 0.66	2006	K20PR-U	IK20TT	K20TT	IK20	VK20	
ViVa 1.0, 0.85	2006	K16PR-U11	IK16TT	K16TT	IK16	VK16	
<b>PEUGEOT</b>							
206, 206CC	2000	K20TXR	IK20TT	K20TT	IK20	VK20	
207 CC 1.6	2006	-	IKH16TT	-	IKH16	VKH16	
306 1.8i	1997-2003	K20TXR	IK20TT	K20TT	IK20	VK20	
307 1.6i	2000-2003	K20TXR	IK20TT	K20TT	IK20	VK20	
308 (T7)	2007	K20PR-U	IK20TT	K20TT	IK20	VK20	

DENSO	9	14	16	20	22	24	27	29	31	32	34	35	DENSO	9	14	16	20	22	24	27	31	32	DENSO	9	14	16	20	22	24	27	31	
NGK	2	4	5	6	7	8	9	9.5	10	10.5	11	11.5	CHAMPION	18	16,14	12,11	10,9	8,7	6,63,61	4,59	57	55	53	BOSCH	10	9	8	7,6	5	4	3	2



	MAKER	YEAR	DENSO					
AUSTRALIA	<b>PEUGEOT</b>							
	405 SR, Sri	1992-1997	K20TXR	IK20TT	K20TT	IK20	VK20	
	406 2.0i	1995-2004	K20TXR	IK20TT	K20TT	IK20	VK20	
CHINA	407 (D2)	2004	-	IKH16TT	-	IKH16	VKH16	
	607 2.2i	2000	-	IKH16TT	-	IKH16	VKH16	
	807 2.0i	2002	-	IKH16TT	-	IKH16	VKH16	
INDIA	<b>PORSCHE</b>							
	911 (996)	1997-2004	VK20	IK20TT	-	IK20	VK20	
	Boxster (986)	1996	IK22	-	-	IK22	VK22	
	Cayenne (9PA)	2002	K20PBR-S10	IK20TT	K20TT	IK20	VK20	
INDONESIA	Cayman	2005	IK22	-	-	IK22	VK22	
	<b>PROTON</b>							
	Arena 1.5L	1999	W16EX-U	IW16TT	W16TT	IW16	VW16	
	Exora 1.6 CPS MPV	2009	T20EPR-U	IT20TT	T20TT	IT20	VT20	
KOREA	Exora Bold 1.6 CFE Turbo	2011	-	IXEH22TT	-	-	-	
	Gen 2 1.3i	2005	T20EPR-U	IT20TT	T20TT	IT20	VT20	
	Gen 2 1.6i	2004	T20EPR-U	IT20TT	T20TT	IT20	VT20	
	Iriz 1.3, 1.6 VVT	2014	-	IXEH22TT	-	-	-	
MALAYSIA	Iswara 1.3, 1.5	1992	W16EX-U	IW16TT	W16TT	IW16	VW16	
	Juara 1.1	2000-2004	XU22EPR-U	-	XU22TT	IXU22	VXU22	
	New Persona 1.6 VVT	2016	-	IXEH22TT	-	-	-	
	Perdana 2.0i V6	1994-2001	K20PR-U11	IK20TT	K20TT	IK20	VK20	
PHILIPPINES	Perdana 2.0i V6 24V	1998-2013	PK20PR-P11	IK20TT	-	IK20	VK20	
	Persona 1.6L	2004	T20EPR-U	IT20TT	T20TT	IT20	VT20	
	Preve 1.6 Campro (Non-Turbo)	2012	T20EPR-U	IT20TT	T20TT	IT20	VT20	
	Preve 1.6 CFE Turbo	2012	-	IXEH22TT	-	-	-	
SAUDI ARABIA	Putra 1.8i	1996-2000	K16PR-U	IK16TT	K16TT	IK16	VK16	
	Saga 1.3, 1.5	1985-1992	W16EX-U	IW16TT	W16TT	IW16	VW16	
	Saga 1.3 VVT	2016	-	IXEH22TT	-	-	-	
	Saga BLM, FL, FLX	2008-2016	T20EPR-U	IT20TT	T20TT	IT20	VT20	
SINGAPORE	Satria 1.3	1996	W16EX-U	IW16TT	W16TT	IW16	VW16	
	Satria 1.5	1996	W16EX-U	IW16TT	W16TT	IW16	VW16	
	Satria 1.6i	1996	K16PR-U	IK16TT	K16TT	IK16	VK16	
	Satria 1.8 GTi 16V	1999-2006	K20PR-U11	IK20TT	K20TT	IK20	VK20	
TAIWAN	Satria Neo 1.3	2006	T20EPR-U	IT20TT	T20TT	IT20	VT20	
	Satria Neo 1.6	2006	T20EPR-U	IT20TT	T20TT	IT20	VT20	
	Savvy 1.2	2005	XE20HR-U9	IXEH20TT	-	-	VFXEH20	
	Tiara 1.1 GL 8V	1995-2000	K16PR-U	IK16TT	K16TT	IK16	VK16	
THAILAND	Waja 1.6i	1999-2006	K20PR-U11	IK20TT	K20TT	IK20	VK20	
	Waja 1.8i	2001	K20PR-U11	IK20TT	K20TT	IK20	VK20	
	Waja Campro CPS 1.6i	2006	T20EPR-U	IT20TT	T20TT	IT20	VT20	
	Wira 1.3, 1.5	1993-2001	W16EX-U	IW16TT	W16TT	IW16	VW16	
VIETNAM	Wira 1.6, 1.8	2000	W16EX-U	IW16TT	W16TT	IW16	VW16	
	Wira 1.6 Xli, 1.8EXi	1995	K16PR-U	IK16TT	K16TT	IK16	VK16	
	X50	2020	-	-	-	-	-	
	X70 1.8 TGD i	2018	-	IK20TT	-	IK20	VK20	
EUROPE & USA	<b>RENAULT</b>							
	19 Cabrio 1.8i	1992-1995	W16EXR-U11	IW16TT	W16TT	IW16	VW16	
	Clio III 1.4	2005	K16PR-U	IK16TT	K16TT	IK16	VK16	
	Espace III (JEO) 2.0	1996-2002	K16PR-U	IK16TT	K16TT	IK16	VK16	
	Kangoo 1.4i	1997	K16PR-U	IK16TT	K16TT	IK16	VK16	
	Laguna 1.8RT, 2.0RXE	1994	W16EX-U	IW16TT	W16TT	IW16	VW16	
	Megane 1.6i, Scenic 1.6i	1996	K16PR-U	IK16TT	K16TT	IK16	VK16	
Megane 2.0i, Scenic 2.0i	1996	W16EXR-U	IW16TT	W16TT	IW16	VW16		
CROSS REFERENCE NUMBER	Traffic 2.2	-	T20EP-U	IT20TT	T20TT	IT20	VT20	
	<b>SKODA</b>							
	Fabia	1999	-	IK20TT	-	IK20	VK20	
	Octavia (1U25)	1996-2004	-	IK16TT	-	IK16	VK16	
PART NUMBER	Octavia (1Z35)	2004	-	IK16TT	-	IK16	VK16	
	Superb	2004	-	IK16TT	-	IK16	VK16	
	<b>SSANGYONG</b>							
	Actyon	2006	K16PR-U	IK16TT	K16TT	IK16	VK16	
Chairman 2.3 DOHC	1997	K16PR-U11	IK16TT	K16TT	IK16	VK16		
Chairman 2.8, 3.2 DOHC	2003	K16TNR-S9	IK16TT	K16TT	IK16	VK16		
Kyron	2005	K16PR-U	IK16TT	K16TT	IK16	VK16		
Rexton RX280, RX320S	2003	K16PR-U	IK16TT	K16TT	IK16	VK16		





MAKER	YEAR	DENSO	IRIDIUM U	TJ	IRIDIUM POWER	IRIDIUM TOUGH	
<b>SUBARU</b>							AUSTRALIA
Forester 2.0i	1997	K20PR-U11	IK20TT	K20TT	IK20	VK20	
Forester 2.0ip	2016	VFXEH22	IXEH22TT	-	-	VFXEH22	
Impreza 1.6 , 1.8	1992-1996	K20PR-U11	IK20TT	K20TT	IK20	VK20	
Impreza 2.0 4WD Outback	2000	K20PR-U11	IK20TT	K20TT	IK20	VK20	
Impreza 2.0 4WD Turbo	1992-2000	K20PR-U11	IK20TT	K20TT	IK20	VK20	
Impreza WRX 2.0 CVT	2014	VFXEH22	IXEH22TT	-	-	VFXEH22	
Impreza WRX STi 2.5 6-MT	2014	VKH20Y	IKH20TT	-	-	VKH20Y	
Legacy 2.0 , 2.2	2004	K20PR-U11	IK20TT	K20TT	IK20	VK20	
Libero 1.2i, 1.2, 4WD	1995	K16PR-U11	IK16TT	K16TT	IK16	VK16	
XV 2.0	2012	VFXEH22	IXEH22TT	-	-	VFXEH22	
<b>SUZUKI</b>							INDONESIA
Alto 1.0	2011	W16EPR-U	IW16TT	W16TT	IW16	VW16	
APV 1.6	-	K20PR-U	IK20TT	K20TT	IK20	VK20	
ERV 1.3	-	K20PR-U	IK20TT	K20TT	IK20	VK20	
Grand Vitara	-	K20PR-U11	IK20TT	K20TT	IK20	VK20	
Jimny 1.3	-	K16PR-U11	IK16TT	K16TT	IK16	VK16	
Swift 1.5	2004	K20PR-U11	IK20TT	K20TT	IK20	VK20	
Swift Sport 1.6	2005-2011	VK20	IK20TT	-	IK20	VK20	
SX4 1.6	2007	VK20	IK20TT	-	IK20	VK20	
Vitara 1.6i , 2.0i	1997-2002	K20PR-U11	IK20TT	K20TT	IK20	VK20	
Vitara 2.0 GLX	2004	K20PR-U11	IK20TT	K20TT	IK20	VK20	
<b>TOYOTA</b>							MALAYSIA
Alphard 2.4	2002-2008	K20R-U11	IK20TT	K20TT	IK20	VK20	
	2008-2015	SK20R11	IK20TT	-	IK20	VK20	
Alphard 2.5	2015	SK16HR11	IKH16TT	-	IKH16	VKH16	
Alphard 3.0	2002-2008	SK20R11	IK20TT	-	IK20	VK20	
Alphard 3.5 V6	2008	FK20HR11	IKH20TT	-	-	VFKH20	
Altis 1.6 , 1.8 VVT-i	2003-2010	K16R-U11	IK16TT	K16TT	IK16	VK16	
Altis 1.6E, 1.8G, 2.0V Dual VVT-i	2010-2014	SC20HR11	IXEH22TT	-	-	VCH20	
Altis 1.8E, 1.8G, 2.0V Dual VVT-i	2016	SC20HR11	IXEH22TT	-	-	VCH20	
	2014-2016	SC20HR11	IXEH22TT	-	-	VCH20	
Avanza 1.3	2004-2006	K20R-U11	IK20TT	K20TT	IK20	VK20	
Avanza 1.3 , 1.5	2006-2015	XU22PR9	-	XU22TT	IXU22	VXU22	
Avanza 1.3, 1.5 (Dual -VVTi)	2015	SC16HR11	IXEH20TT	-	-	VCH16	
Caldina 1.8 (1ZZ-FE)	2002	K16R-U11	IK16TT	K16TT	IK16	VK16	
Caldina 1.8 (7A-FE)	1996-2002	PK16TR13	IK16TT	-	IK16	VK16	
Caldina 2.0 (1AZ-FSE D-4)	2002	SK20BGR11	-	-	-	VKA20	
Caldina 2.0 (3S-FE)	1992-1996	K20R-U11	IK20TT	K20TT	IK20	VK20	
	1996-2002	K20TR11	IK20TT	K20TT	IK20	VK20	
Caldina 2.0 (3S-GTE T/C)	1997-2002	PK20R8	IK20TT	-	-	VK20Y	
Caldina 2.0 ST246W (3S-GTE T/C)	2002	SK20R8	IK20TT	-	-	VK20Y	
Camry 2.0 E VVTI ACV30	2002-2006	SK20R11	IK20TT	-	IK20	VK20	
Camry 2.0E . 2.0G, 2.4V ACV40	2006-2012	SK20R11	IK20TT	-	IK20	VK20	
Camry 2.0E, 2.0G ACV50	2012-2015	SK20R11	IK20TT	-	IK20	VK20	
Camry 2.0E, 2.0G VVTi-W	2015	FK16HBR-J8	IKBH20TT	-	-	VFKBH20	
Camry 2.2i Sedan	1992-2000	PK20TR11	IK20TT	-	IK20	VK20	
Camry 2.4 V VVTI	1992-2000	SK20R11	IK20TT	-	IK20	VK20	
Camry 2.5 ASV70R	2018	-	IKH16TT	-	-	VFKH16	
Camry 2.5 AVV50 Hybrid	2015	FK16HR-A8	IKH16TT	-	-	VFKH16	
Camry 2.5V ACV50	2012-2015	SK16HR11	IKH16TT	-	IKH16	VKH16	
Camry SXV10	-	K20R-U11	IK20TT	K20TT	IK20	VK20	
Camry SXV20	-	PK20TR11	IK20TT	-	IK20	VK20	
Celica 2.0i, 2.2i	1993	K16R-U11	IK16TT	K16TT	IK16	VK16	
C-HR 1.2 Turbo	2018	-	-	-	-	VDCH22F	
C-HR 1.8	2018	-	IXEH20TT	-	-	VCH16	
Corolla (EE111)	-	K16R-U	IK16TT	K16TT	IK16	VK16	
Corolla 1.3i (AE80 , 82)	1997-1999	W16EX-U	IW16TT	W16TT	IW16	VW16	
Corolla 1.6i (AE101)	1994-1997	K16R-U11	IK16TT	K16TT	IK16	VK16	
Corolla 1.6i (AE111)	1997-2002	K20R-U	IK20TT	K20TT	IK20	VK20	
Corolla 1.6i (AE92)	1996-2002	Q16R-U	IQ16TT	Q16TT	IQ16	VQ16	
Corona (ST171R)	-	Q20R-U11	IQ20TT	Q20TT	IQ20	VQ20	
Corona (TT132), 1.6XLI(AT151)	-	W16EX-U	IW16TT	W16TT	IW16	VW16	
Estima 2.4 (2AZ-FE)	2000-2006	K20R-U11	IK20TT	K20TT	IK20	VK20	
	2006	SK20R11	IK20TT	-	IK20	VK20	
Estima 2.4, 3.0	1998-2005	SK20R11	IK20TT	-	IK20	VK20	
Estima 2.5	1993-1997	PK16R11	IK16TT	-	IK16	VK16	
Estima 3.0 (1MZ-FE)	2000-2006	SK20R11	IK20TT	-	IK20	VK20	

CHINA  
INDIA  
INDONESIA  
KOREA  
PHILIPPINES  
SAUDIARABIA  
SINGAPORE  
TAIWAN  
THAILAND  
VIETNAM  
JAPAN  
EUROPE  
& USA  
CROSS  
REFERENCE  
PART  
NUMBER

DENSO	9	14	16	20	22	24	27	29	31	32	34	35	DENSO	9	14	16	20	22	24	27	29	31	32	DENSO	9	14	16	20	22	24	27	31
NGK	2	4	5	6	7	8	9	9.5	10	10.5	11	11.5	CHAMPION	18	16,14	12,11	10,9	8,7	6,63,61	4,59	57	55	53	BOSCH	10	9	8	7,6	5	4	3	2



MAKER	YEAR	DENSO	IRIDIUM T	IRIDIUM RACING	IRIDIUM POWER	IRIDIUM TOUGH
<b>AUSTRALIA</b>						
<b>TOYOTA</b>						
Estima 3.5 (2GR-FE)	2006	FK20HR11	IKH20TT	-	-	VFKH20
Fortuner 2.7	2005	K20HR-U11	IKH20TT	KH20TT	IKH20	VKH20
Fortuner 2.7 Dual VVT-i	2016	FK20HR-A8	IKH20TT	-	-	VFKH20
<b>CHINA</b>						
GT 86	2012	ZXE27HBR8	-	-	-	VXEBH27
Harrier 2.4	2000-2003	K20R-U11	IK20TT	K20TT	IK20	VK20
Harrier 3.0i 24V	1998	SK20R11	IK20TT	-	IK20	VK20
Harrier ASU60/65W 2.0 Turbo	2018	-	-	-	-	VDKH22F
Harrier ZSU60/65W 2.0	2014	-	IXEH20TT	-	-	VCH20
<b>INDIA</b>						
Hiace (2R, 2Y, 3Y, 1RZ)	-	W16EX-U	IW16TT	W16TT	IW16	VW16
Hilux 1.8, 2.2, 2.4	1988-1994	W16EXR-U11	IW16TT	W16TT	IW16	VW16
Innova 2.0	2005	K20HR-U11	IKH20TT	KH20TT	IKH20	VKH20
<b>INDONESIA</b>						
Innova 2.0 Dual VVT-i	2016	FK20HBR-TJ8	IKBH20TT	-	-	VFKBH20
Land Cruiser (Prado) 2.7	1997-2002	K16R-U	IK16TT	K16TT	IK16	VK16
	2002-2004	K16R-U11	IK16TT	K16TT	IK16	VK16
	2004-2007	SK20HR11	IKH20TT	-	IKH20	VKH20
Land Cruiser (Prado) 2.7i 16V	1996	K20R-U	IK20TT	K20TT	IK20	VK20
Land Cruiser (Prado) 3.4i 24V	1996	K16TR11	IK16TT	K16TT	IK16	VK16
Land Cruiser 4.7 (LC100, LC200)	-	SK20R11	IK20TT	-	IK20	VK20
Land Cruiser II 2.4	1988-1996	W16EP-U	IW16TT	W16TT	IW16	VW16
<b>KOREA</b>						
Liteace (KM36)	-	W16EX-U	IW16TT	W16TT	IW16	VW16
<b>MALAYSIA</b>						
Liteace (YM30, 31, 35)	-	W16EX-U	IW16TT	W16TT	IW16	VW16
Liteace 1.5, 1.8	1983-1992	W16EX-U	IW16TT	W16TT	IW16	VW16
MR2 1.6 (AW11), 2.0GTI	1993	K20R-U11	IK20TT	K20TT	IK20	VK20
MR2 2.0 (S-GE)	1989-1997	PK20R8	IK20TT	-	IK20	VK20Y
	1997-1999	PK20R11	IK20TT	-	IK20	VK20
MR2 2.0 (S-GTE T/C)	1989-1999	PK20R8	IK20TT	-	-	VK20Y
<b>PHILIPPINES</b>						
Prius 1.8	2009	SC20HR11	IXEH22TT	-	-	VCH20
Prius C 1.5	2011	SK16R11	IK16TT	-	IK16	VK16
<b>SAUDI ARABIA</b>						
Rav 4 2.0i 16V	1994-2000	K20R-U11	IK20TT	K20TT	IK20	VK20
Rush 1.5	2006	XU22PR9	-	XU22TT	IXU22	VXU22
Rush 1.5 Dual VVT-i	2018	SC16HR11	IXEH20TT	-	-	VCH16
Sienta 1.5 Dual VVT-i	2016	SC16HR11	IXEH20TT	-	-	VCH16
<b>SINGAPORE</b>						
Unser 1.8	1999-2004	W16EXR-U11	IW16TT	W16TT	IW16	VW16
Vellfire 2.4	2009-2015	SK20R11	IK20TT	-	IK20	VK20
Vellfire 2.5	2015	SK16HR11	IKH16TT	-	IKH16	VKH16
Vellfire 3.5 V6	2009	FK20HR11	IKH20TT	-	-	VFKH20
Vios 1.5E, 1.5G	2003-2007	K16R-U11	IK16TT	K16TT	IK16	VK16
<b>TAIWAN</b>						
Vios 1.5J, 1.5E, 1.5G, 1.5GX, TRD (Dual VVTi)	2010-2016	K16R-U11	IK16TT	K16TT	IK16	VK16
Vios 1.5J, 1.5E, 1.5G, 1.5GX, TRD (Dual VVTi)	2016	SC16HR11	IXEH20TT	-	-	VCH16
Wish 1.8 (Japan)	2003-2009	K16R-U11	IK16TT	K16TT	IK16	VK16
Wish 2.0 (Japan)	2003-2009	SK20BGR11	-	-	-	VKA20
<b>THAILAND</b>						
Wish 2.0 (Thailand)	2004-2009	SK20R11	IK20TT	-	IK20	VK20
Yaris 1.5	2006-2009	K16R-U11	IK16TT	K16TT	IK16	VK16
Yaris 1.5 Dual VVT-i	2019	-	-	-	-	-
<b>VOLKSWAGEN</b>						
<b>VIETNAM</b>						
Beetle	-	SC16HR11	IXEH20TT	-	-	VCH16
Beetle (New) 1.6	2002	K20PBR-S10	IK20TT	K20TT	IK20	VK20
Beetle (New) 2.0	2002	VK20	IK20TT	-	IK20	VK20
EOS 2.0	2006	VK20	IK20TT	-	IK20	VK20
<b>JAPAN</b>						
Golf	-	W16EX-U	IW16TT	W16TT	IW16	VW16
Golf V 1.6	2007	K20PBR-S10	IK20TT	K20TT	IK20	VK20
Golf V GTI 2.0	2005	VK20	IK20TT	-	IK20	VK20
Golf VI 1.6	2008	VK20	IK20TT	-	IK20	VK20
Jetta 1.6	2005-2008	K20PBR-S10	IK20TT	K20TT	IK20	VK20
Jetta 2.0 FSI	2005	VK20	IK20TT	-	IK20	VK20
<b>EUROPE &amp; USA</b>						
Passat 2.8 V6	-	K20PBR-S10	IK20TT	K20TT	IK20	VK20
Polo 1.4 FSI	2006	K20PBR-S10	IK20TT	K20TT	IK20	VK20
Polo GTI 1.8 TURBO	2006	VK20	IK20TT	-	IK20	VK20
Polo Sedan 1.6 MPI	2006	VK16	IK16TT	-	IK16	VK16
Tiguan 2.0	2007	VK20	IK20TT	-	IK20	VK20
Touareg (7LA) 3.6 V6 FSI	2002-2006	VXU22	-	-	IXU22	VXU22
<b>CROSS REFERENCE NUMBER</b>						
<b>VOLVO</b>						
740 2.3i	1990-1995	W20EX-U	IW20TT	W20TT	IW20	VW20
850 2.5 GLT	1993-1997	W20EX-U	IW20TT	W20TT	IW20	VW20
850 2.5GLE	1992-1997	K20PR-U	IK20TT	K20TT	IK20	VK20
940 2.3, 2.3T	1991-1997	W20EX-U	IW20TT	W20TT	IW20	VW20
960 2.4, 3.0	1994-1997	PK20PR-P8	IK20TT	-	IK20	VK20Y



MODEL	DENSO	IRIDIUM POWER	MODEL	DENSO	IRIDIUM POWER
<b>APRILIA</b>			<b>HONDA</b>		
ETV CapoNord, RST Futura	XU27EPR-U	<b>IXU27</b>	Wave DASH Repsol	U20EPR9	<b>IU20</b>
MX50, SR50 Street	W27ESR-U	<b>IW27</b>	<b>KAWASAKI</b>		
Pegaso 650, Moto 6.5	X24ES-U	<b>IX24</b>	1400GTR	<b>IU27D</b>	<b>IU27D</b>
RSV1000R, Tuono 1000R	XU27EPR-U	<b>IXU27</b>	AXM100, AN90 (Honey)	U20FS-U	<b>IUF22</b>
RX 250	W31ES-U	<b>IW31</b>	Eliminator 250	U22FS-U	<b>IUF22</b>
RX125, Strada 125, RS125	W27ESR-U/W27ES-U	<b>IW27</b>	ER-6N/F	<b>IU27D</b>	<b>IU27D</b>
SR50, Rally 50	W24ES-U <sub>s</sub>	<b>IW24</b>	K1 Sports, K1 155	W22FP-U <sub>s</sub>	<b>IWF22</b>
Tuareg Rally 250	W27ES-U	<b>IW27</b>	KR150, KRR150	W24ES-U <sub>s</sub>	<b>IW24</b>
<b>BMW</b>			KR150/A, KRR150, Victor	W24EP-U <sub>s</sub>	<b>IW24</b>
F650, F650CS, F650GS	X24ES-U	<b>IX24</b>	KR150/H/J, KRZ, Serpico	W27ES-U	<b>IW27</b>
GS80, R80/7, R80G, R80S	W20EP-U <sub>s</sub>	<b>IW20</b>	Ninja	W24EP-U <sub>s</sub>	<b>IW24</b>
K100, K100RS, K100RT	X22ES-U	<b>IX22</b>	Ninja 1000RX	X24ES-U	<b>IX24</b>
K1200GT	XU22EPR-U	<b>IXU22</b>	Ninja 250/250R	U24ESR-N	<b>IU24</b>
K75C, K75S	X22ES-U	<b>IX22</b>	Ninja ZX-6R, ZXR250, ZX-9R	U27ESR-N	<b>IU27</b>
R1100GS/RS	K22PB	<b>IK22</b>	Ninja ZX-7, ZX-7R, ZX-7RR	U27ESR-N	<b>IU27</b>
R1100S Boxer Cup	K22TNR	<b>IK22</b>	RR100 Ninja, Victor 150	W24ES-U <sub>s</sub>	<b>IW24</b>
R75/5, R75/6, R75/7	W20EP-U <sub>s</sub>	<b>IW20</b>	Serpico 150, KRZ150, KRX150	W27ES-U	<b>IW27</b>
<b>CAGIVA</b>			Versys 1000	<b>IU27D</b>	<b>IU27D</b>
125, Mito 125, ST125	W27ES-U	<b>IW27</b>	VN800/A/B, Vulcan 800	U22ESR-N	<b>IU22</b>
City, Scooter(D)	W24FP-U <sub>s</sub>	<b>IWF24</b>	Vulcan 1500	X22EP-U9	<b>IX22B</b>
Elefant 750	X24EPR-U9	<b>IX24B</b>	Vulcan 500	X27ES-U	<b>IX27</b>
Elefant 900	X27EPR-U9	<b>IX27B</b>	Z1000, ZX-10R, ZZ-R1400	<b>IU27D</b>	<b>IU27D</b>
Mito SP 125	<b>IW29</b>	<b>IW29</b>	ZX500, ZZ-R500, ZZ-R1100	U27ESR-N	<b>IU27</b>
MX250, MXR250	<b>IW27</b>	<b>IW27</b>	ZXR250	U27ESR-N	<b>IU27</b>
Raptor, V-Raptor	U24ESR-N	<b>IU24</b>	ZZR250, Eliminator 250	U24FS-U	<b>IUF24</b>
SS250, SST250, SX250	W24ES-U <sub>s</sub>	<b>IW24</b>	<b>MODENAS</b>		
V-Raptor, X-tra Raptor	U24ETR	<b>IU24A</b>	Ceria, Karisma, Kristar, Ace 115	U22FS-U	<b>IUF22</b>
<b>COMEL/JRD</b>			Dinamik	W27ES-U	<b>IW27</b>
Admiral RD-150R	U20FS-U	<b>IUF22</b>	Elegan 150, Passion	U24ESR-N	<b>IU24</b>
Comet Acerr, Swng, Maxx	U20FS-U	<b>IUF22</b>	Jaguh	U24ES-N	<b>IU24</b>
Manja GS5, Manja II, III	U20FS-U	<b>IUF22</b>	Kriss, Kriss 2, Kriss SE, Kriss SG	U20FS-U	<b>IUF22</b>
Monyet, Summer, Manja Sport	U20FS-U	<b>IUF22</b>	Ninja KRR ZX150	W27ESR-U	<b>IW27</b>
Quest 125R, Cyclone 150	U20FS-U	<b>IUF22</b>	X-Cite, GT128, MR1	U20FS-U	<b>IUF22</b>
Rainbow RB125, RC125, Snow 125R	U20FS-U	<b>IUF22</b>	<b>MOTO-GUZZI</b>		
Storm 125Z, Turbulence 125	U20FS-U	<b>IUF22</b>	1100 Sport, California 1100	W20EP-U <sub>s</sub>	<b>IW20</b>
Traveller 150, Harimau 150	U20FS-U	<b>IUF22</b>	125 Custom, 125TT	W27ES-U	<b>IW27</b>
<b>DEMAK</b>			Breva Naked, Nevada Classic 750	W24ESR-U	<b>IW24</b>
All Scooter Series	U20FS-U	<b>IUF22</b>	Nevada	W24EP-U <sub>s</sub>	<b>IW24</b>
Smart 110, Smart-R 125	U20FS-U	<b>IUF22</b>	Stornello 125, Tuttoterrano 125T	W22ES-U <sub>s</sub>	-
Sparks, Matrix	U20FS-U	<b>IUF22</b>	<b>MZ</b>		
<b>DUCATI</b>			125 SM/SX	U24ESR-N	<b>IU24</b>
600SS, Monster	X27EPR-U9	<b>IX27B</b>	Classic 120, Perintis 120	U22FS-U	<b>IUF22</b>
800 Sport, Monster 800	XU24EPR-U	<b>IXU24</b>	Mantizz 125, Moskito 125	U22FS-U	<b>IUF22</b>
900SS, Monster	XU24EPR-U	<b>IXU24</b>	<b>NAZA BIKES</b>		
916 SPI, Strada	<b>IX27</b>	<b>IX27</b>	Blade 250, Cruise 250	U24ESR-N	<b>IU24</b>
<b>HONDA</b>			Blitz 150	U24ESR-N	<b>IU24</b>
AirBlade 125	U22EPR9	<b>IU22D</b>	Gemilang I, II 150	U22FS-U	<b>IUF22</b>
C70, C86, C90, FAME	U20FS-U	<b>IUF22</b>	GTR 150, 170	X22EP-U9	<b>IX22B</b>
CB100, GL100, GL125, GL145	X22ES-U	<b>IX22</b>	NZ 125R, Flash 125	U22FS-U	<b>IUF22</b>
CBR 150R	U24ESR-N	<b>IU24</b>	Prisma 110	U20FS-U	<b>IUF22</b>
CBR 250R	<b>IU24</b>	<b>IU24</b>	Prisma 125, Symphony 125	U20FS-U	<b>IUF22</b>
CBR 500F, CB500X, CBR500 RR	U24EPR9	<b>IU24D</b>	<b>NITRO</b>		
Click 110	U22FER9/U24FER9	<b>IUH24</b>	Baby Star	W22FP-U <sub>s</sub>	<b>IWF22</b>
Dream, Wave	U20FS-U	<b>IUF22</b>	Bintang I & II, Royal I & II	U22FS-U	<b>IUF22</b>
EX5 110 (New)	U20EPR9	<b>IU20</b>	City Star, Super Star	U22FS-U	<b>IUF22</b>
EX5, EX5 Class, EX5 Class I	U20FS-U	<b>IUF22</b>	Dealim Daystar, Roadwin	U24FER9	<b>IUH24</b>
Future 125	U20EPR9	<b>IU20</b>	Golden Star, City Jumbo	U22FS-U	<b>IUF22</b>
GL1200 Goldwing	X24EP-U9	<b>IX24B</b>	Grand Slam, Rambo, Ranger I & II	X24ES-U	<b>IX24</b>
Hurricane	W20ES-U <sub>s</sub>	-	Grand, 150cc Super Grand	U22FS-U	<b>IUF22</b>
Icon 110	U24EPR9	<b>IU24D</b>	Impala, Super Impala I, II, III	U22FS-U	<b>IUF22</b>
NX105	W20EP-U <sub>s</sub>	<b>IW20</b>	NX5, Power, Energy, Striker	U22FS-U	<b>IUF22</b>
PCX 150	U22EPR9	<b>IU22D</b>	Silver Star, 250cc Winstar	U22FS-U	<b>IUF22</b>
Raider, NSR150R	W24ES-U <sub>s</sub>	<b>IW24</b>	Sonic, Janggo, Action Air	U22FS-U	<b>IUF22</b>
RS150 R	-	<b>IU24D</b>	Summer Star, 150cc Megastar	U22FS-U	<b>IUF22</b>
Spacy 110	U24EPR9	<b>IU24D</b>	Supreme Grand, 125cc Star	U22FS-U	<b>IUF22</b>
VT600, GL1500 Goldwing	X22EP-U9	<b>IX22B</b>	Windstar I, II, III & X	X24ES-U	<b>IX24</b>
Wave 125	U20EPR9	<b>IU20</b>			

AUSTRALIA  
CHINA  
INDIA  
INDONESIA  
KOREA  
MALAYSIA  
PHILIPPINES  
SAUDARABIA  
SINGAPORE  
TAIWAN  
THAILAND  
VIETNAM  
JAPAN  
EUROPE & USA  
CROSS REFERENCE  
PART NUMBER

DENSO	9	14	16	20	22	24	27	29	31	32	34	35	DENSO	9	14	16	20	22	24	27	29	31	32	DENSO	9	14	16	20	22	24	27	31
NGK	2	4	5	6	7	8	9	9.5	10	10.5	11	11.5	CHAMPION	18	16,14	12,11	10,9	8,7	6,6,6,1	4,5,9	57	55	53	BOSCH	10	9	8	7,6	5	4	3	2



# MALAYSIA MOTORCYCLE

▶ Spark plug color codes: ■ for Iridium Tough and Iridium Plugs and Iridium TT, ■ for Iridium Power, ■ for Iridium Racing and Two Tops Plugs, ■ for Platinum Plugs and Platinum TT, and black for general spark plugs.

	MODEL	DENSO	IRIDIUM POWER
AUSTRALIA	<b>SUZUKI</b>		
	Belang 150	U24ESR-N	IU24
	Best 110	W24FP-U <sub>s</sub>	IWF24
CHINA	FD110, FX110, GSX110, Smash, Smash Revo	U20FS-U	IUF22
	FX125, VR125, VS125	U24ESR-N	IU24
	FX150	U24ESR-N	IU24
INDIA	RC100, Scooter V100	W22FP-U <sub>s</sub>	IWF22
	RC80, FR80,	W22FP-U <sub>s</sub>	IWF22
	RG Sport	W24EP-U <sub>s</sub>	IW24
INDONESIA	RGV120	W24EP-U <sub>s</sub>	IW24
	SkyDrive	U20FS-U	IUF22
	Step 125	U20FS-U	IUF22
KOREA	TR-S	W24FP-U <sub>s</sub>	IWF24
	TRS118, PR110 (Best)	W22FP-U <sub>s</sub>	IWF22
	TXR150, RG Sport 110	W24EP-U <sub>s</sub>	IW24
MALAYSIA	V100 Scooter	W22FP-U <sub>s</sub>	IWF22
	VS125, FX125, FX150	U24ESR-N	IU24
	<b>VESPA</b>		
PHILIPPINES	125/P125X/Super/Primavera	W14FP-UL	IWF16
	125GT, 125GTR	W14FP-UL	IWF16
	150 Super, Sprint	W14FP-UL	IWF16
SAUDIARABIA	200 RALLY	W20ES-U <sub>s</sub>	-
	P150S, P150X	W14FP-UL	IWF16
	<b>YAMAHA</b>		
SINGAPORE	AT115 Nouvo	U22FSR-U	IUF22
	Bolt 900	U22EPR9	IU22D
	Ego LC125	U22FS-U	IUF22
TAIWAN	Ego S115	U22FS-U	IUF22
	FZ 150	U24ESR-N	IU24
THAILAND			
VIETNAM			
JAPAN			
EUROPE & USA			
CROSS REFERENCE			
PART NUMBER			

MODEL	DENSO	IRIDIUM POWER
<b>YAMAHA</b>		
Legenda 110	U22FS-U	IUF22
MT-07	-	-
MT-09	U27EPR9	IU27D
NMAX 155	U24EPR9	IU24D
Nouvo AT 135LC	U22ESR-N	IU22
RS125R, RXS115, Y100	W22FP-U <sub>s</sub>	IWF22
RX100	W22FP-U <sub>s</sub>	IWF22
RX135Z	W24EP-U <sub>s</sub>	IW24
RXS115	W24FP-U <sub>s</sub>	IWF24
SPORT (II), SS(II)	W22FP-U <sub>s</sub> 10	IWF22
SRE100, SRX100, SR-Lagenda	U22FS-U	IUF22
TZR125, TZR250A, TZM150	W27ES-U	IW27
TZR250/A	W27ESR-U	IW27
Virago	W22EPR-U	IW22
Virago XV 535, 250	W22FP-U <sub>s</sub>	IWF22
XJ6 Diversion/F	U27ESR-N	IU27
XV250A/AC	U20FS-U	IUF22
XV535S	W22EPR-U	IW22
XVS650 Drag Star	X22EP-U9	IX22B
XVZ 13/AJ Royal Star	X22EP-U9	IX22B
Y100, SS110	W22FP-U <sub>s</sub> 10	IWF22
Y125Z, Y125ZR, RZX135	W24ES-U <sub>s</sub>	IW24
Y135 LC	U24EPR9	IU24D
Y15ZR	U24ESR-N	IU24
Y70	W20FP-U <sub>s</sub>	IWF20
YP250K/L/C/R, Majesty	X24ES-U	IX24
YZF-R25	U27ESR-N	IU27



MODEL	ENGINE	YEAR	DENSO	IRIDIUM	TT	IRIDIUM POWER	IRIDIUM TOUGH	
<b>AUDI</b>								
A3 1.8 TFSI	BZB	2007-2008	-	IK20TT	-	IK20	VK20	AUSTRALIA
A4 1.8 T	AMB/AVJ/BEX/BFB	2000-	-	IK20TT	-	IK20	VK20	CHINA
A4 1.8 T Quattro	AVJ/BEX/BFB	2000-	-	IK20TT	-	IK20	VK20	
A4 1.8 TFSI	CABA/CABB/CDHA/CDHB	2007-	-	IK20TT	-	IK20	VK20	INDIA
A5 3.2 FSI Quattro	CALA	2007	-	IK20TT	-	IK20	VK20	
A6 2.4 Quattro	BDW	2005	-	IK20TT	-	IK20	VK20	INDONESIA
A6 2.8 FSI Quattro	BDX	2001	-	IK20TT	-	IK20	VK20	
Q5 2.0	CDN	-	VK22	-	-	IK22	VK22	KOREA
Q5 3.2	CAL	-	PK20PR-L11	IK20TT	-	IK20	VK20	
R8 5.2	BUJ	-	VK22	-	-	IK22	VK22	MALAYSIA
TT Coupe 2.0	BWA / CCZ	-	VK22	-	-	IK22	VK22	
<b>BMW</b>								
116i (E 87) 1.6	N45 B16A	2004	K20PBR-S10	IK20TT	K20TT	IK20	VK20	PHILIPPINES
118i (E 87)	N46 B20B	2004-2007	-	IK20TT	-	IK20	VK20	
316i (E 30) (E 46)	16 4E 1/2/3	1988-2002	K20TXR	IK20TT	K20TT	IK20	VK20	SAUDI ARABIA
316i (E 46)	N40 B16A / N45 B16A	2002-2006	K20TXR	IK20TT	K20TT	IK20	VK20	
316i (E 90)	N45 B16A	2005	K20PBR-S10	IK20TT	K20TT	IK20	VK20	SINGAPORE
318i (E 30)	18 4E 1	1987-1991	K20TXR	IK20TT	K20TT	IK20	VK20	
	18 4E B / 18 4K A	1983-1987	W16EPR-U	IW16TT	W16TT	IW16	VW16	TAIWAN
318i(E36)(E 46)	18 4E1/ 4E2 / 19 4E1	1990-2001	K20TXR	IK20TT	K20TT	IK20	VK20	
318i(E46)	N42 B20A	2001-2005	K20TXR	IK20TT	K20TT	IK20	VK20	THAILAND
318i(E90)	N46 B20	2005	-	IK20TT	-	IK20	VK20	
320i(E30)	20 6E B/E/Z/ 20 6K A	1982-1991	-	IW16TT	-	IW16	VW16	VIETNAM
320i(E36)(E 46)	20 6S 1/2/3/A	1990-2005	K20TXR	IK20TT	K20TT	IK20	VK20	
320i(E90)	N46 B20	2005	-	IK20TT	-	IK20	VK20	JAPAN
323i(E30)	23 6E B/C/W	1982-1986	-	IW16TT	-	IW16	VW16	
323i(E36)(E 46)	24 6S 2 / 25 6S 4	1996-2000	K20TXR	IK20TT	K20TT	IK20	VK20	EUROPE & USA
323i(E90)	N52 B25	2005	-	IK20TT	-	IK20	VK20	
325i(E30)	25 6E 1/2 /25 6K 1	1985-1991	-	IW16TT	-	IW16	VW16	CROSS REFERENCE
325i(E36)(E 46)	25 6S 1/2/5	1990-2005	K20TXR	IK20TT	K20TT	IK20	VK20	
325i(E90)	N52 B25	2005	-	IK20TT	-	IK20	VK20	PART NUMBER
520i(E34)	20 6E E/K A	1988-1990	-	IW16TT	-	IW16	VW16	
520i(E34)(E 39)	20 6S 1/2/3/4	1989-2003	K20TXR	IK20TT	K20TT	IK20	VK20	131
520i(E60)	N46 B20B	2007	-	IK20TT	-	IK20	VK20	
525i (E 34) (E 39) (E 60)	25 6S 1/2/5	1990-2005	K20TXR	IK20TT	K20TT	IK20	VK20	
525i(E34)	25 6K 1/2	1989-1995	K20TXR	IK20TT	K20TT	IK20	VK20	
	25 6K1	1988-1990	-	IW16TT	-	IW16	VW16	
630i (E 63)	N52 B30	2004	-	IK20TT	-	IK20	VK20	
650i (E 63)	N62 B48B	2005	-	IK20TT	-	IK20	VK20	
730i 3.0	M30B30	-	J16CR-U	IW16TT	W16TT	IW16	VW16	
760Li 6.0	N73B60A	-	VK20	IK20TT	-	IK20	VK20	
X1 sDrive 18i 2.0	N46B20B	-	VK20	IK20TT	-	IK20	VK20	
X3 2.0i (E 83)	N46B20B	2005-2008	-	IK20TT	-	IK20	VK20	
X3 2.5i (E 83)	25 6S 5	2004-2006	K20TXR	IK20TT	K20TT	IK20	VK20	
X3 2.5si (E 83)	N52 B25	2006-2008	-	IK20TT	-	IK20	VK20	
X3 xDrive20i 2.0 (E 83)	B46 B20B	2008	-	IK20TT	-	IK20	VK20	
X3 xDrive20i 2.5 (E 83)	N52 B25	2008	-	IK20TT	-	IK20	VK20	
X5 3.0i (E 53)	30 6S 3	1999-2006	K20TXR	IK20TT	K20TT	IK20	VK20	
X5 3.0si (E 70)	N52 B30	2006-2008	-	IK20TT	-	IK20	VK20	
X5 4.8i (E 70)	N62 B48B	2006-2008	-	IK20TT	-	IK20	VK20	
X5 xDrive30i 3.0 (E 70)	N52 B30	2008	-	IK20TT	-	IK20	VK20	
X5 xDrive48i 4.8 (E 70)	N62 B48B	2008	-	IK20TT	-	IK20	VK20	
Z3 1.9 Roadster	19 4S 1	1995-1998	K20TXR	IK20TT	K20TT	IK20	VK20	
Z3 2.8 Roadster	28 6S 1/2	1996-2000	K20TXR	IK20TT	K20TT	IK20	VK20	
Z3 3.0 Roadster	30 6S 3	2000-2002	K20TXR	IK20TT	K20TT	IK20	VK20	
Z4 sDrive 30i 3.0	N52 B30	2009	-	IK20TT	-	IK20	VK20	
<b>CHANA</b>								
Benni 1.3 De Luxe	JL474Q2	-	K20PR-U11	IK20TT	K20TT	IK20	VK20	
<b>CHERRY</b>								
A1 1.3	SQR473	-	K20PR-U11	IK20TT	K20TT	IK20	VK20	
A5 1.6	SQR481F	2006	K16PR-U11	IK16TT	K16TT	IK16	VK16	
Cowin 1.6	SQR480ED	2006	K16PR-U11	IK16TT	K16TT	IK16	VK16	
Estar 2.0	SQR484F	2008	K16PR-U11	IK16TT	K16TT	IK16	VK16	
Karry 1.6	SQR480ED	2008	K16PR-U11	IK16TT	K16TT	IK16	VK16	
QQ3 0.8	SQR372	2006	K16PR-U11	IK16TT	K16TT	IK16	VK16	
QQ3 1.1	SQR472F	2006	W16EP-U	IW16TT	W16TT	IW16	VW16	
Tiggo 1.6	SQR481F	2006	K16PR-U11	IK16TT	K16TT	IK16	VK16	

DENSO	9	14	16	20	22	24	27	29	31	32	34	35	DENSO	9	14	16	20	22	24	27	29	31	32	DENSO	9	14	16	20	22	24	27	31
NGK	2	4	5	6	7	8	9	9.5	10	10.5	11	11.5	CHAMPION	18	16,14	12,11	10,9	8,7	6,63,61	4,59	57	55	53	BOSCH	10	9	8	7,6	5	4	3	2



▶ Spark plug color codes: ■ for Iridium Tough and Iridium Plugs and Iridium TT, ■ for Iridium Power, ■ for Iridium Racing and Two Tops Plugs, ■ for Platinum Plugs and Platinum TT, and black for general spark plugs.





	MODEL	ENGINE	YEAR	DENSO					
AUSTRALIA	<b>CHERRY</b>								
	V5 2.0	SQR481F	2006	K16PR-U11	IK16TT	K16TT	IK16	VK16	
	<b>CHEVROLET</b>								
CHINA	Aveo 1.2		2002	W16EP-U	IW16TT	W16TT	IW16	VW16	
	Aveo 1.5		2002	W16EP-U	IW16TT	W16TT	IW16	VW16	
	Aveo Sedan 1.4/1.4L		-	K16PR-U11	IK16TT	K16TT	IK16	VK16	
INDIA	Captiva 2.4	RA420 / Z24	2006	K20TXR	IK20TT	K20TT	IK20	VK20	
	Cruze 1.8 L/LS/LT	F18D4	2009-	KJ20CR-L11	IK20TT	K20TT	IK20L	VK20	
	Matiz 1.0		1999-2000	W16EP-U	IW16TT	W16TT	IW16	VW16	
INDONESIA	Optra 1.6		2002	K16PR-U11	IK16TT	K16TT	IK16	VK16	
	Orlando LT 1.8	2HD	2011-	KJ20CR-L11	IK20TT	K20TT	IK20L	VK20	
	Sonic 1.4	14XER	2012-	KJ16CR-11	IK16TT	K16TT	IK16L	VK16	
KOREA	Spark 1.0		2007-2010	W16EP-U	IW16TT	W16TT	IW16	VW16	
	Spark 1.2	L4	2011-	XU24EPR-U	-	-	IXU24	VXU24	
	Suburban 5.3	Vortec	2000-	T16PR-U	IT16TT	T16TT	IT16	VT16	
MALAYSIA	Tahoe 5.3	Vortec	2000-	T16PR-U	IT16TT	T16TT	IT16	VT16	
	<b>FORD</b>								
	E-150 4.6	Triton	1997	T20NR-U11	IT20TT	T20TT	IT20	VT20	
PHILIPPINES	EcoSport 5D 1.5 TiVCT Trend AT		2015	-	ITV20TT	-	ITV20	-	
	EcoSport 5D 1.5 TiVCT Trend MT		2015	-	ITV20TT	-	ITV20	-	
	EcoSport Titanium AT		2017	-	ITV20TT	-	ITV20	-	
SAUDI ARABIA	EcoSport Trend AT		2017	-	ITV20TT	-	ITV20	-	
	EcoSport Trend AT MC		2018	-	ITV20TT	-	ITV20	-	
	EcoSport Trend MT		2017	-	ITV20TT	-	ITV20	-	
SINGAPORE	EcoSport Trend MT MC		2018	-	ITV20TT	-	ITV20	-	
	Expedition 4.6	Modular	1997-2006	T20NR-U11	IT20TT	T20TT	IT20	VT20	
	Expedition 5.4	Triton	1997-	T20NR-U11	IT20TT	T20TT	IT20	VT20	
TAIWAN	Explorer 4.0	Cologne	1995-2009	-	IT16TT	-	IT16	VT16	
	F 150 4.2	Essex / Triton	1997-2004	T20NR-U11	IT20TT	T20TT	IT20	VT20	
	Fiesta 1.5	Duratec He	2004-	VT20	IT20TT	-	IT20	VT20	
VIETNAM	Focus 1.6	Duratec	2011-	T16VR-U10	ITV16TT	TV16TT	ITV16	-	
	Focus 2.0	Duratec He Spi	2009-	VT20	IT20TT	-	IT20	VT20	
	Lynx 1.3		1999-2004	K16PR-U11	IK16TT	K16TT	IK16	VK16	
JAPAN	Lynx 1.6		1999-2004	K16PR-U11	IK16TT	K16TT	IK16	VK16	
	Lynx 2.0 RS		2003-2004	K16PR-U11	IK16TT	K16TT	IK16	VK16	
	Mustang 3.7	Duratec V6	2012-	ITV20	ITV20TT	-	ITV20	-	
EUROPE & USA	Mustang 5.0	Coyote V8	2011-	ITV20	ITV20TT	-	ITV20	-	
	<b>GEELY</b>								
	Emgrand		2012-2016	-	IKH20TT	-	IKH20	VKH20	
THAILAND	<b>HONDA</b>								
	Accord 2.0	F20	1994-2002	K16PR-U11	IK16TT	K16TT	IK16	VK16	
		K20A	2003-2007	K16PR-U11	IK16TT	K16TT	IK16	VK16	
VIETNAM	Accord 2.2	F22A	1990-1997	K16PR-U11	IK16TT	K16TT	IK16	VK16	
	Accord 2.3	F23A	1998-2002	K16PR-U11	IK16TT	K16TT	IK16	VK16	
	Accord 2.4	K24	2003	K16PR-U11	IK16TT	K16TT	IK16	VK16	
JAPAN	Accord 2.4S	K24A	-	KJ20CR-L11	IK20TT	K20TT	IK20L	VK20	
	Accord 3.0	J30A	2003-2007	K16PR-U11	IK16TT	K16TT	IK16	VK16	
	Accord 3.5	J35Z2	2008	K16PR-U11	IK16TT	K16TT	IK16	VK16	
EUROPE & USA	Accord 3.5 SV	J35Z	2009-	DXU22HCR-D11S	-	-	-	-	
	Brio	L13A	2014	K16PR-U11	IK16TT	K16TT	IK16	VK16	
	City 1.3	3A152/152T/D13B/L13A	1996-	K16PR-U11	IK16TT	K16TT	IK16	VK16	
EUROPE & USA	City 1.5	D15B/L15A	1996-	K16PR-U11	IK16TT	K16TT	IK16	VK16	
	City 1.5 E CVT-20		2014	DK20PR-D13	IK20TT	-	-	VFK20F	
	City 1.5 E MT-19		2014	DK20PR-D13	IK20TT	-	-	VFK20F	
EUROPE & USA	City 1.5 Navi + CVT		2014	DK20PR-D13	IK20TT	-	-	VFK20F	
	City 1.5 Navi + MT		2014	DK20PR-D13	IK20TT	-	-	VFK20F	
	City 1.5 VX + CVT-24		2014	DK20PR-D13	IK20TT	-	-	VFK20F	
EUROPE & USA	City 1.5 VX CVT (Modulo Aero Sports)-23		2014	DK20PR-D13	IK20TT	-	-	VFK20F	
	City E CVT		2018	DK20PR-D13	IK20TT	-	-	VFK20F	
	City E CVT MMC		2017	DK20PR-D13	IK20TT	-	-	VFK20F	
EUROPE & USA	City E Limited Edition MMC		2017	DK20PR-D13	IK20TT	-	-	VFK20F	
	City E Modulo Black Edition		2017	DK20PR-D13	IK20TT	-	-	VFK20F	
	City E MT		2018	DK20PR-D13	IK20TT	-	-	VFK20F	
EUROPE & USA	City E MT MMC		2017	DK20PR-D13	IK20TT	-	-	VFK20F	
	City E NAVI+		2017	DK20PR-D13	IK20TT	-	-	VFK20F	
	City SE		2015	DK20PR-D13	IK20TT	-	-	VFK20F	
EUROPE & USA	City Sport		2018	DK20PR-D13	IK20TT	-	-	VFK20F	
	City VX Modulo Black Edition MMC		2017	DK20PR-D13	IK20TT	-	-	VFK20F	





	MODEL	ENGINE	YEAR	DENSO					
AUSTRALIA	<b>KIA</b>								
	Pride 1.1	B1	1987-2000	W16EP-U	IW16TT	W16TT	IW16	VW16	
	Pride 1.3	B3	1987-2000	W16EP-U	IW16TT	W16TT	IW16	VW16	
CHINA	Rio 1.2 LX/SLX	1.2 KAPPA	2011-	XU20HR9	-	XUH20TTI	IXUH20I	VXUH20I	
	Rio 1.3	A3E	2000-2006	W16EP-U	IW16TT	W16TT	IW16	VW16	
	Rio 1.4		2006	K16PR-U11	IK16TT	K16TT	IK16	VK16	
INDIA	Rio 1.6		2000-2006	K16PR-U11	IK16TT	K16TT	IK16	VK16	
	Sorento 2.4 LX GAS	G4KE	2009-	K16HPR-U11	IKH16TT	KH16TT	IKH16	VKH16	
	Soul 1.6 LX	G4FC	2010-	-	-	-	IXUH22I	VXUH22I	
INDONESIA	Soul 2.0 EX		2009	K16PR-U11	IK16TT	K16TT	IK16	VK16	
	Sportage 2.0 G		1993	K16PR-U11	IK16TT	K16TT	IK16	VK16	
	<b>MAZDA</b>								
KOREA	323 1.6	E5	1989	K16PR-U	IK16TT	K16TT	IK16	VK16	
	323 1.8	B6	1989	K16PR-U	IK16TT	K16TT	IK16	VK16	
	626 2.0	FE	1990	K16PR-U	IK16TT	K16TT	IK16	VK16	
MALAYSIA	E2000 2.0	FE	1995	W16EP-U	IW16TT	W16TT	IW16	VW16	
	Mazda 2 1.5	ZY-VE	2007-	SK16PR-A11	IK16TT	-	IK16	VK16	
	Mazda 3 1.6 S/V/Hatchback	MZR	2004	K16PR-U11	IK16TT	K16TT	IK16	VK16	
PHILIPPINES	Mazda 3 2.0	MZR	2004	-	IT20TT	-	IT20	VT20	
	Mazda 6 2.5	MZR	2007	-	IT20TT	-	IT20	VT20	
	Miata (MX-5) 1.6	B6P/B6-ZE	1989-2005	K16PR-U11	IK16TT	K16TT	IK16	VK16	
SAUDI ARABIA	Miata (MX-5) 1.8	BP/BP-Z3	1989-2005	K16PR-U11	IK16TT	K16TT	IK16	VK16	
	Miata (MX-5) 2.0	MZR	2006	-	IT20TT	-	IT20	VT20	
	<b>MERCEDEZ - BENZ</b>								
SINGAPORE	C 180 (202)	M111.920/921	1993-2000	K16P-U11	IK16TT	K16TT	IK16	VK16	
	C 230 (202)	M111.974	1996-1997	K16P-U11	IK16TT	K16TT	IK16	VK16	
	C 230 (203) (204)	M272.920/921	2005-	-	-	-	IXUH22	VXUH22	
TAIWAN	C 280 (202)	M111.941	1993-1997	K16P-U11	IK16TT	K16TT	IK16	VK16	
	C 300 (204)	M272.947/948	2007	-	-	-	IXUH22	VXUH22	
	C 350 (204)	M272.961	2007	-	-	-	IXUH22	VXUH22	
THAILAND	E 200 (124)	M111.94	1993-1995	K16P-U11	IK16TT	K16TT	IK16	VK16	
	E 220 (124)	M111.96	1993-1995	K16P-U11	IK16TT	K16TT	IK16	VK16	
	E 230 (211)	M272.922	2007	-	-	-	IXUH22	VXUH22	
VIETNAM	E 280 (124)	M104.942	1993-1995	K16P-U11	IK16TT	K16TT	IK16	VK16	
	E 280 (211)	M272.943	2005	-	-	-	IXUH22	VXUH22	
	E 320 (124)	M104.992	1993-1995	K16P-U11	IK16TT	K16TT	IK16	VK16	
JAPAN	E 350 (211)	M272.964	2005	-	-	-	IXUH22	VXUH22	
	<b>MITSUBISHI</b>								
	Adventure 2.0	4G63	1997	K16PR-U11	IK16TT	K16TT	IK16	VK16	
EUROPE & USA	Asx 2.0	4B11	2010-	-	IK20TT	-	IK20	VK20Y	
	CBU Mirage GLS AT		2016	-	IKH16TT	-	IKH16	VKH16	
	CBU Mirage GLS MT		2016	-	IKH16TT	-	IKH16	VKH16	
CROSS REFERENCE	CBU Mirage GLX AT		2016	-	IKH16TT	-	IKH16	VKH16	
	CBU Mirage GLX MT		2016	-	IKH16TT	-	IKH16	VKH16	
	CKD MIRAGE G4 GLS AT		2017	-	IKH16TT	-	IKH16	VKH16	
PART NUMBER	CKD MIRAGE G4 GLS MT		2017	-	IKH16TT	-	IKH16	VKH16	
	CKD MIRAGE G4 GLX AT		2017	-	IKH16TT	-	IKH16	VKH16	
	CKD MIRAGE G4 GLX MT		2017	-	IKH16TT	-	IKH16	VKH16	
EUROPE & USA	Eclipse 2.4	4G64	2000-2005	K16PR-U11	IK16TT	K16TT	IK16	VK16	
	Fuzion 2.4	4G64	2005	K16PR-U11	IK16TT	K16TT	IK16	VK16	
	Galant 1.8	4G93	1992-1998	K16PR-U11	IK16TT	K16TT	IK16	VK16	
EUROPE & USA	Galant 2.0	4G63	1992-2002	K16PR-U	IK16TT	K16TT	IK16	VK16	
		4G63/6A12	1996-2006	K16PR-U11	IK16TT	K16TT	IK16	VK16	
	Galant 2.4	4G69	2004	K16PR-U11	IK16TT	K16TT	IK16	VK16	
EUROPE & USA	Galant 2.5	6A13	1996-2006	K16PR-U11	IK16TT	K16TT	IK16	VK16	
	Galant GT 3.8	6G75	-	-	IK20TT	-	IK20	VK20	
	Grandis 2.4	4G69	2003	K16PR-U11	IK16TT	K16TT	IK16	VK16	
EUROPE & USA	L300 2.0	4G63	1989	W16EP-U	IW16TT	W16TT	IW16	VW16	
	L300 Exceed 2.0	4G63	2001-2004	K16PR-U	IK16TT	K16TT	IK16	VK16	
	L400 Space Gear 2.4	4G64	2000-	K16PR-U11	IK16TT	K16TT	IK16	VK16	
EUROPE & USA	Lancer 1.3	4G13	1988-2002	W16EP-U	IW16TT	W16TT	IW16	VW16	
	Lancer 1.5	4G15	1988-2002	W16EP-U	IW16TT	W16TT	IW16	VW16	
	Lancer 1.6	4G18	2002-	K16PR-U11	IK16TT	K16TT	IK16	VK16	
EUROPE & USA		4G92	1988-2002	K16PR-U	IK16TT	K16TT	IK16	VK16	
	Lancer 2.0	4B11	2008	K16PR-U11	IK16TT	K16TT	IK16	VK16	
	Mirage 1.2 Mivec GLS M/T / CVT	3A92	2016	IKH16	IKH16TT	-	IKH16	VKH16	
EUROPE & USA	Mirage 1.2 Mivec GLX M/T / CVT	3A92	2016	IKH16	IKH16TT	-	IKH16	VKH16	
	Mirage G4 GLS M/T / CVT	3A92	2016	IKH16	IKH16TT	-	IKH16	VKH16	



MODEL	ENGINE	YEAR	DENSO				
<b>MAZDA</b>							
<b>MITSUBISHI</b>							
Mirage G4 GLX M/T / CVT	3A92	2016	<b>IKH16</b>	<b>IKH16TT</b>	-	<b>IKH16</b>	<b>VKH16</b>
Mirage G4 GX	3A92	2016	<b>IKH16</b>	<b>IKH16TT</b>	-	<b>IKH16</b>	<b>VKH16</b>
MIRAGE G4GLS G AT-04		2014	-	<b>IKH16TT</b>	-	<b>IKH16</b>	<b>VKH16</b>
MIRAGE G4GLS G MT-03		2014	-	<b>IKH16TT</b>	-	<b>IKH16</b>	<b>VKH16</b>
MIRAGE G4GLX G AT-02		2014	-	<b>IKH16TT</b>	-	<b>IKH16</b>	<b>VKH16</b>
MIRAGE G4GLX G MT-01		2014	-	<b>IKH16TT</b>	-	<b>IKH16</b>	<b>VKH16</b>
Mirage GLS AT (BMC) New		2017	-	<b>IKH16TT</b>	-	<b>IKH16</b>	<b>VKH16</b>
Mirage GLS BMC		2016	-	<b>IKH16TT</b>	-	<b>IKH16</b>	<b>VKH16</b>
Mirage GLS BMC AT		2016	-	<b>IKH16TT</b>	-	<b>IKH16</b>	<b>VKH16</b>
Mirage GLS BMC MT		2016	-	<b>IKH16TT</b>	-	<b>IKH16</b>	<b>VKH16</b>
Mirage GLS MT (BMC) New		2016	-	<b>IKH16TT</b>	-	<b>IKH16</b>	<b>VKH16</b>
Mirage GLX/GLS 1.2	JC08	2013-	<b>IKH16</b>	<b>IKH16TT</b>	-	<b>IKH16</b>	<b>VKH16</b>
Montero Sport GLS 4X2 3.0	6B31	2012-	<b>SXU22HDR8</b>	-	-	<b>IXUH22</b>	<b>VXUH22</b>
Outlander	4B12/4G69	2003	<b>K16PR-U11</b>	<b>IK16TT</b>	<b>K16TT</b>	<b>IK16</b>	<b>VK16</b>
	4G64	2003-2006	<b>K16PR-U</b>	<b>IK16TT</b>	<b>K16TT</b>	<b>IK16</b>	<b>VK16</b>
Outlander SE 2.4	4B12 FI	2009-	<b>IKH20</b>	<b>IKH20TT</b>	-	<b>IKH20</b>	<b>VKH20</b>
Pajero 3.0	6G72	1991-	<b>K16PR-U</b>	<b>IK16TT</b>	<b>K16TT</b>	<b>IK16</b>	<b>VK16</b>
Pajero 3.5	6G74	1993-1999	<b>K16PR-U</b>	<b>IK16TT</b>	<b>K16TT</b>	<b>IK16</b>	<b>VK16</b>
Pajero 3.8	6G75	1999-	<b>K16PR-U</b>	<b>IK16TT</b>	<b>K16TT</b>	<b>IK16</b>	<b>VK16</b>
Space Wagon 1.6	4G63/4G93	1992-1997	<b>K16PR-U</b>	<b>IK16TT</b>	<b>K16TT</b>	<b>IK16</b>	<b>VK16</b>
Xpander		2018	-	<b>IKH16TT</b>	<b>KH16TT</b>	<b>IKH16</b>	<b>VKH16</b>
<b>NISSAN</b>							
350Z 3.5	VQ35DE	2004	<b>K16HPR-U11</b>	<b>IKH16TT</b>	<b>KH16TT</b>	<b>IKH16</b>	<b>VKH16</b>
Almera		-	-	-	-	-	<b>VFXEH20</b>
Altima 2.5L SV CVT	QR25DE	-	<b>FXE20HR11</b>	<b>IXEH20TT</b>	-	-	<b>VFXEH20</b>
Altima 3.5L SL CVT	VQ35DE	-	<b>K16HPR-U11</b>	<b>IKH16TT</b>	<b>KH16TT</b>	<b>IKH16</b>	<b>VKH16</b>
Bluebird 2.0	CA20	1989-1994	<b>K16PR-U11</b>	<b>IK16TT</b>	<b>K16TT</b>	<b>IK16</b>	<b>VK16</b>
Cedric 3.0	VG30	1987-1991	<b>K16PR-U11</b>	<b>IK16TT</b>	<b>K16TT</b>	<b>IK16</b>	<b>VK16</b>
Cefiro 2.0	VQ20DE	1995-2003	-	<b>IK20TT</b>	-	<b>IK20</b>	<b>VK20</b>
Cefiro 2.5	VQ25DE	1995-1998	-	<b>IK20TT</b>	-	<b>IK20</b>	<b>VK20</b>
Cefiro 3.0	VQ30DE	1995-	-	<b>IK20TT</b>	-	<b>IK20</b>	<b>VK20</b>
Grand Livina 1.8	MR18DE	2007	<b>K16HPR-U11</b>	<b>IKH16TT</b>	<b>KH16TT</b>	<b>IKH16</b>	<b>VKH16</b>
Juke	HR16DE	2016-	<b>FXE20HR11</b>	<b>IXEH20TT</b>	-	-	<b>VFXEH20</b>
Maxima 2.0	CA20	1989-1994	<b>K16PR-U</b>	<b>IK16TT</b>	<b>K16TT</b>	<b>IK16</b>	<b>VK16</b>
Murano Z51 3.5	VQ35DE	2007-	<b>K16HPR-U11</b>	<b>IKH16TT</b>	<b>KH16TT</b>	<b>IKH16</b>	<b>VKH16</b>
Patrol 4.5	TB45E	1997-2004	<b>W16EP-U</b>	<b>IW16TT</b>	<b>W16TT</b>	<b>IW16</b>	<b>VW16</b>
Patrol 4.8	TB48DE	2004	<b>K16HPR-U11</b>	<b>IKH16TT</b>	<b>KH16TT</b>	<b>IKH16</b>	<b>VKH16</b>
Patrol Royale 5.6	VK56DE	2012-	<b>FK16HR11</b>	<b>IKH16TT</b>	-	-	<b>VFKH16</b>
Sentra 1.3/FE/LEC	QG13DE/GA13DS	1991-	<b>K16PR-U</b>	<b>IK16TT</b>	<b>K16TT</b>	<b>IK16</b>	<b>VK16</b>
Sentra 1.4	GA14DE/DS	1992-2000	<b>K16PR-U</b>	<b>IK16TT</b>	<b>K16TT</b>	<b>IK16</b>	<b>VK16</b>
Sentra 1.6 / California	GA16DE	1985-	<b>K16PR-U</b>	<b>IK16TT</b>	<b>K16TT</b>	<b>IK16</b>	<b>VK16</b>
Sentra 1.8	QG18DE	2000-2006	<b>K16PR-U</b>	<b>IK16TT</b>	<b>K16TT</b>	<b>IK16</b>	<b>VK16</b>
Sentra 2.0	QR20DE	2003	<b>K16HPR-U11</b>	<b>IKH16TT</b>	<b>KH16TT</b>	<b>IKH16</b>	<b>VKH16</b>
	SR20DE	1999-2005	<b>K16PR-U11</b>	<b>IK16TT</b>	<b>K16TT</b>	<b>IK16</b>	<b>VK16</b>
Sentra 2.5	QR25DE	2005	<b>K16HPR-U11</b>	<b>IKH16TT</b>	<b>KH16TT</b>	<b>IKH16</b>	<b>VKH16</b>
Silvia 2.0	SR20DE	1993-2001	<b>K16PR-U11</b>	<b>IK16TT</b>	<b>K16TT</b>	<b>IK16</b>	<b>VK16</b>
Teana 2.3	VQ23DE	2007	<b>K16HPR-U11</b>	<b>IKH16TT</b>	<b>KH16TT</b>	<b>IKH16</b>	<b>VKH16</b>
Vanette 2.0	Z20	1994-1999	<b>W16EP-U</b>	<b>IW16TT</b>	<b>W16TT</b>	<b>IW16</b>	<b>VW16</b>
Verita 1.3	CG13DE	2000-2003	<b>K16PR-U11</b>	<b>IK16TT</b>	<b>K16TT</b>	<b>IK16</b>	<b>VK16</b>
X-Trail 2.0	QR20DE	2001	<b>K16HPR-U11</b>	<b>IKH16TT</b>	<b>KH16TT</b>	<b>IKH16</b>	<b>VKH16</b>
X-Trail 2.5	QR25DE	2001	<b>K16HPR-U11</b>	<b>IKH16TT</b>	<b>KH16TT</b>	<b>IKH16</b>	<b>VKH16</b>
<b>PORSCHE</b>							
911 3.4		1997-2001	<b>K20PBR-S10</b>	<b>IK20TT</b>	<b>K20TT</b>	<b>IK20</b>	<b>VK20</b>
		1989-1997	<b>K22PBR-S</b>	-	-	<b>IK22</b>	<b>VK22</b>
911 3.6		2004	-	-	-	<b>IK22</b>	<b>VK22</b>
		1999-2001	<b>K20TR11</b>	<b>IK20TT</b>	<b>K20TT</b>	<b>IK20</b>	<b>VK20</b>
911 3.8		1994-1997	<b>K22PBR-S</b>	-	-	<b>IK22</b>	<b>VK22</b>
		2004	-	-	-	<b>IK22</b>	<b>VK22</b>
Boxster 2.5		1996-1999	<b>K20TXR</b>	<b>IK20TT</b>	<b>K20TT</b>	<b>IK20</b>	<b>VK20</b>
Boxster 2.7		1999-2004	<b>K20PBR-S10</b>	<b>IK20TT</b>	<b>K20TT</b>	<b>IK20</b>	<b>VK20</b>
		2004	-	-	-	<b>IK22</b>	<b>VK22</b>
Boxster 2.9		2009	-	-	-	<b>IKH22</b>	<b>VKH22</b>
Boxster 3.2		1999-2004	<b>K20PBR-S10</b>	<b>IK20TT</b>	<b>K20TT</b>	<b>IK20</b>	<b>VK20</b>
		2004-2006	-	-	-	<b>IK22</b>	<b>VK22</b>
Boxster 3.4		2006	-	-	-	<b>IK22</b>	<b>VK22</b>
Boxster 3.4 S		2009	-	-	-	<b>IKH22</b>	<b>VKH22</b>
Cayenne 4.5		2002	<b>K20PBR-S10</b>	<b>IK20TT</b>	<b>K20TT</b>	<b>IK20</b>	<b>VK20</b>

AUSTRALIA  
CHINA  
INDIA  
INDONESIA  
KOREA  
MALAYSIA  
PHILIPPINES  
SAUDI ARABIA  
SINGAPORE  
TAIWAN  
THAILAND  
VIETNAM  
JAPAN  
EUROPE  
& USA  
CROSS  
REFERENCE  
PART  
NUMBER

DENSO	9	14	16	20	22	24	27	29	31	32	34	35	DENSO	9	14	16	20	22	24	27	29	31	32	DENSO	9	14	16	20	22	24	27	31
NGK	2	4	5	6	7	8	9	9.5	10	10.5	11	11.5	CHAMPION	18	16,14	12,11	10,9	8,7	6,6,6,1	4,5,9	57	55	53	BOSCH	10	9	8	7,6	5	4	3	2



	MODEL	ENGINE	YEAR	DENSO				
<b>AUSTRALIA</b>								
<b>PORSCHE</b>								
	Cayenne 4.8 GTS/S/Turbo		2007	-	-	-	IKH22	VKH22
	Cayman 2.7		2006	-	-	-	IK22	VK22
	Cayman 2.9		2009	-	-	-	IKH22	VKH22
<b>CHINA</b>								
	Cayman S 3.4		2005-2009	-	-	-	IK22	VK22
			2009	-	-	-	IKH22	VKH22
	Panamera 4.8 4S/S/Turbo		2009	-	-	-	IKH22	VKH22
<b>INDIA</b>								
<b>PROTON</b>								
	Wira 1.3		1993	W16EP-U	IW16TT	W16TT	IW16	VW16
	Wira 1.5		1993	W16EP-U	IW16TT	W16TT	IW16	VW16
	Wira 1.6		1993	K16PR-U	IK16TT	K16TT	IK16	VK16
<b>INDONESIA</b>								
<b>SUBARU</b>								
	Forester 2.0	EJ20	1997-2005	K16PR-U11	IK16TT	K16TT	IK16	VK16
	Forester 2.5	EJ251	2002	K16PR-U11	IK16TT	K16TT	IK16	VK16
	Impreza 1.6	EJ16/EJ16E/EJ16J/EJ161	1993	-	IK20TT	-	IK20	VK20
	Impreza 1.8	EJ18E	1993-1997	-	IK20TT	-	IK20	VK20
	Impreza 2.0	EJ201/EJ20E	1995-2000	-	IK20TT	-	IK20	VK20
		EJ201/EJ205	2000-	K16PR-U11	IK16TT	K16TT	IK16	VK16
	Impreza 2.5	EJ251	2001-2005	K16PR-U11	IK16TT	K16TT	IK16	VK16
<b>KOREA</b>								
<b>SUZUKI</b>								
	Alto 0.8	F8D	2004	W16EP-U	IW16TT	W16TT	IW16	VW16
	APV 1.6	G16A	2004	K16PR-U	IK16TT	K16TT	IK16	VK16
<b>MALAYSIA</b>								
	Bravo 1.0	F10A	1988	W16EP-U	IW16TT	W16TT	IW16	VW16
	Carry 0.6	F6A	1988	XU22EPR-U	-	XU22TT	IXU22	VXU22
	Carry 0.8	F8A	1988	W16EP-U	IW16TT	W16TT	IW16	VW16
	Carry 1.0	F10A	1988	W16EP-U	IW16TT	W16TT	IW16	VW16
<b>PHILIPPINES</b>								
	Celerio A+ Compact M/T / CVT	K10B	2016-	XU20EPR-U	-	-	-	VXU20
	Celerio GL/GA 1.0	K10B	2010-	XU20EPR-U	-	-	-	VXU20
	Ciaz GL / GLX	K14B	2016-	XU20EPR-U	-	-	-	VXU20
<b>SAUDI ARABIA</b>								
	Ertiga	K14B	2016-	XU20EPR-U	-	-	-	VXU20
<b>SINGAPORE</b>								
	ERTIGA GA (MC)		2015	XU20EPR-U	-	-	-	VXU20
	ERTIGA GA MT-01		2014	XU20EPR-U	-	-	-	VXU20
	ERTIGA GL AT (MC)		2015	XU20EPR-U	-	-	-	VXU20
	ERTIGA GL AT-03		2014	XU20EPR-U	-	-	-	VXU20
	ERTIGA GL MT (MC)		2015	XU20EPR-U	-	-	-	VXU20
	ERTIGA GL MT-02		2014	XU20EPR-U	-	-	-	VXU20
	ERTIGA GLX-04		2014	XU20EPR-U	-	-	-	VXU20
<b>TAIWAN</b>								
	Esteem 1.6	G16B	1988	K16PR-U	IK16TT	K16TT	IK16	VK16
	Grand Vitara 2.0	J20A	1999-	K16PR-U11	IK16TT	K16TT	IK16	VK16
	Grand Vitara 2.4	J24A	2006-	K16PR-U11	IK16TT	K16TT	IK16	VK16
	Grand Vitara 2.5	H25A	1999-2005	K16PR-U11	IK16TT	K16TT	IK16	VK16
	Grand Vitara 2.7	H27A	2002-2006	K16PR-U11	IK16TT	K16TT	IK16	VK16
<b>THAILAND</b>								
	Grand Vitara Special Edition	J24B	2016-	VK20	IK20TT	-	IK20	VK20
	Jimny 1.3	M13A	1998	K16PR-U11	IK16TT	K16TT	IK16	VK16
	Kizashi / Kizashi 2.4L	J24B	2011-	VK20	IK20TT	-	IK20	VK20
	Samurai 1.3	G13A/G13B	1984-2004	W16EP-U	IW16TT	W16TT	IW16	VW16
<b>VIETNAM</b>								
	Super Carry 1.0	F10A`	1988	W16EP-U	IW16TT	W16TT	IW16	VW16
	Swift 1.2	K12M	2016-	XU20EPR-U	-	-	-	VXU20
	Swift 1.4	K14B	2011-	XU20EPR-U	-	-	-	VXU20
	Swift 1.5	M15A	2004	K16PR-U11	IK16TT	K16TT	IK16	VK16
	Swift Dzire 1.2	K12B	2012-	ZXU20PR11	-	-	-	VXU20
<b>JAPAN</b>								
	SX4 1.6	M16A	2007-2009	K16PR-U11	IK16TT	K16TT	IK16	VK16
	Vitara 1.6	G16A	1999-2004	K16PR-U	IK16TT	K16TT	IK16	VK16
	Vitara 2.0	J20A	1998-2002	K16PR-U11	IK16TT	K16TT	IK16	VK16
<b>TOYOTA</b>								
	86	FA20	-	VXEBH27	-	-	-	VXEBH27
<b>EUROPE &amp; USA</b>								
	1.3 E AT Vios FMC		2018	SC16HR11	IXEH20TT	-	-	VCH16
	1.3 E MT Vios FMC		2018	SC16HR11	IXEH20TT	-	-	VCH16
	1.3 E+ AT Vios FMC		2018	SC16HR11	IXEH20TT	-	-	VCH16
	1.3 E+ MT Vios FMC		2018	SC16HR11	IXEH20TT	-	-	VCH16
<b>CROSS REFERENCE NUMBER</b>								
	1.3 J Base Vios		2020	SC16HR11	IXEH20TT	-	-	VCH16
	1.3 J Base Vios FMC		2018	SC16HR11	IXEH20TT	-	-	VCH16
	1.3 J CVT Vios FMC		2018	SC16HR11	IXEH20TT	-	-	VCH16
	1.3 J MT Vios FMC		2018	SC16HR11	IXEH20TT	-	-	VCH16
<b>PART NUMBER</b>								
	1.3 XE CVT Vios		2020	SC16HR11	IXEH20TT	-	-	VCH16
	1.3 XLE CVT Vios		2020	SC16HR11	IXEH20TT	-	-	VCH16
	1.3 XLE MT Vios		2020	SC16HR11	IXEH20TT	-	-	VCH16
	1.5 G AT Vios FMC		2018	SC16HR11	IXEH20TT	-	-	VCH16



MODEL	ENGINE	YEAR	DENSO	IRIDIUM	TJ	IRIDIUM POWER	IRIDIUM TOUGH	
<b>TOYOTA</b>								
1.5 G CVT Vios		2020	SC16HR11	IXEH20TT	-	-	VCH16	AUSTRALIA
1.5 G MT Vios FMC		2018	SC16HR11	IXEH20TT	-	-	VCH16	
1.5 G+ AT Vios FMC		2018	SC16HR11	IXEH20TT	-	-	VCH16	
Alphard 3.5 V6	2GR-FE	-	-	IKH20TT	-	IKH20	VKH20	CHINA
Avanza 1.3	K3-VE	2006	XU22EPR-U	-	XU22TT	IXU22	VXU22	
Avanza 1.3 A/T	NR	2015-2019	SC16HR11	IXEH20TT	-	-	VCH16	INDIA
Avanza 1.3 E / J	1NR-VE	-	SC16HR11	IXEH20TT	-	-	VCH16	
Avanza 1.3 M/T	NR	2015-2019	SC16HR11	IXEH20TT	-	-	VCH16	
Avanza 1.5	3SZ-VE	2006	XU22EPR-U	-	XU22TT	IXU22	VXU22	INDONESIA
Avanza 1.5 A/T	KR	2015-2019	XU22PR9	-	XU22TT	IXU22	-	
Avanza 1.5 G	2NR-VE	-	SC16HR11	IXEH20TT	-	-	VCH16	
Avanza 1.5 M/T	KR	2015-2019	XU22PR9	-	XU22TT	IXU22	-	
Avanza E Gas A/T (IMP)-16		2014	XU22EPR-U	-	XU22TT	IXU22	VXU22	
Avanza E Gas M/T (IMP)-17		2014	XU22EPR-U	-	XU22TT	IXU22	VXU22	
Avanza G Gas A/T (IMP)-14		2014	XU22EPR-U	-	XU22TT	IXU22	VXU22	
Avanza G Gas M/T (IMP)-15		2014	XU22EPR-U	-	XU22TT	IXU22	VXU22	
Camry 2.0	3S-FE	1994-1998	K16PR-U11	IK16TT	K16TT	IK16	VK16	KOREA
Camry 2.2	5S-FE	1996-2002	K20TR11	IK20TT	K20TT	IK20	VK20	
Camry 2.4	2AZ-FE	2002-	K16PR-U11	IK16TT	K16TT	IK16	VK16	
Camry 2.5 V / S / G	2AR-FE	-	K16HPR-U11	IKH16TT	KH16TT	IKH16	VKH16	
Camry 3.0	1MZ-FE	2004	SK20R11	IK20TT	-	IK20	VK20	MALAYSIA
Camry 3.5	2GR-FE	2006	-	IKH20TT	-	IKH20	VKH20	
Corolla 1.3	2E	1987-	W16EP-U	IW16TT	W16TT	IW16	VW16	
Corolla 1.6	4A-F	1987-1992	QJ16AR-U	-	-	-	-	
	4A-FE	1992-2001	K16PR-U11	IK16TT	K16TT	IK16	VK16	
Corolla 1.8	7A-FE	1999-2001	K16PR-U11	IK16TT	K16TT	IK16	VK16	
Corolla Altis 1.6	3ZZ-FE	2001-	K16PR-U11	IK16TT	K16TT	IK16	VK16	
Corolla Altis 1.8	1ZZ-FE	2001-2008	K16PR-U11	IK16TT	K16TT	IK16	VK16	
Corona 2.0	3S-F/FE	1987-1998	K16PR-U11	IK16TT	K16TT	IK16	VK16	
Crown 2.0	1G-FE	1987-1995	K16PR-U	IK16TT	K16TT	IK16	VK16	
Crown 2.2	4Y	1987-1991	W16EP-U	IW16TT	W16TT	IW16	VW16	
Crown 2.8	5M	1983-1991	W16EP-U	IW16TT	W16TT	IW16	VW16	
Echo 1.3	2NZ-FE	1999-2005	K16PR-U11	IK16TT	K16TT	IK16	VK16	
Echo 1.5	1NZ-FE	1999-2005	K16PR-U11	IK16TT	K16TT	IK16	VK16	
FJ Cruiser	1GR-FE	-	K20HR-U11	IKH20TT	KH20TT	IKH20	VKH20	
Fortuner 2.7	2TR-FE	2005	K16HPR-U11	IKH16TT	KH16TT	IKH16	VKH16	
Fortuner 4x2 AT	2TR	2014-2019	K16HPR-U11	IKH16TT	KH16TT	IKH16	VKH16	
Hiace 2.0	1RZ	1989-2004	W16EP-U	IW16TT	W16TT	IW16	VW16	
Hilux 2.7	2TR-FE	2005	K16HPR-U11	IKH16TT	KH16TT	IKH16	VKH16	
Imp. Innova E Gas A/T		2018	K16HPR-U11	IKH16TT	KH16TT	IKH16	VKH16	
Imp. Innova E Gas M/T		2018	K16HPR-U11	IKH16TT	KH16TT	IKH16	VKH16	
Imp. Innova G Gas A/T		2018	K16HPR-U11	IKH16TT	KH16TT	IKH16	VKH16	
Imp. Innova J Gas M/T		2018	K16HPR-U11	IKH16TT	KH16TT	IKH16	VKH16	
Innova 2.0	1TR-FE	2004	K16HPR-U11	IKH16TT	KH16TT	IKH16	VKH16	
Innova 2.0 AT	1TR	2016	K16HPR-U11	IKH16TT	KH16TT	IKH16	VKH16	
Innova 2.0 MT	1TR	2016	K16HPR-U11	IKH16TT	KH16TT	IKH16	VKH16	
Innova Touring Sport A/T		2018	K16HPR-U11	IKH16TT	KH16TT	IKH16	VKH16	
Innova Touring Sport M/T		2018	K16HPR-U11	IKH16TT	KH16TT	IKH16	VKH16	
Land Cruiser Prado 4.0L A/T	1GR-FE	-	K20HR-U11	IKH20TT	KH20TT	IKH20	VKH20	
Liteace 1.5	5K	1985-1998	W16EP-U	IW16TT	W16TT	IW16	VW16	
Previa 2.0	2TZ- FE	1993-2000	K16PR-U	IK16TT	K16TT	IK16	VK16	
Previa 2.4	2AZ-FE	2003-	SK20R11	IK20TT	-	IK20	VK20	
Prius Hybrid 1.8	2ZR-FXE	-	SC20HR11	IXEH22TT	-	-	VCH20	
RAV4 1.8	1ZZ-FE	2001-2005	K16PR-U11	IK16TT	K16TT	IK16	VK16	
RAV4 2.0	1AZ-FE	2001-2005	K16PR-U11	IK16TT	K16TT	IK16	VK16	
	3S-FE	1996-2000	XU22EPR-U	-	XU22TT	IXU22	VXU22	
Revo 1.8	7K-E	1998-2005	W16EP-U	IW16TT	W16TT	IW16	VW16	
Revo 2.0	1RZ-E	1998-2005	W16EP-U	IW16TT	W16TT	IW16	VW16	
Rush 1.5 AT	2NR	2018-	SC16HR11	IXEH20TT	-	-	VCH16	
Rush 1.5 MT	2NR	2018-	SC16HR11	IXEH20TT	-	-	VCH16	
Tamaraw FX 1.5	5K	1986-1992	W16EX-U	IW16TT	W16TT	IW16	VW16	
Tamaraw FX 1.8	7K	1992-1996	W16EX-U	IW16TT	W16TT	IW16	VW16	
Vios 1.3	2NZ-FE	2003-	K16PR-U11	IK16TT	K16TT	IK16	VK16	
	1NZ	2015-2016	K16PR-U11	IK16TT	K16TT	IK16	VK16	
	1NR	2018-	SC16HR11	IXEH20TT	-	-	VCH16	
Vios 1.3 CVT	1NR	2020	SC16HR11	IXEH20TT	-	-	VCH16	
Vios 1.5	1NZ-FE	2003-	K16PR-U11	IK16TT	K16TT	IK16	VK16	

DENSO	9	14	16	20	24	27	29	31	32	34	35	DENSO	9	14	16	20	22	24	27	31	32	DENSO	9	14	16	20	22	24	27	31		
NGK	2	4	5	6	7	8	9	9.5	10	10.5	11	11.5	CHAMPION	18	16,14	12,11	10,9	8,7	6,63,61	4,59	57	55	53	BOSCH	10	9	8	7,6	5	4	3	2

AUSTRALIA  
 CHINA  
 INDIA  
 INDONESIA  
 KOREA  
 MALAYSIA  
 PHILIPPINES  
 SAUDI ARABIA  
 SINGAPORE  
 TAIWAN  
 THAILAND  
 VIETNAM  
 JAPAN  
 EUROPE  
 & USA  
 CROSS  
 REFERENCE  
 NUMBER  
 PART



# PHILIPPINES CAR

▶ Spark plug color codes: ■ for Iridium Tough and Iridium Plugs and Iridium TT, ■ for Iridium Power, ■ for Iridium Racing and Two Tops Plugs, ■ for Platinum Plugs and Platinum TT, and black for general spark plugs.

	MODEL	ENGINE	YEAR	DENSO					
AUSTRALIA	<b>TOYOTA</b>								
	Vios 1.5	2NZ	2015-2016	K16PR-U11	<b>IK16TT</b>	<b>K16TT</b>	<b>IK16</b>	<b>VK16</b>	
		2NR	2018-	SC16HR11	<b>IXEH20TT</b>	-	-	<b>VCH16</b>	
	Vios 1.5 CVT	2NR	2020	SC16HR11	<b>IXEH20TT</b>	-	-	<b>VCH16</b>	
CHINA	Wigo 1.0		2014	XU20HR9	-	<b>XUH20TTI</b>	<b>IXUH20I</b>	<b>VXUH20I</b>	
	Wigo 1.0 E MT MC		2017	XU20HR9	-	<b>XUH20TTI</b>	<b>IXUH20I</b>	<b>VXUH20I</b>	
	Wigo 1.0 G AT MC		2017	XU20HR9	-	<b>XUH20TTI</b>	<b>IXUH20I</b>	<b>VXUH20I</b>	
	Wigo 1.0 G MT MC		2017	XU20HR9	-	<b>XUH20TTI</b>	<b>IXUH20I</b>	<b>VXUH20I</b>	
INDIA	Wigo 1.0 TRD		2015	XU20HR9	-	<b>XUH20TTI</b>	<b>IXUH20I</b>	<b>VXUH20I</b>	
	Yaris 1.5	1NZ-FE	2006	K16PR-U11	<b>IK16TT</b>	<b>K16TT</b>	<b>IK16</b>	<b>VK16</b>	
	<b>VOLKSWAGEN</b>								
INDONESIA	New Beetle 1.6	AWH	1999-2000	XU22EPR-U	-	<b>XU22TT</b>	<b>IXU22</b>	<b>VXU22</b>	
		AYD/BFS	2000-	XU22EPR-U	-	<b>XU22TT</b>	<b>IXU22</b>	<b>VXU22</b>	
	<b>VOLVO</b>								
INDONESIA	850 2.0	B5202S	1994-1996	K20PBR-S10	<b>IK20TT</b>	<b>K20TT</b>	<b>IK20</b>	<b>VK20</b>	
	850 2.5	B5254S	1991-1997	K20PBR-S10	<b>IK20TT</b>	<b>K20TT</b>	<b>IK20</b>	<b>VK20</b>	
	S60 2.0 T	B5204T5	2000-2004	PK20PR-P8	<b>IK20TT</b>	-	-	<b>VK20Y</b>	
KOREA		B5204T5	2004-	-	<b>IKH20TT</b>	-	-	<b>VKH20</b>	
	S80 2.5 T	B5254T6	2006-2009	-	<b>IKH20TT</b>	-	-	<b>VKH20</b>	
	XC60 2.9 T6	B6304T2	2009	-	<b>IKH20TT</b>	-	-	<b>VKH20</b>	
MALAYSIA	XC70 2.3 T	B5234T7	2002-2004	PK20PR-P8	<b>IK20TT</b>	-	-	<b>VK20Y</b>	
	XC70 2.5 T	B5254T2	2002-2007	PK20PR-P8	<b>IK20TT</b>	-	-	<b>VK20Y</b>	
	XC70 3.2 AWD	B6324S	2007	-	<b>IKH20TT</b>	-	<b>IKH20</b>	<b>VKH20</b>	
PHILIPPINES	XC90 2.5 T	B6254T2	2003	PK20PR-P8	<b>IK20TT</b>	-	-	<b>VK20Y</b>	
	XC90 2.9 T6	B6294T	2003-2006	PK20PR-P8	<b>IK20TT</b>	-	-	<b>VK20Y</b>	
	XC90 3.2 AWD	B6324S	2006	-	<b>IKH20TT</b>	-	<b>IKH20</b>	<b>VKH20</b>	



# PHILIPPINES MOTORCYCLE

	MAKER	DENSO			MAKER	DENSO			
SAUDI ARABIA	<b>AEON ATVS</b>				<b>HONDA</b>				
	Cobra 220	U22FSR-U	<b>IUF22</b>	-	CR125R	W27ESR-V	<b>IW27</b>	<b>IW01</b> □	
	New Sport 180cc	U22FS-U	<b>IUF22</b>	-	CRF150R/EXPERT	U24FER9	<b>IUH24</b>	<b>IU01</b> □	
	Overland 180cc	U22FS-U	<b>IUF22</b>	-	CRF250R	<b>VUH24D</b>	<b>IUH24</b>	<b>IU01</b> □	
SINGAPORE	<b>BMW</b>				CRF450R	<b>VK24PRZ11</b>	<b>IK24</b>	<b>IK01</b> □	
	F800 R/S	XU24EPR-U	<b>IXU24</b>	<b>IXU01</b> □	Dream (C100)	U22FS-U	<b>IUF22</b>	-	
	F800 ST	XU24EPR-U	<b>IXU24</b>	<b>IXU01</b> □	Dream 125 (AND125)	U20EPR9	<b>IU20</b>	<b>IU01</b> □	
	G650 Xchallenge	-	<b>IX24</b>	<b>IXU01</b> □	G200/G300	W14FR-U	-	-	
	K1200 GT	X22EPR-U9	<b>IX22B</b>	<b>IXU01</b> □	GL 125	X24EPR-U9	<b>IX24B</b>	<b>IXU01</b> □	
	R1200 GS	XU24EPR-U	<b>IXU24</b>	<b>IXU01</b> □	GX340/340KI/GX160	W20EP-U11	<b>IW20</b>	<b>IW01</b> □	
	R1200 RT	XU24EPR-U	<b>IXU24</b>	<b>IXU01</b> □	Scoopy	U24EPR9	<b>IU24D</b>	<b>IU01</b> □	
	R1200 S	XU24EPR-U	<b>IXU24</b>	<b>IXU01</b> □	SR 125	X24ES-U	<b>IX24</b>	<b>IXU01</b> □	
	R1200 ST	XU24EPR-U	<b>IXU24</b>	<b>IXU01</b> □	TMS 125	X24ES-U	<b>IX24</b>	<b>IXU01</b> □	
	THAILAND	<b>EURO MOTORS</b>				TMX 125	X24EP-U9	<b>IX24B</b>	<b>IXU01</b> □
Absolute 150		U22FS-U	<b>IUF22</b>	-	TMX 125 ST	X24EP-U9	<b>IX24B</b>	<b>IXU01</b> □	
BE 125		U22FS-U	<b>IUF22</b>	-	TMX 155 CDI	X24EP-U9	<b>IX24B</b>	<b>IXU01</b> □	
Chic 70		U22FS-U	<b>IUF22</b>	-	TMX 155 CP	X24ES-U	<b>IX24</b>	<b>IXU01</b> □	
EM 50 QT		U22FS-U	<b>IUF22</b>	-	TMX 155 RT	X24EP-U9	<b>IX24B</b>	<b>IXU01</b> □	
Euro Eagle 125		U22FS-U	<b>IUF22</b>	-	Tmx Supremo	U24EPR9	<b>IU24D</b>	<b>IU01</b> □	
Euro Space 100		U22FS-U	<b>IUF22</b>	-	VFR400R/K/Z	U24FER9	<b>IUH24</b>	<b>IU01</b> □	
VIETNAM		<b>HONDA</b>				VTR1000	X24EPR-U9	<b>IX24B</b>	<b>IXU01</b> □
		AME 100	U20FSR-U	<b>IUF22</b>	-	Wave 100	U20FS-U	<b>IUF22</b>	-
		BeAt	U24EPR9	<b>IU24D</b>	<b>IU01</b> □	Wave 100R	U22FS-U	<b>IUF22</b>	-
	Bravo	U20FS-U	<b>IUF22</b>	-	Wave 110 (NF110)	U20FS-U	<b>IUF22</b>	-	
	C 70	U22FS-U	<b>IUF22</b>	-	Wave 110 ALPHA	U20FS-U	<b>IUF22</b>	-	
JAPAN	CB 125 CL	U20EPR9	<b>IU20</b>	-	Wave 125 (ANF125)	U20EPR9	<b>IU20</b>	<b>IU01</b> □	
	CB110	U22EPR9	<b>IU22D</b>	-	Wave 125S	U24ES-N	<b>IU24</b>	<b>IU01</b> □	
	CB400F/SF/SB/VTEC	U24FER9	<b>IUH24</b>	<b>IU01</b> □	Wave Alpha (NF100)	U20FS-U	<b>IUF22</b>	-	
	CBF 110	U24ESR-N	<b>IU24</b>	<b>IU01</b> □	Wave Dash	U22EPR9	<b>IU22D</b>	-	
	CBR 150R	U24ESR-N	<b>IU24</b>	<b>IU01</b> □	XL 100	X24ES-U	<b>IX24</b>	<b>IXU01</b> □	
	CBR1000RR	X24EPR-U9	<b>IX24B</b>	<b>IXU01</b> □	XL 125	X24ES-U	<b>IX24</b>	<b>IXU01</b> □	
	CBR400F I . II /AF/T	X24ES-U	<b>IX24</b>	<b>IXU01</b> □	XL 185	X24ES-U	<b>IX24</b>	<b>IXU01</b> □	
	CBR600F/FS/F4I/RR	U27FER9	<b>IUH27</b>	<b>IU01</b> □	XLR 200	X24EPR-U9	<b>IX24B</b>	<b>IXU01</b> □	
	CBR900RR	U27FER9	<b>IUH27</b>	<b>IU01</b> □	XR 125L	X27EPR-U9	<b>IX27B</b>	<b>IXU01</b> □	
	CG 125	X24ES-U	<b>IX24</b>	<b>IXU01</b> □	XR 200	X24EPR-U9	<b>IX24B</b>	<b>IXU01</b> □	
EUROPE & USA	CLICK 125	U24EPR9	<b>IU24D</b>	<b>IU01</b> □	XRM 110	U20FS-U	<b>IUF22</b>	-	
	CLICK 150	U24EPR9	<b>IU24D</b>	<b>IU01</b> □	XRM 125	U20EPR9	<b>IU20</b>	<b>IU01</b> □	
CROSS REFERENCE NUMBER									



MAKER	DENSO	IRIDIUM POWER	IRIDIUM RACING	MAKER	DENSO	IRIDIUM POWER	IRIDIUM RACING
<b>HONDA</b>				<b>KAWASAKI</b>			
XRM 125 DS / RS / MOTARD	U20EPR9	IU20	-	ZX-6R/RR/ZX-7RR	U27ESR-N	IU27	IU01-□
Zoomer-X	U24EPR9	IU24D	IU01-□	ZX-9R/ZXR400/R	U27ETR	IU27A	IU01-□
<b>JIANSHE</b>				<b>KTM</b>			
Apache	X24ES-U	IX24	IXU01-□	530 EXC-R	XU24EPR-U	IXU24	IXU01-□
Blitz	U22FS-U	IUF22	-	950 Supermoto	U24ETR	IU24A	IU01-□
Broncho 125	X24ES-U	IX24	IXU01-□	<b>KYMCO</b>			
Cougar 100	U22FS-U	IUF22	-	Active 110	U22FS-U	IUF22	-
CP 125	U22FS-U	IUF22	-	Agility 125 RS	U22FSR-U	IUF22	-
CP 150	U22FS-U	IUF22	-	AXR 110	U22FS-U	IUF22	-
Dagger	U22FS-U	IUF22	-	Cevira 110	U22FS-U	IUF22	-
Dash 110	U22FS-U	IUF22	-	CG 150	X24ESR-U	IX24	IXU01-□
Evolution	U22FS-U	IUF22	-	Dink 150	X22EPR-U9	IX22B	IXU01-□
Intense 110	U22FS-U	IUF22	-	Dink 200i	X22EPR-U9	IX22B	-
Intense 125	U22FS-U	IUF22	-	Free LX 115	U22FSR-U	IUF22	-
Legacy 100	U22FS-U	IUF22	-	Grand Dink 250	X22EPR-U9	IX22B	IXU01-□
Monark 125	X24ES-U	IX24	IXU01-□	Jetix 125	U22FSR-U	IUF22	-
Monark Hunk	X24ES-U	IX24	IXU01-□	Kargador 150	X24ESR-U	IX24	IXU01-□
Prodigy 110	U22FS-U	IUF22	-	K-Pipe 125	U22FSR-U	IUF22	-
Stag 155	X24ES-U	IX24	IXU01-□	Like 125	U22FSR-U	IUF22	-
Stag 50	U22FS-U	IUF22	-	Spike 125	U22FSR-U	IUF22	-
V-150	X24ES-U	IX24	IXU01-□	Stryker 150	X24ESR-U	IX24	IXU01-□
Vision 150	X24ES-U	IX24	IXU01-□	Super 8 125	U22FSR-U	IUF22	-
XVR 150	X24ES-U	IX24	IXU01-□	Topboy 100	W24FR-L	IWF24	-
<b>KAWASAKI</b>				<b>LI FAN</b>			
AR-80 (K)	W24EP-U	IW24	IW01-□	Comet 110	U22FS-U	IUF22	-
Aura Classic (AN110)	U20FS-U	IUF22	-	LF 100-5	U22FS-U	IUF22	-
Aura Nexus (AN112)	U20FS-U	IUF22	-	LF 100-7A	U22FS-U	IUF22	-
Aura Nexus (AN125)	U20FS-U	IUF22	-	LF 110-16	U22FS-U	IUF22	-
Bajaj BYK 100	U22FS-U	IUF22	-	LF 125-12	U22FS-U	IUF22	-
Bajaj Caliber 115	U22FS-U	IUF22	-	LF 150 GY	X24ES-U	IX24	IXU01-□
Bajaj CT 100	U22FS-U	IUF22	-	LF 150-14	X24ES-U	IX24	IXU01-□
Bajaj Wind 125	U22FS-U	IUF22	-	LF 150-14 II	X24ES-U	IX24	IXU01-□
Barako 175 (Electric/Kick)	U24ES-N	IU24	IU01-□	LF 150-A	X24ES-U	IX24	IXU01-□
BC 125	U24ESR-N	IU24	IU01-□	LF 150-B	X24ES-U	IX24	IXU01-□
Boxer CT-150	U22FSR-U	IUF22	-	LF 250-4	U22FS-U	IUF22	-
CT100	U22FS-U	IUF22	-	Saturn 110-2	U22FS-U	IUF22	-
Curve	U22FSR-U	IUF22	-	Viento 110A	U22FS-U	IUF22	-
DH-140 (KC138) Brutus	W22FS-U	IWF22	-	<b>LON CIN</b>			
Discover 100	U22FSR-U	IUF22	-	CG 150 DLX	X24ES-U	IX24	IXU01-□
D-Tracker	U22FSR-U	IUF22	-	Citicruiser	U22FS-U	IUF22	-
Eliminator (BN175)	U24ES-N	IU24	IU01-□	Cruiser 150	U22FS-U	IUF22	-
Fury 125	U20FS-U	IUF22	-	Diamondback	U22FS-U	IUF22	-
GPZ1100	U27ETR	IU27A	IU01-□	Grandventure	U22FS-U	IUF22	-
GPZ900R	X27ES-U	IX27	IXU01-□	Hunder 125	U22FS-U	IUF22	-
HD-I, II, IX, X (KC100)	W22FP-U	IWF22	-	LX 100	U22FS-U	IUF22	-
HD-III (KC125)	W22FP-U	IWF22	-	LX 110	U22FS-U	IUF22	-
KDX-125	W24ESR-U	IW24	IW01-□	LX 150R	X24ES-U	IX24	IXU01-□
KE 100	W24ES-U	IW24	IW01-□	LX 150RS	X24ES-U	IX24	IXU01-□
KE 125	W24ES-U	IW24	IW01-□	Terminator 200	X24ES-U	IX24	IXU01-□
KLX-150	U22FSR-U	IUF22	-	<b>MCX</b>			
KMX 125	W24ES-U	IW24	IW01-□	Agila 150	X24ES-U	IX24	IXU01-□
KR 150SSR	W27ES-U	IW27	IW01-□	Athena 90	U22FS-U	IUF22	-
KSR 110	U20FS-U	IUF22	-	Blink 110	U22FS-U	IUF22	-
KX-125	W27ESR	IW27	IW01-□	Blink 125	U22FS-U	IUF22	-
KX-250F	U24ESR-N	IU24	IU01-□	Comet 110	U22FS-U	IUF22	-
KX-450F	-	IU24	IU01-□	Comet 125	U22FS-U	IUF22	-
Leo Star (AS120)	W24EP-U	IW24	IW01-□	GY 150	X24ES-U	IX24	IXU01-□
Neo Max	U20FS-U	IUF22	-	Mantis 110	U22FS-U	IUF22	-
Ninja 250	U24ESR-N	IU24	IU01-□	Mantis 125	U22FS-U	IUF22	-
Rouser 135	U20FSR-U	IUF22	-	Raine 100	U22FS-U	IUF22	-
Rouser 180	U27ESR-N	IU27	IU01-□	<b>MOTORSTAR</b>			
Wind 125 (BR125)	U22FS-U	IUF22	-	Easy Ride 150-II	U22FS-U	IUF22	-
ZEPHYR 1100	U27ESR-N	IU27	IU01-□	Fox 125	U22FS-U	IUF22	-
ZEPHYR 750	X27ESR-U	IX27	IXU01-□				
Zone 125	U20FS-U	IUF22	-				
ZX-10R Ninja	U27ESR-N	IU27	IU01-□				
ZX130B/C	U20FS-U	IUF22	-				

AUSTRALIA  
CHINA  
INDIA  
INDONESIA  
KOREA  
MALAYSIA  
PHILIPPINES  
SAUDI ARABIA  
SINGAPORE  
TAIWAN  
THAILAND  
VIETNAM  
JAPAN  
EUROPE & USA  
CROSS REFERENCE  
PART NUMBER

DENSO	9	14	16	20	22	24	27	29	31	32	34	35	DENSO	9	14	16	20	22	24	27	29	31	32	DENSO	9	14	16	20	22	24	27	31
NGK	2	4	5	6	7	8	9	9.5	10	10.5	11	11.5	CHAMPION	18	16,14	12,11	10,9	8,7	6,63,61	4,59	57	55	53	BOSCH	10	9	8	7,6	5	4	3	2



# PHILIPPINES MOTORCYCLE

▶ Spark plug color codes: ■ for Iridium Tough and Iridium Plugs and Iridium TT, ■ for Iridium Power, ■ for Iridium Racing and Two Tops Plugs, ■ for Platinum Plugs and Platinum TT, and black for general spark plugs.

	MAKER	DENSO	IRIDIUM POWER	IRIDIUM RACING
AUSTRALIA	<b>MOTORSTAR</b>			
	Hawk 150-II	U22FS-U	IUF22	-
	Jazz 125	U22FS-U	IUF22	-
CHINA	Jazz 70-II	U22FS-U	IUF22	-
	Magnun 250	U22FS-U	IUF22	-
	MSX 125 Sport	U22FS-U	IUF22	-
INDIA	MSX 125-III	U22FS-U	IUF22	-
	MSX 125-IV	U22FS-U	IUF22	-
	MSX 150-II	X24ES-U	IX24	IXU01-□
INDONESIA	MSX 200-II	X24ES-U	IX24	IXU01-□
	Panther 150	U22FS-U	IUF22	-
	Predator 150-II	X24ES-U	IX24	IXU01-□
KOREA	Predator 200	X24ES-U	IX24	IXU01-□
	Sapphire 110-II	U22FS-U	IUF22	-
	Sapphire 125-II	U22FS-U	IUF22	-
MALAYSIA	Starlaser	U22FS-U	IUF22	-
	Star-X 150	X24ES-U	IX24	IXU01-□
	Well 125	U22FS-U	IUF22	-
PHILIPPINES	Xplorer Z-200	X24ES-U	IX24	IXU01-□
	Xplorer Z-250	X24ES-U	IX24	IXU01-□
	Zest 110	U22FS-U	IUF22	-
SAUDI ARABIA	<b>PGO/SACHS</b>			
	G-MAX 125	U22FS-U	IUF22	-
	G-MAX 150	U22FS-U	IUF22	-
SINGAPORE	G-MAX 200	U22FS-U	IUF22	-
	G-MAX 50	W22FP-U	IWF22	-
	MadAss 100	U22FSR-U	IUF22	-
TAIWAN	MadAss 125	U22FSR-U	IUF22	-
	PMX Sport 110	U22FS-U	IUF22	-
	T-REX 150	U22FS-U	IUF22	-
THAILAND	<b>PMR</b>			
	Hataw 150	X24ES-U	IX24	IXU01-□
	Kweeki 50	U22FS-U	IUF22	-
VIETNAM	Kweeki 80 II	U22FS-U	IUF22	-
	Mistah 150	X24ES-U	IX24	IXU01-□
	Racer 110	U22FS-U	IUF22	-
JAPAN	Speedwave 125	U22FS-U	IUF22	-
	Super 138	U22FS-U	IUF22	-
	Tandem 110	U22FS-U	IUF22	-
EUROPE & USA	Variant 150	U22FS-U	IUF22	-
	<b>RUSI</b>			
	DL 100	U22FS-U	IUF22	-
CROSS REFERENCE	DL 110	U22FS-U	IUF22	-
	DL 125	U24ES-N	IU24	IU01-□
	DL 150	U24ES-N	IU24	IU01-□
PART NUMBER	KR 125	U24ES-N	IU24	IU01-□
	MP 110	U22FS-U	IUF22	-
	MP 125-Z	U24ES-N	IU24	IU01-□
	TC 150	U24ES-N	IU24	IU01-□
	<b>SINSKI</b>			
	Beta 150	W22FS-U	IWF22	-
	Big Boy 150	U22FSR-U	IUF22	-
	Blaze 100R	U22FSR-U	IUF22	-
	Blaze 125R	U22FSR-U	IUF22	-
	Cute 70	W22FS-U	IWF22	-
	Dakar 150	U22FSR-U	IUF22	-
	Dio Max 125	U22FSR-U	IUF22	-
	DMAX 150	U22FSR-U	IUF22	-
	Jag 100	U22FS-U	IUF22	-
	Lynx 150	U22FSR-U	IUF22	-
	Maton 150	U22FSR-U	IUF22	-
	Navigator 150	X24ESR-U	IX24	IXU01-□
	Nitro 125	U22FSR-U	IUF22	-
	RMX 125	U22FS-U	IUF22	-
	Road King 250	X24ES-U	IX24	IXU01-□
	SK 125	W24FR-L	IWF24	-
	Vivamas X	U22FSR-U	IUF22	-
	XCT 150	U22FSR-U	IUF22	-

	MAKER	DENSO	IRIDIUM POWER	IRIDIUM RACING
AUSTRALIA	<b>SINSKI</b>			
	XSJ 250-A	X24ES-U	IX24	IXU01-□
	<b>SKYGO</b>			
CHINA	Desire 100	U22FS-U	IUF22	-
	Duke	U22FS-U	IUF22	-
	Earl	U22FS-U	IUF22	-
INDIA	Earl II	U22FS-U	IUF22	-
	Hero 105	U22FS-U	IUF22	-
	King 150	X24ES-U	IX24	IXU01-□
INDONESIA	Knight II	X24ES-U	IX24	IXU01-□
	Prince 100	U22FS-U	IUF22	-
	Prince 110	U22FS-U	IUF22	-
KOREA	Royale 110	U22FS-U	IUF22	-
	Stallion	X24ES-U	IX24	IXU01-□
	Viscount	X24ES-U	IX24	IXU01-□
MALAYSIA	Wizard	X24ES-U	IX24	IXU01-□
	<b>SUZUKI</b>			
	B 120 (X 120)	W20FP-U	IWF20	-
PHILIPPINES	Crystal	W22FS-U	IWF22	-
	DR350	U27ETR	IU27A	IU01-□
	DR500	X27ESR-U	IX27	IXU01-□
SAUDI ARABIA	FA50	W14FP-UL	IWF16	-
	GD110	U20FSR-U	IUF22	-
	GS 175	U24ES-N	IU24	IU01-□
SINGAPORE	GS 500	X24EPR-U9	IX24B	IXU01-□
	GSX1300R	U27ESR-N	IU27	IU01-□
	GSX-R1100W/-R1000	U27ESR-N	IU27	IU01-□
TAIWAN	GSXR400	U24FSR-U	IUF24	-
	GSX-R600/-R750	U27ESR-N	IU27	IU01-□
	Hayate CVT 125	U20FS-U	IUF22	-
THAILAND	Mola 125 (GS 125)	U24ESR-N	IU24	IU01-□
	Mola 150 (GS 150)	U24ESR-N	IU24	IU01-□
	Nex 115	U22EPR9	IU22D	-
VIETNAM	Raider 125 (FU125)	U24ESR-N	IU24	IU01-□
	Raider 150 (FU150)	U24ESR-N	IU24	IU01-□
	Raider J 110 PRO	U20FS-U	IUF22	-
EUROPE & USA	Raider J/R	U20FS-U	IUF22	-
	RC 110	W24FP-U	IWF24	-
	RF600	U27ESR-N	IU27	IU01-□
JAPAN	RM125	W24ESR-V	IW24	IW01-□
	RM250	W24ESR-V	IW24	IW01-□
	SC 110	W24FP-U	IWF24	-
CROSS REFERENCE	Shogun 110 (FD110XSD)	U20FS-U	IUF22	-
	Shogun 125 (FD125XSD)	U20FS-U	IUF22	-
	ShogunPro 125 (FD125XRM)	U20FS-U	IUF22	-
PART NUMBER	Skydrive 125	U20FS-U	IUF22	-
	Smash 110 (FD110XCD)	U20FS-U	IUF22	-
	Smash 115	U22FS-U	IUF22	-
	SS 100	W22FP-U	IWF22	-
	Step 125	U20FS-U	IUF22	-
	Thunder 125	U20EPR9	IU20	-
	TS 100	W24ES-U	IW24	IW01-□
	TS 125 (ER)	W24ES-U	IW24	IW01-□
	TS 185	W22EP-U	IW22	IW01-□
	TSR 125	W24ES-U	IW24	IW01-□
	VS 800/GL	X24EPR-U9	IX24B	IXU01-□
	X 3 (GP 100)	W22FS-U	IWF22	-
	X 4 (GP 125)	W22FS-U	IWF22	-
	<b>SYM</b>			
	Angel	U22FS-U	IUF22	-
	Attila	U22FS-U	IUF22	-
	Blaze 150	X24ES-U	IX24	IXU01-□
	Bonus	U22FS-U	IUF22	-
	Didi 50	W24FR-L	IWF24	-
	Fighter 150	U24ESR-N	IU24	IU01-□
	GTS 250	U24ESR-N	IU24	IU01-□
	Jet 100	W24FR-L	IWF24	-
	Jet 4 125	U22FS-U	IUF22	-



MAKER	DENSO	IRIDIUM POWER	IRIDIUM RACING	MAKER	DENSO	IRIDIUM POWER	IRIDIUM RACING
<b>SYM</b>				<b>YAMAHA</b>			
Jet Alpha (2 Stroke)	W20FR-L	IWF20	-	RX100	-	-	-
Jet Euro	W24FR-L	IWF24	-	RXT 135	W24FP-U	IWF24	-
Jet Power 125	U22FS-U	IUF22	-	Sight	U20FSR-U	IUF22	-
Joyride 200	U24ESR-N	IU24	IU01-□	Sniper MX	U24EPR9	IU24D	IU01-□
Magic RR	U22FS-U	IUF22	-	Sniper T 135	U24EPR9	IU24D	IU01-□
Radar X 125	U22FS-U	IUF22	-	STX 125	U22FS-U	IUF22	-
RV 1	U22FS-U	IUF22	-	SZ16	U24EPR9	IU24D	IU01-□
RV 1-2 Sports 110	U22FS-U	IUF22	-	T105E	U22FS-U	IUF22	-
Shark/Excell	U24ESR-N	IU24	IU01-□	TFX150	U27ESR-N	IU27	IU01-□
Star 110	U22FS-U	IUF22	-	V110E (4US1)	W22FP-U10	IWF22	-
Star X	U22FS-U	IUF22	-	V110E (F1ZR/3AX2)	W22FP-U10	IWF22	-
Wolf 125	X24ESR-U	IX24	IXU01-24	Vega	U20FS-U	IUF22	-
<b>TIGER</b>				Vega Force	U20FS-U	IUF22	-
Boxer 200E	X24ES-U	IX24	IXU01-□	VMX1200	X24EPR-U9	IX24B	IXU01-□
Bulldog 150	X24ES-U	IX24	IXU01-□	X1	U20FS-U	IUF22	-
Bulldog 200	X24ES-U	IX24	IXU01-□	XJR1200	X24EPR-U9	IX24B	IXU01-□
CX135A	U22FS-U	IUF22	-	XJR400	U27ESR-N	IU27	IU01-□
CX135SE	U22FS-U	IUF22	-	XT 225	X24ESR-U	IX24	IXU01-□
CX135SM	U22FS-U	IUF22	-	XTZ 125	U20FSR-U	IUF22	-
Matrix 115E	U22FS-U	IUF22	-	YA90 (4DM3)	W22FP-U10	IWF22	-
Matrix 115R	U22FS-U	IUF22	-	YZ125	-	IW27	IW01-□
Smart 125	U22FS-U	IUF22	-	YZ250F	U24ESR-N	IU24	IU01-□
Smart 135A	U22FS-U	IUF22	-	YZ400F	U24ESR-N	IU24	IU01-□
Smart 135SE	U22FS-U	IUF22	-	YZF-R1	U27ETR	IU27A	IU01-□
<b>YAMAHA</b>				YZF-R6	U31ETR	IU31A	IU01-□
AEROX 155	U24EPR9	IU24D	IU01-□	<b>ZONGSHEN</b>			
CR50Z (3WN2)	W22FP-U10	IWF22	-	Badger (ZS150-27)	X24ES-U	IX24	IXU01-□
CR90Z (3XR2)	W22FP-U10	IWF22	-	Buggy (ZS150T-7)	U22FS-U	IUF22	-
Crypton R/S	U22FSR-U	IUF22	-	Caravan (ZS125-2)	X24ES-U	IX24	IXU01-□
Crypton Z	U20FS-U	IUF22	-	Chase (ZS125-18A)	U22FS-U	IUF22	-
DT 125	W24ES-U	IW24	IW01-□	Chase (ZS125-18B)	U22FS-U	IUF22	-
DT100	-	-	-	Excel (ZS125-31)	X24ES-U	IX24	IXU01-□
FORCE ONE	-	-	-	Glide (ZS125-26)	U22FS-U	IUF22	-
FZ16	U24EPR9	IU24D	IU01-□	Hornet (ZS125T-30)	U22FS-U	IUF22	-
L2GF/DX	W22FS-U	IWF22	-	Icon 125 (ZS125T-7)	U22FS-U	IUF22	-
LB80	W20FS-U	IWF20	-	Loadstar (ZS150-6)	X24ES-U	IX24	IXU01-□
Mio 125 / Mio 125 MXi	U22ESR-N	IU22	-	Manta (ZS110-9B)	U22FS-U	IUF22	-
Mio Aerox	U24EPR9	IU24D	IU01-□	Nova (ZS110-12)	U22FS-U	IUF22	-
Mio Fino	U22FS-U	IUF22	-	Nova (ZS110-18)	U22FS-U	IUF22	-
Mio Fino FI	U20FSR-U	IUF22	-	Ranger (ZS250)	U22FS-U	IUF22	-
Mio Sporty/Mio Soul	U22FS-U	IUF22	-	Sleek (ZS125T-8)	U22FS-U	IUF22	-
NMAX 155	U24EPR9	IU24D	IU01-□	Sprint (ZS150T-8)	U22FS-U	IUF22	-
Nouvo/Nouvo Z	U22FSR-U	IUF22	-	Trojan (ZS150-15)	X24ES-U	IX24	IXU01-□
PW50 (3PTP)	W14FPR-UL	IWF16	-	Trump (ZS150GY)	X24ES-U	IX24	IXU01-□
RS 100T	W20FP-U	IWF20	-	Trump (ZS200GY)	X24ES-U	IX24	IXU01-□
RS 110F	X22EPR-U9	IX22B	-	Tycoon (ZS200)	X22EPR-U9	IX22B	IXU01-□
RS125GE	-	-	-				

AUSTRALIA  
CHINA  
INDIA  
INDONESIA  
KOREA  
MALAYSIA  
PHILIPPINES  
SAUDIARABIA  
SINGAPORE  
TAIWAN  
THAILAND  
VIETNAM  
JAPAN  
EUROPE & USA  
CROSS REFERENCE  
PART NUMBER

DENSO	9	14	16	20	22	24	27	29	31	32	34	35	DENSO	9	14	16	20	22	24	27	29	31	32	DENSO	9	14	16	20	22	24	27	31
NGK	2	4	5	6	7	8	9	9.5	10	10.5	11	11.5	CHAMPION	18	16,14	12,11	10,9	8,7	6,63,61	4,59	57	55	53	BOSCH	10	9	8	7,6	5	4	3	2



	MODEL	ENGINE	YEAR	DENSO				
AUSTRALIA	BUICK ROADMASTER	5000 <E>	1991	T14PR-U	ITF16TT	-	ITF16	-
		5700 <7>	1992-1993	T16PR-U	ITF16TT	-	ITF16	-
CHINA	CHEVROLET CAPRICE	4300<Z>	1990	T14PR-U	ITF16TT	-	ITF16	-
		4300<Z>	1992-1993	T16PR-U	ITF16TT	-	ITF16	-
		5000<E>	1990-1993	T14PR-U	ITF16TT	-	ITF16	-
		5000<Y>	1990	K16PR-U11	IK16TT	K16TT	IK16	VK16
		5700<7>	1990-1992	T16PR-U	ITF16TT	-	ITF16	-
		5700<P>	1984-1990	T16EPR-U15	IT16TT	T16TT	IT16	VT16
INDIA	LUMINA		2007-2011	-	-	-	-	-
			2007-2011	-	-	-	-	-
INDONESIA	FORD CROWN VICTORIA	5800 <G>	1990-1991	T14PR-U	ITF16TT	-	ITF16	-
		4600 <W>	1992-1995	T16EPR-U15	IT16TT	T16TT	IT16	VT16
		5700 <7>	1993	T16EPR-U15	IT16TT	T16TT	IT16	VT16
KOREA	GMC SUBURBAN	5700 <K>	1990-1993	T16PR-U	ITF16TT	-	ITF16	-
		5700 <K>	1994-1995	T20PR-U	ITF20TT	-	ITF20	-
		7400 <K>	1990-1995	T16PR-U	ITF16TT	-	ITF16	-
MALAYSIA	HONDA ACCORD	2300ZVTI	1998-	KJ16CR-L11	IK16TT	K16TT	IK16L	-
		2200MPI	1996-1997	KJ20CR-L11	IK20TT	K20TT	IK20L	-
		2200MPI	1995	KJ16CR-L11	IK16TT	K16TT	IK16L	-
		2000MPI	1996-1997	KJ20CR-L11	IK20TT	K20TT	IK20L	-
		2000MPI	1995	KJ16CR-L11	IK16TT	K16TT	IK16L	-
		2000DOHC	-	Q20PR-U11	IQ20TT	Q20TT	IQ20	VQ20
			2006-2007	KJ20CR-L11	IK20TT	K20TT	IK20L	-
PHILIPPINES	SAUDIARABIA CITY CIVIC	1300	1998-1999	K16PR-U11	IK16TT	K16TT	IK16	VK16
		1600	1992-1994	K20PR-U11	IK20TT	K20TT	IK20	VK20
		1600 MPI	1996-	K16PR-U11	IK16TT	K16TT	IK16	VK16
		1600 MPI	1996-1998	K16PR-U11	IK16TT	K16TT	IK16	VK16
		1500	1990-1991	Q20PR-U11	IQ20TT	Q20TT	IQ20	VQ20
		1300	1988-1991	Q20PR-U11	IQ20TT	Q20TT	IQ20	VQ20
		1300	1984-1987	W20EXR-U11	IW20TT	W20TT	IW20	VW20
			2007-2011	SKJ20DR-M11S	-	-	IK20G	VK20G
			1996-1998	K20PR-U11	IK20TT	K20TT	IK20	VK20
			1997-1999	KJ20CR-L11	IK20TT	K20TT	IK20L	-
SINGAPORE	PRELUDE	2200 MPI	1995-1998	KJ20CR-L11	IK20TT	K20TT	IK20L	-
		2000	1992	Q20PR-U11	IQ20TT	Q20TT	IQ20	VQ20
TAIWAN	HYUNDAI ACCENT	1500 SOHC	-	K16PR-U	IK16TT	K16TT	IK16	VK16
		1300 SOHC	-	K16PR-U11	IK16TT	K16TT	IK16	VK16
			2006-2011	K16PR-U11	IK16TT	K16TT	IK16	VK16
			2012-	-	IK16TT	-	IK16	VK16
VIETNAM	ELANTRA		2006-2011	K16PR-U11	IK16TT	K16TT	IK16	VK16
			2012-	-	IK16TT	-	IK16	VK16
JAPAN	SONATA	2000 DOHC	-	W20EPR-U	IW20TT	W20TT	IW20	VW20
		2500 V6	-	W16EPR-U	IW16TT	W16TT	IW16	VW16
		2400	2006-2011	K16PR-U11	IK16TT	K16TT	IK16	VK16
		3000 V6	2006-2011	K16PR-U	IK16TT	K16TT	IK16	VK16
EUROPE & USA	KIA CREDOS	1800 LPG	-	K20PR-U	IK20TT	K20TT	IK20	VK20
		2000 LPG	-	K20PR-U	IK20TT	K20TT	IK20	VK20
CROSS REFERENCE	SEPHIA	1500	-	K20PR-U	IK20TT	K20TT	IK20	VK20
		1500	-	K20PR-U11	IK20TT	K20TT	IK20	VK20
		2000	-	K20PR-U11	IK20TT	K20TT	IK20	VK20
PART NUMBER	SPORTAGE	2000	-	W20EPR-U11	IW20TT	W20TT	IW20	VW20
		2000	-	W16EX-U	IW16TT	W16TT	IW16	VW16
PART NUMBER	LEXUS LEXUS IS 300	3000<3VZ-FE>	1990	PQ20R	IQ20TT	-	IQ20	VQ20
		3000<1MZ-FE>	1999	PK20TR11	IK20TT	-	IK20	VK20
		4000<1UZ-FE>	1990	PK20R11	IK20TT	-	IK20	VK20
PART NUMBER	LEXUS LS 400 LEXUS LS 700	4000<2UZ-FE>	1998	K20R-U	IK20TT	K20TT	IK20	VK20
PART NUMBER	MAZDA CAPELLA	1600 <F6>	-	W16EPR-U	IW16TT	W16TT	IW16	VW16





MODEL	ENGINE	YEAR	DENSO					
<b>MAZDA</b>								
<b>CAPELLA</b>	1800<F8>	-1989	W16EPR-U	IW16TT	W16TT	IW16	VW16	
	2000<FE>	-	W16EPR-U	IW16TT	W16TT	IW16	VW16	
	2000DOHC <FE>	-	K20PR-U	IK20TT	K20TT	IK20	VK20	
	2500<KL-ZE>	1998	KJ16CR11	IK16TT	K16TT	IK16L	-	
<b>FAMILIA 323</b>								
	1300CARB. <B3>	1990-1992	K16PR-U	IK16TT	K16TT	IK16	VK16	
	1300<B3>	-1989	K16PR-U	IK16TT	K16TT	IK16	VK16	
	1300<B3E>	1992-	W16EPR-U11	IW16TT	W16TT	IW16	VW16	
	1600<E6>	-	W16EPR-U11	IW16TT	W16TT	IW16	VW16	
	1600<B6D>	1992-	K16PR-U	IK16TT	K16TT	IK16	VK16	
	1300	-	K20PR-U	IK20TT	K20TT	IK20	VK20	
	1600	-	K20PR-U	IK20TT	K20TT	IK20	VK20	
<b>LUCE 929</b>								
	2000<FE>	-	W16EPR-U	IW16TT	W16TT	IW16	VW16	
	2200<F2>	-	Q20PR-U	IQ20TT	Q20TT	IQ20	VQ20	
<b>MPV</b>								
	3000EGI <JE>	1995	KJ16CR11	IK16TT	K16TT	IK16L	-	
	3000EGI <JE>	1998-1999	QJ20CR11	IQ20TT	Q20TT	IQ20	VQ20	
	1600<Z6D>	1992	K16PR-U	IK16TT	K16TT	IK16	VK16	
<b>MERCURY</b>								
<b>G-MARQUIS</b>								
	5800 <G>	1990-1991	T14PR-U	ITF16TT	-	ITF16	-	
	4600 <W>	1992-1995	T16EPR-U15	IT16TT	T16TT	IT16	VT16	
<b>MITSUBISHI</b>								
<b>CANTER</b>								
	2400 <T207,T217>	-	W20EP-U	IW20TT	W20TT	IW20	VW20	
		2006-2011	K16P-U	IK16TT	K16TT	IK16	VK16	
<b>GALANT LAMPADA</b>								
	1600 <4G32>	-	W16EP-U	IW16TT	W16TT	IW16	VW16	
	1500 <4G15>	1992-1996	W16EP-U	IW16TT	W16TT	IW16	VW16	
	1500 <4G15>	-	W20EP-U	IW20TT	W20TT	IW20	VW20	
	1300 <4G13>	-	W20EP-U	IW20TT	W20TT	IW20	VW20	
	2600/2000/1600	-	W16EP-U	IW16TT	W16TT	IW16	VW16	
<b>GALANT -SIGMA</b>								
	2000 <4G63>	-	W22EP-U	-	W22TT	IW22	VW22	
	1600 <4G32>	-	W20EP-U	IW20TT	W20TT	IW20	VW20	
<b>LANCER</b>								
	1600 T <4G32>	1985	W22EP-U	-	W22TT	IW22	VW22	
	1500 <4G15>	1985	W20EP-U	IW20TT	W20TT	IW20	VW20	
	1300 <4G13>	1985	W20EP-U	IW20TT	W20TT	IW20	VW20	
		2006-2011	K16P-U	IK16TT	K16TT	IK16	VK16	
<b>PAJERO</b>								
		2006-2011	K16P-U	IK16TT	K16TT	IK16	VK16	
<b>NISSAN</b>								
<b>300EX</b>								
	3000 <VG30>	1996	Q20R-U11	IQ20TT	Q20TT	IQ20	VQ20	
<b>ALTIMA</b>								
	2000 <SR20-DE>	1995	K20R-U	IK20TT	K20TT	IK20	VK20	
		2007-2010	VKH20	IKH20TT	-	IKH20	VKH20	
<b>BLUEBIRD</b>								
<b>CEDRIC</b>								
	1800 <CA18S>	1994	Q16-U	IQ16TT	Q16TT	IQ16	VQ16	
	2000 <CA20S>	-	Q16-U	IQ16TT	Q16TT	IQ16	VQ16	
	3000 <VG30E>	-	Q20-U11	IQ20TT	Q20TT	IQ20	VQ20	
	3000 <VG30S>	1985-	Q20-U11	IQ20TT	Q20TT	IQ20	VQ20	
	3000 <VG30S>	-	Q20-U11	IQ20TT	Q20TT	IQ20	VQ20	
	3000 <VQ30DE>	-	PK16PR11	IK16TT	-	IK16	VK16	
<b>INFINITI</b>								
<b>MAXIMA</b>								
	3000 <VG30-DE>	1995	PK16R11	IK16TT	-	IK16	VK16	
<b>PATH FINDER</b>								
	3300 <VG33E>	1998	W16EPR-U11	IW16TT	W16TT	IW16	VW16	
<b>PATROL</b>								
	2800 <L28>	-	W16EP-U11	IW16TT	W16TT	IW16	VW16	
	4000 <P40>	-	W16EP-U11	IW16TT	W16TT	IW16	VW16	
	3000 <RB30S>	-	K20PR-U	IK20TT	K20TT	IK20	VK20	
	4200 <TB42,TB42S>	-	W16EP-U	IW16TT	W16TT	IW16	VW16	
	2000 <Z20>	1985	W20EP-U	IW20TT	W20TT	IW20	VW20	
<b>PICK UP</b>								
	2400 <Z24>	1990	W20EP-U	IW20TT	W20TT	IW20	VW20	
<b>PRIMERA</b>								
	2000 <SR20-DE>	1998	K16R-U11	IK16TT	K16TT	IK16	VK16	
<b>SAFARI</b>								
	4500 <TB45E>	1998	W16EPR-U11	IW16TT	W16TT	IW16	VW16	
<b>SUNNY</b>								
	1600 <GA16S>	-	Q20-U	IQ20TT	Q20TT	IQ20	VQ20	
		-	W20EP-U	IW20TT	W20TT	IW20	VW20	
		2007-2010	K16HPR-U11	IKH16TT	KH16TT	IKH16	VKH16	
<b>URVAN</b>								
	2000 <Z20>	1985	W16EP-U	IW16TT	W16TT	IW16	VW16	
	2400 <Z24>	1990	W16EP-U	IW16TT	W16TT	IW16	VW16	
<b>X</b>								
	2000,2400 <Z20>,<Z24>	-	W16EPR-U	IW16TT	W16TT	IW16	VW16	
<b>SUBARU</b>								
<b>LEGACY</b>								
	2000	-	K20PR-U	IK20TT	K20TT	IK20	VK20	
	2500	-	K20PR-U	IK20TT	K20TT	IK20	VK20	
<b>SUZUKI</b>								
<b>CULTUS-SWIFT</b>								
	1300	-	W20EP-U	IW20TT	W20TT	IW20	VW20	
	1600	1995	W20EPR-U11	IW20TT	W20TT	IW20	VW20	

AUSTRALIA  
 CHINA  
 INDIA  
 INDONESIA  
 KOREA  
 MALAYSIA  
 PHILIPPINES  
 SAUDI ARABIA  
 SINGAPORE  
 TAIWAN  
 THAILAND  
 VIETNAM  
 JAPAN  
 EUROPE  
 & USA  
 CROSS  
 REFERENCE  
 NUMBER  
 PART

DENSO	9	14	16	20	22	24	27	29	31	32	34	35	DENSO	9	14	16	20	22	24	27	29	31	32	DENSO	9	14	16	20	22	24	27	31
NGK	2	4	5	6	7	8	9	9.5	10	10.5	11	11.5	CHAMPION	18	16,14	12,11	10,9	8,7	6,63,61	4,59	57	55	53	BOSCH	10	9	8	7,6	5	4	3	2



# SAUDI ARABIA CAR

▶ Spark plug color codes: for Iridium Tough and Iridium Plugs and Iridium TT, for Iridium Racing and Two Tops Plugs, for Platinum Plugs and Platinum TT, and black for general spark plugs.

MODEL	ENGINE	YEAR	DENSO					
AUSTRALIA TOYOTA CAMRY	3000<3VX-FE>	1996	Q20R-U11	IQ20TT	Q20TT	IQ20	VQ20	
	2200<5S-FE>	1998-1999	K20TR11	IK20TT	K20TT	IK20	VK20	
	2200<5S-FE>	-1996	K20R-U11	IK20TT	K20TT	IK20	VK20	
CHINA	2400	2007-2011	SK20R11	IK20TT	-	IK20	VK20	
	2500<2AR-FE>	2011-	SK16HR11	IKH16TT	-	IKH16	VKH16	
	3000V6	2007-2011	SK20R11	IK20TT	-	IK20	VK20	
	3000V6	2002-2006	PK20TR11	IK20TT	-	IK20	VK20	
INDIA COROLLA	1600<4A-F>	-1989	Q16R-U	IQ16TT	Q16TT	IQ16	VQ16	
	1600<4A-FE>	-	Q16R-U	IQ16TT	Q16TT	IQ16	VQ16	
	1600<4A-FE>	1996-1998	K16R-U11	IK16TT	K16TT	IK16	VK16	
	1300<2E>	1999	W20EXR-U	IW20TT	W20TT	IW20	VW20	
	1300<4K>	1987-	W16EX-U	IW16TT	W16TT	IW16	VW16	
	1300<2E>	1996-1998	W20EXR-U	IW20TT	W20TT	IW20	VW20	
	1300<4E-FE>	1998	K16R-U11	IK16TT	K16TT	IK16	VK16	
INDONESIA	1300<4E-FE>	1996-1998	K16R-U	IK16TT	K16TT	IK16	VK16	
		2008-2011	K16R-U11	IK16TT	K16TT	IK16	VK16	
	KOREA CORONA	2000 <3S-F,3S-FE>	-	Q20R-U11	IQ20TT	Q20TT	IQ20	VQ20
		1800 <1S>	-	W16EXR-U	IW16TT	W16TT	IW16	VW16
		1600 <4A-F>	-	Q16R-U	IQ16TT	Q16TT	IQ16	VQ16
	MALAYSIA CORONA MK2 CRESSIDA	2000 <18R>	-	W16EX-U/W14EX-U	IW16TT	W16TT	IW16	VW16
		2800 <5M-GE>	1980-1985	W20EXR-U	IW20TT	W20TT	IW20	VW20
2400 <22R>		-	W16EXR-U	IW16TT	W16TT	IW16	VW16	
2000 <1G-E>		-	W20EXR-U	IW20TT	W20TT	IW20	VW20	
2000 <18R>		-1980	W16EX-U/W14EX-U	IW16TT	W16TT	IW16	VW16	
2000 <21R>		1980-1985	W16EXR-U	IW16TT	W16TT	IW16	VW16	
PHILIPPINES CROWN		3000 <2JZ-GE>	1996	K20R-U	IK20TT	K20TT	IK20	VK20
	2800 <5M>	1983-	W16EXR-U	IW16TT	W16TT	IW16	VW16	
	2800 <5M-E>	-1983	W20EXR-U	IW20TT	W20TT	IW20	VW20	
	2800 <5M-GE>	1986-	W16EXR-U	IW16TT	W16TT	IW16	VW16	
SAUDI ARABIA DYNA	2000 <5R>	1983-1984	W16EX-U	IW16TT	W16TT	IW16	VW16	
	2000 <5R>	1980-1982	W16EX-U/W14EX-U	IW16TT	W16TT	IW16	VW16	
	2400 <22R>	-	W16EX-U	IW16TT	W16TT	IW16	VW16	
		2007-2010	K16TR11	IK16TT	K16TT	IK16	VK16	
SINGAPORE FJ CRUISER HIACE		2008-2010	K20HR-U11	IKH20TT	KH20TT	IKH20	VKH20	
	2000 <1RZ>	1999	W16EX-U	IW16TT	W16TT	IW16	VW16	
TAIWAN	2400 <2RZ>	1999	W16EX-U	IW16TT	W16TT	IW16	VW16	
	1600 <12R>	1983	W16EX-U/W14EX-U	IW16TT	W16TT	IW16	VW16	
	2000 <18R>	1983	W16EX-U/W14EX-U	IW16TT	W16TT	IW16	VW16	
	2400 <22R>	1985	W16EX-U	IW16TT	W16TT	IW16	VW16	
		2007-2010	K20HR-U11	IKH20TT	KH20TT	IKH20	VKH20	
THAILAND HILUX	1600 <1Y>	-	W16EX-U	IW16TT	W16TT	IW16	VW16	
	1800 <2Y>	-1997	W16EX-U	IW16TT	W16TT	IW16	VW16	
	2700 <3RZ-FE>	1998-1999	K16R-U	IK16TT	K16TT	IK16	VK16	
	2000 <3Y>	-1997	W16EX-U	IW16TT	W16TT	IW16	VW16	
	2000 <18R>	-	W16EX-U/W14EX-U	IW16TT	W16TT	IW16	VW16	
	2400 <22R>	-1997	W16EXR-U	IW16TT	W16TT	IW16	VW16	
VIETNAM LAND CRUISER		2005-2011	K20HR-U11	IKH20TT	KH20TT	IKH20	VKH20	
	4500 <1FZ-FE>	-1999	K16R-U	IK16TT	K16TT	IK16	VK16	
	4200 <2F>	1981	W14EX-U	IW16TT	W16TT	IW16	VW16	
	4000 <3F>	-	W14EX-U	IW16TT	W16TT	IW16	VW16	
		2007-2008	K20R-U11	IK20TT	K20TT	IK20	VK20	
		2009-2010	SK20HR11	IKH20TT	-	IKH20	VKH20	
	JAPAN LAND CRUISER WAGON	4500 <1FZ-FE>	1999	K16TR11	IK16TT	K16TT	IK16	VK16
4700 <2UZ-FE>		1999	K20R-U	IK20TT	K20TT	IK20	VK20	
EUROPE & USA PRADO	2700 <3RZ-F>	1997-1999	K16R-U	IK16TT	K16TT	IK16	VK16	
	2700 <3RZ-FE>	1997-1999	K16R-U	IK16TT	K16TT	IK16	VK16	
	3400 <5VZ-FE>	1997-1999	K16TR11	IK16TT	K16TT	IK16	VK16	
		2010	K20HR-U11	IKH20TT	KH20TT	IKH20	VKH20	
CROSS REFERENCE PREVIA RAV 4 SEQUOIA TERCEL	2400 <2TZ-FE>	1998	PK16R11	IK16TT	-	IK16	VK16	
	2000 <3S-FE>	1998-1999	K20R-U11	IK20TT	K20TT	IK20	VK20	
		2008	SK20R11	IK20TT	-	IK20	VK20	
		2010	SK20HR11	IKH20TT	-	IKH20	VKH20	
	1500 <2E>	1986-1982	W16EXR-U	IW16TT	W16TT	IW16	VW16	
PART NUMBER	1300 <3E>	1999	W20EXR-U	IW20TT	W20TT	IW20	VW20	

MODEL	YEAR	VEHICLE CODE	ENGINE	DENSO	IRIDIUM	TJ	IRIDIUM POWER	IRIDIUM TOUGH	QTY	
<b>ALFA ROMEO</b>										
147 GTA 3.2	2004-	937AXL	-	PK20PR-P8	IK20TT	-	IK20	VK20Y	6	AUSTRALIA
147 Twin Spark 1.6/2.0	2000-	937AB	-	-	IK20TT+N/A	-	IK20+IU22	VK20+N/A	4	CHINA
156 GTA 3.2	2004-	932BXB	932A	PK20PR-P8	IK20TT	-	IK20	VK20Y	6	
156 Twin Spark 2.0	1998-	932B2	-	-	IK20TT+N/A	-	IK20+IU22	VK20+N/A	4	INDIA
156 V6 2.5	1998-	932A1	-	-	IK20TT	-	IK20	VK20	6	
159 2.2	2006-	-	939A5	-	IK16TT	-	IK16	VK16	4	INDONESIA
159 3.2	2006-	93922	939A	PT16VR13	ITV16TT	-	ITV16	-	6	
166 V6 3.0	1999-	936A1	-	-	IK20TT	-	IK20	VK20	6	KOREA
Brera 2.2	2007-	93922S	939A5	-	IK16TT	-	IK16	VK16	4	
Brera 3.2	2007-	93932S	939A	PT16VR13	ITV16TT	-	ITV16	-	6	MALAYSIA
GT 2.0	2004-	93270L	937A1	-	IK20TT	-	IK20	VK20	4	
GT 3.2	2004-	93732L	936A	-	IK20TT	-	IK20	VK20	6	PHILIPPINES
Spider 2.2	2006-	-	939A5	-	IK16TT	-	IK16	VK16	4	
Spider 3.2	2006-	-	939A	-	ITV16TT	-	ITV16	-	6	SAUDI ARABIA
<b>AUDI</b>										
A3 1.6	1997-	-	AKL	K20PBR-S10	IK20TT	K20TT	IK20	VK20	4	SINGAPORE
A3 1.8	2007-	-	CDA	PK20PR-P8	IK20TT	-	-	VK20Y	4	
A3 S3 2.0	2006-	-	-	-	-	-	-	VKA16	4	TAIWAN
A4 1.8T	1999-	-	APU	K22PBR-S	-	-	IK22	VK22	4	
	2001-	-	AMB	-	-	-	IK22	VK22	4	THAILAND
	2006-	-	BFB	-	-	-	IK22	VK22	4	
A4 2.0	2001-	-	ALT	-	IK16TT	-	IK16	VK16	4	VIETNAM
	2007-	-	BFB	-	-	-	-	VK20Y	4	
A6 1.8T	1999-	-	AJL/AQC	K20PBR-S10	IK20TT	K20TT	IK22	VK20Y	4	JAPAN
A6 2.0	2006-	-	BPJ	PK20PR-P8	IK20TT	-	-	VK20Y	4	
A6 2.4	1999-	-	APS	K20TXR	IK20TT	K20TT	IK20	VK20	6	EUROPE & USA
Q7 3.6	2007-	-	BHK	-	-	-	IXU22	VXU22	6	
Q7 4.2	2006-	-	BAR	-	-	-	-	VKB20	8	CROSS REFERENCE
R8 4.2	2007-	-	BYH	-	-	-	-	VKB20	8	
TT 2.0T	2007-	-	BWA	-	-	-	IK22	VK22	4	PART NUMBER
TT 3.2	2007-	-	BUB	-	-	-	IXU22	VXU22	6	
<b>BMW</b>										
118i 2.0	2005-	-	N46	-	IK20TT	-	IK20	VK20	4	DENSU
120i 2.0	2007-	-	N46	-	IK20TT	-	IK20	VK20	4	
130i 3.0	2007-	-	N52	-	IKH20TT	-	IKH20	VKH20	6	CHAMPION
318i 2.0 Valvetronic	2001-	-	N42	-	IK20TT	-	IK20	VK20	4	
318iS 1.9	1997-	-	M44	K20TXR	IK20TT	K20TT	IK20	VK20	4	BOSCH
320i 2.0	1992-	-	M52	K20TXR	IK20TT	K20TT	IK20	VK20	6	
	2005-	-	N46	-	IK20TT	-	IK20	VK20	4	DENSU
320i 2.2	2000-	-	M54	-	IK20TT	-	IK20	VK20	6	
323i 2.5	2005-	-	N52	-	IKH20TT	-	IKH20	VKH20	6	CHAMPION
325i 2.5	2000-	-	M54	-	IK20TT	-	IK20	VK20	6	
	2005-	-	N52	-	IKH20TT	-	IKH20	VKH20	6	BOSCH
328i 2.8	1995-	-	M52	K20TXR	IK20TT	K20TT	IK20	VK20	6	
330i 3.0	2001-	-	M54	-	IK20TT	-	IK20	VK20	6	DENSU
520i 2.0	1996-	-	M52	K20TXR	IK20TT	K20TT	IK20	VK20	6	
523i 2.5	2006-	-	N52	-	IKH20TT	-	IKH20	VKH20	6	CHAMPION
525i 2.5	2000-	-	M54	-	IK20TT	-	IK20	VK20	6	
528i 2.8	1996-	-	M52	K20TXR	IK20TT	K20TT	IK20	VK20	6	BOSCH
530i 3.0	2001-	-	M54	-	IK20TT	-	IK20	VK20	6	
545i 4.4	2003-	-	N62	-	IK20TT	-	IK20	VK20	8	DENSU
630i 3.0	2005-	-	N52	-	IKH20TT	-	IKH20	VKH20	6	
645Ci 4.4	2004-	-	N62	-	IK20TT	-	IK20	VK20	8	CHAMPION
650i 4.8	2005-	-	N62	-	IK20TT	-	IK20	VK20	8	
735i 3.5	2002-	-	N62	-	IK20TT	-	IK20	VK20	8	BOSCH
740Li 4.0	2005-	-	N62	-	IK20TT	-	IK20	VK20	8	
745i 4.4	2002-	-	N62	-	IK20TT	-	IK20	VK20	8	DENSU
750Li 4.8	2005-	-	N62	-	IK20TT	-	IK20	VK20	8	
760Li 6.0	2003-	-	N73	-	IK20TT	-	IK20	VK20	12	CHAMPION
M3 3.2	2000-	-	S54	-	-	-	IXU24	VXU24	6	
X3 2.5	2004-	-	256S	-	IK20TT	-	IK20	VK20	6	BOSCH
	2006-	-	N52	-	IKH20TT	-	IKH20	VKH20	6	
X5 3.0	2004-	-	306S	-	IK20TT	-	IK20	VK20	6	DENSU
X5 4.8	2005-	-	N62	-	IK20TT	-	IK20	VK20	8	
Z4 2.5	2003-	-	M54	-	IK20TT	-	IK20	VK20	6	CHAMPION
Z4 3.0	2003-	-	M54	-	IK20TT	-	IK20	VK20	6	

DENSU	9	14	16	20	22	24	27	29	31	32	34	35	DENSU	9	14	16	20	22	24	27	29	31	32	DENSU	9	14	16	20	22	24	27	31
NGK	2	4	5	6	7	8	9	9.5	10	10.5	11	11.5	CHAMPION	18	16,14	12,11	10,9	8,7	6,63,61	4,59	57	55	53	BOSCH	10	9	8	7,6	5	4	3	2



▶ Spark plug color codes: ■ for Iridium Tough and Iridium Plugs and Iridium TT, ■ for Iridium Power, ■ for Iridium Racing and Two Tops Plugs, ■ for Platinum Plugs and Platinum TT, and black for general spark plugs.

	MODEL	YEAR	VEHICLE CODE	ENGINE	DENSO	IRIDIUM U	IRIDIUM RACING	IRIDIUM POWER	IRIDIUM TOUGH	QTY	
AUSTRALIA	<b>CHANA</b>										
	Benni 1.3	2007-	-	JL474Q2	K20PR-U11	IK20TT	K20TT	IK20	VK20	4	
	<b>CHERY</b>										
A1 1.3	2008-	DB12B	SQR473	K20PR-U11	IK20TT	K20TT	IK20	VK20	4		
CHINA	A168 1.6	2007-	DA11A	SQR480	K20PR-U11	IK20TT	K20TT	IK20	VK20	4	
	A5 1.6	2007-	-	SQR481	K20PR-U11	IK20TT	K20TT	IK20	VK20	4	
	A5 2.0	2007-	DC24B	SQR484	K20PR-U11	IK20TT	K20TT	IK20	VK20	4	
	QQ 0.8	2007-	-	SQR372	K20PR-U11	IK20TT	K20TT	IK20	VK20	4	
INDIA	QQ 1.1	2007-	-	DA456Q	W16EPR-U	IW16TT	W16TT	IW16	VW16	4	
	T11 1.6	2008-	DB11B	SQR481	K20PR-U11	IK20TT	K20TT	IK20	VK20	4	
	T11 2.0	2008-	DB14B	SQR484	K20PR-U11	IK20TT	K20TT	IK20	VK20	4	
	V5 2.4	2007-	DB24B	4G64	K16PR-U11	IK16TT	K16TT	IK16	VK16	4	
INDONESIA	<b>CHEVROLET (DAEWOO)</b>										
	Aveo 1.4	2004-	-	714B	K20PR-U11	IK20TT	K20TT	IK20	VK20	4	
	Captiva 2.4	2007-	CD26	Z24	K20TXR	IK20TT	K20TT	IK20	VK20	4	
	Epica 2.0	2006-	LA69	X20D	-	IK20TT	-	IK20	VK20	4	
	Optra 1.6	2003-	-	E4H	K20PR-U11	IK20TT	K20TT	IK20	VK20	4	
		2005-	-	F16D	K20PR-U11	IK20TT	K20TT	IK20	VK20	4	
	Spark 0.8	2006-	KA48	A08S	W16EXR-U11	IW16TT	W16TT	IW16	VW16	4	
Spark 1.0	2006-	KF48	B10S	W16EXR-U11	IW16TT	W16TT	IW16	VW16	4		
Vivant 1.6	2002-	-	A16D	K20PR-U11	IK20TT	K20TT	IK20	VK20	4		
MALAYSIA	Vivant 2.0	2002-	-	T20SED	K20TXR	IK20TT	K20TT	IK20	VK20	4	
	<b>CHRYSLER</b>										
	300C 3.5	2004-	-	-	-	IK16TT	-	IK16	VK16	6	
	Crossfire 3.2	2003-	-	112	-	IK16TT	-	IK16	VK16	12	
PHILIPPINES	Grand Voyager SE 3.3	2001-	RG33L	-	-	ITL16TT	-	ITL16	-	6	
	PT Cruiser 2.0	2000-	PT2K20	T,G	-	ITL16TT	-	ITL16	-	4	
	PT Cruiser 2.4	2004-	PT2K24	S	-	ITL16TT	-	ITL16	-	4	
	Sebring 2.4	2001-	-	-	-	ITL16TT	-	ITL16	-	4	
SAUDI ARABIA	<b>CITROEN</b>										
	C1 1.0	2005-	-	1KR-FE	K20HR-U11	IKH20TT	-	IKH20	VKH20	4	
	C3 1.4	2002-	FCKFVE	KFV	K20PR-U	IK20TT	K20TT	IK20	VK20	4	
	C3 1.6	2002-	FCNFUC	NFU	-	IKH20TT	-	IKH20	VKH20	4	
	C4 1.6	2005-	LCNFUF	NFU	-	IKH20TT	-	IKH20	VKH20	4	
	C5 2.0	2001-	DCRFNE	RFN	K16HPR-U11	IKH16TT	KH16TT	IKH16	VKH16	4	
		2005-	RCRFJF	RFJ	K20HR-U11	IKH20TT	KH20TT	IKH20	VKH20	4	
		2001-	DCXFXF	XFX	K16HPR-U11	IKH16TT	KH16TT	IKH16	VKH16	6	
		2006-	-	XVF	-	IKH16TT	-	IKH16	VKH16	6	
	C6 3.0	2004-	-	XFU	-	IKH16TT	-	IKH16	VKH16	6	
	TAIWAN	Grand C4 2.0	2006-	-	RFJ	K16HPR-U11	IKH16TT	KH16TT	IKH16	VKH16	4
Xsara 1.4		1997-	N1KFWB	KFW	K20TXR	IK20TT	K20TT	IK20	VK20	4	
Xsara 1.6		1999-	N1NFUN	NFU	K20TXR	IK20TT	K20TT	IK20	VK20	4	
THAILAND	<b>DAEWOO</b>										
	Kalos 1.5	2003-	-	A13B	W20EXR-U11	IW20TT	W20TT	IW20	VW20	4	
	Lanos 1.5	1997-	-	A15B	W20EXR-U11	IW20TT	W20TT	IW20	VW20	4	
	Lanos 1.6	1997-	-	A16D	K20PR-U11	IK20TT	K20TT	IK20	VK20	4	
	Leganza 2.0	1997-	-	X20SED	K20TXR	IK20TT	K20TT	IK20	VK20	4	
	Leganza 2.2	1998-	-	T22SED	K20TXR	IK20TT	K20TT	IK20	VK20	4	
	Nubira 1.6	1997-	-	ZE1K	K20PR-U11	IK20TT	K20TT	IK20	VK20	4	
VIETNAM	Tacuma 1.6	2002-	-	A16D	K20PR-U11	IK20TT	K20TT	IK20	VK20	4	
	Tacuma 2.0	2002-	-	T20SED	K20TXR	IK20TT	K20TT	IK20	VK20	4	
	<b>DAIHATSU</b>										
JAPAN	Charade 1.0	1990-1993	G100	CB	W16EX-U	IW16TT	W16TT	IW16	VW16	3	
		1993-	G202	CB	W16EX-U	IW16TT	W16TT	IW16	VW16	3	
	Charade 1.3	1990-1993	G102	HC-E	K20PR-U11	IK20TT	K20TT	IK20	VK20	4	
		1993-	G200	HC-E	K20PR-U11	IK20TT	K20TT	IK20	VK20	4	
EUROPE & USA	Extol 1.3	2000-	S221V	K3-VE	K20R-U11	IK20TT	K20TT	IK20	VK20	4	
	Gran Move 1.5	1997-1998	G303G	HE-EG	K20PR-U11	IK20TT	K20TT	IK20	VK20	4	
	Gran Move 1.6	1998-2003	G301G	HD-EP	K20PR-U11	IK20TT	K20TT	IK20	VK20	4	
	Hijet 0.66	1995-1997	S100	EF-NS	W16DTR-S	-	-	-	-	3	
		1999-2000	S200V	EF-SE	K20PR-U11	IK20TT	K20TT	IK20	VK20	3	
CROSS REFERENCE NUMBER	Hijet 1.0	1990-1995	S85	CB	W16EX-U	IW16TT	W16TT	IW16	VW16	3	
	Materia 1.5	2007-	M402	3SZ-VE	XU22EPR-U	-	XU22TT	IXU22	VXU22	4	
	Move 0.85	1997-1999	L601	ED	W16EXR-U11	IW16TT	W16TT	IW16	VW16	3	
	Move 1.0	1999-2000	L901	EJ-DE	K16PR-U11	IK16TT	K16TT	IK16	VK16	3	
	Sirion 1.0	1998-2002	M100S	EJ-DE	K16PR-U11	IK16TT	K16TT	IK16	VK16	3	
	Sirion 1.3	2005-2007	M301	K3-VE	K20R-U11	IK20TT	K20TT	IK20	VK20	4	
		2007-	M301	K3-VE	XU22EPR-U	-	XU22TT	IXU22	VXU22	4	

MODEL	YEAR	VEHICLE CODE	ENGINE	DENSO	IRIDIUM	TJ	IRIDIUM POWER	IRIDIUM TOUGH	QTY	
<b>DAIHATSU</b>										
Sirion 1.5	2007-	M303	3SZ-VE	XU22EPR-U -		XU22TT	IXU22	VXU22	4	AUSTRALIA
Terios 1.5	2006-	J200/210	3SZ-VE	XU22EPR-U -		XU22TT	IXU22	VXU22	4	
Terios 7-Seater 1.5	2008-	F700	3SZ-VE	XU22EPR-U -		XU22TT	IXU22	VXU22	4	CHINA
YRV 1.3	2000-	M201G	K3-VE	K20R-U11	IK20TT	K20TT	IK20	VK20	4	
YRV Turbo 1.3	2002-	M201G	K3-VET	PK20PTR-S9	IK20TT	-	IK20L	-	4	
<b>DAIHATSU (PI)</b>										
Copen 0.66	2007-	L880K	JB-DET	SVK20RZ8	IK20TT	-	IK20	VK20Y	4	INDIA
Hijet 0.66	2004-	S320V	EF	K20PR-U11	IK20TT	K20TT	IK20	VK20	3	
<b>DONGFENG</b>										
Star 1.3	2007-	EQ6380LF	EQ474i	K20PR-U11	IK20TT	K20TT	IK20	VK20	4	INDONESIA
<b>FIAT</b>										
500 1.2	2007-	-	169A4	XU22EPR-U -		XU22TT	IXU22	VXU22	4	KOREA
500 1.4	2007-	-	169A3	XU22EPR-U -		XU22TT	IXU22	VXU22	4	
Bravo 1.4	2007-	-	198A	XU22EPR-U -		XU22TT	IXU22	VXU22	4	
Croma 1.8	2005-	-	939A	KJ16CR-L11	IK16TT	K16TT	IK16L	-	4	
Croma 2.2	2005-	-	194A	-	ITV16TT	-	ITV16	-	4	
Grande Punto 1.4	2006-	-	350A1	XU22EPR-U -		XU22TT	IXU22	VXU22	4	
Panda 1.2	2005-	-	188A4	XU22EPR-U -		XU22TT	IXU22	VXU22	4	
Panda 1.3	2003-	-	188A4	K16PR-U	IK16TT	K16TT	IK16	VK16	4	
Punto 1.3	2003-	-	188A4	K16PR-U	IK16TT	K16TT	IK16	VK16	4	
Ulysse 2.0	2002-	-	RFN	K16HPR-U11	IKH16TT	-	IKH16	VKH16	4	
<b>FORD</b>										
Escape 2.0	2002-	ED75RAA	-	PT16VR13	ITV16TT	-	ITV16	-	4	INDONESIA
Fiesta 1.4	2003-	WF0HXX	-	PT16VR13	ITV16TT	-	ITV16	-	4	
Fiesta 1.6	2004-	WF0FYJ	-	PT16VR13	ITV16TT	-	ITV16	-	4	
Focus 1.6	1998-	WF0FXX	-	PT16VR13	ITV16TT	-	ITV16	-	4	
	2005-	WF05XX	-	-	ITV16TT	-	ITV16	-	4	
Galaxy 2.3	1998-	WF0GXX	-	-	IK20TT	-	IK20	VK20	4	
Ka 1.3	1997-	WF0BXX	-	T20EPR-U	IT20TT	T20TT	IT20	VT20	4	
Laser 1.3/1.6	1998-	BJ	-	KJ16CR-L11	IK16TT	K16TT	IK16L	-	4	
Laser Tierra 1.6	2004-	BVPP	-	KJ16CR-L11	IK16TT	K16TT	IK16L	-	4	
Mondeo 2.0	1997-	WF0FZZ	-	PT16VR13	ITV16TT	-	ITV16	-	4	
	2000-	WF04XX	-	T20EPR-U	IT20TT	T20TT	IT20	VT20	4	
	2005-	WF04XX	-	-	IT20TT	-	IT20	VT20	4	
Mondeo 2.3	2007-	WF0GXX	-	-	ITV16TT	-	ITV16	-	4	
S-Max 2.3	2006-	-	AOWA	-	IT20TT	-	IT20	VT20	4	
<b>GEELY</b>										
CK 1.5	2006-	-	MR479QA	K16PR-U11	IK16TT	K16TT	IK16	VK16	4	INDONESIA
MK 1.5	2006-	-	MR479QA	K16PR-U11	IK16TT	K16TT	IK16	VK16	4	
<b>HAFEI</b>										
Lobo 1.1	2007-	-	DA468	K16PR-U	IK16TT	K16TT	IK16	VK16	4	INDONESIA
Minz 1.1	2007-	-	DA465	K16PR-U11	IK16TT	K16TT	IK16	VK16	4	
Minz 1.3	2007-	-	DA471	K16PR-U11	IK16TT	K16TT	IK16	VK16	4	
<b>HONDA</b>										
Accord 2.0	1997-	CF3	F20B	KJ20CR-L11	IK20TT	K20TT	IK20L	-	4	INDONESIA
	2002-	CL7	K20A	KJ20DR-M11	IK20TT	K20TT	IK20L	-	4	
	2008-	CP1	R20A	KJ20DR-M11	IK20TT	K20TT	IK20L	-	4	
	2013-	CR1	R20Z	-	-	-	-	VXUHC22G	4	
Accord 2.4	2002-	CL9	K24A	KJ20CR-L11	IK20TT	K20TT	IK20L	-	4	
	2008-	CP2	K24Z	SKJ20DR-M11	IK20TT	-	IK20L	-	4	
Accord 3.5	2007-	CP3	J35Z	SXU22HCR11	-	-	IXUH22	VXUH22	6	
City i-DSI T-Spark 1.5	2002-	GD8	L15A	K20PR-U11	IK20TT	K20TT	IK20	VK20	8	
City Vtec 1.5	2005-	GD8	L15A1	SKJ20DR-L13	IK20TT	-	IK20L	-	4	
	2013-	GM6	L15Z	-	IK20TT	-	-	VFK20F	4	
Civic	2016-	FK7	L15C(T/C)	-	-	-	-	VXEHC24G	4	
Civic 1.6	2012-	FB1	R16B	-	-	-	-	VXUHC22G	4	
Civic 3DR TypeR 2.0	2007-	FN2	K20Z	SKJ20DR-M11	IK20TT	-	IK20L	-	4	
Civic Hybrid IMA 1.3	2007-	FD3	LDA	SK20HPR-L11	IKH20TT	-	IKH20	VKH20	8	
Civic Si 2.0	2005-	FD2	K20Z	SKJ20DR-M11	IK20TT	-	IK20L	-	4	
Civic Type-R	2017-	FK8	K20C	-	-	-	-	VXEHC24G	4	
Civic Vtec SOHC 1.5	2001-	ES8	D15B	KJ16CR-L11	IK16TT	K16TT	IK16L	-	4	
Civic Vtec SOHC 1.6	2003-	ES5	D16B	KJ16CR-L11	IK16TT	K16TT	IK16L	-	4	
Civic Vtec SOHC 1.7	2001-	ES1	D17A	KJ20CR-L11	IK20TT	K20TT	IK20L	-	4	
Civic Vti 1.8	2005-	FD1	R18A1	SKJ20DR-M11S	-	-	IK20L	-	4	
CR-V	2011-2019	RM1	R20A	-	-	-	-	VXUHC22G	4	
	2017-	RW1,RW2	L15BY	-	-	-	-	VXEHC24G	4	
CR-V 2.0	2001-	RD5	K20A	KJ20DR-M11	IK20TT	K20TT	IK20L	-	4	

AUSTRALIA  
 CHINA  
 INDIA  
 INDONESIA  
 KOREA  
 MALAYSIA  
 PHILIPPINES  
 SAUDI ARABIA  
 SINGAPORE  
 TAIWAN  
 THAILAND  
 VIETNAM  
 JAPAN  
 EUROPE & USA  
 CROSS REFERENCE NUMBER  
 PART

DENSO	9	14	16	20	22	24	27	29	31	32	34	35	DENSO	9	14	16	20	22	24	27	29	31	32	DENSO	9	14	16	20	22	24	27	31
NGK	2	4	5	6	7	8	9	9.5	10	10.5	11	11.5	CHAMPION	18	16,14	12,11	10,9	8,7	6,6,6,1	4,5,9	57	55	53	BOSCH	10	9	8	7,6	5	4	3	2



# SINGAPORE CAR

▶ Spark plug color codes: ■ for Iridium Tough and Iridium Plugs and Iridium TT, ■ for Iridium Power, ■ for Iridium Racing and Two Tops Plugs, ■ for Platinum Plugs and Platinum TT, and black for general spark plugs.

	MODEL	YEAR	VEHICLE CODE	ENGINE	DENSO	IRIDIUM TT	IRIDIUM RACING	IRIDIUM POWER	IRIDIUM TOUGH	QTY
<b>AUSTRALIA</b>										
<b>HONDA</b>										
	CR-V 2.0	2007-	RE2	R20A	KJ20DR-M11	IK20TT	K20TT	IK20L	-	4
	CR-V 2.4	2007-	RE4	K24Z	SKJ20DR-M11	IK20TT	-	IK20L	-	4
	CR-Z 1.5	2011-	ZF1	LEA1	DK20PR-D13	IK20TT	-	-	VFK20F	4
<b>CHINA</b>										
	Freed	2016-	GB5	L15B	DXE22HCR11S	-	-	-	VFXEHC22G	4
	Freed 1.5	2010-	GB3	L15A	-	IK20TT	-	IK20L	-	4
	Freed Hybrid	2017-	GB7	LEB-H1	DXE22HCR11S	-	-	-	VFXEHC22G	4
	Grace Hybrid	2015-	GM4	LEB-H1	DXE22HCR11S	-	-	-	VFXEHC22G	4
<b>INDIA</b>										
	HR-V 1.5	2013-	RU1	L15Z	-	IK20TT	-	-	VFK20F	4
	Integra TypeR 2.0	2001-	DC5	K20A	SK22PR-M11	-	-	IK22G	VK22G	4
	Jade	2015-	FR5	L15B	DXE22HCR11S	-	-	-	VFXEHC22G	4
	Jazz 1.3	2007-	GE6	L13Z	SKJ20DR-M13	IK20TT	-	IK20L	-	4
<b>INDONESIA</b>										
	Jazz 1.5	2007-	GE8	L15A	SKJ20DR-M13	IK20TT	-	IK20L	-	4
	Jazz i-DSI T-Spark 1.4	2002-	GD1	L13A	K20PR-U11	IK20TT	K20TT	IK20	VK20	8
	Jazz i-vtec 1.3	2013-	GK3	L13B	DXE22HCR11S	-	-	-	VFXEHC22G	4
	Jazz RS i-vtec 1.5	2013-	GK5	L15B	DXE22HCR11S	-	-	-	VFXEHC22G	4
<b>KOREA</b>										
	Mobilio RS i-vtec 1.5	2014-	DD4	L15Z	-	IK20TT	-	-	VFK20F	4
	Odyssey (Except Absolute) 2.4	2013-	RC1	K24W	SXE22HQR11S	-	-	-	-	4
	Odyssey 2.3	2000-	RA6	F23A	KJ16CR-L11	IK16TT	K16TT	IK16L	-	4
	Odyssey 2.4	2003-	RB1/2	K24A	SKJ20DR-M11	IK20TT	-	IK20L	-	4
		2008-	RB3	K24Z	SKJ20DR-M11	IK20TT	-	IK20L	-	4
<b>MALAYSIA</b>										
	Odyssey 2.4 (Except Absolute)	2008-2011	RB3	K24A	DXU22HCR-D11S	-	-	-	VXUHC22G	4
	Odyssey 3.0	2000-	RA8	J30A	KJ16CR-L11	IK16TT	K16TT	IK16L	-	4
	S2000 2.0	2003-	AP1	F20C	PK22PR-L11S	-	-	IK22G	VK22G	4
	S2000 2.2	2006-	AP2	F22C	PK22PR-L11S	-	-	IK22G	VK22G	4
<b>PHILIPPINES</b>										
	Stepwgn Spada	2015-	RP3	L15B	-	-	-	-	VXEHC24G	4
	Stream i-vtec DOHC 2.0	2000-	RN3	K20A	KJ20DR-M11	IK20TT	K20TT	IK20L	-	4
	Stream RSZ 1.8	2007-	RN6	R18A	KJ20DR-M11	IK20TT	K20TT	IK20L	-	4
	Stream Vtec SOHC 1.7	2000-	RN1	D17A	KJ20CR-L11	IK20TT	K20TT	IK20L	-	4
<b>SAUDI ARABIA</b>										
<b>HONDA (PI)</b>										
	Acty 0.66	1999-	HH51	E07Z	SK20PR-L9	IK20TT	-	IK20	VK20	3
	Airwave 1.5	2005-	GJ1	L15A	SKJ20DR-M13	IK20TT	-	IK20L	-	4
	Crossroad 1.8	2007-	RT1	R18A	KJ20DR-M11	IK20TT	K20TT	IK20L	-	4
	CR-Z Hybrid 1.5	2012-	ZF2	LEA-MF6	SKJ20DR-M13	IK20TT	-	IK20L	VK20	4
	Edix 1.7	2004-	BE1	D17A	KJ20CR-L11	IK20TT	K20TT	IK20L	-	4
	ElySION 2.4	2004-	RR1/2	K24A	SKJ20DR-M11	IK20TT	-	IK20L	-	4
	ElySION 3.0	2004-	RR3/4	J30A	SKJ20DR-M11	IK20TT	-	IK20L	-	6
	Fit 1.3	2013-	GK3	L13B	DXE22HCR11S	-	-	-	VFXEHC22G	4
<b>TAIWAN</b>										
	Fit Hybrid 1.5	2013-	GP5/GP6	LEB-H1	DXE22HCR11S	-	-	-	VFXEHC22G	4
	Fit i-Vtec 1.3	2007-	GE6	L13A	SKJ20DR-M13	IK20TT	-	IK20L	-	4
	Fit Vtec 1.5	2002-	GD3	L15A	SKJ20DR-M11	IK20TT	-	IK20L	-	4
	Freed 1.5	2008-	GB3	L15A	SKJ20DR-M13	IK20TT	-	IK20L	-	4
<b>THAILAND</b>										
	Grace 1.5	2015-	GM6/9	L15B	DXE22HCR11S	-	-	-	VFXEHC22G	4
	Insight Hybrid 1.3	2009-	ZE2	LDA	SK20HPR-L11	IKH20TT	-	IKH20	VKH20	8
	Jade 1.5	2015-	FR4	LEB-H1	DXE22HCR11S	-	-	-	VFXEHC22G	4
	Mobilio 1.5	2002-	GB1	L15A	K20PR-U11	IK20TT	K20TT	IK20	VK20	8
<b>VIETNAM</b>										
	Odyssey (Absolute) 2.4	2008-2011	RB3	K24A	SXU22HCR11S	-	-	-	VXUHC22G	4
		2013-	RC1	K24W	DXE22HQR-D11S	-	-	-	-	4
	Shuttle 1.5	2015-	GK8	L15B	DXE22HCR11S	-	-	-	VFXEHC22G	4
	Shuttle Hybrid 1.5	2015-	GP8	LEB-H1	DXE22HCR11S	-	-	-	VFXEHC22G	4
<b>JAPAN</b>										
	Stepwagon 2.0	2001-	RF3/4	K20A	KJ20DR-M11	IK20TT	K20TT	IK20L	-	4
		2005-	RG1	K20A	KJ20DR-M11	IK20TT	K20TT	IK20L	-	4
	Stepwagon 2.4	2003-	RF7/8	K24A	KJ20DR-M11	IK20TT	K20TT	IK20L	-	4
	Stream RSZ 1.8	2007-	RN6	R18A	KJ20DR-M11	IK20TT	K20TT	IK20L	-	4
	VeZel 1.5	2014-	RU1	L15B	DXE22HCR11S	-	-	-	VFXEHC22G	4
	VeZel Hybrid 1.5	2014-	RU3	LEB-H1	DXE22HCR11S	-	-	-	VFXEHC22G	4
<b>EUROPE &amp; USA</b>										
<b>HYUNDAI</b>										
	Accent 1.3/1.5	2000-	CH41	-	K16PR-U11	IK16TT	K16TT	IK16	VK16	4
	Atos Prime 1.0	2001-	AH51	-	K16PR-U11	IK16TT	K16TT	IK16	VK16	4
	Avante 1.6	2006-	DU41	-	KJ16CR-L11	IK16TT	K16TT	IK16L	-	4
		2008-	DU41	-	-	-	-	IXUH22	VXUH22	4
<b>CROSS REFERENCE NUMBER</b>										
	Azera 3.3	2005-	FC41D	-	SK16PR-L11	IK16TT	-	IK16	VK16	6
	Coupe 1.6	1997-	JG3R	-	K16PR-U11	IK16TT	K16TT	IK16	VK16	4
	Coupe 1.8	2002-	HN61	-	K16PR-U11	IK16TT	K16TT	IK16	VK16	4
	Coupe 2.0	1996-	JG3F	-	K20PR-U11	IK20TT	K20TT	IK20	VK20	4
		2002-	HN61	-	K16PR-U11	IK16TT	K16TT	IK16	VK16	4
	Elantra 1.6	2000-	DN41	-	K16PR-U11	IK16TT	K16TT	IK16	VK16	4
	Getz 1.1	2005-	BT51G	-	K16PR-U11	IK16TT	K16TT	IK16	VK16	4

MODEL	YEAR	VEHICLE CODE	ENGINE	DENSO	IRIDIUM	TJ	IRIDIUM POWER	IRIDIUM TOUGH	QTY	
<b>HYUNDAI</b>										
Getz 1.3	2003-	BU51H	-	K16PR-U11	IK16TT	K16TT	IK16	VK16	4	AUSTRALIA
Getz 1.4	2005-	BU51D	-	K16PR-U11	IK16TT	K16TT	IK16	VK16	4	
Getz 1.6	2003-	BU51B	-	K16PR-U11	IK16TT	K16TT	IK16	VK16	4	
Grandeur 3.0	1998-	FU41	-	PK16PR11	IK16TT	-	IK16	VK16	6	CHINA
i 30 1.6	2008-	DC5	-	KJ16CR-L11	IK16TT	K16TT	IK16L	-	4	
Matrix 1.6/1.8	2001-	PN81C/81D	-	K16PR-U11	IK16TT	K16TT	IK16	VK16	4	
Santa Fe 2.4	2000-	SC81B	-	W20EXR-U11	IW20TT	W20TT	IW20	VW20	4	
Santa Fe 2.7	2000-	SC81D	-	PK16PR11	IK16TT	-	IK16	VK16	6	
	2006-	SH81D	-	-	IKH16TT	-	IKH16	VKH16	6	INDIA
Sonata 2.0	1998-	EN41	-	W20EXR-U11	IW20TT	W20TT	IW20	VW20	4	
	2006-	EU41B	-	K16PR-U11	IK16TT	K16TT	IK16	VK16	4	
Sonata 2.0 H-matic	2001-	EN41	-	W20EXR-U11	IW20TT	W20TT	IW20	VW20	4	INDONESIA
Sonata 2.4	2005-	EU41C	-	K16PR-U11	IK16TT	K16TT	IK16	VK16	4	
Terracan 3.5	2005-	NM81C	-	PK16PR-L11	IK16TT	-	IK16	VK16	6	
Trajjet 2.0	1998-	MH81A	-	W20EXR-U11	IW20TT	W20TT	IW20	VW20	4	
Trajjet 2.7	1998-	MH81C	-	PK16PR11	IK16TT	-	IK16	VK16	6	
Tucson 2.0	2004-	JN81V	-	K16PR-U11	IK16TT	K16TT	IK16	VK16	4	KOREA
Tucson 2.7	2004-	JN81D	-	PK16PR11	IK16TT	-	IK16	VK16	6	
Tuscani 2.0	2003-	HM61D	-	K16PR-U11	IK16TT	K16TT	IK16	VK16	4	
Tuscani 2.7	2003-	HM61F	-	PK16PR11	IK16TT	-	IK16	VK16	6	
Verna 1.4	2005-	CM41A	-	K16PR-U11	IK16TT	K16TT	IK16	VK16	4	MALAYSIA
Verna 1.6	2005-	CN41C	-	K16PR-U11	IK16TT	K16TT	IK16	VK16	4	
<b>JAGUAR</b>										
S Type 3.0	2000-	J01	FB	-	IT20TT	-	IT20	VT20	6	
X Type 2.1/2.5/3.0	2002-	J51	YB/WB/XB	-	IT20TT	-	IT20	VT20	6	
XJ6 3.0	2005-	J71VA	-	-	IT16TT	-	IT16	VT16	6	
XJ8 3.5	2004-	J72RA	-	-	IK16TT	-	IK16	VK16	8	
XJ8 4.2	2004-	J72SA	-	-	IK16TT	-	IK16	VK16	8	
XJR 4.2	2003-	J413A	-	-	IK16TT	-	IK16	VK16	8	
XK8 4.0	1996-	J	NB	-	IK20TT	-	IK20	VK20	8	
<b>JEEP</b>										
Cherokee 3.7	2001-	KJ37	K	KJ20CR-L11	IK16TT	K20TT	IK20L	-	6	
Crossfire 3.2	2003-	ZH32	-	-	IK16TT	-	IK16	VK16	12	
Grand Cherokee 4.7	1999-	WJ47	661	K16R-U11	IK16TT	K16TT	IK16	VK16	8	
Wrangler Sport 4.0	1999-	TJ40S	-	KJ16CR-L11	IK16TT	K16TT	IK16L	-	6	
<b>KIA</b>										
Carens 1.8	2000-	FC52	-	K20PR-U	IK20TT	K20TT	IK20	VK20	4	
Carens II 2.0	2003-	FC52	-	K20PR-U	IK20TT	K20TT	IK20	VK20	4	
	2006-	FG52	-	K20PR-U	IK20TT	K20TT	IK20	VK20	4	
Carnival 2.5	2001-	MA75	-	PK20PR-L11	IK20TT	-	IK20	VK20	6	
Cerato 1.6	2004-	FE22	-	K20PR-U11	IK20TT	K20TT	IK20	VK20	4	
	2008-	FG22	-	K20PR-U11	IK20TT	K20TT	IK20	VK20	4	
Cerato Forte 1.6	2008-	FH22	-	-	-	-	IXUH22	VXUH22	4	
Magentis 2.0	2003-	GD22	-	W20EXR-U11	IW20TT	W20TT	IW20	VW20	4	
	2005-	GE22	-	K16PR-U11	IK16TT	K16TT	IK16	VK16	4	
Optima 2.0	2000-	GD22	-	W20EXR-U11	IW20TT	W20TT	IW20	VW20	4	
Picanto 1.1	2004-	BA24	-	K20PR-U11	IK20TT	K20TT	IK20	VK20	4	
Rio 1.3	2000-	DC22	-	W16EXR-U11	IW16TT	W16TT	IW16	VW16	4	
Rio 1.4	2005-	DE22	-	K16PR-U11	IK16TT	K16TT	IK16	VK16	4	
Rio 1.5	2000-	DC22	-	K20PR-U	IK20TT	K20TT	IK20	VK20	4	
Rio 1.6	2005-	DE22	-	K16PR-U11	IK16TT	K16TT	IK16	VK16	4	
Sorento 3.5	2004-	JC52	-	PK16PR11	IK16TT	-	IK16	VK16	6	
Spectra 1.5	2000-	FB22	-	K20PR-U	IK20TT	K20TT	IK20	VK20	4	
Sportage 2.0	2004-	JE55	-	K16PR-U11	IK16TT	K16TT	IK16	VK16	4	
	2007-	ET41	-	K16PR-U	IK16TT	K16TT	IK16	VK16	4	
<b>LEXUS</b>										
CT200h	2011-	ZWA10	2ZR-FXE	SC16HR11	IXEH20TT	-	-	VCH16	4	
ES250	2012-	ASV60	2AR-FE	SK16HR11	IKH16TT	-	IKH16	VKH16	4	
	2018-	AXZA10	A25A-FKS	FC16HR-Q8	-	-	-	VFCH16	4	
ES300 3.0	2001-	MCV30	1MZ-FE	PK16R11	IK16TT	-	IK16	VK16	6	
ES300h	2012-	AVV60	2AR-FXE	FK16HR-A8	IKH16TT	-	-	VFKH16	4	
	2018-	AXZH10	A25A-FXS	FC16HR-Q8	-	-	-	VFCH16	4	
GS450h 3.5	2006-	GWA191	2GR-FSE	FK20HBR11	IKBH20TT	-	-	VFKBH20	6	
IS200 2.0	1998-	GXE10	1G-FE	SK20R11	IK20TT	-	IK20	VK20	6	
IS200t	2015-	ASE30	8AR-FTS (T/C)	-	-	-	-	VDKH22F	4	
IS250	2013-	GSE30	4GR-FSE	FK20HBR11	IKBH20TT	-	-	VFKBH20	6	
IS250 2.5	2005-	GSE25	4GR-FSE	FK20HBR11	IKBH20TT	-	-	VFKBH20	6	

AUSTRALIA  
 CHINA  
 INDIA  
 INDONESIA  
 KOREA  
 MALAYSIA  
 PHILIPPINES  
 SAUDI ARABIA  
 SINGAPORE  
 TAIWAN  
 THAILAND  
 VIETNAM  
 JAPAN  
 EUROPE & USA  
 CROSS REFERENCE NUMBER  
 PART

DENSO	9	14	16	20	22	24	27	29	31	32	34	35	DENSO	9	14	16	20	22	24	27	29	31	32	DENSO	9	14	16	20	22	24	27	31
NGK	2	4	5	6	7	8	9	9.5	10	10.5	11	11.5	CHAMPION	18	16,14	12,11	10,9	8,7	6,63,61	4,59	57	55	53	BOSCH	10	9	8	7,6	5	4	3	2



# SINGAPORE CAR

▶ Spark plug color codes: ■ for Iridium Tough and Iridium Plugs and Iridium TT, ■ for Iridium Power, ■ for Iridium Racing and Two Tops Plugs, ■ for Platinum Plugs and Platinum TT, and black for general spark plugs.

	MODEL	YEAR	VEHICLE CODE	ENGINE	DENSO	IRIDIUM TT	IRIDIUM RACING	IRIDIUM POWER	IRIDIUM TOUGH	QTY
<b>AUSTRALIA</b>										
<b>LEXUS</b>										
	IS300h	2013-	AVE30	2AR-FSE	FK20HBR8	IKBH20TT	-	-	VFKBH20	4
	IS350	2013-	GSE31	2GR-FSE	FK20HBR11	IKBH20TT	-	-	VFKBH20	6
<b>CHINA</b>										
	LS430 4.3	2000-	UCF30/31	3UZ-FE	SK20R11	IK20TT	-	IK20	VK20	8
	LS460 4.6	2006-	USF40	1UR-FSE	FK20HBR11	IKBH20TT	-	-	VFKBH20	8
	LS600hL 5.0	2007-	UVF46	2UR-FSE	FK20HBR11	IKBH20TT	-	-	VFKBH20	8
<b>INDIA</b>										
	NX200t	2014-2017	AGZ10,AGZ15	8AR-FTS (T/C)	-	-	-	-	VDKH22F	4
	NX300h	2014-	AYZ15	2AR-FXE	FK16HR-A8	IKH16TT	-	-	VFKH16	4
	RX200t	2015-	AGL20	8AR-FTS	-	-	-	-	VDKH22F	4
	RX270	2010-2015	AGL10W	1AR-FE	SK16HR11	IKH16TT	-	IKH16	VKH16	4
	RX300	2015-	AGL25	8AR-FTS (T/C)	-	-	-	-	VDKH22F	4
	RX300 3.0	2003-	MCU35	1MZ-FE	SK20R11	IK20TT	-	IK20	VK20	6
<b>INDONESIA</b>										
	RX350	2008-2015	GGL15	2GR-FE	FK20HR11	IKH20TT	-	-	VFKH20	6
	RX350 3.5	2006-	GSU35	2GR-FE	FK20HR11	IKH20TT	-	-	VFKH20	6
	RX400h 3.3	2005-	JHW31	3MZ-FE	SK20R11	IK20TT	-	IK20	VK20	6
	RX450h	2009-2015	GYL15	2GR-FXE	FK20HR11	IKH20TT	-	-	VFKH20	6
		2015-	GYL26	2GR-FXS	FK20HBR8	IKBH20TT	-	-	VFKBH20	6
<b>KOREA</b>										
	RX450h 3.5	2006-	JBC11	2GR-FE	FK20HR11	IKH20TT	-	-	VFKH20	6
	SC430 4.3	2001-	VZZ40	3UZ-FE	SK20R11	IK20TT	-	IK20	VK20	8
	UX200	2018-	MZAA10	M20A-FKS	FC20HR-Q8	IXEH22TT	-	-	-	4
	UX250h	2018-	MZAH10	M20A-FXS	FC16HR-Q8	IXEH20TT	-	-	VFCH16	4
<b>MALAYSIA</b>										
<b>MASERATI</b>										
	Coupe 4.2	2002-	MCP	M138	-	-	-	IU24	-	8
	Spyder 4.2	2002-	SPY	M138	-	-	-	IU24	-	8
<b>MAZDA</b>										
<b>PHILIPPINES</b>										
	323 1.3	1999-	BVY11	QG13DE	KJ16CR-L11	IK16TT	K16TT	IK16L	-	4
	323 1.6	1999-	BJ	B6DE	KJ16CR-L11	IK16TT	K16TT	IK16L	-	4
	5 2.0	2013-	CWFFW	PE-VPS	ZC20HPR11	IXEH22TT	-	-	VCH20	4
	626 2.0	1997-1999	GA07	-	PKJ16CR8	-	-	IK16L	-	4
<b>SAUDI ARABIA</b>										
	Biante 2.0	2009-	CCEFW	LF-VDS	-	-	-	-	ITV20	4
		2013-	CCFFW	PE-VPS	ZC20HPR11	IXEH22TT	-	-	VCH20	4
<b>SINGAPORE</b>										
	CX-3	2016-	DK2W7	PEX3	-	-	-	-	VCH20	4
	CX-30	2019-	DMEP	PE-VPS	ZC20HPR11	IXEH22TT	-	-	VCH20	4
	CX-5	2017-	KF2W	PE-VPS	ZC20HPR11	IXEH22TT	-	-	VCH20	4
	CX-5 2.0	2012-	KEEAW/KEEFW	PE-VPS	ZC20HPR11	IXEH22TT	-	-	VCH20	4
	CX-5 2.5	2013-	KE5AW/KE5FW	PY-VPS	ZC20HPR11	IXEH22TT	-	-	VCH20	4
	CX-7 2.3	2007-	ER3P	L3-VDT	-	ITV20TT	-	ITV20	-	4
	CX-8	2018-	KG5P	PY-VPS	ZC20HPR11	IXEH22TT	-	-	VCH20	4
<b>TAIWAN</b>										
	Mazda 2	2014-	DL	P5-Y5	-	-	-	-	VCH20	4
	Mazda 21.5	2004-	DY10	ZY3	K16PR-U11	IK16TT	K16TT	IK16	VK16	4
		2007-	DE10	ZY	-	IK16TT	-	IK16	VK16	4
	Mazda 3	2013-	BM5FS	P5-VPS	ZC20HPR11	IXEH22TT	-	-	VCH20	4
		2015-	BM	PE-VPH	ZC20HPR11	IXEH22TT	-	-	VCH20	4
<b>THAILAND</b>										
	Mazda 31.6	2004-	6BK	Z6	K16PR-U11	IK16TT	K16TT	IK16	VK16	4
	Mazda 32.0	2007-	6BL	LF	-	IT20TT	-	IT20	VT20	4
	Mazda 5	2010-	CW	PE-VPS	ZC20HPR11	IXEH22TT	-	-	VCH20	4
<b>VIETNAM</b>										
	Mazda 52.0	2005-	CREW	LF-DE	-	IT16TT	-	IT16	VT16	4
	Mazda 6	2016-	GL	PE	ZC20HPR11	IXEH22TT	-	-	VCH20	4
	Mazda 62.0	2003-	GG12/14	LF-DE	-	IT20TT	-	IT20	VT20	4
		2005-	GG10	LF-DE	-	ITV16TT	-	ITV16	-	4
		2008-	GH10	LF-DE	-	ITV20TT	-	ITV20	-	4
<b>JAPAN</b>										
	Mazda 62.3	2003-	GG12/14	L3-VE	-	IT20TT	-	IT20	VT20	4
	Mazda Biante	2013-	CCFFW	PE-VPS	ZC20HPR11	IXEH22TT	-	-	VCH20	4
	MPV 3.0	2002-	LWFW	AJ	-	IT20TT	-	IT20	VT20	6
	MX-5 1.6	1998-	NB6C	B6-ZE	KJ16CR-L11	IK16TT	K16TT	IK16L	-	4
	MX-5 1.8	1993-1998	NA8C	BP-ZE	KJ16CR-L11	IK16TT	K16TT	IK16L	-	4
		1998-	NB8C	BP-ZE	KJ16CR-L11	IK16TT	K16TT	IK16L	-	4
	MX-5 2.0	2005-	NC	LF-DE	-	IT20TT	-	IT20	VT20	4
<b>CROSS REFERENCE NUMBER</b>										
	Premacy 1.8	2002-	CP12	FP-DE	KJ16CR-L11	IK16TT	K16TT	IK16L	-	4
	Premacy 2.0	2000-	CP25	FS-DE	KJ16CR-L11	IK16TT	K16TT	IK16L	-	4
	RX-8 1.3	2004-	JM2SE	13B-MSP	Leading	-	-	IRL01-27	-	2
		2004-	JM2SE	13B-MSP	Trailing	-	-	IRT01-31	-	2
<b>MERCEDES-BENZ</b>										
	200E 2.0	1986-1993	W124	102	T20EPR-U	IT20TT	T20TT	IT20	VT20	4
	A160 1.6	1998-	W168	166	K20PBR-S10	IK20TT	K20TT	IK20	VK20	4
	A170 1.7	2006-	W169	266	K20PR-U	IK20TT	K20TT	IK20	VK20	4
	A190 1.9	1999-	W168	166	K20PBR-S10	IK20TT	K20TT	IK20	VK20	4
	A200 Turbo 2.0	2006-	W169	266M20	-	IK20TT	-	IK20	VK20	4



MODEL	YEAR	VEHICLE CODE	ENGINE	DENSO	IRIDIUM ★	TJ	IRIDIUM POWER	IRIDIUM TOUGH	QTY	
<b>MERCEDES-BENZ</b>										
B170 1.7	2006-	W245	266	K20PR-U	IK20TT	K20TT	IK20	VK20	4	AUSTRALIA
B200 2.0	2006-	W245	266M20	K20PR-U	IK20TT	K20TT	IK20	VK20	4	CHINA
C180 Komp 1.8	2005-	W203	271	-	IKH20TT	-	IKH20	VKH20	4	INDIA
C200 Komp 1.8	2002-	W203	271	-	IKH20TT	-	IKH20	VKH20	4	INDONESIA
C200 Komp 2.0	2000-	W203	111	-	IK20TT	-	IK20	VK20	4	KOREA
C230 2.5	2006-	W203	272M25	-	-	-	IXUH22	VXUH22	6	INDONESIA
C240 2.6	2000-	W203	112M26	-	IK16TT	-	IK16	VK16	12	INDONESIA
C280 3.0	2005-	W203	272M30	-	-	-	IXUH22	VXUH22	6	INDONESIA
CL500 5.5	2006-	W216	273	-	-	-	IXUH22	VXUH22	16	INDONESIA
CL600 5.5	2006-	W215	275	-	-	-	IK22	VK22	24	INDONESIA
CLK200 1.8	2003-	W209	271	-	IKH20TT	-	IKH20	VKH20	4	INDONESIA
E200 Komp 1.8	2003-	W211	271	-	IKH20TT	-	IKH20	VKH20	4	INDONESIA
	2006-	W211	271	-	IKH20TT	-	IKH20	VKH20	4	INDONESIA
E200 Komp 2.0	2000-	W210	111	-	IK20TT	-	IK20	VK20	4	INDONESIA
E200 Komp NGT 1.8	2006-	W211	271	-	IKH20TT	-	IKH20	VKH20	4	INDONESIA
E240 2.4	2000-	W210	112	-	IK16TT	-	IK16	VK16	12	INDONESIA
E240 2.6	2003-	W211	112	-	IK16TT	-	IK16	VK16	12	INDONESIA
E280 3.0	2005-	W211	272	-	-	-	IXUH22	VXUH22	6	INDONESIA
E320 3.2	2000-	W210	112	-	IK16TT	-	IK16	VK16	12	INDONESIA
	2003-	W211	112	-	IK16TT	-	IK16	VK16	12	INDONESIA
E350 3.5	2005-	W211	272	-	-	-	IXUH22	VXUH22	6	INDONESIA
ML350 3.5	2005-	W164	272	-	-	-	IXUH22	VXUH22	6	INDONESIA
ML500 5.0	2005-	W164	113	-	IK16TT	-	IK16	VK16	16	INDONESIA
R350L 3.5	2006-	W251	272	-	-	-	IXUH22	VXUH22	6	INDONESIA
S320 3.2	1998-	W220	112	-	IK16TT	-	IK16	VK16	12	INDONESIA
S350 3.5	2005-	W221	272	-	-	-	IXUH22	VXUH22	6	INDONESIA
S500 5.5	2005-	W221	273	-	-	-	IXUH22	VXUH22	8	INDONESIA
S600L 5.5	2006-	W221	275	-	-	-	IK22	VK22	24	INDONESIA
SLK200 Komp. 1.8	2006-	W171	271	-	IKH16TT	-	IKH16	VKH16	4	INDONESIA
SLK280 3.0	2005-	W171	272M30	-	-	-	IXUH22	VXUH22	6	INDONESIA
<b>MINI</b>										
Cooper 1.6	2004-	RF16	-	-	IK20TT	-	IK20	VK20	4	INDONESIA
Cooper S 1.6	2002-	RE16	-	-	IK20TT	-	IK20	VK20	4	INDONESIA
	2002-	RH16	-	-	IK20TT	-	IK20	VK20	4	INDONESIA
Cooper S Clubman 1.6	2007-	MM16	-	-	-	-	IXUH22	VXUH22	4	INDONESIA
Cooper S Turbo 1.6	2007-	MF16	-	-	-	-	IXUH22	VXUH22	4	INDONESIA
One 1.4	2002-	RA16	-	-	IK20TT	-	IK20	VK20	4	INDONESIA
<b>MITSUBISHI</b>										
Airtrek 2.0	2001-	CU2W	4G63	K20PR-U11	IK20TT	K20TT	IK20	VK20	4	INDONESIA
Airtrek Turbo 2.0	2001-	CU2W	4G63(TC)	P20PR8	IW20TT	-	IW20	VW20	4	INDONESIA
ASX	2010-	GA2W	4B11	-	IK20TT	-	-	-	4	INDONESIA
Attrage	2013-	A13A	3A92	FK16HR11	IKH16TT	-	-	VFKH16	4	INDONESIA
Chariot 2.4	2000-	N84W	4G64	-	-	-	-	VKA20	4	INDONESIA
Colt 1.5	2003-	Z27A	4G15	K16HPR-U11	IKH16TT	KH16TT	IKH16	VKH16	4	INDONESIA
Colt Plus 1.5	2004-	Z27W	4G15	K16HPR-U11	IKH16TT	KH16TT	IKH16	VKH16	4	INDONESIA
Colt Turbo Version-R 1.5	2005-	Z27A	4G15	-	IKH20TT	-	IKH20	VKH20	4	INDONESIA
Delica 2.4	2007-	CV5W	4B12	-	IK16TT	-	IK16	VK16	4	INDONESIA
Dion GDI 1.8T	2002-	CR5W	4G93	-	-	-	-	VKA20	4	INDONESIA
Dion GDI 2.0	2000-	CR9W	4G63	-	-	-	-	VKA16	4	INDONESIA
Eclipse Cross	2017-	GK1W	4B40	-	-	-	IXUH22I	VXUH22I	4	INDONESIA
Galant GDI 2.0	2000-	EA7A	4G94	-	-	-	-	VKA16	4	INDONESIA
Galant Mivec 2.0	1996-	EA/EC	6A12	K20PR-U11	IK20TT	K20TT	IK20	VK20	4	INDONESIA
Galant Turbo 2.5	1996-	EA/EC	6A13	-	-	-	IK22	VK22	4	INDONESIA
Grandis 2.4	2003-	NA4W	4G69	-	IKH20TT	-	IKH20	VKH20	4	INDONESIA
i 0.6	2006-	HA1W	3B20	SXU22HDR9	-	-	IXUH22	VXUH22	3	INDONESIA
Lancer 1.6	2006-	CS3A	4G18	K20PR-U11	IK20TT	K20TT	IK20	VK20	4	INDONESIA
Lancer EX 1.5	2007-	CY2A	4A91	-	IKH20TT	-	IKH20	VKH20	4	INDONESIA
Lancer EX 2.0	2007-	CY4A	4B11	K20PSR-B8	IK20TT	K20TT	IK20	VK20	4	INDONESIA
Lancer GDI 1.5	2000-	CS2A	4G15	-	-	-	-	VKA16	4	INDONESIA
Lancer GL 1.3	1996-1999	CK1A	4G13	W16EXR-U11	IW16TT	W16TT	IW16	VW16	4	INDONESIA
Lancer GLXi 1.6	1996-1999	CK4A	4G92	K20PR-U11	IK20TT	K20TT	IK20	VK20	4	INDONESIA
	2000-	CS3A	4G92	K20PR-U11	IK20TT	K20TT	IK20	VK20	4	INDONESIA
Lancer Mivec MR 1.6	1996-1999	CK4A	4G92	K22TMR11	-	-	IK22	VK22	4	INDONESIA
Lancer MX 1.5	1998-1999	CK2A	4G15	K20PR-U11	IK20TT	K20TT	IK20	VK20	4	INDONESIA
Outlander 2.4	2004-	CU5W	4G93	-	IKH20TT	-	IKH20	VKH20	4	INDONESIA
	2006-	CW5W	4B12	K16PSR-B8	IK16TT	K16TT	IK16	VK16	4	INDONESIA
Pajero 3.0	2007-	V93W	6G72TG	-	IK20TT	-	IK20	VK20	6	INDONESIA

DENSO	9	14	16	20	22	24	27	29	31	32	34	35	DENSO	9	14	16	20	22	24	27	29	31	32	DENSO	9	14	16	20	22	24	27	31
NGK	2	4	5	6	7	8	9	9.5	10	10.5	11	11.5	CHAMPION	18	16,14	12,11	10,9	8,7	6,63,61	4,59	57	55	53	BOSCH	10	9	8	7,6	5	4	3	2

AUSTRALIA  
 CHINA  
 INDIA  
 INDONESIA  
 KOREA  
 MALAYSIA  
 PHILIPPINES  
 SAUDI ARABIA  
 SINGAPORE  
 TAIWAN  
 THAILAND  
 VIETNAM  
 JAPAN  
 EUROPE & USA  
 CROSS REFERENCE NUMBER  
 PART



# SINGAPORE CAR

▶ Spark plug color codes: ■ for Iridium Tough and Iridium Plugs and Iridium TT, ■ for Iridium Power, ■ for Iridium Racing and Two Tops Plugs, ■ for Platinum Plugs and Platinum TT, and black for general spark plugs.

	MODEL	YEAR	VEHICLE CODE	ENGINE	DENSO	IRIDIUM TT	IRIDIUM RACING	IRIDIUM POWER	IRIDIUM TOUGH	QTY	
AUSTRALIA	<b>MITSUBISHI</b>										
	Pajero 3.8	2006-	V97W	6G75	-	IK20TT	-	IK20	VK20	6	
	Space Star	2012-	A03A	3A92	FK16HR11	IKH16TT	-	-	VFKH16	4	
CHINA	<b>MITSUBISHI (PI)</b>										
	eK Wagon 0.66	2006-	H82W	3G83	KJ16CR-L11	IK16TT	K16TT	IK16L	-	3	
	Lancer Evolution V2.0	1998-1999	CP9A	4G63	P22PR8	-	-	IW22	VW22	4	
	Lancer Evolution VI2.0	1999-2000	CP9A	4G63	P22PR8	-	-	IW22	VW22	4	
	Lancer Evolution VII2.0	2001-2003	CT9A	4G63	-	-	-	IW22	VW22	4	
INDIA	Lancer Evolution VIII2.0	2003-	CT9A	4G63	-	-	-	IW22	VW22	4	
	Lancer Evolution IX2.0	2005-	CT9A	4G63	-	-	-	IKH22	VKH22	4	
INDONESIA	<b>NAZA</b>										
	Sutera 1.1	2008-	-	DA468Q6	K20PR-U11	IK20TT	K20TT	IK20	VK20	4	
KOREA	<b>NISSAN</b>										
	350Z 3.5	2003-	Z33	VQ35DE	-	IKH16TT	-	IKH16	VKH16	6	
	Almera 1.5	2014-	N17	HR15	FXE20HE11	IXEH20ETT	-	-	VFXEH20E	4	
	Cefiro 2.0	1998-	A32	VQ20DE	K16PR-U11	IK16TT	K16TT	IK16	VK16	4	
MALAYSIA	Cefiro 2.3	2003-	J31	QR20DE	K16HPR-U11	IKH16TT	KH16TT	IKH16	VKH16	4	
	Cefiro 3.0	2003-	J31	QR23DE	K16HPR-U11	IKH16TT	KH16TT	IKH16	VKH16	6	
	Cefiro 3.0	1998-	A32	VQ30DE	K16PR-U11	IK16TT	K16TT	IK16	VK16	6	
PHILIPPINES	Elgrand 2.5	2004-	ME51	VQ25DE	-	IKH16TT	-	IKH16	VKH16	6	
	Elgrand Star 2.5	2013-	E52	QR25DE	FXE20HR11	IXEH20TT	-	-	VFXEH20	4	
	Juke	2010-	F15	HR15DE	FXE20HE11	IXEH20ETT	-	-	VFXEH20E	4	
	Kicks e-Power	2020-	P15	HR12DE	FXE20HR11	IXEH20TT	-	-	VFXEH20	4	
SAUDI ARABIA	Lafesta 2.0	2004-	B30	MR20DE	ZXE20HR13	IXEH20TT	-	-	VFXEH20	4	
	Latio 1.5	2004-	SC11	HR15DE	FXE20HE11	IXEH20ETT	-	-	VFXEH20E	4	
	March 1.0	1992-	K11	CG10DE	K16PR-U11	IK16TT	K16TT	IK16	VK16	4	
	March 1.2	2003-	AK12	CR12DE	K16HPR-U11	IKH16TT	KH16TT	IKH16	VKH16	4	
SINGAPORE	March 1.4	2003-	BK12	CR14DE	K16HPR-U11	IKH16TT	KH16TT	IKH16	VKH16	4	
	Murano 2.5	2004-	Z50	QR25DE	K16HPR-U11	IKH16TT	KH16TT	IKH16	VKH16	4	
	Murano 3.5	2004-	Z50	VQ35DE	-	IKH16TT	-	IKH16	VKH16	6	
	Note 1.2	2012-	E12	HR12DE	FXE20HR11	IXEH20TT	-	-	VFXEH20	4	
TAIWAN	Note e-Power	2020-	E13	HR12DE	ZUE22HPR8	-	-	-	VSUEH22	4	
	Prairie 2.0	2002-	RM12	QR20DE	K16HPR-U11	IKH16TT	KH16TT	IKH16	VKH16	4	
	Presage 2.5	2004-	U31	QR25DE	K16HPR-U11	IKH16TT	KH16TT	IKH16	VKH16	4	
	Primera 1.8	2003-	P/WP12	SR20DE	K16HPR-U11	IKH16TT	KH16TT	IKH16	VKH16	4	
THAILAND	Qashqai	2013-	J11E	MR20DD	-	IXEH20TT	-	-	-	4	
	Qashqai 1.2	2015-	J11	HRA2	FXE20HR11	IXEH20TT	-	-	VFXEH20	4	
	Qashqai 2.0	2008-	KJ10	MR20DE	FXE20HR11	IXEH20TT	-	-	VFXEH20	4	
	Sunny 1.5	1998-	B14	GA15DE	K20PR-U11	IK20TT	K20TT	IK20	VK20	4	
VIETNAM	Sunny 1.6	2000-	N16	QG15DE	K16PR-U11	IK16TT	K16TT	IK16	VK16	4	
	Sunny 1.6	1998-	B14	GA16DE	K20PR-U11	IK20TT	K20TT	IK20	VK20	4	
	Sunny 1.6	2000-	N16	QG16DE	K16PR-U11	IK16TT	K16TT	IK16	VK16	4	
	Sunny 1.6	2003-	N16	QG16DE	K16HPR-U11	IKH16TT	-	IKH16	VKH16	4	
JAPAN	Sylphy 1.5	2006-	G11	HR15DE	FXE20HE11	IXEH20ETT	-	-	VFXEH20E	4	
	Sylphy 1.8	2012-	TB17	MRA8DE	FXE20HR11	IXEH20TT	-	-	VFXEH20	4	
	Sylphy 2.0	2006-	KG11	MR20DE	ZXE20HR13	IXEH20TT	-	-	VFXEH20	4	
	Teana 2.0	2008-	DUJ32	MR20DE	ZXE20HR13	IXEH20TT	-	-	VFXEH20	4	
EUROPE & USA	Teana 2.5	2008-	BUJ32	VQ25DE	FXE20HR11	IXEH20TT	-	-	VFXEH20	6	
	Teana 2.5	2014-	L33	QR25DE	FXE20HE11	IXEH20ETT	-	-	VFXEH20E	4	
	Teana 3.5	2008-	PJ32	VQ35DE	FXE22HR11	IXEH22TT	-	-	VFXEH22	6	
	Tenna	2013-	L33T	MR20DE	-	IXEH20TT	-	-	-	4	
CROSS REFERENCE NUMBER	X-Trail 2.5	2001-	JN1	QR25DE	K16HPR-U11	IKH16TT	-	IKH16	VKH16	4	
	<b>NISSAN (PI)</b>										
	Cube 1.3	1998-	Z10	CG13DE	K16PR-U11	IK16TT	K16TT	IK16	VK16	4	
	Cube 1.4	2002-	BZ11	CR14DE	-	IKH16TT	-	IKH16	VKH16	4	
PART NUMBER	Dualis 2.0	2007-	KJ10	MR20DE	FXE20HR11	IXEH20TT	-	-	VFXEH20	4	
	GT-R 3.8	2008-	R35	VR38	-	-	-	-	VFXEH20	8	
	Skyline 2.5	2006-	V36	VQ25HR	FXE22HR11	IXEH22TT	-	-	VFXEH22	6	
	<b>OPEL</b>										
PART NUMBER	Astra 1.6	2000-	XK161	X/Z16	K20TXR	IK20TT	K20TT	IK20	VK20	4	
	Astra 1.6	2004-	-	Z16XE	KJ16CR-L11	IK16TT	K16TT	IK16L	-	4	
	Astra 1.8	2004-	-	Z18XE	KJ16CR-L11	IK16TT	K16TT	IK16L	-	4	
	Astra 2.0	2004-	-	Z20LEL	KJ16CR-L11	IK16TT	K16TT	IK16L	-	4	
PART NUMBER	Astra 2.2	2000-	XK220	Z22	-	ITV20TT	-	ITV20	-	4	
	Corsa 1.2	2000-	-	Z12XE	K20TXR	IK20TT	K20TT	IK20	VK20	4	
	Meriva 1.6	2004-	X01Z16	Z162	K20TXR	IK20TT	K20TT	IK20	VK20	4	
	Omega 2.0	1996-2000	XF200	X20	K20TXR	IK20TT	K20TT	IK20	VK20	4	
PART NUMBER	Omega 2.2	2000-	XF220	X22	K20TXR	IK20TT	K20TT	IK20	VK20	4	

MODEL	YEAR	VEHICLE CODE	ENGINE	DENSO	IRIDIUM	TJ	IRIDIUM POWER	IRIDIUM TOUGH	QTY	
<b>OPEL</b>										
Vectra 2.0	1995-2000	XH	X20	K20TXR	IK20TT	K20TT	IK20	VK20	4	AUSTRALIA
Vectra 2.2	2003-	Z02	Z22	-	ITV20TT	-	ITV20	-	4	
Zafira 1.8	2000-	XM180	Z18	K20TXR	IK20TT	K20TT	IK20	VK20	4	CHINA
	2005-	-	Z18XEP	KJ16CR-L11	IK16TT	K16TT	IK16L	-	4	
<b>PERODUA</b>										
Kancil 0.66	1998-	L201	ED	W16EXR-U11	IW16TT	W16TT	IW16	VW16	3	INDIA
Kelisa 1.0	2001-	L701	EJ-DE	K16PR-U11	IK16TT	K16TT	IK16	VK16	3	
Kembara 1.3	2000-	J104	HCE	K20PR-U11	IK20TT	K20TT	IK20	VK20	4	INDONESIA
Kenari 1.0	2006-	L901	EJ-DE	K16PR-U11	IK16TT	K16TT	IK16	VK16	3	
Myvi 1.3	2008-	M301	K3-VE	K20R-U11	IK20TT	K20TT	IK20	VK20	4	KOREA
Viva 1.0	2008-	L251S	EJ-VE	K16PR-U11	IK16TT	K16TT	IK16	VK16	3	
<b>PEUGEOT</b>										
1007 1.6	2006-	A8NFU	-	K16HPR-U11	IKH16TT	KH16TT	IKH16	VKH16	4	INDONESIA
107 1.0	2005-	-	1KR-FE	K20HR-U11	IKH20TT	KH20TT	IKH20	VKH20	4	
206 1.4	2001-	-	KFW	K20PR-U	IK20TT	K20TT	IK20	VK20	4	
206 1.6	2001-	-	NFU	K20HR-U11	IKH20TT	KH20TT	IKH20	VKH20	4	
206 2.0	2002-	-	RFN	K20HR-U11	IKH20TT	KH20TT	IKH20	VKH20	4	
206CC 2.0	2002-	M206CC	RFR	K16HPR-U11	IKH16TT	KH16TT	IKH16	VKH16	4	
307 1.6	2002-	T5***	NFU	K20HR-U11	IKH20TT	KH20TT	IKH20	VKH20	4	
307CC 2.0	2006-	-	-	K20HR-U11	IKH20TT	KH20TT	IKH20	VKH20	4	
406 2.0	1996-1999	D8BR	RFR	K20TXR	IK20TT	K20TT	IK20	VK20	4	MALAYSIA
	2000-	D9BR	RFR	K16HPR-U11	IKH16TT	KH16TT	IKH16	VKH16	4	
407 2.0/2.2	2005-	-	-	-	IKH16TT	-	IKH16	VKH16	4	
407 3.0	2004-	-	ES9A	K16HPR-U11	IKH16TT	KH16TT	IKH16	VKH16	6	PHILIPPINES
607 3.0	2001-	Z8	XFX	-	IKH16TT	-	IKH16	VKH16	6	SINGAPORE
<b>PROTON</b>										
GEN-2 1.3	2006-	CM3	S4PE	T20EPR-U	IT20TT	T20TT	IT20	VT20	4	SAUDARABIA
GEN-2 1.6	2004-	CM6	S4PH	T20EPR-U	IT20TT	T20TT	IT20	VT20	4	
Persona 1.6	2007-	CM6	S4PH	T20EPR-U	IT20TT	T20TT	IT20	VT20	4	
Saga 1.3	2008-	BT3	S4PE	T20EPR-U	IT20TT	T20TT	IT20	VT20	4	
Savvy 1.2	2006-	BT2	D4FA	ZXE20HR13	IXEH20TT	-	-	VFXEH20	4	
Waja 1.6	2000-	CF1	4G18	K20PR-U11	IK20TT	K20TT	IK20	VK20	4	
Wira 1.3/1.5	1994-	C96/97	4G13/4G15	W16EX-U	IW16TT	W16TT	IW16	VW16	4	
Wira 1.6	1994-	C99	4G92	K16PR-U	IK16TT	K16TT	IK16	VK16	4	
<b>RENAULT</b>										
Clio 1.6	2005-	-	K4M	Q20PR-U	IQ20TT	Q20TT	IQ20	VQ20	4	TAIWAN
Clio 16v 1.4	2002-	BB13	K4J	K20TXR	IK20TT	K20TT	IK20	VK20	4	
Clio 8v 1.4	2000-	BB0C/BB0S	E7J	K20TXR	IK20TT	K20TT	IK20	VK20	4	THAILAND
Grand Espace 2.0T	2002-	JK0B	F4R	K20TXR	IK20TT	K20TT	IK20	VK20	4	
	2005-	JK0A	F4R	K20PSR-B8	IK20TT	K20TT	-	VK20Y	4	
Laguna 16v 2.0	2002-	BG0W	F4R	K20TXR	IK20TT	K20TT	IK20	VK20	4	
Megane 16v 5dr 1.6	2002-	BM0J	K4M	K20TXR	IK20TT	K20TT	IK20	VK20	4	
Megane Classis 16v 1.6	2002-	LM0C/LM0J	K4M	K20TXR	IK20TT	K20TT	IK20	VK20	4	
Megane Scenic 16v 1.6	2002-	JM0J/JA04/JA11	K4M	K20TXR	IK20TT	K20TT	IK20	VK20	4	
Megane Scenic 16v 2.0	2002-	JM1N	F4R	K20TXR	IK20TT	K20TT	IK20	VK20	4	
Megane Scenic 8v 1.6	2000-	JA0F	K7M	K20TXR	IK20TT	K20TT	IK20	VK20	4	
<b>SAAB</b>										
9-3 2.0T	1998-2001	-	B204E	-	-	-	IQ22	VQ22	4	VIETNAM
	2004-	-	B207E	-	IK20TT	-	IK20	VK20	4	
9-3 Aero 2.3	1998-2001	-	B235E	-	-	-	IK22	VK22	4	
9-3 Aero 2.8	2006-	-	B284E	-	-	-	IK22	VK22	4	
9-5 2.0T	2004-	-	B205E	Q22PR-U11	-	-	IQ22	VQ22	4	
9-5 2.3T	1997-	-	B235E	-	-	-	IQ22	VQ22	4	JAPAN
	2004-	-	B235R	PK20PR11	IK20TT	-	IK20	VK20	4	
9-5 3.0	1999-	-	B308E	-	-	-	IK22	VK22	6	
9-5 Aero 2.0	1997-	-	B205E	Q20PR-U11	IQ20TT	Q20TT	IQ20	VQ20	4	EUROPE & USA
<b>SKODA</b>										
Fabia 1.4	1999-	-	AUA/ANE	K20PBR-S10	IK20TT	K20TT	IK20	VK20	4	CROSS REFERENCE
	2000-	-	AME/BBY	K20PBR-S10	IK20TT	K20TT	IK20	VK20	4	NUMBER
Octavia 1.6	1998-	-	AEH/AKL	K20PBR-S10	IK20TT	K20TT	IK20	VK20	4	
	2006-	-	BSE	K20PBR-S10	IK20TT	K20TT	IK20	VK20	4	
Octavia 1.8T	1998-	-	AGH	K20PBR-S10	IK20TT	K20TT	IK20	VK20	4	
Octavia 2.0	2006-	-	BWA	PK20PR-P8	IK20TT	-	-	VK20Y	4	
Roomster 1.6	2008-	-	BTS	K20PBR-S10	IK20TT	K20TT	IK20	VK20	4	
Superb 1.8T	2002-	-	AWT	PK20PR-P8	IK20TT	-	-	VK20Y	4	
	2006-	-	CDA	PK20PR-P8	IK20TT	-	-	VK20Y	4	

DENSO	9	14	16	20	22	24	27	29	31	32	DENSO	9	14	16	20	22	24	27	29	31	32	DENSO	9	14	16	20	22	24	27	31	
NGK	2	4	5	6	7	8	9	9.5	10	10.5	11	11.5	18	16,14	12,11	10,9	8,7	6,63,61	4,59	57	55	53	BOSCH	10	9	8	7,6	5	4	3	2



	MODEL	YEAR	VEHICLE CODE	ENGINE	DENSO					QTY	
AUSTRALIA	<b>SSANGYONG</b>										
	Actyon 2.3	2006-	D0B16S7P	-	K16PBR-S10	IK16TT	K16TT	IK16	VK16	4	
CHINA	Chairman CM500S 2.8	2004-	R1C17S6P	-	T20EPR-U	IT20TT	T20TT	IT20	VT20	4	
	Rexton 2.3	2005-	-	-	K16PR-U11	IK16TT	K16TT	IK16	VK16	4	
INDIA	Rexton 2.8	2005-	-	-	K16PR-U11	IK16TT	K16TT	IK16	VK16	4	
	Rexton 3.2	2005-	-	-	K16PR-U11	IK16TT	K16TT	IK16	VK16	4	
INDONESIA	Stavic 3.2	2005-	V0B19S8P	-	K16PR-U	IK16TT	K16TT	IK16	VK16	4	
	<b>SUBARU</b>										
INDONESIA	BRZ 2.0	2012-	ZC6	FA20	ZXE27HBR8	-	-	-	VXEBH27	4	
	Exiga 2.0	2008-	YA5	EJ20D	-	-	-	-	VKH20Y	4	
INDONESIA	Forester	2018-	SK7	FB20	-	IXEH22TT	-	-	-	4	
	Forester 2.0	2002-	SG5	EJ20	PK20PR-P8	IK20TT	-	-	VK20Y	4	
INDONESIA	Forester L 2.0	2007-	SH5	EJ20D	-	-	-	-	VKH20Y	4	
	Forester XT 2.0	2013-	SJ5	FB20	-	IXEH22TT	-	-	VFXEH22	4	
INDONESIA	Forester XT 2.0	2000-	SG5/SF5	EJ20T	PK22PR-P8	IK22TT	-	IK22	VK22	4	
	Forester XT 2.5	2004-	SG9	EJ25T	-	-	-	IKH22	VKH22	4	
KOREA	Impreza	2011-2016	GJ3	FB16	-	IXEH22TT	-	-	VFXEH22	4	
	Impreza 1.6	2005-	GD5	EJ161	K20PR-U11	IK20TT	K20TT	IK20	VK20	4	
KOREA	Impreza 2.0	2007-	GH8	EJ20D	-	-	-	-	VKH20Y	4	
	Impreza 2.0	2008-	GH7	EJ20	PK16PR11	IK16TT	-	IK16	VK16	4	
MALAYSIA	Impreza 2.0	2013-	GP7	FB20	-	IXEH22TT	-	-	VFXEH22	4	
	Impreza 4Dr 1.5	2008-	GE3	EL15D	FK20HR11	IKH20TT	-	-	VFKH20	4	
MALAYSIA	Impreza 5Dr 1.5	2007-	GH3	EL15D	FK20HR11	IKH20TT	-	-	VFKH20	4	
	Impreza GL 1.6	1993-2000	GC3	EJ16	K20PR-U11	IK20TT	K20TT	IK20	VK20	4	
MALAYSIA	Impreza S-GT 2.0	2007-	GRB	EJ20D	-	-	-	-	VKH20Y	4	
	Impreza TS GL 1.6	2000-	GD4	EJ16	K20PR-U11	IK20TT	K20TT	IK20	VK20	4	
PHILIPPINES	Impreza WRX 2.0	1994-	GC8	EJ20T	PK22PR8	IK22TT	-	IK22	VK22	4	
	Impreza WRX 2.0	2001-	GDAK	EJ20T	PK22PR8	IK22TT	-	IK22	VK22	4	
PHILIPPINES	Impreza WRX 2.0	2006-	GDA	EJ20D	PK20PR-P8	IK20TT	-	-	VK20Y	4	
	Impreza WRX 2.5	2005-	GDKG	EJ255	-	IKH20TT	-	IKH20	VKH20	4	
SAUDI ARABIA	Legacy 2.0	1998-	BH5	EJ20T	K20PR-U11	IK20TT	K20TT	IK20	VK20	4	
	Legacy 2.0	2004-	BL5	EJ20	-	IKH20TT	-	IKH20	VKH20	4	
SAUDI ARABIA	Legacy 2.5	2007-	BL9	EJ25	-	IK16TT	-	IK16	VK16	4	
	Outback	2014-	BS9K	FB25A	-	IXEH22TT	-	-	VFXEH22	4	
SINGAPORE	Outback 3.0	2007-	BPE	EZ30	-	IKH20TT	-	IKH20	VKH20	6	
	R1 0.66	2006-	RJ1	EN07	-	-	-	IXUH22	VXUH22	4	
SINGAPORE	R2 0.66	2006-	RC1	EN07	-	-	-	IXUH22	VXUH22	4	
	Tribeca 3.0	2007-	WXE	EZ30U	-	IKH20TT	-	IKH20	VKH20	6	
TAIWAN	VX	2017-	GT3	FB16A	-	IXEH22TT	-	-	VFXEH22	4	
	VX	2017-	GT7	FB20	-	IXEH22TT	-	-	VFXEH22	4	
THAILAND	XV 1.6	2013-	GP3	FB16	-	IXEH22TT	-	-	VFXEH22	4	
	<b>SUZUKI</b>										
THAILAND	APV 1.6	2005-	GC416V	G16A	K20PR-U	IK20TT	K20TT	IK20	VK20	4	
	Grand Vitara 2.0	2005-	JB420W	J20A	K20PR-U11	IK20TT	K20TT	IK20	VK20	4	
THAILAND	Grand Vitara 2.5	2003-	SQ625	H25A	K20PR-U11	IK20TT	K20TT	IK20	VK20	6	
	Grand Vitara 2.7	2005-	JD94A	H27A	K20PR-U11	IK20TT	K20TT	IK20	VK20	6	
VIETNAM	Ignis 1.3	2002-	RG413	M13A	K16PR-U11	IK16TT	K16TT	IK16	VK16	4	
	Ignis Sport 1.5	2003-	RG415	M15A	SK16PR-A11	IK16TT	-	IK16	VK16	4	
VIETNAM	Jimny	2019-	JB74W	K15B	ZXU20PR11	-	-	-	VXU20	4	
	Jimny 1.3	1998-2000	SN413	G13B	K20PR-U	IK20TT	K20TT	IK20	VK20	4	
VIETNAM	Jimny 1.3	2000-	SN413	M13A	K16PR-U11	IK16TT	K16TT	IK16	VK16	4	
	Liana 1.3	2002-	RH413	M13A	K16PR-U11	IK16TT	K16TT	IK16	VK16	4	
JAPAN	Liana 1.6	2002-	RH416	M16A	K20PR-U11	IK20TT	K20TT	IK20	VK20	4	
	Swift	2017-	ZC83S	K12C	-	-	-	IXUH20I	VXUH20I	4	
JAPAN	Swift	2010-	ZC82S	K14B	-	-	-	IXU22	-	4	
	Swift 1.0	1990-	AA44	G10	W16EXR-U11	IW16TT	W16TT	IW16	VW16	4	
EUROPE & USA	Swift 1.3	2007-	ZC11S	M13A	-	IK20TT	-	IK20	VK20	4	
	Swift 1.5	2004-	HT81S	M15A	-	IK20TT	-	IK20	VK20	4	
EUROPE & USA	Swift 1.5	2006-	ZC21S	M15A	-	IK20TT	-	IK20	VK20	4	
	Swift Gti 1.3	1990-	AA34	G13B	-	-	-	IW22	VW22	4	
CROSS REFERENCE	Swift Sport	2011-	ZC32S	M16A	-	IKH20TT	-	IKH20	VKH20	4	
	Swift Sport 1.6	2005-	ZC31S	M16A	-	IK20TT	-	IK20	VK20	4	
PART NUMBER	SX-4	2006-2015	GYA21S,GYC21S	M16A	-	IKH20TT	-	-	-	4	
	SX4 1.6	2006-	YA21S	M16A	-	IK20TT	-	IK20	VK20	4	
PART NUMBER	SX-4 S-cross	2015-	JYA22S,JYB22S	M16A	-	IKH20TT	-	IKH20	VKH20	4	
	Vitara	2014-	APK416	M16A	-	IKH20TT	-	IKH20	VKH20	4	
PART NUMBER	Vitara 1.6	1995-	SE416	G16B	K20PR-U	IK20TT	K20TT	IK20	VK20	4	
	WagonR 0.66	2000-	SP306	F6A	XU22EPR-U	-	XU22TT	IXU22	VXU22	4	

MODEL	YEAR	VEHICLE CODE	ENGINE	DENSO	IRIDIUM	TJ	IRIDIUM POWER	IRIDIUM TOUGH	QTY	
<b>SUZUKI</b>										
WagonR Plus 1.0	1999-	MA63S	K10A	XU22EPR-U	-	XU22TT	IXU22	VXU22	4	AUSTRALIA
<b>SUZUKI (PI)</b>										
Every 0.66	2007-	DA64V	K6A	XU22EPR-U	-	XU22TT	IXU22	VXU22	3	CHINA
Lapin 0.66	2003-	HE21S	K6A	-	-	-	IXU22	VXU22	3	
Swift 1.2	2007-	ZC71S	K12B	ZXU20PR11	-	-	-	VXU20	4	
<b>TOYOTA</b>										
Allion 1.5	2007-2007	NZT260	1NZ-FE	FK20HR11	IKH20TT	-	-	VFKH20	4	INDIA
	2007-2014	NZT260	1NZ-FE	FK16HR11	IKH16TT	-	-	VFKH16	4	
Alphard	2011-	ATH20	2AZ-FXE	SK20R11	IK20TT	-	IK20	VK20	4	INDONESIA
Alphard 2.4	2009-	ANH20R	2AZ-FE	SK20R11	IK20TT	-	IK20	VK20	4	
Alphard 2.5	2015-	AGH30R	2AR-FE	SK16HR11	IKH16TT	-	IKH16	VKH16	4	
Altis	2010-2014	ZRE142	2ZR-FE	SC16HR11	IXEH20TT	-	-	VCH16	4	INDONESIA
	2019-	ZRE210	1ZR-FAE	SC16HR11	IXEH20TT	-	-	VCH16	4	
Altis 1.6	2010-2013	ZRE141R	1ZR-FE	SC20HR11	IXEH22TT	-	-	VCH20	4	INDONESIA
	2013-	ZRE171R	1ZR-FE	SC20HR11	IXEH22TT	-	-	VCH20	4	
Avanza 1.5	2011-	F652RM	3SZ-VE	XU22PR9	-	-	IXU22	VXU22	4	KOREA
Camry	2009-2012	AHV40R	2AZ-FE	SK20R11	IK20TT	-	IK20	VK20	4	
Camry 2.0	2002-	ACV31	1AZ-FE	SK20R11	IK20TT	-	IK20	VK20	4	KOREA
	2006-	ACV41	1AZ-FE	SK20R11	IK20TT	-	IK20	VK20	4	
Camry 2.2	1996-2002	SXV20	5S-FE	K20TR11	IK20TT	K20TT	IK20L	-	4	MALAYSIA
Camry 2.4	2002-	ACV30	2AZ-FE	SK20R11	IK20TT	-	IK20	VK20	4	
	2006-	ACV40	2AZ-FE	SK20R11	IK20TT	-	IK20	VK20	4	
Camry 2.5	2012-	ASV50R	2AR-FE	SK16HR11	IKH16TT	-	-	VKH16	4	PHILIPPINES
Camry Hybrid 2.0	2012-	ACV51R	1AZ-FE	SK16R11	IK16TT	-	-	VK16	4	
Camry Hybrid 2.5	2011-	AVV50R	2AR-FXE	FK16HR-A8	IKH16TT	-	-	VFKH16	4	SAUDI ARABIA
C-HR	2016-	NGX10	8NR-FTS	-	-	-	-	VDCH22F	4	
	2018-	NGX50	8NR-FTS	-	-	-	-	VDCH22F	4	
C-HR Hybrid	2018-	ZGX11R	2ZR-FXE	FC16HR-CY9	IXEH20TT	-	-	VFCH16	4	SINGAPORE
Corolla 1.3	1992-1997	EE101	4E-FE	K16R-U11	IK16TT	K16TT	IK16	VK16	4	
	1997-2001	EE111	4E-FE	K16TR11	IK16TT	K16TT	IK16L	-	4	
Corolla 1.5	2001-2003	NZE121	1NZ-FE	K16R-U11	IK16TT	K16TT	IK16	VK16	4	TAIWAN
Corolla 1.6	1992-1997	AE101	4A-FE	K16R-U11	IK16TT	K16TT	IK16	VK16	4	
	2001-2003	ZZE121	3ZZ-FE	K16R-U11	IK16TT	K16TT	IK16	VK16	4	
Corolla Altis 1.6	2003-	ZZE121	3ZZ-FE	K16R-U11	IK16TT	K16TT	IK16	VK16	4	THAILAND
	2008-	ZZE141	3ZZ-FE	K16R-U11	IK16TT	K16TT	IK16	VK16	4	
Corolla Altis 1.8	2003-	ZZE122	1ZZ-FE	K16R-U11	IK16TT	K16TT	IK16	VK16	4	VIETNAM
	2008-	ZZE142	1ZZ-FE	K16R-U11	IK16TT	K16TT	IK16	VK16	4	
Corolla Axio 1.5	2006-2007	NZE141/144	1NZ-FE	FK20HR11	IKH20TT	-	-	VFKH20	4	VIETNAM
	2007-	NZE141/144	1NZ-FE	FK16HR11	IKH16TT	-	-	VFKH16	4	
Corolla Hybrid	2019-	ZWE211	2ZR-FXE	FC16HR-CY9	IXEH20TT	-	-	VFCH16	4	JAPAN
Corona 1.6	1992-	AT190	4A-FE	K20R-U	IK20TT	K20TT	IK20	VK20	4	
	1996-	AT210	4A-FE	PK16TR13	IK16TT	-	IK16	VK16	4	
Corona 2.0	1992-	ST191	3S-FE	K20R-U11	IK20TT	K20TT	IK20	VK20	4	EUROPE & USA
	1996-	ST210	3S-FE	K20TR11	IK20TT	K20TT	IK20L	-	4	
Corona CD 1.6	1989-	AT171	4A-F	QJ16AR-U	-	-	-	-	4	CROSS REFERENCE
Esquire Hybrid	2014-	ZWR80	2ZR-FXE	SC16HR11	IXEH20TT	-	-	VCH16	4	
Estima	2009	ACR55W	2AZ-FE	-	IK20TT	-	-	-	4	PART NUMBER
	2020-	MXUA80R	M20A-FKS	FC20HR-Q8	IXEH22TT	-	-	VFXEH22	4	
Estima 2.4	2012-	ACR50W/55W	2AZ-FE	SK16R11	IK16TT	-	IK16	VK16	4	
Fortuner 2.7	2005-	TGN51	2TR-FE	SK20HR11	IKH20TT	-	IKH20	VKH20	4	PART NUMBER
	2007-	TGN61	2TR-FE	SK20HR11	IKH20TT	-	IKH20	VKH20	4	
Harrier Hybrid	2020-	AXUH80R	A25A-FXS	FC16HR-Q8	IXEH20TT	-	-	VFCH16	4	
Isis	2009-2018	ZGM10G	2ZR-FAE	SC16HR11	IXEH20TT	-	-	VCH16	4	
Noah Hybrid	2014-	ZWR80	2ZR-FXE	SC16HR11	IXEH20TT	-	-	VCH16	4	
Picnic 2.0	1996-	SXM10	3S-FE	K20TR11	IK20TT	K20TT	IK20L	-	4	PART NUMBER
	2001-	ACM20	3S-FE	K20R-U11	IK20TT	K20TT	IK20	VK20	4	
Previa 2.4	2000-	ACR30	2AZ-FE	K20R-U11	IK20TT	K20TT	IK20	VK20	4	PART NUMBER
	2006-	ACR50	2AZ-FE	K20R-U11	IK20TT	K20TT	IK20	VK20	4	
	2012-	ACR50R	2AZ-FE	SK16R11	IK16TT	-	IK16	VK16	4	
Prius C 1.5	2011-	NHP10R	1NZ-FXE	FK16R-A8	IK16TT	-	-	VFK16	4	
Prius Gen 3 1.8	2011-	ZVW30R	2ZR-FXE	SC20HR11	IXEH22TT	-	-	VCH20	4	
Prius Gen 4 1.8	2015-	ZVW50R	2ZR-FXE	FC16HR-C9	IXEH20TT	-	-	VFCH16	4	
Prius Hybrid 1.5	2005-	NHW20	1NZ-FXE	SK16R11	IK16TT	-	IK16	VK16	4	
Prius Hybrid 1.8	2009-	ZVW30	2ZR-FXE	SC20HR11	IXEH22TT	-	-	VCH20	4	
RAV4	2018-	MXAA52R	M20A-FKS	FC20HR-Q8	IXEH22TT	-	-	VFXEH22	4	
RAV4 2.0	2000-	ACA21	1AZ-FSE	SK20BGR11	-	-	-	VKA20	4	
	2013-	ZSA44R	3ZR-FAE	SC20HR11	IXEH22TT	-	-	VCH20	4	

DENSO	9	14	16	20	22	24	27	29	31	32	34	35	DENSO	9	14	16	20	22	24	27	29	31	32	DENSO	9	14	16	20	22	24	27	31
NGK	2	4	5	6	7	8	9	9.5	10	10.5	11	11.5	CHAMPION	18	16,14	12,11	10,9	8,7	6,63,61	4,59	57	55	53	BOSCH	10	9	8	7,6	5	4	3	2



	MODEL	YEAR	VEHICLE CODE	ENGINE	DENSO	IRIDIUM TT	IRIDIUM RACING	IRIDIUM POWER	IRIDIUM TOUGH	QTY	
<b>AUSTRALIA</b>											
<b>TOYOTA</b>											
	RAV4 2.4	2006-	ACA33	2AZ-FE	K20R-U11	-	-	K20TT	IK20	VK20	4
	Royal Crown 3.0	2004-	GRS182	3GR-FSE	FK20HBR11	IKBH20TT	-	-	-	VFKBH20	6
	Rush	2006-2013	J210E	3SZ-VE	SXU22PR9	-	-	IXU22I	-	VXU22I	4
<b>CHINA</b>											
	Soluna 1.5	1996-	AL50	5A-FE	K16R-U11	IK16TT	-	K16TT	IK16	VK16	4
	Vellfire 2.5	2015-	AGH30R	2AR-FE	SK16HR11	IKH16TT	-	-	IKH16	VKH16	4
	Vios	2007-2014	NCP93R	1NZ-FE	-	IK16TT	-	-	IK16	VK16	4
		2017-	NSP151R	2NR-FE	SC16HR11	-	-	-	-	VCH16	4
<b>INDIA</b>											
	Vios 1.5	2003-	NCP42	1NZ-FE	K16R-U	IK16TT	-	K16TT	IK16	VK16	4
		2007-	NCP43	1NZ-FE	K16R-U	IK16TT	-	K16TT	IK16	VK16	4
		2013-	NCP150R	1NZ-FE	K16R-U	IK16TT	-	K16TT	IK16	VK16	4
	Wish	2003-2009	ANE10G	1AZ-FSE	SK20BGR11	-	-	-	-	VKA20	4
		2009-	ZGE21	3ZR-FAE	SC16HR11	IXEH20TT	-	-	-	VCH16	4
<b>INDONESIA</b>											
	Wish 1.8	2006-	ZNE10	1ZZ-FE	K16R-U11	IK16TT	-	K16TT	IK16	VK16	4
	Yaris	2011-2014	NSP130R	1NR-FE	SC16HR11	IXEH20TT	-	-	-	VCH16	4
		2016-	NSP151R	2NR-FE	SC16HR11	IXEH20TT	-	-	-	VCH16	4
<b>KOREA</b>											
	Yaris 1.5	2006-	NCP91	1NZ-FE	K16R-U11	IK16TT	-	K16TT	IK16	VK16	4
	Yaris Cross	2020-	MXPB10	M15A-FKS	FC16HR-Q8	IXEH20TT	-	-	-	VFCH16	4
	Yasis Cross	2020-	MXPJ10R	M15A-FXE	FC16HR-Q8	IXEH20TT	-	-	-	VFCH16	4
<b>TOYOTA (PI)</b>											
<b>MALAYSIA</b>											
	86	2012-	ZN6	FA20	ZXE27HBR8	-	-	-	-	VXEBH27	4
	Allion 1.5	2001-	NZT240	1NZ-FE	K16R-U11	IK16TT	-	K16TT	IK16	VK16	4
		2014-	NZT260	1NZ-FE	FK16HR11	IKH16TT	-	-	-	VFKH16	4
	Allion 1.8	2001-	ZZT240	1ZZ-FE	K16R-U11	IK16TT	-	K16TT	IK16	VK16	4
	Alphard 2.4	2002-	ANH10	2AZ-FE	K20R-U11	IK20TT	-	K20TT	IK20	VK20	4
		2012-	ANH20W/25W	2AZ-FE	SK16R11	IK16TT	-	-	IK16	VK16	4
	Alphard 2.5	2015-	AGH30R	2AR-FE	SK16HR11	IKH16TT	-	-	IKH16	VKH16	4
	Alphard 3.0	2002-	MNH10	1MZ-FE	SK20R11	IK20TT	-	-	IK20	VK20	6
	Alphard 3.5	2015-	GGH30R	2GR-FE	FK20HR11	IKH20TT	-	-	-	VFKH20	6
<b>PHILIPPINES</b>											
	Alphard Hybrid 2.4	2004-	ATH10W	2AZ-FXE	SK20R11	IK20TT	-	-	IK20	VK20	4
<b>SAUDI ARABIA</b>											
	Altezza 2.0	1999-	SXE10	3S-GE	SK20R11	IK20TT	-	-	IK20	VK20	4
	Aqua Hybrid 1.5	2013-	NHP10	1NZ-FXE	FK16R-AL8	IK16TT	-	-	-	VFK16	4
<b>SINGAPORE</b>											
	Auris 1.5	2007-	NZE15	1NZ-FE	FK20HR11	IKH20TT	-	-	-	VFKH20	4
	Auris 1.6	2012-	ZRE185R	1ZR-FAE	SC20HR11	IXEH22TT	-	-	-	VCH20	4
	Axio 1.5	2007-	NZE121	1NZ-FE	FK20HR11	IKH20TT	-	-	-	VFKH20	4
		2015-	NZE161	1NZ-FE	FK16HR11	IKH16TT	-	-	-	VFKH16	4
		2015-	NRE161G	2NR-FKE	FC16HR8	IXEH20TT	-	-	-	VFCH16	4
	bB 1.3	2006-	QNC20	K3-VE	SVK20RZ11	IK20TT	-	-	IK20	VK20	4
<b>TAIWAN</b>											
	Belta 1.3	2006-	SCP92	2SZ-FE	SK16HR11	IKH16TT	-	-	IKH16	VKH16	4
	Caldina 1.8	2002-	ZZT241W	1ZZ-FE	K16R-U11	IK16TT	-	K16TT	IK16	VK16	4
	Camry 2.4	2006-	ACV40	2AZ-FE	K20R-U11	IK20TT	-	K20TT	IK20	VK20	4
	Celica 1.8	1999-	ZZT230	1ZZ-FE	K16R-U11	IK16TT	-	K16TT	IK16	VK16	4
		1999-	ZZT231	2ZZ-GE	SK20R11	IK20TT	-	-	IK20	VK20	4
<b>THAILAND</b>											
	Crown 2.5	2004-	GRS180	4GR-FSE	FK20HBR11	IKBH20TT	-	-	-	VFKBH20	6
	Esquire 2.0	2014-	ZRR80	3ZR-FAE	SC20HR11	IXEH22TT	-	-	-	VCH20	4
	Estima 2.4	2000-	ACR30	2AZ-FE	K20R-U11	IK20TT	-	K20TT	IK20	VK20	4
		2006-	ACR50	2AZ-FE	K20R-U11	IK20TT	-	K20TT	IK20	VK20	4
<b>VIETNAM</b>											
	Estima Hybrid 2.4	2007-	AHR20W	2AZ-FXE	SK20R11	IK20TT	-	-	IK20	VK20	4
	Fielder 1.5	2006-	NZE141	1NZ-FE	FK20HR11	IKH20TT	-	-	-	VFKH20	4
		2012-	NRE161G	1NZ-FE	FK16HR11	IKH16TT	-	-	-	VFKH16	4
		2015-	NRE161G	2NR-FKE	FC16HR8	IXEH20TT	-	-	-	VFCH16	4
<b>JAPAN</b>											
	Fj Cruiser 4.0	2010-	GSJ15W	1GR-FE	SK20HR11	IKH20TT	-	-	IKH20	VKH20	6
	Harrier 2.0	2013-	ZSU60W	3ZR-FE	SC20HR11	IXEH22TT	-	-	-	VCH20	4
	Harrier 2.4	2000-	ACU10	2AZ-FE	K20R-U11	IK20TT	-	K20TT	IK20	VK20	4
		2003-	ACU30	2AZ-FE	K20R-U11	IK20TT	-	K20TT	IK20	VK20	4
<b>EUROPE &amp; USA</b>											
	Harrier HV 3.3	2005-	MHU38	3MZ-FE	SK20R11	IK20TT	-	-	IK20	VK20	6
	Harrier Hybrid 2.5	2014-	AVU65W	2AR-FXE	FK16HR-A8	IKH16TT	-	-	-	VFKH16	4
	Ipsum 2.0	1996-	SXM10	3S-FE	K20TR11	IK20TT	-	K20TT	IK20L	-	4
	Ipsum 2.4	2001-	ACM21	2AZ-FE	K20R-U11	IK20TT	-	K20TT	IK20	VK20	4
<b>CROSS REFERENCE NUMBER</b>											
	Iq 1.0	2008-	KGJ10	1KR-FE	SK16HR11	IKH16TT	-	-	IKH16	VKH16	3
	ISIS 1.8	2004-	ZNM10G	1ZZ-FE	K16R-U11	IK16TT	-	K16TT	IK16	VK16	4
	IST 1.3	2002-	NCP60	2NZ-FE	K16R-U11	IK16TT	-	K16TT	IK16	VK16	4
	Land Cruiser 4.6	2009-	URJ202W	1UR-FE	SK20HR11	IKH20TT	-	-	IKH20	VKH20	8
	Mark X 2.5	2004-	GRX120	4GR-FSE	FK20HBR11	IKBH20TT	-	-	-	VFKBH20	6
<b>PART NUMBER</b>											
	Mark X Zio 2.4	2007-	ANA10	2AZ-FE	SK20R11	IK20TT	-	-	IK20	VK20	4
	MR-S 1.8	1999-	ZZW30	1ZZ-FE	K16R-U11	IK16TT	-	K16TT	IK16	VK16	4
	Noah 2.0	2014-	ZRR80R	3ZR-FAE	SC20HR11	IXEH22TT	-	-	-	VCH20	4
	Passo 1.0	2004-	KGC10	1KR-FE	SK20HR11	IKH20TT	-	-	IKH20	VKH20	3

MODEL	YEAR	VEHICLE CODE	ENGINE	DENSO	IRIDIUM	TJ	IRIDIUM POWER	IRIDIUM TOUGH	QTY	
<b>TOYOTA (PI)</b>										
Passo 1.3	2004-	QNC10	K3-VE	SVK20RZ11	IK20TT	-	IK20	VK20	4	AUSTRALIA
Passo Sette 1.5	2009-	M502E	3SZ-VE	XU22EPR-U	-	XU22TT	IXU22	VXU22	4	
Porte 1.3	2004-	NNP10	2NZ-FE	K16R-U11	IK16TT	K16TT	IK16	VK16	4	
Prado 2.7	2005-	TRJ120W/125W	2TR-FE	SK20HR11	IKH20TT	-	IKH20	VKH20	4	CHINA
	2009-	TRJ150W	2TR-FE	SK20HR11	IKH20TT	-	IKH20	VKH20	4	
Prado 4.0	2006-	GRJ120W/121W	1GR-FE	K20HR-U11	IKH20TT	KH20TT	IKH20	VKH20	6	INDIA
Premio (Corona) 1.8	2001-	ZZT240	1ZZ-FE	K16R-U11	IK16TT	K16TT	IK16	VK16	4	
	2007-	ZRT260/265	2ZR-FE	SC20HR11	IXEH22TT	-	-	VCH20	4	
Prius A 1.8	2012-	ZVW40W	2ZR-FXE	SC20HR11	IXEH22TT	-	-	VCH20	4	
Prius Hybrid 1.8	2009-	ZVW30	2ZR-FXE	SC20HR11	IXEH22TT	-	-	VCH20	4	
Probox 1.3	2003-	NCP50V	2NZ-FE	K16R-U11	IK16TT	K16TT	IK16	VK16	4	INDONESIA
Ractis 1.5	2006-	NCP100	1NZ-FE	K16R-U11	IK16TT	K16TT	IK16	VK16	4	
RAV4 1.8	2000-	ZCA25/26	1ZZ-FE	K16R-U11	IK16TT	K16TT	IK16	VK16	4	
Rush 1.5	2006-	J200	3SZ-VE	XU22EPR-U	-	XU22TT	IXU22	VXU22	4	
Sienta 1.5	2003-	NCP81	1NZ-FE	FK20HR11	IKH20TT	-	-	VFKH20	4	
	2015-	NSP170G	2NR-FKE	FC16HR8	IXEH20TT	-	-	VFCH16	4	
Sienta Hybrid 1.5	2015-	NHP170	2NR-FKE	FC16HR8	IXEH20TT	-	-	VFCH16	4	
Townace Van 1.5	2008-	S402M	3SZ-VE	XU22PR9	-	XU22TT	IXU22	VXU22	4	KOREA
Vanguard 2.4	2007-	ACA33	2AZ-FE	SK20R11	IK20TT	-	IK20	VK20	4	
Vanguard 3.5	2007-	GSA33	2GR-FE	FK20HR11	IKH20TT	-	-	VFKH20	6	
Vellfire 2.4	2008-	ANH20W	2AZ-FE	SK20R11	IK20TT	-	IK20	VK20	4	MALAYSIA
Vellfire 2.5	2015-	AGH30R	2AR-FE	SK16HR11	IKH16TT	-	IKH20	VKH16	4	
Vellfire 3.5	2011-	GGH20W	2GR-FE	FK20HR11	IKH20TT	-	-	VFKH20	6	
Vitz 1.0	2005-	KSP90	1KR-FE	SK20HR11	IKH20TT	-	IKH20	VKH20	3	
Vitz 1.3	2005-	SCP90	2SZ-FE	SK16HR11	IKH16TT	-	IKH16	VKH16	4	
Voltz 1.8	2002-	ZZE136/138	1ZZ-FE	SK16R11	IK16TT	-	IK16	VK16	4	PHILIPPINES
Voxy 2.0	2001-	AZR60	1AZ-FSE	SK20BGR11	-	-	-	VKA20	4	
	2014-	ZRR80R	3ZR-FAE	SC20HR11	IXEH22TT	-	-	VCH20	4	
Will Cypha 1.5	2002-	NCP75	1NZ-FE	K16R-U11	IK16TT	K16TT	IK16	VK16	4	SAUDARABIA
Windom 3.0	1999-	MCV20	1MZ-FE	SK20R11	IK20TT	-	IK20	VK20	6	
	2001-	MCV30	1MZ-FE	SK20R11	IK20TT	-	IK20	VK20	6	
Wish 1.8	2003-	ZNE10	1ZZ-FE	K16R-U11	IK16TT	K16TT	IK16	VK16	4	
	2009-	ZGE20	2ZR-FAE	SC20HR11	IXEH22TT	-	-	VCH20	4	
<b>VOLKSWAGEN</b>										
Beetle 1.6	2000-	-	AYD/BFS	K20PBR-S10	IK20TT	K20TT	IK20	VK20	4	SINGAPORE
Beetle 1.8t	2002-	-	AWU	-	-	-	IK22	VK22	4	
Beetle 2.0	2002-	-	AQY	K20PBR-S10	IK20TT	K20TT	IK20	VK20	4	
Bora 1.6	2000-	-	AEE	K20PBR-S10	IK20TT	K20TT	IK20	VK20	4	
	2002-	-	AEH	K20PBR-S10	IK20TT	K20TT	IK20	VK20	4	
Golf 1.6	1998-	-	AEH	K20PBR-S10	IK20TT	K20TT	IK20	VK20	4	
	2005-	-	BAG	K20PBR-S10	IK20TT	K20TT	IK20	VK20	4	
Golf 2.0	2004-	-	AXW	K20PBR-S10	IK20TT	K20TT	IK20	VK20	4	
Golf GTI 1.8	1998-	-	AGU	K22PBR-S	-	-	IK22	VK22	4	
Golf GTi 2.0	2005-	-	AXX	-	-	-	-	VK20Y	4	
Golf R32 3.2	2006-	-	BUB	-	-	-	IXU22	VXU22	6	
Jetta 2.0	2006-	-	BLX	-	-	-	-	VKA16	4	
Jetta 2.0T	2006-	-	BWA	-	-	-	IK22	VK22	4	
Passat 1.8T	1999-	-	APT	K20PBR-S10	IK20TT	K20TT	IK20	VK20	4	
Passat 2.0	2003-	-	AZM	K20PBR-S10	IK20TT	K20TT	IK20	VK20	4	
Passat V6 2.8	1998-	-	ACK	K22PBR-S	-	-	IK22	VK22	6	
	2002-	-	BBG	K22PBR-S	-	-	IK22	VK22	6	
Polo 1.4	2004-	-	BKY	KJ20CR-L11	IK20TT	K20TT	IK20L	-	4	JAPAN
	2007-	-	BUD	-	-	-	-	VKA20	4	
Touareg 3.2	2003-	-	AZZ	-	-	-	IXU22	VXU22	6	
	2004-	-	BMV	-	-	-	IXU22	VXU22	6	
Touareg 3.6	2007-	-	BHK	-	-	-	IXUH22	VXUH22	6	
Touran 1.4T	2007-	-	BLG	-	-	-	IK22	VK22	4	VIETNAM
<b>VOLVO</b>										
C30 2.0	2006-	-	B4204	K20TXR	IK20TT	K20TT	IK20	VK20	4	
C30 T5 2.5	2007-	-	B5254	-	-	-	IKH22	VKH22	5	
C70 2.4	1999-	-	-	K20PR-U	IK20TT	K20TT	IK20	VK20	5	
C70 T5 2.5	2006-	-	B5254T3	-	IKH20TT	-	IKH20	VKH20	5	
S40 1.8	1998-	-	-	K20PBR-S10	IK20TT	K20TT	IK20	VK20	4	
S40 2.4i	2004-	-	B5244S4	-	-	-	IKH22	VKH22	5	
S40 T4 1.9	1998-	-	B4194	K20PR-U11	IK20TT	K20TT	IK20	VK20	4	
S40 T5 2.5	2004-	-	B5254T3	-	-	-	IKH22	VKH22	5	
S60 2.0T	2004-	-	B5204T5	K20PBR-S10	IK20TT	K20TT	IK20	VK20	5	

DENSO	9	14	16	20	22	24	27	29	31	32	34	35	DENSO	9	14	16	20	22	24	27	29	31	32	DENSO	9	14	16	20	22	24	27	31
NGK	2	4	5	6	7	8	9	9.5	10	10.5	11	11.5	CHAMPION	18	16,14	12,11	10,9	8,7	6,63,61	4,59	57	55	53	BOSCH	10	9	8	7,6	5	4	3	2

AUSTRALIA  
 CHINA  
 INDIA  
 INDONESIA  
 INDONESIA  
 KOREA  
 MALAYSIA  
 MALAYSIA  
 PHILIPPINES  
 SAUDARABIA  
 SINGAPORE  
 TAIWAN  
 THAILAND  
 VIETNAM  
 VIETNAM  
 JAPAN  
 JAPAN  
 EUROPE  
 & USA  
 CROSS  
 REFERENCE  
 NUMBER  
 PART



# SINGAPORE CAR

▶ Spark plug color codes: ■ for Iridium Tough and Iridium Plugs and Iridium TT, ■ for Iridium Power, ■ for Iridium Racing and Two Tops Plugs, ■ for Platinum Plugs and Platinum TT, and black for general spark plugs.

	MODEL	YEAR	VEHICLE CODE	ENGINE	DENSO	IRIDIUM TT	IRIDIUM RACING	IRIDIUM POWER	IRIDIUM TOUGH	QTY
<b>AUSTRALIA</b>										
<b>VOLVO</b>										
	S60 T5 2.3	2001-	-	B5234	-	-	-	IK22	VK22	5
	S60 T5 2.4	2004-	-	B5244T	-	-	-	IK22	VK22	4
	S60R 2.5	2003-	-	B5254T4	-	-	-	IKH22	VKH22	5
<b>CHINA</b>										
	S80 2.0T	1999-	-	B5204T2	K20PBR-S10	IK20TT	K20TT	IK20	VK20	5
	S80 2.4	2001-	-	B5244S2	K20PR-U	IK20TT	K20TT	IK20	VK20	5
	S80 2.5T	2004-	-	B5254T5	-	-	-	IKH22	VKH22	5
	S80 T6 2.8	2002-	-	B6284T	-	-	-	IK22	VK22	6
<b>INDIA</b>										
	V50 2.0	2004-	-	B5254T3	-	-	-	IKH22	VKH22	5
	V50 2.4i	2004-	-	B5244S4	-	-	-	IKH22	VKH22	5
	V50 T5 2.5	2004-	-	B5254	-	IKH20TT	-	IKH20	VKH20	5
	V70 2.0T	2004-	-	B5204T5	K20PBR-S10	IK20TT	K20TT	IK20	VK20	5
<b>INDONESIA</b>										
	V70 2.5T	2003-	-	B5254T	-	IKH20TT	-	IKH20	VKH20	5
	V70 T5 2.4	2002-	-	B5234T3	-	-	-	IK22	VK22	5
	V70R 2.5	2003-	-	B5254T4	-	-	-	IKH22	VKH22	5
<b>KOREA</b>										
	XC70 2.5T	2002-	-	B5254T2	-	-	-	IK22	VK22	5
	XC90 2.5T	2003-	-	B5254T2	-	-	-	IK22	VK22	5
	XC90 3.2	2006-	-	B6324	-	IKH20TT	-	IKH20	VKH20	6
	XC90 4.4	2006-	-	B8444	-	-	-	-	VK20Y	5
	XC90 T6 2.9	2003-	-	B6294T	-	-	-	IK22	VK22	6
<b>MALAYSIA</b>										
	Journey 1.1	2008-	-	LJ465Q3	W16EXR-U11	IW16TT	W16TT	IW16	VW16	4
	Sunshine 1.1	2008-	-	LJ465Q3	W16EXR-U11	IW16TT	W16TT	IW16	VW16	4
<b>PHILIPPINES</b>										
	Trex 1.6	2007-	RX6400	DA4G18	K16PR-U11	IK16TT	K16TT	IK16	VK16	4

# SINGAPORE MOTORCYCLE



	MODEL	ENGINE CC	YEAR	DENSO	IRIDIUM POWER	IRIDIUM RACING	QTY
<b>APRILLA</b>							
	Atlantic 200	200	2003-	U24ESR-NB	IU24	IU01-□	1
	ETV1000 Capo Nord	1000	2001-	XU27EPR-U	IXU27	IXU01-□	4
	Mojito Custom 125	125	2005-	-	IU22	IU01-□	-
	Pegaso 650	650	1990-	-	IX24	-	1
	RS125(12bhp restricted engine)	125	-	W24ESR-U	IW24	IW01-□	1
	RS125(35bhp unrestricted engine)	125	-	-	IW31	IW01-□	1
	RS250	250	1994-	W27EMR-C	IW27	IW01-□	2
	RSV1000R	1000	2001-	XU27EPR-U	IXU27	IXU01-□	2 / 4
	RSV4	1000	2009-	U27ESR-NB	IU27	IU01-□	4
	Scarabeo 200	200	2000-	U24ESR-NB	IU24	IU01-□	1
	SHIVER 750	750	2009-	-	IU24A	IU01-□	2
	SMV 750 Dorsoduro	750	2007-	-	IU24A	IU01-□	2
	Sportcity 250	250	2004-	U24ESR-NB	IU24	IU01-□	1
	SXV 4.5	450	2006-2008	U24ESR-NB	IU24	IU01-□	2
			2009-	-	IU24A	IU01-□	2
	Tuono 1000	1000	2004-	XU27EPR-U	IXU27	IXU01-□	4
<b>BAJAJ</b>							
	Avenger DTS-i	200	-	U27ESR-N	IU27	IU01-□	-
	Chetak 150	150	2001-	W16FPR-U	IWF16	-	-
	Pulsar DTS-i 180	180	-	U27ESR-N	IU27	IU01-□	-
	Pulsar DTS-i 200	200	-	U27ESR-N	IU27	IU01-□	-
<b>BMW</b>							
	C1 Executive	125	2000-2004	U24ESR-NB	IU24	IU01-□	-
	F 800 R / GS / S / ST	800	2005-	XU24EPR-U	IXU24	IXU01-□	-
	F650CS, GS, GS Dakar	650	2002-2005	-	IX24	-	-
	F650GS (Twin cylinder 798cc)	800	2011-	XU24EPR-U	IXU24	IXU01-□	-
	K 1200 S / R / LT	1170	2007-	XU22EPR-U	IXU22	IXU01-□	-
	K 1300 S / R / GT	1293	2009-	-	IXU27	IXU01-□	-
	R 1100 R / GS / RT	1200	-	-	IK22	IK01-□	-
	R 1150 GS/ R / RS / RT	1130	1999-2003	K22TNR-S	IK22	IK01-□	-
	R 1150 GS/ R / S (Twin Spark)Æ12mm Plug	1130	2003-	XU24EPR-U	IXU24	IXU01-□	-
	R 1150 GS/ R / S (Twin Spark)Æ14mm Plug	1130	2003-	K22TNR-S	IK22	IK01-□	-
	R 1200 C	1170	1997-	K22TNR-S	IK22	IK01-□	-
	R 1200 GS / R / RT / S / ST	1170	2003-2009	XU24EPR-U	IXU24	IXU01-□	-
<b>CAGIVA</b>							
	Mitto 525SP	125	2008-	W27ESR-V	IW27	IW01-□	-
	Planet 125	125	1998-	-	IW29	IW01-□	-





MODEL	ENGINE CC	YEAR	DENSO	IRIDIUM POWER	IRIDIUM RACING	QTY
<b>DAELIM</b>						
Roadwin 150	150		U24FE9	IUH24	IU01-□	-
Roadwin R125	125	2004-	U24FE9	IUH24	IU01-□	-
<b>DUCATI</b>						
916	916		-	IX27	-	-
900 SS	900	1991-	XU24EPR-U	IXU24	IXU01-□	-
998S Bostrom	998	2001-	U27ESR-NB	IU27	IU01-□	-
999R / S	998	2002-2006	U27ESR-NB	IU27	IU01-□	-
Hypermotard 1100 EVO	1100	2007-	XU24EPR-U	IXU24	IXU01-□	-
Hypermotard 1100S	1100	2007-	XU24EPR-U	IXU24	IXU01-□	-
Hypermotard 796	803	2010-	XU24EPR-U	IXU24	IXU01-□	-
Monster 1100 / S	1078	2009-	XU24EPR-U	IXU24	IXU01-□	-
Monster 695	700	2006-2008	XU24EPR-U	IXU24	IXU01-□	-
Monster 696	700	2008-	XU24EPR-U	IXU24	IXU01-□	-
Monster S4RS	1000	2006-2008	U27ESR-NB	IU27	IU01-□	-
Multistrada 1000 DS	1000	2006-	XU24EPR-U	IXU24	IXU01-□	-
Superbike 749 Biposto	800	2002-2006	U27ESR-NB	IU27	IU01-□	-
Supertouring ST4S	1000	2000-	-	IXU27	IXU01-□	-
<b>GAS GAS</b>						
EC200	200	1999-	-	IW31	IW01-□	-
		2002-	W24ESR-V	IW24	IW01-□	-
<b>GILERA</b>						
DNA 180	180	2001-	U27ESR-NB	IU27	IU01-□	-
Fuoco 500	500	2007-	-	IU24A	IU01-□	-
Nexus 500	460	2004-	-	IU24A	IU01-□	-
Runner ST 200	200	2008-	N24EXRB	IU24/IU24A	IU01-□	-
Runner VXR 200	200	2002-2008	N24EXRB	IU24/IU24A	IU01-□	-
<b>HARLEY-DAVIDSON</b>						
Sportster 1200 (All Models)	1200	1988-	XU22EPR-U	IXU22	IXU01-□	-
XL53C, Sportster 883(All Models)	883		XU22EPR-U	IXU22	IXU01-□	-
<b>HONDA</b>						
C70C/E	70	1982-1986	U22FSR-U	IUF22	-	-
CB1100SF-Y X-11	1100	1999-	-	IUH24	IU01-□	-
CB400 Super 4 F1, F2	400		X24ES-U	IX24	-	4
CB750 Nighthawk (DOHC)	750		X27ESR-U	IX27	-	4
CBR1100	1100	1996-	-	IUH27	IU01-□	-
CBR1100 K1 Blackbird	1100	-2001	IUH27D	IUH27	IU01-□	-
CBR1100 K2 Blackbird	1100	2002-	VUH27D	IUH27	IU01-□	-
CBR125R	125	2004-	U24ESR-NB	IU24	IU01-□	-
CBX250 Twister	250	1984-1986	X24EPR-U9	IX24B	-	-
Click 110	110		U22FER9/U24FER9	IUH24	IU01-□	-
EX5. Dream, Wave	100		U20FS-U/U22FS-U	IUF22	-	-
GL1500SEW Goldwing	1500		X22EPR-U9	IX22B	-	-
Hornet	600	1998-	U27FER9	IUH27	IU01-□	-
NSR150 SP	150		W24ES-U	IW24	IW01-□	-
NT650 Deauville	650	1998-2005	X24EPR-U9	IX24B	-	-
ST1100	1100		U24FE9	IUH24	IU01-□	-
ST1300	1260	2002-	U22FER9	-	IU01-□	-
VFR800	800	1997-2002	U27FER9	IUH27	IU01-□	-
		2002-	VNH27Z	-	-	-
VT-1300 Fury	1300	2003-	XU20EPR-U	IXU22	-	-
VT600 Shadow	600		X24EPR-U9	IX24B	-	-
VTR1000 SP1	1000	2000-2001	IK27C11	IK27	IK01-□	-
VTR1000 SP2	1000	2002-	VK27PRZ11	IK27	IK01-□	-
WAVE 125	125		U20EPR9	IU20	-	-
XL1000 Varadero	1000	1998-2002	-	IX27B	-	-
		2003-	-	IX24B	-	-
XL125	125	2001-	U24FE9	IUH24	IU01-□	-
XL250	250		X24ES-U	IX24	-	-
XR125	125	2003-	X24EPR-U9	IX24B	-	-
XR200	200		X24ESR-U	IX24	-	-
XR400	400		X24GPR-U	IXG24	-	-
XR600R-V	600		X24EPR-U9	IX24B	-	-
XR650	650		K22PR-U11	IK22	IK01-□	-
XR750 Africa Twin	750	1990-2003	X24EPR-U9	IX24B	-	-
<b>HUSQVARNA</b>						
SM125	125	1998-	W27ESR-V	IW27	IW01-□	-
SM450	450	2003-	U24ESR-NB	IU24	IU01-□	-

AUSTRALIA  
CHINA  
INDIA  
INDONESIA  
KOREA  
MALAYSIA  
PHILIPPINES  
SAUDI ARABIA  
SINGAPORE  
TAIWAN  
THAILAND  
VIETNAM  
JAPAN  
EUROPE & USA  
CROSS REFERENCE  
PART NUMBER

DENSO	9	14	16	20	22	24	27	29	31	32	34	35	DENSO	9	14	16	20	22	24	27	31	32	DENSO	9	14	16	20	22	24	27	31	
NGK	2	4	5	6	7	8	9	9.5	10	10.5	11	11.5	CHAMPION	18	16,14	12,11	10,9	8,7	6,63,61	4,59	57	55	53	BOSCH	10	9	8	7,6	5	4	3	2



	MODEL	ENGINE CC	YEAR	DENSO	IRIDIUM POWER	IRIDIUM RACING	QTY
AUSTRALIA	<b>HUSQVARNA</b>						
	SM510	510	2010-	U24ESR-NB	IU24	IU01-□	-
	<b>HYOSUNG</b>						
	COMET 125	125		U24ES-N	IU24	IU01-□	-
CHINA	GV250 Aquila	250		U24ESR-NB	IU24	IU01-□	-
	RX125 (DOHC engine)	125	2007-	U24ESR-NB	IU24	IU01-□	-
	RX125 (SOHC engine)	125	2000-2007	U24FE9	IUH24	IU01-□	-
INDIA	<b>KAWASAKI</b>						
	D-Tracker 125	125	2010-	U22FSR-U	IUF22	-	-
	ER6N	650	2006-	IU27D	IU27	IU01-□	-
	KLX125	125	2010-	U22FSR-U	IUF22	-	-
	KRR150	150		W24EP-U	IW24	IW01-□	-
	KSR110	110	2003-	U20FSR-U	IUF22	-	-
INDONESIA	W650	650	1999-2005	U24ESR-NB	IU24	IU01-□	-
	Z1000	1000	1977-1984	W24ES-U	IW24	IW01-□	-
	ZG1400 A8F (1400GTR Concours)	1400	2007-	IU27D	IU27	IU01-□	-
KOREA	ZR1000 B7F-B8F, C7F-C8F, DAF (Z1000)	1000	2007-2009	IU27D	IU27	IU01-□	-
	ZR750 C1-C4 Zephyr 750	750	1991-1994	X27ESR-U	IX27	-	-
	ZR750 C5, D1 Zephyr 750	750	1995-1999	X27ESR-U	IX27	-	-
	ZX1000 C1H (ZX10R)	1000	2004-	IU27D	IU27	IU01-□	-
MALAYSIA	ZX1000 D6F-D7F, E8F, E9F, FAF(Ninja ZX-10R)	1000	2006-	IU27D	IU27	IU01-□	-
	ZX1200 A1-A2 (ZX-12R), B1H-B3H (Ninja ZX-12R)	1200	1999-2007	-	IU27A	IU01-□	-
PHILIPPINES	ZX250R	250		U27ESRN	IU27	IU01-□	-
	ZX400 C2-C3	400	1985-1987	X27EPR-U9	IX27B	-	-
	ZX400 L1-L9 (ZXR400)	400	1991-1999	U27ETR	IU27A	IU01-□	-
SAUDI ARABIA	ZX636R	636	2002-2006	U27ESRN	IU27	IU01-□	-
	ZX-6R	600	1995-1998	U27ESRN	IU27	IU01-□	-
SINGAPORE	<b>KTM</b>						
	ZX750 H1-H2(ZXR750), J1- J2(ZXR750), M1-M2(ZXR750R), L3(ZXR750), N1 (Ninja ZX-7RR), ZX750R (Ninja ZX-7R)	750	1989-2003	U27ESRN	IU27	IU01-□	-
	200 EGS, EXC, MXC	200	1998-	W24ESR-V	IW24	IW01-□	-
	200 EXC, SX	200	2003-	-	IW27	IW01-□	-
	400 EGS-E	400	1997-	X24ESR-U	IX24	-	-
	450SX-F	450	2007-	-	IU27A	IU01-□	-
TAIWAN	Duke 620	620	1997-	X24ESR-U	IX24	-	-
	R640 Adventure	625	2003-	XU24EPR-U	IXU24	IXU01-□	-
	<b>MOTO GUZZI</b>						
THAILAND	Breva V 1100 (Twin Spark)Æ 10mm Plug	1100	2005-	-	IU24	-	-
	Breva V 1100 (Twin Spark)Æ 14mm Plug	1100	2005-	W20EPR-U	IW20	IW01-□	-
	MGS-01 Corsa	1225	2005-	-	IXU27	IXU01-□	-
VIETNAM	Stelvio 1200 ABS	1150	2008-	-	IU24	-	-
	<b>SUZUKI</b>						
	AN250 K4-K5 Burgman	250	2004-	U22ETR	IU24A	IU01-□	-
	AN250 W, X, Y, K1-K3 Burgman	250	-2003	U24ETR	IU24A	IU01-□	-
	AN400 K7-K8 Burgman	400	2007-	U22ESR-N	IU22	IU01-□	-
	AN400 X, Y, K1-K6 Burgman	400	1999-2007	U22ESR-N	IU22	IU01-□	-
JAPAN	DL1000 V-Strom	1000	2002-2008	U24ETR	IU24A	IU01-□	-
	DR125 SM	125	2008-	U24ESR-NB	IU24	IU01-□	-
	DR200SE	200	1996-2009	X24ESR-U	IX24	-	-
	DR-Z400	400	1980-2007	U24ESR-NB	IU24	IU01-□	-
EUROPE & USA	EN125	125		X24ES-U	IX24	-	-
	FD110	110		U20FS-U	IUF22	-	-
	GN125	125	1993-2001	X24ES-U	IX24	-	-
CROSS REFERENCE NUMBER	GS125	125		X24ESR-U	IX24	-	-
	GS400	400		W24ES-U	IW24	IW01-□	-
	GSR600	600	2006-	U27ESRN	IU27	IU01-□	-
	GSX1300R X, Y, K1-K5 Hayabusa	1300	1997-2007	U27ESRN	IU27	IU01-□	-
	GSX600F	600	1998-2006	U27ETR	IU27A	IU01-□	-
	GSX600FJ	600		X27ESR-U	IX27	-	-
PART NUMBER	GSX650F Bandit S	650	2008-2009	U24ESR-NB	IU24	IU01-□	-
	GSX-R 1000	1000	2001-2006	U27ESRN	IU27	IU01-□	-
	GSX-R1000R	1000	2007-2008	IU27D	IU27	IU01-□	-
	GSX-R1100 W-P, R, S, T	1100	1993-1996	U27ESRN	IU27	IU01-□	-
	GSX-R1300 Hayabusa K8	1340	2008-	IU27D	IU27	IU01-□	-
	GSX-R400	400		-	IUF24	-	-
	GSX-R600	600	1997-2006	U27ESRN	IU27	IU01-□	-



MODEL	ENGINE CC	YEAR	DENSO	IRIDIUM POWER	IRIDIUM RACING	QTY
<b>SUZUKI</b>						
GSX-R750		2006-	U27ESRN	IU27	IU01-□	-
RGV250	250	1992-1996	W27EMR-C	IW27	IW01-□	-
RMX250	250	1994-1999	-	IW27	IW01-□	-
RV125	125	2003-	U24ESR-NB	IU24	IU01-□	-
Smash 110	110		U20FS-U	IUF22	-	-
TL1000S	1000	1998-2001	U24ETR	IU24A	IU01-□	-
		1997-	U27ESRN	IU27	IU01-□	-
VZ800	800	2006-2008	X22EPR-U9	IX22B	-	-
VZR1800 C1800R/RT Intruder	1800	2006-	-	IU24	IU01-□	-
<b>SYM</b>						
Joyride 180	180		U24ESR-NB	IU24	IU01-□	-
Joyride 200	200		U24ESR-NB	IU24	IU01-□	-
<b>TRIUMPH</b>						
Daytona 675	680	2005-	U27ETR	IU27A	IU01-□	-
Rocket III Roadster	2300	2004-	X22EPR-U9	IX22B	-	-
Speed Triple	1050	2005-	U24ETR	IU24A	IU01-□	-
Sprint ST	1100	2004-	U24ETR	IU24A	IU01-□	-
Street Triple 675	675	2007-	U27ETR	IU27A	IU01-□	-
T509 Speed Triple	885	1996-1998	X24EPR-U9	IX24B	-	-
Thruxton 900 / SE	900	2003-	X24EPR-U9	IX24B	-	-
Tiger T709	885	1991-	X24EPR-U9	IX24B	-	-
<b>VESPA</b>						
ET4 125	125	1996-2005	U24ESR-NB	IU24	IU01-□	-
Sprint 150	150		W20FS-U	IWF22	-	-
Vespa GTS 250i.e.	250	2005-	U24ESR-NB	IU24	IU01-□	-
Vespa GTS 300	300	2008-	-	IU24A	IU01-□	-
Vespa PX150	150	1983-1990	W20FS-U	IWF22	-	-
Vespa PX200	200		W22ES-U	-	IW01-□	-
<b>YAMAHA</b>						
FJR 1300ABS	1300	2001-	U24ESR-NB	IU24	IU01-□	-
FZ1 Fazer	1000	2006-	U27ETR	IU27A	IU01-□	-
FZ6-S	600	2004-	U27ETR	IU27A	IU01-□	-
FZ-8S Fazer	799	2010-	U27ESRN	IU27	IU01-□	-
MT-01	1670	2005-	X22EPR-U9	IX22B	-	-
Nouvo S / AT 115	115		U22FSR-U	IUF22	-	-
NXC 125FI	125	2004-	U22ESR-N	IU22	IU01-□	-
RXS 115	115		W24EP-U	IW24	IW01-□	-
RXZ 135	135		W24EP-U	IW24	IW01-□	-
TDM 900	900	2002-	X24EPR-U9	IX24B	-	-
TZM150	150		W27ESR	IW27	IW01-□	-
Vmax	1200	1991-2002	X24EPR-U9	IX24B	-	-
WR200	200		W27ESR	IW27	IW01-□	-
XJ6-N Diversion	600		U27ESRN	IU27	IU01-□	-
XP500 TMAX	500		U22ESR-N	IU22	IU01-□	-
XT-1200Z Super Tenere	1200	2001-	-	IU24/IU24A	IU01-□	-
Y125Z	125		W24ES-U	IW24	IW01-□	-
YBR125	125	2005-	U20FSR-U	IUF22	-	-
YP250 Majesty	250	1996-2004	X24ESR-U	IX24	-	-
YP400 Majesty	400	2004-	U22ESR-N	IU22	IU01-□	-
YZF R1	1000		-	IU27	IU01-□	-
YZF R125	125	2008-	U24ESR-NB	IU24	IU01-□	-
YZF R6	600		U31ETR	IU31A	IU01-□	-

AUSTRALIA  
CHINA  
INDIA  
INDONESIA  
KOREA  
MALAYSIA  
PHILIPPINES  
SAUDIARABIA  
SINGAPORE  
TAIWAN  
THAILAND  
VIETNAM  
JAPAN  
EUROPE & USA  
CROSS REFERENCE  
PART NUMBER

DENSO	9	14	16	20	22	24	27	29	31	32	34	35
NGK	2	4	5	6	7	8	9	9.5	10	10.5	11	11.5

DENSO	9	14	16	20	22	24	27	29	31	32
CHAMPION	18	16,14	12,11	10,9	8,7	6,63,61	4,59	57	55	53

DENSO	9	14	16	20	22	24	27	31
BOSCH	10	9	8	7,6	5	4	3	2



▶ Spark plug color codes: ■ for Iridium Tough and Iridium Plugs and Iridium TT, ■ for Iridium Power, ■ for Iridium Racing and Two Tops Plugs, ■ for Platinum Plugs and Platinum TT, and black for general spark plugs.

車型	CC	VEHICLE CODE	ENGINE	YEAR	一般	Genuine P/N	白金				銻合金性能型	銻合金耐久型	Qty
<b>AUSTRALIA</b>													
<b>ALFA ROMEO</b>													
147 1.6TS/2.0TS	1600/2000			2001-2004	-	-	-	IK20TT+N/A	-	-	IK20+IU22	-	4
147 3.2 GTA	3200			2002.11-	-	-	PK20PR-P8	IK20TT	-	-	IK20	VK20Y	4
<b>CHINA</b>													
159 1.9 JTDM / 2.4 JTDM / 3.2 JTS	1900/2400/3200			-	-	-	-	IK16TT	-	-	IK16	-	4
BRERA 2.2	2200			2006-	-	-	-	IK16TT	-	-	IK16	VK16	4
BRERA 3.2	3200			2006-	-	-	-	ITV16TT	-	-	ITV16	-	6
<b>INDIA</b>													
<b>AUDI</b>													
A1 Sportback	1390			2020-	-	-	-	-	-	-	IK22	VK22	4
A2 1.4 (BBY)	1400			2002.05-2006	K20PBR510	-	-	IK20TT	-	-	IK20	VK20	4
A3 1.4 TFSi	1400			2007-2012	SKJ20CR-A8	-	PKJ20CR8	-	-	-	-	-	4
A3 1.8/2.0 TFSi L4 DOHC 16V TURBO (CDAA)	1800/2000			2006-	PK20PR-P8	-	-	IK20TT	-	-	IK20	VK20Y	4
<b>INDONESIA</b>													
A3 2.0L FSI	2000			2002.08-	-	-	-	-	-	-	-	VKA16	4
A3 2.0L TFSi	2000			2004.09-	-	-	PK20PR-P8	IK20TT	-	-	IK20	VK20Y	4
A3 3.2L	3200			2003.07-	-	-	-	-	-	-	IXU22	VXU22	6
A4	1395			2020-	-	-	-	-	-	-	IK22	VK22	4
<b>KOREA</b>													
A4 1.8L	1800			2008-	-	-	-	-	-	-	IK22	VK22	4
A4 1.8T AVAVT	1800			2004-2005	K20PBR510	-	-	IK20TT	K20TT	-	IK20	VK20	4
A4 2.0L	2000			2002-2005	-	-	-	IK16TT	-	-	IK16	VK16	4
A4 3.0L	3000			2002-2005	K20TXR	-	-	IK20TT	K20TT	-	IK20	VK20	6
<b>MALAYSIA</b>													
A6				2004-	-	-	PK20PR-L11	-	-	-	IK20	VK20	6
A6 3.0L	3000			2001-2003	K20TXR	-	-	IK20TT	K20TT	-	IK20	VK20	6
A6 4.2L QUATTRO	4200			2004.09-	K20PBR-S10	-	-	IK20TT	K20TT	-	IK20	VK20	6
A8 3.7L	3700			2004-2005	K20TXR	-	-	IK20TT	K20TT	-	IK20	VK20	6
A8L 4.2L	4200			2003-2005	K20TXR	-	-	IK20TT	K20TT	-	IK20	VK20	6
<b>PHILIPPINES</b>													
Q3	1498			2020-	-	-	-	-	-	-	IK22	VK22	4
RS6 4.2L	4200			2002.07-	-	-	-	-	-	-	IK22	VK22	6
S4 4.2L	4200			2003.03-	K20TXR	-	-	IK20TT	K20TT	-	IK20	VK20	6
<b>SAUDI ARABIA</b>													
TT 1.8T ROADSTER	1800			2005.09-	-	-	PK20PR-P8	IK20TT	-	-	IK20	VK20Y	4
TT 3.2L COUPE	3200			2003.07-	-	-	-	-	-	-	IXU22	VXU22	6
<b>SINGAPORE</b>													
<b>BENZ</b>													
B170 (W245) 1.7 (M266)	1700			2005.04-	K20PR-U	-	-	IK20TT	-	-	IK20	VK20Y	4
B180 1.7 L4 DOHC 8V	1700			2006-	K20PR-U	-	-	IK20TT	-	-	IK20	VK20Y	4
B200T (W245) 2.0 (M266)	2000			2005.04-	K20PR-U	-	-	IK20TT	-	-	IK20	VK20Y	4
B200T 2.0 L4 DOHC 16V	2000			2006-	K20PR-U	-	-	IK20TT	-	-	IK20	VK20Y	4
C180 CLASSIC/AVANTGRADE (M271)				-	-	-	-	-	-	-	IXUH22	VXUH22	4
C180K 1.8L	1800			2000-2005	-	-	-	IK16TT	-	-	IK16	VK16	4
C200K 1.8L	1800			2000-2005	-	-	-	IK16TT	-	-	IK16	VK16	4
<b>TAIWAN</b>													
C230K 2.0L	2000			2000-2005	-	-	-	IK16TT	-	-	IK16	VK16	4
C240 2.6L	2600			2000-2005	-	-	-	IK16TT	-	-	IK16	VK16	6
C320 3.2L	3200			2000-2005	-	-	-	IK16TT	-	-	IK16	VK16	6
C320 AMG K 3.2L	3200			2000-2005	-	-	-	IK16TT	-	-	IK16	VK16	6
<b>THAILAND</b>													
C350 (W203) 3.5 (M272)	3500			2004.12-	-	-	-	-	-	-	IXUH22	VXUH22	6
C55 AMG (W203) 5.4 V8 (M113)	5400			2004.02-	-	-	-	IK20TT	-	-	IK20	VK20	8
C63 AMG ESTATE 6.2 V8 SOHC 32V (M156)	6200			2007-	FXE22HR11	-	-	-	-	-	-	VFXEH22	8
C63 AMG M 156.985 6.2 V8	6200			2007.08-	FXE22HR11	-	-	-	-	-	-	VFXEH22	8
<b>VIETNAM</b>													
CL500 (W140) 5.0 V8 (M113)	5000			2000.09-2007	-	-	-	IK16TT	-	-	IK16	VK16	8
CL500 (W212) 5.5 V8 DOHC 32V	5500			2007-	SXU22HDR8	-	-	-	-	-	IXUH22	VXUH22	8
CL600 (W212) 5.6 V12 DOHC 36V TURBO	5600			2007-	-	-	-	IK20TT	-	-	IK20	VK20Y	12
CL63 AMG (W212) 6.2 V8 DOHC 32V	6200			2007-	-	-	-	IK20TT	-	-	IK20	VK20Y	8
<b>JAPAN</b>													
CLK 200 Kompressor (W208) (M111)				2000.06-2002	-	-	-	IK20TT	-	-	IK20	VK20	4
CLK 200K 1.8 (M271)				2003.02-	-	-	-	-	-	-	-	VKH20Y	4
CLK 230 Kompressor (W208) (M111)				2000.03-	-	-	-	IK20TT	-	-	IK20	VK20	4
CLK 240 (209) M112.912				2003.02-	-	-	PK16PR(-L)11	IK16TT	-	-	IK16	VK16	6
CLK 240 ELEGANCE (W209) (M112)				2003.02-	-	-	-	IK16TT	-	-	IK16	VK16	6
<b>EUROPE &amp; USA</b>													
CLK 280 3.0 V6 (M272)	3000			2006.05-	SXU22HDR8	-	-	-	-	-	IXUH22	VXUH22	6
CLK 320 (W209) (M112)				2003.03-	-	-	-	IK16TT	-	-	IK16	VK16	6
CLK320 ADVANTAGE (W209) 3.2 V6 (M112)	3200			2003.02-	-	-	-	IK16TT	-	-	IK16	VK16	6
CLS350 (W219) 3.5 V6 (M272)	3500			2004.01-	SXU22HDR8	-	-	-	-	-	IXUH22	VXUH22	6
CLS500 (W219) 5.0 V8 (M113)	5000			2006-	-	-	PK16PR(-L)11	IK16TT	-	-	IK16	VK16	8
CLS500 5.0 V8 SOHC 32V	5000			2006-2010	SXU22HDR8	-	-	-	-	-	IXUH22	VXUH22	8
CLS55 AMG (W219) 5.5 V8 (M113)	5500			2005.01-	-	-	-	-	-	-	-	VKH20Y	8
CLS63AMG (M156) 6.2 V8	6200			2006.05-	FXE22HR11	-	-	-	-	-	-	VFXEH22	8
<b>CROSS REFERENCE NUMBER</b>													
E200 CGI 1.8 L4 DOHC 16V TURBO	1800			2009-	-	-	-	-	-	-	-	VKH20Y	4
<b>PART NUMBER</b>													
E200K 1.8L	1800			2003-2005	-	-	-	IKH20TT	-	-	IKH20	VKH20	4
E240/E240T 2.6L	2600			2000-2003	-	-	-	IK16TT	-	-	IK16	VK16	6
E250 CGI COUPE/ESTATE 2.2 L4 DOHC 16V TURBO	2200			2009-	SXU22HDR8	-	-	-	-	-	IXUH22	VXUH22	4
E320 3.2L	3200			2003-2005	-	-	-	IK16TT	-	-	IK16	VK16	6



車型	CC	VEHICLE CODE	ENGINE	YEAR	一般	Genuine P/N	白金	IRIDIUM	T-T	鍍合金性能型	鍍合金耐久型	Qty	
<b>BENZ</b>													
E500 5.0L	5000			2003-2005	-	-	-	IK16TT	-	IK16	VK16	8	AUSTRALIA
S350 3.7L	3700			2003-2005	-	-	-	IK16TT	-	IK16	VK16	6	CHINA
SL280 2.8L	2800			2003-	-	-	-	IK16TT	-	IK16	VK16	6	INDIA
<b>BMW</b>													
116i 1.6L	1600			2005.03-	K20TXR	-	-	IK20TT	K20TT	IK20	VK20	4	INDONESIA
118i 2.0L	2000			2005.03-	-	-	-	IK20TT	-	IK20	VK20	4	INDONESIA
120i 2.0L	2000			2004.09-	-	-	-	-	-	-	-	4	INDONESIA
318i				2008-	-	12122158252	-	-	-	-	VK20	3	INDONESIA
318Ti 2.0L	2000			2001-2005	K20TXR	-	-	IK20TT	K20TT	IK20	VK20	3	INDONESIA
320i				2008-	-	12122158252	-	-	-	-	VK20	6	INDONESIA
320i 2.2L	2200			2000-2005	K20TXR	-	-	IK20TT	K20TT	IK20	VK20	6	INDONESIA
325i 2.5L	2500			2000-2005	K20TXR	-	-	IK20TT	K20TT	IK20	VK20	6	INDONESIA
330i				2008-	-	-	-	-	-	-	VKH20	6	INDONESIA
330i 3.0L	3000			2000-2005	K20TXR	-	-	IK20TT	K20TT	IK20	VK20	6	INDONESIA
520i 2.2L	2200			2003-2005	K20TXR	-	-	IK20TT	K20TT	IK20	VK20	6	INDONESIA
523i				2003-	-	-	-	-	-	-	VKH20	6	INDONESIA
				2007-	-	-	-	-	-	-	VKH20	6	INDONESIA
				2010-	-	-	-	-	-	-	VKH20	6	INDONESIA
525i 2.5L	2500			2003-	K20TXR	-	-	IK20TT	K20TT	IK20	VK20	6	INDONESIA
	2500			2007-	-	-	-	-	-	-	VKH20	6	INDONESIA
528i				2010-	-	-	-	-	-	-	VKH20	6	INDONESIA
530i 3.0L	3000			2003-	K20TXR	-	-	IK20TT	K20TT	IK20	VK20	6	INDONESIA
	3000			2007-	-	-	-	-	-	-	VKH20	6	INDONESIA
540i 4.4L	4400			2004-2005	K20TXR	-	-	IK20TT	K20TT	IK20	VK20	6	INDONESIA
545i 4.4L	4400			2003.11-	-	-	-	IK20TT	-	IK20	VK20	6	INDONESIA
630i 3.0L	3000			2005.01-	-	-	-	IKH20TT	-	IKH20	VKH20	6	INDONESIA
645 Ci CABRIOLET 4.4L	4400			2004.02-	-	-	-	IK20TT	-	IK20	VK20	6	INDONESIA
650i 4.8L	4800			-	-	-	-	IK20TT	-	IK20	VK20	6	INDONESIA
730i 3.0L	3000			2002-2005	K20TXR	-	-	IK20TT	K20TT	IK20	VK20	6	INDONESIA
735i 3.6L	3600			2002-2005	K20TXR	-	-	IK20TT	K20TT	IK20	VK20	6	INDONESIA
740i				2002-	-	12122158252	-	-	-	-	VK20	6	INDONESIA
745i 4.4L	4400			2002-2005	K20TXR	-	-	IK20TT	K20TT	IK20	VK20	8	INDONESIA
760Li 6.0L	6000			2002-2005	K20TXR	-	-	IK20TT	K20TT	IK20	VK20	8	INDONESIA
M3 3.2L	3200			2000.06-	-	-	-	-	-	IXU24	VXU24	4	INDONESIA
	3200			2003.09-	-	-	-	-	-	IXU24	VXU24	4	INDONESIA
M5 5.0L	5000			2000.11-	-	-	-	IK20TT	-	IK20	VK20	10	INDONESIA
X1 18i				2009-	-	12122158252	-	-	-	-	VK20	4	INDONESIA
X3 3.0i	3000			2003-	K20TXR	-	-	-	-	-	-	6	INDONESIA
X3 3.0si				2006-	-	-	-	-	-	-	VKH20	6	INDONESIA
Z4 2.2/2.5/3.0L	2200/2500/3000			2003-	-	-	-	IK20TT	-	IK20	VK20	6	INDONESIA
<b>BUICK</b>													
RENDEZVOUS 3.4L	3400			2000-2004	-	-	-	IT16TT	-	IT16	VT16	6	INDONESIA
<b>CADILLAC</b>													
CTS 2.6/3.2L	2600/3200			2004-	-	-	-	IK20TT	-	IK20	VK20	6	INDONESIA
CTS 2.8/3.6L	2800/3600			2004-	-	-	-	ITV20TT	-	ITV20	-	6	INDONESIA
DEVILLE DHS 4.6L	4600			2003-	-	-	-	IT20TT	-	IT20	VT20	8	INDONESIA
DTS 4.6L	4600			2006-	-	-	PT16EPR-L13	IT16TT	-	IT16	VT16	8	INDONESIA
SEVILLE 4.6L	4600			2003-	-	-	-	IT20TT	-	IT20	VT20	8	INDONESIA
SRX 3.6L	3600			2004-	-	-	-	ITV20TT	-	ITV20	-	6	INDONESIA
SRX 4.6L	4600			2004-	-	-	PT16EPR-L13	IT16TT	-	IT16	VT16	8	INDONESIA
STS 3.6L	3600			2005-	-	-	-	ITV20TT	-	ITV20	-	6	INDONESIA
STS 4.6L	4600			2005-	-	-	PT16EPR-L13	IT16TT	-	IT16	VT16	8	INDONESIA
XLR 4.6L	4600			2004-	-	-	PT16EPR-L13	IT16TT	-	IT16	VT16	8	INDONESIA
<b>CHRYSLER</b>													
300C 2.7L	2700			2005-	-	-	-	ITL16TT	-	ITL16	-	6	INDONESIA
300C 3.5L	3500			2005-	-	-	-	IK16TT	-	IK16	VK16	6	INDONESIA
300M 3.5L	3500			2000-	-	-	-	IK16TT	-	IK16	VK16	6	INDONESIA
CONCORDE 3.5	3500			2003-	-	-	-	IK16TT	-	IK16	VK16	6	INDONESIA
CROSSFIRE 3.2L	3200			2003.12-	-	-	-	IK16TT	-	IK16	VK16	6	INDONESIA
PACIFICA 3.5L	3500			2003-	-	-	-	IK16TT	-	IK16	VK16	6	INDONESIA
PT CRUISER 2.0L/2.4L	2400			2001-2004	-	-	-	ITL16TT	-	ITL16	-	4	INDONESIA
PT CRUISER 2.4L	2400			2005.02-	-	-	-	ITL20TT	-	ITL20	-	4	INDONESIA
SEBRING CONVERTIBLE 2.7L	2700			2003-	-	-	-	ITL20TT	-	ITL20	-	6	INDONESIA
VOYAGER 3.3L	3300			2001-	-	-	-	ITL16TT	-	ITL16	-	6	INDONESIA
<b>CITROEN</b>													
C2 VTR 1.6L	1600			-	K20HPR-U11	-	-	IKH20TT	KH20TT	IKH20	VKH20	4	INDONESIA

AUSTRALIA  
CHINA  
INDIA  
INDONESIA  
KOREA  
MALAYSIA  
PHILIPPINES  
SAUDIARABIA  
SINGAPORE  
TAIWAN  
THAILAND  
VIETNAM  
JAPAN  
EUROPE & USA  
CROSS REFERENCE NUMBER  
PART

DENSO	9	14	16	20	22	24	27	29	31	32	34	35	DENSO	9	14	16	20	22	24	27	29	31	32	DENSO	9	14	16	20	22	24	27	31
NGK	2	4	5	6	7	8	9	9.5	10	10.5	11	11.5	CHAMPION	18	16,14	12,11	10,9	8,7	6,63,61	4,59	57	55	53	BOSCH	10	9	8	7,6	5	4	3	2



▶ Spark plug color codes: ■ for Iridium Tough and Iridium Plugs and Iridium TT, ■ for Iridium Power, ■ for Iridium Racing and Two Tops Plugs, ■ for Platinum Plugs and Platinum TT, and black for general spark plugs.

車型	CC	VEHICLE CODE	ENGINE	YEAR	一般	Genuine P/N	白金				銜合金性能型	銜合金耐久型	Qty
<b>AUSTRALIA</b>													
<b>CITROEN</b>													
C3 1.6L	1600			2002-2005	K20HPR-U11	-	-	IKH20TT	KH20TT	IKH20	VKH20		4
C5 2.0L SX	2000			2001.04-	K16HPR-U11	-	-	IKH16TT	KH16TT	IKH16	VKH16		4
C5 3.0L	3000			2001.04-	-	-	-	IKH16TT	-	IKH16	VKH16		6
<b>CHINA</b>													
C8 2.0L	2000			2002.06-	K16HPR-U11	-	-	IKH16TT	KH16TT	IKH16	VKH16		4
PLURIEL 1.6L	1600			2002-2005	K20HR-U11	-	-	IKH20TT	KH20TT	IKH20	VKH20		4
XSARA 2.0L PICASSO	2000			2000.09-	K16HPR-U11	-	-	IKH16TT	KH16TT	IKH16	VKH16		4
<b>DAIHATSU</b>													
<b>INDIA</b>													
COPEN 1.3L	1300			2006-	SVK20RZ11	-	-	IK20TT	-	IK20	VK20		4
SIRION 1.3L	1300			2000-2005	K16R-U11	-	PK16R11	IK16TT	K16TT	IK16	VK16		4
TERIOS 1.3L	1300			2000-2005	K20R-U11	-	PK20R11	IK20TT	K20TT	IK20	VK20		4
TERIOS 1.5L	1500			-	K20R-U11	-	PK20R11	IK20TT	K20TT	IK20	VK20		4
<b>INDONESIA</b>													
<b>DAWOOD/FORMOSA</b>													
MAGNUS 2.0L	2000			2000.12-	K16PR-U11	-	PK16PR11	IK16TT	K16TT	IK16	VK16		4
MATIZ 0.8L	800			2004-	W16EXR-U11	-	-	IW16TT	W16TT	IW16	VW16		3
MATIZ 1.0L	1000			2004-	K20TXR	-	-	IK20TT	K20TT	IK20	VK20		4
TUCUMA 2.0L	2000			-	K20TXR	-	-	IK20TT	K20TT	IK20	VK20		5
<b>KOREA</b>													
<b>FIAT</b>													
BARCETTA 1.8L	1800			2000-	K20PR-U	-	PK20PR11	IK20TT	K20TT	IK20	VK20		4
IDEA 1.4	1400			2005-	XU22EPR-U	-	-	-	XU22TT	IXU22	VXU22		4
PANDA 1.3	1300			2003-2004	K16PR-U	-	PK16PR11	IK16TT	K16TT	IK16	VK16		4
	1300			2004.01-	XU22EPR-U	-	-	-	XU22TT	IXU22	VXU22		4
PUNTO 1.2L	1200			2005.02-	XU22EPR-U	-	-	-	XU22TT	IXU22	VXU22		4
	1200			2000.09-	XU24EPR-U	-	-	-	-	IXU24	VXU24		4
PUNTO 1.4L	1400			2004-	XU22EPR-U	-	-	-	XU22TT	IXU22	VXU22		4
PUNTO 1.8/1.9L	1800/1900			2002.09-	K20PR-U	-	PK20PR11	IK20TT	K20TT	IK20	VK20		4
PUNTO 1.8L	1800			2000.09-	K20TNR	-	-	IK20TT	K20TT	IK20	VK20		4
STILO 1.8L/2.4L	1800/2400			2001.09-	K20PR-U	-	PK20PR11	IK20TT	K20TT	IK20	VK20		4
<b>PHILIPPINES</b>													
<b>FORD</b>													
<b>SAUDIARABIA</b>													
ACTIVA 1.6L	1600			-	K16PR-U11	-	PK16PR11	IK16TT	K16TT	IK16	VK16		4
ECOSPORT	1000	B515	Duratec-Sigma	2013.11-	-	-	-	ITV20TT	-	ITV20	-		3
	1500	B515	MCA	2018-	-	-	-	-	-	-	-		-
ESCAPE 2.3L	2300			2006.06-	-	-	-	ITV16TT	-	ITV16	-		4
	2300			2004-2006.06	-	-	-	IT20TT	-	IT20	VT20		4
	2300			2011-	-	-	-	ITV16TT	-	ITV16	-		4
ESCAPE 3.0L	3000			2004.05-	T16EPR-U15	-	-	IT16TT	-	IT16	VT16		6
ESCORT				-	-	BL3E 12405 CA	-	-	-	ITV20	-		-
FIESTA 1.4 DOHC 16V	1400	B299	Duratec-Sigma	2010-	-	-	PT16VR13	ITV16TT	-	ITV16	-		4
FIESTA 1.5L	1500			2014-	-	-	-	ITV20TT	-	ITV20	-		4
FIESTA 1.6 DOHC 16V	1600	B299	Duratec-Sigma	2010-	-	-	PT16VR13	ITV16TT	-	ITV16	-		4
FOCUS 1.6L	1600	C346	Duratec-HE	2015-	-	-	-	ITV16TT	-	ITV16	-		4
FOCUS 1.8L	1800			2004.11-	-	-	-	IK16TT	-	IK16	VK16		4
FOCUS 2.0L	2000			2004.12-	-	-	-	IT20TT	-	IT20	VT20		4
	2000			2003.06-	-	-	-	IT20TT	-	IT20	VT20		4
	2000	C346	Duratec-HE	2015-	-	CYFS12Y1	-	ITV20TT	-	ITV20	-		4
FOCUS ST 2.3L	2300			2020-	-	-	-	-	-	ITV22	-		-
<b>SINGAPORE</b>													
FREESTAR 4.2L V6	4200			-	-	-	-	IT20TT	-	IT20	VT20		6
<b>TAIWAN</b>													
i-MAX 2.0L	2000			2007-	-	-	-	IT20TT	-	IT20	VT20		4
	2000			2010-	-	-	-	-	-	IT16	VT16		4
KUGA 2.0L	2000	C520	EcoBoost	2013-	-	-	-	ITV20TT	-	ITV20	-		4
LXION MAV 2.0	2000			-	K16PR-U11	-	PK16PR11	IK16TT	K16TT	IK16	VK16		4
MAV 1.8/2.0L	1800/2000			2004.05-	K16PR-U11	-	PK16PR11	IK16TT	K16TT	IK16	VK16		4
<b>THAILAND</b>													
METROSTAR 2.0L	2000			2002-2005	-	-	-	IT20TT	-	IT20	VT20		4
METROSTAR 2.5L	2500			2003.01-	-	-	PT20VR13	ITV20TT	-	ITV20	-		4
MONDEO Duratec-HEV 2.0L	2000	CD391	Duratec-HEV	2015-	-	-	-	ITV16TT	-	ITV16	-		4
MONDEO ECOBOOST 2.0L	2000			2011-	-	-	-	ITV20TT	-	ITV20	-		4
<b>VIETNAM</b>													
MUSTANG 3.7L	3700	S197	Duratec	2012-	-	-	-	ITV20TT	-	ITV20	-		6
MUSTANG EcoBoost Premium	2300			-	-	-	-	-	-	ITV20	-		-
MUSTANG GT Premium	5000			-	-	-	-	-	-	-	-		-
<b>JAPAN</b>													
NEW MONDEO	2300			2008-	-	-	-	ITL20TT	-	ITL20	-		4
PR-Z 1.0L	1000			-	K20PR-U	-	PK20PR11	IK20TT	K20TT	IK20	VK20		3
RS MONDEO 2.5L	2500			2003.11-	-	-	PT20VR13	ITV20TT	-	ITV20	-		4
TELSTAR 1.8/2.0L	1800/2000			-	W16EXR-U	-	-	IW16TT	W16TT	IW16	VW16		4
TIERRA 1.6L	1600			2003.05-	KJ16CR-11	-	PKJ16CR-L11	IK16TT	K16TT	IK16L	VK16		4
TIERRA 2.0L	2000			2001-	K16PR-U11	-	PK16PR11	IK16TT	K16TT	IK16	VK16		4
VIVID 1.3L	1300			-	W16EX-U11	-	-	IW16TT	W16TT	IW16	VW16		4
好幫手 1.0L	1000			2000-2005	K16PR-U	-	PK16PR11	IK16TT	K16TT	IK16	VK16		4



車型	CC	VEHICLE CODE	ENGINE	YEAR	一般	Genuine P/N	白金	IRIDIUM	T-T	鍍金性能型	鍍金耐久型	Qty	
<b>HONDA</b>													
ACCORD				2000-	KJ16CR-U11	98079-5514G	-	-	-	-	-	-	AUSTRALIA
				2000-	KJ20CR-U11	98079-5614G	-	-	-	-	-	-	CHINA
				2000-	KJ20CR-L11	98079-5615G	-	-	-	-	-	-	INDIA
		CR2	K24W5	2013-2014	DXE22HQR-D11S	12290-5A2-A01	-	-	-	-	-	-	INDONESIA
ACCORD 2.0L(7代)	2000		K20A7	2003-	KJ20DR-M11	-	-	-	-	-	-	4	KOREA
ACCORD 2.0L(8代)	2000		R20A3	2008-	SJ20DR-M11S	-	-	IK20TT	-	IK20G	VK20G	4	INDONESIA
ACCORD 2.0L(9代)油電	2000		LFA1	2017-	-	-	-	-	-	-	-	4	INDONESIA
ACCORD 2.4L	2400			2008-	SXU22HCR11S	-	-	-	-	-	VXUHC22G	4	INDONESIA
ACCORD 2.4L(8代)	2400		K24Z3	2008-	SJ20DR-M11S	-	-	-	-	-	-	4	INDONESIA
ACCORD 2.4L(9代)	2400		K24W1	2013-	DXE22HQR-D11S	-	-	-	-	-	-	4	INDONESIA
ACCORD 3.0L(7代)	3000		J30A4	2003-	KJ20DR-M11	9807B-5617P	-	IK20TT	K20TT	IK20	VK20	6	INDONESIA
ACCORD 3.5L	3500		J35Z2	2008-	SXU22HCR11S	-	-	-	-	IXUH22I	VXUH22I	6	INDONESIA
CITY			L15Z1	2013-	SKJ20DR-M13	12290-RB1-004	-	-	-	IK20	VK20	-	INDONESIA
CITY 1.5L	1500			2015-	DK20PR-D13	-	-	IK20TT	-	-	VFK20F	4	INDONESIA
	1500			2017-	DK20PR-D13	-	-	IK20TT	-	-	VFK20F	4	INDONESIA
CIVIC		FA3	LDA2	2009-	-	12290-RMX-013	-	-	-	-	VKH20	-	KOREA
				-	SK22PR-M11S	98079-571BV	-	-	-	-	-	-	KOREA
CIVIC 1.5L(五代)VTEC	1500			-	KJ16CR-L11	-	PKJ16CR-L11	IK16TT	K16TT	IK16L	VK16	4	KOREA
CIVIC 1.5L(六代)VTEC	1500			-	KJ16CR-L11	-	PKJ16CR-L11	IK16TT	K16TT	IK16L	VK16	4	KOREA
CIVIC 1.8L	1800	FB2	R18Z1	2012-	SXU22HCR11S	12290-R1A-H01	-	-	-	-	VXUHC22G	4	INDONESIA
CIVIC 1.8L(9代)	1800		R18Z1	2012-	SXU22HCR11S	-	-	-	-	-	-	4	INDONESIA
CIVIC 1.8L(八代)	1800	FA1	R18A1	2006-	SKJ20DR-M11S	9807B-561CW	-	IK20TT	-	IK20G	VK20G	4	INDONESIA
CIVIC 2.0L(9代)	2000		R20A5	2012-	SXU22HCR11S	-	-	-	-	-	-	4	INDONESIA
CIVIC 2.0L(八代)	2000	FD1	K20Z2	2006-	SKJ20DR-M11S	9807B-561BW	-	IK20TT	-	IK20L	VK20	4	INDONESIA
CRV				2000-	KJ20CR-U11	98079-5614G	-	-	-	-	-	-	INDONESIA
			RD1	B20B8	2000-	KJ16CR-U11	98079-5514G	-	-	-	-	-	INDONESIA
			RD1	B20B8	2000-	KJ16CR-L11	98079-5515G	-	-	-	-	-	INDONESIA
			RE1	R20A1	-	SKJ20DR-M11	9807B-561BW	-	-	-	-	-	INDONESIA
			RM1	R20A5	2014-	SXU22HCR11S	12290-R1A-H01	-	-	-	-	-	INDONESIA
CRV 2.0L	2000	RE2	R20A1	2010-2011	SKJ20DR-M11S	9807B-561CW	-	IK20TT	-	IK20G	VK20G	4	INDONESIA
	2000			2012-	SXU22HCR11S	12290-R1A-H01	-	-	-	-	VXUHC22G	4	INDONESIA
CRV 2.0L(2代)	2000		K20A4	2002-	KJ20CR-L11	-	PKJ20CR-L11	IK20TT	K20TT	IK20	VK20	4	INDONESIA
CRV 2.0L(3代)	2000	RD5	K20A1	2007-	KJ20DR-M11	9807B-5617P	-	IK20TT	K20TT	IK20	VK20	4	INDONESIA
	2000	RD5	K20A1	2007-	SKJ20DR-M11S	-	-	-	-	IK20G	VK20G	4	INDONESIA
CRV 2.0L(4代)	2000		R20A4	2013-	-	-	-	-	-	-	-	4	INDONESIA
CRV 2.4L	2400			2007.01-	KJ20DR-M11	-	-	IK20TT	K20TT	IK20	VK20	4	INDONESIA
	2400	RE4	K24Z1	2010-	KJ20DR-M11	9807B-5617P	-	IK20TT	-	IK20	VK20	4	INDONESIA
	2400			2012-2013	SXU22HCR11S	12290-R1A-H01	-	-	-	-	VXUHC22G	4	INDONESIA
CRV 2.4L(3代)	2400		K24Z1	2007-	SKJ20DR-M11S	-	-	-	-	-	-	4	INDONESIA
CRV 2.4L(4代)	2400		K24Z9	2013-	SXU22HCR11S	12290-R1A-H01	-	-	-	-	VXUHC22G	4	INDONESIA
CRZ 1.5L	1500		LEA1	2012-	DK20PR-D13	-	-	IK20TT	-	-	VFK20F	4	INDONESIA
	1500	ZF1	LEA3	2013-	SKJ20DR-M13	12290-RB1-004	-	IK20TT	-	IK20	VK20	4	INDONESIA
FERIO K10 1.7L	1700		D17Z1	2000-2004	KJ20CR-L11	-	PKJ20CR-L11	IK20TT	K20TT	IK20	VK20	4	INDONESIA
FIT 1.5	1500			2008-	SKJ20DR-M13	12290-RB1-004	-	IK20TT	-	IK20	VK20	4	INDONESIA
	1500			2019.11-	-	12290-RB0-J110-M1	-	-	-	-	-	4	INDONESIA
FIT 1.5(2代)	1500	GE8	L15A7	2009-	SKJ20DR-M13	12290-RB1-004	-	IK20TT	-	IK20	VK20	4	INDONESIA
FIT 1.5(3代)	1500		L15Z4	2014-	DK20PR-D13	-	-	IK20TT	-	-	VFK20F	4	INDONESIA
HR-V 1.8L	1800		R18ZJ	2016-	SXU22HCR11S	-	-	-	-	-	VXUHC22G	4	INDONESIA
	1800		R18ZJ	2019.05-	SXU22HCR11S	12290-R1A-H012-M1	-	-	-	-	VXUHC22G	4	INDONESIA
INSIGHT 1.3L	1300	ZE2	LDA3	2011-	-	-	-	-	-	-	VFKH20	4	INDONESIA
LEGENDY 3.5L	3500			2007-	SKJ20DR-M11	-	-	IK20TT	-	IK20	VK20	6	INDONESIA
ODYSSEY 2.4L	2400		K24W7	2015-	SXE22HQR11S	-	-	-	-	-	-	4	INDONESIA
STREAM 2.0L	2000		K20A1	2001-	-	-	-	-	-	-	-	4	INDONESIA
<b>HYUNDAI</b>													
COUPE 1.8L	1800			2002-2004	K16PR-U11	-	PK16PR11	IK16TT	K16TT	IK16	VK16	4	INDONESIA
COUPE 2.0L	2000			2002-2004	K20PR-U11	-	PK20PR11	IK20TT	K20TT	IK20	VK20	4	INDONESIA
ELANTRA 1.6L	1600			2002.09-	K16PR-U	-	PK16PR11	IK16TT	K16TT	IK16	VK16	4	INDONESIA
ELANTRA 1.8L	1800			2002.09-	K16PR-U	-	PK16PR11	IK16TT	K16TT	IK16	VK16	4	INDONESIA
GETZ 1.3L	1300			-	K16PR-U11	-	PK16PR11	IK16TT	K16TT	IK16	VK16	4	INDONESIA
i30	1600			2013-	-	-	-	-	-	IXUH22I	VXUH22I	-	INDONESIA
IX30				2007-	-	-	-	-	-	IXUH22I	VXUH22I	-	INDONESIA
IX35				2009-	K16HPR-U11	-	-	IKH16TT	KH16TT	IKH16	VKH16	-	INDONESIA
				2013-	K16HPR-U11	-	-	IKH16TT	KH16TT	IKH16	VKH16	-	INDONESIA
MATRIX 1.6L	1600			2003.06-	K16PR-U11	-	PK16PR11	IK16TT	K16TT	IK16	VK16	4	INDONESIA
MATRIX 1.8L	1800			2003.06-	K16PR-U11	-	PK16PR11	IK16TT	K16TT	IK16	VK16	4	INDONESIA
SANTA 2.7L	2700			2000-2004	-	-	PK16PR-L11	IK16TT	-	IK16	VK16	6	INDONESIA
TARJET 2.7L	2700			2000.07-	-	-	PK16PR-L11	IK16TT	-	IK16	VK16	6	INDONESIA
<b>DENSO</b>													
DENSO	9	14	16	20	22	24	27	29	31	32			
NGK	2	4	5	6	7	8	9	9.5	10	10.5	11	11.5	
<b>DENSO</b>													
DENSO	9	14	16	20	22	24	27	29	31	32			
CHAMPION	18	16,14	12,11	10,9	8,7	6,63,61	4,59	57	55	53			
<b>DENSO</b>													
DENSO	9	14	16	20	22	24	27	29	31	32			
BOSCH	10	9	8	7,6	5	4	3	2					

AUSTRALIA  
CHINA  
INDIA  
INDONESIA  
KOREA  
MALAYSIA  
PHILIPPINES  
SAUDIARABIA  
SINGAPORE  
TAIWAN  
THAILAND  
VIETNAM  
JAPAN  
EUROPE & USA  
CROSS REFERENCE NUMBER  
PART



▶ Spark plug color codes: ■ for Iridium Tough and Iridium Plugs and Iridium TT, ■ for Iridium Power, ■ for Iridium Racing and Two Tops Plugs, ■ for Platinum Plugs and Platinum TT, and black for general spark plugs.

車型	CC	VEHICLE CODE	ENGINE	YEAR	一般	Genuine P/N	白金				鉻合金性能型	鉻合金耐久型	Qty
<b>AUSTRALIA</b>													
<b>HYUNDAI</b>													
TUCSON 2.0L	2000			-	K16PR-U11	-	PK16PR11	IK16TT	K16TT	IK16	VK16		4
XG 2.0L	2000			2000-2005	-		PK16PR-L11	IK16TT	-	IK16	VK16		4
<b>CHINA</b>													
<b>INFINITI</b>													
FX35 3.5L	3500/4500	S50	VQ35DE	2004-2005	-	22401-5M014	-	IKH16TT	-	IKH16	VKH16		6
	3500/4500	S50	VQ35DE	2007-	-	22401-5M016	-	-	-	-	VKH16		6
	3500/4500			2010-	FXE20HR11	-		IXEH20TT	-	-	VFXEH20		4
FX45 4.5L	3500/4500	S50	VQ35DE	2004-2005	-	22401-5M014	-	IKH16TT	-	IKH16	VKH16		8
	3500/4500	S50	VQ35DE	2007-	-	22401-5M016	-	-	-	-	VKH16		8
<b>INDIA</b>													
G35 3.5L	3500	V35	VQ35DE	2006-	-	22401-5M016	-	IKH16TT	-	IKH16	VKH16		6
G35/37/25		V36	VQ35HR	2006-	FXE22HR11	22401-EW61C	-	-	-	-	VFXEH22		6
		V36	VQ37VHR	2012-	FXE24HR11	22401-JK01D	-	-	-	-	-		6
<b>INDONESIA</b>													
M35/45 3.5L/4.5L	3500/4500	Y50	VK45DE	2005-	-	22401-5M016	-	IKH16TT	-	IKH16	VKH16		6
	3500/4500	Y50	VQ35HR	2008-	FXE22HR11	22401-EW61C	-	-	-	-	VFXEH22		6
Q45	4500	F50	VK45DE	2004-	-	22401-5M016	-	-	-	-	VKH16		8
Q50		V37	VQ35HR	2013-	FXE22HR11	22401-EW61C	-	-	-	-	VFXEH22		-
		V37	VQ37VHR	2014-	FXE24HR11	22401-JK01D	-	-	-	-	-		-
<b>KOREA</b>													
Q60/G	2000	HV36	VQ37VHR	2010-	FXE24HR11	22401-JK01D	-	-	-	-	-		4
Q70/M		Y51	VQ37VHR	2010-	FXE24HR11	22401-JK01D	-	-	-	-	-		-
QX70/FX	3700	S51	VK50VE	2013-	FXE22HR11	22401-EW61C	-	-	-	-	VFXEH22		6
		S51	VQ37VHR	2013-	FXE24HR11	22401-JK01D	-	-	-	-	-		-
<b>MALAYSIA</b>													
<b>ISUZU</b>													
RODEO 3.5L	3500			-	-	-	PK16PR-L11	IK16TT	-	IK16	VK16		6
TROOPER 3.5L	3500			-	-	-	PK20PR11	IK20TT	-	IK20	VK20		6
<b>PHILIPPINES</b>													
<b>JAGUAR</b>													
DAIMLER 4.0L	4000			-	K16P-U	-	-	IK16TT	K16TT	IK16	VK16		8
SOVEREIGN 3.2L	3200			-	K20PR-U	-	PK20PR11	IK20TT	K20TT	IK20	VK20		6
S-TYPE 2.5L/3.0L	2500/3000			2003-2005	-	-	PT16EPR-L13	IT16TT	-	IT16	VT16		-
XJ8 3.5L/4.2L	3500/4200			2003.03-	-	-	-	IK16TT	-	IK16	VK16		-
XJ8L 3.5L/4.2L	3500/4200			2003.03-	-	-	-	IK16TT	-	IK16	VK16		-
XK 4.2L	4200			2006.05-	-	-	-	IK16TT	-	IK16	VK16		-
XK8 4.2L	4200			2002.09-	-	-	-	IK16TT	-	IK16	VK16		-
XKR 4.2L	4200			2002.09-	-	-	-	IK16TT	-	IK16	VK16		-
X-TYPE 2.1L/2.5L/3.0L	2100/2500/3000			2001-2005	-	-	PK16PR11	IK16TT	-	IK16	VK16		-
<b>SINGAPORE</b>													
<b>KIA</b>													
EURO STAR 1.1L	1100			-	K16PR-U11	-	PK16PR11	IK16TT	K16TT	IK16	VK16		4
EURO-CARENS 2.0	2000			-	K20PR-U	-	PK20PR11	IK20TT	K20TT	IK20	VK20		4
<b>TAIWAN</b>													
JOICE 2.0L	2000			-	W20EXR-U11	-	-	IW20TT	W20TT	IW20	VW20		-
RIO 1.3L	1300			2000-2003	W16EXR-U11	-	-	IW16TT	W16TT	IW16	VW16		-
RIO 1.5L	1500			2000-2003	K20PR-U11	-	PK20PR11	IK20TT	K20TT	IK20	VK20		-
SHUMA 1.8L	1800			-	K20PR-U	-	PK20PR11	IK20TT	K20TT	IK20	VK20		-
<b>THAILAND</b>													
<b>SORENTO 3.5L</b>													
	3500			-	-	-	PK16PR-L11	IK16TT	-	IK16	VK16		-
<b>VIETNAM</b>													
<b>LEXUS</b>													
CT 200h	1800			2010.12-2015.03	SC20HR11	9091901253	-	IXEH22TT	-	-	VCH20		4
				2015.04-	SC16HR11	9091901275	-	-	-	-	-		4
ES 200	2000			2015-2016	FK16HBR-J8	9091901286	-	-	-	-	-		4
	2000			2018.06-2020.07	FK16HBR-J8	9091901286	-	-	-	-	-		4
	2000			2021.10-	FC20HR-Q8	9091901297	-	-	-	-	-		4
ES 240	2400			2010-2012	SK20R11	9091901210	-	IK20TT	-	IK20	VK20		4
ES 250	2500			2012.06-	SK16HR11	9091901233	-	IKH16TT	-	IKH16	VKH16		6
	2500			2018.06-	FC16HR-Q8	9091901289	-	-	-	-	VFCH16		4
ES 300/330				2003.05-	SK20R11	9091901210	-	IK20TT	-	IK20	VK20		4
ES 300h	2500			2012.06-	FK16HR-A8	9091901259	-	IKH16TT	-	-	VFKH16		4
	2500			2018.06-	FC16HR-Q8	9091901289	-	-	-	-	VFCH16		4
ES 350	3500			2007-2012	FK20HR11	9091901247	-	IKH20TT	-	-	VFKH20		6
	3500			2012.06-	FK20HR11	9091901247	-	IKH20TT	-	-	VFKH20		6
<b>USA</b>													
<b>GS 200t</b>													
	2000			2012-2016	VDKH22F	9091901276	-	-	-	-	VDKH22F		4
	2000			2015.10-	VDKH22F	9091901276	-	-	-	-	VDKH22F		4
GS 250/350	2500/3500			2012.01-2015.10	FK20HBR11	9091901249	-	IKBH20TT	-	-	VFKBH20		6
GS 300/430				2005.01-	FK20HBR11	9091901249	-	IKBH20TT	-	-	VFKBH20		6
GS 300h	2500			2015.10-	FK20HBR8	9091901263	-	IKBH20TT	-	-	VFKBH20		4
	2500			2013.09-	FK20HBR8	9091901263	-	IKBH20TT	-	-	VFKBH20		4
GS 350	3500			2007-2012	FK20HBR11	9091901249	-	IKBH20TT	-	-	VFKBH20		6
	3500			2012-2015	FK20HBR11	9091901249	-	IKBH20TT	-	-	VFKBH20		6
	3500			2015-	FK20HBR8	9091901263	-	IKBH20TT	-	-	VFKBH20		6





車型	CC	VEHICLE CODE	ENGINE	YEAR	一般	Genuine P/N	白金	IRIDIUM	T-T	鍍金性能型	鍍金耐久型	Qty		
<b>LEXUS</b>														
GS 450h	3500			2007-2012	FK20HBR11	9091901249	-			IKBH20TT	-	VFKBH20	6	AUSTRALIA
	3500			2012.03-	FK20HBR8	9091901263	-			IKBH20TT	-	VFKBH20	6	CHINA
GS F	5000			2015.10-	FK20HBR-J8	9091901279	-			-	-	VFKBH20	8	INDIA
IS 200/300				2003.05-	SK20RP11	9091901207	-			IK20TT	-	IK20 VK20	6	INDONESIA
IS 200t/300	2000			2015.08-	VDKH22F	9091901276	-			-	-	VDKH22F	4	KOREA
IS 250	2500			2013.04-2015.08	FK20HBR11	9091901249	-			IKBH20TT	-	VFKBH20	6	PHILIPPINES
IS 250C	2500			2009-2013	FK20HBR11	9091901249	-			IKBH20TT	-	VFKBH20	6	SAUDARABIA
IS 300h	2500			2013.04-	FK20HBR8	9091901263	-			IKBH20TT	-	VFKBH20	4	SINGAPORE
LC 500	5000		汽油版	2017.03-	FK20HBR-J8	9091901279	-			-	-	VFKBH20	8	TAIWAN
LC 500h Hybrid	3500		油電版	2017.03-	FK20HBR8	9091901263	-			IKBH20TT	-	VFKBH20	6	THAILAND
LM 300h				2020.01-	FK16HR-A8	9091901259	-			IKH16TT	-	VFKH16	4	VIETNAM
LS 350	3500			2017.10-	FK20HBR8	9091901263	-			IKBH20TT	-	VFKBH20	6	JAPAN
LS 430	4300			2000-	-	-	-	PK20R11		IK20TT	-	IK20 VK20	8	
	4600/5000			2006-	FK20HBR11	9091901249	-			IKBH20TT	-	VFKBH20	8	
LS 460/600h	4600/5000			2013-2016	FK20HBR11	9091901249	-			IKBH20TT	-	VFKBH20	8	
	4600/5000			2000-	-	-	-	PK20R11		IK20TT	-	IK20 VK20	8	
LS 470				2017.12-	EC22HPR-D7	9091901295	-			-	-	-	6	
LS 500	3500			2017.10-	FK20HBR8	9091901263	-			IKBH20TT	-	VFKBH20	6	
LX 570	5700			2008-2016	SK20HR11	9091901191	-			IKH20TT	-	IKH20 VKH20	8	
NX 200	2000			2017.09-	SC16HR11	9091901275	-			-	-	-	4	
	2000			2021.11-	FC20HR-Q8	9091901297	-			-	-	-	4	
NX 200t	2000			2014.12-2017.09	VDKH22F	9091901276	-			-	-	VDKH22F	4	
NX 250				2021.11-	FC16HR-Q8	9091901289	-			-	-	VFCH16	4	
NX 300	2000			2017.09-	VDKH22F	9091901276	-			-	-	VDKH22F	4	
NX 300h	2500			2014.07-	FK16HR-A8	9091901259	-			IKH16TT	-	VFKH16	4	
NX 350				2021.11-	-	9091901303	-			-	-	-	-	
NX 350h				2021.11-	FC16HR-Q8	9091901289	-			-	-	VFCH16	4	
NX450h+				2021.11-	FC16HR-Q8	9091901289	-			-	-	VFCH16	4	
RC 200t/300	2000			2015.10-2018.10	VDKH22F	9091901276	-			-	-	VDKH22F	4	
RC 300	2000		8AR-FTS	2018.10-2020.09	VDKH22F	9091901276	-			-	-	VDKH22F	4	
RC 300h	2500			2015.10-2018.10	FK20HBR8	9091901263	-			IKBH20TT	-	VFKBH20	4	
RC 350	3500		ZGR-FKS	2017.11-	FK20HBR8	9091901263	-			IKBH20TT	-	VFKBH20	6	
RC F	5000		ZUR-GSE	2014.09-	FK20HBR-J8	9091901279	-			-	-	VFKBH20	8	
RC F Track Edition	5000		ZUR-GSE	2019.05-	FK20HBR-J8	9091901279	-			-	-	VFKBH20	8	
RX 200	2000			2018.06-	FK16HBR-J8	9091901286	-			-	-	-	-	
RX 200t	2000			2015.09-2019.08	VDKH22F	9091901276	-			-	-	VDKH22F	4	
RX 250	2500			2018.06-	FC16HR-Q8	9091901289	-			-	-	VFCH16	4	
RX 270	2700			2012-2015	SK16HR11	9091901233	-			IKH16TT	-	IKH16 VKH16	4	
RX 300			8AR-FTS	2015.09-	VDKH22F	9091901276	-			-	-	VDKH22F	4	
RX 300h	3000			2018.09-	FC16HR-Q8	9091901289	-			-	-	VFCH16	-	
RX 330				2003-	SK20R11	9091901210	-			IK20TT	-	IK20 VK20	6	
RX 350	3500			2014.09-2017.11	FK20HBR11	9091901249	-			IKBH20TT	-	VFKBH20	6	
	3500			2012-2017	FK20HBR11	9091901249	-			IKBH20TT	-	VFKBH20	6	
	3500			2015.09-	FK20HBR8	9091901263	-			IKBH20TT	-	VFKBH20	6	
RX 350長軸				2017.12-	FK20HBR8	9091901263	-			IKBH20TT	-	VFKBH20	6	
RX 400h Hybrid	3300			2006-2008	SK20R11	9091901210	-			IK20TT	-	IK20 VK20	6	
RX 450h	3500			2012-	FK20HR11	9091901247	-			IKH20TT	-	VFKH20	6	
				2015.09-	FK20HBR8	9091901263	-			IKBH20TT	-	VFKBH20	6	
RX 450h長軸				2017.12-	FK20HBR8	9091901263	-			IKBH20TT	-	VFKBH20	6	
SC 430	4300			2001-	SK20R11	9091901210	-			IK20TT	-	IK20 VK20	8	
UX 200				2018.10-	FC20HR-Q8	9091901297	-			-	-	-	4	
UX 250h	2000		M20A-FXS	2018.11-	FC16HR-Q8	9091901289	-			-	-	VFCH16	4	
<b>LUXGEN</b>														
LUXGEN S5 TURBO				-	K20PR-U	-	-			-	-	IK20 VK20	-	
LUXGEN U6 TURBO				-	K20PR-U	-	-			-	-	IK20 VK20	-	
LUXGEN7 MVP/CEO 2.2L	2200			2010-	K16HPR-U11	-	-			IKH16TT KH16TT	-	IKH16 VKH16	4	
LUXGEN7 SUV 2.2L	2200			2010-	K16HPR-U11	-	-			IKH16TT KH16TT	-	IKH16 VKH16	4	
<b>MAZDA</b>														
323 ISAMU 1.6L	1600			2004.12-	K16PR-U11	-	-	PK16PR11		IK16TT K16TT	-	IK16 VK16	4	
CX3 SKY-G 2.0				-	-	-	-			-	-	-	-	
CX5 2.0 SKYACTIV-G	2000			2013-	-	-	-			IXEH22TT	-	VFXEH22	4	
CX7 2.3	2300			2009-2011	-	-	-			ITV20TT	-	ITV20	4	
CX9 2.5	2500			2016-	-	PY8V-1-110	-			-	-	VFXEH22	4	
CX9 3.8 V6	3800			-	-	-	-			-	-	ITV22	6	
MAZDA 2 1.5L	1500			2007-	-	-	-			IK16TT	-	IK16 VK16	4	
MAZDA 3				2013-	-	-	-			IXEH22TT	-	VCH20	4	
MAZDA 3 1.6L	1600			2004.06-	-	-	-			IK16TT	-	IK16 VK16	4	
DENSO	9	14	16	20	22	24	27	29	31	32				
NGK	2	4	5	6	7	8	9	9.5	10	10.5	11	11.5		
DENSO	9	14	16	20	22	24	27	29	31	32				
CHAMPION	18	16,14	12,11	10,9	8,7	6,63,61	4,59	57	55	53				
DENSO	9	14	16	20	22	24	27	31	32					
BOSCH	10	9	8	7,6	5	4	3	2						

AUSTRALIA  
CHINA  
INDIA  
INDONESIA  
KOREA  
MALAYSIA  
PHILIPPINES  
SAUDARABIA  
SINGAPORE  
TAIWAN  
THAILAND  
VIETNAM  
JAPAN  
EUROPE  
& USA  
CROSS  
REFERENCE  
NUMBER  
PART



▶ Spark plug color codes: ■ for Iridium Tough and Iridium Plugs and Iridium TT, ■ for Iridium Power, ■ for Iridium Racing and Two Tops Plugs, ■ for Platinum Plugs and Platinum TT, and black for general spark plugs.

車型	CC	VEHICLE CODE	ENGINE	YEAR	一般	Genuine P/N	白金				鍍金性能型	鍍金耐久型	Qty
<b>AUSTRALIA</b>													
<b>MAZDA</b>													
MAZDA 3 2.0L	2000			2004.06-	-	-	-	IT16TT	-	-	IT16	VT16	4
	2000			2007.03-	-	-	-	ITV16TT	-	-	ITV16	-	4
MAZDA 3 2.5S	2500			2012-	-	-	-	ITV16TT	-	-	ITV16	-	4
<b>CHINA</b>													
MAZDA 5 2.0L	2000			2005.11-	-	-	-	IT16TT	-	-	IT16	VT16	4
	2000			2011-	-	-	-	ITV16TT	-	-	ITV16	-	4
	2000			2015-	LFG1 18 110, L3V2 18 110	-	-	ITV16TT	-	-	ITV16	-	4
<b>INDIA</b>													
MAZDA 6				-	-	-	-	-	-	-	-	-	-
MAZDA 6 2.0 SKYACTIV-G	2000			2013-	-	-	-	IXEH22TT	-	-	-	VFXEH22	4
MAZDA 6 2.0/2.3L	2000/2300			2005-	-	-	PT20EPR-L13	IT20TT	-	-	IT20	VT20	4
MAZDA 6 2.3L	2300			2006.06-	-	-	-	ITV16TT	-	-	ITV16	-	4
MPV 3.0L	3000			2002-	-	-	-	IT20TT	-	-	IT20	VT20	6
<b>INDONESIA</b>													
OSHYARE 3.0L 2WD	3000			2003.07-	-	-	PT20EPR-L13	IT20TT	-	-	IT20	VT20	6
PREMACY 2.0L	2000			2003-	K16PR-U11	-	PK16PR11	IK16TT	K16TT	IK16	VK16	-	4
PROTEGE 1.6L	1600			-	KJ16CR-11	-	PKJ16CR-L11	IK16TT	K16TT	IK16L	VK16	-	4
TRIBUTE 2.0L	2000			2001-2004	-	-	PT16VR13	ITV16TT	-	-	ITV16	-	4
TRIBUTE 2.3L	2300			2006.06-	-	-	-	ITV16TT	-	-	ITV16	-	4
	2300			2004-2006.06	-	-	-	IT20TT	-	-	IT20	VT20	4
TRIBUTE 3.0L	3000			2004.05-	T16EPR-U15	-	-	IT16TT	-	-	IT16	VT16	6
<b>KOREA</b>													
<b>MINI</b>													
COOPER 1.6L	1600			2002-	K20TXR	-	-	IK20TT	K20TT	IK20	VK20	-	4
COOPER S 1.6L	1600			2002-	K20TXR	-	-	IK20TT	K20TT	IK20	VK20	-	4
ONE 1.6L	1600			2002-	K20TXR	-	-	IK20TT	K20TT	IK20	VK20	-	4
<b>MALAYSIA</b>													
<b>MITSUBISHI</b>													
COLT PLUS 1.5L				2017-	-	-	-	IKH16TT	-	-	IKH16	VKH16	4
COLT PLUS 1.6L	1600			2007-	K20PR-U11	-	PK20PR11	IK20TT	K20TT	IK20	VK20	-	4
<b>PHILIPPINES</b>													
GLOBAL LANCER 1.6/1.8L	1600/1800			2001-2005	K16PR-U11	-	PK16PR11	IK16TT	K16TT	IK16	VK16	-	4
	1600/1800			2002-	K20PR-U11	-	PK20PR11	IK20TT	K20TT	IK20	VK20	-	4
<b>SAUDI ARABIA</b>													
GRUNDER 2.4L	2400			2004.12-	-	-	-	IKH20TT	-	-	IKH20	VKH20	4
INSPIRE 2.4L	2400			-	K16PR-U11	-	PK16PR11	IK16TT	K16TT	IK16	VK16	-	-
<b>SINGAPORE</b>													
LANCER		CY4A 4B11		2007-	SK20PR-A8	MN163236	-	-	-	-	-	-	4
LANCER FORTIS 1.8L/io 2.0L	1800/2000			-	K20PSR-B8	-	-	IK20TT	K20TT	IK20	VK20	-	4
MAGIC 1.6L	1600			2000-2005	K16PR-U11	-	PK16PR11	IK16TT	K16TT	IK16	VK16	-	4
<b>TAIWAN</b>													
OUTLANDER 2.4	2400			2003.05-	-	-	-	IKH20TT	-	-	IKH20	VKH20	4
	2400			2007-	K20PSR-B8	-	-	IK20TT	K20TT	IK20	VK20Y	-	4
	2400			2011-	-	-	-	IK16TT	K16TT	IK16	VK16	-	4
	2400	GF3W 4B12		2012-	K16PSR-B8	MN163235	-	IK16TT	K16TT	IK16	VK16	-	4
PAJERO 3.8L	3800			2005-	-	-	-	IK20TT	-	-	IK20	VK20	6
PAJERO PININ 1.8L	1800			2002-	K16PR-U11	-	PK16PR11	IK16TT	K16TT	IK16	VK16	-	4
SAVRIN 2.0L	2000			2002-2005	W20EXR-U11	-	-	IW20TT	W20TT	IW20	VW20	-	4
<b>THAILAND</b>													
SAVRIN 2.4L	2400			-	-	-	-	IKH20TT	-	-	IKH20	VKH20	4
SPACE GEAR 2.4L	2400			2001-2004	K16PR-U11	-	PK16PR11	IK16TT	K16TT	IK16	VK16	-	4
VERYCA 1.2L	1200			2000-2005	K16PR-U11	-	PK16PR11	IK16TT	K16TT	IK16	VK16	-	4
VIRAGE io 1.8L	1800			2001-2005	K20PR-U11	-	PK20PR11	IK20TT	K20TT	IK20	VK20	-	4
<b>VIETNAM</b>													
ZINGER				2016-	K20PR-U11	-	PK20PR11	IK20TT	K20TT	IK20	VK20	-	4
				2017-	K20PR-U11	-	PK20PR11	IK20TT	K20TT	IK20	VK20	-	4
ZINGER 2.4L	2400			2008-	K16PR-U11	-	PK16PR11	IK16TT	K16TT	IK16	VK16	-	4
	2400			2019.10-	K20PR-U11	-	PK20PR11	IK20TT	K20TT	IK20	VK20	-	4
<b>JAPAN</b>													
威力 1.1L	1100			-	XU22EPR-U	-	-	-	XU22TT	IXU22	VXU22	-	4
威力 1.2L	1200			-	K16PR-U11	-	PK16PR11	IK16TT	K16TT	IK16	VK16	-	4
得力卡 2.0L	2000			-	K16PR-U11	-	PK16PR11	IK16TT	K16TT	IK16	VK16	-	4
得力卡 2.4L	2400			-	K16PR-U11	-	PK16PR11	IK16TT	K16TT	IK16	VK16	-	4
	2400			2019.09-	K20PR-U11	-	PK20PR11	IK20TT	K20TT	IK20	VK20	-	4
得力卡 2.5L	2500			-	K16PR-U11	-	PK16PR11	IK16TT	K16TT	IK16	VK16	-	4
<b>EUROPE &amp; USA</b>													
<b>NISSAN</b>													
350Z	3500	Z33	VQ35DE	2003-	-	22401-5M014	-	IKH16TT	-	-	IKH16	VKH16	6
AD RESORT 1.6L	1600			-	K16PR-U11	-	PK16PR11	IK16TT	K16TT	IK16	VK16	-	-
ALL NEW SENTRA M1 2.0L	2000			2003-2005	K16HPR-U11	-	-	IKH16TT	KH16TT	IKH16	VKH16	-	4
AREX 1.8L	1800			-	K16PR-U11	-	PK16PR11	IK16TT	K16TT	IK16	VK16	-	4
BIG TIIDA 1.6L	1600			2013-	FXE20HR11	-	-	IXEH20TT	-	-	VFXEH20	-	4
CEFIRO 3.5L	3500			2003-2005	-	-	-	IKH16TT	-	-	IKH16	VKH16	6
<b>CROSS REFERENCE NUMBER</b>													
GRAND LIVINA				2012-	FXE22HR11	22401-ED816	-	-	-	-	-	VFXEH22	4
		L10N	HR15DE	-	FXE20HE11	22401-ED71B	-	-	-	-	-	-	4
<b>PART NUMBER</b>													
KICKS	1500			2018-	-	-	-	-	-	-	-	-	-
LIVINA		L11N	MR18DE	2013-	FXE22HR11	22401-ED816	-	-	-	-	-	VFXEH22	4
LIVINA 1.8L	1800	L10N	HR15DE	2007-2011	FXE20HR11	22401-ED71B	-	IXEH20TT	-	-	-	VFXEH20	4



車型	CC	VEHICLE CODE	ENGINE	YEAR	一般	Genuine P/N	白金	IRIDIUM	T-T	鍍金性能型	鍍金耐久型	Qty		
<b>NISSAN</b>														
MARCH		K12	CR14DE	2006-	IKH16	22401-8H314	-	-	-	-	-	4	AUSTRALIA	
		K13B	HR16DE	2014-	FXE20HR11	22401-CP51B	-	-	-	-	-	4		
MAXIMA 2.0L	2000						PK16PR-L11	IK16TT		IK16	VK16	4	CHINA	
MURANO		Z52	VQ35DE	2016-	FXE22HR11	22401-EW61C	-	-	-	-	VFXEH22	4		
MURANO 3.5L	3500	Z50	VQ35DE	2006-				IKH16TT		IKH16	VKH16	4	INDIA	
NRV					K16PR-U11		PK16PR11	IK16TT	K16TT	IK16	VK16	4		
QRV 2.0L	2000			2001-2005	K16R-U11		PK16R11	IK16TT	K16TT	IK16	VK16	6	INDONESIA	
QUEST 3.3L	3300			2002-				IK20TT		IK20	VK20	6		
QUEST 3.5L	3500			2005-				IKH16TT		IKH16	VKH16	6	KOREA	
ROGUE 2.5L	2500			2010-	FXE22HR11			IXEH22TT		-	VFXEH22	4		
SENTRA		B16X	MR20DE	2008-	FXE20HR11	22401-CP51B				-	-	4	MALAYSIA	
		B17U	MR20DE	2013-	FXE20HR11	22401-CP51B				-	-	4		
SENTRA 2.5L	2500	QRV		2007-						IKH16	VKH16	4	PHILIPPINES	
SERENA 2.5L	2500			2001.09-	K16R-U11		PK16R11	IK16TT	K16TT	IK16	VK16	6		
SUPER MARCH 1.3L	1300			2004.12-	K16PR-U11		PK16PR11	IK16TT	K16TT	IK16	VK16	4	SAUDI ARABIA	
SYLPHY 2.0L	2000			2007-	FXE20HR11			IXEH20TT		-	VFXEH20	4		
TEANA		J31	QR20DE	2003-	K20HR-U11	22401-8H516				-	-	4	SINGAPORE	
TEANA 2.0L	2000	J32T	MR20DE		FXE22HR11	22401-ED816				-	-	4		
TEANA 2.0L/2.3L	2000/2300	J31Z	VQ23DE	2004.09-		22401-5M014		IKH16TT		IKH16	VKH16	4	TAIWAN	
TEANA 2.0L/2.5L	2000/2500	J32L	VQ25DE	2010-	FXE20HR11	22401-JD01B		IXEH20TT		-	VFXEH20	4		
TEANA 2.3L	2300	J31		2006-				IKH16TT		IKH16	VKH16		THAILAND	
TEANA 2.5L	2500	J32T	VQ25DE		FXE20HR11	22401-JD01B				-	-	4		
TEANA 3.5L	3500	J31Z	VQ23DE	2004.09-		22401-5M014		IKH16TT		IKH16	VKH16	6	VIETNAM	
	3500	J32Z	VQ35DE	2010-	FXE22HR11	22401-EW61C		IXEH22TT		-	VFXEH22	6		
TIIDA 1.6L	1600	C12W	HR16DE	2012-	FXE22HR11	22401-ED816				-	-	4	JAPAN	
TIIDA 1.6L/1.8L	1600/1800			2007-	FXE20HR11			IXEH20TT		-	VFXEH20	4		
TIIDA 1.8L	1800			2008-	FXE20HR11			IXEH20TT		-	VFXEH20	4	EUROPE & USA	
VERITA 1.3L	1300			2005.07-	K16PR-U11		PK16PR11	IK16TT	K16TT	IK16	VK16	4		
X-TRAIL 2.0L	2000		MR20DD	2013-	FXE22HR11					-	-	4	CROSS REFERENCE NUMBER	
X-TRAIL 2.0L/2.5L	2000/2500			2004.05-	K16HPR-U11			IKH16TT	KH16TT	IKH16	VKH16	4		
X-TRAIL 2.5L	2500		QR25DE	2014-	FXE20HE11	22401-ED71B				-	-	4		
<b>OPEL</b>														
ASTRA 1.6L	1600				K20PR-U			IK20TT	K20TT	IK20	VK20	4	PART	
ASTRA-G 1.8L	1800			2001-2005	K20TXR			IK20TT	K20TT	IK20	VK20	4		
CORSA 1.2L	1200			2002-2005	K20TXR			IK20TT	K20TT	IK20	VK20	-		
CORSA 1.8L	1800			2004-2005	K20TXR			IK20TT	K20TT	IK20	VK20	4		
VECTRA-C 2.2L	2200			2004-2005				ITV20TT		ITV20	-	4		
<b>PEUGEOT</b>														
106 1.4L	1400				K20TXR			IK20TT	K20TT	IK20	VK20	4	PART	
206 1.4L	1400			2001.01-	K20PR-U		PK20PR11	IK20TT	K20TT	IK20	VK20	4		
206 1.6L	1600			2000.01-	K20PR-U		PK20PR11	IK20TT	K20TT	IK20	VK20	4		
206 CC 2.0L	2000			2000.01-	K16HPR-U11			IKH16TT	KH16TT	IKH16	VKH16	4		
206 SW 1.6L	1600			2001.03-	K20HPR-U11			IKH20TT	KH20TT	IKH20	VKH20	4		
307 1.6L	1600			2001-2005	K20HPR-U11			IKH20TT	KH20TT	IKH20	VKH20	4		
307 2.0L	2000			2001-2005	K16HPR-U11			IKH16TT	KH16TT	IKH16	VKH16	4		
307 SW 2.0L	2000			2001.04-	K16HPR-U11			IKH16TT	KH16TT	IKH16	VKH16	4		
407 2.2L	2200			2005.06-				IKH16TT		IKH16	VKH16	4		
407 3.0L	3000			2005.06-				IKH16TT		IKH16	VKH16	6		
407 SW 2.2L	2200			2005.06-				IKH16TT		IKH16	VKH16	4		
407SW 3.0L	3000			2005.06-				IKH16TT		IKH16	VKH16	6		
607 2.2L	2200			2000.05-	K16HPR-U11			IKH16TT	KH16TT	IKH16	VKH16	4		
607 3.0L	3000			2000.05-				IKH16TT		IKH16	VKH16	6		
807 2.2L	2200			2004-2005	K16HPR-U11			IKH16TT	KH16TT	IKH16	VKH16	4		
<b>RENAULT</b>														
CLIO 1.4L	1400			2002-2004	K16PR-TP11			IK16TT		IK16	VK16	4		PART
CLIO RS 2.0L	2000			2002-2004	K20TXR			IK20TT	K20TT	IK20	VK20	4		
SPACE 2.0L	2000				W16EXR-U			IW16TT	W16TT	IW16	VW16	4		
LAGUNA 2.0L	2000			2002-2004	K20TXR			IK20TT	K20TT	IK20	VK20	4		
LAGUNA 3.0L	3000			2001-2004				IK20TT		IK20	VK20	6		
MAGANE 2.0L	2000			2004.03-			PK22PR8			IK22	VK22	4		
SAFRANE 2.5L	2500				Q20R-U		PQ20R	IQ20TT	Q20TT	IQ20	VQ20	5		
<b>SAAB</b>														
9-3 AERO TURBO 2.0L	2000			2000-			PK20PR11	IK20TT		IK20	VK20	4	PART	
9-3 AERO TURBO 2.3L	2300			2001-2002			PK20PR11	IK20TT		IK20	VK20	4		
9-3 TURBO 2.3L	2300			2000-			PK22PR11			IK22	VK22	4		
9-3SS TURBO 2.0L	2000			2003-			PK20PR-L11	IK20TT		IK20	VK20	4		
9-5 AERO TURBO 2.3L	2300			2000-			PK20PR11	IK20TT		IK20	VK20	4		
DENSO	9	14	16	20	22	24	27	29	31	32				
NGK	2	4	5	6	7	8	9	9.5	10	10.5	11	11.5		
DENSO	9	14	16	20	22	24	27	29	31	32				
CHAMPION	18	16,14	12,11	10,9	8,7	6,63,61	4,59	57	55	53				
DENSO	9	14	16	20	22	24	27	29	31	32				
BOSCH	10	9	8	7,6	5	4	3	2						

AUSTRALIA  
CHINA  
INDIA  
INDONESIA  
KOREA  
MALAYSIA  
PHILIPPINES  
SAUDI ARABIA  
SINGAPORE  
TAIWAN  
THAILAND  
VIETNAM  
JAPAN  
EUROPE & USA  
CROSS REFERENCE NUMBER  
PART



AUSTRALIA	車型	CC	VEHICLE CODE	ENGINE	YEAR	一般	Genuine P/N	白金				鉻合金性能型	鉻合金耐久型	Qty
		<b>SKODA</b>												
	FABIA 1.2L	1200			2007-	KJ20DR-M11	-	-	IK20TT	-	-	IK20	VK20	4
	FABIA 1.4L	1400			2007-	KJ16CRL11/K16GPR-U11	-	-	-	-	-	-	VKA16	4
	OCTAVIA 1.6L	1600			-	K20PBR-S10	-	-	IK20TT	K20TT	-	IK20	VK20	4
	OCTAVIA 1.8L	1800			2010-	-	-	-	-	-	-	IK22	VK22	4
	OCTAVIA 2.0L	2000			2004-2010	-	-	-	-	-	-	-	VKA16	4
	OCTAVIA TURBO 1.8	1800			2009-	-	-	-	-	-	-	IK22	VK22	4
	SUPERB 1.8L TURBO	1800			2001-2008	-	-	PK20PR-P8	IK20TT	-	-	IK20	VK20Y	4
	SUPERB 2.8L	2800			2001-2008	K20TXR	-	-	IK20TT	K20TT	-	IK20	VK20	6
	SUPERB V6 3.6	3600			-	K20TXR	-	-	IK20TT	K20TT	-	IK20	VK20	6
	YETI 1.2	1200			2009-	-	-	-	-	-	-	IK22	VK22	4
	<b>SUBARU</b>													
	BRZ 2.0L	2000			2012.03-	ZXE27HBR8	-	-	-	-	-	-	VXEBH27	4
	FORESTER 2.0L	2000			2000-2005	-	-	PK20PR11	IK20TT	-	-	IK20	VK20	4
	FORESTER 2.0L FB20	2000			2012-2013	-	-	-	IXEH22TT	-	-	-	VFXEH22	4
		2000			2013-	-	-	-	IXEH22TT	-	-	-	VFXEH22	4
	FORESTER 2.0L FB20(DOHC)	2000			2010-2012	-	-	-	IXEH22TT	-	-	-	VFXEH22	4
	FORESTER 2.0L TURBO	2000			2000-2005	-	-	-	-	-	-	IK20	VK20Y	4
	FORESTER 2.5L	2500			2000-2005	-	-	PK20PR11	IK20TT	-	-	IK20	VK20	4
	FORESTER 2.5L TURBO	2500			2000-2005	-	-	-	-	-	-	IKH22	VKH22	4
	IMPREZA 1.6L FB16	1600			2011-2013	-	-	-	IXEH22TT	-	-	-	VFXEH22	4
		1600			2013-	-	-	-	IXEH22TT	-	-	-	VFXEH22	4
	IMPREZA WRX 2.5L TURBO	2500			2006-	-	-	-	IKH20TT	-	-	IKH20	VKH20	4
	IMPREZA XV HYBRID 2.0L FB20	2000			2013-	-	-	-	IXEH22TT	-	-	-	VFXEH22	4
	LEGACY 2.5L FB25	2500			2012-	-	-	-	IXEH22TT	-	-	-	VFXEH22	4
	OUTBACK 3.0L	3000			2005.02-	-	-	-	IKH20TT	-	-	IKH20	VKH20	6
	<b>SUZUKI</b>													
	ALTO 1.0 (K10B)	1000		K10B	2009-	ZXU20PR11	-	-	-	-	-	-	-	3
	BALENO 1.0L (K10C)	1000		K10C	2017-	-	-	-	-	-	-	-	-	3
	CARRY 1.3L	1300			2000-2005	K20PR-U	-	PK20PR11	IK20TT	K20TT	-	IK20	VK20	4
	ESCUDO 1.6	1600			2001-2005	W16EXR-U	-	-	IW16TT	W16TT	-	IW16	VW16	4
	EVERY 1.3L	1300			2000-2005	K20PR-U	-	PK20PR11	IK20TT	K20TT	-	IK20	VK20	4
	IGNIS 1.2L	1242			2018-	-	-	-	-	-	-	IXUH20I	VXUH20I	4
	IGNIS 1.3L	1300			2001-2004	K20PR-U11	-	PK20PR11	IK20TT	K20TT	-	IK20	VK20	4
	JIMNY 1.3L	1300			2001-2005	K20PR-U	-	PK20PR11	IK20TT	K20TT	-	IK20	VK20	4
		1300			-	K20PR-U11	-	PK20PR11	IK20TT	K20TT	-	IK20	VK20	4
	LANDY 1.3L	1300			2000-2005	K20PR-U	-	PK20PR11	IK20TT	K20TT	-	IK20	VK20	4
	LIANA 1.6L	1600			2004-2005	K20PR-U11	-	PK20PR11	IK20TT	K20TT	-	IK20	VK20	4
	SOLIO 1.3L	1300			2002-2005	K20PR-U11	-	PK20PR11	IK20TT	K20TT	-	IK20	VK20	4
	SWIFT 1.2(K12B)	1200		K12B	2014-	ZXU20PR11	-	-	-	-	-	-	VXU20	4
	SWIFT 1.4L(K14B)	1400		K14B	2011.04-	-	-	-	IKH20TT	-	-	IKH20	VKH20	4
	SWIFT 1.5L	1500			2005.01-	K20PR-U11	-	PK20PR11	IK20TT	K20TT	-	IK20	VK20	4
	SWIFT 1.6L SPORT	1600			2013-2015	-	-	-	IKH20TT	-	-	IKH20	VKH20	4
	SWIFT 1.6L(ZC32S)	1600		ZC32S	2012.03-	-	-	-	IKH20TT	-	-	IKH20	VKH20	4
	SX4 1.6L (M16A)	1600		M16A	2011-2014	K16HPR-U11	-	-	IKH16TT	KH16TT	-	IKH16	VKH16	4
	SX4 4D 1.6 (M16A)	1600		M16A	2006-2011	SVK20RZ11	-	-	IK20TT	-	-	IK20	VK20	4
	SX4 5D 1.6 (M16A)	1600		M16A	2006-2011	SVK20RZ11	-	-	IK20TT	-	-	IK20	VK20	4
	VITARA 1.4L	1400			2016-	-	-	-	-	-	-	-	-	4
	VITARA 1.6L	1600			2001-2005	W16EXR-U	-	-	IW16TT	W16TT	-	IW16	VW16	4
	VITARA 1.6L (w/o ENG A-STOP)	1600			2016-	-	-	-	IKH20TT	KH20TT	-	IKH20	VKH20	4
	VITARA 1.6L (with ENG A-STOP)	1600			2016-	K16HPR-U11	-	-	IKH16TT	KH16TT	-	IKH16	VKH16	4
	<b>TOBE</b>													
	M car 1.3L	1300			2010-	K16R-U	-	PK16R11	IK16TT	K16TT	-	IK16	VK16	4
	<b>TOYOTA</b>													
	ALPHARD 2.4L	2400	ANH20	2AZFE	2009-	SK20R11	90919T1007	-	IK20TT	-	-	IK20	VK20	4
		2400	ANH20	2AZFE	2012-	SK20R11	9091901237	-	IK20TT	-	-	IK20	VK20	4
	ALPHARD 3.5L	3500		2GRFE	2009-	FK20HR11	9091901247	-	IKH20TT	-	-	-	VFKH20	6
		3500		2GRFE	2016-	FK20HR11	9091901247	-	IKH20TT	-	-	-	VFKH20	6
	AURIS 2.0L	2000		M20A-FKS	2018.09-	FC20HR-Q8	9091901297	-	-	-	-	-	-	4
	CAMRY 2.0	2000	ASV51	6ARFSE	2015-	SK16HR11	90919C1006	-	IKH16TT	-	-	IKH16	VKH16	4
	CAMRY 2.0L	2000		1AZ-FE	2002-	SK20R11	9091901237	-	IK20TT	-	-	IK20	VK20	4
		2000			2017-	FK16HBR-J8	9091901286	-	-	-	-	-	-	4
		2000			2021.03-	FC20HR-Q8	9091901297	-	-	-	-	-	-	4
	CAMRY 2.4L				2008-2010	SK20R11	9091901237	-	IK20TT	-	-	IK20	VK20	
	CAMRY 2.5L	2500	ACV51	1AZ-FE	2011.12-	SK16HR11	9091901233	-	IKH16TT	-	-	IKH16	VKH16	4
		2500			2018.11-	SK16HR11	9091901233	-	IKH16TT	-	-	IKH16	VKH16	-
		2500			2021.03-	FC16HR-Q8	9091901289	-	-	-	-	-	VFCH16	
	CAMRY 3.0L	3000		1MZ-FE	2002-	SK20R11	9091901237	-	IK20TT	-	-	IK20	VK20	6



車型	CC	VEHICLE CODE	ENGINE	YEAR	一般	Genuine P/N	白金			鍍合金性能型	鍍合金耐久型	Qty	
<b>TOYOTA</b>													
CAMRY HYBRID 2.5G/2.5V	2500	2ARFXE	2012.02-	FK16HR-A8	9091901259	-		IKH16TT	-	-	VFKH16	4	AUSTRALIA
CAMRY HYBRID 2.5L	2500	2AR-FXE	2015-	FK16HR-A8	9091901259	-		IKH16TT	-	-	VFKH16	4	CHINA
	2500		2018.11-	FC16HR-Q8	9091901289	-		-	-	-	VFCH16	-	
C-HR 1.2	1200	8NRFTS	2017-	VDCH22F	9091901285	-		-	-	-	VDCH22F	4	INDIA
COROLLA ALTIS 1.6L	1600	3ZZ-FE	2001-	K16R-U11	9091901164		PK16R11	IK16TT	K16TT	IK16	VK16	4	INDONESIA
	1600	3ZZ-FE	2007-	K16R-U11	9091901164		PK16R11	IK16TT	K16TT	IK16	VK16	4	
COROLLA ALTIS 1.8	1800	2ZR-FE	2010-	SC20HR11	9091901253	-		IXEH22TT	-	-	VCH20	4	KOREA
	1800		2008.11-	SC20HR11	9091901253	-		IXEH22TT	-	-	VCH20	4	
	1800		2013-	SC20HR11	9091901253	-		IXEH22TT	-	-	VCH20	4	
	1800		2014-	SC20HR11	9091901253	-		-	-	-	VCH20	4	
	1800		2017-	SC20HR11	9091901253	-		-	-	-	VCH20	4	
COROLLA ALTIS 1.8 汽油版	1800		2019.03-	SC16HR11	9091901275	-		-	-	-	-	4	INDONESIA
COROLLA ALTIS 1.8 油電版	1800		2019.03-	FC16HR-CY9	9091901298	-		-	-	-	VFCH16	4	INDONESIA
COROLLA ALTIS 1.8L	1800	1ZZ-FE	2001-	K16R-U11	9091901164		PK16R11	IK16TT	K16TT	IK16	VK16	4	MALAYSIA
	1800	1ZZ-FE	2007-2008.10	K16R-U11	9091901164		PK16R11	IK16TT	K16TT	IK16	VK16	4	
COROLLA ALTIS 2.0	2000	3ZR-FE	2010-	SC20HR11	9091901253	-		IXEH22TT	-	-	VCH20	4	PHILIPPINES
COROLLA CROSS 1.8 汽油版	1800		2020.01-	SC16HR11	9091901275	-		-	-	-	-	4	PHILIPPINES
COROLLA CROSS 1.8 油電版	1800		2020.01-	FC16HR-CY9	9091901298	-		-	-	-	VFCH16	4	PHILIPPINES
COROLLA CROSS GR SPORT			2021.09-	SC16HR11	9091901275	-		-	-	-	-	4	PHILIPPINES
COROLLA X	1800	2ZRFE	2015-	SC16HR11	9091901275	-		-	-	-	-	4	PHILIPPINES
GR SUPRA 2.0	2000	B48	2019.09-	-	90118-WA461	-		-	-	-	-	4	PHILIPPINES
GR SUPRA 2.0 Premium	2000	B48	2019.09-	-	90118-WA461	-		-	-	-	-	4	PHILIPPINES
GR SUPRA 3.0 Premium	3000	B58	2019.09-	-	90118-WA461	-		-	-	-	-	6	PHILIPPINES
GT86	2000	FA20	2013-	ZXE27HBR8	SU00300416	-		-	-	-	VXEBH27	4	PHILIPPINES
LAND CRUISE PRADO	4000	1GRFE	2014-	SK20HR11	9091901191	-		IKH20TT	-	IKH20	VKH20	6	PHILIPPINES
NEW CAMRY 2.0	2000	1AZ-FE	2007-	SK20R11	9091901237	-		IK20TT	-	IK20	VK20	4	PHILIPPINES
	2000	1AZ-FE	2012-	SK20R11	9091901237	-		IK20TT	-	IK20	VK20	4	
NEW CAMRY 2.5	2500	2AR-FE	2012-	SK16HR11	9091901233	-		IKH16TT	-	IKH16	VKH16	4	PHILIPPINES
NEW CAMRY 3.5	3500	2GR-FE	2006.06-	FK20HR11	9091901247	-		IKH20TT	-	-	VFKH20	6	PHILIPPINES
PREVIA			2000.02-	K20R-U11	9091901184		PK20R11	IK20TT	K20TT	IK20	VK20	-	PHILIPPINES
PREVIA 2.4	2400	2AZFE	2007-	SK20R11	9091901237	-		IK20TT	-	IK20	VK20	4	PHILIPPINES
	2400	2AZFE	2012-	SK20R11	9091901237	-		IK20TT	-	IK20	VK20	4	
	2400	2AZFE	-	SK16R11	9091901240	-		IK16TT	-	IK16	VK16	4	
PREVIA 3.5	3500	2GRFE	2000.02-	FK20HR-U11	-	-		IKH20TT	-	-	VFKH20	6	PHILIPPINES
PRIUS			2005.07-2009.03	SK16R11	9091901240	-		IK16TT	-	IK16	VK16	4	PHILIPPINES
PRIUS 1.8L	1800	2ZRFXE	2010.12-	SC20HR11	9091901253	-		IXEH22TT	-	-	VCH20	4	PHILIPPINES
	1800		2019.01-	FC16HR-CY9	9091901298	-		-	-	-	VFCH16	4	
PRIUS 3 HYBRID	1800	2ZRFXE	2009-	SC20HR11	9091901253	-		IXEH22TT	-	-	VCH20	4	PHILIPPINES
PRIUS 4 HYBRID	1800	2ZRFXE	2015-	SC20HR11	9091901253	-		IXEH22TT	-	-	VCH20	4	PHILIPPINES
PRIUS c 1.5L	1500	1NZFXE	2012-	FK16HR-A8	9091901259	-		IKH16TT	-	-	VFKH16	4	PHILIPPINES
	1500	1NZFXE	2012-	SK16R11	9091901240	-		IK16TT	-	IK16	VK16	4	
PRIUS c/ PRIUS c crossover	1500		2018.10-	FK16BR-AL8	9091901284	-		-	-	-	VFKB16	4	PHILIPPINES
PRIUS PHV 1.8L	1800	2ZRFXE	2017-	FC16HR-CY9	9091901298	-		-	-	-	VFCH16	4	PHILIPPINES
	1800	2ZRFXE	2019.08-	FC16HR-CY9	9091901298	-		-	-	-	VFCH16	4	
PRIUS α 1.8L	1800	2ZRFXE	2015-	SC16HR11	9091901275	-		-	-	-	-	4	PHILIPPINES
RAV 4	2000	3ZRFE	2016-	SC16HR11	9091901275	-		-	-	-	-	4	PHILIPPINES
	2500	2ARFE	2016-	SK16HR11	9091901233	-		IKH16TT	-	IKH16	VKH16	4	
	2500	M20A-FKS	2019.10-	FC16HR-Q8	9091901289	-		-	-	-	VFCH16	4	
RAV 4 2.0L	2000	3ZRFE	2013-	SC20HR11	9091901253	-		IXEH22TT	-	-	VCH20	4	PHILIPPINES
	2000	M20A-FKS	2019.03-	FC20HR-Q8	9091901297	-		-	-	-	-	4	
RAV 4 2.4L	2400	2AZFE	2008-2011	SK20R11	9091901237	-		IK20TT	-	IK20	VK20	4	PHILIPPINES
RAV 4 2.5L	2500	2ARFE	2013-	SK16HR11	9091901233	-		IKH16TT	-	IKH16	VKH16	4	PHILIPPINES
	2500	A25A-FXS	2019.03-	FC16HR-Q8	9091901289	-		-	-	-	VFCH16	4	
RAV 4 2.5L HYBRID	2500	2ARFXE	2015-	FK16HR-A8	9091901259	-		IKH16TT	-	-	VFKH16	4	PHILIPPINES
RAV 4 HYBRID	2500	2ARFXE	2016-	SK16HR11	9091901233	-		IKH16TT	-	IKH16	VKH16	4	PHILIPPINES
RAV 4 HYBRID 2.5L	2500	M20A-FKS	2019.10-	FC16HR-Q8	9091901289	-		-	-	-	VFCH16	4	PHILIPPINES
	2500	A25A-FXS	2019.03-	FC16HR-Q8	9091901289	-		-	-	-	VFCH16	4	
SIENNA 3.5L	3500	2GRFE	2010-2016	FK20HR11	9091901247	-		IKH20TT	-	-	VFKH20	6	PHILIPPINES
	3500	2GRFKS	2017-	FK20HBR8	9091901263	-		IKBH20TT	-	-	VFKBH20	6	
	3500		2021.03-	FC16HR-Q8	9091901289	-		-	-	-	VFCH16	4	
SIENTA 1.5L	1500	2NR-FE	2017-	SC16HR11	9091901275	-		-	-	-	-	4	PHILIPPINES
	1500	2NR-FE	2019.11-	SC16HR11	9091901275	-		-	-	-	-	4	
SIENTA 1.8L	1800	2ZR-FAE	2017-	SC16HR11	9091901275	-		-	-	-	-	4	PHILIPPINES
	1800	2ZR-FAE	2019.11-	SC16HR11	9091901275	-		-	-	-	-	4	
TownAce 1.5L	1500		2022.02-	SC16HR11	9091901275	-		-	-	-	-	4	PHILIPPINES
VIOS 1.5	1500		2008.01-	SK16R11	9091901240	-		IK16TT	-	IK16	VK16	4	PHILIPPINES
	1500	1NZ-FE	2014.12-	SK16R11	9091901240	-		IK16TT	-	IK16	VK16	4	

DENSO	9	14	16	20	22	24	27	29	31	32	34	35	DENSO	9	14	16	20	22	24	27	29	31	32	DENSO	9	14	16	20	22	24	27	31
NGK	2	4	5	6	7	8	9	9.5	10	10.5	11	11.5	CHAMPION	18	16,14	12,11	10,9	8,7	6,63,61	4,59	57	55	53	BOSCH	10	9	8	7,6	5	4	3	2

AUSTRALIA  
CHINA  
INDIA  
INDONESIA  
KOREA  
MALAYSIA  
PHILIPPINES  
SAUDARABIA  
SINGAPORE  
TAIWAN  
THAILAND  
VIETNAM  
JAPAN  
EUROPE & USA  
CROSS REFERENCE NUMBER  
PART



車型	CC	VEHICLE CODE	ENGINE	YEAR	一般	Genuine P/N	白金				鍍合金性能型	鍍合金耐久型	Qty
<b>TOYOTA</b>													
AUSTRALIA	VIOS 1.5	1500	2NR-FE	2016-	SC16HR11	9091901275	-	-	-	-	-	-	4
AUSTRALIA	VIOS 1.5L	1500		2003.03-	K16R-U	9091901176	PK16R	IK16TT	K16TT	IK16	VK16		4
	WISH 2.0L	2000		2004.09-	SK20R11	9091901237	-	IK20TT	-	IK20	VK20		4
CHINA		2000	3ZR-FE	2009-	SC20HR11	9091901253	-	-	-	-	VCH20		4
		2000	3ZR-FE	2010-	SC20HR11	9091901253	-	IXEH22TT	-	-	VCH20		4
		2000	3ZR-FE	2012-2015	SC20HR11	9091901253	-	IXEH22TT	-	-	VCH20		4
	YARIS 1.5L	1500	1NZ-FE	2006.11-	K16R-U	9091901176	PK16R	IK16TT	K16TT	IK16	VK16		4
		1500	1NZ-FE	2014-2016	SK16R11	9091901240	-	IK16TT	-	IK16	VK16		4
INDIA		1500	2NRFE	2016-	SC16HR11	9091901275	-	-	-	-	-		4
	YARIS Crossover 1.5L	1500		2019.01-	SC16HR11	9091901275	-	-	-	-	-		4
INDONESIA	ZACE 1.8L	1800		2003.01-	P16R8 (PW16TT)	-	P16R8 (PW16TT)	IW16TT	-	IW16	VW16		4
	ZACE 2.4L	2400		2003.01-	P16R	-	P16R	IW16TT	-	IW16	VW16		4
<b>VOLKSWAGEN</b>													
INDONESIA	BEETLE 1.6L	1600		2001-2005	K20PBRS10	-	-	IK20TT	K20TT	IK20	VK20		4
	BEETLE 1.8T	1800		2001-2005	K20PBRS10	-	-	IK20TT	K20TT	IK20	VK20		4
	BEETLE 2.0L	2000		2000-2002	K20PBRS10	-	-	IK20TT	K20TT	IK20	VK20		4
KOREA	BORA 1.6L	1600		2001-2005	K20PBRS10	-	-	IK20TT	K20TT	IK20	VK20		4
	BORA 2.0L	2000		2000-2002	K20PBRS10	-	-	IK20TT	K20TT	IK20	VK20		4
	BORA 2.3L	2300		2000.09-	-	-	PKJ16CR-L11	IK16TT	-	IK16L	VK16		5
		2300		2001-2002	-	-	PKJ16CRL11	IK16TT	-	IK16L	VK16		5
MALAYSIA	GOLF 2.0L	2000		2000-2002	K20PBRS10	-	-	IK20TT	K20TT	IK20	VK20		4
	GOLF 2.3L	2300		2001-2003	-	-	PKJ16CRL11	IK16TT	-	IK16L	VK16		5
	GOLF GTI 1.8L	1800		2000-2004	K20PBRS10	-	-	IK20TT	K20TT	IK20	VK20		4
	GOLF R32 3.2L	3200		2002.06-	-	-	-	-	-	IXU22	VXU22		6
PHILIPPINES	LUPO 1.4L	1400		2000-2005	K20PBRS10	-	-	IK20TT	K20TT	IK20	VK20		4
	LUPO GTI 1.6L	1600		2003-2005	K20PBRS10	-	-	IK20TT	K20TT	IK20	VK20		4
SAUDIARABIA	PASSAT 1.8T	1800		2001-2005	W20EPBRS	-	-	IW20TT	W20TT	IW20	VW20		4
	PASSAT B5 2.3L	2300		2000-2001	K20TXR	-	-	IK20TT	K20TT	IK20	VK20		5
	PASSAT GP 2.0L	2000		2001-2005	K20PBRS10	-	-	IK20TT	K20TT	IK20	VK20		4
	PASSAT GP 2.3L	2300		2002-2004	K20TXR	-	-	IK20TT	K20TT	IK20	VK20		5
	PASSAT W8 4.0L	4000		2002-2003	K20TXR	-	-	IK20TT	K20TT	IK20	VK20		8
SINGAPORE	PHAETON 3.2L	3200		2002.05-	-	-	-	-	-	IXU22	VXU22		6
	POLO 1.4L	1400		2005.08-	PK20PR-P8	-	-	IK20TT	-	IK20	VK20Y		4
	SHARAN 2.8L	2800		2000.04-	-	-	PKJ16CR-L11	IK16TT	-	IK16L	VK16		6
	T5 2.3L	2300		-	-	-	PKJ16CR-L11	IK16TT	-	IK16L	VK16		5
	TOUAREG 3.2L	3200		2004.05-	-	-	-	-	-	IXU22	VXU22		6
	TOUAREG 4.2L	4200		2003.04-	K20TXR	-	-	IK20TT	K20TT	IK20	VK20		8
<b>VOLVO</b>													
TAIWAN	C70 2.4T	2400		2004-2005	-	-	-	-	-	IK22	VK22		5
	S40 1.9T	1900		2000-	-	-	-	-	-	IK22	VK22		4
	S40 2.0L	2000		2000-2005	K20PBR	-	-	IK20TT	K20TT	IK20	VK20		5
THAILAND	S40 2.0T	2000		2000-2005	-	-	-	-	-	IK22	VK22		5
	S40 2.4L	2400		2004-2005	-	-	-	-	-	IKH22	VKH22		5
	S40 2.5T	2500		2004-2005	-	-	-	-	-	IKH22	VKH22		5
	S60 2.0T	2000		2000-2005	-	-	-	-	-	IK22	VK22		5
VIETNAM	S60 T5 2.3L	2300		2000-2005	-	-	-	-	-	IK22	VK22		5
	S60R 2.5T	2500		2004-2005	-	-	-	-	-	IKH22	VKH22		5
	S80 T5 2.0L	2000		2004-	-	-	-	IK20TT	-	IK20	VK20		4
	V40 2.0L	2000		2000-2005	K20PBR	-	-	IK20TT	K20TT	IK20	VK20		4
	V40 2.0T	2000		2000-2005	-	-	-	-	-	IK22	VK22		4
JAPAN	V50 2.5T	2500		2004-2005	-	-	-	-	-	IKH22	VKH22		5
	V70 2.3T	2300		2001-2005	-	-	-	-	-	IK22	VK22		5
	V70 2.5T	2500		2004-2005	-	-	-	-	-	IK22	VK22		5
	V70R 2.5T	2500		2004-2005	-	-	-	-	-	IKH22	VKH22		5
EUROPE & USA	V7XC 2.4L	2400		2002-	-	-	-	-	-	IK22	VK22		-
	XC70 2.3T	2300		2001-2005	-	-	-	-	-	IK22	VK22		5
	XC70 2.5T	2500		2002.09-	-	-	-	-	-	IK22	VK22		5
	XC90 2.5T	2500		2003-2005	-	-	-	-	-	IK22	VK22		5
CROSS REFERENCE	XC90 4.5L	4500		2004.11-	-	-	-	-	-	IK22	VK22		6
PART NUMBER	XC90 T6 3.0L	3000		2003-2005	-	-	-	-	-	IK22	VK22		6



MODEL	CC	YEAR	DENSO	IRIDIUM POWER	IRIDIUM RACING	Qty
<b>HARTFORD</b>						
MAGIC 125	125	-	U22FSR-U	IUF22	-	1
VR 125/150/200	125/150/200	-	X24ESR-U	IX24	IXU01-□	1
雲豹 125/150/200	125/150/200	-	X24ESR-U	IX24	IXU01-□	1
<b>KYMCO</b>						
A博士 150	150	-	X22EP-U9	IX22B	-	1
CHERRY 100 Fi	100	-	U22FSR-U	IUF22	-	1
CHERRY 俏麗 50/100	50/100	-	U22FS-U	IUF22	-	1
CUE 100(五期)	100	-	U22FSR-U	IUF22	-	1
CUE 100(六期)	100	-	U22FSR-U	IUF22	-	1
CUE 100(七期)	100	-	U22FSR-U	IUF22	-	1
CUE 125	125	-	U22FSR-U	IUF22	-	1
DINK 150	150	-	U22ESN	IU22	IU01-□	1
DOWNTOWN 350(六期)	350	-	U22ESR-N	IU22	IU01-□	1
EASY 100 Fi	100	-	U22FSR-U	IUF22	-	1
EASY 4U 50/100	50/100	-	U22FS-U	IUF22	-	1
EGO 125	125	-	X22EP-U9	IX22B	-	1
EGO 250	250	-	X22EPR-U9	IX22B	-	1
EXCITING 500(化)	500	-	U24ESRN	IU24	IU01-□	1
EXCITING 500(噴)	500	-	U22ESRN	IU22	IU01-□	1
G5 125/150	125/150	-	U24ESRN	IU24	IU01-□	1
G6 125/150	125/150	-	U24ESR-N	IU24	IU01-□	1
G6 150 BREMBO	150	-	U24ESR-N	IU24	IU01-□	1
G6 150(六期)	150	-	U24ESR-N	IU24	IU01-□	1
G-DINK 300 ABS(六期)	300	-	X20EPR-U9	-	-	1
G-DINK 300i	300	-	X20EPR-U9	-	-	1
GOING 50/100	50/100	-	W24FR-L	IWF24	-	1
GP 125 Fi(M2)	125	-	U22FSR-U	IUF22	-	1
GP 125 Fi(M3A)	125	-	U24ESR-N	IU24	IU01-□	1
GP 125(六期)	125	-	U22FSR-U	IUF22	-	1
GP 125(七期)	125	-	U22FSR-U	IUF22	-	1
GP2 125/150	125/150	-	U22FSR-U	IUF22	-	1
G-SENSE 125	125	-	U24EPR9	IU24D	IU01-□	1
HIPSTER勁暴 150	150	-	X24ES-U	IX24	-	1
IDOL 100	100	-	W20FR-L	IWF20	-	1
IDOL 50	50	-	W24FR-L	IWF24	-	1
J-POP 50/70/100	50/70/100	-	U20FSR-U	IUF22	-	1
JR 100	100	-	U22FS-U	IUF22	-	1
JR 100 Fi	100	-	U20FSR-U	IUF22	-	1
KANDY 110(五期)	110	-	U24ESR-N	IU24	IU01-□	1
KIWI 50/70/100	50/70/100	-	U22FS-U	IUF22	-	1
KRIDER 400 ABS	400	-	-	IU27	IU27D	-
KTR 125/150/150Fi	125/150	-	U24ESR-N	IU24	IU01-□	1
KTR 150(六期)	150	-	U24ESR-N	IU24	IU01-□	1
K-XCT 300 ABS	300	-	U22ESR-N	IU22	IU01-□	1
LIKE 125(五期)	125	-	U22FSR-U	IUF22	-	1
LIKE 125(六期)	125	-	U22FSR-U	IUF22	-	1
LIKE 125(七期)	125	-	U22FSR-U	IUF22	-	1
MANBOY 90	90	-	W20FR-L	IWF20	-	1
MANY 50(五期)	50	-	U20ESR-N	IU20	IU01-□	1
MANY 50Fi/100Fi/110Fi	50/100/110	-	U22ESR-N	IU22	IU01-□	1
MANY 110(五期)	110	-	U22ESR-N	IU22	IU01-□	1
MANY 110(六期)	110	-	U22ESR-N	IU22	IU01-□	1
MANY 110(七期)	110	-	U22EPR9	IU22D	-	1
MAXXER 300	300	-	X22EPR-U9	IX22B	-	1
MONGOOSE 250	250	-	X22EPR-U9	IX22B	-	1
MONGOOSE 50	50	-	W24FR-L	IWF24	-	1
MONGOOSE 90	90	-	U22FS-U	IUF22	-	1
MXER 150	150	-	X24ESR-U	IX24	-	1
MXU 150	150	-	X24ESR-U	IX24	-	1
MXU 250/300	250/300	-	X22EPR-U9	IX22B	-	1
MYROAD 700	700	-	U24ESR-N	IU24	IU01-24	2
NEW MANY 110 noodoe旗艦版(六期)	110	-	U22EPR9	IU22D	IU01-□	1
NEW MANY 110(六期)	110	-	U22EPR9	IU22D	IU01-□	1
NEW MANY 125	125	-	U24ESR-N	IU24	IU01-□	1
NEW MANY 125(七期)	125	-	U24ESR-N	IU24	IU01-□	1
NICE 100	100	-	U22FSR-U	IUF22	-	1

AUSTRALIA  
 CHINA  
 INDIA  
 INDONESIA  
 KOREA  
 MALAYSIA  
 PHILIPPINES  
 SAUDIARABIA  
 SINGAPORE  
 TAIWAN  
 THAILAND  
 VIETNAM  
 JAPAN  
 EUROPE & USA  
 CROSS REFERENCE  
 PART NUMBER

DENSO	9	14	16	20	22	24	27	29	31	32	34	35	DENSO	9	14	16	11	20	22	24	27	29	31	32	DENSO	9	14	16	20	22	24	27	31
NGK	2	4	5	6	7	8	9	9.5	10	10.5	11	11.5	CHAMPION	18	16,14	12,11	10,9	8,7	6,63,61	4,59	57	55	53	BOSCH	10	9	8	7,6	5	4	3	2	



	MODEL	CC	YEAR	DENSO	IRIDIUM POWER	IRIDIUM RACING	Qty
	<b>KYMCO</b>						
AUSTRALIA	NICE 100(七期)	100	-	U22FSR-U	IUF22	-	1
	NIKITA 200	200	-	U22ESR-N	IU22	IU01-□	1
	NIKITA 300(六期)	300	-	U22ESR-N	IU22	IU01-□	1
CHINA	NIKITA 300Fi	300	-	U22ESR-N	IU22	IU01-□	1
	NSR150	150	-	W24ES-U	IW24	-	1
	PEOPLE S 300(六期)	300	-	U22ESR-N	IU22	IU01-□	1
	QUANNON 150Fi/NK 150Fi	150	-	U24ESR-N	IU24	IU01-□	1
	RACING 125Fi/150Fi	125	-	U24ESR-N	IU24	IU01-□	1
INDIA	RACING KING 180Fi(ABS)	180	-	U22ESR-N	IU22	IU01-□	1
	RACING S 125 ABS	125	-	U24EPR9	IU24D	IU01-□	1
	RACING S 125(五期)	125	-	U24EPR9	IU24D	IU01-□	1
INDONESIA	RACING S 125(六期)	125	-	U24EPR9	IU24D	IU01-□	1
	RACING S 125(七期)	125	-	U24EPR9	IU24D	IU01-□	1
	RACING S 150	150	-	U24EPR9	IU24D	IU01-□	1
	RACING S 150(六期)	150	-	U24EPR9	IU24D	IU01-□	1
	RACING S 150(七期)	150	-	U24EPR9	IU24D	IU01-□	1
KOREA	ROMEO 125(五期)	125	-	U24ESR-N	IU24	IU01-□	1
	ROMEO 125(六期)	125	-	U24ESR-N	IU24	IU01-□	1
	SO EASY 100 Fi	100	-	U22FSR-U	IUF22	-	1
	STRYKER 150	150	-	X24ESR-U	IX24	IXU01-□	1
MALAYSIA	TECHNO GT 125	125	-	U24ESRN	IU24	IU01-□	1
	TECHNO GT 150	150	-	U22FSRU	IUF22	-	1
	TOPBOY 100	100	-	W20FR-L	IWF20	-	1
	V1 125Fi	125	-	U22ESR-N	IU22	IU01-□	1
	V1 150Fi	150	-	U22FSR-U	IUF22	-	1
PHILIPPINES	VENOX 250/250Fi	250	-	U24ESR-N	IU24	IU01-□	2
	VJR 125(六期)	125	-	U24ESRN	IU24	IU01-□	1
	VJR 125(七期)	125	-	U24ESRN	IU24	-	1
SAUDIARABIA	VJR 50/100/110 Fi	50/100/110	-	U22ESR-N	IU22	IU01-□	1
	VJR 50/110(五期)	50/110	-	U20ESR-N	IU20	IU01-□	1
	V-LINK GP 125	125	-	U22ESRN	IU22	IU01-□	1
	VP 125	125	-	U22ESR-N	IU22	IU01-□	1
	VP 125(六期)	125	-	U22FSR-U	IUF22	-	1
SINGAPORE	XCITING 250/500	250/500	-	U24ESR-N	IU24	IU01-□	1
	XCITING R250Fi	250	-	X20EPR-U9	-	-	1
	XCITING R300	300	-	-	X20EPR-U9	IU01-□	1
	XCITING S400	400	-	U22ESR-N	IU22	IU01-□	1
TAIWAN	XCITING S400 TCS	400	-	U22ESR-N	IU22	IU01-□	1
	XGOING CITY 125	125	-	U22FSR-U	IUF22	-	1
	X-MODE 100 (KDI噴射引擎)	100	-	U22FSRU	IUF22	-	1
	XSENSE 125(五期) SJ25WA	125	-	U22FSR-U	IUF22	-	1
THAILAND	XSENSE 125(五期) SR25EG	125	-	U24ESR-N	IU24	IU01-□	1
	XSENSE 125(六期)	125	-	U22FSR-U	IUF22	-	1
	XSENSE 125(七期)	125	-	U22FSR-U	IUF22	-	1
	XSENSE 150(六期)	150	-	U24EPR9	IU24D	IU01-□	1
VIETNAM	YOUNG UP 90	90	-	W20FR-L	IWF20	-	1
	ZAP 50	50	-	W24FR-L	IWF24	-	1
	王牌HX 135	135	-	W24ES-U	IW24	-	1
	金豪美 50	50	-	W24FR-L	IWF24	-	1
	金牌 125	125	-	U22FS-U	IUF22	-	1
		125	-	U22FSR-U	IUF22	-	1
JAPAN	金牌 125Fi	125	-	U22ESR-N	IU22	IU01-□	1
	金牌 150	150	-	U22FSR-U	IUF22	-	1
	金牌II 125Fi(五期)	125	-	U22FSR-U	IUF22	-	1
	金勇 125/150	125/150	-	X22ES-U	IX22	-	1
EUROPE & USA	金翔鶴 100	100	-	W20FR-L	IWF20	-	1
	豪漢 125/150	125/150	-	U22FS-U	IUF22	-	1
	豪爽 150	150	-	X22ES-U	IX22	-	1
	豪邁 50/80/125	50/80/125	-	U22FS-U	IUF22	-	1
CROSS REFERENCE	豪邁如意 125	125	-	U22FS-U	IUF22	-	1
	酷龍 150	150	-	U24ESR-N	IU24	IU01-24	1
	三冠王 125/150	125/150	-	U22FSR-U	IUF22	-	1
	三冠王 4V 125	125	-	U22ESRN	IU22	IU01-□	1
PART NUMBER	三冠王 125Fi	125	-	U20FSR-U	IUF22	-	1
	小如意 125	125	-	U22FSR-U	IUF22	-	1
	小奔騰V-LINK 125	125	-	U24ESR-N	IU24	IU01-□	1
	新名流 125 ABS	125	-	U22FSR-U	IUF22	-	1





MODEL	CC	YEAR	DENSO	IRIDIUM POWER	IRIDIUM RACING	Qty
<b>KYMCO</b>						
新名流 125(七期)	125	-	U22FSR-U	IUF22	-	1
新名流 150(七期)	150	-	U22FSR-U	IUF22	-	1
新翔鶴 50/100	50/100	-	W24FR-L	IWF24	-	1
探戈 125	125	-	U22FSU	IUF22	-	1
超級金牌 150(六期)	150	-	U20FSR-U	IUF22	-	1
超級金牌 150Fi	150	-	U20FSR-U	IUF22	-	1
頂客 150	150	-	X22EP-U9	IX22B	-	1
頂客 180/180Fi	180	-	X20EPR-U9	-	-	1
頂客 250	250	-	X22EPR-U9	IX22B	-	1
頂尖豪邁 125	125	-	U22FS-U	IUF22	-	1
得意 50/100	50/100	-	U22FS-U	IUF22	-	1
奔馳 125	125	-	U22FS-U	IUF22	-	1
奔騰G4 SR125 Fi(M2)	125	-	U22FSR-U	IUF22	-	1
奔騰G4 SR125/SR125Fi(M3A)	125	-	U24ESR-N	IU24	IU01-□	1
奔騰G5 125/125Fi/150Fi	125/150	-	U24ESR-N	IU24	IU01-□	1
奔騰V2 125	125	-	U22ESR-N	IU22	IU01-□	1
奔騰V2 125(五期)	125	-	U22FSR-U	IUF22	-	1
奔騰V2 150(五期)	150	-	U20FSR-U	IUF22	-	1
名流 125	125	-	U22FSR-U	IUF22	-	1
名流 150	150	-	X22EP-U9	IX22B	-	1
	150	-	U22FSR-U	IUF22	-	1
勁 150	150	-	X22ES-U	IX22	-	1
勁多力 150(六期)	150	-	U24ESR-N	IU24	IU01-□	1
勁多力 150(七期)	150	-	U24ESR-N	IU24	IU01-□	1
勁多力 150Fi	150	-	U24ESR-N	IU24	IU01-□	1
搜索者 150	150	-	X24ESR-U	IX24	-	1
翔鈴 100	100	-	W20FR-L	IWF20	-	1
鐵漢 150	150	-	X22ES-U	IX22	-	1
鐵克諾 150	150	-	U22FSR-U	IUF22	-	1
鐵克諾 GT125/GT125Fi	125	-	U22ESR-N	IU22	IU01-□	1
<b>PGO</b>						
Alpha Max 125	125	-	U24ESR-N	IU24	-	1
Alpha Max 125(七期)	125	-	U24ESR-N	IU24	-	1
BON 125(七期)	125	-	U22FSR-U	IUF22	-	1
BUBU 100	100	-	U22FSU	IUF22	-	1
BUBU 125	125	-	U22FSU	IUF22	-	1
CHARGE 噴射王 125	125	-	U22ESRN	IU22	IU01-□	1
COMET 50	50	-	W22FPU	IWF22	-	1
G-MAX 125/150	125/150	-	U22ESN	IU22	IU01-□	1
G-MAX 150(水冷)/200/220	150/200/220	-	U22ESRN	IU22	IU01-□	1
HOT 100	100	-	W22FPU	IWF22	-	1
HOT 50/90	50/90	-	W22FPU	IWF22	-	1
I-CHARGE 125	125	-	U22FSU	IUF22	-	1
IME 150	150	-	U22ESRN	IU22/IU24	IU01-24	1
J BUBU 115	115	-	U22ESRN	IU22	IU01-□	1
J BUBU 115(七期)	115	-	U22ESRN	IU22	-	1
J BUBU 125(七期)	125	-	U24ESRN	IU24	-	1
MY BOBO 100/125	100/125	-	U22FSU	IUF22	IU01-□	1
PMX 50/90	50/90	-	W22FPU	IWF22	-	1
SPRING 125	125	-	U24ESR-N	IU24	-	1
SUPPORT 50	50	-	W22FPU	IWF22	-	1
TIGRA 125/150/150ABS	125/150	-	U22ESRN	IU22	IU01-□	1
TORNADO 50/90	50/90	-	W22FPU	IWF22	-	1
X - HOT 125	125	-	U20FSRU	IUF22	-	1
X - HOT 150	150	-	U22ESRN	IU22/IU24	IU01-24	1
YOUNG BOBO 100	100	-	U22ESN	IU22	IU01-□	1
快活 110	110	-	W22FPU	IWF22	-	1
恰吉 125	125	-	U22FSU	IUF22	-	1
大驛 125/150	125/150	-	U22FSU	IUF22	-	1
馬路秀 50/90	50/90	-	W22FPU	IWF22	-	1
<b>SUZUKI</b>						
ADDRESS 110	110	-	U22EPR9	IU22D	IU01-□	1
ADDRESS V 125	125	-	U20FSR-U	IUF22	IU01-□	1
ADDRESS V 125 G	125	-	U20FSR-U	IUF22	IU01-□	1
ADDRESS V 125 SS	125	-	U20FSR-U	IUF22	-	1
AN 250	250	-	U24ESR-N	IU24	IU01-□	1
AN 400	400	-	U22ESR-N	IU22	IU01-□	2

AUSTRALIA  
 CHINA  
 INDIA  
 INDONESIA  
 KOREA  
 MALAYSIA  
 PHILIPPINES  
 SAUDIARABIA  
 SINGAPORE  
 TAIWAN  
 THAILAND  
 VIETNAM  
 JAPAN  
 EUROPE  
 & USA  
 CROSS  
 REFERENCE  
 NUMBER  
 PART

DENSO	9	14	16	20	22	24	27	29	31	32	34	35	DENSO	9	14	16	20	22	24	27	31	32	DENSO	9	14	16	20	22	24	27	31	
NGK	2	4	5	6	7	8	9	9.5	10	10.5	11	11.5	CHAMPION	18	16,14	12,11	10,9	8,7	6,63,61	4,59	57	55	53	BOSCH	10	9	8	7,6	5	4	3	2



	MODEL	CC	YEAR	DENSO	IRIDIUM POWER	IRIDIUM RACING	Qty
	<b>SUZUKI</b>						
AUSTRALIA	BOULEVARD 1800	1800	-	U24ETR	IU24A	IU01-□	2
	BURGMAN 400	400	-	-	IU27D	IU01-□	1
	BURGMAN 650	650	-	U24ESR-N	IU24	IU01-□	2
CHINA	CHOINORI 50	50	-	U22FSU	IUF22	-	1
	DAO 100	100	-	U22ESN	IU22	IU01-□	1
	GLADIUS 650	650	-	IU24D	IU24D	IU01-□	2
	GS 150R	150	-	X24ESR-U	IX24	-	1
	GSR 125	125	-	U20FSR-U	IUF22	-	1
INDIA	GSR 125 NEX	125	-	U20FSR-U	IUF22	-	1
	GSX 1300R 隼	1300	1999-2007	U27ESR-N	IU27	IU01-□	2
	GSX-R 1000/A	1000	-	IU27D	IU27D	IU01-□	4
INDONESIA	GSX-R 1000R/Z	1000	-	IU27D	IU27D	IU01-□	4
	GSX-R 150	150	-	U24EPR-N9	IU24D	IU01-□	1
	GSX-S 1000F/FA	1000	-	IU27D	IU27D	IU01-□	4
	GSX-S 150	150	-	U24EPR-N9	IU24D	IU01-□	1
	GSX-S 750A/AZ	750	-	IU27D	IU27D	IU01-□	4
KOREA	JAJA	50	-	W20FP-U	IWF20	IW01-□	1
	MUSIC 125	125	-	U20FSR-U	IUF22	-	1
	SV 1000/S	1000	-	U24ESR-N	IU24	IU01-□	2
	SWING 125	125	-	U22ES-N	IU22	IU01-□	1
MALAYSIA	TU 250	250	-	X24ESR-U	IX24	-	1
	UT 125 GSR 125/NEX 125	125	-	U20FSR-U	IUF22	-	1
	UZ 125	125	-	U20FSR-U	IUF22	-	1
	V-STROM 650XT	650	-	IU24D	IU24D	IU01-□	2
PHILIPPINES	X5-D(蛋蛋車)	50	-	U20FSR-U	IUF22	-	1
	XR 125	125	-	U22ESN	IU22	IU01-□	1
	XZR 100/125	100/125	-	U22ES-N	IU22	IU01-□	1
	X星艦 125	125	-	U22ESN	IU22	IU01-□	1
	X星艦 125(噴射引擎)	125	-	U24ESR-N	IU24	IU01-□	1
SAUDIARABIA	快樂星艦 100	100	-	U22ES-N	IU22	IU01-□	1
	開朗 90	90	-	W22FPU	IWF22	-	1
	極速星艦 150	150	-	U22ES-N	IU22	IU01-□	1
	金贏家 100	100	-	W22FP-U	IWF22	-	1
SINGAPORE	銀河 GSR 125/150	125/150	-	U22ES-N	IU22	IU01-□	1
	幻象 50	50	-	W20EPU	IW20	IW01-□	1
	幻象星艦 125	125	-	U22ES-N	IU22	IU01-□	1
	駿 50	50	-	W20EPU	IW20	IW01-□	1
TAIWAN	晶鑽 100	100	-	U22ES-N	IU22	IU01-□	1
	新貴 50	50	-	W20FP-U	IWF20	IW01-□	1
	新象 50	50	-	W20EPU	IW20	IW01-□	1
	新潮流 50	50	-	W20EPU	IW20	IW01-□	1
THAILAND	星河 100	100	-	U22ES-N	IU22	IU01-□	1
	清雲 100	100	-	W22FP-U	IWF22	-	1
	天箭 50	50	-	W20FP-U	IWF20	-	1
	刀 100	100	-	U22ES-N	IU22	IU01-□	1
VIETNAM	飛翔星艦 150	150	-	U22ES-N	IU22	IU01-□	1
	勇力 125	125	-	W20EPU	IW20	IW01-□	1
	雄獅 125	125	-	W22FP-U	IWF22	-	1
	雷霆 125	125	-	W20EPU	IW20	IW01-□	1
	麗仕 50	50	-	W20FPR-U	IWF20	-	1
JAPAN	歐風 100	100	-	W22FPU	IWF22	-	1
	莎比亞 100	100	-	W22FP-U	IWF22	IW01-□	1
	贏將 125	125	-	W22FP-U	IWF22	-	1
	遨遊星艦 125	125	-	U22ES-N	IU22	IU01-□	1
	鐵拳 TEKKEN 125	125	-	U20FSR-U	IUF22	-	1
EUROPE & USA	霹靂星艦 125/150	125/150	-	U22ES-N	IU22	IU01-□	1
	<b>SYM</b>						
	CHA CHA 50	50	-	W24FR-L	IWF24	-	1
	CHA CHA 90	90	-	W20FR-L	IWF20	-	1
CROSS REFERENCE	CRUI SYM	278	-	U24ESR-N	IU24	IU01-□	1
	DIO 100	100	-	W20FR-L	IWF20	-	1
	DIO 50	50	-	W24FR-L	IWF24	-	1
	DRG	158	-	U24EPR9	IU24D	IU01-□	1
PART NUMBER	DRG BT	158	-	U24EPR9	IU24D	-	1
	F1 4V 150 EFI	150	-	U24ESRN	IU24	IU01-□	1
	FIDDLE 125	125	-	U22FSR-U	IUF22	-	1
	FIDDLE 50	50	-	W24FR-L	IWF24	-	1



MODEL	CC	YEAR	DENSO	IRIDIUM POWER	IRIDIUM RACING	Qty
<b>SYM</b>						
FIDDLE DX 150	150	-	U22FSR-U	IUF22	-	1
FIDDLE LT 115	115	-	U22FSR-U	IUF22	-	1
FIGHTER 125 EFi	125	-	U22ESR-N	IU22	IU01-□	1
FNX 125	125	-	U22FSR-U	IUF22	IU01-□	1
FNX BT	125	-	U22FSR-U	IUF22	IU01-□	1
GP SUPER2 125	125	2018.12-	U22FSR-U	IUF22	-	1
GR125 EFi	125	-	U22FSR-U	IUF22	-	1
GT125 EFi/150 EFi	125/150	-	U22FSR-U	IUF22	-	1
GT125 Super 2	125	-	U22FSR-U	IUF22	-	1
GTS 300i ABS	300	-	U24ESR-N	IU24	IU01-□	1
HUSKY150	150	-	X24ES-U	IX24	IXU01-□	1
IRX 115	115	-	U22ESR-N	IU22	IU01-□	1
JET 100	100	-	W20FR-L	IWF20	-	1
JET 50	50	-	W24FR-L	IWF24	-	1
JET POWER 125 EFi	125	-	U22ESR-N	IU22	IU01-□	1
JET S/SR 六期 七期	125	-	U22EPR9	IU22D	IU01-□	1
JET SL 七期	125	-	U24EPR9	IU24D	-	1
JET六期 七期 125	125	-	U22EPR9	IU22D	IU01-□	1
Joymax Z	278	-	U24ESR-N	IU24	IU01-□	1
MAX 600i	600	-	U24ESR-N	IU24	IU01-□	1
Maxsym 400	399	-	U24EPR9	IU24D	IU01-□	1
Maxsym TL	465	-	U22EPR9	IU22D	IU01-□	1
Mii 100	100	-	U22FSR-U	IUF22	-	1
MIO 115 (開放式置物空間)	115	-	U22FSR-U	IUF22	-	1
MIO 115 (封閉式置物空間)	115	-	U22FSR-U	IUF22	-	1
MIO 50/100	50/100	-	U20FS-U	IUF22	-	1
MIO 50/100 EFi	50/100	-	U20FSR-U	IUF22	-	1
NEW FIGHTER 150 EFi	150	-	U24ESR-N	IU24	IU01-□	1
PARTY 50/100	50/100	-	U20FS-U	IUF22	-	1
R1 125/150	125/150	-	U22FSR-U	IUF22	-	1
R1 50/100	50/100	-	U20FS-U	IUF22	-	1
R1Z 100	100	-	U22FS-U	IUF22	-	1
R1Z 125 EFi	125	-	U22FSR-U	IUF22	-	1
R1Z 125/150	125/150	-	U22FSR-U	IUF22	-	1
RS21 150 EFi	150	-	U24ESR-N	IU24	IU01-□	1
RV 150/180/180EFi/250/250EFi	150/180/250	-	U24ESR-N	IU24	IU01-□	1
RV 180 EURO	180	-	U22ESR-N	IU22	IU01-□	1
	175	-	U24EPR9	IU24D	IU01-□	1
RV 270 EFi	270	-	U24ESR-N	IU24	IU01-□	1
RX 110 / EFi	110	-	U22FSR-U	IUF22	-	1
T1 150	150	-	X22EPR-U9	IX22B	-	1
T2 250	250	-	U24ESR-N	IU24	IU01-□	1
T3 300	300	-	U24ESR-N	IU24	IU01-□	1
TINI 100 EFi	100	-	U22FSR-U	IUF22	-	1
VEGA 125	125	-	U22FSR-U	IUF22	-	1
VEGA 125 ABS/CBS	125	2019.07-	U22FSR-U	IUF22	-	1
VIVO活力 125	125	2019.11-	U22FSR-U	IUF22	-	1
VIVO活力 125 七期	125	-	U22FSR-U	IUF22	-	1
WOO 100	100	-	U22FSR-U	IUF22	-	1
WOO 115	115	-	U22FSR-U	IUF22	-	1
WOO 115 七期	115	-	U22FSR-U	IUF22	-	1
WOWOW 100 EFi	100	-	U20FSR-U	IUF22	-	1
X'PRO 125R EFi	125	-	U22FSR-U	IUF22	-	1
X'PRO 50/100/125	50/100/125	-	U20FS-U	IUF22	-	1
Z1 125	125	-	U22FSR-U	IUF22	-	1
Z1 125 雙碟ABS	125	2019.03-	U22FSR-U	IUF22	-	1
Z1 Attila 125	125	-	U22FSR-U	IUF22	-	1
Z1 Attila 125 ABS	125	2019.12-	U22FSR-U	IUF22	-	1
Z1 Attila 125 CBS/ABS 七期	125	-	U22FSR-U	IUF22	-	1
Z1 Attila 125 雙碟CBS	125	2019.12-	U22FSR-U	IUF22	-	1
阿帝拉 125	125	-	U22FS-U	IUF22	-	1
活力心情 125	125	-	U22FSR-U	IUF22	-	1
競速迪爵 125	125	-	U22FSR-U	IUF22	IU01-□	1
極速高手 100	100	-	U20FS-U	IUF22	-	1
極速高手 125	125	-	U24ESRN	IU24	IU01-□	1
金旺 80/90/100	80/90/100	-	U20FS-U	IUF22	-	1
金發財 125EFi/六期/七期	125	-	U22FSR-U	IUF22	-	1

AUSTRALIA  
 CHINA  
 INDIA  
 INDONESIA  
 KOREA  
 MALAYSIA  
 PHILIPPINES  
 SAUDI ARABIA  
 SINGAPORE  
 TAIWAN  
 THAILAND  
 VIETNAM  
 JAPAN  
 EUROPE & USA  
 CROSS REFERENCE  
 PART NUMBER

DENSO	9	14	16	20	22	24	27	29	31	32	34	35	DENSO	9	14	16	20	22	24	27	31	32	DENSO	9	14	16	20	22	24	27	31	
NGK	2	4	5	6	7	8	9	9.5	10	10.5	11	11.5	CHAMPION	18	16,14	12,11	10,9	8,7	6,63,61	4,59	57	55	53	BOSCH	10	9	8	7,6	5	4	3	2



	MODEL	CC	YEAR	DENSO	IRIDIUM POWER	IRIDIUM RACING	Qty
	<b>SYM</b>						
AUSTRALIA	金發財 150	150	-	U22FSR-U	IUF22	-	1
	高手 100	100	-	U20FSR-U	IUF22	IU01-□	1
	高手 125R	125	-	U22FSR-U	IUF22	IU01-□	1
CHINA	豪華悍將/豪華悍將F1	125/150	-	U22ESR-N	IU22	IU01-□	1
	巡戈 125	125	-	U22FSU	IUF22	-	1
	心情 100	100	-	U20FSR-U	IUF22	-	1
	心情 125	125	-	U22FS-U	IUF22	-	1
INDIA	新金旺 100	100	-	U20FS-U	IUF22	-	1
	新金旺 100EFi	100	-	U20FSR-U	IUF22	-	1
	新達可達 50	50	-	W24FR-L	IWF24	-	1
	新迪爵DUKE 125 七期	125	-	U22FSR-U	IUF22	-	1
INDONESIA	精裝悍將/精裝悍將F1	125/150	-	U22ESR-N	IU22	IU01-□	1
	全新迪爵DUKE 125	125	-	U22FSR-U	IUF22	-	1
	大路易 50	50	-	W22FPU	IWF22	-	1
	頂級悍將/頂級悍將F1 125/150	125/150	-	U22ESR-N	IU22	IU01-□	1
KOREA	飛馳 100	100	-	W20FR-L	IWF20	-	1
	飛馳 50	50	-	W24FR-L	IWF24	-	1
	風 50/100	50/100	-	U20FS-U	IUF22	-	1
	風 50/100 EFi	50/100	-	U20FSR-U	IUF22	-	1
	風雲 125/150	125/150	-	U22FSR-U	IUF22	-	1
MALAYSIA	風尚 50	50	-	W24FR-L	IWF24	-	1
	風速 125	125	-	W20FR-L	IWF20	-	1
	風動 100	100	-	W20FR-L	IWF20	-	1
	風動 125	125	-	U22FSR-U	IUF22	-	1
PHILIPPINES	風動 50	50	-	W24FR-L	IWF24	-	1
	風梭 110	110	-	W20FR-L	IWF20	-	1
	沸騰 50	50	-	W24FR-L	IWF24	-	1
SAUDIARABIA	野狼 125/150	125/150	-	X22ES-U	IX22	-	1
	野狼 125EFi	125	-	X24ESR-U	IX24	-	1
		125	2019.05-	X22EPR-U9	IX22B	-	1
	野狼SB 250/300/300CR/300CR ABS	250/300	-	U24ESR-N	IU24	IU01-□	1
	野狼T2 ABS	251	-	U24ESR-N	IU24	IU01-□	1
	野狼T2/T3	200/300	-	U24ESR-N	IU24	IU01-□	1
	野狼傳奇 125	125	-	X22ES-U	IX22	-	1
	野狼傳奇 125EFi	125	-	X24ESR-U	IX24	-	1
		125	2018.11-	X22EPR-U9	IX22B	-	1
	野狼傳奇 125R/R2	125	-	X22ES-U	IX22	-	1
TAIWAN	野狼傳奇R 150 EFi	150	-	X24ESR-U	IX24	-	1
	野狼傳奇R2 125 EFi	125	-	X24ESR-U	IX24	-	1
	領導 125	125	-	W20FR-L	IWF20	IU01-□	1
	六代FIGHTER 150	150	-	U24ESR-N	IU24	IU01-□	1
THAILAND	來電 100	100	-	U20FS-U	IUF22	-	1
	悍將4V 125/150	125/150	-	U22ESR-N	IU22	IU01-□	1
	悍將4V FIGHTER 125	125	-	U22ESR-N	IU22	IU01-□	1
	悍將4V FIGHTER 125EFi	125	-	U24ESRN	IU24	IU01-□	1
	悍將4V FIGHTER 150/150EFi	150	-	U24ESR-N	IU24	IU01-□	1
VIETNAM	悍將4V FIGHTER 150ZR/150DX	150	-	U24ESR-N	IU24	IU01-□	1
	捍衛巡戈 125	125	-	U22FS-U	IUF22	IU01-□	1
	捍衛巡戈 150	150	-	X27EP-U9	IX27B	IU01-□	1
	發財高手 150/150EFi	150	-	U22FSR-U	IUF22	-	1
JAPAN	迪爵 125系列	125	-	U22FS-U	IUF22	-	1
	迪爵 150	150	-	X22EP-U9	IX22B	-	1
	迪飛 125	125	-	W20FR-L	IWF20	-	1
	迪迪 50	50	-	W24FR-L	IWF24	-	1
	<b>YAMAHA</b>						
EUROPE & USA	AXIS Z 勁豪 碟煞/鼓煞 125	125	-	U20FSR-U	IUF22	IU01-□	1
	BIANCO 125	125	-	U22ESR-N	IU22	IU01-□	1
	BW' S 125Fi/BW' S 125 X Fi	125	-	U22ESR-N	IU22	IU01-□	1
	BW' S 50/100	50/100	-	W22FP-U10	IWF22	IU01-□	1
CROSS REFERENCE	BW' S R 125	125	-	U22ESR-N	IU22	IU01-□	1
	CUXI 100/Fi	100	-	U20FSR-U	IUF22	-	1
	CUXI IS 115	115	-	U20FSR-U	IUF22	-	1
	CYGNUS 125Fi/SR/X 125	125	-	U22ESR-N	IU22	IU01-□	1
PART NUMBER	CYGNUS(七期)	125	-	U24EPR9	IU24D	IU01-□	1
	DRAG FIRE 150	150	-	X24ES-U	IX24	IU01-□	1
	FORCE 155	155	-	U24EPR9	IU24D	IU01-□	1
	FZ150/FZR150	150	-	U22FS-U	IUF22	-	1



MODEL	CC	YEAR	DENSO	IRIDIUM POWER	IRIDIUM RACING	Qty
<b>YAMAHA</b>						
GTR 125	125	-	U22ES-N	IU22	IU01-□	1
GTR 125 Fi/AERO	125	-	U22ESR-N	IU22	IU01-□	1
JOG 100	100	-	U20FS-U	IUF22	-	1
JOG 50/90	50/90	-	W22FP-U10	IWF22	-	1
JOG CIAO 115Fi	115	-	U20FSR-U	IUF22	-	1
JOG FANCY 50	50	-	U22ESN	IU22	IU01-□	1
JOG FANCY 50 Fi	50	-	U22ESR-N	IU22	IU01-□	1
JOG FS 115	115	-	U20FSR-U	IUF22	-	1
JOG RS 100/SWEET 100	100	-	U20FS-U	IUF22	-	1
JOG SWEET 115	115	-	U20FSR-U	IUF22	-	1
JOG(七期)	125	-	U20FSR-U	IUF22	-	1
Limi 110/豪華版	110	-	U20FSR-U	IUF22	-	1
Limi(七期)	125	-	U20FSR-U	IUF22	-	1
MAJESTY 125	125	-	U22ES-N	IU22	IU01-□	1
MAJESTY 125 Fi/DX 125	125	-	U22ESR-N	IU22	IU01-□	1
MAJESTY 250	250	-	X24ESR-U	IX24	IXU01-□	1
MAX 125/SV 125	125	-	U22ES-N	IU22	IU01-□	1
MT-03 320	320	-	U24ESR-N	IU24	IU01-□	2
MT-07	689	-	-	-	-	2
MT-09	847	-	U27EPR-9	IU27D	IU01-□	2
NMAX	155	-	U24EPR9	IU24D	IU01-□	1
PRO 50/90	50/90	-	W22FP-U10	IWF22	IU01-□	1
R3 320	320	-	U24ESR-N	IU24	IU01-□	2
RAY 125	125	-	U22ESR-N	IU22	IU01-□	1
RS NEO	125	-	U20FSR-U	IUF22	-	1
RS NEO(七期)	125	-	U20FSR-U	IUF22	-	1
RS ZERO/100 Fi/125	100	-	U20FSR-U	IUF22	-	1
RS-Z 100	100	-	U20FS-U	IUF22	-	1
RX 125	125	-	W20FR-L	IWF20	-	1
S-MAX 155	155	-	U24EPR9	IU24D	IU01-□	1
SUPER FOUR 100	100	-	U20FS-U	IUF22	IU01-□	1
TMAX 530	530	-	U22ESR-N	IU22	IU01-□	2
TRACER 900GT	847	-	U27EPR9	IU27D	IU01-□	-
TRICITY 150	150	-	U24EPR9	IU24D	IU01-□	1
VINO 50 Fi	50	-	U22ESR-N	IU22	IU01-□	1
VINO 50/90	50/90	-	W22FP-U10	IWF22	-	1
Vinoora(七期)	125	-	U20FSR-U	IUF22	-	1
XMAX	300	-	-	-	-	-
XSR700	689	-	-	-	-	-
愛將 150	150	-	X24ES-U	IX24	IXU01-□	1
迎光 150	150	-	U22ES-N	IU22	IU01-□	1
傑出 90	90	-	W20FP-U10	IWF20	-	1
新VINO 125	125	-	U22ES-N	IU22	IU01-□	1
新勁戰 125/125Fi	125	-	U22ESR-N	IU22/IU24	IU01-24	1
神雕 125	125	-	W20FR-L	IWF20	-	1
迅光 125/150	125/150	-	U22ES-N	IU22	IU01-□	1
旋風 90	90	-	W20FP-U10	IWF20	-	1
大兜風 50/100	50/100	-	W22FP-U10	IWF22	-	1
頂級迅光 125	125	-	U22ES-N	IU22	IU01-□	1
追風 RZX 135	135	-	W24EP-U	IW24	-	1
美的 90	90	-	W20FP-U	IWF20	IW01-□	1
風光 125/SV125/新風光 125	125	-	U22ES-N	IU22	IU01-□	1
凌風 50/90	50/90	-	W22FP-U10	IWF22	-	1
勁風 50/90	50/90	-	W22FP-U10	IWF22	-	1
勁風光 125	125	-	U22ES-N	IU22	IU01-□	1
勁風光 125Fi	125	-	U22ESR-N	IU22	IU01-□	1
勁戰 125	125	-	U22ESN	IU22	IU01-□	1
勁戰 125(噴射)	125	-	U22ESRN	IU22	IU01-□	1
歡喜 50	50	-	U22ES-N	IU22	IU01-□	1

AUSTRALIA  
 CHINA  
 INDIA  
 INDONESIA  
 KOREA  
 MALAYSIA  
 PHILIPPINES  
 SAUDI ARABIA  
 SINGAPORE  
 TAIWAN  
 THAILAND  
 VIETNAM  
 JAPAN  
 EUROPE  
 & USA  
 CROSS  
 REFERENCE  
 PART  
 NUMBER

DENSO	9	14	16	20	22	24	27	29	31	32	34	35	DENSO	9	14	16	20	22	24	27	29	31	32	DENSO	9	14	16	20	22	24	27	31
NGK	2	4	5	6	7	8	9	9.5	10	10.5	11	11.5	CHAMPION	18	16,14	12,11	10,9	8,7	6,63,61	4,59	57	55	53	BOSCH	10	9	8	7,6	5	4	3	2



	MODEL	YEAR	CODE	DENSO					
AUSTRALIA	<b>Alfa Romeo</b>								
	156			-	-	-	IU22	-	
	<b>Audi</b>								
	80			K20PBR-S10	IK20TT	K20TT	IK20	VK20	
CHINA	100			K20PBR-S10	IK20TT	K20TT	IK20	VK20	
	A3			K20PBR-S10	IK20TT	K20TT	IK20	VK20	
	A4 1.8			K20PBR-S10	IK20TT	K20TT	IK20	VK20	
	A4 2.4			K20PBR-S10	IK20TT	K20TT	IK20	VK20	
INDIA	A6			K20PBR-S10	IK20TT	K20TT	IK20	VK20	
	<b>Benz</b>								
	C180	2005-	W203	-	IKH20TT	-	IKH20	VKH20	
	C220	1994-		Q16PR-U	IQ16TT	Q16TT	IQ16	VQ16	
INDONESIA	E230	1996-		Q16PR-U	IQ16TT	Q16TT	IQ16	VQ16	
	E280	1996-		Q16PR-U	IQ16TT	Q16TT	IQ16	VQ16	
	S280	1994-		Q16PR-U	IQ16TT	Q16TT	IQ16	VQ16	
	S320	1994-		Q16PR-U	IQ16TT	Q16TT	IQ16	VQ16	
	S500	1994-		Q16PR-U	IQ16TT	Q16TT	IQ16	VQ16	
KOREA	SLK230	1999-		K20PBR-S10	IK20TT	K20TT	IK20	VK20	
	<b>BMW</b>								
	318i (E36,46,90)			K20TXR	IK20TT	K20TT	IK20	VK20	
	325i (E36,46)			K20TXR	IK20TT	K20TT	IK20	VK20	
MALAYSIA	520i (E34,39)			K20TXR	IK20TT	K20TT	IK20	VK20	
	525i (E34,39,60)			K20TXR	IK20TT	K20TT	IK20	VK20	
	X1 s Drive 18i2.0			K20TXR	IK20TT	K20TT	IK20	VK20	
	X3 2.0 i (E83)	2005-2008		-	IK20TT	-	IK20	VK20	
	X3 2.5 i (E83)	2004-2006		K20TXR	IK20TT	K20TT	IK20	VK20	
PHILIPPINES	X5 3.0 i (E53)	1999-2006		K20TXR	IK20TT	K20TT	IK20	VK20	
	<b>Chevrolet</b>								
SAUDI ARABIA	Aveo 1.5	2008-		-	IK16TT	K16TT	IK16	VK16	
	Captiva	2008-		-	IK20TT	-	IK20	VK20	
	Cruze 1.5	2011-		-	IK16TT	-	IK16	VK16	
	Optra 1.6			-	IK16TT	K16TT	IK16	VK16	
	Optra 1.8			K20TXR	IK20TT	K20TT	IK20	VK20	
	Sonic 1.5	2013-		-	IK16TT	-	IK16	VK16	
	Zafira 1.8			K20TXR	IK20TT	K20TT	IK20	VK20	
	Zafira 2.2			-	ITV16TT	TV16TT	ITV16	-	
	<b>Chrysler</b>								
	TAIWAN	Cherokee 2.5	1993-		QJ16AR-U	IQ16TT	Q16TT	IQ16	VQ16
Cherokee 4.0		1990-		KJ16CR-L11	IK16TT	K16TT	IK16L	-	
Grand Cherokee 4.0		1995-		KJ16CR-L11	IK16TT	K16TT	IK16L	-	
Grand Cherokee 4.7				K16R-U11	IK16TT	K16TT	IK16	VK16	
Neon		1994-		K20PR-U	IK20TT	K20TT	IK20	VK20	
THAILAND	<b>Daewoo</b>								
	Ceilo			W20EPR-U	IW20TT	W20TT	IW20	VW20	
	Espero			W20EPR-U	IW20TT	W20TT	IW20	VW20	
	Fantasy			W20EPR-U	IW20TT	W20TT	IW20	VW20	
	Nexia			W16EPR-U	IW16TT	W16TT	IW16	VW16	
VIETNAM	Racer			W16EPR-U	IW16TT	W16TT	IW16	VW16	
	<b>Daihatsu</b>								
JAPAN	Applause			K20PR-U11	IK20TT	K20TT	IK20	VK20	
	Charade			K20PR-U11	IK20TT	K20TT	IK20	VK20	
	Mira			W20EX-U	IW20TT	W20TT	IW20	VW20	
& EUROPE & USA	<b>Ferrari</b>								
	308			-	-	-	IW24	-	
	348			-	-	-	IX24	-	
	360 Modena			-	-	-	IU24	-	
	456 GT, 456M GT			-	-	-	IXU27	-	
	512TR			-	-	-	IXU27	-	
550 Maranello			-	-	-	IXU27	-		
F355			-	-	-	IU22	-		
CROSS REFERENCE	<b>Fiat</b>								
	Punto			Q20PR-U11	IQ20TT	Q20TT	IQ20	VQ20	
	Tempra			W22EPR-U	-	W22TT	IW22	VW22	
PART NUMBER	<b>Ford</b>								
	Aspire			W16EX-U	IW16TT	W16TT	IW16	VW16	
	Ecosport	2015-	I4	-	-	-	-	-	
	ESCAPE 2.0L	2001-2004		-	ITV20TT	-	ITV20	-	
	Escort			W20EX-U	IW20TT	W20TT	IW20	VW20	

MODEL	YEAR	CODE	DENSO	IRIDIUM U	TJ	IRIDIUM POWER	IRIDIUM TOUGH
<b>Ford</b>							
Fiesta			W16EX-U	IW16TT	W16TT	IW16	VW16
FIESTA 1.6	2004-		-	ITV20TT	-	ITV20	-
Focus 1.8 2.0	2006-		T20EPR-U15	IT20TT	T20TT	IT20	VT20
Laser 1.8	1998-2001	BJ8	K16PR-U11	IK16TT	K16TT	IK16	VK16
Laser Tierra 1.6	2001-2005	PE1	KJ16CR11	IK16TT	K16TT	IK16L	-
Laser Tierra RS 2.0	2001-2005	PE1	K20PR-U11	IK20TT	K20TT	IK20	VK20
Mondeo			PT16VR13	ITV16TT	TV16TT	ITV16	-
Telstar			K20PR-U	IK20TT	K20TT	IK20	VK20
Tierra 1.8	2001-2005	PE1	K16PR-U11	IK16TT	K16TT	IK16	VK16
<b>HONDA</b>							
Accord	1990-1993	CB3,CD5,CD7	KJ16CR-L11	IK16TT	K16TT	IK16L	-
	1994-1997	CB3,CD5,CD7	KJ16CR-L11	IK16TT	K16TT	IK16L	-
	1998-2002	CG5,CF8	KJ16CR-L11	IK16TT	K16TT	IK16L	-
Accord 2.0	2008-		SKJ20DR-M11S	IK20TT	-	IK20G	VK20G
Accord 2.0 E	2015-	R20A3 I4	SKJ20DR-M11S	IK20TT	-	IK20G	VK20G
Accord 2.0 EL	2015-	R20A3 I4	SKJ20DR-M11S	IK20TT	-	IK20G	VK20G
Accord 2.4	2008-		-	-	-	-	-
Accord 2.4 EL	2015-	K24W I4	SXU22HCR11S	-	-	-	VXUHC22G
Accord 3.0	2008-		-	-	XUH22TT	-	VXUH22I
Accord V6 2.4,3.0	2003-2007	CM5,CM6	SKJ20DR-M11	IK20TT	-	IK20	VK20
Amaze	2016-	L12B i-VTEC I4	SKJ20DR-M11	IK20TT	-	IK20	VK20
Brio	2016-	L12B i-VTEC I4	SKJ20DR-M11	IK20TT	-	IK20	VK20
BRV	2016-	L15Z1 i-VTEC I4	SKJ20DR-M11S	IK20TT	-	IK20G	VK20G
City	2008-	HRHGM	SKJ20DR-M13	IK20TT	-	IK20	VK20
	2015-		VFK20F	IK20TT	-	-	VFK20F
City 1.3	1996-1999		K16PR-U11	IK16TT	K16TT	IK16	VK16
City 1.5	1996-1999		K16PR-U11	IK16TT	K16TT	IK16	VK16
City Type Z			K16PR-U11	IK16TT	K16TT	IK16	VK16
City ZX	2005-		K16PR-U11	IK16TT	K16TT	IK16	VK16
Civic	1992-1995		K16PR-U11	IK16TT	K16TT	IK16	VK16
	1996-2000		K16PR-U11	IK16TT	K16TT	IK16	VK16
Civic 1.8,2.0	2014-	FD	SKJ20DR-M11	IK20TT	-	IK20	VK20
	2015-		SXU22HCR11S	-	-	-	VXUHC22G
Civic 3 Drs	1993-1996	EG(3door)	K20PR-U11	IK20TT	K20TT	IK20	VK20
Civic dimention 1.7	2001-2006	ESI	KJ20CR-L11	IK20TT	K20TT	IK20L	-
Civic dimention 2.0	2003-	ET1	KJ20CR-L11	IK20TT	K20TT	IK20L	-
	2006-	ET1	KJ20CR-L11	IK20TT	K20TT	IK20L	-
CRV	2004-	RD7	KJ20CR-L11	IK20TT	K20TT	IK20L	-
	2007-		SKJ20DR-M11	IK20TT	-	IK20	VK20
	1996-2003	RD1,RD5	KJ20CR-L11	IK20TT	K20TT	IK20L	-
CRV 2.0	2015-		SXU22HCR11S	-	-	-	VXUHC22G
Freed			SKJ20DR-M13	IK20TT	-	IK20	VK20
HRV	2015-	L15Z6 I4	-	-	-	-	-
Integra			KJ16CR-L11	IK16TT	K16TT	IK16L	-
Jazz	2003-	GD3	K16PR-U11	IK16TT	K16TT	IK16	VK16
	2007-	MRHGE	SKJ20DR-M13	IK20TT	-	IK20	VK20
	2015-	L15A I4	SKJ20DR-M13	IK20TT	-	IK20	VK20
Legend	1996-2000		PK20PR-L11	IK20TT	K20TT	IK20	VK20
Mobilio	2015-	L15Z1 i-VTEC I4	-	-	-	-	-
NSX			PK20PR-L11	IK20TT	K20TT	IK20	VK20
Odyssey	2000-		KJ16CR-L11	IK16TT	K16TT	IK16L	-
	1995-1998		KJ16CR-L11	IK16TT	K16TT	IK16L	-
Prelude	1992-1996		KJ16CR-L11	IK16TT	K16TT	IK16L	-
	1997-2001		KJ20CR-L11	IK20TT	K20TT	IK20L	-
Stream	2001-	LA-RA3	-	IK20TT	K20TT	IK20	VK20
Vigor			K20PR-L11	IK20TT	K20TT	IK20	VK20
<b>Hyundai</b>							
Accent 1.5L		UE2,VE2	K16PR-U11	IK16TT	K16TT	IK16	VK16
Elantra		JF2 DOHC	W20EPR-U11	IW20TT	W20TT	IW20	VW20
Excel			W20EPR-U11	IW20TT	W20TT	IW20	VW20
Santafe 2.4			-	IW16TT	W16TT	IW16	VW16
Santafe 2.7			-	IK16TT	K16TT	IK16	VK16
Scoupe			K16PR-U11	IK16TT	K16TT	IK16	VK16
Scoupe turbo			K20PR-U11	IK20TT	K20TT	IK20	VK20
Sonata			W20EPR-U11	IW20TT	W20TT	IW20	VW20
Tiburon			K16PR-U11	IK16TT	K16TT	IK16	VK16





AUSTRALIA  
 CHINA  
 INDIA  
 INDONESIA  
 KOREA  
 MALAYSIA  
 PHILIPPINES  
 SAUDIARABIA  
 SINGAPORE  
 TAIWAN  
 THAILAND  
 VIETNAM  
 JAPAN  
 EUROPE  
 & USA  
 CROSS  
 REFERENCE  
 PART  
 NUMBER

DENSO	9	14	16	20	22	24	27	29	31	32	34	35	DENSO	9	14	16	20	22	24	27	29	31	32	DENSO	9	14	16	20	22	24	27	31
NGK	2	4	5	6	7	8	9	9.5	10	10.5	11	11.5	CHAMPION	18	16,14	12,11	10,9	8,7	6,63,61	4,59	57	55	53	BOSCH	10	9	8	7,6	5	4	3	2



	MODEL	YEAR	CODE	DENSO					
AUSTRALIA	Isuzu								
	Vertex			K16PR-U11	IK16TT	K16TT	IK16	VK16	
	Kia								
	Sephia			W20EPR-U11	IW20TT	W20TT	IW20	VW20	
CHINA	Sportage DOCH 2.0	1994-		K20PR-U11	IK20TT	K20TT	IK20	VK20	
	Sportage SOCH 2.0	1994-		K16PR-U11	IK16TT	K16TT	IK16	VK16	
Lamborghini									
	Gallardo			-	-	-	IK27	-	
INDIA	Murcielago			-	-	-	IXU27	-	
	Land Rover								
	623	1994-		KJ20CR-L11	IK20TT	K20TT	IK20L	-	
	820	1994-		K20PR-U	IK20TT	K20TT	IK20	VK20	
INDONESIA	Discovery MPI	1994-		W20EPR-U	IW20TT	W20TT	IW20	VW20	
	Discovery V8	1994-		W20EPR-U	IW20TT	W20TT	IW20	VW20	
INDONESIA	Freelander	2001-		-	IK20TT	K20TT	IK20	VK20	
	Range Rover 4.6	1999-		P20PR8	IW20TT	W20TT	IW20	VW20	
Lexus									
KOREA	ES300	1996-		PK20TR11	IK20TT	K20TT	IK20	VK20	
		2001-		-	IK20TT	K20TT	IK20	VK20	
KOREA	GS300	1997-		PK20TR11	IK20TT	K20TT	IK20	VK20	
		2000-		-	IK20TT	K20TT	IK20	VK20	
MALAYSIA		2005-		PK20TR11	IK20TT	K20TT	IK20	VK20	
	IS300	1999-		-	IK20TT	K20TT	IK20	VK20	
MALAYSIA	LS400	1996-		PK20R11	IK20TT	K20TT	IK20	VK20	
	LS430	2001-		-	IK20TT	K20TT	IK20	VK20	
PHILIPPINES	RX300			-	IK20TT	K20TT	IK20	VK20	
	Maserati								
	3200GT/GTA			-	-	-	IU24	-	
	Quattroporte			-	-	-	IU24	-	
SAUDI ARABIA	Mazda								
	929			KJ16CR-L11	IK16TT	K16TT	IK16L	-	
SINGAPORE	323 Astina			K20PR-U11	IK20TT	K20TT	IK20	VK20	
	323 Protégé 1.6			KJ16CR-L11	IK16TT	K16TT	IK16L	-	
SINGAPORE	323 Protégé 1.8 2.0			KJ16CR-L11	IK16TT	K16TT	IK16L	-	
	323 Sedan			K16PR-U11	IK16TT	K16TT	IK16	VK16	
SINGAPORE	626 Cronos			K20PR-U11	IK20TT	K20TT	IK20	VK20	
	CX5 2.0	2012-		ZC20HPR11	IXEH22TT	-	-	VCH20	
SINGAPORE	CX5 2.5	2012-		ZC20HPR11	IXEH22TT	-	-	VCH20	
	Lantis			K20PR-U11	IK20TT	K20TT	IK20	VK20	
TAIWAN	Mazda 2 1.5	2015-		ZC20HPR11	IXEH22TT	-	-	VCH20	
	Mazda 3 1.6	2005-	MZR16DE	K16PR-U11	IK16TT	K16TT	IK16	VK16	
TAIWAN		2015-		ZC20HPR11	IXEH22TT	-	-	VCH20	
	Mazda 3 2.0	2005-	MZR20DE	-	IT16TT	T16TT	IT16	VT16	
THAILAND	MX5			K16PR-U11	IK16TT	K16TT	IK16	VK16	
	Tribute 2.0	2003-		PT16VR13	ITV16TT	TV16TT	ITV16	-	
THAILAND	Tribute 3.0	2003-		-	IT16TT	T16TT	IT16	VT16	
	Mini								
VIETNAM	Cooper 1.6	2004-	RF16	-	IK20TT	-	IK20	VK20	
	Cooper S 1.6	2002-	RE16,RH16	-	IK20TT	-	IK20	VK20	
Mitsubishi									
JAPAN	Attrage	2014-	A92 I3	FK16HR11	-	-	-	VFKH16	
		2015-	A92 I3	FK16HR11	-	-	-	VFKH16	
JAPAN	Cedia CNG	2008-		K20PR-U11	IK20TT	K20TT	IK20	VK20	
	Champ I II III	1987-1995	CA1A,CB1A,CB2A	W16EX-U	IW16TT	W16TT	IW16	VW16	
JAPAN	Galant		E33	W20EPR-U11	IW20TT	W20TT	IW20	VW20	
	Lancer	1990-	E-CAR,CK2A	W16EX-U	IW16TT	W16TT	IW16	VW16	
EUROPE & USA		1991-1999	E-CAR,CK2A	W16EX-U	IW16TT	W16TT	IW16	VW16	
		1991-1996	CB4A/E-CAR,CK4A	K20PR-U11	IK20TT	K20TT	IK20	VK20	
EUROPE & USA		1996-1999	CB4A/E-CAR,CK4A	K20PR-U11	IK20TT	K20TT	IK20	VK20	
	Lancer cedia	2001-2003	CS3A	K16PR-U11	IK16TT	K16TT	IK16	VK16	
CROSS REFERENCE	Lancer EX	2001-2003	CK5A,CS5A	K20PR-U11	IK20TT	K20TT	IK20	VK20	
			MIVEC II	-	IK20TT	K20TT	IK20	VK20Y	
CROSS REFERENCE	Mirage	2014-	A92 I3	FK16HR11	-	-	-	VFKH16	
		2015-	A92 I3	FK16HR11	-	-	-	VFKH16	
PART NUMBER	New lancer	2003-		K16PR-U11	IK16TT	K16TT	IK16	VK16	
		2007-	CS9A,E55A,E75A	K20PR-U11	IK20TT	K20TT	IK20	VK20	
PART NUMBER	Pajaro	2008-		-	IK16TT	K16TT	IK16	VK16	
	Pajero 3.0i			W16EPR-U11	IW16TT	W16TT	IW16	VW16	



MODEL	YEAR	CODE	DENSO																																																																							
<b>Mitsubishi</b>																																																																										
Pajero 3.5i			-	IK16TT	K16TT	IK16	VK16	AUSTRALIA																																																																		
Space Wagon 2.4	2004-	XP	-	IKH20TT	KH20TT	IKH20	VKH20	CHINA																																																																		
Triton		CNG.BENZINE	K16PR-U11	IK16TT	K16TT	IK16	VK16																																																																			
Ultima			K20P-U, K20PR-U	IK20TT	K20TT	IK20	VK20																																																																			
Xedia 1.6	2002-	CS3	K16PR-U11	IK16TT	K16TT	IK16	VK16	INDIA																																																																		
Xedia 1.8	2002-	CS4	K16PR-U11	IK16TT	K16TT	IK16	VK16																																																																			
<b>Nissan</b>																																																																										
200SX	1992-	S13	Q20PR-U11	IQ20TT	Q20TT	IQ20	VQ20	INDONESIA																																																																		
	1995-	S14	-	IK20TT	K20TT	IK20	VK20																																																																			
300ZX	1993-	Z32	-	IK20TT	K20TT	IK20	VK20	KOREA																																																																		
350Z	2006-		VKH16	IKH16TT	-	IKH16	VKH16																																																																			
Almera 1.2	2010-		FXE20HE11	-	-	-	VFXEH20E	MALAYSIA																																																																		
Bluebird	1993-	U13	K16PR-U11	IK16TT	K16TT	IK16	VK16																																																																			
Cefiro 12V	1990-	A31	Q16R-U11	IQ16TT	Q16TT	IQ16	VQ16	PHILIPPINES																																																																		
Cefiro 2.0	1995-2000	A32,A33	PK16PR(-L)11	IK16TT	K16TT	IK16	VK16																																																																			
Cefiro 24V	1993-	A31	PQ16R	IQ16TT	Q16TT	IQ16	VQ16	SINGAPORE																																																																		
Cefiro 3.0	2000-	A32,A33	PK20PR11	IK20TT	K20TT	IK20	VK20																																																																			
Juke 1.6	2015-	HR16DE I4	FXE20HR11	-	-	-	VFXEH20	TAIWAN																																																																		
March 1.2	2019-		FXE20HR11	-	-	-	VFXEH20																																																																			
New Teana 2.0	2009-2019	J32	-	-	-	-	-	THAILAND																																																																		
New Teana 2.5	2009-2019	J32	FXE20HR11	-	-	-	VFXEH20																																																																			
Note1.2	2015-	HR12DE I3	FXE20HR11	-	-	-	VFXEH20	VIETNAM																																																																		
NV-B 1.8LX,SLX'96		Y10	K20PR-U	IK20TT	K20TT	IK20	VK20																																																																			
NX coupe		GB13	K16PR-U	IK16TT	K16TT	IK16	VK16	JAPAN																																																																		
Presia	1993-	R10	K16PR-U11	IK16TT	K16TT	IK16	VK16																																																																			
Primera	1995-	R11	K16PR-U11	IK16TT	K16TT	IK16	VK16	EUROPE & USA																																																																		
	1997-	P11	K16PR-U11	IK16TT	K16TT	IK16	VK16																																																																			
Serena	1992-	C23	K20PR-U	IK20TT	K20TT	IK20	VK20	CROSS REFERENCE NUMBER																																																																		
Sunny	1982-1988	B11	W16EX-U	IW16TT	W16TT	IW16	VW16																																																																			
	1992-1994	B13,B14	K16PR-U11	IK16TT	K16TT	IK16	VK16																																																																			
	1995-1997	B13,B14	K16PR-U11	IK16TT	K16TT	IK16	VK16																																																																			
	1995-1997	B14,B15	K20PR-U11	IK20TT	K20TT	IK20	VK20																																																																			
	1998-2000	B14,B15	K20PR-U11	IK20TT	K20TT	IK20	VK20																																																																			
	1998-2000	B15	K16PR-U11	IK16TT	K16TT	IK16	VK16																																																																			
Sunny neo 1.6	2001-2006	N16E	K16PR-U	IK16TT	K16TT	IK16	VK16	PART																																																																		
Sunny neo 1.8	2001-2006	N16E	K20PR-U	IK20TT	K20TT	IK20	VK20																																																																			
Sylphy 1.6	2015-	HR16DE I4	FXE20HR11	-	-	-	VFXEH20	PART																																																																		
Teana 2.0	2006-		K16HPR-U11	IKH16TT	KH16TT	IKH16	VKH16																																																																			
Teana 2.3	2014-	MR20DE I4	FXE20HR11	-	-	-	VFXEH20	PART																																																																		
	2004-		K16HPR-U11	IKH16TT	KH16TT	IKH16	VKH16																																																																			
Teana 2.5	2014-	QR25DE I4	FXE20HR11	-	-	-	VFXEH20	PART																																																																		
Teana 3.0	2004-		VKH16	IKH16TT	-	IKH16	VKH16																																																																			
TIDA 1.6	2006-		FXE20HE11	-	-	-	VFXEH20E	PART																																																																		
TIDA 1.8	2006-		FXE20HR11	-	-	-	VFXEH20																																																																			
X-Trail	2005-	T30	VKH16	IKH16TT	-	IKH16	VKH16	PART																																																																		
X-Trail 2.0	2015-	MR20DD 143 hp (106 kW) I4	-	-	-	-	-																																																																			
X-Trail 2.0 Hybrid	2015-		-	-	-	-	-	PART																																																																		
X-Trail 2.5	2015-	QR25DE170 hp (126 kW) I4	FXE20HR11	-	-	-	VFXEH20																																																																			
X-Trail 2.5 Hybrid	2015-		-	-	-	-	-	PART																																																																		
<b>Opel</b>																																																																										
Astra			W20EPR-U	IW20TT	W20TT	IW20	VW20	PART																																																																		
Calibra			W16EPR-U	IW16TT	W16TT	IW16	VW16																																																																			
Commodore			W20EP-U	IW20TT	W20TT	IW20	VW20	PART																																																																		
Corsa			W20EPR-U	IW20TT	W20TT	IW20	VW20																																																																			
Kadett			W20EP-U	IW20TT	W20TT	IW20	VW20	PART																																																																		
Omega			W16EPR-U	IW16TT	W16TT	IW16	VW16																																																																			
Vectra			W16EPR-U	IW16TT	W16TT	IW16	VW16	PART																																																																		
<b>Peugeot</b>																																																																										
205			T20EP-U	IT20TT	T20TT	IT20	VT20	PART																																																																		
305			T20EP-U	IT20TT	T20TT	IT20	VT20																																																																			
405			T20EP-U	IT20TT	T20TT	IT20	VT20	PART																																																																		
505			W20EX-U	IW20TT	W20TT	IW20	VW20																																																																			
605			K20PBR	IK20TT	K20TT	IK20	VK20	PART																																																																		
<b>Proton</b>																																																																										
Gen 2			T20EP-U	IT20TT	T20TT	IT20	VT20	PART																																																																		
<table border="1" style="width:100%; border-collapse: collapse;"> <tr> <td>DENSO</td><td>9</td><td>14</td><td>16</td><td>20</td><td>22</td><td>24</td><td>27</td><td>29</td><td>31</td><td>32</td><td>DENSO</td><td>9</td><td>14</td><td>16</td><td>20</td><td>22</td><td>24</td><td>27</td><td>29</td><td>31</td><td>32</td><td>DENSO</td><td>9</td><td>14</td><td>16</td><td>20</td><td>22</td><td>24</td><td>27</td><td>29</td><td>31</td><td>32</td> </tr> <tr> <td>NGK</td><td>2</td><td>4</td><td>5</td><td>6</td><td>7</td><td>8</td><td>9</td><td>9.5</td><td>10</td><td>10.5</td><td>11</td><td>11.5</td><td>CHAMPION</td><td>18</td><td>16,14</td><td>12,11</td><td>10,9</td><td>8,7</td><td>6,6,3,61</td><td>4,5,9</td><td>57</td><td>55</td><td>53</td><td>BOSCH</td><td>10</td><td>9</td><td>8</td><td>7,6</td><td>5</td><td>4</td><td>3</td><td>2</td> </tr> </table>									DENSO	9	14	16	20	22	24	27	29	31	32	DENSO	9	14	16	20	22	24	27	29	31	32	DENSO	9	14	16	20	22	24	27	29	31	32	NGK	2	4	5	6	7	8	9	9.5	10	10.5	11	11.5	CHAMPION	18	16,14	12,11	10,9	8,7	6,6,3,61	4,5,9	57	55	53	BOSCH	10	9	8	7,6	5	4	3	2
DENSO	9	14	16	20	22	24	27	29	31	32	DENSO	9	14	16	20	22	24	27	29	31	32	DENSO	9	14	16	20	22	24	27	29	31	32																																										
NGK	2	4	5	6	7	8	9	9.5	10	10.5	11	11.5	CHAMPION	18	16,14	12,11	10,9	8,7	6,6,3,61	4,5,9	57	55	53	BOSCH	10	9	8	7,6	5	4	3	2																																										



	MODEL	YEAR	CODE	DENSO				
AUSTRALIA	Proton Neo			-	-	-	-	-
	Persona CNG			-	IT20TT	T20TT	IT20	VT20
	Savvy			W20EP-U/ W20EX-U	IW20TT	W20TT	IW20	VW20
CHINA	Saab 9000			Q20PR-U11	IQ20TT	Q20TT	IQ20	VQ20
	9000I			Q20P-U, Q20PR-U	IQ20TT	Q20TT	IQ20	VQ20
	Seat Cordoba			K22PB	-	-	IK22	VK22
INDIA	Subaru Impreza			K20PR-U11	IK20TT	K20TT	IK20	VK20
	Legacy			K20PR-U11	IK20TT	K20TT	IK20	VK20
	WRX			PK22PR8	-	-	IK22	VK22
INDONESIA	Suzuki APV		G16A	K20PR-U	IK20TT	K20TT	IK20	VK20
	Carry pick-up		G16A,AP416PUM14058	K20PR-U	IK20TT	K20TT	IK20	VK20
	Grand Vitara		J20A,DOHC	K20PR-U11	IK20TT	K20TT	IK20	VK20
KOREA	Swift SX4		M15A,DOHC VVT M16A,VVT	K20PR-U11	IK20TT	K20TT	IK20	VK20
	TOYOTA ALPHARD 3.5 V6		2GR-FE	-	IKH20TT	-	IKH20	VKH20
	MALAYSIA	Altis 1.6	2015-		SC20HR11	IXEH22TT	-	-
		2000-	ZZE121	K16R-U11	IK16TT	K16TT	IK16	VK16
		2008-		K16R-U11	IK16TT	K16TT	IK16	VK16
PHILIPPINES	Altis 1.8	2014-		SC20HR11	IXEH22TT	-	-	VCH20
		2000-	ZZE122	K16R-U11	IK16TT	K16TT	IK16	VK16
		2008-		K16R-U11	IK16TT	K16TT	IK16	VK16
SAUDIARABIA	Altis Cross	2020-		SC20HR11	IXEH22TT	-	-	VCH20
	Avanza	2004-	F600	XU22-PR9	-	XU22TT	IXU22	VXU22
	SINGAPORE	Camry	2012-		SK16HR11	-	-	IKH16
		1992-	SXV10	PK20R11	IK20TT	K20TT	IK20	VK20
		1999-	SXV20	PK20TR11	IK20TT	K20TT	IK20	VK20
		2002-	ACV30,31	SK20R11	-	-	IK20	VK20
		2006-	ACV40,41	SK20R11	-	-	IK20	VK20
TAIWAN	Camry 2.0 G	2015-	6AR-FSE	FK16HBR-J8	-	-	-	-
	Camry 2.5 E	2015-	2AR-FE	SK16HR11	-	-	IKH16	VKH16
	Camry Hybrid	2015-	2AR-FXE	FK16HR-A8	-	-	-	VFKH16
THAILAND	Celica	1989-	ST184	PK20R8	IK20TT	K20TT	IK20	VK20
		1994-	ST204	PK20R8	IK20TT	K20TT	IK20	VK20
	Celica GT-4	1995-	ST205	PK20R8	IK20TT	K20TT	IK20	VK20
VIETNAM	CHR	2013-2019	3NR-FE	SC20HR-G11	-	-	-	-
	Corolla	1992-	EE100	W20EX-U	IW20TT	W20TT	IW20	VW20
		1987-1992	AE92	Q16R-U11	IQ16TT	Q16TT	IQ16	VQ16
		1987-1992	AE92 GTI	K20R-U11	IK20TT	K20TT	IK20	VK20
		1988-1992	EE90	W16EX-U	IW16TT	W16TT	IW16	VW16
		1992-1995	AE101	K16R-U11	IK16TT	K16TT	IK16	VK16
	1993-1995	EE101	K16R-U11, K20R-U11	IK16TT/IK20TT	K16TT/K20TT	IK16/IK20	VK16/VK20	
JAPAN	Corona	1996-1999	AE110	K16R-U11	IK16TT	K16TT	IK16	VK16
		1988-1992	ST171	Q20R-U11	IQ20TT	Q20TT	IQ20	VQ20
		1988-1992	AT171	Q16R-U11, QJ16AR-U	IQ16TT	Q16TT	IQ16	VQ16
EUROPE & USA	Crown	1993-1997	ST191	K20R-U11	IK20TT	K20TT	IK20	VK20
		1993-1997	AT190	K16R-U11	IK16TT	K16TT	IK16	VK16
		1991-	JZS133	PK16R11	IK16TT	K16TT	IK16	VK16
		1995-	JZS155	PK16TR11	IK16TT	K16TT	IK16	VK16
		1999-	JZS175	PK16TR11	IK16TT	K16TT	IK16	VK16
CROSS REFERENCE NUMBER	FORTUNER 2.7	2000-	JZS175	-	IK16TT	K16TT	IK16	VK16
		2007-	2TR-FE	K20HR-U11	-	KH20TT	IKH20	VKH20
		2015-		SK20HR11	-	-	IKH20	VKH20
PART NUMBER	HIACE	2000-	RZH113	W16EXR-U	IW16TT	W16TT	IW16	-
	INNOVA 2.0	2004-		K20HR-U11	IKH20TT	KH20TT	IKH20	VKH20
	Land cruiser	1999-	VX100	-	IK20TT	K20TT	IK20	VK20
PART NUMBER	Prado	1996-	VZJ95	PK16TR11	IK16TT	K16TT	IK16	VK16
		2003-	GRJ120	-	IK20TT	K20TT	IK20	VK20
		2009-	2ZR-FXE(HYBRID)	SC20HR11	IXEH22TT	-	-	VCH20
PART NUMBER	PRIUS 1.8	2009-	2ZR-FXE(HYBRID)	SC20HR11	IXEH22TT	-	-	VCH20
	Rav 4	1995-	SXA11	PK20R11	IK20TT	K20TT	IK20	VK20
PART NUMBER	Revo	2015-		SK20HR11	-	-	IKH20	VKH20



MODEL	YEAR	CODE	DENSO	IRIDIUM U	TT	IRIDIUM POWER	IRIDIUM TOUGH
<b>TOYOTA</b>							
Sienta	2016-	2NR-FE	SC16HR11	IXEH20TT	-	-	VCH16
Soluna	1996-2001	AL50	K16R-U11	IK16TT	K16TT	IK16	VK16
Supra (2JGE)	1993-		PK16TR11	IK16TT	K16TT	IK16	VK16
Supra (2JGTE)	1993-		PK20TR11	IK20TT	K20TT	IK20	VK20
Vios	2002-	NCP42	K16R-U11	IK16TT	K16TT	IK16	VK16
	2007-	NCP93	K16R-U11	IK16TT	K16TT	IK16	VK16
	2015-	1NZ	SK20HR11	-	-	IKH20	VKH20
Yaris	2014-		SK20HR11	-	-	IKH20	VKH20
	2006-	NCP91	K16R-U11	IK16TT	K16TT	IK16	VK16
	2015-	3NR-FE	SC16HR11	IXEH20TT	-	-	VCH16
Yaris Ativ	2015-		SC16HR11	IXEH20TT	-	-	VCH16
<b>Volkswagen</b>							
BEETLE (NEW)1.6	2002-		K20PBR-S10	IK20TT	K20TT	IK20	VK20
BEETLE (NEW)2.0	2002-		VK20	IK20TT	-	IK20	VK20
Golf	1993-		W20EPBR-S	IW20TT	W20TT	IW20	VW20
Passat 1.8	1995-		W20EPBR-S	IW20TT	W20TT	IW20	VW20
Passat 2.0	1998-		W20EPBR-S	IW20TT	W20TT	IW20	VW20
Passat 2.3	2000-		-	IK16TT	K16TT	IK16	VK16
Vento	1994-		W20EPBR-S	IW20TT	W20TT	IW20	VW20
<b>Volvo</b>							
850	1994-		Q20PR-U	IQ20TT	Q20TT	IQ20	VQ20
940	1990-		W20EPR-U	IW20TT	W20TT	IW20	VW20
960 2.4, 3.0 24V	1990-		Q20PR-U	IQ20TT	Q20TT	IQ20	VQ20
S40	1996-		K20TXR	IK20TT	K20TT	IK20	VK20
S70	1998-		-	IK20TT	K20TT	IK20	VK20
S80 2.8	2001-		-	IK20TT	K20TT	IK20	VK20
S90 2.4			K20PR-U	IK20TT	K20TT	IK20	VK20
S90 3.0	1998-		K20TXR	IK20TT	K20TT	IK20	VK20
V40	1996-		K20TXR	IK20TT	K20TT	IK20	VK20
V70	1998-		-	IK20TT	K20TT	IK20	VK20

AUSTRALIA  
CHINA  
INDIA  
INDONESIA  
KOREA  
MALAYSIA  
PHILIPPINES  
SAUDIARABIA  
SINGAPORE  
TAIWAN  
THAILAND  
VIETNAM  
JAPAN  
EUROPE & USA  
CROSS REFERENCE NUMBER  
PART

# THAILAND MOTORCYCLE



MODEL	DENSO	IRIDIUM POWER	IRIDIUM RACING	MODEL	DENSO	IRIDIUM POWER	IRIDIUM RACING
<b>BMW</b>				<b>HONDA</b>			
C600/C650GT	-	-	-	C65	U16FS-U	-	-
F800GS/F800R	XU24EPRU	IXU24	IXU01-□	C70	U20FS-U	IUF22	-
K1600GT/GTL	-	-	-	C700	U20FS-U	IUF22	-
R1200GS	-	IXU24	IXU01-□	C700 (CDI Ignition)	U22FS-U	IUF22	-
R1200R	XU22EPR-U	IXU22	IXU01-□	C700 Old Models	U20FS-U	IUF22	-
R1200RT	-	IXU24	IXU01-□	C90	U20FS-U	IUF22	-
S1000RR	-	-	-	C90 Old Models	U16FS-U	-	-
<b>Ducati</b>				C900	U20FS-U	IUF22	-
899PANIGALE	-	-	-	C900 (CDI Ignition)	U22FS-U	IUF22	-
DIAVEL	-	-	-	C900 CDI Old Models	U20FS-U	IUF22	-
DIAVEL CARBON	-	-	-	CB1000SF/CB1300SF	X24EPR-U9	IX24B	IXU01-□
DIAVEL TITANIUM	-	-	-	CB1100EX	-	-	-
MONSTER1200/S/STRPE/R	-	-	-	CB400SF	U24FER9	IUH24	IU01-□
MONSTER821/DARK	XU24EPR-U	IXU24	IXU01-□	CB400SS	-	IU24	IU01-□
MULTISTRADA1200/S	-	-	-	CB500X	U24FER9	IUH24	IU01-□
STREET FIGHTER848	-	-	-	CB650F	U27FER9	IUH27	IU01-□
<b>HARLEY-DAVIDSON</b>				CBR1000F	VUH27ES	-	IU01-□
ELECTREGLIDE CLASSIC	XU24EPR-U	IXU24	IXU01-□	CBR1000RR	VUH27ES	-	IU01-□
HERITAGE SOFTAIL CLASSIC	XU24EPR-U	IXU24	IXU01-□	CBR1100XX	VUH27D	IUH27	IU01-□
NIGHT ROD SPECIAL	XU24EPR-U	IXU24	IXU01-□	CBR125	U24ESR-N	IU24	IU01-□
ROADKING CLASS	XU24EPR-U	IXU24	IXU01-□	CBR150	U24ESR-N	IU24	IU01-□
SOFTAIL DELUX	XU24EPR-U	IXU24	IXU01-□	CBR150R	U24ESR-N	IU24	IU01-□
STREET GLIDE	XU24EPR-U	IXU24	IXU01-□	CBR250	U24ESR-N	IU24	IU01-□
V-ROD MUSCLE	XU24EPR-U	IXU24	IXU01-□	CBR300F	-	IU24	IU01-□
<b>HONDA</b>				CBR300R	-	IU24	IU01-□
AIRBLADE	U22FER9	IUH24	IU01-□	CBR400RR	U24FER9	IUH24	IU01-□
AIRBLADE-I	U22EPR9	IU22D	IU01-□	CBR500F	U24FER9	IUH24	IU01-□
BEST LS110	W24ES-US	IW24	IW01-□	CBR500R	U24FER9	IUH24	IU01-□
C100 (CDI Ignition)	U22FS-U	IUF22	-	CBR600F/FS/F4I/RR	VUH27ES	-	IU01-□
C100 Old Models	U20FS-U	IUF22	-	CBR650F	U27FER9	IUH27	IU01-□
C50	U16FS-U	-	-	CBR900RR/CBR954RR	VUH27D	IUH27	IU01-□

DENSO	9	14	16	20	22	24	27	29	31	32	34	35	DENSO	9	14	16	20	22	24	27	29	31	32	DENSO	9	14	16	20	22	24	27	31
NGK	2	4	5	6	7	8	9	9.5	10	10.5	11	11.5	CHAMPION	18	16,14	12,11	10,9	8,7	6,63,61	4,59	57	55	53	BOSCH	10	9	8	7,6	5	4	3	2



# THAILAND MOTORCYCLE

▶ Spark plug color codes: ■ for Iridium Tough and Iridium Plugs and Iridium TT, ■ for Iridium Power, ■ for Iridium Racing and Two Tops Plugs, ■ for Platinum Plugs and Platinum TT, and black for general spark plugs.

	MODEL	DENSO	IRIDIUM POWER	IRIDIUM RACING
AUSTRALIA	<b>HONDA</b>			
	CG110-125	X24ES-U	IX24	IXU01-□
	CLICK	U22FER9	IUH24	IU01-□
CHINA	CLICK125	U22EPR9	IU22D	IU01-□
	CLICK-125I	U22EPR10	IU22D	IU01-□
	CLICK-I	U22EPR9	IU22D	IU01-□
INDIA	CR125R	U24ESR-N	IU24	IU01-□
	CR250R	-	IW27	IW01-□
	CR800R/R2	IW31	IW31	-
INDONESIA	CRF100F	U22FSR-U	IUF22	-
	CRF250	U24ESR-N	IU24	IU01-□
	CRF250L	U24ESR-N	IU24	IU01-□
KOREA	CRF250M	-	IU24	IU01-□
		U24ESR-N	IU24	IU01-□
	CRF250R	-	IU24	IU01-□
MALAYSIA	CRF450R	VK24PRZ11	IK24	IK01-□
	CTX1300	U22FER9/U24FER9	IUH24	IU01-□
	CTX700N	-	-	-
PHILIPPINES	CZ-I	U20EPR9S	IU20	IU01-□
	DASH	W22EP-US	IW22	IW01-□
	DREAM	U20FS-U	IUF22	-
SAUDIARABIA	DREAM SUPER CUB100	U20EPR9	IU20	IU01-□
	DREAM110	U16FS-U	-	-
	DREAM110i	U20EPR9S	IU20	IU01-□
SINGAPORE	DREAM125	U24ESR-N	IU24	IU01-□
	FIGHTER	W24ES-US	IW24	IW01-□
	FORZA300	-	IU24	IU01-□
TAIWAN	FSX150	W27ES-U	IW27	IW01-□
	GL100	X24ES-U	IX24	IXU01-□
	GL-X	X24ES-U	IX24	IXU01-□
THAILAND	ICON	U24EPR9	IU24D	IU01-□
	INTEGRA4	-	-	-
	JX110-125	X24ES-U	IX24	IXU01-□
VIETNAM	LS125	W24ES-US	IW24	IW01-□
	MSX125	U20EPR9	IU20	IU01-□
	MTX	W24ES-US	IW24	IW01-□
JAPAN	N	W24ES-US	IW24	IW01-□
	NICE	U20FS-U	IUF22	-
	NICE125i	U20EPR9	IU20	IU01-□
EUROPE & USA	NM4	-	-	-
	NOVA	U24ESR-N	IU24	IU01-□
	NOVA 4GEAR	W20EP-US	IW20	IW01-□
CROSS REFERENCE	NOVA-SR/RS	W22EP-US	IW22	IW01-□
	NS	W24ES-US	IW24	IW01-□
	NSR150	W24ES-US	IW24	IW01-□
PART NUMBER	NSR150SP/R/RR	W27ES-U	IW27	IW01-□
	NSR250R/SE/RSP	-	IWM27	-
	PCX	U22EPR9	IU22D	IU01-□
PART NUMBER	PCX150	U22EPR10	IU22D	IU01-□
	PHANTOM (2cycle)	W27ES-U	IW27	IW01-□
	PHANTOM200	X24EPR-U9	IX24B	IXU01-□
PART NUMBER	QR500	W14FPR-UL	IWF16	-
	R	W24ES-US	IW24	IW01-□
	REBEL300	U20FSR-U	IUF22	-
PART NUMBER	RR	W24ES-US	IW24	IW01-□
	RTL250F	-	IU20	IU01-□
	RTL250R	-	IW20	IW01-□
PART NUMBER	S90	X20FS-U	-	-
	SCOOPY	U24EPR9	IU24D	IU01-□
	SCOOPY-I	U24EPR9	IU24D	IU01-□
PART NUMBER	SMILE	W22EP-US	IW22	IW01-□
	SONIC	U24ESR-N	IU24	IU01-□
	SPACYI	U24EPR9	IU24D	IU01-□
PART NUMBER	SS-1	X24ES-U	IX24	IXU01-□
	SUPER	W22EP-US	IW22	IW01-□
	SUPER CLUB	U20FSU	IUF20	-
PART NUMBER	TENA	W22EP-US	IW22	IW01-□

	MODEL	DENSO	IRIDIUM POWER	IRIDIUM RACING
AUSTRALIA	<b>HONDA</b>			
	TG125 (Wing)	X22ES-U	IX22	IXU01-□
	TLM200R	W24ES-U	IW24	IW01-□
CHINA	TLM220R	W24ESR-U	IW24	IW01-□
	TLM250R	X24ES-U	IX24	IXU01-□
	TLM260R	W20ES-U	-	IW01-□
INDIA	TLR260	W20ESR-U	-	IW01-□
	VFR1200F	-	IUH24	VUH27ES
	VFR1200X	-	IUH24	VUH27ES
INDONESIA	VFR800F	-	-	-
	VTR1000F	-	IX24B	IXU01-□
	VTR1000SP/II	VK27PRZ11	IK27	IK01-□
KOREA	WAVE100	U20FS-U	IUF22	-
	WAVE110	U20FS-U	IUF22	-
	WAVE110AT	U20EPR9S	IU20	IU01-□
MALAYSIA	WAVE110-I	U20EPR9S	IU20	IU01-□
	WAVE110-IAT	U20EPR9S	IU20	IU01-□
	WAVE125	U20EPR9	IU20	IU01-□
PHILIPPINES	WAVE125-I	U20EPR9	IU20	IU01-□
	WAVE-I	U20EPR9	IU20	IU01-□
	WAVE-Z	U16FS-U	-	-
SINGAPORE	XL100	X24ES-U	IX24	IXU01-□
	XR250/Motard	U24FER9	IUH24	IU01-□
	XR250R	U27FER9	IUH27	IU01-□
TAIWAN	XR400Motard	X24GPR-U/X27GPR-U	IXG24/IXG27	IXU01-□
	XR500R/XR700R	U20FSR-U	IUF22	-
	ZOOMER-X	U24EPR9	IU24D	IU01-□
THAILAND	<b>JRD</b>			
	QUEST	U20FS-U	IUF22	-
	SNOW	U20FS-U	IUF22	-
VIETNAM	STROM	U20FS-U	IUF22	-
	SURT	U20FS-U	IUF22	-
	TERNADO	U24ESR-N	IU24	IU01-□
JAPAN	<b>KAWASAKI</b>			
	14000GTR	-	IU27D	IU01-□
	AR125	W24ES-US	IW24	IW01-□
EUROPE & USA	AR150	W24ES-US	IW24	IW01-□
	AX-1	U20FS-U	IUF22	-
	BOSS	U24ES-N,U24ESR-N	IUH24	IU01-□
PART NUMBER	CHEER	U20FS-U	IUF22	-
	COSMO	W22FP-US	IWF22	-
	D-TRACKER X	U24ESR-N	IU24	IU01-□
PART NUMBER	D-TRACKER125	U22FSR-U	IUF22	-
	D-TRACKER250	U24ESR-N	IU24	IU01-□
	ER6 n	-	IU27D	IU01-□
PART NUMBER	GTO	W24EP-US	IW24	IW01-□
	GTX	W24ES-US	IW24	IW01-□
	KAZE	U20FS-U	IUF22	-
PART NUMBER	KAZE125	U20FS-U	IUF22	-
	KH100	W22EP-US	IW22	IW01-□
	KH125	W22EP-US	IW22	IW01-□
PART NUMBER	KLX110	U20FSR-U	IUF22	-
	KLX125	U22FSR-U	IUF22	-
	KLX140L	U22FSR-U	IUF22	-
PART NUMBER	KLX250	U24ESR-N	IU24	IU01-□
	KIX-250L	-	-	-
	KR150A	W24EP-US	IW24	IW01-□
PART NUMBER	KR150K	W27ES-U	IW27	IW01-□
	KSR	U22FSR-U	IUF22	-
	KSRPRO	U20FSR-U	IUF22	-
PART NUMBER	LEO	W22FP-US	IWF22	-
	LEO STER (AS120)	W24EP-US	IW24	IW01-□
	M	W27ES-U	IW27	IW01-□
PART NUMBER	MAGIC	U20FS-U	IUF22	-
	MAGMUN LC	W24ES-US	IW24	IW01-□
	MAX100	U20FS-U	IUF22	-
PART NUMBER	MOTOCROSS110	U20FSR-U	IUF22	-
	NEON	U20FS-U	IUF22	-



MODEL	DENSO	IRIDIUM POWER	IRIDIUM RACING	MODEL	DENSO	IRIDIUM POWER	IRIDIUM RACING
<b>KAWASAKI</b>				<b>SUZUKI</b>			
NEON, LEO	W22FP-US	IWF22	-	STEP125	U20FSR-U	IUF22	-
NINJA H2	-	-	-	SUPER BEST	U20FS-U	IUF22	-
NINJA ZX-14R ABS	-	IU27A	IU01-□	SWING	W24FP-US	IWF24	-
NINJA1000 ABS	-	IU27D	IU01-□	TR100	W24FS-U	IWF24	-
NINJA250SL ABS	U24ESR-N	IU24	IU01-□	TR-S	W24FP-US	IWF24	-
NINJA300	U24ESR-N	IU24	IU01-□	TR-Z	W24FP-US	IWF24	-
NINJA300 ABS	-	-	-	VIVA	U20FS-U	IUF22	-
NINJA650 ABS	-	IU27D	IU01-□	V-STORM650	U24ESR-N	IU24	IU01-□
SERPICO	W27ES-U	IW27	IW01-□	V-STORM650XT	U24ESR-N	IU24	IU01-□
SP	W24EP-US	IW24	IW01-□	<b>TIGER</b>			
TUXEDO	W22FP-US	IWF22	-	JOKER	U22FS-U	IUF22	-
VERSYS1000	-	IU27D	IU01-□	OZONE	U22FS-U	IUF22	-
VERSYS650	-	IU27D	IU01-□	SMART	U22FS-U	IUF22	-
VICTOR	W24EP-US	IW24	IW01-□	<b>YAMAHA</b>			
VICTOR-S	W27ES-U	IW27	IW01-□	ALFA	W22FP-US10	IWF22	-
VULCAN S	X22EP-U9	IX22B	IXU01-□	BELLE100	W22FP-US10	IWF22	-
VULCAN900 CLASSIC	U22EPR9	IU22D	IU01-□	FILANO	U20FSR-U	IUF22	IU01-□
VULCAN900 CUSTOM	U22EPR9	IU22D	IU01-□	FINO	U20FSR-U	IUF22	-
Z1000 ABS	-	IU27D	IU01-□	FIORE	U20FSR-U	IUF20	-
Z250	-	-	-	FJR1300A	U24EPR9	IU24D	IU01-□
Z250SL ABS	-	-	-	FRESH	U20FS-U	IUF22	-
Z300	-	-	-	FZ1	U27ETR	IU27A	IU01-□
Z800	-	-	-	JR120/S	W24EP-US	IW24	IW01-□
ZX130	U20FS-U	IUF22	-	MATE	W22FP-US	IWF22	-
<b>SUZUKI</b>				MATE SUPER	W22FP-US10	IWF22	-
A100	W20FP-US	IWF20	-	MATE100	W22FP-US10	IWF22	-
A80	W20FP-US	IWF20	-	MATE80	W20FP-US	IWF20	-
AKIRA	W24EP-US	IW24	IW01-□	MIO	U22FS-U	IUF22	-
BEST	U20FS-U	IUF22	-	MIO115I	U20FSR-U	IUF20	-
BEST125	U20FS-U	IUF22	-	MIO125I	U22ESR-N	IU22	IU01-□
COOL	W24EP-US	IW24	IW01-□	NOUVO	U22FSR-U	IUF22	-
CRYSTAL	W24FP-US	IWF24	-	NOUVO ELEGENCE	U22ESR-N	IU22	IU01-□
FLASH	W24EP-US	IW24	IW01-□	NOUVO SX	U22ESR-N	IU22	IU01-□
FR80	W20FP-US	IWF20	-	RAINBO	U22FS-U	IUF22	-
GLADIUS650	U24ESR-N	IU24	IU01-□	RX-K (CONCORD)	W24FP-US	IWF24	-
GP1000	W24FS-U	IWF24	-	RX-Z	W24EP-US	IW24	IW01-□
GP125	W24FS-U	IWF24	-	SPARK NANO	U20FS-U	IUF22	-
GSX-R1000	U27ESR-N	IU27	IU01-□	SPARK RX	U20FS-U	IUF22	-
HAYATE	U20FS-U	IUF22	-	SPARK115I	U20FSR-U	IUF20	-
HAYATE125	U20FS-U	IUF22	-	SPARK135	U24EPR9	IU24D	IU01-□
JELATO	U20FS-U	IUF22	-	SPARK135-I	U24EPR9	IU24D	IU01-□
KATANA125	U20FS-U	IUF22	-	SPEED	W24ESR-U, W24ES-US	IW24	IW01-□
RAIDER125	U24ESR-N	IU24	IU01-□	TIARA120	W24EP-US	IW24	IW01-□
RAIDER150	U24ESR-N	IU24	IU01-□	TMAX530	U22ESR-N	IU22	IU01-□
RC100	W22FP-US	IWF22	-	TMR150	W27ESR-U	IW27	IW01-□
RC80	W22FP-US	IWF22	-	TOUCH	W24ESR-U, W24ES-US	IW24	IW01-□
RGV	W24FP-US	IWF24	-	TRICITY	U22ESR-N	IU22	IU01-□
RGV-S	W24EP-US	IW24	IW01-□	TTX	U20FSR-U	IUF22	IU01-□
ROYAL	W24FP-US	IWF24	-	TZM150	W27ESR-U	IW27	IW01-□
SHOGUN AXELO	U20FS-U	IUF22	-	TZR150	W27ESR-U	IW27	IW01-□
SHOGUN125	U20FS-U	IUF22	-	VR150	W24EP-US	IW24	IW01-□
SKYDRIVE	U20FS-U	IUF22	-	X1 (RAINBOW, FRESH..)	U20FS-U	IUF22	-
SKYDRIVE125	U20FS-U	IUF22	-	X-1R135	U24EPR9	IU24D	IU01-□
SMASH	U20FS-U	IUF22	-	YZ250F	U24ESR-N	IU24	IU01-□
SMASH JUNIOR	U20FS-U	IUF22	-	YZ450F	U24ESR-N	IU24	IU01-□
SMASH REVO	U20FS-U	IUF22	-	YZF-R1	U27ETR	IU27A	IU01-□
SPRINTER	W22FP-US	IWF22	-	ZR120	W24EP-US	IW24	IW01-□
SSS	W24EP-US	IW24	IW01-□				

AUSTRALIA  
CHINA  
INDIA  
INDONESIA  
KOREA  
MALAYSIA  
PHILIPPINES  
SAUDI ARABIA  
SINGAPORE  
TAIWAN  
THAILAND  
VIETNAM  
JAPAN  
EUROPE & USA  
CROSS REFERENCE  
PART NUMBER

DENSO	9	14	16	20	22	24	27	29	31	32	35
NGK	2	4	5	6	7	8	9	9.5	10	10.5	11
DENSO	9	14	16	20	22	24	27	29	31	32	
CHAMPION	18	16,14	12,11	10,9	8,7	6,63,61	4,59	57	55	53	
DENSO	9	14	16	20	22	24	27	29	31	32	
BOSCH	10	9	8	7,6	5	4	3	2			



	MODEL	YEAR	CODE	DENSO					
AUSTRALIA	<b>BMW</b>								
	Serie 3	1997-2007	N46B18A,N42B18A	K20TXR	IK20TT	K20TT	IK20	VK20	
		2008-2011	N52 B25 A	KH20TT	IKH20TT	KH20TT	IKH20	VKH20	
2012-2018		N52 B30 A	-	-	-	-	-		
CHINA	Serie 5	2011-2016	N62 B48 B	K20TXR	IK20TT	K20TT	IK20	VK20	
	Serie 6	2011-2018	N62 B48 B	K20TXR	IK20TT	K20TT	IK20	VK20	
	Serie 7	2008-2015	N62 B40 A	K20TXR	IK20TT	K20TT	IK20	VK20	
	X3	2011-2017	256S	-	-	-	IK20	VK20	
INDIA	X5	2006-2013	N62	-	-	-	IK20	VK20	
	Z4	2013-2018	306S	-	-	-	IK20	VK20	
		2009-2016	M54	-	-	-	-	-	
INDONESIA	<b>Daewoo GM</b>								
	Aveo LT	2011-2018	714B	K20PR-U11	IK20TT	K20TT	IK20	VK20	
	Captiva	2006-2015	Z24	K20TXR	IK20TT	K20TT	IK20	VK20	
		2016-	Z24	K20TXR	IK20TT	K20TT	IK20	VK20	
	Lacetti MAX 1.8	2008-2011	T18SED	K20TXR	IK20TT	K20TT	IK20	VK20	
KOREA	Lanos 1.5	1997-2007	LX6(91CUL4)	W20EPR-U	IW20TT	W20TT	IW20	VW20	
	Matiz 0.8	2005-2015	F8CV	W16EXR-U11	IW16TT	W16TT	IW16	VW16	
	Trailblazer	2011-	-	-	-	XU22TT	IXU22	VXU22	
	Vivant 2.0	2008-2011	T20SED	K20TXR	IK20TT	K20TT	IK20	VK20	
MALAYSIA	<b>Daihatsu</b>								
	Terios	1997-2006	-	K20TT	IK20TT	K20TT	IK20	VK20	
	<b>FORD</b>								
	ECOSPORT	2013-	I4	-	-	-	-	-	
	Escape 2.0/2.3	2001-2008	-	PT16VR13	ITV16TT	-	ITV16	-	
		2009-2013	-	PT16VR13	ITV16TT	-	ITV16	-	
	Escape 3.0	2001-2007	-	VT20	-	-	IT20	VT20	
	EXPLORER 2.3	2016-	Ecoboost FM, FN	-	ITV20TT	TV20	ITV20	-	
	EXPLORER 3.5, 3.7	2011-2019	Duratec/Ecoboost	-	ITV20TT	TV20	ITV20	-	
	FIESTA	2012-	-	PT16VR13	ITV16TT	-	ITV16	-	
	FOCUS	2004-2012	-	PT16EPR-L13	IT16TT	-	IT16	VT16	
		2013-	-	VT20	-	-	IT20	VT20	
	LASER 1.6	1998-	B6	K16PR-U	IK16TT	K16TT	IK16	VK16	
	LASER GHIA 1.8	1998-	BP	K20PR-U	IK20TT	K20TT	IK20	VK20	
	Mondeo 2.0	2001-2007	-	T20EPR-U	IT20TT	T20TT	IT20	VT20	
Mondeo 2.3	2010-2014	-	T20EPR-U	IT20TT	T20TT	IT20	VT20		
Mondeo 2.5	2001-2007	-	T20EPR-U	IT20TT	T20TT	IT20	VT20		
TAIWAN	<b>HONDA</b>								
	ACCORD 3.5	2007-2012	J35Z	SXU22HCR11	-	-	IXUH22I	VXUH22I	
		2013-2017	J35Y1/J35Y2	VXUHC22G	-	-	-	VXUHC22G	
	BRIO	2011-	L12B	K20PR-U11	IK20TT	-	IK20L	-	
	CITY 1.5	2014-2019	L15A7/L15Z1	K20PR-U11	IK20TT	K20TT	IK20	VK20	
	CITY 1.5 (Earth Dreams i-VTEC)	2020-	L15ZE/L15ZF	SXE24HCR8S	-	-	-	VXEHC24G	
		2006-2011	-	SKJ20DR-M11	IK20TT	-	IK20L	-	
	CIVIC 1.8	2012-2016	R18A1	SXU22HCR11S	-	-	-	VXUHC22G	
		2006-2011	K20A3,K20Z2	SKJ20DR-M11	IK20TT	-	IK20L	-	
		2011-	K20Z4	SXU22HCR11S	-	-	-	VXUHC22G	
CIVIC 2.0	2017-2022	L15BE	SXE24HCR8S	-	-	-	VXEHC24G		
	2017-2022	R20Z1	SXU22HCR11S	-	-	-	VXUHC22G		
	2009-2014	R20A	SXU22HCR11S	-	-	-	VXUHC22G		
CRV 2.4	2007-2012	K24Z1	SKJ20DR-M11	IK20TT	K20TT	IK20	VK20		
HRV 1.8G	2018-	R18Z9	SXU22HCR11S	-	-	-	VXUHC22G		
	2019-	R18ZF	SXU22HCR11S	-	-	-	VXUHC22G		
	2014-	L15A,L15Z2	IK20TT	IK20TT	-	-	VFK20F		
ODYSSEY	2013-	K24W	KJ16CR-L11	IK16TT	K16TT	IK16L	-		
VIETNAM	<b>HYUNDAI</b>								
	ACCENT 1.4	2010-	G4LC	IXUH20I	-	XUH20TTI	IXUH20I	VXUH20I	
	AVANTE	2010-2015	DU41	KJ16CR-L11	IK16TT	K16TT	IK16L	-	
	ELANTRA 1.6	2016-	G4NA	VXUHC22G	-	-	-	VXUHC22G	
	i10	2011-2013	G4FA	IXUH20I	-	XUH20TTI	IXUH20I	VXUH20I	
	i10 Grand	2014-	G4FA	IXUH20I	-	XUH20TTI	IXUH20I	VXUH20I	
	i20	2008-2014	G4FC	IXUH20I	-	XUH20TTI	IXUH20I	VXUH20I	
		2015-	G4FA	IXUH20I	-	XUH20TTI	IXUH20I	VXUH20I	
	i30 1.6	2012-2016	G4FC	IXUH20I	-	XUH20TTI	IXUH20I	VXUH20I	
	ix35	2010-2014	G4KD	IXUH20I	-	XUH20TTI	IXUH20I	VXUH20I	
JAPAN	SANTA FE	2012-2018	SC81B	PK16PR-L11	IK16TT	-	IK16	VK16	
	SONATA	2009-2015	G6DB	W20EPR-U11	IW20TT	W20TT	IW20	VW20	
		2015-2019	-	W20EPR-U11	IW20TT	W20TT	IW20	VW20	
EUROPE & USA	<b>CROSS REFERENCE NUMBER</b>								
	PART	SANTA FE	2012-2018	SC81B	PK16PR-L11	IK16TT	-	IK16	VK16
		SONATA	2009-2015	G6DB	W20EPR-U11	IW20TT	W20TT	IW20	VW20
	2015-2019	-	W20EPR-U11	IW20TT	W20TT	IW20	VW20		



MODEL	YEAR	CODE	DENSO	IRIDIUM U	TT	IRIDIUM POWER	IRIDIUM TOUGH	
<b>HYUNDAI</b>								
TUCSON	2006-2009	G4GC	K16PR-U11	IK16TT	K16TT	IK16	VK16	AUSTRALIA
	2015-	G4NA	K16PR-U11	IK16TT	K16TT	IK16	VK16	
TUCSON 2.4	2010-2015	G4NC	PK16PR11	IK16TT	-	IK16	VK16	CHINA
<b>ISUZU</b>								
MU-X PRESTIGE 1.9 4X2 AT TROOPER	2015-	4ZE1	W20EPR-U11	IW20TT	W20TT	IW20	VW20	INDIA
	1991-2000	6VD1 (SOHC)	IK16TT	IK16TT	K16TT	IK16	VK16G	
<b>KIA</b>								
CARENS 1.6	2006-2012	-	K20PR-U	IK20TT	K20TT	IK20	VK20	INDONESIA
CARENS 2.0	2006-2012	-	K20PR-U	IK20TT	K20TT	IK20	VK20	
	2013-2019	-	K20PR-U	IK20TT	K20TT	IK20	VK20	
CARNIVAL	2005-2014	G6DC	VXUHC22G	-	-	-	VXUHC22G	INDONESIA
CERATO 1.6	2008-2012	G4ED	K16PR-U11	IK16TT	K16TT	IK16	VK16	INDONESIA
CERATO 2.0	2008-2012	G4KD	K16PR-U11	IK16TT	K16TT	IK16	VK16	
		2012-	G4NA	K16HPR-U11	IKH16TT	KH16TT	IKH16	VKH16
OPTIMA	2005-2010	G6BV	IK16TT	IK16TT	K16TT	IK16	VK16	KOREA
	2011-2015	G6BA	IK16TT	IK16TT	K16TT	IK16	VK16	
	2015-	G6BA	IK16TT	IK16TT	K16TT	IK16	VK16	
RIO	2009-2017	G4FA	W16EXR-U11	IW16TT	W16TT	IW16	VW16	KOREA
	2018-	G4FC	K16PR-U11	IK16TT	K16TT	IK16	VK16	
RONDO 2.0	2013-	G4NC	VXUHC22G	-	-	-	VXUHC22G	MALAYSIA
SORENTO GAS	2009-2013	G4FC	VXUHC22G	-	-	-	VXUHC22G	
	2013-2014	G4NA	VXUHC22G	-	-	-	VXUHC22G	
	2014-	G4NA	VXUHC22G	-	-	-	VXUHC22G	
SOUL	2008-2014	G4FC	IXUH20I	-	XUH20TTI	IXUH20I	VXUH20I	PHILIPPINES
	2008-2014	G4FC	IXUH20I	-	XUH20TTI	IXUH20I	VXUH20I	
SPECTRA	2000-2009	T8	K20PR-U	IK20TT	K20TT	IK20	VK20	SAUDIARABIA
SPORTAGE	2010-2015	G4KD	K16HPR-U11	IKH16TT	KH16TT	IKH16	VKH16	
	2016-	G4NA	IKH16TT	IKH16TT	KH16TT	-	VFKH16	
<b>MAZDA</b>								
CX-3 2.0	2015-	PE-VPS	ZC20HPR11	IXEH22TT	-	-	VCH20	SINGAPORE
CX-5 2.0	2012-2019	PE-VPS	ZC20HPR11	IXEH22TT	-	-	VCH20	
CX-5 2.5	2012-2019	PE-VPS	ZC20HPR11	IXEH22TT	-	-	VCH20	SINGAPORE
CX-9 2.5	2016-	PYZ4	ZC20HPR11	IXEH22TT	-	-	VCH20	
CX-9 3.7	2006-2015	MZI 3.7	-	ITV20TT	-	ITV20	-	SINGAPORE
MAZDA 2	2007-2014	ZY84,ZY66	VFK16	IK16TT	-	IK16	VFK16	
MAZDA 2 1.5	2014-	P5Y4/P5Y6	-	IXEH20TT	-	-	VCH20	SINGAPORE
MAZDA 3	2003-2008	ZY-VE	K16PR-U11	IK16TT	K16TT	IK16	VK16	
MAZDA 3 2.0	2013-	LFX	ZC20HPR11	IXEH20TT	-	-	VCH20	TAIWAN
MAZDA 3 2.5	2013-	PYY1	ZC20HPR11	IXEH20TT	-	-	VCH20	
MAZDA 6	2012-	PYY1,PY-VPR	IT20TT / ITV16TT	IT20TT / ITV16TT	-	IT20 / ITV16	VT20 / -	THAILAND
MAZDA 6 2.0	2002-2008	L3C1	IT20TT / ITV16TT	IT20TT / ITV16TT	-	IT20 / ITV16	VT20 / -	
MAZDA 6 2.3	2002-2008	L3C1	IT20TT / ITV16TT	IT20TT / ITV16TT	-	IT20 / ITV16	VT20 / -	THAILAND
MAZDA 6 2.5	2012-	PYY1	ZC20HPR11	IXEH22TT	-	-	VCH20	
MX-5 1.5	2015-	P5-VPR	ZC20HPR11	IXEH22TT	-	-	VCH20	VIETNAM
MX-5 2.5	2015-	PEX6/PEX4	ZC20HPR11	IXEH22TT	-	-	VCH20	
PREMACY	2004-2010	P5Y5,P5Y4	IXEH22TT	IXEH22TT	-	-	VCH20	VIETNAM
<b>Mercedes</b>								
A Class	2012-2018	M 166.940	K20PR-U	IK20TT	K20TT	IK20	VK20Y	JAPAN
C Class	2000-2007	M 271.946	-	-	XUH22TT	IXUH22	VXUH22	
	2008-2013	M 271.947	VXUH22	-	-	IXUH22	VXUH22	
	2014-	M 271.948	VXUH22	-	-	IXUH22	VXUH22	
CLA Class	2013-2019	-	VXUH22	-	-	-	-	JAPAN
CLS Class	2004-2010	M 272.964	-	-	XU22TT	IXU22	VXU22	
	2011-2018	M 272.964	-	-	-	IXUH22	VXUH22	
E Class	2002-2008	M111.96	K16PR-U	IK16TT	K16TT	IK16	VK16	EUROPE & USA
	2009-2016	M272.922	-	-	-	IXUH22	VXUH22	
G Class	1992-2014	M 113.993	-	IK16TT	-	IK16	VK16	EUROPE & USA
GLA Class	2013-2019	M 273.923	VXUH22I	-	-	IXUH22I	VXUH22I	
GLC Class	2015-	M 273.923	VXUH22I	-	-	IXUH22I	VXUH22I	EUROPE & USA
GLE/M Class	2006-2010	M 273.963	VXUH22I	-	-	IXUH22I	VXUH22I	
	2011-2019	M 273.963	VXUH22I	-	-	IXUH22I	VXUH22I	
GLK Class	2008-2014	M 273.923	VXUH22I	-	-	IXUH22I	VXUH22I	EUROPE & USA
GLS/GL Class	2006-2012	M 273.963	VXUH22I	-	-	IXUH22I	VXUH22I	
	2013-2015	M 273.963	VXUH22I	-	-	IXUH22I	VXUH22I	
R Class	2006-2013	M 113.971	IK16TT	IK16TT	K16TT	IK16	VK16	EUROPE & USA
S Class	2006-2013	M 273.961	VXUH22I	-	-	IXUH22I	VXUH22I	
	2014-2020	M 273.961	VXUH22I	-	-	IXUH22I	VXUH22I	

DENSO	9	14	16	20	22	24	27	29	31	32	DENSO	9	14	16	20	22	24	27	31	32	DENSO	9	14	16	20	22	24	27	31			
NGK	2	4	5	6	7	8	9	9.5	10	10.5	11	11.5	CHAMPION	18	16,14	12,11	10,9	8,7	6,63,61	4,59	57	55	53	BOSCH	10	9	8	7,6	5	4	3	2

AUSTRALIA  
CHINA  
INDIA  
INDONESIA  
KOREA  
MALAYSIA  
PHILIPPINES  
SAUDIARABIA  
SINGAPORE  
TAIWAN  
THAILAND  
VIETNAM  
JAPAN  
EUROPE & USA  
CROSS REFERENCE NUMBER  
PART



	MODEL	YEAR	CODE	DENSO				
AUSTRALIA	<b>Mercedes</b>							
	SLK Class	2004-2010	M 272.963	VXUH22I	-	-	IXUH22I	VXUH22I
		2011-2020	M 272.963	VXUH22I	-	-	IXUH22I	VXUH22I
	<b>MITSUBISHI</b>							
CHINA	ATTRAGE MT 1.2	2015-	A92 I3	FK16HR11	IKH16TT	-	-	VFKH16
	GRANDIS	2003-2011	4G69	K20HR-U11	IKH20TT	KH20TT	IKH20	VKH20
		1998-2010	4G69	K20HR-U11	IKH20TT	KH20TT	IKH20	VKH20
INDIA	LANCER 1.6	2000-2007	4G18	K20PR-U11	IK20TT	K20TT	IK20	VK20
	LANCER 2.0	2000-2007	4B11	K20PSR-B8	IK20TT	K20TT	IK20	VK20
INDONESIA	MIRAGE 1.2	2012-	3A92	K16PR-U	IK16TT	K16TT	IK16	VK16
	OUTLANDER 2.0	2012-2020	4J11	XU22HDR9	-	XUH22TT	IXUH22	VXUH22
INDONESIA	PAJERO 3.0	2006-	6G72	K16PR-U11	IK16TT	K16TT	IK16	VK16
	PAJERO 3.5	2006-	6G74	K16PR-U11	IK16TT	K16TT	IK16	VK16
INDONESIA	PAJERO 3.8	2006-	6G75	K20PR-U11	IK20TT	K20TT	IK20	VK20
	PAJERO SPORT 2.4	2008-2016	4G69	K20HR-U11	IKH20TT	KH20TT	IKH20	VKH20
INDONESIA	PAJERO SPORT 3.0	2008-2016	6B31	-	IXUH22I	XUH20TTI	IXUH22I	-
		2017-	6B31	-	IXUH22I	XUH20TTI	IXUH22I	-
KOREA	PAJERO SPORT 3.5	2008-2016	6G74	K16PR-U11	IK16TT	K16TT	IK16	VK16
	XPANDER 1.5	2018-	4A91	K16HPR-U11	IKH16TT	KH16TT	IKH16	VKH16
	<b>NISSAN</b>							
MALAYSIA	ALMERA 1.0	2019-	HR10DET	SXU22HPR8	IXUH22I	XUH20TTI	IXUH22I	VXUH22I
	NAVARA 2.5	2014-	QR25DE	FXE20HE11	IXEH20ETT	-	-	VFXEH20E
MALAYSIA	QUASHQAI 1.2	2012-	HRA2	FXE20HR11	IXEH20TT	-	-	VFXEH20
	QUASHQAI 2.0	2006-2013	MR20DE	FXE20HR11	IXEH20TT	-	-	VFXEH20
		2014-2020	MR20DD	FXE20HE11	IXEH20ETT	-	-	VFXEH20E
PHILIPPINES	SUNNY XTQ 1.5L AT	2019-	QG15DE	K16PR-U11	IK16TT	K16TT	IK16	VK16
	SUNNY XV 1.5L AT	2012-	GA15DE	K20PR-U11	IK20TT	K20TT	IK20	VK20
SAUDI ARABIA	TEANA 2.0	2008-2013	MR20DE	FXE20HR11	IXEH20TT	-	-	VFXEH20
	TEANA 2.5	2014-2020	QR25DE	FXE20HE11	IXEH20ETT	-	-	VFXEH20E
SAUDI ARABIA	TEANA 2.5 I4	2008-2013	QR25DE	FXE20HE11	IXEH20ETT	-	-	VFXEH20E
	TEANA 2.5 V6	2008-2013	VQ25DE	FXE20HR11	IXEH20TT	-	-	VFXEH20
SAUDI ARABIA	TEANA 3.5	2008-2013	VQ35DE	FXE22HR11	IXEH22TT	-	-	VFXEH22
	TERRA 2.5	2018-	QR25DE	FXE20HE11	IXEH20ETT	-	-	VFXEH20E
SINGAPORE	XTRAIL 2.0	2013-2021	MR20DD	VFXEH20E	-	-	-	VFXEH20E
	XTRAIL 2.5	2014-2021	QR25DE	FXE20HE11	IXEH20ETT	-	-	VFXEH20E
	<b>SUZUKI</b>							
TAIWAN	APV	2004-	G16A (16V)	K20PR-U	IK20TT	K20TT	-	VK20Y
	CELERIO	2014-	K10C,K10B	VXU20	-	-	-	VXU20
TAIWAN	ERTIGA 1.4 MT	2012-2018	K14B	XU20EPR-U	-	-	-	VXU20
	ERTIGA GL 1.4 MT	2018-	-	XU20EPR-U	-	-	-	VXU20
THAILAND	GRAND VITARA	1998-2014	G16B	K20PR-U11	IK20TT	K20TT	IK20	VK20
		2014-	M16A	IK20TT	IK20TT	K20TT	IK20	VK20
THAILAND	SWIFT 1.2 AT	2016-	M16A	IKH20TT	IKH20TT	-	IKH20	VKH20
	SWIFT 1.2 MT	2005-2015	M16A	K20PR-U11	IK20TT	K20TT	IK20	VK20
VIETNAM	VITARA	-2010	M16A	K20PR-U	IK20TT	K20TT	IK20	VK20
		2011-	M16A	K20PR-U	IK20TT	K20TT	IK20	VK20
VIETNAM	WAGON R	2000-	K10B	XU20EPR-U	-	-	-	VXU20
	<b>TOYOTA</b>							
VIETNAM	ALPHARD	2008-	ANH20R	-	-	-	IKH20	VKH20
	AVANZA	2011-	F600	XU22EPR-U	-	XU22TT	IXU22	VXU22
JAPAN	AVANZA PREMIO 1.5	-	2NR-FE	SC16HR11	IXEH20TT	-	-	VCH16
	CAMRY 2.0	2012-2015	3S-FC	K16PR-U11	IK16TT	K16TT	IK16	VK16
JAPAN		2015-2019	3S-FC	K16PR-U11	IK16TT	K16TT	IK16	VK16
	CAMRY 2.4	2002-2006	ACV30	K16PR-U11	IK16TT	K16TT	IK16	VK16
JAPAN		2007-2012	ACV40	K16PR-U11	IK16TT	K16TT	IK16	VK16
	CAMRY 2.5	2012-2015	2AR-FXE,2JM	K16HPR-U11	IKH16TT	KH16TT	IKH16	VKH16
EUROPE & USA		2015-2019	2AR-FE	K16HPR-U11	IKH16TT	KH16TT	IKH16	VKH16
	CAMRY 3.0	2002-2006	1MZ-FE	SK20R11	IK20TT	-	IK20	VK20
EUROPE & USA	CAMRY 3.5	2007-2014	-	-	-	-	IKH20	VKH20
	COROLLA ALTIS	2002-2006	ZZE121	K16PR-U11	IK16TT	K16TT	IK16	VK16
CROSS REFERENCE NUMBER		2007-2013	ZZE141	K16PR-U11	IK16TT	K16TT	IK16	VK16
		2014-2019	ZZE141	K16PR-U11	IK16TT	K16TT	IK16	VK16
PART NUMBER	COROLLA CROSS 1.8	2020-	2ZR-FE	SC16HR11	IXEH20TT	-	-	VCH16
	COROLLA CROSS 1.8HV (HYBRID)	2020-	2ZR-FXE	SC16HR11	IXEH20TT	-	-	VCH16
PART NUMBER	FORTUNER 2.7	2007-2016	2TR-FE	K20HR-U11	IKH20TT	KH20TT	IKH20	VKH20
		2016-	2TR-FE	K20HR-U11	IKH20TT	KH20TT	IKH20	VFKH20
PART NUMBER	FORTUNER 4.0	2007-2016	1GR-FE	K20HR-U11	IKH20TT	KH20TT	IKH20	VKH20
		2016-	1GR-FE	K20HR-U11	IKH20TT	KH20TT	IKH20	VKH20





MODEL	YEAR	CODE	DENSO	IRIDIUM U	TT	IRIDIUM POWER	IRIDIUM TOUGH
<b>TOYOTA</b>							
HIACE 2.7	2004-2019	RZH113	W16EP-U	IW16TT	W16TT	IW16	VW16
INNOVA 2.0	2006-2016	1TR-FE	K16HPR-U11	IKH16TT	KH16TT	IKH16	VKH16
INNOVA 2.0 Dual VVT-i	2017-	1TR-FE	K20HR-U11	IKBH20TT	-	-	VFKBH20
INNOVA 2.7 Dual VVT-i	2017-	2TR-FE	FK20HR-A8	IKH20TT	KH20TT	IKH20	VFKH20
LAND CRUISER (J100) 4.5	1998-2007	1FZ-FE	K16PR-U11	IK16TT	K16TT	IK16	VK16
LAND CRUISER (J100) 4.7	1998-2007	2UZ-FE	K20PR-U11	IK20TT	K20TT	IK20	VK20
LAND CRUISER (J200) 4.0	2008-2020	1GR-FE	K20HR-U11	IKH20TT	KH20TT	IKH20	VKH20
LAND CRUISER (J200) 4.6	2008-2020	1UR-FE	K20HR-U11	IKH20TT	KH20TT	IKH20	VKH20
LAND CRUISER (J200) 4.7	2008-2020	2UZ-FE	K20PR-U11	IK20TT	K20TT	IK20	VK20
LAND CRUISER (J200) 5.7	2008-2020	3UR-FE	K20HR-U11	IKH20TT	KH20TT	IKH20	VKH20
LAND CRUISER (J300) 3.4	2021-	V35A-FTS	EC22HPR-D7	-	-	-	-
LAND CRUISER (J300) 4.0	2021-	1GR-FE	K20HR-U11	IKH20TT	KH20TT	IKH20	VKH20
LAND CRUISER (J80) 4.0	1990-1997	3F-E	W16EXR-U	IW16TT	W16TT	IW16	VW16
LAND CRUISER (J80) 4.7	1990-1997	1FZ-FE	K16PR-U11	IK16TT	K16TT	IK16	VK16
PRADO (J120) 2.7	2002-2004	3RZ-FE	K16PR-U11	IK16TT	K16TT	IK16	VK16
	2005-2009	2TR-FE	K20HR-U11	IKH20TT	KH20TT	IKH20	VKH20
PRADO (J120) 3.4	2002-2004	5VZ-FE	K16PR-U11	IK16TT	K16TT	IK16	VK16
PRADO (J120) 4.0	2005-2009	1GR-FE	K20HR-U11	IKH20TT	KH20TT	IKH20	VKH20
PRADO (J150) 2.7	2010-2015	2TR-FE	K20HR-U11	IKH20TT	KH20TT	IKH20	VKH20
PRADO (J150) 2.7 Dual VVT-i	2015-	2TR-FE	FK20HR-A8	IKH20TT	KH20TT	IKH20	VFKH20
PRADO (J150) 4.0	2010-	1GR-FE	K20HR-U11	IKH20TT	KH20TT	IKH20	VKH20
RAIZE 1.0	2020-	1KR-VET	SC20HR11	IXEH22TT	-	-	VCH20
RUSH 1.5	2017-	2NR-VE	SC16HR11	IXEH20TT	-	-	VCH16
VELOZ CROSS 1.5	2022-	2NR-VE	SC16HR11	IXEH20TT	-	-	VCH16
VENZA 2.0	2020-	M20D-FKS	FC20HR-Q8	IXEH22TT	-	-	VFCH20
VENZA 2.5 HYBRID	2020-	A25A-FXS	FC16HR-Q8	IXEH20TT	-	-	VFCH16
VENZA 2.7	2009-2017	1AR-FE	K16HPR-U11	IKH16TT	KH16TT	IKH16	VKH16
VENZA 3.5	2009-2017	2GR-FE	FK20HR11	IKH20TT	KH20TT	IKH20	VFKH20
VIOS	2002-2006	1NZ-FE	K16PR-U11	IK16TT	K16TT	IK16	VK16
	2007-2014	1NZ-FE	K16PR-U11	IK16TT	K16TT	IK16	VK16
	2014-2016	1NZ-FE	K16PR-U11	IK16TT	K16TT	IK16	VK16
VIOS 1.3	2016-	2NZ-FE/2NR-FE	SC16HR11	IXEH20TT	-	-	VCH16
VIOS 1.5	2016-	2NZ-FE/1NR-FE	SC16HR11	IXEH20TT	-	-	VCH16
WIGO	2012-	-	XU20HR-9	-	XUH20TTI	IXUH20I	VXUH20I
YARIS	2007-2014	NCP91	K16PR-U11	IK16TT	K16TT	IK16	VK16
	2014-2016	NCP91	K16PR-U11	IK16TT	K16TT	IK16	VK16
	2017-2019	NCP91	K16PR-U11	IK16TT	K16TT	IK16	VK16

AUSTRALIA  
CHINA  
INDIA  
INDONESIA  
KOREA  
MALAYSIA  
PHILIPPINES  
SAUDIARABIA  
SINGAPORE  
TAIWAN  
THAILAND  
VIETNAM  
JAPAN  
EUROPE & USA  
CROSS REFERENCE NUMBER  
PART

VIETNAM MOTORCYCLE



MODEL	CC	From	Till	DENSO	IRIDIUM POWER	IRIDIUM RACING
<b>DAELIM</b>						
CITI	100	1998		U20FS-U	IUF22	-
<b>HAESUN</b>						
FG	125			U22FS-U	IUF22	-
KEE WAY	125			U22FS-U	IUF22	-
QUEEN	125			U22ES-N	IU22	IU01-□
SMILE	125			U22FS-U	IUF22	-
VENUS	125			U22ES-N	IU22	IU01-□
<b>HONDA</b>						
@	125/150			U27ESR-N	IU27	IU01-□
AIR BLADE FI (Fuel Injection)	110			U22EPR9	IU22	IU01-□
AIR BLADE (Carburetor)	110	2007		U22FER9	IUH24	IU01-□
AIR BLADE-I (Fuel Injection)	110			U22EPR9	IU22	IU01-□
	125	2012		U22EPR9	IU22	IU01-□
	150	2020		U24EPR9	IU24	IU01-□
C50	50	1978	1982	U16FS-U	-	-
C70	70			U20FS-U	IUF22	-
C90, CD90	90	1990	1998	U20FS-U	IUF22	-
CD50	50	1990	1998	U20FS-U	IUF22	-
CLICK	110	2006		U22FER9	IUH24	IU01-□
<b>HONDA</b>						
CLICK-I	110			U22EPR9	IU22	IU01-□
CZ-I	110			U20EPR9S	IU20	IU01-□
DREAM/DREAM II	100			U20FS-U	IUF22	-
DYLAN	125/150	2001		U27FER9	IUH27	IU01-□
EXY	125			U24FER9	IUH24	IU01-□
FUTURE	110	2002		U20FS-U	IUF22	-
FUTURE II	125	2004	2005	U22EPR9	IU22	IU01-□
FUTURE NEO	125	2007		U20EPR9	IU20/IU22 (high speed)	IU01-□
FUTURE NEO FI	125			U20EPR9	IU20/IU22 (high speed)	IU01-□
LEAD	110			U22FER9	IUH24	IU01-□
	125	2013		U22EPR9	IU22	IU01-□
PCX	125			U22EPR9	IU22	IU01-□
	150	2017		U24EPR9	IU24	IU01-□
SCR	110			U22FER9	IUH24	IU01-□
SH	125/150			U24FER9	IUH24	IU01-□
SH Mode	125	2013		U22EPR9	IU22	IU01-□
SPACY	110/125			U20FSR-U	IUF22	-
	100	1995		U20FSR-U	IUF22	-
SUPER DREAM	100	1998		U20FS-U	IUF22	-
VISION	110			U20EPR9	IU20/IU22 (high speed)	IU01-□
WAVE	100			U20FS-U	IUF22	-

DENSO	9	14	16	20	22	24	27	29	31	32	DENSO	9	14	16	20	22	24	27	31	DENSO	9	14	16	20	22	24	27	31				
NGK	2	4	5	6	7	8	9	9.5	10	10.5	11	11.5	CHAMPION	18	16,14	12,11	10,9	8,7	6,63,61	4,59	57	55	53	BOSCH	10	9	8	7,6	5	4	3	2





# VIETNAM | MOTORCYCLE

▶ Spark plug color codes: ■ for Iridium Tough and Iridium Plugs and Iridium TT, ■ for Iridium Power, ■ for Iridium Racing and Two Tops Plugs, ■ for Platinum Plugs and Platinum TT, and black for general spark plugs.

	MODEL	CC	From	Till	DENSO	IRIDIUM POWER	IRIDIUM RACING
AUSTRALIA	<b>HONDA</b>						
	WAVE	110	2002		U22FS-U	IUF22	-
	WAVE 1	100	2006	2006	U20FS-U	IUF22	-
CHINA	WAVE RS	100	2005		U20FS-U	IUF22	-
	WAVE RSV	100			U20FS-U	IUF22	-
INDIA	WAVE RSX AT FI	110			U20EPR9S	IU20/IU22 (high speed)	IU01-□
	WAVE ZX	100	2004	2005	U20FS-U	IUF22	-
INDONESIA	WAVE α	100	2001		U20FS-U	IUF22	-
	WINNER	150	2016		U27FER9	IUH27	IU01-□
INDONESIA	<b>KAWASAKI</b>						
	CHEER	110			U20FS-U	IUF22	-
	CRISS	110			U20FS-U	IUF22	-
KOREA	LEO	120	1993		W24EP-U	IW24	IW01-□
	NEO - MAX	100	1990		U20FS-U	IUF22	-
	NEO - MAX II	100			U20FS-U	IUF22	-
MALAYSIA	NEON	110			W22FP-U	IWF22	-
	<b>PIAGGIO</b>						
	BEVERLY	125			U24ESR-NB	IU24	IU01-□
PHILIPPINES	FLY	125			U24ESR-N	IU24	IU01-□
	LIBERTY	135			U24ESR-N	IU24	IU01-□
	LX	125			U24ESR-N	IU24	IU01-□
SAUDI ARABIA	LX	150			U24ESR-N	IU24	IU01-□
	LXV	125			U24ESR-N	IU24	IU01-□
	PIAGGIO GT	125			U24ESR-N	IU24	IU01-□
SINGAPORE	ZIP	100			U24ESR-N	IU24	IU01-□
	<b>SUZUKI</b>						
	AMITY	125			U24ESR-N	IU24	IU01-□
TAIWAN	AN	150	2000		U22ESR-N	IU22	IU01-□
	AVENIS	150			U22ESR-N	IU22	IU01-□
	BEST	110	2002		U20FS-U	IUF22	-
THAILAND	EPICURO	150			U22ESR-N	IU22	IU01-□
	GN	125	2001		X24ES-U	IX24	IXU01-□
	HAYATE	125			U20FSR-U	IUF22	-
VIETNAM	LOVE	110	1996		U20FS-U	IUF22	-
	RG SPORT	110	1996		W24EP-U	IW24	IW01-□
	SHOGUN	125	1994		U20FS-U	IUF22	-
JAPAN	SKYDRIVE	125			U20FS-U	IUF22	-

	MODEL	CC	From	Till	DENSO	IRIDIUM POWER	IRIDIUM RACING
EUROPE & USA	<b>SUZUKI</b>						
	SMASH	110	2002		U20FS-U	IUF22	-
	VIVA	110			U20FSR-U	IUF22	-
EUROPE & USA	X-BIKE	125			U20FS-U	IUF22	-
	<b>VMEP(SYM)</b>						
EUROPE & USA	AMIGO	110			U20FS-U	IUF22	-
	ANGEL	80/100	1998		U20FS-U	IUF22	-
EUROPE & USA	ATTILA	125	2001		U22FS-U	IUF22	-
	ATTILA (Victoria, Elizabeth)	125			U20FS-U	IUF22	-
EUROPE & USA	BONUS	125	1996		X22ES-U	IX22	IXU01-□
	ELEGANT	100			U20FS-U	IUF22	-
EUROPE & USA	EXCEL, EXCEL II	150			U22ESR-N	IU22	IU01-□
	EZ	110			U20FS-U	IUF22	-
EUROPE & USA	GALAXY	110			U20FS-U	IUF22	-
	HUSKY	150	1995		X24ES-U	IX24	IXU01-□
EUROPE & USA	MAGIC	100/110	1999		U20FS-U	IUF22	-
	POWER	85			U20FS-U	IUF22	-
EUROPE & USA	RS II	100			U20FS-U	IUF22	-
	SANDA BOSS	110			U20FS-U	IUF22	-
EUROPE & USA	STAR	110	1995		U20FS-U	IUF22	-
	<b>YAMAHA</b>						
EUROPE & USA	CUXI FI	100			U20FSR-U	IUF22	-
	EXCITER	135			U24EPR9	IU24	IU01-□
EUROPE & USA	EXCITER	150	2015		U24EPR9	IU24	IU01-□
	GRAVITA	110			U20FS-U	IUF22	-
EUROPE & USA	JUPITER	110	2004		U20FS-U	IUF22	-
	LEXAM	115			U20FS-U	IUF22	-
EUROPE & USA	LUVIAS	125			U22ESR-N	IU22	IU01-□
	MIO	115	2004		U22FS-U	IUF22	-
EUROPE & USA	NOUVO	115	2002		U22FSR-U	IUF22	-
	NOUVO LX	135			U22ESR-N	IU22	IU01-□
EUROPE & USA	NOUVO SX	125	2012		U22EPR9	IU22	IU01-□
	NVX	125	2016		U22EPR9	IU22	IU01-□
EUROPE & USA	NVX	155	2016		U24EPR9	IU24	IU01-□
	RXZ	135			W24EP-U	IW24	IW01-□
EUROPE & USA	SIRIUS	110			U20FS-U	IUF22	-
	TAURUS	125			U20FS-U	IUF22	-

MODEL	CC	VEHICLE CODE	ENGINE	FROM-TILL	DENSO	GENUINE P/N				QTY	
<b>DAIHATSU</b>											
<b>ALTIS</b>	2200	SXV20N • SXV25N	5S-FE	00.3-01.8	PK20TR11	90919-01194	-	IK20	VK20	4	AUSTRALIA
	2400	ACV30N • ACV35N	2AZ-FE	01.9-06.1	K20R-U11	90919-01184	K20TT	IK20	VK20	4	CHINA
		ACV40N • ACV45N	2AZ-FE	06.1-	SK20R11	90048-51186	-	IK20	VK20	4	
<b>ALTISHYBRID</b>		AVV50N	2AR-FXE	12.5-17.7	FK16HR-A8	90919-01259	-	-	VFKH16	4	INDIA
	2500	AXVH70N	A25A-FXS	17.7-	FC16HR-Q8	90919-01289	-	-	VFCH16	4	
		AXVH75N	A25A-FXS	21.2-	FC16HR-Q8	90919-01289	-	-	VFCH16	4	
<b>APPLAUSE</b>	1600	A101S • A111S	HD-E • HD-F	89.8-97.8	K20PR-U11	90048-51099	K20TT	IK20	VK20	4	INDONESIA
		A101S	HD-E1	97.8-00.3	K20TNR-S	90048-51136	K20TT	IK20	VK20	4	
<b>ATRAI</b>	660	S220V • S230V	EF-DET(DOHC • T/C)	99.1-06.12	K20TNR-S9	90048-51159	K20TT	IK20	VK20Y	3	KOREA
		S220V • S230V	EF-VE(DOHC)	99.1-	K20PR-U11	90048-51099	K20TT	IK20	VK20	3	
	S700V	KF(T/C)	21.12-	SXU22HPR8	90048-51214	-	IXUH22I	VXUH22I	3		
	S700W	KF(T/C)	21.12-	SXU22HPR8	90048-51214	-	IXUH22I	VXUH22I	3		
	S710V	KF(T/C)	21.12-	SXU22HPR8	90048-51214	-	IXUH22I	VXUH22I	3		
	S710W	KF(T/C)	21.12-	SXU22HPR8	90048-51214	-	IXUH22I	VXUH22I	3		
	S221G • S231G	K3-VE(DOHC)	00.7-	K20R-U11	90048-51163	K20TT	IK20	VK20	4		
<b>ATRAI 7 WAGON</b>	660	S220G • S230G	EF-DET(DOHC • T/C)	99.6-01.12	K20TNR-S9	90048-51159	K20TT	IK20	VK20Y	3	MALAYSIA
		S220G • S230G	EF-VE(DOHC)	99.6-01.12	K20PR-U11	90048-51099	K20TT	IK20	VK20	3	
		S220G • S230G	EF-DET(DOHC • T/C)	02.1-05.5	SVK20RZ11	90048-51172	-	IK20	VK20Y	3	
	S220G • S230G	EF-VE(DOHC)	02.1-06.12	K20TNR-S9	90048-51159	K20TT	IK20	VK20	3		
	S320G • S330G	EF-VE(DOHC)	05.5-06.12	K20TNR-S9	90048-51159	K20TT	IK20	VK20	3		
	S320G • S330G	EF-DET(DOHC • T/C)	05.5-07.9	K20TNR-S9	90048-51159	K20TT	IK20	VK20Y	3		
	S321G • S331G	KF-DET(DOHC • T/C)	07.9-15.4	SXU22HPR8	90048-51214	-	IXUH22I	VXUH22I	3		
	S321G	KF(T/C)	15.4-21.12	SXU22HPR8	90048-51214	-	IXUH22I	VXUH22I	3		
	S331G	KF(T/C)	15.4-21.12	SXU22HPR8	90048-51214	-	IXUH22I	VXUH22I	3		
<b>BeGO</b>	1500	J200G • J210G	3SZ-VE	06.1-08.11	SXU22PR9	90048-51188-000	-	IXU22I	VXU22I	4	PHILIPPINES
		J200G • J210G	3SZ-VE	08.11-10.4	XU22PR9	90048-51197-000	XU22TT	IXU22I	VXU22I	4	
		J200G • J210G	3SZ-VE	10.4-	SXU22PR9	90048-51188-000	-	IXU22I	VXU22I	4	
<b>BOON</b>	900	M312S	KJ-VET	06.3-	IXU22	-	-	IXU22	VXU22	4	SAUDIARABIA
		M300S • M310S	1KR-FE	04.6-10.2	SK20HR11	90919-01191	-	IKH20	VKH20	3	
		M600S • M610S	1KR-FE	10.2-14.4	SK20HR11	90919-01191	-	IKH20	VKH20	3	
	1000	M600S	1KR-FE	14.4-	SC16HR11	90919-01275	-	-	VCH16	3	
		M610S	1KR-FE	14.4-	SC16HR11	90919-01275	-	-	VCH16	3	
		M700S	1KR-FE	16.4-	-	-	-	-	VCH16	3	
		M710S	1KR-FE	16.4-	-	-	-	-	VCH16	3	
	1300	M301S	K3-VE(DOHC)	04.6-06.12	SVK20RZ11	90048-51172	-	IK20	VK20Y	4	
		M301S	K3-VE(DOHC)	06.12-07.6	SXU22PR9	90048-51188-000	-	-	VXU22I	4	
		M301S	K3-VE(DOHC)	07.6-10.2	XU22PR9	90048-51197-000	XU22TT	IXU22I	VXU22I	4	
		M601S	1NR-FE	10.2-	SC16HR11	90919-01275	-	-	VCH16	4	
<b>BOON RUMINAS CAST</b>	1500	M502G • M512G	3SZ-VE	08.12-	SXU22PR9	90048-51188-000	-	IXU22I	VXU22I	4	SINGAPORE
		LA250S	KF	15.9-	SXU20HPR11	90048-51208	-	IXUH20I	VXUH20I	3	
	660	LA250S	KF(T/C)	15.9-	SXU22HPR8	90048-51214	-	IXUH22I	VXUH22I	3	
		LA260S	KF	15.9-	SXU20HPR11	90048-51208	-	IXUH20I	VXUH20I	3	
<b>CHARADE/ SOCIAL</b>	1300	G200S	HC-E	93.1-00.3	K20PR-U11	90048-51099	K20TT	IK20	VK20	4	THAILAND
	1500	G203S • G213S	HE-EG	93.8-00.3	K20PR-U11	90048-51099	K20TT	IK20	VK20	4	
	1600	G201S	HD-EG	93.8-00.3	K20PR-U11	90048-51099	K20TT	IK20	VK20	4	
<b>COO</b>	1300	M401S • M411S	K3-VE	06.5-10.7	SXU22PR9	90048-51188-000	-	IXU22I	VXU22I	4	VIETNAM
		M401S • M411S	K3-VE	10.7-	SXU22PR9	90048-51188-000	-	IXU22I	VXU22I	4	
	1500	M402S	3SZ-VE	06.5-10.7	SXU22PR9	90048-51188-000	-	IXU22I	VXU22I	4	
		M402S	3SZ-VE	10.7-	SXU22PR9	90048-51188-000	-	IXU22I	VXU22I	4	
<b>COPEN</b>	660	L880K	JB-DET(T/C)	02.6-10.8	SK20PR-A8	90048-51182	-	-	VK20Y	4	JAPAN
		L880K	JB-DET(T/C)	10.8-12.8	-	-	-	-	-	4	
	LA400K	KF(T/C)	14.6-	SXU22HPR8	90048-51214	-	IXUH22I	VXUH22I	3		
<b>DELTA</b>	4100	TYMMC • M3N	15B-FP/NE(CNG)	02.6-	SK20R5-G	90919-01229	-	-	-	4	EUROPE & USA
<b>DELTA WAGON/ VAN</b>	1500	KR41J	5K-J	96.11-01.11	W16EXR-U	90048-51044-000	W16TT	IW16	VW16	4	
		KR42J • KR42SR	7K	96.11-98.12	W16EXR-U	90048-51044-000	W16TT	IW16	VW16	4	
1800	KR42J	7K-E	98.12-01.11	W16EXR-U11	90048-51091-000	W16TT	IW16	VW16	4		
	2000	SR40N • 50N	3S-FE	96.11-01.11	K20TR11	90919-01198-000	K20TT	IK20	VK20	4	
<b>ESSE</b>	660	L235S • L245S	KF-VE(DOHC)	05.12-	XU20HR9	90048-51212	XUH20TTI	IXUH20I	VXUH20I	3	CROSS REFERENCE NUMBER
<b>GRAN MAX</b>	1500	S403V	2NR-VE	20.9-	SC16HR11	90919-01275	-	-	VCH16	4	
		S413V	2NR-VE	20.9-	SC16HR11	90919-01275	-	-	VCH16	4	
		S403P	2NR-VE	20.9-	SC16HR11	90919-01275	-	-	VCH16	4	
		S413P	2NR-VE	20.9-	SC16HR11	90919-01275	-	-	VCH16	4	
<b>HIJET</b>	660	S100P • S100V • S100C • S100CT • S100W • S110P • S110V • S110C • S110CT • S110W	EF-NS	94.1-99.1	W16DTR-S	90048-51130-000	-	-	-	3	



DENSO	9	14	16	20	22	24	27	29	31	32	34	35
NGK	2	4	5	6	7	8	9	9.5	10	10.5	11	11.5

DENSO	9	14	16	20	22	24	27	29	31	32
CHAMPION	18	16,14	12,11	10,9	8,7	6,63,61	4,59	57	55	53

DENSO	9	14	16	20	22	24	27	31
BOSCH	10	9	8	7,6	5	4	3	2



MODEL	CC	VEHICLE CODE	ENGINE	FROM-TILL	DENSO	GENUINE P/N			QTY			
AUSTRALIA	DAIHATSU HIJET	S100P • S100V • S100C • S100CT • S100W • S110P • S110V • S110C • S110CT • S110W	EF-ES	94.1-99.1	QL20TR-S	90048-51133-000	-	-	3			
		S100P • S100V • S100C • S100CT • S100W • S110P • S110V • S110C • S110CT • S110W	EF-GS(DOHC)/ZS(DOHC)	96.1-97.1	K20TNR-S	90048-51136	K20TT	IK20	VK20	3		
		S100P • S100V • S100C • S100CT • S100W • S110P • S110V • S110C • S110CT • S110W	EF-GS(DOHC)/ZS(DOHC)	97.1-99.1	K20PR-U	90048-51151-000	K20TT	IK20	VK20	3		
		660 S200P • S200C • S200V • S200W • S210P • S210C • S210V • S210W	EF-SE(SOHC)	99.1-04.12	K20PR-U11	90048-51099	K20TT	IK20	VK20	3		
		S200P • S200C • S200V • S210P • S210C • S210V	EF-VE(DOHC)	99.1-04.12	K20PR-U11	90048-51099	K20TT	IK20	VK20	3		
		S200V • S210V	EF-DET(DOHC • T/C)	99.1-04.12	K20TNR-S9	90048-51159	K20TT	IK20	VK20Y	3		
		S200V • S210V	EF-VN(CNG)	99.11-	VK22	NDVK22A	-	IK22	VK22	3		
		S200P • S210P	EF-SE(SOHC)	04.12-07.12	K20PR-U11	90048-51099	K20TT	IK20	VK20	3		
		S200P • S210P	EF-VE(DOHC)	04.12-07.12	K20PR-U11	90048-51099	K20TT	IK20	VK20	3		
		S201P • S211P • S201C	KF-VE(DOHC)	07.12-14.9	XU20HR9	90048-51212	XUH20TTI	IXUH20I	VXUH20I	3		
		S500P	KF	14.9-	SXU20HPR11	90048-51208	-	IXUH20I	VXUH20I	3		
		S510P	KF	14.9-	SXU20HPR11	90048-51208	-	IXUH20I	VXUH20I	3		
MALAYSIA	HIJET ATRAI	S120V • S130V	EF-TS(T/C)	94.1-97.1	W20DTR-S	90048-51115-000	-	-	3			
		S120V • S130V	EF-ES	94.1-99.1	QL20TR-S	90048-51133-000	-	-	3			
		S120V • S130V	EF-GS(DOHC)/ZS(DOHC)	96.1-97.1	K20TNR-S9	90048-51159	K20TT	IK20	VK20	3		
		660 S120V • S130V	EF-RS(T/C)	97.1-99.1	K20TNR-S9	90048-51159	K20TT	IK20	VK20Y	3		
		S120V • S130V	EF-GS(DOHC)/ZS(DOHC)	97.1-99.1	K20PR-U	90048-51151-000	K20TT	IK20	VK20	3		
		S220V • S230V	EF-DET(DOHC • T/C)	99.1-07.10	K20TNR-S9	90048-51159	K20TT	IK20	VK20Y	3		
		S220V • S230V	EF-VE(DOHC)	99.1-07.10	K20PR-U11	90048-51099	K20TT	IK20	VK20	3		
		PHILIPPINES	HIJET CADDIE	660 LA700V	KF	16.6-	SXU20HPR11	90048-51208	-	IXUH20I	VXUH20I	3
				LA700V	KF(T/C)	16.6-	SXU22HPR8	90048-51214	-	IXUH22I	VXUH22I	3
				LA710V	KF	16.6-	SXU20HPR11	90048-51208	-	IXUH20I	VXUH20I	3
				LA710V	KF(T/C)	16.6-	SXU22HPR8	90048-51214	-	IXUH22I	VXUH22I	3
		SAUDIARABIA	HIJET CARGO/DECKVAN	S200V • S210V	EF-DET(DOHC • T/C)	02.1-04.12	SVK20RZ11	90048-51172	-	IK20	VK20Y	3
S200V • S210V	EF-VE(DOHC)			02.1-04.12	K20TNR-S9	90048-51159	K20TT	IK20	VK20	3		
S200V • S210V	EF-SE			02.1-04.12	K20PR-U11	90048-51099	K20TT	IK20	VK20	3		
S320V • S330V	EF-VE Rev(CNG)			05.2-07.12	VK22	NDVK22A	-	IK22	VK22	3		
S320V • S330V • S330W	EF-DET(DOHC • T/C)			04.12-07.12	K20TNR-S9	90048-51159	K20TT	IK20	VK20Y	3		
S320V • S330V • S330W	EF-VE(DOHC)			04.12-07.12	K20PR-U11	90048-51099	K20TT	IK20	VK20	3		
S320V • S320W • S330V • S330W	EF-SE			04.12-07.12	K20PR-U11	90048-51099	K20TT	IK20	VK20	3		
S320V • S330V	EF-VE Rev(CNG)			05.2-07.12	VK22	NDVK22A	-	IK22	VK22	3		
S321V • S331V	KF-VE(DOHC)			07.12-15.4	XU20HR9	90048-51212	XUH20TTI	IXUH20I	VXUH20I	3		
S321V • S331V	KF-DET(DOHC • T/C)			07.12-15.4	SXU22HPR8	90048-51214	-	IXUH22I	VXUH22I	3		
S321V	KF			15.4-21.12	SXU20HPR11	90048-51208	-	IXUH20I	VXUH20I	3		
660 S321V	KF(T/C)			15.4-21.12	SXU22HPR8	90048-51214	-	IXUH22I	VXUH22I	3		
S321W	KF	15.4-21.12	SXU20HPR11	90048-51208	-	IXUH20I	VXUH20I	3				
S331V	KF	15.4-21.12	SXU20HPR11	90048-51208	-	IXUH20I	VXUH20I	3				
S331V	KF(T/C)	15.4-21.12	SXU22HPR8	90048-51214	-	IXUH22I	VXUH22I	3				
S331W	KF	15.4-21.12	SXU20HPR11	90048-51208	-	IXUH20I	VXUH20I	3				
S700V	KF	21.12-	SXU20HPR11	90048-51208	-	IXUH20I	VXUH20I	3				
S700V	KF(T/C)	21.12-	SXU22HPR8	90048-51214	-	IXUH22I	VXUH22I	3				
S700W	KF	21.12-	SXU20HPR11	90048-51208	-	IXUH20I	VXUH20I	3				
S710V	KF	21.12-	SXU20HPR11	90048-51208	-	IXUH20I	VXUH20I	3				
S710V	KF(T/C)	21.12-	SXU22HPR8	90048-51213	-	IXUH22I	VXUH22I	3				
S710W	KF	21.12-	SXU20HPR11	90048-51208	-	IXUH20I	VXUH20I	3				
S320V(HYBRID)	EF-VE(DOHC)	07.12-	K20PR-U11	90048-51099	K20TT	IK20	VK20	3				
EUROPE & USA	HIJET GRAN CARGO MAX	1300 S221V • S231V	K3-VE(DOHC)	01.7-	K20R-U11	90048-51163	K20TT	IK20	VK20	4		
		L950S • L952S • L962S	JB-DET(T/C)	01.10-05.12	SVK20RZ11	90048-51172	-	IK20	VK20Y	4		
		L952S • L960S	EF-DET(DOHC • T/C)	01.10-05.12	SVK20RZ11	90048-51172	-	IK20	VK20Y	3		
		660 L950S	EF-DET(DOHC • T/C)	01.10-05.12	K20TNR-S9	90048-51159	K20TT	IK20	VK20Y	3		
		L960S	EF-VE(DOHC)	01.10-05.12	SVK20RZ11	90048-51172	-	IK20	VK20Y	3		
		L950S	EF-VE(DOHC)	01.10-02.5	K20TNR-S9	90048-51159	K20TT	IK20	VK20	3		
L950S	EF-VE(DOHC)	02.5-05.12	SVK20RZ11	90048-51172	-	IK20	VK20Y	3				
MIRANDA	MEBIUS MIDGET II	1800 ZVW41N	2ZR-FXE	13.4-	SC16HR11	90919-01275	-	-	VCH16	4		
		660 K100C • K100P	EF-CK	96.4-99.9	W16EXR-U	90048-51044-000	W16TT	IW16	VW16	3		
PART NUMBER	MIRA	660 K100C • K100P	EF-SE	99.9-	K20PR-U11	90048-51099	K20TT	IK20	VK20	3		
		L502S • L510S • L512S	JB-EL(DOHC)	94.9-98.10	K22TNR-S	90048-51143-000	-	IK22	VK22	4		
		660 L502S • L510S • L512S	JB-JL(DOHC • T/C)	94.9-98.10	K22TNR-S	90048-51143-000	-	IK22	VK22	4		
		L500V • L510V	EF-CL	94.9-98.10	W16EXR-U	90048-51044-000	W16TT	IW16	VW16	3		



MODEL	CC	VEHICLE CODE	ENGINE	FROM-TILL	DENSO	GENUINE P/N				QTY	
<b>DAIHATSU</b>											
<b>MIRA</b>		L500S · L510S	EF-FL	94.9-98.10	W16EXR-U	90048-51044-000	W16TT	IW16	VW16	3	AUSTRALIA
		L500S · L510S	EF-JL(T/C)	94.9-98.10	QL22TR-S	90048-51110-000	-	-	-	3	CHINA
		L500S · L510S	EF-GL(DOHC)	95.10-98.10	K20TNR-S	90048-51136	K20TT	IK20	VK20	3	INDIA
		L500S · L510S	EF-ZL(DOHC)	95.10-98.10	K22TNR-S	90048-51143-000	-	IK22	VK22	3	INDONESIA
		L500S · L510S	EF-RL(DOHC · T/C)	95.10-98.10	K22TNR-S	90048-51143-000	-	IK22	VK22	3	KOREA
		L700S · L700V · L710S · L710V	EF-SE	98.10-01.9	K20PR-U11	90048-51099	K20TT	IK20	VK20	3	INDONESIA
		L700S · L710S	EF-DET(DOHC · T/C)	98.10-01.9	K20TNR-S9	90048-51159	K20TT	IK20	VK20Y	3	INDONESIA
		L700S · L710S	EF-VE(DOHC)	98.10-01.9	K20TNR-S9	90048-51159	K20TT	IK20	VK20	3	INDONESIA
		L700V · L710V	EF-VN(CNG)	99.11-01.9	VK22	NDVK22A	-	IK22	VK22	3	INDONESIA
		L700S · L710S	EF-DET(DOHC · T/C)	01.10-02.12	SVK20RZ11	90048-51172	-	IK20	VK20Y	3	INDONESIA
		L700S · L710S	EF-VE(DOHC)	01.10-02.8	K20TNR-S9	90048-51159	K20TT	IK20	VK20	3	INDONESIA
	660	L700S · L710S	EF-VE(DOHC)	02.8-02.12	SVK20RZ11	90048-51172	-	IK20	VK20Y	3	INDONESIA
		L700S · L710S	EF-SE	01.10-02.12	K20PR-U11	90048-51099	K20TT	IK20	VK20	3	INDONESIA
		L250S · L260S	EF-SE	02.12-06.11	K20PR-U11	90048-51099	K20TT	IK20	VK20	3	INDONESIA
		L250V · L260V	EF-VE(DOHC)	02.12-07.12	K20TNR-S9	90048-51159	K20TT	IK20	VK20	3	INDONESIA
		L250V	EF-VE(DOHC)	04.12-06.11	K20PR-SU9	90048-51183	K20TT	IK20	VK20	3	INDONESIA
		L250S · L250V · L260S · L260V	EF-VD(DI · DOHC)	02.12-06.10	ZXU22HBR11	90048-51179	-	-	-	3	INDONESIA
		L250V · L260V	EF-VN(CNG)	02.12-06.10	VK22	NDVK22A	-	IK22	VK22	3	INDONESIA
		L275S · L285S	KF-VE(DOHC)	06.12-	XU20HR9	90048-51212	XUH20TTI	IXUH20I	VXUH20I	3	INDONESIA
		L285S	KF(DOHC · CVT)	11.7-	SXU20HPR11	90048-51208	-	IXUH20I	VXUH20I	3	INDONESIA
	L275S · L285S	KF-DET(DOHC · T/C)	06.12-	SXU22HPR8	90048-51214	-	IXUH22I	VXUH22I	3	INDONESIA	
	L275V · L285V	KF-VE(DOHC)	07.12-	XU20HR9	90048-51212	XUH20TTI	IXUH20I	VXUH20I	3	INDONESIA	
	L275V Rev	KF-VE Rev	08.2-	-	-	-	-	-	3	INDONESIA	
MIRA AVANZATO	660	L512S	JB-JL(DOHC · T/C)	94.9-98.10	IK27	NDIK27A	-	IK27	-	4	INDONESIA
<b>MIRA AVY</b>		L250S · L260S	EF-DET(DOHC · T/C)	02.12-09.4	K20TNR-S9	90048-51159	K20TT	IK20	VK20Y	3	INDONESIA
	660	L250S · L260S	EF-VE(DOHC)	02.12-04.12	K20TNR-S9	90048-51159	K20TT	IK20	VK20	3	INDONESIA
		L250S · L260S	EF-VE(DOHC)	04.12-09.4	K20PR-SU9	90048-51183	K20TT	IK20	VK20	3	INDONESIA
<b>MIRA COCOA</b>		L675S · L685S	KF-VE(DOHC)	09.8-11.6	XU20HR9	90048-51212	XUH20TTI	IXUH20I	VXUH20I	3	INDONESIA
		L675S	KF	11.6-12.4	XU20HR9	90048-51212	XUH20TTI	IXUH20I	VXUH20I	3	INDONESIA
	660	L675S	KF	12.4-14.8	SXU20HPR11	90048-51208	-	IXUH20I	VXUH20I	3	INDONESIA
		L675S	KF	14.8-	SXU20HPR11	90048-51208	-	IXUH20I	VXUH20I	3	INDONESIA
		L685S	KF	11.6-	SXU20HPR11	90048-51208	-	IXUH20I	VXUH20I	3	INDONESIA
<b>MIRA e:S</b>		LA300S	KF	11.9-12.11	SXU20HPR11	90048-51208	-	IXUH20I	VXUH20I	3	INDONESIA
		LA310S	KF	11.9-12.11	SXU20HPR11	90048-51208	-	IXUH20I	VXUH20I	3	INDONESIA
		LA300S	KF	12.11-14.7	SXU20HPR11	90048-51208	-	IXUH20I	VXUH20I	3	INDONESIA
	660	LA310S	KF	12.11-14.7	SXU20HPR11	90048-51208	-	IXUH20I	VXUH20I	3	INDONESIA
		LA300S	KF	14.7-17.5	-	-	-	IXUH20I	VXUH20I	3	INDONESIA
		LA310S	KF	14.7-17.5	-	-	-	IXUH20I	VXUH20I	3	INDONESIA
		LA350S	KF	17.5-	-	-	-	IXUH20I	VXUH20I	3	INDONESIA
	LA360S	KF	17.5-	-	-	-	IXUH20I	VXUH20I	3	INDONESIA	
<b>MIRA GINO</b>		L700S · L710S	EF-VE(DOHC)	02.8-04.12	SVK20RZ11	90048-51172	-	IK20	VK20Y	3	INDONESIA
	660	L700S · L710S	EF-DET(DOHC · T/C)	02.8-04.12	SVK20RZ11	90048-51172	-	IK20	VK20Y	3	INDONESIA
		L650 · L660S	EF-VE(DOHC)	04.12-08.12	K20PR-SU9	90048-51183	K20TT	IK20	VK20	3	INDONESIA
	1000	L701S · L711S	EJ-VE	02.8-08.12	K16TNR-S9	90048-51164	K16TT	IK16	VK16	3	INDONESIA
<b>MIRA TOCOT</b>		LA550S	KF	18.6-	SXU20HPR11	90048-51208	-	IXUH20I	VXUH20I	3	INDONESIA
	660	LA560S	KF	18.6-	SXU20HPR11	90048-51208	-	IXUH20I	VXUH20I	3	INDONESIA
<b>MIRA/ CUSTOM</b>		L275S · L285S	KF-VE(DOHC)	06.12-10.7	XU20HR9	90048-51212	XUH20TTI	IXUH20I	VXUH20I	3	INDONESIA
		L275S · L285S	KF-DET(DOHC · T/C)	06.12-	SXU22HPR8	90048-51214	-	IXUH22I	VXUH22I	3	INDONESIA
	660	L275S	KF(DOHC)	06.12-	XU20HR9	90048-51212	XUH20TTI	IXUH20I	VXUH20I	3	INDONESIA
		L285S(Except CVT)	KF(DOHC)	06.12-	XU20HR9	90048-51212	XUH20TTI	IXUH20I	VXUH20I	3	INDONESIA
		L285S(CVT)	KF(DOHC)	06.12-	SXU20HPR11	90048-51208	-	IXUH20I	VXUH20I	3	INDONESIA
<b>MOVE CANBUS</b>		LA800S	KF	16.9-22.7	-	-	-	IXUH20I	VXUH20I	3	INDONESIA
		LA810S	KF	16.9-22.7	-	-	-	IXUH20I	VXUH20I	3	INDONESIA
	660	LA850S	KF	22.7-	-	-	-	-	-	3	INDONESIA
		LA850S	KF(T/C)	22.7-	-	-	-	-	-	3	INDONESIA
		LA860S	KF	22.7-	-	-	-	-	-	3	INDONESIA
		LA860S	KF(T/C)	22.7-	-	-	-	-	-	3	INDONESIA
<b>MOVE CONTE/ CUSTOM</b>		L575S · L585S	KF-VE(DOHC)	08.8-11.6	XU20HR9	90048-51212	XUH20TTI	IXUH20I	VXUH20I	3	INDONESIA
		L575S · L585S	KF-DET(DOHC · T/C)	08.8-13.8	SXU22HPR8	90048-51214	-	IXUH22I	VXUH22I	3	INDONESIA
	660	L575S · L585S	KF	11.6-12.9	SXU20HPR11	90048-51208	-	IXUH20I	VXUH20I	3	INDONESIA
		L575S · L585S	KF	12.9-	SXU20HPR11	90048-51208	-	IXUH20I	VXUH20I	3	INDONESIA
		L575S · L585S	KF(T/C)	13.8-	SXU22HPR8	90048-51214	-	IXUH22I	VXUH22I	3	INDONESIA
<b>MOVE LATTE</b>		L550S · L560S	EF-DET(DOHC · T/C)	04.8-09.12	SK20R11	90048-51186	-	IK20	VK20	3	INDONESIA
	660	L550S · L560S	EF-VE(DOHC)	04.8-08.12	K20PR-SU9	90048-51183	K20TT	IK20	VK20	3	INDONESIA
<b>MOVE/ CUSTOM</b>		L602S	JB-JL(T/C)	95.8-98.10	K22TNR-S	90048-51143-000	-	IK22	VK22	4	INDONESIA
	660	L600S · L610S	EF-ZL(DOHC)	95.8-98.10	K22TNR-S	90048-51143-000	-	IK22	VK22	3	INDONESIA
	L600S	EF-GL(DOHC)	95.8-98.10	K20TNR-S	90048-51136	K20TT	IK20	VK20	3	INDONESIA	

DENSO	9	14	16	20	22	24	27	29	31	32	34	35	DENSO	9	14	16	20	22	24	27	31	DENSO	9	14	16	20	22	24	27	31		
NGK	2	4	5	6	7	8	9	9.5	10	10.5	11	11.5	CHAMPION	18	16,14	12,11	10,9	8,7	6,63,61	4,59	57	55	53	BOSCH	10	9	8	7,6	5	4	3	2

AUSTRALIA  
CHINA  
INDIA  
INDONESIA  
KOREA  
MALAYSIA  
PHILIPPINES  
SAUDIARABIA  
SINGAPORE  
TAIWAN  
THAILAND  
VIETNAM  
JAPAN  
EUROPE & USA  
CROSS REFERENCE  
PART NUMBER



MODEL	CC	VEHICLE CODE	ENGINE	FROM-TILL	DENSO	GENUINE P/N				QTY
AUSTRALIA	DAIHATSU MOVE/ CUSTOM	L600S • L610S	EF-RL(DOHC • T/C)	96.6-98.10	K22TNR-S	90048-51143-000	-	IK22	VK22	3
		L902S	JB-DET(DOHC • T/C)	98.10-01.9	K20TNR	90048-51154-000	K20TT	IK20	VK20	4
CHINA	660	L900S • L910S	EF-DET(DOHC • T/C)	98.10-01.9	K20TNR-S9	90048-51159	K20TT	IK20	VK20Y	3
		L900S • L910S	EF-SE	98.10-01.9	K20PR-U11	90048-51099	K20TT	IK20	VK20	3
		L900S • L910S	EF-VE(DOHC)	98.10-01.9	K20TNR-S9	90048-51159	K20TT	IK20	VK20	3
		L902S • L912S	JB-DET(DOHC • T/C)	01.10-02.10	SVK20RZ11	90048-51172	-	IK20	VK20Y	4
INDIA	660	L910S	EF-DET(DOHC • T/C)	01.10-02.10	SVK20RZ11	90048-51172	-	IK20	VK20Y	3
		L900S	EF-DET(DOHC • T/C)	01.10-02.10	K20TNR-S9	90048-51159	K20TT	IK20	VK20Y	3
INDONESIA	660	L150S • L160S	EF-VE(DOHC)	02.10-04.12	K20TNR-S9	90048-51159	K20TT	IK20	VK20	3
		L150S(Except CVT)	EF-VE(DOHC)	04.12-06.10	K20PR-SU9	90048-51183	K20TT	IK20	VK20	3
KOREA	660	L150S(CVT)	EF-VE(DOHC)	04.12-06.10	K20TNR-S9	90048-51159	K20TT	IK20	VK20	3
		L160S	EF-VE(DOHC)	04.12-06.10	K20PR-SU9	90048-51183	K20TT	IK20	VK20	3
MALAYSIA	660	L150S • L160S	EF-DET(DOHC • T/C)	02.10-06.10	SVK20RZ11	90048-51172	-	IK20	VK20Y	3
		L152S	JB-DET(DOHC • T/C)	02.10-03.9	SVK20RZ8	90048-51167-000	-	-	VK20Y	4
PHILIPPINES	660	L152S	JB-DET(DOHC • T/C)	03.10-06.9	SK20PR-A8	90048-51182	-	-	VK20Y	4
		L175S • L185S	KF-VE(DOHC)	06.10-10.12	XU20HR9	90048-51212	XUH20TTI	IXUH20I	VXUH20I	3
SAUDIARABIA	660	L175S • L185S	KF-DET(DOHC • T/C)	06.10-10.12	SXU22HPR8	90048-51214	-	IXUH22I	VXUH22I	3
		LA100S	KF	10.12-12.12	SXU20HPR11	90048-51208	-	IXUH20I	VXUH20I	3
SINGAPORE	660	LA110S	KF	10.12-12.12	SXU20HPR11	90048-51208	-	IXUH20I	VXUH20I	3
		LA100S • LA110S	KF(T/C)	10.12-13.8	SXU22HPR8	90048-51214	-	IXUH22I	VXUH22I	3
TAIWAN	660	LA100S	KF	12.12-14.12	SXU20HPR11	90048-51208	-	IXUH20I	VXUH20I	3
		LA110S	KF	12.12-14.12	SXU20HPR11	90048-51208	-	IXUH20I	VXUH20I	3
THAILAND	660	LA100S	KF(T/C)	13.8-14.12	SXU22HPR8	90048-51214	-	IXUH22I	VXUH22I	3
		LA110S	KF(T/C)	13.8-14.12	SXU22HPR8	90048-51214	-	IXUH22I	VXUH22I	3
VIETNAM	660	LA150S	KF	14.12-	SXU20HPR11	90048-51208	-	IXUH20I	VXUH20I	3
		LA150S	KF(T/C)	14.12-	SXU22HPR8	90048-51214	-	IXUH22I	VXUH22I	3
VIETNAM	660	LA160S	KF	14.12-	SXU20HPR11	90048-51208	-	IXUH20I	VXUH20I	3
		LA160S	KF(T/C)	14.12-	SXU22HPR8	90048-51214	-	IXUH22I	VXUH22I	3
VIETNAM	660	L750S • L760S(Cold area)	EF-DET(DOHC • T/C)	99.11-04.4	SVK20RZ11	90048-51172	-	IK20	VK20Y	3
		L750S • L760S	EF-DET(DOHC • T/C)	99.11-04.4	K20TNR-S9	90048-51159	K20TT	IK20	VK20Y	3
VIETNAM	660	L750S • L760S	EF-VE(DOHC)	99.11-04.4	K20TNR-S9	90048-51159	K20TT	IK20	VK20	3
		L300S • L310S	EF-KL	92.9-98.12	W16EXR-U	90048-51044-000	W16TT	IW16	VW16	3
VIETNAM	660	L300S • L310S	EF-ZL	95.10-98.12	K22TNR-S	90048-51143-000	-	IK22	VK22	3
		L800S • L810S	EF-DET(DOHC • T/C)	98.12-01.9	K20TNR-S9	90048-51159	K20TT	IK20	VK20Y	3
VIETNAM	660	L800S • L810S	EF-VE(DOHC)	98.12-01.10	K20TNR-S9	90048-51159	K20TT	IK20	VK20	3
		L802S	JB-DET(DOHC • T/C)	98.12-02.8	K20TNR	90048-51154-000	K20TT	IK20	VK20	4
VIETNAM	660	L800S • L810S	EF-SE	98.12-02.8	K20PR-U11	90048-51099	K20TT	IK20	VK20	3
		L800S • L810S	EF-DET(DOHC • T/C)	01.10-02.8	SVK20RZ11	90048-51172	-	IK20	VK20Y	3
VIETNAM	660	L800S • L810S	EF-DET(DOHC • T/C)	01.10-02.8	SVK20RZ11	90048-51172	-	IK20	VK20Y	3
		L800S • L810S	EF-DET(DOHC • T/C)	01.10-02.8	SVK20RZ11	90048-51172	-	IK20	VK20Y	3
VIETNAM	660	L800S • L810S	EF-DET(DOHC • T/C)	01.10-02.8	SVK20RZ11	90048-51172	-	IK20	VK20Y	3
		L800S • L810S	EF-DET(DOHC • T/C)	01.10-02.8	SVK20RZ11	90048-51172	-	IK20	VK20Y	3
VIETNAM	660	L800S • L810S	EF-DET(DOHC • T/C)	01.10-02.8	SVK20RZ11	90048-51172	-	IK20	VK20Y	3
		L800S • L810S	EF-DET(DOHC • T/C)	01.10-02.8	SVK20RZ11	90048-51172	-	IK20	VK20Y	3
VIETNAM	660	L800S • L810S	EF-DET(DOHC • T/C)	01.10-02.8	SVK20RZ11	90048-51172	-	IK20	VK20Y	3
		L800S • L810S	EF-DET(DOHC • T/C)	01.10-02.8	SVK20RZ11	90048-51172	-	IK20	VK20Y	3
VIETNAM	660	L800S • L810S	EF-DET(DOHC • T/C)	01.10-02.8	SVK20RZ11	90048-51172	-	IK20	VK20Y	3
		L800S • L810S	EF-DET(DOHC • T/C)	01.10-02.8	SVK20RZ11	90048-51172	-	IK20	VK20Y	3
VIETNAM	660	L800S • L810S	EF-DET(DOHC • T/C)	01.10-02.8	SVK20RZ11	90048-51172	-	IK20	VK20Y	3
		L800S • L810S	EF-DET(DOHC • T/C)	01.10-02.8	SVK20RZ11	90048-51172	-	IK20	VK20Y	3
VIETNAM	660	L800S • L810S	EF-DET(DOHC • T/C)	01.10-02.8	SVK20RZ11	90048-51172	-	IK20	VK20Y	3
		L800S • L810S	EF-DET(DOHC • T/C)	01.10-02.8	SVK20RZ11	90048-51172	-	IK20	VK20Y	3
VIETNAM	660	L800S • L810S	EF-DET(DOHC • T/C)	01.10-02.8	SVK20RZ11	90048-51172	-	IK20	VK20Y	3
		L800S • L810S	EF-DET(DOHC • T/C)	01.10-02.8	SVK20RZ11	90048-51172	-	IK20	VK20Y	3
VIETNAM	660	L800S • L810S	EF-DET(DOHC • T/C)	01.10-02.8	SVK20RZ11	90048-51172	-	IK20	VK20Y	3
		L800S • L810S	EF-DET(DOHC • T/C)	01.10-02.8	SVK20RZ11	90048-51172	-	IK20	VK20Y	3
VIETNAM	660	L800S • L810S	EF-DET(DOHC • T/C)	01.10-02.8	SVK20RZ11	90048-51172	-	IK20	VK20Y	3
		L800S • L810S	EF-DET(DOHC • T/C)	01.10-02.8	SVK20RZ11	90048-51172	-	IK20	VK20Y	3
VIETNAM	660	L800S • L810S	EF-DET(DOHC • T/C)	01.10-02.8	SVK20RZ11	90048-51172	-	IK20	VK20Y	3
		L800S • L810S	EF-DET(DOHC • T/C)	01.10-02.8	SVK20RZ11	90048-51172	-	IK20	VK20Y	3
VIETNAM	660	L800S • L810S	EF-DET(DOHC • T/C)	01.10-02.8	SVK20RZ11	90048-51172	-	IK20	VK20Y	3
		L800S • L810S	EF-DET(DOHC • T/C)	01.10-02.8	SVK20RZ11	90048-51172	-	IK20	VK20Y	3
VIETNAM	660	L800S • L810S	EF-DET(DOHC • T/C)	01.10-02.8	SVK20RZ11	90048-51172	-	IK20	VK20Y	3
		L800S • L810S	EF-DET(DOHC • T/C)	01.10-02.8	SVK20RZ11	90048-51172	-	IK20	VK20Y	3
VIETNAM	660	L800S • L810S	EF-DET(DOHC • T/C)	01.10-02.8	SVK20RZ11	90048-51172	-	IK20	VK20Y	3
		L800S • L810S	EF-DET(DOHC • T/C)	01.10-02.8	SVK20RZ11	90048-51172	-	IK20	VK20Y	3
VIETNAM	660	L800S • L810S	EF-DET(DOHC • T/C)	01.10-02.8	SVK20RZ11	90048-51172	-	IK20	VK20Y	3
		L800S • L810S	EF-DET(DOHC • T/C)	01.10-02.8	SVK20RZ11	90048-51172	-	IK20	VK20Y	3
VIETNAM	660	L800S • L810S	EF-DET(DOHC • T/C)	01.10-02.8	SVK20RZ11	90048-51172	-	IK20	VK20Y	3
		L800S • L810S	EF-DET(DOHC • T/C)	01.10-02.8	SVK20RZ11	90048-51172	-	IK20	VK20Y	3
VIETNAM	660	L800S • L810S	EF-DET(DOHC • T/C)	01.10-02.8	SVK20RZ11	90048-51172	-	IK20	VK20Y	3
		L800S • L810S	EF-DET(DOHC • T/C)	01.10-02.8	SVK20RZ11	90048-51172	-	IK20	VK20Y	3
VIETNAM	660	L800S • L810S	EF-DET(DOHC • T/C)	01.10-02.8	SVK20RZ11	90048-51172	-	IK20	VK20Y	3
		L800S • L810S	EF-DET(DOHC • T/C)	01.10-02.8	SVK20RZ11	90048-51172	-	IK20	VK20Y	3
VIETNAM	660	L800S • L810S	EF-DET(DOHC • T/C)	01.10-02.8	SVK20RZ11	90048-51172	-	IK20	VK20Y	3
		L800S • L810S	EF-DET(DOHC • T/C)	01.10-02.8	SVK20RZ11	90048-51172	-	IK20	VK20Y	3
VIETNAM	660	L800S • L810S	EF-DET(DOHC • T/C)	01.10-02.8	SVK20RZ11	90048-51172	-	IK20	VK20Y	3
		L800S • L810S	EF-DET(DOHC • T/C)	01.10-02.8	SVK20RZ11	90048-51172	-	IK20	VK20Y	3
VIETNAM	660	L800S • L810S	EF-DET(DOHC • T/C)	01.10-02.8	SVK20RZ11	90048-51172	-	IK20	VK20Y	3
		L800S • L810S	EF-DET(DOHC • T/C)	01.10-02.8	SVK20RZ11	90048-51172	-	IK20	VK20Y	3
VIETNAM	660	L800S • L810S	EF-DET(DOHC • T/C)	01.10-02.8	SVK20RZ11	90048-51172	-	IK20	VK20Y	3
		L800S • L810S	EF-DET(DOHC • T/C)	01.10-02.8	SVK20RZ11	90048-51172	-	IK20	VK20Y	3
VIETNAM	660	L800S • L810S	EF-DET(DOHC • T/C)	01.10-02.8	SVK20RZ11	90048-51172	-	IK20	VK20Y	3
		L800S • L810S	EF-DET(DOHC • T/C)	01.10-02.8	SVK20RZ11	90048-51172	-	IK20	VK20Y	3
VIETNAM	660	L800S • L810S	EF-DET(DOHC • T/C)	01.10-02.8	SVK20RZ11	90048-51172	-	IK20	VK20Y	3
		L800S • L810S	EF-DET(DOHC • T/C)	01.10-02.8	SVK20RZ11	90048-51172	-	IK20	VK20Y	3
VIETNAM	660	L800S • L810S	EF-DET(DOHC • T/C)	01.10-02.8	SVK20RZ11	90048-51172	-	IK20	VK20Y	3
		L800S • L810S	EF-DET(DOHC • T/C)	01.10-02.8	SVK20RZ11	90048-51172	-	IK20	VK20Y	3
VIETNAM	660	L800S • L810S	EF-DET(DOHC • T/C)	01.10-02.8	SVK20RZ11	90048-51172	-	IK20	VK20Y	3
		L800S • L810S	EF-DET(DOHC • T/C)	01.10-02.8	SVK20RZ11	90048-51172	-	IK20	VK20Y	3
VIETNAM	660	L800S • L810S	EF-DET(DOHC • T/C)	01.10-02.8	SVK20RZ11	90048-51172	-	IK20	VK20Y	3
		L800S • L810S	EF-DET(DOHC • T/C)	01.10-02.8	SVK20RZ11	90048-51172	-	IK20	VK20Y	3
VIETNAM	660	L800S • L810S	EF-DET(DOHC • T/C)	01.10-02.8	SVK20RZ11	90048-51172	-	IK20	VK20Y	3
		L800S • L810S	EF-DET(DOHC • T/C)	01.10-02.8	SVK20RZ11	90048-51172	-	IK20	VK20Y	3
VIETNAM	660	L800S • L810S	EF-DET(DOHC • T/C)	01.10-02.8	SVK20RZ11	90048-51172	-	IK20	VK20Y	

MODEL	CC	VEHICLE CODE	ENGINE	FROM-TILL	DENSO	GENUINE P/N				QTY		
<b>DAIHATSU</b>												
<b>TANTO/ CUSTOM</b>		L350S • L360S	EF-VE(DOHC)	03.11-07.12	K20PR-SU9	90048-51183	K20TT	IK20	VK20	3	AUSTRALIA	
		L375S • L385S	KF-VE(DOHC)	07.12-11.6	XU20HR9	90048-51212	XUH20TTI	IXUH20I	VXUH20I	3	CHINA	
		L375S	KF	11.6-12.9	SXU20HPR11	90048-51208	-	IXUH20I	VXUH20I	3	INDIA	
		L375S	KF	12.9-13.10	SXU20HPR11	90048-51208	-	IXUH20I	VXUH20I	3	INDONESIA	
		L375S(Rev)	KF	12.9-13.10	SXU20HPR11	90048-51208	-	IXUH20I	VXUH20I	3	KOREA	
		L385S	KF	11.6-13.10	SXU20HPR11	90048-51208	-	IXUH20I	VXUH20I	3	MALAYSIA	
		L385S	KF	12.9-13.10	SXU20HPR11	90048-51208	-	IXUH20I	VXUH20I	3	PHILIPPINES	
	660	L375S • L385S	KF-DET(DOHC • T/C)	07.12-13.10	SXU22HPR8	90048-51214	-	IXUH22I	VXUH22I	3	SAUDIARABIA	
		LA600S	KF	13.10-19.7	SXU20HPR11	90048-51208	-	IXUH20I	VXUH20I	3	SINGAPORE	
		LA610S	KF	13.10-19.7	SXU20HPR11	90048-51208	-	IXUH20I	VXUH20I	3	TAIWAN	
		LA600S	KF(T/C)	13.10-19.7	SXU22HPR8	90048-51214	-	IXUH22I	VXUH22I	3	THAILAND	
		LA610S	KF(T/C)	13.10-19.7	SXU22HPR8	90048-51214	-	IXUH22I	VXUH22I	3	VIETNAM	
		LA650S	KF	19.7-	-	-	-	-	-	3	JAPAN	
		LA650S	KF(T/C)	19.7-	-	-	-	-	-	3	EUROPE & USA	
		LA660S	KF	19.7-	-	-	-	-	-	3	CROSS REFERENCE	
		LA660S	KF(T/C)	19.7-	-	-	-	-	-	3	PART NUMBER	
<b>TERIOS</b>	1300	J100G	HC-EJ	97.3-00.5	K20TNR-S	90048-51136	K20TT	IK20	VK20	4		
		J102G • J122G	K3-VET(DOHC • T/C)	00.5-05.12	SVK20RZ8	90048-51167-000	-	-	VK20Y	4		
		J102G • J122G	K3-VE(DOHC)	00.5-05.12	K20R-U11	90048-51163	K20TT	IK20	VK20	4		
<b>TERIOS KID</b>	660	J111G • J131G	EF-DEM(DOHC • T/C)	98.10-06.8	K20TNR-S9	90048-51159	K20TT	IK20	VK20Y	3		
		J111G • J131G	EF-DET(DOHC • T/C)	98.10-10.8	K20TNR-S9	90048-51159	K20TT	IK20	VK20Y	3		
		J111G • J131G	EF-DET(DOHC • T/C)	10.8-	K20TNR-S9	90048-51159	-	-	-	3		
<b>TERIOS LUCIA</b>	660	J111G • J131G	EF-DEM(DOHC • T/C)	02.1-03.1	K20TNR-S9	90048-51159	K20TT	IK20	VK20Y	3		
<b>THOR</b>	1000	M900S	1KR-FE	16.11-	-	-	-	-	VCH16	3		
		M900S	1KR-VET(T/C)	16.11-	-	-	-	-	-	3		
		M910S	1KR-FE	16.11-	-	-	-	-	VCH16	3		
<b>WAKE</b>	660	LA700S	KF	14.11-	SXU20HPR11	90048-51208	-	IXUH20I	VXUH20I	3		
		LA710S	KF	14.11-	SXU20HPR11	90048-51208	-	IXUH20I	VXUH20I	3		
		LA700S	KF(T/C)	14.11-	SXU22HPR8	90048-51214	-	IXUH22I	VXUH22I	3		
		LA710S	KF(T/C)	14.11-	SXU22HPR8	90048-51214	-	IXUH22I	VXUH22I	3		
<b>YRV</b>	1000	M200	EJ-VE(DOHC)	00.8-02.12	K16TNR-S9	90048-51164	K16TT	IK16	VK16	3		
	1300	M201G • M211G	K3-VET(DOHC • T/C)	00.8-05.7	SVK20RZ8	90048-51167-000	-	-	VK20Y	4		
		M201G • M211G	K3-VE(DOHC)	00.8-05.7	K20R-U11	90048-51163	K20TT	IK20	VK20	4		
<b>FORD JAPAN</b>												
<b>ESCAPE</b>	2000	EPEW	YF(DOHC)	00.12-03.11	PT16VR13	-	-	ITV16	-	4		
	2300	EP3WF	L3(DOHC)	03.11-	VT16	-	-	IT16	VT16	4		
	3000	EPFW	AJ(DOHC)	00.12-03.11	VT20	-	-	IT20	VT20	6		
<b>FESTIVA</b>	1300	D23PF	B3-MI	93.1-97.10	K16PR-U11	BP02 18 110	K16TT	IK16	VK16	4		
	1500	D25PF	B5-ME	93.1-97.10	K16PR-U11	BP02 18 110	K16TT	IK16	VK16	4		
<b>FESTIVA MINI WAGON</b>	1300	DW3WF	B3 • B3-ME	96.8-01.8	K16PR-U11	BP02 18 110	K16TT	IK16	VK16	4		
	1500	DW5WF	B5 • B5-ME	96.8-01.8	K16PR-U11	BP02 18 110	K16TT	IK16	VK16	4		
<b>FREDA</b>	2000	SGE3F • SGEWF	FE-E	95.6-	K16PR-U11	BP02 18 110	K16TT	IK16	VK16	4		
	2500	SG5WF	J5-D	95.6-	K16PR-U11	BP02 18 110	K16TT	IK16	VK16	4		
<b>IXION</b>	1800	CP8WF	FP-DE(DOHC)	99.4-	K16PR-U11	BP02 18 110	K16TT	IK16	VK16	4		
<b>J80, J100</b>	1800	SS88MF • SS88RF • SS88WF	F8	90.7-	W16EXR-U13	FEDM 18 110	W16TT	IW16	VW16	4		
		SE88TF • SE88HF • SE88MF • SE88VF	F8	90.7-98.10	W16EXR-U13	FEDM 18 110	W16TT	IW16	VW16	4		
	2000	SDEATF	FE	93.9-97.4	K16PR-U11	BP02 18 110	K16TT	IK16	VK16	4		
<b>LASER</b>	1300	BHA3PF	B3	96.10-98.12	K16PR-U11	BP02 18 110	K16TT	IK16	VK16	4		
		BJ3PF	B3E	98.12-	K16PR-U11	BP02 18 110	K16TT	IK16	VK16	4		
		BHALPF • BHALSF	Z5-DE(DOHC)	94.6-98.12	K16PR-U11	BP02 18 110	K16TT	IK16	VK16	4		
		BHA5PF • BHA5SF	B5-ZE(DOHC)	94.6-98.12	K16PR-U11	BP02 18 110	K16TT	IK16	VK16	4		
	1500	BHALPF	Z5-DEL(LEANBURN)	94.9-98.12	IK16	1UD3 18 110	-	IK16	VK16	4		
		BJ5PF • BJ5WF	ZL-VE(DOHC)	98.12-	K16PR-U11	BP02 18 110	K16TT	IK16	VK16	4		
		BJ5PF • BJ5WF	ZL-DE(DOHC)	98.12-	K16PR-U11	BP02 18 110	K16TT	IK16	VK16	4		
	1600	BHA6RF	B6-DE(DOHC)	94.9-	IK16	1UD3 18 110	-	IK16	VK16	4		
	1800	BHA8PF • BHA8SF	BP-ZE(DOHC)	94.6-98.12	K16PR-U11	BP02 18 110	K16TT	IK16	VK16	4		
		BJ8WF	FPD(DOHC)	98.12-	K16PR-U11	BP02 18 110	K16TT	IK16	VK16	4		
<b>PROBE</b>	2500	1ZVTB	KL(DOHC)	92.9-	KJ16CR11	F288 18 110	K16TT	IK16	VK16	6		
<b>SPECTRON TELSTAR</b>	1800	SS88MF • SS88RF • SS88WF	F8	90.7-	W16EXR-U13	FEDM 18 110	W16TT	IW16	VW16	4		
	1800	CG2PPF	FP-DE	94.8-97.7	K16PR-U11	BP02 18 110	K16TT	IK16	VK16	4		
		GF8PF	FP-DE	97.8-99.8	KJ16CR11	F288 18 110	K16TT	IK16	VK16	4		
		GEEPF	KF-ZE(DOHC)	91.10-97.8	K20PR-U11	BP04 18 110	K20TT	IK20	VK20	4		
		GESRF	FS-DE	92.2-97.8	K16PR-U11	BP02 18 110	K16TT	IK16	VK16	4		
	2000	CG2SPF • CG2SRF	FS-DE	94.8-97.8	K16PR-U11	BP02 18 110	K16TT	IK16	VK16	4		
		GFEPF	FS-ZE	97.8-99.8	KJ16CR11	F288 18 110	K16TT	IK16	VK16	4		
		GFERF	FS-DE	97.8-99.8	KJ16CR11	F288 18 110	K16TT	IK16	VK16	4		
	<b>TELSTAR WAGON</b>	1800	GV8WF	F8	92.8-97.11	K20PR-U11	BP04 18 110	K20TT	IK20	VK20	4	

DENSO	9	14	16	20	22	24	27	29	31	32	34	35	DENSO	9	14	16	20	22	24	27	31	DENSO	9	14	16	20	22	24	27	31		
NGK	2	4	5	6	7	8	9	9.5	10	10.5	11	11.5	CHAMPION	18	16,14	12,11	10,9	8,7	6,63,61	4,59	57	55	53	BOSCH	10	9	8	7,6	5	4	3	2



AUSTRALIA  
CHINA  
INDIA  
INDONESIA  
KOREA  
MALAYSIA  
PHILIPPINES  
SAUDIARABIA  
SINGAPORE  
TAIWAN  
THAILAND  
VIETNAM  
JAPAN  
EUROPE & USA  
CROSS REFERENCE  
PART NUMBER



MODEL	CC	VEHICLE CODE	ENGINE	FROM-TILL	DENSO	GENUINE P/N				QTY			
<b>FORD JAPAN</b>													
AUSTRALIA	1800	GW8WF	FP-DE	97.11-99.8	KJ16CR11	F288 18 110	K16TT	IK16	VK16	4			
		GVERF • GVEWF	FE-DE	94.10-97.11	K20PR-U11	BP04 18 110	K20TT	IK20	VK20	4			
	2000	GW5RF	FS-DE • FS-ZE	97.11-99.8	KJ16CR11	F288 18 110	K16TT	IK16	VK16	4			
CHINA	2500	GW5RF	KL-ZE(DOHC)	97.11-99.8	K20PR-U11	BP04 18 110	K20TT	IK20	VK20	6			
<b>HONDA</b>													
<b>ACCORD</b>													
INDIA	1800	CD3	F18B	93.9-97.9	KJ16CR-L11	98079-5515G	K16TT	IK16	VK16	4			
		CF3	F18B(VTEC)	97.9-02.9	PKJ16CR-L13	98079-55A5N	-	IK16	VK16	4			
		CD4	F20B(PGM-FI)	93.9-97.9	KJ16CR-L11	98079-5515G	K16TT	IK16	VK16	4			
		CF3 • CF5	F20B(VTEC)	97.9-02.10	KJ16CR-L11	98079-5515G	K16TT	IK16	VK16	4			
		CF4(LEV)	F20B	97.9-00.6	KJ16CR-L11	98079-5515G	K16TT	IK16	VK16	4			
	2000	CF4	F20B(VTEC)	97.9-00.6	KJ16CR-L11	98079-5515G	K16TT	IK16	VK16	4			
		CF4	F20B(DOHC • VTEC)	97.9-02.10	PKJ20CR-L11	98079-5615N	-	IK20	VK20	4			
		CL7 • CL8	K20A(DOHC • i-VTEC)	02.10-	KJ20DR-M11	9807B-5615P	K20TT	IK20	VK20	4			
		CL7(EURO R)	K20A(DOHC • i-VTEC)	02.10-	SK22PR-M11S(*4)	98079-571CV	-	IK22G(*4)	VK22G(*4)	4			
		CM1	K20A(DOHC • i-VTEC)	04.10-	KJ20DR-M11	9807B-5615P	K20TT	IK20	VK20	4			
INDONESIA	2000	CM1	R20A(SOHC.i-TEC)	11.2-	SKJ20DR-M11S(*4)	9807B-561CW	-	IK20G(*4)	VK20G(*4)	4			
		CU1	R20A	11.2-	SKJ20DR-M11S(*4)	12290-R60-U02	-	IK20G(*4)	VK20G(*4)	4			
		CD5	F22B(PGM-FI)	93.9-97.9	KJ16CR-L11	98079-5515G	K16TT	IK16	VK16	4			
		CD6	H22A(DOHC • VTEC)	93.9-97.9	PKJ20CR-L11	98079-5615N	-	IK20	VK20	4			
		CD7	F22B(VTEC)	94.1-97.9	KJ16CR-L11	98079-5515G	K16TT	IK16	VK16	4			
	2200	CD8	H22A(VTEC)	94.1-97.9	PKJ20CR-L11	98079-5615N	-	IK20	VK20	4			
		CL1(EURO R)	H22A(DOHC • VTEC)	00.6-02.10	PKJ20CR-L11	98079-5615N	-	IK20	VK20	4			
		CL9	K24A(DOHC • i-VTEC)	02.10-08.12	SKJ20DR-M11	9807B-5615W	-	IK20	VK20	4			
		CU2 • CW2	K24A(DOHC • i-VTEC)	08.12-	SXU22HCR11S	12290-R40-A02	-	-	VXUHC22G	4			
		2400	CR6	LFA-MF8	13.6-16.5	-	-	-	-	VFXEHC22G	4		
CR7	LFA-H4		16.5-20.2	-	-	-	-	VFXEHC22G	4				
CV3	LFB-H4		20.2-	-	-	-	-	VFXEHC22G	4				
PHILIPPINES	2000	CW1	R20A(SOHC.i-TEC)	11.2-	SKJ20DR-M11S(*4)	9807B-561CW	-	IK20G(*4)	VK20G(*4)	4			
		CW2	K24A(PGM-FI)	08.12-11.2	SXU22HCR11S	12290-R40-A02	-	-	VXUHC22G	4			
		CW2	K24A(DOHC.i-VTEC)	11.2-	SXU22HCR11S	12290-R40-A02	-	-	VXUHC22G	4			
SAUDIARABIA	2000	CM1	K20A(DOHC • i-VTEC)	04.10-08.12	KJ20DR-M11	9807B-5615P	K20TT	IK20	VK20	4			
		CE1	F22B(VTEC)	94.3-97.9	KJ16CR-L11	98079-5515G	K16TT	IK16	VK16	4			
		CF2	H22A(DOHC • VTEC)	96.9-97.9	PKJ20CR-L11	98079-5615N	-	IK20	VK20	4			
		CF6 • CF7	F23A(VTEC)	97.9-02.10	KJ16CR-L11	98079-5515G	K16TT	IK16	VK16	4			
		CH9	F23A(DOHC • VTEC)	99.1-00.6	PKJ20CR-L11	98079-5615N	-	IK20	VK20	4			
	2300	CH9 • CL2	H23A(DOHC • VTEC)	00.6-02.10	PKJ20CR-L11	98079-5615N	-	IK20	VK20	4			
		CM2 • CM3(24E)	K24A(DOHC • i-VTEC)	02.11-08.12	KJ20DR-M11	9807B-5615P	K20TT	IK20	VK20	4			
		CM2 • CM3(24T)	K24A(DOHC • i-VTEC)	02.11-08.12	KJ20DR-M11	9807B-5615W	-	IK20	VK20	4			
		SINGAPORE	660	HA3 • HA4 • HA5 • HH3 • HH4	E07A	90.4-99.6	K20PR-U11	98079-5615E	K20TT	IK20	VK20	3	
				HA6 • HA7 • HH5 • HH6	E07Z	99.6-09.12	SK20PR-L9	98079-5695U	-	IK20	VK20	3	
HH5 • HH6	E07Z			09.12-10.8	SK20PR-L9	98079-5695U	-	IK20	VK20	3			
TAIWAN	660		HA8	E07Z	09.12-	SK20PR-N9	12290-RV4-004	-	IK20	VK20	3		
			HA9	E07Z	09.12-	SK20PR-N9	12290-RV4-004	-	IK20	VK20	3		
			HH5	E07Z	10.8-	SK20PR-N9	12290-RV4-004	-	IK20	VK20	3		
THAILAND	660	HH6	E07Z	10.8-	SK20PR-N9	12290-RV4-004	-	IK20	VK20	3			
		VIETNAM	1500	AIRWAVE	GJ1 • GJ2	L15A(VTEC)	05.4-	SKJ20DR-M13	9807B-56A5W	-	IK20	VK20	4
				ASCOT	CE4	G20A	93.10-97.9	K20PR-L11	98079-5615J	K20TT	IK20	VK20	5
CE5	G25A			93.10-97.9	K20PR-L11	98079-5615J	K20TT	IK20	VK20	5			
JAPAN	2000	CB3 • CB4	F20A(DOHC)	92.3-97.9	KJ20CR-L11	98079-5615G	K20TT	IK20	VK20	4			
		CB3 • CB4	F20A(PGM-FI)	92.3-97.9	KJ20CR-L11	98079-5615G	K20TT	IK20	VK20	4			
	2300	CC4 • CC5(Except TCS)	H23A(DOHC)	92.3-97.9	KJ20CR-L11	98079-5615G	K20TT	IK20	VK20	4			
		CC4 • CC5(TCS)	H23A(DOHC)	92.3-97.9	PKJ20CR-L11	98079-5615N	-	IK20	VK20	4			
EUROPE & USA	1500	AVANCIER	TA1 • TA2	F23A(SOHC,VTEC)	99.9-03.6	KJ16CR-L11	98079-5515G	K16TT	IK16	VK16	4		
		TA3 • TA4	J30A(SOHC,VTEC)	99.9-03.6	KJ16CR-L11	98079-5515G	K16TT	IK16	VK16	6			
		CAPA	GA4 • GA6	D15B	98.4-02.1	KJ16CR-L11	98079-5515G	K16TT	IK16	VK16	4		
CROSS REFERENCE NUMBER	1300	CIVIC/FERIO/SHUTTLE	EF1 • EY2	D13B	89.10-97.2	Q20PR-U11	98079-56158	-	IQ20	VQ20	4		
		EK2	D13B	95.9-00.9	K16PR-U11	98079-5515E	K16TT	IK16	VK16	4			
		ES9(HYBRID)	LDA-MF3(DOHC)	01.10-05.9	SK16PR-L11	98079-5515V	-	IK16	VK16	8			
		FD3(HYBRID)	LDA	05.9-10.12	SK20HPR-L11	12290-RMX-014	-	IKH20	VKH20	8			
		EF2 • EF4 • EY4	D15B	89.10-97.2	Q20PR-U11	98079-56158	-	IQ20	VQ20	4			
	1500	EK3	D15B(VTEC)	95.9-00.9	KJ20CR-L11	98079-5615G	K20TT	IK20	VK20	4			
		EK3	D15B	95.9-00.9	K16PR-U11	98079-5515E	K16TT	IK16	VK16	4			
		EK3(LEV)	D15B	98.9-00.9	KJ16CR-L11	98079-5515G	K16TT	IK16	VK16	4			
		ES1 • EU1(2WD)	D15B(SOHC)	00.9-10.8	KJ16CR-L11	98079-5515G	K16TT	IK16	VK16	4			
		ES1 • EU1	D15B(VTEC • LEANBURN)	00.9-10.8	SKJ16CR-L11	98079-5515W	-	IK16	VK16	4			
ES2(FERIO,4WD)	D15B(SOHC)	00.9-10.8	SKJ16CR-L11	98079-5515W	-	IK16	VK16	4					

(\*4)G means an SUS (stainless steel) gasket. Models without a G (Ex: VK16, etc.) are a steel gasket, so they cannot be used in this vehicle.





MODEL	CC	VEHICLE CODE	ENGINE	FROM-TILL	DENSO	GENUINE P/N				QTY			
<b>HONDA</b>													
<b>CIVIC/ FERIO/ SHUTTLE</b>	1500	ES2(FERIO,4WD)	D15B(SOHC·VTEC)	00.9-10.8	SKJ16CR-L11	98079-5515W	-	IK16	VK16	4	AUSTRALIA		
		EU1(2WD)	D15B(SOHC·VTEC)	00.9-10.8	KJ16CR-L11	98079-5515G	K16TT	IK16	VK16	4	CHINA		
		EU2(4WD)	D15B(VTEC)	00.9-10.8	KJ20CR-L11	98079-5615G	K20TT	IK20	VK20	4	INDIA		
		FK7	L15C(T/C)	17.9-21.9	-	-	-	-	VXEHC24G	4	INDONESIA		
		FC1	L15B(T/C)	17.9-21.9	-	-	-	-	VXEHC24G	4	KOREA		
		FL1	L15C(T/C)	21.9-	-	-	-	-	-	4	MALAYSIA		
	1600	EF3·EF5·EY5	ZC		87.9-97.2	Q20PR-U11	98079-56158	-	IQ20	VQ20	4	PHILIPPINES	
		EK4	B16A(DOHC·VTEC)		95.9-00.9	K20PR-L11	98079-5615J	K20TT	IK20	VK20	4	SAUDIARABIA	
		EK5	D16A		95.9-00.9	KJ16CR-L11	98079-5515G	K16TT	IK16	VK16	4	SINGAPORE	
		EK8	D16A(LEV)		97.2-98.8	KJ16CR-L11	98079-5515G	K16TT	IK16	VK16	4	TAIWAN	
		EK9(TYPE R)	B16B(DOHC·VTEC)		97.8-01.12	PK22PR-L11S(*4)	98079-5715H	-	IK22G(*4)	VK22G(*4)	4	THAILAND	
		EJ7(CNG)	D16B(VTEC-E,CNG)		98.7-10.8	VK22	-	-	IK22	VK22	4	VIETNAM	
	1700	EU3·EU4·ES3·ET2	D17A(VTEC)		00.9-05.9	KJ20CR-L11	98079-5615G	K20TT	IK20	VK20	4	JAPAN	
		EN2	D17A(CNG)		01.2-10.8	VK22	-	-	IK22	VK22	4	EUROPE & USA	
	1800	FD1	R18A		05.9-10.8	SKJ20DR-M11S(*4)	9807B-561CV	-	IK20G(*4)	VK20G(*4)	4	CROSS REFERENCE NUMBER	
	2000	EP3(TYPE R)	K20A(i-VTEC)		01.12-03.3	SK22PR-M11S(*4)	98079-571CV	-	IK22G(*4)	VK22G(*4)	4		
		EP3(TYPE R)	K20A(i-VTEC)		03.3-07.6	SK22PR-M11S(*4)	98079-571CV	-	IK22G(*4)	VK22G(*4)	4		
		FD2	K20A(DOHC·i-VTEC)		06.4-10.8	SKJ20DR-M11	9807B-5615W	-	IK20	VK20	4		
		FD2(TYPE R)	K20A(DOHC·i-VTEC)		07.6-10.8	SK22PR-M11S(*4)	98079-571CV	-	IK22G(*4)	VK22G(*4)	4		
		FN2(TYPE R)	K20A(DOHC·i-VTEC)		09.11-10.8	SK22PR-M11S(*4)	98079-571CV	-	IK22G(*4)	VK22G(*4)	4		
		FK2	K20C(T/C)		15.12-17.9	-	-	-	-	VXEHC24G	4		
		FK8	K20C(T/C)		17.9-	-	-	-	VXEHC24G	4			
	<b>CLARITY PHEV</b>	1500	ZC5	LEB-H4	18.7-	-	-	-	-	VFXEHC22G	4		
	<b>CROSS ROAD</b>	1800	RT1·RT2	R18A	07.2-	KJ20DR-M11S(*4)	9807B-561CP	-	IK20G(*4)	VK20G(*4)	4		
		2000	RT3·RT4	R20A	07.2-	KJ20DR-M11S(*4)	9807B-561CP	-	IK20G(*4)	VK20G(*4)	4		
		3900	E-LJ	36D(V8i)	93.1-	W20EPR-U	98079-56855	-	IW20	VW20	8		
	<b>CR-V</b>	1500	RW1	L15B(T/C)	18.8-	-	-	-	-	VXEHC24G	4		
			RW2	L15B(T/C)	18.8-	-	-	-	-	VXEHC24G	4		
		2000	RD1·RD2	B20B		95.10-98.12	KJ16CR-L11	98079-5515G	K16TT	IK16	VK16	4	
			RD1·RD2	B20B		98.12-01.6	KJ20CR-L11	98079-5615G	K20TT	IK20	VK20	4	
RD4·RD5			K20A(i-VTEC)		01.7-04.9	KJ20DR-M11	9807B-5615P	K20TT	IK20	VK20	4		
RM1			R20A		11.12-	-	-	-	VXUHC22G	4			
2400		RD6·RD7	K24A(DOHC·i-VTEC)		04.9-	KJ20DR-M11	9807B-5615P	K20TT	IK20	VK20	4		
		RE3·RE4	K24A(DOHC·i-VTEC)		06.10-11.12	KJ20DR-M11	9807B-5615P	K20TT	IK20	VK20	4		
		RM4	K24A		11.12-	SXU22HCR11S	12290-R40-A02	-	-	VXUHC22G	4		
		RT5	LFB-H4		18.11-	-	-	-	-	VFXEHC22G	4		
<b>CR-V HYBRID</b>	2000	RT6	LFB-H4	18.11-	-	-	-	-	VFXEHC22G	4			
<b>CR-X/DEL SOL</b>	1600	EJ4	D16A	95.10-99.8	K16PR-U11	98079-5515E	K16TT	IK16	VK16	4			
<b>CR-Z</b>	1500	ZF1	LEA(i-VTEC·IMA)	10.2-	DK20PR-D13	12290-RTW-004	-	-	VFK20F	4			
		ZF2	LEA-MF6	12.9-	SKJ20DR-M13	12290-RB1-004	-	IK20	VK20	4			
<b>DOMANI</b>	1500	MA7	D15B(VTEC)	94.2-98.3	KJ16CR-L11	98079-5515G	K16TT	IK16	VK16	4			
		MB3	D15B	97.1-99.1	K16PR-U11	98079-5515E	K16TT	IK16	VK16	4			
		MB3	D15B	99.1-	KJ16CR-L11	98079-5515G	K16TT	IK16	VK16	4			
	1600	MA4·MA6	ZC		92.11-98.3	K20PR-U11	98079-5615E	K20TT	IK20	VK20	4		
		MA4	ZC(VTEC)		92.11-98.3	KJ20CR-L11	98079-5615G	K20TT	IK20	VK20	4		
		MB4·MB5	D16A		97.1-	KJ16CR-L11	98079-5515G	K16TT	IK16	VK16	4		
		MB4	D16A(VTEC-E)		97.1-	KJ16CR-L11	98079-5515G	K16TT	IK16	VK16	4		
		MB4(LEV)	D16A		98.2-	KJ16CR-L11	98079-5515G	K16TT	IK16	VK16	4		
		MA5	B18B(DOHC)		92.11-98.3	KJ16CR-L11	98079-5515G	K16TT	IK16	VK16	4		
	<b>EDIX</b>	1700	BE1·BE2	D17A	04.7-06.11	KJ20CR-L11	98079-5615G	K20TT	IK20	VK20	4		
2000		BE3·BE4	K20A	04.7-	KJ20DR-M11	9807B-5615P	K20TT	IK20	VK20	4			
2400		BE8	K24A	06.11-	KJ20DR-M11	9807B-5615P	K20TT	IK20	VK20	4			
<b>ELEMENT</b>	2400	YH2	K24A(DOHC·i-VTEC)	03.4-	SKJ20DR-M11	9807B-5615W	-	IK20	VK20	4			
<b>ELYSION</b>	2400	RR1·RR2	K24A(DOHC·i-VTEC)	04.5-	SKJ20DR-M11	9807B-5615W	-	IK20	VK20	4			
		RR1·RR2(PRESTIGE)	K24A(DOHC·i-VTEC)	07.8-	SKJ20DR-M11	9807B-5615W	-	IK20	VK20	4			
	3000	RR3·RR4	J30A	04.5-	SKJ20DR-M11	9807B-5615W	-	IK20	VK20	6			
	3500	RR5·RR6(PRESTIGE)	J35A	06.12-	SKJ20DR-M11	9807B-5615W	-	IK20	VK20	6			
<b>FIT</b>	1300	GD1·GD2	L13A(i-DSI)	01.6-07.10	K20PR-U11	98079-5615E	K20TT	IK20	VK20	8			
		GE6·GE7	L13A(i-VTEC)	07.10-13.9	DK20PR-D13	12290-RTW-004	-	-	VFK20F	4			
		GP1(HYBRID)	LDA-MF6(SOHC PGM-FI)	10.10-13.9	VFKH20	-	-	-	VFKH20	8			
		GK3	L13B		13.9-20.2	DXE22HCR11S	12290-5R0-004	-	-	VFXEHC22G	4		
		GK4	L13B		13.9-20.2	DXE22HCR11S	12290-5R0-004	-	-	VFXEHC22G	4		
		GR1	L13B		20.2-	DXE22HCR11S	12290-5R0-004	-	-	VFXEHC22G	4		
		GR5	L13B		20.2-	DXE22HCR11S	12290-5R0-004	-	-	VFXEHC22G	4		
		GR2	L13B		20.2-	DXE22HCR11S	12290-5R0-004	-	-	VFXEHC22G	4		
		GR7	L13B		20.2-	DXE22HCR11S	12290-5R0-004	-	-	VFXEHC22G	4		
		GD3·GD4	L15A(VTEC)		02.9-07.10	SKJ20DR-M13	9807B-56A5W	-	IK20	VK20	4		

(\*4)G means an SUS (stainless steel) gasket. Models without a G (Ex: VK16, etc.) are a steel gasket, so they cannot be used in this vehicle.



	MODEL	CC	VEHICLE CODE	ENGINE	FROM-TILL	DENSO	GENUINE P/N				QTY		
AUSTRALIA	HONDA FIT	1500	GE8 • GE9	L15A(i-VTEC)	07.10-13.9	SKJ20DR-M13 •	12290-RB1-004	-	IK20	VK20	4		
			GP4(HYBRID)	LEA-MF6	12.5-13.9	DK20PR-D13	12290-RTW-004	-	-	VFK20F	4		
			GK5	L15B	13.9-20.2	DXE22HCR11S	12290-5R0-004	-	-	VFXEHC22G	4		
CHINA	FIT ARIA	1300	GD6 • GD7	L13A(i-DSI)	02.12-05.10	K20PR-U11	98079-5615E	K20TT	IK20	VK20	8		
			GD8 • GD9	L15A(i-DSI)	05.10-	K20PR-U11	98079-5615E	K20TT	IK20	VK20	8		
			GD8 • GD9	L15A(VTEC)	05.10-	SKJ20DR-M13	9807B-56A5W	-	IK20	VK20	4		
INDIA	FIT HYBRID	1500	GP5	LEB-H1	13.9-20.2	DXE22HCR11S	12290-5R0-004	-	-	VFXEHC22G	4		
			GP6	LEB-H1	14.1-20.2	DXE22HCR11S	12290-5R0-004	-	-	VFXEHC22G	4		
			GR3	LEB-H5	20.2-	DXE22HCR11H	12290-6Y0-004	-	-	VFXEHC22G	4		
			GR6	LEB-H5	20.2-	DXE22HCR11H	12290-6Y0-004	-	-	VFXEHC22G	4		
			GR4	LEB-H5	20.2-	DXE22HCR11H	12290-6Y0-004	-	-	VFXEHC22G	4		
INDONESIA	FIT SHUTTLE FIT SHUTTLE HYBRID	1500	GG7 • GG8	L15A(SOHC)	11.6-	SKJ20DR-M13 •	12290-RB1-004	-	IK20	VK20	4		
			GP2(HYBRID)	LDA-MF6(SOHC)	11.6-13.8	VFKH20	-	-	-	VFKH20	8		
			GP2	LDA-MF6	13.8-	-	-	-	-	VFK20F	8		
KOREA	FREED	1500	GB3 • GB4	L15A(SOHC • iVTEC)	08.5-16.9	SKJ20DR-M13 •	12290-RB1-004	-	IK20	VK20	4		
			GP3(HYBRID)	LEA-MF6	11.10-16.9	-	-	-	-	VFKH20	8		
			GP3(SPIKE, HYBRID)	LEA-MF6	11.10-16.9	-	-	-	-	VFKH20	8		
			GB5	L15B	16.9-	DXE22HCR11S	12290-5R0-004	-	-	VFXEHC22G	4		
			GB6	L15B	16.9-	DXE22HCR11S	12290-5R0-004	-	-	VFXEHC22G	4		
MALAYSIA	FREED HYBRID	1500	GB7	LEB-H1	16.9-	DXE22HCR11S	12290-5R0-004	-	-	VFXEHC22G	4		
			GB8	LEB-H1	16.9-	DXE22HCR11S	12290-5R0-004	-	-	VFXEHC22G	4		
			GM6	L15B	15.6-	DXE22HCR11S	12290-5R0-004	-	-	VFXEHC22G	4		
PHILIPPINES	GRACE	1500	GM9	L15B	15.6-	DXE22HCR11S	12290-5R0-004	-	-	VFXEHC22G	4		
			GM6 Rev	L15B	15.7-	DXE22HCR11S	12290-5R0-004	-	-	VFXEHC22G	4		
			GM4	LEB-H1	14.12-	DXE22HCR11S	12290-5R0-004	-	-	VFXEHC22G	4		
SAUDI ARABIA	GRACE HYBRID	1500	GM5	LEB-H1	14.12-	DXE22HCR11S	12290-5R0-004	-	-	VFXEHC22G	4		
			HORIZON	3200	UBS25GWH	6VD1	94.2-98.3	K20PR-U11	98079-5615E	K20TT	IK20	VK20	6
			3500	UBS26GWH	6VE1	98.3-	PK16PR-L11	98079-5515H	-	IK16	VK16	6	
SINGAPORE	HR-V	1600	GH1 • GH2 • GH3 • GH4(LEV)	D16A	98.9-01.6	KJ16CR-L11	98079-5515G	K16TT	IK16	VK16	4		
			GH2 • GH3 • GH4(LEV)	D16A(VTEC)	01.7-	KJ16CR-L11	98079-5515G	K16TT	IK16	VK16	4		
			INSIGHT	1000	ZE1	ECA-MF2(SOHC)	99.11-09.2	VKH20	-	-	IKH20	VKH20	3
TAIWAN	INSIGHT	1300	ZE2	LDA-MF6(i-VTEC+IMA)	09.2-	VFKH20	-	-	-	VFKH20	8		
			1500	ZE3	LEA-MF6	11.11-18.12	DK20PR-D13	12290-RTW-004	-	-	VFK20F	4	
		2000	ZE4	LEB-H4	18.12-	-	-	-	-	VFXEHC22G	4		
			UA1	G20A	95.2-98.10	K20PR-L11	98079-5615J	K20TT	IK20	VK20	5		
			UA2	G25A	95.2-98.10	K20PR-L11	98079-5615J	K20TT	IK20	VK20	5		
THAILAND	INSPIRE	2500	UA4	J25A	98.10-03.6	PKJ20CR-L11	98079-5615N	-	IK20	VK20	6		
			3000	UC1	J30A(SOHC • i-VTEC)	03.6-07.12	SKJ20DR-M11	9807B-5615W	-	IK20	VK20	6	
		3200	UA3	C32A	95.7-98.10	PK16PR-L11	98079-5515H	-	IK16G(*4)	VK16G(*4)	6		
			UA5	J32A(VTEC)	98.10-01.3	SKJ16CR-L11	98079-5515W	-	IK16	VK16	6		
			UA5	J32A(VTEC)	01.4-03.5	PKJ20CR-M11	12290-PGE-A01	-	IK20	VK20	6		
VIETNAM	INTEGRA	3500	CP3	J35A(VTEC)	07.12-	SXU22HCR11	12290-R70-A02	-	-	VXUHC22G	6		
			1600	DC1 • DB6 • DB9	ZC(PGM-FI)	93.5-01.7	KJ16CR-L11	98079-5515G	K16TT	IK16	VK16	4	
		1800	DC2 • DB8(TYPE R)	B18C(DOHC • VTEC)	95.10-01.7	PK22PR-L11S(*4)	98079-571CH	-	IK22G(*4)	VK22G(*4)	4		
			DC5(TYPE R)	K20A(i-VTEC)	01.7-03.3	SK22PR-M11S(*4)	98079-571CV	-	IK22G(*4)	VK22G(*4)	4		
			DC5(iS)	K20A(i-VTEC)	01.7-04.9	KJ20DR-M11	9807B-5615P	K20TT	IK20	VK20	4		
			DC5(TYPE R)	K20A(i-VTEC)	03.3-	SK22PR-M11S(*4)	98079-571CV	-	IK22G(*4)	VK22G(*4)	4		
			DC5(TYPE S)	K20A(i-VTEC)	04.9-	KJ20DR-M11	9807B-5615P	K20TT	IK20	VK20	4		
JAPAN	INTEGRA SJ	1500	EK3	D15B(HYPER 16V)	96.3-99.1	K16PR-U11	98079-5515E	K16TT	IK16	VK16	4		
			EK3	D15B(VTEC)	96.3-	KJ20CR-L11	98079-5615G	K20TT	IK20	VK20	4		
			EK3	D15B(HYPER 16V)	99.1-	KJ16CR-L11	98079-5515G	K16TT	IK16	VK16	4		
EUROPE & USA	JADE	1500	FR4	LEB-H1	15.2-	DXE22HCR11S	12290-5R0-004	-	-	VFXEHC22G	4		
			FR5	L15B(T/C)	15.5-	-	-	-	-	VXEHC24G	4		
			LAGREAT	3500	RL1	J35A(VTEC)	99.6-	KJ16CR-L11	98079-5515G	K16TT	IK16	VK16	6
CROSS REFERENCE	LEGEND	3500	KA9	C35A	96.2-04.10	PK16PR-L11	98079-5515H	-	IK16G(*4)	VK16G(*4)	6		
			KB1	J35A	04.10-08.9	SKJ20DR-M11	9807B-5615W	-	IK20	VK20	6		
		3700	KB2	J37A	08.9-	SXU22HCR11S	12290-R40-A02	-	-	VXUHC22G	6		
PART NUMBER	LEGEND HYBRID LIFE	3500	KC2	JNB	15.2-	-	-	-	-	VFXUHC22FG	6		
			JA4	E07A	97.4-98.10	K20PR-U11	98079-5615E	K20TT	IK20	VK20	3		
			JB1 • JB2	E07Z	98.10-03.9	K20PR-U11	98079-5615E	K20TT	IK20	VK20	3		
			JB5 • JB6	P07A(i-DSI)	03.9-08.11	K20PR-U9S(*4)	98079-569CE	-	IK20G(*4)	VK20G(*4)	6		
			JB7 • JB8	P07A(SOHC • i-DSI, T/C)	03.9-04.6	SK20PR-L9S(*4)	98079-569CU	-	IK20G(*4)	VK20G(*4)	6		
			JB7 • JB8	P07A(SOHC • i-DSI, T/C)	04.7-08.11	SK20PR-N9S(*4)	12290-RS9-004	-	IK20G(*4)	VK20G(*4)	6		
			JC1 • JC2	P07A(i-DSI)	08.11-	K20PR-U8S(*4)	98079-568CE	-	IK20G(*4)	VK20G(*4)	6		
JC1 • JC2	P07A(SOHC • i-DSI, T/C)	08.11-	SK20PR-N9S(*4)	12290-RS9-004	-	IK20G(*4)	VK20G(*4)	6					

(\*4)G means an SUS (stainless steel) gasket. Models without a G (Ex: VK16, etc.) are a steel gasket, so they cannot be used in this vehicle.



MODEL	CC	VEHICLE CODE	ENGINE	FROM-TILL	DENSO	GENUINE P/N				QTY		
<b>HONDA</b>												
LIFE DUNK LOGO	660	JB3 • JB4	E07Z(T/C)	00.12-03.9	SK20PR-L9	98079-5695U	-	IK20	VK20	3	AUSTRALIA	
		GA3 • GA5	D13B(2VALVE)	96.10-01.6	KJ16CR-L11	98079-5515G	K16TT	IK16	VK16	4		
	1300	GA3	D13B(4VALVE)	98.11-01.6	K16PR-U11	98079-5515E	K16TT	IK16	VK16	4	CHINA	
MDX MOBILIO		3500	YD1	J35A	03.3-	SKJ16DR-M11	9807B-5515W	-	IK16	VK16	6	
	1500	GB1 • GB2	L15A(i-DSI)	01.12-	K20PR-U11	98079-5615E	K20TT	IK20	VK20	8	INDIA	
		GB1	L15A(VTEC)	04.1-	SKJ20DR-M13	9807B-56A5W	-	IK20	VK20	4		
MOBILIO SPIKE N BOX	1500	GK1 • GK2	L15A(VTEC)	02.9-	SKJ20DR-M13	9807B-56A5W	-	IK20	VK20	4	INDONESIA	
		JF1	S07A	11.12-13.12	SXU22HCR8S	12290-R9G-004	-	-	VXUHC22G	3		
	JF1	S07A(T/C)	11.12-13.12	SXU22HCR8S	12290-R9G-004	-	-	VXUHC22G	3			
	JF2	S07A	11.12-13.12	SXU22HCR8S	12290-R9G-004	-	-	VXUHC22G	3			
	JF2	S07A(T/C)	11.12-13.12	SXU22HCR8S	12290-R9G-004	-	-	VXUHC22G	3			
	660	JF1	S07A	13.12-17.9	DXE22HCR11S	12290-5R0-004	-	-	VFXEHC22G	3		
		JF1	S07A(T/C)	13.12-17.9	SXE24HCR8S	12290-5Z2-004	-	-	VXEHC24G	3		
		JF2	S07A	13.12-17.9	DXE22HCR11S	12290-5R0-004	-	-	VFXEHC22G	3		
		JF2	S07A(T/C)	13.12-17.9	SXE24HCR8S	12290-5Z2-004	-	-	VXEHC24G	3		
		JF3	S07B	17.9-	-	-	-	-	-	3		
		JF3	S07B(T/C)	17.9-	-	-	-	-	-	3		
		660	JF4	S07B	17.9-	-	-	-	-	3		
			JF4	S07B(T/C)	17.9-	-	-	-	-	3		
	N BOX SLASH	660	JF1	S07A	14.12-	DXE22HCR11S	12290-5R0-004	-	-	VFXEHC22G	3	INDONESIA
JF1			S07A(T/C)	14.12-	SXE24HCR8S	12290-5Z2-004	-	-	VXEHC24G	3		
JF2			S07A	14.12-	DXE22HCR11S	12290-5R0-004	-	-	VFXEHC22G	3		
JF2			S07A(T/C)	14.12-	SXE24HCR8S	12290-5Z2-004	-	-	VXEHC24G	3		
N BOX+	660	JF1	S07A	12.7-13.12	SXU22HCR8S	12290-R9G-004	-	-	VXUHC22G	3	INDONESIA	
		JF1	S07A(T/C)	12.7-13.12	SXU22HCR8S	12290-R9G-004	-	-	VXUHC22G	3		
	660	JF2	S07A	12.7-13.12	SXU22HCR8S	12290-R9G-004	-	-	VXUHC22G	3		
		JF2	S07A(T/C)	12.7-13.12	SXU22HCR8S	12290-R9G-004	-	-	VXUHC22G	3		
		JF1 Rev	S07A	12.7-13.12	SXU22HCR8S	12290-R9G-004	-	-	VXUHC22G	3		
		JF2 Rev	S07A	12.7-13.12	SXU22HCR8S	12290-R9G-004	-	-	VXUHC22G	3		
		JF1	S07A	13.12-	DXE22HCR11S	12290-5R0-004	-	-	VFXEHC22G	3		
		JF1	S07A(T/C)	13.12-	SXE24HCR8S	12290-5Z2-004	-	-	VXEHC24G	3		
		JF2	S07A	13.12-	DXE22HCR11S	12290-5R0-004	-	-	VFXEHC22G	3		
		JF2	S07A(T/C)	13.12-	SXE24HCR8S	12290-5Z2-004	-	-	VXEHC24G	3		
N ONE	660	JG1	S07A	12.11-14.5	SXU22HCR8S	12290-R9G-004	-	-	VXUHC22G	3	INDONESIA	
		JG1	S07A(T/C)	12.11-14.5	SXU22HCR8S	12290-R9G-004	-	-	VXUHC22G	3		
	660	JG2	S07A	12.11-14.5	SXU22HCR8S	12290-R9G-004	-	-	VXUHC22G	3		
		JG2	S07A(T/C)	12.11-14.5	SXU22HCR8S	12290-R9G-004	-	-	VXUHC22G	3		
	660	JG1	S07A	14.5-20.11	DXE22HCR11S	12290-5R0-004	-	-	VFXEHC22G	3		
		JG1	S07A(T/C)	14.5-20.11	SXE24HCR8S	12290-5Z2-004	-	-	VXEHC24G	3		
		JG2	S07A	14.5-20.11	DXE22HCR11S	12290-5R0-004	-	-	VFXEHC22G	3		
		JG2	S07A(T/C)	14.5-20.11	SXE24HCR8S	12290-5Z2-004	-	-	VXEHC24G	3		
		JG3	S07B	20.11-	-	-	-	-	-	3		
		JG3	S07B(T/C)	20.11-	-	-	-	-	-	3		
		JG4	S07B	20.11-	-	-	-	-	-	3		
		JG4	S07B(T/C)	20.11-	-	-	-	-	-	3		
	NSX	3000	NA1	C30A	90.9-99.9	PK20PR-L11	98079-5615H	-	IK20G(*4)	VK20G(*4)	6	INDONESIA
			NA1	C30A	99.9-	PK16PR-L11	98079-5515H	-	IK16G(*4)	VK16G(*4)	6	
3200		NA2	C32B	97.2-99.9	PK20PR-L11	98079-5615H	-	IK20G(*4)	VK20G(*4)	6		
3500		NC1	JNC(T/C)	17.2-	-	-	-	-	VXEHC24G	6	INDONESIA	
N-VAN	660	JJ1	S07B	18.7-	-	-	-	-	3			
		JJ1	S07B(T/C)	18.7-	-	-	-	-	3			
	660	JJ2	S07B	18.7-	-	-	-	-	3			
		JJ2	S07B(T/C)	18.7-	-	-	-	-	3			
N-WGN	660	JH1	S07A	13.11-19.8	DXE22HCR11S	12290-5R0-004	-	-	VFXEHC22G	3	INDONESIA	
		JH1	S07A(T/C)	13.11-19.8	SXE24HCR8S	12290-5Z2-004	-	-	VXEHC24G	3		
	660	JH2	S07A	13.11-19.8	DXE22HCR11S	12290-5R0-004	-	-	VFXEHC22G	3		
		JH2	S07A(T/C)	13.11-19.8	SXE24HCR8S	12290-5Z2-004	-	-	VXEHC24G	3		
		JH3	S07B	19.8-	-	-	-	-	-	3		
		JH3	S07B(T/C)	19.8-	-	-	-	-	-	3		
		JH4	S07B	19.8-	-	-	-	-	-	3		
		JH4	S07B(T/C)	19.8-	-	-	-	-	-	3		
ODYSSEY	2200	RA1 • RA2	F22B	94.10-97.8	KJ16CR-L11	98079-5515G	K16TT	IK16	VK16	4	INDONESIA	
		RA3 • RA4	F23A(VTEC)	97.8-00.1	KJ16CR-L11	98079-5515G	K16TT	IK16	VK16	4		
	2300	RA6 • RA7	F23A(VTEC)	00.1-08.10	KJ16CR-L11	98079-5515G	K16TT	IK16	VK16	4		
		RB1 • RB2	K24A(DOHC • i-VTEC)	03.10-08.10	SKJ20DR-M11	9807B-5615W	-	IK20	VK20	4		
	2400	RB3(ABSOLUTE)	K24A	08.10-13.11	SXU22HCR11S	12290-R40-A02	-	-	VXUHC22G	4		
		RB4(ABSOLUTE)	K24A	08.10-13.11	SXU22HCR11S	12290-R40-A02	-	-	VXUHC22G	4		

(\*4)G means an SUS (stainless steel) gasket. Models without a G (Ex: VK16, etc.) are a steel gasket, so they cannot be used in this vehicle.



MODEL	CC	VEHICLE CODE	ENGINE	FROM-TILL	DENSO	GENUINE P/N				QTY		
AUSTRALIA	HONDA ODYSSEY	RB3(Except Absolute)	K24A	08.10-11.10	DXU22HCR-D11S	12290-R41-L01	-	-	VFXUHC22FG	4		
		RB4(Except Absolute)	K24A	08.10-11.10	DXU22HCR-D11S	12290-R41-L01	-	-	VFXUHC22FG	4		
		RB3(Except Absolute)	K24A	11.10-13.11	DXU22HCR-D11S	12290-R41-L01	-	-	VFXUHC22FG	4		
		RB4(Except Absolute)	K24A	11.10-13.11	DXU22HCR-D11S	12290-R41-L01	-	-	VFXUHC22FG	4		
		CHINA	2400	RC1(ABSOLUTE)	K24W	13.11-17.11	DXE22HQR-D11S	12290-5A2-A02	-	-	VFXEH22	4
				RC2(ABSOLUTE)	K24W	13.11-17.11	DXE22HQR-D11S	12290-5A2-A02	-	-	VFXEH22	4
				RC1(Except ABSOLUTE)	K24W	13.11-	SXE22HQR11S	12290-5B0-Y02	-	-	VCH20	4
				RC2(Except ABSOLUTE)	K24W	13.11-	SXE22HQR11S	12290-5B0-Y02	-	-	VCH20	4
				RC1(ABSOLUTE)	K24W	17.11-20.11	DXE22HQR-D11S	12290-5A2-A02	-	-	VFXEH22	4
				RC2(ABSOLUTE)	K24W	17.11-20.11	DXE22HQR-D11S	12290-5A2-A02	-	-	VFXEH22	4
				RC1(ABSOLUTE)	K24W	20.11-	SXE22HQR11S	12290-5B0-Y02	-	-	VCH20	4
				RC2(ABSOLUTE)	K24W	20.11-	SXE22HQR11S	12290-5B0-Y02	-	-	VCH20	4
INDONESIA	3000			RA5	J30A(VTEC)	97.10-00.1	KJ16CR-L11	98079-5515G	K16TT	IK16	VK16	6
				RA8 • RA9	J30A(VTEC)	00.1-03.10	KJ16CR-L11	98079-5515G	K16TT	IK16	VK16	6
INDONESIA	ODYSSEY HYBRID	2000	RC4	LFA-H4	16.2-	-	-	-	VFXEHC22G	4		
		1800	EL1	B18B	96.2-99.6	KJ16CR-L11	98079-5515G	K16TT	IK16	VK16	4	
KOREA	ORTHIA	2000	EL2 • EL3	B20B	96.2-99.6	KJ16CR-L11	98079-5515G	K16TT	IK16	VK16	4	
			EL2 • EL3	B20B(DOHC)	99.6-02.1	KJ20CR-L11	98079-5615G	K20TT	IK20	VK20	4	
KOREA	PARTNER	1300	EY6	D13B	96.3-06.3	K16PR-U11	98079-5515E	K16TT	IK16	VK16	4	
			EY7	D15B	96.3-99.6	K16PR-U11	98079-5515E	K16TT	IK16	VK16	4	
MALAYSIA	1500	EY7	D15B(LEV)	99.6-06.3	KJ16CR-L11	98079-5515G	K16TT	IK16	VK16	4		
		GJ3 • GJ4	L15A(i-DSI)	06.3-	K20PR-U11	98079-5615E	K20TT	IK20	VK20	8		
		1600	EY8 • EY9	D16A	96.3-06.3	KJ16CR-L11	98079-5515G	K16TT	IK16	VK16	4	
			PRELUDE	BB5	F22B	96.11-00.8	KJ20CR-L11	98079-5615G	K20TT	IK20	VK20	4
PHILIPPINES	2200	BB5 • BB7	F22B(DOHC)	96.11-00.8	KJ20CR-L11	98079-5615G	K20TT	IK20	VK20	4		
		BB6 • BB8	H22A(DOHC • VTEC)	96.11-00.8	PKJ20CR-L11	98079-5615N	-	IK20	VK20	4		
		RAFAGA	2000	CE4	G20A(PGM-FI)	93.10-97.9	K20PR-L11	98079-5615J	K20TT	IK20	VK20	5
SAUDIARABIA	2500	CE5	G25A(PGM-FI)	93.10-97.9	K20PR-L11	98079-5615J	K20TT	IK20	VK20	5		
		S2000	2000	AP1	F20C(DOHC • VTEC)	99.4-01.8	PK22PR-L11S(*4)	98079-571CH	-	IK22G(*4)	VK22G(*4)	4
AP1	F20C(DOHC • VTEC)			01.9-05.11	PK22PR-L11S(*4)	98079-571CH	-	IK22G(*4)	VK22G(*4)	4		
AP2	F22C(DOHC)			05.11-09.6	PK22PR-L11S(*4)	98079-571CH	-	IK22G(*4)	VK22G(*4)	4		
SAUDIARABIA	S660	660	JW5	S07A(T/C)	15.4-	SXE24HCR8S	12290-522-004	-	VXEHC24G	3		
SINGAPORE	SABER	2000	UA1	G20A	95.2-98.10	K20PR-L11	98079-5615J	K20TT	IK20	VK20	5	
			UA2	G25A	95.2-98.10	K20PR-L11	98079-5615J	K20TT	IK20	VK20	5	
			UA4	J25A	98.10-	PKJ20CR-L11	98079-5615N	-	IK20	VK20	6	
		2500	UA3	C32A	95.7-98.10	PK16PR-L11	98079-5515H	-	IK16G(*4)	VK16G(*4)	6	
			UA5	J32A	98.10-01.3	SKJ16CR-L11	98079-5515W	-	IK16	VK16	6	
			UA5	J32A(VTEC)	01.4-	PKJ20CR-M11	12290-PGE-A01	-	IK20	VK20	6	
TAIWAN	SHUTTLE	1500	GK8	L15B	15.5-	DXE22HCR11S	12290-5R0-004	-	VFXEHC22G	4		
			GK9	L15B	15.5-	DXE22HCR11S	12290-5R0-004	-	VFXEHC22G	4		
THAILAND	SHUTTLE HYBRID	1500	GP7	LEB-H1	15.5-	DXE22HCR11S	12290-5R0-004	-	VFXEHC22G	4		
			GP8	LEB-H1	15.5-	DXE22HCR11S	12290-5R0-004	-	VFXEHC22G	4		
VIETNAM	S-MX	2000	RH1 • RH2	B20B	96.11-99.9	KJ16CR-L11	98079-5515G	K16TT	IK16	VK16	4	
			RH1 • RH2	B20B	99.9-02.1	KJ20CR-L11	98079-5615G	K20TT	IK20	VK20	4	
JAPAN	STEPWAGON	1500	RP1	L15B(T/C)	15.4-22.5	-	-	-	VXEHC24G	4		
			RP2	L15B(T/C)	15.4-22.5	-	-	-	VXEHC24G	4		
			RP3	L15B(T/C)	15.4-22.5	-	-	-	VXEHC24G	4		
			RP4	L15B(T/C)	15.4-22.5	-	-	-	VXEHC24G	4		
			RP6	L15C(T/C)	22.5-	-	-	-	-	-	4	
			RP7	L15C(T/C)	22.5-	-	-	-	-	-	4	
			2400	RF1 • RF2	B20B	96.5-99.5	KJ16CR-L11	98079-5515G	K16TT	IK16	VK16	4
		RF1 • RF2		B20B	99.5-01.3	KJ20CR-L11	98079-5615G	K20TT	IK20	VK20	4	
		RF3 • RF4 • RF5 • RF6		K20A(DOHC • i-VTEC)	01.4-05.4	KJ20DR-M11	9807B-5615P	K20TT	IK20	VK20	4	
		RG1 • RG2		K20A(DOHC • i-VTEC)	05.5-07.11	KJ20DR-M11	9807B-5615P	K20TT	IK20	VK20	4	
		RG1 • RG2		K20A(DOHC • i-VTEC)	07.11-09.10	SKJ20DR-M11	9807B-5615W	-	IK20	VK20	4	
		EUROPE & USA	2000	RK1 • RK2	R20A	09.10-11.8	SKJ20DR-M11S(*4)	9807B-561CW	-	IK20G(*4)	VK20G(*4)	4
RK1	R20A			11.8-15.4	SKJ20DR-M11S(*4)	12290-R60-U02	-	IK20G(*4)	VK20G(*4)	4		
RK2	R20A			11.8-15.4	SKJ20DR-M11S(*4)	12290-R60-U02	-	IK20G(*4)	VK20G(*4)	4		
RK3	R20A			11.8-15.4	SKJ20DR-M11S(*4)	12290-R60-U02	-	IK20G(*4)	VK20G(*4)	4		
RK4	R20A			11.8-15.4	SKJ20DR-M11S(*4)	12290-R60-U02	-	IK20G(*4)	VK20G(*4)	4		
RK5 • RK6(SPADA)	R20A			09.10-11.8	SKJ20DR-M11S(*4)	9807B-561CW	-	IK20G(*4)	VK20G(*4)	4		
RK5(SPADA)	R20A			11.8-15.4	SKJ20DR-M11S(*4)	12290-R60-U02	-	IK20G(*4)	VK20G(*4)	4		
RK6(SPADA)	R20A			11.8-15.4	SKJ20DR-M11S(*4)	12290-R60-U02	-	IK20G(*4)	VK20G(*4)	4		
RK7(SPADA)	R20A			11.8-15.4	SKJ20DR-M11S(*4)	12290-R60-U02	-	IK20G(*4)	VK20G(*4)	4		
2400	RF7 • RF8			K24A(DOHC • i-VTEC)	03.6-05.4	KJ20DR-M11	9807B-5615P	K20TT	IK20	VK20	4	
RG3 • RG4	K24A(DOHC • i-VTEC)	05.5-	KJ20DR-M11	9807B-5615P	K20TT	IK20	VK20	4				
CROSS REFERENCE NUMBER	STEPWAGON HYBRID	2000	RP5	LFA-H4	17.9-22.5	-	-	VFXEHC22G	4			

(\*4)G means an SUS (stainless steel) gasket. Models without a G (Ex: VK16, etc.) are a steel gasket, so they cannot be used in this vehicle.



MODEL	CC	VEHICLE CODE	ENGINE	FROM-TILL	DENSO	GENUINE P/N				QTY	
<b>HONDA</b>											
STEPWAGON HYBRID	2000	RP8	LFA-H4	22.5-	-	-	-	-	-	4	AUSTRALIA
STREAM	1700	RN1 • RN2	D17A(DOHC • VTEC)	00.10-06.7	KJ20CR-L11	98079-5615G	K20TT	IK20	VK20	4	CHINA
	1800	RN6 • RN7	R18A(SOHC • i-VTEC)	06.7-	KJ20DR-M11S(*4)	9807B-561CP	-	IK20G(*4)	VK20G(*4)	4	
		RN3	K20A(DOHC • i-VTEC)	00.10-03.9	SKJ20DR-M13	9807B-56A5W	-	IK20	VK20	4	
		RN4(4WD)	K20A(DOHC • i-VTEC)	00.10-03.9	KJ20DR-M11	9807B-5615P	K20TT	IK20	VK20	4	
	2000	RN3 • RN4	K20A(DOHC • i-VTEC)	03.9-06.7	KJ20DR-M11	9807B-5615P	K20TT	IK20	VK20	4	
		RN5	K20B(DI)	03.5-06.7	-	-	-	-	-	4	
		RN8 • RN9	R20A(SOHC • i-VTEC)	06.7-	KJ20DR-M11S(*4)	9807B-561CP	-	IK20G(*4)	VK20G(*4)	4	
THAT'S	660	JD1 • JD2	E07Z(T/C)	02.2-	SK20PR-L9	98079-5695U	-	IK20	VK20	3	INDIA
		JD1 • JD2	E07Z	02.2-	K20PR-U11	98079-5615E	K20TT	IK20	VK20	3	
TODAY	660	JA2 • JA3 • JA4 • JA5 • JW3 • JW4	E07A	90.2-98.2	K20PR-U11	98079-5615E	K20TT	IK20	VK20	3	
TORNEO	1800	CF3	F18B(VTEC)	97.9-02.10	PKJ16CR-L13	98079-55A5N	-	IK16	VK16	4	INDONESIA
	2000	CF3 • CF4 • CF5	F20B(VTEC)	97.9-02.10	KJ16CR-L11	98079-5515G	K16TT	IK16	VK16	4	
		CF4	F20B(DOHC • VTEC)	97.9-02.10	PKJ20CR-L11	98079-5615N	-	IK20	VK20	4	
		CL1(EURO R)	H22A(DOHC • VTEC)	00.6-02.10	PKJ20CR-L11	98079-5615N	-	IK20	VK20	4	
VAMOS	660	HM1 • HM2	E07Z	99.6-01.8	SK20PR-L9	98079-5695U	-	IK20	VK20	3	KOREA
		HM1 • HM2	E07Z(T/C)	00.2-	SK20PR-L9	98079-5695U	-	IK20	VK20	3	
		HM1 • HM2	E07Z	01.8-	K20PR-U11	98079-5615E	K20TT	IK20	VK20	3	
VAMOS HOBIO	660	HM3 • HM4	E07Z	03.4-	K20PR-U11	98079-5615E	K20TT	IK20	VK20	3	MALAYSIA
		HM3 • HM4	E07Z(T/C)	03.4-	SK20PR-L9	98079-5695U	-	IK20	VK20	3	
	HJ1 • HJ2	E07Z	03.4-10.8	SK20PR-L9	98079-5695U	-	IK20	VK20	3		
	HJ1	E07Z	10.8-	SK20PR-N9	12290-RV4-004	-	IK20	VK20	3		
VEZEL	1500	RU1	L15B	13.12-21.4	DXE22HCR11S	12290-5R0-004	-	-	VFXEHC22G	4	PHILIPPINES
		RU2	L15B	13.12-21.4	DXE22HCR11S	12290-5R0-004	-	-	VFXEHC22G	4	
	RV3	L15Z	21.4-	DXE22HCR11H	12290-6Y0-004	-	-	VFXEHC22G	4		
	RV4	L15Z	21.4-	DXE22HCR11H	12290-6Y0-004	-	-	VFXEHC22G	4		
	RU3	LEB-H1	13.12-21.4	DXE22HCR11S	12290-5R0-004	-	-	VFXEHC22G	4		
VEZEL HYBRID	1500	RU4	LEB-H1	13.12-21.4	DXE22HCR11S	12290-5R0-004	-	-	VFXEHC22G	4	SAUDIARABIA
		RV5	LEC-H5	21.4-	DXE22HCR11H	12290-6Y0-004	-	-	VFXEHC22G	4	
		RV6	LEC-H5	21.4-	DXE22HCR11H	12290-6Y0-004	-	-	VFXEHC22G	4	
		PA1	E07Z	98.10-02.1	K20PR-U11	98079-5615E	K20TT	IK20	VK20	3	
Z	660	PA1	E07Z(T/C)	98.10-02.1	SK20PR-L9	98079-5695U	-	IK20	VK20	3	SINGAPORE
		PA1	E07Z	98.10-02.1	K20PR-U11	98079-5615E	K20TT	IK20	VK20	3	
ZEST	660	JE1 • JE2	P07A(SOHC)	06.3-08.12	K20PR-U9S(*4)	98079-569CE	-	IK20G(*4)	VK20G(*4)	6	TAIWAN
		JE1 • JE2	P07A(SOHC)	08.12-	K20PR-U8S(*4)	98079-568CE	-	IK20G(*4)	VK20G(*4)	6	
		JE1 • JE2	P07A(SOHC T/C)	06.3-08.12	IK20G	-	-	-	IK20G(*4)	VK20G(*4)	
ZEST SPARK	660	JE1 • JE2	P07A(SOHC)	08.12-	K20PR-U8S(*4)	98079-568CE	-	IK20G(*4)	VK20G(*4)	6	THAILAND
		JE1 • JE2	P07A(SOHC T/C)	08.12-	SK20PR-N9S(*4)	12290-RS9-004	-	IK20G(*4)	VK20G(*4)	6	
<b>ISUZU</b>											
ASKA	1800	CJ2	F18B(VTEC)	97.10-02.3	PKJ16CR-L13	-	-	IK16	VK16	4	VIETNAM
	2000	CJ1	F20B	94.3-97.10	KJ16CR-L11	-	K16TT	IK16	VK16	4	
		CJ3	F20B(VTEC)	97.10-02.3	PKJ16CR-L13	-	-	IK16	VK16	4	
BIGHORN	3200	UBS25GW • UBS25DW	6VD1	95.10-98.2	PK16PR11	8-97111376-0	-	IK16	VK16	6	VIETNAM
	3500	UBS26GW • UBS26DW	6VE1	98.2-02.12	K16PR-P11	8-97170268-0	-	IK16	VK16	6	
COMO	2000	JVPE25	KA20DE	01.5-	K16PR-U11	-	K16TT	IK16	VK16	4	VIETNAM
		JVR2E26	QR20DE	12.7-	FXE20HR11	22401-JD01B	-	-	VFXEH20	4	
	2400	JQGE25	KA24DE	01.5-	K20PR-U	8-97012930-0	K20TT	IK20	VK20	4	
	2500	JCS4E26	QR25DE	12.7-	FXE20HR11	22401-JD01B	-	-	VFXEH20	4	
ELF		NPR82-XN	4HV		GX8-1	8-98119290-0	-	-	-	4	
ELF 100	2000	ASK2F23 • ASK4F23	NA20S	95.6-99.6	VW16	-	-	IW16	VW16	4	JAPAN
		ASH2F23 • ASH4F23	KA20DE	99.6-	K16PR-U11	-	K16TT	IK16	VK16	4	
FARGO	2000	WFR12DT • WFR12DV • WFR12FV • WFR12FVH • NFR12DT	4ZC1	85.12-99.9	W20EXR-U	8-94160627-0	-	IW20	VW20	4	EUROPE & USA
		JVTGE24	NA20S	96.8-99.9	VW16	-	-	IW16	VW16	4	
	3000	JFEGE24	VG30E	95.8-99.9	VK20	-	-	IK20	VK20	6	
FARGO FILLY/ FILLY	3300	JALE50 • JALWE50	VG33E	98.1-00.10	K16PR-U11	-	K16TT	IK16	VK16	6	EUROPE & USA
	3500	JAPE50	VQ35DE	00.10-	VKH16	-	-	IKH16	VKH16	6	
FORWARD	7800	FRR90S2 Rev • FRR34S2 Rev • FTR34S2 Rev	6HF1-TCN		GX8-1	8-98119290-0	-	-	-	6	
GEMINI	1500	MJ3	D15B(VTEC-E)	95.1-98.3	KJ16CR-L11	-	K16TT	IK16	VK16	4	CROSS REFERENCE NUMBER
		MJ4	D15B	97.2-99.1	K16PR-U11	-	K16TT	IK16	VK16	4	
		MJ4	D15B	99.1-00.6	KJ16CR-L11	-	K16TT	IK16	VK16	4	
	1600	MJ1 • MJ2	ZC	93.8-97.3	K20PR-U11	8-94328374-0	K20TT	IK20	VK20	4	
		MJ1	ZC(VTEC)	93.8-97.1	KJ20CR-L11	-	K20TT	IK20	VK20	4	
		MJ5 • MJ6	D16A	97.2-00.6	KJ16CR-L11	-	K16TT	IK16	VK16	4	
MJ5	D16A(VTEC-E)	97.2-00.6	KJ16CR-L11	-	K16TT	IK16	VK16	4			
MU	2600	UCS17DW • UCS17DH	4ZE1	89.5-98.6	W16EXR-U11	8-94120561-0	W16TT	IW16	VW16	4	

(\*4)G means an SUS (stainless steel) gasket. Models without a G (Ex: VK16, etc.) are a steel gasket, so they cannot be used in this vehicle.



▶ Spark plug color codes: ■ for Iridium Tough and Iridium Plugs and Iridium TT, ■ for Iridium Power, ■ for Iridium Racing and Two Tops Plugs, ■ for Platinum Plugs and Platinum TT, and black for general spark plugs.

	MODEL	CC	VEHICLE CODE	ENGINE	FROM-TILL	DENSO	GENUINE P/N				QTY	
AUSTRALIA	<b>ISUZU</b>											
	MU	3200	UES25EW • UES25FW	6VD1	98.6-02.5	K16PR-P11	8-97170268-0	-	<b>IK16</b>	<b>VK16</b>	6	
	VEHICROSS	3200	UGS25DW	6VD1	97.3-99.3	K16PR-P11	8-97170268-0	-	<b>IK16</b>	<b>VK16</b>	6	
	WIZARD	3200	UES25FW • UER25FW	6VD1	98.6-02.12	PK16PR11	8-97111376-0	-	<b>IK16</b>	<b>VK16</b>	6	
CHINA	<b>LEXUS</b>											
	CT200h	1800	ZWA10	2ZR-FXE(HYBRID)	11.1-	SC16HR11	90919-01275	-	-	<b>VCH16</b>	4	
	ES300h	2500	AXZH10	A25A-FXS	18.10-20.8	FC16HR-Q8	90919-01289-79	-	-	<b>VFCH16</b>	4	
			AXZH11	A25A-FXS	20.8-	FC16HR-Q8	90919-01289-79	-	-	<b>VFCH16</b>	4	
INDIA	GS F	5000	URL10	2UR-GSE	15.11-	FK20HBR-J8	90919-01279-79	-	-	<b>VFKBH20</b>	8	
	GS200t	2000	ARL10	8AR-FTS(T/C)	16.9-	VDKH22F	-	-	-	<b>VDKH22F</b>	4	
	GS250	2500	GRL11	4GR-FSE	12.1-	FK20HBR11	90919-01249	-	-	<b>VFKBH20</b>	6	
INDONESIA	GS300	2000	ARL10	8AR-FTS(T/C)	17.8-	VDKH22F	-	-	-	<b>VDKH22F</b>	4	
	GS300h	2500	AWL10	2AR-FSE	13.10-	FK20HBR8	90919-01263	-	-	<b>VFKBH20</b>	4	
			GRS191 • GRS196	2GR-FSE(D-4S)	05.8-12.1	FK20HBR11	90919-01249	-	-	<b>VFKBH20</b>	6	
	GS350	3500	GRL10	2GR-FSE	12.1-15.11	FK20HBR11	90919-01249	-	-	<b>VFKBH20</b>	6	
			GRL15	2GR-FSE	12.1-15.11	FK20HBR11	90919-01249	-	-	<b>VFKBH20</b>	6	
GRL12			2GR-FKS	15.11-	FK20HBR8	90919-01263-79	-	-	<b>VFKBH20</b>	6		
	GS430	4300	UZS190	3UZ-FE	05.8-07.10	SK20R11	90919-01210	-	<b>IK20</b>	<b>VK20</b>	8	
KOREA	GS450h	3500	GWS191	2GR-FSE(D-4S)	06.3-	FK20HBR11	90919-01249	-	-	<b>VFKBH20</b>	6	
			GWL10	2GR-FXE	12.3-	FK20HBR8	90919-01263-79	-	-	<b>VFKBH20</b>	6	
MALAYSIA	GS460	4600	URS190	1UR-FSE	07.10-	FK20HBR11	90919-01249	-	-	<b>VFKBH20</b>	8	
	HS250h	2400	ANF10	2AZ-FXE	09.7-12.6	SK20R11	90919-01210	-	<b>IK20</b>	<b>VK20</b>	4	
			ANF10	2AZ-FXE	12.6-	SK16R11	90919-01240-79	-	<b>IK16</b>	<b>VK16</b>	4	
PHILIPPINES	IS F	5000	USE20	2UR-GSE	07.12-	FK20HBR11	90919-01249	-	-	<b>VFKBH20</b>	8	
	IS200t	2000	ASE30	8AR-FTS(T/C)	15.8-	VDKH22F	-	-	-	<b>VDKH22F</b>	4	
	IS250	2500	GSE20 • GSE25	4GR-FSE(D-4)	05.8-13.5	FK20HBR11	90919-01249	-	-	<b>VFKBH20</b>	6	
			GSE30	4GR-FSE	13.5-	FK20HBR11	90919-01249-79	-	-	<b>VFKBH20</b>	6	
			GSE35	4GR-FSE	13.5-	FK20HBR11	90919-01249-79	-	-	<b>VFKBH20</b>	6	
IS250C	2500	GSE20	4GR-FSE	09.5-	FK20HBR11	90919-01249-79	-	-	<b>VFKBH20</b>	6		
SAUDI ARABIA	IS300	2000	ASE30	8AR-FTS(T/C)	18.8-	VDKH22F	-	-	-	<b>VDKH22F</b>	4	
	IS300h	2500	AVE30	2AR-FSE	13.5-	FK20HBR8	90919-01263-79	-	-	<b>VFKBH20</b>	4	
			AVE35	2AR-FSE	15.8-	FK20HBR8	90919-01263-79	-	-	<b>VFKBH20</b>	4	
	IS350	3500	GSE21	2GR-FSE(D-4S)	05.8-13.5	FK20HBR11	90919-01249	-	-	<b>VFKBH20</b>	6	
			GSE31	2GR-FSE	13.5-18.8	FK20HBR11	90919-01249-79	-	-	<b>VFKBH20</b>	6	
GSE31			2GR-FKS	18.8-20.11	FK20HBR8	90919-01276-79	-	-	<b>VFKBH20</b>	6		
GSE31			2GR-FKS	20.11-	FK20HBR8	90919-01263-79	-	-	<b>VFKBH20</b>	6		
IS350C	3500	GSE21	2GR-FSE	10.8-	FK20HBR11	90919-01249-79	-	-	<b>VFKBH20</b>	6		
TAIWAN	LC500	5000	URZ100	2UR-GSE	17.4-	FK20HBR-J8	90919-01279-79	-	-	<b>VFKBH20</b>	8	
	LC500h	3500	GWZ100	8GR-FXS	17.3-	FK20HBR8	90919-01263-79	-	-	<b>VFKBH20</b>	6	
	LFA	4800	LFA	1LR-GUE	10.12-12.12	PK22HTBR-L8	90919-01260	-	-	-	10	
THAILAND	LS460	4600	USF40	1UR-FSE	06.9-	FK20HBR11	90919-01249	-	-	<b>VFKBH20</b>	8	
			USF45	1UR-FSE	08.8-	FK20HBR11	90919-01249	-	-	<b>VFKBH20</b>	8	
	LS460L	4600	USF41 • USF46	1UR-FSE	08.8-	FK20HBR11	90919-01249	-	-	<b>VFKBH20</b>	8	
VIETNAM	LS500	3400	VXFA50	V35A-FTS(T/C)	17.12-	EC22HPR-D7	90919-01295	-	-	-	6	
			VXFA55	V35A-FTS(T/C)	17.12-	EC22HPR-D7	90919-01295	-	-	-	6	
	LS500h	3500	GVF50	8GR-FXS	17.10-	FK20HBR8	90919-01263-79	-	-	<b>VFKBH20</b>	6	
			GVF55	8GR-FXS	17.10-	FK20HBR8	90919-01263-79	-	-	<b>VFKBH20</b>	6	
LS600h	5000	UVF45	2UR-FSE	07.5-	FK20HBR11	90919-01249	-	-	<b>VFKBH20</b>	8		
LS600hL	5000	UVF46	2UR-FSE	07.5-	FK20HBR11	90919-01249	-	-	<b>VFKBH20</b>	8		
JAPAN	LX570	5700	URJ201W	3UR-FE	15.9-22.1	SK20HR11	90919-01191-79	-	<b>IKH20</b>	<b>VKH20</b>	8	
	LX600	3400	VJA310W	V35A-FTS(T/C)	22.1-	EC22HPR-D7	90919-01295	-	-	-	6	
	NX200t	2000	AGZ10	8AR-FTS(T/C)	14.7-17.9	VDKH22F	-	-	-	<b>VDKH22F</b>	4	
			AGZ15	8AR-FTS(T/C)	14.7-17.9	VDKH22F	-	-	-	<b>VDKH22F</b>	4	
	NX250	2500	AAZA20	A25A-FKS	21.11-	FC16HR-Q8	90919-01289	-	-	-	4	
AAZA25			A25A-FKS	21.11-	FC16HR-Q8	90919-01289	-	-	-	4		
NX300	2000	AGZ10	8AR-FTS(T/C)	17.9-21.11	VDKH22F	-	-	-	<b>VDKH22F</b>	4		
		AGZ15	8AR-FTS(T/C)	17.9-21.11	VDKH22F	-	-	-	<b>VDKH22F</b>	4		
NX300h	2500	AYZ10	2AR-FXE	14.7-21.11	FK16HR-A8	90919-01259-79	-	-	<b>VFKH16</b>	4		
		AYZ15	2AR-FXE	14.7-21.11	FK16HR-A8	90919-01259-79	-	-	<b>VFKH16</b>	4		
CROSS REFERENCE NUMBER	NX350	2400	TAZA25	T24A-FTS(T/C)	21.11-	-	-	-	-	-	4	
	NX350h	2500	AAZH20	A25A-FXS	21.11-	FC16HR-Q8	90919-01289	-	-	-	4	
			AAZH25	A25A-FXS	21.11-	FC16HR-Q8	90919-01289	-	-	-	4	
NX450h	2500	AAZH26	A25A-FXS	21.11-	FC16HR-Q8	90919-01289	-	-	-	4		
PART NUMBER	RC F	5000	USC10	2UR-GSE	14.10-	FK20HBR-J8	90919-01279	-	-	<b>VFKBH20</b>	8	
	RC200t	2000	ASC10	8AR-FTS(T/C)	15.10-17.11	VDKH22F	-	-	-	<b>VDKH22F</b>	4	
	RC300	2000	ASC10	8AR-FTS(T/C)	17.11-	VDKH22F	-	-	-	<b>VDKH22F</b>	4	
	RC300h	2500	AVC10	2AR-FSE	14.10-	FK20HBR8	90919-01263	-	-	<b>VFKBH20</b>	4	

MODEL	CC	VEHICLE CODE	ENGINE	FROM-TILL	DENSO	GENUINE P/N				QTY		
<b>LEXUS</b>												
RC350	3500	GSC10	2GR-FSE	14.10-17.11	FK20HBR11	90919-01249	-	-	VFKBH20	6	AUSTRALIA	
		GSC10	2GR-FKS	17.11-	FK20HBR8	90919-01263	-	-	VFKBH20	6	CHINA	
RX200t	2000	AGL20W	8AR-FTS(T/C)	15.10-	VDKH22F	-	-	-	VDKH22F	4	INDIA	
		AGL25W	8AR-FTS(T/C)	15.10-	VDKH22F	-	-	-	VDKH22F	4	INDONESIA	
RX270	2700	AGL10W	1AR-FE	10.8-	SK16HR11	90919-01233	-	IKH16	VKH16	4	KOREA	
RX300	2000	AGL20W	8AR-FTS(T/C)	17.12-	VDKH22F	-	-	-	VDKH22F	4	INDONESIA	
		AGL25W	8AR-FTS(T/C)	17.12-	VDKH22F	-	-	-	VDKH22F	4	INDONESIA	
RX350	3500	GGL10W · GGL15W · GGL16W	2GR-FE	09.1-	FK20HR11	90919-01247	-	-	VFKH20	6	INDONESIA	
RX450h	3500	GYL10W · GYL15W · GYL16W	2GR-FXE	09.4-15.10	FK20HR11	90919-01247	-	-	VFKH20	6	INDONESIA	
		GYL20W	2GR-FXS	15.10-	FK20HBR8	90919-01263-79	-	-	VFKBH20	6	INDONESIA	
		GYL25W	2GR-FXS	15.10-	FK20HBR8	90919-01263-79	-	-	VFKBH20	6	INDONESIA	
RX450hL	3500	GYL26W	2GR-FXS	17.12-	FK20HBR8	90919-01263-79	-	-	VFKBH20	6	INDONESIA	
SC430	4300	UZZ40	3UZ-FE	05.8-	SK20R11	90919-01210	-	IK20	VK20	8	INDONESIA	
UX200	2000	MZAA10	M20A-FKS	18.11-	FC20HR-Q8	90919-01297-79	-	-	VFXEH22	4	INDONESIA	
UX250h	2000	MZAH10	M20A-FXS	18.11-	FC16HR-Q8	90919-01289-79	-	-	VFCH16	4	INDONESIA	
		MZAH15	M20A-FXS	18.11-	FC16HR-Q8	90919-01289-79	-	-	VFCH16	4	INDONESIA	
<b>MAZDA</b>												
ATENZA	2000	GGEP · GGES	LF-DE	02.5-05.6	VT20	-	-	IT20	VT20	4	INDONESIA	
		GIEW	LF-DE	02.6-05.6	VT20	-	-	IT20	VT20	4	INDONESIA	
		GGEP · GGES · GHEFP · GHEFS	LF-VE	05.6-12.11	ITV16	-	-	-	ITV16	-	4	INDONESIA
		GIEW	LF-VE	05.6-08.1	ITV16	-	-	-	ITV16	-	4	INDONESIA
		GHEFW	LF-VE	08.1-10.1	ITV16	-	-	-	ITV16	-	4	INDONESIA
		GHEFW	LF-VD	10.1-	ITV20	-	-	-	ITV20	-	4	INDONESIA
		GJFEP	PE-VPR	12.11-	ZC20HPR11	PE5S-18-110	-	-	-	VCH20	4	INDONESIA
		GJEFW	PE-VPR	12.11-	ZC20HPR11	PE5S-18-110	-	-	-	VCH20	4	INDONESIA
		GG3P · GG3S	L3-VE	02.5-05.6	VT20	-	-	-	IT20	VT20	4	INDONESIA
		GY3W	L3-VE	02.6-05.6	VT20	-	-	-	IT20	VT20	4	INDONESIA
	2300	GG3P · GG3S	L3-VE	05.6-08.1	ITV16	-	-	-	ITV16	-	4	INDONESIA
		GY3W	L3-VE	05.6-08.1	ITV16	-	-	-	ITV16	-	4	INDONESIA
		GG3P	L3-VDT(T/C)	05.6-08.1	ITV20	-	-	-	ITV20	-	4	INDONESIA
		GH5FP · GH5FS · GH5AP · GH5AS	L5-VE	08.1-	ITV16	-	-	-	ITV16	-	4	INDONESIA
	2500	GH5FW · GH5AW	L5-VE	08.1-	ITV16	-	-	-	ITV16	-	4	INDONESIA
		GJ5FP	PY-VPR	12.11-	ZC20HPR11	PE5S-18-110	-	-	-	VCH20	4	INDONESIA
		GJ5FW	PY-VPR	12.11-	ZC20HPR11	PE5S-18-110	-	-	-	VCH20	4	INDONESIA
		BK5P	ZY-VE	03.10-06.6	SK16PR-E11	Z601 18 110	-	-	IK16	VK16	4	INDONESIA
	1500	BK5P	ZY-VE	06.6-09.6	FK16PR11(*7)	ZYY1 18 110	-	-	-	VFK16(*7)	4	INDONESIA
		BL5FW · BL5FP	ZY-VE	09.6-13.11	FK16PR11(*7)	ZYY1 18 110	-	-	-	VFK16(*7)	4	INDONESIA
BM5FP		P5-VPS	13.11-	ZC20HPR11	PE5S 18 110	-	-	-	VCH20	4	INDONESIA	
BM5AP		P5-VPS	13.11-	ZC20HPR11	PE5S 18 110	-	-	-	VCH20	4	INDONESIA	
BM5FS		P5-VPS	13.11-	ZC20HPR11	PE5S 18 110	-	-	-	VCH20	4	INDONESIA	
BM5AS		P5-VPS	13.11-	ZC20HPR11	PE5S 18 110	-	-	-	VCH20	4	INDONESIA	
1600		BL6FJ	Z6-VE	09.6-	K16PR-U11	BP02 18 110	-	K16TT	IK16	VK16	4	INDONESIA
		BKEP	LF-DE	03.10-04.2	VT20	-	-	-	IT20	VT20	4	INDONESIA
		BKEP	LF-DE	04.2-09.6	VT16	-	-	-	IT16	VT16	4	INDONESIA
		BKEP	LF-VE	06.6-09.6	ITV16	-	-	-	ITV16	-	4	INDONESIA
	BLEFW · BLEFP	LF-VDS	09.6-	ITV20	-	-	-	ITV20	-	4	INDONESIA	
	BLEAW · BLEAP	LF-VE	09.6-	ITV16	-	-	-	ITV16	-	4	INDONESIA	
	BLFFP	PE-VPS	11.9-12.7	FC20HPR8	PE02 18 110	-	-	-	VCH20	4	INDONESIA	
	BLFFW	PE-VPS	11.9-12.7	FC20HPR8	PE02 18 110	-	-	-	VCH20	4	INDONESIA	
	BLFFP · BLFFW	PE-VPS	12.8-	ZC20HPR11	PE5S 18 110	-	-	-	VCH20	4	INDONESIA	
	BMEFS	PE-VPR	13.11-	ZC20HPR11	PE5S 18 110	-	-	-	VCH20	4	INDONESIA	
2300	BK3P	L3-VE	03.10-04.2	VT20	-	-	-	IT20	VT20	4	INDONESIA	
	BK3P	L3-VE	04.2-06.6	VT16	-	-	-	IT16	VT16	4	INDONESIA	
	BK3P	L3-VE	06.6-09.6	ITV16	-	-	-	ITV16	-	4	INDONESIA	
	BK3P	L3-VDT(T/C)	06.6-09.6	ITV20	-	-	-	ITV20	-	4	INDONESIA	
	BL3FW	L3-VDT(T/C)	09.6-	ITV20	-	-	-	ITV20	-	4	INDONESIA	
AXELA HYBRID	2000	BYEFP	PE-VPH	13.11-	ZC20HPR11	PE5S 18 110	-	-	VCH20	4	INDONESIA	
AZ-3	1500	EC5SA	B5-DE	91.6-98.1	K16PR-U11	BP02 18 110	-	K16TT	IK16	VK16	4	INDONESIA
	1800	ECPSA	K8(DOHC) · K8-ZE(DOHC)	91.6-98.1	K16PR-U11	BP02 18 110	-	K16TT	IK16	VK16	6	INDONESIA
AZ-OFFROAD	660	JM23W	K6A(DOHC · T/C)	98.10-08.9	IXU22C(*5)	1A11 18 110	-	IXU22(*5)	VXU22(*5)	3	INDONESIA	
		JM23W	K6A(DOHC · T/C)	08.9-14.3	IXU22HPR(*5)	1A13 18 110	-	IXUH22(*5)	VXUH22(*5)	3	INDONESIA	
AZ-WAGON	660	CY21S · CZ21S	F6A(DOHC)	94.9-98.10	XU22EP-U	AY01 18 110	-	XU22TT	IXU22	VXU22	3	INDONESIA
		CY21S · CZ21S	F6A(T/C)	95.10-98.10	W16EPR-U	AZ09 18 110	-	W16TT	IW16	VW16	3	INDONESIA
		CY51S · CZ51S	K6A(DOHC)	97.5-98.10	XU22EP-P	1A60 18 110	-	-	IXU22	VXU22	3	INDONESIA
		CY51S · CZ51S	K6A(DOHC · T/C)	97.5-98.10	XU22EP-P	1A60 18 110	-	-	IXU22	VXU22	3	INDONESIA
		MD21S	K6A(DOHC)	98.10-00.11	XU22EPR-U	ZZS2 18 110	-	XU22TT	IXU22	VXU22	3	INDONESIA
MD21S	K6A(DOHC · T/C)	98.10-00.11	IXU22	1UD9 18 110	-	-	IXU22	VXU22	3	INDONESIA		

(\*5)The plug reach may be 19mm or 26.5mm even with the same engine and the same vehicle code. Please confirm the plug reach and choose the correct DENSO type. If there is an "H" in DENSO type, it has a reach of 26.5mm. If it doesn't, its reach is 19mm. (\*7)OEM:ZY5118110(FoMoCo brand) OES:ZY118110 (Mazda brand)

AUSTRALIA  
CHINA  
INDIA  
INDONESIA  
KOREA  
MALAYSIA  
PHILIPPINES  
SAUDI ARABIA  
SINGAPORE  
TAIWAN  
THAILAND  
VIETNAM  
JAPAN  
EUROPE & USA  
CROSS REFERENCE NUMBER  
PART





▶ Spark plug color codes: ■ for Iridium Tough and Iridium Plugs and Iridium TT, ■ for Iridium Power, ■ for Iridium Racing and Two Tops Plugs, ■ for Platinum Plugs and Platinum TT, and black for general spark plugs.

	MODEL	CC	VEHICLE CODE	ENGINE	FROM-TILL	DENSO	GENUINE P/N				QTY		
AUSTRALIA	MAZDA AZ-WAGON		MD11S	F6A(DOHC)	98.10-00.11	XU22EPR-U	ZZS2 18 110	XU22TT	IXU22	VXU22	3		
			MD11S	F6A(T/C)	98.10-00.11	W16EPR-U	AZ09 18 110	W16TT	IW16	VW16	3		
			MD22S	K6A(DOHC · T/C)	00.12-03.10	IXU22C	1A11 18 110	-	IXU22	VXU22	3		
CHINA	660		MD22S	K6A(DOHC)	00.12-03.10	XU22EPR-U	ZZS2 18 110	XU22TT	IXU22	VXU22	3		
			MD12S	F6A(SOHC)	00.12-01.10	W16EPR-U	AZ09 18 110	W16TT	IW16	VW16	3		
			MJ21S · MJ22S	K6A(ALL ENGINES)	03.10-08.9	IXU22C	1A11 18 110	-	IXU22	VXU22	3		
			MJ23S	K6A(DOHC)	08.9-	IXU22HPR(*5)	1A13 18 110	-	IXUH22(*5)	VXUH22(*5)	3		
INDIA	BIANTE	2000	CCEAW · CCEFW	LF-VD(DOHC)	08.7-	ITV20	-	-	ITV20	-	4		
			CCEFW	LF-VDS(DOHC)	09.6-	ITV20	-	-	ITV20	-	4		
INDONESIA	BONGO	2300	CCEAW	LF-VD	13.5-	ITV20	-	-	ITV20	-	4		
			CCEFW	PE-VPS	13.5-	ZC20HPR11	PE5S-18-110	-	-	VCH20	4		
KOREA	BONGO	1500	CC3FW	L3-VE	08.7-	ITV16	-	-	ITV16	-	4		
			S403Z	2NR-VE	20.9-	SC16HR11	1HY0-18-110	-	-	VCH16	4		
			S413Z	2NR-VE	20.9-	SC16HR11	1HY0-18-110	-	-	VCH16	4		
			S403F	2NR-VE	20.9-	SC16HR11	1HY0-18-110	-	-	VCH16	4		
MALAYSIA	BONGO	1800	S413F	2NR-VE	20.9-	SC16HR11	1HY0-18-110	-	-	VCH16	4		
			SE88M · SE88T · SS88H · SS88M	F8	90.7-98.10	W16EXR-U13	FEDM 18 110	W16TT	IW16	VW16	4		
			SE88M · SE88R · SE88V · SS88W	F8	90.7-99.6	W16EXR-U13	FEDM 18 110	W16TT	IW16	VW16	4		
			SD89T · SE88M · SR89V	F8	90.7-99.6	W16EXR-U13	FEDM 18 110	W16TT	IW16	VW16	4		
			SK82V · SK82M · SK82T · SK82L	F8-E	99.7-16.2	K16PR-U11	BP02 18 110	K16TT	IK16	VK16	4		
			SLP2V	L8	16.2-20.9	VT16	-	-	IT16	VT16	4		
			SLP2M	L8	16.2-20.9	VT16	-	-	IT16	VT16	4		
			SLP2T	L8	16.2-20.9	VT16	-	-	IT16	VT16	4		
			SLP2L	L8	16.2-20.9	VT16	-	-	IT16	VT16	4		
			PHILIPPINES	BONGO	2000	SRE9V · SREAV	FE	93.9-99.6	K16PR-U11	BP02 18 110	K16TT	IK16	VK16
SDEAT	FE	93.9-99.6				K16PR-U11	BP02 18 110	K16TT	IK16	VK16	4		
SKE4T · SKE6T · SKE6V	FE-E	99.7-				K16PR-U11	BP02 18 110	K16TT	IK16	VK16	4		
TRH200M	1TR-FE	19.5-				FK20HBR-TJ8	1M01-18-110	-	-	-	4		
SAUDI ARABIA	BONGO FRIENDEE	2000	SGEW · SGE3	FE-E	95.6-	K16PR-U11	BP02 18 110	K16TT	IK16	VK16	4		
		2500	SG5W	J5-DE	95.6-02.8	K16PR-U11	BP02 18 110	K16TT	IK16	VK16	6		
SINGAPORE	CAPELLA	1800	CG2PP	FP-DE(DOHC)	94.8-97.8	K16PR-U11	BP02 18 110	K16TT	IK16	VK16	4		
			GF8P	FP-DE · FP	97.8-02.4	KJ16CR11	F288 18 110	K16TT	IK16	VK16	4		
			GF8P(DEIVING SCHOOL)	FP(LPG)	98.10-	KJ16CR11	F288 18 110	-	-	VK20T(*8)	4		
		2000	CG2SP · CG2SR	FS-DE	94.8-97.8	K16PR-U11	BP02 18 110	K16TT	IK16	VK16	4		
			GFER	FS-DE(DOHC)	97.8-02.4	KJ16CR11	F288 18 110	K16TT	IK16	VK16	4		
			GFEP	FS-ZE(DOHC)	97.8-02.4	KJ16CR11	F288 18 110	K16TT	IK16	VK16	4		
TAIWAN	CAPELLA CARGO/WAGON	1600	GV6V	B6	87.2-98.9	J16AR-U11	B64P 18 110	-	-	-	4		
		1800	GV8W	F8D(DOHC)	92.8-97.11	K20PR-U11	BP04 18 110	K20TT	IK20	VK20	4		
			GW8W	FP-DE(DOHC)	97.11-02.4	KJ16CR11	F288 18 110	K16TT	IK16	VK16	4		
		2000	GVER · GVEW	FE-DE	89.6-97.11	K20PR-U11	BP04 18 110	K20TT	IK20	VK20	4		
			GVER · GVEW	FE-ZE	96.7-97.11	K20PR-U11	BP04 18 110	K20TT	IK20	VK20	4		
			GWER · GWEW	FS-DE(DOHC)	97.11-02.4	KJ16CR11	F288 18 110	K16TT	IK16	VK16	4		
2500	GW5R	KL-ZE(DOHC)	97.11-01.1	K20PR-U11	BP04 18 110	K20TT	IK20	VK20	6				
	GW5R	KL-ZE(DOHC)	01.2-02.4	KJ16CR11	F288 18 110	K16TT	IK16	VK16	6				
VIETNAM	CAROL		AC6P	F6A(2VALVE · T/C)	95.10-98.10	W16EPR-U	AZ09 18 110	W16TT	IW16	VW16	3		
			AC6P · AC6R	F6A(4VALVE)	95.10-98.10	XU22EP-U	AY01 18 110	XU22TT	IXU22	VXU22	3		
			HB12S	F6A(DOHC)	98.10-00.12	XU22EPR-U	ZZS2 18 110	XU22TT	IXU22	VXU22	3		
			HB22S	K6A(DOHC)	98.10-00.12	XU22EPR-U	ZZS2 18 110	XU22TT	IXU22	VXU22	3		
			HB22S	K6A(LEANBURN)	99.10-01.5	IXU22C	1A11 18 110	-	IXU22	VXU22	3		
			HB23S	K6A(DOHC)	00.12-04.9	XU22EPR-U	ZZS2 18 110	XU22TT	IXU22	VXU22	3		
			HB23S	K6A(DOHC · VVT)	00.12-04.9	XU22EPR-U	ZZS2 18 110	XU22TT	IXU22	VXU22	3		
			HB23S	K6A(LEANBURN)	01.5-04.9	IXU22C	1A11 18 110	-	IXU22	VXU22	3		
			HB24S	K6A(DOHC)	04.9-09.12	XU22EPR-U	ZZS2 18 110	XU22TT	IXU22	VXU22	3		
			HB25S	K6A(DOHC)	09.12-15.1	IXU22HPR	1A13 18 110	-	IXUH22	VXUH22	3		
JAPAN	CAROL		HB35S	R06A	12.11-15.1	-	-	-	-	VSUEH22	3		
			HB36S	R06A	15.1-22.1	ZXU22HPR8	1A15-18-110	-	IXUH22	VXUH22	3		
			HB37S	R06A	22.1-	ZXU22HPR8	-	-	IXUH22	VXUH22	3		
			HB97S	R06D	22.1-	-	-	-	-	-	3		
		EUROPE & USA	CAROL HYBRID	660	DKLFW	P5-VPS	20.6-	ZC20HPR11	PE5S-18-110	-	-	VCH20	4
				1500	DKLAW	P5-VPS	20.6-	ZC20HPR11	PE5S-18-110	-	-	VCH20	4
					DKEFW	PE-VPS	17.7-	ZC20HPR11	PE5S-18-110	-	-	VCH20	4
				2000	DKEFW	PE-VPR	17.7-	ZC20HPR11	PE5S-18-110	-	-	VCH20	4
					DKEAW	PE-VPS	17.7-	ZC20HPR11	PE5S-18-110	-	-	VCH20	4
					DKEAW	PE-VPR	17.7-	ZC20HPR11	PE5S-18-110	-	-	VCH20	4
CROSS REFERENCE NUMBER	CX-3	2000	DMEP	PE-VPS	19.10-	ZC20HPR11	PE5S 18 110	-	-	VCH20	4		

(\*5)The plug reach may be 19mm or 26.5mm even with the same engine and the same vehicle code. Please confirm the plug reach and choose the correct DENSO type. If there is an "H" in DENSO type, it has a reach of 26.5mm. If it doesn't, its reach is 19mm. (\*8)This is IRIIDIUM PLUS.





MODEL	CC	VEHICLE CODE	ENGINE	FROM-TILL	DENSO	GENUINE P/N				QTY			
<b>MAZDA</b>													
<b>CX-30 HYBRID</b>	2000	DMFP	HF-VPH(S/C)	20.1-21.11	-	-	-	-	-	4	AUSTRALIA		
		DMFP	HF-VPH(S/C)	21.11-	-	-	-	-	-	4	CHINA		
<b>CX-5</b>	2000	KEEFW • KEEAW	PE-VPS	12.2-12.7	FC20HPR8	PE02 18 110	-	-	VCH20	4	INDIA		
		KEEAW • KEEFW	PE-VPS	12.8-	ZC20HPR11	PE5S 18 110	-	-	VCH20	4	INDONESIA		
		KFEP	PE-VPS	17.2-	ZC20HPR11	PE5S 18 110	-	-	VCH20	4	KOREA		
	2500	KE5FW	PY-VPS	13.10-17.2	ZC20HPR11	PE5S 18 110	-	-	VCH20	4	INDONESIA		
		KE5AW	PY-VPS	13.10-17.2	ZC20HPR11	PE5S 18 110	-	-	VCH20	4	INDONESIA		
		KF5P	PY-VPS	17.2-18.2	ZC20HPR11	PE5S 18 110	-	-	VCH20	4	INDONESIA		
		KF5P	PY-RPS	18.3-	ZC20HPR11	PE5S 18 110	-	-	VCH20	4	INDONESIA		
KF5P	PY-VPTS(T/C)	18.11-	-	-	-	-	-	-	4	INDONESIA			
<b>CX-7</b>	2300	ER3P	L3-VDT(T/C)	06.12-	ITV20	-	-	ITV20	-	4	INDONESIA		
<b>CX-8</b>	2500	KG5P	PY-VPS	18.11-	ZC20HPR11	PE5S 18 110	-	-	VCH20	4	INDONESIA		
		KG5P	PY-VPTS(T/C)	18.11-	-	-	-	-	-	4	INDONESIA		
<b>DEMIO</b>	1300	DW3W	B3-ME • B3E	96.8-02.8	K16PR-U11	BP02 18 110	K16TT	IK16	VK16	4	INDONESIA		
		DY3W • DY3R	ZJ-VE	02.8-07.7	K16PR-U11	BP02 18 110	K16TT	IK16	VK16	4	INDONESIA		
		DE3AS • DE3FS	ZJ-VE	07.7-	FK16PR11(*7)	ZYY1 18 110	-	-	VFK16(*7)	4	INDONESIA		
		DE3FS	ZJ-VEM	07.7-	FK16PR11(*7)	ZYY1 18 110	-	-	VFK16(*7)	4	INDONESIA		
		DEJFS	P3-VPS	11.6-12.7	FC20HPR8	PE02 18 110	-	-	VCH20	4	INDONESIA		
		DJ3FS	P3-VPS	12.8-	ZC20HPR11	PE5S 18 110	-	-	VCH20	4	INDONESIA		
		DJ3FS	P3-VPS	14.9-	ZC20HPR11	PE5S 18 110	-	-	VCH20	4	INDONESIA		
	DJ3AS	P3-VPS	14.12-	ZC20HPR11	PE5S 18 110	-	-	VCH20	4	INDONESIA			
	1500	DW5W	B5-ME • B5E	96.8-02.8	K16PR-U11	BP02 18 110	K16TT	IK16	VK16	4	INDONESIA		
		DY5W • DY5R	ZY-VE[Except GREENTAX CAR]	02.8-07.7	K16PR-U11(*10)	BP02 18 110	K16TT	IK16	VK16	4	INDONESIA		
		DY5W • DY5R	ZY-VE[GREENTAX CAR]	05.10-07.7	FK16PR11(*7)(*10)	ZYY1 18 110	-	-	VFK16	4	INDONESIA		
DE5FS		ZY-VE	07.7-	FK16PR11(*7)	ZYY1 18 110	-	-	VFK16(*7)	4	INDONESIA			
DJLFS	P5-VPS	15.10-	ZC20HPR11	PE5S-18-110	-	-	VCH20	4	INDONESIA				
DJLAS	P5-VPS	18.8-	ZC20HPR11	PE5S-18-110	-	-	VCH20	4	INDONESIA				
<b>EUNOS 800</b>	2300	TA3Y • TA3Z • TA3A • TA3P	KJ-ZEM(DOHC)	94.6-03.8	PKJ16CR8	KJ14 18 110	-	IK16	VK16	6	INDONESIA		
	2500	TA5Y • TA5Z • TA5A • TA5P	KL-ZE(DOHC)	93.10-03.8	K20PR-U11	BP04 18 110	K20TT	IK20	VK20	6	INDONESIA		
<b>EUNOS PRESSO</b>	1500	EC5S	B5-DE	91.6-98.1	K16PR-U11	BP02 18 110	K16TT	IK16	VK16	4	INDONESIA		
	1800	EC8SE • EC8S	K8(DOHC) • K8-ZE(DOHC)	91.6-98.1	K16PR-U11	BP02 18 110	K16TT	IK16	VK16	6	INDONESIA		
<b>FAMILIA</b>	1200	BVYA12	CR12DE	07.1-	IKH16	-	-	IKH16	VKH16	4	INDONESIA		
		BVY10 • BMVfy10	GA13	94.5-99.6	K16PR-U11	BP02 18 110	K16TT	IK16	VK16	4	INDONESIA		
		BHA3P • BHA3S	B3-ME	96.10-99.5	K16PR-U11	BP02 18 110	K16TT	IK16	VK16	4	INDONESIA		
		BJ3P	B3E	98.6-03.8	K16PR-U11	BP02 18 110	K16TT	IK16	VK16	4	INDONESIA		
	1300	BVY11	QG13DE	99.6-	K16PR-U11	BP02 18 110	K16TT	IK16	VK16	4	INDONESIA		
		BHALP • BHALS	Z5-DE(DOHC)	94.6-99.5	K16PR-U11	BP02 18 110	K16TT	IK16	VK16	4	INDONESIA		
		BVfy10 • BVFNy10 • BVFY10 • BVFNY10	GA15(DOHC)	94.9-99.6	K16PR-U11	BP02 18 110	K16TT	IK16	VK16	4	INDONESIA		
		BHALP	Z5-DEL(LEANBURN)	94.9-99.5	IK16	1UD3 18 110	-	-	IK16	VK16	4	INDONESIA	
		BJ5P • BJ5W	ZL-DE(DOHC)	98.6-03.8	K16PR-U11	BP02 18 110	K16TT	IK16	VK16	4	INDONESIA		
		BJ5P • BJ5W	ZL-VE(DOHC • S-VT)	98.6-03.8	K16PR-U11	BP02 18 110	K16TT	IK16	VK16	4	INDONESIA		
		1500	BVfy11	QG15DE	99.6-02.8	K16PR-U11(*5)	BP02 18 110	K16TT	IK16(*5)	VK16(*5)	4	INDONESIA	
			BVfy11	QG15DE	02.8-	K16HPR-U11(*5)	-	-	IKH16(*5)	VKH16(*5)	4	INDONESIA	
			BWfy11	QG15DE	99.6-	VK16	1UT4 18 110	-	-	IK16	VK16	4	INDONESIA
			BVY12	HR15DE	07.1-	FXE20HE11	1N24 18 110	-	-	VFXEH20E	4	INDONESIA	
			NCP160M	1NZ-FE	18.6-	FK16HR11	1M00 18 110	-	-	VFKH16	4	INDONESIA	
			NCP165M	1NZ-FE	18.6-	FK16HR11	1M00 18 110	-	-	VFKH16	4	INDONESIA	
			1600	BHA6R	B6DE(DOHC)	96.10-98.6	K16PR-U11	BP02 18 110	K16TT	IK16	VK16	4	INDONESIA
		BVZNY12		HR16DE	10.8-	FXE20HR11	-	-	-	VFXEH20	4	INDONESIA	
		1800	BHA8P • BHA8S	BP-ZE(DOHC)	94.6-99.5	K16PR-U11	BP02 18 110	K16TT	IK16	VK16	4	INDONESIA	
	BWHY10 • BWHNY10		SR18DE	96.6-99.6	K16PR-U11	BP02 18 110	K16TT	IK16	VK16	4	INDONESIA		
	BJ8W		FP-DE(DOHC)	98.6-03.8	K16PR-U11	BP02 18 110	K16TT	IK16	VK16	4	INDONESIA		
	BWHNY11		QG18DE	99.6-99.12	K16PR-U11	BP02 18 110	K16TT	IK16	VK16	4	INDONESIA		
	BVHNY11		QG18DE	99.6-02.8	K16PR-U11(*5)	BP02 18 110	K16TT	IK16(*5)	VK16(*5)	4	INDONESIA		
BVHNY11	QG18DE		02.8-	K16HPR-U11(*5)	-	-	IKH16(*5)	VKH16(*5)	4	INDONESIA			
BVGY11	QG18DEN(CNG)		02.8-	IK22	-	-	-	IK22	VK22	4	INDONESIA		
BVJY12	MR18DE		07.1-	FXE20HR11	-	-	-	VFXEH20	4	INDONESIA			
2000	BJFP • BJFW		FS-ZE(DOHC)	99.8-03.8	KJ16CR11	F288 18 110	K16TT	IK16	VK16	4	INDONESIA		
<b>FAMILIAHYBRID</b>	1500		NHP160M	1NZ-FXE	22.4-	FK16BR-AL8	1M02 18 110	-	-	-	4	INDONESIA	
<b>FLAIR</b>	660	MJ34S	R06A	12.10-	-	-	-	-	VSUEH22	3	CROSS REFERENCE NUMBER		
		MJ34S	R06A(T/C)	12.10-	-	-	-	-	VSUEH22	3	CROSS REFERENCE NUMBER		
		MJ34S	R06A(CVT)	15.9-	ZXU22HPR8	1A15-18-110	-	-	IXUH22	VXUH22	3	CROSS REFERENCE NUMBER	
	MJ44S	R06A(S-ene CHARGE)	14.8-15.9	-	-	-	-	-	VSUEH22	3	CROSS REFERENCE NUMBER		
	MJ44S	R06A(S-ene CHARGE)	15.9-	ZXU22HPR8	1A15-18-110	-	-	-	IXUH22	VXUH22	3	CROSS REFERENCE NUMBER	
	MJ44S	R06A(T/C • S-ene CHARGE)	15.9-	-	-	-	-	-	VSUEH22	3	CROSS REFERENCE NUMBER		
<b>FLAIR CROSSOVER</b>	660	MS31S	R06A	14.1-15.5	-	-	-	-	VSUEH22	3	CROSS REFERENCE NUMBER		
		MS31S	R06A(T/C)	14.1-15.12	-	-	-	-	VSUEH22	3	CROSS REFERENCE NUMBER		

(\*5)The plug reach may be 19mm or 26.5mm even with the same engine and the same vehicle code. Please confirm the plug reach and choose the correct DENSO type. If there is an "H" in DENSO type, it has a reach of 26.5mm. If it doesn't, its reach is 19mm. (\*7)OEM:ZY5118110(FoMoCo brand) OES:ZYY118110 (Mazda brand) (\*10)If there is a 4-star GREEN TAX label on the rear glass of the vehicle, it is FK16PR11, if not, it is K16PR-U11.



	MODEL	CC	VEHICLE CODE	ENGINE	FROM-TILL	DENSO	GENUINE P/N					QTY	
AUSTRALIA	MAZDA FLAIR CROSSOVER	660	MS41S	R06A(S-ene CHARGE)	15.5-20.2	ZXU22HPR8	1A15-18-110	-	IXUH22	VXUH22		3	
			MS41S	R06A(T/C · S-ene CHARGE)	15.12-20.2	-	-	-	-	-	VSUEH22		3
CHINA	FLAIR CROSSOVER HYBRID	660	MS92S	R06D	20.2-	-	-	-	IXUH22I	VXUH22I		3	
			MS52S	R06A(T/C)	20.2-	ZXU22HPR8	1A15-18-110	-	IXUH22	VXUH22		3	
INDIA	FLAIR HYBRID	660	MJ55S	R06A	17.3-20.1	-	-	-	IXUH22I	VXUH22I		3	
			MJ95S	R06D	20.1-	-	-	-	-	IXUH22I	VXUH22I		3
INDONESIA	FLAIR WAGON	660	MM21S	K6A	12.6-13.4	IXU22HPR	1A13 18 110	-	IXUH22	VXUH22		3	
			MM21S	K6A(T/C)	12.6-13.4	IXU22HPR	1A13 18 110	-	IXUH22	VXUH22		3	
			MM32S	R06A	13.4-15.5	-	-	-	-	-	VSUEH22		3
			MM32S	R06A(T/C)	13.7-15.5	-	-	-	-	-	VSUEH22		3
			MM42S	R06A(S-ene CHARGE)	15.5-18.2	ZXU22HPR8	1A15-18-110	-	IXUH22	VXUH22		3	
			MM42S	R06A(T/C · S-ene CHARGE)	15.8-18.2	-	-	-	-	-	VSUEH22		3
INDONESIA	FLAIR WAGON HYBRID	660	MM53S	R06A	18.2-	-	-	-	IXUH22I	VXUH22I		3	
			MM53S	R06A(T/C)	18.2-	ZXU22HPR8	1A15-18-110	-	IXUH22	VXUH22		3	
KOREA	LANTIS	1800	CBA8P	BP-ZE	93.9-97.9	K16PR-U11	BP02 18 110	K16TT	IK16	VK16		4	
		2000	CBAEP	KF-ZE(DOHC)	93.9-97.9	K20PR-U11	BP04 18 110	K20TT	IK20	VK20		6	
MALAYSIA	LAPUTA	660	HP11S	F6A(T/C)	99.3-	W16EPR-U	AZ09 18 110	W16TT	IW16	VW16		3	
			HP21S	K6A(DOHC · T/C)	99.3-99.10	XU22EPR-U	ZZS2 18 110	XU22TT	IXU22	VXU22		3	
			HP21S	K6A(DOHC · T/C)	99.11-01.4	IXU22C	1A11 18 110	-	IXU22	VXU22		3	
			HP21S	K6A(DOHC · VVT)	00.10-01.3	XU22EPR-U	ZZS2 18 110	XU22TT	IXU22	VXU22		3	
			HP22S	K6A(DOHC · T/C)	01.4-	IXU22C	1A11 18 110	-	IXU22	VXU22		3	
			HP22S	K6A(DOHC · VVT)	01.4-02.11	XU22EPR-U	ZZS2 18 110	XU22TT	IXU22	VXU22		3	
PHILIPPINES	MAZDA M2 (1001)	1600	NA6CE	B6-ZE(DOHC)	92.3-	K22PR-U11	BP06 18 110	-	IK22	VK22		4	
		MAZDA DRIVING INSTRUCTION CAR	1500	DJLFI	P5-VP	19.5-	ZC20HPR11	-	-	-	VCH20		4
SAUDI ARABIA	MAZDA2	1500	DJLFS	P5-VPS	19.9-	ZC20HPR11	PE5S 18 110	-	-	-	VCH20	4	
			DJLFS	P5-VPR	19.9-	ZC20HPR11	PE5S 18 110	-	-	-	VCH20	4	
			DJLAS	P5-VPS	19.9-	ZC20HPR11	PE5S 18 110	-	-	-	VCH20	4	
			DJLAS	P5-VPR	19.9-	ZC20HPR11	PE5S 18 110	-	-	-	VCH20	4	
			DJLFS	P5-VPS(EGR INSTALLED VEHICLES)	21.6-	VFXEH22	-	-	-	-	-	-	4
			DJLAS	P5-VPR(EGR INSTALLED VEHICLES)	21.6-	VFXEH22	-	-	-	-	-	-	4
SINGAPORE	MAZDA3	1500	BP5P	P5-VPS	19.5-	ZC20HPR11	PE5S 18 110	-	-	-	VCH20	4	
		2000	BPFP	PE-VPS	19.7-	ZC20HPR11	PE5S 18 110	-	-	-	VCH20	4	
TAIWAN	MAZDA3 HYBRID	2000	BPEP	HF-VPH(S/C)	19.12-21.11	-	-	-	-	-	-	4	
			BPEP	HF-VPH(S/C)	21.11-	-	-	-	-	-	-	-	4
THAILAND	MAZDA6	2000	GJEFP	PE-VPR	19.8-	ZC20HPR11	PE5S 18 110	-	-	-	VCH20	4	
			GJEFW	PE-VPR	19.8-	ZC20HPR11	PE5S 18 110	-	-	-	VCH20	4	
			GJ5FP	PY-RPR	19.8-	ZC20HPR11	PE5S 18 110	-	-	-	VCH20	4	
		2500	GJ5FP	PY-VPTS(T/C)	19.8-	-	-	-	-	-	-	VCH20	4
			GJ5FW	PY-RPR	19.8-	ZC20HPR11	PE5S 18 110	-	-	-	VCH20	4	
			GJ5FW	PY-VPTS(T/C)	19.8-	-	-	-	-	-	-	-	4
VIETNAM	MILLENNIA	2000	TAFP	KF-ZE(DOHC)	98.7-02.1	K20PR-U11	BP04 18 110	K20TT	IK20	VK20		6	
		2300	TA3A · TA3P	KJ-ZEM(DOHC)	94.6-03.8	PKJ16CR8	KJ14 18 110	-	IK16	VK16		6	
		2500	TA5A · TA5P	KL-ZE(DOHC)	93.10-03.8	K20PR-U11	BP04 18 110	K20TT	IK20	VK20		6	
JAPAN	MPV	2000	LWEW	FS-DE	99.6-02.4	KJ16CR11	F288 18 110	K16TT	IK16	VK16		4	
			LY3P	L3-VE	06.2-	ITV16	-	-	ITV16	-	-	4	
		2300	LY3P	L3-VDT(T/C)	06.2-	ITV20	-	-	ITV20	-	-	4	
			LW3W(identification No.100001~308378)	L3	02.4-06.12	VT20	-	-	IT20	VT20		4	
		LW3W(identification No.308379~)	L3	02.4-06.12	VT16	-	-	IT16	VT16		4		
		2500	LV5W	G5E	95.10-99.6	KJ16CR11	F288 18 110	K16TT	IK16	VK16		4	
			LW5W	GY-DE	99.6-06.2	IT16	-	-	IT16	VT16		6	
		3000	LVEW	JE-E	95.10-99.6	K16PR-U11	BP02 18 110	K16TT	IK16	VK16		6	
LWFW	AJ		02.4-06.2	VT16	-	-	IT16	VT16		6			
EUROPE & USA	MS-8	2000	MBEP	KF-ZE(DOHC)	92.3-98.2	K20PR-U11	BP04 18 110	K20TT	IK20	VK20		6	
	MX-30	2000	DREJ3P	PE-VPH	20.10-	ZC20HPR11	PE5S-18-110	-	-	-	VCH20	4	
CROSS REFERENCE NUMBER	PREMACY	1800	CP8W	FP-DE(DOHC)	99.3-02.6	K16PR-U11	BP02 18 110	K16TT	IK16	VK16		4	
			CP8W	FP-DE(DOHC)	02.6-05.2	KJ16CR11	F288 18 110	K16TT	IK16	VK16		4	
		2000	CPEW	FS-DE(DOHC)	01.7-02.11	KJ16CR11	F288 18 110	K16TT	IK16	VK16		4	
			CPEW	FS-ZE(DOHC)	02.11-05.2	K16PR-U11	BP02 18 110	K16TT	IK16	VK16		4	
			CREW	LF-DE(DOHC)	05.2-07.9	VT16	-	-	IT16	VT16		4	
			CREW	LF-VE	07.9-10.7	ITV16	-	-	ITV16	-	-	4	
			CREW	LF-VD(DISI)	07.1-10.7	ITV20	-	-	ITV20	-	-	4	
			CWEFW	LF-VD(DOHC-DISI)	10.7-12.2	ITV20	-	-	ITV20	-	-	4	
		CWEFW	LF-VDS(DOHC-DISI)	10.7-12.2	ITV20	-	-	ITV20	-	-	4		
		CWEFW	LF-VD	12.2-	ITV20	-	-	ITV20	-	-	4		
CWEFW	LF-VDS	12.2-	-	-	-	-	ITV20	-	-	4			

MODEL	CC	VEHICLE CODE	ENGINE	FROM-TILL	DENSO	GENUINE P/N				QTY		
<b>MAZDA PREMACY</b>	2000	CWEAW	LF-VE	10.8-12.2	ITV16	-	-	ITV16	-	4	AUSTRALIA	
		CWEAW	LF-VE	12.2-	ITV16	-	-	ITV16	-	4	CHINA	
		CWFFW	PE-VPS	13.1-	ZC20HPR11	PE5S-18-110	-	-	VCH20	4		
	2300	CR3W	L3-VE(DOHC)	05.2-07.2	VT16(*6)	-	-	IT16(*6)	VT16(*6)	4	INDIA	
		CR3W	L3-VE(DOHC)	07.2-	ITV16(*6)	-	-	ITV16(*6)	-	4		
<b>PROCEED LEVANTE</b>	2000	TJ51W	J20A	96.11-97.11	K20PR-U	BP50 18 110	K20TT	IK20	VK20	4	INDONESIA	
		TJ52W · TF52W · TF51W	J20A	97.11-	K20PR-U11	BP04 18 110	K20TT	IK20	VK20	4		
	2500	TJ61W	H25A	96.11-98.3	K20PR-U	BP50 18 110	K20TT	IK20	VK20	6		
		TJ62W	H25A	98.3-	K20PR-U11	BP04 18 110	K20TT	IK20	VK20	6		
<b>PROCEED/ MARVY</b>	2500	UV56R	G5-E	96.3-99.1	KJ16CR11	F288 18 110	K16TT	IK16	VK16	4	KOREA	
	2600	UF66M · UV66R	G6	90.2-99.1	KJ16CR11	F288 18 110	K16TT	IK16	VK16	4		
<b>REVUE</b>	1300	DB3PA	B3-MI	90.9-99.3	K16PR-U11	BP02 18 110	K16TT	IK16	VK16	4	MALAYSIA	
	1500	DB5PA	B5-MI	90.9-99.3	K16PR-U11	BP02 18 110	K16TT	IK16	VK16	4		
<b>ROADSTER</b>	1500	ND5RC	P5-VP	15.5-	ZC20HPR11	PE5S-18-110	-	-	VCH20	4	PHILIPPINES	
		ND5RC	P5-VPR	15.5-	ZC20HPR11	PE5S-18-110	-	-	VCH20	4		
	1600	NA6CE	B6-ZE(DOHC)	91.9-98.1	K16PR-U11	BP02 18 110	K16TT	IK16	VK16	4	SAUDIARABIA	
		NB6C	B6-ZE(DOHC)	98.1-	K16PR-U11	BP02 18 110	K16TT	IK16	VK16	4		
	1800	NA8C	BP-ZE(DOHC)	93.9-98.1	K16PR-U11	BP02 18 110	K16TT	IK16	VK16	4	SINGAPORE	
		NB8C	BP-ZE(DOHC)	98.1-00.7	K16PR-U11	BP02 18 110	K16TT	IK16	VK16	4		
		NB8C	BP-VE(DOHC)	00.7-03.12	K16PR-U11	BP02 18 110	K16TT	IK16	VK16	4		
		NB8C	BP-ZET(DOHC · T/C)	03.12-05.8	SK16PR-F8	BP8K 18 110	-	-	IK16	VK16		4
	2000	NCEC	LF-VE(DOHC)	05.8-15.5	ITV20	-	-	-	ITV20	4	TAIWAN	
		NDERC	PE-VPR	16.12-	ZC20HPR11	PE5S 18 110	-	-	VCH20	4		
	<b>RX-7</b>	ROTARY	FD3S	13B-REW(T/C)	91.11-02.8	-	-	-	-	4	THAILAND	
	<b>RX-8</b>	ROTARY	SE3P	13B-MSP	03.5-	-	-	-	-	EACH 2		
<b>SCRUM</b>	660	DL51V · DM51V	F6A(2VALVE · T/C)	91.10-99.1	W16EPR-U	AZ09 18 110	W16TT	IW16	VW16	3	VIETNAM	
		DL51V · DM51V	F6A(4VALVE)	91.10-99.1	XU22EPR-U	ZZS2 18 110	XU22TT	IXU22	VXU22	3		
		DJ51T · DK51T	F6A(2VALVE · T/C)	91.10-99.1	VW16	1UT0 18 110	-	-	IW16	VW16		3
		DJ51T · DJ51B · DK51T · DK51B	F6A(4VALVE)	91.10-99.1	XU22EPR-U	ZZS2 18 110	XU22TT	IXU22	VXU22	3		
		DG52V · DG52T · DH52V · DH52T	F6A(DOHC)	99.1-01.8	XU22EPR-U	ZZS2 18 110	XU22TT	IXU22	VXU22	3		
		DG52V · DG52T · DH52V · DH52T	F6A(T/C)	99.1-01.8	W16EPR-U	AZ09 18 110	W16TT	IW16	VW16	3		
		DG52W	F6A(2VALVE · T/C)	99.12-01.8	IW16	1UD0 18 110	-	-	IW16	VW16		3
		DG62W	K6A(DOHC · T/C)	01.9-05.9	IXU22C	1A11 18 110	-	-	IXU22	VXU22		3
		DG62V · DG62W · DG62T	K6A(DOHC)	01.9-05.9	XU22EPR-U	ZZS2 18 110	XU22TT	IXU22	VXU22	3		
		DG63T(Except 4WD AT)	K6A(DOHC)	02.5-13.9	XU22EPR-U	ZZS2 18 110	XU22TT	IXU22	VXU22	3		
		DG63T(4WD AT)	K6A(DOHC)	02.5-13.9	IXU22C	1A11 18 110	-	-	IXU22	VXU22		3
		DG64V	K6A(DOHC)	05.9-10.5	IXU22C(*5)	1A11 18 110	-	-	IXU22(*5)	VXU22(*5)		3
		DG64V	K6A(DOHC)	10.5-15.3	IXU22HPR(*5)	1A13 18 110	-	-	IXUH22(*5)	VXUH22(*5)		3
		DG64W	K6A · K6A(DOHC · T/C)	05.9-10.5	IXU22C(*5)	1A11 18 110	-	-	IXU22(*5)	VXU22(*5)		3
		DG64W	K6A(DOHC · T/C)	10.5-15.3	IXU22HPR(*5)	1A13 18 110	-	-	IXUH22(*5)	VXUH22(*5)		3
		DG16T	R06A	13.9-15.8	-	-	-	-	-	VSUEH22		3
		DG17V	R06A	15.3-	-	-	-	-	-	VSUEH22		3
DG17W	R06A(T/C)	15.3-	-	-	-	-	-	VSUEH22	3			
DG16T	R06A	15.8-	-	-	-	-	-	VSUEH22	3			
<b>SENTIA SPIANO</b>	3000	HEEP · HEEA	JE-E · JE-ZE	95.10-	KJ16CR11	F288 18 110	K16TT	IK16	VK16	6	JAPAN	
	660	HF21S	K6A(DOHC)	02.1-03.9	XU22EPR-U	ZZS2 18 110	XU22TT	IXU22	VXU22	3		
		HF21S	K6A(DOHC)	03.9-	IXU22C	1A11 18 110	-	-	IXU22	VXU22		3
<b>TITAN</b>	4000	WGAEH · WGEAT · WGTAE	TF(LPG)	94.10-	VK20T(*8)	-	-	-	VK20T(*8)	4	EUROPE & USA	
		WHF5T · WHF5G	TF(CNG)	00.11-	VK22	-	-	-	VK22	4		
<b>TITAN DASH</b>	2000	SYE4T · SYE6T	FE-E	00.10-	K16PR-U11	BP02 18 110	K16TT	IK16	VK16	4	CROSS REFERENCE NUMBER	
		SYE6T Rev	FE-C	07.8-	K16PR-U	BP48 18 110	K16TT	IK16	VK16	4		
<b>TRIBUTE</b>	2000	EPEW	YF(DOHC)	00.10-03.12	PT16VR13	-	-	ITV16	-	4	PART	
	2300	EP3W	L3(DOHC)	03.12-	VT20	-	-	IT20	VT20	4		
	3000	EPFW	AJ(DOHC)	00.10-	VT20	-	-	IT20	VT20	6		
<b>VERISA</b>	1500	DC5R · DC5W	ZY-VE	04.6-06.8	K16PR-U11	BP02 18 110	K16TT	IK16	VK16	4	PART	
		DC5W	ZY-VE	06.8-	FK16PR11(*7)	ZYY1 18 110	-	-	VFK16(*7)	4		
		DC5R	ZY-VE	06.8-	K16PR-U11	BP02 18 110	K16TT	IK16	VK16	4		
<b>MITSUBISHI AIRTREK</b>	2000	CU2W	4G63(MPI)	01.6-05.10	K20PR-U11	MS851728	K20TT	IK20	VK20	4	PART	
		CU2W	4G63(T/C)	02.6-05.10	P20PR8	-	-	-	IW20	VW20		4
		CU4W	4G64(GDI)	01.6-04.1	VKA16	-	-	-	-	VKA16		4
	2400	CU4W	4G64(ECI · MULTI)	03.1-04.1	K16PR-U11	MS851727	K16TT	IK16	VK16	4		
		CU5W	4G69(MIVEC)	04.1-05.10	IKH20	-	-	-	IKH20	VKH20		4
<b>ASPIRE</b>	1800	EA1A · EC1A	4G93(GDI)	98.8-00.5	VKA16	-	-	-	VKA16	4	PART	
	2000	EA7A · EC7A	4G94(GDI)	00.5-	VKA16	-	-	-	VKA16	4		



(\*5)The plug reach may be 19mm or 26.5mm even with the same engine and the same vehicle code. Please confirm the plug reach and choose the correct DENSO type. If there is an "H" in DENSO type, it has a reach of 26.5mm. If it doesn't, its reach is 19mm. (\*6)SXU22HPR9 replaces. (\*7)OEM:ZY5118110(FoMoCo brand) OES:ZY5118110 (Mazda brand) (\*8)This is IRIDIUM PLUS.



▶ Spark plug color codes: ■ for Iridium Tough and Iridium Plugs and Iridium TT, ■ for Iridium Power, ■ for Iridium Racing and Two Tops Plugs, ■ for Platinum Plugs and Platinum TT, and black for general spark plugs.

MODEL	CC	VEHICLE CODE	ENGINE	FROM-TILL	DENSO	GENUINE P/N				QTY
AUSTRALIA	2000	FA500A • FA500B • FA510A • FA510B • FA580B • FA590B	4G63	96.9-04.2	K16PR-U11	MS851727	K16TT	IK16	VK16	4
		FB700A • FB700B	4G63	04.2-	K16PR-U	MS851737	K16TT	IK16	VK16	4
CHINA	2400	FA523B • FC563B	4G64(LPG)	96.9-	K20PR-U	MS851738	-	-	VK20T(*8)	4
	3900	FE73CB • FE73CEB • FE82CEV • FE83CEV	4D33(CNG/LPG)	02.5-	VK22	MZ602042	-	IK22	VK22	4
	1800	DA2A	4G93	96.10-97.10	K20PR-U11	MS851728	K20TT	IK20	VK20	4
		DA2A	4G93(GDI)	97.10-	VKA16	-	-	-	VKA16	4
INDIA	3000	K96W	6G72	96.7-98.8	PK20PR-P11	MS851502	-	IK20	VK20	6
	3500	K99W	6G74(GDI)	97.8-	VKA16	-	-	-	VKA16	6
CHARIOT/ GRANDIS	2000	N33W • N43W	4G63	91.5-97.1	K16PR-U11	MS851727	K16TT	IK16	VK16	4
		N43W	4G63(T/C)	95.5-97.1	W20EPR-U	MS851403	-	IW20	VW20	4
INDONESIA	2400	N34W • N44W	4G64	93.5-97.10	K16PR-U11	MS851727	K16TT	IK16	VK16	4
		N84W • N94W	4G64(GDI)	97.10-01.4	VKA16	-	-	-	VKA16	4
		N84W • N94W	4G64(GDI)	01.4-03.5	VKA16	-	-	-	VKA16	4
		NA4W	4G69(SOHC)	03.5-09.4	IKH20	-	-	IKH20	VKH20	4
3000	N86W • N96W	6G72(GDI)	99.10-02.5	VKA16	-	-	-	VKA16	6	
	Z25A • Z26A	4G19	02.11-04.10	VKH16	-	-	IKH16	VKH16	4	
KOREA	1300	Z21A • Z22A	4A90(MIVEC)	04.10-10.6	VKH20	-	-	IKH20	VKH20	4
		Z21A	4A90	10.6-	-	-	-	-	VFKH16	4
		Z22A	4A90	10.6-	-	-	-	-	VFKH16	4
		Z27A • Z28A	4G15(MIVEC)	02.11-04.10	VKH16	-	-	IKH16	VKH16	4
MALAYSIA	1500	Z23A • Z24A	4G91(MIVEC)	04.10-	VKH20	-	-	IKH20	VKH20	4
		Z23A • Z24A	4A91(MIVEC)	04.10-	VKH20	-	-	IKH20	VKH20	4
		Z27A	4G15(MIVEC • T/C)	04.10-	VKH20Y	-	-	-	VKH20Y	4
		Z27AG	4G15(MIVEC • T/C)	06.10-	VKH20Y	-	-	-	VKH20Y	4
COLT PLUS	1300	Z21W • Z22W	4A90(MIVEC)	-	-	-	-	-	VFKH16	4
		Z23W • Z24W	4A91(MIVEC)	04.10-	VKH20	-	-	IKH20	VKH20	4
	1500	Z27W	4G15(MIVEC • T/C)	04.10-	VKH20Y	-	-	-	VKH20Y	4
		Z27WG	4G15(MIVEC • T/C)	06.10-	VKH20Y	-	-	-	VKH20Y	4
DEBONAIR	3000	S22A	6G72	92.10-00.2	W20EPR11	MS851418	-	IW20	VW20	6
		S22A	6G72(LPG)	92.10-	P20PR11	MS851473	-	-	VW20T(*8)	6
	3500	S26A • S27A	6G74(DOHC)	92.10-00.2	PK16PR-P11	MS851501	-	IK16	VK16	6
DELICA	1600	P06V • P02T	4G92	94.5-	K16PR-U11	MS851727	K16TT	IK16	VK16	4
		BVM20	HR16DE	11.10-	FXE20HR11	-	-	-	VFXEH20	4
	1800	SK82VM • SK82TM	F8-E	99.9-	K16PR-U11	MS851727	K16TT	IK16	VK16	4
		PA3V • P13T	4G63	94.5-99.9	K16PR-U11	MS851727	K16TT	IK16	VK16	4
2000	P07V • P17V • P27V	4G63	94.5-99.9	K16PR-U11	MS851727	K16TT	IK16	VK16	4	
	SKE6VM	FE-E	99.9-	K16PR-U11	MS851727	K16TT	IK16	VK16	4	
DELICA D:2	1200	MB15S	K12B(DOHC • VVT)	11.3-13.12	ZXU20PR11	MQ500368	-	-	VXU20	4
		MB15S	K12B(2WD)	13.12-15.12	ZXU20PR11	MQ500368	-	-	VXU20	4
		MB15S	K12B(ISS • 2WD)	13.12-15.12	ZXU20HPR11	MQ503107	-	IXUH20I	VXUH20I	4
		MB15S	K12B(4WD)	13.12-15.12	ZXU20HPR11	MQ503107	-	IXUH20I	VXUH20I	4
DELICA D:2 HYBRID	1200	MB36S	K12C	15.12-20.12	-	-	-	IXUH20I	VXUH20I	4
		MB46S	K12C	17.1-20.12	-	-	-	IXUH20I	VXUH20I	4
		MB37S	K12C	20.12-	-	-	-	IXUH20I	VXUH20I	4
DELICA D:3	1600	BM20	HR16DE	11.10-	FXE20HR11	-	-	VFXEH20	4	
DELICA D:5	2000	CV4W(2WD)	4B11(MIVEC)	09.12-11.11	-	-	-	-	VFK20F	4
		CV2W(2WD)	4J11	11.12-	-	-	-	-	-	4
	2400	CV5W	4B12	07.1-09.12	K16PSR-B8	1822A030	-	IK16	VK16	4
		CV5W	4B12	09.12-10.1	-	-	-	-	VFK16	4
2400	CV5W	4B12	10.1-	-	-	-	-	VFK16	4	
DELICA SPACE GEAR	2400	PA4W • PB4W • PC4W • PD4W	4G64	94.6-04.10	K16PR-U11	MS851727	K16TT	IK16	VK16	4
	3000	PB6W • PD6W • PF6W	6G72	94.6-04.10	PK20PR-P11	MS851502	-	IK20	VK20	6
		PD6W	6G72(SOHC)	04.10-07.1	VK20	MZ602041	-	IK20	VK20	6
DIAMANTE	2500	F31A • F41A	6G73(DOHC)	95.1-97.8	F)K20PR-U11 R)PK20PR-P11	F)MS851728 R)MS851502	F)K20TT R)-	IK20	VK20	EACH 3
		F31A • F41A	6G73(MVV)	95.1-97.8	F)K20PR-U11 R)PK20PR-P11	F)MS851728 R)MS851502	F)K20TT R)-	IK20	VK20	EACH 3
		F31A • F41A	6G73(GDI)	99.9-01.9	VKA16	-	-	-	VKA16	6
	F31A • F41A	6G73(GDI)	01.9-02.10	VKA16	-	-	-	VKA16	6	
	F34A	6A13	02.10-	SK20PR-B8	MR984646	-	IK20	VK20	6	
	K45	6G72(SOHC)	93.10-97.10	W20EP11	MS851028	-	IW20	VW20	6	
	3000	F36A	6G72(MIVEC)	95.1-97.8	F)K20TNR R)PK20PR-P8	F)- R)MS851506	F)K20TT R)-	IK20	VK20	EACH 3
		F36A • F46A • F47A	6G72(DOHC)	95.1-97.8	F)K20PR-U11 R)PK20PR-P11	F)MS851728 R)MS851502	F)K20TT R)-	IK20	VK20	EACH 3
F36A • F46A	6G72(GDI)	97.7-02.10	VKA16	-	-	-	VKA16	6		

(\*5)The plug reach may be 19mm or 26.5mm even with the same engine and the same vehicle code. Please confirm the plug reach and choose the correct DENSO type. If there is an "H" in DENSO type, it has a reach of 26.5mm. If it doesn't, its reach is 19mm. (\*8)This is IRIDIUM PLUS.

MODEL	CC	VEHICLE CODE	ENGINE	FROM-TILL	DENSO	GENUINE P/N				QTY			
<b>MITSUBISHI</b>													
<b>DIAMANTE</b>	3000	F36W	6G7(SOHC)	97.8-02.10	F)K20PR-U11 R)PK20PR11	F)MS851728 R)MD322771	F)K20TT R)-	IK20	VK20	EACH 3	AUSTRALIA		
	<b>DIGNITY</b>	3500	BHGY51	VQ35HR	12.7-	FXE22HR11	22401-EW61C	-	-	VFXEH22	6	CHINA	
<b>DION</b>	1800	CR5W	4G93(GDI · T/C)	02.5-	VKA20	-	-	-	VKA20	4	INDIA		
	2000	CR9W	4G63(DOHC · GDI)	00.1-02.5	VKA16	-	-	-	VKA16	4	INDONESIA		
		CR6W	4G94(DOHC · GDI)	00.7-	VKA16	-	-	-	VKA16	4	INDONESIA		
<b>ECLIPSE</b>	2000	D32A	4G63(T/C)	95.6-04.10	W20ETR-L8	MS851792	-	IW20	VW20	4	INDONESIA		
		D38A	4G63(T/C)	96.5-04.10	W20ETR-L8	MS851792	-	IW20	VW20	4	INDONESIA		
	3000	D53A	6G72(MPI)	04.10-	K20PSR-B8	MN163807	-	IK20	VK20	6	INDONESIA		
<b>ECLIPSE CROSS</b>	1500	GK1W	4B40(T/C)	18.3-	-	-	-	IXUH22I	VXUH22I	4	INDONESIA		
<b>ECLIPSE CROSS PHEV</b>	2400	GL3W	4B12	20.12-	-	-	-	-	-	4	INDONESIA		
<b>eK ACTIVE</b>	660	H81W	3G83(SOHC)	04.5-08.8	KJ16CR-U11	MD362098	K16TT	IK16	VK16	3	INDONESIA		
		H81W	3G83(SOHC)	08.8-	KJ20CR-U11	MD358202	K20TT	IK20	VK20	3	INDONESIA		
		H81W	3G83(T/C)	04.5-	SVK20RZ8	MN122257	-	-	VK20Y	3	INDONESIA		
<b>eK CLASSY</b>	660	H81W	3G83(SOHC)	03.5-08.8	KJ16CR-U11	MD362098	K16TT	IK16	VK16	3	INDONESIA		
<b>eK CUSTOM</b>	660	B11W	3B20(IRIDIUM PLUGS INSTALLED VEHICLES)	13.6-14.6	-	-	-	IXUH20I	VXUH20I	3	INDONESIA		
		B11W	3B20(Except IRIDIUM PLUGS INSTALLED VEHICLES)	13.6-14.6	-	-	XUH20TTI	IXUH20I	VXUH20I	3	INDONESIA		
	660	B11W	3B20(T/C, IRIDIUM PLUGS INSTALLED VEHICLES)	13.6-14.6	SXU22HDR8	1822A010	-	IXUH22	VXUH22	3	INDONESIA		
		B11W	3B20(T/C, Except IRIDIUM PLUGS INSTALLED VEHICLES)	13.6-14.6	XU22HDR9	1822A009	XUH22TT	IXUH22	VXUH22	3	INDONESIA		
		B11W	3B20	14.6-17.1	-	-	-	IXUH20I	VXUH20I	3	INDONESIA		
		B11W	3B20(T/C)	14.6-19.3	SXU22HDR8	1822A010	-	IXUH22	VXUH22	3	INDONESIA		
		B11W	3B20	17.1-19.3	-	-	-	IXUH20I	VXUH20I	3	INDONESIA		
<b>eK SPACE</b>	660	B11A	3B20	14.2-16.12	-	-	-	IXUH20I	VXUH20I	3	INDONESIA		
		B11A	3B20(T/C)	14.2-20.3	SXU22HDR8	1822A010	-	IXUH22	VXUH22	3	INDONESIA		
		B11A	3B20	16.12-20.3	-	-	-	IXUH20I	VXUH20I	3	INDONESIA		
<b>eK SPACE HYBRID</b>	660	B34A	BR06	20.3-	-	-	-	-	VSUEH22	3	INDONESIA		
		B35A	BR06(T/C)	20.3-	-	-	-	-	VSUEH22	3	INDONESIA		
		B37A	BR06	20.3-	-	-	-	-	VSUEH22	3	INDONESIA		
		B38A	BR06(T/C)	20.3-	-	-	-	-	VSUEH22	3	INDONESIA		
		B38A	BR06(T/C)	20.3-	-	-	-	-	VSUEH22	3	INDONESIA		
<b>eK SPORT</b>	660	H81W	3G83(SOHC)	02.9-08.8	KJ16CR-U11	MD362098	K16TT	IK16	VK16	3	INDONESIA		
		H81W	3G83(SOHC)	08.8-	KJ20CR-U11	MD358202	K20TT	IK20	VK20	3	INDONESIA		
		H82W	3G83(SOHC)	06.9-10.8	KJ20CR-U11	MD358202	K20TT	IK20	VK20	3	INDONESIA		
		H82W	3G83(SOHC)	10.8-13.6	KJ16CR-U11	MD362098	K16TT	IK16	VK16	3	INDONESIA		
		H81W	3G83(T/C)	02.9-06.9	SVK20RZ8	MN122257	-	-	VK20Y	3	INDONESIA		
		H82W	3G83(T/C)	06.9-	SVK20RZ8	MN122257	-	-	VK20Y	3	INDONESIA		
		<b>eK WAGON</b>	660	H81W	3G83(SOHC)	01.10-08.8	KJ16CR-U11	MD362098	K16TT	IK16	VK16	3	INDONESIA
H81W	3G83(SOHC)			08.8-	KJ20CR-U11	MD358202	K20TT	IK20	VK20	3	INDONESIA		
H82W	3G83(SOHC)			06.9-10.8	KJ16CR-U11	MD362098	K16TT	IK16	VK16	3	INDONESIA		
H82W	3G83(SOHC)			10.8-13.6	KJ20CR-U11	MD358202	K20TT	IK20	VK20	3	INDONESIA		
H81W	3G83(T/C)			02.9-06.9	SVK20RZ8	MN122257	-	-	VK20Y	3	INDONESIA		
660	B11W		3B20(IRIDIUM PLUGS INSTALLED VEHICLES)	13.6-14.6	-	-	-	IXUH20I	VXUH20I	3	INDONESIA		
	B11W		3B20(Except IRIDIUM PLUGS INSTALLED VEHICLES)	13.6-14.6	-	-	XUH20TTI	IXUH20I	VXUH20I	3	INDONESIA		
	B11W		3B20	14.6-17.1	-	-	-	IXUH20I	VXUH20I	3	INDONESIA		
	B11W		3B20(T/C)	15.10-19.3	SXU22HDR8	1822A010	-	IXUH22	VXUH22	3	INDONESIA		
	B11W		3B20	17.1-19.3	-	-	-	IXUH20I	VXUH20I	3	INDONESIA		
	B33W		BR06	19.3-	-	-	-	-	VSUEH22	3	INDONESIA		
	B36W		BR06	19.3-	-	-	-	-	VSUEH22	3	INDONESIA		
	<b>eK X HYBRID</b>		660	B34W	BR06	19.3-	-	-	-	-	VSUEH22	3	INDONESIA
				B35W	BR06(T/C)	19.3-	-	-	-	-	VSUEH22	3	INDONESIA
				B37W	BR06	19.3-	-	-	-	-	VSUEH22	3	INDONESIA
B38W		BR06(T/C)		19.3-	-	-	-	-	VSUEH22	3	INDONESIA		
B38W		BR06(T/C)		19.3-	-	-	-	-	VSUEH22	3	INDONESIA		
<b>eK X SPACE HYBRID</b>	660	B34A	BR06	20.3-	-	-	-	-	VSUEH22	3	INDONESIA		
		B35A	BR06(T/C)	20.3-	-	-	-	-	VSUEH22	3	INDONESIA		
		B37A	BR06	20.3-	-	-	-	-	VSUEH22	3	INDONESIA		
		B38A	BR06(T/C)	20.3-	-	-	-	-	VSUEH22	3	INDONESIA		
<b>ETERNA SIGMA FTO</b>	1800	E19A	4G93(LPG)	96.1-	K20PR-U	MS851738	-	-	VK20T(*8)	4	INDONESIA		
	1800	DE2A	4G93	94.10-00.8	K16P-U11	MS851731	-	IK16	VK16	4	INDONESIA		
		2000	DE3A	6A12(MIVEC)	94.10-00.8	F)K22TMR11 R)VK22	F)MD319586 R)-	-	IK22	VK22	EACH 3	INDONESIA	

(\*8)This is IRIDIUM PLUS.

INDONESIA  
MALAYSIA  
PHILIPPINES  
SAUDI ARABIA  
SINGAPORE  
TAIWAN  
THAILAND  
VIETNAM  
JAPAN  
EUROPE & USA  
CROSS REFERENCE NUMBER  
PART NUMBER



MODEL	CC	VEHICLE CODE	ENGINE	FROM-TILL	DENSO	GENUINE P/N				QTY
AUSTRALIA	<b>MITSUBISHI</b>									
	<b>FTO</b>									
	2000	DE3A	6A12	94.10-00.8	F)K20PR-U11 R)PK20PR-P11	F)MS851728 R)MS851502	F)K20TT R)-	IK20	VK20	EACH 3
CHINA	<b>GALANT</b>									
	1800	EA1A	4G93(GDI)	96.8-97.1	VKA20	-	-	-	VKA20	4
		EA1A · EC1A	4G93(GDI)	97.1-00.5	VKA16	-	-	-	VKA16	4
	2000	EA7A · EC7A	4G94(GDI)	00.5-	VKA16	-	-	-	VKA16	4
	2400	EA3A · EC3A	4G64(GDI)	98.8-01.4	VKA16	-	-	-	VKA16	4
	EA3A · EC3A	4G64(GDI)	01.4-	VKA16	-	-	-	VKA16	4	
INDIA	<b>GALANT FORTIS</b>									
	1800	CY3A	4B10(MIVEC)	09.12-	-	-	-	-	VFK16	4
		CY6A	4J10	11.10-	-	-	-	-	-	4
	2000	CY4A	4B11(MIVEC)	07.8-09.12	K20PSR-B8	MN163807	-	IK20	VK20	4
INDONESIA	<b>GALANT FORTIS SPORTBACK</b>									
	1800	CX3A	4B10(MIVEC)	09.12-	-	-	-	-	VFK16	4
		CX6A	4J10	11.10-	-	-	-	-	-	4
	2000	CX4A	4B11(MIVEC)	08.12-09.12	K20PSR-B8	MN163807	-	IK20	VK20	4
KOREA	<b>GALANT SIGMA</b>									
	1800	E19A	4G93(LPG)	96.1-	K20PR-U	MS851738	-	-	VK20(*8)	4
MALAYSIA	<b>GRANDIS</b>									
	2400	NA4W	4G69(MIVEC)	03.5-	-	-	-	-	-	4
MALAYSIA	<b>GTO</b>									
	3000	Z16A	6G72	95.6-00.8	F)K20PR-U11 R)PK20PR-P11	F)MS851728 R)MS851502	F)K20TT R)-	IK20	VK20	EACH 3
	3000	Z15A · Z16A	6G72(DOHC · T/C)	95.6-00.8	F)K20PR-U11 R)PK20PR-P11	F)MS851728 R)MS851502	F)K20TT R)-	IK20	VK20	EACH 3
PHILIPPINES	<b>i</b>									
	660	HA1W	3B20(DOHC)	06.1-09.11	XU22HDR9	1822A009	XUH22TT	IXUH22	VXUH22	3
		HA1W	3B20(T/C)	06.1-	SXU22HDR8	1822A010	-	IXUH22	VXUH22	3
	660	HA1W	3B20(MIVEC)	09.11-	FXU22HR11	1822A061	-	-	-	3
SAUDI ARABIA	<b>LANCER</b>									
	1300	CB1A · CK1A	4G13	91.10-	W16EPR11	MS851417	W16TT	IW16	VW16	4
		CK2A · CM2A	4G15(DOHC)	95.10-	K16PR-U11	MS851727	K16TT	IK16	VK16	4
	1500	CK2A	4G15(MVV)	95.10-97.8	W16EPR11	MS851417	W16TT	IW16	VW16	4
		CS2A	4G15	03.2-	K16PR-U11	MS851727	K16TT	IK16	VK16	4
		CS2W	4G15	05.1-	K16PR-U11	MS851727	K16TT	IK16	VK16	4
	1600	CB4A · CK4A	4G92(DOHC · MIVEC)	92.10-	K22TMR11	MD319586	-	IK22	VK22	4
		CM5A	4G93(DOHC · T/C)	95.10-05.1	K20PR-U	MS851738	K20TT	IK20	VK20	4
	1800	CK6A	6A11	95.10-05.1	F)K20PR-U11 R)PK20PR11	F)MS851728 R)MD322771	F)K20TT R)-	IK20	VK20	EACH 3
		CS5W	4G93(GDI · T/C)	03.2-	VKA20	-	-	-	VKA20	4
	CS5A · CS5W	4G93(GDI)	03.2-	VKA16	-	-	-	VKA16	4	
TAIWAN	<b>LANCER CARGO</b>									
	1200	CVAY12	CR12DE	08.12-	IKH16	-	-	IKH16	VKH16	4
		CS2V	4G15	03.1-08.12	K16PR-U11	MS851727	K16TT	IK16	VK16	4
	1500	CVY12	HR15DE	08.12-13.6	FXE20HE11	22401-ED71B	-	-	VFXEH20E	4
		CVY12	HR15DE	13.6-	FXE20HE11	22401-ED71B	-	-	VFXEH20E	4
THAILAND	<b>LANCER CEDIA/WAGON</b>									
	1500	CS2A	4G15(GDI)	00.5-03.2	VKA16	-	-	-	VKA16	4
		CS2A	4G15	01.5-03.2	K16PR-U11	MS851727	K16TT	IK16	VK16	4
	1800	CS5A · CS5W	4G93(GDI)	00.5-01.6	VKA16	-	-	-	VKA16	4
		CS5A · CS5W	4G93(GDI)	01.6-03.2	VKA16	-	-	-	VKA16	4
	CS5W	4G93(GDI · T/C)	01.6-03.2	VKA20	-	-	-	VKA20	4	
JAPAN	<b>LANCER EVOLUTION</b>									
		CN9A(EVOIV)	4G63(DOHC · T/C)	96.8-98.1	P22PR8	MD343244	-	IW22	VW22	4
		CP9A(EVOV)	4G63(DOHC · T/C)	98.1-99.1	P22PR8	MD343244	-	IW22	VW22	4
		CP9A(EVOVI)	4G63(DOHC · T/C)	99.1-00.1	P22PR8	MD343244	-	IW22	VW22	4
		CP9A(EVOVII · Tommy Makinenn Edition)	4G63(DOHC · T/C)	00.1-01.1	S22PR-A7	MD371435	-	IW22	VW22	4
		CT9A(EVOVII/GTA)	4G63(DOHC · T/C)	01.2-03.1	VW22	MZ602048	-	IW22	VW22	4
	2000	CT9A(EVOVIII)	4G63(DOHC · T/C)	03.1-05.3	VW22	MZ602048	-	IW22	VW22	4
		CT9A(EVOIX)	4G63(DOHC · T/C)	05.3-07.10	VKH22	-	-	IKH22	VKH22	4
		CT9W(WAGON · MT)	4G63(DOHC · T/C)	05.9-	VKH22	-	-	IKH22	VKH22	4
		CT9W(WAGON · AT)	4G63(DOHC · T/C)	05.9-	VW22	MZ602048	-	IW22	VW22	4
EUROPE & USA	<b>LEGNUM</b>									
	1800	EA1W · EC1W	4G93(GDI)	96.8-97.1	VKA20	-	-	-	VKA20	4
		EA1W · EC1W	4G93(GDI)	97.1-00.5	VKA16	-	-	-	VKA16	4
	2000	EA4W · EC4W	6A12	96.8-00.5	F)K20PR-U11 R)PK20PR11	F)MS851728 R)MD322771	F)K20TT R)-	IK20	VK20	EACH 3
	EA7W · EC7W	4G94(GDI)	00.5-02.8	VKA16	-	-	-	VKA16	4	
	2400	EA3W · EC3W	4G64(GDI)	98.8-01.4	VKA16	-	-	-	VKA16	4

(\*8)This is IRIDIUM PLUS.



MODEL	CC	VEHICLE CODE	ENGINE	FROM-TILL	DENSO	GENUINE P/N	<b>TJ</b>	<b>IRIDIUM POWER</b>	<b>IRIDIUM TOUGH</b>	QTY	
<b>MITSUBISHI</b>											
<b>LEGNUM</b>	2400	EA3W • EC3W	4G64(GDI)	01.4-02.8	VKA16	-	-	-	VKA16	4	AUSTRALIA
		EC5W	6A13(DOHC • T/C)	96.8-98.9	PK20PR-P8	MS851506	-	-	VK20Y	6	
	2500	EA5W • EC5W	6A13	96.8-98.9	F)K20PR-U11 R)PK20PR11	F)MS851728 R)MD322771	F)K20TT R)-	IK20	VK20	EACH 3	CHINA
		<b>LIBERO/ CARGO</b>	1300	CB1V	4G13	92.6-02.	W16EPR11	MS851417	W16TT	IW16	VW16
	1500	CB2V • CD2V	4G15	92.6-02.	W16EPR11	MS851417	W16TT	IW16	VW16	4	INDIA
		CB2W	4G15(ECI-MVV)	94.1-00.	W16EPR11	MS851417	W16TT	IW16	VW16	4	
	1600	CB4W • CB5W	4G92	96.10-00.	K16PR-U11	MS851727	K16TT	IK16	VK16	4	INDONESIA
		CB5W • CD5W	4G93	92.6-00.	K16PR-U11	MS851727	K16TT	IK16	VK16	4	
	1800	CD5W	4G93(DOHC • T/C)	94.1-00.	K20P-U	MS851722	K20TT	IK20	VK20	4	KOREA
		<b>MINICA</b>	H31A • H36A	4A30(DOHC • T/C)	93.9-98.10	XU22EPR-U	MS851487	XU22TT	IXU22	VXU22	
	660	H31A • H36A	4A30(ECI)	93.9-98.10	XU22EPR-U	MS851487	XU22TT	IXU22	VXU22	4	MALAYSIA
		H31A • H36A	4A30	93.9-98.10	XU20EPR-U	MS851486	-	IXU22	VXU22	4	
	660	H32A • H32V • H37A • H37V	3G83(2VALVE)	93.9-98.10	W16EPR11	MS851417	W16TT	IW16	VW16	3	PHILIPPINES
		H42A • H42V • H47A • H47V	3G83(MVV)LEANBURN	98.10-01.10	-	-	-	-	-	3	
	660	H42A • H42V • H47A • H47V	3G83(4VALVE)	01.10-08.8	KJ16CR-U11	MD362098	K16TT	IK16	VK16	3	SAUDIARABIA
		H42A • H42V • H47A • H47V	3G83(4VALVE)	08.8-	KJ20CR-U11	MD358202	K20TT	IK20	VK20	3	
<b>MINICAB</b>	660	U41V • U42V	3G83(DOHC • T/C)	91.2-99.1	XU22EPR-U	MS851487	XU22TT	IXU22	VXU22	3	SINGAPORE
		U41V • U42V	3G83(DOHC • 5VALVE)	91.2-99.1	XU22EPR-U	MS851487	XU22TT	IXU22	VXU22	3	
	660	U41V • U42V	3G83(4VALVE)	91.2-99.1	K20PR-U11	MS851728	K20TT	IK20	VK20	3	TAIWAN
		U41T • U41V • U42T • U42V	3G83(2VALVE)	91.2-99.1	W16EPR11	MS851417	W16TT	IW16	VW16	3	
	660	U41T • U41TP • U42T • U42TP	3G83(4VALVE)	91.2-99.1	K20PR-U11	MS851728	K20TT	IK20	VK20	3	THAILAND
		U43V • U44V	4A30(DOHC • T/C)	94.1-99.1	XU22EPR-U	MS851487	XU22TT	IXU22	VXU22	4	
	660	U43V • U44V	4A30	94.1-99.1	XU22EPR-U	MS851487	XU22TT	IXU22	VXU22	4	VIETNAM
		U61T • U61TP • U61V • U62T • U62TP • U62V	3G83(MVV)LEANBURN	99.1-02.8	-	-	-	-	-	3	
	660	U61T • U61TP • U61V • U62T • U62TP • U62V	3G83	02.8-	KJ20CR-U11	MD358202	K20TT	IK20	VK20	3	JAPAN
		U61V	3G83(T/C)	11.12-	SVK20RZ8	MN122257	-	-	VK20Y	3	
	660	U62V	3G83(T/C)	11.12-	SVK20RZ8	MN122257	-	-	VK20Y	3	EUROPE & USA
		DS16T	R06A	14.2-15.9	-	-	-	-	VSUEH22	3	
<b>MINICAB, BRAVO</b>	550	U14V • U14TG • U14VG • U15T • U15TG • U15V • U15VG	3G81(S/C)	89.1-91.1	W20EPR-U	MS851403	-	IW20	VW20	3	CROSS REFERENCE NUMBER
		660	U18T • U18TP • U18V • U19T • U19V	3G83(2VALVE)	90.2-99.1	W16EPR11	MS851417	W16TT	IW16	VW16	
<b>MINICAB, FUEL</b>	660		(Bi-Fuel)	07.10-	KJ20CR-U11	MD358202	K20TT	IK20	VK20	3	
<b>MIRAGE</b>	1000	A05A	3A90	12.8-	FK16HR11	-	-	-	VFKH16	3	
		A03A	3A92	14.12-	FK16HR11	-	-	-	VFKH16	3	
	1200	A03A	3A92	16.1-	-	-	-	-	VFKH16	3	
		1300	CA1A • CB1A • CJ1A • CK1A	4G13	91.10-	W16EPR11	MS851417	W16TT	IW16	VW16	4
	1500	CJ2A • CK2A • CL2A • CM2A	4G15(DOHC)	95.10-	K16PR-U11	MS851727	K16TT	IK16	VK16	4	
		CK2A	4G15(MVV)	95.10-97.8	W16EPR11	MS851417	W16TT	IW16	VW16	4	
	1600	CK4A • CJ4A	4G92(MIVEC)	95.10-	K22TMR11	MD319586	-	IK22	VK22	4	
		CM5A	4G93(DOHC • T/C)	95.10-	K20PR-U	MS851738	K20TT	IK20	VK20	4	
	1800	CK6A	6A11	95.10-	F)K20PR-U11 R)PK20PR11	F)MS851728 R)MD322771	F)K20TT R)-	IK20	VK20	EACH 3	
		<b>MIRAGE DINGO</b>	1300	CQ1A	4G13	00.1-02.8	K16PR-U11	MS851727	K16TT	IK16	VK16
	1500	CQ2A	4G15(GDI)	98.12-02.8	VKA16	-	-	-	VKA16	4	
		CQ5A	4G93(GDI)	00.2-01.4	VKA16	-	-	-	VKA16	4	
	1800	CQ5A	4G93(GDI)	01.4-	VKA16	-	-	-	VKA16	4	
		<b>OUTLANDER</b>	2000	CW4W	4B11(MIVEC)	10.2-12.10	-	-	-	VFK20F	4
	2000	GF7W	4J11	12.10-	-	-	-	-	-	4	
		CW5W	4B12(MIVEC)	05.10-09.9	IK16	MZ602020	-	IK16	VK16	4	
	2400	CW5W	4B12	09.9-12.10	-	-	-	-	VFK16	4	
		GF8W	4J12	12.10-	-	-	-	-	-	4	
	3000	CW6W	6B31(MIVEC)	07.10-	SXU22HDR8	1822A010	-	IXUH22	VXUH22	6	
		<b>OUTLANDER PHEV</b>	2000	GG2W	4B11	13.1-13.8	-	-	-	VFK20F	4
	2000	GG2W	4B11	13.8-15.7	-	-	-	-	-	4	
		GG2W	4B11	15.7-18.8	-	-	-	-	-	4	
	2400	GG3W	4B12	18.8-21.12	-	-	-	-	-	4	
		GN0W	4B12	21.12-	-	-	-	-	-	4	
<b>PAJERO</b>	2400	V21W	4G64	96.6-99.9	K16PR-U11	MS851727	K16TT	IK16	VK16	4	
		V23W • V23C • V43W	6G72	91.1-99.9	W16EPR11	MS851417	W16TT	IW16	VW16	6	
	3000	V63W • V73W	6G72(MPI)	01.8-06.10	SK20PR-A11	MD373645	-	IK20	VK20	6	



DENSO	9	14	16	20	22	24	27	29	31	32	34	35	DENSO	9	14	16	20	22	24	27	31	32	DENSO	9	14	16	20	22	24	27	31	
NGK	2	4	5	6	7	8	9	9.5	10	10.5	11	11.5	CHAMPION	18	16,14	12,11	10,9	8,7	6,63,61	4,59	57	55	53	BOSCH	10	9	8	7,6	5	4	3	2

AUSTRALIA  
 CHINA  
 INDIA  
 INDONESIA  
 KOREA  
 MALAYSIA  
 PHILIPPINES  
 SAUDIARABIA  
 SINGAPORE  
 TAIWAN  
 THAILAND  
 VIETNAM  
 JAPAN  
 EUROPE & USA  
 CROSS REFERENCE NUMBER  
 PART



MODEL	CC	VEHICLE CODE	ENGINE	FROM-TILL	DENSO	GENUINE P/N				QTY	
AUSTRALIA	3000	V83W • V93W	6G72(SOHC)	06.10-09.12	SVK20RZ8	MN122257	-	IK20	VK20	6	
		V83W • V93W	6G72(SOHC)	09.12-	-	-	-	-	VFK20F	6	
CHINA	3500	V25C • V25W • V45W	6G74	93.7-97.5	PK16PR-P11	MS851501	-	IK16	VK16	6	
		V25W • V45W	6G74(GDI)	97.5-99.9	VKA16	-	-	-	VKA16	6	
		V55W(Evo)	6G74(MIVEC)	97.9-00.8	VK22	MZ602042	-	IK22	VK22	6	
		V65W • V75W	6G74(GDI)	99.9-02.9	VKA16	-	-	-	VKA16	6	
		V65W • V75W	6G74(GDI)	02.9-06.10	VKA16	-	-	-	VKA16	6	
		V77W	6G75	05.11-06.10	IK20	-	-	IK20	VK20	6	
INDIA	3800	V97W • V87W	6G75(MIVEC • SOHC • 4VALVE)	06.10-	VK20	MZ602041	-	IK20	VK20	6	
		H61W • H66W • H71W • H76W	4G93(GDI)	98.6-01.4	VKA16	-	-	-	VKA16	4	
INDONESIA	1800	H61W • H66W • H71W • H76W	4G93(GDI)	01.4-02.9	VKA16	-	-	-	VKA16	4	
		H76W	4G93(GDI • T/C)	00.7-02.9	VKB20	-	-	-	VKB20	4	
		H76W	4G93(GDI • T/C)	02.9-06.1	VKA20	-	-	-	VKA20	4	
		H76W	4G93(ECI • MULTI)	02.9-	K16PR-U11	MS851727	K16TT	IK16	VK16	4	
		H62W • H67W • H72W • H77W	4G94(GDI)	00.6-	VKA16	-	-	-	VKA16	4	
KOREA	1100	H57A	4A31	95.11-98.6	XU22EPR-U	MS851487	XU22TT	IXU22	VXU22	4	
		H51A • H56A	4A30	94.12-98.10	XU22EPR-U	MS851487	XU22TT	IXU22	VXU22	4	
MALAYSIA	660	H56A	4A30(T/C)	94.12-98.10	XU22EPR-U	MS851487	XU22TT	IXU22	VXU22	4	
		H53A • H58A	4A30(DOHC • T/C)	98.10-02.9	XU22EPR-U	MS851487	XU22TT	IXU22	VXU22	4	
		H53A • H58A	4A30(LEANBURN)	98.10-	XU22EPR-U	MS851487	XU22TT	IXU22	VXU22	4	
		H53A • H58A	4A30(T/C)	99.10-02.9	XU22EPR-U	MS851487	XU22TT	IXU22	VXU22	4	
		H53A • H58A	4A30(DOHC • T/C)	02.9-	SXU22PR-A9	MN122493	-	IXU22	VXU22	4	
		H44A	4A31(GDI-ASG)	99.12-01.10	-	-	-	-	VXU20	4	
PHILIPPINES	2500	BY51	VQ25HR	12.7-	FXE22HR11	22401-EW61C	-	-	VFXEH22	6	
		S32A • S33A	6G74(GDI)	00.2-01.5	VKA16	-	-	-	VKA16	6	
		BKY51	VQ37VHR	12.7-	FXE24HR11	22401-JK01D	-	-	-	6	
		BKNY51	VQ37VHR	12.7-	FXE24HR11	22401-JK01D	-	-	-	6	
		S43A	8A80(GDI)	00.2-01.5	VKB16	-	-	-	VKB16	8	
SAUDIARABIA	1800	GA4W	4J10	11.10-	-	-	-	-	-	4	
		N11W • N21W • N21WG	4G93	91.7-97.11	K16PR-U11	MS851727	K16TT	IK16	VK16	4	
		N61W • N71W	4G93(GDI)	97.11-01.11	VKA16	-	-	-	VKA16	4	
		N61W • N71W	4G93(GDI)	01.11-10.1	VKA16	-	-	-	VKA16	4	
		GA3W	4B10(MIVEC)	10.2-	-	-	-	-	VFK16	4	
		N13W • N23W • N23WG	4G63(DOHC)	91.2-97.11	W20EP11	MS851028	-	IW20	VW20	4	
		N23WG(SUPER SPORTSGEAR)	4G63(DOHC • T/C)	94.9-97.11	W20EP	MS851023	-	IW20	VW20	4	
		N23W • 23WG(HYPER SPORTSGEAR)	4G63(DOHC • T/C)	97.1-97.11	W20EP	MS851023	-	IW20	VW20	4	
		N73WG(SUPER SPORTSGEAR)	4G63(DOHC • T/C)	97.11-02.8	VW20	-	-	IW20	VW20	4	
		N64WG • N74WG	4G64(GDI)	97.11-01.11	VKA16	-	-	-	VKA16	4	
TAIWAN	2400	N64WG • N74WG	4G64(GDI)	01.11-10.1	VKA16	-	-	-	VKA16	4	
		H82A	3G83(SOHC)	08.9-	KJ20CR-U11	MD358202	K20TT	IK20	VK20	3	
THAILAND	660	H82A	3G83(T/C)	08.9-	SVK20RZ8	MN122257	-	-	VK20Y	3	
		H42A • H47A	3G83(MVV)LEANBURN	98.10-01.10	-	-	-	-	-	3	
		H42A • H47A	3G83(SOHC)	01.10-08.9	KJ16CR-U11	MD362097	K16TT	IK16	VK16	3	
		H42V • H47V	3G83(MVV)LEANBURN	00.1-01.10	-	-	-	-	-	3	
		H41A • H46A	4A30(DOHC • T/C)	98.10-	XU22EPR-U	MS851487	XU22TT	IXU22	VXU22	4	
VIETNAM	1100	H41A • H46A	4A30(T/C)	99.10-	XU22EPR-U	MS851487	XU22TT	IXU22	VXU22	4	
		H43A • H48A	4A31	99.1-05.5	XU22EPR-U	MS851487	XU22TT	IXU22	VXU22	4	
		U61W • U62W	3G83(MVV)LEANBURN	99.4-02.8	-	-	-	-	-	3	
		U61W • U62W	3G83	02.8-	KJ20CR-U11	MD358202	K20TT	IK20	VK20	3	
		U61W • U62W	3G83(T/C)	02.9-	SVK20RZ8	MN122257	-	-	VK20Y	3	
JAPAN	660	U63W • U64W	4A30(DOHC • T/C)	99.4-02.9	XU22EPR-U	MS851487	XU22TT	IXU22	VXU22	4	
		DS64W	K6A(T/C)	14.2-15.3	IXU22HPR	MQ504109	-	-	VSUEH22	3	
		DS17W	R06A(T/C)	15.3-	-	-	-	-	VSUEH22	3	
		U65W • U66W	4A31	99.6-01.5	XU22EPR-U	MS851487	XU22TT	IXU22	VXU22	4	
EUROPE & USA	3500	KB9T	6G74(MPI • SOHC • 4VALVE)	06.9-	SK16PR-A11	MD361067	-	IK16	VK16	6	
		<b>MITSUOKA</b>									
CROSS REFERENCE NUMBER	2000	HK30	RB20E	94.2-01.8	Q16PR-U11	-	-	IQ16	VQ16	6	
		2500	Y50	VQ25DE	05.7-	VKH16	-	-	IKH16	VKH16	6
		3500	PY50	VQ35DE	05.7-	VKH16	-	-	IKH16	VKH16	6
PART NUMBER	1500	NZE141 Rev • NZE144 Rev	1NZ-FE	08.2-	FK20HR11	90919-01247	-	-	VFKH20	4	
		1800	ZRE142 Rev • ZRE144 Rev	2ZR-FE	08.2-	SC16HR11	90919-01275	-	-	VCH16	4
PART NUMBER	2500	MY34	VQ25DD	99.12-05.7	VK16	-	-	IK16	VK16	6	
		3000	HY34	VQ30DD	99.12-05.7	VK16	-	-	IK16	VK16	6
PART NUMBER	2500	Y50	VQ25HR	07.12-	FXE22HR11	22401-EW61C	-	-	VFXEH22	6	
		3000	PY50 • PNY50	VQ35HR	07.12-	FXE22HR11	22401-EW61C	-	-	VFXEH22	6
PART NUMBER	1500	NZE141 • NZE144	1NZ-FE	10.3-	FK16HR11	90919-01243	-	-	VFKH16	4	
		1800	ZRE142 • ZRE144	2ZR-FE	10.3-	SC16HR11	90919-01275	-	-	VCH16	4



MODEL	CC	VEHICLE CODE	ENGINE	FROM-TILL	DENSO	GENUINE P/N				QTY		
<b>MITSUOKA</b>												
GALUE CONVERTIBLE	4000	FORD MUSTANG	-	07.4-	IT20	-	-	IT20	VT20	6	AUSTRALIA	
	4600	FORD MUSTANG	-	07.4-	-	-	-	-	-	8	CHINA	
GALUE LIMOUSINE S50	2500	Y50 Rev	VQ25HR	08.11-	FXE20HR11	22401-JD01B	-	-	VFXEH20	6	INDIA	
	3500	PY50 Rev · PNY50 Rev	VQ35HR	08.11-	FXE20HR11	22401-JD01B	-	-	VFXEH20	6	INDONESIA	
GALUE LIMOUSINE S51	3500	PY50 Rev	VQ35HR	08.10-	FXE20HR11	22401-JD01B	-	-	VFXEH20	6	KOREA	
GALUE LIMOUSINE S52	3500	PNY50 Rev	VQ35HR	08.10-	FXE20HR11	22401-JD01B	-	-	VFXEH20	6	PHILIPPINES	
HIMIKO	2000	NCEC	LF-VE	08.12-	ITV20	-	-	ITV20	-	4	SAUDI ARABIA	
K-1/K-2	50	-	MC-1E	98.10-	W24FR-L	-	-	IWF24	-	1	SINGAPORE	
LE SEYDE	2000	-	SR20DE(DOHC)	00.11-06.2	K20R-U	-	K20TT	IK20	VK20	4	TAIWAN	
MC-1	50	MC-1	MC-1E	98.7-	W24FR-L	-	-	IWF24	-	1	THAILAND	
MG-TD	2000	TD2000	3S-FE	04.10-	K20R-U11	-	K20TT	IK20	VK20	4	VIETNAM	
NOUERA	1500	NZE141 · NZE141G · NZE144 · NZE144G	1NZ-FE	08.7-	FK16HR11	90919-01243	-	-	VFKH16	4	JAPAN	
	1800	ZRE142 · ZRE142G · ZRE144 · ZRE144G	2ZR-FE	08.7-	SC16HR11	90919-01275	-	-	VCH16	4	EUROPE & USA	
	2000	CL7 · CL8	K20A(DOHC · i-VTEC)	04.4-08.7	KJ20DR-M11	9807B-5615P	K20TT	IK20	VK20	4	CROSS REFERENCE	
	2400	CL9	K24A(DOHC · i-VTEC)	04.4-08.7	SKJ20DR-M11	9807B-5615W	-	IK20	VK20	4	PART NUMBER	
OROCHI	3300	MSP1	3MZ-FE	07.6-	SK20R11	90919-01210	-	IK20	VK20	6		
OROCHI · KABUTO	3300	-	3MZ-FE	08.9-	SK20R11	90919-01210	-	IK20	VK20	6		
RAY	660	AC6P	F6A(DOHC)	99.9-	XU22EPR-U	-	XU22TT	IXU22	VXU22	3		
		L700S	EF-VE	02.5-	K20TNR-S9	-	K20TT	IK20	VK20	3		
RYOGA	1500	FB15 · FNB15	QG15DE	01.7-	K16PR-U11	-	K16TT	IK16	VK16	4		
	1800	P11 · WP11	SR18DE(DOHC)	98.2-01.6	K16R-U11	-	K16TT	IK16	VK16	4		
		QB15 Rev	QG18DD(NEO D1)	01.7-	PK16R11	-	-	IK16	VK16	4		
	2000	HP11 · HNP11	SR20VE(DOHC)	98.2-01.6	K20PR-U	-	K20TT	IK20	VK20	4		
WHP11 · WHNP11		SR20VE(DOHC)	98.2-01.6	K20PR-U	-	K20TT	IK20	VK20	4			
TYPE F	1800	MS01	BP-ZE(DOHC)	97.5-	K16PR-U11	-	K16TT	IK16	VK16	4		
VIEWT	1000	K11	CG10DE(DOHC)	93.1-05.9	K16PR-U11	-	K16TT	IK16	VK16	4		
	1200	AK12	CR12DE	05.9-	VKH16	-	-	IKH16	VKH16	4		
	1300	HK11	CG13DE(DOHC)	93.1-05.9	K16PR-U11	-	K16TT	IK16	VK16	4		
	1400	BNK12	CR14DE	05.9-	VKH16	-	-	IKH16	VKH16	4		
	1500	YK12	HR15DE	05.9-	FXE20HE11	22401-ED71B	-	-	VFXEH20E	4		
YUGA	1300	AZ10 · Z10	CGA3DE · CG13DE	98-01.10	K16PR-U11	-	K16TT	IK16	VK16	4		
ZERO 1	1800	MS01	BP-ZE(DOHC)	94.1-00.7	K16PR-U11	-	K16TT	IK16	VK16	4		
<b>NISSAN</b>												
180SX	2000	RPS13 · KRPS13	SR20DET(T/C)	91.1-99.1	PK20PR-P8	-	-	-	VK20Y	4		
		RPS13 · KRPS13	SR20DE	96.8-99.1	VK20	-	-	IK20	VK20	4		
AD, AD MAX (VAN, WAGON)	1300	VY10 · WY10 · WY10 · MVY10	GA13DS	90.10-99.5	K16PR-U11	-	K16TT	IK16	VK16	4		
		VY10 · WY10 · WY10 · MVY10	GA13DE	95.6-99.5	K16PR-U11	-	K16TT	IK16	VK16	4		
		VY10	GA13(Rev)LPG	-	K16PR-U11	-	-	-	VK20T(*8)	4		
		VY11	QG13DE	99.6-	K16PR-U11	-	K16TT	IK16	VK16	4		
	1500	VFY10 · VFNY10 · WY10 · WFNY10	GA15DS	90.10-99.5	K16PR-U11	-	K16TT	IK16	VK16	4		
		VFY10 · VFNY10 · WY10 · WFNY10	GA15DE	95.6-99.5	K16PR-U11	-	K16TT	IK16	VK16	4		
		VFGY10 · WFGY10 · MVFY10	GA15DS	92.6-99.5	K16PR-U11	-	K16TT	IK16	VK16	4		
		VFY10	GA15 Rev(LPG)	-	K16PR-U11	-	-	-	VK20T(*8)	4		
		VFY11	QG15DE	99.6-02.8	K16PR-U11(*5)	-	K16TT	IK16(*5)	VK16(*5)	4		
		VFY11	QG15DE	02.8-	K16HPR-U11(*5)	-	-	IKH16(*5)	VKH16(*5)	4		
	1800	VHNY11	QG18DE	99.6-02.8	K16PR-U11(*5)	-	K16TT	IK16(*5)	VK16(*5)	4		
		VHNY11	QG18DE	02.8-	K16HPR-U11(*5)	-	-	IKH16(*5)	VKH16(*5)	4		
	AD,AD EXPERT	1200	VAY12	CR12DE	07.1-	IKH16	-	-	IKH16	VKH16	4	
			VY12	HR15DE	07.1-13.5	FXE20HE11	22401-ED71B	-	-	VFXEH20E	4	
1500		VY12	HR15DE	13.5-16.12	FXE20HE11	22401-ED71B	-	-	VFXEH20E	4		
		VY12	HR15DE	21.5-	FXE20HE11	-	-	-	VFXEH20E	4		
1600		VZNY12	HR16DE	08.12-16.12	FXE20HR11	22401-JD01B	-	-	VFXEH20	4		
		VZNY12	HR16DE	21.5-	FXE20HE11	-	-	-	VFXEH20E	4		
1800		VJY12	MR18DE	07.1-	FXE20HR11	22401-JD01B	-	-	VFXEH20	4		
ATLAS		2000	SK2F23 · SK4F23	NA20/S	92.2-99.6	W16EXR-U11	-	W16TT	IW16	VW16	4	
			SH2F23 · SH4F23	KA20DE	99.6-07.6	K16PR-U11	-	K16TT	IK16	VK16	4	
			SQ1F24 · SQ2F24	QR20DE	07.6-	FXE20HR11	22401-JD01B	-	-	VFXEH20	4	
AVENIR/ SALUT	1600	VEW10 · VENW10	GA16DS	90.5-99.6	K16PR-U11	-	K16TT	IK16	VK16	4		
		W10	SR18Di · SR18DE	90.5-98.8	K16R-U	-	K16TT	IK16	VK16	4		
	1800	W11	QG18DE	98.8-02.7	K16PR-U11(*5)	-	K16TT	IK16(*5)	VK16(*5)	4		
		W11	QG18DE	02.8-	K16HPR-U11(*5)	-	-	IKH16(*5)	VKH16(*5)	4		
	2000	PW10 · PNW10	SR20DE	94.11-98.8	K16PR-U	-	K16TT	IK16	VK16	4		
		PNW10	SR20DET(T/C)	95.8-98.8	PK20PR-P8	-	-	-	VK20Y	4		
		PNW11 · PW11	SR20DE	98.8-02.7	K16R-U11	-	K16TT	IK16	VK16	4		
2000	PNW11 · PW11	QR20DE	02.8-	K16HPR-U11	-	-	IKH16	VKH16	4			
	PNW11	SR20DET(T/C)	98.8-02.7	PK20PR-P8	-	-	-	VK20Y	4			

(\*5)The plug reach may be 19mm or 26.5mm even with the same engine and the same vehicle code. Please confirm the plug reach and choose the correct DENSO type. If there is an "H" in DENSO type, it has a reach of 26.5mm. If it doesn't, its reach is 19mm. (\*8)This is IRIDIUM PLUS.



# JAPAN CAR

▶ Spark plug color codes: ■ for Iridium Tough and Iridium Plugs and Iridium TT, ■ for Iridium Power, ■ for Iridium Racing and Two Tops Plugs, ■ for Platinum Plugs and Platinum TT, and black for general spark plugs.

AUSTRALIA	MODEL	CC	VEHICLE CODE	ENGINE	FROM-TILL	DENSO	GENUINE P/N						QTY	
AUSTRALIA	NISSAN BASSARA	2400	JU30 · JNU30	KA24DE	99.11-01.7	K16PR-U11	-	K16TT	IK16	VK16			4	
		2500	JTU30 · JTNU30	QR25DE(NEO)	01.8-	K16HPR-U11	-	-	IKH16	VKH16			4	
		3000	JHU30	VQ30DE(LEV)	99.11-	VK16	-	-	IK16	VK16			6	
CHINA	Be-1 BLUEBIRD	1000	BK10	MA10	87.1-02.2	W16EX-U11	-	W16TT	IW16	VW16			4	
			PJ811 · PJ910 · KP900 · P910	Z18P(LPG)	79.2-01.8	W20EX-U	-	-	-	VW20T(*8)			8	
			PC910	Z18P(LPG)	88.2-01.8	VW20T(*8)	-	-	-	VW20T(*8)			8	
INDIA	Be-1 BLUEBIRD	1800	EU14	SR18DE(LEANBURN)	96.1-98.9	VK16	-	-	IK16	VK16			4	
			ENU14	SR18DE	96.1-01.8	K16R-U11	-	K16TT	IK16	VK16			4	
			QU14	QG18DE(LEANBURN)	98.9-01.8	K16PR-U11	-	K16TT	IK16	VK16			4	
INDONESIA	Be-1 BLUEBIRD SYLPHY	2000	HU14 · HNU14	SR20DE	96.1-00.8	K16R-U11	-	K16TT	IK16	VK16			4	
			HU14	SR20VE	97.9-00.8	K20PR-U	-	K20TT	IK20	VK20			4	
			FG10	QG15DE	00.8-03.2	K16PR-U11	-	K16TT	IK16	VK16			4	
KOREA	Be-1 BLUEBIRD SYLPHY	1500	FG10	QG15DE	03.2-05.12	K16HPR-U11	-	-	IKH16	VKH16			4	
			G11 · NG11	HR15DE	05.12-	FXE20HE11	22401-ED71B	-	-	-	VFXEH20E			4
			QG10 · QNG10	QG18DE	00.8-03.1	K16PR-U11(*5)	-	K16TT	IK16(*5)	VK16(*5)			4	
MALAYSIA	CARAVAN	2000	QG10 · QNG10	QG18DE	03.2-05.12	K16HPR-U11(*5)	-	-	IKH16(*5)	VKH16(*5)			4	
			TG10	QR20DD(NEO-Di)	00.8-05.12	-	-	-	-	-			4	
			KG11	MR20DE	05.12-	FXE20HR11	22401-JD01B	-	-	-	VFXEH20			4
PHILIPPINES	CARAVAN	2000	VTE24 · VTGE24 · CTGE24	NA20S	90.8-99.6	VW16	-	-	IW16	VW16			4	
			DTGE24 · FTGE24	NA20S	90.8-99.6	VW16	-	-	IW16	VW16			4	
			CPGE24 · VPE24 · VPGE24	KA20DE	99.6-07.8	K16PR-U11	-	K16TT	IK16	VK16			4	
SAUDI ARABIA	CARAVAN	2000	VPE25	KA20DE	01.4-07.8	K16PR-U11	-	K16TT	IK16	VK16			4	
			VPE25(LPG)	KA20DE	01.4-07.8	K16PR-U11	-	K16TT	IK16	VK16			4	
			VPE25(CNG)	KA20DE	01.4-07.8	-	-	-	-	-			4	
SINGAPORE	CARAVAN	2400	VRE25	QR20DE	07.8-	FXE20HR11	22401-JD01B	-	-	VFXEH20			6	
			VRE25	QR20DE	07.8-	FXE20HR11	22401-JD01B	-	-	-	VFXEH20			4
			VR2E26	QR20DE	21.10-	FXE20HR11	-	-	-	VFXEH20			4	
TAIWAN	CARAVAN	2500	CQGE24	KA24DE	99.6-01.3	K16PR-U11	-	K16TT	IK16	VK16			4	
			CQGE25	KA24DE	01.4-07.8	K16PR-U11	-	K16TT	IK16	VK16			4	
			DQGE25	KA24DE	01.4-07.8	K16PR-U11	-	K16TT	IK16	VK16			4	
THAILAND	CARAVAN	3000	QGE25	KA24DE	01.4-07.8	K16PR-U11	-	K16TT	IK16	VK16			4	
			QE25	KA24DE	03.5-07.8	K16PR-U11	-	K16TT	IK16	VK16			4	
			CSGE25 · DSGE25 · SGE25 · SE25	QR25DE	07.8-	FXE20HR11	22401-JD01B	-	-	-	VFXEH20			4
VIETNAM	CEDRIC	2000	CS4E26	QR25DE	21.10-	FXE20HE11	22401-ED71B	-	-	VFXEH20E			4	
			CS8E26	QR25DE	21.10-	FXE20HE11	22401-ED71B	-	-	VFXEH20E			4	
			KS2E26	QR25DE	21.10-	FXE20HE11	22401-ED71B	-	-	VFXEH20E			4	
JAPAN	CEDRIC	2500	KS4E26	QR25DE	21.10-	FXE20HE11	22401-ED71B	-	-	VFXEH20E			4	
			KS6E26	QR25DE	21.10-	FXE20HE11	22401-ED71B	-	-	VFXEH20E			4	
			KS8E26	QR25DE	21.10-	FXE20HE11	22401-ED71B	-	-	VFXEH20E			4	
EUROPE & USA	CEDRIC	3000	DS4E26	QR25DE	21.10-	FXE20HE11	22401-ED71B	-	-	VFXEH20E			4	
			DS8E26	QR25DE	21.10-	FXE20HE11	22401-ED71B	-	-	VFXEH20E			4	
			KEE24 · AEGE24	VG30E	88.10-89.8	VK20	-	-	-	IK20	VK20			6
CROSS REFERENCE NUMBER	CEDRIC	2000	KEE24 · AEGE24	VG30E	89.9-90.10	VK16	-	-	IK16	VK16			6	
			KEE24 · AEGE24 · FEGE24	VG30E	90.10-01.3	VK20	-	-	-	IK20	VK20			6
			Y31 · KY31 · Y32	VG20E	89.6-99.6	Q16PR-U11	-	-	-	IQ16	VQ16			6
PART NUMBER	CEDRIC	2000	Y33	VG20E	96.1-99.6	Q16PR-U11	-	-	IQ16	VQ16			6	
			MJY31 · CMJY31	RB20P(LPG)	89.6-99.6	VK20T(*8)	-	-	-	VK20T(*8)			6	
			QJY31	NA20P(LPG)	91.6-10.9	VW20T(*8)	-	-	-	VW20T(*8)			4	
PART NUMBER	CEDRIC	2500	QJY31	NA20PE	10.9-	FXE20HR11	22401-JD01B	-	-	VFXEH20			4	
			CBJY31 · BJY31	VG20P(LPG)	04.1-04.9	PK20PR11	-	-	-	IK20	VK20T(*8)			6
			ENY33	RB25DET(T/C)	97.6-99.6	VK16	-	-	-	IK16	VK16			6
PART NUMBER	CEDRIC	3000	ENY34	RB25DET(T/C)	99.6-04.9	VK20	-	-	IK20	VK20			6	
			MY33	VQ25DE	97.6-99.6	VK16	-	-	-	IK16	VK16			6
			MY34	VQ25DD(NEO-Di)	99.6-01.12	VK16(*5)	-	-	-	IK16(*5)	VK16(*5)			6
PART NUMBER	CEDRIC	3000	MY34	VQ25DD(NEO-Di)	02.1-04.9	IKH16(*5)	-	-	IKH16(*5)	VKH16(*5)			6	
			PY30 · PY31 · PY32 · PY33 · YPY30 · YPY31 · PAY31	VG30E	95.6-99.6	Q16PR-U11	-	-	-	IQ16	VQ16			6
			HY33 · HBY33	VQ30DE	95.6-99.6	VK16	-	-	-	IK16	VK16			6
PART NUMBER	CEDRIC	3000	HY33 · HBY33	VQ30DET(T/C)	95.6-99.6	VK20	-	-	IK20	VK20			6	
			HY34	VQ30DET(T/C)	99.6-01.12	VK20	-	-	-	IK20	VK20			6
			HY34	VQ30DD(NEO-Di)	99.6-01.12	VK16(*5)	-	-	-	IK16(*5)	VK16(*5)			6
PART NUMBER	CEFIRO/WAGON	2000	HY34	VQ30DD(NEO-Di)	02.1-04.9	IKH16(*5)	-	-	IKH16(*5)	VKH16(*5)			6	
			A32	VQ20DE	94.8-98.12	VK16	-	-	-	IK16	VK16			6
			WA32	VQ20DE	97.6-01.2	VK16	-	-	-	IK16	VK16			6
PART NUMBER	CEFIRO/WAGON	2500	A33	VQ20DE(LEANBURN)	98.12-03.2	VK16	-	-	IK16	VK16			6	
			PA32	VQ25DE	94.8-98.12	VK16	-	-	-	IK16	VK16			6
			WPA32	VQ25DE	97.6-03.2	VK16	-	-	-	IK16	VK16			6

(\*5)The plug reach may be 19mm or 26.5mm even with the same engine and the same vehicle code. Please confirm the plug reach and choose the correct DENSO type. If there is an "H" in DENSO type, it has a reach of 26.5mm. If it doesn't, its reach is 19mm. (\*8)This is IRIDIUM PLUS.



MODEL	CC	VEHICLE CODE	ENGINE	FROM-TILL	DENSO	GENUINE P/N				QTY		
<b>NISSAN</b>												
CEFIRO/WAGON	2500	PA33	VQ25DD(NEO-Di)	98.12-03.2	VK16	-	-	IK16	VK16	6	AUSTRALIA	
	3000	HA32	VQ30DE	94.6-01.2	VK16	-	-	IK16	VK16	6	CHINA	
		WHA32	VQ30DE	97.6-99.10	VK16	-	-	IK16	VK16	6		
CIMA	3000	FHY33	VQ30DET(T/C)	96.6-01.1	VK20	-	-	IK20	VK20	6	INDIA	
		HF50	VQ30DET(T/C)	01.1-10.8	VK20	-	-	IK20	VK20	6		
	4100	FGY33 • FGDY33 • FGNY33	VH41DE	96.6-01.1	VK16	-	-	IK16	VK16	8		
	4500	GF50 • GNF50	VK45DD(NEO-Di)	01.1-03.8	IKH16	-	-	IKH16	VKH16	8		
		GF50	VK45DE	03.8-10.8	VKH16	-	-	IKH16	VKH16	8		
CIMAHYBRID	3500	HGY51	VQ35HR	12.5-	FXE22HR11	22401-EW61C	-	-	VFXEH22	6		
CIVILIAN	4500	DJW41 • DHW41	TB45E	04.9-	W16EPR-U11	-	W16TT	IW16	VW16	6		
CLIPPER	660	U71T • U71TP • U71V • U72T • U72TP • U72V	3G83	03.10-12.1	KJ20CR-U11	-	K20TT	IK20	VK20	3		
CLIPPER RIO	660	U71W	3G83	07.6-	KJ20CR-U11	-	K20TT	IK20	VK20	3	INDONESIA	
		U72W	3G83(T/C)	07.6-	SVK20RZ8	MN122257	-	-	VK20Y	3		
CONDOR	2000	SK2F23 • SK4F23	NA20	95.6-99.6	W16EXR-U11	-	W16TT	IW16	VW16	4	KOREA	
		SH2F23 • SH4F23	KA20DE	99.6-	K16PR-U11	-	K16TT	IK16	VK16	4		
	4400	BKR81 • BPR72	4HF1(CNG)	04.7-	-	-	-	-	-	4		
	7000	LK25A • MK25A • PK25A	FU6(CNG)	03.7-	-	-	-	-	-	6		
CREW	2000	HK30 • THK30	RB20E	94.1-02.6	Q16PR-U11	-	-	IQ16	VQ16	6	MALAYSIA	
		QK30	NA20P(LPG)	93.7-98.6	VW20T(*8)	-	-	-	VW20T(*8)	4		
		QK30	NA20P(LPG)	98.6-	VW20T(*8)	-	-	-	VW20T(*8)	4		
CUBE	1300	Z10	CG13DE	98.2-99.11	K16PR-U11	-	K16TT	IK16	VK16	4	PHILIPPINES	
		AZ10 • ANZ10	CGA3DE	99.11-01.4	K16PR-U11	-	K16TT	IK16	VK16	4		
		AZ10 • ANZ10	CGA3DE	01.5-02.10	K20PR-U11	-	K20TT	IK20	VK20	4		
	1400	BZ11 • BNZ11 • BGZ11	CR14DE	02.10-	IKH16	-	-	IKH16	VKH16	4		
		YZ11 • YGZ11 • YGNZ11	HR15DE	05.5-08.11	FXE20HE11	22401-ED71B	-	-	VFXEH20E	4		
1500	Z12 • NZ12	HR15DE	08.11-	FXE20HE11	22401-ED71B	-	-	VFXEH20E	4			
	1400	BGZ11	CR14DE	03.9-08.10	IKH16	-	-	IKH16	VKH16	4	SAUDIARABIA	
1500		YGZ11 • YGNZ11	HR15DE	05.5-08.11	FXE20HE11	22401-ED71B	-	-	VFXEH20E	4		
DATSUN (PICKUP TRUCK)	2000	QD22	NA20S	97.1-99.6	W16EXR-U	-	W16TT	IW16	VW16	4	SINGAPORE	
		PD22 • PLD22	KA20DE	99.6-	K16PR-U11	-	K16TT	IK16	VK16	4		
	2400	LFMD22	KA24E	97.1-99.6	K16GPR-U11	-	-	-	VKA16	4		
		LFD22 • LFMD22	KA24DE	99.6-	K16PR-U11	-	K16TT	IK16	VK16	4		
DAYZ	660	B21W	3B20(IRIDIUM PLUGS INSTALLED VEHICLES)	13.6-14.7	-	-	-	IXUH20I	VXUH20I	3	TAIWAN	
		B21W	3B20(Except IRIDIUM PLUGS INSTALLED VEHICLES)	13.6-14.7	-	-	XUH20TTI	IXUH20I	VXUH20I	3		
		B21W	3B20(T/C,IRIDIUM PLUGS INSTALLED VEHICLES)	13.8-14.7	SXU22HDR8	1822A010	-	-	IXUH22	VXUH22		3
		B21W	3B20(T/C,Except IRIDIUM PLUGS INSTALLED VEHICLES)	13.8-14.7	XU22HDR9	1822A009	XUH22TT	IXUH22	VXUH22	3		
		B21W	3B20	14.7-17.1	-	-	-	IXUH20I	VXUH20I	3		
		B21W	3B20(T/C)	14.7-19.3	SXU22HDR8	1822A010	-	-	IXUH22	VXUH22		3
		B21W	3B20	17.1-19.3	-	-	-	IXUH20I	VXUH20I	3		
		B43W	BR06	19.3-	-	-	-	-	VSUEH22	3		
		B46W	BR06	19.3-	-	-	-	-	VSUEH22	3		
		B44W	BR06	19.3-	-	-	-	-	VSUEH22	3		
DAYZ HYBRID	660	B45W	BR06(T/C)	19.3-	-	-	-	VSUEH22	3	THAILAND		
		B47W	BR06	19.3-	-	-	-	VSUEH22	3			
		B48W	BR06(T/C)	19.3-	-	-	-	VSUEH22	3			
		B21A	3B20(T/C)	14.2-	SXU22HDR8	1822A010	-	IXUH22	VXUH22		3	
DAYZ ROOX	660	B21A	3B20	14.2-	-	-	-	IXUH20I	VXUH20I	3	VIETNAM	
		B21A	3B20	14.2-	-	-	-	IXUH20I	VXUH20I	3		
DUALIS	2000	J10 • NJ10	MR20DE	07.5-08.5	FXE20HR11	22401-JD01B	-	-	VFXEH20	4	JAPAN	
		KJ10 • KNJ10	MR20DE	08.5-	FXE20HR11	22401-JD01B	-	-	VFXEH20	4		
ELGRAND	2500	E51 • NE51 • ME51 • MNE51	VQ25DE	04.12-10.8	VKH16	-	-	IKH16	VKH16	6	EUROPE & USA	
		TE52 • TNE52	QR25DE	10.8-	FXE20HR11	22401-JD01B	-	-	VFXEH20	4		
	3300	ALE50 • ALWE50	VG33E	97.5-00.8	K16PR-U11	-	K16TT	IK16	VK16	6		
	3500	APE50 • APWE50 • E51 • NE51	VQ35DE	00.8-10.8	VKH16	-	-	IKH16	VKH16	6		
PE52 • PNE52		VQ35DE	10.8-	FXE22HR11	22401-EW61C	-	-	VFXEH22	6			
EXPERT	1800	VW11 • VNW11	QG18DE	99.6-02.8	K16PR-U11(*5)	-	K16TT	IK16(*5)	VK16(*5)	4	CROSS REFERENCE NUMBER	
		VW11 • VNW11	QG18DEN(CNG)	00.1-	IK22	-	-	IK22	VK22	4		
		VW11 • VNW11	QG18DE	02.8-	K16HPR-U11(*5)	-	-	IKH16(*5)	VKH16(*5)	4		
FAIRLADY Z	3000	Z32 • GZ32 • HZ32	VG30DE	89.7-02.7	VK20	-	-	IK20	VK20	6	PART NUMBER	
		CZ32 • GCZ32	VG30DETT(T/C)	89.7-02.7	VK20	-	-	IK20	VK20	6		
	3500	Z33 • HZ33	VQ35DE	02.7-07.1	VKH16	-	-	IKH16	VKH16	6		
		Z33 • HZ33	VQ35HR	07.1-08.12	FXE22HR11	22401-EW61C	-	-	VFXEH22	6		
	3700	Z34 • HZ34	VQ37VHR	08.12-	FXE24HR11	22401-JK01D	-	-	-	6		
FUGA	2500	Y50	VQ25DE	04.10-07.12	VKH16	-	-	IKH16	VKH16	6		

(\*5)The plug reach may be 19mm or 26.5mm even with the same engine and the same vehicle code.Please confirm the plug reach and choose the correct DENSO type. If there is an"H" in DENSO type,it has a reach of 26.5mm. If it doesn't ,its reach is 19mm. (\*8)This is IRIDIUM PLUS.



MODEL	CC	VEHICLE CODE	ENGINE	FROM-TILL	DENSO	GENUINE P/N				QTY	
AUSTRALIA	<b>NISSAN FUGA</b>										
	2500	Y50	VQ25HR	07.12-09.11	<b>FXE22HR11</b>	22401-EW61C -	-	-	<b>VFXEH22</b>	6	
		Y51	VQ25HR	09.11-	<b>FXE22HR11</b>	22401-EW61C -	-	-	<b>VFXEH22</b>	6	
	3500	PY50 • PNY50	VQ35DE	04.10-07.12	<b>VKH16</b>	-	-	<b>IKH16</b>	<b>VKH16</b>	6	
PY50 • PNY50		VQ35HR	07.12-09.11	<b>FXE22HR11</b>	22401-EW61C -	-	-	<b>VFXEH22</b>	6		
CHINA	3700	KY51 • KNY51	VQ37VHR	09.11-	<b>FXE24HR11</b>	22401-JK01D -	-	-	-	6	
	4500	GY50	VK45DE	05.8-09.11	<b>VKH16</b>	-	-	<b>IKH16</b>	<b>VKH16</b>	8	
	FUGA HYBRID	3500	HY51	VQ35HR(HYBRID)	10.1-	<b>FXE22HR11</b>	22401-EW61C -	-	-	<b>VFXEH22</b>	6
		<b>GLORIA</b>									
INDIA	2000	Y31 • KY31 • Y32	VG20E	89.6-99.6	<b>Q16PR-U11</b>	-	-	<b>IQ16</b>	<b>VQ16</b>	6	
		Y33	VG20E	96.1-99.6	<b>Q16PR-U11</b>	-	-	<b>IQ16</b>	<b>VQ16</b>	6	
		MJY31 • CMJY31	RB20P(LPG)	89.6-99.6	<b>VK20T(*8)</b>	-	-	-	<b>VK20T(*8)</b>	6	
		QJY31	NA20P(LPG)	91.6-	<b>VW20T(*8)</b>	-	-	-	<b>VW20T(*8)</b>	4	
INDONESIA	2500	CBJY31 • BJY31	VG20P(LPG)	04.1-04.9	<b>PK20PR11</b>	-	-	<b>IK20</b>	<b>VK20T(*8)</b>	6	
		ENY33	RB25DET(T/C)	97.6-99.6	<b>VK16</b>	-	-	<b>IK16</b>	<b>VK16</b>	6	
		ENY34	RB25DET(T/C)	99.6-04.9	<b>VK20</b>	-	-	<b>IK20</b>	<b>VK20</b>	6	
		MY33	VQ25DE	97.6-99.6	<b>VK16</b>	-	-	<b>IK16</b>	<b>VK16</b>	6	
KOREA	2500	MY34	VQ25DD(NEO-Di)	99.6-01.12	<b>VK16(*5)</b>	-	-	<b>IK16(*5)</b>	<b>VK16(*5)</b>	6	
		MY34	VQ25DD(NEO-Di)	02.1-04.9	<b>IKH16(*5)</b>	-	-	<b>IKH16(*5)</b>	<b>VKH16(*5)</b>	6	
		PY30 • PY31 • PY32 • PY33 • YPY30 • YPY31 • PAY31	VG30E	95.6-99.6	<b>Q16PR-U11</b>	-	-	<b>IQ16</b>	<b>VQ16</b>	6	
		HY33 • HBY33	VQ30DE	95.6-99.6	<b>VK16</b>	-	-	<b>IK16</b>	<b>VK16</b>	6	
MALAYSIA	3000	HY33 • HBY33	VQ30DET(T/C)	95.6-99.6	<b>VK20</b>	-	-	<b>IK20</b>	<b>VK20</b>	6	
		HY34	VQ30DET(T/C)	99.6-01.12	<b>VK20</b>	-	-	<b>IK20</b>	<b>VK20</b>	6	
		HY34	VQ30DD(NEO-Di)	99.6-01.12	<b>VK16(*5)</b>	-	-	<b>IK16(*5)</b>	<b>VK16(*5)</b>	6	
		HY34	VQ30DD(NEO-Di)	02.1-04.9	<b>IKH16(*5)</b>	-	-	<b>IKH16(*5)</b>	<b>VKH16(*5)</b>	6	
PHILIPPINES	3800	R35	VR38DETT(T/C)	07.12-	<b>VDCH22F</b>	-	-	-	<b>VDCH22F</b>	6	
SAUDIARABIA	<b>GT-R</b>										
	<b>HOMY</b>										
	2000	VTE24 • VTGE24 • CTGE24	NA20S	90.8-99.6	<b>VW16</b>	-	-	<b>IW16</b>	<b>VW16</b>	4	
		DTGE24 • FTGE24	NA20S	90.8-99.6	<b>VW16</b>	-	-	<b>IW16</b>	<b>VW16</b>	4	
	3000	KEE24 • AEGE24	VG30E	88.10-89.8	<b>VK20</b>	-	-	<b>IK20</b>	<b>VK20</b>	6	
KEE24 • AEGE24		VG30E	89.9-90.10	<b>VK16</b>	-	-	<b>IK16</b>	<b>VK16</b>	6		
	KEE24 • AEGE24 • FEGE24	VG30E	90.10-01.3	<b>VK20</b>	-	-	<b>IK20</b>	<b>VK20</b>	6		
SINGAPORE	4500	G50 • HG50	VH45DE	89.11-97.9	<b>VK20</b>	-	-	<b>IK20</b>	<b>VK20</b>	8	
TAIWAN	<b>INFINITI Q45</b>										
	<b>JUKE</b>										
	1500	F15 • NF15	MR16DDT(T/C)	10.11-14.9	-	-	-	-	-	4	
		F15	MR16DDT(T/C)	14.9-	-	-	-	-	-	4	
1600	NF15	MR16DDT(T/C)	14.9-	-	-	-	-	-	4		
	NF15	MR16DDT(T/C)	14.9-	-	-	-	-	-	4		
THAILAND	1600	NF15	MR16DDT(T/C)	14.11-	-	-	-	-	4		
VIETNAM	660	H59A	4A30(T/C)	08.11-	<b>SXU22PR-A9</b>	-	-	<b>IXU22</b>	<b>VXU22</b>	4	
	1200	P15	HR12DE	20.6-	<b>FXE20HR11</b>	-	-	-	<b>VFXEH20</b>	3	
	2000	B30 • NB30	MR20DE	04.12-05.11	<b>ZXE20HR13</b>	22401-EN215 -	-	-	<b>VFXEH20</b>	4	
		B30 • NB30	MR20DE	05.12-	<b>FXE20HR11</b>	22401-JD01B -	-	-	<b>VFXEH20</b>	4	
		CWEFWN(2WD)	LF-VD(DOHC DISI)	11.6-	<b>ITV20</b>	-	-	<b>ITV20</b>	-	4	
LAFESTA		CWEFWN(2WD)	LF-VDS(DOHC DISI)	11.6-	<b>ITV20</b>	-	-	<b>ITV20</b>	-	4	
	2000	CWEAWN(4WD)	LF-VE	11.6-13.3	<b>ITV20</b>	-	-	<b>ITV20</b>	-	4	
		CWEAWN	LF-VE	13.3-	<b>ITV16</b>	-	-	<b>ITV16</b>	-	4	
		CWFFWN	PE-VPS	13.3-	<b>ZC20HPR11</b>	PE5S 18 110 -	-	-	<b>VCH20</b>	4	
JAPAN	2400	W30 • CW30 • NW30 • NCW30	KA24DE	93.5-99.6	<b>K16PR-U</b>	-	<b>K16TT</b>	<b>IK16</b>	<b>VK16</b>	4	
	1200	N17	HR12DE	12.10-	<b>FXE20HR11</b>	22401-JD01B -	-	-	<b>VFXEH20</b>	3	
EUROPE & USA	<b>LARGO</b>										
	<b>LATIO</b>										
	<b>LAUREL</b>										
	2000	HC33 • HCC33 • HC34	RB20DE/DET(T/C)	88.12-97.6	<b>VQ16</b>	-	-	<b>IQ16</b>	<b>VQ16</b>	6	
		HC33 • HC34	RB20E	89.1-97.6	<b>Q16PR-U11</b>	-	-	<b>IQ16</b>	<b>VQ16</b>	6	
		HC35	RB20DE(LEANBURN)	97.6-	<b>VK16</b>	-	-	<b>IK16</b>	<b>VK16</b>	6	
		HC35	RB20DE	97.6-	<b>VK16</b>	-	-	<b>IK16</b>	<b>VK16</b>	6	
	2500	GC34 • GCC34 • GNC34	RB25DE/DET(T/C)	93.1-97.6	<b>VK16</b>	-	-	<b>IK16</b>	<b>VK16</b>	6	
		GC35 • GNC35	RB25DE	97.6-	<b>VK16</b>	-	-	<b>IK16</b>	<b>VK16</b>	6	
		GC35 • GCC35	RB25DET(T/C)	97.6-	<b>VK16</b>	-	-	<b>IK16</b>	<b>VK16</b>	6	
LEOPARD	2000	JY33	VG20E	97.1-99.6	<b>Q16PR-U11</b>	-	-	<b>IQ16</b>	<b>VQ16</b>	6	
	2500	JENY33	RB25DET(T/C)	97.10-99.6	<b>VK16</b>	-	-	<b>IK16</b>	<b>VK16</b>	6	
		JMY33	VQ25DE	97.10-99.6	<b>VK16</b>	-	-	<b>IK16</b>	<b>VK16</b>	6	
	3000	JPY33	VG30E	96.3-97.12	<b>Q16PR-U11</b>	-	-	<b>IQ16</b>	<b>VQ16</b>	6	
		JHY33	VQ30DE	96.3-99.6	<b>VK16</b>	-	-	<b>IK16</b>	<b>VK16</b>	6	
		JHBY33 • JHY33	VQ30DET	96.3-99.6	<b>VK20</b>	-	-	<b>IK20</b>	<b>VK20</b>	6	
	JHY33	VQ30DD(NEO-Di)	97.10-99.6	<b>VK16</b>	-	-	<b>IK16</b>	<b>VK16</b>	6		
CROSS REFERENCE NUMBER	<b>LIVERTY LUCINO</b>										
	2000	RM12 • RNM12	QR20DE	01.5-04.12	<b>K16HPR-U11</b>	-	-	<b>IKH16</b>	<b>VKH16</b>	4	
		1500	FN15 • FNN15	GA15DE	95.1-	<b>K16PR-U11</b>	-	<b>K16TT</b>	<b>IK16</b>	<b>VK16</b>	4
	1600	EN15	GA16DE	95.1-	<b>K16PR-U11</b>	-	<b>K16TT</b>	<b>IK16</b>	<b>VK16</b>	4	
		JN15(VZ-R)	SR16VE(VVL)	97.9-	<b>K20PR-U</b>	-	<b>K20TT</b>	<b>IK20</b>	<b>VK20</b>	4	
JN15(VZ-R • N1)		SR16VE(VVL)	97.9-	<b>VK22</b>	-	-	<b>IK22</b>	<b>VK22</b>	4		
1800	HN15	SR18DE	92.8-	<b>K16R-U</b>	-	<b>K16TT</b>	<b>IK16</b>	<b>VK16</b>	4		
	HN15	SR18DE	98.10-	<b>K16R-U11</b>	-	<b>K16TT</b>	<b>IK16</b>	<b>VK16</b>	4		

(\*5)The plug reach may be 19mm or 26.5mm even with the same engine and the same vehicle code.Please confirm the plug reach and choose the correct DENSO type. If there is an"H" in DENSO type,it has a reach of 26.5mm. If it doesn't ,its reach is 19mm. (\*8)This is IRIDIUM PLUS.



MODEL	CC	VEHICLE CODE	ENGINE	FROM-TILL	DENSO	GENUINE P/N	<b>T-T</b>	<b>IRIDIUM POWER</b>	<b>IRIDIUM TOUGH</b>	QTY		
<b>NISSAN</b>												
<b>LUCINO COUPE</b>	1500	FB14	GA15DE	94.1-98.10	K16PR-U11	-	<b>K16TT</b>	<b>IK16</b>	<b>VK16</b>	4	AUSTRALIA	
	1600	JB14	SR16VE	97.9-98.10	K20PR-U	-	<b>K20TT</b>	<b>IK20</b>	<b>VK20</b>	4		
	1800	HB14	SR18DE	94.1-97.5	K16R-U	-	<b>K16TT</b>	<b>IK16</b>	<b>VK16</b>	4		
<b>LUCINO S-RV</b>	1500	FN15 • FNN15	GA15DE	96.5-	K16PR-U11	-	<b>K16TT</b>	<b>IK16</b>	<b>VK16</b>	4	CHINA	
	1600	JN15	SR16VE	97.9-	K20PR-U	-	<b>K20TT</b>	<b>IK20</b>	<b>VK20</b>	4		
	1800	HNN15(4WD)	SR18DE	96.5-	K16R-U11	-	<b>K16TT</b>	<b>IK16</b>	<b>VK16</b>	4		
		HNN15(2WD)	SR18DE	96.5-	K16R-U	-	<b>K16TT</b>	<b>IK16</b>	<b>VK16</b>	4		
<b>MARCH</b>	1000	K11 • WK11	CG10DE	92.1-02.2	K16PR-U11	-	<b>K16TT</b>	<b>IK16</b>	<b>VK16</b>	4	INDIA	
		K12	CR10DE	02.3-03.6	<b>IKH16</b>	-	-	<b>IKH16</b>	<b>VKH16</b>	4		
	1200	AK12	CR12DE	02.3-08.7	<b>IKH16</b>	-	-	<b>IKH16</b>	<b>VKH16</b>	4		
		K13 • NK13	HR12DE	10.7-	<b>FXE20HR11</b>	22401-JD01B	-	-	<b>VFXEH20</b>	3		
	1300	HK11 • FHK11	CG13DE	92.1-99.11	K16PR-U11	-	<b>K16TT</b>	<b>IK16</b>	<b>VK16</b>	4	INDONESIA	
		AK11 • ANK11 • WAK11	CGA3DE	99.11-02.2	K16PR-U11	-	<b>K16TT</b>	<b>IK16</b>	<b>VK16</b>	4		
		BK12(Except 14S)	CR14DE	02.3-05.8	<b>IKH16</b>	-	-	<b>IKH16</b>	<b>VKH16</b>	4		
	1400	BNK12	CR14DE	02.9-10.7	<b>IKH16</b>	-	-	<b>IKH16</b>	<b>VKH16</b>	4		
		BK12(14S)	CR14DE	03.7-05.8	<b>VKH20</b>	-	-	<b>IKH20</b>	<b>VKH20</b>	4		
	1500	YK12	HR15DE	05.8-10.7	<b>FXE20HE11</b>	22401-ED71B	-	-	<b>VFXEH20E</b>	4	KOREA	
	<b>MICRA C+C MOCO</b>	1600	FHZK12	HR16DE	07.7-	<b>FXE20HR11</b>	22401-JD01B	-	-	<b>VFXEH20</b>	4	
			MG21S	K6A(T/C)	02.4-06.2	<b>IXU22C</b>	-	-	<b>IXU22</b>	<b>VXU22</b>	3	
			MG21S(4WD)	K6A	02.4-06.2	<b>XU22EPR-U</b>	-	<b>XU22TT</b>	<b>IXU22</b>	<b>VXU22</b>	3	
			MG21S(2WD)	K6A	02.4-06.2	<b>IXU22C</b>	-	-	<b>IXU22</b>	<b>VXU22</b>	3	
660		MG22S	K6A(DOHC)	06.2-09.6	<b>IXU22C(*5)</b>	-	-	<b>IXU22(*5)</b>	<b>VXU22(*5)</b>	3	MALAYSIA	
		MG22S	K6A(DOHC)	09.6-11.2	<b>IXU22HPR(*5)</b>	09482-00608	-	<b>IXUH22(*5)</b>	<b>VXUH22(*5)</b>	3		
		MG22S	K6A(T/C)	06.2-11.2	<b>IXU22C(*5)</b>	-	-	<b>IXU22(*5)</b>	<b>VXU22(*5)</b>	3		
		MG33S	R06A	11.2-	-	-	-	-	<b>VSUEH22</b>	3	PHILIPPINES	
MG33S		R06A(T/C)	11.2-	-	-	-	-	<b>VSUEH22</b>	3	SAUDIARABIA		
<b>MURANO</b>	2500	TZ50	QR25DE	04.9-08.9	K16HPR-U11	-	-	<b>IKH16</b>	<b>VKH16</b>	4	SINGAPORE	
		TNZ51 • TZ51	QR25DE	08.9-	<b>FXE20HR11</b>	22401-JD01B	-	-	<b>VFXEH20</b>	4		
	3500	PNZ50 • PZ50	VQ35DE	04.9-08.9	<b>VKH16</b>	-	-	<b>IKH16</b>	<b>VKH16</b>	6	THAILAND	
PNZ51		VQ35DE	08.9-	<b>FXE22HR11</b>	22401-EW61C	-	-	<b>VFXEH22</b>	6	VIETNAM		
<b>NOTE</b>	1200	E12	HR12DE	12.9-20.12	<b>FXE20HR11</b>	22401-JD01B	-	-	<b>VFXEH20</b>	3		
		E12	HR12DDR(S/C)	12.9-20.12	-	-	-	-	-	3		
		NE12	HR12DE	12.9-20.12	<b>FXE20HR11</b>	22401-JD01B	-	-	<b>VFXEH20</b>	3		
	1500	E11 • NE11	HR15DE	05.1-12.9	<b>FXE20HE11</b>	22401-ED71B	-	-	<b>VFXEH20E</b>	4		
	1600	ZE11	HR16DE	08.10-12.9	<b>FXE20HR11</b>	22401-JD01B	-	-	<b>VFXEH20</b>	4		
		E12(Rev)	HR16DE	14.10-20.12	<b>FXE20HE11</b>	22401-ED71B	-	-	<b>VFXEH20E</b>	4		
<b>NOTE AURA</b>	1200	FE13	HR12DE	21.8-	<b>ZUE22HPR8</b>	22401-6XJ1D	-	-	-	3		
		FSNE13	HR12DE	21.8-	<b>ZUE22HPR8</b>	22401-6XJ1D	-	-	-	3		
<b>NOTE e-POWER</b>	1200	HE12	HR12DE	16.11-20.12	<b>FXE20HR11</b>	-	-	-	<b>VFXEH20</b>	3	TAIWAN	
		SNE12	HR12DE	18.7-20.12	<b>FXE20HR11</b>	-	-	-	<b>VFXEH20</b>	3		
		E13	HR12DE	20.12-	<b>ZUE22HPR8</b>	22401-6XJ1D	-	-	<b>VSUEH22</b>	3		
		SNE13	HR12DE	21.3-	<b>ZUE22HPR8</b>	22401-6XJ1D	-	-	<b>VSUEH22</b>	3		
<b>NT100 CLIPPER</b>	660	U71T	3G83	12.1-13.12	KJ20CR-U11	-	<b>K20TT</b>	<b>IK20</b>	<b>VK20</b>	3		
		U71TP	3G83	12.1-13.12	KJ20CR-U11	-	<b>K20TT</b>	<b>IK20</b>	<b>VK20</b>	3		
		U72T	3G83	12.1-13.12	KJ20CR-U11	-	<b>K20TT</b>	<b>IK20</b>	<b>VK20</b>	3		
	DR16T	R06A	13.12-15.8	-	-	-	-	<b>VSUEH22</b>	3			
	DR16T	R06A	15.8-	-	-	-	-	<b>VSUEH22</b>	3			
<b>NV100 CLIPPER</b>		U71V	3G83	12.1-13.12	KJ20CR-U11	-	<b>K20TT</b>	<b>IK20</b>	<b>VK20</b>	3		
		U71V	3G83(T/C)	12.1-13.12	<b>SVK20RZ8</b>	MN122257	-	-	<b>VK20Y</b>	3		
		U72V	3G83	12.1-13.12	KJ20CR-U11	-	<b>K20TT</b>	<b>IK20</b>	<b>VK20</b>	3		
		U72V	3G83(T/C)	12.1-13.12	<b>SVK20RZ8</b>	MN122257	-	-	<b>VK20Y</b>	3		
	660	DR64V	K6A	13.12-15.3	<b>IXU22HPR</b>	-	-	<b>IXUH22</b>	<b>VXUH22</b>	3		
		DR64V	K6A(T/C)	13.12-15.3	<b>IXU22HPR</b>	-	-	<b>IXUH22</b>	<b>VXUH22</b>	3		
		DR64W	K6A(T/C)	13.12-15.3	<b>IXU22HPR</b>	-	-	<b>IXUH22</b>	<b>VXUH22</b>	3		
		DR17V	R06A	15.3-	-	-	-	-	<b>VSUEH22</b>	3		
		DR17W	R06A(T/C)	15.3-	-	-	-	-	<b>VSUEH22</b>	3		
<b>NV150 AD</b>	1500	VY12	HR15DE	16.12-21.5	<b>FXE20HE11</b>	22401-ED71B	-	-	<b>VFXEH20E</b>	4		
	1600	VZNY12	HR16DE	16.12-21.5	<b>FXE20HR11</b>	22401-JD01B	-	-	<b>VFXEH20</b>	4		
<b>NV200 VANETTE</b>		M20 • VM20	HR16DE	09.5-21.7	<b>XE20HR-U9</b>	-	-	<b>VFXEH20</b>	4			
		VNM20	HR16DE	18.1-21.7	<b>FXE20HR11</b>	22401-JD01B	-	-	<b>VFXEH20</b>	4		
	1600	VM20	HR16DE	21.7-	<b>FXE20HE11</b>	-	-	-	<b>VFXEH20E</b>	4		
		VNM20	HR16DE	21.7-	<b>FXE20HE11</b>	-	-	-	<b>VFXEH20E</b>	4		
		M20	HR16DE	21.7-	<b>FXE20HE11</b>	-	-	-	<b>VFXEH20E</b>	4		
<b>NV200 VANETTE TAXI</b>	1600	M20	HR16DE	10.12-	<b>XE20HR-U9</b>	-	-	<b>VFXEH20</b>	4			
<b>NV350 CARAVAN</b>	2000	VR2E26	QR20DE	12.6-21.10	<b>FXE20HR11</b>	22401-JD01B	-	-	<b>VFXEH20</b>	4		
	2500	KS2E26	QR25DE	12.6-20.9	<b>FXE20HR11</b>	22401-JD01B	-	-	<b>VFXEH20</b>	4		

(\*5)The plug reach may be 19mm or 26.5mm even with the same engine and the same vehicle code. Please confirm the plug reach and choose the correct DENSO type. If there is an "H" in DENSO type, it has a reach of 26.5mm. If it doesn't, its reach is 19mm.



AUSTRALIA  
CHINA  
INDIA  
INDONESIA  
KOREA  
MALAYSIA  
PHILIPPINES  
SAUDIARABIA  
SINGAPORE  
TAIWAN  
THAILAND  
VIETNAM  
JAPAN  
EUROPE & USA  
CROSS REFERENCE NUMBER  
PART



▶ Spark plug color codes: ■ for Iridium Tough and Iridium Plugs and Iridium TT, ■ for Iridium Power, ■ for Iridium Racing and Two Tops Plugs, ■ for Platinum Plugs and Platinum TT, and black for general spark plugs.

AUSTRALIA	MODEL	CC	VEHICLE CODE	ENGINE	FROM-TILL	DENSO	GENUINE P/N				QTY
AUSTRALIA	NISSAN NV350 CARAVAN		KS4E26	QR25DE	12.6-20.9	FXE20HR11	22401-JD01B	-	-	VFXEH20	4
			CS4E26	QR25DE	12.7-21.10	FXE20HR11	22401-JD01B	-	-	VFXEH20	4
			DS4E26	QR25DE	12.12-21.10	FXE20HR11	22401-JD01B	-	-	VFXEH20	4
CHINA		2500	CS8E26	QR25DE	17.12-21.10	FXE20HE11	22401-ED71B	-	-	VFXEH20E	4
			DS8E26	QR25DE	17.12-21.10	FXE20HE11	22401-ED71B	-	-	VFXEH20E	4
			KS2E26	QR25DE	20.9-21.10	FXE20HE11	22401-ED71B	-	-	VFXEH20E	4
			KS4E26	QR25DE	20.9-21.10	FXE20HE11	22401-ED71B	-	-	VFXEH20E	4
			OTTI	H91W	3G83(SOHC)	05.6-06.10	KJ16CR-U11	MD362098	K16TT	IK16	VK16
INDIA		660	H91W	3G83(T/C)	05.6-06.10	SVK20RZ8	MN122257	-	-	VK20Y	3
			H92W	3G83(SOHC)	06.10-	KJ20CR-U11	-	K20TT	IK20	VK20	3
			H92W	3G83(T/C)	06.10-	SVK20RZ8	MN122257	-	-	VK20Y	3
			PINO	660	HC24S	K6A(DOHC)	07.1-	IXU22C	09482-00563	-	IXU22
INDONESIA	PRAIRIE/LIBERTY	2000	PM11 • PNM11	SR20DE	95.8-98.11	K16R-U	-	K16TT	IK16	VK16	4
			PM12 • PNM12	SR20DE	98.11-01.4	K16R-U11	-	K16TT	IK16	VK16	4
			PNM12	SR20DET(T/C)	99.10-01.4	VK20	-	-	IK20	VK20	4
KOREA	PRESAGE	2400	U30 • NU30 • HN30	KA24DE	98.6-01.7	K16PR-U11	-	K16TT	IK16	VK16	4
		2500	TU30 • TNU30	QR25DE	01.8-03.6	K16HPR-U11	-	-	IKH16	VKH16	4
			TU31 • TNU31	QR25DE	03.7-06.5	K16HPR-U11	-	-	IKH16	VKH16	4
		3000	HU30	VQ30DE	98.6-03.6	VK16	-	-	IK16	VK16	6
		3500	PU31 • PNU31	VQ35DE	03.7-	VKH16	-	-	IKH16	VKH16	6
MALAYSIA	PRESEA	1500	R11	GA15DE	95.1-00.8	K16PR-U11	-	K16TT	IK16	VK16	4
		1800	PR11	SR18DE	95.1-00.8	K16R-U	-	K16TT	IK16	VK16	4
		2000	HR11	SR20DE	95.1-00.8	K16R-U	-	K16TT	IK16	VK16	4
PHILIPPINES	PRESIDENT	4500	JHG50 • JG50	VH45DE	93.4-02.8	VK16	-	-	IK16	VK16	8
			PGF50	VK45DE	03.10-10.8	VKH16	-	-	IKH16	VKH16	8
SAUDIARABIA	PRIMERA/WAGON	1800	P11 • WP11	SR18DE	95.9-98.9	K16PR-U11	-	K16TT	IK16	VK16	4
			WQP11 • QP11	QG18DD(NEO-Di)	98.9-01.1	VK16	-	-	IK16	VK16	4
			WQP11 • QP11	QG18DE(LEANBURN)	98.9-01.1	VK16	-	-	IK16	VK16	4
			QP12	QG18DE	02.2-	K16HPR-U11(*5)	-	-	IKH16(*5)	VKH16(*5)	4
		2000	HP11 • HNP11	SR20DE	95.9-01.1	K16R-U11	-	K16TT	IK16	VK16	4
			FHP11 • WHP11 • WHNP11	SR20DE	97.2-01.1	K16R-U11	-	K16TT	IK16	VK16	4
			HP11 • WHP11	SR20VE	97.9-01.1	K20PR-U	-	K20TT	IK20	VK20	4
			TP12 • WTP12 • WTNP12	QR20DE(NEO)	01.1-	K16HPR-U11	-	-	IKH16	VKH16	4
			TNP12	QR20DE	01.8-	K16HPR-U11	-	-	IKH16	VKH16	4
			HP12 • WHP12	SR20VE(NEO VVL)	01.8-03.6	VKH20	-	-	IKH20	VKH20	4
SINGAPORE	PULSAR SERIE S-RV	1500	FN15 • FNN15	GA15DE	96.5-	K16PR-U11	-	K16TT	IK16	VK16	4
		1600	JN15	SR16VE	97.9-	K20PR-U	-	K20TT	IK20	VK20	4
TAIWAN	PULSAR/SERIE	1500	HNN15(4WD)	SR18DE	96.5-	K16R-U11	-	K16TT	IK16	VK16	4
			HNN15(2WD)	SR18DE	96.5-	K16R-U	-	K16TT	IK16	VK16	4
	1600	FN15 • FNN15	GA15DE	95.1-	K16PR-U11	-	K16TT	IK16	VK16	4	
		EN15	GA16DE	95.1-	K16PR-U11	-	K16TT	IK16	VK16	4	
		JN15(VZ-R)	SR16VE(VVL)	97.9-	K20PR-U	-	K20TT	IK20	VK20	4	
	1800	JN15(VZ-R • N1)	SR16VE(VVL)	97.9-	VK22	-	-	IK22	VK22	4	
		HN14 • HN15 • HNN15	SR18DE	92.8-	K16R-U	-	K16TT	IK16	VK16	4	
VIETNAM	RASHEEN/FORZA	1500	RFB14	GA15DE	94.12-00.8	K16PR-U11	-	K16TT	IK16	VK16	4
		1800	RHB14	SR18DE	97.1-00.8	K16R-U11	-	K16TT	IK16	VK16	4
		2000	RKB14	SR20DE	98.4-00.8	K16R-U11	-	K16TT	IK16	VK16	4
JAPAN	R'NESSA	2000	N30	SR20DE	97.10-00.1	K16PR-U11	-	K16TT	IK16	VK16	4
			N30	SR20DE	00.1-01.7	PK20PR-P8	-	-	IK20	VK20	4
		2400	NN30	SR20DET(T/C)	97.10-01.7	PK20PR-P8	-	-	-	VK20Y	4
			PNN30	KA24DE	97.10-01.7	K16PR-U11	-	K16TT	IK16	VK16	4
EUROPE & USA	ROOX	660	ML21S	K6A	09.12-	IXU22HPR	09482-00608	-	IXUH22	VXUH22	3
			ML21S	K6A(T/C)	09.12-	IXU22HPR	09482-00608	-	IXUH22	VXUH22	3
			B45A	BR06(T/C)	20.3-	-	-	-	-	VSUEH22	3
			B44A	BR06	20.3-	-	-	-	-	VSUEH22	3
			B47A	BR06	20.3-	-	-	-	-	VSUEH22	3
			B48A	BR06(T/C)	20.3-	-	-	-	-	VSUEH22	3
CROSS REFERENCE NUMBER	SAFARI	4000	FG161	PF	83.9-97.10	W16EX-U	-	W16TT	IW16	VW16	6
		4200	FGY60 • WGY60	TB42S • TB42E	91.11-98.3	W16EXR-U	-	W16TT	IW16	VW16	6
		4500	WGY61	TB45E	97.10-02.11	W16EPR-U11	-	W16TT	IW16	VW16	6
		4800	WFGY61	TB48DE	02.11-	VKH16	-	-	IKH16	VKH16	6
PART NUMBER	SERENA	1600	KAJC23	GA16DE	91.6-99.6	K16PR-U11	-	K16TT	IK16	VK16	4
			KB23 • KBCC23 • KBNC23	SR20DE	91.6-99.6	K16R-U	-	K16TT	IK16	VK16	4
		2000	PC24 • PNC24	SR20DE	99.6-01.11	K16R-U11	-	K16TT	IK16	VK16	4
PC24 • PNC24	SR20DE		99.6-	K16R-U11	-	K16TT	IK16	VK16	4		

(\*5)The plug reach may be 19mm or 26.5mm even with the same engine and the same vehicle code.Please confirm the plug reach and choose the correct DENSO type. If there is an"H" in DENSO type,it has a reach of 26.5mm. If it doesn't ,its reach is 19mm.

MODEL	CC	VEHICLE CODE	ENGINE	FROM-TILL	DENSO	GENUINE P/N				QTY			
NISSAN SERENA	2000	TC24 • TNC24	QR20DE(NEO)	01.12-05.5	K16HPR-U11	-	-	<b>IKH16</b>	<b>VKH16</b>	4	AUSTRALIA		
		TC24 • TNC24	QR20DE	01.12-	K16HPR-U11	-	-	<b>IKH16</b>	<b>VKH16</b>	4	CHINA		
		C25 • NC25	MR20DE	05.5-05.12	<b>FXE20HR11</b>	22401-JD01B	-	-	-	<b>VFXEH20</b>	4	INDIA	
		C25 • NC25	MR20DE	05.12-10.11	<b>FXE20HR11</b>	22401-JD01B	-	-	-	<b>VFXEH20</b>	4	INDONESIA	
		CC25 • CNC25	MR20DE	06.6-10.11	<b>FXE20HR11</b>	22401-JD01B	-	-	-	<b>VFXEH20</b>	4	KOREA	
		C26 • NC26 • FC26 • FNC26	MR20DD	10.11-16.8	-	-	-	-	-	-	4	MALAYSIA	
		FC26 • FNC26 • HC26 • HFC26	MR20DD(HYBRID)	12.8-16.8	-	-	-	-	-	-	4	PHILIPPINES	
		FPC26	MR20DD	15.11-	-	-	-	-	-	-	4	SAUDIARABIA	
		FNPC26	MR20DD	15.11-	-	-	-	-	-	-	4	SINGAPORE	
		C27	MR20DD	16.8-18.9	<b>DXE22H11CT</b>	22401-5TA1C	-	-	-	-	4	TAIWAN	
		C27	MR20DD	18.9-	<b>DXE22H11C</b>	22401-6CT1C	-	-	-	-	4	THAILAND	
		RC24	QR25DE(NEO)	01.12-05.5	K16HPR-U11	-	-	-	<b>IKH16</b>	<b>VKH16</b>	4	VIETNAM	
		RC24	QR25DE	01.12-	K16HPR-U11	-	-	-	<b>IKH16</b>	<b>VKH16</b>	4	JAPAN	
		SERENA e-POWER	1200	HC27	HR12DE	18.3-	<b>FXE20HR11</b>	-	-	-	<b>VFXEH20</b>	3	EUROPE & USA
				HFC27	HR12DE	18.3-	<b>FXE20HR11</b>	-	-	-	<b>VFXEH20</b>	3	CROSS REFERENCE NUMBER
		NISSAN SERENA HYBRID	2000	GC27	MR20DD	16.8-18.9	<b>DXE22H11CT</b>	22401-5TA1C	-	-	-	4	
GFC27	MR20DD			16.8-18.9	<b>DXE22H11CT</b>	22401-5TA1C	-	-	-	4			
GNC27	MR20DD			16.8-18.9	<b>DXE22H11CT</b>	22401-5TA1C	-	-	-	4			
GFNC27	MR20DD			16.8-18.9	<b>DXE22H11CT</b>	22401-5TA1C	-	-	-	4			
GC27	MR20DD			18.9-20.8	<b>DXE22H11C</b>	22401-6CT1C	-	-	-	4			
GFC27	MR20DD			18.9-20.8	<b>DXE22H11C</b>	22401-6CT1C	-	-	-	4			
GNC27	MR20DD			18.9-20.8	<b>DXE22H11C</b>	22401-6CT1C	-	-	-	4			
GFNC27	MR20DD			18.9-20.8	<b>DXE22H11C</b>	22401-6CT1C	-	-	-	4			
GC27	MR20DD			20.8-	<b>DXE22H11C</b>	22401-5TT1C	-	-	-	4			
GFC27	MR20DD			20.8-	<b>DXE22H11C</b>	22401-5TT1C	-	-	-	4			
GNC27	MR20DD			20.8-	<b>DXE22H11C</b>	22401-5TT1C	-	-	-	4			
GFNC27	MR20DD	20.8-	<b>DXE22H11C</b>	22401-5TT1C	-	-	-	4					
NISSAN SILVIA	2000	PS13 • S14 • CS14	SR20DE	91.1-99.1	<b>VK20</b>	-	-	<b>IK20</b>	<b>VK20</b>	4			
		KPS13 • PS13 • S14 • CS14 • S15	SR20DET(T/C)	91.1-01.8	<b>PK20PR-P8</b>	-	-	-	<b>VK20Y</b>	4			
		S15	SR20DE	99.1-01.8	<b>K20R-U</b>	-	<b>K20TT</b>	<b>IK20</b>	<b>VK20</b>	4			
		HR33	RB20E	93.8-98.5	<b>Q16PR-U11</b>	-	-	<b>IQ16</b>	<b>VQ16</b>	6			
NISSAN SKYLINE	2000	HR34 • ENR34	RB20DE(LEANBURN)	98.5-01.5	<b>VK16</b>	-	-	<b>IK16</b>	<b>VK16</b>	6			
		ZV37	274930(T/C)	14.6-14.11	-	-	-	-	-	4			
		YV37	274A(T/C)	14.11-16.11	-	-	-	-	-	4			
		YV37	274A(T/C)	16.11-19.9	-	-	-	-	-	4			
		ER33 • ECR33	RB25DET(T/C)	93.8-98.5	<b>VK16</b>	-	-	<b>IK16</b>	<b>VK16</b>	6			
		ER33 • ECR33 • ENR33	RB25DE	93.8-98.5	<b>VK16</b>	-	-	<b>IK16</b>	<b>VK16</b>	6			
	2500	ER34 • ENR34	RB25DE	98.5-01.5	<b>VK16</b>	-	-	<b>IK16</b>	<b>VK16</b>	6			
		ER34	RB25DET(T/C)	98.5-01.5	<b>VK20</b>	-	-	<b>IK20</b>	<b>VK20</b>	6			
		V35 • NV35	VQ25DD(NEO-Di)	01.6-06.11	<b>IKH16</b>	-	-	<b>IKH16</b>	<b>VKH16</b>	6			
		V36 • NV36	VQ25HR	06.11-	<b>FXE22HR11</b>	22401-EW61C	-	-	<b>VFXEH22</b>	6			
	2600	BCNR33	RB26DETT(T/C)	95.1-99.1	<b>VQ20</b>	-	-	<b>IQ20</b>	<b>VQ20</b>	6			
		BNR34	RB26DETT(T/C)	99.1-01.5	<b>VQ20</b>	-	-	<b>IQ20</b>	<b>VQ20</b>	6			
	3000	HV35	VQ30DD(NEO-Di)	01.6-04.11	<b>IKH16</b>	-	-	<b>IKH16</b>	<b>VKH16</b>	6			
		RV37	VR30DDTT(T/C)	19.9-	-	-	-	-	-	6			
	3500	PV35	VQ35DE	02.1-06.11	<b>VKH16</b>	-	-	<b>IKH16</b>	<b>VKH16</b>	6			
		PV36	VQ35HR	06.11-08.12	<b>FXE22HR11</b>	22401-EW61C	-	-	<b>VFXEH22</b>	6			
3700	KV36	VQ37VHR	08.12-14.2	<b>FXE24HR11</b>	22401-JK01D	-	-	-	6				
NISSAN SKYLINE COUPE	3500	CPV35	VQ35DE	03.1-07.10	<b>VKH16</b>	-	-	<b>IKH16</b>	<b>VKH16</b>	6			
		CKV36	VQ37VHR	07.10-14.2	<b>FXE24HR11</b>	22401-JK01D	-	-	-	6			
NISSAN SKYLINE CROSSOVER	3700	J50 • NJ50	VQ37VHR	09.7-	<b>FXE24HR11</b>	22401-JK01D	-	-	-	6			
		HV37	VQ35HR	14.2-	<b>FXE22HR11</b>	22401-EW61C	-	-	<b>VFXEH22</b>	6			
NISSAN SKYLINE HYBRID	3500	HNV37	VQ35HR	14.2-	<b>FXE22HR11</b>	22401-EW61C	-	-	<b>VFXEH22</b>	6			
		WHC34	RB20E	96.10-97.8	<b>Q16PR-U11</b>	-	-	<b>IQ16</b>	<b>VQ16</b>	6			
NISSAN STAGEA	2000	WHC34	RB20DE(LEANBURN)	97.8-01.9	<b>VK16</b>	-	-	<b>IK16</b>	<b>VK16</b>	6			
		WGC34 • WGNC34	RB25DET(T/C)	96.10-98.8	<b>VK16</b>	-	-	<b>IK16</b>	<b>VK16</b>	6			
	2500	WGC34 • WGNC34	RB25DET(T/C)	98.8-01.10	<b>VK20</b>	-	-	<b>IK20</b>	<b>VK20</b>	6			
		WGC34 • WGNC34	RB25DE	96.10-01.9	<b>VK16</b>	-	-	<b>IK16</b>	<b>VK16</b>	6			
		NM35 • M35	VQ25DD(NEO-Di)	01.10-	<b>IKH16</b>	-	-	<b>IKH16</b>	<b>VKH16</b>	6			
		NM35	VQ25DET(T/C)	01.10-04.8	<b>VKH20Y</b>	-	-	-	<b>VKH20Y</b>	6			
	2600	WGNC34(260RS)	RB26DETT(T/C)	97.11-01.9	<b>VQ20</b>	-	-	<b>IQ20</b>	<b>VQ20</b>	6			
	3000	HM35 • M35	VQ30DD(NEO-Di)	01.10-04.8	<b>IKH16</b>	-	-	<b>IKH16</b>	<b>VKH16</b>	6			
	3500	PM35 • PNM35	VQ35DE	04.8-	<b>VKH16</b>	-	-	<b>IKH16</b>	<b>VKH16</b>	6			
		NISSAN SUNNY	1300	B14	GA13DE	94.1-98.10	K16PR-U11	-	<b>K16TT</b>	<b>IK16</b>	<b>VK16</b>	4	
B15	QG13DE			98.10-04.9	K16PR-U11	-	<b>K16TT</b>	<b>IK16</b>	<b>VK16</b>	4			
1500	FB14 • FNB14		GA15DE	94.1-98.10	K16PR-U11	-	<b>K16TT</b>	<b>IK16</b>	<b>VK16</b>	4			
	FB14 • FNB14	GA15DE(LEANBURN)	94.5-98.10	<b>VK16</b>	-	-	<b>IK16</b>	<b>VK16</b>	4				



DENSO	9	14	16	20	22	24	27	29	31	32	34	35	DENSO	9	14	16	20	22	24	27	31	DENSO	9	14	16	20	22	24	27	31		
NGK	2	4	5	6	7	8	9	9.5	10	10.5	11	11.5	CHAMPION	18	16,14	12,11	10,9	8,7	6,6,3,61	4,5,9	57	55	53	BOSCH	10	9	8	7,6	5	4	3	2



MODEL	CC	VEHICLE CODE	ENGINE	FROM-TILL	DENSO	GENUINE P/N				QTY
AUSTRALIA	1500	FB15 • FNB15	QG15DE(LEANBURN)	98.10-02.4	K16PR-U11	-	K16TT	IK16	VK16	4
			QG15DE	98.10-02.4	K16PR-U11	-	K16TT	IK16	VK16	4
			QG15DE	02.5-04.9	K16HPR-U11	-	-	IKH16	VKH16	4
CHINA	1600	EB14	GA16DE	94.1-98.10	K16PR-U11	-	K16TT	IK16	VK16	4
			SR16VE	98.10-04.9	K20PR-U	-	K20TT	IK20	VK20	4
			SR18DE	94.1-97.5	K16R-U	-	K16TT	IK16	VK16	4
INDIA	1800	QB15	QG18DD	98.9-02.4	VK16	-	-	IK16	VK16	4
			MRA8DE	12.12-	FXE20HR11	-	-	-	VFXEH20	4
			VQ23DE	03.2-08.5	VKH16	-	-	IKH16	VKH16	6
INDONESIA	2500	TNJ31	QR25DE	03.2-08.5	K16HPR-U11	-	-	IKH16	VKH16	4
			QR25DE	08.6-14.2	FXE20HR11	22401-JD01B	-	-	VFXEH20	4
			QR25DE	14.2-	FXE20HE11	22401-ED71B	-	-	VFXEH20E	4
KOREA	3500	PJ31	VQ35DE	03.2-08.5	VKH16	-	-	IKH16	VKH16	6
			VQ35DE	08.6-14.2	FXE22HR11	22401-EW61C	-	-	VFXEH22	6
			VG33E	95.9-02.8	K16PR-U11	-	K16TT	IK16	VK16	6
MALAYSIA	1500	C11 • NC11	HR15DE	04.9-	FXE20HE11	22401-ED71B	-	-	VFXEH20E	4
			HR15DE	04.10-	FXE20HE11	22401-ED71B	-	-	VFXEH20E	4
			HR16DE	08.9-	FXE20HR11	22401-JD01B	-	-	VFXEH20	4
PHILIPPINES	1800	JC11 • SJC11	MR18DE	05.1-05.10	FXE20HR11	22401-JD01B	-	-	VFXEH20	4
			MR18DE	05.10-	FXE20HR11	22401-JD01B	-	-	VFXEH20	4
			QG18DE	98.12-02.9	K16PR-U11(*5)	-	K16TT	IK16(*5)	VK16(*5)	4
SAUDIARABIA	2000	HV10	SR20DE	98.12-02.10	K16R-U11	-	K16TT	IK16	VK16	4
			QG18DH	00.4-02.10	K16PR-U11	-	K16TT	IK16	VK16	4
			QG18DH	00.4-02.10	K16PR-U11	-	K16TT	IK16	VK16	4
SINGAPORE	1800	SKP2MN	L8-DE	10.8-12.2	VT16	-	-	IT16	VT16	4
			L8-DE	12.2-	VT16	-	-	IT16	VT16	4
			L8-DE	12.6-	VT16	-	-	IT16	VT16	4
TAIWAN	1500	WFY11	QG15DE	02.11-05.11	K16HPR-U11	-	-	IKH16	VKH16	4
			QG15DE(LEANBURN)	99.5-01.9	K16PR-U11	-	K16TT	IK16	VK16	4
			QG15DE(LEANBURN)	01.10-05.11	VK16	-	-	IK16	VK16	4
THAILAND	2000	WRY11	SR20VE(VVL)	99.6-01.9	K20PR-U	-	K20TT	IK20	VK20	4
			QR20DE	01.10-05.11	K16HPR-U11	-	-	IKH16	VKH16	4
			SR20VE(VVL)	99.6-01.9	K20PR-U	-	K20TT	IK20	VK20	4
VIETNAM	2000	NT31 • T31	MR20DE	07.8-13.12	FXE20HR11	22401-JD01B	-	-	VFXEH20	4
			MR20DD	13.12-	-	-	-	-	-	4
			MR20DD	13.12-	-	-	-	-	-	4
JAPAN	2500	TNT31	QR25DE	07.8-13.12	FXE20HR11	22401-JD01B	-	-	VFXEH20	4
			MR20DD	15.5-	-	-	-	-	-	4
			MR20DD	15.5-	-	-	-	-	-	4
EUROPE & USA	2000	ZC6	FA20	12.3-15.4	ZXE27HBR8	22401AA801	-	-	VXEBH27	4
			FA20	15.4-21.8	ZXE27HBR8	22401AA801	-	-	VXEBH27	4
			FA24	21.8-	ZXE27HBR8	22401AA801	-	-	VXEBH27/VXEBH27	4
CROSS REFERENCE NUMBER	660	LA600F	KF	16.12-19.7	SXU20HPR11	90048-51208	-	-	IXUH20I	3
			KF	16.12-19.7	SXU20HPR11	90048-51208	-	-	IXUH20I	3
			KF(T/C)	16.12-19.7	SXU22HPR8	90048-51214	-	-	IXUH22I	3
PART NUMBER	1300	M401F • M411F	KF(T/C)	16.12-19.7	SXU22HPR8	90048-51214	-	-	IXUH22I	3
			KF	19.7-	-	-	-	-	-	3
			KF(T/C)	19.7-	-	-	-	-	-	3
DEX	1300	M401F • M411F	K3-VE	08.11-10.7	SXU22PR9	90048-51188-000	-	-	IXU22I	4

(\*5)The plug reach may be 19mm or 26.5mm even with the same engine and the same vehicle code.Please confirm the plug reach and choose the correct DENSO type. If there is an"H" in DENSO type,it has a reach of 26.5mm. If it doesn't ,its reach is 19mm.





MODEL	CC	VEHICLE CODE	ENGINE	FROM-TILL	DENSO	GENUINE P/N				QTY		
<b>SUBARU</b>												
<b>DEX</b>	1300	M401F • M411F	K3-VE	10.7-	<b>SXU22PR9</b>	90048-51188-000	-	<b>IXU22I</b>	<b>VXU22I</b>	4	AUSTRALIA	
<b>DIAS WAGON</b>		TW1 • TW2	EN07(SOHC)	03.11-09.8	<b>K20PR-U</b>	22401KA150	<b>K20TT</b>	<b>IK20</b>	<b>VK20</b>	4	CHINA	
		TW1 • TW2	EN07(SOHC • S/C)	99.8-09.8	<b>K20PR-U</b>	22401KA150	<b>K20TT</b>	-	<b>VK20Y</b>	4	INDIA	
	660	S321N • S331N	KF-DET(DOHC • T/C)	09.9-15.4	<b>SXU22HPR8</b>	90048-51214	-	<b>IXUH22I</b>	<b>VXUH22I</b>	3	INDONESIA	
		S321N	KF(T/C)	15.4-	<b>SXU22HPR8</b>	90048-51214	-	<b>IXUH22I</b>	<b>VXUH22I</b>	3	KOREA	
		S331N	KF(T/C)	15.4-	<b>SXU22HPR8</b>	90048-51214	-	<b>IXUH22I</b>	<b>VXUH22I</b>	3	MALAYSIA	
<b>DOMINGO EXIGA</b>	1200	FA7 • FA8	EF12	94.6-98.12	<b>W20EPR-U11</b>	22401AA130	-	<b>IW20</b>	<b>VW20</b>	3	PHILIPPINES	
		YA4 • YA5	EJ20(DOHC)	08.6-	<b>VKH20</b>	SAB330DE2670	-	<b>IKH20</b>	<b>VKH20</b>	4	SAUDI ARABIA	
	2000	YA5	EJ20(DOHC • T/C)	08.6-	<b>VKH20Y</b>	SAB330DE4540	-	-	<b>VKH20Y</b>	4	SINGAPORE	
		YA5(STI)	EJ20(DOHC • T/C)	09.10-10.3	<b>VKH20Y</b>	SAB330DE4540	-	-	<b>VKH20Y</b>	4	TAIWAN	
		YA9	EJ25(SOHC)	09.12-	<b>VK20</b>	SAB330DE0720	-	<b>IK20</b>	<b>VK20</b>	4	THAILAND	
	2500	YAM	FB25	12.7-13.8	-	-	-	-	<b>VFXEH22</b>	4	VIETNAM	
	YAM	FB25	13.8-	-	-	-	-	<b>VFXEH22</b>	4	JAPAN		
<b>FORESTER</b>	1800	SK5	CB18(T/C)	20.10-	-	-	-	-	-	4	EUROPE & USA	
		SF5	EJ20(DOHC • T/C)	97.2-02.2	<b>PK20PR-P8</b>	-	-	-	-	4	CROSS REFERENCE NUMBER	
		SF5	EJ20(DOHC • T/C)	97.2-02.2	<b>PK20PR-P8</b>	-	-	-	<b>VK20Y</b>	4		
		SF5	EJ20	97.6-00.1	<b>K20PR-U11</b>	22401AA320	<b>K20TT</b>	<b>IK20</b>	<b>VK20</b>	4		
		SF5	EJ20	00.1-02.2	<b>PK20PR11</b>	-	-	<b>IK20</b>	<b>VK20</b>	4		
		SG5	EJ20(DOHC • T/C)	02.2-07.12	<b>PK20PR-P8</b>	-	-	-	<b>VK20Y</b>	4		
		SG5	EJ20	02.2-07.12	<b>PK16PR11</b>	-	-	<b>IK16</b>	<b>VK16</b>	4		
	2000	SH5	EJ20	07.12-10.10	<b>VKH20</b>	SAB330DE2670	-	<b>IKH20</b>	<b>VKH20</b>	4		
		SH5	EJ20(DOHC • T/C)	07.12-09.1	<b>VKH20Y</b>	SAB330DE4540	-	-	<b>VKH20Y</b>	4		
		SHS	EJ20(DOHC • AVCS • T/C)	09.1-	<b>VKH20Y</b>	SAB330DE4540	-	-	<b>VKH20Y</b>	4		
		SHJ	FB20(DOHC)	10.10-12.11	-	-	-	-	<b>VFXEH22</b>	4		
		SJ5	FB20	12.11-13.10	-	-	-	-	<b>VFXEH22</b>	4		
		SJ5	FB20	13.10-18.7	-	-	-	-	<b>VFXEH22</b>	4		
		SJG	FA20(T/C)	12.11-18.7	-	-	-	-	-	4		
		SKE	FB20(e-BOXER)	18.9-	-	-	-	-	-	4		
	2500	SF9	EJ25(DOHC)	98.9-02.2	<b>PK20PR11</b>	-	-	<b>IK20</b>	<b>VK20</b>	4		
		SG9	EJ25(DOHC • T/C)	04.2-07.12	<b>VKH20Y</b>	SAB330DE4540	-	-	<b>VKH20Y</b>	4		
		SH9	EJ25(DOHC • T/C)	10.10-	<b>VKH20Y</b>	SAB330DE4540	-	-	<b>VKH20Y</b>	4		
		SK9	FB25	18.7-	-	-	-	-	-	4		
	<b>IMPREZA</b>		GC1 • GC2 • GF1 • GF2	EJ15	92.11-00.5	<b>K20PR-U11</b>	22401AA320	<b>K20TT</b>	<b>IK20</b>	<b>VK20</b>	4	
			GD2 • GD3 • GG2 • GG3	EJ15	00.8-05.6	<b>PK16PR11</b>	-	-	<b>IK16</b>	<b>VK16</b>	4	
1500		GD2 • GD3 • GG2 • GG3	EJ15(SOHC)	05.6-07.7	<b>PK16PR11</b>	-	-	<b>IK16</b>	<b>VK16</b>	4		
		GDC • GDD • GGC • GGD	EL15(DOHC)	05.6-07.7	<b>IKH20</b>	SAB330DE2640	-	<b>IKH20</b>	<b>VKH20</b>	4		
		GH2 • GH3	EL15(DOHC)	07.7-11.12	<b>FK20HR11</b>	22401AA700	-	-	<b>VFKH20</b>	4		
		GE2 • GE3	EL15(DOHC)	08.10-11.12	<b>FK20HR11</b>	22401AA700	-	-	<b>VFKH20</b>	4		
		GP2	FB16	11.12-13.11	-	-	-	-	<b>VFXEH22</b>	4		
		GP3	FB16	11.12-13.11	-	-	-	-	<b>VFXEH22</b>	4		
		GJ2	FB16	11.12-13.11	-	-	-	-	<b>VFXEH22</b>	4		
		GJ3	FB16	11.12-13.11	-	-	-	-	<b>VFXEH22</b>	4		
1600		GP2	FB16	13.11-16.12	-	-	-	-	<b>VFXEH22</b>	4		
		GP3	FB16	13.11-16.12	-	-	-	-	<b>VFXEH22</b>	4		
		GJ2	FB16	13.11-16.12	-	-	-	-	<b>VFXEH22</b>	4		
		GJ3	FB16	13.11-16.12	-	-	-	-	<b>VFXEH22</b>	4		
		GT2	FB16	16.12-	-	-	-	-	<b>VFXEH22</b>	4		
		GT3	FB16	16.12-	-	-	-	-	<b>VFXEH22</b>	4		
		GK2	FB16	16.12-	-	-	-	-	<b>VFXEH22</b>	4		
		GK3	FB16	16.12-	-	-	-	-	<b>VFXEH22</b>	4		
1800		GC6 • GF6 • GF5 • GFA	EJ18	92.11-00.8	<b>K20PR-U11</b>	22401AA320	<b>K20TT</b>	<b>IK20</b>	<b>VK20</b>	4		
		GC8 • GF8	EJ20(T/C)	92.11-00.5	<b>PK20PR-P8</b>	-	-	-	<b>VK20Y</b>	4		
		GC8 • GF8		96.1-98.9	<b>K20PR-U11</b>	22401AA320	<b>K20TT</b>	<b>IK20</b>	<b>VK20</b>	4		
		GC8 • GF8	EJ20	98.9-00.5	<b>PK20PR-P8</b>	-	-	<b>IK20</b>	<b>VK20</b>	4		
		GD9 • GG9	EJ20(DOHC)	00.5-07.7	<b>KJ20SR11</b>	22401AA610	-	<b>IK20</b>	<b>VK20</b>	4		
		GDA • GGA	EJ20(DOHC • T/C)	00.8-07.7	<b>PK20PR-P8</b>	-	-	-	<b>VK20Y</b>	4		
		GDB • GGB	EJ20(DOHC • T/C)	00.10-07.7	<b>VK22</b>	SAB330DE0730	-	<b>IK22</b>	<b>VK22</b>	4		
		GH6 • GH7	EJ20(SOHC)	07.7-11.12	<b>PK16PR11</b>	-	-	<b>IK16</b>	<b>VK16</b>	4		
2000		GH8	EJ20(DOHC • T/C)	07.7-11.12	<b>VKH20Y</b>	SAB330DE4540	-	-	<b>VKH20Y</b>	4		
		GRB(WRX STI)	EJ20(DOHC • T/C)	07.10-	<b>VKH20Y</b>	SAB330DE4540	-	-	<b>VKH20Y</b>	4		
		GE6 • GE7	EJ20(SOHC)	08.10-	<b>PK16PR11</b>	-	-	<b>IK16</b>	<b>VK16</b>	4		
		GH6	EJ20(SOHC)	08.11-11.12	<b>PK16PR11</b>	-	-	<b>IK16</b>	<b>VK16</b>	4		
		GVB(WRX STI)	EJ20(DOHC • T/C)	10.7-	<b>VKH20Y</b>	SAB330DE4540	-	-	<b>VKH20Y</b>	4		
		GP6	FB20	11.12-13.11	-	-	-	-	<b>VFXEH22</b>	4		
	GP7	FB20	11.12-13.11	-	-	-	-	<b>VFXEH22</b>	4			
	GJ6	FB20	11.12-13.11	-	-	-	-	<b>VFXEH22</b>	4			
	GJ7	FB20	11.12-13.11	-	-	-	-	<b>VFXEH22</b>	4			

DENSO	9	14	16	20	22	24	27	29	31	32	35	DENSO	9	14	16	20	22	24	27	29	31	32	DENSO	9	14	16	20	22	24	27	31	
NGK	2	4	5	6	7	8	9	9.5	10	10.5	11	11.5	CHAMPION	18	16,14	12,11	10,9	8,7	6,63,61	4,59	57	55	53	BOSCH	10	9	8	7,6	5	4	3	2

AUSTRALIA  
CHINA  
INDIA  
INDONESIA  
KOREA  
MALAYSIA  
PHILIPPINES  
SAUDI ARABIA  
SINGAPORE  
TAIWAN  
THAILAND  
VIETNAM  
JAPAN  
EUROPE & USA  
CROSS REFERENCE NUMBER  
PART



MODEL	CC	VEHICLE CODE	ENGINE	FROM-TILL	DENSO	GENUINE P/N				QTY		
AUSTRALIA CHINA INDIA INDONESIA KOREA MALAYSIA PHILIPPINES SAUDI ARABIA SINGAPORE TAIWAN THAILAND VIETNAM	<b>SUBARU IMPREZA</b>											
	2000	GP6	FB20	13.11-16.10	-	-	-	-	-	VFXEH22	4	
		GP7	FB20	13.11-16.10	-	-	-	-	-	VFXEH22	4	
		GJ6	FB20	13.11-16.10	-	-	-	-	-	VFXEH22	4	
		GJ7	FB20	13.11-16.10	-	-	-	-	-	VFXEH22	4	
		GT6	FB20	16.10-	-	-	-	-	-	-	4	
		GT7	FB20	16.10-	-	-	-	-	-	-	4	
		GK6	FB20	16.10-	-	-	-	-	-	-	4	
		GK7	FB20	16.10-	-	-	-	-	-	-	4	
		GTE	FB20(e-BOXER)	18.10-	-	-	-	-	-	VFXEH22	4	
		2200	GC8(22B STI)	EJ22(DOHC·T/C)	98.3-98.9	PK20PR-P8	-	-	-	VK20Y	4	
	2500	GRF(WRX STI)	EJ25	09.2-	VKH20Y	SAB330DE4540	-	-	IKH20	VKH20Y	4	
		GVF(WRX STI)	EJ25(DOHC·T/C)	09.2-	VKH20Y	SAB330DE4540	-	-	-	VKH20Y	4	
	IMPREZA HYBRID	2000	GPE	FB20	15.7-	-	-	-	-	VFXEH22	4	
	IMPREZA XV HYBRID	2000	GPE	FB20	13.6-	-	-	-	-	VFXEH22	4	
	JAPAN	<b>JUSTY</b>										
		1000	M900F	1KR-FE	16.11-	-	-	-	-	-	-	3
			M900F	1KR-VET(T/C)	16.11-	-	-	-	-	-	-	3
			M910F	1KR-FE	16.11-	-	-	-	-	-	VCH16	3
		EUROPE & USA	<b>LEGACY</b>									
1800			BD2·BD3·BG2·BG3	EJ18	96.6-98.12	K20PR-U11	22401AA320	K20TT	IK20	VK20	4	
			BT5	CB18(T/C)	21.12-	-	-	-	-	-	-	4
			BD5·BG5	EJ20(DOHC·T/C)	93.10-98.12	PK20PR-P8	-	-	-	-	VK20Y	4
			BD4·BD5·BG4·BG5·BGA	EJ20(SOHC)	93.10-98.12	K20PR-U11	22401AA320	K20TT	IK20	VK20	4	
			BD4·BD5·BG5	EJ20(DOHC)	94.10-98.12	PK20PR11	-	-	-	IK20	VK20	4
	BD5·BG5		EJ20(SOHC·LEANBURN)	96.6-98.12	PK20PR11	-	-	-	IK20	VK20	4	
	BE5		EJ20(DOHC)	98.12-03.5	PK20PR-P8	-	-	-	IK20	VK20	4	
	BE5		EJ20(DOHC·T/C)	98.12-03.5	PK20PR-P8	-	-	-	-	VK20Y	4	
	BE5		EJ20(DOHC·T/C)	98.6-03.5	PK20PR-P8	-	-	-	-	VK20Y	4	
	BES(S401 STI)		EJ20(DOHC·T/C)	02.10-	PK20PR-P8	-	-	-	-	VK20Y	4	
2000	BH5		EJ20(SOHC·LEANBURN)	98.6-00.5	PK20PR11	-	-	-	IK20	VK20	4	
	BH5		EJ20(DOHC)	98.6-01.5	PK20PR-P8	-	-	-	IK20	VK20	4	
	BH5		EJ20(SOHC)	00.5-03.5	PK16PR11	-	-	-	IK16	VK16	4	
	BH5		EJ20(DOHC)	01.5-03.5	KJ20SR11	22401AA610	-	-	IK20	VK20	4	
	BH5		EJ20(DOHC·T/C)	98.6-03.5	PK20PR-P8	-	-	-	-	VK20Y	4	
	BL5·BP5(2.0GT)		EJ20-R(DOHC·T/C)	03.5-09.5	VKH20Y	SAB330DE4540	-	-	-	VKH20Y	4	
	BL5·BP5(2.0R)		EJ20-R(DOHC)	03.5-09.5	VKH20	SAB330DE2670	-	-	IKH20	VKH20	4	
	BL5·BP5(2.0i)		EJ20I(SOHC)	03.5-09.5	VK16	SAB330DE0710	-	-	IK16	VK16	4	
	BL5 Rev		EJ204(CNG)	04.5-09.5	VKH22	SAB330DE2680	-	-	IKH22	VKH22	4	
	BMG	FA20(T/C)	12.5-13.5	-	-	-	-	-	-	4		
BRG	FA20(T/C)	13.5-14.10	-	-	-	-	-	-	4			
BRG	FA20(T/C)	12.5-13.5	-	-	-	-	-	-	4			
BRG	FA20(T/C)	13.5-	-	-	-	-	-	-	4			
EUROPE & USA	1500	BD9·BG9·BGC	EJ25(DOHC)	94.10-98.12	PK20PR11	-	-	IK20	VK20	4		
		BH9·BHC	EJ25(DOHC)	99.5-01.5	PK20PR11	-	-	IK20	VK20	4		
		BE9·BH9	EJ25(DOHC)	01.5-03.5	KJ20SR11	22401AA610	-	-	IK20	VK20	4	
		BP9	EJ25(SOHC)	03.10-09.5	VK16	SAB330DE0710	-	-	IK16	VK16	4	
		BL9	EJ25(SOHC)	07.11-09.5	VK16	SAB330DE0710	-	-	IK16	VK16	4	
		BL9(S402 STI)	EJ25(DOHC·T/C)	08.6-09.2	VKH20Y	SAB330DE4540	-	-	-	VKH20Y	4	
		BP9(S402 STI)	EJ25(DOHC·T/C)	08.6-09.2	VKH20Y	SAB330DE4540	-	-	-	VKH20Y	4	
		BM9·BR9	EJ25(SOHC)	09.5-	VK20	SAB330DE0720	-	-	IK20	VK20	4	
		BM9·BR9	EJ25(DOHC·T/C)	09.5-	VKH20Y	SAB330DE4540	-	-	-	VKH20Y	4	
		BMM	FB25	12.5-14.10	-	-	-	-	-	VFXEH22	4	
EUROPE & USA	3000	BRM	FB25	12.5-	-	-	-	-	VFXEH22	4		
		BN9	FB25	14.10-	-	-	-	-	VFXEH22	4		
		BS9	FB25	14.10-21.12	-	-	-	-	VFXEH22	4		
		BEE·BHE	EZ30(DOHC)	00.5-03.5	VKH20	SAB330DE2670	-	-	IKH20	VKH20	6	
EUROPE & USA	3600	BLE·BPE	EZ30(DOHC)	03.9-09.5	VKH20	SAB330DE2670	-	-	IKH20	VKH20	6	
		BRF	EZ36(DOHC)	09.5-14.10	VKH20	SAB330DE2670	-	-	IKH20	VKH20	6	
		LEONE	CVFY10·CVFNY10	GA15DS	94.4-98.11	K16PR-U11	22401KA200	K16TT	IK16	VK16	4	
EUROPE & USA	1500	CVFY11	QG15DE	99.6-01	K16PR-U11	22401KA200	K16TT	IK16	VK16	4		
		1800	CVHNY11	QG18DE	99.6-01	K16PR-U11	22401KA200	K16TT	IK16	VK16	4	
		EUROPE & USA	1600	VM4	FB16(T/C)	14.6-20.11	-	-	-	-	-	4
				1800	VN5	CB18(T/C)	20.11-	-	-	-	-	-
2000	VMG			FA20(T/C)	14.6-20.11	-	-	-	-	-	4	
EUROPE & USA	2400	VNH	FA24(T/C)	22.2-	-	-	-	-	-	4		
		EUROPE & USA	660	L455F·L465F	KF-VE(DOHC)	10.4-	XU20HR9	90048-51212	XUH20TTI	IXUH20I	VXUH20I	3
				L455F·L465F	KF-DET(DOHC·T/C)	10.4-	SXU22HPR8	90048-51214	-	IXUH22I	VXUH22I	3
				L455F·L465F	KF-VE(DOHC)	10.4-	XU20HR9	90048-51212	XUH20TTI	IXUH20I	VXUH20I	3
L455F·L465F	KF-DET(DOHC·T/C)			10.4-12.11	SXU22HPR8	90048-51214	-	IXUH22I	VXUH22I	3		

MODEL	CC	VEHICLE CODE	ENGINE	FROM-TILL	DENSO	GENUINE P/N				QTY	
<b>SUBARU LUCRA/CUSTOM</b>	660	L455F	KF(T/C)	12.11-	SXU22HPR8	90048-51214	-	IXUH22I	VXUH22I	3	AUSTRALIA
		L465F	KF(T/C)	12.11-	SXU22HPR8	90048-51214	-	IXUH22I	VXUH22I	3	CHINA
		L455F	KF	11.7-12.11	SXU20HPR11	90048-51208	-	IXUH20I	VXUH20I	3	INDIA
		L455F	KF	12.11-	SXU20HPR11	90048-51208	-	IXUH20I	VXUH20I	3	INDONESIA
		L465F	KF	11.7-12.11	SXU20HPR11	90048-51208	-	IXUH20I	VXUH20I	3	KOREA
		L465F	KF	12.11-	SXU20HPR11	90048-51208	-	IXUH20I	VXUH20I	3	MALAYSIA
<b>PLEO PLUS</b>	660	LA300F	KF	12.12-14.7	SXU20HPR11	90048-51208	-	IXUH20I	VXUH20I	3	PHILIPPINES
		LA310F	KF	12.12-14.7	SXU20HPR11	90048-51208	-	IXUH20I	VXUH20I	3	SAUDI ARABIA
		LA300F	KF	14.7-17.5	-	-	-	IXUH20I	VXUH20I	3	SINGAPORE
		LA310F	KF	14.7-17.5	-	-	-	IXUH20I	VXUH20I	3	TAIWAN
		LA350F	KF	17.5-	-	-	-	IXUH20I	VXUH20I	3	THAILAND
		LA360F	KF	17.5-	-	-	-	IXUH20I	VXUH20I	3	VIETNAM
<b>PLEO/CUSTOM</b>	660	L275F · L285F	KF-VE(DOHC)	10.4-	XU20HR9	90048-51212	XUH20TTI	IXUH20I	VXUH20I	3	JAPAN
		L275F · L285F	KF-DET(DOHC · T/C)	10.4-	SXU22HPR8	90048-51214	-	IXUH22I	VXUH22I	3	EUROPE & USA
		L275B · L285B	KF-VE(DOHC)	10.4-	XU20HR9	90048-51212	XUH20TTI	IXUH20I	VXUH20I	3	CROSS REFERENCE
		L275F · L285F	KF-VE(DOHC · 5door · 4WD)	10.4-	SXU20HPR11	90048-51208	-	IXUH20I	VXUH20I	3	PART NUMBER
<b>PLEO/NESTA/NICOT</b>	660	RA1 · RA2	EN07(SOHC)	98.10-07.6	K16PR-U11	22401KA200	K16TT	IK16	VK16	4	
		RA1 · RA2	EN07(DOHC · S/C)	98.10-07.6	IXU24	SAB330DE8730	-	IXU24	VXU24	4	
		RA1 · RA2	EN07(SOHC · S/C)	98.10-07.6	K20PR-U	22401KA150	K20TT	-	VK20Y	4	
		RA1 · RA2	EN07(SOHC · M/C)	98.10-07.6	K20PR-U	22401KA150	K20TT	-	VK20Y	4	
		RV1 · RV2	EN07(SOHC)	98.10-09.12	K16PR-U11	22401KA200	K16TT	IK16	VK16	4	
<b>R1</b>	660	RJ1 · RJ2	EN07(SOHC)	05.11-	K16PR-U11	22401KA200	K16TT	IK16	VK16	4	
		RJ1 · RJ2	EN07(DOHC)	05.1-	IXUH22	SAB330DE8740	-	IXUH22	VXUH22	4	
		RJ1 · RJ2	EN07(DOHC · S/C)	05.11-	IXU24	SAB330DE8730	-	IXU24	VXU24	4	
<b>R2</b>	660	RC1 · RC2	EN07(SOHC)	03.12-	K16PR-U11	22401KA200	K16TT	IK16	VK16	4	
		RC1 · RC2	EN07(DOHC)	03.12-	IXUH22	SAB330DE8740	-	IXUH22	VXUH22	4	
		RC1 · RC2	EN07(DOHC · S/C)	03.12-	IXU24	SAB330DE8730	-	IXU24	VXU24	4	
<b>SAMBAR</b>	660	KS3 · KS4(AGRICULTURE)	EN07(CARB)	91.9-99.2	K16PR-U11	22401KA200	K16TT	IK16	VK16	4	
		KS3 · KS4 · KV3 · KV4	EN07(CARB)	91.9-99.2	K16PR-U11	22401KA200	K16TT	IK16	VK16	4	
		KS3 · KS4 · KV3 · KV4	EN07(S/C)	91.9-99.2	K20PR-U11	22401AA320	K20TT	IK20	VK20	4	
		TT1 · TT2 · TV1 · TV2 · TW1 · TW2	EN07(SOHC)	99.2-01.8	K16PR-U11	22401KA200	K16TT	IK16	VK16	4	
		TT1 · TT2 · TV1 · TV2 · TW1 · TW2	EN07(S/C)	99.2-01.8	K20PR-U	22401KA150	K20TT	IK20	VK20Y	4	
		TT1 · TT2 · TV1 · TV2 · TW2	EN07Y(S/C)	01.8-12.4	K20PR-U	22401KA150	K20TT	IK20	VK20Y	4	
		TT1 · TT2 · TV1 · TV2	EN07F/V	01.8-03.11	K16PR-U	-	K16TT	IK16	VK16	4	
		TT1 · TT2 · TV1 · TV2 · TW1	EN07F/V	03.11-12.4	K20PR-U	22401KA150/SAB330DE2340	K20TT	IK20	VK20	4	
		S321B	KF	12.4-15.4	XU20HR9	90048-51212	XUH20TTI	IXUH20I	VXUH20I	3	
		S321B	KF(T/C)	12.4-15.4	SXU22HPR8	90048-51214	-	IXUH22I	VXUH22I	3	
		S331B	KF	12.4-15.4	XU20HR9	90048-51212	XUH20TTI	IXUH20I	VXUH20I	3	
		S331B	KF(T/C)	12.4-15.4	SXU22HPR8	90048-51214	-	IXUH22I	VXUH22I	3	
		S201J	KF	12.4-14.9	XU20HR9	90048-51212	XUH20TTI	IXUH20I	VXUH20I	3	
		S201H	KF	12.4-	XU20HR9	90048-51212	XUH20TTI	IXUH20I	VXUH20I	3	
		S211J	KF	12.4-14.9	XU20HR9	90048-51212	XUH20TTI	IXUH20I	VXUH20I	3	
		S211H	KF	12.4-	XU20HR9	90048-51212	XUH20TTI	IXUH20I	VXUH20I	3	
		S321Q	KF	12.7-15.4	XU20HR9	90048-51212	XUH20TTI	IXUH20I	VXUH20I	3	
		S331Q	KF	12.7-15.4	XU20HR9	90048-51212	XUH20TTI	IXUH20I	VXUH20I	3	
		S500J	KF	14.9-	SXU20HPR11	90048-51208	-	IXUH20I	VXUH20I	3	
		S510J	KF	14.9-	SXU20HPR11	90048-51208	-	IXUH20I	VXUH20I	3	
S321B	KF	15.4-22.1	SXU20HPR11	90048-51208	-	IXUH20I	VXUH20I	3			
S321B	KF(T/C)	15.4-22.1	SXU22HPR8	90048-51214	-	IXUH22I	VXUH22I	3			
S321Q	KF	15.4-22.1	SXU20HPR11	90048-51208	-	IXUH20I	VXUH20I	3			
S331B	KF	15.4-22.1	SXU20HPR11	90048-51208	-	IXUH20I	VXUH20I	3			
S331B	KF(T/C)	15.4-22.1	SXU22HPR8	90048-51214	-	IXUH22I	VXUH22I	3			
S331Q	KF	15.4-22.1	SXU20HPR11	90048-51208	-	IXUH20I	VXUH20I	3			
<b>SAMBAR (AKABOU)</b>	660	KS3 · KS4 · KV3 · KV4	EN07	96.9-99.2	-	-	-	-	-	4	
		TT1 · TT2 · TV1 · TV2	EN07(SOHC)	99.2-01.8	-	-	-	-	-	4	
		TT1 · TT2 · TV1 · TV2	EN07Y(S/C)	01.8-12.4	-	-	-	-	-	4	
		TT1 · TT2 · TV1 · TV2	EN07L(LPG)/F	01.8-12.4	-	-	-	-	-	4	
		S201J	KF	12.4-	SXU22HPR8	90048-51214	-	IXUH22I	VXUH22I	3	
		S201H	KF	12.4-	SXU22HPR8	90048-51214	-	IXUH22I	VXUH22I	3	
		S211J	KF	12.4-	SXU22HPR8	90048-51214	-	IXUH22I	VXUH22I	3	
<b>SAMBER</b>	660	S211H	KF	12.4-	SXU22HPR8	90048-51214	-	IXUH22I	VXUH22I	3	
		S331B	KF	12.4-	SXU22HPR8	90048-51214	-	IXUH22I	VXUH22I	3	
		S700B	KF	22.1-	SXU20HPR11	90048-51208	-	IXUH20I	VXUH20I	3	
		S700B	KF(T/C)	22.1-	SXU22HPR8	90048-51214	-	IXUH22I	VXUH22I	3	
		S710B	KF	22.1-	SXU20HPR11	90048-51208	-	IXUH20I	VXUH20I	3	
S710B	KF(T/C)	22.1-	SXU22HPR8	90048-51214	-	IXUH22I	VXUH22I	3			
<b>STELLA/CUSTOM</b>	660	RN1 · RN2	EN07(DOHC)	06.6-11.5	IXUH22	SAB330DE8740	-	IXUH22	VXUH22	4	

DENSO	9	14	16	20	22	24	27	29	31	32	34	35	DENSO	9	14	16	20	22	24	27	31	DENSO	9	14	16	20	22	24	27	31		
NGK	2	4	5	6	7	8	9	9.5	10	10.5	11	11.5	CHAMPION	18	16,14	12,11	10,9	8,7	6,63,61	4,59	57	55	53	BOSCH	10	9	8	7,6	5	4	3	2



AUSTRALIA  
CHINA  
INDIA  
INDONESIA  
KOREA  
MALAYSIA  
PHILIPPINES  
SAUDI ARABIA  
SINGAPORE  
TAIWAN  
THAILAND  
VIETNAM  
JAPAN  
EUROPE & USA  
CROSS REFERENCE  
PART NUMBER



▶ Spark plug color codes: ■ for Iridium Tough and Iridium Plugs and Iridium TT, ■ for Iridium Power, ■ for Iridium Racing and Two Tops Plugs, ■ for Platinum Plugs and Platinum TT, and black for general spark plugs.

AUSTRALIA	MODEL	CC	VEHICLE CODE	ENGINE	FROM-TILL	DENSO	GENUINE P/N				QTY		
	<b>SUBARU</b>												
	CHINA	STELLA/CUSTOM	RN1 • RN2		EN07(DOHC • S/C)	06.6-11.5	IXU24	SAB330DE8730 -	IXU24	VXU24	4		
LA100F • LA110F			KF(DOHC)	11.5-13.1	SXU20HPR11	90048-51208 -	IXUH20I	VXUH20I	3				
LA100F • LA110F			KF(DOHC)	11.5-13.1	SXU20HPR11	90048-51208 -	IXUH20I	VXUH20I	3				
LA100F			KF(T/C)	11.5-13.1	SXU22HPR8	90048-51214 -	IXUH22I	VXUH22I	3				
LA110F			KF(T/C)	11.5-13.1	SXU22HPR8	90048-51214 -	IXUH22I	VXUH22I	3				
LA100F • LA110F			KF(DOHC • T/C)	11.8-	SXU22HPR8	90048-51214 -	IXUH22I	VXUH22I	3				
LA100F			KF	13.1-14.12	SXU20HPR11	90048-51208 -	IXUH20I	VXUH20I	3				
LA110F			KF	13.1-14.12	SXU20HPR11	90048-51208 -	IXUH20I	VXUH20I	3				
LA100F			KF(T/C)	13.1-13.8	SXU22HPR8	90048-51214 -	IXUH22I	VXUH22I	3				
LA110F			KF(T/C)	13.1-13.8	SXU22HPR8	90048-51214 -	IXUH22I	VXUH22I	3				
LA100F			KF(T/C)	13.8-14.12	SXU22HPR8	90048-51214 -	IXUH22I	VXUH22I	3				
LA110F			KF(T/C)	13.8-14.12	SXU22HPR8	90048-51214 -	IXUH22I	VXUH22I	3				
LA150F			KF	14.12-	SXU20HPR11	90048-51208 -	IXUH20I	VXUH20I	3				
LA150F			KF(T/C)	14.12-	SXU22HPR8	90048-51214 -	IXUH22I	VXUH22I	3				
LA160F			KF	14.12-	SXU20HPR11	90048-51208 -	IXUH20I	VXUH20I	3				
LA160F			KF(T/C)	14.12-	SXU22HPR8	90048-51214 -	IXUH22I	VXUH22I	3				
INDONESIA			TRAVIQ	1800	XM182	Z18(DOHC)	03.7-04.12	K20TXR	-	K20TT	IK20	VK20	4
				2200	XM220	Z22(DOHC)	01.8-04.12	ITV20	SAB330DE3715 -	ITV20	-	-	4
INDONESIA	TREZIA	1300	NSP120X	1NR-FE	10.11-14.5	SC16HR11	90919-01275 -	-	-	VCH16	4		
			NSP120X	1NR-FKE	14.5-	FC16HR8	90919-01280 -	-	-	VFCH16	4		
INDONESIA	VIVIO/BISTRO	660	KK3 • KK4 • KY3		EN07(SOHC • S/C)	92.3-98.10	K20PR-U	22401KA150	K20TT	-	VK20Y	4	
			KW3 • KW4		EN07(CARB)	92.3-98.10	K16PR-U11	22401KA200	K16TT	IK16	VK16	4	
INDONESIA	VIVIO/BISTRO	660	KK3 • KK4 • KY3		EN07(MPI)	94.3-98.10	K16PR-U11	22401KA200	K16TT	IK16	VK16	4	
			KK3 • KK4 • KY3		EN07(DOHC • S/C)	96.11-98.10	XU24EPR-U	-	-	IXU24	VXU24	4	
INDONESIA	VIVIO/BISTRO	660	KK3 • KK4 (ECVT)		EN07(DOHC • S/C)	97.5-98.10	XU22EPR-U	22401KA260	XU22TT	IXU22	VXU22	4	
			2000	VAB	EJ20(T/C)	14.8-22.2	-	-	-	-	-	4	
INDONESIA	WRX	VAG		FA20(T/C)	14.8-22.2	-	-	-	-	-	4		
		2400	VBH	FA24(T/C)	22.2-	-	-	-	-	-	4		
<b>SUZUKI</b>													
INDONESIA	AERIO	1500	RA21S • RB21S	M15A(DOHC • VT)	01.1-	SK16PR-A11	09482-00562 -	IK16	VK16	4			
		1800	RC51S • RD51S	M18A(DOHC • VT)	03.1-	VK16	99000-79K73-K16 -	IK16	VK16	4			
INDONESIA	ALTO	660	HA37S	R06A	21.12-	ZXU22HPR8	-	-	IXUH22	VXUH22	3		
		660	HA35S	R06A	11.12-	-	-	-	VSUEH22	3			
INDONESIA	ALTO ECO	660	HE21S	K6A(DOHC)	00.12-03.9	XU22EPR-U	09482-00449	XU22TT	IXU22	VXU22	3		
			HE21S	K6A(DOHC)	03.9-08.11	IXU22C	09482-00563 -	IXU22	VXU22	3			
INDONESIA	ALTO LAPIN	660	HE21S	K6A(DOHC • T/C)	02.1-08.11	IXU22C	09482-00563 -	IXU22	VXU22	3			
			HE22S	K6A(DOHC)	08.11-15.6	IXU22HPR(*5)	09482-00608 -	IXUH22(*5)	VXUH22(*5)	3			
INDONESIA	ALTO LAPIN	660	HE22S	K6A(DOHC • T/C)	08.11-15.6	IXU22HPR(*5)	09482-00608 -	IXUH22(*5)	VXUH22(*5)	3			
			HE33S	R06A	15.6-22.6	ZXU22HPR8	09482-00633 -	IXUH22	VXUH22	3			
INDONESIA	ALTO LAPIN	660	HE33S	R06A	22.6-	-	-	-	-	3			
			HA21S • HB21S	K6A(DOHC • T/C)	94.12-98.10	XU22EP-P	09482-00512 -	IXU22	VXU22	3			
INDONESIA	ALTO/WORKS	660	HA11S • HC11V • HD11V	F6A(2VALVE)	94.12-98.10	W16EPR-U11	09482-00496	W16TT	IW16	VW16	3		
			HA11S • HB11S	F6A(4VALVE)	94.12-98.10	XU22EP-U	09482-00368	XU22TT	IXU22	VXU22	3		
INDONESIA	ALTO/WORKS	660	HA11S • HB11S	F6A(2VALVE • T/C)	94.12-98.10	W16EPR-U	09482-00468	W16TT	IW16	VW16	3		
			HA22S	K6A(DOHC)	98.10-00.12	XU22EPR-U	09482-00449	XU22TT	IXU22	VXU22	3		
INDONESIA	ALTO/WORKS	660	HA22S	K6A(DOHC • T/C)	98.10-00.12	IXU22	99000-79J80-U22 -	IXU22	VXU22	3			
			HA22S	K6A(DOHC • LEANBURN)	98.10-01.4	IXU22	99000-79J80-U22 -	IXU22	VXU22	3			
INDONESIA	ALTO/WORKS	660	HA12V	F6A(4VALVE)	98.10-00.12	XU22EPR-U	09482-00449	XU22TT	IXU22	VXU22	3		
			HA12V	F6A(2VALVE • CARB)	98.10-99.10	W16EPR-U11	09482-00496	W16TT	IW16	VW16	3		
INDONESIA	ALTO/WORKS	660	HA12S	F6A(2VALVE • T/C)	98.10-00.12	W16EPR-U	09482-00468	W16TT	IW16	VW16	3		
			HA12S	F6A(4VALVE)	99.10-00.12	XU22EPR-U	09482-00449	XU22TT	IXU22	VXU22	3		
INDONESIA	ALTO/WORKS	660	HA23S	K6A(DOHC)	00.12-04.9	XU22EPR-U	09482-00449	XU22TT	IXU22	VXU22	3		
			HA23S • HA23V	K6A(DOHC)	00.12-04.9	XU22EPR-U	09482-00449	XU22TT	IXU22	VXU22	3		
INDONESIA	ALTO/WORKS	660	HA23S • HA23V	K6A(LEANBURN)	01.4-04.9	IXU22C	09482-00563 -	IXU22	VXU22	3			
			HA24S	K6A(DOHC)	04.9-09.12	IXU22C	09482-00563 -	IXU22	VXU22	3			
INDONESIA	ALTO/WORKS	660	HA24V	K6A(DOHC)	05.1-09.12	IXU22C	09482-00563 -	IXU22	VXU22	3			
			HA25S • HA25V	K6A(DOHC)	09.12-14.12	IXU22HPR	09482-00608 -	IXUH22	VXUH22	3			
INDONESIA	ALTO/WORKS	660	HA36S	R06A	14.12-21.12	ZXU22HPR8	09482-00633 -	IXUH22	VXUH22	3			
			HA36V	R06A	14.12-21.12	ZXU22HPR8	09482-00633 -	IXUH22	VXUH22	3			
INDONESIA	ALTO/WORKS	660	HA36S	R06A(T/C)	15.3-21.12	ZXU22HPR8	09482-00633 -	IXUH22	VXUH22	3			
			ALTOHYBRID	660	HA97S	R06D	21.12-	-	-	-	-	3	
INDONESIA	BALENO	1000	WB42S	K10C(T/C)	16.5-	-	-	-	IXUH22I	VXUH22I	3		
		1200	WB32S	K12C	16.3-	-	-	-	IXUH20I	VXUH20I	4		
INDONESIA	CAPPUCCINO	660	EA21R	K6A(T/C)	95.5-98.8	XU22EP-P	09482-00512 -	IXU22	VXU22	3			
		660	PG6SS	F6A(DOHC)	93.1-95.12	IXU22	99000-79J80-U22 -	IXU22	VXU22	3			
INDONESIA	CARRY	660	DE51V • DF51V	F6A(2VALVE • T/C)	91.9-99.1	W16EPR-U	09482-00468	W16TT	IW16	VW16	3		

(\*5)The plug reach may be 19mm or 26.5mm even with the same engine and the same vehicle code. Please confirm the plug reach and choose the correct DENSO type. If there is an "H" in DENSO type, it has a reach of 26.5mm. If it doesn't, its reach is 19mm.

MODEL	CC	VEHICLE CODE	ENGINE	FROM-TILL	DENSO	GENUINE P/N				QTY		
<b>SUZUKI CARRY</b>	660	DE51V · DF51V · DC51T · DC51B · DD51T · DD51B	F6A(4VALVE)	91.9-99.1	XU22EPR-U	09482-00449	XU22TT	IXU22	VXU22	3	AUSTRALIA	
		DC51T · DD51T	F6A(2VALVE · T/C)	97.4-99.1	VW16	99000-79K73-W16	-	IW16	VW16	3	CHINA	
		DA52T · DB52T	F6A(4VALVE)	99.1-01.9	XU22EPR-U	09482-00449	XU22TT	IXU22	VXU22	3	INDIA	
		DA52T · DB52T	F6A(2VALVE · T/C)	99.1-00.5	W16EPR-U	09482-00468	W16TT	IW16	VW16	3	INDONESIA	
		DA62T · DA63T	K6A(DOHC)	01.9-10.10	XU22EPR-U(*5)	09482-00449	XU22TT	IXU22(*5)	VXU22(*5)	3	KOREA	
		DA62T · DA63T	K6A(DOHC)	10.10-13.9	IXU22HPR(*5)	09482-00608	-	IXUH22(*5)	VXUH22(*5)	3	INDONESIA	
		DA63T	K6A(DOHC)	01.9-10.10	IXU22C(*5)	09482-00563	-	IXU22(*5)	VXU22(*5)	3	INDONESIA	
		DA63T	K6A(DOHC)	10.10-13.9	IXU22HPR(*5)	09482-00608	-	IXUH22(*5)	VXUH22(*5)	3	INDONESIA	
		DA65T	K6A(DOHC)	05.11-10.5	IXU22C(*5)	09482-00563	-	IXU22	VXU22	3	INDONESIA	
		DA65T	K6A(DOHC)	10.5-13.9	IXU22HPR(*5)	09482-00608	-	IXUH22(*5)	VXUH22(*5)	3	INDONESIA	
		DA16T	R06A	13.9-15.8	-	-	-	-	-	VSUEH22	3	INDONESIA
		DA16T	R06A	15.8-22.4	-	-	-	-	-	VSUEH22	3	INDONESIA
		DA16T	R06A	22.4-	-	-	-	-	-	-	3	INDONESIA
<b>CERVO</b>	660	HG21S	K6A(DOHC · VVT)	06.11-09.5	IXU22C(*5)	09482-00563	-	IXU22(*5)	VXU22(*5)	3	INDONESIA	
		HG21S	K6A(DOHC · VVT)	09.5-09.12	IXU22HPR(*5)	09482-00608	-	IXUH22(*5)	VXUH22(*5)	3	INDONESIA	
		HG21S	K6A(DOHC · VVT · T/C)	06.11-09.12	IXU22C(*5)	09482-00563	-	IXU22(*5)	VXU22(*5)	3	INDONESIA	
<b>CERVO MODE</b>	660	CN21S · CN22S · CP21S · CP22S	F6A(4VALVE)	90.10-98.10	XU22EPR-U	09482-00449	XU22TT	IXU22	VXU22	3	INDONESIA	
		CN21S · CN22S · CP21S · CP22S	F6A(2VALVE · T/C)	90.7-98.10	W16EPR-U	09482-00468	W16TT	IW16	VW16	3	INDONESIA	
		CN31S · CN32S · CP31S · CP32S	F6B(DOHC · T/C)	90.7-98.10	IXU22	99000-79J80-U22	-	IXU22	VXU22	4	INDONESIA	
<b>CHEVROLET CRUZE</b>	1300	HR51S · HR52S	M13A(DOHC · VVT)	01.11-10.8	·SK16PR-A11	09482-00562	-	IK16	VK16	4	INDONESIA	
	1500	HR81S · HR82S	M15A(DOHC · VVT)	01.11-06.5	·SK16PR-A11	09482-00562	-	IK16	VK16	4	INDONESIA	
<b>CULTUS WAGON/ CRESCENT WAGON</b>	1500	GC21W	G15A	96.2-02	K20PR-U11	09482-00508	K20TT	IK20	VK20	4	INDONESIA	
	1600	GD31W	G16A	96.2-02	K20PR-U11	09482-00508	K20TT	IK20	VK20	4	INDONESIA	
	1800	GC41W	J18A	96.2-02	K20PR-U11	09482-00508	K20TT	IK20	VK20	4	INDONESIA	
<b>CULTUS/ CRESCENT</b>	1000	AA44S · AB44S	G10	91.7-02	W16EPR-U11	09482-00496	W16TT	IW16	VW16	3	INDONESIA	
		AA34S · AF34S	G13B(DOHC)	91.7-02	W22EPR-U	09482-00498	-	IW22	VW22	4	INDONESIA	
	1300	AA34S · AB34S · AF34S · AK34S	G13B	91.7-02	K20PR-U11	09482-00508	K20TT	IK20	VK20	4	INDONESIA	
		GA11S	G13B	95.1-00.5	K20PR-U11	09482-00508	K20TT	IK20	VK20	4	INDONESIA	
	1500	GA21S · GB21S · GC21S · GD21S	G15A	95.1-02	K20PR-U11	09482-00508	K20TT	IK20	VK20	4	INDONESIA	
	1600	GB31S · GD31S	G16A	96.2-02	K20PR-U11	09482-00508	K20TT	IK20	VK20	4	INDONESIA	
<b>ESCUDO</b>	1400	YEA1S	K14C(T/C)	17.7-22.4	-	-	-	IXUH22I	VXUH22I	4	INDONESIA	
		TA01W · TA01R · TD01W	G16A	90.9-97.11	K20PR-U	09482-00429	K20TT	IK20	VK20	4	INDONESIA	
		TA02W · TD02W	G16A	97.11-00.4	K20PR-U11	09482-00508	K20TT	IK20	VK20	4	INDONESIA	
		TA02W	G16A	00.4-06.6	VK20	99000-79K73-K20	-	IK20	VK20	4	INDONESIA	
		TA74W	M16A	06.6-08.6	VK20	99000-79K73-K20	-	IK20	VK20	4	INDONESIA	
		YD21S	M16A	15.10-	-	99000-79K73-KH2	-	IKH20	VKH20	4	INDONESIA	
		YE21S	M16A	15.10-	-	99000-79K73-KH2	-	IKH20	VKH20	4	INDONESIA	
	2000	TA51W · TD51W	J20A	96.10-97.11	K20PR-U	09482-00429	K20TT	IK20	VK20	4	INDONESIA	
		TA52W · TD52W	J20A	97.11-00.4	K20PR-U11	09482-00508	K20TT	IK20	VK20	4	INDONESIA	
		TL52W · TD54W	J20A	00.4-08.6	VK16	99000-79K73-K16	-	IK16	VK16	4	INDONESIA	
	2400	TDA4W	J24B	08.6-	VKH20	99000-79K73-KH2	-	IKH20	VKH20	4	INDONESIA	
		TD61W	H25A	96.10-97.11	K20PR-U	09482-00429	K20TT	IK20	VK20	6	INDONESIA	
		TD62W	H25A	98.2-00.4	K20PR-U11	09482-00508	K20TT	IK20	VK20	6	INDONESIA	
	2500	TD62W	H25A	00.4-05.6	VK16	99000-79K73-K16	-	IK16	VK16	6	INDONESIA	
		TD94W	H27A	05.6-08.6	VK20	99000-79K73-K20	-	IK20	VK20	6	INDONESIA	
	3200	TDB4W	N32A	08.6-	ITV16	-	-	ITV16	-	6	INDONESIA	
	<b>ESCUDOHYBRID EVERY</b>	1500	YEH1S	K15C	22.4-	-	-	-	-	4	INDONESIA	
<b>EVERY</b>	660	DA51V · DB51V · DE51V · DF51V	F6A(2VALVE · T/C)	90.3-99.1	W16EPR-U	09482-00468	W16TT	IW16	VW16	3	INDONESIA	
		DA51V · DB51V · DE51V · DF51V	F6A(4VALVE)	90.3-99.1	XU22EPR-U	09482-00449	XU22TT	IXU22	VXU22	3	INDONESIA	
		DA52V · DB52V	F6A(4VALVE)	99.1-01.8	XU22EPR-U	09482-00449	XU22TT	IXU22	VXU22	3	INDONESIA	
		DA52V · DB52V	F6A(2VALVE · T/C)	99.1-99.11	W16EPR-U	09482-00468	W16TT	IW16	VW16	3	INDONESIA	
		DA52V · DB52V	F6A(2VALVE · T/C)	99.11-01.8	IW16	99000-79J80-W16	-	IW16	VW16	3	INDONESIA	
		DA52V · DB52V	F6A(CNG)	00.5-01.9	IXU27	-	-	IXU27	-	3	INDONESIA	
		DA62V · DA62W	K6A(DOHC · T/C)	01.9-05.8	IXU22	99000-79J80-U22	-	IXU22	VXU22	3	INDONESIA	
		DA62V · DA62W	K6A(DOHC)	01.9-07.7	XU22EPR-U	09482-00449	XU22TT	IXU22	VXU22	3	INDONESIA	
		DA62V	K6A(CNG)	01.11-	IXU27	-	-	IXU27	-	3	INDONESIA	
		DA64V	K6A(DOHC)	05.8-10.5	IXU22C(*5)	09482-00563	-	IXU22(*5)	VXU22(*5)	3	INDONESIA	
		DA64V	K6A(DOHC)	10.5-15.2	IXU22HPR(*5)	09482-00608	-	IXUH22(*5)	VXUH22(*5)	3	INDONESIA	
		DA64V	K6A(DOHC · T/C)	05.8-10.5	IXU22C(*5)	09482-00563	-	IXU22(*5)	VXU22(*5)	3	INDONESIA	
		DA64V	K6A(DOHC · T/C)	10.5-15.2	IXU22HPR(*5)	09482-00608	-	IXUH22(*5)	VXUH22(*5)	3	INDONESIA	
		DA17V	R06A	15.2-22.4	-	-	-	-	-	VSUEH22	3	INDONESIA
		DA17V	R06A(T/C)	15.2-	-	-	-	-	-	VSUEH22	3	INDONESIA
		DA17V	R06A	22.4-	-	-	-	-	-	-	3	INDONESIA
		<b>EVERY LANDY</b>	1300	DA32W	G13B	01.5-	K20PR-U	09482-00429	K20TT	IK20	VK20	4
<b>EVERY PLUS</b>	1300	DA32W	G13B(LEV)	99.6-01.5	K20PR-U	09482-00429	K20TT	IK20	VK20	4	INDONESIA	
<b>EVERY WAGON</b>	660	DA52W	F6A(T/C)	99.6-99.11	W16EPR-U	09482-00468	W16TT	IW16	VW16	3	INDONESIA	
		DA52W	F6A(T/C)	99.11-01.8	IW16	99000-79J80-W16	-	IW16	VW16	3	INDONESIA	



(\*5)The plug reach may be 19mm or 26.5mm even with the same engine and the same vehicle code. Please confirm the plug reach and choose the correct DENSO type. If there is an "H" in DENSO type, it has a reach of 26.5mm. If it doesn't, its reach is 19mm.

AUSTRALIA  
CHINA  
INDIA  
INDONESIA  
KOREA  
MALAYSIA  
PHILIPPINES  
SAUDI ARABIA  
SINGAPORE  
TAIWAN  
THAILAND  
VIETNAM  
JAPAN  
EUROPE & USA  
CROSS REFERENCE  
PART NUMBER



AUSTRALIA	MODEL	CC	VEHICLE CODE	ENGINE	FROM-TILL	DENSO	GENUINE P/N				QTY	
	SUZUKI EVERY WAGON		DA62V • DA62W	K6A(DOHC • T/C)	01.9-05.8	IXU22	99000-79J80-U22	-	IXU22	VXU22	3	
			DA62V • DA62W	K6A(DOHC)	01.9-07.7	XU22EPR-U	09482-00449	XU22TT	IXU22	VXU22	3	
		660	DA64W	K6A(T/C)	05.8-10.5	IXU22C(*5)	09482-00563	-	IXU22(*5)	VXU22(*5)	3	
			DA64W	K6A(T/C)	10.5-15.2	IXU22HPR(*5)	09482-00608	-	IXU22(*5)	VXU22(*5)	3	
CHINA	GRAND ESCUDO HUSTLER	2700	TX92W	R06A(T/C)	15.2-	-	-	-	-	VSUEH22	3	
			TX92W	H27A	00.12-	VK16	99000-79K73-K16	-	IK16	VK16	6	
		660	MR31S	R06A	14.1-15.12	-	-	-	-	VSUEH22	3	
			MR31S	R06A(T/C)	14.1-15.12	-	-	-	-	VSUEH22	3	
INDIA		660	MR41S	R06A(S-ene CHARGE)	15.5-20.1	ZXU22HPR8	09482-00633	-	IXUH22	VXUH22	3	
			MR31S	R06A	15.12-20.1	ZXU22HPR8	09482-00633	-	IXUH22	VXUH22	3	
		660	MR41S	R06A(T/C • S-ene CHARGE)	15.12-20.1	-	-	-	-	VSUEH22	3	
			MR92S	R06D	20.1-	-	-	-	-	IXUH22I	VXUH22I	3
INDONESIA	HUSTLER HYBRID	660	MR52S	R06A(T/C)	20.1-	-	-	-	-	IXUH22	VXUH22	3
			FF21S	K12C	16.2-	-	-	-	-	IXUH20I	VXUH20I	4
	JIMNY	1200	JA12C • JA12V • JA12W	F6A(T/C)	95.11-98.10	-	-	-	-	-	3	
			JA22W	K6A	95.11-98.10	XU22EP-P	09482-00512	-	IXU22	VXU22	3	
		660	JB23W	K6A(DOHC • T/C)	98.10-02.1	IXU22	99000-79J80-U22	-	IXU22	VXU22	3	
			JB23W	K6A(DOHC • T/C)	02.1-08.6	IXU22C(*5)	09482-00563	-	IXU22(*5)	VXU22(*5)	3	
		660	JB23W	K6A(DOHC • T/C)	08.6-18.7	IXU22HPR(*5)	09482-00608	-	IXU22(*5)	VXU22(*5)	3	
			JB64W	R06A(T/C)	18.7-	-	-	-	-	IXUH22	VXUH22	3
MALAYSIA	JIMNY SIERRA	1300	JB32W	G13B	95.11-98.1	K20PR-U	09482-00429	K20TT	IK20	VK20	4	
			JB43W	M13A(DOHC)	02.1-12.5	SK16PR-A11	09482-00562	-	IK16	VK16	4	
		1300	JB43W	M13A	12.5-18.7	SVK20RZ11	-	-	IK20	VK20	4	
			JB74W	K15B	18.7-	ZXU20PR11	09482-00602	-	-	VXU20	4	
PHILIPPINES	JIMNY WIDE	1300	JB33W	G13B	98.1-00.4	K20PR-U	09482-00429	K20TT	IK20	VK20	4	
			JB43W	M13A(DOHC)	00.4-01.12	SK16PR-A11	09482-00562	-	IK16	VK16	4	
	KEI	660	HN11S • HN12S	F6A(T/C)	98.1-01.10	W16EPR-U	09482-00468	W16TT	IW16	VW16	3	
			HN21S	K6A(DOHC)	98.10-01.3	XU22EPR-U	09482-00449	XU22TT	IXU22	VXU22	3	
		660	HN21S	K6A(DOHC • T/C)	98.10-01.3	IXU22	99000-79J80-U22	-	IXU22	VXU22	3	
			HN22S	K6A(DOHC • T/C)	01.4-	IXU22	99000-79J80-U22	-	IXU22	VXU22	3	
		660	HN22S	K6A(DOHC • VVT)	01.4-02.11	XU22EPR-U	09482-00449	XU22TT	IXU22	VXU22	3	
			HN22S	K6A(DOHC • VVT)	02.11-	IXU22C	09482-00563	-	IXU22	VXU22	3	
SAUDI ARABIA	KIZASHI LANDY	2400	RE91S • RF91S	J24B	09.10-	VKH20	99000-79K73-KH2	-	IKH20	VKH20	4	
			SC25 • SNC25	MR20DE	07.1-10.12	FXE20HR11	28800-CY000	-	-	VFXEH20	4	
		2000	SC26 • SNC26	MR20DD	10.12-16.12	-	-	-	-	-	4	
			SHC26	MR20DD	12.8-16.12	-	-	-	-	-	-	4
		2000	SC27	MR20DD	16.12-18.9	DXE22H11CT	11182-52200	-	-	-	4	
			SC27	MR20DD	18.9-	DXE22H11C	11182-52202	-	-	-	-	4
TAIWAN	LANDYHYBRID	2000	SGC27	MR20DD	16.12-18.9	DXE22H11CT	11182-52200	-	-	-	4	
			SGNC27	MR20DD	16.12-18.9	DXE22H11CT	11182-52200	-	-	-	-	4
		2000	SGC27	MR20DD	18.9-	DXE22H11C	11182-52202	-	-	-	4	
			SGNC27	MR20DD	18.9-	DXE22H11C	11182-52202	-	-	-	-	4
THAILAND	MR WAGON	660	MF21S	K6A(DOHC • T/C)	01.12-06.1	IXU22C	09482-00563	-	IXU22	VXU22	3	
			MF21S	K6A(DOHC • VVT)	01.12-02.4	XU22EPR-U	09482-00449	XU22TT	IXU22	VXU22	3	
		660	MF21S	K6A(DOHC • VVT)	02.4-06.1	IXU22C	09482-00563	-	IXU22	VXU22	3	
			MF22S	K6A(DOHC • VVT)	06.1-09.6	IXU22C(*5)	09482-00563	-	IXU22(*5)	VXU22(*5)	3	
		660	MF22S	K6A(DOHC • VVT)	09.6-11.1	IXU22HPR(*5)	09482-00608	-	IXU22(*5)	VXU22(*5)	3	
			MF22S	K6A(DOHC • T/C)	06.1-11.1	IXU22C(*5)	09482-00563	-	IXU22(*5)	VXU22(*5)	3	
		660	MF33S	R06A(DOHC • VVT)	11.1-	-	-	-	-	VSUEH22	3	
			MF33S	R06A(DOHC • VVT • T/C)	11.1-	-	-	-	-	VSUEH22	3	
JAPAN	PALETTE	660	MK21S	K6A(DOHC)	08.1-09.9	IXU22C(*5)	09482-00563	-	IXU22(*5)	VXU22(*5)	3	
			MK21S	K6A(DOHC • T/C)	08.1-09.9	IXU22C(*5)	09482-00563	-	IXU22(*5)	VXU22(*5)	3	
		660	MK21S	K6A(DOHC)	09.9-	IXU22HPR(*5)	09482-00608	-	IXU22(*5)	VXU22(*5)	3	
			MK21S	K6A(DOHC • T/C)	09.9-	IXU22HPR(*5)	09482-00608	-	IXU22(*5)	VXU22(*5)	3	
EUROPE & USA	SOLIO	1200	MA15S	K12B(DOHC • VVT)	10.12-13.11	ZXU20PR11	09482-00602	-	-	VXU20	4	
			MA15S	K12B(2WD)	13.11-15.8	ZXU20PR11	09482-00602	-	-	VXU20	4	
		1200	MA15S	K12B(1SS • 2WD)	13.11-15.8	ZXU20HPR11	09482-00629	-	IXUH20I	VXUH20I	4	
			MA15S	K12B(4WD)	13.11-15.8	ZXU20HPR11	09482-00629	-	IXUH20I	VXUH20I	4	
		1300	MA26S	K12C	15.8-20.12	-	-	-	IXUH20I	VXUH20I	4	
			MA27S	K12C	20.12-	-	-	-	IXUH20I	VXUH20I	4	
CROSS REFERENCE NUMBER	SOLIO HYBRID	1200	MA34S	M13A(DOHC)	04.4-10.12	SK16PR-A11	09482-00562	-	IK16	VK16	4	
			MA36S	K12C	15.8-20.12	-	-	-	IXUH20I	VXUH20I	4	
		1200	MA46S	K12C	16.11-20.12	-	-	-	IXUH20I	VXUH20I	4	
			MA37S	K12C	20.12-	-	-	-	IXUH20I	VXUH20I	4	
PART NUMBER	SPACIA	660	MK32S	R06A	13.3-15.5	-	-	-	-	VSUEH22	3	
			MK32S	R06A(T/C)	13.3-15.8	-	-	-	-	VSUEH22	3	

(\*5)The plug reach may be 19mm or 26.5mm even with the same engine and the same vehicle code. Please confirm the plug reach and choose the correct DENSO type. If there is an "H" in DENSO type, it has a reach of 26.5mm. If it doesn't, its reach is 19mm.



MODEL	CC	VEHICLE CODE	ENGINE	FROM-TILL	DENSO	GENUINE P/N				QTY		
<b>SUZUKI SPACIA</b>	660	MK32S Rev	R06A	15.6-	- / ZXU22HPR8	- / 09482-00633	-	- / IXUH22	VSUEH22 / VXUH22	3	AUSTRALIA	
MK42S		R06A(S-ene CHARGE)	15.5-17.12	ZXU22HPR8	09482-00633	-	IXUH22	VXUH22	3	CHINA		
MK42S		R06A(T/C · S-ene CHARGE)	15.8-17.12	-	-	-	-	VSUEH22	3			
<b>SPACIAHYBRID</b>	660	MK53S	R06A	17.12-	-	-	-	IXUH22I	VXUH22I	3	INDIA	
MK53S		R06A(T/C)	17.12-	-	-	-	-	IXUH22	VXUH22	3		
<b>SPLASH SWIFT</b>	1200	XB32S	K12B(DOHC · VVT)	08.10-	ZXU20PR11	09482-00602	-	-	VXU20	4	INDONESIA	
1000	ZC13S	K10C(T/C)	17.1-	-	-	-	-	IXUH22I	VXUH22I	3		
		ZC71S	K12B(DOHC · VVT)	07.5-10.8	ZXU20PR11	09482-00602	-	-	VXU20	4		
		ZC72S · ZD72S	K12B(DOHC · VVT)	10.8-13.7	ZXU20PR11	09482-00602	-	-	VXU20	4		
		ZC72S	K12B	13.7-17.1	ZXU20PR11	09482-00602	-	-	VXU20	4		
	1200	ZC72S	K12B(ISS)	13.7-17.1	ZXU20HPR11	09482-00629	-	IXUH20I	VXUH20I	4		
		ZD72S	K12B	13.7-17.1	ZXU20HPR11	09482-00629	-	IXUH20I	VXUH20I	4		
		ZC83S	K12C	17.1-	-	-	-	IXUH20I	VXUH20I	4		
		ZD83S	K12C	17.1-	-	-	-	IXUH20I	VXUH20I	4		
	1300	HT51S	M13A(DOHC)	00.1-04.11	·SK16PR-A11	09482-00562	-	IK16	VK16	4		KOREA
		ZC11S · ZD11S	M13A(DOHC)	04.11-	VK20	99000-79K73-K20	-	IK20	VK20	4		
	1500	HT81S	M15A(DOHC · VVT)	03.6-04.11	VK20	99000-79K73-K20	-	IK20	VK20	4	MALAYSIA	
		ZC21S · ZD21S	M15A(DOHC · VVT)	04.11-	VK20	99000-79K73-K20	-	IK20	VK20	4		
<b>SWIFT SPORTS</b>	1400	ZC33S	K14C(T/C)	17.9-	-	-	-	IXUH22I	VXUH22I	4	PHILIPPINES	
	1600	ZC31S	M16A(DOHC)	05.8-10.9	VK20	99000-79K73-K20	-	IK20	VK20	4		
		ZC32S	M16A(DOHC · VVT)	11.12-16.12	VKH20	99000-79K73-KH2	-	IKH20	VKH20	4		
<b>SWIFTHYBRID</b>	1200	ZC53S	K12C	17.1-	-	-	-	IXUH20I	VXUH20I	4	SAUDIARABIA	
		ZD53S	K12C	17.1-	-	-	-	IXUH20I	VXUH20I	4		
		ZC43S	K12C	17.7-	-	-	-	IXUH20I	VXUH20I	4		
<b>SX4</b>	1500	YA11S · YB11S · YC11S	M15A(DOHC · VVT)	06.7-09.5	VK20(*5)	99000-79K73-K20	-	IK20(*5)	VK20(*5)	4	SINGAPORE	
		YA11S · YB11S · YC11S	M15A(DOHC · VVT)	09.5-	VKH20(*5)	99000-79K73-KH2	-	IKH20(*5)	VKH20(*5)	4		
	2000	YA41S · YB41S	J20A	06.7-09.4	VK16	99000-79K73-K16	-	IK16	VK16	4	TAIWAN	
<b>SX4 S-CROSS</b>	1600	YA22S	M16A	15.2-	VKH20	99000-79K73-KH2	-	IKH20	VKH20	4		
		YB22S	M16A	15.2-	VKH20	99000-79K73-KH2	-	IKH20	VKH20	4		
<b>TWIN WAGON R</b>	660	EC22S(HYBRID) · EC22S	K6A(DOHC)	03.1-05.8	IXU22C	09482-00563	-	IXU22	VXU22	3	VIETNAM	
		CT21S · CV21S	F6A(4VALVE)	93.9-98.10	XU22EP-U	09482-00368	XU22TT	IXU22	VXU22	3		
		CT21S · CV21S	F6A(2VALVE · T/C)	95.2-98.10	W16EPR-U	09482-00468	W16TT	IW16	VW16	3		
		CT51S · CV51S	K6A(DOHC · T/C)	97.4-98.10	XU22EP-P	09482-00512	-	IXU22	VXU22	3		
		CT51S · CV51S(Except Column AT)	K6A(DOHC)	97.4-98.10	XU22EP-P	09482-00512	-	IXU22	VXU22	3		
		CT51S · CV51S(Column AT)	K6A(DOHC)	97.11-98.10	XU22EPR-U	09482-00449	XU22TT	IXU22	VXU22	3		
		MC21S	K6A(DOHC)	98.10-00.12	XU22EPR-U	09482-00449	XU22TT	IXU22	VXU22	3		
		MC21S	K6A(DOHC · T/C)	98.10-00.12	IXU22	99000-79J80-U22	-	IXU22	VXU22	3		
		MC11S	F6A(4VALVE)	98.10-00.12	XU22EPR-U	09482-00449	XU22TT	IXU22	VXU22	3		
		MC11S	F6A(2VALVE · T/C)	98.10-00.12	W16EPR-U	09482-00468	W16TT	IW16	VW16	3		
		MC11S	F6A(CNG)	99.6-	IXU27	-	-	IXU27	-	3		
		MC22S	K6A(DOHC)	00.12-03.9	XU22EPR-U	09482-00449	XU22TT	IXU22	VXU22	3		
		MC22S	K6A(DOHC · T/C)	00.12-03.9	IXU22	99000-79J80-U22	-	IXU22	VXU22	3		
		MC12S	F6A(2VALVE · T/C)	00.12-01.10	W16EPR-U	09482-00468	W16TT	IW16	VW16	3		
	660	MH21S	K6A(DOHC)	03.9-08.9	IXU22C	09482-00563	-	IXU22	VXU22	3		
		MH21S	K6A(DOHC · T/C)	03.9-08.9	IXU22C	09482-00563	-	IXU22	VXU22	3		
		MH21S	K6A(DOHC · T/C · DI)	03.9-08.9	IXU22C	09482-00563	-	IXU22	VXU22	3		
		MH21S Rev	K6A Rev(CNG)	04.5-	IXU27	-	-	IXU27	-	3		
		MH22S	K6A(DOHC · VVT)	07.4-08.9	IXU22C	09482-00563	-	IXU22	VXU22	3		
		MH23S	K6A(DOHC · VVT)	08.9-12.9	IXU22HPR	09482-00608	-	IXUH22(*5)	VXUH22(*5)	3		
		MH23S	K6A(DOHC · T/C)	08.9-10.8	IXU22HPR	09482-00608	-	IXUH22(*5)	VXUH22(*5)	3		
		MH34S	R06A(Vehicle identification ~500000)	12.9-15.8	-	-	-	-	VSUEH22	3		
		MH44S	R06A(S-ene CHARGE)	14.8-15.8	-	-	-	-	VSUEH22	3		
		MH34S	R06A(Vehicle identification 500001~)	15.8-17.2	ZXU22HPR8	09482-00633	-	IXUH22	VXUH22	3		JAPAN
	MH44S	R06A(S-ene CHARGE)	15.8-17.2	ZXU22HPR8	09482-00633	-	IXUH22	VXUH22	3			
	MH35S	R06A	17.2-20.1	-	-	-	-	IXUH22I	VXUH22I	3		
	MH85S	R06D	20.1-	-	-	-	-	IXUH22I	VXUH22I	3		
	MH55S	R06A	17.2-20.1	-	-	-	-	IXUH22I	VXUH22I	3		
<b>WAGON R HYBRID</b>	660	MH95S	R06D	20.1-	-	-	-	IXUH22I	VXUH22I	3	EUROPE & USA	
<b>WAGON R PLUS</b>	1000	MA63S	K10A(DOHC)	99.5-00.12	XU22EPR-U	09482-00449	XU22TT	IXU22	VXU22	4		
		MA63S	K10A(DOHC · T/C)	99.5-00.12	IXU22	99000-79J80-U22	-	IXU22	VXU22	4		
<b>WAGON R SMILE</b>	660	MX81S	R06D	21.9-	-	-	-	-	-	3	CROSS REFERENCE NUMBER	
<b>WAGON R SMILE HYBRID</b>	660	MX91S	R06D	21.9-	-	-	-	-	-	3		
<b>WAGON R SOLIO</b>	1000	MA64S	K10A(DOHC)	00.11-02.11	XU22EPR-U	09482-00449	XU22TT	IXU22	VXU22	4	PART NUMBER	
	1300	MA34S	M13A(DOHC)	00.11-05.8	·SK16PR-A11	09482-00562	-	IK16	VK16	4		

(\*5)The plug reach may be 19mm or 26.5mm even with the same engine and the same vehicle code. Please confirm the plug reach and choose the correct DENSO type. If there is an "H" in DENSO type, it has a reach of 26.5mm. If it doesn't, its reach is 19mm.



	MODEL	CC	VEHICLE CODE	ENGINE	FROM-TILL	DENSO	GENUINE P/N				QTY																						
AUSTRALIA	SUZUKI WAGON R STINGRAY																																
												MH22S	K6A(DOHC · VVT)	07.2-08.9	IXU22C	09482-00563	-	IXU22	VXU22	3													
												MH22S	K6A(DOHC · T/C)	07.2-08.9	IXU22C	09482-00563	-	IXU22	VXU22	3													
												MH22S	K6A(DOHC · T/C · DI)	07.2-08.9	IXU22C	09482-00563	-	IXU22	VXU22	3													
												CHINA	660	MH23S	K6A(DOHC · VVT)	08.9-12.9	IXU22HPR	09482-00608	-	IXUH22	VXUH22	3											
														MH23S	K6A(DOHC · T/C)	08.9-12.9	IXU22HPR	09482-00608	-	IXUH22	VXUH22	3											
														MH34S	R06A	12.9-15.8	-	-	-	-	VSUEH22	3											
														MH34S	R06A(T/C)	12.9-15.8	-	-	-	-	VSUEH22	3											
														MH44S	R06A(S-ene CHARGE)	14.8-15.8	-	-	-	-	VSUEH22	3											
														MH44S	R06A(S-ene CHARGE)	15.8-17.2	ZXU22HPR8	09482-00633	-	IXUH22	VXUH22	3											
												INDIA																					
																								MH44S	R06A(T/C · S-ene CHARGE)	15.8-17.2	-	-	-	-	VSUEH22	3	
MH35S	R06A	17.2-20.1	-	-	-	-	IXUH22I	VXUH22I	3																								
INDONESIA	WAGON R STINGRAY HYBRID	660																															
												MH55S	R06A	17.2-20.1	-	-	-	-	IXUH22I	VXUH22I	3												
												MH55S	R06A(T/C)	17.2-	ZXU22HPR8	09482-00633	-	IXUH22	VXUH22	3													
	WAGON R WIDE	1000																															
												MH95S	R06D	20.1-	-	-	-	-	IXUH22I	VXUH22I	3												
												MA61S · MB61S	K10A(DOHC)	97.2-99.5	XU22EPR-U	09482-00449	XU22TT	IXU22	VXU22	4													
KOREA	X-90	1600																															
												MA61S · MB61S	K10A(DOHC · T/C)	97.2-99.5	XU22EP-P	09482-00512	-	IXU22	VXU22	4													
	XBEE	1000																															
												LB11S	G16A	95.10-	K20PR-U	09482-00429	K20TT	IK20	VK20	4													
	TOYOTA																																
												MN71S	K10C(T/C)	17.12-	-	-	-	-	IXUH22I	VXUH22I	3												
MALAYSIA	86																																
												ZN6	FA20	12.4-16.8	ZXE27HBR8	SU003-04931	-	-	VXEBH27	4													
												2000	GRMN86-FRSPORT	FA20-GR(GRMN)	16.2-	ZXE27HBR8	SU003-04931	-	-	VXEBH27	4												
													ZN6	FA20	16.8-21.10	ZXE27HBR8	SU003-04931	-	-	VXEBH27	4												
												2400	ZN8	FA24	21.10-	ZXE27HBR8	SU003-04931	-	-	VXEBH27	4												
													ALLEX	1500																			
												NZE121 · NZE124												1NZ-FE	01.1-04.4	K16R-U11	90919-01164	K16TT	IK16	VK16	4		
												NZE121(2WD,AT)												1NZ-FE	04.4-06.10	FK20HR11	90919-01247	-	-	VFKH20	4		
												1800																					
																									NZE124(4WD,AT)	1NZ-FE	04.4-06.10	K16R-U11	90919-01164	K16TT	IK16	VK16	4
																									ZZE122 · ZZE124	1ZZ-FE	02.9-06.10	K16R-U11	90919-01164	K16TT	IK16	VK16	4
												SAUDIARABIA	ALLION																				
ZZE123	2ZZ-GE	01.1-06.10	SK20R11	90919-01210	-	-	IK20	VK20	4																								
1500																																	
																								NZT240	1NZ-FE	01.12-07.6	K16R-U11	90919-01164	K16TT	IK16	VK16	4	
																								NZT260	1NZ-FE	07.6-07.9	FK20HR11	90919-01247	-	-	VFKH20	4	
1800																																	
																								NZT260	1NZ-FE	07.9-	FK16HR11	90919-01243	-	-	VFKH16	4	
																								ZZT240 · ZZT245	1ZZ-FE	01.12-07.6	K16R-U11	90919-01164	K16TT	IK16	VK16	4	
																								ZRT260 · ZRT265	2ZR-FE	07.6-10.4	SC16HR11	90919-01275	-	-	VCH16	4	
																								ZRT260 · ZRT265	2ZR-FAE	10.4-	SC16HR11	90919-01275	-	-	VCH16	4	
																								ZRT261	3ZR-FAE	08.1-	SC16HR11	90919-01275	-	-	VCH16	4	
SINGAPORE	ALPHARD																																
												AZT240	1AZ-FSE(D-4)	01.12-07.6	SK20BGR11	90919-01221	-	-	VKA20	4													
												2400																					
																								ZRT261	3ZR-FAE	08.1-	SC16HR11	90919-01275	-	-	VCH16	4	
																								ANH10W · ANH15W	2AZ-FE	02.5-08.5	K20R-U11	90919-01184	K20TT	IK20	VK20	4	
																								ANH20W · ANH25W	2AZ-FE	08.5-12.6	SK20R11	90919-01210	-	-	IK20	VK20	4
																								ANH20W	2AZ-FE	12.6-15.1	SK16R11	90919-01240	-	-	IK16	VK16	4
																								ANH25W	2AZ-FE	12.6-15.1	SK16R11	90919-01240	-	-	IK16	VK16	4
												2500																					
																								AGH30W	2AR-FE	15.1-	SK16HR11	90919-01233	-	-	IKH16	VKH16	4
																								AGH35W	2AR-FE	15.1-	SK16HR11	90919-01233	-	-	IKH16	VKH16	4
												THAILAND	3000																				
MNH10W · MNH15W	1MZ-FE	02.5-08.5	SK20R11	90919-01210	-	-	IK20	VK20	6																								
GGH20W · GGH25W	2GR-FE	08.5-15.1	FK20HR11	90919-01247	-	-	VFKH20	6																									
GGH30W	2GR-FE	15.1-18.1	FK20HR11	90919-01247	-	-	VFKH20	6																									
GGH35W	2GR-FE	15.1-18.1	FK20HR11	90919-01247	-	-	VFKH20	6																									
GGH30W	2GR-FKS	18.1-	FK20HBR8	90919-01263	-	-	VFKBH20	6																									
VIETNAM	ALPHARD HYBRID	2400																															
												GGH35W	2GR-FKS	18.1-	FK20HBR8	90919-01263	-	-	VFKBH20	6													
												ATH10W	2AZ-FXE	03.7-	SK20R11	90919-01210	-	-	IK20	VK20	4												
JAPAN	ALTEZZA																																
												ATH20W	2AZ-FXE	11.11-12.6	SK20R11	90919-01237	-	-	IK20	VK20	4												
												ATH20W	2AZ-FXE	12.6-15.1	SK16R11	90919-01240	-	-	IK16	VK16	4												
												2500	AYH30W	2AR-FXE	15.1-	FK16HR-A8	90919-01259	-	-	VFKH16	4												
												2000																					
																								GXE10	1G-FE	98.10-02.8	K20R-U11	90919-01184	K20TT	IK20	VK20	6	
GXE10	1G-FE	02.8-05.9	K20R-U11	90919-01184	K20TT	IK20	VK20	6																									
SXE10(A/T)	3S-GE	98.10-02.8	PK20R11	90919-01220	-	-	IK20	VK20	4																								
EUROPE & USA	ALTEZZA GITA	2000																															
												SXE10(M/T)	3S-GE	98.10-02.8	SK20R11	90919-01210	-	-	IK20	VK20	4												
												SXE10	3S-GE	02.8-05.9	SK20R11	90919-01210	-	-	IK20	VK20	4												
												GXE10W · GXE15W	1G-FE	01.7-05.9	K20R-U11	90919-01184	K20TT	IK20	VK20	6													
CROSS REFERENCE PART NUMBER	AQUA																																
												3000	JCE10W · JCE15W	2JZ-GE	01.7-05.9	PK16TR11	90919-01196	-	-	IK16	VK16	6											
												1500																					
																								NHP10	1NZ-FXE(HYBRID)	11.12-13.1	FK16R-A8	90919-01265	-	-	VFK16	4	
																								NHP10	1NZ-FXE(HYBRID)	13.1-14.1	FK16R-AL8	90919-01272	-	-	VFK16	4	
																								NHP10	1NZ-FXE(HYBRID)	14.1-21.7	FK16BR-AL8	90919-01284	-	-	VFKB16	4	
																								NHP10H	1NZ-FXE(HYBRID)	17.7-21.7	FK16BR-AL8	90919-01284	-	-	VFKB16	4	
																								MXP10	M15A-FXE	21.7-	FC16HR-Q8	-	-	-	VFCH16	3	
												MXP11	M15A-FXE	21.7-	FC16HR-Q8	-	-	-	VFCH16	3													
												MXP15	M15A-FXE	21.7-	FC16HR-Q8	-	-	-	VFCH16	3													
MXP16	M15A-FXE	21.7-	FC16HR-Q8	-	-	-	VFCH16	3																									



MODEL	CC	VEHICLE CODE	ENGINE	FROM-TILL	DENSO	GENUINE P/N				QTY	
<b>TOYOTA</b>	<b>ARISTO</b>	JZS147	2JZ-GE	91.10-97.8	PK16R11	90919-01168	-	IK16	VK16	6	AUSTRALIA
		JZS147	2JZ-GTE(T/C)	93.8-97.8	SK20R11	90919-01210	-	IK20	VK20	6	CHINA
		JZS160	2JZ-GE	97.8-05.8	PK16TR11	90919-01196	-	IK16	VK16	6	INDIA
		JZS161	2JZ-GTE(T/C)	97.8-05.8	PK20TR11	90919-01194	-	IK20	VK20	6	INDONESIA
		UZS143	1UZ-FE	92.10-97.8	SK20R11	90919-01210	-	IK20	VK20	8	KOREA
<b>AURIS</b>	1200	NRE185H	8NR-FTS(T/C)	15.4-	VDCH22F	-	-	-	VDCH22F	4	INDONESIA
		NZE151H · NZE154H	1NZ-FE	06.10-07.11	FK20HR11	90919-01247	-	-	VFKH20	4	INDONESIA
	1500	NZE151H · NZE154H	1NZ-FE	07.11-12.8	FK16HR11	90919-01243	-	-	VFKH16	4	INDONESIA
		NZE181H	1NZ-FE	12.8-	FK16HR11	90919-01243	-	-	VFKH16	4	INDONESIA
		NZE184H	1NZ-FE	12.8-	FK16HR11	90919-01243	-	-	VFKH16	4	INDONESIA
1800	ZRE152H · ZRE154H	2ZR-FE	06.10-09.10	SC16HR11	90919-01275	-	-	VCH16	4	INDONESIA	
	ZRE152H · ZRE154H	2ZR-FAE	09.10-12.8	SC16HR11	90919-01275	-	-	VCH16	4	INDONESIA	
	ZRE186H	2ZR-FAE	12.8-	SC16HR11	90919-01275	-	-	VCH16	4	INDONESIA	
<b>AURIS HYBRID</b>	1800	ZWE186H	2ZR-FXE	16.4-	SC16HR11	90919-01275	-	-	VCH16	4	INDONESIA
<b>AVARON</b>	3000	MCX10	1MZ-FE	95.5-97.10	SK20R11	90919-01210	-	IK20	VK20	6	INDONESIA
		MCX10	1MZ-FE	97.10-00.7	PK20TR11	90919-01194	-	IK20	VK20	6	INDONESIA
<b>AVENSIS</b>	2000	AZT250 · AZT250W · AZT255 · AZT255W	1AZ-FSE(D-4)	03.10-	SK20BGR11	90919-01221	-	-	VKA20	4	INDONESIA
		ZRT272W	3ZR-FAE	11.9-	SC16HR11	90919-01275	-	-	VCH16	4	INDONESIA
	2400	AZT251 · AZT251W	2AZ-FSE	05.9-	SK20BR11	90919-01230	-	-	VKB20	4	INDONESIA
<b>bB</b>	1300	NCP30	2NZ-FE	00.2-05.12	K16R-U11	90919-01164	K16TT	IK16	VK16	4	INDONESIA
		QNC20 · QNC25	K3-VE	05.12-10.7	SXU22PR9	90048-51188-000	-	IXU22I	VXU22I	4	INDONESIA
	1500	QNC20 · QNC25	K3-VE	10.7-	SXU22PR9	90048-51188-000	-	IXU22I	VXU22I	4	INDONESIA
		NCP31 · NCP35	1NZ-FE	00.2-05.12	K16R-U11	90919-01164	K16TT	IK16	VK16	4	INDONESIA
		NCP34	1NZ-FE	01.6-05.12	K16R-U11	90919-01164	K16TT	IK16	VK16	4	INDONESIA
		QNC21	3SZ-VE	05.12-10.7	SXU22PR9	90048-51188-000	-	IXU22I	VXU22I	4	INDONESIA
<b>BELTA</b>	1000	KSP92	1KR-FE	05.11-	SK20HR11	90919-01191	-	IKH20	VKH20	3	INDONESIA
		SCP92	2SZ-FE	05.11-	SK16HR11	90919-01233	-	IKH16	VKH16	4	INDONESIA
	1300	NCP96	2NZ-FE	05.11-	K16R-U11	90919-01164	K16TT	IK16	VK16	4	INDONESIA
<b>BLADE</b>	2400	AZE156H · AZE154H	2AZ-FE	06.12-	SK20R11	90919-01210	-	IK20	VK20	4	INDONESIA
	3500	GRE156H	2GR-FE	07.8-	FK20HR11	90919-01247	-	-	VFKH20	6	INDONESIA
<b>BREVIS</b>	2500	JCG10 · JCG15	1JZ-FSE(D-4)	01.4-07.6	SK20BR11	90919-01226	-	-	VKB20	6	INDONESIA
	3000	JCG11	2JZ-FSE(D-4)	01.4-07.6	SK20BR11	90919-01226	-	-	VKB20	6	INDONESIA
<b>CALDINA</b>	1500	ET196V	5E-FE	92.11-97.8	K16R-U11	90919-01164	K16TT	IK16	VK16	4	INDONESIA
		ET196V	5E-FE	97.8-02.9	K16TR11	90919-01192	K16TT	IK16	VK16	4	INDONESIA
	1800	AT191G	7A-FE	96.1-97.9	PK16TR13	90919-01200	-	IK16	VK16	4	INDONESIA
		AT211G	7A-FE	97.9-02.9	PK16TR13	90919-01200	-	IK16	VK16	4	INDONESIA
	2000	ZZT241W	1ZZ-FE	02.9-	K16R-U11	90919-01164	K16TT	IK16	VK16	4	INDONESIA
		ST195G	3S-GE	95.2-97.9	PK20R8	90919-01180	-	IK20	VK20	4	INDONESIA
		ST195G · ST191G	3S-FE	96.1-97.9	K20TR11	90919-01198	K20TT	IK20	VK20	4	INDONESIA
		ST215G · ST210G	3S-FE	97.9-02.9	K20TR11	90919-01198	K20TT	IK20	VK20	4	INDONESIA
		ST215G · ST210G	3S-GE	97.9-02.9	PK20R8	90919-01180	-	IK20	VK20	4	INDONESIA
		ST215W	3S-GTE(T/C)	97.9-02.9	PK20R8	90919-01180	-	-	VK20Y	4	INDONESIA
		ST246W	3S-GTE(T/C)	02.9-07.6	SK20R8	90919-01231	-	-	VK20Y	4	INDONESIA
		AZT241W · AZT246W	1AZ-FSE(D-4)	02.9-07.6	SK20BGR11	90919-01221	-	-	VKA20	4	INDONESIA
<b>CAMI</b>	1300	J100E	HC-EJ	99.5-00.4	K20TNR-S	90048-51136	K20TT	IK20	VK20	4	INDONESIA
		J102E	K3-VET(DOHC · T/C)	00.5-05.12	SVK20RZ8	-	-	-	VK20Y	4	INDONESIA
		J102E · J122E	K3-VE	00.5-05.12	K20R-U11	90919-01184	K20TT	IK20	VK20	4	INDONESIA
<b>CAMRY</b>	1800	SV40	4S-FE	96.5-98.7	K20TR11	90919-01198	K20TT	IK20	VK20	4	INDONESIA
		ZZV50 · ZZ50G	1ZZ-FE	98.7-01.8	K16TR11	90919-01192	K16TT	IK16	VK16	4	INDONESIA
	2000	SV41 · SV42 · SV43	3S-FE	96.5-98.7	K20TR11	90919-01198	K20TT	IK20	VK20	4	INDONESIA
		SV55 · SV55G	3S-FE	98.7-01.8	K20TR11	90919-01198	K20TT	IK20	VK20	4	INDONESIA
	2200	SV50 · SV50G	3S-FSE(D-4)	98.7-01.8	PK20GR8	90919-01208	-	-	VKA20	4	INDONESIA
	2400	SXV20 · SXV25	5S-FE	99.8-01.8	PK20TR11	90919-01194	-	IK20	VK20	4	INDONESIA
<b>CAMRY GRACIA</b>	2200	ACV30 · ACV35	2AZ-FE	01.9-06.1	K20R-U11	90919-01184	K20TT	IK20	VK20	4	INDONESIA
		ACV40 · ACV45	2AZ-FE	06.1-	SK20R11	90919-01210	-	IK20	VK20	4	INDONESIA
<b>CAMRY HYBRID</b>	2500	MCV21	2MZ-FE	99.8-01.8	PK20TR11	90919-01194	-	IK20	VK20	6	INDONESIA
		SXV20W · SXV25W	5S-FE	96.12-01.7	PK20TR11	90919-01194	-	IK20	VK20	4	INDONESIA
	2500	SXV20 · SXV25	5S-FE	96.12-99.8	PK20TR11	90919-01194	-	IK20	VK20	4	INDONESIA
		MCV21W · MCV25W	2MZ-FE	96.12-01.7	PK20TR11	90919-01194	-	IK20	VK20	6	INDONESIA
<b>CARINA</b>	1500	MCV21	2MZ-FE	96.12-99.8	PK20TR11	90919-01194	-	IK20	VK20	6	INDONESIA
		AVV50	2AR-FXE	11.9-17.7	FK16HR-A8	90919-01259	-	-	VFKH16	4	INDONESIA
		AXVH70	A25A-FXS	17.7-	FC16HR-Q8	90919-01289	-	-	VFCH16	4	INDONESIA
		AXVH75	A25A-FXS	19.12-	FC16HR-Q8	90919-01289	-	-	VFCH16	4	INDONESIA
		AT212	5A-FE	96.8-98.11	K16R-U11	90919-01164	K16TT	IK16	VK16	4	INDONESIA

INDONESIA  
MALAYSIA  
PHILIPPINES  
SAUDI ARABIA  
SINGAPORE  
TAIWAN  
THAILAND  
VIETNAM  
EUROPE & USA  
CROSS REFERENCE NUMBER  
PART

DENSO	9	14	16	20	22	24	27	29	31	32	34	35	DENSO	9	14	16	20	22	24	27	31	DENSO	9	14	16	20	22	24	27	31		
NGK	2	4	5	6	7	8	9	9.5	10	10.5	11	11.5	CHAMPION	18	16, 14	12, 11	10, 9	8, 7	6, 6.3, 6.1	4, 5, 9	5, 7	5, 5	5, 3	BOSCH	10	9	8	7, 6	5	4	3	2



# JAPAN CAR

▶ Spark plug color codes: ■ for Iridium Tough and Iridium Plugs and Iridium TT, ■ for Iridium Power, ■ for Iridium Racing and Two Tops Plugs, ■ for Platinum Plugs and Platinum TT, and black for general spark plugs.

REGION	MODEL	CC	VEHICLE CODE	ENGINE	FROM-TILL	DENSO	GENUINE P/N	IRIDIUM POWER	IRIDIUM TOUGH	QTY	
AUSTRALIA	TOYOTA CARINA	1600	AT210	4A-GE/FE	96.8-01.11	SK20R11	90919-01210	-	IK20 VK20	4	
		1800	AT211	7A-FE(LEAMBURN)	96.8-01.11	PK16TR13	90919-01200	-	IK16 VK16	4	
		2000	ST215	3S-FE	96.8-01.11	K20TR11	90919-01198	K20TT	IK20 VK20	4	
CHINA	CARINA ED	1800	ST200 · ST201	4S-FE	96.6-98.4	K20TR11	90919-01198	K20TT	IK20 VK20	4	
		2000	ST182 · ST183 · ST202 · ST205 ST202 · ST203	3S-GE 3S-FE	89.8-98.4 96.6-01.11	PK20R8 K20TR11	90919-01180 90919-01198	- K20TT	IK20 VK20 IK20 VK20	4 4	
INDIA	CAVALIER CELICA	2400	TJG00	T2	96.1-00.9	PT16EPR-L13	-	-	IT16 VT16	4	
		1800	ZZT230	1ZZ-FE	99.9-06.4	K16R-U11	90919-01164	K16TT	IK16 VK16	4	
			ZZT231	2ZZ-GE	99.9-06.4	SK20R11	90919-01210	-	IK20 VK20	4	
INDONESIA	CELSIOR	4000	ST185H · SST205	3S-GTE(T/C)	89.8-99.9	PK20R8	90919-01180	-	-	VK20Y	4
			ST202 · ST202C	3S-GE	93.10-97.12	PK20R8	90919-01180	-	IK20 VK20	4	
		2000	ST202 · ST202C ST202 · ST202C · ST203	3S-GE 3S-FE	97.12-99.9 96.6-99.9	SK20R11 K20TR11	90919-01210 90919-01198	- K20TT	IK20 VK20 IK20 VK20	4 4	
KOREA	CENTURY	4000	UCF20 · UCF21	1UZ-FE	96.8-97.7	SK20R11	90919-01210	-	IK20 VK20	8	
			UCF20 · UCF21	1UZ-FE	97.7-00.8	SK20R11	90919-01210	-	IK20 VK20	8	
MALAYSIA	CHASER	1800	UCF30 · UCF31	3UZ-FE	00.8-06.5	SK20R11	90919-01210	-	IK20 VK20	8	
			VG40	5V-EU	82.10-97.4	P16R	90919-01115	-	IW16 VW16	8	
		5000	GZG50	1GZ-FE	97.4-00.4	SK16R-P11	90919-01209	-	IK16 VK16	12	
PHILIPPINES	CHASER	1800	GZG50	1GZ-FE	00.4-10.8	SK16R-P11	90919-01219	-	IK16 VK16	12	
			GZG50	1GZ-FNE(CNG)	03.1-	SK16R8-PG	90919-01239	-	-	VK20T(*8)	12
		2000	GZG50	1GZ-FE	10.8-	PK16TBR-L11	90919-01260	-	-	-	12
SAUDI ARABIA	CHASER	1800	UWG60	2UR-FSE	18.6-	FK20HBR11	90919-01249	-	-	VFKBH20	8
			SX100	4S-FE	97.4-	K20TR11	90919-01198	K20TT	IK20 VK20	4	
		2000	GX70G	1G-FE	88.8-97.4	K16R-U11	90919-01164	K16TT	IK16 VK16	6	
SINGAPORE	CHASER	2000	YX78V	3Y-E	93.2-97.4	·P16R	90919-01143	-	IW16 VW16	4	
			GX100 · GX105	1G-FE	96.9-98.8	K16R-U11	90919-01164	K16TT	IK16 VK16	6	
		2500	GX100 · GX105	1G-FE	98.8-00.9	K20R-U11	90919-01184	K20TT	IK20 VK20	6	
TAIWAN	CHASER	2500	JZX100 · JZX105	1JZ-GE	96.9-00.9	PK16TR11	90919-01196	-	IK16 VK16	6	
			JZX100	1JZ-GTE(T/C)	96.9-00.9	PK20TR11	90919-01194	-	IK20 VK20	6	
		3000	JZX101	2JZ-GE	96.9-00.9	PK16TR11	90919-01196	-	IK16 VK16	6	
THAILAND	C-HR	1200	NGX50	8NR-FTS(T/C)	16.12-	VDCH22F	-	-	VDCH22F	4	
			NGX10	8NR-FTS(T/C)	18.5-	VDCH22F	-	-	VDCH22F	4	
		1800	ZYX10	2ZR-FXE	16.12-18.5	FC16HR-C9	90919-01281	-	-	VFCH16	4
VIETNAM	C-HR HYBRID	1800	ZYX10	2ZR-FXE	18.5-19.10	FC16HR-CY9	90919-01298	-	-	VFCH16	4
			ZYX11	2ZR-FXE	19.10-	FC16HR-CY9	90919-01298	-	-	VFCH16	4
		1500	HZB50(HYBRID)	5E-FE	97.8-07	K16TR11	90919-01192	K16TT	IK16 VK16	4	
JAPAN	COASTER	4100	BZB40 · BZB50	1BZ-FPE(LPG)	04.8-	SK20R5-G	90919-01229	-	-	4	
			BZB50	1BZ-FPE	11.8-	SK20R-B5	90919-01264	-	-	4	
		2000	YXS11	3Y-PE(LPG)	95.12-	P20R8	90919-01147	-	-	VW20T(*8)	4
EUROPE & USA	COMFORT	2000	TSS13Y	1TR-FE	08.8-	FK20HBR11-T	90919-01255	-	-	VFKBH20	4
			TSS11	1TR-FPE(LPG)	08.8-	SK20HR-GT8	90919-01277	-	-	VKH20T(*8)	4
		TSS11Y	1TR-FPE(LPG)	08.8-	SK20HR-GT8	90919-01277	-	-	VKH20T(*8)	4	
CROSS REFERENCE NUMBER	COROLLA	660	LA400A	KF(T/C)	19.10-	SXU22HPR8	90048-51214	-	IXUH221 VXUH221	3	
		1200	NRE210	8NR-FTS(T/C)	19.9-	-	-	-	-	4	
		1800	ZRE212	2ZR-FAE	19.9-	FC16HR-Q8	90919-01289	-	-	VFCH16	4
PART	COROLLA AXIO	1300	NRE160	1NR-FE	12.5-13.11	SC16HR11	90919-01275	-	-	VCH16	4
			NRE160	1NR-FE	13.11-	SC16HR11	90919-01275	-	-	VCH16	4
		1500	NZE141 · NZE144	1NZ-FE	06.10-07.11	FK20HR11	90919-01247	-	-	VFKH20	4
JAPAN	COROLLA AXIO	1500	NZE141 · NZE144	1NZ-FE	07.11-	FK16HR11	90919-01243	-	-	VFKH16	4
			NZE161	1NZ-FE	12.5-	FK16HR11	90919-01243	-	-	VFKH16	4
		1800	NZE164	1NZ-FE	12.5-	FK16HR11	90919-01243	-	-	VFKH16	4
EUROPE & USA	COROLLA AXIO HYBRID	1500	NRE161	2NR-FKE	15.4-17.4	FC16HR8	90919-01280	-	-	VFCH16	4
			NRE161	2NR-FKE	17.4-	FC16HR-Q8	90919-01289	-	-	VFCH16	4
		1800	ZRE142 · ZRE144	2ZR-FE	06.10-	SC16HR11	90919-01275	-	-	VCH16	4
CROSS REFERENCE NUMBER	COROLLA CROSS	1800	NKE165	1NZ-FXE	13.8-14.1	FK16R-AL8	90919-01272	-	-	VFK16	4
			NKE165	1NZ-FXE	14.1-	FK16BR-AL8	90919-01284	-	-	VFKB16	4
		1800	ZSG10	2ZR-FAE	21.9-	FC16HR-Q8	90919-01289	-	-	-	4
PART	COROLLA CROSS HYBRID	1800	ZVG11	2ZR-FXE	21.9-	FC16HR-CY9	90919-01298	-	-	-	4
			ZVG15	2ZR-FXE	21.9-	FC16HR-CY9	90919-01298	-	-	-	4
		1500	NZE121G · NZE124G	1NZ-FE	00.8-04.4	K16R-U11(*5)	90919-01164	K16TT	IK16(*5) VK16(*5)	4	
CROSS REFERENCE NUMBER	COROLLA FIELDER	1500	NZE121G(2WD/MT)	1NZ-FE	04.4-06.10	K16R-U11(*5)	90919-01164	K16TT	IK16(*5) VK16(*5)	4	
			NZE121G(2WD/AT)	1NZ-FE	04.4-06.10	FK20HR11(*5)	90919-01247	-	-	VFKH20(*5)	4
		NZE124G(4WD)	1NZ-FE	04.4-06.10	K16R-U11(*5)	90919-01164	K16TT	IK16(*5) VK16(*5)	4		
PART	COROLLA FIELDER	1500	NZE141G · NZE144G	1NZ-FE	06.10-07.11	FK20HR11	90919-01247	-	-	VFKH20	4
			NZE141G · NZE144G	1NZ-FE	07.11-12.5	FK16HR11	90919-01243	-	-	VFKH16	4
		NZE161G	1NZ-FE	12.5-	FK16HR11	90919-01243	-	-	VFKH16	4	
			NZE164G	1NZ-FE	12.5-	FK16HR11	90919-01243	-	-	VFKH16	4

(\*5)The plug reach may be 19mm or 26.5mm even with the same engine and the same vehicle code. Please confirm the plug reach and choose the correct DENSO type. If there is an "H" in DENSO type, it has a reach of 26.5mm. If it doesn't, its reach is 19mm. (\*8)This is IRIDIUM PLUS.



MODEL	CC	VEHICLE CODE	ENGINE	FROM-TILL	DENSO	GENUINE P/N				QTY	
<b>TOYOTA</b> <b>COROLLA</b> <b>FIELDER</b>	1500	NRE161G	2NR-FKE	15.4-17.4	FC16HR8	90919-01280	-	-	VFCH16	4	AUSTRALIA
		NRE161G	2NR-FKE	17.4-	FC16HR-Q8	90919-01289	-	-	VFCH16	4	CHINA
	1800	ZZE122G · ZZE124G	1ZZ-FE	00.8-04.4	K16R-U11	90919-01164	K16TT	IK16	VK16	4	INDIA
		ZZE122G · ZZE124G	1ZZ-FE	04.4-06.10	K16R-U11	90919-01164	K16TT	IK16	VK16	4	INDONESIA
		ZZE123G	2ZZ-GE	00.8-04.4	SK20R11	90919-01210	-	IK20	VK20	4	KOREA
		ZZE123G	2ZZ-GE	04.4-06.10	SK20R11	90919-01210	-	IK20	VK20	4	INDONESIA
		ZRE142G · ZRE144G	2ZR-FE	06.10-12.5	SC16HR11	90919-01275	-	-	VCH16	4	INDONESIA
ZRE162G	2ZR-FAE	12.5-	SC16HR11	90919-01275	-	-	VCH16	4	INDONESIA		
<b>COROLLA</b> <b>FIELDER</b> <b>HYBRID</b>	1500	NKE165G	1NZ-FXE	13.8-14.1	FK16R-AL8	90919-01272	-	-	VFK16	4	INDONESIA
		NKE165G	1NZ-FXE	14.1-	FK16BR-AL8	90919-01284	-	-	VFKB16	4	INDONESIA
<b>COROLLA</b> <b>HYBRID</b>	1800	ZWE211	2ZR-FXE	19.9-	FC16HR-CY9	90919-01298	-	-	VFCH16	4	INDONESIA
		ZWE214	2ZR-FXE	19.9-	FC16HR-CY9	90919-01298	-	-	VFCH16	4	INDONESIA
<b>COROLLA</b> <b>II</b>	1300	EL51	4E-FE	94.9-97.12	K16R-U11	90919-01164	K16TT	IK16	VK16	4	INDONESIA
		EL51	4E-FE	97.12-99.7	K16TR11	90919-01192	K16TT	IK16	VK16	4	INDONESIA
	1500	EL53 · EL55	5E-FE	94.9-97.12	K16R-U11	90919-01164	K16TT	IK16	VK16	4	INDONESIA
		EL53 · EL55	5E-FE	97.12-99.7	K16TR11	90919-01192	K16TT	IK16	VK16	4	INDONESIA
<b>COROLLA</b> <b>RUMION</b>	1500	NZE151N	1NZ-FE	07.10-	FK16HR11	90919-01243	-	-	VFKH16	4	INDONESIA
	1800	ZRE152N · ZRE154N	2ZR-FE	07.10-09.12	SC16HR11	90919-01275	-	-	VCH16	4	INDONESIA
		ZRE152N · ZRE154N	2ZR-FAE	09.12-	SC16HR11	90919-01275	-	-	VCH16	4	INDONESIA
<b>COROLLA</b> <b>RUNX</b>	1500	NZE121 · NZE124	1NZ-FE	01.1-04.4	K16R-U11(*5)	90919-01164	K16TT	IK16(*5)	VK16(*5)	4	INDONESIA
		NZE121(2WD/MT)	1NZ-FE	04.4-06.9	K16R-U11(*5)	90919-01164	K16TT	IK16(*5)	VK16(*5)	4	INDONESIA
		NZE121(2WD/AT)	1NZ-FE	04.4-06.9	FK20HR11(*5)	90919-01247	-	-	VFKH20(*5)	4	INDONESIA
		NZE124(4WD)	1NZ-FE	04.4-06.9	K16R-U11(*5)	90919-01164	K16TT	IK16(*5)	VK16(*5)	4	INDONESIA
	1800	ZZE122 · ZZE124	1ZZ-FE	02.9-04.4	K16R-U11	90919-01164	K16TT	IK16	VK16	4	INDONESIA
		ZZE123	2ZZ-GE	01.1-04.4	SK20R11	90919-01210	-	IK20	VK20	4	INDONESIA
		ZZE122 · ZZE124	1ZZ-FE	04.4-06.9	K16R-U11	90919-01164	K16TT	IK16	VK16	4	INDONESIA
ZZE123	2ZZ-GE	04.4-06.9	SK20R11	90919-01210	-	IK20	VK20	4	INDONESIA		
<b>COROLLA</b> <b>SPACIO</b>	1500	NZE121N	1NZ-FE	01.5-07.6	K16R-U11	90919-01164	K16TT	IK16	VK16	4	INDONESIA
	1600	AE111N	4A-FE	97.1-01.4	K16R-U11	90919-01164	K16TT	IK16	VK16	4	INDONESIA
	1800	AE115N	7A-FE	97.7-01.4	K16R-U11	90919-01164	K16TT	IK16	VK16	4	INDONESIA
		ZZE122N · ZZE124N	1ZZ-FE	01.5-07.6	K16R-U11	90919-01164	K16TT	IK16	VK16	4	INDONESIA
<b>COROLLA</b> <b>SPORT</b>	1200	NRE210H	8NR-FTS(T/C)	18.6-	VDCH22F	-	-	VDCH22F	4	INDONESIA	
		NRE214H	8NR-FTS(T/C)	18.6-	VDCH22F	-	-	VDCH22F	4	INDONESIA	
<b>COROLLA</b> <b>SPORT</b> <b>HYBRID</b>	1800	ZWE211H	2ZR-FXE	18.6-20.6	FC16HR-CY9	90919-01298	-	-	VFCH16	4	INDONESIA
		ZWE213H	2ZR-FXE	20.6-	FC16HR-CY9	90919-01298	-	-	VFCH16	4	INDONESIA
<b>COROLLA</b> <b>TOURING</b>	1200	NRE210W	8NR-FTS(T/C)	19.9-	-	-	-	-	4	INDONESIA	
	1800	ZRE212W	2ZR-FAE	19.9-	FC16HR-Q8	90919-01289	-	-	VFCH16	4	INDONESIA
	2000	MZEA12W	M20A-FKS	20.6-	FC20HR-Q8	90919-01297	-	-	-	4	INDONESIA
<b>COROLLA</b> <b>TOURING</b> <b>HYBRID</b>	1800	ZWE211W	2ZR-FXE	19.9-	FC16HR-CY9	90919-01298	-	-	VFCH16	4	INDONESIA
		ZWE214W	2ZR-FXE	19.9-	FC16HR-CY9	90919-01298	-	-	VFCH16	4	INDONESIA
<b>COROLLA/</b> <b>CELES/</b> <b>LEVIN/FX</b>	1300	EE96V · EE106V	2E · 2E-LJ	87.8-00.8	W16EX-U	90919-01059	W16TT	IW16	VW16	4	INDONESIA
		EE111 · EE102V	4E-FE	95.1-97.4	K16R-U11	90919-01164	K16TT	IK16	VK16	4	INDONESIA
		EE111 · EE102V	4E-FE	97.4-00.8	K16TR11	90919-01192	K16TT	IK16	VK16	4	INDONESIA
		NZE120	2NZ-FE	00.8-04.4	K16R-U11	90919-01164	K16TT	IK16	VK16	4	INDONESIA
		NZE120	2NZ-FE	04.4-06.10	K16R-U11	90919-01164	K16TT	IK16	VK16	4	INDONESIA
	1500	AE100 · AE100G	5A-FE	91.6-00.8	K16R-U11	90919-01164	K16TT	IK16	VK16	4	INDONESIA
		AE110	5A-FE	95.5-00.8	K16R-U11	90919-01164	K16TT	IK16	VK16	4	INDONESIA
		EE103V · EE104G	5E-FE	91.9-97.4	K16R-U11	90919-01164	K16TT	IK16	VK16	4	INDONESIA
		EE103V · EE104G	5E-FE	97.4-00.8	K16TR11	90919-01192	K16TT	IK16	VK16	4	INDONESIA
		NZE121 · NZE124	1NZ-FE	00.8-04.4	K16R-U11(*5)	90919-01164	K16TT	IK16(*5)	VK16(*5)	4	INDONESIA
	1600	NZE121(2WD/MT)	1NZ-FE	04.4-06.10	K16R-U11(*5)	90919-01164	K16TT	IK16(*5)	VK16(*5)	4	INDONESIA
		NZE121(2WD/AT)	1NZ-FE	04.4-06.10	FK20HR11(*5)	90919-01247	-	-	VFKH20(*5)	4	INDONESIA
		NZE124(4WD)	1NZ-FE	04.4-06.10	K16R-U11(*5)	90919-01164	K16TT	IK16(*5)	VK16(*5)	4	INDONESIA
		AE111	4A-GE	95.5-00.8	SK20R11	90919-01210	-	IK20	VK20	4	INDONESIA
		AE109V · AE111 · AE114	4A-FE	96.5-00.8	K16R-U11	90919-01164	K16TT	IK16	VK16	4	INDONESIA
1800	AE101	4A-GE	96.5-00.8	SK20R11	90919-01210	-	IK20	VK20	4	INDONESIA	
	ZZE122 · ZZE124	1ZZ-FE	00.8-04.4	K16R-U11	90919-01164	K16TT	IK16	VK16	4	INDONESIA	
	ZZE122 · ZZE124	1ZZ-FE	04.4-06.10	K16R-U11	90919-01164	K16TT	IK16	VK16	4	INDONESIA	
<b>CORONA</b>	1800	YT140	2Y-PU(LPG)	82.10-01.11	·P16R	90919-01143	-	-	VW20T(*8)	4	INDONESIA
<b>CORONA</b> <b>EXIV /</b> <b>COUPE</b>	1800	ST200 · ST201	4S-FE	96.6-98.4	K20TR11	90919-01198	K20TT	IK20	VK20	4	INDONESIA
		ST200 · ST201	4S-FE	96.6-98.4	K20TR11	90919-01198	K20TT	IK20	VK20	4	INDONESIA
		ST182 · ST183 · ST202 · ST205	3S-GE	89.8-98.4	PK20R8	90919-01180	-	IK20	VK20	4	INDONESIA
	2000	ST202 · ST205	3S-GE	94.10-98.4	PK20R8	90919-01180	-	IK20	VK20	4	INDONESIA
		ST202 · ST203	3S-FE	96.6-01.11	K20TR11	90919-01198	K20TT	IK20	VK20	4	INDONESIA
<b>CORONA</b> <b>PREMIO</b>	1600	AT210	4A-FE	96.1-01.11	PK16TR13	90919-01200	-	IK16	VK16	4	INDONESIA
	1800	AT211	7A-FE	96.1-01.11	PK16TR13	90919-01200	-	IK16	VK16	4	INDONESIA
	2000	ST210 · ST215	3S-FE	96.1-01.11	K20TR11	90919-01198	K20TT	IK20	VK20	4	INDONESIA

(\*5)The plug reach may be 19mm or 26.5mm even with the same engine and the same vehicle code. Please confirm the plug reach and choose the correct DENSO type. If there is an "H" in DENSO type, it has a reach of 26.5mm. If it doesn't, its reach is 19mm. (\*8)This is IRIDIUM PLUS.



AUSTRALIA  
CHINA  
INDIA  
INDONESIA  
KOREA  
MALAYSIA  
PHILIPPINES  
SAUDI ARABIA  
SINGAPORE  
TAIWAN  
THAILAND  
VIETNAM  
JAPAN  
EUROPE & USA  
CROSS REFERENCE NUMBER  
PART



▶ Spark plug color codes: ■ for Iridium Tough and Iridium Plugs and Iridium TT, ■ for Iridium Power, ■ for Iridium Racing and Two Tops Plugs, ■ for Platinum Plugs and Platinum TT, and black for general spark plugs.

AUSTRALIA	MODEL	CC	VEHICLE CODE	ENGINE	FROM-TILL	DENSO	GENUINE P/N				QTY
AUSTRALIA	<b>TOYOTA</b>										
	<b>CORONA PREMIO</b>	2000	ST210	3S-FSE(D-4)	97.9-01.11	PK20GR8	90919-01208	-	-	VKA20	4
AUSTRALIA	<b>CORSA</b>	1300	EL51	4E-FE	94.9-97.12	K16R-U11	90919-01164	K16TT	IK16	VK16	4
			EL51	4E-FE	97.12-99.7	K16TR11	90919-01192	K16TT	IK16	VK16	4
CHINA		1500	EL53 · EL55	5E-FE	94.9-97.12	K16R-U11	90919-01164	K16TT	IK16	VK16	4
			EL53 · EL55	5E-FE	97.12-99.7	K16TR11	90919-01192	K16TT	IK16	VK16	4
INDIA	<b>CRESTA</b>	1800	SX100	4S-FE	97.4-	K20TR11	90919-01198	K20TT	IK20	VK20	4
			GX70G	1G-FE	88.8-97.4	K16R-U11	90919-01164	K16TT	IK16	VK16	6
			YX78V	3Y-E	93.2-97.4	·P16R	90919-01143	-	IW16	VW16	4
			GX100 · GX105	1G-FE	96.9-98.8	K16R-U11	90919-01164	K16TT	IK16	VK16	6
INDONESIA		2500	JZX100 · JZX105	1JZ-GE	96.9-00.9	PK16TR11	90919-01196	-	IK16	VK16	6
			JZX100	1JZ-GTE(T/C)	96.9-00.9	PK20TR11	90919-01194	-	IK20	VK20	6
INDONESIA	<b>CROWN COMFORT</b>	1800	JZX101	2JZ-GE	96.9-00.9	PK16TR11	90919-01196	-	IK16	VK16	6
			SXS11Y	4S-FE	96.4-01.7	K20R-U11	90919-01184	K20TT	IK20	VK20	4
KOREA		2000	GXS12	1G-FE	01.8-	K20R-U11	90919-01184	K20TT	IK20	VK20	6
			GXS10	1G-GPE(LPG)	95.12-01.6	PK20R8	90919-01180	-	-	VK20T(*8)	6
KOREA		2000	YXS10 · YXS10Y	3Y-PE(LPG)	95.12-	P20R8	90919-01147	-	-	VW20T(*8)	4
			TSS10	1TR-FPE(LPG)	08.8-14.1	SK20HR-GT8	90919-01277	-	-	VKH20T(*8)	4
KOREA		2000	TSS10	1TR-FPE(LPG)	14.1-	SK20HR-GT8	90919-01277	-	-	VKH20T(*8)	4
			TSS10	1TR-FPE(LPG)	14.1-	SK20HR-GT8	90919-01277	-	-	VKH20T(*8)	4
MALAYSIA	<b>CROWN SEDAN</b>	2000	GXS10	1G-GPE(LPG)	01.10-02.10	PK20R8	90919-01180	-	-	VK20T(*8)	6
			<b>CROWN/MAJESTA</b>								
MALAYSIA		2000	GS130 · GS130G · GS131 · GS131H · GS136V	1G-FE	88.9-01.8	K16R-U11	90919-01164	K16TT	IK16	VK16	6
			GS130W	1G-FE	95.12-01.8	K16R-U11	90919-01164	K16TT	IK16	VK16	6
PHILIPPINES		2000	GS151 · GS151H	1G-FE	95.8-98.8	K16R-U11	90919-01164	K16TT	IK16	VK16	6
			GS151 · GS151H	1G-FE	98.8-00.4	K20R-U11	90919-01184	K20TT	IK20	VK20	6
SAUDIARABIA		2000	GS171	1G-FE	00.4-01.7	K16R-U11	90919-01164	K16TT	IK16	VK16	6
			GS171 · GS171W	1G-FE	01.8-08.2	K20R-U11	90919-01184	K20TT	IK20	VK20	6
SINGAPORE		2000	GXS12	1G-FE	01.8-08.2	K20R-U11	90919-01184	K20TT	IK20	VK20	6
			GS151 · GS151H	1G-GP(LPG)	95.12-01.2	PK20R8	90919-01180	-	-	VK20T(*8)	6
SINGAPORE		2000	YXS10 · YXS10H · YXS11	3Y-PE(LPG)	01.8-08.8	P20R8	90919-01147	-	-	VW20T(*8)	4
			TSS10H	1TR-FPE(LPG)	08.8-	SK20HR-GT8	90919-01277	-	-	VKH20T(*8)	4
TAIWAN		2500	GBS12(MILD HYBRID)	1G-FE	02.1-	K20R-U11	90919-01184	K20TT	IK20	VK20	6
			GBS12(MILD HYBRID)	1G-FE+1GM	02.1-	K20R-U11	90919-01184	K20TT	IK20	VK20	6
TAIWAN		2500	TSS10	1TR-FPE(LPG)	08.8-	SK20HR-GT8	90919-01277	-	-	VKH20T(*8)	4
			ARS210	8AR-FTS(T/C)	15.10-18.6	VDKH22F	-	-	-	VDKH22F	4
THAILAND		2500	ARS220	8AR-FTS(T/C)	18.6-	VDKH22F	-	-	-	VDKH22F	4
			JZS130G	1JZ-GE	96.9-99.9	PK16TR11	90919-01196	-	IK16	VK16	6
VIETNAM		3000	JZS151 · JZS153	1JZ-GE	96.9-01.7	PK16TR11	90919-01196	-	IK16	VK16	6
			JZS171 · JZS171W	1JZ-GTE(T/C)	99.12-08.2	PK20TR11	90919-01194	-	IK20	VK20	6
VIETNAM		3000	JZS171 · JZS171W · JZS173W · JZS173W	1JZ-GE	99.12-00.4	SK16R-P11	90919-01209	-	IK16	VK16	6
			JZS171 · JZS173 · JZS171W · JZS173W	1JZ-GE	00.4-08.2	·SK16R-P11	90919-01219	-	IK16	VK16	6
VIETNAM		3000	JZS171 · JZS171W	1JZ-FSE(D-4)	01.8-03.12	SK20BR11	90919-01226	-	-	VKB20	6
			GRS180 · GRS181	4GR-FSE(D-4)	03.12-08.2	FK20HBR11	90919-01249	-	-	VFKBH20	6
VIETNAM		3000	GRS200 · GRS201	4GR-FSE(D-4)	08.2-12.12	FK20HBR11	90919-01249	-	-	VFKBH20	6
			GRS210	4GR-FSE	12.12-	FK20HBR11	90919-01249	-	-	VFKBH20	6
VIETNAM		3000	GRS211	4GR-FSE	12.12-	FK20HBR11	90919-01249	-	-	VFKBH20	6
			JZS155 · JZS157	2JZ-GE	95.8-97.7	PK16TR11	90919-01196	-	IK16	VK16	6
VIETNAM		3000	JZS175 · JZS175W · JZS177	2JZ-FSE(D-4)	99.9-03.12	SK20BR11	90919-01226	-	-	VKB20	6
			JKS175(MILD HYBRID)	2JZ-FSE(D-4)+1GM	01.8-	SK20BR11	90919-01226	-	-	VKB20	6
VIETNAM		3000	JZS179	2JZ-GE	99.9-03.12	PK16TR11	90919-01196	-	IK16	VK16	6
			GRS182 · GRS183	3GR-FSE(D-4)	03.12-08.2	FK20HBR11	90919-01249	-	-	VFKBH20	6
VIETNAM		3000	GRS202 · GRS203	3GR-FSE(D-4)	08.2-12.12	FK20HBR11	90919-01249	-	-	VFKBH20	6
			GRS184	2GR-FSE(D-4S)	05.10-08.2	FK20HBR11	90919-01249	-	-	VFKBH20	6
VIETNAM		3500	GRS204	2GR-FSE(D-4S)	08.2-12.12	FK20HBR11	90919-01249	-	-	VFKBH20	6
			GWS204(HYBRID)	2GR-FSE(D-4S)	08.5-12.12	FK20HBR11	90919-01249	-	-	VFKBH20	6
VIETNAM		4000	GRS214	2GR-FSE	12.12-	FK20HBR11	90919-01249	-	-	VFKBH20	6
			UZS151 · UZS155 · UZS157	1UZ-FE	97.7-01.7	SK20R11	90919-01210	-	IK20	VK20	8
VIETNAM		4000	UZS171 · UZS173 · UZS175	1UZ-FE	99.9-04.7	SK20R11	90919-01210	-	IK20	VK20	8
			UZS186 · UZS187	3UZ-FE	04.7-09.3	SK20R11	90919-01210	-	IK20	VK20	8
VIETNAM		4300	UZS207	3UZ-FE	09.3-	SK20R11	90919-01210	-	IK20	VK20	8
			URS206	1UR-FSE	09.3-	FK20HBR11	90919-01249	-	-	VFKBH20	8
VIETNAM	<b>CROWN/MAJESTA HYBRID</b>	2500	AWS210	2AR-FSE	12.12-18.6	FK20HBR8	90919-01263	-	-	VFKBH20	4
			AWS211	2AR-FSE	14.7-18.6	FK20HBR8	90919-01263	-	-	VFKBH20	4
VIETNAM		2500	AWS215	2AR-FSE	14.7-	FK20HBR8	90919-01263	-	-	VFKBH20	4
			AZSH20	A25A-FXS	18.6-	FC16HR-Q8	90919-01289	-	-	VFCH16	4
VIETNAM		2500	AZSH21	A25A-FXS	18.6-	FC16HR-Q8	90919-01289	-	-	VFCH16	4
			3500	GWS214	2GR-FXE	13.9-	FK20HBR8	90919-01263	-	-	VFKBH20

(\*8)This is IRIDIUM PLUS.

MODEL	CC	VEHICLE CODE	ENGINE	FROM-TILL	DENSO	GENUINE P/N				QTY		
<b>TOYOTA</b>												
CROWN/MAJESTA HYBRID	3500	GWS224	8GR-FXS	18.6-	FK20HBR8	90919-01263	-	-	VFKBH20	6	AUSTRALIA	
CURREN	1800	ST208	4S-FE	96.6-98.7	K20TR11	90919-01198	K20TT	IK20	VK20	4	CHINA	
	2000	ST206	3S-GE	94.2-98.7	PK20R8	90919-01180	-	IK20	VK20	4		
CYNOS	1300	ST206 • ST207	3S-FE	96.6-98.7	K20TR11	90919-01198	K20TT	IK20	VK20	4	INDIA	
		EL52	4E-FE	95.8-97.12	K16R-U11	90919-01164	K16TT	IK16	VK16	4		
		EL52	4E-FE	97.12-99.7	K16TR11	90919-01192	K16TT	IK16	VK16	4		
		EL52C	4E-FE	96.10-98.2	K16R-U11	90919-01164	K16TT	IK16	VK16	4		
DUET	1500	EL54 • EL54C	5E-FHE	95.8-99.7	K20R-U11	90919-01184	K20TT	IK20	VK20	4	INDONESIA	
	1000	M100A • M110A	EJ-DE	98.9-00.5	K16PR-U11	-	K16TT	IK16	VK16	3		
DYNA	2000	M100A • M110A	EJ-DE	00.5-01.11	K16TNR-S9	90048-51164	K16TT	IK16	VK16	3	KOREA	
		M100A • M110A	EJ-VE	01.12-04.5	K16TNR-S9	90048-51164	K16TT	IK16	VK16	3		
		M101A • M111A	K3-VE2	00.5-04.5	K20R-U11	90919-01184	K20TT	IK20	VK20	4		
		M101A • M111A	K3-VE	01.12-04.5	K20R-U11	90919-01184	K20TT	IK20	VK20	4		
DYNA	2000	YY101 • YY121 • YY131 • YY201 • YY211	3Y	95.5-01.5	P16R	90919-01115	-	IW16	VW16	4	MALAYSIA	
		LY161	3Y-P(LPG)	98.5-	P16R	90919-01143	-	-	VW20T(*8)	4		
		RZY220 • RZY230	1RZ-E	01.6-03.7	P16R8	90919-01223	-	IW16	VW16	4		
		TRY220 • TRY230	1TR-FE	08.1-	FK20HBR11-T	90919-01255	-	-	VFKBH20	4		
	2700	RZU100 • RZU100A • RZU140	3RZ-FE	95.5-01.5	K16R-U	90919-01176	K16TT	IK16	VK16	4		
		RZU100 • RZU100A • RZU140	3RZ-FE	95.5-	K16R-U	90919-01176	K16TT	IK16	VK16	4		
		RZU100A • RZU100H	3RZ-FP(LPG)	95.5-01.5	K16R-U	90919-01176	-	-	VK20T(*8)	4		
		RZU300	3RZ-FPE(LPG)	01.6-03.7	SK16R8-P8	90919-01214	-	-	VK20T(*8)	4		
		BU280K	3RZ-FPE(LPG)	01.6-	K16R-U	90919-01176	-	-	VK20T(*8)	4		
		RZY231H • RZY281H	3RZ-FPE(LPG)	03.7-	SK16R8-PG	90919-01239	-	-	VK20T(*8)	4		
		TRU300 • TRU300A • TRU340 • TRU500	2TR-FE	07.8-	SK20HR11	90919-01191	-	IKH20	VKH20	4		
		TRC600 • TRU600 • TRC600A	2TR-FE	11.7-	SK20HR11	90919-01191	-	IKH20	VKH20	4		
	4100	BU102A • BU102H • BU142	15B-FP(LPG)	97.8-01.5	PK20R8	90919-01180	-	-	VK20T(*8)	4		PHILIPPINES
		RZU100 • RZU100A • RZU100H	15B-FP(LPG)	99.5-01.5	PK20R8	90919-01180	-	-	VK20T(*8)	4		
		XZU301A • XZU302 • XZU342 • XZU412	15B-FNE(CNG)	01.6-	SK20R5-G	90919-01229	-	-	-	4		
		XZU301	15B-FPE(LPG)	01.6-	PK20R8	90919-01180	-	-	VK20T(*8)	4		
BZU300 • BZU410		1BZ-FNE(CNG)	03.5-	SK20R5-G	90919-01229	-	-	-	4			
BZU300 • BZU340		1BZ-FPE(LPG)	07.8-	SK20R5	90919-01222	-	-	-	4			
BZU600		1BZ-FPE(LPG)	11.7-	DK16R-B5	90919-01283	-	-	-	4			
SAUDIARABIA		2000	ZRR80G	3ZR-FAE	14.10-	SC16HR11	90919-01275	-	-	VCH16	4	
ESTIMA	1800	ZWR80G	2ZR-FXE	14.10-	SC16HR11	90919-01275	-	-	VCH16	4	SINGAPORE	
ESTIMA	2400	TCR10W • TCR11W • TCR20W • TCR21W	2TZ-FE	90.5-98.1	PK16R11	90919-01168	-	IK16	VK16	4	TAIWAN	
		TCR10W • TCR11W • TCR20W • TCR21W	2TZ-FZE(S/C)	94.8-00.2	SK20R11	90919-01210	-	IK20	VK20	4		
		ACR30W • ACR40W	2AZ-FE	00.2-06.1	K20R-U11	90919-01184	K20TT	IK20	VK20	4		
		ACR50W • ACR55W	2AZ-FE	06.1-12.5	SK20R11	90919-01210	-	IK20	VK20	4		
		ACR50W	2AZ-FE	12.5-14.9	SK16R11	90919-01240	-	IK16	VK16	4		
		ACR55W	2AZ-FE	12.5-14.9	SK16R11	90919-01240	-	IK16	VK16	4		
		ACR50W	2AZ-FE	14.9-	SK16R11	90919-01240	-	IK16	VK16	4		
	ACR55W	2AZ-FE	14.9-	SK16R11	90919-01240	-	IK16	VK16	4			
	3000	MCR30W • MCR40W	1MZ-FE	00.2-06.1	SK20R11	90919-01210	-	IK20	VK20	6		THAILAND
	3500	GSR50W • GSR55W	2GR-FE	06.1-	FK20HR11	90919-01247	-	-	VFKH20	6		
ESTIMA EMINA/LUCIDA	2400	TCR10G • TCR11G • TCR20G • TCR21G	2TZ-FE	92.1-00.2	PK16R11	90919-01168	-	IK16	VK16	4	Vietnam	
ESTIMA HYBRID	2400	AHR10W	2AZ-FXE	01.6-06.6	SK20R11	90919-01210	-	IK20	VK20	4	EUROPE & USA	
		AHR20W	2AZ-FXE	06.6-12.5	SK20R11	90919-01210	-	IK20	VK20	4		
		AHR20W	2AZ-FXE	12.5-	SK16R11	90919-01240	-	IK16	VK16	4		
		AHR20W	2AZ-FXE	14.9-	SK16R11	90919-01240	-	IK16	VK16	4		
FJ CRUISER	4000	GSJ15W	1GR-FE	10.10-13.7	SK20HR11	90919-01191	-	IKH20	VKH20	6	CROSS REFERENCE NUMBER	
		GSJ15W	1GR-FE	13.7-	SK16HR11	90919-01233	-	IKH16	VKH16	6		
FUN CARGO	1300	NCP20	2NZ-FE	99.9-05.10	K16R-U11	90919-01164	K16TT	IK16	VK16	4	PART	
	1500	NCP21 • NCP25	1NZ-FE	99.9-05.10	K16R-U11	90919-01164	K16TT	IK16	VK16	4		
GAIA	2000	SXM10G • SXM15G	3S-FE	98.5-02.7	K20TR11	90919-01198	K20TT	IK20	VK20	4	NUMBER	
		ACM10G • ACM15G	1AZ-FSE(D-4)	01.4-04.9	SK20BGR11	90919-01221	-	-	VKA20	4		
GRAND HIACE	3400	VCH10W • VCH16W • VCH22K • VCH28K	5VZ-FE	99.8-05.12	PK16TR11	90919-01196	-	IK16	VK16	6		
GRANVIA	2700	RCH11W	3RZ-FE	95.8-98.5	PK16R11	90919-01168	-	IK16	VK16	4		

(\*8)This is IRIDIUM PLUS.



MODEL	CC	VEHICLE CODE	ENGINE	FROM-TILL	DENSO	GENUINE P/N				QTY			
AUSTRALIA	<b>TOYOTA</b>												
	<b>GRANVIA</b>	3400	VCH10W · VCH16W · VCH22K · VCH28K	5VZ-FE	97.8-02.5	PK16TR11	90919-01196	-	IK16	VK16	6		
CHINA	<b>HARRIER</b>		ZSU60W	3ZR-FAE	13.12-20.6	SC16HR11	90919-01275	-	-	VCH16	4		
			ZSU65W	3ZR-FAE	13.12-20.6	SC16HR11	90919-01275	-	-	VCH16	4		
		2000	ASU60W	8AR-FTS(T/C)	17.6-20.6	VDKH22F	-	-	-	-	VDKH22F	4	
			ASU65W	8AR-FTS(T/C)	17.6-20.6	VDKH22F	-	-	-	-	VDKH22F	4	
			MXUA80	M20A-FKS	20.6-	FC20HR-Q8	90919-01297	-	-	-	-	4	
			MXUA85	M20A-FKS	20.6-	FC20HR-Q8	90919-01297	-	-	-	-	4	
INDIA	2200	SXU10W · SXU15W	5S-FE	98.1-03.2	PK20TR11	90919-01194	-	IK20	VK20	4			
		ACU10W · ACU15W	2AZ-FE	00.11-03.2	K20R-U11	90919-01184	K20TT	IK20	VK20	4			
		ACU30W · ACU35W	2AZ-FE	03.2-10.9	K20R-U11	90919-01184	K20TT	IK20	VK20	4			
INDONESIA	2400	ACU30W · ACU35W	2AZ-FE	10.9-	SK20R11	90919-01210	-	IK20	VK20	4			
		ACU30W	2AZ-FE	12.6-13.12	SK16R11	90919-01240	-	IK16	VK16	4			
		ACU35W	2AZ-FE	12.6-13.12	SK16R11	90919-01240	-	IK16	VK16	4			
		MCU10W · MCU15W	1MZ-FE	98.1-03.2	SK20R11	90919-01210	-	IK20	VK20	6			
KOREA	3000	MCU30W · MCU31W · MCU35W · MCU36W	1MZ-FE	03.2-05.12	SK20R11	90919-01210	-	IK20	VK20	6			
		3500	GSU30W · GSU35W · GCU31W · GCU36W	2GR-FE	06.1-08.11	FK20HR11	90919-01247	-	-	VFKH20	6		
MALAYSIA	<b>HARRIER HV HARRIER HYBRID</b>	3300	MHU38W	3MZ-FE	05.3-	SK20R11	90919-01210	-	IK20	VK20	6		
		2500	AVU65W	2AR-FXE	14.1-20.6	FK16HR-A8	90919-01259	-	-	VFKH16	4		
			AXUH80	A25A-FXS	20.6-	FC16HR-Q8	90919-01289	-	-	VFCH16	4		
PHILIPPINES	<b>HIACE</b>	1800	KM70 · KM75 · KM80 · KM85	7K-E	99.6-02.8	W16EXR-U11	90919-01091	W16TT	IW16	VW16	4		
			RZH100G · RZH110G · RZH102V · RZH112V · RZH112K · RZH124B	1RZ-E	89.8-03.7	P16R	90919-01115	-	IW16	VW16	4		
			RZH102V · RZH112V · RZH112K · RZH122V · RZH124B	1RZ	89.8-03.7	W16EXR-U	90919-01064	W16TT	IW16	VW16	4		
		2000	TRH102V · TRH112K · TRH112V · TRH122K · TRH124B	1TR-FE	03.7-04.8	SK20HR11	90919-01191	-	IKH20	VKH20	4		
			TRH200K · TRH200V · TRH201K	1TR-FE	04.8-07.8	SK20HR11	90919-01191	-	IKH20	VKH20	4		
			TRH200K · TRH200V · TRH201K	1TR-FE	07.8-08.1	FK20HBR11	90919-01249	-	-	VFKBH20	4		
			TRH200K · TRH200V · TRH201K	1TR-FE	08.1-15.1	FK20HBR11-T	90919-01255	-	-	VFKBH20	4		
			TRH200K	1TR-FE	15.1-17.12	FK20HBR-TJ8	90919-01288	-	-	VFKBH20	4		
			TRH200V	1TR-FE	15.1-17.12	FK20HBR-TJ8	90919-01288	-	-	VFKBH20	4		
			TRH200K	1TR-FE	17.12-	FK20HBR-TJ8	90919-01288	-	-	VFKBH20	4		
		2400	TRH200V	1TR-FE	17.12-	FK20HBR-TJ8	90919-01288	-	-	VFKBH20	4		
			RZH100G · RZH133S	2RZ-E	89.8-99.7	P16R	90919-01115	-	-	VW16	4		
RZH101G · RZH111G · RZH133S · RZH133V	2RZ-E		99.7-04.8	P16R	90919-01115	-	-	VW16	4				
SAUDI ARABIA	<b>HIACE</b>	2400	TRH221K · TRH226K · TRH214W · TRH219W	2TR-FE	04.8-12.5	SK20HR11	90919-01191	-	IKH20	VKH20	4		
			TRH224W · TRH229W	2TR-FE	05.1-12.5	SK20HR11	90919-01191	-	IKH20	VKH20	4		
			TRH211K · TRH216K · TRH223B · TRH228B	2TR-FE	07.8-12.5	SK20HR11	90919-01191	-	IKH20	VKH20	4		
		TRH211K	2TR-FE	12.5-15.1	SK20HR-A11	90919-01266	-	IKH20	VKH20	4			
		TRH221K	2TR-FE	12.5-15.1	SK20HR-A11	90919-01266	-	IKH20	VKH20	4			
		TRH216K	2TR-FE	12.5-15.1	SK20HR-A11	90919-01266	-	IKH20	VKH20	4			
		TRH226K	2TR-FE	12.5-15.1	SK20HR-A11	90919-01266	-	IKH20	VKH20	4			
		TRH223B	2TR-FE	12.5-15.1	SK20HR-A11	90919-01266	-	IKH20	VKH20	4			
		TRH228B	2TR-FE	12.5-15.1	SK20HR-A11	90919-01266	-	IKH20	VKH20	4			
		TRH224W	2TR-FE	12.5-15.1	SK20HR-A11	90919-01266	-	IKH20	VKH20	4			
		2700	TRH214W	2TR-FE	12.5-15.1	SK20HR-A11	90919-01266	-	IKH20	VKH20	4		
			TRH229W	2TR-FE	12.5-15.1	SK20HR-A11	90919-01266	-	IKH20	VKH20	4		
			TRH219W	2TR-FE	12.5-15.1	SK20HR-A11	90919-01266	-	IKH20	VKH20	4		
		SINGAPORE	<b>HIACE</b>	2400	TRH211K	2TR-FE	15.1-	FK20HR-A8	90919-01287	-	-	VFKH20	4
					TRH221K	2TR-FE	15.1-	FK20HR-A8	90919-01287	-	-	VFKH20	4
TRH216K	2TR-FE				15.1-	FK20HR-A8	90919-01287	-	-	VFKH20	4		
TRH226K	2TR-FE			15.1-	FK20HR-A8	90919-01287	-	-	VFKH20	4			
TRH223B	2TR-FE			15.1-	FK20HR-A8	90919-01287	-	-	VFKH20	4			
TRH228B	2TR-FE			15.1-	FK20HR-A8	90919-01287	-	-	VFKH20	4			
TRH214W	2TR-FE			15.1-	FK20HR-A8	90919-01287	-	-	VFKH20	4			
TRH224W	2TR-FE			15.1-	FK20HR-A8	90919-01287	-	-	VFKH20	4			
TRH219W	2TR-FE			15.1-	FK20HR-A8	90919-01287	-	-	VFKH20	4			
TAIWAN	<b>HIACE</b>	2700	TRH229W	2TR-FE	15.1-	FK20HR-A8	90919-01287	-	-	VFKH20	4		
			TRH219W	2TR-FE	15.1-	FK20HR-A8	90919-01287	-	-	VFKH20	4		
			TRH229W	2TR-FE	15.1-	FK20HR-A8	90919-01287	-	-	VFKH20	4		
THAILAND	<b>HIACE</b>	2000	RCH42V	1RZ-E	97.6-	P16R	90919-01115	-	IW16	VW16	4		
			RCH41W · RCH47W	3RZ-FE	97.4-98.8	PK16R11	90919-01168	-	IK16	VK16	4		
VIETNAM	<b>HIACE</b>	2000	RCH42V	1RZ-E	97.6-	P16R	90919-01115	-	IW16	VW16	4		
			RCH41W · RCH47W	3RZ-FE	97.4-98.8	PK16R11	90919-01168	-	IK16	VK16	4		
JAPAN	<b>HIACE</b>	2000	RCH42V	1RZ-E	97.6-	P16R	90919-01115	-	IW16	VW16	4		
			RCH41W · RCH47W	3RZ-FE	97.4-98.8	PK16R11	90919-01168	-	IK16	VK16	4		
EUROPE & USA	<b>HIACE</b>	2000	RCH42V	1RZ-E	97.6-	P16R	90919-01115	-	IW16	VW16	4		
			RCH41W · RCH47W	3RZ-FE	97.4-98.8	PK16R11	90919-01168	-	IK16	VK16	4		
CROSS REFERENCE NUMBER	<b>HIACE</b>	2000	RCH42V	1RZ-E	97.6-	P16R	90919-01115	-	IW16	VW16	4		
			RCH41W · RCH47W	3RZ-FE	97.4-98.8	PK16R11	90919-01168	-	IK16	VK16	4		

MODEL	CC	VEHICLE CODE	ENGINE	FROM-TILL	DENSO	GENUINE P/N	IRIDIUM POWER	IRIDIUM TOUGH	QTY		
<b>TOYOTA</b>											
<b>HIACE REGIUS HILUX/ SURF</b>	2700	RCH41W • RCH47W	3RZ-FE	98.8-	SK16R11	90919-01240	-	IK16	VK16	4	
		YN100 • YN105 • YN107	3Y	88.9-97.9	W16EX-U	90919-01059	W16TT	IW16	VW16	4	
	2000	YN81 • YN86 • YN107 • YN130G	3Y-E	89.5-97.9	P16R	90919-01115	-	IW16	VW16	4	
		RZN147 • RZN152H • RZN167	1RZ-E	97.9-04.8	W16EXR-U	90919-01064	W16TT	IW16	VW16	4	
	2700	RZN169H • RZN174H • RZN180W • RZN185W	3RZ-FE	95.12-00.8	K16R-U	90919-01176	K16TT	IK16	VK16	4	
		RZN180W • RZN210W • RZN215W	3RZ-FE	00.8-04.8	K16R-U11	90919-01164	K16TT	IK16	VK16	4	
		TRN210W • TRN215W	2TR-FE	04.8-	SK20HR11	90919-01191	-	IKH20	VKH20	4	
	3400	VZN180W • VZN185W	5VZ-FE	95.12-02.11	K16TR11	90919-01192	K16TT	IK16	VK16	6	
		VZN210W • VZN215W	5VZ-FE	02.11-05.7	K16TR11	90919-01192	K16TT	IK16	VK16	6	
	4000	GRN215W	1GR-FE	05.7-	K20HR-U11	90919-01235	-	IKH20	VKH20	6	
<b>IPSUM</b>	2000	SXM10G • SXM15G	3S-FE	96.5-01.4	K20TR11	90919-01198	K20TT	IK20	VK20	4	
	2400	ACM21W • ACM26W	2AZ-FE	01.5-09.12	K20R-U11	90919-01184	K20TT	IK20	VK20	4	
<b>iQ</b>	1000	KGJ10	1KR-FE	08.10-	SK16HR11	90919-01233	-	IKH16	VKH16	3	
	1300	NGJ10	1NR-FE	09.8-	SC16HR11	90919-01275	-	-	VCH16	4	
<b>ISIS</b>	1800	ZNM10W • ZNM10G	1ZZ-FE	04.9-09.9	K16R-U11	90919-01164	K16TT	IK16	VK16	4	
		ZGM10G • ZGM10W • ZGM15G • ZGM15W	2ZR-FAE	09.9-	SC16HR11	90919-01275	-	-	VCH16	4	
	2000	ANM10W • ANM10G • ANM15W • ANM15G	1AZ-FSE(D-4)	04.9-09.9	SK20BGR11	90919-01221	-	-	VKA20	4	
		ZGM11G • ZGM11W	3ZR-FAE	09.9-	SC16HR11	90919-01275	-	-	VCH16	4	
<b>iST</b>	1300	NCP60	2NZ-FE	02.5-05.5	K16R-U11	90919-01164	K16TT	IK16	VK16	4	
		NCP60	2NZ-FE	05.5-	SK16R11	90919-01240	-	IK16	VK16	4	
	1500	NCP61 • NCP65	1NZ-FE	02.5-07.7	K16R-U11	90919-01164	K16TT	IK16	VK16	4	
		NCP110 • NCP115	1NZ-FE	07.7-07.11	FK20HR11	90919-01247	-	-	VFKH20	4	
		NCP110 • NCP115	1NZ-FE	07.11-	FK16HR11	90919-01243	-	-	VFKH16	4	
	1800	ZSP110	2ZR-FE	07.7-	SC16HR11	90919-01275	-	-	VCH16	4	
<b>JPN TAXI</b>	1500	NTP10	1NZ-FXP	17.10-	VDKH16T	-	-	-	VDKH16T	4	
<b>KLUGER HV</b>	3300	MHU28W	3MZ-FE	05.3-07.4	SK20R11	90919-01210	-	IK20	VK20	6	
<b>KLUGER V/L</b>	2400	ACU20W • ACU25W	2AZ-FE	00.11-07.4	K20R-U11	90919-01184	K20TT	IK20	VK20	4	
	3000	MCU20W • MCU25W	1MZ-FE	00.11-07.4	SK20R11	90919-01210	-	IK20	VK20	6	
<b>LAND CRUISER</b>	4500	FZJ80G	1FZ-FE	92.8-98.1	PK16R11	90919-01168	-	IK16	VK16	6	
	4600	URJ202W	1UR-FE	09.5-	SK20HR11	90919-01191	-	IKH20	VKH20	8	
	4700	UZJ100W	2UZ-FE	98.1-07.9	SK20R11	90919-01210	-	IK20	VK20	8	
		UZJ200W	2UZ-FE	07.9-	SK20R11	90919-01210	-	IK20	VK20	8	
<b>LAND CRUISER PRADO</b>	2700	RZJ90W • RZJ95W	3RZ-FE	97.4-02.10	K16R-U	90919-01176	K16TT	IK16	VK16	4	
		RZJ120W • RZJ125W	3RZ-FE	02.10-04.8	K16R-U11	90919-01164	K16TT	IK16	VK16	4	
	2700	TRJ120W • TRJ125W	2TR-FE	04.8-07.9	SK20HR11	90919-01191	-	IKH20	VKH20	4	
		TRJ150W	2TR-FE	09.9-12.7	SK20HR11	90919-01191	-	IKH20	VKH20	4	
		TRJ150W	2TR-FE	12.7-15.6	SK20HR-A11	90919-01266	-	IKH20	VKH20	4	
	3400	TRJ150W	2TR-FE	15.6-	FK20HR-A8	90919-01287	-	-	VFKH20	4	
		VZJ90W • VZJ95W	5VZ-FE	96.5-99.6	K16TR11	90919-01192	K16TT	IK16	VK16	6	
		VZJ90W • VZJ95W	5VZ-FE	99.6-02.10	PK16TR11	90919-01196	-	IK16	VK16	6	
		VZJ120W • VZJ121W • VZJ125W	5VZ-FE	02.10-09.9	K16TR11	90919-01192	K16TT	IK16	VK16	6	
		GRJ120W • GRJ121W	1GR-FE	05.7-09.9	K20HR-U11	90919-01235	-	IKH20	VKH20	6	
	4000	GRJ150W • GRJ151W	1GR-FE	09.9-13.6	K20HR-U11	90919-01235	-	IKH20	VKH20	6	
		GRJ150W	1GR-FE	13.6-	SK16HR11	90919-01233	-	IKH16	VKH16	6	
		GRJ151W	1GR-FE	13.6-	SK16HR11	90919-01233	-	IKH16	VKH16	6	
	<b>LAND CRUISER300</b>	3400	VJA300W	V35A-FTS(T/C)	21.8-	EC22HPR-D7	90919-01295	-	-	-	6
<b>LAND CRUISER70</b>	4000	GRJ76K	1GR-FE	14.8-	K20HR-U11	90919-01235	-	IKH20	VKH20	6	
		GRJ79K	1GR-FE	14.8-	K20HR-U11	90919-01235	-	IKH20	VKH20	6	
<b>LITEACE</b>	1500	S412M	3SZ-VE	10.7-	XU22PR9	90048-51197	-	IXU22I	VXU22I	4	
		S412U	3SZ-VE	10.7-	XU22PR9	90048-51197	-	IXU22I	VXU22I	4	
<b>LITEACE/ NOAH</b>	1500	KR41V	5K	96.10-98.12	W16EXR-U	90919-01064	W16TT	IW16	VW16	4	
		S402M • S402U	3SZ-VE	08.1-	XU22PR9	90048-51197	-	IXU22I	VXU22I	4	
	1800	YM31V • YM55 • YM60 • YM65	2Y • 2Y-J	95.8-99	P16R	90919-01115	-	IW16	VW16	4	
		KR42V	7K	96.10-98.12	W16EXR-U	90919-01064	W16TT	IW16	VW16	4	
		KR42V	7K-E	98.12-02.8	W16EXR-U11	90919-01091	W16TT	IW16	VW16	4	
		KM70 • KM75 • KM80 • KM85	7K-E	99.6-02.8	W16EXR-U11	90919-01091	W16TT	IW16	VW16	4	
		KR42V • KM70 • KM75 • KM80 • KM85	7K-E	02.8-07.7	W16EXR-U	90919-01064	W16TT	IW16	VW16	4	
	2000	KR52V	7K-E	04.11-07.7	W16EXR-U	90919-01064	W16TT	IW16	VW16	4	
	<b>MARK II</b>	1800	SR40G • SR50G	3S-FE	96.10-07.7	K20TR11	90919-01198	K20TT	IK20	VK20	4
			SX100	4S-FE	97.4-	K20TR11	90919-01198	K20TT	IK20	VK20	4
2000		GX70G	1G-FE	88.8-97.4	K16R-U11	90919-01164	K16TT	IK16	VK16	6	
		YX78V	3Y-E	93.2-97.4	P16R	90919-01143	-	IW16	VW16	4	
	GX100 • GX105	1G-FE	96.9-98.8	K16R-U11	90919-01164	K16TT	IK16	VK16	6		
		GX100 • GX105	1G-FE	98.8-00.9	K20R-U11	90919-01184	K20TT	IK20	VK20	6	

AUSTRALIA  
CHINA  
INDIA  
INDONESIA  
KOREA  
MALAYSIA  
PHILIPPINES  
SAUDIARABIA  
SINGAPORE  
TAIWAN  
THAILAND  
VIETNAM  
JAPAN  
EUROPE & USA  
CROSS REFERENCE NUMBER  
PART

DENSO	9	14	16	20	22	24	27	29	31	32	34	35	DENSO	9	14	16	20	22	24	27	31	DENSO	9	14	16	20	22	24	27	31		
NGK	2	4	5	6	7	8	9	9.5	10	10.5	11	11.5	CHAMPION	18	16,14	12,11	10,9	8,7	6,63,61	4,59	57	55	53	BOSCH	10	9	8	7,6	5	4	3	2





# JAPAN CAR

▶ Spark plug color codes: ■ for Iridium Tough and Iridium Plugs and Iridium TT, ■ for Iridium Power, ■ for Iridium Racing and Two Tops Plugs, ■ for Platinum Plugs and Platinum TT, and black for general spark plugs.

MODEL	CC	VEHICLE CODE	ENGINE	FROM-TILL	DENSO	GENUINE P/N				QTY	
AUSTRALIA	TOYOTA MARK II	2000	GX110 • GX115	1G-FE	00.10-	K20R-U11	90919-01184	K20TT	IK20	VK20	6
			JZX100 • JZX105	1JZ-GE	96.9-00.9	PK16TR11	90919-01196	-	IK16	VK16	6
			JZX100	1JZ-GTE(T/C)	96.9-00.9	PK20TR11	90919-01194	-	IK20	VK20	6
CHINA		2500	JZX110	1JZ-GTE(T/C)	00.10-04.10	SK20R-P11	90919-01207	-	IK20	VK20	6
			JZX110	1JZ-FSE(D-4)	00.10-04.10	SK20BR11	90919-01226	-	-	VKB20	6
			JZX115	1JZ-GE	00.10-04.10	SK16R-P11	90919-01219	-	IK16	VK16	6
INDIA	MARK II BLIT	3000	JZX101	2JZ-GE	96.9-00.9	PK16TR11	90919-01196	-	IK16	VK16	6
		2000	GX110W • GX115W	1G-FE	02.1-04.11	K20R-U11	90919-01184	K20TT	IK20	VK20	6
			JZX110W	1JZ-GTE(T/C)	02.1-04.11	PK20TR11	90919-01194	-	IK20	VK20	6
INDONESIA	MARK II QUALIS	2500	JZX115W	1JZ-GE	02.1-04.11	SK16R-P11	90919-01219	-	IK16	VK16	6
			JZX110W	1JZ-FSE(D-4)	02.1-04.11	SK20BR11	90919-01226	-	-	VKB20	6
		2200	SXV20W • SXV25W	5S-FE	97.4-02.1	PK20TR11	90919-01194	-	IK20	VK20	4
KOREA	MARK X	2500	MCV21W • MCV25W	2MZ-FE	97.4-02.1	PK20TR11	90919-01194	-	IK20	VK20	6
			MCV20W	1MZ-FE	97.4-98.8	PK20TR11	90919-01194	-	IK20	VK20	6
			MCV20W	1MZ-FE	98.8-02.1	SK20R11	90919-01210	-	IK20	VK20	6
MALAYSIA	MARK X ZIO	2500	GRX120 • GRX125	4GR-FSE(D-4)	04.11-09.10	FK20HBR11	90919-01249	-	-	VFKBH20	6
			GRX130 • GRX135	4GR-FSE(D-4)	09.10-	FK20HBR11	90919-01249	-	-	VFKBH20	6
		3000	GRX121	3GR-FSE(D-4)	04.11-09.10	FK20HBR11	90919-01249	-	-	VFKBH20	6
PHILIPPINES	MR2	3500	GRX133	2GR-FSE(D-4S)	09.10-	FK20HBR11	90919-01249	-	-	VFKBH20	6
		2400	ANA10 • ANA15	2AZ-FE	07.9-12.6	SK20R11	90919-01210	-	IK20	VK20	4
			ANA10	2AZ-FE	12.6-	SK16R11	90919-01240	-	IK16	VK16	4
SAUDI ARABIA	MR2		ANA15	2AZ-FE	12.6-	SK16R11	90919-01240	-	IK16	VK16	4
		3500	GGA10	2GR-FE	07.9-	FK20HR11	90919-01247	-	-	VFKH20	6
		2000	SW20	3S-GE	89.10-97.12	PK20R8	90919-01180	-	IK20	VK20	4
SINGAPORE	MR-S NADIA		SW20	3S-GTE(T/C)	89.10-99.10	PK20R8	90919-01180	-	-	VK20Y	4
			SW20	3S-GE	97.12-99.10	SK20R11	90919-01210	-	IK20	VK20	4
		1800	ZZW30	1ZZ-FE	99.10-	K16R-U11	90919-01164	K16TT	IK16	VK16	4
TAIWAN	NOAH		SXN10 • SXN15 • SXN10H • SXN15H	3S-FE	98.8-02.7	K20TR11	90919-01198	K20TT	IK20	VK20	4
		2000	SXN10	3S-FSE(D-4)	98.8-01.3	PK20GR8	90919-01208	-	-	VKA20	4
			ACN10 • ACN10H • ACN15	1AZ-FSE(D-4)	01.4-03.8	SK20BGR11	90919-01221	-	-	VKA20	4
THAILAND	NOAH HYBRID		AZR60G • AZR65G	1AZ-FSE(D-4)	01.11-07.6	SK20BGR11	90919-01221	-	-	VKA20	4
			ZRR70G • ZRR75G • ZRR75W	3ZR-FE	07.6-10.5	SC16HR11	90919-01275	-	-	VCH16	4
			ZRR70G • ZRR75G • ZRR75W	3ZR-FAE	10.5-14.1	SC16HR11	90919-01275	-	-	VCH16	4
VIETNAM	ORIGIN PASSO		ZRR70W	3ZR-FAE	07.6-14.1	SC16HR11	90919-01275	-	-	VCH16	4
			ZRR80G	3ZR-FAE	14.1-22.1	SC16HR11	90919-01275	-	-	VCH16	4
		2000	ZRR80W	3ZR-FAE	14.1-22.1	SC16HR11	90919-01275	-	-	VCH16	4
JAPAN	PASSO SETTE PIXIS EPOCH		ZRR85G	3ZR-FAE	14.1-22.1	SC16HR11	90919-01275	-	-	VCH16	4
			ZRR85W	3ZR-FAE	14.1-22.1	SC16HR11	90919-01275	-	-	VCH16	4
			MZRA90W	M20A-FKS	22.1-	FC20HR-Q8	90919-01297	-	-	-	4
EUROPE & USA	PASSO SETTE PIXIS EPOCH		MZRA95W	M20A-FKS	22.1-	FC20HR-Q8	90919-01297	-	-	-	4
			ZWR80G	2ZR-FXE	14.2-22.1	SC16HR11	90919-01275	-	-	VCH16	4
		1800	ZWR80W	2ZR-FXE	16.1-22.1	SC16HR11	90919-01275	-	-	VCH16	4
CROSS REFERENCE NUMBER	PIXIS JOY		ZWR90W	2ZR-FXE	22.1-	FC16HR-CY9	90919-01298	-	-	-	4
			ZWR95W	2ZR-FXE	22.1-	FC16HR-CY9	90919-01298	-	-	-	4
		1800	ZCT10 • ZCT15	1ZZ-FE	00.5-05.12	K16R-U11	90919-01164	K16TT	IK16	VK16	4
PART	PIXIS JOY	2000	ACT10	1AZ-FSE(D-4)	00.5-05.12	SK20BGR11	90919-01221	-	-	VKA20	4
		3000	JCG17	2JZ-GE	00.11-01.6	PK16TR11	90919-01196	-	IK16	VK16	6
			KGC10 • KGC15	1KR-FE	04.6-10.2	SK20HR11	90919-01191	-	IKH20	VKH20	3
PART	PIXIS JOY		KGC30 • KGC35	1KR-FE	10.2-14.4	SK20HR11	90919-01191	-	IKH20	VKH20	3
		1000	KGC30	1KR-FE	14.4-	SC16HR11	90919-01275	-	-	VCH16	3
			KGC35	1KR-FE	14.4-	SC16HR11	90919-01275	-	-	VCH16	3
PART	PIXIS JOY		M700A	1KR-FE	16.4-	-	-	-	-	VCH16	3
			M710A	1KR-FE	16.4-	-	-	-	-	VCH16	3
			QNC10	K3-VE	04.6-06.12	SK20PR-A8	90048-51182	-	IK20	VK20Y	4
PART	PIXIS JOY	1300	QNC10	K3-VE	06.12-10.2	SXU22PR9	90048-51188-000	-	IXU22I	VXU22I	4
			NGC30	1NR-FE	10.2-	SC16HR11	90919-01275	-	-	VCH16	4
		1500	M502E • M512E	3SZ-VE	08.12-	SXU22PR9	90048-51188-000	-	IXU22I	VXU22I	4
PART	PIXIS JOY		LA310A	KF	12.5-12.11	SXU20HPR11	90048-51208	-	IXUH20I	VXUH20I	3
			LA300A	KF	12.11-14.7	SXU20HPR11	90048-51208	-	IXUH20I	VXUH20I	3
			LA310A	KF	12.11-14.7	SXU20HPR11	90048-51208	-	IXUH20I	VXUH20I	3
PART	PIXIS JOY	660	LA300A	KF	14.7-17.5	-	-	-	IXUH20I	VXUH20I	3
			LA310A	KF	14.7-17.5	-	-	-	IXUH20I	VXUH20I	3
			LA350A	KF	17.5-	-	-	-	IXUH20I	VXUH20I	3
PART	PIXIS JOY		LA360A	KF	17.5-	-	-	-	IXUH20I	VXUH20I	3
		660	LA250A	KF	16.8-	SXU20HPR11	90048-51208	-	IXUH20I	VXUH20I	3
			LA250A	KF(T/C)	16.8-	SXU22HPR8	90048-51214	-	IXUH22I	VXUH22I	3
PART	PIXIS JOY		LA260A	KF	16.8-	SXU20HPR11	90048-51208	-	IXUH20I	VXUH20I	3





MODEL	CC	VEHICLE CODE	ENGINE	FROM-TILL	DENSO	GENUINE P/N				QTY	
<b>TOYOTA</b>											
<b>PIXIS JOY</b>	660	LA260A	KF(T/C)	16.8-	SXU22HPR8	90048-51214	-	IXUH22I	VXUH22I	3	AUSTRALIA
		LA700A	KF	15.7-	SXU20HPR11	90048-51208	-	IXUH20I	VXUH20I	3	CHINA
		LA700A	KF(T/C)	15.7-	SXU22HPR8	90048-51214	-	IXUH22I	VXUH22I	3	
		LA710A	KF	15.7-	SXU20HPR11	90048-51208	-	IXUH20I	VXUH20I	3	
		LA710A	KF(T/C)	15.7-	SXU22HPR8	90048-51214	-	IXUH22I	VXUH22I	3	
<b>PIXIS SPACE</b>	660	L575A · L585A	KF	11.9-12.9	SXU20HPR11	90048-51208	-	IXUH20I	VXUH20I	3	INDIA
		L585A	KF	11.9-12.9	SXU20HPR11	90048-51208	-	IXUH20I	VXUH20I	3	INDONESIA
		L575A	KF	12.9-	SXU20HPR11	90048-51208	-	IXUH20I	VXUH20I	3	
		L585A	KF	12.9-	SXU20HPR11	90048-51208	-	IXUH20I	VXUH20I	3	
<b>PIXIS SPACE CUSTOM</b>	660	L575A	KF	11.9-12.9	SXU20HPR11	90048-51208	-	IXUH20I	VXUH20I	3	KOREA
		L575A	KF(T/C)	11.9-13.8	SXU22HPR8	90048-51214	-	IXUH22I	VXUH22I	3	
		L585A	KF	11.9-12.9	SXU20HPR11	90048-51208	-	IXUH20I	VXUH20I	3	MALAYSIA
		L585A	KF(T/C)	11.9-13.8	SXU22HPR8	90048-51214	-	IXUH22I	VXUH22I	3	
		L575A	KF	12.9-	SXU20HPR11	90048-51208	-	IXUH20I	VXUH20I	3	
		L575A	KF(T/C)	13.8-	SXU22HPR8	90048-51214	-	IXUH22I	VXUH22I	3	
		L585A	KF	12.9-	SXU20HPR11	90048-51208	-	IXUH20I	VXUH20I	3	
		L585A	KF(T/C)	13.8-	SXU22HPR8	90048-51214	-	IXUH22I	VXUH22I	3	
<b>PIXIS TRUCK</b>	660	S201U	KF	11.12-14.9	XU20HR9	90048-51212	XUH20TTI	IXUH20I	VXUH20I	3	PHILIPPINES
		S211U	KF	11.12-14.9	XU20HR9	90048-51212	XUH20TTI	IXUH20I	VXUH20I	3	
		S500U	KF	14.9-	SXU20HPR11	90048-51208	-	IXUH20I	VXUH20I	3	
		S510U	KF	14.9-	SXU20HPR11	90048-51208	-	IXUH20I	VXUH20I	3	
		S321M	KF	11.12-15.4	XU20HR9	90048-51212	XUH20TTI	IXUH20I	VXUH20I	3	
<b>PIXIS VAN</b>	660	S321M	KF(T/C)	11.12-15.4	SXU22HPR8	90048-51214	-	IXUH22I	VXUH22I	3	SAUDIARABIA
		S331M	KF	11.12-15.4	XU20HR9	90048-51212	XUH20TTI	IXUH20I	VXUH20I	3	
		S331M	KF(T/C)	11.12-15.4	SXU22HPR8	90048-51214	-	IXUH22I	VXUH22I	3	SINGAPORE
		S321M	KF	15.4-21.12	SXU20HPR11	90048-51208	-	IXUH20I	VXUH20I	3	
		S321M	KF(T/C)	15.4-21.12	SXU22HPR8	90048-51214	-	IXUH22I	VXUH22I	3	
		S331M	KF	15.4-21.12	SXU20HPR11	90048-51208	-	IXUH20I	VXUH20I	3	
		S331M	KF(T/C)	15.4-21.12	SXU22HPR8	90048-51214	-	IXUH22I	VXUH22I	3	
		S700M	KF	21.12-	SXU20HPR11	90048-51208	-	IXUH20I	VXUH20I	3	
		S700M	KF(T/C)	21.12-	SXU22HPR8	90048-51214	-	IXUH22I	VXUH22I	3	
		S710M	KF	21.12-	SXU20HPR11	90048-51208	-	IXUH20I	VHUH20I	3	
		S710M	KF(T/C)	21.12-	SXU22HPR8	90048-51214	-	IXUH22I	VXUH22I	3	
<b>PLATZ</b>	1000	SCP11	1SZ-FE	99.9-05.11	K16R-U	90919-01176	K16TT	IK16	VK16	4	THAILAND
	1300	NCP16	2NZ-FE	99.9-05.11	K16R-U11	90919-01164	K16TT	IK16	VK16	4	
	1500	NCP12	1NZ-FE	99.9-05.11	K16R-U11	90919-01164	K16TT	IK16	VK16	4	
<b>PORTE</b>	1300	NNP10	2NZ-FE	04.7-12.7	K16R-U11	90919-01164	K16TT	IK16	VK16	4	VIETNAM
		NSP140	1NR-FE	12.7-	SC16HR11	90919-01275	-	-	VCH16	4	
		NNP11 · NNP15	1NZ-FE	04.7-12.7	K16R-U11	90919-01164	K16TT	IK16	VK16	4	
		NCP141	1NZ-FE	12.7-	FK16HR11	90919-01243	-	-	VFKH16	4	
	1500	NCP145	1NZ-FE	12.7-	FK16HR11	90919-01243	-	-	VFKH16	4	
		NSP141	2NR-FKE	15.7-17.12	FC16HR8	90919-01280	-	-	VFCH16	4	
		NSP141	2NR-FKE	17.12-	FC16HR-Q8	90919-01289	-	-	VFCH16	4	
		NZT240	1NZ-FE	01.12-07.6	K16R-U11	90919-01164	K16TT	IK16	VK16	4	
<b>PREMIO</b>	1500	NZT260	1NZ-FE	07.6-07.11	FK20HR11	90919-01247	-	-	VFKH20	4	JAPAN
		NZT260	1NZ-FE	07.11-	FK16HR11	90919-01243	-	-	VFKH16	4	
		ZZT240 · ZZT245	1ZZ-FE	01.12-07.6	K16R-U11	90919-01164	K16TT	IK16	VK16	4	
	1800	ZRT260 · ZRT265	2ZR-FE	07.6-10.4	SC16HR11	90919-01275	-	-	VCH16	4	
		ZRT260 · ZRT265	2ZR-FAE	10.4-	SC16HR11	90919-01275	-	-	VCH16	4	
	2000	AZT240	1AZ-FSE(D-4)	01.12-08.1	SK20BGR11	90919-01221	-	-	VKA20	4	
		ZRT261	3ZR-FAE	08.1-	SC16HR11	90919-01275	-	-	VCH16	4	
		NHW10	1NZ-FXE(HYBRID)	97.12-00.4	K16R-U11	90919-01164	K16TT	IK16	VK16	4	
<b>PRIUS</b>	1500	NHW11 · NHW20	1NZ-FXE(HYBRID)	00.5-	SK16R11	90919-01240	-	IK16	VK16	4	EUROPE & USA
		ZVW30	2ZR-FXE(HYBRID)	09.5-15.12	SC16HR11	90919-01275	-	-	VCH16	4	
	1800	ZVW51	2ZR-FXE(HYBRID)	15.12-18.12	FC16HR-C9	90919-01281	-	-	VFCH16	4	
		ZVW50	2ZR-FXE(HYBRID)	15.12-18.12	FC16HR-C9	90919-01281	-	-	VFCH16	4	
		ZVW55	2ZR-FXE(HYBRID)	15.12-18.12	FC16HR-C9	90919-01281	-	-	VFCH16	4	
		ZVW51	2ZR-FXE(HYBRID)	18.12-	FC16HR-CY9	90919-01298	-	-	VFCH16	4	
		ZVW55	2ZR-FXE(HYBRID)	18.12-	FC16HR-CY9	90919-01298	-	-	VFCH16	4	
		ZVW35	2ZR-FXE(HYBRID)	12.1-17.2	SC16HR11	90919-01275	-	-	VCH16	4	
<b>PRIUS PHV</b>	1800	ZVW52	2ZR-FXE(HYBRID)	17.2-17.9	FC16HR-C9	90919-01281	-	-	VFCH16	4	CROSS REFERENCE NUMBER
		ZVW52	2ZR-FXE(HYBRID)	17.9-	FC16HR-CY9	90919-01298	-	-	VFCH16	4	
		ZVW40W · ZVW41W	2ZR-FXE(HYBRID)	11.5-	SC16HR11	90919-01275	-	-	VCH16	4	
<b>PRIUS α</b>	1800	NCP50V	2NZ-FE	02.7-10.6	K16R-U11	90919-01164	K16TT	IK16	VK16	4	PART NUMBER
		NCP50V	2NZ-FE	10.6-14.9	SK16R11	90919-01240	-	IK16	VK16	4	
	1300	NSP160V	1NR-FE	14.9-	SC16HR11	90919-01275	-	-	VCH16	4	
		NCP51V · NCP55V · NCP58G · NCP59G	1NZ-FE	02.7-10.6	K16R-U11	90919-01164	K16TT	IK16	VK16	4	

DENSO	9	14	16	20	22	24	27	29	31	32	34	35	DENSO	9	14	16	20	22	24	27	31	DENSO	9	14	16	20	22	24	27	31		
NGK	2	4	5	6	7	8	9	9.5	10	10.5	11	11.5	CHAMPION	18	16,14	12,11	10,9	8,7	6,63,61	4,59	57	55	53	BOSCH	10	9	8	7,6	5	4	3	2



MODEL	CC	VEHICLE CODE	ENGINE	FROM-TILL	DENSO	GENUINE P/N				QTY		
AUSTRALIA	1500	<b>TOYOTA PROBOX</b>										
		NCP51V	1NZ-FE	10.6-14.9	SK16R11	90919-01240	-	IK16	VK16	4		
		NCP55V	1NZ-FE	10.6-14.9	SK16R11	90919-01240	-	IK16	VK16	4		
		NCP58G	1NZ-FE	10.6-	SK16R11	90919-01240	-	IK16	VK16	4		
		NCP59G	1NZ-FE	10.6-	SK16R11	90919-01240	-	IK16	VK16	4		
		NCP52V	1NZ-FNE(CNG)	03.4-	SK20R8-G	90919-01190	-	-	VK20T(*8)	4		
		NCP160V	1NZ-FE	14.9-	FK16HR11	90919-01243	-	-	VFKH16	4		
CHINA	1500	NCP165V	1NZ-FE	14.9-	FK16HR11	90919-01243	-	-	VFKH16	4		
		PROBOX HYBRID	1500	NHP160V	1NZ-FXE	18.12-	FK16BR-AL8	90919-01284	-	-	VFKB16	4
		PROGRES	2500	JCG10 · JCG15	1JZ-GE	98.5-01.3	PK16TR11	90919-01196	-	IK16	VK16	6
INDIA	2500	JCG10 · JCG15	1JZ-FSE(D-4)	01.4-07.6	SK20BR11	90919-01226	-	-	VKB20	6		
		JCG11	2JZ-GE	98.5-01.3	PK16TR11	90919-01196	-	IK16	VK16	6		
INDONESIA	3000	JCG11	2JZ-FSE(D-4)	01.4-07.6	SK20BR11	90919-01226	-	-	VKB20	6		
		PRONARD RACTIS	3000	MCX20	1MZ-FE	00.4-03.11	SK20R11	90919-01210	-	IK20	VK20	6
KOREA	1300	SCP100	2SZ-FE	05.10-	SK16HR11	90919-01233	-	IKH16	VKH16	4		
		NSP120 · NSP122	1NR-FE	10.12-14.5	SC16HR11	90919-01275	-	-	VCH16	4		
		NSP120	1NR-FKE	14.5-	FC16HR8	90919-01280	-	-	VFCH16	4		
		NSP122	1NR-FKE	14.5-	FC16HR8	90919-01280	-	-	VFCH16	4		
MALAYSIA	1500	NCP100(2WD)	1NZ-FE	05.10-07.11	FK20HR11	90919-01247	-	-	VFKH20	4		
		NCP100(2WD)	1NZ-FE	07.11-	FK16HR11	90919-01243	-	-	VFKH16	4		
		NCP105(4WD)	1NZ-FE	05.10-	K16R-U11	90919-01164	K16TT	IK16	VK16	4		
PHILIPPINES	1000	RAIZE										
		A200A	1KR-VET(T/C)	19.11-21.11	-	-	-	-	-	3		
SAUDI ARABIA	1200	A210A	1KR-VET(T/C)	19.11-21.11	-	-	-	-	-	3		
		A201A	WA-VE	21.11-	FC20HR-Q8	90048-51223	-	-	-	3		
		RAIZE HYBRID	1200	A202A	WA-VEX	21.11-	FC20HR-Q8	90048-51223	-	-	3	
SINGAPORE	1500	RAUM										
		EXZ10 · EXZ15	5E-FE	97.5-03.5	K16TR11	90919-01192	K16TT	IK16	VK16	4		
TAIWAN	1800	RAV4										
		NCZ20 · NCZ25	1NZ-FE	03.5-	K16R-U11	90919-01164	K16TT	IK16	VK16	4		
		ZCA25W · ZCA26W	1ZZ-FE	00.5-05.11	K16R-U11	90919-01164	K16TT	IK16	VK16	4		
		SXA10G · SXA11G	3S-FE	94.5-97.9	K20R-U11	90919-01184	K20TT	IK20	VK20	4		
		SXA10W · SXA11W	3S-GE	96.8-98.8	PK20R8	90919-01180	-	IK20	VK20	4		
		SXA10C · SXA10G · SXA10W · SXA11G · SXA11W · SXA15G · SXA16G	3S-FE	97.9-98.8	K20TR11	90919-01198	K20TT	IK20	VK20	4		
		SXA10W · SXA11W	3S-GE	98.8-00.5	SK20R11	90919-01210	-	IK20	VK20	4		
THAILAND	2000	SXA10C · SXA10G · SXA10W · SXA11G · SXA11W · SXA15G · SXA16G	3S-FE	98.8-00.5	K20R-U11	90919-01184	K20TT	IK20	VK20	4		
		ACA20W · ACA21W	1AZ-FSE(D-4)	00.5-05.11	SK20BGR11	90919-01221	-	-	VKA20	4		
		MXAA52	M20A-FKS	19.4-	FC20HR-Q8	90919-01297	-	-	VFXE22	4		
		MXAA54	M20A-FKS	19.4-	FC20HR-Q8	90919-01297	-	-	VFXE22	4		
VIETNAM	2400	ACA31W · ACA36W	2AZ-FE	05.11-12.12	SK20R11	90919-01210	-	IK20	VK20	4		
		ACA36W	2AZ-FE	12.12-19.4	SK16R11	90919-01240	-	IK16	VK16	4		
		ACA31W	2AZ-FE	12.12-19.4	SK16R11	90919-01240	-	IK16	VK16	4		
JAPAN	2500	RAV4 HYBRID										
		AXAH52	A25A-FXS	19.4-	FC16HR-Q8	90919-01289	-	-	VFCH16	4		
EUROPE & USA	2500	RAV4 PHV										
		AXAH54	A25A-FXS	19.4-	FC16HR-Q8	90919-01289	-	-	VFCH16	4		
		AXAP54	A25A-FXS	20.6-	FC16HR-Q8	90919-01289	-	-	VFCH16	4		
		REGIUS ACE VAN										
		RZH102V	1RZ-E	99.8-03.7	P16R	90919-01115	-	IW16	VW16	4		
		TRH102V · TRH112K · TRH112V · TRH122K · TRH124B	1TR-FE	03.7-04.8	SK20HR11	90919-01191	-	IKH20	VKH20	4		
		TRH200K · TRH200V	1TR-FE	04.8-07.8	SK20HR11	90919-01191	-	IKH20	VKH20	4		
		TRH200K · TRH200V	1TR-FE	07.8-08.1	FK20HBR11	90919-01249	-	-	VFKBH20	4		
		TRH200K · TRH200V	1TR-FE	08.1-15.1	FK20HBR11-T	90919-01255	-	-	VFKBH20	4		
		TRH200K	1TR-FE	15.1-17.12	FK20HBR-TJ8	90919-01288	-	-	VFKBH20	4		
CROSS REFERENCE NUMBER	2700	TRH200V	1TR-FE	15.1-17.12	FK20HBR-TJ8	90919-01288	-	-	VFKBH20	4		
		TRH200K	1TR-FE	17.12-	FK20HBR-TJ8	90919-01288	-	-	VFKBH20	4		
		TRH200V	1TR-FE	17.12-	FK20HBR-TJ8	90919-01288	-	-	VFKBH20	4		
		TRH211K · TRH216K · TRH221K · TRH226K	2TR-FE	04.8-	SK20HR11	90919-01191	-	IKH20	VKH20	4		
		TRH211K	2TR-FE	12.5-15.1	SK20HR-A11	90919-01266	-	IKH20	VKH20	4		
		TRH221K	2TR-FE	12.5-15.1	SK20HR-A11	90919-01266	-	IKH20	VKH20	4		
		TRH216K	2TR-FE	12.5-15.1	SK20HR-A11	90919-01266	-	IKH20	VKH20	4		
		TRH226K	2TR-FE	12.5-15.1	SK20HR-A11	90919-01266	-	IKH20	VKH20	4		
		TRH221K	2TR-FE	15.1-	FK20HR-A8	90919-01287	-	-	VFKH20	4		
		TRH211K	2TR-FE	15.1-	FK20HR-A8	90919-01287	-	-	VFKH20	4		
PART NUMBER	1000	ROOMY										
		M900A	1KR-FE	16.11-	SC16HR11	90919-01275	-	-	VCH16	3		

(\*8) This is IRIDIUM PLUS.

MODEL	CC	VEHICLE CODE	ENGINE	FROM-TILL	DENSO	GENUINE P/N				QTY	
<b>TOYOTA ROOMY</b>	1000	M900A	1KR-VET(T/C)	16.11-	-	-	-	-	-	3	AUSTRALIA
		M910A	1KR-FE	16.11-	SC16HR11	90919-01275	-	-	VCH16	3	
<b>RUSH</b>	1500	J200E · J210E	3SZ-VE	06.1-10.4	SXU22PR9	90048-51188-000	-	IXU22I	VXU22I	4	CHINA
		J200E · J210E	3SZ-VE	10.4-	SXU22PR9	90048-51188-000	-	IXU22I	VXU22I	4	
<b>SAI</b>	2400	AZK10	2AZ-FXE	09.10-12.6	SK20R11	90919-01210	-	IK20	VK20	4	INDIA
		AZK10	2AZ-FXE	12.6-	SK16R11	90919-01240	-	IK16	VK16	4	
<b>SIENTA</b>	1500	NCP81G(2WD)	1NZ-FE	03.9-07.11	FK20HR11	90919-01247	-	-	VFKH20	4	INDONESIA
		NCP81G(2WD)	1NZ-FE	07.11-15.7	FK16HR11	90919-01243	-	-	VFKH16	4	
		NCP85G(4WD)	1NZ-FE	03.9-11.6	K16R-U11	90919-01164	K16TT	IK16	VK16	4	
		NCP85G(4WD)	1NZ-FE	11.6-15.7	SK16R11	90919-01240	-	IK16	VK16	4	
	NSP170G	2NR-FKE	15.7-18.9	FC16HR8	90919-01280	-	-	VFCH16	4		
	NSP172G	2NR-FKE	15.7-18.9	FC16HR8	90919-01280	-	-	VFCH16	4		
	NCP175G	1NZ-FE	15.7-	FK16HR11	90919-01243	-	-	VFKH16	4		
	NSP170G	2NR-FKE	18.9-	FC16HR-Q8	90919-01289	-	-	VFCH16	4		
	NSP172G	2NR-FKE	18.9-	FC16HR-Q8	90919-01289	-	-	VFCH16	4		
	<b>SIENTA HYBRID SOARER</b>	1500	NHP170G	1NZ-FXE	15.7-	FK16BR-AL8	90919-01284	-	-	VFKB16	
2500	JZZ30	1JZ-GTE(T/C)	96.8-01.3	PK20TR11	90919-01194	-	IK20	VK20	6		
	JZZ31	2JZ-GE	94.1-97.8	PK16R11	90919-01168	-	IK16	VK16	6		
3000	JZZ31	2JZ-GE	97.8-01.3	PK16TR11	90919-01196	-	IK16	VK16	6		
	4000	UZZ30 · UZZ31 · UZZ32	1UZ-FE	91.5-01.3	SK20R11	90919-01210	-	IK20	VK20	8	
4300	UZZ40	3UZ-FE	01.4-05.8	SK20R11	90919-01210	-	IK20	VK20	8	MALAYSIA	
<b>SPADE</b>	1300	NCP140	1NR-FE	12.7-	SC16HR11	90919-01275	-	-	VCH16		4
		NCP141	1NZ-FE	12.7-	FK16HR11	90919-01243	-	-	VFKH16		4
1500	NCP145	1NZ-FE	12.7-	FK16HR11	90919-01243	-	-	VFKH16	4		
	NSP141	2NR-FKE	15.7-17.12	FC16HR8	90919-01280	-	-	VFCH16	4		
	NSP141	2NR-FKE	17.12-	FC16HR-Q8	90919-01289	-	-	VFCH16	4		
<b>SPARKY</b>	1300	S221E · S231E	K3-VE	00.9-03.8	K20R-U11	90919-01184	K20TT	IK20	VK20	4	PHILIPPINES
<b>SPRINTER CARIB</b>	1600	AE111G · AE114G	4A-FE	95.8-00.8	K16R-U11	90919-01164	K16TT	IK16	VK16	4	
		AE111G	4A-FE	96.5-00.8	SK20R11	90919-01210	-	IK20	VK20	4	
1800	AE115G	7A-FE	95.8-00.8	K16R-U11	90919-01164	K16TT	IK16	VK16	4	SAUDI ARABIA	
<b>SPRINTER/MARINO/TRUENO</b>	1300	EE96V · EE106V	2E · 2E-LJ	87.8-00.8	W16EX-U	90919-01059	W16TT	IW16	VW16		4
		EE111 · EE102V	4E-FE	95.1-97.4	K16R-U11	90919-01164	K16TT	IK16	VK16		4
		EE111 · EE102V	4E-FE	97.4-00.8	K16TR11	90919-01192	K16TT	IK16	VK16		4
1500	AE100 · AE100G	5A-FE	91.6-00.8	K16R-U11	90919-01164	K16TT	IK16	VK16	4		
	AE110	5A-FE	95.5-00.8	K16R-U11	90919-01164	K16TT	IK16	VK16	4		
	EE103V · EE104G	5E-FE	91.9-97.4	K16R-U11	90919-01164	K16TT	IK16	VK16	4		
	EE103V · EE104G	5E-FE	97.4-00.8	K16TR11	90919-01192	K16TT	IK16	VK16	4		
1600	AE111	4A-FE	95.5-00.8	SK20R11	90919-01210	-	IK20	VK20	4		
	AE109V · AE111 · AE114	4A-FE	96.5-00.8	K16R-U11	90919-01164	K16TT	IK16	VK16	4		
AE101	4A-FE	96.5-00.8	SK20R11	90919-01210	-	IK20	VK20	4	SINGAPORE		
<b>STARLET</b>	1300	EP91 · EP95	4E-FE	96.1-97.12	K16R-U11	90919-01164	K16TT	IK16			VK16
		EP91	4E-FE	96.1-99.7	SK20R11	90919-01210	-	IK20		VK20	4
EP91 · EP95	4E-FE	97.12-99.7	K16TR11	90919-01192	K16TT	IK16	VK16	4		THAILAND	
<b>SUCCEED</b>	1500	NCP51V · NCP55V · NCP58G · NCP59G	1NZ-FE	02.7-10.6	K16R-U11	90919-01164	K16TT	IK16	VK16		4
		NCP51V	1NZ-FE	10.6-14.9	SK16R11	90919-01240	-	IK16	VK16		4
		NCP55V	1NZ-FE	10.6-14.9	SK16R11	90919-01240	-	IK16	VK16		4
		NCP58G	1NZ-FE	10.6-	SK16R11	90919-01240	-	IK16	VK16		4
	NCP59G	1NZ-FE	10.6-	SK16R11	90919-01240	-	IK16	VK16	4		
	NCP160V	1NZ-FE	14.9-	FK16HR11	90919-01243	-	-	VFKH16	4		
	NCP165V	1NZ-FE	14.9-	FK16HR11	90919-01243	-	-	VFKH16	4		
	<b>SUCCEED HYBRID SUPRA</b>	1500	NHP160V	1NZ-FXE	18.12-	FK16BR-AL8	90919-01284	-	-	VFKB16	4
2000	DB82	B48(T/C)	19.5-	-	-	-	-	-	4		
	DB22	B48(T/C)	19.5-	-	-	-	-	-	4		
3000	JZA80	2JZ-GE	93.5-97.8	PK16R11	90919-01168	-	IK16	VK16	6		
	JZA80	2JZ-GE	97.8-02.7	PK16TR11	90919-01196	-	IK16	VK16	6		
	JZA80	2JZ-GTE(T/C)	93.5-97.8	SK20R11	90919-01210	-	IK20	VK20	6		
	JZA80	2JZ-GTE(T/C)	97.8-02.7	PK20TR11	90919-01194	-	IK20	VK20	6		
	DB42	B58(T/C)	19.5-20.4	-	-	-	-	-	6		
	DB02	B58(T/C)	20.4-	-	-	-	-	-	6		
<b>TANK</b>	1000	M900A	1KR-FE	16.11-	-	-	-	-	VCH16	3	JAPAN
		M900A	1KR-VET(T/C)	16.11-	-	-	-	-	-	3	
		M910A	1KR-FE	16.11-	-	-	-	-	VCH16	3	
<b>TERCEL</b>	1300	EL51	4E-FE	94.9-97.12	K16R-U11	90919-01164	K16TT	IK16	VK16	4	EUROPE & USA
		EL51	4E-FE	97.12-99.7	K16TR11	90919-01192	K16TT	IK16	VK16	4	
	1500	EL53 · EL55	5E-FE	94.9-97.12	K16R-U11	90919-01164	K16TT	IK16	VK16	4	
		EL53 · EL55	5E-FE	97.12-99.7	K16TR11	90919-01192	K16TT	IK16	VK16	4	
<b>TOURING HIACE</b>	2700	RCH41W · RCH47W	3RZ-FE	98.8-	SK16R11	90919-01240	-	IK16	VK16	4	CROSS REFERENCE NUMBER

DENSO	9	14	16	20	22	24	27	29	31	32	34	35	DENSO	9	14	16	20	22	24	27	31	DENSO	9	14	16	20	22	24	27	31		
NGK	2	4	5	6	7	8	9	9.5	10	10.5	11	11.5	CHAMPION	18	16,14	12,11	10,9	8,7	6,63,61	4,59	57	55	53	BOSCH	10	9	8	7,6	5	4	3	2

AUSTRALIA  
CHINA  
INDIA  
INDONESIA  
KOREA  
MALAYSIA  
PHILIPPINES  
SAUDI ARABIA  
SINGAPORE  
TAIWAN  
THAILAND  
VIETNAM  
JAPAN  
EUROPE & USA  
CROSS REFERENCE NUMBER  
PART





# JAPAN CAR

▶ Spark plug color codes: ■ for Iridium Tough and Iridium Plugs and Iridium TT, ■ for Iridium Power, ■ for Iridium Racing and Two Tops Plugs, ■ for Platinum Plugs and Platinum TT, and black for general spark plugs.

AUSTRALIA	MODEL	CC	VEHICLE CODE	ENGINE	FROM-TILL	DENSO	GENUINE P/N	IRIDIUM POWER	IRIDIUM TOUGH	QTY		
CHINA	TOYOTA TOWNACE	1500	S412M	3SZ-VE	10.7-20.9	XU22PR9	90048-51197	-	IXU22I VXU22I	4		
			S412U	3SZ-VE	10.7-20.9	XU22PR9	90048-51197	-	IXU22I VXU22I	4		
			S403M	2NR-VE	20.9-	SC16HR11	9004A-91068	-	-	VCH16	4	
			S413M	2NR-VE	20.9-	SC16HR11	9004A-91068	-	-	VCH16	4	
			S403U	2NR-VE	20.9-	SC16HR11	9004A-91068	-	-	VCH16	4	
			S413U	2NR-VE	20.9-	SC16HR11	9004A-91068	-	-	VCH16	4	
INDIA	TOWNACE/NOAH	1500	KM51	5K	90.8-	J16B-U11	90919-01117	-	-	4		
			KR41V	5K	96.10-	W16EXR-U	90919-01064	W16TT	IW16 VW16	4		
			S402M • S402U	3SZ-VE	08.1-20.9	XU22PR9	90048-51197	-	IXU22I VXU22I	4		
		1800	YM55 • YM60 • YM65	2Y	95.8-	P16R	90919-01115	-	IW16 VW16	4		
			KR42V	7K	96.10-98.12	W16EXR-U	90919-01064	W16TT	IW16 VW16	4		
			KR42V	7K-E	98.12-02.8	W16EXR-U11	90919-01091	W16TT	IW16 VW16	4		
			KM70 • KM75 • KM80 • KM85	7K-E	99.6-02.8	W16EXR-U11	90919-01091	W16TT	IW16 VW16	4		
			KM70 • KM75 • KM80 • KM85	7K-E	02.8-	W16EXR-U	90919-01064	W16TT	IW16 VW16	4		
			KR52V	7K-E	04.11-	W16EXR-U	90919-01064	W16TT	IW16 VW16	4		
			2000	SR40G • SR50G	3S-FE	96.10-01.11	K20TR11	90919-01198	K20TT	IK20 VK20	4	
KOREA	TOYOACE	2000	YY101 • YY121 • YY131 • YY201 • YY211	3Y	95.5-01.5	W16EXR-U	90919-01064	W16TT	IW16 VW16	4		
			YY61 • YU60 • YU80	3Y-P(LPG)	98.5-01.5	P16R	90919-01143	-	VW20T(*8)	4		
		2000	RZY220 • RZY230	1RZ-E	01.6-03.7	P16R8	90919-01223	-	IW16 VW16	4		
			TRY220 • TRY230	1TR-FE	03.7-07.8	SK20HR11	90919-01191	-	IKH20 VKH20	4		
			TRY220 • TRY230	1TR-FE	07.8-08.1	FK20HBR11	90919-01249	-	-	VFKBH20	4	
			TRY220 • TRY230	1TR-FE	08.1-	FK20HBR11-T	90919-01255	-	-	VFKBH20	4	
			TRY220 • TRY230	1TR-FE	08.1-	FK20HBR11-T	90919-01255	-	-	VFKBH20	4	
			RZU100 • RZU100A • RZU140	3RZ-FE	95.5-01.5	K16R-U	90919-01176	K16TT	IK16 VK16	4		
		2700	RZU100 • RZU100A • RZU140	3RZ-FE	95.5-	K16R-U	90919-01176	K16TT	IK16 VK16	4		
			RZU100H • RZU100A	3RZ-FP(LPG)	95.5-01.5	K16R-U	90919-01176	-	-	VK20T(*8)	4	
RZU300	3RZ-FPE(LPG)		01.6-03.7	SK16R8-PG	90919-01239	-	-	VK20T(*8)	4			
BU280K	3RZ-FPE(LPG)		01.6-	K16R-U	90919-01176	-	-	VK20T(*8)	4			
RZY231H • RZY281H	3RZ-FPE(LPG)		03.7-	SK16R8-PG	90919-01239	-	-	VK20T(*8)	4			
RZY231H • RZY281H	3RZ-FPE(LPG)		03.7-	SK16R8-PG	90919-01239	-	-	VK20T(*8)	4			
TRU300 • TRU300A • TRU340 • TRU500	2TR-FE		07.8-	SK20HR11	90919-01191	-	IKH20 VKH20	4				
TRC600 • TRU600 • TRC600A	2TR-FE		11.7-	SK20HR11	90919-01191	-	IKH20 VKH20	4				
BU102A • BU102H • BU142	15B-FP(LPG)		97.8-01.5	PK20R8	90919-01180	-	-	VK20T(*8)	4			
RZU100 • RZU100A • RZU100H	15B-FP(LPG)		99.5-01.5	PK20R8	90919-01180	-	-	VK20T(*8)	4			
4100	XZU301	15B-FPE(LPG)	01.6-	PK20R8	90919-01180	-	-	VK20T(*8)	4			
	XZU301A • XZU302 • XZU342 • XZU412	15B-FNE(CNG)	01.6-	SK20R5-G	90919-01229	-	-	-	4			
	BZU300 • BZU340	1BZ-FPE(LPG)	07.8-	SK20R5	90919-01222	-	-	-	4			
	BZU600	1BZ-FPE(LPG)	11.7-	DK16R-B5	90919-01283	-	-	-	4			
THAILAND	TOYOTA DRIVING INSTRUCTION CAR	1500	NZE161	1NZ-FE	18.2-	FK16HR11	90919-01243	-	-	VFKH16	4	
			VANGUARD	2400	ACA33W	2AZ-FE	07.8-12.6	SK20R11	90919-01210	-	IK20 VK20	4
ACA38W(2WD)	2AZ-FE	08.8-12.6			SK20R11	90919-01210	-	IK20 VK20	4			
ACA38W	2AZ-FE	12.6-		SK16R11	90919-01240	-	IK16 VK16	4				
ACA33W	2AZ-FE	12.6-		SK16R11	90919-01240	-	IK16 VK16	4				
VIETNAM	VELLFIRE	3500	GSA33W	2GR-FE	07.8-	FK20HR11	90919-01247	-	-	VFKH20	6	
			2400	ANH20W • ANH25W	2AZ-FE	08.5-12.6	SK20R11	90919-01210	-	IK20 VK20	4	
				ANH20W	2AZ-FE	12.6-15.1	SK16R11	90919-01240	-	IK16 VK16	4	
		2500	ANH25W	2AZ-FE	12.6-15.1	SK16R11	90919-01240	-	IK16 VK16	4		
			AGH30W	2AR-FE	15.1-	SK16HR11	90919-01233	-	IKH16 VKH16	4		
			AGH35W	2AR-FE	15.1-	SK16HR11	90919-01233	-	IKH16 VKH16	4		
			GGH20W • GGH25W	2GR-FE	08.5-15.1	FK20HR11	90919-01247	-	-	VFKH20	6	
			GGH30W	2GR-FE	15.1-18.1	FK20HR11	90919-01247	-	-	VFKH20	6	
			3500	GGH35W	2GR-FE	15.1-18.1	FK20HR11	90919-01247	-	-	VFKH20	6
				GGH30W	2GR-FKS	18.1-	FK20HBR8	90919-01263	-	-	VFKBH20	6
GSA35W	2GR-FKS	18.1-	FK20HBR8	90919-01263	-	-	VFKBH20	6				
	2400	ATH20W	2AZ-FXE	11.11-12.6	SK20R11	90919-01237	-	IK20 VK20	4			
ATH20W		2AZ-FXE	12.6-15.1	SK16R11	90919-01240	-	IK16 VK16	4				
2500	AYH30W	2AR-FXE	15.1-	FK16HR-A8	90919-01259	-	-	VFKH16	4			
	2000	GX110 • GX115	1G-FE	01.7-04.4	K20R-U11	90919-01184	K20TT	IK20 VK20	6			
2500		JZX110	1JZ-GTE(T/C)	01.7-04.4	PK20TR11	90919-01194	-	IK20 VK20	6			
		JZX110	1JZ-FSE(D-4)	01.7-04.4	SK20BR11	90919-01226	-	-	VKB20	6		
PART NUMBER	VISTA/ARDEO	1800	SV40	4S-FE	96.5-98.7	K20TR11	90919-01198	K20TT	IK20 VK20	4		
			ZZV50 • ZZV50G	1ZZ-FE	98.7-00.4	K16TR11	90919-01192	K16TT	IK16 VK16	4		
		ZZV50 • ZZV50G	1ZZ-FE	00.4-03.10	K16R-U11	90919-01164	K16TT	IK16 VK16	4			
		2000	SV41 • SV42 • SV43	3S-FE	96.5-98.7	K20TR11	90919-01198	K20TT	IK20 VK20	4		

(\*8)This is IRIDIUM PLUS.

MODEL	CC	VEHICLE CODE	ENGINE	FROM-TILL	DENSO	GENUINE P/N				QTY	
<b>TOYOTA</b>											
<b>VISTA/ARDEO</b>	2000	SV55 • SV55G	3S-FE	98.7-02.4	K20TR11	90919-01198	K20TT	IK20	VK20	4	AUSTRALIA
		SV50 • SV50G	3S-FSE(D-4)	98.7-01.7	PK20GR8	90919-01208	-	-	VKA20	4	CHINA
		AZV50 • AZV50G	1AZ-FSE(D-4)	01.8-03.7	SK20BGR11	90919-01221	-	-	VKA20	4	INDIA
		AZV55 • AZV55G	1AZ-FSE(D-4)	02.4-03.7	SK20BGR11	90919-01221	-	-	VKA20	4	INDONESIA
<b>VITZ</b>	1000	SCP10	1SZ-FE	99.1-05.2	K16R-U	90919-01176	K16TT	IK16	VK16	4	KOREA
		KSP90	1KR-FE	05.2-10.12	SK20HR11	90919-01191	-	IKH20	VKH20	3	INDONESIA
		KSP130	1KR-FE	10.12-14.4	SK20HR11	90919-01191	-	IKH20	VKH20	3	INDONESIA
		KSP130	1KR-FE	14.4-	SC16HR11	90919-01275	-	-	VCH16	3	INDONESIA
	1300	NCP10 • NCP15	2NZ-FE	99.8-05.2	K16R-U11	90919-01164	K16TT	IK16	VK16	4	INDONESIA
		NCP95	2NZ-FE	05.2-	K16R-U11	90919-01164	K16TT	IK16	VK16	4	INDONESIA
		SCP13(CVT)	2SZ-FE	03.1-05.2	SK16HR11	90919-01233	-	IKH16	VKH16	4	INDONESIA
		SCP90	2SZ-FE	05.2-10.12	SK16HR11	90919-01233	-	IKH16	VKH16	4	INDONESIA
		NSP130 • NSP135	1NR-FE	10.12-	SC16HR11	90919-01275	-	-	VCH16	4	INDONESIA
		NSP130	1NR-FKE	14.4-18.5	FC16HR8	90919-01280	-	-	VFCH16	4	INDONESIA
		NSP130	1NR-FKE	18.5-	FC16HR-Q8	90919-01289	-	-	VFCH16	4	INDONESIA
		1500	NCP13	1NZ-FE	00.10-05.2	K16R-U11	90919-01164	K16TT	IK16	VK16	4
	NCP91		1NZ-FE	05.2-07.11	FK20HR11	90919-01247	-	-	VFKH20	4	INDONESIA
	NCP91		1NZ-FE	07.11-10.12	FK16HR11	90919-01243	-	-	VFKH16	4	INDONESIA
	NCP131		1NZ-FE	10.12-	FK16HR11	90919-01243	-	-	VFKH16	4	INDONESIA
	NCP131		1NZ-FE(T/C-GRMN)	13.9-	VKH20Y	90919-01278	-	-	VKH20Y	4	INDONESIA
1800	NSP131	2ZR-FE(S/C-GRMN)	18.6-	-	90919-01278	-	-	-	4	INDONESIA	
<b>VITZHYBRID</b>	1500	NHP130	1NZ-FXE	17.1-	FK16BR-AL8	90919-01284	-	-	VFKB16	4	INDONESIA
<b>VOLTZ</b>	1800	ZZE136 • ZZE138	1ZZ-FE	02.8-04.2	SK16R11	90919-01240	-	IK16	VK16	4	INDONESIA
		ZZE137	2ZZ-GE	02.8-04.2	SK20R11	90919-01210	-	IK20	VK20	4	INDONESIA
<b>VOXY</b>	2000	AZR60G • AZR65G	1AZ-FSE(D-4)	01.11-07.6	SK20BGR11	90919-01221	-	-	VKA20	4	INDONESIA
		ZRR70G • ZRR75G • ZRR70W • ZRR75W	3ZR-FE	07.6-10.4	SC16HR11	90919-01275	-	-	VCH16	4	INDONESIA
		ZRR70W • ZRR75W	3ZR-FAE	07.6-14.1	SC16HR11	90919-01275	-	-	VCH16	4	INDONESIA
		ZRR80G	3ZR-FAE	14.1-22.1	SC16HR11	90919-01275	-	-	VCH16	4	INDONESIA
		ZRR80W	3ZR-FAE	14.1-22.1	SC16HR11	90919-01275	-	-	VCH16	4	INDONESIA
		ZRR85G	3ZR-FAE	14.1-22.1	SC16HR11	90919-01275	-	-	VCH16	4	INDONESIA
		ZRR85W	3ZR-FAE	14.1-22.1	SC16HR11	90919-01275	-	-	VCH16	4	INDONESIA
		MZRA90W	M20A-FKS	22.1-	FC20HR-Q8	90919-01297	-	-	-	4	INDONESIA
		MZRA95W	M20A-FKS	22.1-	FC20HR-Q8	90919-01297	-	-	-	4	INDONESIA
<b>VOXY HYBRID</b>	1800	ZWR80G	2ZR-FXE	14.2-22.1	SC16HR11	90919-01275	-	-	VCH16	4	INDONESIA
		ZWR80W	2ZR-FXE	16.1-22.1	SC16HR11	90919-01275	-	-	VCH16	4	INDONESIA
		ZWR90W	2ZR-FXE	22.1-	FC16HR-CY9	90919-01298	-	-	-	4	INDONESIA
		ZWR95W	2ZR-FXE	22.1-	FC16HR-CY9	90919-01298	-	-	-	4	INDONESIA
<b>Will CYPHA</b>	1300	NCP70	2NZ-FE	02.10-	K16R-U11	90919-01164	K16TT	IK16	VK16	4	INDONESIA
	1500	NCP75	1NZ-FE	02.10-	K16R-U11	90919-01164	K16TT	IK16	VK16	4	INDONESIA
<b>Will Vi</b>	1300	NCP19	2NZ-FE	00.2-01.12	K16R-U11	90919-01164	K16TT	IK16	VK16	4	INDONESIA
<b>Will VS</b>	1500	NZE127	1NZ-FE	02.1-04.4	K16R-U11	90919-01164	K16TT	IK16	VK16	4	INDONESIA
	1800	ZZE127 • ZZE129	1ZZ-FE	01.4-04.4	K16R-U11	90919-01164	K16TT	IK16	VK16	4	INDONESIA
ZZE128		2ZZ-GE	01.4-04.4	SK20R11	90919-01210	-	IK20	VK20	4	INDONESIA	
<b>WINDOM</b>	2500	MCV21	2MZ-FE	96.8-01.7	PK20TR11	90919-01194	-	IK20	VK20	6	INDONESIA
		MCV20	1MZ-FE	96.8-99.8	PK20TR11	90919-01194	-	IK20	VK20	6	INDONESIA
	3000	MCV20	1MZ-FE	99.8-01.7	SK20R11	90919-01210	-	IK20	VK20	6	INDONESIA
		MCV30	1MZ-FE	01.8-	SK20R11	90919-01210	-	IK20	VK20	6	INDONESIA
<b>WISH</b>	1800	ZNE10G • ZNE14G	1ZZ-FE	03.1-09.4	K16R-U11	90919-01164	K16TT	IK16	VK16	4	INDONESIA
		ZGE20G • ZGE25G • ZGE20W • ZGE25W	2ZR-FAE	09.4-	SC16HR11	90919-01275	-	-	VCH16	4	INDONESIA
	2000	ANE10G • ANE11W	1AZ-FSE(D-4)	03.4-09.4	SK20BGR11	90919-01221	-	-	VKA20	4	INDONESIA
<b>YARIS</b>	1000	ZGE21G • ZGE22W	3ZR-FAE	09.4-	SC16HR11	90919-01275	-	-	VCH16	4	INDONESIA
		KSP210	1KR-FE	20.2-	FC16HR-Q8	90919-01289	-	-	VFCH16	3	INDONESIA
	1500	MXPA10	M15A-FKS	20.2-	FC16HR-Q8	90919-01289	-	-	VFCH16	3	INDONESIA
		MXPA15	M15A-FKS	20.3-	FC16HR-Q8	90919-01289	-	-	VFCH16	3	INDONESIA
	1600	MXPA12	M15A-FKS	20.9-	FC16HR-Q8	90919-01289	-	-	VFCH16	3	INDONESIA
<b>YARIS CROSS</b>	1500	GXPA16	G16E-GTS(T/C)	20.9-	-	-	-	-	3	INDONESIA	
		MXPB10	M15A-FKS	20.8-	FC16HR-Q8	90919-01289	-	-	VFCH16	3	INDONESIA
<b>YARIS CROSS HYBRID</b>	1500	MXPB15	M15A-FKS	20.8-	FC16HR-Q8	90919-01289	-	-	VFCH16	3	INDONESIA
		MXPJ10	M15A-FXE	20.8-	FC16HR-Q8	90919-01289	-	-	VFCH16	3	INDONESIA
<b>YARIS HYBRID</b>	1500	MXPJ15	M15A-FXE	20.8-	FC16HR-Q8	90919-01289	-	-	VFCH16	3	INDONESIA
		MXPH10	M15A-FXE	20.2-	FC16HR-Q8	90919-01289	-	-	VFCH16	3	INDONESIA
		MXPH15	M15A-FXE	20.2-	FC16HR-Q8	90919-01289	-	-	VFCH16	3	INDONESIA

INDONESIA  
MALAYSIA  
PHILIPPINES  
SAUDI ARABIA  
SINGAPORE  
TAIWAN  
THAILAND  
VIETNAM  
JAPAN  
EUROPE & USA  
CROSS REFERENCE  
PART NUMBER



# JAPAN MOTORCYCLE

▶ Spark plug color codes: ■ for Iridium Tough and Iridium Plugs and Iridium TT, ■ for Iridium Power, ■ for Iridium Racing and Two Tops Plugs, ■ for Platinum Plugs and Platinum TT, and black for general spark plugs.

AUSTRALIA	CC MODEL	FROM-TILL	IRIDIUM POWER	IRIDIUM RACING	DENSO	QTY
	<b>HONDA</b>					
25 PEOPLE	84.3	-	IWF16	-	W14FP-JUL	1
50 APE(SUPER SE HEAD KIT) (*3)	-		IY24	-	-	1
50 APE/DX(FI)	07.12	-	IUF22	-	U20FSR-U	1
50 APE/SPECIAL/DX	01.2	-07	IUF22	-	U20FSR-U	1
50 BENLY (CD50)	87.9	-	IUF22	-	U20FSR-U	1
50 BENLY (CD50S/SP)	96.4	-	IUF22	-	U20FSR-U	1
50 BENLY (CL50)	97.4	-	IUF22	-	U20FS-U	1
50 BENLY /BENLY PRO	12.1	-	IU24D	IU01-□	U24EPR9	1
50 BITE	02.2	-	IUH24	IU01-□	U24FER9	1
50 BROAD	95.1	-	IWF20	-	W20FR-L	1
50 CABINA50/STAND UP	94.9	-	IWF20	-	W20FR-L	1
50 CHALY(CF50)	83.5	-88.3	IUF22	-	U20FS-U	1
50 CHALY50	88.3	-01	IUF22	-	U20FSR-U	1
50 CREA SCOOPY	07.10	-	IUH24	IU01-□	U24FER9	1
50 CREA SCOOPY/SPECIAL/i	01	-07	IUH24	IU01-□	U24FER9	1
50 CRF50F	03.9	-	IUF22	-	U20FSR-U	1
50 CRM50	88.2	-	IW24	IW01-□	W24ESR-U	1
50 DAX	-		IUF22	-	U20FSR-U	1
50 DIO CESTA	04.7	-07	IUF22	-	U22FSR-U	1
50 DIO ST	96.7	-	IWF20	-	W20FR-L	1
50 DIO XR BAJA/CESTA	-		IWF20	-	W20FR-L	1
50 DIO ZX/FIT	94.1	-01	IWF20	-	W20FR-L	1
50 DIO(~No.3128591)	03.10	-	IUF22	-	U22FSR-U	1
50 DIO(No.3128592~)	03.10	-	IUF22	-	U22FSR-U	1
50 DIO/CESTA	07.10	-	IUF22	-	U22FSR-U	1
50 DIO50/SE/SP	88.1	-89.12	IWF22	-	W22FPR-U	1
50 DIO50/SR	90.1	-90.12	IWF24	-	W24FSR	1
50 DIO50/SR/ZX	90.12	-93.12	IWF20	-	W20FR-L	1
50 DJ1/R/L	85.4	-89	IWF20	-	W20FP-L	1
50 DJ1RR	88.4	-89	IWF22	-	W22FPR-U	1
50 DREAM 50/SPECIAL	97.2	-01	IUH24	IU01-□	U24FER9	1
50 DREAM 50R	03	-	IUH27	IU01-□	IUH27D	1
50 DUNK	14.2	-	IU24D	IU01-□	U24EPR9	1
50 G DASH	89.1	-90	IWF24	-	W24FSR	1
50 GIORCUB(SNC50)	99.8	-	IUF22	-	U20FSR-U	1
50 GIORNO	11.1	-	IUF22	-	U22FSR-U	1
50 GIORNO CREA/DELUXE	99.6	-	IUH24	IU01-□	U24FER9	1
50 GIORNO SPECIAL/DELUXE	92.3	-99.5	IWF20	-	W20FR-L	1
50 GIORNO/SPORT	12.1	-	IUF22	-	U22FSR-U	1
50 GORILLA	99.9	-07	IUF22	-	U20FSR-U	1
50 GORILLA(ULTRA SE BOREUP KIT) (*4)	-		IY24	-	-	1
50 GORILLA(Z50J)	78	-	IUF22	-	U20FS-U	1
50 GYRO CANOPY50	90.12	-99.10	IWF24	-	W24FSR	1
50 GYRO CANOPY50	99.10	-08.3	IWF24	-	W24FR-L	1
50 GYRO CANOPY50	08.3	-	IY24	-	Y24EFR-C	1
50 GYRO UP50	85.9	-00.4	IWF20	-	W20FP-L	1
50 GYRO UP50	00.4	-07	IWF24	-	W24FR-L	1
50 GYRO X50	82.10	-99.12	IWF20	-	W20FR-L	1
50 GYRO X50	99.12	-	IWF24	-	W24FR-L	1
50 GYRO X50	08.3	-	IY24	-	Y24FER-C	1
50 HUMMING/G	80	-81	IWF16	-	W14FP-JUL	1
50 JAZZ	86.4	-	IUF22	-	U20FSR-U	1
50 JOKER50	96.8	-	IWF20	-	W20FR-L	1
50 JULIO	98.7	-03	IWF20	-	W20FR-L	1
50 LEAD SS/SDX/R	83	-87	IWF20	-	W20FP-L	1
50 LEAD50	83.2	-92.2	IWF20	-	W20FP-L	1
50 LEAD50	92.3	-96.12	IWF22	-	W22FPR-U	1
50 LEAD50	97.1	-	IWF20	-	W20FR-L	1
50 LITTLE CUB	07.9	-	IUF22	-	U20FSR-U	1
50 LITTLE CUB	96.12	-07	IUF22	-	U20FSR-U	1
50 LIVE DIO/J/S/S SPECIAL	99.9	-03	IWF20	-	W20FR-L	1
50 LIVE DIO/ZX/SR/SP/ST/ZX-SP	94.1	-03	IWF20	-	W20FR-L	1
50 MAGNA50	95.4	-07	IUF22	-	U20FSR-U	1
50 MBX50	82	-	IW24	IW01-□	W24ES-U	1
50 MONKEY	99.9	-07	IUF22	-	U20FSR-U	1
50 MONKEY BAJA	91	-	IUF22	-	U20FSR-U	1
50 MONKEY FI	09.2	-	IUF22	-	U20FSR-U	1

CHINA	CC MODEL	FROM-TILL	IRIDIUM POWER	IRIDIUM RACING	DENSO	QTY
	<b>HONDA</b>					
50 MONKEY R	87.3	-	IUF22	-	U20FS-U	1
50 MONKEY(GOLD)	81	-	IUF22	-	U20FS-U	1
50 MONKEY(ULTRA SE BOREUP KIT) (*4)	-		IY24	-	-	1
50 MONKEY(Z50J)	74	-	IUF22	-	U20FS-U	1
50 MONKEY/RT/SP	85	-	IUF22	-	U20FSR-U	1
50 MOTOCOMPO	81	-	IWF16	-	W14FP-JUL	1
50 MOTRA	82	-	IUF22	-	U20FS-U	1
50 MTX50R	83	-	IW24	IW01-□	W24ES-U	1
50 NS-1	91.2	-95.2	IWF22	IW01-□	W22ESR-U	1
50 NS-1	95.3	-01	IWF24	IW01-□	W24ESR-U	1
50 NS50F AERO	87.2	-91.2	IWF24	IW01-□	W24ESR-U	1
50 NS50R	96.8	-	IWF24	IW01-□	W24ESR-U	1
50 NSR50	87.6	-89.5	IWF24	IW01-□	W24ES-U	1
50 NSR50	89.6	-95.1	IWF22	IW01-□	W22ESR-U	1
50 NSR50	95.2	-01	IWF24	IW01-□	W24ESR-U	1
50 PAL 50	90.1	-	IWF20	-	W20FR-L	1
50 PAL 50	87.4	-89.12	IWF20	-	W20FPR-L	1
50 PRESS CUB	88.2	-07	IUF22	-	U20FSR-U	1
50 PRESS CUB50ST/DX	07.9	-	IUF22	-	U20FSR-U	1
50 QR50(MOTOCROSSER)	83	-	IWF22	-	W14FPR-JUL	1
50 ROADFOX	84.7	-85	IWF20	-	W20FP-L	1
50 SGX50 VIA	97.6	-01	IWF20	-	W20FR-L	1
50 SMART DIO Z4	04.2	-07	IY24	-	-	1
50 SMART DIO/DELUXE/Z4	01.3	-07	IUH24	IU01-□	U24FER9	1
50 SOLO	03.3	-	IUF22	-	U20FSR-U	1
50 SPACY	84	-86	IUF22	-	U20FS-U	1
50 STAND UP TACT	89.3	-92	IWF24	-	W24FSR	1
50 SUPER CUB 50 PRO	12.7	-	IU22D	IU01-□	U20EPR9S	1
50 SUPER CUB50/STREET	89.1	-07	IUF22	-	U20FSR-U	1
50 SUPER CUB50SDX	82.4	-07	IUF22	-	U22FS-U	1
50 SUPER CUB50ST/DX	82.3	-88.12	IUF22	-	U20FS-U	1
50 SUPER CUB50ST/DX/CUSTOM	07.9	-	IUF22	-	U20FSR-U	1
50 SUPER CUB50SUPERCUSTOM	-	-88.12	IUF22	-	U20FS-U	1
50 SUPER DIO/SE/SP/SR/ZXSP	-		IWF20	-	W20FR-L	1
50 TACT BASIC	89.9	-92	IWF22	-	W22FPR-U	1
50 TACT FULLMARK/S	82.9	-92.7	IWF20	-	W20FP-L	1
50 TACT IVY	86.4	-87	IUF22	-	U20FS-U	1
50 TACT/BASIC	92.7	-93.4	IWF24	-	W24FSR	1
50 TACT/S/STAND UP	93.4	-	IWF20	-	W20FR-L	1
50 TODAY	07.8	-	IUF22	-	U22FSR-U	1
50 TODAY	02.8	-07	IUF22	-	U22FSR-U	1
50 TOPIC(PRO/FLEX)	95.4	-01	IWF20	-	W20FR-L	1
50 VIA(SGX50)	97.6	-01	IWF20	-	W20FR-L	1
50 VOCAL	83.7	-	IUF22	-	U20FS-U	1
50 XR50MOTARD	05.2	-07	IUF22	-	U20FSR-U	1
50 XR50MOTARD (ULTRA SE BOREUP KIT) (*4)	-		IY24	-	-	1
50 XR50R	00.12	-	IUF22	-	U20FSR-U	1
50 Z50R	95.7	-	IUF22	-	U20FSR-U	1
50 ZOOK	90.2	-91	IWF24	-	W24FSR	1
50 ZOOMER	07.10	-	IUH24	IU01-□	U24FER9	1
50 ZOOMER	01.4	-13.4	IUH24	IU01-□	U24FER9	1
50 ZOOMER X	13.5	-	IU24D	IU01-□	U24EPR9	1
70 BENLY(CD70K)	-		IUF22	-	U20FS-U	1
70 CHALY(CF70)	83.5	-01	IUF22	-	U20FS-U	1
70 CRF70F	03.9	-	IUF22	-	U20FSR-U	1
70 SUPER CUB 70	95.2	-	IUF22	-	U20FSR-U	1
70 SUPER CUB C70SDX	82.3	-	IUF22	-	U20FS-U	1
70 XR70R	96.8	-	IUF22	-	U20FSR-U	1
80 CR80	-		IWF31	IW01-□	IWF31	1
80 CR80R	87.9	-02	IWF31	IW01-□	IWF31	1
80 CR80R II	96	-02	IWF31	IW01-□	IWF31	1
80 CRF80F	07.6	-	IUF22	-	U22FSR-U	1
80 CRM80	88.3	-	IWF24	IW01-□	W24ESR-U	1
80 LEAD80	82	-88	IWF20	-	W20FP-U	1
80 MBX80 INTEGRA	83.6	-	IWF24	IW01-□	W24ES-U	1
80 MTX80R	83.6	-	IWF24	IW01-□	W24ES-U	1

(\*3)KITACO TUNING HEAD (\*4)KITACO TUNING HEAD 85cc,88cc,104cc,108cc,117cc,124cc



CC	MODEL	FROM-TILL	IRIDIUM POWER	IRIDIUM RACING	DENSO	QTY
<b>HONDA</b>						
80	NSR80	87.11-89.5	IW24	IW01-□	W24ESR-U	1
80	NSR80	89.6-01	IW22	IW01-□	W22ESR-U	1
80	NSR80R	-	IW24	IW01-□	W24ESR-U	1
80	XLR80R	87.8-	IUF22	-	U22FS-U	1
80	XR80R	86.6-	IUF22	-	U22FSR-U	1
85	CR85R/R II	03-	IW31	IW01-□	IW31	1
90	BENLY CD90	81-87.8	IUF22	-	U20FS-U	1
90	BENLY CD90	87.9-01	IUF22	-	U20FS-U	1
90	BENLY CD90S	96.4-	IUF22	-	U20FSR-U	1
90	BROAD90	95.1-	IWF20	-	W20FR-L	1
90	CABINA90	94.9-	IWF20	-	W20FR-L	1
90	EZ-9	90.9-	IWF22	-	W22FSR	1
90	FOURTRAX90EX(QUAD)	94-	IUF22	-	U22FSR-U	1
90	JOKER90	96.8-	IWF20	-	W20FR-L	1
90	LEAD90	88-94.6	IWF20	-	W20FR-L	1
90	LEAD90	94.7-98	IWF20	-	W20FR-L	1
90	NEW SUPER CUB C90	80-94	IUF22	-	U20FS-U	1
90	SUPER CUB90	95.2-	IUF22	-	U20FSR-U	1
100	APE100(ULTRA SE BOREUP KIT) (*5)	-	IY24	-	-	1
100	APE100/DX	02.2-	IUF22	-	U22FSR-U	1
100	CRF100F	03.9-	IUF22	-	U22FSR-U	1
100	LEAD100	98.1-03	IWF20	-	W20FR-L	1
100	LEAD100(Import)	-	IUF22	-	U22FSR-U	1
100	SPACY100	03.9-	IUF22	-	U20FSR-U	1
100	SUPER CUB100/EX	94-99	IUF22	-	U22FSR-U	1
100	WAVE100(Import)	04-	IUF22	-	U20FS-U	1
100	XR100(ULTRA SE BOREUP KIT) (*5)	-	IY24	-	-	1
100	XR100/R	90-	IUF22	-	U22FSR-U	1
100	XR100MOTARD	05.2-	IUF22	-	U22FSR-U	1
110	BENLY 110/BENLY 110PRO	12.1-	IU24D	IU01-□	U24EPR9	1
110	CROSSCUB	13.6-	IU22D	IU01-□	U20EPR9	1
110	CT110	81-	IX24	IXU01-□	X24ES-U	1
110	CZ-i110(Import)	08-	IU20	IU01-□	-	1
110	DIO 110	11.6-15.3	IU24D	IU01-□	U24EPR9	1
110	DIO 110	15.3-	IU24D	IU01-□	-	1
110	DIO 110	21.1-	IU22D	IU01-□	-	1
110	LEAD/EX	08.1-	IUH24	IU01-□	U22FER9	1
110	NICE110S(Import)	-	IUF22	-	U20FS-U	1
110	SUPER CUB110	09.6-12.3	IU22D	IU01-□	U20EPR9S	1
110	SUPER CUB110	09.6-	IU22D	IU01-□	U20EPR9S	1
110	SUPER CUB110PRO	09.10-	IU22D	IU01-□	U20EPR9S	1
110	WAVE110- i (Import)	-	IU22D	IU01-□	U20EPR9S	1
110	ZOOMER X	13.6-	IU24D	IU01-□	U24EPR9	1
125	@125(Import)	-	IUH24	IU01-□	U24FER9	1
125	125T MASTER CUSTOM	82-	IUF22	-	U22FS-U	2
125	ANF125i Innova(Import)	-	IU20	IU01-□	U20EPR9	1
125	BENLY CD125T	79.5-93.6	IUF22	-	U20FS-U	2
125	BENLY CD125T	93.7-01.2	IUF22	-	U20FSR-U	2
125	BENLY CD125T	01.3-	IUH24	IU01-□	U24FER9	2
125	BIALS TL125/S	73-	IX24	IXU01-□	X24ES-U	1
125	CB125JX	81-	IX24	IXU01-□	X24ES-U	1
125	CB125T	81-	IUF22	-	U22FSR-U	2
125	CBF125	08-	IU22D	IU01-□	U22EPR9	1
125	CBR125R	13.6-	IU24	IU01-□	U24ESR-N	1
125	CBR125R(Import)	04-	IU24	IU01-□	U24ESR-N	1
125	CBX125/F	84.3-93.2	IX27B	IXU01-□	X27EPR-U9	1
125	CBX125CUSTOM	84.3-	IX24B	IXU01-□	X24EPR-U9	1
125	CBX125F	93.3-	IX27B	IXU01-□	X27EPR-U9	1
125	CR125	83-	IW27	IW01-□	-	1
125	CR125R	82-96.7	IW27	IW01-□	-	1
125	CR125R	96.7-98.7	IW27	IW01-□	-	1
125	CR125R	98.8-	IW27	IW01-□	-	1
125	CR125R	01.9-	IW27	IW01-□	W27ESR-V	1
125	DASH RS(Import)	-	IW20	IW01-□	W20EP-U	1
125	DREAM125(Import)	-	IU20	IU01-□	U20EPR9	1
125	DYLAN125(Import)	-	IUH24	IU01-□	U24FER9	1
125	GROM	13-	IU20	IU01-□	U20EPR9	1

(\*5) KITACO TUNING HEAD 115cc,125cc,145cc

CC	MODEL	FROM-TILL	IRIDIUM POWER	IRIDIUM RACING	DENSO	QTY
<b>HONDA</b>						
125	LEAD/LEAD EX	08-	IUH24	IU01-□	U22FER9	1
125	LEAD125	13-	IU22D	IU01-□	U22EPR9	1
125	LS125R(Import)	-	IW24	IW01-□	W24ES-U	1
125	MBX125F	83.3-85	IW27	IW01-□	W27ES-U	1
125	MTX125R	82-	IW27	IW01-□	W27ES-U	1
125	NSR125	-	IW27	IW01-□	W27ESR-U	1
125	NSR125F	89.6-01	IW27	IW01-□	W27ESR-U	1
125	NX125	88-	IX24	IXU01-□	X24ESR-U	1
125	PANTHEON125(Import)	03-	IUH24	IU01-□	U24FER9	1
125	PCX	10.3-	IU22D	IU01-□	U22EPR9	1
125	RS125R withDetonationCounter	-	-	IA01-□	IA01-32	1
125	RS125R withoutDetonationCounter	-	-	IAE01-□	IAE01-32	1
125	Sh mode	13.9-	IU22D	IU01-□	U22EPR9	1
125	SH125(Import)	-	IUH24	IU01-□	U24FER9	1
125	SHADOW125	-	IUH24	IU01-□	U24FER9	2
125	SONIC125RS(Import)	-	IU24	IU01-□	U24ESR-N	1
125	SPACY125	94.2-95.8	IX22B	IXU01-□	X22EPR-U9	1
125	SPACY125	95.8-	IUF22	-	U22FSR-U	1
125	SPACY125STRIKER	83.3-87.2	IX22B	IXU01-□	X22EP-U9	1
125	VARADERO125(Import)	-	IUH24	IU01-□	U24FER9	1
125	WAVE125/i(Import)	-	IU22D	IU01-□	U20EPR9	1
125	XLR125R	93.6-	IX24B	IXU01-□	X24EPR-U9	1
125	XR125L(Import)	03-	IX24B	IXU01-□	X24EPR-U9	1
150	@150(Import)	-	IUH24	IU01-□	U24FER9	1
150	CBR150R(Import)	-	IU24	IU01-□	U24ESR-N	1
150	CRF150F(Import)	04-	IX22B	IXU01-□	X22EPR-U9	1
150	CRF150R/R II	06-	IUH24	IU01-□	U24FER9	1
150	DYLAN150(Import)	-	IUH24	IU01-□	U24FER9	1
150	NSR150	-	IW24	IW01-□	W24ES-U	1
150	NSR150SP/RR	-	IW27	IW01-□	W27ES-U	1
150	PANTHEON150(Import)	03-	IUH24	IU01-□	U24FER9	1
150	PCX150	12.6-18.4	IU22D	IU01-□	U22EPR9	1
150	PCX150	18.4-	-	-	-	-
150	SH150(Import)	-	IUH24	IU01-□	U24FER9	1
200	MTX200R	83.2-	IW27	IW01-□	W27ES-U	1
200	PHANTOM(Import)	-	IX24B	IXU01-□	X24EPR-U9	1
200	TLM200R	85-	IW24	IW01-□	W24ES-U	1
200	TLR200	83-	IX24	IXU01-□	X24ES-U	1
200	XL200R	82-	IX24	IXU01-□	X24ES-U	1
200	XLR200R	93.6-	IX24B	IXU01-□	X24EPR-U9	1
200	XR200R	81-	IX24	IXU01-□	X24ESR-U	1
220	TLM220R	88.3-	IW24	IW01-□	W24ESR-U	1
223	CB223S	08.3-	IX24B	IXU01-□	X24EPR-U9	1
223	FTR223/D	00.9-	IX24B	IXU01-□	X24EPR-U9	1
230	CRF230F(Import)	04-	IX24B	IXU01-□	X24EPR-U9	1
230	CRF230L(Import)	08-	IX24B	IXU01-□	X24EPR-U9	1
230	SL230	97.4-	IX24B	IXU01-□	X24EPR-U9	1
230	XL230	02.4-04	IX24B	IXU01-□	X24EPR-U9	1
230	XR230	05.3-	IX24B	IXU01-□	X24EPR-U9	1
250	250T MASTER/LA CUSTOM	81-	IUF22	-	U22FS-U	2
250	AX-1(250)1000001-1003044	87.12-89.6	IUH24	IU01-□	U24FER9	1
250	AX-1(250)1003045-	89.7-	IUH27	IU01-□	U27FER9	1
250	BROS PRODUCT1/2	-	IX24B	IXU01-□	X24EPR-U9	2
250	CB250F	14.7-	IU24	IU01-□	-	1
250	CB250RS/RS-Z	80.3-	IX24	IXU01-□	X24ES-U	1
250	CBF250(Import)	04-	IUH24	IU01-□	U24FER9	1
250	CBR250Four	86.4-	IUH27	IU01-□	U27FER9	4
250	CBR250R	87.9-90.3	IUH27	IU01-□	U27FER9	4
250	CBR250R	11.3-	IU24	IU01-□	-	1
250	CBR250RR	90.3-	IUH27	IU01-□	U27FER9	4
250	CBX250RS	83.5-	IX24B	IXU01-□	X24EP-U9	1
250	CBX250S	85-	IXG24	IXU01-□	X24GP-U	1
250	CD250u	88.4-93	IUF22	-	U20FSR-U	2
250	CR250	-	IW24	IW01-□	-	1
250	CR250R	87.9-90.8	IW27	IW01-□	-	1
250	CR250R	90.9-96.9	IW24	IW01-□	-	1
250	CR250R	96.9-98.6	IW24	IW01-□	-	1

AUSTRALIA  
CHINA  
INDIA  
INDONESIA  
KOREA  
MALAYSIA  
PHILIPPINES  
SAUDIARABIA  
SINGAPORE  
TAIWAN  
THAILAND  
VIETNAM  
JAPAN  
EUROPE & USA  
CROSS REFERENCE  
PART NUMBER



# JAPAN MOTORCYCLE

▶ Spark plug color codes: ■ for Iridium Tough and Iridium Plugs and Iridium TT, ■ for Iridium Power, ■ for Iridium Racing and Two Tops Plugs, ■ for Platinum Plugs and Platinum TT, and black for general spark plugs.

AUSTRALIA	CC MODEL	FROM-TILL	IRIDIUM POWER	IRIDIUM RACING	DENSO	QTY
	<b>HONDA</b>					
250 CR250R	98.7 -05.1	IW24	IW01-□	-	1	
250 CR250R	05.1 -	IW27	IW01-□	-	1	
250 CRF250L	12.5 -	IU24	IU01-□	-	1	
250 CRF250M	13.4 -	IU24	IU01-□	-	1	
250 CRF250R	03.9 -04.8	IUH24D	IU01-□	VUH24D	1	
250 CRF250R	04.8 -09	-	IU01-□	IU01-24	1	
250 CRF250R	12.4 -	IU24	IU01-□	-	1	
250 CRF250R/X	09.9 -	-	-	-	1	
250 CRF250X(Import)	04 -09	IUH24D	IU01-□	VUH24D	1	
250 CRM250/R	89.4 -	IW24	IW01-□	W24ESR-U	1	
250 CRM250AR	97.1 -	IW24	IW01-□	W24ESR-U	1	
250 FAZE/ABS/TYPE-S	09.7 -	-	-	-	1	
250 FORESIGHT/SE/EX	97.6 -07	IX22B	IXU01-□	X22EPR-U	1	
250 FORZA Z/ABS	07.12-	-	-	-	1	
250 FORZA 250/S/T/ST/X	00.3 -04.3	IX22B	IXU01-□	X22EPR-U9	1	
250 FORZA Si	13.7 -	-	-	-	1	
250 FORZA X/Z	04.4 -	IX22B	IXU01-□	X22EPR-U9	1	
250 FREEWAY250	94.2 -99	IX22B	IXU01-□	X20EP-U9	1	
250 FTR250	86 -	IXG24	IXU01-□	X24GP-U	1	
250 FUSION250/SE	86.4 -99	IX22B	IXU01-□	X20EP-U9	1	
250 FUSION250/X/XX	03.3 -07	IX22B	IXU01-□	X20EPR-U	1	
250 GB250CLUBMAN	83.12-	IX24B	IXU01-□	X24EPR-U	1	
250 HELIX	-	IX22B	IXU01-□	X20EPR-U	1	
250 HORNET	96.2 -00.1	IUH24	IU01-□	U24FER9	4	
250 HORNET	00.1 -07	IUH27	IU01-□	U27FER9	4	
250 JADE250/S	91.2 -	IUH24	IU01-□	U24FER9	4	
250 MVX250F	83.2 -84.4	IW24(IW27)	IW01-□	W24ES-U (W27ES-U)	3	
250 NIGHTHAWK250	92 -	IUF22	-	U20FSR-U	2	
250 NS250F/R/R Rothmans	84.5 -86.9	IW24	IW01-□	W24ES-U	2	
250 NSR250R	86.10-87.12	IWM27	IWM01-□	-	2	
250 NSR250R/SP	88.1 -89.12	IWM27	IWM01-□	-	2	
250 NSR250R/SP/SE	90.1 -93.10	IWM27	IWM01-□	-	2	
250 NSR250R/SP/SE	93.11-01	IWM27	IWM01-□	-	2	
250 PS250	04.6 -07	IX22B	IXU01-□	X22EPR-U9	1	
250 REBEL(CA250T)/SPECIAL	85.4 -	IUF22	-	U20FS-U	2	
250 REBEL250	94.2 -	IUF22	-	U20FSR-U	2	
250 RS250R withDetonationCounter	-	-	IA01-□	IA01-32	2	
250 RS250R withoutDetonationCounter	-	-	IAE01-□	IAE01-32	2	
250 RTL250F	05 -	IU20	IU01-□	-	1	
250 RTL250R	-	IW20	IW01-□	W20ESR-U	1	
250 SPACY250FREEWAY	84 -	IX22B	IXU01-□	X20EP-U9	1	
250 TLR250R	86.4 -	IX24	IXU01-□	X24ES-U	1	
250 VT250F/INTEGRA	82.6 -87	IX24B	IXU01-□	X24EP-U9	2	
250 VT250SPADA	88.12-91	IUH24	IU01-□	U24FER9	2	
250 VT250Z	84 -84	IX24B	IXU01-□	X24EP-U9	2	
250 VTR	09.3 -	IUH24	IU01-□	U24FER9	2	
250 VTR250	98.1 -07	IUH24	IU01-□	U24FER9	2	
250 V-TWIN MAGNA250/S	94.6 -07	IUH24	IU01-□	U24FER9	2	
250 VT250H/H-2 1021001~1033408	87 -88	IX24B	IXU01-□	X24EP-U9	2	
250 VT250J/K 1055001~1104798	88.6 -89	IUH24	IU01-□	U24FER9	2	
250 XELVIS250	91.1 -	IUH24	IU01-□	U24FER9	2	
250 XL DEGREE250	91.4 -	IUH24	IU01-□	U24FER9	1	
250 XL250/S/R	74 -	IX24	IXU01-□	X24ES-U	1	
250 XLR250BAJA	90 -95	IXG24	IXU01-□	X24GPR-U	1	
250 XLR250R	85 -90.1	IXG24	IXU01-□	X24GP-U	1	
250 XLR250R	90.2 -93.12	IXG24	IXU01-□	X24GPR-U	1	
250 XLR250R	94.1 -95.2	IXG27	IXU01-□	X27GPR-U	1	
250 XLX250R	83 -	IX24B	IXU01-□	X24EP-U9	1	
250 XR BAJA	95 -	IUH24	IU01-□	U24FER9	1	
250 XR250	95.2 -03.1	IUH24	IU01-□	U24FER9	1	
250 XR250	03.2 -	IUH24	IU01-□	U24FER9	1	
250 XR250 MOTARD	03.4 -07	IUH24	IU01-□	U24FER9	1	
250 XR250R	- -95	IXG27	IXU01-□	X27GPR-U	1	
250 XR250R	95 -	IUH27	IU01-□	U27FER9	1	
260 RTL260F	08 -	IU20	-	-	1	
260 TLM260R	89 -	IW20	IW01-□	W20ES-U	1	

CHINA	CC MODEL	FROM-TILL	IRIDIUM POWER	IRIDIUM RACING	DENSO	QTY
	<b>HONDA</b>					
260 TLR260	94.12-	IW20	IW01-□	W20ESR-U	1	
300 FOURTRAX300EX(QUAD)	94 -	IX24	IXU01-□	X24ESR-U	1	
300 SH300i(Import)	-	-	-	-	1	
350 CB350	68 -	IW22	IW01-□	W22ES-U	2	
350 CB350Four	72.6 -	IX22	IXU01-□	X22ES-U	4	
400 400X	13.6 -	IU24D	IU01-□	U24EPR9	2	
400 BROS400 PRODUCT2	88.1 -94	IX24B	IXU01-□	X24EPR-U9	4	
400 CB1(400)	89.3 -	IUH24	IU01-□	U24FER9	4	
400 CB400F	13.5 -	IU24D	IU01-□	U24EPR9	2	
400 CB400F VERSION	-	IUH24	IU01-□	U24FER9	4	
400 CB400F( I · II )	74.12-	IX24	IXU01-□	X24ES-U	4	
400 CB400FOUR	97.4 -	IUH24	IU01-□	U24FER9	4	
400 CB400LC	82 -	IX24	IXU01-□	X24ES-U	4	
400 CB400SS/CAFE RACER STYLE	01.10-	IXG24	IXU01-□	X24GPR-U	1	
400 CB400SUPER BOLD'OR	05.3 -07	IUH24	IU01-□	U24FER9	4	
400 CB400SUPER FOUR/SUPER BOLD'OR	07.12-	IUH24	IU01-□	U24FER9	4	
400 CB400SuperFour	00.2 -02.1	IUH24	IU01-□	U24FER9	4	
400 CB400SuperFour SPECII	02.1 -03.12	IUH24	IU01-□	U24FER9	4	
400 CB400SuperFour SPECIII	03.12-07	IUH24	IU01-□	U24FER9	4	
400 CB400SuperFour/S/R	92.4 -00.2	IUH24	IU01-□	U24FER9	4	
400 CBR400F/ENDURANCE	83.12-	IX24	IXU01-□	X24ES-U	4	
400 CBR400R	86.7 -	IUH27	IU01-□	U27FER9	4	
400 CBR400R	13.4 -	IU24D	IU01-□	U24EPR9	2	
400 CBR400RR	88.1 -	IUH24	IU01-□	U24FER9	4	
400 CBX400CUSTOM	83 -	IX24B	IXU01-□	X24EP-U9	4	
400 CBX400F/INTEGRA	81.11-	IXG24	IXU01-□	X24GP-U	4	
400 CL400/RS	98.9 -	IXG24	IXU01-□	X24GP-U	1	
400 CM400T	79.8 -	IX24	IXU01-□	X24ES-U	2	
400 CX CUSTOM	83.3 -	IX24	IXU01-□	X24ES-U	2	
400 CX EURO	82 -	IX24	IXU01-□	X24ES-U	2	
400 FT400	82.6 -	IX24	IXU01-□	X24ES-U	1	
400 GB400TT·MKII	85.7 -	IX24B	IXU01-□	X24EP-U9	1	
400 HAWK CB400N/T/T-AT	77 -	IX24	IXU01-□	X24ES-U	2	
400 NS400R	85.5 -86	IW24	IW01-□	W24ES-U	3	
400 NV400CUSTOM/SP	83.3 -	IX24B	IXU01-□	X24EPR-U9	4	
400 NV400STEED	-	IX22B	IXU01-□	X22EPR-U9	4	
400 RVF400	94.1 -01	IY27	-	-	4	
400 SHADOW CLASSIC/CUSTOM	08.11-	IX22B	IXU01-□	X22EPR-U9	4	
400 SHADOW SLASHER	00.4 -	IX22B	IXU01-□	X22EPR-U9	4	
400 SHADOW400	97 -	IX22B	IXU01-□	X22EPR-U9	4	
400 SILVERWING GT400/ABS	09.3 -	IUH24	IU01-□	U24FER9	2	
400 SILVERWING400/ABS	01.11-09.2	IUH24	IU01-□	U24FER9	2	
400 STEED VLS	98.3 -	IX22B	IXU01-□	X22EPR-U9	4	
400 STEED VSE/VLX/VCL	96.1 -	IX22B	IXU01-□	X22EPR-U9	4	
400 TRANSALP400V	92.3 -	IX24B	IXU01-□	X24EPR-U9	4	
400 VF400F/INTEGRA	82.12-	IX24B	IXU01-□	X24EP-U9	4	
400 VFR400R	87.4 -89.1	IUH24	IU01-□	U24FER9	4	
400 VFR400R	89.1 -93	IY27	-	-	4	
400 VFR400Z	87.4 -90.1	IUH24	IU01-□	U24FER9	4	
400 VRX ROADSTAR	95.7 -	IX22B	IXU01-□	X22EPR-U9	4	
400 VT400S	10.11-	IX22B	IXU01-□	X22EPR-U9	4	
400 XL400R	82 -	IX24	IXU01-□	X24ES-U	1	
400 XL400V	-	IX24B	IXU01-□	X24EP-U9	4	
400 XR400 MOTARD	05.3 -	IXG24	IXU01-□	X24GPR-U	1	
400 XR400R	97.7 -	IXG24	IXU01-□	X24GP-U	1	
450 CRF450R	01.11-08	IK24	IK01-□	VK24PRZ11	1	
450 CRF450R	08.10-	-	-	-	1	
500 CB500/S	96 -03	IUH24	IU01-□	U24FER9	2	
500 CBF500(Import)	04 -	IUH24	IU01-□	U24FER9S	2	
500 CR500/R	-	IW24	IW01-□	-	1	
500 FT500	82.5 -	IX24	IXU01-□	X24ES-U	1	
500 GB500TT	85 -	IX24B	IXU01-□	X24EP-U9	1	
500 NSR500V withDetonationCounter	-	-	IU01-□	IA01-32	2	
500 TRX500(QUAD)	01 -	IX22B	IXU01-□	VX22BC	1	
500 WING GL500/CUSTOM	78 -	IX24	IXU01-□	X24ES-U	2	
500 XL500S	79 -	IX24	IXU01-□	X24ES-U	1	
550 CBX550INTEGRA	82 -	IX24	IXU01-□	X24ES-U	4	

DENSO	9	14	16	20	22	24	27	29	31	32	34	35	DENSO	9	14	16	20	22	24	27	29	31	32	DENSO	9	14	16	20	22	24	27	31
NGK	2	4	5	6	7	8	9	9.5	10	10.5	11	11.5	CHAMPION	18	16,14	12,11	10,9	8,7	6,63,61	4,59	57	55	53	BOSCH	10	9	8	7,6	5	4	3	2





CC	MODEL	FROM-TILL	IRIDIUM POWER	IRIDIUM RACING	DENSO	QTY
<b>HONDA</b>						
600	CB600F	98.3 -	IUH24	IU01-□	U24FER9	4
600	CB600F HORNET/ABS(Import)	07 -	IUH27	IU01-□	U27FER9	4
600	CB600F/ABS(Import)	11 -	IUH27	IU01-□	U27FER9	4
600	CBF600/S ABS(Import)	04 -	IUH24	IU01-□	U24FER9	4
600	CBR600F	92.6 -	IUH24	IU01-□/ RU01-□	U24FER9	4
600	CBR600F(Import)	88 -00.9	IUH27	IU01-□	U27FER9	4
600	CBR600F(Import)	00.10-	IUH27	IU01-□/ RU01-□	IUH27D	4
600	CBR600F4i	01.3 -	IUH27	IU01-□/ RU01-□	IUH27D	4
600	CBR600FS(Import)	00.10-	IUH27	IU01-□/ RU01-□	IUH27D	4
600	CBR600RR	03 -04	IUH24D	IU01-□	VUH24D	4
600	CBR600RR	05 -08	IUH24D	IU01-□	-	4
600	CBR600RR RACE BASE	03 -	IUH24	IU01-□	-	4
600	CBR600RR(Import)	03 -04	IUH27D	IU01-□	VUH27D	4
600	CBR600RR(Import)	05 -08	IUH27D	IU01-□	-	4
600	CBR600RR/ABS	09.2 -	IUH24D	IU01-□	-	4
600	CBR600RR/ABS(Import)	09 -	IUH24D	IU01-□	-	4
600	FJS600SILVERWING	01 -	IUH24	IU01-□	U24FER9	2
600	HORNET S(Import)	-	IUH27	IU01-□	U27FER9	4
600	HORNET600/S	98.3 -	IUH24	IU01-□	U24FER9	4
600	NV600STEED	88.1 -	IX22B	IXU01-□	X22EPR-U9	4
600	SILVER WING GT600/ABS	09.6 -	IUH24	IU01-□	U24FER9	2
600	SILVERWING600/ABS	01.3 -	IUH24	IU01-□	U24FER9	2
600	STEED VLX	96 -	IX22B	IXU01-□	X22EPR-U9	4
600	TRANSALP600V	87.4 -	IX24B	IXU01-□	X24EPR-U9	4
600	VT600C/CD SHADOW VLX/DX	86 -	IX24B	IXU01-□	X24EPR-U9	4
600	XL600V TRANSALP	87 -	IX24B	IXU01-□	X24EPR-U9	4
600	XR600R	86 -	IX24B	IXU01-□	X24EPR-U9	1
650	AFRICATWIN650	88 -90	IX24B	IXU01-□	X24EPR-U9	4
650	BROS650PRODUCT1/2	88.1 -	IX24B	IXU01-□	X24EPR-U9	4
650	CBX650CUSTOM	82.12-	IX24B	IXU01-□	X24EP-U9	4
650	DEAUVILLE(NT650V)	-	IX24B	IXU01-□	X24EPR-U9	4
650	FMX650(Import)	-	IX24B	IXU01-□	X24EPR-U9	1
650	FX650 VIGOR	-	IX24B	IXU01-□	X24EPR-U9	1
650	NTV650	88 -	IX24B	IXU01-□	X24EPR-U9	4
650	NX650DOMINATOR	88 -	IX24B	IXU01-□	X24EPR-U9	1
650	SLR650	-	IX22B	IXU01-□	X22EPR-U9	1
650	TRX650FA	02.5 -	IK16	IK01-□	VK16PRZ11	1
650	XL650V TRANSALP	-	IX24B	IXU01-□	X24EPR-U9	4
650	XR650L	92 -	IX22B	IXU01-□	X22EPR-U9	1
650	XR650R	00.1 -	IK22	IK01-□	K22PR-U11	1
670	CTX700/700N	13 -	IK20	IK01-□	-	2
670	INTEGRA(NC700D)	12 -	IK20	IK01-□	-	2
670	NC700S	12 -	IK20	IK01-□	-	2
670	NC700X	12 -	IK20	IK01-□	-	2
680	DEAUVILLE(Import)	06 -	IU24D	IU01-□	U24EPR9	2
680	DN-01	08.3 -	IU24	IU01-□	-	2
680	XL700V TRANSALP(Import)	08 -	IU24D	IU01-□	U24EPR9	2
700	WING INTERSTATE	83 -	IX24B	IXU01-□	X24EPR-U9	2
750	AFRICATWIN750	90.2 -	IX24B	IXU01-□	X24EPR-U9	4
750	CB750 Four	69 -77	IX24	IXU01-□	X24ES-U	4
750	CB750/F2	92.2 -09	IX24B	IXU01-□	X24EPR-U9	4
750	CB750AERO	77.4 -	IX22	IXU01-□	X22ES-U	4
750	CB750CUSTOM EXCLUSIVE	80 -	IX24	IXU01-□	X24ES-U	4
750	CB750K·F	78.12-	IX24	IXU01-□	X24ES-U	4
750	CBR750F	-	IX24	IXU01-□	X24ES-U	4
750	CBR750SUPER AERO	87.2 -	IX24B	IXU01-□	X24EP-U9	4
750	CBX750F	83.12-	IX24B	IXU01-□	X24EP-U9	4
750	CBX750HORIZON	84.3 -	IX24B	IXU01-□	X24EP-U9	4
750	INTEGRA(NC750D)	14.2 -	IK20	IK01-□	-	2
750	NC750S	14 -	IK20	IK01-□	-	2
750	NC750X	14 -	IK20	IK01-□	-	2
750	NIGHTHAWK750	91.6 -	IX24B	IXU01-□	X24EPR-U9	4
750	NR(750)	92.5 -93	IY27	-	-	8

CC	MODEL	FROM-TILL	IRIDIUM POWER	IRIDIUM RACING	DENSO	QTY
<b>HONDA</b>						
750	NV750CUSTOM	82 -83	IX24B	IXU01-□	X24EPR-U9	4
750	RS750MAGNA	93.7 -96	IUH24	IU01-□	U24FER9	4
750	RVF750(RC45)	94 -95	IUH27	RU01-□	IUH27	4
750	SHADOW PHANTOM	09.11-	IX22B	IXU01-□	X22EPR-U9	4
750	SHADOW SLASHER750	00.11-	IX22B	IXU01-□	X22EPR-U9	4
750	SHADOW750	97.3 -03	IX22B	IXU01-□	X22EPR-U9	4
750	SHADOW750/ABS	04 -	IX22B	IXU01-□	X22EPR-U9	4
750	V45MAGNA	87 -93	IX24B	IXU01-□	X24EP-U9	4
750	VF750C	93.7 -01	IUH24	IU01-□	U24FER9	4
750	VF750F	82.12-	IX24B	IXU01-□	X24EP-U9	4
750	VF750SAVER·MAGNA	82 -96	IX24B	IXU01-□	X24EP-U9	4
750	VFR750F	86 -89	IX24B	IXU01-□	X24EPR-U9	4
750	VFR750F	90.2 -93	IUH24	IU01-□	U24FER9	4
750	VFR750R	87.8 -	IUH27	IU01-□	U27FE9	4
750	VT750S	10.3 -	IX22B	IXU01-□	X22EPR-U9	4
750	XLV750E/R	83 -	IX24B	IXU01-□	X24EPR-U9	4
800	CROSSRUNNER(Import)	11 -	-	IU01-□	VNH27ZB	4
800	PACIFIC COAST(PC800)	90.11-01	IX22B	IXU01-□	X22EPR-U9	4
800	VFR800	02 -	IX24	IU01-□	VNH24Z	4
800	VFR800	98.4 -02	IU24	IU01-□	U24FER9	4
800	VFR800(Import)	02 -09	-	IU01-□	VNH27Z	4
800	VFR800(Import)	98 -01	IU27	IU01-□	U27FER9	4
800	VFR800F	14.4 -	-	IU01-□	VNH27ZB	4
800	VFR800F	14.12-	-	IU01-□	VNH27ZB	4
900	CB900HORNET	01.10-	IUH24	IU01-□	U24FER9	4
900	CBR900RR FIREBLADE	92 -99	IUH27	IU01-□/ RU01-□	U27FER9	4
900	CBR900RR FIREBLADE(Import)	00.1 -01.12	IUH27	IU01-□/ RU01-□	IUH27D	4
929	CBR929RR FIREBLADE(Import)	00.1 -01.12	IUH27	IU01-□/ RU01-□	IUH27D	4
954	CBR954RR	02.3 -03	IUH24D	IU01-□	VUH24D	4
954	CBR954RR(Import)	02 -03	IUH27D	IU01-□	VUH27D	4
1000	CB1000R(Import)	08 -	IUH27	IU01-□	VUH27ES	4
1000	CB1000R(Import)	08 -	IUH24	IU01-□	U24FER9	4
1000	CB1000SF(Import)	-	IX27B	IXU01-□	X27EPR-U9	4
1000	CB1000SuperFour	92.11-	IX24B	IXU01-□	X24EPR-U9	4
1000	CBF1000/ABS(Import)	-	IUH24	IU01-□	U24FER9	4
1000	CBF1000/ABS(Import)	10 -	IUH24	IU01-□	VUH24ES	4
1000	CBR1000F	93.4 -	IX24B	IXU01-□	X24EPR-U9	4
1000	CBR1000F(Import)	87 -	IX27B	IXU01-□	X27EPR-U9	4
1000	CBR1000RR	04.4 -07	IUH27D	IU01-□	-	4
1000	CBR1000RR	08.7 -	IUH27	IU01-□	VUH27ES	4
1000	CBR1000RR RACE BASE	04.3 -04.12	-	RU01-□	-	4
1000	CBR1000RR RACE BASE	05.1 -07	-	IU01-□	-	4
1000	CBR1000RR RACE BASE	08 -	-	RU01-□	-	4
1000	CBR1000RR(Import)	04 -07	IUH27D	IU01-□	-	4
1000	CBR1000RR(Import)	08 -	IUH27	IU01-□	VUH27ES	4
1000	CBX1000	-	IX24	IXU01-□	X24ESR-U	6
1000	FIRESTORM	97.4 -03	IX24B	IXU01-□	IX24B	2
1000	RC51(RVT1000R)(Import)	00.1 -	IK27	IK01-□	IK27C11	2
1000	VTR1000F(Import)	97 -	IX27B	IXU01-□	IX27B	2
1000	VTR1000SP-1(Import)	00.1 -01.12	IK27	IK01-□	IK27C11	2
1000	VTR1000SP-2(Import)	02 -	IK27	IK01-□	VK27PRZ11	2
1000	XL1000V VARADERO/ABS	99 -	IX24B	IXU01-□	IX24B	2
1000	XL1000V VARADERO/ABS	03 -	-	-	-	2
1100	C2T	-	IX22B	IXU01-□	X22EPR-U9	2
1100	CB1100EX	14.2 -	-	-	-	4
1100	CB1100Type I /ABS	10.3 -	-	-	-	4
1100	CB1100Type II /ABS	10.6 -	-	-	-	4
1100	CBR1100XX SUPERBLACKBIRD	97 -01	IUH27	IU01-□	IUH27	4
1100	CBR1100XX SUPERBLACKBIRD	01.3 -	IUH27D	IU01-□	VUH27D	4
1100	SHADOW	95.1 -	IX22B	IXU01-□	X22EPR-U9	4
1100	SHADOW AERO	98.3 -	IX22B	IXU01-□	X22EPR-U9	4
1100	ST1100/A PAN EUROPEAN	90 -	IUH24	IU01-□	U24FER9	4
1100	VT1100/C/C2/CM	94.2 -	IX22B	IXU01-□	X22EPR-U9	2
1100	X11	99.11-01	IUH24	IU01-□	IUH24	4

AUSTRALIA  
CHINA  
INDIA  
INDONESIA  
KOREA  
MALAYSIA  
PHILIPPINES  
SAUDIARABIA  
SINGAPORE  
TAIWAN  
THAILAND  
VIETNAM  
JAPAN  
EUROPE & USA  
CROSS REFERENCE NUMBER  
PART



▶ Spark plug color codes: ■ for Iridium Tough and Iridium Plugs and Iridium TT, ■ for Iridium Power, ■ for Iridium Racing and Two Tops Plugs, ■ for Platinum Plugs and Platinum TT, and black for general spark plugs.

AUSTRALIA	CC MODEL		FROM-TILL	IRIDIUM POWER	IRIDIUM RACING	DENSO	QTY
	HONDA						
	1200	CTX1300	14.2 -	IU22(Street use) / IU24(Hi-speed use)	IU01-□	U22FER9 / U24FER9	4
	1200	VFR1200F	12.11-	IUH27	IU01-□	VUH27ES	4
CHINA	1200	VFR1200F(EURO)	10.3 -	IUH27	IU01-□	VUH27ES	4
	1200	VFR1200X	14.3 -	IUH24	IU01-□	VUH24ES	4
INDIA	1300	CB1300SUPER BOLD'OR	05.2 -	IX24B	IXU01-□	X24EPR-U9	4
	1300	CB1300SUPERFOUR	98.3 -03.1	IX24B	IXU01-□	X24EPR-U9	4
	1300	CB1300SUPERFOUR	03.2 -	IX24B	IXU01-□	X24EPR-U9	4
INDONESIA	1300	CB1300SUPERTOURING	09.12-	IX24B	IXU01-□	X24EPR-U9	4
	1300	PAN-EUROPEAN/ABS	-	IUH24	IU01-□	U22FER9	4
	1300	VT1300CR/ABS	10.4 -	IXU22	IXU01-□	XU20EPR-U	4
INDONESIA	1300	VT1300CS/ABS	10.5 -	IXU22	IXU01-□	XU20EPR-U	4
	1300	VT1300CX/ABS	09.11-	IXU22	IXU01-□	XU20EPR-U	4
	1300	VTX1300C/S	02.6 -	IXU22	IXU01-□	XU20EPR-U	4
KOREA	1300	X4	97 -	IX24B	IXU01-□	X24EPR-U9	4
	1300	X4LD	00.3 -	IX24B	IXU01-□	X24EPR-U9	4
	1500	F6C	-	IX24B	IXU01-□	X24EPR-U9	6
MALAYSIA	1500	GOLDWING ASPENCADE GL1500/SE	-	IX24B	IXU01-□	X24EPR-U9	6
	1500	GOLDWING GL1500/SE	-	IX22B	IXU01-□	X22EPR-U9	6
	1500	VALKYRIE GL1500C	98.10-	IX22B	IXU01-□	X22EPR-U9	6
PHILIPPINES	1500	VALKYRIE INTERSTATE	-	IX24B	IXU01-□	X24EPR-U9	6
	1500	VALKYRIE TOURER GL1500CT	-	IX24B	IXU01-□	X24EPR-U9	6
	1500	VALKYRIE(Import)	-	IX22B	IXU01-□	X22EPR-U9	6
SAUDIARABIA	1500	VALKYRIE/TOURER	-	IX24B	IXU01-□	X24EPR-U9	6
	1800	GOLDWING F6B	13.2 -	IK20	IK01-□	K20PR-U11	6
	1800	GOLDWING GL1800	01.9 -	IK20	IK01-□	K20PR-U11	6
SINGAPORE	1800	VALKYRIE RUNE(Import)	03 -	IK16	IK01-□	K16PR-U11	6
	1800	VTX	01 -02	IK20	IK01-□	VK20PRZ11	4
	1800	VTX Cruiser	01 -	IK20	IK01-□	VK20PRZ11	4
TAIWAN	<b>KAWASAKI</b>						
	50	KDX50	04 -	IWF16	-	W14FPR-UL	1
	50	KS-I	88.1 -90.3	IW24	IW01-□	W24ESR-U	1
	50	KSR-I	90.3 -	IW24	IW01-□	W24ESR-U	1
	60	KX60	93.1 -93.12	IW27	IW01-□	-	1
	60	KX60	-	IW27	IW01-□	-	1
	60	KX60	94.8 -99	IW27	IW01-□	-	1
	65	KX65	00.8 -	IW31	IW01-□	IW31	1
	65	KX65	06 -	IW31	IW01-□	-	1
	80	KS-II	88.1 -90.3	IW24	IW01-□	W24EPR-U	1
	80	KSR-II	90.3 -	IW24	IW01-□	W24ESR-U	1
	80	KX80/II	82.10-91.7	IW27	IW01-□	-	1
	80	KX80/II	91.8 -94.6	-	IW01-□	IW01-32	1
	80	KX80/II	94.7 -96.7	-	IW01-□	IW01-32	1
	80	KX80/II	96.7 -00.8	-	IW01-□	IW01-32	1
THAILAND	85	KX85/II	00.8 -	-	IW01-□	IW01-32	1
	110	KLX110	01.12-	IUF22	-	U20FSR-U	1
	110	KLX110(ULTRA SE BOREUP KIT) (*3)	-	IY24	-	-	1
VIETNAM	110	KLX110L	09.11-	IUF22	-	U20FSR-U	1
	110	KSR110	02.11-08	IUF22	-	U20FSR-U	1
	110	KSR110(ULTRA SE BOREUP KIT) (*3)	-	IY24	-	-	1
JAPAN	120	LEOSTAR(Import)	-	IW24	IW01-□	W24ESR-U	1
	125	D-TRACKER125	09.12-	IUF22	-	U22FSR-U	1
	125	ELIMINATOR125	97.7 -08	IU22	IU01-□	U22ESR-N	1
	125	KDX125SR	90 -	IW24	IW01-□	W24ESR-U	1
	125	KLX125	09.12-	IUF22	-	U22FSR-U	1
	125	KLX125/L(Import)	04 -09	IX24	IXU01-□	X24ESR-U	1
	125	KMX125	86 -	IW24	IW01-□	W24ES-U	1
	125	KX125	90.8 -91.8	-	IW01-□	IW01-32	1
	125	KX125	91.9 -93.7	-	IW01-□	IW01-32	1
	125	KX125	93.7 -94.7	IW24	IW01-□	IW24	1
	125	KX125	94.7 -03.7	IW27	IW01-□	IW27	1
	125	KX125	03.8 -	-	IW01-□	IW01-27	1
	150	CERPICO SE	98.7 -	IW27	IW01-□	W27ES-U	1
	150	EPSILON150	02.3 -	IU22	IU01-□	U22ESR-N	1
	150	KR150SE	-	IW24	IW01-□	W24ES-U	1
150	KRR150SE	98.6 -	IW27	IW01-□	W27ES-U	1	
150	VICTOR M150	-	IW24	IW01-□	W24ES-U	1	

AUSTRALIA	CC MODEL		FROM-TILL	IRIDIUM POWER	IRIDIUM RACING	DENSO	QTY
	KAWASAKI						
	200	KDX200/S/SR	89.1 -94	IW27	IW01-□	W27ESR-U	1
	200	KDX200R	88 -91.11	IW27	IW01-□	W27ESR-U	1
	200	KDX200R	91.12-94	IW27	IW01-□	W27ESR-U	1
	200	KMX200	87.2 -	IW24	IW01-□	W24ESR-U	1
	220	BAYOU220	-	IX27	IXU01-□	X27ESR-U	1
	220	KDX220SR/R	94.4 -	IW24	IW01-□	W24ESR-U	1
	220	KLF220	-	IX27	IXU01-□	X27ESR-U	1
	250	250TR	02.2 -07	IX27	IXU01-□	X27ESR-U	1
	250	250TR	07.2 -	IX24	IXU01-□	X24ESR-U	1
	250	BALIUS/II	91.4 -07	IU27	IU01-□	U27ESR-N	4
	250	CASUAL SPORT250	85 -	IX27B	IXU01-□	X27EP-U9	2
	250	D TRACKER	98.2 -08.3	IU24	IU01-□	U24ESR-N	1
	250	D TRACKER X	08.4 -	IU24	IU01-□	U24ESR-N	1
	250	D TRACKER X	11.~ -	IU24	IU01-□	U24ESR-N	1
	250	ELIMINATOR250/SE/LX	87 -98	IUF24	-	U24FSR-U	2
	250	ELIMINATOR250V	98.1 -07	IU27	IU01-□	U27ESR-N	2
	250	EPSILON250	02.3 -03	IU24A	IU01-□	U24ETR	1
	250	EPSILON250	04 -06	IU24A	IU01-□	U22ETR	1
	250	ESTRELLA	07.2 -	IX24	IXU01-□	X24ESR-U	1
	250	ESTRELLA CUSTOM/RS	96.3 -06	IX27	IXU01-□	X27ESR-U	1
	250	ESTRELLA/RS	92.5 -06	IX27	IXU01-□	X27ESR-U	1
	250	GPZ250	83 -	IX27B	IXU01-□	X27EP-U9	2
	250	GPZ250R	85 -	IUF24	-	U24FS-U	2
	250	KDX250S/R	90 -	IW27	IW01-□	W27ESR-U	1
	250	KDX250SR	91 -92	IW27	IW01-□	W27ESR-U	1
	250	KDX250SR	92 -	IW24	IW01-□	W24ESR-U	1
	250	KL250	82.11-	IW24	IW01-□	W24ES-U	1
	250	KL250R	84 -	IX27B	IXU01-□	X27EP-U9	1
	250	KLE250ANHELO	93 -95	IUF24	-	U24FSR-U	2
	250	KLR250(Import)	-	IX27B	IXU01-□	X27EP-U9	1
	250	KLX250	98.2 -	IU24	IU01-□	U24ESR-N	1
	250	KLX250	08.04-	IU24	IU01-□	U24ESR-N	1
	250	KLX250ES/SR/R	94.3 -	IU24	IU01-□	U24ESR-N	1
	250	KLX250R/SR	-	IU27	IU01-□	U27ESR-N	1
	250	KR-1	88 -	IW27	IW01-□	W27ESR-U	2
	250	KR-1R	89 -	IW31	IW01-□	W31ESR-U	2
	250	KR-1S	89 -	IW31	IW01-□	W31ESR-U	2
	250	KR250/S	84.4 -	IW27	IW01-□	W27ES-U	2
	250	KX250	90.9 -91.8	IW27	IW01-□	-	1
	250	KX250	91.9 -92	-	IW01-□	IW01-27	1
	250	KX250	94 -94	IW27	IW01-□	IW27	1
	250	KX250	94.7 -96.7	IW24	IW01-□	IW24	1
	250	KX250	96.7 -98.6	IW22	IW01-□	IW22	1
	250	KX250	98.7 -00.7	IW24	IW01-□	IW24	1
	250	KX250	00.8 -04.7	IW24	IW01-□	IW24	1
	250	KX250	04.8 -	IWM24	IWM01-□	IWM24	1
	250	KX250	10 -	IU24	IU01-□	U24ESR-N	1
	250	KX250F	04 -05	IU24	IU01-□	U24ESR-NB	1
	250	KX250F	06 -10	IU24	IU01-□	U24ESR-N	1
	250	KX250F	10.8 -	IU24D	IU01-□	-	1
	250	KX250F	11.~ -	IU24D	IU01-□	-	1
	250	NINJA 250 / 250R	08.4 -	IU24	IU01-□	U24ESR-N	2
	250	SUPERSHERPA	97.2 -07	IU24	IU01-□	U24ESR-U	1
	250	Z250FS/LTD	82.12-	IW24	IW01-□	W24ES-U	1
	250	Z250FT	79 -	IX24	IXU01-□	X24ES-U	2
	250	Z250LTD BELT DRIVE	84 -	IX24	IXU01-□	X24ES-U	2
	250	Z250LTD TWIN	81 -	IX24	IXU01-□	X24ES-U	2
	250	ZXR250/R	89.2 -	IU27	IU01-□	U27ESR-N	4
	250	ZZ-R250	90 -	IUF24	-	U24FSR-U	2
	300	BAYOU(QUAD)	-	IX24	IXU01-□	X24ESR-U	1
	300	KLF(QUAD)	-	IX24	IXU01-□	X24ES-U	1
	300	KLX300R	96.3 -	IU24	IU01-□	U24ESR-N	1
	300	MULE500(QUAD)	-	IW16	IW01-□	W16EP-U	1
	360	KVF360(QUAD)	02.6 -	IX24B	IXU01-□	X24EPR-U9	1
	400	BAYOU400(QUAD)	-	IX24B	IXU01-□	X24EPR-U9	1
	400	ELIMINATOR400	86.2 -88.3	IX27	IXU01-□	X27ES-U	4
	400	ELIMINATOR400/SE/LX	88.3 -	IX27	IXU01-□	X27ESR-U	4

(\*3) KITACO TUNING HEAD



CC	MODEL	FROM-TILL	IRIDIUM POWER	IRIDIUM RACING	DENSO	QTY
<b>KAWASAKI</b>						
400	EN400TWIN	85 -88.11	<b>IX24</b>	IXU01-□	X24ES-U	2
400	EN400TWIN	88.12-	<b>IX24</b>	IXU01-□	X24ESR-U	2
400	ER-4n/ABS	10.8 -	<b>IU27D</b>	IU01-□	<b>IU27D</b>	2
400	EX-4	94 -95	<b>IX27</b>	IXU01-□	X27ESR-U	2
400	FX400R	85 -89.5	<b>IX27</b>	IXU01-□	X27ES-U	4
400	FX400R	89.6 -	<b>IX27</b>	IXU01-□	X27ESR-U	4
400	GPZ400/F	83 -	<b>IX27B</b>	IXU01-□	X27EP-U9	4
400	GPZ400R	85.2 -	<b>IX27</b>	IXU01-□	X27ESR-U	4
400	GPZ400S	86 -	<b>IX27</b>	IXU01-□	X27ES-U	2
400	KH400	76 -	<b>IWF24</b>	-	W24FS-U	3
400	KLE400	-	<b>IX24</b>	IXU01-□	X24ESR-U	2
400	KLF400(QUAD)	-	<b>IX27B</b>	IXU01-□	X27EPR-U9	4
400	KLX400R	03 -	<b>IU24</b>	IU01-□	U24ESR-N	1
400	NINJA 400	18.2 -	-	-	-	2
400	NINJA 400R/ABS	10.8 -18.2	<b>IU27D</b>	IU01-□	<b>IU27D</b>	2
400	VULCAN400	91 -94.3	<b>IX24</b>	IXU01-□	X24ESR-U	2
400	VULCAN400	94 -94	<b>IX27</b>	IXU01-□	X27ESR-U	2
400	VULCAN400CLASSIC	95.12-03	<b>IU22</b>	IU01-□	U22ESR-N	2
400	VULCAN400DRIFTER	99.2 -03	<b>IU22</b>	IU01-□	U22ESR-N	2
400	VULCAN II	95.5 -	<b>IU22</b>	IU01-□	U22ESR-N	2
400	W400	06.3 -08	<b>IU24D</b>	IU01-□	U24EPR9	2
400	XANTHUS400	92.4 -95	<b>IU27A</b>	IU01-□	U27ETR	4
400	Z400FX	79.4 -	<b>IX24</b>	IXU01-□	X24ES-U	4
400	Z400GP	82.3 -	<b>IX24</b>	IXU01-□	X24ES-U	4
400	Z400LTD/BELT DRIVE	79 -	<b>IW22</b>	IW01-□	W22ES-U	2
400	Z400LTD-II	81 -	<b>IX24</b>	IXU01-□	X24ES-U	4
400	ZEPHYR x	96.3 -08	<b>IU27</b>	IU01-□	U27ESR-N	4
400	ZEPHYR400	89.4 -95	<b>IX27B</b>	IXU01-□	X27EPR-U9	4
400	ZRX400/II	94.2 -08	<b>IU27</b>	IU01-□	U27ESR-N	4
400	ZX-4	88 -	<b>IU27A</b>	IU01-□	U27ETR	4
400	ZXR400/R	89.3 -	<b>IU27A</b>	IU01-□	U27ETR	4
400	ZZ-R400	90 -	<b>IU27</b>	IU01-□	U27ESR-N	4
450	KLX450R	08.1 -	<b>IU24D</b>	IU01-□	-	1
450	KX450F	06 -08	<b>IU24D</b>	IU01-□	-	1
450	KX450F	09 -	<b>IU24D</b>	IU01-□	-	1
450	KX450F	10.8 -	<b>IU24D</b>	IU01-□	-	1
450	MULE1000 (QUAD)	-	<b>IX22</b>	IXU01-□	X20ES-U	2
500	EN500	90 -	<b>IX27</b>	IXU01-□	X27ESR-U	2
500	ER-5	-	<b>IX27</b>	IXU01-□	X27ESR-U	2
500	GPX500S(Import)	90 -	<b>IX27</b>	IXU01-□	X27ESR-U	2
500	KLE500(Import)	-	<b>IX27</b>	IXU01-□	X27ESR-U	2
500	KX500(Import)	83 -	<b>IW24</b>	IW01-□	-	1
500	VULCAN500(Import)	-	<b>IX27</b>	IXU01-□	X27ES-U	2
600	ELIMINATOR600	-	<b>IX27</b>	IXU01-□	X27ESR-U	4
600	GPX600R	-	<b>IX27</b>	IXU01-□	X27ESR-U	4
600	GPZ600R	85 -	<b>IX27</b>	IXU01-□	X27ES-U	4
600	KL600R	84 -	<b>IX24</b>	IXU01-□	X24ES-U	1
600	NINJA ZX-6R RACE BASE	07 -	<b>IU31</b>	IU01-□	<b>IU31</b>	4
600	NINJA ZX-6R(Import)	95 -02	<b>IU27</b>	IU01-□	U27ESR-N	4
600	NINJA ZX-6R(Import)	07 -	<b>IU27</b>	IU01-□	U27ESR-N	4
600	NINJA ZX-6RR RACE BASE	04 -06	<b>IU31</b>	IU01-□	-	4
600	NINJA ZX-6RR(Import)	03 -06	<b>IU27</b>	IU01-□	U27ESR-N	4
600	ZZ-R600	90 -	<b>IU27</b>	IU01-□	U27ESR-N	4
636	NINJA ZX-6R(Import)	03 -06	<b>IU27</b>	IU01-□	U27ESR-N	4
650	650RS	-	<b>IW24</b>	IW01-□	W24ES-U	4
650	ER-6f(Import)	06 -	<b>IU27D</b>	IU01-□	<b>IU27D</b>	2
650	ER-6n(Import)	06 -	<b>IU27D</b>	IU01-□	<b>IU27D</b>	2
650	KLR650	87 -	<b>IX24B</b>	IXU01-□	X24EP-U9	1
650	KLX650/R	93 -	<b>IX24B</b>	IXU01-□	X24EPR-U9	1
650	NINJA 650R(Import)	-	<b>IU27D</b>	IU01-□	<b>IU27D</b>	2
650	VERSYS(Import)	07 -	<b>IU27D</b>	IU01-□	<b>IU27D</b>	2
650	W650	99.2 -08	<b>IU24</b>	IU01-□	U24ESR-N	2
750	ELIMINATOR750	85.12-	<b>IX24</b>	IXU01-□	X24ES-U	4
750	GPX750R	87 -	<b>IX24</b>	IXU01-□	X24ES-U	4
750	GPZ750 TURBO	83 -85	<b>IW27</b>	IW01-□	W27ESR-U	4
750	GPZ750/F	83 -	<b>IW27</b>	IW01-□	W27ES-U	4
750	GPZ750R	84.6 -	<b>IX24</b>	IXU01-□	X24ES-U	4

CC	MODEL	FROM-TILL	IRIDIUM POWER	IRIDIUM RACING	DENSO	QTY
<b>KAWASAKI</b>						
750	NINJA ZX-7R/RR(Import)	96 -	<b>IU27</b>	RU01-□	U27ESR-N	4
750	VULCAN750(Import)	-	<b>IX22B</b>	IXU01-□	X22EP-U9	2
750	VZ750TWIN	85 -	<b>IX24B</b>	IXU01-□	X24EP-U9	4
750	Z750(Import)	04 -10	<b>IU27A</b>	IU01-□	U27ETR	4
750	Z750Four(A4/5)	76 -77	<b>IW24</b>	IW01-□	W24ES-U	4
750	Z750Four(D1)	77 -78	<b>IW24</b>	IW01-□	W24ES-U	4
750	Z750FX(D2/3)	79 -80	<b>IW24</b>	IW01-□	W24ES-U	4
750	Z750GP/SPECTER	82.8 -	<b>IW24</b>	IW01-□	W24ES-U	4
750	Z750RS(Z2/A)	73 -75	<b>IW24</b>	IW01-□	W24ES-U	4
750	ZEPHYR750	90.8 -	<b>IX27</b>	IXU01-□	X27ESR-U	4
750	ZEPHYR750RS	96.2 -	<b>IX27</b>	IXU01-□	X27ESR-U	4
750	ZR-7/S	99.3 -	<b>IX27</b>	IXU01-□	X27ESR-U	4
750	ZR750C	90.1 -	<b>IX27</b>	IXU01-□	X27ESR-U	4
750	ZX-7R/RR	96 -	<b>IU27</b>	IU01-□	U27ESR-N	4
750	ZXR750	89.1 -95	<b>IU27</b>	IU01-□	U27ESR-N	4
800	VN800/CLASSIC(Import)	-	<b>IU22</b>	IU01-□	U22ESR-N	2
800	VULCAN800/CLASSIC	95 -	<b>IU22</b>	IU01-□	U22ESR-N	2
800	VULCAN800DRIFTER	99.2 -	<b>IU22</b>	IU01-□	U22ESR-N	2
800	W800	11.2 -	<b>IU24</b>	IU01-□	U24ESR-N	2
900	900Super4(Z1)	73 -73	<b>IW24</b>	IW01-□	W24ES-U	4
900	ELIMINATOR	84 -	<b>IX24</b>	IXU01-□	X24ESR-U	4
900	GPZ900R	84 -03	<b>IX27</b>	IXU01-□	X27ESR-U	4
900	NINJA ZX-9R(Import)	94 -	<b>IU27A</b>	IU01-□	U27ETR	4
900	VN900CLASSIC(Import)	06 -	<b>IU22D</b>	IU01-□	U22EPR9	2
900	VULCAN900CUSTOM/CLASSIC	07.2 -09	<b>IU22D</b>	IU01-□	U22EPR9	2
900	Z1(Z1A/B)	74 -75	<b>IW24</b>	IW01-□	W24ES-U	4
900	Z900	76 -76	<b>IW24</b>	IW01-□	W24ES-U	4
1000	1000GTR(Import)	86 -	<b>IX27</b>	IXU01-□	X27ESR-U	4
1000	GPZ1000RX(Import)	86 -	<b>IX27</b>	IXU01-□	X27ESR-U	4
1000	KLV1000(Import)	04 -	<b>IU24</b>	IU01-□	U24ESR-N	2
1000	KZ1000POLICE(Import)	82 -	<b>IW24</b>	IW01-□	W24ESR-U	4
1000	NINJA 1000/ABS(Import)	11 -	<b>IU27D</b>	IU01-□	<b>IU27D</b>	4
1000	NINJA ZX-10R(Import)	04 -10	<b>IU27D</b>	IU01-□	<b>IU27D</b>	4
1000	NINJA ZX-10R/ABS(Import)	11 -	<b>IU27D</b>	IU01-□	<b>IU27D</b>	4
1000	VERSYS1000	11 -	<b>IU27D</b>	IU01-□	-	4
1000	Z1000(Import)	03 -06	<b>IU27A</b>	IU01-□	U27ETR	4
1000	Z1000(Import)	07 -	<b>IU27D</b>	IU01-□	<b>IU27D</b>	4
1000	Z1000(J)	81 -83	<b>IW24</b>	IW01-□	W24ESR-U	4
1000	Z1000/Mk II	77 -80	<b>IW24</b>	IW01-□	W24ES-U	4
1000	Z1000FI	77 -80	<b>IW24</b>	IW01-□	W24ES-U	4
1000	Z1000R	82 -83	<b>IW24</b>	IW01-□	W24ESR-U	4
1000	Z1R	78 -78	<b>IW24</b>	IW01-□	W24ES-U	4
1000	Z1R-II	79 -80	<b>IW24</b>	IW01-□	W24ES-U	4
1000	ZL1000	86 -	<b>IX27</b>	IXU01-□	X27ESR-U	4
1000	ZX-10(Import)	87 -90	<b>IU27</b>	IU01-□	U27ESR-N	4
1100	GPz1100	83 -85	<b>IW24</b>	IW01-□	W24ESR-U	4
1100	GPZ1100(Import)	95.3 -	<b>IU27A</b>	IU01-□	U27ETR	4
1100	GPZ1100ABS(Import)	96.3 -	<b>IU27A</b>	IU01-□	U27ETR	4
1100	Z1100GP	81 -82	<b>IW24</b>	IW01-□	W24ESR-U	4
1100	Z1100LTD	84 -	<b>IW24</b>	IW01-□	W24ESR-U	4
1100	Z1100R	84 -85	<b>IW24</b>	IW01-□	W24ESR-U	4
1100	Z1100SPECTRE	82 -	<b>IW24</b>	IW01-□	W24ESR-U	4
1100	ZEPHYR1100	92.3 -	<b>IU27</b>	IU01-□	U27ESR-N	8
1100	ZEPHYR1100RS	96.2 -	<b>IU27</b>	IU01-□	U27ESR-N	8
1100	ZRX1100/II	96.12-	<b>IU27A</b>	IU01-□	U27ETR	4
1100	ZZ-R1100(ZX-11)(Import)	90 -01	<b>IU27</b>	IU01-□	U27ESR-N	4
1200	NINJA ZX-12R(Import)	00.3 -06	<b>IU27A</b>	IU01-□	<b>IU27A</b>	4
1200	VOYAGERX II(Import)	86 -	<b>IX24B</b>	IXU01-□	X24EPR-U9	4
1200	ZRX1200 DAEG	09.2 -	<b>IU27A</b>	IU01-□	U27ETR	4
1200	ZRX1200R/S	01.3 -08	<b>IU27A</b>	IU01-□	U27ETR	4
1200	ZZ-R1200(Import)	02 -05	<b>IU27</b>	IU01-□	U27ESR-N	4
1300	VOYAGER(Import)	83 -	<b>IW20</b>	IW01-□	W20EPR-U	6
1400	1400GTR(Import)	08 -	<b>IU27D</b>	IU01-□	<b>IU27D</b>	4
1400	Ninja ZX-14R	11 -	<b>IU27D</b>	IU01-□	<b>IU27D</b>	4
1400	ZZR1400(Import)	06 -	<b>IU27D</b>	IU01-□	<b>IU27D</b>	4
1500	VN1500CLASSIC	-	-	IXU01-□	X16EPR-U9	4
1500	VULCAN1500CLASSIC	96.4 -98.2	<b>IX22B</b>	IXU01-□	X22EPR-U9	4

AUSTRALIA  
CHINA  
INDIA  
INDONESIA  
KOREA  
MALAYSIA  
PHILIPPINES  
SAUDI ARABIA  
SINGAPORE  
TAIWAN  
THAILAND  
VIETNAM  
JAPAN  
EUROPE & USA  
CROSS REFERENCE NUMBER  
PART



# JAPAN MOTORCYCLE

▶ Spark plug color codes: ■ for Iridium Tough and Iridium Plugs and Iridium TT, ■ for Iridium Power, ■ for Iridium Racing and Two Tops Plugs, ■ for Platinum Plugs and Platinum TT, and black for general spark plugs.

COUNTRY	CC MODEL		FROM-TILL	IRIDIUM POWER	IRIDIUM RACING	DENSO	QTY
	CC	MODEL					
AUSTRALIA	<b>KAWASAKI</b>						
	1500	VULCAN1500CLASSIC	98.2 -99	-	IXU01-□	X16EPR-U9	4
	1500	VULCAN1500CLASSIC/TOURER Fi	00.3 -03	IX22B	IXU01-□	X20EPR-U9	4
CHINA	1500	VULCAN1500DRIFTER	99.3 -99	IX22B	IXU01-□	X20EPR-U9	4
	1500	VULCAN1500MEAN STREAK	02 -03	IX22B	IXU01-□	X20EPR-U9	4
	1500	VULCAN88	87 -	IX22B	IXU01-□	X22EPR-U9	4
INDIA	1600	VULCAN1600CLASSIC	03 -	IX22B	IXU01-□	X22EPR-U9	4
	1600	VULCAN1600MEAN STREAK	03 -	-	-	X20EPR-U9	4
	2000	VN2000-VULCAN2000(Import)	04 -05	IK20	IK01-□	VK20	2
INDONESIA	<b>SUZUKI</b>						
	50	2CYCLE BIRDIE50(RC50)	96.11-	IWF20	-	W20FPR-U	1
KOREA	50	4CYCLE BIRDIE50(FB50)	96.1 -	IUF22	-	U20FSR-U	1
	50	ADDRESS EX	89 -	IWF20	-	W20FPR-U	1
MALAYSIA	50	ADDRESS TUNE(AD50T)	88 -	IWF20	-	W20FPR-U	1
	50	ADDRESS V/TUNE	90 -	IWF20	-	W20FPR-U	1
PHILIPPINES	50	ADDRESS V50/G	06.3 -	IUF22	-	U20FSR-U	1
	50	ADDRESS WAY(AD50W)	88 -	IWF20	-	W20FPR-U	1
SAUDI ARABIA	50	ADDRESS(AD50)	87 -	IWF20	-	W20FPR-U	1
	50	BIRDIE(FB50)	83.10-91.2	IUF22	-	U20FS-U	1
SINGAPORE	50	BIRDIE(FB50)	91.3 -95.4	IUF22	-	U20FSR-U	1
	50	BIRDIE(FR50L/G)	91.7 -95.5	IWF16	-	W14FPR-UL	1
TAIWAN	50	BIRDIE50	95.5 -04.10	IWF20	-	W20FPR-U	1
	50	BIRDIE50	04.11-	IUF22	-	U20FSR-U	1
THAILAND	50	CHOINORI/SEL/SS	03.2 -07	IUF22	-	U20FSR-U	1
	50	COLLEDA SCRAMBLER50	96.9 -	IWF20	-	W20FPR-U	1
VIETNAM	50	COLLEDA SPORT50	96.3 -	IWF20	-	W20FPR-U	1
	50	DR-Z50	08.4 -	IUF22	-	U20FSR-U	1
JAPAN	50	EPO	95.3 -	IWF20	-	W20FPR-U	1
	50	GAG50	86.2 -	IUF22	-	U20FS-U	1
EUROPE & USA	50	GEMMA QUEST(FE50)	86.2 -	IWF20	-	W20FPR-U	1
	50	G550	05.2 -	IUF22	-	U20FSR-U	1
CROSS REFERENCE	50	HIUP50/R50	88 -	IWF20	-	W20FPR-U	1
	50	HUSTLER(TS50)	80 -95.1	IWF22	IWF16	W22EP-U	1
PART NUMBER	50	HUSTLER50	95.2 -	IWF24	IWF16	W24EPR-U	1
	50	K50	91.3 -	IWF20	-	W20FPR-U	1
EUROPE & USA	50	LET'S/II/II G	96.2 -07	IWF20	-	W20FPR-U	1
	50	LET'S/4G/PALLET	04.10-	IUF22	-	U20FSR-U	1
CROSS REFERENCE	50	LET'S/5/5G	08.3 -	IUF22	-	U20FSR-U	1
	50	LET'S II COMBINATION BRAKE	98.2 -07	IWF20	-	W20FPR-U	1
PART NUMBER	50	LET'S IIS/II/II STANDARD/II G	97.2 -07	IWF20	-	W20FPR-U	1
	50	MODE50	87.2 -	IWF20	-	W20FP-U	1
EUROPE & USA	50	MOLLET	86 -94.5	IWF20	-	W20FPR-U	1
	50	MOLLET	94.5 -	IWF22	-	W22FPR-U	1
CROSS REFERENCE	50	MOLLET(FE50)	86 -94	IWF20	-	W20FP-U	1
	50	MOLLET(FE50PR)	94.5 -	IWF22	-	W22FPR-U	1
PART NUMBER	50	RAN	83.1 -88.6	IWF16	-	W16FP-U	1
	50	RAN(CF50)	88.6 -	IWF16	-	W16FPR-U	1
EUROPE & USA	50	RG50r	82 -88.5	IWF24	IWF16	W24EP-U	1
	50	RG50r	88.5 -	IWF24	IWF16	W24EPR-U	1
CROSS REFERENCE	50	SEPIA/RS/ZZ	95.2 -	IWF22	-	W22FPR-U	1
	50	SEPIA/RS/ZZ(AF50)	89 -95.2	IWF20	-	W20FPR-U	1
PART NUMBER	50	STREETMAGIC (TR50)/S/II/SD	97.2 -	IWF20	-	W20FPR-U	1
	50	SUPER MOLLET	94 -99	IWF22	-	W22FPR-U	1
EUROPE & USA	50	SUPER MOLLET	00.1 -07	IWF20	-	W20FPR-U	1
	50	TR50/S/V[STREETMAGIC]	97.2 -	IWF20	-	W20FPR-U	1
CROSS REFERENCE	50	VERDE	98.3 -00.2	IWF22	-	W22FPR-U	1
	50	VERDE	00.4 -	IWF20	-	W20FPR-U	1
PART NUMBER	50	WOLF50(TV50)	90.1 -	IWF24	IWF16	W24EPR-U	1
	50	ZZ	00.5 -07	IWF20	-	W20FPR-U	1
EUROPE & USA	70	DR-Z70	09.4 -	IUF22	-	U22FSR-U	1
	70	DR-Z70(Import)	-	IUF22	-	U22FSR-U	1
CROSS REFERENCE	80	4CYCLE BIRDIE80(FB80)	96.10-	IUF22	-	U20FSR-U	1
	80	BIRDIE(FB80)	84 -91.2	IUF22	-	U20FS-U	1
PART NUMBER	80	BIRDIE(FB80)	91.3 -96.9	IUF22	-	U20FSR-U	1
	80	JR80	-	-	-	W22ESR-U	1
EUROPE & USA	80	LT80(QUAD)	-	IWF22	-	W22FP-U	1
	80	RM80	89.8 -90.6	IWF27	IWF16	W27ESR-U	1
CROSS REFERENCE	80	RM80	90.7 -93	IWF31	IWF16	W31ES-U	1

COUNTRY	CC MODEL		FROM-TILL	IRIDIUM POWER	IRIDIUM RACING	DENSO	QTY
	CC	MODEL					
AUSTRALIA	<b>SUZUKI</b>						
	80	RM80	93 -96.7	IWF31	IWF16	IWF31	1
CHINA	80	RM80/LW	96.7 -	IWF31	IWF16	IWF31	1
	85	RM85/85L	03 -	IWF31	IWF16	W31WSR-U	1
INDIA	90	BIRDIE90	01.10-09	IUF22	-	U20FSR-U	1
	90	FB90	-	IUF22	-	U20FSR-U	1
INDONESIA	90	GEMMA QUEST(CS90)	86 -	IWF20	-	W20FPR-U	1
	90	K90	91.3 -	IWF16	-	W14FPR-UL	1
KOREA	100	ADDRESS V100/TYPE S	91 -05	IWF22	-	W22FPR-U	1
	110	ADDRESS110	98.4 -00.3	IWF22	-	W22FPR-U	1
MALAYSIA	110	ADDRESS110	00.3 -05	IWF20	-	W20FPR-U	1
	110	ADDRESS110	15.3 -	IUF22	IUF16	U22EPR9	1
PHILIPPINES	110	STREETMAGIC/II	98.6 -	IWF22	-	W22FPR-U	1
	125	ADDRESS V125	11 -	IUF22	-	U20FSR-U	1
SAUDI ARABIA	125	ADDRESS V125/G/G LIMITED	05.2 -	IUF22	-	U20FSR-U	1
	125	ADDRESS V125S/SS/S LIMITED	10 -	IUF22	-	U20FSR-U	1
SINGAPORE	125	AVENIS125	98.12-	IUF22	IUF16	U22ESR-N	1
	125	DF125E	97.9 -	IX24	IXU01-□	X24ESR-U	1
TAIWAN	125	DJEBEL125/SE	93 -	IX24	IXU01-□	X24ESR-U	1
	125	DR-Z125/L	04 -	IX24	IXU01-□	X24ESR-U	1
THAILAND	125	GZ125H(Import)	-	IUF22	IUF16	U24ESR-N	1
	125	GZ125HS(Import)	-	IUF22	IUF16	U22ESR-N	1
VIETNAM	125	INTRUDER LC125	-	IUF22	IUF16	U24ESR-N	2
	125	K125	95.1 -	IWF16	-	W14FPR-UL	1
JAPAN	125	MARAUDER125	98.3 -	IX24	IXU01-□	X24ESR-U	1
	125	RG125r	85.2 -91.11	IWF27	IWF16	W27ES-U	1
EUROPE & USA	125	RG125r	91.11-	IWF27	IWF16	-	1
	125	RGV125Pr	-	IWF27	IWF16	-	1
CROSS REFERENCE	125	RM125	83 -91.6	IWF27	IWF16	IWF27	1
	125	RM125	91.7 -96.7	IWF27	IWF16	IWF27	1
PART NUMBER	125	RM125	96.8 -	-	-	IWF16-24	1
	125	TS125R	89 -	IWF24	IWF16	W24ESR-U	1
EUROPE & USA	125	VANVAN125(Import)	02 -	IX24	IXU01-□	X24ESR-U	1
	125	VANVAN125(RV125)	74 -	IWF22	-	W22FPR-U	1
CROSS REFERENCE	125	VECSTAR125	94.7 -95.12	IUF24	IUF16	U24ESR-N	1
	125	VECSTAR125(ANT125T)	95.12-05	IUF22	IUF16	U22ESR-N	1
PART NUMBER	125	WOLF125	92 -	IWF27	IWF16	-	1
	150	AVENIS150	98.12-	IUF22	IUF16	U22ESR-N	1
EUROPE & USA	150	VECSTAR150(AN150S)	94.10-95.12	IUF24	IUF16	U24ESR-N	1
	150	VECSTAR150(AN150T)	95.12-	IUF22	IUF16	U22ESR-N	1
CROSS REFERENCE	200	BURGMAN200	14.2 -	IUF24A	IUF16	U24ETR	1
	200	DF200E	97.3 -	IX24	IXU01-□	X24ESR-U	1
PART NUMBER	200	DJEBEL200	93.3 -	IX24	IXU01-□	X24ESR-U	1
	200	RG200r	92.5 -	IWF24	IWF16	W24ESR-U	1
EUROPE & USA	200	SX200R	85 -88.1	IX24	IXU01-□	X24ES-U	1
	200	SX200R	88.1 -	IX24	IXU01-□	X24ESR-U	1
CROSS REFERENCE	200	TS200R	89 -	IWF27	IWF16	W27ESR-U	1
	200	VANVAN200/Z	02.3 -	IX24	IXU01-□	X24ESR-U	1
PART NUMBER	200	WOLF200	92.5 -	IWF24	IWF16	W24ESR-U	1
	250	250SB	02.2 -	IUF24	IUF16	U24ESR-N	1
EUROPE & USA	250	ACROSS250	90.4 -	IUF22	-	U22FSR-U	1
	250	BANDIT250/V(GSF250)/VZ	89.12-	IUF24	IUF16	U24ESR-N	4
CROSS REFERENCE	250	DJEBEL250	92.11-	IX27B	IXU01-□	X27EPR-U9	1
	250	DJEBEL250GPS	98.2 -	IUF27	IUF16	U27ESR-N	1
PART NUMBER	250	DJEVEL250XC	96.2 -	IUF27	IUF16	U27ESR-N	1
	250	DR250R	95 -	IUF27	IUF16	U27ESR-N	1
EUROPE & USA	250	DR250S	- -89.12	IX24	IXU01-□	X24ES-U	1
	250	DR250S/SH/SHE	90.1 -	IX27B	IXU01-□	X27EPR-U9	1
CROSS REFERENCE	250	DR-Z250	01 -	IUF27	IUF16	U27ESR-N	1
	250	GEMMA	08.7 -	IUF24A	IUF16	U22ETR	1
PART NUMBER	250	GF250/S	85 -	IUF24	-	U24FS-U	4
	250	GOOSE250	92 -	IUF24A	IUF16	U24ETR	1
EUROPE & USA	250	GRASSTRACKER/BIGBOY	00.6 -04.3	IX24	IXU01-□	X24ESR-U	1
	250	GRASSTRACKER/BIGBOY	04.4 -	IX24	IXU01-□	X24ESR-U	1
CROSS REFERENCE	250	GS250FW	80.3 -	IX27	IXU01-□	X27ES-U	4
	250	GSR250/S	12 -	IUF22	-	U22ESR-N	4
PART NUMBER	250	G SX250/L/T/E	82.2 -	IX24	IXU01-□	X24ES-U	2
	250	G SX250FX	02.1 -	IUF27	IUF16	U27ESR-N	4

DENSO	9	14	16	20	22	24	27	29	31	32	34	35	DENSO	9	14	16	20	22	24	27	29	31	32	DENSO	9	14	16	20	22	24	27	31
NGK	2	4	5	6	7	8	9	9.5	10	10.5	11	11.5	CHAMPION	18	16,14	12,11	10,9	8,7	6,6,61	4,5,9	57	55	53	BOSCH	10	9	8	7,6	5	4	3	2



CC	MODEL	FROM-TILL	IRIDIUM POWER	IRIDIUM RACING	DENSO	QTY
<b>SUZUKI</b>						
250	GSX250R(GSX-R250)	87 -88.3	IUF24	-	-	4
250	GSX250R(GSX-R250)	88.3 -	IUF24	-	-	4
250	GSX250S[COBRA]	89.9 -	IU24	IU01-□	U24ESR-N	4
250	GSX250S[KATANA]/VS	91.5 -	IU24	IU01-□	U24ESR-N	4
250	GSX-R250R	-	IU27	IU01-□	U27ESR-N	4
250	INTRUDER(LC250)	99.11-	IU22	IU01-□	U22ESR-N	2
250	MARAUDER250	98.3 -	IX24	IXU01-□	X24ESR-U	1
250	NZ250/S	-	IX24B	IXU01-□	X24EP-U9	1
250	RG250/E	78 -	IW27	IW01-□	W27ES-U	2
250	RG250r/HB	83.2 -88.2	IW27	IW01-□	W27ES-U	2
250	RGV250P r/SP	88.3 -90.1	IWM27	IWM01-□	-	2
250	RGV250 r/SP	88.3 -90.1	IW27	IW01-□	W27ESR-U	2
250	RGV250 r/SP	90.2 -	IWM27	IWM01-□	-	2
250	RH250	88.6 -	IW24	IW01-□	W24ESR-U	1
250	RM250	83 -91.7	IW24	IW01-□	IW24	1
250	RM250	91.8 -96.8	IW24	IW01-□	IW24	1
250	RM250	96.9 -01.5	-	IW01-□	IW01-24	1
250	RM250	00.9 -	IW31	IW01-□	W31ESR-U	1
250	RMX250	88 -92	IW24	IW01-□	IW24	1
250	RMX250	94.12-96.3	IW27	IW01-□	IW27	1
250	RMX250	96.4 -	IW27	IW01-□	IW27	1
250	RMX250S	92.5 -93	IW24	IW01-□	W24ESR-U	1
250	RMX250S	93 -	IW27	IW01-□	W27ESR-U	1
250	RM-Z250	03.8 -06	IU24	IU01-□	U24ESR-NB	1
250	RM-Z250	07 -09	IU24D	IU01-□	IU24D	1
250	RM-Z250	10 -	IU24D	IU01-□	IU24D	1
250	SKYWAVE TYPE I / II	98.2 -00.8	IU24	IU01-□	U24ESR-N	1
250	SKYWAVE TYPE I / II/S	00.8 -02.7	IU24A	IU01-□	U24ETR	1
250	SKYWAVE250/M/S/SS/LIMITED	06.4 -	IU24A	IU01-□	U22ETR	1
250	SKYWAVE250/TypeS/SS	02.8 -06.3	IU24A	IU01-□	U24ETR	1
250	ST250/Etype	03.12-	IX24	IXU01-□	X24ESR-U	1
250	SW-1	92.2 -	IX24	IXU01-□	X24ESR-U	1
250	VL250	99.1 -	IU22	IU01-□	U22ESR-N	2
250	VOLTY TYPE I / II/C/T	95.11-	IX24	IXU01-□	X24ESR-U	1
250	VOLTYGRASSTRACKER	00.4 -	IX24	IXU01-□	X24ESR-U	1
250	WOLF250	88.6 -	IW24	IW01-□	W24ES-U	2
350	DR350	93.9 -	IU27A	IU01-□	U27ETR	1
350	GOOSE350	91.12-	IU24A	IU01-□	U24ETR	1
400	BANDIT400/V	89.6 -94.2	IU24A	IU01-□	U24ETR	4
400	BANDIT400/V	94.3 -	IU24	IU01-□	U24ESR-N	4
400	BANDIT400VZ	97.2 -	IU24	IU01-□	U24ESR-N	4
400	BOULEVARD400	10.3 -	IX22B	IXU01-□	-	2
400	BOULEVARD400/LIMITED	05.3 -09	IX22B	IXU01-□	X22EPR-U9	2
400	DESPERADO WINDER	99.5 -	IX24B	IXU01-□	X24EPR-U9	2
400	DESPERADO/X	96.5 -	IX24B	IXU01-□	X24EPR-U9	2
400	DR-Z400/S	00.5 -10	IU24	IU01-□	U24ESR-N	1
400	DR-Z400SM	04.12-10	IU24	IU01-□	U24ESR-N	1
400	GLADIUS400 ABS	09.12-	IU24D	IU01-□	IU24D	2
400	GN400E	80 -	IX24	IXU01-□	X24ES-U	1
400	GS400/E/L	77.12-	-	-	W20ES-U	2
400	GS400E	91.10-	IX24B	IXU01-□	X24EPR-U9	2
400	GS400E	-	IX24B	IXU01-□	X24EPR-U9	2
400	GS400E	-	IX24B	IXU01-□	X24EPR-U9	2
400	GSR400/ABS	06.5 -09.2	IU24A	IU01-□	U24ETR	4
400	GSR400/ABS	09.3 -	IU24D	IU01-□	IU24D	4
400	GSX400/ZR[IMPULSE]	94.2 -	IU24	IU01-□	U24ESR-N	4
400	GSX400[IMPULSE]/TYPE S	96.2 -	IU24	IU01-□	U24ESR-N	4
400	GSX400[IMPULSE]/TYPE S	04.10-10	IU24	IU01-□	U24ESR-N	4
400	GSX400E/L/T	80 -	IX24	IXU01-□	X24ES-U	4
400	GSX400F	81.4 -88.5	IX24	IXU01-□	X24ES-U	4
400	GSX400F	88.6 -	IU24A	IU01-□	U24ETR	4
400	GSX400FS[IMPULSE]	82 -	IX27	IXU01-□	X27ES-U	4
400	GSX400FSV[INAZUMA]	97.3 -00.12	IU27A	IU01-□	U27ETR	4
400	GSX400FW/R	83 -86.3	IUF24	-	U24FS-U	4
400	GSX400R	86.4 -88.2	IUF24	-	-	4
400	GSX400S[KATANA]	92.4 -	IU24	IU01-□	U24ESR-N	4
400	GSX-R400/R/R-SP	88.3 -	IU24A	IU01-□	U24ETR	4
400	INAZUMA	01.1 -	IU24A	IU01-□	U24ETR	4

CC	MODEL	FROM-TILL	IRIDIUM POWER	IRIDIUM RACING	DENSO	QTY
<b>SUZUKI</b>						
400	INTRUDER	94.4 -	IX24B	IXU01-□	X24EPR-U9	2
400	INTRUDER CLASSIC	01.3 -	IX22B	IXU01-□	X22EPR-U9	2
400	RF400R/RV	93.3 -	IU24A	IU01-□	U24ETR	4
400	RG400r	85.7 -	IW27	IW01-□	W27ES-U	4
400	SAVAGE(LS400)	87.1 -92.11	IX24B	IXU01-□	X24EP-U9	1
400	SAVAGE(LS400)	92.11-	IX24B	IXU01-□	X24EPR-U9	1
400	SKYWAVE400	98.9 -02.8	IU22	IU01-□	U22ESR-N	1
400	SKYWAVE400/LTD/S	02.9 -06.5	IU22	IU01-□	U22ESR-N	1
400	SKYWAVE400/S/LIMITED	06.6 -	IU22	IU01-□	U22ESR-N	1
400	SV400/S	98.9 -	IU24	IU01-□	U24ESR-N	2
400	TEMPTER(ST400V)	97.4 -	IX24B	IXU01-□	X24EPR-U9	1
450	RM-Z450	04.9 -07.9	IU24	IU01-□	IU24	1
450	RM-Z450	07.10-	IU24	IU01-□	-	1
500	GS500/F	04 -	IX24B	IXU01-□	X24EPR-U9	2
500	RG500r	85.4 -	IW27	IW01-□	W27ES-U	4
550	GXS550L	84 -	IX27	IXU01-□	X27ES-U	4
600	BANDIT600/S(Import)	-	IU27A	IU01-□	U27ETR	4
600	GSF600/S(Import)	-	IU27A	IU01-□	U27ETR	4
600	GSR600/ABS(Import)	06 -	IU27	IU01-□	U27ESR-N	4
600	GXS600F(Import)	-	IU27A	IU01-□	U27ETR	4
600	GSX-R600(Import)	98 -03	IU27	IU01-□	U27ESR-N	4
600	GSX-R600(Import)	04 -07	IU27	IU01-□	U27ESR-N	4
600	GSX-R600(Import)	08 -	IU27D	IU01-□	IU27D	4
600	RF600RR/R(Import)	93 -	IU27	IU01-□	U27ESR-N	4
650	DR650RSE	91 -	IX27B	IXU01-□	X27EPR-U9	1
650	DR650SE	-	IU31	IU01-□	U31ESR-N	2
650	GS650G	81.4 -	IX24	IXU01-□	X24ES-U	4
650	GSF650(Import)	05 -	IU24A	IU01-□	U24ETR	4
650	LS650	86 -	IX24B	IXU01-□	X24EP-U9	1
650	LS650P	-	IX24B	IXU01-□	X24EPR-U9	1
650	SFV650 GLADIUS(Import)	09 -	IU24D	IU01-□	IU24D	4
650	SKYWAVE650/LX	02.6 -08.10	IU24	IU01-□	U24ESR-N	2
650	SKYWAVE650LX	08.11-	IU22	IU01-□	U22ESR-N	2
650	SV650/S	99 -	IU24	IU01-□	U24ESR-N	2
650	V-STROM650/ABS(Import)	-	IU24	IU01-□	U24ESR-N	2
650	XF650FREEWIND	-	IU31	IU01-□	U31ESR-N	2
750	GSF750	96.1 -	IU27A	IU01-□	U27ETR	4
750	GSR750	13.2 -	IU27D	IU01-□	IU27D	4
750	GSR750/A(Import)	11 -	IU27D	IU01-□	IU27D	4
750	GSX750E	83.2 -	IX24	IXU01-□	X24ES-U	4
750	GSX750F	89.3 -	IX27	IXU01-□	X27ETR	4
750	GSX750R	-	IX27	IXU01-□	X27ES-U	4
750	GSX750S	84.3 -	IX24	IXU01-□	X24ES-U	4
750	GSX750W/SP	94.3 -	IU27	IU01-□	U27ESR-N	4
750	GSX-R750	88.3 -89.12	IX27	IXU01-□	X27ETR	4
750	GSX-R750	90.1 -92.1	IU31A	IU01-□	U31ETR	4
750	GSX-R750	92.1 -95.12	IU27A	IU01-□	U27ETR	4
750	GSX-R750 (Import)	04 -07	IU27	IU01-□	U27ESR-N	4
750	GSX-R750 (Import)	08 -	IU27D	IU01-□	IU27D	4
750	GSX-R750/SP	95.12-03	IU27	IU01-□	U27ESR-N	4
750	GSX-R750R/RK	89.4 -	IU31A	IU01-□	U31ETR	4
750	VS750	85 -	IX24B	IXU01-□	X24EP-U9	2
800	BOULEVARD800	05.3 -	IX24B	IXU01-□	X24EPR-U9	2
800	DESPERADO800/X	96.11-	IX24B	IXU01-□	X24EPR-U9	2
800	DR800S	90 -	IX27B	IXU01-□	X27EPR-U9	1
800	INTRUDER 800	93.5 -	IX24B	IXU01-□	X24EPR-U9	2
800	INTRUDER CLASSIC	01.3 -	IX22B	IXU01-□	X22EPR-U9	2
800	MARAUDER800	-	IX24B	IXU01-□	X24EPR-U9	2
800	VS800	-	IX24B	IXU01-□	X24EPR-U9	2
800	VS800GL	-	IX24B	IXU01-□	X24EPR-U9	2
800	VX800	90.9 -	IX24B	IXU01-□	X24EPR-U9	4
900	RF900R(Import)	94.3 -	IU27	IU01-□	U27ESR-N	4
1000	GSX-R1000 RACE BASE	01 -06	-	IU01-□	-	4
1000	GSX-R1000 RACE BASE	07 -	-	IU01-□	-	4
1000	GSX-R1000(Import)	01 -06	IU27	IU01-□	U27ESR-N	4
1000	GSX-R1000(Import)	07 -	IU27D	IU01-□	IU27D	4
1000	SV1000/S	03.8 -	IU24A	IU01-□	U24ETR	2

AUSTRALIA  
CHINA  
INDIA  
INDONESIA  
KOREA  
MALAYSIA  
PHILIPPINES  
SAUDIARABIA  
SINGAPORE  
TAIWAN  
THAILAND  
VIETNAM  
JAPAN  
EUROPE & USA  
CROSS REFERENCE  
PART NUMBER



▶ Spark plug color codes: ■ for Iridium Tough and Iridium Plugs and Iridium TT, ■ for Iridium Power, ■ for Iridium Racing and Two Tops Plugs, ■ for Platinum Plugs and Platinum TT, and black for general spark plugs.

	CC MODEL	FROM-TILL	IRIDIUM POWER	IRIDIUM RACING	DENSO	QTY
AUSTRALIA	<b>SUZUKI</b>					
	1000 TL1000R(Import)	98.4 -	IU24A	IU01-□	U24ETR	2
	1000 TL1000S	97.2 -98.11	IU27	IU01-□	U27ESR-N	2
CHINA	1000 TL1000S	98.11-	IU24	IU01-□	U24ESR-N	2
	1000 V-STROM1000(Import)	02 -	IU24A	IU01-□	U24ETR	2
	1100 GSX1100F(Import)	88 -	IX27	IXU01-□	X27ETR	4
INDIA	1100 GSX1100S[KATANA]	81 -	IX24	IXU01-□	X24ESR-U	4
	1100 GSX-R1100(Import)	86 -92	IX27	IXU01-□	X27ETR	4
	1100 GSX-R1100W(Import)	93 -	IU27	IU01-□	U27ESR-N	4
INDONESIA	1200 BANDIT1200/S	00.5 -07	IX24	IXU01-□	IX24	4
	1200 GS1200SS	01 -	IX24	IXU01-□	IX24	4
	1200 GSF1200/S/SAV	95.1 -00.4	IX24	IXU01-□	IX24	4
KOREA	1200 INAZUMA1200	98.4 -	IX24	IXU01-□	IX24	4
	1250 BANDIT1250/S ABS	07 -	IU20	IU01-□	U20ESR-N	4
	1250 BANDIT1250F ABS	10 -	IU20	IU01-□	U20ESR-N	4
MALAYSIA	1300 B-KING	08 -	IU27D	IU01-□	IU27D	4
	1300 GSX1300R HAYABUSA	14 -	IU24D	IU01-□	IU24D	4
	1300 GSX1300R HAYABUSA(Import)	99 -07	IU27	IU01-□	U27ESR-N	4
PHILIPPINES	1300 GSX1300R HAYABUSA(Import)	08 -	IU27D	IU01-□	IU27D	4
	1400 GSX1400	01.3 -10	IU24A	IU01-□	U24ETR	4
	1400 VS1400GL/GLP	86 -	IX24B	IXU01-□	X24EPR-U9	2
SAUDI ARABIA	1500 INTRUDER LC	97.12-98.11	IX24B	IXU01-□	X24EPR-U9	2
	1500 INTRUDER LC	98.11-	IX22B	IXU01-□	X22EPR-U9	2
	1600 MARAUDER1600	04 -	-	-	X20EPR-U9	2
SINGAPORE	1800 BOULEVARD C109R(Import)	08 -	IU24A	IU01-□	U22ETR	4
	1800 BOULEVARD M109R/R2(Import)	06 -	IU24A	IU01-□	U24ETR	4
	<b>YAMAHA</b>					
TAIWAN	50 ACTIVE SPORT(CH50ET)	84.4 -	IWF22	-	W22FP-U	1
	50 ACTIVE(CH50E)	85.6 -	IWF22	-	W22FP-U	1
	50 APRIO NATURAL	98.6 -	IWF22	-	W22FPR-U	1
THAILAND	50 AXIS50(YA50/D/H/HS)	91.7 -	IWF22	-	W22FPR-U	1
	50 BJ	03.10-	IWF22	-	W22FPR-U	1
	50 BOXN(CQ50E)	85.4 -	IWF20	-	W20FP-U10	1
VIETNAM	50 BUSINESS V50/B/D/N	-	IWF22	-	W22FSR	1
	50 BW'S	12.10-	IU22	IU01-□	U22ESR-N	1
	50 BW'S SPORTS	89.1 -	IWF22	-	W22FPR-U	1
JAPAN	50 BW'S(YW50)	98.4 -	IWF22	-	W22FPR-U	1
	50 BW'S50(BW50)	88.4 -	IWF22	-	W22FPR-U	1
	50 CHAMP CX	88.3 -	IWF22	-	W22FPR-U	1
EUROPE & USA	50 CHAMP(CJ50E/ES)	86.7 -	IWF20	-	W20FP-U10	1
	50 CHAMP50RS	87.4 -	IWF22	-	W22FP-U	1
	50 CUTE(CN50EC/ED)	84.6 -	IWF20	-	W20FP-U10	1
CROSS REFERENCE	50 DT50	82 -87.2	IW24	IW01-□	W24ES-U	1
	50 DT50	87.3 -93.7	IW24	IW01-□	W24ES-U	1
	50 DT50	93.8 -	IW24	IW01-□	W24ES-U	1
PART NUMBER	50 EXCEL50	86.5 -	IWF20	-	W20FP-U10	1
	50 GEAR	07.10-	IU24	IU01-□	U24ESR-N	1
	50 GEAR ALLROUND	00.1 -	IWF22	-	W22FSR	1
EUROPE & USA	50 GEAR/C	94.9 -07	IWF22	-	W22FSR	1
	50 JOG ZII	98.3 -	IWF22	-	W22FPR-U	1
	50 JOG ZR	09.1 -	IU22	IU01-□	U22ESR-N	1
CROSS REFERENCE	50 JOG(YG50/Z)	-	IWF22	-	W22FPR-U	1
	50 JOG/Deluxe	07.10-	IU22	IU01-□	U22ESR-N	1
	50 JOG/REMOTECONTROL JOG/ZR/ZII	-	IWF22	-	W22FPR-U	1
PART NUMBER	50 JOG50	87.2 -	IWF22	-	W22FP-U	1
	50 JOG50/EX/Z/ZR	-	IWF22	-	W22FPR-U	1
	50 JOGAPRIO	93.11-	IWF22	-	W22FPR-U	1
EUROPE & USA	50 JOGAPRIO TYPE II	95.4 -	IWF22	-	W22FPR-U	1
	50 JOGC	98.2 -	IWF22	-	W22FPR-U	1
	50 JOGPOCHE	92.6 -	IWF22	-	W22FPR-U	1
CROSS REFERENCE	50 JOGSPORT(CY50Z)	90.9 -	IWF22	-	W22FPR-U	1
	50 JOGSPORT50	88.2 -90.8	IWF20	-	W20FPR-U	1
	50 JOGTRUNK(YG50D)	91.3 -	IWF22	-	W22FPR-U	1
PART NUMBER	50 MATE V50/S/D/N	-	IWF22	-	W22FSR	1
	50 MIINT50	87.1 -	IWF20	-	W20FP-U10	1
	50 MINT50SPECIAL	89.1 -	IWF20	-	W20FP-U	1
EUROPE & USA	50 NEWJOG	89.2 -	IWF20	-	W20FPR-U	1
	50 NEWS GEAR	96.6 -07	IWF22	-	W22FSR	1

	CC MODEL	FROM-TILL	IRIDIUM POWER	IRIDIUM RACING	DENSO	QTY
AUSTRALIA	<b>YAMAHA</b>					
	50 NEWS GEAR	07.10-	IU24	IU01-□	U24ESR-N	1
	50 NEWSMATE V50N	00.5 -	IWF22	-	W22FSR	1
CHINA	50 NEWSMATEV50BUSINESSII	-	IW20	IW01-□	W20ES-U	1
	50 POCKE(QA50)	80 -	IWF22	-	W20FS-U	1
	50 PW50(MOTOCROSS)	82 -00.7	IWF22(*1)	-	W14FP-UL	1
INDIA	50 PW50(MOTOCROSS)	00.8 -	IWF22(*1)	-	W14FPR-UL	1
	50 RZ50	81.6 -98.4	IW24	IW01-□	W24ES-U	1
	50 RZ50	98.4 -	IW24	IW01-□	W24ESR-U	1
INDONESIA	50 SLIDER 50(Import)	-	IWF24	-	W24FSR	1
	50 SUPERJOG ZR	94.12-	IWF22	-	W22FPR-U	1
	50 TDR50	88.7 -	IW24	IW01-□	W24ESR-U	1
KOREA	50 TOWNMATE T50S/D/ED	82 -	IUF22	-	U20FS-U	1
	50 TRY(CP50E)	85.3 -	IWF20	-	W20FP-U10	1
	50 TT-R50E	06 -	IUF22	-	U22FSR-U	1
MALAYSIA	50 TY50	75.2 -	IWF22	-	W22FS-U	1
	50 TZ50	90.2 -	IW27	IW01-□	IW27	1
	50 TZM50R	94.3 -	IW27	IW01-□	W27ESR-U	1
PHILIPPINES	50 TZR50	90.2 -93.3	IW27	IW01-□	W27ESR-U	1
	50 TZR50	93.3 -	IW24	IW01-□	W24ESR-U	1
	50 TZR50R	93.3 -94.2	IW22	IW01-□	W22ESR-U	1
SAUDI ARABIA	50 TZR50R	94.2 -	IW27	IW01-□	W27ESR-U	1
	50 VINO Molfe	09.4 -	IU22	IU01-□	U22ESR-N	1
	50 VINO(YJ50R)/CLASSIC	97.3 -04	IWF20	-	W20FPR-U	1
SINGAPORE	50 VINO/Delux	07.11-	IU22	IU01-□	U22ESR-N	1
	50 VINO/Delux	04.3 -07	IU22	IU01-□	U22ESR-N	1
	50 VOX	06.5 -	IU22	IU01-□	U22ESR-N	1
TAIWAN	50 YB-1	96.1 -	IWF20	-	W20FPR-U	1
	50 YB-1 FOUR	00.4 -	IUF22	-	U22FSR-U	1
	50 YB50	-	IWF22	-	W22FSR	1
THAILAND	50 YB50	00.5 -	IUF22	-	U22FSR-U	1
	50 YG50/Z	-	IWF22	-	W22FPR-U	1
	50 YSR50	86.5 -	IWF24	-	W24FS-U	1
VIETNAM	50 YV50/C	-	IWF22	-	W22FPR-U	1
	70 MATE V70	71 -	IWF22	-	W20FS-U	1
	80 BELUGA D(CV80ED)	-	IWF20	-	W20FP-U	1
EUROPE & USA	80 BELUGA(CV80E)	81 -	IWF20	-	W20FP-U	1
	80 BUSINESS V80D/N	-	IWF22	-	W22FPR-U	1
	80 BW80	85 -	IWF22	-	W22FP-U	1
CROSS REFERENCE	80 CHAMP(CJ80E)	86.8 -	IWF22	-	W22FP-U	1
	80 JOGSPORTS80	88.2 -90.4	IWF22	-	W22FPR-U	1
	80 MATE V80/N	82 -92.2	IWF20	-	W20FP-U	1
PART NUMBER	80 MATE V80/N	92.2 -	IWF20	-	W20FPR-U	1
	80 MR80	-	IWF22	-	W22FS-U	1
	80 NEWSMATE80	88.7 -	IWF22	-	W22FPR-U	1
EUROPE & USA	80 PW80	83 -	IWF20	-	W20FP-U	1
	80 RX80SP	81 -	IWF22	-	W22FS-U	1
	80 TDR80	88.8 -	IW24	IW01-□	W24EPR-U	1
CROSS REFERENCE	80 TOWNMATE T80	-	IUF22	-	U22FS-U	1
	80 TOWNMATE T80D/ED	93.6 -	IUF22	-	U20FS-U	1
	80 TOWNMATE T80D/ED	-	IWF20	-	W20FPR-U	1
PART NUMBER	80 TY80	75 -	IWF22	-	W20FS-U	1
	80 YF80M(QUAD)	-	IUF22	-	U22FSR-U	1
	80 YFM80W(QUAD)	02 -	IUF22	-	U22FSR-U	1
EUROPE & USA	80 YM80M	-	IUF22	-	U22FSR-U	1
	80 YSR80	86 -	IWF24	-	W24FS-U	1
	80 YZ80	82.9 -92	IW27	IW01-□	-	1
CROSS REFERENCE	80 YZ80	93 -00	IW31	IW01-□	-	1
	80 YZ80LW	94.8 -00	IW31	IW01-□	-	1
	80 YZ80LW	01 -	IW31	IW01-□	-	1
PART NUMBER	85 YZ85/LW	-	IW31	IW01-□	-	1
	85 YZ85/LW	04 -	IW31	IW01-□	IW31	1
	90 AXIS90(YA90)	90.7 -	IWF20	-	W20FPR-U	1
EUROPE & USA	90 JOGSPORTS90(CY90Z)	90.3 -	IWF22	-	W22FPR-U	1
	90 NEWSMATE T90N/D	94.6 -	IUF22	-	U20FSR-U	1
	90 TOWNMATE T90D	97.1 -	IUF22	-	U20FSR-U	1
CROSS REFERENCE	90 TT-R90	-	IUF22	-	U20FSR-U	1
	90 YFM90R(QUAD)	08.10-	IUF22	-	U22FSR-U	1

(\*1) Plugs for motocross are three heat ranges higher. They cannot be used for normal operation, due to carbon fouling.



CC	MODEL	FROM-TILL	IRIDIUM POWER	IRIDIUM RACING	DENSO	QTY
<b>YAMAHA</b>						
100	BW'S100	99 -	IWF22	-	W22FPR-U	1
100	GRANDAXIS100(YA100)	98.9 -	IWF22	-	W22FPR-U	1
100	YA100W	-	IWF20	-	W20FPR-U	1
100	YF100M(QUAD)	-	IUF22	-	U22FSR-U	1
110	MIO	03 -	IUF22	-	U22FSR-U	1
110	NUOVO	-	IUF22	-	U22FSR-U	1
110	TT-R110E(Import)	08 -	IUF22	-	U20FSR-U	1
125	AXIS TREET	09.8 -	IU22	IU01-□	U22ESR-N	1
125	BREEZE YFA125(QUAD)	-	IUF22	-	U22FSR-U	1
125	BW's125FI(Import)	08 -	IU22	IU01-□	U22ESR-N	1
125	CYGNUS (XC125)	88 -94	IUF22	-	U20FS-U	1
125	CYGNUS SI(XC125)	98 -	IU22	IU01-□	U22ESR-N	1
125	CYGNUS SV(XC125SV)	01 -	IU22	IU01-□	U22ESR-N	1
125	CYGNUS125(XC125T/D)	94 -	IU22	IU01-□	U22ESR-N	1
125	CYGNUS-X/SR(XC125/SR)	03.7 -07	IU22	IU01-□	U22ESR-N	1
125	CYGNUS-X/SR(XC125/SR)FI	07.10-	IU22	IU01-□	U22ESR-N	1
125	CZ125TRACY	83.6 -	IW24	IW01-□	W24EP-U	1
125	DT125	74 -	IW24	IW01-□	W24ES-U	1
125	DT125R	85.7 -88.5	IW24	IW01-□	W24ESR-U	1
125	DT125R/RE	88.6 -	IW27	IW01-□	W27FSR-U	1
125	GRIZZLY125(QUAD)	-	IUF22	-	U22FSR-U	1
125	MAJESTI FI	07 -	IU27A	IU01-□	-	1
125	MAJESTY125(Import)	- -06	IU22	IU01-□	U22ESR-N	1
125	MAJESTY125(Import)	07 -	IU24	IU01-□	U24ESR-N	1
125	RZ125	85.4 -	IW24	IW01-□	W24ESR-U	1
125	SR125	81.5 -	IX24	IXU01-□	X24ES-U	1
125	SR125B	97.2 -	IX24	IXU01-□	X24ESR-U	1
125	TDR125/R	-	IW24	IW01-□	W24ESR-U	1
125	TRICITY125	14.7 -	IU22	IU01-□	U22ESR-N	1
125	TT-R125LW	00.4 -	IUF22	-	U22FSR-U	1
125	TW125(Import)	-	IX24	IXU01-□	X24ESR-U	1
125	TZ125 withDetonationCounter	95.11-	-	IA01-□	IA01-32	1
125	TZ125 withoutDetonationCounter	95.11-	-	IAE01-□	IAE01-32	1
125	TZ125 withoutDetonationCounter	95.11-	-	IW01-□	IW01-32	1
125	TZR125	87.4 -89.11	IW27	IW01-□	W27ESR-U	1
125	TZR125	94.2 -	IW27	IW01-□	W27ESR-U	1
125	TZR125R	89.12-	IW24	IW01-□	W24ESR-U	1
125	XT125	82.3 -	IX24	IXU01-□	X24ES-U	1
125	XTZ(Import)	-	IUF22	-	U22FSR-U	1
125	XV125VIRAGO	-	IUF22	-	U20FSR-U	2
125	XVS125DRAGSTAR	-	IUF22	-	U22FSR-U	2
125	YB125	72 -	IWF22	-	W20FS-U	1
125	YB125E(Import)	08 -	IUF22	-	U20FSR-U	1
125	YD125/S	89.4 -	IX22	IXU01-□	X22ESR-U	1
125	YFA-1(TRIKE)	-	IUF22	-	U22FSR-U	1
125	YZ125	74 -91.7	IW27	IW01-□	-	1
125	YZ125	91.8 -96.7	IW27	IW01-□	-	1
125	YZ125	96.7 -98.8	IW27	IW01-□	-	1
125	YZ125	98.8 -	IW27	IW01-□	-	1
125	YZ125	05.7 -	IW27	IW01-□	-	1
125	YZF-R125	08 -	IU24	IU01-□	U24ESR-N	1
150	CYGNUS GT(XC150LC)	92 -	IU22	-	U22ESR-N	1
150	FZ-16(Import)	08 -	IU24D	IU01-□	U24EPR9	1
155	MAJYSTY	13.8 -	IU24D	-	U24EPR9	1
175	DT175(Import)	-	IW24	IW01-□	W24ES-U	1
180	CYGNUS(XC180)	82 -	IX22	IXU01-□	X22ES-U	1
200	AG200	85.2 -	IX24	IXU01-□	X24ES-U	1
200	BLASTER YF200S(QUAD)	90.3 -	IW24	IW01-□	W24ESR-U	1
200	BW200	85.2 -	IX24	IXU01-□	X24ES-U	1
200	DT200R	84 -88.5	IW24	IW01-□	W24ESR-U	1
200	DT200R	88.6 -	IW27	IW01-□	W27ESR-U	1
200	DT200WR	91.1 -93.2	IW27	IW01-□	W27ESR-U	1
200	DT200WR	93.3 -	IW24	IW01-□	W24ESR-U	1
200	SDR200	87.7 -	IW27	IW01-□	W27ESR-U	1
200	TW200	91.2 -02.5	IX24	IXU01-□	X24ESR-U	1
200	TW200E	96.5 -02.5	IX24	IXU01-□	X24ES-U	1
200	XT200	82 -	IX24	IXU01-□	X24ES-U	1

CC	MODEL	FROM-TILL	IRIDIUM POWER	IRIDIUM RACING	DENSO	QTY
<b>YAMAHA</b>						
225	BRONCO(ST225)	97.5 -	IX24	IXU01-□	X24ESR-U	1
225	SEROW225	85.8 -89.7	IX24	IXU01-□	X24ESR-U	1
225	SEROW225/S	89.8 -93.5	IX24	IXU01-□	X24ESR-U	1
225	SEROW225W/W(E)(XT225WE)	93.6 -	IX24	IXU01-□	X24ESR-U	1
225	TW225/E	02.6 -	IX24	IXU01-□	X24ESR-U	1
230	LANZA(DT230)	97.1 -	IW27	IW01-□	W27ESR-U	1
230	TT-R230	07 -	IX24	IXU01-□	X24ESR-U	1
250	DRAGSTAR 250	00.7 -	IUF22	-	U20FSR-U	2
250	DRAGSTAR 250	08.5 -	IUF22	-	U20FSR-U	2
250	FZ250FAZER	86 -	IU27	IU01-□	U27ES-N	4
250	FZR250	88.4 -	IU27	IU01-□	U27ESR-N	4
250	FZR250R	94.3 -	IU24	IU01-□	U24ESR-N	4
250	GRAND MAJESTY	04.3 -	IU22D	IU01-□	U22EPR9	1
250	MAJESTY	07.5 -	IU22D	IU01-□	U22EPR9	1
250	MAJESTY250/C	99 -	IX24	IXU01-□	X24ESR-U	1
250	MAJESTY250/SV/ABS	95.8 -99	IX24	IXU01-□	X24ESR-U	1
250	MAXAM	05.4 -	IU22D	IU01-□	U22EPR9	1
250	MAXAM	-	IU22D	IU01-□	U22EPR9	1
250	R1-Z	90.6 -	IW27	IW01-□	W27ESR-U	2
250	RENAISSA	96.4 -	IUF22	-	U22FSR-U	2
250	RZ250	80.8 -83.1	IW24	IW01-□	W24ES-U	2
250	RZ250R	83.2 -86.6	IW24	IW01-□	W24ESR-U	2
250	RZ250R	86.7 -	IW27	IW01-□	W27ESR-U	2
250	RZ250RR	84.3 -86.6	IW24	IW01-□	W24ESR-U	2
250	SEROW250	05.4 -07	IX22	IXU01-□	X22ESR-U	1
250	SEROW250/S	08.1 -	IX22	IXU01-□	X22ESR-U	1
250	SR250	80.4 -	IW22	IW01-□	W22EP-U	2
250	SRV250/S/T	92.4 -	IUF22	-	U22FSR-U	2
250	SRX250/F	90.3 -	IX24	IXU01-□	X24ES-U	1
250	TDR250	88.1 -	IW27	IW01-□	W27ESR-U	2
250	TRICKER(XG250)/S	04.3 -07	IX22	IXU01-□	X22ESR-U	1
250	TRICKER/S	08.1 -	IX22	IXU01-□	X22ESR-U	1
250	TT250R	93.4 -	IU27	IU01-□	U27ESR-N	1
250	TT250R RAID	94.3 -	IU27	IU01-□	U27ESR-N	1
250	TT-R250	-	IU27	IU01-□	U27ESR-N	1
250	TY250R	85 -	IW20	IW01-□	IW20	1
250	TY250R SCOTTISH	-	IW24	IW01-□	W24ES-U	1
250	TY250Z	94.12-	IW20	IW01-□	IW20	1
250	TY250Z SCOTTISH	94.12-	IW20	IW01-□	IW20	1
250	TZ250	73 -94	-	IWM01-□	IWM01-32	2
250	TZ250	95 -	-	IWM01-□	IWM01-32	2
250	TZ250 withDetonationCounter	95 -	-	IA01-□	IA01-32	2
250	TZ250 withoutDetonationCounter	95 -	-	IAE01-□	IAE01-32	2
250	TZR250	89.3 -90.2	IW24	IW01-□	W24ESR-U	2
250	TZR250/SP	85.11-89.2	IW27	IW01-□	W27ESR-U	2
250	TZR250/SP	90.2 -91.3	IW27	IW01-□	W27ESR-U	2
250	TZR250R/RS	94.2 -	IWM24	IWM01-□	-	2
250	TZR250R/RS/RSP	91.3 -94.1	IWM27	IWM01-□	-	2
250	TZR250SPR	94.12-	IWM27	IWM01-□	-	2
250	WR250F(4ST)	03 -	IU24	IU01-□	U24ESR-N	1
250	WR250R	01 -	IU24	IU01-□	U24ESR-N	1
250	WR250R/X	07.11-	IU27A	IU01-□	U27ETR	1
250	WR250Z	92.1 -96.6	IW24	IW01-□	-	1
250	WR250Z	96.7 -00	IW24	IW01-□	-	1
250	XS250/S	82 -	IX24	IXU01-□	X24ES-U	2
250	XS250SP	82.5 -	IX24	IXU01-□	X24ES-U	2
250	XT250T	83.4 -	IX24	IXU01-□	X24ES-U	1
250	XT250X	06.3 -	IX22	IXU01-□	X22ESR-U	1
250	XT250X	08.5 -	IX22	IXU01-□	X22ESR-U	1
250	XV250/S VIRAGO	94.3 -	IUF22	-	U20FS-U	2
250	YD250	86.9 -89.8	IW22	IW01-□	W22EP-U	1
250	YD250/S	89.9 -	IW22	IW01-□	W22EPR-U	1
250	YFB250FW(QUAD)	-	IX22	IXU01-□	X22ESR-U	1
250	YFM250R(QUAD)	08 -	IX22	IXU01-□	X22ESR-U	1
250	YP250/S/A	-	IX24	IXU01-□	X24ESR-U	1
250	YZ250	74 -96.7	IW24	IW01-□	-	1
250	YZ250	96.7 -	IW24	IW01-□	-	1

AUSTRALIA  
CHINA  
INDIA  
INDONESIA  
KOREA  
MALAYSIA  
PHILIPPINES  
SAUDIARABIA  
SINGAPORE  
TAIWAN  
THAILAND  
VIETNAM  
JAPAN  
EUROPE & USA  
CROSS REFERENCE  
PART NUMBER



▶ Spark plug color codes: ■ for Iridium Tough and Iridium Plugs and Iridium TT, ■ for Iridium Power, ■ for Iridium Racing and Two Tops Plugs, ■ for Platinum Plugs and Platinum TT, and black for general spark plugs.

AUSTRALIA	CC MODEL	FROM-TILL	IRIDIUM POWER	IRIDIUM RACING	DENSO	QTY
	<b>YAMAHA</b>					
	250 YZ250F	00.10-	IU24	IU01-□	U24ESR-N	1
	250 YZF-R25	15 -18.1	IU27	IU01-□	U27ESR-N	2
	250 YZF-R25	18.1 -	-	-	-	2
CHINA	250 ZEAL250(FZX250)	92.2 -	IU24	IU01-□	U24ESR-N	4
	320 MT-03	15.10-18.3	IU24	IU01-□	U24ESR-N	2
	320 MT-03	18.3 -	-	-	-	2
INDIA	320 YZF-R3	15.4 -18.1	IU24	IU01-□	U24ESR-N	2
	320 YZF-R3	18.1 -	-	-	-	2
	350 BANSHEE YF350Z(QUAD)	90.3 -	IW24	IW01-□	W24ESR-U	2
INDONESIA	350 RZ350	81.3 -83.4	IW24	IW01-□	W24ES-U	2
	350 RZ350R/RR	83.5 -	IW24	IW01-□	W24ESR-U	2
	350 TY350R	86 -	IW20	IW01-□	IW20	1
KOREA	350 WARRIOR YFM350X(QUAD)	-	IX24	IXU01-□	X24ES-U	1
	350 YF350E(QUAD)	-	IX24	IXU01-□	X24ESR-U	1
	350 YFM350R(QUAD)	04 -	IX24	IXU01-□	X24ESR-U	1
MALAYSIA	400 ARTESIA(XT400)	91.8 -	IX24B	IXU01-□	X24EPR-U9	1
	400 DIVERSION400	91.7 -	IU24	IU01-□	U24ESR-N	4
	400 DRAGSTAR CLASSIC	98.3 -09	IX22B	IXU01-□	X22EPR-U9	2
PHILIPPINES	400 DRAGSTAR CLASSIC400	09.11-	IX22B	IXU01-□	-	2
	400 DRAGSTAR FOUR	01.3 -09	IX22B	IXU01-□	X22EPR-U9	2
	400 DRAGSTAR(XVS400)	96.2 -01	IX22B	IXU01-□	X22EPR-U9	2
SAUDI ARABIA	400 DRAGSTAR400	09.11-	IX22B	IXU01-□	-	2
	400 FZ400	97.3 -	IU24	IU01-□	U24ESR-N	4
	400 FZ400(SCHOOL MODEL)	97.3 -	IU20	IU01-□	U20ESR-N	4
SINGAPORE	400 FZ400R/N	84.5 -	IX24	IXU01-□	X24ES-U	4
	400 FZR400	86.5 -88.3	IU27	IU00-□	U27ES-N	4
	400 FZR400	88.5 -89.3	IU24	IU01-□	U24ESR-N	4
TAIWAN	400 FZR400R	87.4 -	IU27	IU01-□	U27ESR-N	4
	400 FZR400R	89.3 -89.12	IU24	IU01-□	U24ESR-N	4
	400 FZR400RR/SP	89.12-94	IU24	IU01-□	U24ESR-N	4
THAILAND	400 GRAND MAJESTY400	05.3 -08.3	IU22D	IU01-□	U22EPR9	1
	400 GRAND MAJESTY400	08.3 -	IU22	IU01-□	U22ESR-N	1
	400 KODIAK YFM400FWA(QUAD)	-	IX24	IXU01-□	X24ESR-U	1
VIETNAM	400 SR400	88.8 -09	IW20	IW01-□	W20EPR-U	1
	400 SR400	09.12-	IW20	IW01-□	W20EPR-U	1
	400 SR400S LIMITED EDITION	95.8 -	IW20	IW01-□	W20EPR-U	1
JAPAN	400 SRX400	85.4 -91.6	IX22B	IXU01-□	X22EP-U9	1
	400 SRX400	91.7 -96	IX24B	IXU01-□	X24EPR-U9	1
	400 WR400F	98 -00	IU24	IU01-□	U24ESR-N	1
EUROPE & USA	400 XJ400/D/SP/Z/S/Z-E	80.6 -	IX24	IXU01-□	X24ES-U	4
	400 XJR400	93.3 -95.3	IU24	IU01-□	U24ESR-N	4
	400 XJR400/R	95.3 -95.12	IU27	IU01-□	U27ESR-N	4
CROSS REFERENCE	400 XJR400/R II	96.1 -	IU27	IU01-□	U27ESR-N	4
	400 XS400SP	80 -82.5	IW20	IW01-□	W20EP-U	2
	400 XS400SP	82.5 -	IX24	IXU01-□	X24ES-U	2
PART NUMBER	400 XT400	82 -	IX22	IXU01-□	X22ES-U	1
	400 XV400SP	83.3 -	IW22	IW01-□	W22EP-U	4
	400 XV400VIRAGO	87.3 -91.2	IW22	IW01-□	W22EP-U	4
	400 XV400VIRAGO	91.3 -	IW22	IW01-□	W22EPR-U	2
	400 XVS400DRAGSTAR	00.4 -	IX22B	IXU01-□	X22EPR-U9	2
	400 XZ400/D	82 -	IX24	IXU01-□	X24ES-U	2
	400 YF400M-FW(QUAD)	94 -98	IX24	IXU01-□	X24ESR-U	2
	400 YZ400F	98 -99	IU24	IU01-□	U24ESR-N	1
	426 YZ426F	00.10-02.8	IU24	IU01-□	U24ESR-N	1
	450 WR450F	03 -	IU24	IU01-□	U24ESR-N	1
	450 YFZ450(QUAD)	04 -09	IU24	IU01-□	U24ESR-N	1
	450 YFZ450R(QUAD)	10 -	IU24	IU01-□	U24ESR-N	1
	450 YZ450F	02.9 -09	IU24	IU01-□	U24ESR-N	1
	450 YZ450F	09.10-	IU24	IU01-□	U24ESR-N	1
	500 RZV500R	84.5 -	IWF24	-	W24FSR	4
	500 SR500	88.7 -	IW20	IW01-□	W20EPR-U	1
	500 TMAX	01.8 -04.8	IU22	IU01-□	U22ESR-N	2
	500 TMAX	04.9 -08.6	IU22	IU01-□	U22ESR-N	2
	500 TMAX	08.7 -	IU22	IU01-□	U22ESR-N	2
	530 TMAX530	-	IU22	IU01-□	U22ESR-N	2
	530 TMAX530	14.1 -	IU22	-	U22ESR-N	2
	535 XV535/S	-	IW20	IW01-□	W20EPR-U	2

AUSTRALIA	CC MODEL	FROM-TILL	IRIDIUM POWER	IRIDIUM RACING	DENSO	QTY
	<b>YAMAHA</b>					
	535 XV535DX VIRAGO(Import)	-	IW20	IW01-□	W20EPR-U	2
	550 GRIZZLY 550FI(QUAD)	08.9 -	-	-	-	1
	550 XZ550D	81 -	IX24	IXU01-□	X24ES-U	2
	600 FZ6R(Import)	09 -	IU27	IU01-□	U27ESR-N	4
	600 FZ6-S FAZER/N(Import)	04 -	IU27A	IU01-□	U27ETR	4
	600 FZR600	89 -	IU27	IU01-□	U27ESR-N	4
	600 FZS600FAZER	-	IU24	IU01-□	U24ESR-N	4
	600 SRX600	85.4 -91.6	IX22B	IXU01-□	X22EP-U9	1
	600 SRX600	91.7 -92.5	IX24B	IXU01-□	X24EPR-U9	1
	600 TT600R/RE(Import)	-	IX24B	IXU01-□	X24EPR-U9	1
	600 XJ6 DIVERSION/F(Import)	09 -	IU27	IU01-□	U27ESR-N	4
	600 XJ600S/N	92.8 -	IU24	IU01-□	U24ESR-N	4
	600 XJ6N/S(Import)	09 -	IU27	IU01-□	U27ESR-N	4
	600 XT600E	-	IX24B	IXU01-□	X24EPR-U9	1
	600 XT600Z TENERE	83 -	IX22B	IXU01-□	X22EP-U9	1
	600 YZF600R THUNDERCAT	96 -98	IU27	IU01-□	U27ESR-N	4
	600 YZF-R6(Import)	98 -03	IU31A	RU01-□/ IU01-□	U31ETR	4
	600 YZF-R6(Import)	04 -	IU31A	RU01-□/ IU01-□	U31ETR	4
	650 DRAGSTAR650	-	IX22B	IXU01-□	X22EPR-U9	2
	650 XJ650SP	80.7 -	IW22	IW01-□	W22EP-U	4
	650 XS650SP	78 -	IW22	IW01-□	W22EP-U	2
	650 XVS650DRAGSTAR(Import)	98 -	IX22B	IXU01-□	X22EPR-U9	2
	660 GRIZZLY660(QUAD)	04 -	IX24B	IXU01-□	X24EPR-U9	1
	660 MT-03(Import)	06 -	IU22	-	U22ESR-N	1
	660 SZR660(Import)	-	IX24B	IXU01-□	X24EPR-U9	1
	660 XT660R/X(Import)	04 -	IU22	IU01-□	U22ESR-N	1
	660 XTZ660TENERE	92 -	IX24B	IXU01-□	X24EPR-U9	1
	660 YFM660R(QUAD)	03.1 -	IX24B	IXU01-□	X24EPR-U9	1
	700 GRIZZLY 700FI(QUAD)	08.9 -	-	-	-	1
	700 MT-07/07A	14 -	-	-	-	4
	700 YFM700 GRIZZLY(QUAD)	07 -08	IU22D	IU01-□	U22EPR9	1
	750 FZ750	85.4 -	IX24B	IXU01-□	X24EPR-U9	4
	750 FZR750	87.2 -	IX24B	IXU01-□	X24EP-U9	4
	750 FZR750R	89.2 -	IX27	IXU01-□	X27ESR-U	4
	750 FZX750	86.3 -	IX24B	IXU01-□	X24EPR-U9	4
	750 XJ750E/EII/D/A	81 -	IW22	IW01-□	W22EP-U	4
	750 XS750SP	78 -	IW22	IW01-□	W22EP-U	2
	750 XTZ750SUPERTENERE	89 -	IX24B	IXU01-□	X24EPR-U9	2
	750 XV750	-	IW22	IW01-□	W22EPR-U	2
	750 XV750E	82.1 -	IW22	IW01-□	W22EP-U	2
	750 XV750SP	81.3 -	IW22	IW01-□	W22EP-U	2
	750 XV750VIRAGO	81 -	IW22	IW01-□	W22EP-U	2
	750 YZF750SP	93.2 -	IU27	RU01-□	U27ESR-N	4
	750 YZF-R7	-	-	RU01-□/ IU01-□	RU01-31	4
	800 FAZER8/ABS	10 -	IU27	IU01-□	U27ESR-N	4
	800 FZ8-N/S	10 -	IU27	IU01-□	U27ESR-N	4
	850 MT-09	14.4 -	IU27D	IU01-□	U27EPR9	3
	850 TDM850	91 -93.4	IX24B	IXU01-□	X24EPR-U9	2
	850 TDM850	93.5 -94.1	IX27B	IXU01-□	X27EPR-U9	2
	850 TDM850	94.2 -01	IX24B	IXU01-□	X24EPR-U9	2
	850 TRX850	95.3 -99	IX24B	IXU01-□	X24EPR-U9	2
	900 TDM900	02 -	IX24B	IXU01-□	X24EPR-U9	2
	900 XJ900S DIVERSION	95 -03	IX24B	IXU01-□	X24EPR-U9	4
	950 BOLT/BOLT-R	13.12-	IU22D	IU01-□	U22EPR-U	2
	950 XVS950A(Import)	09 -	IU22D	IU01-□	U22EPR9	2
	1000 FZ1 FAZER(Import)	06 -	IU27A	RU01-□/ IU01-□	U27ETR	4
	1000 FZ1/Fazer	08.2 -	IU27A	IU01-□	U27ETR	4
	1000 FZR1000	87 -	IX24	IXU01-□	X24ESR-U	4
	1000 FZS1000FAZER	01 -	IU27	IU01-□	U27ESR-N	4
	1000 GTS1000/A	93 -	IX24B	IXU01-□	X24EPR-U9	4
	1000 YZF1000R/THUNDERACE	96 -	IX24	IXU01-□	X24ESR-U	4
	1000 YZF-R1	09.6 -	-	-	-	4

DENSO	9	14	16	20	22	24	27	29	31	32	35	DENSO	9	14	16	20	22	24	27	31	DENSO	9	14	16	20	22	24	27	31			
NGK	2	4	5	6	7	8	9	9.5	10	10.5	11	11.5	CHAMPION	18	16,14	12,11	10,9	8,7	6,63,61	4,59	57	55	53	BOSCH	10	9	8	7,6	5	4	3	2





CC	MODEL	FROM-TILL	IRIDIUM POWER	IRIDIUM RACING	DENSO	QTY
<b>YAMAHA</b>						
1000	YZF-R1(Import)	98 -01	IU27	RU01-□/ IU01-□	U27ESR-N	4
1000	YZF-R1(Import)	02 -03	IU27D	RU01-□/ IU01-□	IU27D	4
1000	YZF-R1(Import)	04 -08	IU27A	RU01-□/ IU01-□	U27ETR	4
1000	YZF-R1(Import)	09 -	-	-	-	4
1100	BT1100BULLDOG(Import)	02 -	IW22	IW01-□	W22EPR-U	2
1100	XV1100VIRAGO	95.2 -	IW22	IW01-□	W22EPR-U	2
1100	XVS1100 DRAGSTAR 11	99.3 -	IW22	IW01-□	W22EPR-U	2
1100	XVS1100A DRAGSTAR 11 CLASSIC	00.3 -	IW22	IW01-□	W22EPR-U	2
1200	FJ1200	91.3 -	IX24B	IXU01-□	X24EPR-U9	4
1200	V-MAX	85 -07	IX24B	IXU01-□	X24EPR-U9	4
1200	XJR1200/R	94.3 -98.3	IX24B	IXU01-□	X24EPR-U9	4
1200	XT1200Z SuperTenera(Import)	10 -	IU24D	IU01-□	-	4
1300	FJR1300/A	01 -13.12	IU24	IU01-□	U24ESR-N	4

CC	MODEL	FROM-TILL	IRIDIUM POWER	IRIDIUM RACING	DENSO	QTY
<b>YAMAHA</b>						
1300	FJR1300/A	13.12-	IU24D	IU01-□	U24EPR9	4
1300	FJR1300A/AS	06 -13.12	IU24	IU01-□	U24ESR-N	4
1300	FJR1300A/AS	13.12-	IU24D	IU01-□	U24EPR9	4
1300	ROYALSTAR VENTURE	97 -	IX24B	IXU01-□	X24EPR-U9	4
1300	ROYALSTAR/TOURCLASSIC	96.4 -98	IX22B	IXU01-□	X22EPR-U9	4
1300	XJR1300	06.10-	IX24B	IXU01-□	X24EPR-U9	4
1300	XJR1300/SP	98.3 -06.9	IX24B	IXU01-□	X24EPR-U9	4
1300	XVS1300(Import)	07 -	-	-	-	2
1300	XVZ1300A ROYALSTAR	96 -98	IX22B	IXU01-□	X22EPR-U9	4
1600	XV1600ROADSTAR	99 -	IX22B	IXU01-□	X22EPR-U9	4
1600	XV1600ROADSTAR(Import)	99 -00	IX22B	IXU01-□	X22EPR-U9	4
1680	VMAX	09.4 -	IU27D	IU01-□	IU27D	4
1680	VMAX(Import)	09 -	IU27D	IU01-□	IU27D	4
1700	MT-01(Import)	05 -	IX22B	IXU01-□	X22EPR-U9	4
1700	ROADSTAR WARRIOR XV1700	02 -	IX22B	IXU01-□	X22EPR-U9	4
1900	XU1900A/CU(Import)	06 -	IX24B	IXU01-□	X24EPR-U9	4

AUSTRALIA  
CHINA  
INDIA  
INDONESIA  
KOREA  
MALAYSIA  
PHILIPPINES  
SAUDIARABIA  
SINGAPORE  
TAIWAN  
THAILAND  
VIETNAM  
JAPAN  
EUROPE & USA  
CROSS REFERENCE NUMBER  
PART



# RACING KART

	MAKER	CC	ENGINE	COOLING	IRIDIUM POWER	IRIDIUM RACING	
AUSTRALIA	BILAND	250	SA250	WATER	IU24A	IU01-□	
	COMER	60	S60·W60	AIR	IWF22	-	
		80	K80·W80	AIR	IWF22	-	
		100	351L/VT/VTI	AIR	IWF31	IW01-□	
CHINA	CRG		S-10T1·S-20T1	-	IWF31	IW01-□	
			- SS97/98/99·SW97/98/99	-	IWF31	IW01-□	
			WTP60	-	IWF27	IW01-□	
	FOX	100	RTW	WATER	IWF31	IW01-□	
INDIA	FUJI ROBIN		- EC03/04/05	-	IWF22	-	
	HETSCHEL	100	KZH 100D/100M	AIR/WATER	IWF31	IW01-□	
INDONESIA	HONDA	120	GX120	AIR	IWF20	IW01-□	
		160	GX160	AIR	IWF20	IW01-□	
		200	GX200	AIR	IWF20	IW01-□	
		270	GX270	AIR	IWF20	IW01-□	
KOREA	HRT	100	REED·ROTARY	WATER	IWF31	IW01-□	
		IAME	60	Parilla 60GAZELLE/SWIFT	AIR	IWF31	IW01-□
			80	Parilla 80LEVRIER	AIR	IWF31	IW01-□
MALAYSIA	98.3	Komet K55/Super		AIR	IWF31	IW01-□	
		Parilla 100·Sirio 100		AIR	IWF31	IW01-□	
		Parilla REEDJET RL/MAXI-RL		WATER	IWF31	IW01-□	
		Parilla REEDJET JP.S		AIR	IWF31	IW01-□	
		Parilla TT37/38/39		AIR	IWF31	IW01-□	
		Parilla TT38/39/40		WATER	IWF31	IW01-□	
		Sirio RAP95/TT53/TT56		AIR	IWF31	IW01-□	
PHILIPPINES	120	Komet Panther TaG		AIR	IWF31	IW01-□	
		Parilla LEOPARD125 TaG		WATER	IWF31	IW01-□	
		- Parilla MAG95		-	IWF31	IW01-□	
		125 X30 125 RL		WATER	IWF31	IW01-□	
SAUDI ARABIA	ITAL SYSTEM	ML21·ML31·MV21·MV31		AIR	IWF31	IW01-□	
		99 SL11·SL21·SV11·SV21		AIR	IWF31	IW01-□	
		SV31·ML41·MV41		WATER	IWF31	IW01-□	
SINGAPORE	MAXTER	100	MX-L·MX-V	WATER	IWF31	IW01-□	
		MUGEN	100	MKR100AI	AIR	IWF31	IW01-□
TAIWAN	PCR	98.1	TSV98·TSL98·PV50	AIR	IWF31	IW01-□	
		100	PV50W	WATER	IWF31	IW01-□	
		PRD	100	RK100/C/EH	AIR	IWF27	IW01-□
125	AVANTI FIREBALL		AIR WATER	IWF27	IW01-□		
THAILAND	ROTAX	99.27	DS-FR	WATER	IWF31	IW01-□	
		100	DS-DL/DR·DS-EL/ER		AIR	IWF31	IW01-□
			VM95·VME		WATER	IWF31	IW01-□
		125	125MAX DD2		WATER	IWF27☆	IW01-□
			FR125MAX/JUNIOR MAX(From 02 ~ ) FR125MAX/JUNIOR MAX(Up to 01) FR125Mini MAX		WATER WATER WATER	IWF27☆ IWF31☆ IWF27☆	IW01-□ IW01-□ IW01-□
VIETNAM	SUBARU	130	EX13	AIR	IWF22	-	
		170	EX17	AIR	IWF22	-	
		210	EX21	AIR	IWF22	-	
		270	EX27	AIR	IWF22	-	
		210	KX21	AIR	IWF22	-	
JAPAN	TITAN	100	LL-1/2/3·RV-1·RV-2	AIR	IWF31	IW01-□	
	TKM	200	-	WATER	IU31	IU01-□	
	TM RACING	99.15	K11·K12	WATER	IWF31	IW01-□	
EUROPE & USA	TOHATSU	- K-470 II		-	IWF27	IW01-□	
		VORTEX	VL/B/C/95/95C		AIR	IWF31	IW01-□
			100 VL/CW·VL/BW VR/C/CW/95/95C		WATER AIR	IWF31 IWF31	IW01-□ IW01-□
			125 ROK125 SUPER ROK125		WATER WATER	IWF31 IWF31	IW01-□ IW01-□
CROSS REFERENCE NUMBER	YAMAHA	80	YZ80SK	WATER	IWF31	IW01-□	
		85	YZ85	WATER	IWF31	IW01-□	
		97.6	KT100FP/AZ/SC/SD/SEC		AIR	IWF27	IW01-□
			KT100J KT100SP·KT100FA		AIR AIR	IWF24 IWF31	IW01-□ IW01-□
		125	YZ125		WATER	IWF27	IW01-□
			FK250		AIR	IU27A	IU01-□
		PART NUMBER	250	M250WR-F		WATER	IU24
WR250FK				WATER	IU24	IU01-□	

☆ Denso's Genuine Parts share: 100%

(Note) When driving vehicles with water-cooled engines using IW01-□, there are cases where the plug comes in contact with the driver's arm; if this is the case, please use the following plug types, which have short heads: IWM01-□, IAE01-□.

# MARINE, JETSKI & SNOWMOBILE



MODEL	ENGINE	IRIDIUM POWER	IRIDIUM RACING	DENSO	
<b>ARCTIC CAT</b>					AUSTRALIA
<b>SNOWMOBILE</b>	F7 Firecat EFI	IW27	IW01-□	W27ESR	
	F5 Firecat	IW27	IW01-□	W27ESR	
	Mountain Cat 570	IW27	IW01-□	W27ESR	
	Mountain Cat 600 EFI	IW27	IW01-□	W27ESR	
	Mountain Cat 800 EFI	IW27	IW01-□	W27ESR	
	Mountain Cat 900	IW27	IW01-□	W27ESR	
<b>BOMBARDIER</b>					CHINA
<b>SEA-DOO</b>	150 SPEEDSTER	IXU24	IXU01-□	-	
	180 CHALLENGER SE	IXU24	IXU01-□	-	
	200 SPEEDSTER	IXU24	IXU01-□	-	
	205 UTOPIA SE	IXU24	IXU01-□	-	
	230 CHALLENGER SE/SP	IXU24	IXU01-□	-	
	230 WAKE	IXU24	IXU01-□	-	
	CHALLENGER1800/2000/X-20	IWF24	-	W24FPR-U10	
	GSX · GSX-L · GTI · GTI-rx · GTX · GTX-L · LRV	IW24	IW01-□	W24ESR	
	GTI 130/SE 130/SE 155	IXU24	IXU01-□	-	
	GTI-RFI/LE RFI	IW24	IW01-□	W24ESR	
	GTX 155/iS 215 · GTX LTD iS 255	IXU24	IXU01-□	-	
	GTX 4-TEC LTD SC	IXU24	IXU01-□	-	
	GTX 4-TEC Supercharged/LTD	IXU24	IXU01-□	-	
	GTX 4-TEC/WAKEBOARD/WE	IXU24	IXU01-□	-	
	GTX-RFI · HX · SPX · XP · XP-L	IW24	IW01-□	W24ESR	
	ISLAND SPEEDSTAR	IWF24	-	W24FPR-U10	
	ISLANDIA SE	IXU24	IXU01-□	-	
	RX-DI · GTX-DI(00.4 ~ )	IK16	IK01-□	KJ14CR-L11	
	RXP	IXU24	IXU01-□	-	
	RXP 215 · RXP-X 255 RS	IXU24	IXU01-□	-	
	RXT 215/iS 255 · RXT-X 255RS	IXU24	IXU01-□	-	
	SPEEDSTER 200	IXU24	IXU01-□	-	
	SPEEDSTER WAKE	IXU24	IXU01-□	-	
	SPORTSTER 4-TEC	IXU24	IXU01-□	-	
	SPORTSTER/1800	IW24	IW01-□	W24ESR	
	WAKE 155/PRO 215	IXU24	IXU01-□	XU24EPR-U	
	XP DI · LRV-DI	IK16	IK01-□	KJ14CR-L11	
	YUTOPIA185/205	IWF24	-	W24FPR-U10	
<b>SKI-DOO</b>	EXPEDITION SPORT	IW27	IW01-□	W27ESR	
	EXPEDITION TUV(12mmHead)	IXU24	IXU01-□	-	
	EXPEDITION TUV(14mmHead)	IW27	IW01-□	W27ESR	
	FORMULA III 700 · Z583/500/500S/500E	IW27	IW01-□	W27ESR	
	GRAND TOURING SE583/500	IW27	IW01-□	W27ESR	
	GSX FAN(380F) · GSX FAN(550F)	IW27	IW01-□	W27ESR	
	GTX FAN · GTX SPORT	IW27	IW01-□	W27ESR	
	MACH 1	IW27	IW01-□	W27ESR	
	MACH Z(98)	IW31	IW01-□	W31ESR-U	
	MACH Z(99)	IW27	IW01-□	W27ESR	
	MINI Z	IW20	IW01-□	W20EPR-U	
	MXZ 670 H.O/670/600/500/440	IW27	IW01-□	W27ESR	
	MXZ FAN/RenegadeX	IW27	IW01-□	W27ESR	
	MXZ X(600H0 · 600H0 SDI · 800H0)	IW27	IW01-□	W27ESR	
	SKANDIC LT	IW27	IW01-□	W27ESR	
	SKANDIC SUV(550F)	IW27	IW01-□	W27ESR	
	SKANDIC SUV(600)	IW27	IW01-□	W27ESR	
	SKANDIC SWT/WT/WT(LC)500/380	IW27	IW01-□	W27ESR	
	SKANDIC TUNDRA	IW27	IW01-□	W27ESR	
	SUMMIT 670/600/583/500	IW27	IW01-□	W27ESR	
	SUMMIT ADRENALINE 144(600H0)	IW27	IW01-□	W27ESR	
	SUMMIT ADRENALINE 144(800H0)	IW27	IW01-□	W27ESR	
	SUMMIT FAN	IW27	IW01-□	W27ESR	
	SUMMIT X 144	IW27	IW01-□	W27ESR	
	SUMMIT X 151	IW27	IW01-□	W27ESR	
	SUMMIT X 159	IW27	IW01-□	W27ESR	
	TOURING SLE/LE/E	IW27	IW01-□	W27ESR	
	TUNDRA R	IW27	IW01-□	W27ESR	
<b>HONDA</b>					INDIA
<b>OUTBOARD</b>	BF2A	-	-	W14MR-U	
	BF2D(2000 ~ )	IUF14-UB	-	U14FSR-UB	
	BF2D( ~ 99)	IUF14-UB	-	U16FSR-UB	
<b>DENSO</b>					INDONESIA
DENSO	9	14	16	20	
NGK	2	4	5	6	
<b>DENSO</b>					KOREA
DENSO	9	14	16	20	
CHAMPION	18	16,14	12,11	10,9	
<b>DENSO</b>					MALAYSIA
DENSO	9	14	16	20	
BOSCH	10	9	8	7,6	
<b>DENSO</b>					PHILIPPINES
DENSO	9	14	16	20	
BOSCH	10	9	8	7,6	
<b>DENSO</b>					SAUDI ARABIA
DENSO	9	14	16	20	
BOSCH	10	9	8	7,6	
<b>DENSO</b>					SINGAPORE
DENSO	9	14	16	20	
BOSCH	10	9	8	7,6	
<b>DENSO</b>					TAIWAN
DENSO	9	14	16	20	
BOSCH	10	9	8	7,6	
<b>DENSO</b>					THAILAND
DENSO	9	14	16	20	
BOSCH	10	9	8	7,6	
<b>DENSO</b>					VIETNAM
DENSO	9	14	16	20	
BOSCH	10	9	8	7,6	
<b>DENSO</b>					JAPAN
DENSO	9	14	16	20	
BOSCH	10	9	8	7,6	
<b>DENSO</b>					EUROPE & USA
DENSO	9	14	16	20	
BOSCH	10	9	8	7,6	
<b>DENSO</b>					CROSS REFERENCE NUMBER
DENSO	9	14	16	20	
BOSCH	10	9	8	7,6	
<b>DENSO</b>					PART NUMBER
DENSO	9	14	16	20	
BOSCH	10	9	8	7,6	

AUSTRALIA  
 CHINA  
 INDIA  
 INDONESIA  
 KOREA  
 MALAYSIA  
 PHILIPPINES  
 SAUDI ARABIA  
 SINGAPORE  
 TAIWAN  
 THAILAND  
 VIETNAM  
 JAPAN  
 EUROPE & USA  
 CROSS REFERENCE NUMBER  
 PART NUMBER

DENSO	9	14	16	20	22	24	27	29	31	32	34	35	DENSO	9	14	16	20	22	24	27	29	31	32	DENSO	9	14	16	20	22	24	27	31
NGK	2	4	5	6	7	8	9	9.5	10	10.5	11	11.5	CHAMPION	18	16,14	12,11	10,9	8,7	6,63,61	4,59	57	55	53	BOSCH	10	9	8	7,6	5	4	3	2



# MARINE, JETSKI & SNOWMOBILE

	MODEL	ENGINE	IRIDIUM POWER	IRIDIUM RACING	DENSO
AUSTRALIA	<b>HONDA</b>				
	<b>OUTBOARD</b>				
CHINA		BF50	IW16	IW01-□	W16EPR-U
		BF5A · BF5AK	IW16	IW01-□	W16EPR-U
		BF8A/M/9.9A/35A/45A/75/100	-	-	X16FSR-U
		BF8D/9.9D/15D/20D	-	IU01-□	U16FER9
		BF9.9A/15A	-	-	X20FSR-U
		BF25/25A/25D/30/30A/30D/35A/35AM/40/40A	IX22	IXU01-□	X22ESR-U
INDIA		BF40D/50D	IX22	IXU01-□	X22ESR-UB
		BF45A/45AM/50/50A	IX22	IXU01-□	X22ESR-U
		BF60A/BFP60A	-	-	-
		BF75AT/90AT	IX22	IXU01-□	X22ESR-U
INDONESIA		BF75D/90D	-	-	-
		BF115A/130A	IK22	IK01-□	KJ22CR-L8
		BF115(10.6 ~)	IK20	IK01-□	KJ20DR-M11
		BF135A(03 ~ 10)/BF150A(03 ~ 10)	IK20	IK01-□	SKJ20DR-M11
		BF135/150(10.6 ~)	IK20	IK01-□	KJ20DR-M11
KOREA		BF220/225(01.10 ~) · BF175A/200A/225A	-	IK01-□	VKJ20RZM11
	<b>HSR-BENELLI</b>				
MALAYSIA	<b>PWC</b>				
		S4 STANDUP	IK22	IK01-□	IK22
PHILIPPINES		S4 PRO EDITION	IK22	IK01-□	IK22
	<b>KAWASAKI</b>				
SAUDI ARABIA	<b>JET SKI</b>				
		JET MATE(650)	IW22	IW01-□	W22ESR-U
SINGAPORE		JET SKI 300·440·650SX/X-2/TS/SC	IW22	IW01-□	W22ESR-U
		JET SKI 550(61 ~)	IW24	IW01-□	W24ESR
TAIWAN		JET SKI 550SX	IW24	IW01-□	W24ESR
		JET SKI 750SX/Sxi/SXi PRO/ST/STX/STS	IW24	IW01-□	W24ESR
THAILAND		JET SKI 750Xi/Zxi/Xi Sport/X-4	IW24	IW01-□	W24ESR
		JET SKI 800SX-R	IW24	IW01-□	W24ESR
VIETNAM		JET SKI 900STX/STA/Zxi/STS · 1100STX/ZXi	IW27	IW01-□	W27ESR
		JET SKI 1100STX D.I.(00.4 ~)	-	-	-
JAPAN		JET SKI 1200STX-R	IW27	IW01-□	W27ESR
		JET SKI Ultra 130D.I.	-	-	-
EUROPE & USA		JET SKI Ultra 150(JH1200-A2 ~)	IW27	IW01-□	W27ESR
		JET SKI Ultra 150(JH1200-A1)	-	IW01-□	IW01-27
CROSS REFERENCE		JET SKI Ultra 150(1200cc)(99.1 ~ 99.12)	-	IW01-□	IW01-27
		JET SKI Ultra 150(1200cc)(00.1 ~)	IW27	IW01-□	W27ESR
PART NUMBER		JET SKI Ultra 250X(07 ~)	IU27	IU01-□	-
		JET SKI Ultra 260X/LX	IU27	IU01-□	-
	JET SKI Ultra LX(07 ~)	IU27A	IU01-□	U27ETR	
	JET SKI Ultra 300X(1500cc)(11.4 ~)	IU27	IU01-□	-	
	JET SKI Ultra 300LX(1500cc)(11.5 ~)	IU27	IU01-□	-	
	JET SKI ST/STX/STS(750cc)	IW24	IW01-□	W24ESR	
	JET SKI STX-12F/15F/15S	IU27A	IU01-□	U27ETR	
	JET SKI X-2(800cc)	IW24	IW01-□	W24ESR	
	JET SKI X-4/ZXi	IW24	IW01-□	W24ESR	
	JET SKI Xi/Xi Sport(750cc)	IW24	IW01-□	W24ESR	
<b>MERCURY</b>					
<b>OUTBOARD</b>					
		FourStroke 30/40/50/60	IXU22	IXU01-□	XU22EPR-U
		FourStroke 5	IXU22	IXU01-□	XU20EPR-U
		FourStroke 75/90/115	IKH16	IKH01-□	K16HPR-U11
		Optimax 115L/135/150/175/200/225	IK16	IK01-□	PKJ16CR-L11
		Optimax 90L/250XS	-	-	-
		ProMax 200XS	-	-	-
		ProMax 225X	IW24	IW01-□	IW24
		ProMax 250XB	IWF27	-	W27FSR
		ProMax 300X	IWF27	-	IWF27
		SeaPro 8/9.8	IWF22	-	W22FP-U
		SeaPro 10/15/18/25/40	IWF24	-	W24FPR-U10
		Standard 3.3	IWF20	-	W20FPR-U10
		Standard 4/5	IWF22	-	W22FPR-U
		Standard 30/40/50/60	IWF24	-	W24FPR-U10
		Standard 75/90	-	-	SF51
		Standard 115/125	IWF24	-	W24FPR-U10
		Standard 140/150XRi/200XRi/200L XRi	IWF24	-	W24FPR-U10
		Standard 225XRi/250XRi/250L XRi	IWF24	-	W24FSR
		Supercharged 225/250(2006 ~)4stroke,6cyl.	IKH22	IKH01-□	VKH22
		Verado 225/250(2004 ~)4stroke,6cyl.	IKH22	IKH01-□	VKH22

# MARINE, JETSKI & SNOWMOBILE



MODEL	ENGINE	IRIDIUM POWER	IRIDIUM RACING	DENSO	
<b>NISSAN</b>					AUSTRALIA CHINA INDIA INDONESIA KOREA MALAYSIA PHILIPPINES SAUDIARABIA SINGAPORE TAIWAN THAILAND VIETNAM JAPAN EUROPE & USA CROSS REFERENCE PART NUMBER
<b>INBOARD</b>					
	HA100S/120S	-	IW01-□	W16ESR-U	
	VGA30E/30ET	IQ20	IQ01-□	Q20PR-U11	
	YA190S	IW16	IW01-□	W14EPR-U	
<b>OUTBOARD</b>					
	NS5B/8B	IWF22	-	W22FP-U10	
	NS3.5A	IWF20	-	W20FPR-U10	
	NS9.9B/9.9B2/12C/12C2/15B/15B2	IWF22	-	W22FS-U10	
	NS18C/18C2/25C/25C2/30A2/30A3	IWF22	-	W22FS-U10	
	NS35C/40C/40D	IWF22	-	W22FS-U10	
	NS45A/50C/50D/55B/60A/70A/70A2/90A	IWF24	-	W24FSR-U10	
	NV120A/140A	IWF24	-	W24FSR-U10	
	BF2D	IUF14-UB	-	U16FSR-UB	
	BF5A	IW16	IW01-□	W16EPR-U	
	BF8A/9.9A	-	-	X16FSR-U	
	BF15A	-	-	X20FSR-U	
	BF25A/30A/40A/50A	IX22	IXU01-□	X22ESR-U	
	BF75A/90A	IX22	IXU01-□	X22ESR-U	
	BF115A/130A	IK22	IK01-□	KJ22CR-L8	
<b>WATERJET</b>					
	HA145J/170J	IW22	IW01-□	W22ESR-U	
	VG30ETJ	IQ20	IQ01-□	Q20PR-U11	
	YA190J	IW16	IW01-□	W14EPR-U	
<b>POLARIS</b>					
<b>PWC</b>					
	GENESIS	IW27	IW01-□	W27ESR	
	GENESIS i · TSX140 · VIRAGE Txi	-	-	-	
	OCTANE · PRO1200 · VIRAGE TX	IW27	IW01-□	W27ESR	
	SL750 · SLT750	IW22	IW01-□	W22EPR-U	
	SL780	IW24	IW01-□	W24EPR-U	
<b>SNOWMOBILE</b>					
	120 PRO X(04 ~ )	-	IW01-□	W20ESR-U	
	600 RMK(03 ~ )	IW27	IW01-□	IW27	
	Frontier Classic(03 ~ )	IK16	IK01-□	K16PR-U	
	Frontier Touring(03 ~ )	IK16	IK01-□	K16PR-U	
	INDY 120 XC SP	-	IW01-□	W20ESR-U	
	INDY 500 XC SP	IW29	IW01-□	-	
	INDY 700 RMK Vertical EDGE	IW29	IW01-□	-	
	INDY 800 PRO X/X2/XR(03 ~ )	IW29	IW01-□	-	
	INDY 800 RMK Vertical Escape	IW29	IW01-□	-	
	INDY LITE 340(91 ~ 98)	IW24	IW01-□	W24ESR	
	INDY LITE/TRAIL/TRAIL TOURING	IW24	IW01-□	-	
	INDY STORM 800(94 ~ 98)	IW27	IW01-□	W27ESR	
	INDY STORM RMK	IW24	IW01-□	-	
	INDY STORM RMK 800(97)	IW27	IW01-□	W27ESR	
	INDY TRAIL 500(95 ~ 97)	IW27	IW01-□	W27ESR	
	INDY TRAIL 500(98 ~ 99)	IW24	IW01-□	W24ESR	
	INDY TRAIL RMK	IW27	IW01-□	W27ESR	
	INDY TRAIL RMK 550(99 ~ )	IW27	IW01-□	W27ESR	
	INDY TRAIL TOURING 550(00)	IW24	IW01-□	W24ESR	
	INDY TRAIL TOURING 550(02 ~ )	IW27	IW01-□	W27ESR	
	INDY WIDETRAK LX	IW24	IW01-□	W24ESR	
	INDY XCR 440(95 ~ 98)	IW27	IW01-□	W27ESR	
	INDY XCR 600(95 ~ 98)	IW27	IW01-□	W27ESR	
	INDY XLT PMK/440XCR/600XCR	IW24	IW01-□	-	
	INDY XLT SP 600(97 ~ 99)	IW27	IW01-□	W27ESR	
	INDY XLT/600XCRSP	IW27	IW01-□	-	
	WIDE TRAK LX/500/500EFI	IW24	IW01-□	-	
<b>SUZUKI</b>					
<b>JETBOAT</b>					
	PJ650(05501J)(STINGER JET I )	IW24	IW01-□	W24ESR	
	PJ650(05501J)(STINGER JET II )	IW24	IW01-□	W24ESR	
	TIGER SHARK(BARRACUDA · DAYTONA)	IW27	IW01-□	W27ESR	
	TIGER SHARK( MONDEGO · MONTECARO)	IW27	IW01-□	W27ESR	
<b>OUTBOARD</b>					
	DF2	IUF22	-	U20FSR-U	
	DF5	IU20	IU01-□	U20EPR9	
	DF8/8E/9.9/9.9E(09.7 ~ )	IU20	IU01-□	U20ESR-N	
	DF9.9/15/25/30/40/50	IXU22	IXU01-□	XU20EPR-U	
	DF9.9/9.9E( ~ 09.6)	IK20	IK01-□	K20PR-U	
	DF15E	IK20	IK01-□	K20PR-U	
	DF25R/25E	IK20	IK01-□	K20PR-U	
	DF30T/30QE	IXU22	IXU01-□	XU20EPR-U	
	DF40T/40QH	IXU22	IXU01-□	XU20EPR-U	

DENSO	9	14	16	20	22	24	27	29	31	32	34	35	DENSO	9	14	16	20	22	24	27	31	32	DENSO	9	14	16	20	22	24	27	31	
NGK	2	4	5	6	7	8	9	9.5	10	10.5	11	11.5	CHAMPION	18	16,14	12,11	10,9	8,7	6,63,61	4,59	57	55	53	BOSCH	10	9	8	7,6	5	4	3	2



# MARINE, JETSKI & SNOWMOBILE

	MODEL	ENGINE	IRIDIUM POWER	IRIDIUM RACING	DENSO
AUSTRALIA	<b>SUZUKI</b>				
	<b>OUTBOARD</b>				
CHINA	DF50T/50TH/50QH		IXU22	IXU01-□	XU20EPR-U
	DF60/70		IW16	IW01-□	W16EPR-U
INDIA	DF60T		IW20	IW01-□	W20EPR-U
	DF60T/TH(09.12 ~ )		IXU22	IXU01-□	XU20EPR-U
INDONESIA	DF70T/70TH( ~ 08.7)		IW20	IW01-□	W20EPR-U
	DF70T/70TH(08.8 ~ )		IXU22	IXU01-□	XU20EPR-U
KOREA	DF90/115/140		IK20	IK01-□	K20PR-U
	DF80T/80TH		IXU22	IXU01-□	XU20EPR-U
MALAYSIA	DF90T( ~ 08.7)		IK20	IK01-□	K20PR-U
	DF90T/90TH(08.8 ~ )		IXU22	IXU01-□	XU20EPR-U
PHILIPPINES	DF100T		IK20	IK01-□	K20PR-U
	DF115T/115Z		IK20	IK01-□	K20PR-U
SAUDI ARABIA	DF140T		IK20	IK01-□	K20PR-U
	DF150T/150Z		IK20	IK01-□	K20PR-U
SINGAPORE	DF175T/175Z		IK20	IK01-□	K20PR-U
	DF200T/200Z		IK20	IK01-□	K20PR-U
TAIWAN	DF225T/225Z		IK20	IK01-□	K20PR-U
	DF250T/250Z		IK20	IK01-□	K20PR-U
THAILAND	DF300T/300Z		IK20	IK01-□	K20PR-U
	DT2( ~ 90)		-	-	W14FR-U
VIETNAM	DT2(91 ~ ) · DT2.2(97 ~ )		-	-	W16FSR
	DT3.5/5( ~ 94)/5W/8		IWF20	-	W20FR-U
JAPAN	DT4(85 ~ ) · J2 · J4		IWF16	-	W16FPR-U
	DT5Y		IWF22	-	W22FSR
EUROPE & USA	DT5(95 ~ ) · DT6 · DT9(87 ~ )		IWF22	-	W20FSR-U
	DT9.9K/16P/20P/25P		IWF22	-	W22FSR
CROSS REFERENCE	DT9.9(83 ~ ) · DT15(83 ~ )		IWF22	-	W22FS-U10
	DT20/25/25K/30/30C		IWF22	-	W22FS-U10
PART NUMBER	DT35AC/36K/40WK/50K		IWF22	-	W22FS-U10
	DT40/40C/50/50C/55C/55TC		IWF24	-	W24FSR-U10
	DT65C/65TC/75TC/85TC		IWF24	-	W24FSR-U10
	DT90TC/100TC/115TC/140TC/150TC		IWF24	-	W24FSR-U10
	DT150YC		IWF24	-	W24FSR-U10
	DT175TC/200TC		IWF24	-	W24FSR-U10
	<b>TOHATSU</b>				
	<b>OUTBOARD</b>				
	M2.5A/A2 · M3.5A/A2 · M3.5B/B2		IWF20	-	W20FPR-U10
	M4C/5B/5BS/6B/8B/9.8B		IWF22	-	W22FP-U10
	M9.9C/9.9D/9.9D2/15C/15D/15D2		IWF22	-	W22FS-U10
	M18D/18E/18E2/25C2/25C3		IWF22	-	W22FS-U10
	M30A3/30A4/35C/40C/40D/40D2		IWF22	-	W22FS-U10
	M50D/50D2/60B/60C/70B/70C/80A		IWF24	-	W24FSR-U10
	M90A/120A/120A2/140A/140A2		IWF24	-	W24FSR-U10
	MFS9.9B/15B/18B		IXU22	IXU01-□	XU20EPR-U
	MFS4A/5A/6A		IXU22	IXU01-□	XU20EPR-U
	MFS8A/9.8A/25A/30A		IXU22	IXU01-□	XU20EPR-U
	TLDI 40B/50B/70B/90B		-	-	-
	<b>YAMAHA</b>				
	<b>MARINEJET</b>				
	EXCITER 1430TR/SPORT		IWF24	-	W24FSR
	EXCITER LS2000		IWF24	-	W24FSR
	MJ-650M		IWF24	-	W24FS-U
	MJ-700FX/SJ/TZT/XL		IWF22	-	W22FS-U
	MJ-700FX/SJ/TZT/XL · MJ-SJ700		IWF22	-	W22FSR
	MJ-700RA/ST/TL/TZ/VN/VNR/VN LTD		IWF24	-	W24FSR
	MJ-700XL LTD · MJ-XL700/LTD		IWF24	-	W24FSR
	MJ-760GP/RA/RZ/VN/VN LTD/XL		IWF24	-	W24FSR
	MJ-800GP( ~ 98) · MJ-1100RA · MJ-1200GP/XL/SUV		IWF24	-	W24FSR
	MJ-800GP(99 ~ ) · MJ-800TZ/XL · MJ-1200XLL		IW24	IW01-□	W24ESR
	MJ-800R/GP · EXCITER1430TR/SPORT		IW24	IW01-□	W24ESR
	MJ-1100VN(97 ~ )		IWF24	-	W24FSR
	MJ-1200R/GP/XLT		IW24	IW01-□	W24ESR
	MJ-FX Cruiser High Output(FX1100)(06 ~ )		IU27	IU01-□	U27ESR-NB
	MJ-FX SHO/Cruiser SHO		IKH20	IKH01-□	-
	MJ-FX140/CRUISER · MJ-FX160/CRUISER		IU27	IU01-□	U27ESR-NB
	MJ-FZR		IKH20	IKH01-□	-
	MJ-FZS		IKH20	IKH01-□	-
	MJ-GP1200R/RC(00.5 ~ ) · MJ-XL1200LTD		IW24	IW01-□	-
	MJ-GP1300R		IW24	IW01-□	W24ESR

# MARINE, JETSKI & SNOWMOBILE



MODEL	ENGINE	IRIDIUM POWER	IRIDIUM RACING	DENSO		
<b>YAMAHA</b>					<b>AUSTRALIA</b>	
<b>MARINEJET</b>						
	MJ-GP800R/XLT800	IW24	IW01-□	W24ESR		
	MJ-SJ700(02 ~ )	IWF22	-	W22FS-U		
	MJ-Super Jet	IWF22	-	W22FS-U		
	MJ-SUV1200	IWF24	-	W24FSR		
	MJ-VX/DX/Cruiser	IU27	IU01-□	U27ESR-NB		
	MJ-VX110DX/SP(VX1100)(06 ~ )	IU27	IU01-□	U27ESR-NB		
	MJ-XL800(00.3 ~ )	IW24	IW01-□	W24ESR		
	MJ-XL1200LTD(03 ~ )	IW24	IW01-□	W24ESR		
	MJ-XLT1200/GP1200R	IW24	IW01-□	W24ESR	<b>CHINA</b>	
<b>OUTBOARD</b>						
	2B · 5D	-	-	W16FSR		
	2C · 4A/AC/AS · 4B · 4BC · 5C/CS · 20C/CM/CEM	IWF22	-	W22FSR		
	3A · 6D · F4A · EK8D	IWF22	-	W20FSR-U		
	6CEM/CM · 8CEM/CM · 9.9D/DE · 15D/DE	IWF22	-	W22FS-U10		
	9.9D/DE · 15D/DE · 20DEN/DM	IWF22	-	W22FS-U10		
	9.9F · 13.5F · 15F · 20D · 25J/N/V · 30D · 40V	IWF22	-	W22FS-U10		
	13.5A · 25B · 25J · 25N · 25V · 30D	IWF22	-	W22FS-U10		
	20DEM/DM · 25NE/NEH/NM/GE/GEM/GM	IWF22	-	W22FS-U10	<b>INDIA</b>	
	25D · 30A/AEM/AM · 40J/JEK/JEMK/X	IWF22	-	W22FSR		
	25HEK/HEMK/HMK/V · 4CV · 150AETO(84,85)	IWF22	-	W22FS-U10		
	25NEM · 30G · 50H/DEO/DEMO/DEPO/DEMPO	IWF24	-	W24FSR-U10		
	25X · 30H · 40Y · 50G · 50H · 55B · 55D · 60F	IWF24	-	W24FS-U10		
	40G( ~ 02) · 40V · 40X(01 ~ 02)	IWF22	-	W22FS-U10		
	40G(03 ~ )	IWF22	-	W22FS-U		
	40HM/HEMO/HEO/HEPO/HEMPO · 4C · 6C · 8C	IWF22	-	W22FS-U10		
	40Y · 115C(03 ~ )	IWF24	-	W24FSR		
	50ETK/EMTK · 55B/D	IWF24	-	W24FSR-U10	<b>INDONESIA</b>	
	60F/FEMO/FEO/FETO · 70B/BEO/BETO/BEMO	IWF24	-	W24FSR-U10		
	70C · 75A/B/C · 80A/AEO/AETO · 85A · 90A	IWF24	-	W24FSR-U10		
	90A/AEO/AETO · 100A · 115B/C/CETO/F	IWF24	-	W24FSR-U10		
	130B · L130B · 140B/C	IWF27	-	W27FSR-U10		
	140C · 225C/F/G/BETO · 250B/C	IWF27	-	W27FSR-U10		
	140CETO( ~ 92) · 150AETO(86,87)	IWF24	-	W24FSR-U10		
	140CETO(93 ~ )	IWF27	-	W27FSR-U10		
	150AET(98 ~ 01) · 150CETO(92 ~ 94)	IWF24	-	W24FSR-U10		
	150F/G/J/L · D150N · L150F/J	IWF22	-	W22FS-U10	<b>KOREA</b>	
	175AET(98 ~ 01) · 175AETO(84 ~ 87)	IWF24	-	W24FSR-U10		
	175BETO(92 ~ 94) · 200BETO(92 ~ 94)	IWF24	-	W24FSR-U10		
	175D/F · 200F/G/H/J · 225D	IWF24	-	W24FSR-U10		
	200AET(98 ~ 03) · 200AET(84 ~ 87)	IWF24	-	W24FSR-U10		
	250A/AETO · 115BETO · D150H/N · S175D	IWF24	-	W24FSR-U10		
	E8D · E9.9C · E15C · E25A · EK9.9H · EK15N · EK25A	IWF22	-	W22FS-U10		
	E9.9D · E15D · E30H	IWF24	-	W24FS-U10		
	E40G/J/X · E48C · EK40G · K40J	IWF22	-	W22FSR		
	E55C	IWF24	-	W24FSR	<b>MALAYSIA</b>	
	E60H/J · E65A · E75B · E115A	IWF24	-	W24FSR-U10		
	EK9.9H · EK15N · EK25A · EK25B	IWF22	-	W22FS-U10		
	F4A	IWF20	-	W20FS-U		
	F2A · F6A/B · F8C · F9.9F · FT8D · FT9.9G	IWF20	-	W20FSR-U		
	F6C · F5A	IUF22	-	-		
	F8B	-	-	U16FSR-U		
	F9.9B · FT9.9A	IUF22	-	U20FSR-U		
	F9.9C/D · FT9.9D · F13.5A · F15A · F20A · F25A · F30A	IX22B	IXU01-□	X20EPR-U9		
	F15C · F20B · F25D · F30B · F40F · F50F · F60C · FT60D	-	-	-	<b>PHILIPPINES</b>	
	F40A/B · F45A · F50A/D · FT25B · FT50B/C	IX22B	IXU01-□	X20EPR-U9		
	F40C · F60A · FT60A/B	-	-	X16EPR-U9		
	F70A	-	-	-		
	F75A · F80A/B · F90A/B · F95A · F100A/B/C	IKH16	IKH01-□	K16HPR-U11		
	F115A · F250A · FL115A · FL250A	IKH20	IKH01-□	K20HR-U11		
	F150A · F200A · F225A · FL150A · FL200A · FL225A	IKH16	IKH01-□	K16HPR-U11		
	F300A · F350A · FL300A · FL350A	IKH20	IKH01-□	K20HR-U11		
	K50E · L200A	IWF24	-	W24FSR-U10		
	L150A	IWF24	-	W24FS-U10	<b>SAUDI ARABIA</b>	
	L200F/J · S200F · SL200F · L250A	IWF24	-	W24FSR-U10		
	L225C/F · L250B · S250A · SL250A	IWF27	-	W27FSR-U10		
	S150F · SL150F · E25B · EK25B	IWF22	-	W22FS-U10		
	V-MAX 200G · 175F	IWF24	-	W24FSR-U10		
	V-MAX 200H · 150G	IWF22	-	W22FSR		
						<b>SINGAPORE</b>
					<b>TAIWAN</b>	
					<b>THAILAND</b>	
					<b>VIETNAM</b>	
					<b>JAPAN</b>	
					<b>EUROPE &amp; USA</b>	
					<b>CROSS REFERENCE NUMBER</b>	

DENSO	9	14	16	20	22	24	27	29	31	32	35	DENSO	9	14	16	20	22	24	27	29	31	32	DENSO	9	14	16	20	22	24	27	31	
NGK	2	4	5	6	7	8	9	9.5	10	10.5	11	11.5	CHAMPION	18	16,14	12,11	10,9	8,7	6,63,61	4,59	57	55	53	BOSCH	10	9	8	7,6	5	4	3	2



# MARINE, JETSKI & SNOWMOBILE

	MODEL	ENGINE	IRIDIUM POWER	IRIDIUM RACING	DENSO
AUSTRALIA	<b>YAMAHA</b>				
	<b>OUTBOARD</b>				
CHINA		V-MAX 250C · 225G	IWF27	-	W27FSR-U10
		V-MAX F225G · F250F · F275A	IKH20	IKH01-□	K20HR-U11
		V-MAX Z150P( ~ 01) · LZ150P( ~ 01)	IK20	IK01-□	K20PR-U11
		V-MAX Z150P/Q(02 ~ ) · LZ150P(02 ~ )	IK20	IK01-□	K20TXR
		V-MAX Z150Q(00 ~ 01)	IK20	IK01-□	K20PR-U11
		V-MAX Z150Q(02 ~ 05)/QETO · Z240B/BETO	IK20	IK01-□	K20TXR
		V-MAX Z175G(02 ~ )	IK22	IK01-□	K22TNR-S
		V-MAX Z175G/H( ~ 01)	IK22	IK01-□	K22PR-U11
		V-MAX Z175H(02 ~ 05)/HETO · Z200P/PETO	IK22	IK01-□	K22TNR-S
		V-MAX Z200N(99 ~ 01) · Z200P(01) · LZ200N(01)	IK22	IK01-□	K22PR-U11
		V-MAX Z200N/P(02 ~ ) · LZ200N(02 ~ )	IK22	IK01-□	K22TNR-S
		V-MAX Z225H(03 ~ )	IK22	IK01-□	K22TNR-S
		V-MAX Z250D(03 ~ )/F(03 ~ ) · LZ250D(03 ~ )	IK22	IK01-□	K22TNR-S
INDONESIA	<b>SNOWMOBILE</b>				
		CS340E · ET410TR/PT · EX570E/LT/SX	IW27	IW01-□	W27ESR
KOREA		FX Nytro M-TX/R-TX/X-TX	IU27	IU01-□	U27ESR-N
		MM600 · MM700	IW27	IW01-□	W27ESR
MALAYSIA		PHAZER/Mountain Lite	IU27A	IU01-□	-
		PHAZER R-TX/M-TX	IU27A	IU01-□	-
PHILIPPINES		PZ480E/ED/LT/ST · PZ500/ST/ML	IW27	IW01-□	W27ESR
		RS Vector ER/MTN/SE · RS Venture TF · RS Rage	IU24	IU01-□	U24ESR-N
		RS Vector(RS10R/S/ST/SUV/M/MS)(05 ~ )	IU24	IU01-□	U24ESR-N
		RS Viking Professional	IU24	IU01-□	U24ESR-N
		RX Warrior(04 ~ )	IU27	IU01-□	U27ESR-N
		RX-1(03 ~ )	IU27	IU01-□	U27ESR-N
		RX-1/ER/Mountain	IU27	IU01-□	U27ESR-N
		RX-1 Mountain(RX10M)(06 ~ )	IU27	IU01-□	U27ESR-NB
		RX-1 M-TX	IU27	IU01-□	U27ESR-NB
		S340 · ET400TR	IW24	IW01-□	W24ESR
		SE80/80E · SV125E · BR250/250L/250T	IWF24	-	W24FSR
		SRX600/600S( ~ 98) · SRX700S( ~ 98)	IW31	IW01-□	W31ESR-U
	SAUDI ARABIA		SX Viper700/Mountain · SX Venom	IW27	IW01-□
		SX500 · SX600 · SX700	IW27	IW01-□	W27ESR
		SXV600(SXVenom)(04 ~ )	IW27	IW01-□	W27ESR
		SXV700(SXViper)(02 ~ )	IW27	IW01-□	W27ESR
		VENTURE Multi Purpose	IU27A	IU01-□	-
		VENTURE Multi Purpose(07-)	IU27A	IU01-□	-
		VK Professional	IU24	IU01-□	U24ESR-N
		VK540E/ED/E II /E III · VT480E · VX500DE/LT	IW27	IW01-□	W27ESR
		VT500XL(04 ~ )	IW27	IW01-□	W27ESR
		VT700	IW27	IW01-□	W27ESR
		VX500SXB/XT/XZ	IW27	IW01-□	W27ESR
		VX500DE/LT · VX500SXB/XT/XZ	IW27	IW01-□	W27ESR
		VX600E/ER/LT/ST/SXB/SXS/XT/XZ	IW27	IW01-□	W27ESR
	VX600ST · SRX600S(99 ~ ) · VX700S(99 ~ )	IW27	IW01-□	W27ESR	
	VX700ST/SXB · VX750/ST/SXS	IW27	IW01-□	W27ESR	
TAIWAN					
THAILAND					
VIETNAM					
JAPAN					
EUROPE & USA					
CROSS REFERENCE					
PART NUMBER					



MODEL	CC	VEHICLE CODE	ENGINE	FROM-TILL	DENSO		IRIDIUM POWER	IRIDIUM TOUGH	QTY	
<b>ABARTH</b>										
500	1400	ABA-312141	312A1(T/C)	09.4 ~	IXU27	-	IXU27	-	4	AUSTRALIA
500C	1400	ABA-312142	312A3(T/C)	10.10~	IXU27	-	IXU27	-	4	CHINA
595/C	1400	ABA-312142	312A3(T/C)	13.1 ~	IXU27	-	IXU27	-	4	
695 TRIBUTO FERRARI EDIZIONE MASERATI	1400	ABA-312142	312A3(T/C)	10.11~	IXU27	-	IXU27	-	4	
GRANDE PUNTO	1400	ABA-199143	199A8(T/C)	09.2 ~	IXU27	-	IXU27	-	4	
<b>ALFA ROMEO</b>										
145	2000	E-930A5	-	96.8 ~	VK20+IU22	-	IK20+IU22	-	EACH4	INDIA
		GF-930A534	32301	98.10~	VK20+IU22	-	IK20+IU22	-	EACH4	
		E-950A534	-	98.10~	VK20+IU22	-	IK20+IU22	-	EACH4	
147	1600	ABA-937BXB · GH-937BXB	32104	04.6 ~	VK20+IU22	-	IK20+IU22	-	EACH4	INDONESIA
	2000	ABA-937AB · GF-937AB · GH-937AB	32310	01.10~	VK20+IU22	-	IK20+IU22	-	EACH4	
	3200	GH-937AXL	-	03.5 ~07	PK20PR-P8	-	IK20	VK20	6	
155	2000	E-167A2A	67.201	92.7 ~95	K22PR-U	-	IK22	VK22	8	KOREA
		E-167A2G	67.204	95.8 ~98	VK20+IU22	-	IK20+IU22	-	EACH4	
		E-167A2E	67.203	95.8 ~	W20EPBR-S	-	IW20	VW20	4	
		E-167A1E	67.303	95.7 ~	W22EPR-U	-	IW22	VW22	6	
156	2000	E-932A2 · GF-932A2	32301	98.4 ~02	VK20+IU22	-	IK20+IU22	-	EACH4	MALAYSIA
		GF-932B2	-	00.6 ~	VK20+IU22	-	IK20+IU22	-	EACH4	
		GH-932BXW	-	03 ~06.4	VK20	-	IK20	VK20	4	
		GH-932B2	-	00 ~02	VK20+IU22	-	IK20+IU22	-	EACH4	
	2500	E-932A1 · GF-932A1	32401	98.4 ~02	VK20	-	IK20	VK20	6	
		GF-932B1	-	00.7 ~02.7	VK20	-	IK20	VK20	6	
		GH-932AC	AR32405	02.7 ~06.4	VK20	-	IK20	VK20	6	
		GH-932BW	-	03 ~06.4	VK20	-	IK20	VK20	6	
156GTA	3200	GH-932AXB	932A000	02.7 ~06.4	VK20	-	IK20	VK20	6	PHILIPPINES
		GH-932BXB	932A000	03.11~06.4	VK20	-	IK20	VK20	6	
156JTS	2000	GH-932AXA	937A1000	02.7 ~06.4	VK20	-	IK20	VK20	4	SAUDARABIA
159	2200	GH-93922 · ABA-93922	939A5	06.2 ~	IK16	-	IK16	VK16	4	
164	3000	GH-93932 · ABA-93932	939A	06.2 ~	ITV16	-	ITV16	-	6	SINGAPORE
		E-168B	-	93.5 ~95	VK20	-	IK20	VK20	6	
		E-164B	064.305	93.5 ~95	W20EPR-U	-	IW20	VW20	6	
		E-164KIC	64304;64308	94.10~	VK20	-	IK20	VK20	6	
		E-164K1H	64304	95.6 ~	VK20	-	IK20	VK20	6	
		E-164K1P	64305	95.6 ~	W20EPR-U	-	IW20	VW20	6	
166	2500	E-164K1G	64304;64308	95.8 ~	VK20	-	IK20	VK20	6	TAIWAN
		GF-936A2	-	99.9 ~	VK20	-	IK20	VK20	-	
		GF-936A1 · GH-936A1	-	99.9 ~08.10	VK20	-	IK20	VK20	6	
4C	1700	ABA-96018	960A1(T/C)	14.7 ~	-	-	-	4	THAILAND	
GIULIA	2000	ABA-95220	55273835(T/C)	17.10~	-	-	-	4		
GIULIETTA	2900	ABA-95229	670050436(T/C)	17.10~	-	-	-	6	VIETNAM	
		1400	ABA-940141	940A2(T/C)	14.6 ~	IXU27	-	IXU27		-
	1700	ABA-940141	940A2(T/C)	17.2 ~	-	-	IXU24	-		4
		ABA-940181	940B2(T/C)	15.1 ~	-	-	-	-		4
GT	3200	ABA-94018P	940B2(T/C)	19.1 ~	-	-	-	4	JAPAN	
		GH-93720L · ABA-93720L	937A1	04 ~	VK20	-	IK20	VK20		4
GTV	2000	GH-93732L	936A	04 ~	VK20	-	IK20	VK20	6	EUROPE & USA
		E-916C2A	162.02	95.12~97	W22EPR-U	-	IW22	VW22	6	
	GH-91626G	-	04.7 ~	VK20+IU22	-	IK20+IU22	-	4		
	3000	E-916C1	-	97.6 ~	VK20	-	IK20	VK20	6	
		GF-916C1 · GH-916C1B	16102	00 ~03.7	VK20	-	IK20	VK20	6	
	3200	GH-916CXB · GH-916SXB	-	03.7 ~	PK20PR-P8	-	IK20	VK20	6	
MITO	1400	ABA-95514P	955A2(T/C)	10.3 ~	IXU27	-	IXU27	-	4	CROSS REFERENCE NUMBER
		ABA-955141	199A8(T/C)	09.5 ~	IXU27	-	IXU27	-	4	
		ABA-955143	940A2(T/C)	10.7 ~	IXU27	-	IXU27	-	4	
		ABA-955142	955A7(T/C)	14.1 ~	IXU27	-	IXU27	-	4	
		ABA-955142	955A7(T/C)	17.2 ~	-	-	IXU24	-	4	
Stelvio	2000	ABA-94920	55273835(T/C)	18.7 ~	-	-	-	4	PART	
	2900	7BA-94929	670052589(T/C)	18.11~	-	-	-	6		
SPIDER	2000	E-916S2	16.201	95.11~98	VK20+IU22	-	IK20+IU22	-	EACH4	PART
		GF-916S2	-	96 ~98	VK20+IU22	-	IK20+IU22	-	EACH4	
		E-916S2B · GF-916S2B	-	98.12~04.7	VK20+IU22	-	IK20+IU22	-	EACH4	
		GH-91620S · GH-91620G	-	04.7 ~06.10	VK20+IU22	-	IK20+IU22	-	EACH4	
	2200	ABA-93922S · GH-93922S	939A5	06.10~	IK16	-	IK16	VK16	4	
	3000	GF-916S1B · GH-916S1B	16105	01.9 ~03.7	VK20	-	IK20	VK20	6	
3200	GH-916SXB	-	03.7 ~06.10	PK20PR-P8	-	IK20	VK20	6		

T/C=Turbo Charger  
S/C=Super Charger



# EUROPE & U.S.A. | CAR

▶ Spark plug color codes: ■ for Iridium Tough and Iridium Plugs and Iridium TT, ■ for Iridium Power, ■ for Iridium Racing and Two Tops Plugs, ■ for Platinum Plugs and Platinum TT, and black for general spark plugs.

	MODEL	CC	VEHICLE CODE	ENGINE	FROM-TILL	DENSO		IRIDIUM POWER	IRIDIUM TOUGH	QTY					
AUSTRALIA	<b>ALFA ROMEO</b>														
	SPIDER	3200	ABA-93932S	GH-93932S	939A	06.10~	ITV16	-	ITV16	-	6				
	SPORT WAGON	2000	GF-932B2	-	-	00.8 ~	VK20+IU22	-	IK20+IU22	-	EACH4				
2500		GF-932B1	-	-	00.8 ~	VK20	-	IK20	VK20	6					
CHINA	BRERA	2200	ABA-93922S	GH-93922S	939A5	06.4 ~	IK16	-	IK16	VK16	4				
		3200	ABA-93932S	GH-93932S	939A	06.4 ~	ITV16	-	ITV16	-	6				
	<b>AMG MERCEDES</b>														
INDIA	A45	2000	CBA-176052	133(T/C)	13.7 ~	-	-	-	-	4					
	Mercedes-AMG A35	2000	4BA-177051M	260(T/C)	19.8 ~	-	-	-	-	4					
			4BA-177151M	260(T/C)	19.10~	-	-	-	-	4					
	Mercedes-AMG A45	2000	CBA-176052	133(T/C)	15.11~	-	-	-	-	4					
CBA-176052			133(T/C)	17.7 ~	-	-	-	-	4						
INDONESIA	C280	2800	E-202A28S	-	95.3 ~	K16PR-U	K16TT	IK16	VK16	6					
			E-C280	-	98.3 ~	VK16	-	IK16	VK16	6					
KOREA	C32	3200	GF-203065	112	02 ~03	VK20	-	IK20	VK20	12					
			GH-203065	112(S/C)	03 ~	VK20Y	-	-	VK20Y	12					
			GF-203265	112	02 ~03	VK20	-	IK20	VK20	12					
			GH-203265	112(S/C)	03 ~	VK20Y	-	-	VK20Y	12					
MALAYSIA	C36	3600	E-202A36S	-	94.3 ~	K20PR-U	K20TT	IK20	VK20	6					
			E-202B36S	-	96.11~	K16PR-U	K16TT	IK16	VK16	6					
PHILIPPINES	C43	4300	E-C43	E-C43T	-	97.12~99	VK16	-	IK16	VK16	16				
			GF-C43T	-	98.12~	VK16	-	IK16	VK16	16					
SAUDI ARABIA	Mercedes-AMG C43	3000	CBA-205364	CBA-205464	CBA-205064	CBA-205264	276M30(T/C)	16.9 ~	-	-	6				
	C450	3000	CBA-205064	CBA-205264	276M30(T/C)	15.9 ~	-	-	-	6					
	C55	5500	GH-203076	DBA-203076	DBA-203276	GH-203276	113M55	04.6 ~08.4	VK20	-	IK20	VK20	16		
SINGAPORE	C63	6200	ABA-204507	156	13.8 ~	FXE22HR11	-	-	VFXEH22	8					
			CBA-204077	156	07.10~	VFXEH22	-	-	VFXEH22	8					
	C63 Coupe	6300	CBA-204277	156	08.4 ~	VFXEH22	-	-	VFXEH22	8					
			CBA-204377	156	11.8 ~	FXE22HR11	-	-	VFXEH22	8					
TAIWAN	Mercedes-AMG C63	4000	CBA-205386	CBA-205387	177(T/C)	16.8 ~	-	-	-	8					
			CBA-205487	177(T/C)	16.9 ~	-	-	-	-	8					
			CBA-205086	CBA-205087	CBA-205286	CBA-205287	177(T/C)	17.2 ~	-	-	-	8			
			CBA-205487	177(T/C)	17.7 ~	-	-	-	-	-	8				
THAILAND	CL550	4700	CBA-205086	CBA-205087	CBA-205487	CBA-205386	CBA-205387	CBA-205286	CBA-205287	177(T/C)	18.7 ~	-	-	-	8
			CL55	5500	GH-215374	113M55	02.11~	VK16	-	IK16	VK16	16			
			-		11398660	01.9 ~07.3	VK16	-	IK16	VK16	16				
VIETNAM	CL63	5500	CBA-216374	157(T/C)	12.2 ~	-	-	-	-	8					
			-	-	02.3 ~07.3	VK20	-	IK20	VK20	24					
			CBA-216377	156	07.3 ~	VFXEH22	-	-	VFXEH22	8					
JAPAN	CL65	6000	-	(T/C)	03.10~07.7	VK20Y	-	-	VK20Y	24					
			ABA-216379	-	07.7 ~	VK20Y	-	-	VK20Y	24					
EUROPE & USA	Mercedes-AMG CLA35	2000	4BA-118351M	4BA-118651M	260(T/C)	20.2 ~	-	-	-	4					
	Mercedes-AMG CLA45	2000	CBA-117352	CBA-117952	133(T/C)	15.11~	-	-	-	4					
			CBA-117352	CBA-117952	133(T/C)	17.7 ~	-	-	-	4					
	4BA-118354M	4BA-118654M	139(T/C)	19.11~	-	-	-	-	4						
CROSS REFERENCE NUMBER	CLK320	3200	E-CLK320	GF-CLK320	112	98.3 ~	VK16	-	IK16	VK16	12				
			GF-CLK55	M113E55	00.8 ~03.1	VK16	-	IK16	VK16	16					
	CLK55	5500	GH-209376	DBA-209376	M113E55	03.1 ~06.9	VK20	-	IK20	VK20	16				
			ABA-209476	113M55	05.9 ~06.9	VK16	-	IK16	VK16	16					
CLK63	6300	ABA-209477	DBA-209377	156	06.9 ~	VFXEH22	-	-	VFXEH22	8					
PART NUMBER	Mercedes-AMG CLS53	3000	CAA-257361	256(T/C)	18.9 ~	-	-	-	-	6					
			4AA-257361	M256(T/C)	20.9 ~	-	-	-	-	6					
PART NUMBER	CLS55	5500	CBA-219376	113M55(S/C)	05.2 ~06.9	VKH20	-	-	VKH20Y	16					
			CBA-218374	157(T/C)	12.8 ~	-	-	-	-	8					
	CLS63	5500	CBA-218375	CBA-218376	CBA-218976	157(T/C)	14.10~	-	-	-	8				
CBA-219377			156	06.9 ~	VFXEH22	-	-	VFXEH22	8						
PART NUMBER	Mercedes-AMG E43	3000	CBA-213064	276M30(T/C)	16.10~	-	-	-	-	6					
			CBA-213264	276M30(T/C)	16.11~	-	-	-	-	6					
E50	5000	E-210A50S	M119E50	96.2 ~	K20TXR	K20TT(*5)	IK20	VK20	8						

(\*5) : It can be used only for a plug with a terminal.

MODEL	CC	VEHICLE CODE	ENGINE	FROM-TILL	DENSO		IRIDIUM POWER	IRIDIUM TOUGH	QTY	
<b>AMG MERCEDES</b>										
Mercedes-AMG E53	3000	CAA-213061 · CAA-238461 · CAA-238361 · CAA-213261	256(T/C)	18.9 ~	-	-	-	-	6	AUSTRALIA
		4AA-213061 · 4AA-213261	M256(T/C)	20.9 ~	-	-	-	-	6	CHINA
		4AA-238461 · 4AA-238361	M256(T/C)	20.10~	-	-	-	-	6	
E55	5500	E-E55 · GF-E55	11386	97.12~02.12	VK16	-	IK16	VK16	16	INDIA
		GF-E55T	11386	98.12~04.7	VK16	-	IK16	VK16	16	
		GH-211076 · DBA-211076	113M55(S/C)	03 ~06.8	VKH20Y	-	-	VKH20Y	16	INDONESIA
		GH-211276 · DBA-211276	113M55(S/C)	03.11~	VKH20Y	-	-	VKH20Y	16	
E63	5500	CBA-212074 · CBA-212274	157(T/C)	11.11~	-	-	-	-	8	KOREA
		CBA-212075 · CBA-212076 · CBA-212292 · CBA-212276	157(T/C)	14.10~	-	-	-	-	8	
	6300	CBA-211077 · CBA-211277	156	06.8 ~10.1	VFXEH22	-	-	VFXEH22	8	MALAYSIA
CBA-212077	-	10.2 ~	VFXEH22	-	-	VFXEH22	8			
Mercedes-AMG E63	4000	CBA-213089	177(T/C)	17.5 ~	-	-	-	-	8	PHILIPPINES
		CBA-213088 · CBA-213288 · CBA-213289	177(T/C)	17.8 ~	-	-	-	-	8	
		7BA-213089 · 7BA-213289	M177(T/C)	20.9 ~	-	-	-	-	8	SAUDI ARABIA
G55L	5500	GF-CLK55	M113E55	00.8 ~	VK16	-	IK16	VK16	16	
		GH-463243	113M55	03.5 ~04.7	VK16	-	IK16	VK16	16	
		GH-463270	113M55	04.7 ~06.11	VKH20	-	IKH20	VKH20	16	TAIWAN
		ABA-463270	113M55	06.11~	VKH20	-	IKH20	VKH20	16	
G63	5500	ABA-463272	157(T/C)	12.8 ~	-	-	-	8	THAILAND	
Mercedes-AMG G63	4000	ABA-463276	177(T/C)	18.6 ~	-	-	-	8		
	5500	ABA-463272	157(T/C)	15.12~	-	-	-	8	VIETNAM	
GL63	5500	CBA-166874	157(T/C)	13.4 ~	-	-	-	8		JAPAN
Mercedes-AMG GLA35	2000	4BA-247751M	M260(T/C)	20.10~	-	-	-	4	EUROPE & USA	
Mercedes-AMG GLA45	2000	CBA-156952	133(T/C)	17.4 ~	-	-	-	4		
Mercedes-AMG GLB35	2000	4BA-247651M	M260(T/C)	21.1 ~	-	-	-	4	CROSS REFERENCE NUMBER	
Mercedes-AMG GLC43	3000	CBA-253964	276M30(T/C)	16.9 ~	-	-	-	6		
		CBA-253364	276M30(T/C)	17.3 ~	-	-	-	6		
		4BA-253964 · 4BA-253364	276(T/C)	19.10~	-	-	-	6		
		4BA-253964 · 4BA-253364	M276M30(T/C)	21.1 ~	-	-	-	6		
Mercedes-AMG GLC63	4000	CBA-253988 · CBA-253388 · CBA-253989 · CBA-253389	177(T/C)	18.1 ~	-	-	-	8	PART	
		4BA-253988 · 4BA-253989 · 4BA-253388 · 4BA-253389	177(T/C)	19.10~	-	-	-	8		
	7BA-253989 · 7BA-253389	M177(T/C)	21.1 ~	-	-	-	8			
Mercedes-AMG GLE43	3000	CBA-166064	276M30(T/C)	16.4 ~	-	-	-	6	PART	
Mercedes-AMG GLE53	3000	4AA-167161	256(T/C)	20.5 ~	-	-	-	6		
		4AA-167361	256(T/C)	20.6 ~	-	-	-	6		
Mercedes-AMG GLE63	4000	7AA-167189 · 7AA-167389	M177(T/C)	20.12~	-	-	-	8	PART	
		CBA-166074	157(T/C)	15.10~	-	-	-	8		
	5500	CBA-166074	157(T/C)	16.8 ~	-	-	-	8		
Mercedes-AMG GLS63	4000	7AA-167989	M177(T/C)	20.12~	-	-	-	8	PART	
	5500	CBA-166874	157(T/C)	16.4 ~	-	-	-	8		
Mercedes-AMG GT	3000	4AA-290659C · 4AA-290659 · 4AA-290661	256(T/C)	19.2 ~	-	-	-	6	PART	
		4AA-290659C · 4AA-290659 · 4AA-290661	M256(T/C)	20.7 ~	-	-	-	6		
		CBA-190378	178(T/C)	15.5 ~	-	-	-	8	PART	
	CBA-190377	178(T/C)	15.9 ~	-	-	-	8			
	ABA-190379	178(T/C)	17.6 ~	-	-	-	8			
	ABA-190477 · ABA-190480	178(T/C)	17.8 ~	-	-	-	8			
	ABA-190380 · CBA-190377 · CBA-190378	178(T/C)	17.10~	-	-	-	8			
	4BA-290689	177(T/C)	19.2 ~	-	-	-	8			
	4BA-290689	M177(T/C)	20.7 ~	-	-	-	8			
	ABA-190478	178(T/C)	19.2 ~	-	-	-	8			
	7BA-190382 · 7BA-190380 · 7BA-190379 · 7BA-190482 · 7BA-190480	M178(T/C)	20.8 ~	-	-	-	8			
ML55	5500	GF-ML55	11386	00.6 ~	VK16	-	IK16	VK16	16	PART
		GF-ML55	113M55	01.10~02.11	VK16	-	IK16	VK16	16	
		GH-163174	113M55	02.11~	VK16	-	IK16	VK16	16	
ML63	5500	CBA-166074	157(T/C)	12.6 ~	-	-	-	8	PART	
	6300	CBA-164177	-	06.9 ~	VFXEH22	-	-	VFXEH22		8
R63	6300	DBA-211077 · DBA-211277	-	07.2 ~	VFXEH22	-	-	VFXEH22	8	PART



# EUROPE & U.S.A. CAR

▶ Spark plug color codes: ■ for Iridium Tough and Iridium Plugs and Iridium TT, ■ for Iridium Power, ■ for Iridium Racing and Two Tops Plugs, ■ for Platinum Plugs and Platinum TT, and black for general spark plugs.

	MODEL	CC	VEHICLE CODE	ENGINE	FROM-TILL	DENSO		IRIDIUM POWER	IRIDIUM TOUGH	QTY	
<b>AUSTRALIA</b>											
<b>AMG MERCEDES</b>											
	R63	6300	DBA-251077	156	07.2 ~	VFXEH22	-	-	VFXEH22	8	
	S55		GF-S55S · GFS55SA	11386	99.9 ~01.6	VK16	-	IK16	VK16	16	
		5500	GF-220073	M113 55	02 ~	VK16	-	IK16	VK16	16	
			GH-220074	113M55(S/C)	02.11~	VKH20Y	-	-	VKH20Y	16	
	S55A	5500	GF-S55SA		00.4 ~	VK16	-	IK16	VK16	16	
	S55L		GH-220174	113M55(S/C)	03 ~	VKH20Y	-	-	VKH20Y	16	
		5500	GF-S55L · GFS55LA	-	99.9 ~	VK16	-	IK16	VK16	16	
			GF-220173	M113 55	01.6 ~	VK16	-	IK16	VK16	16	
			GH-220174	113M55	02.11~	VKH20	-	IKH20	VKH20	16	
	S63	5500	CBA-222177C · CBA-222178	157(T/C)	14.6 ~	-	-	-	-	8	
	Mercedes-AMG S63	4000	CBA-222187 · CBA-222188	177(T/C)	17.8 ~	-	-	-	-	8	
				CBA-217488 · CBA-217388	177(T/C)	18.6 ~	-	-	-	-	8
		5500	CBA-217478	157(T/C)	16.6 ~	-	-	-	-	8	
	S63L	5500	CBA-221174	157(T/C)	11.7 ~	-	-	-	-	8	
		6300	CBA-221177	156	07.3 ~	VFXEH22	-	-	VFXEH22	8	
	S65	6000	-	275982	07.1 ~	VK20Y	-	-	VK20Y	24	
			CBA-222179C	279(T/C)	13.11~	VK20Y	-	-	VK20Y	12	
	Mercedes-AMG S65	6000	ABA-222179C	279(T/C)	17.8 ~	VK20Y	-	-	VK20Y	12	
				ABA-217479 · ABA-217379C	279(T/C)	18.6 ~	VK20Y	-	-	VK20Y	24
	S65L	6000	-	275982	06.11~07.8	VK20Y	-	-	VK20Y	24	
			ABA-221179	(T/C)	03.11~	VK20Y	-	-	VK20Y	24	
	SL500	5500	GH-230474	113M55	02.7 ~	VK16	-	IK16	VK16	16	
	SL55	5500	GH-230474	113M55(S/C)	02.7 ~05.8	VKH20Y	-	-	VKH20Y	16	
				DBA-230474	113M55(S/C)	05.8 ~08.5	VKH20Y	-	-	VKH20Y	16
	SL63	5500	CBA-231474	157(T/C)	12.3 ~	-	-	-	-	8	
		6300	CBA-230470	156	08.5 ~	VFXEH22	-	-	VFXEH22	8	
	Mercedes-AMG SL63	5500	CBA-231474	157(T/C)	16.6 ~	-	-	-	-	8	
	SL65	6000	-	-	04.7 ~06.11	VK20Y	-	-	VK20Y	24	
				DBA-230472	275981	06.11~	VK20Y	-	-	VK20Y	24
	Mercedes-AMG SLC43	3000	CBA-172466	276M30(T/C)	16.6 ~	-	-	-	-	6	
	SLK32	3200	GF-170466 · GH-170466	112	02 ~	VK16	-	IK16	VK16	12	
	SLK55	5500	CBA-171473	113M55(S/C)	04.9 ~	VK20	-	IK20	VK20	16	
				CBA-172475	152	13.8 ~	-	-	-	-	8
	SLS	6300	-	M159	10.6 ~	-	-	-	-	8	
<b>ASTONMARTIN</b>											
	DB7 COUPE	3200	E-AM7	-	~99	Q22PR-U	-	IQ22	VQ22	6	
	DB7 VANTAGE	6000	GF-AMV7	AM2	00.10~	VT20	-	IT20	VT20	12	
	DB7 VOLANTE	3200	E-AMC7	-	98 ~99	Q22PR-U	-	IQ22	VQ22	6	
	DB9	6000	-	AM04	04 ~	VT20	-	IT20	VT20	12	
	VANQUISH	6000	-	AM3	01.10~	VT20	-	IT20	VT20	12	
				-	AM06	04 ~	VT20	-	IT20	VT20	12
	V8 COUPE	5300	-	-	-	Q20PR-U	-	IQ20	VQ20	8	
	V8 VANTAGE	5300	-	-	-	IQ24	-	IQ24	-	8	
	VIRAGE	5300	E-AM689	-	94.5 ~	K20PR-U	K20TT	IK20	VK20	8	
<b>AUDI</b>											
	80	2000	E-8CABK	ABK	92.3 ~96.1	W20EPBR-S	-	IW20	VW20	4	
			2300	E-8CNG	NG	92.3 ~96.1	W16ETR-S(*2)	-	IW16	VW16	5
			2600	E-8CABC	ABC	93.10~96.1	K20PBR-S10	-	IK20	VK20	6
			2800	E-8CAAH	AAH	92.5 ~96.1	K20PBR-S10	-	IK20	VK20	6
	100	2600	E-4AABC	ABC	93.10~94.7	K20PBR-S10	-	IK20	VK20	6	
			2800	E-4AAAHF	AAH	93.11~94.7	K20PBR-S10	-	IK20	VK20	6
				DBA-8XCHZ	CHZ(T/C)	15.6 ~	-	-	-	-	3
	A1	1000	3BA-GBDKL	DKL(T/C)	20.6 ~	-	-	-	-	3	
				3BA-GBDKR	DKR(T/C)	20.11~	-	-	-	3	
				DBA-8XCAX	CAX(T/C)	11.1 ~	-	-	-	4	
		1400	DBA-8XCPT	CPT(T/C)	14.6 ~	VKH22	-	IKH22	VKH22	4	
			DBA-8XCZE	CZE(T/C)	15.6 ~	-	-	-	-	4	
		1500	3BA-GBDAD	DAD(T/C)	19.11~	-	-	-	-	4	
	A3		ABA-8PCAX	CAX(T/C)	09.7 ~	-	-	-	-	4	
				DBA-8PCAX	CAX(T/C)	11.9 ~	-	-	-	4	
				DBA-8VCXS	CXS(T/C)	13.9 ~	-	-	-	4	
				DBA-8VCPT	CPT(T/C)	13.9 ~	-	-	-	4	
			1400	DBA-8VCXSL	CXS(T/C)	14.1 ~	-	-	-	4	
				DBA-8VCPTL	CPT(T/C)	14.1 ~	-	-	-	4	
				DBA-8VCXSL	CXS(T/C)	14.8 ~	-	-	-	4	
				DBA-8VCPTL	CPT(T/C)	14.8 ~	-	-	-	4	
			DBA-8VCXS	CXS(T/C)	14.8 ~	-	-	-	4		

(\*2) : USE REMOVABLE TYPE



MODEL	CC	VEHICLE CODE	ENGINE	FROM-TILL	DENSO		IRIDIUM POWER	IRIDIUM TOUGH	QTY		
<b>AUDI A3</b>	1400	DBA-8VCPT	CPT(T/C)	14.8 ~	-	-	-	-	4	AUSTRALIA	
		DLA-8VCUK	CUK(T/C)	15.11~	-	-	-	-	4		
		DBA-8VCXSL · DBA-8VCXS	CXS(T/C)	17.1 ~	-	-	-	-	4		
	1600	GH-8PBGU	BGU	04.2 ~	K20PBR-S10	-	IK20	VK20	4	CHINA	
		ABA-8PBSE · GH-8PBSE	BSE	05.7 ~08.9	K20PBR-S10	-	IK20	VK20	4		
		E-8LAGN	AGN	97.1 ~98.9	K20PBR-S10	-	IK20	VK20	4		
	1800	GF-8LAGN	AGN	98.9 ~01.3	K20PBR-S10	-	IK20	VK20	4		
		GF-8LAGU	AGU(T/C)	98.9 ~01.3	VK20Y	-	-	VK20Y	4		
		GF-8LAPG · GH-8LAPG	APG	01.4 ~03.9	K20PBR-S10	-	IK20	VK20	4	INDIA	
		E-8LAGU	AGU(T/C)	97.1 ~98.8	K22PBR-S	-	IK22	VK22	4		
		GF-8LAQAF	AQA(T/C)	99.9 ~03.9	K22PBR-S	-	IK22	VK22	4		
		GF-8LAUQ · GH-8LAUQ	AUQ(T/C)	02.4 ~03.9	VK20Y	-	-	VK20Y	4	INDONESIA	
		ABA-8PBZB	BZB(T/C)	07.8 ~08.9	VK20Y	-	-	VK20Y	4		
		ABA-8PCDA	CDA(T/C)	08.9 ~	VK22	-	IK22	VK22	4		
		ABA-8VCJSF	CJS(T/C)	13.9 ~	VKH22	-	IKH22	VKH22	4		
		ABA-8VCJSL	CJS(T/C)	14.1 ~	VKH22	-	IKH22	VKH22	4		
		ABA-8VCJSL · ABA-8VCJSF	CJS(T/C)	14.8 ~	VKH22	-	IKH22	VKH22	4	KOREA	
		2000	GH-8PAXW	AXW	03.9 ~05.7	VKA16	-	-	VKA16	4	
			GH-8PBLX	BLX	04.10~	VKA16	-	-	VKA16	4	
			GH-8PAXX	AXX(T/C)	04.10~06.7	VK20Y	-	-	VK20Y	4	
			GH-8PBVY	BVY	06.7 ~	VKA16	-	-	VKA16	4	MALAYSIA
	ABA-8PBWA · GH-8PBWA		BWA(T/C)	06.7 ~08.9	VK20Y	-	-	VK20Y	4		
	GH-8PBLR		BLR	05.7 ~06.7	VKA16	-	-	VKA16	4		
	ABA-8PCCZF		CCZ(T/C)	08.9 ~	VK22	-	IK22	VK22	4		
	ABA-8VCZPL · ABA-8VCZPF		CZP(T/C)	17.1 ~	VKH22	-	IKH22	VKH22	4	PHILIPPINES	
	3200	GH-8PBDBF	BDB	03.12~05.7	-	-	-	-	6	SAUDARABIA	
		GH-8PBMJF	BMJ	04.10~06.7	-	-	-	-	6		
		ABA-8PBUBF · GH-8PBUBF	BUB	06.7 ~	-	-	-	-	6	SINGAPORE	
	<b>A4</b>	1400	ABA-8WCVN	CVN(T/C)	16.10~	-	-	-	-	4	
			E-8DADR	ADR	95.10~99.6	K20PBR-S10	-	IK20	VK20	4	
			GF-8DADR	ADR	99.6 ~99.10	K20PBR-S10	-	IK20	VK20	4	
		1800	GF-8DAPT	APT	99.10~	K20PBR-S10	-	IK20	VK20	4	
			E-8DAEBF	AEB(T/C)	96.2 ~99.6	K22PBR-S	-	IK22	VK22	4	
			GF-8DAPUF	APU(T/C)	99.6 ~99.11	K22PBR-S	-	IK22	VK22	4	
			GF-8DAJLF	AJL	99.11~	PK20PR-P8	-	-	VK20Y	4	
			GH-8EAMBF · GF-8EAMBF	AMB(T/C)	01.11~	VK20Y	-	-	VK20Y	4	
			GH-8EBFB · ABA-8EBFB	BFB(T/C)	06.7 ~	VK20Y	-	-	VK20Y	4	
			ABA-8K CAB	CAB(T/C)	08.3 ~	VK20Y	-	-	VK20Y	4	
			ABA-8KCDH	CDH(T/C)	08.9 ~	VK22	-	IK22	VK22	4	
			GF-8EALT · GH-8EALT · ABA-8EALT	ALT	01.5 ~08.3	IK16	-	IK16	VK16	4	TAIWAN
			GH-8EBGBF	BGB(T/C)	05.2 ~06.3	VK20Y	-	-	VK20Y	4	
			GH-8EBWEF · ABA-8EBWEF	BWE(T/C)	06.3 ~08.3	VK20Y	-	-	VK20Y	4	THAILAND
			ABA-8KCDNF	CDN(T/C)	09.3 ~	VK22(*6)	-	IK22(*6)	VK22(*6)	4	
			DBA-8KCDNF	CDN(T/C)	13.7 ~	VKH22(*6)	-	IKH22(*6)	VKH22(*6)	4	
			DBA-8KCDN	CDN(T/C)	11.4 ~	VK22(*6)	-	IK22(*6)	VK22(*6)	4	
DBA-8KCDN			CDN(T/C)	13.7 ~	VKH22(*6)	-	IKH22(*6)	VKH22(*6)	4		
2000		ABA-8KCNCA	CNC(T/C)	14.8 ~	VKH22	-	IKH22	VKH22	4		
		ABA-8WCVK	CVK(T/C)	16.2 ~	VKH22	-	IKH22	VKH22	4	VIETNAM	
		ABA-8WCYRF	CYR(T/C)	16.2 ~	VKH22	-	IKH22	VKH22	4		
		ABA-8WCYRA	CYR(T/C)	16.9 ~	-	-	IK22	VK22	4		
		ABA-8WCYRA · DBA-8WCYRF	CYR(T/C)	17.1 ~	VKH22	-	IKH22	VKH22	4		
		DBA-8WCVK	CVK(T/C)	17.7 ~	VKH22	-	IKH22	VKH22	4	JAPAN	
		DBA-8WCYRF · ABA-8WCYRA	CYR(T/C)	19.1 ~	-	-	-	-	4		
		3AA-8WDDWF	DDW(T/C)	20.10~	-	-	-	-	4		
		3AA-8WDDWA	DDW(T/C)	20.10~	VKH22	-	IKH22	VKH22	4		
		3AA-8WDEM	DEM(T/C)	20.10~	VKH22	-	IKH22	VKH22	4		
		2400	E-8DAGA	AGA	98.1 ~98.6	K20PBR-S10	-	-	-	6	
			E-8DAGAF · GF-8DAGAF	AGA	98.6 ~	K20TXR	K20TT(*5)	-	-	6	EUROPE & USA
GF-8DAPSF			APS	99.6 ~	K20PBR-S10	-	-	-	6		
GF-8DAPS			APS	99.6 ~01.10	K20PBR-S10	-	-	-	6	CROSS REFERENCE NUMBER	
GF-8EBDV			BDV	01.11~	VK20	-	-	-	6		
GH-8HBDV			BDV	02.9 ~	K20TXR	K20TT(*5)	IK20	VK20	6		
GH-8EBDV			BDV	02.8 ~	K20TXR	K20TT(*5)	IK20	VK20	6		
2600		E-8DABC	ABC	95.7 ~99.5	K20PBR-S10	-	IK20	VK20	6		
		E-8DAAHF	AAH	96.1 ~99.5	K20PBR-S10	-	IK20	VK20	6		
2800		E-8DACKF	ACK	96.8 ~99.5	K20PBR-S10	-	IK20	VK20	6		
		GF-8DAPRF	APR	99.4 ~	K20TXR	K20TT(*5)	IK20	VK20	6		

(\*5) : It can be used only for a plug with a terminal. (\*6) : The plug reach may be 19mm or 26.5mm even with the same engine and the same vehicle code. Please confirm the plug reach and choose the correct DENSO type. If there is an "H" in DENSO type, it has a reach of 26.5mm. If it doesn't, its reach is 19mm



# EUROPE & U.S.A. | CAR

▶ Spark plug color codes: ■ for Iridium Tough and Iridium Plugs and Iridium TT, ■ for Iridium Power, ■ for Iridium Racing and Two Tops Plugs, ■ for Platinum Plugs and Platinum TT, and black for general spark plugs.

MODEL	CC	VEHICLE CODE	ENGINE	FROM-TILL	DENSO		IRIDIUM POWER	IRIDIUM TOUGH	QTY	
<b>AUDI</b>										
AUSTRALIA	A4	3000	GH-8EASN*F • GF-8EASN*F	ASN	01.6 ~	K20TXR	K20TT(*5)	IK20	VK20	6
		3200	GH-8EAU*F • ABA-8EAU*F	AUK	05.2 ~08.3	-	-	-	-	6
CHINA	A5	3200	ABA-8KCALF	CAL	08.3 ~	VK20	-	IK20	VK20	6
		2000	ABA-8TCDNF	CDN(T/C)	09.5 ~	VK22	-	IK22	VK22	4
		2000	ABA-8TCDNL	CDN(T/C)	10.1 ~	VK22	-	IK22	VK22	4
		2000	DBA-8TCDNF • DBA-8FCDNF • DBA-8TCDNL	CDN(T/C)	12.1 ~	VK22	-	IK22	VK22	4
INDIA	A5	2000	DBA-F5CYRF • DBA-F5CYRL	CYR(T/C)	17.4 ~	VKH22	-	IKH22	VKH22	4
		2000	DBA-F5CVKL	CVK(T/C)	17.7 ~	VKH22	-	IKH22	VKH22	4
		2000	ABA-F5CYRC	CYR(T/C)	17.9 ~	VKH22	-	IKH22	VKH22	4
		2000	DBA-F5CYRL	CYR(T/C)	18.11~	-	-	-	-	4
INDONESIA	A6	3200	3AA-F5DDWF • 3AA-F5DDWL	DDW(T/C)	21.1 ~	VKH22	-	IKH22	VKH22	4
		3200	ABA-8TCALF	CAL	08.2 ~	VKH22	-	IKH22	VKH22	6
KOREA	A6	1800	ABA-4GCGY	GY(T/C)	15.7 ~	VKH22	-	IKH22	VKH22	4
		2000	DAA-4GCHJS	CHJ-EAFA(T/C)	12.9 ~	VK22	-	IK22	VK22	4
		2000	DBA-4GCDN	CDN(T/C)	14.2 ~	VK22	-	IK22	VK22	4
		2000	ABA-4GCYPS	CYP(T/C)	15.7 ~	VKH22	-	IKH22	VKH22	4
MALAYSIA	A6	2400	3AA-F2DKNF	DKN(T/C)	20.1 ~	-	-	-	-	4
		2400	E-4BAGAF	AGA	97.9 ~98.5	K20PBR-S10	-	IK20	VK20	6
		2400	E-4BAGA • E-4BAGAF	AGA	98.5 ~99.9	K20TXR	K20TT(*5)	IK20	VK20	6
		2400	GF-4BAPS • GF-4BAPSF	APS	99.9 ~00.10	K20TXR	K20TT(*5)	IK20	VK20	6
		2400	GH-4BBDV • GF-4BBDV	BDV	00.10~04.7	K20TXR	K20TT(*5)	IK20	VK20	6
		2400	GH-4EBDW	BDW	04.9 ~	VK20	-	IK20	VK20	6
		2400	GH-4BBDW	BDW	04.7 ~	PK20PR-L11	-	IK20	VK20	6
		2400	GH-4FBDW • ABA-4FBDW	BDW	04.7 ~	VK20	-	IK20	VK20	6
		2600	E-4AABC	ABC	94.11~97.8	K20PBR-S10	-	IK20	VK20	6
		2700	GF-4BAZAF	AZA(T/C)	01.1 ~01.11	VK20Y	-	-	VK20Y	6
		2700	GF-4BARES	ARE(T/C)	01.11~02.9	VK20Y	-	-	VK20Y	6
		PHILIPPINES	A6	2800	GF-4BBESS • GH-4BBESS	BES(T/C)	02.9 ~	VK20Y	-	-
2800	E-4AAAHF			AAH	94.10~97.9	K20PBR-S10	-	IK20	VK20	6
2800	E-4AACKF			ACK	97.9 ~98.5	K20PBR-S10	-	IK20	VK20	6
2800	E-4BACKF			ACK	98.5 ~99.9	K20TXR	K20TT(*5)	IK20	VK20	6
2800	GF-4BAPRF			APR	99.9 ~	K20TXR	K20TT(*5)	IK20	VK20	6
2800	ABA-4FBDXS			BDX	07.8 ~	VK20	-	IK20	VK20	6
2800	ABA-4FCES			CCE	09.1 ~	VK20	-	IK20	VK20	6
2800	ABA-4GCHVS			CHV	11.8 ~	VK20	-	IK20	VK20	6
2800	DBA-4GCHVS			CHV	13.7 ~	VK20	-	IK20	VK20	6
3000	GF-4BASNF • GH-4BASNF			ASN	01.11~04.7	K20TXR	K20TT(*5)	IK20	VK20	6
3000	ABA-4FCAJS • ABA-4FCAJA			(S/C)	09.1 ~	IK24	-	IK24	-	6
SAUDI ARABIA	A6			3000	ABA-4GCGWS	CGW(S/C)	11.8 ~	IK24	-	IK24
		3000	DBA-4GCGWS	CGW(S/C)	13.7 ~	IK24	-	IK24	-	6
		3000	DBA-4GCGWB	CGW(S/C)	14.8 ~	VK20	-	IK20	VK20	6
		3000	ABA-4GCRES • ABA-4GCREB	CRE(S/C)	15.7 ~	IK24	-	IK24	-	6
		3000	AAA-F2DLZF	DLZ(T/C)	19.3 ~	-	-	-	-	6
		3200	ABA-4FAUKA	AUK	04.7 ~	-	-	-	-	8
SINGAPORE	A6	4200	GH-4FBATS • GH-4FBATA	BAT	04.7 ~06.8	K20PBR-S10	-	IK20	VK20	8
		4200	ABA-4FBVJA	BVJ	06.8 ~	VKB20	-	-	VKB20	8
		3200	GH-4FAUKS	AUK	04.9 ~	-	-	-	-	6
		3200	ABA-4FAUKS	AUK	06.9 ~	-	-	-	-	6
TAIWAN	A6 3.2 QUATTRO	4200	GH-4FBATS	BAT	04.9 ~	K20PBR-S10	-	IK20	VK20	8
		4200	GH-4FBATA	BAT	05.8 ~06.8	K20PBR-S10	-	IK20	VK20	8
		2700	GF-4BAREF	ARE(T/C)	01.2 ~02.8	VK20Y	-	-	VK20Y	6
		2700	GH-4BBESF	BES(T/C)	02.9 ~	VK20Y	-	-	VK20Y	6
THAILAND	A6 4.2 QUATTRO	4200	GH-4BBASF	BAS	03.11~	K20PBR-S10	-	IK20	VK20	8
		2000	ABA-4GCYPC	CYP(T/C)	15.7 ~	VKH22	-	IKH22	VKH22	4
		2000	3AA-F2DKNS	DKN(T/C)	20.1 ~	-	-	-	-	4
		3000	ABA-4GCGWC	CGW(S/C)	11.5 ~	IK24	-	IK24	-	6
VIETNAM	A6 ALL ROAD	3000	DBA-4GCGWC	CGW(S/C)	13.7 ~	IK24	-	IK24	-	6
		3000	ABA-4GCREC	CRE(S/C)	15.4 ~	IK24	-	IK24	-	6
		3000	AAA-F2DLZS	DLZ(T/C)	18.9 ~	-	-	-	-	6
		2000	DAA-4HCHJA	CHJ-EAFA(T/C)	13.2 ~	VK22	-	IK22	VK22	4
JAPAN	A6	2000	DAA-4HCHJA	CHJ(T/C)	14.8 ~	-	-	IK22	VK22	4
		3000	DBA-4HCGWF	CGW(S/C)	12.9 ~	IK24	-	IK24	-	6
		3000	DBA-4HCREF	CGW(S/C)	14.3 ~	IK24	-	IK24	-	6
		3200	AAA-F8CZSF	CZS(T/C)	18.10~	-	-	-	-	6
EUROPE & USA	A7	3200	GH-4EBPKF • ABA-4EBPKF	BPK	05.8 ~	-	-	-	-	6
		2000	ABA-4GCYPC	CYP(T/C)	15.7 ~	VKH22	-	IKH22	VKH22	4
		2000	3AA-F2DKNS	DKN(T/C)	20.1 ~	-	-	-	-	4
		3000	ABA-4GCGWC	CGW(S/C)	11.5 ~	IK24	-	IK24	-	6
CROSS REFERENCE NUMBER	A8	3000	DBA-4GCGWC	CGW(S/C)	13.7 ~	IK24	-	IK24	-	6
		3000	ABA-4GCREC	CRE(S/C)	15.4 ~	IK24	-	IK24	-	6
		3000	AAA-F2DLZS	DLZ(T/C)	18.9 ~	-	-	-	-	6
		2000	DAA-4HCHJA	CHJ-EAFA(T/C)	13.2 ~	VK22	-	IK22	VK22	4

(\*5) : It can be used only for a plug with a terminal.



MODEL	CC	VEHICLE CODE	ENGINE	FROM-TILL	DENSO		IRIDIUM POWER	IRIDIUM TOUGH	QTY		
<b>AUDI</b>											
<b>A8</b>	3700	E-4DAEW	AEW	96.8 ~ 97.10	T20EPR-U	-	IT20	VT20	8	AUSTRALIA	
		GF-4DAQG	AQG	99.4 ~	VK20	-	IK20	VK20	8		
		GH-4EBFLF	BFL	05.8 ~	K20TXR	K20TT(*5)	IK20	VK20	8		
	4000	ABA-4HCEUF	CEU(T/C)	12.9 ~	-	-	-	-	8	CHINA	
		ABA-4HCEUL	CEU(T/C)	12.9 ~	IKH24	-	IKH24	-	8		
		ABA-4HCTGF · ABA-4HCTGL	CEU(T/C)	14.3 ~	IKH24	-	IKH24	-	8		
		AAA-F8CXYF · AAA-F8CXYL	CXY(T/C)	18.10~	-	-	-	-	8		
	4200	E-4DABZ	ABZ	94.10~99.7	T20EPR-U	-	-	VT20	8	INDIA	
		GF-4DAQF	AQF	99.8 ~	K20PBR-S10	-	-	VK20	8		
		GH-4EBFML	BFM	04.9 ~ 06.8	K20TXR	K20TT(*5)	-	VK20	8		
		GH-4EBFMF	BFM	04.2 ~ 06.8	K20PBR-S10	-	-	VK20	8		
		GF-4DAUW · GH-4DAUW	AUW	00.9 ~	VK20	-	-	VK20	8	INDONESIA	
		ABA-4EBVJF · ABA-4EBVJL	BVJ	06.8 ~	VKB20	-	-	VKB20	8		
	6000	GH-4EBHTN	BHT	05.3 ~ 06.12	VKA20	-	-	VKA20	12	KOREA	
		GH-4EBHTF · ABA-4EBHTF	BHT	05.3 ~	VKA20	-	-	VKA20	12		
	6300	ABA-4HCEJL	CEJ	11.6 ~	-	-	-	-	12		
		ABA-4HCTNL	CTN	14.5 ~	-	-	-	-	12		
	<b>CABRIO</b>	2300	E-8GNBK	NG	92.10~	W20EPB	-	IW20	VW20	5	
		2600	E-8GABCK	ABC	94.10~	K20PBR-S10	-	IK20	VK20	6	
	<b>COUPE</b>	2600	E-8BABC	ABC	93.10~	K20PBR-S10	-	IK20	VK20	6	
2800		E-8BAAH	AAH	92.3 ~	K20PBR-S10	-	IK20	VK20	6		
<b>Q2</b>	1000	ABA-GACHZ	CHZ(T/C)	17.6 ~	-	-	-	-	3	MALAYSIA	
	1400	ABA-GACZE	CZE(T/C)	17.6 ~	-	-	-	-	4		
<b>Q3</b>	1400	ABA-8UCHP	CHP(T/C)	14.8 ~	-	-	-	-	4		
		ABA-8UCZD	CZD(T/C)	15.5 ~	-	-	-	-	4		
	1500	3BA-F3DPC	DPC(T/C)	20.8 ~	VKH22	-	IKH22	VKH22	4		
		ABA-8UCPSF	CPS(T/C)	12.5 ~	VK22	-	IK22	VK22	4		
	2000	ABA-8UCCZF	CCZ(T/C)	13.8 ~	VK22	-	IK22	VK22	4		
		ABA-8UCULB · ABA-8UCULC	CUL(T/C)	15.5 ~	VKH22	-	IKH22	VKH22	4		
	2500	ABA-8UCULB	CUL(T/C)	17.9 ~	-	-	-	-	4		
		ABA-8UCTSF	CTS(T/C)	14.3 ~	-	-	-	-	5		
		ABA-8UCZGF	CZG(T/C)	15.5 ~	-	-	IKH24	-	5		
		ABA-8UCZGF	CZG(T/C)	16.8 ~	-	-	IKH24	-	5		
<b>Q5</b>	3000	3BA-F3DNWF	DNW(T/C)	20.12~	-	-	-	-	5		
		ABA-8RCDNF	CDN(T/C)	09.6 ~	VK22(*6)	-	IK22(*6)	VK22(*6)	4		
		ABA-8RCNCF	CNC(T/C)	12.11~	VKH22(*6)	-	IKH22(*6)	VKH22(*6)	4		
	2000	DAA-8RCHJF	CHJ-EAFA(T/C)	13.2 ~	VK22	-	IK22	VK22	4		
		DBA-FYDAXS · DBA-FYDAXA	DAX(T/C)	17.10~	VKH22	-	IKH22	VKH22	4		
	3000	3AA-FYDGKS · 3AA-FYDGKA	DGK(T/C)	21.3 ~	VKH22	-	IKH22	VKH22	4		
3200	ABA-8RCTVF	CTV(S/C)	12.11~	IK24	-	IK24	-	6			
<b>Q7</b>	2000	ABA-8RCALF	CAL	09.6 ~	PK20PR-L11	-	IK20	VK20	6		
		ABA-4MCYRS · ABA-4MCYRA	CYR(T/C)	16.3 ~	VKH22	-	IKH22	VKH22	4		
	3000	ABA-4LCJTS	CJT(S/C)	10.7 ~	VK22	-	IK22	VK22	6		
		ABA-4MCRE · ABA-4MCREA	CRE(S/C)	16.3 ~	IK24	-	IK24	-	6		
		3AA-4MDCBS · 3AA-4MDCBA	DCB(T/C)	20.8 ~	-	-	-	-	6		
3600	ABA-4LBHKS	BHK	07.4 ~	-	-	-	-	6			
<b>Q8</b>	4200	ABA-4LBARS	BAR	06.10~	VKB20	-	-	VKB20	8		
	3000	AAA-F1DCBS · AAA-F1DCBA	DCB(T/C)	19.9 ~	-	-	-	-	6		
<b>R8</b>	4000	3AA-F1DHUA	DHU(T/C)	21.2 ~	-	-	-	-	8		
		ABA-42BYHF	BYH	07.7 ~	-	-	-	-	8		
<b>R8</b>	4200	ABA-42CNDF	CND	13.4 ~	VK22	-	IK22	VK22	8		
		ABA-42BUJF	BUJ	09.4 ~	-	-	-	-	10		
	5200	ABA-42CTYF	CTY	13.4 ~	VK22	-	IK22	VK22	10		
		ABA-4SCSPF · ABA-4SCSPD	CSP	16.7 ~	VK22	-	IK22	VK22	10		
		ABA-4SCSPF	CSP	17.6 ~	-	-	IK22	VK22	10		
	7BA-4SDMWF	DMW	19.8 ~	-	-	IK22	VK22	10			
	<b>RS3</b>	2500	ABA-4SDKAF · ABA-4SDKAD	DKA	18.7 ~	-	-	IK22	VK22	10	
ABA-8VCZGF			CZG(T/C)	15.10~	-	-	IKH24	-	5		
ABA-8VDAZL			DAZ(T/C)	17.7 ~	-	-	-	-	5		
<b>RS4</b>	2900	ABA-8VDAZF	DAZ(T/C)	17.11~	-	-	-	-	5		
		ABA-8WDECF	DEC(T/C)	19.1 ~	-	-	-	-	6		
<b>RS4</b>	4200	3BA-8WDECF	DEC(T/C)	21.1 ~	-	-	-	-	6		
		GH-8EBNSF · ABA-8EBNSF	BNS	06.9 ~	VKB20	-	-	VKB20	8		
	ABA-8KCFSF	CFS	13.4 ~	VK22	-	IK22	VK22	8			
<b>RS5</b>	2900	ABA-F5DECF	DEC(T/C)	17.9 ~	-	-	-	-	6		
		ABA-F5DECL	DEC(T/C)	19.8 ~	-	-	-	-	6		
		3BA-F5DECF · 3BA-F5DECL	DEC(T/C)	21.1 ~	-	-	-	-	6		

(\*5) : It can be used only for a plug with a terminal. (\*6) : The plug reach may be 19mm or 26.5mm even with the same engine and the same vehicle code. Please confirm the plug reach and choose the correct DENSO type. If there is an "H" in DENSO type, it has a reach of 26.5mm. If it doesn't, its reach is 19mm

AUSTRALIA  
 CHINA  
 INDIA  
 INDONESIA  
 KOREA  
 MALAYSIA  
 PHILIPPINES  
 SAUDI ARABIA  
 SINGAPORE  
 TAIWAN  
 THAILAND  
 VIETNAM  
 JAPAN  
 EUROPE & USA  
 CROSS REFERENCE NUMBER  
 PART



# EUROPE & U.S.A. CAR

▶ Spark plug color codes: ■ for Iridium Tough and Iridium Plugs and Iridium TT, ■ for Iridium Power, ■ for Iridium Racing and Two Tops Plugs, ■ for Platinum Plugs and Platinum TT, and black for general spark plugs.

COUNTRY	MODEL	CC	VEHICLE CODE	ENGINE	FROM-TILL	DENSO	TJ	IRIDIUM POWER	IRIDIUM TOUGH	QTY
AUSTRALIA	AUDI RS5	4200	ABA-8TCFSF	CFS	12.8 ~	VK22	-	IK22	VK22	8
			ABA-8FCFSF	CFS	13.10~	VK22	-	IK22	VK22	8
CHINA	RS6	4000	ABA-4GCRDS	CRD(T/C)	13.10~	IKH24	-	IKH24	-	8
			ABA-4GCWUS	CWU(T/C)	15.7 ~	IKH24	-	IKH24	-	8
			3AA-F2DJPF · 3AA-F2DJPL	DJP(T/C)	21.1 ~	-	-	-	-	8
			GH-4BBCYF	BCY	03.12~	VK22	-	IK22	VK22	8
INDIA	RS7	4000	ABA-4FBUHS	BXA(T/C)	09.1 ~	VK22	-	IK22	VK22	10
			ABA-4GCRDC	CRD(T/C)	14.1 ~	IKH24	-	IKH24	-	8
			ABA-4GCWUC	CWU(T/C)	15.4 ~	IKH24	-	IKH24	-	8
			3AA-F2DJPS · 3AA-F2DJPA	DJP(T/C)	21.1 ~	-	-	-	-	8
INDONESIA	S1	2000	ABA-8XCWZF	CWZ(T/C)	14.11~	VKH22	-	IKH22	VKH22	4
			S3	1800	GF-8LAMKF	AMK	01.1 ~02.1	VK20	-	IK20
INDONESIA	S3	2000	GF-8LBAMF · GH-8LBAMF		BAM(T/C)	02.1 ~	VK20Y	-	-	VK20Y
			ABA-8PCDLF	(T/C)	09.2 ~	VK22	-	IK22	VK22	4
			ABA-8VCJXL	CJX(T/C)	14.1 ~	VKH22	-	IKH22	VKH22	4
			ABA-8VCJXL · ABA-8VCJXF	CJX(T/C)	14.8 ~	-	-	-	-	4
KOREA	S4	2200	ABA-8VDJHL · ABA-8VDJHF	DJH(T/C)	17.1 ~	-	-	-	-	4
			E-4AAAN	AAN	93.1 ~	VK22	-	IK22	VK22	5
MALAYSIA	S4	2700	GF-8DAGBF	AGB	99.6 ~03.9	VK20	-	IK20	VK20	6
			GF-8DAZBF	AZB	00.12~	VK20	-	IK20	VK20	6
			ABA-8KCAKF	(S/C)	09.5 ~	IK24	-	IK24	-	6
			ABA-8KCGWF	CWG(S/C)	12.4 ~	IK24	-	IK24	-	6
PHILIPPINES	S5	3000	ABA-8WCWGF	CWG(T/C)	16.10~	-	-	-	-	6
			3BA-8WCWGF	CWG(T/C)	20.10~	-	-	-	-	6
			GH-8EBBF · ABA-8EBBF	BBK	03.9 ~08.1	K20PBR-S10	-	IK20	VK20	8
			ABA-8TCGWL	CGW(S/C)	12.1 ~	IK24	-	IK24	-	6
SAUDI ARABIA	S5	3000	ABA-8TCGWL	CGW(S/C)	12.1 ~	IK24	-	IK24	-	6
			ABA-F5CWGF · ABA-F5CWGL	CWG(T/C)	17.4 ~	-	-	-	-	6
			ABA-F5CWGC	CWG(T/C)	17.7 ~	-	-	-	-	6
			3BA-F5CWGF · 3BA-F5CWGL	CWG(T/C)	21.1 ~	-	-	-	-	6
SINGAPORE	S6	4200	ABA-8TCAUF	BBK	08.2 ~	VKB20	-	-	VKB20	8
			E-4AAAN	AAN	99.1 ~	VK22	-	IK22	VK22	5
			3AA-F2DKML	DKM(T/C)	20.9 ~	-	-	-	-	6
			ABA-4GCEUA	CEU(T/C)	12.8 ~	IKH24	-	IKH24	-	8
TAIWAN	S7	4000	ABA-4GCTGA	CTG(T/C)	15.7 ~	IKH24	-	IKH24	-	8
			GF-4BAQJF	AQJ	99.11 ~01.11	K20PBR-S10	-	IK20	VK20	8
			GF-4BANKF · GH-4BANKF	ANK	01.11~06.6	VK20	-	IK20	VK20	8
			ABA-4FBXAS	BXA	06.6 ~	VKB20	-	-	VKB20	10
THAILAND	S8	4000	3AA-F2DKMA	DKM(T/C)	20.9 ~	-	-	-	-	6
			ABA-4GCEUL	CEU(T/C)	12.8 ~	IKH24	-	IKH24	-	8
			ABA-4GCTGL	CTG(T/C)	15.4 ~	IKH24	-	IKH24	-	8
			ABA-4HCGTF	CGT(T/C)	12.8 ~	IKH24	-	IKH24	-	8
VIETNAM	S8	4000	ABA-4HCTFF	CTF(T/C)	14.5 ~	IKH24	-	IKH24	-	8
			ABA-4HDDTF	DDT(T/C)	16.4 ~	-	-	IKH24	-	8
			3AA-F8CWWF	CWW(T/C)	20.8 ~	-	-	-	-	8
			GF-4DBCS	BCS	00 ~	K20PBR-S10	-	IK20	VK20	8
JAPAN	SQ2	2000	GF-4DAYS	AYS	01.1 ~	K20PBR-S10	-	IK20	VK20	8
			ABA-4EBSMF	-	06.6 ~	VKB20	-	-	VKB20	10
EUROPE & USA	SQ5	3000	3BA-GADNUF	DNU(T/C)	19.12~	-	-	-	-	4
			ABA-8RCTXF	CTX(S/C)	13.10~	IK24	-	IK24	-	6
			ABA-FYCWGS	CWG(T/C)	17.10~	-	-	-	-	6
			ABA-FYCWGA	CWG(T/C)	18.12~	-	-	-	-	6
CROSS REFERENCE NUMBER	TT COUPE	1800	GF-8NAPXF · GH-8NAPXF	APX(T/C)	99.1 ~00.12	VK20Y	-	-	VK20Y	4
			GF-8NBAMF · GH-8NBAMF	BAM(T/C)	00.11~03.9	VK20Y	-	-	VK20Y	4
			GF-8NAUQ · GH-8NAUQ	AUQ(T/C)	01.1 ~05.11	VK20Y	-	-	VK20Y	4
			GH-8NBVR	BVR(T/C)	05.11~	VK20Y	-	-	VK20Y	4
			ABA-8JCDA	CDA(T/C)	12.1 ~	VK22	-	IK22	VK22	4
			ABA-FVCJS	CJS(T/C)	16.8 ~	-	-	-	-	4
			ABA-8JBWA	BWA(T/C)	06.7 ~08.9	VK20Y	-	-	VK20Y	4
			ABA-8JCCZF	CCZ(T/C)	08.9 ~	VK22	-	IK22	VK22	4
			ABA-8JCES · ABA-8JCESF	CES(T/C)	11.7 ~	VK22	-	IK22	VK22	4
			ABA-FVCHH · ABA-FVCHHF	CHH(T/C)	15.8 ~	VKH22	-	IKH22	VKH22	4
			ABA-FVDKZ	DKZ(T/C)	19.5 ~	VKH22	-	IKH22	VKH22	4
			ABA-FVCHHF	CHH(T/C)	19.6 ~	-	-	-	-	4
PART NUMBER	TT ROADSTER	1800	GH-8NBHEF	BHE	03.11~06.7	-	-	-	-	6
			ABA-8JBUBF	BUB	06.7 ~	-	-	-	-	6
PART NUMBER	TT ROADSTER	1800	GF-8NAPXF	APX(T/C)	00.5 ~	VK20Y	-	-	VK20Y	4

DENSO	9	14	16	20	22	24	27	29	31	32	34	35	DENSO	9	14	16	20	22	24	27	31	32	DENSO	9	14	16	20	22	24	27	31	
NGK	2	4	5	6	7	8	9	9.5	10	10.5	11	11.5	CHAMPION	18	16,14	12,11	10,9	8,7	6,63,61	4,59	57	55	53	BOSCH	10	9	8	7,6	5	4	3	2





MODEL	CC	VEHICLE CODE	ENGINE	FROM-TILL	DENSO		IRIDIUM POWER	IRIDIUM TOUGH	QTY	
<b>AUDI</b>										
<b>TT ROADSTER</b>	1800	GF-8NAUQ • GH-8NAUQ	AUQ(T/C)	01.1 ~05.11	VK20Y	-	-	VK20Y	4	AUSTRALIA
		GF-8NBAMF • GH-8NBAMF	BAM(T/C)	01.1 ~	VK20Y	-	-	VK20Y	4	CHINA
	2000	ABA-8JCESF	CES(T/C)	11.7 ~	VK22	-	IK22	VK22	4	INDIA
		ABA-FVCHHF	CHH(T/C)	15.8 ~	VKH22	-	IKH22	VKH22	4	INDONESIA
		ABA-FVCHHF	CHH(T/C)	19.6 ~	-	-	-	-	4	INDONESIA
<b>TTRS COUPE</b>	2500	ABA-8JCEPF	CEP(T/C)	10.1 ~	VKH22	-	IKH22	VKH22	5	INDONESIA
		ABA-FVDAZF	DAZ(T/C)	17.5 ~	VKH22	-	IKH22	VKH22	5	INDONESIA
		7BA-FVDAZF	DAZ(T/C)	20.10~	-	-	-	-	5	INDONESIA
<b>TTRS PLUS COUPE</b>	2500	ABA-8JCEPF	CEP(T/C)	13.2 ~	VK22	-	IK22	VK22	5	INDONESIA
<b>TTRS ROADSTER</b>	2500	ABA-FVDAZF	DAZ(T/C)	17.5 ~	VKH22	-	IKH22	VKH22	5	INDONESIA
<b>TTS COUPE</b>	2000	ABA-8JCDLF	CDL(T/C)	08.9 ~	VK20Y	-	-	VK20Y	4	INDONESIA
		ABA-FVCJXF	CJX(T/C)	15.8 ~	VKH22	-	IKH22	VKH22	4	INDONESIA
		ABA-FVCJXF	CJX(T/C)	17.9 ~	VKH22	-	IKH22	VKH22	4	INDONESIA
		ABA-FVCJXF	CJX(T/C)	19.6 ~	-	-	-	-	4	INDONESIA
<b>V8</b>	4200	E-44ABHL	ABH	92.4 ~93.11	T20EPR-U	-	IT20	VT20	8	INDONESIA
<b>BENTLEY</b>										
<b>ARNAGE</b>	4400	GF-BL	448	00 ~00	K20TXR	K20TT(*5)	IK20	VK20	8	KOREA
	4500	GF-BL	-	98.6 ~00	K20TXR	K20TT(*5)	IK20	VK20	8	KOREA
		GF-BLC	L410MT	01 ~	IK20	-	IK20	VK20	8	INDONESIA
	6700	GF-BLE	L410MT	01 ~01	IK20	-	IK20	VK20	8	INDONESIA
		-	-	04.7 ~	IW16	-	IW16	VW16	8	INDONESIA
<b>ARNAGE R</b>	6700	GH-BLC	L410MT	02 ~	IK16	-	IK16	VK16	8	INDONESIA
<b>ARNAGE RL</b>	6700	GH-BLE	L410MT	03 ~	IK16	-	IK16	VK16	8	INDONESIA
<b>ARNAGE T</b>	6700	GF-BLF • GH-BLF	L410MT(T/C)	01.4 ~	IK16	-	IK16	VK16	8	INDONESIA
<b>AZURE</b>	6700	GF-BK	L410MT	95 ~	IK20	-	IK20	VK20	8	INDONESIA
		E-BK	-	95.8 ~	K16PR-U	K16TT	IK16	VK16	8	INDONESIA
<b>BROOKLANDS</b>	6700	E-BET	L410MT	93 ~97	IK16	-	IK16	VK16	8	INDONESIA
		E-BME	-	93.10~	IW16	-	IW16	VW16	8	INDONESIA
		E-BYE	-	93.2 ~	IW16	-	IW16	VW16	8	INDONESIA
		E-BMF	-	94.4 ~97	IW16	-	IW16	VW16	8	INDONESIA
		E-BF • E-BE	-	95.9 ~	K16PR-U	K16TT	IK16	VK16	8	INDONESIA
<b>CONTINENTAL</b>	6000	-	-	04.6 ~	IW16	-	IW16	VW16	8	INDONESIA
		E-BYD	-	92.10~	IW16	-	IW16	VW16	8	INDONESIA
	6700	E-BYB	-	92.4 ~	IW16	-	IW16	VW16	8	INDONESIA
		E-BMD	-	94.4 ~	IK16	-	IK16	VK16	8	INDONESIA
<b>CONTINENTAL R</b>	6700	GF-BB	L410MT	92 ~	IK20	-	IK20	VK20	8	INDONESIA
		E-BMB	-	93.10~	IW16	-	IW16	VW16	8	INDONESIA
<b>CONTINENTAL T</b>	6700	GF-BU	L410MT(T/C)	96 ~	IK20	-	IK20	VK20	8	INDONESIA
<b>MULSANNE</b>	6700	E-BYF	-	92.10~	IW16	-	IW16	VW16	8	INDONESIA
<b>TURBO R</b>	6700	E-BYP	(T/C)	92.4 ~	IW16	-	IW16	VW16	8	INDONESIA
		E-BYR	(T/C)	92.8 ~96	IW16	-	IW16	VW16	8	INDONESIA
		E-BMP	(T/C)	93.10~99	IW16	-	IW16	VW16	8	INDONESIA
		E-BMR	(T/C)	94.2 ~96	IW16	-	IW16	VW16	8	INDONESIA
		E-BMT	(T/C)	95.2 ~	K16PR-U	K16TT	IK16	VK16	8	INDONESIA
		E-BR	(T/C)	95.8 ~96	K16PR-U	K16TT	IK16	VK16	8	INDONESIA
		E-BP	(T/C)	95.9 ~	K16PR-U	K16TT	IK16	VK16	8	INDONESIA
<b>BMW</b>										
<b>116i</b>	1600	GH-UF16	N45B16A	05.3 ~07.5	K20TXR	K20TT(*5)	IK20	VK20	4	INDONESIA
		ABA-UE16	N45B16A	07.5 ~	K20TXR	K20TT(*5)	IK20	VK20	4	INDONESIA
		LBA-UE16	N43B16A	10.5 ~	-	-	-	-	4	INDONESIA
		DBA-1A16	N13B16A(T/C)	11.9 ~	-	-	-	-	4	INDONESIA
		DBA-1A16	N13B16A(T/C)	13.8 ~	-	-	-	-	4	INDONESIA
<b>118i</b>	1500	DBA-1R15	B38B15A(T/C)	15.9 ~	-	-	-	-	3	INDONESIA
		DBA-1R15	B38B15A(T/C)	17.8 ~	-	-	-	-	3	INDONESIA
		3BA-7K15	B38A15A(T/C)	19.8 ~	-	-	-	-	3	INDONESIA
<b>120i</b>	1600	DBA-1A16	N13B16A(T/C)	15.5 ~	-	-	-	-	4	INDONESIA
		GH-UF18	N46B20B	05.3 ~07.5	VK20	-	IK20	VK20	4	INDONESIA
		DBA-1A16	N13B16A(T/C)	11.9 ~	-	-	-	-	4	INDONESIA
<b>130i</b>	2000	GH-UF20	N46B20B	04.10~07.5	VK20	-	IK20	VK20	4	INDONESIA
		ABA-UD20 • ABA-UL20	N46B20B	07.5 ~	VK20	-	IK20	VK20	4	INDONESIA
		LBA-UD20 • LBA-UC20 • LBA-UM20	N43B20A	10.5 ~	-	-	-	-	4	INDONESIA
		DBA-1S20G	B48B20A(T/C)	16.11~	-	-	-	-	4	INDONESIA
<b>135i</b>	3000	ABA-UF30	N52B30A	05.11~07.5	-	-	-	-	6	INDONESIA
		ABA-UD30	N52B30A	07.5 ~	-	-	-	-	6	INDONESIA
<b>135i</b>	3000	ABA-UC35	N54B30A(T/C)	08.2 ~10.5	-	-	-	-	6	INDONESIA
		ABA-UC30	N55B30A(T/C)	10.5 ~	-	-	-	-	6	INDONESIA

(\*5) : It can be used only for a plug with a terminal.



# EUROPE & U.S.A. | CAR

▶ Spark plug color codes: ■ for Iridium Tough and Iridium Plugs and Iridium TT, ■ for Iridium Power, ■ for Iridium Racing and Two Tops Plugs, ■ for Platinum Plugs and Platinum TT, and black for general spark plugs.

	MODEL	CC	VEHICLE CODE	ENGINE	FROM-TILL	DENSO		IRIDIUM POWER	IRIDIUM TOUGH	QTY	
AUSTRALIA	BMW 218i	1500	DBA-2A15	B38A15A(T/C)	14.10~	-	-	-	-	3	
			DBA-2D15	B38A15A(T/C)	15.6 ~	-	-	-	-	3	
			DBA-2D15	B38A15A(T/C)	17.4 ~	-	-	-	-	3	
CHINA	220i	2000	DBA-6S15 • DBA-6V15	B38A15A(T/C)	18.6 ~	-	-	-	-	3	
			3BA-7K15	B38A15A(T/C)	19.10~	-	-	-	-	3	
INDIA	225i	2000	DBA-1J20	N20B20B(T/C)	14.2 ~	-	-	-	-	4	
			DBA-2D20	B48A20A(T/C)	15.6 ~	-	-	-	-	4	
			DBA-2F20	B48B20A(T/C)	16.9 ~	-	-	-	-	4	
			DBA-2D20	B48A20A(T/C)	16.9 ~	-	-	-	-	4	
			CBA-6V20	B48A20A(T/C)	18.6 ~	-	-	-	-	4	
INDONESIA	225xe	1500	DBA-2A20	B48A20B(T/C)	14.10~	-	-	-	-	4	
			DBA-2A20	B48A20B(T/C)	17.4 ~	-	-	-	-	4	
INDONESIA	316ti	1800	DLA-2C15	B38A15A-P160(T/C)	16.1 ~	-	-	-	-	3	
			DLA-2C15	B38A15A(T/C)	17.4 ~	-	-	-	-	3	
KOREA	316ti M Sport	1900	GH-AT18	N42B18A	01.11~	VK20	-	IK20	VK20	4	
			GF-CG19	194S	00 ~	VK20	-	IK20	VK20	4	
KOREA	318Ci	2000	GH-BX20	N42B20A	05.4 ~	VK20	-	IK20	VK20	4	
			DBA-8E15	B38B15A(T/C)	16.10~	-	-	-	-	3	
KOREA	318i	1800	E-CA18D	-	93.11~98.6	K20TXR	-	IK20	VK20	4	
			1900	GF-AL19 • GH-AL19	194E	98.7 ~01.10	K20TXR	-	IK20	VK20	4
			2000	3BA-5F20	B48B20A(T/C)	20.8 ~	-	-	-	-	4
MALAYSIA	318i/Ci	2000	3BA-6K20	B48B20A(T/C)	20.9 ~	-	-	-	-	4	
			GH-AY20	N42B20A	01.10~	VK20	-	IK20	VK20	4	
PHILIPPINES	318iS	1800	E-BE18	M42B18	93.3 ~96.3	K20TXR	-	IK20	VK20	4	
			1900	E-BE19	M44B19	96.4 ~99.12	K20TXR	-	IK20	VK20	4
PHILIPPINES	318ti	1800	E-CG18	-	95.1 ~96.10	K20TXR	-	IK20	VK20	4	
			1900	E-CG19	M44B19	96.11~00	K20TXR	K20TT(*5)	IK20	VK20	4
			2000	GH-AU20	N42B20A	01.11~	VK20	-	IK20	VK20	4
SAUDIARABIA	320i	2000	E-BF20	M50B20	92.5 ~95	K20TXR	K20TT(*5)	IK20	VK20	6	
			GF-AM20	-	99.7 ~00	K20TXR	K20TT(*5)	IK20	VK20	6	
			ABA-VA20 • ABA-VR20 • ABA-WA20	N46B20B	05.4 ~10.5	VK20	-	IK20	VK20	4	
			LBA-PG20 • LBA-KD20 • LBA-US20	N43B20A	10.5 ~	-	-	-	-	4	
			DBA-3B20	N20B20B(T/C)	12.4 ~	-	-	-	-	4	
			DBA-3X20	N20B20B(T/C)	13.6 ~	-	-	-	-	4	
			DBA-3X20	N20B20B(T/C)	14.11~	-	-	-	-	4	
			DBA-8A20	B48B20A(T/C)	15.9 ~	-	-	-	-	4	
			DBA-8A20	B48B20A(T/C)	16.5 ~	-	-	-	-	4	
			DBA-8X20	B48B20A(T/C)	16.10~	-	-	-	-	4	
TAIWAN	320i	2200	3BA-5F20	B48B20B(T/C)	19.3 ~	-	-	-	-	4	
			3BA-6K20	B48B20A(T/C)	19.9 ~	-	-	-	-	4	
			GH-AV22	226S	00.11~05.4	VK20	-	IK20	VK20	6	
THAILAND	323i	2500	GF-AM25	-	98.9 ~00	K20TXR	K20TT(*5)	IK20	VK20	6	
			ABA-VB23	N52B25A	05 ~	-	-	-	-	6	
VIETNAM	325i	2500	E-BJ25	M50B25	93.7 ~	K20TXR	K20TT(*5)	IK20	VK20	6	
			GH-AV25	256S,M54	00.11~	VK20	-	IK20	VK20	6	
			ABA-VB25 • ABA-VS25 • ABA-VF25	N52B25A	05.4 ~10.5	-	-	-	-	6	
VIETNAM	328i	3000	LBA-PH25 • LBA-UT25 • LBA-KE25	N53B30A	10.5 ~	-	-	-	-	6	
			DBA-3A20	N20B20A(T/C)	12.9 ~	-	-	-	-	4	
			DBA-3X28	N20B20A(T/C)	13.6 ~	-	-	-	-	4	
JAPAN	328i	2800	DBA-3X28	N20B20A(T/C)	14.11~	-	-	-	-	4	
			E-CD28 • E-BK28	M521328	95.6 ~99	K20TXR	K20TT(*5)	-	-	6	
JAPAN	328i/Ci	2800	GF-AM28	-	98.7 ~00	K20TXR	K20TT(*5)	-	-	6	
			GH-AV30	306S	00.8 ~05.4	VK20	-	IK20	VK20	6	
EUROPE & USA	330i/Ci/Xi	3000	ABA-VD30	N52B30A	05.10~	-	-	-	-	6	
			DBA-8E20	B48B20A(T/C)	16.1 ~	-	-	-	-	4	
EUROPE & USA	330e	2000	3LA-5X20	B48B20B(T/C)	19.5 ~	-	-	-	-	4	
			DBA-8A20	B48B20B(T/C)	15.9 ~	-	-	-	-	4	
			DBA-8A20	B48B20B(T/C)	16.5 ~	-	-	-	-	4	
EUROPE & USA	330i	2000	3BA-6K20	B48B20B(T/C)	19.9 ~	-	-	-	-	4	
			ABA-VB30	N52B30A	05.4 ~	-	-	-	-	6	
CROSS REFERENCE NUMBER	335i	3000	ABA-VB35 • ABA-VS35 • ABA-WB35 • ABA-WL35(E92)	N54B30A(T/C)	06.10~10.5	-	-	-	-	6	
			ABA-PM35 • ABA-UV35 • ABA-KG35 • ABA-DX35	N55B30A(T/C)	10.5 ~	-	-	-	-	6	
			DBA-3A30	N55B30A(T/C)	13.4 ~	-	-	-	-	6	
			DBA-3X30	N55B30A(T/C)	13.6 ~	-	-	-	-	6	
EUROPE & USA	340i	3000	DBA-8B30	B58B30A(T/C)	15.9 ~	-	-	-	6		

(\*5) : It can be used only for a plug with a terminal.



MODEL	CC	VEHICLE CODE	ENGINE	FROM-TILL	DENSO		IRIDIUM POWER	IRIDIUM TOUGH	QTY			
<b>BMW</b>												
<b>340i</b>	3000	DBA-8B30	B58B30A(T/C)	16.5 ~	-	-	-	-	6	AUSTRALIA		
<b>ACTIVE HYBRID 3</b>	3000	DAA-3F30	N55B30A-M230(T/C)	12.7 ~	-	-	-	-	6	CHINA		
<b>420i</b>	2000	DBA-3N20	N20B20B(T/C)	14.1 ~	-	-	-	-	4			
		DBA-4A20	N20B20B(T/C)	14.6 ~	-	-	-	-	4			
		DBA-4N20 • DBA-4D20	B48B20A(T/C)	16.4 ~	-	-	-	-	4			
		3BA-12AP20	B48B20A(T/C)	20.10~	-	-	-	-	4			
<b>428i</b>	2000	DBA-3N28	N20B20A(T/C)	13.9 ~	-	-	-	-	4	INDIA		
		DBA-4A28	N20B20A(T/C)	14.6 ~	-	-	-	-	4			
<b>430i</b>	2000	DBA-4N20 • DBA-4D20	B48B20B(T/C)	16.4 ~	-	-	-	-	4	INDONESIA		
<b>435i</b>	3000	DBA-3R30	N55B30A(T/C)	13.9 ~	-	-	-	-	6			
		DBA-4B30	N55B30A(T/C)	14.6 ~	-	-	-	-	6			
<b>440i</b>	3000	DBA-4P30 • DBA-4E30	B58B30A(T/C)	16.4 ~	-	-	-	-	6	KOREA		
<b>523i</b>	2000	DBA-XG20	N20B20B	11.10~	-	-	-	-	4			
		DBA-XL20	N20B20B(T/C)	13.9 ~	-	-	-	-	4			
		DBA-JA20	B48B20A(T/C)	17.2 ~	-	-	-	-	4			
		DBA-JL10	B48B20A(T/C)	17.6 ~	-	-	-	-	4			
		3BA-JR20S	B48B20A(T/C)	20.9 ~	-	-	-	-	4			
<b>525i</b>	2500	DBA-FP25 • DBA-MT25	N52B25A	10.7 ~	-	-	-	-	6	MALAYSIA		
		E-DD25 • E-DD25A	M50B25	96.4 ~98.8	K20TXR	K20TT(*5)	IK20	VK20	6			
	E-DD25 • E-DD25A	-	98.8 ~99	VK20	-	IK20	VK20	6				
	GF-DM25	-	98.9 ~	K20TXR	K20TT(*5)	IK20	VK20	6				
	GH-DT25 • GH-DS25 • GH-DS25A	256S	00.11~03.8	VK20	-	IK20	VK20	6				
	GH-NA25	256S	03.11~05.6	VK20	-	IK20	VK20	6				
	GH-NG25	256S	04.6 ~07.6	VK20	-	IK20	VK20	6				
	ABA-NE25	N52B25A	05.6 ~07.6	-	-	-	-	6				
	ABA-NL25	N52B25A	05.6 ~	-	-	-	-	6				
	ABA-NU25	N52B25A	07.6 ~10.5	-	-	-	-	6				
	ABA-PU25	N52B25A	07.6 ~	-	-	-	-	6				
<b>528i</b>	2000	DBA-XG28	N20B20A	11.11~	-	-	-	-	4	PHILIPPINES		
		DBA-XL28	N20B20A(T/C)	11.11~	-	-	-	-	4			
		DBA-SZ20	N20B20A(T/C)	13.9 ~	-	-	-	-	4			
		DBA-XG28 • DBA-SZ20 • DBA-XL28	N20B20A(T/C)	14.6 ~	-	-	-	-	4			
	2800	E-DD28 • E-DD28A	M52B28	96.4 ~98.6	K20TXR	K20TT(*5)	IK20	VK20	6	SAUDIARABIA		
		GF-DP28 • GF-DM28	-	98.6 ~00	K20TXR	K20TT(*5)	IK20	VK20	6			
	3000	DBA-FR30 • DBA-MU30	N52B30A	10.5 ~	-	-	-	-	6	SINGAPORE		
<b>530e</b>	2000	CLA-JA20P	B48B20A(T/C)	17.2 ~	-	-	-	-	4			
		3LA-JA20PH	B48B20A(T/C)	20.9 ~	-	-	-	-	4			
<b>530i</b>	2000	DBA-JA20	B48B20B(T/C)	17.2 ~	-	-	-	-	4	TAIWAN		
		DBA-JL20	B48B20B(T/C)	17.6 ~	-	-	-	-	4			
	3000	3BA-JR20S • 3BA-JT20T	B48B20B(T/C)	20.9 ~	-	-	-	-	4	THAILAND		
		E-HE30	M60B30	93.3 ~95	K20TXR	K20TT(*5)	IK20	VK20	8			
		GH-DS30 • GH-DT30	306S	00.11~03.8	VK20	-	IK20	VK20	6			
		GH-NA30	306S	03.8 ~05.6	VK20	-	IK20	VK20	6			
		ABA-NE30 • ABA-NL30	N52B30A	05.6 ~07.6	-	-	-	-	6			
		ABA-NU30	N52B30A	07.6 ~10.5	-	-	-	-	6			
		ABA-PU30 • ABA-PV30	N52B30A	07.6 ~	-	-	-	-	6			
		ABA-NU30	N52B30A	07.6 ~	-	-	-	-	6			
<b>530Xi</b>	3000	ABA-PV30	N52B30A	07.6 ~	-	-	-	-	6	VIETNAM		
<b>535i</b>	3000	CBA-SN30	N55B30A(T/C)	09.11~	-	-	-	-	6			
		DBA-SN30	N55B30A(T/C)	12.9 ~	-	-	-	-	6			
	3000	DBA-FR35 • DBA-MU35	N55B30A(T/C)	10.5 ~	-	-	-	-	6	JAPAN		
<b>540i</b>		3000	DBA-JB30	B58B30A(T/C)	17.2 ~	-	-	-	-		6	
			DBA-JM30	B58B30A(T/C)	17.6 ~	-	-	-	-		6	
			3BA-JS30 • 3BA-JT30	B58B30C(T/C)	20.9 ~	-	-	-	-		6	
		4000	E-HE40	M60B40	93.3 ~95.12	K20TXR	K20TT(*5)	IK20	VK20		8	
			ABA-NB40	N62B40A	05.11~07.6	VK20	-	IK20	VK20		8	
		4400	ABA-NW40	N62B40A	07.6 ~10.5	VK20	-	IK20	VK20		8	EUROPE & USA
			E-DE44	M62B44	96.9 ~99.8	K20TXR	K20TT(*5)	IK20	VK20		8	
	GF-DN44		-	99.8 ~00	VK20	-	IK20	VK20	8			
	GH-DN44		448S	00.11~	VK20	-	IK20	VK20	8			
<b>545i</b>	4400	GH-NB44	N62B44A	03.11~	VK20	-	IK20	VK20	8	CROSS REFERENCE NUMBER		
<b>550i</b>	4400	ABA-SN44	N63B44A(T/C)	09.11~	-	-	-	-	8			
		CBA-SN44	N63B44B(T/C)	12.9 ~	-	-	-	-	8			
		ABA-FR44 • ABA-SP44	N63B44A(T/C)	10.5 ~	-	-	-	-	8			
		CBA-KN44 • CBA-HR44	N63B44B(T/C)	13.9 ~	-	-	-	-	8			
		ABA-NB48 • ABA-NH48	N62B48B	05.11~07.6	VK20	-	IK20	VK20	8			
	4800	ABA-NW48	N62B48B	07.6 ~10.5	VK20	-	IK20	VK20	8			
		ABA-PW48	N62B48B	07.6 ~	VK20	-	IK20	VK20	8			

(\*5) : It can be used only for a plug with a terminal.



# EUROPE & U.S.A. CAR

▶ Spark plug color codes: ■ for Iridium Tough and Iridium Plugs and Iridium TT, ■ for Iridium Power, ■ for Iridium Racing and Two Tops Plugs, ■ for Platinum Plugs and Platinum TT, and black for general spark plugs.

	MODEL	CC	VEHICLE CODE	ENGINE	FROM-TILL	DENSO		IRIDIUM POWER	IRIDIUM TOUGH	QTY
AUSTRALIA	<b>BMW</b>									
	<b>ACTIVE HYBRID 5</b>	3000	DAA-FZ35	N55B30A-M230(T/C)	12.8 ~	-	-	-	-	6
CHINA	<b>630i</b>	2000	ABA-JX20S	B48B20B(T/C)	18.8 ~	-	-	-	-	4
		3000	GH-EH30	N52B30A	04.11 ~05.10	-	-	-	-	6
INDIA	<b>640i Coupe</b>	2000	ABA-EH30	N52B30A	05.10~	-	-	-	-	6
		3000	DBA-LW30C	N55B30A(T/C)	11.8 ~	-	-	-	-	6
INDONESIA	<b>640i Gran Coupe</b>	3000	DBA-6A30	N55B30A(T/C)	12.6 ~	-	-	-	-	6
		3000	DBA-LW30	N55B30A	12.8 ~	-	-	-	-	6
INDONESIA	<b>640i Cabriolet</b>	3000	DBA-LW30	N55B30A	12.8 ~	-	-	-	-	6
		3000	DBA-JV30A	B58B30A(T/C)	17.10~	-	-	-	-	6
INDONESIA	<b>645Ci</b>	4400	GH-EH44 · GH-EK44	N62B44A	04.2 ~	VK20	-	IK20	VK20	8
		4400	ABA-LX44C	N63B44A(T/C)	11.8 ~	-	-	-	-	8
INDONESIA	<b>650i Coupe</b>	4400	CBA-YM44C	N63B44B(T/C)	12.8 ~	-	-	-	-	8
		4400	CBA-YP44	N63B44B(T/C)	12.8 ~	-	-	-	-	8
INDONESIA	<b>650i Cabriolet</b>	4400	CBA-YP44	N63B44B(T/C)	12.8 ~	-	-	-	-	8
		4400	CBA-6B44	N63B44B(T/C)	13.8 ~	-	-	-	-	8
INDONESIA	<b>650i</b>	4400	CBA-6B44	N63B44B(T/C)	14.5 ~	-	-	-	-	8
		4800	CBA-YP44 · CBA-YM44C	N63B44B(T/C)	15.7 ~	-	-	-	-	8
KOREA	<b>735i</b>	4800	ABA-EK48 · ABA-EH48	N62B48B	05.11~	VK20	-	IK20	VK20	8
		3500	E-GF35	M62B35	96.5 ~99	K20TXR	K20TT(*5)	IK20	VK20	6
KOREA	<b>740e</b>	3500	GH-GG35	358S	00.11 ~01.10	VK20	-	IK20	VK20	8
		3600	GH-GL36	N62B36A	02.3 ~	VK20	-	IK20	VK20	8
MALAYSIA	<b>740i</b>	2000	DLA-7D20	B48B20B(T/C)	16.10~	-	-	-	-	4
		3000	ABA-KA30	N54B30A(T/C)	09.3 ~	-	-	-	-	6
DBA-YA30	N55B30A(T/C)		12.9 ~	-	-	-	-	6		
DBA-7A30	B58B30A(T/C)		16.10~	-	-	-	-	6		
DBA-7A30	B58B30A(T/C)		17.8 ~	-	-	-	-	6		
3BA-7R30	B58B30C(T/C)		19.6 ~	-	-	-	-	6		
PHILIPPINES	<b>740Li</b>	4000	E-GD40	M60B40	92.11 ~94.10	K20TXR	K20TT(*5)	IK20	VK20	8
		4000	E-GF40	M60B40	94.10~96.5	K20TXR	K20TT(*5)	IK20	VK20	8
SAUDI ARABIA	<b>740Li</b>	4400	ABA-HL40	N62B40A	05.5 ~	VK20	-	IK20	VK20	8
		4400	E-GF44	M62B44	96.6 ~97	K20TXR	K20TT(*5)	IK20	VK20	8
SINGAPORE	<b>740Li</b>	4400	GH-GG44	448S	00.11~	VK20	-	IK20	VK20	8
		3000	ABA-KB30	N54B30A(T/C)	09.3 ~	-	-	-	-	6
DBA-YE30	N55B30A(T/C)		12.9 ~	-	-	-	-	6		
DBA-7E30	B58B30A(T/C)		16.10~	-	-	-	-	6		
DBA-7E30	B58B30A(T/C)		17.8 ~	-	-	-	-	6		
3BA-7T30	B58B30C(T/C)		19.6 ~	-	-	-	-	6		
TAIWAN	<b>740iL</b>	4000	E-GD40L	M60B40	92.11 ~94.10	K20TXR	K20TT(*5)	IK20	VK20	8
		3000	3LA-7D30	B58B30C(T/C)	19.6 ~	-	-	-	-	6
THAILAND	<b>745i</b>	4400	GH-GL44	-	02.3 ~05.5	VK20	-	IK20	VK20	8
		3000	3LA-7W30	B58B30C(T/C)	19.6 ~	-	-	-	-	6
VIETNAM	<b>745Le</b>	4400	GH-GN44	-	02.6 ~	VK20	-	IK20	VK20	8
		4400	ABA-KA44	N63B44A(T/C)	09.3 ~	-	-	-	-	8
CBA-YA44	N63B44B(T/C)		12.9 ~	-	-	-	-	8		
CBA-YA44	N63B44B(T/C)		14.8 ~	-	-	-	-	8		
CBA-7A44	N63B44C(T/C)		17.8 ~	-	-	-	-	8		
3BA-7R44	N63B44D(T/C)		19.6 ~	SXB24LCF-D6	-	-	-	8		
VIETNAM	<b>750i</b>	4800	ABA-HL48	N62B48B	05.5 ~	VK20	-	IK20	VK20	8
		4400	ABA-KB44	N63B44A(T/C)	09.3 ~	-	-	-	-	8
CBA-YE44	N63B44B(T/C)		12.9 ~	-	-	-	-	8		
CBA-YE44	N63B44B(T/C)		14.8 ~	-	-	-	-	8		
CBA-7F44	N63B44C(T/C)		17.8 ~	-	-	-	-	8		
3BA-7U44	N63B44D(T/C)		19.6 ~	SXB24LCF-D6	-	-	-	8		
JAPAN	<b>750iL</b>	4800	ABA-HN48	N62B48B	05.5 ~	VK20	-	IK20	VK20	8
		5400	E-GK50	M73B54	96.6 ~99	KJ16CR-L11	-	-	VKA16	12
EUROPE & USA	<b>760Li</b>		5412	GH-GJ50	5412	00.10~01	VK20	-	IK20	VK20
		6000	GH-GN60	N73B60A	03.3 ~06.11	VK20	-	IK20	VK20	12
ABA-GN60	N73B60A		06.11~	VK20	-	IK20	VK20	12		
ABA-KB60	N74B60A(T/C)		09.7 ~	-	-	-	-	12		
CBA-YG60	N74B60A(T/C)		12.9 ~	-	-	-	-	12		
CROSS REFERENCE NUMBER	<b>ACTIVE HYBRID 7</b>	3000	DAA-YA30	N55B30A-M230(T/C)	12.9 ~	-	-	-	-	8
		4400	-	-	09.10~	-	-	-	-	8
PART NUMBER	<b>ACTIVE HYBRID 7L</b>	3000	DAA-YE30	N55B30A-M230(T/C)	12.9 ~	-	-	-	-	8
		4000	E-E40	M60B40	94.1 ~96	K20TXR	K20TT(*5)	IK20	VK20	8
840Ci	4400		E-EF44	M62B44	96.4 ~99	K20TXR	K20TT(*5)	IK20	VK20	8
	840i	3000	3BA-GV30	B58B30C(T/C)	19.10~	-	-	-	-	6
3BA-AE30			B58B30C(T/C)	20.4 ~	-	-	-	-	6	
850Ci	5000	E-EG50	M70B50	93.3 ~94.12	KJ16CR-L11	-	-	VKA16	12	
	5600	E-850CSi	M70B56	94.3 ~96	KJ16CR-L11	-	-	VKA16	12	

(\*5) : It can be used only for a plug with a terminal.

MODEL	CC	VEHICLE CODE	ENGINE	FROM-TILL	DENSO		IRIDIUM POWER	IRIDIUM TOUGH	QTY	
<b>BMW</b>										
i3	650	DLA-1Z06	W20K06A	13.11~	-	-	-	-	2	AUSTRALIA CHINA INDIA INDONESIA KOREA MALAYSIA PHILIPPINES SAUDIARABIA SINGAPORE TAIWAN THAILAND VIETNAM JAPAN EUROPE & USA CROSS REFERENCE NUMBER PART
		3LA-8P06	W20K06A	19.2 ~	-	-	-	-	2	
i8	1500	DLA-2Z15	B38K15A(T/C)	13.11~	-	-	-	-	3	
		CLA-2Z15U	B38K15A(T/C)	18.4 ~	-	-	-	-	3	
L7	5400	GF-L7	5412	98.10~01	VK20	-	IK20	VK20	12	
M COUPE	3200	GF-CM32	S50B32	98.10~01	IXU22	-	IXU22	VXU22	6	
		GH-CM32	326S4	01.7 ~	VXU24	-	IXU24	VXU24	6	
M ROADSTER	3200	GF-CK32	S50B32	98.10~01.7	IXU22	-	IXU22	VXU22	6	
		GH-CK32	326S4	01.7 ~	VXU24	-	IXU24	VXU24	6	
		GH-CL32	326S4	01.8 ~06.4	VXU24	-	IXU24	VXU24	6	
		ABA-BT32	326S4	06.4 ~	IXU24	-	IXU24	VXU24	6	
M135i	2000	3BA-7L20	B48A20E(T/C)	19.8 ~	-	-	-	-	4	
	3000	DBA-1B30	N55B30A	12.8 ~	-	-	-	-	6	
M140i	3000	DBA-1S30	B58B30A(T/C)	16.9 ~	-	-	-	6		
M235i	2000	3BA-7L20	B48A20E(T/C)	19.10~	-	-	-	-	4	
	3000	DBA-1J30	N55B30A(T/C)	14.2 ~	-	-	-	-	6	
M240i	3000	ABA-2G30G · DBA-2G30	B58B30A(T/C)	16.9 ~	-	-	-	6		
M2	3000	CBA-1H30	N55B30A(T/C)	16.1 ~	-	-	-	-	6	
		CBA-1H30G	N55B30A(T/C)	16.10~	-	-	-	-	6	
		CBA-2U30	S55B30A(T/C)	18.8 ~	-	-	-	-	6	
M3	3000	E-M3B	30 6S	92.9 ~95.12	-	-	-	-	6	
		CBA-3C30	S55B30A(T/C)	14.2 ~	-	-	-	-	6	
	3200	E-M3C	326S	96.7 ~	IXU22	-	IXU22	VXU22	6	
		GF-BL32	326S	01.1 ~	IXU24	-	IXU24	VXU24	6	
		GH-BL32	326S4	02.12~	IXU24	-	IXU24	VXU24	6	
		GH-M3CSL	326S4	03.5 ~	VXU24	-	IXU24	VXU24	6	
4000	ABA-VA40 · ABA-WD40	S65B40A	07.9 ~	-	-	-	-	8		
	CBA-VA40 · CBA-WD40	S65B40A	10.5 ~	-	-	-	-	8		
M340i	3000	3BA-5U30	B58B30B(T/C)	19.5 ~	-	-	-	-	6	
		3BA-6N30	B58B30B(T/C)	19.9 ~	-	-	-	-	6	
M4	3000	CBA-3C30	S55B30A(T/C)	14.2 ~	-	-	-	6		
M440i	3000	3BA-12AR30	B58B30B(T/C)	20.10~	-	-	-	6		
M5	3800	E-M5H(E34)	S38B38(386S)	93 ~96	XU22EPR-U	XU22TT	IXU22	VXU22	6	
		ABA-FV44M	S63B44B	11.7 ~	-	-	-	-	8	
	4400	ABA-JF44M	S63B44B(T/C)	17.10~	-	-	-	-	8	
		7BA-82CH44	S63B44B(T/C)	20.9 ~	-	-	-	-	8	
	5000	ABA-NB50	-	04.11~	-	-	-	-	10	
		GF-DE50 · GH-DE50	508S	99.4 ~04.11	VK20	-	IK20	VK20	8	
M550i	4400	3BA-JS44	N63B44D(T/C)	20.9 ~	SXB24LCF-D6	-	-	8		
M6	4400	ABA-LZ44M	S63B44B	12.4 ~	-	-	-	-	8	
		ABA-LZ44M · ABA-6C44M	S63B44B(T/C)	15.7 ~	-	-	-	-	8	
	5000	ABA-EH50	S85B50A	05.9 ~	-	-	-	-	10	
		ABA-EK50	S85B50A	06.9 ~	-	-	-	-	10	
M760Li	6600	CBA-7H66	N74B66B(T/C)	16.10~	-	-	-	-	12	
		3BA-7U66	N74B66C(T/C)	19.6 ~	SXB24HCF-D7	-	-	-	12	
M8	4400	7BA-AE44M	S63B44B(T/C)	19.6 ~	-	-	-	-	8	
		3BA-GV44M	S63B44B(T/C)	20.1 ~	-	-	-	-	8	
M850i	4400	3BA-BC44	N63B44D(T/C)	18.11~	SXB24LCF-D6	-	-	-	8	
		3BA-GV44	N63B44D(T/C)	19.10~	SXB24LCF-D6	-	-	-	8	
MINI ONE	1200	DBA-XM12	B38A12A(T/C)	14.7 ~	-	-	-	-	3	
		DBA-XS12	B38A12A(T/C)	14.12~	-	-	-	-	3	
		DBA-XM12 · DBA-XS12	B38A12A(T/C)	16.12~	-	-	-	-	3	
	1400	ABA-ME14	-	07.5 ~10.3	-	-	-	-	4	
		DBA-LN15	B38A15A(T/C)	16.4 ~	-	-	-	-	3	
	1500	DBA-YS15	B38A15A(T/C)	17.10~	-	-	-	-	3	
		DBA-XR15M · DBA-XU15M	B38A15A(T/C)	18.5 ~	-	-	-	-	3	
	1600	GH-RA16	-	02.2 ~07.2	VK20	-	IK20	VK20	4	
		CBA-SR16 · DBA-SR16 (98PS)	-	10.3 ~	-	-	-	-	4	
	MINI COOPER	1500	DBA-XM15	B38A15A(T/C)	14.4 ~	-	-	-	-	3
DBA-LN15			B38A15A(T/C)	15.11~	-	-	-	-	3	
DBA-WG15			B38A15A(T/C)	16.3 ~	-	-	-	-	3	
DBA-XM15 · DBA-XS15			B38A15A(T/C)	16.12~	-	-	-	-	3	
1600		DBA-XR15M · DBA-XU15M · CBA-WJ15M	B38A15A(T/C)	18.5 ~	-	-	-	-	3	
		3BA-YW15	B38A15A(T/C)	19.9 ~	-	-	-	-	3	
		3BA-LV15M	B38A15A(T/C)	19.10~	-	-	-	-	3	
		GH-RF16	W10B16A	04.9 ~07.2	VK20	-	IK20	VK20	4	



# EUROPE & U.S.A. CAR

▶ Spark plug color codes: ■ for Iridium Tough and Iridium Plugs and Iridium TT, ■ for Iridium Power, ■ for Iridium Racing and Two Tops Plugs, ■ for Platinum Plugs and Platinum TT, and black for general spark plugs.

COUNTRY	MODEL	CC	VEHICLE CODE	ENGINE	FROM-TILL	DENSO	TJ	IRIDIUM POWER	IRIDIUM TOUGH	QTY	
AUSTRALIA	<b>BMW</b>										
	<b>MINI COOPER</b>										
CHINA	1600		<b>GH-RA16</b>	-	02.2 ~07.2	<b>VK20</b>	-	<b>IK20</b>	<b>VK20</b>	4	
			<b>ABA-MF16</b> · <b>ABA-ML16</b>	-	07.2 ~10.3	-	-	-	-	4	
			<b>ABA-RF16</b> · <b>ABA-RH16</b>	-	08.10~09.4	-	-	<b>K20TT</b>	<b>IK20</b>	<b>VK20</b>	4
			<b>ABA-MR16</b>	-	09.4 ~10.3	-	-	-	-	-	4
INDIA	2000		<b>DBA-XS15</b>	B38A15A(T/C)	14.10~	-	-	-	-	3	
			<b>DBA-SX16</b> · <b>CBA-SX16</b>	N16B16A	11.9 ~	-	-	-	-	4	
INDONESIA	1600		<b>DBA-XS20</b>	B48A20A(T/C)	14.10~	-	-	-	-	4	
			<b>CLA-YU15</b>	B38A15A-P160(T/C)	17.7 ~	-	-	-	-	3	
			<b>3LA-YU15T</b>	B38A15A-P160(T/C)	19.9 ~	-	-	-	-	3	
			<b>3LA-22BS15</b>	B38A15A-P160(T/C)	20.9 ~	-	-	-	-	3	
KOREA	1600		<b>GH-RE16</b> · <b>GH-RH16</b>	(S/C)	02.2 ~07.2	<b>VK20</b>	-	<b>IK20</b>	<b>VK20</b>	4	
			<b>ABA-MF16S</b> · <b>ABA-MM16</b> · <b>ABA-MS16</b>	(T/C)	07.2 ~10.3	-	-	-	-	4	
			<b>DBA-SV16</b> · <b>DBA-ZP16</b> · <b>DBA-ZG16</b>	(184PS)(T/C)	10.3 ~	-	-	-	-	4	
			<b>DBA-XM20</b>	B48A20A(T/C)	14.4 ~	-	-	-	-	4	
MALAYSIA	2000		<b>DBA-LN20</b>	B48A20A(T/C)	15.11~	-	-	-	-	4	
			<b>DBA-WG20</b>	B48A20A(T/C)	16.3 ~	-	-	-	-	4	
			<b>DBA-XM20</b> · <b>DBA-XS20</b>	B48A20A(T/C)	16.12~	-	-	-	-	4	
			<b>CBA-XR20M</b> · <b>DBA-XU20M</b>	B48A20A(T/C)	18.5 ~	-	-	-	-	4	
PHILIPPINES	1600		<b>CBA-WJ20M</b>	B48A20F(T/C)	18.5 ~	-	-	-	-	4	
			<b>3BA-YW20</b>	B48A20A(T/C)	19.9 ~	-	-	-	-	4	
			<b>3BA-LV20M</b>	B48A20F(T/C)	19.10~	-	-	-	-	4	
			<b>MINI COOPER S Coupe</b>	<b>DBA-SX16S</b>	N18B16A(T/C)	11.9 ~	-	-	-	-	4
SAUDI ARABIA	1600		<b>MINI JOHN COOPER</b>	<b>ABA-MFJCW</b> · <b>ABA-MMJCW</b> · <b>ABA-MSJCW</b>	08.9 ~	-	-	-	-	4	
			<b>MINI JOHN COOPER WORKS</b>	<b>DBA-LVJCW</b>	B48A20B(T/C)	17.1 ~	-	-	-	4	
SINGAPORE	2000		<b>3BA-JZJCWM</b>	B48A20E(T/C)	19.10~	-	-	-	-	4	
			<b>3BA-YZ20</b>	B48A20E(T/C)	19.10~	-	-	-	-	4	
			<b>MINI JOHN COOPER WORKS COUPE</b>	<b>ABA-SXJCW</b>	N14B16C(T/C)	11.9 ~	-	-	-	4	
			<b>CBA-XDJCW</b>	N18B16C(T/C)	13.1 ~	-	-	-	-	4	
TAIWAN	1600		<b>DBA-WHJCW</b>	B48A20B(T/C)	16.3 ~	-	-	-	-	4	
			<b>DBA-YS20</b>	B48A20B(T/C)	17.5 ~	-	-	-	-	4	
			<b>CBA-XRJCWM</b> · <b>CBA-WJJCWM</b>	B48A20B(T/C)	18.5 ~	-	-	-	-	4	
			<b>X1</b>	<b>ABA-JG15</b>	B38A15A(T/C)	17.8 ~	-	-	-	-	3
THAILAND	1500		<b>3BA-AA15</b>	B38A15A(T/C)	19.10~	-	-	-	-	3	
			<b>ABA-VL18</b>	N46B20B	10.4 ~	<b>VK20</b>	-	<b>IK20</b>	<b>VK20</b>	4	
			<b>DBA-VM20</b>	N20B20A	11.10~	-	-	-	-	4	
			<b>CBA-VL18</b>	N46B20B	12.9 ~	-	-	-	-	4	
VIETNAM	2000		<b>DBA-VL20</b> · <b>DBA-VM20</b>	N20B20A(T/C)	12.9 ~	-	-	-	-	4	
			<b>CBA-VL18</b>	N46B20B	15.4 ~	-	-	-	-	4	
			<b>DBA-VL20</b> · <b>DBA-VM20</b>	N20B20A(T/C)	15.4 ~	-	-	-	-	4	
			<b>CBA-JG20</b>	B48A20B(T/C)	17.11~	-	-	-	-	4	
JAPAN	2000		<b>ABA-JG20A</b>	B48A20A(T/C)	18.5 ~	-	-	-	-	4	
			<b>CBA-JG20</b>	B48A20B(T/C)	18.5 ~	-	-	-	-	4	
			<b>3BA-AB20</b>	B48A20A(T/C)	19.10~	-	-	-	-	4	
			<b>3BA-AB20</b>	B48A20B(T/C)	19.10~	-	-	-	-	4	
EUROPE & USA	3000		<b>ABA-VL25</b>	N52B30A	10.4 ~	-	-	-	-	6	
			<b>X2</b>	<b>DBA-YH15</b>	B38A15A(T/C)	18.4 ~	-	-	-	3	
			<b>ABA-YH20</b>	B48A20A(T/C)	18.4 ~	-	-	-	-	4	
			<b>3BA-YN20</b>	B48A20E(T/C)	19.1 ~	-	-	-	-	4	
CROSS REFERENCE NUMBER	2000		<b>DBA-WX20</b>	N20B20A	12.3 ~	-	-	-	-	4	
			<b>DBA-WX20</b>	N20B20A(T/C)	14.6 ~	-	-	-	-	4	
			<b>DBA-TR20</b>	B48B20A(T/C)	17.10~	-	-	-	-	4	
			<b>3BA-TY20</b>	B48B20A(T/C)	19.11~	-	-	-	-	4	
PART NUMBER	2500		<b>3LA-TS20</b>	B48B20A(T/C)	20.4 ~	-	-	-	-	4	
			<b>GH-PA25</b>	25 6S	04.7 ~06.10	<b>VK20</b>	-	<b>IK20</b>	<b>VK20</b>	6	
			<b>ABA-PC25</b>	N52B25A	06.10~11.3	-	-	-	-	6	
			<b>GH-PA30</b>	30 6S	04.7 ~06.10	<b>VK20</b>	-	<b>IK20</b>	<b>VK20</b>	6	
PART NUMBER	3000		<b>ABA-PC30</b>	N52B30A	06.10~11.3	-	-	-	-	6	
			<b>CBA-WX30</b>	N52B30A	11.3 ~	-	-	-	-	6	
			<b>DBA-WX35</b>	N55B30A(T/C)	11.3 ~	-	-	-	-	6	
			<b>3BA-TY30</b>	B58B30B(T/C)	20.3 ~	-	-	-	-	6	
PART NUMBER	3000		<b>X3 M</b>	<b>3BA-TS30</b>	S58B30A(T/C)	19.6 ~	-	-	-	6	
			<b>X4</b>	<b>DBA-XW20</b>	N20B20A(T/C)	14.8 ~	-	-	-	4	
			<b>CBA-UJ20</b>	B48B20B(T/C)	18.9 ~	-	-	-	4		

DENSO	9	14	16	20	22	24	27	29	31	32	34	35	DENSO	9	14	16	20	22	24	27	31	32	DENSO	9	14	16	20	22	24	27	31	
NGK	2	4	5	6	7	8	9	9.5	10	10.5	11	11.5	CHAMPION	18	16,14	12,11	10,9	8,7	6,63,61	4,59	57	55	53	BOSCH	10	9	8	7,6	5	4	3	2



MODEL	CC	VEHICLE CODE	ENGINE	FROM-TILL	DENSO		IRIDIUM POWER	IRIDIUM TOUGH	QTY	
<b>BMW</b>										
<b>X4</b>	3000	DBA-XW35	N55B30A(T/C)	14.8 ~	-	-	-	-	6	AUSTRALIA
		DBA-XW35M	N55B30A(T/C)	16.1 ~	-	-	-	-	6	
		DBA-XW35 · DBA-XW35M	N55B30A(T/C)	16.6 ~	-	-	-	-	6	
		CBA-UJ30	B58B30A(T/C)	18.9 ~	-	-	-	-	6	
<b>X4 M</b>	3000	3BA-TS30	S58B30A(T/C)	19.6 ~	-	-	-	6	CHINA	
<b>X5</b>	2000	CLA-KT20	N20B20A-P251(T/C)	15.9 ~	-	-	-	-	4	INDIA
		CLA-KT20	N20B20A-P251(T/C)	16.3 ~	-	-	-	-	4	
		CLA-KT20	N20B20A(T/C)	17.5 ~	-	-	-	-	4	
	3000	GH-FA30	M54	01.1 ~03.10	VK20	-	IK20	VK20	6	
		GH-FA30N	306S	03.12~07.6	VK20	-	IK20	VK20	6	
		ABA-FE30	N52B30A	07.6 ~10.5	-	-	-	-	6	
		ABA-ZV30S	N55B30A(T/C)	10.5 ~	-	-	-	-	6	
		DBA-KR30 · DBA-KR30S	N55B30A(T/C)	14.10~	-	-	-	-	6	
		3LA-TA30	B58B30C(T/C)	19.12~	-	-	-	-	6	
		GH-FB44	448S	00.9 ~	K20TXR	K20TT(*5)	IK20	VK20	8	
	4400	GH-FB44N	N62B44A	03.12~	VK20	-	IK20	VK20	8	
		ABA-ZV44S	N63B44A(T/C)	10.5 ~	-	-	-	-	8	
		CBA-KR44 · CBA-KR44S	N63B44B(T/C)	13.11~	-	-	-	-	8	
		3BA-JU44S · 3BA-JU44A	N63B44D(T/C)	19.12~	SXB24HCF-D7	-	-	-	8	
	4600	GH-FB46	-	02.3 ~04.5	VK20	-	IK20	VK20	8	
	4800	GH-FA48	N62B48A	04.6 ~07.6	VK20	-	IK20	VK20	8	
ABA-FE48		N62B48B	07.6 ~10.5	-	-	-	-	8		
<b>X5 M</b>	4400	ABA-GY44	S63B44A(T/C)	09.7 ~	-	-	-	8	INDONESIA	
		ABA-KT44	S63B44B(T/C)	14.11~	-	-	-	8		
		ABA-KT44	S63B44B(T/C)	16.3 ~	-	-	-	8		
		ABA-KT44	S63B44B(T/C)	17.5 ~	-	-	-	8		
		3BA-JU44M	S63B44B(T/C)	20.3 ~	-	-	-	8		
<b>X6</b>	3000	ABA-FG30	N54B30A(T/C)	08.6 ~10.5	-	-	-	6	KOREA	
		ABA-FG35	N55B30A(T/C)	10.5 ~	-	-	-	6		
		DBA-FG35	N55B30A(T/C)	12.6 ~	-	-	-	6		
		DBA-KU30S · DBA-KU30	N55B30A(T/C)	14.8 ~	-	-	-	6		
		DBA-KU30 · DBA-KU30S	N55B30A(T/C)	17.5 ~	-	-	-	6		
	4400	ABA-FG44	N63B44A(T/C)	08.6 ~10.5	-	-	-	8		
		ABA-FG44	N63B44A(T/C)	12.6 ~	-	-	-	8		
		CBA-KU44S · CBA-KU44	N63B44B(T/C)	14.8 ~	-	-	-	8		
		3BA-CY44	N63B44D(T/C)	19.12~	SXB24LCF-D6	-	-	8		
		ABA-GZ44	S63B44A(T/C)	09.7 ~	-	-	-	8		
<b>X6 M</b>	4400	ABA-KT44	S63B44B(T/C)	14.11~	-	-	-	8	MALAYSIA	
		ABA-KT44	S63B44B(T/C)	16.3 ~	-	-	-	8		
		ABA-KT44	S63B44B(T/C)	17.5 ~	-	-	-	8		
		ABA-KT44	S63B44B(T/C)	20.3 ~	-	-	-	8		
		3BA-JU44M	S63B44B(T/C)	20.3 ~	-	-	-	8		
<b>X7</b>	4400	3BA-CX44	N63B44D(T/C)	19.6 ~	SXB24HCF-D7	-	-	8	PHILIPPINES	
<b>Z3</b>	1900	E-CH19	194S	96.9 ~99	K20TXR	K20TT(*5)	IK20	VK20	4	SAUDIARABIA
	2000	GF-CL20		99.7 ~00	K20TXR	K20TT(*5)	IK20	VK20	6	
	2200	GH-CN22	M54	00.12~	VK20	-	IK20	VK20	6	
		GF-CK28	M52B28	98.4 ~00	K20TXR	K20TT(*5)	IK20	VK20	6	
	2800	GF-CJ28	M52B28	98.4 ~98	K20TXR	K20TT(*5)	IK20	VK20	6	
		GF-CK28	M53TUB28	98.10~00	K20TXR	K20TT(*5)	IK20	VK20	6	
		GF-CJ28	M53TUB28	98.10~98	K20TXR	K20TT(*5)	IK20	VK20	6	
		GF-CH28	286S	98.6 ~00	VK20	-	IK20	VK20	6	
		3000	GH-CN30	-	00.8 ~	K20TXR	K20TT(*5)	IK20	VK20	
	<b>Z4</b>	2000	DBA-LL20	N20B20A(T/C)	13.4 ~	-	-	-	4	
3BA-HF20			B48B20B(T/C)	19.3 ~	-	-	-	4		
2200		GH-BT22	226S	03.12~06.4	VK20	-	IK20	VK20	6	
		GH-BT25	256S	03.1 ~06.4	VK20	-	IK20	VK20	6	
2500		ABA-BU25	N52B25A	06.4 ~	-	-	-	6		
		ABA-LM25	N52B25A	09.5 ~	-	-	-	6		
		GH-BT30	306S	03.5 ~06.4	VK20	-	IK20	VK20	6	
3000		ABA-BU30 · ABA-DU30	N52B30A	06.4 ~	-	-	-	6		
		ABA-LM30	N54B30A(T/C)	09.5 ~	-	-	-	6		
		ABA-LM35	N54B30A(T/C)	10.5 ~	-	-	-	6		
	3BA-HF30	B58B30C(T/C)	19.3 ~	-	-	-	6			
3200	ABA-BT32 · ABA-DU32	S54B32	06.4 ~	VXU24	-	IXU24	VXU24	6		
<b>Z8</b>	5000	GH-EJ50	508S	99.10~	K20TXR	K20TT(*5)	IK20	VK20	8	TAIWAN
<b>BMW ALPINA</b>										
<b>B3 3.0</b>	3000	E-3E3J	E3J	93.4 ~96.2	K20TXR	K20TT(*5)	IK20	VK20	6	THAILAND
<b>B3 3.2</b>	3200	E-3E4J	E4J	96.4 ~99.3	K20TXR	K20TT(*5)	IK20	VK20	6	

(\*5) : It can be used only for a plug with a terminal.



# EUROPE & U.S.A. | CAR

▶ Spark plug color codes: ■ for Iridium Tough and Iridium Plugs and Iridium TT, ■ for Iridium Power, ■ for Iridium Racing and Two Tops Plugs, ■ for Platinum Plugs and Platinum TT, and black for general spark plugs.

	MODEL	CC	VEHICLE CODE	ENGINE	FROM-TILL	DENSO		IRIDIUM POWER	IRIDIUM TOUGH	QTY	
<b>AUSTRALIA</b>											
<b>BMW ALPINA</b>											
	B3 3.2	3200	-	E4J	96.4 ~99.3	K20TXR		K20TT(*5)	IK20	VK20	6
	B3 3.3	3300	GF-3E44	E44	99.3 ~00.9	VK20		-	IK20	VK20	6
			GF-3E46	E4/6	00.11~	VK20		-	IK20	VK20	6
<b>CHINA</b>											
	B3 3.4	3400	-	-	02.10 ~07.10	VK20		-	IK20	VK20	6
	B5 4.4	4400	-	-	05.10~	PK22PR8		-	IK22	VK22	8
	B6 2.8	2800	-	E42J	96.10 ~98.11	K20TXR		K20TT(*5)	IK20	VK20	6
	B6 4.4	4400	-	-	05.9 ~	PK22PR8		-	IK22	VK22	8
<b>INDIA</b>											
	B7 4.4	4400	ABA-TH10 • ABA-NH10	-	03.10~	PK22PR8		-	IK22	VK22	8
	B8 4.0	3900	-	F11	95.1 ~98.11	K20TXR		K20TT(*5)	IK20	VK20	8
	B8 4.6	4600	E-8F21	F21	95.1 ~98.11	K20TXR		K20TT(*5)	IK20	VK20	8
	B10 3.2	3200	E-AF43	E43	97.8 ~98.12	K20TXR		K20TT(*5)	IK20	VK20	6
<b>INDONESIA</b>											
	B10 3.3	3300	GF-FE45	E45	99.2 ~00.9	VK20		-	IK20	VK20	6
			GF-YE47	E4/7	01.2 ~	VK20		-	IK20	VK20	6
	B10 4.6	4600	E-AF3	F3	97.1 ~98.10	K20TXR		K20TT(*5)	IK20	VK20	8
			-	F3	97.8 ~99.9	K20TXR		K20TT(*5)	IK20	VK20	8
			-	F4	97.8 ~99.9	VK20		-	IK20	VK20	8
<b>KOREA</b>											
	B10 V8	4600	GF-AF4 GF-JF4	F4 F4	99.1 ~ 99.12~00.7	VK20 VK20		-	IK20 IK20	VK20 VK20	8 8
	B10 V8 S	4837	GH-EF50	F5	02.3 ~03.4	VK20		-	IK20	VK20	8
<b>MALAYSIA</b>											
	B12 5.7	5646	E-RD3 • E-PD3	D3	95.12~98.8	K20TXR		K20TT(*5)	IK20	VK20	12
	B12 6.0	6000	GF-KD32 • GF-LD32	D32	99.7 ~01.7	VK20		-	IK20	VK20	12
	ROADSTER S	3400	(E85)	E5/2	04 ~	VK20		-	IK20	VK20	6
	ROADSTER V8	4837	GH-GF51(E52)	F5/1	02 ~10	VK20		-	IK20	VK20	8
<b>PHILIPPINES</b>											
	<b>BUICK GM</b>										
	PARK AVENUE	3800	E-BC33A	-	95.11~96	PT16EPR-L13		-	IT16	VT16	6
	REGAL	3100	E-BA43CW • E-BA43C	-	93.11 ~95.10	T16EPR-U		-	IT16	VT16	6
			E-BA43CW • E-BA43C	-	95.11~96	PT16EPR-L13		-	IT16	VT16	6
<b>SAUDI ARABIA</b>											
	<b>CADILLAC GM</b>										
	ALLANTE	4600	E-AV14K	-	92.8 ~	T16EPR-U15		-	IT16	VT16	8
	CONCOURS	4600	E-AK44K • GF-AK44K	-	93.11~	PT16EPR-L13		-	IT16	VT16	8
	ATS	2000	ABA-A1SL	1D(T/C)	13.9 ~	-		-	ITV16	-	4
			ABA-A1SL	1D(T/C)	16.1 ~	-	-		-	ITV16	-
	ATS-V	3600	ABA-A1SLV	3K(T/C)	16.1 ~	-		-	-	-	6
	CT5	2000	7BA-A2LL	LSY(T/C)	21.1 ~	-		-	-	-	4
	CT6	3600	ABA-O1SL	3L	16.10~	-		-	-	-	6
	CTS	2000	ABA-A1LL	1D(T/C)	14.4 ~	-		-	ITV16	-	4
			GH-AD32F	2F	03.3 ~	VK20		-	IK20	VK20	6
	CTS	2800	GH-AD32G	2G	04.11~	ITV16		-	ITV16	-	6
			ABA-X322A	2G	08.1 ~	ITV16		-	ITV16	-	6
			GH-AD33G	3G	03.3 ~04.11	VK20		-	IK20	VK20	6
	CTS-V	3600	GH-AD33H	3H	04.11~	ITV16		-	ITV16	-	6
			ABA-X322B	3H	08.1 ~	ITV16		-	ITV16	-	6
	CTS-V	6200	ABA-X322V	-(S/C)	09.1 ~	IT20		-	IT20	VT20	8
			ABA-A1LLV	6K(S/C)	16.1 ~	-	-		-	-	-
<b>SINGAPORE</b>											
	DTS	4600	GH-X272 • ABA-X272	4K	06.6 ~	PT16EPR-L13		-	IT16	VT16	8
<b>TAIWAN</b>											
	DEVILLE	4600	GF-AK64K • GH-AK64K	4K	99.10~	PT16EPR-L13		-	IT16	VT16	8
<b>THAILAND</b>											
	ELDORADO	4600	E-AE44K • GF-AE44K	-	92.9 ~	T16EPR-U15		-	IT16	VT16	8
	ESCALADE	6000	-	HO	04.2 ~	VT16		-	IT16	VT16	8
			6200	Vortech6200	07.11~	IT20		-	IT20	VT20	8
<b>VIETNAM</b>											
	FLEETWOOD	5700	E-AD25B	-	92.9 ~95	T16EPR-U15		-	IT16	VT16	8
<b>JAPAN</b>											
	SEVILLE	4600	E-AK34K	-	92.9 ~97	T16EPR-U15		-	IT16	VT16	8
			E-AK54K	-	97.11 ~98.11	PT16EPR-L13		-	IT16	VT16	8
			GF-AK54K	-	98.11~03.3	PT16EPR-L13		-	IT16	VT16	8
			GH-AK54K	4K	03.3 ~	PT16EPR-L13		-	IT16	VT16	8
<b>EUROPE &amp; USA</b>											
	SRX	3000	ABA-T166C	2H	13.10~	-		-	ITV16	-	6
			GH-T265S	3H	04.11~	ITV16		-	ITV16	-	6
			GH-T265E	4M	04.1 ~	PT16EPR-L13		-	IT16	VT16	8
	STS	3600	GH-X295S	3H	05 ~	ITV16		-	ITV16	-	6
			ABA-X295S	3H	08.1 ~	ITV16		-	ITV16	-	6
	STS-V	4600	GH-X295E • ABA-X295E	4M	04.1 ~	PT16EPR-L13		-	IT16	VT16	8
			GH-X295V • ABA-X295V	4N(S/C)	06.1 ~	PT22EPR10		-	IT22	-	8
	XLR	4600	GH-X215	4M	04.2 ~	PT16EPR-L13		-	IT16	VT16	8
	XLR-V	4600	ABA-X215V	4N	07.11~	PT16EPR-L13		-	IT16	VT16	8
<b>CROSS REFERENCE NUMBER</b>											
	XT4	2000	7BA-E2UL	LSY(T/C)	21.1 ~	-		-	-	-	4
	XT5	3600	ABA-C1UL	3L	17.10~	-		-	-	-	6
			7BA-C1UL	3L	21.1 ~	-	-		-	-	-
	XT6	3600	7BA-C1TL	3L	20.1 ~	-		-	-	-	6

(\*5) : It can be used only for a plug with a terminal.



MODEL	CC	VEHICLE CODE	ENGINE	FROM-TILL	DENSO		IRIDIUM POWER	IRIDIUM TOUGH	QTY	
<b>CATERHAM</b>										
SUPER SEVEN	1400	Rover K-series	16V	92 ~	K20PR-U	K20TT	IK20	VK20	4	AUSTRALIA
		Rover K-series	16V Supersport	92 ~	IK22	-	IK22	VK22	4	CHINA
	1600	Rover K-series	i 16V	95.4 ~	K20PR-U	K20TT	IK20	VK20	4	INDIA
<b>CHEVROLET GM</b>										
ASTRO 2WD	4300	E-CL14G	-	- ~95.12	T20PR-U11	-	ITF20	-	6	INDONESIA
		E-CL14G	-	96.1 ~99.12	PT16EPR-L13	-	IT16	VT16	6	KOREA
		GF-CL14G · GH-CL14G	-	00.1 ~05	PT16EPR-L13	-	IT16	VT16	6	PHILIPPINES
ASTRO 4WD	4300	E-CM14G(S)	-	- ~95.12	T20PR-U11	-	ITF20	-	6	INDONESIA
		E-CM14G(S)	-	96.1 ~99.12	PT16EPR-L13	-	IT16	VT16	6	INDONESIA
		GF-CM14G · GH-CM14G	-	00.1 ~05	PT16EPR-L13	-	IT16	VT16	6	INDONESIA
BLAZER, TRAIL BLAZER	4200	GH-T360 · GH-T360G · ABA-T360G	4L	01.9 ~	ITV16	-	ITV16	-	6	INDONESIA
		GH-T370L	4L	03 ~07.5	ITV16	-	ITV16	-	6	INDONESIA
	4300	E-CT34G	-	95.5 ~99.9	PT16EPR-L13	-	IT16	VT16	6	INDONESIA
		GF-CT34G	-	99.10~	PT16EPR-L13	-	IT16	VT16	6	INDONESIA
	5300	GH-T370V	5F	03.2 ~	PTJ16R15	-	IT16	VT16	8	INDONESIA
CAMARO	2000	7BA-A1XC	1D(T/C)	20.12~	-	-	-	-	4	INDONESIA
		E-CF43F	-	93.5 ~95	T16PR-U11	-	ITF16	-	6	INDONESIA
	3400	E-CF43FK	-	94.1 ~95	T16PR-U11	-	ITF16	-	6	INDONESIA
		-	LLT	-	09.12~	ITV20	-	ITV20	-	6
	3800	E-CF43A	-	95.10 ~98.10	IT20	-	IT20	VT20	6	INDONESIA
		E-CF43AK	-	95.11 ~98.10	IT20	-	IT20	VT20	6	INDONESIA
		GF-CF43A	3A	98.11~	PT16EPR-L13	-	IT16	VT16	6	INDONESIA
		GF-CF43AK	3A	98.11~01	PT16EPR-L13	-	IT16	VT16	6	INDONESIA
	5700	E-CF45B	-	93.4 ~97.3	T16EPR-U15	-	IT16	VT16	8	INDONESIA
		E-CF45BK	-	94.1 ~96.9	T16EPR-U15	-	IT16	VT16	8	INDONESIA
		E-CF45BK	-	96.10 ~98.11	PT16EPR-L13	-	IT16	VT16	8	INDONESIA
		E-CF45B	-	97.4 ~98.11	PT16EPR-L13	-	IT16	VT16	8	INDONESIA
		E-CF45E	-	97.9 ~98.11	PT16EPR-L13	-	IT16	VT16	8	INDONESIA
	6200	GF-CF45E	-	98.11~	PT16EPR-L13	-	IT16	VT16	8	INDONESIA
		-	L99	-	09.12~	IT20	-	IT20	VT20	8
	7BA-A1XCE	6J(T/C)	-	20.12~	-	-	-	-	8	INDONESIA
		<b>CHEVROLET MW</b>								
1000	LA-ME64S	K10A(DOHC)	01.1 ~	XU22EPR-U	XU22TT	IXU22	VXU22	4	INDONESIA	
	1300	LA-ME34S	M13A(DOHC)	01.1 ~06.1	IK16	-	IK16	VK16	4	INDONESIA
CORVETTE	5700	ABA-ME34S · DBA-ME34S	M13A(DOHC)	06.1 ~	IK16	-	IK16	VK16	4	INDONESIA
		E-CY15BK · E-CY15B	-	95.11~	IT20	-	IT20	VT20	8	INDONESIA
	E-CY25E	-	97 ~99	IT20	-	IT20	VT20	8	INDONESIA	
	GF-CY25E	5E	99 ~02.3	PT16EPR-L13	-	IT16	VT16	8	INDONESIA	
	GF-CY25E	5E	02.3 ~04	PTJ16R15	-	IT16	VT16	8	INDONESIA	
	GH-CY25E	5E	02.5 ~04	VT16	-	IT16	VT16	8	INDONESIA	
	6000	GH-X245	5G	05.2 ~07.10	VT20	-	IT20	VT20	8	INDONESIA
	6200	ABA-X245S	6F	07.10~	VT20	-	IT20	VT20	8	INDONESIA
	7000	GH-X245A · ABA-X245A	6E	06.11~	VT20	-	IT20	VT20	8	INDONESIA
		<b>CRUZE</b>								
1300	LA-HR51S	M13A	01.11 ~03.11	· SK16PR-A11	-	IK16	VK16	4	INDONESIA	
	UA-HR52S · DBA-HR52S · MBA-HR52S	M13A	03.11~10.8	· SK16PR-A11	-	IK16	VK16	4	INDONESIA	
	1500	LA-HR81S	M15A	01.11 ~03.11	· SK16PR-A11	-	IK16	VK16	4	INDONESIA
UA-HR82S · CBA-HR82S	M15A	03.11~10.8	· SK16PR-A11	-	IK16	VK16	4	INDONESIA		
SONIC	1600	ABA-KT300	F16	13.11~	KJ16CR-L11	K16TT	IK16	VK16	4	INDONESIA
HHR	2200	-	-	07.6 ~	ITV16	-	ITV16	-	4	INDONESIA
	2400	-	-	07.6 ~	ITV16	-	ITV16	-	4	INDONESIA
SILVERADO	4800	-	-	10.4 ~	IT20	-	IT20	VT20	8	INDONESIA
TAHOE	5300	-	Vortech5.3 V8	08.2 ~	IT20	-	IT20	VT20	8	INDONESIA
TRUCK S-10	4300	E-CTS4G	-	- ~94	T16PR-U11	-	ITF16	-	6	INDONESIA
<b>CHRYSLER</b>										
300	3600	ABA-LX36	G	12.12~	-	-	-	VXUHC22G	6	EUROPE & USA
300C	3500	GH-LE35T	-	-	-	-	-	VKA16	6	EUROPE & USA
	5700	GH-LX57	7	05.2 ~	ITL16	-	ITL16	-	16	EUROPE & USA
300M	3500	GF-LR35	-	00.6 ~	VK16	-	IK16	VK16	6	CROSS REFERENCE NUMBER
		GH-LR35	-	- ~	VK16	-	IK16	VK16	6	CROSS REFERENCE NUMBER
YPSILON	880	ABA-84609	312A2(T/C)	12.12~	-	-	-	-	2	CROSS REFERENCE NUMBER
CROSSFIRE	3200	GH-ZH32 · GH-Z32C	112	03.12~	VK16	-	IK16	VK16	12	CROSS REFERENCE NUMBER
GRAND VOYAGER	3300	E-GS33L	-	97.1 ~99.10	IW16	-	IW16	VW16	6	CROSS REFERENCE NUMBER
		GF-GS33L	-	99.10~00	IW16	-	IW16	VW16	6	CROSS REFERENCE NUMBER
		GF-RG33L · GF-RG33S	-	01 ~01	ITL16	-	ITL16	-	6	CROSS REFERENCE NUMBER
		GH-RG33L · GH-RG3LA	-	02 ~	ITL16	-	ITL16	-	6	CROSS REFERENCE NUMBER
		3800	GF-GS38L	-	99.10~00	IW16	-	IW16	VW16	6



# EUROPE & U.S.A. CAR

▶ Spark plug color codes: ■ for Iridium Tough and Iridium Plugs and Iridium TT, ■ for Iridium Power, ■ for Iridium Racing and Two Tops Plugs, ■ for Platinum Plugs and Platinum TT, and black for general spark plugs.

CROSS REFERENCE PART NUMBER	MODEL	CC	VEHICLE CODE	ENGINE	FROM-TILL	DENSO	TJ	IRIDIUM POWER	IRIDIUM TOUGH	QTY	
AUSTRALIA	<b>CHRYSLER</b>										
	JEEP CHEROKEE	2000	ABA-KL20L	N(T/C)	19.3 ~	-	-	-	-	-	4
2400		ABA-KL24	B	19.3 ~	-	-	-	-	-	4	
CHINA	JEEP CHEROKEE	3700	GF-KJ37 · GH-KJ37 · ABA-KJ37	K	01.10~08.6	KJ20CR-L11	-	-	VKA20	6	
		4000	ABA-KK37	K	08.6 ~	KJ20CR-L11	-	-	VKA20	6	
INDIA	JEEP COMMANDER	4700	GH-XH47 · ABA-XH47	661	06.5 ~	KJ20CR-L11	K20TT	IK20	VK20	8	
		5700	GH-XH57 · ABA-XH57	7	06.5 ~07	ITL16	-	ITL16	-	16	
INDONESIA	JEEP GRAND CHEROKEE	3600	ABA-WK36 · ABA-WK36A	G	11.12~	-	-	-	VXUHC22G	6	
			ABA-WK36T · ABA-WK36TA	G	13.11~	-	-	-	VXUHC22G	6	
MALAYSIA	JEEP GRAND CHEROKEE	3600	ABA-WK36T · ABA-WK36TA	G	17.3 ~	-	-	IK20	VK20	6	
			DBA-WK36T · DBA-WK36TA	G	18.6 ~	-	-	-	VXUHC22G	6	
PHILIPPINES	JEEP GRAND CHEROKEE	3600	7BA-WK36P	G	20.8 ~	-	-	-	VXUHC22G	6	
			E-ZMX	-	92.12~95	KJ16CR-L11	-	-	VKA16	6	
SAUDI ARABIA	JEEP COMPASS	4000	E-ZG40	-	96.3 ~98	KJ16CR-L11	-	-	VKA16	6	
			GF-WJ40	MX	99.3 ~03.2	KJ16CR-L11	-	-	VKA16	6	
SINGAPORE	JEEP COMPASS	4000	GH-WJ40	MX	03.2 ~	KJ16CR-L11	-	-	VKA16	6	
			GF-WJ47 · GH-WJ47	661	99.3 ~05.7	KJ20CR-L11	-	-	VKA20	8	
TAIWAN	JEEP COMPASS	4700	GH-WH47 · ABA-WH47	661	05.7 ~	KJ20CR-L11	-	-	VKA20	8	
			E-ZY	-	92.12~95	K16R-U	K16TT	IK16	VK16	8	
THAILAND	JEEP COMPASS	5200	E-ZG52	-	95.12~98	KJ16CR-L11	K16TT	-	VKA16	8	
			GH-WH57 · ABA-WH57	7	05.7 ~08.12	ITL16	-	ITL16	-	16	
VIETNAM	JEEP COMPASS	5700	ABA-WK57A	7	11.12~	IKH16	-	IKH16	VKH16	16	
			ABA-WK57A	7	13.11~	-	-	-	-	16	
VIETNAM	JEEP COMPASS	6100	-	-	06.9 ~	ITL20	-	ITL20	-	16	
			6400	ABA-WK64	4L	17.6 ~	-	-	-	-	16
VIETNAM	JEEP PATRIOT	2000	ABA-MK49	A	12.3 ~	KJ16CR-L11	K16TT	-	VKA16	4	
			2400	ABA-MK4924	B	13.7 ~	KJ16CR-L11	K16TT	-	VKA16	4
VIETNAM	JEEP PATRIOT	2400	ABA-M624	B	17.12~	-	-	-	-	4	
			2000	ABA-MK7420	A	12.2 ~	KJ16CR-L11	K16TT	-	VKA16	4
VIETNAM	JEEP PATRIOT	2400	ABA-MK74	B	07.8 ~	KJ16CR-L11	K16TT	-	VKA16	4	
			ABA-MK74	B	12.2 ~	KJ16CR-L11	K16TT	-	VKA16	4	
VIETNAM	JEEP WRANGLER	2000	ABA-JL20L	N(T/C)	18.11~	-	-	-	-	4	
			3600	ABA-JK36S · ABA-JK36L	G	12.1 ~	-	-	-	VXUHC22G	6
VIETNAM	JEEP WRANGLER	3600	ABA-JK36L · ABA-JK36LR	G	18.1 ~	-	-	-	VXUHC22G	6	
			3800	ABA-JL36S · ABA-JL36L	G	18.11~	-	-	-	VXUHC22G	6
VIETNAM	JEEP WRANGLER	3800	ABA-JK38S · ABA-JK38L	8	07.3 ~	ITL16	-	ITL16	-	6	
			E-SYMX · E-HYMX	-	92.12~95	KJ16CR-L11	-	-	VKA16	6	
VIETNAM	JEEP WRANGLER	4000	E-TJ40S · E-TJ40H	-	96.9 ~99	KJ16CR-L11	-	-	VKA16	6	
			GF-TJ40S · GH-TJ40S	MX	99.6 ~07.3	KJ16CR-L11	-	-	VKA16	6	
VIETNAM	JEEP WRANGLER	4000	GF-TJ40H	-	99.10~01	KJ16CR-L11	-	-	VKA16	6	
			JEEP RENEGADE	1300	3BA-BU13	55282328(T/C)	19.2 ~	-	-	-	-
7LA-BV13	46337540(T/C)	20.11~			-	-	-	-	-	4	
VIETNAM	JEEP RENEGADE	1400	ABA-BU14	55263624(T/C)	18.6 ~	-	-	-	IXU24	4	
			2400	ABA-BU24	6	18.6 ~	-	-	-	-	4
VIETNAM	NEON	1800	E-PL18	-	98.1 ~	K16PR-U	K16TT	IK16	VK16	4	
			2000	E-PL20	-	96.3 ~99.8	K20PR-U	K20TT	IK20	VK20	4
VIETNAM	NEON	2000	GF-PL2K20	466	99.9 ~00	K20PR-U	K20TT	IK20	VK20	4	
			PT CRUISER	2000	GF-PT2K20 · GH-PT2K20	T, G	00.7 ~	ITL16	-	ITL16	-
GH-PT2K24 · ABA-PT2K24	S	04 ~			ITL16	-	ITL16	-	4		
VIETNAM	PT CRUISER	2400	GH-PT24	S	04.10~	ITL16	-	ITL16	-	4	
			GH-PT24T · ABA-PT24T	(T/C)	05.2 ~	ITL16	-	ITL16	-	4	
VIETNAM	STRATUS	2500	E-JA25	-	95.11~	VK16	-	IK16	VK16	6	
			VIPER GTS	8000	-	-	99.10~01	KJ20CR-L11	K20TT	IK20	VK20
VIETNAM	VISION	3500			E-LHF	-	93.12~95	KJ16CR-L11	K16TT	IK16	VK16
			EUROPE & USA	VOYAGER	3300	E-GS33L · E-GS33S	-	97.2 ~99.9	VW16	-	IW16
GF-GS33E · GF-GS33S · GF-GS33L	-	99.10 ~01.10				VW16	-	IW16	VW16	6	
EUROPE & USA	VOYAGER	3300	GF-RG33S · GF-RG33L	R	01.1 ~	ITL16	-	ITL16	-	6	
			GH-RG33S · GH-RG33L	-	02 ~	ITL16	-	ITL16	-	6	
EUROPE & USA	VOYAGER	3800	ABA-RG33S	-	- ~	ITL16	-	ITL16	-	6	
			GF-GS38L · GF-GS38S	-	99.10~00	VW16	-	IW16	VW16	6	
EUROPE & USA	<b>CITROEN</b>										
	C2	1400	GH-A6KFV · ABA-A6KFV	KFV	04.4 ~	K20PR-U	K20TT	IK20	VK20	4	
1600			GH-A6NFU · ABA-A6NFU	NFU	04.3 ~	K20HR-U11	-	IKH20	VKH20	4	
EUROPE & USA	C2	1600	GH-A6NFS · ABA-A6NFS	NFS	06.3 ~	K20HR-U11	-	IKH20	VKH20	4	
			C3	1200	ABA-A5HM01	HM01	14.2 ~	-	-	IXUH20I	VXUH20I
ABA-B6HN01	HN01(T/C)	17.7 ~			-	-	-	-	-	3	
EUROPE & USA	C3	1200	3BA-A8HN05	HN05(T/C)	19.7 ~	-	-	-	-	3	

DENSO	9	14	16	20	22	24	27	29	31	32	34	35	DENSO	9	14	16	20	22	24	27	31	32	DENSO	9	14	16	20	22	24	27	31	
NGK	2	4	5	6	7	8	9	9.5	10	10.5	11	11.5	CHAMPION	18	16,14	12,11	10,9	8,7	6,63,61	4,59	57	55	53	BOSCH	10	9	8	7,6	5	4	3	2

MODEL	CC	VEHICLE CODE	ENGINE	FROM-TILL	DENSO		IRIDIUM POWER	IRIDIUM TOUGH	QTY		
<b>CITROEN</b>											
<b>C3</b>	1200	5BA-B6HN05	HN05(T/C)	21.1 ~	-	-	-	-	3	AUSTRALIA	
		GH-A8KFV	KFV	02.10~06.3	K20PR-U	K20TT	IK20	VK20	4		
	1400	GH-A31KFU · ABA-A31KFU	KFU	06.3 ~	XE20HR-U9	-	-	-	4	CHINA	
		GH-A8NFU	NFU	02.12~06.3	K20HR-U11	-	IKH20	VKH20	4		
	1600	GH-A31NFU · ABA-A31NFU	NFU	06.3 ~	K20HR-U11	-	IKH20	VKH20	4		
		GH-A42NFU · ABA-A42NFU	NFU	05.4 ~	K20HR-U11	-	IKH20	VKH20	4		
ABA-A55F01		5F01	10.5 ~	-	-	-	-	4			
<b>C4</b>	1200	ABA-B7HN02	HN02(T/C)	15.9 ~	-	-	-	-	3	INDIA	
		GH-B5NFU · ABA-B5NFU	NFU	05.6 ~	K20HR-U11	-	IKH20	VKH20	4		
	1600	ABA-B75F01 · ABA-B75F01S	5F01	11.7 ~	-	-	-	-	4	INDONESIA	
		ABA-B75F02S	5F02(T/C)	11.7 ~	-	-	-	-	4		
		ABA-B75F02	5F02(T/C)	13.5 ~	-	-	-	-	4		
		ABA-B785G01 · ABA-B785G01	5G01(T/C)	14.10~	-	-	-	-	4		
		3BA-B7875G06	5G06(T/C)	19.3 ~	-	-	-	-	4		
		GH-B5RFJ · ABA-B5RFJ	RFJ	05.6 ~	K16HPR-U11	-	IKH16	VKH16	4		
	2000	GH-B5RFK · ABA-B5RFK	RFK	05.6 ~	K16HPR-U11	-	IKH16	VKH16	4	KOREA	
		ABA-B55FW	5FW	09.2 ~	-	-	-	-	4		
	<b>C4 PICASSO</b>	1600	ABA-B585FXP	5FX(T/C)	09.2 ~	-	-	-	-	4	INDONESIA
			ABA-B585FTP	5FT(T/C)	09.2 ~	-	-	-	-	4	
ABA-B585F04P			5FX(T/C)	10.4 ~	-	-	-	-	4		
2000		ABA-B585F02P	5F02(T/C)	11.2 ~	-	-	-	-	4		
		ABA-B58RFJP	RFJ	07.6 ~	IKH16	-	IKH16	VKH16	4	INDONESIA	
		ABA-B58RFJ	RFJ	08.2 ~	IKH16	-	IKH16	VKH16	4		
<b>C5</b>	1600	ABA-X75F02	5F02(T/C)	12.10~	-	-	-	-	4	INDONESIA	
		3BA-C845G06	5G06(T/C)	20.4 ~	-	-	-	-	4		
	2000	GF-X4RFN · GH-X4RFN · GF-X4RFNW · GH-X4RFNW	RFN	01.7 ~04.12	K16HPR-U11	-	IKH16	VKH16	4	INDONESIA	
		GH-X3RFJ · ABA-X3RFJ	RFJ	04 ~08.10	K20HR-U11	-	IKH20	VKH20	4		
		ABA-X7RFJ	-	08.10~	K20HR-U11	-	IKH20	VKH20	4		
	3000	GF-X4FXW · GH-X4FXW	ES9J4S	01.7 ~	IKH16	-	IKH16	VKH16	6	INDONESIA	
		GF-X4XFX · GH-X4XFX	-	01.7 ~	IKH16	-	IKH16	VKH16	6		
		GH-X3XFU · ABA-X3XFU	XFU	04 ~08.10	IKH16	-	IKH16	VKH16	6		
		ABA-X7XFV	-	08.10~	IKH16	-	IKH16	VKH16	6		
	<b>C6</b>	3000	ABA-X6XFV	XFV	06.10~	IKH16	-	IKH16	VKH16	6	INDONESIA
<b>CHANSON</b>	1600	E-S8NF	NFZ	96.12~99	K20TNR	K20TT	IK20	VK20	4	INDONESIA	
<b>DS3</b>	1200	ABA-A5CHM01	HM01	14.2 ~	-	-	IXUH20I	VXUH20I	3	INDONESIA	
		ABA-A5CHN01	HN01(T/C)	15.11~	-	-	-	-	3		
		ABA-A5CHN01	HN01(T/C)	16.6 ~	-	-	-	-	3	TAIWAN	
		ABA-A5CHN05	HN05(T/C)	18.10~	-	-	-	-	3		
		3BA-D34HN05	HN05(T/C)	19.6 ~	-	-	-	-	3		
		5BA-D34HN05	HN05(T/C)	20.5 ~	-	-	-	-	3		
	1600	ABA-A5C5F01	5F01	10.3 ~	-	-	-	-	4	THAILAND	
		ABA-A5C5F04	5F04	10.5 ~	-	-	-	-	4		
		ABA-A5C5F02	5F02(T/C)	12.4 ~	-	-	-	-	4		
		ABA-A5C5F02	5F02(T/C)	13.7 ~	-	-	-	-	4		
		ABA-A5C5G01	5G01(T/C)	15.2 ~	-	-	-	-	4		
		ABA-B7C5F02S	5F02(T/C)	11.9 ~	-	-	-	-	4	VIETNAM	
<b>DS4</b>	1600	ABA-B7C5F03S	5F03(T/C)	11.9 ~	-	-	-	-	4		
		ABA-B7C5F06S	5F06(T/C)	12.9 ~	-	-	-	-	4		
		ABA-B7C5G01	5G01(T/C)	15.6 ~	-	-	-	-	4		
		ABA-B85F02	5F02(T/C)	12.8 ~	-	-	-	-	4	JAPAN	
<b>DS5</b>	1600	ABA-B85G01	5G01(T/C)	16.4 ~	-	-	-	-	4		
		ABA-X745G06	5G06(T/C)	18.7 ~	-	-	-	-	4		
<b>DS7</b>	1600	ABA-X745G06	5G06(T/C)	19.6 ~	-	-	-	-	4		
		3LA-X745G06H	5G06(T/C)	21.3 ~	-	-	-	-	4		
		GF-S8NFS · GH-S8NFS	NF	99.3 ~	K20TNR	K20TT	IK20	VK20	4	EUROPE & USA	
<b>SAXO XANTIA</b>	1600	E-X1RF	XU10J	93.7 ~99.5	K20TXR	K20TT(*5)	IK20	VK20	4	CROSS REFERENCE NUMBER	
		E-X1RFW	XU10J	95.12~99.5	K20TXR	K20TT(*5)	IK20	VK20	4		
	3000	GF-X2RF · GF-X2RFW	RF	98.8 ~01	K20TXR	K20TT(*5)	IK20	VK20	4		
		GF-X2XF	XF	98.5 ~01	K20TXR	K20TT(*5)	IK20	VK20	6		
<b>XM</b>	3000	E-Y3SFW	SF	92.12~95	K20PBR	-	IK20	VK20	6		
		E-Y3UFW	UF	93.8 ~	K20PBR	-	IK20	VK20	6		
		E-Y3UF	UF	93.9 ~	K20PBR	-	IK20	VK20	6		
	3000	E-Y4UF	UF	94.9 ~97	K20PBR	-	IK20	VK20	6		
		E-Y4UFW	ZP	94.11~97	K20PBR	-	IK20	VK20	6		
		E-Y4XF	-	97.10~01	K20PBR	-	IK20	VK20	6		

(\*5) : It can be used only for a plug with a terminal.



# EUROPE & U.S.A. CAR

▶ Spark plug color codes: ■ for Iridium Tough and Iridium Plugs and Iridium TT, ■ for Iridium Power, ■ for Iridium Racing and Two Tops Plugs, ■ for Platinum Plugs and Platinum TT, and black for general spark plugs.

	MODEL	CC	VEHICLE CODE	ENGINE	FROM-TILL	DENSO		IRIDIUM POWER	IRIDIUM TOUGH	QTY	
AUSTRALIA	<b>CITROEN</b>										
	XM	3000	E-Y4XFW	XF	97.10~98	K20PBR	-	IK20	VK20	6	
GF-Y4XF			ES9J4	- ~00.12	K16TR11	K16TT	IK16	VK16	6		
CHINA	XSARA	1600	GF-N6LFW	LF	98.11~99	K20TXR	K20TT(*5)	IK20	VK20	4	
			GF-N6NF • GF-N6NFR	NF	99.12 ~01.12	K20TXR	K20TT(*5)	IK20	VK20	4	
			GF-N6NFW	-	00.2 ~01.12	K20PR-U	K20TT	IK20	VK20	4	
			GF-N7NFU • GH-N7NFU • GF-N7NFUW • GH-N7NFUW	TU5JP4	01.12~	K20HR-U11	-	IKH20	VKH20	4	
INDIA	1800	E-N6LF	LF	98.3 ~99	K20TXR	K20TT(*5)	IK20	VK20	4		
		GF-N6LFW	LF	98.11~99	K20TXR	K20TT(*5)	IK20	VK20	4		
		GF-N6RFS	RF	98.9 ~	K20TXR	K20TT(*5)	IK20	VK20	4		
		GF-N6RF	RF	98.11~01.5	K20TXR	K20TT(*5)	IK20	VK20	4		
INDONESIA	2000	GF-N6RFW	RF	98.11~01.9	K20TXR	K20TT(*5)	IK20	VK20	4		
		GF-N7RFN • GF-N7RFN • GH-N7RFN	RFN	01.6 ~	K16HPR-U11	-	IKH16	VKH16	4		
		GF-N7RFNW • GH-N7RFNW	RFN	01.9 ~	K16HPR-U11	-	IKH16	VKH16	4		
		GH-N7RFN	RFN(EW10J4)	03.4 ~	K16HPR-U11	-	IKH16	VKH16	4		
KOREA	ZX	1600	GF-N68RFN	RFN	04.6 ~	K16HPR-U11	-	IKH16	VKH16	4	
			E-N2BD	XU5M4Z	92.2 ~	K20PR-U	K20TT	IK20	VK20	4	
			E-N2LF	XU7JP	93.12~97	K20TXR	K20TT(*5)	IK20	VK20	4	
			E-N2LFW	XU7JP	95.2 ~97	K20TXR	K20TT(*5)	IK20	VK20	4	
MALAYSIA	1900	E-N22LFW	XU7JP	- ~97	K20TXR	K20TT(*5)	IK20	VK20	4		
		E-N2DK	XU9JAZ	92.2 ~94	K20PR-U	K20TT	IK20	VK20	4		
PHILIPPINES	2000	E-N2RF	XU10J	94.9 ~95	K20TXR	K20TT(*5)	IK20	VK20	4		
		<b>DAEWOO(大宇)GM</b>									
SAUDIARABIA	MATIZ	800	GF-KLA4	F8CV	99.11~	W16EXR-U11	W16TT	IW16	VW16	3	
			GF-KLA4M	-	00.9 ~	W16EXR-U11	W16TT	IW16	VW16	3	
SINGAPORE	<b>DODGE CHRYSLER</b>										
	AVENGER	2700	ABA-JSD27	-	07 ~	ITL20	-	ITL20	-	6	
	CALIBER	2000	ABA-PM20	-	07 ~	KJ16CR-L11	K16TT	IK16	VK16	4	
	CHARGER	5700	-	-	07.12~	ITL16	-	ITL16	-	16	
		6100	-	-	07 ~	ITL20	-	ITL20	-	16	
	NITRO	3700	ABA-KA37	-	07 ~	KJ20CR-L11	K20TT	IK20	VK20	6	
	MICHIGAN	2200	E-KD22	-	- ~	W16EPR-U	W16TT	IW16	VW16	4	
	RAM1500	5700	-	-	04.1 ~08.9	ITL16	-	ITL16	-	16	
	<b>DONKervoort</b>										
	D8 SPORT	1800	-	-	98.4 ~04.1	-	-	-	-	4	
TAIWAN	<b>FERRARI</b>										
	348	3400	E-F348S	-	94.1 ~	IX24	-	IX24	-	8	
	360	3600	GF-F360 • GH-F360	F131	99.6 ~	IU24	-	IU24	-	8	
			GF-F360S • GH-F360S	F131	00 ~	IU24	-	IU24	-	8	
	430 SCUDERIA	4300	ABA-F430SC	-	08.5 ~09	IU24	-	IU24	-	8	
	456GT	5500	E-F456	F116	94.1 ~98	IXU27	-	IXU27	-	12	
	456M GT	5500	GF-F456 • GH-F456	F113	98 ~	IXU27	-	IXU27	-	12	
	512TR	5000	E-F512TR	F113	92.3 ~	IXU27	-	IXU27	-	12	
	550	5500	E-F550	F133A	96.11~	IXU27	-	IXU27	-	12	
			GF-F550B	F113	01 ~	IXU27	-	IXU27	-	12	
599F1	6000	ABA-F599	F140C	06.10~	IU24	-	IU24	-	12		
612SCAGLIETTI	5700	GH-F612	-	03 ~	IXU27	-	IXU27	-	12		
VIETNAM	<b>CHALLENGE STRADALE</b>										
	F355	3600	GH-F360SC	-	03 ~	IU24	-	IU24	-	8	
	F355	3500	E-F355B	F129	94.6 ~99	IU22	-	IU22	-	8	
	F355 SPIDER	3500	E-F355S	F129	- ~99	IU22	-	IU22	-	8	
	F430	4300	GH-F430 • GH-F430S	-	04.9 ~	IU24	-	IU24	-	8	
	F50	4700	E-F50	F130B	96.1 ~	IU22	-	IU22	-	12	
	F512M	4900	E-F512M	F113	95.3 ~96	IXU27	-	IXU27	-	12	
	JAPAN	MARANELLO	5500	GF-F550	F116	97 ~	IXU27	-	IXU27	-	12
				GF-F575M • GH-F575M	F113E	02.5 ~	IXU27	-	IXU27	-	12
	EUROPE & USA	<b>FIAT</b>									
<b>BARCETTA</b>											
1800		E-183A1	183A1	96.2 ~99.10	K20TNR	K20TT	IK20	VK20	4		
		GF-183A1	183A1	99.11~01	K20TNR	K20TT	IK20	VK20	4		
		GF-183A6	183A1	02 ~	K20TNR	K20TT	IK20	VK20	4		
		GH-18318	-	04.9 ~	K20PR-U	K20TT	IK20	VK20	4		
FIAT500/500C		880	ABA-31209	312A2(T/C)	11.3 ~	-	-	-	2		
			ABA-31209	312A2(T/C)	16.1 ~	-	-	-	2		
		1200	ABA-31212	169A4	08.3 ~	XU22EPR-U	XU22TT	IXU22	VXU22	4	
		1400	ABA-31214	169A3	08.5 ~	XU22EPR-U	XU22TT	IXU22	VXU22	4	
500X	1300	3BA-33413	55282328(T/C)	19.5 ~	-	-	-	4			
		3BA-33413PM	55282328(T/C)	20.8 ~	-	-	-	4			

(\*5) : It can be used only for a plug with a terminal.



MODEL	CC	VEHICLE CODE	ENGINE	FROM-TILL	DENSO		IRIDIUM POWER	IRIDIUM TOUGH	QTY	
<b>FIAT 500X</b>	1400	ABA-33414	55263624(T/C)	15.10~	-	-	IXU24	-	4	AUSTRALIA
		ABA-33414	55263623(T/C)	15.10~	-	-	IXU24	-	4	
<b>BRAVISSIMO COUPE FIAT</b>	1600	E-182AB1	-	98.1 ~	K20TNR	K20TT	IK20	VK20	4	CHINA
		E-175A1	175A1.000	94.12~97.3	W20EPBR-S	-	IW20	VW20	4	
	2000	E-175A3	175A3.000(T/C)	97.4 ~98.12	K20PBR-S10	-	IK20	VK20	5	
GF-175A3		175A3(T/C)	99.11~01	K20PBR-S10	-	IK20	VK20	5		
<b>GRAND PUNTO</b>	1400	ABA-199142	350A1	06.10~	XU22EPR-U	XU22TT	IXU22	VXU22	4	INDIA
		ABA-199141	199A6	06.6 ~	XU22EPR-U	XU22TT	IXU22	VXU22	4	
<b>PANDA</b>	880	ABA-13909	312A2(T/C)	14.11~	-	-	-	-	2	INDONESIA
		E-F153A2	-	92.12~	K20PR-U	K20TT	IK20	VK20	4	
	1100	E-F141B3	-	93.7 ~	K20PR-U	K20TT	IK20	VK20	4	
		E-141AKB · E-141AKA	176B2	95.4 ~99	K20PR-U	K20TT	IK20	VK20	4	
	1200	GH-16912	188A4(~No2533527)	04.7 ~	K16PR-U	K16TT	IK16	VK16	4	
		GH-16912	188A4(No2533528~)	04.7 ~	XU22EPR-U	XU22TT	IXU22	VXU22	4	
		GH-16912Q	188A4(No2533528~)	05.4 ~07.4	XU22EPR-U	XU22TT	IXU22	VXU22	4	
		ABA-16912	188A4	07.2 ~	XU22EPR-U	XU22TT	IXU22	VXU22	4	
		ABA-16912Q	188A4	07.4 ~	XU22EPR-U	XU22TT	IXU22	VXU22	4	
	1400	ABA-16914(limited edition vehicle)	169A6	07.10~	-	-	-	-	4	
<b>PUNTO</b>	1200	E-176AR2	176A7	96.12~	K20PR-U	K20TT	IK20	VK20	4	KOREA
		E-176AR5	-	97.1 ~98	K20PR-U	K20TT	IK20	VK20	4	
	1240	GF-176AR2	-	99.11~99	K20PR-U	K20TT	IK20	VK20	4	
		GF-176BV3	176B9	99.11~01	XU24EPR-U	-	IXU24	VXU24	4	
	1700	GF-188A5 · GH-188A5	188A5	00.5 ~	XU24EPR-U	-	IXU24	VXU24	4	
		GF-188A6	183A1	00.5 ~02	K20TNR	K20TT	IK20	VK20	4	
	1800	GH-188A6	183A1	03 ~	K16PR-U	K16TT	IK16	VK16	4	
		GF-188A1	183A1.000	00.5 ~01	K20TNR	K20TT	IK20	VK20	4	
<b>MULTIPLA</b>	1600	GH-186B6	-	03.4 ~04.11	K16PR-U	K16TT	IK16	VK16	4	MALAYSIA
<b>TEMPRA</b>	2000	E-F60A6	159A6.046	92.5 ~	W22EPR-U	-	IW22	VW22	4	
<b>TIPO</b>	2000	E-F60A6	-	92.1 ~95.10	W22EPR-U	-	IW22	VW22	4	PHILIPPINES
		E-F60A8	-	92.12 ~95.10	W22EPR-U	-	IW22	VW22	4	
<b>FORD EUROPE</b>										
<b>FIESTA</b>	1000	ABA-WF0SFJ	SFJ(T/C)	14.2 ~	-	-	-	-	3	SINGAPORE
	1600	GH-WFOFYJ	-	04.4 ~	PT16VR13	-	ITV16	-	4	
	2000	GH-WF0N4J	-	05.5 ~	VT20	-	IT20	VT20	4	
<b>FOCUS</b>	1500	ABA-MPBM9D	M9D(T/C)	15.10~	-	-	-	-	4	TAIWAN
	1600	GH-WFOHWD	-	05.12~	ITV16	-	ITV16	-	4	
		GH-WFOEDD · GH-WFOEDD	ZETEC SE	00.10~	PT16VR13	-	ITV16	-	4	
	2000	GH-WFOALD	-	03.1 ~	ITV24	-	ITV24	-	4	
		GH-WFOAOD · ABA-WFOAOD	-	06.2 ~	VT20	-	IT20	VT20	4	
		ABA-MPBMGD	MGD	13.4 ~	-	-	-	-	4	
	2500	GH-WFOHYD	-	06.6 ~	-	-	-	-	5	
1600	GF-WFOFYD · GH-WFOFYD	ZETEC SE	00.3 ~	PT16VR13	-	ITV16	-	4		
<b>GALAXY GHIA</b>	2800	GF-WFOGAA	-	99.3 ~	K20TXR	K20TT(*5)	-	VK20	6	THAILAND
<b>GALAXY GLX</b>	2300	GF-WFOGY5	-	99.3 ~	VK20	-	IK20	VK20	4	
<b>KA</b>	1300	GF-WFOBJ4	-	99.1 ~	T20EPR-U	-	IT20	VT20	4	VIETNAM
<b>KUGA</b>	1500	ABA-WF0M9M	M9M(T/C)	15.9 ~	-	-	-	-	4	
	1600	ABA-WFOJTM	JTM(T/C)	13.9 ~	-	-	-	-	4	
	2000	ABA-WF0TPM	TPM(T/C)	15.9 ~	-	-	-	-	4	
	2500	ABA-WFOHYDP	HYD (T/C)	12.9 ~	-	-	IKH20	VKH20	5	
<b>MONDEO</b>	1800	E-WFONRK · E-WFOFRK	-	94.4 ~98	PT16VR13	-	ITV16	-	4	
		E-WFONNG · E-WFOFNG	-	94.4 ~99.2	PT16VR13	-	ITV16	-	4	
	2000	GF-WFOFNG · GF-WFONNG	-	99.3 ~01.4	PT16VR13	-	ITV16	-	4	
		GH-WFOCJB	CJB	01.5 ~	IT20	-	IT20	VT20	4	
	2500	E-WFOFSE	-	94.12~98	PT16EPR-L13	-	IT16	VT16	6	
		E-WFONRF	-	00.10~	IT20	-	IT20	VT20	6	
		GH-WFOLCB	-	02.4 ~	PT16EPR-L13	-	IT16	VT16	6	
3000	GH-WF0MEB	-	06.6 ~	IT20	-	IT20	VT20	6		
<b>FORD U.S.A.</b>										
<b>ECOSPORT</b>	1500	ABA-MAJUEJ	UEJ	14.5 ~	-	-	ITV20	-	4	EUROPE & USA
<b>ESCAPE</b>	2000	TA-EPEWF	YF	01.6 ~03.11	PT16VR13	-	ITV16	-	4	
		ABA-LFAL3	L3	06.6 ~08.2	VT16	-	IT16	VT16	4	
2300	ABA-LFAL3 · ABA-LFAL3F · ABA-LFAL3P	L3	08.2 ~	ITV20	-	ITV20	-	-	4	
	3000	LA-EPFWF	AJ	03.11~06.6	IT20	-	IT20	VT20	6	
<b>EXPEDITION</b>	5400	GF-1FMLU18	-	98.12~	PT16EPR-L13	-	IT16	VT16	8	

(\*5) : It can be used only for a plug with a terminal.

AUSTRALIA  
 CHINA  
 INDIA  
 INDONESIA  
 KOREA  
 MALAYSIA  
 PHILIPPINES  
 SAUDIARABIA  
 SINGAPORE  
 TAIWAN  
 THAILAND  
 VIETNAM  
 JAPAN  
 EUROPE & USA  
 CROSS REFERENCE NUMBER  
 PART



# EUROPE & U.S.A. CAR

▶ Spark plug color codes: ■ for Iridium Tough and Iridium Plugs and Iridium TT, ■ for Iridium Power, ■ for Iridium Racing and Two Tops Plugs, ■ for Platinum Plugs and Platinum TT, and black for general spark plugs.

MODEL	CC	VEHICLE CODE	ENGINE	FROM-TILL	DENSO		IRIDIUM POWER	IRIDIUM TOUGH	QTY		
AUSTRALIA <b>FORD U.S.A. EXPLORER</b>	2000	ABA-1FMHK9	9(T/C)	13.11~	-	-	-	-	4		
	2300	ABA-1FM5KH	H(T/C)	15.10~	-	-	-	-	4		
CHINA	3500	ABA-1FMHK8	8	11.5 ~	ITV20	-	ITV20	-	6		
		ABA-1FM5K8	8	15.10~	-	-	ITV20	-	6		
INDIA	4000	E-FMUX4	-	93.4 ~	T16EPR-U15	-	IT16	VT16	6		
		E-1FMXU34	-	94.11~97	T16EPR-U15	-	IT16	VT16	6		
		E-1FMXU24	-	94.11~	T16EPR-U15	-	IT16	VT16	6		
		E-1FMXU34	-	96.8 ~97	PT16EPR-L13	-	IT16	VT16	6		
		E-1FMXSU34	-	96.8 ~98	PT16EPR-L13	-	IT16	VT16	6		
		E-1FMXSU24	-	96.8 ~97	PT16EPR-L13	-	IT16	VT16	6		
		GF-1FMXSU34	-	99 ~01	PT16EPR-L13	-	IT16	VT16	6		
INDONESIA	4600	GF-1FMEU74・GH-1FMEU74・ABA-1FMEU74	-	02 ~	PT16EPR-L13	-	IT16	VT16	6		
		ABF-1FMKU51	-	07.6 ~	IT20	-	IT20	VT20	6		
KOREA	4600	GF-1FMWU74	-	02 ~	-	-	-	-	8		
		GH-1FMWU74	-	02 ~05.11	-	-	-	-	8		
KOREA	5400	ABA-1FMWU74	-	07.10~	-	-	-	-	8		
		F150	-	99 ~00	PT16EPR-L13	-	IT16	VT16	8		
KOREA	5400	-	-	99 ~00	PT16EPR-L13	-	IT16	VT16	8		
		MALAYSIA	3800	E-1FA4P44・E-1FA4P40	-	94.1 ~94.6	T20EPR-U	-	IT20	VT20	6
E-1FA4P44・GH-1FA4P44 RW	-			95 ~	PT16EPR-L13	-	IT16	VT16	6		
E-1FARW40	-			95.8 ~98	IT20	-	IT20	VT20	6		
E-1FARW44	-			96.8 ~98	IT20	-	IT20	VT20	6		
GF-1FARWP4	-			99.5 ~	PT16EPR-L13	-	IT16	VT16	6		
GF-1FARWP4	-			99.2 ~	IT20	-	IT20	VT20	6		
GH-1FARWP4	-			01 ~	PT16EPR-L13	-	IT16	VT16	6		
GH-1FARW4	-			04.2 ~	PT16EPR-L13	-	IT16	VT16	6		
PHILIPPINES	4600			E-1FAV2P47	-	95.12~98	PT16EPR-L13	-	IT16	VT16	8
				GF-1FAV2P4	-	99 ~99	PT16EPR-L13	-	IT16	VT16	8
		E-1FAF145・E-1FAF142	-	95.8 ~98	PT16EPR-L13	-	IT16	VT16	8		
		GF-1FAV2P4	-	99.5 ~99	PT16EPR-L13	-	IT16	VT16	8		
		GF-1FAF1P4	-	99.6 ~	PT16EPR-L13	-	IT16	VT16	8		
		GF-1FAF1P4・GH-1FAF1P4 F1	-	99.7 ~	PT16EPR-L13	-	IT16	VT16	8		
		GH-1FARW4	-	04.2 ~	PT16EPR-L13	-	IT16	VT16	6		
		E-1FAV2P47	-	95.12~98	PT16EPR-L13	-	IT16	VT16	8		
SAUDIARABIA	4900	E-1FATP45・E-1FATP42	-	94.1 ~	T16PR-U15	-	ITF16	-	8		
		E-1FASP57	-	95.12~96.7	PT16EPR-L13	-	IT16	VT16	6		
SINGAPORE	3000	E-1FASP52	-	95.12~97.8	PT16EPR-L13	-	IT16	VT16	6		
		E-1FANP52	-	96.2 ~	PT16EPR-L13	-	IT16	VT16	6		
		E-1FASP57	-	96.8 ~97	PT16EPR-L13	-	IT16	VT16	6		
		E-1FANP54	-	96 ~99	PT16EPR-L13	-	IT16	VT16	6		
TAIWAN	3300	E-1FASP54	-	96.8 ~	PT16EPR-L13	-	IT16	VT16	6		
		E-1FASP54	-	96.8 ~	PT16EPR-L13	-	IT16	VT16	6		
THAILAND	3800	E-FA542・E-FA541	-	92.11~94.9	T20EPR-U	-	IT20	VT20	6		
		E-FA542・E-FA541	-	92.11~94.9	T20EPR-U	-	IT20	VT20	6		
THUNDERBIRD	4900	E-FA6T1	-	92.11~	T16PR-U	-	ITF16	-	8		
<b>HOME PARK</b>											
ROADTREK 170	5200	-	-	~	KJ16CR-L11	K16TT	IK16	VK16	8		
ROADTREK 190	5900	-	-	~	KJ16CR-L11	K16TT	IK16	VK16	8		
<b>HUMMER GM</b>											
HUMMER H2	6000	-	LQ4	03.2 ~08	VT16	-	IT16	VT16	8		
HUMMER H3	3500	ABA-T345F	-	05.6 ~06	ITV16	-	ITV16	-	5		
	3700	ABA-T345F	-	07 ~09	ITV16	-	ITV16	-	5		
<b>HYUNDAI(現代)</b>											
COUPE	2700	GH-GK27・ABA-GK27	G6BA	02 ~	VK16	-	IK16	VK16	6		
ELANTRA	1800	GF-XD18・GH-XD18	G4GB	01.1 ~	K16PR-U11	K16TT	IK16	VK16	4		
		GH-ZD18	G4GB	03 ~	K16PR-U11	K16TT	IK16	VK16	4		
	2000	GF-XD20・GH-XD20	G4GC	01.1 ~	K16PR-U11	K16TT	IK16	VK16	4		
GRANDEUR	2700	ABA-TG27L	L6EA	06.11~	VK16	-	IK16	VK16	6		
	3400	ABA-TG33	G6DB	06.1 ~	VK16	-	IK16	VK16	6		
SANTA FE	2400	GF-SM24・GH-SM24	G4JS	01.1 ~	VW16	-	IW16	VW16	4		
	2700	GF-SM27・GH-SM27	G6BA	01.1 ~	VK16	-	IK16	VK16	6		
SONATA	2400	GH-NF24	G4KC	05.9 ~	VK16	-	IK16	VK16	4		
i30	1600	ABA-FD16	-	08.7 ~	IXUH22	-	IXUH22	VXUH22	4		
	2000	ABA-FD20	-	08.7 ~	K16PR-U11	K16TT	IK16	VK16	4		
i30cw	1600	ABA-FDW16	-	09.5 ~	IXUH22	-	IXUH22	VXUH22	4		
	2000	ABA-FDW20	-	09.5 ~	K16PR-U11	K16TT	IK16	VK16	4		
JM	2000	GH-JM20・ABA-JM20	G4GC	04.9 ~	K16PR-U11	K16TT	IK16	VK16	4		
	2700	GH-JM27・ABA-JM27	G6BA	04.9 ~	PK16PR-L11	-	IK16	VK16	6		
TB	1300	LA-TB13	G4EA	02.10~	K16PR-U11	K16TT	IK16	VK16	4		

DENSO	9	14	16	20	24	27	29	31	32	34	35	DENSO	9	14	16	20	22	24	27	29	31	32	DENSO	9	14	16	20	22	24	27	31	
NGK	2	4	5	6	7	8	9	9.5	10	10.5	11	11.5	CHAMPION	18	16,14	12,11	10,9	8,7	6,63,61	4,59	57	55	53	BOSCH	10	9	8	7,6	5	4	3	2

MODEL	CC	VEHICLE CODE	ENGINE	FROM-TILL	DENSO		IRIDIUM POWER	IRIDIUM TOUGH	QTY	
<b>HYUNDAI(現代)</b>										
TB	1400	DBA-TB14	G4EE	05.11~	K16PR-U11	K16TT	IK16	VK16	4	AUSTRALIA
TRAJET	2000	GF-F20・GH-F20	G4JP	01.1 ~	W20EXR-U	-	IW20	VW20	4	CHINA
	2700	GF-F27・GH-F27	G6BA	01.1 ~	VK16	-	IK16	VK16	6	
XG	3000	GF-XG30・GH-XG30	G6CT	01.5 ~	VK16	-	IK16	VK16	6	CHINA
XG250	2500	GH-TXG25	G6CT	04.3 ~	VK16	-	IK16	VK16	6	
XG300	3000	GH-XB30	G6CT	03.3 ~	VK16	-	IK16	VK16	6	
		GH-TXG30	G6CT	04.3 ~	VK16	-	IK16	VK16	6	
<b>JAGUAR</b>										
DAIMLER	4200	CBA-D82TB	TB(S/C)	05.7 ~	VK16	-	IK16	VK16	8	INDIA
	6000	E-DMSA	8E	95 ~96	T22EP-U	-	IT22	-	12	
DAIMLER SUPER	4000	E-DMFB	DC	97 ~00	VK20	-	IK20	VK20	8	INDONESIA
		GF-D25MB・GH-D25MB	MB	00.10~	VK16	-	IK16	VK16	8	
DOUBLE SIX	6000	E-DLSA	-	94.10~95	T22EP-U	-	IT22	-	12	INDONESIA
MAJESTIC	6000	E-DMS	-	94.2 ~	T22EP-U	-	IT22	-	12	
E PACE	2000	DBA-DF2XA	PT204(T/C)	18.2 ~	-	-	-	VXEHC24G	4	KOREA
F PACE	2000	DBA-DC2XB	PT204(T/C)	17.12~	-	-	-	-	4	
	3000	CBA-DC3VA	306PS(S/C)	16.1 ~	-	-	-	-	6	
F TYPE	2000	7BA-DC5SC	508PS(S/C)	18.12~	-	-	-	-	8	MALAYSIA
		DBA-J60XB	PT204(T/C)	17.9 ~	-	-	-	VXEHC24G	4	
		3BA-J60XC	PT204(T/C)	20.1 ~	-	-	-	VXEHC24G	4	
	3000	CBA-J608A	306PS(S/C)	13.5 ~	-	-	-	-	6	
		CBA-J608A	306PS(S/C)	14.6 ~	-	-	-	-	6	
		3BA-J608C	306PS(S/C)	20.1 ~	-	-	-	-	6	
	5000	CBA-J60MA	508PS(S/C)	13.5 ~	-	-	-	-	8	
		CBA-J60MA	508PS(S/C)	18.6 ~	-	-	-	-	8	
		CBA-J60MA	508PS(S/C)	19.7 ~	-	-	-	-	8	
		3BA-J60MC	508PS(S/C)	20.1 ~	-	-	-	-	8	
S TYPE 3.0 Executive	3000	CBA-J01FD	FB	06.1 ~	VT20	-	IT20	VT20	6	PHILIPPINES
S TYPE R	4200	GH-J011C	1B(S/C)	02.7 ~	IK16	-	IK16	VK16	8	
S TYPE SOVEREIGN	4200	GH-J01HC	-	04.5 ~	IK16	-	IK16	VK16	8	SAUDARABIA
S TYPE V6	2500	GH-J01JC	JB	02.7 ~	IT20	-	IT20	VT20	6	
		GF-J01FA	FC	99.5 ~01	IT20	-	IT20	VT20	6	
	3000	GF-J01FB	FB	00.10~	IT20	-	IT20	VT20	6	
S TYPE V8	4000	GH-J01FC	FB	02.7 ~	IT20	-	IT20	VT20	6	
		GF-J01GA	GC	99.5 ~01	VK16	-	IK16	VK16	8	
	4200	GF-J01GB	-	00.10~	VK16	-	IK16	VK16	8	
SOVEREIGN	4000	CBA-J01HD・CBA-J011D	HB	06 ~	VK16	-	IK16	VK16	8	SINGAPORE
		GH-J01HC	HB	02.7 ~06	VK16	-	IK16	VK16	8	
		E-JMDA	9J	97 ~97	K20PR-U	K20TT	IK20	VK20	6	
		E-JMDB	-	97.9 ~	K20PR-U	K20TT	IK20	VK20	6	
		GF-JMDC	LC	99.6 ~	VK20	-	IK20	VK20	8	
GF-J23LB・GH-J23LB	LB	00.10~	IK16	-	IK16	VK16	8			
SOVEREIGN/XJ6/XJ12	6000	E-JLS	-	93.5 ~	T22EP-U	-	IT22	-	12	THAILAND
SUPERV8	4200	GH-J73TA	TB	03.5 ~	VK16	-	IK16	VK16	8	
X TYPE	2000	ABA-J51YB	YB	05.6 ~	VT20	-	IT20	VT20	6	VIETNAM
		GH-J51YA	YB	02.5 ~	IT20	-	IT20	VT20	6	
	2500	GH-J51XA	XB	01.9 ~	IT20	-	IT20	VT20	6	
		ABA-J51XB	XB	05.6 ~	VT20	-	IT20	VT20	6	
	3000	GH-J51WA	WB	01.9 ~	IT20	-	IT20	VT20	6	
		ABA-J51WB	WB	05.6 ~	VT20	-	IT20	VT20	6	
		CBA-JA2GA	204PT(T/C)	16.7 ~	-	-	-	-	4	
XE	2000	DBA-JA2XC	PT204(T/C)	18.10~	-	-	-	VXEHC24G	4	JAPAN
		CBA-JA3VA	306PS(S/C)	16.7 ~	-	-	-	-	6	
XF	2000	CBA-JB2GA	204PT(T/C)	15.9 ~	-	-	-	-	4	EUROPE & USA
		DBA-JB2XC・DBA-JBS2XC	PT204(T/C)	17.11~	-	-	-	-	4	
		DBA-JB2XC・DBA-JBS2XC	PT204(T/C)	18.10~	-	-	-	VXEHC24G	4	
	CBA-J05A・CBA-J05FA	FB	07.11~	VT20	-	IT20	VT20	6		
	3000	CBA-JB3VA	306PS (S/C,Vehicle identification number: up to U04717)	15.9 ~	-	-	-	-	6	
		CBA-JB3VA	306PS (S/C,Vehicle identification number: starting from U04718)	15.9 ~	-	-	-	-	6	
	4200	CBA-J05HA	HB	07.11~	VK16	-	IK16	VK16	8	
		CBA-J051A	1B(S/C)	07.11~	VK16	-	IK16	VK16	8	
5000	CBA-J05LB・CBA-J05MB	508PN(S/C)	09.4 ~	VFXEH20	-	-	VFXEH20	8		
XJ	2000	CBA-J12PB	204PT(T/C)	12.5 ~	-	-	-	-	4	PART NUMBER
		CBA-J71VB	VB	06.1 ~	VT20	-	IT20	VT20	6	
	3000	CBA-J128B	306PN(S/C)	12.5 ~	-	-	-	-	6	



# EUROPE & U.S.A. CAR

▶ Spark plug color codes: ■ for Iridium Tough and Iridium Plugs and Iridium TT, ■ for Iridium Power, ■ for Iridium Racing and Two Tops Plugs, ■ for Platinum Plugs and Platinum TT, and black for general spark plugs.

	MODEL	CC	VEHICLE CODE	ENGINE	FROM-TILL	DENSO		IRIDIUM POWER	IRIDIUM TOUGH	QTY
AUSTRALIA	JAGUAR	3000	CBA-J128B	306PS(S/C)	16.9 ~	-	-	-	-	6
				E-JLGB	AC	97 ~99	IK20	-	IK20	VK20
CHINA	3200	GF-JLGC	KC	99.6 ~00	VK20	-	IK20	VK20	8	
		GF-J13KB	KB, G	00 ~	VK16	-	IK16	VK16	8	
		GH-J13KB	KB	- ~	IK16	-	IK16	VK16	8	
INDIA	4000	GF-J13KB	-	01.7 ~	IK16	-	IK16	VK16	8	
		E-JLDB	BC	98 ~98	IK20	-	IK20	VK20	8	
		GF-JLDC	LC	99.6 ~00	VK20	-	IK20	VK20	8	
		GF-J13LB	LB, G	00 ~	VK16	-	IK16	VK16	8	
		GH-J13LB	LB	- ~	IK16	-	IK16	VK16	8	
		GF-J23LB	-	00.10~	VK16	-	IK16	VK16	8	
INDONESIA	4200	CBA-J72SB	SB	06.1 ~	IK16	-	IK16	VK16	8	
		GH-J80SA	-	04.7 ~	VK16	-	IK16	VK16	8	
		CBA-J73TB	CBA-J82TB	TB(S/C)	06.6 ~	VK16	-	IK16	VK16	8
		GH-J80TA	-	04.7 ~	VK16	-	IK16	VK16	8	
KOREA	5000	CBA-J12LA	-	10.6 ~	VFXEH20	-	-	VFXEH20	8	
		CBA-J12MA	CBA-J24MA	(S/C)	10.6 ~	VFXEH20	-	-	VFXEH20	8
		CBA-J12MA	CBA-J24MA	508PS(S/C)	12.5 ~	-	-	-	-	8
MALAYSIA	3000	GH-J71VA	-	04.4 ~	VT16	-	IT16	VT16	6	
		E-JLGA	-	94.10~97	K20PR-U	K20TT	IK20	VK20	6	
		E-JLDA	-	94.10~97	K20PR-U	K20TT	IK20	VK20	6	
XJ8	3600	GH-J72RA	-	03.5 ~	VK16	-	IK16	VK16	8	
		GH-J72SA	SB	03.5 ~	VK16	-	IK16	VK16	8	
XJ12	6000	E-JLSA	-	94.10~95	T22EP-U	-	IT22	-	12	
PHILIPPINES	4000	E-JLFA	-	94.10~98	K22PR-U	-	IK22	VK22	6	
		E-JLFB	DC(S/C)	98 ~99	VK20	-	IK20	VK20	8	
		GF-J15MB	MB, G, SC(S/C)	00 ~	VK20	-	IK20	VK20	8	
		GH-J15MB	MB(S/C)	- ~	VK20	-	IK20	VK20	8	
		GH-J73TA	TB	03.5 ~	VK16	-	IK16	VK16	8	
SAUDI ARABIA	4200	CBA-J73TB	TB(S/C)	06.6 ~	VK16	-	IK16	VK16	8	
		XJR-S	6000	E-JES	-	92.5 ~	T20EPR-U	-	IT20	VT20
SINGAPORE	4000	E-JDD	-	92.7 ~	K20PR-U	K20TT	IK20	VK20	6	
		E-JED2	-	94.5 ~96	K20PR-U	K20TT	IK20	VK20	6	
		E-JES2	-	93.5 ~95	T22EP-U	-	IT22	-	12	
TAIWAN	4200	E-JDS	-	93.5 ~	T22EP-U	-	IT22	-	12	
		CBA-J435A	5B	06.7 ~	IK16	-	IK16	VK16	8	
		CBA-J438B	508PN(S/C)	10.6 ~	VFXEH20	-	-	VFXEH20	8	
THAILAND	5000	CBA-J438B	508PN	14.1 ~	-	-	-	-	8	
		GH-JFDA	GF-JEDA	-	96.8 ~99.1	VK20	-	IK20	VK20	8
		GH-JEDC	-	99.2 ~00	VK20	-	IK20	VK20	8	
VIETNAM	4200	GH-J41NB	NB	00.10 ~02.11	VK16	-	IK16	VK16	8	
		GH-J412A	2B	02.12~	VK16	-	IK16	VK16	8	
		GH-J412A	2B	02.12~	VK16	-	IK16	VK16	8	
		GF-JEFB	EC	99.2 ~99.10	VK20	-	IK20	VK20	8	
		GF-J41PA	-	99.10 ~00.10	VK16	-	IK16	VK16	8	
JAPAN	5700	GF-J41PB	PB	00.10 ~02.11	VK16	-	IK16	VK16	8	
		GH-J413A	3B	02.12~	VK16	-	IK16	VK16	8	
		CBA-J 439A	9B	07.4 ~	VK16	-	IK16	VK16	8	
		CBA-J 43YB	508PS(S/C)	09.4 ~	VK16	-	IK16	VK16	8	
EUROPE & USA	5000	CBA-J43YB	508PS(S/C)	14.1 ~	-	-	-	-	8	
		LAMBORGHINI								
EUROPE & USA	5700	DIABLO								
		E-DE21	-	99 ~	IXU27	-	IXU27	-	12	
		E-LD4	-	99 ~00	IXU27	-	IXU27	-	12	
		E-DE01	L522-12	00.10~	IXU27	-	IXU27	-	12	
		GF-DE01A	L522-6	00.3 ~	IXU27	-	IXU27	-	12	
EUROPE & USA	6000	L522-61T	99.10~00.9	IXU27	-	IXU27	-	12		
		GALLARDO	5000	-	04 ~	IK27	-	IK27	-	10
EUROPE & USA	6200	MURCIELAGO	GH-BC10E	L535	01.10~	IXU27	-	IXU27	-	12
		LANCIA								
EUROPE & USA	2000	DEDRA	E-A835A8	-	92.3 ~96	W20EPBR-S	-	IW20	VW20	4
		DELTA	E-L31E5	-	92.3 ~96	W20EPBR-S	-	IW20	VW20	4
		LYBRA	-	00 ~	K20TNR	K20TT	IK20	VK20	5	
		THEMA	E-A834F2	-	93.9 ~96	W20EPBR-S	-	IW20	VW20	4
		E-L34F	-	94.6 ~97	W20EPR-U	-	IW20	VW20	6	
EUROPE & USA	2000	LAND ROVER								
		DISCOVERY	CBA-LC2A	204PT(T/C)	16.8 ~	-	-	-	-	4
		DBA-LC2XB	PT204(T/C)	17.11~	-	-	-	VXEHC24G	4	
EUROPE & USA	3000	5BA-LC2XC	PT204(T/C)	19.11~	-	-	-	VXEHC24G	4	

DENSO	9	14	16	20	22	24	27	29	31	32	34	35	DENSO	9	14	16	20	22	24	27	29	31	32	DENSO	9	14	16	20	22	24	27	31
NGK	2	4	5	6	7	8	9	9.5	10	10.5	11	11.5	CHAMPION	18	16,14	12,11	10,9	8,7	6,63,61	4,59	57	55	53	BOSCH	10	9	8	7,6	5	4	3	2





MODEL	CC	VEHICLE CODE	ENGINE	FROM-TILL	DENSO		IRIDIUM POWER	IRIDIUM TOUGH	QTY	
<b>LAND ROVER</b>										
<b>DISCOVERY</b>	3000	ABA-LR3VA	306PS(S/C)	17.5 ~	-	-	-	-	6	AUSTRALIA
		ABA-LR3VA	306PS(S/C)	18.11~	-	-	-	-	6	CHINA
	3900	GF-LT56	56D	00.11~03.1	VK16	-	IK16	VK16	8	INDIA
		GF-LT56A	-	00.11~03.1	VK16	-	IK16	VK16	8	INDONESIA
	4000	ABA-LA40A	406PN	05.5 ~	-	-	-	-	6	KOREA
		GH-LT94A	94D	03 ~05.5	VK16	-	IK16	VK16	8	INDONESIA
	4400	ABA-LA44	408PN	05.5 ~	VK16	-	IK16	VK16	8	INDONESIA
	5000	ABA-LA5N	508PN	09.6 ~	-	-	-	-	8	INDONESIA
ABA-LA5N		508PN	11.12~	-	-	-	-	8	INDONESIA	
<b>DEFENDER</b>	2000	3BA-LE72XAA · 3BA-LE62XCA	PT204(T/C)	20.4 ~	-	-	-	VXEHC24G	4	INDONESIA
<b>FREELANDER</b>	2500	GF-LN25 · GH-LN25	25K	01.2 ~07.6	VK20	-	IK20	VK20	6	INDONESIA
	3200	CBA-LF32	B6324S	07.6 ~	VKH20Y	-	-	-	6	INDONESIA
<b>RANGE ROVER</b>										
	2000	CBA-LV2A	204PT(T/C)	12.3 ~	-	-	-	-	4	INDONESIA
		DBA-LY2XCB · DBA-LY2XAB	PT204(T/C)	17.7 ~	-	-	-	VXEHC24G	4	INDONESIA
		DBA-LV2XB	PT204(T/C)	17.11~	-	-	-	VXEHC24G	4	INDONESIA
		5BA-LZ2XA · 5AA-LZ2XHA	PT204(T/C)	19.6 ~	-	-	-	VXEHC24G	4	INDONESIA
		5LA-LG2YE · 5LA-LW2YC	PT204(T/C)	19.12~	-	-	-	VXEHC24G	4	INDONESIA
		5LA-LGL2YE	PT204(T/C)	20.9 ~	-	-	-	VXEHC24G	4	INDONESIA
	3000	ABA-LW3SA	306PS(S/C)	15.10~	-	-	-	-	6	INDONESIA
		ABA-LG3SB · ABA-LGL3SC	306PS(S/C)	16.12~	-	-	-	-	6	INDONESIA
		CBA-LY3VA	306PS(S/C)	17.7 ~	-	-	-	-	6	INDONESIA
		7AA-LW3UD	PT306(T/C)	19.12~	-	-	-	VXEHC24G	6	INDONESIA
	4000	GF-LP58D	58D	99.5 ~02.4	VK16	-	IK16	VK16	8	INDONESIA
	4200	ABA-LM42S	428PS(S/C)	05.7 ~	VK16	-	IK16	VK16	8	INDONESIA
		ABA-LS42S	428PS(S/C)	06.1 ~	VK16	-	IK16	VK16	8	INDONESIA
	4400	ABA-LM44	448PN	05.7 ~08.3	VK16	-	IK16	VK16	8	INDONESIA
		ABA-LS44	448PN	06.1 ~	VK16	-	IK16	VK16	8	INDONESIA
		GH-LM44	-	02.4 ~	VK20	-	IK20	VK20	8	INDONESIA
4600	GF-LP60D	60D	99.5 ~02.4	VK16	-	IK16	VK16	8	INDONESIA	
5000	ABA-LS5N · ABA-LM5N	508PN	09.6 ~	VFXEH20	-	-	VFXEH20	8	INDONESIA	
	ABA-LS5N · ABA-LM5N	508PN	11.12~	-	-	-	-	8	INDONESIA	
	ABA-LS5S · ABA-LM5S	508PS(S/C)	09.6 ~	VFXEH20	-	-	VFXEH20	8	INDONESIA	
	ABA-LM5S · ABA-LS5S	508PS(S/C)	11.12~	-	-	-	-	8	INDONESIA	
	ABA-LW5SA	508PS(S/C)	15.10~	-	-	-	-	8	INDONESIA	
	ABA-LGL5SC	508PS(S/C)	16.12~	-	-	-	-	8	INDONESIA	
	ABA-LG5SC	508PS(S/C)	18.4 ~	-	-	-	-	8	INDONESIA	
	ABA-LW5SA	508PS(S/C)	19.12~	-	-	-	-	8	INDONESIA	
	3BA-LG5SF · 3BA-LGL5SF · 3BA-LW5SE	508PS(S/C)	20.9 ~	-	-	-	-	8	INDONESIA	
<b>LINCOLN U.S.A.</b>										
<b>CONTINENTAL</b>	3800	E-LN941	-	92.11~	T20EPR-U	-	IT20	VT20	6	INDONESIA
		E-1LNV97	-	95.8 ~97	PT16EPR-L13	-	IT16	VT16	8	INDONESIA
	4600	E-1LNVH97	-	97.9 ~99.1	PT16EPR-L13	-	IT16	VT16	8	INDONESIA
		GF-1LNVH97	-	99.2 ~01	PT16EPR-L13	-	IT16	VT16	8	INDONESIA
<b>LS V6</b>	3000	GF-1LNAM86	-	99.10~	IT16	-	IT16	VT16	6	INDONESIA
<b>LS V8</b>	3900	GF-1LNAM87	-	99.10~	IK16	-	IK16	VK16	8	INDONESIA
<b>MARK 8</b>	4600	E-L90V	-	93.2 ~98	T20EPR-U15	-	IT20	VT20	8	INDONESIA
<b>TOWN CAR</b>	4600	E-1LNWM82	-	98 ~01	PT16EPR-L13	-	IT16	VT16	8	INDONESIA
		GF-1LNWM82	-	01 ~	PT16EPR-L13	-	IT16	VT16	8	INDONESIA
	4600	GF-M85W · GH-M85W	-	02.3 ~	PT16EPR-L13	-	IT16	VT16	8	INDONESIA
		GH-M82W	-	- ~	PT16EPR-L13	-	IT16	VT16	8	INDONESIA
<b>NAVIGATOR</b>	5400	-	-	08.5 ~	PT16EPR-L13	-	IT16	VT16	8	INDONESIA
<b>LOTUS</b>										
<b>ELISE</b>	1800	GF-111	18K	- ~01	VK20	-	IK20	VK20	4	INDONESIA
<b>ELISE 111R</b>	1800	GH-1117	2ZZ-GE	04.2 ~	SK20R11	-	IK20	VK20	4	INDONESIA
<b>ESPRIT</b>	2200	E-82L	-	93.10~	W20ETR-L	-	IW20	VW20	4	INDONESIA
<b>ESPRIT V8-SE</b>	3500	GF-82	-	99 ~	K20TNR	K20TT	IK20	VK20	8	INDONESIA
<b>EXIGE</b>	1800	GF-111	18K	00 ~	K22PR-U	-	IK22	VK22	4	INDONESIA
		GH-1117	2ZZ-GE	04.6 ~	SK20R11	-	IK20	VK20	4	INDONESIA
<b>NEW ELISE</b>	1800	-	18K	01 ~	VK20	-	IK20	VK20	4	INDONESIA
<b>SPORT ELISE</b>	1800	-	18K	99 ~	Q22PR-U	-	IQ22	VQ22	4	INDONESIA
<b>TYPE 99T</b>	1800	-	18K	03 ~	VK20	-	IK20	VK20	4	INDONESIA
<b>MASERATI</b>										
<b>3200GT/GTA</b>	3200	GF-338	AM585	99 ~	IU24	-	IU24	-	8	INDONESIA
<b>COUPE</b>	4200	GF-MCP	M138	02.3 ~	IU24	-	IU24	-	8	INDONESIA
<b>GHIBLI</b>	2800	E-MG	AM574	92 ~95	XU24EPR-U	-	IXU24	VXU24	6	INDONESIA
<b>QUATTROPORTE</b>	2800	E-MQ	AM574	95 ~98	XU24EPR-U	-	IXU24	VXU24	6	INDONESIA

AUSTRALIA  
 CHINA  
 INDIA  
 INDONESIA  
 KOREA  
 MALAYSIA  
 PHILIPPINES  
 SAUDI ARABIA  
 SINGAPORE  
 TAIWAN  
 THAILAND  
 VIETNAM  
 JAPAN  
 EUROPE & USA  
 CROSS REFERENCE  
 PART NUMBER



# EUROPE & U.S.A. CAR

▶ Spark plug color codes: ■ for Iridium Tough and Iridium Plugs and Iridium TT, ■ for Iridium Power, ■ for Iridium Racing and Two Tops Plugs, ■ for Platinum Plugs and Platinum TT, and black for general spark plugs.

	MODEL	CC	VEHICLE CODE	ENGINE	FROM-TILL	DENSO		IRIDIUM POWER	IRIDIUM TOUGH	QTY	
AUSTRALIA	<b>MASERATI</b>										
	QUATTROPORTE	2800	E-QP6 · GF-QP6	AM574	95.3 ~	XU27EPR-U	-	IXU27	-	6	
			GF-QP6	AM574	98 ~	XU24EPR-U	-	IXU24	VXU24	6	
		3200	E-MQ8	AM578	95 ~98	XU24EPR-U	-	IXU24	VXU24	8	
CHINA		4200	-	-	95.3 ~	-	-	-	-	8	
	SHAMAL	3200	E-SM	-	93.3 ~96	XU27EPR-U	-	IXU27	-	8	
	SPIDER	4200	GF-SPY	M138	01 ~	IU24	-	IU24	-	8	
INDIA	SPIDER ZAGATO	2800	E-MS	-	01.5 ~	W24EP-U	-	IW24	-	6	
	<b>MERCEDES BENZ</b>										
	220E	2200	E-124022	M111.960	92.11~93.6	Q16P-U11	-	IQ16	VQ16	4	
	220TE	2200	E-124082	M111.960	92.11~93.6	Q16P-U11	-	IQ16	VQ16	4	
INDONESIA	280E	2800	E-124028	M104.942	92.11~93.6	Q16P-U11	-	IQ16	VQ16	6	
	320CE	3200	E-124052 · E-124066	M104.992	92.11~93.6	K16PR-U	K16TT	IK16	VK16	6	
	320E	3200	E-124032	M104.992	92.11~93.6	K16PR-U	K16TT	IK16	VK16	6	
	320TE	3200	E-124092	M104.992	92.11~	K16PR-U	K16TT	IK16	VK16	6	
KOREA	400E	4200	E-124034	M119.975	92.1 ~93.6	K16PR-U	K16TT	IK16	VK16	8	
	400SEL	4200	E-140043	M119.971	92.9 ~93.7	K16PR-U	K16TT	IK16	VK16	8	
	500GE	5000	E-4632281	M117.965	93.8 ~	W20EPR-U	-	IW20	VW20	8	
	500SL	5000	E-129067	M119.972	93.6 ~	K16PR-U	K16TT	IK16	VK16	8	
	600SE	6000	E-140056	M120.080	93.2 ~93.5	K16PR-U	K16TT	IK16	VK16	12	
MALAYSIA	600SEC	6000	E-140076	M120.980	93.2 ~93.5	K16PR-U	K16TT	IK16	VK16	12	
	600SL	6000	E-129076	M120.981	92.11~93.6	K16PR-U	K16TT	IK16	VK16	12	
PHILIPPINES	A160	1600	GF-168033 · GH-168033	166	98.9 ~	K20PBR-S10	-	IK20	VK20	4	
	A160L	1600	GF-168133 · GH-168133	166	01.9 ~	K20PBR-S10	-	IK20	VK20	4	
SAUDIARABIA	A170	1700	DBA-169032	266	05.2 ~09.8	K20PR-U	K20TT	IK20	VK20	4	
	A180	1300	5BA-177084	282(T/C)	18.10~	-	-	-	-	4	
			5BA-177184	282(T/C)	19.7 ~	-	-	-	-	4	
			5BA-177084 · 5BA-177184	M282(T/C)	20.9 ~	-	-	-	-	4	
	A180	1600	DBA-176042	270(T/C)	15.11~	-	-	-	-	4	
			DBA-176042	270(T/C)	17.7 ~	-	-	-	-	4	
	A190	1900	GF-168032 · GH-168032	1669	99.10~	K20PBR-S10	-	IK20	VK20	4	
SINGAPORE	A200	2000	DBA-169033	266M20	05.2 ~	K20PR-U	K20TT	IK20	VK20	4	
			CBA-169034	266M20(T/C)	05.11~	VK20	-	IK20	VK20	4	
	A210EVOLUTION	2100	GH-168135	-	02.5 ~	VK20	-	IK20	VK20	4	
TAIWAN	A210L	2100	GH-203742	-	03.5 ~	VK20	-	IK20	VK20	4	
			A250	2000	DBA-176046	270M20(T/C)	14.4 ~	-	-	-	4
					DBA-176051	270M20(T/C)	15.11~	-	-	-	4
					5BA-177147M	260(T/C)	19.7 ~	-	-	-	4
					5BA-177147M	M260(T/C)	20.9 ~	-	-	-	4
B170	1700	CBA-245232	266	06.1 ~09.8	K20PR-U	K20TT	IK20	VK20	4		
THAILAND	B180	1300	5BA-247084	282(T/C)	19.6 ~	-	-	-	4		
			5BA-247084	M282(T/C)	20.9 ~	-	-	-	4		
		1600	DBA-246242	270(T/C)	15.2 ~	-	-	-	4		
			DBA-246242	270(T/C)	17.7 ~	-	-	-	4		
	B200	1700	CBA-245232	266	09.8 ~	K20PR-U	K20TT	IK20	VK20	4	
VIETNAM	B200	2000	CBA-245233	266M20	06.1 ~	K20PR-U	K20TT	IK20	VK20	4	
			CBA-245234	266M20(T/C)	06.1 ~	VK20	-	IK20	VK20	4	
JAPAN	C180	1500	5BA-205076C · 5BA-205476C · 5BA-205476 · 5BA-205376C · 5BA-205376 · 5BA-205276C	264(T/C)	19.9 ~	-	-	-	-	4	
			DBA-205040C	274M16(T/C)	14.7 ~	-	-	-	4		
			DBA-205240C	274M16(T/C)	14.10~	-	-	-	4		
			DBA-205340C	274M16(T/C)	16.3 ~	-	-	-	4		
			1600	DBA-205440C	274M16(T/C)	16.9 ~	-	-	-	4	
				DBA-205040C	274M16(T/C)	17.2 ~	-	-	-	4	
				DBA-205040C · DBA-205240C · DBA-205340C · DBA-205440C	274M16(T/C)	17.7 ~	-	-	-	4	
			1800	DBA-205440 · DBA-205340	274M16(T/C)	18.7 ~	-	-	-	4	
				DBA-204349 · DBA-204049 · DBA-204249	271	11.10~	-	-	IXUH22	VXUH22	4
				DBA-204349	271(T/C)	14.6 ~	VXUH22	-	IXUH22	VXUH22	4
EUROPE & USA	CROSS REFERENCE NUMBER	2000	GF-203035	M111.20	00.12 ~02.10	VK20	-	IK20	VK20	4	
			GF-203235	M111.20	01.6 ~02.10	VK20	-	IK20	VK20	4	
PART NUMBER	C180 KOMPRESSOR	1800	GH-203046 · GH-203246	M271.940(S/C)(*3)	02.9 ~	VKH20	-	IKH20	VKH20	4	
			GH-203746	271(S/C)(*3)	03.9 ~	VKH20	-	IKH20	VKH20	4	

(\*3) : Up to ENG No. 30853899



MODEL	CC	VEHICLE CODE	ENGINE	FROM-TILL	DENSO		IRIDIUM POWER	IRIDIUM TOUGH	QTY	
<b>MERCEDES BENZ</b>										
<b>C180 KOMPRESSOR</b>	1800	DBA-203046 • DBA-203246 • DBA-203746 • DBA-203746	271(S/C)(*3)	05.8 ~	VKH20	-	IKH20	VKH20	4	AUSTRALIA
<b>C200</b>	1500	5AA-205077C • 5AA-205077 • 5AA-205277C • 5AA-205277 • 5AA-205078C • 5AA-205078 • 5AA-205278C • 5AA-205278	264(T/C)	18.7 ~	-	-	-	-	4	CHINA
	1800	DBA-204048 • DBA-204248	271(T/C)	10.2 ~	VXUH22	-	IXUH22	VXUH22	4	INDIA
		E-202020	M111.941.945	94.3 ~98	K16PR-U	K16TT	IK16	VK16	4	
		GF-202080	-	98 ~00	K20PBR-S10	-	IK20	VK20	4	
		GF-202020	-	99 ~00	K20PBR-S10	-	IK20	VK20	4	
	2000	RBA-205042C • RBA-205042	274(T/C)	14.7 ~	-	-	-	-	4	INDONESIA
		RBA-205242C • RBA-205242	274(T/C)	14.10~	-	-	-	-	4	
		RBA-205042C • RBA-205042 • DBA-205043C • DBA-205043 • RBA-205242C • RBA-205242 • DBA-205243C • DBA-205243	274(T/C)	17.2 ~	-	-	-	-	4	
<b>C200 KOMPRESSOR</b>	1800	GH-203242	M271.940(S/C)(*3)	02.9 ~	VKH20	-	IKH20	VKH20	4	KOREA
		GH-203042	M271.940(S/C)(*3)	02.9 ~05.8	VKH20	-	IKH20	VKH20	4	
		GH-203742	271(S/C)(*3)	03.9 ~	VKH20	-	IKH20	VKH20	4	MALAYSIA
		DBA-203042 • DBA-203242 • DBA-203742	271(S/C)(*3)	05.8 ~	VKH20	-	IKH20	VKH20	4	
		DBA-204041 • DBA-204241	271(S/C)(*4)	07.5 ~	VXUH22	-	IXUH22	VXUH22	4	PHILIPPINES
		GF-203045	M111(S/C)	00 ~	VK20	-	IK20	VK20	4	
		GF-203745 • GH-203745	11195(S/C)	00 ~	VK20	-	IK20	VK20	4	
		GF-202087	111M20, G, SC(S/C)	00.9 ~01	VK20	-	IK20	VK20	4	
	2000	GF-203245	(S/C)	01 ~	VK20	-	IK20	VK20	4	
<b>C220</b>	2200	E-202022	M111.961	93.9 ~96	K16PR-U	K16TT	IK16	VK16	4	
<b>C230</b>	2300	E-202083	M117.974	96.8 ~97	K16PR-U	K16TT	IK16	VK16	4	
		E-202023	M117.974	96.9 ~97	K16PR-U	K16TT	IK16	VK16	4	
	2500	DBA-203052 • DBA-203252	272M25	05.8 ~	VXUH22	-	IXUH22	VXUH22	6	
<b>C230 KOMPRESSOR</b>	1800	GH-203040 • GH-203240	271(S/C)(*3)	04.6 ~	VKH20	-	IKH20	VKH20	4	
<b>C240</b>	2400	E-202026 • GF-202026	112	97.7 ~00	VK16	-	IK16	VK16	12	SINGAPORE
		E-202086 • GF-202086	112	97.7 ~99	VK16	-	IK16	VK16	12	
		GF-202088	M112	00.7 ~01.6	VK16	-	IK16	VK16	12	
		GF-203061	112M26	00.7 ~02.10	VK16	-	IK16	VK16	12	
	2600	GF-203261	-	01 ~	VK16	-	IK16	VK16	12	TAIWAN
		GH-203061 • GH-203261 • GH-203081 • GH-203281	112M26	02.9 ~	VK16	-	IK16	VK16	12	
<b>C250</b>	1800	DBA-204047 • DBA-204247	271(T/C)	10.2 ~	VXUH22	-	IXUH22	VXUH22	4	THAILAND
		DBA-204347	271	11.10~	-	-	IXUH22	VXUH22	4	
		RBA-205045	274(T/C)	14.7 ~	-	-	-	-	4	VIETNAM
		RBA-205245	274(T/C)	14.10~	-	-	-	-	4	
		RBA-205245 • RBA-205045	274(T/C)	17.2 ~	-	-	-	-	4	
	2500	DBA-204052 • DBA-204252	272M25	06.11~	VXUH22	-	IXUH22	VXUH22	12	
<b>C280</b>	2800	E-202028	M104.941	93.9 ~98	K16PR-U	K16TT	IK16	VK16	6	JAPAN
		E-202029 • GF-202029	-	97.7 ~00	VK16	-	IK16	VK16	12	
	3000	DBA-203054 • DBA-203254 • DBA-203092 • DBA-203292	272M30	05.8 ~	VXUH22	-	IXUH22	VXUH22	6	
<b>C300</b>	2000	DBA-205348	274(T/C)	16.8 ~	-	-	-	-	4	EUROPE & USA
		DBA-204054 • DBA-204254	272M30	07.6 ~	VXUH22	-	IXUH22	VXUH22	6	
	3000	DBA-205448	274(T/C)	16.9 ~	-	-	-	-	4	CROSS REFERENCE NUMBER
		GF-203064	M112	00.7 ~	VK16	-	IK16	VK16	12	
<b>C320</b>	3200	GF-203264	M112	01 ~	VK16	-	IK16	VK16	12	PART
		GH-203264 • GH-203064	112	02.9 ~	VK16	-	IK16	VK16	12	
<b>C350</b>	2000	DLA-205047 • DLA-205247	274(T/C)	16.1 ~	-	-	-	-	4	EUROPE & USA
		5LA-205053C • 5LA-205053	274(T/C)	19.9 ~	-	-	-	-	4	
	3500	RBA-204057 • RBA-204257	276	11.10~	-	-	-	-	6	
<b>CL500</b>	5000	GF-215375	-	99 ~	VK16	-	-	VK16	16	CROSS REFERENCE NUMBER
		GH-215375	113	02.11~	VK16	-	IK16	VK16	16	
<b>CL550</b>	4700	CBA-216373	278(T/C)	12.2 ~	-	-	-	-	8	PART
	5500	DBA-216371	273	06.11~	VXUH22	-	IXUH22	VXUH22	16	
<b>CL600</b>	5500	GH-215376	275(T/C)	02.11~	VK20Y	-	-	VK20Y	24	PART
		ABA-216376	275(T/C)	06.11~	VK20Y	-	-	VK20Y	24	
	5800	GF-215378 • GH-215378	113	99.10 ~02.10	VK20	-	IK20	VK20	24	PART
	6000	E-140076	120	95.10~99.9	K20PR-U	K20TT	IK20	VK20	12	
<b>CLA180</b>	1300	5BA-118384M • 5BA-118684M	282(T/C)	20.2 ~	-	-	-	-	4	PART
		5BA-118384M • 5BA-118684M	M282(T/C)	20.9 ~	-	-	-	-	4	

(\*3) : Up to ENG No. 30853899

(\*4) : ENG No. 30853900 and up



# EUROPE & U.S.A. CAR

▶ Spark plug color codes: ■ for Iridium Tough and Iridium Plugs and Iridium TT, ■ for Iridium Power, ■ for Iridium Racing and Two Tops Plugs, ■ for Platinum Plugs and Platinum TT, and black for general spark plugs.

	MODEL	CC	VEHICLE CODE	ENGINE	FROM-TILL	DENSO		IRIDIUM POWER	IRIDIUM TOUGH	QTY	
AUSTRALIA	<b>MERCEDES BENZ</b>										
	CLA180	1600	DBA-117342	270(T/C)	13.7 ~	-	-	-	-	4	
			DBA-117942	270(T/C)	15.6 ~	-	-	-	-	4	
DBA-117342 · DBA-117942			270(T/C)	17.7 ~	-	-	-	-	4		
CHINA	CLA220	2000	DBA-117347 · DBA-117947	270M20(T/C)	17.7 ~	-	-	-	4		
	CLA250	2000	DBA-117344	270M20(T/C)	13.7 ~	-	-	-	4		
			DBA-117944 · DBA-117946	270M20(T/C)	15.6 ~	-	-	-	4		
INDIA	CLK200	2000	DBA-117951	270M20(T/C)	15.11~	-	-	-	4		
			DBA-117351	270M20(T/C)	16.8 ~	-	-	-	4		
			5BA-118347M · 5BA-118647M	260(T/C)	19.8 ~	-	-	-	4		
INDONESIA	CLK200 KOMPRESSOR	1800	5BA-118347M · 5BA-118647M	M260(T/C)	20.9 ~	-	-	-	4		
			E-208335 · GF-208335	-	97.9 ~00	K20TXR	K20TT(*5)	IK20	VK20	4	
			GF-208344	M111	00 ~02	VK20	-	IK20	VK20	4	
KOREA	CLK240	2600	GH-209342 · DBA-209342	271(S/C)(*3)	03.5 ~06.5	VKH20	-	IKH20	VKH20	4	
			DBA-209341	271(S/C)(*4)	06.5 ~	VXUH22	-	IXUH22	VXUH22	4	
			GH-209361	112	02.4 ~	VK16	-	IK16	VK16	12	
MALAYSIA	CLK320	3200	E-208365 · GF-208365	112	97.9 ~	VK16	-	IK16	VK16	12	
			GF-208465 · GH-208465	112	00.8 ~02	VK16	-	IK16	VK16	12	
			GH-209365	112	02.4 ~	VK16	-	IK16	VK16	12	
PHILIPPINES	CLK430	4300	GH-209465	112	03.5 ~	VK16	-	IK16	VK16	12	
			GH-170415	112 947	- ~	VK16	-	IK16	VK16	12	
			-	M113	98.6 ~	VK16	-	IK16	VK16	16	
SAUDIARABIA	CLS350	3500	DBA-219356 · DBA-219356C	272	05.2 ~	VXUH22	-	IXUH22	VXUH22	6	
			RBA-218359C · RBA-218359	276	12.8 ~	-	-	-	-	6	
			RBA-218959C · RBA-218959	276	14.1 ~	-	-	-	-	6	
SINGAPORE	CLK350	3500	DBA-209356 · DBA-209456	272	05.9 ~	VXUH22	-	IXUH22	VXUH22	6	
	CLS400	3500	MBA-218361 · MBA-218961	276(T/C)	15.2 ~	-	-	-	6		
	CLS450	3000	DAA-257359	256(T/C)	18.6 ~	-	-	-	6		
TAIWAN	CLS500	5000	CBA-219375	-	05.2 ~	VK16	-	IK16	VK16	16	
			CLS550	4700	CBA-218373	278(T/C)	11.10~	-	-	-	8
					DBA-218373 · DBA-218991	278(T/C)	14.10~	-	-	-	8
THAILAND	E200	1500	CBA-219372	273	06.9 ~	VXUH22	-	IXUH22	VXUH22	16	
			4AA-213077C · 4AA-213277C · 4AA-213078C · 4AA-213278C	264(T/C)	19.3 ~	-	-	-	-	4	
			4AA-238477C · 4AA-238377C	264(T/C)	19.10~	-	-	-	-	4	
VIETNAM	E220	2200	4AA-213077C · 4AA-213277C · 4AA-213078C · 4AA-213278C	M264(T/C)	20.9 ~	-	-	-	4		
			4AA-238477C · 4AA-238377C	M264(T/C)	20.10~	-	-	-	4		
			RBA-213042C	274(T/C)	16.7 ~	-	-	-	4		
JAPAN	E230	2300	RBA-213242C	274(T/C)	16.11~	-	-	-	4		
			DBA-213043C	274(T/C)	16.10~	-	-	-	4		
			DBA-213243C	274(T/C)	16.11~	-	-	-	4		
EUROPE & USA	E240	2400	RBA-238342C	274(T/C)	17.5 ~	-	-	-	4		
			RBA-238442C	M274(T/C)	18.1 ~	-	-	-	4		
			RBA-213042C · RBA-238442C · RBA-238342C · RBA-213242C · DBA-213043C · DBA-213243C	274(T/C)	18.8 ~	-	-	-	-	4	
EUROPE & USA	E250	1800	E-124022	112	93.6 ~95.6	Q20PR-U	-	IQ20	VQ20	4	
			E-210037	M111.970	95.9 ~97	K16PR-U	K16TT	IK16	VK16	4	
			E-210061 · GF-210061 · E-210261 · GF-210261	112	97.9 ~00	VK16	-	IK16	VK16	12	
EUROPE & USA	E280	2800	GF-210262 · GH-210262	112941	00.7 ~	VK16	-	IK16	VK16	12	
			GF-210262	112M26	00.7 ~03.8	VK16	-	IK16	VK16	12	
			GH-211061	112	02.6 ~	VK16	-	IK16	VK16	12	
EUROPE & USA	E300	2000	GH-211261	112M26	03.8 ~	VK16	-	IK16	VK16	12	
			DBA-207347 · DBA-212047C · DBA-212247C	271(T/C)	09.10~	VXUH22	-	IXUH22	VXUH22	4	
			RBA-207336 · RBA-207436	274(T/C)	13.8 ~	-	-	-	-	4	
EUROPE & USA	E280	2800	RBA-212036C · RBA-212236C	274(T/C)	14.10~	-	-	-	4		
			RBA-207336 · RBA-207436	274(T/C)	15.5 ~	-	-	-	4		
			RBA-213245C	274(T/C)	16.11~	-	-	-	4		
EUROPE & USA	E280	2800	RBA-213045C	274(T/C)	16.10~	-	-	-	4		
			RBA-213045C	274(T/C)	16.10~	-	-	-	4		
			RBA-213045C · RBA-213245C	274(T/C)	18.8 ~	-	-	-	4		
EUROPE & USA	E280	2800	DBA-211052C · DBA-211252C	272M25	07.8 ~	VXUH22	-	IXUH22	VXUH22	6	
			E-124088 · E-124028	M104.942	93.10~96	K16PR-U	K16TT	IK16	VK16	6	
			DBA-211054C · DBA-211254C · DBA-211054C · DBA-211254C	272M30	05.8 ~	VXUH22	-	IXUH22	VXUH22	6	
EUROPE & USA	E300	2000	DBA-238348C	274(T/C)	17.5 ~	-	-	-	4		

(\*3) : Up to ENG No. 30853899 (\*4) : ENG No. 30853900 and up (\*5) : It can be used only for a plug with a terminal.



MODEL	CC	VEHICLE CODE	ENGINE	FROM-TILL	DENSO		IRIDIUM POWER	IRIDIUM TOUGH	QTY		
<b>MERCEDES BENZ</b>											
<b>E300</b>	2000	DBA-238348C	274(T/C)	18.8 ~	-	-	-	-	4	AUSTRALIA CHINA INDIA INDONESIA KOREA MALAYSIA PHILIPPINES SAUDIARABIA SINGAPORE TAIWAN THAILAND VIETNAM JAPAN	
		5BA-213083C • 5BA-213283C	264M20(T/C)	19.3 ~	-	-	-	-	4		
		5BA-238483C • 5BA-238383C	264M20(T/C)	19.10~	-	-	-	-	4		
		5BA-213083 • 5BA-213283	M264M20(T/C)	20.9 ~	-	-	-	-	4		
		5BA-238483 • 5BA-238383	M264M20(T/C)	20.10~	-	-	-	-	4		
	3000	DBA-212054C • DBA-212254C	272M30	09.5 ~	VXUH22	-	IXUH22	VXUH22	6		
		3500	RBA-212055C • RBA-212080C	276	11.11~	-	-	-	6		
			RBA-212255C	276	11.11~	-	-	IXUH22	VXUH22		6
			RBA-212280C	276	11.11~	-	-	-	-		6
	RBA-212255C		276	14.4 ~	-	-	-	-	6		
	<b>E320</b>	3200	E-210055	M104.995	95.9 ~98	K16PR-U	K16TT	IK16	VK16		6
			E-210082 • GF-210082 • E-210065 • GF-210065 • E-210282 • GF-210282	112	97.7 ~	VK16	-	IK16	VK16		12
E-210265 • GF-210265 • GH-210265			112941	97.7 ~	VK16	-	IK16	VK16	12		
GH-211065			112	02.6 ~	VK16	-	IK16	VK16	12		
GH-211282			112	03.11~	VK16	-	IK16	VK16	12		
GH-211265C			112	03.8 ~	VK16	-	IK16	VK16	12		
<b>E350</b>		2000	DLA-213050C	274(T/C)	17.8 ~	-	-	-	-	4	
			DLA-213050C	274(T/C)	18.8 ~	-	-	-	-	4	
			5LA-213053C	274(T/C)	19.10~	-	-	-	-	4	
			5LA-213053	M274(T/C)	20.9 ~	-	-	-	-	4	
		3500	DBA-211056C • DBA-211256C • DBA-211087 • DBA-211287	272	05.2 ~	VXUH22	-	IXUH22	VXUH22	6	
			DBA-207356	272	09.7 ~	VXUH22	-	IXUH22	VXUH22	6	
	DBA-212256C • DBA-212287C		272	10.2 ~	VXUH22	-	IXUH22	VXUH22	6		
	DBA-212056C • DBA-212087C		272	09.5 ~	VXUH22	-	IXUH22	VXUH22	6		
	DBA-207456		272	10.4 ~	VXUH22	-	IXUH22	VXUH22	6		
	RBA-207359 • RBA-207459		276	11.7 ~	-	-	-	-	6		
	RBA-212059C • RBA-212059 • RBA-212259C • RBA-212259		276	11.11~	-	-	-	-	6		
	<b>E400</b>		3000	DBA-238366	276M30(T/C)	17.5 ~	-	-	-	-	6
DBA-238466		M276(T/C)		18.1 ~	-	-	-	-	6		
DAA-212095C		276		14.10~	-	-	-	-	6		
3500		MBA-207361 • MBA-207461	276(T/C)	15.1 ~	-	-	-	-	6		
		MBA-212061C • MBA-212261C	276(T/C)	15.2 ~	-	-	-	-	6		
		RBA-213071	276(T/C)	16.10~	-	-	-	-	6		
4000		RBA-213271	276(T/C)	16.11~	-	-	-	-	6		
4200		E-210072	M119.985	96.3 ~97	K16PR-U	K16TT	IK16	VK16	8		
<b>E430</b>		4300	E-210070 • GF-210070 • GH-210070	-	97.9 ~	VK16	-	IK16	VK16	16	
			E-210270 • GF-210270	-	98.7 ~	VK16	-	IK16	VK16	16	
<b>E450</b>		3000	DBA-213068 • DBA-238468 • DBA-238368 • DBA-213268	276M30(T/C)	18.8 ~	-	-	-	-	6	
			DBA-238468 • DBA-238368	276M30(T/C)	19.10~	-	-	-	-	6	
	5AA-213059 • 5AA-213259		M256(T/C)	20.9 ~	-	-	-	-	6		
	5AA-238459 • 5AA-238359		M256(T/C)	20.10~	-	-	-	-	6		
	<b>E500</b>		5000	GH-211070	113	02.6 ~	VK16	-	IK16	VK16	16
GH-211270		113		03.11~	VK16	-	IK16	VK16	12		
E-124036		-		- ~94	K16PR-U	K16TT	IK16	VK16	8		
CBA-211070 • CBA-211270		113		05.8 ~	VK16	-	IK16	VK16	16		
<b>E550</b>	4700	CBA-207373 • CBA-212073 • CBA-212273	278(T/C)	11.11~	-	-	-	-	8		
		DBA-212073 • DBA-212273	278(T/C)	14.10~	-	-	-	-	8		
		CBA-211072 • CBA-211272	273	07.1 ~	VXUH22	-	IXUH22	VXUH22	16		
	5500	CBA-212072 • CBA-207372 • CBA-212272	273	09.5 ~	VXUH22	-	IXUH22	VXUH22	16		
		<b>G320</b>	3200	E-463230 • E-463231	M104.996	94.12~98	K16PR-U	K16TT	IK16	VK16	6
E-463208	M104.996			95.8 ~98	K16PR-U	K16TT	IK16	VK16	6		
GF-G320S • GF-G320L	112			97.10~01	VK16	-	IK16	VK16	12		
GF-463244 • GH-463244	112			01 ~	VK16	-	IK16	VK16	12		
<b>G320L</b>	3200	GF-463245 • GH-463245	112	01 ~	VK16	-	IK16	VK16	12		
<b>G500</b>	5000	GF-G500L • GF-G500S	113	99.10~01	VK16	-	IK16	VK16	16		
<b>G500L</b>	5000	GF-463248 • GH-463248 • ABA-463248	113	01.6 ~	VK16	-	IK16	VK16	16		
<b>G550</b>	4000	ABA-463234	176(T/C)	15.12~	-	-	-	-	8		
		ABA-463234	176(T/C)	16.11~	-	-	-	-	8		
		ABA-463260	176(T/C)	18.6 ~	-	-	-	-	8		
<b>G550L</b>	5500	ABA-463236	273	09.3 ~	VXUH22	-	IXUH22	VXUH22	8		



# EUROPE & U.S.A. CAR

▶ Spark plug color codes: ■ for Iridium Tough and Iridium Plugs and Iridium TT, ■ for Iridium Power, ■ for Iridium Racing and Two Tops Plugs, ■ for Platinum Plugs and Platinum TT, and black for general spark plugs.

COUNTRY	MODEL	CC	VEHICLE CODE	ENGINE	FROM-TILL	DENSO	TJ	IRIDIUM POWER	IRIDIUM TOUGH	QTY	
AUSTRALIA	<b>MERCEDES BENZ</b>										
	GL550	4700	CBA-166873	278(T/C)	13.4 ~	-	-	-	-	8	
		5500	CBA-164886	273	06.10~	VXUH22	-	IXUH22	VXUH22	8	
	GLA180	1600	DBA-156942	270(T/C)	17.4 ~	-	-	-	-	4	
CHINA	GLA220	2000	DBA-156947	270M20(T/C)	17.9 ~	-	-	-	-	4	
	GLA250	2000	DBA-156946	270M20(T/C)	14.5 ~	-	-	-	-	4	
			DBA-156946	270M20(T/C)	17.4 ~	-	-	-	-	4	
	GLB250	2000	5BA-247647M	260(T/C)	20.6 ~	-	-	-	-	4	
INDIA	GLC200	2000	DBA-253942C · DBA-253342C	274(T/C)	17.2 ~	-	-	-	-	4	
	GLC250	2000	DBA-253946C	274(T/C)	16.2 ~	-	-	-	-	4	
			DBA-253946 · DBA-253346	274(T/C)	17.2 ~	-	-	-	-	4	
	GLC300	2000	5BA-253984 · 5BA-253384	264M20(T/C)	19.10~	-	-	-	-	4	
			5BA-253984 · 5BA-253384	M264M20(T/C)	21.1 ~	-	-	-	-	4	
INDONESIA	GLC350	2000	DLA-253954	274(T/C)	16.9 ~	-	-	-	-	4	
			DLA-253354	274(T/C)	17.2 ~	-	-	-	-	4	
			5LA-253353	274(T/C)	20.4 ~	-	-	-	-	4	
			5LA-253953	M274(T/C)	21.1 ~	-	-	-	-	4	
			5LA-253353	M274(T/C)	21.1 ~	-	-	-	-	4	
KOREA	GLE450	3000	5AA-167159	256(T/C)	19.6 ~	-	-	-	-	6	
	GLK300	3000	CBA-204981	272M30	08.10~	VXUH22	-	IXUH22	VXUH22	6	
	GLK350	3500	RBA-204988	276	12.7 ~	-	-	-	-	6	
MALAYSIA	GLS550	4700	CBA-166873	278(T/C)	16.4 ~	-	-	-	-	8	
	GLS580	4000	4AA-167986	176(T/C)	20.3 ~	-	-	-	-	8	
PHILIPPINES	M200	2000	CBA-245233	266M20	06.1 ~	VK20	-	IK20	VK20	4	
	M200 TURBO	2000	CBA-245234	266M20(T/C)	06.1 ~	VK20	-	IK20	VK20	4	
SAUDI ARABIA	ML320	3200	GF-163154 · GH-163154	112	98.9 ~	VK16	-	IK16	VK16	12	
	ML350	3500	DBA-164186	272	05.10~	VXUH22	-	IXUH22	VXUH22	6	
			RBA-166057	276	12.6 ~	-	-	-	-	6	
		3700	GH-163157	112M37	03.3 ~05.10	VK16	-	IK16	VK16	12	
SINGAPORE	ML430	4300	GF-163172	113(4)	98.8 ~01	VK16	-	IK16	VK16	16	
	ML500	5000	CBA-164175C	113	05.10~	VK16	-	IK16	VK16	16	
TAIWAN	ML550	5500	CBA-164172C	273	07.1 ~	VXUH22	-	IXUH22	VXUH22	8	
	R350	3500	DBA-251065	272	06.3 ~	VXUH22	-	IXUH22	VXUH22	6	
	RBA-251057		276	12.1 ~	-	-	-	-	6		
THAILAND	R500	5000	CBA-251075	113	06.3 ~	VK16	-	IK16	VK16	6	
	R550	5500	CBA-251072	273	07.10~	VXUH22	-	IXUH22	VXUH22	8	
VIETNAM	S280	2800	E-140028	M104.944	93.10~95	K16PR-U	K16TT	IK16	VK16	6	
	S320	3200	E-140032M	M104.944	93.9 ~98	K16PR-U	K16TT	IK16	VK16	6	
	GF-220065 · GH-220065		112	98.11~	VK16	-	IK16	VK16	12		
JAPAN	S350	3500	DBA-221056	272	05.10~	VXUH22	-	IXUH22	VXUH22	6	
			RBA-221057	276	11.7 ~	-	-	-	-	6	
		3700	GH-220067	112972	02.11~	VK16	-	IK16	VK16	12	
THAILAND	S400	3000	DBA-217364	276M30(T/C)	16.3 ~	-	-	-	-	6	
			DBA-222066	276M30(T/C)	17.8 ~	-	-	-	-	6	
	S400 HYBRID	3500	DAA-222057	276	14.6 ~	-	-	-	-	6	
VIETNAM	S430	4300	GF-220070	113(4)	98.11 ~02.11	VK16	-	IK16	VK16	16	
			GH-220083	1134	02.11~	VK16	-	IK16	VK16	16	
VIETNAM	S450	3000	DAA-222058 · DAA-222158	256(T/C)	18.3 ~	-	-	-	-	6	
			DBA-217364	276M30(T/C)	18.6 ~	-	-	-	-	6	
JAPAN	S500	3000	5AA-223063 · 5AA-223163	M256(T/C)	21.1 ~	-	-	-	-	6	
		5000	E-140070 · E-140050 · E-140051	M119.970.980	93.10~	K16PR-U	K16TT	IK16	VK16	8	
			GF-220075 · GH-220075	113	98.11 ~05.10	VK16	-	IK16	VK16	16	
JAPAN	S500L	5000	DBA-221071	273	05.10 ~06.11	VXUH22	-	IXUH22	VXUH22	8	
			GF-220175 · GH-220175	113	98.11 ~05.10	VK16	-	IK16	VK16	16	
EUROPE & USA	S550	4700	DBA-221171 · DBA-221186	273	05.10~	VXUH22	-	IXUH22	VXUH22	8	
			CBA-221073	278(T/C)	11.7 ~	-	-	-	-	8	
			DBA-222182 · DBA-222182C	278(T/C)	13.10~	-	-	-	-	8	
EUROPE & USA		5500	DBA-217482	278(T/C)	16.6 ~	-	-	-	-	8	
			DBA-221071 · DBA-221086	273	06.11~	VXUH22	-	IXUH22	VXUH22	8	
EUROPE & USA	S550 HYBRID	3000	DLA-222163	276M30(T/C)	14.11~	-	-	-	-	6	
	S550L	4700	CBA-221173 · CBA-221194	278(T/C)	11.7 ~	-	-	-	-	8	
	DBA-221171		273	06.11~	VXUH22	-	IXUH22	VXUH22	8		
EUROPE & USA	S560	3000	DLA-222173	276M30(T/C)	18.12~	-	-	-	-	6	
			DBA-222183 · DBA-222186	176(T/C)	17.8 ~	-	-	-	-	8	
EUROPE & USA		4000	DBA-217483 · DBA-217383C · DBA-217386	176(T/C)	18.6 ~	-	-	-	-	8	
	S600 HYBRID		3500	DAA-221095	272(HYBRID)	10.11~	VXUH22	-	IXUH22	VXUH22	6
	S600	6000	E-140056	120	93.10~94	K16PR-U	K16TT	IK16	VK16	12	

DENSO	9	14	16	20	22	24	27	29	31	32	34	35	DENSO	9	14	16	20	22	24	27	29	31	32	DENSO	9	14	16	20	22	24	27	31
NGK	2	4	5	6	7	8	9	9.5	10	10.5	11	11.5	CHAMPION	18	16,14	12,11	10,9	8,7	6,63,61	4,59	57	55	53	BOSCH	10	9	8	7,6	5	4	3	2



MODEL	CC	VEHICLE CODE	ENGINE	FROM-TILL	DENSO	IRIIDIUM POWER	IRIIDIUM TOUGH	QTY	
<b>MERCEDES BENZ</b>									
<b>S600</b>	6000	E-140076	120	93.10~98	K16PR-U	K16TT	IK16	VK16	12
		CBA-222176C	277(T/C)	14.6 ~	-	-	-	-	12
		ABA-222176C	277(T/C)	17.8 ~	VK20Y	-	-	VK20Y	12
<b>S600L</b>	5500	GH-220176	275(T/C)	03 ~	VK20Y	-	-	VK20Y	24
		ABA-221176 · DBA-221176	275(T/C)	06.11~	VK20Y	-	-	VK20Y	24
		GH-220178	137970(T/C)	- ~03	VK20	-	IK20	VK20	24
	5800	GF-220178	137(T/C)	00.5 ~	VK20	-	IK20	VK20	24
	6000	E-140057	120	93.10~98	K16PR-U	K16TT	IK16	VK16	12
<b>S600L HYBRID</b>	3500	DAA-221195	272(HYBRID)	11.7 ~	VXUH22	-	IXUH22	VXUH22	6
<b>SL320</b>	3200	GF-129064	112	98.8 ~01	VK16	-	IK16	VK16	12
<b>SL350</b>	3500	CBA-230456	272	06.11~08.5	VXUH22	-	IXUH22	VXUH22	6
		DBA-230458	272	08.5 ~	VXUH22	-	IXUH22	VXUH22	6
		RBA-231457	276	12.3 ~	-	-	-	-	6
		RBA-231457	276	15.9 ~	-	-	-	-	6
	3700	GH-230467	112M37	03.6 ~05.10	VK16	-	IK16	VK16	12
	CBA-230467	112M37	05.10 ~06.10	VK16	-	IK16	VK16	12	
<b>SL400</b>	3000	DBA-231466	276M30(T/C)	16.6 ~	-	-	-	6	
<b>SL500</b>	5000	GF-129068	-	98.8 ~01	VK16	-	IK16	VK16	16
		GH-230475	113	01.10~03.5	VK16	-	IK16	VK16	16
		CBA-230475	113	05.10 ~06.10	VK16	-	IK16	VK16	16
<b>SL550</b>	4700	CBA-231473	278(T/C)	12.3 ~	-	-	-	8	
		CBA-231473	278(T/C)	16.6 ~	-	-	-	8	
<b>SL600</b>	5500	GH-230476	275(T/C)	03.6 ~	VK20Y	-	-	VK20Y	12
		CBA-230477 · ABA-230477	275(T/C)	- ~	VK20Y	-	-	VK20Y	12
	6000	E-129076	120	93.10~00	VK16	-	IK16	VK16	12
<b>SLC180</b>	1600	DBA-172431	274M16(T/C)	16.6 ~	-	-	-	4	
<b>SLC200</b>	2000	DBA-172434	274(T/C)	16.6 ~	-	-	-	4	
<b>SLK200</b>	1800	DBA-172448	271(T/C)	13.2 ~	-	-	IXUH22	VXUH22	4
		CBA-172448 · DBA-172448	271(T/C)	13.8 ~	VXUH22	-	IXUH22	VXUH22	4
		CBA-172448 · DBA-172448	271(T/C)	14.8 ~	-	-	-	-	4
		DBA-172434	274(T/C)	15.8 ~	-	-	-	-	4
<b>SLK200 KOMPRESSOR</b>	1800	CBA-171442	271(S/C)(*3)	06.2 ~08.5	VKH20	-	IKH20	VKH20	4
		DBA-171445	271(S/C)(*4)	08.5 ~	VXUH22	-	IXUH22	VXUH22	4
<b>SLK230 KOMPRESSOR</b>	2300	E-170447	-	96.12~	IK16	-	IK16	VK16	4
		GF-170447 (S/C)	1118(S/C)	99 ~00	K20PBR-S10	-	IK20	VK20	4
GF-170449 · GH-170449	1118(S/C)	01 ~	VK20	-	IK20	VK20	4		
<b>SLK280</b>	3000	DBA-171454	272M30	05.8 ~	VXUH22	-	IXUH22	VXUH22	6
<b>SLK320</b>	3200	GF-170465 · GH-170465	112947	00 ~	VK16	-	IK16	VK16	12
		CBA-171456	272	04.9 ~08.5	VXUH22	-	IXUH22	VXUH22	6
		DBA-171458	272	08.5 ~	VXUH22	-	IXUH22	VXUH22	6
<b>SLK350</b>	3500	MBA-172457	276	13.8 ~	-	-	-	6	
		GH-199376	155(S/C)	04.10~07.8	VKH20	-	IKH22	VKH20	16
		ABA-199476	M155(S/C)	07.8 ~	VXUH22	-	IXUH22	VXUH22	8
<b>V230</b>	2300	GF-638230 · GH-638230	-	98.6 ~	K20PBR-S10	-	IK20	VK20	4
		GF-638234 · GH-638234	-	98.6 ~99	K20PBR-S10	-	IK20	VK20	4
<b>V260</b>	2000	ABA-447813	274(T/C)	18.11~	-	-	-	4	
<b>V280</b>	2800	GF-638280	-	99.5 ~06.11	K20TXR	K20TT(*5)	IK20	VK20	6
<b>V350</b>	3500	ABA-639811 · ABA-639811C	112M37	06.11 ~07.11	VXUH22	-	IXUH22	VXUH22	6
		ABA-639350 · ABA-639350C	M272E35	07.11~	VXUH22	-	IXUH22	VXUH22	6
<b>VANEO</b>	1900	GH-414700	1669	03.10~	VK20	-	IK20	VK20	4
<b>VIANO</b>	3200	GH-639811 · GH-639811C	112	03.10~	VK16	-	IK16	VK16	12
<b>MERCEDES MAYBACH S550</b>	4700	DBA-222982C	278(T/C)	15.2 ~	-	-	-	8	
		DBA-222985	278(T/C)	15.9 ~	-	-	-	8	
<b>MERCEDES MAYBACH S560</b>	4000	DBA-222983C · DBA-222986	176(T/C)	17.9 ~	-	-	-	8	
<b>MERCEDES MAYBACH S600</b>	6000	ABA-222976C	277(T/C)	15.2 ~	VK20Y	-	-	VK20Y	24
<b>MERCEDES MAYBACH S650</b>	6000	ABA-222980C	279(T/C)	17.9 ~	VK20Y	-	-	VK20Y	12
<b>MERCURY FORD</b>									
<b>222</b>	2800	E-24V	-	92.4 ~	W24EP-U	-	IW24	-	6
<b>COUGAR</b>	2500	GF-12WCLC	-	99.6 ~00	T16EPR-U15	-	IT16	VT16	6
<b>GRAND MARQUIS</b>	4600	E-M71W	-	93.12 ~98.11	T16EPR-U15	-	IT16	VT16	8
		GF-1MEWM75	-	98.12~	T16EPR-U15	-	IT16	VT16	8
		GF-M71W	W	01 ~	PT16EPR-L13	-	IT16	VT16	8
<b>TOWN CAR</b>	4600	GF-1LNWM82	W	01 ~	PT16EPR-L13	-	IT16	VT16	8
<b>MG-ROVER</b>									
<b>MG F</b>	1800	E-RD18K	-	95.8 ~	VK20	-	IK20	VK20	4
<b>MG TF135</b>	1800	GH-RD18K	18K	03.7 ~	VK16	-	IK16	VK16	4

(\*3) : Up to ENG No. 30853899

(\*4) : ENG No. 30853900 and up

(\*5) : It can be used only for a plug with a terminal.

AUSTRALIA CHINA INDIA INDONESIA KOREA MALAYSIA PHILIPPINES SAUDIARABIA SINGAPORE TAIWAN THAILAND VIETNAM JAPAN EUROPE & USA CROSS REFERENCE NUMBER PART



# EUROPE & U.S.A. CAR

▶ Spark plug color codes: ■ for Iridium Tough and Iridium Plugs and Iridium TT, ■ for Iridium Power, ■ for Iridium Racing and Two Tops Plugs, ■ for Platinum Plugs and Platinum TT, and black for general spark plugs.

	MODEL	CC	VEHICLE CODE	ENGINE	FROM-TILL	DENSO		IRIDIUM POWER	IRIDIUM TOUGH	QTY	
AUSTRALIA	<b>MG-ROVER</b>										
	MG TF160	1800	GH-RD18K	18K	03.7 ~	VK16	-	IK16	VK16	4	
	MG RV8	3900	E-RA48A	-	93.10~97	W20EPR-U	-	IW20	VW20	8	
CHINA	<b>MORGAN</b>										
	+8	4000		-	01 ~	VK20	-	IK20	VK20	8	
		4600		-	97 ~99	VK20	-	IK20	VK20	8	
	4/4	1800		-	93.2 ~	ITV22	-	ITV22	-	4	
INDIA	AERO 8	4400		BMW M62B44	00 ~	VK20	-	IK20	VK20	8	
	ROADSTER	3000			05 ~	-	-	-	-	6	
INDONESIA	<b>MAYBACH</b>										
	MAYBACH57	5500	GH-240078	M285	02.9 ~	VK20	-	IK20	VK20	12	
	MAYBACH62	5500	GH-240178	M285	02.9 ~	VK20	-	IK20	VK20	12	
KOREA	<b>OPEL</b>										
	ASTRA	1600	E-XD160 • E-XD160W		X16	96.9 ~98.10	K20TXR	K20TT(*5)	IK20	VK20	4
			GF-XK160		X16	98.11 ~00.11	K20TXR	K20TT(*5)	IK20	VK20	4
			GF-XK161		Z16(XE)	00.11~04.5	K20TXR	K20TT(*5)	IK20	VK20	4
			TA-XK161		Z16	04.5 ~	K20TXR	K20TT(*5)	IK20	VK20	4
			E-XD180W • E-XD180K		X18	96.9 ~	K20TXR	K20TT(*5)	IK20	VK20	4
			E-XD180		X18	96.9 ~98.6	K20TXR	K20TT(*5)	IK20	VK20	4
			GF-XK180		-	98.6 ~00.11	K20TXR	K20TT(*5)	IK20	VK20	4
	MERIVA	1800	GF-XK181		Z18(XE)	00.11~	K20TXR	K20TT(*5)	IK20	VK20	4
			TA-XK181		Z18	04.5 ~04.11	K20TXR	K20TT(*5)	IK20	VK20	4
			GH-AH04Z18 • GH-AH04Z18W		Z18	04.11~	KJ16CR-L11	-	-	VKA16	4
			E-XD201		C20XE	92.11~98.6	K20PR-U	K20TT	IK20	VK20	4
			E-XD200W		C20NE	92.11~98.6	K20PR-U	K20TT	IK20	VK20	4
			E-XD200		C20NE	92.12~98.6	K20PR-U	K20TT	IK20	VK20	4
			E-XD200K		C20NE	94.2 ~98.6	K20PR-U	K20TT	IK20	VK20	4
	CALIBRA	2000	E-XD202W • E-XD202		X20	95.9 ~98.6	K20TXR	K20TT(*5)	IK20	VK20	4
			GF-XK200		-	00.6 ~01	K20TXR	K20TT(*5)	IK20	VK20	4
			GH-AH04Z20 • GH-AH04Z20W		Z20(T/C)	04.11~	KJ16CR-L11	-	-	VKA16	4
			GF-XK220		Z22(SE)	00.11~02	ITV20	-	ITV20	-	4
			TA-XK220		Z22	03 ~	ITV20	-	ITV20	-	4
			E-XE20TF		C20LET	94.3 ~95	K20TXR	K20TT(*5)	IK20	VK20	4
			E-XE200		X20XE	94.1 ~95	K20TXR	K20TT(*5)	IK20	VK20	4
	OMEGA	1600	TA-X01Z16		Z16	04.3 ~	K20TXR	K20TT(*5)	IK20	VK20	4
			2000	E-XF200W • E-XF200		X20	95.9 ~99.9	K20TXR	K20TT(*5)	IK20	VK20
	2500	E-XF250W • E-XF250		X25XE	94.9 ~99.9	K20TXR	K20TT(*5)	IK20	VK20	6	
		GF-XF250W • GF-XF250		X25	00.6 ~02	K20TXR	K20TT(*5)	IK20	VK20	6	
	VECTRA	2600	E-XB260		C26NE	92.9 ~94	W20FPR-U	-	IWF20	-	6
TA-XF260			Y26(SE)	02 ~	K20PBR-S10	-	IK20	VK20	6		
3000		E-XB301W • E-XB301		C30SE	92.3 ~94	K20TXR	K20TT(*5)	IK20	VK20	6	
		E-XF300 • E-XF300W		X30XE	94.9 ~99.9	K20TXR	K20TT(*5)	IK20	VK20	6	
GF-XF300W • GF-XF300		X30	00.6 ~02	K20TXR	K20TT(*5)	IK20	VK20	6			
SIGNUM		2200	TA-Z02Z22L		Z22	03.12~	K20PBR	-	IK20	VK20	4
	3200	TA-Z02Z32L		Z32	03.12~	K20PBR-S10	-	IK20	VK20	6	
SPEEDSTER	2200	GH-E00Z22		Z22	03.1 ~	ITV20	-	ITV20	-	4	
	TIGRA	1400	E-XJ140		X14XE	95.10 ~98.10	K20TXR	K20TT(*5)	IK20	VK20	4
1600		GF-XJ160		-	98.11 ~99.12	K20TXR	K20TT(*5)	IK20	VK20	4	
VIETNAM	1800	E-XH180 • E-XH180W		X18	96.2 ~99.2	K20TXR	K20TT(*5)	IK20	VK20	4	
		GF-XH181		X18(XE)	98.12~00	K20TXR	K20TT(*5)	IK20	VK20	4	
		GF-XH182		Z18(XE)	01.3 ~	K20TXR	K20TT(*5)	IK20	VK20	4	
	2000	E-XC200P		C20	95.3 ~	K20TXR	K20TT(*5)	IK20	VK20	4	
		E-XH200 • E-XH200W		X20	96.2 ~99.2	K20TXR	K20TT(*5)	IK20	VK20	4	
		GF-XH201		C20(SEL)	98.12~	K20TXR	K20TT(*5)	IK20	VK20	4	
	2200	GF-XH220		Z22(SE)	00.10~	ITV20	-	ITV20	-	4	
		TA-Z02Z22		Z22(SE)	02.7 ~	ITV20	-	ITV20	-	4	
	2500	E-XC250		C25	94.3 ~95	K20TXR	K20TT(*5)	IK20	VK20	6	
		E-XH250 • GF-XH250		X25	96.2 ~	K20TXR	K20TT(*5)	IK20	VK20	6	
E-XH250W • GF-XH250W		X25XE	97.2 ~	K20TXR	K20TT(*5)	IK20	VK20	6			
3200	GF-XH260		Y26(SE)	01 ~01	K20PBR-S10	-	IK20	VK20	6		
	TA-Z02Z32		Z32	03.3 ~	K20PBR-S10	-	IK20	VK20	6		
JAPAN	1200	GF-XG120		X12	00.6 ~01.12	K20TXR	K20TT(*5)	IK20	VK20	4	
		GF-XN120 • TA-XN120		Z12(XE)	01.12 ~02.12	K20TXR	K20TT(*5)	IK20	VK20	4	
	1400	E-XG140		X14	95.2 ~98.10	K20TXR	K20TT(*5)	IK20	VK20	4	
		E-XG141		X14	96.9 ~98.10	K20TXR	K20TT(*5)	IK20	VK20	4	
		GF-XG142		-	00.6 ~	K20TXR	K20TT(*5)	IK20	VK20	4	
		GF-XN140		Z14(XE)	01 ~	K20TXR	K20TT(*5)	IK20	VK20	4	
GF-XN140 • TA-XN140		Z14(XE)	01.3 ~	K20TXR	K20TT(*5)	IK20	VK20	4			

(\*5) : It can be used only for a plug with a terminal.





MODEL	CC	VEHICLE CODE	ENGINE	FROM-TILL	DENSO		IRIDIUM POWER	IRIDIUM TOUGH	QTY		
<b>OPEL</b>											
<b>VITA</b>	1600	E-XG160	X16	95.3 ~98.10	K20TXR	K20TT(*5)	IK20	VK20	4	AUSTRALIA	
		GF-XG161	-	00.6 ~	K20TXR	K20TT(*5)	IK20	VK20	4		
	1800	GF-XN180 • TA-XN180	Z18(XE)	01.12~	K20TXR	K20TT(*5)	IK20	VK20	4		
<b>ZAFIRA</b>	1800	GF-XM180	X181	00.2 ~00.11	K20TXR	K20TT(*5)	IK20	VK20	4		CHINA
		GF-XM181	Z18(XE)	00.11~	K20TXR	K20TT(*5)	IK20	VK20	4		
	2200	GH-AH05Z22	Z22	06.1 ~	IK16	-	IK16	VK16	4		
<b>PEUGEOT</b>											
<b>RCZ</b>	1600	ABA-T7R5F02 • ABA-T7R5F03	-	10.7 ~	-	-	-	-	4		INDIA
<b>1007</b>	1400	ABA-A8KFV • GH-A8KFV	-	06.3 ~	K20PR-U	K20TT	IK20	VK20	4		
	1600	ABA-A8NFU • GH-A8NFU	-	06.3 ~	K20HR-U11	-	IKH20	VKH20	4		
<b>106</b>	1600	E-S2S	NFX	96.9 ~00.3	K20TXR	K20TT(*5)	IK20	VK20	4		INDONESIA
		GF-S2S	TU5J4 L4	01 ~02	K20PR-U	K20TT	IK20	VK20	4		
		GH-S2NFX	NFX	03 ~	K20PR-U	K20TT	IK20	VK20	4		
		E-S10	NFY	95.3 ~96.9	K20TXR	K20TT(*5)	IK20	VK20	4		
<b>2008</b>	1200	ABA-A94HM01	HM01	14.2 ~	-	-	IXUH20I	VXUH20I	3		
		ABA-A94HN01	HN01(T/C)	16.9 ~	-	-	-	-	3		
		ABA-A94HN01	HN01(T/C)	18.7 ~	-	-	IXUH20I	VXUH20I	3		
<b>205</b>	1600	E-205	XU5MZ	94.6 ~	K20PR-U	K20TT	IK20	VK20	4	KOREA	
<b>206</b>	1400	GF-T14LA	KFW	99 ~	K20PR-U	K20TT	IK20	VK20	4		
		GF-T14	-	99.5 ~01.5	K20R-U	K20TT	IK20	VK20	4		
	1400	GF-T14	TU3JP	00.5 ~	K20PR-U	K20TT	IK20	VK20	4		
		GF-T14M	-	00.10~01.9	K20PR-U	K20TT	IK20	VK20	4		
	1600	GF-T14L4	TU3JP4	01.9 ~03.1	K20PR-U	K20TT	IK20	VK20	4		
		GH-T1KFW	KFW	03.1 ~	K20PR-U	K20TT	IK20	VK20	4		
	1600	GF-T16	-	99.5 ~01.3	K20R-U	K20TT	IK20	VK20	4		
		GF-A206CC • GH-A206CC	NFU	00.1 ~	K20HR-U11	-	IKH20	VKH20	4		
	1600	GF-T16L4	TU5JP4/L4	01.9 ~02.9	K20HR-U11	-	IKH20	VKH20	4		
		GF-T16XT	NFU	01.3 ~01.9	K20HR-U11	-	IKH20	VKH20	4		
	1600	GF-T16LA	NFU	01 ~	K20HR-U11	-	IKH20	VKH20	4		
		GH-2EKNFU	NFU	02.10~	K20HR-U11	-	IKH20	VKH20	4		
	1600	GH-T1NFU	NFU/TU5JP4	03 ~	K20HR-U11	-	IKH20	VKH20	4		
		GH-T16RG	TU5JP4	03.7 ~	K20HR-U11	-	IKH20	VKH20	4		
	2000	GH-206RC	RFK	03.10~	IKH20	-	IKH20	VKH20	4		
		GF-T1S16	RFR	99.7 ~01.5	K16HPR-U11	-	IKH16	VKH16	4		
	2000	GF-T1S16L4	-	00.12~	K16HPR-U11	-	IKH16	VKH16	4		
		GH-2EKRFN	RFN	02.10~	K20HR-U11	-	IKH20	VKH20	4		
	2000	GF-M206CC • GH-M206CC	RFR	02.6 ~	K16HPR-U11	-	IKH16	VKH16	4		
	2000	GH-T1RFN	RFN	02.9 ~	IKH16	-	IKH16	VKH16	4		
<b>207</b>	1400	ABA-A7KFUP	-	08.8 ~	XE20HR-U9	-	-	-	4	MALAYSIA	
		ABA-A75FW • ABA-A7C5FW	-	07.5 ~	-	-	-	-	4		
		ABA-A7W5FW	-	08.4 ~	-	-	-	-	4		
	1600	ABA-A75FX • ABA-A7C5FX (T/C)	(T/C)	07.3 ~	-	-	-	-	4		
		ABA-A75FY • ABA-A7W5FY (T/C)	(T/C)	07.6 ~	-	-	-	-	4		
		ABA-A75F01	(120PS)	09.10~	-	-	-	-	4		
		ABA-A7W5F01	5F01	11.7 ~	-	-	-	-	4		
		ABA-A75F04	(156PS)(T/C)	10.7 ~	-	-	-	-	4		
		ABA-A7C5F01	5F01	12.2 ~	-	-	-	-	4		
<b>208</b>	1200	ABA-A9CHM01 • ABA-A9HM01	HM01	14.1 ~	-	-	IXUH20I	VXUH20I	3		PHILIPPINES
		ABA-A9HN01	HN01(T/C)	15.10~	-	-	-	-	3		
		3BA-P21HN05	HN05(T/C)	20.7 ~	-	-	-	-	3		
	5BA-P21HN05	HN05(T/C)	21.2 ~	-	-	-	-	3			
	1600	ABA-A95F01	EP6C	12.11~	-	-	-	-	4		
ABA-A9C5F02		EP6CDT(T/C)	12.11~	-	-	-	-	4			
	1600	ABA-A9C5F03	EP6CDT(T/C)	13.7 ~	-	-	-	4			
	1600	ABA-A9C5G04 • ABA-A9X5G04	5G04(T/C)	15.10~	-	-	-	4			
<b>3008</b>	1600	ABA-T85F02	5F02(T/C)	10.6 ~	-	-	-	-	4	SAUDARABIA	
		ABA-T85F02	5G01(T/C)	16.3 ~	-	-	-	-	4		
	ABA-P845G01	5G01(T/C)	17.3 ~	-	-	-	-	4			
	3BA-P845G06	5G06(T/C)	19.5 ~	-	-	-	-	4			
	3LA-P845G06H • 5BA-P845G06	5G06(T/C)	21.1 ~	-	-	-	-	4			
<b>306</b>	1800	E-N3	XU7JPZ	94.2 ~95.11	K20PR-U	K20TT	IK20	VK20	4		SINGAPORE
		E-N3	XU7JPZ	95.11~99.7	K20TXR	K20TT(*5)	IK20	VK20	4		
		E-N5M • GF-N5M	LFY	97 ~	K20TXR	K20TT(*5)	IK20	VK20	4		
		E-N5A	LFZ	97 ~00.8	K20TXR	K20TT(*5)	IK20	VK20	4		
	2000	E-N3XT	XU10J2Z	94.11~99.7	K20PR-U	K20TT	IK20	VK20	4		
		E-N3SI	XU10J2Z	94.2 ~95.6	K20PR-U	K20TT	IK20	VK20	4		
		E-N3S16 • E-N3S16A	XU10J4	94.5 ~99.7	K20PR-U	K20TT	IK20	VK20	4		

(\*5) : It can be used only for a plug with a terminal.



# EUROPE & U.S.A. CAR

▶ Spark plug color codes: ■ for Iridium Tough and Iridium Plugs and Iridium TT, ■ for Iridium Power, ■ for Iridium Racing and Two Tops Plugs, ■ for Platinum Plugs and Platinum TT, and black for general spark plugs.

	MODEL	CC	VEHICLE CODE	ENGINE	FROM-TILL	DENSO		IRIDIUM POWER	IRIDIUM TOUGH	QTY			
AUSTRALIA	PEUGEOT 306		E-N3C	XU10J2Z	94.6 ~99.7	K20PR-U	K20TT	IK20	VK20	4			
			E-N5SI • E-N5S16	XU10J2	97.8 ~99.7	K20PR-U	K20TT	IK20	VK20	4			
			E-N5C	XU10J2	97.8 ~99.7	K20TXR	K20TT(*)	IK20	VK20	4			
		CHINA	2000	GF-N5XT • GF-N5SI	XU10J4R	99.8 ~	K20TXR	K20TT(*)	IK20	VK20	4		
				GF-N5C	XU10J4	99.8 ~	K16R-U	K16TT	IK16	VK16	4		
				GF-N5M	-	99.8 ~01	K20TXR	K20TT(*)	IK20	VK20	4		
				GF-N5BR	-	99.8 ~	K16R-U	K16TT	IK16	VK16	4		
				E-N5BR	-	00 ~	K20TXR	K20TT(*)	IK20	VK20	4		
		INDIA	306 S16(FBA#Since8028)	2000	GF-N5XT	RFV	97 ~99	K20TXR	K20TT(*)	IK20	VK20	4	
306 S16(FBA#Up to 8028)	2000			GF-N5S16	XU10J4RS	00 ~	K16PR-U	K16TT	IK16	VK16	4		
INDONESIA	307	1600	GF-T5NFU • GH-T5NFU • ABA-T5NFU	NFU	02.6 ~08.6	K20HR-U11	-	IKH20	VKH20	4			
			GH-3EHNFU	NFU	02.9 ~08.6	K20HR-U11	-	IKH20	VKH20	4			
			GH-3EHNFJ	-	02.8 ~	K16HPR-U11	-	IKH16	VKH16	4			
		2000	GF-T5	RFN	01.10~02.8	K16HPR-U11	-	IKH16	VKH16	4			
			GH-3EHRFN	RFN	02.9 ~03.10	K16HPR-U11	-	IKH16	VKH16	4			
			GH-T5RFN	EW10J4	02.8 ~03.10	K16HPR-U11	-	IKH16	VKH16	4			
			GH-T5RFJ • ABA-T5RFJ • GH-T5RFK	-	05.11~08.6	VKH16	-	IKH16	VKH16	4			
			GH-3EHRFJ • ABA-3EHRFJ	-	05.11~08.6	VKH16	-	IKH16	VKH16	6			
			GH-3CCRFJ	-	05.11~08.6	VKH16	-	IKH16	VKH16	4			
MALAYSIA	307CC	2000	GH-A307CC	EW10J4	04.4 ~05.11	K20HR-U11	-	IKH20	VKH20	4			
		GH-M307CC	EW10J4S	04.5 ~08.6	K20HR-U11	-	IKH20	VKH20	4				
PHILIPPINES	308	1200	ABA-T9HN02 • ABA-T9WHN02	HN02(T/C)	15.7 ~	-	-	-	-	3			
			3BA-T9HN05 • 3BA-T9WHN05	HN05(T/C)	19.5 ~	-	-	-	-	3			
			ABA-T75FT	(145PS)(T/C)	08.6 ~	-	-	-	-	4			
		1600	ABA-T75FY	(175PS)(T/C)	08.6 ~	-	-	-	-	4			
			ABA-T7W5FT	(140PS)(T/C)	08.9 ~	-	-	-	-	4			
			ABA-T75FX	(150PS)(T/C)	09.2 ~	-	-	-	-	4			
			ABA-T7C5FT	(140PS)(T/C)	09.6 ~	-	-	-	-	4			
			ABA-T75FW	(120PS)	09.11~	-	-	-	-	4			
			ABA-T7C5F02	(156PS)(T/C)	10.3 ~	-	-	-	-	4			
			ABA-T75F01	(156PS)(T/C)	11.4 ~	-	-	-	-	4			
			ABA-T75F02 • ABA-T75F02S • ABA-T7W5F02	(156PS)(T/C)	10.7 ~	-	-	-	-	4			
			SINGAPORE	405	1900	E-15DW	XU9J4	92.1 ~	K20PBR	-	IK20	VK20	4
					2000	E-D70MI	XU10J4Z	93.2 ~95	K20PR-U	K20TT	IK20	VK20	4
E-D70BR	XU10J2Z	93.2 ~96				K20PR-U	K20TT	IK20	VK20	4			
E-D70	XU10J4Z	93.2 ~96				K20PR-U	K20TT	IK20	VK20	4			
TAIWAN	406	2000	E-D8	XU10J4R	96.11~99	K20TXR	K20TT(*)	IK20	VK20	4			
			E-D8BR	RFR	97 ~99	K20TXR	K20TT(*)	IK20	VK20	4			
		GF-D9	RFR/RFN	00.3 ~01.5	K16HPR-U11	-	IKH16	VKH16	4				
		E-D9BR • GF-D9BR	RFR	00.3 ~01.5	K16HPR-U11	-	IKH16	VKH16	4				
		GF-D9L4 • GH-D9L4 • GF-D9BRL4 • GH-D9BRL4	EW10J4	01 ~	K16HPR-U11	-	IKH16	VKH16	4				
		2200	GF-D93FZ • GH-D93FZ	EW12J4	02.6 ~	K16HPR-U11	-	IKH16	VKH16	4			
		VIETNAM	3000	E-D8V • E-D8CPV • E-D8BRV	ES9J4	96.11~99	K20TNR	K20TT	IK20	VK20	6		
				GF-D9CPV • GF-D9V • GH-D9V	ES9J4S	00 ~	IKH20	-	IKH20	VKH20	6		
GF-D9BRV	ES9J4S-XFX			00.6 ~	VKH16	-	IKH16	VKH16	6				
GH-D9CPV • GH-D9BRV	ES9J4S-XFX			03 ~	VKH16	-	IKH16	VKH16	6				
JAPAN	407	2200	GH-D2 • GH-D2BR	-	05.6 ~07.5	VKH16	-	IKH16	VKH16	4			
			GH-D2CPV • ABA-D2CPV	-	06.6 ~	VKH16	-	IKH16	VKH16	4			
		ABA-D2Y • ABA-D2BRY	-	08.5 ~	VKH16	-	IKH16	VKH16	4				
		3000	GH-D2V • ABA-D2V • GH-D2BRV • ABA-D2BRV	-	05.6 ~	VKH16	-	IKH16	VKH16	6			
EUROPE & USA	5008	1600	ABA-T875F02	5F02(T/C)	14.3 ~	-	-	-	4				
			ABA-P875G01	5G01(T/C)	17.9 ~	-	-	-	4				
			3BA-P875G06	5G06(T/C)	19.5 ~	-	-	-	4				
508	1600	ABA-W25F02 • ABA-W2W5F02	5F02(T/C)	11.7 ~	-	-	-	4					
		ABA-W25G01 • ABA-W2W5G01	5G01(T/C)	15.1 ~	-	-	-	4					
605	3000	3BA-R85G06	5G06(T/C)	19.3 ~	-	-	-	4					
		E-6SK	-	93.11~	K20PBR	-	IK20	VK20	6				
		E-Z6	-	93.11~97	K20PBR	-	IK20	VK20	6				
607	3000	E-Z6NV	XFZ	98 ~99	K20TXR	K20TT(*)	IK20	VK20	6				
		GF-Z8	XFX	01 ~	VKH16	-	IKH16	VKH16	6				
PART NUMBER	PONTIAC GM BONNEVILLE	3800	E-PH23D	-	92.3 ~	T16EPR-U15	-	IT16	VT16	6			

(\*)5 : It can be used only for a plug with a terminal.



MODEL	CC	VEHICLE CODE	ENGINE	FROM-TILL	DENSO		IRIDIUM POWER	IRIDIUM TOUGH	QTY		
<b>PONTIAC GM</b>											
<b>GRAND AM</b>	2400	E-VB22E	-	95.10~	PT16EPR-L13	-	IT16	VT16	4	AUSTRALIA	
	3100	E-VB23C	-	94.11~96	T16EPR-U	-	IT16	VT16	6		
<b>GRAND PRIX</b>	3400	E-PPW13E	-	92.6 ~	T16EPR-U	-	IT16	VT16	6		
<b>PORSCHE</b>											
<b>911 CARRERA</b>	3400	GF-99666K • GF-99666	-	97.10~01	K20PBR-S10	-	IK20	VK20	6	CHINA	
		E-993	-	93.11~	K22PBR-S	-	IK22	VK22	12		
	3600	E-993K	-	94.6 ~	K22PBR-S	-	IK22	VK22	12	INDIA	
		GH-99705 • GH-99705K	-	04.8 ~07.8	IK22	-	IK22	VK22	6		
		ABA-99705	-	07.8 ~08.7	IK22	-	IK22	VK22	6		
	3800	ABA-997MA101 • ABA-997MA101S	-	08.7 ~	IKH20	-	IKH20	VKH20	6		
<b>911 CARRERA 4</b>	3400	GF-99668K • GF-99668	-	97.10~01	K20PBR-S10	-	IK20	VK20	6	INDONESIA	
	3600	ABA-99705 • ABA-99705K • ABA-99705KF	-	- ~	IK22	-	IK22	VK22	6		
<b>911 CARRERA 4 GTS</b>	3800	ABA-997MA101S	MA101S	11.7 ~	-	-	-	-	6		
<b>911 CARRERA 4S</b>	3600	E-993C4S	-	95.11~97.9	K22PBR-S	-	IK22	VK22	12	KOREA	
		GF-99603 • GH-99603	-	02 ~	K20PBR-S10	-	IK20	VK20	6		
	3800	ABA-997M9701KF	-	- ~	IK22	-	IK22	VK22	6		
<b>911 CARRERA RS</b>	3600	E-993RS	-	95.8 ~97.9	K22PBR-S	-	IK22	VK22	12		
<b>911 CARRERA S</b>	3800	GH-997M9701 • GH-997M9701K • ABA-997M9701	-	- ~	IK22	-	IK22	VK22	6	INDONESIA	
<b>911 TARGE</b>	3600	GF-99603	-	02 ~	K20PBR-S10	-	IK20	VK20	6	INDONESIA	
		ABA-997MA102	-	08.7 ~	IKH20	-	IKH20	VKH20	6		
	3800	ABA-997MA101	-	08.7 ~	IKH20	-	IKH20	VKH20	6		
<b>911 TURBO</b>	3600	E-993T	(T/C)	95.6 ~	K22TNR	-	IK22	VK22	6	INDONESIA	
<b>911 TURBO S</b>	3800	ABA-997MA170	M97.70(T/C)	09.8 ~	VK20	-	IK20	VK20	6	INDONESIA	
		ABA-997MA170	M41.70(T/C)	09.8 ~	VKH20	-	IKH20	VKH20	6		
<b>911GT2</b>	3600	GF-996S64 • GH-996S64	S64	01.6 ~	K22TNR	-	IK22	VK22	6	INDONESIA	
		ABA-99770S	-	- ~	VK22	-	IK22	VK22	6		
<b>911GT3</b>	3600	GF-99663	-	99.8 ~	K22PBR-S	-	IK22	VK22	6	INDONESIA	
		GH-99667	-	00 ~	IK22	-	IK22	VK22	6		
	3800	ABA-99776	-	- ~	-	-	-	-	6		
	3800	ABA-997M9777	-	10.2 ~	IKH20	-	IKH20	VKH20	6		
<b>911GT3RS</b>	3600	ABA-99776RS	-	- ~	IXU01-31	-	-	-	6	INDONESIA	
<b>928 GTS</b>	5400	E-928M28	-	92.4 ~	W20EPB	-	IW20	VW20	8	INDONESIA	
<b>968</b>	3000	E-968	-	92.2 ~	W20EPB	-	IW20	VW20	4	INDONESIA	
<b>BOXSTER</b>	2500	E-986K	-	96.11~98.9	K20TXR	K20TT(*5)	IK20	VK20	6	INDONESIA	
		GF-986K	-	98.10~99.9	K20TXR	K20TT(*5)	IK20	VK20	6		
		GF-98665	-	99.10~	K20TXR	K20TT(*5)	IK20	VK20	6		
		GH-98623	-	00 ~	K20PBR-S10	-	IK20	VK20	6		
	2700	GH-98725 • GH-98726	-	- ~	IK22	-	IK22	VK22	6	INDONESIA	
		ABA-98720	-	05.8 ~	IK22	-	IK22	VK22	6		
		ABA-981MA122	MA122	12.6 ~	-	-	-	-	6		
	2900	ABA-987MA120	-	09.7 ~	IKH20	-	IKH20	VKH20	6	INDONESIA	
	3200	GF-98667	-	99.10~	K20PBR-S10	-	IK20	VK20	6		
		GH-98624	-	00 ~	K20PBR-S10	-	IK20	VK20	6		
	3400	ABA-98721	-	05.8 ~	IK22	-	IK22	VK22	6	INDONESIA	
		ABA-987MA121 • ABA-987MA121C	-	09.7 ~	IKH20	-	IKH20	VKH20	6		
	<b>CAYENNE</b>	3200	GH-9PABFD	ABF	04.2 ~	-	-	-	-	6	INDONESIA
		3600	ABA-9PAM5501	-	- ~	-	-	-	-	6	
4500		GH-9PA00 • GH-9PA00A	-	03 ~	K20PBR-S10	-	IK20	VK20	8	INDONESIA	
		GH-9PA50A	(T/C)	03 ~	VK22	-	IK22	VK22	8		
		ABA-9PAM4801 • ABA-9PAM4801G	-	- ~	IKH22	-	IKH22	VKH22	8		
4800		ABA-9PAM4851A • ABA-9PAM4851TA	(T/C)	- ~	VKH22	-	IKH22	VKH22	8		
<b>CAYENNE S HYBRID</b>	3000	DAA-92ACGE	CGE-EACA(S/C)	10.11~	IK24	-	IK24	-	6	INDONESIA	
<b>CAYMAN</b>	2700	ABA-98720	-	05.8 ~08	IK22	-	IK22	VK22	6	INDONESIA	
	2900	ABA-987MA120	-	09.7 ~	IKH22	-	IKH22	VKH22	8		
	3400	ABA-98721	-	05.8 ~	IK22	-	IK22	VK22	6	INDONESIA	
		ABA-987MA121	-	09.7 ~	IKH20	-	IKH20	VKH20	6		
<b>PANAMERA S HYBRID</b>	3000	DAA-970CGEA	CGE-EACA(S/C)	11.6 ~	IK24	-	IK24	-	6	INDONESIA	
<b>PANAMERA</b>	3600	ABA-970M46	-	10.3 ~	-	-	-	-	6	INDONESIA	
	4800	ABA-970M48A	-	09.3 ~	-	-	-	-	8		
<b>PANAMERA TURBO</b>	4800	ABA-970M48A	(T/C)	09.3 ~	-	-	-	-	8	INDONESIA	
<b>PORSCHE TURBO</b>	3600	E-964T2	(T/C)	93.5 ~	Q22P-U	-	IQ22	VQ22	6	INDONESIA	
<b>RENAULT</b>											
<b>19</b>	1700	E-B532	F3N	92.1 ~	W20EPR-U	-	IW20	VW20	4	INDONESIA	
<b>AVANTIME</b>	3000	GH-EL7X	L7X	02.11~	VKH16	-	IKH16	VKH16	6	INDONESIA	

(\*5) : It can be used only for a plug with a terminal.

AUSTRALIA  
 CHINA  
 INDIA  
 INDONESIA  
 KOREA  
 MALAYSIA  
 PHILIPPINES  
 SAUDI ARABIA  
 SINGAPORE  
 TAIWAN  
 THAILAND  
 VIETNAM  
 JAPAN  
 EUROPE & USA  
 CROSS REFERENCE  
 PART NUMBER



# EUROPE & U.S.A. CAR

▶ Spark plug color codes: ■ for Iridium Tough and Iridium Plugs and Iridium TT, ■ for Iridium Power, ■ for Iridium Racing and Two Tops Plugs, ■ for Platinum Plugs and Platinum TT, and black for general spark plugs.

	MODEL	CC	VEHICLE CODE	ENGINE	FROM-TILL	DENSO		IRIDIUM POWER	IRIDIUM TOUGH	QTY
AUSTRALIA	<b>RENAULT</b>									
	WIND	1600	ABA-ENK4M	K4M	11.7 ~	VK22	-	IK22	VK22	4
	KADJAR	1200	ABA-HEH5F	H5F(T/C)	18.4 ~	-	-	-	-	4
CHINA	KANGOO		ABA-KWH5F	H5F(T/C)	14.5 ~	-	-	-	-	4
		1200	ABA-KWH5F	H5F(T/C)	16.2 ~	-	-	-	-	4
		ABA-KWH5F1	H5F(T/C)	16.7 ~	-	-	-	-	4	
	1400	GF-KCK7J	K7J	01 ~03.8	K20PR-U	K20TT	IK20	VK20	4	
INDIA	KANGOO		GH-KCK4M · ABA-KCK4M	K4M	03.8 ~	K20PR-U	K20TT	IK20	VK20	4
		1600	ABA-KWK4M	K4M	09.9 ~	K20PR-U	K20TT	IK20	VK20	4
			ABA-KWK4M	K4M	11.9 ~	K20PR-U	K20TT	IK20	VK20	4
			ABA-KWK4M	K4M	14.2 ~	K20PR-U	K20TT	IK20	VK20	4
INDONESIA	CAPTUR	1200	ABA-2RH5F	H5F(T/C)	14.2 ~	-	-	-	-	4
			ABA-2RH5F1	H5F(T/C)	16.3 ~	-	-	-	-	4
	1300	3BA-HJBH5H	H5H(T/C)	21.2 ~	-	-	-	-	4	
KOLEOS	2500	ABA-Y2TR	QR25DE,2TR	09.5 ~	VFXEH20	-	-	VFXEH20	4	
		ABA-Y2TR	2TR	13.11~	-	-	-	-	4	
KOREA	GRAND SCENIC	2000	ABA-JMF4	F4	07.5 ~	K20PR-U	K20TT	IK20	VK20	4
		LAGUNA	2000	E-56F3R	F3R	94.10~97	W20EPR-U	-	IW20	VW20
			GF-56F3R	-	99 ~01	W20EPR-U	-	IW20	VW20	4
		GH-GF4	F4R	03.1 ~	K20PR-U	K20TT	IK20	VK20	4	
MALAYSIA	LUTECIA	3000	E-56Z7X	-	94.10~96	K20TXR	-	-	VK20Y	6
			GH-GL7X	L7X	03.1 ~	VKH16	-	IKH16	VKH16	6
	900	ABA-RH4B	H4B(T/C)	15.1 ~	-	-	-	-	3	
		ABA-RH4B	H4B(T/C)	17.10~	-	-	-	-	3	
PHILIPPINES	LUTECIA	1200	GH-BD4F	D4F	03.2 ~	XE20HR-U9	-	-	4	
			ABA-RH5F	H5F(T/C)	13.9 ~	-	-	-	4	
		ABA-RH5F	H5F(T/C)	14.7 ~	-	-	-	4		
		ABA-RH5F1	H5F(T/C)	16.2 ~	-	-	-	4		
	1300	7BA-BJAH5H	H5H(T/C)	20.11~	-	-	-	-	4	
		E-57E7J	-	94.7 ~97	K20PR-U	K20TT	IK20	VK20	4	
SAUDI ARABIA	1400	GF-57E7J	E7J	97 ~98	Q16PR-U	-	IQ16	VQ16	4	
		GF-BK4J · GH-BK4J	K4J	01 ~	K20PR-U	K20TT	IK20	VK20	4	
		GF-BK7M	-	98.10~	K20TXR	K20TT(*5)	IK20	VK20	4	
		GF-BK4M	K4M	98.10~01	K20TXR	K20TT(*5)	IK20	VK20	4	
SINGAPORE	1600	ABA-RK4M	K4M	06.3 ~	K20PR-U	K20TT	IK20	VK20	4	
		ABA-RM5M	M5M(T/C)	13.11~	FXE20HR11	-	-	VFXEH20	4	
		ABA-RM5M1	M5M(T/C)	15.11~	-	-	-	4		
		ABA-RM5M	M5M(T/C)	17.7 ~	-	-	-	4		
TAIWAN	1800	E-57F3P	F3P	95.1 ~	W20EPR-U	-	IW20	VW20	4	
		E-57F7P	F7P	95.1 ~	K20PR-U	K20TT	IK20	VK20	4	
		E-57F3PQ	F3PQ	95.8 ~	W20EPR-U	-	IW20	VW20	4	
THAILAND	2000	GF-BF4	F4	00.12~01	IK20	-	IK20	VK20	4	
		ABA-RF4C	F4	09.10~	VK22	-	IK22	VK22	4	
	3000	GF-BL7X · GH-BL7X	L7X	02 ~	VKH20	-	IKH20	VKH20	6	
VIETNAM	MEGANE	1200	ABA-ZH5F	H5F(T/C)	15.5 ~	-	-	-	4	
			ABA-BBH5F	H5F(T/C)	17.11~	-	-	-	4	
		GF-AK4M · GF-AK4ME	-	99 ~	K20TXR	K20TT(*5)	IK20	VK20	4	
	1600	GH-MK4M · ABA-MK4M · ABA-MK4MM · GH-MK4MM	K4M	03 ~	K20PR-U	K20TT	IK20	VK20	4	
		GH-KMK4M · ABA-KMK4M	K4M	04.6 ~	K20PR-U	K20TT	IK20	VK20	4	
		ABA-BBM5M · ABA-KBM5M	M5M(T/C)	17.11~	-	-	-	4		
	1800	ABA-BBM5P	M5P(T/C)	18.8 ~	-	-	-	4		
		ABA-BBM5P	M5P(T/C)	19.3 ~	-	-	-	4		
		7BA-BBM5P	M5P(T/C)	19.10~	-	-	-	4		
	EUROPE & USA	E-AF3RD2 · E-AF3R2	F3R	96.10~98	W20EP-U	-	IW20	VW20	4	
			F7R	96.10~99	K20TXR	K20TT(*5)	IK20	VK20	4	
		E-AF3RD	F3R	96.6 ~98	W20EP-U	-	IW20	VW20	4	
E-AF7RD		F7R	96.6 ~98	K20TXR	K20TT(*5)	IK20	VK20	4		
E-AF3R		F3R	96.7 ~98	W20EP-U	-	IW20	VW20	4		
E-AF3RJ		F3R	97.4 ~99	W16EPR-U	W16TT	IW16	VW16	4		
2000		GF-AF3R2	-	99 ~	W20EPR-U	-	IW20	VW20	4	
GH-MF4 · ABA-MF4 · ABA-MF4M · GH-MF4M		F4R	03 ~	K20PR-U	K20TT	IK20	VK20	4		
ABA-DZF4R		F4R(T/C)	12.7 ~	-	-	-	-	4		
GH-KMF4		F4R2	04.6 ~	K20PR-U	K20TT	IK20	VK20	4		
GH-MF4R2		F4R2(T/C)	04.10 ~06.10	VK22	-	IK22	VK22	4		
ABA-MF4R2		F4R2(T/C)	06.10~	VK22	-	IK22	VK22	4		
ABA-MF4 · ABA-MF4M	F4	06.11~	K20PR-U	K20TT	IK20	VK20	4			

(\*5) : It can be used only for a plug with a terminal.

MODEL	CC	VEHICLE CODE	ENGINE	FROM-TILL	DENSO		IRIDIUM POWER	IRIDIUM TOUGH	QTY	
<b>RENAULT</b>										
<b>MEGANE</b>	2000	ABA-KMF4	F4	07.4 ~	K20PR-U	K20TT	IK20	VK20	4	AUSTRALIA
		GH-EMF4 · ABA-EMF4	F4	05.1 ~	K20PR-U	K20TT	IK20	VK20	4	CHINA
		ABA-ZM4R	M4R	11.5 ~	FXE20HR11	-	-	VFXEH20	4	
		ABA-KZM4R	M4R	12.12~	FXE20HR11	-	-	VFXEH20	4	
		ABA-KZF4R	F4R(T/C)	13.5 ~	-	-	-	-	4	
<b>SAFRANE</b>	3000	E-54Z7X	Z7X	94.9 ~97	K22PBR-S	-	IK22	VK22	6	INDIA
<b>SCENIC</b>	2000	GF-AF4J	F4, G	00.8 ~	K20PR-U	K20TT	IK20	VK20	4	INDONESIA
		GF-AF4J2	F4R	01 ~	K20PR-U	K20TT	IK20	VK20	4	
<b>SPORT SPIDER</b>	2000	E-FF7R	F7R	97 ~97	K20PBR	-	IK20	VK20	4	KOREA
<b>SPORT V6</b>	3000	GH-BL7X	L7X	03 ~	VKH20	-	IKH20	VKH20	6	INDONESIA
<b>TWINGO</b>	900	DBA-AHH4B	H4B(T/C)	16.9 ~	-	-	-	-	3	MALAYSIA
		ABA-AHH4B1	H4B(T/C)	18.2 ~	-	-	-	-	3	
		3BA-AHH4B	H4B(T/C)	19.8 ~	-	-	-	-	3	
		3BA-AHH4B	H4B(T/C)	20.5 ~	-	-	-	-	3	
	1000	ABA-AHH4D	H4D	17.1 ~	-	-	-	-	3	PHILIPPINES
		7BA-AHB4D	B4D	20.2 ~	-	-	-	-	3	
	1100	E-06D7F	D7F	97.7 ~98.12	K20TXR	K20TT(*5)	IK20	VK20	4	SAUDARABIA
		GF-06D7F	-	99 ~	K20TXR	K20TT(*5)	IK20	VK20	4	
	1200	E-06C3G	C3G	95.7 ~97.7	W16EP-U	W16TT	IW16	VW16	4	SINGAPORE
		ABA-ND4F	D4F	08.11~	XE20HR-U9	-	-	VFXEH20	4	
	1600	ABA-ND4FT	D4FT(T/C)	08.11~	XE20HR-U9	-	-	-	4	TAIWAN
		ABA-NK4M	K4M	09.10~	K20PR-U	K20TT	IK20	VK20	4	
		ABA-NK4M	K4M	11.6 ~	VK22	-	IK22	VK22	4	
<b>ROLLS ROYCE</b>										
<b>CORNICHE</b>	6700	E-RMD	-	94.1 ~96	IW16	-	IW16	VW16	8	THAILAND
		GF-AK	L410MT	99 ~	IK20	-	IK20	VK20	8	
<b>FLYING SPUR</b>	6700	E-RMG	-	94.11~	IW16	-	IW16	VW16	8	VIETNAM
<b>PARKWARD</b>	5400	GF-AD	54 12	00 ~	KJ14CR11	-	IK16	VK16	12	
<b>PHAMTOM</b>	6700	E-AWT	-	97.1 ~	IK16	-	IK16	VK16	8	JAPAN
		GH-1S68	-	04 ~	VK20	-	IK20	VK20	8	
<b>SILVER SPIRIT</b>	6700	E-RRS	-	93.2 ~	IW16	-	IW16	VW16	8	EUROPE & USA
		E-RMS	-	94.1 ~	IW16	-	IW16	VW16	8	
		E-AS	-	95.9 ~	K16PR-U	K16TT	IK16	VK16	8	
<b>SILVER SPUR</b>	6700	E-RRN	-	92.4 ~	IW16	-	IW16	VW16	8	CROSS REFERENCE PART NUMBER
		E-SCAZN	-	92.4 ~	W16EXR-U	W16TT	IW16	VW16	8	
		E-RMN	-	93.10~	IW16	-	IW16	VW16	8	
		E-SCAZL	-	95.11~	W16EXR-U	W16TT	IW16	VW16	8	
		E-AW	-	95.11~	IK16	-	IK16	VK16	8	
		E-AN	-	95.8 ~	IK16	-	IK16	VK16	8	
		E-ANY	L410MT	96 ~00	IK16	-	IK16	VK16	8	
		E-ANT	-	96.8 ~98	IK16	-	IK16	VK16	8	
		E-AYT	L410MT	97 ~00	IK16	-	IK16	VK16	8	
		E-SCAZN2	-	97.4 ~	W16EXR-U	W16TT	IW16	VW16	8	
<b>TOURING LIMOUSINE</b>	6700	E-RRW	-	92.9 ~	IW16	-	IW16	VW16	8	
		E-RMW	-	94.4 ~	IW16	-	IW16	VW16	8	
<b>ROVER</b>										
<b>75</b>	2500	GF-RJ25	25K	99.7 ~	VK16	-	IK16	VK16	6	VIETNAM
<b>75 SALOON</b>	2500	GH-RJ25	25K	03.7 ~	VK16	-	IK16	VK16	6	
<b>75 TOURER</b>	2500	GH-RJ25T	25K	03.7 ~	VK16	-	IK16	VK16	6	
<b>200</b>	1800	E-RF18	-	96.12~99	K20PR-U	K20TT	IK20	VK20	4	JAPAN
		E-RF18	-	96.7 ~99	K20PR-U	K20TT	IK20	VK20	4	
<b>216</b>	1600	E-XWD16K · E-XWD16	D16A8	92.12~96	K20PR-U11	K20TT	IK20	VK20	4	EUROPE & USA
		E-XWD16S · E-XWD16KS	D16A8	94.12~	K20PR-U11	K20TT	IK20	VK20	4	
		E-RF16	16K	96.7 ~00	K20PR-U	K20TT	IK20	VK20	4	
<b>220</b>	2000	E-XW20T	20T4G(T/C)	92.12~96	K20PR-U	K20TT	IK20	VK20	4	CROSS REFERENCE PART NUMBER
		E-XW20TS	20T4G(T/C)	94.12~	K20PR-U	K20TT	IK20	VK20	4	
		E-XWD20TG	(T/C)	- ~	K20PR-U	K20TT	IK20	VK20	4	
<b>416</b>	1600	E-XWD16W	D16A8	94.12~96	K20PR-U11	K20TT	IK20	VK20	4	VIETNAM
		E-RTD16	-	96.7 ~	K20PR-U11	K20TT	IK20	VK20	4	
<b>420</b>	2000	E-XWG	-	94.5 ~	K20R-U	K20TT	IK20	VK20	4	EUROPE & USA
<b>618</b>	1800	E-RHF18	-	96.1 ~	KJ20CR-L11	-	-	VKA20	4	
<b>620</b>	2000	E-XSU	-	94.10~	KJ20CR-L11	-	-	VKA20	4	CROSS REFERENCE PART NUMBER
		E-RHF20	F20Z1	94.10~	KJ20CR-L11	-	-	VKA20	4	
<b>623</b>	2300	E-XSS	-	94.10~	KJ20CR-L11	-	-	VKA20	4	VIETNAM
		E-RHH23	H23A3	94.10~	KJ20CR-L11	-	-	VKA20	4	
		E-RHF23	-	- ~98	KJ20CR-L11	-	-	VKA20	4	
<b>820</b>	2000	E-RSC27A	-	93.1 ~97	K20PR-U	K20TT	IK20	VK20	4	JAPAN

(\*5) : It can be used only for a plug with a terminal.



# EUROPE & U.S.A. CAR

▶ Spark plug color codes: ■ for Iridium Tough and Iridium Plugs and Iridium TT, ■ for Iridium Power, ■ for Iridium Racing and Two Tops Plugs, ■ for Platinum Plugs and Platinum TT, and black for general spark plugs.

	MODEL	CC	VEHICLE CODE	ENGINE	FROM-TILL	DENSO		IRIDIUM POWER	IRIDIUM TOUGH	QTY	
AUSTRALIA	<b>ROVER</b>										
	825	2500	E-RS25	-	96.3 ~	K20PR-U	K20TT	IK20	VK20	6	
CHINA	827	2700	E-RSC27A	-	93.1 ~	KJ20CR-L11	-	-	VKA20	6	
	<b>CABRIOLET</b>	1600	E-XW16K	-	96.3 ~	K20PR-U11	K20TT	IK20	VK20	4	
INDIA	<b>COUPE</b>	1600	E-XW16	-	96.3 ~	K20PR-U11	K20TT	IK20	VK20	4	
	<b>LAND ROVER</b>	1800	E-XW18	-	96.3 ~	VK20	-	IK20	VK20	4	
2500		Q-LJ13L	-	93.9 ~	W20EPR-U	-	IW20	VW20	4		
		Y-LJL	-	94.5 ~95	W20EPR-U	-	IW20	VW20	4		
3500		E-LJ23D	-	92.12~	W20EPR-U	-	IW20	VW20	8		
3900		E-LJ36D	-	93.9 ~	W20EPR-U	-	IW20	VW20	8		
	E-LJR	36D	94.10~	W20EPR-U	-	IW20	VW20	8			
INDONESIA	<b>MINI</b>	1300	E-LD30 • E-LD31	-	97.6 ~98	W16EXR-U	W16TT	IW16	VW16	8	
			E-XN12A	-	92.1 ~00	W20EPR-U	-	IW20	VW20	4	
KOREA	<b>RANGE ROVER</b>	3900	E-XN12A	-	96.11~00	W20EPR-U	-	IW20	VW20	4	
			E-LH36D	-	92.11~	J16CR-U	-	IW16	VW16	8	
MALAYSIA	<b>TOURER</b>	1600	E-LP42D	42D	95.1 ~99	W16EPR-U	W16TT	IW16	VW16	8	
			1800	E-XW18W	-	96.3 ~	VK20	-	IK20	VK20	4
PHILIPPINES	<b>SAAB</b>	2000	ABA-LM42S	(S/C)	05.7 ~	VK16	-	IK16	VK16	8	
			2300	E-LH40D	-	92.11~	J16CR-U	-	IW16	VW16	8
SAUDI ARABIA	<b>900 16V</b>	2000	4600	E-LP46D	46D	95.1 ~99	W20EPR-U	-	IW20	VW20	8
			5000	ABA-LG5NA	508PN	13.3 ~	-	-	-	-	8
SINGAPORE	<b>900TURBO16V</b>	2000	ABA-LG5SA	508PS(S/C)	13.3 ~	-	-	-	-	8	
			E-AB202SK • E-AB202S	B202S	92.3 ~	IQ22	-	IQ22	VQ22	4	
TAIWAN	<b>9000</b>	2300	E-DB206I	B206I	94.1 ~	Q20PR-U11	-	IQ20	VQ20	4	
			E-DB204I	B204I	94.10~98	Q20PR-U11	-	IQ20	VQ20	4	
THAILAND	<b>9-3</b>	1800	E-DB234I	B234I	93.11~98	IQ20	-	IQ20	VQ20	4	
			E-DB234IK	B234I	94.7 ~98	IQ20	-	IQ20	VQ20	4	
VIETNAM	<b>9-5</b>	2000	E-DB258I	B258I	93.11~97	K20TXR	K20TT(*5)	IK20	VK20	6	
			E-AB20S	B20S(T/C)	93.1 ~	IQ22	-	IQ22	VQ22	4	
JAPAN	<b>SMART</b>	600	E-DB204L • E-DB204LK	B204L(T/C)	96.11~98	Q22PR-U	-	IQ22	VQ22	4	
			E-CB234R	B234R	93.6 ~96.12	Q22PR-U11	-	IQ22	VQ22	4	
EUROPE & USA	<b>SMART COUPE/CABRIO</b>	700	E-CB234E	B234E	95.11~97	Q22PR-U11	-	IQ22	VQ22	4	
			E-CB234E	B234E	96.12~97	Q22PR-U11	-	IQ22	VQ22	4	
CROSS REFERENCE NUMBER	<b>SMART ROADSTER</b>	900	E-CB234R	B234R	96.12~	Q22PR-U	-	IQ22	VQ22	4	
			E-CB308I	B308I	94.11~	K20TXR	K20TT(*5)	IK20	VK20	6	
PART NUMBER	<b>SMART BRABUS</b>	900	GH-FB207	(T/C)	03.1 ~	VK20	-	IK20	VK20	4	
			GH-FB207	B204(T/C)	98.6 ~00	Q22PR-U11	-	IQ22	VQ22	4	
PART NUMBER	<b>SMART FORTWO</b>	1000	GH-FB205	B205(150PS)	00.11~	Q20PR-U11	-	IQ20	VQ20	4	
			GH-FB205	B205(205PS)(T/C)	99.11~	VK20	-	IK20	VK20	4	
PART NUMBER	<b>SMART FORTWO</b>	1000	GH-FB207 • ABA-FB207	(T/C)	03.1 ~	VK20	-	IK20	VK20	4	
			GH-FB207 • ABA-FB207	-	- ~	VK20	-	IK20	VK20	4	
PART NUMBER	<b>SMART FORTWO</b>	1000	GF-DB234	B234	98.5 ~	Q20PR-U11	-	IQ20	VQ20	4	
			GH-FB284 • ABA-FB284	-	05.11~	VKH20	-	IKH20	VKH20	6	
PART NUMBER	<b>SMART FORTWO</b>	1000	GF-EB205 • GH-EB205	-	99.11~	VQ22	-	IQ22	VQ22	4	
			GH-EB205	B205(T/C)	03.5 ~	Q22PR-U11	-	IQ22	VQ22	4	
PART NUMBER	<b>SMART FORTWO</b>	1000	GF-EB235 • GH-EB235	B235E(170PS)(185PS)(T/C)	97.10~	VQ22	-	IQ22	VQ22	4	
			GF-EB308 • GH-EB308	B308E(T/C)	99.1 ~03.11	K22PR-U11	-	IK22	VK22	6	
PART NUMBER	<b>SMART FORTWO</b>	1000	E-S8Z • GF-S8Z • E-S8ZC	1C	96.11~02	K16PR-U11	K16TT	IK16	VK16	4	
			GF-S8ZC	1C, G	00.5 ~02	K16PR-U11	K16TT	IK16	VK16	4	
PART NUMBER	<b>SMART FORTWO</b>	1000	GF-MC01M • GH-MC01M	13(T/C)	00.10~	K20TXR	K20TT(*5)	IK20	VK20	6	
			GF-MC01K • GH-MC01K	13(T/C)	00.12~	K20TXR	K20TT(*5)	IK20	VK20	6	
PART NUMBER	<b>SMART FORTWO</b>	1000	GF-MC01L	13(T/C)	01.4 ~	K20TXR	K20TT(*5)	IK20	VK20	6	
			GF-MC01C • GH-MC01C	13(T/C)	01.10~	K20TXR	K20TT(*5)	IK20	VK20	6	
PART NUMBER	<b>SMART FORTWO</b>	1000	GH-450335	13(T/C)	03 ~	K20TXR	K20TT(*5)	IK20	VK20	6	
			GH-MC01X	(T/C)	03 ~	K20TXR	K20TT(*5)	IK20	VK20	6	
PART NUMBER	<b>SMART FORTWO</b>	1000	DBA-453444	281M09(T/C)	17.8 ~	-	-	-	-	3	
			GH-450332 • GH-450333 • GH-450432 • GH-450433	(T/C)	03 ~	-	-	-	-	-	6
PART NUMBER	<b>SMART FORTWO</b>	1000	GH-452334 • GH-452434	(T/C)	03 ~	-	-	-	-	6	
			ABA-453062	281M09(T/C)	17.5 ~	-	-	-	-	-	3
PART NUMBER	<b>SMART FORTWO</b>	1000	DBA-453344	281M09(T/C)	17.8 ~	-	-	-	-	3	
			CBA-451331 • CBA-451380 • CBA-451431 • CBA-451480	3B21	07.10~	XU22HDR9	XUH22TT	IXUH22	VXUH22	3	
PART NUMBER	<b>SMART FORTWO</b>	1000	ABA-451333	(T/C)	08.7 ~	XU22HDR9	XUH22TT	IXUH22	VXUH22	3	

(\*5) : It can be used only for a plug with a terminal.



MODEL	CC	VEHICLE CODE	ENGINE	FROM-TILL	DENSO		IRIDIUM POWER	IRIDIUM TOUGH	QTY	
<b>SMART</b>										
SMART FORFOUR	900	DBA-453044	281M09(T/C)	17.8 ~	-	-	-	-	3	AUSTRALIA
	1300	GH-454031	135	04.9 ~06.12	K20HR-U11	-	IKH20	VKH20	4	CHINA
	1500	GH-454032	1355	04.9 ~06.12	K20HR-U11	-	IKH20	VKH20	4	INDIA
<b>TVR</b>										
CERBERA	4000		-	99.11~	XU24EPR-U	-	IXU24	VXU24	6	INDONESIA
	4200		-	02.2 ~	K20TXR	K20TT(*5)	IK20	VK20	8	KOREA
	4500		-	99.11~	K20TXR	K20TT(*5)	IK20	VK20	8	INDONESIA
CHIMAERA	4000	-	-	95.3 ~02.1	-	-	-	-	8	INDONESIA
	4500		-	95.3 ~02.1	IW24	-	IW24	-	8	INDONESIA
	5000		-	95.3 ~99.11	-	-	-	-	8	INDONESIA
GRIFFITH	4000		-	93.3 ~99.11	-	-	-	-	8	INDONESIA
	5000		-	93.3 ~02.1	-	-	-	-	8	INDONESIA
TAMORA	3600		-	02.2 ~	XU24EPR-U	-	IXU24	VXU24	6	INDONESIA
TUSCAN	3600		SP6	00.11~	XU24EPR-U	-	IXU24	VXU24	6	INDONESIA
	4000		SP6	00.11~	XU24EPR-U	-	IXU24	VXU24	6	INDONESIA
<b>VOLKSWAGEN</b>										
up !	1000	DBA-AACHY	CHY	12.10~	-	-	-	-	3	INDONESIA
		DBA-AACHYW	CHY	15.8 ~	-	-	-	-	3	INDONESIA
		ABA-AADKR	DKR(T/C)	18.7 ~	-	-	-	-	3	INDONESIA
ARTEON	2000	ABA-3HDJHF	DJH(T/C)	17.10~	-	-	-	-	4	INDONESIA
EOS	2000	ABA-1FBWA · GH-1FBWA	BWA(T/C)	06.10~09.1	VK20Y	-	-	VK20Y	4	INDONESIA
		ABA-1FCAW	CAW(T/C)	09.1 ~	VK22	-	IK22	VK22	4	INDONESIA
		ABA-FBUB · GH-FBUB	BUB	06.10~	-	-	-	-	6	INDONESIA
BORA	2000	GF-1JAPK	APK	99.9 ~02.9	K20PBR-S10	-	IK20	VK20	4	INDONESIA
		GH-1JAZJ	AZJ	02.9 ~	VKA16	-	-	VKA16	4	INDONESIA
	2300	GF-1JAGZ	AGZ	99.9 ~01.7	K20TXR	K20TT(*5)	IK20	VK20	5	INDONESIA
		GF-1J AQN · GH-1J AQN	AQN	01.9 ~	VKA16	-	-	VKA16	5	INDONESIA
		GF-1J AUEF	AUE	00.10~01.7	VKA16	-	-	VKA16	6	INDONESIA
	2800	GF-3BAMXF · GH-3BAMXF	AMX	01 ~	K20TXR	K20TT(*5)	IK20	VK20	6	INDONESIA
		GF-1JBDEF · GH-1JBDEF	BDE	01.9 ~05.2	VKA16	-	-	VKA16	6	INDONESIA
CORRADO	2000	E-509A	9A	92.10~	K22PBR-S	-	IK22	VK22	4	INDONESIA
	2900	E-50ABV	ABV	92.4 ~	K20TXR	K20TT(*5)	IK20	VK20	6	INDONESIA
CROSSPOLO	1200	DBA-6RCBZW	CBZ(T/C)	10.6 ~	-	-	-	-	4	INDONESIA
		DBA-6RCJZW	CJZ(T/C)	14.11~	-	-	-	-	4	INDONESIA
		DBA-6RCJZW	CJZ(T/C)	16.5 ~	-	-	-	-	4	INDONESIA
1600	GH-9NBTS · ABA-9NBTS	BTS	07.9 ~	VKA20	-	-	VKA20	4	INDONESIA	
GOLF	1200	DBA-AUCJZ	CJZ(T/C)	13.6 ~	-	-	-	-	4	INDONESIA
		DBA-AUCJZ	CJZ(T/C)	15.7 ~	-	-	-	-	4	INDONESIA
	1400	DBA-1KCTHK	CTH(S/C+T/C)	13.3 ~	-	-	-	-	4	INDONESIA
		DBA-AUCPT	CPT(T/C)	13.6 ~	-	-	-	-	4	INDONESIA
		DBA-AUCHP	CHP(T/C)	14.1 ~	-	-	-	-	4	INDONESIA
		DBA-1TCTHW	CTH(S/C+T/C)	14.1 ~	-	-	-	-	4	INDONESIA
		DBA-AUCPT	CPT(T/C)	15.7 ~	-	-	-	-	4	INDONESIA
		DBA-AUCHP	CHP(T/C)	15.7 ~	-	-	-	-	4	INDONESIA
		DLA-AUCUK	CUK(T/C)	15.9 ~	-	-	-	-	4	INDONESIA
		DBA-1TCZD	CZD(T/C)	16.1 ~	-	-	-	-	4	INDONESIA
	1800	ABA-AUCJSF	CJS(T/C)	15.7 ~	-	-	-	-	4	INDONESIA
		ABA-AUCJSF	CJS(T/C)	17.5 ~	VKH22	-	IKH22	VKH22	4	INDONESIA
	2000	ABA-AUCHH	CHH(T/C)	13.9 ~	VKH22	-	IKH22	VKH22	4	INDONESIA
		ABA-AUCJXF	CJX(T/C)	14.2 ~	VKH22	-	IKH22	VKH22	4	INDONESIA
ABA-AUDJHF		DJH(T/C)	17.5 ~	-	-	-	-	4	INDONESIA	
ABA-AUDLB		DLB(T/C)	19.2 ~	VKH22	-	IKH22	VKH22	4	INDONESIA	
GOLF3	1800	E-1HABS	ABS	92.3 ~94.9	W20EPBR-S	-	IW20	VW20	4	INDONESIA
		E-1HADZ	ADZ	94.10~	W20EPBR-S	-	IW20	VW20	4	INDONESIA
	2000	E-1H2E	2E	92.3 ~94.9	W20EPBR-S	-	IW20	VW20	4	INDONESIA
		E-1HABF	ABF	92.10~98.7	IK20	-	IK20	VK20	4	INDONESIA
		E-1E2EK	2E	94.2 ~94.9	W20EPBR-S	-	IW20	VW20	4	INDONESIA
		E-1EADYK	ADY	94.10~	W20EPBR-S	-	IW20	VW20	4	INDONESIA
		E-1HADY	ADY	94.10~96	W20EPBR-S	-	IW20	VW20	4	INDONESIA
		E-1EAGGK · E-1HAGG	AGG	96.1 ~98.7	W20EPBR-S	-	IW20	VW20	4	INDONESIA
	2800	E-1HAAA	AAA	92.10~98.7	K20TXR	K20TT(*5)	IK20	VK20	6	INDONESIA
	GOLF4	1600	GF-1JAEH	AEH	98.8 ~01.7	K20PBR-S10	-	IK20	VK20	4
GF-1JAVU			AVU	01.7 ~02.8	K20PBR-S10	-	IK20	VK20	4	INDONESIA
GF-1JBFQ · GH-1JBFQ			BFQ	02.8 ~	K20PBR-S10	-	IK20	VK20	4	INDONESIA
1800		GF-1JAGN	AGN	98.8 ~99	K20PBR-S10	-	IK20	VK20	4	INDONESIA
		GF-1JAUM	AUM	01.9 ~02.8	VK20	-	IK20	VK20	4	INDONESIA
		GH-1JAUM	AUM	03 ~	VK20	-	IK20	VK20	4	INDONESIA

(\*5) : It can be used only for a plug with a terminal.

AUSTRALIA  
 CHINA  
 INDIA  
 INDONESIA  
 KOREA  
 MALAYSIA  
 PHILIPPINES  
 SAUDI ARABIA  
 SINGAPORE  
 TAIWAN  
 THAILAND  
 VIETNAM  
 JAPAN  
 EUROPE & USA  
 CROSS REFERENCE NUMBER  
 PART



# EUROPE & U.S.A. CAR

▶ Spark plug color codes: ■ for Iridium Tough and Iridium Plugs and Iridium TT, ■ for Iridium Power, ■ for Iridium Racing and Two Tops Plugs, ■ for Platinum Plugs and Platinum TT, and black for general spark plugs.

MODEL	CC	VEHICLE CODE	ENGINE	FROM-TILL	DENSO	TJ	IRIDIUM POWER	IRIDIUM TOUGH	QTY
AUSTRALIA	1800	GF-1JAGU	AGU(T/C)	98.8 ~01	VK20Y	-	-	VK20Y	4
		GF-1JAPK	APK	98.8 ~02.8	K20PBR-S10	-	IK20	VK20	4
CHINA	2000	GF-1EAGG	AGG	99.2 ~	W20EPBR-S	-	IW20	VW20	4
		GH-1JAZJ	AZJ	03.10~	VKA16	-	-	VKA16	4
INDIA	3200	GH-1JBFHF	BFH	03 ~06.2	-	-	-	-	6
		ABA-1KBLG	BLG(T/C)	07.2 ~	-	-	-	-	4
INDONESIA	1400	ABA-1KBMV	BMV(T/C)	08.1 ~	VK20Y	-	-	VK20Y	4
		ABA-1KCAX	CAX(T/C)	08.6 ~10.2	-	-	-	-	4
KOREA	1600	GH-1KBAG	BAG	04.4 ~	K20PBR-S10	-	IK20	VK20	4
		GH-1KBLP	BLF	04.9 ~	K20PBR-S10	-	IK20	VK20	4
MALAYSIA	2000	GH1-KAXW	AXW	04.6 ~04.9	VKA16	-	-	VKA16	4
		GH-1KBLX	BLR	05.10~06.2	VKA16	-	-	VKA16	4
PHILIPPINES	2000	GH-1KBLX	BVY	06.2 ~07.10	VKA16	-	-	VKA16	4
		ABA-1KAXX	BWA(T/C)	07.8 ~	VK20Y	-	-	VK20Y	4
SAUDI ARABIA	2000	GH-1KAXX	BWA(T/C)	05.5 ~06.2	VK20Y	-	-	VK20Y	4
		ABA-1KBYD	BYD(T/C)	08.10~	-	-	IK22	VK22	4
SINGAPORE	3200	ABA-1KBUBF · GH-1KBUBF	BUB	06.2 ~	-	-	-	-	6
		DBA-1KCBZ	CBZ(T/C)	10.6 ~	-	-	-	-	4
TAIWAN	1200	ABA-1KCAX	CAX(T/C)	09.4 ~	-	-	-	-	4
		DBA-1KCAV	CAV(S/C+T/C)	11.8 ~	-	-	-	-	4
THAILAND	1400	DBA-1KCAV	CAX(T/C)	10.2 ~	-	-	-	-	4
		ABA-1KCAV	CAV(S/C+T/C)	09.4 ~	-	-	-	-	4
VIETNAM	2000	DBA-1KCAVK	CAV(S/C+T/C)	11.10~	-	-	-	-	4
		DBA-1TCTHW	CTH(S/C+T/C)	12.11~	-	-	-	-	4
JAPAN	2000	ABA-1KCDLF	CDL(T/C)	10.3 ~	VK22	-	IK22	VK22	4
		ABA-1KCCZ	CCZ(T/C)	09.9 ~	VK22	-	IK22	VK22	4
EUROPE & USA	1600	GH-1KBLP	BLF	04.9 ~	K20PBR-S10	-	IK20	VK20	4
		2000	GH-1KBLX	BLX	05.10~	VKA16	-	-	VKA16
EUROPE & USA	1200	DBA-16CBZK	CBZ(T/C)	13.3 ~	-	-	-	-	4
		DBA-16CBZ	CBZ(T/C)	15.7 ~	-	-	-	-	4
EUROPE & USA	1400	ABA-16CZD	CZD(T/C)	16.11~	-	-	-	-	4
		2000	ABA-16CPL	CPL(T/C)	13.10~	VKH22	-	IKH22	VKH22
EUROPE & USA	1400	ABA-1KBLG	BLG	07.10~	-	-	-	-	4
		ABA-1KCAV	CAV(S/C+T/C)	08.9 ~	-	-	-	-	4
EUROPE & USA	2000	GH-1KBLX	BLX	05.10 ~07.10	VKA16	-	-	VKA16	4
		GH-1KAXX · ABA-1KAXX	BWA(T/C)	06.2 ~	VK20Y	-	-	VK20Y	4
EUROPE & USA	1400	GF-6XAU	AUA	01.7 ~02.9	K20PBR-S10	-	IK20	VK20	4
		GH-6XBBY	BBY	02.9 ~	VKA16	-	-	VKA16	4
EUROPE & USA	1600	GH-6EAVY	AVY	03.4 ~	K20PBR-S10	-	IK20	VK20	4
		1600	ABA-9CBFS · GH-9CBFS	BFS	04.10~	K20PBR-S10	-	IK20	VK20
EUROPE & USA	1800		GF-9CAVC	AVC	00.4 ~02.2	VK20	-	IK20	VK20
		GF-9CAWU · GH-9CAWU	AWU(T/C)	02.6 ~	VK20Y	-	-	VK20Y	4
EUROPE & USA	2000	GF-9CAQY	AQY	99.9 ~02.8	K20PBR-S10	-	IK20	VK20	4
		ABA-9CAZJ · GH-9CAZJ	AZJ	02.8 ~	VKA16	-	-	VKA16	4
EUROPE & USA	2000	ABA-1YAZJ · GH-1YAZJ	AZJ	03.5 ~	VKA16	-	-	VKA16	4
		1400	DBA-3CCAX	CAX(T/C)	11.5 ~	-	-	-	-
EUROPE & USA	1800		DBA-3CCAX	CAX(T/C)	13.4 ~	-	-	-	-
		DBA-3CCZE	CZE(T/C)	15.7 ~	-	-	-	-	4
EUROPE & USA	2300	DLA-3CCUK	CUK(T/C)	16.6 ~	-	-	-	-	4
		E-3BADR	ADR	97.8 ~99	K20PBR-S10	-	IK20	VK20	4
EUROPE & USA	1800	E-3BAEB	AEB(T/C)	97.8 ~99	K20PBR-S10	-	-	VK20Y	4
		GF-3BAPU	APU(T/C)	98 ~01.10	VK20Y	-	-	VK20Y	4
EUROPE & USA	2000	GF-3BAPT	APT	99.1 ~	K20PBR-S10	-	IK20	VK20	4
		ABA-3CBZB	BZB(T/C)	08.2 ~	VK20Y	-	-	VK20Y	4
EUROPE & USA	2000	E-3A2E	2E	94.2 ~94.12	W20EPBR-S	-	IW20	VW20	4
		E-3A2E	ADY	94.10~97.7	W20EPBR-S	-	IW20	VW20	4
EUROPE & USA	2000	GF-3BAZM · GH-3BAZM	AZM	02.4 ~06.4	K20PBR-S10	-	IK20	VK20	4
		ABA-3CBVY · GH-3CBVY	BVY	06.4 ~08.1	VKA16	-	-	VKA16	4
EUROPE & USA	2000	ABA-3CAXX · GH-3CAXX	BWA(T/C)	06.4 ~08.1	VK20Y	-	-	VK20Y	4
		ABA-3CCAW	CAW(T/C)	08.5 ~	-	-	-	-	4
EUROPE & USA	2300	ABA-3CCHH	CHH(T/C)	16.9 ~	VKH22	-	IKH22	VKH22	4
		GF-3BAZX · GH-3BAZX	AZX	01.10~06.4	VKA16	-	-	VKA16	5
EUROPE & USA	2800	E-31AAA	AAA	92.10~94.1	K20TXR	K20TT(*5)	IK20	VK20	6
		E-3AAAA	AAA	94.2 ~97.7	K20TXR	K20TT(*5)	IK20	VK20	6
EUROPE & USA	2800	E-3BACKF	ACK	98.4 ~99	K20PBR-S10	-	-	VK20Y	6
		GF-3BAPRF	APR	99.3 ~01	K20TXR	K20TT(*5)	IK20	VK20	6
EUROPE & USA	2800	GF-3BAMX · GH-3BAMX	AMX	01.10~06.4	K20TXR	K20TT(*5)	IK20	VK20	6

(\*5) : It can be used only for a plug with a terminal.





MODEL	CC	VEHICLE CODE	ENGINE	FROM-TILL	DENSO		IRIDIUM POWER	IRIDIUM TOUGH	QTY		
<b>VOLKSWAGEN</b>											
<b>PASSAT</b>	2800	GF-3BAMXF · GH-3BAMXF	AMX	01.9 ~06.4	K20TXR	K20TT(*5)	IK20	VK20	6	AUSTRALIA	
	3200	ABA-3CAXZF · GH-3CAXZF	AXZ	06.7 ~	-	-	-	-	6	CHINA	
	3600	ABA-3CBWSF	BWS	08.9 ~	-	-	-	-	6		
	4000	GH-3BBDNF	BDN	02.5 ~06.4	K20TXR	K20TT(*5)	IK20	VK20	8		
<b>PASSAT CC</b>	2000	ABA-3CCAWC	CAW(T/C)	08.11~10.3	-	-	-	-	4	INDIA	
		ABA-3CCCZC	CCZ(T/C)	10.3 ~	VK22	-	IK22	VK22	4		
	3600	ABA-3CBWSC	BWS	08.11~	-	-	-	-	6		
<b>VOLKSWAGEN CC</b>	1800	ABA-3CCDAC	CDA(T/C)	12.7 ~	VK22	-	IK22	VK22	4	INDONESIA	
<b>POLO</b>	1000	ABA-AWCHZ	CHZ(T/C)	18.3 ~	-	-	-	-	3	KOREA	
		3BA-AWDKL	DKL(T/C)	20.12~	-	-	-	-	3		
		DBA-6RCBZ	CBZ(T/C)	10.6 ~	-	-	-	-	4		
	1200	DBA-6RCJZ	CJZ(T/C)	14.8 ~	-	-	-	-	4	MALAYSIA	
		DBA-6RCJZ	CJZ(T/C)	15.7 ~	-	-	-	-	4		
	1400	E-6NAFH	AFH	96.9 ~	K20PBR-S10	-	IK20	VK20	4	PHILIPPINES	
		GF-6NAHW	AHW	00.5 ~02.3	K20PBR-S10	-	IK20	VK20	4		
		GH-9NBBY	BBY	02.6 ~04.10	VKA16	-	-	VKA16	4		
		GH-9NBKY	BKY	04.10 ~07.10	KJ16CR-L11	-	-	VKA16	4		
		ABA-9NBUD	BUD	07.10 ~09.10	VKA20	-	-	VKA20	4		
		ABA-6RCGG	CGG	09.10~	VKA20	-	-	VKA20	4		
		ABA-6RCAV	CAV(S/C+T/C)	12.11~	-	-	-	-	4		
		DBA-6RCPT	CPT(T/C)	13.9 ~	-	-	-	-	4		
		ABA-6RCTH	CTH(S/C+T/C)	13.9 ~	-	-	-	-	4		
		DBA-6RCZE	CZE(T/C)	14.10~	-	-	-	-	4		
	1500	ABA-AWDAD	DAD(T/C)	19.1 ~	-	-	-	-	4	SAUDIARABIA	
		3BA-AWDAD	DAD(T/C)	20.12~	-	-	-	-	4		
	1600	E-6NAEE	AEE	95.9 ~99	-	-	-	-	4	SINGAPORE	
		E-6NAHS	AHS	96.5 ~99	W16ETR-S(*2)	-	IW16	VW16	4		
		GF-6NARC	ARC	00.5 ~04.10	K20PBR-S10	-	IK20	VK20	4		
		ABA-9NBTS · GH-9NBTS	BTS	06.4 ~	VKA20	-	-	VKA20	4		
	1800	ABA-9NBX	BJX(T/C)	05.9 ~	VK20Y	-	-	VK20Y	4	TAIWAN	
		ABA-6RDAJ	DAJ(T/C)	15.2 ~	VKH22	-	IKH22	VKH22	4		
	2000	ABA-AWCZP	CZP(T/C)	18.7 ~	VKH22	-	IKH22	VKH22	4	VIETNAM	
		3BA-AWCZP	CZP(T/C)	20.12~	VKH22	-	IKH22	VKH22	4		
	<b>SCIROCCO</b>	1400	ABA-13CAV	CAV(T/C·S/C)	09.5 ~	-	-	-	-	4	THAILAND
			DBA-13CTH	CTH(S/C+T/C)	13.4 ~	-	-	-	-	4	
		ABA-13CAW	CAW(T/C)	09.5 ~	VK22	-	IK22	VK22	4		
		2000	ABA-13CCZ	CCZ(T/C)	10.1 ~	VK22	-	IK22	VK22	4	
	1400	ABA-13CDL	CDL(T/C)	10.2 ~	VK22	-	IK22	VK22	4	JAPAN	
		DBA-7NCAV	CAV(S/C+T/C)	12.10~	-	-	-	-	4		
	<b>SHARAN</b>	1400	DBA-7NCZD	CZD(T/C)	15.9 ~	-	-	-	-	4	THAILAND
2800			E-7MAAA	AAA	96.8 ~03.9	K20TXR	K20TT(*5)	IK20	VK20	6	
<b>T-Cross</b>	1000	3BA-C1DKR	DKR(T/C)	20.1 ~	-	-	-	-	3	VIETNAM	
<b>TIGUAN</b>	1400	DBA-5NCTH	CTH(S/C+T/C)	12.11~	-	-	-	-	4		
		DBA-5NCTH	CTH(S/C+T/C)	13.9 ~	-	-	-	-	4		
		ABA-5NCZE	CZE(T/C)	17.1 ~	-	-	-	-	4		
	2000	ABA-5NCZD	CZD(T/C)	19.1 ~	-	-	-	-	4		
		ABA-5NCAW	CAW(T/C)	09.10~10.9	VK22	-	IK22	VK22	4		
		ABA-5NCCZ	CCZ(T/C)	10.9 ~	VK22	-	IK22	VK22	4		
<b>TOUAREG</b>	3000	DAA-7PCGEA	CGE(S/C)	12.12~	IK24	-	IK24	-	6	EUROPE & USA	
	3200	GH-7LAZZS	AZZ	03.9 ~04.8	-	-	-	-	6		
		GH-7LBMVS	BMV	04.8 ~07.5	-	-	-	-	6		
	3600	ABA-7LBHKS	BHK	07.5 ~	-	-	-	-	6		
		DBA-7PCGRA · DBA-7PCGRS	CGR	12.12~	-	-	-	-	6		
	4200	GH-7LAXQS · GH-7LAXQA	AXQ	03.9 ~07.5	K20PBR-S10	-	IK20	VK20	8		
		ABA-7LBARA	BAR	07.5 ~	VKB20	-	-	VKB20	8		
6000	GH-7LBJNA	BJN	05.7 ~	VKA20	-	-	VKA20	12			
<b>TOURAN</b>	1400	ABA-1TBMV	BMV(T/C)	07.4 ~	-	-	-	-	4	CROSS REFERENCE NUMBER	
		ABA-1TBLG	BLG(T/C)	07.4 ~	-	-	-	-	4		
		ABA-1TCAV	CAV(S/C+T/C)	09.9 ~	-	-	-	-	4		
		DBA-1TCAV	CAV(S/C+T/C)	12.7 ~	-	-	-	-	4		
	1600	GH-1TBLP	BLP	04.7 ~	K20PBR-S10	-	IK20	VK20	4		
		GH-1TBAG	BAG	04.4 ~04.7	K20PBR-S10	-	IK20	VK20	4		
	2000	GH-1TAXW	AXW	04.4 ~04.7	VKA16	-	-	VKA16	4		
		GH-1TBLX	BLX	04.7 ~06.5	VKA16	-	-	VKA16	4		
		GH-1TBLX	BVY	06.5 ~07.4	VKA16	-	-	VKA16	4		
		2500	E-70AAF	AAF	93.5 ~	W16EPB10	W16TT	IW16	VW16		5

(\*2) : USE REMOVABLE TYPE

(\*5) : It can be used only for a plug with a terminal.



# EUROPE & U.S.A. CAR

▶ Spark plug color codes: ■ for Iridium Tough and Iridium Plugs and Iridium TT, ■ for Iridium Power, ■ for Iridium Racing and Two Tops Plugs, ■ for Platinum Plugs and Platinum TT, and black for general spark plugs.

	MODEL	CC	VEHICLE CODE	ENGINE	FROM-TILL	DENSO		IRIDIUM POWER	IRIDIUM TOUGH	QTY	
AUSTRALIA	VOLKSWAGEN VANAGON	2500	E-70ACU	ACU	94.2 ~96.4	W20EPBR-S	-	IW20	VW20	5	
			GF-70ACUC	ACU	96.5 ~	W20EPBR-S	-	IW20	VW20	5	
			E-7DAET	AET	96.11~	W20EPBR-S	-	IW20	VW20	5	
CHINA	VENTO	1800	E-1HABS	ABS	92.3 ~	W20EPBR-S	-	IW20	VW20	4	
			E-1HADZ	ADZ	94.10~98	W20EPBR-S	-	IW20	VW20	4	
			E-1H2E	2E	92.3 ~94.9	W20EPBR-S	-	IW20	VW20	4	
		2000	E-1HADY	ADY	94.10~98	W20EPBR-S	-	IW20	VW20	4	
			E-1HAGG	AGG	96.1 ~	W20EPBR-S	-	IW20	VW20	4	
INDIA		2800	E-1HAAA	AAA	92.10~97	K20TXR	K20TT(*5)	IK20	VK20	6	
<b>VOLVO</b>											
INDONESIA	850	2300	E-8B5234·E-8B5234W	B5234(T/C)	93.8 ~95.7	IK22	-	IK22	VK22	5	
			E-8B5254	B2554	92.3 ~96	K20PR-U	K20TT	IK20	VK20	5	
		2400	E-8B5252	B5252	92.9 ~96	K20PR-U	K20TT	IK20	VK20	5	
			E-8B5254W	B5254	93.8 ~96	K20PR-U	K20TT	IK20	VK20	5	
			E-8B5252W	B5252	93.8 ~96	K20PR-U	K20TT	IK20	VK20	5	
KOREA	940	2300	E-9B230·E-9B230W	B230(T/C)	- ~95	W20EPR-U	-	IW20	VW20	4	
			960	2500	E-9B6254W·E-9B6254	B6254	94.9 ~96	K20PR-U	K20TT	IK20	VK20
KOREA	C30	2000	CBA-MB4204S	B4204S	09.3 ~	VT20	-	IT20	VT20	4	
			2400	CBA-MB5244	B5254	07.7 ~	K20HR-U11	-	IKH20	VKH20	5
		2500	DBA-MB5254	B5254(T/C)	07.7 ~	-	-	-	VKH20Y	5	
			MALAYSIA	C70	E-8B5234K	B5234T3(T/C)	97.5 ~99.11	-	-	IK22	VK22
2300	GF-8B5234K	B5234(T/C)			99.7 ~00	-	-	-	VK20Y	5	
	TA-8B5234K	B5234(T/C)			04.7 ~06.12	-	-	-	VK20Y	5	
2400	CBA-MB5244	B5254		10.4 ~	IKH20	-	IKH20	VKH20	5		
	E-8B5254K	B5254T(T/C)		98.9 ~99.7	-	-	IK22	VK22	5		
	GF-8B5244K	B5244(T/C)		99.7 ~01.10	-	-	-	VK20Y	5		
	GF-8B5244K	B5244(T/C)		01.1 ~01	-	-	-	VK20Y	5		
	GH-8B5244K	B5244(T/C)	01.10~04.7	-	-	-	VK20Y	5			
2500	CBA-MB5244	B5244	06.12~	K20HR-U11	-	IKH20	VKH20	5			
MALAYSIA	S40	1800	E-4B4184W	-	98 ~99	K20PBR-S10	-	IK20	VK20	4	
			GF-4B4184	-	99.7 ~00	K20PBR	-	IK20	VK20	4	
			1900	E-4B4194	B4194(T/C)	98 ~99	VK20Y	-	-	VK20Y	4
		2000	E-4B4204	-	98 ~99	K20PBR-S10	-	IK20	VK20	4	
			GF-4B4204	(T/C)	99.7 ~02	K20PBR	-	IK20	VK20	4	
			GH-4B4204	B4204S2	02.7 ~04.5	K20PBR	-	IK20	VK20	4	
			CBA-MB4204S	B4204S	09.3 ~	VT20	-	IT20	VT20	4	
			2400	UA-MB5244	B5244	04.5 ~	K20HR-U11	-	IKH20	VKH20	5
		2400	CBA-MB5244	B5244	04 ~	K20HR-U11	-	IKH20	VKH20	5	
			CBA-MB5244	B5254(T/C)	04.10~	-	-	-	VKH20Y	5	
			UA-MB5254	B5254(T/C)	04.5 ~	-	-	-	VKH20Y	5	
			2500	CBA-MB5244	B5244	04.10~	K20HR-U11	-	IKH20	VKH20	5
		MALAYSIA	S60	1500	DBA-FB4154T	B4154T(T/C)	16.2 ~	ZXE24HR7	-	-	-
DBA-FB4154T	B4154T(T/C)				17.8 ~	ZXE24HLR7	-	-	-	4	
1600	DBA-FB4164T				B4164T(T/C)	11.7 ~	-	-	-	-	4
2000	DBA-FB420			B420(T/C)	14.2 ~	ZXE24HR7	-	-	-	-	4
	DBA-FB420			B420(S/C+T/C)	16.2 ~	ZXE24HR7	-	-	-	-	4
	DBA-FB420			B420(T/C)	17.8 ~	ZXE24HLR7	-	-	-	-	4
	DBA-FB420			B420(S/C+T/C)	17.8 ~	ZXE24HLR7	-	-	-	-	4
	DBA-ZB420			B420(T/C)	19.11~	ZXE24HLR7	-	-	-	-	4
	5LA-ZB420PT6			B420(S/C+T/C)	19.11~	ZXE24HLR7	-	-	-	-	4
	5AA-ZB420TM			B420T6(T/C)	20.11~	ZXE24L-S7	-	-	-	-	4
5AA-ZB420TM	B420T2(T/C)			20.11~	ZXE24L-S7	-	-	-	-	4	
5LA-ZB420PT6	B420(S/C+T/C)			20.11~	ZXE24L-S7	-	-	-	-	4	
2300	TA-RB5234			B5234(T/C)	01.10~	PK20PR-P8	-	-	-	VK20Y	5
	GH-RB5244	B5244	01.1 ~05.1	K20PR-U	K20TT	IK20	VK20	5			
	GH-RB5244	B5244(T/C)	01.1 ~01.10	-	-	-	VK20Y	5			
	TA-RB5244	B5244	01.10~	-	-	IK20	VK20	5			
	2400	TA-RB5244·TA-RB5244A	B5244(T/C)	01.10~	-	-	-	VK20Y	5		
		LA-RB5244	B5244	02.1 ~05.1	K20PBR	-	IK20	VK20	5		
		CBA-RB5244T	B5244T(T/C)	04.10~	-	-	-	VK20Y	5		
		CBA-RB5244	B5244	05.1 ~	K20PBR	-	IK20	VK20	5		
2500	LA-RB5254A	B5254(T/C)	02.11~	-	-	-	VK20Y	5			
	LA-RB5254	B5254(T/C)	03.5 ~04.10	-	-	-	VK20Y	5			
	CBA-RB5254A	B5254(T/C)	05.8 ~	-	-	-	VK20Y	5			
	CBA-RB5254	B5254(T/C)	05.11~	-	-	-	VK20Y	5			

(\*5) : It can be used only for a plug with a terminal.



MODEL	CC	VEHICLE CODE	ENGINE	FROM-TILL	DENSO		IRIDIUM POWER	IRIDIUM TOUGH	QTY			
<b>VOLVO</b>												
<b>S60</b>	3000	CBA-FB6304T	B6304T(T/C)	11.7 ~	FK20HQR10	-	-	VFKH20	6	AUSTRALIA		
<b>S60R</b>	2500	CBA-RB5254A	B5254(T/C)	05.8 ~	-	-	-	VKH20Y	5	CHINA		
<b>S70</b>	2400	GF-8B5244	B5244	99.7 ~	K20PR-U	K20TT	IK20	VK20	5	INDIA		
		GF-8B5244	B5244(T/C)	99.7 ~	-	-	-	VK20Y	5			
		E-8B5254	B5254(T/C)	97.2 ~	-	-	-	VK20Y	5			
	2500	E-8B5252	B5252	97.2 ~99	K20PR-U	K20TT	IK20	VK20	5			
		E-8B5254	B5254	97.2 ~	K20PR-U	K20TT	IK20	VK20	5			
		GF-TB5244	B5244	98.12~00.8	K20PR-U	K20TT	IK20	VK20	5			
<b>S80</b>	2400	GH-TB5244	B5244	00.8 ~01.10	K20PR-U	K20TT	IK20	VK20	5	INDONESIA		
		2500	DBA-AB5254	B5254(T/C)	09.4 ~	-	-	VKH20Y	5			
	2800	GF-TB6284	B6284(T/C)	98.8 ~01.10	-	-	-	VK20Y	6			
		LA-TB6284	B6284(T/C)	02 ~	IK22	-	IK22	VK22	6			
	2900	GF-TB6304	B6304	99.7 ~00	K20PR-U	K20TT	IK20	VK20	6			
		GF-TB6294	B6294	99.7 ~01.10	K20PRR	-	IK20	VK20	6			
		LA-TB6294	B6294	01.10~	K20PRR	-	IK20	VK20	6			
		LA-TB6294	B6294(T/C)	01.10~	-	-	-	VK20Y	6			
		3000	DBA-AB6304T <small>(Last 6 digits of vehicle identification number: up to 134000)</small>	B6304T(T/C)	09.7 ~	-	-	-	VKH20Y		6	
	3200	DBA-AB6304T <small>(Last 6 digits of vehicle identification number: starting from 134001)</small>	B6304T(T/C)	09.7 ~	FK20HQR10	-	-	VFKH20	6			
		CBA-AB6304T	B6304T(T/C)	10.7 ~	FK20HQR10	-	-	VFKH20	6			
		CBA-AB6324	B6324	06.11~	IKH20	-	IKH20	VKH20	6			
		4400	CBA-AB8444	B8444	06.11~	VK20	-	IK20	VK20		8	
	<b>S90</b>	2500	E-986254	-	97.1 ~98.12	K20PR-U	K20TT	IK20	VK20		6	MALAYSIA
		3000	E-986304	-	97.1 ~98.12	K20PR-U	K20TT	IK20	VK20		6	
<b>V40</b>	1500	DBA-MB4154T	B4154T(T/C)	15.8 ~	ZXE24HR7	-	-	-	4	PHILIPPINES		
	1600	DBA-MB4164T	B4164T(T/C)	13.12~	-	-	-	-	4			
	1800	E-4B4184W	B4184S	97.10~	K20PBR	-	IK20	VK20	4			
		GF-4B4184W	-	99.7 ~00	K20PBR	-	IK20	VK20	4			
	1900	E-4B4194W	B4194(T/C)	97.10~	-	-	-	VK20Y	4			
		E-4B4204W	B4204	97.10~	K20PBR	-	IK20	VK20	4			
		GF-4B4204W	B4204(T/C)	99.7 ~	-	-	-	VK20Y	4			
	2000	GF-4B4204W	B4204	99.7 ~	K20PBR	-	IK20	VK20	4			
		GH-4B4204W	B4204(T/C)	02.7 ~	-	-	-	VK20Y	4			
		GH-4B4204W	B4204	02.7 ~	K20PBR	-	IK20	VK20	4			
		DBA-MB5204T	B5204T(T/C)	13.4 ~	VKH22	-	IKH22	VKH22	5			
		DBA-MB420	B420(T/C)	14.11~	ZXE24HR7	-	-	-	4			
		CBA-MB420XC	B420(T/C)	15.7 ~	ZXE24HR7	-	-	-	4			
<b>V50</b>	2000	CBA-MB4204S	B4204S	09.3 ~	VT20	-	IT20	VT20	4	SAUDIARABIA		
		CBA-MBA4204S	B4204S	11.7 ~	IT20	-	IT20	VT20	4			
	2400	UA-MB5244	B5244	04.5 ~	IKH22	-	IKH22	VKH22	5			
		CBA-MB5244	B5244	04.6 ~	IKH20	-	IKH20	VKH20	5			
	2500	UA-MB5254	B5254(T/C)	04.5 ~	-	-	-	VKH20Y	5			
		CBA-MB5254A	B5254(T/C)	04.10~	-	-	-	VKH20Y	5			
		DBA-MB5254A · DBA-MB5254	B5254(T/C)	05.8 ~	-	-	VKH20Y	5				
<b>V60</b>	1500	DBA-FB4154T	B4154T(T/C)	16.2 ~	ZXE24HR7	-	-	-	4	SINGAPORE		
		DBA-FB4154T	B4154T(T/C)	17.8 ~	ZXE24HLR7	-	-	-	4			
	1600	DBA-FB4164T	B4164T(T/C)	11.6 ~	-	-	-	-	4			
		DBA-FB420	B420(T/C)	14.2 ~	ZXE24HR7	-	-	-	4			
	2000	DBA-FB420	B4204T(T/C)	14.2 ~	-	-	-	-	4			
		DBA-FB420	B420(S/C+T/C)	16.2 ~	ZXE24HR7	-	-	-	4			
		DBA-FB420	B420(T/C)	17.8 ~	ZXE24HLR7	-	-	-	4			
		DBA-FB420	B420(S/C+T/C)	17.8 ~	ZXE24HLR7	-	-	-	4			
		DBA-ZB420	B420(T/C)	18.9 ~	ZXE24HLR7	-	-	-	4			
		5LA-ZB420PT6 · 5LA-ZB420P	B420(S/C+T/C)	18.9 ~	ZXE24HLR7	-	-	-	4			
		5AA-ZB420TM	B420T6(T/C)	20.10~	ZXE24L-S7	-	-	-	4			
		5AA-ZB420TM	B420T2(T/C)	20.10~	ZXE24L-S7	-	-	-	4			
			5LA-ZB420PT6	B420(S/C+T/C)	20.10~	ZXE24L-S7	-	-	4			
	3000	CBA-FB6304T	B6304T(T/C)	11.6 ~	FK20HQR10	-	-	VFKH20	6			
<b>V70</b>	1600	DBA-BB4164TW	B4164T	11.10~	-	-	-	-	4	TAIWAN		
	2000	CBA-BB4204TW	B4204T	11.10~	-	-	-	-	4			
		DBA-BB420W	B420(T/C)	14.12~	ZXE24HR7	-	-	-	4			
	2300	E-8B5234W	B5234(T/C)	97.7 ~99	VK22	-	IK22	VK22	5			
		E-8B5234AW	B5234(T/C)	97.7 ~	VK22	-	IK22	VK22	5			
		GH-SB5234W	B5234(T/C)	00.4 ~	VK22	-	IK22	VK22	5			
		TA-SB5234W	B5234(T/C)	02.1 ~	-	-	-	VK20Y	5			
	2400	E-8B5252W	B5255	97.2 ~99	K20PR-U	K20TT	IK20	VK20	5			

AUSTRALIA  
 CHINA  
 INDIA  
 INDONESIA  
 KOREA  
 MALAYSIA  
 PHILIPPINES  
 SAUDIARABIA  
 SINGAPORE  
 TAIWAN  
 THAILAND  
 VIETNAM  
 JAPAN  
 EUROPE & USA  
 CROSS REFERENCE NUMBER  
 PART



# EUROPE & U.S.A. CAR

▶ Spark plug color codes: ■ for Iridium Tough and Iridium Plugs and Iridium TT, ■ for Iridium Power, ■ for Iridium Racing and Two Tops Plugs, ■ for Platinum Plugs and Platinum TT, and black for general spark plugs.

MODEL	CC	VEHICLE CODE	ENGINE	FROM-TILL	DENSO		IRIDIUM POWER	IRIDIUM TOUGH	QTY		
AUSTRALIA CHINA INDIA INDONESIA KOREA MALAYSIA PHILIPPINES SAUDIARABIA SINGAPORE TAIWAN THAILAND VIETNAM JAPAN	VOLVO V70	E-8B5254W	B5254(T/C)	97.1 ~99	K20PR-U	K20TT	IK20	VK20	5		
		E-8B5254AW	B5254(T/C)	97.3 ~99	K20PR-U	-	-	VK20Y	5		
		E-8B5254AWL	B5254(T/C)	98.9 ~	-	-	-	VK20Y	5		
		GF-8B5244W	B5244	99.7 ~	K20PR-U	K20TT	IK20	VK20	5		
		NA-8B5252W	B5252(Bi-Fuel)	99.7 ~	-	-	-	-	5		
		GF-8B5244AW	B5244(T/C)	99.7 ~	-	-	-	VK20Y	5		
		GF-8B5244AWL	B5244(T/C)	99.7 ~	-	-	-	VK20Y	5		
		NA-8B5244W	B5244(Bi-Fuel)	99.7 ~	-	-	-	-	5		
		2400	GH-SB5244W	B5244(T/C)	00.4 ~	-	-	-	VK20Y	5	
			GH-SB5244W	B5244	00.7 ~	K20PBR	-	IK20	VK20	5	
			TA-SB5244W	B5244(T/C)	01.10~	-	-	-	VK20Y	5	
			TA-SB5244W	B5244	01.10~	K20PBR	-	IK20	VK20	5	
			TA-SB5244AW	B5244(T/C)	01.10~	-	-	-	VK20Y	5	
			LA-SB5244W	B5244	02.1 ~	K20PBR	-	IK20	VK20	5	
			LA-SB5254W	B5254(T/C)	03.5 ~	-	-	-	VK20Y	5	
			CBA-SB5244TW	B5244(T/C)	04.10~	-	-	-	VK20Y	5	
			CBA-SB5244W	B5244	05.1 ~	K20PBR	-	IK20	VK20	5	
			LA-SB5254AW	B5254(T/C)	02.11~	-	-	-	VKH20Y	5	
			2500	CBA-SB5254W · CBA-SB5254AW	B5254(T/C)	04.10~	-	-	-	VK20Y	5
				DBA-BB5254W	B5254(T/C)	08.1 ~	-	-	-	VKH20Y	5
		3000		DBA-BB6304TW	B6304T(T/C)	07.11~	-	-	-	VKH20Y	6
				CBA-BB6304TW	B6304T(T/C)	07.11~	-	-	-	-	6
		CBA-BB6304TW		B6304T(T/C)	11.10~	FK20HQR10	-	-	VFKH20	6	
		3200		CBA-BB6324W	B6324	07.11~	IKH20	-	IKH20	VKH20	6
V90	2000	DBA-PB420 · DBA-PB420A	B420(T/C)	17.2 ~	ZXE24HLR7	-	-	-	4		
		DBA-PB420 · DBA-PB420A	B420(S/C+T/C)	17.2 ~	ZXE24HLR7	-	-	-	4		
		DLA-PB420PA	B420(S/C+T/C)	17.7 ~	ZXE24HLR7	-	-	-	4		
		5LA-PB420PA	B420(S/C+T/C)	19.9 ~	ZXE24HLR7	-	-	-	4		
		5AA-PB420TM · 5AA-PB420TMA	B420T2(T/C)	20.10~	ZXE24L-S7	-	-	-	4		
		5AA-PB420TM · 5AA-PB420TMA	B420T(S/C+T/C)	20.10~	ZXE24L-S7	-	-	-	4		
		5LA-PB420PA	B420(S/C+T/C)	20.10~	ZXE24L-S7	-	-	-	4		
		2500	E-9B6254W	-	97.1 ~98.12	-	K20TT	IK20	VK20	6	
	3000	E-9B6304W	-	97.1 ~98.12	K20PR-U	K20TT	IK20	VK20	6		
	XC40	1500	5LA-XB3154XCP	B3154(T/C)	20.8 ~	-	-	-	-	3	
DBA-XB420XC			B420(T/C)	18.3 ~	ZXE24HLR7	-	-	-	4		
2000		5AA-XB420TXCM	B420T6(T/C)	20.8 ~	ZXE24L-S7	-	-	-	4		
		5AA-XB420TXCM	B420T2(T/C)	20.8 ~	ZXE24L-S7	-	-	-	4		
XC60	2000	CBA-DB4204TXC	B4204T(T/C)	10.8 ~	-	-	ITV22	-	4		
		DBA-DB420XC	B420(T/C)	14.2 ~	ZXE24HR7	-	-	-	4		
		DBA-DB420XC	B420(S/C+T/C)	16.2 ~	ZXE24HR7	-	-	-	4		
		DBA-UB420XC · DBA-UB420XCA	B420(T/C)	17.10~	ZXE24HLR7	-	-	-	4		
		DLA-UB420XCPA	B420(S/C+T/C)	17.10~	ZXE24HLR7	-	-	-	4		
		DBA-UB420XC	B420(S/C+T/C)	18.8 ~	ZXE24HLR7	-	-	-	4		
		5LA-UB420XCPA	B420(S/C+T/C)	19.3 ~	ZXE24HLR7	-	-	-	4		
		5AA-UB420TXCM · 5AA-UB420TXCMA	B420T2(T/C)	20.4 ~	ZXE24L-S7	-	-	-	4		
		5AA-UB420TXCM	B420T(S/C+T/C)	20.8 ~	ZXE24L-S7	-	-	-	4		
		5LA-UB420XCPA · 5LA-UB420XCP	B420(S/C+T/C)	20.8 ~	ZXE24L-S7	-	-	-	4		
		2500	CBA-DB525XC	B525(T/C)	15.7 ~	FK20HQR8	-	-	VFKH20	5	
		3000	CBA-DB6304TXC <small>(Last 6 digits of vehicle identification number: up to 134999)</small>	B6304T(T/C)	09.6 ~	-	-	-	VKH20Y	6	
CBA-DB6304TXC <small>(Last 6 digits of vehicle identification number: starting from 135000)</small>	B6304T(T/C)		09.6 ~	FK20HQR10	-	-	VFKH20	6			
XC70	2000	DBA-BB420XC	B420(T/C)	15.7 ~	ZXE24HR7	-	-	-	4		
		LA-SB5254AWL	B5254T2	02.11~	-	-	-	VK20Y	5		
	2500	CBA-SB5254AWL	B5254(T/C)	04.10~	-	-	-	VK20Y	5		
		CBA-BB525XC	B525(T/C)	15.7 ~	VKH20Y	-	-	VKH20Y	5		
	3000	CBA-BB6304TXC <small>(Last 5 digits of vehicle identification number: up to 94000)</small>	B6304T(T/C)	09.7 ~	VKH22	-	IKH22	VKH22	6		
CBA-BB6304TXC <small>(Last 5 digits of vehicle identification number: starting from 94001)</small>	B6304T(T/C)	09.7 ~	FK20HQR10	-	-	VFKH20	6				
3200	CBA-BB6324XC	B6324	07.11~	IKH20	-	IKH20	VKH20	6			
XC90	2000	DBA-LB420XC · DBA-LB420XCA	B420(T/C)	16.1 ~	ZXE24HR7	-	-	-	4		
		DBA-LB420XC · DBA-LB420XCA · DLA-LB420XCP · DLA-LB420XCPA	B420(S/C+T/C)	16.1 ~	ZXE24HR7	-	-	-	4		
		DBA-LB420XC · DBA-LB420XCA	B420(T/C)	17.7 ~	ZXE24HLR7	-	-	-	4		



MODEL	CC	VEHICLE CODE	ENGINE	FROM-TILL	DENSO		IRIDIUM POWER	IRIDIUM TOUGH	QTY	
<b>VOLVO XC90</b>	2000	DBA-LB420XC • DBA-LB420XCA • DLA-LB420XCPA	B420(S/C+T/C)	17.7 ~	ZXE24HLR7	-	-	-	4	AUSTRALIA
		5LA-LB420XCPA	B420(S/C+T/C)	19.8 ~	ZXE24HLR7	-	-	-	4	CHINA
		5AA-LB420TXCM	B420T2(T/C)	20.4 ~	ZXE24L-S7	-	-	-	4	
		5AA-LB420TXCMA	B420T2(T/C)	20.8 ~	ZXE24L-S7	-	-	-	4	
		5AA-LB420TXCM • 5AA-LB420TXCMA	B420T(S/C+T/C)	20.8 ~	ZXE24L-S7	-	-	-	4	INDIA
		5LA-LB420XCPA	B420(S/C+T/C)	20.8 ~	ZXE24L-S7	-	-	-	4	
	2500	LA-CB5254AW	B5254(T/C)	03.5 ~	-	-	-	VK20Y	5	
		CBA-CB5254AW	B5254(T/C)	04.10~	-	-	-	VK20Y	5	
	2900	LA-CB6294AW	B6294T(T/C)	03.5 ~	-	-	-	VK20Y	6	INDONESIA
	3200	CBA-CB6324AW <small>(Last 6 digits of vehicle identification number: up to 568000)</small>	B6324	06.10~	IKH20	-	IKH20	VKH20	6	KOREA
		CBA-CB6324AW <small>(Last 6 digits of vehicle identification number: starting from 568001)</small>	B6324	06.10~	FK20HQR10	-	-	VFKH20	6	
	4400	CBA-CB8444AW	B8444	05.8 ~	-	-	-	VK20Y	5	MALAYSIA

PHILIPPINES SAUDIARABIA SINGAPORE TAIWAN THAILAND VIETNAM JAPAN

EUROPE & USA CROSS REFERENCE NUMBER PART



# EUROPE & U.S.A. MOTORCYCLE

Spark plug color codes: ■ for Iridium Tough and Iridium TT, ■ for Iridium Power, ■ for Iridium Racing and Two Tops Plugs, ■ for Platinum Plugs and Platinum TT, and black for general spark plugs.

AUSTRALIA	CC MODEL	FROM-TILL	IRIDIUM POWER	IRIDIUM RACING	DENSO	QTY	
	<b>ADIVA</b>						
	125 N125	-	IU24	IU01-□	U24ESR-N	1	
	125 R125	-	IU24	IU01-□	U24ESR-N	1	
	250 AD250/IE	-	IU27	IU01-□	U27ESR-N	1	
CHINA	<b>APRILIA</b>						
	50 AREA51	-	IWF24	-	W24FSR	1	
	50 CLASSIC	-	IWF24	IW01-□	W24ES-U	1	
INDIA	50 GULLIVER50	-	IWF22	-	W22FSR	1	
	50 H2O	-	IWF24	-	W24FSR	1	
	50 HABANA50/CUSTOM50	-	IWF24	-	W24FPR	1	
	50 MOJITO50/C	-	IWF24	-	W24FPR	1	
	50 MX50	-	IWF27	IW01-□	W27ESR	1	
INDONESIA	50 RALLY(AIRCOOL)	-	IWF22	-	W22FSR	1	
	50 RALLY(LIQUIDCOOL)	-	IWF24	-	W24FSR	1	
	50 RS50	-	IWF24	IW01-□	W24ES-U	1	
	50 RX50	-	IWF24	IW01-□	W24ES-U	1	
	50 SCARABEO50	93 -01	IWF22	-	W22FSR	1	
KOREA	50 SCARABEO50ST	02 -	IU24	IU01-□	U24ESR-N	1	
	50 SONIC50	-	IWF24	-	W24FSR	1	
	50 SR50(Fi)	03 -	IU24A	IU01-□	-	1	
	50 SR50(CARB)	- -04	IWF24	-	W24FSR	1	
	50 SR50(CARB)	05 -	IWF27	IW01-□	W27ESR-U	1	
MALAYSIA	50 SR50 Purejet	-	-	-	N24EXRB	1	
	50 TUONO50	-	IWF24	IW01-□	W24ES-U	1	
	125 ATLANTIC125	03 -	IU24	IU01-□	U24ESR-NB	1	
	125 LEONARDO	-	IU24	IU01-□	U24ESR-N	1	
	125 RS125	-	IWF31	IW01-□	-	1	
PHILIPPINES SAUDIARABIA SINGAPORE	125 SCARABEO125	99 -	IU24	IU01-□	IU24	1	
	125 SR125	-	IWF24	IW01-□	W24ESR-U	1	
	150 LEONARDO	-	IU24	IU01-□	U24ESR-N	1	
	150 SR150	-	IWF24	IW01-□	W24ESR-U	1	
	200 ATLANTIC200	03 -	IU24	IU01-□	U24ESR-NB	1	
	200 SCARABEO200	99 -	IU24	IU01-□	U24ESR-N	1	
	200 SPORTCITY200	05 -	IU22	IU01-□	-	1	
	250 ATLANTIC250	05 -	IU24	IU01-□	U24ESR-NB	1	
	250 LEONARDO250	99 -01	IX24	IXU01-□	X24ESR-U	1	
	250 RS250/SP	-	IWF27	IW01-□	-	2	
	250 SCARABEO250/GT	05 -	IU24	IU01-□	U24ESR-NB	1	
	250 SPORTCITY250	06 -	IU27	IU01-□	-	1	
	250 SPORTCITY CUBE 250IE	-	IU27	IU01-□	-	1	
	400 ATLANTIC400	06 -	IU22	IU01-□	-	1	
	400 SCARABEO400 IE	06 -	IU22	IU01-□	-	1	
THAILAND VIETNAM	450 RXV450	06 -	IU24	IU01-□	U24ESR-NB	2	
	450 SXV450	06 -	IU24	IU01-□	U24ESR-NB	2	
	500 ATLANTIC500	01 -	IU22	IU01-□	-	1	
	500 SCARABEO500	03 -	IU22	IU01-□	-	1	
	550 RXV550	06 -	IU24	IU01-□	U24ESR-NB	2	
JAPAN	550 SXV550	06 -	IU24	IU01-□	U24ESR-NB	2	
	650 MOTO6.5	-	IX24	IXU01-□	X24ES-U	1	
	650 PEGASO650 ie/STRADA	01 -04	IX24	IXU01-□	-	1	
	650 PEGASO650STRADA	05 -	IU22	IU01-□	U22ESR-N	1	
	750 DORSODURO	09 -	IU22	IU01-□	-	2	
	750 SL750 SHIVER/GT	08 -	IU22	IU01-□	-	2	
	850 NA850 MANA/GT	08 -	IU22	IU01-□	-	2	
	1000 ETV1000 CAPONORD	05 -	IXU27	IXU01-□	XU27EPR-U	4	
	1000 RST1000 FUTURA	01 -	IXU27	IXU01-□	XU27EPR-U	4	
	1000 RSV1000/MILLE/R	99.1 -04	IXU27	IXU01-□	XU27EPR-U	4	
EUROPE & USA	1000 RSV1000R/R FACTORY	04 -	IXU27	IXU01-□	XU27EPR-U	2	
	1000 RSV1000SP	01 -	IU27	IU01-□	U27ESR-N	2	
	1000 RSV4 FACTORY/R	09 -10	IU27	IU01-□	-	4	
	1000 RSV4 FACTORY/R	11 -	IU27A	IU01-□	-	4	
	1000 SL1000 FALCO	-	IXU27	IXU01-□	XU27EPR-U	4	
	1000 TUONO1000/R/R FACTORY	03 -	IXU27	IXU01-□	XU27EPR-U	4	
	<b>BENELLI</b>						
	50 491RR/REPLICA	99 -	IWF24	-	W24FSR	1	
	50 491ST	99 -02	IWF24	-	W24FSR	1	
	50 NAKED	02 -	IWF24	-	W24FSR	1	
125 ADIVA125	01 -	IU22	IU01-□	-	1		

AUSTRALIA	CC MODEL	FROM-TILL	IRIDIUM POWER	IRIDIUM RACING	DENSO	QTY	
	<b>BENELLI</b>						
	125 VELVET125	98 -	IX24	IXU01-□	X24ESR-U	1	
	150 ADIVA150	01 -	IU22	IU01-□	-	1	
	150 VELVET150	01 -	IU24	IU01-□	U24ESR-N	1	
	250 VELVET250	01 -	IU24	IU01-□	U24ESR-N	1	
	900 TORNADO900/TRE	03 -	IU27	IU01-□	U27ESR-N	3	
	1130 TnT1130	04 -	IU27	IU01-□	U27ESR-N	3	
INDIA	<b>BETA</b>						
	125 REV'125	-	IWF22	IW01-□	W22EP-U	1	
	200 ALP200	01 -	IX24	IXU01-□	X24ESR-U	1	
	200 REV'200	-	IWF22	IW01-□	W22EP-U	1	
	250 REV-3	-	IWF22	IW01-□	W22EP-U	1	
	250 REV'250	-	IWF22	IW01-□	W22EP-U	1	
	250 TECHNO	94 -99	IWF22	IW01-□	W22EP-U	1	
	250 ZERO	90 -93	IWF22	IW01-□	W22EP-U	1	
	<b>BIMOTA</b>						
	400 db-2Jr	-	IWF22	-	W22FP-U	2	
400 FW96	97 -	IWF22	-	W22FP-U	2		
400 TESI 1D400J	- -95	IWF22	-	W22FP-U	2		
400 TESI 1D400J	96 -	IWF20	-	W20FP-U	2		
400 YB-7	-	IU27	IU01-□	IU27	4		
400 YB-7FORGORE	-	IU24	IU01-□	U24ESR-N	4		
600 BELLARIA600	-	IU24	IU01-□	U24ESR-N	4		
600 YB-9/SR/SRi	-	IU27	IU01-□	IU27	4		
600 YB-9SR	94 -95	IU27	IU01-□	U27ESR-N	4		
600 YB-9SRi	96 -98	IU27	IU01-□	U27ESR-N	4		
652 BB1BIPOST (SUPERMONO BIPOST)	96 -98	IX24	IXU01-□	X24ES-U	2		
750 db-1/S/SR	-	IX24	IXU01-□	X24ESR-U	2		
750 SB-7	-	IU27A	IU01-□	U27ETR	4		
750 YB-4	-	IX27	IXU01-□	X27ESR-U	4		
900 db-2/SR	-	IX24B	IXU01-□	X24EPR-U9	2		
900 db-2FE	-	IX22B	IXU01-□	X22EPR-U9	2		
904 DB3 MANTRA	95 -00	IX22B	IXU01-□	X22EPR-U9	2		
904 db-4/IE	-	IXU24	IXU01-□	XU24EPR-U	2		
906 TESI 1D906SR	-	IX24	IXU01-□	X24ES-U	2		
906 TESI 1D906SR-S	-	IX24	IXU01-□	X24ESR-U	2		
992 db-5	05 -	IXU24	IXU01-□	XU24EPR-U	4		
992 TESI 2D	-	IXU24	IXU01-□	-	4		
996 SB8R/SP/K	-	IU27A	IU01-□	U27ETR	2		
1000 DIECI·YB-6·YB-8	-	IX27	IXU01-□	X27ESR-U	4		
1000 FRANO	-	IX27	IXU01-□	X27ESR-U	4		
1000 TUATARA	-	IX24	IXU01-□	X24ESR-U	2		
1000 YB11	-	IX24	IXU01-□	X24ESR-U	4		
1078 DB5C 1080/1100	-	IXU24	IXU01-□	-	4		
1078 DB6C 1080/1100	-	IXU24	IXU01-□	-	4		
1078 TESI 3D CONCEPT	-	IXU24	IXU01-□	-	4		
1100 SB6·SB6-R	-	IU27	IU01-□	IU27	4		
<b>BMW</b>							
450 G450X	08 -	IU27A	IU01-□	-	1		
450 R45	78 -85	IWF20	IW01-□	W20EP-U	2		
650 C600/C650GT	-	-	-	-	2		
650 F650/ST/GS DAKAR/FUNDURO	94 -99	IX24	IXU01-□	X24ES-U	2		
650 F650GS/DAKAR/CS	00 -01	IX24	IXU01-□	X24ES-U	1		
650 F650GS/DAKAR/CS	02 -	IX24	IXU01-□	-	2		
650 G650Xcountry/Xmoto/Xchallenge	07 -	IX24	IXU01-□	-	2		
650 R65	85 -94	IWF22	IW01-□	W22EP-U	2		
650 R65/LS	78 -85	IWF22	IW01-□	W22EP-U	2		
650 R65G/S	81 -87	IWF20	IW01-□	W20EP-U	2		
750 K75/C/RT/S	85 -96	IX22	IXU01-□	X22ES-U	3		
800 F650GS	08 -08	IXU24	IXU01-□	XU24EPR-U	2		
800 F800S/ST	06 -	IXU24	IXU01-□	XU24EPR-U	2		
800 F800GS	09 -	IXU24	IXU01-□	XU24EPR-U	2		
800 F800R	09 -	IXU24	IXU01-□	XU24EPR-U	2		
800 R80/7/G/S/GS/RT/ST	78 -94	IWF20	IW01-□	W20EP-U	2		
850 R850R	94 -99	IK20	IK(Q)01-□	K20TNR	2		
850 R850R	00 -06	IK22	IK01-□	K22TNR-S	2		

DENSO	9	14	16	20	22	24	27	29	31	32	34	35	DENSO	9	14	16	20	22	24	27	31	32	DENSO	9	14	16	20	22	24	27	31	
NGK	2	4	5	6	7	8	9	9.5	10	10.5	11	11.5	CHAMPION	18	16,14	12,11	10,9	8,7	6,6,61	4,5,9	5,7	5,5	5,3	BOSCH	10	9	8	7,6	5	4	3	2



CC	MODEL	FROM-TILL	IRIDIUM POWER	IRIDIUM RACING	DENSO	QTY
<b>BMW</b>						
1000	K1	89 -92	IX22B	IXU01-□	X22EP-U9	4
1000	K100/LT/RS/RT	82 -92	IX22B	IXU01-□	X22EP-U9	4
1000	R100/7	77 -84	IW20	IW01-□	W20EP-U	2
1000	R100CS/RS/RT/S/T	77 -84	IW22	IW01-□	W22EP-U	2
1000	R100R/RS/RT/GS	87 -96	IW20	IW01-□	W20EP-U	2
1000	S1000RR	10 -	-	-	-	4
1100	K1100LT/RS	92 -96	IX22	IXU01-□	X22ESR-U	4
1100	R1100GS/R/RS/RT/S	92 -02	IK22	IK01-□	K22TNR-S	2
1100	R1100S	03 -06	IK22+ IXU22	IK01-□+ IXU01-□	K22TNR-S+ XU22EPR-U	EACH 2
1150	R1150GS/R/RT/RS	99 -02.12	IK22	IK01-□	K22TNR-S	2
1150	R1150GS/R/RT/RS	03.1 -06	IK22+ IXU22	IK01-□+ IXU01-□	K22TNR-S+ XU22EPR-U	EACH 2
1150	R1150R ROCKSTER	03.3 -	IK22+ IXU22	IK01-□+ IXU01-□	K22TNR-S+ XU22EPR-U	EACH 2
1200	HP2 ENDURO	06 -	IXU24	IXU01-□	XU24EPR-U	4
1200	HP2 MEGAMOTO	07 -	IXU24	IXU01-□	XU24EPR-U	4
1200	HP2 SPORTS	08 -	-	-	-	2
1200	K1200GT	03.3 -	IX22B	IXU01-□	X22EPR-U9	4
1200	K1200LT(115PS)	04.6 -	IX22B	IXU01-□	X22EPR-U9	4
1200	K1200LT	97 -04.5	IX22B	IXU01-□	X22EPR-U9	4
1200	K1200RS	97 -	IX22B	IXU01-□	X22EPR-U9	4
1200	K1200S/R	04 -08	IXU27	IXU01-□	XU27EPR-U	4
1200	R1200C	97 -03	IK22	IK01-□	K22PBR-S	2
1200	R1200C	04 -06	IK22+ IXU22	IK01-□+ IXU01-□	K22TNR-S+ XU22EPR-U	EACH 2
1200	R1200C AVANTGARDE	- -03	IK22	IK01-□	K22PBR-S	2
1200	R1200C AVANTGARDE	04 -04	IK22+ IXU22	IK01-□+ IXU01-□	K22TNR-S+ XU22EPR-U	EACH 2
1200	R1200C INDEPENDENT	00 -03	IK22	IK01-□	K22PBR-S	2
1200	R1200C INDEPENDENT	04 -04	IK22+ IXU22	IK01-□+ IXU01-□	K22TNR-S+ XU22EPR-U	EACH 2
1200	R1200C MONTAUK	04 -06	IK22+ IXU22	IK01-□+ IXU01-□	K22TNR-S+ XU22EPR-U	EACH 2
1200	R1200CL	03 -03	IK22	IK01-□	K22TNR-S	2
1200	R1200CL	04 -	IK22+ IXU22	IK01-□+ IXU01-□	K22TNR-S+ XU22EPR-U	EACH 2
1200	R1200GS	04 -09	IXU24	IXU01-□	-	4
1200	R1200GS	10 -	-	-	-	2
1200	R1200GS	13 -	-	-	-	2
1200	R1200R	07 -10	IXU24	IXU01-□	XU24EPR-U	4
1200	R1200R/Classic	11 -	-	-	-	2
1200	R1200RT	05 -09	IXU24	IXU01-□	-	4
1200	R1200RT	10 -	-	-	-	2
1200	R1200ST	05 -	IXU24	IXU01-□	XU24EPR-U	4
1200	R1200S	06.5 -	IXU24	IXU01-□	XU24EPR-U	4
1300	K1300S/R/GT	09 -	IXU27	IXU01-□	XU27EPR-U	4
1600	K1600GT/GTL	-	-	-	-	6
<b>BOSSHOSS</b>						
4300	V6 AT2SPEED	-	ITF16	-	-	6
4300	V6TRIKE	-	ITF16	-	-	6
5730	V8 AT2SPEED	-	IK16	IK01-□	IK16	8
5730	V8TRIKE	-	IK16	IK01-□	IK16	8
8200	502BIGBLOCK AT2SPEED	-	IW16	IW01-□	W16EP-U	8
8200	502BIGBLOCK TRIKE	-	IW16	IW01-□	W16EP-U	8
<b>BUELL</b>						
1000	XB9R FIREBOLT	01.9 --	IXU24	IXU01-□	XU24EPR-U	2
1000	XB9S LIGHTNING	02.9 --	IXU24	IXU01-□	XU24EPR-U	2
1000	XB9SX LIGHTNING CITY	05 -10	IXU24	IXU01-□	XU24EPR-U	2
1200	CYCLONE M2	- -99	IXU22	IXU01-□	XU22EPR-U	2
1200	CYCLONE M2	00 -01	IXU24	IXU01-□	XU24EPR-U	2
1200	LIGHTNING S-1	- -99	IXU22	IXU01-□	XU22EPR-U	2
1200	LIGHTNING S-1	00 -01	IXU24	IXU01-□	XU24EPR-U	2
1200	LIGHTNING X-1	- -99	IXU22	IXU01-□	XU22EPR-U	2
1200	LIGHTNING X-1/MILLENNIUM	00 -01	IXU24	IXU01-□	XU24EPR-U	2
1200	THUNDERBOLT S-3	- -99	IXU22	IXU01-□	XU22EPR-U	2
1200	THUNDERBOLT S-3	00 -01	IXU24	IXU01-□	XU24EPR-U	2

\*USE REMOVABLE TYPE

CC	MODEL	FROM-TILL	IRIDIUM POWER	IRIDIUM RACING	DENSO	QTY
<b>BUELL</b>						
1200	XB12R FIREBOLT	03.8 -10	IXU24	IXU01-□	XU24EPR-U	2
1200	XB12S/cg LIGHTNING	03.8 -10	IXU24	IXU01-□	XU24EPR-U	2
1200	XB12Ss LIGHTNING	05 -10	IXU24	IXU01-□	XU24EPR-U	2
1200	XB12STT LIGHTNING SUPER	07 -07	IXU24	IXU01-□	XU24EPR-U	2
1200	XB12X/XT ULYSSES	05 -10	IXU24	IXU01-□	XU24EPR-U	2
<b>BULTACO</b>						
50	LOBITO	01.1 -	IW27	IW01-□	W27ES-U	1
<b>CAGIVA</b>						
50	CUCCIOLO	-	IWF24	-	W24FS-U	1
50	MITO50	-	IW31	IW01-□	W31ES-U	1
50	PRIMA50	-	IW24	IW01-□	W24ES-U	1
115	STELLA115	-	-	-	-	1
125	125MITO Ev	-	IW27	IW01-□	-	1
125	CUCCIOLO125	-	IU22	IU01-□	U22ESR-N	1
125	MITO125	-	IW27	IW01-□	-	1
125	PLANET125	-	IW29	IW01-□	IW29	1
125	RAPTOR125	-	IW27	IW01-□	W27ESR-V	1
600	CANYON	-	IQ22	IQ01-□	Q22P-U	1
600	RIVER	-	IQ22	IQ01-□	Q22P-U	1
650	RAPTOR650·V RAPTOR650	-	IU24	IU01-□	U24ESR-N	2
900	ie CANYON	-	IXU24	IXU01-□	XU24EPR-U*	2
1000	XTRA RAPTOR	-	IU24A	IU01-□	U24ETR	2
1000	NAVIGATOR	00 -	IU24A	IU01-□	U24ETR	2
1000	RAPTOR·V RAPTOR	00 -	IU24A	IU01-□	U24ETR	2
<b>DERBI</b>						
50	Antorcha·Coppa·Diablo	- -91	IWF22	-	W22FS-U	1
50	Aventura	95 -	IWF24	-	W24FS-U	1
50	FDS·GTS·RD-2	- -91	IWF22	-	W22FS-U	1
50	Fenix·FDS·Super·StartDS	92 -	IWF24	-	W24FS-U	1
50	Furax	95 -	IWF24	-	W24FS-U	1
50	GPR	01.1 -	IW31	IW01-□	W31ES-U	1
50	Hunter(D+A)	95 -	IWF22	-	W22FP-U	1
50	Hunter(Spain)	95 -	IWF24	-	W24FS-U	1
50	Olimpica·Savanah·Start	- -91	IWF22	-	W22FS-U	1
50	PREDATOR	- -01.8	IW24	IW01-□	W24ES-U	1
50	RD-2 Country	92 -	IWF24	-	W24FS-U	1
50	Senda	-	IW27	IW01-□	W27ES-U	1
50	Sendra-R	95 -	IW24	IW01-□	W24ES-U	1
50	Sport·Variant·Yumbo	- -91	IWF22	-	W22FS-U	1
50	SUPERMOTORD	01.1 -	IW27	IW01-□	W27ES-U	1
50	Urban	95 -	IWF24	-	W24FS-U	1
50	Vamos	-	IWF24	-	W24FSR	1
50	VariantBox/SportR/Top	92 -	IWF24	-	W24FS-U	1
75	1001·ExtraSportCoppa	-	IW24	IW01-□	W24ES-U	1
75	CR74	-	IW31	IW01-□	IW31	1
75	EuropaRD15·Scoot74	-	IW24	IW01-□	W24ES-U	1
75	GPR·75·Sport·75	-	IW31	IW01-□	IW31	1
75	GranPrix74	-	IWF22	-	W20FS-U	1
75	VIVO-75	-	IWF16	-	W16FP-U	1
80	BI 3	95 -	IW24	IW01-□	W24ES-U	1
125	CRS·RC	-	IW31	IW01-□	IW31	1
125	Enduro·RS125TT·Karmathan	-	IW27	IW01-□	IW27	1
125	SportCoppa·TTS9	-	IW27	IW01-□	W27ES-U	1
200	2002·GranPrix·6V	-	IW27	IW01-□	W27ES-U	1
250	CRX·RC·Enduro	-	IW31	IW01-□	IW31	1
250	Turismo250	-	IW27	IW01-□	W27ES-U	1
659	MULHACEN659	-	IU22	-	U22ESR-N	1
<b>DUCATI</b>						
349	350XL PANTAH	82 -83	IWF22	-	W22FPR-U	2
398	F3	86 -88	IWF22	-	W22FPR-U	2
398	MONSTER 400	95 -97	IWF22	-	W22FPR-U	2
398	MONSTER 400/DARK	00 -08	IXU24	IXU01-□	XU24EPR-U*	2
398	SS/SSJ	89 -94	IWF22	-	W22FPR-U	2
499	500SL PANTAH	79 -81	IWF22	-	W22FPR-U	2
583	600SL PANTAH	81 -82	IWF22	-	W22FPR-U	2
583	600SS	91 -97	IXU24	IXU01-□	XU24EPR-U	2
583	600TL	82 -83	IWF22	-	W22FPR-U	2

AUSTRALIA  
CHINA  
INDIA  
INDONESIA  
KOREA  
MALAYSIA  
PHILIPPINES  
SAUDIARABIA  
SINGAPORE  
TAIWAN  
THAILAND  
VIETNAM  
JAPAN  
EUROPE & USA  
CROSS REFERENCE NUMBER  
PART



# EUROPE & U.S.A. MOTORCYCLE

Spark plug color codes: ■ for Iridium Tough and Iridium Plugs and Iridium TT, ■ for Iridium Power, ■ for Iridium Racing and Two Tops Plugs, ■ for Platinum Plugs and Platinum TT, and black for general spark plugs.

AUSTRALIA	CC MODEL	FROM-TILL	IRIDIUM POWER	IRIDIUM RACING	DENSO	QTY
	<b>DUCATI</b>					
583 MONSTER 600	93 -06	IXU24	IXU01-□	XU24EPR-U	2	
583 MONSTER 600DARK	98 -06	IXU24	IXU01-□	XU24EPR-U	2	
620 620SPORT	02 -	IXU27	IXU01-□	-	2	
CHINA	620 MONSTER 620/ie/DARK	03 -	IXU27	IXU01-□	-	2
620 MONSTER 620/ie/DARK	05 -	IXU24	IXU01-□	XU24EPR-U	2	
620 MULTISTRADA620	05 -06	IXU24	IXU01-□	XU24EPR-U	2	
648 650SL PANTAH	82 -83	IWF22	-	W22FPR-U	2	
INDIA	695 MONSTER 695	07 -	IXU24	IXU01-□	XU24EPR-U	2
696 MONSTER 696/+	08 -	IXU24	IXU01-□	XU24EPR-U*	2	
748 748MONOPOSTO/BIPOSTO/S	95 -03	IXU27	IXU01-□	IXU27	2	
748 748R	00 -03	IXU27	IXU01-□	IXU27	2	
INDONESIA	748 748SP	95 -97	IXU27	IXU01-□	IXU27	2
748 748SPS	98 -99	IXU27	IXU01-□	IXU27	2	
748 750F1	85 -88	IXU24	IXU01-□	XU24EPR-U*	2	
748 750PASO	87 -88	IXU24	IXU01-□	XU24EPR-U*	2	
748 750SPORT	88 -89	IXU24	IXU01-□	XU24EPR-U*	2	
748 750SPORT	02 -03	IXU24	IXU01-□	XU24EPR-U*	2	
748 750SS	91 -97	IXU24	IXU01-□	XU24EPR-U*	2	
748 MONSTER 750DARK	99 -03	IXU24	IXU01-□	XU24EPR-U*	2	
748 MONSTER750	96 -03	IXU24	IXU01-□	XU24EPR-U*	2	
MALAYSIA	748 SS750FF/HF	99 -03	IXU24	IXU01-□	XU24EPR-U*	2
749 749/S/DARK	03 -07	IU27(◆)	IU01-□(◆)	IU27(◆)	2	
749 749R	04 -07	-	RU01-□(◆)	-	2	
749 750SS	73 -75	IWF22	-	W22FS-U	2	
749 750SS	76 -77	IWF22	-	W22FPR-U	2	
749 750SS IMOLA	73 -74	IWF22	-	W22FS-U	2	
796 HYPERMOTARD796	10 -	IXU24	IXU01-□	XU24EPR-U	2	
796 MONSTER796	10 -	IXU24	IXU01-□	XU24EPR-U	2	
802 800SPORT FF/HF	03 -05	IXU24	IXU01-□	XU24EPR-U	2	
802 MONSTER800S/DARK ie	03 -04	IXU24	IXU01-□	XU24EPR-U	2	
802 MONSTER S2R	05 -07	IXU24	IXU01-□	XU24EPR-U	2	
802 SS800FF/HF	03 -07	IXU24	IXU01-□	XU24EPR-U	2	
848 848	09 -	-	-	-	2	
851 851RACING	88 -88	IXU27	IXU01-□	IXU27	2	
851 851STRADA	88 -92	IXU27	IXU01-□	IXU27	2	
864 900MHR	79 -84	IWF22	-	W22FPR-U	2	
864 900SD	83 -84	IWF22	-	W22FPR-U	2	
TAIWAN	864 900SD Darmah	77 -80	IWF22	-	W22FPR-U	2
864 900SS	75 -82	IWF22	-	W22FPR-U	2	
888 851SP2	90 -90	IXU27	IXU01-□	IXU27	2	
888 851SP3	91 -91	IXU27	IXU01-□	IXU27	2	
888 888SP4	92 -92	IXU27	IXU01-□	IXU27	2	
888 888SP5	93 -93	IXU27	IXU01-□	IXU27	2	
888 888SP5(RacingUse)	93 -93	-	IXU01-□	-	2	
888 888SPS	92 -92	IXU27	IXU01-□	IXU27	2	
888 888SPS(RacingUse)	92 -92	-	IXU01-□	-	2	
888 888STRADA	93 -94	IXU27	IXU01-□	IXU27	2	
VIETNAM	904 900 SPORT	02 -03	IXU24	IXU01-□	XU24EPR-U*	2
904 900SS	91 -98	IXU24	IXU01-□	XU24EPR-U*	2	
904 900SS FE	98 -98	IXU24	IXU01-□	XU24EPR-U*	2	
904 900SS SUPERLIGHT	92 -97	IXU24	IXU01-□	XU24EPR-U*	2	
904 900SUPER SPORT	89 -90	IXU24	IXU01-□	XU24EPR-U*	2	
904 906PASO	89 -90	IXU24	IXU01-□	XU24EPR-U*	2	
904 907ie	91 -91	IXU24	IXU01-□	XU24EPR-U*	2	
JAPAN	904 MH900e	01 -02	IXU24	IXU01-□	XU24EPR-U*	2
904 MONSTER 900	93 -99	IXU24	IXU01-□	XU24EPR-U*	2	
904 MONSTER 900CITY	99 -99	IXU24	IXU01-□	XU24EPR-U*	2	
904 MONSTER 900CROMO	98 -99	IXU24	IXU01-□	XU24EPR-U*	2	
904 MONSTER 900DARK	98 -99	IXU24	IXU01-□	XU24EPR-U*	2	
904 MONSTER 900DARK ie	00 -03	IXU24	IXU01-□	XU24EPR-U*	2	
904 MONSTER 900ie	00 -03	IXU24	IXU01-□	XU24EPR-U*	2	
904 MONSTER 900SPECIAL	98 -99	IXU24	IXU01-□	XU24EPR-U*	2	
904 MONSTER 900SPECIAL ie	00 -03	IXU24	IXU01-□	XU24EPR-U*	2	
904 SS900FF/HF	00 -02	IXU24	IXU01-□	XU24EPR-U*	2	
904 SS900ie	98 -99	IXU24	IXU01-□	XU24EPR-U*	2	
916 916MONOPOSTO/BIPOSTO/S	95 -98	IXU27	IXU01-□	IXU27	2	
916 916SP	94 -96	IXU27	IXU01-□	IXU27	2	

CC MODEL	FROM-TILL	IRIDIUM POWER	IRIDIUM RACING	DENSO	QTY
<b>DUCATI</b>					
916 916SP(RacingUse)	94 -96	-	IXU01-□	-	2
916 916STRADA	94 -94	IXU27	IXU01-□	IXU27	2
916 MONSTER S4	01 -03	IXU27	IXU01-□	IXU27	2
916 ST4	99 -03	IXU27	IXU01-□	IXU27	2
944 ST2	97 -03	IXU24	IXU01-□	XU24EPR-U	2
973 1000MHRmille/S2mille	85 -85	IWF22	-	W22FPR-U	2
989 DESMOSEDICI RR	07 -08	-	-	-	4
992 GT1000	06 -	IXU24	IXU01-□	XU24EPR-U	4
992 MONSTER 1000S/DARK ie	03 -05	IXU24	IXU01-□	XU24EPR-U	4
992 MONSTER S2R 1000	06 -07	IXU24	IXU01-□	XU24EPR-U	4
992 MULTISTRADA1000DS/SDS	03 -06	IXU24	IXU01-□	XU24EPR-U	4
992 PAUL SMART1000	06 -06	IXU24	IXU01-□	XU24EPR-U	4
992 SPORT1000/S	06 -09	IXU24	IXU01-□	XU24EPR-U	4
992 SS1000DS FF/HF	03 -06	IXU24	IXU01-□	XU24EPR-U	4
992 ST3	04 -07	IU27	IU01-□	IU27	4
996 916SPS	97 -98	IXU27	IXU01-□	IXU27	2
996 916SPS(RacingUse)	97 -98	-	IXU01-□	-	2
996 996MONOPOSTO/BIPOSTO/S	99 -99	IXU27	IXU01-□	IXU27	2
996 996SPS	99 -00	IXU27	IXU01-□	IXU27	2
996 996SPS(RacingUse)	99 -00	-	IXU01-□	-	2
996 MONSTER S4R	03 -06	IXU27	IXU01-□	IXU27	2
996 ST4S/ABS	00 -05	IXU27	IXU01-□	IXU27	2
998 996R	01 -01	IU27(◆)	IU01-□(◆)	IU27(◆)	2
998 998/S	02 -02	IU27(◆)	IU01-□(◆)	IU27(◆)	2
998 998R	02 -02	IU27(◆)	IU01-□(◆)	IU27(◆)	2
998 MONSTER S4R/ S4RS Testastretta	06 -07	IU27(◆)	IU01-□(◆)	IU27(◆)	2
998 MONSTER S4R/ S4RS Testastretta	08 -	-	-	-	2
999 999/S/R	03 -07	IU27(◆)	IU01-□(◆)	IU27(◆)	2
999 999BIPOST	05 -07	IU27(◆)	IU01-□(◆)	IU27(◆)	2
1098 1098/R/S/S Tricolore	07 -08	-	-	-	2
1098 STREETFIGHTER/S	09 -	-	-	-	2
1100 HYPERMOTARD1100/S	08 -	IXU24	IXU01-□	XU24EPR-U	4
1100 MONSTER 1100/S	09 -	IXU24	IXU01-□	XU24EPR-U	4
1100 MULTISTRADA1100/S	07 -09	IXU24	IXU01-□	XU24EPR-U	4
1198 1198/S/R	09 -	-	-	-	2
1200 MULTISTRADA1200/S	10 -	-	-	-	2
<b>ENFIELD</b>					
250 BULLET350STD	-	-	IW01-□	W22ES-U	1
350 BULLET350DX	-	-	IW01-□	W22ES-U	1
<b>ETHOS DESIGN</b>					
100 KONDY100	-	-	-	U16FSR-U	1
<b>G G</b>					
1100 DUET	-	IX22	IXU01-□	X22ESR-U	4
1100 SPARTACO	-	IW20	IW01-□	W20EPR-U	2
1200 CRUSO	-	IK22	IK01-□	K22PBR-S	2
<b>GASGAS</b>					
50 EC50BOY	-	IK16	IK01-□	IK16	1
50 EC50ROOKIE/SM	-	IW27	IW01-□	IW27	1
50 SM50ROOKIE	-	IW27	IW01-□	IW27	1
50 TXT50BOY	-	IK16	IK01-□	IK16	1
50 TXT50ROOKIE	-	IW27	IW01-□	IW27	1
80 TXT80ROOKIE	-	IW27	IW01-□	IW27	1
125 EC125/SM/OHLINS	-	IW24	IW01-□	-	1
125 SM125	-	IW24	IW01-□	-	1
125 TX RANDONNE	11 -	IUF22	-	U20FSR-U	1
125 TXT125/PRO	-	IW16	IW01-□	W16EPR-U	1
200 EC200/OHLINS	-	IW24	IW01-□	-	1
200 TXT200/PRO	-	IW16	IW01-□	W16EPR-U	1
250 EC250/SM/OHLINS	-	IW24	IW01-□	-	1
250 PAMPERA250	-	IW22	IW01-□	W22EPR-U	1
250 SM250	-	IW24	IW01-□	-	1
250 TXT250/PRO	-	IW16	IW01-□	W16EPR-U	1
280 TXT280/PRO	-	IW16	IW01-□	W16EPR-U	1
300 EC300/OHLINS	-	IW24	IW01-□	-	1
300 TXT300/PRO	04 -	IW16	IW01-□	W16EPR-U	1

\*USE REMOVABLE TYPE ◆ For installation NB3-16SP(nepros) or B3A-16SP by KTC is recommended





CC	MODEL	FROM-TILL	IRIDIUM POWER	IRIDIUM RACING	DENSO	QTY
<b>GASGAS</b>						
321	TXT321	-	IW16	IW01-□	W16EPR-U	1
450	EC450FSE/OHLINS	-	IU24	IU01-□	U24ESR-N	1
450	EC450FSE SM/OHLINS	-	IU24	IU01-□	U24ESR-N	1
<b>GHEZZI&amp;BRIAN</b>						
1100	FURIA	02 -	IW20	IW01-□	W20EPR-U	2
1100	SUPERTWIN1100	01 -	IW20	IW01-□	W20EPR-U	2
<b>GILERA</b>						
50	RCR50	-	IW27	IW01-□	W27ES-U	1
50	RUNNER SP50	-	IW27	IW01-□	W27ESR-U	1
50	SMT50	-	IW27	IW01-□	W27ES-U	1
125	CRONO125	-	IW31	IW01-□	IW31	1
125	CX125	-	IW31	IW01-□	IW31	1
125	DNA125	01 -	IU27	IU01-□	U27ESR-NB	1
125	RUNNER FX125SP	-	IW27	IW01-□	W27ESR-U	1
125	RUNNER VX125 4T	-	IU27	IU01-□	U27ESR-N	1
175	RUNNER FXR/FXR-DD/SP	-	IW27	IW01-□	W27ESR-U	1
180	DNA180	01 -	IU24	IU01-□	U24ESR-NB	1
180	RUNNER VXR	01 -	IU24	IU01-□	U24ESR-NB	1
200	RUNNER VXR200 4T	-	IU24	IU01-□	U24ESR-N	1
350	SATURNO ISLE OF MAN350	-	IX27B	IXU01-□	X27EPR-U9	1
350	SATURNO350	94 -	IX27B	IXU01-□	X27EPR-U9	1
350	SATURNO350	-	IX24B	IXU01-□	X24EP-U9	1
500	NEXUS500 SS	-	IU24	IU01-□	U24ESR-N	1
500	SATURNO ISLE OF MAN500	-	IX27B	IXU01-□	X27EPR-U9	1
500	SATURNO500	94 -	IX27B	IXU01-□	X27EPR-U9	1
500	SATURNO500	-	IX24B	IXU01-□	X24EP-U9	1
<b>HARLEY-DAVIDSON</b>						
883	SPORTSTER(XL)	85 -03	IXU22	IXU01-□	XU22EPR-U	2
883	SPORTSTER(XL883)	04 -09	IXU22	IXU01-□	XU22EPR-U	2
883	SPORTSTER(XL883C)	04 -09	IXU22	IXU01-□	XU22EPR-U	2
883	SPORTSTER(XL883L)	04 -	IXU22	IXU01-□	XU22EPR-U	2
883	SPORTSTER(XL883N)	09 -	IXU22	IXU01-□	XU22EPR-U	2
883	SPORTSTER(XL883R)	05 -	IXU22	IXU01-□	XU22EPR-U	2
1000	XL	79 -85	IWF22	-	W22FPR-U	2
1000	XR	83 -85	IW20	IW01-□	W20EPR-U	2
1100	EVOLUTION1100SERIES	86 -87	IXU22	IXU01-□	XU22EPR-U	2
1130	NIGHT ROD(VRSCD)	06 -07	IXU24	IXU01-□	XU24EPR-U	2
1130	NIGHT ROD SPECIAL(VRSCDX)	07 -07	IXU24	IXU01-□	XU24EPR-U	2
1130	STREET ROD(VRSCR)	05 -07	IXU24	IXU01-□	XU24EPR-U	2
1130	V-ROD(VRSCA·VRSCB)	02.1 -07	IXU24	IXU01-□	XU24EPR-U	2
1200	EVOLUTION1200SERIES	86 -98	IXU22	IXU01-□	-	2
1200	FL PANHEAD	48 -65	-	-	W16PR-U	2
1200	FL SHOVELHEAD	66 -74	-	-	W16PR-U	2
1200	FL SHOVELHEAD	75 -81	IW16	IW01-□	-	2
1200	FX PANHEAD	48 -65	-	-	W16PR-U	2
1200	FX SHOVELHEAD	75 -81	IW16	IW01-□	-	2
1200	SPORTSTER(XL)	98 -03	IXU22	IXU01-□	XU22EPR-U	2
1200	SPORTSTER(XL1200C)	04 -	IXU22	IXU01-□	XU22EPR-U	2
1200	SPORTSTER(XL1200R)	04 -09	IXU22	IXU01-□	XU22EPR-U	2
1200	SPORTSTER(XL1200L)	06 -11	IXU22	IXU01-□	XU22EPR-U	2
1200	SPORTSTER(XL1200N)NIGHTSTER	08 -	IXU22	IXU01-□	XU22EPR-U	2
1200	SPORTSTER(XL50)	07 -07	IXU22	IXU01-□	XU22EPR-U	2
1200	XL1200S(TWINPLUG)	98 -03	IXU22	IXU01-□	XU22EPR-U	4
1200	XL1200X	11 -	IXU24	IXU01-□	XU24EPR-U	2
1200	XR1200	09 -10	IXU24	IXU01-□	XU24EPR-U	2
1200	XR1200X	10 -11	IXU24	IXU01-□	XU24EPR-U	2
1250	V-ROD(VRSCAW)	08 -10	IXU24	IXU01-□	XU24EPR-U	2
1250	V-ROD MUSCLE(VRSCF)	08 -	IXU24	IXU01-□	XU24EPR-U	2
1250	NIGHT ROD(VRSCD)	08 -08	IXU24	IXU01-□	XU24EPR-U	2
1250	NIGHT ROD SPECIAL(VRSCDX)	08 -	IXU24	IXU01-□	XU24EPR-U	2
1250	V-ROD 10th Anniversary (VRSCDN ANV)	12 -	IXU24	IXU01-□	XU24EPR-U	2
1340	DYNAGLIDE(FXD)	84 -98	IW16	IW01-□	-	2
1340	ELECTRAGLIDE(FLH)	84 -98	IW16	IW01-□	-	2
1340	FL SHOVELHEAD	78 -81	IW16	IW01-□	-	2
1340	FL SHOVELHEAD	82 -84	IW16	IW01-□	-	2
1340	FX SHOVELHEAD	82 -84	IW16	IW01-□	-	2

CC	MODEL	FROM-TILL	IRIDIUM POWER	IRIDIUM RACING	DENSO	QTY
<b>HARLEY-DAVIDSON</b>						
1340	HERITAGE·FATBOY(FLS)	84 -00	IW16	IW01-□	-	2
1340	ROADKING·ROADGLIDE(FLH)	84 -98	IW16	IW01-□	-	2
1340	SOFTAIL·BADBOY(FXS)	84 -00	IW16	IW01-□	-	2
1450	DYNA LOWLIDER(FXDL/FXDLI)	99 -06	IXU22	IXU01-□	XU22EPR-U	2
1450	DYNA STREET BOB(FXDBI)	06 -06	IXU22	IXU01-□	XU22EPR-U	2
1450	DYNA SUPERGLIDE(FXDI)	06 -06	IXU22	IXU01-□	XU22EPR-U	2
1450	DYNA SUPERGLIDE CUSTOM(FXDCI)	05 -06	IXU22	IXU01-□	XU22EPR-U	2
1450	DYNA SUPERGLIDE SPORT(FXDX)	99 -05	IXU22	IXU01-□	XU22EPR-U	2
1450	DYNA SUPERGLIDE(FXD)	99 -05	IXU22	IXU01-□	XU22EPR-U	2
1450	DYNA WIDEGLIDE(FXDWG)	99 -06	IXU22	IXU01-□	XU22EPR-U	2
1450	ELECTRAGLIDE CLASSIC(FLHTC)	99 -06	IXU22	IXU01-□	XU22EPR-U	2
1450	ELECTRAGLIDE STANDARD(FLHT)	99 -06	IXU22	IXU01-□	XU22EPR-U	2
1450	FAT BOY(FLSTF)	00 -06	IXU22	IXU01-□	XU22EPR-U	2
1450	HERITAGE SOFTAIL(FLST)	06 -06	IXU22	IXU01-□	XU22EPR-U	2
1450	HERITAGE SOFTAIL CLASSIC (FLSTC/FLSTCI)	00 -06	IXU22	IXU01-□	XU22EPR-U	2
1450	NIGHTTRAIN(FXSTB)	00 -06	IXU22	IXU01-□	XU22EPR-U	2
1450	ROADGLIDE INJECTION(FLTRI)	05 -06	IXU22	IXU01-□	XU22EPR-U	2
1450	ROADKING CLASSIC(FLHRCI)	99 -06	IXU22	IXU01-□	XU22EPR-U	2
1450	ROADKING CUSTOM(FLHRS)	04 -06	IXU22	IXU01-□	XU22EPR-U	2
1450	ROADKING(FLHR)	99 -06	IXU22	IXU01-□	XU22EPR-U	2
1450	SOFTAIL DEUCE(FXSTD/FXSTDI)	00 -06	IXU22	IXU01-□	XU22EPR-U	2
1450	SOFTAIL DELUX(FLSTN)	05 -06	IXU22	IXU01-□	XU22EPR-U	2
1450	SOFTAIL STANDARD(FXST)	00 -06	IXU22	IXU01-□	XU22EPR-U	2
1450	SPRINGER SOFTAIL CLASSIC(FLSTSC)	05 -06	IXU22	IXU01-□	XU22EPR-U	2
1450	SPRINGER SOFTAIL(FXSTS)	00 -06	IXU22	IXU01-□	XU22EPR-U	2
1450	STREET GLIDE(FLHX)	06 -06	IXU22	IXU01-□	XU22EPR-U	2
1450	ULTRACASSIC ELECTRAGLIDE SIDECAR(FLHTCUI S/C)	99 -06	IXU22	IXU01-□	XU22EPR-U	2
1450	ULTRACASSIC ELECTRAGLIDE(FLHTCUI)	99 -06	IXU22	IXU01-□	XU22EPR-U	2
1580	DYNA STREET BOB(FXDB)	07 -	IXU22	IXU01-□	XU22EPR-U	2
1580	DYNA SUPERGLIDE(FXD)	07 -10	IXU22	IXU01-□	XU22EPR-U	2
1580	DYNA SUPERGLIDE CUSTOM(FXDC)	07 -	IXU22	IXU01-□	XU22EPR-U	2
1580	DYNA SWITCH BACK(FLD)	11 -	IXU22	IXU01-□	XU22EPR-U	2
1580	DYNA LOWLIDER(FXDL)	07 -	IXU22	IXU01-□	XU22EPR-U	2
1580	DYNA WIDEGLIDE(FXDWG)	07 -07	IXU22	IXU01-□	XU22EPR-U	2
1580	DYNA WIDEGLIDE(FXDWG)	10 -	IXU22	IXU01-□	XU22EPR-U	2
1580	FAT BOB(FXDF)	08 -	IXU22	IXU01-□	XU22EPR-U	2
1580	FAT BOY(FLSTF)	07 -	IXU22	IXU01-□	XU22EPR-U	2
1580	FAT BOY LO(FLSTFB)	10 -	IXU22	IXU01-□	XU22EPR-U	2
1580	SOFTAIL BLACK LINE(FXS)	11 -	IXU22	IXU01-□	XU22EPR-U	2
1580	SOFTAIL CUSTOM(FXSTC)	07 -10	IXU22	IXU01-□	XU22EPR-U	2
1580	SOFTAIL DELUXE(FLSTN)	07 -	IXU22	IXU01-□	XU22EPR-U	2
1580	HERITAGE SOFTAIL CLASSIC(FLSTC)	07 -	IXU22	IXU01-□	XU22EPR-U	2
1580	SOFTAIL SPRINGER CLASSIC(FLSTSC)	07 -07	IXU22	IXU01-□	XU22EPR-U	2
1580	SOFTAIL STANDARD(FXST)	07 -11	IXU22	IXU01-□	XU22EPR-U	2
1580	NIGHT TRAIN(FXSTB)	07 -09	IXU22	IXU01-□	XU22EPR-U	2
1580	SOFTAIL DEUCE(FXSTD)	07 -07	IXU22	IXU01-□	XU22EPR-U	2
1580	SOFTAIL ROCKER(FXCWC)	08 -09	IXU22	IXU01-□	XU22EPR-U	2
1580	SOFTAIL ROCKER C(FXCWC)	08 -11	IXU22	IXU01-□	XU22EPR-U	2
1580	SOFTAIL X-BONES(FLSTSB)	08 -11	IXU22	IXU01-□	XU22EPR-U	2
1580	ULTRACASSIC ELECTRAGLIDE(FLHTCU)	07 -10	IXU22	IXU01-□	XU22EPR-U	2
1580	ELECTRAGLIDE STANDARD(FLHT)	07 -10	IXU22	IXU01-□	XU22EPR-U	2
1580	ELECTRAGLIDE CLASSIC(FLHTC)	07 -11	IXU22	IXU01-□	XU22EPR-U	2
1580	STREET GLIDE(FLHX)	07 -11	IXU22	IXU01-□	XU22EPR-U	2
1580	ROADKING CLASSIC(FLHRC)	07 -11	IXU22	IXU01-□	XU22EPR-U	2
1580	ROADKING CUSTOM(FLHRS)	07 -07	IXU22	IXU01-□	XU22EPR-U	2
1580	ROADKING(FLHR)	07 -11	IXU22	IXU01-□	XU22EPR-U	2
1580	ROADGLIDE(FLTR)	07 -09	IXU22	IXU01-□	XU22EPR-U	2
1580	ROADGLIDE CUSTOM(FLTRX)	10 -11	IXU22	IXU01-□	XU22EPR-U	2

AUSTRALIA  
CHINA  
INDIA  
INDONESIA  
KOREA  
MALAYSIA  
PHILIPPINES  
SAUDIARABIA  
SINGAPORE  
TAIWAN  
THAILAND  
VIETNAM  
JAPAN  
EUROPE & USA  
CROSS REFERENCE NUMBER  
PART



# EUROPE & U.S.A. MOTORCYCLE

Spark plug color codes: ■ for Iridium Tough and Iridium Plugs and Iridium TT, ■ for Iridium Power, ■ for Iridium Racing and Two Tops Plugs, ■ for Platinum Plugs and Platinum TT, and black for general spark plugs.

AUSTRALIA	CC MODEL		FROM-TILL	IRIDIUM POWER	IRIDIUM RACING	DENSO	QTY	
	<b>HARLEY-DAVIDSON</b>							
	1580	ULTRACLASSIC ELECTRAGLIDE WITH SIDECAR (FLHTCU S/C)	07 - 10	IXU22	IXU01-□	XU22EPR-U	2	
	1580	CVO ROADGLIDE (FLTR3-CVO)	09 - 09	IXU22	IXU01-□	XU22EPR-U	2	
CHINA	1580	CVO ROADKING (FLHR4-CVO)	08 - 08	IXU22	IXU01-□	XU22EPR-U	2	
	1580	CVO ULTRACLASSIC ELECTRAGLIDE (FLHTCU3-CVO)	08 - 08	IXU22	IXU01-□	XU22EPR-U	2	
	1580	CVO ULTRACLASSIC ELECTRAGLIDE (FLHTCU4-CVO)	09 - 09	IXU22	IXU01-□	XU22EPR-U	2	
INDIA	1580	CVO DYNA FAT BOB (FXDF2-CVO)	10 - 10	IXU22	IXU01-□	XU22EPR-U	2	
	1690	ELECTRAGLIDE ULTRA LIMITED (FLHTK103)	10 -	IXU22	IXU01-□	XU22EPR-U	2	
INDONESIA	1690	ELECTRAGLIDE ULTRA LIMITED (FLHTK103 W/SC)	11 - 11	IXU22	IXU01-□	XU22EPR-U	2	
	1690	ROADGLIDE CUSTOM (FLTRX103)	12 -	IXU22	IXU01-□	XU22EPR-U	2	
	1690	ROADGLIDE ULTRA (FLTRU103)	11 -	IXU22	IXU01-□	XU22EPR-U	2	
	1690	ROADKING (FLHR103)	12 -	IXU22	IXU01-□	XU22EPR-U	2	
	1690	STREET GLIDE (FLHX103)	12 -	IXU22	IXU01-□	XU22EPR-U	2	
KOREA	1690	ULTRACLASSIC ELECTRAGLIDE (FLHTCU103)	11 -	IXU22	IXU01-□	XU22EPR-U	2	
MALAYSIA	1690	CVO ULTRACLASSIC ELECTRAGLIDE (FLHTCUSE5)	10 - 10	IXU22	IXU01-□	XU22EPR-U	2	
	1690	CVO STREET GLIDE (FLHXSE)	10 - 10	IXU22	IXU01-□	XU22EPR-U	2	
	1800	CVO ROADGLIDE CUSTOM (FLTRXSE)	12 -	IXU22	IXU01-□	XU22EPR-U	2	
	1800	CVO ROADGLIDE ULTRA (FLTRUSE)	11 - 11	IXU22	IXU01-□	XU22EPR-U	2	
	1800	CVO SOFTAIL CONVERTIBLE (FLSTSE2)	11 - 11	IXU22	IXU01-□	XU22EPR-U	2	
	1800	CVO SOFTAIL CONVERTIBLE (FLSTSE3)	12 -	IXU22	IXU01-□	XU22EPR-U	2	
	1800	CVO STREET GLIDE (FLHXSE2)	11 - 11	IXU22	IXU01-□	XU22EPR-U	2	
	1800	CVO STREET GLIDE (FLHXSE3)	12 -	IXU22	IXU01-□	XU22EPR-U	2	
PHILIPPINES	1800	CVO ULTRACLASSIC ELECTRAGLIDE (FLHTCUSE6)	11 - 11	IXU22	IXU01-□	XU22EPR-U	2	
SAUDI ARABIA	1800	CVO ULTRACLASSIC ELECTRAGLIDE (FLHTCUSE7)	12 -	IXU22	IXU01-□	XU22EPR-U	2	
SINGAPORE	<b>HUSABERG</b>							
	250	FE250e	-	IXU24	IXU01-□	XU24EPR-U	1	
	400	DESERT FX400E	00 -	IXU24	IXU01-□	XU24EPR-U	1	
	400	DESERT FX400E	- -99	IU24	IU01-□	U24ES-N	1	
	400	ENDURO FE400/E	00 -	IXU24	IXU01-□	XU24EPR-U	1	
TAIWAN	400	ENDURO FE400/E	- -99	IU24	IU01-□	U24ES-N	1	
	400	ENDURO2 FE400S	98 -99	IU24	IU01-□	U24ES-N	1	
	400	FE400e	01 -	IXU24	IXU01-□	XU24EPR-U	1	
	400	FS400c	01 -	IXU24	IXU01-□	XU24EPR-U	1	
	400	FS400e	01 -	IXU24	IXU01-□	XU24EPR-U	1	
THAILAND	400	MOTOCROSS FC400	- -99	IU24	IU01-□	U24ES-N	1	
	400	MOTOCROSS FC400	00 -	IXU24	IXU01-□	XU24EPR-U	1	
	400	SUPERMOTORD FE400ESM	- -99	IU24	IU01-□	U24ES-N	1	
	400	SUPERMOTORD FE400ESM	00 -	IXU24	IXU01-□	XU24EPR-U	1	
VIETNAM	450	FC450	-	IXU24	IXU01-□	XU24EPR-U	1	
	450	FE450e	-	IXU24	IXU01-□	XU24EPR-U	1	
	450	FS450c	-	IXU24	IXU01-□	XU24EPR-U	1	
	450	FS450e	-	IXU24	IXU01-□	XU24EPR-U	1	
JAPAN	470	FC470/6	01 -	IXU24	IXU01-□	XU24EPR-U	1	
	470	FC470e	01 -	IXU24	IXU01-□	XU24EPR-U	1	
	470	FX470e	01 -	IXU24	IXU01-□	XU24EPR-U	1	
	500	DESERT FX501E	- -99	IU24	IU01-□	U24ES-N	1	
	500	DESERT FX501E	00 -	IXU24	IXU01-□	XU24EPR-U	1	
	500	ENDURO FE501/E	- -99	IU24	IU01-□	U24ES-N	1	
	500	ENDURO FE501/E	00 -	IXU24	IXU01-□	XU24EPR-U	1	
	500	ENDURO II FE501S	98 -99	IU24	IU01-□	U24ES-N	1	
	500	MOTOCROSS FC501	- -99	IU24	IU01-□	U24ES-N	1	
	500	MOTOCROSS FC501	00 -	IXU24	IXU01-□	XU24EPR-U	1	
	500	SUPERMOTORD FE501ESM	- -99	IU24	IU01-□	U24ES-N	1	
	500	SUPERMOTORD FE501ESM	00 -	IXU24	IXU01-□	XU24EPR-U	1	
	501	FE501e	01 -	IXU24	IXU01-□	XU24EPR-U	1	
	550	FC550	-	IXU24	IXU01-□	XU24EPR-U	1	
	550	FC550/4	01 -	IXU24	IXU01-□	XU24EPR-U	1	
	550	FC550/6	01 -	IXU24	IXU01-□	XU24EPR-U	1	
	550	FE550e	-	IXU24	IXU01-□	XU24EPR-U	1	

HUSABERG	CC MODEL		FROM-TILL	IRIDIUM POWER	IRIDIUM RACING	DENSO	QTY
	600	DESERT FX600E	- -99	IU24	IU01-□	U24ES-N	1
600	DESERT FX600E	00 -	IXU24	IXU01-□	XU24EPR-U	1	
600	ENDURO FE600/E	- -99	IU24	IU01-□	U24ES-N	1	
600	ENDURO FE600/E	00 -	IXU24	IXU01-□	XU24EPR-U	1	
600	ENDURO II FE600S	98 -99	IU24	IU01-□	U24ES-N	1	
600	FC600SM	00 -00	IXU24	IXU01-□	XU24EPR-U	1	
600	MOTOCROSS FC600	- -99	IU24	IU01-□	U24ES-N	1	
600	MOTOCROSS FC600	00 -	IXU24	IXU01-□	XU24EPR-U	1	
600	SUPERMOTORD FE600ESM	- -99	IU24	IU01-□	U24ES-N	1	
600	SUPERMOTORD FE600ESM	00 -	IXU24	IXU01-□	XU24EPR-U	1	
650	FE650e	01 -	IXU24	IXU01-□	XU24EPR-U	1	
650	FS650c	01 -	IXU24	IXU01-□	XU24EPR-U	1	
650	FS650e	01 -	IXU24	IXU01-□	XU24EPR-U	1	
650	FX650e	01 -	IXU24	IXU01-□	XU24EPR-U	1	
<b>HUSQVARNA</b>							
50	HUSKYBOY S/J	-	IWF22	-	W20FS-U	1	
125	CR125	-	IW31	IW01-□	IW31	1	
125	SM125	99 -	IW27	IW01-□	-	1	
125	SM125	-	IW27	IW01-□	-	1	
125	WR125	-	IW27	IW01-□	-	1	
125	WRE125	-	IW27	IW01-□	-	1	
250	CR250	-	IW24	IW01-□	-	1	
250	TC250	01 -	IU24	IU01-□	U24ES-NB	1	
250	TE250	01 -	IU24	IU01-□	U24ES-NB	1	
250	WR250	-	IW24	IW01-□	-	1	
360	WR360	91 -96	IW24	IW01-□	IW24	1	
400	SM400R	-	IU24	IU01-□	U24ES-NB	1	
400	TE400	01 -	IU22	IU01-□	U22ES-N	1	
400	TE410	-	IU22	IU01-□	U22ES-N	1	
450	SM450R	03 -	IU24	IU01-□	U24ES-NB	1	
450	TE450	-	IU24	IU01-□	U24ES-NB	1	
510	SM510R	-	IU24	IU01-□	U24ES-NB	1	
510	TE510/CENTENNIAL	04 -	IU24	IU01-□	U24ES-NB	1	
570	SM570R	01 -	IU22	IU01-□	U22ES-N	1	
570	TE570E	01 -	IU22	IU01-□	U22ES-N	1	
610	SM610	08 -	IU24A	IU01-□	U24EPR	1	
610	SM610/S	00 -07	IU22	IU01-□	U22ES-N	1	
610	SM610R	00 -07	IU24	IU01-□	U24ES-N	1	
610	TC610	-	IU22	IU01-□	U22ES-N	1	
610	TE610/E	-	IU22	IU01-□	U22ES-N	1	
630	SM630R	-	-	RU01-□(♦)	-	1	
<b>HYOSUNG</b>							
50	SD50 Sense	02 -	IWF20	-	W20FP-U	1	
50	SF50 Prima	02 -	IWF24	-	W24FR-L	1	
100	EZ100M	02 -	IWF22	-	W22FP-U	1	
110	FX110M MidasGold	02 -	IUF22	-	U20FS-U	1	
125	GT125 COMET	03 -	IU24	IU01-□	U24ESR-N	2	
125	MS-1-125Exceed	02 -	IX24	IXU01-□	X24ESR-U	1	
125	RT125D	09 -	IU24	IU01-□	U24ESR-N	1	
125	RT125 KARION	03 -	IUH24	IU01-□	U24FE9	1	
125	RX125	03 -	IUH24	IU01-□	U24FE9	1	
250	GT250 COMET	03 -	IU24	IU01-□	U24ESR-N	2	
250	GV250 Aquila	02 -	IU24	IU01-□	U24ESR-N	2	
<b>ITALJET</b>							
30	TIFFANY	-	IWF16	-	W16FS-U	1	
35	VELOCIFERO	- -97	IWF20	-	W20FP-L	1	
50	DRAGSTAR50	96 -97	IWF24	-	W24FPR	1	
50	FORMULA50/50LC	98 -	IWF24	-	W24FSR	1	
50	TORPEDO50	98 -	IWF24	-	W24FSR	1	
50	VELOCIFERO	98 -	IWF24	-	W24FSR	1	
125	DRAGSTAR125	98 -	IW27	IW01-□	W27ESR-U	1	
125	FORMULA125	98 -	IWF24	-	W24FSR	2	
125	FORMULA125	- -97	IWF22	-	W22FP-U	1	
125	TORPEDO125 4T	98 -	IU22	IU01-□	U22ESR-N	1	
150	JET-SET150	02 -	IU27	IU01-□	U27ESR-N	1	
180	DRAGSTAR180	98 -	IW24	IW01-□	W24ESR-U	1	

♦ For installation NB3-16SP(nepros) or B3A-16SP by KTC is recommended



CC	MODEL	FROM-TILL	IRIDIUM POWER	IRIDIUM RACING	DENSO	QTY
<b>KANNON</b>						
5000	FORD KANNON	-	ITF16	-	-	8
5700	CHEVY KANNON	-	IQ16	IQ01-□	IQ16	8
8200	BIG KANNON	-	ITF16	-	-	8
<b>KTM</b>						
50	50ADVENTURE	99 -	IWF24	-	W24FS-U	1
50	50MINI ADVENTURE	03 -	IWM24	IWM01-□	-	1
50	50PROJUNIOR	99 -	IWF24	-	W24FS-U	1
50	50PROSENIOR	99 -	IWF24	-	W24FS-U	1
50	50 SENIOR ADVENTURE	04 -	IWM24	IWM01-□	-	1
50	50SX	10 -	IUF24	-	-	1
50	50SX MINI	09 -	IUF24	-	-	1
50	50SX PROJUNIOR LC	03 -	IWM24	IWM01-□	-	1
50	50SX PROSENIOR LC	03 -	IWM24	IWM01-□	-	1
60	60SX	99 -99	IQ31	IQ02-□	IQ31	1
60	60SX	00 -	IW31	IW01-□	IW31	1
65	65SX	99 -99	IQ31	IQ02-□	IQ31	1
65	65SX	00 -	IW31	IW01-□	IW31	1
65	65SX	03 -	IWM24	IWM01-□	-	1
65	65SX	09 -	IUF24	-	-	1
85	85SX	04 -	IWM31	IWM01-□	IWM31	1
85	85SX	07 -	IWM27	-	-	1
105	105SX	11 -	IWM27	-	-	1
125	125ENDURO	- -98	IW27	IW01-□	IW27	1
125	125ENDURO	99 -99	-	IW01-□	IW01-24	1
125	125ENDURO	00 -	IW27	IW01-□	-	1
125	125EXC	00 -	IW27	IW01-□	IW27	1
125	125EXC	09 -	IWM27	-	W27EMR-C	1
125	125STREET ENDURO	-	IW31	IW01-□	IW31	1
125	125SX	-	IW27	IW01-□	IW27	1
125	125SX	08 -	IWM27	-	W27EMR-C	1
125	125DUKE	11 -	-	-	-	1
150	150SX	09 -	IWM27	-	-	1
150	150XC	10 -	IWM27	-	-	1
200	200DUKE	-	-	-	-	1
200	200ENDURO/AL	99 -	IW24	IW01-□	-	1
200	200EXC	00 -	IW24	IW01-□	-	1
200	200EXC	00 -	IW24	IW01-□	-	1
200	200SX	-	IW27	IW01-□	IW27	1
200	200XC-W	06 -	IW24	IW01-□	W24ESR-V	1
250	250ENDURO	- -98	IW24	IW01-□	IW24	1
250	250ENDURO	99 -	IWM24	IWM01-□	-	1
250	250EXC	03 -	-	IW01-□	W22ESR-U	1
250	250EXC-F	06 -	IU27A	IU01-□	-	1
250	250EXC-R	03 -	IXU24	IXU01-□	XU24EPR-U	1
250	250EXC RACING	-	IXU24	IXU01-□	XU24EPR-U	1
250	250STREET ENDURO	-	IW24	IW01-□	-	1
250	250SX	03 -	IWM24	IWM01-□	-	1
250	250SX-F	06 -	IU27A	IU01-□	-	1
250	250SX-F	13 -	-	-	-	1
250	250XC-F/XCF-W	07 -	IU27A	IU01-□	-	1
250	250XC-F	13 -	-	-	-	1
300	300ENDURO	- -98	IW24	IW01-□	IW24	1
300	300ENDURO	99 -	IWM24	IWM01-□	-	1
300	300EXC	04 -	-	IW01-□	W22ESR-U	1
300	300XC-/W	06 -	-	IW01-□	W22ESR-U	1
350	350SX-F	11 -	-	-	-	1
350	350XC-F	11 -	-	-	-	1
350	350XCF-W	12 -	-	-	-	1
360	360ENDURO	-	IW24	IW01-□	-	1
380	380ENDURO	- -98	IW24	IW01-□	IW24	1
380	380ENDURO	99 -	IWM24	IWM01-□	-	1
380	380SX	-	IWM24	IWM01-□	-	1
400	400EXC	06 -	IXU24	IXU01-□	XU24EPR-U	1
400	400EXC	09 -	-	-	-	1
400	400EXC-R	04 -	IXU24	IXU01-□	XU24EPR-U	1
400	400EXC RACING	-	IXU24	IXU01-□	XU24EPR-U	1
400	400ENDURO RACING(EXC-R)	00 -	IU24A	IU01-□	U24ETR	1

CC	MODEL	FROM-TILL	IRIDIUM POWER	IRIDIUM RACING	DENSO	QTY
<b>KTM</b>						
400	400SERIES	93 -99	IX24	IXU01-□	X24ES-U	1
400	400SUPER ENDURO E	99 -99	IX24	IXU01-□	X24ESR-U	1
400	400SUPER ENDURO E	00 -	IX24B	IXU01-□	X24EPR-U9	1
400	400XC-W	-	IXU24	IXU01-□	XU24EPR-U	1
400	400XC-W	09 -	-	-	-	1
450	450EXC	09 -	-	-	-	1
450	450EXC-R	08 -	-	-	-	1
450	450EXC RACING	03 -07	IXU24	IXU01-□	XU24EPR-U	1
450	450SMR	04 -	IXU24	IXU01-□	XU24EPR-U	1
450	450SMR	08 -	IU27A	IU01-□	-	1
450	450SMR	13 -	-	-	-	1
450	450SX/R	03 -	IXU24	IXU01-□	XU24EPR-U	1
450	450SX-F	06 -	IU27A	IU01-□	-	1
450	450SX-F FACTORY	12 -	-	-	-	1
450	450XC-/W	-	IXU24	IXU01-□	XU24EPR-U	1
450	450XC-F	12 -	-	-	-	1
450	450XC-W	12 -	-	-	-	1
450	450XC-W SixDays	10 -	-	-	-	1
450	450XCR-W	08 -	-	-	-	1
500	500EXC	12 -	-	-	-	1
500	500XC-W	12 -	-	-	-	1
520	520ENDURO RACING(EXC/R)	00 -	IU24A	IU01-□	U24ETR	1
525	525EXC RACING	03 -07	IXU24	IXU01-□	XU24EPR-U	1
525	525MXC DESERT RACING	03 -	IXU24	IXU01-□	XU24EPR-U	1
525	525SMR	04 -	IXU24	IXU01-□	XU24EPR-U	1
525	525SX	03 -06	IXU24	IXU01-□	XU24EPR-U	1
525	525XC-/W	07 -	IXU24	IXU01-□	XU24EPR-U	1
530	530EXC-R/XCR-W	08 -	-	-	-	1
530	530XC-W SixDays	10 -	-	-	-	1
540	540SUPERCROSS COUNTRY	99 -99	IX24	IXU01-□	X24ESR-U	1
540	540SUPERCROSS COUNTRY	00 -	IX24B	IXU01-□	X24EPR-U9	1
560	560SMR	07 -	IXU24	IXU01-□	XU24EPR-U	1
620	620SERIES	93 -96	IX24	IXU01-□	X24ES-U	1
620	620SERIES	97 -98	IX24	IXU01-□	IX24	1
620	620SUPERCOMPE	99 -99	IX24	IXU01-□	X24ES-U	1
620	620SUPERCOMPE	00 -	IX24B	IXU01-□	X24EPR-U9	1
620	620SUPERMOTOCOMPE	00 -	IX24B	IXU01-□	X24EPR-U9	1
625	625SMC/SXC	03 -	IXU24	IXU01-□	XU24EPR-U	1
640	640ADVENTURE R	99 -99	IX24	IXU01-□	X24ES-U	1
640	640ADVENTURE R	00 -	IX24B	IXU01-□	X24EPR-U9	1
640	640DUKE	03 -	IXU24	IXU01-□	XU24EPR-U	1
640	640DUKE TYPE II	99 -99	IX24	IXU01-□	X24ESR-U	1
640	640DUKE TYPE II	00 -	IX24B	IXU01-□	X24EPR-U9	1
640	640ENDURO	00 -	IX24B	IXU01-□	X24EPR-U9	1
640	640LC4 ADVENTURE	03 -	IXU24	IXU01-□	XU24EPR-U	1
640	640LC4 ENDURO	03 -	IXU24	IXU01-□	XU24EPR-U	1
640	640LC4 SUPERMOTO	03 -	IXU24	IXU01-□	XU24EPR-U	1
640	640RALLY	98 -98	IX24	IXU01-□	IX24	1
640	640RALLY E	99 -	IX24	IXU01-□	X24ESR-U	1
640	640SUPERENDURO E	99 -99	IX24	IXU01-□	X24ESR-U	1
640	640SUPERMOTO	99 -99	IX24	IXU01-□	X24ESR-U	1
640	640SUPERMOTO	00 -	IX24B	IXU01-□	X24EPR-U9	1
660	660FACTORY REPLICA	03 -	IX27	IXU01-□	X27ESR-U	1
660	660RALLY E	99 -99	IX24	IXU01-□	X24ESR-U	1
660	660RALLY E	00 -	IX24B	IXU01-□	X24EPR-U9	1
660	660SMC	03 -	IXU24	IXU01-□	XU24EPR-U	1
660	660SMS	04 -	IXU24	IXU01-□	XU24EPR-U	1
690	690DUKE	08 -	-	-	-	1
690	690ENDURO/SMC	08 -	-	-	-	1
690	690SUPERMOTO/PRESTIGE/R	07 -	-	-	-	1
950	950 LC8 ADVENTURE/S	03 -	IU24A	IU01-□	U24ETR	2
950	950DUKE	03 -	IU24A	IU01-□	U24ETR	2
950	950SUPER ENDURO R	06 -	IU24A	IU01-□	U24ETR	2
950	950SUPERMOTO/R	06 -	IU24A	IU01-□	U24ETR	2
990	990ADVENTURE/S	06 -	IXU24	IXU01-□	XU24EPR-U	2
990	990SMR	11 -	-	-	IXU01-□	2
990	990SMT	11 -	-	-	IXU01-□	2

AUSTRALIA  
CHINA  
INDIA  
INDONESIA  
KOREA  
MALAYSIA  
PHILIPPINES  
SAUDIARABIA  
SINGAPORE  
TAIWAN  
THAILAND  
VIETNAM  
JAPAN  
EUROPE & USA  
CROSS REFERENCE NUMBER  
PART



# EUROPE & U.S.A. MOTORCYCLE

Spark plug color codes: ■ for Iridium Tough and Iridium Plugs and Iridium TT, ■ for Iridium Power, ■ for Iridium Racing and Two Tops Plugs, ■ for Platinum Plugs and Platinum TT, and black for general spark plugs.

	CC MODEL	FROM-TILL	IRIDIUM POWER	IRIDIUM RACING	DENSO	QTY
AUSTRALIA	<b>KTM</b>					
	990 990 SUPER DUKE	05 -	IXU24	IXU01-□	XU24EPR-U	2
	990 990SUPERDUKE	06.9 -	-	IXU01-□	-	2
CHINA	990 990SUPERDUKE R	-	-	IXU01-□	-	2
	990 990SUPERMOTO/R	08 -	-	IXU01-□	-	2
	990 990SUPERMOTO T	09 -	-	IXU01-□	-	2
INDIA	1190 RC8	08 -	-	-	-	2
	1190 RC8R	09 -	-	-	-	2
	<b>KYMCO</b>					
INDONESIA	50 AGILITY50	-	IUF22	-	U20FSR-U	1
	50 CARO50/II	-	IUF22	-	U22FSR-U	1
	50 LOOKER50	-	IWF24	-	W24FR-L	1
MALAYSIA	50 SOONER50S/RS	02.5 -	IWF24	-	W24FR-L	1
	50 SUPER9/S	03 -	IWF24	-	W24FR-L	1
	50 TOPBOY50/OFF	-	IWF24	-	W24FR-L	1
PHILIPPINES	50 VITALITY50 4T	-	IUF22	-	U22FSR-U	1
	50 YUP50	-	IWF24	-	W24FR-L	1
	100 CARO II 100	-	IUF22	-	U22FS-U	1
SINGAPORE	100 SOONER100/S	-	IWF24	-	W24FR-L	1
	100 TOPBOY100/OFF	-	IWF24	-	W24FR-L	1
	125 AGILITY125	-	IUF22	-	U22FSR-U	1
TAIWAN	125 CAPTURE125	-	IUF22	-	U22FSR-U	1
	125 DINK125	-	IX22B	IXU01-□	X22EPR-U9	1
	125 GD125Z	-	IX22B	IXU01-□	X22EPR-U9	1
VIETNAM	125 GRAND DINK125X	-	IX22B	IXU01-□	X22EPR-U9	1
	125 KCR125	06 -	IU24	IU01-□	U24ESR-N	1
	125 LOOKAR125	07 -	IUF22	-	U22FSR-U	1
JAPAN	125 MOVIE AFI 125	-	IU24	IU01-□	U24ESR-N	1
	125 RACING125	-	IU24	IU01-□	U24ESR-N	1
	125 SUPER8 125	-	IUF22	-	U22FSR-U	1
EUROPE & USA	125 V-LINK 125/SR	-	IUF22	-	U22FSR-U	1
	150 GRAND DINK150	-	IX22B	IXU01-□	X22EPR-U9	1
	150 MOVIE XL150	-	IUF22	-	U22FSR-U	1
EUROPE & USA	150 RACING150	-	IU24	IU01-□	U24ESR-N	1
	200 DINK200i	08 -	IX22B	IXU01-□	X22EPR-U9	1
	250 B&W250	-	IX22B	IXU01-□	X22EPR-U9	1
EUROPE & USA	250 GD250Z	-	IX22B	IXU01-□	X22EPR-U9	1
	250 GRAND DINK250/X	-	IX22B	IXU01-□	X22EPR-U9	1
	250 XCITING250	-	IX22B	IXU01-□	X22EPR-U9	1
EUROPE & USA	250 VENOX250	-	IUF24	-	U24FER9	1
	<b>LAVERDA</b>					
	668 668CAFE RACER	-	IX27B	IXU01-□	X27EPR-U9	2
EUROPE & USA	750 750S	-	IXU24	IXU01-□	XU24EPR-U*	2
	750 750S FORMULA	-	IXU24	IXU01-□	XU24EPR-U*	2
	750 DIAMANTE	-	IXU24	IXU01-□	XU24EPR-U*	2
EUROPE & USA	750 GHOST/STRIKE	-	IXU24	IXU01-□	XU24EPR-U*	2
	<b>LEM</b>					
	50 LX1	02 -	IWF22	-	W22FSR	1
EUROPE & USA	50 LX2SPORT/RACER	97 -	IWF22	-	W22FSR	1
	50 LX3SPORT	03 -	IWF22	-	W22FSR	1
	<b>MAGNI</b>					
EUROPE & USA	400 SFIDA	-	IWF22	IWF01-□	W22EP-U	2
	1000 ARTURO/SFIDA	-	IWF22	IWF01-□	W22EP-U	2
	1000 AUSTRALIA/2	-	IX27	IXU01-□	X27ESR-U	2
EUROPE & USA	1100 GIAPPONE52	-	IWF22	IWF01-□	W20EPR-U	2
	1100 SFIDA1100 IE	-	IWF22	IWF01-□	W20EPR-U	2
	1200 SPORT1200S	-	IX24	IXU01-□	IX24	4
EUROPE & USA	<b>MALAGUTI</b>					
	50 F12PHANTOM50	-	IWF22	-	W22FSR	1
	50 F15FIREFOX	-	IWF24	-	W24FPR	1
EUROPE & USA	50 GRIZZLY10	-	IWF22	-	W20FSR-U	1
	50 GRIZZLY12	-	IWF22	-	W20FSR-U	1
	50 YESTERDAY	-	IWF24	-	W24FPR	1
EUROPE & USA	100 F12PHANTOM100	-	IWF24	-	W24FSR	1
	125 MADISON R125	-	IU24	IU01-□	U24ESR-N	1
	125 MADISON125	-	IU24	IU01-□	U24ESR-N	1
EUROPE & USA	150 MADISON150	-	IU24	IU01-□	U24ESR-N	1

	CC MODEL	FROM-TILL	IRIDIUM POWER	IRIDIUM RACING	DENSO	QTY	
EUROPE & USA	<b>MALAGUTI</b>						
	200 MADISON S200	-	IU24	IU01-□	U24ESR-N	1	
	250 PHANTOM MAX	-	IU22	IU01-□	-	1	
	250 MADISON RS250	-	IU27	IU01-□	U27ESR-N	1	
	250 MADISON250	-	IX24	IXU01-□	X24ESR-U	1	
EUROPE & USA	400 MADISON400	04 -	IU27	IU01-□	U27ESR-N	1	
	500 SPIDERMAX500	04 -	IU24A	IU01-□	-	1	
	<b>MONDIAL</b>						
	1000 PIEGA	02 -	IK27	IK02-□	IK27C11	2	
	<b>MONTESA</b>						
EUROPE & USA	315 COTA315R	-	IWF22	IWF01-□	W20ESR-U	1	
	260 COTA4RT	05 -	-	IU01-□	-	1	
<b>MOTO GUZZI</b>							
EUROPE & USA	380 V40CAPRICE	-	IUF24	-	U24FS-U	2	
	380 V40IMOLA	-	IX24	IXU01-□	X24ES-U	2	
	380 V40TARGA	- -96	IWF22	IWF01-□	W22EP-U	2	
	750 BREVA V750	03 -	IWF24	IWF01-□	W24ESR-U	2	
	750 NEVADA BASE/CLUB	01 -	IWF24	IWF01-□	W24ES-U	2	
	750 NEVADA CLASSIC 750	03 -	IWF24	IWF01-□	W24ESR-U	2	
	750 NTX	- -93	IWF24	IWF01-□	W24ES-U	2	
	750 V7 CLASSIC	08 -	IWF24	IWF01-□	W24ESR-U	2	
	850 LE MANS	-	IWF22	IWF01-□	W20EP-U	2	
	EUROPE & USA	850 GRISO850	06 -	IWF22 IU24	-	W20PR-U -	2 2
		1000 1000S	-	IWF22	IWF01-□	W22EP-U	2
	EUROPE & USA	1000 DAYTONA	97 -	IX27	IXU01-□	X27ESR-U	2
		1000 DAYTONA	- -96	IX27	IXU01-□	X27ES-U	2
	EUROPE & USA	1000 DAYTONA RS	-	IX27	IXU01-□	X27ESR-U	2
		1000 LE MANS	-	IWF22	IWF01-□	W20EP-U	2
EUROPE & USA	1000 SPII	-	IWF22	IWF01-□	W20EP-U	2	
	1000 V10 CENTAURO	97 -	IX27	IXU01-□	X27ESR-U	2	
EUROPE & USA	1100 BREVA 1100	06 -	IWF22+ IU24	IWF01-□+ IU01-□	-	EACH 2	
	1100 CALIFORNIA	96 -	IWF22	IWF01-□	W20EPR-U	2	
EUROPE & USA	1100 CALIFORNIA	- -95	IWF22	IWF01-□	W22EP-U	2	
	1100 CALIFORNIA ALUMINUM/TITANIUM	03 -05	IWF22	IWF01-□	W20EPR-U	2	
EUROPE & USA	1100 CALIFORNIA EV/JACKAL/TOURING	-	IWF22	IWF01-□	W20EPR-U	2	
	1100 CALIFORNIA INJECTION	97 -	IWF22	IWF01-□	W20EPR-U	2	
EUROPE & USA	1100 CALIFORNIA STONE/SPECIAL SPORT	01 -	IWF22	IWF01-□	W20EPR-U	2	
	1100 CALIFORNIA VINTAGE	-	IWF22	IWF01-□	W20EPR-U	2	
EUROPE & USA	1100 GRISO 1100	05 -	IWF22+ IU24	IWF01-□+ IU01-□	-	EACH 2	
	1100 QUOTA1100ES	-	IWF22	IWF01-□	W20EPR-U	2	
EUROPE & USA	1100 SPORT	-	IWF22	IWF01-□	W20EPR-U	2	
	1100 SPORT CARBURETOR	97 -	IWF22	IWF01-□	W20EPR-U	2	
EUROPE & USA	1100 SPORT CORSA	99 -	IWF22	IWF01-□	W20EPR-U	2	
	1100 SPORT INJECTION	97 -	IWF22	IWF01-□	W20EPR-U	2	
EUROPE & USA	1100 V11 BALLABIO	06 -	IWF22	IWF01-□	W20EPR-U	2	
	1100 V11COPPA ITALIA/SPORT BALLABIO	03 -	IWF22	IWF01-□	W20EPR-U	2	
EUROPE & USA	1100 V11LE MANS/ROSSO CORSA/NERO CORSA	01 -06	IWF22	IWF01-□	W20EPR-U	2	
	1100 V11ROSSO MANDELLO	03 -06	IWF22	IWF01-□	W20EPR-U	2	
EUROPE & USA	1100 V11SPORT NAKED/SCURA	03 -06	IWF22	IWF01-□	W20EPR-U	2	
	1100 V11SPORT/CAFE SPORT	-	IWF22	IWF01-□	W20EPR-U	2	
EUROPE & USA	1200 1200 SPORT	-	IWF22+ IU24	IWF01-□+ IU01-□	-	EACH 2	
	1200 GRISO 8V	08 -	IU24	IU01-□	-	2	
EUROPE & USA	1200 NORGE 1200GT	-	IWF22+ IU24	IWF01-□+ IU01-□	-	EACH 2	
	<b>MOTO MORINI</b>						
EUROPE & USA	1200 9 1/2	07 -	IU27	IU01-□	U27ESR-N	2	
	1200 CORSARO1200	06 -	IU27	IU01-□	U27ESR-N	2	

\*USE REMOVABLE TYPE



CC	MODEL	FROM-TILL	IRIDIUM POWER	IRIDIUM RACING	DENSO	QTY
<b>MuZ</b>						
660	SKORPION SPORT	-	IX24B	IXU01-□	X24EPR-U9	1
660	SKORPION TOUR	-	IX24B	IXU01-□	X24EPR-U9	1
<b>MV AGUSTA</b>						
750	BRUTALE S/SERIE ORO	01 -	IU27	IU01-□	U27ESR-NB	4
750	F4S/SR/SPR/SENNA/SERIE ORO/AGO	00 -	IU27	IU01-□	U27ESR-NB	4
910	BRUTALE910S/R	05 -	IU27	IU01-□	U27ESR-NB	4
1000	F4 1000S/TAMBURINI/AGO	04 -	IU27A	RU01-□/ IU01-□	-	4
<b>MZ</b>						
125	125SM	02.7 -	IU24	IU01-□	U24ESR-N	1
125	RT125/CLASSIC	02.7 -	IU24	IU01-□	U24ESR-N	1
<b>OVER</b>						
850	OV-15A EURO TWIN	-	IX24B	IXU01-□	X24EPR-U9	2
900	OV-10A COMPLETE	-	IXU24	IXU01-□	XU24EPR-U	2
<b>PEUGEOT</b>						
50	FOX	-	IWF22	-	W22FS-U	1
50	METAL-X/X2/X3	02 -	IWF22	-	W22FSR	1
50	SPEEDFIGHT2 206WRC	50	IWF22	-	W22FSR	1
50	SPEEDFIGHT2(AIRCOOL)	-	IWF22	-	W22FSR	1
50	SPEEDFIGHT2(LIQUIDCOOL)	-	IWF22	-	W22FSR	1
50	VIVACITY 50	-	IWF22	-	W22FSR	1
50	VOGUE DX/SE	-	IWF22	-	W22FSR	1
50	VOGUE SP/LA POSTE	-	IWF16	-	W16FP-U	1
100	ELYSEO	-	IW24	IW01-□	W24ESR-U	1
100	SPEEDFIGHT2	-	IW24	IW01-□	W24ESR-U	1
100	SPEEDFIGHT2 WRC	-	IW27	IW01-□	W27ESR-U	1
100	VIVACITY 100	-	IW24	IW01-□	W24ESR-U	1
125	JETFORCE125	03.6 -	IU22	IU01-□	-	1
<b>PGO</b>						
50	PMX50	-	IUF22	-	U22FSR-U	1
50	PMX50 SPORTS	-	IWF22	-	W22FP-U	1
50	RODOSHOW50	-	IWF22	-	W22FPR-U	1
110	PMX110/110NAKID	-	IUF22	-	U22FSR-U	1
110	PMX110 SPORTS	01.1 -	IWF22	-	W22FP-U	1
125	ALLORO125	-	IUF22	-	U22FSR-U	1
125	G-MAX125	-	IUF22	-	U22FSR-U	1
125	i-CHARGE125	-	IUF22	-	U22FSR-U	1
125	iBUBU125	-	IUF22	-	U20FSR-U	1
125	i'ME125	-	IUF22	-	U22FSR-U	1
125	MY BUBU125/α	-	IUF22	-	U22FS-U	1
125	T-REX125	01.1 -	IUF22	-	U22FS-U	1
125	TIGRA125	-	IU22	-	U22ESR-N	1
125	X-HOT125	-	IU22	-	U22ESR-N	1
150	G-MAX4V150	-	IU22	-	U22ES-N	1
150	T-REX150	01.1 -	IUF22	-	U22FS-U	1
150	X-HOT150	-	IU22	-	U22ESR-N	1
200	G-MAX200	-	IU22	-	U22ESR-N	1
220	G-MAX220	-	IU22	-	U22ESR-N	1
<b>PIAGGIO</b>						
50	BRAVO PV	-	IWF24	-	W24FSR	1
50	CIAO-P	-	IWF24	-	W24FSR	1
50	DNA50	-	IW27	IW01-□	W27ESR-U	1
50	ICE50	-	IW27	IW01-□	W27ESR-U	1
50	LIBERTY50	-	IU27	IU01-□	U27ESR-N	1
50	NRG POWER MC3	-	IW27	IW01-□	W27ESR-U	1
50	TYPHOON50	-	IW27	IW01-□	W27ES-U	1
50	VESPA 50ET4	-	IU27	IU01-□	U27ESR-N	1
50	ZIP50	-	IW27	IW01-□	W27ES-U	1
50	ZIP&ZIP(HYBRID)	-	IW27	IW01-□	W27ES-U	1
80	TYPHOON80	-	IW27	IW01-□	W27ES-U	1
125	BEVERLY125	-	IU24	IU01-□	U24ESR-NB	1
125	LIBERTY125	-	IU22	IU01-□	U22ESR-N	1
125	RUNNER125VX	02 -	IU24	IU01-□	U24ESR-NB	1
125	SKIPPER125	-	IW27	IW01-□	W27ES-U	1
125	TYPHOON125	-	IW27	IW01-□	W27ESR-U	1
125	VESPA 125ET4	-	IU22	IU01-□	-	1

\*USE REMOVABLE TYPE

CC	MODEL	FROM-TILL	IRIDIUM POWER	IRIDIUM RACING	DENSO	QTY
<b>PIAGGIO</b>						
125	X8-125	-	IU27	IU01-□	U27ESR-N	1
125	ZIP125 4t	-	IU27	IU01-□	U27ESR-N	1
150	HEXAGON150	-	IW27	IW01-□	W27ES-U	1
150	LIBERTY150/LE	-	IU27	IU01-□	U27ESR-N	1
176	RUNNER FXR	-	IW27	IW01-□	W27ESR-U	1
176	RUNNER FXR DD	-	IW27	IW01-□	W27ESR-U	1
180	X9Amalfi	-	IU24	IU01-□	U24ESR-NB	1
200	BEVERLY200	-	IU24	IU01-□	U24ESR-NB	1
200	RUNNER200VXR	02 -	IU24	IU01-□	U24ESR-NB	1
200	X8-200	04.8 -	IU24	IU01-□	U24ESR-N	1
200	X9 200Amalfi	-	IU24	IU01-□	U24ESR-N	1
250	BEVERLY250	-	IU27	IU01-□	U27ESR-N	1
250	MP3 250RL	07 -	IU27	IU01-□	-	1
250	X9 250/EVOLUTION	-	IX22B	IXU01-□	X22EPR-U9	1
500	BEVERLY500	-	IU24	IU01-□	U24ESR-N	1
500	X9 500	01 -	IU24A	IU01-□	-	1
<b>ROYAL ENFIELD</b>						
350	BULLET CLASSIC350	-	IWF22	-	W22FS-U	1
350	BULLET DELUX350	-	IWF22	-	W22FS-U	1
500	BULLET CLASSIC500	-	IW24	IW01-□	W24ESR-U	1
500	BULLET DELUX500	-	IW24	IW01-□	W24ESR-U	1
535	BULLET CLASSIC535	-	IW24	IW01-□	W24ESR-U	1
535	BULLET DELUX535	-	IW24	IW01-□	W24ESR-U	1
535	LIGHTNING CUSTOM535	-	IW24	IW01-□	W24ESR-U	1
<b>SACHS</b>						
50	OPTIMA50	-	IWF24	-	W24FSR	1
50	MADASS50	-	IUF22	-	U22FSR-U	1
<b>SANYANG(SYM)</b>						
50	DD50	03 -	IWF24	-	W24FR-L	1
50	FIDDLE50	03 -	IWF24	-	W24FR-L	1
100	X' PRO100	03 -	IUF22	-	U20FS-U	1
125	FIDDLE125	-	IUF22	-	U22FSR-U	1
125	RV125JP	02 -	IU24	IU01-□	U24ESR-N	1
150	X' PRO fighter150	07 -	IU24	IU01-□	U24ESR-N	1
<b>SCORPA</b>						
125	SY125F	-	IUF22	-	U22FSR-U	1
125	TY-S125F	-	IUF22	-	U22FSR-U	1
200	SY200FR	08 -	IUF22	-	U22FSR-U	1
250	SY250F/FR	07 -	IU24	IU01-□	U24ESR-N	1
250	SY250R LONGRIDE	-	IW22	IW01-□	W22EP-U	1
250	SY250R	-	IW22	IW01-□	W22EP-U	1
250	T-RIDE 250F	08 -	IU24A	IU01-□	U24ESR-N	1
<b>SHERCO</b>						
50	SHERCO 0.5	-	IW27	IW01-□	W27ES-U	1
80	SHERCO 0.8	-	IW16	IW01-□	W16EP-U	1
125	SHERCO 1.25	-	IW16	IW01-□	W16EP-U	1
200	SHERCO 2.0	-	IW16	IW01-□	W16EP-U	1
250	SHERCO 2.5	-	IW16	IW01-□	W16EP-U	1
290	SHERCO 2.9	-	IW16	IW01-□	W16EP-U	1
320	SHERCO 4T 3.2	-	IQ20	IQ01-□	Q20PR-U*	1
<b>SOLEX</b>						
50	S3800	-	IWF16	-	W16FS-U	1
<b>TITAN</b>						
1573	GECKO SX/RM	-	IW16	IW01-□	W16EPR-U	2
1573	PHENIX T-RM	-	IW16	IW01-□	W16EPR-U	2
1573	PHENIX Z-RM	-	IW16	IW01-□	W16EPR-U	2
1573	ROADRUNNER RM	-	IW16	IW01-□	W16EPR-U	2
1573	SIDEWINDER RM	-	IW16	IW01-□	W16EPR-U	2
<b>TM RACING</b>						
125	TM125ED	96 -	IW27	IW01-□	-	1
250	TM250 4T	01 -	IU24	IU01-□	U24ESR-N	1
250	TM250ED	96 -	IW24	IW01-□	-	1
400	TM400 4T	01 -	IU24	IU01-□	U24ESR-N	1
<b>TOMOS</b>						
50	ALPINO	-	IWF22	-	W22FS-U	1
50	CLASSIC I / II	-	IWF22	-	W22FS-U	1
50	FLEXER SPORT	-	IWF22	-	W22FS-U	1

AUSTRALIA  
CHINA  
INDIA  
INDONESIA  
KOREA  
MALAYSIA  
PHILIPPINES  
SAUDIARABIA  
SINGAPORE  
TAIWAN  
THAILAND  
VIETNAM  
JAPAN  
EUROPE & USA  
CROSS REFERENCE  
PART NUMBER



# EUROPE & U.S.A. MOTORCYCLE

▶ Spark plug color codes: ■ for Iridium Tough and Iridium Plugs and Iridium TT, ■ for Iridium Power, ■ for Iridium Racing and Two Tops Plugs, ■ for Platinum Plugs and Platinum TT, and black for general spark plugs.

AUSTRALIA	CC MODEL	FROM-TILL	IRIDIUM POWER	IRIDIUM RACING	DENSO	QTY
	<b>TOMOS</b>					
	50 REVIVAL	-	IWF22	-	W22FS-U	1
<b>TRIUMPH</b>						
	600 DAYTONA 600	03 -	IU27A	IU01-□	U27ETR	4
CHINA	600 SPEED FOUR	02 -	IU27A	IU01-□	U27ETR	4
	600 TT600	-	IU27A	IU01-□	U27ETR	4
	620 620SERIES	-	IX27B	IXU01-□	X27EPR-U9	3
INDIA	675 DAYTONA 675	-	IU27A	IU01-□	U27ETR	3
	675 SPEED TRIPLE	-	IU27A	IU01-□	U27ETR	3
	675 STREET TRIPLE	-	IU27A	IU01-□	U27ETR	3
INDONESIA	800 BONNEVILLE AMERICA	02 -	IX24B	IXU01-□	X24EPR-U9	2
	800 BONNEVILLE/T100	01 -03	IX24B	IXU01-□	X24EPR-U9	2
	800 SPEEDMASTER	03 -05	IX24B	IXU01-□	X24EPR-U9	2
KOREA	865 BONNEVILLE/T100	04 -07	IX24B	IXU01-□	X24EPR-U9	2
	865 BONNEVILLE/T100	08 -	IX24B	IXU01-□	X24EPR-U9	2
	865 SCRAMBLER	06 -	IX24B	IXU01-□	X24EPR-U9	2
MALAYSIA	865 SPEEDMASTER	06 -	IX24B	IXU01-□	X24EPR-U9	2
	865 THRUXTON900	04 -07	IX24B	IXU01-□	X24EPR-U9	2
	865 THRUXTON900	08 -	IX24B	IXU01-□	X24EPR-U9	2
PHILIPPINES	885 ADVENTURER	96 -	IX27B	IXU01-□	X27EPR-U9	3
	885 LEGEND TT	99 -	IX24B	IXU01-□	X24EPR-U9	3
	885 T509SPEED TRIPLE	97 -98	IX24B	IXU01-□	X24EPR-U9	3
SAUDI ARABIA	885 THUNDERBIRD/SPORT	-	IX27B	IXU01-□	X27EPR-U9	3
	885 TIGER	99 -00	IX24B	IXU01-□	X24EPR-U9	3
	900 SPEED TRIPLE900	-	IX27B	IXU01-□	X27EPR-U9	3
SINGAPORE	900 SPRINT900	-	IX27B	IXU01-□	X27EPR-U9	3
	900 TROPHY900	96 -	IX27B	IXU01-□	X27EPR-U9	3
	955 DAYTONA T595	97 -98	IX24B	IXU01-□	X24EPR-U9	3
TAIWAN	955 DAYTONA955i	99 -01	IX24B	IXU01-□	X24EPR-U9	3
	955 DAYTONA955i	02 -	IU27A	IU01-□	U27ETR	3
	955 SPEED TRIPLE	99 -01	IX24B	IXU01-□	X24EPR-U9	3
THAILAND	955 SPEED TRIPLE	02 -	IU27A	IU01-□	U27ETR	3
	955 SPRINT RS	00 -01	IX24B	IXU01-□	X24EPR-U9	3
	955 SPRINT RS	02 -	IU27A	IU01-□	U27ETR	3
VIETNAM	955 SPRINT ST	99 -01	IX24B	IXU01-□	X24EPR-U9	3
	955 SPRINT ST	02 -04	IU27A	IU01-□	U27ETR	3
	955 TIGER	01 -04	IX24B	IXU01-□	X24EPR-U9	3
JAPAN	1050 TIGER	05 -	IU27A	IU01-□	U27ETR	3
	1050 SPEED TRIPLE	05 -	IU27A	IU01-□	U27ETR	3
	1050 SPRINT ST	05 -	IU27A	IU01-□	U27ETR	3
EUROPE & USA	1200 DAYTONA1200	-	IX27B	IXU01-□	X27EPR-U9	4
	1200 TROPHY1200	96 -	IX27B	IXU01-□	X27EPR-U9	4
	2300 ROCKET III/CLASSIC/TOURING	04 -09	IX24B	IXU01-□	X24EPR-U9	6
<b>URAL</b>						
	650 BAVARIAN CLASSIC	-	IWF22	-	W22FP-U	2
	650 DECO CLASSIC	-	IWF22	-	W22FP-U	2
	650 SOLO	-	IWF24	-	W24FP-U	2
	650 SPORTSMAN	-	IWF24	-	W24FP-U	2
<b>VEE TWO</b>						
	900 SQUALO/SP	-	IWF22	-	W20FS-U	1
<b>VERTEMATI</b>						
	570 C570	-	IU24A	IU01-□	U24ETR	1

VERTEMATI	CC MODEL	FROM-TILL	IRIDIUM POWER	IRIDIUM RACING	DENSO	QTY
		570 E570J/EJ	-	IU24A	IU01-□	U24ETR
	570 S570J/EJ STRADA	03 -	IU24A	IU01-□	U24ETR	1
	600 SR600 CORSA	03 -	IU24A	IU01-□	U24ETR	1
<b>VESPA</b>						
	50 50A AUTOMATICA	-	IW24	IW01-□	W24ES-U	1
	50 50ET2CARBURETOR	-	IW27	IW01-□	W27ES-U	1
	50 50ET2INJECTION	98 -	IXU27	IXU01-□	IXU27	1
	50 50ET4	-	IU27	IU01-□	U27ESR-N	1
	50 50HP	-	IWF22	-	W20FS-U	1
	50 50S VINTAGE	-	IWF22	-	W22FS-U	1
	50 LX50 2T	05 -	IW27	IW01-□	W27ESR	1
	50 PK50/S	-	IWF22	-	W20FS-U	1
	50 PK50SS	-	IWF22	-	W22FS-U	1
	50 VESPCAR APE50VAN	-	IWF22	-	W22FS-U	1
	80 PK80E/S	-	IW20	IW01-□	W20ES-U	1
	100 100VINTAGE	- -00	IWF22	-	W22FS-U	1
	125 125A AUTOMATICA	-	IWF24	-	W24FS-U	1
	125 125ET3/VINTAGE	-	IWF22	-	W22FS-U	1
<b>VESPA</b>						
	125 125ET4	98 -	IU27	IU01-□	U27ESR-N	1
	125 GT125L	-	IU24	IU01-□	U24ESR-N	1
	125 LX125	05 -	IU22	IU01-□	-	1
	125 LXV125	06 -	IU22	IU01-□	-	1
	125 P125X/SUPER	-	IWF22	-	W22FS-U	1
	125 PK125S	-	IWF22	-	W22FS-U	1
	125 PX125 FL2	02.7 -	IWF22	-	W20FS-U	1
	125 PX125E	-	IWF22	-	W22FS-U	1
	150 150ET4	-	IU27	IU01-□	U27ESR-N	1
	150 150ORIGINALE	99 -	IWF22	-	W20FS-U	1
	150 PX150	02 -	IWF22	-	W20FSR-U	1
	150 PX150E	81 -	IWF22	-	W20FS-U	1
	150 PX150 FL2	02.7 -	IW20	IW01-□	W20ES-U	1
	200 COSA LX200	97 -	IWF24	-	W24FS-U	1
	200 COSA2(No.3000001~3028249)	-	IW24	IW01-□	W24ES-U	1
	200 COSA2(No.3028250~)	-	IWF24	-	W24FS-U	1
	200 GT200L	-	IU24	IU01-□	U24ESR-N	1
	200 P200E	-	IW20	IW01-□	W20ES-U	1
	200 PX200E/FL2	-	IW20	IW01-□	W20ES-U	1
	250 GTS250IE	07 -	IU24	IU01-□	U24ESR-NB	1
	250 GTV250IE	-	IU24	IU01-□	U24ESR-NB	1
<b>VOR</b>						
	400 400ENDURO	00 -01	IU24A	IU01-□	U22ETR	1
	400 400SUPERMOTORD	00 -01	IU24A	IU01-□	U22ETR	1
	450 450ED	02 -	IU24A	IU01-□	U22ETR	1
	450 450SM	02 -	IU24A	IU01-□	U22ETR	1
	500 500ENDURO	00 -01	IU24A	IU01-□	U22ETR	1
	500 500SUPERMOTORD	00 -01	IU24A	IU01-□	U22ETR	1
	503 503SM	02 -	IU24A	IU01-□	U22ETR	1
	530 530ED	02 -	IU24A	IU01-□	U22ETR	1
	530 530SM	00 -01	IU24A	IU01-□	U22ETR	1
<b>VYRUS</b>						
	992 984C3.2V	-	IXU24	IXU01-□	XU24EPR-U	4

# CROSS REFERENCE

## ⚠ CAUTION:

In Asia Market (Except Japan), use extended type Iridium Power IK16L and IK20L instead of IK16 and IK20.

No extended type Iridium Tough is available.

Concerned cross reference and Denso Normal to Iridium Power chart are shown below.

AC (U.S.A.)	DENSO	IRIDIUM POWER	IRIDIUM TOUGH	CHAMPION (U.S.A.)	DENSO	IRIDIUM POWER	IRIDIUM TOUGH	NGK (Japan)	DENSO	IRIDIUM POWER	IRIDIUM TOUGH	MOTORCRAFT (U.S.A.)	DENSO	IRIDIUM POWER	IRIDIUM TOUGH
41-806	KJ16CR-L11	IK16L	-	RC12MCC4/MC4	KJ16CR-L11	IK16L	-	ZFR5P-G	KJ16CR-L11	IK16L	-	AGSP34C	KJ20CR11	IK20L	-
R44XLSE	KJ16CR-L11	IK16L	-	RC12PEC5	PKJ16CR-L13	IK16L	-	NHSP (China)	DENSO	IRIDIUM POWER	IRIDIUM TOUGH	NGK (Japan)	DENSO	IRIDIUM POWER	IRIDIUM TOUGH
AUTOLITE (U.S.A.)	DENSO	IRIDIUM POWER	IRIDIUM TOUGH	MOTORCRAFT (U.S.A.)	DENSO	IRIDIUM POWER	IRIDIUM TOUGH	K5RHCW	KJ16CR-L11	IK16L	-	FR5-1	KJ20CR-L11	IK20L	-
2585	KJ16CR-L11	IK16L	-	1Y0G-18-110	KJ16CR-L11	IK16L	-	TORCH (China)	DENSO	IRIDIUM POWER	IRIDIUM TOUGH	IZFR6K11	SKJ20DR-M11	IK20L	-
BERU (Germany)	DENSO	IRIDIUM POWER	IRIDIUM TOUGH	AG44	KJ16CR-L11	IK16L	-	K4RTC3	KJ16CR	IK16L	-	IZFR6K13	SKJ20DR-M13	IK20L	-
14F-7HUR2	KJ16CR-L11	IK16L	-	AG54	KJ16CR-L11	IK16L	-	UNIPARTS (U.K.)	DENSO	IRIDIUM POWER	IRIDIUM TOUGH	PZFR6E11	PKJ20CR-L11	IK20L	-
14F-8LUR	KJ16CR11	IK16L	-	NGK (Japan)	DENSO	IRIDIUM POWER	IRIDIUM TOUGH	GSP7666	KJ16CR-L11	IK16L	-	PZFR6F11	PKJ20CR-L11	IK20L	-
BOSCH (Germany)	DENSO	IRIDIUM POWER	IRIDIUM TOUGH	IZFR5F11	SKJ16CR-L11	IK16L	-	AUTOLITE (U.S.A.)	DENSO	IRIDIUM POWER	IRIDIUM TOUGH	PZFR6J11	PKJ20CR-L11	IK20L	-
4428	PKJ16CR-L11	IK16L	-	IZFR5K11	SKJ16DR-M11	IK16L	-	5224	KJ20CR11	IK20L	-	PZFR6R	PKJ20CR8	IK20L	-
F7HER02	KJ16CR-L11	IK16L	-	IZFR5L11	SKJ16CR-L11	IK16L	-	BOSCH (Germany)	DENSO	IRIDIUM POWER	IRIDIUM TOUGH	ZFR6F11 (HONDA)	KJ20CR-L11 (HONDA)	IK20L	-
F7HPP222	PKJ16CR-L11	IK16L	-	PZFR5D11	PKJ16CR-L11	IK16L	-	F7LCR	KJ20CR11	IK20L	-	ZFR6F11 (MAZDA)	KJ20CR11 (MAZDA)	IK20L	-
F7HPP222U	PKJ16CR-L11	IK16L	-	PZFR5E11	PKJ16CR-L11	IK16L	-	FR7LC2	KJ20CR11	IK20L	-	ZFR6F11 (MITSUBISHI)	KJ20CR-U11 (MITSUBISHI)	IK20L	-
F8LCR	KJ16CR11	IK16L	-	PZFR5F	PKJ16CR8	IK16L	-	FR7LCX	KJ20CR11	IK20L	-	ZFR6FIX11	IK20	IK20L	-
F8LCR2	KJ16CR11	IK16L	-	PZFR5F11	PKJ16CR-L11	IK16L	-	CHAMPION (U.S.A.)	DENSO	IRIDIUM POWER	IRIDIUM TOUGH	ZFR6FIX11P	VK20	IK20L	-
F9LCR	KJ14CR11	IK16L	-	PZFR5F13	PKJ16CR-L13	IK16L	-	QC12PEP	SKJ20CR-A8	IK20L	-	ZFR6J11	KJ20CR-L11	IK20L	-
F9LCR2	KJ14CR-L11	IK16L	-	PZFR5J11	PKJ16CR-L11	IK16L	-	QC12PEPB	SKJ20CR-A8	IK20L	-	ZFR6K11	KJ20DR-M11	IK20L	-
FQR8LE2	KJ16CR-L11	IK16L	-	ZFR4F11 (HONDA)	KJ14CR-L11 (HONDA)	IK16L	-	RC8PMPA	PKJ20CR8	IK20L	-	ZFR6T11G	KJ20DR-M11/PK20GR8	IK20L	-
FQR8LEU2	KJ16CR-L11	IK16L	-	ZFR4F11 (MAZDA)	KJ14CR11 (MAZDA)	IK16L	-	RC9MC4	KJ20CR-L11	IK20L	-	ZFR6U11	KJ20CR-L11	IK20L	-
FR8LCX	KJ16CR11	IK16L	-	ZFR5C11G	KJ16CR-L11	IK16L	-	RC9MCC4	KJ20CR-L11	IK20L	-	SPLITFIRE (U.S.A.)	DENSO	IRIDIUM POWER	IRIDIUM TOUGH
CHAMPION (U.S.A.)	DENSO	IRIDIUM POWER	IRIDIUM TOUGH	ZFR5F	KJ16CR	IK16L	-	MOTORCRAFT (U.S.A.)	DENSO	IRIDIUM POWER	IRIDIUM TOUGH	SF522D	KJ20CR11	IK20L	-
FN14LY	KJ16CR-L11	IK16L	-	ZFR5F11 (HONDA)	KJ16CR-L11 (HONDA)	IK16L	-	RC9MCC4	KJ20CR-L11	IK20L	-	SF98E	KJ20CR-L11	IK20L	-
RC10PMPA	PKJ16CR8	IK16L	-	ZFR5F11 (MAZDA)	KJ16CR11 (MAZDA)	IK16L	-	RC9MCC4	KJ20CR-L11	IK20L	-	UNIPARTS (U.K.)	DENSO	IRIDIUM POWER	IRIDIUM TOUGH
RC11LCC4	KJ16CR-L11	IK16L	-	ZFR5F11 (MITSUBISHI)	KJ16CR-U11 (MITSUBISHI)	IK16L	-	MOTORCRAFT (U.S.A.)	DENSO	IRIDIUM POWER	IRIDIUM TOUGH	GSP6962	KJ20CR-L11	IK20L	-
RC12ECC	KJ16CR-L11	IK16L	-	ZFR5FIX11	IK16	IK16L	-	1Y0H-18-110	KJ20CR-L11	IK20L	-	GSP7664	KJ20CR-L11	IK20L	-
RC12LC4	KJ16CR-L11	IK16L	-	ZFR5FIX11P	VK16	IK16L	-	AGSP33C	KJ20CR11	IK20L	-				
RC12LYC	KJ16CR-L11	IK16L	-	ZFR5J11	KJ16CR-L11	IK16L	-								
				ZFR5LP13G	-	IK16L	-								
				ZFR5N11	KJ16CR-L11	IK16L	-								

## DENSO NORMAL to IRIDIUM POWER in Asia

DENSO	IRIDIUM POWER	IRIDIUM TOUGH	DENSO	IRIDIUM POWER	IRIDIUM TOUGH	DENSO	IRIDIUM POWER	IRIDIUM TOUGH
KJ14CR11	IK16L	-	KJ20CR-L11	IK20L	-	PKJ20CR-L11	IK20L	-
KJ14CR-L11	IK16L	-	KJ20DR-M11	IK20L	-	SKJ16CR-L11	IK16L	-
KJ16CR	IK16L	-	PKJ16CR8	IK16L	-	SKJ16DR-M11	IK16L	-
KJ16CR11	IK16L	-	PKJ16CR-L11	IK16L	-	SKJ20CR-A8	IK20L	-
KJ16CR-L11	IK16L	-	PKJ16CR-L13	IK16L	-	SKJ20DR-M11	IK20L	-
KJ16CR-U11	IK16L	-	PKJ20CR8	IK20L	-	SKJ20DR-M13	IK20L	-
KJ20CR11	IK20L	-	PKJ20CR-L11	IK20L	-			

AUSTRALIA  
 CHINA  
 INDIA  
 INDONESIA  
 KOREA  
 MALAYSIA  
 PHILIPPINES  
 SAUDI ARABIA  
 SINGAPORE  
 TAIWAN  
 THAILAND  
 VIETNAM  
 JAPAN  
 EUROPE & USA  
 CROSS REFERENCE  
 PART NUMBER

# CROSS REFERENCE ( other DENSO )

	NGK (Japan)		DENSO		IRIDIUM POWER		IRIDIUM TOUGH/PLUS		NGK (Japan)		DENSO		IRIDIUM POWER		IRIDIUM TOUGH/PLUS		NGK (Japan)		DENSO		IRIDIUM POWER		IRIDIUM TOUGH/PLUS	
	NGK (Japan)	DENSO	DENSO		IRIDIUM POWER	IRIDIUM TOUGH/PLUS	IRIDIUM POWER	IRIDIUM TOUGH/PLUS	NGK (Japan)	DENSO	DENSO		IRIDIUM POWER	IRIDIUM TOUGH/PLUS	IRIDIUM POWER	IRIDIUM TOUGH/PLUS	NGK (Japan)	DENSO	DENSO		IRIDIUM POWER	IRIDIUM TOUGH/PLUS	IRIDIUM POWER	IRIDIUM TOUGH/PLUS
AUSTRALIA	A6	M17	-	-					B8ET	IRE01-27	-	-					BCPR6EP8	PQ20R8	IQ20	VQ20	BKR6E9S	K20PR-U9S	IK20G	VK20G
	A6FS	MA20PR-U	-	-					B8EV	-	IW24	-					BCPR6EP-N11	PQ20R-P11	IQ20	VQ20	BKR6E-E	K20PR-UR	IK20	VK20
	A7	M22	-	-					B8EVX	-	IW24	-					BCPR6EP-N8	PQ20R-P8	IQ20	VQ20	BKR6EGP	IK20	IK20	VK20
	AB2	-	-	-					B8HCS	W24FS-U	IWF24	-					BCPR6ES	Q20PR-U	IQ20	VQ20	BKR6E-H	-	-	-
CHINA	AB6	MW17	-	-					B8HS	W24FS-U	IWF24	-					BCPR6ES11	Q20PR-U11	IQ20	VQ20	BKR6EIX	IK20	IK20	VK20
	AB7	-	-	-					B8HS10	W24FS-U10	IWF24	-					BCPR6ET	K20PBR	IK20	VK20	BKR6EIX(LPG)	VK20T	-	VK20T
	AP4FS	MA9P-U	-	-					B8HV	IWF24	IWF24	-					BCPR6EV	-	IQ20	VQ20	BKR6EIX11	IK20	IK20	VK20
	AP5FS	MA16PR-U	-	-					B8HVX	IWF24	IWF24	-					BCPR6EV11	-	IQ20	VQ20	BKR6EIX11P	VK20	IK20	VK20
	AP6FS	MA20P-U	-	-					B8S	W24S-U	-	-					BCPR6EVX	-	IQ20	VQ20	BKR6EIX(LPG)	SK20R5	-	-
	AP9FS	-	-	-					B95EGP	IW01-29	-	-					BCPR6EVX11	-	IQ20	VQ20	BKR6EIXP	VK20Y	-	VK20Y
INDIA	APR5FS	MA16PR-U	-	-					B95EGV	IW29	IW29	-					BCPR6EY	Q20R-U	IQ20	VQ20	BKR6EK	K20TXR	IK20	VK20
	APR6FS	MA20PR-U	-	-					B9ECS	-	IW27	-					BCPR6EY11	Q20R-U11	IQ20	VQ20	BKR6EK11	K20TR11	IK20	VK20
	AR6FS	MA20PR-U	-	-					B9EFS	-	IT27	-					BCPR6EY-N11	Q20PR-U11	IQ20	VQ20	BKR6EKC	K20TNR	IK20	VK20
	AR6FS11	MA20PR-U	-	-					B9EG	W27ES-V	IW27	-					BCPR6EY-N11	Q20R-U11	IQ20	VQ20	BKR6EKC-N11	K20TNR	IK20	VK20
	B105EGP	IW01-32	-	-					B9EGV	IW27	IW27	-					BCPR7E	Q22PR-U	IQ22	VQ22	BKR6EKE	K20TXR	IK20	VK20
INDONESIA	B10ECS	W31ES-U	IW31	-					B9EM	IRE01-27	-	-					BCPR7E11	Q22PR-U11	IQ22	VQ22	BKR6EKP	PK20TR11	IK20	VK20
	B10EG	IW31	IW31	-					B9ES	W27ES-U	IW27	-					BCPR7EDIX	-	-	-	BKR6EKP	SK20PR-A8	-	VK20Y
	B10EGP	IW01-31	-	-					B9EV	-	IW27	-					BCPR7EKD	QL22TR-S	-	-	BKR6EKP11	PK20TR11	IK20	VK20
	B10EGP	IW06-31	-	-					B9EVX	-	IW27	-					BCPR7ES	Q22PR-U	IQ22	VQ22	BKR6EQU	K20TXR	IK20	VK20
	B10EGV	IW31	IW31	-					B9HCS	IWF27	IWF27	-					BCPR7ES11	Q22PR-U11	IQ22	VQ22	BKR6EKUB	K20TXR	IK20	VK20
	B10ES	W31ES-U	IW31	-					B9HS	W27FS-U	IWF27	-					BCPR7ET	K22PBR-S	IK22	VK22	BKR6EKUC	-	-	VKA20
	B10EV	-	IW31	-					B9HS10	W27FS-U10	IWF27	-					BCPR7EV	-	IQ22	VQ22	BKR6EKUD	-	-	VKA20
	B10EVX	-	IW31	-					B9HV	-	IWF27	-					BCPR7E11	-	IQ22	VQ22	BKR6EKU	K20TXR	IK20	VK20
	B10HS	W31FS	-	-					B9HVX	-	IWF27	-					BCPR7EVX	-	IQ22	VQ22	BKR6EN	K20PR-U	IK20	VK20
	B10HVX	W31FS	-	-					B9S	W27S-U	-	-					BCPR7EVX11	-	IQ22	VQ22	BKR6EN11	K20PR-L11	IK20	VK20
	B11EG	IW34	IW34	-					BCP4ES	Q14R-U11	IQ16	VQ16					BCPR7EY	Q22PR-U	IQ22	VQ22	BKR6EP11	PK20R11	IK20	VK20
	B11EGP	IW01-34	-	-					BCP4ES11	Q14R-U11	IQ16	VQ16					BCPR7EY-11	Q22PR-U11	IQ22	VQ22	BKR6EP13	PK20R13	IK20	VK20
	B11EGP	IW06-34	-	-					BCP5E	Q16P-U11	IQ16	VQ16					BCPR7EY-N11	Q22PR-U11	IQ22	VQ22	BKR6EP8	PK20R8	IK20	VK20
	B11EGV	IW34	IW34	-					BCP5E11	Q16P-U11	IQ16	VQ16					BCPR8EVX11	-	IQ24	-	BKR6EP8(For LPG)	VK20T	-	VK20T
	B2	W9-U	-	-					BCP5ES	Q16-U	IQ16	VQ16					BCR8ES	-	IQ24	-	BKR6EPA8	PK20GR8	-	VKA20
	B2LM	W9LM-US	-	-					BCP5ES11	Q16-U11	IQ16	VQ16					BCRE527Y	QJ16AR-U	-	-	BKR6EP-N8	PK20R-P8	IK20	VK20
	B2LMY	W9LM-US	-	-					BCP5ET	K20PBR	IK20	VK20					BCRE527Y11	QJ16AR-U11	-	-	BKR6EQU	K20TXR	IK20	VK20
	B4	W14-U	-	-					BCP5EV	-	IQ16	VQ16					BE527Y11	J16A-U11	-	-	BKR6EQUA	K20TXR	IK20	VK20
	B4-10	W14-U	-	-					BCP5EV11	-	IQ16	VQ16					BE529Y11	J16B-U11	-	-	BKR6EQUB	K20TXR	IK20	VK20
	B4ES	W14E	-	-					BCP5EVX	-	IQ16	VQ16					BK5E	K16P-U	IK16	VK16	BKR6EQUP	K20TXR	IK20	VK20
	B4H	W14F-U	-	-					BCP5EVX11	-	IQ16	VQ16					BK5E11	K16P-U11	IK16	VK16	BKR6EQUPA	K20TXR	IK20	VK20
	B4H-10	W14F-U	-	-					BCP5EY11	Q16-U11	IQ16	VQ16					BK6E	K20P-U	IK20	VK20	BKR6ERX-11P	VFK20F	IK20	VK20
	B4HS	W14F-U	-	-					BCP6E	Q20P-U	IQ20	VQ20					BK6E11	K20PR-U11	IK20	VK20	BKR6ERX-P	VFK20F	IK20	VK20Y
	B4L	W14L	-	-					BCP6E11	Q20P-U11	IQ20	VQ20					BK7E11	K22PR-U11	IK22	VK22	BKR6ERX-PS	VFK20F	IK20G	VK20G
	B4LM	W14LM-U	-	-					BCP6ES	Q20-U	IQ20	VQ20					BK7EK-N11	K22TM11	IK22	VK22	BKR6ES	K20PR-U	IK20	VK20
	B4LMY	W14LM-U	-	-					BCP6ES11	Q20-U11	IQ20	VQ20					BKR4EIX	IK16	IK16	VK16	BKR6ES11	K20PR-U11	IK20	VK20
	B5EB	W16ES-U	-	-					BCP6ET	K20PBR	IK20	VK20					BKR4ESA11	-	IK16	VK16	BKR6ESZ-10	K20PR-U11	IK20	VK20
	B5EB11	W16EKR-S11	IW16	VW16					BCP6EV	-	IQ20	VQ20					BKR5E	K16PR-U	IK16	VK16	BKR6ETA10	K20PBR	IK20	VK20
	B5ES	W16ES-U	-	-					BCP6EV11	-	IQ20	VQ20					BKR5E11	K16PR-U11	IK16	VK16	BKR6ETP	-	-	-
	B5HS	W16FS-U	-	-					BCP6EVX	-	IQ20	VQ20					BKR5E11(For LPG)	K16PR-U11	-	VK20T	BKR6ETUB	K20PBR-S10	-	VKB20
	B5S	W16S-U	-	-					BCP6EVX11	-	IQ20	VQ20					BKR5E-E	K16PR-UR	IK16	VK16	BKR6ETUC	K20PBR-S10	-	VKB20
	B6EB	W20EKR-S11	IW20	VW20					BCP6EY11	Q20-U11	IQ20	VQ20					BKR5EGP	IK16	IK16	VK16	BKR6EVX11	-	IK20	VK20
	B6EB11	W20EKR-S11	IW20	VW20					BCP7E	Q22P-U	IQ22	VQ22					BKR5EIX	IK16	IK16	VK16	BKR6EY	K20R-U	IK20	VK20
	B6EB-L11	W20EKR-S11	IW20	VW20					BCP7E11	Q22PR-U11	IQ22	VQ22					BKR5EIX11	IK16	IK16	VK16	BKR6EY11	K20R-U11	IK20	VK20
	B6EFS	T20EP-U	IT20	VT20					BCP7ES	Q22P-U	IQ22	VQ22					BKR5EIX11P	VK16	IK16	VK16	BKR6EY11	K20R-U11	IK20	VK20
	B6EM	W20EAR	-	-					BCP7ES11	Q22PR-U11	IQ22	VQ22					BKR5EIXP	VK16	IK16	VK16	BKR6EYA	K20R-U	IK20	VK20
	B6ES	W20ES-U	-	-					BCP7ET	K22PB	IK22	VK22					BKR5EK	K20TXR	IK20	VK20	BKR6EYA11	K20R-U11	IK20	VK20
	B6ES-11	W20ES-U	-	-					BCP7EV	-	IQ22	VQ22					BKR5EKB11	K16TR11	IK16	VK16	BKR6EZ	K20PR-U	IK20	VK20
	B6HS	W20FS-U	-	-					BCP7EV11	-	IQ22	VQ22					BKR5EKC	K16TNR-S9	IK16	VK16	BKR6EZB	K20PR-U	IK20	VK20
	B6HS10	W20FS-U	-	-					BCP7EVX	-	IQ22	VQ22					BKR5EKP11	PK16TR11	IK16	VK16	BKR7E	K22PR-U	IK22	VK22
	B6HSA	W20FS-U	-	-					BCP7EVX11	-	IQ22	VQ22					BKR5EKP13	PK16TR13	IK16	VK16	BKR7E11	K22PR-U11	IK22	VK22
	B6L	W16LS	-	-					BCP8EVX11	-	IQ24	-					BKR5EQU	K20TXR	IK20	VK20	BKR7E-E	K22PR-UR	IK22	VK22
	B6LY	W16LS	-	-					BCPR4ES11	Q14R-U11	IQ16	VQ16					BKR5EKUC	-	-	VKA16	BKR7EIX	IK22	IK22	VK22
	B6S	W20S-U	-	-					BCPR4EY11	Q14R-U11	IQ16	VQ16					BKR5EKUD	-	-	VKA16	BKR7EIX11	IK22	IK22	VK22
	B6Y	W20S-U	-	-					BCPR5E	Q16PR-U	IQ16	VQ16					BKR5EKUP	K20TXR	IK20	VK20	BKR7EIX11PS	VK22G	IK22G	VK22G
	B77HC	W24FS-U	IWF24	-					BCPR5E11	Q16PR-U11	IQ16	VQ16					BKR5EN	K16PR-U	IK16	VK16	BKR7EIXP	VK22	IK22	VK22
	B7EB	W22EKR-S11	IW22	VW22					BCPR5E11X	IQ16	IQ16	VQ16					BKR5EN11	K16PR-L11	IK16	VK16	BKR7EKC	K22TNR-S	IK22	VK22
	B7EB11	W22EKR-S11	IW22	VW22					BCPR5E1XP	VQ16	IQ16	VQ16					BKR5EP11	PK16R11	IK16	VK16	BKR7EKC-N	K22TMR11	IK22	VK22
	B7ECS	W22ES-U	-	-					BCPR5EP11	PQ16R	IQ16	VQ16					BKR5EP8	PK16R8	IK16	VK16	BKR7EK-N11	K22TMR11	IK22	VK22
	B7EM	W22EBR	-	-					BCPR5EP13	PQ16R13	IQ16	VQ16					BKR5EQUA	-	IK16	VK16	BKR7EQU	K22TNR-S	IK22	VK22
	B7ES	W22ES-U	-	-					BCPR5EP8	PQ16R8	IQ16	VQ16					BKR5ERX-11P	VFK16	IK16	VK16	BKR7E-N11	K22PR-L11	IK22	VK22
	B7ES11	W22ES-U	-	-					BCPR5EP-N11	PQ16R-P11	IQ16	VQ16					BKR5ERX-P	VFK16	IK16	VK16	BKR7EQUP	-	-	-
	B7ET	W22EBR	-	-					BCPR5ES	Q16PR-U	IQ16	VQ16					BKR5ES	K16PR-U	IK16	VK16	BKR7ES11	K22PR-U11	IK22	VK22
	B7EV	W22ES-U	-	-					BCPR5ES11	Q16PR-U11	IQ16	VQ16					BKR5ES-11	K16PR-U11	IK16	VK16	BKR7EVX	-	IK22	VK22
	B7EVX</																							



# CROSS REFERENCE ( )

NGK (Japan)		DENSO		IRIDIUM POWER		IRIDIUM TOUGH/PLUS		NGK (Japan)		DENSO		IRIDIUM POWER		IRIDIUM TOUGH/PLUS		NGK (Japan)		DENSO		IRIDIUM POWER		IRIDIUM TOUGH/PLUS		
BKUR7EK	K22TNR-S	IK22	VK22	BP6ES11	W20EPR-U11	IW20	VW20	BPR5E11	W16EPR-U11	IW16	VW16	BPR7HS-10	W22FPR-U	IWF22	-	-	BPR7HS-10	W22FPR-U	IWF22	-	-	-	-	
BKUR7ET	K22PBR-S	IK22	VK22	BP6ES11	W20EX-U11	IW20	VW20	BPR5E11	W16EPR-U11	IW16	VW16	BPR7HXV	-	IWF22	-	-	BPR7HXV	-	IWF22	-	-	-	-	
BL6H	-	-	-	BP6ES13	W20EX-U13	IW20	VW20	BPR5EA-11	W14EXR-U11	IW16	VW16	BPR8EIX	IW24	IWF24	-	-	BPR8EIX	IW24	IWF24	-	-	-	-	
BM4A	W14M-U	-	-	BP6ESZ	W20EP-U	IW20	VW20	BPR5EA-L	W16EXR-U	IW16	VW16	BPR8ES	W24EPR-U	IW24	-	-	BPR8ES	W24EPR-U	IW24	-	-	-	-	
BM6	W20M-U	-	-	BP6ET	W20EPB	IW20	VW20	BPR5EA-L11	W16EXR-U11	IW16	VW16	BPR8EV	-	IWF24	-	-	BPR8EV	-	IWF24	-	-	-	-	
BM6A	W20M-U	-	-	BP6EV	-	IW20	VW20	BPR5EF	T16EPR-U	IT16	VT16	BPR8EVX	-	IWF24	-	-	BPR8EVX	-	IWF24	-	-	-	-	
BM6F	T20M-U	-	-	BP6EVX	-	IW20	VW20	BPR5EFIX13P	VT16	IT16	VT16	BPR8HIX	IWF24	IWF24	-	-	BPR8HIX	IWF24	IWF24	-	-	-	-	
BM6FY	T20M-U	-	-	BP6EVX11	-	IW20	VW20	BPR5EFS	T16EPR-U	IT16	VT16	BPR8HS	W24FPR	IWF24	-	-	BPR8HS	W24FPR	IWF24	-	-	-	-	
BM7	W22M-U	-	-	BP6EY	W20EX-U	IW20	VW20	BPR5EFS13	T16EPR-U15	IT16	VT16	BPR8HSA	W24FR-L	IWF24	-	-	BPR8HSA	W24FR-L	IWF24	-	-	-	-	
BM7A	W22M-U	-	-	BP6EY11	W20EX-U11	IW20	VW20	BPR5EFVX	IT16	IT16	VT16	BPR9EIX	IW27	IWF27	-	-	BPR9EIX	IW27	IWF27	-	-	-	-	
BM7F	T22M-U	-	-	BP6FS	T20P-U	ITF20	-	BPR5EGP	IW16	IW16	VW16	BPR9ES	W27ESR	IW27	-	-	BPR9ES	W27ESR	IW27	-	-	-	-	
BMR2A	W9LMR-US	-	-	BP6HS	W20FP-U	IWF20	-	BPR5EIX	IW16	IW16	VW16	BPR9ES	W27ESR-U	IW27	-	-	BPR9ES	W27ESR-U	IW27	-	-	-	-	
BMR2A-10	W9LMR-US	-	-	BP6HS10	W20FP-U10	IWF20	-	BPR5EIX11	IW16	IW16	VW16	BPR9EV	-	IWF27	-	-	BPR9EV	-	IWF27	-	-	-	-	
BMR4A	W14MR-U	-	-	BP6HSA	W20FP-L	IWF20	-	BPR5EIX11-P	VW16	IW16	VW16	BPR9EVX	-	IWF27	-	-	BPR9EVX	-	IWF27	-	-	-	-	
BMR6A	W20MR-U	-	-	BP6HV	-	IWF20	-	BPR5EIX-P	VW16	IW16	VW16	BPR9EVX (For LPG)	-	-	VW20T	-	-	BPR9EVX (For LPG)	-	-	-	-	-	-
BMR6F	T20M-U	-	-	BP6HVX	-	IWF20	-	BPR5EJ	J16AYR	-	-	BPZ7HS10	W22FPR-U	IWF22	-	-	BPZ7HS10	W22FPR-U	IWF22	-	-	-	-	
BMR7A	W22M-U	-	-	BP6S	W20PR-U	-	-	BPR5EK-A	W16ETR-S	IW16	VW16	BPZ8H-N10	W24FPR-U10	IWF24	-	-	BPZ8H-N10	W24FPR-U10	IWF24	-	-	-	-	
BP10EV	-	IW31	-	BP7E	W22EP-U	IW22	VW22	BPR5EKB	W16DTR-S	-	-	BPZ8HS10	W24FPR-U10	IWF24	-	-	BPZ8HS10	W24FPR-U10	IWF24	-	-	-	-	
BP10EVX	-	IW31	-	BP7EFS	T22EP-U	IT22	-	BPR5EKB	W16ETR-S	IW16	VW16	BR10ECS	W24FPR-U10	IWF24	-	-	BR10ECS	W24FPR-U10	IWF24	-	-	-	-	
BP2E	W9EP	-	-	BP7EFVX	IT22	IT22	-	BPR5EP11	P16R	IW16	VW16	BR10ECM	-	IWM31	-	-	BR10ECM	-	IWM31	-	-	-	-	
BP2E	W9EX-U	-	-	BP7EK-N	W22ETR-L	IW22	VW22	BPR5EP11 (For LPG)	P16R	-	VW20T	BR10ECMIX	IWM31	IWM31	-	-	BR10ECMIX	IWM31	IWM31	-	-	-	-	
BP2ES	W9EP	-	-	BP7ES	W22EP-U	IW22	VW22	BPR5EP13	P16R13	IW16	VW16	BR10ECMVX	-	IWM31	-	-	BR10ECMVX	-	IWM31	-	-	-	-	
BP2ES	W9EX-U	-	-	BP7ES11	W22EP11	IW22	VW22	BPR5ES	W16EPR-U	IW16	VW16	BR10ECS	W31ESR-U	IW31	-	-	BR10ECS	W31ESR-U	IW31	-	-	-	-	
BP2H	W9FP	-	-	BP7ES11	W22EP-U11	IW22	VW22	BPR5ES	W16EXR-U	IW16	VW16	BR10EG	-	IWF31	-	-	BR10EG	-	IWF31	-	-	-	-	
BP2HA	W9FP-UL	-	-	BP7ET	W22EPB	IW22	VW22	BPR5ES11	W16EPR11	IW16	VW16	BR10EGV	-	IWF31	-	-	BR10EGV	-	IWF31	-	-	-	-	
BP2HS	W9FP-UL	-	-	BP7EV	-	IW22	VW22	BPR5ES11	W16EXR-U11	IW16	VW16	BR10EIX	IW31	IWF31	-	-	BR10EIX	IW31	IWF31	-	-	-	-	
BP-4	W14PR-U	-	-	BP7EVX	-	IW22	VW22	BPR5ES13	W16EXR-U13	IW16	VW16	BR10ES	W31ESR-U	IW31	-	-	BR10ES	W31ESR-U	IW31	-	-	-	-	
BP4E	W14EX-U	IW16	VW16	BP7EVX11	-	IW22	VW22	BPR5ES-A	W16EXR-U	IW16	VW16	BR10ET	IRE01-27	-	-	-	BR10ET	IRE01-27	-	-	-	-	-	
BP4EA11	W14EX-U11	IW16	VW16	BP7EY	W22EP-U	IW22	VW22	BPR5EV	-	IW16	VW16	BR10ET	W29EBR	-	-	-	BR10ET	W29EBR	-	-	-	-	-	
BP4EFS	T16EPR-U	IT16	VT16	BP7HS	W22FP-U	IWF22	-	BPR5EVX	-	IW16	VW16	BR10EV	-	IWF31	-	-	BR10EV	-	IWF31	-	-	-	-	
BP4ES	W14EP-U	IW16	VW16	BP7HS10	W22FP-U10	IWF22	-	BPR5EVX11	-	IW16	VW16	BR10EYA	W31ESR-U	IW31	-	-	BR10EYA	W31ESR-U	IW31	-	-	-	-	
BP4ES	W14EX-U	IW16	VW16	BP7HV	-	IWF22	-	BPR5EY	W16EXR-U	IW16	VW16	BR10HIX	-	-	-	-	BR10HIX	-	-	-	-	-	-	
BP4ES11	W14EX-U11	IW16	VW16	BP7HVX	-	IWF22	-	BPR5EY11	W16EXR-U11	IW16	VW16	BR2LM	W9LMR-US	-	-	-	BR2LM	W9LMR-US	-	-	-	-	-	
BP4ES-L11	W14EX-U11	IW16	VW16	BP8ES	W24EP-U	IW24	-	BPR5F5	T16PR-U	ITF16	-	BR4ES	W14E	-	-	-	BR4ES	W14E	-	-	-	-	-	
BP4EY	W14EX-U	IW16	VW16	BP8EV	-	IW24	-	BPR5F511	T16PR-U11	ITF16	-	BR4HS	W14FR-U	-	-	-	BR4HS	W14FR-U	-	-	-	-	-	
BP4EY11	W14EX-U11	IW16	VW16	BP8EVX	-	IW24	-	BPR5F515	T16PR-U15	ITF16	-	BR4HSA	W14FR-L	IWF16	-	-	BR4HSA	W14FR-L	IWF16	-	-	-	-	
BP4FS	T14PR-U	ITF16	-	BP8H-N10	W24FPR-U10	IWF24	-	BPR5HS	W16FPR-U	IWF16	-	BR4LM	W14LM-U	-	-	-	BR4LM	W14LM-U	-	-	-	-	-	
BP4H	W14FP-U	IWF16	-	BP8HS	W24FP-U	IWF24	-	BPR6E	W20EPR-U	IW20	VW20	BR5EF	T16EPR-U	IT16	VT16	-	BR5EF	T16EPR-U	IT16	VT16	-	-	-	
BP4HA	W14FP-UL	IWF16	-	BP8HS-10	W24FPR-U10	IWF24	-	BPR6EFIX10	IT20	IT20	VT20	BR5ES	W16ESR-U	-	-	-	BR5ES	W16ESR-U	-	-	-	-	-	
BP4HS	W14FP-UL	IWF16	-	BP8HS-15	W24FPR-U10	IWF24	-	BPR6EFIX13P	VT20	IT20	VT20	BR5ES11	W16ESR-U	-	-	-	BR5ES11	W16ESR-U	-	-	-	-	-	
BP4HS10	W14FP-UL10	IWF16	-	BP8HSA	W24FR-L	IWF24	-	BPR6EFS	T20EPR-U	IT20	VT20	BR5FS	T16R-U	-	-	-	BR5FS	T16R-U	-	-	-	-	-	
BP4HSA	W14FP-UL	IWF16	-	BP8HSA-N10	W24FP-U	IWF24	-	BPR6EFS13	T20EPR-U15	IT20	VT20	BR5FS15	T16R-U15	-	-	-	BR5FS15	T16R-U15	-	-	-	-	-	
BP5E	W16EP-U	IW16	VW16	BP9ES	W27ES-U	IW27	-	BPR6EFS15	T20EPR-U15	IT20	VT20	BR5HS	W16FSR	-	-	-	BR5HS	W16FSR	-	-	-	-	-	
BP5EA	W14EX-U	IW16	VW16	BP9EV	-	IW27	-	BPR6EGP	IW20	IW20	VW20	BR6EB11	W20EKR-S11	IW20	VW20	-	BR6EB11	W20EKR-S11	IW20	VW20	-	-	-	
BP5EA11	W14EX-U11	IW16	VW16	BP9EVX	-	IW27	-	BPR6EIX	IW20	IW20	VW20	BR6EBL	W20EKR-S11	IW20	VW20	-	BR6EBL	W20EKR-S11	IW20	VW20	-	-	-	
BP5EA-L	W16EX-U	IW16	VW16	BP9HS	W27FS-U	IWF27	-	BPR6EIX (LPG)	VW20T	-	VW20T	BR6EBL11	W20EKR-S11	IW20	VW20	-	BR6EBL11	W20EKR-S11	IW20	VW20	-	-	-	
BP5EA11	W16EX-U11	IW16	VW16	BP9HVX	-	IWF27	-	BPR6EIX11	IW20	IW20	VW20	BR6EM	W20EAR	-	-	-	BR6EM	W20EAR	-	-	-	-	-	
BP5EFS	T16EPR-U	IT16	VT16	BPM4A	W14MP-U10	-	-	BPR6EIX11-P	VW20	IW20	VW20	BR6ES	W20ESR-U	-	-	-	BR6ES	W20ESR-U	-	-	-	-	-	
BP5EFS-13	T16EPR-U15	IT16	VT16	BPM4A10	W14MP-U10	-	-	BPR6EIX-P	VW20	IW20	VW20	BR6ES11	W20ESR-U	-	-	-	BR6ES11	W20ESR-U	-	-	-	-	-	
BP5EJ	J16AY	-	-	BPM6A	W20MP-U	-	-	BPR6EKA	W20ET-S	IW20	VW20	BR6FS15	T20R-U	-	-	-	BR6FS15	T20R-U	-	-	-	-	-	
BP5EK-A	W16ET-S	IW16	VW16	BPM6A10	W20MP-U10	-	-	BPR6EKB	W20DTR-S	-	-	BR6FVX	-	-	-	-	BPR6EKB	W20DTR-S	-	-	-	-	-	
BP5EKN	W16ET-S	IW16	VW16	BPM6F	T20MP-U	-	-	BPR6EKB-L	W20DTR-SA	-	-	BR6HIX	IWF22	IWF22	-	-	BPR6EKB-L	W20DTR-SA	-	-	-	-	-	
BP5ES	W16EP-U	IW16	VW16	BPM6Y	W20MP-U	-	-	BPR6EK-N	W20ETR-L	IW20	VW20	BR6HS	W20FSR-U	IWF22	-	-	BPR6EK-N	W20ETR-L	IW20	VW20	-	-	-	
BP5ES	W16EX-U	IW16	VW16	BPM7A	W22MP-U	-	-	BPR6EP11	VW20	IW20	VW20	BR6HS10	W20FSR-U	IWF22	-	-	BPR6EP11	VW20	IW20	VW20	-	-	-	
BP5ES11	W16EP11	IW16	VW16	BPM7F	T22MP-U	-	-	BPR6EP8	VW20	IW20	VW20	BR6HSA	W20FR-L	IWF20	-	-	BPR6EP8	VW20	IW20	VW20	-	-	-	
BP5ES11	W16EP-U11	IW16	VW16	BPM7Y	W22MP-U	-	-	BPR6EP8 (For LPG)	VW20T	-	VW20T	BR6S	W20SR-U	-	-	-	BPR6EP8 (For LPG)	VW20T	-	-	-	-	-	
BP5ES11	W16EX-U11	IW16	VW16	BPM8Y	-	-	-	BPR6ES	W20EPR-U	IW20	VW20	BR7EF	T22EP-U	IT22	-	-	BPR6ES	W20EPR-U	IW20	VW20	-	-	-	
BP5ES13	W16EX-U13	IW16	VW16	BPMR4A	W14MPR-U10	-	-	BPR																

# CROSS REFERENCE ( **other** **DENSO** )

	NGK (Japan)			DENSO			NGK (Japan)			DENSO			NGK (Japan)			DENSO		
	IRIDIUM POWER	IRIDIUM TOUGH/PLUS		IRIDIUM POWER	IRIDIUM TOUGH/PLUS		IRIDIUM POWER	IRIDIUM TOUGH/PLUS		IRIDIUM POWER	IRIDIUM TOUGH/PLUS		IRIDIUM POWER	IRIDIUM TOUGH/PLUS		IRIDIUM POWER	IRIDIUM TOUGH/PLUS	
AUSTRALIA	BR8HCS10	W24FSR-U10	IWF24	-	C8HA	U24FS-U	IUF24	-	C55 (BM4A)	W14M-U	-	-	DILKAR8E9HS	-	-	-	-	
	BR8HIX	IWF24	IWF24	-	C8HSA	U24FS-U	IUF24	-	CY51	Not Plug	-	-	DILKAR8J9G	-	-	-	VDCX22F	
	BR8HS	W24FSR	IWF24	-	C8HV	-	IUF24	-	D10EA	X31ESR-U	-	-	DILKR6D11G	-	-	-	-	
	BR8HS10	W24FSR-U10	IWF24	-	C8HVX	-	IUF24	-	D10HS	-	-	-	DILZKR7A11G	-	-	-	VFXUHC22FG	
	BR8HSA	W24FR-L	IWF24	-	C9E	U27ES-N	IU27	-	D5HS	X16FSR-U	-	-	DILZKR7B11GS	-	-	-	VFXUHC22FG	
CHINA	BR8HV	-	IWF24	-	C9EH9	U27FER9	IUH27	-	D6EA	X20ES-U	-	-	DILKR7B6	-	-	-	-	
	BR8HVX	-	IWF24	-	C9EHVX9	IUH27	IUH27	-	D6HA	X20FS-U	-	-	DILKR8B6	-	-	-	-	
	BR9ECM	W27EMR-C	IWM27	-	C9EVX	-	IU27	-	D7EA	X22ES-U	IX22	-	DILZKAR6A11	FXE20HE11	-	-	VFXEH20E	
	BR9ECMIX	IWM27	IWM27	-	CM4H	-	-	-	D7EV	-	IX22	-	DILZKAR7A11G	-	-	-	-	
	BR9ECMVX	-	IWM27	-	CMR4A	-	-	-	D7EVX	-	IX22	-	DILZKAR7A11GS	-	-	-	-	
INDIA	BR9ECS	W27ESR	IW27	-	CMR4H	-	-	-	D8EA	X24ES-U	IX24	-	DILZKAR7C11H	-	-	-	VFXEH22G	
	BR9ECS	W27ESR-U	IW27	-	CMR5H	-	-	-	D8EV	-	IX24	-	DILZKAR7C11S	DXE22HCR11S	-	-	-	
	BR9ECS-5	-	-	-	CMR6A	-	-	-	D8EVX	-	IX24	-	DILZKAR7A11G	DXU22HCR-D11S	-	-	VFXUHC22FG	
	BR9ECSIX	IW01-27	IW27	-	CMR6H	-	-	-	D8HA	X24FS-U	-	-	DILZKAR7A11GS	DXU22HCR-D11S	-	-	VFXUHC22FG	
	BR9ECSIX5	IW01-27	IW27	-	CMR7A	-	-	-	D9EA	X27ES-U	IX27	-	DILZKAR7B11	-	-	-	VFXUHC22FG	
INDONESIA	BR9EG	W27ESR-V	IW27	-	CMR7H	-	-	-	D9EV	-	IX27	-	DILZKR7B11G	-	-	-	VFXUHC22FG	
	BR9EG-N8	W27ESR-V	IW27	-	CPR6EA9	U20EPR9	IU20	-	D9EVX	-	IX27	-	DILZKR7B11GS	DXU22HCR-D11S	-	-	VFXUHC22FG	
	BR9EGV	IW27	IW27	-	CPR6EB9	-	IU20	-	DCP6E	XU20EPR-U	IXU22	VXU22	DIMR8A10	-	-	IU24	-	
	BR9EIX	IW27	IW27	-	CPR7EA9	U22EPR9	IU22D	-	DCP7E	XU22EP-U	IXU22	VXU22	DP6EA9	X20EPR-U9	-	-	-	
	BR9EQ14	IRE01-27	-	-	CPR7EAIX9	-	IU22D	-	DCP7EVX	-	IXU22	VXU22	DP7EA9	X22EP-U9	IX22B	-	-	
KOREA	BR9EQ14	W27EDR14	-	-	CPR8E	N24EXRB	IU24D	-	DCP8E	XU24EP(R)-U	IXU24	VXU24	DP7EV9	-	-	IX22B	-	
	BR9ES	W27ESR	IW27	-	CPR8EA9	U24EPR9	IU24D	-	DCP8EVX	-	IXU24	VXU24	DP8EA9	X24EP-U9	IX24B	-	-	
	BR9ES	W27ESR-U	IW27	-	CPR8EB9	-	IU24D	-	DCPR6E	XU20EPR-U	IXU22	VXU22	DP8EV9	-	-	IX24B	-	
	BR9ET	IRE01-27	-	-	CPR9EA9	U27EPR9	IU27D	-	DCPR6EIX	-	IXU22	VXU22	DP8EVX9	-	-	IX24B	-	
	BR9ET	W27EBR	-	-	CPR9EB9	-	IU27D	-	DCPR7E	XU22EPR-U	IXU22	VXU22	DP8Z	X24GP-U	IXG24	-	-	
MALAYSIA	BR9EV	-	IW27	-	CR10E	U31ESR-N	IU31	-	DCPR7EA9	XU22PR9	IXU22*	VXU22*	DP9EA9	X27EP-U9	IX27B	-	-	
	BR9EVX	-	IW27	-	CR10EH9	U31FER9	-	-	DCPR7EGP	IXU22	IXU22	VXU22	DP9EV9	-	-	IX27B	-	
	BR9EYA	W27ESR	IW27	-	CR10EIA9	-	IU31	-	DCPR7EIX	IXU22	IXU22	VXU22	DP9EVX9	-	-	IX27B	-	
	BR9EYA	W27ESR-U	IW27	-	CR10EK	U31ETR	IU31A	-	DCPR7EIXP	VXU22	IXU22	VXU22	DP9Z	X27GPR-U	IXG27	-	-	
	BR9HIX	IWF27	IWF27	-	CR4HSA	-	-	-	DCPR7E-N	XU22EPR-U	IXU22	VXU22	DP9Z	X27GPR-U	IXG27	-	-	
PHILIPPINES	BR9HS	W27FSR	IWF27	-	CR4HSB	U14FSR-UB	IUF14-UB	-	DCPR7E-N10	XU22EPR-U	IXU22	VXU22	DPR5EA9	X16EPR-U9	-	-	-	
	BR9HS10	W27FSR-U10	IWF27	-	CR5EH9	U16FER9	-	-	DCPR7ERX-P	-	IXU22	VXU22	DPR6EB-9	-	-	IX22B	-	
	BRE527Y11	J16AR-U11	-	-	CR5HIX	-	-	-	DCPR7EVX	-	IXU22	VXU22	DPR7EA9	X22EPR-U9	IX22B	-	-	
	BRE529Y11	J16BR-U11	-	-	CR5HS	U16FSR-U	-	-	DCPR8E	XU24EPR-U	IXU24	VXU24	DPR7EIX9	IX22B	IX22B	-	-	
	BU6EA11	W20EP-S11	IW20	VW20	CR5HSA	U16FSR-U	-	-	DCPR8EIX	IXU24	IXU24	VXU24	DPR7EV9	-	-	IX22B	-	
SAUDIARABIA	BU6EFSZ	T20EP-U	IT20	VT20	CR5HSB	U16FSR-UB	-	-	DCPR8EKC	XU24EPR-U	IXU24	VXU24	DPR7Z	-	-	-	-	
	BU7EA11	W22EP-S11	IW22	VW22	CR6E	U20ESR-N	IU20	-	DCPR8EKP	IXU24	IXU24	VXU24	DPR8EA9	X24EPR-U9	IX24B	-	-	
	BU8H	SF24	IWF24	-	CR6EH9	-	-	-	DCPR8EN	XU24EPR-U	IXU24	VXU24	DPR8EIX9	IX24B	IX24B	-	-	
	BU8H	W24FS-U	IWF24	-	CR6EIA9	IU20	IU20	-	DCPR8EVX	-	IXU24	VXU24	DPR8EV9	-	-	IX24B	-	
	BUE	-	-	-	CR6HIX	IUF22	IUF22	-	DCPR9E	XU27EPR-U	IXU27	-	DPR8EVX9	-	-	IX24B	-	
SINGAPORE	BUH	SF50	-	-	CR6HS	U20FSR-U	IUF22	-	DCPR9EIX	IXU27	IXU27	-	DPR8Z	X24GPR-U	IXG24	-	-	
	BUHW	SF50	-	-	CR6HSA	U20FSR-U	IUF22	-	DCPR9EVX	-	IXU27	-	DPR8ZIX	IXG24	IXG24	-	-	
	BUHW-2	SF51	-	-	CR7E	U22ESR-N	IU22	-	DCR7EIX	IXU22	IXU22	VXU22	DCR9EA9	X27EPR-U9	IX27B	-	-	
	BUHWX-1	-	-	-	CR7EB	-	IU22	-	DCR8EIX	IXU24	IXU24	VXU24	DPR9EIX9	IX27B	IX27B	-	-	
	BUR4EB11	W14EKR-S11	-	-	CR7EH9	U22FER9	-	-	DCR9EIX	IXU27	IXU27	-	DPR9EVX9	-	-	IX27B	-	
TAIWAN	BUR5EB11	W16EKR-S11	IW16	VW16	CR7EIA9	IU22D	IU22	-	DF5A11A	FK16PR11 (FROM MAZDA BRAND) <sup>1919</sup>	-	-	VFK16	-	-	-	-	
	BUR5ET	W20EPBR-S	IW20	VW20	CR7EIX	IU22	IU22	-	DF5B11A	FK16HR11	-	-	VFKH16	-	-	-	-	
	BUR5ET10	W20EPBR-S	IW20	VW20	CR7EK	U22ETR	IU22	-	DF6H11A	FXE20HE11	-	-	VFXEH20E	-	-	-	-	
	BUR5ETB-10	W20EPBR-S	IW20	VW20	CR7EKB	-	IU22	-	DF6H11A	VFXEH20E	-	-	VFXEH20E	-	-	-	-	
	BUR6EA11	W20EPR-S11	IW20	VW20	CR7HIX	IUF22	IUF22	-	DF6H11B	VFXEH20	-	-	VFXEH20	-	-	-	-	
THAILAND	BUR6EB11	W20EKR-S11	IW20	VW20	CR7HS	U22FSR-U	IUF22	-	DF6H11B	FXE20HR11	-	-	VFXEH20	-	-	-	-	
	BUR6EFSZ	T20EPR-U	IT20	VT20	CR7HSA	U22FSR-U	IUF22	-	DF7H11B	VFXEH20	-	-	VFXEH20	-	-	-	-	
	BUR6EQP	-	-	-	CR7HSA9	U22FSR-U	IUF22	-	DF7H11B	FXE22HR11	-	-	VFXEH22	-	-	-	-	
	BUR6ET	W20EPBR-S	IW20	VW20	CR8E	U24ESR-N	IU24	-	DF8H11B	VFXEH22	-	-	VFXEH22	-	-	-	-	
	BUR7EA11	W22EP-S11	IW22	VW22	CR8EB	U24ESR-NB	IU24	-	DFH6B11A	FK20HR11	-	-	VFKBH20	-	-	-	-	
VIETNAM	BUR7EB11	W22EP-S11	IW22	VW22	CR8EH9	U24FER9	IUH24	-	DFH6B11A	VFKBH20	-	-	VFKBH20	-	-	-	-	
	BUR7EQ	IRE01-27	-	-	CR8EH9S	U24FER9S	IUH24	-	DIFR5C11	-	-	-	VFK16	-	-	-	-	
	BUR7EQP	IRE01-27	-	-	CR8EHIX9	IUH24	IUH24	-	DIFR5E11	-	-	-	VFK16	-	-	-	-	
	BUR8EQP	IRE01-27	-	-	CR8EHVX9	-	IUH24	-	DIFR6A13G	DK20PR-D13	-	-	VFK20F	-	-	-	-	
	BUR9EQ	IRE01-27	-	-	CR8EIA	IU24	IU24	-	DIFR6C11	-	-	-	VFK20F	-	-	-	-	
JAPAN	BUR9EQP	IRE01-27	-	-	CR8EIB	IU24	IU24	-	DIFR6D13	-	-	-	VFK20F	-	-	-	-	
	BUZ8H	SF24	IWF24	-	CR8EIB10	IU24	IU24	-	DILFR5A	-	-	-	VFKH16	-	-	-	-	
	BUZ8H	W24FS-U	IWF24	-	CR8EIX	IU24	IU24	-	DILFR5A11	FK16HR11	-	-	VFKH16	-	-	-	-	
	BUZHW	SF50	-	-	CR8EK	U24ETR	IU24A	-	DILFR5A11D	FK16HR11	-	-	VFKH16	-	-	-	-	
	BUZHW2	SF51	-	-	CR8EKB	-	IU24A	-	DILFR5E11	FK16HR11	-	-	VFKH16	-	-	-	-	
EUROPE & USA	BUZ	-	-	-	CR8EKPA	IU24A	IU24A	-	DILFR5L11	-	-	-	VFKH16	-	-	-	-	
	BZ7HS-10	W22FSR	IWF22	-	CR8EVX	IU24	IU24	-	DILFR5M8D	-	-	-	VFKH16	-	-	-	-	
	C10EH9	U31FER9	-	-	CR8HIX	IUF24	IUF24	-	DILFR6A11	-	-	-	VFKH16	-	-	-	-	
	C2H	-	-	-	CR8HS	U24FSR-U	IUF24	-	DILFR6A11	FK20HR11	-	-	VFKH20	-	-	-	-	
	C4HSB	U14FS-UB	IUF14-UB	-	CR8HSA	U24FSR-U	IUF24	-	DILFR6D11	FK20HR11	-	-	VFKH20	-	-	-	-	
CROSS REFERENCE	C50	-	-	-	CR8HVX	IUF24	IUF24	-	DILFR6F11G	-	-	-	VFKH20	-	-	-	-	
	C5HA	U16FS-U	-	-	CR9E	U27ESR-N	IU27	-	DILFR6J11	-	-	-	VFKH20	-	-	-	-	
	C5HSA	U16FS-U	-	-	CR9EB	U27ESR-NB	IU27	-	DILFR7B10G	-	-	-	-	-	-	-	-	
	C5HSB	U16FS-UB	-	-	CR9EH9	U27FER9	IUH27	-	DILFR7K9G	-	-	-	VDKH22F	-	-	-	-	
	C6HA	U20FS-U	IUF22	-	CR9EH9S	-	IUH27	-	DILKARGA11	FXE20HR11	-	-	VFXEH20	-	-	-	-	
PART NUMBER	C6HSA	U20FS-U	IUF22	-	CR9EHIX9	IUH27	IUH27	-	DILKAR7B8	-	-	-	VDCX22F	-	-	-	-	
	C7E	U22ES-N	IU22	-	CR9EHVX9	-	IUH27	-	DILKAR7B11	-	-	-	VFXEH22	-	-	-	-	
	C7EH9	U22FE9	-	-	CR9EIA9	IU27D	IU27	-	DILKAR7C9H	-	-	-	-	-	-	-	-	
	C7HA	U22FS-U	IUF22	-	CR9EIX	IU27	IU27	-	DILKAR7D11H	-	-	-	-	-	-	-	-	
	C7HSA	U22FS-U	IUF22	-	CR9EK	U27ETR	IU27A	-	DILKAR7E9HS	-	-	-	-	-	-	-	-	

# CROSS REFERENCE ( → )

(\*6) Purchase via DAIHATSU.

NGK (Japan)				DENSO				IRIDIUM POWER				IRIDIUM TOUGH PLUS				NGK (Japan)				DENSO				IRIDIUM POWER				IRIDIUM TOUGH PLUS			
NGK (Japan)	DENSO	IRIDIUM POWER	IRIDIUM TOUGH PLUS	NGK (Japan)	DENSO	IRIDIUM POWER	IRIDIUM TOUGH PLUS	NGK (Japan)	DENSO	IRIDIUM POWER	IRIDIUM TOUGH PLUS	NGK (Japan)	DENSO	IRIDIUM POWER	IRIDIUM TOUGH PLUS	NGK (Japan)	DENSO	IRIDIUM POWER	IRIDIUM TOUGH PLUS	NGK (Japan)	DENSO	IRIDIUM POWER	IRIDIUM TOUGH PLUS	NGK (Japan)	DENSO	IRIDIUM POWER	IRIDIUM TOUGH PLUS	NGK (Japan)	DENSO	IRIDIUM POWER	IRIDIUM TOUGH PLUS
GR5	W16EXR-U	IW16	VW16	ILKAR7C10	-	-	-	ITR6F13	VT20	IT20	VT20	LMAR8A9	-	-	-	LMAR8A9	-	-	-	-	-	-	-	-	-	-	-	-	-	-	
GR5A110	IW16	IW16	VW16	ILKAR7D6G	-	-	-	IZFR5B	-	-	VKB16	LMAR9E-J	-	-	-	LMAR9E-J	-	-	-	-	-	-	-	-	-	-	-	-	-		
GR5IX	IW16	IW16	VW16	ILKAR7F8	FC20HPR8	-	VFXEH22	IZFR5C	-	-	VKA16	LPG1	-	-	VKA16	LPG1	-	-	-	-	-	-	-	-	-	-	-	-	VK20		
HAMP-FR5C111G	HAMP-1K16F	IK16	VK16	ILKAR7D8	SXU22HPR8	IXUH22	VXUH22I	IZFR5F11	SKJ16CR-L11	IK16	VK16	LPG1	-	-	-	LPG1	-	-	-	-	-	-	-	-	-	-	-	-	VK20T		
HAMP-FR6C111G	HAMP-1K20F	IK20	VK20	ILKAR7F7G	-	-	-	IZFR5G	-	-	-	LPG2	-	-	-	LPG2	-	-	-	-	-	-	-	-	-	-	-	-	VW20T		
HAMP-FR6D111G	HAMP-1Q20F	IQ20	VQ20	ILKAR7G9	-	-	-	IZFR5J	-	-	-	LPG3	-	-	-	LPG3	-	-	-	-	-	-	-	-	-	-	-	-	VW20T		
HAMP-ZFR5F111G	HAMP-1K16FJ	IK16	VK16	ILKAR7G7	-	-	-	IZFR5K11	SKJ16DR-M11	IK16	VK16	LPG3	-	-	-	LPG3	-	-	-	-	-	-	-	-	-	-	-	-	VQ20		
HAMP-ZFR6F111G	HAMP-1K20FJ	IK20	VK20	ILKAR7K8	-	IXUH22	VXUH22	IZFR5L11	SKJ16CR-L11	IK16	VK16	LPG4	-	-	-	LPG4	-	-	-	-	-	-	-	-	-	-	-	-	ITV16		
HAMP-ZFR6K111G	HAMP-1KD20F	IK20	VK20	ILKAR7K11S	-	-	SXE22HOR11S	IZFR6B	-	-	VKB20	LPG5	-	-	-	LPG5	-	-	-	-	-	-	-	-	-	-	-	-	VT20		
HB6AIX11P	VKA20	-	VKA20	ILKAR7L11	ZC20HPR11	-	VCH20	IZFR6D11	-	-	-	LPG6	-	-	-	LPG6	-	-	-	-	-	-	-	-	-	-	-	-	VK20		
HB6BIX11P	VKB20	-	VKB20	ILKAR8H6	-	-	-	IZFR6F11	VKJ20RZ-M11	IK20	VK20	LPG7	-	-	-	LPG7	-	-	-	-	-	-	-	-	-	-	-	-	VKH20		
IFR5A11	SK16R11	IK16	VK16	ILKR6F11	SXU20HPR11	IXUH20I	VXUH20I	IZFR6H11	VK20	IK20	VK20	LR4CE	U14FSR-UB	IUF14-UB	-	LR4CE	U14FSR-UB	IUF14-UB	-	-	-	-	-	-	-	-	-	-	-		
IFR5A-BN(For LPG)	SK16R-P8	-	VK20T	ILKR7A11T	ZXU22HBR11 <sup>(6)</sup>	-	-	IZFR6J	-	-	-	LR8A	U24FSR-U	IUF24	-	LR8A	U24FSR-U	IUF24	-	-	-	-	-	-	-	-	-	-	-		
IFR5D10	VK16	IK16	VK16	ILKR7B8	SXU22HHR8	IXUH22	VXUH22	IZFR6K11	SKJ20DR-M11	IK20	VK20	LR8B	-	IUF24	-	LR8B	-	-	-	-	-	-	-	-	-	-	-	-	-		
IFR5E11	-SK16PR-A11	IK16	VK16	SXU22HR9	(Use SXU22HPR9)	IXUH22I	VXUH22I	IZFR6K11NS	SKJ20DR-M11S	IK20G	VK20G	LTR5ARX-13P	-	ITV16	-	LTR5ARX-13P	-	-	-	-	-	-	-	-	-	-	-	-	-		
IFR5G11	SK16PR-L11	IK16	VK16	ILKR7C9	(Use SXU22HPR9)	IXUH22I	VXUH22I	IZFR6K11S	SKJ20DR-M11S	IK20G	VK20G	LTR5BI-13	-	ITV16	-	LTR5BI-13	-	-	-	-	-	-	-	-	-	-	-	-	-		
IFR5G11K	SK16PR-L11	IK16	VK16	ILKR7D9	SXU22HPR9	IXUH22I	VXUH22I	IZFR6K13	SKJ20DR-M13	IK20	VK20	LTR5IX11	ITV16	ITV16	-	LTR5IX11	ITV16	-	-	-	-	-	-	-	-	-	-	-	-		
IFR5J11	VK16	IK16	VK16	ILKR7D8	SXU22HPR8	IXUH22I	VXUH22I	IZFR6P7	-	-	-	LTR6A-10	-	ITV20	-	LTR6A-10	-	-	-	-	-	-	-	-	-	-	-	-	-		
IFR5L11	VK16PRZ11	IK16	VK16	ILKR7D11	SXU22HPR11	IXUH22I	VXUH22I	IZFR7E-D	-	-	-	LTR6AI-9	-	ITV20	-	LTR6AI-9	-	-	-	-	-	-	-	-	-	-	-	-	-		
IFR5N	VK16	IK16	VK16	ILKR7F11	SXU22HPR11	IXUH22I	VXUH22I	IZFR7M	-	-	-	LTR6AP11	-	ITV20	-	LTR6AP11	-	-	-	-	-	-	-	-	-	-	-	-	-		
IFR5N10	VK16	IK16	VK16	ILKR7E6	-	IXUH22	VXUH22	IZKR6B10E	-	-	-	LTR6ARX-13P	-	ITV20	-	LTR6ARX-13P	-	-	-	-	-	-	-	-	-	-	-	-	-		
IFR6A11	SK20R11	IK20	VK20	ILKR7J8	ZXU22HPR8	IXUH22	VXUH22	IZKR7A	-	-	-	LTR6B-10T	-	ITV20	-	LTR6B-10T	-	-	-	-	-	-	-	-	-	-	-	-	-		
IFR6B	SVK20RZ8	-	VK20Y	ILKR7K8	SXU22HHR8	IXUH22	VXUH22	IZKR7B	-	-	-	LTR6B-9T	-	ITV20	-	LTR6B-9T	-	-	-	-	-	-	-	-	-	-	-	-	-		
IFR6B-K	SVK20RZ8	-	VK20Y	ILKR8E6	-	-	-	J10A	X31ETR	-	-	LTR6BI-13	-	ITV20	-	LTR6BI-13	-	-	-	-	-	-	-	-	-	-	-	-	-		
IFR6C	SK20PR-L9	IK20	VK20	ILKR9G8	-	-	-	J10B	X31ETR	-	-	LTR6BP13	-	ITV20	-	LTR6BP13	-	-	-	-	-	-	-	-	-	-	-	-	-		
IFR6CS	SK20PR-L9S	IK20G	VK20G	ILMAR7A8	-	-	VSUEH22	J9A	X27ETR	IX27	-	LTR6DI-8	-	ITV20	-	LTR6DI-8	-	-	-	-	-	-	-	-	-	-	-	-	-		
IFR6D10	VK20	IK20	VK20	ILTR5A13G	-	-	ITV16	J9B	X27ETR	IX27	-	LTR6IX11	-	ITV20	-	LTR6IX11	-	-	-	-	-	-	-	-	-	-	-	-	-		
IFR6E11	VK20	IK20	VK20	ILTR5B11	-	-	ITL16	JR10B	X31ETR	-	-	LTR7IX11	-	ITV22	-	LTR7IX11	-	-	-	-	-	-	-	-	-	-	-	-	-		
IFR6G11K	SK20PR-L11	IK20	VK20	ILTR5C11	-	-	ITL16	JR8B	-	IX24	-	LZFR5AQP	-	-	-	LZFR5AQP	-	-	-	-	-	-	-	-	-	-	-	-	-		
IFR6J	SVK20RZ8	-	VK20Y	ILTR5D	-	-	ITV16	JR8C	-	IX24	-	LZFR5C11	K16HPR-U11	IKH16	VKH16	LZFR5C11	K16HPR-U11	IKH16	VKH16	-	-	-	-	-	-	-	-	-	-		
IFR6J11	SK20RZ11	IK20	VK20	ILTR5E11	-	-	ITV16	JR9A	X27ETR	IX27	-	LZFR5C11G	K16HPR-U11	IKH16	VKH16	LZFR5C11G	K16HPR-U11	IKH16	VKH16	-	-	-	-	-	-	-	-	-	-		
IFR6L11	VK20PRZ11	IK20	VK20	ILTR6A13G	-	-	ITV20	JR9B	X27ETR	IX27	-	LZFR6AI	IKH20	IKH20	VKH20	LZFR6AI	IKH20	IKH20	VKH20	-	-	-	-	-	-	-	-	-	-		
IFR6Q-G	VK20Y	-	VK20Y	ILTR6A8G	-	-	ITV20	JR9C	X27ETR	IX27	-	LZFR6AP11GS	-	-	-	LZFR6AP11GS	-	-	-	-	-	-	-	-	-	-	-	-	-		
IFR6Q-S	VK20G	IK20G	VK20G	ILTR6B11	-	-	ITL20	KR6A10	XU20EPR-U	IXU22	VXU22	LZFR6AQP	-	-	-	LZFR6AQP	-	-	-	-	-	-	-	-	-	-	-	-	-		
IFR6S	SK20PR-A8	-	VK20Y	ILTR6E11	-	-	ITV20	KR7AI	IXU22	IXU22	VXU22	LZFR6AT-S	-	-	-	LZFR6AT-S	-	-	-	-	-	-	-	-	-	-	-	-	-		
IFR6T11	SK20R11	IK20	VK20	ILTR6G8G	-	-	-	KR8AI	IXU24	IXU24	VXU24	LZFR6B10E	-	IKH20	VKH20	LZFR6B10E	-	IKH20	VKH20	-	-	-	-	-	-	-	-	-	-		
IFR6V-7G	VK20Y	-	VK20Y	ILTR6H8G	-	-	ITV22	KR8BI	IXU24	IXU24	VXU24	LZKAR6AP11	FXE20HR11	-	VFXEH22	LZKAR6AP11	FXE20HR11	-	VFXEH22	-	-	-	-	-	-	-	-	-	-		
IFR6Z-7G	VK20Y	-	VK20Y	ILZFR5B	VKH16	IKH16	VKH16	KR8DI	-	-	-	LZKAR7A	XE20HR-U9	-	VFXEH22	LZKAR7A	XE20HR-U9	-	VFXEH22	-	-	-	-	-	-	-	-	-	-		
IFR7F-6D	-	IK22	VK22	ILZFR6A11	VKH20	IKH20	VKH20	KR9CI	IXU27	IXU27	-	LZFR6AI-10G	-	IXUH20I	VXUH20I	LZFR6AI-10G	-	IXUH20I	VXUH20I	-	-	-	-	-	-	-	-	-	-		
IFR7F-8D	VK22	IK22	VK22	ILZFR6B	VKH20Y	-	VKH20Y	L4265S(Use IZFR7E-D)	-	-	-	LZKR6B10E	-	IXUH20I	VXUH20I	LZKR6B10E	-	IXUH20I	VXUH20I	-	-	-	-	-	-	-	-	-	-		
IFR7F-8J	VK22	IK22	VK22	ILZFR6C11K	VKH20	IKH20	VKH20	L4265T(Use IZFR7E-D)	-	-	-	LZKR6B-E	-	IXUH20I	VXUH20I	LZKR6B-E	-	IXUH20I	VXUH20I	-	-	-	-	-	-	-	-	-	-		
IFR7F-D	VK22	IK22	VK22	ILZFR6CCK	VKH20Y	-	VKH20Y	LFR5A11	K16HPR-U11	IKH16	VKH16	LZTR4A11	-	ITL16	-	LZTR4A11	-	-	-	-	-	-	-	-	-	-	-	-	-		
IFR7F-4D	-	-	-	ILZFR6D11	-	-	-	LFR5A1X11	IKH16	IKH16	VKH16	LZTR4AGP	-	ITL16	-	LZTR4AGP	-	-	-	-	-	-	-	-	-	-	-	-	-		
IFR7G11K	SK22PR-M11	IK22	VK22	ILZKR6F11	-	-	-	LFR5A1X11P	VKH16	IKH16	VKH16	LZTR4A1X13	ITL16	ITL16	-	LZTR4A1X13	ITL16	-	-	-	-	-	-	-	-	-	-	-	-		
IFR7G11KS	SK22PR-M11S	IK22G	VK22G	ILZKAR5AP11	-	-	-	LFR5AP11	IKH16	IKH16	VKH16	LZTR5A13	-	ITL20	-	LZTR5A13	-	-	-	-	-	-	-	-	-	-	-	-	-		
IFR7L11	VK22PRZ11	IK22	VK22	ILZKAR6AP11	-	-	-	LFR5AQP	IKH16	IKH16	VKH16	LZTR5AGP	-	ITL20	-	LZTR5AGP	-	-	-	-	-	-	-	-	-	-	-	-	-		
IFR7N10	VK22	IK22	VK22	ILZKAR7A	-	-	VFXEH22	LFR5ARX-11P	VFKH16	IKH16	VKH16	LZTR5A1X13	ITL20	ITL20	-	LZTR5A1X13	ITL20	-	-	-	-	-	-	-	-	-	-	-	-		
IFR7U	VK22	IK22	VK22	ILZKAR7A10	FXE22HR11	-	VFXEH22	LFR5B	K16HPR-U11	IKH16	VKH16	LZTR6A1X13	ITL20	ITL20	-	LZTR6A1X13	ITL20	-	-	-	-	-	-	-	-	-	-	-	-		
IFR7X-7G	VK22	IK22	VK22	ILZKAR7AP11	-	-	VFXEH22	LFR5BP11	IKH16	IKH16	VKH16	LZTR6AP11EG	-	-	-	LZTR6AP11EG	-	-	-	-	-	-	-	-	-	-	-	-	-		
IFR8H11	VK24PRZ11	IK24	-	ILZKAR7B11	-	-	-	LFR5P11	IKH16	IKH16	VKH16	LZTR7A1X13	-	-	-	LZTR7A1X13	-	-	-	-	-	-	-	-	-	-	-	-	-		
IFR8L11	VK24PRZ11	IK24	-	ILZKAR7B11GS	-	-	-	LFR6A11	K20HR-U11	IKH20	VKH20	MAR8B-JDS	-	-	-	MAR8B-JDS	-	-	-	-	-	-	-	-	-	-	-	-	-		
IFR9H11	VK27PRZ11	IK27	-	ILZKAR7E11S	-	-	-	LFR6A1X11	IKH20	IKH20	VKH20	MAR9A-J	-	-	-	MAR9A-J	-	-	-	-	-	-	-	-	-	-	-	-	-		
IFR9L11	VK27PRZ11	IK27	-	ILZKAR8F8S	SXE24HCR8S	-	VXEHC24G	LFR6A1X11P	VKH20	IKH20	VKH20	MAR9B-JDS	-	-	-	MAR9B-JDS	-	-	-	-	-	-	-	-	-	-	-	-	-		
IGR5B10-D	VW16	IW16	VW16	ILZKAR8J8S	-	-	VXEHC24G	LFR6A1X-LPG	VKH20T	-	VKH20T	MAR10A-J	-	-	-	MAR10A-J	-	-	-	-	-	-	-	-	-	-	-	-	-		
IGR6A11	VW20	IW20	VW20	ILZKAR8H8S	-	-	VXEHC24G	LFR6A1XP	VKH20Y	IKH20	VKH20Y	ME8	-	-	-	ME8	-	-													

# CROSS REFERENCE ( → )

	AUSTRALIA				CHINA				INDIA				INDONESIA				KOREA				MALAYSIA				PHILIPPINES				SAUDIARABIA				SINGAPORE				TAIWAN				THAILAND				VIETNAM				JAPAN				EUROPE & USA				CROSS REFERENCE				PART NUMBER			
	NGK (Japan)	DENSO	IRIDIUM POWER	IRIDIUM TOUGH/PLUS	NGK (Japan)	DENSO	IRIDIUM POWER	IRIDIUM TOUGH/PLUS	NGK (Japan)	DENSO	IRIDIUM POWER	IRIDIUM TOUGH/PLUS	NGK (Japan)	DENSO	IRIDIUM POWER	IRIDIUM TOUGH/PLUS	NGK (Japan)	DENSO	IRIDIUM POWER	IRIDIUM TOUGH/PLUS	NGK (Japan)	DENSO	IRIDIUM POWER	IRIDIUM TOUGH/PLUS	NGK (Japan)	DENSO	IRIDIUM POWER	IRIDIUM TOUGH/PLUS	NGK (Japan)	DENSO	IRIDIUM POWER	IRIDIUM TOUGH/PLUS	NGK (Japan)	DENSO	IRIDIUM POWER	IRIDIUM TOUGH/PLUS	NGK (Japan)	DENSO	IRIDIUM POWER	IRIDIUM TOUGH/PLUS	NGK (Japan)	DENSO	IRIDIUM POWER	IRIDIUM TOUGH/PLUS	NGK (Japan)	DENSO	IRIDIUM POWER	IRIDIUM TOUGH/PLUS																
PFR6E10	PK20PR-L11	IK20	VK20	PTR4B15	PT16EPR-L13	IT16	VT16	R2558A-10	-	-	-	R5724-8	IT24	IT24	-																																																	
PFR6G	PK20PR-P8	-	VK20Y	PTR4G15	PT16EPR-L13	IT16	VT16	(M12x26.5x14)	-	-	-	R5724-9	IT27	IT27	-																																																	
PFR6G11	PK20PR-L11	IK20	VK20	PTR5A10	PT16VR10	ITV16	-	R2558A-8	-	-	-	R5830-10	IQ01-31	IQ01-31	-																																																	
PFR6G11	PK20PR-L11	IK20	VK20	PTR5A13	PT16VR13	ITV16	-	(M12x26.5x14)	-	-	-	R5883-10	-	-	-																																																	
PFR6G11-E	PK20PR-L11	IK20	VK20	PTR5C13	PT16EPR-L13	IT16	VT16	R2558A-9	-	-	-	R5883-11	-	-	-																																																	
PFR6G11-E	PK20PR-L11	IK20	VK20	PTR6D13G	VT20	IT20	VT20	(M12x26.5x14)	-	-	-	R5883-9	-	-	-																																																	
PFR6G13	PK20PR-L13	IK20	VK20	PTR6E13	VT20	IT20	VT20	R4118S-10	IW31	IW31	-	R6021E-10	IW31	IW31	-																																																	
PFR6G13E	PK20PR-L13	IK20	VK20	PTR6F13	VT20	IT20	VT20	R4118S-10S	IW01-32	-	-	R6021E-10S	IW01-32	-	-																																																	
PFR6G-9	PK20PR-P8	-	VK20Y	PZFR5B	-	-	VKB16	R4118S-11	IW34	IW34	-	R6021E-11	IW34	IW34	-																																																	
PFR6H10	PQ20R	IQ20	VQ20	PZFR5C	-	-	VKA16	R4118S-7	IW22	IW22	VW22	R6021E-7	IW22	IW22	VW22																																																	
PFR6J	PK20PR-P8	IK20	VK20	PZFR5D11	SKJ16CR-L11	-	VKA16	R4118S-7S	-	-	-	R6021E-7S	-	-	-																																																	
PFR6J11	PK20PR-P11	IK20	VK20	PZFR5E11	SKJ16CR-L11	IK16	VK16	R4118S-8	IW24	IW24	-	R6021E-8	IW24	IW24	-																																																	
PFR6J13	PK20PR-L13	IK20	VK20	PZFR5F	PKJ16CR8	IK16	VK16	R4118S-8S	-	-	-	R6021E-8S	-	-	-																																																	
PFR6K11	PQ20R	IQ20	VQ20	PZFR5F11	SKJ16CR-L11	IK16	VK16	R4118S-9	IW27	IW27	-	R6021E-9	IW27	IW27	-																																																	
PFR6L13	PK20PR-L13	IK20	VK20	PZFR5F13	PKJ16CR-L13	IK16	VK16	R4118S-9S	IW29	IW29	-	R6021E-9S	IW29	IW29	-																																																	
PFR6M	PK20PR-P8	-	VK20Y	PZFR5J11	SKJ16CR-L11	IK16	VK16	R4304-A10	IW31	IW31	-	R6051-11	-	-	-																																																	
PFR6N11	PK20PR-L11	IK20	VK20	PZFR5N11T	-	-	VKA16	R4304-A7	IW22	IW22	VW22	R6061-10	IW01-31	-	-																																																	
PFR6P	PK20R8	-	VK20Y	PZFR5N11TG	-	-	VKA16	R4304-A8	IW24	IW24	-	R6061-10	IW06-31	-	-																																																	
PFR6P11	PK20PR-(L)11	IK20	VK20	PZFR6B	-	-	VKB20	R4304-A9	IW27	IW27	-	R6061-11	IW01-34	-	-																																																	
PFR6Q	PK20PR-P8	-	VK20Y	PZFR6E11	PKJ20CR-L11	IK20	VK20	R4630A-10	IW01-31	-	-	R6061-11	IW06-34	-	-																																																	
PFR6R11	PK20PR-L11	IK20	VK20	PZFR6F	SKJ20CR-AB/PKJ20CR8	IK20	VK20Y	R4630A-10	IW06-31	-	-	R6061-7	-	-	-																																																	
PFR6T10	PK20PR-L11	IK20	VK20	PZFR6F11	PKJ20CR-L11	IK20	VK20	R4630A-10S	IW01-32	-	-	R6061-8	-	-	-																																																	
PFR6T10G	PK20PR-L11	IK20	VK20	PZFR6H	-	-	-	R4630A-11	IW01-34	-	-	R6061-9	IW01-27	-	-																																																	
PFR6T-G	PK20PR-P8	IK20	VK20	PZFR6J11	PKJ20CR-L11	IK20	VK20	R4630A-11	IW06-34	-	-	R6061-9	IW06-27	-	-																																																	
PFR6U11G	PK20PR-L11	IK20	VK20	PZFR6Q	-	-	-	R4630A-8	IW01-24	-	-	R6120-□	IAE01-□	-	-																																																	
PFR6V10D(For LPG)	VK20T	-	VK20T	PZFR6R	-	-	-	R4630A-8S	-	-	-	R6120A-10	IA01-31	-	-																																																	
PFR6V-W-T	-	-	VKB20	PZFR7G-G	-	-	-	R4630A-9	IW01-27	-	-	R6120A-10S	IA01-32	-	-																																																	
PFR6X11	PK20PR-L11	IK20	VK20	PZKER7A8EGS	-	-	-	R4630A-9	IW06-27	-	-	R6120A-11	IA01-34	-	-																																																	
PFR7A11	VQ22	IQ22	VQ22	PZNR6A11H	-	-	-	R4630A-9S	IW01-29	-	-	R6120C-□	-	-	-																																																	
PFR7AB	-	IK22	VK22	PZTR5A15	PT16EPR-L13	IT16	VT16	R5184-10	IWM01-31	-	-	R6120M-□	-	-	-																																																	
PFR7B	PK22PR8	IK22	VK22	R0045G-□	-	-	-	R5184-10S	IWM01-32	-	-	R6179A-10SP	IWM01-32	-	-																																																	
PFR7B11	VK22	IK22	VK22	R0045J-10	RU01-31	-	-	R5184-11	IWM01-34	-	-	R6179A-10P	IWM01-31	-	-																																																	
PFR7B-4D	VK22	IK22	VK22	R0045J-11	RU01-34	-	-	R5184-9	-	-	-	R6179A-11P	IWM01-34	-	-																																																	
PFR7B9	VK22	IK22	VK22	R0045J-12	-	-	-	R5184-9S	IWM01-29	-	-	R6179C-10SPA	-	-	-																																																	
PFR7B-D	VK22	IK22	VK22	R0045J-9	RU01-27	-	-	R5300A-10	-	-	-	R6198C-9	IW01-27	-	-																																																	
PFR7G	PK22PR8	IK22	VK22	R0045Q-10	RU01-31	-	-	R5300A-10S	-	-	-	R6198C-9	IW06-27	-	-																																																	
PFR7G11	PK22PR-L11	IK22	VK22	R0045Q-11	RU01-34	-	-	R5300A-11	-	-	-	R6252E-8	-	-	-																																																	
PFR7G11	VK22	IK22	VK22	R016-10	IU01-31	-	-	R5300-N□	-	-	-	R6252K-10S	IW01-32	-	-																																																	
PFR7G11S	PK22PR-L11S	IK22G	VK22G	R016-11	IU01-34	-	-	R5400(F)-10	IQ31	IQ31	-	R6254E-10S	IW01-32	-	-																																																	
PFR7G9	PK22PR8	IK22	VK22	R0161-10	IUF31A	IUF31A	-	R5400(F)-7	IQ22	IQ22	VQ22	R6254E-8	IW01-24	-	-																																																	
PFR7H10	VK22	IK22	VK22	R0161-11	-	-	-	R5400(F)-8	IQ24	IQ24	-	R6254E-9	IW01-27	-	-																																																	
PFR7M	PK22PR8	IK22	VK22	R0161-9	IUF27A	IUF27A	-	R5400(F)-9	IQ27	IQ27	-	R6254E-9	IW06-27	-	-																																																	
PFR7N-D	PK22PR8	IK22	VK22	R016-8	IU01-24	-	-	R5425-10	-	-	-	R6254K-10S	IW01-32	-	-																																																	
PFR7Q	PK22PR8	IK22	VK22	R016-9	IU01-27	-	-	R5525-11	-	-	-	R6255(F)-10	IK31	IK31	-																																																	
PFR7S8EG	-	IK22	VK22	R017-10	IU31A	IU31A	-	R5525-7	IWF22	IWF22	-	R6255(F)-7	IK22	IK22	VK22																																																	
PFR7S8G	-	IK22	VK22	R017-11	IU01-34	-	-	R5525-8	IWF24	IWF24	-	R6255(F)-8	IK24	IK24	-																																																	
PFR7W-T	-	IK22	VK22	R017-12	-	-	-	R5525-9	IWF27	IWF27	-	R6255(F)-9	IK27	IK27	-																																																	
PFR7Z-TG	-	IK22	VK22	R017-8	IU24A	IU24A	-	R5530-10	-	-	-	R6326-10	IK31	IK31	-																																																	
PFR8B	-	IK24	-	R017-9	IU27A	IU27A	-	R5530-11	-	-	-	R6326-7	IK22	IK22	VK22																																																	
PFR8B9	-	IK24	-	R0256K-12	-	-	-	R5530-12	-	-	-	R6326-8	IK24	IK24	-																																																	
PGR5A	P16PR8	IW16	VW16	R0373A-□(lr)	IU01-□	-	-	R5530-9	IWF27	-	-	R6326-9	IK27	IK27	-																																																	
PGR5A11	P16PR11	IW16	VW16	R0379A-10(lr)	IU01-31	-	-	R5540-F10	-	-	-	R6337-10	IQ31	IQ31	-																																																	
PGR6A	P20PR8	IW20	VW20	R0406A-8	IU01-24	-	-	R5540-F10.5	-	-	-	R6337-7	IQ22	IQ22	VQ22																																																	
PGR6A	P20R8	IW20	VW20	R0406A-9	IU01-27	-	-	R5649-10	-	-	-	R6337-8	IQ24	IQ24	-																																																	
PGR6A(For LPG)	P20PR8	-	VW20T	R0409B-10(lr)	IU01-31	-	-	R5649-11	-	-	-	R6337-9	IQ27	IQ27	-																																																	
PGR6A(For LPG)	P20R8	-	VW20T	R0409B-8(lr)	IU01-24	-	-	R5649-9	-	-	-	R6385-10SP	IW01-32	-	-																																																	
PGR6A11	VW20	IW20	VW20	R0409B-9(lr)	IU01-27	-	-	R5670-5	W16PR-U	-	-	R6385-10P	IW01-31	-	-																																																	
PGR6A-D	VW20	IW20	VW20	R0451B-8	-	-	-	R5670-6	W20PR-U	-	-	R6385-10P	IW06-31	-	-																																																	
PGR6B	VW20	IW20	VW20	(M10x26.5x14)	-	-	-	R5670-7	W22S-U	-	-	R6385-11P	IW01-34	-	-																																																	
PGR7A	P22PR8	IW22	VW22	R0465B-10	-	-	-	R5670-8	W24S-U	-	-	R6385-11P	IW06-34	-	-																																																	
PJR7A	IX22B	IX22B	-	(M10x26.5x14)	-	-	-	R5670-9	W27S-U	-	-	R6385-75P	-	-	-																																																	
PJR8A	IX24B	IX24B	-	R216-10	IXU01-31	-	-	R5671A-10	IK31	IK31	-	R6385-7P	-	-	-																																																	
PKER7A8EGS	-	-	-	R216-11	IXU01-34	-	-	R5671A-11	IK34	IK34	-	R6385-8P	IW01-24	-	-																																																	
PKR7A	VXU22	IXU22	VXU22	R216-12	-	-	-	R5671A-7	IK22	IK22	VK22	R6385-9P	IW01-27	-	-																																																	
PKR9B	-	IXU27	-	R216-9	IXU01-27	-	-	R5671A-8	IK24	IK24	-	R6385-9P	IW06-27	-	-																																																	
PLFER7A8EG	-	IKH22	VKH22	R217-10	IXU01-31	-	-	R5671A-9	IK27	IK27	-	R6385A-10SP	IW01-32	-	-																																																	
PLFR4A11	VKH16	IKH16	VKH16	R217-11	IXU01-34	-	-	R5672A-10	IK31	IK31	-	R6469-9	-	-	-																																																	
PLFR5A11	VKH16	IKH16	VKH16	R217-12	-	-	-	R5672A-8	IK24	IK24	-	R6601-10	-	-	-																																																	
PLFR5A11D	VKH16	IKH16	VKH16	R217-9	IX27	IX27	-	R5672A-9	IK27	IK27	-	R6601-11	-	-	-																																																	
PLFR6A11	VKH20	IKH20	VKH20	R2188-□	-	-	-	R5673-10	-	-	-	R6601-8	-	-	-																																																	
PLFR6A9	VKH20	IKH20	VKH20	R2270-10	-	-	-	R5673-6	ITF20	ITF20	-	R6601-9	-	-	-																																																	
PLKR6A	-	IXUH22	VXUH22	R2270-11	-	-	-	R5673-7	ITF22	ITF22	-	R6690-□	-	-	-																																																	
PLKR7A	SXU22HDR8	IXUH22	VXUH22	R2270-9	-	-	-	R5673-8	ITF24	ITF24	-	R6711-10	-	-	-																																																	
PLKR7A	SXU22HPR9	IXUH22	VXUH22	R2349-10	-	-	-	R5673-9	ITF27	ITF27	-	R6711-9	-	-	-																																																	
PLKR7B8E	VXUH22	IXUH22	VXUH22	R2349-11	-	-	-	R5674-10	-	-	-	R6712-10	-	-	-																																																	
PLTR6A10G	ITV20	ITV20	-	R2430-□	-	-	-	R5674-6	ITF20	ITF20	-	R6712-9	-	-	-																																																	
PLZFR5B-13G	VKH16	IKH16	VKH16	R2525-10	IXU01-31	-	-	R5674-7	ITF22	ITF22	-	R6725-10	IRE01-31	-	-																																																	
PLZFR6A-11S	VKH20	IKH20	VKH20	R2525-11	IXU01-34	-	-	R5674-8	ITF24	ITF24	-	R6725-10S	IRE01-32	-	-																																																	
PLZKAR6A11	FXE20HR11	-	VFXEH20	R2525-9	IXU01-27	-	-	R5674-9	ITF27	ITF27	-	R6725-11	IRE01-34	-	-																																																	
PLZKBR7A-G(BIHEX)	-	-	-	R2556B-10	-	-	-	R5686-10	IQ31	IQ31	-	R6725-11S	IRE01-35	-	-																																																	
PLZTR5A13	-	ITL16	-	(M12x26.5x16)	-	-	-	R5686-8	IQ24	IQ24	-	R6725-9	IRE01-27	-	-																																																	
PMR7A	IU22	IU22	-	R2556B-8	-	-	-	R5686-9	IQ27	IQ27	-	R6809-9	IK27																																																			

# CROSS REFERENCE ( ⇒ )

(\*3) MITSUBISHI lean burn excluded.

NGK (Japan) DENSO				IRIDIUM POWER IRIDIUM TOUGH/PLUS				NGK (Japan) DENSO				IRIDIUM POWER IRIDIUM TOUGH/PLUS				NGK (Japan) DENSO				IRIDIUM POWER IRIDIUM TOUGH/PLUS			
R6918 B-7	-	-	-	R7440A-9L (lr)	IRL01-27	-	-	UR4IX	ITF16	ITF16	-	ZKER6A-10EG	-	-	-								
R6918 B-8	IW01-24	-	-	R7440B-10T (lr)	IRT01-31	-	-	UR4VX	ITF16	ITF16	-	ZKR7A	XU22EPR-U	IXU22	VXU22								
R6918 B-9	IW01-27	-	-	R7440B-11T (lr)	IRT01-34	-	-	UR5	T20PR-U	ITF20	-	ZKR7A10	XU22EPR-U	IXU22	VXU22								
R6918 B-9	IW06-27	-	-	R8102A-10	-	-	-	UR5	T20PR-U11	ITF20	-	ZMR7AP	IU22	IU22	-								
R6918C-□	IW01-□	-	-	R847-10	-	-	-	UR55	T20PR-U15	ITF20	-	AC (U.S.A.) DENSO											
R7112-10	IK31	IK31	-	R847-11	-	-	-	UR55IX	ITF20	ITF20	-	12	IT16	IT16	VT16								
R7112-7	IK22	IK22	VK22	RE7AL	-	-	-	UR55VX	-	ITF20	-	121XLS	X24EP-U9	IX24B	-								
R7112-8	IK24	IK24	-	RE7CL	-	-	-	UR5IX	ITF20	ITF20	-	41	W27S-U	-	-								
R7112-9	IK27	IK27	-	RE9BT	-	-	-	UR5VX	-	ITF20	-	41-101 (TR4A15)	VT16	IT16	VT16								
R7113-10	IK31	IK31	-	SD10	-	-	-	UR6IX	ITF20	ITF20	-	41-103 (LTR5B11)	-	ITL16	-								
R7113-7	IK22	IK22	VK22	SD10	S29	-	-	UR6VX	-	ITF20	-	41-104 (ZT20R10/DENSO)	ZTJ20R10	IT20	VT20								
R7113-8	IK24	IK24	-	SD10	S29A	-	-	WR4-1	MA9P-U	-	-	41-105 (LTR5C11)	-	ITL16	-								
R7113-9	IK27	IK27	-	SD10A	IRE01-27	-	-	WR5	MA20PR-U	-	-	41-108 (LTR5D)	-	ITV16	-								
R7114-10	IK31	IK31	-	SD10A	S29A	-	-	WR5IX	-	-	-	41-109 (GM12622561)	-	ITV16	-								
R7114-8	IK24	IK24	-	SD11A	IRE01-31	-	-	XR4	W16PR-U	-	-	41-110	ZTJ16R10	IT16	VT16								
R7114-9	IK27	IK27	-	SD11A	S31A	-	-	XR40	W16PR-U	-	-	41-116 (GM12626906)	-	ITV16	-								
R7115-10	IK31	IK31	-	SIFR6A11	VK20	IK20	VK20	XR45	W16PR-U	-	-	41-125 (GM12647827)	-	ITV16	-								
R7115-8	IK24	IK24	-	SILFR6A	VKH20Y	-	VKH20Y	XR45IX	-	-	-	41-600	T16EPR-U15	IT16	VT16								
R7115-9	IK27	IK27	-	SILFR6A11	VKH20	IKH20	VKH20	XR4IX	-	-	-	41-601	T16EPR-U15	IT16	VT16								
R7116-10	IK01-31	-	-	SILFR6A6	VKH20Y	-	VKH20Y	XR5	W20PR-U	-	-	41-602	K20PR-U	IK20	VK20								
R7116-8	IK01-24	-	-	SILFR6B8	VKH20Y	-	VKH20Y	XR5IX	-	-	-	41-603	K16PR-U	IK16	VK16								
R7116-9	IK01-27	-	-	SILFR6C11	VKH20	IKH20	VKH20	YR5	T20R-U	-	-	41-606	T16EPR-U15	IT16	VT16								
R7117-10	IK01-31	-	-	SILKAR6G11G	-	-	VFXEH20	YR55	T20R-U	-	-	41-608	K16PR-U11	IK16	VK16								
R7117-8	IK01-24	-	-	SILKAR8C6DS	-	-	-	YR55IX	ITF20	ITF20	-	41-610	K16PR-U	IK16	VK16								
R7117-9	IK01-27	-	-	SILKR9A7ES	-	-	-	YR55VX	-	ITF20	-	41-611	K16PR-U11	IK16	VK16								
R7118-10	IK02-31	-	-	SILKR6D10G	-	-	IXUH20I VXUH20I	YR5IX	ITF20	ITF20	-	41-627	K16PR-U11	IK16	VK16								
R7118-8	IK02-24	-	-	SILKR7H8	-	-	-	YR5VX	-	ITF20	-	41-628	K16PR-U	IK16	VK16								
R7118-9	IK02-27	-	-	SILKR8AS	-	-	-	ZF6A11	QJ20CR11	IQ20	VQ20	41-629	K16PR-U	IK16	VK16								
R7119-10	IK02-31	-	-	SILMAR9A9S	-	-	-	ZFR4F11 (HONDA)	KJ14CR-L11	IK16	VK16	41-801	K20PR-U11	IK20	VK20								
R7119-8	IK02-24	-	-	SILTR6A7G	-	ITV20	-	ZFR4F11 (MAZDA)	KJ14CR11	IK16	VK16	41-806	KJ16CR-L11	IK16	VK16								
R7119-9	IK02-27	-	-	SILZBR8D8S	-	-	-	ZFR5A11	QJ16CR11	IQ16	VQ16	41-900	PT16EPR-L13	IT16	VT16								
R7232-10	IQ31	IQ31	-	SILZKAR7AS	-	-	-	ZFR5A11	QJ16CR11	IQ16	VQ16	41-902	PT16EPR-L13	IT16	VT16								
R7232-11	IQ34	IQ34	-	SILZKAR7B11	-	-	VFXEH22	ZFR5A11	QJ16CR11	IQ16	VQ16	41-904	PT16EPR-L13	IT16	VT16								
R7232-7	IQ22	IQ22	VQ22	SILZKAR7E8S	-	-	-	ZFR5C11G	KJ16CR-L11	IK16	VK16	41-905	ITF16	ITF16	-								
R7232-8	IQ24	IQ24	-	SILZKBR8C8S	-	-	-	ZFR5D11	K16GPR-U11	-	-	41-906	PT16EPR-L13	IT16	VT16								
R7232-9	IQ27	IQ27	-	SILZKFR8B7S	-	-	-	ZFR5E11	K16GPR-U11	-	-	41-907	PT16EPR-L13	IT16	VT16								
R7233-10	IQ31	IQ31	-	SILZKFR8C7S	-	-	-	ZFR5F	KJ16CR	IK16	VK16	41-908	PT16EPR-L13	IT16	VT16								
R7233-7	IQ22	IQ22	VQ22	SILZKFR8D7G	-	-	-	ZFR5F11 (HONDA)	KJ16CR-L11	IK16	VK16	41-910	PT16EPR-L13	IT16	VT16								
R7233-8	IQ24	IQ24	-	SILZKFR8D7S	-	-	-	ZFR5F11 (LPG,MAZDA)	KJ16CR11	-	VK20T	41-919	PT16EPR-L13	IT16	VT16								
R7233-9	IQ27	IQ27	-	SILZKFR8E7S	-	-	-	ZFR5F11 (MAZDA)	KJ16CR11	IK16	VK16	41-921	PT16EPR-L13	IT16	VT16								
R7234-10	IQ31	IQ31	-	SILZKGBR8B8S	-	-	-	ZFR5F11 (MITSUBISHI)	KJ16CR-U11 <sup>(*)</sup> (*)	IK16	VK16	41-928	PT16EPR-L13	IT16	VT16								
R7234-8	IQ24	IQ24	-	SILZKR6B10E	-	IXUH20I VXUH20I		ZFR5FGP	IK16	IK16	VK16	41-929	PT16EPR-L13	IT16	VT16								
R7234-9	IQ27	IQ27	-	SILZKR6B-11	-	IXUH20I VXUH20I		ZFR5F11 (MAZDA)	KJ16CR11	IK16	VK16	41-931	PT16EPR-L13	IT16	VT16								
R7235-10	IQ31	IQ31	-	SILZKR6D8E	ZXE20HCR8	IXUH20I VXUH20I		ZFR5F11 (MITSUBISHI)	KJ16CR-U11 <sup>(*)</sup> (*)	IK16	VK16	41-932	PT16EPR-L13	IT16	VT16								
R7235-8	IQ24	IQ24	-	SILZKR7C-11S	SXU22HCR11S	-	VXUH20I	ZFR5F5X11P	VK16	IK16	VK16	41-933	PT16EPR-L13	IT16	VT16								
R7235-9	IQ27	IQ27	-	SILZMFR8A7S	-	-	-	ZFR5G	K16DTR-S11	-	-	41-936	PT16EPR-L13	IT16	VT16								
R7236-10	IQ01-31	-	-	SILZNR8C7H	-	-	-	ZFR5J11	KJ16CR-L11	IK16	VK16	41-937 (DENSO)	PT16EPR-L13	IT16	VT16								
R7236-8	IQ01-24	-	-	SIMR8A9	-	IU24	-	ZFR5LP13G	-	-	-	41-940	PT16EPR-L13	IT16	VT16								
R7236-9	IQ01-27	-	-	SIZFR6A6D	-	-	-	ZFR5N11	KJ16CR-L11	IK16	VK16	41-942	PT16EPR-L13	IT16	VT16								
R7237-10	IQ01-31	-	-	SIZFR6B8EG	-	-	-	ZFR5P-G	KJ16CR-L11	-	VKA16	41-943	PT16EPR-L13	IT16	VT16								
R7237-8	IQ01-24	-	-	SR5	T20NR-U11	IT20	VT20	ZFR6A11	QJ20CR11	IQ20	VQ20	41-947	PT16EPR-L13	IT16	VT16								
R7237-9	IQ01-27	-	-	T813J-N13	-	-	-	ZFR6F11 (HONDA)	KJ20CR-L11	IK20	VK20	41-948	PT16EPR-L13	IT16	VT16								
R7238-10	IQ02-31	-	-	TR4	T16EPR-U	IT16	VT16	ZFR6F11 (MAZDA)	KJ20CR11	IK20	VK20	41-950	PT16EPR-L13	IT16	VT16								
R7238-8	IQ02-24	-	-	TR4-2	T16EPR-U	IT16	VT16	ZFR6F11 (MITSUBISHI)	KJ20CR-U11 <sup>(*)</sup> (*)	IK20	VK20	41-952	PT16EPR-L13	IT16	VT16								
R7238-9	IQ02-27	-	-	TR4IX	IT16	IT16	VT16	ZFR6F11G	-	-	-	41-954	ITV20	ITV20	-								
R7239-10	IQ02-31	-	-	TR4VX	IT16	IT16	VT16	ZFR6FIX11	IK20	IK20	VK20	41-965	PT16EPR-L13	IT16	VT16								
R7239-8	IQ02-24	-	-	TR5	T20EPR-U	IT20	VT20	ZFR6FIX11P	VK20	IK20	VK20	41-975 (PTRS C15)	PT16EPR-L13	IT16	VT16								
R7239-9	IQ02-27	-	-	TR5-1	T20EPR-U	IT20	VT20	ZFR6G	K20DTR-S11	-	-	41-980	-	-	-								
R7279-□ (lr)	IK02-□	-	-	TR5-1IX	IT20	IT20	VT20	ZFR6J11	KJ20CR-L11	IK20	VK20	41-981	-	ITV16	-								
R7282-□ (lr)	IAE01-□	-	-	TR5-1VX	IT20	IT20	VT20	ZFR6K11	KJ20DR-M11	IK20	VK20	41-983 (DENSO)	TJ14R-P15	IT16	VT16								
R7282A-□ (lr)	IA01-□	-	-	TR55	T20EPR-U15	IT20	VT20	ZFR6K11S	KJ20DR-M11S	IK20G	VK20G	41-985 (DENSO)	ZTJ16R10	IT16	VT16								
R7282C-□ (lr) No Gasket	-	-	-	TR55-1VX	IT20	IT20	VT20	ZFR6K1X11PS	VK20G	IK20G	VK20G	41-986 (DENSO)	PT16EPR10	IT16	VT16								
R7282M-□ (lr)	-	-	-	TR55-1IX	-	-	-	ZFR6MP	SKJ20CR-A8	IK20	VK20	41-987 (DENSO)	PT16EPR13	IT16	VT16								
R7345-9	IKH27	IKH27	-	TR55IX	IT20	IT20	VT20	ZFR6S-Q	K20PBR-S10	IK20	VK20	41-990 (HR8NPP302)	PT16VR13	ITV16	-								
R7376-□ (lr)	IW01-□	-	-	TR55VX	IT20	IT20	VT20	ZFR6T11G	KJ20DR-M11	-	VKA20	41-993 (GM12607234)	PT16EPR-L13	IT16	VT16								
R7376-7	-	-	-	TR5A10	T16VR-U10	ITV16	-	ZFR6U9	KJ20CR-L11	IK20	VK20Y	41F	W27FS-U	IWF27	-								
R7376B-□ (lr)	-	-	-	TR5A13	T16VR-U10	ITV16	-	ZFR6U11	KJ20CR-L11	IK20	VK20	41XL	W27ES-U	IW27	-								
R7420-□ (lr)																							

CROSS REFERENCE ( other ⇒ DENSO )

	AC (U.S.A.)	DENSO	IRIDIUM POWER	IRIDIUM TOUGH/ PLUS	AC (U.S.A.)	DENSO	IRIDIUM POWER	IRIDIUM TOUGH/ PLUS	AC (U.S.A.)	DENSO	IRIDIUM POWER	IRIDIUM TOUGH/ PLUS	AC (U.S.A.)	DENSO	IRIDIUM POWER	IRIDIUM TOUGH/ PLUS
AUSTRALIA	43FS	W20FP-U	IWF20	-	CR42CLTS	T20EPR-U	IT20	VT20	R43CS	W20PR-U	-	-	S104F	U20FS-U	IUF22	-
	43LS	W16LS	-	-	CR42CTS	T20PR-U	ITF20	-	R43CT6	T20R-U	-	-	S121XL	X24ES-U	IX24	-
	43N	W20ES-U	-	-	CR42N	W22ESR-U	-	-	R43CTS	T20PR-U	ITF20	-	S122F	X24FS-U	-	-
	43S	W20PR-U	-	-	CR42TS	T20PR-U	ITF20	-	R43CTS6	T20PR-U15	ITF20	-	S123XL	X22ES-U	IX22	-
	43TS	T20P-U	ITF20	-	CR42XLS	W20EPR-U	IW20	VW20	R43CXL	W20ESR-U	-	-	S124FS	X20FS-U	-	-
CHINA	43XL	W20ES-U	-	-	CR42XLSX	W20EPR-U11	IW20	VW20	R43CXLS	W20EXR-U	IW20	VW20	S404XLG	IW01-27	IW27	-
	43XLS	W20EP-U	IW20	VW20	CR43	W20SR-U	-	-	R43FS	W20FPR-U	IWF20	-	S40F	W27FS-U	IWF27	-
	43XLS	W20EX-U	IW20	VW20	CR43CXLS	W16EPR-U	IW16	VW16	R43LTS	T20EPR-U	IT20	VT20	S40FG	-	-	-
	44	W16S-U	-	-	CR43N	W20ESR-U	-	-	R43LTSE	T20EPR-U	IT20	VT20	S40FR	W27FSR	IWF27	-
	44F	W16FS-U	-	-	CR43S	W20PR-U	-	-	R43LTSX	T20EPR-U15	IT20	VT20	S40XL	W27ES-U	IW27	-
INDIA	44FFS	W16FP-U	IWF16	-	CR43TS	T20PR-U	ITF20	-	R43N	W20ESR-U	-	-	S40XLG	-	IW31	-
	44N	W20ES-U	-	-	CR43TSM	T20PR-U	ITF20	-	R43NS	W20EPR-U	IW20	VW20	S40XLR	W27ESR	IW27	-
	44NS	W16EP-U	IW16	VW16	CR44N	W20ESR-U	-	-	R43NS	W20EXR-U	IW20	VW20	S40XLR	W27ESR-U	IW27	-
	44NS	W16EX-U	IW16	VW16	CR44NS	W16EPR-U	IW16	VW16	R43NTS6	T20EPR-U15	IT20	VT20	S412FR	W24FSR	IWF24	-
	44S	W16PR-U	-	-	CR45L	W14L	-	-	R43NTSE	T20NR-U11	IT20	VT20	S41F	W24FS-U	IWF24	-
	44TS	T16P-U	ITF16	-	CR45TS	T16PR-U	ITF16	-	R43S	W20PR-U	-	-	S41FG	-	IWF27	-
	44XL	W20ES-U	-	-	CS41	W22M-U	-	-	R43T	T20R-U	-	-	S41FR	W24FSR	IWF24	-
INDONESIA	44XLS	W16EP-U	IW16	VW16	CS42	W22M-U	-	-	R43TS	T20PR-U	ITF20	-	S41SLG	IW01-27	IW27	-
	44XLS	W16EX-U	IW16	VW16	CS42S	W22MP-U	-	-	R43TS6	T20PR-U15	ITF20	-	S41XL	W27ES-U	IW27	-
	45	W14-U	-	-	CS42T	T22M-U	-	-	R43TSK	T20PR-U	ITF20	-	S41XLR	W27ESR	IW27	-
	45F	W16FS-U	-	-	CS45	W20M-U	-	-	R43TSX	T20PR-U15	ITF20	-	S41XLR	W27ESR-U	IW27	-
	45FFS	W14FP-U	IWF16	-	CS45T	T20M-U	-	-	R43TX	T20R-U	-	-	S42	W24S-U	-	-
	45L	W14L	-	-	CS49	W14M-U	-	-	R43XL	W20ESR-U	-	-	S42F	W22FS-U	IWF22	-
	45LS	W14L	-	-	FR1LS	K20PR-U11	IK20	VK20	R43XLS	W20EPR-U	IW20	VW20	S42FR	W22FSR	IWF22	-
	45NS	W14EP-U	IW16	VW16	FR2LS	K20PR-U11	IK20	VK20	R43XLS	W20EXR-U	IW20	VW20	S42XL	W22ES-U	-	-
	45NS	W14EX-U	IW16	VW16	FR3CLS	K16PR-U11	IK16	VK16	R44CF	W16FSR	-	-	S42XLR	W22ESR-U	-	-
	45S	W14PR-U	-	-	FR3CLS	K16R-U11	IK16	VK16	R44CXL	W20ESR-U	-	-	S43XL	W20ES-U	-	-
	45TS	T16P-U	ITF16	-	FR3LM	QJ16HR-U9	-	-	R44CXLS	W16EPR-U	IW16	VW16	S43XLR	W20ESR-U	-	-
	45XL	W16ES-U	-	-	FR3LS	K16PR-U11	IK16	VK16	R44CXLS	W16EXR-U	IW16	VW16	S44	W16S-U	-	-
	45XLS	W14EP-U	IW16	VW16	FR3LS	K16R-U11	IK16	VK16	R44F	W16FSR	-	-	S44F	W16FS-U	-	-
	45XLS	W14EX-U	IW16	VW16	FR3LS6	K16PR-U11	IK16	VK16	R44LT	W16EPR-U	IW16	VW16	S44XL	W20ES-U	-	-
	46	W9-U	-	-	FR3LSK	K16PR-U11	IK16	VK16	R44LTS	T16EPR-U	IT16	VT16	S45F	W16FS-U	-	-
	46F	W14F-U	-	-	FR4LE	QJ16HR-U9	-	-	R44LTS6	T16EPR-U15	IT16	VT16	S46	W9-U	-	-
	46FFS	W9FP	-	-	FR5LS	K16PR-U11	IK16	VK16	R44LTS6K	T16EPR-U15	IT16	VT16	S81F	M22	-	-
	46N	W16ES-U	-	-	HE2	ITV20	-	-	R44LTSM	T16EPR-U	IT16	VT16	S82F	M22	-	-
	46S	W9PR-U	-	-	LM46	W14LM-U	-	-	R44N	W16ESR-U	-	-	S83F	M17	-	-
	46TS	T14PR-U	ITF16	-	LM49	W14LM-U	-	-	R44NS	W16EPR-U	IW16	VW16	S85F	L14-U/M14	-	-
	46XL	W16ES-U	-	-	M40FFG	-	-	-	R44NS	W16EXR-U	IW16	VW16	SV4XL	SF50	-	-
	46XLS	W9EP	-	-	M40FFX	W27FS-U10	IWF27	-	R44NSX	W16EPR-U11	IW16	VW16	V40FFK	SF51	-	-
	47XL	W14E	-	-	M41FF	W24FS-U	IWF24	-	R44NTSE	T16NR-U11	IT16	VT16	V40FFM	SF50	-	-
	83CTS	MA20P-U	-	-	M41FFG	-	IWF27	-	R44S	W16PR-U	-	-	V40FFS	SF50	-	-
	83TS	MA20P-U	-	-	M41K	W22S-U	-	-	R44SX	W16PR-U	-	-	VB40FFK	SF50	-	-
	84T	MA16PR-U	-	-	M42FF	W22FS-U	IWF22	-	R44T	T16R-U	-	-	VR40FFM	SF50	-	-
	84TS	MA16PR-U	-	-	M43FF	W20FS-U	IWF22	-	R44TS	T16PR-U	ITF16	-				
	85T	MA16PR-U	-	-	M43S	W20PR-U	-	-	R44TS8	T16PR-U15	ITF16	-	APEX (Japan)	DENSO	IRIDIUM POWER	IRIDIUM TOUGH/ PLUS
	85TS	MA16PR-U	-	-	M44C	W16S-U	-	-	R44TSX	T16PR-U15	ITF16	-	06	IQ20	IQ20	VQ20
	86TS	MA9P-U	-	-	M44L	W14L	-	-	R44TX	T16R-U15	-	-	06STD	IK20	IK20	VK20
	B43	W20S-U	-	-	M45	W14-U	-	-	R44XL	W20ESR-U	-	-	07	IQ22	IQ22	VQ22
	C41CLTS	T22EP-U	IT22	-	M45FF	W16FS-U	-	-	R44XLS	W16EPR-U	IW16	VW16	07STD	IK22	IK22	VK22
	C41CXLS	W22EP-U	IW22	VW22	M47	W9-U	-	-	R44XLS	W16EXR-U	IW16	VW16	08	IQ24	IQ24	-
	C42-1	W24S-U	-	-	MR43LTS	T20EPR-U	IT20	VT20	R44XLS6	W16EXR-U11	IW16	VW16	08STD	IK24	IK24	-
	C42CFS	W22FP-U	IWF22	-	MR441	T16R-U	-	-	R44XLSE	KJ16CR-L11	IK16	VK16	09	IQ27	IQ27	-
	C42CLTS	T20EP-U	IT20	VT20	R121CXLS	X24EPR-U9	IX24B	-	R44XLSM	J16BR-U	-	-	09STD	IK27	IK27	-
	C42CXLS	W20EP-U	IW20	VW20	R121XLS	X24EPR-U9	IX24B	-	R45NS	W14EP-U	IW16	VW16	AUTOLITE (U.S.A.)	DENSO	IRIDIUM POWER	IRIDIUM TOUGH/ PLUS
	C42N	W22ES-U	-	-	R41CF	W24FSR	IWF24	-	R45NS	W14EXR-U	IW16	VW16	2684	IRE01-27	-	-
	C42XLS	W20EP-U	IW20	VW20	R41CXL	W27ESR	IW27	-	R45NSX	W14EXR-U11	IW16	VW16	2686	IRE01-27	-	-
	C43	W20S-U	-	-	R41CXL	W27ESR-U	IW27	-	R45NTSE	T16NR-U11	IT16	VT16	103	T20EPR-U	IT20	VT20
	C43CXLS	W16EP-U	IW16	VW16	R41F	W24FSR	IWF24	-	R45S	W14PR-U	-	-	104	T20EPR-U	IT20	VT20
	C43L	W16LS	-	-	R41XL	W27ESR	IW27	-	R45SX	W14PR-U	-	-	105	T16EPR-U	IT16	VT16
	C43N	W20ES-U	-	-	R41XL	W27ESR-U	IW27	-	R45T	T16R-U	-	-	106	T16EPR-U	IT16	VT16
	C44	W16S-U	-	-	R42CF	W22FSR	IWF22	-	R45TS	T16PR-U	ITF16	-	115	MA20P-U	-	-
	C44N	W20ES-U	-	-	R42CFS	W22FPR-U	IWF22	-	R45TS8	T16PR-U15	ITF16	-	117	MA16PR-U	-	-
	C44NS	W16EX-U	IW16	VW16	R42CLTS	T20EPR-U	IT20	VT20	R45TSX	T16PR-U15	ITF16	-	124	MA20PR-U	-	-
	C44S	W16PR-U	-	-	R42CLTS6	T20EPR-U15	IT20	VT20	R45XL	W16ESR-U	-	-	127	MA16PR-U	-	-
	C45	W14-U	-	-	R42CT	T20R-U	-	-	R45XLS	W14EP-U	IW16	VW16	13	T20P-U	ITF20	-
	C45L	W14L	-	-	R42CTS	T20PR-U	ITF20	-	R45XLS	W14EXR-U	IW16	VW16	14	T20P-U	ITF20	-
	C47W	W9-U	-	-	R42CXL	W22ESR-U	-	-	R45XLS6	W14EXR-U11	IW16	VW16	144	T20R-U	-	-
	C49	W9-U	-	-	R42CXLS	W22EPR-U	IW22	VW22	R46LTS	T16EPR-U	IT16	VT16	145	T20R-U	-	-
	C81	M22	-	-	R42F	W22FSR	IWF22	-	R46S	W9PR-U	-	-	146	T16R-U	-	-
	C82	M22	-	-	R42FS	W22FPR-U	IWF22	-	R46SX	W9PR-U	-	-	147	T16R-U	-	-
	C82T	MA20P-U	-	-	R42LTS	T20EPR-U	IT20	VT20	R46SZ	W9PR-U	-	-	15	T16P-U	ITF16	-
	C83	M17	-	-	R42LTS6	T20EPR-U15	IT20	VT20	R46T	T16R-U	-	-	156	MA16PR-U	-	-
	C85	L14-U	-	-	R42LTSM	T20EPR-U	IT20	VT20	R46TS	T14PR-U	ITF16	-	16	T16P-U	ITF16	-
	C85S	L14-U	-	-	R42NS	W22EPR-U	IW22	VW22	R46TSX	T14PR-U15	ITF16	-	166	MA16PR-U	-	-
	C85TS	MA16PR-U	-	-	R42S	W20PR-U	-	-	R46TX	T16R-U15	-	-	175	W16PR-U	-	-
	C86	L14-U	-	-	R42T	T20R-U	-	-	R47S	W9PR-U	-	-	203	T20PR-U	ITF20	-
	C86S	L14-U	-	-	R42TS	T20PR-U	ITF20	-	R47SX	W9PR-U	-	-	215	W16LS	-	-
	C87	L14-U	-	-	R42TSM	T20PR-U	ITF20	-	R83CTS	MA20PR-U	-	-	216	W14L	-	-
	C88	L14-U	-	-	R42TX	T20R-U	-	-	R83TS	MA20PR-U	-	-	217	W14L	-	-
	C88L	L14-U	-	-	R42XL	W22ESR-U	-	-	R84TS	MA16PR-U	-	-	218	W14L	-	-
	CFR1CLS	K22PR-U	IK22	VK22	R42XLS	W22EPR-U	IW22	VW22	R84TSX							

# CROSS REFERENCE ( other DENSO )

AUTOLITE (U.S.A.)	DENSO	IRIDIUM POWER	IRIDIUM TOUGH/PLUS	AUTOLITE (U.S.A.)	DENSO	IRIDIUM POWER	IRIDIUM TOUGH/PLUS	AUTOLITE (U.S.A.)	DENSO	IRIDIUM POWER	IRIDIUM TOUGH/PLUS	AUTOLITE (U.S.A.)	DENSO	IRIDIUM POWER	IRIDIUM TOUGH/PLUS	
2414	-	IW31	-	3116	L14-U	-	-	494	W16LS	-	-	9921	K20PBR	IK20	VK20	
2415	IW01-27	IW27	-	312	W27S-U	-	-	495	W16LS	-	-	996	W14L	-	-	
2416	IW24	IW24	-	313	W24S-U	-	-	497	W14L	-	-	AG12	W24EP-U	IW24	-	
2417	IW24	IW24	-	314	W20S-U	-	-	51	W24EP-U	IW24	-	AG22	W22EP-U	IW22	VW22	
2453	-	-	-	315	W16S-U	-	-	5125	MA20PR-U	-	-	AP5143	IT20	IT20	VT20	
2454	-	-	-	316	W14-U	-	-	5143	T20EPR-U	IT20	VT20	APP5144	PT16EPR-L13	IT20	VT20	
2455	-	IWF27	-	317	W14-U	-	-	5144	T20EPR-U	IT20	VT20	APP5144	PTJ16R15	IT20	VT20	
2456	-	IWF24	-	318	W9-U	-	-	5164	T20EPR-U	IT20	VT20	AP64	PK20PR11	IK20	VK20	
2457	-	IWF24	-	33	MA20P-U	-	-	5184	K16PR-U11	IK16	VK16	APP3923	PK20PR11	IK20	VK20	
25	T16PR-U	ITF16	-	34	MA20P-U	-	-	52	W24EP-U	IW24	-	APP3924	PK16PR-(L)11	IK16	VK16	
2526	IRE01-27	-	-	35	MA16PR-U	-	-	5224	KJ20CR11	IK20	VK20	AR5383	IW06-31	-	-	
2526	W25EDR14	-	-	353	W24S-U	-	-	53	W22EP-U	IW22	VW22	MP4316	-	IWF22	-	
253	W22M-U	-	-	354	W20S-U	-	-	535	W16FS-U	-	-	XP63 (Pt, Ir)	VW20	IW20	VW20	
254	W22M-U	-	-	355	W16S-U	-	-	536	W14F-U	-	-	<b>BERU (Germany) DENSO</b>				
2543	T20NR-U11	IT20	VT20	356	W14-U	-	-	54	W20EP-U	IW20	VW20	12-5DU	X22EP-U9	IX22B	-	
2544	T20NR-U11	IT20	VT20	357	W9-U	-	-	54	W20EX-U	IW20	VW20	12R-5DU	X22EPR-U9	IX22B	-	
2545	T16NR-U11	IT16	VT16	358	W9-U	-	-	55	W16EP-U	IW16	VW16	12VR-8SE	XE20HR-U9	-	VFXEH20	
2546	T16NR-U11	IT16	VT16	36	MA16PR-U	-	-	55	W16EX-U	IW16	VW16	12ZR-6SP2 (BIHEX)	-	-	-	
255	W20M-U	-	-	3606	T16PR-U15	ITF16	-	56	W14EP-U	IW16	VW16	12ZR-6SP2 (BIHEX)	-	-	-	
2553	T22M-U	-	-	37	MA9P-U	-	-	56	W14EX-U	IW16	VW16	12ZR-6SP03 (BIHEX)	-	-	-	
2554	T22M-U	-	-	373	M22	-	-	565	W16PR-U	-	-	-	-	-	-	
258	W14M-U	-	-	374	M22	-	-	566	W14PR-U	-	-	-	-	-	-	
2585	KJ16CR-L11	IK16	VK16	375	M17	-	-	567	W9PR-U	-	-	-	-	-	-	
2592	W31ES-U	IW31	-	376	L14-U	-	-	57	W9EP	-	-	-	-	-	-	
2593	W27ES-U	IW27	-	377	L14-U	-	-	584	MA20PR-U	-	-	-	-	-	-	
2594	W24ES-U	IW24	-	378	L14-U	-	-	601	T16EPR-U15	IT16	VT16	-	-	-	-	
26	T16PR-U	ITF16	-	379	L14-U	-	-	602	K20PR-U	IK20	VK20	-	-	-	-	
2611	W31ES-U	IW31	-	386	L14-U	-	-	603	K16R-U	IK16	VK16	-	-	-	-	
2612	W27ES-U	IW27	-	3922	K22PR-U	IK22	VK22	604	T20EPR-U15	IT20	VT20	-	-	-	-	
2613	W24ES-U	IW24	-	3923	K20PR-U	IK20	VK20	605	T16EPR-U15	IT16	VT16	-	-	-	-	
2614	W22ESR-U	-	-	3924	PQ16R	IQ16	VQ16	63	W22EPR-U	IW22	VW22	-	-	-	-	
2614	W22ES-U	-	-	3926	K16PR-U11	IK16	VK16	64	W20EPR-U	IW20	VW20	-	-	-	-	
2615	W22ESR-U	-	-	3926	K16R-U11	IK16	VK16	64	W20EXR-U	IW20	VW20	-	-	-	-	
2615	W22ES-U	-	-	393	W22ES-U	-	-	646	W14EXR-U13	IW16	VW16	-	-	-	-	
2616	W20ESR-U	-	-	394	W20ES-U	-	-	65	W16EPR-U	IW16	VW16	-	-	-	-	
2616	W20ES-U	-	-	395	W16ES-U	-	-	65	W16EXR-U	IW16	VW16	-	-	-	-	
2634	W27FS-U10	IWF27	-	396	W16ES-U	-	-	66	W14EP-U	IW16	VW16	-	-	-	-	
2635	W22FS-U	IWF22	-	397	W14E	-	-	66	W14EXR-U	IW16	VW16	-	-	-	-	
2636	W20FS-U	IWF22	-	398	W14E	-	-	664	T20PR-U15	ITF20	-	-	-	-	-	
2652	W24FS-U	IWF24	-	402	W22ESR-U	-	-	665	T16PR-U15	ITF16	-	-	-	-	-	
2653	W22FS-U	IWF22	-	403	W22ESR-U	-	-	666	T16PR-U15	ITF16	-	-	-	-	-	-
2654	W22FS-U	IWF22	-	404	W20ESR-U	-	-	667	T14PR-U15	ITF16	-	-	-	-	-	-
2655	W20FS-U	IWF22	-	405	W16ESR-U	-	-	67	W14EXR-U	IW16	VW16	-	-	-	-	
2656	W16FS-U	-	-	4051	W31ES-U	IW31	-	684	T20R-U	-	-	-	-	-	-	
2675	W16LS	-	-	4052	W31ES-U	IW31	-	685	T20R-U	-	-	-	-	-	-	
2676	W14L	-	-	4053	W27ES-U	IW27	-	687	T16R-U15	-	-	-	-	-	-	
2677	W14L	-	-	4054	W24ES-U	IW24	-	724	T20PR-U	ITF20	-	-	-	-	-	
2696	M22	-	-	4055	W22ES-U	-	-	725	T16PR-U	ITF16	-	-	-	-	-	-
2697	M17	-	-	4056	W20ES-U	-	-	726	T16PR-U	ITF16	-	-	-	-	-	-
27	T14PR-U	ITF16	-	406	W16ESR-U	-	-	727	T14PR-U	ITF16	-	-	-	-	-	-
2715	X24FS-U	-	-	4062	W31ES-U	IW31	-	73	W20PR-U	-	-	-	-	-	-	
2716	X20FS-U	-	-	4063	W27ESR	IW27	-	74	W20PR-U	-	-	-	-	-	-	-
273	W22FP-U	IWF22	-	4063	W27ESR-U	IW27	-	745	MA16PR-U	-	-	-	-	-	-	-
2735	X20FS-U	-	-	4092	W24FSR	IWF24	-	746	MA16PR-U	-	-	-	-	-	-	-
274	W20FP-U	IWF20	-	4093	W22FSR	IWF22	-	747	MA9P-U	-	-	-	-	-	-	-
275	W16FP-U	IWF16	-	411	W24FS-U	IWF24	-	75	W16PR-U	-	-	-	-	-	-	-
2755	X22ES-U	IX22	-	4113	W20FP-U	IWF20	-	76	W14PR-U	-	-	-	-	-	-	-
276	W9FP	-	-	4114	W20FP-U	IWF20	-	763	T16NR-U11	IT16	VT16	-	-	-	-	-
2772	M22	-	-	4123	W20FPR-U	IWF20	-	764	T20EPR-U	IT20	VT20	-	-	-	-	-
2773	M22	-	-	413	W22FS-U	IWF22	-	765	T16EPR-U	IT16	VT16	-	-	-	-	-
2775	L14-U/M14	-	-	4132	X27ES-U	IX27	-	766	T16EPR-U	IT16	VT16	-	-	-	-	-
2794	U24FS-U	IUF24	-	4133	X24ES-U	IX24	-	767	T16EPR-U	IT16	VT16	-	-	-	-	-
2795	U22FS-U	IUF22	-	414	W20FS-U	IWF22	-	77	W9PR-U	-	-	-	-	-	-	-
2796	U20FS-U	IUF22	-	4143	X24ESR-U	IX24	-	784	MA20PR-U	-	-	-	-	-	-	-
284	W20FPR-U	IWF20	-	415	W16FS-U	-	-	804	MA20PR-U	-	-	-	-	-	-	-
2852	SF50	-	-	4152	X27EP-U9	IX27B	-	84	W20PR-U	-	-	-	-	-	-	-
2872	SF51	-	-	4153	X24EP-U9	IX24B	-	847	W9PR-U	-	-	-	-	-	-	-
2892	SF50	-	-	416	W14F-U	-	-	85	W16PR-U	-	-	-	-	-	-	-
292	W27S-U	-	-	4162	X27EPR-U9	IX27B	-	86	W14PR-U	-	-	-	-	-	-	-
294	W16S-U	-	-	4163	X24EPR-U9	IX24B	-	864	T20EPR-U	IT20	VT20	-	-	-	-	-
295	W14-U	-	-	4164	X22EPR-U9	IX22B	-	865	T16EPR-U	IT16	VT16	-	-	-	-	-
2954	T22M-U	-	-	4173	X24FS-U	-	-	87	W9PR-U	-	-	-	-	-	-	-
2956	T20M-U	-	-	425	W16FSR	-	-	884	T20EPR-U15	IT20	VT20	-	-	-	-	-
297	W9-U	-	-	4251	W24ES-U	IW24	-	9061	K22PBR-S	IK22	VK22	-	-	-	-	-
2974	W22MP-U	-	-	4253	W16EX-U	IW16	VW16	9062	K20PBR	IK20	VK20	-	-	-	-	-
2976	W16S-U	-	-	426	W14FR-U	-	-	9063	K20PBR	IK20	VK20	-	-	-	-	-
298	W9-U	-	-	4263	W20EXR-U	IW20	VW20	9064	K20TXR	IK20	VK20	-	-	-	-	-
2985	W22MP-U	-	-	4265	W16EXR-U	IW16	VW16	907	K20PR-U11	IK20	VK20	-	-	-	-	-
3013	W24S-U	-	-	4275	W16PR-U	-	-	908	T16EPR-U15	IT16	VT16	-	-	-	-	-
3014	W20S-U	-	-	437	W14L	-	-	915	J16BR-U	-	-	-	-	-	-	-
3017	W9-U	-	-	44	MA20PR-U	-	-	925	J16BR-U	-	-	-	-	-	-	-
302	W20SR-U	-	-	45	MA16PR-U	-	-	94	T22EP-U	IT22	-	-	-	-	-	-
303	W20S-U	-	-	456	W14LM-U	-	-	945	T20EPR-U	IT20	VT20	-	-	-	-	-
3035	L14-U/M14	-	-	458	W14LM-U	-	-	965	T16PR-U15	ITF16	-	-	-	-	-	-
3055	MA20PR-U	-	-	46	MA16PR-U	-	-	966	T16PR-U15	ITF16	-	-	-	-	-	-
306	W9-U	-	-	483	T20EPR-U	IT20	VT20	985	T20EPR-U	IT20	VT20	-	-	-	-	-

AUSTRALIA CHINA INDIA INDONESIA KOREA MALAYSIA PHILIPPINES SAUDI ARABIA SINGAPORE TAIWAN THAILAND VIETNAM JAPAN EUROPE & USA CROSS REFERENCE PART NUMBER

(1) This comparison chart does not guarantee capability with any vehicle. Please use it for reference only. (2) Plug specifications (design, materials, etc.) varies according to manufacturer. (3) Choose your plug model by referring to the vehicle model compatibility table. (4) When choosing a plug model for tuning vehicles and vehicles not listed in the vehicle model compatibility chart, the customer is responsible for determining the correct plug.





# CROSS REFERENCE ( ⇒ )

BOSCH (Germany)	DENSO	IRIDIUM POWER	IRIDIUM TOUGH/PLUS	BOSCH (Germany)	DENSO	IRIDIUM POWER	IRIDIUM TOUGH/PLUS	BOSCH (Germany)	DENSO	IRIDIUM POWER	IRIDIUM TOUGH/PLUS	BOSCH (Germany)	DENSO	IRIDIUM POWER	IRIDIUM TOUGH/PLUS
FR8DP	IK16	IK16	VK16	HR5DC	T22EP-U	IT22	-	M10A0	L14-U	-	-	W4DP0	IW24	IW24	-
FR8DP1X	IK16	IK16	VK16	HR6BC	T20PR-U	ITF20	-	M10AC	L14-U/M14	-	-	W5AC	W22FS-U	IWF22	-
FR8DPX	IK16	IK16	VK16	HR6D+	T20EPR-U	IT20	VT20	M10ACO	L14-U	-	-	W5AP	IWF22	IWF22	-
FR8DS	IK16	IK16	VK16	HR6DC	T20EPR-U	IT20	VT20	M12B	L14-U/M14	-	-	W5AP	IWF22	IWF22	-
FR8HC	QJ16HR-U9	-	-	HR6DP	T20EPR-U	IT20	VT20	M5A	M22	-	-	W5AS	IWF22	IWF22	-
FR8HCOX	QJ16HR-U9	-	-	HR6DPP33V	VT20	IT20	VT20	M5AC	M22	-	-	W5B	W22FP-U	IWF22	-
FR8HP	QJ16HR-U9	-	-	HR6DS	T20EPR-U	IT20	VT20	M7A	M17	-	-	W5BC	W22FP-U	IWF22	-
FR8HP0	QJ16HR-U9	-	-	HR78	VT20	IT20	VT20	M7AC	M17	-	-	W5BP	IWF22	IWF22	-
FR8HPX	-	-	-	HR78X	VT20	IT20	VT20	M8A	L14-U/M14	-	-	W5C	W22ES-U	-	-
FR8KDC	K16TR11	IK16	VK16	HR7BC	T20PR-U	ITF20	-	M8A0	L14-U	-	-	W5CC	W22ES-U	-	-
FR8LCX	KJ16CR11	IK16	VK16	HR7CCY	-	-	-	M8AC	L14-U/M14	-	-	W5CCX	W22ES-U	-	-
FR8LDC	K20TXR	IK20	VK20	HR7D+	T20EPR-U	IT20	VT20	M8AC0	L14-U	-	-	W5CP	W22ES-U	-	-
FR8LDC4	K20TXR	IK20	VK20	HR7DC	T20EPR-U	IT20	VT20	M95T1	L14-U/M14	-	-	W5CS	W22ES-U	-	-
FR8LP	IK16	IK16	VK16	HR7DC0	T20EPR-U	IT20	VT20	U260T1	U22FS-U	IUF22	-	W5D	W22EP-U	IW22	VW22
FR8LPX	IK16	IK16	VK16	HR7DCX	T20EPR-U	IT20	VT20	U2A	U24FS-U	IUF24	-	W5D1	W22EP-U	IW22	VW22
FR8MC9	K16HPR-U11	IKH16	VKH16	HR7DCY	T20EPR-U15	IT20	VT20	U3CC	U22ES-N	IU22	-	W5DC	W22EP-U	IW22	VW22
FR8ME	K16HPR-U11	IKH16	VKH16	HR7DP	IT20	IT20	VT20	U4A	U22FS-U	IUF22	-	W5DCO	W22EP-U	IW22	VW22
FR8NP	IKH16	IKH16	VKH16	HR7DPP22	ZT20EPR11	IT20	VT20	U4AC	U22FS-U	IUF22	-	W5DP	IW22	IW22	VW22
FR8SE0	K16HPR-U11	IKH16	VKH16	HR7DPX	IT20	IT20	VT20	U5AC	U20FS-U	IUF22	-	W5DPO	W22ES-U	-	-
FR8SPP332	VKH16	IKH16	VKH16	HR7MCU	T16VR-U10	ITV16	-	U6AC	U20FS-U	IUF22	-	W5DTC	W22EPB	IW22	VW22
FR8TE2	-	-	-	HR7MPP	PT16VR13	ITV16	-	UH4CC	U24FER9	IUH24	-	W5EC	W22S-U	-	-
FR8T1332	-	-	-	HR7MPP+	PT16VR13	ITV16	-	UH5CC	U24FER9	IUH24	-	W6AC	W20FS-U	IWF22	-
FR91X	-	-	-	HR7MPP+V	PT16VR13	ITV16	-	UR2AS	IUF24	IUF24	-	W6BC	W20FP-U	IWF20	-
FR9DCX	Q14R-U11	IQ16	VQ16	HR7MPP22U	PT16VR13	ITV16	-	UR2CC	U24ESR-N	IU24	-	W6CC	W22ES-U	-	-
FR9HC	QJ16HR-U9	-	-	HR7MPP22V	PT16VR13	ITV16	-	UR3AC	U22FSR-U	IUF22	-	W6D	W20EP-U	IW20	VW20
FR9HCX	QJ16HR-U9	-	-	HR7MPP302X	PT16VR13	ITV16	-	UR3AS	U22FSR-U	IUF22	-	W6D1	W20EP-U	IW20	VW20
FR9HX	QJ16HR-U9	-	-	HR7MEV	-	-	-	UR3CC	U22ESR-N	IU22	-	W6DC	W20EP-U	IW20	VW20
H09DC	IT27	IT27	-	HR7N332(Fomoco)	-	ITV20	-	UR4AC	U22FSR-U	IUF22	-	W6DC0	W20EP-U	IW20	VW20
H10B	T14PR-U	ITF16	-	HR8AC	T20R-U	-	-	UR4AS	U20FSR-U	IUF22	-	W6DP	IW20	IW20	VW20
H10BC	T16P-U	ITF16	-	HR8ACV	T20R-U	-	-	UR5AC	U20FSR-U	IUF22	-	W6DP0	W22ES-U	-	-
H2CS	IT27	IT27	-	HR8AP	T20R-U	-	-	UR5DC	U20EPR9	IU20	-	W6DTC	W20EPB	IW20	VW20
H3CS	IT24	IT24	-	HR8APY	T20R-U	-	-	UR6AC	U20FSR-U	IUF22	-	W7AC	W20FS-U	IWF22	-
H4CS	IT24	IT24	-	HR8BC	T16PR-U	ITF16	-	USR7AC	-	-	-	W7ACY	W20FS-U	IWF22	-
H56	T22EP-U	IT22	-	HR8BCY	T16PR-U15	ITF16	-	V6S113828	-	-	-	W7AP	-	IWF22	-
H5DC	T22EP-U	IT22	-	HR8BP	T16PR-U	ITF16	-	VR8SE	XE20HR-U9	-	VFXEH20	W7B	W20FP-U	IWF20	-
H5DC0	T22EP-U	IT22	-	HR8BPX	T16PR-U11	ITF16	-	VR8SEV	XE20HR-U9	-	VFXEH20	W7BC	W20FP-U	IWF20	-
H5DP	T22EP-U	IT22	-	HR8BPY	T16PR-U15	ITF16	-	VR8SEW	XE20HR-U9	-	VFXEH20	W7BP	-	IWF22	-
H6B	T20P-U	ITF20	-	HR8BPZ	T16PR-U15	ITF16	-	W06AS	W31FS	-	-	W7C0	W20ES-U	-	-
H6BC	T20P-U	ITF20	-	HR8D+	T20EPR-U	IT20	VT20	W06CS	IW34	IW34	-	W7CC	W20ES-U	-	-
H6DC	T20EP-U	IT20	VT20	HR8DC	T20EPR-U	IT20	VT20	W07AS	W31FS	-	-	W7CC0	W20ES-U	-	-
H6DC0	T20EP-U	IT20	VT20	HR8DCX	T16EPR-U	IT16	VT16	W07CS	IW34	IW34	-	W7D	W20EP-U	IW20	VW20
H6DP	T20EP-U	IT20	VT20	HR8DCY	T16EPR-U15	IT16	VT16	W08AS	IWF27	IWF27	-	W7DC	W20EP-U	IW20	VW20
H7BC	T20P-U	ITF20	-	HR8DP	IT16	IT16	VT16	W08CS	IW31	IW31	-	W7DC0	W20EP-U	IW20	VW20
H7CC	-	-	-	HR8DPP15V	PT16EPR-L13	IT16	VT16	W10A	W14F-U	-	-	W7DCR	W20EP-U	IW20	VW20
H7DC	T20EP-U	IT20	VT20	HR8DPP22U	PT16EPR-L13	IT16	VT16	W10AC	W14F-U	-	-	W7DCX	W20EPR-U11	IW20	VW20
H7DC0	T20EP-U	IT20	VT20	HR8DPP22U	PT16EPR-L13	IT16	VT16	W10C	W14E	-	-	W7DP	IW20	IW20	VW20
H7DCY	T20EP-U15	IT20	VT20	HR8DPV	IT16	IT16	VT16	W10CC	W14E	-	-	W7DPX	IW20	IW20	VW20
H7DP	T20EP-U	IT20	VT20	HR8DPX	IT16	IT16	VT16	W10D	W9EP	-	-	W7DSR	IW20	IW20	VW20
H7DPY	IT20	IT20	VT20	HR8DPY	IT16	IT16	VT16	W10DC	W9EP	-	-	W7DTC	W20EPB	IW20	VW20
H7LDCR	T20EPR-U	IT20	VT20	HR8LCO	T20NR-U11	IT20	VT20	W10DCX	W9EP	-	-	W7DX	W20EPR-U11	IW20	VW20
H8BC	T16P-U	ITF16	-	HR8LPX	T16NR-U11	IT16	VT16	W10EC	W14-U	-	-	W7EC	W20S-U	-	-
H8D	T16EPR-U	IT16	VT16	HR8MEV	T16VR-U10	ITV16	-	W10F	W14PR-U	-	-	W7FC	W20PR-U	-	-
H8DC	T16EPR-U	IT16	VT16	HR8MPV	ITV16	ITV16	-	W10FC	W14PR-U	-	-	W7LTCR	W20EPR-S	IW20	VW20
H8DC0	T16EPR-U	IT16	VT16	HR8NPP302	PT16VR13	ITV16	-	W10LCX	-	-	-	W8A	W16FS-U	-	-
H8DP	IT16	IT16	VT16	HR91GX	T16PR-U	ITF16	-	W11E0	-	-	-	W8A0	W16FS-U	-	-
H9B	T14PR-U	ITF16	-	HR91Y0	-	-	-	W12A	-	-	-	W8AC	W16FS-U	-	-
H9BC	T14PR-U	ITF16	-	HR9AC	T16R-U	-	-	W2A	W27FS-U	IWF27	-	W8AO	W16FS-U	-	-
H9BCY	T14PR-U15	ITF16	-	HR9ACV	T16R-U15	-	-	W2AC	W27FS-U	IWF27	-	W8AP	IWF16	IWF16	-
H9DC	T16EPR-U	IT16	VT16	HR9AP	T16R-U	-	-	W2AS	IWF27	IWF27	-	W8B	W16FP-U	IWF16	-
H9DC0	T16EPR-U	IT16	VT16	HR9APX	T16R-U15	-	-	W2CC	W27ES-U	IW27	-	W8BC	W16FP-U	IWF16	-
H9DCY	T16EPR-U15	IT16	VT16	HR9APY	T16R-U15	-	-	W2CS	IW31	IW31	-	W8BP	W16FP-U	IWF16	-
HGR6DQI (Pt-Ir FUSION)	VT20	IT20	VT20	HR9BC	T16PR-U	ITF16	-	W3A	W24FS-U	IWF24	-	W8CC	W16ES-U	-	-
HGR6KQC	T20EPR-U	IT20	VT20	HR9BCY	T16PR-U15	ITF16	-	W3AC	W24FS-U	IWF24	-	W8DC	W16EP-U	IW16	VW16
HGR7DQI (Pt-Ir FUSION)	VT20	IT20	VT20	HR9BCZ	T16PR-U15	ITF16	-	W3AP	IWF24	IWF24	-	W8DC0	W16EP-U	IW16	VW16
HGR7HQPE0	-	-	-	HR9BP	T16PR-U	ITF16	-	W3AS	IWF24	IWF24	-	W8DC04	W20EP-U	IW20	VW20
HGR7KQC	T20EPR-U	IT20	VT20	HR9BPX	T16PR-U11	ITF16	-	W3C	W24ES-U	IW24	-	W8DCX	W16EP-U11	IW16	VW16
HGR8DQI (Pt-Ir FUSION)	VT16	IT16	VT16	HR9BPY	T16PR-U15	ITF16	-	W3CC	W24ES-U	IW24	-	W8DP	IW16	IW16	VW16
HGR8MQI (Pt-Ir FUSION)	-	ITV16	-	HR9BPZ	T16PR-U15	ITF16	-	W3CP	IW24	IW24	-	W8DPV	W16EP-U11	IW16	VW16
HGR9BQI (Pt-Ir FUSION)	-	ITF16	-	HR9DC	T16EPR-U	IT16	VT16	W3CS	IW24	IW24	-	W8DPX	W16EP-U11	IW16	VW16
HGR9DQI (Pt-Ir FUSION)	-	-	-	HR9DCX	T16EPR-U15	IT16	VT16	W3DP	W24EP-U	IW24	-	W8DTC	W20EPB	IW20	VW20
HLR8STEX	ITV20	ITV20	-	HR9DCY	T16EPR-U15	IT16	VT16	W3DPO	IW01-24	-	-	W8DX	W16EP-U11	IW16	VW16
HR10AC	T14PR-U	ITF16	-	HR9DPX	IT16	IT16	VT16	W3DPO	IW24	IW24	-	W8E	W16S-U	-	-
HR10ACY	T14PR-U15	ITF16	-	HR9DPY	IT16	IT16	VT16	W4A	W24FS-U	IWF24	-	W8EC	W16S-U	-	-
HR10BC	T14PR-U	ITF16	-	HR9HCO	T20NR-U11	IT20	VT20	W4A1	W24FS-U	IWF24	-	W8FC	W16PR-U	-	-
HR10BCX	T14PR-U15	ITF16	-	HR9HCO	T16EPR-U	IT16	VT16	W4A2	W24FS-U	IWF24	-	W8LCR	J16CR-U	IW16	VW16
HR10BCY	T14PR-U15	ITF16	-	HR9HP0	-	-	-	W4AC	W24FS-U	IWF24	-	W8LDCR	W16ETR-S	IW16	VW16
HR10BCZ	T14PR-U15	ITF16	-	HR9LCO	T16NR-U11	IT16	VT16	W4AP	IWF24	IWF24	-	W8LPR	J16CR-U	IW16	VW16
HR10DCX	T16EPR-U	IT16	VT16	HR9LCX	-	-	-	W4AS	IWF24	IWF24	-	W8LTCR	W20EPR-S	IW20	VW20
HR10HC0	T16EPR-U	IT16	VT16	HR9LPPY	PTJ16R15	IT16	VT16	W4C1	W24ES-U	IW24	-	W9A	W14F-U	-	-
HR10LC0	T16NR-U11	IT16	VT16	HR9LPX	T16NR-U11	IT16	VT16	W4C2	W24ES-U	IW24	-	W9A0	W14F-U	-	-
				HS5E	T22M-U	-	-	W4CC	W24ES-U	IW24	-	W9AC	W14F-U	-	-
				HS6E	T22M-U	-	-	W4CP	IW24	IW24	-	W9AC0	W14F-U	-	-
				HS7E	T20M-U	-	-	W4CPX	W24ES-U	IW24	-	W9CC	W14E	-	-
				HS7F	T20MP-U	-	-	W4CS	IW24	IW24	-	W9DC	W14EP-U	IW16	VW16
				HS8E	T20M-U	-	-	W4DP	IW22	IW22	VW22	W9DC0	W14EP-U	IW16	VW16
				LGF6TC	-	-	-	W4DP0	IW01-24	-	-	W9DCX	W14EX-U11	IW16	VW16

AUSTRALIA CHINA INDIA INDONESIA KOREA MALAYSIA PHILIPPINES SAUDIARABIA SINGAPORE TAIWAN THAILAND VIETNAM JAPAN EUROPE & USA CROSS REFERENCE PART NUMBER

(1) This comparison chart does not guarantee capability with any vehicle. Please use it for reference only. (2) Plug specifications (design, materials, etc.) varies according to manufacturer. (3) Choose your plug model by referring to the vehicle model compatibility table. (4) When choosing a plug model for tuning vehicles and vehicles not listed in the vehicle model compatibility chart, the customer is responsible for determining the correct plug.

# CROSS REFERENCE ( other DENSO )

	BOSCH (Germany)				BOSCH (Germany)				BOSCH (Germany)				CHAMPION (U.S.A.)			
	DENSO	IRIDIUM POWER	IRIDIUM TOUGH/PLUS		DENSO	IRIDIUM POWER	IRIDIUM TOUGH/PLUS		DENSO	IRIDIUM POWER	IRIDIUM TOUGH/PLUS		DENSO	IRIDIUM POWER	IRIDIUM TOUGH/PLUS	
AUSTRALIA	W9DTC	W16EPB10	IW16	VW16	WR7DC+	W20EPR-U	IW20	VW20	X4CC	X24ES-U	IX24	-	9801 (Iridium)	VK20Y	-	VK20Y
	W9E	W14-U	-	-	WR7DCX	W20EPR-U	IW20	VW20	X4CS	IX24	IX24	-	9802 (Iridium)	VK20	IK20	VK20
	W9E0	W14LM-U	-	-	WR7DCX	W20EPR-U11	IW20	VW20	X4DC	X27EP-U9	IX27B	-	9803 (Iridium)	VK20	IK20	VK20
	W9EC	W14-U	-	-	WR7DP	IW20	IW20	VW20	X5CC	X24ES-U	IX24	-	9804 (Iridium)	VW20	IW20	VW20
	W9EC0	W14LM-U	-	-	WR7DP1	IW20	IW20	VW20	X5DC	X22EP-U9	IX22B	-	A10	X20ES-U	-	-
CHINA	W9LC	J14CR-U	IW16	VW16	WR7DP1X	IW20	IW20	VW20	X5DTC	X22ES-U	IX22	-	A57C	X31ESR-U	-	-
	W9LCX	J14CR-U	IW16	VW16	WR7DPX	IW20	IW20	VW20	XR2AS	X24FS-U	-	-	A57G	IXU01-31	-	-
	W9LDCR	W16ETR-S	IW16	VW16	WR7DS	IW20	IW20	VW20	XR2CS	IX24	IX24	-	A59C	X27ES-U	IX27/IXU27	-
	W9LVX	-	-	-	WR7DS+	IW20	IW20	VW20	XR4AS	X24FS-U	-	-	A59G	IX27/IXU27	IX27/IXU27	-
	WEA	SF50	-	-	WR7DTC	W20EPBR-S	IW20	VW20	XR4CS	X24ESR-U	IX24	-	A59GC	IX27/IXU27	IX27/IXU27	-
INDIA	WGR6DQI (Pt-IR FUSION)	VW20	IW20	VW20	WR7EC	W20SR-U	-	-	XR4DC	X27EP-U9	IX27B	-	A59C	X27EP-U9	IX27B	-
	WGR7DQI (Pt-IR FUSION)	VW20	IW20	VW20	WR7LC	J16CR-U	IW16	VW16	XR5CC	X24ESR-U	IX24	-	A6	X24ES-U	IX24	-
	WGR8DQI (Pt-IR FUSION)	VW16	IW16	VW16	WR7LDC	W20ET-S	IW20	VW20	XR5DC	X22EPR-U9	IX22B	-	A61	X27ES-U	IX27/IXU27	-
	WGR9DQI (Pt-IR FUSION)	-	-	-	WR7LT+	W20EPBR-S	IW20	VW20	XR6CC	X24ESR-U	IX24	-	A61G	IX27	IX27	-
	WK175T1	W20M-U	-	-	WR8AC	W16FSR	-	-	XR7CC	X22ESR-U	IX22	-	A6G	IX24	IX24	-
INDONESIA	WR10AC	W14FR-L	IWF16	-	WR8AP	W16FSR	-	-	XR7DC	X22EPR-U9	IX22B	-	A6HC	X24EP-U9	IX24B	-
	WR10AC	W14FR-U	-	-	WR8B+	W16FPR-U	IW16	VW16	XR7LDC	-	-	-	A6YC	X24ES-U	IX24	-
	WR10BC	W14FPR-U	IWF16	-	WR8B+	W16FPR-U	IWF16	-	XR8DC	X20EPR-U9	-	-	A8HC	X22EP-U9	IX22B	-
	WR10DC	W14EPR-U	IW16	VW16	WR8BP	W16FPR-U	IWF16	-	Y5DDC	XU22EPR-U	-	-	A8Y	X24ES-U	IX24	-
	WR10DCX	W14EXR-U11	IW16	VW16	WR8CC	W16ESR-U	-	-	Y6DC	XU20EPR-U	IXU22	VXU22	A8YC	X22EP-U9	IX22B	-
KOREA	WR10FC	W14PR-U	-	-	WR8CCX	W16ESR-U	-	-	Y6NPP332	VXUH22	IXUH22	VXUH22	BL11Y	T20P-U	ITF20	-
	WR10FCY	W14PR-U	-	-	WR8CP	W16ESR-U	-	-	Y7LPP332W	VXU22	IXU22	VXU22	BL55	-	-	-
	WR10FCZ	W14PR-U	-	-	WR8D+	W16EPR-U	IW16	VW16	Y7MPP33	VXUH22	IXUH22	VXUH22	BL57	-	-	-
	WR10FY	W14PR-U	-	-	WR8D+	W16EPR-U	IW16	VW16	Y7MPP332	VXUH22	IXUH22	VXUH22	BL57Y	-	-	-
	WR10FYC	W14PR-U	-	-	WR8D+X	W16EPR-U11	IW16	VW16	YR5DDE	XU24EPR-U	IXU24	VXU24	BN14Y	T16EPR-U	IT16	VT16
MALAYSIA	WR10FC	W14PR-U	-	-	WR8DC	W16EPR-U	IW16	VW16	YR5LDE	XU24EPR-U	IXU24	VXU24	C10YCC	K20P-U	IK20	VK20
	WR10FYC	W14PR-U	-	-	WR8DC04	W20EPR-U	IW20	VW20	Y6NPP3320	VXUH22	IXUH22	VXUH22	C11YCC	K16P-U11	IK16	VK16
	WR10FYCZ	W14PR-U	-	-	WR8DC4	W16EPR-U	IW16	VW16	YR6LDE	XU22EPR-U	IXU22	VXU22	C12YCC	K16P-U11	IK16	VK16
	WR10FYCZ	W14PR-U	-	-	WR8DCX	W16EPR-U11	IW16	VW16	YR6LDEM14	XU22EPR-U	IXU22	VXU22	C279YC	K22PR-U	IK22	VK22
	WR10FYCZ	W14PR-U	-	-	WR8DP	IW16	IW16	VW16	YR6NPP332	VXUH22	IXUH22	VXUH22	C281YC	K20P-U	IK20	VK20
PHILIPPINES	WR10LC	J14CR-U	IW16	VW16	WR8DP1	IW16	IW16	VW16	YR7DC	XU22EPR-U	IXU22	VXU22	C53C	IK31	IK31	-
	WR10LCV	J14CR-U	IW16	VW16	WR8DP1X	IW16	IW16	VW16	YR7DE	XU22EPR-U	IXU22	VXU22	C55C	IK31	IK31	-
	WR11E0	W9LMR-US	-	-	WR8DPX	IW16	IW16	VW16	YR7LPP332W	VXU22	IXU22	VXU22	C57	IK01-31	-	-
	WR11F	W9PR-U	-	-	WR8DS	W16EPR-U	IW16	VW16	YR7MPP33	VXUH22	IXUH22	VXUH22	C57A	IK01-31	-	-
	WR12EC	W9LMR-US	-	-	WR8E	W16S-U	-	-	Z65113320R (BiHex)	-	-	-	C57C/CX	IK31	IK31	-
SAUDI ARABIA	WR2CC	W31ESR-U	IW31	-	WR8FC	W16PR-U	-	-	ZGR5TPP332 (BiHex)	-	-	-	C57J4	IK01-31	-	-
	WR3AP	IWF27	IWF27	-	WR8HP	-	-	-	ZGR6STE2 (BiHex)	-	-	-	C57YC	IK31	IK31	-
	WR3CC	W27ESR	IW27	-	WR8HP	J16AR-U11	-	-	ZQR85 (BiHex)	-	-	-	C59C	IK27	IK27	-
	WR3CC	W27ESR-U	IW27	-	WR8LP	IW16	IW16	VW16	ZRS51332 (BiHex)	-	-	-	C59YC	IK27	IK27	-
	WR3CP	IW27	IW27	-	WR8LT+	W20EPBR-S	IW20	VW20	ZR5TPP330 (BiHex)	-	-	-	C61C	IK27	IK27	-
SINGAPORE	WR3CS	IW27	IW27	-	WR91	VW16	IW16	VW16	ZR5TPP330A (BiHex)	-	-	-	C61YC	IK27	IK27	-
	WR3CS	IW27	IW27	-	WR91V	P16PR11	IW16	VW16	ZR5TPP33-S (BiHex)	-	-	-	C63C	IK24	IK24	-
	WR3CTC	IRE01-27	-	-	WR91V0	-	-	-	Z65113320R (BiHex)	-	-	-	C63YC	IK24	IK24	-
	WR3DC	IW27	IW27	-	WR91X	VW16	IW16	VW16	ZR8TPP15 (BiHex)	-	-	-	C6BMC	K22PBR-S	IK22	VK22
	WR4AC	W24FSR	IWF24	-	WR9CC	W14E	-	-	CHAMPION (U.S.A.)	DENSO	IRIDIUM POWER	IRIDIUM TOUGH/PLUS	C6BYC	K22PB	IK22	VK22
TAIWAN	WR4AP	IWF24	IWF24	-	WR9D+	W16EPR-U	IW16	VW16	206	IK20	IK20	VK20	C6BYC4	K22PB	IK22	VK22
	WR4CC	W24ESR-U	IW24	-	WR9DC	W14EPR-U	IW16	VW16	207	IK22	IK22	VK22	C6VPYC	IK22	IK22	VK22
	WR4CP	IW24	IW24	-	WR9DCX	W14EXR-U11	IW16	VW16	208	IK24	IK24	-	C6YCC	K22PR-U	IK22	VK22
	WR4DP0	IW01-24	-	-	WR9DCY	W14EXR-U11	IW16	VW16	209	IK27	IK27	-	C7GY	IK22	IK22	VK22
	WR4DP0	IW24	IW24	-	WR9DP	W14EPR-U	IW16	VW16	307	IW22	IW22	VW22	C7YC	K22PR-U	IK22	VK22
THAILAND	WR56	VW22	IW22	VW22	WR9DPX	W14EXR-U11	IW16	VW16	308	IW24	IW24	-	C7YCC	K22PR-U	IK22	VK22
	WR5AC	W22FSR	IWF22	-	WR9DS	W14EPR-U	IW16	VW16	470	-	ITL20	-	C7YCX	K22PR-U	IK22	VK22
	WR5AP	IWF22	IWF22	-	WR9E0	W14LM-U	-	-	860	MA20PR-U	-	-	C9BMC	K20TXR	IK20	VK20
	WR5CC	W22ESR-U	-	-	WR9EC	W14-U	-	-	870	MA16PR-U	-	-	C9BYC	K20PBR	IK20	VK20
	WR5CP	W22ES-U	-	-	WR9EC0	W14-U	-	-	3013	T16EPR-U15	IT16	VT16	C9GY	IK20	IK20	VK20
VIETNAM	WR5D+	W22EPR-U	IW22	VW22	WR9EC3	W14-U	-	-	3015	T16EPR-U	IT16	VT16	C9MCC	K20-U	IK20	VK20
	WR5DC	W22EPR-U	IW22	VW22	WR9ECO	W14-U	-	-	3018	T16PR-U11	ITF16	-	C9YC	K20P-U	IK20	VK20
	WR5DP	IW22	IW22	VW22	WR9FC	W14PR-U	-	-	3025	T16PR-U15	ITF16	-	C9YC4	K20PR-U11	IK20	VK20
	WR5DS	IW22	IW22	VW22	WR9FCY	W14PR-U	-	-	3031	W16EXR-U13	IW16	VW16	C9YCC	K20P-U	IK20	VK20
	WR6AC	W22FSR	IWF22	-	WR9FCZ	W14PR-U	-	-	3034	-	IK16	VK16	C9YCX	K20P-U	IK20	VK20
JAPAN	WR6BC	W20FPR-U	IWF20	-	WR9FP	W14PR-U	-	-	3071	Q16PR-U	IQ16	VQ16	CJ11	W14M-U	-	-
	WR6CC	W22ESR-U	-	-	WR9FPY	W14PR-U	-	-	3322	W16EPR-U	IW16	VW16	CJ14	W14M-U	-	-
	WR6D+	W20EPR-U	IW20	VW20	WR9FPZ	W14PR-U	-	-	3344	K20PR-U	IK20	VK20	CJ4	W22M-U	-	-
	WR6DC	W20EPR-U	IW20	VW20	WR9HC	J16AR-U11	-	-	3401	T16EPR-U	IT16	VT16	CJ6	W22M-U	-	-
	WR6DCX	W20EPR-U11	IW20	VW20	WR9LE	J14CR-U	IW16	VW16	3405	W16EXR-U	IW16	VW16	CJ7Y	W22MP-U	-	-
EUROPE & USA	WR6DP0	IW20	IW20	VW20	WR9LEV	J14CR-U	IW16	VW16	3407	T16EPR-U15	IT16	VT16	CJ7Y	W22MP-U	-	-
	WR6DP1X	IW20	IW20	VW20	WR9LP	J14CR-U	IW16	VW16	3415	W20EPR-U	IW20	VW20	CJ8	W20M-U	-	-
	WR6DPX	IW20	IW20	VW20	WR9LS	J14CR-U	IW16	VW16	7015 (Double-Pt)	VT16	IT16	VT16	CJ8Y	W20MP-U	-	-
	WR6DS	IW20	IW20	VW20	WS12E	W14M-U	-	-	7018 (Double-Pt)	ITF16	ITF16	-	D10	M17	-	-
	WR6DTC	W20EPBR-S	IW20	VW20	WS5E	W22M-U	-	-	7032 (Double-Pt)	PT16VR13	ITV16	-	D14	L14-U	-	-
CROSS REFERENCE NUMBER	WR78	W20EPBR-S	IW20	VW20	WS5F	W22MP-U	-	-	7034 (Double-Pt)	J16AR-U11	-	-	D14	L14-U/M14	-	-
	WR78G	IWF20	IWF20	-	WS6E	W20M-U	-	-	7318 (Double-Pt)	VK16	IK16	VK16	D14N	L14-U	-	-
	WR78X	W20EPBR-S	IW20	VW20	WS6F	W20MP-U	-	-	7436 (Double-Pt)	VK16	IK16	VK16	D15Y	L14-U	-	-
	WR7AC	W20FSR-U	IWF22	-	WS7E	W20M-U	-	-	7440 (Double-Pt)	ITL20	ITL20	-	D15Y	L14-U/M14	-	-
	WR7AP	-	IWF22	-	WS7F	W20MP-U	-	-	7940 (Double-Pt)	VT16	IT16	VT16	D16	L14-U	-	-
WR7B	W20FPR-U	IWF20	-	WS8E	W20M-U	-	-	7963 (Double-Pt)	VT16	IT16	VT16	D16J	L14-U	-	-	
WR7B+	W20FPR-U	IWF20	-	WS8F	W20MP-U	-	-	7983 (Double-Pt)	VT16	IT16	VT16	D18Y	L14-U	-	-	
WR7BC	W20FPR-U	IWF20	-	WS9EC	W14M-U	-	-	9001 (Iridium)	VK16	IK16	VK16	D18Y	L14-U/M14	-	-	
WR7BP	-	IWF22	-	WSR5F	W22MPR-U	-	-	9002 (Iridium)	VK16	IK16	VK16	D21	L14-U	-	-	
WR7CC	W20ESR-U	-	-	WSR6E	W20MR-U	-	-	9204 (Iridium)	VT20	IT20	VT20	D21	L14-U/M14	-	-	
WR7CCX	W20ESR-U	-	-	WSR6F	W22MPR-U	-	-	9401 (Iridium)	VT16	IT16	VT16	D23	L14-U	-	-	
WR7CP	W20ESR-U	-	-	WSR7F	W20MPR-U10	-	-	9402 (Iridium)	VT20	IT20	VT20	D23	L14-U/M14	-	-	
WR7CPX	-	-	-	WSR8E	W14MR-U	-	-	9404 (Iridium)	VT16	IT16	VT16	D9	M22	-	-	
WR7D+	W20EPR-U	IW20	VW20	WSR8F	W20MPR-U10	-	-	9701 (Iridium)	VXU22	IXU22	VXU22	D9J	M22	-	-	
WR7D+X	W20EPR-U11	IW20	VW20	X3CPO	IXU01-27	-	-									
WR7DC	W20EPR-U	IW20	VW20	X3CPO	IX27	-	-									

# CROSS REFERENCE ( ⇒ )

CHAMPION (U.S.A.)	DENSO	IRIDIUM POWER	IRIDIUM TOUGH/PLUS	CHAMPION (U.S.A.)	DENSO	IRIDIUM POWER	IRIDIUM TOUGH/PLUS	CHAMPION (U.S.A.)	DENSO	IRIDIUM POWER	IRIDIUM TOUGH/PLUS	CHAMPION (U.S.A.)	DENSO	IRIDIUM POWER	IRIDIUM TOUGH/PLUS
DJ6J	T22M-U	-	-	L60R	-	IWF24	-	N62R	IW06-27	-	-	QL81Y	W22FPR-U	IWF22	-
DJ6Y	T22MP-U	-	-	L61Y	W24FP-U	IWF24	-	N64Y	W24EP-U	IW24	-	QL82C	W22FSR	IWF22	-
DJ7J	T20M-U	-	-	L62R	-	IWF24	-	N65Y	W22EP-U	IW22	VW22	QL82YC	W22FPR-U	IWF22	-
DJ7Y	T20MP-U	-	-	L64Y	W22FP-U	IWF22	-	N66Y	W20EP-U	IW20	VW20	QL86C	W20FSR-U	IWF22	-
DJ8J	T20M-U	-	-	L66Y	W20FP-U	IWF20	-	N6BYC	W22EPB	IW22	VW22	QL87C	W20FSR-U	IWF22	-
F10	MA20PR-U	-	-	L6G	IWF22	IWF22	-	N6GY	IW24	IW24	-	QL87YC	W20FPR-U	IWF20	-
F10C	MA20PR-U	-	-	L76V	SF50	-	-	N6YC	W24EP-U	IW24	-	QN2C	W27ESR	IW27	-
F11Y	MA16PR-U	-	-	L77J	W27FS-U	IWF27	-	N6YCC	W24EP-U	IW24	-	QN2C	W27ESR-U	IW27	-
F11YC	MA16PR-U	-	-	L77J4	W27FS-U10	IWF27	-	N6YCX	W24EP-U	IW24	-	QN2G	IW27	IW27	-
F14Y	MA9P-U	-	-	L77JC	W27FS-U	IWF27	-	N7	W16ES-U	-	-	QN3C	W24ESR-U	IW24	-
F14YC	MA9P-U	-	-	L77JC4	W27FS-U10	IWF27	-	N74C	W22ES-U	-	-	QN53VS	IW01-32	-	-
F7Y	MA20P-U	-	-	L78C	W24FS-U	IWF24	-	N79Y	W22EP-U	IW22	VW22	QN84	W27ESR-V	IW27	-
F7YC	MA20P-U	-	-	L78V	SF51	-	-	N7BMC	W20ETR-L	IW20	VW20	QN86	W24ESR-V	IW24	-
F7YCC	MA20P-U	-	-	L78Y	W24FP-U	IWF24	-	N7BYC	W22EPB	IW22	VW22	R10	X20ES-U	-	-
F9Y	MA20P-U	-	-	L7J	W22FS-U	IWF22	-	N7GY	W22I	IW22	VW22	R6	X24ES-U	IX24	-
F9YC	MA20P-U	-	-	L81Y	W22FP-U	IWF22	-	N7YC	W22EP-U	IW22	VW22	R6G	IX24	IX24	-
FN14LY	KJ16CR-L11	IK16	VK16	L82C	W22FS-U	IWF22	-	N7YC4	W22EP-U11	IW22	VW22	R8	X22ES-U	IX22	-
FR5LP1	-	-	-	L82R	-	-	-	N7YCC	W22EP-U	IW22	VW22	RA4GHC	XU27EPR-U	IXU27	-
G2	U24ESR-N	IU24	-	L82YC	W22FP-U	IWF22	-	N7YCX	W22EP-U	IW22	VW22	RA4HC	XU24EPR-U	IXU24	VXU24
G53C	IU01-34	-	-	L82YCC	W22FP-U	IWF22	-	N8	W14E	-	-	RA4YC	XU27EPR-U	IXU27	-
G53R	IU01-34	-	-	L84R	-	-	-	N80G	IW34	IW34	-	RA59GC	IXU27	IXU27	-
G54V	RU01-31	-	-	L85C	W20FS-U	IWF22	-	N82	-	IW29	-	RA59PP	IXU27	IXU27	-
G55	U31ESR-N	IU31	-	L86C	W16FS-U	-	-	N82G	IW31	IW31	-	RA6HC	XU24EPR-U	IXU24	VXU24
G55C	U31ESR-N	IU31	-	L86CC	W16FS-U	-	-	N82S	IW31	IW31	-	RA6YC	XU24EPR-U	IXU24	VXU24
G55R	IU01-31	-	-	L87R	-	IWF27	-	N84	W27ES-V	IW27	-	RA8HC	XU22EPR-U	IXU22	VXU22
G57C	U31ESR-N	IU31	-	L87YC	W20FP-U	IWF20	-	N84G	IW29	IW29	-	RA8YC	XU22EPR-U	IXU22	VXU22
G57R	IU01-31	-	-	L87YCC	W20FP-U	IWF20	-	N86	W24ES-V	IW24	-	RAX92C	X27ESR-U	IX27	-
G58	U27ES-N	IU27	-	L88A	W16FS-U	-	-	N86G	IW27	IW27	-	RAX92DC	X27ETR	IX27	-
G59C	U27ES-N	IU27	-	L89CM	W16FS-U	-	-	N87	W24ES-U	IW24	-	RAX92YC	X27EPR-U9	IX27B	-
G59R	IU01-27	-	-	L90C	W16FS-U	-	-	N87G	IW24	IW24	-	RAX94C	X24ESR-U	IX24	-
G61	U27ES-N	IU27	-	L92Y	W16FP-U	IWF16	-	N8GY	IW20	IW20	VW20	RAX94YC	X24EPR-U9	IX24B	-
G63	U24ES-N	IU24	-	L92YC	W16FP-U	IWF16	-	N8L	J16BR-U	-	-	RAX96C	X22ESR-U	IX22	-
G63	U24ESR-N	IU24	-	L95Y	W9FP	-	-	N8Y	W20EP-U	IW20	VW20	RAX96YC	X22EPR-U9	IX22B	-
GI	U27ES-N	IU27	-	L95YC	W9FP	-	-	N9BMC	W20ETR-L	IW20	VW20	RC10MC4	K16R-U11	IK16	VK16
H10C	W14L	-	-	L9G	-	IWF22	-	N9BYC	W20EPB	IW20	VW20	RC10MCC	KJ16CR-L11	IK16	VK16
H10C	W16LS	-	-	L9J	W20FS-U	IWF22	-	N9BYC4	W20EPB	IW20	VW20	RC10PMPA	PKJ16CR8	IK16	VK16
H10J	W14L	-	-	N1	W31ES-U	IW31	-	N9Y	W20EP-U	IW20	VW20	RC10PYC	IK16	IK16	VK16
H11	W14L	-	-	N10PY	IW20	IW20	VW20	N9YC	W20EP-U	IW20	VW20	RC10PP4	PK16PR-(L)11	IK16	VK16
H12	W14L	-	-	N10Y	W20EP-U	IW20	VW20	N9YC	W20EX-U	IW20	VW20	RC10PPB4	PK16PR-(L)11	IK16	VK16
H18Y	W16LS	-	-	N10Y	W20EX-U	IW20	VW20	N9YC4	W20EPR-U11	IW20	VW20	RC10WYPB4	-	-	-
H8C	W16LS	-	-	N10Y4	W20EPR-U11	IW20	VW20	N9YC4	W20EX-U11	IW20	VW20	RC10YC	K16PR-U	IK16	VK16
H8J	W16LS	-	-	N10Y4	W20EX-U11	IW20	VW20	N9YC4	W20EX-U11	IW20	VW20	RC10YC4	K16PR-U11	IK16	VK16
J10	W20S-U	-	-	N11YC	W16EP-U	IW16	VW16	N9YCC	W20EP-U	IW20	VW20	RC10YCC	K16PR-U	IK16	VK16
J10Y	W20PR-U	-	-	N11YC	W16EX-U	IW16	VW16	N9YCX	W20EP-U	IW20	VW20	RC10YCC4	K16PR-U11	IK16	VK16
J11C	W9-U	-	-	N11YC4	W16EP-U11	IW16	VW16	OBL9Y	T20PR-U	ITF20	-	RC11LC4	KJ16CR-L11	IK16	VK16
J11J	W9-U	-	-	N11YC4	W16EX-U11	IW16	VW16	ON11Y	W16EPR-U	IW16	VW16	RC11PYB4	PK16PR-(L)11	IK16	VK16
J11Y	W16PR-U	-	-	N11YCC	W16EP-U	IW16	VW16	ON12Y	W16EPR-U	IW16	VW16	RC11ZYC4	K16GPR-U11	-	-
J12C	W9-U	-	-	N12YC	W16EP-U	IW16	VW16	P7	X24FS-U	-	-	RC12ECC	KJ16CR-L11	IK16	VK16
J12J	W9-U	-	-	N12YC	W16EX-U	IW16	VW16	P7G	-	-	-	RC12LC4	KJ16CR-L11	-	VKA16
J12YC	W16PR-U	-	-	N12YCC	W16EP-U	IW16	VW16	P82M	W22FS-U	IWF22	-	RC12LYC	KJ16CR-L11	-	VKA16
J13Y	W14PR-U	-	-	N13L	J16BR-U	-	-	P86M	W16FS-U	-	-	RC12MC4	KJ16CR-L11	IK16	VK16
J14J	W9-U	-	-	N13Y	W16EP-U	IW16	VW16	P8G	-	-	-	RC12MCC4	KJ16CR-L11	IK16	VK16
J14YC	W14PR-U	-	-	N14LY	J16AR-U11	-	-	P8Y	X20FS-U	-	-	RC12PEC5	PKJ16CR-L13	IK16	VK16
J17LM	W14LM-U	-	-	N14Y	W16EP-U	IW16	VW16	P-A5HC	X22ES-U	IX22	-	RC12PYP	PK16PR8	IK16	VK16
J18YC	W9PR-U	-	-	N16YC	W16EP-U	IW16	VW16	P-A7HC	X22ES-U	IX22	-	RC12YC	K16PR-U	IK16	VK16
J19LM	W9LM-US	-	-	N178B	IRE01-27	-	-	P-G7C	U22ES-N	IU22	-	RC12YC	K16R-U	IK16	VK16
J2J	W27S-U	-	-	N179BC	IRE01-27	-	-	P-L7YC4	W20FP-U10	IWF20	-	RC12YC4	K16PR-U11	IK16	VK16
J4C	W24S-U	-	-	N180B	IRE01-27	-	-	P-L9YC	W20FP-U	IWF20	-	RC12YC5	K16R-U11	IK16	VK16
J4J	W24S-U	-	-	N19V	-	-	-	P-N5C	W24ES-U	IW24	-	RC279YC	K22PR-U	IK22	VK22
J5	W22S-U	-	-	N1C	W27ES-U	IW27	-	P-RA7HC	X22EPR-U9	IX22B	-	RC281YC	K20PR-U	IK20	VK20
J6C	W20S-U	-	-	N21	W14E	-	-	P-RL5SC	W20FR-L	IWF20	-	RC57C	IK31	IK31	-
J6J	W20S-U	-	-	N279Y	W22EP-U	IW22	VW22	P-RL9SC	W14FR-L	IWF16	-	RC59C	IK27	IK27	-
J7	W16S-U	-	-	N279YC	W22EP-U	IW22	VW22	P-RZ9HC	U20FSR-U	IUF22	-	RC59YC	IK27	IK27	-
J7J	W16S-U	-	-	N281YC	W20EP-U	IW20	VW20	P-Z7HC	U22FS-U	IUF22	-	RC61YC	IK27	IK27	-
J8C	W14-U	-	-	N288	W20ES-U	-	-	P-Z9HC	U20FS-U	IUF22	-	RC6BMC	K22PBR-S	IK22	VK22
J8J	W14-U	-	-	N2C	W27ES-U	IW27	-	QC12PEP	SKJ20CR-A8	IK20L/IK20	-	RC6PYP	PK22PR8	IK22	VK22
K13	L14-U/M14	-	-	N2G	IW27	IW27	-	QC12PEPB	SKJ20CR-A8	IK20L/IK20	-	RC6VPC	IK22	IK22	VK22
K15J	L14-U/M14	-	-	N3C	W24ES-U	IW24	-	QC57	IK31	IK31	-	RC6YC	K22PR-U	IK22	VK22
K8	M22	-	-	N3CX	W24ES-U	IW24	-	QC57C	IK31	IK31	-	RC6YCC	K22PR-U	IK22	VK22
K9	M22	-	-	N3G	IW24	IW24	-	QC59	IK31	IK31	-	RC7BMC	K22PBR-S	IK22	VK22
KC10PYPB4	PK16PR-(L)11	IK16	VK16	N4C	W22ES-U	-	-	QC59C	IK27	IK27	-	RC7BYC	K22PBR-S	IK22	VK22
L10	W16FS-U	-	-	N4G	W22ES-U	-	-	QC59YC	IK27	IK27	-	RC7BYC4	K22PBR-S	IK22	VK22
L10S	W22FS-U	IWF22	-	N4YC	W22EP-U	IW22	VW22	QC9MC4	KJ20CR-L11	IK20	VK20	RC7GYC	IK22	IK22	VK22
L12Y	W16FP-U	IWF16	-	N52R	-	-	-	QL16V	SF24	IWF24	-	RC7PYCB	IK22	IK22	VK22
L15Y	W9FP	-	-	N54R	IW01-34	-	-	QL16V	W24FS-U	IWF24	-	RC7PYCB4	IK22	IK22	VK22
L20V	SF50	-	-	N54R	IW06-34	-	-	QL55	W31FS	-	-	RC7YC	K22PR-U	IK22	VK22
L2G	IWF27	IWF27	-	N55G	IW34	IW34	-	QL76V	SF50	-	-	RC7YC4	K22PR-U11	IK22	VK22
L3G	IWF24	IWF24	-	N57	W31ES-U	IW31	-	QL77CC	W27FSR	IWF27	-	RC7YCC	K22PR-U	IK22	VK22
L4G	IWF22	IWF22	-	N57G	IW31	IW31	-	QL77J	W27FSR	IWF27	-	RC7YCC4	K22PR-U11	IK22	VK22
L4J	W27FS-U	IWF27	-	N57R	IW01-31	-	-	QL77J4	W27FSR-U10	IWF27	-	RC7YCX	K22PR-U	IK22	VK22
L5	W22FS-U	IWF22	-	N59G	IW29	IW29	-	QL77JC	W27FSR	IWF27	-	RC87YCL	K20PR-U	IK20	VK20
L54R	-	-	-	N5C	W20ES-U	-	-	QL77JC4	W27FSR-U10	IWF27	-	RC89PYC	IK16	IK16	VK16
L55C	W31FS	-	-	N6	W16ES-U	-	-	QL78C	W24FSR	IWF24	-	RC89TMC	K20PBR-S10	IK20	VK20
L55G	W31FS	-	-	N60	W27ES-U	IW27	-	QL78V	SF51	-	-	RC8BYC	K20PBR	IK20	VK20
L57R	-	IWF27	-	N60R	IW01-29	-	-	QL78YC	W24FPR	IWF24	-	RC8PMPA	SKJ20CR-A8	IK20	VK20
L58R	-	IWF27	-	N62R	IW01-27	-	-	QL7J	W22FSR	IWF22	-	RC8PYP	PK20PR-P8	IK20	VK20

AUSTRALIA | CHINA | INDIA | INDONESIA | KOREA | MALAYSIA | PHILIPPINES | SAUDI ARABIA | SINGAPORE | TAIWAN | THAILAND | VIETNAM | JAPAN | EUROPE & USA | CROSS REFERENCE | PART NUMBER

(1) This comparison chart does not guarantee capability with any vehicle. Please use it for reference only. (2) Plug specifications (design, materials, etc.) varies according to manufacturer. (3) Choose your plug model by referring to the vehicle model compatibility table. (4) When choosing a plug model for tuning vehicles and vehicles not listed in the vehicle model compatibility chart, the customer is responsible for determining the correct plug.

# CROSS REFERENCE ( other )

CROSS REFERENCE PART NUMBER	AUSTRALIA				CHINA				INDIA				INDONESIA				KOREA				MALAYSIA				PHILIPPINES				SAUDIARABIA				SINGAPORE				TAIWAN				THAILAND				VIETNAM				JAPAN				EUROPE & USA																																																																																																																																																																																																																																																																																																																																																																																																																																																																																																																																																																																																																																																																																																																																																																																																																																																																																																																																																																																																																																																																																																																																																																																																																																																																																																																																																																										
	CHAMPION (U.S.A.)	DENSO	IRIDIUM POWER	IRIDIUM TOUGH/PLUS	CHAMPION (U.S.A.)	DENSO	IRIDIUM POWER	IRIDIUM TOUGH/PLUS	CHAMPION (U.S.A.)	DENSO	IRIDIUM POWER	IRIDIUM TOUGH/PLUS	CHAMPION (U.S.A.)	DENSO	IRIDIUM POWER	IRIDIUM TOUGH/PLUS	CHAMPION (U.S.A.)	DENSO	IRIDIUM POWER	IRIDIUM TOUGH/PLUS	CHAMPION (U.S.A.)	DENSO	IRIDIUM POWER	IRIDIUM TOUGH/PLUS	CHAMPION (U.S.A.)	DENSO	IRIDIUM POWER	IRIDIUM TOUGH/PLUS	CHAMPION (U.S.A.)	DENSO	IRIDIUM POWER	IRIDIUM TOUGH/PLUS	CHAMPION (U.S.A.)	DENSO	IRIDIUM POWER	IRIDIUM TOUGH/PLUS	CHAMPION (U.S.A.)	DENSO	IRIDIUM POWER	IRIDIUM TOUGH/PLUS																																																																																																																																																																																																																																																																																																																																																																																																																																																																																																																																																																																																																																																																																																																																																																																																																																																																																																																																																																																																																																																																																																																																																																																																																																																																																																																																																																																							
RC8PYP4	PK20PR11	IK20	VK20	RJ13Y	W14PR-U	-	-	RN9GY	IW20	IW20	VW20	UN79Y	W22EP-U	IW22	VW22	RC8VTYC	K20PBR-S10	IK20	VK20	RJ14YC	W14PR-U	-	-	RN9YC	W20EPR-U	IW20	VW20	V12YC	T16P-U	ITF16	-	RC8YC	K20PR-U	IK20	VK20	RJ17LM	W14LM-U	-	-	RN9YC	W20EXR-U	IW20	VW20	V15YC	T16P-U	ITF16	-	RC8YCC	K20PR-U11	IK20	VK20	RJ18YC	W9PR-U	-	-	RN9YC4	W20EPR-U11	IW20	VW20	V55C	-	-	-	RC8YCC4	K20PR-U11	IK20	VK20	RJ18YC6	W9PR-U	-	-	RN9YC4	W20EXR-U11	IW20	VW20	V57C	-	-	-	RC8YCC4	K20PR-U11	IK20	VK20	RJ18YC8	W9PR-U	-	-	RN9YCC	W20EPR-U	IW20	VW20	V57YC	-	-	-	RC8YCL	K20PR-U	IK20	VK20	RJ19LM	W9LMR-US	-	-	RN9YCC4	W20EPR-U11	IW20	VW20	V59C	-	ITF27	-	RC8YLC	K20PR-U	IK20	VK20	RJ6C	W20SR-U	-	-	RN9YCX	W20EPR-U	IW20	VW20	V61	-	ITF24	-	RC92LYC	-	-	-	RJ6J	W20SR-U	-	-	RP7	X24FS-U	-	-	V9YC	T20P-U	ITF20	-	RC9BMC	K20TXR	IK20	VK20	RJ7	W20SR-U	-	-	RS10LC	T20EPR-U	IT20	VT20	V92YC	K16PR-U	IK16	VK16	RC9BYC	K20PBR	IK20	VK20	RJ8C	W20SR-U	-	-	RS10LC	T20NR-U11	IT20	VT20	XJ10Y	W20PR-U	-	-	RC9MC4	KJ20CR-L11	IK20	VK20	RL12Y	W16FPR-U	IWF16	-	RS12PYP	PT16EPR-L13	IT16	VT16	Y82	-	-	-	RC9MCC	K20R-U	IK20	VK20	RL19	W16FSR	-	-	RS12YC	T16EPR-U	IT16	VT16	Z10	U20FS-U	IUF22	-	RC9MCC4	KJ20CR-L11	IK20	VK20	RL4J	W24FSR	IWF24	-	RS12YC6	T16EPR-U15	IT16	VT16	Z10G	IUF22	IUF22	-	RC9YC	K20PR-U	IK20	VK20	RL77J	W27FSR	IWF27	-	RS13LYC	T16NR-U11	IT16	VT16	Z12	U20FS-U	IUF22	-	RC9YC4	K20PR-U11	IK20	VK20	RL77JC4	W27FSR-U10	IWF27	-	RS13LYC	T20EPR-U	IT20	VT20	Z6	U24FS-U	IUF24	-	RC9YCC	K20PR-U	IK20	VK20	RL78C	W24FSR	IWF24	-	RS14LC	T16NR-U11	IT16	VT16	Z7G	IUF22	IUF22	-	RC9YCC4	K20PR-U11	IK20	VK20	RL7J	W22FSR	IWF22	-	RS14YC	T16EPR-U	IT16	VT16	Z8	U22FS-U	IUF22	-	RC9YCN4	K20PR-U11	IK20	VK20	RL82C	W22FSR	IWF22	-	RS14YC6	T16EPR-U15	IT16	VT16	Z9Y	U22FS-U	IUF22	-	RCJ4	W22M-U	-	-	RL82YC	W22FPR-U	IWF22	-	RS15LYC	T16NR-U11	IT16	VT16					RCJ6	W22M-U	-	-	RL82YCC	W22FPR-U	IWF22	-	RS16YC	T16EPR-U	IT16	VT16					RCJ6Y	W22MPR-U	-	-	RL86C	W20FSR-U	IWF22	-	RS17YC	T16EPR-U	IT16	VT16					RCJ6Y	W22MP-U	-	-	RL87YC	W20FPR-U	IWF20	-	RS279YC	T22EP-U	IT22	-					RCJ7Y	W22MPR-U	-	-	RL87YCC	W20FPR-U	IWF20	-	RS281YC	T20EPR-U	IT20	VT20					RCJ8	W20MR-U	-	-	RL90	W16FSR	-	-	RS5C	T22EP-U	IT22	-					RCJ8Y	W20MPR-U10	-	-	RL92YC	W16FPR-U	IWF16	-	RS6YC	T22EP-U	IT22	-					RD14	L14-U	-	-	RN10GY	IW20	IW20	VW20	RS6YCC	T22EP-U	IT22	-					RD15Y	L14-U	-	-	RN10PYP4	VW20	IW20	VW20	RS7YC	T22EP-U	IT22	-					RD16	L14-U	-	-	RN10VTC4	W20EPR-U	IW20	VW20	RS9YC	T20EPR-U	IT20	VT20					RD16J	L14-U	-	-	RN10Y4	W20EPR-U11	IW20	VW20	RS9YCC	T20EPR-U	IT20	VT20					RD18Y	L14-U	-	-	RN10Y4	W20EXR-U11	IW20	VW20	RS9YCX	T20EPR-U	IT20	VT20					RDJ6J	T22M-U	-	-	RN10YC	W20EPR-U	IW20	VW20	RV12C	T16R-U	-	-					RDJ7J	T20M-U	-	-	RN11YC	W16EPR-U	IW16	VW16	RV12YC	T16R-U15	-	-					RDJ7Y	T20MP-U	-	-	RN11YC	W16EXR-U	IW16	VW16	RV12YC6	T20PR-U	ITF20	-					RDJ8J	T20M-U	-	-	RN11YC4	W16EPR-U11	IW16	VW16	RV12YC6	T20PR-U11	ITF20	-					RE10LC	T20NR-U11	IT20	VT20	RN11YC4	W16EXR-U11	IW16	VW16	RV12YC6	T20PR-U15	ITF20	-					RE10PM5	-	ITL20	-	RN11YCC	W16EPR-U	IW16	VW16	RV15YC	T16PR-U	ITF16	-					RE10PMCS	-	ITL20	-	RN11YCC4	W16EPR-U11	IW16	VW16	RV15YC4	T16PR-U11	ITF16	-					RE12PEC5	-	ITL16	-	RN12MC4	W16EXR-U11	IW16	VW16	RV15YC6	T16PR-U15	ITF16	-					RE14MCC5	-	ITL16	-	RN12YC	W16EPR-U	IW16	VW16	RV15YC8	T16PR-U15	ITF16	-					RE14PLP5	-	ITL16	-	RN12YC	W16EXR-U	IW16	VW16	RV17YC	T14PR-U	ITF16	-					RE16MC	-	ITL16	-	RN12YC4	W16EXR-U11	IW16	VW16	RV17YC6	T14PR-U15	ITF16	-					RE7PYC5	-	ITV16	-	RN12YC6	W16EPR-U11	IW16	VW16	RV19YC	T14PR-U	ITF16	-					RE7PYP6	PT16VR13	ITV16	-	RN12YCC	W16EPR-U	IW16	VW16	RV19YC6	T14PR-U15	ITF16	-					RE7YCC	T16VR-U10	ITV16	-	RN13L	J16BR-U	-	-	RV8C	T20R-U	-	-					RE8MCL	XE20HR-U9	-	VFXEH20	RN13LYC	J16BR-U	-	-	RV8C6	T20R-U	-	-					RE8WYPB4	ZC20HPR11	-	VCH20	RN14LY	J16BR-U	-	-	RV9YC	T20PR-U	ITF20	-					REC14PYC	K16HPR-U11	IKH16	VKH16	RN14MC5	W16EXR-U13	IW16	VW16	RZ8	U22FSR-U	IUF22	-					REC9MCLX	K20HR-U11	IKH20	VKH20	RN14PMP5	P16R13	IW16	VW16	RZ94C	U24FSR-U	IUF24	-					REC9YCL	K20HR-U11	IKH20	VKH20	RN14Y	W14EPR-U	IW16	VW16	RZ96C	U22FSR-U	IUF22	-					RER8MCL	-	IXUH22	VXUH22	RN14Y	W14EXR-U	IW16	VW16	RZ98C	U20FSR-U	IUF22	-					RER8YC	-	IXUH22	VXUH22	RN14Y6	W14EXR-U11	IW16	VW16	S10YCC	T20EPR-U	IT20	VT20					RER8ZYCB4	-	-	-	RN14YC	W14EXR-U	IW16	VW16	S12YC	T16EPR-U	IT16	VT16					RF10C	MA20PR-U	-	-	RN14YC	W16EPR-U	IW16	VW16	S12YC6	T16EPR-U	IT16	VT16					RF11LC	MA20PR-U	-	-	RN16YC	W14EPR-U	IW16	VW16	S14YC	T16EPR-U	IT16	VT16					RF11YC	MA16PR-U	-	-	RN16YC5	W14EXR-U11	IW16	VW16	S279YC	T20EPR-U	IT20	VT20					RF12	MA16PR-U	-	-	RN179BC	IRE01-27	-	-	S281YC	T20EPR-U	IT20	VT20					RF12-5	MA16PR-U11	-	-	RN180B	W22EBR	-	-	S379YC	T22EP-U	IT22	-					RF14LC	MA16PR-U	-	-	RN1C	W27ESR	IW27	-	S57YC	-	IT27	-					RF14Y	MA9P-U	-	-	RN1C	W27ESR-U	IW27	-	S59YC	-	IT27	-					RF14Y4	MA16PR-U11	-	-	RN2	W27ESR	IW27	-	S6YC	T22EP-U	IT22	-					RF14YC	MA16PR-U	-	-	RN2	W27ESR-U	IW27	-	S6YCC	T22EP-U	IT22	-					RF18YC	MA9P-U	-	-	RN279YC	W22EPR-U	IW22	VW22	S7YC	T22EP-U	IT22	-					RF7YCC	MA20PR-U	-	-	RN281YC	W20EPR-U	IW20	VW20	S7YCC	T22EP-U	IT22	-					RF9YC	MA20PR-U	-	-	RN2C	W27ESR	IW27	-	S9YC	T20EPR-U	IT20	VT20					RFN14LY	QJ16AR-U	-	-	RN2C	W27ESR-U	IW27	-	S9YCC	T20EPR-U	IT20	VT20					RFN14LY	QJ16HR-U9	-	-	RN2G	IW27	IW27	-	S9YCX	T20EPR-U	IT20	VT20					RG4HC	U27ESR-N	IU27	-	RN3C	W24ESR-U	IW24	-	UD16	L14-U	-	-					RG4PHP	IU27	IU27	-	RN3G	IW24	IW24	-	UJ12	W9-U	-	-					RG59V	RU01-31	-	-	RN4C	W22ESR-U	-	-	UJ12C	W14-U	-	-					RG6YC	U24ESR-N	IU24	-	RN57YC	IW29	IW29	-	UJ12Y	W16PR-U	-	-					RG6YCA	U24ESR-N	IU24	-	RN5C	W20ESR-U	-	-	UJ2J	W24S-U	-	-					RG92C	U27ESR-N	IU27	-	RN6YC	W24EPR-U	IW24	-	UJ4J	W24S-U	-	-					RG92DC	U27ETR	IU27A	-	RN6YCX	W24EPR-U	IW24	-	UJ6	W20S-U	-	-					RG94C	U24ESR-N	IU24	-	RN74C	W22ESR-U	-	-	UJ8	W20S-U	-	-					RG96C	U22ESR-N	IU22	-	RN7BYC	W22EPB	IW22	VW22	UJ81C	W22S-U	-	-					RGU92C	U27FER9	IUH27	-	RN7GY	IW22	IW22	VW22	UJ81J	W22S-U	-	-					RGU94C	U24FER9	IUH24	-	RN7Y	W22EPR-U	IW22	VW22	UK10	M17	-	-					RH10C	W16LS	-	-	RN7YC	W22EPR-U	IW22	VW22	UL17V	SF50	-	-					RH12	W16LS	-	-	RN7YC4	W22EPR-U11	IW22	VW22	UL18V	SF50	-	-					RH8C	W16LS	-	-	RN7YCC	W22EPR-U	IW22	VW22	UL19V	SF50	-	-					RJ10Y	W20PR-U	-	-	RN7YCC4	W22EPR-U11	IW22	VW22	UL4J	W22FS-U	IWF22	-					RJ11Y	W16PR-U	-	-	RN7YCX	W22EPR-U	IW22	VW22	UL7V	SF50	-	-					RJ12Y	W16PR-U	-	-	RN8	W20ESR-U	-	-	UL81C	W24FS-U	IWF24	-					RJ12Y6	W16PR-U	-	-	RN8L	J16BR-U	-	-	UL81J	W24FS-U	IWF24	-					RJ12YC6	W16PR-U	-	-	RN8VTC	W20EPR-S	IW20	VW20	UN19V	-	-	-				

# CROSS REFERENCE ( ⇒ )

EYQUEM (France)	DENSO	IRIDIUM POWER	IRIDIUM TOUGH/PLUS	EYQUEM (France)	DENSO	IRIDIUM POWER	IRIDIUM TOUGH/PLUS	HKS (Japan)	DENSO	IRIDIUM POWER	IRIDIUM TOUGH/PLUS	MOTORCRAFT (U.S.A.)	DENSO	IRIDIUM POWER	IRIDIUM TOUGH/PLUS	
70M	W20FS-U	IWF22	-	RC52LJS	T20EPR-U	IT20	VT20	M40i	IK24	IK24	-	AER32	W20FPR-U	IWF20	-	
750	W20FS-U	IWF22	-	RC52LJS5	T20EPR-U	IT20	VT20	M40iL	IKH24	IKH24	-	AER4	W16FSR	-	-	
750L	W20ES-U	-	-	RC52LS	W20EPR-U	IW20	VW20	M40LF	ITV24	ITV24	-	AER4X	W16FSR	-	-	
750LS	W20EP-U	IW20	VW20	RC52LS5	W20EPR-U11	IW20	VW20	M40X	IXU24	IXU24	VXU24	AER6	W14FR-U	-	-	
753LJS	T20EP-U	IT20	VT20	RC62HJSDP	PT16VVR13	ITV16	-	M45	IQ27	IQ27	-	AE54C	W16FS-U	-	-	
755	W22FS-U	IWF22	-	RC62LJS	T20EPR-U	IT20	VT20	M45G	IW27	IW27	-	AF22	T20P-U	ITF20	-	
755C	W22S-U	-	-	RC62LJS5	T20EPR-U	IT20	VT20	M45i	IK27	IK27	-	AF32	T20P-U	ITF20	-	
755CJT	T22M-U	-	-	RC62LS	W20EPR-U	IW20	VW20	M45iL	IKH27	IKH27	-	AF3NX	T22M-U	-	-	
755CM	W20S-U	-	-	RC62LS5	K20PR-U11	IK20	VK20	M45RE	IRE01-27	-	-	AF42C	T16P-U	ITF16	-	
755CT	W22M-U	-	-	RC62LS5	W20EPR-U11	IW20	VW20	M45REL	IRL01-27	-	-	AF52C	T16P-U	ITF16	-	
755L	W20ES-U	-	-	RC62S	W22FPR-U	IWF22	-	M45X	IXU27	IXU27	-	AF5NX	T20M-U	-	-	
755LJS	T20EP-U	IT20	VT20	RC72LJS5	T22EP-U	IT22	-	M50RE	IRE01-31	-	-	AG040	-	IW31	-	
755LS	W20EP-U	IW20	VW20	RC72LS	W22EPR-U	IW22	VW22	M50RET	IRT01-31	-	-	AG051	W31ES-U	IW31	-	
755M	W20FS-U	IWF22	-	RC72LS5	W22EPR-U11	IW22	VW22	M525RE	IRE01-32	-	-	AG071	W27ES-U	IW27	-	
755S	W22FP-U	IWF22	-	RC82LS	W22EPR-U	IW22	VW22	M55RE	IRE01-34	-	-	AG091	W24ES-U	IW24	-	
755SX	W22FP-U	IWF22	-	RC82LS5	W22EPR-U11	IW22	VW22	S30i	IK20	IK20	VK20	AG092C	W24ES-U	IW24	-	
755X	W22FS-U	IWF22	-	RFC42LS	K16PR-U	IK16	VK16	S35	IQ22	IQ22	VQ22	AG12C	W24EP-U	IW24	-	
75LM	W20ES-U	-	-	RFC42LS2E	K20TXR	IK20	VK20	S35i	IK22	IK22	VK22	AG1C	W24ES-U	IW24	-	
75M	W20FS-U	IWF22	-	RFC42LS5	K16PR-U11	IK16	VK16	S40	IQ24	IQ24	-	AG1CX	W24ES-U	IW24	-	
775SX	W20FP-U	IWF20	-	RFC42LZ2E	K20TXR	IK20	VK20	S40i	IK24	IK24	-	AG1X	W22ES-U	-	-	
775X	W20FS-U	IWF22	-	RFC50LZ2E	K20TXR	IK20	VK20	MOTORCRAFT (U.S.A.)		DENSO		AG2	W22ES-U	-	-	
800LJS	T20EP-U	IT20	VT20	RFC52LS	K20PR-U	IK20	VK20	1Y00-18-110		W16EPR-U	IW16	VW16	AG200	-	IW34	-
800LS	W22EP-U	IW22	VW22	RFC52LS2E	K20TXR	IK20	VK20	1Y01-18-110		W20EPR-U	IW20	VW20	AG203	-	IW34	-
803LJS	T22EP-U	IT22	-	RFC52LS3	K20PBR	IK20	VK20	1Y03-18-110		W16EPR-U11	IW16	VW16	AG22C	W22EP-U	IW22	VW22
805L	W22ES-U	-	-	RFC52LS5	K20PR-U11	IK20	VK20	1Y06-18-110		K16PR-U	IK16	VK16	AG22CT	W20EPB	IW20	VW20
805LJS	T22EP-U	IT22	-	RFC52LSP	PK20PR11	IK20	VK20	1Y07-18-110		K20PR-U	IK20	VK20	AG23	IW24	IW24	-
805LP	IW24	IW24	-	RFC57LS3	K20PBR	IK20	VK20	1Y09-18-110		K16PR-U11	IK16	VK16	AG2C	W22ES-U	-	-
850	W22FS-U	IWF22	-	RFC58LS	K20PR-U	IK20	VK20	1Y0A-18-110		K20PR-U11	IK20	VK20	AG2CX	W22ES-U	-	-
850LS	W22EP-U	IW22	VW22	RFC58LS2E	K20TXR	IK20	VK20	1Y0B-18-110		K22PR-U11	IK22	VK22	AG2X	W22ES-U	-	-
C30LS	W14EP-U	IW16	VW16	RFC58LS3	K20PBR	IK20	VK20	1Y0F-18-110		XU22EPR-U	IXU22	VXU22	AG3	W20ES-U	-	-
C32LS	W16EP-U	IW16	VW16	RFC58LS5	K20PR-U11	IK20	VK20	1Y0G-18-110		KJ16CR-L11	IK16	VK16	AG32	W20EP-U	IW20	VW20
C32S	W16FP-U	IWF16	-	RFC58LSP	PK20PR11	IK20	VK20	1Y0H-18-110		KJ20CR-L11	IK20	VK20	AG32A	W20EP-U	IW20	VW20
C42LJS3	T16EPR-U	IT16	VT16	RFC58LZ2E	K20TXR	IK20	VK20	1Y0K-18-110		W16EXR-U13	IW16	VW16	AG32A	W20EX-U	IW20	VW20
C42S	W20FP-U	IWF20	-	RFC58LZK	K20PR-U11	IK20	VK20	1Y0L-18-110		J16AR-U11	-	-	AG32C	W20EP-U	IW20	VW20
C52LJS	T20EPR-U	IT20	VT20	RFC62LS	K22PR-U	IK22	VK22	1YR1-18-110		VW20	IW20	VW20	AG32C	W20EX-U	IW20	VW20
C52LS	W16EP-U	IW16	VW16	RFC62LS3	K22PBR-S	IK22	VK22	1YR7-18-110		VK20	IK20	VK20	AG32CT	W20EPB	IW20	VW20
C52LS3X	W16EPB10	IW16	VW16	RFC62LS5	K22PR-U11	IK22	VK22	1YR9-18-110		VK16	IK16	VK16	AG3C	W20ES-U	-	-
C62	W22FS-U	IWF22	-	RFC82LS	K22PR-U	IK22	VK22	1YR9-18-110		VK16	IK16	VK16	AG3CX	W20ES-U	-	-
C62LJS	T20EP-U	IT20	VT20	RFC82LS3	K22PBR-S	IK22	VK22	1YR8-18-110		VXU22	IXU22	VXU22	AG3X	W20ES-U	-	-
C62LS	W20EP-U	IW20	VW20	RFC82LS5	K22PBR-S	IK22	VK22	1YR9-18-110		VK16	IK16	VK16	AG4	W16ES-U	-	-
C62LS3X	W20EPB	IW20	VW20	RFC82LS5	K22PR-U11	IK22	VK22	1YR8-18-110		VK20	IK20	VK20	AG400	-	IW31	-
C62S	W22FP-U	IWF22	-	RFN52HZ	K16HPR-U11	IKH16	VKH16	1YR8-18-110		VK20	IK20	VK20	AG403	-	IW31	-
C72LJS	T22EP-U	IT22	-	RFN52HZ3A	K16HPR-U11	IKH16	VKH16	A11		W9-U	-	-	AG42C	W16EP-U	IW16	VW16
C72LS	W22EP-U	IW22	VW22	RFN52LZ	K16PR-U	IK16	VK16	A11LM		W14LM-U	-	-	AG44	KJ16CR-L11	IK16	VK16
C72LS3X	W22EPB	IW22	VW22	RFN58HZ	K20HR-U11	IKH20	VKH20	A11NX		W14M-U	-	-	AG5	W16ES-U	-	-
C82LJS	T22EP-U	IT22	-	RFN58LZ	K20PR-U	IK20	VK20	A11X		W9-U	-	-	AG501	W31ES-U	IW31	-
C82LS	W22EP-U	IW22	VW22	RKC52JS	MA20PR-U	-	-	A21X		W24S-U	-	-	AG501X	W31ES-U	IW31	-
C82LS3X	W22EPB	IW22	VW22	T850	U22FS-U	IUF22	-	A22		W20PR-U	-	-	AG52	W14EP-U	IW16	VW16
C83LJS	T22EP-U	IT22	-	XC30LS	W14EPR-U	IW16	VW16	A22NX		W22MP-U	-	-	AG52C	W14EX-U	IW16	VW16
C92LS	W24EP-U	IW24	-	XC32LS	W16EPR-U	IW16	VW16	A2C		W24S-U	-	-	AG54	KJ16CR-L11	IK16	VK16
D1000	X24FS-U	-	-	XC42S	W20FPR-U	IWF20	-	A2NX		W22M-U	-	-	AG600	IW01-27	IW27	-
D1000L	X27ES-U	IX27	-	XC52LS	W16EPR-U	IW16	VW16	A32		W20PR-U	-	-	AG603	W27ES-U	IW27	-
D1050L	X27ES-U	IX27	-	XC62LJS	T20EPR-U	IT20	VT20	A3NX		W22M-U	-	-	AG7	W14E	-	-
D755	X20FS-U	-	-	XC62LS	W20EPR-U	IW20	VW20	A3X		W20S-U	-	-	AG701C	W27ES-U	IW27	-
D775	X16FSR-U	-	-	XC62S	W22FPR-U	IWF22	-	A42C		W16PR-U	-	-	AG701X	W27ES-U	IW27	-
D800L	X22ES-U	IX22	-	XC72LS	W22EPR-U	IW22	VW22	A42N		W16S-U	-	-	AG82	W9EP	-	-
D900L	X24ES-U	IX24	-	XFC62LS	K22PR-U	IK22	VK22	A5		W16S-U	-	-	AG9	W14E	-	-
FC42LS	K16P-U11	IK16	VK16	XFC82LS	K22PR-U	IK22	VK22	A52		W14PR-U	-	-	AG901	W24ES-U	IW24	-
FC42LS2E	K20TXR	IK20	VK20	XKC52JS	MA20PR-U	-	-	A5X		W16S-U	-	-	AG901X	W24ES-U	IW24	-
FC52LS	K20P-U	IK20	VK20	XKC62JS	MA20PR-U	-	-	A7C		W14-U	-	-	AG902	W24EP-U	IW24	-
FC58LS	K20P-U	IK20	VK20	HARLEY-DAVIDSON (U.S.A.)		DENSO		A7CLM		W14LM-U	-	-	AG903	IW24	IW24	-
FC58LS2E	K20TXR	IK20	VK20	10R12A	XU24EPR-U	IXU24	VXU24	A7CX		W14-U	-	-	AGF12C	T22EP-U	IT22	-
FC58LS3	K20PBR	IK20	VK20	10R12X	XU24EPR-U	IXU24	VXU24	A7LM		W14LM-U	-	-	AGF22C	T20EP-U	IT20	VT20
FC62LS	K20P-U	IK20	VK20	3	W16LS	-	-	A7NX		W20M-U	-	-	AGFS22FE13J	T20EPR-U	IT20	VT20
FC62LS3	K20PBR	IK20	VK20	3-4	W16PR-U	-	-	A7X		W14-U	-	-	AGFS22IPJ	VT20	IT20	VT20
FC62LS3X	K20PBR	IK20	VK20	4	W16LS	-	-	A82		W9PR-U	-	-	AGP12C	K22PR-U	IK22	VK22
FC72LS	K22PR-U	IK22	VK22	4-5	W22FP-U	IWF22	-	A9		W9-U	-	-	AGP22C	K20P-U	IK20	VK20
FC82LS	K22PR-U	IK22	VK22	4R	W16LS	-	-	A901		W27S-U	-	-	AGPR12C	K22PR-U	IK22	VK22
FC82LS2	K22TMR11	IK22	VK22	4R5	W22FP-U10	IWF22	-	A9X		W9-U	-	-	AGPR12PP	PK20PR-P11	IK20	VK20
FC82LS3	K22PB	IK22	VK22	5	W20S-U	-	-	AE1C		W22FS-U	IWF22	-	AGPR12PP8	PK20PR-P8	IK20	VK20
K200M	L14-U/M14	-	-	5A6	W16EX-U	IW16	VW16	AE1X		W22FS-U	IWF22	-	AGPR22C	K20PR-U	IK20	VK20
K300JS	MA16PR-U	-	-	5R6	W16EXR-U	IW16	VW16	AE22C		W22FP-U	IWF22	-	AGPR22C1	K20PR-U11	IK20	VK20
K300M	M17	-	-	5R6A	W16EXR-U11	IW16	VW16	AE2X		W22FS-U	IWF22	-	AGPR22P	IK20	IK20	VK20
K450JS	MA16PR-U	-	-	5RL	J16CR-U	IW16	VW16	AE3C		W20FP-U	IWF20	-	AGPR22PP	PK20PR11	IK20	VK20
K500M	M17	-	-	6R12	XU22EPR-U	IXU22	VXU22	AE32C		W20FP-U	IWF20	-	AGPR22PP8	PK20PR-P8	IK20	VK20
K550JS	MA20P-U	-	-	8	IW31	IW31	-	AE3C		W20FS-U	IWF22	-	AGPR22PPJ	PK20PR11	IK20	VK20
K600M	M22	-	-	HKS (Japan)		DENSO		AE3X		W20FS-U	IWF22	-	AGPR32C	K20PR-U	IK20	VK20
K750M	M17	-	-	M35	IQ22	IQ22	VQ22	AE4		W16FS-U	-	-	AGPR32C1	K20PR-U11	IK20	VK20
KC52JS	MA20P-U	-	-	M35G	IW22	IW22	VW22	AE42		W16FP-U	IWF16	-	AGPR901C	-	IQ24	-
KC62JS	MA20P-U	-	-	M35i	IK22	IK22	VK22	AE4X		W16FS-U	-	-	AGPR902C	-	IQ27	-
R1000	W24FSR	IWF24	-	M35iL	IKH22	IKH22	VKH22	AE6		W14F-U	-	-	AGPR902P	IQ27	IQ27	-
R850	W22FSR	IWF22	-	M35LF	ITV22	ITV22	-	AE62		W9FP	-	-	AGR12C	W24EPR-U	IW24	-
RC30LS	W14EPR-U	IW16	VW16	M40	IQ24	IQ24	-	AE901		W24FS-U	IWF24	-	AGR1C	W22ESR-U	-	-
RC32LS	W16EPR-U	IW16	VW16	M40G	IW24	IW24	-	AE901X		W24FS-U	IWF24	-	AGR1X	W22ESR-U	-	-
RC32LS5	W16EPR-U11	IW16	VW16	HKS (Japan)		DENSO		AER22C		W22FPR-U	IWF22	-	AGR21	W22ESR-U	-	-
RC42S	W20FPR-U	IWF20	-	M40G	IW24	IW24	-	AER2X		W22FSR	IWF22	-	AGR22C	W22EPR-U	IW22	VW22

AUSTRALIA CHINA INDIA INDONESIA KOREA MALAYSIA PHILIPPINES SAUDIARABIA SINGAPORE TAIWAN THAILAND VIETNAM JAPAN EUROPE & USA CROSS REFERENCE PART NUMBER

(1) This comparison chart does not guarantee capability with any vehicle. Please use it for reference only. (2) Plug specifications (design, materials, etc.) varies according to manufacturer. (3) Choose your plug model by referring to the vehicle model compatibility table. (4) When choosing a plug model for tuning vehicles and vehicles not listed in the vehicle model compatibility chart, the customer is responsible for determining the correct plug.



# CROSS REFERENCE ( ⇒ )

NHSP (China)				DENSO				SPLITFIRE (U.S.A.)				TORCH (China)				DENSO				TORCH (China)				DENSO																			
NHSP (China)				DENSO				SPLITFIRE (U.S.A.)				TORCH (China)				DENSO				TORCH (China)				DENSO																			
NHSP (China)				DENSO				SPLITFIRE (U.S.A.)				TORCH (China)				DENSO				TORCH (China)				DENSO																			
NHSP (China)				DENSO				SPLITFIRE (U.S.A.)				TORCH (China)				DENSO				TORCH (China)				DENSO																			
NHSP (China)				DENSO				SPLITFIRE (U.S.A.)				TORCH (China)				DENSO				TORCH (China)				DENSO																			
K6RTCX	-	-	-	-	-	-	-	SF2D6	T20PR-U	ITF20	-	D77C	X22EP-U9	IX22B	-	T1137C	U22FS-U	IUF22	-	T1137C	U22FS-U	IUF22	-	T5RTC	MA16PR-U	-	-	T5RTC	MA16PR-U	-	-	T5TC	MA16PR-U	-	-	T6RTC	MA20PR-U	-	-	T6TC	MA20PR-U	-	-
K6RTDC	K20TXR	IK20	VK20	K20TXR	IK20	VK20	VK20	SF2E	T16PR-U	ITF16	-	D8C	X24ES-U	IX24	-	T5TRC	MA16PR-U	-	-	T5TRC	MA16PR-U	-	-	T5TC	MA16PR-U	-	-	T6RTC	MA20PR-U	-	-	T6TC	MA20PR-U	-	-	T6TC	MA20PR-U	-	-				
K6RTJC	K20PBR	IK20	VK20	K20PBR	IK20	VK20	VK20	SF30C	W20S-U	-	-	D8RC	X24ESR-U	IX24	-	T6RTC	MA20PR-U	-	-	T6RTC	MA20PR-U	-	-	T6TC	MA20PR-U	-	-	T6TC	MA20PR-U	-	-	T6TC	MA20PR-U	-	-								
K6TC	Q16-U	IQ16	VQ16	Q16-U	IQ16	VQ16	VQ16	SF392A	K24PR-U11	IK24	-	D8RTC	X24EPR-U9	IX24B	-	T6TC	MA20PR-U	-	-	T6TC	MA20PR-U	-	-	T6TC	MA20PR-U	-	-	T6TC	MA20PR-U	-	-	T6TC	MA20PR-U	-	-								
K6TCOR	-	-	-	-	-	-	-	SF392B	K22PR-U	IK22	VK22	D8TC	X24EP-U9	IX24B	-	-	-	-	-	-	-	-	-	-	-	-	-	-	-	-	-	-	-	-	-								
K6TJC	K20PBR	IK20	VK20	K20PBR	IK20	VK20	VK20	SF392C	K20PR-U	IK20	VK20	D8TC	X24EP-U	IX24B	-	-	-	-	-	-	-	-	-	-	-	-	-	-	-	-	-	-	-	-	-								
K7RTC	K20PR-U11	IK20	VK20	K20PR-U11	IK20	VK20	VK20	SF392D	K16PR-U	IK16	VK16	DK7RTC	XU22EPR-U	IXU22	VXU22	-	-	-	-	-	-	-	-	-	-	-	-	-	-	-	-	-	-	-	-								
K7RTC	Q20R-U	IQ20	VQ20	Q20R-U	IQ20	VQ20	VQ20	SF392D6	K16PR-U	IK16	VK16	DK7RTC9	XU22PR9	IXU22	VXU22	-	-	-	-	-	-	-	-	-	-	-	-	-	-	-	-	-	-	-	-								
K7RTC0	-	-	-	-	-	-	-	SF393C	-	-	-	DK7RTPP	-	-	-	-	-	-	-	-	-	-	-	-	-	-	-	-	-	-	-	-	-	-	-								
K7RTC0	-	-	-	-	-	-	-	SF405A	W31ES-U	IWF31	-	E4RTC	W14FPR-UL	IWF16	-	-	-	-	-	-	-	-	-	-	-	-	-	-	-	-	-	-	-	-	-								
K7RTCX	-	-	-	-	-	-	-	SF405D	W24ES-U	IWF24	-	E4TC	W14FP-UL	IWF16	-	-	-	-	-	-	-	-	-	-	-	-	-	-	-	-	-	-	-	-	-								
K7RTJC	K20PBR	IK20	VK20	K20PBR	IK20	VK20	VK20	SF405F	W22ES-U	-	-	E5RTC	W16FPR-U	IWF16	-	-	-	-	-	-	-	-	-	-	-	-	-	-	-	-	-	-	-	-	-								
K7TC	Q20-U	IQ20	VQ20	Q20-U	IQ20	VQ20	VQ20	SF406B	W27ES-U	IWF27	-	E5TC	W16FP-U	IWF16	-	-	-	-	-	-	-	-	-	-	-	-	-	-	-	-	-	-	-	-	-								
K7TJC	K20PBR	IK20	VK20	K20PBR	IK20	VK20	VK20	SF406C	W24ES-U	IWF24	-	E6C	W20FS-U	IWF22	-	-	-	-	-	-	-	-	-	-	-	-	-	-	-	-	-	-	-	-	-								
L5C	W14M-U	-	-	W14M-U	-	-	-	SF409B	W24FS-U	IWF24	-	E6RC	W20FSR-U	IWF22	-	-	-	-	-	-	-	-	-	-	-	-	-	-	-	-	-	-	-	-	-								
L5T	W14MP-U10	-	-	W14MP-U10	-	-	-	SF409C	W22FS-U	IWF22	-	E6RTC	W20FPR-U	IWF20	-	-	-	-	-	-	-	-	-	-	-	-	-	-	-	-	-	-	-	-	-								
L6T	W20MP-U	-	-	W20MP-U	-	-	-	SF40D	W20ESR-U	-	-	E6TC	W20FP-U	IWF20	-	-	-	-	-	-	-	-	-	-	-	-	-	-	-	-	-	-	-	-	-								
L6T	W20M-U	-	-	W20M-U	-	-	-	SF412C	W20FPR-U	IWF20	-	E7RTC	W22FPR-U	IWF22	-	-	-	-	-	-	-	-	-	-	-	-	-	-	-	-	-	-	-	-	-								
L7	W22M-U	-	-	W22M-U	-	-	-	SF413B	X27ES-U	IX27	-	E7TC	W22FP-U	IWF22	-	-	-	-	-	-	-	-	-	-	-	-	-	-	-	-	-	-	-	-	-								
L7T	W22MP-U	-	-	W22MP-U	-	-	-	SF415B	X27EP-U9	IX27B	-	E8C	W24FS-U	IWF24	-	-	-	-	-	-	-	-	-	-	-	-	-	-	-	-	-	-	-	-	-								
L7Y	W22M-U	-	-	W22M-U	-	-	-	SF416B	X27EPR-U9	IX27B	-	E8RC	W24FSR	IWF24	-	-	-	-	-	-	-	-	-	-	-	-	-	-	-	-	-	-	-	-	-								
L8RT	W22MPR-U	-	-	W22MPR-U	-	-	-	SF416C	X24EPR-U9	IX24B	-	E8RTC	W24FPR	IWF24	-	-	-	-	-	-	-	-	-	-	-	-	-	-	-	-	-	-	-	-	-								
L9	W22M-U	-	-	W22M-U	-	-	-	SF416D	X22EPR-U9	IX22B	-	E8TC	W24FP-U	IWF24	-	-	-	-	-	-	-	-	-	-	-	-	-	-	-	-	-	-	-	-	-								
L9T	W22MP-U	-	-	W22MP-U	-	-	-	SF419D	U20FS-U	IUF22	-	F5RF	W16EXR-U	IWF16	VW16	-	-	-	-	-	-	-	-	-	-	-	-	-	-	-	-	-	-	-	-								
N6	T20M-U	-	-	T20M-U	-	-	-	SF426C	W20EXR-U	IWF20	VW20	F5RTC	W16EXR-U	IWF16	VW16	-	-	-	-	-	-	-	-	-	-	-	-	-	-	-	-	-	-	-	-								
N9	T22M-U	-	-	T22M-U	-	-	-	SF426E	W16EXR-U	IWF16	VW16	F5TC	W16EX-U	IWF16	VW16	-	-	-	-	-	-	-	-	-	-	-	-	-	-	-	-	-	-	-	-								
Q7TC	T16EPR-U	IT16	VT16	T16EPR-U	IT16	VT16	VT16	SF430B	U27ESR-U	IU27	-	F5TC	W16EP-U11	IWF16	VW16	-	-	-	-	-	-	-	-	-	-	-	-	-	-	-	-	-	-	-	-								
R4C	MW17	-	-	MW17	-	-	-	SF430C	U24ESR-N	IU24	-	F5TC11	W16EP-U11	IWF16	VW16	-	-	-	-	-	-	-	-	-	-	-	-	-	-	-	-	-	-	-	-								
T5RTC	MA20PR-U	-	-	MA20PR-U	-	-	-	SF45F	W14LM-U	-	-	F6RF	W20EXR-U	IWF20	VW20	-	-	-	-	-	-	-	-	-	-	-	-	-	-	-	-	-	-	-	-								
T5RTC	MA20PR-U	-	-	MA20PR-U	-	-	-	SF4E	MA16PR-U	-	-	F6RTC	W20EXR-U	IWF20	VW20	-	-	-	-	-	-	-	-	-	-	-	-	-	-	-	-	-	-	-	-								
T5RTC	MA20PR-U	-	-	MA20PR-U	-	-	-	SF512E	MA20PR-U	-	-	F6T	W20EX-U	IWF20	VW20	-	-	-	-	-	-	-	-	-	-	-	-	-	-	-	-	-	-	-	-								
T5RTC	MA20PR-U	-	-	MA20PR-U	-	-	-	SF514D	T20EPR-U	IT20	VT20	F6TC	W20EX-U	IWF20	VW20	-	-	-	-	-	-	-	-	-	-	-	-	-	-	-	-	-	-	-	-								
T5RTC	MA20PR-U	-	-	MA20PR-U	-	-	-	SF516D	T20EPR-U	IT20	VT20	F7C	W22ES-U	-	-	-	-	-	-	-	-	-	-	-	-	-	-	-	-	-	-	-	-	-	-								
T5RTC	MA20PR-U	-	-	MA20PR-U	-	-	-	SF522D	KJ20CR11	IK20	VK20	F7RC	W22ESR-U	-	-	-	-	-	-	-	-	-	-	-	-	-	-	-	-	-	-	-	-	-	-								
T5RTC	MA20PR-U	-	-	MA20PR-U	-	-	-	SF524E	T16EPR-U	IT16	VT16	F7RTC	W22EPR-U	IWF22	VW22	-	-	-	-	-	-	-	-	-	-	-	-	-	-	-	-	-	-	-	-								
T5RTC	MA20PR-U	-	-	MA20PR-U	-	-	-	SF550C	K20PR-U11	IK20	VK20	F7RTJC	W20EPB	IWF20	VW20	-	-	-	-	-	-	-	-	-	-	-	-	-	-	-	-	-	-	-	-								
T5RTC	MA20PR-U	-	-	MA20PR-U	-	-	-	SF552B	-	-	-	F7TC	W22EP-U	IWF22	VW22	-	-	-	-	-	-	-	-	-	-	-	-	-	-	-	-	-	-	-	-								
T5RTC	MA20PR-U	-	-	MA20PR-U	-	-	-	SF552C	-	-	-	F7TJC	W20EPB	IWF20	VW20	-	-	-	-	-	-	-	-	-	-	-	-	-	-	-	-	-	-	-	-								
T5RTC	MA20PR-U	-	-	MA20PR-U	-	-	-	SF6A	W24EPR-U	IWF24	-	F7TC	W22EP-U	IWF22	VW22	-	-	-	-	-	-	-	-	-	-	-	-	-	-	-	-	-	-	-	-								
T5RTC	MA20PR-U	-	-	MA20PR-U	-	-	-	SF6C	W20EPR-U	IWF20	VW20	F7TJC	W20EPB	IWF20	VW20	-	-	-	-	-	-	-	-	-	-	-	-	-	-	-	-	-	-	-	-								
T5RTC	MA20PR-U	-	-	MA20PR-U	-	-	-	SF6D	W20EPR-U	IWF20	VW20	F8C	W24ES-U	IWF24	-	-	-	-	-	-	-	-	-	-	-	-	-	-	-	-	-	-	-	-	-								
T5RTC	MA20PR-U	-	-	MA20PR-U	-	-	-	SF6E	W16EPR-U	IWF16	VW16	F8RC	W24ESR-U	IWF24	-	-	-	-	-	-	-	-	-	-	-	-	-	-	-	-	-	-	-	-	-								
T5RTC	MA20PR-U	-	-	MA20PR-U	-	-	-	SF6F6	W14EXR-U11	IWF16	VW16	F8RTC	W24EPR-U	IWF24	-	-	-	-	-	-	-	-	-	-	-	-	-	-	-	-	-	-	-	-	-								
T5RTC	MA20PR-U	-	-	MA20PR-U	-	-	-	SF8E	W16PR-U	-	-	F8TC	W24EPR-U	IWF24	-	-	-	-	-	-	-	-	-	-	-	-	-	-	-	-	-	-	-	-	-								
T5RTC	MA20PR-U	-	-	MA20PR-U	-	-	-	SF98E	KJ20CR-L11	IK20	VK20	G4C	W14-U	-	-	-	-	-	-	-	-	-	-	-	-	-	-	-	-	-	-	-	-	-	-								
T5RTC	MA20PR-U	-	-	MA20PR-U	-	-	-	TP430B	U27ESR-N	IU27	-	G4RC	W14-U	-	-	-	-	-	-	-	-	-	-	-	-	-	-	-	-	-	-	-	-	-	-								
T5RTC	MA20PR-U	-	-	MA20PR-U	-	-	-	TP430B	U27ESR-N	IU27	-	G6C	W20S-U	-	-	-	-	-	-	-	-	-	-	-	-	-	-	-	-	-	-	-	-	-	-								
T5RTC	MA20PR-U	-	-	MA20PR-U	-	-	-	TP430B	U27ESR-N	IU27	-	G6RC	W20SR-U	-	-	-	-	-	-	-	-	-	-	-	-	-	-	-	-	-	-	-	-	-	-								
T5RTC	MA20PR-U	-	-	MA20PR-U	-	-	-	TP430B	U27ESR-N	IU27	-	GL4	W14LM-U	-	-	-	-	-	-	-	-	-	-	-	-	-	-	-	-	-	-	-	-	-	-								
T5RTC	MA20PR-U	-	-	MA20PR-U	-</																																						

# CAR MAKER GENUINE P/N CROSS REFERENCE

98079-56841

other

DENSO

AUSTRALIA	ABARTH	DENSO	IRIDIUM POWER	IRIDIUM TOUGH/PLUS	AUDI/VW	DENSO	IRIDIUM POWER	IRIDIUM TOUGH/PLUS	BMW	DENSO	IRIDIUM POWER	IRIDIUM TOUGH/PLUS	
		55210685 (IKR9F8)	-	IXU27	-	101-000-033AG	-	IK16	VK16	12-12-0032-136 (BKR6EQU)	K20TXR	IK20	VK20
	ALFA ROMEO	DENSO	IRIDIUM POWER	IRIDIUM TOUGH/PLUS	101-000-034AA	W20EP-U	IW20	VW20	12-12-0032-137 (ILZFR6D11)	-	-	-	
	0007686643 (WR6DTC)	W20EPBR-S	IW20	VW20	101-000-035AB (BKR5EQU)	K20TXR	IK20	VK20	12-12-0032-273 (LKR8AP)	-	-	-	
	0055182623 (FR5CP)	IK16	IK16	VK16	101-000-035AE (BK7EQU)	K22TM11	IK22	VK22	12-12-0034-091 (ZKBR7A-HTU)	-	-	-	
	07-85723 (PTR6E13)	VT20	IT20	VT20	101-000-035AH (BKR5EQU)	K20TXR	IK20	VK20	12-12-0034-098 (PLZKBR7AG, Bi Hex)	-	-	-	
	4644-9690 (BKR6EKP)	IK20	IK20	VK20	101-000-035H (BKR6EQU)	K20TXR	IK20	VK20	12-12-0037-581 (ZMR5TPP33)	-	-	-	
	4652-1529 (BKR6EKP)	IK20	IK20	VK20	101-000-036AA (BUR6ET)	W20EPBR-S	IW20	VW20	12-12-0037-582 (ZMR5TPP33-S)	-	-	-	
	4655-0992 (CR7EKC)	-	IU22	-	101-000-036AB (BURSET)	W20EPBR-S	IW20	VW20	12-12-0037-580 (ZMR5TPP33)	-	-	-	
	50051491 (ILZKR7G7G)	-	-	-	101-000-036AC (BURSET-10)	W20EPBR-S	IW20	VW20	12-12-0037-581 (ZMR5TPP33)	-	-	-	
	55210685 (IKR9F8)	-	IXU27	-	101-000-038AA	W16ETR-S	IW16	VW16	12-12-0035-531 (ILZKBR7A-8G)	-	-	-	
	55217232 (ILKAR7D6G)	-	-	-	101-000-038AB	W16ETR-S	IW16	VW16	12-12-0035-747 (PFR7B)	PK22PR8	IK22	VK22	
	55249868 (IKR9J8)	-	IXU24	VXU24	101-000-039AA	W16ETR-S	IW16	VW16	12-12-0035-915 (ILZFR6D11)	-	-	-	
	6056-9086 (PGR6A)	P20PR8	IW20	VW20	101-000-039AB (BRP5EQU)	W16ETR-S	IW16	VW16	12-12-0037-051 (ZR5TPP332)	-	-	-	
	6056-9957 (PFR6B W/O Nut)	VK20	IK20	VK20	101-000-040AC	W20EPBR-S	IW20	VW20	12-12-0037-244 (ZGR6SET2)	-	-	-	
	6057-9903 (PFR6B Solid)	PK20PR-P8	IK20	VK20	101-000-040AD	W20EPBR-S	IW20	VW20	12-12-0037-580 (ZMR5TPP33)	-	-	-	
	6059-9495 (PMR7A)	IU22	IU22	-	101-000-040AE	W20EPBR-S	IW20	VW20	12-12-0037-581 (ZMR5TPP33)	-	-	-	
	670050892 (LKR8AP7JDS)	-	-	-	101-000-041AC (147GH7)	K20PBR-S10	IK20	VK20	12-12-0037-582 (ZMR5TPP33)	-	-	-	
	ASTONMARTIN	DENSO	IRIDIUM POWER	IRIDIUM TOUGH/PLUS	101-000-041AD	K20PBR-S10	IK22	VK22	12-12-0037-582 (ZMR5TPP33-S)	-	-	-	
	07-100528 (PTR7E13)	-	IT22	-	101-000-041AE	K22PBR-S	IK22	VK22	12-12-0037-608 (BKR6EQU)	K20TXR	IK20	VK20	
	07-10056 (IFR7N10)	VK22	IK22	VK22	101-000-044AA (FR8DS)	IK16	IK16	VK16	12-12-0037-663 (LZFR6AP11GS)	-	-	-	
	07-23116 (BCPR6E)	Q20PR-U	IQ20	VQ20	101-000-047AA	W16EP-U	IW16	VW16	12-12-0038-349 (ZKBR7A-HTU)	-	-	-	
	07-70920 (BCR8ES)	IQ24	IQ24	-	101-000-047AB	P20PR8	IW20	VW20	12-12-0038-704 (SILZKBR8CS, Bi Hex)	-	-	-	
	07-85126 (PTR6E13)	VT20	IT20	VT20	101-000-049AD	-	IK20	VK20	12-12-0038-832 (ZMR5TPP339, Bi Hex)	-	-	-	
	07-85890 (PTR5E13)	VT16	IT16	VT16	101-000-050AA	W20EPBR-S	IW20	VW20	12-12-0038-894 (ZMR5TPP339, Bi Hex)	-	-	-	
	AUDI/VW	DENSO	IRIDIUM POWER	IRIDIUM TOUGH/PLUS	101-000-050AB	W20EPBR-S	IW20	VW20	12-12-0038-896 (SILZKBR8CS, Bi Hex)	-	-	-	
	04C-905-606A (ZKER6A-10EG)	-	-	-	101-000-050AC	W20EPBR-S	IW20	VW20	12-12-0039-634 (ZMR5TPP330)	-	-	-	
	04C-905-616A (O 241 135 516)	-	-	-	101-000-051AA (F7LTCR)	K20PBR-S10	IK20	VK20	12-12-0039-664 (SILZBR8DS)	-	-	-	
	03C-905-601A (PZFR6R8EG)	-	-	-	101-000-051AB	K22PBR-S	IK22	VK22	12-12-0040-551 (RERK4ZVYB, Bi Hex)	-	-	-	
	03C-905-601B (SIZFR6B8EG)	-	-	-	101-000-052AA (HGR7KQC)	T20EPR-U	IT20	VT20	12-12-0040-552 (SILZGR8BS, Bi Hex) 3pc set	-	-	-	
	03F-905-600 (PZFR6Q)	-	-	-	101-000-054AC (FGR7KQE)	K20TXR	IK20	VK20	12-12-0040-573 (SILZKBR8ES)	-	-	-	
	03F-905-600A (IZFR6P7)	-	-	-	101-000-055AA	K20TXR	IK20	VK20	12-12-0040-581 (ZMR5TPP330A)	-	-	-	
	04E-905-601 (PKZER7A8EGS)	-	-	-	101-000-062AA (PZFR6D-11)	-	-	VKA16	12-12-0041-666 (SILZGR8BS, Bi Hex)	-	-	-	
	04E-905-601B (PKZER7B8EGS)	-	-	-	101-000-062AB (PZFR5D-11)	-	-	VKA16	12-12-0041-946 (ZMR5TPP332, Bi Hex)	-	-	-	
	04E-905-602 (PKER7A8EGS)	-	-	-	101-000-063AA (PFR6Q)	PK20PR-P8	-	VK20Y	12-12-0046-646 (SILZGR8CS, Bi Hex)	-	-	-	
	04E-905-602D (IKER7A8EGS)	-	-	-	101-000-063AC (PFR7Q)	PK22PR8	IK22	VK22	12-12-0054-451 (ZMR5TPP320, Bi Hex)	-	-	-	
	04E-905-612 (O 241 145 513)	-	-	-	101-000-065AA (BKR6ETA-10)	K20TXR	IK20	VK20	12-12-0054-451 (ZMR5TPP320, Bi Hex)	-	-	-	
	04E-905-612C (O 241 145 519)	-	-	-	101-000-067AA (BKR6EQUA)	K20TXR	IK20	VK20	12-12-2-158-165 (12ZR-65P2)	-	-	-	
	06E-905-611 (O6E905611)	IK20	VK20	-	101-000-068AA (ZFR6S-Q)	K20PBR-S10	IK20	VK20	12-12-2-158-253 (IZFR6H11)	-	-	-	
	06H-905-601A (PFR7S8EG)	IK22	VK22	-	101-000-068AA (FGR6HQEO)	K20PBR-S10	IK20	VK20	12-12-2-455-258 (SILZGR8ES)	-	-	-	
	06H-905-601C (PFR7S8G)	IK22	VK22	-	101-905-600A (PZFR6J-11)	SKJ16CR-L11	IK16	VK16	12-12-2-293-697 (12ZR-65PP2-1)	-	-	-	
	06H-905-611 (BOSCH O 241 245 670)	IK22	VK22	-	101-905-600C (PZFR5Q11)	SKJ16CR-L11	IK16	VK16	12-12-2-343-144 (D8EA)	X24ES-U	IX24	-	
	06H-905-621 (BERU)	IK22	VK22	-	101-905-601 (PZFR5D-11)	SKJ16CR-L11	-	VKA16	12-12-2-357-197 (LMAR8A1-8E)	-	-	-	
	06K-905-601B (PLFER7A8EG)	IKH22	VKH22	-	101-905-601F (VW-AG, BOSCH)	KJ20DR-M11	IK20L	VKA20	12-12-7-653-439 (CR8EB)	U24ESR-NB	IU24	-	
	06K-905-601D (PLFER7A8EG)	IKH22	VKH22	-	101-905-601F (VW-AG, BOSCH)	PK20GR8	IK20L	VKA20	12-12-7-664-404 (DR8EB)	IX24	IX24	-	
	06K-905-601L (ILFER7A8EG)	-	-	-	101-905-602 (PZFR6M-11G)	-	-	-	12-12-7-671-301 (DCPR8EKC)	XU24EPR-U	IXU24	VXU24	
	06K-905-601M (SILFER8C7ES)	-	-	-	101-905-603B (14F-7HUR2)	KJ20CR-L11	IK20	VK20	12-12-7-671-302 (YR6LDE)	XU22EPR-U	IXU22	VXU22	
	06K-905-611C (BOSCH 06K 905 611C)	IKH22	VKH22	-	101-905-603B (14F-7HUR2)	KJ20CR-L11	IK20	VK20	12-12-7-677-560 (YR5LDE)	XU24EPR-U	IXU24	VXU24	
	06M-905-606F (SILKGR9A7ES)	-	-	-	101-905-606A (IZKR7B)	-	-	-	12-12-7-698-956 (MAR9B-JDS)	-	-	-	
	079-905-626E (BERU)	IKH24	-	-	101-905-606A (IZKR7B)	K20TXR	IK20	VK20	12-12-7-699-116 (KR9CI)	IXU27	IXU27	-	
	079-905-626G (BERU)	IKH24	-	-	101-905-607 (BKR6EKUE)	K20TXR	IK20	VK20	12-12-7-710-636 (CR9EKB)	-	-	-	
	079-905-626J (BERU)	IKH24	-	-	101-905-608AA (FGR6HQEO)	K20PBR-S10	IK20	VK20	12-12-7-726-112 (MAR8B-JDS)	-	-	-	
	079-905-626L (BERU)	IKH24	-	-	101-905-611 (PFR6U-11G)	PK20PR-L11	IK20	VK20	12-12-9-064-619 (BKR6EK)	K20TXR	IK20	VK20	
	101-000-000AB	W20EP-U	IW20	VW20	101-905-611A (PFR6X11)	PK20PR-L11	IK20	VK20	12-12-9-069-048 (PKR7A)	VXU22	IXU22	VXU22	
	101-000-001AB	W20EPB	IW20	VW20	101-905-611D (PFR6S11E)	-	-	-	12-12-9-071-003 (BKR6EQU)	K20TXR	IK20	VK20	
	101-000-001AC	W20EPB	IW20	VW20	101-905-611G (PFR8S8EG)	IK24	IK24	-	7-699-166 (KR9CI)	IXU27	IXU27	-	
	101-000-001AD	W16EPB10	IW16	VW16	101-905-615A (FGR7KQEO)	K20PBR-S10	IK20	VK20	CHRYSLER	DENSO	IRIDIUM POWER	IRIDIUM TOUGH/PLUS	
	101-000-001AE	W16EPB10	IW16	VW16	101-905-616 (BKR6EQUA)	K20TXR	IK20	VK20	SP0ZFR5F11 (ZFR5F11)	-	VKA16	-	
	101-000-002AB	W20EP-U	IW20	VW20	101-905-617 (ZFR5P-G)	-	-	-	SP149125AD (RER8ZVWYCB4)	-	IXUH22I	VXUH22I	
	101-000-003AA	K22PB	IK22	VK22	101-905-617C (ZFR6T-11G)	KJ20DR-M11	-	VKA20	SP149212AC (LZTR6AP11G)	-	-	-	
	101-000-004AA	K22PB	IK22	VK22	101-905-617C (ZFR6T-11G)	PK20GR8	-	VKA16	SP149212AC (LZTR6AP11G)	-	-	-	
	101-000-005AA	W20EPB	IW20	VW20	101-905-620 (PZFR5N-11TG)	-	-	VKA16	SP149212AC (LZTR6AP11G)	-	-	-	
	101-000-005AB (W7DTC)	W20EPB	IW20	VW20	101-905-621 (PFR7W-T)	-	IK22	VK22	SP149212AC (LZTR6AP11G)	-	-	-	
	101-000-005AC	W22EPB	IW22	VW22	101-905-621A (PFR7W-T)	-	-	VKB20	SP149212AC (LZTR6AP11G)	-	-	-	
	101-000-005AD	W16EPB10	IW16	VW16	101-905-621B (PFR6W-TG)	-	-	VKB20	SP149212AC (LZTR6AP11G)	-	-	-	
	101-000-005AE	W16EPB10	IW16	VW16	101-905-621C (PFR7W-TG)	-	IK22	VK22	SP149212AC (LZTR6AP11G)	-	-	-	
	101-000-005AF	W16EPB10	IW16	VW16	101-905-622 (ILZKR7A)	-	-	-	SP149212AC (LZTR6AP11G)	-	-	-	
	101-000-006AB	W20EP-U	IW20	VW20	101-905-622A (ILZKR8A)	-	-	-	SP149212AC (LZTR6AP11G)	-	-	-	
	101-000-006AC	W20EP-U	IW20	VW20	101-905-624 (ZKR7APQ)	-	-	-	SP149212AC (LZTR6AP11G)	-	-	-	
	101-000-007AA	W20EPB	IW20	VW20	101-905-624 (ZKR7APQ)	-	-	-	SP149212AC (LZTR6AP11G)	-	-	-	
	101-000-007AB	W20EPB	IW20	VW20	101-905-626 (EYQUEM)	SKJ20CR-AB/PKJ20CR8	-	-	-	SP149212AC (LZTR6AP11G)	-	-	-
	101-000-007AC	W16EPB10	IW16	VW16	101-905-626A (SIZFR6A6D)	-	-	-	SP149212AC (LZTR6AP11G)	-	-	-	
	101-000-007AD	W20EPB	IW20	VW20	101-905-626E (EYQUEM)	-	IKH27	-	SP149212AC (LZTR6AP11G)	-	-	-	
	101-000-016AA	PK22PR8	IK22	VK22	101-905-626G (EYQUEM)	-	IKH27	-	SP149212AC (LZTR6AP11G)	-	-	-	
	101-000-016AB	PK20PR-P8	IK20	VK20	101-905-631A (F7KPP332U)	VK20	IK20	VK20	SP149212AC (LZTR6AP11G)	-	-	-	
	101-000-017AA	K22PB	IK22	VK22	101-905-631B (F6KPP332S)	VK20	IK20	VK20	SP149212AC (LZTR6AP11G)	-	-	-	
	101-000-026AA	-	IW16	VW16	101-905-631C (BOSCH)	VK16	IK16	VK16	SP149212AC (LZTR6AP11G)	-	-	-	
	101-000-026AB	W20EPBR-S	IW20	VW20	101-905-631F (BOSCH)	VK16	IK16	VK16	SP149212AC (LZTR6AP11G)	-	-	-	
	101-000-027AA (BP6ET)	W20EPB	IW20	VW20	101-905-631G (O-241-245-665)	-	IK24						



# CAR MAKER GENUINE P/N CROSS REFERENCE

98079-56841

other



(\*6) Purchase via DAIHATSU.

CITROEN	DENSO	IRIDIUM POWER	IRIDIUM TOUGH/PLUS	DAIHATSU	DENSO	IRIDIUM POWER	IRIDIUM TOUGH/PLUS	DAIHATSU	DENSO	IRIDIUM POWER	IRIDIUM TOUGH/PLUS
5960.G4 (PLZKBR7AG)	-	-	-	90048-51169-000	K20BR-S10	IK20	VK20	999-06910-X9-016 (DPR8EIX9)	-	IX24B	-
5960.J3 (RFC58LZK)	K20PR-U11	IK20	VK20	90048-51170	K20PTR-S	IK20	VK20	999-06910-X9-017 (DPR9EIX9)	-	IX27B	-
5960.L0 (ZQR8S1302, Bi Hex)	-	-	-	90048-51172	SVK20RZ11	IK20	VK20	999-06910-X9-018 (DCPR7EIX)	-	IXU22	VXU22
5960.L5 (ILZKBR7A8G, Bi Hex)	-	-	-	90048-51173-000 (IFR6J11)	SVK20RZ11	IK20	VK20	999-06910-X9-019 (ZFR5FIX11)	-	IK16	VK16
5962.7W (FR7ME)	K20HR-U11	IKH20	VKH20	90048-51175-000	PK20PTR-S9	IK20	VK20	999-06910-X9-020 (ZFR6FIX11)	-	IK20	VK20
9807776680 (ZR55PP3320)	-	-	-	90048-51178-000 (IFR6J)	SVK20RZ8	-	VK20Y	999-06910-X9-021 (CR8EIX9)	-	IUH24	-
9808465980 (ZR551332, Bi Hex)	-	-	-	90048-51179	ZXU22HBR11	-	-	999-06910-X9-022 (CR9EIX9)	-	IUH27	-
9813769880 (ILZKBR8C7G, Bi Hex)	-	-	-	90048-51180-000 (ILKR7A11T)	ZXU22HBR11 (*6)	-	-	999-06910-X9-023 (CR8EIX)	-	IU24	-
				90048-51182	SK20PR-A8	-	VK20Y	999-06910-X9-024 (CR9EIX)	-	IU27	-
				90048-51183	K20PR-SU9	IK20	VK20	999-06910-X9-026 (BPR5EIX)	-	IW16	VW16
				90048-51184-000 (BKUR6E)	K20PR-SU9	IK20	VK20	999-06910-X9-027 (BPR6EIX)	-	IK16	VK16
				90048-51185-000 (ILFR6C11)	SK20HR11	IKH20	VKH20	999-06910-X9-028 (BKRS5EIX)	-	IK22	VK22
				90048-51186	SK20R11	IK20	VK20	999-06910-X9-030 (BKR7EIX11)	-	-	-
				90048-51187-000 (IKR7C)	SXU22PR9	IXU221	VXU221	999-06910-X9-031 (BCPR7EDIX)	-	-	-
				90048-51188-000	SXU22PR9	IXU221	VXU221	999-06910-X9-032 (BKR5EIXP)	-	-	-
				90048-51189-000	XU22HR9	IXUH221	VXUH221	999-06910-X9-033 (BKR5EIX11P)	-	-	-
				90048-51190-000 (Use 51214)	SXU22HR9 (Use SXU22HPR9)	IXUH221	VXUH221	999-06910-X9-034 (BKR6EIXP)	-	-	-
				90048-51192 (LKR7C)	XU22HR9	IXUH221	VXUH221	999-06910-X9-035 (BKR6EIX11P)	-	-	-
				90048-51194 (IKR7E9)	VXU22	IXU22	VXU22	99906-850P9-006	W20FPR-U	IWF20	-
				90048-51195	SXU22HPR11	IXUH221	VXUH221	99906-850P9-009	W22ESR-U	-	-
				90048-51196 (DCPR7EA9)	XU22PR9	IXU221	VXU221	99906-850P9-011	W16EPR11	IW16	VW16
				90048-51197-000	XU22PR9	IXU221	VXU221	99906-850P9-012	W20EPR11	IW20	VW20
				90048-51198-000	SXU22HPR9	IXUH221	VXUH221	99906-850P9-013	W16EXR-U13	IW16	VW16
				90048-51199 (ILKR7D9)	SXU22HPR9	IXUH221	VXUH221	99906-850P9-015	W16ETR-S	IW16	VW16
				90048-51200 (IKR7D)	SXU22PR9	IXU22	VXU22	99906-850P9-017	J16AR-U11	-	-
				90048-51207 (ILKR6F11)	SXU20HPR11	IXUH201	VXUH201	99906-850P9-018	J16BR-U11	-	-
				90048-51208	SXU20HPR11	IXUH201	VXUH201	99934-07685-100	W16EX-U11	IW16	VW16
				90048-51210	SXU22HPR9	IXUH221	VXUH221	99934-08685-100	W20EX-U11	IW20	VW20
				90048-51211	XU20HR9 (LKR6C)	IXUH201	VXUH201	99934-09685-100	W20FP-U	IWF20	-
				90048-51212	XU20HR9	IXUH201	VXUH201	99934-10685-100	W9EP	-	-
				90048-51213 (ILKR7D8)	SXU22HPR8	IXUH221	VXUH221	99934-12685-100	W16FP-U	IWF16	-
				90048-51214	SXU22HPR8	IXUH221	VXUH221	99934-13685-100	W20EP11	IW20	VW20
				90048-51215 (SILKR6D10G)	-	IXUH201	VXUH201	99934-14685-100	W16EX-U13	IW16	VW16
				90048-51216 (SILKAR6G11G)	-	-	VFXEH20	NDIK16	IK16	IK16	VK16
				90048-51220 (SILKAR7G8G)	-	-	-	NDIK16A	IK16	IK16	VK16
				9004A-91039 (DCPR7EA9)	XU22PR9	IXU22	VXU22	NDIK20	IK20	IK20	VK20
				90919-01056-000	W14EX-U	IW16	VW16	NDIK20A	IK20	IK20	VK20
				90919-01059	W16EX-U	IW16	VW16	NDIK22	IK22	IK22	VK22
				90919-01060-000 (BP5EA)	W14EX-U	IW16	VW16	NDIK22A	IK22	IK22	VK22
				90919-01065-000	W14EXR-U	IW16	VW16	NDIK24A	IK24	IK24	-
				90919-01085-000	W14EX-U11	IW16	VW16	NDIK27A	IK27	IK27	-
				90919-01086-000 (BP5EA-11)	W14EX-U11	IW16	VW16	NDIQ16	IQ16	IQ16	VQ16
				90919-01087-000 (BP5EK-A)	W16ET-S	IW16	VW16	NDIQ16A	IQ16	IQ16	VQ16
				90919-01090-000	W16ET-S	IW16	VW16	NDIQ20	IQ20	IQ20	VQ20
				90919-01106-000 (BP4EY-11)	W14EX-U11	IW16	VW16	NDIQ20A	IQ20	IQ20	VQ20
				90919-01110-000 (BPR5EP-11)	P16R	IW16	VW16	NDIQ22	IQ22	IQ22	VQ22
				90919-01115-000	P16R	IW16	VW16	NDIQ22A	IQ22	IQ22	VQ22
				90919-01116-000 (BPR5EP-11)	P16R	IW16	VW16	NDIQ24A	IQ24	IQ24	-
				90919-01117-000	J16B-U11	-	-	NDIQ27A	IQ27	IQ27	-
				90919-01118-000 (BE529Y-11)	J16B-U11	-	-	NDIW16	IW16	IW16	VW16
				90919-01191	SK20HR11	IKH20	VKH20	NDIW16A	IW16	IW16	VW16
				90919-01202-000 (BKR6EKB-11)	K20TR11	IK20	VK20	NDIW20A	IW20	IW20	VW20
				90919-01259 (FK16HR-A8)	FK16HR-A8	-	VFKH16	NDIW22	IW22	IW22	VW22
				90919-01289 (FC16HR-Q8)	FC16HR-Q8	-	VFCH16	NDIW22A	IW22	IW22	VW22
				90919-51072-000 (BP5ES)	W16EX-U	IW16	VW16	NDIXU22	IXU22	IXU22	VXU22
				90919-51072-000 (BP5ES)	W16EP-U	IW16	VW16	NDIXU22A	IXU22	IXU22	VXU22
				94448-51155-000 (BKR6EKC)	K20TNR	IK20	VK20	NDIXU24A	IXU24	IXU24	VXU24
				94448-51201 (ILKR7D11)	SXU22HPR11	IXUH221	VXUH221	NDIXUH20IA	IXUH201	IXUH201	VXUH201
				94448-51204 (ILKR7F11)	SXU22HPR11	IXUH221	VXUH221	NDIXUH22IA	IXUH221	IXUH221	VXUH221
				96762-88180 (LZKR6AI-10C)	-	IXUH201	VXUH201	NDVK20Y	VK20Y	-	VK20Y
				99113-39236-200	MW17	-	-	NDVK20YA	VK20Y	-	VK20Y
				999-06910-P9-013 (BPR5EK-A)	W16ETR-S	IW16	VW16	NDVXUH20IA	VXUH201	VXUH201	VXUH201
				999-06910-P9-015 (BPR4EY-11)	W14EXR-U11	IW16	VW16	NDVXUH22IA	VXUH221	IXUH221	VXUH221
				999-06910-X9-001 (BPR5EIX11)	-	IW16	VW16	NDVK16	VK16	IK16	VK16
				999-06910-X9-002 (BPR6EIX11)	-	IW20	VW20	NDVK16A	VK16	IK16	VK16
				999-06910-X9-003 (BPR7EIX)	-	IW22	VW22	NDVK20	VK20	IK20	VK20
				999-06910-X9-004 (BCPR5EIX11)	-	IQ16	VQ16	NDVK20A	VK20	IK20	VK20
				999-06910-X9-005 (BCPR6EIX11)	-	IQ20	VQ20	NDVK22	VK22	IK22	VK22
				999-06910-X9-006 (BKR5EIX11)	-	IK16	VK16	NDVK22A	VK22	IK22	VK22
				999-06910-X9-007 (BKR6EIX11)	-	IK20	VK20	NDVQ16	VQ16	IQ16	VQ16
				999-06910-X9-008 (BPR6HIX)	-	IWF20	-	NDVQ16A	VQ16	IQ16	VQ16
				999-06910-X9-009 (BPR7HIX)	-	IWF22	-	NDVQ20	VQ20	IQ20	VQ20
				999-06910-X9-010 (BR6HIX)	-	-	-	NDVQ20A	VQ20	IQ20	VQ20
				999-06910-X9-011 (BR7HIX)	-	IWF22	-	NDVQ22	VQ22	IQ22	VQ22
				999-06910-X9-012 (BR8EIX)	-	IW24	-	NDVQ22A	VQ22	IQ22	VQ22
				999-06910-X9-013 (BR9EIX)	-	IW27	-	NDVQ22A	VQ22	IQ22	VQ22
				999-06910-X9-014 (DR8EIX)	-	IX24	-	NDVQ22A	VQ22	IQ22	VQ22
				999-06910-X9-015 (DR9EIX)	-	IX27	-				

(1) This comparison chart does not guarantee capability with any vehicle. Please use it for reference only. (2) Plug specifications (design, materials, etc.) varies according to manufacturer. (3) Choose your plug model by referring to the vehicle model compatibility table. (4) When choosing a plug model for tuning vehicles and vehicles not listed in the vehicle model compatibility chart, the customer is responsible for determining the correct plug.

AUSTRALIA  
CHINA  
INDIA  
INDONESIA  
KOREA  
MALAYSIA  
PHILIPPINES  
SAUDI ARABIA  
SINGAPORE  
TAIWAN  
THAILAND  
VIETNAM  
JAPAN  
EUROPE & USA  
CROSS REFERENCE NUMBER  
PART NUMBER



# CAR MAKER GENUINE P/N CROSS REFERENCE

98079-56841

other

DENSO

HONDA	DENSO	IRIDIUM POWER	IRIDIUM TOUGH/PLUS	HONDA	DENSO	IRIDIUM POWER	IRIDIUM TOUGH/PLUS	HONDA	DENSO	IRIDIUM POWER	IRIDIUM TOUGH/PLUS
98059-57916 (CR7EH9)	U22FER9	IUH24	-	98079-5514G (ZFR5F-11)	KJ16CR-L11	IK16	VK16	98079-571CV	SK22PR-M11S	IK22G	VK22G
98059-57926	U22FER9	IUH24	-	98079-5514H (PFR5G-11)	PK16PR-(L)11	IK16	VK16	98079-57816 (BR7E5)	W22ESR-U	-	-
98059-58910 (C8EH-9)	U24FE9	IUH24	-	98079-5514N (PZFR5F-11)	SKJ16CR-L11	IK16	VK16	98079-57840 (B7E5)	W22ES-U	-	-
98059-58916 (CR8EH-9)	U24FER9	IUH24	-	98079-5514P (ZFR5J-11)	KJ16CR-L11	IK16	VK16	98079-57855	W22EPR-U	IW22	VW22
98059-58920	U24FE9	IUH24	-	98079-55155	W16EPR-U11	IW16	VW16	98079-5785C	K22PR-UR	IK22	VK22
98059-58926	U24FER9	IUH24	-	98079-55158	Q16PR-U11	IQ16	VQ16	98079-57877 (BR7E5)	W22ESR-U	-	-
98059-5892D	IUH24D	IUH24	-	98079-5515E	K16PR-U11	IK16	VK16	98079-5787G (ZFR7F)	KJ22CR-L8	IK22	VK22
98059-58916 (CR8EH9S)	U24FER9S	IUH24	-	98079-5515G	KJ16CR-L11	IK16	VK16	98079-5787T (PFR7N-D)	PK22PR8	IK22	VK22
98059-589K6	U24FER9S	IUH24	-	98079-5515H	PK16PR-L11	IK16	VK16	98079-5815E	K24PR-U11	IK24	-
98059-59910 (C9EH-9)	U27FER9	IUH27	-	98079-5515J	K16PR-L11	IK16	VK16	98079-5815U	IK24C11	IK24	-
98059-59916 (CR9EH-9)	U27FER9	IUH27	-	98079-5515N	PKJ16CR-L11	IK16	VK16	98079-5817U (FR8B1-11)	IK24C11	IK24	-
98059-5991U (IMR9A-9H)	IUH27D	IUH27	-	98079-5515U	VK16PR-Z11	IK16	VK16	98079-58644 (B8EV)	-	IW24	-
98059-5992U	IUH27D	IUH27	-	98079-5515W	SKJ16CR-L11	IK16	VK16	98079-58678 (B8EG)	W24ES-V	IW24	-
98059-599J6 (CR9EH-9S)	-	IUH27	-	98079-55173 (BUR5EB-11)	W16EKR-S11	IW16	VW16	98079-58816 (BR8E5)	W24ESR	IW24	-
98061-58611 (DP8Z)	X24GP-U	IXG24	-	98079-5517U (IFR5L11)	VK16PRZ11	IK16	VK16	98079-58816 (BR8E5)	W24ESR-U	IW24	-
98061-58616 (DPR8Z)	X24GPR-U	IXG24	-	98079-5517V (IFR5G1K)	W16PR-L11	IK16	VK16	98079-58840 (B8E5)	W24ES-U	IW24	-
98061-59616 (DPR9Z)	X27GPR-U	IXG27	-	98079-5517W (IZFR5F11)	SKJ16CR-L11	IK16	VK16	98079-58857	W24ESR-U	IW24	-
98066-55716 (DR5HS)	X16FSR-U	-	-	98079-55183	W16EKR-S11	IW16	VW16	98079-5915U	IK27C11	IK27	-
98066-55740 (D5HS)	X16FSR-U	-	-	98079-55827	W16EPR-U (THREAD)	IW16	VW16	98079-5917U (FR9B11)	IK27C11	IK27	-
98066-56717 (D6HA)	X20FS-U	-	-	98079-55840 (B5E5)	W16ES-U	-	-	98079-59644 (B9EV)	-	IW27	-
98066-56726	X20FSR-U	-	-	98079-55841 (BP5E5)	W16EX-U	IW16	VW16	98079-59659	W27ESR-V	IW27	-
98066-58717 (D8HA)	X24FS-U	-	-	98079-55841 (BP5E5)	W16EP-U	IW16	VW16	98079-59678 (B9EG)	W27ES-V	IW27	-
98069-38716 (DR8ES-L)	X24ESR-U	IX24	-	98079-55846 (BPR5E5)	W16EXR-U	IW16	VW16	98079-59811 (B9E5)	W27ES-U	IW27	-
98069-38719 (DR8ES-L)	X24ESR-U	IX24	-	98079-55846 (BPR5E5)	W16EPR-U	IW16	VW16	98079-59819 (BR9ECS)	W27ESR	IW27	-
98069-56911 (DP6EA-9)	X20EPR-U9	-	-	98079-55855	W16EPR-U (SOLID)	IW16	VW16	98079-59819 (BR9ECS)	W27ESR-U	IW27	-
98069-5692U	VX20BC	-	-	98079-55855	W16EPR-U	IW16	VW16	98079-59840 (B9E5)	W27ES-U	IW27	-
98069-57717 (D7EA)	X22ES-U	IX22	-	98079-5585C	K16PR-UR	IK16	VK16	98079-59847 (BR9E5)	W27ESR	IW27	-
98069-57726	X22ESR-U	IX22	-	98079-5585V	J16CR-U	IW16	VW16	98079-59847 (BR9E5)	W27ESR-U	IW27	-
98069-57756	X22ESR-UB	IX22	-	98079-5587V (ZGR5A)	J16CR-U	IW16	VW16	98079-59855	W27EMR-C	IWM27	-
98069-57911 (DP7EA-9)	X22EP-U9	IX22B	-	98079-55A4N (PFR5F-13)	PQ16R	IQ16	VQ16	98079-59872 (B9ECS)	-	IW27	-
98069-57916 (DPR7EA-9)	X22EPR-U9	IX22B	-	98079-55A5N	PKJ16CR-L13	IK16	VK16	98079-59875 (BR9ECM)	W27EMR-C	IWM27	-
98069-5792U	VX22BC	IX22B	-	98079-56132	W20EXR-U11	IW20	VW20	98079-60875 (BR10ECM)	-	IWM31	-
98069-57956	X22EPR-UB9	IX22B	-	98079-56144 (BP6E5-11)	W20EX-U11	IW20	VW20	9807B-5515W	SKJ16DR-M11	IK16	VK16
98069-58717 (D8EA)	X24ES-U	IX24	-	98079-56144 (BP6E5-11)	W20EPR-U11	IW20	VW20	9807B-5615P	KJ20DR-M11	IK20	VK20
98069-58726	X24ESR-U	IX24	-	98079-56146 (BPR6EY-11)	W20EXR-U11	IW20	VW20	9807B-5615W	SKJ20DR-M11	IK20	VK20
98069-58911 (DP8EA-9)	X24EP-U9	IX24B	-	98079-56148 (BCPR6E-11)	Q20PR-U11	IQ20	VQ20	9807B-5617P (ZFR6K11)	KJ20DR-M11	IK20	VK20
98069-58916 (DPR8EA-9)	X24EPR-U9	IX24B	-	98079-5614A (BCPR6EY-N11)	Q20R-U11	IQ20	VQ20	9807B-561BP-00 (ZFR6K1S)	KJ20DR-M11S	IK20G	VK20G
98069-58926	X24EPR-U9	IX24B	-	98079-5614E (BKRG6E-11)	K20PR-U11	IK20	VK20	9807B-561CP	KJ20DR-M11S	IK20G	VK20G
98069-5991F (DPR9EVX-9)	IX27B	IX27B	-	98079-5614F (BCPR6EVX-11)	-	IQ20	VQ20	9807B-561CW	SKJ20DR-M11S	IK20G	VK20G
98069-59926	X27EPR-U9	IX27B	-	98079-5614G (ZFR6F-11)	KJ20CR-L11	IK20	VK20	9807B-56A5W	SKJ20DR-M13	IK20	VK20
98073-54740 (BM4A)	W14M-U	-	-	98079-5614H (PFR6G-11)	PK20PR-L11	IK20	VK20	9807B-56A7W (IZFR6K13)	SKJ20DR-M13	IK20	VK20
98073-54744 (BMR4A)	W14MR-U	-	-	98079-5614J (BKRG6E-N11)	K20PR-L11	IK20	VK20				
98073-54750	W14M-U	-	-	98079-5614N (PZFR6F-11)	PKJ20CR-L11	IK20	VK20				
98073-54754	W14MR-U	-	-	98079-5614P (ZFR6J-11)	KJ20CR-L11	IK20	VK20				
98073-54941 (BPM4A-10)	W14MP-U10	-	-	98079-56155	W20EPR-U11	IW20	VW20				
98073-54944 (BPMR4A)	W14MPR-U10	-	-	98079-56158	Q20PR-U11	IQ20	VQ20				
98073-54951	W14MP-U10	-	-	98079-5615E	K20PR-U11	IK20	VK20				
98073-56740 (BM6A)	W20M-U	-	-	98079-5615G	KJ20CR-L11	IK20	VK20				
98073-56744 (BMR6A)	W20MR-U	-	-	98079-5615H	PK20PR-L11	IK20	VK20				
98073-56750	W20M-U	-	-	98079-5615J	K20PR-L11	IK20	VK20				
98073-56941 (BPM6A-10)	W20MP-U10	-	-	98079-5615N	PKJ20CR-L11	IK20	VK20				
98073-56944 (BPMR6A)	W20MPR-U10	-	-	98079-5615U	VK20PRZ11	IK20	VK20				
98076-54710 (B-4H)	W14F-U	-	-	98079-5615V	SK20PR-L11	IK20	VK20				
98076-54711 (BP4HS)	W14FP-UL	IWF16	-	98079-56173 (BUR6EB-11)	W20EKR-S11	IW20	VW20				
98076-54719 (BP4HS)	W14FP-UL	IWF16	-	98079-56183	W20EKR-S11	IW20	VW20				
98076-54747 (BPR4HS)	W14FPR-UL	IWF16	-	98079-561CJ	K20PR-L11S	IK20G	VK20G				
98076-54911 (BP4HS-10)	W14FP-UL10	IWF16	-	98079-56832	W20EXR-U	IW20	VW20				
98076-54914 (BPR4HS-10)	W14FPR-UL10	IWF16	-	98079-56840 (B6E5)	W20ES-U	-	-				
98076-5491G (BR4HSA-9)	W14FR-L	IWF16	-	98079-56841 (BP6E5)	W20EX-U	IW20	VW20				
98076-54921	W14FP-UL10	IWF16	-	98079-56841 (BP6E5)	W20EP-U	IW20	VW20				
98076-55711 (BP5HS)	W16FP-U	IWF16	-	98079-56846 (BPR6E5)	W20EXR-U	IW20	VW20				
98076-55719 (BP5HS)	W16FP-U	IWF16	-	98079-56846 (BPR6E5)	W20EPR-U	IW20	VW20				
98076-56713 (BP6HSA)	W20FR-L	IWF20	-	98079-56847 (BR6E5)	W20ESR-U	-	-				
98076-56715 (BPR6HSA)	W20FR-L	IWF20	-	98079-56854	W20EP-U	IW20	VW20				
98076-56717 (BPR6HS)	W20FPR-U	IWF20	-	98079-56855	W20EPR-U	IW20	VW20				
98076-56719 (BP6HS)	W20FP-U	IWF20	-	98079-56855-03	W20EPR-U	IW20	VW20				
98076-5671G (BR6HSA)	W20FR-L	IWF20	-	98079-5685C	K20PR-UR	IK20	VK20				
98076-56721	W20FP	IWF20	-	98079-568CE	K20PR-U8S	IK20G	VK20G				
98076-56725	W20FPR-L	IWF20	-	98079-5695U	SK20PR-L9	IK20	VK20				
98076-56729	W20FPR-U	IWF20	-	98079-5697U (IFR6C)	SK20PR-L9	IK20	VK20				
98076-5672G	W20FR-L	IWF20	-	98079-5698E (BKRG6E-9S)	K20PR-U9S	IK20G	VK20G				
98076-56756	W20FPR	IWF20	-	98079-5699U (IFR6CS)	SK20PR-L9S	IK20G	VK20G				
98076-56917 (BPR6HS-10)	W20FPR-U10	IWF20	-	98079-569CE	K20PR-U9S	IK20G	VK20G				
98076-5691G (BR6HSA-9)	W20FR-L	IWF20	-	98079-569CU	SK20PR-L9S	IK20G	VK20G				
98076-56927	W20FPR-U10	IWF20	-	98079-56A7W (IZFR6K13)	SKJ20DR-M13	IK20	VK20				
98076-5692G	W20FR-L9	IWF20	-	98079-5714H (PFR7G-11)	PK22PR-L11	IK22	VK22				
98076-57717 (BPR7HS)	W22FPR-U	IWF22	-	98079-57155-01	W22EPR-U11	IW22	VW22				
98076-58710 (B8HS)	W24FS-U	IWF24	-	98079-57158	Q22PR-U11	IQ22	VQ22				
98076-58716 (BR8HS)	W24FSR	IWF24	-	98079-5715E	K22PR-U11	IK22	VK22				
98076-5871G (BR8HSA)	W24FR-L	IWF24	-	98079-5715G	KJ22CR-L11	IK22	VK22				
98076-5872G	W24FR-L	IWF24	-	98079-5715H (Use 571CH)	PK22PR-L11 (Use PK22PR-L1S)	IK22	VK22				
98076-5891G (BR8HSA-9)	W24FR-L	IWF24	-	98079-5715J	K22PR-L11	IK22	VK22				
98079-54855	W14EPR-U	IW16	VW16	98079-5715U	VK22PR-Z11	IK22	VK22				
98079-5485V	J14CR-U	IW16	VW16	98079-5715V	SK22PR-M11	IK22	VK22				
98079-55132	W16EXR-U11	IW16	VW16	98079-57173 (BUR7EB-11)	W22EP-S11	IW22	VW22				
98079-55145 (BPR5E5-11)	W16EXR-U11	IW16	VW16	98079-57175 (BR6EB-L11)	W20EKR-S11	IW20	VW20				
98079-55146 (BPR5EY-11)	W16EXR-U11	IW16	VW16	98079-57183	W22EKR-S11	IW22	VW22				
98079-55148 (BCPR5E-11)	Q16PR-U11	IQ16</									

# CAR MAKER GENUINE P/N CROSS REFERENCE

98079-56841

other

DENSO

AUSTRALIA  
CHINA  
INDIA  
INDONESIA  
KOREA  
MALAYSIA  
PHILIPPINES  
SAUDI ARABIA  
SINGAPORE  
TAIWAN  
THAILAND  
VIETNAM  
JAPAN  
EUROPE  
& USA  
CROSS  
REFERENCE  
PART  
NUMBER

ISUZU	DENSO	IRIDIUM POWER	IRIDIUM TOUGH/PLUS	KAWASAKI	DENSO	IRIDIUM POWER	IRIDIUM TOUGH/PLUS	MAZDA	DENSO	IRIDIUM POWER	IRIDIUM TOUGH/PLUS
5-86003124-0(ZFR6F-11)	KJ20CR-L11	IK20	VK20	J4520-IX27	IX27	IX27		1002-77-550(BP5EY)	W16EX-U	IW16	VW16
5-86007635-0(BKR5E-11)	K16PR-U11	IK16	VK16	J4520-IX27B	IX27B	IX27B		1003-77-550(BP6EY)	W20EX-U	IW20	VW20
5-86007636-0(ZFR5J-11)	KJ16CR-L11	IK16	VK16	J4520-IXU01-27	IXU01-27	-		1409 18 110	W16EX-U13	IW16	VW16
5-86007639-0(ZFR6J-11)	KJ20CR-L11	IK20	VK20	J4520-IXU01-31	IXU01-31	-		1410-18-110(BP5E-13)	W16EX-U13	IW16	VW16
5-86013957-0(PZFR5F-13)	PKJ16CR-L13	IK16	VK16	J4520-IXU01-34	IXU01-34	-		1482-18-600A(BR8EQ)	IRE01-27	-	-
5-86103386-0(PFR6B-11)	K20PR11	IK20	VK20	J4520-IXU22	IXU22	IXU22	VXU22	1482-18-600A(BR8EQ)	W25EDR14	-	-
5-86103389-0(PGR5A-11)	P16PR11	IW16	VW16	J4520-IXU24	IXU24	IXU24	VXU24	1483 18 600	W25EDR	-	-
5-86121749-0(BKR5E-11)	K16PR-U11	IK16	VK16	J4520-U20FSR-U	U20FSR-U	IUF22		1534 18 110	W16EX-U	IW16	VW16
5-86141-3160(DILKAR6A11)	FXE20HR11	-	VFXEH20	J4520-U22ESR-N	U22ESR-N	IU22		1A01-18-110(PGR5A)	P16PR8	IW16	VW16
8-94120560-0(BPR5E-11)	W16EXR-U11	IW16	VW16	J4520-U22FSR-U	U22FSR-U	IUF22		1A02-18-110(KR7A)	IXU22	IXU22	VXU22
8-94120561-0	W16EXR-U11	IW16	VW16	J4520-U24ESR-N	U24ESR-N	IU24		1A03-18-110(KR7A)	VXU22	IXU22	VXU22
8-94120562-0	W20EXR-U11	IW20	VW20	J4520-U27ESR-N	U27ESR-N	IU27		1A10-18-110(GR5A1-10)	IW16	IW16	VW16
8-94160627-0	W20EXR-U	IW20	VW20	J4520-U27ETR	U27ETR	IU27A		1A11 18 110	IXU22C	IXU22	VXU22
8-94217232-0(BPR6E-11)	W20EXR-U11	IW20	VW20	J4520-W20EP-U	W20EP-U	IW20	VW20	1A12 18 110(LKR7B18)	IXU22HPR	IXUH22	VXUH22
8-94217232-0(BPR6E-11)	W20EPR-U11	IW20	VW20	J4520-W20EPR-U	W20EPR-U	IW20	VW20	1A13 18 110	IXU22HPR	IXUH22	VXUH22
8-94219943-0(BPR6E-11)	W20EXR-U	IW20	VW20	J4520-W20FPR-U	W20FPR-U	IWF20		1A14 18 110(ILMAR7A8)	-	-	VSUEH22
8-94219943-0(BPR6E-11)	W20EPR-U	IW20	VW20	J4520-W22FPR-U	W22FPR-U	IWF22		1A15 18 110	ZXU22HPR8	IXUH22	VXUH22
8-94235966-0(BP5E-11)	W16EX-U11	IW16	VW16	J4520-W24ESR-U	W24ESR-U	IW24		1A16 18 110(ILK7R78)	ZXU22HPR8	IXUH22	VXUH22
8-94235966-0(BP5E-11)	W16EP-U11	IW16	VW16	J4520-W24FS-U10	W24FS-U10	IWF24		1A17 18 110(LMKR7CI-A8)	-	-	VSUEH22
8-94237203-0	W16EX-U11	IW16	VW16	J4520-W27ES-U	W27ES-U	IW27		1A18 18 110(SILKR7F11)	-	-	IXUH22I VXUH22I
8-94241059-0(BP6E-11)	W20EX-U11	IW20	VW20	J4520-W27ESR-U	W27ESR-U	IW27		1A61 18 110(DCPR7EVX)	-	-	IXU22 VXU22
8-94241059-0(BP6E-11)	W20EPR-U11	IW20	VW20	J4520-W31ESR-U	W31ESR-U	IW31		IM00 18 110	FK16HR11	-	VFKH16
8-94252270-0	W20EX-U11	IW20	VW20	J4520-X20EPR-U9	X20EPR-U9	-		1N04 18 110(BKR5EY-11)	K16R-U11	IK16	VK16
8-94328372-0(BKR6E-11)	K20PR-U11	IK20	VK20	J4520-X20FS-U	X20FS-U	-		1N08 18 110(PFR5G-11)	PK16PR(L)11	IK16	VK16
8-94328374-0	K20PR-U11	IK20	VK20	J4520-X22EPR-U9	X22EPR-U9	IX22B		1N14 18 110	FXE16HE11	-	-
8-94328375-0	K22PR-U11	IK22	VK22	J4520-X24EP-U9	X24EP-U9	IX24B		1N19 18 110(LZKAR6AP11)	FXE20HR11	-	VFXEH20
8-97012928-0(BKR6E)	K20PR-U	IK20	VK20	J4520-X24EPR-U9	X24EPR-U9	IX24B		1N24 18 110	FXE20HE11	-	VFXEH20E
8-97012930-0	K20PR-U	IK20	VK20	J4520-X24ES-U	X24ES-U	IX24		1N25 18 110(DILZKAR6A11)	FXE20HE11	-	VFXEH20E
8-97012931-0	K22PR-U	IK22	VK22	J4520-X24ESR-U	X24ESR-U	IX24		1UD0 18 110	IW16	IW16	VW16
8-97111376-0	PK16PR11	IK16	VK16	J4520-X24GP-U	X24GP-U	IXG24		1UD1 18 110	IW20	IW20	VW20
8-97170268-0	K16PR-P11	IK16	VK16	J4520-X27EPR-U9	X27EPR-U9	IX27B		1UD2 18 110	IW22	IW22	VW22
8-97311393-0	SXU16HPR9	-	-	<b>KTM DENSO</b>		<b>IRIDIUM POWER</b>	<b>IRIDIUM TOUGH/PLUS</b>	1UD3 18 110	IK16	IK16	VK16
8-97350555-0(IZFR7E-D)	-	-	-	78039093000(LKAR8A9)	-	-	-	1UD4 18 110	IK20	IK20	VK20
8-97380046-0	GX8-1	-	-	90139093000	-	-	-	1UD6 18 110	IQ16	IQ16	VQ16
9-9811929-0	GX8-1	-	-	<b>KUBOTA DENSO</b>		<b>IRIDIUM POWER</b>	<b>IRIDIUM TOUGH/PLUS</b>	1UD7 18 110	IQ20	IQ20	VQ20
9-82513103-0(BP6E-11)	W20EX-U	IW20	VW20	0790923150	W20M-U	-	-	1UD9 18 110	IXU22	IXU22	VXU22
9-82513103-0(BP6E-11)	W20EPR-U	IW20	VW20	0790923160	W22M-U	-	-	1UN0 18 110(BPR5EIX)	-	-	IW16 VW16
9-82513106-0(BP5E-11)	W16EX-U	IW16	VW16	1264767710	W20FPR-U	IWF20		1UN1 18 110(BPR6EIX)	-	-	IW20 VW20
9-82513106-0(BP5E-11)	W16EP-U	IW16	VW16	1268167740	W16ESR-U	-	-	1UN2 18 110(BPR7EIX)	-	-	IW22 VW22
	<b>JAGUAR DENSO</b>	<b>IRIDIUM POWER</b>	<b>IRIDIUM TOUGH/PLUS</b>	1307867710	W20EP-U	IW20	VW20	1UN3 18 110(BPR5EIX11)	-	-	IW16 VW16
AJ812146(ILKAR6C10)	VFXEH20	-	VFXEH20	1310167711	W16S-U	-	-	1UN4 18 110(BPR6EIX11)	-	-	IW20 VW20
AJ813092(ILTR6G8G)	-	-	-	1315767710	W14M-U	-	-	1UN6 18 110(BKR5EIX)	-	-	IK16 VK16
AJ812988(SILZKAR7C10S)	-	-	-	1317367711-1328167711	W14F-U10-W14F-U	IWF16		1UN7 18 110(BKR6EIX)	-	-	IK20 VK20
C2A1535(IFR5N10)	VK16	IK16	VK16	1321167711	W14-U	-	-	1UN9 18 110(BKR5EIX11)	-	-	IK16 VK16
C2P23089(ILKAR7C10)	-	-	-	1328167711	W14F-U	-	-	1UNA 18 110(BKR6EIX11)	-	-	IK20 VK20
C2S46895(TR6AP13E)	IT20	IT20	VT20	1330267710	W9-U	-	-	1UNC 18 110(BCPR5EIX11)	-	-	IQ16 VQ16
C2Z28434(SILZKAR7E8S)	-	-	-	1337567740	W14FPR-UL10	IWF16		1UND 18 110(BCPR6EIX11)	-	-	IQ20 VQ20
EAC008584(BR7EFS)	T22EP-U	IT22	-	1340367711	W20S-U	-	-	1UNF 18 110(DCPR7EIX)	-	-	IXU22 VXU22
EBC004021(BR7EFS)	T22EP-U	IT22	-	1341267710	W22S-U	-	-	1UNG 18 110(ZFR5F1X11)	-	-	IK16 VK16
NAB3850DA(BR6EF)	T20EPR-U	IT20	VT20	1345167712	W20FS-U	IWF22		1UNH 18 110(ZFR6F1X11)	-	-	IK20 VK20
NCA3850DA2(BKR6EVA-11)	-	IK20	VK20	1358167710	W22FS-U	IWF22		1UTO 18 110	VW16	IW16	VW16
	<b>KAWASAKI DENSO</b>	<b>IRIDIUM POWER</b>	<b>IRIDIUM TOUGH/PLUS</b>	1366167711	W9FP	-	-	1UT1 18 110	VW20	IW20	VW20
J4520-IU01-24	IU01-24	-	-	1371167711	W14-U10	-	-	1UT2 18 110	VW22	IW22	VW22
J4520-IU01-27	IU01-27	-	-	1374267711	W14FP-UL10	IWF16		1UT3 18 110	VK16	IK16	VK16
J4520-IU01-31	IU01-31	-	-	1390267711	W20FP-U	IWF20		1UT4 18 110	VK20	IK20	VK20
J4520-IU01-34	IU01-34	-	-	<b>LAND ROVER DENSO</b>		<b>IRIDIUM POWER</b>	<b>IRIDIUM TOUGH/PLUS</b>	1UT6 18 110	VQ16	IQ16	VQ16
J4520-IU22	IU22	IU22	-	ERR3799(RN11YC)	W16EXR-U	IW16	VW16	1UT7 18 110	VQ20	IQ20	VQ20
J4520-IU24	IU24	IU24	-	LR005483(FoMoCo: ILFR6B)	VKH20Y	-	VFXEH20	1UT9 18 110	VXU22	IXU22	VXU22
J4520-IU24A	IU24A	IU24A	-	LR019484(ILKAR6C10)	-	-	-	1UX0 18 110(BPR5EIXP)	-	-	VW16
J4520-IU27	IU27	IU27	-	LR025605(ILTR6G8G)	-	-	-	1UX1 18 110(BPR6EIXP)	-	-	VW20
J4520-IU27A	IU27A	IU27A	-	LR032080(ILKAR7C10)	-	-	-	1UX3 18 110(BPR5EIX-11P)	-	-	VW16
J4520-IU31	IU31	IU31	-	LR050998(SILZKAR7E8S)	-	-	-	1UX4 18 110(BPR6EIX-11P)	-	-	VW20
J4520-IU31A	IU31A	IU31A	-					1UX6 18 110(BKR5EIXP)	-	-	VK16
J4520-IUF22	IUF22	IUF22	-					1UX7 18 110(BKR6EIXP)	-	-	VK20/VK20Y
J4520-IUF24	IUF24	IUF24	-					1UX9 18 110(BKR5EIX11P)	-	-	VK16
J4520-IUH24	IUH24	IUH24	-					1UXA 18 110(BKR6EIX11P)	-	-	VK20
J4520-IUH27	IUH27	IUH27	-					1UXC 18 110(BCPR5EIX11P)	-	-	VQ16
J4520-IW01-24	IW01-24	-	-					1UXD 18 110(BCPR6EIX11P)	-	-	VQ20
J4520-IW01-27	IW01-27	-	-					1UXF 18 110(DCPR7EIXP)	-	-	VXU22
J4520-IW01-29	IW01-29	-	-	A100E6277S(BKR6E)	K20PR-U	IK20	VK20	1UXG 18 110(ZFR5F1X11P)	-	-	VK16
J4520-IW01-31	IW01-31	-	-	A910E7009F(BPR6EK-N)	W20ETR-L	IW20	VW20	1UXH 18 110(ZFR6F1X11P)	-	-	VK20
J4520-IW01-32	IW01-32	-	-	A918E6039F(BKR6EK)	K20TNR	IK20	VK20	1UXJ 18 110(BPR5EIX13P)	-	-	VT16
J4520-IW01-34	IW01-34	-	-	PS30-4017621AF(BK6E)	K20P-U	IK20	VK20				
J4520-IW16	IW16	IW16	VW16					<b>MASERATI DENSO</b>		<b>IRIDIUM POWER</b>	<b>IRIDIUM TOUGH/PLUS</b>
J4520-IW20	IW20	IW20	VW20					CND-96596(BP8E5)	W24EP-U	IW24	-
J4520-IW22	IW22	IW22	VW22					CND-96875(DCPR8E)	XU24EPR-U	IXU24	VXU24
J4520-IW24	IW24	IW24	-					CND-97219(DCPR9E)	XU27EPR-U	IXU27	-
J4520-IW27	IW27	IW27	-					000310235(SILKAR8C6DS)	-	-	-
J4520-IW29	IW29	IW29	-					<b>MAZDA DENSO</b>		<b>IRIDIUM POWER</b>	<b>IRIDIUM TOUGH/PLUS</b>
J4520-IW31	IW31	IW31	-					0222 18 110	W20EX-U	IW20	VW20
J4520-IW34	IW34	IW34	-					0259-18-110(BP6E5)	W20EX-U	IW20	VW20
J4520-IWF22	IWF22	IWF22	-					0259-18-110(BP6E5)	W20EP-U	IW20	VW20
J4520-IWF24	IWF24	IWF24	-					0418 18 110 A	W22ES-U	-	-
J4520-IWF27	IWF27	IWF27	-					0419-18-110(B7E5)	W22ES-U	-	-
J4520-IX22	IX22	IX22	-					0420-18-110(B8E5)	W24ES-U	IW24	-
J4520-IX22B	IX22B	IX22B	-					0660-18-110(BP5E5)	W16EX-U	IW16	VW16
J4520-IX24	IX24	IX24	-					0660-18-110(BP5E5)	W16EP-U	IW16	VW16
J4520-IX24B	IX24B	IX24B	-					0801 18 600	W20EAR	-	

# CAR MAKER GENUINE P/N CROSS REFERENCE

98079-56841

other

DENSO

(\*)3) MITSUBISHI lean burn excluded.

MAZDA	DENSO	IRIDIUM POWER	IRIDIUM TOUGH/PLUS	MAZDA	DENSO	IRIDIUM POWER	IRIDIUM TOUGH/PLUS	MAZDA	DENSO	IRIDIUM POWER	IRIDIUM TOUGH/PLUS	MAZDA	DENSO	IRIDIUM POWER	IRIDIUM TOUGH/PLUS
AJ03-18-110(AGSF32W)	T16EPR-U15	IT16	VT16	N331 18 110	S29A	-	-	1822A085(DILFR5A)	-	-	-			-	VFKH16
AJ09-18-110(AGSF32M)	T16EPR-U15	IT16	VT16	N338-18-110(SD11A)	IRE01-31	-	-	1822A088(DILKR6D11G)	-	-	-			-	-
AY02-18-110(DCP7E)	XU22EP-U	IXU22	VXU22	N338-18-110(SD11A)	S31A	-	-	1822A104(SILKR7H8)	-	-	-			-	-
AY01 18 110	XU22EP-U	IXU22	VXU22	N339-18-110(SD10A)	IRE01-27	-	-	1822A125(ILKR7K8)	SXU22HDR8	IXUH22	VXUH22			-	-
AZ08-18-110(BPR5E)	W16EPR-U	IW16	VW16	N339-18-110(SD10A)	S29A	-	-	1822A130(ILKR6K8)	-	IXUH20I	VXUH20I			-	-
AZ09 18 110	W16EPR-U	IW16	VW16	N342-18-110(BUR9EQ)	IRE01-27	-	-	1822A150(DILFR5L11)	-	-	-			-	VFKH16
AZ28-18-110(DCP7EVX)	-	IXU22	VXU22	N343-18-110(BUR7EQ)	-	-	-	1822A154(DIFR5E11)	-	-	-			-	-
B602 18 110	W16EXR-U11	IW16	VW16	N3A1-18-110(BUR9EQP)	IRE01-27	-	-	801001	-	-	-			-	-
B64N-18-110(BRES27Y-11)	J16AR-U11	-	-	N3A2-18-110(BUR7EQP)	-	-	-	MD313443(PFR6G-11)	W14	-	-			-	-
B64P 18 110	J16AR-U11	-	-	P51R-18-110(REA8WYPB4)	ZC20HPR11	-	VCH20	MD314766(BKR7EKC-N)	PK20PR11	IK20	VK20			-	-
B660-18-110(BCP6E-11)	Q20P-U11	IQ20	VQ20	PE01-18-110(DILKAR7F8)	FC20HPR8	-	VFXEH22	MD320543(BKR7EKC-N11)	K22TMR11	IK22	VK22			-	-
B667 18 110	Q20P-U11	IQ20	VQ20	PE02 18 110	FC20HPR8(MAZDA)	-	VFXEH22	MD321150(BKR6EKC-N11)	K22TMR11	IK22	VK22			-	-
B673 18 110	AGN4CU(MOTORCRAFT)W16EPR-U	IW16	VW16	PE5R 18 110(ILKAR7L11)	ZC20HPR11	-	VCH20	MD3227771	PK20PR11	IK20	VK20			-	-
B696 18 110	Q20PR-U	IQ20	VQ20	PE5S 18 110	ZC20HPR11	-	VCH20	MD336367(PZFR6B)	-	-	-			-	VKB20
B6B3-18-110(BCPR5E-11)	Q16PR-U11	IQ16	VQ16	PY8V-18-110(DILKAR7M8)	-	-	-	MD338991(PGR7A)	P22PR8	IW22	VW22			-	-
B6B4 18 110	Q16PR-U11	IQ16	VQ16	YF10-18-110(AZFS32FE)	-	-	-	MD343244	P22PR8	IW22	VW22			-	-
BP01-18-110(BKR5E-11)	K16PR-U11	IK16	VK16	Z601 18 110	SK16PR-E11	IK16	VK16	MD343277(PGR6A)	VW20	IW20	VW20			-	-
BP02 18 110	K16PR-U11(DENSO)	IK16	VK16	Z6B7 18 110	K16PZR13	IK16	VK16	MD348296(PZFR5B)	-	-	-			-	VKB16
BP03-18-110(BKR6E-11)	K20PR-U11	IK20	VK20	ZJ46 18 110	SK16PR-E13(FoMoCo)	IK16	VK16	MD350291(RC8YC4)	K20PR-U11	IK20	VK20			-	-
BP04 18 110	K20PR-U11(DENSO)	IK20	VK20	ZJY6 18 110	SK16PR-E13(MAZDA)	IK16	VK16	MD351467(PZFR5C)	-	-	-			-	VKB16
BP05-18-110(BKR7E-11)	K22PR-U11	IK22	VK22	ZM01 18 110	SKJ16CR-A8	IK16	VK16	MD355067(BKR6EKUC)	-	-	-			-	VKA20
BP06 18 110	K22PR-U11	IK22	VK22	ZM02 18 110	SKJ20CR-A8	IK20	VK20	MD357531	P20PR-P8	IK20	VK20Y			-	-
BP48 18 110	K16PR-U	IK16	VK16	ZY51 18 110	FK16PR11(FoMoCo)	-	-	MD358200(ZFR6F11)	KJ20CR-U11(*)3)	IK20	VK20			-	-
BP49-18-110(BKR6E)	K20PR-U	IK20	VK20	ZYY1 18 110	FK16PR11(MAZDA)	-	-	MD358202	KJ20CR-U11(*)3)	IK20	VK20			-	-
BP50 18 110	K20PR-U	IK20	VK20	ZZJ1 18 110	-	ITV22	-	MD360019(IZFR6B)	-	-	-			-	VKB20
BP8J 18 110	SK20PR-F8	IK20	VK20	ZZS1-18-110(DCPR7E)	XU22EPR-U	IXU22	VXU22	MD360383(IZFR5B)	-	-	-			-	VKB16
BP8K 18 110	SK16PR-F8	IK16	VK16	ZZS2 18 110	XU22EPR-U	IXU22	VXU22	MD361067	SK16PR-A11	IK16	VK16			-	-
BPY2 18 110	K16PR-U11(MAZDA)	IK16	VK16	ZZS4 18 110	J16CR-U	IW16	VW16	MD362097(ZFR5F-11)	KJ16CR-U11(*)3)	IK16	VK16			-	-
BPY4 18 110	K20PR-U11(MAZDA)	IK20	VK20					MD362098	KJ16CR-U11(*)3)	IK16	VK16			-	-
E356-18-110(BE527Y-11)	J16A-U11	-	-					MD362902(BKR5EKUC)	-	-	-			-	VKA16
E357 18 110	J16A-U11	-	-					MD366819(IZFR5C)	-	-	-			-	VKA16
E552 18 110	AGN4CU(MOTORCRAFT)W16EPR-U	IW16	VW16					MD370906(DCPR6EKU)	-	-	-			-	-
F201-18-110(ZFR6A-11)	QJ20CR11	IQ20	VQ20					MD371434(IGR7A)	VW22	IW22	VW22			-	-
F202 18 110 A	QJ20CR11	IQ20	VQ20					MD371435	S22PR-A7	IW22	VW22			-	-
F204 18 110	QJ16CR11	IQ16	VQ16					MD372421(BKR5EKUD)	-	-	-			-	VKA16
F211 18 110	Q16PR-U	IQ16	VQ16					MD372422(BKR6EKUD)	-	-	-			-	VKA20
F220-18-110(BCPR6E-11)	Q20PR-U11	IQ20	VQ20					MD372553(IFR5E11)	SK16PR-A11	IK16	VK16			-	-
F221 18 110	Q20PR-U11	IQ20	VQ20					MD372588(IFR6E11)	SK20PR-A11	IK20	VK20			-	-
F285-18-110(ZFR6F-11)	KJ20CR11	IK20	VK20					MD373645	SK20PR-A11	IK20	VK20			-	-
F286 18 110	KJ20CR11	IK20	VK20					MD374841(IGR7A-G)	VW22	IW22	VW22			-	-
F287-18-110(ZFR5F-11)	KJ16CR11	IK16	VK16					MD375642(BKR5ETUA)	-	-	-			-	VKA16
F288 18 110	KJ16CR11(DENSO)	IK16	VK16					MD378582(IFR6B)	SVK20RZ8	-	VK20Y			-	-
F2SK 18 110	W9EXR-U/Copper Gasket	-	-					ME220826(IFR7-FD)	VK22	IK22	VK22			-	-
F2Y2 18 110	KJ16CR11(MAZDA)	IK16	VK16					ME22165(IFR7-F8)	VK22	IK22	VK22			-	-
F8L6-18-110(ZFR4F-11)	KJ14CR11	IK16	VK16					MN119256(ILZFR5B)	VKH16	IKH16	VKH16			-	-
F8L7 18 110	KJ14CR11	IK16	VK16					MN119487(IFR6S)	SK20PR-A8	-	VK20Y			-	-
F8L8-18-110(BPR4E5-13)	W14EXR-U13	IW16	VW16					MN119500(IGR6A11)	VW20	IW20	VW20			-	-
F8L9 18 110	W14EXR-U13	IW16	VW16					MN119942(BKR6ETUB)	K20PBR-S10	-	VKB20			-	-
FE6F 18 110	Q22PR-U11	IQ22	VQ22					MN122257	SVK20RZ8	-	VK20Y			-	-
FE79-18-110(BPR6E5-11)	W20EXR-U11	IW20	VW20					MN122493	SXU22PR-A9	IXU22	VXU22			-	-
FE79-18-110(BPR6E5-11)	W20EPR-U11	IW20	VW20					MN122494(IGR7B)	VXU22	IXU22	VXU22			-	-
FE82 18 110	W20EXR-U11	IW20	VW20					MN128362(FR7SE)	IKH20	IKH20	VKH20			-	-
FEDK-18-110(BPR5E5-13)	W16EXR-U13	IW16	VW16					MN137919(FR7NPP33)	VKH20	IKH20	VKH20			-	-
FEDM 18 110	W16EXR-U13	IW16	VW16					MN158596(LZFR6A1)	IKH20	IKH20	VKH20			-	-
FEEG-18-110(BPR6E5-13)	W20EXR-U13	IW20	VW20					MN163235(FR5E1)	IK16	IK16	VK16			-	-
FEEH 18 110	W20EXR-U13	IW20	VW20					MN163807	K20PSR-B8	IK20	VK20			-	-
GY01 18 110	-	IT16	VT16					MN176628(FR7S130)	IKH20	IKH20	VKH20			-	-
GY02 18 110	-	IT16	VT16					MQ500368	ZXU20PR11	-	VXU20			-	-
IA50-18-110(BKR6E)	K20PR-U	IK20	VK20					MQ503107	ZXU20HPR11	IXUH20I	VXUH22I			-	-
JE26-18-110(BCPR5EVX-11)	-	IK20	VK20					MQ507909(LMAR7CI-8)	-	-	-			-	VSUEH22
JE28 18 110	Q16PR-TP11	IQ16	VQ16					MQ504108(ILKR7B18)	IXU22HPR	IXUH22	VXUH22			-	-
JE41-18-110(BKR5EVX-11)	-	IK16	VK16					MQ504109	IXU22HPR	IXUH22	VXUH22			-	-
JE42 18 110	K16PR-TP11	IK16	VK16					MQ504110(ILMARA8)	-	-	-			-	VSUEH22
JE43-18-110(BKR6EVX-11)	IK20	IK20	VK20					MQ510099(ILZKR6F11)	IXUH20I	IXUH20I	VXUH20I			-	-
JE44 18 110	K20PR-TP11	IK20	VK20					MQ701126(ILZKAR5AP11)	-	-	-			-	-
JF03-18-110(BCP5E-11)	Q16P-U11	IQ16	VQ16					MQ701127(ILZKAR6AP11)	-	-	-			-	VFXEH20
JF04 18 110	Q16P-U11	IQ16	VQ16					MQ701128(ILZKAR7AP11)	-	-	-			-	VFXEH22
KJ11-18-110(PZFR6F)	SKJ20CR-A8/PKJ20CR8	IK20	VK20					MQ703981(DILZKAR6A11)	FXE20HE11	-	VFXEH20			-	-
KJ12 18 110	PKJ20CR8	IK20	VK20					MR984943	SK20PR-A8	IK20	VK20			-	-
KJ13-18-110(PZFR5F)	PKJ16CR8	IK16	VK16					MS851022	W16EP	IW16	VW16			-	-
KJ14 18 110	PKJ16CR8	IK16	VK16					MS851023	W20EP	IW20	VW20			-	-
L303-18-110(ITR5F13)	VT16	IT16	VT16					MS851024	W22EP	IW22	VW22			-	-
L341-18-110(ITR6F13)	IT20	IT20	VT20					MS851027	W16EP11	IW16	VW16			-	-
L3Y1-18-110(ILTR6A13G)	-	ITV20	-					MS851028	W20EP11	IW20	VW20			-	-
L3Y2-18-110(ILTR5A13G)	-	ITV16	-					MS851029	W22EP11	IW22	VW22			-	-
L3Y3-18-110(ILTR6A8G)	-	ITV20	-					MS851097	W16EX-U	IW16	VW16			-	-
L813-18-110(ITR6F13)	VT20	IT20	VT20					MS851101	W14EX-U	IW16	VW16			-	-
L845-18-110(TR5AI 13)	VT16	IT16	VT16					MS851102	W16EX-U	IW16	VW16			-	-
LFJD-18-110(LTR5B1 13)	-	ITV16	-					MS851104	W20EX-U	IW20	VW20			-	-
LFJF-18-110(LTR5B1 13)	-	ITV16	-												

(\*1) Remove the gasket before use.

# CAR MAKER GENUINE P/N CROSS REFERENCE

98079-56841

other

DENSO

AUSTRALIA  
CHINA  
INDIA  
INDONESIA  
KOREA  
MALAYSIA  
PHILIPPINES  
SAUDI ARABIA  
SINGAPORE  
TAIWAN  
THAILAND  
VIETNAM  
JAPAN  
EUROPE & USA  
CROSS REFERENCE  
PART NUMBER

MITSUBISHI	DENSO	IRIDIUM POWER	IRIDIUM TOUGH/PLUS	MITSUBISHI	DENSO	IRIDIUM POWER	IRIDIUM TOUGH/PLUS	NISSAN	DENSO	IRIDIUM POWER	IRIDIUM TOUGH/PLUS	NISSAN	DENSO	IRIDIUM POWER	IRIDIUM TOUGH/PLUS
MS851187(BP5E-11)	W16EP-U11	IW16	VW16	MZ602037	IXU22	IXU22	VXU22	22401-58S15(PFR5A-11)	VQ16	IQ16	VQ16	22401-58S15(PFR6A-11)	VQ20	IQ20	VQ20
MS851188(BP6E-11)	W20EX-U11	IW20	VW20	MZ602038	IXU24	IXU24	VXU24	22401-5M014(PLFR4A-11)	-	-	-	22401-5M015(PLFR5A-11)	VKH16	IKH16	VKH16
MS851188(BP6E-11)	W20EPR-U11	IW20	VW20	MZ602039	IXU27	IXU27	-	22401-5M016(PLFR6A-11)	VKH20	IKH20	VKH20	22401-5TA1C	DXE22H11CT	-	-
MS851189(BP7E-11)	W22EP-U11	IW22	VW22	MZ602040	VK16	IK16	VK16	22401-6A00G(ILKR7K8)	SXU22HDR8	IXUH22	VXUH22	22401-6A00G(ILKR7K8)	-	-	-
MS851232(BPR5E5)	W16EXR-U	IW16	VW16	MZ602041	VK20	IK20	VK20	22401-6N215(LZFR5AQP)	-	-	-	22401-85E15(LZFR5A-11)	K16PR-U11	IK16	VK16
MS851232(BPR5E5)	W16EPR-U	IW16	VW16	MZ602042	VK22	IK22	VK22	22401-85E16(BKR6E-11)	K20PR-U11	IK20	VK20	22401-85E16(BKR6E-11)	K20PR-U11	IK20	VK20
MS851233(BPR6E5)	W20EXR-U	IW20	VW20	MZ602043	VQ16	IQ16	VQ16	22401-8H616(PLFR6A-9)	VKH20	IKH20	VKH20	22401-8H514(LFR4A-11)	-	-	-
MS851233(BPR6E5)	W20EPR-U	IW20	VW20	MZ602044	VQ20	IQ20	VQ20	22401-8H515(LFR5A-11)	-	-	-	22401-8H515(LFR5A-11)	K16HPR-U11	IKH16	VKH16
MS851237(BUR7E-11)	W16EPR11	IW16	VW16	MZ602045	VQ22	IQ22	VQ22	22401-8H516(LFR6A-11)	K20PR-U11	IK20	VK20	22401-8P315(PFR5P)	VK16	IK16	VK16
MS851238(BPR6E-11)	W20EPR11	IW20	VW20	MZ602046	VW16	IW16	VW16	22401-97E65(PFR5C-11)	VK16	IK16	VK16	22401-97E65(PFR5C-11)	ZXE27HBR8	-	VXEBH27
MS851239(BPR7E-11)	W22EPR-U11	IW22	VW22	MZ602047	VW20	IW20	VW20	22401-AA800	-	-	-	22401-A780(SILZKAR7B11)	-	-	VFXEH22
MS851243(BP5EA-L)	W16EX-U	IW16	VW16	MZ602048	VW22	IW22	VW22	22401-A781(SILZKAR7B11)	-	-	-	22401-A781(SILZKAR7B11)	-	-	VFXEH22
MS851254(BU6EA-11)	W20EP-S11	IW20	VW20	MZ602049	VXU22	IXU22	VXU22	22401-AG215(PLFR5A-11)	VK16	IK16	VK16	22401-AG215(PLFR5A-11)	VK16	IK16	VK16
MS851254(BU7EA-11)	W22EP-S11	IW22	VW22	MZ602050	VXU24	IXU24	VXU24	22401-AG315(BKR5EQUA)	VK16	IK16	VK16	22401-AG315(BKR5EQUA)	VK16	IK16	VK16
MS851273(BUR6EA-11)	W20EPR-S11	IW20	VW20	MZ602060(BPR5EIX11)	-	IW16	VW16	22401-AH415(LFR5B-11)	IK16	IK16	VK16	22401-AH415(LFR5B-11)	IK16	IK16	VK16
MS851274(BUR7EA-11)	W22EP-S11	IW22	VW22	MZ602061(BPR6EIX11)	-	IW20	VW20	22401-ALS15(LFR5B-11)	IKH16	IKH16	VKH16	22401-ALS15(LFR5B-11)	IKH16	IKH16	VKH16
MS851283(BP6E)	W20EP-U	IW20	VW20	MZ602062(BPR7EIX)	-	IW22	VW22	22401-AR015(LFR5AQP)	IKH16	IKH16	VKH16	22401-AR015(LFR5AQP)	IKH16	IKH16	VKH16
MS851292(PGR6B)	P20PR-S11	IW20	VW20	MZ602063(BCPR5EIX11)	-	IQ16	VQ16	22401-CK81B(PLZKAR6A11)	FXE20HR11	-	VFXEH20E	22401-CK81B(PLZKAR6A11)	FXE20HR11	-	VFXEH20E
MS851302(PGR6A-11)	VW20	IW20	VW20	MZ602064(BCPR6EIX11)	-	IQ20	VQ20	22401-ED715(Use ED71B)	FXE20HE11	-	VFXEH20E	22401-ED715(Use ED71B)	FXE20HE11	-	VFXEH20E
MS851302(PGR6A-11)LPG	VW20T	-	VW20T	MZ602065(BCPR5EIX11)	-	IK16	VK16	22401-ED71A	FXE16HE11	-	-	22401-ED71A	FXE16HE11	-	-
MS851316(DCPR6E)	XU20EPR-U	IXU22	VXU22	MZ602066(BKR6EIX11)	-	IK20	VK20	22401-ED71B	FXE20HE11	-	VFXEH20E	22401-ED71B	FXE20HE11	-	VFXEH20E
MS851317(DCPR7E)	XU22EPR-U	IXU22	VXU22	MZ602067(DCPR7EIX)	-	IXU22	VXU22	22401-ED814(LZKAR5AP11)	-	-	-	22401-ED814(LZKAR5AP11)	-	-	-
MS851332(PFR6B-11)	PK20PR11	IK20	VK20	MZ602068(ZFR5FIX11)	-	IK16	VK16	22401-ED815(LZKAR6AP11)	FXE20HR11	-	VFXEH20	22401-ED815(LZKAR6AP11)	FXE20HR11	-	VFXEH20
MS851335(PFR5J-11)	PK16PR-P11	IK16	VK16	MZ602069(ZFR6FIX11)	-	IK20	VK20	22401-ED816(LZKAR7AP11)	FXE22HR11	-	VFXEH22	22401-ED816(LZKAR7AP11)	FXE22HR11	-	VFXEH22
MS851336(PFR6J-11)	PK20PR-P11	IK20	VK20	MZ602070(BPR5EIX)	-	IK20	VK20	22401-EN215	ZXE20HR13	-	VFXEH20	22401-EN215	ZXE20HR13	-	VFXEH20
MS851346(PFR6M)	PK20PR-P8	IK20	VK20	MZ602071(BPR6EIX)	-	IW16	VW16	22401-EW61C	FXE22HR11	-	VFXEH22	22401-EW61C	FXE22HR11	-	VFXEH22
MS851347(PFR7M)	VK22	IK22	VK22	MZ602072(BKR5EIX)	-	IW20	VW20	22401-F6515(PFR5A-11A)	VQ16(*1)	IQ16(*1)	VQ16(*1)	22401-F6515(PFR5A-11A)	VQ16(*1)	IQ16(*1)	VQ16(*1)
MS851352(BK6E)	K20P-U	IK20	VK20	MZ602073(BKR6EIX)	-	IK20	VK20	22401-F6516(PFR6A-11A)	VQ20(*1)	IQ20(*1)	VQ20(*1)	22401-F6516(PFR6A-11A)	VQ20(*1)	IQ20(*1)	VQ20(*1)
MS851357(BKR5E-11)	K16PR-U11	IK16	VK16	MZ602074(BPR6EIX-LPG)	-	-	VW20T	22401-HA009(ITR5F13)	-	-	-	22401-HA009(ITR5F13)	-	-	-
MS851358(BKR6E-11)	K20PR-U11	IK20	VK20	MZ602075(BKR6EIX-LPG)	-	-	VK20Y	22401-HA00C(LTR5B1-3)	IT16	IT16	VT16	22401-HA00C(LTR5B1-3)	IT16	IT16	VT16
MS851359(BKR7E-11)	K22PR-U11	IK22	VK22	MZ602077(BKR6EIX11P)	-	-	VK20	22401-HA00F(ILKR7L11)	ITV16	ITV16	-	22401-HA00F(ILKR7L11)	ITV16	ITV16	-
MS851361(BK5E-11)	K16P-U11	IK16	VK16	MZ602078(BCPR5EIX11P)	-	-	VQ16	22401-HC000(BPR5E-13)	ZC20HPR11	-	VCH20	22401-HC000(BPR5E-13)	ZC20HPR11	-	VCH20
MS851362(BK6E-11)	K20PR-U11	IK20	VK20	MZ602079(BCPR6EIX11P)	-	-	VQ20	22401-HC001(BPR5E-13)	W16EXR-U13	IW16	VW16	22401-HC001(BPR5E-13)	W16EXR-U13	IW16	VW16
MS851363(BK7E-11)	K22PR-U11	IK22	VK22	MZ602080(DCPR7EIXP)	-	-	VXU22	22401-JA01B(DILKAR6A11)	FXE20HR11	-	VFXEH20	22401-JA01B(DILKAR6A11)	FXE20HR11	-	VFXEH20
MS851368(BKR6E)	K20PR-U	IK20	VK20	MZ602081(BKR7EIX11)	-	IK22	VK22	22401-JD01B	FXE20HR11	-	VFXEH20	22401-JD01B	FXE20HR11	-	VFXEH20
MS851402	W16EPR-U	IW16	VW16	MZ602082(BKR5EIXP)	-	-	VK16	22401-JF01D(DILKAR8A8)	-	-	-	22401-JF01D(DILKAR8A8)	-	-	-
MS851403	W20EPR-U	IW20	VW20	MZ602083(BKR6EIXP)	-	-	VK20Y	22401-JK01D	FXE24HR11	-	-	22401-JK01D	FXE24HR11	-	-
MS851412	W16EPR	IW16	VW16	MZ602084(ZFR5FIX11P)	-	-	VK16	22401-M7715(B5E5)	W16ES-U	-	-	22401-M7715(B5E5)	W16ES-U	-	-
MS851413	W20EPR	IW20	VW20	MZ602085(ZFR6FIX11P)	-	-	VK20	22401-M7716(B6E5)	W20ES-U	-	-	22401-M7716(B6E5)	W20ES-U	-	-
MS851417	W16EPR11	IW16	VW16	MZ602110	K16TT	IK16	VK16	22401-N8714(BP4E5-11)	W14EX-U11	IW16	VW16	22401-N8714(BP4E5-11)	W14EX-U11	IW16	VW16
MS851418	W20EPR11	IW20	VW20	MZ602111	K20TT	IK20	VK20	22401-N8715(BP5E5-11)	W16EX-U11	IW16	VW16	22401-N8715(BP5E5-11)	W16EX-U11	IW16	VW16
MS851419	W22EPR11	IW22	VW22	MZ602114	XU22TT	IXU22	VXU22	22401-N8716(BP6E5-11)	W20EX-U11	IW20	VW20	22401-N8716(BP6E5-11)	W20EX-U11	IW20	VW20
MS851428	W20EP-S11	IW20	VW20	MZ602112	XUH22TT	IXUH22	VXUH22	22401-OA622(BKR6E-H)	-	-	-	22401-OA622(BKR6E-H)	-	-	-
MS851429	W22EP-S11	IW22	VW22	MZ602113	W16TT	IW16	VW16	22401-OP615(PFR5E-11A)	VQ16(*1)	IQ16(*1)	VQ16(*1)	22401-OP615(PFR5E-11A)	VQ16(*1)	IQ16(*1)	VQ16(*1)
MS851437	W16EP-U	IW16	VW16	MZ602113	-	-	VK16	22401-OP616(PFR6F-11A)	VQ20(*1)	IQ20(*1)	VQ20(*1)	22401-OP616(PFR6F-11A)	VQ20(*1)	IQ20(*1)	VQ20(*1)
MS851438	W20EP-U	IW20	VW20	MZ602114	-	-	VK20	22401-P8314(BPR4E5-11)	W14EXR-U11	IW16	VW16	22401-P8314(BPR4E5-11)	W14EXR-U11	IW16	VW16
MS851439	W22EP-U	IW22	VW22	MZ602115	-	-	VK16	22401-P8315(BPR5E5-11)	W16EXR-U11	IW16	VW16	22401-P8315(BPR5E5-11)	W16EXR-U11	IW16	VW16
MS851447	W20EPR-S11	IW20	VW20	MZ602116	-	-	VK20	22401-P8316(BPR6E5-11)	W20EXR-U11	IW20	VW20	22401-P8316(BPR6E5-11)	W20EXR-U11	IW20	VW20
MS851448	W16EPR-S11	IW16	VW16	MZ602117	-	-	VK20Y	22401-P8317(BPR6E5-11)	W20EPR-U11	IW20	VW20	22401-P8317(BPR6E5-11)	W20EPR-U11	IW20	VW20
MS851463	P20PR-S11	IW20	VW20	MZ602118	-	-	VK16	22401-S6015(BP5E5-13)	W16EX-U13	IW16	VW16	22401-S6015(BP5E5-13)	W16EX-U13	IW16	VW16
MS851473	P20PR11	IW20	VW20	MZ602119	-	-	VK20	22401-V0516(BP6E5(0.7))	W20EX-U	IW20	VW20	22401-V0516(BP6E5(0.7))	W20EX-U	IW20	VW20
MS851486	XU20EPR-U	IXU22	VXU22	MZ602120	-	-	VK20	22401-V0516(BP6E5(0.7))	W20EP-U	IW20	VW20	22401-V0516(BP6E5(0.7))	W20EP-U	IW20	VW20
MS851487	XU22EPR-U	IXU22	VXU22	MZ602121	-	-	VK20	22401-V1414(BPR4E5)	W14EXR-U	IW16	VW16	22401-V1414(BPR4E5)	W14EXR-U	IW16	VW16
MS851501	PK16PR-P11	IK16	VK16	MZ602122	-	-	VK22	22401-V1415(BPR5E5)	W16EXR-U	IW16	VW16	22401-V1415(BPR5E5)	W16EXR-U	IW16	VW16
MS851502	PK20PR-P11	IK20	VK20	MZ602123	-	-	VK22	22401-V5015(BCP5E5-11)	Q16-U11	IQ16	VQ16	22401-V5015(BCP5E5-11)	Q16-U11	IQ16	VQ16
MS851506	PK20PR-P8	-	VK20Y	MZ602124	-	-	VK22	22401-V5016(BCP6E5-11)	Q20P-U11	IQ20	VQ20	22401-V5016(BCP6E5-11)	Q20P-U11	IQ20	VQ20
MS851722	K20P-U	IK20	VK20	MZ602125	-	-	VK22	22401-VB000(BPR5E-11)	W16EPR-U11	IW16	VW16	22401-VB000(BPR5E-11)	W16EPR-U11	IW16	VW16
MS851727	K16PR-U11	IK16	VK16	MZ602126	-	-	VK22	22401-VR306(IGR6B-10D)LPG	VW20T	-	VW20T	22401-VR306(IGR6B-10D)LPG	VW20T	-	VW20T
MS851728	K20PR-U11	IK20	VK20	MZ602127	-	-	VK22	22401-VS116(PFR610D)LPG	VK20T	-	VK20T	22401-VS116(PFR610D)LPG	VK20T	-	VK20T
MS851728(BKR6E-11)	K20PR-U11	IK20	VK20	MZ602128	-	-	VK22	22401-W8915(BP5E5)	W16EX-U	IW16	VW16	22401-W8915(BP5E5)	W16EX-U	IW16	VW16
MS851729	K22PR-U11	IK22	VK22	MZ602129	-	-	VK22	22401-W8916(BP6E5)	W16EP-U	IW16	VW16	22401-W8916(BP6E5)	W16EP-U	IW16	VW16
MS851732(Use MS851728)	K2														







# CAR MAKER GENUINE P/N CROSS REFERENCE

98079-56841

other

DENSO

(\*3) MITSUBISHI lean burn excluded.

SUZUKI	DENSO	IRIDIUM POWER	IRIDIUM TOUGH/PLUS	TACTI	DENSO	IRIDIUM POWER	IRIDIUM TOUGH/PLUS	TACTI	DENSO	IRIDIUM POWER	IRIDIUM TOUGH/PLUS	AUSTRALIA
99000-79K24-24B	IX24B	IX24B	-	267700-1420	IQ01-27	-	-	V9110-3121	K20PR-U11	IK20	VK20	
99000-79K24-27A	IU27A	IU27A	-	267700-1430	IQ01-31	-	-	V9110-3122	K20R-U	IK20	VK20	
99000-79K24-27B	IX27B	IX27B	-	267700-1440	IQ01-34	-	-	V9110-3129	Q16R-U	IQ16	VQ16	
99000-79K24-31A	IU31A	IU31A	-	267700-1460	IQ02-24	-	-	V9110-3130	K16PR-U11	IK16	VK16	
99000-79K24-F22	IUF22	IUF22	-	267700-1470	IQ02-27	-	-	V9110-3131	KJ16CR11	IK16	VK16	
99000-79K24-F24	IUF24	IUF24	-	267700-1480	IQ02-31	-	-	V9110-3132	KJ16CR-L11	IK16	VK16	
99000-79K24-H24	IUH24	IUH24	-	267700-1570	RU01-27	-	-	V9110-3133	KJ20CR11	IK20	VK20	
99000-79K24-H27	IUH27	IUH27	-	267700-1580	RU01-31	-	-	V9110-3135	K16GPR-U11	-	-	
99000-79K24-IW4	IW24	IW24	-	267700-1590	RU01-34	-	-	V9110-3137	Q16PR-U	IQ16	VQ16	
99000-79K24-IW7	IW27	IW27	-	267700-2940	IAE01-32	-	-	V9110-3139	K20R-U11	IK20	VK20	
99000-79K24-U22	IU22	IU22	-	267700-2950	IAE01-34	-	-	V9110-3140	Q20R-U	IQ20	VQ20	
99000-79K24-U24	IU24	IU24	-	267700-4450	IKH01-24	-	-	V9110-3141	PK20PR-P11	IK20	VK20	
99000-79K24-U27	IU27	IU27	-	267700-4460	IKH01-27	-	-	V9110-3142	PK20PR-L11	IK20	VK20	
99000-79K24-U31	IU31	IU31	-	267700-4470	IKH01-31	-	-	V9110-3143	K16PR-L11	IK16	VK16	
99000-79K24-W22	IWF22	IWF22	-	V9110-2001	W16EXR-U11	IW16	VW16	V9110-3144	K20PR-L11	IK20	VK20	
99000-79K24-W24	IWF24	IWF24	-	V9110-2002	W16EXR-U	IW16	VW16	V9110-3145	K20PR-U	IK20	VK20	
99000-79K24-W27	IWF27	IWF27	-	V9110-2003	K16R-U11	IK16	VK16	V9110-3167	KJ14CR-L11	IK16	VK16	
99000-79K24-W31	IW31	IW31	-	V9110-2005	J16BR-U	-	-	V9110-3168	PK20PR11	IK20	VK20	
99000-79K24-X22	IX22	IX22	-	V9110-2010	K20R-U11	IK20	VK20	V9110-3169	KJ20CR-L11	IK20	VK20	
99000-79K24-X24	IX24	IX24	-	V9110-2011	XU22EPR-U	IXU22	VXU22	V9110-3170	W22EKR-S11	IW22	VW22	
99000-79K24-X27	IX27	IX27	-	V9110-2012	Q20R-U11	IQ20	VQ20	V9110-3175	PKJ16CR8	IK16	VK16	
99000-79K60-BP6 (BPR6EIX11)	-	IW20	VW20	V9110-2022	J16AYR	-	-	V9110-3176	XU22EP-U	IXU22	VXU22	
99000-79K60-DCT (DCPR7EIX)	-	IXU22	VXU22	V9110-2023	KJ20CR-L11	IK20	VK20	V9110-3178	KJ20PR-U	IXU22	VXU22	
99000-79K60-K5R (BKR5EIX)	-	IK16	VK16	V9110-2028	KJ16CR-L11	IK16	VK16	V9110-3179	XU22EPR-U	IXU22	VXU22	
99000-79K60-K6R (BKR6EIX)	-	IK20	VK20	V9110-2039	K22TNR-S	IK22	VK22	V9110-3180	XU24EPR-U	IXU24	VXU24	
99000-79K60-KR6 (BKR6EIX1)	-	IK20	VK20	V9110-2041	K20TR11	IK20	VK20	V9110-3181	Q16-U11	IQ16	VQ16	
99000-79K60-P5R (BPR5EIX)	-	IW16	VW16	V9110-2043	K20PR-U11	IK20	VK20	V9110-3182	Q20-U11	IQ20	VQ20	
99000-79K60-P6R (BPR6EIX)	-	IW20	VW20	V9110-2044	W16EPR-U	IW16	VW16	V9110-3183	Q14R-U11	IQ16	VQ16	
99000-79K60-P7R (BPR7EIX)	-	IW22	VW22	V9110-2047	K20PR-U	IK20	VK20	V9110-3186	Q16PR-U11	IQ16	VQ16	
99000-79K60-PR5 (BPR5EIX11)	-	IW16	VW16	V9110-2048	KJ16CR-U11(*3)	IK16	VK16	V9110-3187	Q20PR-U11	IQ20	VQ20	
99000-79K73-K16	VK16	IK16	VK16	V9110-2049	K20TNR-S9	IK20	VK20	V9110-3188	QL20PR-U	-	-	
99000-79K73-K20	VK20	IK20	VK20	V9110-2301	IQ16	IQ16	VQ16	V9110-3189	QL20TR-S	-	-	
99000-79K73-KH2	VKH20	IKH20	VKH20	V9110-2302	IQ20	IQ20	VQ20	V9110-3190	QL22TR-S	-	-	
99000-79K73-U20	VXU20	-	VXU20	V9110-2303	IK16	IK16	VK16	V9110-3191	K16PR-U	IK16	VK16	
99000-79K73-U22	VXU22	IXU22	VXU22	V9110-2304	IK20	IK20	VK20	V9110-3192	K22PR-U11	IK22	VK22	
99000-79K73-U24	VXU24	IXU24	VXU24	V9110-2305	IW16	IW16	VW16	V9110-3194	K16TR11	IK16	VK16	
99000-79K73-UH2	IXUH22	IXUH22	VXUH22	V9110-2306	IW20	IW20	VW20	V9110-3195	K20TR11	IK20	VK20	
99000-79K73-W16	VW16	IW16	VW16	V9110-2307	IW22	IW22	VW22	V9110-3196	K20TNR-S	IK20	VK20	
99000-79K73-W20	VW20	IW20	VW20	V9110-2308	IXU22	IXU22	VXU22	V9110-3197	K22TNR-S	IK22	VK22	
99000-79K73-W22	VW22	IW22	VW22	V9110-2309	IXU24	IXU24	VXU24	V9110-3198	K20DTR-S11	-	-	
99000-79L65-001 (BKR6EIX11P)	-	-	VK20	V9110-2601	VQ16	IQ16	VQ16	V9110-3199	W16EP-U11	IW16	VW16	
99000-79L65-002 (BKR5EIXP)	-	-	VK16	V9110-2602	VQ20	IQ20	VQ20	V9110-3201	W16EPR-U11	IW16	VW16	
99000-79L65-003 (BKR6EIXP)	-	-	VK20Y	V9110-2603	VK16	IK16	VK16	V9110-3202	W14EX-U	IW16	VW16	
99000-79L65-004 (DCPR7EIXP)	-	-	VXU22	V9110-2604	VK20	IK20	VK20	V9110-3203	W16EX-U	IW16	VW16	
99000-79L65-005 (BKR5EIX11P)	-	-	VK16	V9110-2605	VW16	IW16	VW16	V9110-3204	W20EX-U	IW20	VW20	
99000-79L65-006 (BKR7EIXP)	-	-	VK22	V9110-2606	VW20	IW20	VW20	V9110-3205	W16EX-U11	IW16	VW16	
99000-79L65-008 (BPR5EIX11P)	-	-	VW16	V9110-2607	VW22	IW22	VW22	V9110-3206	W20EX-U11	IW20	VW20	
99000-79L65-009 (BPR6EIXP)	-	-	VW20	V9110-2608	VXU22	IXU22	VXU22	V9110-3208	LP20-U(LPG)	-	VW20T	
99000-79L65-010 (BPR6EIX11P)	-	-	VW20	V9110-2609	VXU24	IXU24	VXU24	V9110-3210	W16EXR-U	IW16	VW16	
99000-79X12-K16	K16TT	-	-	V9110-3000	J16AR-U11	-	-	V9110-3211	W20EXR-U	IW20	VW20	
99000-79X12-K20	K20TT	-	-	V9110-3001	J16BR-U	-	-	V9110-3212	W20EXR-U11	IW20	VW20	
99000-79X12-W16	W16TT	-	-	V9110-3002	J16BR-U11	-	-	V9110-3213	W16EXR-U13	IW16	VW16	
99000-79X12-XU2	XU22TT	-	-	V9110-3006	Q16R-U11	IQ16	VQ16	V9110-3214	LP20R-U(LPG)	-	VW20T	
99000-79X12-XUH	XUH22TT	-	-	V9110-3007	Q20PR-U	IQ20	VQ20	V9110-3215	W16ET-S	IW16	VW16	
11182-51201 (DILKAR7D11H)	-	-	-	V9110-3009	Q20R-U11	IQ20	VQ20	V9110-3216	W16ETR-S	IW16	VW16	
11182-52200 (DXE22H11CT)	-	-	-	V9110-3012	W14EX-U11	IW16	VW16	V9110-3217	W16DTR-S	-	-	
				V9110-3013	W14EXR-U	IW16	VW16	V9110-3218	W20DTR-S	-	-	
				V9110-3014	W14EXR-U11	IW16	VW16	V9110-3219	W20DTR-SA	-	-	
067600-1810	IW06-27	-	-	V9110-3016	W16EKR-S11	IW16	VW16	V9110-3220	J16A-U11	-	-	
067600-1820	IW06-31	-	-	V9110-3018	W16EP-U	IW16	VW16	V9110-3221	J16B-U11	-	-	
067600-1830	IW06-34	-	-	V9110-3021	W16EPR-U	IW16	VW16	V9110-3232	W16FP-U10	IWF16	-	
267700-1010	IU01-24	-	-	V9110-3025	W16ES-U	-	-	V9110-3235	QJ16AR-U	-	-	
267700-1020	IU01-27	-	-	V9110-3029	W16EX-U13	IW16	VW16	V9110-3245	PK20PR-P8	-	VK20Y	
267700-1030	IU01-31	-	-	V9110-3032	W16EXR-U11	IW16	VW16	V9110-3247	PKJ20CR-L11	IK20	VK20	
267700-1040	IU01-34	-	-	V9110-3033	W16FSR	-	-	V9110-3248	K16DTR-S11	-	-	
267700-1060	IXU01-24	-	-	V9110-3034	W16FS-U	-	-	V9110-3249	K22TMR11	IK22	VK22	
267700-1070	IXU01-27	-	-	V9110-3035	W16LS	-	-	V9110-3252	S29	-	-	
267700-1080	IXU01-31	-	-	V9110-3037	W16PR-U	-	-	V9110-3261	J16AYR	-	-	
267700-1090	IXU01-34	-	-	V9110-3041	W20EKR-S11	IW20	VW20	V9110-3264	PK16PR11	IK16	VK16	
267700-1110	IW01-24	-	-	V9110-3043	W20EP-U	IW20	VW20	V9110-3266	Q16PR-TP11	IQ16	VQ16	
267700-1120	IW01-27	-	-	V9110-3047	W20EPR-U	IW20	VW20	V9110-3293	K16PR-P11	IK16	VK16	
267700-1130	IW01-29	-	-	V9110-3049	W20EPR-U11	IW20	VW20	V9110-3304	K20TNR	IK20	VK20	
267700-1140	IW01-31	-	-	V9110-3051	W20ES-U	-	-	V9110-3305	K20TNR-S9	IK20	VK20	
267700-1150	IW01-32	-	-	V9110-3057	W20ESR-U	-	-	V9110-3311	KJ16CR-U11(*3)	IK16	VK16	
267700-1160	IW01-34	-	-	V9110-3059	W20ET-S	IW20	VW20	V9110-3329	K16TNR-S9	IK16	VK16	
267700-1210	IWM01-29	-	-	V9110-3060	W20ETR-S	IW20	VW20	V9110-3374	KJ20DR-M11	IK20	VK20	
267700-1220	IWM01-31	-	-	V9110-3068	W20FP-U	IWF20	-	V9110-3381	K20HR-U11	IKH20	VKH20	
267700-1230	IWM01-32	-	-	V9110-3072	W20FSR	IWF22	-	V9110-3445	XU22HDR9	IXUH22	VXUH22	
267700-1240	IWM01-34	-	-	V9110-3073	W20FS-U	IWF22	-	V9110-3451	KJ20CR-U11(*3)	IK20	VK20	
267700-1260	IA01-31	-	-	V9110-3075	W20S-U	-	-	V9110-3455	KJ20DR-M11S	IK20G	VK20G	
267700-1270	IA01-32	-	-	V9110-3076	W20SR-U	-	-	V9110-3456	K20PR-SU9	IK20	VK20	
267700-1280	IA01-34	-	-	V9110-3085	W22EP-U	IW22	VW22	V9110-3463	K20PR-U8S	IK20G	VK20G	
267700-1310	IK01-24	-	-	V9110-3088	W22EPR-U	IW22	VW22	V9110-3470	K20PR-U9S	IK20G	VK20G	
267700-1320	IK01-27	-	-	V9110-3093	W22ES-U	-	-	V9110-3486	XU2			

# CAR MAKER GENUINE P/N CROSS REFERENCE (

98079-56841

other →

DENSO

**AUSTRALIA**  
**CHINA**  
**INDIA**  
**INDONESIA**  
**KOREA**  
**MALAYSIA**  
**PHILIPPINES**  
**SAUDI ARABIA**  
**SINGAPORE**  
**TAIWAN**  
**THAILAND**  
**VIETNAM**  
**JAPAN**  
**EUROPE & USA**  
**CROSS REFERENCE**  
**PART NUMBER**

TACTI	DENSO	IRIDIUM POWER	IRIDIUM TOUGH/PLUS	TACTI	DENSO	IRIDIUM POWER	IRIDIUM TOUGH/PLUS	TACTI	DENSO	IRIDIUM POWER	IRIDIUM TOUGH/PLUS
V9110-4012	W14F-U	-	-	V9110-5337	IXU27	IXU27	-	V9110-5686	VXEBH27	-	VXEBH27
V9110-4013	W14FP-U	IWF16	-	V9110-5338	ITV16	ITV16	-	V9110-5719	IRE01-27	-	-
V9110-4014	W14FP-UL	IWF16	-	V9110-5339	ITV20	ITV20	-	V9110-5720	IRE01-31	-	-
V9110-4019	W16FP-U	IWF16	-	V9110-5340	ITV22	ITV22	-	V9110-5721	IRE01-32	-	-
V9110-4021	W22FP-U	IWF22	-	V9110-5341	ITV24	ITV24	-	V9110-5722	IRE01-34	-	-
V9110-4024	W22FSR	IWF22	-	V9110-5342	ITV27	ITV27	-	V9110-5741	IRE01-35	-	-
V9110-4025	W22FS-U	IWF22	-	V9110-5343	IKH16	IKH16	VKH16	V9110-5752	IRT01-31	-	-
V9110-4027	W22S-U	-	-	V9110-5344	IKH20	IKH20	VKH20	V9110-5753	IRT01-34	-	-
V9110-4028	W24EP-U	IW24	-	V9110-5345	IKH22	IKH22	VKH22	V9110-5754	IRL01-27	-	-
V9110-4030	W24ES-U	IW24	-	V9110-5346	IKH24	IKH24	-	V9110-5755	IRL01-31	-	-
V9110-4033	W24ESR-U	IW24	-	V9110-5347	IKH27	IKH27	-	V9110-6004	W9-U	-	-
V9110-4034	W24ES-V	IW24	-	V9110-5348	IK22G	IK22G	VK22G	V9110-6008	W14-U	-	-
V9110-4037	W24FSR	IWF24	-	V9110-5349	ITL16	ITL16	-	V9110-6009	W14E	-	-
V9110-4038	W24FS-U	IWF24	-	V9110-5350	ITL20	ITL20	-	V9110-6010	W14EP-U	IW16	VW16
V9110-4045	W27ESR-U	IW27	-	V9110-5351	IK16G	IK16G	VK16G	V9110-6011	W14EPR-U	IW16	VW16
V9110-4046	W27ES-U	IW27	-	V9110-5352	IK20G	IK20G	VK20G	V9110-6021	W14PR-U	-	-
V9110-4047	W27ES-V	IW27	-	V9110-5353	IXUH22	IXUH22	VXUH22	V9110-6022	W20M-U	-	-
V9110-4052	W27FS-U	IWF27	-	V9110-5354	IXUH20I	IXUH20I	VXUH20I	V9110-6023	W20MP-U	-	-
V9110-4054	W27FSR	IWF27	-	V9110-5355	IXU22I	IXU22I	VXU22I	V9110-6026	W22M-U	-	-
V9110-4075	X16FSR-U	-	-	V9110-5356	IXUH22I	IXUH22I	VXUH22I	V9110-6027	W22MP-U	-	-
V9110-4076	X20ES-U	-	-	V9110-5359	IWF16	IWF16	-	V9110-6028	W27FS-U10	IWF27	-
V9110-4078	X20FS-U	-	-	V9110-5360	IU20	IU20	-	V9110-6037	W20FP-U10	IWF20	-
V9110-4080	X20FSR-U	-	-	V9110-5361	IU22	IU22	-	V9110-6039	T20M-U	-	-
V9110-4086	X22EPR-U9	IX22B	-	V9110-5362	IU24	IU24	-	V9110-6041	T22M-U	-	-
V9110-4090	X22ES-U	IX22	-	V9110-5363	IU27	IU27	-	V9110-6044	W9EXR-U	-	-
V9110-4091	X22ESR-U	IX22	-	V9110-5364	IU31	IU31	-	V9110-6045	W9EP	-	-
V9110-4096	X24EPR-U9	IX24B	-	V9110-5365	IU24A	IU24A	-	V9110-6046	W9EX-U	-	-
V9110-4099	X24ES-U	IX24	-	V9110-5366	IU27A	IU27A	-	V9110-6047	W24FS-U10	IWF24	-
V9110-4101	X24ESR-U	IX24	-	V9110-5367	IU31A	IU31A	-	V9110-6076	K16HPR-U11	IKH16	VKH16
V9110-4103	X24FS-U	-	-	V9110-5368	IUH24	IUH24	-	V9110-7001	K16TT	-	-
V9110-4111	X27EPR-U9	IX27B	-	V9110-5369	IUH27	IUH27	-	V9110-7002	K20TT	-	-
V9110-4114	X27ES-U	IX27	-	V9110-5371	IX22	IX22	-	V9110-7003	W16TT	-	-
V9110-4116	X27ESR-U	IX27	-	V9110-5372	IX24	IX24	-	V9110-7004	XU22TT	-	-
V9110-4148	W16FP-UL	IWF16	-	V9110-5373	IX27	IX27	-	V9110-7005	XUH22TT	-	-
V9110-4149	W20FP-L	IWF20	-	V9110-5375	IX22B	IX22B	-	V9110-7006	XUH20TTI	IXUH20I	VXUH20I
V9110-4150	X24GP-U	IXG24	-	V9110-5376	IX24B	IX24B	-				
V9110-4152	W9FP-UL	-	-	V9110-5377	IX27B	IX27B	-	<b>TOYOTA</b>	<b>DENSO</b>	<b>IRIDIUM POWER</b>	<b>IRIDIUM TOUGH/PLUS</b>
V9110-4157	X20ESR-U	-	-	V9110-5378	IWF20	IWF20	-	90048-51185(ILFR6C11)	SK20HR-A11	IKH20	VKH20
V9110-5000	L14-U	-	-	V9110-5379	IWF22	IWF22	-	90048-51207(ILKR6F11)	SXU20HPR11	IXUH20I	VXUH20I
V9110-5008	MA16PR-U	-	-	V9110-5380	IWF24	IWF24	-	90048-51208	SXU20HPR11	IXUH20I	VXUH20I
V9110-5013	MA20PR-U	-	-	V9110-5381	IWF27	IWF27	-	90048-51213(ILKR7D8)	SXU22HPR8	IXUH22I	VXUH22I
V9110-5020	T14PR-U	ITF16	-	V9110-5383	IUF22	IUF22	-	90048-51214	SXU22HPR8	IXUH22I	VXUH22I
V9110-5022	T16EPR-U	IT16	VT16	V9110-5384	IUF24	IUF24	-	90048-51215(SILKR6D10G)	-	IXUH20I	VXUH20I
V9110-5023	T16EPR-U15	IT16	VT16	V9110-5391	IWM24	IWM24	-	90048-51216(SILKAR6G11G)	-	-	VFXEH20
V9110-5026	T16PR-U11	ITF16	-	V9110-5392	IWM27	IWM27	-	90048-51220(SILKAR7G8G)	-	-	-
V9110-5032	T20EPR-U	IT20	VT20	V9110-5393	IWM31	IWM31	-	9004A-91031(Malaysia)	XU22PR9	IXU22	VXU22
V9110-5036	T20PR-U11	ITF20	-	V9110-5394	IXG24	IXG24	-	9004A-91032(Indonesia)	XU22PR9	IXU22	VXU22
V9110-5040	T22EP-U	IT22	-	V9110-5395	IXG27	IXG27	-	9004A-91039(DCPR7EA9)	XU22PR9	IXU22	VXU22
V9110-5044	W16S-U	-	-	V9110-5501	VK20T	-	VK20T	90080-91032	Q16R-U11(Overseas Product)	IQ16	VQ16
V9110-5046	W20PR-U	-	-	V9110-5502	VW20T	-	VW20T	90080-91048(B CPR5EY)	Q16R-U	IQ16	VQ16
V9110-5060	K20PBR	IK20	VK20	V9110-5503	VKH20T	-	VKH20T	90080-91048(FR7KC)	K20R-U	IK20	VK20
V9110-5061	K20PBR-S10	IK20	VK20	V9110-5601	VQ16	IQ16	VQ16	90080-91065	PK20R13(Overseas Product)	IK20	VK20
V9110-5063	K20TXR	IK20	VK20	V9110-5602	VQ20	IQ20	VQ20	90080-91066	K20R-U(Overseas Product)	IK20	VK20
V9110-5064	W16EPB10	IW16	VW16	V9110-5603	VK16	IK16	VK16	90080-91108(FR7KCW)	K20R-U11	IK20	VK20
V9110-5065	W20EPB	IW20	VW20	V9110-5604	VK20	IK20	VK20	90080-91116	PK20TR11(Overseas Product)	IK20	VK20
V9110-5070	PT16EPR-L13	IT16	VT16	V9110-5605	VW16	IW16	VW16	90080-91145	K16TR11(Overseas Product)	IK16	VK16
V9110-5301	IQ16	IQ16	VQ16	V9110-5606	VW20	IW20	VW20	90080-91159	SK20R-P13(Overseas Product)	IK20	VK20
V9110-5302	IQ20	IQ20	VQ20	V9110-5607	VW22	IW22	VW22	90080-91161-A	K16R-U11(Overseas Product)	IK16	VK16
V9110-5303	IK16	IK16	VK16	V9110-5608	VXU22	IXU22	VXU22	90080-91180-B	SK20R11(Overseas Product)	IK20	VK20
V9110-5304	IK20	IK20	VK20	V9110-5609	VXU24	IXU24	VXU24	90080-91184	SK16R11(Overseas Product)	IK16	VK16
V9110-5305	IW16	IW16	VW16	V9110-5610	VK22	IK22	VK22	90080-91184-B	SK16R11(Overseas Product)	IK16	VK16
V9110-5306	IW20	IW20	VW20	V9110-5611	VXUH22	IXUH22	VXUH22	90080-91193-B	K16R-U11(Overseas Product)	IK16	VK16
V9110-5307	IW22	IW22	VW22	V9110-5613	VQ22	IQ22	VQ22	90080-91200(BKR5EYA11)	K16R-U11	IK16	VK16
V9110-5308	IXU22	IXU22	VXU22	V9110-5617	VKH16	IKH16	VKH16	90080-91204(FR7KCU)	K20R-U11	IK20	VK20
V9110-5309	IXU24	IXU24	VXU24	V9110-5618	VKH20	IKH20	VKH20	90080-91217(BKR5EYA11)	K16R-U11	IK16	VK16
V9110-5310	IK22	IK22	VK22	V9110-5619	VKH22	IKH22	VKH22	90080-91229-B	K16R-U(Overseas Product)	IK16	VK16
V9110-5311	IK24	IK24	-	V9110-5620	VK20Y	-	VK20Y	90080-91234(BPR5EY)	W16EXR-U	IW16	VW16
V9110-5312	IK27	IK27	-	V9110-5621	VT16	IT16	VT16	90080-91235(BPR5EY11)	W16EXR-U11	IW16	VW16
V9110-5313	IQ22	IQ22	VQ22	V9110-5622	VKA16	-	VKA16	90080-91236-A	W16EXR-U11(Overseas Product)	IW16	VW16
V9110-5314	IQ24	IQ24	-	V9110-5623	VKA20	-	VKA20	90080-91237-A	W16EXR-U(Overseas Product)	IW16	VW16
V9110-5315	IQ27	IQ27	-	V9110-5624	VKB16	-	VKB16	90080-91243	K20R-U(Overseas Product)	IK20	VK20
V9110-5316	IW24	IW24	-	V9110-5625	VKB20	-	VKB20	90919-01055	W9EP	-	-
V9110-5317	IW27	IW27	-	V9110-5626	VK22G	IK22G	VK22G	90919-01056	W14EX-U	IW16	VW16
V9110-5318	IW29	IW29	-	V9110-5637	VCH20	-	VCH20	90919-01056-8N	W14EX-U(Overseas Product)	-	-
V9110-5319	IW31	IW31	-	V9110-5638	VT20	IT20	VT20	90919-01059	W16EX-U	IW16	VW16
V9110-5320	IW34	IW34	-	V9110-5639	VKH20Y	-	VKH20Y	90919-01059-8N	W16EX-U(Overseas Product)	IW16	VW16
V9110-5321	IK31	IK31	-	V9110-5640	VK16G	IK16G	VK16G	90919-01064	W16EXR-U	IW16	VW16
V9110-5322	IK34	IK34	-	V9110-5641	VK20G	IK20G	VK20G	90919-01065	W14EXR-U	IW16	VW16
V9110-5323	IQ31	IQ31	-	V9110-5643	VFKBH20	-	VFKBH20	90919-01083	W20EX-U	IW20	VW20
V9110-5324	IQ34	IQ34	-	V9110-5644	VFXEH20E	-	VFXEH20E	90919-01083-8N	W20EX-U(Overseas Product)	IW20	VW20
V9110-5325	IT16	IT16	VT16	V9110-5645	VFXEH20	-	VFXEH20	90919-01084	W20EXR-U	IW20	VW20
V9110-5326	IT20	IT20	VT20	V9110-5646	VFXEH22	-	VFXEH22	90919-01084-8N	W20EXR-U(Overseas Product)	IW20	VW20
V9110-5327	IT22	IT22	-	V9110-5647	VFK16	-	VFK16	90919-01085	W14EX-U11	IW16	VW16
V9110-5328	IT24	IT24	-	V9110-5648	VFK20F	-	VFK20F	90919-01087(BP5EK-A)	W16ET-S	IW16	VW16
V9110-5329	IT27	IT27	-	V9110-5649	VXU20	-	VXU20	90919-01088(BP6EK-A)	W20ET-S	IW20	VW20
V9110-5330	ITF16	ITF16	-	V9110-5650	VXUH20I	IXUH20I	VXUH20I	90919-01089	W20ET-S	IW20	VW20
V9110-5331	ITF20	ITF20	-	V9110-5651	VXU22I	IXU22I	VXU22I	90919-01090	W16ET-S	IW16	VW16
V9110-5332	ITF22	ITF22	-	V9110-5654	VFKH16	-	VFKH16	90919-01091	W16EXR-U11	IW16	VW16
V9110-5333	ITF24	ITF24	-	V9110-5655	VFKH20	-	VFKH20	90919-01092(BPR6EK-A)	W20ET-S	IW20	VW20
V9110-5334	ITF27	ITF27	-	V9110-5656	VXUH22I	IXUH22I	VXUH22I	90919-01094	W16EX-U11	IW16	VW16

# CAR MAKER GENUINE P/N CROSS REFERENCE ( 98079-56841 ⇒ DENSO )

TOYOTA	DENSO	IRIDIUM POWER	IRIDIUM TOUGH/PLUS	TOYOTA	DENSO	IRIDIUM POWER	IRIDIUM TOUGH/PLUS	TOYOTA	DENSO	IRIDIUM POWER	IRIDIUM TOUGH/PLUS
90919-01095	W16ETR-S IW16	VW16	VW16	90919-01192	K16TR11 IK16	VK16	VK16	90919-01284	FK16BR-AL8 -	VFKB16	VFKB16
90919-01096 (BPR5EK-A)	W16ETR-S IW16	VW16	VW16	90919-01193 (BKRS5EK-B1)	K16TR11 IK16	VK16	VK16	90919-01285 (DILKAR8J9G)	-	-	VDCH22F
90919-01097	W20ETR-S IW20	VW20	VW20	90919-01194	PK20TR11 IK20	VK20	VK20	90919-01286	FK16HBR-J8 -	-	-
90919-01098 (BPR6EY)	W20EXR-U IW20	VW20	VW20	90919-01195 (BKRG6EKP-B1)	PK20TR11 IK20	VK20	VK20	90919-01287	FK20HR-A8 -	VFKH20	VFKH20
90919-01100	T16EX-U IT16	VT16	VT16	90919-01196	PK16TR11 IK16	VK16	VK16	90919-01288	FK20HBR-TJ8 -	VFKBH20	VFKBH20
90919-01102 (BPR5EY)	W16EXR-U IW16	VW16	VW16	90919-01197 (BKRS5EKPB-B1)	PK16TR11 IK16	VK16	VK16	90919-01289	FC16HR-Q8 -	VFCH16	VFCH16
90919-01103 (BPR4EY)	W14EXR-U IW16	VW16	VW16	90919-01198	K20TR11 IK20	VK20	VK20	90919-01290	SC16HR-G11 -	-	-
90919-01104 (BPR5EY-11)	W16EXR-U11 IW16	VW16	VW16	90919-01200	PK16TR13 IK16	VK16	VK16	90919-01291	FC20HR-G8 -	-	-
90919-01108	W14EXR-U11 IW16	VW16	VW16	90919-01201 (BKRS5EKPB-13)	PK16TR13 IK16	VK16	VK16	90919-01292	FC16HR-GQ8 -	VFCH16	VFCH16
90919-01109 (BPR4EY-11)	W14EXR-U11 IW16	VW16	VW16	90919-01202 (BKRG6EKB-11)	K20TR11 IK20	VK20	VK20	90919-01294 (DILFR5M8D)	-	-	VDKH16T
90919-01113	J16AR-U11 -	-	-	90919-01203	PK16R-P8 IK16	VK16	VK16	90919-01295	EC22HPR-D7 -	-	-
90919-01114 (BRES27Y-11)	J16AR-U11 -	-	-	90919-01205	PK16R8 IK16	VK16	VK16	90919-01296	FK16HBR-Q8 -	-	-
90919-01115	P16R IW16	VW16	VW16	90919-01206 (BKRS5EP-8)	PK16R8 IK16	VK16	VK16	90919-01297	FK20HR-J8 -	-	-
90919-01116 (BPR5EP-11)	P16R IW16	VW16	VW16	90919-01207	SK20R-P11 IK20	VK20	VK20	90919-01298	FC16HR-CY9 -	VFCH16	VFCH16
90919-01116 (BPR5EP-11) LPG	•P16R -	-	VW20T	90919-01208	PK20GR8 -	VKA20	VKA20	90919-A1002	SK20HR11 (Overseas Product)	IKH20	VKH20
90919-01117	J16B-U11 -	-	-	90919-01209	SK16R-P11 IK16	VK16	VK16	90919-A1003	SK16HR11 (Overseas Product)	IKH16	VKH16
90919-01118 (BE529Y-11)	J16B-U11 -	-	-	90919-01210	SK20R11 IK20	VK20	VK20	90919-T1002-A	K16R-U (Overseas Product)	IK16	VK16
90919-01119	J16BR-U -	-	-	90919-01211 (IFR6A11)	SK20R11 IK20	VK20	VK20	90919-T1003	K16R-U11 (Overseas Product)	IK16	VK16
90919-01120 (BRES29Y)	J16AR-U11 -	-	-	90919-01212	SK20R-P13 IK20	VK20	VK20	90919-T1004-A	K20HR-U11 (Overseas Product)	IKH20	VKH20
90919-01121	PQ16R IQ16	VQ16	VQ16	90919-01213 (BKRG6EPA-8)	PK20GR8 -	VKA20	VKA20	90919-T1005	K20HR-U (Overseas Product)	IKH20	VKH20
90919-01121-83	PQ16R (Overseas Product)	IQ16	VQ16	90919-01214	SK16R-P8 IK16	VK16	VK16	90919-T1006	SK20HR11 (Overseas Product)	IKH20	VKH20
90919-01122 (BCPR5EP-11)	PQ16R IQ16	VQ16	VQ16	90919-01215 (IFR5A-8N) LPG	SK16R-P8 -	VK20T	VK20T	90919-T1007-A	SK20R11 (Overseas Product)	IK20	VK20
90919-01123	J16BR-U11 -	-	-	90919-01216	PK20TR-G11 -	VK20T	VK20T	90919-T1009	SK20HR11 (Overseas Product)	-	VCH20
90919-01125	W20EXR-U11 IW20	VW20	VW20	90919-01217	SK16R11 IK16	VK16	VK16	90919-W1001-A	K20HR-U11 (Overseas Product)	IKH20	VKH20
90919-01126 (BPR6EY-11)	W20EXR-U11 IW20	VW20	VW20	90919-01218 (IFR5A11)	SK16R11 IK16	VK16	VK16	90919-W1002	SK20HR11 (Overseas Product)	IKH20	VKH20
90919-01127	PQ20R IQ20	VQ20	VQ20	90919-01219	•SK16R-P11 IK16	VK16	VK16	90919-WX002 (ILKAR7G9)	-	-	VKH20Y
90919-01127-83	PQ20R (Overseas Product)	IQ20	VQ20	90919-01220	•PK20R11 IK20	VK20	VK20	90919-YZZAA	Q16-U IQ16	VQ16	VQ16
90919-01128 (BCPR6EP-11)	PQ20R IQ20	VQ20	VQ20	90919-01221	SK20BGR11 -	VKA20	VKA20	90919-YZZAB	Q20-U IQ20	VQ20	VQ20
90919-01129	Q16R-U11 IQ16	VQ16	VQ16	90919-01222	SK20R5 -	-	-	90919-YZZAC	Q20-U11 IQ20	VQ20	VQ20
90919-01129-8N	Q16R-U11 (Overseas Product)	IQ16	VQ16	90919-01223	P16R8 IW16	VW16	VW16	90919-YZZAD	K16-U IQ16	VK16	VK16
90919-01131	Q20R-U11 IQ20	VQ20	VQ20	90919-01224 (BPR5EP8)	P16R8 IW16	VW16	VW16	90919-YZZAE	K16-U11 IK16	VK16	VK16
90919-01131-8N	Q20R-U11 (Overseas Product)	IQ20	VQ20	90919-01225	•SK20R-P11 IK20	VK20	VK20	90919-YZZAF	K20-U IK20	VK20	VK20
90919-01133	P16R13 IW16	VW16	VW16	90919-01226	SK20BR11 (For Japan) -	VKB20	VKB20	90919-YZZAG	K20-U11 IK20	VK20	VK20
90919-01134 (BPR5EP-13)	P16R13 IW16	VW16	VW16	90919-01228	PK20TR8-G IK20	VK20	VK20	90999-09006	W16EX-U (Removable)	IW16	VW16
90919-01135	•PQ20R-P11 IQ20	VQ20	VQ20	90919-01229	SK20R5-G -	-	-	90999-09007	W20EX-U (Removable)	IW20	VW20
90919-01136 (BCPR6EP-N-11)	PQ20R-P11 IQ20	VQ20	VQ20	90919-01230	SK20BR11 (For EU) -	VKB20	VKB20	SU003-00416	ZXE27HBR8 -	VXEBH27	VXEBH27
90919-01139	W20EX-U11 IW20	VW20	VW20	90919-01231	SK20R8 -	VK20Y	VK20Y	SU003-04931	ZXE27HBR8 -	VXEBH27	VXEBH27
90919-01141	PQ16R-P11 IQ16	VQ16	VQ16	90919-01233	SK16HR11 IKH16	VKH16	VKH16				
90919-01143	•P16R IW16	VW16	VW16	90919-01235	K20HR-U11 IKH20	VKH20	VKH20				
90919-01144 (BPR5EP-11)	P16R IW16	VW16	VW16	90919-01236 (LFR6A11)	K20HR-U11 IKH20	VKH20	VKH20				
90919-01144 (BPR5EP-11) LPG	•P16R -	-	VW20T	90919-01237 (USE 01210)	SK20R11 (OEM ONLY) IK20	VK20	VK20				
90919-01145	PQ20R-P8 IQ20	VQ20	VQ20	90919-01238 (IFR6A11)	SK20R11 IK20	VK20	VK20				
90919-01146 (BCPR6EP-N-8)	PQ20R-P8 IQ20	VQ20	VQ20	90919-01239	SK16R8-PG -	VK20T	VK20T				
90919-01147	P20R8 -	-	VW20T	90919-01240 (USE 01217)	SK16R11 (OEM ONLY) IK16	VK16	VK16				
90919-01148 (BPR6EP-8)	P20R8 IW20	VW20	VW20	90919-01240-79	SK16R11 IK16	VK16	VK16				
90919-01148 (BPR6EP-8) LPG	P20R8 -	-	VW20T	90919-01241 (IFR5A11)	SK16R11 IK16	VK16	VK16				
90919-01149	Q20R-U IQ20	VQ20	VQ20	90919-01242 (USE 01164)	K16R-U11 (OEM ONLY) IK16	VK16	VK16				
90919-01149-8N	Q20R-U (Overseas Product)	IQ20	VQ20	90919-01243	FK16HR11 -	VFKH16	VFKH16				
90919-01151	PQ16R8 IQ16	VQ16	VQ16	90919-01244 (USE 01176)	K16R-U (OEM ONLY) IK16	VK16	VK16				
90919-01151-83	PQ16R8 (Overseas Product)	IQ16	VQ16	90919-01245 (BKRS5EYA)	K16R-U IK16	VK16	VK16				
90919-01152 (BCPR5EP-8)	PQ16R8 IQ16	VQ16	VQ16	90919-01247	FK20HR11 -	VFKH20	VFKH20				
90919-01153	Q16R-U IQ16	VQ16	VQ16	90919-01248 (ILFR6D11)	FK20HR11 -	VFKH20	VFKH20				
90919-01153-8N	Q16R-U (Overseas Product)	IQ16	VQ16	90919-01249	FK20HBR11 -	VFKBH20	VFKBH20				
90919-01155	QJ16AR-U -	-	-	90919-01249-79	FK20HBR11 -	VFKBH20	VFKBH20				
90919-01155-8N	QJ16AR-U (Overseas Product)	-	-	90919-01250	S20R8-G -	VW20T	VW20T				
90919-01157	PQ16R13 IQ16	VQ16	VQ16	90919-01252	FK16R11 -	-	-				
90919-01158 (BCPR5EP-13)	PQ16R13 IQ16	VQ16	VQ16	90919-01253	SC20HR11 -	VCH20	VCH20				
90919-01159	Q16-U11 IQ16	VQ16	VQ16	90919-01254	SK20HR8-T -	VKH20T	VKH20T				
90919-01161	PQ20R8 IQ20	VQ20	VQ20	90919-01255	FK20HBR11-T -	VFKBH20	VFKBH20				
90919-01162 (BCPR6EP-8)	PQ20R8 IQ20	VQ20	VQ20	90919-01256	FC22HR9 -	-	-				
90919-01164	K16R-U11 IK16	VK16	VK16	90919-01256A	FC22HR9-G -	-	-				
90919-01165 (BKRS5EYA-11)	K16R-U11 IK16	VK16	VK16	90919-01258	K16HR-U11 IKH16	VKH16	VKH16				
90919-01166	K20R-U IK20	VK20	VK20	90919-01259	FK16HR-A8 -	VFKH16	VFKH16				
90919-01166-8N	K20R-U (Overseas Product)	IK20	VK20	90919-01259-79	FK16HR-A8 -	-	-				
90919-01168	PK16R11 IK16	VK16	VK16	90919-01260	PK16TR-L11 -	-	-				
90919-01168-83	PK16R11 (Overseas Product)	IK16	VK16	90919-01261	FK20HR11-G -	-	-				
90919-01169 (BKRS5EP-11)	PK16R11 IK16	VK16	VK16	90919-01262	FK20HR8-G -	VKH20T	VKH20T				
90919-01170	Q14R-U11 IQ16	VQ16	VQ16	90919-01263	FK20HBR8 -	VFKBH20	VFKBH20				
90919-01172	PK20R-P8 IK20	VK20	VK20	90919-01263-79	FK20HBR8 -	VFKBH20	VFKBH20				
90919-01173 (BKRS6EP-N-8)	PK20R-P8 IK20	VK20	VK20	90919-01264	SK20R-B5 -	-	-				
90919-01174	QJ16AR-U11 -	-	-	90919-01265	FK16R-A8 -	VFK16	VFK16				
90919-01176	K16R-U IK16	VK16	VK16	90919-01266	SK20HR-A11 IKH20	VKH20	VKH20				
90919-01177 (BKRS5EYA)	K16R-U IK16	VK16	VK16	90919-01267	K20HR-UAG8 -	-	-				
90919-01178	PK20R11 IK20	VK20	VK20	90919-01268	K16R-UAG8 -	-	-				
90919-01178-83	PK20R11 (Overseas Product)	IK20	VK20	90919-01269	SK16HR-G11 -	-	-				
90919-01179 (BKRS6EP-11)	PK20R11 IK20	VK20	VK20	90919-01270	SC20HR-G11 -	-	-				
90919-01180	PK20R8 -	-	VK20Y	90919-01271 (TRD:90919-A0002)	VXUH22 IXUH22	VXUH22	VXUH22				
90919-01180 *LPG	PK20R8 -	-	VK20T	90919-01272	FK16R-AL8 -	VFK16	VFK16				
90919-01180-83	PK20R8 (Overseas Product)	-	VK20T	90919-01274	FC20HR-BG9 -	-	-				
90919-01181 (BKRS6EP-8)	PK20R8 IK20	VK20	VK20	90919-01275	SC16HR11 -	-	-				
90919-01181 (BKRS6EP-8) LPG	PK20R8 -	-	VK20T	90919-01276 (DILFR7K9G)	-	-	-				
90919-01182	PQ20R13 IQ20	VQ20	VQ20	90919-01276-79 (DILFR7K9G)	-	-	-				
90919-01184	K20R-U11 IK20	VK20	VK20	90919-01277	SK20HR-GT8 -	VKH20	VKH20				
90919-01184-8N	K20R-U11 (Overseas Product)	IK20	VK20	90919-01278	VKH20Y (GRMN) -	VKH20Y	VKH20Y				
90919-01185 (BKRS6EYA-11)	K20R-U11 IK20	VK20	VK20	90919-01279	FK20HBR-J8 -	VFKBH20	VFKBH20				
90919-01187	PK20R13 IK20	VK20	VK20	90919-							

# CAR MAKER GENUINE P/N CROSS REFERENCE





98079-56841

other →



DENSO

CROSS REFERENCE PART NUMBER	YAMAHA				DENSO				YAMAHA (Overseas)				DENSO			
	YAMAHA	DENSO	IRIDIUM POWER	IRIDIUM TOUGH/PLUS	YAMAHA	DENSO	IRIDIUM POWER	IRIDIUM TOUGH/PLUS	YAMAHA (Overseas)	DENSO	IRIDIUM POWER	IRIDIUM TOUGH/PLUS	YAMAHA (Overseas)	DENSO	IRIDIUM POWER	IRIDIUM TOUGH/PLUS
AUSTRALIA	90793-20155 (DPR9EIX9)	-	IX27B	-	94703-00117 (BP7ES)	W22EP-U	IW22	VW22	9079E-ND022	W20EP-U	IW20	VW20	9079E-ND023	W20FP-U	IWF20	-
	90793-20156 (BPR6HIX)	-	IWF20	-	94703-00133 (BP5ES)	W16EX-U	IW16	VW16	9079E-ND024	W20FPR-U	IWF20	-	9079E-ND026	W22EP-U	IW22	VW22
CHINA	90793-20157 (BPR7HIX)	-	IWF22	-	94703-00133 (BP5ES)	W16EP-U	IW16	VW16	9079E-ND027	W22EP-U	IW22	VW22	9079E-ND028	W22FPR-U	IWF22	-
	90793-20158 (BR6HIX)	-	-	-	94703-00157 (D8EA)	X24ES-U	IX24	-	9079E-ND030	W24ES-U	IW24	-	9079E-ND031	W24ESR-U	IW24	-
INDIA	90793-20159 (BR7HIX)	-	IWF22	-	94703-00159 (BP4HS)	W14FP-UL	IWF16	-	9079E-ND032	W24ESR-U	IW24	-	9079E-ND033	W24FP-U	IWF24	-
	90793-20160 (BR8EIX)	-	IW24	-	94703-00160 (B8HS-10)	W24FS-U10	IWF24	-	9079E-ND035	W27ES-U	IW27	-	9079E-ND036	W27ESR-U	IW27	-
INDONESIA	90793-20161 (BR9EIX)	-	IW27	-	94703-00168 (BP5HS)	W16FP-U	IWF16	-	9079E-ND037	W27ES-U	IW27	-	9079E-ND038	X22EP-U9	IX22B	-
	90793-20162 (CR8EIX9)	-	IUH24	-	94703-00181	X24ES-U	IX24	-	9079E-ND039	X24EPR-U9	IX24B	-	9079E-ND040	X24ES-U	IX24	-
MALAYSIA	90793-20163 (CR9EIX9)	-	IUH27	-	94703-00188 (BR9ES)	W27ESR	IW27	-	9079E-ND041	W22FP-U	IWF22	-	9079E-ND042	W22FP-U10	IWF20	-
	90793-20164 (BR8HIX)	-	IWF24	-	94703-00188 (BR9ES)	W27ESR-U	IW27	-	9079E-ND043	X20FS-U	-	-	9079E-ND044	X24ESR-U	IX24	-
PHILIPPINES	90793-20165 (BR10EIX)	-	IW31	-	94703-00189 (D7EA)	X22ES-U	IX22	-	9079E-ND045	U27ES-N	IU27	-	9079E-ND046	W20FP-U10	IWF20	-
	90793-20166 (BPR8HIX)	-	IWF24	-	94703-00194 (BPR5HS)	W16FPR-U	IWF16	-	9079E-ND047	X20FS-U	-	-	9079E-ND048	X24ESR-U	IX24	-
SAUDI ARABIA	90793-20167 (BPR5EIX)	-	IW16	VW16	94703-00198 (BPR6HS)	W20FPR-U	IWF20	-	9079E-ND049	W20FP-U	IW20	-	9079E-ND050	X24FS-U	-	-
	90793-20168 (BPR6EIX)	-	IW20	VW20	94703-00203 (DR8ES-L)	X24ESR-U	IX24	-	9079E-ND051	U16FS-U	-	-	9079E-ND052	U16FS-U	-	-
SINGAPORE	90793-20169 (CR5HIX)	-	-	-	94703-00204 (BR8ES)	W24ESR	IW24	-	9079E-ND053	W22FP-U10	IWF22	-	9079E-ND054	W22FP-U11	IWF22	VW22
	90793-20170 (CR6HIX)	-	IUF22	-	94703-00204 (BR8ES)	W24ESR-U	IW24	-	9079E-ND055	W16FP-U	IWF16	-	9079E-ND056	X27GPR-U	IXG27	-
TAIWAN	90793-20171 (CR7HIX)	-	IUF22	-	94703-00207 (B4ES)	W14E	-	-	9079E-ND057	X27EPR-U	IWF22	-	9079E-ND058	U24ESR-N	IU24	-
	90793-20172 (CR7EIX)	-	IU22	-	94703-00213 (C6HA)	U20FS-U	IUF22	-	9079E-ND059	U27ESR-N	IU27	-	9079E-ND060	U27ESR-U	IW27	-
VIETNAM	90793-20173 (DPR7EIX9)	-	IX22B	-	94703-00215 (C7HA)	U22FS-U	IUF22	-	9079E-ND061	X20EPR-U9	-	-	9079E-ND062	W20FS-U10	IWF20	-
	90793-20174 (CR8HIX)	-	IUF24	-	94703-00217 (B7HS-10)	W22FS-U10	IWF22	-	9079E-ND063	W27EPR-U	IW27	-	9079E-ND064	W9EXR-U	-	-
THAILAND	90793-20175 (BPR7EIX)	-	IW22	VW22	94703-00218 (BPR7ES)	W22EPR-U	IW22	VW22	9079E-ND065	W27EPR-U	IW27	-	9079E-ND066	X22ESR-U	IX22	-
	90793-22008	W16ES-U	-	-	94703-00220	W22EPR-U	IW22	VW22	9079E-ND067	W27EPR-U	IW27	-	9079E-ND068	X22ESR-U	IX22	-
JAPAN	90793-22010	W27ES-U	IW27	-	94703-00222	X24ESR-U	IX24	-	9079E-ND069	X27EPR-U9	IX27B	-	9079E-ND069	X27EPR-U9	IX27B	-
	90793-22035	W20ESR-U	-	-	94703-00223	W20FP-U	IWF20	-	9079E-ND070	X22EPR-U9	IX22B	-	9079E-ND070	X22EPR-U9	IX22B	-
EUROPE & USA	90793-22036	W22ESR-U	-	-	94703-00227 (BPR7HS)	W22FPR-U	IWF22	-	9079E-ND071	W20EPR-U	IW20	VW20	9079E-ND071	W20EPR-U	IW20	VW20
	90793-22037	W27ESR-U	IW27	-	94703-00232 (BP6HS-10)	W20FP-U10	IWF20	-	9079E-ND072	W16EPR-U	IW16	VW16	9079E-ND072	W16EPR-U	IW16	VW16
INDONESIA	90793-22039	W24FSR	IWF24	-	94703-00234 (BPR6ES)	W20EXR-U	IW20	VW20	9079E-ND073	X24EPR-U9	IX24B	-	9079E-ND073	X24EPR-U9	IX24B	-
	90793-22045	W20EXR-U11	IW20	VW20	94703-00234 (BPR6ES)	W20EPR-U	IW20	VW20	9079E-ND074	U27ES-N	IU27	-	9079E-ND074	U27ES-N	IU27	-
MALAYSIA	90793-22047	X22EPR-U9	IX22B	-	94703-00235	W20FPR-U	IWF20	-	9079E-ND075	W16EP-U	IW16	VW16	9079E-ND075	W16EP-U	IW16	VW16
	90793-22093	IU22	IU22	-	94703-00241 (DPR8EA-9)	X24EPR-U9	IX24B	-	9079E-ND076	W9EXR-U	-	-	9079E-ND076	W9EXR-U	-	-
PHILIPPINES	90793-22094	IU24	IU24	-	94703-00254 (C7HSA)	U22FS-U	IUF22	-	9079E-ND077	X22ESR-U	IX22	-	9079E-ND077	X22ESR-U	IX22	-
	90793-22095	IU27	IU27	-	94703-00256 (C6HSA)	U20FS-U	IUF22	-	9079E-ND078	X27ES-U	IX27	-	9079E-ND078	X27ES-U	IX27	-
SAUDI ARABIA	90793-22096	IUH24	IUH24	-	94703-00258 (BPR4HS)	W14FPR-UL	IWF16	-	9079E-ND079	X27ES-U	IX27	-	9079E-ND079	X27ES-U	IX27	-
	90793-22097	IUH27	IUH27	-	94703-00262 (DPR7EA-9)	X22EPR-U9	IX22B	-	9079E-ND081	K16HPR-U11	IKH16	VKH16	9079E-ND081	K16HPR-U11	IKH16	VKH16
SINGAPORE	90793-22098	IX22B	IX22B	-	94703-00263 (DP7EA-9)	X22EP-U9	IX22B	-	9079E-ND082	IWF20	IWF20	-	9079E-ND082	IWF20	IWF20	-
	90793-22099	IX24B	IX24B	-	94703-00264 (BP7HS-10)	W22FP-U10	IWF22	-	9079E-ND083	W20M-U	-	-	9079E-ND083	W20M-U	-	-
TAIWAN	90793-22100	IX27B	IX27B	-	94703-00266 (BP8ES-11)	W24EP-U	IW24	-	9079E-ND084	XU22EPR-U	IXU22	VXU22	9079E-ND084	XU22EPR-U	IXU22	VXU22
	90793-22101	IW22	IW22	VW22	94703-00275 (DP8EA-9)	X24EP-U9	IX24B	-	9079E-ND085	-	-	-	9079E-ND085	-	-	-
VIETNAM	90793-22102	IU31	IU31	-	94703-00307	U27ES-N	IU27	-	IQG-10862-20	-	-	-	IQG-10862-20	-	-	-
	90793-22103	IU24A	IU24A	-	94703-00310 (C-2H)	-	-	-	YANASE	DENSO	IRIDIUM POWER	IRIDIUM TOUGH/PLUS	5105 0K16	IK16	IK16	VK16
THAILAND	90793-22104	IU27A	IU27A	-	94703-00314 (C8E)	U24ES-N	IU24	-	5105 0K20	IK20	IK20	VK20	5105 0K22	IK22	IK22	VK22
	90793-22105	IU31A	IU31A	-	94703-00315 (C9E)	U27ES-N	IU27	-	5105 0Q16	IQ16	IQ16	VQ16	5105 0Q20	IQ20	IQ20	VQ20
EUROPE & USA	90793-22106	IX22	IX22	-	94703-00318 (CR9E)	U27ESR-N	IU27	-	5105 0Q22	IQ22	IQ22	VQ22	5105 0Q22	IQ22	IQ22	VQ22
	90793-22107	IX24	IX24	-	94703-00319	U27ESR-N	IU27	-	5105 0T16	IT16	IT16	VT16	5105 0T16	IT16	IT16	VT16
INDONESIA	90793-22108	IX27	IX27	-	94703-00320 (BP7ES-11)	W22EP-U11	IW22	VW22	5105 0T20	IT20	IT20	VT20	5105 0T20	IT20	IT20	VT20
	90793-22109	IWF22	IWF22	-	94703-00323 (B8EG)	W24ES-V	IW24	-	5105 0T22	IT22	IT22	-	5105 0T22	IT22	IT22	-
MALAYSIA	90793-22110	IWF24	IWF24	-	94703-00325 (B9EG)	W22ES-V	IW27	-	5105 0W16	IW16	IW16	VW16	5105 0W16	IW16	IW16	VW16
	90793-22111	IWF27	IWF27	-	94703-00327	W22FPR-U	IWF22	-	5105 0W20	IW20	IW20	VW20	5105 0W20	IW20	IW20	VW20
PHILIPPINES	90793-22112	IW16	IW16	VW16	94703-00329	U24ESR-N	IU24	-	5105 0W22	IW22	IW22	VW22	5105 0W22	IW22	IW22	VW22
	90793-22114	IUF22	IUF22	-	94703-00330 (CR8E)	U24ESR-N	IU24	-	5105 TF16	ITF16	ITF16	-	5105 TF16	ITF16	ITF16	-
SAUDI ARABIA	90793-22115	IUF24	IUF24	-	94703-00332 (R5184-10S)	IWM01-32	-	-	5105 TF20	ITF20	ITF20	-	5105 TF20	ITF20	ITF20	-
	90793-22088	IW24	IW24	-	94703-00333 (DR8EA)	X24ESR-U	IX24	-	5105 TV16	ITV16	ITV16	-	5105 TV16	ITV16	ITV16	-
VIETNAM	90793-22089	IW27	IW27	-	94703-00345 (DR7EA)	X22ESR-U	IX22	-	5105 TV20	ITV20	ITV20	-	5105 TV20	ITV20	ITV20	-
	90793-22090	IW29	IW29	-	94703-00352	U22ESR-N	IU22	-	5105 VK16	VK16	IK16	VK16	5105 VK16	VK16	IK16	VK16
THAILAND	90793-22091	IW31	IW31	-	94703-00353 (CR7E)	U22ESR-N	IU22	-	5105 VK20	VK20	IK20	VK20	5105 VK20	VK20	IK20	VK20
	90793-22092	IW34	IW34	-	94703-00355	W22FSR	IWF22	-	5105 VKH2 00	VKH20	IKH20	VKH20	5105 VKH2 00	VKH20	IKH20	VKH20
EUROPE & USA	90890-78079 (BP6EV)	-	IW20	VW20	94703-00366 (CR7HSA)	U22FSR-U	IUF22	-	5105 VQ16	VQ16	IQ16	VQ16	5105 VQ16	VQ16	IQ16	VQ16
	90890-78082 (B10EGV)	IW31	IW31	-	94703-00367 (B10EG)	-	IW31	-	5105 VQ20	VQ20	IQ20	VQ20	5105 VQ20	VQ20	IQ20	VQ20
INDONESIA	90890-78086	W24ESR-U	IW24	-	94709-00195 (BR8HS)	W24FSR	IWF24	-	5105 VQ22	VQ22	IQ22	VQ22	5105 VQ22	VQ22	IQ22	VQ22
	90890-78094	W20FS-U	IWF22	-	94709-00247 (BR8HS-10)	W24FSR-U10	IWF24	-	5105 VT16	VT16	IT16	VT16	5105 VT16	VT16	IT16	VT16
MALAYSIA	90890-78097	W14FP-UL	IWF16	-	94709-00324 (BR9EC)	W27ESR-U	IW27	-	5105 VW16	VW16	IW16	VW16	5105 VW16	VW16	IW16	VW16
	90890-78102	W20M-U	-	-	94709-00357 (BR9ECM)	W27EMR-C	IWM27	-	5105 VW20	VW20	IW20	VW20	5105 VW20	VW20	IW20	VW20
PHILIPPINES	90893-22113	IW20	IW20	VW20	94709-00383 (BR9ECS)	W27ESR-V	IW27	-	5105 VW22	VW22	IW22	VW22	5105 VW22	VW22	IW22	VW22
	94700-00886 (Indonesia)	U22FS-U	IUF22	-	94709-00384 (BR10ECS)	-										

DENSO → IRIIDIUM POWER, TOUGH, PLUS,  

No.	DENSO	IRIDIUM POWER	IRIDIUM TOUGH/PLUS		IRIDIUM 	No.	DENSO	IRIDIUM POWER	IRIDIUM TOUGH/PLUS		IRIDIUM 
1	K16TNR-S9	IK16	VK16	K16TT	IK16TT	112	IRT01-34	-	-	-	-
2	K20PTR-S	IK20	VK20	K20TT	IK20TT	113	IT16	IT16	VT16	-	IT16TT
3	K20TNR-S	IK20	VK20	K20TT	IK20TT	114	IT20	IT20	VT20	-	IT20TT
4	K20TNR-S9	IK20	VK20	K20TT	IK20TT	115	IT22	IT22	-	-	-
5	P16R	-	VW20T	-	IW20TT	116	IT24	IT24	-	-	-
6	P16R	IW16	VW16	W16TT	IW16TT	117	IT27	IT27	-	-	-
7	PK20R11	IK20	VK20	-	IK20TT	118	ITF16	ITF16	-	-	ITF16TT
8	PQ20R-P11	IK20	VQ20	-	IQ20TT	119	ITF20	ITF20	-	-	ITF20TT
9	SK16PR-A11	IK16	VK16	-	IK16TT	120	ITF22	ITF22	-	-	-
10	SK16R-P11	IK16	VK16	-	IK16TT	121	ITF24	ITF24	-	-	-
11	W16EPR-U	IW16	VW16	W16TT	IW16TT	122	ITF27	ITF27	-	-	-
12	XU22EPR-U	IXU22	VXU22	XU22TT	-	123	ITL16	ITL16	-	-	ITL16TT
13	DK16R-B5	-	-	-	-	124	ITL20	ITL20	-	-	-
14	DK20PR-D13	-	-	-	IK20TT	125	ITV16	ITV16	-	-	ITV16TT
15	DXE22HQR-D11S	-	-	-	-	126	ITV20	ITV20	-	-	ITV20TT
16	DXU22HCR-D11S	-	-	-	-	127	ITV22	ITV22	-	-	-
17	FC16HR-CQ	-	VFCH16	-	IXEH20TT	128	ITV24	ITV24	-	-	-
18	FC16HR-CYQ	-	VFCH16	-	IXEH20TT	129	ITV27	ITV27	-	-	-
19	FC16HR-GQ8	-	VFCH16	-	IXEH20TT	130	IU01-24	-	-	-	-
20	FC16HR-Q8	-	VFCH16	-	IXEH20TT	131	IU01-27	-	-	-	-
21	FC20HR-G8	-	-	-	IXEH22TT	132	IU01-31	-	-	-	-
22	FC20HR-GQ8	-	-	-	IXEH22TT	133	IU01-34	-	-	-	-
23	FC20HR-Q8	-	-	-	IXEH22TT	134	IU20	IU20	-	-	-
24	FC20HPR8	-	-	-	IXEH22TT	135	IU22	IU22	-	-	-
25	FC22HR9	-	-	-	-	136	IU22D	IU22D	-	-	-
26	FC22HR9-G	-	-	-	-	137	IU24	IU24	-	-	-
27	FK16HQR11	-	VFKH16	-	IKH16TT	138	IU24A	IU24A	-	-	-
28	FK16HR11	-	VFKH16	-	IKH16TT	139	IU24D	IU24	-	-	-
29	FK16HR-A8	-	-	-	IKH16TT	140	IU27	IU27	-	-	-
30	FK16R-A8	-	-	-	IK16TT	141	IU27A	IU27A	-	-	-
31	FK16R11	-	VFK16	-	IK16TT	142	IU27D	IU27	-	-	-
32	FK20HBR8	-	VFKBH20	-	IKBH20TT	143	IU31	IU31	-	-	-
33	FK20HBR11	-	VFKBH20	-	IKBH20TT	144	IU31A	IU31A	-	-	-
34	FK20HBR11-T	-	VFKBH20	-	IKBH20TT	145	IUF14-UB	IUF14-UB	-	-	-
35	FK20HQR8(HYUNDAI)	-	VFKH20	-	IKH20TT	146	IUF22	IUF22	-	-	-
36	FK20HQR8(VOLVO)	-	VFKH20	-	IKH20TT	147	IUF24	IUF24	-	-	-
37	FK20HQR10(VOLVO)	-	VFKH20	-	IKH20TT	148	IUF27A	IUF27A	-	-	-
38	FK20HQR10(FOMOCO)	-	VFKH20	-	IKH20TT	149	IUF31A	IUF31A	-	-	-
39	FK20HR11	-	VFKH20	-	IKH20TT	150	IUH24	IUH24	-	-	-
40	FK20HR8-G	-	-	-	IKH20TT	151	IUH24D	IUH24	-	-	-
41	FK20HR11-G	-	-	-	IKH20TT	152	IUH27	IUH27	-	-	-
42	FXE16HE11	-	-	-	-	153	IUH27D	IUH27	-	-	-
43	FXE20HE11C(OE)	-	-	-	IXEH20ETT	154	IW01-24	-	-	-	-
44	FXE20HE11C(AM)	-	-	-	IXEH20ETT	155	IW01-27	-	-	-	-
45	FXE20HE11(AM)	-	VFXEH20E	-	IXEH20ETT	156	IW01-29	-	-	-	-
46	FXE20HE11(OE)	-	VFXEH20E	-	IXEH20ETT	157	IW01-31	-	-	-	-
47	FXE20HR11(AM)	-	VFXEH20	-	IXEH20TT	158	IW01-32	-	-	-	-
48	FXE20HR11(OE)	-	VFXEH20	-	IXEH20TT	159	IW01-34	-	-	-	-
49	FXE20HR11(OE)	-	VFXEH20	-	IXEH20TT	160	IW06-27	-	-	-	-
50	FXE22HR11(AM)	-	VFXEH22	-	IXEH22TT	161	IW06-31	-	-	-	-
51	FXE22HR11(OE)	-	VFXEH22	-	IXEH22TT	162	IW06-34	-	-	-	-
52	FXE24HR11(AM)	-	-	-	-	163	IW16	IW16	VW16	-	IW16TT
53	FXE24HR11(OE)	-	-	-	-	164	IW20	IW20	VW20	-	IW20TT
54	FXU16HR11	-	-	-	-	165	IW22	IW22	VW22	-	-
55	FXU22HR11	-	-	-	-	166	IW24	IW24	-	-	-
56	FXU22HR8	-	-	-	-	167	IW27	IW27	-	-	-
57	GE3-F(For CNG)	-	-	-	-	168	IW29	IW29	-	-	-
58	GX8-1(For CNG)	-	-	-	-	169	IW31	IW31	-	-	-
59	IA01-31	-	-	-	-	170	IW34	IW34	-	-	-
60	IA01-32	-	-	-	-	171	IWF16	IWF16	-	-	-
61	IA01-34	-	-	-	-	172	IWF20	IWF20	-	-	-
62	IAE01-32	-	-	-	-	173	IWF22	IWF22	-	-	-
63	IAE01-34	-	-	-	-	174	IWF24	IWF24	-	-	-
64	IK01-24	-	-	-	-	175	IWF27	IWF27	-	-	-
65	IK01-27	-	-	-	-	176	IWM01-29	-	-	-	-
66	IK01-31	-	-	-	-	177	IWM01-31	-	-	-	-
67	IK01-34	-	-	-	-	178	IWM01-32	-	-	-	-
68	IK02-24	-	-	-	-	179	IWM01-34	-	-	-	-
69	IK02-31	-	-	-	-	180	IWM24	IWM24	-	-	-
70	IK16	IK16	VK16	-	IK16TT	181	IWM27	IWM27	-	-	-
71	IK16G	IK16G	VK16G	-	IK16TT	182	IWM31	IWM31	-	-	-
72	IK20	IK20	VK20	-	IK20TT	183	IX22	IX22	-	-	-
73	IK20G	IK20G	VK20G	-	IK20TT	184	IX22B	IX22B	-	-	-
74	IK22	IK22	VK22	-	-	185	IX24	IX24	-	-	-
75	IK22G	IK22G	VK22G	-	-	186	IX24B	IX24B	-	-	-
76	IK24	IK24	-	-	-	187	IX27	IX27	-	-	-
77	IK24C11	IK24	-	-	-	188	IX27B	IX27B	-	-	-
78	IK27	IK27	-	-	-	189	IXG24	IXG24	-	-	-
79	IK27C11	IK27	-	-	-	190	IXG27	IXG27	-	-	-
80	IK31	IK31	-	-	-	191	IXU01-24	-	-	-	-
81	IK34	IK34	-	-	-	192	IXU01-27	-	-	-	-
82	IKH01-24	-	-	-	-	193	IXU01-31	-	-	-	-
83	IKH01-27	-	-	-	-	194	IXU01-34	-	-	-	-
84	IKH01-31	-	-	-	-	195	IXU22	IXU22	VXU22	-	-
85	IKH16	IKH16	VKH16	-	IKH16TT	196	IXU22C	IXU22	VXU22	-	-
86	IKH20	IKH20	VKH20	-	IKH20TT	197	IXU22HPR	IXUH22	VXUH22	-	-
87	IKH22	IKH22	VKH22	-	-	198	IXU22I	IXU22I	VXU22I	-	-
88	IKH24	IKH24	-	-	-	199	IXU24	IXU24	VXU24	-	-
89	IKH27	IKH27	-	-	-	200	IXU27	IXU27	-	-	-
90	IQ01-24	-	-	-	-	201	IXUH20I	IXUH20I	VXUH20I	-	-
91	IQ01-27	-	-	-	-	202	IXUH22	IXUH22	VXUH22	-	-
92	IQ01-31	-	-	-	-	203	IXUH22I	IXUH22I	VXUH22I	-	-
93	IQ01-34	-	-	-	-	204	IY24	IY24	-	-	-
94	IQ02-24	-	-	-	-	205	IY27	IY27	-	-	-
95	IQ02-27	-	-	-	-	206	IY31	IY31	-	-	-
96	IQ02-31	-	-	-	-	207	J14CR-U	IW16	VW16	K16TT	IW16TT
97	IQ16	IQ16	VQ16	-	IQ16TT	208	J16AR-U11	-	-	-	-
98	IQ20	IQ20	VQ20	-	IQ20TT	209	J16A-U11	-	-	-	-
99	IQ22	IQ22	VQ22	-	-	210	J16AY	-	-	-	-
100	IQ24	IQ24	-	-	-	211	J16AYR	-	-	-	-
101	IQ27	IQ27	-	-	-	212	J16BR-U	-	-	-	-
102	IQ31	IQ31	-	-	-	213	J16BR-U11	-	-	-	-
103	IQ34	IQ34	-	-	-	214	J16B-U11	-	-	-	-
104	IRE01-27	-	-	-	-	215	J16CR-U	IW16	VW16	K16TT	IW16TT
105	IRE01-31	-	-	-	-	216	J16CR-U	IW16	VW16	K16TT	IW16TT
106	IRE01-32	-	-	-	-	217	K16DTR-S11	-	-	-	-
107	IRE01-34	-	-	-	-	218	K16GPR-U11	-	-	-	-
108	IRE01-35	-	-	-	-	219	K16HPR-U11	IKH16	VKH16	KH16TT	IKH16TT
109	IRL01-27	-	-	-	-	220	K16HR-U11	IKH16	VKH16	KH16TT	IKH16TT
110	IRL01-31	-	-	-	-	221	K16PR-L11	IK16	VK16	K16TT	IK16TT
111	IRT01-31	-	-	-	-	222	K16PR-P11	IK16	VK16	K16TT	IK16TT

AUSTRALIA CHINA INDIA INDONESIA KOREA MALAYSIA PHILIPPINES SAUDI ARABIA SINGAPORE TAIWAN THAILAND VIETNAM JAPAN EUROPE & USA CROSS REFERENCE PART NUMBER

	No.	DENSO	IRIDIUM POWER	IRIDIUM TOUGH/PLUS		IRIDIUM TT	No.	DENSO	IRIDIUM POWER	IRIDIUM TOUGH/PLUS		IRIDIUM TT
AUSTRALIA	223	K16PR-TP11	IK16	VK16	K16TT	IK16TT	334	PK20PR-P8	-	VK20Y	-	IK20TT
	224	K16PR-U	IK16	VK16	K16TT	IK16TT	335	PK20PTR-S9	IK20	VK20	-	IK20TT
	225	K16PR-U	IK16	VK16	K16TT	IK16TT	336	PK20R11	IK20	VK20	-	IK20TT
	226	K16PR-U11	-	VK20T	-	-	337	PK20R13	IK20	VK20	-	IK20TT
	227	K16PR-U11	IK16	VK16	K16TT	IK16TT	338	PK20R8	IK20	VK20T	-	IK20TT
	228	K16PR-JR	IK16	VK16	K16TT	IK16TT	339	PK20R8	IK20	VK20	-	IK20TT
	229	K16PSR-B8	IK16	VK16	K16TT	IK16TT	340	PK20R-P8	IK20	VK20	-	IK20TT
	230	K16P-U	IK16	VK16	K16TT	IK16TT	341	PK20TR11	IK20	VK20	-	IK20TT
	231	K16P-U11	IK16	VK16	K16TT	IK16TT	342	PK20TR11-G	IK20	VK20	-	IK20TT
	232	K16R-U	-	VK20T	-	-	343	PK20TR8-G	IK20	VK20	-	IK20TT
CHINA	233	K16R-U	-	VK20T	-	-	344	PK22PR11	IK22	VK22	-	-
	234	K16R-U	IK16	VK16	K16TT	IK16TT	345	PK22PR8	IK22	VK22	-	-
	235	K16R-U	IK16	VK16	K16TT	IK16TT	346	PK22PR-L11S	IK22G	VK22G	-	-
	236	K16R-U11	IK16	VK16	K16TT	IK16TT	347	PKJ16CR8	IK16	VK16	-	IK16TT
	237	K16TR11	IK16	VK16	K16TT	IK16TT	348	PKJ16CR-L11	IK16	VK16	-	IK16TT
	238	K16TT	-	-	K16TT	IK16TT	349	PKJ16CR-L13	IK16	VK16	-	IK16TT
	239	K16-U	IK16	VK16	K16TT	IK16TT	350	PKJ20CR8	IK20	VK20	-	IK20TT
	240	K16-U11	IK16	VK16	K16TT	IK16TT	351	PKJ20CR-L11	IK20G	VK20G	-	IK20TT
	241	K20BR-S10	IK20	VK20	K20TT	IK20TT	352	PKJ20CR-L11	IK20	VK20	-	IK20TT
	242	K20DTR-S11	-	-	-	-	353	PKJ20CR-M11	IK20	VK20	-	IK20TT
INDIA	243	K20HR-U11	IKH20	VKH20	K20TT	IKH20TT	354	PQ16R	IQ16	VQ16	-	IQ16TT
	244	K20PBR	IK20	VK20	K20TT	IK20TT	355	PQ16R13	IQ16	VQ16	-	IQ16TT
	245	K20PBR-S 10	IK20	VK20	K20TT	IK20TT	356	PQ16R8	IQ16	VQ16	-	IQ16TT
	246	K20PR-L11	IK20	VK20	K20TT	IK20TT	357	PQ16R-P11	IQ16	VQ16	-	IQ16TT
	247	K20PR-SU9	IK20	VK20	K20TT	IK20TT	358	PQ20R	IQ20	VQ20	-	IQ20TT
	248	K20PR-TP11	IK20	VK20	K20TT	IK20TT	359	PQ20R13	IQ20	VQ20	-	IQ20TT
	249	K20PR-U	-	VK20T	-	IK20TT	360	PQ20R8	IQ20	VQ20	-	IQ20TT
	250	K20PR-U	-	VK20Y	-	IK20TT	361	PQ20R-P11	IQ20	VQ20	-	IQ20TT
	251	K20PR-U	-	VK20T	-	IK20TT	362	PQ20R-P8	IQ20	VQ20	-	IQ20TT
	252	K20PR-U	-	VK20Y	-	IK20TT	363	PT16EPR10	IT16	VT16	-	IT16TT
INDONESIA	253	K20PR-U	IK20	VK20	K20TT	IK20TT	364	PT16EPR13	IT16	VT16	-	IT16TT
	254	K20PR-U	IK20	VK20	K20TT	IK20TT	365	PT16EPR-L13	IT16	VT16	-	IT16TT
	255	K20PR-U11	IK20	VK20	K20TT	IK20TT	366	PT16VR10	ITV16	-	-	ITV16TT
	256	K20PR-U11	IK20	VK20	K20TT	IK20TT	367	PT16VR13	ITV16	-	-	ITV16TT
	257	K20PR-U8S	IK20G	VK20G	-	IK20TT	368	PTJ14R15	IT16	VT16	-	IT16TT
	258	K20PR-U9S	IK20G	VK20G	-	IK20TT	369	PTJ16R15	IT16	VT16	-	IT16TT
	259	K20PR-JR	IK20	VK20	K20TT	IK20TT	370	Q14R-U11	IQ16	VQ16	Q16TT	IQ16TT
	260	K20PSR-B8	IK20	VK20	K20TT	IK20TT	371	Q16PR-TP11	IQ16	VQ16	Q16TT	IQ16TT
	261	K20P-U	IK20	VK20	K20TT	IK20TT	372	Q16PR-U	IQ16	VQ16	Q16TT	IQ16TT
	262	K20R-U	IK20	VK20	K20TT	IK20TT	373	Q16PR-U	IQ16	VQ16	Q16TT	IQ16TT
MALAYSIA	263	K20R-U11	IK20	VK20	K20TT	IK20TT	374	Q16PR-U11	IQ16	VQ16	Q16TT	IQ16TT
	264	K20TNR	IK20	VK20	K20TT	IK20TT	375	Q16PR-U11	IQ16	VQ16	Q16TT	IQ16TT
	265	K20TR11	IK20	VK20	K20TT	IK20TT	376	Q16PR-U15	IQ16	VQ16	Q16TT	IQ16TT
	266	K20TT	-	-	K20TT	IK20TT	377	Q16P-U11	IQ16	VQ16	Q16TT	IQ16TT
	267	K20TXR	IK20	VK20	K20TT	IK20TT	378	Q16P-U11	IQ16	VQ16	Q16TT	IQ16TT
	268	K20-U	IK20	VK20	K20TT	IK20TT	379	Q16R-U	IQ16	VQ16	Q16TT	IQ16TT
	269	K20-U11	IK20	VK20	K20TT	IK20TT	380	Q16R-U11	IQ16	VQ16	Q16TT	IQ16TT
	270	K22PB	IK22	VK22	-	-	381	Q16-U	IQ16	VQ16	Q16TT	IQ16TT
	271	K22PBR-S	IK22	VK22	-	-	382	Q16-U11	IQ16	VQ16	Q16TT	IQ16TT
	272	K22PR-L11	IK22	VK22	-	-	383	Q20PR-U	IQ20	VQ20	Q20TT	IQ20TT
PHILIPPINES	273	K22PR-U	IK22	VK22	-	-	384	Q20PR-U	IQ20	VQ20	Q20TT	IQ20TT
	274	K22PR-U11	IK22	VK22	-	-	385	Q20PR-U11	IQ20	VQ20	Q20TT	IQ20TT
	275	K22PR-UR	IK22	VK22	-	-	386	Q20PR-U11	IQ20	VQ20	Q20TT	IQ20TT
	276	K22TM11	IK22	VK22	-	-	387	Q20P-U	IQ20	VQ20	Q20TT	IQ20TT
	277	K22TMR11	IK22	VK22	-	-	388	Q20P-U11	IQ20	VQ20	Q20TT	IQ20TT
	278	K22TNR-S	IK22	VK22	-	-	389	Q20P-U11	IQ20	VQ20	Q20TT	IQ20TT
	279	K24PR-U11	IK24	-	-	-	390	Q20R-U	IQ20	VQ20	Q20TT	IQ20TT
	280	KJ14CR11	IK16	VK16	K16TT	IK16TT	391	Q20R-U11	IQ20	VQ20	Q20TT	IQ20TT
	281	KJ14CR-L11	IK16	VK16	K16TT	IK16TT	392	Q20-U	IQ20	VQ20	Q20TT	IQ20TT
	282	KJ16CR	IK16	VK16	K16TT	IK16TT	393	Q20-U11	IQ20	VQ20	Q20TT	IQ20TT
SAUDI ARABIA	283	KJ16CR11	-	VK20T	-	IK16TT	394	Q22PR-U	IQ22	VQ22	-	-
	284	KJ16CR11	IK16	VK16	K16TT	IK16TT	395	Q22PR-U11	IQ22	VQ22	-	-
	285	KJ16CR-L11	IK16	VK16	K16TT	IK16TT	396	Q22PR-U11	IQ22	VQ22	-	-
	286	KJ16CR-U11(*)	IK16	VK16	K16TT	IK16TT	397	Q22P-U	IQ22	VQ22	-	-
	287	KJ20CR11	IK20	VK20	K20TT	IK20TT	398	QJ14C11	IQ16	VQ16	Q16TT	IQ16TT
	288	KJ20CR-L11	IK20	VK20	K20TT	IK20TT	399	QJ16AR-U	-	-	-	-
	289	KJ20CR-U11(*)	IK20	VK20	K20TT	IK20TT	400	QJ16AR-U11	-	-	-	-
	290	KJ20DR-M11	IK20	VK20	K20TT	IK20TT	401	QJ16CR11	IQ16	VQ16	Q16TT	IQ16TT
	291	KJ20SR11	IK20	VK20	K20TT	IK20TT	402	QJ16HR-U	-	-	-	-
	292	KJ22CR-L11	IK22	VK22	-	-	403	QJ20CR11	IQ20	VQ20	Q20TT	IQ20TT
SINGAPORE	293	KJ22CR-L8	IK22	VK22	-	-	404	QL20PR-U	-	-	-	-
	294	L14-U	-	-	-	-	405	QL20TR-S	-	-	-	-
	295	LP20R-U	-	VW20T	-	IW20TT	406	QL22TR-S	-	-	-	-
	296	LP20-U	-	VW20T	-	IW20TT	407	RU01-27	-	-	-	-
	297	M14	-	-	-	-	408	RU01-31	-	-	-	-
	298	M17	-	-	-	-	409	RU01-34	-	-	-	-
	299	M22	-	-	-	-	410	S20R8-G	-	VW20T	-	IW20TT
	300	M24S	-	-	-	-	411	S22PR-A7	IW22	VW22	-	-
	301	MA16PR-U	-	-	-	-	412	S-29	-	-	-	-
	302	MA16PR-U11	-	-	-	-	413	S-29A	-	-	-	-
TAIWAN	303	MA20PR-U	-	-	-	-	414	S-31A	-	-	-	-
	304	MA20P-U	-	-	-	-	415	SC20HR11	-	VCH20	-	IXEH22TT
	305	MA9P-U	-	-	-	-	416	SF-24	-	-	-	-
	306	MW17	-	-	-	-	417	SF-50	-	-	-	-
	307	N24EXRB	IU24/IU24A	-	-	-	418	SF-51	-	-	-	-
	308	P16PR11	IW16	VW16	-	IW16TT	419	SK16HR11	IKH16	VKH16	-	IKH16TT
	309	P16PR8	IW16	VW16	-	IW16TT	420	SK16PR-A11	IK16	VK16	-	IK16TT
	310	P16R	-	VW20T	-	IW20TT	421	SK16PR-E11	IK16	VK16	-	IK16TT
	311	P16R	IW16	VW16	-	IW16TT	422	SK16PR-F8	IK16	VK16	-	IK16TT
	312	P16R13	IW16	VW16	-	IW16TT	423	SK16PR-L11	IK16	VK16	-	IK16TT
THAILAND	313	P16R8	IW16	VW16	-	IW16TT	424	SK16R11	IK16	VK16	-	IK16TT
	314	P20PR11	IW20	VW20	-	IW20TT	425	SK16R8-PG	IK16	VK20T	-	IK20TT
	315	P20PR8	IW20	VW20	-	IW20TT	426	SK16R-P11	IK16	VK16	-	IK16TT
	316	P20PR-S11	IW20	VW20	-	IW20TT	427	SK16R-P8	IK16	VK16	-	IK16TT
	317	P20R11	IW20	VW20	-	IW20TT	428	SK20BGR11	-	VKA20	-	-
	318	P20R8	-	VW20T	-	IW20TT	429	SK20BR11(For EU)	-	VKB20	-	-
	319	P20R8	IW20	VW20	-	IW20TT	430	SK20BR11(For Japan)	-	VKB20	-	-
	320	P22PR8	IW22	VW22	-	IW20TT	431	SK20HPR-L11	IKH20	VKH20	-	IKH20TT
	321	PK16PR11	IK16	VK16	-	IK16TT	432	SK20HR11	IKH20	VKH20	-	IKH20TT
	322	PK16PR-L11	IK16G	VK16G	-	IK16TT	433	SK20HR-GT8	-	-	-	-
VIETNAM	323	PK16PR-L11	IK16	VK16	-	IK16TT	434	SK20HR8-T	-	VKH20T	-	-
	324	PK16PR-P11	IK16	VK16	-	IK16TT	435	SK20PR-A11	IK20	VK20	-	IK20TT
	325	PK16R11	IK16	VK16	-	IK16TT	436	SK20PR-A8	IK20	VK20	-	IK20TT
	326	PK16R8	IK16	VK16	-	IK16TT	437	SK20PR-B8	IK20	VK20	-	IK20TT
	327	PK16TR11	IK16	VK16	-	IK16TT	438	SK20PR-F8	IK20	VK20	-	IK20TT
	328	PK16TR13	IK16	VK16	-	IK16TT	439	SK20PR-L11	IK20	VK20	-	IK20TT
	329	PK20GR8	-	VKA20	-	-	440	SK20PR-L9	IK20	VK20	-	IK20TT
	330	PK20PR11	IK20	VK20	-	IK20TT	441	SK20PR-N9	IK20	VK20	-	IK20TT
	331	PK20PR-L11	IK20	VK20	-	IK20TT	442	SK20PR-N9S	IK20G	VK20G	-	IK20TT
	332	PK20PR-L13	IK20	VK20	-	IK20TT	443	SK20R11	IK20	VK20	-	IK20TT
JAPAN	333	PK20PR-P11	IK20	VK20	-	IK20TT	444	SK20R5	-	-	-	-



(\*) MITSUBISHI lean burn excluded.

DENSO → IRIIDIUM POWER, TOUGH, PLUS, T, T

No.	DENSO	IRIDIUM POWER	IRIDIUM TOUGH/PLUS	T	IRIDIUM T	No.	DENSO	IRIDIUM POWER	IRIDIUM TOUGH/PLUS	T	IRIDIUM T
445	SK20R5G	-	-	-	-	556	VFCH16	-	-	-	-
446	SK20R8	-	VK20Y	-	IK20TT	557	VFK16	-	-	-	IK16TT
447	SK20R8G	-	VK20T	-	-	558	VFK20F	-	-	-	IK20TT
448	SK20R-B5	-	-	-	-	559	VFKB16	-	-	-	-
449	SK20R-P11	IK20	VK20	-	IK20TT	560	VFKBH20	-	-	-	IKBH20TT
450	SK20R-P13	IK20	VK20	-	IK20TT	561	VFKH16	-	-	-	-
451	SK22PR-M11	IK22	VK22	-	-	562	VFKH20	-	-	-	IKH20TT
452	SK22PR-M11S	IK22G	VK22G	-	-	563	VFXEH20	-	-	-	IXEH20TT
453	SKJ16CR-A8	IK16	VK16	-	IK16TT	564	VFXEH20E	-	-	-	IXEH20ETT
454	SKJ16CR-L11	IK16	VK16	-	IK16TT	565	VFXEH22	-	-	-	IXEH22TT
455	SKJ16DR-M11	IK16	VK16	-	IK16TT	566	VFXEHC22G	-	-	-	-
456	SKJ20CR-A8	IK20	VK20	-	IK20TT	567	VFXUHC22FG	-	-	-	-
457	SKJ20DR-M11	IK20	VK20	-	IK20TT	568	VK16	IK16	-	-	IK16TT
458	SKJ20DR-M11S	IK20G	VK20G	-	IK20TT	569	VK16G	IK16G	-	-	IK16TT
459	SKJ20DR-M11S	IK20G	VK20G	-	IK20TT	570	VK16PRZ11	IK16	-	-	IK16TT
460	SKJ20DR-M13	IK20	VK20	-	IK20TT	571	VK20	IK20	-	-	IK20TT
461	SKJ20DR-M13	IK20	VK20	-	IK20TT	572	VK20G	IK20G	-	-	IK20TT
462	SVK20RZ11	IK20	VK20	-	IK20TT	573	VK20PRZ11	IK20	-	-	IK20TT
463	SVK20RZ8	-	VK20Y	-	IK20TT	574	VK20T	-	-	-	IK20TT
464	SXE22HQR11S	-	-	-	-	575	VK22	IK22	-	-	-
465	SXU16HPR9	-	-	-	-	576	VK22G	IK22G	-	-	-
466	SXU22HCR8S	-	VXUHC22G	-	-	577	VK22PRZ11	IK22	-	-	-
467	SXU22HCR11	-	VXUHC22G	-	-	578	VK24PRZ11	IK24	-	-	-
468	SXU22HCR11S	-	VXUHC22G	-	-	579	VK27PRZ11	IK27	-	-	-
469	SXU22HDR8	IXUH22	VXUH22	-	-	580	VKA16	-	-	-	-
470	SXU22HPR8	IXUH22I	VXUH22I	-	-	581	VKA20	-	-	-	-
471	SXU22HPR11	IXUH22I	VXUH22I	-	-	582	VKB16	-	-	-	-
472	SXU22HPR9	IXUH22I	VXUH22I	-	-	583	VKB20	-	-	-	-
473	SXU22PR9	IXU22	VXU22	-	-	584	VKH16	IKH16	-	-	IKH16TT
474	SXU22PR-A9	IXU22	VXU22	-	-	585	VKH20	IKH20	-	-	IKH20TT
475	T14PR-U	ITF16	-	-	ITF16TT	586	VKH20T	-	-	-	IKH20TT
476	T14PR-U15	ITF16	-	-	ITF16TT	587	VKH20Y	-	-	-	IKH20TT
477	T16EPR-U	IT16	VT16	T16TT	IT16TT	588	VKH22	IKH22	-	-	-
478	T16EPR-U15	IT16	VT16	T16TT	IT16TT	589	VKJ20RZ-M11	-	-	-	-
479	T16NR-U11	IT16	VT16	T16TT	IT16TT	590	VNH24Z	-	-	-	-
480	T16PR-U	ITF16	-	-	ITF16TT	591	VNH27Z	-	-	-	-
481	T16PR-U11	ITF16	-	-	ITF16TT	592	VQ16	IQ16	-	-	IQ16TT
482	T16PR-U15	ITF16	-	-	ITF16TT	593	VQ20	IQ20	-	-	IQ20TT
483	T16P-U	ITF16	-	-	ITF16TT	594	VQ22	IQ22	-	-	-
484	T16R-U	-	-	-	-	595	VSUEH22	-	-	-	-
485	T16R-U15	-	-	-	-	596	VT16	IT16	-	-	IT16TT
486	T16-U15	-	-	-	-	597	VT20	IT20	-	-	IT20TT
487	T16VR-U10	ITV16	-	TV16TT	ITV16TT	598	VUH24D	IUH24	-	-	-
488	T20EPR-U	IT20	VT20	T20TT	IT20TT	599	VUH27D	IUH27	-	-	-
489	T20EPR-U15	IT20	VT20	T20TT	IT20TT	600	VUH24ES	IUH24	-	-	-
490	T20EP-U	IT20	VT20	T20TT	IT20TT	601	VUH27ES	IUH27	-	-	-
491	T20EP-U15	IT20	VT20	T20TT	IT20TT	602	VW16	IW16	-	-	IW16TT
492	T20MP-U	-	-	-	-	603	VW16R-A13	IW16	VW16	-	IW16TT
493	T20M-U	-	-	-	-	604	VW20	IW20	VW20	-	IW20TT
494	T20NR-U11	IT20	VT20	T20TT	IT20TT	605	VW20T	-	VW20T	-	IW20TT
495	T20PR-U	ITF20	-	-	ITF20TT	606	VW22	IW22	VW22	-	-
496	T20PR-U11	ITF20	-	-	ITF20TT	607	VX22BC	IX22B	-	-	-
497	T20PR-U15	ITF20	-	-	ITF20TT	608	VXEBH27	-	VXEBH27	-	-
498	T20P-U	ITF20	-	-	ITF20TT	609	VXEHC24G	-	VXEHC24G	-	-
499	T20R-U	-	-	-	-	610	VXU20	-	VXU20	-	-
500	T22EP-U	IT22	-	-	-	611	VXU22	IXU22	VXU22	-	-
501	T22MP-U	-	-	-	-	612	VXU24	IXU24	VXU24	-	-
502	T22M-U	-	-	-	-	613	VXU22I	IXU22I	VXU22I	-	-
503	TJ14R-P15	IT16	VT16	T16TT	IT16TT	614	VXUH22	IXUH22	VXUH22	-	-
504	TR22-10	IWF22	-	-	-	615	VXUH20I	IXUH20I	VXUH20I	-	-
505	U14FSR-UB	IUF14-UB	-	-	-	616	VXUH22I	IXUH22I	VXUH22I	-	-
506	U14FS-UB	IUF14-UB	-	-	-	617	VXUHC22G	-	VXUHC22G	-	-
507	U16FER9	-	-	-	-	618	W14E	-	-	-	-
508	U16FSR-U	-	-	-	-	619	W14EKR-S11	-	-	-	-
509	U16FSR-UB	-	-	-	-	620	W14EPR-U	IW16	VW16	W16TT	IW16TT
510	U16FS-U	-	-	-	-	621	W14EP-U	IW16	VW16	W16TT	IW16TT
511	U16FS-UB	-	-	-	-	622	W14EXR-U	IW16	VW16	W16TT	IW16TT
512	U20EPR9	IU20	-	-	-	623	W14EXR-U11	IW16	VW16	W16TT	IW16TT
513	U20ESR-N	IU20	-	-	-	624	W14EXR-U13	IW16	VW16	W16TT	IW16TT
514	U20ESR-N	IU20	-	-	-	625	W14EX-U	IW16	VW16	W16TT	IW16TT
515	U20FSR-U	IUF22	-	-	-	626	W14EX-U	IW16	VW16	W16TT	IW16TT
516	U20FS-U	IUF22	-	-	-	627	W14EX-U11	IW16	VW16	W16TT	IW16TT
517	U22EPR9	IU22	-	-	-	628	W14FP-L	IWF16	-	-	-
518	U22EPR9	IU24A(High Speed)	-	-	-	629	W14FPR-U	IWF16	-	-	-
519	U22EPR9	IU24D(High Speed)	-	-	-	630	W14FPR-UL	IWF16	-	-	-
520	U22ES-N	IU22	-	-	-	631	W14FPR-UL10	IWF16	-	-	-
521	U22ESR-N	IU22	-	-	-	632	W14FP-U	IWF16	-	-	-
522	U22ESR-N	IU22	-	-	-	633	W14FP-UL	IWF16	-	-	-
523	U22ETR	-	-	-	-	634	W14FP-UL10	IWF16	-	-	-
524	U22ETR	-	-	-	-	635	W14FR-L	IWF16	-	-	-
525	U22FER9	-	-	-	-	636	W14FR-U	-	-	-	-
526	U22FSR-U	IUF22	-	-	-	637	W14F-U	-	-	-	-
527	U22FS-U	IUF22	-	-	-	638	W14F-U	-	-	-	-
528	U24EPR9	IU24A	-	-	-	639	W14L	-	-	-	-
529	U24ES-N	IU24	-	-	-	640	W14LM-U	-	-	-	-
530	U24ESR-N	IU24	-	-	-	641	W14LM-US	-	-	-	-
531	U24ESR-N	IU24	-	-	-	642	W14MPR-U10	-	-	-	-
532	U24ESR-NB	IU24	-	-	-	643	W14MP-U10	-	-	-	-
533	U24ETR	IU24A	-	-	-	644	W14MR-U	-	-	-	-
534	U24ETR	IU24A	-	-	-	645	W14M-U	-	-	-	-
535	U24FE9	IUH24	-	-	-	646	W14PR-U	-	-	-	-
536	U24FER9	IUH24	-	-	-	647	W14-U	-	-	-	-
537	U24FER9S	IUH24	-	-	-	648	W16DTR-S	-	-	-	-
538	U24FSR-U	IUF24	-	-	-	649	W16EKR-S11	IW16	VW16	W16TT	IW16TT
539	U24FS-U	IUF24	-	-	-	650	W16EP	IW16	VW16	W16TT	IW16TT
540	U27ES-N	IU27	-	-	-	651	W16EP11	IW16	VW16	W16TT	IW16TT
541	U27ESR-N	IU27	-	-	-	652	W16EPB 10	IW16	VW16	W16TT	IW16TT
542	U27ESR-N	IU27	-	-	-	653	W16EPR	IW16	VW16	W16TT	IW16TT
543	U27ESR-NB	IU27	-	-	-	654	W16EPR	IW16	VW16	W16TT	IW16TT
544	U27ETR	IU27A	-	-	-	655	W16EPR11	IW16	VW16	W16TT	IW16TT
545	U27ETR	IU27A	-	-	-	656	W16EPR-U	IW16	VW16	W16TT	IW16TT
546	U27FER9	IUH27	-	-	-	657	W16EPR-U	IW16	VW16	W16TT	IW16TT
547	U31ESR-N	IU31	-	-	-	658	W16EPR-U10	IW16	VW16	W16TT	IW16TT
548	U31ESR-N	IU31	-	-	-	659	W16EPR-U11	IW16	VW16	W16TT	IW16TT
549	U31ETR	IU31A	-	-	-	660	W16EP-U	IW16	VW16	W16TT	IW16TT
550	U31ETR	IU31A	-	-	-	661	W16EP-U11	IW16	VW16	W16TT	IW16TT
551	VCH20	-	VCH20	-	IXEH22TT	662	W16ESR-U	-	-	-	-
552	VCH16	-	VCH16	-	IXEH20TT	663	W16ES-U	-	-	-	-
553	VDCH22F	-	VDCH22F	-	-	664	W16ETR-S	IW16	VW16	W16TT	IW16TT
554	VDKH16T	-	VDKH16	-	-	665	W16ETR-S	IW16	VW16	W16TT	IW16TT
555	VDKH22F	-	VDKH22F	-	-	666	W16ET-S	IW16	VW16	W16TT	IW16TT

AUSTRALIA CHINA INDIA INDONESIA KOREA MALAYSIA PHILIPPINES SAUDI ARABIA SINGAPORE TAIWAN THAILAND VIETNAM JAPAN EUROPE & USA CROSS REFERENCE PART NUMBER

**DENSO → IRIIDIUM POWER, TOUGH, PLUS, , **

	No.	DENSO	IRIDIUM POWER	IRIDIUM TOUGH/PLUS		IRIDIUM IT	No.	DENSO	IRIDIUM POWER	IRIDIUM TOUGH/PLUS		IRIDIUM IT
AUSTRALIA	667	W16EXR-U	IW16	VW16	W16TT	IW16TT	778	W24EMR-C	IWM24	-	-	-
	668	W16EXR-U	IW16	VW16	W16TT	IW16TT	779	W24EP	IW24	-	-	-
	669	W16EXR-U11	IW16	VW16	W16TT	IW16TT	780	W24EPR	IW24	-	-	-
	670	W16EXR-U11	IW16	VW16	W16TT	IW16TT	781	W24EPR-U	IW24	-	-	-
	671	W16EXR-U13	IW16	VW16	W16TT	IW16TT	782	W24EP-U	IW24	-	-	-
	672	W16EX-U	IW16	VW16	W16TT	IW16TT	783	W24ESR	IW24	-	-	-
	673	W16EX-U	IW16	VW16	W16TT	IW16TT	784	W24ESR-U	IW24	-	-	-
	674	W16EX-U11	IW16	VW16	W16TT	IW16TT	785	W24ESR-V	IW24	-	-	-
	675	W16EX-U11	IW16	VW16	W16TT	IW16TT	786	W24ES-U	IW24	-	-	-
	676	W16EX-U13	IW16	VW16	W16TT	IW16TT	787	W24ES-V	IW24	-	-	-
CHINA	677	W16FPR-U	IWF16	-	-	-	788	W24FPR	IWF24	-	-	-
	678	W16FP-U	IWF16	-	-	-	789	W24FPR-U10	IWF24	-	-	-
	679	W16FP-U10	IWF16	-	-	-	790	W24FP-U	IWF24	-	-	-
	680	W16FSR	-	-	-	-	791	W24FR-L	IWF24	-	-	-
	681	W16FS-U	-	-	-	-	792	W24FSR	IWF24	-	-	-
	682	W16LS	-	-	-	-	793	W24FSR-U10	IWF24	-	-	-
	683	W16PR-U	-	-	-	-	794	W24FS-U	IWF24	-	-	-
	684	W16S-U	-	-	-	-	795	W24FS-U10	IWF24	-	-	-
	685	W16TT	-	-	W16TT	-	796	W24S-U	-	-	-	-
	686	W20DTR-S	-	-	-	-	797	W25EDR14	-	-	-	-
INDIA	687	W20DTR-SA	-	-	-	-	798	W27EBR	-	-	-	-
	688	W20EAR	-	-	-	-	799	W27EDR14	-	-	-	-
	689	W20EKR-S11	IW20	VW20	W20TT	IW20TT	800	W27EDR14	-	-	-	-
	690	W20EP	IW20	VW20	W20TT	IW20TT	801	W27EMR-C	IWM27	-	-	-
	691	W20EP11	-	VW20T	-	IW20TT	802	W27ESR	IW27	-	-	-
	692	W20EP11	IW20	VW20	W20TT	IW20TT	803	W27ESR-U	IW27	-	-	-
	693	W20EPB	IW20	VW20	W20TT	IW20TT	804	W27ESR-V	IW27	-	-	-
	694	W20EPBR-S	IW20	VW20	W20TT	IW20TT	805	W27ES-U	IW27	-	-	-
	695	W20EPR	IW20	VW20	W20TT	IW20TT	806	W27ES-V	IW27	-	-	-
	696	W20EPR11	IW20	VW20	W20TT	IW20TT	807	W27FSR	IWF27	-	-	-
INDONESIA	697	W20EPR-S11	IW20	VW20	W20TT	IW20TT	808	W27FSR-U10	IWF27	-	-	-
	698	W20EPR-U	IW20	VW20	W20TT	IW20TT	809	W27FS-U	IWF27	-	-	-
	699	W20EPR-U	IW20	VW20	W20TT	IW20TT	810	W27FS-U10	IWF27	-	-	-
	700	W20EPR-U10	IW20	VW20	W20TT	IW20TT	811	W27S-U	-	-	-	-
	701	W20EPR-U11	IW20	VW20	W20TT	IW20TT	812	W29EBR	-	-	-	-
	702	W20EP-S11	IW20	VW20	W20TT	IW20TT	813	W31ESR-U	IW31	-	-	-
	703	W20EP-U	IW20	VW20	W20TT	IW20TT	814	W31ES-U	IW31	-	-	-
	704	W20EP-U	IW20	VW20	W20TT	IW20TT	815	W31FS	-	-	-	-
	705	W20EP-U11	IW20	VW20	W20TT	IW20TT	816	W31S-U	-	-	-	-
	706	W20ESR-U	-	-	-	-	817	W9EP	-	-	-	-
KOREA	707	W20ES-U	-	-	-	-	818	W9EP	-	-	-	-
	708	W20ETR-L	IW20	VW20	W20TT	IW20TT	819	W9EXR-U	-	-	-	-
	709	W20ET-S	IW20	VW20	W20TT	IW20TT	820	W9EXR-U	-	-	-	-
	710	W20EXR-U	-	VW20T	-	IW20TT	821	W9EX-U	-	-	-	-
	711	W20EXR-U	-	VW20T	-	IW20TT	822	W9FP	-	-	-	-
	712	W20EXR-U	IW20	VW20	W20TT	IW20TT	823	W9FP	-	-	-	-
	713	W20EXR-U	IW20	VW20	W20TT	IW20TT	824	W9FP-UL	-	-	-	-
	714	W20EXR-U11	-	VW20T	-	IW20TT	825	W9LMR-US	-	-	-	-
	715	W20EXR-U11	-	VW20T	-	IW20TT	826	W9LM-US	-	-	-	-
	716	W20EXR-U11	IW20	VW20	W20TT	IW20TT	827	W9PR-U	-	-	-	-
MALAYSIA	717	W20EXR-U11	IW20	VW20	W20TT	IW20TT	828	W9P-U	-	-	-	-
	718	W20EXR-U13	IW20	VW20	W20TT	IW20TT	829	W9-U	-	-	-	-
	719	W20EX-U	-	VW20T	-	IW20TT	830	X16EPR-U9	-	-	-	-
	720	W20EX-U	-	VW20T	-	IW20TT	831	X16FSR-U	-	-	-	-
	721	W20EX-U	IW20	VW20	W20TT	IW20TT	832	X20EPR-U9	-	-	-	-
	722	W20EX-U	IW20	VW20	W20TT	IW20TT	833	X20ESR-U	-	-	-	-
	723	W20EX-U11	IW20	VW20	W20TT	IW20TT	834	X20ES-U	-	-	-	-
	724	W20EX-U11	IW20	VW20	W20TT	IW20TT	835	X20FSR-U	-	-	-	-
	725	W20EX-U13	IW20	VW20	W20TT	IW20TT	836	X20FS-U	-	-	-	-
	726	W20FP	IWF20	-	WF20TT	-	837	X22EPR-U9	IX22B	-	-	-
PHILIPPINES	727	W20FP-L	IWF20	-	WF20TT	-	838	X22EP-U9	IX22B	-	-	-
	728	W20FPR	IWF20	-	WF20TT	-	839	X22ESR-U	IX22	-	-	-
	729	W20FPR-U	IWF20	-	WF20TT	-	840	X22ESR-UB	IX22	-	-	-
	730	W20FPR-U10	IWF20	-	WF20TT	-	841	X22ES-U	IX22	-	-	-
	731	W20FP-U	IWF20	-	WF20TT	-	842	X24EPR-U9	IX24B	-	-	-
	732	W20FP-U10	IWF20	-	WF20TT	-	843	X24EP-U9	IX24B	-	-	-
	733	W20FR-L	IWF20	-	WF20TT	-	844	X24ESR-U	IX24	-	-	-
	734	W20FR-L9	IWF20	-	WF20TT	-	845	X24ES-U	IX24	-	-	-
	735	W20FS	IWF22	-	-	-	846	X24FS-U	-	-	-	-
	736	W20FSR	IWF22	-	-	-	847	X24GPR-U	IXG24	-	-	-
SAUDIARABIA	737	W20FSR-U	IWF22	-	-	-	848	X24GP-U	IXG24	-	-	-
	738	W20FS-U	IWF22	-	-	-	849	X27EPR-U9	IX27B	-	-	-
	739	W20MPR-U10	-	-	-	-	850	X27EP-U9	IX27B	-	-	-
	740	W20MP-U	-	-	-	-	851	X27ESR-U	IX27	-	-	-
	741	W20MP-U10	-	-	-	-	852	X27ES-U	IX27	-	-	-
	742	W20MR-U	-	-	-	-	853	X27ETR	IX27	-	-	-
	743	W20M-U	-	-	-	-	854	X27GPR-U	IXG27	-	-	-
	744	W20M-US	-	-	-	-	855	X31ESR-U	-	-	-	-
	745	W20PR-U	-	-	-	-	856	X31ES-U	-	-	-	-
	746	W20P-U	-	-	-	-	857	X31ETR	-	-	-	-
SINGAPORE	747	W20SR-U	-	-	-	-	858	XE20HR-U9	-	VFXEH20	-	IXEH20TT
	748	W20S-U	-	-	-	-	859	XU20EPR-U	IXU22	VXU22	-	-
	749	W22EBR	-	-	-	-	860	XU20HR9	IXUH20I	VXUH20I	XUH20TTI	-
	750	W22EKR-S11	IW22	VW22	W22TT	-	861	XU22EP-P	IXU22	VXU22	-	-
	751	W22EP	IW22	VW22	W22TT	-	862	XU22EPR-U	IXU22	VXU22	-	-
	752	W22EP	IW22	VW22	W22TT	-	863	XU22EP-U	IXU22	VXU22	-	-
	753	W22EPB	IW22	VW22	W22TT	-	864	XU22HDR9	IXUH22	VXUH22	-	-
	754	W22EPR	IW22	VW22	W22TT	-	865	XU22HR9	IXUH22I	VXUH22I	-	-
	755	W22EPR11	IW22	VW22	W22TT	-	866	XU22PR9	IXU22	VXU22	-	-
	756	W22EPR-U	IW22	VW22	W22TT	-	867	XU22TT	-	-	-	-
TAIWAN	757	W22EPR-U	IW22	VW22	W22TT	-	868	XU24EPR-U	-	VXU24	-	-
	758	W22EPR-U11	IW22	VW22	W22TT	-	869	XU24EPR-U	IXU24	VXU24	-	-
	759	W22EP-S11	IW22	VW22	W22TT	-	870	XU24EP-U	IXU24	VXU24	-	-
	760	W22EP-U	IW22	VW22	W22TT	-	871	XU27EPR-U	IXU27	-	-	-
	761	W22EP-U11	IW22	VW22	W22TT	-	872	XUH20TTI	IXUH20I	VXUH20I	-	-
	762	W22ESR	-	-	-	-	873	XUH22TT	IXU22	VXU22	-	-
	763	W22ESR-U	-	-	-	-	874	Y24FER-C	IY24	-	-	-
	764	W22ES-U	-	-	-	-	875	Y27FER-C	IY27	-	-	-
	765	W22ETR-L	IW22	VW22	-	-	876	Y31FER-C	IY31	-	-	-
	766	W22ETR-L8	IW22	VW22	-	-	877	ZC20HPR11	-	VCH20	-	IXEH22TT
THAILAND	767	W22FPR	IWF22	-	-	-	878	ZK20HQR8	-	VKH20Y	-	IKH20TT
	768	W22FPR-U	IWF22	-	-	-	879	ZT20EPR11	IT20	VT20	-	IT20TT
	769	W22FP-U	IWF22	-	-	-	880	ZTJ16R10	IT20	VT20	-	IT20TT
	770	W22FP-U10	IWF22	-	-	-	881	ZTJ16VR10	ITV16	-	-	ITV16TT
	771	W22FSR	IWF22	-	-	-	882	ZXE20HR13(AM)	-	VFXEH20	-	IXEH20TT
	772	W22FS-U	IWF22	-	-	-	883	ZXE20HR13(OE)	-	VFXEH20	-	IXEH20TT
	773	W22FS-U10	IWF22	-	-	-	884	ZXE27HBR8	-	VXEBH27	-	-
	774	W22MPR-U	-	-	-	-	885	ZXU20HCR8	-	-	-	-
	775	W22MP-U	-	-	-	-	886	ZXU20PR11	-	VXU20	-	-
	776	W22M-U	-	-	-	-	887	ZXU22HBR11	-	-	-	-
777	W22S-U	-	-	-	-	-	-	-	-	-	-	



DENSO, PART No., SPECIFICATIONS, LIST (  ⇒ 0677009760 )

No	DENSO	PART NUMBER	SPEC.	GROUND/E.	NUT
1	·K20PTR-S	067700-9760	2-Ground electrodes surface discharge Nickel plug	Nickel	S
2	·PK20R11	067700-8880	Platinum plug	Platinum	S
3	·PQ20R-P11	067700-3992	Platinum plug	Platinum	S
4	·SK16PR-A11	267700-0870	Iridium plug	Platinum	S
5	·SK16R-P11	067700-8860	Iridium plug	Platinum	S
6	·SK20R-P11	067700-3150	Iridium plug	Platinum	S
7	·W16EPR-U	267700-4570	Nickel plug	Nickel	T
8	·XU22EPR-U	067700-8870	Nickel plug	Nickel	S
9	DK16R-B5	267700-8580	Double needle Iridium plug	Needle	S
10	DK20PR-D13	267700-7390	Double needle Iridium plug	Needle	S
11	DXE22HCR11S	267700-8320	Double needle Iridium plug w/t SUS Gasket	Needle	S
12	DXE22HQR-D11S	267700-7800	Double needle Iridium plug w/t SUS Gasket	Needle	S
13	DXU22HCR-D11S	267700-7580	Double needle Iridium plug w/t SUS Gasket	Needle	S
14	FC16HR8	267700-8180	Double needle Iridium plug	Needle	S
15	FC16HR-C9	267700-8620	Double needle Iridium plug	Needle	S
16	FC16HR-CY9	267700-8970	Double needle Iridium plug	Needle	S
17	FC16HR-GQ8	267700-8810	Double needle Iridium plug w/t Grease	Needle	S
18	FC16HR-Q8	267700-8780	Double needle Iridium plug	Needle	S
19	FC20HPR8	267700-7710	Double needle Iridium plug	Needle	S
20	FC20HR-BG9	267700-8360	Double needle Iridium plug w/t Grease	Needle	S
21	FC20HR-G8	267700-8730	Double needle Iridium plug w/t Grease	Needle	S
22	FC20HR-GQ8	267700-8870	Double needle Iridium plug w/t Grease	Needle	S
23	FC20HR-Q8	267700-8690	Double needle Iridium plug	Needle	S
24	FC22HR9	267700-7400	Double needle Iridium plug	Needle	S
25	FC22HR9-G	267700-7620	Double needle Iridium plug w/t Grease	Needle	S
26	FK16BR-AL8	267700-8560	3-Ground electrodes double needle Iridium plug	Needle	S
27	FK16HBR-J8	267700-8590	3-Ground electrodes double needle Iridium plug	Needle	S
28	FK16HQR11	267700-5920	Double needle Iridium plug	Needle	S
29	FK16HR11	267700-7140	Double needle Iridium plug	Needle	S
30	FK16HR-A8	267700-7700	Double needle Iridium plug	Needle	S
31	FK16R11	267700-5290	Double needle Iridium plug	Needle	S
32	FK16R-A8	267700-7780	Double needle Iridium plug	Needle	S
33	FK16R-AL8	267700-8340	Double needle Iridium plug	Needle	S
34	FK20HBR11	267700-4200	3-Ground electrodes double needle Iridium plug	Needle	S
35	FK20HBR11-T	267700-7180	3-Ground electrodes double needle Iridium plug	Needle	S
36	FK20HBR8	267700-7770	3-Ground electrodes double needle Iridium plug	Needle	S
37	FK20HQR10	067800-7860	Double needle Iridium plug	Needle	S
38	FK20HQR10	267700-7340	Double needle Iridium plug	Needle	S
39	FK20HQR8	067800-7920	Double needle Iridium plug	Needle	S
40	FK20HQR8	267700-7190	Double needle Iridium plug	Needle	S
41	FK20HR11	267700-4230	Double needle Iridium plug	Needle	S
42	FK20HR11-G	267700-7600	Double needle Iridium plug w/t Grease	Needle	S
43	FK20HR8-G	267700-7570	Double needle Iridium plug w/t Grease	Needle	S
44	FXE16HE11·	267700-4950	Double needle Iridium plug	Needle	S
45	FXE20HE11·(AM)	267700-5480	Double needle Iridium plug	Needle	S
46	FXE20HE11·(OE)	267700-7310	Double needle Iridium plug	Needle	S
47	FXE20HE11C	267700-7720	Double needle Iridium plug	Needle	S
48	FXE20HE11C	267700-7730	Double needle Iridium plug	Needle	S
49	FXE20HR11·(AM)	267700-4880	Double needle Iridium plug	Needle	S
50	FXE20HR11·(OE)	267700-7300	Double needle Iridium plug	Needle	S
51	FXE20HR11·(OE)	267700-7320	Double needle Iridium plug	Needle	S
52	FXE22HR11·(AM)	267700-5830	Double needle Iridium plug	Needle	S
53	FXE22HR11·(OE)	267700-7290	Double needle Iridium plug	Needle	S
54	FXE24HR11·(AM)	267700-6970	Double needle Iridium plug	Needle	S
55	FXE24HR11·(OE)	267700-7280	Double needle Iridium plug	Needle	S
56	FXU16HR11	267700-7260	Double needle Iridium plug	Needle	S
57	FXU22HR11	267700-7520	Double needle Iridium plug	Needle	S
58	FXU22HR8	267700-7560	Double needle Iridium plug	Needle	S
59	GE3-F	067800-9250	Iridium plug	Platinum	S
60	GX8-1·	267700-5590	Iridium plug	Platinum	S
61	IA01-31	267700-1261	Iridium plug	Platinum	S
62	IA01-32	267700-1271	Iridium plug	Platinum	S
63	IA01-34	267700-1281	Iridium plug	Platinum	S
64	IAE01-32	267700-2941	Iridium plug	Platinum	S
65	IAE01-34	267700-2951	Iridium plug	Platinum	S
66	IK01-24	267700-1311	Iridium plug	Platinum	S
67	IK01-27	267700-1321	Iridium plug	Platinum	S
68	IK01-31	267700-1331	Iridium plug	Platinum	S
69	IK01-34	267700-1341	Iridium plug	Platinum	S
70	IK02-24	267700-1361	Iridium plug	Platinum	S
71	IK02-27	267700-1371	Iridium plug	Platinum	S
72	IK02-31	267700-1381	Iridium plug	Platinum	S
73	IK16	067700-8681	Iridium plug	Nickel	S
74	IK16G	267700-5611	Iridium plug w/t SUS Gasket	Nickel	S
75	IK16TT	267700-8450	Iridium TT plug	Needle	S
76	IK20	067700-8691	Iridium plug	Nickel	S
77	IK20G	267700-5621	Iridium plug w/t SUS Gasket	Nickel	S
78	IK20TT	267700-8530	Iridium TT plug	Needle	S
79	IK22	067700-8431	Iridium plug	Nickel	S
80	IK22G	267700-5661	Iridium plug w/t SUS Gasket	Nickel	S
81	IK24	067700-8461	Iridium plug	Nickel	S
82	IK24C11	067700-9550	Iridium plug	Nickel	S
83	IK27	067700-8472	Iridium plug	Nickel	S
84	IK27C11	067700-9520	Iridium plug	Nickel	S
85	IK31	067700-9221	Iridium plug	Nickel	S
86	IK34	067700-9591	Iridium plug	Nickel	S

AUSTRALIA  
CHINA  
INDIA  
INDONESIA  
KOREA  
MALAYSIA  
PHILIPPINES  
SAUDIARABIA  
SINGAPORE  
TAIWAN  
THAILAND  
VIETNAM  
JAPAN  
EUROPE & USA  
CROSS REFERENCE  
PART NUMBER

S: SOLID; R: REMOVABLE; RC: CRIMPED; T: THREAD

	No	DENSO	PART NUMBER	SPEC.	GROUND/E.	NUT
AUSTRALIA	87	IKBH20TT	267700-8480	3-Ground electrodes Iridium TT plug	Needle	S
	88	IKH01-24	267700-4451	Iridium plug	Platinum	S
	89	IKH01-27	267700-4461	Iridium plug	Platinum	S
CHINA	90	IKH01-31	267700-4471	Iridium plug	Platinum	S
	91	IKH16	267700-3661	Iridium plug	Nickel	S
	92	IKH16TT	267700-8460	Iridium TT plug	Needle	S
INDIA	93	IKH20	267700-3671	Iridium plug	Nickel	S
	94	IKH20TT	267700-8470	Iridium TT plug	Needle	S
	95	IKH22	267700-2651	Iridium plug	Nickel	S
INDONESIA	96	IKH24	267700-4281	Iridium plug	Nickel	S
	97	IKH27	267700-4291	Iridium plug	Nickel	S
	98	IQ01-24	267700-1411	Iridium plug	Platinum	S
KOREA	99	IQ01-27	267700-1421	Iridium plug	Platinum	S
	100	IQ01-31	267700-1431	Iridium plug	Platinum	S
	101	IQ01-34	267700-1441	Iridium plug	Platinum	S
MALAYSIA	102	IQ02-24	267700-1461	Iridium plug	Platinum	S
	103	IQ02-27	267700-1471	Iridium plug	Platinum	S
	104	IQ02-31	267700-1481	Iridium plug	Platinum	S
PHILIPPINES	105	IQ16	067700-8701	Iridium plug	Nickel	S
	106	IQ16TT	267700-8190	Iridium TT plug	Needle	S
	107	IQ20	067700-8711	Iridium plug	Nickel	S
SAUDI ARABIA	108	IQ20TT	267700-8200	Iridium TT plug	Needle	S
	109	IQ22	067700-8481	Iridium plug	Nickel	S
	110	IQ24	067700-8491	Iridium plug	Nickel	S
SINGAPORE	111	IQ27	067700-8502	Iridium plug	Nickel	S
	112	IQ31	067700-9231	Iridium plug	Nickel	S
	113	IQ34	067700-9601	Iridium plug	Nickel	S
TAIWAN	114	IRE01-27	267700-1521	Iridium plug	Platinum	S
	115	IRE01-31	267700-1531	Iridium plug	Platinum	S
	116	IRE01-32	267700-1541	Iridium plug	Platinum	S
THAILAND	117	IRE01-34	267700-1551	Iridium plug	Platinum	S
	118	IRE01-35	267700-1561	Iridium plug	Platinum	S
	119	IRL01-27	267700-4821	Iridium plug	Platinum	S
VIETNAM	120	IRL01-31	267700-4831	Iridium plug	Platinum	S
	121	IRT01-31	267700-4841	Iridium plug	Platinum	S
	122	IRT01-34	267700-4851	Iridium plug	Platinum	S
JAPAN	123	IT16	267700-0611	Iridium plug	Nickel	S
	124	IT16TT	267700-8230	Iridium TT plug	Needle	S
	125	IT20	267700-0621	Iridium plug	Nickel	S
EUROPE & USA	126	IT20TT	267700-8520	Iridium TT plug	Needle	S
	127	IT22	267700-0631	Iridium plug	Nickel	S
	128	IT24	267700-0641	Iridium plug	Nickel	S
CROSS REFERENCE	129	IT27	267700-0651	Iridium plug	Nickel	S
	130	ITF16	267700-0661	Iridium plug	Nickel	S
	131	ITF16TT	267700-8260	Iridium TT plug	Needle	S
PART NUMBER	132	ITF16TT	267700-8270	Iridium TT plug	Needle	S
	133	ITF20	267700-0671	Iridium plug	Nickel	S
	134	ITF22	267700-0681	Iridium plug	Nickel	S
EUROPE & USA	135	ITF24	267700-0691	Iridium plug	Nickel	S
	136	ITF27	267700-0701	Iridium plug	Nickel	S
	137	ITL16	267700-4981	Iridium plug	Nickel	S
EUROPE & USA	138	ITL16TT	267700-8280	Iridium TT plug	Needle	S
	139	ITL20	267700-4991	Iridium plug	Nickel	S
	140	ITV16	267700-3701	Iridium plug	Nickel	S
EUROPE & USA	141	ITV16TT	267700-8240	Iridium TT plug	Needle	S
	142	ITV20	267700-3711	Iridium plug	Nickel	S
	143	ITV20TT	267700-8250	Iridium TT plug	Needle	S
EUROPE & USA	144	ITV22	267700-2501	Iridium plug	Nickel	S
	145	ITV24	267700-2511	Iridium plug	Nickel	S
	146	ITV27	267700-2521	Iridium plug	Nickel	S
EUROPE & USA	147	IU01-24	267700-1011	Iridium plug	Platinum	R
	148	IU01-27	267700-1021	Iridium plug	Platinum	R
	149	IU01-31	267700-1031	Iridium plug	Platinum	R
EUROPE & USA	150	IU01-34	267700-1041	Iridium plug	Platinum	R
	151	IU20	267700-5021	Iridium plug	Nickel	R
	152	IU22	067700-9262	Iridium plug	Nickel	R
EUROPE & USA	153	IU22D	267700-0830	Iridium plug	Nickel	T
	154	IU24	067700-9272	Iridium plug	Nickel	R
	155	IU24A	067700-9302	Iridium plug	Nickel	R
EUROPE & USA	156	IU24D	267700-0840	Iridium plug	Nickel	T
	157	IU27	067700-9282	Iridium plug	Nickel	R
	158	IU27A	067700-9312	Iridium plug	Nickel	R
EUROPE & USA	159	IU27D	267700-0850	Iridium plug	Nickel	T
	160	IU31	067700-9292	Iridium plug	Nickel	R
	161	IU31A	067700-9321	Iridium plug	Nickel	R
EUROPE & USA	162	IU31D	267700-0860	Iridium plug	Nickel	T
	163	IUF14-UB	267700-0540	Iridium plug	Nickel	S
	164	IUF22	067700-9481	Iridium plug	Nickel	R
EUROPE & USA	165	IUF24	067700-9491	Iridium plug	Nickel	R
	166	IUF27A	067700-9701	Iridium plug	Nickel	R
	167	IUF31A	067700-9711	Iridium plug	Nickel	R
EUROPE & USA	168	IUH24	067700-9331	Iridium plug	Nickel	R
	169	IUH24D	067700-9560	Iridium plug	Nickel	T
	170	IUH27	067700-9341	Iridium plug	Nickel	R
EUROPE & USA	171	IUH27D	067700-9570	Iridium plug	Nickel	T
	172	IW01-24	267700-1111	Iridium plug	Platinum	RC

S: SOLID; R: REMOVABLE; RC: CRIMPED; T: THREAD

DENSO, PART No., SPECIFICATIONS, LIST (  ⇒ 0677009760 )

No	DENSO	PART NUMBER	SPEC.	GROUND/E.	NUT
173	IW01-27	267700-1121	Iridium plug	Platinum	RC
174	IW01-29	267700-1131	Iridium plug	Platinum	RC
175	IW01-31	267700-1141	Iridium plug	Platinum	RC
176	IW01-32	267700-1151	Iridium plug	Platinum	RC
177	IW01-34	267700-1161	Iridium plug	Platinum	RC
178	IW06-27	067600-1811	Iridium plug	Platinum	S
179	IW06-31	067600-1821	Iridium plug	Platinum	S
180	IW06-34	067600-1831	Iridium plug	Platinum	S
181	IW16	067700-8651	Iridium plug	Nickel	RC
182	IW16TT	267700-8210	Iridium TT plug	Needle	S
183	IW20	067700-8661	Iridium plug	Nickel	RC
184	IW20TT	267700-8220	Iridium TT plug	Needle	S
185	IW22	067700-8671	Iridium plug	Nickel	RC
186	IW24	067700-8891	Iridium plug	Nickel	RC
187	IW27	067700-8901	Iridium plug	Nickel	RC
188	IW29	067700-8911	Iridium plug	Nickel	RC
189	IW31	067700-8921	Iridium plug	Nickel	RC
190	IW34	067700-8931	Iridium plug	Nickel	RC
191	IWF16	267700-5001	Iridium plug	Nickel	R
192	IWF20	267700-5011	Iridium plug	Nickel	R
193	IWF22	067700-9411	Iridium plug	Nickel	R
194	IWF24	067700-9421	Iridium plug	Nickel	R
195	IWF27	067700-9431	Iridium plug	Nickel	R
196	IWM01-29	267700-1211	Iridium plug	Platinum	S
197	IWM01-31	267700-1221	Iridium plug	Platinum	S
198	IWM01-32	267700-1231	Iridium plug	Platinum	S
199	IWM01-34	267700-1241	Iridium plug	Platinum	S
200	IWM24	267700-2891	Iridium plug	Nickel	S
201	IWM27	267700-2901	Iridium plug	Nickel	S
202	IWM31	267700-2911	Iridium plug	Nickel	S
203	IX22	067700-9351	Iridium plug	Nickel	R
204	IX22B	067700-9381	Iridium plug	Nickel	R
205	IX24	067700-9361	Iridium plug	Nickel	R
206	IX24B	067700-9391	Iridium plug	Nickel	R
207	IX27	067700-9371	Iridium plug	Nickel	R
208	IX27B	067700-9401	Iridium plug	Nickel	R
209	IXEH20ETT	267700-8490	Iridium TT plug	Needle	S
210	IXEH20TT	267700-8500	Iridium TT plug	Needle	S
211	IXEH22TT	267700-8510	Iridium TT plug	Needle	S
212	IXG24	267700-2921	Iridium plug	Nickel	R
213	IXG27	267700-2931	Iridium plug	Nickel	R
214	IXU01-24	267700-1061	Iridium plug	Platinum	R
215	IXU01-27	267700-1071	Iridium plug	Platinum	R
216	IXU01-31	267700-1081	Iridium plug	Platinum	R
217	IXU01-34	267700-1091	Iridium plug	Platinum	R
218	IXU22	067700-8721	Iridium plug	Nickel	RC
219	IXU22C	267700-5170	Iridium plug	Nickel	S
220	IXU22HPR	267700-7170	Iridium plug	Nickel	S
221	IXU22I	267700-8431	Iridium plug	Nickel	S
222	IXU24	067700-8731	Iridium plug	Nickel	RC
223	IXU27	067700-8601	Iridium plug	Nickel	RC
224	IXUH20I	267700-8171	Iridium plug	Nickel	S
225	IXUH22	267700-6451	Iridium plug	Nickel	S
226	IXUH22I	267700-7371	Iridium plug	Nickel	S
227	IY24	267700-4491	Iridium plug	Nickel	R
228	IY27	267700-4501	Iridium plug	Nickel	R
229	IY31	267700-4511	Iridium plug	Nickel	R
230	J14CR-U	067700-6980	Nickel plug	Nickel	S
231	J16CR-U	067700-6990	Nickel plug	Nickel	S
232	K16DTR-S11	067700-7330	2-Ground electrodes surface discharge Nickel plug	Nickel	S
233	K16PR-P11	067700-8250	Platinum plug	Nickel	S
234	K16PSR-B8	267700-5860	Iridium plug	Nickel	S
235	K16PZR13	267700-7900	Nickel plug	Nickel	S
236	K16R-UAG8	267700-7920	Nickel plug w/t Grease	Nickel	S
237	K20HR-UAG8	267700-7860	Nickel plug w/t Grease	Nickel	S
238	K20PR-U8S	267700-6290	Nickel plug w/t SUS Gasket	Nickel	S
239	K20PR-U9S	267700-4390	Nickel plug w/t SUS Gasket	Nickel	S
240	K20PSR-B8	267700-4380	Iridium plug	Nickel	S
241	K20-U11	067600-0770	Nickel plug	Nickel	S
242	K22PR-UR	267700-5250	Nickel plug	Nickel	S
243	KJ20DR-M11	267700-0550	Nickel plug	Nickel	S
244	KJ20SR11	267700-0950	Iridium plug	Nickel	S
245	L14-U	067600-7570	Nickel plug	Nickel	R
246	LP20R-U	067700-0442	Nickel plug	Nickel	S
247	LP20-U	067600-4182	Nickel plug	Nickel	S
248	M17	067600-0320	Nickel plug	Nickel	R
249	M22	067600-0330	Nickel plug	Nickel	R
250	MA16PR-U	067700-3630	Nickel plug	Nickel	R
251	MA20PR-U	067700-3660	Nickel plug	Nickel	R
252	MA20P-U	067600-7550	Nickel plug	Nickel	R
253	MA9P-U	067600-7511	Nickel plug	Nickel	R
254	P16PR11	067700-3390	Platinum plug	Platinum	S
255	P16R	067700-4130	Platinum plug	Platinum	S
256	P16R13	067700-4110	Platinum plug	Platinum	S
257	P16R8	067700-8960	Platinum plug	Platinum	S
258	P20PR11	067700-3400	Platinum plug	Platinum	S

AUSTRALIA  
 CHINA  
 INDIA  
 INDONESIA  
 KOREA  
 MALAYSIA  
 PHILIPPINES  
 SAUDI ARABIA  
 SINGAPORE  
 TAIWAN  
 THAILAND  
 VIETNAM  
 JAPAN  
 EUROPE & USA  
 CROSS REFERENCE  
 PART NUMBER

S: SOLID; R: REMOVABLE; RC: CRIMPED; T: THREAD

	No	DENSO	PART NUMBER	SPEC.	GROUND/E.	NUT
AUSTRALIA	259	P20PR8	067700-8270	Platinum plug	Platinum	S
	260	P20R8	067700-4140	Platinum plug	Platinum	S
	261	P22PR8	067700-7250	Platinum plug	Platinum	S
	262	PK16PR11	067700-7370	Platinum plug	Platinum	S
	263	PK16PR-L11	067700-6740	Platinum plug	Platinum	S
CHINA	264	PK16PR-P11	067700-6870	Platinum plug	Platinum	S
	265	PK16R11	067700-6680	Platinum plug	Platinum	S
	266	PK16R8	067700-6661	Platinum plug	Platinum	S
	267	PK16TR11	067700-7990	2-Ground electrodes Platinum plug	Nickel	S
INDIA	268	PK16TR13	067700-8120	2-Ground electrodes Platinum plug	Nickel	S
	269	PK16TT	267700-6320	Platinum TT plug	Nickel	S
	270	PK20GR8	067700-8211	Platinum plug	Platinum	S
	271	PK20PR11	067700-7380	Platinum plug	Platinum	S
	272	PK20PR-L11	067700-6750	Platinum plug	Platinum	S
	273	PK20PR-L13	067700-7480	Platinum plug	Platinum	S
	274	PK20PR-P11	067700-6460	Platinum plug	Platinum	S
	275	PK20PR-P8	067700-0020	Platinum plug	Platinum	S
	276	PK20PTR-S9	267700-2320	2-Ground electrodes surface discharge Platinum plug	Nickel	S
	277	PK20R11	067700-6690	Platinum plug	Platinum	S
INDONESIA	278	PK20R13	067700-6710	Platinum plug	Platinum	S
	279	PK20R8	067700-6670	Platinum plug	Platinum	S
	280	PK20TR11	067700-7930	2-Ground electrodes Platinum plug	Nickel	S
	281	PK20TT	267700-6330	Platinum TT plug	Nickel	S
	282	PK22PR11	067700-7390	Platinum plug	Platinum	S
	283	PK22PR8	067700-7690	Platinum plug	Platinum	S
	284	PK22PR-L11S	267700-4160	Platinum plug w/t SUS Gasket	Platinum	S
	285	PK22TT	267700-7790	Platinum TT plug	Nickel	S
	286	PKH16TT	267700-6340	Platinum TT plug	Nickel	S
	287	PKH20TT	267700-6350	Platinum TT plug	Nickel	S
KOREA	288	PKJ16CR8	067700-7800	Platinum plug	Platinum	S
	289	PKJ16CR-L11	067700-7130	Platinum plug	Platinum	S
	290	PKJ20CR8	067700-7810	Platinum plug	Platinum	S
	291	PKJ20CR-L11	067700-7140	Platinum plug	Platinum	S
	292	PKJ20CR-M11	067700-9460	Platinum plug	Platinum	S
	293	PQ16R	067700-4171	Platinum plug	Platinum	S
	294	PQ16TT	267700-6360	Platinum TT plug	Nickel	S
	295	PQ20R	067700-4191	Platinum plug	Platinum	S
	296	PQ20R13	067700-4220	Platinum plug	Platinum	S
	297	PQ20R8	067700-4861	Platinum plug	Platinum	S
MALAYSIA	298	PQ20R-P11	067700-4082	Platinum plug	Platinum	S
	299	PQ20R-P8	067700-4102	Platinum plug	Platinum	S
	300	PQ20TT	267700-6370	Platinum TT plug	Nickel	S
	301	PT16EPR10	067800-9390	Platinum plug	Platinum	S
	302	PT16EPR13	067800-9400	Platinum plug	Platinum	S
	303	PT16EPR-L13	067700-8140	Platinum plug	Platinum	S
	304	PT16TT	267700-7200	Platinum TT plug	Nickel	S
	305	PT16TT	267700-7240	Platinum TT plug	Nickel	S
	306	PT16VR10	267700-6120	Platinum plug	Platinum	S
	307	PT16VR13	067700-7940	Platinum plug	Platinum	S
PHILIPPINES	308	PT20TT	267700-7210	Platinum TT plug	Nickel	S
	309	PT20TT	267700-7250	Platinum TT plug	Nickel	S
	310	PTJ16R15	067800-7280	Platinum plug	Platinum	S
	311	PTV16TT	267700-7220	Platinum TT plug	Nickel	S
	312	PW16TT	267700-6380	Platinum TT plug	Nickel	S
	313	PW20TT	267700-6390	Platinum TT plug	Nickel	S
	314	Q20PR-U11	067700-4520	Nickel plug	Nickel	R
	315	Q20PR-U11	067700-6070	Nickel plug	Nickel	S
	316	QJ16AR-U	067700-5920	Nickel plug	Nickel	S
	317	QL20TR-S	067700-7260	2-Ground electrodes surface discharge Nickel plug	Nickel	S
SAUDI ARABIA	318	QL22TR-S	067700-7270	2-Ground electrodes surface discharge Nickel plug	Nickel	S
	319	RU01-31	267700-1580	Surface discharge plug	None	R
	320	S20R8-G	267700-4690	Iridium plug	Platinum	S
	321	S22PR-A7	067700-9670	Iridium plug	Platinum	S
	322	SC20HR-G11	267700-7930	Iridium plug w/t Grease	Platinum	S
	323	SF-50	067800-0031	Surface discharge plug	None	R
	324	SF-51	067800-0041	Surface discharge plug	None	R
	325	SK16HR11	267700-3000	Iridium plug	Platinum	S
	326	SK16HR-G11	267700-7870	Iridium plug w/t Grease	Platinum	S
	327	SK16PR-A11	067700-8640	Iridium plug	Platinum	S
SINGAPORE	328	SK16PR-E11	267700-2740	Iridium plug	Platinum	S
	329	SK16PR-F8	267700-4340	Iridium plug	Platinum	S
	330	SK16PR-L11	267700-2200	Iridium plug	Platinum	S
	331	SK16R11	067700-8840	Iridium plug	Platinum	S
	332	SK16R8-PG	267700-3130	Iridium plug	Platinum	S
	333	SK16R-P11	067700-8280	Iridium plug	Platinum	S
	334	SK16R-P8	067700-8350	Iridium plug	Platinum	S
	335	SK20BGR11	067700-9730	3-Ground electrodes Iridium plug	Platinum	S
	336	SK20BR11	067700-3560	3-Ground electrodes Iridium plug	Platinum	S
	337	SK20BR11	067700-9530	3-Ground electrodes Iridium plug	Platinum	S
TAIWAN	338	SK20HBR-J8	267700-8570	3-Ground electrodes Iridium plug	Platinum	S
	339	SK20HPR-L11	267700-5500	Iridium plug	Platinum	S
	340	SK20HR11	267700-4120	Iridium plug	Platinum	S
	341	SK20HR8-T	267700-6070	Iridium plug	Platinum	S
	342	SK20HR-A11	267700-7850	Iridium plug	Platinum	S
	343	SK20HR-GT8	267700-8540	Iridium plug w/t Grease	Platinum	RC
	344	SK20PR-A11	267700-0570	Iridium plug	Platinum	S

S: SOLID; R: REMOVABLE; RC: CRIMPED; T: THREAD

DENSO, PART No., SPECIFICATIONS, LIST (  → 0677009760 )

No	DENSO	PART NUMBER	SPEC.	GROUND/E.	NUT
345	SK20PR-A8	267700-2340	Iridium plug	Platinum	S
346	SK20PR-B8	267700-2310	Iridium plug	Platinum	S
347	SK20PR-F8	267700-4360	Iridium plug	Platinum	S
348	SK20PR-L11	267700-5600	Iridium plug	Platinum	S
349	SK20PR-L9	067700-8630	Iridium plug	Platinum	S
350	SK20PR-N9	267700-6690	Iridium plug	Platinum	S
351	SK20PR-N9S	267700-6150	Iridium plug w/t SUS Gasket	Platinum	S
352	SK20R11	067700-8340	Iridium plug	Platinum	S
353	SK20R11	267700-2980	Iridium plug	Platinum	S
354	SK20R5-G	067700-3520	Iridium plug w/t Grease	Platinum	S
355	SK20R8	267700-2570	Iridium plug	Platinum	S
356	SK20R8-G	267700-4140	Iridium plug w/t Grease	Platinum	S
357	SK20R-B5	267700-6700	Iridium plug	Platinum	S
358	SK20R-P11	067700-8200	Iridium plug	Platinum	S
359	SK20R-P13	067700-8360	Iridium plug	Platinum	S
360	SK22PR-M11	267700-0930	Iridium plug	Platinum	S
361	SK22PR-M11S	267700-6160	Iridium plug w/t SUS Gasket	Platinum	S
362	SKJ16CR-A8	267700-0890	Iridium plug	Platinum	S
363	SKJ16CR-L11	067700-9680	Iridium plug	Platinum	S
364	SKJ16DR-M11	267700-2610	Iridium plug	Platinum	S
365	SKJ20CR-A8	267700-1760	Iridium plug	Platinum	S
366	SKJ20DR-M11	267700-0910	Iridium plug	Platinum	S
367	SKJ20DR-M11S	267700-4930	Iridium plug w/t SUS Gasket	Platinum	S
368	SKJ20DR-M11S	267700-6100	Iridium plug w/t SUS Gasket	Platinum	S
369	SKJ20DR-M13	267700-0560	Iridium plug	Platinum	S
370	SKJ20DR-M13	267700-6110	Iridium plug	Platinum	S
371	SVK20RZ11	067700-8620	Iridium plug	Platinum	S
372	SVK20RZ8	067700-9740	Iridium plug	Platinum	S
373	SXE22HQR11S	267700-7810	Iridium plug w/t SUS Gasket	Platinum	S
374	SXE24HCR8S	267700-8390	Iridium plug w/t SUS Gasket	Platinum	S
375	SXU16HPR9	267700-2190	Iridium plug	Platinum	S
376	SXU20HPR11	267700-8130	Iridium plug	Platinum	S
377	SXU22HCR11	267700-6050	Iridium plug	Platinum	S
378	SXU22HCR11S	267700-5530	Iridium plug w/t SUS Gasket	Platinum	S
379	SXU22HCR8S	267700-7740	Iridium plug w/t SUS Gasket	Platinum	S
380	SXU22HDR8	267700-4530	Iridium plug	Platinum	S
381	SXU22HPR11	267700-7590	Iridium plug	Platinum	S
382	SXU22HPR8	267700-7330	Iridium plug	Platinum	S
383	SXU22HPR9	267700-5970	Iridium plug	Platinum	S
384	SXU22HPR9	267700-8310	Iridium plug	Platinum	S
385	SXU22PR9	267700-5900	Iridium plug	Platinum	S
386	SXU22PR-A9	267700-3020	Iridium plug	Platinum	S
387	T14PR-U	067700-5700	Nickel plug	Nickel	S
388	T16EPR-U	067700-3130	Nickel plug	Nickel	R
389	T16EPR-U15	067700-3190	Nickel plug	Nickel	R
390	T16PR-U	067700-5750	Nickel plug	Nickel	S
391	T16PR-U11	067700-5760	Nickel plug	Nickel	S
392	T16PR-U15	067700-5770	Nickel plug	Nickel	S
393	T16P-U	067600-9700	Nickel plug	Nickel	S
394	T16TT	267700-7820	Nickel TT plug	Nickel	S
395	T16VR-U10	267700-4810	Nickel plug	Nickel	S
396	T20EPR-U	067700-3140	Nickel plug	Nickel	R
397	T20EPR-U15	067700-3210	Nickel plug	Nickel	R
398	T20EP-U	067600-7380	Nickel plug	Nickel	R
399	T20MP-U	067600-8470	Nickel plug	Nickel	R
400	T20M-U	067600-8450	Nickel plug	Nickel	R
401	T20PR-U	067700-5851	Nickel plug	Nickel	S
402	T20P-U	067600-9711	Nickel plug	Nickel	S
403	T20R-U	067700-5950	Nickel plug	Nickel	S
404	T20TT	267700-7830	Nickel TT plug	Nickel	S
405	T22EP-U	067600-7390	Nickel plug	Nickel	R
406	TJ14R-P15	067800-7260	Platinum plug	Nickel	S
407	TR22-10	067600-9270	Nickel plug	Nickel	R
408	TV16TT	267700-7490	Nickel TT plug	Nickel	S
409	U14FS-UB	067800-6400	Nickel plug	Nickel	S
410	U16FSR-U	267700-6610	Nickel plug	Nickel	T
411	U20ESR-N	267700-6510	Nickel plug	Nickel	T
412	U22ESR-N	267700-6520	Nickel plug	Nickel	T
413	U22ETR	067700-5560	2-Ground electrodes Nickel plug	Nickel	T
414	U22ETR	267700-6560	2-Ground electrodes Nickel plug	Nickel	T
415	U24ESR-N	267700-6530	Nickel plug	Nickel	T
416	U24ETR	067700-5450	2-Ground electrodes Nickel plug	Nickel	T
417	U24ETR	267700-6570	2-Ground electrodes Nickel plug	Nickel	T
418	U24FE9	067800-4820	Nickel plug	Nickel	T
419	U24FS-U	067800-4620	Nickel plug	Nickel	T
420	U24FS-U	067800-7790	Nickel plug	Nickel	T
421	U27ESR-N	267700-6540	Nickel plug	Nickel	T
422	U27ETR	067700-5460	2-Ground electrodes Nickel plug	Nickel	T
423	U27ETR	267700-6580	2-Ground electrodes Nickel plug	Nickel	T
424	U31ESR-N	267700-6550	Nickel plug	Nickel	T
425	U31ETR	067700-5630	2-Ground electrodes Nickel plug	Nickel	T
426	U31ETR	267700-6590	2-Ground electrodes Nickel plug	Nickel	T
427	VCH16	267700-9211	Iridium plug	Platinum	S
428	VCH20	267700-7671	Iridium plug	Platinum	S
429	VDCH22F	267700-9291	Double needle Iridium plug	Needle	S
430	VDKH16T	267700-8920	Double needle Iridium plug	Needle	S

AUSTRALIA  
CHINA  
INDIA  
INDONESIA  
KOREA  
MALAYSIA  
PHILIPPINES  
SAUDIARABIA  
SINGAPORE  
TAIWAN  
THAILAND  
VIETNAM  
JAPAN  
EUROPE & USA  
CROSS REFERENCE  
PART NUMBER

S: SOLID; R: REMOVABLE; RC: CRIMPED; T: THREAD

DENSO, PART No., SPECIFICATIONS, LIST (  → 0677009760 )

	No	DENSO	PART NUMBER	SPEC.	GROUND/E.	NUT
AUSTRALIA	431	VDKH22F	267700-8751	Double needle Iridium plug	Needle	S
	432	VFCH16	267700-9281	Double needle Iridium plug	Needle	S
	433	VFK16	267700-9151	Double needle Iridium plug	Needle	S
	434	VFK20F	267700-9161	Double needle Iridium plug	Needle	S
	435	VFKB16	267700-9271	3-Ground electrodes Iridium plug	Needle	S
CHINA	436	VFKBH20	267700-7661	3-Ground electrodes Iridium plug	Needle	S
	437	VFKH16	267700-7411	Double needle Iridium plug	Needle	S
	438	VFKH20	267700-7421	Double needle Iridium plug	Needle	S
	439	VFXE20	267700-7641	Double needle Iridium plug	Needle	S
	440	VFXE20E	267700-7631	Double needle Iridium plug	Needle	S
INDIA	441	VFXE22	267700-7651	Double needle Iridium plug	Needle	S
	442	VFXEHC22G	267700-9221	Double needle Iridium plug w/t SUS Gasket	Needle	S
	443	VFXUHC22FG	267700-8681	Double needle Iridium plug w/t SUS Gasket	Needle	S
	444	VK16	267700-0711	Iridium plug	Platinum	S
	445	VK16G	267700-5631	Iridium plug w/t SUS Gasket	Platinum	S
INDONESIA	446	VK16PRZ11	267700-1840	Iridium plug	Platinum	S
	447	VK20	267700-0721	Iridium plug	Platinum	S
	448	VK20G	267700-5641	Iridium plug w/t SUS Gasket	Platinum	S
	449	VK20PRZ11	267700-1850	Iridium plug	Platinum	S
	450	VK20T	067700-9540	Iridium plug	Platinum	S
KOREA	451	VK20Y	267700-3721	Iridium plug	Platinum	S
	452	VK22	267700-0731	Iridium plug	Platinum	S
	453	VK22G	267700-5671	Iridium plug w/t SUS Gasket	Platinum	S
	454	VK22PRZ11	267700-1860	Iridium plug	Platinum	S
	455	VK24PRZ11	267700-1870	Iridium plug	Platinum	S
MALAYSIA	456	VK27PRZ11	267700-2050	Iridium plug	Platinum	S
	457	VKA16	267700-5031	3-Ground electrodes Iridium plug	Platinum	S
	458	VKA20	267700-5041	3-Ground electrodes Iridium plug	Platinum	S
	459	VKB16	267700-5051	3-Ground electrodes Iridium plug	Platinum	S
	460	VKB20	267700-5061	3-Ground electrodes Iridium plug	Platinum	S
PHILIPPINES	461	VKH16	267700-3681	Iridium plug	Platinum	S
	462	VKH20	267700-3691	Iridium plug	Platinum	S
	463	VKH20T	267700-7760	Iridium plug	Platinum	S
	464	VKH20Y	267700-4541	Iridium plug	Platinum	S
	465	VKH22	267700-2681	Iridium plug	Platinum	S
SAUDI ARABIA	466	VKJ20RZ-M11	267700-1970	Iridium plug	Platinum	S
	467	VNH24Z	267700-2060	Iridium plug	Platinum	S
	468	VNH27Z	267700-2070	Iridium plug	Platinum	S
	469	VNH27ZB	267700-1920	Iridium plug	Platinum	S
	470	VQ16	267700-0741	Iridium plug	Platinum	S
SINGAPORE	471	VQ20	267700-0751	Iridium plug	Platinum	S
	472	VQ22	267700-0761	Iridium plug	Platinum	S
	473	VSUEH22	267700-9241	Iridium plug	Platinum	S
	474	VT16	267700-2811	Iridium plug	Platinum	S
	475	VT20	267700-4481	Iridium plug	Platinum	S
TAIWAN	476	VUH24D	267700-2011	Iridium plug	Platinum	T
	477	VUH24ES	267700-6130	Iridium plug w/t SUS Gasket	Platinum	T
	478	VUH27D	267700-1931	Iridium plug	Platinum	T
	479	VUH27ES	267700-4770	Iridium plug w/t SUS Gasket	Platinum	T
	480	VW16	267700-0771	Iridium plug	Platinum	S
THAILAND	481	VW16R-A13	267700-1640	Iridium plug	Platinum	S
	482	VW20	267700-0781	Iridium plug	Platinum	S
	483	VW20T	067700-9240	Iridium plug	Platinum	S
	484	VW22	267700-0791	Iridium plug	Platinum	S
	485	VX20BC	067700-9830	Iridium plug	Platinum	T
VIETNAM	486	VX22BC	067700-9720	Iridium plug	Platinum	T
	487	VXEBH27	267700-9171	3-Ground electrodes Iridium plug	Platinum	S
	488	VXEHC24G	267700-9231	Iridium plug w/t SUS Gasket	Platinum	S
	489	VXU20	267700-9141	Iridium plug	Platinum	S
	490	VXU22	267700-0801	Iridium plug	Platinum	RC
JAPAN	491	VXU22I	267700-8441	Iridium plug	Platinum	S
	492	VXU24	267700-0811	Iridium plug	Platinum	RC
	493	VXUH20I	267700-8161	Iridium plug	Platinum	S
	494	VXUH22	267700-6461	Iridium plug	Platinum	S
	495	VXUH22I	267700-7381	Iridium plug	Platinum	S
EUROPE & USA	496	VXUHC22G	267700-8671	Iridium plug w/t SUS Gasket	Platinum	S
	497	W14FP-L	067600-6522	Nickel plug	Nickel	T
	498	W14FR-U	067700-3330	Nickel plug	Nickel	R
	499	W16DTR-S	067700-7440	2-Ground electrodes surface discharge Nickel plug	Nickel	S
	500	W16EP	067600-1761	Nickel plug	Nickel	S
CROSS REFERENCE	501	W16ETR-S	067700-2171	2-Ground electrodes surface discharge Nickel plug	Nickel	S
	502	W16TT	267700-6301	Nickel TT plug	Nickel	RC
	503	W20ETR-L	067700-2160	2-Ground electrodes Nickel plug	Nickel	S
	504	W20ETR-S	067700-2181	2-Ground electrodes surface discharge Nickel plug	Nickel	S
	505	W20TT	267700-6311	Nickel TT plug	Nickel	RC
PART NUMBER	506	W22EP	067600-1792	Nickel plug	Nickel	S
	507	W22EPR	067700-0271	Nickel plug	Nickel	R
	508	W22ESR	067700-0352	Nickel plug	Nickel	R
	509	W22TT	267700-7510	Nickel TT plug	Nickel	RC
	510	W24EPR	067700-0211	Nickel plug	Nickel	R
	511	W9EXR-UA	267700-8420	Nickel plug	Nickel	S
	512	W9-U	067600-6900	Nickel plug	Nickel	R
	513	WF20TT	267700-7500	Nickel TT plug	Nickel	RC
	514	X20ES-U	067800-4110	Nickel plug	Nickel	T
	515	X22EP-U9	067800-4350	Nickel plug	Nickel	T
	516	X22ESR-UB	267700-6430	Nickel plug	Nickel	S

S: SOLID; R: REMOVABLE; RC: CRIMPED; T: THREAD

**DENSO, PART No., SPECIFICATIONS, LIST (  ⇒ 0677009760 )**

No	DENSO	PART NUMBER	SPEC.	GROUND/E.	NUT
517	X27ETR	067700-5030	2-Ground electrodes Nickel plug	Nickel	T
518	XE20HR-U9	267700-5810	Nickel plug	Nickel	S
519	XU22TT	267700-7080	Nickel TT plug	Nickel	S
520	XUH20TTI	267700-8291	Nickel TT plug	Nickel	S
521	XUH22TT	267700-7090	Nickel TT plug	Nickel	S
522	ZC20HPR11	267700-7940	Iridium plug	Platinum	S
523	ZK20HQR8	267700-7750	Iridium plug	Platinum	S
524	ZT20EPR11	067800-7340	Iridium plug	Platinum	S
525	ZTJ16R10	AN067800-8180	Iridium plug	Platinum	S
526	ZTJ16VR10	AN067800-7870	Iridium plug	Platinum	S
527	ZXE20HR13(AM)	267700-4320	Iridium plug	Platinum	S
528	ZXE20HR13(OE)	267700-4640	Iridium plug	Platinum	S
529	ZXE27HBR8	267700-6210	Iridium plug	Platinum	S
530	ZXU20HCR8	267700-7550	Iridium plug	Platinum	S
531	ZXU20HPR11	267700-7950	Iridium plug	Platinum	S
532	ZXU20PR11	267700-7020	Iridium plug	Platinum	S
533	ZXU22HBR11	267700-2970	3-Ground electrodes double needle Iridium plug	Platinum	S
534	ZXU22HCR8	267700-7970	Iridium plug	Platinum	S

AUSTRALIA | CHINA | INDIA | INDONESIA | KOREA | MALAYSIA | PHILIPPINES | SAUDI ARABIA | SINGAPORE | TAIWAN | THAILAND | VIETNAM | JAPAN | EUROPE & USA | CROSS REFERENCE PART NUMBER

S: SOLID; R: REMOVABLE; RC: CRIMPED; T: THREAD

DENSO, PART No., SPECIFICATIONS, LIST (  ⇒ 0677009760 )

	No	DENSO	PART NUMBER	SPEC.	GROUND/E.	NUT
AUSTRALIA	1	·K16TNR-S9	MW067700-9770	2-Ground electrodes surface discharge Nickel plug	Nickel	S
	2	·K20TNR-S	MW067700-8000	2-Ground electrodes surface discharge Nickel plug	Nickel	S
	3	·K20TNR-S9	MW067700-8800	2-Ground electrodes surface discharge Nickel plug	Nickel	S
	4	J16BR-U	MW067700-3472	Nickel plug	Nickel	S
	5	J16BR-U11	MW067700-3571	Nickel plug	Nickel	S
CHINA	6	J16B-U11	MW067600-7971	Nickel plug	Nickel	S
	7	J16CR-U	MW067700-8190	Nickel plug	Nickel	R
	8	K16GPR-U11	MW067700-0540	Nickel plug	Nickel	S
	9	K16HPR-U11	MW067700-3020	Nickel plug	Nickel	S
	10	K16HR-U11	MW267700-6280	Nickel plug	Nickel	S
INDIA	11	K16PR-L11	MW067700-6550	Nickel plug	Nickel	S
	12	K16PR-U	MW067700-6300	Nickel plug	Nickel	S
	13	K16PR-U@	MW067700-7500	Nickel plug	Nickel	R
	14	K16PR-U11	MW067700-6270	Nickel plug	Nickel	S
	15	K16P-U	MW067600-0380	Nickel plug	Nickel	S
INDONESIA	16	K16R-U	MW067700-6400	Nickel plug	Nickel	S
	17	K16R-U11	MW067700-6420	Nickel plug	Nickel	S
	18	K16TR11	MW067700-7900	2-Ground electrodes Nickel plug	Nickel	S
	19	K16-U11	MW067600-0750	Nickel plug	Nickel	S
	20	K20BR-S10	MW067700-9750	3-Ground electrodes surface discharge Nickel plug	Nickel	S
KOREA	21	K20HR-U11	MW267700-2880	Nickel plug	Nickel	S
	22	K20PBR	MW067700-8050	3-Ground electrodes Nickel plug	Nickel	R
	23	K20PBR-S10	MW067700-8060	3-Ground electrodes surface discharge Nickel plug	Nickel	R
	24	K20PR-L11	MW067700-6560	Nickel plug	Nickel	S
	25	K20PR-U	MW067700-6310	Nickel plug	Nickel	S
MALAYSIA	26	K20PR-U@	MW067700-7510	Nickel plug	Nickel	R
	27	K20PR-U11	MW067700-6260	Nickel plug	Nickel	S
	28	K20P-U	MW067600-0390	Nickel plug	Nickel	S
	29	K20R-U	MW067700-6410	Nickel plug	Nickel	S
	30	K20R-U11	MW067700-6580	Nickel plug	Nickel	S
PHILIPPINES	31	K20TNR	MW067700-8770	2-Ground electrodes Nickel plug	Nickel	S
	32	K20TR-11	MW067700-8110	2-Ground electrodes Nickel plug	Nickel	S
	33	K20TXR	MW067700-8080	2-Ground electrodes semi surface discharge Nickel plug	Nickel	R
	34	K22PB	MW067600-2770	3-Ground electrodes Nickel plug	Nickel	R
	35	K22PBR-S	MW067700-8070	3-Ground electrodes surface discharge Nickel plug	Nickel	R
SAUDIARABIA	36	K22PR-U@	MW067700-7520	Nickel plug	Nickel	R
	37	K22PR-U11	MW067700-6290	Nickel plug	Nickel	S
	38	K22TNR-S	MW067700-7910	2-Ground electrodes surface discharge Nickel plug	Nickel	S
	39	KJ14CR-L11	MW067700-7450	Nickel plug	Nickel	S
	40	KJ16CR11	MW067700-6770	Nickel plug	Nickel	S
SINGAPORE	41	KJ16CR-L11	MW067700-6970	Nickel plug	Nickel	S
	42	KJ16CR-U11(*)	MW067700-8810	Nickel plug	Nickel	S
	43	KJ20CR11	MW067700-6780	Nickel plug	Nickel	S
	44	KJ20CR-L11	MW067700-6950	Nickel plug	Nickel	S
	45	KJ20CR-U11(*)	MW067700-7780	Nickel plug	Nickel	S
TAIWAN	46	Q14R-U11	MW067700-4670	Nickel plug	Nickel	S
	47	Q16PR-U	MW067700-4450	Nickel plug	Nickel	R
	48	Q16PR-U	MW067700-6000	Nickel plug	Nickel	S
	49	Q16PR-U11@	MW067700-4510	Nickel plug	Nickel	R
	50	Q16R-U	MW067700-4410	Nickel plug	Nickel	S
THAILAND	51	Q16R-U11	MW067700-4431	Nickel plug	Nickel	S
	52	Q16-U	MW067600-0700	Nickel plug	Nickel	S
	53	Q20PR-U	MW067700-6060	Nickel plug	Nickel	S
	54	Q20PR-U@	MW067700-4460	Nickel plug	Nickel	R
	55	Q20PR-U11	MW067700-4520	Nickel plug	Nickel	R
VIETNAM	56	Q20P-U	MW067600-7680	Nickel plug	Nickel	R
	57	Q20P-U11	MW067600-7300	Nickel plug	Nickel	R
	58	Q20R-U	MW067700-4421	Nickel plug	Nickel	S
	59	Q20R-U11	MW067700-4441	Nickel plug	Nickel	S
	60	Q20-U11	MW067600-7081	Nickel plug	Nickel	S
JAPAN	61	Q22PR-U	MW067700-4470	Nickel plug	Nickel	R
	62	Q22PR-U11	MW067700-4530	Nickel plug	Nickel	R
	63	QJ16HR-U	MW067700-5910	Nickel plug	Nickel	R
	64	U14FSR-UB	MW067700-8290	Nickel plug	Nickel	S
	65	U16FER9	MW267700-0520	Nickel plug	Nickel	T
EUROPE & USA	66	U16FSR-UB	MW067700-5990	Nickel plug	Nickel	S
	67	U16FS-U	MW067800-4590	Nickel plug	Nickel	S
	68	U20EPR9	MW267700-4580	Nickel plug	Nickel	T
	69	U20EPR9S	MW067800-7750	Nickel plug	Nickel	T
	70	U20ESR-N	MW067700-8850	Nickel plug	Nickel	T
CROSS REFERENCE	71	U20FSR-U	MW067700-5590	Nickel plug	Nickel	T
	72	U20FS-U	MW067800-4600	Nickel plug	Nickel	S
	73	U22EPR9	MW267700-6480	Nickel plug	Nickel	T
	74	U22ES-N	MW067800-4850	Nickel plug	Nickel	T
	75	U22ESR-N	MW067700-5320	Nickel plug	Nickel	T
PART NUMBER	76	U22FER9	MW067700-5810	Nickel plug	Nickel	T
	77	U22FSR-U	MW067700-5600	Nickel plug	Nickel	T
	78	U22FS-U	MW067800-4610	Nickel plug	Nickel	S
	79	U24EPR9	MW267700-6490	Nickel plug	Nickel	T
	80	U24ES-N	MW067800-4860	Nickel plug	Nickel	T
	81	U24ESR-N	MW067700-5380	Nickel plug	Nickel	T
	82	U24ESR-NB	MW267700-2300	Nickel plug	Nickel	S
	83	U24FER9	MW067700-5820	Nickel plug	Nickel	T
	84	U24FSR-U	MW067700-5610	Nickel plug	Nickel	T
	85	U27EPR9	MW067800-7840	Nickel plug	Nickel	T
	86	U27ES-N	MW067800-4870	Nickel plug	Nickel	T

S: SOLID; R: REMOVABLE; RC: CRIMPED; T: THREAD



DENSO, PART No., SPECIFICATIONS, LIST (  ⇒ 0677009760 )

No	DENSO	PART NUMBER	SPEC.	GROUND/E.	NUT
87	U27ESR-N	MW067700-5390	Nickel plug	Nickel	T
88	U27ESR-NB	MW267700-2280	Nickel plug	Nickel	S
89	U27FER9	MW067700-5830	Nickel plug	Nickel	T
90	U31ESR-N	MW067700-5640	Nickel plug	Nickel	T
91	W14E	MW067600-0881	Nickel plug	Nickel	R
92	W14EPR-U	MW067700-2651	Nickel plug	Nickel	R
93	W14EP-U	MW067600-7221	Nickel plug	Nickel	R
94	W14EXR-U	MW067700-1522	Nickel plug	Nickel	S
95	W14EXR-U11	MW067700-2421	Nickel plug	Nickel	S
96	W14EX-U	MW067600-4663	Nickel plug	Nickel	S
97	W14EX-U	MW067600-6372	Nickel plug	Nickel	R
98	W14EX-U11	MW067600-6322	Nickel plug	Nickel	S
99	W14FP-U	MW067600-6121	Nickel plug	Nickel	R
100	W14FP-UL	MW067600-6591	Nickel plug	Nickel	R
101	W14FP-US	MW067800-6780	Nickel plug	Nickel	R
102	W14F-U	MW067600-6821	Nickel plug	Nickel	R
103	W14L	MW067600-3341	Nickel plug	Nickel	R
104	W14LM-U	MW067600-6711	Nickel plug	Nickel	R
105	W14MP-U10	MW067600-7461	Nickel plug	Nickel	R
106	W14MR-U	MW067700-3201	Nickel plug	Nickel	R
107	W14M-U	MW067600-7421	Nickel plug	Nickel	R
108	W14PR-U	MW067700-2931	Nickel plug	Nickel	R
109	W14-U	MW067600-6781	Nickel plug	Nickel	R
110	W16EPB10	MW067600-7850	3-Ground electrodes Nickel plug	Nickel	R
111	W16EPR-U	MW067700-2661	Nickel plug	Nickel	R
112	W16EPR-U	MW067700-5960	Nickel plug	Nickel	S
113	W16EPR-U11	MW067700-2710	Nickel plug	Nickel	S
114	W16EP-U	MW067600-7231	Nickel plug	Nickel	R
115	W16EP-U	MW067800-6060	Nickel plug	Nickel	S
116	W16EP-U11	MW067600-7621	Nickel plug	Nickel	S
117	W16EP-U11	MW067800-6770	Nickel plug	Nickel	R
118	W16ES-U	MW067600-6031	Nickel plug	Nickel	R
119	W16EXR-U	MW067700-1531	Nickel plug	Nickel	S
120	W16EXR-U	MW067700-1571	Nickel plug	Nickel	R
121	W16EXR-U11	MW067700-2431	Nickel plug	Nickel	S
122	W16EX-U	MW067600-4671	Nickel plug	Nickel	S
123	W16EX-U	MW067600-6381	Nickel plug	Nickel	R
124	W16EX-U11	MW067600-6331	Nickel plug	Nickel	S
125	W16FPR-U	MW067700-4700	Nickel plug	Nickel	S
126	W16FP-U	MW067600-6131	Nickel plug	Nickel	R
127	W16FP-US	MW067800-5980	Nickel plug	Nickel	R
128	W16FSR	MW067700-0831	Nickel plug	Nickel	R
129	W16FS-U	MW067600-6831	Nickel plug	Nickel	R
130	W16PR-U	MW067700-2921	Nickel plug	Nickel	R
131	W16S-U	MW067600-6791	Nickel plug	Nickel	R
132	W20EPB	MW067600-2740	3-Ground electrodes Nickel plug	Nickel	R
133	W20EPBR-S	MW067700-8040	3-Ground electrodes surface discharge Nickel plug	Nickel	R
134	W20EPR-U	MW067700-2671	Nickel plug	Nickel	R
135	W20EPR-U	MW067700-3440	Nickel plug	Nickel	S
136	W20EPR-U11	MW067700-2701	Nickel plug	Nickel	S
137	W20EP-U	MW067600-7241	Nickel plug	Nickel	R
138	W20EP-U	MW067600-7311	Nickel plug	Nickel	S
139	W20EP-US	MW067800-7130	Nickel plug	Nickel	R
140	W20ESR-U	MW067700-2341	Nickel plug	Nickel	R
141	W20ES-U	MW067600-6041	Nickel plug	Nickel	R
142	W20ES-US	MW067800-7100	Nickel plug	Nickel	R
143	W20EXR-U	MW067700-1541	Nickel plug	Nickel	S
144	W20EXR-U	MW067700-1581	Nickel plug	Nickel	R
145	W20EXR-U11	MW067700-2441	Nickel plug	Nickel	S
146	W20EXR-U11	MW067700-2481	Nickel plug	Nickel	R
147	W20EX-U	MW067600-4681	Nickel plug	Nickel	S
148	W20EX-U	MW067600-6391	Nickel plug	Nickel	R
149	W20EX-U11	MW067600-6341	Nickel plug	Nickel	S
150	W20FPR-U	MW067700-3831	Nickel plug	Nickel	R
151	W20FP-U	MW067600-6141	Nickel plug	Nickel	R
152	W20FP-US	MW067800-5990	Nickel plug	Nickel	R
153	W20FR-L	MW067700-6810	Nickel plug	Nickel	T
154	W20FSR-U	MW067700-3341	Nickel plug	Nickel	R
155	W20FS-U	MW067600-6841	Nickel plug	Nickel	R
156	W20FS-US	MW067800-7070	Nickel plug	Nickel	R
157	W20MPR-U10	MW067700-3301	Nickel plug	Nickel	R
158	W20MP-U	MW067600-7481	Nickel plug	Nickel	R
159	W20MR-U	MW067700-3221	Nickel plug	Nickel	R
160	W20M-U	MW067600-7441	Nickel plug	Nickel	R
161	W20M-US	MW067600-8590	Nickel plug	Nickel	R
162	W20S-U	MW067600-6801	Nickel plug	Nickel	R
163	W22EPR-U	MW067700-2681	Nickel plug	Nickel	R
164	W22EPR-U	MW067700-3450	Nickel plug	Nickel	S
165	W22EPR-U11	MW067700-2720	Nickel plug	Nickel	S
166	W22EP-U	MW067600-7251	Nickel plug	Nickel	R
167	W22EP-US	MW067800-7140	Nickel plug	Nickel	R
168	W22ESR-U	MW067700-2351	Nickel plug	Nickel	R
169	W22ES-U	MW067600-6051	Nickel plug	Nickel	R
170	W22ES-US	MW067800-7110	Nickel plug	Nickel	R
171	W22FPR-U	MW067700-3841	Nickel plug	Nickel	R
172	W22FP-U	MW067600-6151	Nickel plug	Nickel	R

AUSTRALIA  
CHINA  
INDIA  
INDONESIA  
KOREA  
MALAYSIA  
PHILIPPINES  
SAUDIARABIA  
SINGAPORE  
TAIWAN  
THAILAND  
VIETNAM  
JAPAN  
EUROPE & USA  
CROSS REFERENCE  
PART NUMBER

S: SOLID; R: REMOVABLE; RC: CRIMPED; T: THREAD

	No	DENSO	PART NUMBER	SPEC.	GROUND/E.	NUT
AUSTRALIA	173	W22FP-US	MW067800-6000	Nickel plug	Nickel	R
	174	W22FP-US10	MW067800-6430	Nickel plug	Nickel	R
	175	W22FSR	MW067700-0851	Nickel plug	Nickel	R
	176	W22FS-U	MW067600-6851	Nickel plug	Nickel	R
	177	W22FS-U10	MW267700-4710	Nickel plug	Nickel	R
CHINA	178	W22FS-US	MW067800-7080	Nickel plug	Nickel	R
	179	W22MPR-U	MW067700-3350	Nickel plug	Nickel	R
	180	W22MP-U	MW067600-7491	Nickel plug	Nickel	R
	181	W22M-U	MW067600-7451	Nickel plug	Nickel	R
	182	W24EPR-U	MW067700-2691	Nickel plug	Nickel	R
INDIA	183	W24EP-U	MW067600-7261	Nickel plug	Nickel	S
	184	W24EP-US	MW067800-7150	Nickel plug	Nickel	R
	185	W24ESR	MW067700-5180	Nickel plug	Nickel	S
	186	W24ESR-U	MW067700-2361	Nickel plug	Nickel	R
	187	W24ESR-V	MW067700-1921	Nickel plug	Nickel	S
INDONESIA	188	W24ES-U	MW067600-6061	Nickel plug	Nickel	R
	189	W24ES-US	MW067800-7120	Nickel plug	Nickel	R
	190	W24FPR-U10	MW067700-8820	Nickel plug	Nickel	R
	191	W24FP-U	MW067600-6281	Nickel plug	Nickel	R
	192	W24FP-US	MW067800-6010	Nickel plug	Nickel	R
KOREA	193	W24FP-US10	MW067800-6440	Nickel plug	Nickel	R
	194	W24FR-L	MW067700-6820	Nickel plug	Nickel	T
	195	W24FSR	MW067700-0861	Nickel plug	Nickel	R
	196	W24FSR-U10	MW067700-8170	Nickel plug	Nickel	R
	197	W24FS-U	MW067600-6861	Nickel plug	Nickel	R
MALAYSIA	198	W24FS-U10	MW067600-6671	Nickel plug	Nickel	R
	199	W27ESR	MW067700-5190	Nickel plug	Nickel	S
	200	W27ESR-U	MW067700-2371	Nickel plug	Nickel	R
	201	W27ESR-V	MW067700-1931	Nickel plug	Nickel	S
	202	W27ES-U	MW067600-6071	Nickel plug	Nickel	R
PHILIPPINES	203	W27FSR	MW067700-0871	Nickel plug	Nickel	R
	204	W27FSR-U10	MW067700-0891	Nickel plug	Nickel	R
	205	W27FS-U	MW067600-6871	Nickel plug	Nickel	R
	206	W27FS-U10	MW067600-6191	Nickel plug	Nickel	R
	207	W31ESR-U	MW067700-6500	Nickel plug	Nickel	R
SAUDIARABIA	208	W9EP	MW067600-0871	Nickel plug	Nickel	R
	209	W9EP	MW067600-1713	Nickel plug	Nickel	S
	210	W9EXR-U	MW067700-1511	Nickel plug	Nickel	S
	211	W9EXR-U/Copper Gasket	MW067700-7280	Nickel plug w/t Copper Gasket	Nickel	S
	212	W9EX-U	MW067600-4641	Nickel plug	Nickel	S
SINGAPORE	213	W9FP-UL	MW067800-1410	Nickel plug	Nickel	R
	214	W9LMR-US	MW067700-7850	Nickel plug	Nickel	R
	215	W9LM-US	MW067600-8790	Nickel plug	Nickel	R
	216	X20EPR-U9	MW067700-5280	Nickel plug	Nickel	T
	217	X20FS-U	MW067800-1780	Nickel plug	Nickel	S
TAIWAN	218	X22EPR-U9	MW067700-5290	Nickel plug	Nickel	T
	219	X22EP-U	MW067800-1820	Nickel plug	Nickel	S
	220	X22ESR-U	MW067700-5070	Nickel plug	Nickel	T
	221	X22ES-U	MW067800-4120	Nickel plug	Nickel	S
	222	X24EPR-U9	MW067700-5300	Nickel plug	Nickel	T
THAILAND	223	X24EP-U	MW067800-1830	Nickel plug	Nickel	S
	224	X24EP-U9	MW067800-4361	Nickel plug	Nickel	S
	225	X24ESR-U	MW067700-5080	Nickel plug	Nickel	T
	226	X24ES-U	MW067800-4130	Nickel plug	Nickel	S
	227	X24FS-U	MW067800-4040	Nickel plug	Nickel	T
VIETNAM	228	X27EPR-U9	MW067700-5310	Nickel plug	Nickel	T
	229	X27ESR-U	MW067700-5090	Nickel plug	Nickel	T
	230	X27ES-U	MW067800-4140	Nickel plug	Nickel	T
	231	XU20EPR-U	MW067700-5800	Nickel plug	Nickel	S
	232	XU20HR9	MW267700-8140	Nickel plug	Nickel	S
JAPAN	233	XU22EPR-U	MW067700-5260	Nickel plug	Nickel	S
	234	XU22EP-U	MW067800-4180	Nickel plug	Nickel	S
	235	XU22HDR9	MW267700-4520	Nickel plug	Nickel	S
	236	XU22PR9	MW267700-5490	Nickel plug	Nickel	S
	237	XU24EPR-U	MW067700-5250	Nickel plug	Nickel	S
EUROPE & USA	238	XU24EPR-U	MW067800-7720	Nickel plug	Nickel	R
	239	XU27EPR-U	MW067700-8090	Nickel plug	Nickel	R

	No	DENSO	PART NUMBER	SPEC.	GROUND/E.	NUT
CROSS REFERENCE PART NUMBER	1	K16TT	JK267700-7430	Nickel TT plug	Nickel	S
	2	K20TT	JK267700-7440	Nickel TT plug	Nickel	S
	3	KH16TT	JK267700-7450	Nickel TT plug	Nickel	S
	4	KH20TT	JK267700-7460	Nickel TT plug	Nickel	S
	5	Q16TT	JK267700-7470	Nickel TT plug	Nickel	S
	6	Q20TT	JK267700-7480	Nickel TT plug	Nickel	S
	7	SC16HR11	JK267700-8301	Iridium plug	Platinum	S
	8	SC20HR11	JK267700-5580	Iridium plug	Platinum	S

S: SOLID; R: REMOVABLE; RC: CRIMPED; T: THREAD

DENSO, PART No., SPECIFICATIONS, LIST ( 0677009760 ⇒  )

No	PART NUMBER	DENSO	SPEC.	GROUND/E.	NUT
1	067600-0320	M17	Nickel plug	Nickel	R
2	067600-0330	M22	Nickel plug	Nickel	R
3	067600-0770	K20-U11	Nickel plug	Nickel	S
4	067600-1761	W16EP	Nickel plug	Nickel	S
5	067600-1792	W22EP	Nickel plug	Nickel	S
6	067600-1811	IW06-27	Iridium plug	Platinum	S
7	067600-1821	IW06-31	Iridium plug	Platinum	S
8	067600-1831	IW06-34	Iridium plug	Platinum	S
9	067600-4182	LP20-U	Nickel plug	Nickel	S
10	067600-6522	W14FP-L	Nickel plug	Nickel	T
11	067600-6900	W9-U	Nickel plug	Nickel	R
12	067600-7380	T20EP-U	Nickel plug	Nickel	R
13	067600-7390	T22EP-U	Nickel plug	Nickel	R
14	067600-7511	MA9P-U	Nickel plug	Nickel	R
15	067600-7550	MA20P-U	Nickel plug	Nickel	R
16	067600-7570	L14-U	Nickel plug	Nickel	R
17	067600-8450	T20M-U	Nickel plug	Nickel	R
18	067600-8470	T20MP-U	Nickel plug	Nickel	R
19	067600-9270	TR22-10	Nickel plug	Nickel	R
20	067600-9700	T16P-U	Nickel plug	Nickel	S
21	067600-9711	T20P-U	Nickel plug	Nickel	S
22	067700-0020	PK20PR-P8	Platinum plug	Platinum	S
23	067700-0211	W24EPR	Nickel plug	Nickel	R
24	067700-0271	W22EPR	Nickel plug	Nickel	R
25	067700-0352	W22ESR	Nickel plug	Nickel	R
26	067700-0442	LP20R-U	Nickel plug	Nickel	S
27	067700-2160	W20ETR-L	2-Ground electrodes Nickel plug	Nickel	S
28	067700-2171	W16ETR-S	2-Ground electrodes surface discharge Nickel plug	Nickel	S
29	067700-2181	W20ETR-S	2-Ground electrodes surface discharge Nickel plug	Nickel	S
30	067700-3130	T16EPR-U	Nickel plug	Nickel	R
31	067700-3140	T20EPR-U	Nickel plug	Nickel	R
32	067700-3150	·SK20R-P11	Iridium plug	Platinum	S
33	067700-3190	T16EPR-U15	Nickel plug	Nickel	R
34	067700-3210	T20EPR-U15	Nickel plug	Nickel	R
35	067700-3330	W14FR-U	Nickel plug	Nickel	R
36	067700-3390	P16PR11	Platinum plug	Platinum	S
37	067700-3400	P20PR11	Platinum plug	Platinum	S
38	067700-3520	SK20R5-G	Iridium plug w/t Grease	Platinum	S
39	067700-3560	SK20BR11	3-Ground electrodes Iridium plug	Platinum	S
40	067700-3630	MA16PR-U	Nickel plug	Nickel	R
41	067700-3660	MA20PR-U	Nickel plug	Nickel	R
42	067700-3992	·PQ20R-P11	Platinum plug	Platinum	S
43	067700-4082	PQ20R-P11	Platinum plug	Platinum	S
44	067700-4102	PQ20R-P8	Platinum plug	Platinum	S
45	067700-4110	P16R13	Platinum plug	Platinum	S
46	067700-4130	P16R	Platinum plug	Platinum	S
47	067700-4140	P20R8	Platinum plug	Platinum	S
48	067700-4171	PQ16R	Platinum plug	Platinum	S
49	067700-4191	PQ20R	Platinum plug	Platinum	S
50	067700-4220	PQ20R13	Platinum plug	Platinum	S
51	067700-4520	Q20PR-U11	Nickel plug	Nickel	R
52	067700-4861	PQ20R8	Platinum plug	Platinum	S
53	067700-5030	X27ETR	2-Ground electrodes Nickel plug	Nickel	T
54	067700-5450	U24ETR	2-Ground electrodes Nickel plug	Nickel	T
55	067700-5460	U27ETR	2-Ground electrodes Nickel plug	Nickel	T
56	067700-5560	U22ETR	2-Ground electrodes Nickel plug	Nickel	T
57	067700-5630	U31ETR	2-Ground electrodes Nickel plug	Nickel	T
58	067700-5700	T14PR-U	Nickel plug	Nickel	S
59	067700-5750	T16PR-U	Nickel plug	Nickel	S
60	067700-5760	T16PR-U11	Nickel plug	Nickel	S
61	067700-5770	T16PR-U15	Nickel plug	Nickel	S
62	067700-5851	T20PR-U	Nickel plug	Nickel	S
63	067700-5920	QJ16AR-U	Nickel plug	Nickel	S
64	067700-5950	T20R-U	Nickel plug	Nickel	S
65	067700-6070	Q20PR-U11	Nickel plug	Nickel	S
66	067700-6460	PK20PR-P11	Platinum plug	Platinum	S
67	067700-6661	PK16R8	Platinum plug	Platinum	S
68	067700-6670	PK20R8	Platinum plug	Platinum	S
69	067700-6680	PK16R11	Platinum plug	Platinum	S
70	067700-6690	PK20R11	Platinum plug	Platinum	S
71	067700-6710	PK20R13	Platinum plug	Platinum	S
72	067700-6740	PK16PR-L11	Platinum plug	Platinum	S
73	067700-6750	PK20PR-L11	Platinum plug	Platinum	S
74	067700-6870	PK16PR-P11	Platinum plug	Platinum	S
75	067700-6980	J14CR-U	Nickel plug	Nickel	S
76	067700-6990	J16CR-U	Nickel plug	Nickel	S
77	067700-7130	PKJ16CR-L11	Platinum plug	Platinum	S
78	067700-7140	PKJ20CR-L11	Platinum plug	Platinum	S
79	067700-7250	P22PR8	Platinum plug	Platinum	S
80	067700-7260	QL20TR-S	2-Ground electrodes surface discharge Nickel plug	Nickel	S
81	067700-7270	QL22TR-S	2-Ground electrodes surface discharge Nickel plug	Nickel	S
82	067700-7330	K16DTR-S11	2-Ground electrodes surface discharge Nickel plug	Nickel	S
83	067700-7370	PK16PR11	Platinum plug	Platinum	S
84	067700-7380	PK20PR11	Platinum plug	Platinum	S
85	067700-7390	PK22PR11	Platinum plug	Platinum	S
86	067700-7440	W16DTR-S	2-Ground electrodes surface discharge Nickel plug	Nickel	S

AUSTRALIA  
 CHINA  
 INDIA  
 INDONESIA  
 KOREA  
 MALAYSIA  
 PHILIPPINES  
 SAUDIARABIA  
 SINGAPORE  
 TAIWAN  
 THAILAND  
 VIETNAM  
 JAPAN  
 EUROPE & USA  
 CROSS REFERENCE PART NUMBER

S: SOLID; R: REMOVABLE; RC: CRIMPED; T: THREAD

	No	PART NUMBER	DENSO	SPEC.	GROUND/E.	NUT
AUSTRALIA	87	067700-7480	PK20PR-L13	Platinum plug	Platinum	S
	88	067700-7690	PK22PR8	Platinum plug	Platinum	S
	89	067700-7800	PKJ16CR8	Platinum plug	Platinum	S
	90	067700-7810	PKJ20CR8	Platinum plug	Platinum	S
	91	067700-7930	PK20TR11	2-Ground electrodes Platinum plug	Nickel	S
CHINA	92	067700-7940	PT16VR13	Platinum plug	Platinum	S
	93	067700-7990	PK16TR11	2-Ground electrodes Platinum plug	Nickel	S
	94	067700-8120	PK16TR13	2-Ground electrodes Platinum plug	Nickel	S
	95	067700-8140	PT16EPR-L13	Platinum plug	Platinum	S
	96	067700-8200	SK20R-P11	Iridium plug	Platinum	S
INDIA	97	067700-8211	PK20GR8	Platinum plug	Platinum	S
	98	067700-8250	K16PR-P11	Platinum plug	Nickel	S
	99	067700-8270	P20PR8	Platinum plug	Platinum	S
	100	067700-8280	SK16R-P11	Iridium plug	Platinum	S
	101	067700-8340	SK20R11	Iridium plug	Platinum	S
INDONESIA	102	067700-8350	SK16R-P8	Iridium plug	Platinum	S
	103	067700-8360	SK20R-P13	Iridium plug	Platinum	S
	104	067700-8431	IK22	Iridium plug	Nickel	S
	105	067700-8461	IK24	Iridium plug	Nickel	S
	106	067700-8472	IK27	Iridium plug	Nickel	S
KOREA	107	067700-8481	IQ22	Iridium plug	Nickel	S
	108	067700-8491	IQ24	Iridium plug	Nickel	S
	109	067700-8502	IQ27	Iridium plug	Nickel	S
	110	067700-8601	IXU27	Iridium plug	Nickel	RC
	111	067700-8620	SVK20RZ11	Iridium plug	Platinum	S
MALAYSIA	112	067700-8630	SK20PR-L9	Iridium plug	Platinum	S
	113	067700-8640	SK16PR-A11	Iridium plug	Platinum	S
	114	067700-8651	IW16	Iridium plug	Nickel	RC
	115	067700-8661	IW20	Iridium plug	Nickel	RC
	116	067700-8671	IW22	Iridium plug	Nickel	RC
PHILIPPINES	117	067700-8681	IK16	Iridium plug	Nickel	S
	118	067700-8691	IK20	Iridium plug	Nickel	S
	119	067700-8701	IQ16	Iridium plug	Nickel	S
	120	067700-8711	IQ20	Iridium plug	Nickel	S
	121	067700-8721	IXU22	Iridium plug	Nickel	RC
SAUDI ARABIA	122	067700-8731	IXU24	Iridium plug	Nickel	RC
	123	067700-8840	SK16R11	Iridium plug	Platinum	S
	124	067700-8860	·SK16R-P11	Iridium plug	Platinum	S
	125	067700-8870	·XU22EPR-U	Nickel plug	Nickel	S
	126	067700-8880	·PK20R11	Platinum plug	Platinum	S
SINGAPORE	127	067700-8891	IW24	Iridium plug	Nickel	RC
	128	067700-8901	IW27	Iridium plug	Nickel	RC
	129	067700-8911	IW29	Iridium plug	Nickel	RC
	130	067700-8921	IW31	Iridium plug	Nickel	RC
	131	067700-8931	IW34	Iridium plug	Nickel	RC
TAIWAN	132	067700-8960	P16R8	Platinum plug	Platinum	S
	133	067700-9221	IK31	Iridium plug	Nickel	S
	134	067700-9231	IQ31	Iridium plug	Nickel	S
	135	067700-9240	VW20T	Iridium plug	Platinum	S
	136	067700-9262	IU22	Iridium plug	Nickel	R
THAILAND	137	067700-9272	IU24	Iridium plug	Nickel	R
	138	067700-9282	IU27	Iridium plug	Nickel	R
	139	067700-9292	IU31	Iridium plug	Nickel	R
	140	067700-9302	IU24A	Iridium plug	Nickel	R
	141	067700-9312	IU27A	Iridium plug	Nickel	R
VIETNAM	142	067700-9321	IU31A	Iridium plug	Nickel	R
	143	067700-9331	IUH24	Iridium plug	Nickel	R
	144	067700-9341	IUH27	Iridium plug	Nickel	R
	145	067700-9351	IX22	Iridium plug	Nickel	R
	146	067700-9361	IX24	Iridium plug	Nickel	R
JAPAN	147	067700-9371	IX27	Iridium plug	Nickel	R
	148	067700-9381	IX22B	Iridium plug	Nickel	R
	149	067700-9391	IX24B	Iridium plug	Nickel	R
	150	067700-9401	IX27B	Iridium plug	Nickel	R
	151	067700-9411	IWF22	Iridium plug	Nickel	R
EUROPE & USA	152	067700-9421	IWF24	Iridium plug	Nickel	R
	153	067700-9431	IWF27	Iridium plug	Nickel	R
	154	067700-9460	PKJ20CR-M11	Platinum plug	Platinum	S
	155	067700-9481	IUF22	Iridium plug	Nickel	R
	156	067700-9491	IUF24	Iridium plug	Nickel	R
CROSS REFERENCE	157	067700-9520	IK27C11	Iridium plug	Nickel	S
	158	067700-9530	SK20BR11	3-Ground electrodes Iridium plug	Platinum	S
	159	067700-9540	VK20T	Iridium plug	Platinum	S
	160	067700-9550	IK24C11	Iridium plug	Nickel	S
	161	067700-9560	IUH24D	Iridium plug	Nickel	T
PART NUMBER	162	067700-9570	IUH27D	Iridium plug	Nickel	T
	163	067700-9591	IK34	Iridium plug	Nickel	S
	164	067700-9601	IQ34	Iridium plug	Nickel	S
	165	067700-9670	S22PR-A7	Iridium plug	Platinum	S
	166	067700-9680	SKJ16CR-L11	Iridium plug	Platinum	S
	167	067700-9701	IUF27A	Iridium plug	Nickel	R
	168	067700-9711	IUF31A	Iridium plug	Nickel	R
	169	067700-9720	VX22BC	Iridium plug	Platinum	T
	170	067700-9730	SK20BGR11	3-Ground electrodes Iridium plug	Platinum	S
	171	067700-9740	SVK20RZ8	Iridium plug	Platinum	S
	172	067700-9760	·K20PTR-S	2-Ground electrodes surface discharge Nickel plug	Nickel	S

S: SOLID; R: REMOVABLE; RC: CRIMPED; T: THREAD

DENSO, PART No., SPECIFICATIONS, LIST ( 0677009760 ⇒  )

No	PART NUMBER	DENSO	SPEC.	GROUND/E.	NUT
173	067700-9830	VX20BC	Iridium plug	Platinum	T
174	067800-0031	SF-50	Surface discharge plug	None	R
175	067800-0041	SF-51	Surface discharge plug	None	R
176	067800-4110	X20ES-U	Nickel plug	Nickel	T
177	067800-4350	X22EP-U9	Nickel plug	Nickel	T
178	067800-4620	U24FS-U	Nickel plug	Nickel	T
179	067800-4820	U24FE9	Nickel plug	Nickel	T
180	067800-6400	U14FS-UB	Nickel plug	Nickel	S
181	067800-7260	TJ14R-P15	Platinum plug	Nickel	S
182	067800-7280	PTJ16R15	Platinum plug	Platinum	S
183	067800-7340	ZT20EPR11	Iridium plug	Platinum	S
184	067800-7790	U24FS-U	Nickel plug	Nickel	T
185	067800-7860	FK20HQR10	Double needle Iridium plug	Needle	S
186	067800-7920	FK20HQR8	Double needle Iridium plug	Needle	S
187	067800-9250	GE3-F	Iridium plug	Platinum	S
188	067800-9390	PT16EPR10	Platinum plug	Platinum	S
189	067800-9400	PT16EPR13	Platinum plug	Platinum	S
190	267700-0540	IUF14-UB	Iridium plug	Nickel	S
191	267700-0550	KJ20DR-M11	Nickel plug	Nickel	S
192	267700-0560	SKJ20DR-M13	Iridium plug	Platinum	S
193	267700-0570	SK20PR-A11	Iridium plug	Platinum	S
194	267700-0611	IT16	Iridium plug	Nickel	S
195	267700-0621	IT20	Iridium plug	Nickel	S
196	267700-0631	IT22	Iridium plug	Nickel	S
197	267700-0641	IT24	Iridium plug	Nickel	S
198	267700-0651	IT27	Iridium plug	Nickel	S
199	267700-0661	ITF16	Iridium plug	Nickel	S
200	267700-0671	ITF20	Iridium plug	Nickel	S
201	267700-0681	ITF22	Iridium plug	Nickel	S
202	267700-0691	ITF24	Iridium plug	Nickel	S
203	267700-0701	ITF27	Iridium plug	Nickel	S
204	267700-0711	VK16	Iridium plug	Platinum	S
205	267700-0721	VK20	Iridium plug	Platinum	S
206	267700-0731	VK22	Iridium plug	Platinum	S
207	267700-0741	VQ16	Iridium plug	Platinum	S
208	267700-0751	VQ20	Iridium plug	Platinum	S
209	267700-0761	VQ22	Iridium plug	Platinum	S
210	267700-0771	VW16	Iridium plug	Platinum	S
211	267700-0781	VW20	Iridium plug	Platinum	S
212	267700-0791	VW22	Iridium plug	Platinum	S
213	267700-0801	VXU22	Iridium plug	Platinum	RC
214	267700-0811	VXU24	Iridium plug	Platinum	RC
215	267700-0830	IU22D	Iridium plug	Nickel	T
216	267700-0840	IU24D	Iridium plug	Nickel	T
217	267700-0850	IU27D	Iridium plug	Nickel	T
218	267700-0860	IU31D	Iridium plug	Nickel	T
219	267700-0870	·SK16PR-A11	Iridium plug	Platinum	S
220	267700-0890	SKJ16CR-A8	Iridium plug	Platinum	S
221	267700-0910	SKJ20DR-M11	Iridium plug	Platinum	S
222	267700-0930	SK22PR-M11	Iridium plug	Platinum	S
223	267700-0950	KJ20SR11	Iridium plug	Nickel	S
224	267700-1011	IU01-24	Iridium plug	Platinum	R
225	267700-1021	IU01-27	Iridium plug	Platinum	R
226	267700-1031	IU01-31	Iridium plug	Platinum	R
227	267700-1041	IU01-34	Iridium plug	Platinum	R
228	267700-1061	IXU01-24	Iridium plug	Platinum	R
229	267700-1071	IXU01-27	Iridium plug	Platinum	R
230	267700-1081	IXU01-31	Iridium plug	Platinum	R
231	267700-1091	IXU01-34	Iridium plug	Platinum	R
232	267700-1111	IW01-24	Iridium plug	Platinum	RC
233	267700-1121	IW01-27	Iridium plug	Platinum	RC
234	267700-1131	IW01-29	Iridium plug	Platinum	RC
235	267700-1141	IW01-31	Iridium plug	Platinum	RC
236	267700-1151	IW01-32	Iridium plug	Platinum	RC
237	267700-1161	IW01-34	Iridium plug	Platinum	RC
238	267700-1211	IWM01-29	Iridium plug	Platinum	S
239	267700-1221	IWM01-31	Iridium plug	Platinum	S
240	267700-1231	IWM01-32	Iridium plug	Platinum	S
241	267700-1241	IWM01-34	Iridium plug	Platinum	S
242	267700-1261	IA01-31	Iridium plug	Platinum	S
243	267700-1271	IA01-32	Iridium plug	Platinum	S
244	267700-1281	IA01-34	Iridium plug	Platinum	S
245	267700-1311	IK01-24	Iridium plug	Platinum	S
246	267700-1321	IK01-27	Iridium plug	Platinum	S
247	267700-1331	IK01-31	Iridium plug	Platinum	S
248	267700-1341	IK01-34	Iridium plug	Platinum	S
249	267700-1361	IK02-24	Iridium plug	Platinum	S
250	267700-1371	IK02-27	Iridium plug	Platinum	S
251	267700-1381	IK02-31	Iridium plug	Platinum	S
252	267700-1411	IQ01-24	Iridium plug	Platinum	S
253	267700-1421	IQ01-27	Iridium plug	Platinum	S
254	267700-1431	IQ01-31	Iridium plug	Platinum	S
255	267700-1441	IQ01-34	Iridium plug	Platinum	S
256	267700-1461	IQ02-24	Iridium plug	Platinum	S
257	267700-1471	IQ02-27	Iridium plug	Platinum	S
258	267700-1481	IQ02-31	Iridium plug	Platinum	S

AUSTRALIA  
CHINA  
INDIA  
INDONESIA  
KOREA  
MALAYSIA  
PHILIPPINES  
SAUDIARABIA  
SINGAPORE  
TAIWAN  
THAILAND  
VIETNAM  
JAPAN  
EUROPE & USA  
CROSS REFERENCE  
PART NUMBER

S: SOLID; R: REMOVABLE; RC: CRIMPED; T: THREAD

	No	PART NUMBER	DENSO	SPEC.	GROUND/E.	NUT
AUSTRALIA	259	267700-1521	IRE01-27	Iridium plug	Platinum	S
	260	267700-1531	IRE01-31	Iridium plug	Platinum	S
	261	267700-1541	IRE01-32	Iridium plug	Platinum	S
	262	267700-1551	IRE01-34	Iridium plug	Platinum	S
	263	267700-1561	IRE01-35	Iridium plug	Platinum	S
CHINA	264	267700-1580	RU01-31	Surface discharge plug	None	R
	265	267700-1640	VW16R-A13	Iridium plug	Platinum	S
	266	267700-1760	SKJ20CR-A8	Iridium plug	Platinum	S
	267	267700-1840	VK16PRZ11	Iridium plug	Platinum	S
	268	267700-1850	VK20PRZ11	Iridium plug	Platinum	S
INDIA	269	267700-1860	VK22PRZ11	Iridium plug	Platinum	S
	270	267700-1870	VK24PRZ11	Iridium plug	Platinum	S
	271	267700-1920	VNH27ZB	Iridium plug	Platinum	S
	272	267700-1931	VUH27D	Iridium plug	Platinum	T
	273	267700-1970	VKJ20RZ-M11	Iridium plug	Platinum	S
INDONESIA	274	267700-2011	VUH24D	Iridium plug	Platinum	T
	275	267700-2050	VK27PRZ11	Iridium plug	Platinum	S
	276	267700-2060	VNH24Z	Iridium plug	Platinum	S
	277	267700-2070	VNH27Z	Iridium plug	Platinum	S
	278	267700-2190	SXU16HPR9	Iridium plug	Platinum	S
KOREA	279	267700-2200	SK16PR-L11	Iridium plug	Platinum	S
	280	267700-2310	SK20PR-B8	Iridium plug	Platinum	S
	281	267700-2320	PK20PTR-S9	2-Ground electrodes surface discharge Platinum plug	Nickel	S
	282	267700-2340	SK20PR-A8	Iridium plug	Platinum	S
	283	267700-2501	ITV22	Iridium plug	Nickel	S
MALAYSIA	284	267700-2511	ITV24	Iridium plug	Nickel	S
	285	267700-2521	ITV27	Iridium plug	Nickel	S
	286	267700-2570	SK20R8	Iridium plug	Platinum	S
	287	267700-2610	SKJ16DR-M11	Iridium plug	Platinum	S
	288	267700-2651	IKH22	Iridium plug	Nickel	S
PHILIPPINES	289	267700-2681	VKH22	Iridium plug	Platinum	S
	290	267700-2740	SK16PR-E11	Iridium plug	Platinum	S
	291	267700-2811	VT16	Iridium plug	Platinum	S
	292	267700-2891	IWM24	Iridium plug	Nickel	S
	293	267700-2901	IWM27	Iridium plug	Nickel	S
SAUDIARABIA	294	267700-2911	IWM31	Iridium plug	Nickel	S
	295	267700-2921	IXG24	Iridium plug	Nickel	R
	296	267700-2931	IXG27	Iridium plug	Nickel	R
	297	267700-2941	IAE01-32	Iridium plug	Platinum	S
	298	267700-2951	IAE01-34	Iridium plug	Platinum	S
SINGAPORE	299	267700-2970	ZXU22HBR11	3-Ground electrodes double needle Iridium plug	Platinum	S
	300	267700-2980	SK20R11	Iridium plug	Platinum	S
	301	267700-3000	SK16HR11	Iridium plug	Platinum	S
	302	267700-3020	SXU22PR-A9	Iridium plug	Platinum	S
	303	267700-3130	SK16R8-PG	Iridium plug	Platinum	S
TAIWAN	304	267700-3661	IKH16	Iridium plug	Nickel	S
	305	267700-3671	IKH20	Iridium plug	Nickel	S
	306	267700-3681	VKH16	Iridium plug	Platinum	S
	307	267700-3691	VKH20	Iridium plug	Platinum	S
	308	267700-3701	ITV16	Iridium plug	Nickel	S
THAILAND	309	267700-3711	ITV20	Iridium plug	Nickel	S
	310	267700-3721	VK20Y	Iridium plug	Platinum	S
	311	267700-4120	SK20HR11	Iridium plug	Platinum	S
	312	267700-4140	SK20R8-G	Iridium plug w/t Grease	Platinum	S
	313	267700-4160	PK22PR-L11S	Platinum plug w/t SUS Gasket	Platinum	S
VIETNAM	314	267700-4200	FK20HBR11	3-Ground electrodes double needle Iridium plug	Needle	S
	315	267700-4230	FK20HR11	Double needle Iridium plug	Needle	S
	316	267700-4281	IKH24	Iridium plug	Nickel	S
	317	267700-4291	IKH27	Iridium plug	Nickel	S
	318	267700-4320	ZXE20HR13(AM)	Iridium plug	Platinum	S
JAPAN	319	267700-4340	SK16PR-F8	Iridium plug	Platinum	S
	320	267700-4360	SK20PR-F8	Iridium plug	Platinum	S
	321	267700-4380	K20PSR-B8	Iridium plug	Nickel	S
	322	267700-4390	K20PR-U9S	Nickel plug w/t SUS Gasket	Nickel	S
	323	267700-4451	IKH01-24	Iridium plug	Platinum	S
EUROPE & USA	324	267700-4461	IKH01-27	Iridium plug	Platinum	S
	325	267700-4471	IKH01-31	Iridium plug	Platinum	S
	326	267700-4481	VT20	Iridium plug	Platinum	S
	327	267700-4491	IY24	Iridium plug	Nickel	R
	328	267700-4501	IY27	Iridium plug	Nickel	R
CROSS REFERENCE	329	267700-4511	IY31	Iridium plug	Nickel	R
	330	267700-4530	SXU22HDR8	Iridium plug	Platinum	S
	331	267700-4541	VKH20Y	Iridium plug	Platinum	S
	332	267700-4570	W16EPR-U	Nickel plug	Nickel	T
	333	267700-4640	ZXE20HR13(OE)	Iridium plug	Platinum	S
PART NUMBER	334	267700-4690	S20R8-G	Iridium plug	Platinum	S
	335	267700-4770	VUH27ES	Iridium plug w/t SUS Gasket	Platinum	T
	336	267700-4810	T16VR-U10	Nickel plug	Nickel	S
	337	267700-4821	IRL01-27	Iridium plug	Platinum	S
	338	267700-4831	IRL01-31	Iridium plug	Platinum	S
	339	267700-4841	IRT01-31	Iridium plug	Platinum	S
	340	267700-4851	IRT01-34	Iridium plug	Platinum	S
	341	267700-4880	FXE20HR11(AM)	Double needle Iridium plug	Needle	S
	342	267700-4930	SKJ20DR-M11S	Iridium plug w/t SUS Gasket	Platinum	S
	343	267700-4950	FXE16HE11	Double needle Iridium plug	Needle	S
	344	267700-4981	ITL16	Iridium plug	Nickel	S

S: SOLID; R: REMOVABLE; RC: CRIMPED; T: THREAD

DENSO, PART No., SPECIFICATIONS, LIST ( 0677009760 ⇒  )

No	PART NUMBER	DENSO	SPEC.	GROUND/E.	NUT
345	267700-4991	ITL20	Iridium plug	Nickel	S
346	267700-5001	IWF16	Iridium plug	Nickel	R
347	267700-5011	IWF20	Iridium plug	Nickel	R
348	267700-5021	IU20	Iridium plug	Nickel	R
349	267700-5031	VKA16	3-Ground electrodes Iridium plug	Platinum	S
350	267700-5041	VKA20	3-Ground electrodes Iridium plug	Platinum	S
351	267700-5051	VKB16	3-Ground electrodes Iridium plug	Platinum	S
352	267700-5061	VKB20	3-Ground electrodes Iridium plug	Platinum	S
353	267700-5170	IXU22C	Iridium plug	Nickel	S
354	267700-5250	K22PR-UR	Nickel plug	Nickel	S
355	267700-5290	FK16R11	Double needle Iridium plug	Needle	S
356	267700-5480	FXE20HE11·(AM)	Double needle Iridium plug	Needle	S
357	267700-5500	SK20HPR-L11·	Iridium plug	Platinum	S
358	267700-5530	SXU22HCR11S	Iridium plug w/t SUS Gasket	Platinum	S
359	267700-5590	GX8-1·	Iridium plug	Platinum	S
360	267700-5600	SK20PR-L11·	Iridium plug	Platinum	S
361	267700-5611	IK16G	Iridium plug w/t SUS Gasket	Nickel	S
362	267700-5621	IK20G	Iridium plug w/t SUS Gasket	Nickel	S
363	267700-5631	VK16G	Iridium plug w/t SUS Gasket	Platinum	S
364	267700-5641	VK20G	Iridium plug w/t SUS Gasket	Platinum	S
365	267700-5661	IK22G	Iridium plug w/t SUS Gasket	Nickel	S
366	267700-5671	VK22G	Iridium plug w/t SUS Gasket	Platinum	S
367	267700-5810	XE20HR-U9	Nickel plug	Nickel	S
368	267700-5830	FXE22HR11·(AM)	Double needle Iridium plug	Needle	S
369	267700-5860	K16PSR-B8	Iridium plug	Nickel	S
370	267700-5900	SXU22PR9	Iridium plug	Platinum	S
371	267700-5920	FK16HQR11	Double needle Iridium plug	Needle	S
372	267700-5970	SXU22HPR9	Iridium plug	Platinum	S
373	267700-6050	SXU22HCR11	Iridium plug	Platinum	S
374	267700-6070	SK20HR8-T	Iridium plug	Platinum	S
375	267700-6100	SKJ20DR-M11S·	Iridium plug w/t SUS Gasket	Platinum	S
376	267700-6110	SKJ20DR-M13·	Iridium plug	Platinum	S
377	267700-6120	PT16VR10	Platinum plug	Platinum	S
378	267700-6130	VUH24ES	Iridium plug w/t SUS Gasket	Platinum	T
379	267700-6150	SK20PR-N9S	Iridium plug w/t SUS Gasket	Platinum	T
380	267700-6160	SK22PR-M11S·	Iridium plug w/t SUS Gasket	Platinum	S
381	267700-6210	ZXE27HBR8	Iridium plug	Platinum	S
382	267700-6290	K20PR-U8S	Nickel plug w/t SUS Gasket	Nickel	S
383	267700-6301	W16TT	Nickel TT plug	Nickel	RC
384	267700-6311	W20TT	Nickel TT plug	Nickel	RC
385	267700-6320	PK16TT	Platinum TT plug	Nickel	S
386	267700-6330	PK20TT	Platinum TT plug	Nickel	S
387	267700-6340	PKH16TT	Platinum TT plug	Nickel	S
388	267700-6350	PKH20TT	Platinum TT plug	Nickel	S
389	267700-6360	PQ16TT	Platinum TT plug	Nickel	S
390	267700-6370	PQ20TT	Platinum TT plug	Nickel	S
391	267700-6380	PW16TT	Platinum TT plug	Nickel	S
392	267700-6390	PW20TT	Platinum TT plug	Nickel	S
393	267700-6430	X22ESR-UB	Nickel plug	Nickel	S
394	267700-6451	IXUH22	Iridium plug	Nickel	S
395	267700-6461	VXUH22	Iridium plug	Platinum	S
396	267700-6510	U20ESR-N·	Nickel plug	Nickel	T
397	267700-6520	U22ESR-N·	Nickel plug	Nickel	T
398	267700-6530	U24ESR-N·	Nickel plug	Nickel	T
399	267700-6540	U27ESR-N·	Nickel plug	Nickel	T
400	267700-6550	U31ESR-N·	Nickel plug	Nickel	T
401	267700-6560	U22ETR·	2-Ground electrodes Nickel plug	Nickel	T
402	267700-6570	U24ETR·	2-Ground electrodes Nickel plug	Nickel	T
403	267700-6580	U27ETR·	2-Ground electrodes Nickel plug	Nickel	T
404	267700-6590	U31ETR·	2-Ground electrodes Nickel plug	Nickel	T
405	267700-6610	U16FSR-U	Nickel plug	Nickel	T
406	267700-6690	SK20PR-N9	Iridium plug	Platinum	S
407	267700-6700	SK20R-B5	Iridium plug	Platinum	S
408	267700-6970	FXE24HR11·(AM)	Double needle Iridium plug	Needle	S
409	267700-7020	ZXU20PR11	Iridium plug	Platinum	S
410	267700-7080	XU22TT	Nickel TT plug	Nickel	S
411	267700-7090	XUH22TT	Nickel TT plug	Nickel	S
412	267700-7140	FK16HR11	Double needle Iridium plug	Needle	S
413	267700-7170	IXU22HPR	Iridium plug	Nickel	S
414	267700-7180	FK20HBR11-T	3-Ground electrodes double needle Iridium plug	Needle	S
415	267700-7190	FK20HQR8	Double needle Iridium plug	Needle	S
416	267700-7200	PT16TT	Platinum TT plug	Nickel	S
417	267700-7210	PT20TT	Platinum TT plug	Nickel	S
418	267700-7220	PTV16TT	Platinum TT plug	Nickel	S
419	267700-7240	PT16TT	Platinum TT plug	Nickel	S
420	267700-7250	PT20TT	Platinum TT plug	Nickel	S
421	267700-7260	FXU16HR11	Double needle Iridium plug	Needle	S
422	267700-7280	FXE24HR11·(OE)	Double needle Iridium plug	Needle	S
423	267700-7290	FXE22HR11·(OE)	Double needle Iridium plug	Needle	S
424	267700-7300	FXE20HR11·(OE)	Double needle Iridium plug	Needle	S
425	267700-7310	FXE20HE11·(OE)	Double needle Iridium plug	Needle	S
426	267700-7320	FXE20HR11·(OE)	Double needle Iridium plug	Needle	S
427	267700-7330	SXU22HPR8	Iridium plug	Platinum	S
428	267700-7340	FK20HQR10	Double needle Iridium plug	Needle	S
429	267700-7371	IXUH22I	Iridium plug	Nickel	S
430	267700-7381	VXUH22I	Iridium plug	Platinum	S

AUSTRALIA  
 CHINA  
 INDIA  
 INDONESIA  
 KOREA  
 MALAYSIA  
 PHILIPPINES  
 SAUDIARABIA  
 SINGAPORE  
 TAIWAN  
 THAILAND  
 VIETNAM  
 JAPAN  
 EUROPE & USA  
 CROSS REFERENCE  
 PART NUMBER

S: SOLID; R: REMOVABLE; RC: CRIMPED; T: THREAD

	No	PART NUMBER	DENSO	SPEC.	GROUND/E.	NUT
AUSTRALIA	431	267700-7390	DK20PR-D13	Double needle Iridium plug	Needle	S
	432	267700-7400	FC22HR9	Double needle Iridium plug	Needle	S
	433	267700-7411	VFKH16	Double needle Iridium plug	Needle	S
	434	267700-7421	VFKH20	Double needle Iridium plug	Needle	S
	435	267700-7490	TV16TT	Nickel TT plug	Nickel	S
CHINA	436	267700-7500	WF20TT	Nickel TT plug	Nickel	RC
	437	267700-7510	W22TT	Nickel TT plug	Nickel	RC
	438	267700-7520	FXU22HR11	Double needle Iridium plug	Needle	S
INDIA	439	267700-7550	ZXU20HCR8	Iridium plug	Platinum	S
	440	267700-7560	FXU22HR8	Double needle Iridium plug	Needle	S
	441	267700-7570	FK20HR8-G	Double needle Iridium plug w/t Grease	Needle	S
	442	267700-7580	DXU22HCR-D11S	Double needle Iridium plug w/t SUS Gasket	Needle	S
	443	267700-7590	SXU22HPR11	Iridium plug	Platinum	S
	444	267700-7600	FK20HR11-G	Double needle Iridium plug w/t Grease	Needle	S
	445	267700-7620	FC22HR9-G	Double needle Iridium plug w/t Grease	Needle	S
	446	267700-7631	VFXEH20E	Double needle Iridium plug	Needle	S
	447	267700-7641	VFXEH20	Double needle Iridium plug	Needle	S
	448	267700-7651	VFXEH22	Double needle Iridium plug	Needle	S
INDONESIA	449	267700-7661	VFKBH20	3-Ground electrodes Iridium plug	Needle	S
	450	267700-7671	VCH20	Iridium plug	Platinum	S
	451	267700-7700	FK16HR-A8	Double needle Iridium plug	Needle	S
	452	267700-7710	FC20HPR8	Double needle Iridium plug	Needle	S
	453	267700-7720	FXE20HE11C	Double needle Iridium plug	Needle	S
KOREA	454	267700-7730	FXE20HE11C	Double needle Iridium plug	Needle	S
	455	267700-7740	SXU22HCR8S	Iridium plug w/t SUS Gasket	Platinum	S
	456	267700-7750	ZK20HQR8	Iridium plug	Platinum	S
	457	267700-7760	VKH20T	Iridium plug	Platinum	S
	458	267700-7770	FK20HBR8	3-Ground electrodes double needle Iridium plug	Needle	S
MALAYSIA	459	267700-7780	FK16R-A8	Double needle Iridium plug	Needle	S
	460	267700-7790	PK22TT	Platinum TT plug	Nickel	S
	461	267700-7800	DXE22HQR-D11S	Double needle Iridium plug w/t SUS Gasket	Needle	S
	462	267700-7810	SXE22HQR11S	Iridium plug w/t SUS Gasket	Platinum	S
	463	267700-7820	T16TT	Nickel TT plug	Nickel	S
	464	267700-7830	T20TT	Nickel TT plug	Nickel	S
	465	267700-7850	SK20HR-A11	Iridium plug	Platinum	S
	466	267700-7860	K20HR-UAG8	Nickel plug w/t Grease	Nickel	S
	467	267700-7870	SK16HR-G11	Iridium plug w/t Grease	Platinum	S
	468	267700-7900	K16PZR13	Nickel plug	Nickel	S
SAUDIARABIA	469	267700-7920	K16R-UAG8	Nickel plug w/t Grease	Nickel	S
	470	267700-7930	SC20HR-G11	Iridium plug w/t Grease	Platinum	S
	471	267700-7940	ZC20HPR11	Iridium plug	Platinum	S
	472	267700-7950	ZXU20HPR11	Iridium plug	Platinum	S
	473	267700-7970	ZXU22HCR8	Iridium plug	Platinum	S
	474	267700-8130	SXU20HPR11	Iridium plug	Platinum	S
	475	267700-8161	VXUH20I	Iridium plug	Platinum	S
	476	267700-8171	IXUH20I	Iridium plug	Nickel	S
	477	267700-8180	FC16HR8	Double needle Iridium plug	Needle	S
	478	267700-8190	IQ16TT	Iridium TT plug	Needle	S
TAIWAN	479	267700-8200	IQ20TT	Iridium TT plug	Needle	S
	480	267700-8210	IW16TT	Iridium TT plug	Needle	S
	481	267700-8220	IW20TT	Iridium TT plug	Needle	S
	482	267700-8230	IT16TT	Iridium TT plug	Needle	S
	483	267700-8240	ITV16TT	Iridium TT plug	Needle	S
	484	267700-8250	ITV20TT	Iridium TT plug	Needle	S
	485	267700-8260	ITF16TT	Iridium TT plug	Needle	S
	486	267700-8270	ITF16TT	Iridium TT plug	Needle	S
	487	267700-8280	ITL16TT	Iridium TT plug	Needle	S
	488	267700-8291	XUH20TTI	Nickel TT plug	Nickel	S
THAILAND	489	267700-8310	SXU22HPR9	Iridium plug	Platinum	S
	490	267700-8320	DXE22HCR11S	Double needle Iridium plug w/t SUS Gasket	Needle	S
	491	267700-8340	FK16R-AL8	Double needle Iridium plug	Needle	S
	492	267700-8360	FC20HR-BG9	Double needle Iridium plug w/t Grease	Needle	S
	493	267700-8390	SXE24HCR8S	Iridium plug w/t SUS Gasket	Platinum	S
	494	267700-8420	W9EXR-UA	Nickel plug	Nickel	S
	495	267700-8431	IXU22I	Iridium plug	Nickel	S
	496	267700-8441	VXU22I	Iridium plug	Platinum	S
	497	267700-8450	IK16TT	Iridium TT plug	Needle	S
	498	267700-8460	IKH16TT	Iridium TT plug	Needle	S
VIETNAM	499	267700-8470	IKH20TT	Iridium TT plug	Needle	S
	500	267700-8480	IKBH20TT	3-Ground electrodes Iridium TT plug	Needle	S
	501	267700-8490	IXEH20ETT	Iridium TT plug	Needle	S
	502	267700-8500	IXEH20TT	Iridium TT plug	Needle	S
	503	267700-8510	IXEH22TT	Iridium TT plug	Needle	S
	504	267700-8520	IT20TT	Iridium TT plug	Needle	S
	505	267700-8530	IK20TT	Iridium TT plug	Needle	S
	506	267700-8540	SK20HR-GT8	Iridium plug w/t Grease	Platinum	RC
	507	267700-8560	FK16BR-AL8	3-Ground electrodes double needle Iridium plug	Needle	S
	508	267700-8570	SK20HBR-J8	3-Ground electrodes Iridium plug	Platinum	S
JAPAN	509	267700-8580	DK16R-B5	Double needle Iridium plug	Needle	S
	510	267700-8590	FK16HBR-J8	3-Ground electrodes double needle Iridium plug	Needle	S
	511	267700-8620	FC16HR-C9	Double needle Iridium plug	Needle	S
	512	267700-8671	VXUHC22G	Iridium plug w/t SUS Gasket	Platinum	S
	513	267700-8681	VFXUHC22FG	Double needle Iridium plug w/t SUS Gasket	Needle	S
	514	267700-8690	FC20HR-Q8	Double needle Iridium plug	Needle	S
	515	267700-8730	FC20HR-G8	Double needle Iridium plug w/t Grease	Needle	S
	516	267700-8751	VDKH22F	Double needle Iridium plug	Needle	S

S: SOLID; R: REMOVABLE; RC: CRIMPED; T: THREAD



**DENSO, PART No., SPECIFICATIONS, LIST ( 0677009760 ⇒  )**

No	PART NUMBER	DENSO	SPEC.	GROUND/E.	NUT
517	267700-8780	FC16HR-Q8	Double needle Iridium plug	Needle	S
518	267700-8810	FC16HR-GQ8	Double needle Iridium plug w/t Grease	Needle	S
519	267700-8870	FC20HR-GQ8	Double needle Iridium plug w/t Grease	Needle	S
520	267700-8920	VDKH16T	Double needle Iridium plug	Needle	S
521	267700-8970	FC16HR-CY9	Double needle Iridium plug	Needle	S
522	267700-9141	VXU20	Iridium plug	Platinum	S
523	267700-9151	VFK16	Double needle Iridium plug	Needle	S
524	267700-9161	VFK20F	Double needle Iridium plug	Needle	S
525	267700-9171	VXEBH27	3-Ground electrodes Iridium plug	Platinum	S
526	267700-9211	VCH16	Iridium plug	Platinum	S
527	267700-9221	VFXEHC22G	Double needle Iridium plug w/t SUS Gasket	Needle	S
528	267700-9231	VXEHC24G	Iridium plug w/t SUS Gasket	Platinum	S
529	267700-9241	VSUEH22	Iridium plug	Platinum	S
530	267700-9271	VFKB16	3-Ground electrodes Iridium plug	Needle	S
531	267700-9281	VFCH16	Double needle Iridium plug	Needle	S
532	267700-9291	VDCH22F	Double needle Iridium plug	Needle	S
533	AN067800-7870	ZTJ16VR10	Iridium plug	Platinum	S
534	AN067800-8180	ZTJ16R10	Iridium plug	Platinum	S

AUSTRALIA | CHINA | INDIA | INDONESIA | KOREA | MALAYSIA | PHILIPPINES | SAUDI ARABIA | SINGAPORE | TAIWAN | THAILAND | VIETNAM | JAPAN | EUROPE & USA | CROSS REFERENCE PART NUMBER

S: SOLID; R: REMOVABLE; RC: CRIMPED; T: THREAD

	No	PART NUMBER	DENSO	SPEC.	GROUND/E.	NUT
AUSTRALIA	1	MW067600-0380	K16P-U	Nickel plug	Nickel	S
	2	MW067600-0390	K20P-U	Nickel plug	Nickel	S
	3	MW067600-0700	Q16-U	Nickel plug	Nickel	S
	4	MW067600-0750	K16-U11	Nickel plug	Nickel	S
	5	MW067600-0871	W9EP	Nickel plug	Nickel	R
CHINA	6	MW067600-0881	W14E	Nickel plug	Nickel	R
	7	MW067600-1713	W9EP	Nickel plug	Nickel	S
	8	MW067600-2740	W20EPB	3-Ground electrodes Nickel plug	Nickel	R
	9	MW067600-2770	K22PB	3-Ground electrodes Nickel plug	Nickel	R
	10	MW067600-3341	W14L	Nickel plug	Nickel	R
INDIA	11	MW067600-4641	W9EX-U	Nickel plug	Nickel	S
	12	MW067600-4663	W14EX-U	Nickel plug	Nickel	S
	13	MW067600-4671	W16EX-U	Nickel plug	Nickel	S
	14	MW067600-4681	W20EX-U	Nickel plug	Nickel	S
	15	MW067600-6031	W16ES-U	Nickel plug	Nickel	R
INDONESIA	16	MW067600-6041	W20ES-U	Nickel plug	Nickel	R
	17	MW067600-6051	W22ES-U	Nickel plug	Nickel	R
	18	MW067600-6061	W24ES-U	Nickel plug	Nickel	R
	19	MW067600-6071	W27ES-U	Nickel plug	Nickel	R
	20	MW067600-6121	W14FP-U	Nickel plug	Nickel	R
KOREA	21	MW067600-6131	W16FP-U	Nickel plug	Nickel	R
	22	MW067600-6141	W20FP-U	Nickel plug	Nickel	R
	23	MW067600-6151	W22FP-U	Nickel plug	Nickel	R
	24	MW067600-6191	W27FS-U10	Nickel plug	Nickel	R
	25	MW067600-6281	W24FP-U	Nickel plug	Nickel	R
MALAYSIA	26	MW067600-6322	W14EX-U11	Nickel plug	Nickel	S
	27	MW067600-6331	W16EX-U11	Nickel plug	Nickel	S
	28	MW067600-6341	W20EX-U11	Nickel plug	Nickel	S
	29	MW067600-6372	W14EX-U	Nickel plug	Nickel	R
	30	MW067600-6381	W16EX-U	Nickel plug	Nickel	R
PHILIPPINES	31	MW067600-6391	W20EX-U	Nickel plug	Nickel	R
	32	MW067600-6591	W14FP-UL	Nickel plug	Nickel	R
	33	MW067600-6671	W24FS-U10	Nickel plug	Nickel	R
	34	MW067600-6711	W14LM-U	Nickel plug	Nickel	R
	35	MW067600-6781	W14-U	Nickel plug	Nickel	R
SAUDIARABIA	36	MW067600-6791	W16S-U	Nickel plug	Nickel	R
	37	MW067600-6801	W20S-U	Nickel plug	Nickel	R
	38	MW067600-6821	W14F-U	Nickel plug	Nickel	R
	39	MW067600-6831	W16FS-U	Nickel plug	Nickel	R
	40	MW067600-6841	W20FS-U	Nickel plug	Nickel	R
SINGAPORE	41	MW067600-6851	W22FS-U	Nickel plug	Nickel	R
	42	MW067600-6861	W24FS-U	Nickel plug	Nickel	R
	43	MW067600-6871	W27FS-U	Nickel plug	Nickel	R
	44	MW067600-7081	Q20-U11	Nickel plug	Nickel	S
	45	MW067600-7221	W14EP-U	Nickel plug	Nickel	R
TAIWAN	46	MW067600-7231	W16EP-U	Nickel plug	Nickel	R
	47	MW067600-7241	W20EP-U	Nickel plug	Nickel	R
	48	MW067600-7251	W22EP-U	Nickel plug	Nickel	R
	49	MW067600-7261	W24EP-U	Nickel plug	Nickel	S
	50	MW067600-7300	Q20P-U11	Nickel plug	Nickel	R
THAILAND	51	MW067600-7311	W20EP-U	Nickel plug	Nickel	S
	52	MW067600-7421	W14M-U	Nickel plug	Nickel	R
	53	MW067600-7441	W20M-U	Nickel plug	Nickel	R
	54	MW067600-7451	W22M-U	Nickel plug	Nickel	R
	55	MW067600-7461	W14MP-U10	Nickel plug	Nickel	R
VIETNAM	56	MW067600-7481	W20MP-U	Nickel plug	Nickel	R
	57	MW067600-7491	W22MP-U	Nickel plug	Nickel	R
	58	MW067600-7621	W16EP-U11	Nickel plug	Nickel	S
	59	MW067600-7680	Q20P-U	Nickel plug	Nickel	R
	60	MW067600-7850	W16EPB10	3-Ground electrodes Nickel plug	Nickel	R
JAPAN	61	MW067600-7971	J16B-U11	Nickel plug	Nickel	S
	62	MW067600-8590	W20M-US	Nickel plug	Nickel	R
	63	MW067600-8790	W9LM-US	Nickel plug	Nickel	R
	64	MW067700-0540	K16GPR-U11	Nickel plug	Nickel	S
	65	MW067700-0831	W16FSR	Nickel plug	Nickel	R
EUROPE & USA	66	MW067700-0851	W22FSR	Nickel plug	Nickel	R
	67	MW067700-0861	W24FSR	Nickel plug	Nickel	R
	68	MW067700-0871	W27FSR	Nickel plug	Nickel	R
	69	MW067700-0891	W27FSR-U10	Nickel plug	Nickel	R
	70	MW067700-1511	W9EXR-U	Nickel plug	Nickel	S
CROSS REFERENCE	71	MW067700-1522	W14EXR-U	Nickel plug	Nickel	S
	72	MW067700-1531	W16EXR-U	Nickel plug	Nickel	S
	73	MW067700-1541	W20EXR-U	Nickel plug	Nickel	S
	74	MW067700-1571	W16EXR-U	Nickel plug	Nickel	R
	75	MW067700-1581	W20EXR-U	Nickel plug	Nickel	R
PART NUMBER	76	MW067700-1921	W24ESR-V	Nickel plug	Nickel	S
	77	MW067700-1931	W27ESR-V	Nickel plug	Nickel	S
	78	MW067700-2341	W20ESR-U	Nickel plug	Nickel	R
	79	MW067700-2351	W22ESR-U	Nickel plug	Nickel	R
	80	MW067700-2361	W24ESR-U	Nickel plug	Nickel	R
	81	MW067700-2371	W27ESR-U	Nickel plug	Nickel	R
	82	MW067700-2421	W14EXR-U11	Nickel plug	Nickel	S
	83	MW067700-2431	W16EXR-U11	Nickel plug	Nickel	S
	84	MW067700-2441	W20EXR-U11	Nickel plug	Nickel	S
	85	MW067700-2481	W20EXR-U11	Nickel plug	Nickel	R
	86	MW067700-2651	W14EPR-U	Nickel plug	Nickel	R

S: SOLID; R: REMOVABLE; RC: CRIMPED; T: THREAD

DENSO, PART No., SPECIFICATIONS, LIST ( 0677009760 ⇒  )

No	PART NUMBER	DENSO	SPEC.	GROUND/E.	NUT
87	MW067700-2661	W16EPR-U	Nickel plug	Nickel	R
88	MW067700-2671	W20EPR-U	Nickel plug	Nickel	R
89	MW067700-2681	W22EPR-U	Nickel plug	Nickel	R
90	MW067700-2691	W24EPR-U	Nickel plug	Nickel	R
91	MW067700-2701	W20EPR-U11	Nickel plug	Nickel	S
92	MW067700-2710	W16EPR-U11	Nickel plug	Nickel	S
93	MW067700-2720	W22EPR-U11	Nickel plug	Nickel	S
94	MW067700-2921	W16PR-U	Nickel plug	Nickel	R
95	MW067700-2931	W14PR-U	Nickel plug	Nickel	R
96	MW067700-3020	K16HPR-U11	Nickel plug	Nickel	R
97	MW067700-3201	W14MR-U	Nickel plug	Nickel	R
98	MW067700-3221	W20MR-U	Nickel plug	Nickel	R
99	MW067700-3301	W20MPR-U10	Nickel plug	Nickel	R
100	MW067700-3341	W20FSR-U	Nickel plug	Nickel	R
101	MW067700-3350	W22MPR-U	Nickel plug	Nickel	R
102	MW067700-3440	W20EPR-U	Nickel plug	Nickel	S
103	MW067700-3450	W22EPR-U	Nickel plug	Nickel	S
104	MW067700-3472	J16BR-U	Nickel plug	Nickel	S
105	MW067700-3571	J16BR-U11	Nickel plug	Nickel	S
106	MW067700-3831	W20FPR-U	Nickel plug	Nickel	R
107	MW067700-3841	W22FPR-U	Nickel plug	Nickel	R
108	MW067700-4410	Q16R-U	Nickel plug	Nickel	S
109	MW067700-4421	Q20R-U	Nickel plug	Nickel	S
110	MW067700-4431	Q16R-U11	Nickel plug	Nickel	S
111	MW067700-4441	Q20R-U11	Nickel plug	Nickel	S
112	MW067700-4450	Q16PR-U	Nickel plug	Nickel	R
113	MW067700-4460	Q20PR-U@	Nickel plug	Nickel	R
114	MW067700-4470	Q22PR-U	Nickel plug	Nickel	R
115	MW067700-4510	Q16PR-U11@	Nickel plug	Nickel	R
116	MW067700-4520	Q20PR-U11	Nickel plug	Nickel	R
117	MW067700-4530	Q22PR-U11	Nickel plug	Nickel	R
118	MW067700-4670	Q14R-U11	Nickel plug	Nickel	S
119	MW067700-4700	W16FPR-U	Nickel plug	Nickel	R
120	MW067700-5070	X22ESR-U	Nickel plug	Nickel	T
121	MW067700-5080	X24ESR-U	Nickel plug	Nickel	T
122	MW067700-5090	X27ESR-U	Nickel plug	Nickel	T
123	MW067700-5180	W24ESR	Nickel plug	Nickel	S
124	MW067700-5190	W27ESR	Nickel plug	Nickel	S
125	MW067700-5250	XU24EPR-U	Nickel plug	Nickel	S
126	MW067700-5260	XU22EPR-U	Nickel plug	Nickel	S
127	MW067700-5280	X20EPR-U9	Nickel plug	Nickel	T
128	MW067700-5290	X22EPR-U9	Nickel plug	Nickel	T
129	MW067700-5300	X24EPR-U9	Nickel plug	Nickel	T
130	MW067700-5310	X27EPR-U9	Nickel plug	Nickel	T
131	MW067700-5320	U22ESR-N	Nickel plug	Nickel	T
132	MW067700-5380	U24ESR-N	Nickel plug	Nickel	T
133	MW067700-5390	U27ESR-N	Nickel plug	Nickel	T
134	MW067700-5590	U20FSR-U	Nickel plug	Nickel	T
135	MW067700-5600	U22FSR-U	Nickel plug	Nickel	T
136	MW067700-5610	U24FSR-U	Nickel plug	Nickel	T
137	MW067700-5640	U31ESR-N	Nickel plug	Nickel	T
138	MW067700-5800	XU20EPR-U	Nickel plug	Nickel	S
139	MW067700-5810	U22FER9	Nickel plug	Nickel	T
140	MW067700-5820	U24FER9	Nickel plug	Nickel	T
141	MW067700-5830	U27FER9	Nickel plug	Nickel	T
142	MW067700-5910	QJ16HR-U	Nickel plug	Nickel	R
143	MW067700-5960	W16EPR-U	Nickel plug	Nickel	S
144	MW067700-5990	U16FSR-UB	Nickel plug	Nickel	S
145	MW067700-6000	Q16PR-U	Nickel plug	Nickel	S
146	MW067700-6060	Q20PR-U	Nickel plug	Nickel	S
147	MW067700-6260	K20PR-U11	Nickel plug	Nickel	S
148	MW067700-6270	K16PR-U11	Nickel plug	Nickel	S
149	MW067700-6290	K22PR-U11	Nickel plug	Nickel	S
150	MW067700-6300	K16PR-U	Nickel plug	Nickel	S
151	MW067700-6310	K20PR-U	Nickel plug	Nickel	S
152	MW067700-6400	K16R-U	Nickel plug	Nickel	S
153	MW067700-6410	K20R-U	Nickel plug	Nickel	S
154	MW067700-6420	K16R-U11	Nickel plug	Nickel	S
155	MW067700-6500	W31ESR-U	Nickel plug	Nickel	R
156	MW067700-6550	K16PR-L11	Nickel plug	Nickel	S
157	MW067700-6560	K20PR-L11	Nickel plug	Nickel	S
158	MW067700-6580	K20R-U11	Nickel plug	Nickel	S
159	MW067700-6770	KJ16CR11	Nickel plug	Nickel	S
160	MW067700-6780	KJ20CR11	Nickel plug	Nickel	S
161	MW067700-6810	W20FR-L	Nickel plug	Nickel	T
162	MW067700-6820	W24FR-L	Nickel plug	Nickel	T
163	MW067700-6950	KJ20CR-L11	Nickel plug	Nickel	S
164	MW067700-6970	KJ16CR-L11	Nickel plug	Nickel	S
165	MW067700-7280	W9EXR-U/Copper Gasket	Nickel plug w/t Copper Gasket	Nickel	S
166	MW067700-7450	KJ14CR-L11	Nickel plug	Nickel	S
167	MW067700-7500	K16PR-U@	Nickel plug	Nickel	R
168	MW067700-7510	K20PR-U@	Nickel plug	Nickel	R
169	MW067700-7520	K22PR-U@	Nickel plug	Nickel	R
170	MW067700-7780	KJ20CR-U11(*)	Nickel plug	Nickel	S
171	MW067700-7850	W9LMR-US	Nickel plug	Nickel	R
172	MW067700-7900	K16TR11	2-Ground electrodes Nickel plug	Nickel	S

AUSTRALIA  
CHINA  
INDIA  
INDONESIA  
KOREA  
MALAYSIA  
PHILIPPINES  
SAUDIARABIA  
SINGAPORE  
TAIWAN  
THAILAND  
VIETNAM  
JAPAN  
EUROPE & USA  
CROSS REFERENCE  
PART NUMBER

S: SOLID; R: REMOVABLE; RC: CRIMPED; T: THREAD

	No	PART NUMBER	DENSO	SPEC.	GROUND/E.	NUT
AUSTRALIA	173	MW067700-7910	K22TNR-S	2-Ground electrodes surface discharge Nickel plug	Nickel	S
	174	MW067700-8000	·K20TNR-S	2-Ground electrodes surface discharge Nickel plug	Nickel	S
	175	MW067700-8040	W20EPBR-S	3-Ground electrodes surface discharge Nickel plug	Nickel	R
	176	MW067700-8050	K20PBR	3-Ground electrodes Nickel plug	Nickel	R
	177	MW067700-8060	K20PBR-S10	3-Ground electrodes surface discharge Nickel plug	Nickel	R
	178	MW067700-8070	K22PBR-S	3-Ground electrodes surface discharge Nickel plug	Nickel	R
	179	MW067700-8080	K20TXR	2-Ground electrodes semi surface discharge Nickel plug	Nickel	R
	180	MW067700-8090	XU27EPR-U	Nickel plug	Nickel	R
	181	MW067700-8110	K20TR-11	2-Ground electrodes Nickel plug	Nickel	S
	182	MW067700-8170	W24FSR-U10	Nickel plug	Nickel	R
183	MW067700-8190	J16CR-U	Nickel plug	Nickel	R	
INDIA	184	MW067700-8290	U14FSR-UB	Nickel plug	Nickel	S
	185	MW067700-8770	K20TNR	2-Ground electrodes Nickel plug	Nickel	S
	186	MW067700-8800	·K20TNR-S9	2-Ground electrodes surface discharge Nickel plug	Nickel	S
INDONESIA	187	MW067700-8810	KJ16CR-U11(*)	Nickel plug	Nickel	S
	188	MW067700-8820	W24FPR-U10	Nickel plug	Nickel	R
	189	MW067700-8850	U20ESR-N	Nickel plug	Nickel	T
	190	MW067700-9750	K20BR-S10	3-Ground electrodes surface discharge Nickel plug	Nickel	S
	191	MW067700-9770	·K16TNR-S9	2-Ground electrodes surface discharge Nickel plug	Nickel	S
	192	MW067800-1410	W9FP-UL	Nickel plug	Nickel	R
	193	MW067800-1780	X20FS-U	Nickel plug	Nickel	S
	194	MW067800-1820	X22EP-U	Nickel plug	Nickel	S
	195	MW067800-1830	X24EP-U	Nickel plug	Nickel	S
	196	MW067800-4040	X24FS-U	Nickel plug	Nickel	T
KOREA	197	MW067800-4120	X22ES-U	Nickel plug	Nickel	S
	198	MW067800-4130	X24ES-U	Nickel plug	Nickel	S
	199	MW067800-4140	X27ES-U	Nickel plug	Nickel	T
	200	MW067800-4180	XU22EP-U	Nickel plug	Nickel	S
	201	MW067800-4361	X24EP-U9	Nickel plug	Nickel	S
	202	MW067800-4590	U16FS-U	Nickel plug	Nickel	S
	203	MW067800-4600	U20FS-U	Nickel plug	Nickel	S
	204	MW067800-4610	U22FS-U	Nickel plug	Nickel	S
	205	MW067800-4850	U22ES-N	Nickel plug	Nickel	T
	206	MW067800-4860	U24ES-N	Nickel plug	Nickel	T
PHILIPPINES	207	MW067800-4870	U27ES-N	Nickel plug	Nickel	T
	208	MW067800-5980	W16FP-US	Nickel plug	Nickel	R
	209	MW067800-5990	W20FP-US	Nickel plug	Nickel	R
	210	MW067800-6000	W22FP-US	Nickel plug	Nickel	R
	211	MW067800-6010	W24FP-US	Nickel plug	Nickel	R
	212	MW067800-6060	W16EP-U	Nickel plug	Nickel	S
	213	MW067800-6430	W22FP-US10	Nickel plug	Nickel	R
	214	MW067800-6440	W24FP-US10	Nickel plug	Nickel	R
	215	MW067800-6770	W16EP-U11	Nickel plug	Nickel	R
	216	MW067800-6780	W14FP-US	Nickel plug	Nickel	R
SAUDIARABIA	217	MW067800-7070	W20FS-US	Nickel plug	Nickel	R
	218	MW067800-7080	W22FS-US	Nickel plug	Nickel	R
	219	MW067800-7100	W20ES-US	Nickel plug	Nickel	R
	220	MW067800-7110	W22ES-US	Nickel plug	Nickel	R
	221	MW067800-7120	W24ES-US	Nickel plug	Nickel	R
	222	MW067800-7130	W20EP-US	Nickel plug	Nickel	R
	223	MW067800-7140	W22EP-US	Nickel plug	Nickel	R
	224	MW067800-7150	W24EP-US	Nickel plug	Nickel	R
	225	MW067800-7720	XU24EPR-U	Nickel plug	Nickel	R
	226	MW067800-7750	U20EPR9S	Nickel plug	Nickel	T
SINGAPORE	227	MW067800-7840	U27EPR9	Nickel plug	Nickel	T
	228	MW267700-0520	U16FER9	Nickel plug	Nickel	T
	229	MW267700-2280	U27ESR-NB	Nickel plug	Nickel	S
	230	MW267700-2300	U24ESR-NB	Nickel plug	Nickel	S
	231	MW267700-2880	K20HR-U11	Nickel plug	Nickel	S
	232	MW267700-4520	XU22HDR9	Nickel plug	Nickel	S
	233	MW267700-4580	U20EPR9	Nickel plug	Nickel	T
	234	MW267700-4710	W22FS-U10	Nickel plug	Nickel	R
	235	MW267700-5490	XU22PR9	Nickel plug	Nickel	S
	236	MW267700-6280	K16HR-U11	Nickel plug	Nickel	S
TAIWAN	237	MW267700-6480	U22EPR9	Nickel plug	Nickel	T
	238	MW267700-6490	U24EPR9	Nickel plug	Nickel	T
	239	MW267700-8140	XU20HR9	Nickel plug	Nickel	S

	No	PART NUMBER	DENSO	SPEC.	GROUND/E.	NUT
EUROPE & USA	1	JK267700-5580	SC20HR11	Iridium plug	Platinum	S
	2	JK267700-7430	K16TT	Nickel TT plug	Nickel	S
	3	JK267700-7440	K20TT	Nickel TT plug	Nickel	S
	4	JK267700-7450	KH16TT	Nickel TT plug	Nickel	S
	5	JK267700-7460	KH20TT	Nickel TT plug	Nickel	S
	6	JK267700-7470	Q16TT	Nickel TT plug	Nickel	S
	7	JK267700-7480	Q20TT	Nickel TT plug	Nickel	S
	8	JK267700-8301	SC16HR11	Iridium plug	Platinum	S

	No	PART NUMBER	DENSO	SPEC.	GROUND/E.	NUT
CROSS REFERENCE	1	JK267700-5580	SC20HR11	Iridium plug	Platinum	S
	2	JK267700-7430	K16TT	Nickel TT plug	Nickel	S
	3	JK267700-7440	K20TT	Nickel TT plug	Nickel	S
	4	JK267700-7450	KH16TT	Nickel TT plug	Nickel	S
	5	JK267700-7460	KH20TT	Nickel TT plug	Nickel	S
	6	JK267700-7470	Q16TT	Nickel TT plug	Nickel	S
	7	JK267700-7480	Q20TT	Nickel TT plug	Nickel	S
	8	JK267700-8301	SC16HR11	Iridium plug	Platinum	S

# MEMO

A series of horizontal dashed lines for writing.

# MEMO

A series of horizontal dashed lines for writing.

# MEMO

A series of horizontal dashed lines for writing.

# MEMO

A series of horizontal dashed lines for writing.



# MEMO

A series of horizontal dashed lines for writing.

# MEMO

A series of horizontal dashed lines for writing.

# IDENTIFYING DENSO PLUGS

## Iridium Plugs / Platinum Plugs / Normal Plugs

F	K	20	H	R	11																																																									
S	XU	22		PR	9																																																									
	KJ	20		CR	11																																																									
Type of precious metal	Thread Diameter and Hex Size	Heat Range	Reach	Shape (Type)	Shape (Type)	Gap																																																								
<b>D,E,F</b> ..... C.E. : Iridium G.E. : Needle type platinum <b>SV,VZ</b> ..... C.E. : Iridium G.E. : Platinum <b>P</b> ..... C.E. : Platinum G.E. : Platinum	<b>C</b> ..... 12×14.0 <b>L</b> ..... 18×22.2 (Reach: 12.7 mm) <b>M</b> ..... 18×25.4 (Reach: 12 mm) <b>MA</b> ..... 18×20.6 (Taper seat, Reach: 12 mm) <b>MW</b> ..... 18×20.6 (Reach: 12 mm) <b>J</b> ..... 14×20.6 (Projected plug) <b>K</b> ..... 14×16.0 (Miniature plug) <b>KJ</b> ..... 14×16.0 (Projected Miniature plug) <b>LP</b> ..... 14×20.6 (Plug for LPG applications) <b>Q</b> ..... 14×16.0 (Miniature plug) <b>QJ</b> ..... 14×16.0 (Projected Miniature plug) <b>QL</b> ..... 14×20.6 (Miniature long cylinder housing plug) <b>S</b> ..... 14×20.6 (Surface gap plug(for RE engines)) <b>T</b> ..... 14×16.0 (Taper seat) <b>W</b> ..... 14×20.6 (Compact type) <b>X</b> ..... 12×18.0 <b>XE</b> ..... 12×14.0 <b>XU</b> ..... 12×16.0 <b>N</b> ..... 10×16.0 <b>U</b> ..... 10×16.0 <b>Y</b> ..... 8×13.0 <b>XB</b> ..... 12×(Bi-hex) <b>UE</b> ..... 10×14	<table border="1"> <thead> <tr> <th>DENSO</th> <th>NGK</th> <th>CHAMPION</th> <th>BOSCH</th> </tr> </thead> <tbody> <tr> <td>4</td> <td></td> <td></td> <td></td> </tr> <tr> <td>9</td> <td>2</td> <td>18</td> <td>10</td> </tr> <tr> <td>14</td> <td>4</td> <td>16,14</td> <td>9</td> </tr> <tr> <td>16</td> <td>5</td> <td>12,11</td> <td>8</td> </tr> <tr> <td>20</td> <td>6</td> <td>10,9</td> <td>7,6</td> </tr> <tr> <td>22</td> <td>7</td> <td>8,7</td> <td>5</td> </tr> <tr> <td>24</td> <td>8</td> <td>6,63,61</td> <td>4</td> </tr> <tr> <td>27</td> <td>9</td> <td>4,59</td> <td>3</td> </tr> <tr> <td>29</td> <td>9.5</td> <td>57</td> <td></td> </tr> <tr> <td>31</td> <td>10</td> <td>55</td> <td>2</td> </tr> <tr> <td>32</td> <td>10.5</td> <td>53</td> <td></td> </tr> <tr> <td>34</td> <td>11</td> <td></td> <td></td> </tr> <tr> <td>35</td> <td>11.5</td> <td></td> <td></td> </tr> </tbody> </table>	DENSO	NGK	CHAMPION	BOSCH	4				9	2	18	10	14	4	16,14	9	16	5	12,11	8	20	6	10,9	7,6	22	7	8,7	5	24	8	6,63,61	4	27	9	4,59	3	29	9.5	57		31	10	55	2	32	10.5	53		34	11			35	11.5			<b>A</b> ..... 19.0 mm (Spark position: 7.0 mm) J16AR-U11 <b>A</b> ..... 21.5 mm S29A <b>B</b> ..... 19.0 mm (Spark position: 9.5 mm) J16BR-U <b>C</b> ..... 19.0 mm (Spark position: 5.0 mm) KJ20CR-L11 <b>D</b> ..... 20.5 mm (Shroud 2) K20DTR-S11 <b>E</b> (With gasket) ..... 19.0 mm W16EX-U <b>E</b> (With gasket) ..... 20.0 mm W25EBR <b>E</b> ..... Shroud 2.0mm FXE20HE11 <b>F</b> ..... 12.7 mm W20FP-U <b>FE</b> ..... 19.0 mm (Half thread) U24FER9 <b>G</b> ..... 22.0 mm (Shroud 3.0) PK20GR8 <b>G</b> ..... 21.8 mm (Shroud 2.8) X27GPR-U <b>H</b> ..... 26.5 mm K16HPR-U11 <b>H</b> ..... 19.0 mm (Spark position: 8.5 mm) QJ16HR-U <b>L</b> ..... 11.2 mm W14L <b>N</b> (Taper seat, Half thread) ..... 17.5 mm T20NR-U11 <b>V</b> (Taper seat) ..... 25.0 mm PT16VR13 <b>None</b> ..... 9.5 mm W14M-U 11.2 mm L14-U, M24S 19.0 mm SK20R11 21.5 mm S29A <b>None</b> (Taper seat) ..... 8.3 mm T20M-U 11.2 mm W14L	<b>A</b> ..... Double ground electrodes W22EA <b>AY</b> ..... Double ground electrodes with bert shape J16AY <b>B</b> ..... Triple ground electrodes W22EB <b>BG</b> ..... Triple ground electrodes (shroud) SK20BGR11 <b>C</b> ..... Shroud 1.5mm SXU22HCR11 <b>D</b> ..... 4 ground electrodes W22EDR <b>D</b> ..... Projected (1.5 mm projection, spark position 3.5 mm) XU22HDR9 <b>K</b> ..... Projected (1 mm projection) W16EKR-S11 <b>LM</b> ..... Compact type (Hex 20.6 mm) W14LM-U <b>M</b> ..... Shortened insulator head length W27EMR-C <b>M</b> ..... Compact type (Hex 19.0 mm) W20M-U <b>P</b> ..... Projected (1.5 mm projection) W16EP-U <b>Q</b> ..... Projected 2mm, Spark position 3.5mm <b>R</b> ..... 5Kohm resistor K16R-U <b>S</b> ..... Non-projected (0 mm Projection) W22ES-U <b>S</b> ..... Iridium on a single side KJ20SR11 <b>T</b> ..... Double ground electrodes K16TR11 <b>TM</b> ..... Double ground electrodes K22TMR11 <b>TN</b> ..... Double ground electrodes K22TNR-S <b>X</b> ..... Fully projected (2.5 mm Projection) W16EX-U	<b>-A</b> ..... Special specification SK16PR-A11 <b>-B</b> ..... Special specification K16PSR-B8 <b>-C</b> ..... Cut-back ground electrode W27EMR-C <b>-CY</b> ..... Special specification FC16HR-CY9 <b>-D</b> ..... Copper-core Ground DK20PR-D13 <b>-E</b> ..... Special specification SK16PR-E11 <b>-F</b> ..... Special specification J17SK16PR-F11 <b>-G</b> ..... Grease applied on to threads, for CNG SK20R8-G <b>-GL</b> ..... Platinum center electrode X22EPR-GL <b>-L</b> ..... Heat resistant ground electrode K20PR-L11 <b>-L</b> ..... 3.5 mm projected insulator for motorcycles W20FP-UL <b>-L</b> ..... Retracted insulator for motorcycles W20FR-L <b>-M</b> ..... Larger ground electrode SK20PR-M11S <b>-N</b> ..... For Yamaha and Kawasaki U27ESR-N <b>-P</b> ..... Double Platinum Ground Electrode SK20R-P11 <b>-P</b> ..... Single-sided platinum plug K16PR-P11 <b>-Q</b> ..... Special specification FC16HR-Q8 <b>-R</b> ..... 10K ohm resistor K22PR-UR <b>-S</b> ..... Semi-surface gap discharge type W20EP-S11 <b>-S</b> ..... Stainless gasket U27FER9S <b>-T</b> ..... For LPG SK20HR8-T <b>-T</b> ..... Special specification FK20HBR11-T <b>-TP</b> ..... Taper-cut, single-side platinum plug K20PR-TP11 <b>-U</b> ..... U groove ground electrode K16PR-U <b>-V</b> ..... 1.3 mm diameter, nickel center electrode W27ES-V	<b>5</b> ..... 0.5 mm (.020") <b>8</b> ..... 0.8 mm (.032") <b>9</b> ..... 0.9 mm (.035") <b>10</b> ..... 1.0 mm (.040") <b>11</b> ..... 1.1 mm (.044") <b>13</b> ..... 1.3 mm (.050") <b>14</b> ..... 1.4 mm (.055") <b>15</b> ..... 1.5 mm (.060") <None> Cars: 0.8 mm M/C: 0.7 mm <Exceptions> P16R, PQ16R, PQ20R are 1.1 mm
DENSO	NGK	CHAMPION	BOSCH																																																											
4																																																														
9	2	18	10																																																											
14	4	16,14	9																																																											
16	5	12,11	8																																																											
20	6	10,9	7,6																																																											
22	7	8,7	5																																																											
24	8	6,63,61	4																																																											
27	9	4,59	3																																																											
29	9.5	57																																																												
31	10	55	2																																																											
32	10.5	53																																																												
34	11																																																													
35	11.5																																																													
C.E. : Center electrode G.E. : Ground electrode																																																														

## IRIDIUMPOWER® Series (Power, Tough, Plus) &

I	U	27	A																																												
VF	KH	20																																													
High Performance Plug	Thread Diameter, Reach, and Hex Size	Heat Range	Shape (Type)																																												
<b>I</b> ..... C.E. : Iridium <b>V,VS</b> ..... C.E. : Iridium G.E. : Platinum <b>VF,VD</b> ..... C.E. : Iridium G.E. : Needle type platinum <b>P</b> ..... C.E. : Platinum G.E. : Platinum	<Thread Diameter × Reach × Hex Size> (mm) <b>K</b> ..... 14 × 19.0 × 16.0 <b>KB</b> ..... 14 × 19.0 × 16.0 (New Triple Electrodes) <b>KA</b> ..... 14 × 22.0 (Shroud 3.0) × 16.0 (New Triple Electrodes) <b>KD</b> ..... 14 × 20.5 (Shroud 1.5) × 16.0 <b>KH</b> ..... 14 × 26.5 × 16.0 <b>KBH</b> ..... 14 × 26.5 × 16.0 (New Triple Electrodes) <b>Q</b> ..... 14 × 19.0 × 16.0 <b>W</b> ..... 14 × 19.0 × 20.6 <b>WF</b> ..... 14 × 12.7 × 20.6 <b>WM</b> ..... 14 × 19.0 × 20.6 (Compact Insulator) <b>T</b> ..... 14 × 17.5 (Taper Seat) × 16.0 <b>TF</b> ..... 14 × 11.2 (Taper Seat) × 16.0 <b>TL</b> ..... 14 × 25.0 (Taper Seat) × 16.0 (Long Insulator) <b>TV</b> ..... 14 × 25.0 (Taper Seat) × 16.0 <b>XU</b> ..... 12 × 19.0 × 16.0 <b>XUH</b> ..... 12 × 26.5 × 16.0 <b>CH</b> ..... 12 × 26.5 × 14.0 <b>XEH</b> ..... 12 × 26.5 × 14.0 <b>XEBH</b> ..... 12 × 26.5 × 14.0 (New Triple Electrodes) <b>X</b> ..... 12 × 19.0 × 18.0 <b>XG</b> ..... 12 × 21.8 (Shroud 2.8) × 18.0 <b>XEHC</b> ..... 12 × 28 (Shroud 1.5) × 14 <b>U</b> ..... 10 × 19.0 × 16.0 <b>UF</b> ..... 10 × 12.7 × 16.0 <b>UH</b> ..... 10 × 19.0 (Half Thread) × 16.0 <b>NH</b> ..... 10 × 19.0 (Half Thread) × 16.0 <b>UEH</b> ..... 10 × 26.5 × 14 <b>Y</b> ..... 8 × 19.0 (Half Thread) × 13.0	<table border="1"> <thead> <tr> <th>DENSO</th> <th>NGK</th> <th>CHAMPION</th> <th>BOSCH</th> </tr> </thead> <tbody> <tr> <td>16</td> <td>5</td> <td>12,11</td> <td>8</td> </tr> <tr> <td>20</td> <td>6</td> <td>10,9</td> <td>7,6</td> </tr> <tr> <td>22</td> <td>7</td> <td>8,7</td> <td>5</td> </tr> <tr> <td>24</td> <td>8</td> <td>6,63,61</td> <td>4</td> </tr> <tr> <td>27</td> <td>9</td> <td>4,59</td> <td>3</td> </tr> <tr> <td>29</td> <td>9.5</td> <td>57</td> <td></td> </tr> <tr> <td>31</td> <td>10</td> <td>55</td> <td>2</td> </tr> <tr> <td>32</td> <td>10.5</td> <td>53</td> <td></td> </tr> <tr> <td>34</td> <td>11</td> <td></td> <td></td> </tr> <tr> <td>35</td> <td>11.5</td> <td></td> <td></td> </tr> </tbody> </table>	DENSO	NGK	CHAMPION	BOSCH	16	5	12,11	8	20	6	10,9	7,6	22	7	8,7	5	24	8	6,63,61	4	27	9	4,59	3	29	9.5	57		31	10	55	2	32	10.5	53		34	11			35	11.5			<b>A</b> ..... Slant electrode, No U-Groove, No taper cut <b>B</b> ..... Projected insulator (1.5 mm) <b>C</b> ..... No U-Groove <b>D</b> ..... No U-Groove <b>E</b> ..... Shroud: 2 mm <b>ES</b> ..... Stainless steel gasket <b>F</b> ..... Special specification <b>G</b> ..... Stainless steel gasket, Terminal one type <b>I</b> ..... Spark position: 4 mm Projected insulator (1.5 mm) <b>J</b> ..... Spark position: 5 mm <b>K</b> ..... Spark position: 4 mm Projected insulator (2.5mm) <b>L</b> ..... Spark position: 5 mm <b>T</b> ..... For LPG applications<PLUS> <b>TT</b> ..... TT series <b>Y</b> ..... 0.8 mm gap <b>Z</b> ..... Taper cut
DENSO	NGK	CHAMPION	BOSCH																																												
16	5	12,11	8																																												
20	6	10,9	7,6																																												
22	7	8,7	5																																												
24	8	6,63,61	4																																												
27	9	4,59	3																																												
29	9.5	57																																													
31	10	55	2																																												
32	10.5	53																																													
34	11																																														
35	11.5																																														

# DENSO SPARK PLUGS SALES COMPANIES

<b>Australia</b>	<b>DENSO AUTOMOTIVE SYSTEMS AUSTRALIA PTY.LTD.</b> 46 Merrindale Drive, Croydon, Victoria 3136, Australia <b>TEL</b> +61-3-8761-1100 <b>FAX</b> +61-3-8761-1505 <b>Website</b> <a href="http://www.denso.com.au">www.denso.com.au</a> <b>Find your plugs</b> <a href="https://www.denso.com.au/part-search">https://www.denso.com.au/part-search</a>	<b>DNAU</b>
<b>Brazil</b>	<b>DENSO DO BRASIL LTDA.</b> Rua Joao Chede, No.891, CIC, CEP:81170-220, Curitiba, Parana, Brazil <b>TEL</b> +55-41-2141-4300 <b>FAX</b> +86-10-5758-2781 <b>Website</b> <a href="http://www.denso.com.br/velas">http://www.denso.com.br/velas</a>	<b>DNBR</b>
<b>China</b>	<b>DENSO (CHINA) INVESTMENT CO., LTD.</b> Room No. 518, The Beijing Fortune Building, No.5 Dong San Huan Bei Lu, Chaoyang District, Beijing, 100004, China <b>TEL</b> +86-10-6590-8337 <b>FAX</b> +86-10-5758-2781 <b>Website</b> <a href="https://www.denso.com/cn/zh/">https://www.denso.com/cn/zh/</a>	<b>DICH</b>
	<b>DENSO AUTO PARTS SALES (TIANJIN) CO., LTD.</b> Unit 603, Block A, Yingke Center, No. 2 Gongti North Road, Chaoyang District, Beijing, China <b>TEL</b> +86-10-65909636~9 <b>FAX</b> +86-10-65393539 <b>Find your plugs</b> <a href="https://www.denso.com/global/en/products-and-services/automotive-service-parts-and-accessories/plug/search/china.html">https://www.denso.com/global/en/products-and-services/automotive-service-parts-and-accessories/plug/search/china.html</a>	<b>DSCH</b>
<b>Germany</b>	<b>DENSO AUTOMOTIVE Deutschland GmbH</b> Freisinger Strasse 21, 85386 Eching, Germany <b>TEL</b> +49-8165-944-0 <b>FAX</b> +49-8165-944800 <b>Website</b> <a href="https://www.denso-am.eu/de/products/ignition/spark-plug">https://www.denso-am.eu/de/products/ignition/spark-plug</a> <b>Find your plugs</b> <a href="https://www.denso-am.eu/de">https://www.denso-am.eu/de</a>	<b>DNDE</b>
<b>India</b>	<b>DENSO INTERNATIONAL INDIA PVT.LTD.</b> Plot No. 3, Sector-3, IMT Manesar, Gurugram, Haryana-122052, India <b>TEL</b> +91-124-4803200 <b>FAX</b> +91-124-4803201 <b>Find your plugs</b> <a href="https://www.denso.com/global/en/products-and-services/automotive-service-parts-and-accessories/plug/search/india.html">https://www.denso.com/global/en/products-and-services/automotive-service-parts-and-accessories/plug/search/india.html</a>	<b>DIIN</b>
<b>Indonesia</b>	<b>PT DENSO SALES INDONESIA</b> JL. Gaya Motor I, Sunter II, Kel Sungai Bambu, Tanjung Priok, Jakarta Utara, Jakarta, Indonesia <b>TEL</b> +62-21-6512279 <b>FAX</b> +62-21-6512284 <b>Find your plugs</b> <a href="https://www.denso.com/global/en/products-and-services/automotive-service-parts-and-accessories/plug/search/indonesia.html">https://www.denso.com/global/en/products-and-services/automotive-service-parts-and-accessories/plug/search/indonesia.html</a>	<b>DSIA</b>
<b>Japan</b>	<b>DENSO SOLUTION CORPORATION</b> 1-1, Showa-cho, Kariya, Aichi 448-8661, Japan <b>TEL</b> +81-566-55-9711 <b>FAX</b> +81-3-6367-9619 <b>Website</b> <a href="https://www.denso.com/jp/ja/products-and-services/automotive-service-parts-and-accessories/plug/">https://www.denso.com/jp/ja/products-and-services/automotive-service-parts-and-accessories/plug/</a> <b>Find your plugs</b> <a href="https://www.denso.com/jp/ja/products-and-services/automotive-service-parts-and-accessories/plug/search/">https://www.denso.com/jp/ja/products-and-services/automotive-service-parts-and-accessories/plug/search/</a>	<b>DSJP</b>
<b>Korea</b>	<b>DENSO KOREA CORPORATION</b> Cheomdan Industry 3, Masanhappo-gu, Changwon-si, Gyeongsangnam-do, KOREA <b>TEL</b> +82-55-220-9000 <b>Find your plugs</b> <a href="https://www.denso.com/global/en/products-and-services/automotive-service-parts-and-accessories/plug/search/korea.html">https://www.denso.com/global/en/products-and-services/automotive-service-parts-and-accessories/plug/search/korea.html</a>	<b>DNKR</b>
<b>Malaysia</b>	<b>DENSO (MALAYSIA) SDN.BHD.</b> Lot 2, jalan P/1, Section 13, 43650 Bandar Baru Bangi, Selangor Darul Ehsan, Malaysia <b>TEL</b> +60-3-87328888 <b>FAX</b> +60-3-87328822 <b>Find your plugs</b> <a href="https://www.denso.com/global/en/products-and-services/automotive-service-parts-and-accessories/plug/search/malaysia.html">https://www.denso.com/global/en/products-and-services/automotive-service-parts-and-accessories/plug/search/malaysia.html</a>	<b>DNMY</b>
<b>Netherlands</b>	<b>DENSO EUROPE B.V.</b> Hogeweyselaan 165, 1382 JL Weesp, The Netherlands <b>TEL</b> +31-294-493493 <b>FAX</b> +31-294-417122 <b>Website</b> <a href="https://www.denso-am.eu/products/ignition/spark-plug">https://www.denso-am.eu/products/ignition/spark-plug</a> <b>Find your plugs</b> <a href="https://www.denso-am.eu/">https://www.denso-am.eu/</a>	<b>DNEU</b>
<b>Philippines</b>	<b>DENSO PHILIPPINES CORPORATION</b> 109 Unity Avenue, Carmelray Industrial Park 1, 4037 Canlubang, Calamba City, Laguna, Philippines <b>TEL</b> +63-49-549-3030 loc 4711 <b>FAX</b> +63-49-549-3088 <b>Find your plugs</b> <a href="https://www.denso.com/global/en/products-and-services/automotive-service-parts-and-accessories/plug/search/philippines.html">https://www.denso.com/global/en/products-and-services/automotive-service-parts-and-accessories/plug/search/philippines.html</a>	<b>DNPH</b>
<b>Singapore</b>	<b>DENSO INTERNATIONAL ASIA PTE.LTD.</b> 51 Science Park Road, #01-19 The Aries, Science Park II, 117586, Singapore <b>TEL</b> +65-67768268 <b>FAX</b> +65-67768698 <b>Find your plugs</b> <a href="https://www.denso.com/global/en/products-and-services/automotive-service-parts-and-accessories/plug/search/singapore.html">https://www.denso.com/global/en/products-and-services/automotive-service-parts-and-accessories/plug/search/singapore.html</a>	<b>DIAS</b>
<b>Taiwan</b>	<b>DENSO TAIWAN CORP.</b> 525, Sec. 2, Mei Su Road Yang Mei Town Taoyuan Hsien, Taiwan <b>TEL</b> +886-3-482-8001 <b>FAX</b> +886-3-482-8003 <b>Website</b> <a href="https://www.denso.com/tw/zh/">https://www.denso.com/tw/zh/</a> <b>Find your plugs</b> <a href="https://www.denso.com/global/en/products-and-services/automotive-service-parts-and-accessories/plug/search/taiwan.html">https://www.denso.com/global/en/products-and-services/automotive-service-parts-and-accessories/plug/search/taiwan.html</a>	<b>DNTW</b>
<b>Thailand</b>	<b>DENSO SALES (THAILAND) CO., LTD.</b> 888 Moo 1, Bangna-Trad Km. 27.5, Tambol Bangbo, Amphur Bangbo, Samutprakarn 10560 Thailand <b>TEL</b> +66-2-315-9500 <b>FAX</b> +66-2-315-9555 <b>Find your plugs</b> <a href="https://www.denso.com/global/en/products-and-services/automotive-service-parts-and-accessories/plug/search/thailand.html">https://www.denso.com/global/en/products-and-services/automotive-service-parts-and-accessories/plug/search/thailand.html</a>	<b>DSTH</b>
<b>Russia</b>	<b>DENSO SALES RUS, LLC.</b> Vodny Business Center, 8th floor Golovinskoye shosse 5 building 1, Moscow 125212 Russia <b>TEL</b> +7-495-970-57-57 <b>FAX</b> +7-495-645-68-22 <b>Website</b> <a href="https://www.denso-am.eu/ru/products/zazhiganie/svechi-zazhiganiya">https://www.denso-am.eu/ru/products/zazhiganie/svechi-zazhiganiya</a> <b>Find your plugs</b> <a href="https://www.denso-am.eu/ru/">https://www.denso-am.eu/ru/</a>	<b>DSRU</b>
<b>Saudi Arabia</b>	<b>DENSO SALES MIDDLE EAST &amp; NORTH AFRICA FZE. - Jeddah Representative Office (DJ AUTO PARTS CO. LTD.)</b> Al Nakhil District/2, Abdulmalek Bin Said Al Ansari St. (24), Jeddah 23242, KSA <b>TEL</b> +966-2-608-3352 <b>FAX</b> +966-2-608-3350 <b>Find your plugs</b> <a href="https://www.denso.com/global/en/products-and-services/automotive-service-parts-and-accessories/plug/search/saudi_arabia.html">https://www.denso.com/global/en/products-and-services/automotive-service-parts-and-accessories/plug/search/saudi_arabia.html</a>	<b>DNJM</b>
<b>UAE</b>	<b>DENSO SALES MIDDLE EAST &amp; NORTH AFRICA FZE.</b> P.O.Box 261986, Jebel Ali Free Zone South, Dubai, United Arab Emirates (Showroom No. S3B3SR02) <b>TEL</b> +971-4-880-7789 <b>FAX</b> +971-4-880-7790 <b>Website</b> <a href="https://www.denso.com/ae/en/">https://www.denso.com/ae/en/</a>	<b>DSMN</b>
<b>U.K.</b>	<b>DENSO SALES UK LTD.</b> 1 Bishop Square, Hatfield, Herts., AL10 9NE, The United Kingdom <b>TEL</b> +44-1707-282400 <b>FAX</b> +44-1707-282450 <b>Website</b> <a href="https://www.denso-am.eu/uk/products/ignition/spark-plug">https://www.denso-am.eu/uk/products/ignition/spark-plug</a> <b>Find your plugs</b> <a href="https://www.denso-am.eu/uk">https://www.denso-am.eu/uk</a>	<b>DSUK</b>
<b>U.S.A.</b>	<b>DENSO PRODUCTS AND SERVICES AMERICAS, INC.</b> 3900 Via Oro Avenue, Long Beach, California 90810, U.S.A. <b>TEL</b> +1-310-834-6352 <b>FAX</b> +1-310-513-7319 <b>Website</b> <a href="https://densoautoparts.com/spark-plugs.aspx">https://densoautoparts.com/spark-plugs.aspx</a> <b>Find your plugs</b> <a href="https://densoautoparts.com/find-my-part.aspx">https://densoautoparts.com/find-my-part.aspx</a>	<b>DPAM</b>

**DENSO CORPORATION**

1-1, Showa-cho, Kariya, Aichi 448-8661, Japan