

Multiconductor[®]

Insulated conductor bar

Technical information



Multiconductor[®] housing RN7: innumerable possibilities and variations!

The conductor housing RN7 is available in various models, indicated in the summary as listed below. As such you are able to optimally gear your installation to the industrial circumstances. It provides you with the opportunity to easily adjust variations in the occupancy of the (copper) conductors, to tune your installation to your changing industrial circumstances. All conductor models can be provided with flexible, rubber sealings, model AS7 (refer to photograph). Protection class of all conductor models is IP23. Including **rubber sealing AS7** the protection class is **IP44**.

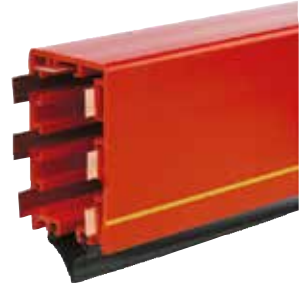

Standard performances:

Type RN7

Colour: signal red.

Temperature range as of -30 °C up to +60 °C.

The anti-reverse rib (A) in the housing ensures that the collector trolley can only be installed in one way and prevents cross phasing. A continuous yellow stripe (B) on one side of the housing ensures correct fitting of het system. The PVC with a high impact strength is self extinguishing.

Type RN7W

Colour: white. Dimensions similar to type RN7.

Temperature range as of -30 °C up to +60 °C.

When radiant heat is applicable, such as in green houses, a white conductor housing is advised.

Type RNV7

Colour: grey white. Dimensions similar to type RN7.

Temperature range as of -20 °C up to +80 °C.

For applications with higher environmental temperatures.

Type RNHS7

Colour: signal red.

Temperature range as of -30 °C up to +60 °C.

Due to the spacer strips at the bottom side this conductor housing model is well suited for installations positioned at a low level. The strips provide additional protection against splashing water.

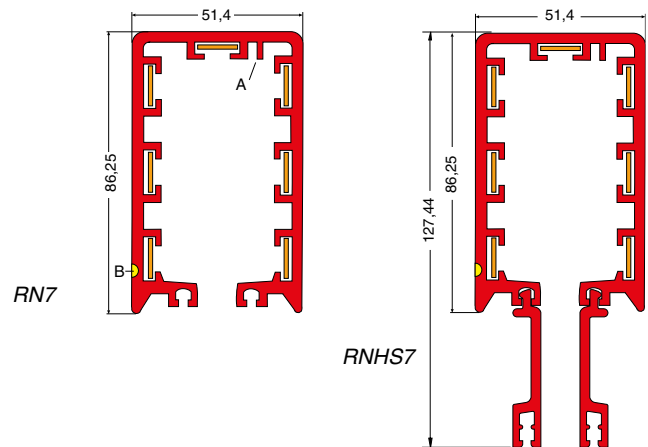

Technical data of housings

Material

Unplasticized Hard-PVC with approximate values:

Notch shock strength	5-10 kJ/m ²
E-modulus	2500-3000 N/mm ²
Softening point (Vicat)	81-83°C
Linear expansion	70.10 ⁻⁶ m/m/°C

Electrical data

Volume resistivity with 100 V	>4.10 ¹⁵ Ω/cm
Dielectric strength with 50 Hz	>30 kV/mm
Flame class UL94	V0

Length of housing 4 m standard

Flexible sealing strips AS7

Type AS7 C chloroprene, colour black

This is used to ensure the suitability of a Multiconductor installation for application in a **dusty, humid** or even **corrosive** atmosphere. Corrosion of copper conductors is nearly always prevented! This sealing is recommended for all outdoor installations and specific industries e.g. **concrete brick-works, coal storage and transshipment, dairies, galvanising plants, textile production** etc.

Rail type RN(HS)7 **with AS7** meets protection degree **IP44** and is permitted to be mounted on every desired height.

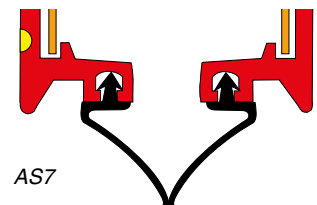

AKAPP NO.	DESCRIPTION	red	white	linear 10 ⁻⁶ m/m/°C	min. temp. °C	max. temp. °C	HS, extra protection	combined with transfer guides	combined with curves
1001050	PVC housing, red RN7	x		70	-30	60		x	x
1000940	PVC housing, white RN7W		x	70	-30	60		x	x
1001360	Railkoker, extra protection RNHS7	x		70	-30	60	x	x	x
1001960	PVC housing VICAT 93 RNV7		x	70	-20	80		x	x

Ultimate logistical control: uninterrupted feed at all times

Each Multiconductor installation is supplied with the joint-free copper conductors, rolled on and based on track length. Copper strips are available for current intensities of **35, 50, 80, 125 and 160A** (D.C. 80%). Material: electrolytic copper.

When 2 strips are parallel connected for each of the 3 phases of a three-phase system, current intensities of **250A** (2x125) and **320A** (2x160) are possible. The 7th conductor being utilised as earth supply.

Upon parallel installation of various Multiconductor installations a significant higher current capacities can be attained. By means of parallel installation the **multipole** installations can be assembled; **of importance with regard to control purposes.**

Partially due to the joint-free conductors the Multiconductor **is well suited for control current and data transfer**; eventually whilst using silver-plated conductors. Contact your AKAPP-STEMMANN supplier on this subject.

Special material conductors

The concept of the Multiconductor system allows the application of other metal apart from copper. For example silver-plated copper (advantageous for data transfer!).

Installation of the copper conductors

Following the installation of the conductor housings the flat copper conductors can easily be drawn into the copper channels directly from the cable drum. This can be easily and quickly effected by means of the copper pulling cassette, pulling block and pulling attachment, available as an option.

A simple stretchblock is supplied for conductors CU125 and CU160. This is designed to make installation easier and also to reduce any resistance on very long installations.

Volt drop in copper conductors. By virtue of the continuous conductor concept, Volt drop in the AKAPP Multiconductor system is kept to an absolute and constant minimum.

With a power factor (cos. φ) of < 1 the figures mentioned in the adjacent table have to be changed accordingly, e.g. with $\cos \varphi = 0.85$ the Volt drop figures have to be multiplied by 0.85.



For applications where higher temperatures exist, the resistance, and therefore the Volt drop, increases.

Solution: using next size copper conductors.

Volt drop in V /meter Multiconductor/ A nominal current, $\cos \varphi = 1, +20 \text{ }^\circ\text{C}$ ambient

copper conductor	3 phase ~	1 phase ~ en =	When utilizing 2 copper conductors in parallel the volt drop values in the table will be halved. On request, impedance data can be supplied
CU35 *	0,00588	0,00679	
CU50	0,00339	0,00391	
CU80	0,00217	0,00251	
CU 125	0,00119	0,00138	
CU 160	0,00092	0,00106	
with + 35 °C multiply by 1,079;			
with + 45 °C multiply by 1,118;			
with + 55 °C multiply by 1,157.			

* Copper conductors 35A can not be combined with expansion joints

Arrangement of the copper conductors

Whilst using the standard conductor housings and the 5 different copper conductors, a vast array of combinations is possible.

Please find some examples below. Attention: the earth conductor is always located at the yellow marker strip!

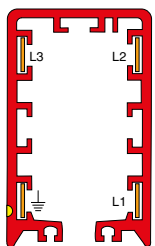

standard
4-pole

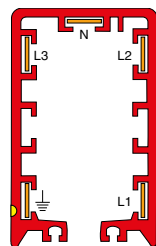

standard
5-pole

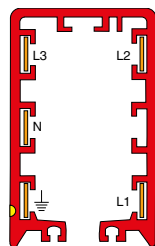

5-pole, for
installations with
curves

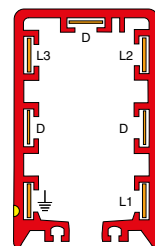

3 phase+earth and
3 conductors D for
control and data

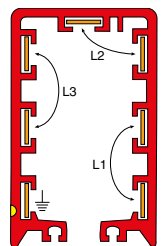

per phase 2
conductors in
parallel+earth

AKAPP NO.	DESCRIPTION	max In (A) (DC=80%)	dimension mm (b x d)	linear exp. K-6 $10^{-6} \text{ m/m}^2\text{ }^\circ\text{C}$	DC resistance Ω/m	specific conductance (ρ) Sm/mm^2	max. length track part Δt $25 \text{ }^\circ\text{C}$	max. length track part $\Delta t > 25 \text{ }^\circ\text{C}$	max. speed (m/min.)
1002170	Copper conductor 35A CU35	35	12,7 x 0,4	17,00	0,003444882	58	90	60	80
1002560	Copper conductor 50A CU50	50	12,6 x 0,7	17,00	0,001984127	58	525	525	n.v.t.
1002640	Copper conductor 80A CU80	80	12,5 x 1,1	17,00	0,001272727	58	325	325	n.v.t.
1002720	Copper conductor 125A CU125	125	12,5 x 2,0	17,00	0,0007	58	200	200	n.v.t.
1002870	Copper conductor 160A RN7 CU160/7	160	12,5 x 2,6	17,00	0,000538462	58	150	150	n.v.t.
1003370	Copper conductor silv. 50A CU50/AG	50	12,6 x 0,7	17,00	0,001984127	58	525	525	n.v.t.

Hanging and fixing of the housing: free expansion at all times!

The principle of the AKAPP conductor bar systems with uninterrupted conductors is based on the free expansion of the pvc housing and the internal conductors. The conductor housing is therefore suspended in sliding hangers in which these conductors - upon the occurrence of differences of expansion - can slide continuously and who are fixed at the feed point only by means of a **fixed point clamp** at the construction. Sliding hangers and fixed point clamps are available in 4 types, for maximal adaption to the environmental conditions. See adjacent frame.

Finishing of metal sliding hangers and joints

Type Z - Galvanised, for **normal indoor installations**.

Type L - Galvanised + epoxy coated, for **outdoors and corrosive environments**.

Type LR - As Type L, with stainless steel bolts and nuts A2

Type R - Stainless steel AISI304, for **corrosive environments**.

Sliding hanger

Type BN7-Z, Type BN7-L, Type BN7-R, and Type BN7-LR

The sliding hangers are fastened to the suspension frame by means of a bolt. As such the installation can be **aligned vertically**.

Centre distance of hanger supports:

1333 mm : travel speed up to 250 m/min.;
1000 mm : travel speed up to >250 m/min.;
2000 mm : with CU35, CU50, CU80, for 6- and 7-pole installations up to a max. ambient temperature difference of 40 °C.

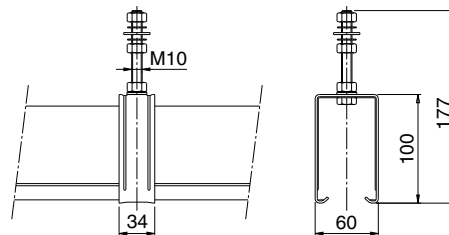

BN7-L

Fixed point clamp

Type VMN7-Z, Type VMN7-L, Type VMN7-R, and Type VMN7-LR

The complete conductor installation is to be fastened to the suspension frame by means of a self-gripping fixed point clamp. As of this location, the conductor housing can slide freely in the sliding hangers when expansion differences, due to temperature variation, occurs.

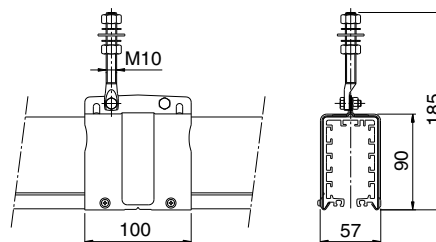

VMN7-L

Support bracket

Type UH330 : l=330 mm, galvanised
Type UH500/(R) : l=500 mm, galvanised/(SS)
Type UH700/(R) : l=700 mm, galvanised/(SS)
Special length on request. These brackets have clamps attached to sliding nut assemblies thus facilitating a flexible mounting arrangement ca-pable of accomodating various sizes of RSJ (INP) beams, allowing simple **horizontal alignment**.

Note: For fast mounting on site, **pre-mounted** support brackets with sliding hanger are available on request! Please ask our sales department.

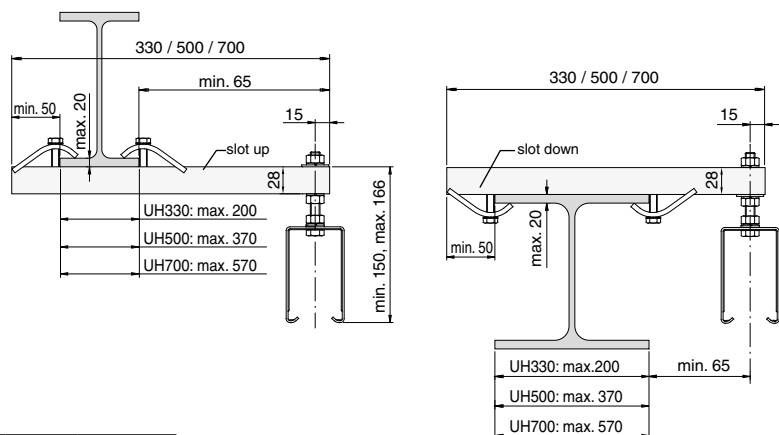

AKAPP NO.	DESCRIPTION	ambient is		
		dry	humid	chem. agr.
1004570	Sliding hanger galvanised	BN7-Z	x	
1004650	Sliding hanger epoxy coated	BN7-L		x
1004420.B0000	Sliding hanger galv.+epox.+A2	BN7-LR		x
1005540	Sliding hanger SS-A2/304	BN7-R		x
1005200	Rolling hanger galvanised	RB7	x	x
1004960	Fixed point clamp galvanised	VMN7-Z	x	
1005070	Fixed point clamp galv.+epoxy coat.	VMN7-L		x
1005310.B0000	Fixed point clamp galv.+epox.+A2	VMN7-LR		x
1005770	Fixed point clamp A2/304	VMN7-R		x

AKAPP NO.	DESCRIPTION	length (mm)
1018010	Support bracket galvanised 330mm UH330	330
1018160	Support bracket galvanised 500mm UH500	500
1018320	Support bracket galvanised 700mm UH700	700
1018370.B0000	Support bracket stainl. steel 330mm UH330-R	330
1018380	Support bracket stainl. steel 500mm UH500-R	500
1018390	Support bracket stainl. steel 700mm UH700-R	700

Joint clamps: for the easy connection of conductor housings

The lengths of the housing are connected by means of standard joint clamps. There are 2 variations:

- standard metal joint clamp
- ABS expansion joint clamp

Metal joint clamps are available in 4 types, to ensure a maximum tuning to the operating conditions. Also refer to the upper right frame on page 4.



VN7-Z

Joint clamp

Type VN7-Z, Type VN7-L, Type VN7-R, and Type VN7-LR

The conductor housings are connected by means of a self-gripping joint clamp. The self-drilling screws, as supplied, ensure an extra firm connection with longer system lengths (from 80m length 2 pc. per joint; from 200m length 4 pc. per joint).

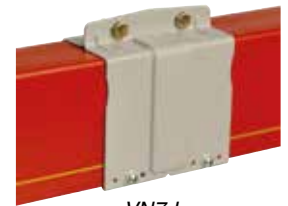
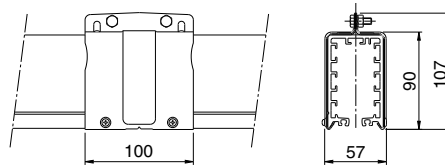

VN7-L

Insulating tape

Type T50 (50 mm width, roll of 10 m)

This adhesive tape is used to ensure a permanent shroud around the housing joints, prior to fitting the joint clamps, for both indoor and outdoor installations.

1 roll is sufficient for 35 joints.

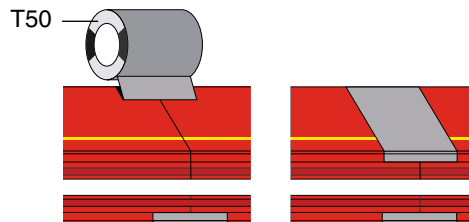

Expansion joint

Type KEV7

This ABS expansion joint is applied when a free expansion of the Multiconductor from one fixed point is not possible. E.g. with very long installations, tracks in which there are several current supply connections, closed curved tracks, etc.

The PVC housing is then fixed to the support construction with a fixed point clamp adjacent to an expansion gap at recommended positions.

Important: Read the supplied mounting instructions carefully **before** mounting, to determine the expansion gaps. If in doubt, please consult your AKAPP supplier.

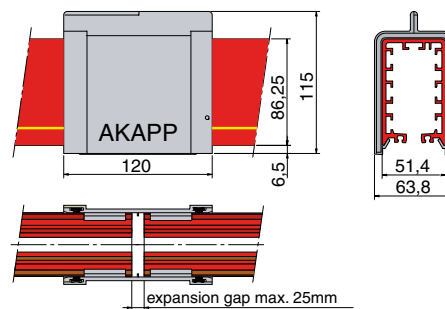

KEV7

The rubber sealing at the inner side of the synthetic expansion joint clamp, together with the continuous AS7 sealing strips, also allows **installations outdoors**.

Installations with expansion joints require collector trolleys type “../E” (see page 11).

AKAPP NO.	DESCRIPTION	ambient is			with VN7-	with VN7- and humidity	U max with humidity	max. free expansion in joint (mm)
		dry	humid	chemical aggress.				
1004730	Joint clamp galvanised VN7-Z	x					400V	0
1004810	Joint clamp galv/epox.VN7-L		x				400V	0
1004340	Joint clamp galv.+epox.+A2 VN7-LR			x			400V	0
1005620	Joint clamp A2/304 VN7-R			x			400V	0
1006040	Insulating tape 10m x 50mm T50				x	x		0
1005461	Expansion joint KEV7	x	x	x			400V	25

End feed boxes

efficient and reliable solutions

End feed boxes are used for the connection of the feeding cable to the outer end of the Multiconductor system (see picture).

All feed boxes are fitted with metric glands. It is possible to use extra glands and/or several diametre ranges from type EB40.

End feed clamps are required for connection of copper conductors 125A or 160A (see details below).

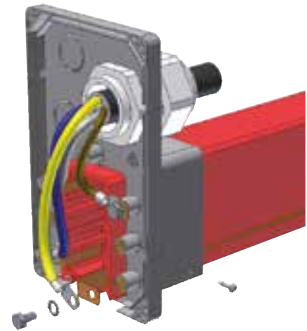

EB40 (opened)

End feed boxes

Type EBS32

Compact end feed box with cable gland M32, suitable for cables Ø10-Ø21 mm. Connecting screws M6 included.

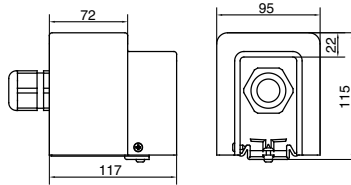

EBS32

Type EB40

End feed box for with cable gland M40, suitable for cables Ø16-Ø28 mm. The push-through holes offer easy mounting of various cable glands. Connecting screws M6 included.

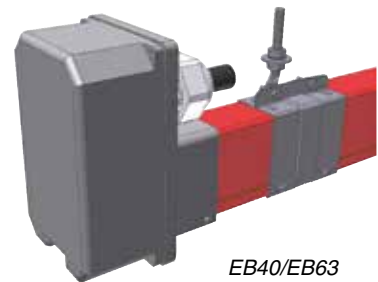
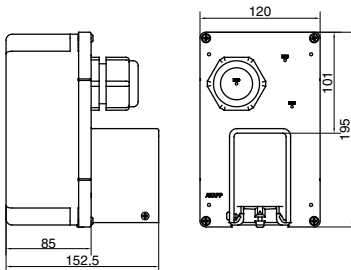

EB40/EB63

Type EB63

As end feed box EB40, but with cable gland M63, suitable for cables Ø30-Ø44,5 mm. Connecting screws M6 included.

End feed clamps

Type EC160

Required for connecting copper conductors 125A or 160A to the cable lug of the connection cable. To be ordered separately.

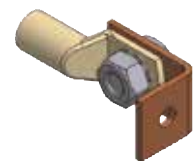
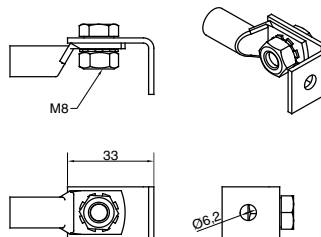

EC160

Special arrangements and gland sizes on request.

AKAPP NO.	DESCRIPTION	max. temp. (°C)	range of diametre feeding cable (mm)	max. copper conductors mounted	I max (80% D.C.) non-parallel (A)	protection degree without AS7	protection degree with AS7
1006830	End feed box 1xM32 EBS32	80	10 - 21	4xCu80 / 7xCu50	80	IP23	IP44
1006800	End feed box 1xM40 EB40	80	16 - 28	4xCu125 / 7xCu80	125	IP23	IP44
1006810	End feed box 1x63 EB63	80	30 - 44	4xCu160 / 7xCu80		IP23	IP44
1006820	End feed box EB	80	no glands				
1013010	End feed clamp EC160	80			160		

Line feed boxes: designed for more flexibility

Lines feed boxes are used for the connection of the feeder cable on any random point of the system. The feeder cable is connected to line feed clamps, kept in place by the line clamp holder that is partly slid over the 2 housing parts in which up to 7 line feed clamps (see page 8) can be fitted. The copper conductors will not be interrupted!

Basis of all the line feed boxes is the modular collar that is fitted with push through holes to fit various glands M32 to M63 in size. For custom configurations, you can easily add glands by removing the pre-cut sections.

The line feed clamp holder (LCH or LH) connects 2 adjacent rail housings and holds the line feed clamps at the same time. The principle is a 90–120 mm Line feed clamp holder that slides over 2 housing parts. Then it is screwed on the sides.

Line feed clamps are fitted, copper goes through the line feed clamps and is connected to a power cable. Cover comes over the collars and clicks into position.

Line feed boxes types LB

Type LB40

Line feed box for connection of copper conductors up to 125A. With 1 gland M40 for cables Ø16-Ø28 mm.

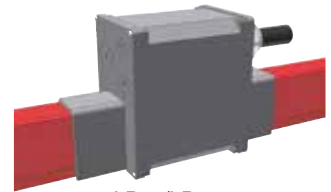
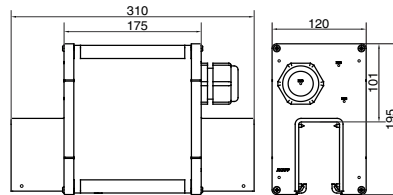

LB40/LB63

Type LB63

Line feed box for connection of copper conductors up to 160A. With 1 gland M63 for cables Ø30-Ø44,5 mm.

Type LB32-4

Similar to LB63, but with 4 glands M32 for cables Ø10-Ø21 mm.

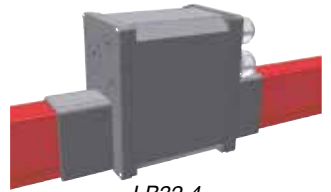
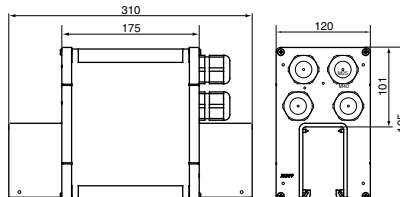

LB32-4

Type LB32-7

Similar to LB32-4, but with 7 glands M32 for cables Ø10-Ø21 mm.

Line feed clamp holders

Type RN7-LCH

Applicable for line feed connections with continuous copper (all sizes), irrespective the number of poles. The required line feed clamps have to be ordered separately.

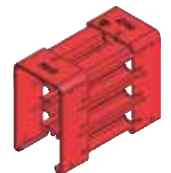
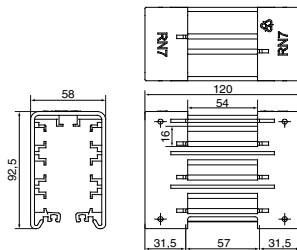

RN7-LCH

Type RNHS7-LCH

Similar to RN7-LCH, but with spacer strips for use with extra hand-safe housing RNHS7.

Type RN-LH

Applicable for line feed connections with continuous copper that require joints in the line feed (i.e. in multi curved systems, very long tracks etc.). The RN-LH is composed of 2 halves that "click" together around the rail housing leaving the copper joints free. Includes bolts/nuts M6 for connections of conductors.

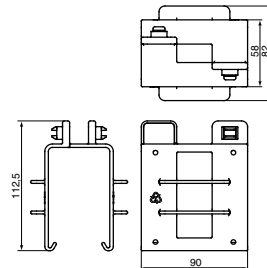

RN-LH
(mounted)

AKAPP NO.	DESCRIPTION	max. temp. (°C)	range of diametre feeding cable (mm)	max. copper conductors mounted	I max (80% D.C.) non-parallel (A)	I max (80% D.C.) parallel (A)	protection degree without AS7	protection degree with AS7
1006900	Line feed box 1xM40 LB40	80	16-28	4xCU125 / 7xCU80	125	-	IP23	IP44
1006910	Line feed box 1x M63 LB63	80	30-44	4xCU160 / 7xCU125	160	250	IP23	IP44
1006920	Line feed box 4xM32 LB32-4	80	4x 10-21	4xCU160	160	-	IP23	IP44
1006930	Line feed box 7xM32 LB32-7	80	7x 10-21	7xCU160	160	320	IP23	IP44
1006940	Line feed box LB	80	no glands				IP23	IP44
1006035	Line feed clamp holder RN7-LCH	80						
1006035.B0001	Line feed clamp holder RNHS-LCH	80						
1006950	Set line feed RN-LH	80						

Connecting the copper conductors: skilful solutions with clamps and boxes

All line feed systems require clamp holders and feed clamps to connect the copper conductors within the rail housing to the cores of the supply cable (see also page 7).

There are 2 types of feed clamps: LC80 and LC200.

To connect the copper conductors to a cable terminal in a transition box, the transition cables OK25 or OK35 can be used. In some cases, it can replace a feeding cable with a too large outer diameter.

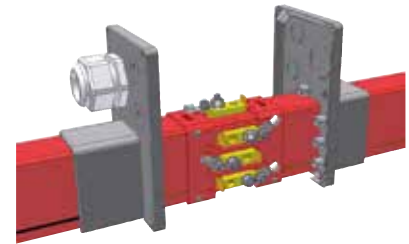

LCH + LC80

Feed clamps

Type LC80

To be applied for mounting copper conductors Cu35 - Cu80.

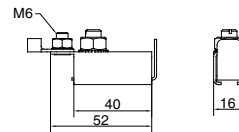

LC80

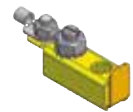

Type LC200

To be applied for mounting copper conductors Cu125 - Cu160.

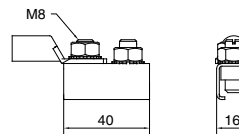

LC200



Transition cables

Type OK25

Cable 1x 25 mm², length 1,5 m, fitted with cable lugs on both sides. For max. current capacity 125A or 250A (with 2 cables in parallel connection) and Cu125 copper conductor. To be used with Transition box OGV320 (see below).

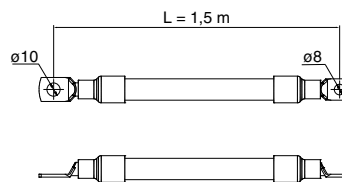

Type OK35

Cable 1x 35 mm², length 1,5 m, fitted with cable lugs on both sides. For max. current capacity 320A (with 2 cables in parallel connection and Cu160 copper conductor). To be used with Transition box OGV320 (see below).

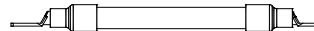

Transition cable series OK

Transition box for for feed connection Multiconductor

Type OGV320

Complete with 2x5 bolts M10 for cable lug connections, 7 glands PG21 and a special grommet for cables of Ø20 - Ø75 mm .

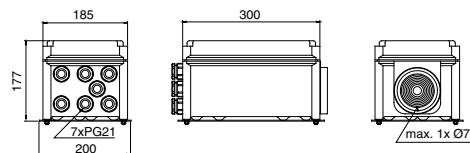

OGV320

LINE FEED CLAMPS	DESCRIPTION	NUMBER	max. current (A) (100% D.C.)	with type line feed holder
AKAPP NO				
1012750	Feed clamp small LC80	1 per conductor	72	RN7-LCH
1013000	Feed clamp LC200	1 per conductor	179	RN7-LCH
TRANSITION CABLES	DESCRIPTION	NUMBER	max. current (A) (100% D.C.)	with type transition box
AKAPP NO				
1499560	Cable, 1x25 mm ² , L=1,5m OK25	1 per conductor	135	OGV320
1499640	Cable, 1x35 mm ² , L=1,5m OK35	1 per conductor	169	OGV320
TRANSITION BOX	DESCRIPTION	NUMBER	max. current (A) (100% D.C.)	protection degree
AKAPP NO				
1010510	Overgangskast OGV320	1 per system	286,3	IP44

Other components: end caps, inspection units

An end cap is to be mounted for sealing off the open ends of a Multiconductor system.

In order to eliminate length differences between copper conductors and pvc housing due to temperature variations, it is important that the conductors have sufficient length within the end cap. For installations with extreme length differences, extra long end caps can be applied. Your AKAPP supplier can advise you further on this subject.

An inspection unit is fitted with 2 joint clamps VN7 in Multiconductor installations where inspection of the trolley is not possible by removing an end cap or end feed. E.g. on endless curved tracks or on applications where several collector trolleys are fitted, or where a special location area for the inspection is available.

Alternatively, a special wooden wedge set can be used for taking out and inserting a trolley. Both possibilities are described on this page.

End caps

Type EN7

Length 300 mm. Attached to the housing by means of a joint clamp (to be ordered separately). See photo.

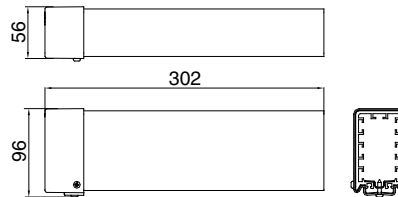

EN7

Type EN7-W

Similar to EN7, but colour white.

Type ENHS7

For Multiconductor RNHS7, similar to EN7, however with distance strips.

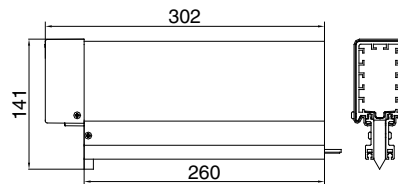

ENHS7

Type ENV7

For Multiconductor RNV7. Similar to EN7, but for temperature range -20 °C to +80 °C. Colour grey white.

Inspection unit

Type UN7

Length 200 mm. The inspection unit is fitted with 2 joint clamps VN7 in Multiconductor systems. Inspection units for **curves** can be supplied on request.

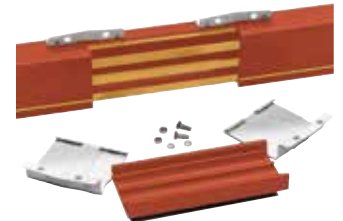
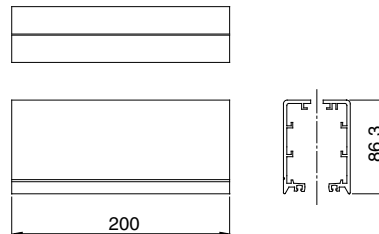

UN7

Type UNHS7

For Multiconductor RNHS7.

Wooden wedge set

Type OBA

For fast taking out and inserting trolleys at almost any location of a Multiconductor system. The set consists of two wooden wedges with two pvc plates. By inserting the wedges into the housing and then turning it, the housing will widen and the trolley can be taken out easily. When inserting the trolley again, the two plates can be used to guide it into the housing.

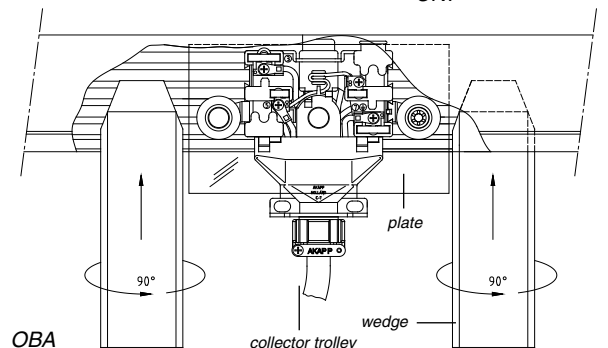

OBA

AKAPP NO.	DESCRIPTION	length (m)	red	white	grey	max. poles	IP23	sealing rubber AS7 applicable	IP44 with AS7	HS, extra protection
1014140	End cap red EN7	0,30	x			7	x	x	x	
1014800	End cap white EN7W	0,30		x		7	x	x	x	
1014370	End cap red for RNHS7 ENHS7	0,30	x			7	x	x	x	x
1014690	End cap for RNV7 ENV7	0,30			x	7	x	x		
1015030	Inspection unit red UN7	0,30	x			7		x		
1015260.B0000	Inspection unit red f. RNHS7 UNHS7	0,30	x			7		x		x

Collector trolleys: standard series for high performance

The current conduction of the Multiconductor to the device to be fed is effected through the collector trolley. The contact with the flat copper conductors is maintained uninterruptedly by means of flexible, extreme wear-resistant carbon brushes manufactured from a specific bronze-coal alloy. The collector trolley is pulled into the Multiconductor by the moving machine to be fed and by means of a trolley towing arm mounted onto this machine. The uninterrupted copper conductors of the Multiconductor system ensure **extreme high traverse speeds**.

The standard collector trolleys, supplied with low wear Nylon wheels, are suitable for **traverse speeds up to 100 m/min**. For **higher traverse speeds**, for **heavy duty** and/or for **dusty environments** the collector trolleys are fitted with **dust proof, ball bearing wheels** (type "S"). See also special current collectors, page 11. For **traverse speeds > 250 m/min**, special instructions with regard to the Multiconductor installation are applied.

On page 22 you'll find more information on all collector trolley series concerning maintenance and spare parts.

Standard collector trolleys

Multiconductor collector trolleys are available for range 2 to 7 conductors with current carrying capacities of **35A, 70A and 100A** (D.C. 60%) or **27,11A, 54,22A and 77,46A** (D.C. 100%). Applicable from -20°C (types ../LT from -30°C) up to +80°C.

These collector trolleys are fitted as standard with a supply cable. The connection with the apparatus/machine to be fed is via a transition box (ordered separately) which can be located adjacent to the collector trolley towing arm position (see page 14).

Selection chart of standard collector trolleys + transition boxes

A max.	35		70		100	
number of poles	type trolley	type trans. box	type trolley	type trans. box	type trolley	type trans. box
2	CL7-2-35	TTB35-4	CL7-2-70	TTB70-4	CL7-2-100	TTB100-4
3	CL7-3-35		CL7-3-70		CL7-3-100	
4	CL7-4-35		CL7-4-70		CL7-4-100	
5	CL7-5-35	TTB35-7	CL7-5-70	TTB70-7	CL7-5-100	TTB100-7
6	CL7-6-35		CL7-6-70		CL7-6-100	
7	CL7-7-35		CL7-7-70		CL7-7-100	

When application of **2 or 3 separate collector trolleys per apparatus to be fed** (e.g. for transfer installations), the following transition boxes are used:

number of trolleys	type trolleys	type transition box
2 collector trolleys	CL7-2 t/m 4-35	TTB70-4
2 collector trolleys	CL7-5 t/m 7-35	TTB70-7
2 collector trolleys	CL7-2 t/m 5-70	OG300-7
2 collector trolleys	CL7-6 t/m 7-70	OG300-7
2 collector trolleys	CL7-2 t/m 4-100	OG300-7
2 collector trolleys	CL7-5 t/m 7-100	OG300-7
3 collector trolleys	CL7-2 t/m 4-35	TTB100-4
3 collector trolleys	CL7-5 t/m 7-35	TTB100-7
3 collector trolleys	CL7-2 t/m 4-70	OG300-7
3 collector trolleys	CL7-5 t/m 7-70	OG300-7

Carbon brushes

The collector trolleys are supplied as standard with carbon brushes for 35A, positioned according to the table below.

The brushes in positions 4 and 5 are both fitted as double brushes ("twin brushes"). Twin brushes are smaller than the others and their capacity is 35A per set. Advantages of this construction are a **perfect balanced** collector trolley and an **improved transmission of control signals**.

CARBON BRUSH TYPES		Standard carbon brushes		Silver graphite brushes*	
Application	Brush position in collector trolley	Art.no.	for normal conductors	Art.no.	for silvered conductors
Phase brush** norm.	1,2,3 en 6	1411021	K91P	1412221	KZ91P
Phase brush** twin	4 en 5	1410601	C91D	1410621	CZ91D
Ground brush	7	1410521	C91A	1410531	CZ91A

* Silvergraphite brushes are softer than the conductors
** Also suitable for DC

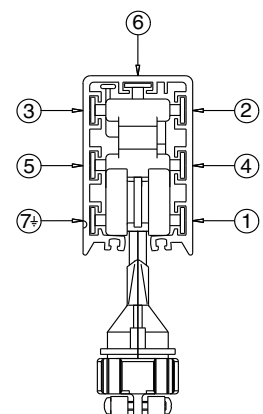
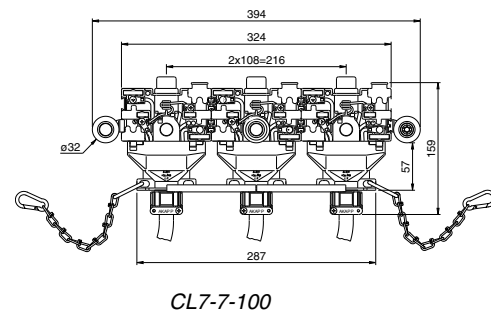
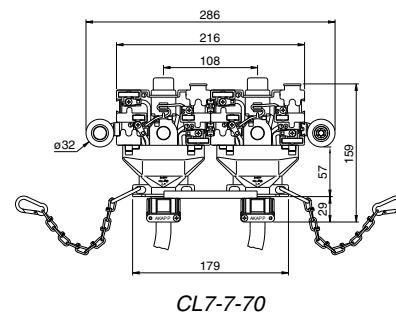
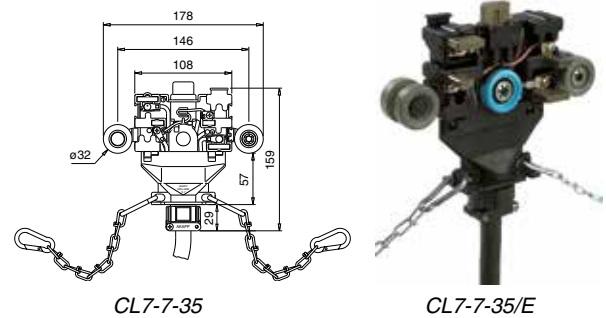

Schedule brush positions in CL7

Collector trolleys: adaptions for special applications

Apart from the numerous models of the standard collector trolleys, a vast array of special models are possible and available. The collector trolleys of the CL7 series can easily be adapted to **exceptional** circumstances such as installations with **very high traverse speeds, transfer guides, curves, expansion gaps** etcetera.

In many cases, the available pre-mounted wheel sets make the right adaption. The dove-tail construction makes it very easy to install or exchange the wheel sets and create the

trolley that fits the specific needs. You can of course also order trolleys with the adaptions you need. In the table below, an overview of the possibilities is listed, together with the respective suffix. Please refer to these suffixes when ordering. For unlisted models, please contact your supplier of AKAPP-STEMMANN.

Current collector trolleys series S(L)7 and NLHS7 are available for installations with **curves** or **housing type HS, extra protection**.

Current collecting capacity doubles when parallel connecting copper conductors.

A Multiconductor with 7 copper conductors offers the opportunity to double the current capacity when 3 phase ~, by application of 2 conductors per phase in parallel. The 7th conductor is utilised for the earth supply. The extra capacity is also reflected with regard to the selection of suitable collector trolleys.

Selection chart of 7-pole trolleys and transition boxes for installations with copper conductors in parallel for 3 phase+earth feed.

A max.	type collector trolley	number of poles	type trans. box
70	CL7-7-35	7	TTB70-4
140	CL7-7-70	7	TTB140-4-2
200	CL7-7-100	7	OG300-7
280	CL7-7-70 2 pcs	7	OG300-7

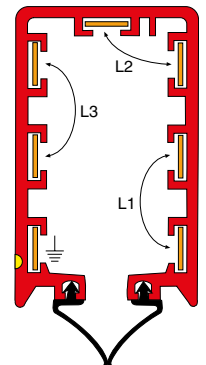

RN7-7-160/parallel

Collector trolleys for special applications

There is a number of possibilities to adapt the standard current collector series CL7. Wheel sets are available that can be mounted or exchanged easily by means of dove-tail connections (see photo).

In the table below a number of special performances is listed with its respective suffix.

Performance	Type	Performance	Type
Expansion (KEV's)	CL7-.../E	Low temperatures *	CL7-.../LT
Top wheels	CL7-.../T	90 degree gland	CL7-.../HWK
Side and top wheels	CL7-.../TZ	Silver graphite brushes	CL7-.../AG
Dust proof wheels	CL7-.../S	Special cable length	CL7-.../M
High travel speeds *	CL7-.../S	Transfer guide small (ITKN)	CLTK7-.../...
For galvanising plants	CL7-.../V	Transfer guide large (ITN)	CLTG7-.../...

* from 100 m/min.

* up to -30 °C

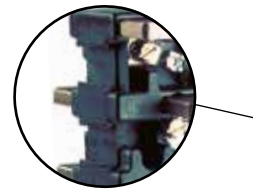

Dove-tail connections



Extra wheel (.../E)



Top wheels (beared .../T/S, or not beared .../T)



Double top wheels with side wheels (.../TZ)

Collector trolleys for Multiconductor RNHS7

Types CL7-4-35/HS and CL7-7-35/HS

For Multiconductor type RNHS7 special trolleys with an elongated lower moulding are utilised. For 4 or 7 conductors. Other types on request.

Collector trolleys for curves

Type S7-...-35

For installations with curves of a radius < 800 mm, special flexible current collectors are required. See also page 18. More information via your AKAPP-STEMMANN supplier.



CL7-7-35/HS (for RNHS7)



S7-4-35 (for BRN7)

Collector trolleys:

economic collector trolleys series C4

If an application with AKAPP Multiconductor requires no critical demands to the collector trolley, it is possible to apply a trolley of the C(L)4 series. These collector trolleys are available only for systems with 4 conductors. The 70A and 100A collector trolleys are formed by mounting 2 resp. 3 separate trolleys 35A on a metal strip (see the figures opposite).

All collector trolleys can be delivered with or without 1 m cable (type "C4-..", resp. "CL4-..").

It is recommended to use a transition box when connecting the trolley with the apparatus to be fed. This box (order separately) can be mounted on the towing arm (see figure on page 13).

These collector trolleys are supplied with Nylon wheels, suitable for **traverse speeds** up to **60 m/min**. For **higher traverse speeds** and for **heavy duty environments** you should use collector trolleys of series 'C(L)7-..'. See page 10 and further for more details.

Standard collector trolleys

Series C4 collector trolleys are available for 4 conductors with current carrying capacities of **35A, 70A and 100A** (D.C. 60%).
Applicable from -20°C up to +80°C.

These collector trolleys are fitted as standard with a supply cable. The connection with the apparatus/machine to be fed is via a transition box (ordered separately) which can be located adjacent to the collector trolley towing arm position (see page 14).

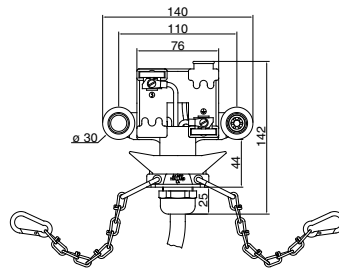

CL4-35

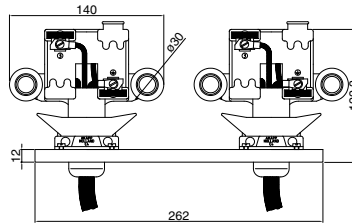

CL4-70

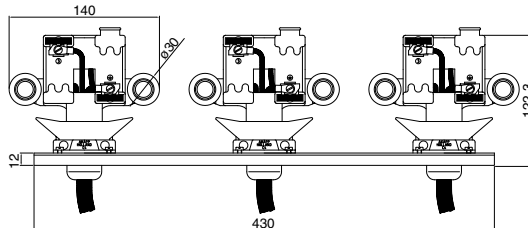

CL4-100

Carbon brushes

The collector trolleys type CL4 are supplied as standard with carbon brushes for 35A, according to the table below.

CARBON BRUSH TYPES			Standard brushes
Art. no.	Application	Brush position in collector trolley	for normal conductors
1411021	Phase brush compl.	1, 2 and 3	K91P
1410521	Ground brush compl.	4	C91A

Transition boxes for collector trolleys

This unit facilitates the connection of the flexible cable from the collector trolley with the fixed wiring from the apparatus/machine being fed.

Using the included attachments, the transition box can be mounted easily on the (AKAPP) towing arm or close to the apparatus/machine.

Types of transition boxes:

trans. box type	for trolley	inlet	outlet
TTB35-4	C(L)4-35	1xM32	1xM32
TTB70-4	C(L)4-70	2xM32	1xM40
TTB100-4	C(L)4-100	3xM32	1xM40

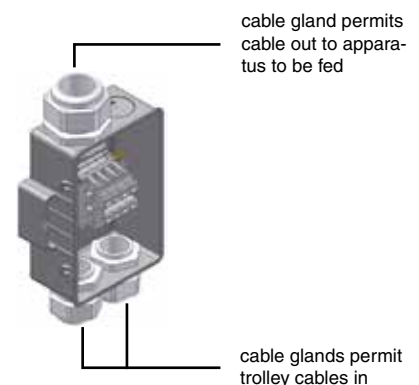

TTB70-4

Collector trolleys series CL4-40: the compact solution for double brushes per phase

AKAPP offers the possibility to use a singular collector trolley, type CL4-40, with double brushes. This trolley applies to the IEC 60204.32.13.8.2 standard, describing the situations whereas conductor bar systems need to apply double carbon brushes.

The CL4-40 trolley is a good and cost effective solution for those cases whereas the above standard is applied. In addition, the CL4-40 will improve the cost effectiveness of systems that are controlled by frequency inverters.

The CL4-40 is a 4 pole trolley, capacity 40 Amps at 60% duty cycle at 50 °C. Applicable from -20°C up to +80°C.

The CL4-40 uses twin carbon brushes C91D for phases and special twin ground brushes C91DA.

All CL4-40 trolleys are available with cable lengths of 1, 2, 3, 4 or 5m. For standard cable length 1m you do not need to indicate anything. For other cable lengths add /2M, /3M, /4M or /5M to the type description.

Standard collector trolleys

Type CL4-40

4-pole trolley with standard wheels. Max. speed 100 m/min.
For all RN-types of housings.
Standard fitted with 1m cable.

Type CL4-40/S

4-pole trolley with ball beared wheels. Max. speed 250 m/min.
For all RN-types of housings.
Standard fitted with 1m cable.

Note: Trolleys without cable are also possible. Please cancel the "L" in the type description; e.g. type 'C4-40' is a 40 Amps trolley without cable.

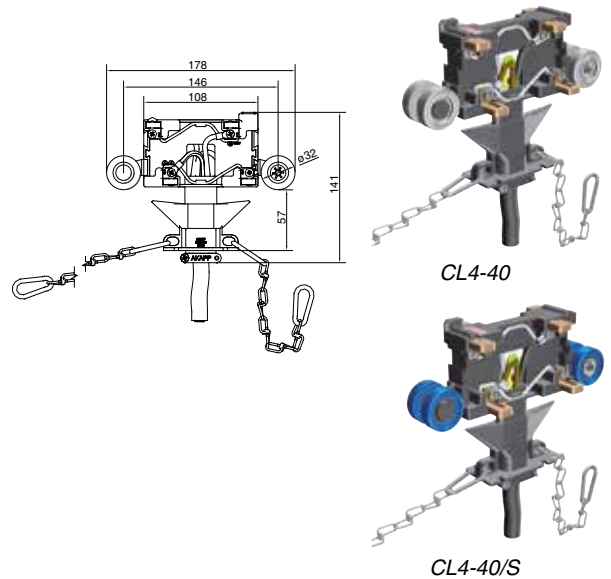

Collector trolley assemblies

Type CL4-40/BMV/TTB

For easy ordering, we created a fully assembled version of the collector trolley CL4-40, complete with towing arm BMV35 and trolley transition box TTB35. See table below for order reference. For dimensions see table on page 14 (top).



CL4-40/BMV/TTB

Carbon brushes and wheel sets

The following parts are applicable:

AKAPP NO.	DESCRIPTION	TYPE
1410601	Carbon brush twin phase	C91D *)
1410631	Carbon brush twin ground	C91DA
1630100	Wheel set standard (grey)	W *)
1630110	Wheel set high speed (blue)	WS *)

*) similar as on CL7 collector

AKAPP NO.	DESCRIPTION	EXTENSIONS		max. In (A) (D.C.=100%)	number of poles	max. speed (m/min)	APPLICABLE FOR					
		ext. 1	ext. 2				expansion joint (KEV)	dust proof	acid proof	RNHS profile	data silvered	vertical curves
1088600	Collector trolley + cable			31,00	4	100	-	x	-	-	-	-
1088600.B0002	Collector trolley + cable CL4-40	/2M		31,00	4	100	-	x	-	-	-	-
1088600.B0003	Collector trolley + cable CL4-40	/3M		31,00	4	100	-	x	-	-	-	-
1088600.B0004	Collector trolley + cable CL4-40	/4M		31,00	4	100	-	x	-	-	-	-
1088600.B0005	Collector trolley + cable CL4-40	/5M		31,00	4	100	-	x	-	-	-	-
1088620	Collector trolley + cable CL4-40	/S		31,00	4	250	-	x	-	-	-	-
1088620.B0002	Collector trolley + cable CL4-40	/S	/2M	31,00	4	250	-	x	-	-	-	-
1088620.B0003	Collector trolley + cable CL4-40	/S	/3M	31,00	4	250	-	x	-	-	-	-
1088620.B0004	Collector trolley + cable CL4-40	/S	/4M	31,00	4	250	-	x	-	-	-	-
1088620.B0005	Collector trolley + cable CL4-40	/S	/5M	31,00	4	250	-	x	-	-	-	-
1088640	Assembly CL4-40/BMV/TTB			31,00	4	100	-	x	-	-	-	-

Accessoires for collector trolleys:

towing arms, transition boxes

A towing arm is attached to the moving machinery and connected to the collector trolley via chains.

The arrangement is such that when pulling in either direction one of the collector towing chains is taut, the other remaining slack. In this way lateral movements of the crane, hoist, etc. are not transmitted to the trolley.

This tolerance provides ultimate **security of service!**

Attention: The towing connector on the arm should be installed 10 mm lower than the towing connection on the trolley in the highest position and at 30 mm lower than the towing connection on the trolley in the lowest position and should be aligned directly below the housing opening in the vertical plane.

A transition box can be mounted on the towing arm or close by the apparatus/machine. This unit facilitates the connection of the flexible cable from the collector trolley with the fixed wiring from the apparatus/machine being fed.

Standard performances towing arms

Type BMV35 for collector trolleys 35A

Type BMV70 for collector trolleys 70A

Type BMV100 for collector trolleys 100A

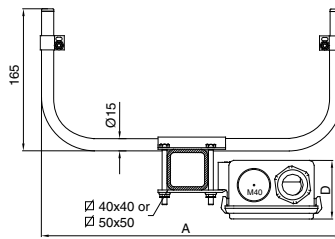

	BMV35 + TTB35	BMV70 + TTB70	BMV100 + TTB100
A	370	505	640
B	175	175	195
C	115	115	160
D	70	70	80
Input	1xM32	2xM32	3xM32
Output	1xM32	1xM40	1xM40

Types of transition boxes for collector trolleys

type no. transition box	dimensions lwxh mm	connecting terminals	cable inlet
TTB35-4 and TTB35-7	175x115x70	4 st. 4 mm ²	2 glands M32
		7 st. 4 mm ²	
TTB70-4 and TTB70-7	175x115x70	4 st. 10 mm ²	2 glands M32 1 gland M40
		7 st. 10 mm ²	
TTB100-4 and TTB100-7	195x160x80	4 st. 16 mm ²	3 glands M32 1 gland M40
		7 st. 16 mm ²	
TTB140-4-2	195x160x80	4 st. 35 mm ²	2 glands M32 1 gland M50
OG300-7	300x190x180	7 st. bolts M10	6 glands PG21 1 special inlet 20-70 mmØ

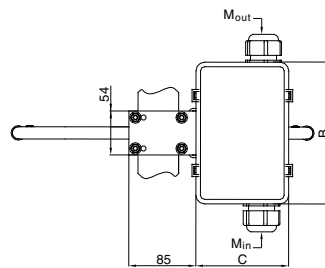

BMV + TTB

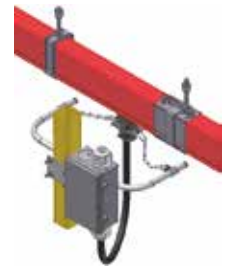

BMV35 + TTB35-4

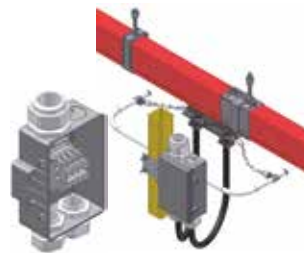

BMV70 + TTB70-4

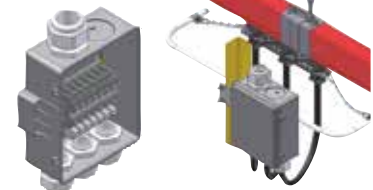

BMV100 + TTB100-7

The box types TTB35 up to TTB140 can be mounted directly on the fastening clamp of the towing arm type BMV. Box type OG300 is supplied with a mounting plate, which ensures easy mounting of these boxes to the apparatus to be fed.

Spring loaded towing arm

For installations with large transfer guides (type ITN7, see page 16) special spring loaded towing arms are supplied (see picture).

Type MVSP35 for trolleys 35A

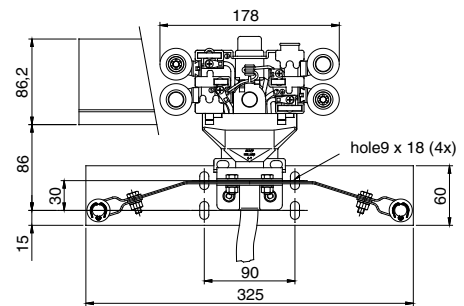

CL7-7-35 + MVSP

Overview standard collector trolleys, towing arms and transition boxes

In the chart below you can view the most common standard collector trolleys of the series CL7. The AKAPP reference numbers and some details are listed for each type.

This overview however does not show all possibilities. For further information on this (see also page 11), we recommend you to contact your AKAPP-STEMMANN supplier.

The other charts show all towing arms and transition boxes including their reference numbers.

Selection chart standard collector trolleys

AKAPP NO.	DESCRIPTION	max in (A) (D.C.=100%)	number of poles	max. speed m/min.	APPLICABLE FOR						
					expansion joint (KEV)	transfer guides ITN7	transfer guides ITKN7	HS, hand safe	silvered	vertical	
1088470	Collector trolley + cable CL4-35	27,11	4	80	-	-	-	-	-	-	
1089360	Collector trolley + cable CL4-70	54,22	4	80	-	-	-	-	-	-	
1089750	Collector trolley + cable CL4-100	77,46	4	80	-	-	-	-	-	-	
1093440	Collector trolley + cable CL7-4-35	27,11	4	100	-	-	-	-	-	-	
1093510	Collector trolley + cable CL7-5-35	27,11	5	100	-	-	-	-	-	-	
1093580.B0000	Collector trolley + cable CL7-6-35	27,11	6	100	-	-	-	-	-	-	
1093650	Collector trolley + cable CL7-7-35	27,11	7	100	-	-	-	-	-	-	
1093860	Collector trolley + cable CL7-4-70	54,22	4	100	-	-	-	-	-	-	
1093930.B0000	Collector trolley + cable CL7-5-70	54,22	5	100	-	-	-	-	-	-	
1094000.B0000	Collector trolley + cable CL7-6-70	54,22	6	100	-	-	-	-	-	-	
1094070	Collector trolley + cable CL7-7-70	54,22	7	100	-	-	-	-	-	-	
1094280	Collector trolley + cable CL7-4-100	77,46	4	100	x	-	-	-	-	-	
1094350.B0000	Collector trolley + cable CL7-5-100	77,46	5	100	x	-	-	-	-	-	
1094420.B0000	Collector trolley + cable CL7-6-100	77,46	6	100	x	-	-	-	-	-	
1094490	Collector trolley + cable CL7-7-100	77,46	7	100	x	-	-	-	-	-	
1094720	Collector trolley + cable CLTG7-4-35	27,11	4	100	-	x	-	-	-	-	
1094780.B0000	Collector trolley + cable CLTG7-5-35	27,11	5	100	-	x	-	-	-	-	
1094840.B0000	Collector trolley + cable CLTG7-6-35	27,11	6	100	-	x	-	-	-	-	
1094900	Collector trolley + cable CLTG7-7-35	27,11	7	100	-	x	-	-	-	-	
1093440.B0026	Collector trolley + cable CL7-4-35/E/T/Z	27,11	4	100	x	-	-	-	-	x	
1093480.B0002	Collector trolley + cable CL7-4-35/S/E/T/Z	27,11	4	100	x	-	-	-	-	x	
1093550.B0002	Collector trolley + cable CL7-5-35/S/E/T/Z	27,11	5	100	x	-	-	-	-	x	
1095410	Collector trolley + cable CLITK7-6-35/S/E/T/Z	27,11	6	100	x	-	x	-	-	x	
1095510	Collector trolley + cable CLITK7-7-35/S/E/T/Z	27,11	7	100	x	-	x	-	-	x	

Selection chart towing arms

AKAPP NO.	DESCRIPTION	COLLECTOR TROLLEY
1019050	Towing arm BMV35	...35/...40
1019130	Towing arm BMV70	...70
1019210	Towing arm BMV100	...100
1018940	Towing arm, stainl.st. BMV35-R	...35
1019830	Towing arm, stainl.st. BMV70-R	...70
1019910	Towing arm, stainl.st. BMV100-R	...100

Selection chart transition boxes

AKAPP NO.	DESCRIPTION
1020000	Transition box for collector trolleys TTB35-4
1020010	Transition box for collector trolleys TTB35-7
1020020	Transition box for collector trolleys TTB70-4
1020030	Transition box for collector trolleys TTB70-7
1020040	Transition box for collector trolleys TTB100-4
1020050	Transition box for collector trolleys TTB100-7
1020060	Transition box for collector trolleys TTB140-4-2
1010430	Transition box for collector trolleys OG300-7

Other components: transfer guides

These units are for the passage of collector trolleys through conductor transfers on e.g. turn or slide switches (see drawing). The type is related to the mechanical tolerance of the transfer system itself.

The correct execution of a transfer guide shall be detailed by your AKAPP-STEMMANN supplier after receipt of a clear description and a situation drawing of the installation to be fed.

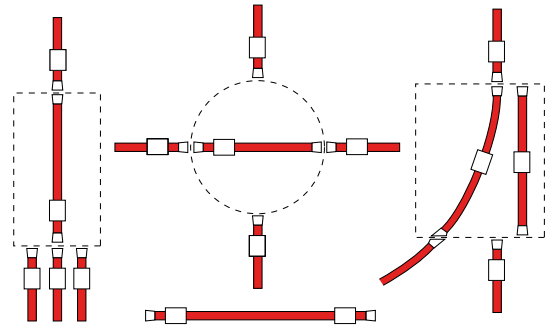

Type ITN7

Suitable for mechanical tolerances vertical and horizontal planes of less than 10 mm; infinite gap.

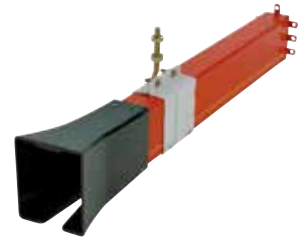
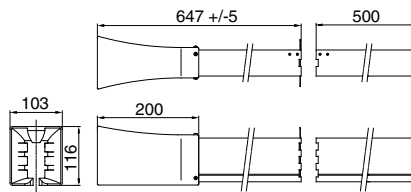

Type ITKN7

Suitable for mechanical tolerances, vertical and horizontal planes less than 2 mm and gap less than 3 mm.

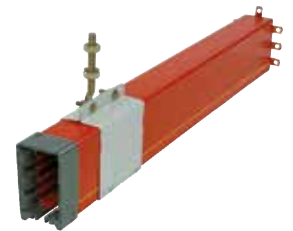
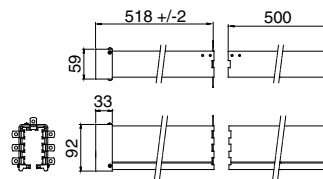

Applicable for all types of transfer guides:

- N.B.1.** Max. travel speed on transfer guides is 60 m/min.
- N.B.2.** The transfer guides are not suitable for electrical switching.

This transfer guide includes: 1 trumpet to which is fitted 500 mm of housing RN7, in which are already fitted copper conductors CU 125 (ITN7) or CU50 (ITKN7), 500 mm of housing RN7 to attach the transfer guide section to the Multiconductor (incl. mounting material). To be ordered separate: a line feed box for shrouding the connection between the trumpet housing and opposite RN7-housing and 2 fixed point clamps placed each side of the line feed.

AKAPP NO.	DESCRIPTION	left	right	space between transf. guides <= 3mm	vertical tolerance <= 2mm	horizontal tolerance <= 2mm	red	white	length m	min. temperature °C	max. temperature °C	max. number of poles	protection degree IP23	sealing rubber AS7 applicable	HS, extra protection
1016310	Transfer guide large red ITN7-L	x					x		1,15	-30	60	7	x	x	
1016540	Transfer guide large red ITN7-R		x				x		1,15	-30	60	7	x	x	
1017830.B0000	Transfer guide large, ITN7W-L	x						x	1,15	-30	60	7	x	x	
1017840.B0000	Transfer guide large, ITN7W-R		x					x	1,15	-30	60	7	x	x	
1016630.B0000	Transfer guide vicat ITNV7-L	x							1,15	-20	80	7	x	x	
1016640.B0000	Transfer guide vicat ITNV7-R		x						1,15	-20	80	7	x	x	
1017040	Transfer guide small red ITKN7-L	x		x	x	x	x			-30	60	7	x	x	
1016930	Transfer guide small red ITKN7-R		x	x	x	x	x		1,025	-30	60	7	x	x	

Other components: conductor isolation sections

Copper conductor isolation sections are used in the event an electrical division between one single or various conductors for i.e. control, is required.

Two models are available:

SO7 - for electrical isolation of 1 - 7 strips

SO1/SRN1 - for electrical isolation of 1 strip

It is important to consider the correct compensation for the expansion differences.

If one or more isolation sections are applied, we strongly recommend you to send us a situation drawing of the feeding system to determine the correct execution of it.

Conductor isolation sections

Type SO7

This isolation section is fitted into a Multiconductor in between 2 housings RN7. This section is shrouded with one of the line feed boxes (see page 7, ordered separately) on each side of which a fixed point clamp is positioned (2 pc., ordered separately).

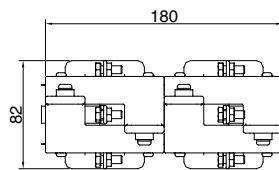

SO7

Type SOHS7 for Multiconductor RNHS7. Similar to SO7, but with spacer strips at the bottom, for use with extra hand-safe housing RNHS7.

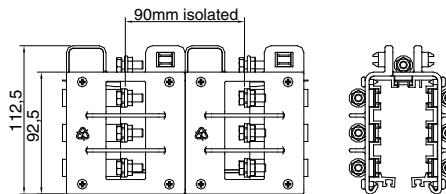

Special conductor isolation sections:

Type SO1

In case only 1 or 2 isolations in the controlling current conductors are required, these small isolation sections can be used. At the position of the required isolation, slots are made in the housing, through which the copper conductors are bent outwards. A small isolation section is then placed between the conductors after which the assembly is enclosed by a small cover 45x38x20 mm. Connecting of a supply cable is possible by piercing a hole in the cover. When sealed with silicone-mastic (not supplied) this unit is also suitable for outdoor installations.

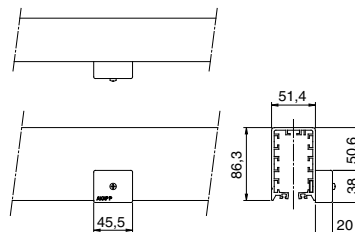

SO1

Type SRN1

This prepared housing (200 mm length) is available as an alternative to cutting slots in the standard housing and is fitted in the Multiconductor by means of 2 joint clamps typeVN7.

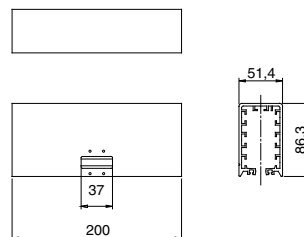

SRN1

N.B. The conductor isolation section is not suitable for electrical switching.

Curved tracks: horizontal and vertical

The AKAPP Multiconductor is also used for curved installations such as i.e. at concrete skipper installations. In general, the curved segments are made to measure in the required radius. **A correct drawing is therefore of utmost importance.**

When ordering **horizontal** curves it is important to define the position of the yellow marking stripe on the housing (in inner or outer radius), to take the positioning thereof into consideration with regard to the other conductor segments.

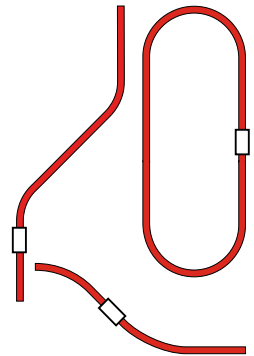

Curved housings

Type BRN7- (radius)

Horizontal curves are available from R=600 mm and vertical curves from R=1800 mm (center sizes, see drawing).

In curves the center distance of the hanger support varies from 600 - 1000 mm (in general min. 2 hanger supports per curved section).

Vertical curves exist in 2 varieties:

- concave:** biggest radius at the bottom (=opening) of the housing;
- convex:** smallest radius at the bottom of the housing. See drawings.

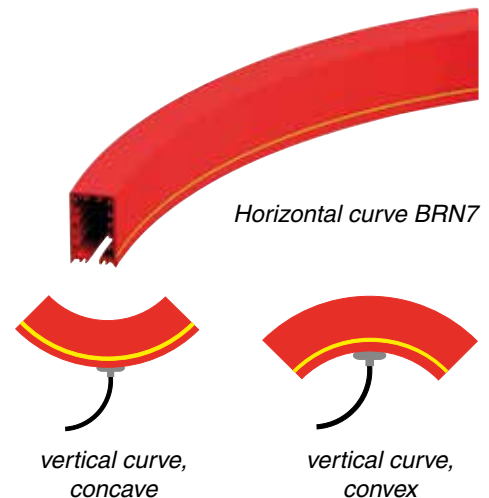
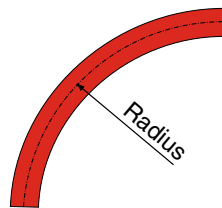

Type BRNHS7- .. (radius)

Curves for Multiconductor RNHS7.

Collector trolleys in installations with curves

For installations with curves, only 35A collector trolleys should be used. It is possible to use more collector trolleys in parallel for higher current capacities. For curves with bending radius <800 mm the flexible trolley type S7-..-35 is used (see photo). See also page 11.



Copper conductors in curved tracks

Should, when horizontal curves are applicable, the copper channel in the topside also be used for a copper conductor, these conductors can be supplied as pre-bend. However this depends on radius of the curve as well as on the thickness of the conductors. The same applies for vertical curves and the copper conductors in the side of the Multiconductor. See table.

In all other cases the copper conductors can be rolled directly from the drum through the curves.

Pre-bend strips are required for installations with following conductors and radii (horizontal or vertical):

type copper conductor	curves up to radius R
Cu35 *)	1200 mm
Cu50 *)	1500 mm
Cu80	2000 mm
Cu125	2500 mm
Cu160	3000 mm

*) Copper conductors Cu35 and Cu50 can not be pre-bend. If required, Cu80 shall be applied in the curve(s).

Installation tools: for optimal efficiency

AKAPP Multiconductor can easily be installed. All components have been designed as such that a combined installation is perfectly suitable.

However several operations during the installation process may be arranged even more efficient if you should opt for the auxiliary tools as detailed below. Therefore, we strongly recommend you to add these tools to the delivery (refer to the relevant product).

It is of importance to use the products as detailed below, whenever possible. You could save time. Read the instructions carefully and prior to the use of said products.

Should you have any questions, please feel free to contact your AKAPP-STEMMANN supplier. Further information can be obtained via our web site as well (see front cover).

Our Engineering staff could ensure the perfect installation of your AKAPP Multiconductor, if so required. We would be pleased to submit a fitting quotation!

Copper pulling-cassette

This device can be included in all new installations of the AKAPP Multiconductor.

The copper rolls are placed onto the cassette after which the roll will be rolled off smoothly. The roll is provided with a feed-through aperture. A limiter prevents the rolling off of the roll onto the platform.



Copper drawing block

In order to smoothen the drawing of the copper conductor into the copper channels of the Multiconductor, a wooden drawing block can be included in all new complete installations. This drawing block includes a drawbar eye into which a rope can be attached. To be used in combination with the aforementioned copper pulling cassette.

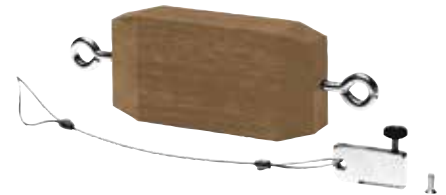

Pressing tool for sealing strips (‘Tom Thumb’)

To be used for the easy application of the flexible rubber seal AS7 to the bottom side of the Multiconductor. In one single movement, the rubber strips can be applied to both rubber channels of the Multiconductor.



Copper straightener

It is strongly recommended to use this tool for the easy mounting of the copper conductors 125A and 160A in the Multiconductor. The stretcher eliminates the ridged form of the copper during the mounting thereof. This is mainly of importance with regard to track lengths from approximately 50 meter.



AKAPP NO.	DESCRIPTION	length >25m	AS7	HS	CU 125	CU 160
1003610	Drawing block for conductors	x				
1003760	Tom thumb	x	x			
1003800	Tom thumb for RNHS5/7	x	x	x		
1003920	Straightning device STR125 for CU125	x			x	
1003950	Straightning device STR125 for CU160	x				x
1039510	Reel with core for AS7	x	x			

AKAPP NO.	DESCRIPTION	length >25m	size inner core mm	max. outer-ø Cu mm
1039820	Copper cassette 50x50 cm compl	x	245	450
1040220	Copper cassette 80x80 cm compl	x	455	750
1040450	Copper cassette 100x100cm cpl	x	455	950

More on Multiconductor: technical data and ordering references

General technical data

Nominal voltage: 660 Volt. Under humid conditions and on all outdoor installations for the 6 and 7-pole Multiconductor systems: 500 Volt.

For further technical details refer to the components description in this catalogue.

Comprehensive installation instructions will accompany every AKAPP conductor system.

System extensions

It is generally possible to increase the length of an existing system utilising standard components. Please consult the AKAPP-STEMMANN sales office giving full details of the existing system and required extension.

Design and dimensions

We reserve the right to amend dimensions/design of components in the interests of design advancement without prior notification.

Multiconductor internal heating

When extreme stringent circumstance apply and condensation and ice is to be prevented, the Multiconductor can be heated along a part or the entire length of the system.

Type ESR20 (A), Not insulated.

For up to 6-pole systems. 1 channel fitted with self regulating heating cable. Max. track length 60 m. Connecting voltage: AC 230V. Automatic control of required capacity based on the ambient temperature. Capacity 20W/m at +10°C.

Type VB7 (B), Insulated.

For up to 7-pole systems. Pull into slot next to anti-reverse rib. Max. track length 80 m. Connecting voltage AC 230V. Self regulating. Capacity 23W/m at +5°C.

Type SS STRIP (C), Not insulated.

For systems including a minimum of 2 free channels. Stainless steel strip 13x0,5mm; $R=0,1106 \Omega/m$. Not self regulating; transformer and thermostat needed (not included).

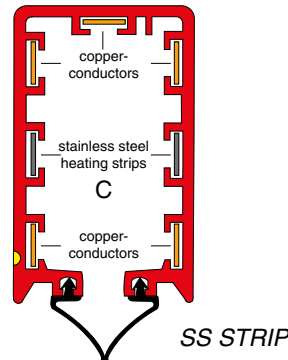
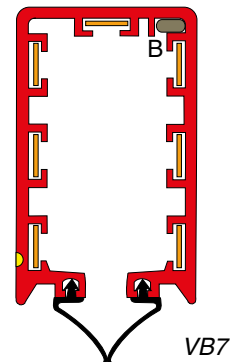
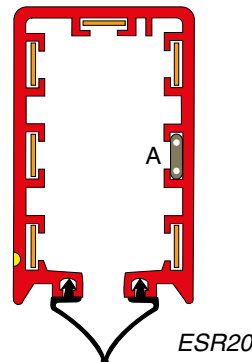

Ventilation housing

Type RN7-B

A ventilation housing can be used in a Multiconductor system where condensation may occur because the system has a transition to a section with a large temperature difference (e.g. from inside to outside). The ventilation housing is then to be placed outside, at 1 meter from the transition point. The copper conductors are **not** interrupted at the ventilation housing.

The ventilation housing consists of 1 meter RN7, with a vented middle section of 400 mm, serving the air flow. Above these openings a protection cap is placed (protection class IP22).

The ventilation housing should be placed horizontally.

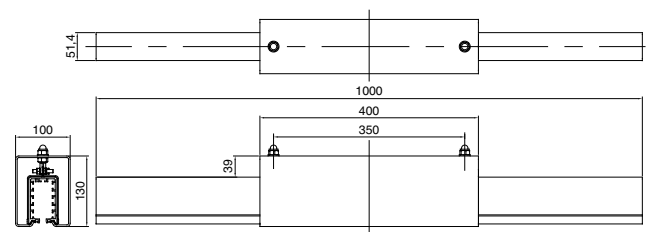
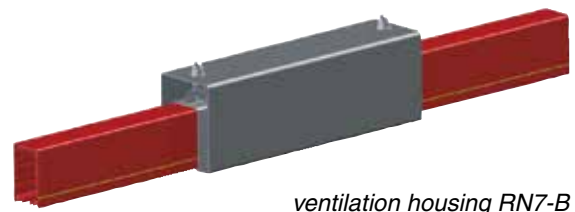

Installation examples: system configuration

The construction method to be used with the AKAPP Multiconductor is based on "controlled expansion". This guarantees the solution of expansion related problems which coincide with three different elements: synthetics, copper and suspension frame. The linear expansion and shrinking of the PVC conductor housing is 0.07 mm/°C/m. Which is the 5-fold of copper conductors to be mounted into the conductor housing as well as the suspension frame.

The AKAPP Multiconductor design permits the free movement of the three elements thus resolving problems often experienced with other systems.

Most common installations with one feed point at the end or somewhere along the installation (see illustration below, examples A or B) are mounted on the basis of free expansion. The expansion movement takes place from the fixed point. Maximum lengths for application of **fixed** joints type VN7 are mentioned in the list on page 3.

For installations where the required system is longer than stated in this list or where similar to one of the applications C up to F, please refer to your AKAPP-STEMMANN sales office for additional installation instructions.

Multiconductor system construction

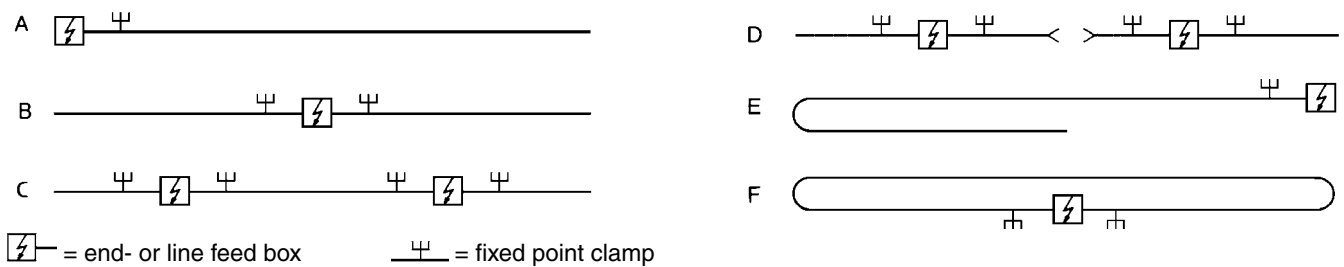

Multiconductor system configuration End feed

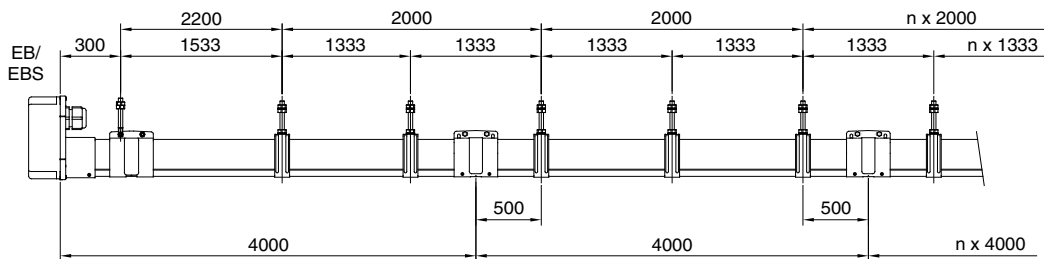

Multiconductor system configuration Line feed

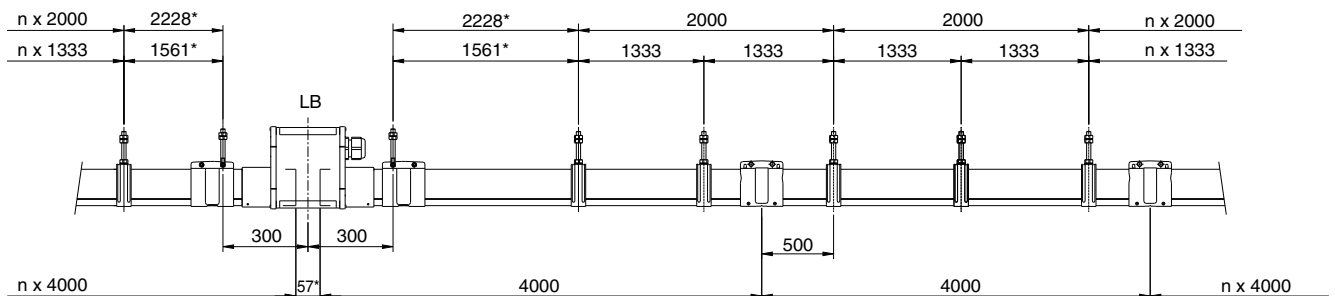

With AKAPP Multiconductor an optimum reliability is achieved by the unique composition of this conductor system. We offer our experience following many years of service to industry, covering practically all types of ambient conditions.

We should be most pleased to assist with your system selection. Please do not hesitate to seek the advice of our specialised sales team. For more information you can visit our web site: www.akapp.com.

All information in this brochure is under proviso. All dimensions in this brochure are in mm.

Appendix:

Maintenance and spare parts of collector trolleys

When replacing or revising an AKAPP collector trolley, the information below needs your special attention to prevent accidents or failures of the installation.

Older trolley models (serie "S") have a different numbering of the cable wires to the brushes.

The table below shows all information concerning the spare parts, used in each trolley model.

Further information on installing AKAPP collector trolleys can be found in the respective manual instruction.

Wabtec Netherlands can provide all extensive manual instructions concerning our conductor bar system and/or other products on demand.

Please visit our website www.akapp.com for more information or contact our head office by phone or fax. The references are on the front of this brochure.

ATTENTION!

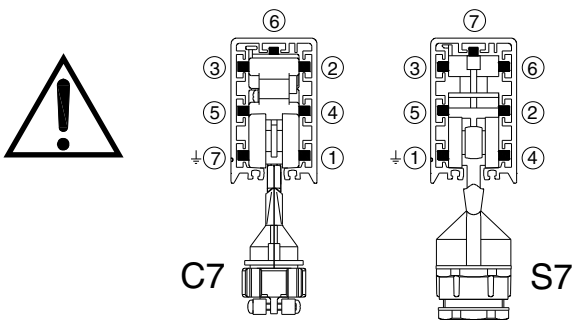

Trolley type S7 has different cable numbering.

Please check before installing that the internal wiring of the trolley is correct!

Length of the towing chains for 35A trolleys is 5 links and for 70A and 100A trolleys 6 links.

Spare parts

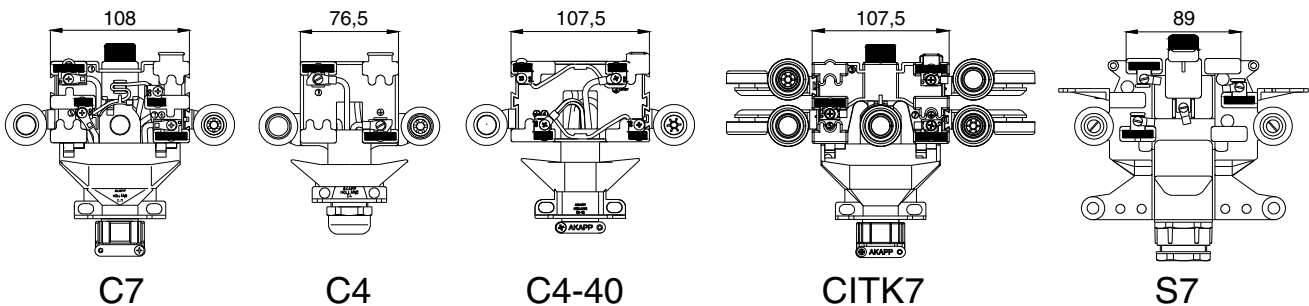

AKAPP NO.	TYPE	DESCRIPTION	C7	C4	C4-40	CITK7	S7
1411021	K91P	Carbon brush phase	x	x		x	
1410521	C91A	Carbon brush ground	x	x		x	
1410601	C91D	Carbon brush twin phase	x		x		
1410631	C91DA	Carbon brush twin ground			x		
1412061	K91A	Carbon brush ground					
1410130	B91SP	Carbon brush phase					x
1410210	B91SA	Carbon brush ground					x
1410050	B91SN	Carbon brush neutral					x
1630100	W	Wheel set	x		x	x	
1630110	WS	Wheel set ball beared	x		x	x	
1630120	WZ	Wheel set + side wheel	x		x	x	
1630130	WSZ	Wheel set ball beared + side wheel	x		x	x	
1096550	WE	Set middle wheel	x			x	
1096500	BG	Set bow	x			x	
1331930	G	Gliding shoe	x		x	x	
1510460		Wheel C4		x			
1510230		Wheel					x

Special applications: the sky is the limit!

AKAPP Multiconductor can be applied in installations with transfer guides, horizontal and/or vertical curves. Even closed curved tracks are a possibility! Your specific configuration can be further and detailed adjusted by our professionals to become a perfect fitting installation.

On this page only a brief section of the numerous possibilities are given.

For further information, please contact your AKAPP-STEMMANN supplier.



Four closed curved tracks for feeding of a rotating elevator.



Curved installation for window cleaning equipment



A 500 m long enclosed track for a passenger train in the zoo



Feed and control of bridge cranes in a galvanising plant



Feed and control of a concrete skipper

Wabtec Netherlands: Flexible with energy!



Wabtec Netherlands is a market leader with our made to order conductor bar systems. We offer you the best possible solution for almost any application in whatever the circumstances. We welcome your inquiries!



Our festoon systems offer the most flexible solutions for transporting flat or round cables and hoses. A wide variety of profiles and components guarantees reliable installations, adapted to the environment.



The AKAPP products are designed by the highest standards and are certified by UL, CCC and CE.

More information on our products can be found in our brochures, which we are happy to send you on request. Or visit our website www.akapp.com, where you can find more relevant information, download brochures and make online inquiries; fast and easy!

