

HODGGE™

Built Tough Since 1936

A Division of DURHAM Mfg. Co., Inc.

Heavy Duty All Welded Equipment



**BUILT TOUGH
IN THE USA
SINCE 1936!**



Cabinets



Mobile Cabinets



Shelving



Carts



Trucks



Racks



Maintenance & Safety products



Work Benches



HODGE KEEPS THINGS MOVING

HODGE products improve workflow in manufacturing plants, warehouses, distribution centers, medical facilities, retail stores, and a wide variety of other businesses.

We make non-powered material handling equipment and other steel and plastic products used to store and transport a wide variety of goods from place to place. Our products are heavy-duty, reliable, durable and proven on the job since 1936. Today we are a division of The Durham Manufacturing Company, an established manufacturer of steel and plastic storage, handling and packaging products. At today's Hodge Manufacturing Company you will find:





Products That Last

Standard features like heavy gauge steel, all welded assemblies and powder coat finishes make HODGE products among the toughest you can find.

Products That Save Space

HODGE cabinets, bins, racks and shelving are designed to concentrate more parts and goods into fewer square feet of valuable floor space. We also help you move awkward or heavy items out of the way.

Products That Save Time & Money

The more concentrated and organized parts storage is, the faster items can be picked for shipping or assembly. In addition, our line of workbenches and work surfaces speeds assembly and maintenance jobs.

Versatile Products

HODGE products not only allow you to do more with less... they also help you do special jobs more efficiently.

HODGE Adds Value to Material Handling

Lots of items can easily be moved through a plant or warehouse without expensive powered equipment. HODGE heavy-duty trucks, carts, mobile tables, racks and dollies help you move them without wasting time and effort.

HODGE Service Gets What You Want, Where You Want It, When You Want It

Durham Manufacturing has always taken pride in responsive customer service, streamlined manufacturing and a commitment to fast delivery. Now we can offer the same great service on HODGE products, as well. HODGE quality and Durham service... it's a combination that's hard to beat.

HODGE
Division of the Durham Mfg. Co.
www.hodgemfg.com





HODGE MANUFACTURING



We've been a leader in the manufacture of heavy-duty all welded storage equipment and non-powered material handling equipment since 1936. We offer a high-quality line of standard and customized equipment. In 2003 we became a division of The Durham Manufacturing Company located a short distance from our Springfield, Massachusetts Headquarters. You'll find HODGE products for sale at leading Material Handling Dealers, Industrial Supply Houses and business to business mail order catalog companies throughout North America.

HODGE Manufacturing products are commonly found in metalworking plants, maintenance operations, electronic manufacturing, hospitals and other medical facilities, janitorial services, horticultural nurseries, shipping areas, stock picking applications, warehouses, assembly areas, supermarkets, and offices. They are noted for their heavy-duty durability and ability to save time and space.

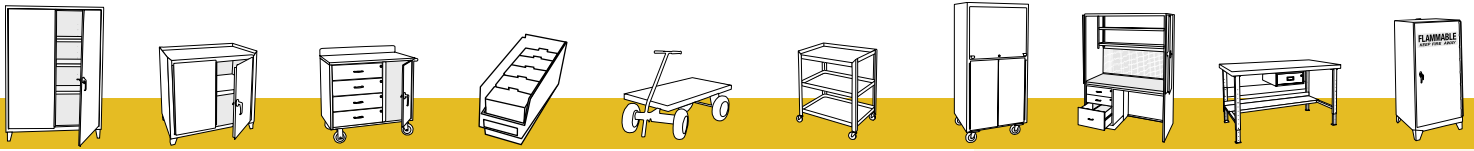

HODGE SERVICE CAPABILITIES

Our goal is to make your job as easy as possible. Here are some of the special Value-Added Services you can take advantage of at HODGE.

- EDI (Electronic Data Interchange) Ordering
- On Line Order Status, Shipment Tracking and Invoice Status
- Automated Order Receipt and Shipment Acknowledgement
- Custom Labeling and Bar Coding of Shipping Cartons
- All Standard Products in Stock for Shipment in 3-5 days
- Special Product Identification and Custom Colors
- Design and Production of all Advertising Material in Digital Format
- Regional Managers Assure Fast, Responsive Sales and Service, Coast to Coast
- Trained, Technically Competent Customer Service Representatives

IF YOU DON'T SEE IT HERE... ASK

HODGE is a versatile manufacturer with a standard line of unsurpassed quality. Because of the versatility of our manufacturing processes and our engineering expertise, we are capable of meeting precise customer requirements. This catalog features our standard product line. If you don't see it here... call 800-262-4634 and let's see about getting you exactly what you need.



STRATEGICALLY LOCATED WAREHOUSES

The Durham Manufacturing Company currently operates seven warehouses in the United States and one in Europe.

- | | |
|-------------|----------------|
| California | Massachusetts |
| Connecticut | Texas |
| Georgia | Washington |
| Illinois | United Kingdom |

HODGE CABINETS	6
BIN & STORAGE CABINETS	7
WORK TABLE BIN CABINETS	15
SHELVING & RACK	16
MOBILE CABINETS	17
ACCESSORIES	21

HODGE HEAVY-DUTY TRUCKS	22
Platform, High End Platform, Utility, Security, Pan & Tray, Stock, Service, 5th Wheel, 2 & 3 Sided, Stock-Picking, Sloped Shelf	

HODGE LONG PARTS TRUCKS AND RACKS	30
Stationary & Mobile	

HODGE SERVICE CARTS	32
----------------------------	-----------

HODGE WORK CARTS	33
Stock-Picking, Ladder, Gas Cylinder, Stationary & Portable Tool	

HODGE PORTABLE TABLES & WORK STATIONS	
MOBILE TABLES	36
WORK STATIONS	37

ACCESSORIES	38
--------------------	-----------

HODGE STATIONARY WORK STATIONS & SHOP DESKS	39
--	-----------

HODGE WORK BENCHES	41
---------------------------	-----------

HODGE MAINTENANCE AND SAFETY PRODUCTS	45
Bulk Containers, Flammable Storage, Gas Cylinder Storage, Drum Dollies, Work Platforms	

PRODUCT MODIFICATIONS AND CUSTOM BUILT PRODUCTS	48
--	-----------

DURHAM PRODUCTS OVERVIEW	49
---------------------------------	-----------

INDEX	50
--------------	-----------

WARRANTY AND TERMS	51
---------------------------	-----------

CONTACT INFORMATION	<i>Back Cover</i>
----------------------------	-------------------



HODGE HEAVY-DUTY CABINET FEATURES

Available with or without durable Hook-On Bins™

HODGE BIN & STORAGE CABINETS CONCENTRATE MORE PARTS IN LESS SPACE

An ideal way to concentrate the storage of small parts and other items with locking doors to also keep parts clean and safe. Yellow polyethylene Hook-On Bins™ hang from doors and/or back wall (depending on model) giving you even more storage space without adding linear shelving units.

ALL WELDED CONSTRUCTION
is solid and will not loosen at key stress points.

3-POINT LOCKING HANDLES
Provide sure locking action and enhanced security. Super Strong 60" wide Model "SSC" cabinet models have provisions for a padlock (not included). All models supplied with locking handles and two keys. Locking rods are 3/8" diameter.

GRAY POWDER COAT FINISH
baked on for durability and scratch resistance.



SHELVES CAN BE RELOCATED
Using compression clips that fit into uprights punched 1" on center



SSC MODEL 60" DOOR HANDLE
(padlock not included)

YELLOW POLYETHYLENE HOOK-ON BINS™
Open bin fronts improve visibility and make it easier to pick parts. Optional bin dividers are available.

HEAVY-DUTY PIANO HINGES
make it easy to swing open fully loaded doors without sagging. 650 lbs. door capacity.

LOUVERED DOOR & BACK PANELS
hold Hook-On Bins™

SUPER STRONG - FLUSH DOOR STYLE

60" Wide

29 cubic feet more storage space than traditional 36"W x 24"D x 72"H cabinets

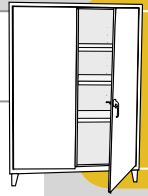

SSC-602484-BDLP-95 (not shown)
Cabinet with louvered back and door panels, but without Hook-On Bins™ and adjustable shelves.



SSC-602484-3S-95
Like models available with 4 or 5 shelves



SSC-602484-BDLP-185-3S-95
185 Hook-On Bins™ and 3 heavy-duty shelves.

Hook-On Bins™

All welded construction



SSC-602484-BDLP-227-95
227 Hook-On Bins™

Reinforced doors hold fully loaded bins

3-point locking handle with provisions for padlock

13-gauge steel throughout with reinforced base

Gray powder coat finish

6" High Legs offer space for lift truck forks making the entire units forkliftable

Model	Dim: WxDxH	Bins: WxDxH	Shelves: WxD	Ship Wt.
SSC-602484-BDLP-227-95	60" x 24" x 84"	80 - 4" x 5" x 3" 90 - 4" x 7" x 3" 30 - 6" x 11" x 5" 18 - 8" x 15" x 7" 9 - 16" x 15" x 7"		857 lbs.
SSC-602484-BDLP-185-3S-95	60" x 24" x 84"	80 - 4" x 5" x 3" 90 - 4" x 7" x 3" 6 - 8" x 15" x 7" 9 - 16" x 15" x 7"	3 - 60" x 18"	874 lbs.
SSC-602484-3S-95	60" x 24" x 84"		3 - 60" x 24"	720 lbs.
SSC-602484-4S-95	60" x 24" x 84"		4 - 60" x 24"	748 lbs.
SSC-602484-5S-95	60" x 24" x 84"		5 - 60" x 24"	776 lbs.
SSC-602484-BDLP-95	60" x 24" x 84"			700 lbs.
BSH-6024-95	extra shelf for models without Hook-On Bins		60" x 24"	35 lbs.
BSH-6018-95	extra shelf for models with door mounted Hook-On Bins		60" x 18"	25 lbs.



SUPER JUMBO - 4" DEEP BOX DOOR STYLE

48"W x 24"D x 84"H

21 Cubic feet more storage space than traditional 36"W x 24"D x 72"H cabinets

Box style double doors turn each door into 24"W x 4"D x 84"H storage bins.

48"W x 20"D main cabinet. 4" doors make closed depth 24".

Full height doors maximize storage space.

650 lbs. door capacity

14-gauge steel

3-point locking handle with 2 keys and 3/8" diameter rods

Hook-On Bins™

Gray powder coat finish

All welded construction



SJC-DLP-144-4S-95

144 Hook-On Bins™ with (4) adjustable shelves.

48" wide units pack 56 cubic feet of storage space into only 8 square feet of floor space.



SJC-BDLP-192-95
192 Hook-On Bins™



SJC-BDLP-84-2S-6DS-95
84 Hook-On Bins™
2 adjustable cabinet shelves
6 adjustable door shelves



SJC-DLP-4S-14DS-95
4 adjustable cabinet shelves
14 adjustable door shelves

SJC-BDLP-95 (not shown)
Cabinet with louvered back and door panels, but no Hook-On Bins™ or adjustable shelves.

Model	Dim: WxDxH	Bins: WxDxH	Shelves: WxD	Ship Wt.
SJC-BDLP-192-95	48" x 24" x 84"	72 - 4" x 5" x 3" 72 - 4" x 7" x 3" 24 - 6" x 11" x 5" 18 - 8" x 15" x 7" 6 - 16" x 15" x 7"		579 lbs.
SJC-BDLP-84-2S-6DS-95	48" x 24" x 84"	64 - 4" x 7" x 3" 20 - 8" x 15" x 7"	2 - 48" x 18" 6 - 18" x 4" (door shelves)	587 lbs.
SJC-DLP-4S-14DS-95	48" x 24" x 84"		4 - 48" x 18" 14 - 18" x 4" (door shelves)	
SJC-DLP-144-4S-95	48" x 24" x 84"	144 - 4" x 5" x 3"	4 - 48" x 18"	572 lbs.
SJC-BDLP-95	48" x 24" x 84"			465 lbs.
BSH-4818-95	extra shelf		48" x 18"	23 lbs.
DSH-184-95	extra door shelves (std. pkg. 6)		18" x 4"	18 lbs.

See page 21 for optional Hook-On Bins™

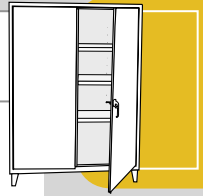

JUMBO - FLUSH DOOR STYLE

48"W x 24"D x 78"H | 13 Cubic feet more storage space than traditional 36"W x 24"D x 72"H cabinets

48" wide units pack 52 cubic feet of storage space into only 8 square feet of floor space.

JC-482478-BDLP-95 (not shown)
Cabinet with louvered back and door panels, but without Hook-On Bins™ or adjustable shelves.



JC-482478-BDLP-171-95
171 Hook-On Bins™



JC-482478-5S-95
(5) adjustable shelves



JC-482478-BDLP-137-3S-95
137 Hook-On Bins™, (3) adjustable cabinet shelves
6" base

- All welded construction
- 14-gauge steel
- 3-point locking handle with 2 keys and 3/8" diameter rods
- 48"W x 24"D main cabinet
- Gray powder coat finish
- Hook-On Bins™
- Flush style double doors

Model	Dim: WxDxH	Bins: WxDxH	Shelves: WxD	Ship Wt.
JC-482478-BDLP-171-95	48" x 24" x 78"	64 - 4" x 5" x 3" 64 - 4" x 7" x 3" 24 - 6" x 15" x 7" 13 - 8" x 15" x 7" 6 - 16" x 15" x 7"		521 lbs.
JC-482478-BDLP-137-3S-95	48" x 24" x 78"	64 - 4" x 5" x 3" 64 - 4" x 7" x 3" 3 - 8" x 15" x 7" 6 - 16" x 15" x 7"	3 - 48" x 18"	533 lbs.
JC-482478-BDLP-95	48" x 24" x 78"			410 lbs.
JC-482478-3S-95	48" x 24" x 78"		3 - 48" x 24"	473 lbs.
JC-482478-4S-95	48" x 24" x 78"		4 - 48" x 24"	494 lbs.
JC-482478-5S-95	48" x 24" x 78"		5 - 48" x 24"	515 lbs.
BSH-4824-95	24" deep shelf - for shelf only models		48" x 24"	29 lbs.
BSH-4818-95	18" deep shelf - for bin models		48" x 18"	23 lbs.

See page 21 for optional Hook-On Bins™



COMBINATION BIN & DRAWER CABINETS

48"W x 24"D x 72"H | Ultimate flexibility in maintenance room storage

** Flush door JC cabinets are 78"H*

Hook on Bins™ All welded construction 48"W x 20"D main cabinet Full extension drawers easily slide in and out and have adjustable dividers. Each drawer with 300 lbs. capacity

4" Deep Box style doors

3-point locking handle with 2 keys and 3/8" diameter rods

Adjustable door shelves

14-gauge steel

650 lbs. door capacity

Gray powder coat finish

DC-482472-BDLP-72-1S-4RDR-95
 (72) Hook-On Bins™ (4) Extension Drawers. (12) adjustable door shelves. (1) adjustable cabinet shelf.

JC-482478-BDLP-69-1S-4RDR-95
 (69) Hook-On Bins™ Flush style double doors. (12) adjustable door shelves and in cabinet. 4 Full extension drawers. Base adds 6" to height.

Model	Dim: WxDxH	Bins: WxDxH	Shelves	Drawers	Ship Wt
DC-482472-BDLP-72-1S-4RDR-95	48" x 24" x 72"	56 - 4" x 5" x 3" 8 - 6" x 11" x 5" 6 - 8" x 15" x 7" 2 - 16" x 15" x 7"	1 - 48" x 18" 12 - 18" x 4" door shelves	2 - 43" W x 16" D x 3"H 1 - 43" W x 16" D x 5"H 1 - 43" W x 16" D x 6"H	534 lbs.
DC-482472-BDLP-69-1S-4RDR-95	48" x 24" x 72"	56 - 4" x 5" x 3" 11 - 8" x 15" x 7" 2 - 16" x 15" x 7"	1 - 48" x 18" 12 - 18" x 4" door shelves	2 - 43" W x 16" D x 3"H 1 - 43" W x 16" D x 5"H 1 - 43" W x 16" D x 6"H	551 lbs.
JC-482478-BDLP-69-1S-4RDR-95	48" x 24" x 78"	56 - 4" x 5" x 3" 11 - 8" x 15" x 7" 2 - 16" x 15" x 7"	1 - 48" x 18" 12 - 18" x 4" door shelves	2 - 43" W x 16" D x 3"H 1 - 43" W x 16" D x 5"H 1 - 43" W x 16" D x 6"H	551 lbs.
JC-482478-BDLP-72-1S-4RDR-95	48" x 24" x 78"	56 - 4" x 5" x 3" 8 - 6" x 11" x 5" 6 - 8" x 15" x 7" 2 - 16" x 15" x 7"	1 - 48" x 18" 12 - 18" x 4" door shelves	2 - 43" W x 16" D x 3"H 1 - 43" W x 16" D x 5"H 1 - 43" W x 16" D x 6"H	534 lbs.
DC-482472-BDLP-176-95	48" x 24" x 72"	64 - 4" x 5" x 3" 64 - 4" x 7" x 3" 24 - 6" x 11" x 5" 18 - 8" x 15" x 7" 6 - 16" x 15" x 7"			530 lbs.
DC-482472-BDLP-84-2S-6DS-95	48" x 24" x 72"	64 - 4" x 7" x 3" 20 - 8" x 15" x 7"	2 - 48" x 18" 6 - 18" x 4" door shelves		533 lbs.
DC-482472-BDLP-112-6DS-95	48" x 24" x 72"	64 - 4" x 7" x 3" 24 - 6" x 11" x 5" 18 - 8" x 15" x 7" 6 - 16" x 15" x 7"	6 - 18" x 4" door shelves		519 lbs.
DC-482472-BDLP-95	48" x 24" x 72"				418 lbs.
DC-482472-DLP-128-4S-95	48" x 24" x 72"	128 - 4" x 5" x 3"	4 - 48" x 18"		562 lbs.
DC-482472-DLP-4S-14DS-95	48" x 24" x 72"		4 - 48" x 18" 14 - 18" x 4" door shelves		537 lbs.
DC-482472-DLP-64-4S-8DS-95	48" x 24" x 72"	64 - 4" x 7" x 3"	4 - 48" x 18" 8 - 18" x 4" door shelves		552 lbs.
BSH-4818-95	extra shelf		48" x 18"		23 lbs.
DSH-184-95	extra door shelf		18" x 4" (std. pkg-6)		30 lbs.

See page 21 for optional Hook-On Bins™

CABINETS

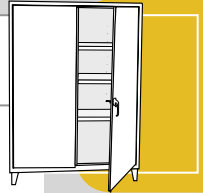

36"W x 24"D x 72"H | Bring more organization to traditional 36" wide cabinets

These heavy-duty units offer four types of organizational efficiency - bins, shelves, door shelves and full extension drawers - in only 6 sq. ft. of floor space.



- All welded construction
- Hook-On Bins™
- Heavy 14-gauge steel
- 650 lbs. door capacity
- Full extension drawers easily slide in and out. Each drawer with 300 lbs. capacity
- 3-point locking handle with 2 keys and 3/8" diameter rods
- Gray powder coat finish
- Adjustable shelf rests on easy-to-move compression clips

3501-BDLP-58-1S-4RDR-95

Flush door style with (58) Hook-On Bins™ (4) full extension drawers, (12) 12" x 4" adjustable door shelves and (2) in cabinet.

DC models all supplied with 4" deep box doors



DC-BDLP-64-2S-6DS-95

(64) Hook-On Bins™, (2) adjustable shelves and (6) adjustable door shelves.



DC-DLP-4S-12DS-95

(4) adjustable shelves and (12) adjustable door shelves.

Model	Dim: WxDxH	Bins: WxDxH	Shelves	Drawers	Ship Wt
3501-BDLP-58-1S-4RDR-95	36" x 24" x 72"	36 - 4" x 5" x 3" 18 - 6" x 11" x 5" 4 - 8" x 15" x 7"	1 - 36" x 18" 12 - 12" x 4" door shelves	2 - 31" W x 16" D x 3" H 1 - 31" W x 16" D x 5" H 1 - 31" W x 16" D x 6" H	495 lbs.
DC-203672-BDLP-52-1S-4RDR-95	36" x 24" x 72"	36 - 4" x 5" x 3" 12 - 6" x 11" x 5" 4 - 8" x 15" x 7"	1 - 36" x 18" 12 - 12" x 4" door shelves	2 - 31" W x 16" D x 3" H 1 - 31" W x 16" D x 5" H 1 - 31" W x 16" D x 6" H	482 lbs.
DC-BDLP-64-2S-6DS-95	36" x 24" x 72"	48 - 4" x 7" x 3" 16 - 8" x 15" x 7"	2 - 36" x 18" 6 - 12" x 4" door shelves		425 lbs.
DC-DLP-4S-12DS-95	36" x 24" x 72"		4 - 36" x 18" 12 - 12" x 4" door shelves		305 lbs.
DC-DLP-96-4S-95	36" x 24" x 72"	96 - 4" x 5" x 3" 4 - 36" x 18"			374 lbs.
3501-BDLP-52-1S-4RDR-95	36" x 24" x 72"	36 - 4" x 5" x 3" 12 - 6" x 11" x 5" 4 - 8" x 15" x 7"	1 - 36" x 18" 12 - 12" x 4" door shelves	2 - 31" W x 16" D x 3" H, 1-5" H 1 - 31" W x 16" D x 6" H	482 lbs.
DC-203672-BDLP-58-1S-4RDR-95	36" x 24" x 72"	36 - 4" x 5" x 3" 12 - 6" x 11" x 5" 4 - 8" x 15" x 7"	1 - 36" x 18" 12 - 12" x 4" door shelves	2 - 31" W x 16" D x 3" H, 1-5" H 1 - 31" W x 16" D x 6" H	495 lbs.
DC-203672-BDLP-95	36" x 24" x 72"				300 lbs.
DC-203672-BDLP-132-95	36" x 24" x 72"	48 - 4" x 5" x 3" 48 - 4" x 7" x 3" 18 - 16" x 11" x 5" 12 - 8" x 15" x 7" 6 - 16" x 15" x 7"			400 lbs.
BSH-3618-95	extra shelf		36" x 18"		17 lbs.
DSH-124-95	extra door shelf		12" x 4" (std. pkg-6)		18 lbs.

See page 21 for optional Hook-On Bins™



CABINETS - FLUSH DOOR STYLE

36"W x 24"D x 72"H | The most highly organized 36" wide cabinets available

Every one of the 36 cubic feet of storage space in these cabinets can be used as valuable storage space... even the doors.



3501-BDLP-132-95 (Shown)
132 Removable Hook-On Bins™

3501-BDLP-64-95 (Not Shown)
64 Hook-On Bins™ (2) adjustable cabinet shelves and (6) adjustable door shelves.

3501-BDLP-95 (Not Shown)
Without Hook-On Bins™ Includes louvered back and door panels. No shelves.

14-gauge steel construction

Gray powder coat finish

Hook-On Bins™

Full-Height flush doors

All welded construction

Louvered back and door panel

Adjustable shelves rest on easy-to-move compression clips

3-point locking handle with 2 keys and 3/8" rods

650 lbs. door capacity



3501-BDLP-102-3S-95

102 Hook-On Bins™ and (3) adjustable shelves.

Model	Dim: WxDxH	Bins: WxDxH	Shelves	Ship Wt
3501-BDLP-132-95	36" x 24" x 72"	48 - 4" x 5" x 3" 48 - 4" x 7" x 3" 18 - 6" x 11" x 5" 12 - 8" x 15" x 7" 6 - 16" x 15" x 7"		400 lbs.
3501-BDLP-102-3S	36" x 24" x 72"	48 - 4" x 5" x 3" 48 - 4" x 7" x 3" 6 - 16" x 15" x 7"	3 - 36" x 18"	425 lbs.
3501-BDLP-64-95	36" x 24" x 72"	48 - 4" x 7" x 3" 16 - 8" x 15" x 7"	2 - 36" x 18" 6 - 12" x 4" door shelves	400 lbs.
3501-BDLP-95	36" x 24" x 72"			400 lbs.
BSH-3618-95	extra shelf		36" x 18"	17 lbs.
DSH-124-95	extra door shelf		12" x 4" (std. pkg. 6)	18 lbs.

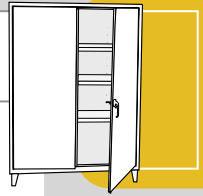

CABINETS - FLUSH DOOR STYLE

36"W x 18" and 24"D x 72" H | Heavy-duty cabinets with or without Unbreakable Hook-On Bins™



3602-BLP-36-95
36 Hook-On Bins™ hang from louvered back panels only.

3602-BLP-95 (Not Shown)
Without Hook-On Bins™ Includes louvered back panels only, but no Hook-On Bins™ or adjustable shelves



3602-BLP-14-2S-95
14 Hook-On Bins™ and (2) adjustable shelves.

- 14-gauge steel construction
- Shelves adjust on 1" centers
- 3-point locking handle with 2 keys and 3/8" rods
- Adjustable shelves rest on easy-to-move compression clips
- Gray Powder Coat Finish

Model	Dim: WxDxH	Bins: WxDxH	Shelves	Ship Wt
3602-BLP-14-2S-95	36" x 18" x 72"	12 - 8" x 15" x 7" 2 - 16" x 15" x 7"	3 - 36" x 18" adj. shelves (BSH-3618)	425 lbs.
3602-BLP-36-95	36" x 18" x 72"	18 - 6" x 11" x 5" 12 - 8" x 15" x 7" 6 - 16" x 15" x 7"		355 lbs.
3602-BLP-95	36" x 18" x 72"			285 lbs.
BSH-3618-95	Extra Shelf		36" x 18"	17 lbs.

All welded construction

Gray powder coat finish

Adjustable shelves rest on easy to relocate compression clips

14-gauge steel construction



3 point locking handles with 2 keys and 3/8" diameter rods

Flush-style doors

Model	Dimensions: WxDxH	Shelves	Ship Wt.
3500-95	36" x 24" x 84"	3 adjustable	385 lbs.
3501-95	36" x 24" x 72"	3 adjustable	365 lbs.
3502-95	48" x 24" x 72"	3 adjustable	400 lbs.
3503-95	36" x 24" x 42"	2 adjustable	210 lbs.
3600-95	36" x 18" x 48"	2 adjustable	220 lbs.
3601-95	36" x 18" x 60"	3 adjustable	285 lbs.
3602-95	36" x 18" x 72"	4 adjustable	320 lbs.
3603-95	36" x 18" x 84"	4 adjustable	360 lbs.
Extra Adjustable Shelves			
BSH-3618-95	for 36" x 18" cabinets		17 lbs.
BSH-3624-95	for 36" x 24" cabinets		22 lbs.
BSH-4824-95	for 48" x 24" cabinets		29 lbs.

3500-95
Full-Height unit has 3 adjustable shelves

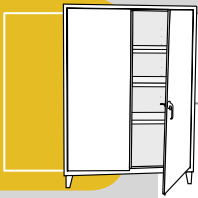

CABINETS - FLUSH DOOR STYLE

Heavy-duty Secure storage for special applications



JSC-602460-95 - JOB-SITE STORAGE CABINET 60"W x 24"D x 60"H

Holds tools, accessories and supplies. Forkliftable. Includes (3) welded in place full width shelves.

- All welded construction
- 16-gauge steel construction
- Double doors have protected padlock attachment (lock not included)
- Skid plates that allow access for forklift
- Storage shelves are full width and welded in place
- Gray powder coat finish
- Side drop handles



Welded corners with drip shield, protect and deflect rain

Model	Dim: WxDxH	Ship Wt.
JSC-602460-95	60" x 24" x 60"	475 lbs.

INSTITUTIONAL HEAVY-DUTY LOCKERS

CLEARVIEW CABINETS



Hanger rod

(4) adjustable shelves rest on easy-to-move compression clips

All welded construction

Gray powder coat finish

14-gauge steel construction

3-point locking handle with 2 keys and 3/8" rods

Expanded metal door panels



3500-HDL-95 (shown) 36"W x 24"D x 84" H

Room to store uniforms, clothing, boxed items, janitor supplies, cans and more. The full shelf at top is welded in place. (4) half shelves are adjustable. Includes Coat Rod.

- Coat Rod
- Adjustable Half Shelves
- Welded Top Shelf

3501-HDL-95 (not shown)

Coat rack rod, (3) adjustable half shelves and welded top shelf

Model	Dim: WxDxH	Shelves	Ship Wt.
3500-HDL-95	36" x 24" x 84"	4 adjustable, 1 fixed	450 lbs.
3501-HDL-95	36" x 24" x 72"	3 adjustable, 1 fixed	370 lbs.

EMDC-482472-95

48" & 36"W x 18" and 24"D

See-through security with rugged expanded metal doors.

Model	Dim: WxDxH	Shelves	Ship Wt.
EMDC-361848-95	36" x 18" x 48"	2 adjustable	147 lbs.
EMDC-361860-95	36" x 18" x 60"	3 adjustable	258 lbs.
EMDC-361872-95	36" x 18" x 72"	4 adjustable	298 lbs.
EMDC-361884-95	36" x 18" x 84"	4 adjustable	330 lbs.
EMDC-481872-95	48" x 18" x 72"	3 adjustable	371 lbs.
EMDC-362442-95	36" x 24" x 42"	2 adjustable	188 lbs.
EMDC-362472-95	36" x 24" x 72"	3 adjustable	335 lbs.
EMDC-362484-95	36" x 24" x 84"	3 adjustable	355 lbs.
EMDC-482472-95	48" x 24" x 72"	3 adjustable	370 lbs.

Extra Adjustable Shelves

BSH-3618-95	for 36" x 18" cabinets	17 lbs.
BSH-3624-95	for 36" x 24" cabinets	22 lbs.
BSH-4824-95	for 48" x 24" cabinets	29 lbs.



WORKTABLE CABINETS

36"W x 24"D x 36"H | Keep parts and tools stored directly below the work surface

Heavy-duty Cabinets are an ideal combination of work space and storage space, featuring 4" box style doors with Hook-On Bins™ hanging from louvered back and door panels. That's a lot of well-organized storage space that can be placed right below a work surface.

CREATE A WORKTABLE by ordering an optional 30" x 60" laminated Maple or Plastic top. Top will overhang 3" front and back and 12" on each side creating an ideal work surface with parts storage below.

Optional rugged work surfaces - Either laminated plastic or laminated maple - turns unit into worktable



DC203636-BDLP-66-LMT-95
Laminated Maple Top with (66) Hook-On Bins™

OPTIONAL WORKTABLE TOPS



WOOD SHOP TOP



LAMINATED MAPLE



LAMINATED PLASTIC

Model	Dim: WxDxH	Bins: WxDxH	Ship Wt
DC-203636-BDLP-60-95	36" x 24" x 36"	24 - 4" x 5" x 3" 24 - 4" x 7" x 3" 8 - 8" x 15" x 7" 4 - 16" x 15" x 7"	210 lbs.
DC-203636-BDLP-64-95	36" x 24" x 36"	24 - 4" x 5" x 3" 24 - 4" x 7" x 3" 6 - 6" x 11" x 5" 8 - 8" x 15" x 7" 2 - 16" x 15" x 7"	210 lbs.
DC-203636-BDLP-66-95	36" x 24" x 36"	24 - 4" x 5" x 3" 24 - 4" x 7" x 3" 12 - 6" x 11" x 5" 4 - 8" x 15" x 7" 2 - 16" x 15" x 7"	208 lbs.
DC-203636-BDLP-95	36" x 24" x 36"		165 lbs.
Optional Worktable Tops			
Laminated Maple: Add -LMT before -95 on Model No.	60" x 30"		90 lbs.
Laminated Plastic: Add -LPT before -95 on Model No.	60" x 30"		65 lbs.
Wood Shop Top: Add -WST before -95 on Model No.	60" x 30"		65 lbs.

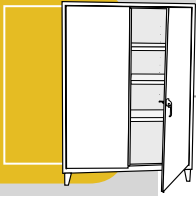

CABINETS - FLUSH DOOR STYLE

Heavy-duty Secure storage for special applications

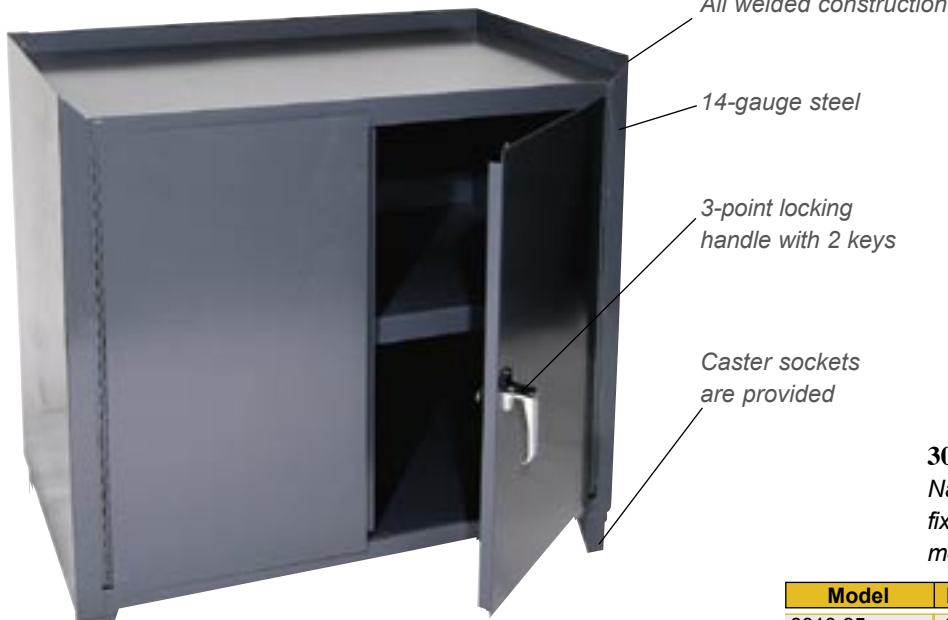

All welded construction

14-gauge steel

3-point locking handle with 2 keys

Caster sockets are provided

3000-95
Table high, 36" wide unit has 1 fixed shelf.

4" legs make units forkliftable

3010-95
Narrow, 21"W x 15"D, table high unit has 1 fixed shelf and fits in tight spaces. Utilizes little more than 2 square feet of floor space.

Model	Dimensions: WxDxH	Shelves	Ship Wt.
3010-95	21" x 15" x 34-1/2"	1 fixed	85 lbs.
3000-95	36" x 24" x 34-1/2"	1 fixed	146 lbs.
HC1101S	3" x 1" optional casters		1 lb.

HEAVY-DUTY SHELVING

HEAVY DUTY

KNOCKED DOWN

Standard 5-shelf unit holds 3,000 lbs evenly distributed per shelf. Ideal for heavier boxed items, dies, tools, cans, and other open stock.

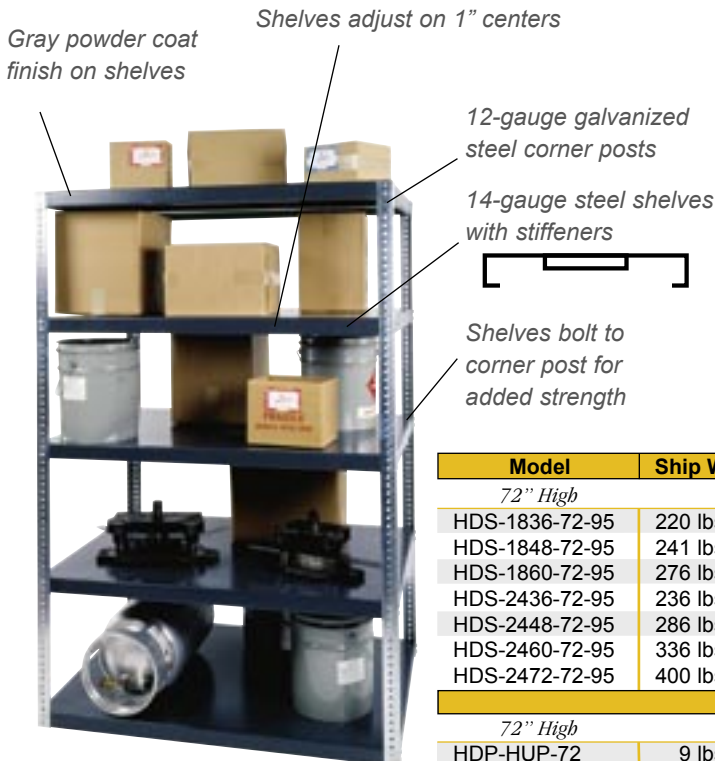

Shelves adjust on 1" centers

Gray powder coat finish on shelves

12-gauge galvanized steel corner posts

14-gauge steel shelves with stiffeners

Shelves bolt to corner post for added strength

CONVERSION KIT CREATES 15° SLOPED SHELF UNITS

Special Brackets allow you to turn our standard "HDS" series shelving into flow racking. Just purchase the appropriate Conversion Kit for either 36"W or 48"W shelves. Each kit contains 20 special brackets, 5 front stops and necessary hardware.

Model	For Shelf Width	Ship Wt
HDS-SLOPEKIT-36-95	36"	23 lbs.
HDS-SLOPEKIT-48-95	48"	28 lbs.

Model	Ship Wt	Model	Ship Wt	Model	Ship Wt	Size
<i>72" High</i>		<i>96" High</i>		<i>Additional Shelves</i>		
HDS-1836-72-95	220 lbs.	HDS-1836-96-95	235 lbs.	HDS-1836-95	34 lbs.	18" x 36"
HDS-1848-72-95	241 lbs.	HDS-1848-96-95	256 lbs.	HDS-1848-95	41 lbs.	18" x 48"
HDS-1860-72-95	276 lbs.	HDS-1860-96-95	291 lbs.	HDS-1860-95	48 lbs.	18" x 60"
HDS-2436-72-95	236 lbs.	HDS-2436-96-95	251 lbs.	HDS-2436-95	40 lbs.	24" x 36"
HDS-2448-72-95	286 lbs.	HDS-2448-96-95	301 lbs.	HDS-2448-95	50 lbs.	24" x 48"
HDS-2460-72-95	336 lbs.	HDS-2460-96-95	351 lbs.	HDS-2460-95	60 lbs.	24" x 60"
HDS-2472-72-95	400 lbs.	HDS-2472-96-95	415 lbs.	HDS-2472-95	70 lbs.	24" x 72"
Additional Uprights						
<i>72" High</i>		<i>96" High</i>				
HDP-HUP-72	9 lbs.	HDP-HUP-96	12 lbs.			

HODGE MOBILE CABINETS



Mobile Cabinets with Locking Doors and Storage Cabinets with 1200 lbs. capacity

These versatile 34" high mobile units are easily moved wherever you need them. Metal work surfaces rest atop your choice of drawers, and cabinet configuration. 16-gauge fully welded steel construction helps them live up to their name... Econoline... while easily standing up to rugged industrial environments.



8-Drawer Unit

Single Door, 4-Drawer Unit

GRAY POWDER COAT FINISH
provides an easy-to-clean, durable finish.

CYLINDER LOCKS
keep stored items secure and prevent drawers from accidentally opening during transport.

PUSH HANDLES
make it easy to move cabinets about.

ALL WELDED CONSTRUCTION
These units were built to provide years of trouble-free service.

PLATED PULL HANDLES
used on all drawers

LOCKING HANDLE
provides sure locking action and enhanced security. Supplied with 2 keys.



EMC-2136-4DR-95

LONG LIFE POLYURETHANE CASTERS
standard bolt-on casters last longer. (2) rigid and (2) swivel.

BALL BEARING DRAWER SLIDES
make it easy to open and close drawers.

FULL PIANO HINGES
long-lasting hinges make it easy to swing doors open and closed

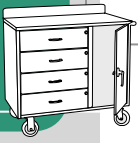

ECONOLINE MOBILE CABINETS

36" x 46" wide cabinets, 1200 lbs. capacity



46" wide units



36" wide units



Model	Dim: WxDxH	No. & Size of Drawers	Side Comp: WxDxH	No. Shelves	Hook-On Bins	Ship Wt.
EMC-2146-DD-2S-95	46" x 21" x 34"		2-20-1/2" x 20" x 25"	1 per side		195 lbs.
EMC-2146-8DR-95	46" x 21" x 34"	8-20" x 19-3/4" x 5"				285 lbs.
EMC-2146-4DR-45	46" x 21" x 34"	4-20" x 19-3/4" x 5"	1-20-1/2" x 20" x 25"			250 lbs.
EMC-2146-4DR-RM-20B-17	46" x 21" x 34"	4-20" x 19-3/4" x 5"	1-20-1/2" x 20" x 25"		20-4" x 5" x 3"	263 lbs.
EMC-2136-4DR-95	36" x 21" x 34"	4-20" x 19-3/4" x 5"	1-20-1/2" x 20" x 11-1/2"			230 lbs.
EMC-2136-DD-2S-95	36" x 21" x 34"		2-20-1/2" x 20" x 16-1/4"	1 per side		180 lbs.
EMC-2136-4DR-RM-10B-17	36" x 21" x 34"	4-20" x 19-3/4" x 5"	1-20-1/2" x 20" x 11-1/2"		10-4" x 5" x 3"	240 lbs.

See page 21 for optional Hook-On Bins™

ECONOLINE MOBILE CABINETS



1200 lbs. capacity units have 3-sided protective lips around top surface

1/2" Lip on sides and back of top surface



Push handle

16-gauge steel

Gray powder coat finish

Cylinder locks on drawers supplied with 2 keys

Full piano hinge resists sagging

Drawers move on ball bearing slides

5" x 1-1/4" polyurethane bolt-on casters
(2) Swivel
(2) Rigid

Single point locking handle on door supplied with 2 keys. Drawers and handles are keyed alike

EMB-2023-2DR-95
23"W x 20"D x 34"H
Combines drawer and compartment storage.



EMB-2023-4DR-95
23"W x 20"D x 34"H
4 locking drawers.



EMB-2023-95
23"W x 20"D x 34"H
Single locking door with welded center shelf.

Model	Dim: WxDxH	No. & Size of Drawers	Side Comp: WxDxH	Ship Wt.
EMB-2023-2DR-95	23" x 20" x 34"	2-20" x 19-3/4" x 5"	20-1/2" x 20" x 12-1/2"	132 lbs.
EMB-2023-4DR-95	23" x 20" x 34"	4-20" x 19-3/4" x 5"		172 lbs.
EMB-2023-95	23" x 20" x 34"		20-1/2" x 20" x 25"	100 lbs.

See page 37 for optional casters



MOBILE BENCH CABINETS

High-capacity, heavy-duty mobile cabinets combine storage, security, mobility and a work surface

3100-95
36"W x 24"D x 37-1/2"H
 2,000 lbs. capacity double door unit with welded center shelf. Back & side steps are 1-1/2" high.



3200-95
36"W x 24"D x 37-1/2"H
 2,000 lbs. capacity double door unit with (4) drawers and cabinet space. Back & side steps are 1-1/2" high.



3300-95
36"W x 24"D x 37-1/2"H
 2,000 lbs. capacity 4-drawer unit with single door and (1) welded center shelf in cabinet. Back & side steps are 1-1/2" high.



3400-95
60"W x 24"D x 38"H
 2,000 lbs. capacity double door unit includes 12" vise support shelf. Cabinet is 48" x 24". Back & side steps are 3" high.



3401-95
60"W x 24"D x 38"H
 2,000 lbs. capacity double door unit with full extension drawers. Double door unit includes 12" vise support. Drawers hold up to 250 lbs. Back and side stops are 3" high. Cabinet is 48" x 24".
 See page 38 for caster options



Full extension drawers have 250 lbs. capacity

Drawers supplied with cylinder locks and 2 keys. All drawers keyed alike.

MBC-3060-95
60"W x 30"D x 34"H

4,000 capacity super heavy-duty unit with drawers. Single door unit has (4) full extension drawers at each end. Super heavy-duty shelf is 14-gauge steel with stiffener below and channel formed on all four sides. Each full extension drawer holds up to 250 lbs.



3-point locking handle with 2 keys. Handles and cylinder locks are keyed alike

6" x 2" phenolic bolt-on casters
 (2) Swivel
 (2) Rigid

Louvered back panel
 14-gauge steel
 1-1/2" back and side stops
 Doors have 3-point locking handles and 2 keys
 Gray powder coat finish
 Push handle
 Hook-On Bins™
 6" x 2" phenolic bolt-on casters
 (2) Swivel
 (2) Rigid

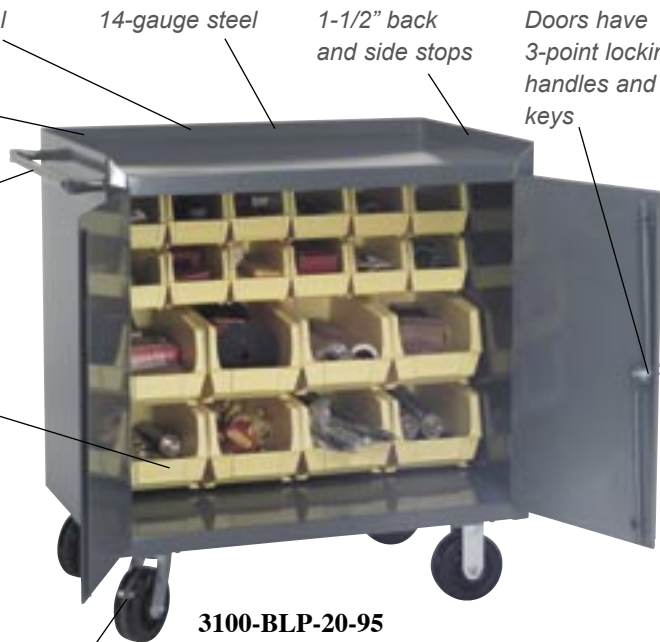

3100-BLP-20-95
36"W x 24"D x 37-1/2"H
 2,000 lbs. capacity double door unit with 20 Hook-On Bins.™

Model	Dim: WxDxH	No. & Size of Drawers	Available Drawer Space	Ship Wt.
3100-95	36" x 24" x 37-1/2"			193 lbs.
3200-95	36" x 24" x 37-1/2"	4-14" x 20" x 5"		265 lbs.
3300-95	36" x 24" x 37-1/2"	4-14" x 20" x 5"		296 lbs.
3400-95	60" x 24" x 38"			254 lbs.
3401-95	60" x 24" x 38"	4-19-1/2" x 24" x 4"	22"	375 lbs.
3402-95	60" x 24" x 38"	5-All 19-1/2" x 24", 4-4"H, 1-6"H	22"	400 lbs.
3403-95	60" x 24" x 38"	5-All 19-1/2" x 24", 2-4"H, 1-6"H, 1-8"H	22"	425 lbs.
MBC-3060-95	60" x 30" x 34"		22"	530 lbs.
Model	Dim: WxDxH	Bins: WxDxH		Ship Wt.
3100-BLP-95	36" x 24" x 37-1/2"			205 lbs.
3100-BLP-18-95	36" x 24" x 37-1/2"	12-6" x 11" x 5", 4-8" x 15" x 7", 2-16" x 15" x 7"		229 lbs.
3100-BLP-20-95	36" x 24" x 37-1/2"	12-6" x 11" x 5", 8-8" x 15" x 7"		232 lbs.

HOOK-ON-BINS™



Hook-On Bins™ save storage space and save time

All Hodge Hook-On Bins™ are yellow.

Durable polyethylene copolymer construction.

Back tab hook over louver panels and rails for use on cabinets, carts and work benches.

Molded top edge for secure stacking.



Molded finger grips for easy, comfortable handling.

Optional dividers separate bins lengthwise allowing storage of different parts in the same bin.

Slots on front hold identification cards, tags and labels.

DURABLE HOOK-ON™ BINS SAVE STORAGE SPACE AND SAVE TIME

HODGE Hook-On Bins™ are used to concentrate parts and supplies into fewer square feet of valuable storage space. They allow you to make use of every cubic foot inside a cabinet to store bulk quantities of small parts and supplies. You can even store different parts in the same bin. Hook-On Bins™ can easily be removed while fully loaded to carry parts to remote weighing, assembly and other work areas making them a highly efficient way to handle small parts and other items.

Hook-On Bins™ are made from durable polyethylene with integral back hooks for hanging. The lowered front edge design improves visibility while making it easy to pick parts.

HODGE Hook-On Bins™ are valuable accessories on HODGE cabinets, transport carts and work stations. They all fit neatly on other cabinet and shelving brands.

MULTIPLE SIZES

Hook-On Bins™ are available in five different sizes to hold a wide variety of parts, supplies and other items.

Model	Dim: WxLxH	Dividers
PB30210-21	4" x 5" x 3"	PB30161
PB30220-21	4" x 7" x 3"	PB30166
PB30230-21	6" x 11" x 5"	PB30171
PB30240-21	8" x 15" x 7"	PB30176
PB30250-21	16" x 15" x 7"	PB30176

PB30250-21
16"W x 15"L x 7"H - 3 DIVIDER SLOT

PB30240-21
8"W x 15"L x 7"H



PB30220-21
4"W x 7"L x 3"H

PB30230-21
6"W x 11"L x 5"H

PB30210-21
4"W x 5"L x 3"H



Hook-On Bins™ can also be stacked on shelves, work tables, carts and other flat surfaces.



Back tabs hold securely on louvered panels. Hook-On Bins™ can also be used on rails and other bin holding systems.

HODGE HEAVY-DUTY TRUCKS

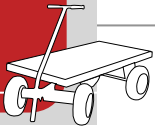

When it comes to moving anything from here to there, few other companies give you as many money-saving, efficiency-building options as we do. These rugged mobility units are manufactured to provide years of dependable service in a wide variety of applications. Here are a few of the ways we've created a line of mobile units that last longer and work harder.

JOB SPECIFIC UNITS

Many HODGE units were specially designed to do certain types of jobs better than any other products available.



Steel

Wood

STEEL BOUND HARDWOOD (SHOWN)

REMOVABLE PUSH HANDLE

GRAY POWDER COAT FINISH

SWIVEL CASTERS

provide easy maneuverability.

ALL WELDED CONSTRUCTION

creates rigid frames that will not loosen at key stress points.

DIFFERENT PLATFORMS

for different application requirements.

HEAVY GAUGE STEEL AND/OR HARDWOOD CONSTRUCTION

gives HODGE mobility units a more rugged frame and goes a long way toward explaining why they last longer.

RIGID CASTERS

keep units on the straight and narrow.



PLATFORM TRUCKS

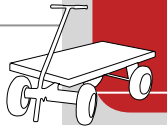

Rugged industrial-duty trucks are easy to push even when fully loaded

Gray powder coat finish

Handles rise 36" above floor

2,000 lbs. capacity



EPT-2436-95

WDPT-2448-95

STEEL PLATFORM TRUCK

14 gauge steel platform with stiffeners underneath. Transport up to 2,000 lbs. without pushing hard.

Model	Size: W x D	Ship Wt
EPT-1836-95	18" X 36"	52 lbs.
EPT-2436-95	24" X 36"	56 lbs.
EPT-2448-95	24" X 48"	85 lbs.
EPT-2460-95	24" X 60"	111 lbs.
EPT-2472-95	24" X 72"	120 lbs.
EPT-3048-95	30" X 48"	110 lbs.
EPT-3060-95	30" X 60"	115 lbs.
EPT-3072-95	30" X 72"	136 lbs.
EPT-3660-95	36" X 60"	140 lbs.
EPT-3672-95	36" X 72"	150 lbs.

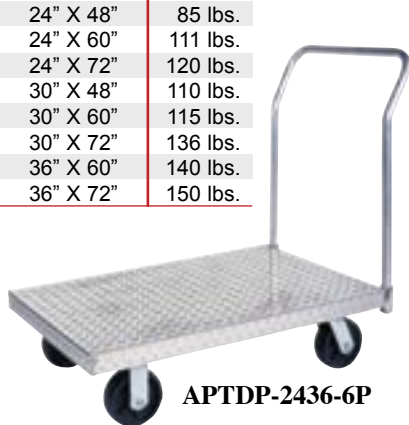

APTDP-2436-6P

ALUMINUM PLATFORM TRUCK

1/8" thick diamond plate aluminum deck is supplied within stiffeners for added strength. Light weight and heavy duty.

Model	Size: W x D	Ship Wt
<i>2000 lbs. Capacity 6" Phenolic Casters</i>		
APTDP-2436-6P	36" x 24"	60 lbs.
APTDP-2448-6P	48" x 24"	68 lbs.
APTDP-3060-6P	60" x 30"	82 lbs.
APTDP-3672-6P	72" x 36"	99 lbs.
<i>2400 lbs. Capacity 8" Mold-On Rubber Casters</i>		
APTDP-2436-8MR	36" x 24"	64 lbs.
APTDP-2448-8MR	48" x 24"	72 lbs.
APTDP-3060-8MR	60" x 30"	86 lbs.
APTDP-3672-8MR	72" x 36"	107 lbs.
<i>8" Full Pneumatic Casters</i>		
APTDP-2436-8FP	36" x 24"	72 lbs.
APTDP-2448-8FP	48" x 24"	80 lbs.
APTDP-3060-8FP	60" x 30"	94 lbs.
APTDP-3672-8FP	72" x 36"	111 lbs.



EWDT-2748-95

STEEL BOUND HARDWOOD DECK PLATFORM TRUCKS

Utilizes angle steel frame for extra strength and longer life. Platform is varnished hardwood. Deck height is 9-1/2"

Model	Size: W x D	Ship Wt
WDPT-2448-95	24" x 48"	113 lbs.
WDPT-2742-95	27" x 42"	100 lbs.
WDPT-2748-95	27" x 48"	115 lbs.
WDPT-2754-95	27" x 54"	137 lbs.
WDPT-3060-95	30" x 60"	144 lbs.
WDPT-3672-95	36" x 72"	164 lbs.

ALL WOOD DECK PLATFORM TRUCKS

Castors are bolted to varnished hardwood deck. 6" x 2" phenolic casters, 2 rigid/2swivel. Deck height is 9-1/2"

Model	Size: W x D	Ship Wt
EWDT-2436-95	24" x 36"	55 lbs.
EWDT-2442-95	24" x 42"	60 lbs.
EWDT-2448-95	24" x 48"	65 lbs.
EWDT-2748-95	27" x 48"	78 lbs.
EWDT-2754-95	27" x 54"	78 lbs.



CUT-2448-61

CUSHIONED UTILITY TRUCK

Pneumatic tires provide cushioned ride. Angle iron frame with plywood platform sits atop a 1" steel tubing framework that raises platform 19" above floor. Move front axle one hole lower to create 1" slope from handle to front. Bicycle grip handles. 8" diameter front wheels swivel for 360° turning radius. Back tires are 16" diameter. Dark green powder coat finish.

Model	Size: W x D	Ship Wt
CUT-2448-61	24" x 48" x 36"	78 lbs.

5TH WHEEL, HIGH-END PLATFORM & TUBULAR TRUCKS

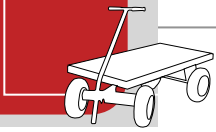

5th WHEEL WAGON TRUCKS 24" - 48" Wide

Gray powder coat finish

These heavy-duty Pull Trucks can be used for large parts. The pull handle makes for more maneuverability.



All steel
14-gauge deck

1" tubular steel handles

All welded construction



Deck Height:
16-3/4" with pneumatic tires
15" with mold on rubber wheels

Widths: 24" - 48"

Lengths: 48" - 96"

Pneumatic tires & mold on rubber wheels are available

Dark blue powder coat finish

STEEL DECK UNITS

14 gauge steel deck.

Model	Ship Wt	Model	Ship Wt	Size
3000 lbs. Capacity 10" x 2 1/2" Mold-On Rubber Wheel		2000 lbs. Capacity 12" x 3 1/2" Pneumatic Wheel		
5WT-SD-2448-10-95	140 lbs.	5WT-SD-2448-12-95	144 lbs.	24" x 48"
5WT-SD-3060-10-95	158 lbs.	5WT-SD-3060-12-95	162 lbs.	30" x 60"
5WT-SD-3660-10-95	205 lbs.	5WT-SD-3660-12-95	209 lbs.	36" x 60"
5WT-SD-3672-10-95	228 lbs.	5WT-SD-3672-12-95	232 lbs.	36" x 72"
5WT-SD-4284-10-95	244 lbs.	5WT-SD-4284-12-95	248 lbs.	42" x 84"
5WT-SD-4896-10-95	310 lbs.	5WT-SD-4896-12-95	314 lbs.	48" x 96"

VARNISHED HARDWOOD DECK UNITS

Wood deck is bolted to angle frame.

Model	Ship Wt	Model	Ship Wt	Size
3000 lbs. Capacity 10" x 2 1/2" Mold-On Rubber Wheel		2000 lbs. Capacity 12" x 3 1/2" Pneumatic Wheel		
5WT-2448-10-01	137 lbs.	5WT-2448-12-01	140 lbs.	24" x 48"
5WT-3060-10-01	155 lbs.	5WT-3060-12-01	157 lbs.	30" x 60"
5WT-3660-10-01	202 lbs.	5WT-3660-12-01	204 lbs.	36" x 60"
5WT-3672-10-01	223 lbs.	5WT-3672-12-01	225 lbs.	36" x 72"
5WT-4284-10-01	237 lbs.	5WT-4284-12-01	240 lbs.	42" x 84"
5WT-4896-10-01	303 lbs.	5WT-4896-12-01	305 lbs.	48" x 96"

HIGH END PLATFORM TRUCK ("U" Boats)

1,500 lbs. capacity with (2) Removable End Racks.
Tight turning radius with swivel casters on ends and fixed wheels in middle.

- Steel bound wood or all steel decks
- Gray Powder Coat Finish
- 14 gauge steel deck on PTS models
- Angle iron frame on PTW models
- 1" pipe end racks
- Removable end racks stand 61" high
- 8" x 2" mold on rubber rigid center casters
- Polyurethane swivel end casters, 2 on each end, 4" x 1-1/4"



Model	Width	Depth	Ship Wt
<i>Steel Bound Wood Deck</i>			
PTW-1648-95	16"	48"	96 lbs.
PTW-1660-95	16"	60"	113 lbs.
PTW-2448-95	24"	48"	104 lbs.
PTW-2460-95	24"	60"	122 lbs.

Model	Width	Depth	Ship Wt
<i>All Steel Deck</i>			
PTS-1648-95	16"	48"	110 lbs.
PTS-1660-95	16"	60"	120 lbs.
PTS-2448-95	24"	48"	120 lbs.
PTS-2460-95	24"	60"	132 lbs.

HIGH END PLATFORM TRUCK
with optional Hang Bar
* Consult factory for price



See page 37 for caster options

TUBULAR STEEL TRUCKS

1,200 lbs. capacity.
Versatile, multi-purpose trucks.

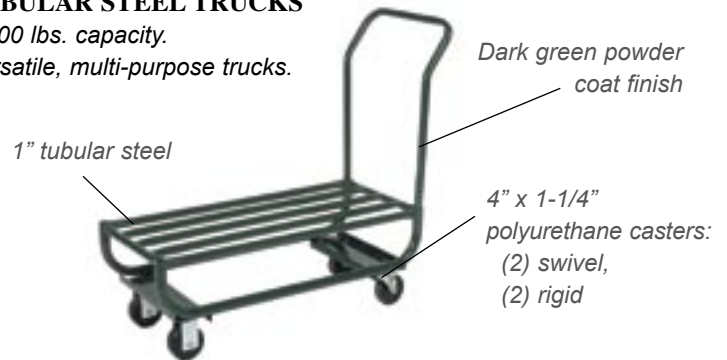

A. Removable handle. 12" Deck height.



B. Welded-on handle. 26" Deck height.

A	Ship Wt	B	Ship Wt	Width	Depth
<i>One Removable Handle 36" Above Floor 1200 lbs. Capacity</i>		<i>Welded Construction 26" Above Floor 1200 lbs. Capacity</i>			
HT-163612-61	36 lbs.	HT-163626-61	61 lbs.	36"	16"
HT-184112-61	46 lbs.			41"	18"
HT-185312-61	59 lbs.			53"	18"

2 AND 3 SIDED TRUCKS

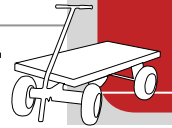

1,200 lbs. and 2,000 lbs. capacity stock trucks



A
Solid sheet metal end panels and top with (2) welded shelves and top.

- Walls extend 52" above decks
- Gray powder coat finish
- 14-gauge shelves and 16-gauge sides and backs
- Casters:
1,200 lb. capacity – 5" x 1-1/4" polyurethane bolt-on
2,000 lb. capacity – 8" x 2" mold on rubber bolt-on
(2) Swivel Casters
(2) Rigid Casters



B
Solid sheet metal sides and back



C
Solid sheet metal sides and back with welded shelf.

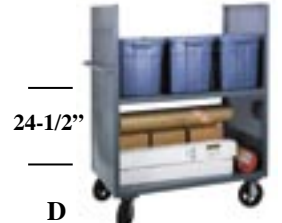

D
Solid sheet metal end panels with welded shelf.

Width	Depth	A		B		C		D	
		1200 lbs. Cap. Model	2000 lbs. Cap. Model	1200 lbs. Cap. Model	2000 lbs. Cap. Model	1200 lbs. Cap. Model	2000 lbs. Cap. Model	1200 lbs. Cap. Model	2000 lbs. Cap. Model
36"	24"	2SPT-2436-2-1.2K-95	2SPT-2436-2-2K-95	3SPT-2436-1.2K-95	3SPT-2436-2K-95	3SPT-2436-1-1.2K-95	3SPT-2436-1-2K-95	2SPT-2436-1-1.2K-95	2SPT-2436-1-2K-95
42"	24"	2SPT-2442-2-1.2K-95	2SPT-2442-2-2K-95	3SPT-2442-1.2K-95	3SPT-2442-2K-95	3SPT-2442-1-1.2K-95	3SPT-2442-1-2K-95	2SPT-2442-1-1.2K-95	2SPT-2442-1-2K-95
48"	24"	2SPT-2448-2-1.2K-95	2SPT-2448-2-2K-95	3SPT-2448-1.2K-95	3SPT-2448-2K-95	3SPT-2448-1-1.2K-95	3SPT-2448-1-2K-95	2SPT-2448-1-1.2K-95	2SPT-2448-1-2K-95
48"	30"	2SPT-3048-2-1.2K-95	2SPT-3048-2-2K-95	3SPT-3048-1.2K-95	3SPT-3048-2K-95	3SPT-3048-1-1.2K-95	3SPT-3048-1-2K-95	2SPT-3048-1-1.2K-95	2SPT-3048-1-2K-95
60"	30"	2SPT-3060-2-1.2K-95	2SPT-3060-2-2K-95	3SPT-3060-1.2K-95	3SPT-3060-2K-95	3SPT-3060-1-1.2K-95	3SPT-3060-1-2K-95	2SPT-3060-1-1.2K-95	2SPT-3060-1-2K-95



3ST-SM SERIES
Solid Sheet Metal Sides with 14-gauge Steel Construction throughout.

Gray powder coat finish

Push handles made of 1" pipe

Sides & back extend 48" above decks

Shown with optional shelves

14-gauge steel bases with lips up

Casters:
2,000 lb. capacity – 6"x2" phenolic bolt-on casters
(2) Swivel
(2) Rigid



3ST-EX SERIES
Expanded Mesh Sides with 1-1/2" x 1/8" Angle Iron Corners and Top Rail.



3ST-SL SERIES
Steel Strap Sides with 1-1/2" x 1/8" Angle Iron Corners and Top Rail.

Width	Depth	Capacity	Model		
			Expanded Mesh Slides	Solid Metal Slides	Slat-Type Slides
36"	18"	2000 lb.	3ST-EX1836-95	3ST-SM1836-95	3ST-SL1836-95
42"	24"	2000 lb.	3ST-EX2442-95	3ST-SM2442-95	3ST-SL2442-95
48"	24"	2000 lb.	3ST-EX2448-95	3ST-SM2448-95	3ST-SL2448-95
60"	24"	2000 lb.	3ST-EX2460-95	3ST-SM2460-95	3ST-SL2460-95
42"	30"	2000 lb.	3ST-EX3042-95	3ST-SM3042-95	3ST-SL3042-95
48"	30"	2000 lb.	3ST-EX3048-95	3ST-SM3048-95	3ST-SL3048-95
60"	30"	2000 lb.	3ST-EX3060-95	3ST-SM3060-95	3ST-SL3060-95
72"	30"	2000 lb.	3ST-EX3072-95	3ST-SM3072-95	3ST-SL3072-95
60"	36"	2000 lb.	3ST-EX3660-95	3ST-SM3660-95	3ST-SL3660-95
72"	36"	2000 lb.	3ST-EX3672-95	3ST-SM3672-95	3ST-SL3672-95

HEAVY-DUTY SHOP TRUCKS

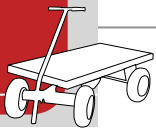

LOW-DECK TRUCKS

Raised handle units make it easy to push these low rise trucks through crowded aisles. Ideal for picking items from lower shelves.

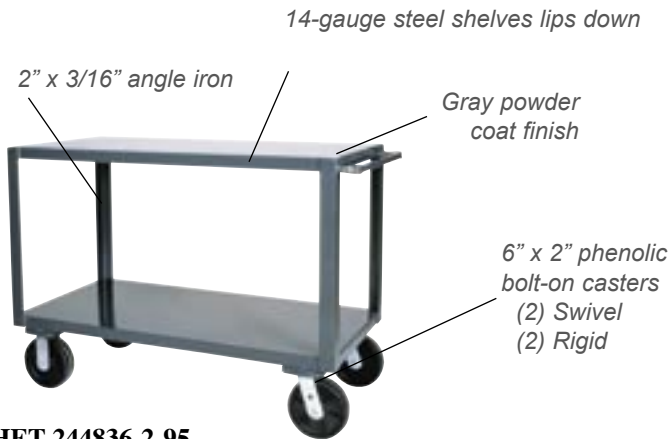

HET-244836-2-95

HEAVY DUTY SERVICE TRUCK

4,000 lbs. capacity Service Truck available with 2 or 3 shelves.

Model	Width	Depth	No. of Shelves	Ship Wt
HET-243636-2-95	36"	24"	2	145 lbs.
HET-243636-3-95	36"	24"	3	190 lbs.
HET-244836-2-95	48"	24"	2	155 lbs.
HET-244836-3-95	48"	24"	3	216 lbs.
HET-246036-2-95	60"	24"	2	182 lbs.
HET-246036-3-95	60"	24"	3	246 lbs.
HET-247236-2-95	72"	24"	2	205 lbs.
HET-247236-3-95	72"	24"	3	276 lbs.
HET-304836-2-95	48"	30"	2	180 lbs.
HET-304836-3-95	48"	30"	3	232 lbs.
HET-306036-2-95	60"	30"	2	196 lbs.
HET-306036-3-95	60"	30"	3	266 lbs.
HET-307236-2-95	72"	30"	2	222 lbs.
HET-307236-3-95	72"	30"	3	306 lbs.
HET-364836-2-95	48"	36"	2	195 lbs.
HET-364836-3-95	48"	36"	3	270 lbs.
HET-366036-2-95	60"	36"	2	225 lbs.
HET-366036-3-95	60"	36"	3	315 lbs.
HET-367236-2-95	72"	36"	2	255 lbs.
HET-367236-3-95	72"	36"	3	360 lbs.

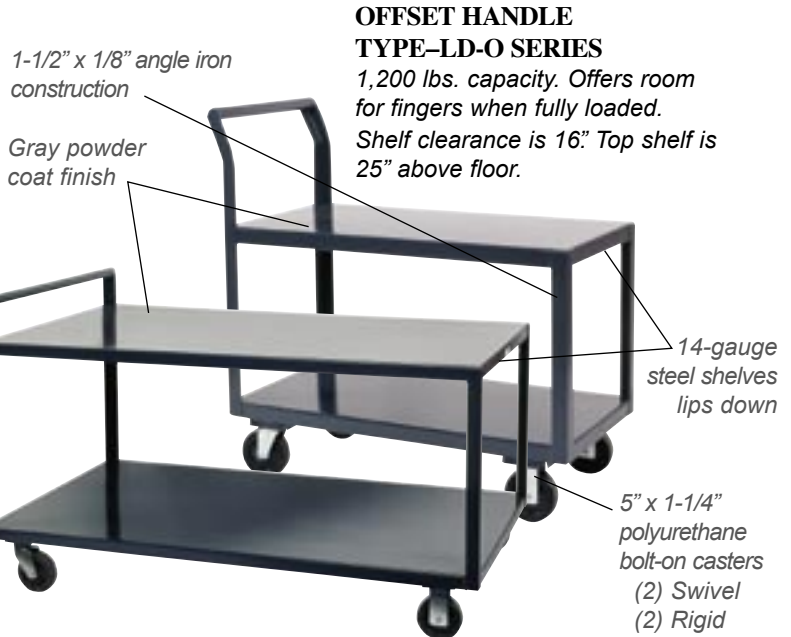

OFFSET HANDLE TYPE-LD-O SERIES

1,200 lbs. capacity. Offers room for fingers when fully loaded. Shelf clearance is 16". Top shelf is 25" above floor.

STRAIGHT HANDLE TYPE-LD-S SERIES

1,200 lbs. capacity. Shelf clearance is 21". Top shelf is 30" above floor.

Model	Ship Wt	Model	Ship Wt	Width	Depth
<i>Offset Handle Type</i>		<i>Straight Handle Type</i>			
LD-O-183025-95	68 lbs.	LD-S-183030-95	90 lbs.	30"	18"
LD-O-183625-95	94 lbs.	LD-S-183630-95	94 lbs.	36"	18"
LD-O-184825-95	100 lbs.	LD-S-184830-95	100 lbs.	48"	18"
LD-O-243625-95	94 lbs.	LD-S-243630-95	100 lbs.	36"	24"
LD-O-244225-95	105 lbs.	LD-S-244230-95	102 lbs.	42"	24"
LD-O-244825-95	109 lbs.	LD-S-244830-95	109 lbs.	48"	24"
LD-O-246025-95	120 lbs.	LD-S-246030-95	120 lbs.	60"	24"
LD-O-304225-95	125 lbs.	LD-S-304230-95	120 lbs.	42"	30"
LD-O-304825-95	126 lbs.	LD-S-304830-95	126 lbs.	48"	30"
LD-O-306025-95	140 lbs.	LD-S-306030-95	140 lbs.	60"	30"
LD-O-307225-95	158 lbs.	LD-S-307230-95	158 lbs.	72"	30"
LD-O-366025-95	158 lbs.	LD-S-366030-95	158 lbs.	60"	36"
LD-O-367225-95	170 lbs.	LD-S-367230-95	170 lbs.	72"	36"

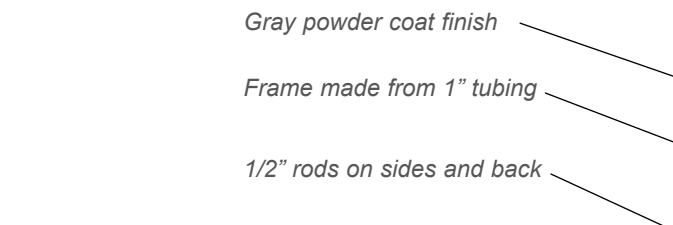

OPEN PORTABLE SHELF TRUCK

2,000 lbs. capacity. Truck has 4 fixed shelves

Model	Width	Depth	Ship Wt
OPT-3624-95	36"	24"	193 lbs.
OPT-7224-95	72"	24"	342 lbs.
OPT-4224-95	42"	24"	225 lbs.
OPT-4824-95	48"	24"	245 lbs.
OPT-4830-95	48"	30"	260 lbs.
OPT-6030-95	60"	30"	340 lbs.
OPT-7230-95	72"	30"	403 lbs.
OPT-7236-95	72"	36"	458 lbs.



TRUCKS

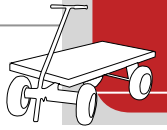

Secure and handle expensive freight and merchandise

Tilted shelves prevent stock from falling off during transport. Two-sided for greater efficiency and see-through mesh sides and center panel make it easy to see on-board items.

MESH STOCK TRUCK

2,000 lbs. capacity on 6" phenolic
3,000 lbs. capacity on 8" polyurethane

Expanded metal sides and partition

Heavy-duty angle frame construction

6" phenolic bolt-on casters or 8" polyurethane casters
(2) Swivel
(2) Rigid
Diamond pattern



14-gauge steel shelves

Gray powder coat finish

Model	Ship Wt	Model	Ship Wt	Width	Depth
<i>2,000 lbs. capacity 6" phenolic casters</i>		<i>3,000 lbs. capacity 8" polyurethane casters</i>			
EX-2436-2SC-6PH-95	160 lbs.	EX-2436-2SC-8PU-95	164 lbs.	36"	24"
EX-2448-2SC-6PH-95	190 lbs.	EX-2448-2SC-8PU-95	194 lbs.	48"	24"
EX-2848-2SC-6PH-95	200 lbs.	EX-2848-2SC-8PU-95	204 lbs.	48"	28"
EX-2860-2SC-6PH-95	240 lbs.	EX-2860-2SC-8PU-95	244 lbs.	60"	28"
EX-3036-2SC-6PH-95	185 lbs.	EX-3036-2SC-8PU-95	189 lbs.	36"	30"
EX-3048-2SC-6PH-95	220 lbs.	EX-3048-2SC-8PU-95	224 lbs.	48"	30"
EX-3060-2SC-6PH-95	306 lbs.	EX-3060-2SC-8PU-95	310 lbs.	60"	30"



**MODEL (B)
4-SIDED TRUCK**

LOW DECK STOCK TRUCKS

1,200 lbs. capacity. 40"H. Platform 20"H

- Available in 3-sided and 4-sided models
- 5" x 1-1/4" polyurethane bolt-on casters, (2) Swivel, (2) Rigid
- Gray powder coat finish
- 1-1/2" angle iron frame
- 14-gauge steel shelves
- 16-gauge sides

Model (A)	Ship Wt	Model (B)	Ship Wt	Width	Depth
<i>3-Sided</i>		<i>4-Sided</i>			
3SLT-1836-1.2K-95	100 lbs.	4SLT-1836-1.2K-95	115 lbs.	36"	18"
3SLT-2436-1.2K-95	120 lbs.	4SLT-2436-1.2K-95	130 lbs.	36"	24"
3SLT-2442-1.2K-95	123 lbs.	4SLT-2442-1.2K-95	140 lbs.	42"	24"
3SLT-2448-1.2K-95	140 lbs.	4SLT-2448-1.2K-95	160 lbs.	48"	24"
3SLT-3048-1.2K-95	145 lbs.	4SLT-3048-1.2K-95	170 lbs.	48"	30"

Identification panel



**HTL-4474-DD-95
2 hinged doors**

SECURITY TRUCKS

- Heavy gauge base and top
- Heavy gauge expanded metal
- 1-1/2" x 3/16" angle iron
- All HTL units are 72" high
- Gray powder coat finish
- 6" x 2" phenolic bolt-on casters (2) swivel (2) rigid

Model	Width	Depth	Ship Wt
HTL-2436-DD-95	36"	24"	320 lbs.
HTL-2442-DD-95	42"	24"	325 lbs.
HTL-2448-DD-95	48"	24"	330 lbs.
HTL-2460-DD-95	60"	24"	340 lbs.
HTL-3042-DD-95	42"	30"	345 lbs.
HTL-3048-DD-95	48"	30"	350 lbs.
HTL-3060-DD-95	60"	30"	355 lbs.
HTL-3660-DD-95	60"	36"	365 lbs.
HTL-3672-DD-95	72"	36"	370 lbs.
HTL-4474-DD-95	74"	44"	390 lbs.

PAN, TRAY & SHELF TRUCKS

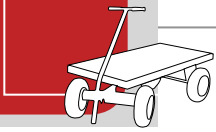

16-gauge 1/2" expanded metal

Enclosed model

Provisions for padlock
*padlock not included

14-gauge perforated steel

PERFORATED TRAY



14-gauge steel

SOLID TRAY



1-1/4" x 1/8" angle iron construction

Gray powder coat finish

5" x 1/4" bolt-on polyurethane swivel casters

*Trays sold separately

PAN & TRAY TRUCKS

1,200 lbs. capacity. 33"W x 67"H

PERFORATED AND SOLID TRAYS

Model	Size	For Use In
<i>Perforated Trays</i>		
TRM-2430-95	24" x 30"	24" deep models
TRM-3030-95	30" x 30"	30" deep models
TRM-3630-95	36" x 30"	36" deep models
<i>Solid Trays</i>		
TRS-2430-95	24" x 30"	24" deep models
TRS-3030-95	30" x 30"	30" deep models
TRS-3630-95	36" x 30"	36" deep models

PAN & TRAY TRUCKS

Model	Ship Wt	Model	Ship Wt	Depth	Spacing	Tray Cap
<i>Open Model</i>		<i>Enclosed Model</i>				
PAT-24-2-27-95	170 lbs.	PAT-EX-24-2-27-95	280 lbs.	24"	2"	27
PAT-24-4-14-95	115 lbs.	PAT-EX-24-4-14-95	225 lbs.	24"	4"	14
PAT-24-6-9-95	95 lbs.	PAT-EX-24-6-9-95	205 lbs.	24"	6"	9
PAT-30-2-27-95	118 lbs.	PAT-EX-30-2-27-95	288 lbs.	30"	2"	27
PAT-30-4-14-95	127 lbs.	PAT-EX-30-4-14-95	227 lbs.	30"	4"	14
PAT-30-6-9-95	95 lbs.	PAT-EX-30-6-9-95	215 lbs.	30"	6"	9
PAT-36-2-27-95	236 lbs.	PAT-EX-36-2-27-95	366 lbs.	36"	2"	27
PAT-36-4-14-95	150 lbs.	PAT-EX-36-4-14-95	280 lbs.	36"	4"	14
PAT-36-6-9-95	117 lbs.	PAT-EX-36-6-9-95	247 lbs.	36"	6"	9

FIVE SHELF TRUCK

1,200 and 3,000 lbs. capacity. Units have 1-1/2" lips up on all shelves to prevent lost parts during transport.

Model	Ship Wt	Model	Ship Wt	Width	Depth
<i>1,200 lb. Capacity Overall Height 56" Shelf Clearance 10"</i>		<i>3,000 lb. Capacity Overall Height 65" Shelf Clearance 12"</i>			
5S-1.2K-1836-95	120 lbs.	5S-3K-1836-95	220 lbs.	36"	18"
5S-1.2K-1848-95	135 lbs.	5S-3K-1848-95	250 lbs.	48"	18"
5S-1.2K-2436-95	145 lbs.	5S-3K-2436-95	250 lbs.	36"	24"
5S-1.2K-2442-95	160 lbs.	5S-3K-2442-95	275 lbs.	42"	24"
5S-1.2K-2448-95	175 lbs.	5S-3K-2448-95	300 lbs.	48"	24"
5S-1.2K-2460-95	205 lbs.	5S-3K-2460-95	350 lbs.	60"	24"
5S-1.2K-3042-95	185 lbs.	5S-3K-3042-95	330 lbs.	42"	30"
5S-1.2K-3048-95	200 lbs.	5S-3K-3048-95	350 lbs.	48"	30"
5S-1.2K-3060-95	240 lbs.	5S-3K-3060-95	415 lbs.	60"	30"
5S-1.2K-3660-95	255 lbs.	5S-3K-3660-95	480 lbs.	60"	36"
5S-1.2K-3672-95	270 lbs.	5S-3K-3672-95	520 lbs.	72"	36"



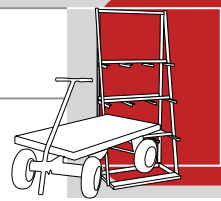

ADJUST-A-TRAY TRUCKS

A versatile 38" wide material handling system that allows you to place trays where you need them. Trays can be taken to work area, filled and returned to unit. These time-saving mobile units are used in receiving, inspection, processing, assembly, sloping and storage applications.



TRAY DIVIDERS

Model	Fits Trays	Ship Wt
TR-DIV-6-95	TR-1501-95 & TR-1503-95	1 lbs.
TR-DIV-15-95	TR-1500-95 & TR-1502-95	2 lbs.



HANGER BAR AND SPINDLES

Hang parts from 1/2" rod spindles or use them to separate long parts. Come in standard package of 5.

Model	Description	Ship Wt
HB-36-95	4" H x 36" L	8 lbs.
SP-515-95	1/2" rod x 15" L	1 lb.



TR-1500-95

TR-1502-95

HOOK-ON TRAYS

Model	Style	Width	Depth	Height	Max Capacity	Ship Wt
TR-1500-95	Open Front	36"	15"	6"	250 lbs.	22 lbs.
TR-1501-95	Open Front	36"	9"	3"	150 lbs.	20 lbs.
TR-1502-95	3" Closed Front	36"	15"	6"	250 lbs.	22 lbs.
TR-1503-95	3" Closed Front	36"	9"	3"	150 lbs.	20 lbs.

"A" FRAME TRUCKS

These 2,000 lbs. capacity trucks offer lots of versatility to move different types of products. You can hang things from the top or middle beams, carry long parts and boxes all on the same rugged truck.

Model	Width	Depth	Space on Each Side of "A"
AF-2436-95	36"	24"	4-1/4"
AF-2448-95	48"	24"	4-1/4"
AF-2460-95	60"	24"	4-1/4"
AF-3042-95	42"	30"	6-1/4"
AF-3048-95	48"	30"	6-1/4"
AF-3060-95	60"	30"	6-1/4"
AF-3072-95	72"	30"	6-1/4"
AF-3648-95	48"	36"	9-1/4"
AF-3660-95	60"	36"	9-1/4"
AF-3672-95	72"	36"	9-1/4"

1-1/2" angle iron frame construction

11-gauge steel slotted uprights

Wire handles

Gray powder coat finish

6" x 2" phenolic bolt-on casters
(2) Swivel
(2) Rigid



ATT-2438-95

ATT-4038-95

16-gauge steel Hook-On Trays and Dividers

ADJUST-A-TRAY TRUCKS

38"W Removable trays hook onto central mobile frame.

Model	Style	Width	Depth	Capacity	Tray Capacity	Ship Wt
ATT-2438-95	Single Sided	38"	24"	1500 lbs	7-6"	115 lbs.
ATT-1838-95	Single Sided	38"	18"	1500 lbs	7-6"	110 lbs.
ATT-4038-95	Double Sided	38"	40"	2500 lbs	14"-6"	130 lbs.
ATT-3038-95	Double Sided	38"	30"	2500 lbs	14"-6"	120 lbs.

Models ATT-1838-95 & ATT-3038-95 are not designed for use with trays TR-1500-95 & TR-1502-95. Using these trays with these trucks may cause it to tip.



1-1/2" angle iron frame construction

1" lip on bottom deck prevents parts from falling off during transport

6" x 2" phenolic bolt-on swivel casters

Gray powder coat finish

14-gauge steel base with reinforced channels underneath

TRUCKS AND RACKS FOR HANDLING LONG PARTS



VERTICAL LONG PARTS STORAGE RACK
36"W X 24"D X 84"H

Stores long parts in less space with integrated shelf space for short parts and boxed items.

Model	Dim: WxDxH	Ship Wt
VBR-8436-95	36" x 24" x 84"	110 lbs.



Model	Width	Length	Ship Wt
PSR-3060-95	30"	60"	155 lbs.
PSR-3660-95	36"	60"	170 lbs.
PSR-3672-95	36"	72"	180 lbs.



BAR CRADLE TRUCKS
4,000 and 10,000 lbs. capacity.
Designed for more efficient handling of pipe, tubing and bar stock.

Model	Length	Capacity	No of Cradles	Ship Wt
BCTE-2860-4K-95	5'	4000 lbs.	3	160 lbs.
BCTE-2872-4K-95	6'	4000 lbs.	3	172 lbs.
BCTE-2896-4K-95	8'	4000 lbs.	3	185 lbs.
BCT-2860-10K-95	5'	10000 lbs.	3	344 lbs.
BCT-2872-10K-95	6'	10000 lbs.	3	368 lbs.
BCT-2896-10K-95	8'	10000 lbs.	4	424 lbs.
BCT-28120-10K-95	10'	10000 lbs.	4	478 lbs.
BCT-28144-10K-95	12'	10000 lbs.	5	555 lbs.

Wheels & casters are arranged in diamond pattern with 1/2" tilt
(2) 6" x 2" phenolic bolt-on swivel casters on 4,000 lbs. capacity trucks
8" x 2-1/2" phenolic bolt-on swivel casters on 10,000 lbs. capacity trucks

TRUCKS AND RACKS FOR HANDLING LONG PARTS

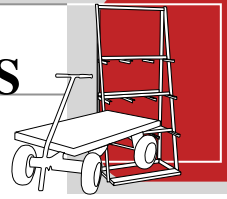

HEAVY DUTY BAR STORAGE RACK

16,000 lbs. capacity unit organizes different sized bar stock, pipe, and other heavy long items.

STARTER UNIT



- Bolt together construction
- (66) 5-1/2" x 5-1/2" storage openings
- Gray powder coat finish
- 1-1/2" x 14-gauge tubing
- 1" x 1/4" bar cross-braces

BSR-66-95 – Starter Unit

3 panels with brackets.

BSR-ADDON-95 – Add-On Unit

Adds 5,300 lbs capacity to unit. Single panel with brackets bolt to starter unit.

BSR-SHELF-95 – Optional Shelf

Stores smaller pieces.

Add-on unit to store any length stock. When you order add-on panel, you get 1 panel & support.

ADD-ON UNIT

HORIZONTAL STORAGE RACKS

22" x 22" x 84" overall height

Heavy-duty units are ideally used in pairs for easy access long parts storage. Pyramid shape adds stability.

- 13-gauge steel
- Arms are spaced 7" on center
- 9 storage levels
- Gray powder coat finish
- 16-gauge steel brackets



Model	Description	Dim: WxDxH	Capacity	Ship Wt
BSR-66-95	Starter Unit	36-1/2" x 41-1/2" x 74-3/4"	16,000 lbs.	264 lbs.
BSR-ADDON-95	Add-on Unit	17" x 41-1/2" x 74-3/4"	5,300 lbs.	92 lbs.
BSR-SHELF-95	Optional Shelf	5-1/2"W x 36"L		5 lbs.

Model	Dim: WxDxH	Capacity	Ship Wt
HSR-2284-95	22" x 22" x 84"	2600 lbs.	64 lbs.

EXTENDABLE PORTABLE BAR RACK

5,000 lbs. Capacity portable unit has adjustable arm assemblies to handle different sizes of pipe, tubing and bar stock. Arms slide together and apart along heavy-duty channel with position locks.

Uprights slide along channel assembly up to 144" apart

Arms are angled to secure loads

Gray powder coat finish

Arms and uprights are 3" structural channel

Wheels & casters are arranged in diamond pattern with 1/2" tilt

- (2) 12" x 3" phenolic load wheels
- (2) 6" x 2" phenolic bolt-on swivel casters

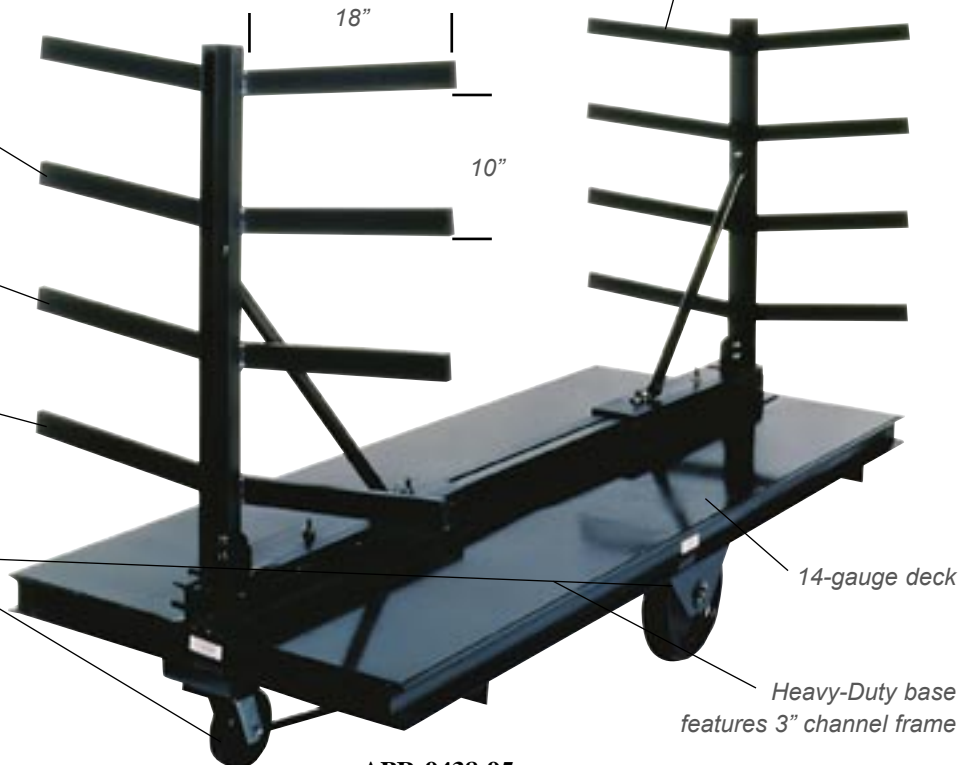

14-gauge deck

Heavy-Duty base features 3" channel frame

Model	Dim: WxDxH	Capacity
APR-9438-95	38" x 94" x 39"	5,000 lbs.

APR-9438-95



BIN SERVICE CARTS

BIN SERVICE CARTS

36"W x 35"H x 24" & 18" deep

Hook-On Bins™ store small parts below carrying surface.



RSC-1836-BLP-112-220-95
112 Hook-On Bins™

RSC-1836-BLP-95
No bins. Louvered center panels.

RSC-2436-BLP-48-230-95

48 Hook-On Bins™

RSC-2436-BLP-95

No bins. Louvered center panels.

Model	Dimensions: W x D x H	Bins: W X D x H	Ship Wt
RSC-2436-BLP-48-230-95	36" x 24" x 35"	48 - 6" x 11" x 5"	145 lbs.
RSC-2436-BLP-64-210-95	36" x 24" x 35"	64 - 4" x 5" x 3"	125 lbs.
RSC-2436-BLP-64-220-95	36" x 24" x 35"	64 - 4" x 7" x 3"	138 lbs.
RSC-1836-BLP-112-210-95	36" x 18" x 35"	112 - 4" x 5" x 3"	141 lbs.
RSC-1836-BLP-112-220-95	36" x 18" x 35"	112 - 4" x 7" x 3"	163 lbs.
RSC-1836-BLP-95	36" x 18" x 35"	No Bins	107 lbs.
RSC-2436-BLP-95	36" x 24" x 35"	No Bins	106 lbs.

ROLLING SERVICE STOCK CARTS

1,200 lbs. capacity. Easy transport of heavier parts like dies and tools, as well as picking stock items in plants, warehouses and institutions.

- 14-gauge steel
- Push handle
- Shelves have lips to keep stock from falling during transport
- 1-1/2" x 1/8" angle iron uprights
- Gray powder coat finish
- 5" x 1-1/4" bolt-on polyurethane casters (2) Swivel (2) Rigid



RSC1.5-183035-3-95

Has 1-1/2" lips around shelves



RSC3-163035-3-95

Has 3" lips around shelves

Model	Dimensions: WxDxH	No of Shelves	Ship Wt
-------	-------------------	---------------	---------

1-1/2" Lip Model

RSC1.5-183035-2-95	30" x 18" x 35"	2	58 lbs.
RSC1.5-183035-3-95	30" x 18" x 35"	3	73 lbs.
RSC1.5-183049-4-95	30" x 18" x 49"	4	96 lbs.
RSC1.5-183635-2-95	36" x 18" x 35"	2	63 lbs.
RSC1.5-183635-3-95	36" x 18" x 35"	3	85 lbs.
RSC1.5-183649-4-95	36" x 18" x 49"	4	99 lbs.
RSC1.5-184835-2-95	48" x 18" x 35"	2	95 lbs.
RSC1.5-184835-3-95	48" x 18" x 35"	3	100 lbs.
RSC1.5-184849-4-95	48" x 18" x 49"	4	105 lbs.
RSC1.5-243635-2-95	36" x 24" x 35"	2	80 lbs.
RSC1.5-243635-3-95	36" x 24" x 35"	3	108 lbs.
RSC1.5-243649-4-95	36" x 24" x 49"	4	104 lbs.
RSC1.5-244235-2-95	42" x 24" x 35"	2	100 lbs.
RSC1.5-244235-3-95	42" x 24" x 35"	3	120 lbs.
RSC1.5-244249-4-95	42" x 24" x 49"	4	140 lbs.
RSC1.5-244835-2-95	48" x 24" x 35"	2	108 lbs.
RSC1.5-244835-3-95	48" x 24" x 35"	3	125 lbs.
RSC1.5-244849-4-95	48" x 24" x 49"	4	154 lbs.

Model	Dimensions: WxDxH	No of Shelves	Ship Wt
-------	-------------------	---------------	---------

3" Lip Model

RSC3-163035-2-95	30" x 16" x 35"	2	50 lbs.
RSC3-163035-3-95	30" x 16" x 35"	3	80 lbs.
RSC3-183635-2-95	36" x 18" x 35"	2	75 lbs.
RSC3-183635-3-95	36" x 18" x 35"	3	90 lbs.
RSC3-223635-2-95	36" x 22" x 35"	2	80 lbs.
RSC3-223635-3-95	36" x 22" x 35"	3	98 lbs.

LADDER CARTS



LC-204138-48-95

1,200 lbs. capacity with safety ladder attached makes it easy to reach upper shelves while picking or replacing stock.

Gray powder coat finish

All shelves have 1-1/2" lips

2" x 1/8" angle iron uprights

14-gauge steel shelves

5" bolt-on polyurethane casters
(2) Swivel
(2) Rigid



Rubber tips prevent marking floor

Spring loaded ladder grips floor when stepped on

Model	Dim: WxDxH	No of Steps	Ladder Height	Ship Wt
LC-204138-48-95	41" x 20" x 38"	3	48"	150 lbs.
LC-244838-48-95	48" x 24" x 38"	3	48"	165 lbs.
LC-204138-78-95	41" x 20" x 38"	4	78"	169 lbs.
LC-244838-78-95	48" x 24" x 38"	4	78"	185 lbs.

KNOCKED DOWN

ECONOLINE PORTABLE STOCK TRUCKS

Cost-saving 2 and 3 shelf service carts. 500 and 1,000 lbs. capacity

Save handling and time with these 2" and 3" deep tray carts. All shelves have hemmed edges for support and safety. Top trays can be inverted to use as a work surface. 500 lbs. capacity carts are supplied with shelves with 3" lips, 1,000 lbs. capacity carts are supplied with shelves with 2" lips. 500 lbs. capacity = 22-gauge, 1,000 lbs. capacity = 18-gauge.

Model	Dim: WxDxH	Capacity	No. of Trays	Ship Wt
<i>Carts With 3" Deep Trays</i>				
ESC-163032-3L-2S-95	30" x 16" x 32"	500 lbs.	2	30 lbs.
ESC-243632-3L-2S-95	36" x 24" x 32"	500 lbs.	2	40 lbs.
ESC-163032-3L-3S-95	30" x 16" x 32"	500 lbs.	3	37 lbs.
ESC-243632-3L-3S-95	36" x 24" x 32"	500 lbs.	3	51 lbs.

<i>Carts With 2" Deep Trays</i>				
MSC-163035-2L-2S-95	30" x 16" x 35"	1,000 lbs.	2	36 lbs.
MSC-183635-2L-2S-95	36" x 18" x 35"	1,000 lbs.	2	40 lbs.
MSC-243635-2L-2S-95	36" x 24" x 35"	1,000 lbs.	2	50 lbs.
MSC-244835-2L-2S-95	48" x 24" x 35"	1,000 lbs.	2	56 lbs.
MSC-163035-2L-3S-95	30" x 16" x 35"	1,000 lbs.	3	45 lbs.
MSC-183635-2L-3S-95	36" x 18" x 35"	1,000 lbs.	3	50 lbs.
MSC-243635-2L-3S-95	36" x 24" x 35"	1,000 lbs.	3	67 lbs.
MSC-244835-2L-3S-95	48" x 24" x 35"	1,000 lbs.	3	76 lbs.

<i>Extra Shelves</i>				
EXS-1630-2-95	30" x 16"	2" Deep Shelf		10 lbs.
EXS-1836-2-95	36" x 18"	2" Deep Shelf		11 lbs.
EXS-2436-2-95	36" x 24"	2" Deep Shelf		11 lbs.
EXS-2448-2-95	48" x 24"	2" Deep Shelf		16 lbs.
EXS-1630-3-95	30" x 16"	3" Deep Shelf		12 lbs.
EXS-2436-3-95	36" x 24"	3" Deep Shelf		16 lbs.



5" x 1-1/4" polyolefin casters: (2) Swivel (2) Rigid

ESC Series
500 lbs. capacity

14-gauge steel uprights

Gray powder coat finish



Tubular push handle for easy control

5" x 1-1/4" polyolefin casters: (2) Swivel (2) Rigid

MSC Series
1,000 lbs. capacity



PORTABLE TOOL CARTS

Special purpose carts improve efficiency

1,200 lbs. capacity carts are available with and without drawers.



PTC-301TS-95
27" wide unit
with top shelf



PTC-300-95
27" wide unit



PTC-236-95
36" wide unit

14-gauge steel

Top Shelf has 1" lips on 3 sides

Welded on drawer (only on units with "D" in Model number)

Drawers slide on ball bearing rollers and recessed handle has cylinder lock and 2 keys

Gray powder coat finish

Center and bottom shelves have 1-1/2" lips up

5" x 1-1/4" polyurethane, bolt-on casters
(2) Swivel
(2) Rigid



PTC-300D-95
27" wide unit with drawer

PTC-236D-95
36" wide unit with drawer

Model	Dim: W x D x L	Ship Wt
PTC-300-95	27" x 20" x 34"	55 lbs.
PTC-301TS-95	27" x 20" x 39"	80 lbs.
PTC-300D-95	27" x 20" x 34"	110 lbs.
PTC-236-95	36" x 24" x 34"	90 lbs.
PTC-236D-95	36" x 24" x 34"	133 lbs.

GAS CYLINDER CART

GC-2131-61

21-1/2"W X 31-1/2"L X 38"H

Moves up to 24 size D or E cylinders safely and with minimum effort. An ideal cart for handling all kinds of gas cylinders, including Oxygen, Carbon Dioxide, Nitrous Oxide and Carbogen in hospitals.

- 1" x 1/8" angle iron frame with 3/8" steel rod dividers
- 1-1/4" x 1/8" angle iron uprights
- Straight push handle
- Dark green powder coat finish
- 5" x 1-1/4" polyurethane, bolt-on casters
(2) Swivel
(2) Rigid
- 14-gauge steel base
- 1,200 lbs. capacity

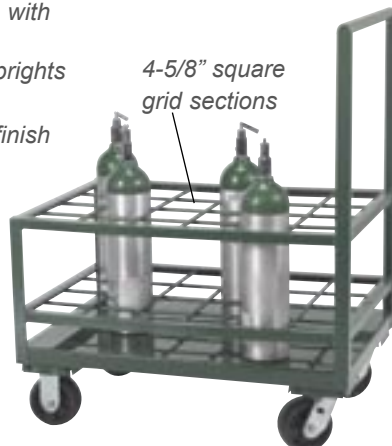

4-5/8" square grid sections

STOCK PICKING CART

SPC-2448-95

24" x 48" x 41"H

Includes writing surface and space for boxed or bulk parts.

- 14-gauge steel welded construction
- 1,200 lbs. capacity
- 1-1/2" lips on carrying surfaces
- Push handle
- Gray powder coat finish
- 5" x 1-1/4" polyurethane, bolt-on casters
(2) Swivel
(2) Rigid



Model	Dim: W x D x H	Capacity	Ship Wt
GC-2131-61	21-1/2" x 31-1/2" x 38"	1,200 lbs.	75 lbs.
SPC-2448-95	24" x 48" x 41"	1,200 lbs.	125 lbs.

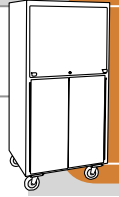

PORTABLE TABLES & WORK STATIONS

BRING THE WORK TO THE RIGHT PLACE

HODGE mobile work surfaces save time and money by making it possible to do many jobs in the best place possible. You can perform maintenance on heavy parts without transporting them through the plant. You can fill out documentation forms where assemblies are being completed. You can work on lubricant-filled parts without carrying them from one part of your plant to another.

HEAVY GAUGE STEEL CONSTRUCTION

for more durability in tough industrial environments.

ALL WELDED CONSTRUCTION

is solid and will not loosen at key stress points.

HEAVY-DUTY PIANO HINGES

on cabinet doors keep pressure off hinges for longer life and easy opening accessibility.

POWDER COAT FINISH

Baked on for durability and scratch resistance.

LOCKING DRAWERS

with easy to grab handles offer both security and convenience. Supplied with cylinder lock and 2 keys.

LOCKING HANDLE

supplied with 2 keys. Handle and cylinder locks are keyed alike.



POLYURETHANE & PHENOLIC CASTERS

Standard on most models. They are durable and will not leave marks on the floor.

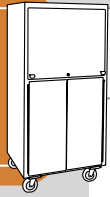

PORTABLE TABLES

20" and 30" overall height. 1,200 lbs. capacity



HIGH DECK
Overall height is 30"

1-1/2" x 1/8" angle iron frame



LOW DECK
Overall height is 20"

1-1/2" x 1/8" angle iron frame

14-gauge steel shelves

Gray powder coat finish

5" x 1-1/4" polyurethane bolt-on casters

(2) Swivel
(2) Rigid

Model	Width	Depth	No. of Shelves	Ship Wt
HMT-183630-2-95	36"	18"	2	85 lbs.
HMT-183630-3-95	36"	18"	3	105 lbs.
HMT-184830-2-95	48"	18"	2	93 lbs.
HMT-184830-3-95	48"	18"	3	114 lbs.
HMT-243630-2-95	36"	24"	2	93 lbs.
HMT-243630-3-95	36"	24"	3	114 lbs.
HMT-244230-2-95	42"	24"	2	100 lbs.
HMT-244230-3-95	42"	24"	3	121 lbs.
HMT-244830-2-95	48"	24"	2	102 lbs.
HMT-244830-3-95	48"	24"	3	135 lbs.
HMT-246030-2-95	60"	24"	2	116 lbs.
HMT-246030-3-95	60"	24"	3	156 lbs.
HMT-304830-2-95	48"	30"	2	115 lbs.
HMT-304830-3-95	48"	30"	3	152 lbs.
HMT-306030-2-95	60"	30"	2	133 lbs.
HMT-306030-3-95	60"	30"	3	178 lbs.
HMT-307230-2-95	72"	30"	2	151 lbs.
HMT-307230-3-95	72"	30"	3	194 lbs.
HMT-366030-2-95	60"	36"	2	151 lbs.
HMT-366030-3-95	60"	36"	3	194 lbs.
HMT-367230-2-95	72"	36"	2	163 lbs.
HMT-367230-3-95	72"	36"	3	205 lbs.

Model	Width	Depth	Ship Wt
LT-183020-95	30"	18"	90 lbs.
LT-183620-95	36"	18"	95 lbs.
LT-184820-95	48"	18"	104 lbs.
LT-243620-95	36"	24"	104 lbs.
LT-244220-95	42"	24"	90 lbs.
LT-244820-95	48"	24"	92 lbs.
LT-246020-95	60"	24"	95 lbs.
LT-304220-95	42"	30"	95 lbs.
LT-304820-95	48"	30"	105 lbs.
LT-306020-95	60"	30"	123 lbs.
LT-307220-95	72"	30"	141 lbs.
LT-366020-95	60"	36"	141 lbs.
LT-367220-95	72"	36"	153 lbs.

HEAVY DUTY KNOCKED DOWN

REPAIR BENCHES

48" and 60"W x 30D"
Available with or without casters
Height adjusts from 33" to 47"

Work on anything containing liquids. This 1,200 lbs. capacity unit goes where you need it and adjusts to a comfortable work height. 14"W x 20"D x 5"H drawer is fully enclosed in case.

Mobile Model	Width	Depth	Stationary Model	Ship Wt
MRB-3048-17	48"	30"	MRB-3048-NC-17	135 lbs.
MRB-3060-17	60"	30"	MRB-3060-NC-17	150 lbs.

WORK STATIONS

Red powder coat finish
4" x 1-1/4" polyurethane casters
(2) Swivel with side brakes
(2) Rigid



Work surface slopes to center drain plug

1" retaining lip

14-gauge steel work surface and shelf

Locking drawer with 2 keys

MRB-3048-17

Drip pan 9-3/4"W x 14"L x 5"H slides on angle runners

12"D adjustable shelf

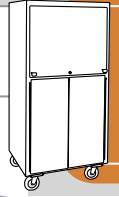

MOBILE WORK STATIONS

MOBILE STEEL COMPUTER WORK STATION MCW-243063-95 30"W X 24"D X 63"H

Protects and keeps computers clean as you move them around your plant or warehouse. 1,200 lbs. capacity



- Monitor Section:**
27"W x 23"D x 22"H (I.D.)
- Ventilated top section
 - Shelf adjusts for larger monitors.
 - Slide-Out Cover has cylinder lock.



- Bottom Section:**
27"W x 23"D x 29"H (I.D.)
- Holds printer, supplies or CPU
 - Keyboard Drawer slides out, tilts and swivels for comfortable usage.
 - Double Doors with 3-point locking handle.



- Casters:**
- 5" x 1-1/4" bolt-on polyurethane casters
 - (2) Swivel
 - (2) Rigid

16-gauge steel pull-up door

14-gauge steel construction

Comes with (2) adjustable shelves



(Closed)

(Open)

Gray powder coat finish

Model	Overall Dim: W x D x H	Top Dim: W x D x H	Bottom Dim: W x D x H	Weight
MCW-243063-95	30" x 24" x 63"	27" x 23" x 22"	27" x 23" x 29"	285 lbs.

MOBILE SHOP DESK MSD-2023-95 23"W x 20"D X 51"H

An organized work area that easily moves anywhere you need it. 500 lbs. capacity.

Also Available Stationary

- Drawer has ball bearing slides, plated handle, cylinder lock & 2 keys
- Sloped work surface with pencil rest lip
- Top storage compartments
- Half shelf sits 15" above floor
- (4) 3" swivel rubber plug-in casters
- Gray powder coat finish



MOBILE SHOP DESK CART FED-2023-95 23"W X 20"D X 51"H

An organized mobile work area with secure storage for files and records.

1,200 lbs. capacity.

- 16-gauge steel
- Sliding drawers have cylinder locks
- Drawers have ball bearing slides, plated handle, cylinder lock & 2 keys
- Lower storage compartment has single point locking handle and 2 keys. Cylinder locks & handle keyed alike
- Center shelf welded in place
- Sloped work surface with pencil rest lip
- Gray powder coat finish
- 5" x 1-1/4" bolt-on polyurethane casters
- (2) Swivel
- (2) Rigid



PORTABLE SHOP DESK PSD-2027-95 20"W X 27"D X 50"H

Holds parts and supplies below work surface. 500 lbs. capacity.

- 14-gauge steel
- Flat work surface is 40" above floor
- Top shelf has front lip bent down & 3 lips up
- All surfaces have retaining lips
- Drawer has ball bearing slides, plated handle, cylinder lock & 2 keys
- Gray powder coat finish
- (4) 3" x 1" rubber plug-in casters
- Center & bottom shelves have 1-1/2" lips up



Model	Overall Dim: W x D x H	Weight
MSD-2023-95	23" x 20" x 51"	83 lbs.
FED-2023-95	23" x 20" x 51"	120 lbs.
PSD-2027-95	27" x 20" x 50"	73 lbs.

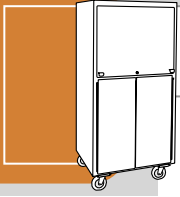

CASTERS

A selection of casters to make sure you get the right caster for your application

Every piece of HODGE Mobile Equipment comes with a standard caster offering. However, your application may have special needs requiring a different type of caster. We offer a range of caster options to help make sure you get exactly what you need.

If your application calls for something special, not shown here, call us. We can supply HODGE Mobile Equipment with the casters you specify.



POLYURETHANE
Rugged, long lasting and will not mark floors.



PHENOLIC
Exceptionally durable and easy to roll.



HARD RUBBER
Durable casters provide a quiet ride.



MOLD ON RUBBER
These are extremely quiet.



FULL PNEUMATIC
Air-filled tires provide the smoothest ride possible across rough areas.



**POLYOLEFIN/
PLASTIC**
Exceptionally durable and easy to roll.



**SOFT RUBBER
PLUG/STEM**
Quiet, light duty.

Model	Description	Weight Lbs.	Capacity
HC1101S	3 X 1 Soft Rubber Plug/Stem in Swivel	1	75 lbs.
HC1103S	3 x 1 1/4 Polyolefin/Plastic Swivel	2	250 lbs.
HC1147S	4 x 1 1/4 Polyurethane Swivel	2-1/2	300 lbs.
HC1146R	4 x 1 1/4 Polyurethane Rigid	2-1/2	300 lbs.
HC1107S	4 x 1 5/8 Hard Rubber Swivel	4	350 lbs.
HC1108R	4 x 1 5/8 Hard Rubber Rigid	4	350 lbs.
HC1149S	5 X 1 1/4" Polyurethane Swivel	3	300 lbs.
HC1150R	5 X 1 1/4 Polyurethane Rigid	3	300 lbs.
HC1115S	5 X 2 Mold On Rubber Swivel	4	500 lbs.
HC1116R	5 X 2 Mold On Rubber Rigid	4	500 lbs.
HC1151S	6 X 2 Phenolic, Swivel	8	900 lbs.
HC1152R	6 X 2 Phenolic, Rigid	8	900 lbs.
HC1123S	8 X 2 Mold On Rubber Swivel	9	600 lbs.
HC1124R	8 X 2 Mold On Rubber Rigid	9	600 lbs.
HC1153S	8 X 2 Polyurethane Swivel	9	900 lbs.
HC1154R	8 X 2 Polyurethane Rigid	9	900 lbs.
HC1125S	8 X 2 1/2 Full Pneumatic Swivel	11	300 lbs.
HC1126R	8 X 2 1/2 Full Pneumatic Rigid	11	300 lbs.
HC1144S	10 X 3.5 Full Pneumatic Swivel	12	470 lbs.
HC1145R	10 X 3.5 Full Pneumatic Rigid	12	470 lbs.

STATIONARY WORK STATIONS

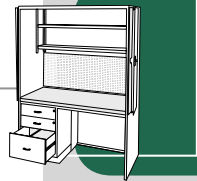

GIANT SECURITY WORK STATION 61"W X 30-1/2"D X 84"H

Set up a workstation anywhere with this unique combination of drawers, file storage, work bench, shelves and pegboard. Files and supplies are within handy reach. Tools can be stored on pegboard hooks. Everything you need is here securely locked behind double doors.

Flush latch



HGSW-613084-LPT-61

Pegboard and holders

30" x 60" laminated plastic work surface

Double bi-fold doors lock shut top section

2 drawers
20"W x 19-3/4"D x 5"H

All drawers have ball bearing slides, handle, cylinder lock and 2 keys. All drawers keyed alike.

File drawer
20" x 19-3/4" x 11"

1-1/2" diameter hole for electrical cord on side

10"D adjustable shelves

Dark green powder coat finish



Large 35-1/2"W x 30-1/4"H clearance for person to sit comfortably

Model	Dim: W x D x H	Laminated Top	Ship Wt
HGSW-613084-LPT-61	61" x 30-1/2" x 84"	Plastic	650 lbs.
HGSW-613084-LMT-61	61" x 30-1/2" x 84"	Maple	650 lbs.
HGSW-613084-WST-61	61" x 30-1/2" x 84"	Shop Top	650 lbs.

Drawer

20"W x 20"D x 5"H

Drawer

14"W x 20"D x 5"H



SFWS-392955-95

STATIONARY FILE WORK STATIONS AND STAND UP DESK 39"W X 29"D X 55-1/2"H

Heavy duty desk with handy file storage drawers and supply storage areas.

- Gray powder coat finish
- 16-gauge steel construction
- 8-compartment riser has space for papers, forms, etc.
- Smooth writing surface is 43-1/2" above floor
- All drawers have ball bearing slides, recessed handle, cylinder locks & 2 keys
- All drawers are keyed alike

File Drawers
14"W x 20"D x 11"H

Model	Dim: W x D x H	Ship Wt
SFWS-392955-95	39" x 29" x 55-1/2"	350 lbs.

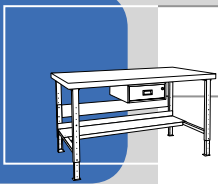

PEDESTAL-STYLE WORK STATIONS

A versatile, heavy-duty work station system

Your choice of pedestals support your choice of work surfaces and storage attachments. The versatile configuration starts with the basic unit, supplied with a top of your choice, (2) pedestals and a foot support. Add work and storage accessories to meet your requirements.



Optional riser shelf
See page 42

5 different work surfaces are available
See page 42

Drawers slide on
ball bearing rollers

Flush pulls

Cylinder locks
keyed alike

Locking handle
with 2 keys

Steel pedestals

Laminated maple top unit shown with
optional 60" wide riser shelf, 4-drawer
pedestal and cabinet pedestal

STEEL ALL-WELDED PEDESTALS

Select from three different pedestal styles to get your desired configuration. All pedestals are 16-5/8" x 29" D x 32" H.

Model	Size W x D x H	Ship Wt
WB-PED-291632-4DR-95	16 5/8" x 29" x 32"	130 lbs
WB-PED-291632-CAB-95	16 5/8" x 29" x 32"	90 lbs
WB-PED-291632-3DR-95	16 5/8" x 29" x 32"	129 lbs



WB-PED-291632-4DR-95
Pedestal w/4 Locking Drawers



WB-PED-291632-CAB-95
Pedestal w/Locking Cabinet



WB-PED-291632-3DR-95
Pedestal w/3 Locking Drawers
and Cabinet

ERGONOMIC WORK BENCHES

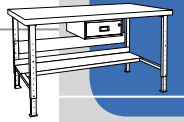

Add the right storage and organizational riser accessories

Available in basic and folding leg designs. You can easily adjust surface heights from 28" to 42" above the floor and choose the right work surface for your application. Add shelves and drawers as needed. 2,000 lbs. capacity. These work benches create more comfortable and productive work areas.



Easy to assemble

Top bolts to legs through tapped holes for sturdiness

5" wide stringers lock legs in position

Bench legs adjust from 28" to 42" on 2" centers

14-gauge steel work surface, stringers and optional shelves

Boxed ends

Bench legs are pre-punched to accommodate top, stringer and shelf

Drawer has ball bearing slides, recessed handle, cylinder locks & 2 keys

Gray powder coat finish

Pre-punched for lagging to floor

BASIC MODEL WITH STRINGER & OPTIONAL SHELF AND DRAWER

10' wide units utilize 3 bench legs. Available in 5 widths from 48" to 120" and 3 depths from 30", 36" & 48"

FOLDING LEG STYLE BENCHES

have support braces to hold legs in place and replace stringers. Assembles in minutes.



Tempered hard board over steel top

FOLDING LEG STYLE WORK BENCHES

can be stored in less space and stacked on top of each other.



10' WIDE FOLDING LEG WORK BENCH WITH OPTIONAL SHELF

- Adjusts from 28" to 42" above ground
- Legs are hinged and welded at top

Model	Model	Dim: W x D	Ship Wt
<i>Basic</i>			
WB-3048-95		48" x 30"	103 lbs.
WB-3648-95		48" x 36"	115 lbs.
WB-3060-95	<i>Folding Leg</i>	60" x 30"	115 lbs.
WB-3660-95	WBF-3660-95	60" x 36"	129 lbs.
WB-3072-95	WBF-3072-95	72" x 30"	127 lbs.
WB-3672-95	WBF-3672-95	72" x 36"	142 lbs.
WB-3084-95	WBF-3084-95	84" x 30"	146 lbs.
WB-3684-95	WBF-3684-95	84" x 36"	163 lbs.
WB-4884-95	WBF-4884-95	84" x 48"	205 lbs.
WB-3096-95	WBF-3096-95	96" x 30"	160 lbs.
WB-3696-95	WBF-3696-95	96" x 36"	180 lbs.
WB-4896-95	WBF-4896-95	96" x 48"	226 lbs.
WB-30120-95	WBF-30120-95	120" x 30"	222 lbs.
WB-36120-95	WBF-36120-95	120" x 36"	247 lbs.
WB-48120-95	WBF-48120-95	120" x 48"	308 lbs.

For Tempered Hardboard over Steel top Add -TH to Model No. For example: WB-TH-3048-95

SELECT THE RIGHT WORK SURFACE

Basic models come with smooth 14-gauge steel tops with channels on all four sides and welded corners ground smooth. You can also select Laminated Maple, Laminated Plastic, Tempered Hardwood over Steel and Shop Tops. See page 42

ADD A SHELF

14-gauge half shelves are 12" wide, flanged at back and pre-punched to attach to bench legs. See page 43

ADD A DRAWER

Locking drawer is fully enclosed and easily bolts to underside of work surface using angles. Use it to store supplies, files and valuable tools. See page 43

ADD A STORAGE OR UTILITY RISER

Bolt-On Risers can be used to keep small parts, supplies, manuals, files and documentation forms close at hand. See page 42

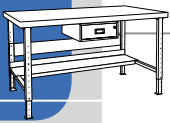

ACCESSORIES

Everything has its place with these organizational accessories for both Pedestal-style Work Stations and Ergonomic Work Benches

ADD THE RIGHT ACCESSORIES

RISER SHELF

Supplied with the riser shelf and hardware for mounting.

Model	Size W x D x H	Ship Wt
WB-RS-48-95	48" x 10" x 14"	24 lbs.
WB-RS-60-95	60" x 10" x 14"	27 lbs.
WB-RS-72-95	72" x 10" x 14"	30 lbs.
WB-RS-84-95	84" x 10" x 14"	33 lbs.



LOUVERED PANEL ACCESSORY

Supplied with uprights, 18" louvered panel and necessary hardware. Optional bins, order separately (see pg. 21).

Model	Size W x H	Ship Wt
WB-BPL-48-95	48" x 18"	26 lbs.
WB-BPL-60-95	60" x 18"	28 lbs.
WB-BPL-72-95	72" x 18"	33 lbs.
WB-BPL-84-95	84" x 18"	38 lbs.



TWO SHELF BENCH ACCESSORY

Supplied with two adjustable shelves, uprights and hardware for mounting.

Model	Size W x D x H	Ship Wt
WB-BA-2S-48-95	48" x 12" x 42"	37 lbs.
WB-BA-2S-60-95	60" x 12" x 42"	44 lbs.
WB-BA-2S-72-95	72" x 12" x 42"	50 lbs.
WB-BA-2S-84-95	84" x 12" x 42"	57 lbs.



TOP WORK SURFACES

Basic models come with smooth 14-gauge steel tops with channels on all four sides and welded corners ground smooth. Tops are also available in:



STEEL TOP



LAMINATED PLASTIC TOP



MAPLE TOP



WOOD SHOP TOP



TEMPERED HARD BOARD OVER STEEL

Size Top	Plastic	Ship Wt	Maple	Ship Wt	Shop Top	Ship Wt	Hard Board	Ship Wt
30" x 48"	LPT3048-300-43	50 lbs.	LMT3048-975	70 lbs.	WST3048-150	70 lbs.	WB-TH-3048-95	114 lbs.
36" x 48"	LPT3648-300-43	60 lbs.	LMT3648-975	84 lbs.	WST3648-150	84 lbs.	WB-TH-3648-95	128 lbs.
30" x 60"	*LPT3060-300-43	63 lbs.	*LMT3060-975	88 lbs.	*WST3060-150	88 lbs.	WB-TH-3060-95	129 lbs.
36" x 60"	*LPT3660-300-43	75 lbs.	*LMT3660-975	105 lbs.	*WST3660-150	105 lbs.	WB-TH-3660-95	145 lbs.
30" x 72"	*LPT3072-300-43	75 lbs.	*LMT3072-975	105 lbs.	*WST3072-150	105 lbs.	WB-TH-3072-95	143 lbs.
36" x 72"	*LPT3672-300-43	90 lbs.	*LMT3672-975	126 lbs.	*WST3672-150	126 lbs.	WB-TH-3672-95	162 lbs.
30" x 84"	LPT3084-300-43	88 lbs.	LMT3084-975	123 lbs.	WST3084-150	123 lbs.	WB-TH-3084-95	165 lbs.
36" x 84"	LPT3684-300-43	105 lbs.	LMT3684-975	147 lbs.	WST3684-150	147 lbs.	WB-TH-3684-95	186 lbs.
48" x 84"	LPT4884-300-43	140 lbs.	LMT4884-975	196 lbs.	WST4884-150	196 lbs.	WB-TH-4884-95	238 lbs.
30" x 96"	LPT3096-300-43	100 lbs.	LMT3096-975	140 lbs.	WST3096-150	140 lbs.	WB-TH-3096-95	182 lbs.
36" x 96"	LPT3696-300-43	120 lbs.	LMT3696-975	168 lbs.	WST3696-150	168 lbs.	WB-TH-3696-95	207 lbs.
48" x 96"	LPT4896-300-43	160 lbs.	LMT4896-975	224 lbs.	WST4896-150	224 lbs.	WB-TH-4896-95	263 lbs.
30" x 120"	LPT30120-300-43	125 lbs.	LMT30120-975	175 lbs.	WST30120-150	175 lbs.	WB-TH-30120-95	250 lbs.
36" x 120"	LPT36120-300-43	150 lbs.	LMT36120-975	210 lbs.	WST36120-150	210 lbs.	WB-TH-36120-95	270 lbs.
48" x 120"	LPT48120-300-43	200 lbs.	LMT48120-975	280 lbs.	WST48120-150	280 lbs.	WB-TH-48120-95	355 lbs.

*These tops are available from stock

ERGONOMIC WORK TABLE ACCESSORIES

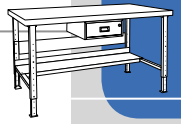

BENCH LEGS

Adjustable legs for use with variety of tops to make your own bench. Welded channel construction with base plate pre-punched for lagging to floor. Pre-punched to accommodate top, stringer and shelf. Bolts used to attach legs to top go into tapped holes to make bench even sturdier.



BENCH LEGS

Model	Dimensions
WB-LEG-25-95	25" for 30" deep top
WB-LEG-31-95	31" for 36" deep top
WB-LEG-45-95	45" for 48" deep top

DRAWERS

Fully enclosed drawer unit attaches beneath the work surface using supplied angle brackets. For HODGE Steel Top Work Benches. Attaches to wood tops with wood screws. For HODGE Steel Bench Tops you must order the corresponding drawer. (see chart)

Metal drawer enclosure bolts to underside of workbench surface

Cylinder lock with two keys

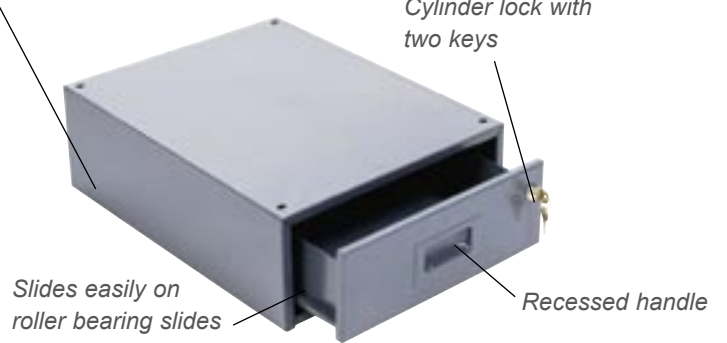

177-DRAWER-95

For maple, plastic or shop top benches. 14"W x 20"D x 5"H drawer is fully encased in a 15-3/4"W x 20"D x 6-7/8"H case.

For Steel Top Benches	Drawer Model
30" Deep	177-DRAWER-30-95
36" Deep	177-DRAWER-36-95
48" Deep	177-DRAWER-48-95



SHELVES

14-gauge steel shelves have 3" back lip and 1-1/2" front flange. Easily bolts to cross braces on legs and sits 9-3/4" above the floor.

STRINGERS

14-gauge steel stringers provide additional rigidity to work benches by locking legs into position.

Model	Ship Wt	Model	Ship Wt	Length
<i>Stringers</i>		<i>Shelves</i>		
WB-STRINGER-48-95	6 lbs.	WB-SHELF-48-95	15 lbs.	48" long
WB-STRINGER-60-95	8 lbs.	WB-SHELF-60-95	19 lbs.	60" long
WB-STRINGER-72-95	9 lbs.	WB-SHELF-72-95	23 lbs.	72" long
WB-STRINGER-84-95	10 lbs.	WB-SHELF-84-95	32 lbs.	84" long
WB-STRINGER-96-95	13 lbs.	WB-SHELF-96-95	40 lbs.	96" long
WB-STRINGER-120-95	25 lbs.	WB-SHELF-120-95	50 lbs.	120" long

BACK & END STOPS

Prevent parts from accidentally slipping off the work table.



Model	Size	Ship Wt
WB-BE-3048-95	30" x 48"	14 lbs.
WB-BE-3648-95	36" x 48"	15 lbs.
WB-BE-3060-95	30" x 60"	15 lbs.
WB-BE-3660-95	36" x 60"	16 lbs.
WB-BE-3072-95	30" x 72"	17 lbs.
WB-BE-3672-95	36" x 72"	18 lbs.
WB-BE-3084-95	30" x 84"	18 lbs.
WB-BE-3684-95	36" x 84"	19 lbs.
WB-BE-4884-95	48" x 84"	22 lbs.
WB-BE-3096-95	30" x 96"	19 lbs.
WB-BE-3696-95	36" x 96"	20 lbs.
WB-BE-4896-95	48" x 96"	23 lbs.
WB-BE-30120-95	30" x 120"	22 lbs.
WB-BE-36120-95	36" x 120"	23 lbs.
WB-BE-48120-95	48" x 120"	26 lbs.

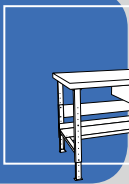

EXTRA HEAVY-DUTY WORKBENCHES

10,000 lbs. capacity brings heavy work to a comfortable level

The Big Bruiser of workbenches makes it as easy as possible to work on the heaviest assemblies. Everything about this workbench is as heavy-duty as it gets from the 1/4" thick steel plate work surface to the sturdy channel-shaped legs made from solid 3/16" thick steel.

2-1/2" back stop



Optional drawer opens and closes easily on ball bearing slides

3" "C" channel frame

29-1/2" deep shelf sits 10" above floor

1/4" steel plate welded to 3" channel frame

3" x 3" x 3/16" angle iron legs

HWB-3672-177D-95
with drawer



OPTIONAL DRAWER

14"W x 20"D x 5"H drawer is fully encased in a 15-3/4"W x 20"D x 6-7/8"H case. Attaches to underside of work surface with bolts using pre-drilled holes that place drawer in the center. Opens and closes easily on ball bearing slides. Recessed handle with lock and 2 keys.



HWB-3672-95
Includes full shelf 10" above floor

Model	Top Size	Weight
HWB-3648-95	36" x 48"	316 lbs.
HWB-3660-95	36" x 60"	353 lbs.
HWB-3672-95	36" x 72"	390 lbs.

With Drawer

HWB-3648-177D-95	36" x 48"	336 lbs.
HWB-3660-177D-95	36" x 60"	373 lbs.
HWB-3672-177D-95	36" x 72"	410 lbs.



STEEL BULK CONTAINERS

Rugged ribbed steel containers handle up to 4,000 lbs. of metal scrap and parts

These all-welded, stackable containers can hold up to 4,000 lbs. of heavy scrap and parts. The raised legs make them forkliftable so you can easily move them around your plant.

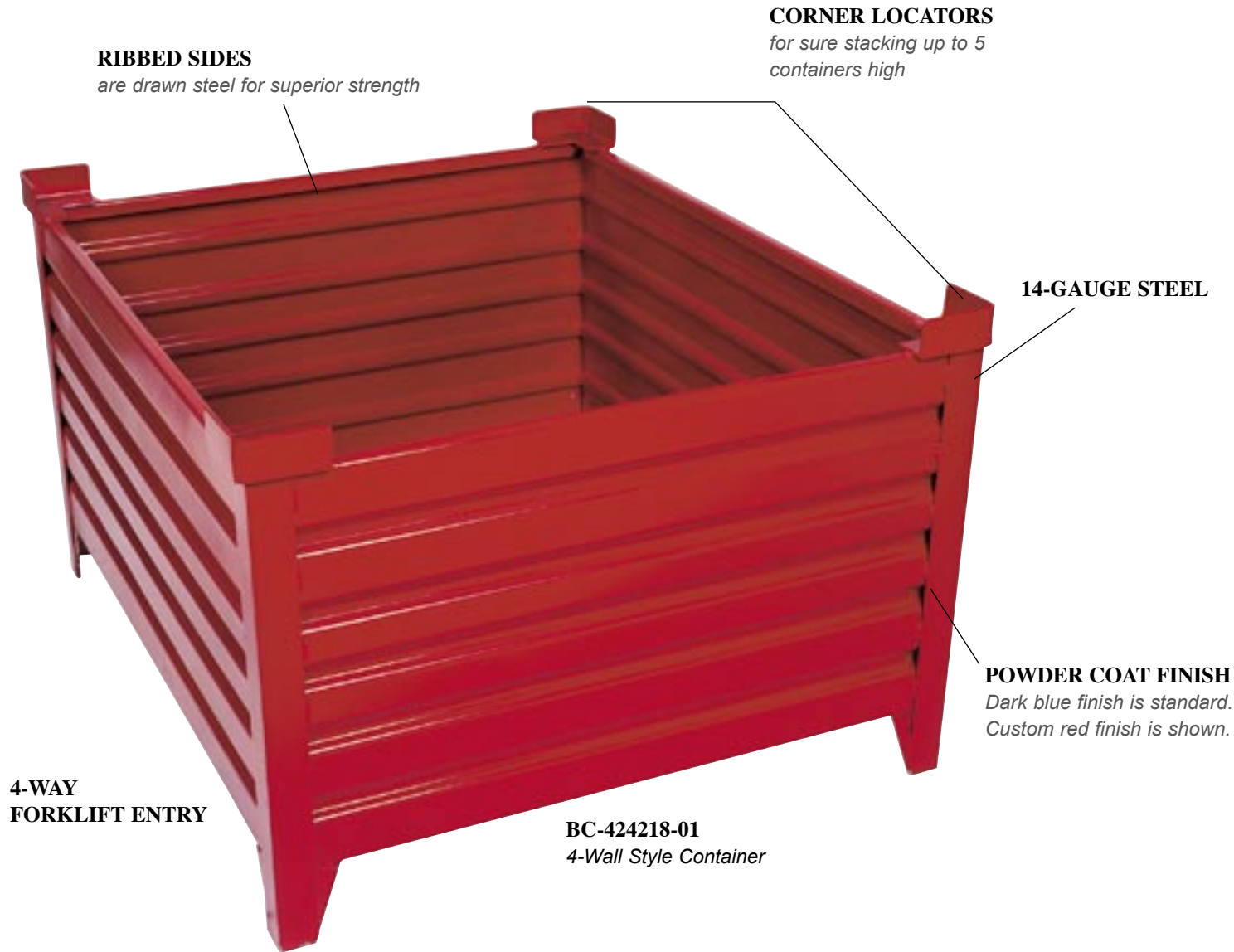

BC-424218-01
4-Wall Style Container

4-WALL CONTAINERS

Model	Inside Dim: WxLxH	Ship Wt
BC-303018-01	30" x 30" x 18"	111 lbs.
BC-303618-01	36" x 30" x 18"	127 lbs.
BC-304218-01	42" x 30" x 18"	144 lbs.
BC-304818-01	48" x 30" x 18"	151 lbs.
BC-363618-01	36" x 36" x 18"	140 lbs.
BC-364218-01	42" x 36" x 18"	153 lbs.
BC-364818-01	48" x 36" x 18"	174 lbs.
BC-424218-01	42" x 42" x 18"	178 lbs.
BC-424818-01	48" x 42" x 18"	192 lbs.
BC-484818-01	48" x 48" x 18"	210 lbs.

Model	Inside Dim: WxLxH	Ship Wt
BC-303024-01	30" x 30" x 24"	138 lbs.
BC-303624-01	36" x 30" x 24"	148 lbs.
BC-304224-01	42" x 30" x 24"	165 lbs.
BC-304824-01	48" x 30" x 24"	177 lbs.
BC-363624-01	36" x 36" x 24"	163 lbs.
BC-364224-01	42" x 36" x 24"	180 lbs.
BC-364824-01	48" x 36" x 24"	200 lbs.
BC-424224-01	42" x 42" x 24"	201 lbs.
BC-424824-01	48" x 42" x 24"	220 lbs.
BC-484824-01	48" x 48" x 24"	240 lbs.



FLAMMABLE & GAS CYLINDER STORAGE

Store flammable materials safely and securely

DOUBLE WALL FLAMMABLE STORAGE CONTAINERS

- Store 5-gallon cans or flammable materials safely and securely

2" pipe vent with cap on top can be connected to a ventilating system

Safety yellow powder coat finish

3-point locking handle with 2 keys

4" high legs



FC-60-25

Warning labels

14-gauge steel top

Draft channels welded to inside back panel

Full piano hinges

16-gauge sides have 1-1/2" space between double walls

Removable (not adjustable) shelves

2" leak proof base controls spills



ECONOLINE GAS CYLINDER STORAGE CABINETS



EGCC8-423068-25

Safely store 20, 30 and 43 lb. cylinders of flammable gases. Lockable cabinets store cylinders of fuel, LP Gas and other flammable materials on easy to access, sloped cradle racks.

- Expanded metal sides, back and doors. Solid top
- **NO SMOKING** signs are riveted to doors
- Piano hinges
- 1-1/2" x 1/8" angle iron frame
- Hasp on doors for use with padlock
- Sloped cradle racks
- Pre-drilled holes for lagging to floor
- Safety yellow powder coat finish



EGCVC-425668-25

Model	Capacity	Dim: WxDxH	# Shelves	Ship Wt
EGCC4-423041-25	4 cylinders	30" x 42" x 41"	2	190 lbs.
EGCC8-423068-25	8 cylinders	30" x 42" x 68-1/2"	4	265 lbs.
EGCC12-424268-25	12 cylinders	42" x 42" x 68-1/2"	4	398 lbs.
EGCC16-425668-25	16 cylinders	56" x 42" x 68-1/2"	4	415 lbs.
EGCVC-425668-25	10/20 cylinders	56" x 42" x 68-1/2"	0	310 lbs.
FC-20-25	20 gallons	28" x 28" x 29"	0	175 lbs.
FC-40-25	40 gallons	28" x 28" x 39"	1	260 lbs.
FC-60-25	60 gallons	28" x 28" x 55"	2	340 lbs.



DOLLIES AND WORK PLATFORMS



HWP-364862-25

FORK TRUCK WORK PLATFORM

Shown with optional hook-on tool tray and fluorescent tube caddy.

Model	Dim: WxDxH	Capacity	Ship Wt
HWP-364862-25	36" x 48" x 62"	1,000 lbs.	250 lbs.
HWP-364884-25	36" x 48" x 84"	1,000 lbs.	265 lbs.



HOOK-ON TOOL TRAY: HWP-36-TRAY-95

Rests across handrails and use for tools and parts. Gray powder coat finish.

FLUORESCENT TUBE CADDY: HWP-TC129-95

Hooks securely on side of work platform to keep bulbs safe and close at hand. Gray powder coat finish. 12" x 9".



DOLLIES



SAD-119D1-95

SAD-119D1 & SAD-119D2 STEEL DRUM DOLLIES

800 and 1,500 lbs. capacity dollies make 55-Gallon drums mobile. Rugged units are constructed of 1-1/4" x 1-1/4" x 1/8" angle iron. Gray powder coat finish.

Model	Capacity	Ship Wt
SAD-119D1-95	55 Gal./800 lbs.	16 lbs.
SAD-119D2-95	55 Gal./1,500 lbs.	20 lbs.

SAD-119-1-95

4" hard rubber swivel casters on 1,500 lbs. capacity dollies



3" polyolefin swivel casters on 800 lbs. capacity dollies

STEEL ANGLE IRON DOLLIES

800 and 1,500 lbs. capacity units easily move items around your plant, warehouse or facility. Available in both Lip-Up and Flush Top styles. Gray powder coat finish.

Model	Dim: WxLxH	Capacity	Ship Wt
<i>Dollies With Lips Up</i>			
SAD-119-1-95	22-1/2" x 26-1/2" x 5"	800 lbs.	25 lbs.
SAD-119-2-95	22-1/2" x 26-1/2" x 6"	1,500 lbs.	26 lbs.
<i>Dollies With Flush Tops</i>			
SAD-119-3-95	22-1/2" x 26-1/2" x 5"	800 lbs.	25 lbs.
SAD-119-4-95	22-1/2" x 26-1/2" x 6"	1,500 lbs.	26 lbs.

PRODUCT MODIFICATIONS AND CUSTOM-BUILT PRODUCTS

This is not something new at HODGE. We've done special things for our customers for over 65 years.

Sometimes you need something different in order to do the job right. This is the reason we have built as much flexibility as possible into our manufacturing processes. We have the ability to get the heavy-duty equipment you need in (1) the size you need it, (2) with the mobility required, (3) in the exact configuration you want, and (4) in the special color you need. We can even engineer and manufacture products totally different than anything you see in this catalog... all you have to do is ask.

Here are some of the most common ways we customize products for customers:

SPECIAL COLORS:

In addition to the standard colors, we can also produce products quickly in the following colors:

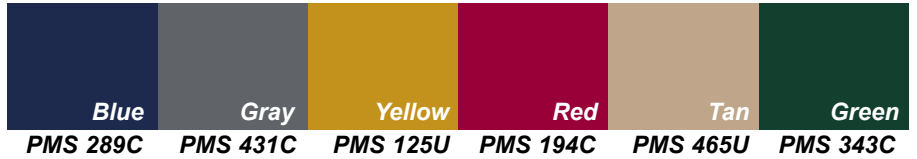

SPECIAL MOBILITY

You may require different casters than are normally offered on a particular product. Select from the caster types shown on page 38, or specify something not shown. You can also specify floor locks and side brakes for casters.



SPECIAL CONFIGURATIONS

Add locker handles and transport handles. Tilt shelves for gravity feed applications. Turn shelves lip up or down for different needs. Add shelves, Hook-On Bins™, fork channels, holes or cutouts, stacking feet, rubber corner bumpers and a host of other special features you require.



SHELVING

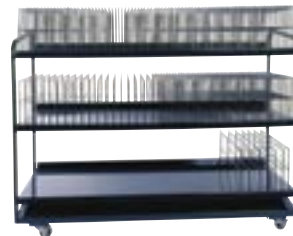

FILE CART



A-FRAME BIN TRUCK

SPECIAL SIZES

Add width, depth or height to meet your needs.



CART



SLOPED TOP CABINET



MOBILE CABINET

SPECIAL PRODUCTS

Tell us what you want and we'll find a solution.



DROP BOX



WORK PLATFORM



SATELLITE DISH MOUNT

DURHAM FAMILY OF PRODUCTS

FIRST AID

Commercial, Industrial and Consumer Plastic and Metal Kits, Cabinets and Cases for the Packaging of a wide variety of Unitized and Non-Unitized First Aid Products, Devices and Supplies



LITERATURE ORGANIZERS

Models for the organization, Storage and display of magazines, catalogs, manuals, work orders and paper forms in the office, factory, warehouse, reception area and retail environments of all types.



INDUSTRIAL/ COMMERCIAL STORAGE

Storage products for the organization, merchandising and packaging of fasteners, hydraulic and pipe fittings, plumbing specialties, electrical/electronic components and virtually all types of small parts.



INDEX

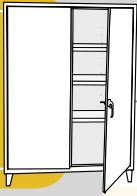

HODGE CABINETS

Super Strong – Flush Door Style (60"W)	7
Super Jumbo – 4" D Box Door Style (48"W)	8
Jumbo – Flush Door Style (48"W)	9
Jumbo – Combination Bin & Drawer (48"W)	10
Combination Bin & Drawer (36"W)	11
Flush Door Style (36"W)	12-13
Job-Site Storage	14
Institutional Heavy-Duty Lockers	14
Clearview	14
Worktable Top	15
Table High Storage Cabinets	16

HODGE HEAVY-DUTY SHELVING

Open-type Shelving	16
Sloped Shelf Units	16

HODGE MOBILE CABINETS

Econoline Bench Units	18-19
Mobile Bench	20
Super Heavy-Duty	20
Mobile Bin Unit	20

HODGE CABINET ACCESSORIES

Hook-On Bins™	21
---------------	----

HODGE HEAVY-DUTY TRUCKS

Steel Platform	23
Steel Bound Hardwood Deck Platform	23
All Wood Deck Platform	23
Aluminum Platform	23
Cushioned Utility	23
5 th Wheel Wagon Trucks (Steel and Hardwood Deck)	24
High End Platform (U-Boats)	24
Tubular Steel	24
2 and 3 Sided - Sheet Metal Sides	24
3 Sided – Expanded Metal Sides	24
3 Sided – Solid Metal Sides	25
3 Sided – Steel Strap Sides	25
Heavy-Duty Shop – Straight & Offset Handle Trucks	26
Open Portable Shelf	26
Mesh Stock	27
Low Deck Stock – 3 & 4 Sided	27
Security	27
Pan & Tray	28
5 Shelf	28
Adjust-A-Tray	29
"A" Frame	29

HODGE LONG PARTS HANDLING RACKS & TRUCKS

Vertical Long Parts Storage Rack	30
Portable Bar Rack	30
Bar Cradle Trucks	30
Heavy-Duty Bar Storage Rack	31
Horizontal Storage Rack	31
Extendable Portable Bar Rack	31

HODGE MOBILE SERVICE & WORK CARTS

Bin	32
Rolling	32
Ladder	33
Econoline Portable Stock	33
Portable Tool	34
Gas Cylinder	34
Stock Picking	34

HODGE PORTABLE TABLES

High Deck	36
Low Deck	36
Repair Benches	36

HODGE MOBILE WORK STATIONS

Computer	37
Shop Desks	37

HODGE MOBILE ACCESSORIES

Casters	38
---------	----

HODGE STATIONARY WORK STATIONS

Giant Security	39
Stand Up Desk with File Drawers	39
Pedestal-Style	40-42

HODGE WORK BENCHES

Ergonomic	41-44
Folding Leg Ergonomic	41-44
Extra Heavy-duty	44

HODGE MAINTENANCE & SAFETY PRODUCTS

4-Wall Steel Bulk Containers	46
Flammable Storage Containers	46
Econoline Gas Cylinder Storage Cabinets	46
Fork Truck Work Platform	47
Hook-On Tool Tray	47
Fluorescent Tube Caddy	47
Dollies – Steel Drum	47
Dollies – Steel Angle Iron	47

HODGE CUSTOM-BUILT PRODUCTS & MODIFICATIONS

WARRANTY & TERMS

WARRANTY & TERMS

Warranty

HODGE Division warrants that, at time of shipment, the products manufactured by HODGE Division are free from defects in material and workmanship. Hodge Division's obligation under this warranty is limited to replacement or repair of such products within one year from the date of shipment. No material is accepted for replacement or repair without the written authority of Hodge Division. Replacement or repair is made only after an examination at the Springfield, MA plant shows defective material or workmanship of the manufacture. All shipping charges on the returned material must be prepaid by the customer. HODGE Division is in no event liable for consequential damages, installation costs or other costs of any nature as a result of the use of the products manufactured by HODGE Division, whether used in accordance with the instructions or not. This warranty is in lieu of all others, either expressed or implied. No representative is authorized to assume for HODGE Division any other liability in connection with HODGE Division's products.

Terms

The terms are net 30 days FOB Springfield, MA, to all companies with approved credit. To establish credit, submit one bank and three trade references. An open account can be established on a satisfactory Dun & Bradstreet Rating.

Method of Shipment

Orders will be shipped by specifically requested carriers whenever possible. If there are no special instructions, HODGE Division will ship via the best available routing, prepaid & add.

Damaged Shipments

Customers must inspect all incoming freight and note damage in writing on the freight bill. Claims for loss or damage by motor carrier must be filed by the customer directly with the freight company. UPS claims are to be reported to a Customer Service Representative.

Returns

Returned goods will not be accepted without a Return Authorization Number which can be obtained by calling Customer Service. All returns must be shipped back in the original cartons and packing material, freight prepaid. All returns are subject to a 25% restocking charge. Custom or modified items are non-returnable.

** Products shown in this catalog are subject to change.*

HODGE

A STRONG LINK IN THE SUPPLY CHAIN

HODGE Heavy-Duty Equipment is built to last in rugged industrial and commercial environments. This is the kind of equipment we have made since 1936. Today, as a Division of The Durham Manufacturing Company, we are in an even stronger position to take care of your non-powered material handling and storage product needs.

At HODGE you will find products to help move goods through your facility; products that make it easier for employees to work; and products that help you organize storage in as little space as possible. You will also find a spirit of cooperation to help you get the right products for your application, when and where you need them. We can even modify and customize existing products, or design an entirely new product if the need demands.

Call your HODGE dealer, today and start putting more strength in your material handling systems. If you need help finding a HODGE dealer near you, please call and we'll point you in the right direction.



THE DURHAM MANUFACTURING CO.
Website: www.durhammfg.com

HODGE
Division of The Durham Manufacturing Co.
Website: www.hodgemfg.com



A Division of  DURHAM Mfg. Co., Inc.

Distributed By:

