



Office Supplies & Stationery

***Section 8
Product Groups 787 - 849***

Section 8 Contents

Description	Group	Page
Archive Boxes & Storage	800	1326 - 1327
Banding, Strapping & Accessories	837	1394 - 1396
Briefcases & Luggage	803	1328 - 1329
Calculators	825	1378 - 1379
Catering Appliances	787	1322 - 1323
Catering Consumables	788	1324 - 1325
Clocks	802	1330
Communications	838	1408
Computer Accessories	803	1332 - 1334
Computer Cleaners	803	1335
Computer Media	804	1336 - 1337
Copier & Printer Paper	805	1338 - 1340
Desk Organisers & Trays	806	1341
Data Books	849	1435
Envelopes	809	1345
Fans & Heaters	828	1388
Filing - Expanding Files & Box Files	810	1346
- Lever Arch & Ring Binders	810	1347 - 1348
- Punched Pockets & Dividers	810	1349 - 1350
- Wallets & Folders	810	1351 - 1353
Fire Resistant Safes	820	1371
Furniture	811	1354 - 1365
Highlighters	846	1420
Hole Punches	838	1408
Key Cabinets & Safes	820	1370 - 1371
Labelling Machines	821	1372 - 1373
Printers	822	1374
Labels	823	1375 - 1377
Machines - Consumables	826	1383
- Office	825	1380 - 1383
Markers - Ink	846	1421 - 1423
Note Books & Pads	827	1384 - 1387
Office Adhesives	807	1344
Presentation & Organisers	801	1328
Packaging - Cartons & Tubes	837	1397
- Paper & Bubble	837	1399 - 1400
- Padded Envelopes	837	1398 - 1399
- Polythene	837	1401 - 1403
Paper Clips & Clipboards	807	1342
Presentation & Conference - Accessories & Consumables	836	1390 - 1393
- Boards	836	1389 - 1392
- Holders & Frames	836	1391 - 1392
Rubber Bands, Pins, Tags & Clips	807	1343
Safes	820	1371
Security Badges - Key Rings	820	1368 - 1369
Security Mirrors	820	1369
Stamps & Inks	817	1366 - 1367
Staplers & Staples - Office	838	1406 - 1407
Tackers & Staplers - Heavy Duty	838	1404 - 1405
Time Recording	802	1331
Toner & Inkjet Cartridges	839	1409 - 1415
Trimmers & Guillotines	840	1416
Waste Bins	843	1417
Weighing Scales	844	1418 - 1419
Writing Instruments & Accessories	846	1424 - 1434

KOBE Cordless Kettle

Rapid boil.
Water level indicator.
Drip free spout.
Auto shut off.
Heat proof handle.
Thermal overload protector.
240V, 2200W.



1.7 LTR

Wattage	Capacity	Order Code	Offer Price/1
2200W	1.7ltr Cordless Kettle	KBE-787 -0080K	£10.37

Swan 3.5 Litre Catering Kettle

NEW

SWK35
Part of the Swan Professional Series this 3.5 litre stainless steel catering kettle is perfect for canteens and kitchens. Two year guarantee. Stainless steel body and lid. Boil-dry protection, large lid for easy filling. Detachable cord with moulded plug. 3.5 litres or approx 14 cups capacity.



3.5 LTR

Wattage	Capacity	Order Code	Offer Price/1
2000W	3.5ltr Professional Kettle	SWA-787 -0040K	£49.12

KENNEDY Plastic Jerry Cans

Secure water containers manufactured from food grade plastic available in 10, 15 and 20ltr capacities, fitted with a collared screw top for ease of refilling and a twist on-off tap for spill free dispensing. The moulded handle design makes it ideal for transporting and storing water in and around the work place, home or when travelling.



UP TO 20LTR

Capacity	Type	Order Code	List Price/1	Offer Price/1
10ltr	Water	KEN-540 -6500K	£11.99	£8.63
15ltr	Water	-6520K	£13.99	£10.07
20ltr	Water	-6540K	£16.99	£12.23

Chrome Pump Pot

Stainless steel pump pot that is glass vacuum insulated for maximum temperature retention whether hot or cold. 1.9ltr capacity. Easy-to-use air pump dispenser. Click-lock top keeps lid secure and guards against spills.



1.9 LTR

Capacity	Order Code	Offer Price/1
1.9ltr	PRO-787 -0002A	£9.99

Stainless Steel Vacuum Flasks

Rustproof stainless steel construction with attractive satin finish. Suitable for storing food and drink. Screw-top lid. One touch 'easy pour' system prevents loss of thermal insulation by removing the need to expose the contents during pouring.



UP TO 1LTR

Size	Capacity	Order Code	Offer Price/1
Large	1.0ltr	CTL-787 -0009A	£7.14
Small	0.5ltr	-0010A	£5.19

CYGNET Stainless Steel High Duty Urns

Stainless steel butterfly element. Thermostat controlled, variable temperature regulator and with automatic boil-dry protection. Non-drip tap, removable lid and cool touch handles. Power on' light. One year warranty.



Wattage	Capacity	Order Code	List Price/1	Offer Price/1
2000W	9ltr	CYG-787 -0010K	£110.85	£110.85
3000W	18ltr	-0020K	£118.10	£118.10
3000W	27ltr	-0030K	£123.90	£123.90

Stainless Steel Catering Urns

Modern attractive urns with a stainless steel and black finish. Non-slip rubber feet and secure locking lid. Both have an integral level indicator and non-drip two-way tap. Automatic boil-dry protection and 'Power on' light.

Capacities: 8ltr/48 cup.
16ltr/67cup.
20ltr/80 cup.



Wattage	Capacity	Order Code	List Price/1	Offer Price/1
1300W	8ltr	SWA-787 -0010K	£79.99	£59.99
2000W	16ltr	-0020K	£92.99	£69.74
2200W	20ltr	-0030K	£102.99	£77.24

Office Supplies & Stationery

KOBE Hot Plate

240 VOLTS

TEC-HP03

Compact and portable hot plate made to current CE specifications. It has cast iron elements and a thermostatic control from simmer to boil in six settings with a durable easy to clean surface. Two hot plates, a 190mm 1.5kW and 160mm 1kW.



**2 Hot Plates
1.5kW & 1kW**

TEC-HP03

Model Number	Type	Rated Power	Colour	Order Code KBE-787	List Price/1	Offer Price/1
TEC-HP03	2 Hotplates	2.5kW	White	-0090K	£25.99	£16.24

Insect Killers

The Kobe™ IKE Series slimline, two tube fly killers can be suspended from the ceiling or wall and as soon as you switch on, it'll start to attract any flies or insects in the area; as soon as they touch the high voltage inner grill they get ZAPPED! The remains fall into the removable metal collection tray for disposal. Kobe™ IKE electric insect killers are economical and effective in use making them ideal for shops, takeaways, kitchens and other applications requiring effective fly control at a competitive price.

20 WATTS

Model: IKE020.
Voltage: 220 - 240V.
Frequency: 50/50Hz.
Power: 20W protects an area up to 120m².
Output: DC3500 - 7000V.
Tube type: 2x TLD10W.



IKE020

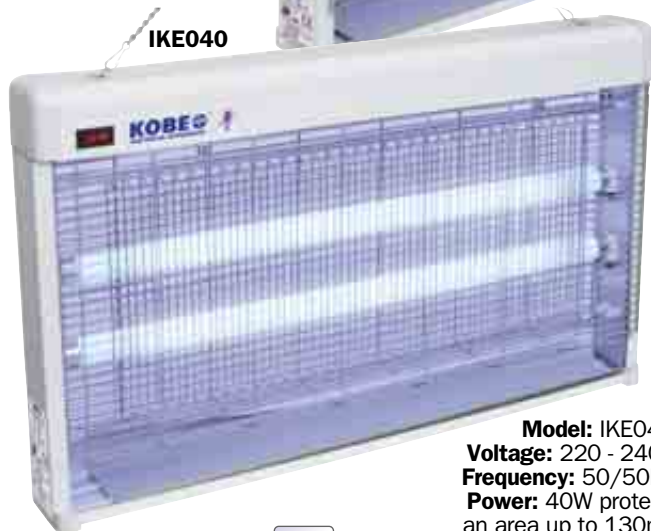

IKE040

40 WATTS

Model: IKE040.
Voltage: 220 - 240V.
Frequency: 50/50Hz.
Power: 40W protects an area up to 130m².
Output: DC3500 - 7000V.
Tube type: 2x TLD20W.

Model Number	Capacity	Rated Power	Colour	Order Code KBE-787	List Price/1	Offer Price/1
IKE020	120m ²	20W	White	-0040K	£39.50	£24.69
IKE040	130m ²	40W	White	-0050K	£49.90	£31.19
Replacement tube for 20W Kobe Fly Killer				-0060K	£8.80	£5.50
Replacement tube for 40W Kobe Fly Killer				-0070K	£7.99	£4.99

Microwave Oven

MWW900

High power microwave oven with 900W output power. Suitable for all domestic and general use. With six power levels and 30 minute timer, defrost setting and audible cooking end signal. Large heat control and time setting dials. Internal light.

Specification:
23ltr/0.8cu.ft, power consumption: AC230V/50Hz/1400W.
Microwave power output: 900W.
Manual control with six power levels.
Pull handle door.
Turntable: 314mm.
Cavity finish: painted.
Cavity (W x D x H): 215 x 350 x 330mm (23ltr/0.8cu.ft).
Exterior (W x D x H): 305 x 508 x 405mm.
Gross weight: 17.5kg
Net weight: 15.6kg.



900 WATTS

Model Number	Capacity	Rated Power	Colour	Order Code KBE-789	List Price/1	Offer Price/1
MWW900	23ltr	900W	White	-0010K	£89.91	£53.95

Compact Refrigerator

BC-50

Ideally suited for use in the office, visitor's room, workshop, small kitchen, chalet or caravan. Ice making compartment. Single shelf. Storage space below shelf - deeper storage above. Bottle and cheese compartments in door.

Specifications:
Capacity: 50ltr.
Temperature range: 0 - 10°C.
Voltage: 240V
Rated power: 90W.
Power consumption: 0.4kWh/24h.

Refrigerant: 50R134ag.
Climate class: N.
Safety class: I.
Gross weight: 21kg.
Dimensions (H x W x D): 490 x 445 x 460mm.



90 WATTS

Model Number	Capacity	Rated Power	Colour	Order Code KBE-796	List Price/1	Offer Price/1
BC-50	50ltr	90W	White	-0010K	£109.91	£64.85

GROUP 788 CATERING CONSUMABLES

Plastic Vending Cups

Convenient and disposable plastic vending cups - fit most vending machines. Made to rigid specifications for maximum reliability.

Capacity: 22cl (7oz).

PACK OF 100



Size	Pack Quantity	Order Code CTL-788	Offer Price/Pk
Tall	100	-0340K	£4.74
Squat	100	-0310K	£4.26

Polystyrene Drinks Cups

Retain the temperature of hot or cold drinks. Cups stay firm and easy to hold, even at high temperatures.

Capacity: 22cl (7oz).

PACK OF 50



Pack Quantity	Order Code CTL-788	Offer Price/Pk
50	-0320K	£2.56

Disposable Napkins

High quality 2-ply disposable napkins with an elegant border. Extra thickness, perfect for all types of dining.

Pack quantity: 100.

Size: 20cm (quarter fold).

PACK OF 100



Size (mm)	Pack Quantity	Order Code CTL-788	Offer Price/Pk
400 x 400	100	-0400K	£7.38

Plastic Cup Holders

To prevent scalding from hot drinks. Suitable for use with tall and squat plastic cups. Supplied as a box of 12 individual holders.

PACK OF 12



Pack Quantity	Order Code CTL-788	Offer Price/Pk
12	-0350K	£11.11

Plastic Drink Stirrers

Heat-resistant. Supplied in dispenser box.

PACK OF 1500



Pack Quantity	Order Code CTL-788	Offer Price/Pk
1500	-0360K	£13.29

Aluminium Catering Foil

Durable catering foil in a dispensing box. Extra long roll for commercial use. Suitable for all food use and oven-safe.

75m



Roll Size (mm x m)	Box Quantity	Order Code CTL-788	List Price/1	Offer Price/1
300 x 75	1	-0430K	£8.80	£8.36
450 x 75	1	-0440K	£11.75	£11.16
500 x 75	1	-0450K	£12.49	£11.87

Plastic Cups for Cold Drinks

Suitable for water and other cold drinks. Not suitable for use in hot drinks machines or with boiling water.

Capacity: 22cl (7oz).

PACK OF 1000



Size	Pack Quantity	Order Code CTL-788	Offer Price/Pk
Tall	1000	-0330K	£32.15

Disposable Cutlery

White plastic, single-use disposable cutlery. Ideal for canteens, parties, picnics, packed lunches etc.

PACK OF 100



Type	Pack Quantity	Order Code CTL-788	Offer Price/Pk
Fork	100	-0370K	£1.59
Knife	100	-0380K	£1.59
Teaspoon	100	-0390K	£1.59

Cling Film

Durable catering film in a dispensing box. Extra long roll for commercial use. Suitable for all food use. Microwave-safe.

300m



Roll Size (mm x m)	Box Quantity	Order Code CTL-788	List Price/1	Offer Price/1
300 x 300	1	-0460K	£10.24	£9.73
450 x 300	1	-0470K	£14.74	£14.00

Milk Pots

Provide the finishing touch to your drink. 12ml pots of UHT milk that require no refrigeration. 120 pots of milk per pack.

PACK OF 120



Pack Quantity	Order Code CTL-788	Offer Price/Pk
120	-0260K	£13.70

Milk Stix

Dairystix, easy tear and pour UHT milk and cream sachets. No need to refrigerate. Tastes just like fresh milk.

Sachet size: 12ml.

Pack size: 200 sachets.



Type	Order Code CTL-788	Offer Price/Pk
UHT Semi-Skimmed	-0720K	£16.14
UHT Whole Milk	-0730K	£16.14
UHT Half Cream	-0740K	£21.84

Coffee-mate Cream Whitener

The original and most popular cream-whitener. For a smooth delicious creamier cup of coffee.



Size	Order Code CTL-788	Offer Price/Pk
500g	-0250K	£3.76
1.5kg	-0530K	£7.88

Office Supplies & Stationery

Cadbury Chocolate Break

Hot chocolate in an instant, simply add water. The easiest way to enjoy a creamy Cadbury hot chocolate drink, without compromising on the taste. Made from cocoa powder with added sugar and milk extracts. Cadbury's Drinking Chocolate can be useful as a coating on truffles or whipped cream!

High Lights

New luxury taste. 40 calories per serving. Just add hot water for the perfect low-calorie drink anytime of the day. 50 sachets per box.



Description	Size	Order Code CTL-788	Offer Price/1
Choc' Break	2kg	-0230K	£17.57
High Lights	50	-0240K	£13.39

Tate Lyle Granulated Sugar

Pure cane sugar. All purpose for drinks and cereals and catering.

Pack of: 6x 2kg bags.



PACK OF 6

Bags Per Pack	Pack Weight	Order Code CTL-788	Offer Price/Pk
6 x 2kg	12kg	-0280K	£21.09

Sugar Sachets

Provide the finishing touch to your drink. Handy one spoon sugar sachets. 600 sachets of sugar per box.



PACK OF 600

Pack Quantity	Order Code CTL-788	Offer Price/Pk
600	-0270K	£10.40

Bottled Water

Bottled water for use with water coolers. Size: 15ltr.



15 LTR

Description	Size	Order Code CTL-788	Offer Price/1
Water	15ltr	-0100K	£11.69

NESCAFÉ

Nescafe Original Coffee

Freeze dried soluble coffee. Rich and full flavoured.



Description	Size	Order Code CTL-788	Offer Price/1
Nescafe Cappuccino	500g	-0160K	£11.99
Nescafe Original	750g	-0140K	£23.59
Nescafe Latte	500g	-0170K	£11.19
Nescafe Decaffeinated	500g	-0150K	£21.51

Nescafe Gold Blend Coffee

Freeze dried soluble coffee. New richer aroma. We select and blend only premium beans and capture the freshly roasted golden aroma to give the Gold Standard in coffee.



Description	Size	Order Code CTL-788	Offer Price/1
Gold Blend	500g	-0180K	£21.59
Gold Blend	750g	-0190K	£26.79

Kenco

Really Smooth

Superior quality instant coffee made with a blend of beans which are expertly roasted to give you a great tasting coffee. A smooth coffee taste with an alluring aroma.



Description	Size	Order Code CTL-788	Offer Price/1
Really Smooth	750g	-0210K	£28.49

Decaffeinated

The finest decaffeinated coffee beans roasted to capture the smooth coffee taste and rich aroma of Kenco. Perfect even for those who are not watching their caffeine intake.



Description	Size	Order Code CTL-788	Offer Price/1
Decaffeinated	500g	-0220K	£19.44

Original Filter Coffee

For Filter Machines. A blend of Arabica and Robusta coffee beans. These are specially selected and carefully roasted to give a rounded and balanced coffee.



Description	Size	Order Code CTL-788	Offer Price/1
Original Filter	1kg	-0200K	£18.89

Tetley Tea Bags

Catering packs ideal for the office. Size: 440 or 1100 bags.



Pack Quantity	Order Code CTL-788	Offer Price/Pk
440	-0110K	£10.79
1100	-0120K	£23.99

Typhoo Tea Bags

PACK OF 440

Catering packs ideal for the office. Size: 440 bags.



Pack Quantity	Order Code CTL-788	Offer Price/Pk
440	-0290K	£11.39

PG Tips Tea Bags

A high quality blend of tea that consistently delivers the best PG quality every time.



Type	Pack Quantity	Order Code CTL-788	Offer Price/1
Pyramid	460	-0660K	£12.68
Pyramid	1150	-0670K	£29.25
One Cup	200	-0680K	£11.39

Office Supplies & Stationery

GROUP 800 ARCHIVE BOXES & STORAGE

Rkive SYSTEM *The Total Document Management System*



A modular system, tailored to meet individual needs.

All products within the system are compatible, allowing you to develop a system to suit your personal needs.

Optimise use of space

Selected items are suitable for stacking, providing compact multi-level storage. Stacking frames on the Stax file store provide extra stability.

Rkive PREMIUM Storage Boxes

Extra strong offering maximum strength, durability and stacking performance. Triple wall construction on end panels, double wall on side. Dust cover lid. Tote handles for easy transportation. Holds A4 and foolscap files.



PACK OF 10

Dimensions (H x W x D):
330 x 254 x 381mm.

Colour	Pack Quantity	Order Code	Offer Price/Pk
Woodgrain	10	-0240K	£39.90
Red/White	10	-0260K	£39.90
Blue/White	10	-0250K	£39.90

Rkive BASICS Storage Boxes

Unique design with tear-off attached lid. Lid remains attached until ready to use, so cannot be lost or misplaced. Double wall construction to end panels and base for additional strength.



PACK OF 10

Dimensions (W x H x D):
305 x 254 x 381mm.

Colour	Pack Quantity	Order Code	Offer Price/Pk
Brown	10	-0680K	£19.44

Storage Box

Economical storage box for many applications. 100% recycled, 100% recyclable.

Dimensions (W x H x D):
330 x 425 x 254mm.



PACK OF 10

Colour	Pack Quantity	Order Code	Offer Price/Pk
Brown	10	-0290K	£26.22

Transfer Files

Suitable for storage of A4 or foolscap papers and files. Lid with locking tab. Compatible with the R-Kive Basics storage boxes. 100% recycled, 100% recyclable.



PACK OF 20

Dimensions (W x H x D):
127 x 362 x 254mm.

Colour	Pack Quantity	Order Code	Offer Price/Pk
Brown	20	-0270K	£19.80

Large Storage Boxes

Fastfold quick and easy assembly storage box. Double wall thickness end panels. Ideal for storage of many items including box files, lever arch files, transfer files, even computer listing paper.

100% recycled, 100% recyclable.

Dimensions Size (W x H x D):
380 x 287 x 430mm.



PACK OF 10

Colour	Pack Quantity	Order Code	Offer Price/Pk
Grey/White	10	-0490K	£32.21

Eastlight Storage Bags

Ellesmere 'STORALL'

The simplest form of archival storage. Kraft manilla bag with cloth tapes and reinforced paper for added security. Spine label with large labelling area for easy referencing. Supplied flat packed for space saving.



PACK OF 50

Dimensions (L x H x W):
255 x 355 x 104mm.

Pack Quantity	Order Code	Offer Price/Pk
50	-0010K	£14.99

AVON Archive Boxes

Rigid cardboard box with carrying handles and attached lid to prevent loss/damage. Suitable for storage and transportation of large quantities of non-active records. Suitable for stacking. Large contents panel for clear labelling and easy retrieval.

Dimensions (W x H x D):
430 x 360 x 257mm.

PACK OF 10



Colour	Pack Quantity	Order Code	Offer Price/Pk
White	10	-0030K	£17.99
Brown	10	-0040K	£16.24

Office Supplies & Stationery

Deluxe Document Storage

Transparent stacking plastic storage boxes, strong enough to support an adults weight and light enough to transport easily. Ideal for office media, the transparency allows for ease of contents identification. No holes in carrying handles preventing dust, moisture and rodent entry. Positively stack for rigidity and a safe archiving area.

Really Useful Boxes

3ltr box, will hold 18 CDs or 10 DVDs. Other uses include rubber stamp box, plumbing accessories.



Priced per box

Weight: 500g.

Dimensions (L x W x D):

External: 245 x 180 x 160mm.

Internal: 190 x 143 x 120mm.

Size	Order Code RUP-800	List Price/1	Offer Price/1
3ltr	-0010K	£5.61	£4.21

18ltr multimedia box, will hold 93 CDs or 44 DVDs. Other uses include knitting box, electrical DIY equipment.



Priced per box

Weight: 1.3kg.

Dimensions (L x W x D):

External: 480 x 390 x 200mm.

Internal: 380 x 310 x 170mm.

Size	Order Code RUP-800	List Price/1	Offer Price/1
18ltr	-0030K	£13.79	£10.34

64ltr box, large capacity for cost effective storage. Other uses include Foolsap files, toy box, loft storage, sports equipment.



Priced per box

Weight: 3.1kg.

Dimensions (L x W x D):

External: 710 x 440 x 310mm.

Internal: 605 x 370 x 280mm.

Size	Order Code RUP-800	List Price/1	Offer Price/1
64ltr	-0050K	£22.99	£17.24

9ltr box, will hold 40 CDs or 20 DVDs or A4 paper. Other uses include men's shoes, dress patterns.



Priced per box

Weight: 900g.

Dimensions (L x W x D):

External: 395 x 255 x 155mm.

Internal: 335 x 210 x 140mm.

Size	Order Code RUP-800	List Price/1	Offer Price/1
9ltr	-0020K	£8.49	£6.37

35ltr box complete with 10 A4 suspension files and 2 lever arch files. For A4 and Foolsap. Other uses - A4 files, Foolsap files, Christmas decorations, car boot box.



Priced per box

Weight: 2.1kg.

Dimensions (L x W x D):

External: 480 x 390 x 310mm.

Internal: 370 x 310 x 280mm.

Size	Order Code RUP-800	List Price/1	Offer Price/1
35ltr	-0040K	£35.99	£26.99

84ltr box, extra large capacity for cost effective storage. Other uses include clothes, blankets, overalls, dust sheets, wellies.



Priced per box

Weight: 3.3kg.

Dimensions (L x W x D):

External: 710 x 440 x 380mm.

Internal: 605 x 370 x 355mm.

Size	Order Code RUP-800	List Price/1	Offer Price/1
84ltr	-0060K	£29.49	£22.12

Rxive SYSTEM System Desk Top Sorter

Eight compartment for easy organisation of paperwork or literature. Front cabinet area suitable for labels if required. Stackable space saving. 100% recycled, 100% recyclable.



Dimensions (W x H x D):

490 x 260 x 310mm.

Colour	Pack Quantity	Order code FEL-800	Offer Price/1
Grey/White	1	-0500K	£13.49

Magazine Files

Suitable for storage of A4 size literature or magazines. 100% recycled, 100% recyclable.



PACK OF 20

Dimensions (W x H x D):

78 x 311 x 258mm.

Colour	Pack Quantity	Order Code FEL-800	Offer Price/Pk
Brown	20	-0280K	£15.60

Q-CONNECT Business Easy Set-Up Storage Box

NEW

With double wall construction to end panels. 'Pop-up' construction feature allows easy assembly. Lift off lid and cut out handles for ease of transportation. Takes 3 Q-Connect business magazine files or 3 Q-Connect business transfer cases.

Internal dimensions(W x D x L):
327 x 387 x 250mm.

100% RECYCLED



PACK OF 10

Order Code QUE-801	List Price/Pk	Offer Price/Pk
-0040K	£16.19	£9.71

Offis Aluminium Laptop Cases

Protect laptops and accessories from damage. Locking aluminium case with padded liner and four positionable side pads. Two elasticated straps secure laptop in position whilst in transit. On the under side of the lid is an A4 document holder with two velcro fastening pockets and two pen holders. Supplied complete with nylon shoulder strap. Non-slip carry handle. Available as keyed or with combination locks.



Size	Internal Dimensions	Lock Type	Order Code OFI-802	List Price/1	Offer Price/1
Notebook	340 x 290 x 65mm	Combination Key	-0160K	£21.99	£16.49
		Key	-0170K	£19.99	£14.99
Laptop	390 x 290 x 65mm	Combination Key	-0180K	£21.32	£15.99
		Key	-0190K	£21.32	£15.99

Aluminium Pilot Cases

The rounded corners with additional corner reinforcing and the two thirds hinged lid with piano hinge makes this one of the most robust cases in the Offis range. Ideally suitable for protecting valuable items whilst in transit.

Sponge feel grip for added carrying comfort. Integral A4 document holder, two business card holders, three pen holders and a velcro fastening pocket.



Internal Dimensions	Lock Type	Order Code OFI-802	List Price/1	Offer Price/1
470 x 290 x 65mm	Key	-0210K	£22.65	£16.99

Business Bag

Polyurethane leather look business bag which is fully padded for laptop carrying with a rear file section, three large internal compartments, comfortable handle and detachable shoulder strap. Also features an exterior zip organiser.



Type	Order Code OFI-804	List Price/1	Offer Price/1
Business Bag	-0090K	£19.99	£11.99

Personal Organiser

A4 multi-purpose padded zipped folio with ringbinder. Document organiser and pockets section. Central four ring binder, A4 pad slot and three sided zip opening.

Size (W x D x H):
290 x 40 x 360mm.



Type	Size W x D x H (mm)	Order Code OFI-804	List Price/1	Offer Price/1
Zipped Organiser	290 x 40 x 360	-0010K	£12.49	£7.49

Presentation Binders

A4/foolscap ring binder, dual pen holder and expandable business card holder. Real leather padded exterior with a large pocket on the back.



Type	Size W x D x H (mm)	Order Code CTL-804	List Price/1	Offer Price/1
With Flap	295 x 45 x 360	-3440K	£36.27	£19.95
No Flap		-3450K	£36.27	£19.95

Telephone/Address Book

Ring bound address/telephone book in durable PVC. Loose leaf name and address pages featuring space for home, office, fax and mobile numbers with A-Z section dividers and also business card holders.



Type	Order Code CTL-804	List Price/1	Offer Price/1
Telephone/Address Book	-0360K	£11.99	£6.59
Refill	-0362K	£2.99	£1.64

Organiser & Business Card Holder

Personal Organiser:

PVC leather look padded organiser. Six internal pockets and press stud fastener. Complete with 20 leaved lined A4 pad. Pen and pen holder.

+ Business Card Holder:

PVC leather-look padded holder. Organise, store and view up to 96 cards.

Size (H x W x D):
200 x 120 x 17mm.

Set:
1x organiser and
1x business
card holder.



-0100K



Type	Order Code OFI-804	List Price/1	Offer Price/1
Business Card Holder	-0100K	£8.49	£5.09
Set of above	-0180K	£13.32	£7.99

PRESS STUD

SWISS+PACKS

Universal Holdall

A versatile and well constructed holdall that's hardwearing and water resistant. Features include tough webbing side handles and shoulder strap, interior zipped mesh pocket, pockets at each end, and a front u-shaped pocket with interior zip security.



External Dimensions (mm)	Order Code	Offer Price/1
300 x 520 x 290	SWP-593 -0060K	£6.49

Laptop/Business Bag

SwissPacks™ laptop/business bag has an attractive and stylish two-tone charcoal and silver-blue finish manufactured from water resistant woven polyester fabric, featuring reinforced carrying handles and clip-on adjustable shoulder strap.

The three main compartments all have mesh, zip and velcro fastening to securely hold laptops and important documents in place whilst in transit. Large external zipped pockets on the front and rear of the bag for keeping items you need quickly close at hand. The padded sidewalls and rubber 'bump-proof' edges provide additional protection for items whilst in transit. The Swisspack laptop/business bag comes complete with a pull out identification card holder, that can be personalised to ensure your bag can be easily identified at all times.



External Dimensions (mm)	Order Code	Offer Price/1
450 x 350 x 250	SWP-593 -0070K	£10.99

Laptop Briefcase

F12575
Made from DuraTuff 600. Laptop compartment is fully padded with DuraGuard. Front external pocket with flapover cover. Handgrip and detachable shoulder strap.

Dimensions (W x H x D):
40 x 30 x 12cm.
Available in black.



Type	Weight	Order Code	List Price/1	Offer Price/1
Laptop Bag	1kg	FAL-803 -0010K	£33.49	£20.09

Backpack/Trolley Case

A Lightweight 'backpack' carry case that has its own independent trolley system, with in-line low friction wheels and an extendable trolley handle. Fully lined interior with large main compartment that has two elastic pockets and a large zipped mesh pocket. The exterior features a u-shaped front pocket, an identification ticket holder on the rear and small mesh and zip pockets on either side.



External Dimensions (mm)	Order Code	Offer Price/1
550 x 380 x 220	SWP-593 -0050K	£14.99

Laptop Business Trolley

Trolley F12570T
Heavy duty DuraFibre. Main compartment has removable padded 15.4" laptop envelope. Compartment for filing.

Front compartment with organiser section, with detachable shoulder strap. Lockable zips. Available in black.

Dimensions (W x H x D):
43 x 33 x 23cm.
Available in black.



Type	Weight	Order Code	List Price/1	Offer Price/1
Trolley	3.5kg	FAL-803 -0030K	£88.95	£53.37

Office Supplies & Stationery

CONTRACT PRICES AVAILABLE FOR VOLUME PURCHASES

All Prices Exclude V.A.T. © 2011



Chrome Wall Clock

Traditional 12 hour clock. Analogue display with quartz movement. Requires 1x AA battery, supplied separately - Order Code EDI-904-3020K - pack of 4. 355mm (14"). Chrome finish rim with white clock face, easy to read extra large black digits, divisions and hands, red second hand. Manufactured to CE requirements. Moulded hanging slot.



Size	Order Code	List Price/1	Offer Price/1
355mm (14")	OFI-823	£11.49	£6.89

White Wall Clock

Traditional 12 hour clock. Analogue display with quartz movement. Requires 1x AA battery, supplied separately - Order Code EDI-904-3020K - pack of 4. 25.4cm (10") Silver finish round rim with white clock face, easy to read black digits, divisions and hands. Moulded hanging slot. Manufactured to CE requirements.



Size	Order Code	List Price/1	Offer Price/1
254mm (10")	OFI-823	£8.65	£5.19

Radio Controlled Clocks

Moulded case with silver finish front bezel and glass lens. Stylish 12 hour dial. Radio controlled movement with 1x alkaline AA battery, offering 100% time keeping accuracy and automatic summer/winter time changes.



Size	Order Code	List Price/1	Offer Price/1
300mm (12")	OFI-802	£31.99	£23.99
450mm (18")	-0520K	£38.39	£28.79

24 Hour Clocks

White moulded case with shatterproof front lens. Clear 12 hour full figure dial with 24 hour inner ring. Quartz movement with AA battery supplied.



Size	Order Code	List Price/1	Offer Price/1
215mm (8½")	CTL-804	£14.53	£7.99

Radio Controlled Clocks

Quantum 900RC
White moulded case with shatterproof front lens. Clear 12 hour full figure dial. Radio controlled movement with alkaline AA battery, offering 100% timekeeping accuracy and automatic summer/winter time changes.



Size	Order Code	List Price/1	Offer Price/1
215mm (8½")	CTL-804	£34.53	£18.99
254mm (10")	-1850K	£41.80	£22.99

24 Hour Clock

254mm (10") dial with a white plastic rim. Large easy to read digits, hands and divisions. Moulded hanging slot for wall mounting. Quartz movement. Requires 1x AA battery (not supplied). **Conforms to CE.**



Size	Order Code	List Price/1	Offer Price/1
254mm (10")	OFI-802	£5.99	£4.49

Water Resistant Clocks

Quantum 555
White moulded case, sealed front and back with rubber gaskets and shatterproof front lens. Suitable for outdoor use and in damp or dusty areas. Clear 12 hour full figure dial. Quartz controlled movements. Includes battery.



Size	Order Code	List Price/1	Offer Price/1
400mm (16")	CTL-804	£78.16	£42.99

Silent Clocks

White moulded case with shatterproof front lens. Clear 12 hour full figure dial. Silent quartz movement with a sweeping second, which is particularly suitable for areas such as hospital wards, libraries etc where quiet areas are required. Includes battery.



Size	Order Code	List Price/1	Offer Price/1
215mm (8½")	CTL-804	£14.53	£7.99
254mm (10")	-1810K	£18.16	£9.99
300mm (12")	-1820K	£26.35	£14.49

LCD Radio Controlled Clock Calendar

Silver moulded case. LCD displays time, date, month, day and temperature. Radio controlled movement with AA battery, offering 100% timekeeping accuracy with automatic time changes.



Type	Order Code	List Price/1	Offer Price/1
LCD	CTL-804	£48.00	£26.40

Office Supplies & Stationery

Time-Precision Calculating Time Recorder

QR-375

The high featured QR-375 calculating time recorder was developed for easy payroll operation. It offers you daily elapsed time calculation between IN and OUT time and its accumulation per pay period. Insert your encoded time card and your periodical present time is shown.

Features:

- Auto feed and eject of time cards.
- Selectable 3 pay periods: monthly, weekly and bi-weekly.
- Built-in lithium back-up battery for 5 years data protection.
- Calculates the elapsed time between IN/OUT punches and prints a running total of accumulated time.
- 50 card memory capacity.
- Back-lit LCD display.
- Optional Ni-Cd battery back-up system providing time keeping and printing operation during power failures.



NEW

Description	Order Code	Offer Price/1
QR-375 Time Recorder	-0030K	£310.50
Clock Cards (Pk 200)	-0060K	£25.00
25 Card Slot Rack (Plastic)	-0080K	£25.00

Quartz Time Recorders

T-P Series

The unique T-P100D and T-P200D time clock has been designed to be truly 'set and forget'. Fully automatic for all functions and time adjustments. Simply insert your card and a clear, accurate clocking is printed.

Features:

- Easy to read LCD clockface with time and date. Tough ABS construction.
- Maintenance free, long life printhead.
- 6 clockings per day per employee.
- Automatic IN/OUT printing and spacing.
- Built-in battery back up.
- Selectable payroll cut-off date for weekly, monthly, mid-monthly and bi-weekly.
- Wall or table top mounting.

T-P100D print time cards in single colour - black.
T-P200D print time cards in two colours - red and black for exception recording.



Description	Order Code	Offer Price/1
T-P100D Time Recorder	-0010K	£220.50
T-P200 Time Recorder	-0020K	£265.50
Clock Cards (Pk 1000)	-0050K	£31.00
25 Card Slot Rack (Plastic)	-0080K	£25.00

nobo T-Card Panels

EXTENDED RANGE

Quartet Duramax

Panels available in 24, 32 or 54 slots.



Description	T-Card Size	Order Code	Offer Price/1
24 Slot	2	-4320K	£16.44
32 Slot	2	-4330K	£17.49
54 Slot	2	-4340K	£22.04
24 Slot	3	-4350K	£18.89
32 Slot	3	-4360K	£21.34
54 Slot	3	-4370K	£25.19
24 Slot	4	-4380K	£21.34
32 Slot	4	-4390K	£25.19
54 Slot	4	-4400K	£29.04

Coloured T-Cards

A comprehensive choice of colours including white, dark green, light green, yellow, pink, red, and light blue. Packs of 100. Packaging also doubles as a storage holder on the system.



T-Card Sizes

- Size 1: 16.5 x 49mm.
- Size 2: 48.5 x 85mm.
- Size 3: 80 x 120mm.
- Size 4: 112 x 180mm.

Size	Colour	Pack Quantity	Order Code	Offer Price/Pk
1	White	100	-0120K	£2.79
2	White	100	-0130K	£3.70
2	Red	100	-0140K	£3.70
2	Yellow	100	-0150K	£3.70
2	Dark Green	100	-0160K	£3.70
2	Pink	100	-0180K	£3.70
2	Light Green	100	-0200K	£3.70
2	Light Blue	100	-0220K	£3.70
3	White	100	-4430K	£4.05
3	Light Green	100	-4450K	£4.05
3	Dark Green	100	-4460K	£4.05
3	Yellow	100	-4470K	£4.05
3	Pink	100	-4480K	£4.05
3	Red	100	-4490K	£4.05
3	Light Blue	100	-4510K	£4.05
4	White	100	-4520K	£7.06
4	Buff	100	-4530K	£7.06
4	Light Green	100	-4540K	£7.06
4	Dark Green	100	-4550K	£7.06
4	Yellow	100	-4560K	£7.06
4	Pink	100	-4570K	£7.06
4	Red	100	-4580K	£7.06
4	Light Blue	100	-4600K	£7.06

TIME RECORDING

7 Day T-Card Kit

This system may be used as a weekly planner or for up to seven machines, rooms, departments etc.

Kit contains: 7x 26 size 2 slotted panels. 1x 26 size 1 slotted index panel. 2 x size 2 card holders for spare card storage. Backboard incorporating tracking. 700 x size 2 assorted colours and 100 x size 1 white T-cards. **Dimensions (W x H):** 480 x 480mm.



Description	Order Code	Offer Price/1
7 Day T Card Kit	-0100K	£62.99

12 Month T-Card Kit

This system may be used as a weekly planner or for up to 12 machines, rooms, departments etc.

Kit contains: 12 x 32 size 2 slotted panels. 1 x 32 size 1 slotted. 2 x size 2 card holders for spare card storage.

Backboard incorporating tracking. 1000 x size 2 assorted colours and 100 x size 1 white T-cards.

Dimensions (W x H): 800 x 730mm.

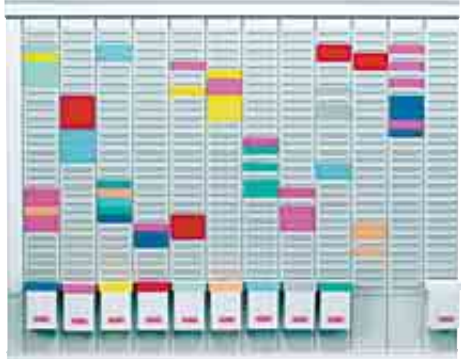

Description	Order Code	Offer Price/1
12 Month T-Card Kit	-0110K	£160.99

In/Out Boards

Simple sliding mechanism to indicate who is in or out. Supplied with perforated card inserts which can be printed or written on before separating. Spare pack of insert cards available if replacements are required.



Description	Order Code	Offer Price/1
10 Slot	-3420K	£81.19
20 Slot	-3430K	£104.29
In/Out Card Inserts (Pk 30)	-3440K	£3.88

CONTRACT PRICES AVAILABLE FOR VOLUME PURCHASES

All Prices Exclude V.A.T. © 2011

Office Supplies & Stationery

Kensington Wired & Wireless Mouse

Kensington® range of computer mice to suit how you prefer to control your computer. Choose from 2 full-size mice (in both wired and wireless) and 2 mice designed for use with mobile computers (wireless or with retractable wire).



Wired Full Size



Wireless Full Size



Retractable Mini



Wireless Mini

Type	Order Code KNT-803	List Price/1	Offer Price/1
Wired Full-Size	-0470K	£17.99	£15.29
Wireless Full-Size	-0480K	£27.99	£23.79
Retractable Wired Mini	-0460K	£15.99	£13.59
Wireless Mini	-0490K	£20.99	£17.84

Wireless Presentation Remote Control

2.4GHz Wireless USB receiver stores inside remote. AAA battery (included). Controls presentations from up to 60 feet away. Compact and lightweight with intuitive controls. Built-in laser pointer.



Product Type	Order Code KNT-803	Offer Price/1
Wireless Presentation Remote	-0410K	£49.29

Kensington Wired Optical Mouse

High speed Diamond Eye® optical technology for unmatched speed and accuracy. Rubberised grips for superior comfort. Five programmable buttons that can be customised to streamline important tasks. Compatible with Windows® XP, 2000 and Mac systems.



OPTICAL MOUSE

Product Type	Order Code KNT-803	Offer Price/1
Optical Mouse	-0310K	£15.29

Q-CONNECT Retractable Wire Mini Mouse

Grey mini mouse with a USB retractable cable. Has a million cycle life. Compatible with Windows 98/2000/ME/NT/XP/Vista.



Product Type	Order Code QUE-804	Offer Price/1
Retractable Mini Mouse	-0010K	£7.83

Offis Corded Mice

Simple efficient mousing. Simple design is comfortable to use. Perfect for left and right handed use. PS/2 plug with additional serial adaptor. No installation needed.



Description	Order Code OFI-803	Offer Price/1
PS2 Button Mouse	-0010K	£0.74
PS2 Scroll Mouse	-0020K	£1.49

Mouse and Adaptor Pack

Connect a PS2 Mouse and Keyboard to one USB port of the computer or notebook. Supplied with a button mouse or scroll mouse.



Type	Order Code PRO-803	Offer Price/1
Button	-0007A	£3.20
Scroll	-0008A	£4.33

Kensington USB Wired Keyboards

Contemporary designed, 'Qwerty' keyboard to leave plenty of valuable desk space. Tactile feedback keys for exceptional comfort and essential Euro currency symbol. USB and PS/2 connectivity.



Product Number	Colour	Order Code ACC-805	Offer Price/1
1500109	Black	-0020K	£12.96

USB Wired Keyboard

Stylish USB multimedia 'Qwerty' keyboard with 18 enhanced hot keys for use on audio and video playback, Windows and the internet. Compatible with Windows 98/Me/2000/XP.

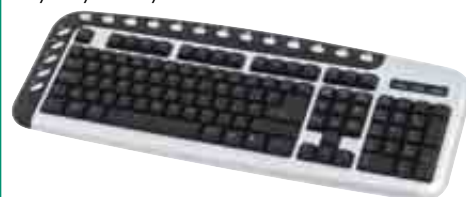

Product Type	Order Code PRO-804	Offer Price/1
USB Wired Keyboard	-0011A	£4.47

7 Port USB2 Pocket Hub

7 additional USB 2.0 ports. Fully backwards compatible with all USB speeds.



Product Type	Order Code KNT-803	Offer Price/1
7 Port USB2 Pocket Hub	-0440K	£32.29

USB Cables

High quality USB cables to connect a multitude of devices to your PC.

A/A Type: Male extension cable.



A/B Type: Suitable for connections such as printers and scanners.



Length	Type	Order Code QUE-803	List Price/1	Offer Price/1
1.8m	A/B	-0010K	£6.80	£3.06
3.0m	A/B	-0020K	£7.65	£3.44
1.8m	A/A	-0030K	£6.80	£3.06
3.0m	A/A	-0040K	£7.65	£3.44



Crystal Gel Wrist Supports

Ergonomic gel wrist supports in rich, translucent colours. Unique co-moulding technology. Flowing forms with dual colours. Natural ventilation between moulds to keep hands cool and dry.



Type	Colour	Order Code	Offer Price/1
Mouse Support/Pad	Blue/Black	-0220K	£13.59
Mouse Support/Pad	Graphite	-0230K	£13.59
Keyboard Support	Blue/Black	-0240K	£13.59
Keyboard Support	Graphite	-0250K	£13.59

Height Adjustable Gel Keyboard & Mouse Wrist Supports

Gel mouse wrist support has dual height wrist support non-skid base stability and gel comfort pillow. Gel keyboard wrist support has dual height wrist support, non-skid base stability and gel comfort pillow.



Type	Colour	Order Code	Offer Price/1
Mouse Support/Pad	Black	-0180K	£16.14
Keyboard Support	Black	-0200K	£16.14

Foam Keyboard Wrist Supports

Economy foam keyboard wrist support pillows. Cushioned pad covered with soft fabric distributes wrist pressure more evenly for comfort. Provides support for all-day working comfort. Non-slip base pad in place. Available in black or blue.



Colour	Order Code	Offer Price/1
Black	-0140K	£9.34
Blue	-0150K	£9.34



Crystal Gel Wrist Supports

Gel crystal wrist supports are ergonomically designed to increase comfort and support to your wrists whether you are typing on the keyboard or mousing. Gel cushion conforms to your wrist to redistribute pressure points. Mouse pads are optical-mouse friendly with a superior tracking surface.



Type	Colour	Order Code	Offer Price/1
Keyboard Support	Blue	-0510K	£10.97
Mouse Support/Pad	Blue	-0520K	£10.97

Gel Wrist Support & Mouse Pad

Ergonomically designed gel wrist support conforms to your wrist, providing a firm support. Mouse pad provides superior tracking control. Durable lycra covering on the wrist rest is smooth and comforting to the touch. Non-skid base holds rest in place. Mouse not included.



Type	Order Code	Offer Price/1
Mouse Support/Pad	-0170K	£12.55

Economy Mouse Mat

Economical computer accessory. Helps relieve the stress of prolonged keyboard and mouse use. Smooth cloth surface provides excellent tracking and control. Non-skid base protects your desk and secures the pad in place. Available in blue, grey or red.



Colour	Order Code	List Price/1	Offer Price/1
Blue	-1750K	£1.80	£0.99
Black	-1752K	£1.80	£0.99
Red	-1754K	£1.80	£0.99



Crystal Gel Wrist Supports

Clear gel wrist rest with anti slip PU backing. Helps to alleviate wrist aches from extended computer keyboard use.

Available in three colours: grey, blue and green.



Colour	Order Code	List Price/1	Offer Price/1
Grey	-0050K	£13.29	£9.30
Blue	-0060K	£13.29	£9.30
Green	-0070K	£13.29	£9.30

Crystal Gel Wrist Support & Mouse Pads

Clear gel mouse mat complete with cord router to organise mouse cables. Also has a lift up PVC cover allowing you to insert and change pictures, etc.



Colour	Order Code	List Price/1	Offer Price/1
Grey	-0020K	£12.79	£8.95
Blue	-0030K	£12.79	£8.95
Green	-0040K	£12.79	£8.95

Gel Wrist Support

Angled, ergonomic wrist rest manufactured from soft gel and covered with lycra ensuring maximum comfort and support whilst typing. A non-slip base ensures the wrist rest stays in position. N.B. Keyboard not included.



Type	Order Code	Offer Price/1	Offer Price/1
Gel Wrist Support	-0090K	£15.49	£10.84

Black Gel Mouse Mat

Cushioned support helps avoid strain. Mouse pad has integrated wrist rest. Non-skid base. Made from lycra to stretch and conform to the wrist.



Type	Order Code	List Price/1	Offer Price/1
Black Gel Mouse Mat	-0080K	£13.29	£9.30

Office Supplies & Stationery

CONTRACT PRICES AVAILABLE FOR VOLUME PURCHASES

All Prices Exclude V.A.T. © 2011

GROUP 803 COMPUTER ACCESSORIES

Offis Screen Filters

Anti-glare screen filters and anti-static radiation screen filters.



Type	Screen Size	Order Code	Offer Price/1
Anti-Glare	14" - 15"	OFI-803 -0050K	£11.99

Fellowes Flat Screen Monitor Riser with Paper Shelf

Supports up to 14kg or 17" monitor, modern design compliments flat screen TFT/LCD monitor styles, unique height adjustability from 76mm to 114mm, platform rotates 45° to assist shared viewing, includes storage tray for paper supplies.



Adjustment Range	Order Code	List Price/1	Offer Price/1
76 - 114mm	FEL-803 -0550K	£30.81	£23.11

Fellowes Monitor Riser

Supports up to 27kg or 17" monitor, height adjusts from 50mm to 100mm, non skid foot rings ensure stability on any surface.



Adjustment Range	Order Code	List Price/1	Offer Price/1
50 - 100mm	FEL-803 -0540K	£24.99	£18.74

Laptop Riser

Part of the 'Office Suites' range providing a complete and coordinated workspace solution, places your laptop at a comfortable viewing angle for ease of use, supporting front edge prevents laptop from sliding off riser, adjustable tilt allows you to customise your viewing angle, stacks on letter trays for a convenient space saving solution.

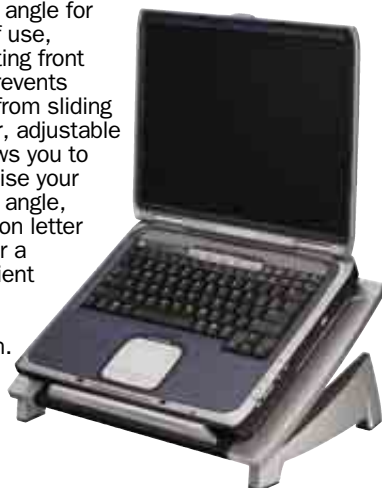

Type	Order Code	List Price/1	Offer Price/1
Laptop Riser	FEL-803 -0600K	£29.69	£22.27

Kensington TFT Flat Screen Stand

Sleek design uses minimal desk space. Height adjustable for optimum screen viewing, storage area for keyboards and notebooks. Handy side shelves for accessories. Recommended use flat panel. Recommended TV set size up to 21".

Dimensions (W x D x H):
58 x 30 x 10cm.



NEW



Product Number	Order Code	Offer Price/1
60039	KNT-803 -0450K	£29.74

Desktop Copyholder

The ultimate solution for handling your copy. Unique built-in arms support computer forms. Adjustable clip provides for A4 and foolscap size papers. Multiple angle adjustments accommodate your viewing preference. Faceplate can be adjusted from portrait to landscape viewing.



Size	Order Code	Offer Price/1
A4/Foolscap	FEL-803 -0020K	£13.29

Weighted Base Copyholder

Firm base allows for free-standing convenience. Faceplate can be converted from portrait to landscape to allow for comfortable viewing of copy.



Size	Order Code	Offer Price/1
A4	FEL-803 -0010K	£32.48

Textured Footrest

SoleSaver

Reduce muscle strain and fatigue with the SoleSaver textured platform footrest. With a choice of heights and angles you choose the most comfortable position. Dual height adjustment, adjust height/angle simply by reversing the legs. Angle adjustable to two positions - 10 and 15°. Textured footgrip platform.



Product Number	Type	Order Code	Offer Price/1
56152	SoleSaver	ACC-805 -0010K	£15.19

Office Supplies & Stationery

SOLENT OFFICE CLEANING & HYGIENE
Air Duster

NEW

HFC-free. Designed to remove dust and dirt from hard to reach areas. Environmentally friendly, does not contribute to global warming. Extension tube included.
Size: 400ml can.



Order Code	List Price/1	Offer Price/1
SOL-780		
-6800A	£8.75	£7.17

Anti-Static Screen Cleaner

Antistatic screen cleaner for use on all screens including TFT, TV and Plasma screens. No alcohol, non-toxic, non-hazardous cleaner and protector. Will reduce build-up of dust and dirt that can cause headaches and eyestrain. 250ml spray bottle. Use with Solent Dry Wipe Cloths (SOL-780-6840E) available separately.



NEW

Order Code	List Price/1	Offer Price/1
SOL-780		
-6860G	£4.99	£4.09

Antistatic Screen Wipes

PACK OF 100

Antistatic screen wipes. Pre-saturated for use on screens including TFT, TV and Plasma screens. Will reduce build-up of dust that can cause headaches and eyestrain. Bio-degradable. No alcohol, non-toxic, non-hazardous. Pack of 100.

NEW



Order Code	List Price/Pk	Offer Price/Pk
SOL-780		
-6880J	£4.34	£3.56

Screen Wipe Hygiene Sachets

Hygienic sachets for use on most screens. No alcohol, non-toxic, non-hazardous cleaner and protector. Will reduce build-up of dust and dirt that can cause headaches and eyestrain. Pack of 50.

NEW



Order Code	List Price/Pk	Offer Price/Pk
SOL-780		
-6890K	£9.07	£7.44

Multi-Purpose Wipes

PACK OF 100

Antibacterial multi-purpose wipes. Effectively cleans hard surfaces, computer casing, desks, telephones etc. Anti-bacterial formulation effective against E.coli, salmonella, MRSA and influenza virus. Helps to reduce build-up of dust and dirt where germs can breed. Pack of 100.

NEW



Order Code	List Price/Pk	Offer Price/Pk
SOL-780		
-6920N	£4.49	£3.68

Telephone Wipe Hygiene Sachets

Effectively cleans telephones, headsets and any other equipment that comes into contact with ear or mouth. Non-toxic, non-hazardous cleaner. Will help to reduce the build-up of dirt and dust where germs can breed. Pack of 50 sachets.

PACK OF 50



NEW

Order Code	List Price/Pk	Offer Price/Pk
SOL-780		
-6950R	£6.18	£5.07

Dry Absorbent Wipes

Essential for mopping up desktop spills fast! Tough and very absorbent. Safe to use on most screens as the material has a low lint content and will not scratch. Useable with all cleaning fluids and foams. Pack of 50.

PACK OF 50

NEW



Order Code	List Price/Pk	Offer Price/Pk
SOL-780		
-6840E	£7.62	£6.25

Whiteboard Cleaner

Cleans like new! Effectively cleans dry wipe marker pen from most whiteboards. Non-toxic, non-hazardous fluid. Leaves whiteboards looking new. 250ml spray bottle. Use with Solent Dry Wipe Cloths (SOL-780-6840E) available separately.



NEW

Order Code	List Price/1	Offer Price/1
SOL-780		
-7000A	£5.58	£4.58

Whiteboard Wipes

Pre-moistened whiteboard wipes effectively cleans dry wipe marker pen from most whiteboards. Non-toxic. Non-hazardous. Leaves whiteboards looking like new. **Tub contents:** 100.

NEW



Order Code	List Price/Pk	Offer Price/Pk
SOL-780		
-7020C	£9.26	£7.59

Q-CONNECT Wet & Dry Wipes

PACK OF 20

Designed specifically for use on all screens including laptops, PDAs, LCD, plasma and TFT displays, sat-navs and touch screens. Gently remove grease, dirt and surface grime. Anti-static, non-alcohol non-toxic formula designed for all screens. Contain screen cleaner protector liquid. Suitable for all hard surfaces. Will help remove the grime where germs breed. **Pack quantity:** 20 large wipes.



Product Number	Order Code	List Price/1	Offer Price/1
	QUE-792		
KF32148	-0100K	£7.19	£3.60

GROUP 804 COMPUTER MEDIA

Esselte CD/DVD Flight Cases with Keyed Lock

An attractive lockable box for carrying and protecting CDs and DVDs. Supplied with pockets (2 or 4 CDs per pocket). Supplied with keys and shoulder strap. 32 or 64 CD/DVD capacity.



Dimensions (W x D x H):
32 CD: 180 x 160 x 76mm.
64 CD: 297 x 170 x 79mm.

Capacity (discs)	Order Code	List Price/1	Offer Price/1
32 CD/DVD	ESS-803	£20.90	£12.54
64 CD/DVD	-0120K	£31.40	£18.84

CD/DVD Flight Case with Combination Lock

A sturdy case with four ring mechanism. Supplied with 16 pocket sheets. Double combination lock for security and confidentiality. Metal carry handle on lid with carry shoulder strap for easy transportation. Storage for 200 CD/DVDs.



Capacity (discs)	Order Code	List Price/1	Offer Price/1
200 CD/DVD	ESS-803	£61.85	£37.11

Q-CONNECT CD/DVD Jewel Cases

Black/clear protection and storage cases for your CD/DVD disks. Available in packs of 10, 25.



Type	Pack Quantity	Order Code	Offer Price/Pk
Standard	10	-0050K	£3.78
Slim	25	-0060K	£6.30

Fellowes CD Wallets

Easy access, with double-sided, lined sleeves. Secures and protects CDs/DVDs.



Capacity (discs)	Order Code	List Price/1	Offer Price/1
24	-0700K	£4.32	£3.24
48	-0710K	£7.54	£5.66
64	-0720K	£9.48	£7.11
96	-0730K	£12.62	£9.46
128	-0740K	£16.42	£12.31

CD Storage Box

Transparent storage box that holds up to 60 CDs in jewel cases. Supplied complete with 30 double-sided durable CD sleeves and index inserts.



Capacity (discs)	Order Code	List Price/1	Offer Price/1
60	-0100K	£6.69	£4.68

CD Envelopes

Protective envelopes for the safe storage of CDs. Available in white or assorted coloured paper or plain or punched polypropylene.

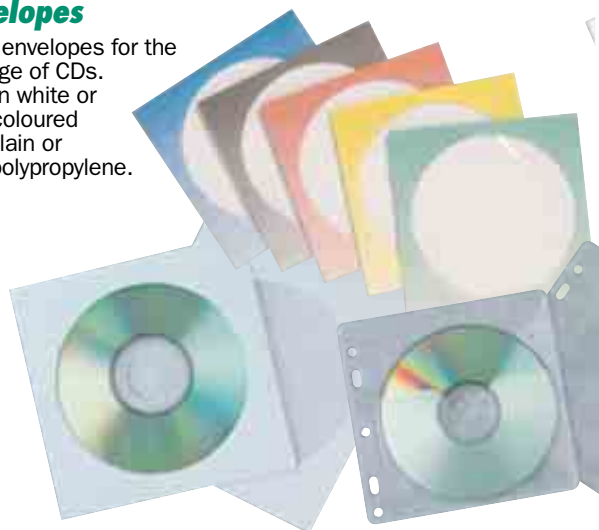

* Punched					
Colour	Type	Pk Qty	Order Code	List Price/Pk	Offer Price/Pk
White	Paper	50	-7850K	£5.96	£3.28
White	Paper	100	-7950K	£6.05	£3.33
Assorted	Paper	100	-7960K	£5.15	£2.83
Clear	Poly	50	-7860K	£6.22	£3.42
White*	Poly	40	-7870K	£6.05	£3.33

USB 2.0 Flash Drives

Very quick and simple to use and compatible with both PCs and Macs. Simply plug the device into your USB port and you can transfer files or run presentations in an instant. On the majority of computers the USB Flash Drive is plug and play.

Features: Plugs into any USB port. Hi-speed USB 2.0. Locking function. Fits on your key ring or in your pocket.



Size	Order Code	List Price/1	Offer Price/1
4GB	CTL-804	£23.62	£12.99
8GB	-1735F	£39.98	£21.99

Size	Order Code	List Price/1	Offer Price/1
2GB	OFI-804	£14.99	£8.99

Office Supplies & Stationery

Memorex CDs

Memorex CD-R with or without white printable face. Ideal for recording a wide variety of digital files. 700MB (80 min) capacity. Quick random access. 52x write speed. High playback compatibility. Write-once disc.



PRINTABLE

Type	Pack Type	Pack Qty	Order Code MEM-804	Offer Price/Pk
CDR	Slim Jewel Case	10	-0010K	£5.09
	Cake Pack	10	-0020K	£4.24
	Cake Pack	25	-0030K	£6.79
CDR Printables	Cake Pack	50	-0040K	£10.19
	Cake Pack	100	-0050K	£17.84
	Cake Pack	25	-0070K	£7.41
		50	-0080K	£14.16
		100	-0090K	£23.79

CD-RW 700MB 80Min 12x Speed in Slim Jewel Case

Memorex 12x speed CD-RWs offer the ideal re-writable solution for recording a wide variety of digital files including valuable data, precious photos, favourite music and video clips in High Speed recorders. Ease of use and cost effectiveness have made Memorex CD-RW's the most popular media for data storage and data transfer purposes. The CD-RW allows you to record, erase and re-record on the same disc as often as you wish and so is perfect for back-ups, transferring data and a wide range of other applications.

PACK OF 10



Description	Pack Quantity	Order Code MEM-804	Offer Price/Pk
CD-RW	10	-0100K	£7.64

DVDs

Burn home movies, family photos and vital data using the fastest burn time and the highest performance available write-once, single-sided disks. Up to 16x speed.



Type	Pack Type	Pack Qty	Order Code MEM-804	Offer Price/Pk
DVD-R	Slim Jewel Case	10	-0110K	£3.80
	Cake Pack	10	-0120K	£5.09
	Cake Pack	25	-0130K	£8.49
	Cake Pack	50	-0140K	£14.44
		100	-0150K	£23.79
DVD+R	Cake Pack	10	-0180K	£5.09
	Cake Pack	25	-0190K	£8.49
	Cake Pack	50	-0200K	£13.59
	Cake Pack	100	-0210K	£23.79
DVD+RW	Slim Jewel Case	5	-0250K	£5.94
	Slim Jewel Case	10	-0260K	£6.79

SD and microSD Travelcards

Approximately the size of a postage stamp, these Travelcards are small and light, yet offer consumers stable, secure, high-speed storage. Uniquely, they also feature a write protection switch, which means that your photos, or any other data are safe and cannot be erased by accident. Content protected by CPRM (Content Protection for Recorded Media) Security software.



Type	Capacity	Order Code MEM-804	Offer Price/1
SD	2GB	-0290K	£10.19
Micro	2GB	-0310K	£11.72
SD	4GB HC	-0320K	£16.65

Imation CD-RWs

Ideal for data, music, photo and video. CD-RW can be overwritten hundreds of times. Up to 700MB of data, 80 minutes of audio.



Description	Write Speed	Order Code MMM-803	Offer Price/1
CD-RW	up to 4x	-0100K	£0.84

TDK 3.5" HD Formatted Diskettes

These high quality preformatted diskettes save you time and money. All backed by a lifetime warranty and satisfaction guarantee. IBM formatted.

PACK OF 10



Description	Pack Quantity	Order Code TDK-804	Offer Price/1
HD	10	-0010K	£2.09

CONTRACT PRICES AVAILABLE FOR VOLUME PURCHASES

All Prices Exclude V.A.T. © 2011

Office Supplies & Stationery

GROUP 805 COPIER & PRINTER PAPER

Offis Premium Quality Copier Paper

Ideal for: laser, inkjet, copier, fax. Bright white 80g/m² paper. Made from TCF pulp.



A4 **80 GSM**

Size	Pack Qty	Weight (gsm)	Order Code	List Price/Pk	Offer Price/Pk
A4	500	80	OFI-805	£3.99	£3.39

Multi-purpose Copier Paper

A smooth white, even-sided multipurpose office paper. Guaranteed for trouble-free use on mono and colour copiers, laser printers, inkjet printers and plain paper fax machines. Excellent environmental credentials **Nordic Swan and ISO 14001**. *Non-stop box.



A3 **80 GSM**

Size	Pack Qty	Weight (gsm)	Order Code	List Price/Pk	Offer Price/Pk
A5	500	80	MDD-801	£4.89	
A4	2500*	80	-0030K	£26.40	
A3	500	80	-0050K	£12.60	

Copier Paper — White

Elements Earth

A dependable everyday, no nonsense paper that offers a good value for money solution for volume printing and copying. Suitable for mono inkjets, lasers, photo copiers and fax machines. **Size:** A4. **Weight:** 80gsm. **Box quantity:** 2500 sheets.

A4 **80 GSM**

BOX OF 2500 SHEETS



NON-STOP BOX

Size	Weight (gsm)	Order Code	Offer Price/Pk
A4	80	CTL-805	£16.99

Multi-purpose Office Paper

A superior weight sheet specifically manufactured for office documents that require a look of distinction.



A4 **90 GSM**

Size	Pack Qty	Weight (gsm)	Order Code	Offer Price/Pk
A4	500	90	-6200K	£4.29

High Performance Copier Paper

High performance paper. Guaranteed for copying, laser, inkjet and litho printing. Available in A4, 80, 100, 120 and 160gsm.

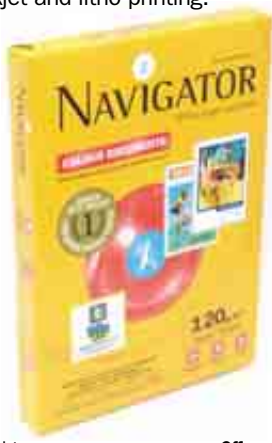

80 GSM **A4**

90 GSM **100 GSM**

120 GSM **160 GSM**

Size	Pack Qty	Weight (gsm)	Order Code	List Price/Pk	Offer Price/Pk
A4	500	80	NAV-805	£17.18	£3.60
	500	90	-0110K	£21.14	£7.99
	500	100	-0120K	£10.23	£4.99
	250	120	-0130K	£14.21	£4.99
	250	160	-0140K	£19.02	£6.99

Copier Paper

A premium uncoated paper that produces superior print quality and guarantees exceptionally sharp, well-defined images and text. Colours appear true to the original with fantastic clarity. Ideal for: colour copiers, inkjet and laser machines.

Colour: white.



A4 **100 GSM**

Size	Pack Qty	Weight (gsm)	Order Code	Offer Price/Pk
A4	500	100	WTS-805	£7.99

Copier Paper

Suitable for use when larger copying is required, i.e. architectural and engineering drawings.



75 GSM **A2** **A1**

Size	Pack Qty	Weight (gsm)	Order Code	Offer Price/Pk
A2	250	75	-0180K	£17.48
A1	250	75	-0190K	£27.80

Copier Paper

Ideal for black/white laser, black/white inkjet, black/white copies and FAX.

Colour: white.



A5 **80 GSM**

A4 **75 GSM**

Size	Pack Qty	Weight (gsm)	Order Code	Offer Price/Pk
A5	500	80	WTS-805	£2.99
A4	500	75	-0370K	£3.99

Recycled Copier Paper

All purpose white copier/laser paper. Available in A4 and A3. 80gsm.



80 GSM

A4 **A3**

Size	Pack Qty	Order Code	Offer Price/1	Offer Price/5+
A4	500	-0380K	£5.19	£4.41
A3	500	-0390K	£10.49	£8.92

Economy Copier Paper

All purpose white copier/laser paper. Available in A4 and A3. Available in 80gsm.



80 GSM

A4 **A3**

Size	Pack Qty	Weight (gsm)	Order Code	Offer Price/Pk
A4	2500	80	-1560K	£13.99
A3	500	80	-1580K	£8.99

Office Supplies & Stationery

White Card

This white card is heavier than 'standard' photocopy paper and could be used as 'dividers' or even to make your own greetings cards, for example.



CARD

A4 **210 GSM**

Size	Pack Qty	Weight (gsm)	Order Code	Offer Price/Pk
A4	200	210	-0320K	£7.30

Bright Coloured Card

High performance paper. Guaranteed for copying, laser, inkjet and litho-printing.

Pack quantity: 250.

Multi Buy



A4 **160 GSM**

CARD

*Colours in table are for guidance only.

Colour*	Weight (gsm)	Order Code	Offer Price/Pk 1	Offer Price/Pk 2
Yellow	160	-0200K	£9.39	£7.98
Orange	160	-0210K	£9.39	£7.98
Bright Red	160	-0220K	£9.39	£7.98
Dark Red	160	-0230K	£9.39	£7.98
Light Blue	160	-0240K	£9.39	£7.98
Dark Blue	160	-0250K	£9.39	£7.98
Dark Green	160	-0260K	£9.39	£7.98

Coloured Copier Paper

Pastel coloured copier paper. Other colours available on request.



A4 **80 GSM**

*Colours in table are for guide only.

Size	Colour*	Pack Qty	Weight (gsm)	Order Code	Offer Price/Pk
A4	Pale Yellow	500	80	-2020X	£5.66
A4	Pale Pink	500	80	-2021Y	£5.66
A4	Pale Blue	500	80	-2022Z	£5.66
A4	Pale Green	500	80	-2023A	£5.66
A4	Cream	500	80	-2024A	£5.66

Coloured Copier Paper

Pastel coloured copier paper for laser printers, high volume copiers and typewriters. Produced from sustainable forests. ECF low chlorine. Other colours available.



A4 **80 GSM**

*Colours in table are for guide only.

Size	Colour*	Pack Qty	Weight (gsm)	Order Code	Offer Price/Pk
A4	Pale Yellow	500	80	-1515K	£5.29
A4	Red	500	80	-1517K	£5.69
A4	Pale Pink	500	80	-1518K	£5.29
A4	Pale Blue	500	80	-1521K	£5.29
A4	Pale Green	500	80	-1524K	£5.29

Offis Business Card Paper

NEW

Matt finish business card paper which prints to a high resolution and gives a clean edge. 10 cards per sheet.



A4 **250 GSM**

Size	Weight (gsm)	Pk Qty	Order Code	List Price/Pk	Offer Price/Pk
A4	250	10	-0550K	£8.30	£7.05

Coloured Card

High performance. Guaranteed for copying, laser, inkjet and litho-printing.

*Colours in table are for guidance only.

Size	Colour*	Pack Quantity	Weight (gsm)	Order Code	Offer Price/Pk
A4	Blue	250	160	-2020X	£6.49
A4	Green	250	160	-2021Y	£6.49
A4	Pink	250	160	-2022Z	£6.49
A4	Yellow	250	160	-2023A	£6.49
A4	Cream	250	160	-2024B	£6.49



CARD
Packs of 250 sheets

Coloured Copier Paper

A4, 80gsm coloured copier paper.

- Pale:** 100 sheets of each: vanilla, yellow, soft pink, green and blue
- Bold:** 100 sheets of each: sun yellow, orange, coral red, dark green and deep blue
- Neon:** 50 sheets of each: neon orange, neon green, neon yellow and neon pink
- Boldsoft:** 50 sheets each of vanilla, yellow, soft pink, green, blue, sun yellow, orange, coral red, dark green and deep blue.



*Colours in table are for guide only.

Size	Colour*	Pack Qty	Order Code	Offer Price/Pk
A4	Pale	500	-0270K	£11.89
A4	Bold	500	-0280K	£13.59
A4	Boldsoft	500	-0290K	£12.74
A4	Neon	200	-0300K	£5.94

Pastel Coloured Copier Paper

Tinted copier paper for laser printers, high volume copiers and typewriters.



A4 **80 GSM**

*Colours in table are for guide only.

Size	Colour*	Pack Quantity	Weight (gsm)	Order Code	Offer Price/Pk
A4	Blue	200	80	-0140K	£1.56
A4	Green	200	80	-0150K	£1.56

Coloured Copier Paper

Other colours available.

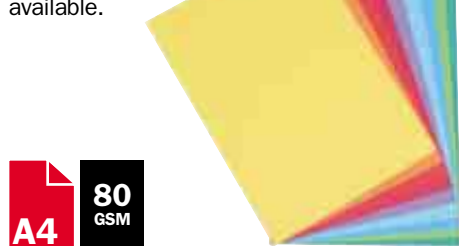

A4 **80 GSM**

*Colours in table are for guide only.

Size	Colour*	Pack Qty	Order Code	Offer Price/Pk
A4	Bright Yellow	500	-0090K	£6.79
A4	Orange	500	-0100K	£6.79
A4	Bright Red	500	-0110K	£6.79
A4	Dark Red	500	-0120K	£6.79
A4	Purple	500	-0130K	£6.79
A4	Royal Blue	500	-0140K	£6.79
A4	Dark Blue	500	-0150K	£6.79
A4	Bright Green	500	-0160K	£6.79
A4	Dark Green	500	-0170K	£6.79

Office Supplies & Stationery

GROUP 805 COPIER & PRINTER PAPER

Offis Iron-On Transfers For Fabric

Bright matt finish, prints to a high resolution with a great feel and look. Print onto the transfer and then iron your design onto your T-shirt. Full instructions provided.



Size	Fabric Colour	Pk Qty	Order Code OFI-805	List Price/Pk	Offer Price/Pk
A4	White	5	-0580K	£4.30	£3.65
A4	White	10	-0590K	£8.55	£7.27

Photo Paper - Silk

Instant dry photo paper. Fully coated on both sides to allow duplex printing. Recommended for: photo experimenting, proof printing and volume printing.



PACK OF 50

A4 100 GSM

Size	Pack Qty	Weight (gsm)	Order Code OFI-805	Offer Price/Pk
A4	50	100	-0010K	£4.79

Photo Paper - Matt

Instant dry matt coated photo paper. Prints to any resolution with a smudge-proof surface.



PACK OF 50

A4 180 GSM

Size	Pack Qty	Weight (gsm)	Order Code OFI-805	Offer Price/Pk
A4	50	180	-0400K	£8.94

hp Large Format Bright White Inkjet Paper

A bright white plain paper for black and colour line drawings. 90gsm. Suitable for HP Designjet 1050C and 1055CM printers.



Model Number	Size	Order Code HEW-805	Offer Price/1
C6035A	610mm x 45m	-0070K	£19.41
C6036A	914mm x 45m	-0080K	£44.30

Photo Paper - Satin

Micro porous with an instant dry coating. Satin finish offers the same 'feel' as prints from 35mm film cameras. Recommended for: professional digital photo printing and professional photograph reproduction.



PACK OF 50

A4 180 GSM

Size	Pack Qty	Weight (gsm)	Order Code OFI-805	Offer Price/Pk
A4	50	180	-0230K	£8.22

Photo Paper - Gloss

Instant dry coated photo paper. Offers good results from most inkjet printers. Suitable for 'edge to edge' printing up to 2880dpi. Recommended for: low resolution printers, proof printing and volume printing.



A4 180 GSM **6x4"** 180 GSM **7x5"** 280 GSM

Size	Pack Qty	Weight (gsm)	Order Code OFI-805	Offer Price/Pk
A4	20	180	-0080K	£3.67
A4	50	180	-0020K	£8.99
A4	50	280	-0040K	£21.24
6x4"	50	180	-0090K	£4.62
6x4"	50	280	-0180K	£8.49
7x5"	50	280	-0190K	£11.30

Listing Paper

Continuous listing paper available in plain, music ruled, recycled plain and inkjet plain. Paper flows easily through your printer, then stacks neatly. Wood-free ensures crisp clean images and jam-free performance. (All paper is wood-free unless otherwise stated).



Ruling	Parts	Perforations	Pack Qty	Order Code REX-804	Offer Price/1
11" x 241mm (11" x 9 1/2")					
Plain	1	Microperf	2000	-8570K	£19.42
Plain	2	-	1000	-8590K	£26.99
Plain	2	Microperf	1000	-8610K	£19.99
11" x 370mm (11" x 14 1/2")					
Plain	1	-	2000	-8750K	£22.99
Music Ruled	1	-	2000	-8760K	£22.99

Fax Rolls

Quality fax rolls at economy prices. Excellent quality fax rolls individually wrapped for added protection. Bright white paper gives a crisp, clear image every time.



Size	Core Size	Length	Order Code CTL-801	Offer Price/1
210mm	12.7mm	15m	-2510K	£1.16
Size	Core Size	Length	Order Code WTS-805	Offer Price/1
210mm	12.7mm	30m	-2530K	£1.89
216mm	12.7mm	30m	-2570K	£1.49
210mm	25.4mm	30m	-2540K	£1.89
210mm	25.4mm	100m	-2630K	£3.29
210mm	25.4mm	50m	-2590K	£2.59

hp Premium Inkjet Paper

Perfect for deep black text, colourful graphics and realistic photographic images. Pure white, matt surface provides sharp contrast with no bleeding.



PACK OF 200

A4 120 GSM

Size	Model Number	Pack Qty	Order Code HEW-805	Offer Price/Pk
A4	Q6593A	200	-0090K	£19.79

Filing Cabinets
Allura

Filing drawer set suitable for A4-plus sized documents. Easy glide drawers with stops, label holder and label.



No. of Drawers	Colour	Order Code ESS-806	List Price/1	Offer Price/1
4	Crystal Blue	-0010K	£72.95	£32.10
4	Quartz Grey	-0020K	£72.95	£32.10
5	Crystal Blue	-0030K	£72.95	£32.10
5	Quartz Grey	-0040K	£72.95	£32.10
6	Crystal Blue	-0050K	£72.95	£32.10
6	Quartz Grey	-0060K	£72.95	£32.10

Memo Box

Plastic note block holder with anti-slip feet and a pen rest. Comes with 800 sheets of 95 x 93mm white paper. Refill pads available.



*Colours in table are a guide only.

Colour*	Order Code QUE-806	Offer Price/1
Red	-0170K	£2.96
Blue	-0180K	£2.96
Black	-0200K	£2.96
Refill Pad	-0190K	£2.19

Desk Organiser

Gloss finish polypropylene, rounded sides for easy removal of small items. 6 compartments ideal for pens, pencils, scissors, erasers etc. Overall height: 135mm.



*Colours in table are a guide only.

Colour*	Order Code QUE-806	Offer Price/1
Black	-0130K	£1.24
Blue	-0140K	£1.24
Red	-0150K	£1.24
Grey	-0160K	£1.24

Letter Trays

Organise your paperwork. Keep your papers neat and tidy - accepts A4 and foolscap papers. Separate stacking risers for variable height.



*Colours in table are a guide only.

Colour*	Order Code QUE-806	Offer Price/1
Black	-0210K	£1.31
Blue	-0220K	£1.31
Grey	-0230K	£1.31
Red	-0240K	£1.31
Risers (Set of 4)	-0280K	£0.98

Letter Trays

Wide entry trays for all oversized letters. Can be stacked with or without risers.



*Colours in table are a guide only.

Colour*	Order Code FIV-806	Offer Price/1
Black	-0010K	£3.29
Blue	-0020K	£3.29
Grey	-0030K	£3.29
Red	-0040K	£3.29

'Pigeon Hole' Organisers

Ideal for sorting literature, mail etc. Made from laminated particle board. Colour: grey.



NEW

Compartments	Overall H x W x D (mm)	Order Code	Offer Price/1
24	594 x 737 x 302	-0400K	£88.25
36	881 x 737 x 302	-0410K	£114.78
8	260 x 490 x 310	-0500K	£13.49

DR400 Desk Tidy
DR400

Holds media, address cards, Post-It notes.



*Colours in table are a guide only.

Colour*	Order Code AVE-804	Offer Price/1
Black	-0010K	£7.12
Blue	-0020K	£7.12

Magazine Files

Accept both A4 and foolscap documents. Available in black, blue and red plastic.



KF21659 (Pk10) made of corrugated board.

Colour	Order Code DEF-806	List Price/1	Offer Price/1
Black	-0050K	£2.09	£1.88
Blue	-0060K	£2.09	£1.88
Red	-0070K	£2.09	£1.88

Magazine File	Order Code QUE-801	List Price/1	Offer Price/1
KF21659 (Pk10)	-0040K	£16.19	£9.71

Letter Trays

55mm letter tray, includes index system and non-slip feet. Separate stacking risers for variable height.



*Colours in table are a guide only.

Description	Colour*	Order Code ACC-804	Offer Price/1
Letter Tray	Charcoal	-0120K	£7.20
	Blue	-0130K	£7.20
Risers (Pk5)	Charcoal	-0240K	£2.44
	Blue	-0250K	£2.44

Letter Tray

Modern letter tray accepts both A4 and foolscap paper. Trays can be stacked two high with a set of risers. Non-slip protective feet to prevent scuffing and scratching. Corrosion and scratch resistant.



Description	Colour	Order Code ACC-803	Offer Price/1
Wire Tray	Black	-0420K	£9.22
Risers (Pk4)	Black	-0440K	£4.49

Pencil/Pen Holder

Ideal for home or office. Tidy storage for pens, pencils, scissors and markers. Corrosion and scratch resistant.



Colour	Order Code ACC-803	Offer Price/1
Black	-0460K	£4.72

Pencil/Pen Holder

Attractively finished wire mesh pencil cup.

Size:
H105 x 95mm (dia).



Colour	Order Code ESS-806	Offer Price/1
Silver	-0070K	£1.61

Magazine File

Silver wire mesh, attractively finished magazine file.

Size:
250mm x 72mm x 304mm.



Colour	Order Code ESS-806	Offer Price/1
Silver	-0110K	£3.08

Letter Tray

Attractively finished wire mesh 3-section letter tray.



Size: 179 x 130 x 77mm.

Colour	Order Code ESS-806	Offer Price/1
Silver	-0090K	£2.39

Letter Tray

Highly functional steel letter trays that provide efficient and effective desktop management.



Colour	Order Code AVE-800	Offer Price/1
Grey	-0510K	£36.54

GROUP 807 PAPER CLIPS & CLIPBOARDS

Offis Masonite Clipboards

Masonite clipboards are manufactured from strong brown hardboard with a glazed front to provide a smooth writing surface. Heavy duty clip ensures that papers are held secure. Ideally suitable for stores, warehouse, stocktaking and inspection procedures.



Size	Order Code	Offer Price/1
A4	OFI-804	£2.09
A3	-1700K	£2.28



RAPESCO Supaclip Dispensers & Refills

NEW

Dispenses reusable clips for binding paper or card without damage. Ideal for colour coding project work, reports and papers.

Two sizes available:
Supaclip '40' for 2 - 40 sheets.
Supaclip '60' for 10 - 60 sheets.

Supaclip '40' dispenser is offered with 25 clips in assorted colours. Larger pack refills for the use in the Supaclip 40 dispenser are available in stainless steel, blue or assorted colours.

Supaclip '60' comes with eight stainless steel clips.



Type	Clip Colour	Pack Quantity	Order Code	Offer Price/Pk
40 Dispenser	Assorted	1	-0010K	£4.04
40 Refill	Stainless	50	-0070K	£2.72
40 Refill	Stainless	200	-0090K	£10.16
40 Refill	Blue	200	-0040K	£10.58
60 Dispenser	Stainless	1	-0020K	£4.63
60 Refill	Stainless	25	-0030K	£2.76

PVC Clipboards

Keeps paper firmly in place. Rigid PVC covered board with heavy-duty clip. Suitable for foolscap and A4 papers. Fold over clipboard has an inside pocket for protecting papers.



Type	Colour	Order Code	List Price/1	Offer Price/1
Single	Black	-1720K	£2.40	£1.44
Single	Blue	-1725K	£2.40	£1.44
Single	Red	-1730K	£2.40	£1.44
Foldover	Black	-1740K	£3.16	£1.90
Foldover	Blue	-1745K	£3.16	£1.90
Foldover	Red	-1750K	£3.16	£1.90



Bantex PVC Clipboards

Keeps paper firmly in place. Rigid blue PVC covered board with heavy-duty clip. Suitable for foolscap, A4 and A3 papers.



Size	Order Code	Offer Price/1
A3 - 1 Clip	-0170K	£6.88



Steel Clipboard

Manufactured from thin gauge steel (1mm). Finished in grey. Heavy-duty clip with hanging hole.



Size	Order Code	List Price/1	Offer Price/1
A4/Foolscap	-1260K	£11.45	£6.30



Q-CONNECT Foldback Clips

Keep loose paper work bound together. Manufactured from high quality steel. Handles fold flat for space saving filing.



Size	Pack Quantity	Order Code	Offer Price/Pk
19mm	10	-2221Y	£0.82
24mm	10	-2222Z	£1.16
32mm	10	-2223A	£1.40
42mm	10	-2224B	£2.24
51mm	10	-2225C	£3.20

PACK OF 10

NEW

Q-Grip Clips

Ideal for clipping large batches of paper together. The famous name in clips which can be used for a multitude of tasks. Strong and reliable. Will hang on hooks and clips. Assorted coloured versions also available.



Size	Pack Qty	Order Code	Offer Price/Pk
25mm	10	-4021Y	£1.67
32mm	10	-4022Z	£2.23
51mm	10	-4023A	£2.51
70mm	10	-4024B	£5.73

PACK OF 10

NEW

Paper Clips

Paper clips in plain, coloured and wavy styles. Packed in 100s or 1000s.



NEW

Size	Type	Size	Pack Qty	Order Code	Offer Price/Pk
Small	Plain	26mm	1000	-6021Y	£1.81
Large	Plain	32mm	1000	-6520X	£2.03
Large	Plain	32mm	100	-6521Y	£0.22
Large	Lipped	32mm	1000	-5520X	£2.03
Large	Lipped	32mm	100	-5521Y	£0.27
Giant	Plain	50mm	100	-6020X	£0.65
Jumbo	Wavy	77mm	100	-8820X	£2.70

Office Supplies & Stationery

RUBBER BANDS, PINS, TAGS & CLIPS

Q-CONNECT Treasury Tags

Ideal for holding large quantities of paper. A range of strung tags for holding punched paper and computer listing paper. 23mm double cross bar tag in tinned steel with green cotton cord, to hold papers securely. **Pack:** 100.



Size	Pack Quantity	Order Code QUE-807	Offer Price/Pk
25mm	100	-5820X	£1.26
51mm	100	-5821Y	£1.30
76mm	100	-5822Z	£1.35
101mm	100	-5823A	£1.39
127mm	100	-5824B	£1.57
152mm	100	-5825C	£1.62

Rexel 2 Piece Filing Clips

Economical way to secure punched papers. Simple to use 8cm two-piece filing clip. Binds loose papers securely. Holds up to 2" (50mm) capacity.



PACK OF 50

Pack Quantity	Order Code ACC-804	Offer Price/Pk
50	-2070K	£1.60

Ring Reinforcements

Self adhesive rings manufactured from a strong vinyl in dispenser. Permanent adhesive. Ideal for reinforcing punched filed documents.

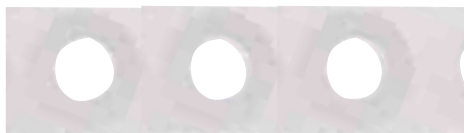

PACK OF 250

Type	Pack Quantity	Order Code CTL-804	Offer Price/Pk
Vinyl	250	-2303K	£0.67

Rubber Bands

Strong, long lasting. Use again and again. 450gm (1lb) packs in a range of sizes.

*Unstretched.



Size	Length* (mm)	Width (mm)	Order Code CTL-804	Offer Price/Pk
8	22	2	-2140K	£2.14
10	32	2	-2142K	£2.14
12	40	2	-2144K	£2.14
14	50	2	-2146K	£2.14
16	64	2	-2148K	£2.14
18	76	2	-2150K	£2.14
19	89	2	-2152K	£2.14
30	51	3	-2154K	£2.14
31	64	3	-2156K	£2.14
32	76	3	-2158K	£2.14
33	89	3	-2160K	£2.14
34	102	3	-2162K	£2.14
35	114	3	-2164K	£2.14
36	127	3	-2166K	£2.14
38	152	3	-2168K	£2.14
63	76	6	-2170K	£2.14
64	89	6	-2172K	£2.14
65	102	6	-2174K	£2.14
69	152	6	-2176K	£2.14
89	182	6	-2178K	£2.14
Assorted			-2180K	£2.14

Q-CONNECT Thimblettes

For leaf-turning, note counting and similar office or factory work. Made of high quality pliable rubber.



PACK OF 12

*Colours in table are a guide only.

Size	Colour	Pack Quantity	Order Code QUE-831	Offer Price/Pk
00	Red	12	-8010L	£1.68
0	Green	12	-8011M	£1.68
1	Blue	12	-8012N	£1.68
2	Yellow	12	-8013P	£2.80
3	Orange	12	-8014Q	£2.96

Brass Drawing Pins

11mm head diameter.

Colour: brass.

Pack quantity: 150.



Colour	Pk Qty	Order Code FIV-807	List Price/Pk	Offer Price/Pk
Brass	150	-0110K	£1.74	£0.61

Indicator Pins

White centre panel for additional referencing 15mm or 20mm pin head diameter. Assorted colours.



Pin Size	Pk Qty	Order Code FIV-807	List Price/Pk	Offer Price/Pk
15mm	20	-0100K	£1.79	£0.63
20mm	10	-0130K	£1.74	£0.61

Push Pins

Pins in assorted colours. Total length including pin 24mm.

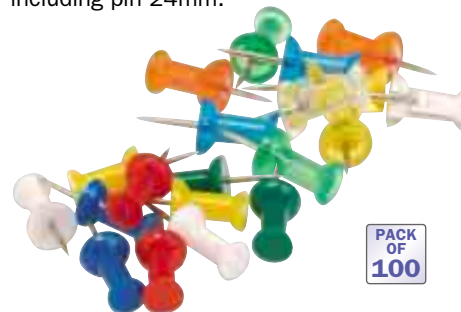

Colour	Pk Qty	Order Code FIV-807	List Price/Pk	Offer Price/Pk
Transparent	100	-0080K	£2.20	£0.77
Opaque	100	-0090K	£2.20	£0.77

Marking Flags

Plastic coloured flag on a hardened steel pin. Assorted colours.

Pack quantity: 100.

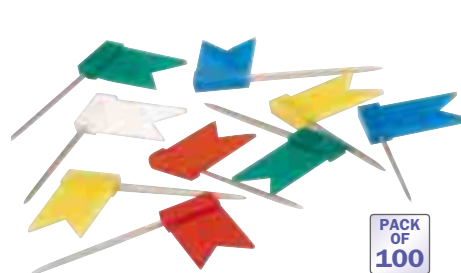

Colour	Pk Qty	Order Code FIV-807	List Price/Pk	Offer Price/Pk
Assorted	100	-0120K	£1.74	£0.61

Map Pins

Plastic coloured head on a hardened steel pin. 5mm diameter head.



Colour	Pk Qty	Order Code FIV-807	List Price/Pk	Offer Price/Pk
Assorted	100	-0010K	£2.20	£0.77

GROUP 807 OFFICE ADHESIVES

3M Artists' Spray Adhesives

Spray Mount™
Non-permanent adhesive for use with artwork, photographs etc. Allows for repositioning. Improved spray pattern for reduced overspray and easier application.



Size	Order Code	Offer Price/1
200ml	MMM-802-0030K	£7.96
400ml	MMM-802-4120K	£13.76

Display Mount™
General-purpose adhesive for permanent bonds. Improved spray pattern for reduced overspray and easier application.



Size	Order Code	Offer Price/1
400ml	MMM-802-4100K	£13.27

Photo Mount™
Permanent adhesive specifically formulated for use with photographic prints. Improved spray pattern for reduced overspray and easier application.



Size	Order Code	Offer Price/1
400ml	MMM-802-4110K	£13.27

90 High Strength Spray Adhesive
For high strength bonds with hard to hold materials e.g. decorative laminates, lightweight metals, plastic, including polythene, polypropylene and most other lightweight materials such as felt, fabrics, cardboard and flexible foams. High contact bond strength and fast drying.



Size	Order Code	Offer Price/1
500ml	MMM-705-0090G	£8.76

77 Multi-Purpose Adhesive

High coverage with low soak-in. Fast aggressive tack that securely bonds lightweight materials, e.g. film, foils and fabrics. Suitable for use on expanded polystyrene foam without meltdown. Can be applied to either one or two surfaces.



Size	Order Code	List Price/1	Offer Price/1
500ml	MMM-802-1050K	£8.99	£8.09

UHU® Glue Stick

Strong, Clear all-purpose glue. Versatile applicator for precise 'glue dots' or twist to apply a narrow or wide glue line. Ideal for paper, cardboard, wood, felt, fabrics, and cork. Washable with soap. Acid-free and non-toxic. Size: 40g



Product	Order Code	List Price/1	Offer Price/1
Twist & Glue	UHU-725-0030K	£2.46	£2.19

Pritt® Glue Sticks

The original stick adhesive for paper and card. Washable, non toxic and completely safe. Suitable for home and office. Stick application means no mess.



Size	Order Code	Offer Price/1
Standard - 10g	PRI-807-0020K	£0.79
Medium - 20g	PRI-807-0030K	£1.51
Large - 40g	PRI-807-0040K	£2.27
Jumbo - 90g	PRI-807-0010K	£3.31

Glue Sticks

Non-toxic, solvent-free instant adhesive, ideal for schools and colleges. 'Lipstick style' applicator for precision operation and helps to reduce accidental application. Click on cap to protect when not in use. Handy alternative to aerosol and liquid adhesives. Ideal for sticking paper, card and photographs.



Size	Order Code	Offer Price/1
Medium - 20g	CTL-807-0020K	£0.52
Large - 40g	CTL-807-0030K	£0.66

Q-CONNECT®

Quick Mount Spray

Suited to the repeated mounting of light materials such as film, acetate and layout paper. Transparent aerosol will not soak through or wrinkle light materials. CFC free. 400ml can.



Size	Order Code	Offer Price/1
400ml	QUE-807-0020K	£5.00

Sellotape® Office Sticky Fixers®

Double sided foam pads for permanent mounting. Can be used instead of nails, screws and glue. Available in two pack sizes: 56 and 140 pads. Each pad is 12 x 25mm and has a weight loading of 108g.



Pack Quantity	Order Code	Offer Price/Pk
56	SEL-802-0010K	£1.09
140	SEL-802-8550K	£1.96



Bostik® Blu-Tack

The original No.1 reusable adhesive. Holds up, holds down, holds safe, almost anything. Available in handy and economy sizes.

NEW



Pack Size	Order Code	Offer Price/Pk
Handy - 60g	BST-807-0010K	£1.42
Economy - 120g	BST-807-0020K	£1.07



Office Supplies & Stationery

VELCRO® Double-Sided Sticky Foam Pads

Permanent fixing solution and are a quick and easy way of securing a multitude of items around the home, including pictures and plastic hanging hooks, as well as for craft projects. Can be used with card, paper, ceramic, metal, glass (not to be exposed to UV light), wood and plastic. Size: 12 x 25mm.



Pack Quantity	Order Code	Offer Price/Pk
70 Pads	VEL-807-0430K	£1.12

Q-CONNECT® Quick Tac

Adhesive Putty
Economic reusable adhesive will hold papers or light objects to most surfaces. Will not mark walls or dry out.



Size	Order Code	Offer Price/Pk
70g	QUE-807-8901B	£0.92
140g	QUE-807-8902C	£1.27



NEW

Standard White Envelopes



Type	Weight	Size (W x H)	Pack Qty	Order Code WTS-804	Offer Price/Pk
Pocket Envelopes					
Self Seal	90gsm	C5 162 x 229mm	500	-7420K	£9.99
Self Seal Window	90gsm	C5 229 x 162mm	500	-7425K	£10.59
Self Seal	90gsm	C4 229 x 324mm	250	-0470K	£9.45
Self Seal Window	90gsm	C4 229 x 324mm	250	-0480K	£8.99
Banker Envelopes					
Self Seal	80gsm	DL 220 x 110mm	1000	-7330K	£11.99
Self Seal	100gsm	DL 220 x 110mm	1000	-7350K	£13.20
Self Seal Window	80gsm	DL 220 x 110mm	1000	-7335K	£12.99
Self Seal	90gsm	DL 220 x 110mm	1000	-0920K	£12.99
Low Window S/Seal	80gsm	DL 220 x 110mm	1000	-0840K	£17.73
Low Window S/Seal	90gsm	DL 220 x 110mm	1000	-0930K	£15.99

Premium White Envelopes

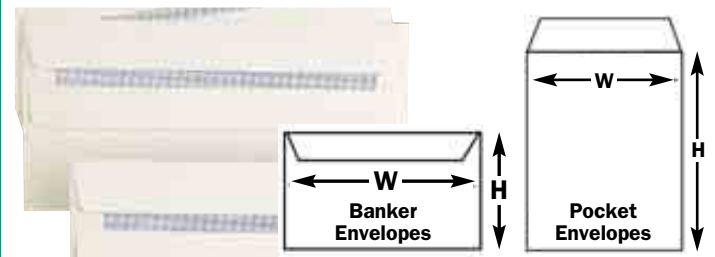

Type	Weight	Size (W x H)	Pack Qty	Order Code WTS-804	Offer Price/Pk
Pocket Envelopes					
Self Seal	100gsm	DL 110 x 220mm	500	-0800K	£13.80
Banker Envelopes					
Self Seal	100gsm	DL 220 x 110mm	1000	-1000K	£18.99
Self Seal Low Window	100gsm	DL 220 x 110mm	1000	-1010K	£21.99

Heavyweight Manilla Envelopes

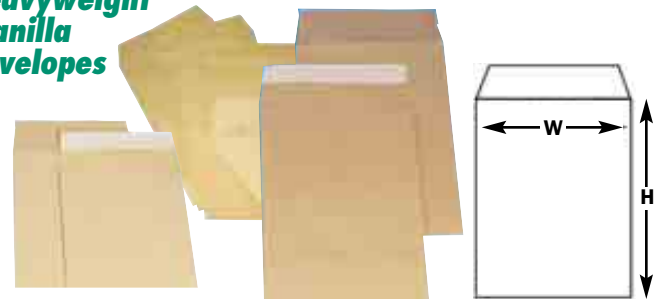

Type	Weight	Size (W x H)	Pack Qty	Order Code WTS-804	Offer Price/Pk
Pocket Envelopes					
Self Seal	115gsm	C5 162 x 229mm	250	-0820K	£8.13
Self Seal	115gsm	C4 334 x 229mm	250	-7498K	£10.89
Self Seal	115gsm	381 x 254mm	250	-7560K	£14.99

Standard White Envelopes

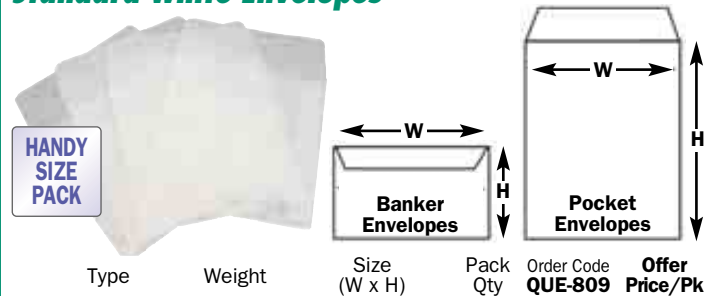

Type	Weight	Size (W x H)	Pack Qty	Order Code QUE-809	Offer Price/Pk
Pocket Envelopes					
Self Seal Window	90gsm	C5 162 x 229mm	25	-0230K	£1.99
Self Seal	90gsm	C5 162 x 229mm	25	-0240K	£1.86
Self Seal	90gsm	C4 229 x 324mm	25	-0260K	£2.74
Banker Envelopes					
Self Seal	80gsm	DL 220 x 110mm	50	-0190K	£1.92
Self Seal Window	80gsm	DL 220 x 110mm	50	-0200K	£2.19
Self Seal	80gsm	C6 162 x 114mm	50	-0210K	£2.25

Manilla Envelopes



Type	Weight	Size (W x H)	Pack Qty	Order Code WTS-804	Offer Price/Pk
Pocket Envelopes					
Self Seal	80gsm	C5 229 x 162mm	500	-1020K	£9.60
Self Seal	90gsm	C5 229 x 162mm	500	-7540K	£10.77
Self Seal	80gsm	C4 334 x 229mm	250	-7520K	£8.40
Self Seal	90gsm	C4 334 x 229mm	250	-0240K	£8.85
Self Seal	90gsm	305 x 406mm	250	-7515K	£17.67

Handy Pack Manilla Envelopes



Type	Weight	Size (W x H)	Pack Qty	Order Code QUE-809	Offer Price/Pk
Pocket Envelopes					
Self Seal	80gsm	C5 162 x 229mm	25	-0220K	£1.96
Self Seal	80gsm	C4 229 x 324mm	25	-0250K	£2.14

Q-CONNECT Wage Envelopes

Self Seal Wage Envelopes. Easy to seal wage envelopes without cut away flap. Contents cannot be checked before packet is opened. Suitable for holding coins.
Type: plain. **Weight:** 80gsm.

Pack Qty	Size (Height x Width)	Order Code QUE-809	Offer Price/1
50	108 x 102mm	-0270K	£2.19
Pack Qty	Size (Height x Width)	Order Code WTS-804	Offer Price/1
1000	108 x 102mm	-0250K	£13.38

River Series Self Seal Envelopes

Manilla Range
A high quality, versatile envelope range. Ideal for business correspondence and all general mailing requirements. Self seal without window.

Weight (gsm)	Size (mm)	Pack Qty	Order Code WTS-809	Offer Price/Pk
Self Seal Plain				
80	C5 229 x 162	500	-0130K	£9.99
115	C5 229 x 162	250	-0140K	£7.41
80	C4 324 x 229	250	-0150K	£8.31
115	C4 324 x 229	250	-0160K	£10.40

White Range

A high quality, versatile envelope range. Ideal for business correspondence and all general mailing requirements. Self seal.

Weight (gsm)	Size (mm)	Pack Qty	Order Code WTS-809	Offer Price/Pk
Self Seal Plain				
80	DL 110 x 220	1000	-0070K	£14.69
90	C5 229 x 162	500	-0090K	£12.15
90	C4 324 x 229	250	-0110K	£11.28
Self Seal Window				
80	DL 110 x 220	1000	-0080K	£13.95
90	C5 229 x 162	500	-0100K	£13.20
90	C4 324 x 229	250	-0120K	£11.97

CONTRACT PRICES AVAILABLE FOR VOLUME PURCHASES

All Prices Exclude V.A.T. © 2011

GROUP 810 FILING - EXPANDING FILES & BOX FILES

Eastlight® Homefile Expanding Case

Designed to ensure safe, convenient storage of bills, guarantees, correspondence and other important documents. Ideal for office and domestic use.



Size	Colour	Order Code ESL-810	Offer Price/1
Foolscap	Black	-0520K	£12.41
	Blue	-0530K	£12.41

CATHEDRAL Metal Foolscap Office File Boxes

Portable filing system to safely organise documents. Has a recessed handle and is stackable for easy storage. Manufactured from powder coated metal. Accommodates both foolscap and A4 documents. Complete with five foolscap suspension files, indexing system, lockable lid and spare key.

Dimensions (W x D x H):
425 x 220 x 295mm.



Colour*	Order Code CTH-810	List Price/1	Offer Price/1
Black	-0010K	£19.99	£14.99
Blue	-0020K	£19.99	£14.99
Red	-0040K	£19.99	£14.99

*Colours in table are a guide only.

CATHEDRAL Expanding Cases

Expanding files to accept both A4 and Foolscap paper available in either Multi-purpose (16 pockets) or A-Z (19 pockets) formats.



Type	Order Code CTH-810	List Price/1	Offer Price/1
Multipurpose (16 pockets)	-0090K	£5.49	£4.12
A-Z (19 pockets)	-0100K	£6.52	£4.89

Multi-Purpose File Case

Foolscap
Expanding concertina type inner with hard cardboard outer case.

Tabs printed 1 - 21, A - Z, monthly and utilities.

Utilities List:
Car records, bank records, budget, credit card, dental records, expenses, income, insurance, investments, legal, loans, medical records, mortgage/rent, personal, real estate, receipts, school, taxes, utilities, warranties.



Colour*	Order Code CTH-810	List Price/1	Offer Price/1
Black	-0050K	£8.99	£6.74
Blue	-0060K	£8.99	£6.74
Red	-0070K	£8.99	£6.74
Purple	-0080K	£8.99	£6.74

*Colours in table are a guide only.

Offis Box Files

Practical storage for invoices, orders and receipts and other vital documents. A4 or Foolscap document size. Features pull tab and internal spring clip holding mechanism to keep papers secure and in place. With spine label.

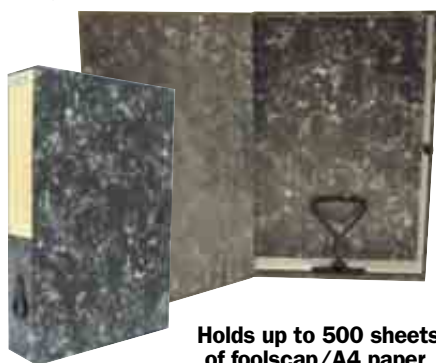

Holds up to 500 sheets of foolscap/A4 paper.

Size	Colour	Pack Qty	Order Code OFI-804	Offer Price/Pk
A4/Foolscap	Black	1	-0160K	£2.49
	Black	10	-0120K	£22.19

Box Files

Box files fitted with strong lock springs to hold contents firmly in place whilst lid clip ensures positive closure. Extra wide giving comfortable storage of foolscap document wallets and up to 500 sheets of A4 paper.

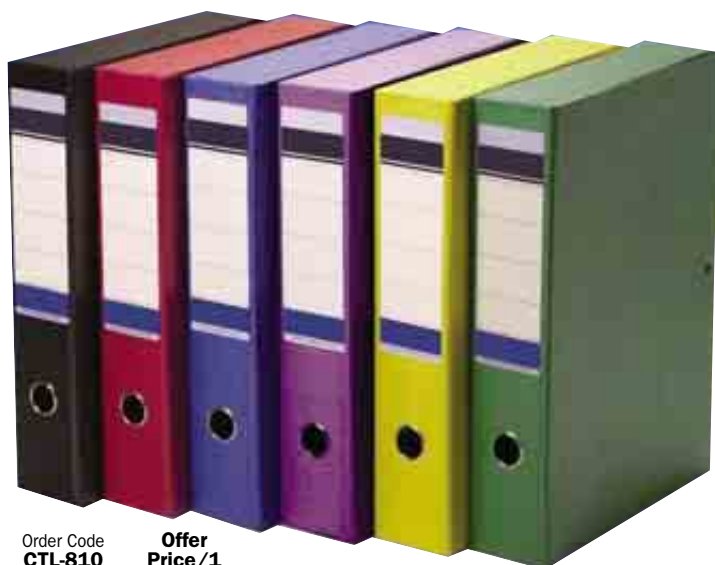

Size	Colour*	Order Code CTL-810	Offer Price/1
A4/Foolscap	Blue	-0180K	£2.62
	Green	-0190K	£2.62
	Red	-0210K	£2.62
	Yellow	-0220K	£2.62
	Purple	-0200K	£2.62

*Other colours available on request. Colours in table are a guide only.

Office Supplies & Stationery

FILING - LEVER ARCH & RING BINDERS

Lever Arch Files

Top quality lever arch mechanism for content security. Finger ring on the spine allows for easy shelf retrieval. Metal edges to prevent scuffing. Arch lock on cover for secure file closure.



Size	Colour	Order Code CTL-810	Offer Price/1
Foolscap	Blue	-0230K	£1.42
	Green	-0240K	£1.42
	Red	-0250K	£1.42
	Yellow	-0260K	£1.42
	Purple	-0270K	£1.42
A4	Blue	-0280K	£1.42
	Green	-0290K	£1.42
	Red	-0300K	£1.42
	Yellow	-0310K	£1.42
	Purple	-0320K	£1.42

Lever Arch Files

NEW

Constructed to the highest specification. Metal runners for lasting wear. Thumb-hole for easy retrieval. Front cover lock to keep contents secure, quality mechanism and large reversible spine ticket for easy identification.



Size	Colour	Order Code HLZ-810	Offer Price/1
A4	Black	-6010K	£18.00
	Blue	-6020K	£18.00
	Green	-6030K	£18.00
	Red	-6040K	£18.00
	Yellow	-6050K	£18.00
Foolscap	Black	-6110K	£18.00
	Blue	-6120K	£18.00
	Green	-6130K	£18.00
	Red	-6140K	£18.00
	Yellow	-6150K	£18.00

Offis Lever Arch Files

Tough board lever arch files. Finger pull for easy retrieval. Large label area enables quick identification. Fitted shoes for protection. Complete with eyelets to assist filing on shelves - files won't fall over. Available in packs of 10, A4 or foolscap.



Size	Pack Quantity	Colour	Order Code OFI-810	Offer Price/Pk
A4	10	Cloud	-0220K	£12.20
Foolscap	10	Cloud	-0230K	£12.20

O-CONNECT Lever Arch Module

A convenient way to store your lever arch files. Each file holder has space to store up to six A4/Foolscap lever arch files. Available in black. Internal dimensions: H360 x W525 x D280mm.



Files not included

Pack Quantity	Order Code QUE-800	Offer Price/1
1	-0060K	£9.33
5	-0070K	£46.54

Esselte PVC Ring Binders

For small format papers. 30mm capacity, two 'O' ring mechanism. Spine ticket for quick reference. Available in a choice of colours.



Ring Size	Colour	Order Code ESS-810	Offer Price/1
25mm	Red	-1100K	£1.59
	Blue	-1110K	£1.59
	Green	-1120K	£1.59
	Black	-1130K	£1.59

Coloured Lever Arch Files

These Lever Arch Files are PVC covered for extra durability. Available in two sizes and three colours they are excellent for storing volume documentation.



Size	Colour	Order Code OFI-810	Offer Price/1
Foolscap	Black	-0060K	£13.99
	Blue	-0070K	£13.99
	Green	-0080K	£13.99
A4	Black	-0240K	£13.99
	Blue	-0250K	£13.99
	Green	-0260K	£13.99

Fellowes Filestore Filing Modules

Keep your files upright. Easily assembled filing modules will store and transport lever arch files and ring binders. Each lever arch module houses 6 files in individual compartments. Modules have push in tote handles for portability and will stack up to four high.



Files not included

Type	File Capacity	Order Code FEL-800	Offer Price/1
Lever Arch	6	-0360K	£9.98

Landscape Presentation Ring Binder

Manufactured from heavy board (board is 100% recycled) and covered with wipe-clean polypropylene. 4x 25mm rings and 36mm spine. A3 landscape - rings are along the short edge.



Ring Size	Colour	Order Code ESS-810	Offer Price/1
25mm	Blue	-0010K	£9.43

CONTRACT PRICES AVAILABLE FOR VOLUME PURCHASES

GROUP 810 FILING - LEVER ARCH & RING BINDERS

Offis A4 2-Ring Binders

A4, two-ring binders available in black, blue and red. Perfect for storing low volumes of punched paper. Complete with spine pockets and insert labels.

Ring size: 25mm.

Pack quantity: 10 binders.



PACK OF 10

Cover Type	Colour	Order Code OFI-810	Offer Price/1
Board	Black	-0270K	£8.99
	Blue	-0280K	£8.99
	Red	-0290K	£8.99
Poly	Black	-0300K	£9.34
	Blue	-0310K	£9.34
	Red	-0320K	£9.34

Covered Ring Binders

Ideal for storing low volumes of punched paper. Self adhesive spine label for indexing. Colourful paper covering material. 25mm ring capacity.



A4 2 O-RINGS

PACK OF 10

Ring Size	Colour	Order Code HLZ-810	Offer Price/1
25mm	Black	-7210K	£9.90
	Blue	-7220K	£9.90
	Green	-7230K	£9.90
	Red	-7240K	£9.90
	Yellow	-7250K	£9.90

Poly' Presentation Ring Binders

A4, 2 or 4 'D' ring polypropylene ring binders with clear pocket on front and spine.



A4 2 OR 4 D-RINGS

Size	Colour	Order Code ESS-810	Offer Price/1
25mm 2 Ring	Blue	-0240K	£2.10
	Black	-0250K	£2.10
	Red	-0260K	£2.10
	White	-0270K	£2.10
16mm 4 Ring	White	-0310K	£2.12
	White	-0350K	£2.25
25mm 4 Ring	Blue	-0320K	£2.25
	Black	-0330K	£2.25
	Red	-0340K	£2.25
40mm 4 Ring	White	-0390K	£2.38
	Blue	-0360K	£2.38
	Black	-0370K	£2.38
50mm 4 Ring	Red	-0380K	£2.38
	White	-0430K	£2.94
	Black	-0410K	£2.94
60mm 4 Ring	Red	-0420K	£2.94
	White	-0470K	£3.49
	Blue	-0440K	£3.49
4 Ring	Black	-0450K	£3.49
	Red	-0460K	£3.49

PVC Ring Binders

Textured linen-look ring binder. Durable PVC A4 four ring binder with 25mm 'O' ring capacity. Label holder on 35mm spine for easy identification of files.



LINEN LOOK

A4 4 O-RINGS

Ring Size	Colour	Order Code ESS-810	Offer Price/1
25mm	Black	-1220K	£1.44
	Blue	-1230K	£1.44
	Green	-1240K	£1.44
	Red	-1250K	£1.44
	Yellow	-1260K	£1.44

PVC Ring Binders

With spine pockets and insert labels. 25mm ring capacity.



A4 2 O-RINGS

PACK OF 10

Ring Size	Colour	Order Code HLZ-810	Offer Price/1
25mm	Black	-6310K	£10.35
	Blue	-6320K	£10.35
	Green	-6330K	£10.35
	Red	-6340K	£10.35
	Yellow	-6350K	£10.35

PVC Ring Binders

Extra capacity binders. Durable PVC A4 four ring binder with label holder and thumb hole for easy retrieval. With a 54mm spine. Extra wide binder for use with punched pockets and maxi dividers.



A4 4 D-RINGS

Ring Size	Colour	Order Code ESS-810	Offer Price/1
40mm	Red	-1140K	£4.39
	Blue	-1150K	£4.39
	Green	-1160K	£4.39
	Black	-1170K	£4.39

Office Supplies & Stationery

Esselte Standard Pockets

Heavyweight polypropylene pocket ideal for storing papers in constant use. Lightly embossed to reduce glare. Copysafe material prevents text uplift. Multi-punched with coloured reinforced strip for extra strength.



Size	Type	Pack Quantity	Order Code	Offer Price/Pk
A5	Top Opening	25	ESS-810	£3.25
A3	Landscape	10	-1180K	£4.48

Esselte 'At Hand' Punched Pockets

Pockets that are ALWAYS At Hand, save time, space and provide a new pocket every time. Sturdy, compact box containing 50 pockets. Box with rip-off section for easy access to the contents. One pocket at a time can be easily removed. Light, copysafe, polypropylene. Thirty-eight micron orange peel pockets (blown film), with white reinforcement strip. Patented dispenser and mechanism for dispensing.



Size	Pack Quantity	Order Code	Offer Price/Pk
A4	50	ESS-810	£2.29

Rexel Clear Reinforced Pockets

Pockets in polished anti-static material which helps prevent off-setting from photocopies and duplicated documents. Reinforcing strip (green) provides extra strength. Top opening allows contents to be changed without releasing binder. High clarity of contents.



Size	Pack Quantity	Order Code	Offer Price/Pk
A4	100	ACC-804	£20.99

Offis A4 Punched Pockets

A4 top opening. Manufactured from hard-wearing anti-static polypropylene and lightly embossed to reduce glare. Heavy duty reinforced binding edge with conventional 11 hole punch which fits all 2, 3 and 4-ring binders. Ideal for everyday use.



Size	Pack Quantity	Order Code	Offer Price/Pk
A4	100	OFI-804	£2.09

Premium Expanding Pocket

Heavy duty gusseted pocket ideal for storing catalogues, directories and project work. Features top opening for easy access to contents and strong reinforced strip. Maximum capacity of 250 pages.

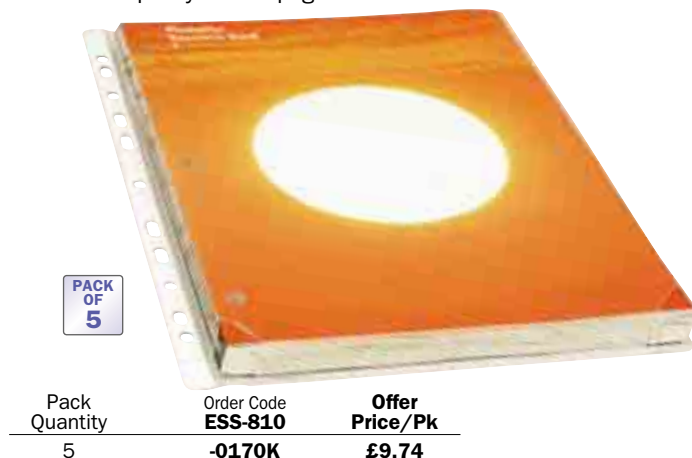

Pack Quantity	Order Code	Offer Price/Pk
5	ESS-810	£9.74

Office Glass Clear Pocket

A4 Multi Punched Pockets. Glass clear, top opening, 60-micron pockets with white reinforcing strips. Ideal for protecting frequently used papers in everyday use.



Size	Order Code	List Price/1	Offer Price/1
A4	FIV-810	£26.99	£4.32

Office Supplies & Stationery

GROUP 810 FILING - PUNCHED POCKETS & DIVIDERS

Subject Dividers

NEW

Keep your filing in order. Made from 230 micron pulp board for durability. Different colours to allow easy location of papers. Punched 11 holes to cover all punching systems. Individually shrink wrapped to ensure dividers are kept in good condition until used.



A4

Type	Order Code FIV-810	Offer Price/1
5 Part	-0090K	£0.24
10 Part	-0100K	£0.55
12 Part	-0110K	£0.86
15 Part	-0120K	£0.99
20 Part	-0130K	£1.52

Classic Indexes

Extra strong tabs withstand constant use. High quality white board index with mylar reinforced clear tabs and punched holes for durability. Printed contents list for easy cross referencing. Punched four holes to fit any binder.



A4

Size	Type	Order Code JET-810	Offer Price/1
A4	5 Part 1 - 5	-0410K	£1.75
	10 Part 1 - 10	-0430K	£2.44
	12 Part 1 - 12	-0350K	£2.77
	20 Part 1 - 20	-0420K	£4.19
	26 Part A - Z	-0400K	£5.99

PVC 10 Part Index

Extra strong index for constant use. White PVC index with matching paper contents page. Extremely hard wearing and can be wiped clean if necessary. Quality 145 micron extra heavyweight PVC.



A4

Type	Order Code JET-810	Offer Price/1
10 Part 1 - 10	-0220K	£2.48

Subject Dividers

Organise file contents by subject using a different divider for each subject. High quality dividers in white or assorted colours. Write or type onto tabs to create individual indexing system. Functional and easy to use.



A4

Type	Order Code JET-810	Offer Price/1
Assorted A4		
5 Part	-0440K	£0.48
10 Part (5 Colours)	-0320K	£0.95
10 Part (10 Colours)	-0330K	£1.17
12 Part	-0310K	£1.65
20 Part (5 Colours)	-0340K	£2.44

Multicolour Indexes

Gives that professional look to your presentations. White board with mylar reinforced tabs and clear punched holes for durability. Multi-colour matching contents page. A4 punched 4 holes to fit any binder.



A4

Size	Type	Order Code JET-810	Offer Price/1
A4	5 Part 1 - 5	-0370K	£1.98
	10 Part 1 - 10	-0390K	£2.83
	20 Part 1 - 20	-0360K	£4.72
	A - Z	-0380K	£4.79
	Jan - Dec	-0210K	£3.34

Polypropylene Indexes

Extra strong dividers for constant use. Multi-punched tear and stain resistant dividers will last and last. Grey polypropylene with matching contents page for easy cross reference.



A4

Type	Order Code JET-810	Offer Price/1
5 Part 1 - 5	-0230K	£0.63
10 Part 1 - 10	-0240K	£0.91
12 Part 1 - 12	-0250K	£1.08
15 Part 1 - 15	-0260K	£1.36
20 Part 1 - 20	-0270K	£1.60
31 Part 1 - 31	-0280K	£2.05
A - Z	-0290K	£1.25
Jan - Dec	-0300K	£1.08

Type	Order Code JET-810	Offer Price/1
Extra Wide A4 20 Part A - Z	-0450K	£3.63
Extra Wide A4 5 Part	-0460K	£0.79
Extra Wide A4 10 Part	-0470K	£1.49

Subject Dividers

Bright subject dividers and indexes with assorted coloured tabs.

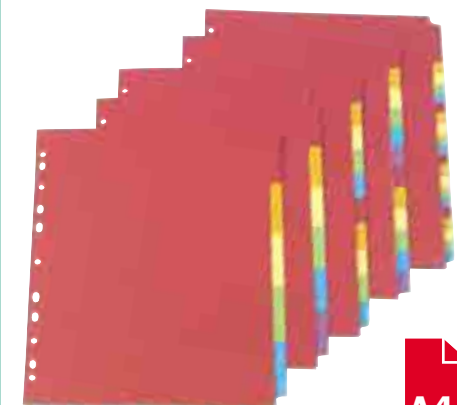

A4

Type	Order Code JET-810	List Price/Pk	Offer Price/Pk
Assorted A4 - Bright			
5 Part	-0010K	£0.75	£0.56
6 Part	-0020K	£0.94	£0.70
10 Part	-0030K	£1.47	£1.10
12 Part	-0040K	£2.33	£1.75
A - Z	-0050K	£3.83	£2.87

Polypropylene Indices - White

Reinforced holes for extra strength. Durable, crisp and clean. Popular deep blue print colour. A4. 1 - 20 tabs.



Size	Type	Order Code FIV-810	Offer Price/Pk
A4	15 Part 1 - 15	-0180K	£1.62
A4	20 Part 1 - 20	-0190K	£1.90
A4	31 Part 1 - 31	-0200K	£2.42
A4	26 Part A - Z	-0210K	£1.29

Multi Coloured Divider Sets

A4. Available in card or polypropylene material.

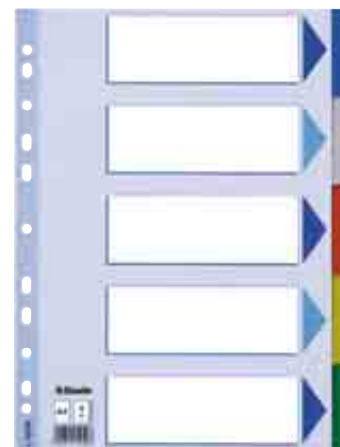

Material	Tabs	Order Code ESS-810	List Price/Pk	Offer Price/Pk
Card	5	-0060K	£0.71	£0.32
	10	-0070K	£1.13	£0.51
Polypropylene	10	-0090K	£2.09	£0.94

Office Supplies & Stationery



Foolscap Suspension Files

Has clamped steel support bar, smooth gliding hooks and indicator tabs. For easier storage and retrieval of important documentation.



PACK OF 50

50 TABS + INSERTS INC.

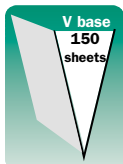

Colour	Pack Quantity	Order Code	Offer Price/Pk
Green	50	OFI-804	£10.79

Description	Pack Quantity	Order Code	Offer Price/Pk
Tabs	50	-0060K	£3.60
Inserts	50	-0050K	£0.99

Crystalfile® Foolscap Suspension Files

Classic V Base

The original suspension file. Environmentally friendly files V made from recycled material. Contrasting interiors help prevent mis-filing. Designed for heavy usage and speedy retrieval of information. Supplied complete with tabs and inserts.



PACK OF 50

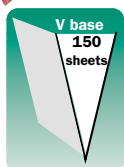

Colour	Pack Quantity	Order Code	Offer Price/Pk
Green	50	ACC-804	£43.39
Inserts	50	-0730K	£1.81

Description	Pack Quantity	Order Code	Offer Price/Pk
Tabs	50	-0060K	£3.60

A4 Suspension Files

Made from tough manilla. Supplied complete with tabs and inserts.

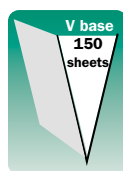

PACK OF 50

A4

Colour	Pack Quantity	Order Code	Offer Price/Pk
Green	50	PRE-804	£9.24

Foolscap Document Wallets

Economical 250gsm document filing wallet. Capacity 32mm. Pre-printed labelling area for easy referencing. Assorted colours for colour coded filing.

PACK OF 50



Colour	Pack Quantity	Order Code	Offer Price/Pk
Buff	50	-0130K	£4.54
Blue	50	-0120K	£4.54
Green	50	-0140K	£4.54
Pink	50	-0150K	£4.54
Yellow	50	-0160K	£4.54

Q-CONNECT® Foolscap Tabbed Folders

Tabbed folders in quality recycled kraft manilla. Tabbed in five positions. Printed identification panel. Foolscap.



PACK OF 100

Colour	Pack Quantity	Order Code	Offer Price/Pk
Buff	100	QUE-810	£4.95

CONTRACT PRICES AVAILABLE FOR VOLUME PURCHASES

GROUP 810 FILING - WALLET & FOLDERS

Esselte 'At Hand' Cut Flush Folders

Sturdy, compact box containing 50 cut flush folders. Box with rip-off section for easy access to the contents. One folder at a time can be easily removed. Light, copysafe, polypropylene. 55 micron orange peel folders with rounded thumb cut for easy opening. Patented dispenser and mechanism for dispensing material. 25mm capacity.



A4 **NEW** **PACK OF 50**

Size	Pack Quantity	Order Code	Offer Price/Pk
A4	50	ESS-810	£2.56

Square Cut Folders

Lightweight 180gsm
Easy to file, easy to find. Pre-creased folders to accommodate large quantities of paper. Folders fit neatly into suspension files. Foolscap.



PACK OF 100

Other colours shown are available on request.

Foolscap

Colour	Pack Quantity	Order Code	Offer Price/Pk
Buff	100	AVE-804	£3.52

Rexel Nyrex Datafiles

For general correspondence, reports, projects and proposals. Clear front cover and flexible opaque back cover. Flat bar mechanism inside to hold A4 punched papers and full length title and indexing strip on the front. Red.



PACK OF 25

A4

Colour	Pack Quantity	Order Code	Offer Price/Pk
Red	25	ACC-804	£28.90

Clear Top Opening Card Holder

Protects documents in all conditions. High quality polished polypropylene. A4, tough, grease-proof, wipe clean covers. Top opening.



PACK OF 25

A4

Size	Pack Quantity	Order Code	Offer Price/Pk
A4	25	ACC-804	£12.24

Nyrex Business Card Pocket

Nyrex premium quality pocket with eight business card locations to enable you to organise and store 20 business cards into standard A4 ring binders.



A4

Size	Capacity	Order Code	Offer Price/10
A4	20 Cards	ACC-804	£9.30

Q-CONNECT® Elasticated Folios

Three flap elasticated file manufactured from tough hardwearing polypropylene. Internal flaps prevent papers from falling out and elasticated corners holds file closed while in transit. Takes A4 paper. Available in red, blue, green and black.



All prices are each

Colour	Order Code	List Price/1	Offer Price/1
Red	-0480K	£2.99	£1.35
Blue	-0490K	£2.99	£1.35
Green	-0500K	£2.99	£1.35
Black	-0510K	£2.99	£1.35

Cut Flush Folders

Durable coloured folders ideal for everyday filing. Open top and side with easy access thumb cut-out. Ideal for colour coding documents and files.

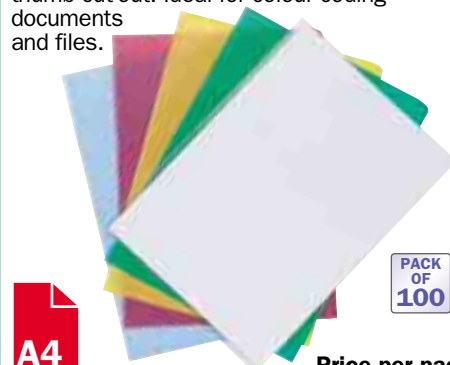

A4

PACK OF 100

Colour	Order Code	List Price/Pk	Offer Price/Pk
Red	-0070K	£12.42	£5.59
Blue	-0080K	£12.42	£5.59
Yellow	-0090K	£12.42	£5.59
Green	-0100K	£12.42	£5.59
Clear	-0110K	£9.78	£4.40

Snake Zippa Bags

The S-type zippa-bag with tough plastic closure and metal zip pull. Manufactured from transparent, flexible material. Ideal for hundreds of uses in office, industry, home and school. Different colour 'zip-strips'.

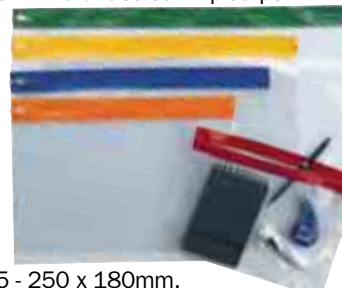

Sizes: A5 - 250 x 180mm.
A4 - 320 x 230mm.
A4+ - 370 x 255mm.
A3 - 480 x 350mm.

PACK OF 25

Size	Colour	Order Code	List Price/Pk	Offer Price/Pk
A5	Green	-0040K	£29.10	£9.89
A5	Assorted	-0050K	£29.10	£9.89
A4	Blue	-0060K	£35.27	£11.99
A4	Red	-0070K	£35.27	£11.99
A4	Yellow	-0080K	£35.27	£11.99
A4	Green	-0090K	£35.27	£11.99
A4	Assorted	-0100K	£35.27	£11.99
A4+	Blue	-0110K	£38.22	£12.99
A3	Red	-0120K	£38.22	£12.99
A4+	Assorted	-0150K	£38.22	£12.99
A3+	Assorted	-0210K	£52.28	£17.78

Office Supplies & Stationery

Rexel Carry Folders

The colourful way to store and carry documents and projects. Made from polypropylene to give good resistance to everyday wear and tear. Translucent finish, polypropylene - hard wearing, durable, protective, wipe clean. Popper - secures contents and matches folder colour. Holds up to 150 sheets (80gsm) of paper.

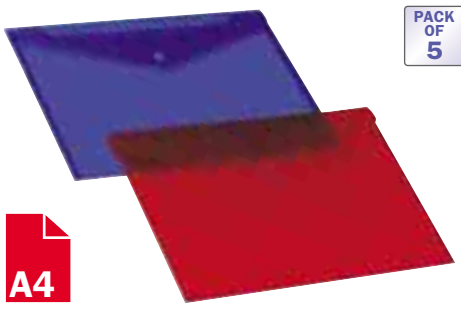

A4

PACK OF 5

Colour	Pack Quantity	Order Code	Offer Price/Pk
Blue	5	-3340K	£4.41
Red	5	-3350K	£4.41

Eastlight® Jiffex Files

A popular file that allows for easy insertion and removal of papers without disturbing the sequence of the remaining papers. Features an easy to use twin coil mechanism and variable spine thickness to suit required capacity.



PACK OF 50

Colour	Pack Quantity	Size	Order Code ESL-810	Offer Price/Pk
Buff	50	Foolscap	-0540K	£57.84
Blue	50		-0550K	£57.84
Green	50		-0560K	£57.84
Red	50		-0570K	£57.84

Q-CONNECT® Project Folders

Quality lightweight folder, perfect for quotes, reports and proposals. Glass clear cover and coloured back and spine. Full length index strip for identification. Standard 8cm two prong flat bar mechanism for keeping punched documents secure.



Colour	Pack Quantity	Order Code QUE-810	Offer Price/Pk
Black	25	-0620K	£8.55
Blue	25	-0630K	£8.55
Red	25	-0640K	£8.55
Green	25	-0650K	£8.55
Yellow	25	-0660K	£8.55



PACK OF 25

Polypropylene Document Folders

A stylish and colourful way to store and carry documents. Hard wearing, low-cost polypropylene document folders. Transparent with a press-stud closing mechanism to keep contents secure.

Size: A4.



Colour	Pack Quantity	Order Code QUE-810	Offer Price/Pk
Red	1	-0560K	£0.58
Yellow	1	-0570K	£0.58
Blue	1	-0580K	£0.58
Green	1	-0590K	£0.58
Clear	1	-0600K	£0.58
Assorted	12	-0610K	£7.33



Rexel® Plastic Folders

Keep important information neat, clean and easy to find. Ideal for protecting plans, proposals, course notes, hand-outs etc. Superfine folders are produced in clear anti-static polypropylene. Budget folders made from embossed polypropylene. Opens two sides with thumb hole for easy access.



Type	Pack Qty	Order Code ACC-804	Offer Price/Pk
Budget	100	-1380K	£13.22

Offis Pocket Display Books

These pocket display books are excellent value. Available in three colours, they are made from polypropylene and contain either 40 or 60 pockets welded into the spine. The spine sleeve wraps around onto the front enabling titles to be easily seen.

Size: A4.

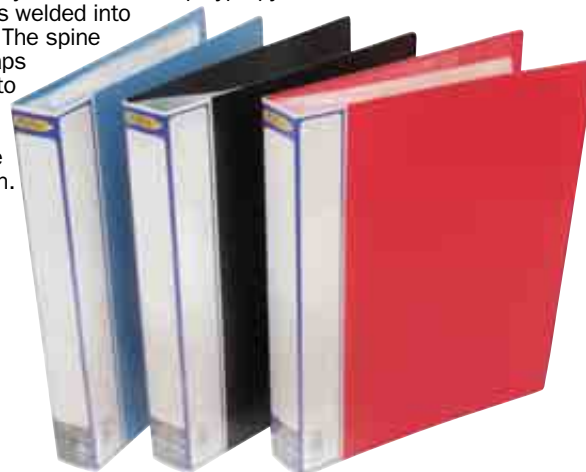

Colour	Number of Pockets	Order Code OFI-810	Offer Price/1
Red	40	-0180K	£1.09
Red	60	-0210K	£1.64
Black	40	-0160K	£1.09
Black	60	-0190K	£1.64
Blue	40	-0170K	£1.09
Blue	60	-0200K	£1.64



Clip Files

A lightweight A4 document wallet with clear cover and metal slide clip for securing your documents. Ideal for quotes, reports, proposals etc.

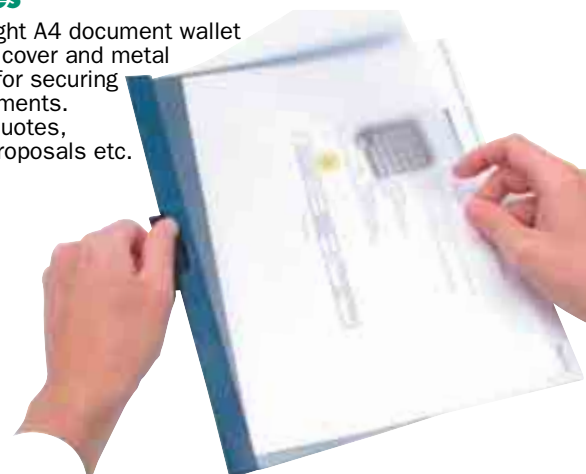

Colour	Size	Order Code OFI-810	List Price/1	Offer Price/1
Black	A4	-0010K	£1.36	£0.75
Red	A4	-0030K	£1.36	£0.75

Swivel Clip File

No need to punch, save your time. Made of high quality polypropylene. Capacity from 1 to 30 sheets of 80gsm, A4 paper. Available in blue, purple, transparent or yellow. Size: A4.

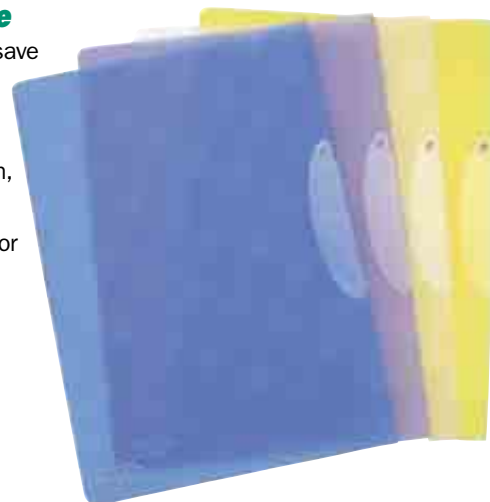

Colour	Order Code OFI-810	Offer Price/1
Transparent	-0140K	£0.53
Blue	-0120K	£0.53
Yellow	-0150K	£0.53
Purple	-0130K	£0.53



sirius **Steel Filing Cabinets**

Fitted with anti-tilt mechanism and secure locks, with two keys. Each drawer has a full width handle. Accepts foolscap suspension files.

Dimensions (W x D x H):
470 x 622mm x Height (select below).



7 YEAR WARRANTY

3 - 5 Days

DELIVERED FULLY ASSEMBLED

Height (mm)	Number of Drawers	Colour	Order Code SIR-811	List Price/1	Offer Price/1
711	2	Grey	-6800K	£178.00	£95.69
711	2	Coffee Cream	-6805K	£178.00	£95.69
1015	3	Grey	-6810K	£204.00	£104.99
1015	3	Coffee Cream	-6815K	£204.00	£104.99
1321	4	Grey	-6820K	£212.00	£108.99
1321	4	Coffee Cream	-6825K	£212.00	£108.99

Steel Cupboards

Dual purpose shelves can accommodate lateral filing with 330mm centres. Robust welded carcass construction. Three point locking for added security. Hard wearing textured finish.

Dimensions (W x D x H):
914 x 400mm x Height (select below).



5 YEAR WARRANTY

3 - 5 Days

DELIVERED FULLY ASSEMBLED

Height (mm)	Number of Drawers	Colour	Order Code SIR-811	List Price/1	Offer Price/1
1000	1	Coffee Cream	-1630K	£176.00	£114.40
1000	1	Grey	-1634K	£176.00	£114.40
1806	3	Coffee Cream	-1670K	£216.00	£140.40
1806	3	Grey	-1674K	£216.00	£140.40
Additional Shelf			Black	-1610K	£13.00

Phoenix Excel 2240 Series Firefile Cabinets

Offers 90 minutes fire resistance at temperature of 1045°C. Able to accommodate foolscap, A4 and A5 files on width adjustable rails. A high security keylock operates independently on each drawer. Ground floor delivery included, please enquire for upper floor delivery charge.



OPTIONAL DATA PROTECTION INSERT
OPTIONAL HIGH SECURITY ELECTRONIC LOCKING
(Both available at extra cost)

10 - 14 Days

Product Number	Dimensions (H x W x D)	Weight each	Order Code PHX-820	List Price/1	Offer Price/1
2242	805 x 530 x 675mm	145kg	-0040K	£1026.00	£769.50
2244	1495 x 530 x 675mm	226kg	-0050K	£1605.00	£1203.75

PROBE **Medical Cupboards**

10 - 14 Days

Under the Health and Safety Regulations 1981, workplaces must have first aid provision. To satisfy a wide range of first aid equipment we have designed an attractive and highly visible range of Probe cabinets for your working environment. Strong robust construction. All cabinets feature adjustable shelves. Two point locking on all cabinet doors. High visibility 270° labelling complying to **BS5499-1**. Reinforced doors for extra strength.

AC+IVECOAT
anti-bacterial technology

THE hard wearing anti-bacterial powder coating for the most stringent hygienic environment.



NO CARRIAGE CHARGE

OTHER SIZES AVAILABLE ON REQUEST

Product Number	Description	Order Code	Offer Price/1
MED-T	Low Medical Cabinet	-5030K	£315.15
MED-U	Small Medical Cabinet	-5040K	£151.76
MED-V	Cube Medical Cabinet	-5050K	£96.73

BISLEY **Multi Drawer Cabinets**

A choice of two cabinet heights to provide a versatile solution to storage problems. Non-locking. Goose grey.

Size:
10 drawer: 279 x 429 x 673mm,
15 drawer: 279 x 429 x 940mm.



NO CARRIAGE CHARGE

3 - 5 Days

1 YEAR WARRANTY

Number of Drawers	Order Code BSY-811	Offer Price/1
10	-0600K	£89.70
15	-0620K	£129.35

Folding Leg & Table Top, Table

FCT160

Ideal as a temporary work surface. Legs fold flat to reduce transportation dimensions. Wallpaper pasting table style folding table top further reduces the overall transportation dimensions. 695mm tubular steel legs. Carry handle.



Table top dimensions:
1600 x 600mm.

Description	Order Code	List Price/1	Offer Price/1
Folding Leg Table	PRO-800 -0004A	£38.99	£31.19

Folding Leg Trestle Table

FLT180

One piece table top is able to hold extra weight. Ideal as a temporary work surface. Legs fold flat for easy storage and transportation. 760mm tubular steel legs.



Table top dimensions:
1800 x 665mm.

Description	Order Code	List Price/1	Offer Price/1
Folding Leg Trestle Table	PRO-800 -0005A	£41.24	£32.99

Reception Tables

Reception table available in two shapes. Five year guarantee.

Colour: beech.

Dimensions:

Rectangular: W600 x D1000 x H360mm.

Square: W600 x D600 x H360mm.



Type	Order Code	List Price/1	Offer Price/1
Square	KTF-811 -0200K	£99.99	£54.99
Rectangular	KTF-811 -0210K	£144.99	£79.74

Oval Meeting Table

Oval conference table. Five year guarantee.

Colour: beech.

Dimensions:

L (See below) x W1000 x H730mm.



Length	Order Code	List Price/1	Offer Price/1
1800mm	KTF-811 -0180K	£356.99	£196.34
2400mm	KTF-811 -0190K	£449.99	£247.49

Sirius[®] Canteen/Office Tables

Rectangular

Can be used in combination with other Sirius shaped tables to create different combinations. Available in rustic oak, maple or beech finishes. Three widths available.

Dimensions:

W1200/1600/1800 x D800mm.



Size (W)	Order Code SIR-811			List Price/1	Offer Price/1
	Rustic Oak	Maple	Beech		
1200mm	-0170K	-0180K	-0190K	£139.00	£97.30
1600mm	-0200K	-0210K	-0220K	£140.00	£98.00
1800mm	-0230K	-0240K	-0250K	£155.00	£108.50

Semi-Circular

A range of semi-circular shaped tables. Can be used as stand alone tables or combined with another to form a round table and if used in conjunction with rectangular tables to form a larger oval meeting table.

Colours:

rustic oak, maple or beech finishes.

Dimensions:

W1600 x D800mm.



Size (W)	Order Code SIR-811			List Price/1	Offer Price/1
	Rustic Oak	Maple	Beech		
1800mm	-0290K	-0300K	-0310K	£202.00	£141.40

Circular

A range of circular shaped tables ideal for use in an office environment for informal meetings.

Colours:

rustic oak, maple or beech finishes.

Dimensions:

Diameter: 1200mm.



Size (W)	Order Code SIR-811			List Price/1	Offer Price/1
	Rustic Oak	Maple	Beech		
1200mm	-0380K	-0390K	-0400K	£228.00	£148.20

Office Range Circular Meeting Table

Circular meeting table. Five year guarantee.

Colour: beech.

Dimensions:

Diameter: 1200 x H730mm.



Type	Order Code	List Price/1	Offer Price/1
Meeting Table	KTF-811 -0170K	£249.99	£137.49

Satellite Office Furniture

Satellite is a stylish, durable and affordable range supplied with 25mm tops on all products. Workstations comprise of 18mm modesty panels.

Installation available on request

Standard colours available



Beech Oak Maple

Other colours on request

Non returnable



Single Cantilever Standard Workstations

Single rail cantilever end frames with skirting clearance and no cable ports. Fixed pedestals can be added to either or both ends of the desk.

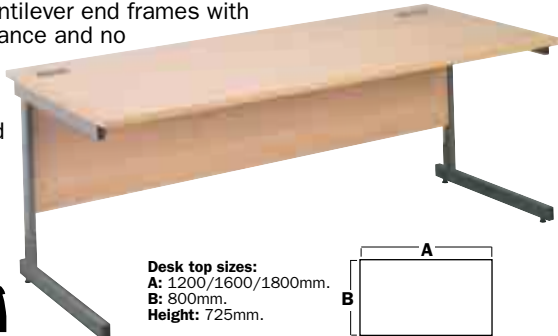

Desk top sizes:
A: 1200/1600/1800mm.
B: 800mm.
Height: 725mm.



Size (W)	Order Code SAE-811			List Price/1	Offer Price/1
	Beech	Light Oak	Maple		
1200mm	-1330K	-2310K	-8226K	£160.61	£96.37
1600mm	-1320K	-2320K	-8228K	£179.99	£107.99
1800mm	-1310K	-2330K	-8230K	£194.95	£116.97

Panel End Standard Workstations

25mm panel ends with skirting clearance and no cable ports. Fixed pedestals can be added to either or both ends of the desk (800mm only one end).

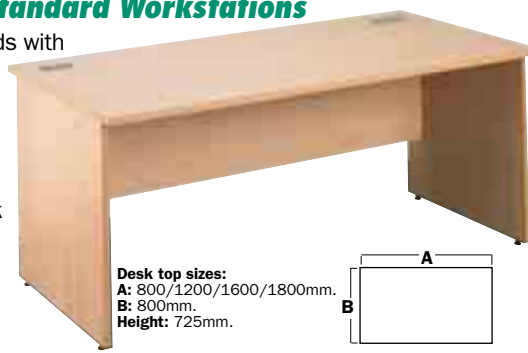

Desk top sizes:
A: 800/1200/1600/1800mm.
B: 800mm.
Height: 725mm.



Size (W)	Order Code SAE-811			List Price/1	Offer Price/1
	Beech	Light Oak	Maple		
800mm	-5540K	-5550K	-8240K	£126.73	£76.04
1200mm	-5560K	-5570K	-8242K	£145.45	£87.27
1600mm	-5580K	-5590K	-8244K	£165.99	£99.59
1800mm	-5600K	-5610K	-8246K	£175.77	£105.46

Single Cantilever Crescent Workstations

Provides ample desktop workspace even when using a VDU screen. Single rail cantilever end frames with skirting clearance and one cable port. Fixed pedestals can be added to the 800mm end of desk.

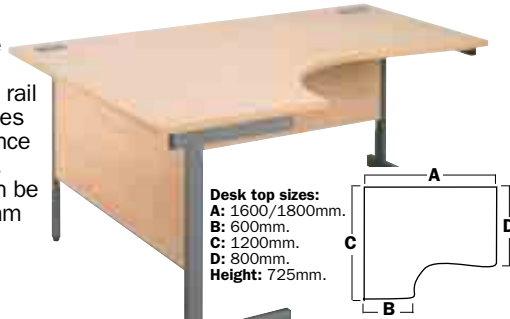

Desk top sizes:
A: 1600/1800mm.
B: 600mm.
C: 1200mm.
D: 800mm.
Height: 725mm.



Size (W)	Order Code SAE-811			List Price/1	Offer Price/1
	Beech	Light Oak	Maple		
1600mm Left Hand	-1360K	-4370K	-8202K	£254.99	£152.99
1600mm Right Hand	-1370K	-4360K	-8204K	£254.99	£152.99
1800mm Left Hand	-1340K	-4390K	-8206K	£303.05	£181.83
1800mm Right Hand	-1350K	-4380K	-8208K	£303.05	£181.83

Panel End Crescent Workstations

Provides ample desktop workspace even when using a VDU screen. 25mm panel ends with skirting clearance and one cable port. Fixed pedestals can be added to the 800mm end of the desk.

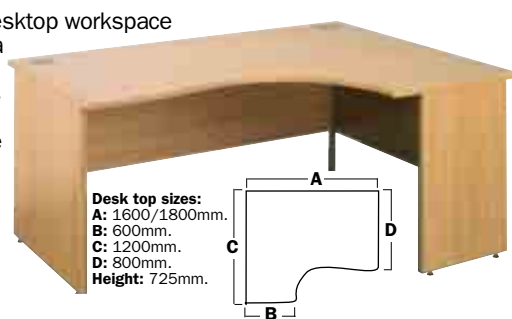

Desk top sizes:
A: 1600/1800mm.
B: 600mm.
C: 1200mm.
D: 800mm.
Height: 725mm.



Size (W)	Order Code SAE-811			List Price/1	Offer Price/1
	Beech	Light Oak	Maple		
1600mm Left Hand	-5300K	-5310K	-8210K	£236.35	£141.81
1600mm Right Hand	-5320K	-5330K	-8212K	£236.35	£141.81
1800mm Left Hand	-5340K	-5350K	-8214K	£288.99	£173.39
1800mm Right Hand	-5360K	-5370K	-8216K	£288.99	£173.39

Single Cantilever Wave Workstations

Stylish wave shaped workstation for ease of VDU usage. Single rail cantilever end frames with skirting clearance and one cable port. Fixed pedestals can be added to the 800mm end of desk.

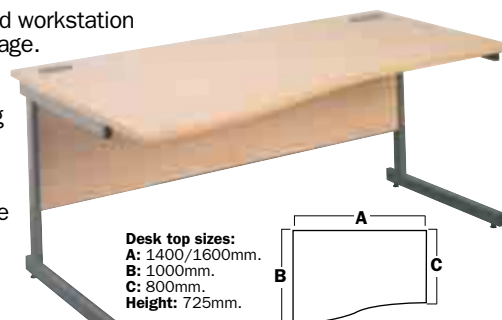

Desk top sizes:
A: 1400/1600mm.
B: 1000mm.
C: 800mm.
Height: 725mm.



Size (W)	Order Code SAE-811			List Price/1	Offer Price/1
	Beech	Light Oak	Maple		
1400mm Left Hand	-2210K	-4420K	-8224K	£218.08	£130.85
1400mm Right Hand	-2230K	-4430K	-8222K	£218.08	£130.85
1600mm Left Hand	-1750K	-4410K	-8220K	£226.95	£136.17
1600mm Right Hand	-1730K	-4400K	-8218K	£226.95	£136.17

Panel End Wave Workstations

Stylish wave shaped workstation for ease of VDU usage. 25mm panel ends with skirting clearance and one cable port. Fixed pedestals can be added to the 800mm end of desk.

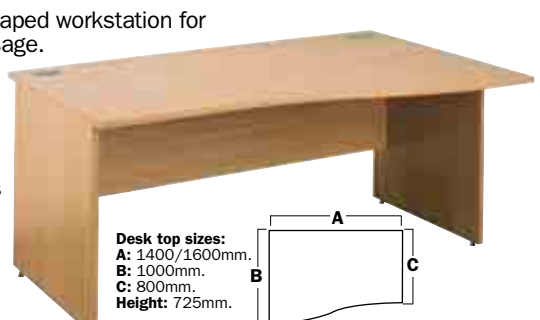

Desk top sizes:
A: 1400/1600mm.
B: 1000mm.
C: 800mm.
Height: 725mm.



Size (W)	Order Code SAE-811			List Price/1	Offer Price/1
	Beech	Light Oak	Maple		
1400mm Left Hand	-7140K	-7160K	-8236K	£202.85	£121.71
1400mm Right Hand	-7150K	-7170K	-8238K	£202.85	£121.71
1600mm Left Hand	-7100K	-7120K	-8232K	£212.99	£127.79
1600mm Right Hand	-7110K	-7130K	-8234K	£212.99	£127.79

CARRIAGE WILL BE CHARGED EXTRA AT COST WHERE INCURRED

Please contact your local branch for further details

Fixed Pedestals

2 and 3 Drawer

Pedestals can be fixed to the 800mm end of all the Satellite workstations. Silver finish handles with central locking.

Dimensions (W x D x H):
400 x 600 x 452mm.



DELIVERED PART ASSEMBLED

7 - 14 Days

Drawers	Order Code SAE-811			List Price/1	Offer Price/1
	Beech	Light Oak	Maple		
2 Drawer Mobile	-0570K	-0560K	-8200K	£128.99	£77.39
3 Drawer Mobile	-0550K	-0540K	-8198K	£128.99	£77.39

Mobile Pedestals

Two or three drawer mobile pedestals with central locking and silver finished handles.

Dimensions (W x D x H):
400 x 600 x 535mm.
NB. beech illustrated.



DELIVERED PART ASSEMBLED

7 - 14 Days

Drawers	Order Code SAE-811			List Price/1	Offer Price/1
	Beech	Light Oak	Maple		
2 Drawer Mobile	-3390K	-3380K	-8270K	£160.61	£96.37
3 Drawer Mobile	-3370K	-3360K	-8272K	£160.61	£96.37

Desk High Pedestals

Three or four drawer desk high pedestals with skirting clearance to match workstations. Silver finish handles.

Dimensions (W x D x H):
400 x Depth (select below) x 725mm.
N.B. beech illustrated.



DELIVERED PART ASSEMBLED

7 - 14 Days

Drawers	Order Code SAE-811			List Price/1	Offer Price/1
	Beech	Light Oak	Maple		
3 Drawer Desk High 600	-0590K	-0580K	-8274K	£195.99	£117.59
4 Drawer Desk High 600	-7190K	-7180K	-8278K	£195.99	£117.59
3 Drawer Desk High 800	-0610K	-0600K	-8276K	£254.55	£152.73
4 Drawer Desk High 800	-6960K	-6950K	-8280K	£254.55	£152.73

Saturn Reception Tables

A superb cost effective range of tables that would complement any office environment. Tables have all steel under-frames and 18mm desk tops.

Dimensions (W x D x H):
800 x 800 x 396mm.
N.B. light oak illustrated.



FAST ASSEMBLY TOOLS REQUIRED

7 - 14 Days

Type	Order Code SRN-811			List Price/1	Offer Price/1
	Beech	Light Oak	Maple		
Reception Table	-1970K	-1960K	-8248K	£164.99	£85.79

Satellite Filing Cabinets

Anti-tilt and central locking with 35kg weight limit per drawer.

Dimensions (W x D x H):
509 x 600mm x Height (select below).

Desk High Dimensions (W x D x H):
509 x 600 x 725mm.

N.B. beech illustrated.



NEW

DELIVERED PART ASSEMBLED

7 - 14 Days

Height	No. of Drawers	Order Code SAE-811			List Price/1	Offer Price/1
		Beech	Light Oak	Maple		
700mm	2 Drawer	-8510K	-8520K	-8530K	£320.45	£192.27
1065mm	3 Drawer	-8560K	-8570K	-8580K	£365.19	£219.11
1405mm	4 Drawer	-8610K	-8620K	-8630K	£403.29	£241.97
725mm	2 Drawer	-8710K	-8720K	-8730K	£385.89	£231.53

Saturn Rectangular Conference Tables

60mm diameter height adjustable legs.

Dimensions (W x D x H):
Width (select below) x 800 x 725mm.



FAST ASSEMBLY TOOLS REQUIRED

7 - 14 Days

Size (Width)	Order Code SRN-811			List Price/1	Offer Price/1
	Beech	Light Oak	Maple		
1600mm	-2010K	-2000K	-8256K	£259.99	£135.19
1800mm	-1990K	-1980K	-8254K	£269.99	£140.39

Saturn Circular Conference Tables

60mm diameter height adjustable legs.

Dimensions:
Diameter: 1200 x H725mm.



FAST ASSEMBLY TOOLS REQUIRED

7 - 14 Days

Size	Order Code SRN-811			List Price/1	Offer Price/1
	Beech	Light Oak	Maple		
Diameter 1200mm	-1950K	-1940K	-8258K	£378.99	£197.07

CONTRACT PRICES AVAILABLE FOR VOLUME PURCHASES

All Prices Exclude V.A.T. © 2013



CARRIAGE WILL BE CHARGED EXTRA AT COST WHERE INCURRED

Please contact your local branch for further details

Office Range

This furniture range has been designed to provide a cost-effective, adaptable solution to suit any office environment. Workstations are available with 25mm worktops and 3mm edging in a variety of shapes and sizes. All pedestals and storage units are lockable and have matching silver handles. Available in beech and oak finishes.



Colours available



Single Cantilever Standard Workstations

Rectangular silver cantilever workstation, supplied with two cable ports in both the worktop and modesty panel for easy and clean two cable management.

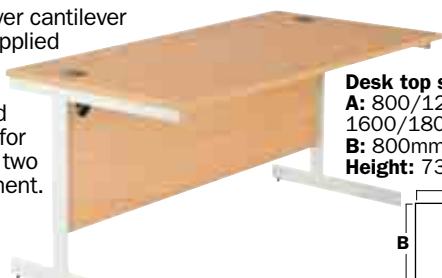

Desk top sizes:
A: 800/1200/1400/1600/1800mm.
B: 800mm.
Height: 730mm.

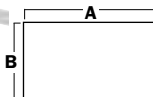

Size (W)	Order Code KTF-811		List Price/1	Offer Price/1
	Beech	Oak		
800mm	-0670K	-0880K	£169.99	£93.49
1200mm	-0040K	-0360K	£189.99	£104.49
1400mm	-0680K	-0890K	£199.99	£109.99
1600mm	-0050K	-0370K	£212.99	£117.14
1800mm	-0060K	-0380K	£232.99	£128.14

Panel End Standard Workstations

Rectangular panel end workstation, supplied with two cable ports in both the worktop and modesty panel for easy and clean two cable management.



Desk top sizes:
A: 800/1200/1400/1600/1800mm.
B: 800mm.
Height: 730mm.

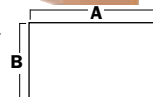

Size (W)	Order Code KTF-811		List Price/1	Offer Price/1
	Beech	Oak		
800mm	-0650K	-0860K	£169.99	£93.49
1200mm	-0010K	-0330K	£189.99	£104.49
1400mm	-0660K	-0870K	£199.99	£109.99
1600mm	-0020K	-0340K	£212.99	£117.14
1800mm	-0030K	-0350K	£232.99	£128.14

Single Cantilever Crescent Workstations

Crescent silver cantilever workstation, supplied with two cable ports in both the worktop and modesty panel for easy and clean cable management.

N.B. beech right hand version illustrated.

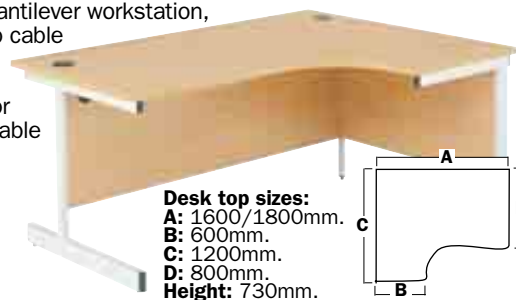

Desk top sizes:
A: 1600/1800mm.
B: 600mm.
C: 1200mm.
D: 800mm.
Height: 730mm.

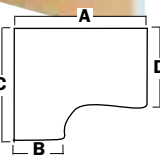

Size (W)	Order Code KTF-811		List Price/1	Offer Price/1
	Beech	Oak		
1600mm Left Hand	-0090K	-0410K	£293.99	£161.69
1600mm Right Hand	-0100K	-0420K	£293.99	£161.69
1800mm Left Hand	-0710K	-0920K	£314.99	£173.24
1800mm Right Hand	-0720K	-0930K	£314.99	£173.24

Panel End Crescent Workstations

Single panel end crescent desk, supplied with two cable ports in both the worktop and modesty panel for clean two cable management.

N.B. oak right hand version illustrated.

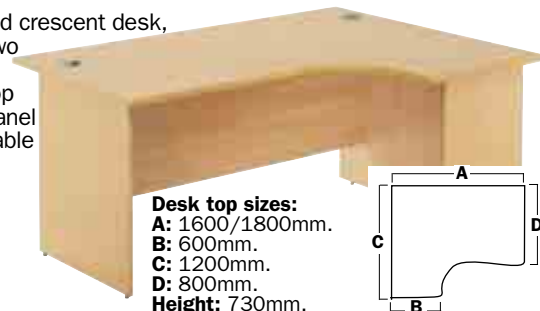

Desk top sizes:
A: 1600/1800mm.
B: 600mm.
C: 1200mm.
D: 800mm.
Height: 730mm.

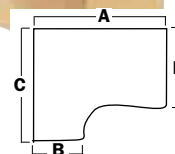

Size (W)	Order Code KTF-811		List Price/1	Offer Price/1
	Beech	Oak		
1600mm Left Hand	-0730K	-0940K	£294.99	£162.24
1600mm Right Hand	-0740K	-0950K	£294.99	£162.24
1800mm Left Hand	-0750K	-0960K	£314.99	£173.24
1800mm Right Hand	-0760K	-0970K	£314.99	£173.24

Single Cantilever Wave Workstations

Wave silver cantilever workstation, supplied with two cable ports in both the worktop and modesty panel for easy and clean cable management.

N.B. beech right hand version illustrated.



Desk top sizes:
A: 1400/1600mm.
B: 1000mm.
C: 800mm.
Height: 730mm.

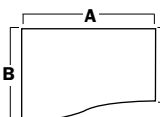

Size (W)	Order Code KTF-811		List Price/1	Offer Price/1
	Beech	Oak		
1600mm Left Hand	-0070K	-0390K	£293.99	£161.69
1600mm Right Hand	-0080K	-0400K	£293.99	£161.69

Panel End Wave Workstations

Single panel end wave desk, supplied with two cable ports in both the worktop and modesty panel for easy and clean two cable management.

N.B. oak right hand version illustrated.



Desk top sizes:
A: 1400/1600mm.
B: 990mm.
C: 1000mm.
Height: 730mm.

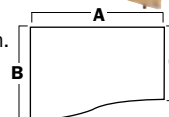

Size (W)	Order Code KTF-811		List Price/1	Offer Price/1
	Beech	Oak		
1600mm Left Hand	-0790K	-1000K	£293.99	£161.69
1600mm Right Hand	-0800K	-1010K	£293.99	£161.69

Office Supplies & Stationery



CARRIAGE WILL BE CHARGED EXTRA AT COST WHERE INCURRED

Please contact your local branch for further details

Mobile Pedestals

Two/three drawer lockable mobile pedestal with silver handles. Five year guarantee.

Dimensions (W x D x H):
404 x 500 x 595mm.
N.B. oak illustrated.



DELIVERED PART ASSEMBLED



Type	Order Code KTF-811		List Price/1	Offer Price/1
	Beech	Oak		
2 Drawer	-0130K	-0450K	£179.99	£98.99
3 Drawer	-0140K	-0460K	£179.99	£98.99

Bookcases

Available in four heights with adjustable shelves. Five year guarantee.

Dimensions (W x D x H):
952 x 400mm x Height (select below).
N.B. beech illustrated.



Size (H)	Order Code KTF-811		List Price/1	Offer Price/1
	Beech	Oak		
730mm - 1 Shelf	-0220K	-0540K	£199.99	£109.99
1200mm - 2 Shelves	-0230K	-0550K	£249.99	£137.49
1600mm - 3 Shelves	-0240K	-0560K	£319.99	£175.99
2000mm - 4 Shelves	-0250K	-0570K	£359.99	£197.99

3 Drawer Desk High Pedestals

Three drawer lockable desk high pedestal with silver handles. Five year guarantee.

Dimensions (W x D x H):
400 x Depth (select below) x 730mm.
N.B. oak illustrated.



DELIVERED PART ASSEMBLED



Size (D)	Order Code KTF-811		List Price/1	Offer Price/1
	Beech	Oak		
600mm	-0150K	-0470K	£236.99	£130.34
800mm	-0160K	-0480K	£262.99	£144.64

Fixed Pedestals

Pedestals can be fixed to 800mm end of all workstations. Silver handles with central locking. Five year guarantee.

Dimensions (W x D x H):
400 x 500 x 510mm.
N.B. oak illustrated.



DELIVERED PART ASSEMBLED



Type	Order Code KTF-811		List Price/1	Offer Price/1
	Beech	Oak		
2 Drawer	-0110K	-0430K	£142.99	£78.64
3 Drawer	-0120K	-0440K	£142.99	£78.64

Filing Cabinets

Anti-tilt and central locking. Five year guarantee.

Dimensions (W x D x H):
466 x 600mm x Height (select below).
N.B. oak illustrated.



DELIVERED PART ASSEMBLED



Height	No. of Drawers	Order Code KTF-811		List Price/1	Offer Price/1
		Beech	Oak		
710mm	2	-0320K	-0640K	£279.99	£153.99
1365mm	4	-0300K	-0620K	£449.99	£247.49

Cupboards

Available in four heights with adjustable shelves. Five year guarantee.

Dimensions (W x D x H):
952 x 400mm x Height (select below).
N.B. beech illustrated.

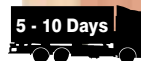

Size (H)	Order Code KTF-811		List Price/1	Offer Price/1
	Beech	Oak		
730mm - 1 Shelf	-0260K	-0580K	£295.99	£162.79
1200mm - 2 Shelves	-0270K	-0590K	£349.99	£192.49
1600mm - 3 Shelves	-0280K	-0600K	£456.99	£251.34
2000mm - 4 Shelves	-0290K	-0610K	£499.99	£274.99

CONTRACT PRICES AVAILABLE FOR VOLUME PURCHASES

All Prices Exclude V.A.T. © 2011



CARRIAGE WILL BE CHARGED EXTRA AT COST WHERE INCURRED

Please contact your local branch for further details

Lincoln Leather Faced Manager's Chairs

Medium (illustrated) or high back height, leather faced, manager's chair. Gas assisted height adjustment and seat base tension control. 3" thick seat and back padding for optimal comfort. Five star base for stability with covered dual wheel castors on each spur for moving seat location. With shaped arm rests.

Maximum weight: 16 stones.

Dimensions:

High Back

Seat: D508 x W508mm.

Back: H699 x W508mm.

Seat height: 460mm.

Medium Back

Seat: D489 x W536mm.

Back: H508 x W536mm.

Seat height: 460mm.



Type	Colour	Order Code	List Price/1	Offer Price/1
Executive High Back	Black	-0100K	£79.99	£67.99
Medium Back	Black	-0110K	£69.99	£59.49

High Backed Manager's Chairs

Fabric covered, high backed, manager's chair. Gas assisted height adjustment and seat base tension control. 3" thick seat and back padding for optimal comfort. Five star base for stability with covered dual wheel castors on each spur for moving seat location. Shaped arm rests for comfort.

Colours: charcoal, royal blue and red.

Maximum weight: 16 stones.

Dimensions:

Seat: D504 x W539mm.

Back: H628 x W529mm.

Seat height: 460mm.



Colour	Order Code	List Price/1	Offer Price/1
Charcoal	LNC-811	£69.95	£59.46
Royal Blue	-0080K	£69.95	£59.46
Red	-0090K	£69.95	£59.46

Executive High Backed Leather Chair

Leather upholstery and FR foam, chrome base, gas lift, executive tilt, tension control.

Maximum weight: 17 stones.

Colour: black.

Dimensions:

Seat: D510 x W510mm.

Back: H720 x W510mm.

Seat height: 510 - 620mm.



5 YEAR WARRANTY
NO CARRIAGE CHARGE



Colour	Order Code	List Price/1	Offer Price/1
Black	-0030K	£147.99	£96.19

Executive High Backed Leather Chair Wooden Arms

Executive high back leather faced chair with wooden arms and matching base. Reclining/locking tilt mechanism with tension control. Hooded twin wheel castors mounted into sturdy five star base. Flat packed for easy shipping and assembly.

Colours: tan and black.

Maximum weight: 18 stones.

Dimensions:

Seat: D490 x W510mm.

Back:

H660 x W520mm.

Seat height:

460 - 550mm.



NO CARRIAGE CHARGE
5 YEAR WARRANTY



Colour	Order Code	List Price/1	Offer Price/1
Tan	-0050K	£201.90	£131.24
Black	-0060K	£198.99	£129.34

Leather Manager's Chair

Durable nylon five star base, gas height adjustment, reclining back tilt, lockable back tilt, weight tilt, tension control, fixed black arms. 50mm easy glide castors.

Maximum weight: 18 stones.

Colour: black.

Seat: H465/555 x D480 x W510mm.

Overall: H1130/1220 x W615mm.



2 YEAR WARRANTY



Colour	Order Code	List Price/1	Offer Price/1
Black	-0110K	£178.99	£116.34

Nevada Luxury Leather Chairs

Luxurious leather executive armchair. Premium-grade leather, polished chrome detailing, pronounced headrest, smooth knee-tilt mechanism and generous cushioning on seat, back and arms. Available in black or brown leather. Five year guarantee.

Maximum weight: 18 stones.

Dimensions:

Seat: D520 x W510mm.

Back: H765 x W510mm.

Seat height: 470 - 540mm.



Colour	Order Code	List Price/1	Offer Price/1
Black	-8352K	£254.99	£165.74
Brown	-8354K	£254.99	£165.74



5 YEAR WARRANTY
NO CARRIAGE CHARGE

Office Supplies & Stationery



CARRIAGE WILL BE CHARGED EXTRA AT COST WHERE INCURRED

Please contact your local branch for further details

Lincoln High Back Operator Chair

Fabric covered, medium backed, operators chair. Gas assisted height adjustment and seat base tension control. Back height adjustment. 3" thick seat and back padding for optimal comfort. Five star base for stability with covered dual wheel castors on each spur for moving seat location. Arm rests available as an optional extra.

Colours: charcoal, royal blue and red.
Maximum weight: 16 stones.
Dimensions:
Seat: D470 x W486mm.
Back: H501 x W460mm.
Seat height: 460mm.



Colour	Order Code	List Price/1	Offer Price/1
Charcoal	-0010K	£55.28	£46.99
Royal Blue	-0030K	£55.28	£46.99
Red	-0040K	£55.28	£46.99
Fixed Arms	-0050K	£6.99	£5.94
Adjustable Arms	-0230K	£19.99	£16.99



Executive High Back Operators' Chair

High back operator chairs. Deep foam cushioning on seat and back. Integral lumbar support. Three lever asynchro mechanism. Material: Pyra. Medium fire retardancy. Guaranteed for two years. Optional accessories include fixed or adjustable arms.

Colours: charcoal and royal blue.
Dimensions:
Seat: D435 x W455mm.
Back: H500 x W440mm.
Seat height: 490 - 620mm.



Colour	Order Code	List Price/1	Offer Price/1
Charcoal	-0280K	£74.69	£63.49
Royal Blue	-0290K	£74.69	£63.49
Fixed Arms	-0300K	£11.49	£9.77
Adjustable Arms	-0310K	£20.99	£17.84



Tub Chair

Ideal for reception areas and waiting rooms. Stylish modern design to impress visiting sales representatives, directors and VIP's. Leather faced to fit into most workplace environments. Provides all round seating support. Chrome feet. 4" thick seat padding for extra comfort. Double stitched seams.

Colours: leather/black and leather/blue.
Dimensions (W x D x H): 700 x 625 x 800mm.



Colour	Order Code	List Price/1	Offer Price/1
Leather/Black	-0150K	£99.99	£84.99
Leather/Blue	-0160K	£99.99	£84.99

Posture High Back Chairs

This chair offers full body-support at exceptional value, and meets the need for affordable, ergonomic seating. Whether you require support whilst at the workstation or in meetings, this chair is your answer. Five year guarantee.

Colours: charcoal, blue and burgundy.
Maximum weight: 18 stones.
Dimensions:
Seat: D540 x W500mm.
Back: H675 x W490mm.
Seat height: 475 - 605mm.

Chrome base and various arm options available on request.



Colour	Order Code	List Price/1	Offer Price/1
Charcoal	-4910K	£278.99	£181.34
Blue	-4920K	£278.99	£181.34
Burgundy	-4930K	£278.99	£181.34



Puma Black Leather Operators' Chair

A mid back leather operator chair. Sturdy and supportive, distinctive stitching detail with deep cushioned seat and back, integral lumbar support, polished chrome base, plus adjustable arms as standard. Five year guarantee.

Colour: black.
Maximum weight: 18 stones.
Dimensions:
Seat: D440 x W490mm.
Back: H515 x W450mm.
Seat height: 510 - 620mm.



Colour	Order Code	List Price/1	Offer Price/1
Black	-8342K	£145.99	£94.89



Fonz Mesh Chair

High back modern Operators' chair. Stylish mesh back design, adjustable arms and head rest, integral lumbar support with chrome base and detailing. Five year guarantee.

Colour: black.
Maximum weight: 18 stones.
Dimensions:
Seat: D460 x W510mm.
Back: H650 x W495mm.
Seat height: 440 - 525mm.

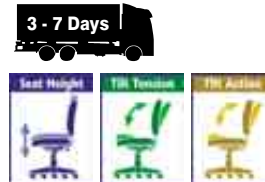

Colour	Order Code	List Price/1	Offer Price/1
Black	-8340K	£239.99	£155.99



CONTRACT PRICES AVAILABLE FOR VOLUME PURCHASES

All Prices Exclude V.A.T. © 2011



CARRIAGE WILL BE CHARGED EXTRA AT COST WHERE INCURRED

Please contact your local branch for further details

Marathon 24 Hour Operators' Chair

A 24 hour chair with ratchet back, adjustable arms and moulded seat to provide comfort and durability. Tested by FIRA to meet BS5459. Ratchet back and heavy duty mechanism. Five year guarantee. Available in fabric or leather.

Colours: black, blue or burgundy.
Maximum weight: 22 stones.
Dimensions:
Seat: D535 x W530mm
Back: H630 x W495mm,
Seat height: 455 - 550mm.

Aluminium base available on request



BS5459: Part 2

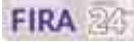

Colour	Order Code TCS-811	List Price/1	Offer Price/1
Black	-4950K	£276.99	£180.04
Blue	-4960K	£276.99	£180.04
Burgundy	-4970K	£276.99	£180.04
Black Leather	-4940K	£299.99	£194.99



Champion 24 Hour Operators' Chair

This 24 hour operator chair is sturdy and supportive and will adjust to find your perfect seating position, whatever the task, whatever the hour. Tested by FIRA to meet BS5459. Has adjustable armrests and fully adjustable asynchro mechanism. Five year guarantee.

Colours: black, blue or burgundy.
Maximum weight: 24 stones.
Dimensions:
Seat: D495 x W535mm
Back: H500 x W470mm
Seat height: 445 - 540mm.

Aluminium base available on request



BS5459: Part 2



Colour	Order Code TCS-811	List Price/1	Offer Price/1
Black	-2360K	£240.99	£156.64
Blue	-2370K	£240.99	£156.64
Burgundy	-2380K	£240.99	£156.64



High Back Operators' Chairs

Designed for comfort and flexibility. Upholstered in tough wearing fabric with deep foam cushioning. This chair also has an integral lumbar support. Meeting fire retardancy standard BS1716. Five year guarantee. Optional fixed arms available.

Colours: charcoal, blue or claret.
Maximum weight: 18 stones.
Dimensions:
Seat: D470 x W465mm.
Back: H510 x W445mm.
Seat height: 465 - 600mm.

Chrome base and various arm options available on request.

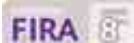

Colour	Order Code TCS-811	List Price/1	Offer Price/1
Charcoal	-8300K	£119.99	£77.99
Blue	-8302K	£119.99	£77.99
Claret	-8304K	£119.99	£77.99
Fixed Arms	-9802K	£32.99	£21.44



Cheetah 24 Hour Managers' Chair

Available in fabric or leather.

Colours: black, marine blue and ruby.
Maximum weight: 22 stones.
Dimensions:
Seat: D490 x W530mm
Back: H730 x W530mm
Seat height: 490 - 550mm.
Material: Flamblend or leather (black only).
Usage: 24 hours.
Fire retardancy: Flamblend - medium, leather - low.
Guarantee: five years.
Mechanism: Asynchro.

Aluminium base available on request



BS5459: Part 2



Colour	Order Code TCS-811	List Price/1	Offer Price/1
Black	-8332K	£334.99	£217.74
Marine Blue	-8334K	£334.99	£217.74
Ruby	-8336K	£334.99	£217.74
Black Leather	-8330K	£410.00	£266.50



Panther 24 Hour Managers' Chair

Available in fabric or leather.

Colours: black, marine blue and ruby.
Maximum weight: 22 stones.
Dimensions:
Seat: D555 x W530mm.
Back: H645 x W515mm.
Seat height: 475 - 565mm.
Material: Flamblend or leather (black only).
Usage: 24 hours.
Fire retardancy: Flamblend - medium, leather - low.
Guarantee: five years.
Mechanism: Asynchro.

Aluminium base available on request



BS5459: Part 2



Colour	Order Code TCS-811	List Price/1	Offer Price/1
Black	-0370K	£321.43	£208.93
Marine Blue	-0380K	£321.43	£208.93
Ruby	-0390K	£321.43	£208.93
Black Leather	-0360K	£321.43	£208.93





CARRIAGE WILL BE CHARGED EXTRA AT COST WHERE INCURRED

Please contact your local branch for further details

Banqueting Chairs

This fire retardant banqueting chair with a black sturdy steel frame, rubber feet, deep cushioned seat and back is ideal for schools, hospitals and government departments. Two year guarantee.

Colours: charcoal or blue.
Maximum weight: 18 stones.
Dimensions:
Seat: D380 x W420
Back: H335mm x W330.
Seat height: 500mm.



DELIVERED FULLY ASSEMBLED

2 YEAR WARRANTY

Colour	Order Code	List Price/1	Offer Price/1
Charcoal	TCS-811-4830K	£49.99	£32.49
Blue	-4840K	£49.99	£32.49

Club Chrome Conference Chairs

Multi-purpose stacking chair with chrome frame and comfortable deep foamed seat and back. Five year guarantee.

Colours: charcoal, blue or burgundy.
Maximum weight: 18 stones.
Dimensions:
Seat: D415 x W470 x H495mm.
Back: W490 x H335mm.

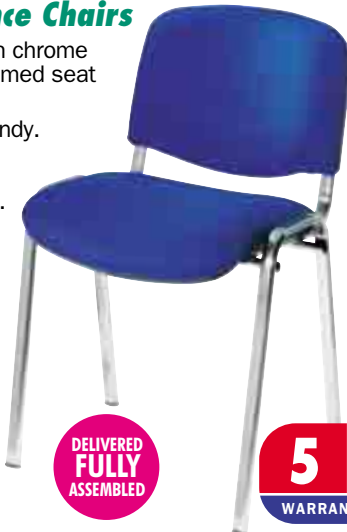

Arms and Links available on request



DELIVERED FULLY ASSEMBLED

5 YEAR WARRANTY

Colour/Chrome	Order Code	List Price/1	Offer Price/1
Charcoal	TCS-811-4800K	£49.99	£32.49
Blue	-4810K	£49.99	£32.49
Burgundy	-4820K	£49.99	£32.49

Pavilion Heavy Duty Conference Chairs

Heavy duty black steel or chrome frame with fully upholstered, deep foam cushioned seat and back. Five year guarantee.

Colours: charcoal, blue or burgundy (burgundy/black illustrated).
Maximum weight: 18 stones.
Dimensions:
Seat: D485 x W495 x H485mm.
Back: W475 x H370mm.



DELIVERED FULLY ASSEMBLED

5 YEAR WARRANTY

Colour	Order Code	List Price/1	Offer Price/1
Charcoal/Black	TCS-811-4850K	£99.99	£64.99
Blue/Black	-4860K	£99.99	£64.99
Burgundy/Black	-4870K	£99.99	£64.99
Charcoal/Chrome	-4880K	£109.99	£71.49
Blue/Chrome	-4890K	£109.99	£71.49

Club Stacker Conference Chairs

Stackable conference chairs with shaped upholstered seat and black frame. Curved back.

Colours: blue, charcoal or red.
Maximum weight: 18 stones.
Dimensions:
Seat: D415 x W470x H495mm.
Back: W490 x H335mm.



Arms and Links available on request



NO CARRIAGE CHARGE

DELIVERED FULLY ASSEMBLED

5 YEAR COMPONENT WARRANTY

Colour	Order Code	List Price/1	Offer Price/1
Blue	TCS-811-4500K	£45.95	£29.87
Charcoal	-4510K	£45.95	£29.87
Red	-4520K	£45.95	£29.87

Pinnacle Conference Chairs

Heavy-duty, multi-purpose chair. Sturdy black frame, stackable to four high with soft cushioning on the seat and back. Black leather-look. Five year guarantee.

Colour: black leather-look.
Maximum weight: 20 stones.
Dimensions:
Seat: D500 x W470mm.
Back: H365 x W460mm.
Seat height: 485mm.



5 YEAR WARRANTY

Colour	Order Code	List Price/1	Offer Price/1
Black Leather-look	TCS-811-8368K	£114.82	£74.63

Office Supplies & Stationery

CONTRACT PRICES AVAILABLE FOR VOLUME PURCHASES

All Prices Exclude V.A.T. © 2013



CARRIAGE WILL BE CHARGED EXTRA AT COST WHERE INCURRED

Please contact your local branch for further details

sirius Polypropylene Stacking Chairs

Sirius polypropylene stacking chair. Tough moulded, textured seat with black epoxy coated frame, manufactured to **F.I.R.A. Grade 4**. Suitable for both indoor and outdoor use, fully stackable, ideal for schools.

Colours: charcoal, royal blue, grey, red, brown or black.

Dimensions (W x D x H): 510 x 500 x 450mm.



DELIVERED FULLY ASSEMBLED

3 - 5 Days

Colour	Order Code	List Price/1	Offer Price/1
Charcoal	SIR-811	£20.00	£15.49
Royal Blue	-9552K	£20.00	£15.49
Grey	-9554K	£20.00	£15.49
Red	-9557K	£20.00	£15.49
Brown	-9558K	£20.00	£15.49
Black	-9559K	£20.00	£15.49

Cantilever Chairs

Stylish stacking design. Sturdy flexible steel tube ideal for meeting room or visitors chair.

Colours: blue or charcoal.
Maximum weight: 18 stones.
Dimensions (W x D x H):
Seat: 480 x 420 x 470mm.



2 YEAR FABRIC WARRANTY

2 - 3 Days

Colour	Order Code	List Price/1	Offer Price/1
Blue	TCS-811	£80.99	£52.64
Charcoal	-6250K	£80.99	£52.64

Multi-Purpose Folding Chairs

Sirius multi-purpose fold flat chair. Ideal for all seating applications indoors and outdoors. Maximum recommended use of five hours.

Colours: black, blue, red or white.
Dimensions:
Seat: D380 x W410mm.
Back: H170 x W450mm.
Seat height: 450mm.



DELIVERED FULLY ASSEMBLED

3 - 5 Days

Colour	Order Code	List Price/1	Offer Price/1
Black	SIR-811	£39.99	£25.99
Blue	-0110K	£39.99	£25.99
Red	-0120K	£39.99	£25.99
White	-0130K	£39.99	£25.99

Club Plastic Canteen Chairs

This ideal canteen chair is strong and made with hard-wearing polypropylene seat and back. Oval steel frame can be linked for conference use. Practical wipeable seat and back, and stackable to eight high.

Colours: black, blue or green.
Maximum weight: 18 stones.
Dimensions:
Seat: D390 x W460mm.
Back: H310 x W460mm.
Seat height: 430mm.



DELIVERED FULLY ASSEMBLED

5 YEAR WARRANTY

3 - 5 Days

Colour	Order Code	List Price/1	Offer Price/1
Black	TCS-811	£38.99	£25.34
Blue	-8378K	£38.99	£25.34
Green	-8380K	£38.99	£25.34

Hat & Coat Stand

Sirius hat and coat stand, modern and compact. Manufactured from tubular steel with three conveniently situated coat hooks.

Colour: black.
Overall height: 1550mm.



NEW

2 - 3 Days

Colour	Order Code	List Price/1	Offer Price/1
Black	SIR-811	£30.00	£24.95
Black	-9670K	£30.00	£24.95

Kick Stool

Manufactured in high quality durable plastic, lightweight and easy to move. Incorporates three sprung loaded castors which retract when weight is applied.

Colour: grey.
Maximum load: 125kg.

NEW



Colour	Order Code	List Price/1	Offer Price/1
Grey	GPC-811	£31.69	£26.94
Grey	-0010K	£31.69	£26.94

Lincoln Kick Stools

Metal kick stool fitted with three spring loaded castors for robust maximum mobility. The base ring holds the kick stool rigid to the floor immediately after weight is applied. Heavy-duty construction.

Colours: black, blue, grey or red.
Diameter: 29cm.



Colour	Order Code	List Price/1	Offer Price/1
Black	LNC-811	£34.99	£29.74
Blue	-0190K	£34.99	£29.74
Grey	-0200K	£34.99	£29.74
Red	-0210K	£34.99	£29.74

Office Supplies & Stationery



CARRIAGE WILL BE CHARGED EXTRA AT COST WHERE INCURRED

Please contact your local branch for further details

Lincoln Draughtsman's Chair

Fabric covered, fixed position chair. Five star base for stability.

Colours: charcoal or royal blue fabric colours.
Maximum weight: 16 stones.
Height adjustable chrome foot ring: (between 200 - 400mm).
Seat height adjustment: (590 - 830mm).
Medium back with depth adjustment.



Colour	Order Code	List Price/1	Offer Price/1
Charcoal	-0120K	£77.99	£66.29
Royal Blue	-0130K	£77.99	£66.29

High Industrial PU Chair

Moulded plastic, fixed position chair. Five star base for stability.

Colour: black.
Maximum weight: 16 stones.
Dimensions:
Height adjustable chrome foot ring: 200 - 400mm.
Seat height adjustment: 590 - 830mm.
Medium back with depth adjustment.



Colour	Order Code	List Price/1	Offer Price/1
Black	-0140K	£99.99	£84.99
Spare Seat	-0240K	£19.99	£16.99

Tek Chair

High rise adjustment with gas lift. Posture shaped seat and adjustable glides. Gas operated seat height adjustment.

Colour: silver/chrome.
Maximum weight: 12 stones.
Dimensions:
Seat width: 430mm.
Seat depth: 350mm.
Seat height: 530 - 780mm.
Back width: 360mm.



NO CARRIAGE CHARGE

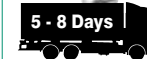

Colour	Order Code	List Price/1	Offer Price/1
Silver/Chrome	-0010K	£68.50	£44.52

Low Industrial PU Chair No Foot Ring

Easy to clean polyurethane ideal for the factory floor, workshop or laboratory.

Colour: black.
Dimensions:
Seat: W460 x D420 x H410 - 530mm.
Back: H310mm.



Colour	Order Code	List Price/1	Offer Price/1
Black	-0250K	£79.98	£67.98

sirius Sirius High Stools with Back Rest

Practical stool ideal for canteen, restaurants and work benches. Manufactured from strong 1" square section steel with a black epoxy coating, foot bar and a comfortable upholstered seat and back rest.

Colours: royal blue, charcoal or black vinyl.
Dimensions (W x D x H): 410 x 410 x 700mm.



Colour	Order Code	List Price/1	Offer Price/1
Royal Blue	-0070K	£90.00	£58.50
Charcoal	-0080K	£90.00	£58.50
Black Vinyl	-0090K	£84.00	£54.60

Polyurethane Stool

Easy clean soft polyurethane seat with pneumatic seat height adjustment. Sturdy five star base and twin wheel castors.

Colour: charcoal.



NO CARRIAGE CHARGE



Colour	Order Code	List Price/1	Offer Price/1
Charcoal	-0070K	£82.99	£53.94

CONTRACT PRICES AVAILABLE FOR VOLUME PURCHASES

All Prices Excl. V.A.T. © 2011

GROUP 817 STAMPS & INKS

dormy *Reliable Line Dater*

For use with a stamp pad. Traditional and economical. 4mm date size. 12 years of dates.

NEW



28 AUG 2010

Description	Type	Order Code	Offer Price/1
Reliable Line Dater	4mm Date	-0330K	£2.39

trodar *Office Printy Word Stamp*

No stamp pad required. Features the most popular words and phrases used in an office. Two colour impression. Ideal for repetitive stamping.

FAXED COPY

NEW



Description	Type	Order Code	Offer Price/1
Office Printy	Copy	-0370K	£8.95
	Faxed	-0380K	£8.95

Self Inking Date Stamp

4810
Built-in ink pad with spring mechanism that automatically re-inks between impressions.

NEW



Description	Order Code	Offer Price/1
Trodar 4810	-0450K	£4.92

trodar *Printy Stock Wording Dater*

4750

No stamp pad required. Self-inking date stamp comes with a built-in red and blue stamp pad. Ideal for repetitive use. 4mm date size.



Description	Type	Order Code	Offer Price/1
L1 - Received	4mm Date	-0350K	£17.59

Replacement Stamp Pads

Product Number	Colour	Order Code	Offer Price/1
83312	Black	-0420K	£4.15
78253	Blue/Red	-0430K	£8.16
83307	Black	-0440K	£3.60

Printy Line Dater

4820

No stamp pad required. Neat and lightweight plastic self-inking date stamp, comes with a built-in black stamp pad. Ideal for repetitive use. 4mm date size. 12 years of dates.



28 AUG 2010

Description	Order Code	Offer Price/1
Trodar Printy 4820	-0340K	£8.99

Professional Line Dial-A-Phrase Dater

5117

No stamp pad required. Choice of 12 words before a date. Heavy-duty stamp. Wheel turned phrase band, select phrase from index on top of inner frame. 4mm characters.

Texts available:

ANSWERED;
BACK ORDERED;
CANCELLED;
BILLED;
RECEIVED;
CHARGED;
CHECKED;
DELIVERED;
ENTERED; PAID;
SHIPPED and FAXED.
12 years of dates.



Description	Type	Order Code	Offer Price/1
Professional Line 5117	4mm Characters	-0360K	£29.59

Xstamper Word Stamps

The most popular stamp impressions are available off-the-shelf. 100,000 print sharp impressions before re-inking is required. Elastamer soft touch handle and an impression cover. Ink colours supplied in red and blue. **Lifetime guarantee.**



Type	Order Code	Offer Price/1
Paid (Blue)	-0010K	£8.37
Copy (Blue)	-0020K	£8.37
Checked (Red)	-0030K	£8.37
Urgent (Red)	-0050K	£8.37
Faxed (Red)	-0070K	£8.37
Order Confirmation (Red)	-0100K	£8.37

Office Supplies & Stationery

Q-CONNECT® Stamp Pads & Ink

NEW

Create the right impression. Quality stamp pads concealed in a flip top plastic container. Available in a range of colours. No.3 size 141 x 108mm. No.2 size 110 x 70mm.



Size	Colour	Order Code	Offer Price/1
No. 2	Blue	-0040K	£1.51
No. 2	Black	-0050K	£1.51
No. 2	Red	-0060K	£1.51
No. 3	Blue	-0070K	£2.41
No. 3	Black	-0080K	£2.41
No. 3	Red	-0090K	£2.41

Endorsing Ink

28ml bottles of endorsing ink, available in three colours.



Size	Colour	Order Code	Offer Price/1
28ml	Black	-0010K	£0.87
28ml	Blue	-0020K	£0.87
28ml	Red	-0030K	£0.87

dormy® Reliable Numberer

For use with a stamp pad. A traditional and economical numberer. Six band - 4mm characters. Durable steel frame.



NEW

Description	Order Code	Offer Price/1
Reliable Numberer	-0400K	£3.91

trodax® Printy Typo DIY Stamp

NEW

4912



No stamp pad required. Four lines of text. The kit contains: self-inking stamp with ribbed back reusable rubber type containing letters, numbers and symbols, plus a set of tweezers.

Description	Order Code	Offer Price/1
Printy Typo 4912	-0390K	£19.19

Professional Line Numberer

NEW

5546

No stamp pad required. Self-inking stamp, comes with a built-in black stamp pad. Ideal for heavy duty use. 4mm character size. Six bands of numbers and symbols.



Description	Order Code	Offer Price/1
Professional Line Numberer	-0410K	£16.55

Custom Stamp Order Form

Please photocopy this page and send it to your local branch via fax



Account No. Order No. Order Date.

Your Name and Address

Contact Tel. No. **FAO**

N.B. It is very important to supply a contact name for delivery.

Self Inking	Rubber Stamp	Pre-inked
Built-in stamp pad	For use with a stamp pad	No stamp pad required
Quantity	Quantity	Quantity
Stamp Code	Stamp Code	Stamp Code
Actual size of impression	Actual size of impression	Actual size of impression
Length	Length	Length
Depth	Depth	Depth
Dater Model	Dater Model	-
UPPER CASE	Upper and Lower Case (please tick)	

Please **PRINT CLEARLY BELOW** the wording you require. Please ensure you differentiate between letters and numbers e.g. S's and 5's. For stamps with logos or signatures please send **ORIGINAL BLACK AND WHITE ARTWORK** and order form by post. Alternatively send by email in a **PC FORMATTED TIF FILE**, to your area representative - please fax all other orders.

STAMPS		
Border	Yes	No
Format (Please Tick)	Ink Colour	
Rectangle	Black	
Circle	Red	
Oval	Blue	
Layout	Green	
Flush Left	Violet	
Centre	Red/Blue	
Flush Right	(Self-inking Daters)	

Please print clearly in black ink only

GROUP 820 SECURITY BADGES - KEY RINGS

IDENTIBADGE Coloured Security Badges
Professional Badges & Identification Systems

For colour coding and corporate image. High quality plastic in either clear or with a coloured strip. To take insert W90 x H60mm. Supplied with or without straps.

EXTENDED RANGE



Colour	Pack Quantity	Type	Order Code IDB-820	List Price/Pk	Offer Price/Pk
Blue	25	With Straps	-0010K	£36.08	£23.45
Green	25		-0020K	£36.08	£23.45
Red	25		-0030K	£36.08	£23.45
Yellow	25		-0040K	£36.08	£23.45
Clear Landscape	25		-0050K	£36.08	£23.45
Clear Portrait	25		-0060K	£36.08	£23.45
Blue	50	Without Straps	-0070K	£35.26	£22.92
Green	50		-0080K	£35.26	£22.92
Red	50		-0090K	£35.26	£22.92
Yellow	50		-0100K	£35.26	£22.92
Clear Landscape	50		-0110K	£35.26	£22.92

Swipe Card Holders

Single sided holders to take credit card sized passes. Can be used with straps, chains and lanyards, (pass size 54 x 86mm)

Insert not supplied.



PACK OF 50

Colour	Quantity	Type	Order Code IDB-820	List Price/Pk	Offer Price/Pk
Blue	50	Single Side	-0160K	£39.14	£25.44
Black	50		-0170K	£39.14	£25.44
Green	50		-0180K	£39.14	£25.44
Neutral	50		-0190K	£39.14	£25.44
Red	50		-0200K	£39.14	£25.44

Badge Strap

Plastic strap and teeth with metal clip, for use with all identibadges.



Description	Order Code IDB-820	List Price/50	Offer Price/50
Badge Strap	-0130K	£30.38	£19.75

Badge Reels

Snap back retractable badge reels in two styles, suitable for use with most identibadge holders. YY2 is chrome and heavy duty, extending to 7000mm. YY3 is black plastic medium duty extending to 660mm.



Type	Cord Length	Pack Quantity	Order Code IDB-820	List Price/Pk	Offer Price/Pk
Medium-Duty	660mm	10	-0140K	£39.69	£25.80
Heavy-Duty	7000mm	10	-0150K	£46.31	£30.10

Badges

Transparent badges with blank inserts for self-labelling. Visitor's badge has thumb hole for easy insertion and removal of badge inserts.

Self-laminating badge has self-adhesive film that sticks to face of card to prevent tampering.



Type	Size H x W (mm)	Pack Qty	Order Code FIV-820	Offer Price/Pk
Visitor	60 x 90	25	-0010K	£6.29
Name	54 x 90	50	-0020K	£5.80
Self Laminating	54 x 90	25	-0030K	£5.87

IDENTIBADGE Breakaway Lanyards
Professional Badges & Identification Systems

Flat woven fabric lanyards with metal dog clip and black plastic health and safety breakaway feature. 10mm wide, 500mm from end to end hanging length. Lanyards are also available printed with your company name and logo. Enquire for further details.

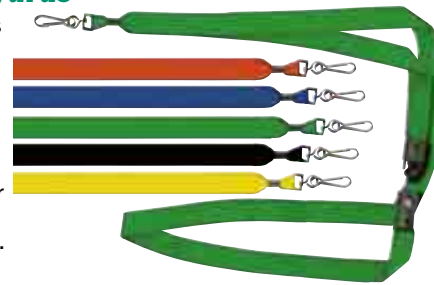

Colour	Pack Quantity	Length	Order Code IDB-820	List Price/Pk	Offer Price/Pk
Blue	50	500mm	-0280K	£70.29	£45.69
Black	50		-0290K	£70.29	£45.69
Green	50		-0300K	£70.29	£45.69
Red	50		-0310K	£70.29	£45.69
Yellow	50		-0320K	£70.29	£45.69
Blue	10	500mm	-0330K	£16.16	£10.50
Black	10		-0340K	£16.16	£10.50
Green	10		-0350K	£16.16	£10.50
Red	10		-0360K	£16.16	£10.50
Yellow	10		-0370K	£16.16	£10.50

Printed Breakaway Lanyards

Identibadge lanyards are also available pre-printed with wording and colour as illustrated. 10mm wide, 500mm from end to end hanging length.



Type	Quantity	Length	Order Code IDB-820	List Price/Pk	Offer Price/Pk
Contractor	10	500mm	-0380K	£22.40	£14.56
Visitor	10	500mm	-0390K	£22.40	£14.56

DURABLE Badge Reels

Badge reel clip with a choice of three attachments to suit your requirements. Attaches securely to your belt and rewinds automatically. 600mm reach.



Type	Pack Quantity	Order Code DBS-820	List Price/Pk	Offer Price/Pk
Clip	10	-0010K	£15.75	£12.60
Snap Hook	10	-0020K	£18.40	£14.72
Key Ring	10	-0030K	£18.40	£14.72

Office Supplies & Stationery



Wall Mounted Key Garage

787C

A convenient way to leave keys for people you trust. Strong, sturdy weather-resistant construction. Four digit resettable combination to set our own PIN. Complete with easy to fit wall fixings.



Dimensions (H x W x D)	Order Code	List Price/1	Offer Price/1
115 x 80 x 43mm	ABU-950	£19.96	£18.96

SECURIKEY®

Select Access Key Storage Unit

4-digit programmable combination unit offering 10,000 possible codes. Rust free - zinc cast body to resist all weather, hammering or sawing. Easily mounts to most surfaces (fixings provided).



Dimensions (H x W x D) external: 119 x 85 x 35mm.

Description	Weight each	Order Code	Offer Price/1
Secure Key Storage Box	1.0kg	-0050K	£26.70

Rear View Mirror

Curved mirror for wide angle viewing. Essential in all industrial areas where fork lifts are used. Provides the driver with 180° rearward vision. Fits under the overhead canopy. High polished mirror surface for the brightest of reflection. Manufactured from shatter resistant lightweight acrylic. Scratch-resistant.



Size W x D (mm)	Order Code	Offer Price/1
300 x 150	-0060K	£65.00

Plastic Identity Tags

With ruled identification insert and sliding protecting window. Ideal for identifying keys, luggage, camera cases, business bags, tool boxes, tools, etc. Pack of assorted colours.

Dimensions:

Small: 55 x 30mm.
Large: 70 x 40mm.



Range	Pack Qty	Order Code	List Price/Pk	Offer Price/Pk
		CTL-820		
Small	100	-0300K	£13.99	£10.49
Large	50	-0310K	£14.99	£11.24

Retracting Key Reels

Helps to prevent loss, misplacement or theft of keys by returning them to the users side after use. Keeps keys always to hand. Stainless steel cable/chain.



Range	Order Code	Offer Price/1
	SEK-820	
1.2m - Cable	-0320K	£17.00
0.6m - Chain	-0330K	£15.50

Security Mirrors

The economical way to protect people and property. Convex shatterproof acrylic mirrors allow observation of aisle areas or corners on commercial premises or car parks where safety and security are paramount. No plastic or stick-on components. Improve security, reduce accidents, avoid personal injury, prevent theft and reduce losses. Internal type mounted on hardboard with grey PVC edge. External type mounted on 9mm high density particle board with grey vinyl coating for extra protection and PVC edge. Supplied with screws and fixings.



Type	Diameter (mm)	Order Code	Offer Price/1
Interior	300	-0270K	£74.00
Interior	450	-0280K	£89.00
Interior	600	-0290K	£136.00
Outdoor	450	-0300K	£118.00
Outdoor	600	-0310K	£187.00

MATLOCK Blue Plastic Key Rings

Manufactured from plastic with a removable address label. Fitted with a metal key ring.



50 PIECES

Description	Order Code	List Price/Pk	Offer Price/Pk
	MTL-820		
Key Ring	-9020K	£14.99	£11.99

Jet Kevron 'Clicktag' Key Tags

Plastic tags in bright colours with easy access inserts. High strength stainless spring rings assorted colours.



100 PIECES

Description	Order Code	List Price/Pk	Offer Price/Pk
	JET-820		
Key Tags	-0010K	£35.00	£28.00

Helix External Round Security Mirror

Ideal for car parks, exterior of warehouses etc for improved visibility around blind corners or areas of restricted sight. Protruding weather protection cap for improved visibility in bad weather conditions.



NEW

Durable polycarbonate construction with a full surface film cover to protect mirrors until mounted. Supplied with wall and post mounting brackets. (Without brackets).

Type	Size (mm)	Order Code	List Price/1	Offer Price/1
		HEX-820		
PW4040	450	-0010K	£109.99	£76.99
PW5040	600	-0020K	£159.99	£111.99

MATLOCK Acrylic Security Mirrors

Internal and external acrylic convex mirrors with fully adjustable fixing brackets. For use in all situations i.e. security, safety, traffic surveillance, Warehousing, car parks, retail business, road way (exit from drive to road.) etc. Each mirror comes complete with wall mounting hardware and instructions for maximum viewing.



Type	Size (mm)	Order Code	List Price/1	Offer Price/1
		MTL-820		
Interior	400	-8040K	£62.49	£49.99
Interior	600	-8060K	£87.49	£69.99
Outdoor	600	-8160K	£112.49	£89.99

CONTRACT PRICES AVAILABLE FOR VOLUME PURCHASES

All Prices Exclude V.A.T. © 2011

Office Supplies & Stationery

GROUP 820 SECURITY - KEY CABINETS

MATLOCK Key Cabinets

All heavy gauge steel construction for secure key storage. Fitted with security lock and supplied complete with two keys. All key hooks are numbered for easier identification. Easily fitted to walls with screws (fixings not supplied).



Capacity	Dimensions W x D x H (mm)	Order Code MTL-820	List Price/1	Offer Price/1
20 Keys	160 x 80 x 20	-0200K	£14.69	£11.75
48 Keys	180 x 80 x 250	-0250K	£24.69	£19.75
93 Keys	240 x 80 x 300	-0300K	£29.30	£23.44

Helix Key Cabinets

Manufactured from steel with hardwearing anthracite black paint finish. Supplied with two keys, plastic self-adhesive numbers, removable index chart and screws for wall fixing.



Product Number	Key Capacity	Dimensions W x D x H (mm)	Order Code HEX-820	List Price/1	Offer Price/1
729254	20	190 x 45 x 250	-0060K	£21.99	£15.39
729262	30	190 x 50 x 250	-0070K	£22.59	£16.94
729270	50	275 x 80 x 275	-0080K	£34.99	£26.24
729301	100	275 x 80 x 500	-0090K	£49.99	£37.49
729319	150	275 x 80 x 500	-0100K	£60.99	£45.74
729327	200	275 x 80 x 500	-0110K	£64.99	£48.74

SECURIKEY Key Cabinets

Made from heavy gauge steel with flush closing rim. Fitted with a strong security lock and comes with two keys. Easily fitted to a wall with screws or bolts (fittings not included). Colour coded bars and key tabs. Removable control index allowing instant recognition of keys by the authorised user.

*Control index not included.



Product Number	Key Capacity	Dimensions W x D x H (mm)	Weight each	Order Code SEK-820	Offer Price/1
System 20	20	185 x 80 x 260	2.0kg	-0210K	£62.00
System 30	30	215 x 80 x 305	3.0kg	-0220K	£81.00
System 35	35	245 x 80 x 320	4.0kg	-0230K	£90.00
System 48	48	300 x 80 x 355	5.0kg	-0240K	£147.00
System 64	64	300 x 80 x 450	6.0kg	-0250K	£200.00
System 100	100	380 x 80 x 550	8.0kg	-0260K	£243.00

PHOXIS Electronic Key Safe

0031
High security electronic lock with up to 8 digit code. 3mm body thickness and 4mm door thickness. Ready prepared for wall fixing (bolts supplied). Holds a maximum of 48 keys. One-way key deposit facility for extra security. Comes with manual override key. Complete with key rings and coloured tags.

Dimensions (W x D x H):
300 x 100 x 365mm.



Description	Weight	Order Code PHX-820	List Price/1	Offer Price/1
Electronic Key Safe	9kg	-0210K	£105.00	£78.75

Helix Portable Key Cabinets

NEW

Robust steel construction with silver effect finish and black sturdy plastic handle. Complete convenience and added key security with built-in carry handle. Can be temporarily located on the wall during the day and then easily removed and taken at night. Ideal for use in vehicles, building sites, estate agents and temporary work

environments. Supplied with key fobs, removable magnetic hanging strips, two door keys and wall mounting kit.



Capacity	Order Code HEX-820	List Price/1	Offer Price/1
16 Keys	-0030K	£79.99	£55.99
32 Keys	-0040K	£92.99	£64.99
48 Keys	-0050K	£105.99	£74.49

Heavy-Duty Key Safes

Heavy-duty locking key cabinets, with capacity for up to 100 keys. Suitable for wall mounting. Includes bolts. Finished in scratch resistant powder coat paint. All digital safes require 4x AA batteries (supplied separately).



KC50HD - 50 Key Cabinet with Perspex Window
Cabinet dimensions: W380 x D80 x H550mm.

KC25S - Key Safe with Digital Lock - 25 Key
Cabinet dimensions: W320 x D120 x H295mm.



EXTENDED RANGE

KC60S Key Safe with Digital Lock - 60 Key
Cabinet dimensions: W400 x D120 x H340mm. Requires 4x AA batteries.



Part No.	Type	Capacity (keys)	Order Code CTL-820	List Price/1	Offer Price/1
KC50HD	Keyed	50	-0100K	£99.99	£74.99
KC25S	Digital	25	-0110K	£115.29	£86.47
KC60S	Digital	60	-0120K	£130.99	£98.24

SECURIKEY Emergency Key Boxes

All steel construction with break glass front, designed to hold a restricted key near a locked door for emergency use only.

Model K1 - With cylinder lock.

Model K0 - Has lock and provision for a seal - also supplied with hammer and chain for breaking glass.



Model	Dimensions W x D x H (cm)	Order Code SEK-820	Offer Price/1
K1	12.0 x 3.1 x 15.0	-0040K	£24.00
K0	13.4 x 3.1 x 15.4	-0030K	£22.99

Office Supplies & Stationery

CATHEDRAL Cash Boxes

Steel cash box with a lockable lid, removable plastic tray, complete with two keys.

BEST SELLER



Colour	Size	Order Code	List Price/1	Offer Price/1
Blue	8"	-0110K	£14.99	£11.24
Black		-0120K	£14.99	£11.24
Red		-0130K	£14.99	£11.24
Blue	12"	-0140K	£15.99	£11.99
Black		-0150K	£15.99	£11.99
Red		-0160K	£15.99	£11.99

Helix Post/Suggestion Box

Ensures confidential internal mail. High quality plastic front with steel back which can be fixed to either the wall or door. 12" high, water resistant with a lock and two keys. Comes complete with four fixing screws.

NEW

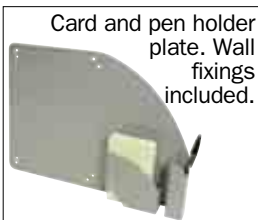

Card and pen holder plate. Wall fixings included.

Colour	Order Code	Offer Price/1
Red	-0120K	£33.74
Grey	-0130K	£33.74
Card & Pen Holder	-0140K	£14.34

Fire Resistant Safes - Centurion 1250 Series

High security, fire resistant safe for residential and business use. One hour fire resistant at temperatures of 927°C for paper documents. Recommended for a maximum cash risk of £2000 or £20,000, depending on area conditions and location. Fitted with a high security electronic lock, programmable with users own code up to 16 digits. Ground floor delivery included, enquire for upper floor delivery charge.



1251



1252



1253

Product Number	Dimensions (HxWxD)		Weight each	Order Code	List Price/1	Offer Price/1
1251	220x330x225	300x420x360	26kg	-0010K	£224.00	£168.00
1252	320x260x305	487x345x400	36kg	-0020K	£265.00	£198.75
1253	410x300x300	530x460x480	53kg	-0030K	£448.00	£336.00



MATLOCK Mechanical Keyed Safes

High security key operated safe with double locking bolts. Fine powder coated finish.



Product Number	Dimensions (mm)		Weight each	Order Code	List Price/1	Offer Price/1
	Internal	External		MTL-820		
190x290x155	200x300x200	9.5kg	-2010K	£29.36	£23.49	
240x340x205	250x350x250	113kg	-2020K	£41.10	£32.88	

Home Safes

Smart exterior safe for use in and around the home. Motorised opening and locking activated by your personal 4 - 6 digit code or emergency key. Double locking bolts. Single-time moulded case with unique spray coating technique which ensures a rust free case for a minimum of five years. Complete with one fixed shelf.



Product Number	Dimensions (mm)		Weight each	Order Code	List Price/1	Offer Price/1
	Internal	External		MTL-820		
RL23W	200x427x290	229x432x360	16kg	-7020K	£49.99	£39.99
RL30W	275x400x265	305x405x335	19.5kg	-7030K	£51.24	£40.99

Electronic Safes

Electronic safe complete with mounting bolts and floor carpet. One fixed shelf. 3 - 8 digit locking code. Concealed emergency manual key lock. Double locking bolts. Fine powder coated finish.



Product Number	Dimensions (mm)		Weight each	Order Code	List Price/1	Offer Price/1
	Internal	External		MTL-820		
240x340x195	250x350x250	13.5kg	-5020K	£39.99	£31.99	
290x370x245	300x380x300	16kg	-5030K	£46.99	£37.59	
490x340x255	500x350x310	22kg	-5050K	£64.99	£51.99	

Fire Proof Electronic Safe

All steel construction. Resistant to most hand and mechanical tool attacks. Four digit pin code can be changed. Integral plastic key cover. Audible correct/incorrect PIN number indicator. Offers one hour fire protection at 1000°. Complete with hold down kit for cash and jewellery insurance ratings*. Low battery indicator light. Internal protection to door hinges. Ideal to store valuable items that require fire protection. Conforms to: **EN50081 : 1992** and **EN61000-6-2:2001**. Underwriter's Laboratories (UL-72 standard class 103, 1o3T).

*Consult your local insurance provider for cash and jewellery ratings.



Product Number	Dimensions (mm)		Weight each	Order Code	List Price/1	Offer Price/1
	Internal	External		MTL-820		
FES249	145x330x215	250x430x355	30kg	-6000K	£124.88	£99.90

DYMO LabelManager 260P

ABC Portable label maker. The large 2-line graphical display shows exactly how your label will print. This means no more guessing what the labels will look like. Prints professional quality labels on 6, 9 and 12mm easy-peel split-back DYMO D1 tape. Separate set of keys for numerics. Logical flow of label making from start to print — very user friendly. Quick access buttons to punctuation, currency symbols and diacriticals. Customize labels and add emphasis by using one of 3 fonts, 6 font sizes, one of the many styles, and one of 8 different boxes or underline. Stores up to 9 labels and is capable of inserting saved text. Prints up to 10 copies of a label. Rechargeable lithium-ion batteries.

NEW

Accepts 6, 9 & 12mm Tapes See Below



Model Number	Order Code	Offer Price/1
LM 260P	DYM-821-0050K	£48.99

LabelManager 220P

A portable label maker with a typewriter-style keyboard, is a great option for all your labelling needs. You can operate this exclusive and compact label maker with your thumbs, just like your favourite PDA. Additionally, the LabelManager 220P offers a wide range of features: create distinctive custom labels for everything from safety warnings to invoice files. The result will be an unmistakable and immediate improvement in the professional appearance and effectiveness of your work environment. Unlike other label makers, the large graphical display shows exactly how your label will print. This means no more guessing what the label will look like. What you see is what you get!

Accepts 6, 9 & 12mm Tapes See Below



NEW

Model Number	Order Code	Offer Price/1
LM 220P	DYM-821-0080K	£39.99
D1/40075 Replacement 240V adaptor Plug	-0110K	£29.38

LabelManager 420P

The best choice for anyone who depends on labels to create a more efficient and productive workplace.

- Use standalone — or connect via USB to your PC or Mac and use DYMO Label Software (1) to print barcodes, logos, batch labels from data files, and much more
- Large 4-line backlit display — shows text effects on screen before you print.
- 8 fonts, 7 font sizes, 10 text styles, 8 boxes plus underline.
- Powered by a rechargeable lithium-ion battery — no more disposable AA battery expense and inconvenience.
- Uses DYMO D1 labels in 6mm, 9mm, 12mm, and 19mm widths.

(1)DYMO Label Software is compatible with Windows Vista, Windows 7, Windows XP, Mac OS® v10.5.8 or later.

Accepts 6, 9, 12 & 19mm Tapes See Below



Model Number	Order Code	Offer Price/1
420P	DYM-821-0140K	£86.99

LabelManager 210D

The new LabelManager 210D is the label maker that belongs on every desk. Versatile, yet easy to use, the LabelManager 210D has all the features a professional label maker should have.

A completely new user interface makes this label maker extremely easy to use. Easy navigation from start to print with quick access buttons to symbols, 6 font sizes, 7 styles and 8 different boxes to customise your label.

Accepts 6, 9 & 12mm Tapes See Below



NEW

Model Number	Order Code	Offer Price/1
LM 210D	DYM-821-0070K	£39.99
D1/40075 Replacement 240V adaptor Plug	-0110K	£29.38

Dymo LetraTag

Perfect for organising the home office, DIY, etc. Prints on 12mm (1/2") labels in a variety of materials and colours at a push of a button. Batteries and tapes supplied separately.



Model Number	Order Code	Offer Price/1
LetraTag	DYM-821-0100K	£18.74

Dymo LetraTag Tape

Colour	Order Code	Offer Price/1
Paper	DYM-822	
White	-4900A	£3.90
Plastic		
Blue	-4905F	£4.78
Green	-4904E	£4.78
Red	-4903D	£4.78
White	-4901B	£4.78
Yellow	-4902C	£4.78

Dymo D1/D2 Tape Cassettes

Wide range of label widths and colours to create attractive and professional looking labels.

Colour	Order Code	Order Code	Order Code	Order Code	Order Code
	DYM-822	DYM-822	DYM-822	DYM-822	DYM-822
	6mm x 7m	9mm x 7m	12mm x 7m	19mm x 7m	24mm x 7m
LM100+, LM150, LM200, LM210D, LM220P, LM260P, LM300, LM350, LM400, LM450, LP200, LP300, LP350, LMPC 1000/1000, Plus/2000/5000/5500, LW450-Duo 420P	-2410L	-2440T	-2470B	-2500A	-2530H
LM100, LM100+, LM150, LM200, LM210D, LM220P, LM260P, LM350, LM400, LM450, LP100, LP150, LP200, LP250, LP300, LP350, LMPC Pocket/1000/1000 Plus/2000/3500/5000/5500, LW450-Duo 420P	-2413P	-2443X	-2473E	-2503D	-2533L
LM100, LM100+, LM150, LM200, LM210D	-	-	-2474F	-2504E	-2534M
LM220P, LM260P, LM300, LM350, LM400, LM450, LP100, LP150, LP200, LP250, LP300, LP350, LMPC 1000/1000 Plus/2000/3500/5000/5500, LW450-Duo 420P	-	-2445Z	-2475G	-2505F	-2535N
LM200, LM300, LM350, LM450, LP100, LP200, LP300, LP350, 2000/5000 LMPC, LW450-Duo 420P	-	-2446A	-2476H	-	-
LM300, LM400, LM450, LMPC, LW450-Duo 420P	-	-2447B	-2477J	-2507H	-2537Q
	Black/Clear	Black/White	Black/Yellow	Black/Blue	Black/Red
	-2418V	-2448C	-2478K	-2508J	-2538R
	-	-2449D	-2479L	-	-2539S
	-	-	-2481N	-2511M	-2541V
	Offer Price/1	£7.88	£8.51	£9.12	£11.47
					£12.07

Office Supplies & Stationery

DYMO RhinoPRO 6000 Labeller

Ideal for high-end, demanding datacom, electrical, MRO, pro audio/video and other professionals. Select from five materials in as many as four label widths: 1/4" (6mm), 3/8" (9mm), 1/2" (12mm) and 3/4" (19mm).

Features:

- 'Hot Keys' for fast and easy formatting of commonly used label types.
- Pre-programmed industry terms and symbols.
- Prints six different bar codes.
- Uses thermal transfer print technology - no ink!
- Preview multiple labels on the large backlit LCD.
- Quick-charge lithium-ion battery.
- Integrated impact bumper protects against accidental falls while allowing easy access to label cartridge.
- Power-assisted label cutter.
- Works with Rhino Connect™ software (sold separately) to provide PC connectivity.



NEW

Model	Description	Order Code DYM-821	Offer Price/1
RhinoPro 6000	Industrial Label Printer	-0120K	£259.99

RhinoPRO 5200 Kit Case

Kit contents:

protective carry case, RhinoPRO 5200 printer and protective bumper surround, 1 x 19mm flexible nylon tape, AC adaptor 6x AA batteries and user manual.

Features:

- 'Quick access keys' provide fast and easy labelling for marking wire and cables, patch panels, electrical components, etc.
- Includes commonly used electrical and datacom symbols.
- Prints bar code 39 and code 128.
- 8 memory locations.
- Adjustable font size.
- Selection of 16 languages.
- Prints onto 6, 9, 12 and 19mm RhinoPRO industrial tapes.



NEW

Model	Description	Order Code DYM-821	Offer Price/1
RhinoPro 5200	Industrial Label Printer	-0040K	£119.99

RhinoPRO 1000 Labeller

The simple interface and instant label and symbol keys will help you produce labels quickly. Choose from many materials in two label widths: 3/8" (9mm) and 1/2" (12mm).

Features:

- "Hot keys" provide automatic label formatting for flag, fixed-length and vertical labels.
- Serial key for automatic printing of incremental text and numerical information.
- Flag key prints two-sided labels for cables and wires with a single touch.
- Fixed length key automatically centres and prints to your specs (ideal for outlets, bins, warehouse and more).
- Last-label memory eliminates re-keying.
- Prints up to two lines in three font sizes — horizontally and vertically.
- Prints italics, underline and boxed text.
- Large, backlit 11-character display.



NEW

Model	Description	Order Code DYM-821	Offer Price/1
RhinoPro 1000	Label Printer	-0130K	£38.89

Label Cassettes for RhinoPRO

White polyester ideal for highly textured surfaces - also solvent, scratch, UV and oil-resistant.



Colour	Width	Order Code DYM-822	Offer Price/1
White	9mm	-1580M	£10.99
White	12mm	-1580Q	£11.49
White	19mm	-1580X	£12.99
White	24mm	-6040K	£14.99

Label Cassettes for RhinoPRO

Vinyl, ideal for any surface - also solvent/scratch/UV and oil-resistant.



Colour	Width	Order Code DYM-822	Offer Price/1
Yellow	9mm	-1582P	£10.99
Yellow	12mm	-1582W	£11.49
Yellow	19mm	-1583E	£12.99
White	9mm	-6102M	£10.99
White	12mm	-6103P	£11.49
White	19mm	-6104T	£12.99

Dymo M11 Tapewriter

Lasting labels for the industrial environment are made easily with this tough cast-metal labeller. Features a front scissor cut-off and a built-in hole-punching device that makes a hole for hanging and tacking. Imprints 12mm wide metal tapes that withstand chemicals, extreme weather conditions, very high and low temperatures, salty water and abrasion. Great for tagging pipes, underground cables, greasy engine components, manufacturing equipment.



Prints also on traditional DYMO vinyl tapes.

Model	Description	Order Code DYM-821	Offer Price/1
M11 Dymo Tapewriter	Industrial Label Printer	-0090K	£399.99

Aluminium Adhesive Dymo Tape
12mm x 3.65m Aluminium adhesive label tape suitable for the M11 Tapewriter.

Product Number	Size (mm)	Description	Order Code DYM-822	Offer Price/1
35800	12	Aluminium Dymo Tape	-0030H	£14.92

DYMO LabelWriter Printers

Dymo LabelWriter 450 range printers are the fast and easy way to print labels in seconds from a PC, without tying up the main printer. The user simply highlights the address, clicks on the icon and within seconds the label is printed. Advanced software gives users the ability to produce sophisticated labels with images and logos, if required.

Features:

- Superb, laser sharp, print quality.
- Label widths up to 60mm.
- High print speed (51 to 71 labels per minute).
- Compact unit with small footprint taking up minimum desk space.
- First label rewind preventing loss of first label on loading.
- User friendly stand-alone software that integrates with Microsoft Office.
- Address book database.
- Software add-ins for Word, Excel, Outlook, Corex Cardscan, Palm Desktop, Act and Goldmine.
- PC or Mac compatible, Minimum system requirement, Windows 95/98/ME/2000. Mac: OS10.1,2,X.
- Includes printer, software, adaptor, USB connection cable, roll of address labels and cleaning card.

NEW



Model Number	Max Label Width	Labels/Minute	PC Connectable	Size (mm) W x D x H	Order Code	Offer Price/1
LW450	60mm	51	USB	127x185x133	-0010K	£83.99
LW450 Turbo	60mm	71	USB	127x185x133	-0020K	£109.99
LW450 Duo	60mm	71	USB	140x201x190	-0030K	£164.98

Labels for Dymo LabelWriter

Permanent adhesive labels for all your labelling requirements.

Label Description	Size L x W (mm)	Colour	Compatibility	Labels/Order Code Roll	Order Code DYM-822	Offer Price/1
Standard Address (2 rolls)	89 x 28	White		130	-4710L	£8.27
Standard Address	89 x 28	Yellow, Pink, Blue, Green		130	-4711M	£23.33
Large Add (2 rolls)	89 x 36	White	300 Series, 400 Series, & 450 Series	260	-4712N	£15.83
Large Plastic Address	89 x 36	White		260	-4713P	£17.78
Ship/Name Labels	101 x 54	White		220	-4714Q	£13.67
Diskette	70 x 54	White		320	-4715R	£15.11
Suspension Files	50 x 12	White		220	-4717T	£7.91

Large Plastic Address Labels

Suspension file labels

Standard Address Labels

Shipping/name badge Labels

Large Address Labels

Label Description	Size L x W (mm)	Colour	Compatibility	Labels/Order Code Roll	Order Code DYM-822	Offer Price/1
Multi Purpose	57 x 32	White	300 Series, 400 Series, & 450 Series	1000	-4734M	£16.19
Lever Arch Files Large	190 x 59	White		110	-4719W	£17.27

Positive I.D. C6 One Line Labeller

Simple, robust machine suitable for one line coding or batch numbers, etc. Available in two models, C6 format (six bold characters) and Dater as seen on 'best before' labels.



Labeller Guns

Model	Description	Order Code PLS-821	Offer Price/1
C6	One Line Labeller Gun	-0010K	£46.99
C6 Dater	as above but with Dater	-0020K	£54.99

Label Rolls

No. of Rolls	Label Size (mm)	Label Type	Pack Qty.	Order Code PLS-821	Offer Price/1
1	26 x 12	White Plain	1500	-0060K	£10.26
1	26 x 12	Batch No.	1500	-0070K	£10.26
1	26 x 12	Yellow Plain	1500	-0080K	£10.26
Ink Roller for C6 Label Gun				1	-0040K £5.70

C17 Two Line Labeller

Highly versatile two line machine with 10 characters on the top line and seven on the bottom.



Labeller Gun

Model	Description	Order Code PLS-821	Offer Price/1
C17	Two Line Labeller Gun	-0030K	£75.24

Label Rolls

No. of Rolls	Label Size (mm)	Label Type	Pack Qty.	Order Code PLS-821	Offer Price/1
1	26 x 16	White Plain	1000	-0090K	£4.28
1	26 x 16	Best Before	1000	-0100K	£5.55
1	26 x 16	Yellow Plain	1000	-0110K	£5.23
Ink Roller for C17 Label Gun				1	-0050K £5.70

Bespoke labels Have the labels printed in the colour of your preference and to suit your particular application.

Example Colours: [Orange] [Red] [Yellow] [Blue]

Example Print:

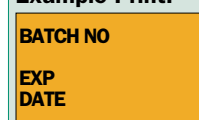

Label Size (mm)	Minimum Quantity
26 x 12	90,000
26 x 16	90,000

Prices quoted will include the cost of printing and origination

Please Ring For Prices

Office Supplies & Stationery



Pre-Cut Printer Labels

Multi-purpose labels for use with most laser, inkjet and copier machines. Includes face paper which allows good toner fusion and ensures inks do not bleed. Quality backing sheet allows the labels to stay flat for trouble-free printing.



Label Size (mm)	Labels Per Sheet	Order Code OFI-822	Offer Price/Pk
1 199.6 x 289	1	-0040K	£4.99
2 199.6 x 143.5	2	-0050K	£4.99
3 99.1 x 67.7	8	-0060K	£4.99
4 99.1 x 38	14	-0070K	£4.99
5 99.1 x 34	16	-0080K	£4.99
6 63.5 x 46.5	18	-0110K	£4.99
7 63.5 x 38	21	-0090K	£4.99
8 64 x 33.9	24	-0100K	£4.99
9 38.1 x 21.2	65	-0120K	£4.99

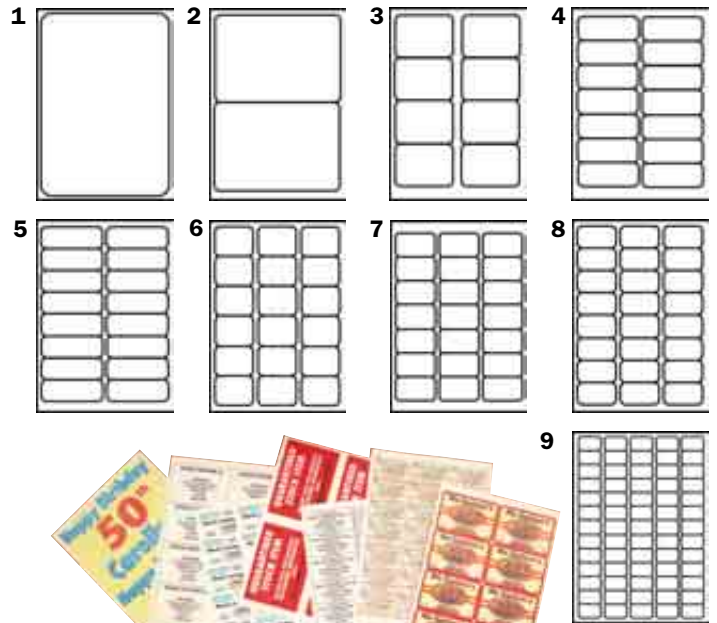

LABELS SHOULD BE RUN THROUGH MACHINES ONLY ONCE



Jam Free Laser Labels

Tested on most popular black and white laser printers to guarantee trouble-free printing. Label templates are referenced in most popular software packages. The adhesive is designed to withstand the high heat of laser printers and the stripped edge prevents adhesive leakage. Brilliant white with rounded corners and no toner flaking. Sold in individual packs of 100 sheets of labels.

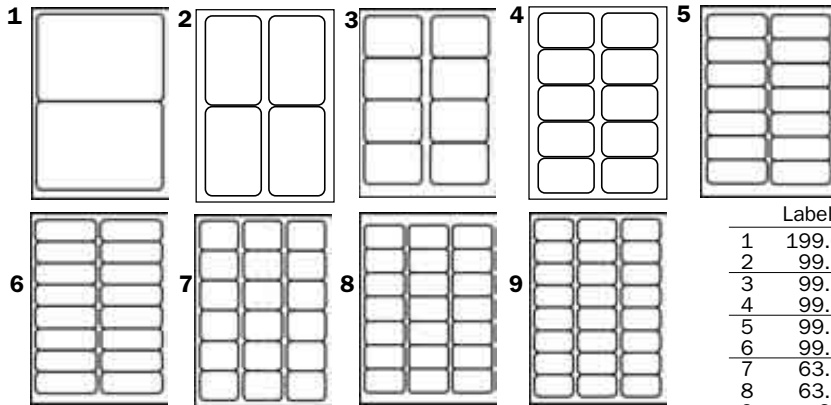

LABELS SHOULD BE RUN THROUGH MACHINES ONLY ONCE!



Label Size (mm)	Avery Code	Labels Per Sheet	Order Code AVE-822	Offer Price/Pk
1 199.6 x 143.5	L7168-100	2	-0120K	£24.52
2 99.1 x 139	L7169-100	4	-0040K	£24.52
3 99.1 x 67.7	L7165-100	8	-0130K	£24.52
4 99.1 x 57	L7173-100	10	-0050K	£24.52
5 99.1 x 38.1	L7163-100	14	-0140K	£24.52
6 99.1 x 34	L7162-100	16	-0150K	£24.52
7 63.5 x 46.6	L7161-100	18	-0160K	£24.52
8 63.5 x 38.1	L7160-100	21	-0170K	£24.52
9 64 x 34	L7159-100	24	-0030K	£24.52



Labelling Tapes

A selection of laminated tapes for use with the P-Touch labelling machines. Laminated tapes are waterproof and resistant to extremes in temperature, making labels durable and long lasting. A laminate film on the tape protects text and colours from chemical agents commonly found in industrial environments.



Model No.	Description	Colour	Order Code BRT-822	Offer Price/1
TZ-111	6mm x 8m	Black on Clear	-0300K	£12.72
TZ-211	6mm x 8m	Black on White	-0302K	£12.39
TZ-611	6mm x 8m	Black on Yellow	-0305K	£13.43
TZ-315	6mm x 8m	White on Black	-0304K	£14.39
TZ-121	9mm x 8m	Black on Clear	-0310K	£13.43
TZ-221	9mm x 8m	Black on White	-0318K	£14.39
TZ-325	9mm x 8m	White on Black	-0326K	£18.51
TZ-421	9mm x 8m	Black on Red	-0328K	£14.39
TZ-521	9mm x 8m	Black on Blue	-0330K	£14.39
TZ-621	9mm x 8m	Black on Yellow	-0332K	£14.39
TZ-721	9mm x 8m	Black on Green	-0334K	£15.22
TZ-131	12mm x 8m	Black on Clear	-0340K	£14.39
TZ-231	12mm x 8m	Black on White	-0348K	£14.39
TZ-631	12mm x 8m	Black on Yellow	-0368K	£16.91
TZ-531	12mm x 8m	Black on Blue	-0364K	£16.91
TZ-431	12mm x 8m	Black on Red	-0360K	£16.91
TZ-335	12mm x 8m	White on Black	-0358K	£20.97
TZ-141	18mm x 8m	Black on Clear	-0390K	£17.19
TZ-241	18mm x 8m	Black on White	-0394K	£20.79
TZ-441	18mm x 8m	Black on Red	-0404K	£18.23
TZ-541	18mm x 8m	Black on Blue	-0406K	£17.99
TZ-641	18mm x 8m	Black on Yellow	-0408K	£17.99
TZ-345	18mm x 8m	White on Black	-0402K	£21.59
TZ-251	24mm x 8m	Black on White	-0424K	£23.49
TZ-451	24mm x 8m	Black on Red	-0434K	£19.99
TZ-551	24mm x 8m	Black on Blue	-0438K	£19.99
TZ-651	24mm x 8m	Black on Yellow	-0442K	£19.99
TZ-751	24mm x 8m	Black on Green	-0446K	£19.99
TZ-161	36mm x 8m	Black on Clear	-0460K	£25.59
TZ-561	36mm x 8m	Black on White	-0464K	£26.39
TZ-661	36mm x 8m	Black on Yellow	-0478K	£29.99

CONTRACT PRICES AVAILABLE FOR VOLUME PURCHASES

All Prices Exclude V.A.T. © 2011

Communiqué *Communique Multifunction Labels*

Ideal for correspondence addresses and archive labelling. Designed to cope with the demands of modern high speed laser, copier and inkjet machines. Great for printing colour and mono and suitable for pre-printing. Chill grade adhesive - allows for labels to be frozen.
Box quantity: 100 sheets per box.



LABELS SHOULD BE RUN THROUGH MACHINES ONLY ONCE

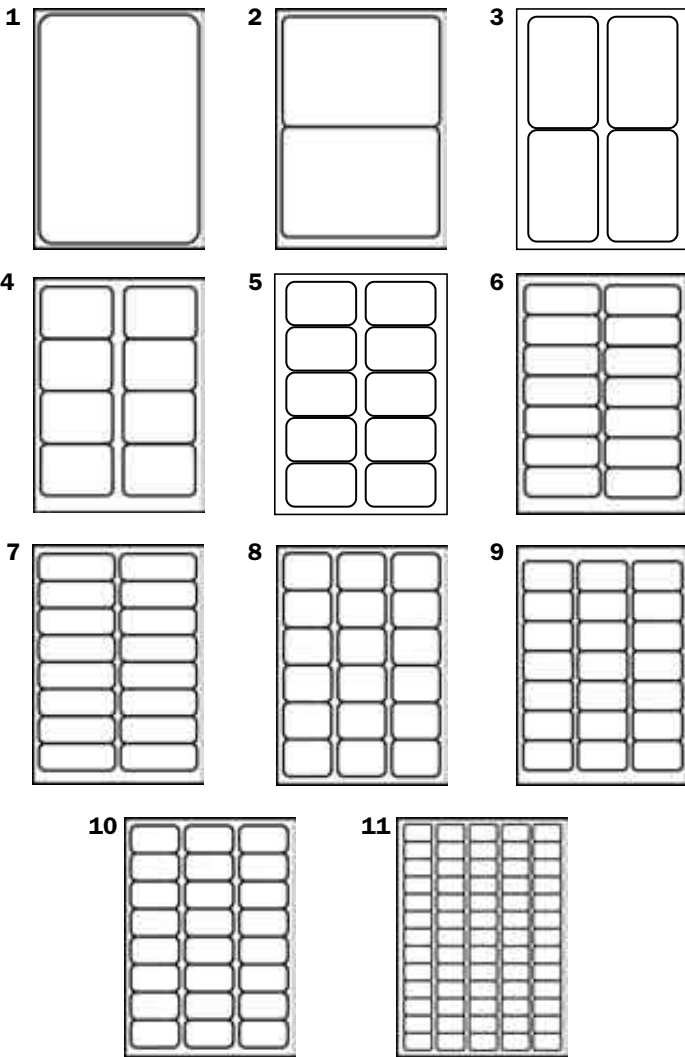

Label Size (mm)	Labels Per Sheet	Order Code WTS-822	Offer Price/Pk
100 Sheets Per Pack			
1 199.6 x 289.0	1	-0120K	£6.12
2 199.6 x 143.5	2	-0130K	£6.12
3 99.1 x 139.0	4	-0140K	£6.12
4 99.1 x 67.7	8	-0150K	£6.12
5 99.1 x 57.0	10	-0160K	£6.12
6 99.1 x 38.0	14	-0170K	£6.12
7 99.1 x 34.0	16	-0180K	£6.12
8 63.5 x 46.5	18	-0190K	£6.12
9 63.5 x 38.0	21	-0200K	£6.12
10 64.0 x 33.9	24	-0210K	£6.12
11 38.1 x 21.2	65	-0220K	£6.12

Blick
Circular Labels

Ideal for product identification. Coloured labels that are useful in home or office.

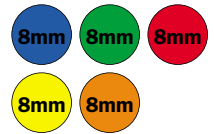

Multi Buy

Colours are for Guidance only

Diameter	Colour	Labels per pack	Order Code RYS-804	Offer Price/Pk	Offer Price/20+
8mm	Blue	490	-0165K	£0.99	£0.84
8mm	Green	490	-0175K	£0.99	£0.84
8mm	Orange	490	-0195K	£0.99	£0.84
8mm	Red	490	-0215K	£0.99	£0.84
8mm	Yellow	490	-0225K	£0.99	£0.84
8mm	Assorted	320	-0235K	£0.99	£0.84

Fluorescent Circular Labels

For labels which really stand out use Blick fluorescent.

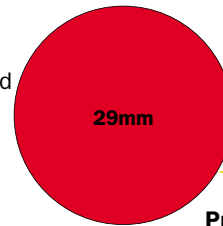

Colours are for Guidance Only

PACK OF 36

Multi Buy

Prices are Per Pack

Diameter	Colour	Labels per pack	Order Code RYS-804	Offer Price/Pk	Offer Price/20+
29mm	Red	36	-0305K	£0.99	£0.84

Circular White Label Dispensers

Ideal for the frequent user. Allow for easy storage of large quantities of labels. Labels per dispenser are shown in table.

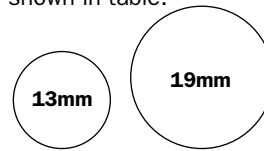

Diameter	Labels per pack	Order Code RYS-804	Offer Price/Pk
13mm	2800	-0300K	£3.26
19mm	1400	-0320K	£3.26

AVERY *Circular Labels*

19mm diameter self-adhesive labels. Supplied in easy to use dispensers. 1120 labels per pack.

Pack dimensions: 30x100x100mm.

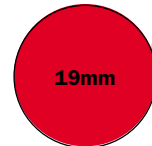

Colour	Labels per pack	Order Code AVE-822	Offer Price/Pk
Blue	1120	-0080K	£3.15
Green	1120	-0090K	£3.15
Red	1120	-0100K	£3.15
Yellow	1120	-0110K	£3.15

Circular Labels

Fluorescent 13mm diameter self-adhesive labels. Available in a range of colours. 210 labels per pack.

Colour	Labels per pack	Order Code AVE-822	Offer Price/Pk
Blue	210	-0180K	£0.97
Green	210	-0190K	£0.97
Orange	210	-0200K	£0.97
Red	210	-0210K	£0.97
Yellow	210	-0220K	£0.97



PACK OF 210

AVERY® Full Face CD/DVD Black & White Laser Labels

Print design covers the whole of the CD/DVD face area, giving perfect representation of photo images and colour designs. Larger 117mm diameter increases print area even more. Easy to format using existing software. Black and White.

Pack quantity: 25 A4 Sheets, 2 labels per sheet (50 labels).

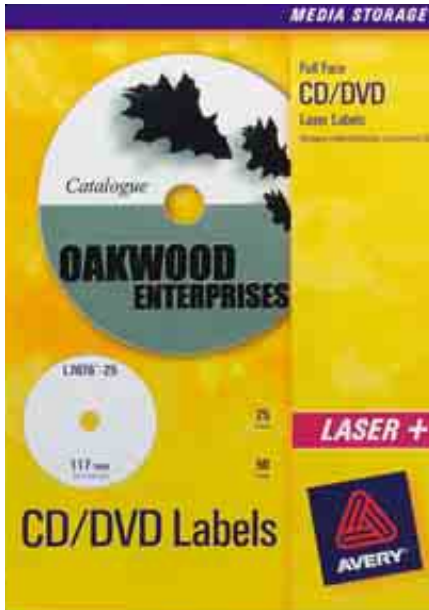

PACK OF 50

Label Size (mm)	Avery Code	Description	Labels Per Sheet	Order Code AVE-822	Offer Price/Pk
117 Dia.	L7676-25	CD/DVD Label	2	-0060K	£9.90

CD Labels

Multipurpose CD labels for use on most inkjet and laser printers.

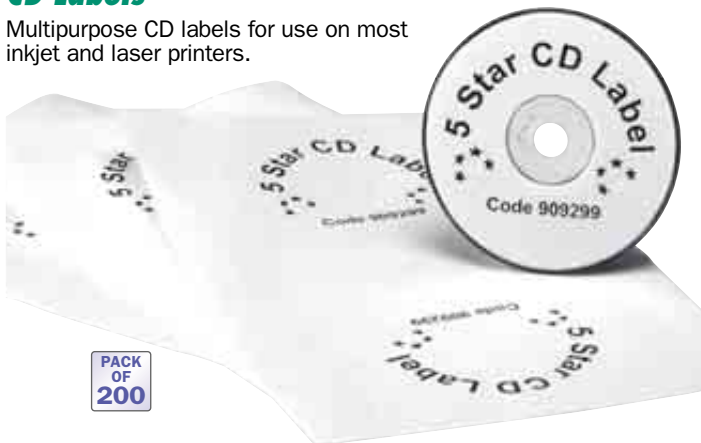

PACK OF 200

Pack Quantity	Order Code CTL-822	Offer Price/Pk
200	-0020K	£6.28

►► DURABLE Ordofix Lever Arch Labels

Strong PVC self-adhesive replacement spine labels for lever arch files. Allows colour coding of existing systems and 'renovation' of old files. Clear window pocket and inserts for labelling. Fits both A4 and foolscap lever arch files.



PACK OF 10

Colour	Pack Quantity	Order Code DBS-810	Offer Price/Pk
Black	10	-0040K	£5.53
Blue	10	-0050K	£5.53
Green	10	-0060K	£5.53
Red	10	-0070K	£5.53
Yellow	10	-0080K	£5.53

Tagging Gun

Reliable simple mechanism lasts for years. Fast trigger action requires one squeeze to attach tag. Fires both 50 and 100 clip fasteners. Safe new ergonomic design to reduce RSI. Needle hood for when needle is not in use.



Description	Order Code AVE-821	Offer Price/1
Standard Mark III 01031	-0010K	£13.13

Swiftachers™

The world's leading brand of ticket attachments renowned for their quality. Available in four sizes and a hook variety also available. Packed in boxes of 5000.



Description	Order Code AVE-822	Offer Price/Pk
20mm PK5000 08960/02121	-0070K	£10.79

Q-CONNECT® Address Labels - Easy Peel

Continuous address labels for your typewriter. Self-adhesive labels adhere instantly without moisture or mess. Suitable for addressing envelopes, labelling files and many other uses. Supplied in a convenient dispenser style box.



PACK OF 200

Size	Pack Quantity	Order Code QUE-822	Offer Price/Pk
89 x 36mm	200	-0030K	£1.48

Offis Address Labels

Continuous address label reel. Suitable for use in a typewriter. Self-adhesive labels adhere instantly. Easy peel/easy stick. Ideal for addressing envelopes and labelling files. Supplied in a convenient dispenser.

Size: 89 x 36mm. **Quantity:** Pack of 250.



NEW

PACK OF 250

Size	Pack Quantity	Order Code OFI-822	List Price/1	Offer Price/1
89 x 36mm	250	-0130K	£1.29	£1.03

GROUP 825 CALCULATORS

HOME IMPROVER

Project Calc Calculator

DIY'ers dimensional calculator. Helps solve 100s of building and home improvement projects. **Works directly** in metric, yards, feet, inches and fractions. **Calculate the quantities** of blocks, tiles, bricks and even gravel. **Finds the number of studs**, 4 x 8 sheets, drywall, roofing bundles, does square ups. **Easily solves** coverage for paint, wallpaper, panelling, board feet and **much much more**. Full instructions supplied.



Model	Order Code	Offer Price/1
Project Calc	PRO-804 -0007A	£14.32

ibico Pocket Calculators

081X
8 digit LCD display. Soft touch rubber keys. Handy and compact design. Complete with protective wallet.



Dimensions:
100 x 60 x 7mm.

Model Number	Order Code	Offer Price/1
081X	ACC-804 -4600K	£4.82

210X
10 digit display with tiltable LCD screen. Large comfortable keys. Extra large + key.



Model Number	Order Code	Offer Price/1
210X	ACC-804 -4620K	£12.59

CASIO Scientific Calculator

FX-85GT PLUS
Natural V-PAM textbook display. TwinLine LCD dot matrix screen. Suitable for key stages 3, 4 and above. Displays answers as written in textbooks. Solar powered with battery (LR44) backup. Dimensions: 13.7 x 80 x 161mm.



NEW

Model Number	Order Code	List Price/1	Offer Price/1
FX-85GT PLUS	CAS-825 -0030K	£12.65	£8.86

082X
Handy and compact pocket calculator with cost-sell margin function, 10 Digit display, 3 memory keys and Solar power.



Dimensions:
68 x 112 x 8mm.

Model Number	Order Code	Offer Price/1
082X	ACC-804 -2600K	£6.29

212X
12 digit 'tiltable' LCD display. Raised keys for fast entry. Tax +/- function. Rounding function.



Model Number	Order Code	Offer Price/1
212X	ACC-804 -4630K	£14.20

Scientific Calculator

FX-83GT PLUS
10+2 digit LCD display. 260 function, including fractions, permutations and combinations etc. Recommended for GCSE and A/AS level. Solar powered with battery backup.



NEW

Model Number	Order Code	List Price/1	Offer Price/1
FX-83GT PLUS	CAS-825 -0040K	£11.45	£7.99

101X
10 digit LCD display. Easy to use plastic keys. Flip jumbo display. Fully closable hard cover case.



Model Number	Order Code	Offer Price/1
101X	ACC-804 -4610K	£8.88

Replacement Paper Rolls

57mm wide white paper rolls. Suitable for most makes of printing calculator.



PACK OF 20

Pack Quantity	Order Code	List Price/Box	Offer Price/Box
Pack of 20	CTL-801 -2750K	£9.22	£5.99

Office Supplies & Stationery

EDISON Desktop Calculator

DPC 012

Large 12 digit display. Memory function. Percentage key. Solar with battery back-up. Automatic power off. Optional stand.

Dimensions (W x H):
150 x 160mm.



DUAL POWER



Model Number	Order Code	List Price/1	Offer Price/1
DPC012	EDI-801 -6010K	£9.99	£5.69

Large Desktop Calculator

DLC 012

3 digit comma marker. Large tilting 12 digit display. Solar with battery back up.

Dimensions (W x H):
140 x 190mm.



DUAL POWER



Model Number	Order Code	List Price/1	Offer Price/1
DLC012	EDI-801 -6100K	£10.29	£5.87

aurora Semi Desk Calculator

12 digit. VAT and tax functions. Durable plastic keys. Solar powered with battery back-up. Supplied with LR1130 batteries.



DUAL POWER



Model Number	Order Code	Offer Price/1
DT661	AUR-801 -0590K	£9.26

EDISON Scientific Calculator

DPS 010

10 digit display. Memory function. User instructions included. Solar with battery back-up. 158 functions. Protective hard case.

Dimensions (W x H):
75 x 130mm.



DUAL POWER



Model	Order Code	List Price/1	Offer Price/1
DPS010	EDI-801 -6200K	£12.99	£7.40

Desktop Calculator

DDC 008

8 digit display. Memory function. Percentage key. Solar with battery back-up. Big display. Desktop shape.

Dimensions (W x H):
85 x 140mm.



DUAL POWER



Model	Order Code	List Price	Offer Price/1
DDC008	EDI-801 -6050K	£6.65	£3.79

Financial Calculators

3 digit comma markers. Large 12 digit displays. Dual power, solar with battery back up. Automatic power off. Flip down stands.

DFC 012

Additional Features:

Clock. Decimal place selector; 'Floating', '4,2,0 Digits' or 'Add 2 (=Divide by 100)'. Rounding function; 'Round-down' or 'Round-nearest'. Tax (with presettable rate), cost, sell, margin.



DUAL POWER



Model	Order Code	List Price/1	Offer Price/1
DFC012	EDI-801 -5900K	£6.99	£3.98

DFC 036

Additional Features:

3 line display. Decimal place selector; 'Floating', '4,2,0 Digits' or 'Add 2 (=Divide by 100)'. Rounding function; 'Round-down' or 'Round-nearest'. Tax (with presettable rate), cost, sell margin, currency (with presettable rate), HMS (time).



DUAL POWER



Model	Order Code	List Price/1	Offer Price/1
DFC036	EDI-801 -5920K	£8.76	£4.99

Shredding - Don't become a victim of identity theft



WHAT TO SHRED?

Bank Statements, Credit Card Statements, Receipts, Utilities Bills, Confidential Reports, Address Lists

Our Shredders conform to the Document Security Levels set in **DIN 727 57**. The quality and durability of our shredders means that you can shred with peace of mind.

WHICH MACHINE IS RIGHT FOR YOU?

When choosing a shredder it is important that you first answer the following two questions:

1. HOW CONFIDENTIAL IS THE INFORMATION YOU WISH TO SHRED?

The security a shredder provides is determined by how small the paper is shredded.

Cross Cut provides a higher level of security than **Straight Cut** but the straight cut machines can shred more sheets of paper in one go than its cross cut equivalent.

DIN Level 2 - S2
Ideal for everyday level of security.

DIN Level 3 - S3
Ideal for confidential documents, waste also compacts down improving bin capacity.

2. HOW FREQUENTLY WILL THE SHREDDER BE USED?

The environment in which the shredder is placed is usually the best guide to how much shredding a machine will do.

- Home**
 - Ideal for a single user who works from home
 - Designed for light use - typically 20 sheets per day
 - Economical way to ensure homeworkers can shred confidential business information
- Home & Office**
 - Ideal for home use or in an office environment with 1-2 users
 - Designed for light to medium use - typically 50 sheets per day
- Work**
 - Ideal for shared use in an office with 3+ users
 - Designed for medium duty use - typically 50-100 sheet per day
 - Heavy-duty design to withstand everyday office use
- Commercial**
 - High performance, high volume machines designed for continuous use
 - Ideal as a centralised machine for all company users or in departments such as Accounts or IT, where continuous shredding is needed.

Paper & CD Shredder

Cross Cut Electric Paper & CD Shredder. Suitable for light shredding in the home or office. Shreds up to five sheets at the same time into cross cut unreadable pieces (4 x 23mm). Destroys CDs. Safety cut-off in the event of overloading.



Sheet Capacity	Cut Size	Order Code	List Price/1	Offer Price/1
5	4 x 23mm	-0001A	£38.65	£28.99

Rexel Whisper Shredders

V30WS - Straight Cut
Quiet as a whisper for minimum disturbance in the office. Auto start/stop. Auto reverse. Up to 50% quieter than other machines in its class.



Model No	Sheet Cap.	Cut Size (mm)	Order Code	List Price/1	Offer Price/1
V30WS	8	5.8	-0030K	£95.99	£49.99
V35WS	5	4x4.5	-0040K	£121.99	£69.99

Shredder Oil Sheets

The easy way to oil your shredder. Distributes the oil evenly over the cutters. Patented envelope design so no handling and no mess or waste. Recommended to be used once a month.



Description	Order Code	List Price/Pk	Offer Price/Pk
Oil Sheets (Pk-12)	-0020K	£22.99	£14.94
Oil Sheets (Pk-20)	-0030K	£32.59	£21.18

Home/Office Personal Shredder

For general use in the home or office. Shreds up to 12 sheets into unreadable 4 x 48mm particles securely destroying all your old paperwork i.e. bank statements, bills cheque stubs etc. 3 position switch with auto off, reverse and auto reverse function in the event of overloading. Also shreds CDs/DVD's and credit cards. Complete with 28ltr removable waste basket. Low noise design (60dB).



Sheet Capacity	Cut Size	Order Code	List Price/1	Offer Price/1
12	4 x 48mm	-0008A	£87.49	£65.62

Bin Top Shredder

OLM004
Identity theft is one of the UK's fastest growing crimes. Protect yourself with this simple shredder.
Sheet capacity: five sheets at once.
Shreds: paper and staples.
Cut size: 6.3mm.
Security level: 1. Auto start/reverse function.
Dimensions: (H x W x D) 60 x 330 x 120mm.
CE approved.



Sheet Capacity	Cut Size	Order Code	List Price/1	Offer Price/1
5	6.3mm	-0003A	£6.65	£4.99

Fellowes Home/Office Deskside Shredder

MS450CS - Safe Sense™
Active Sensor technology stops shredding when touched ensuring user safety. Accepts small staples, paper clips, credit cards and CDs



Sheet Capacity	Cut Size	Order Code	List Price/1	Offer Price/1
7	2.0x8mm	-0240K	£473.19	£283.91

Office Supplies & Stationery

Rexel Home Shredders

Compact shredder for use at home. Lasts up to 3 times longer than other personal shredders. Easy lift off head for emptying. Auto start, stop and reverse functions. Select from ribbon cut or high security confetti cut models. Shreds credit cards. Two year warranty.



10 Litre Bin 14 Litre Bin

Model Type	Sheet Capacity	Bin Capacity	Cut Size	Order Code ACC-825	List Price/1	Offer Price/1
Ribbon	5/6	10ltr	6.5mm	-0120K	£54.99	£32.99
Confetti	5/6	14ltr	4 x 30mm	-0130K	£75.90	£45.54

Mercury Shredders

The shredder mouth illuminates to warn when there is too much paper inserted. Remove sheets to continue shredding. No time wasted, no mess made. Mercury illuminated feed slot. Prevents paper jams. Super silent running. Easy use controls. Separate pull out bin. Also shreds credit cards and CDs.



NEW



32 Litre Bin 50 Litre Bin

Model Number	Sheet Capacity	Bin Capacity	Cut Size	Order Code ACC-825	List Price/1	Offer Price/1
RSX1632	16	32ltr	4 x 45mm	-0230K	£575.99	£345.59
RSS2250	22	50ltr	5.8mm	-0240K	£813.99	£488.39
RDX1850	18	50ltr	4 x 45mm	-0250K	£844.99	£506.99

Office Shredders

V120
Strip personal office shredders. Ideal for high volume use at home and in the office. Large capacity bin. Shreds up to 13 sheets per pass. 35ltr bin holds up to 230 sheets. Auto start and stop. Reverse function to help clear accidental jams. **Security level:** (Strip cut) S2



35 Litre Bin

Sheet Capacity	Cut Size	Order Code ACC-825	List Price/1	Offer Price/1
12/13	5.8mm	-0060K	£208.99	£125.39

ProStyle Shredder

Ideal for executives who want a smart personal shredder by or under their desk. Includes induction motor for quieter shredding. Confetti cut (4 x 35mm). Bin window alerts user when bin needs emptying. Two year warranty. **Bin capacity:** 20ltr.



20 Litre Bin

Model	Order Code ACC-825	List Price/1	Offer Price/1
ProStyle	-0160K	£235.99	£141.59

Personal Shredder

P180/CD
For general use in the home and in the office. Auto start/auto stop. Reverse function to help clear accidental jams. Cabinet style. Large pull out bin for ease of emptying. Use for occasional CD and credit card destruction. **Feed per min:** 3m. **Weight:** 13.7kg.



35 Litre Bin

Sheet Cap.	Cut Size	Order Code ACC-825	List Price/1	Offer Price/1
22	5.8mm	-0290K	£364.99	£218.99

CONTRACT PRICES AVAILABLE FOR VOLUME PURCHASES

Fellowes Hot Laminators

Features advanced temperature control for consistent lamination quality. Unique HeatGuard Technology™ uses double-walled insulation to keep heat inside so laminator is comfortable to touch. Offers two temperature settings. Release lever disengages pouch for re-centring or removal. Dual-purpose tray guides pouch and acts as a protective dust cover. Sturdy carrying handle plus stand-up feet with cord storage. Slim, professional design suits any office décor. Includes laminating starter kit.



Up To A3

Maximum sleeve size	Order Code	List Price/1	Offer Price/1
A4	FEL-825	£142.05	£84.99
A3	-0140K	£193.68	£115.99

CATHEDRAL A4 Laminator

LMA4
A4 laminator features advanced hot roller technology for best laminating effect.

Features:
Fast warm up time.
Jam release function.
Seals airtight in seconds.
Accommodates 160 & 250 micron laminating pouches - starter pack of laminating pouches included.
Accepts documents up to 230mm wide and 250 microns thick.
Fixed temperature and speed.
Machine size (L x W x H):
330 x 100 x 80mm.

Up To A4



NEW

Description	Order Code	List Price/1	Offer Price/1
A4 Laminator	CTH-825	£26.99	£22.94

Major Debit/Credit Cards Accepted
Maestro DELTA MasterCard VISA

OPENING TIMES
Mon - Thurs 7.30am - 5.15pm
Fri 7.30am - 4.15pm
Sat 8.00am - 11.30am

Purpose Built World Distribution Centre in Leicester

Swordfish A3 Professional Laminator 330HD

330HD
A stylish and versatile laminator for all applications up to A3 size. Allows the correct amount of heat to be set for a specific pouch thickness. Integrated release button prevents pouches jamming in the machine, thereby avoiding damage to documents and the laminator.

Features:
Hot seal laminator with 4 rollers, 2 of which are heated.
Temperature control.
Jam release button.
350mm/min laminating speed.
Works with up to 2x250 (500) micron professional pouches.
Cold lamination option.
Warm-up time 4-8 minutes.
Dimensions: 475x170x100mm.
Weight: 4kg.

NEW

Up To A3



Description	Order Code	List Price/1	Offer Price/1
A3 Laminator	SWD-825	£368.99	£109.99

Laminator & Value Pack

Laminator: Variable temperature control with a warm up time of 3 minutes for all pouches up to 2x80 microns. Max lamination width: 9"/230mm with a lamination speed of 350mm/min. Will cold laminate with no pouch carrier required.
230V - 0.9A and is guaranteed for 2 years.

50 Laminating pouches -
10 x A4, 10 x A5,
10 x A6, 20 x credit card.

Trimmer: Comfortable to hold, ideal for shapes and crafting. 8 sheets, 310mm capacity.

*Exact set contents may vary slightly.

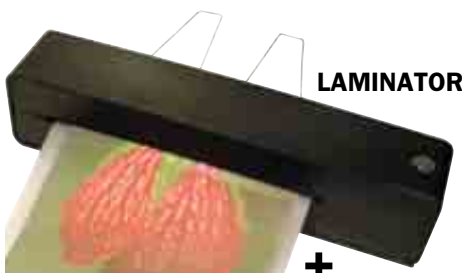

LAMINATOR

+ 50 POUCHES



+ TRIMMER

Maximum sleeve size	Order Code	List Price/1	Offer Price/1
A4	PRO-825	£21.32	£15.99

Offis Laminating Pouches

For use in desktop laminating machines. High quality glossy laminating pouches ideal for preserving photos, menus, price lists, certificates etc. and for the enhancement of important document covers. Suitable for hot and cold laminating. Packs come complete with carriers. 150 microns.



PACK OF 100

Description	Order Code	List Price/Pk	Offer Price/Pk
A4 Gloss	OFI-826	£14.82	£8.89
A3 Gloss	-0020K	£20.98	£12.59

Rexel Laminating Pouches

High quality polyester laminating pouches for use with Rexel and other laminating machines. All packs come complete with pouch carriers.



Size	Pack Qty	Order Code	Offer Price/Pk
Credit Card 360µ	50	ACC-826	£4.54
A4 x 150µ	100	-0580K	£22.74
A4 x 250µ	100	-0550K	£38.02

Laminating Pouches

High quality polyester laminating pouches for use with Rexel and other laminating machines. All packs come complete with pouch carriers.

PACK OF 100



Size	Order Code	List Price/Pk	Offer Price/Pk
A5 x 150 µ	CTL-801	£15.75	£10.24
A4 x 250 µ	-3520K	£30.74	£19.98
A3 x 250 µ	-3610K	£56.85	£36.95

Office Supplies & Stationery

Esselte Comb Binder

CombBIND

Helps organise and bind multiple leaf documents together for filing or presentation purposes. Suitable for binding up to A4. Comb binding is semi permanent that allows pages to be inserted/removed after binding.



CombBIND 100

Type: manual.

Punching capacity: 8 pages (80 gsm).

Binding capacity: 145 pages (16mm spine).

Model/Type	Order Code	List Price/1	Offer Price/1
100/Comb	-0010K	£59.00	£47.20

A4 Binding Covers

Produce a professional quality presentation every time by using different colours and finishes. You can fully personalise your important work. Supplied in packs of 50.

PACK OF 50



Type	Colour	Pack Qty	Order Code	List Price/Pk	Offer Price/Pk
250 micron Economy	Clear	50	-0280K	£12.84	£8.35
Plain Board	White	50	-0360K	£11.89	£7.73
Plain Board	Red	50	-0380K	£11.89	£7.73
Plain Board	Blue	50	-0400K	£11.89	£7.73

office Comb Binding Rings

A4 size binding combs to suit most comb binding machines. Available in 4 diameters (6, 8, 10 & 12mm) and 4 colours (red, blue, black & white).

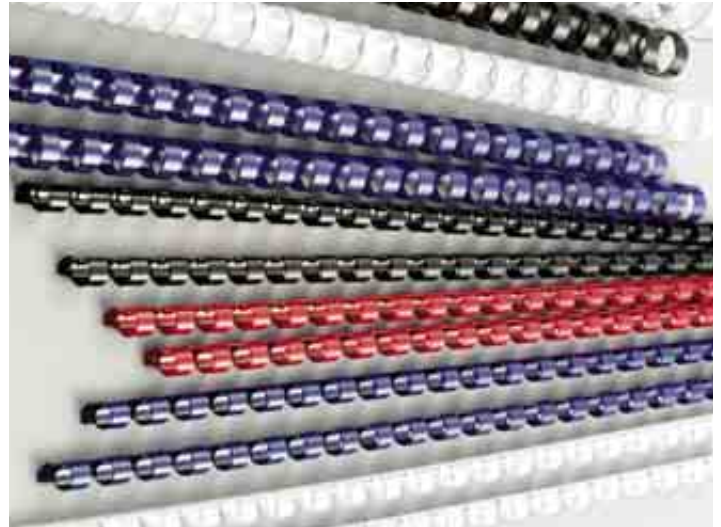

Size (mm)	Capacity Sheets	Colour	Pack Quantity	Order Code	List Price/Pk	Offer Price/Pk
6	30	Black	100	-0010K	£13.79	£2.76
		Blue	100	-0020K	£13.79	£2.76
8	50	Black	100	-0030K	£14.89	£2.98
		Blue	100	-0040K	£14.89	£2.98
10	95	Black	100	-0050K	£19.29	£3.86
		Blue	100	-0060K	£19.29	£3.86
12	125	Black	100	-0070K	£25.79	£4.99
		Blue	100	-0080K	£25.79	£4.99

A4 Binding Covers

Produce a professional quality presentation every time by using different colours and finishes. You can fully personalise your important work. Supplied in packs of 100.

PACK OF 100



Type	Colour	Pack Qty	Order Code	List Price/Pk	Offer Price/Pk
150 micron	Clear	100	-0090K	£19.48	£5.29
200 micron	Clear	100	-0100K	£24.19	£6.49
250 micron	Clear	100	-0110K	£29.08	£8.49
Plain Board	White	100	-0120K	£22.63	£6.49
Leather Grain	Blue	100	-0130K	£22.63	£6.49
Leather Grain	Black	100	-0140K	£22.63	£6.49

Office Supplies & Stationery

CONTRACT PRICES AVAILABLE FOR VOLUME PURCHASES

All Prices Excludes V.A.T. © 2011

GROUP 827 NOTE BOOKS & PADS

Offis Shorthand Pads

The most popular pad size for note taking 128 x 205mm. Wire spiral bound on top edge for rapid flip action, with rigid backing board. 80 sheets narrow feint ruled on both sides.



Pages	Pack Qty	Order Code	List Price/Pk	Offer Price/Pk
80	10	OFI-827	£5.38	£2.69
80	1	-0040K	£0.60	£0.30

Q-CONNECT Shorthand Note Book

Spiral bound with stiff board cover. 150 sheets feint ruled paper. **Size:** 203 x 125mm (5" x 8").



Size	Sheets	Order Code	List Price/1	Offer Price/1
8" x 5"	150	QUE-827	£1.57	£0.79

Spiral Note Books

Spiral bound note pad ideal for note taking. A4 pad, constructed over a rigid back board with micro-perf for easy removal of sheets. Punched four holes for filing. Pad contains 80 sheets of paper ruled feint and margin.



PACK OF 5 A4

Size	Pack Qty	Order Code	List Price/Pk	Offer Price/Pk
A4	5	-0290K	£14.97	£7.49

Note Books & Manuscripts

Microperforated for easy sheet removal, feint ruled with margin, 70gsm paper. Manuscript: Hard wearing covers, feint ruled no margin, 70gsm paper.



Size	Type	Pages	Order Code	Offer Price/1
A4	Notebook	50	-0030K	£1.55
A4	Manuscript	80	-0040K	£2.39
A5	Manuscript	80	-0050K	£1.33

CATHEDRAL Neon A6 Notebooks

Handy notebooks for bag or pocket in 3 bright neon colours. A6 only with 200 pages of lined 80gsm paper. **Size:** A6.



Colour	Order Code	Offer Price/1	Offer Price/5+
Purple	-0010K	£1.32	£0.99
Pink	-0020K	£1.32	£0.99
Yellow	-0030K	£1.32	£0.99

PP Cover Notebooks

250 pages of 80gsm paper. With secure twin wire binding and perforated sheets.



Colour	Size	Order Code	Offer Price/1	Offer Price/5+
Purple	A6	-0040K	£1.79	£1.34
Blue		-0050K	£1.79	£1.34
Black		-0060K	£1.79	£1.34
Purple	A5	-0070K	£2.65	£1.99
Blue		-0080K	£2.65	£1.99
Black		-0090K	£2.65	£1.99
Purple	A4	-0100K	£4.99	£3.74
Blue		-0110K	£4.99	£3.74
Black		-0120K	£4.99	£3.74

PP Cover Project Books

250 pages of 80gsm paper and 4 PP dividers to keep projects in separate sections. The dividers have PP pockets to file any loose notes.



Colour	Size	Order Code	Offer Price/1	Offer Price/5+
Purple	A6	-0130K	£2.49	£1.87
Blue		-0140K	£2.49	£1.87
Black		-0150K	£2.49	£1.87
Purple	A5	-0160K	£4.12	£3.09
Blue		-0170K	£4.12	£3.09
Black		-0180K	£4.12	£3.09
Purple	A4	-0190K	£6.25	£4.69
Blue		-0200K	£6.25	£4.69
Black		-0210K	£6.25	£4.69

Hardback Notebooks

With attractive, cushioned covers these notebooks have 196 pages of 80gsm paper lined and with margins.



Colour	Size	Order Code	Offer Price/1	Offer Price/5+
Black	A6	-0220K	£1.50	£1.12
Raindrop		-0230K	£1.50	£1.12
Black	A5	-0240K	£2.49	£1.87
Raindrop		-0250K	£2.49	£1.87
Black	A4	-0260K	£4.45	£3.34
Raindrop		-0270K	£4.45	£3.34

SILVINE Memo Note Books

Distinctive red cover memo note book. Feint ruled. 36 leaves. 6" x 3 7/8".



PACK OF 24

Size	Pack Qty	Order Code	Offer Price/Pk
6" x 3 7/8"	24	-0180K	£9.79

Spiral Exercise Books

Ideal for general note taking. Student exercise books with wipe clean red laminated covers. Punched two holes to fit in ring binders. Feint ruled. A4: 52 leaves. 5" x 3 1/2" 36 leaves.



A4

PACK OF 12

Size	Leaves	Pack Qty	Order Code	List Price/Pk	Offer Price/Pk
A4	52	12	-0020K	£35.70	£24.99

Spiral Note Books

Handy A4 size note book for all those essential notes. Stylish stiff green manilla cover for easier note taking. Feint ruled both sides, 96 leaves. Secure spiral binding ensures pages won't fall out.



PACK OF 6

Size	Pages	Pack Qty	Order Code	List Price/Pk	Offer Price/Pk
A4	96	6	-0230K	£20.99	£14.69



Pocket Note Book

Stiff cover note book with fitted elastic band. 80 leaves, feint ruled. **Size:** 83 x 127mm.



Multi Buy

Price each

Size (mm)	Order Code	List Price/1	Offer Price/1	Offer Price/12+
83 x 127	OFI-827	£1.78	£0.89	£0.78

Refill Pads

High quality paper, narrow feint ruled 80 sheet A4 refill pad, four hole punched for filing. Bound at head with cover to protect your notes. Rigid backing board.



BINDER SUPPLIED SEPARATELY

A4

Pages	Pack Qty	Order Code	List Price/Pk	Offer Price/Pk
80	10	OFI-827	£9.34	£4.67
80	1	-0020K	£0.98	£0.49



Printed Note Pads

Single sheet pads. 100 A6 (105 x 148mm) sheets per pad.

Multi Buy

Price each

Printed Pads	Order Code	List Price/1	Offer Price/1	Offer Price/3+
Petty Cash	-0090K	£1.45	£0.72	£0.65
Telephone	-0100K	£1.45	£0.72	£0.65
Stores Requisition	-0110K	£1.45	£0.72	£0.65

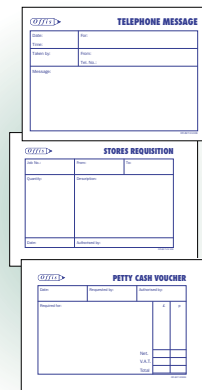

SILVINE

Elastic Band Type Note Book

Stiff cover, 80 leaves feint ruled. **Size:** 83 x 127mm.



Size	Order Code	Offer Price/1
83 x 127mm	SLV-827	£2.06

Memo Pads

Manufactured from quality bond paper with board back. White pads have 80 sheets per pad with a choice of sizes and rulings.



A4 **PACK OF 10**

Size	Colour	Pack Quantity	Order Code	Offer Price/Pk
A4	White	10	SLV-804	£4.49
A4	Yellow	10	-5250K	£4.49

Black n' Red Hardback Bound Books

Quality sewn binding gives added strength. Choice of sizes available for all personal and office records. Feint ruled for easy reading.



A6 **PACK OF 5**

Size	No. of pages	Bind Type	Order Code	Offer Price/Pk
A6	192	Case	JDI-804	£16.45
A4	192	Case	-0570K	£31.13
A4	140	Wire	-0700K	£30.29

Q-CONNECT Executive Pads

NEW

High quality A4 executive pads. Stitched and bound at head with micro-perforations for easy sheet removal. Each pad contains 50 sheets.



A4 **PACK OF 10**

Size	Colour	Pack Quantity	Order Code	Offer Price/Pk
A4	White	10	QUE-827	£7.50
A4	Yellow	10	-0280K	£7.64

Collins Wire Bound Book

A4 with 192 feint ruled pages. Wire bound book will lie flat when opened making it easier to use.



A4

Size	Type	Order Code	Offer Price/1
A4	Feint Ruled	COL-804	£6.50

Concord Company Visitors Book

Record visitors details, name, date, company, car registration, visiting badge number, time in and out. 2000 entries per binder. Black padded binder with contrasting quarter bound spine. Loose leaf sheets with reinforced punched holes.

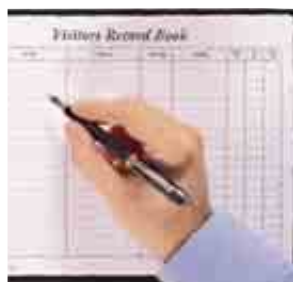

Description	Order Code	List Price/1	Offer Price/1
Visitors Book	JET-827	£30.83	£21.58
Refill - 50 Page	-0080K	£9.85	£6.89

Tachograph Charts

CK801

EC approved discs that provide a superior trace for easier analysis. Up to three vehicle changes can be accommodated, reverse side allows for handwritten entries to be made in the event of malfunction of recording equipment.



PACK OF 100

Description	Pack Quantity	Order Code	Offer Price/Pk
Tachograph Charts	100	CWL-801	£8.06

IDENTIBADGE Visitors Book & Badge System

Professional Badges & Identification Systems

A carbonless copy of this remains in the book while the top copy tears out and is worn in a badge. Security sheet restricts viewing of previous visitors for total confidentiality.



Type	Order Code	List Price/1	Offer Price/1
Book C/W 100 Inserts	IDB-820	£30.82	£19.99
100 Insert Refill	-0570K	£21.89	£14.23
Book C/W 300 Inserts	-0590K	£74.04	£48.13
300 Insert Refill	-0600K	£59.49	£38.67
Book C/W 100 Inserts & 10 Badges	-0610K	£44.12	£28.68
Book C/W 300 Inserts & 10 Badges	-0620K	£87.00	£56.55

Q-CONNECT Telephone Message Books

Easy to use duplicate message book with space for messages and tick boxes for action required. Perforated for easy removal of top copy - duplicate stays bound in book.



Type	Messages Per Pad	Order Code	List Price/1	Offer Price/1
Carbonless	200	QUE-827	£5.17	£2.58
	400	-0170K	£7.98	£3.99

GROUP 827 NOTE BOOKS & PADS

Offis Manuscript Books

Distinctive blue hardbound cover with eighty pages of high quality feint ruled paper. Ideal for documenting important records.

Available in two sizes A4 or A5.



Size	Colour	Order Code OFI-837	List Price/1	Offer Price/1
A4	Blue	-0010K	£1.99	£1.59
A5	Blue	-0020K	£1.20	£0.96

Q-CONNECT Manuscript Books

Ideal for documenting important records. Hard wearing linen effect cover and quality sewn binding endures heavy usage. Printed on high quality ruled paper.



Size	Type	Order Code QUE-827	List Price/1	Offer Price/1
A6	Feint Ruled	-0140K	£1.57	£0.79
A6	Indexed	-0150K	£2.98	£1.49
A5	Indexed	-0130K	£2.17	£1.08
A4	Indexed	-0110K	£3.38	£1.69

Card Index Boxes

Quick and easy reference to your records. Hinged lid gives extra storage. Available in the three most popular record card sizes.



Size	Colour	Order Code QUE-806	Offer Price/1
127 x 76mm (5" x 3")	Black	-0010K	£1.97
	Blue	-0020K	£1.97
	Red	-0030K	£1.97
152 x 101mm (6" x 4")	Black	-0040K	£2.40
	Blue	-0050K	£2.40
	Red	-0060K	£2.40
203 x 127mm (8" x 5")	Black	-0070K	£3.49
	Blue	-0080K	£3.49
	Red	-0090K	£3.49

Guide Cards & Record Cards

Locate your records quickly and easily. Tabbed A - Z in 25 positions.



Record Cards

Size	Pack Quantity	Order Code QUE-806	List Price/Pk	Offer Price/Pk
5" x 3"	100	-0250K	£2.09	£0.94
6" x 4"	100	-0260K	£2.89	£1.30
8" x 5"	100	-0270K	£4.59	£2.07

Guide Cards

Size	Pack Quantity	Order Code QUE-806	List Price/Pk	Offer Price/Pk
5" x 3"	1 Set	-0100K	£1.42	£0.99
6" x 4"	1 Set	-0110K	£1.69	£1.18
8" x 5"	1 Set	-0120K	£1.99	£1.39

CHALLENGE Manuscript Book

Full bound in blue marbled PVC coated material. Quality white paper with royal blue bookmark ribbon sewn in.



Size	Type	Pages	Order Code JDI-804	Offer Price/1
A4	Feint Ruled	192	-0660K	£8.39

Duplicate Books With Colour Copies

Traditional duplicate books, pre-printed for ease of use, with colour coded copy sheets. Complete with carbon paper. Numbered in sets 1 - 100.



Size	Pack Qty	Order Code JDI-804	List Price/Pk	Offer Price/Pk
Duplicate - Feint Ruled				
105 x 130	5	-0450K	£15.75	£9.45
216 x 130	5	-0400K	£27.27	£16.36

Carbonless Duplicate Books

Books with pre-printed headings in carbonless format. Wire bound for ease of use. Numbered in sets 1 - 50. Colour coded copy sheet. Feint ruled.



Size	Pack Qty	Order Code JDI-804	Offer Price/Pk
216 x 130mm	5	-0410K	£17.14



Type	Order Code QUE-827	List Price/1	Offer Price/1
Size: 102 x 127mm			
Duplicate	-0030K	£1.99	£0.99
Triplicate	-0090K	£2.79	£1.40
Size: 210 x 127mm			
Duplicate	-0040K	£3.29	£1.65
Dupe Delivery Book	-0060K	£4.98	£2.49
Invoice Duplicate	-0070K	£4.98	£2.49
Dupe Order Book	-0080K	£4.98	£2.49
Triplicate	-0100K	£5.29	£2.65
Size: 297 x 210mm (A4)			
Duplicate	-0050K	£7.49	£3.75

Office Supplies & Stationery



Repositional Notes

Incorporating a special adhesive strip on the reverse enabling them to be stuck down, removed and re-stuck to almost any surface without leaving a mark. Available in a choice of convenient sizes. Invaluable for messages and notes.

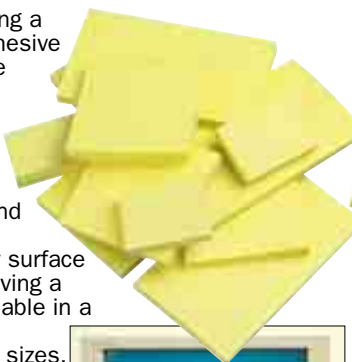

Size (mm)	Sheets /Pad	Pads /Pack	Order Code OFI-827	List Price/Pk	Offer Price/Pk
76x76	75	12	-0060K	£4.19	£2.10
76x125	100	12	-0070K	£5.97	£2.98

Q-CONNECT Quick Notes

Rainbow

Multi-coloured Quick Notes in vibrant colours. In a choice of pastel shades or bright neon colours. 100 sheets per pad. 76 x 125mm (3" x 5")

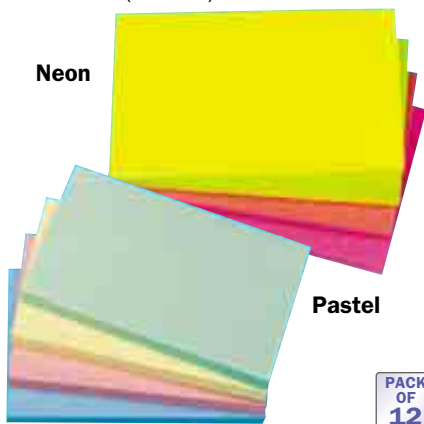

Colours	Pads /Pack	Order Code QUE-827	List Price/Pk	Offer Price/Pk
Pastel	12	-0220K	£21.00	£7.98
Neon	12	-0230K	£23.29	£8.85

Quick Note Cubes

These handy 400 sheet multi-coloured cubes are an essential tool for effective communication, ideal for use in the office or home. **Size:** 76 x 76mm (3" x 3").

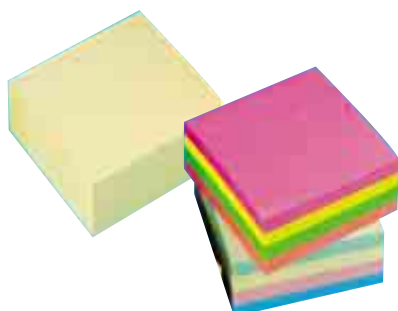

Colour	Size (mm)	Pads /Pack	Order Code QUE-827	List Price/1	Offer Price/1
Yellow	76x76	1	-0190K	£5.99	£2.28
Pastel	76x76	1	-0200K	£6.89	£2.62
Neon	76x76	1	-0210K	£6.48	£2.46

Post-it Post-it Notes



Incorporating a special adhesive strip on the reverse enabling them to be stuck down, removed and re-stuck to almost any surface without leaving a mark. Available in a choice of convenient sizes. Invaluable for messages and notes. Colours: Yellow or neon yellow. 100 sheets per pad. *75 sheets per pad.



Size (mm)	Colour	Pads /Pack	Order Code MMM-827	List Price/Pk	Offer Price/Pk
76x76	Neon	6	-6003D	£11.19	£7.27
76x125	Neon	6	-6004E	£14.88	£9.67
76x125	Yellow	12	-6008J	£24.60	£15.99
38x51	Yellow	12	-8020X	£4.45	£2.89
76x125	Yellow	12	-8021Y*	£8.29	£5.39

Post-it Note Rainbow Pack

Multi-coloured Post-it® Notes in vibrant/neon colours. Colours included in each pack are yellow, green, orange, pink and purple. 100 sheets per pad.



Size (mm)	Sheets /Pad	Pads /Pack	Order Code MMM-827	List Price/Pk	Offer Price/Pk
76x76	100	6	-6013P	£11.30	£7.34
127x76	100	6	-6006G	£15.02	£9.76

Q-CONNECT Quick Notes

Incorporating a special adhesive strip on the reverse enabling them to be stuck down, removed and re-stuck to almost any surface without leaving a mark. Invaluable for messages and notes.

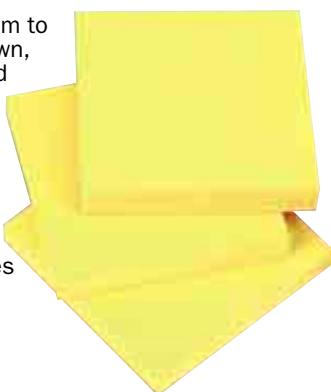

Size (mm)	Sheets /Pad	Pads /Pack	Order Code QUE-827	List Price/Pk	Offer Price/Pk
76x100	100	12	-0260K	£20.99	£7.98

Post-it Note Cubes

These handy 450 sheet cubes are an essential tool for effective communication, ideal for use in the office or home.

Ice Blue

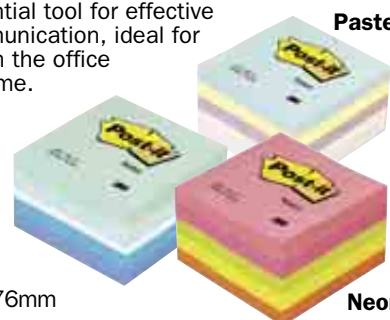

Size:
76 x 76mm

Colour	Size (mm)	Pads /Pack	Order Code MMM-827	List Price/1	Offer Price/1
Pastel	76x76	1	-6001B	£7.46	£4.85
Ice Blue	76x76	1	-6005F	£7.46	£4.85
Neon	76x76	1	-6007H	£7.46	£4.85

Index Tabs

For convenient page marking. Clear, so copy will show through. Durable, removable and reusable, will not tear or pop off. Tabs can be written on. Can also be used as refill for index starter kit.

Tab Size: 25 x 44mm (1" x 1 3/4").

50 tabs per dispenser.



Colour	Tabs /Pack	Order Code MMM-827	List Price/Pk	Offer Price/Pk
Red	50	-6009K	£3.33	£2.16
Blue	50	-6010L	£3.33	£2.16
Yellow	50	-6011M	£3.33	£2.16
Purple	50	-6012N	£3.33	£2.16

Post-It Z Notes

Two sizes of Post-it® Z-Notes, designed for use with Post-it® Z-Note dispensers. Plastic dispenser holds the Z-notes pad securely, with spring loaded action to ensure a note is always within easy reach.

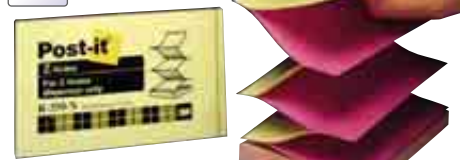

Size (mm)	Sheets /Pad	Pads /Pack	Order Code MMM-827	List Price/Pk	Offer Price/Pk
76x76	100	12	-6002C	£20.03	£13.02

Quick Tabs

Repositionable tabs ideal for marking, tabbing, highlighting and colour coding all your important information. Available in packs of four colours, 40 tabs per colour.



Colour	Tabs /Pack	Order Code QUE-827	List Price/Pk	Offer Price/Pk
Transparent	160	-0240K	£4.99	£1.90
Neon	160	-0250K	£4.19	£1.59

KOBE Office Fans

Adjustable head tilt. 90° oscillating control. Variable speeds. Silent running.

Desk Fans
230mm (9")

45W power. 2 speeds.

300mm (12")
45W power. 3 speeds.

400mm (16")
58W power. 3 speeds.

Pedestal Fan
400mm (16")

60W power. 3 speeds.
Adjustable height:
1100 - 1350mm.



Type	Size (mm)	Order Code	List Price/1	Offer Price/1
Desk	230 (9")	-0040K	£20.99	£16.79
Desk	300 (12")	-0030K	£23.74	£18.99
Desk	400 (16")	-0020K	£29.99	£23.99
Pedestal	400 (16")	-0010K	£34.99	£27.99

Q-CONNECT 150mm Clip-On Fan

NEW

The high grip clip allows the fan to be attached to flat objects between 3.2mm and 19mm thick, so that it's positioned exactly where you require it. 240V. Fitted with three pin fused plug.

Specifications:
Fan size 150mm (6").
2 speed rotary switch.
45° head tilt.
360° rotation.
1.8m cable.



No of Speeds	Order Code	List Price/1	Offer Price/1
2	-1020X	£30.49	£10.98

Halogen Heater

Streamline halogen heater with swivel function and automatic tip-over protection. 3 settings: 400W, 800W, 1200W.

Dimensions:
(H x W x D)
360 x 152 x 543mm.



3 HEAT SETTINGS

Max Output	Weight (each)	Order Code	List Price/1	Offer Price/1
1200W	2.64kg	-0009A	£23.27	£16.99

2kW Flat Fan Heater

2 heat settings - 1000W & 2000W. Variable heat thermostat with frost protection. Cooling fan setting. Safety overheat cut-out. Power Indicator light.



2 HEAT SETTINGS

NEW

Max Output	Weight (each)	Order Code	List Price/1	Offer Price/1
2000W	1.26kg	-0120K	£19.99	£15.99

Convector Heater with Timer

3 heat settings: 750W, 1250W and 2000W. Convenient carry handles on each side of the heater. Overheat protection. Freestanding or wall-mounted. Adjustable thermostat control. Timer function included. Comes with turbo function.

Dimensions: (L x W x H)
620 x 140 x 440mm.



Thermostat control and programmable timer



3 HEAT SETTINGS

Max Output	Weight (each)	Order Code	List Price/1	Offer Price/1
2000W	3.6kg	-0012A	£47.93	£34.99

7 Fin Oil Filled Radiator with Timer

With thermo-efficient fins for optimal heat exchange, three heat settings, 600W, 900W and 1500W. Fitted with a variable thermostat with 24 hour timer and safety overheat cut-out. It is free standing and has castors for moving around. The power cable has its own storage compartment, making it tidy when not in use.

Dimensions: (H x W x D)
560 x 330 x 150mm.



Thermostat control and programmable timer

Cable storage

3 HEAT SETTINGS

Max Output	Order Code	List Price/1	Offer Price/1
1500W	-0013A	£68.48	£49.99

Office Supplies & Stationery

Offis Drywipe Boards

These whiteboards have a revolutionary new surface which is ultra smooth to improve eraseability and reduce ghosting. Plain white surface, supplied with wall fixings and pen tray.

Ultra Smooth Single Sided Magnetic Whiteboards

Surface guaranteed for five years in normal use. Surface can be used with any whiteboard markers and easy to wipe off.

Ultra Smooth Non-magnetic Whiteboard

Laminated dry-wipe whiteboard surface. Use with any whiteboard markers and easily wiped off by eraser.

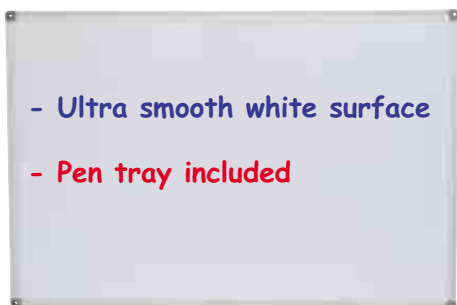

- Ultra smooth white surface
- Pen tray included

Description	Size	Order Code OFI-836	Offer Price/1
Standard	900 x 600mm	-0030K	£21.59
	1200 x 900mm	-0040K	£29.99
Magnetic	900 x 600mm	-0010K	£25.99
	1200 x 900mm	-0020K	£36.99

Non-Magnetic Whiteboard

Whiteboard with aluminium trim. Easy to clean non-magnetic dry wipe surface. Includes pen tray and wall fixings.

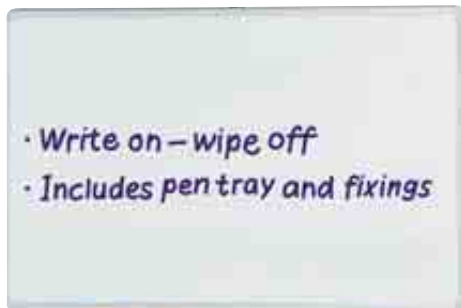

Size	Order Code CTL-836	Offer Price/1
1800 x 1200mm (6' x 4')	-0810K	£127.99

edding Magnetic Whiteboards

New magnetic whiteboards have a durable, easy clean surface and smart aluminium trim. Includes pen tray and wall fixings. Available in two sizes.



Size	Order Code EDD-836	Offer Price/1
900 x 600mm (3' x 2')	-0020K	£35.10
1200 x 900mm (4' x 3')	-0030K	£52.65

Executive Dry Wipe Boards

The Offis™ Executive dry wipe white board is ideal to use in training seminars, presentations, in the classroom or anywhere else ideas or procedures need communicating to several people at the same time. The extra smooth bright white surface improves erasability, reduces ghosting and provides a good contrast to anything written or drawn on it. Finished with an attractive aluminium trim and ABS plastic corners that will compliment any conference or meeting room, supplied with concealed wall fixings and pen tray.

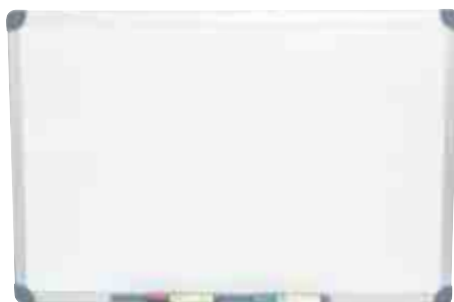

Size (mm)	Order Code OFI-836	List Price/1	Offer Price/1
Magnetic			
900 x 600	-0240K	£36.24	£28.99
1200 x 900	-0250K	£56.19	£44.95
Non-magnetic			
600 x 300	-0340K	£17.49	£13.99
900 x 600	-0260K	£34.99	£27.99
1200 x 900	-0270K	£48.74	£38.99

nobo Easyline Drywipe Boards

Aluminium trim, double sided board with alternative geometric or curved profile. Feint grid lines on one side. Choice of three colours of Coverfix caps hide the fixings. Board surface guaranteed for five years under normal use. Drymarker, dry wiper and a pen tray included. White.



Size	Order Code NBO-836	Offer Price/1
600 x 300mm (2' x 1')	-4910K	£36.11
1500 x 1000mm (5' x 3'3")	-4920K	£144.19

Mobile Whiteboard

With vertical pivot. Stylish and modern to compliment all conference and meeting rooms. Drywipe or steel magnetic surfaces. Integral pen tray at base. Four lockable castors.



Size (mm)	Order Code NBO-836	List Price/1	Offer Price/1
1200 x 900	-0240K	£456.24	£319.37
1500 x 1200	-0250K	£515.98	£361.19

Ultimate Magnetic Whiteboard & Flipchart Easel

Adjustable height. Double sided dry-wipe magnetic writing surface. Tilting whiteboard for final presentation amendments. Hinged pen tray. Suitable for A1, two hole drilled pads. One piece legs can also double as foot bar to prevent unwanted movement.



Size	Order Code OFI-836	Offer Price/1
600 x 900mm	-0180K	£41.99

Mobile Magnetic Drywipe Boards

Stylish and modern aluminium-framed mobile whiteboard to complement all conference and meeting rooms.

Magnetic surface. Whiteboard is suspended on a horizontal pivot and mobility is provided by four leg castors.

Available in two sizes:

1200 x 900mm and 1500 x 1200mm.



Size (mm)	Order Code OFI-836	List Price/1	Offer Price/1
1200 x 900	-0360K	£119.99	£95.99
1500 x 1200	-0370K	£169.99	£135.99

Folding Magnetic Drywipe Board

Silver trimmed folding whiteboard.

Dimensions: 1200 x 900mm with two folding end panels which double the display area. Panels can be closed; useful for concealing sensitive information, for example. Includes pen tray and wall fixings.



Size (mm)	Order Code OFI-836	List Price/1	Offer Price/1
1200 x 900	-0350K	£99.99	£79.99

SOLENT OFFICE CLEANING & HYGIENE **Whiteboard Cleaner & Wipes**

Whiteboard Cleaner

Cleans like new! Effectively cleans dry wipe marker pen from most whiteboards. Non-toxic, non-hazardous fluid. Leaves whiteboards looking new. 250ml spray bottle. Use with Solent Dry Wipe Cloths (SOL-780-6840E) available separately.

Whiteboard Wipes

Pre-moistened whiteboard wipes effectively cleans dry wipe marker pen from most whiteboards. Non-toxic. Non-hazardous. Leaves whiteboards looking like new.

Tub contents: 100.

NEW



Description	Order Code	List Price/1	Offer Price/1
Cleaner	SOL-780	£5.58	£4.58
Wipes - Tub 100	-7020C	£9.26	£7.59

Q-CONNECT Economy Drywipe Markers

Non-toxic ink, chisel-tipped.



Colour	Order Code	Offer Price/1
Black	-0080K	£0.36
Blue	-0090K	£0.36
Green	-0100K	£0.36
Red	-0110K	£0.36
Assorted 4	-0120K	£1.28

Drywipe Cleaner

A powerful cleaning agent to be used when presenting has finished to remove any residue. 125ml pump action container.



Size	Order Code	Offer Price/1
125ml	BSQ-836	£2.74

nobo Flipchart Pad Markers

With new ink additive to prevent pen dry-out. Ink is light-resistant, ensuring pens retain their brightness on the page. Good resistance to bleed-through on all papers. In handy re-sealable wallet with one of each colour. Do not contain xylene.



Description	Order Code	Offer Price/1
4 Assorted Colours	NBO-836	£3.54

Pentel Whiteboard Markers

Easyflo whiteboard markers. Economical ball pen writes smooth, medium lines and is fully retractable. Uses BKS10HBP2-K6 refills.



Colour	Order Code	Offer Price/1
Black	PNL-846	£1.51
Blue	-0970K	£1.51
Red	-0980K	£1.51

Artline Conference Kit

Complete set of writing tools ideal for conferences or meetings. **Contents:** 3x bullet point whiteboard markers, red, blue and black. 4x fine point OHP markers, red, blue, black and green. 3x bullet point flip chart markers red, blue and black. One whiteboard eraser.



Description	Order Code	Offer Price/1
Conference Kit	ART-846	£11.34

White Board Cleaning Tissues

Contains 100 perforated wipes in a handy dispenser. Effective removal of ink, dust and stains leaving no residue.



Pack Quantity	Order Code	Offer Price/Pk
100	BSQ-836	£4.67

Artline Big Nib Whiteboard Markers

Big nib whiteboard markers that give thick 5mm, vivid lines that are clearly visible from a distance. Easily erasable with either a whiteboard eraser or dry cloth.



Colour	Type	Order Code	Offer Price/1
Black	Bullet Tip	ART-846	
Blue	Bullet Tip	-0060K	£3.10
Blue	Bullet Tip	-0070K	£3.10
Black	Chisel Tip	-0090K	£3.10
Blue	Chisel Tip	-0100K	£3.10
Assorted	Bullet Tip (4 Pk)	-0080K	£12.37
	Chisel Tip (4 Pk)	-0110K	£12.37

STAEDTLER White Board Compact Marker

Lumocolor 341

With universal tip for variable line widths of approx. 1-2mm. DRY SAFE - can be left uncapped for days without drying up (test ISO 554).

Pack Quantity	Ink Colour	Order Code	Offer Price/Pk
10	Red	STD-846	£7.97
10	Blue	-1060K	£7.97
10	Black	-1070K	£7.97
		-1090K	£7.97

Pack Quantity	Order Code	List Price/Pk	Offer Price/Pk
4	STD-846	£6.89	£3.79

Offis Magnetic Drywipe Eraser

Handle is magnetised for ease of storage and location. Available in Blue or Yellow.

Colour	Order Code	Offer Price/1
Blue	OFI-836	£1.99
Yellow	-0200K	£1.99

Artline Drywipe Eraser

For effective removal of whiteboard writing, high quality and economical whiteboard eraser.

Description	Order Code	Offer Price/1
Whiteboard Eraser	ART-836	£4.93

PAPER MATE Expo Grip Magnetic Eraser Mouse

Eight layer erasing pad supplied with magnetic storage base that can be used to store mouse close to the board.

Description	Order Code	List Price/1	Offer Price/1
Mag. Eraser Mouse	PAP-846	£4.39	£2.85

Office Supplies & Stationery

deflect-o® Multi Literature Holders

Display your leaflets in these stylish, durable holders. Free-standing or wall mounted holders for A4 size (three tier) or a 1/3 A4 (four tier). Made from clear styrene to ensure good visibility for all leaflets.



Size	Order Code DEF-836	Offer Price/1
1/3 A4 - 4 Tier	-0250K	£13.28
A5 - 4 Tier	-0260K	£16.46
A4 - 3 Tier	-0240K	£16.46

Freestanding Sign Holders

Ideal for retail outlets, restaurants, trade shows and more. The 10° slanted version is single sided and loads from the side, the vertical holder is double sided and loads from the bottom. The clear sprung acrylic display clip holds menus, sales messages and literature.



Size	Type	Order Code DEF-836	Offer Price/1
A5 Portrait	Vertical	-0110K	£4.49
A4 Portrait	Vertical	-0210K	£8.78
A4 Landscape	Vertical	-0200K	£8.96
A4 Portrait	10° Slanted	-0090K	£7.99

Wall Sign Holders

For internal notices and signs. Drilled for wall mounting, loads from top. The optional adjustable bracket enables signs to hang from screens or partitions.



Size	Order Code DEF-836	Offer Price/1
A5 Portrait	-0160K	£3.59
A4 Portrait	-0150K	£8.28
A3 Portrait	-0170K	£14.58
A4 Landscape	-0140K	£8.19

Business Card Holder

Clear business card holder. Size: 110 x 20mm.



Size	Order Code DEF-836	Offer Price/1
110 x 20mm Clear	-0040K	£1.10

Counter Literature Holders

Clear free standing single pocket literature holders.



Size	Order Code DEF-836	Offer Price/1
A4 Clear	-0010K	£6.20
A5 Clear	-0020K	£4.94
1/3 A4 Clear	-0030K	£3.59

Wall Mounted Literature Holders

Clear flat back wall literature holders.



Size	Order Code DEF-836	Offer Price/1
A4 Clear	-0050K	£8.36
A5 Clear	-0060K	£6.83
1/3 A4 Clear	-0070K	£4.67

A4 Aluminium Frame

A4 Aluminium picture frame with perspex insert. Size: 210 x 297mm.



Description	Order Code CTL-836	Offer Price/1
A4 Aluminium Frame	-0360K	£8.39

Clear Suggestion Box & Sign Holder

Has a built-in sign holder which will accommodate signs 203 x 375mm. Ideal for the collection of business cards, raffles, suggestions, comments, etc.



Description	Order Code DEF-836	Offer Price/1
Suggestion Box/Sign Holder	-0120K	£37.80

Clear File & Chart Holder

Made from virtually unbreakable polycarbonate. Ideal for clipboards, X-rays, current files, today's jobs, etc. Spring tongue holds documents. supplied with wall fixings.

Dimensions (W x D x H): 254 x 51 x 267mm.



Description	Order Code DEF-836	Offer Price/1
Clear File/Chart Holder	-0130K	£15.29

Offis A1 Freestanding 'A' Frame

Suitable for indoor/outdoor. Ideal for promoting products or displaying awareness information. Can be used in multiples to promote a series of information to people on the move. Double sided to display alternate traffic directions simultaneously. Anti-glare PVC poster cover helps to protect against environment and help maintain maximum visibility.



Description	Order Code OFI-836	Offer Price/1
A1 Freestanding 'A' Frame	-0190K	£49.99

Snap Frames

Lightweight frames for indoor or outdoor use. Attractive 'cushion profile' frames made from smooth satin finish Aluminium. With four pre-drilled hanging holes on back for portrait or landscape hanging. A clear flexible plastic front sheet protects the contents from dust and contact.



Size	Type	Order Code OFI-836	Offer Price/1
A4	Plain	-0220K	£7.95
A3	Plain	-0230K	£9.96

Large Format Snap Frames

Snap frames suitable for indoor or outdoor use. Aluminium. With four pre-drilled hanging holes on back for portrait or landscape hanging. A clear flexible plastic front sheet protects the contents from dust and contact.



Size	Type	Order Code CTL-836	Offer Price/1
A2	Snapframe	-0340K	£15.99
A1	Snapframe	-0350K	£24.99



Cork Notice Boards

Cork boards are preferable for displaying notices and communications and they free your working area of knick-knacks. The boards will last for years even with daily use. Available in a choice of three sizes with anodised aluminium or wood frame finish.



Size	Trim	Order Code OFI-836	Offer Price/1
600 x 450mm	Aluminium	-0160K	£13.69
900 x 600mm	Aluminium	-0170K	£15.99
600 x 450mm	Wood	-0130K	£4.29
900 x 600mm	Wood	-0140K	£6.49
1200 x 900mm	Wood	-0150K	£12.69

Felt Notice Boards

Boards covered with felt in a range of colours for your business or personal use. Four fabric colours: blue, green, grey and red. In two sizes.



Colour	Size	Order Code OFI-836	List Price/1	Offer Price/1
Blue	900 x 600mm	-0050K	£23.74	£18.99
Green		-0060K	£23.74	£18.99
Grey		-0070K	£23.74	£18.99
Red	1200 x 900mm	-0080K	£23.74	£18.99
Blue		-0090K	£30.99	£24.79
Green		-0100K	£30.99	£24.79
Grey	900mm	-0110K	£30.99	£24.79
Red		-0120K	£30.99	£24.79

Executive Felt Covered Notice Boards

Aluminium framed, executive felt covered notice boards. Available in blue, green, and grey with a satin finish aluminium frame.



Colour	Size	Order Code OFI-836	List Price/1	Offer Price/1
Blue	900 x 600mm	-0280K	£33.70	£26.96
Green		-0290K	£33.70	£26.96
Grey		-0300K	£33.70	£26.96
Blue	1200 x 900mm	-0310K	£42.45	£33.96
Green		-0320K	£42.45	£33.96
Grey		-0330K	£42.45	£33.96

Show Case Notice Boards

A range of Aluminium-framed 'Notice Board' Show Cases. Ideal for announcements, job opportunities, company memos and general information. Show Cases are available in a choice of 2 sizes, 900 x 600mm or 1200 x 900mm and documents are protected by a closing door with perspex front. Available in a choice of 4 colours, red, grey, blue or green.



Colour	Size (mm)	Order Code OFI-836	List Price/1	Offer Price/1
Blue	900 x 600	-0380K	£54.99	£43.99
Green		-0390K	£54.99	£43.99
Grey		-0400K	£54.99	£43.99
Red		-0410K	£54.99	£43.99
Blue	1200 x 900	-0420K	£104.99	£83.99
Green		-0430K	£104.99	£83.99
Grey		-0440K	£104.99	£83.99
Red		-0450K	£104.99	£83.99

Q-CONNECT Felt Notice Boards **NEW**

Aluminium framed notice boards. Ideal for announcements, job opportunities, company memos and much more. Top quality felt that accepts pins and velcro dots. Supplied complete with fittings.



Size	Colour	Order Code QUE-836	Offer Price/1
1800 x 1200mm	Green	-0080K	£84.69
1800 x 1200mm	Blue	-0070K	£84.69

Freestanding Snap Frame

Lightweight frames for indoor or outdoor use. Attractive 'cushion profile' frames made from smooth satin finish Aluminium. A clear flexible plastic front sheet protects the contents from dust and contact. Height adjustable tubular steel stand features a ratchet slider mechanism to allow rapid adjustment. Mirror chrome finish. Ideal for use in lobbies, receptions or as a temporary traffic direction sign.



Ratchet slide adjustment



Frame Size	Height Range (mm)	Base Dia.	Weight (each)	Order Code OFI-836	Offer Price/1
A4	1050-1450	245	2.5kg	-0460K	£23.99

Flipchart Easel

All in one flipchart easel and whiteboard. Robust and sturdy yet lightweight and portable. Telescopic legs make the easel easy to use. Handy pen shelf to store markers.



Description	Order Code CTL-836	Offer Price/1
Flipchart Easel	-0580K	£39.57

Flipchart Pad

Quality 80gsm white paper, 40 sheets. Punched holes to suit most easels.



Description	Order Code CTL-836	Offer Price/1
Plain Paper	-0820K	£2.56

Office Supplies & Stationery

PRESENTATION & CONFERENCE - ACCESSORIES & CONSUMABLES

nobo Magnetic Markers

PACK OF 10

Round, flat-top magnets for use on magnetic planning boards, whiteboards or easels. 20mm diameter holds a weight up to 120g. Pack of 10.



Colour	Order Code	List Price/Pk	Offer Price/Pk
Red	-1110K	£12.30	£8.61
Black	-1120K	£12.30	£8.61
Blue	-1130K	£12.30	£8.61

Offis Board Erasers

Specially designed magnetic erasers that allow easy adhesion to magnetic drywipe boards.

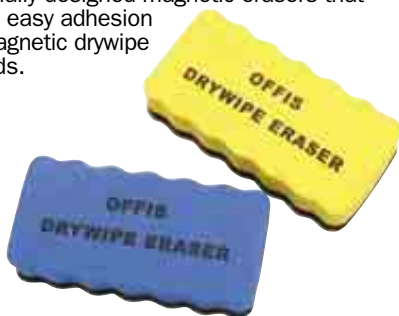

Colour	Order Code	List Price/1	Offer Price/1
Blue	OFI-836	£2.49	£1.99
Yellow	O210K	£2.49	£1.99

Adhesive Gridding Tape

Narrow adhesive tape for laying semi-permanent grids on non-magnetic drywipe boards. Available in red or black, 1.5 or 3mm. Length: 10m.



Product Number	Width	Colour	Order Code	Offer Price/1
1901119	1.5mm	Red	-0010K	£8.74
1901120	1.5mm	Black	-0020K	£8.74
1901121	3.0mm	Red	-0030K	£10.35
1901122	3.0mm	Black	-0060K	£10.35

Liquid Ink Drywipe Markers

Create impact with your next presentation. Bright colours dry instantly but are quickly erased. Ink contains no xylene or toluene. Bullet tipped.



Colour	Order Code	Offer Price/1
Black	-0020K	£1.28
Blue	-0030K	£1.28
Green	-0040K	£1.28
Red	-0050K	£1.28

Magnetic Tape

Coloured magnetic ribbon for use on magnetic, whiteboards, planning boards and magnetic easels. Use colours to colour-code projects, 10mm x 5m.



Colour	Order Code	List Price/1	Offer Price/1
Red	-4160K	£19.49	£13.64
Yellow	-4170K	£19.49	£13.64
Green	-4180K	£19.49	£13.64
Blue	-4190K	£19.49	£13.64
Black	-4200K	£19.49	£13.64

Pentel Drywipe Markers & Eraser Set

Suitable for use on all drywipe whiteboards. Pens held in a handy holder mounted to a board eraser. Four colours supplied: green, blue, red and black.



Description	Order Code	Offer Price/1
Markers & Eraser Set	PNL-846	£7.74

Magnetic Whiteboard Rule

X24050
60cm/24" Imperial version. The essential accessory for classrooms, offices, meetings and conference room whiteboards. Magnetic effect enables user to position on board exactly where required. Detachable handle eraser with two storage compartments for whiteboard markers and magnets (not included).

NEW

Description	Order Code	Offer Price/1
Magnetic Whiteboard Rule	HEX-836	£8.24

Magnetic Planning Kit

Easy to apply, can be cut to suit, contains tiles, tapes, name holders and month and day symbols. Instructions included.

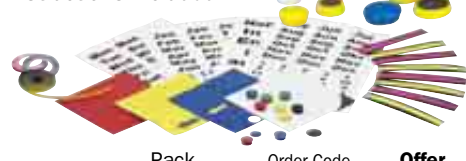

Diameter	Pack Quantity	Order Code	Offer Price/Pk
25mm	10	-0020K	£2.89
30mm	10	-0030K	£3.89
Magnetic Planning Kit		-0040K	£29.99

Drywipe Planning Kit

Makes planning on a drywipe board easy, contains months, days and symbols, easy to apply and remove, can be cut to suit application.



Description	Order Code	Offer Price/1
Drywipe Planning Kit	FIV-836	£16.99

Gridding Tape

Suitable for making temporary or permanent grids/tables on whiteboards and magnetic whiteboards.

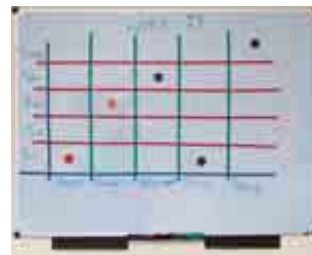

Type	Width (mm)	Length (m)	Colour	Order Code	Offer Price/1
Magnetic	10.0	5.0	Blue	-0010K	£5.72
			Green	-0020K	£5.72
			Yellow	-0030K	£5.72
			Red	-0040K	£5.72
Adhesive	6.0	10.0	Black	-0050K	£5.72
			Black	-0060K	£5.20
			Black	-0070K	£6.38
			Black	-0080K	£5.64

Drywipe Eraser & Marker Set

Pentel drywipe eraser complete with one black and one blue easyflo drywipe markers.



Description	Order Code	Offer Price/1
Markers & Eraser Set	PNL-846	£3.77

Magnets

Set of round magnets in coloured plastic. Use as planning markers or to hold papers on magnetic boards. 10 assorted colours.



Diameter	Pack Quantity	Order Code	List Price/Pk	Offer Price/Pk
25mm	10	-0110K	£12.45	£6.85
35mm	10	-0120K	£12.45	£6.85

Offis Bullet Tip Drywipe Markers

For use on drywipe boards. Dries immediately. Can be removed using a dry cloth. Non-toxic ink.

PACK OF 10



Colour	Pack Quantity	Order Code	Offer Price/Pk
Black	10	-0170K	£2.35
Blue	10	-0180K	£2.35
Red	10	-0190K	£2.35



Tensioner/Crimper Tool for Polypropylene - Heavy Duty

Combines tensioner, sealer and cutter all in one unit. Heavy duty construction with windlass and ratchet device for fast, non-slip tensioning. Extra long handles and shaped grips for easy tensioning, crimping and cutting. Suitable for 12mm polypropylene strapping and 12-25 seals. Designed for use on top of parcels and pallets.

Polypropylene

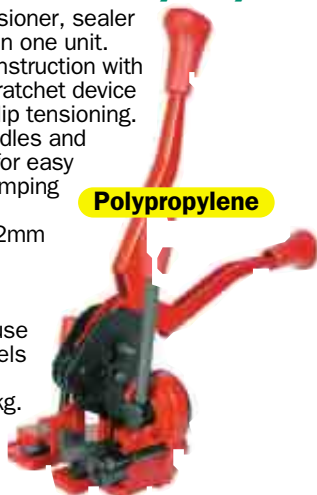

Priced per tensioner

Strapping Size	Order Code	Offer Price/1
12mm	PAC-835	£124.45

Light Duty Combination Tool for Polypropylene Strapping

Combines tensioner, sealer and cutter all in one unit. Robust construction for use with 12mm polypropylene strap with full length handles for easy tensioning, crimping and cutting. Non-slip ratchet tensioning with tough handle grips. Suitable for 12mm polypropylene strapping and 12-25 and 28mm seals. Designed for use on top of parcels and pallets.

Polypropylene

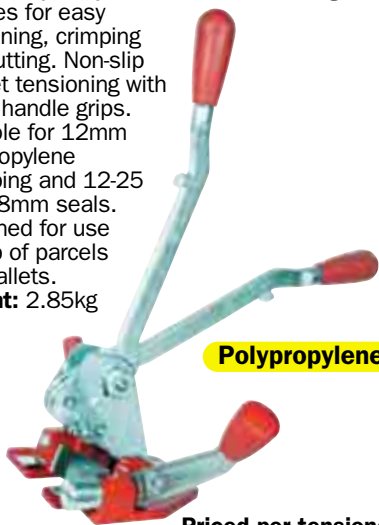

Priced per tensioner

Strapping Size	Order Code	Offer Price/1
12mm	PAC-835	£92.89

Strapping Tensioner for Polypropylene

Robustly built 12-15mm non-slip ratchet tensioner with cutter for polypropylene strapping. Versatile two-part system ideal for different shapes and sizes of products. Can be used horizontally to palletise goods. For use along side crimpers.

Polypropylene

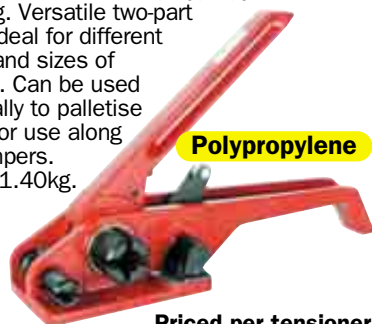

Priced per tensioner

Strapping Size	Order Code	Offer Price/1
12-15mm	PAC-835	£41.99

Mobile Coil Holder for Polypropylene Banding

Mobile coil holder for use with plastic strap wound on 200/190mm and 200/150mm cardboard cores. The unit is fitted with durable moulded polymer side plates, quick release clamping collar and over-run brake for tangle free dispensing of strap. Powder coat finish with seal tray.



Banding and Seals sold separately

Polypropylene

Priced per holder

Description	Order Code	List Price/1	Offer Price/1
Mobile Dispenser	-0050K	£99.98	£84.98

Crimper for Polypropylene

Full length chromed steel handles for easy crimping on polypropylene seals. Hardened steel jaws for durability.

12mm Crimper for use with 12-25, 12-28 or 12-32 seals. Weight: 1.70kg.

16mm Crimper for use 16-32 seals. Weight: 1.90kg.



Polypropylene

Strapping Size (mm)	Seal Size (mm)	Order Code	Offer Price/1
12mm	12/32	-0070K	£19.95
16mm	16/32	-0080K	£24.99



Machine Quality Polypropylene Banding

Suitable for use on automatic strapping machines. Supplied on 200/190mm cardboard cores 0.55mm thick.

Colour: blue.
Breaking strain: 130kg*.



Polypropylene

*All breaking strains are approximate.

Width x Length	Order Code	Offer Price/1	Offer Price/2+
12mm x 3000m	-1790K	£38.47	£34.62

Banding Kit - Polypropylene

Contents:

1 x Mobile Dispenser

Mobile trolley dispenser with metal flanges. For use with hand or machine grade strapping on 200mm cores. Accommodates strapping reel widths 150 - 190mm.

1 x Combination Tool

Combines tensioner, sealer and cutter all in one unit, suitable for 12mm strapping and 12/25mm seals. Designed for use on top of parcels and pallets.

2 x Polypropylene Banding Coils
2000 x Standard Seals

For securing polypropylene banding around objects.

Standard Seals x2000

Banding Coil x2

Polypropylene

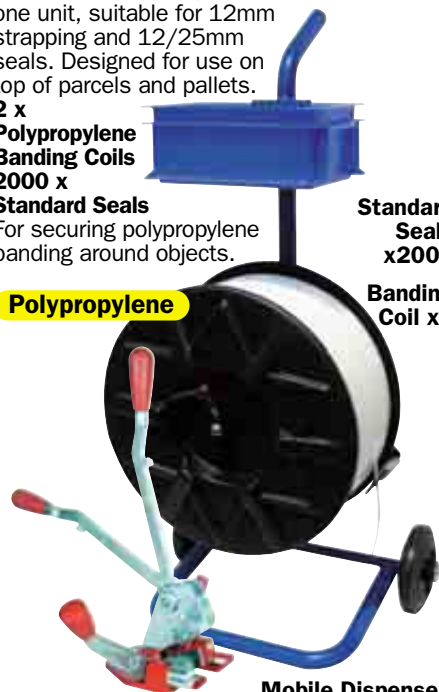

Combination Tool

Item	Order Code	Offer Price/1
Banding Kit	-0002A	£229.99

Strap and Seal Kit - Polypropylene

Ideal starter kit in a dispenser box.

Contents:

800m of 12mm polypropylene strapping and 300 metal seals.

Weight: 4.10kg.



Polypropylene

Description	Order Code	Offer Price/1
Strap & Seal Kit	-0090K	£20.50

Polypropylene Banding

Polypropylene plastic banding supplied on reels suitable for hand banding. Black, packed individually. **Width:** 12mm.

Approximate breaking strain:

R13: 130kg, **R21:** 210kg, **R30:** 300kg. Up to 300kg breaking strain.



Polypropylene

Priced per reel

Type	Length (m)	Order Code	Offer Price/1	Offer Price/2+
R13	2000	-1800K	£26.99	£24.29
R21	1300	-1810K	£27.49	£24.74
R30	1000	-1820K	£33.29	£29.96

FROMM 18V Friction Weld Tool

P326

Distinguished by its high reliability operation. Reinforced 18V motor and Lithium-Ion battery. For Polypropylene (PP) and Polyester (PET).

Specifications:

Battery: 18 VDC/3.0Ah Li-Ion.

Weight: 3.95kg.

Joint: friction weld joint with approx 75% average joint strength, dependent on strap quality.

Strap tensions:

400-2400N/90-540lbs.

To **EN415-8**.



NEW

Polypropylene

Extruded Polyester

Strapping Size (mm)	Order Code	List Price/1	Offer Price/1
13mm x 0.65mm	-0060K	£1924.16	£1481.60
13mm x 1.05mm	-0070K	£1924.16	£1481.60
16mm x 0.65mm	-0080K	£1924.16	£1481.60
16mm x 1.05mm	-0090K	£1924.16	£1481.60

Combination Strapping Tool

A strapping tool for 12/16mm polyester/polypropylene strap and serrated seals that is designed for the rigours of an industrial environment. Combines tensioner sealer and cutter in one unit. The tool is ideal for both vertical and horizontal strap applications.



Polypropylene

Extruded Polyester

Strapping Size (mm)	Order Code	List Price/1	Offer Price/1
12/16mm	-0030K	£379.00	£303.20

Mobile Stand for Plastic Banding

PMD

Electro-plated steel brake with strap guide. Plastic tool box mounted on handle ensures seals and tools are always at hand.

For use with strapping wound on plastic reels. There is provision for two-part strapping tools.



Description	Order Code	Offer Price/1
Mobile Dispenser	PSC-835	£59.49

Static Stand for Plastic Banding

PSD

Floor standing static dispenser. For use with strapping wound on plastic wheels. Electro-plated steel brake with strap guide. Built-in carrying handle for ease of use.



Description	Order Code	Offer Price/1
Static Stand	-0040K	£29.74

PACKER Strapping Tensioner

Suitable to tension and cut polypropylene, extruded polyester and woven polyester strapping. Ergonomic design with non-slip ratchet tensioning.



Polypropylene

Extruded Polyester

Strapping Size (mm)	Order Code	Offer Price/1
12-15mm	PAC-835	£38.65

Heavy-Duty Tensioner

For high tension and cutting on polypropylene extruded polyester strap and on woven polyester strapping. Built for heavy-duty use.



Polypropylene

Extruded Polyester

Strapping Size (mm)	Order Code	Offer Price/1
12-19mm	PAC-835	£125.00

AVON Polyester Strapping

Low creep factor enables excellent retention of applied load, while ease of application and disposal enables efficient packaging by manual or automatic process.

Breaking strain
300kg -0480K
350kg -0490K
450kg -0500K



UP TO 450kg BREAKING STRAIN

Extruded Polyester

Width x Length	Order Code	Priced per reel	
		Offer Price/1	Offer Price/2+
12.0 x 0.60mm x 2500m	-0480K	£69.99	£62.99
12.0 x 0.68mm x 2200m	-0490K	£70.99	£63.89
15.5 x 0.68mm x 1750m	-0500K	£71.99	£64.79

Crimper for Polyester

Full length chrome steel handles and off-set hardened steel jaws for easy crimping of compression seals.

Weight: 1.95kg.

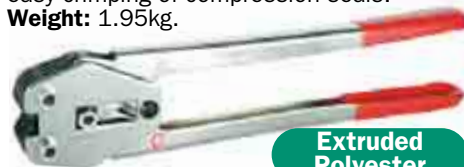

Extruded Polyester

Strapping Size (mm)	Order Code	Offer Price/1
12mm	PAC-835	£30.75
16mm	-0040K	£31.50

Polypropylene Banding Seals

For securing polypropylene banding around objects. **Width:** 12mm.



Extruded Polyester

Polypropylene

Type	Pk Qty	Order Code	List per pack	
			Price/Pk	Offer Price/Pk
Polypropylene				
Standard	2000	-0690K	£15.54	£13.99
Heavy	2000	-0700K	£28.88	£25.99
Polypropylene & Polyester - Serrated				
12mm	1000	-0770K	£26.88	£24.19
16mm	1000	-0780K	£37.99	£34.19

Mobile Stand for Polyester Banding

For use with polyester strap wound on 406mm cardboard cores with a 150mm width, fitted with heavy-duty steel discs a plastic tool tray, and over-run brake for tangle free uncoiling of the strap.



Extruded Polyester

Description	Order Code	Offer Price/1
Mobile Dispenser	PSC-835	£139.96

AVON Steel Hand Banding Ribbon

Ribbon: Each layer is wound directly over the one below, so that the width of coil is the width of strap. 0.5mm thickness.

Approximate breaking strain:

12mm: 561kg,
16mm: 714kg,
19mm: 846kg.

Approximate reel length:

12mm: 395m,
16mm: 337m,
19mm: 395m.



Mill Wound: Each layer oscillates across the layer below, uniformly and tightly across the 63.5mm width of the coil. 0.5mm thickness.

Approximate breaking strain:

12mm: 561kg,
16mm: 714kg,
19mm: 846kg.

Approximate reel length:

12mm: 930m,
16mm: 744m,
19mm: 605m.

Prices for steel banding may change subject to manufacturers surcharges.

Width x Length	Order Code AVN-837	List Price/1	Offer Price/1
12mm x 395m	-1730K	£34.65	£31.18
16mm x 337m	-1740K	£37.21	£33.49
19mm x 395m	-1750K	£41.45	£37.30

Ribbon Wound Priced per reel

Width x Length	Order Code AVN-837	List Price/1	Offer Price/1
12mm x 930m	-1760K	£70.48	£63.43
16mm x 744m	-1770K	£76.53	£68.88
19mm x 605m	-1780K	£73.60	£66.24

Steel

Mill Wound Priced per reel

Seals

Zinc finish. **Snap On:** Placed over the overlapping strap ends.

Lap Over: Must be threaded onto strap before tensioning.

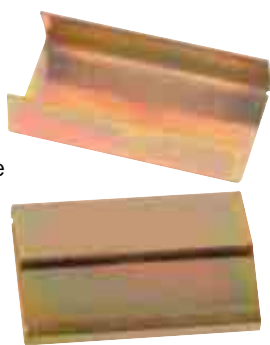

Type	Pk Qty	Size (mm)	Order Code AVN-835	List Price/Pk	Offer Price/Pk
Snap on	1000	12	-0710K	£30.69	£27.62
	1000	16	-0720K	£23.77	£21.39
	1000	19	-0730K	£35.54	£31.99
Lap over	3500	12	-0740K	£63.32	£56.99
	2500	16	-0750K	£57.10	£51.39
	2000	19	-0760K	£65.54	£58.99

Cardboard Edge

Cardboard edge protectors used on the sides of pallets to distribute the strapping tension evenly.

Size: 35 x 35 x 910mm.

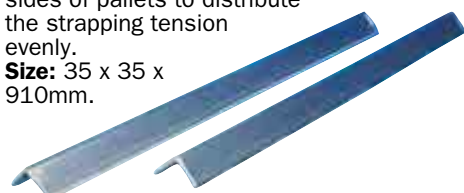

Box Quantity	Order Code AVN-830	List Price/Pk	Offer Price/Pk
50	-0320K	£13.28	£11.95

Edge Protectors

Plastic pallet load edge protectors help stop the straps from getting cut whilst also protecting the products on the pallet from the strap tension.



Size	Pk Qty	Order Code AVN-830	List Price/Pk	Offer Price/Pk
Medium	1000	-0300K	£25.99	£23.39
Large	1000	-0310K	£53.69	£48.32

Mobile Ribbon Wound Coil Holder

Mobile coil holder for ribbon wound steel strapping. Suitable for use with banding widths ranging from 12 - 32mm. Heavy-duty roller bearings are used to allow the coil to easily rotate. Complete with large clip on tool tray.



Steel

Type	Order Code PSC-835	Offer Price/1
Mill Wound	-0070K	£116.00
Ribbon Wound	-0080K	£89.25

Seal-less Tool for Strapping

Tensions and joins steel banding in one easy and efficient operation. Seal is formed by punching the top band through the bottom band. The opposing force from the punched sections interlocks the steel bands to form the seal.

Accepts banding up to 0.6mm thick and is adjustable between 13 and 19mm.



Steel

Banding Width	Order Code PSC-835	List Price/1	Offer Price/1
13 - 19mm	-0020K	£669.00	£568.65

Mobile Mill Wound Coil Holder

Mobile strapping stand with strap guide. Suitable for mill wound steel strapping. Coil rotates on smooth running, heavy-duty roller bearings. Plastic box mounted on handle ensures seals and tools are always at hand.



Steel

Description	Order Code PSC-835	Offer Price/1
Mobile Mill Wound Holder	-0090K	£84.98

Sealers

Suitable for use with 13mm, 16mm or 19mm seals. Use in conjunction with tensioner.

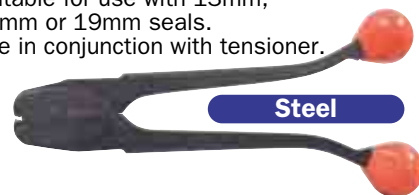

Steel

Product Number	Size (mm)	Order Code PAC-835	Offer Price/1
4213/SS	13	-0110K	£23.99
4216/SS	16	-0120K	£25.99
4219/SS	19	-0130K	£27.99

Tensioner

Tensions steel strapping around parcels and pallets. Suitable for widths up to 19mm. This versatile tool can be used either horizontally or vertically. Use in conjunction with sealer.



Steel

Description	Order Code PAC-835	Offer Price/1
Tensioner	-0150K	£59.99

Safety Shears

Safety shears which will hold and cut strapping up to 30mm wide.



Steel

Description	Order Code PAC-835	Offer Price/1
Safety Shears	-0140K	£25.99

AVON Corrugated Cartons

A range of cartons including some with variable depths that will suit a variety of packaging requirements. Manufactured from high quality fluted corrugated board making them ideal for packaging to be transported by road, rail or air.

Popular carton sizes (L x W):

- *A4 = 305 x 229mm.
- *A5 = 229 x 152mm.
- *Multi-depth = 305 x 229 x 229 (152mm).
305 x 305 x 305 (229/152mm).
406 x 406 x 406 (305/152mm).
457 x 305 x 305 (229mm).

Single Wall Board



Double Wall Board

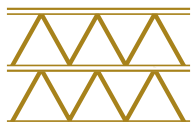

Priced per pack

Dimensions L x W x H (mm)	Dimensions L x W x H (inch)	Pk Qty	Order Code AVN-830	Offer Price/Pk	Offer Price/3+
Single Wall Cases					
152 x 101 x 101	6 x 4 x 4	25	-0330K	£8.60	£8.12
152 x 152 x 152	6 x 6 x 6	25	-0340K	£10.79	£10.19
610 x 394 x 280	6 x 15 x 11	25	-0760K	£31.00	£29.27
178 x 127 x 127	7 x 5 x 5	25	-0350K	£10.79	£10.19
203 x 203 x 203	8 x 8 x 8	25	-0360K	£14.39	£13.59
*229 x 152 x 152	9 x 6 x 6	25	-0370K	£12.41	£11.72
305 x 229 x 152	12 x 9 x 6	25	-0670K	£12.99	£12.27
*305 x 229 x 229	12 x 9 x 9	25	-0380K	£9.89	£9.34
305 x 305 x 305	12 x 12 x 12	25	-0390K	£22.49	£21.24
381 x 254 x 254	15 x 10 x 10	25	-0400K	£25.99	£24.55
457 x 305 x 305	18 x 12 x 12	25	-0410K	£28.79	£27.19
Double Wall Cases					
*305 x 229 x 229	12 x 9 x 9	20	-0690K	£19.79	£18.69
254 x 254 x 254	10 x 10 x 10	20	-0685K	£16.99	£16.05
*305 x 305 x 305	12 x 12 x 12	20	-0700K	£21.59	£20.39
355 x 355 x 355	14 x 14 x 14	15	-0705K	£29.00	£27.39
*406 x 406 x 406	16 x 16 x 16	20	-0710K	£42.50	£40.14
*457 x 305 x 305	18 x 12 x 12	20	-0720K	£26.99	£25.49
457 x 457 x 457	18 x 18 x 18	20	-0730K	£51.29	£48.44

Packing List Envelopes

This range of self-adhesive polythene envelopes ensures that important documentation such as delivery notes, invoices and packing lists reach your customer safely. Contents are clearly visible without opening. Water and oil-resistant. Will not rip. Polythene thickness 60 microns.

EXTENDED RANGE

Place your documents inside the envelope

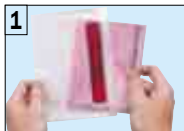

Remove silicone backing paper to expose adhesive



Position and press the envelope to your package



Size	Type	Pack Qty	Order Code AVN-830	List Price/Pk	Offer Price/Pk
A4	Plain	500	-2050K	£45.49	£40.94
A4	Doc Enc	500	-2114K	£41.88	£37.69
A4	Doc Enc	1000	-2112K	£41.88	£37.69
A5	Doc Enc	1000	-2060K	£58.32	£52.49
A5	Plain	1000	-2070K	£56.65	£50.98
A6	Plain	1000	-2080K	£29.99	£26.99
A6	Doc Enc	1000	-2090K	£28.88	£25.99
A7	Doc Enc	1000	-2100K	£23.29	£20.96
A7	Plain	1000	-2110K	£22.10	£19.89
DIN Long	Doc Enc	1000	-2116K	£44.99	£40.49
DIN Long	Plain	1000	-2118K	£42.99	£38.69

PACKER Air Cushion System

Mini PAK'R'

A compact machine with its own internal air source which produces cushions for packaging avoiding the cost of transporting and storing additional bubble film. The cushions are produced from recyclable film and are 99% air giving considerable material savings against other void fill products. Produces five variety of cushions (see below). Can be bench or wall mounted.



Size (L x W x H):
360 x 330 x 28mm.
Weight: 6kg.

Voltage	Order Code PAC-834	Offer Price/1
230V	-0380K	£1549.00

Air Cushions

Use in conjunction with the Packer Mini PAK'R' air void fill machine (above) to produce 5 types of protective cushion depending on your packing requirements.



Type	Roll Dimensions	Order Code PAC-837	Offer Price/1
Large Quilt	400 x 150mm x 200m	-0010K	£49.95
Small Quilt	400 x 150mm x 200m	-0020K	£49.95
Supertube	400 x 150mm x 200m	-0030K	£49.95
Cushions	200 x 130mm x 325m	-0040K	£38.95
Double Cushions	400 x 150mm x 200m	-0050K	£49.95

AVON Postal Tubes

Strong cardboard tubes complete with plastic end caps. Ideal for mailing artwork, plans, maps, charts etc.



Size	Dimensions Dia. x L (mm)	Order Code AVN-830	Offer Price/1
A4	50 x 330	-2150K	£0.69
A2	50 x 430	-2140K	£0.99
A1	50 x 625	-2130K	£1.13
A0	50 x 890	-2120K	£1.66

Silica Gel Sachets

When used within enclosed storage areas, silica gel absorbs up to 40% of its weight in moisture to create a protective shield of dry air preventing condensation which can cause damage such as: rust, corrosion, fungus, mould, spotting and toning.

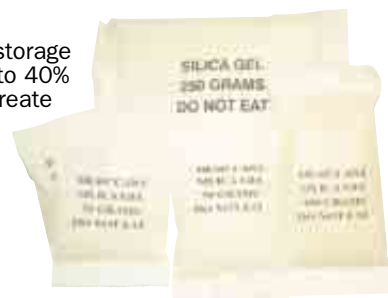

Pack Quantity	Weight each	Order Code AVN-780	Offer Price/Pk
100	25g	-0020K	£52.48
	50g	-0030K	£78.73
	100g	-0040K	£104.98
	250g	-0010K	£189.00

Jiffy Lite Envelopes

Tough on protection light on cost. A lighter weight postal bag saves you postage costs and is ideal for large volume mailings. Each bag has a self-seal flap to keep contents secure and gives excellent protection.



'SPLIT PACK' QUANTITIES ARE ALSO AVAILABLE PLEASE ASK FOR DETAILS

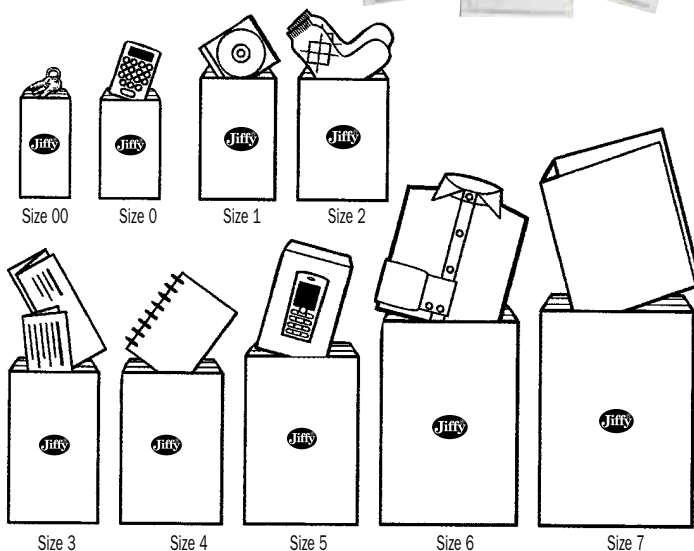

Product Number	Internal Dimensions	Pack Quantity	Order Code JIF-918	List Price/Pk	Offer Price/Pk
JL000	90 x 145mm	150	-0210K	£24.40	£14.64
JL00	115 x 195mm	100	-0200K	£14.79	£8.87
JL0	140 x 195mm	100	-0190K	£20.83	£12.50
JL1	170 x 245mm	100	-0220K	£27.13	£16.28
JL2	205 x 245mm	100	-0230K	£31.02	£18.61
JL3	205 x 320mm	50	-0240K	£18.72	£11.23
JL4	230 x 320mm	50	-0250K	£20.27	£12.16
JL5	260 x 345mm	50	-0260K	£25.67	£15.40
JL6	290 x 445mm	50	-0270K	£34.87	£20.92
JL7	340 x 445mm	50	-0280K	£37.70	£22.62

Gold 'Air filled' Mailing Bags

Manufactured from a high quality kraft paper outer, with brand leading protective bubble film cushioning, your products will arrive with your customers in excellent condition.

- Available in a range of 11 stock sizes offering cost-effective protection for all mailing applications.
- Lightweight construction reduces postal costs.
- High slip bubble film inner makes them easy to use in high speed packing environments.
- All bags come with a strong self seal strip for extra security.



Item Pictured Size C

Product Number	Internal Dimensions	Pack Quantity	Order Code FET-830	List Price/Pk	Offer Price/Pk
Size A	110 x 165mm	200	-0010K	£27.60	£15.46
Size B	120 x 215mm	200	-0020K	£33.55	£18.79
Size C	150 x 215mm	100	-0030K	£17.80	£9.97
Size D	180 x 265mm	100	-0040K	£23.06	£12.91
Size E	220 x 265mm	100	-0050K	£26.23	£14.69
Size F	220 x 335mm	100	-0060K	£31.86	£17.84
Size G	240 x 335mm	100	-0070K	£33.73	£18.89
Size H	270 x 360mm	100	-0080K	£44.05	£24.67
Size J	300 x 445mm	50	-0090K	£30.23	£16.93
Size K	350 x 470mm	50	-0100K	£34.64	£19.40
Size L	460 x 660mm	50	-0110K	£70.69	£39.59

Protective Envelopes - White

Mail Lite

Mail Lite envelopes have an outer kraft lined with barrier-sealed bubble, offering the perfect solution for ultimate protective mailings. Use Mail Lite for tools, parts, clothing, CDs, DVDs, brochures, books and many other commercial mailings. Mail Lite bags are perfect for soft or unbreakable items.



All prices per pack

Product Number	Internal Dimensions	Pack Quantity	Order Code WTS-830	List Price/Pk	Offer Price/Pk
52450	150 x 210mm	100	-0010K	£14.99	£11.24
52446	240 x 330mm	50	-0020K	£14.59	£10.94
52447	270 x 360mm	50	-0030K	£17.99	£13.49
52443	180 x 260mm	100	-0040K	£20.99	£15.74
52441	120 x 210mm	100	-0060K	£14.99	£11.24
52444	220 x 260mm	100	-0070K	£22.99	£17.24
61579	240 x 330mm	50	-0190K	£19.99	£14.99
61581	350 x 470mm	50	-0210K	£33.99	£25.49

Cushioned Protective Envelopes

Mail Tuff

Outer kraft lined with barrier-sealed bubble, offering the perfect solution for ultimate protective mailings. Use Mail Tuff cushioned for tools, parts, clothing, CDs, etc. Mail Tuff cushioned envelopes are perfect for soft or unbreakable items. Peel 'n' Seal closure for speed, and easy opening strip. Use in conjunction with additional bubble wrap for extra protection. Sizes shown are internal dimensions. When choosing a size, pick an envelope approximately 1/4 larger than the size of the item you are sending.



All prices per pack

Product Number	Internal Dimensions	Pack Quantity	Order Code WTS-830	List Price/Pk	Offer Price/Pk
61577	150 x 210mm	100	-0170K	£21.99	£16.49
61578	180 x 260mm	100	-0180K	£26.49	£19.87
61580	270 x 360mm	50	-0200K	£18.65	£13.99

Protective Envelopes

Mail Lite Plus Oyster

Mail Lite Plus Oyster envelopes have an outer kraft lined with barrier-sealed bubble, offering the perfect solution for ultimate protective mailings. Can be used for tools, parts, clothing, CDs, etc. Perfect for soft or unbreakable items.

Peel 'n' Seal closure for speed, and easy opening strip. Use in conjunction with additional bubble wrap for extra protection. Sizes shown are internal dimensions. When choosing a size, pick an envelope approximately 1/4 larger than the size of the item you are sending. Ideal for heavy or fragile items.



All prices per pack

Product No.	Internal Dimensions	Pack Quantity	Order Code WTS-830	List Price/Pk	Offer Price/Pk
21039	120 x 210mm	100	-0080K	£16.99	£12.74
21040	150 x 210mm	100	-0090K	£19.99	£14.99
21041	180 x 260mm	100	-0100K	£21.99	£16.49
21042	220 x 260mm	100	-0110K	£25.99	£19.49
21043	220 x 330mm	50	-0120K	£16.99	£12.74
21044	240 x 330mm	50	-0130K	£20.49	£15.37
21045	270 x 360mm	50	-0140K	£22.99	£17.24
21046	300 x 440mm	50	-0150K	£29.99	£22.49
21047	350 x 470mm	50	-0160K	£33.99	£25.49

Jiffy Mailmiser Envelopes

Strong protection for important mailings. Self-seal. Extremely lightweight. Air bubble cushion. Sizes listed are internal measurements.



Product Number	Internal Dimensions	Pk Qty	Order Code	List Price/Pk	Offer Price/Pk
JFM00	115 x 195mm	100	-0020K	£23.00	£13.80
JFM0	140 x 195mm	100	-0010K	£23.20	£13.92
JFM1	170 x 245mm	100	-0030K	£34.74	£20.84
JFM2	205 x 245mm	100	-0040K	£39.67	£23.80
JFM3	205 x 320mm	50	-0050K	£23.52	£14.11
JFM4	230 x 320mm	50	-0060K	£25.97	£15.58
JFM5	260 x 345mm	50	-0070K	£34.02	£20.41
JFM6	290 x 445mm	50	-0080K	£45.52	£27.31
JFM7	340 x 445mm	50	-0090K	£53.09	£31.85

Padded Envelopes

Recycled fibre-fill padding keeps contents protected. Genuine jiffy fibres expand if the bag is handled in transit. Ideal for fragile or breakable items. Available in a choice of sizes. Sizes listed are internal measurements.

AVAILABLE IN SIZES TO SUIT ALL APPLICATIONS



Product Number	Internal Dimensions	Pk Qty	Order Code	List Price/Pk	Offer Price/Pk
JFP00	107 x 235mm	200	-0330K	£25.61	
JFP0	132 x 235mm	200	-0100K	£27.42	
JFP1	164 x 285mm	100	-0340K	£18.30	
JFP2	196 x 285mm	100	-0350K	£20.81	
JFP3	196 x 350mm	100	-0360K	£28.26	
JFP4	221 x 350mm	100	-0370K	£27.39	
JFP5	247 x 387mm	100	-0380K	£35.79	
JFP6	298 x 464mm	50	-0390K	£23.79	
JFP7	336 x 489mm	50	-0400K	£27.90	
JFP8	437 x 666mm	50	-0410K	£49.29	

AVON Pure Kraft Paper Rolls

Manufactured from pure wood pulp. This gives the pure kraft paper properties of higher strength and makes it a more durable paper with a higher burst strength than imitation kraft paper.

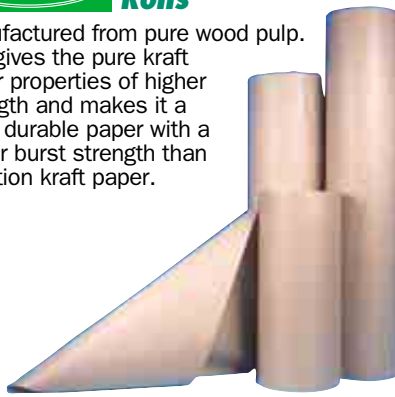

Size	Order Code	Offer Price/1
450mm x 285m	-0120K	£19.99
500mm x 285m	-0130K	£20.99
600mm x 285m	-0140K	£27.89
750mm x 285m	-0150K	£33.29
900mm x 285m	-0160K	£41.39
1200mm x 285m	-0170K	£55.79

Waxed Kraft Paper Rolls

A water-resistant paper made by waxing on both sides, frequently used for the wrapping of engineering components.



Size	Order Code	Offer Price/1
900mm x 100m (55gsm)	-0260K	£18.89
900mm x 100m (65gsm)	-0270K	£20.69
900mm x 100m (120gsm)	-0280K	£30.00

Imitation Kraft Paper Rolls

Manufactured from recycled kraft paper pulp, making it suitable for most applications but with a lower burst strength than pure kraft paper.



Size	Order Code	Offer Price/1
600mm x 220m	-0230K	£21.59
750mm x 220m	-0240K	£22.49
900mm x 220m	-0250K	£32.39

Counter Roll Holders

Suitable for all types of wrapping paper. Will accommodate roll sizes up to 240mm diameter. For counter top use, suspended under a workbench or attached to the wall. Brackets and screws provided. Frame is rustproof and maintenance-free.

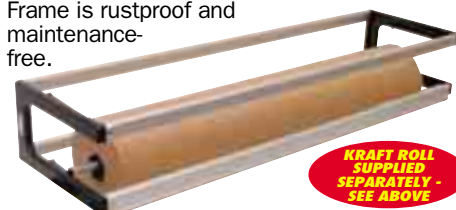

Size	Order Code	Offer Price/1
600mm	-0170K	£52.95
800mm	-0180K	£72.00
1000mm	-0190K	£79.99

KRAFT ROLL SUPPLIED SEPARATELY - SEE ABOVE

Woven Polypropylene Sacks

A material made by weaving polypropylene tapes in two directions to form a lightweight breathable fabric suitable for grains, seeds, minerals, sand and other products. Woven polypropylene bags offer the best packaging for a large variety of products in industries such as agriculture, chemical, mining, building materials, and construction. Woven polypropylene bags offer economy, better protection, weight savings, and greater strength than other available packaging.

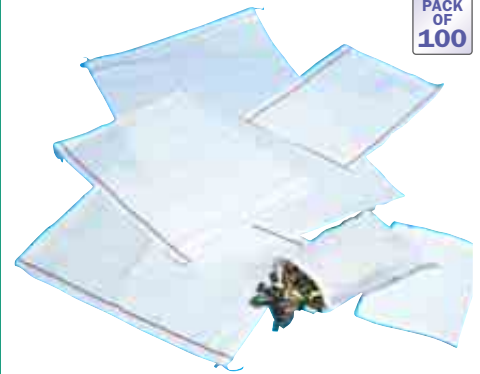

PACK OF 100

Size (mm)	Size	Order Code	List Price/Pk	Offer Price/Pk
230 x 310	9" x 12"	-0020K	£24.45	£19.56
310 x 460	12" x 18"	-0030K	£26.97	£21.58
380 x 500	15" x 20"	-0040K	£28.18	£22.54
460 x 620	18" x 24"	-0050K	£29.41	£23.53
620 x 1000	24" x 40"	-0060K	£61.21	£48.97

Sack Tying Tool

The tying tool to quickly and easily twist the tie around the neck of the sack to seal it.



Description	Order Code	List Price/1	Offer Price/1
Sack Tying Tool	-0790K	£15.99	£14.39

Sack Ties

PVC coated stainless steel sack ties, for use on polypropylene woven sacks and polythene sacks. Made from 1.2mm thick wire. Each tie is looped at each end. Sold in bundles of 1000 ties. These are easily applied with a sack tying tool sold separately.

BUNDLES OF 1000



Size	Order Code	List Price/Pk	Offer Price/Pk
150mm (6")	-0800K	£12.21	£10.99
200mm (8")	-0810K	£14.43	£12.99
230mm (9")	-0820K	£16.10	£14.49

Letter & Parcel Openers

Features a serrated edge for opening parcels and a straight edge for envelopes.

Description	Order Code	List Price/1	Offer Price/1
Metal Handle	-0190K	£2.65	£1.99

AVON Single-Faced Corrugated Paper

One of today's most versatile and commonly used protective packaging mediums. Manufactured from 100% recycled material and is 100% recyclable, meeting today's environmental demands.



Roll Diameter 600mm

Width x Length	Order Code AVN-830	Offer Price/Roll
300mm x 75m	-1810K	£8.90
450mm x 75m	-1820K	£13.78
600mm x 75m	-1830K	£18.27
650mm x 75m	-1840K	£20.99
750mm x 75m	-1850K	£22.99
900mm x 75m	-1860K	£26.99
1200mm x 75m	-1870K	£35.95

Polystyrene Loose-Fill 15cu.ft.

Polystyrene loose-fill provides the perfect protection for boxed goods. Loose-fill can be sprinkled into cartons, boxes or even bags to surround and protect delicate or fragile contents. Extremely lightweight minimising freight costs.



Carriage At Extra Cost

Pack Volume	Order Code AVN-830	Offer Price/1
15cu.ft.	-1880K	£18.99

Bubble Film Dispenser Box

Eliminates all storing and handling problems of bubble film. One roll 300mm x 35m small bubble. Supplied with a free safety cutter.



Pack Size	Order Code AVN-830	Offer Price/1
300mm x 35m	-2000K	£10.48

Bubble Wrap Rolls

Highly versatile packaging. Thousands of tiny air filled bubbles effectively protect the contents of your package against knocks and shocks. Can be used as a space filler.

Carriage At Extra Cost



Bubble Type	Size	Bubble Diameter	Pack Quantity	Order Code AVN-830	Offer Price/Pk
Small	300mm x 100m	9.5mm	5	-1200K	£54.95
	500mm x 100m		3	-1210K	£54.95
	600mm x 100m		2	-1220K	£42.68
	750mm x 100m		2	-1230K	£54.95
	900mm x 100m		1	-1236K	£32.99
	1200mm x 100m		1	-1240K	£42.68
Large	1500mm x 100m	25mm	1	-1250K	£51.83
	300mm x 45m		5	-1010K	£60.01
	500mm x 45m		3	-1020K	£60.01
	750mm x 45m		2	-1030K	£60.01
Extra Large	1500mm x 45m	30mm	1	-1040K	£60.01
	1500mm x 45m		1	-1140K	£65.51
Anti-Static	500mm x 100m	9.5mm	3	-1260K	£60.48
	750mm x 100m		2	-1270K	£60.48
	1500mm x 100m		1	-1280K	£60.48



Antistatic Bubble Bags

Antistatic bubble bags that are primarily used for protecting electrical equipment where static may cause problems. All bags have an easy peel self seal strip to make it easy to seal shut. Available in a range of standard sizes.



Size	Dimensions (mm)	Pack Quantity	Order Code AVN-830	Offer Price/Pk
BB2	130 x 185	500	-1720K	£39.99
BB3	180 x 235	300	-1730K	£31.99
BB4	230 x 285	300	-1740K	£41.39
BB5	280 x 360	150	-1750K	£26.95
BB6	305 x 435	150	-1760K	£38.90

Anti-Static



Bubble Bags

Highly versatile packaging. Thousands of tiny air-filled bubbles effectively protect the contents of your package against knocks and shocks. Can be used as a space filler. Fitted with a self-adhesive sealing strip. Sizes listed are internal measurements.



Size	Dimensions (mm)	Pack Quantity	Order Code AVN-830	Offer Price/Pk
BB1	100 x 135	750	-1610K	£49.99
BB2	130 x 185	500	-1620K	£41.98
BB3	180 x 235	300	-1630K	£34.19
BB4	230 x 285	300	-1640K	£42.29
BB5	280 x 360	150	-1650K	£34.19
BB6	305 x 435	150	-1660K	£39.99
BB7	380 x 435	100	-2040K	£35.00

AVON Polythene Bags (Plain)

A range of various sized light to heavy duty food grade polythene bags to suit all of your packaging requirements.



Size	Pack Quantity	AVN-837 Light Duty	List Price/Pk	Offer Price/Pk	Pack Quantity	AVN-837 Med. Duty	List Price/Pk	Offer Price/Pk	Pack Quantity	AVN-837 Heavy Duty	List Price/Pk	Offer Price/Pk
4" x 6"	1000	-1050K	£6.49	£5.84	1000	-1170K	£9.32	£8.39	200	-1280K	£18.21	£16.39
6" x 8"	1000	-1060K	£6.96	£6.26	1000	-1410K	£11.10	£9.99	1000	-1290K	£15.76	£14.18
8" x 10"	1000	-1070K	£9.82	£8.84	1000	-1180K	£20.88	£18.79	500	-1300K	£21.91	£19.72
8" x 12"	1000	-1080K	£11.80	£10.62	1000	-1190K	£25.06	£22.55	500	-1310K	£26.32	£23.69
9" x 12"	-	-	-	-	-	-	-	-	250	-1315K	£14.68	£13.21
10" x 12"	1000	-1090K	£14.77	£13.29	1000	-1200K	£15.65	£14.09	250	-1330K	£16.43	£14.79
10" x 15"	1000	-1100K	£18.38	£16.54	500	-1210K	£19.58	£17.62	250	-1340K	£20.55	£18.50
12" x 15"	1000	-1110K	£22.11	£19.90	500	-1220K	£23.55	£21.20	250	-1350K	£24.66	£22.19
12" x 18"	1000	-1120K	£26.55	£23.89	500	-1230K	£28.32	£25.49	250	-1360K	£29.54	£26.59
15" x 20"	1000	-1130K	£43.32	£38.99	500	-1240K	£38.55	£34.70	100	-1370K	£15.36	£13.82
18" x 24"	500	-1140K	£26.55	£23.89	250	-1250K	£39.99	£35.99	200	-1380K	£44.22	£39.80
20" x 30"	500	-1150K	£36.84	£33.16	250	-1260K	£41.10	£36.99	100	-1390K	£30.77	£27.69
24" x 36"	500	-1160K	£52.99	£47.69	250	-1270K	£44.26	£39.83	100	-1400K	£44.22	£39.80

Gripseal Polythene Bags - Plain

Plain gripseal bags. Medium duty.

Pack of 1000.



PACK OF 1000

Size (mm)	Size (inch)	Order Code AVN-837	List Price/Pk	Offer Price/Pk
38 x 40	1½" x 2½"	-1420K	£2.77	£2.49
57 x 57	2¼" x 2¼"	-1430K	£5.49	£4.94
75 x 75	2¼" x 3"	-1440K	£5.90	£5.31
75 x 90	3" x 3½"	-1450K	£7.88	£7.09
75 x 190	3" x 7½"	-1460K	£16.25	£14.62
88 x 114	3½" x 4½"	-1470K	£11.21	£10.09
100 x 140	4" x 5½"	-1480K	£14.71	£13.24
114 x 114	4½" x 4½"	-1490K	£15.29	£13.76
122 x 190	5" x 7½"	-1500K	£23.32	£20.99
152 x 228	6" x 9"	-1510K	£28.84	£25.96
223 x 280	8" x 11"	-1520K	£29.86	£26.87
228 x 324	9" x 12¾"	-1530K	£56.88	£51.19
250 x 350	10" x 14"	-1540K	£38.72	£34.85
280 x 406	11" x 16"	-1550K	£52.20	£46.98
324 x 324	12¾" x 12¾"	-1560K	£54.89	£49.40
400 x 500	15" x 20"	-1570K	£87.70	£78.93

Gripseal Polythene Bags - Write On

Gripseal bags with three write-on stripes. Medium duty.

Pack of 1000.

PACK OF 1000



Size (mm)	Size (inch)	Order Code AVN-837	List Price/Pk	Offer Price/Pk
57 x 57	2¼" x 2¼"	-1580K	£4.58	£4.12
75 x 86	3" x 3½"	-1590K	£10.40	£9.36
90 x 115	3½" x 4½"	-1610K	£9.77	£8.79
100 x 140	4" x 5½"	-1620K	£12.77	£11.49
127 x 190	5" x 7½"	-1630K	£19.32	£17.39
150 x 230	6" x 9"	-1640K	£25.08	£22.57
190 x 190	7½" x 7½"	-1690K	£26.99	£24.29
203 x 280	8" x 11"	-1650K	£45.49	£40.94
255 x 355	10" x 14"	-1660K	£69.33	£62.40
320 x 225	12¾" x 9"	-1670K	£66.04	£59.44

Heat Sealer

The easy way to seal layflat tubing. 230V, 50Hz.

Roller Stand To Be Ordered Separately



CAN ALSO BE USED WITH POLYTHENE BAGS

Size	Order Code PAC-834	Offer Price/1
Heat Sealer		
200mm	-0240K	£69.99
300mm	-0260K	£84.99
400mm	-0020K	£115.00
Heat Sealer & Cutter		
200mm	-0250K	£74.99
300mm	-0270K	£94.99
400mm	-0010K	£127.00
Size	Order Code PAC-835	Offer Price/1
Unrolling Device	-0200K	£54.95

Layflat Polythene Tubing

Customise your polythene bag size! Choose your preferred width and use the layflat tubing to make your own custom sized bags or sleeves. Tubing can be heat sealed, tied or stapled closed.



LARGER SIZES AVAILABLE ON REQUEST

Price per pack

Width	Order Code AVN-837			Order Code AVN-837			Order Code AVN-837		
	Offer Price/1	Offer Price/3+	Offer Price/1	Offer Price/1	Offer Price/3+	Offer Price/1 roll	Offer Price/3 rolls	Offer Price/1 roll	
250g Gauge/330m Clear									
50mm	-0730K	£10.62	£9.56	-0890K	£10.62	£9.56	-	-	-
75mm	-0740K	£13.98	£12.58	-0900K	£13.98	£12.58	-	-	-
100mm	-0750K	£16.97	£15.28	-0910K	£16.97	£15.28	-	-	-
125mm	-0760K	£19.64	£17.67	-0920K	£19.64	£17.67	-	-	-
150mm	-0770K	£21.97	£19.77	-0930K	£21.97	£19.77	-0420K	£19.77	£17.79
200mm	-0780K	£28.85	£25.97	-0940K	£28.85	£25.97	-	-	-
225mm	-	-	-	-0945K	£32.94	£29.65	-	-	-
250mm	-0790K	£35.86	£32.27	-0950K	£35.86	£32.27	-0430K	£44.95	£40.45
300mm	-0800K	£43.06	£38.75	-0960K	£43.06	£38.75	-	-	-
350mm	-0810K	£49.94	£44.95	-0970K	£49.94	£44.95	-	-	-
375mm	-0820K	£53.28	£47.95	-0980K	£53.28	£47.95	-	-	-
400mm	-0830K	£56.16	£50.54	-0990K	£56.16	£50.54	-0440K	£55.33	£49.80
450mm	-0840K	£61.48	£55.33	-1000K	£61.48	£55.33	-	-	-
500mm	-0850K	£69.93	£62.94	-1010K	£69.93	£62.94	-0450K	£88.90	£80.02
600mm	-0860K	£82.00	£73.80	-1020K	£82.00	£73.80	-	-	-
750mm	-0870K	£98.78	£88.91	-1030K	£98.78	£88.91	-	-	-
800mm	-0875K	£107.09	£89.90	-	-	-	-	-	-
900mm	-0880K	£114.30	£102.87	-1040K	£114.30	£102.87	-	-	-

CONTRACT PRICES AVAILABLE FOR VOLUME PURCHASES

All Prices Excludes V.A.T. © 2011

AVON *Blown Stretch Wrap*

For wrapping and stabilising pallet loads. Protects from weather and dust whilst in transit or storage. Sticks only to itself and not the wrapped items. All case quantities are per six except 100mm x 150mm which are per 48. (*Extended Core.)



All prices are per roll

Roll Size	Thickness (Micron)	Colour	Order Code AVN-837	Offer Price/1
100mm x 150m	17	Clear	-0520K *	£2.06
100mm x 150m	20	Clear	-0530K *	£2.27
100mm x 150m	22	Black	-0620K	£3.39
400mm x 300m	15	Clear	-0540K	£7.70
	17	Clear	-0550K	£8.49
	20	Clear	-0560K	£9.89
	25	Black	-0570K *	£12.59
	17	Red	-0580K *	£8.29
500mm x 300m	17	Blue	-0590K *	£8.29
	20	Clear	-0670K	£12.20
	35	Clear	-0660K	£9.69
500mm x 200m	35	Clear	-0660K	£9.69
400mm x 300m	17	Clear	-0600K *	£8.29
(Extended Core)	20	Clear	-0610K *	£9.20



High Yield Hand Stretch Wrap

Ideal for wrapping uniform shaped pallet loads where cost is a concern. The lower micron high yield stretch wrap will perform as well as higher micron blown stretch wrap on uniform low to medium weight pallet loads. Used to protect and stabilise pallet loads, prevents split deliveries and damage from weather and dust whilst in transit or storage. Sticks only to itself and not the wrapped items.



Roll Size (mm x m)	Thickness	Case Qty	Order Code AVN-837	Offer Price/1
400 x 300	12 Micron	6 rolls	-0700K	£4.85

Stretch Wrap Dispensers

Adjustable Dispenser
Strong, lightweight aluminium base and core cover. Can be adjusted from 12" to 20" with a foam grip handle. Capacities: stretch wrap width 12" to 20". Core sizes - 1½", 2" and 3".

Mini Dispenser

For use with 100mm x 150mm stretch wrap rolls.



Description	Order Code AVN-834	Offer Price/1
Standard Dispenser	-0130K	£19.90
Mini Dispenser	-0070K	£6.07
Adjustable Dispenser	-0110K	£23.99

Standard Dispenser
For 400/50mm stretch wrap on 38/50/75mm Core. Weight 1.45kg.



Machine Stretch Film

Cast film is extruded as a flat sheet, resulting in higher outputs than blown film extrusion. Cast film predominates in machine applications and generally has superior optical properties of clarity and gloss.

Standard Cast Film

Will stretch in excess of 140%. For use on standard wrapping machines.

Super Power Pre-Stretch Film

Will stretch in excess of 250% when used on a power pre-stretch machine.



Roll Size (Width x Length)	Thickness (Micron)	Order Code AVN-837	Offer Price/1
Standard			
500mm x 1550m	23	-0710K	£47.69
Super Power			
500mm x 1800m	20	-0720K	£52.19

Centrefold & Multifold Polythene Sheeting

Quality polythene sheeting ideal for virtually all needs including packaging, dust protection, floor protection and waterproofing. Superb all round quality polythene. Supplied folded on rolls for easy storage.



Sheet Width (Folded/Open)	Overall Length	Micron	Order Code AVN-837	Offer Price/1
1m/2m	300m	32	-0070K	£56.69
0.9m/1.8m	100m	50	-0080K	£33.99
0.5m/1m	100m	100	-0085K	£65.69
1m/2m	50m	125	-0090K	£43.19
1m/4m	50m	30	-0100K	£21.59
1m/4m	50m	65	-0110K	£41.49
1m/4m	25m	130	-0120K	£47.99
1m/4m	25m	200	-0125K	£61.79

Polythene Sheeting

65 micron polythene sheeting ideal for a multitude of tasks including packaging, dust protection, floor protection and waterproofing. Available in a choice of rolls of 750mm and 1M widths and roll length of 660M.



Size	Thickness (Micron)	Order Code AVN-837	Offer Price/1
660m/1m	65	-1700K	£97.70
660m/0.75m	65	-1710K	£75.83

Office Supplies & Stationery



Polythene Shrink Wrap

Centre Fold Sheeting - Type AS

Suitable for irregular and awkward shaped products, such as trolleys, trucks, machinery and furniture. Supplied centre folded on the roll.

Roll weight: 25kg.



All prices are per roll

Sheet Width (folded/open)	Film Thickness	Roll Length	Order Code AVN-837	Offer Price/1	Offer Price/3+
1.25/2.50m	125 micron	85m	-0020K	£119.99	£107.99
1.00/2.00m	125 micron	99m	-0025K	£110.99	£99.89
1.50/3.00m	150 micron	58m	-0050K	£106.99	£96.29

Ripack 2200 Shrink Gun (Gas)

Ripack 2200 heat gun complete with one double safety adjustable regulator and 8m propane type hose with swivel connector. Supplied in a robust plastic carry case. Ergonomical design with rotating nozzle and swivel hose connection to prevent twisting.

Fast heating on large areas. Short shrinking time reduces operating costs. Adjustable valved regulator to suit all kinds of film. Total gas safety: Guard and 'dead-man's trigger' device. Protected against internal overheating.



Description	Order Code	Offer Price/1
Gas Shrink Gun	PAC-834	£569.99

AVON Anti-Rust Paper Rolls

Corrosion inhibiting papers are a clean and convenient way of wrapping metal products to prevent the onset of corrosion. These papers are performance tested and approved to the German TL 8135-0002 standard.

VCI Paper: Volatile Corrosion Inhibitor (VCI) paper, VCI chemicals volatilize, attach themselves to metal and form a protective layer just a few molecules thick. This layer prevents humidity, salt, dirt from depositing on the metal and causing corrosion. For use with ferrous metals only.

MPI Paper: Superior multi-purpose corrosion inhibitor paper for use as a wrapper for all metals, e.g. ground rollers, or as an interleave for packing light components.

Size: 900mm x 200m.



Type	Order Code	Offer Price/1
VCI	AVN-830	£41.96
MPI	-1890K	£41.96
	-1900K	£57.69

Lay Flat Tubing - Type VH

Gusset shrink tubing. Quick and easy to use. For wrapping pallets of varying heights. Available in a choice of two sizes.

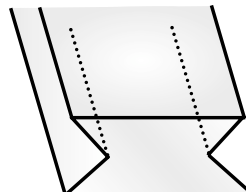

All prices are per roll

Roll Width Folded/Open	Film Thickness	Roll Length	Weight	Order Code AVN-837	Offer Price/1	Offer Price/3+
1.25/2.25m	125 micron	50m	27kg	-0030K	£162.50	£146.25
1.20/2.30m	200 micron	30m	26kg	-0040K	£162.50	£146.25

Shrink Gun (Gas)

For heat shrinking, shrink-wrapping around loads, pallets and parcels. Fitted with 'dead man's' trigger to prevent accidental operation, and nozzle heat protection cowl.

Gas pressure: 3bars (45psi).

Gas consumption: 5lb/hr (2kg/hr).

Heat variable: 20,000 BTU/lb (5.8kw).



Contents:

Gun, 6mm diameter high pressure LPG hose, oil, excess flow check valve, adjustable spanner and regulator and instructions.

Description	Order Code	Offer Price/1
Gas Shrink Gun	SHI-835	£299.00
Spares	SHI-835	
Replacement Ignitors	-0020K	£30.00
Replacement Electrode	-0030K	£14.00

Foam Rolls

Packaging foam material on a roll that gives excellent surface protection. Combined foam with polyethylene film to create a strong, lightweight, moisture repelling composite sheet. Gives excellent surface protection. Will not mark or contaminate products. Can be safely used to protect highly sensitive products. Superior protection against moisture and grease. Adds rigidity. Puncture resistance.



Width	Pack Qty	Order Code AVN-837	Offer Price/Pk	Order Code AVN-837	Offer Price/Pk
Gauge x Length:		1mm x 300m		2.5mm x 120m	
1500mm	1	-0140K	£78.74	-0220K	£70.99
1000mm	1	-0150K	£45.99	-0230K	£51.29
750mm	2	-0160K	£71.99	-0240K	£70.99
500mm	3	-0170K	£71.99	-0250K	£70.99
Gauge x Length:		1.5mm x 200m		4.0mm x 75m	
1500mm	1	-0180K	£82.99	-0260K	£70.99
1000mm	1	-0190K	£49.99	-0270K	£51.29
750mm	2	-0200K	£70.99	-0280K	£70.99
500mm	3	-0210K	£70.99	-0290K	£70.99

GROUP 838 TACKERS & STAPLERS - HEAVY-DUTY

TACWISE® Professional Hand Staple & Nail Tacker

Z1-140 Series

Fires 140 Series staples from 6 - 8mm. Tension adjustment. Handle lock down system. Bottom loading magazine. Staple refill window. Stainless steel belt clip. Margin edge adjuster.

Z3-140 Series

Fires 140 Series staples from 6-14mm, 15mm 18 gauge nails and 15mm 18 gauge headless pins. Tension adjustment. Handle lock down system. Bottom loading magazine. Staple refill window. Stainless steel belt clip. Margin edge adjuster.



Type	Capability	Order Code	Offer Price/1
Z1-140	6-8mm	-0020K	£15.26
Z3-140	6-14mm/15mm 18 gauge nails/15mm 18 gauge headless pins	-0050K	£22.91

Rexel Heavy-Duty Tacker

Robust metal housing. Loads No.23/6, No.23/8, No.23/10 or No.23/13 staples. Pulling handle prevents staples firing when locking down handle. Rear loading.

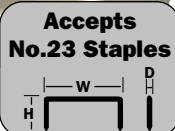

Description	Staple Size	Order Code	List Price/1	Offer Price/1
Heavy Duty	23/6, 8 23/10, 13	ACC-838	£34.99	£27.99

General-Purpose Tacker

Strong metal housing. Loads No.23/6, No.23/8 or No.23/10 staples. Pulling handle prevents staples firing when locking down handle. Rear loading.

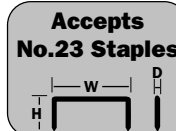

Description	Staple Size	Order Code	List Price/1	Offer Price/1
General	23/6,8,10	ACC-838	£24.99	£19.99

Rapid Heavy-Duty Tacker

Heavy-duty hand tacker. Very strong construction, hardened steel working parts. Fold down de-activated handle for safe storage. Capacity 84x type 140 staples 6 - 14mm. Adjustable impact power.

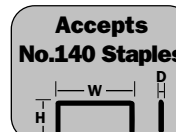

Model Number	Staple Size	Order Code	List Price/1	Offer Price/1
R34	140/6,8,10	-6100K	£32.94	£24.70

Staples to suit R34

Staple Type	Staple Size	Box Qty	Order Code	List Price/Pk	Offer Price/Pk
140	140/6	5000	-0190K	£6.39	£5.11
140	140/8	5000	-0200K	£7.39	£5.91
140	140/6	2000	-0210K	£3.29	£2.63
140	140/8	2000	-0220K	£3.40	£2.72
140	140/10	2000	-0230K	£3.79	£3.03

Arrow Multi-Purpose Staple Gun Kit

A multi-purpose, heavy-duty, jam-proof, all steel stapler that can be used on insulation, carpet padding, roofing felt and upholstery.

Kit contents:

T50 heavy-duty staple gun. T50 screen/ piggyback attachment. T50 wiring attachment. T50 window shade attachment. SL50 staple lifter. 1x pack of 1250 T50 staples - 1/4" (6mm). 1 pack of 1250 T50 staples - 3/8" (10mm). 1x pack of 1250 T50 - 17/32" (13mm) Ceiltile staples plus a sturdy moulded storage case.



Contents	Order Code	List Price/1	Offer Price/1
As Above	ARW-840	£45.10	£38.34

Heavy-Duty Chrome Staple Gun

Heavy-duty steel construction with a long lasting chrome finish. Easy squeeze handle with an anti-jam feature. Suitable for upholstery, wiring, roofing felt, screening, carpet adding etc. Accepts 4 - 14mm (5/32" - 9/16") staples - Arrow JT21.



SUPPLIED WITH 200 STAPLES

Description	Staple Size	Order Code	Offer Price/1
Heavy Duty	4-14mm	PRO-840	£11.99

Heavy-Duty Cable Tacker

Blister packed heavy-duty all steel cable tacker. Unique patented staple guiding system, adjustable impact power. Capacity 84x type 36 10 - 14mm, 14mm white finish and 14mm black finish cable staples. Designed to fix cables up to 6mm diameter.



Model Number	Order Code	Offer Price/1
R36	RPD-840	£37.48

Staples to suit Cable Tacker

Staple Type	Staple Size	Box Qty	Order Code	List Price/Pk	Offer Price/Pk
36	10mm	5000	-6300K	£16.29	£12.22
36	12mm	5000	-6320K	£17.99	£13.49

TACKERS & STAPLERS - HEAVY-DUTY

ARROW Hammer Tacker

Heavy-Duty
Accept 0.050" (T50 staples) x 5/16", 3/8", 1/2" and staples.

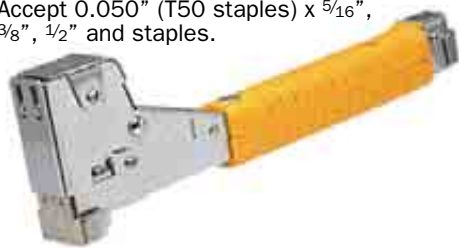

Model Number	For Staple Size	Order Code ARW-840	Offer Price/1
HT50P	0.050" - 1/2"	-0101B	£38.34
Staples to Suit			
3/8"	Box of 5000	-0228F	£8.20
3/4"	Box of 2400	-0105M	£17.20

Junior Staple Guns
Accept 0.030" x 1/4", 5/16" and 3/8" staples.

JT-21
Baked enamel.

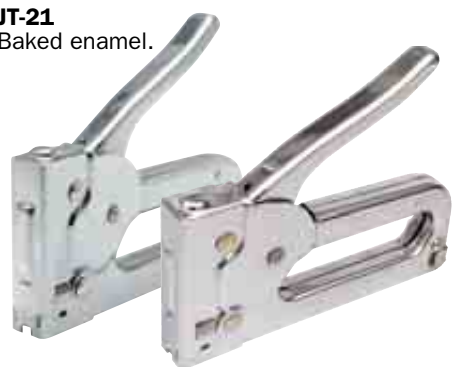

Model Number	For Staple Size	Order Code ARW-840	Offer Price/1
JT21	.030" - 3/8"	-0110B	£12.84
JT21C	.030" - 3/8"	-0111N	£13.77
Staples to Suit			
1/4"	Box of 5000	-0200G	£7.45
1/4"	Box of 1000	-0205P	£1.49
5/16"	Box of 5000	-0210H	£7.45
5/16"	Box of 1000	-0215Q	£1.48
3/8"	Box of 5000	-0220J	£8.45
3/8"	Box of 1000	-0225C	£1.69

Manual Carton Stapler

This easy-to-use hand operated carton stapler has been designed for accurate sealing of carton top flaps. Uses 32mm x 15 or 18mm staples. Four position staple depth adjustment. Supplied with free staple remover.



Uses No. 32 Staples

Staple Size (mm)	Order Code PAC-834	Offer Price/1
32 x 15 or 18	-0330K	£79.99

Multi-Purpose Tacker

Heavy-Duty
Accepts 0.050" x 1/4", 5/16", 3/8", 1/2", 9/16" and Ceiltile staples. Enamel finish.



Model Number	For Staple Size	Order Code ARW-840	Offer Price/1
T55	.050" to 9/16"	-0140E	£20.98
Staples to Suit			
3/8"	Box of 5000	-0228F	£8.20
1/4"	Box of 5000	-0230K	£7.45
1/4"	Box of 1250	-0235R	£1.86
5/16"	Box of 5000	-0240L	£7.55
5/16"	Box of 1250	-0245S	£1.89
3/8"	Box of 5000	-0250M	£8.45
3/8"	Box of 1250	-0255T	£2.11
9/16"	Box of 5000	-0270P	£10.20
9/16"	Box of 1250	-0275W	£2.55
1/2"	Box of 5000	-0260N	£9.25
1/2"	Box of 1250	-0265V	£2.31
17/32"	Box of 5000	-0119Q	£10.55

Hammer Tacker — Heavy-Duty

HTX50
Fitted with a surface guard flange to help reduce damage to breathable membrane, roofing felt and vapour barrier surfaces. Safety handle with an ergonomical soft rubber grip for comfortable all day use. The handle has a recessed area to protect your hand from scraping and also has a rear slip guard to help keep the tacker in your hand. Uses Arrow T50 staples 5/16" (8mm), 3/8" (10mm), 1/2" (12mm) sizes. All internal steel jam-proof construction.



Staple Type	Order Code ARW-840	List Price/1	Offer Price/1
T50	-0107R	£49.62	£42.18

TACWISE® A11 Hammer Tacker

Single handed operation. Rugged all-steel construction, rubber grip for comfort and durable chrome finish. Uses type 140 staples, 6 to 10mm.



Staple Type	Order Code RAP-838	List Price/1	Offer Price/1
No.140	-0070K	£34.95	£27.96

Rapid Hand Tacker - Ergonomic

Ergonomic hand tacker, blister packed. Capacity 156 type 53 staples x 4, 6, 8 and 10mm. Handle deactivates and locks down for safe storage. Heavy-duty ABS outer body, with hardened all-steel working parts combines light weight with a staple magazine for long working life.



Model Number	Order Code RPD-840	Offer Price/1
R53E	-6200K	£12.29
Staples to Suit		
53/6 (Box quantity 5000)	-6400K	£4.27
53/8 (Box quantity 5000)	-6420K	£4.64

Rexel Economy Tacker

Durable plastic housing, loads No.23/6 or No.23/8 staples. Pulling handle prevents staples firing when locking down handle, ruler on bottom, rear loading.



Model	Order Code ACC-838	Offer Price/1
Economy	-0010K	£9.67

Light-Duty Tacker

Durable metal housing. Loads No.23/6 or No.23/8 staples. Pulling handle prevents staples firing when locking down handle. Rear loading.

NEW

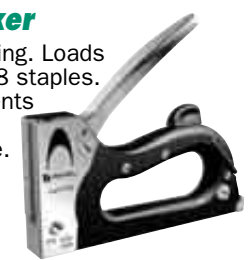

Staple Type	Order Code ACC-838	List Price/1	Offer Price/1
No.23/6 or No.23/8	-0020K	£15.99	£12.79

Rapid Hammer Tacker

Powerful and durable hammer tacker for heavy-duty stapling of insulation materials, lining paper, roofing felt, fitted carpets etc.



Product Number	Order Code RPD-840	List Price/1	Offer Price/1
R11	-6010K	£41.40	£31.05

Staples to suit R11 (Box 5000).

Staple Type	Order Code RPD-840	List Price/1	Offer Price/1
R11	-6510K	£6.99	£5.24

R3 Pro Staple Remover

All metal construction with vice grip. Used for removal of both staple legs. **Size (L x W):** 200 x 31mm.



Staple Type	Order Code RAP-838	List Price/1	Offer Price/1
No.40	-0060K	£8.49	£6.79

CONTRACT PRICES AVAILABLE FOR VOLUME PURCHASES

All Prices Exclude V.A.T. © 2011

GROUP 838 STAPLERS & STAPLES - OFFICE

Offis Half Strip Stapler

Half strip stapler with metal base. Opens fully for tacking. Top loading. Staples up to 15 80gsm sheets at once.

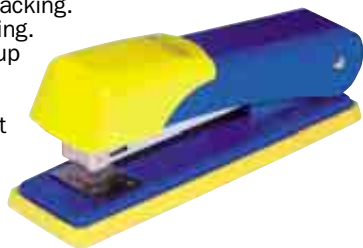

Strip	Base	Colour	Order Code	Offer Price/1
Half	Plastic	Blue/Yellow	-0040K	£1.38

Stand-Up & Desktop Staplers

Ergonomically designed with contoured rubber grip for comfortable use. The stand-up feature gives a smaller footprint on the desktop and makes them easy to locate. Capacity: 25 sheets.



Type	Order Code	Offer Price/1
Large Stand-up Full Strip	-0050K	£1.49
Medium Stand-up Half Strip	-0060K	£1.39

Rexel Gazelle Stapler

Sheet capacity 20/25, throat depth 48mm. Full rubber base.



Colour	Order Code	Offer Price/1
Silver/Black	-0100K	£8.31
Black	-0110K	£8.31

56 Office Plier Stapler

All-metal body with contoured plastic cover and soft feel handle. Loads 100 No.56 (26/6) or 84 No.16 (24/6) staples. Staples up to 25 sheets 80gsm paper. Hook for optional security cable. Suitable for stapling office reports and jiffy bags.



Model	Order Code	List Price/1	Offer Price/1
56 Plier Stapler	-0200K	£19.99	£15.99

Staplers

Accepts 26/6 staples. **Half Strip** metal base with full rubber grip, single anvil and plastic cover. **Full Strip** all plastic or metal base with rubber feet and double anvil.



Strip	Base	Colour	Order Code	Offer Price/1
Full	Plastic	Black	-8215K	£1.49

RAPESCO See-Through Stapler

See-through stapler with easy top-loading and safety lockback feature. Pring roller mechanism. Takes Rapesco 26/6 and 24/6mm staples with supply indicator. Capacity upto 20 sheets. Full metal chassis and rubber feet. Staples supplied in storage chamber.



Type	Order Code	Offer Price/1
Half Stapler	RAP-838	£3.27

Gazelle Stapler with Docking Station

Keep your stapler close at hand with this innovative docking station. Comes complete with Gazelle stapler, 1,000 No.56 staples, staple remover and docking station.



Colour	Order Code	Offer Price/1
Silver/Black	-0120K	£9.25

Meteor Stapler

New design with soft rubber cap and base. Half strip stapler for general office use. Uses No. 56 (26/6mm) staples. Capacity up to 25 sheets of paper. Throat depth of 55mm. Simple and quick auto top loading of staples.



Colour	Order Code	Offer Price/1
Black	-0400K	£6.26

Rexel Matador Stapler

Britain's favourite half strip stapler. Hard wearing stapler - will last for years and years. Easy automatic pull back loading. Staples up to 25 sheets of paper at a time.



Colour	Order Code	Offer Price/1
Silver/Black	-0140K	£11.99
Silver/Blue	-0150K	£11.99
Black	-0160K	£11.99

Staples

No. 26 Staples
Standard 26/6 staples suitable for most desk staplers. Boxed in 5000s.



Quantity	Order Code	Offer Price/Pk
Box of 5000	-0040K	£1.35

RAPESCO Spinna Full Strip Stapler

Executive, heavy duty full strip front loading stapler. Magazine release button for easy full strip loading. Magazine safety brake system. Adjustable paper guide/margin edge adjuster. All steel chassis. Dimensions (L x W): 190 x 47mm.



Takes 26/6-8mm and 24/6-8mm staples. Maximum 50 sheets.

Capacity	Order Code	Offer Price/Pk
50 Sheet	-0080K	£13.80

Whale Stapling Pliers

Tough metal construction, with top loading spring mechanism. Throat depth 53mm. Dimensions (L x W): 170 x 31mm. Takes 26/6-8mm and 24/6-8mm staples. Maximum 50 sheets.



Capacity	Order Code	Offer Price/Pk
50 Sheets	-0130K	£13.16

Office Supplies & Stationery

RAPESCO® X5 Half Strip Stapler

Half strip, front loading stapler. Personalisation window. Dimensions (L x W): 131 x 41mm. Takes 26/6mm and 24/6mm staples. Maximum 15 sheets.



Capacity	Order Code	Offer Price/1
15 sheets	RAP-838	£8.36

Luna Half Strip Stapler

Executive, heavy-duty half strip front loading stapler. Magazine release button for easy full strip loading. Magazine safety brake system to control the ejection of the front loading magazine. All steel chassis. Dimensions (L x W): 163 x 44mm. Takes 26/6-8mm and 24/6-8mm staples. Maximum 50 sheets.



Capacity	Order Code	Offer Price/1
50 sheets	RAP-838	£11.48

Turtle Stapling Pliers

Tough metal construction, with top loading spring mechanism. Throat depth 48mm. Dimensions (L x W): 170 x 29mm. Takes 21/4mm staples. Maximum 12 sheets.



Capacity	Order Code	Offer Price/1
12 sheets	RAP-838	£9.08

Stapler & Hole Punch Set

P20 Stapler: Stylish premium quality half strip ABS stapler. Easy top loading. Safety lock back feature. Full rubber base with personalisation window. Takes 26/6mm and 24/6mm staples. Maximum 20 sheets.
P30 Punch: 2-hole punch in matching design to P20 Shimma Stapler. Stylish premium quality ABS design. Handle safety lock-down switch for easy storage. Neat open flap confetti tray. Adjustable calibrated paper guide. Maximum 30 sheets.



Description	Order Code	Offer Price/1
Set	RAP-838	£8.76

Rexel® Goliath Stapler

Rear loading heavy duty. Loads 6mm and 8mm staples.



Description	Order Code	Offer Price/1
Heavy Duty	ACC-838	£37.59

Odyssey Heavy-Duty Stapler

Robust heavy-duty stapler which staples up to 60 sheets of 80gsm paper. Sleek silver finish. Includes 500 free staples.



Description	Colour	Order Code	Offer Price/1
Heavy Duty Stapler	Silver	ACC-838	£26.39
Odyssey Staples (2500)	-	-0360K	£5.99

Long Reach Stapler

Full strip top load stapler. Loads 210 No.56 (26/6) or 168 No.16 (24/6) staples. Throat depth 308mm. Pins and staples up to 15 sheets of 80gsm paper.



Description	Colour	Order Code	Offer Price/1
Long Reach Stapler	Black	ACC-838	£17.59

Staple Range

Rexel staples are precision engineered to the highest standards of quality and performance.



Product Number	Pack Quantity	Order Code	Offer Price/Pk
23 (23/8)	1000	-0050K	£1.76
23 (23/13)	1000	-0060K	£2.40

Product Number	Pack Quantity	Order Code	Offer Price/Pk
18 (24/8)	5000	-0290K	£7.19
56 (26/6)	5000	-0320K	£1.72
56 (26/6)	1000	-0310K	£0.88
66 (66/8)	5000	-0300K	£13.80
66 (66/11)	5000	-0330K	£14.52
66 (66/14)	5000	-0340K	£16.40
73 (73/10)	5000	-0350K	£13.80

Trojan Plier Stapler

Heavy-duty plier style stapler with compound lever action for easy single handed use. All-metal construction with extremely durable hammer finish top cover and chrome plated mechanism. Suitable for stapling card, padded envelopes, fabric and other materials.



For use with No. 73 staples (11mm wide by 6, 8 or 10mm long).

Description	Staples Used	Order Code	Offer Price/1
Trojan Heavy Duty	No. 73	-0410K	£39.99

Plier Stapler - Full Strip

Rear loading heavy-duty. Loads 6mm and 8mm staples.



Description	Order Code	Offer Price/1
Plier Stapler	CTL-838	£17.42
80/8 Staples (Pk 5000)	-0020K	£6.37

RAPESCO® Staple Extractor

Crocodile type with easy to grip plastic wings and strong steel spring.



Description	Order Code	Offer Price/1
Staple Extractor	RAP-838	£0.52

Staple Range

Precision engineered to the finest tolerances, all Rapesco staples are produced from premium quality raw materials to ensure accurate stapling performance time after time.



Type/Size (mm)	Pack Qty	Order Code	Offer Price/Pk
23/10	1000	-0020K	£5.43
23/8	4000	-0040K	£1.16
13/8	5000	-0300K	£4.39
13/10	5000	-0310K	£4.95
140/12	2000	-0240K	£3.16
140/14	2000	-0250K	£3.59
53/6	2000	-0260K	£1.59
53/8	2000	-0270K	£1.75
32/15	2000	-0150K	£5.88
32/18	2000	-0160K	£6.82
73/12	5000	-0170K	£6.67
80/10	10000	-0180K	£9.64

CONTRACT PRICES AVAILABLE FOR VOLUME PURCHASES

All Prices Exclude V.A.T. © 2011

Offis Paper Hole Punches

Competitively priced paper hole punches with adjustable paper guides to accept different paper sizes. Robust metal construction. Large handles for extra leverage and reduced effort in use. Waste is retained in base compartment with removable 'confetti tray'.

Three different sizes available:

PHP210 punches two holes in up to 10 sheets.

PHP218 punches two holes in up to 18 sheets.

PHP418 punches four holes in up to 18 sheets.



- 0020K

Model Number	Type	Sheet Capacity	Order Code OFI-838	Offer Price/1
PHP210	2-Hole	10	-0010K	£0.49
PHP218	2-Hole	18	-0020K	£0.99
PHP418	4-Hole	18	-0030K	£1.99

Rexel Premium 2-Hole Punches

Unique paper alignment indicator - ensures accurate punching every time

Retractable paper size guide showing all European paper sizes

Soft feel materials incorporated into the punch

Name plate facility for personalisation

Special hinged confetti hatch

Paper size window

Angled base for easy paper insertion

Handle hold down feature for clear desk policies



P215

Model Number	Sheet Capacity	Colour	Order Code ACC-838	Offer Price/1
P215	15	Silver/Black	-0420K	£6.95
		Silver/Blue	-0430K	£6.95
		Black	-0440K	£6.95
P225	25	Silver/Black	-0450K	£8.96
		Silver/Blue	-0460K	£8.96

Heavy-Duty Hole Punch

Heavy-duty hole punch with retractable paper size guide to accept A4, A5 and A6. Robust metal construction with large handle to enable ease of use. Punches up to 30 sheets with two holes. Waste is retained in base compartment with removable plastic 'confetti tray'.



Model	Sheet Capacity	Order Code FIV-838	List Price/1	Offer Price/1
Heavy Duty Hole Punch	30	-0010K	£9.98	£3.99

Walkie Talkies

2-Way Walkie Talkies

Pack of two eight channel handsets with a frequency range of up to 5km. Features include backlit LCD display for use in dark or poorly lit areas, auto power save, audible alert tone, on/off/volume knob and plastic belt clip. Each handset comes complete with four AAA Nimh rechargeable batteries and mains charger unit.



PACK OF 2

COMPLETE WITH BATTERIES & MAINS CHARGER UNITS

Type	Order Code PRO-785	Offer Price/1
2-Way Walkie Talkies (Pk 2)	-0004A	£38.99

Telephone Extension Accessories

15m double socket extension lead, double socket, 5m extension lead, 15m extension lead.

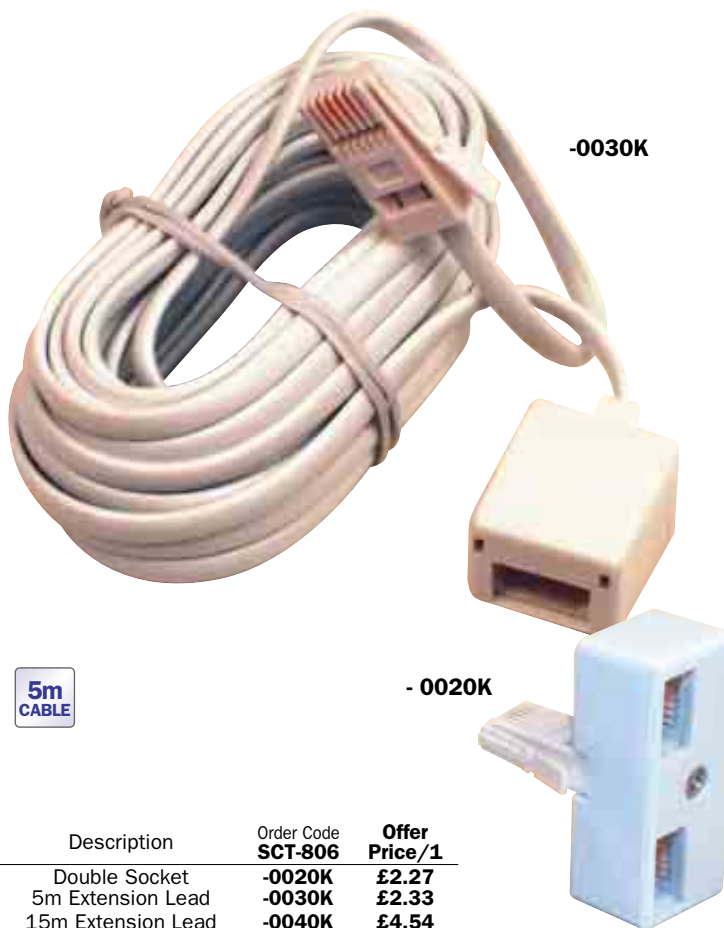

-0030K

5m CABLE

- 0020K

Description	Order Code SCT-806	Offer Price/1
Double Socket	-0020K	£2.27
5m Extension Lead	-0030K	£2.33
15m Extension Lead	-0040K	£4.54

office basics Inkjet Cartridges

EXTENDED RANGE

Welcome to Office Basics. A range of compatible, replacement inkjet and laser toner cartridges for a wide range of Inkjet and Laser Printers. Every product is manufactured to the highest possible standard, at a fraction of the price!



Manufacturer's Code	Compatibility	Colour	Printer Model	Order Code OBC-839	Offer Price/1
OB-IT040140	Epson T040140	Black	Epson Stylus C62/CX3200/CX3250	-0060K	£2.69
OB-IT040140	Epson T040140	Colour	Epson Stylus C62/CX3200	-0070K	£3.49
OB-CL3T044140	Epson T044140	Black	Epson C64/C84/C86/CX6400	-0080K	£2.89
OB-IT071240	Epson T071140	Black	Epson Stylus D78	-0190K	£4.30
OB-IT071140	Epson T071240	Cyan	DX4000/DX4050/	-0200K	£4.30
OB-IT071340	Epson T071340	Magenta	DX5000/DX5050/	-0210K	£4.30
OB-IT071440	Epson T071440	Yellow	DX6000/DX6050	-0220K	£4.30
OB-IT061240	Epson T061140	Black	Epson Stylus D88	-0230K	£3.39
OB-IT061140	Epson T061240	Cyan		-0240K	£3.39
OB-IT061340	Epson T061340	Magenta		-0250K	£3.39
OB-IT061440	Epson T061440	Yellow		-0260K	£3.39
OB-IT051140	Epson T051140	Black	Epson Stylus Colour 740/760/800/850/860/1160/1520	-0550K	£2.99
OB-ILC1000BK	Brother LC1000BK	Black	Brother DCP130C/330C/350C/540CN/560CN/750CW/770CW/MFC240C/440CN/660CN/845CW/885CW/3360C/465CN/5460CN/5860CN	-0620K	£4.29
OB-ILC1000C	Brother LC1000C	Cyan		-0630K	£3.59
OB-ILC1000M	Brother LC1000M	Magenta		-0640K	£3.59
OB-ILC1000Y	Brother LC1000Y	Yellow		-0650K	£3.59

Manufacturer's Code	Compatibility	Colour	Printer Model	Order Code OBC-839	Offer Price/1
OB-I45A	HP 51645A	Black	HP Deskjet 710C/815C/820/850/870/880/995/1100/1220/1600	-0950K	£4.99
OB-I78A	HP C6578A	Colour	HP DeskJet 970CXI/P1000 Photosmart	-0960K	£10.99
OB-I15D	HP C6615D	Black	HP DeskJet 810C/840/843C/845C/940C/3822 Series/PSC750/950/500	-0970K	£4.99
OB-I6625A	HP C6625A	Colour	HP DeskJet 816C/825C/840/C843C/845C	-1000K	£11.99
OB-I4844A	HP C4844A	Black	HP No10 DJ1700/2000/2200/2500/2600/3000	-1010K	£8.89
OB-I4836A	HP C4836A	Cyan	HP No11 DJ1700/2200/2600	-1020K	£8.99
OB-I4837A	HP C4837A	Magenta		-1030K	£8.99
OB-I6656A	HP C6656A	Black	P Dheskjet 450C/5500/5600/OfficeJet 6110/PSC1205/1210/2100/2510	-1070K	£8.99
OB-I6657A	HP C6657A	Colour		-1080K	£13.99
OB-I8727A	HP C8727A	Black	HP Deskjet 3320/3325/3420/3425	-1090K	£10.19
OB-I8728A	HP C8728A	Colour		-1100K	£16.29
OB-I8767EE	HP C8767EE	Black	HP No339 Photosmart 8150/8450	-1110K	£13.69
OB-I9363EE	HP C9363EE	Colour	HP No344 5740/5745	-1120K	£16.69

Laser Toner Cartridges

Welcome to Office Basics. A range of compatible, replacement inkjet and laser toner cartridges for a wide range of inkjet and laser printers. Every product is manufactured to the highest possible standard, at a fraction of the price!

EXTENDED RANGE



Manufacturer's Code	Compatibility	Colour	Printer Model	Order Code OBC-839	Offer Price/1
OB-T3313A	Panasonic Imaging Unit UG3313		Panasonic UF550/560/770/880/885/895	-1430K	£49.99
OB-T98A	HP 92298A	Black	HP LaserJet Series 4/4+/	-1450K	£27.91
OB-TQ2612A	HP Q2612A	Black	HP LaserJet 1010/1012/1015	-1500K	£32.99
OB-T27X	HP C4127X	Black	HP Laserjet 4000/4050	-1610K	£35.99
OB-TQ7553X	HP Q7553X	Black	HP Laserjet P2015	-1700K	£54.99
OB-TQ6000A	HP Q6000A	Black	HP Colour Laserjet 1600/2600	-1790K	£47.99
OB-TQ6001A	HP Q6001A	Cyan		-1800K	£42.99
OB-TQ6003A	HP Q6003A	Magenta		-1810K	£42.99
OB-TQ6002A	HP Q6002A	Yellow		-1820K	£42.99

CONTRACT PRICES AVAILABLE FOR VOLUME PURCHASES

All Prices Exclude V.A.T. © 2011

Office Supplies & Stationery

GROUP 839 TONER & INKJET CARTRIDGES



HP printer supplies are part of a complete precision printing system. HP has designed HP LaserJet printers, HP toner cartridges and HP media to interact with optimal compatibility during the printing process to ensure that you get results that are always clear, always sharp.



Please note that these products may be subject to price fluctuations - Ring now for our Best Price



Product Number	Printer Model	Description	Order Code HEW-839	Offer Price/1
C7115A	HP LaserJet 1000W/1200/1220/3300	Black Laser Cartridge	-1680K	£67.95
C8061X	HP LaserJet 4100/4100MFP	Black Laser Cartridge	-1690K	£140.95
C4092A	HP LaserJet 1100/A	Black Toner	-1990K	£65.29
C4096A	HP LaserJet 2100 Series	Black Toner	-2000K	£110.73
C4127A		Black Toner	-1620K	£109.80
C4127X	HP LaserJet 4000/N/T/4050/N/T/TN	Black High Capacity Toner	-2010K	£140.95
C4129X	HP LaserJet 5000/GN/N	Black Toner	-1630K	£180.85
C3903A	HP LaserJet 5MP/5P/6MP/6P	Black Toner	-1870K	£99.24
C8061A	HP LaserJet 4100/4101	Black Laser Cartridge	-1720K	£109.91
C9700A	HP Colour LaserJet 1500/2500	Black Toner Cartridge	-0120K	£91.44
CB542A		Yellow Print Cartridge/ColorSphere Toner	-1390K	£71.29
CB543A		Magenta Print Cartridge/ColorSphere Toner	-1400K	£71.29
CB541A	CP1215/CP1515/CP1518	Cyan Print Cartridge/ColorSphere Toner	-1410K	£71.29
CB540A		Black Print Cartridge/ColorSphere Toner	-1420K	£77.99
CB435A	LaserJet P1005/P1006	Black Print Cartridge/Smart Printing Technology	-1430K	£57.72
CC364A	LaserJet P4014/P4015/P4515	Black Print Cartridge	-1540K	£137.29
CC530A		Black Print Cartridge	-2310K	£144.30
CC533A		Magenta Print Cartridge	-2320K	£135.46
CC532A	LaserJet CP2025	Yellow Print Cartridge	-2330K	£135.46
CC531A		Cyan Print Cartridge	-2340K	£135.46
HPC3906A	LaserJet 3100/3150/5L/6L	Black Print Cartridge	-1880K	£75.11
HPQ7582A		Yellow Print Cartridge/ColorSphere Toner	-1440K	£187.93
HPQ7581A	HP Colour LaserJet 3800	Cyan Print Cartridge/ColorSphere Toner	-1450K	£187.93
HPQ7583A		Magenta Print Cartridge/ColorSphere Toner	-1460K	£187.93
CB436A	LaserJet P1505/MF 1120MFP/M1522MFP	Black Print Cartridge/Smart Printing Technology	-1570K	£62.99
Q2670A		Black Toner Cartridge	-0010K	£144.64
Q2671A		Cyan Toner Cartridge	-0020K	£143.80
Q2672A	HP Colour LaserJet 3500/3550	Yellow Toner Cartridge	-0030K	£143.80
Q2673A		Magenta Toner Cartridge	-0040K	£143.80
Q5942A	HP LaserJet 4250/4350	Black Smart Cartridge	-0100K	£162.91
C9720A		Black Toner Cartridge	-0160K	£171.13
C9721A		Cyan Toner Cartridge	-0170K	£231.55
C9723A	HP Colour LaserJet 4600/4610/4650	Magenta Toner Cartridge	-0180K	£231.55
C9722A		Yellow Toner Cartridge	-0190K	£231.55
C7115X	HP LaserJet Series 1200/1220/3300	Black Laser Cartridge	-0240K	£84.73
Q2612A	HP LaserJet 1010/1012/1020/1022	Black Toner Cartridge	-0450K	£77.18
Q1338A	HP LaserJet 4200	Black Printer Cartridge	-0470K	£169.13
Q2610A	HP LaserJet 2300L/2300	Black Smart Cartridge	-0480K	£132.55
Q2613A	HP LaserJet 1300	Black Toner Cartridge	-0520K	£78.85
Q5949A	HP LaserJet 1320	Black Toner Cartridge	-0530K	£78.85
Q6511A	HP LaserJet 2400/2410/1420/2420D/ 2420DN/2420N/2430 DTN/2430N/ 2430T/2430TN	Black Toner Cartridge	-0550K	£136.79
Q5949X	HP LaserJet 1320	Black Smart Cartridge	-0610K	£144.29
Q3960A		Black Laser Cartridge	-0840K	£91.44
Q3961A		Cyan Laser Cartridge	-0850K	£110.15
Q3962A	HP LaserJet 2550/2820/2840	Yellow Laser Cartridge	-0860K	£110.15
Q3963A		Magenta Laser Cartridge	-0870K	£110.15
Q3964A		Imaging Drum	-0880K	£94.38
Q6000A		Black Laser Cartridge	-0890K	£83.99
Q6001A		Cyan Laser Cartridge	-0900K	£91.44
Q6002A	HP LaserJet 2600N	Yellow Laser Cartridge	-0910K	£91.44
Q6003A		Magenta Laser Cartridge	-0920K	£91.44
92298A	HP LaserJet 4/4M/4+/4M+/5/5M/5N	Black Toner	-1970K	£116.27
Q7553A	HP LaserJet P2015	Black Toner Cartridge	-1020K	£88.93
Q5942X	HP LaserJet 4250/4350	Black Print Cartridge	-1060K	£249.16
Q6460A	HP LaserJet Series 4730	Black Print Cartridge	-1090K	£155.20
CB336EE	HP 350XL	Black Inkjet Print Cartridge/Vivera Ink	-1520K	£29.52
CB338EE	HP 351XL	Tri-colour Inkjet Print Cartridge/Vivera Inks	-1530K	£32.20
C9701A		Cyan LaserJet smart print cartridge	-0130K	£110.15
C9702A	LaserJet 2500 series	Yellow LaserJet smart print cartridge	-0140K	£110.15
C9703A		Magenta LaserJet smart print cartridge	-0150K	£110.15
Q6471A		Cyan Laser Cartridge	-0940K	£144.95
Q6472A	HP LaserJet 3600/3600DN/3600N	Yellow Laser Cartridge	-0950K	£144.95
Q6473A		Magenta Laser Cartridge	-0960K	£144.95
Q6470A	HP LaserJet 3600/3800	Black Laser Cartridge	-0970K	£145.95
Q7560A		Black Print Cartridge	-1180K	£148.49
Q7561A		Cyan Print Cartridge	-1190K	£142.62
Q7562A	HP LaserJet 3000 Series	Yellow Print Cartridge	-1200K	£142.62
Q7563A		Magenta Print Cartridge	-1210K	£142.62

Inkjet Cartridges

Product Number	Printer Model	Description	Order Code HEW-839	Offer Price/1
C4841A		(No.10) Large 69ml Cyan	-2020K	£31.99
C4842A		(No.10) Large 69ml Yellow	-2030K	£31.99
C4843A	HP2000C/CN/2500C/CM	(No.10) Large 69ml Magenta	-2040K	£31.99
C4844A		(No.10) Large 69ml Black	-2050K	£30.38
C4838A		Yellow	-1670K	£30.69
C4837A	Business Inkjet 10PS/20PS/50PS/2200/ 2250/2600	(No.11) 28ml Magenta	-1660K	£30.69
C4836A		Cyan	-1650K	£30.69
C4811A		Cyan	-1780K	£31.69
C4812A		Magenta	-1790K	£31.69
C4813A	DesignJet 10PS/20PS/50PS/2200/2250/2600	(No.11 Printhead) Yellow	-1800K	£31.69
C4810A		Black	-1810K	£31.69

Office Supplies & Stationery

HP Inkjet Cartridges con't

Product Number	Printer Model	Description	Order Code HEW-839	Offer Price/Pk
C4909AE C4907AE C4908AE C4906AE	OfficeJet Pro 8000/8500	(No.940XL) Yellow Cyan Yellow Black	-2390K -2400K -2410K -2420K	£19.06 £19.06 £19.06 £29.48
C6578D	DesignJet 930C/950C/970CXi/1220C/ Officejet G55/85/95	(No.78) 19ml 3 Colour	-2060K	£30.98
C6615N	DeskJet 810C/830C/840C/843C/845C/920C/ 940C/OfficeJet V40/V45/S110	(No.15) 14ml Black	-2090K	£16.54
C6615D	DeskJet 810C/830C/840C/843C/845C/ 920C/940C/OfficeJet V40/V45/S110	(No.15) 25ml Black	-2080K	£26.68
C6625A	DeskJet 840C/843C/845C/920CX/V40/V45	(No.17) 15ml 3 Colour	-2100K	£39.35
C1823D	DJ710C/720/880C/890C/1120C	(No.23) 30ml Colour	-1960K	£31.98
51626A	DeskJet 400/500 Series, DesignJet 200 Series/660	(No.26) 40ml Black	-1890K	£30.99
51629A	DeskJet 600/660C/670C/690C/695C DW600/ 660C/OJ590/635/700 Series	(No.29) 40ml Black	-1900K	£30.60
51640A	DJ1200/C/PS, DesignJet 200/300/600 Series	(No.40) Black	-1910K	£28.85
51645A	DeskJet 700/800 Series/DJ1100C/ 1120C/1600 Series	(No.45) 42ml Black	-1930K	£28.40
51649A	Colour DeskJet 600 Series/DW600/660C/ OJ700 Series	(No.49) 3 Colour	-1950K	£31.99
C6656A	DeskJet SS50/SS52/Photosmart 7150/7350/ PSC 2110/2115/2210/DeskJet 450	(No.56) 19ml Black	-1710K	£18.82
C6657A	DeskJet SS50/SS52/Photosmart P100/ PS7150/PS7350	(No.57) 17ml 3 Colour	-1700K	£30.95
C6578A	DeskJet 930C/950C/970CXi/1220C/ OfficeJet G55/85/95	(No.78) 38ml 3 Colour	-1580K	£56.30
C6658A	Photosmart P100/130/230/2410/7150/7260/ 7350/7550/7660/7760/7960	(No.58) 17ml 3 Colour	-1730K	£23.48
C5010DE C5011DE	OfficeJet D125X/D135/D145/D150xi/D155xi/ 7110/7130/7140xi	(No.14) 23ml 3 Colour Black	-1740K -1750K	£27.65 £21.29
C8719EE	Photosmart 3110/3210/3310/8250/C5180/ C6180/C7180/D6160/D7160/D7360	(No.363XL) Black	-1220K	£29.49
C8727AE C8721EE	DeskJet 3320/3420	(No.27) 10ml Black Black	-1760K -2210K	£17.49 £14.18
C8771EE C8772EE C8773EE C8774EE C8775EE	Photosmart 3110/3210/3310/8250/C5180/ C6180/C6270/C6280/C6285/C7180/C7280/ C8180/D6160/D7160/D7260/D7360/D7460	(No.363) Cyan Magenta Yellow Light Cyan Light Magenta	-2220K -2230K -2240K -2250K -2260K	£9.54 £9.54 £9.54 £9.54 £9.54
C8728AE C8765EE	DeskJet 3320/3420/3550/3650/5100	(No.28) 3 Colour Black	-1770K -1820K	£20.31 £18.48
C8767EE C8766EE	DeskJet 6540D/6540/5740/6840/ OfficeJet 7410/6210/Photosmart 8150/8450	(No.338) 11ml (No.339) 21ml (No.343) 7ml 3 Colour	-1830K -1840K	£27.77 £21.57
C9363EE C9369EE	DeskJet 6540/5740/6840	(No.344) 14ml 3 Colour 3 Colour	-1850K -1860K	£30.94 £23.66
C9381A C9382A	OfficeJet Pro K550/L7550/L7580/L7600/ L7680/L7700	(No.88) Black/ Yellow Print Head Magenta/ Cyan Print Head	-1260K -1250K	£49.99 £49.99
C9385A	OfficeJet Pro K550/L7550/L7580/L7600/ L7680/L7700	(No.88) 20.5ml Black	-1290K	£17.82
C9386A C9388A C9387A	OfficeJet Pro K550/L7550/L7580/L7600/ L7680/L7700	(No.88) 10ml Cyan Yellow Magenta	-1270K -1280K -1300K	£13.49 £13.49 £13.35
C9396A C9392A C9391A C9393A	OfficeJet Pro Series K550/K5400/ L7580/L7680/L7780	(No.88) 58ml Black Magenta Cyan Yellow	-0980K -0990K -1000K -1010K	£29.94 £21.25 £21.25 £21.25
C9362EE C9361EE	DeskJet 5420/5440/5440xi/5442/5443	(No.336) (No.342) Black 3 Colour	-0570K -0580K	£14.05 £16.11
C9351AE C9352AE	DeskJet 3920/3940/PSC1410	(No.21) 5ml (No.22) 5ml Black 3 Colour	-0730K -0740K	£13.78 £15.74
C9370A C9371A C9372A C9373A C9374A	HP DesignJet T610/T620/T770/T1100/ T1200/T1200HD	(No.72) 130ml Black Cyan Magenta Yellow Grey	-2110K -2120K -2130K -2140K -2150K	£58.86 £58.86 £58.86 £58.86 £58.86
C9502AE	DeskJet 450/450CBI/450I/5150/5550/5552/ 5600/5650/5850/9600/9650/9670/9680 9680 Series/Digital Copier 410 Series/ OfficeJet 4110/4110V/4110XI	(No.56) 2 x 19ml Black	-0750K	£33.42
C9503AE	DeskJet 450C/5550 Series/5100/5600 Series/ 5850/OfficeJet 4105/4110/4215/4219/4255/ PSC 310/Series/5505/5510/5515/ 5550 Series/6110/PSC 1100/1100/ 1200 Series/1210 Series/1210 Series/ 2100/2200 Series/Copier 410/PSC2410/2510	(No.57) 2 x 17ml Colour	-0760K	£49.85
C9504EE C9505EE	DeskJet 5740/5745/5940/6540/6620/ 6840/9800	(No.339) 2 x 21ml (No.344) 2 x 21ml Black 3 Colour	-0770K -0780K	£45.75 £50.18
C9364E	DeskJet 5940/6940/6980/D4160/ OfficeJet 6310/6315	(No.337) 11ml Black	-1120K	£18.48
CB304AE CB331EE	Photosmart A516/A432/A433	(No.110) 5ml 3 Colour	-1170K	£19.95
CB332EE	DesignJet 6520/6540d/6620/6540/5740/ 6840/Photosmart 370/2610/2710/8150/8450/ OfficeJet 7210/7310/7410/6210/9800/ PSC1510/1610/2355/2550/2570	(No.338) (No.343) 2 x 7ml 3 Colour	-1130K -1140K	£30.99 £35.85
CB335EE CB337EE	OfficeJet J5780/J5785 MFC/DeskJet 4260 OfficeJet J5780/J5785 MFC/DeskJet 4260	(No.350) (No.351) Black 3 Colour	-1240K -1230K	£14.05 £16.11
CC640E CC643E	HP DeskJet D1660/D2560/D2660/D5560/ F2420/F2480/F2492/F4210/F4224/F4272/ HP Photosmart C4670/C4680/C4685/C4780 F4280/F4580/	(No.300) Black 3 Colour	-2270K -2280K	£11.35 £13.49
C4913A C4911A C4912A	DesignJet 500/500PS/800/800PS	(No.82) 269ml Yellow Cyan Magenta	-0360K -0370K -0380K	£33.23 £33.23 £33.23

Office Supplies & Stationery

EPSON® Inkjet Cartridges

Epson inkjet cartridges are tested to the highest standards to ensure a first class performance on a day to day basis. Epson's specially developed inks penetrate and dry faster than conventional inks - drying in less than a tenth of a second, therefore eliminating smudging and wet output.

Please note that these products may be subject to price fluctuations - Ring now for our Best Price



EPSON® Printer & Type Ribbons

A range of ribbons to suit the most popular printers and typewriters. This is a small selection of a wide range of ribbons, so if your machine is not listed please call us. We will match your printer or typewriter to the correct ribbon.

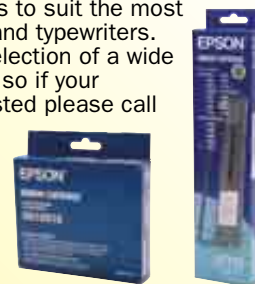

Original Printer/ Typewriter Model	Pack Quantity	Order Code EPS-839	Offer Price/1
LQ800/MX807753	1	-0770K	£5.89
FX/LX/MX/RX80	1	-0780K	£4.56
FX2170/LQ2070 /2080/2180	1	-0790K	£5.69

Product Number	Printer Model	Description	Pack Qty	Order Code EPS-839	Offer Price/1
T036140	Epson Photo 900/1270/1290/1290S	Intelligence Cartridge	1	-0820K	£30.46
T008401	Epson Stylus Photo 790/870/890/895/915	Intelligence Cartridge	1	-0830K	£26.99
T036140	Epson Stylus Color C42	Inkjet Cartridge	1	-0850K	£21.99
T037040	Epson Stylus Color C42UX	Inkjet Cartridge	1	-0860K	£28.73
T040140	Epson Stylus C63/CX3200	Inkjet Cartridge	1	-0940K	£44.99
T041040	Epson Stylus C64/C66/C84/C86/CX3600/CX3650/CX6400	Inkjet Cartridge	1	-0950K	£39.99
T044140	Epson Stylus C64/C66/C84/C86/CX3600/CX3650/CX6400	Inkjet Cartridge	1	-0960K	£22.39
T044240	Epson Stylus C64/C66/C84/C86/CX3600/CX3650/CX6400/CX6600	Inkjet Cartridge	1	-0970K	£16.69
T044340	Epson Stylus C64/C66/C84/C86/CX3600/CX3650/CX6400/CX6600	Inkjet Cartridge	1	-0980K	£16.69
T044440	Epson Stylus C64/C66/C84/C86/CX3600/CX3650/CX6400/CX6600	Inkjet Cartridge	1	-0990K	£16.69
T052040	Epson Stylus Color 400/440/460/600/640/660/670/740/760/800/850/860/1160/1520/Scan 2000/2500	Ink Cartridge	1	-0060K	£37.99
T048140	Epson Stylus Photo R300	Inkjet Cartridge	1	-0130K	£18.29
T048240	Epson Stylus Photo R300	Inkjet Cartridge	1	-0140K	£18.29
T048340	Epson Stylus Photo R300	Inkjet Cartridge	1	-0150K	£18.29
T048440	Epson Stylus Photo R300	Inkjet Cartridge	1	-0160K	£18.29
T050140	Epson Stylus Photo 700/Ex/750/750 Millennium	Inkjet Cartridge	1	-0050K	£33.65
T045240	Epson Stylus C64/C66/C84/CX6400	Inkjet Cartridge	1	-0020K	£13.47
T045440	Epson Stylus C64/C66/C84/CX6400	Inkjet Cartridge	1	-0030K	£13.47
T045340	Epson Stylus C64/C66/C84/CX6400	Inkjet Cartridge	1	-0040K	£13.47
T051140	Epson Stylus 880/850/860/1520	Inkjet Cartridge	1	-0080K	£38.40
T009401	Epson Stylus Photo 900/1270/1240/1290S	Intelligence Inkjet Cartridge	1	-0250K	£34.99
T048540	Epson Stylus R200/R300/R320/RX500/RX600/RX620	Inkjet Cartridge	1	-0300K	£18.29
T048640	Epson Stylus R200/R300/R320/RX500/RX600/RX620	Inkjet Cartridge	1	-0310K	£18.29
T061140	Epson Stylus D68PE/D88/D88PE/DX3850/DX4250/DX4850	Inkjet Cartridge	1	-0390K	£9.49
T061240	Epson Stylus D68PE/D88/D88PE/DX3850/DX4250/DX4850	Inkjet Cartridge	1	-0400K	£9.49
T061340	Epson Stylus D68PE/D88/D88PE/DX3850/DX4250/DX4850	Inkjet Cartridge	1	-0410K	£9.49
T061440	Epson Stylus D68PE/D88/D88PE/DX3850/DX4250/DX4850	Inkjet Cartridge	1	-0420K	£9.49
T055140	Epson Stylus Photo R240/R245/RX420/RX425/RX520	Inkjet Cartridge	1	-0430K	£9.49
T055240	Epson Stylus Photo R240/R245/RX420/RX425/RX520	Inkjet Cartridge	1	-0440K	£9.49
T055340	Epson Stylus Photo R240/R245/RX420/RX425/RX520	Inkjet Cartridge	1	-0450K	£9.49
T055440	Epson Stylus Photo R240/R245/RX420/RX425/RX520	Inkjet Cartridge	1	-0460K	£9.49
T071140	Epson Stylus D120/D82/D78/DX4000/DX4050/DX4450/DX5050/DX6050/DX7400/DX4900	DURABright Inkjet Cartridge	1	-0600K	£9.49
T071240	Epson Stylus D120/D82/D78/DX4000/DX4050/DX4450/DX5050/DX6050/DX7400/DX4900	DURABright Inkjet Cartridge	1	-0610K	£9.49
T071340	Epson Stylus D120/D82/D78/DX4000/DX4050/DX4450/DX5050/DX6050/DX7400/DX4900	DURABright Inkjet Cartridge	1	-0620K	£9.49
T071440	Epson Stylus D120/D82/D78/DX4000/DX4050/DX4450/DX5050/DX6050/DX7400/DX4900	DURABright Inkjet Cartridge	1	-0630K	£9.49
T071540	Epson Stylus DX4400/DX5000/DX7400/DX4450/DX5050/DX8400	DURABright Inkjet Cartridge	1	-0650K	£32.99
T080140	Epson Stylus Photo RX560/R265/R360/Stylus RX685/RX585/R285	Claria Inkjet Cartridge	1	-0660K	£9.49
T080240	Epson Stylus Photo RX560/R265/R360/Stylus RX685/RX585/R285	Claria Inkjet Cartridge	1	-0670K	£9.49
T080340	Epson Stylus Photo RX560/R265/R360/Stylus RX685/RX585/R285	Claria Inkjet Cartridge	1	-0680K	£9.49
T080440	Epson Stylus Photo RX560/R265/R360/Stylus RX685/RX585/R285	Claria Inkjet Cartridge	1	-0690K	£9.49
T080540	Epson Stylus Photo RX560/R265/R360/Stylus RX685/RX585/R285	Claria Inkjet Cartridge	1	-0700K	£9.49
T080640	Epson Stylus Photo RX560/R265/R360/Stylus RX685/RX585/R285	Claria Inkjet Cartridge	1	-0710K	£9.49
T080740	Epson Stylus Photo RX560/R265/R360/Stylus RX685/RX585/R285	Claria Inkjet Cartridge Multi Pack	1	-0720K	£48.69
T089140	Epson Stylus Office BX300F/S21/SX100/SX105	Inkjet Cartridges	1	-1140K	£9.50
T089240	Epson Stylus Office BX300F/S21/SX100/SX105	Inkjet Cartridges	1	-1150K	£9.50
T089340	Epson Stylus Office BX300F/S21/SX100/SX105	Inkjet Cartridges	1	-1160K	£9.50
T089440	Epson Stylus Office BX300F/S21/SX100/SX105	Inkjet Cartridges	1	-1170K	£9.50

Office Supplies & Stationery

Canon Inkjet Cartridges

Canon toner ink has been specially developed to maximise print quality and optimise the performance of your plain paper fax machine.

Please note that these products may be subject to price fluctuations - Ring now for our Best Price

EXTENDED RANGE



Product Number	Printer Model	Description	Pack Quantity	Order Code CNN-839	Offer Price/1
CLI521M	Pixma iP3600/iP4600/iP4700/MP540/MP550/	Magenta	1	-0530K	£10.93
CLI521C	MP560/MP620/MP630/MP640/MP980/MP990/	Cyan	1	-0540K	£10.93
CLI521Y	MX860	Yellow	1	-0550K	£10.93
CLI521BK		Black	1	-0560K	£10.93
PGI520BK	Pixma iP3600/iP4600/iP4700/MP540/MP550/MP560/MP620/MP630/MP640/MP980/MP990/MX860/MX870	Ink Tank 19ml Black	1	-0570K	£12.25
BX-3	Canon B100/110/150, 155 Multipass 10	Toner	1	-0460K	£32.68
F41- 8801 (E30)	Canon FC200/210/220/230/310/330/336/530, PC740/750/C760/C770/C780	Toner	1	-0450K	£139.49
FX3	Canon L250, L300, Multipass L60/90	Toner	1	-0470K	£72.98
BCI-24BK	Bubblejet i250/i400X/S200/i320/i455/S200X/i350	Ink Tank	1	-0480K	£8.02
BCI-24C	i470D/S300/i450/S330 Photo	Colour	1	-0490K	£17.48
BCI-6BK		Black	1	-0010K	£10.52
BCI-6C	Canon BJC8200/S800/S280/S8300/S9000/S900/	Cyan	1	-0020K	£10.52
BCI-6M	i9100/i950/i905d/i965	Magenta	1	-0030K	£10.52
BCI-6Y		Yellow	1	-0040K	£10.52
PG40	Pixma MP150/170/450/iP2200	Ink Tank	1	-0200K	£17.88
CL41	Pixma MP150/170/450/iP600/iP2200/ip6210/iP6220	Ink Tank	1	-0210K	£22.92
PG50	Pixma MP150/170/450/iP2200	Ink Tank High Yield	1	-0220K	£26.62
CL51	Pixma MP150/170/450/iP600/iP2200/ip6210/iP6220	Ink Tank High Yield	1	-0230K	£31.13
CLI-8BK	Pixma Series: iP3300/iP4200/iP4300/iP5200/	Black	1	-0290K	£12.98
CLI-8C	iP5200R/iP5300/iX4000/iX5000	Cyan	1	-0300K	£12.98
CLI-8M	MP50D/MP510/MP530/MP600/	Magenta	1	-0310K	£12.98
CLI-8Y	MP600R/MP800/MP800R/MP810/	Yellow	1	-0320K	£12.98
PG1-5BK	MP830/MP960	Ink Tank 26ml Black	1	-0330K	£14.63
PG-37	Pixma MP210/140/220, MX300/310 iP1800/1900/2500/2600	Ink	1	-0510K	£13.87
CL-38	Pixma MP210/140/220, MX300/310 iP1800/1900/2500/2600	Ink	1	-0520K	£18.32

LEXMARK Inkjet Cartridges

Lexmark inkjet cartridges perfectly enhance the capabilities of inkjet printers and ensure the best performance from Lexmark and IBM printers. Lexmark products are manufactured to last longer, save energy and are less environmentally unfriendly.



Please note that these products may be subject to price fluctuations - Ring now for our Best Price

Ref No	Printer Model	Type	Order Code LEX-839	Offer Price/1
10N0217	Z13/Z23/Z24/Z25/Z33/Z34, Z35/i3/A10/X74/X75/X110 Series/Z600 Series	Black	-0070K	£20.03
10N0227		Colour	-0080K	£21.15
18C0031E		Photo	-0110K	£30.62
18C0032E		Black	-0120K	£21.98
18C0033E	Jetprinter Z815/X5250	Colour	-0130K	£23.65
18C0034E		Black	-0140K	£23.37
18C0035E		Colour	-0150K	£29.22
18Y0144E	x4850/X4875/X4975/X6570/X6575/X7550/X7675/X9350/X9570/X9575/Z1520	Black	-0250K	£23.89
18Y0143E		Colour	-0260K	£29.22
10N0217/10N0227	Lexmark i3/X74/X75 X1100 Series/X2200 Series/Z13/Z23/Z24/Z25/Z33/Z34/Z35/Z2500 Series/Z7600 Series/Compag U650 Series	Black & Colour Twin Pack	-0310K	£34.99
18C0781E	Lexmark X2350/X2450/X2470/Z730/Z735	Black/Colour Inkjet	-0240K	£21.98
10N0016	Lexmark Z13, Z23, Z33	Black	-0470K	£29.99
10N0026		Colour	-0480K	£29.79

CONTRACT PRICES AVAILABLE FOR VOLUME PURCHASES

All Prices Exclude V.A.T. © 2011

brother At your side. **Toner/Inkjet Cartridges**

Using original Brother Toner/Inkjet Cartridges gives superb results time after time.



Black Correction Film Ribbon

Yield up to 50,000 characters. For use with AX Series, LW Series and WP-Series (except WP-1) typewriters.

Capacity: 0.1kg.



Product No.	Order Code	Offer Price/1
BA1030	BRT-839 -0490K	£6.90

Product Number	Printer Model	Description	Pack Qty	Order Code	Offer Price/1
LC900U6	DCP1100C/115C/117C/120C/310CN/315CN/3400N/MFC210C/215C/410CN/425CN/620CN/640CN/820CN/MFC3240C/3840CN/5440CN/5840CN/1840C/1940CN	Inkjet Cartridge Multipack	1 Set	-0350K	£47.60
LC1000C	MFC845CN/DPC330C/MFC240C/	Inkjet Cartridges	Cyan	1	-0300K £10.38
LC1000M	MFC5860CN/DCP540CN/		Magenta	1	-0310K £10.38
LC1000Y	MFC4400CN/MFC660CN		Yellow	1	-0320K £10.38
LC1000BK	DCP130C/DPC750CW/MFC5460CN/		Black	1	-0290K £18.85
LC1100C	DCP385C/MFC6490CW/DCP6690CW/	Inkjet Cartridges	Cyan	1	-0530K £8.78
LC1100M	MFC5890CN/MFC490CW/DCP585CW/		Magenta	1	-0510K £8.78
LC1100Y	MFC5490CN/MFC790CW/MFC990CW/		Yellow	1	-0540K £8.78
LC1100BK	MFC6890CDW		Black	1	-0520K £16.70
TN-2000	HL-2030/HL-2040/HL-2070N/DCP-7010/DCP-7010L/DCP-7025/MFC-7420/MFC-7820N/FAX-2820/FAX-2825/FAX-2920/MFC-7225N	Toner Cartridge	1	-0250K	£64.15
TN-3130	DCP-3060/HL5240/HL5250DN/HL5270DN/HL5280DW	Toner Cartridge	1	-0370K	£75.06
TN-3170	DCP8060/8065DN/MFC8460N/8860DN/8870DW	Toner Cartridge	1	-0340K	£99.67

Thermal Fax Cartridges

Brother thermal ribbon cartridges guarantee top quality results from your Brother plain paper fax machine.



Please note that these products may be subject to price fluctuations - Ring now for our Best Price

Model Number	Printer Model	Type	Pack Qty	Order Code	Offer Price/1
PC301	FAX 920/930/MFC 925	Thermal Ribbon Cartridge	1	-0460K	£29.72
PC201	FAX 1020/MFC 1025/1030	Thermal Ribbon Cartridge	1	-0470K	£39.22
TN6300	HL1030, 1240	Toner	1	-0440K	£64.15
TN6600	1250, 1270N, 8750P	High Yield Toner	1	-0450K	£89.77
TN8000	8070, 8070P, MFC 9030, 9070, 9160, 9181	Black Toner	1	-0480K	£33.18

Model Number	Printer Model	Type	Pack Qty	Order Code	Offer Price/1
PC72RF	94, 98	Cartridge	2	-0030K	£35.80
LC900BK	DCP11C, Intellifax, 1940C,	Black Inkjet	1	-0140K	£19.80
LC900C	1840C, 2240C, MFC	Cyan Inkjet	1	-0150K	£10.90
LC900M	3240C, 5540CN, 3340CN,	Magenta Inkjet	1	-0160K	£10.90
LC900Y	210C, 410CN, 620CN	Yellow Inkjet	1	-0170K	£10.90

Office Supplies & Stationery

DELL Ink Cartridges

The high resolution cartridge features small ink-drop size for excellent clarity and fine detail. The cartridge produces high resolution printouts with sharp images and brilliant photos. For A720 & A920 printers.



Model Number/ Type	Pack Qty	Order Code DEL-839	Offer Price/1
T0529 Black	1	-0010K	£36.99
T0530 Colour	1	-0020K	£42.99

Panasonic Printer & Typewriter Ribbons

Ribbons to suit the most popular printers and typewriters. This is a small selection of a wide range of ribbons, so if your machine is not listed please call us. We will match your printer or typewriter to the correct ribbon.



Original Printer/ Typewriter Model	Pack Qty	Order Code PAN-839	Offer Price/1
KXP3626, 3696, KXP170	1	-0020K	£20.55
KXP110 KXP115	1	-0030K	£10.28

OKI Printer & Typewriter Ribbons

A range of ribbons to suit the most popular printers and typewriters. This is a small selection of a wide range of ribbons, so if your machine is not listed please call us. We will match your printer or typewriter to the correct ribbon.



Original Printer/ Typewriter Model	Pack Qty	Order Code OKI-839	Offer Price/1
OKI 182, 192, 193, MNC1 82	1	-0030K	£8.75
Microline 390, 391, 520, 521	1	-0040K	£11.95
	1	-0050K	£15.42

Fax Machine Toner Cartridges

Using Panasonic original fax supplies with your Panasonic fax machine gives superb results time after time.



Printer Model	Type	Pack Qty	Order Code PAN-839	Offer Price/1
UF585, UF595	Fax, Toner	1	-0050K	£158.38

SAMSUNG Fax Machine Toner Cartridges

Using Samsung Printer/Fax supplies gives superb results time after time.



Model Number	Type	Pack Qty	Order Code SAM-839	Offer Price/1
SCX 4216D3 To Suit: SF-560/565P/SF-750/755P Only/ CF560/565P/CF-750/755P Only/ SCX4X16/Msys 75X	Laser Toner Cartridge Black	1	-0020K	£80.16
INK-M40 To Suit: SF330/340/360 Series	Fax Cartridge Black	1	-0030K	£36.26
INK-M55 To Suit: SF-350	Fax Cartridge Black	1	-0090K	£42.57

PHILIPS Thermal Fax Film Ribbon

For Phillips Magic 3 Series FAX machines. Prints approximately 140, A4 pages.



Product Number	Fax Models	Description	Contents	Order Code PHI-839	Offer Price/1
PFA331	Magic 3 Series: PPF531/PPF575/ PPF585/PPF531/ PPF575/PPP585	Thermal Fax Film Ribbon	Black	-0030K	£28.86

Please note that these products may be subject to price fluctuations - Ring now for our Best Price

CONTRACT PRICES AVAILABLE FOR VOLUME PURCHASES

All Prices Exclude V.A.T. © 2013

GROUP 840 TRIMMERS & GUILLOTINES

Offis A3 & A4 Trimmers

Low volume paper trimmers that cut paper and card quickly, accurately and safely. Fitted with a stainless steel rotary blade that is enclosed for safety. Strong metal base and plastic end caps. Capacity to cut five sheets of 80gsm paper.

Item shown:
A3 Cutter

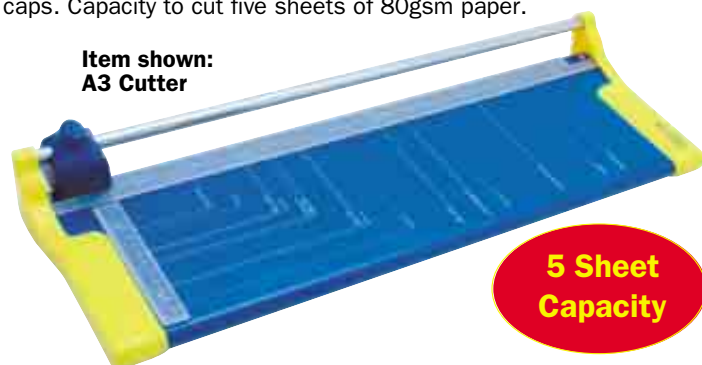

5 Sheet Capacity

Cutter Size	Order Code	Offer Price/1
A4	OFI-840	£7.99
A3	-0020K	£8.99

Rexel SmartCut Rotary Trimmers

A range of Rotary Trimmers designed to revolutionise application use by the family, the hobbyist, the school, the office or the reprographic centre. Unique range of design features include multi-functionality of finish options - trim, wave, score, perforate. 'Safe-trim' blade mechanisms that make blade changing safe; the multi-functional blade allows for easy change by 'turning the dial'.

SmartCut A100

Features:

- 300mm trim length.
- 5 sheet capacity.
- Metric/inch rules.
- 'Safe-trim' blade mechanism.
- Spare blade.



Product Description	Order Code	Offer Price/1
A100	GBC-813	£13.29

SmartCut A200 3-in-1

A multi-functional A4 paper trimmer, perfect for home and hobby use with three built-in finish styles.

Features:

- Straight-cut, Wave-cut and Score.
- 300mm trim length.
- 5 sheet (80gsm) capacity.
- Metric/inch rules.
- 'Safe-Trim' blade mechanism.
- Replacement blades available.



Product Description	Order Code	Offer Price/1
A200 3-in-1	GBC-813	£24.99

Rexel ClassicCut Guillotines

Safety guards to keep hands away from blades, stylish acrylic bases, carrying handles for true portability around the home or office and ergonomic handles and easy-lock paper clamps.

Classic Cut A3/A4 Guillotines

Easy-to-use guillotines, ideal for the home or small offices. Self-sharpening stainless steel blade lock for extra safety, acrylic safety guard and high quality ABS plastic base, ergonomic handle stays in upright position for extra safety and easier paper positioning. Paper guides for precise cutting positioning (A4, A5, A6). Ruler in centimetres and inches. Cuts 10 sheets 70gsm. Base area 320 x 300mm.

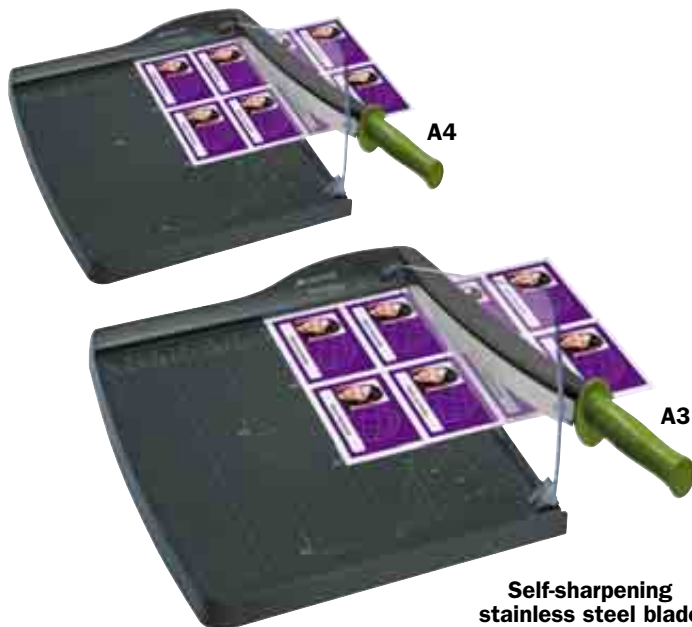

Model Number	Size	Order Code	Offer Price/1
CL100	A4	GBC-813	£49.99
CL120	A3	-0050K	£79.99

SmartCut A425 4-in-1

Multi-functional A4 desktop trimmer. Ideal for both home/hobby and personal office use.

Features:

- Trim, wave cut, score and perforate by simply turning the blade 'Trim-dial'.
- 320mm trim length.
- 10 sheet (80gsm) capacity.
- Metric/inch rules and markings.
- 'Safe-Trim' blade mechanism.
- Spare blade.



Product Description	Order Code	Offer Price/1
A425 4-in-1	GBC-813	£50.99

Office Supplies & Stationery

WASTE BINS

Wire Waste Basket

Lightweight, sturdy construction. Ideal for home or office. Large capacity, needs emptying less often.



Colour	Order Code	Offer Price/1
Black	-0500K	£24.44

Wire Waste Basket

Stylish mesh waste bin. Silver colour mesh.

Size: H357 x W292mm.



Colour	Order Code	Offer Price/1
Silver	-0010K	£5.15

Offis ReCycle Now Bin Kit

A convenient set of three 54ltr recycling bins, ideal for the Home or Office. Grey coloured bins, each of which has a colour-coded lid and description of it's contents:

Red: plastic. **Blue:** paper. **Yellow:** cans.



Description	Order Code	Offer Price/1
Set of 3	-0090K	£48.74

48ltr Steel Waste Bins

A durable range of steel waste bins designed for the safe segregation of litter and waste.



Colour	Order Code	List Price/1	Offer Price/1
Light Grey	-0030K	£30.99	£23.24
Black	-0040K	£30.99	£23.24

Metal Waste Paper Bin

With ribbed sides, seamed bottom and turned over edges.

Size: W305 x H292mm.

Weight: 1.00kg.



Colour	Order Code	List Price/1	Offer Price/1
Light Grey	-0010K	£7.49	£5.62
Black	-0020K	£7.49	£5.62

15ltr Plastic Waste Paper Bins

Plastic, 15ltr capacity. Ideal for use in the office or warehouse. Available in four colours.

Weight: 600g.



Colour	Litres	Order Code	List Price/1	Offer Price/1
Black	15ltr	-0110K	£4.26	£2.98
Blue		-0120K	£4.26	£2.98
Grey		-0130K	£4.26	£2.98
Red		-0140K	£4.26	£2.98

60ltr Acorn Waste Paper Recycling Bin

60ltr green bin, made from 80% recycled material.

Use in conjunction with Acorn 'Green' clear bin liners to prolong the life of the bin. Pack of 5.

Size: H677 x W360mm.



PACK OF 5

Item	Order Code	List Price/Pk	Offer Price/Pk
Paper Bin	-0150K	£48.99	£34.29
Liners (Pk 50)	-0160K	£26.99	£18.89

25ltr Swing Top Bin

Slate grey swing top bin ideal for the Home or Office.

Balanced top for easy closing and opening. Durable wipe-clean body and lid. Bin liner can be secured under lid.



Colour	Litres	Order Code	Offer Price/1
Slate Grey	25ltr	-0100K	£9.97

Acorn Cartridge Recycling Bin

80% recycled cardboard with a patented drop out bottom allowing the bins to be emptied from the bottom reducing the risk of back injury. Pack of 5.

Size: W360 x H677mm.



PACK OF 5

Pack Qty	Order Code	List Price/Pk	Offer Price/Pk
5	-0170K	£48.29	£33.80

Offis 40ltr Office Swing Bins

40ltr capacity. Balanced top for easy opening and closing. Ideal for kitchen, bathroom or office. Bin liner can be secured under lid. Durable, wipe-clean body and lid. Available in four colours: blue, green, red and white.



Colour	Litres	Order Code	Offer Price/1
Blue	40ltr	-0050K	£15.74
Green		-0060K	£15.74
Red		-0070K	£15.74
White		-0080K	£15.74

Office Supplies & Stationery

CONTRACT PRICES AVAILABLE FOR VOLUME PURCHASES

All Prices Exclude V.A.T. © 2011

GROUP 844 WEIGHING SCALES

Glass Platform Bathroom Scales

Stylish digital bathroom scales with tempered safety plate glass platform.

Maximum capacity: 330lb, 150kg.

Graduation: 0.2lb/0.1kg.

Units measure:

Pounds (oz),

Kilograms (g).

Auto shut-off: after 10 seconds. Supplied with 2x CR2032 lithium batteries.

Dimensions (L x W x H): 320 x 325 x 38mm.



Maximum Capacity	Unit Scale	Order Code	List Price/1	Offer Price/1
150kg	0.1g	PRO-844	£20.95	£17.81

SALTER Micromail II Letter & Brecknell Parcel Scales

Operated postal scale suitable for 1st and 2nd class letters and small parcels. Wipe clean vinyl chart and special marker pen allows current postal rates to be entered in the appropriate boxes - then when rate changes occur old rates can be simply wiped off and replaced. Ideal for the postal room that requires to update its letter rates.



Display: 13mm LCD.

Operational keys: On/off, zero key, units toggle key, hold key - allows larger letters to be weighed even when the display is covered. Weighs in both grams and lbs/oz.

Maximum Capacity	Unit Scale	Platform Size (mm)	Order Code	List Price/1	Offer Price/1
2000g/5lb	1g/1/8oz	140	SLT-844	£58.00	£52.20

General-Purpose Bench/Despatch Scales

A rugged 22 gauge steel despatch/warehouse scale with ribbed base that provides consistently accurate weight measurement. Portable - ideal for despatch and warehouse applications. Weights are clearly displayed in large 2.54cm backlit LCD numbers. Continues to display weight even after item is removed from the scale making it easier to weigh oversized items. Battery powered option provides complete freedom of use.

Units: kilogram or pounds.

Tare: establishes the weight of an empty container at zero to provide an accurate net weight for items placed in the container.

Auto shutdown: turns off the display after two minutes of non-use.

Battery alert: scale will display 'LO' when the battery is weak.



Maximum Capacity	Unit Scale	Platform Size (mm)	Order Code	List Price/1	Offer Price/1
45kg/100lb	100g/0.2lb	278 x 318	SLT-844	£99.50	£89.55
110kg/250lb	200g/0.5lb	x 56	-0020K	£99.50	£89.55

Glass Platform Kitchen Scales

Hygienic glass platform kitchen scales with large LCD screen for easy reading. Scales can be set to weigh in either pounds and ounces or grams and kilograms. Weigh directly onto platform or use with a bowl. Automatically adjusts for use with most bowls or containers.



Platform size:

160mm.

Capacity: 5kg/11lb.

Supplied with 9V battery.

Maximum Capacity	Unit Scale	Platform Size (mm)	Order Code	List Price/1	Offer Price/1
5kg	1g	160	PRO-844	£24.95	£21.21

Platform Scales

S133

Low cost, high weighing performance platform scale with strong aluminium base and frame. Stainless platform and stainless steel pole. Indicator can be bench or column mounted (with swivel) as standard - large clear LCD display. Built-in rechargeable battery or mains powered as required (adaptor/recharger supplied).

Function keys: On/Off/Zero, Gross, Net, Tare, Units, Print Memory Recall and Accumulate.

Typical Applications: Warehouse/Despatch Checkweigher for volume despatches/receipts, commercial applications where accuracy and speed of weighing is key.

Display height: 850mm.



Maximum Capacity	Unit Scale	Platform Size (mm)	Order Code	List Price/1	Offer Price/1
60kg	10g	520 x 420	SLT-844	£450.00	£405.00
150kg	20g	520 x 420	-0040K	£450.00	£405.00
300kg	50g	520 x 420	-0060K	£525.00	£472.50

Electronic Beam Scales

DP1200

Weighing beams supplied calibrated with Salter Abs Case Indicator. Weights are clearly displayed in 7x 20mm high digits. Backlit LCD to provide excellent viewing conditions in poor light. Unit has RS232 for linking to printer or PC. IP65 Stainless steel housing. Ideal for weighing pallets, long loads, under conveyors, tanks, containers etc.

Key Functions:

On/Print; Zero/Off; Net/Gross; Tare; kg/lb/ Motion/Under, Over, Target.

Beam size (x2): 1200 x 100 x 60mm.



Maximum Capacity	Order Code	List Price/1	Offer Price/1
2500kg	SLT-844	£695.00	£625.50

Office Supplies & Stationery

SALTER *Samson Suspended Brecknell Digital Balance Scales*

Hand-held or suspended electronic digital scales. Suitable for a wide variety of applications from poultry weighing, fishing, fire extinguisher and general-purpose suspended weighing.

Key features: include kg/lb/oz switching, display hold, tare and auto shut-off to maximise battery life.

Supplied with: Top T-bar grip handle, bottom hook, padded carrying pouch with belt clip and one 9 volt battery.



Maximum Capacity	Unit Scale	Order Code	List Price/1	Offer Price/1
10kg	10g	-0150K	£78.00	£70.20
25kg	20g	-0160K	£78.00	£70.20
45kg	50g	-0170K	£78.00	£70.20

OXFORD PRECISION *Weighing Scales*

The Oxford range of weighing equipment provides you with a choice of capacity and accuracy to suit the majority of purposes.

Suspended Scales
These sturdy scales have a dual-reading dial protected by a plastic cover. With a capacity of up to 25kg/55lb they are ideal for workshops, schools and offices and have a zero setting of ±15% with accuracy to 1 part in 250. It comes complete with top and bottom chrome vanadium hooks.



Model No.	Maximum Capacity	Order Code	List Price/1	Offer Price/1
55-25M	25kg	-3500K	£23.52	£19.99

Weigh & Count Scales

B120
Totally portable machines, ideal for use in applications where mains power is not available. The red LED display makes it ideal for use in poorly lit areas. The B120 is a self-contained unit powered by an internal rechargeable battery with a 20 hour battery life between recharges. Alternatively the machine can be powered direct from mains via the 12V AC adaptor included.
Platform size: 300mm x 200mm.



Maximum Capacity	Unit Scale	Order Code	List Price/1	Offer Price/1
6kg	1g	-0070K	£299.00	£269.10

Electronic Parcel Scales

WS300
1 part in 6000 resolution, these platform scales give a weighing performance of 300kg x 50g. They incorporate four full load bridge load cells with self-levelling, anti-slip feet to give a solid base in use. Stainless steel indicator pod features 17mm high LCD display digits. Bracket included enables indicator to be wall or bench mounted.

Capacity: 300kg x 50g.
Platform size: 550mm x 550mm x 60mm.



Maximum Capacity	Unit Scale	Order Code	List Price/1	Offer Price/1
300kg	50g	-0140K	£295.00	£265.50

Portable Bench Scale

WS60/WS120
Two bench scales that offer 1:3000 resolution - giving 60kg x 20g or 120kg x 50g performance. Four full load bridge load cells, with self-levelling anti-slip rubber feet. Tough low profile platform with brushed stainless steel top. Brushed stainless steel display pod which features clear 17mm high LCD digits. Bracket included to allow the display to be wall or bench mounted. Key display features are on/off; push button tare to enable weights of empty containers to be removed and net weight only displayed; kg/lb switching to give readings in either metric/imperial and hold which allows the weight to be frozen, even when the package is removed. Auto-off.

Capacity:
WS60: 60kg x 20g/130lb x 0.05lb.
WS120: 120kg x 50g/260lb x 0.1lb.
Power: 6V UK/EU power adaptor (supplied), 4x 1.5V AAA batteries (not supplied),
Platform size: 380 x 300 x 27mm high.
Display pod size: 158 x 80 x 27mm.
Display: LCD display 17mm high digits.
Function keys: On/off; tare; kg/lb; hold.
Annunciators: Zero; net; hold; kg/lb.
Tare: 100% subtractive.
Operating temperature: 5°C to 40°C.
Approvals: CE WEEE directive.
Weight: 3.9kg.



Model No.	Max Capacity	Order Code	List Price/1	Offer Price/1
WS-60	60kg	-2110K	£110.00	£99.00
WS120	120kg	-2120K	£110.00	£99.00

Electronic Weighing Scales

Suitable for office, post room and stores applications. Digital display. Designed to run on mains power via the 12Vdc 650mA AC adaptor provided or the 6V4AH rechargeable battery (included). Units will run up to 20 hours on a single full charge.

Model WS-6E: Capacity 6kg/12lb. Graduation 0.001kg/0.002lb.
Model WS-15E: Capacity 15kg/31lb. Graduation 0.002kg/0.005lb.



Model No.	Max Capacity	Order Code	List Price/1	Offer Price/1
WS-6E	6kg	-2200K	£117.64	£99.99
WS-15E	15kg	-2220K	£117.64	£99.99

Electronic Bench Scales

Versatile scales suitable for warehouse or light industrial applications comes with a clear digital readout that can be desk or wall mounted. RS232 interface for easy PC connection. AC power (AC adaptor included) or 4x AA batteries (supplied).

BS-60E
Capacity: 60kg/132.28lb.
Graduation: 0.02kg/0.05lb.

BS-120E
Capacity: 120kg/264.56lb.
Graduation: 0.05kg/0.1lb.



Model No.	Max Capacity	Order Code	List Price/1	Offer Price/1
BS-60E	60kg	-5110K	£129.39	£109.98
BS-120E	120kg	-5130K	£141.17	£119.99

GROUP 846 HIGHLIGHTERS



Bright, fluorescent colours to highlight important information. Quick drying and bleedproof. Improved ink formulation lasts even longer. Works on virtually any paper, including fax and carbonless paper.

Assorted Packs

Set of 4:
Yellow, Pink, Orange, Green (x1 of each).

Set of 10:
Yellow x3, Pink x3, Orange x2, Green x1, Blue x1,



Colour	Pack Quantity	Order Code OFI-846	List Price/Pk	Offer Price/Pk
Assorted	4	-0090K	£0.99	£0.74
	10	-0100K	£2.89	£2.17
Yellow	10	-0110K	£2.89	£2.17
Pink	10	-0120K	£2.89	£2.17
Orange	10	-0130K	£2.89	£2.17

PACK OF 4 PACK OF 10

Q-CONNECT Duo Nib Felt Tip Pen

Crisp felt tip pens with dual nib. Ideal for both thick and thin sketching, colouring and drawing. Pack of 10 assorted colours.



Pack Contents	Order Code QUE-846	List Price/Pk	Offer Price/Pk
10	-0180K	£4.99	£2.00

STABILO Highlighters

The brand leading highlighter. Bright fluorescent colours highlight important words. Quick drying and bleedproof ink. Works on virtually any paper.



PACK OF 10

Colour	Pack Quantity	Order Code STO-846	Offer Price/Pk
Yellow	10	-0270K	£7.21
Green	10	-0240K	£7.21
Pink	10	-0260K	£7.21
Orange	10	-0250K	£7.21
Blue	10	-0230K	£7.21

Colour	Pack Quantity	Order Code STO-846	Offer Price/Pk
Assorted	Set of 10	-0310K	£7.21
Assorted	Set of 4	-0280K	£2.99
Assorted	Set of 6	-0290K	£4.32
Assorted	Set of 8	-0300K	£5.76

Luminator XT Pens

71/4
Larger liquid ink reservoir than traditional highlighters. Uniform ink application right down to the last drop, with no fading. Multi award-winning design. Doesn't leak under pressure e.g. on a plane. Ink level indicator for constant control. Water-based ink for paper, copy or fax. Long cap-off time. Lasts considerably longer than regular highlighters. Pack of 4 assorted colours.



PACK OF 4

NEW

Pack Contents	Order Code STO-846	List Price/Pk	Offer Price/Pk
4	-0110K	£13.62	£7.49

Office Supplies & Stationery

edding Highlighters

Highlighter pens with chisel tip, water-based, non-bleed ink with brilliant smudgeproof colours, suitable for use on inkjet documents. Available in blue, green, grey, pink, red, orange and yellow.



PACK OF 10

Colour	Pack Quantity	Order Code EDD-846	List Price/Pk	Offer Price/Pk
Blue	10	-0020K	£8.35	£3.92
Green	10	-0030K	£8.35	£3.92
Grey	10	-0040K	£8.35	£3.92
Pink	10	-0050K	£8.35	£3.92
Red	10	-0060K	£8.35	£3.92
Orange	10	-0070K	£8.35	£3.92
Yellow	10	-0080K	£8.35	£3.92

Highlighters

Bright, fluorescent colours - light up important words. Chisel tip draws broad lines for highlighting and narrow lines for underlining. Suitable for most papers - will not fade on faxes.



Colour	Order Code QUE-846	List Price/1	Offer Price/1
Green	-0030K	£7.47	£2.99
Blue	-0020K	£7.47	£2.99
Pink	-0050K	£7.47	£2.99
Orange	-0040K	£7.47	£2.99
Yellow	-0060K	£7.47	£2.99
Set of 4	-0070K	£4.22	£1.69

Pentel Textile Marker

Black, xylene-free permanent fabric marker which leaves a clear vivid line with minimal bleeding into the cloth and excellent adhesion. Fine point.



Colour	Order Code	Offer Price/1
Black	PNL-846	£1.36

NEW

Sharpie Mini Permanent Marker Set

PACK OF 4

Small enough to go anywhere! Portable 90mm (3 1/2") long Sharpie fine tip marker, half the size of regular length marker pens. Cap clip easily attaches to key chains, golf bags, lanyards, and more. Permanent on most surfaces. Quick drying, AP ACMI Certified (The Art & Creative Materials Institute) non-toxic ink formula. **Colours:** black, blue, green and red.



Pack Quantity	Order Code	List Price/Pk	Offer Price/Pk
4	SHP-846	£3.13	£2.19



Q-CONNECT OHP Pens

All the pens you need to produce a colourful and effective overhead projector display. Permanent/non permanent markers with fine and medium tips. Available packed in 10 (black only) or in wallets of four (black, blue, red and green).



Colour	Type	Pack Quantity	Order Code	Offer Price/Pk
Assorted	Permanent Fine	Wallet 4	QUE-846	£2.65
Black	Permanent Fine	10	-0300K	£6.80
Black	Permanent Medium	10	-0310K	£6.80
Black	Non-Permanent Fine	10	-0320K	£6.80
Black	Non-Permanent Medium	10	-0330K	£6.80

Fine Permanent Markers

PACK OF 12

The original pen style permanent marker. Permanent on most surfaces. Fade and water resistant ink encourages multiple project uses. Quick drying, AP ACMI Certified (The Art & Creative Materials Institute) non-toxic ink formula.



Ink Colour	Pack Quantity	Order Code	List Price/Pk	Offer Price/Pk
Black	12	-0010K	£11.16	£7.81
Blue	12	-0020K	£11.16	£7.81
Red	12	-0030K	£11.16	£7.81



Luxor CD and DVD markers.

Permanent data proof personalisation of CDs and DVDs. Scratch free soft tip with a 1mm line width. Pack of 10.



Colour	Pack Quantity	Order Code	Offer Price/Pk
Black	10	-0090K	£2.39

PACK OF 10

Retractable Fine Point Permanent Markers

PACK OF 12

Retractable marker for easy one-handed operation. Safety Seal™ valve design helps prevents dry out. Quick drying, AP ACMI Certified (The Art & Creative Materials Institute) non-toxic ink formula.



Ink Colour	Pack Quantity	Order Code	List Price/Pk	Offer Price/Pk
Black	12	-0050K	£19.56	£13.69
Blue	12	-0060K	£19.56	£13.69
Red	12	-0070K	£19.56	£13.69



edding CD Marker

Permanent, water-based pigment ink and water-resistant once dry. Gives permanent lettering on CDs and does not affect CD performance. **Line width:** 1.0mm.



Colour	Order Code	Offer Price/1
Black	EDD-846	£1.95

Permanent Marker

Permanent marker with medium bullet nib writes a 1.5-3mm line. Light-fast quick-drying ink is weather-resistant and waterproof on most surfaces. Low-odour ink with no added toluene/xylene. Marks most surfaces including metal, glass, wood and plastic.



Colour	Order Code	Offer Price/1
Black	EDD-846	£1.25

NEW

Tyre Marker

Permanent white low odour ink for marking on tyres and rubber surfaces, round tip with strike width 2 - 4mm.



Colour	Order Code	Offer Price/1
White	-0260K	£4.32

Aerospace Marker

Suited for marking of parts and identification. Weather-resistant, waterproof and quick drying. Approved to **BAe ABP-9-3323 Class A**. Resistant to many solvents, oils and coatings. Marks on most metals, plastics and acetates.



Colour	Order Code	Offer Price/1
Black	-0300K	£2.19

Corrosion-free Metal Marker NLS

Permanent ink with low halogen and chlorine content, specially developed for corrosion-free marking of metals. 1.5 - 3.0mm point size. Complies with aviation standard **LN9051**.



Colour	Order Code	Offer Price/1
Blue	-0240K	£2.24
Red	-0230K	£2.24

GROUP 846 MARKERS - INK

edding Permanent Marker

Quick drying, low-odour ink. Water-resistant. Chisel tip, stroke 4 - 12mm. **Colour:** black.



Colour	Order Code	Offer Price/1
Black	-0170K	£2.47

Tile Grout Marker

To renovate grouting, shake, pump and then write over the grouting. Width: 2 - 4 mm. Anti-fungal agent. Two spare nibs.



Colour	Order Code	Offer Price/1
White	EDD-846	£3.30

NEW

Paint Marker

White paint marker with metal-framed bullet tip. Permanent, quick drying, low-odour pigment ink providing an opaque lacquer finish. Valve-controlled ink-flow and heat-resistant until 300°C. For marking, writing and colouring on glass, plastic, metal or wood.



Colour	Order Code	Offer Price/1
White	EDD-846	£2.58

Fine Black Paint Marker

Paint marker with permanent, opaque pigment ink. Dries quickly, light and water-resistant on most materials. Lacquer-type finish ink is also suitable for use on transparent and dark materials.



Colour	Order Code	Offer Price/1
Black	EDD-734	£2.70

NEW

Pentel Permanent Markers

Produces fine or broad lines. Handy-sized chisel tip permanent marker producing fine to broad lines up to a maximum 8mm line width. Jumbo marker ideal for posters, notices, etc. Chisel tip - 14mm width.



Colour	Pack Quantity	Order Code	Offer Price/Pk
Black	12	PNL-846	£20.25
Jumbo - Black	1	-1310K	£3.81
Jumbo - Black	6	-0830K	£22.86
Jumbo - Blue	6	-0840K	£22.86

ZEBRA Double-Ended Marker

Double-ended permanent marker with chisel and flat tips that will write on most surfaces. Dual felt and acrylic tip enables a variety of markings up to 17mm wide.

Colour	Order Code	Offer Price/1
Black	ZEB-846	£3.59



Artline Laundry Marker

Indelible ink withstands repeated washing. Instant drying, fine bullet tip. Line width 0.7mm. Ideal for marking on linens - the ink will not run, nor fade with repeated washing.

Colour	Size	Pack Quantity	Order Code	Offer Price/Pk
Black	0.7mm	12	ART-846	£20.49



Freezer Bag Marker

Ideal for marking frozen food packages. Writes easily over greasy surfaces. 0.7mm bullet tip marker.

Colour	Size	Order Code	Offer Price/1
Black	0.7mm	ART-846	£1.71



Garden Marker

0.8mm bullet tip marker. Ideal for both indoor and outdoor use. Ideal for marking on all kinds of gardening goods - labels, flower pots etc. Fade resistant and waterproof.

Colour	Size	Order Code	Offer Price/1
Black	0.8mm	ART-846	£1.34



Chisel Tip Permanent Markers



Versatile chisel tip marks both broad and fine line widths. Permanent on most surfaces. Quick-drying, fade and water-resistant ink encourages multiple project uses. Unique anti-roll barrel design. AP ACMI Certified (The Art & Creative Materials Institute) non-toxic ink formula.



Ink Colour	Pack Quantity	Order Code	List Price/Pk	Offer Price/Pk
Black	12	SHP-846	£21.96	£15.37
Blue	12	-0130K	£21.96	£15.37

Twin Tip Permanent Markers

Dual degrees of precision. Increased functionality with both fine and ultra fine tips in one marker. Permanent on most surfaces. Fade and water-resistant ink to encourage multiple project uses. Quick drying, AP ACMI Certified (The Art & Creative Materials Institute) non-toxic ink formula.



Ink Colour	Pack Quantity	Order Code	List Price/Pk	Offer Price/Pk
Black	12	SHP-846	£16.56	£11.59
Blue	12	-0090K	£16.56	£11.59
Red	12	-0100K	£16.56	£11.59

Office Supplies & Stationery

NEW

PACK OF 12

NEW

NEW



Permanent Marker

PACK OF 10

Permanent marker pens. Alcohol-based odourless ink. Non-toxic. Water-resistant. Fast drying. Bullet point tip.

Colour	Pack Quantity	Order Code OFI-846	List Price/Pk	Offer Price/Pk
Black	10	-0140K	£2.89	£2.17
Blue	10	-0150K	£2.89	£2.17
Red	10	-0160K	£2.89	£2.17



Permanent Markers

PACK OF 10

Designed for use on all surfaces. Waterproof, low solvent content. Xylene-free.

Colour	Pack Quantity	Order Code KEN-734	List Price/Pk	Offer Price/Pk
Black	10	-5020K	£9.95	£7.66
Blue	10	-5060K	£9.95	£7.66
Red	10	-5040K	£9.95	£7.66
Green	10	-5070K	£9.95	£7.66



Permanent Markers

NEW

The brand leading permanent marker. Bullet or chisel tip. Long lasting waterproof ink.

Order Code PNL-846		Order Code PNL-846	
Bullet Tip	Chisel Tip	Bullet Tip	Chisel Tip
-0740K	-0780K	-1240K	-1280K
-0750K	-0790K	-1250K	-1290K
-0770K	-0810K	-1270K	-1300K
		-1260K	-

Offer Price/12 £11.34 **Offer Price/1 £1.16**



Retractable Markers

Retractable tip - no cap to lose! Tip protector - reduces risk of drying out. Safety lock mechanism - to prevent accidental marking. Xylene-free formula, low odour permanent ink, suitable for a variety of surfaces. Medium bullet tip - ideal for most requirements.

Colour	Pack Quantity	Order Code PNL-846	Offer Price/Pk
Black	12	-1090K	£14.95



PACK OF 12



Permanent Markers

NEW

PACK OF 12

Long-lasting economical general-purpose marker suitable for most surfaces including glass. The marker is fibre-tipped and uses unique 'autoseal' ink and produces a 1.2mm line width.



Colour	Pack Quantity	Order Code BER-846	Offer Price/Pk
Black	12	-0100K	£10.85



Indelible Markers

PACK OF 12

This fine point, fibre-tip, permanent and waterproof marker has a 2mm tip which gives approximately 1mm line width. Writes on paper, glass, wood, metal, vinyl, plastic etc. Ideal for fine line marking and labelling.



Colour	Pack Quantity	Order Code PNL-846	Offer Price/Pk
Black	12	-1230K	£16.29



Permanent Markers

PACK OF 12

1.5mm bullet tip and 5mm chisel tip. Fast drying waterproof ink. Pack of 12.

NEW



Order Code ART-846		Offer Price/Pk
Bullet Tip	Chisel Tip	
-3200A	-3210L	£6.70

Toughpoint Permanent Markers

NEW

PACK OF 12

Heavy duty black permanent marker with reversible bullet tip and extra large ink capacity. Marks concrete, brick and most other surfaces. Filled with autoseal ink the cap can be left off for up to 2 weeks without drying out.



Colour	Pack Quantity	Order Code BER-846	Offer Price/Pk
Black	12	-0110K	£14.59

Permanent Marker

Non-toxic permanent markers. Available as chisel tipped.



Order Code WTS-846	Chisel Tip
-0050K	
-0060K	
-0070K	
-0080K	
Offer Price/1	£0.34

Long Nib Marker

Ideal for marking deep holes and inspections. Permanent and waterproof, xylene free, low odour, refillable, 1mm nib.



Colour	Pack Quantity	Order Code ART-846	List Price/1	Offer Price/1
Black	1	-0010K	£2.91	£2.18

CONTRACT PRICES AVAILABLE FOR VOLUME PURCHASES

All Prices Exclude V.A.T. © 2011

Office Supplies & Stationery

Offis Pencils

Premium quality graphite pencils with a comfortable hexagonal barrel and smooth core for easy writing and drawing. Ideal for everyday office use. Pack of 12.

PACK OF 12



Lead Grade	Pack Quantity	Order Code	Offer Price/Pk
HB	12	OFI-846 -0010K	£0.69

DERWENT Pencils

General-purpose HB grade graphite pencils. Natural wood barrel with black imprint. Box of 144. Convenient for schools, colleges etc.



PACK OF 144

Lead	Pack Quantity	Order Code	Offer Price/Pk
HB	144	ACC-846 -0040K	£11.52

Q-CONNECT Coloured Pencil Crayons

Clean and bright crayons with attractive tin case to protect and store the crayons. 4mm. Box of 12 assorted colours.



PACK OF 12

Lead	Pack Quantity	Order Code	Offer Price/Pk
HB	12	QUE-846 -0190K	£2.40

DERWENT Carpenters' Pencils

Pencils of oblong section which can be sharpened to a chisel shaped edge. This eliminates the tendency of a pointed pencil to follow the grain. Pack of 12.



PACK OF 12

Colour	Grade	Order Code	Offer Price/Pk
Blue	Soft	ACC-846 -0010K	£7.39
Red	Medium	-0020K	£7.39
Green	Hard	-0030K	£7.39

Sharpie China Markers

Ideal for marking on the more tricky surfaces. 'Self-sharpening' wax cored marker is suitable for marking on glass, ceramics, smooth plastics and much more. The coloured lead is revealed by pulling the string and peeling away a section of the paper casing.

NEW

PACK OF 12

Colour	Pack Quantity	Order Code	Offer Price/Pk
Blue	12	SHP-846 -0170K	£11.17
Black	12	-0160K	£11.17
Red	12	-0180K	£11.17
Yellow	12	-0190K	£11.17
White	12	-0200K	£11.17

Pencils

Low cost quality pencils. Excellent value pencils ideal for everyday office use. Comfortable hexagonal burnished barrel. Strong HB lead gives smudge free lines, available with eraser tip.

PACK OF 12

Hardness	Pack Quantity	Order Code	Offer Price/Pk
HB with Eraser	12	CTL-802 -6100K	£0.65

STAEDTLER Pencils

Wooden cased pencil with distinctive black and yellow barrel.

PACK OF 12

Lead	Pack Quantity	Order Code	Offer Price/Pk
HB	12	STD-846 -0170K	£3.18

Pencils

Low cost quality pencils. Excellent value pencils ideal for everyday office use. Comfortable hexagonal burnished barrel. Choice of grades.

PACK OF 12

Hardness	Pack Quantity	Order Code	List Price/Pk	Offer Price/Pk
Soft	4B	STD-846 -0070K	£6.95	£3.82
	HB	-0110K	£6.95	£3.82
Hard	2H	STD-846 -0140K	£6.95	£3.82
	4H	-0160K	£6.95	£3.82

Lumocolor Pencils

Ideal tool for users in industry and trade. For use on almost all surfaces, e.g. glass, leather, textiles, stone, metal, wood and plastic. For opaque marking even on dark and transparent surfaces. No bleeding through paper. Colour-intensive and lightfast. Non-corrosive colour pigments. No drying up. Odourless.

PACK OF 12

Colour	Pack Quantity	Order Code	List Price/Pk	Offer Price/Pk
White	12	STD-846 -0010K	£17.49	£9.62
Yellow	12	-0020K	£0.02	£0.01
Red	12	-0030K	£17.49	£9.62
Blue	12	-0040K	£17.49	£9.62
Black	12	-0060K	£17.49	£9.62

Non-Permanent

Colour	Pack Quantity	Order Code	List Price/Pk	Offer Price/Pk
White	12	STD-846 -1240K	£16.99	£9.34
Yellow	12	-1250K	£16.99	£9.34
Red	12	-1260K	£16.99	£9.34
Blue	12	-1270K	£16.99	£9.34
Green	12	-1280K	£16.99	£9.34

ROYAL SOVEREIGN Chinagraph Pencils

NEW

PACK OF 12

The original and leading marker pencil for marking on glass, china, acetate, film and polished surfaces. Pack of 12.

Colour	Pack Quantity	Order Code	Offer Price/Pk
Black	12	RYS-846 -0010K	£7.74
Red	12	-0020K	£7.74
White	12	-0030K	£7.74
Yellow	12	-0040K	£7.74

Pentel Automatic Pencils

Popular automatic pencil. Push button control releases exact amount of lead. Holds up to 12 spare leads without reloading.



Built-in eraser. Adjustable pocket clip and clearing pin.

Lead size	Order Code PNL-846	Offer Price/1
Pencil - 0.5mm	-1390K	£3.98
Pencil - 0.7mm	-1400K	£3.98
Pencil - 0.9mm	-0870K	£3.98

Automatic Pencil Leads

Hi-polymer leads, suitable for use on all paper, tracing and drafting media. Packed as single tubes of 12 leads or 12 tubes of 12 leads. Grade - HB.



Lead size	Pack Quantity	Order Code PNL-846	Offer Price/Pk
HB 0.5mm	1 pack of 12	-1410K	£0.84
HB 0.7mm	1 pack of 12	-1420K	£0.75
HB 0.5mm	12pks of 12	-0880K	£9.75
HB 0.7mm	12pks of 12	-0890K	£7.80

Automatic Pencils

Ideal for drawing, drafting or writing.



Lead size	Order Code PNL-846	Offer Price/1
Pencil - 0.5mm	-1370K	£2.54
Pencil - 0.7mm	-1380K	£2.54

Automatic Pencils

Choice of 4 colours. 0.5 and 0.7mm lead diameters complete with eraser inside the lid. Refillable.



Colour	Order Code PNL-846	
	0.5mm Dia.	0.7mm Dia.
Black	-1160K	-1200K
Blue	-1170K	-1210K
Green	-1180K	-
Red	-1190K	-1220K
Offer Price	£0.65 each	

NEW

ZEBRA Automatic Pencils

Z Grip

Automatic self loading pencil with built-in eraser. Soft cushion rubberised finger grip and pocket clip. Takes 0.5mm pencil leads.



Colour	Order Code ZEB-846	Offer Price/1
Black	-0190K	£0.35
Blue	-0200K	£0.35

NEW

Offis Automatic Pencils

Push button control releases exact amount of lead. Holds up to 12 spare leads without reloading.



Lead Size	Order Code OFI-846	Offer Price/1
0.5mm	-0050K	£0.81
0.7mm	-0060K	£0.81

Automatic Pencil Leads

Suitable for use on all paper, tracing and drafting media. Grade - HB. Pack of 12 leads.

PACK OF 12



Lead size	Pack Quantity	Order Code OFI-846	Offer Price/Pk
HB 0.5mm	1 pack of 12	-0020K	£0.73
HB 0.7mm	1 pack of 12	-0030K	£0.73

PAPER MATE Automatic Pencil

PACK OF 12

The non-stop lead is advanced and retracted by a simple twist action. No sharpening means no waste, no mess, no irritation. An economical and handy disposable pencil. 0.5mm. Grade - HB. Assorted Neon barrels.



Lead	Pack Quantity	Order Code PAP-846	Offer Price/Pk
HB	12	-0300K	£3.43

Artline Automatic Pencils

NEW

The Artline 7050 and 7070 mechanical pencils feature a triangular section rubber grip which enhances the writing comfort. The pencil has a retracting lead guard which propels the lead down to the point of writing contact. It also retracts as the lead is being used. The 0.5mm and 0.7mm lead diameter is ideal for detailed work. There is also a built-in vinyl eraser which is efficient, clean and smooth.



Model	Lead Diameter	Order Code ART-846	Offer Price/1
7050	0.5mm	-2055K	£1.27
7070	0.7mm	-2057M	£1.27

PAPER MATE Stick Pens

PACK OF 50

2020
Custom ballpoint pen delivers smooth and consistent writing. Available in 2 line widths: Fine (0.8mm) and Medium (1.0mm).

Ink Colour	Line Size	Pack Qty	Order Code PAP-846	List Price/Pk	Offer Price/Pk
Black	Fine	50	-0010K	£9.50	£6.17
Blue	Fine	50	-0020K	£9.50	£6.17
Black	Medium	50	-0030K	£9.50	£6.17
Blue	Medium	50	-0040K	£9.50	£6.17
Red	Medium	50	-0050K	£9.50	£6.17

Ballpoint Pens - Medium

PACK OF 50

Clear barrel for visible ink supply. Hexagonal design helps prevent rolling. Non-slip grip for comfortable writing. 1.2mm ultra smooth writing system.

Ink Colour	Pack Quantity	Order Code PAP-846	List Price/Pk	Offer Price/Pk
Black	50	-0210K	£7.50	£4.88
Blue	50	-0220K	£7.50	£4.88
Red	50	-0230K	£7.50	£4.88
Green	50	-0240K	£7.50	£4.88

BIC Ballpoint Pens

NEW

PACK OF 20

PACK OF 50

The worlds best selling ball pen. Available in packs of 20 (fine tip) or 50 (medium tip).

Colour	Size	Pack Quantity	Order Code BIC-846	List Price/Pk	Offer Price/Pk
Blue	Medium	50	-0180K	£9.32	£9.32
Black	Medium	50	-0170K	£9.32	£9.32
Red	Medium	50	-0190K	£9.32	£9.32

Colour	Size	Pack Quantity	Order Code BIC-846	List Price/Pk	Offer Price/Pk
Black	Fine	20	-0200K	£3.73	£3.73
Blue	Fine	20	-0210K	£3.73	£3.73
Red	Fine	20	-0230K	£3.73	£3.73

'Soft Feel' Retractable Ball Pen - Black

PACK OF 12

Retractable ball pen with rubberised barrel and ribbed finger grips for greater writing comfort. Ball point for skip and blob free performance. Barrel colour matches colour of ink.

Colour	Pack Quantity	Order Code BIC-846	List Price/Pk	Offer Price/Pk
Black	12	-0150K	£9.62	£5.29

Ballpoint Pens

NEW

PACK OF 20

Cristal Grip
Ballpoint pen, high writing comfort at an affordable price. Cristal Grip has a clear barrel with a added grip for comfort and control (the grip colour matches the ink colour) and meets ISO 11540 standard.

Colour	Pack Quantity	Order Code BIC-846	List Price/Pk	Offer Price/Pk
Black	20	-0120K	£8.10	£4.46
Blue	20	-0130K	£8.10	£4.46
Red	20	-0140K	£8.10	£4.46

Clic Ballpoint Pens

NEW

PACK OF 50

Medium point retractable ballpoint pens. Classic comfortable round barrel provides consistently smooth writing. Durable long lasting tungsten ball for ultimate reliability. Excellent quality and superb value for money.

Colour	Pack Quantity	Order Code BIC-846	List Price/Pk	Offer Price/Pk
Blue	50	-0090K	£31.07	£15.54
Black	50	-0100K	£31.07	£15.54

PILOT Begreen Pens

PACK OF 10

Super Gel Pens — 93% recycled Super Gel stick pen.
Permaball Pens — 77.4% recycled Permaball multi-surface rollerball pen.



Colour	Pack Quantity	Type	Order Code PIL-846	List Price/Pk	Offer Price/Pk
Black	10	Super Gel	-0030K	£8.90	£6.23
Blue	10	Super Gel	-0040K	£8.90	£6.23
Black	10	Permaball	-0050K	£19.99	£13.99
Blue	10	Permaball	-0060K	£19.99	£13.99

STAEDTLER Ballpoint Stick Pens

PACK OF 10

PACK OF 50

430
Extremely long lasting ink. Ink flow has been regulated to avoid blobbing or scratching.

Ink Colour	Pack Quantity	Order Code STD-846	List Price/Pk	Offer Price/Pk
Red	10	-1160K	£3.10	£1.71
Blue	10	-1170K	£3.10	£1.71
Green	10	-1180K	£3.10	£1.71
Black	10	-1190K	£3.10	£1.71

Ink Colour	Pack Quantity	Order Code STD-846	List Price/Pk	Offer Price/Pk
Red	50	-1200K	£13.09	£7.20
Blue	50	-1210K	£13.09	£7.20
Green	50	-1220K	£13.09	£7.20
Black	50	-1230K	£13.09	£7.20

LUXOR Ballpoint Pens

PACK OF 48

Ranger
Medium tip (0.8mm) ballpoint pens. A cost effective alternative where pens are used in bulk quantities. Available in black, blue and red.

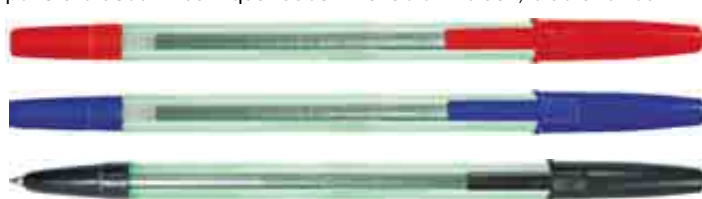

*Colours in table are for guidance only

Colour*	Pack Quantity	Order Code LUX-846	List Price/Pk	Offer Price/Pk
Black	48	-0010K	£3.99	£2.39
Blue	48	-0020K	£3.99	£2.39
Red	48	-0030K	£3.99	£2.39

PAPER MATE 4-Colour Ballpoint Pens

4 ink colours in one convenient retractable pen. Ink colours: black, blue, red & green. Tip: Medium (1.0mm).

Tip Size	Order Code PAP-846	Offer Price/1
Medium (1.00mm)	-0200K	£0.84

Office Supplies & Stationery

PACK OF 12

PAPER MATE *Ballpoint Pens*

Flexgrip Smooth writing ballpoint pen with comfortable rubberised barrel. Lubriglide® ink system provides smooth writing.

Colour	Type	Pack Qty	Order Code PAP-846	List Price/Pk	Offer Price/Pk
Black	Ball Pen	12	-0150K	£14.52	£9.44
Blue		12	-0160K	£14.52	£9.44



Flexgrip Ultra Smooth writing ball pen with comfortable rubberised barrel and Lubriglide® ink system provides smooth writing.

Colour	Type	Pack Qty	Order Code PAP-846	List Price/Pk	Offer Price/Pk
Black	Fine	12	-0100K	£12.48	£8.11
Blue		12	-0110K	£12.48	£8.11
Black	Medium	12	-0120K	£12.48	£8.11
Blue		12	-0130K	£12.48	£8.11
Red		12	-0140K	£12.48	£8.11



PACK OF 12

ZEBRA *Retractable Ballpoint Pens*

Z Grip Soft grip ballpoint pens with pocket clip and a medium 1.0mm retractable tip.

Colour	Pack Quantity	Order Code ZEB-846	Offer Price/Pk
Black	12	-0210K	£3.99
Blue	12	-0220K	£3.31

NEW



PACK OF 12

4-Colour Ballpoint Pen

Combination of 4 coloured pens. Easy retraction mechanism. All points are medium 1.0mm. Ink colours are black, blue, red and green.

Description	Order Code ZEB-846	Offer Price/1
4 Colour	-0330K	£1.13



BIC *Retractable Ballpoint Pen*

Retractable ballpoint pen with rubberised barrel and ribbed finger grips for greater writing comfort. Skip and blob free performance.

Colour	Pack Quantity	Order Code BIC-846	Offer Price/1
Black	12	-0150K	£5.29



PACK OF 12

PARKER *Stainless Steel Pen*

A Parker classic that is known worldwide for its tough reliability and simple line.

Colour	Pen Type	Order Code PAR-846	Offer Price/1
Blue	Stainless Steel	-0140K	£5.75



Parker Pen Refills

Refills to suit all Parker ballpoint pens.

Colour	Size	Type	Order Code PAR-846	Offer Price/1	Colour	Size	Type	Order Code PAR-846	Offer Price/1
Black	Fine	Ballpoint	-0030K	£2.06	Black	Fine	Rollerball	-0090K	£2.24
Blue	Fine	Ballpoint	-0040K	£2.06	Blue	Fine	Rollerball	-0100K	£2.24
Black	Medium	Ballpoint	-0050K	£2.06	Black	Medium	Rollerball	-0070K	£2.24
Blue	Medium	Ballpoint	-0060K	£2.06	Blue	Medium	Rollerball	-0080K	£2.24

Silver Food Industry Pen

Suitable for the food processing and manufacturing industry. One piece design offers the benefit that no internal parts can fall out of the pen (i.e. spring mechanism). Can easily be detected and removed by magnetic scanners and parts separators to ensure high standards of safety. Non-retractable. Satin finish stainless steel barrel. Blue ink.

Description	Order Code CTL-830	Offer Price/1
Food Industry Pen	-0040K	£0.99
Food Industry Pen with clip	-0050K	£1.09



Q-CONNECT *Retractable Ballpoint Pens*

Retractable ballpoint pens with soft rubberised grip Contemporary design. Medium point.

Colour	Pack Qty	Order Code QUE-846	Offer Price/Pk
Black	10	-0130K	£3.49
Blue	10	-0140K	£3.49
Red	10	-0150K	£3.49

PACK OF 10



Reception Pen on Chain

Pen attached by a chain to a solid base. Pen includes 2 black refills. Easy to use adhesive base.

Colour	Order Code QUE-846	Offer Price/1
Black	-0160K	£3.74



Artline® Rollerball Pens

PACK OF 12

Ink flow adjuster controls ink flow. Ink level can be seen through the transparent barrel. Good for sharp carbon copies.

Colour	Pack Qty	Ball Diameter	Order Code	Offer Price/Pk
Black	12	0.2	ART-802	£2.93
Blue	12	0.2	-1350K	£2.93
Red	12	0.2	-1380K	£2.93



Colour	Pack Qty	Ball Diameter	Order Code	Offer Price/Pk
Blue	12	0.4	-1770B	£2.86
Red	12	0.4	-1773D	£2.86



ZEBRA Rollerball Pens

NEW

PACK OF 12

XP-05 Liquid ink rollerball pens featuring a soft rubber grip for writing comfort, metal tip is durable and long lasting. Metallic design on barrel adds a touch of style and liquid ink offers a smooth and effortless write. 0.5mm needle tip point.

Colour	Pack Quantity	Order Code	Offer Price/Pk
Blue	12	ZEB-846	£7.19
Red	12	-0160K	£7.19



Rollerball Pens

XA Liquid ink rollerball pen with soft cushion grip. Size: 0.5mm fine point and 0.7mm medium point with arrow tip.

PACK OF 12

Colour	Pack Quantity	Order Code	Offer Price/Pk
Fine - 0.5mm			
Black	12	-0080K	£7.19
Blue	12	-0090K	£7.19
Red	12	-0100K	£7.19
Medium - 0.7mm			
Black	12	-0110K	£7.19
Blue	12	-0120K	£7.19
Red	12	-0130K	£7.19



Rollerball Pens

Marathon Gel ink rollerball pens with soft rubber grip and 0.7mm medium point. Tank barrel holds up to 3 times more ink than other gel ink pens.

PACK OF 12

Colour	Pack Quantity	Order Code	Offer Price/Pk
Black	12	-0020K	£9.72
Blue	12	-0030K	£9.72
Red	12	-0040K	£9.72

NEW



Q-CONNECT® Rollerball Pens

PACK OF 10

Liquid ink rollerball pens offer a constant ink supply, the ultimate in silky smooth writing performance. 0.5mm line width. Visible ink levels and a writing length over 2000m. Available in black, blue and red.

Colour	Pack Quantity	Order Code	Offer Price/Pk
Black	10	-0230K	£5.99
Blue	10	-0240K	£5.99
Red	10	-0250K	£5.99



Pentel® Rollerball Pens

NEW

PACK OF 12

R50 The leading brand for roller ball. Fine 0.8mm point for smooth writing action. Long lasting hardwearing point.

Colour	Pack Quantity	Order Code	Offer Price/Pk
Black	12	-0660K	£9.02
Blue	12	-0670K	£9.02
Red	12	-0680K	£9.02



STAEDTLER® Fibre Tipped Hand Writing Pens

PACK OF 10

309 Fibre tipped pen with 0.6mm line width, ideal for carbon copies. Dry safe ink, cap off time minimum of 2 weeks

Colour	Pack Quantity	Order Code	List Price/Pk	Offer Price/Pk
Blue	10	-0190K	£12.99	£7.14
Black	10	-0210K	£12.99	£7.14



Office Supplies & Stationery

PILOT *Gel Ink Ball Pen* **NEW**

G1 Rubber grip for added comfort. Gel ink ball pen with consistent smooth ink flow gives superb quality writing. 0.7mm tip.

Colour	Pack Quantity	Order Code	Offer Price/Pk
Black	12	PIL-846 -0200K	£14.20
Blue	12	-0210K	£14.20



PACK OF 12

Gel Ink Retractable Pen

G2 Retractable pen with gel ink which will guarantee exceptionally smooth writing. Rubberised grip prevents writing fatigue. Refillable. 0.7mm tip.

Colour	Pack Quantity	Order Code	Offer Price/Pk
Black	12	PIL-846 -0220K	£16.46
Blue	12	-0240K	£16.46
Red	12	-0230K	£16.46

NEW



PACK OF 12

edding *Gel Ink Ball Pens* **NEW**

2170 Water-based gel ink and practical, ergonomic rubber grip area guarantee particular accurate lettering and a soft, fine stroke width of 0.5 mm.

Colour	Pack Quantity	Order Code	Offer Price/Pk
Black	10	EDD-846 -0310K	£5.92
Blue	10	-0330K	£5.92
Red	10	-0320K	£5.92



PACK OF 10

ZEBRA *Gel Ink Ball Pens* **NEW**

Orbitz The 0.7mm medium point gel ink rollerball offers smooth effortless writing and a soft rubber grip.

Colour	Pack Quantity	Order Code	Offer Price/Pk
Black	12	ZEB-846 -0050K	£5.64
Blue	12	-0060K	£5.64
Red	12	-0070K	£5.64



PACK OF 12

Gel Ink Ball Pens **NEW**

Duogel Oil-based gel ink pens that write up to 3 times longer than normal gel pens. Partly rubberised barrel for comfortable grip.

Colour	Pack Quantity	Order Code	Offer Price/Pk
Black	12	ZEB-846 -0300K	£5.99
Blue	12	-0310K	£5.99
Red	12	-0320K	£5.99

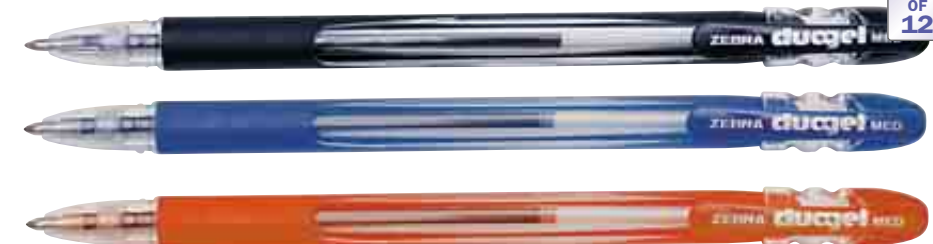

PACK OF 12

Q-CONNECT *Gel Ink Ball Pens*

Stylish smooth writing gel rollerball pen. Rubber grip for extra comfort and control. 0.3mm line width. Available in black, blue and red. Pack of 10.

Colour	Pack Quantity	Order Code	Offer Price/Pk
Black	10	QUE-846 -0200K	£4.80
Blue	10	-0210K	£4.80
Red	10	-0220K	£4.80



PACK OF 10

PILOT *Fountain Pen* **NEW**

Disposable fountain pen. Alloy nib suitable for right and left-handers. Viewing window on barrel indicates ink level. Special vein system regulates ink flow for smooth writing. No blobbing or clogging.

Colour	Order Code	Offer Price/1
Blue	PIL-846 -0370K	£2.18



CONTRACT PRICES AVAILABLE FOR VOLUME PURCHASES

All Prices Exclude V.A.T. © 2011

PAPER MATE Fibre-Tipped Pens

Tough nylon tipped pen for general office use. Long lasting nylon tip does not smudge or fray. Ideal for office, home or school.

Colour	Pack Quantity	Order Code	Offer Price/Pk
Black	12	PAP-846	£7.80
Blue	12	-0070K	£7.80
Red	12	-0080K	£7.80
Green	12	-0090K	£7.80



PACK OF 12

Pentel Fibre-Tipped Pens **NEW**

S520 The original fibre-tipped pen. Ideal for the office or studio, with water soluble ink.

Colour	Pack Quantity	Order Code	Offer Price/Pk
Black	12	PNL-846	£9.67
Red	12	-0710K	£9.67



PACK OF 12

Ultra Fine Pens

S570 Ideal for accounting and detailed work. Smooth, consistent writing. Never skips or smears. Plastic tip and metal reinforced collar. Sharp 0.3mm tip keeps its shape.

Colour	Pack Quantity	Order Code	Offer Price/Pk
Black	12	-0720K	£9.02



PACK OF 12

PILOT Ultra Fine Pens

The ideal pen for precise writing. Needle thin tip allows super smooth, even writing. Large ink supply. Contains liquid ink which never skips or blobs. Jumbo ink tank with viewing eye.

Colour	Pack Quantity	Order Code	Offer Price/1
V5 - 0.3mm Tip			
Black	1	-0290K	£1.64
Blue	1	-0300K	£1.64
Red	1	-0310K	£1.64
V7 - 0.7mm Tip			
Black	1	-0320K	£1.64
Blue	1	-0330K	£1.64
Red	1	-0340K	£1.64



Gel Ball Pens

G1 New generation ball pen ensures superb, consistent smooth ink flow. Contoured finger grip for comfortable writing. Fine 0.7mm tip.

Colour	Pack Quantity	Order Code	Offer Price/Pk
Black	12	-0250K	£12.35
Blue	12	-0260K	£12.35



PACK OF 12

TRIESTE Ultra Fine Pens

Japanese plastic tip with German non-toxic ink for fine writing with bright colours.

Colour	Pack Quantity	Order Code	Offer Price/Pk
Black	12	CTL-802	£2.65
Blue	12	-7860K	£2.65
Red	12	-7870K	£2.65
Green	12	-7880K	£2.68



PACK OF 12

ALPINA Rollerball Pens

Swiss metal tipped rollerball with tungsten carbide ball. Non-toxic ink and colour-coded cap.

Colour	Pack Quantity	Order Code	Offer Price/Pk
Black	12	-7800K	£3.19
Blue	12	-7810K	£3.19
Red	12	-7820K	£3.19



PACK OF 12

Office Supplies & Stationery

STAEDTLER® *Overhead Projector Pens*

PACK OF 10

Lumocolor®

Guarantees professional and effective presentation on all overhead transparencies. Not just an OHP pen! - can be used on most other glossy surfaces. Available in single colour packs of 10, wallets of 4 assorted (red, blue, green and black), wallets of 6 assorted (red, blue, green, black, orange, brown) and wallets of 8 assorted (yellow, orange, red, purple, blue, green, brown, black).

313 Lumocolor® Permanent Superfine 0.4mm



314 Lumocolor® Permanent Broad 1.0 - 2.5mm



315 Lumocolor® Non-permanent Medium 0.8mm



316 Lumocolor® Non-permanent Fine 0.6mm



317 Lumocolor® Permanent Medium 0.8mm



318 Lumocolor® Permanent Fine 0.6mm



SET OF 4

SET OF 6

SET OF 4

SET OF 8



Colour	Order Code STD-846		List Price/Pk	Offer Price/Pk
	313	314		
Red	-0430K	-0530K	£19.60	£10.78
Blue	-0440K	-0540K	£19.60	£10.78
Black	-0490K	-0590K	£19.60	£10.78
Assorted Set 4	-0500K	-0600K	£7.89	£4.34
Assorted Set 6	-0510K	-0610K	£11.19	£6.15

Colour	Order Code STD-846				List Price/Pk	Offer Price/Pk
	315	316	317	318		
Red	-0630K	-0740K	-0850K	-0960K	£16.34	£8.99
Blue	-0640K	-0750K	-0860K	-0970K	£16.34	£8.99
Green	-0660K	-0770K	-0880K	-0990K	£16.34	£8.99
Brown	-0680K	-0790K	-0900K	-1010K	£16.34	£8.99
Black	-0690K	-0800K	-0910K	-1020K	£16.34	£8.99
Assorted Set 4	-0700K	-0810K	-0920K	-1030K	£6.50	£3.58
Assorted Set 8	-0720K	-0830K	-0940K	-1050K	£13.00	£7.15

CONTRACT PRICES AVAILABLE FOR VOLUME PURCHASES

All Prices Exclude V.A.T. © 2011

Office Supplies & Stationery

PAPER MATE Correction Tape

Dryline grip correction mouse
Easy to use ergonomic dispenser with comfort grip applies dry for instant corrections with no mess.
Tape width: 5mm.



Size	Order Code	List Price/1	Offer Price/1
5mm x 8.5m	PAP-846	£2.16	£1.40

Correction Tape

Covers mistakes accurately and cleanly with a dry opaque tape, which can be overwritten immediately.
Tape size: 5mm x 6m.



Size	Order Code	Offer Price/1
5mm x 6m	HKO-846	£0.79

Pentel Correction Tape

25
Pentel's new tape is up to three times longer than most other tapes on the market. Massive 25m of tape, 4.2mm tape width. Crisp, precise action and clean cut-off. Visible tape reel and sliding tip protector. Covers whole lines of text or rows of figures. Instant write-over.



Size	Order Code	Offer Price/1
4.2mm x 25m	PNL-846	£3.02

Tipp-Ex Mini Correction Tape

Dry correction roller covers up mistakes quickly and effectively. Easy to use - simply roll cassette over your mistake to leave a covering of smooth opaque film. Tape can be written on immediately.



Description	Order Code	Offer Price/Pk
3 Correction Rollers	TPX-846	£3.12

Mini Correction Tape

Dry correction roller covers up mistakes quickly and effectively. Easy to use - simply roll cassette over your mistake to leave a covering of smooth opaque film. Tape can be written on immediately.



Type	Order Code	Offer Price/1
Correction Tape	TPX-846	£1.29

Superfine Micro Correct Pen

Micro correct with a new superfine tip giving a precise line width of only 1.4mm. Metal tip. Easy to control 'bellows' action. Trichloroethane-free formula. Clear cap with pocket clip.



Size	Order Code	Offer Price/1
1.4mm	PNL-846	£1.65

Correction Pen

Shake 'n' Squeeze
Correction fluid in a pen format with a squeezable body. 8ml.



Size	Pack Quantity	Order Code	Offer Price/Pk
8ml	10	TPX-846	£12.98
8ml	1	-0040K	£1.39

Correction Pen

Fine point correction pen with dense, quick drying white fluid. Self-sealing tip prevents leakage whilst also stopping the ink drying out.

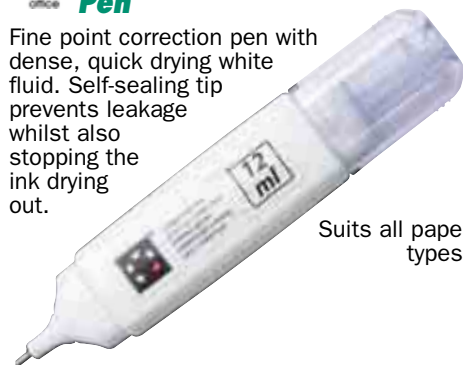

Type	Order Code	Offer Price/1
Correction Pen	FIV-846	£0.99

Pentel Micro Correct Pen

Ultra-fine metal tip for precision accuracy. Covers evenly and smoothly. Trichloroethane-free formula. Long lasting value. White opaque fluid.



Size	Pack Quantity	Order Code	Offer Price/1
7ml	1	PNL-846	£2.19

Micro Correct Pen

Micro fine point correction pen. Dense, quick drying white fluid. Self-sealing tip prevents drying out and spillage. Trichloroethane free.



Size	Pack Quantity	Order Code	Offer Price/Pk
12ml	1	PNL-846	£2.11
12ml	12	-0900K	£25.37

Office Supplies & Stationery

WRITING INSTRUMENTS & ACCESSORIES

Q-CONNECT[®] Correction Pen

Stylish pen shaped corrector with fine metal tip. Squeezable body to control the flow. Contains 8ml of fluid. Covers evenly and smoothly.

Pack of 10.

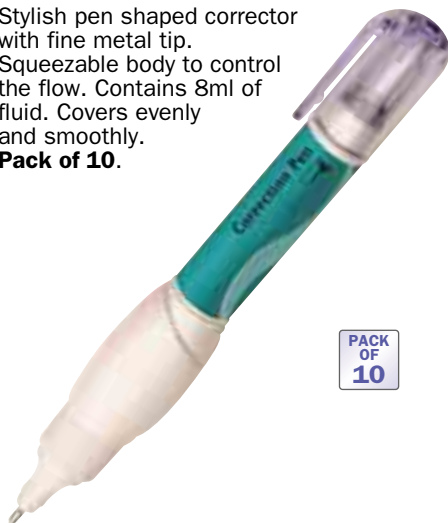

PACK OF 10

Size	Order Code	Offer Price/Pk
8ml	QUE-846 -0010K	£4.80

Correction Fluid

All purpose fast drying correction fluid. No hazardous chemicals. 20ml bottle.



Size	Order Code	Offer Price/1
20ml	CTL-802 -1350K	£0.59

Offis Pencil Sharpeners

Single 8mm diameter.



NEW

Size	Order Code	Offer Price/Pk
8mm diameter	OFI-846 -0200K	£0.49

PAPER MATE[®] Correction Fluid

Liquid Paper

For all correction needs. Premium coverage formula dries quickly. Smooth and durable finish resists cracking. For recycled and other white papers.

PACK OF 12



Size	Pack Quantity	Order Code	Offer Price/Pk
20ml	12	PAP-846 -0310K	£7.49

Two Hole Pencil Sharpener

Double, 8 and 11mm diameter.



NEW

Size	Order Code	Offer Price/1
8 & 11mm diameter	OFI-846 -0210K	£0.58

Pencil Sharpener

8mm and 10mm 2 hole pencil sharpener with integral waste bin. Top unscrews to allow shavings to be emptied.



Size	Order Code	Offer Price/1
8 & 10mm	OFI-846 -0040K	£0.89

Tipp-Ex[®] Correction Fluid

Europe's No.1 correction fluid. The Rapid Correction Fluid has a revolutionary new formulation for all types of corrections for ultimate coverage and performance with unrivalled drying time.



Size	Pack Quantity	Order Code	Offer Price/Pk
20ml	10	TPX-846 -0010K	£9.36
20ml	1	-0020K	£1.00

Swordfish Desk Pencil Sharpener

Professional manual pencil sharpener comes with a robust plastic body, and a transparent tray to hold the pencil shavings. Sharpener comes complete with desk clamp.

NEW



Description	Order Code	Offer Price/1
Pencil Sharpener with Desk Clamp	SWD-846 -0010K	£10.87

Office Supplies & Stationery

Offis Stationery Set

Ideal for general use and excellent value. **Set contents***: Storage case, 1x blue pen, 1x HB pencil, 2x plastic eraser, 1x single hole pencil sharpener, 1x 0.5mm propelling pencil + 0.5mm leads (pk 12), 1x correction mouse (5mm x 5m), 2x highlighters, 1x 30cm ruler, 1x shorthand notebook, 1x A4 feint ruled refill pad, 1x 10 digit desktop calculator.

*Exact set contents may vary slightly.



Description	Order Code	List Price/1	Offer Price/1
14 Piece Stationery Set	OFI-801	£8.99	£6.74

Plastic Clear Rulers

High quality rulers for use in offices, schools or at home. Manufactured from acrylic with measurements in millimetres and inches.



Size	Type	Order Code	Offer Price/1
30cm/12"	Economy	OFI-830	£0.22
30cm/12"	Standard	-0050K	£0.25

Q-CONNECT Plastic Rulers

Range of high quality rulers for use in offices, schools or at home.

Clear Ruler - Plastic

Manufactured from acrylic with measurements in millimetres and inches.

Length: 150mm or 300mm.

Shatterproof Ruler

Measurements in millimetres and inches.

Length: 300mm.

Type	Size	Order Code	Offer Price/1
Clear	15cm	-8008K	£0.22
Clear	30cm	-8010K	£0.26
Shatterproof Clear	30cm	-8020K	£0.49
Shatterproof White	30cm	-0140K	£0.49



Offis Erasers

Plastic eraser for general office use. Rubs pencil marks out without ghosting. Supplied in pack of 5 or 48 erasers.



Type	Pack Quantity	Order Code	Offer Price/Pk
Plastic	5	-0010K	£0.26
Plastic	48	-0020K	£1.99

Pentel Hi-Polymer Erasers

Specially designed for use on paper. Medium 65 x 24.5 x 12.5mm.

NEW



Size	Order Code	Offer Price/1
Medium	PNL-846	£0.68

STABILO Plastic Erasers

Coloured plastic eraser.

NEW

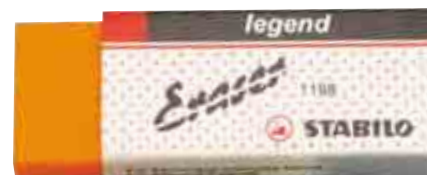

Type	Order Code	Offer Price/1
Plastic	STO-846	£0.39

Office Supplies & Stationery

Engineers Reference Data Charts

Now with 38 pages of engineering data. Each page coated with an anti-glare matt lamination to protect against the dirt and grease encountered in workshop conditions.

Contents:

- **Basic forms of heat treatment**
Colour charts for tempering and for hardening & forging.
- **Material groups**
Colour coded machineability chart and hardness listing.
- **Tensile strength and hardness**
Shore hardness and equivalent tensile strengths and conversions included.
- **Lubricant selection**
Colour coded materials chart and dilution guidelines.
- **Hole and shaft tolerances**
H7-e8 tolerances for counterbores included.
- **Metric screw and hole sizes**
- **Thread notation**
Explains terminology used to define thread characteristics.
- **Standard thread forms;**
Sequenced logically, tapping and clearance sizes integrated into single chart and colour highlighted for quick reference. Includes special metric pitches & NPT, distinctions made between 'Rp' and 'G' series BSP. ISO 529 pitch form diagrams shown. Now also lists tapping and clearance drill sizes for fluteless tap.
- **Dimensions of common shank types**
Now includes screwed shank, Weldon, DIN Taper, BT Taper, ISO Taper in addition to Morse taper shank details.
- **Standards for engineering drawings**
Comprehensive listing including contemporary listings and illustrations.
- **Abbreviations used in engineering drawings**
- **Common CNC codes**
Comprehensive listing including contemporary listings.
- **Axis nomenclature for machine tools**
Newly added page explaining the use of letter addresses to define directional motion.
- **Trigonometry formulae**
Colour coded CAD produced illustrations for quick reference.
- **Sines and Cosines**
Calculated to six decimal places with colour coded axes for quick reference.

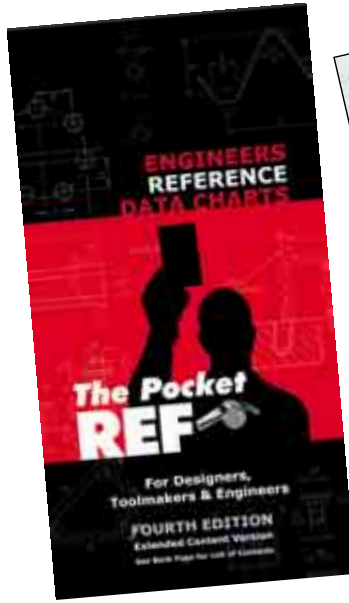

FOURTH EDITION
Extended Content Version

LAMINATED EDITION

Pocket Size
164 x 84mm

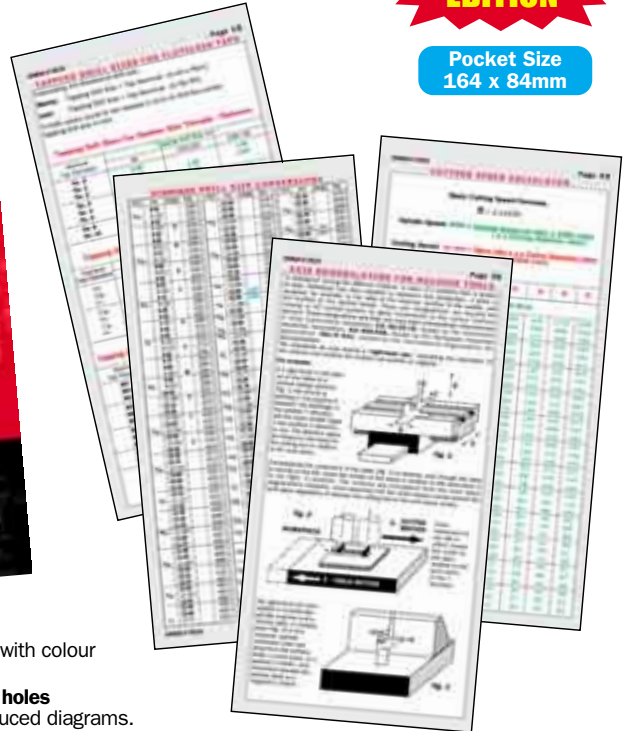

- **Tangents and Cotangents**
Calculated to six decimal places with colour coded axes for quick reference.
- **Co-ordinates for equally pitched holes**
Clear and easy to read CAD produced diagrams.
- **Bending allowances for malleable materials**
Listed as metric radius and thickness with nearest equivalent SWG given for guidance. Clear and easy to read CAD produced diagrams.
- **Cutting speed calculator**
Gives required RPM for known cutter diameters and cutting speeds.
- **Standard drill size conversions;**
No & letter sizes integrated into a single chart, standard sizes are highlighted in bold text, size range extended from 25.25mm up to 32.50mm. All inch-fractional sizes converted to mm equivalent as well as inch-decimal and Morse Taper shank sizes are indicated against drill diameter ranges.

- **Abbreviations and formulae**
Definitions of standard meanings with specific attention given to turning, milling and drilling. Comprehensive list of commonly used abbreviations.
- **Weight and measure systems, useful conversions and constants**
A comprehensive listing of contemporary and old systems, along with the necessary conversion formulae.

Item	Order Code	List Price/1	Offer Price/1
Data Charts	-0356C	£3.58	£2.99

Engineers Reference Handbook

- A handy pocket-sized reference booklet of data charts and tables
- Suitable for the drawing office, toolroom or workshop
- 9 sections
- 209 pages

Pocket Size
148 x 100mm

DESK EDITION

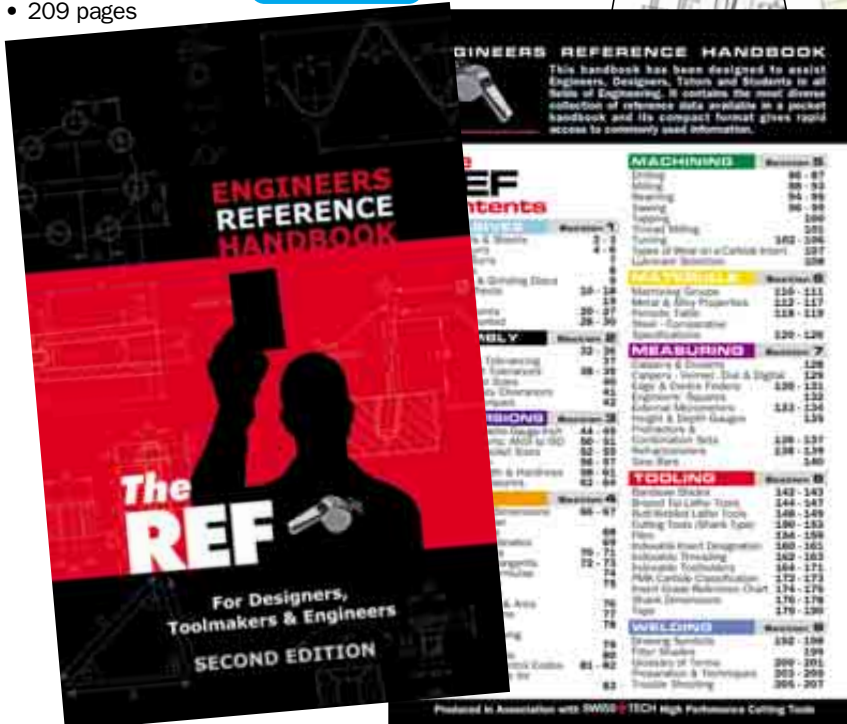

Item	Order Code	List Price/1	Offer Price/1
Handbook	-0356A	£6.95	£3.99

Office Supplies & Stationery

CONTRACT PRICES AVAILABLE FOR VOLUME PURCHASES

All Prices Exclude V.A.T. © 2011