



This manual covers the following model:

210-3311

Purchase Details and Service History

Thank you for choosing an SKC product. Your purchase is covered by our warranty, details of which can be found inside the rear cover of this manual.

Product Model Number	Product Serial Number	Date of Purchase
210-3311		

SKC recommends annual servicing of this product. The first service is due one year from the date of purchase, and then at yearly intervals on this date.

Service	Date	Service	Date	Service	Date
1		5		9	
2		6		10	
3		7		11	
4		8		12	

Please note that SKC Ltd are the only authorised service centre in the UK, guaranteeing you access to the full range of genuine SKC replacement parts. For all other areas a full list of SKC approved distributors and service centres can be found at www.skcltd.com

SKC UK service centre - Tel: +44 (0)1258 480188 Fax: +44 (0)1258 480184 Email: info@skcltd.com

Blank Page

Intrinsic Safety Information	4
Specifications	6
General Information	10
Diagram of the AirChek 3000 Pump	12
AirChek 3000 Pump LCD Screen	14
AirChek 3000 Pump Keypad	15
Getting Started	16
1) Charging the Battery Pack	16
2) Battery Status Indicator	17
3) SLEEP Mode	17
4) HOLD and RUN Modes	18
5) Pump Run LED Indicator	18
6) Flow Fault	18
7) Entering and Navigating the User Interface.....	19
Run Time Data Screens.....	20
User Interface Level One.....	22
1) Setting and Manual Calibration of the Pump Flow Rate.....	22
2) Setting and Automatic Calibration of the Pump Flow Rate Using CalChek	23
3) Full (Multiple Point) Flow Calibration Using CalChek	26

User Interface Level Two.....	29
1) Changing the Display Units	29
2) Setting the Clock Time.....	30
3) Setting a Sample Run Time	31
4) Deleting a Sample Run Time.....	33
5) Setting a Delayed Start Time.....	34
6) Deleting a Delayed Start Time or DataTrac Program.....	36
7) Resetting the Run Time Data	37
Low Flow Sampling	38
General Troubleshooting	40
CalChek Calibration Error Code Troubleshooting	42
Care of the Battery Pack.....	44
AirChek 3000 Pump Components	46
AirChek 3000 Pump Replacement Parts.....	48
AirChek 3000 Pump Accessories	49
AirChek 3000 Pump DataTrac Software.....	52
Intrinsic Safety Certification.....	54
Warranty Information	62

The AirChek 3000 Deluxe (model 210-3311) air sampling pump

- Complies with the EU ATEX Directive 2014/34/EU on equipment intended for use in potentially explosive atmospheres within Europe, and with the international IECEx certification scheme. The AirChek 3000 pump carries the following markings:



II 1D Ex ia IIIC T120°C Da
II 1G Ex ia IIC T4 Ga
I M1 Ex ia I Ma

Ta = 0°C to +40°C IP64

- ATEX certificate number: SIRA 11ATEX2121X.
- IECEx certificate number: IECEx SIR 11.0055X.
- European (EN) and International (IEC) standards applied: Refer to Intrinsic Safety Certification on pages 54 to 61.
- The equipment may be used in zones 20, 21 & 22 (flammable dusts), apparatus groups IIIA, IIIB & IIIC, temperature class T120°C, and equipment protection levels (EPLs) Da, Db & Dc.
- The equipment may be used in zones 0, 1 & 2 (flammable gases, vapours and mists), apparatus groups IIA, IIB & IIC, temperature classes T1, T2, T3 & T4, and equipment protection levels (EPLs) Ga, Gb & Gc.
- The equipment may be used in mines (firedamp and/or coal dust), apparatus group I, and equipment protection levels (EPLs) Ma & Mb.
- The equipment is certified for use in ambient temperatures (Ta) in the range 0°C to +40°C and should not be used outside this range when in a hazardous location.
- The equipment has a casing IP rating of IP64, corresponding to dust-tight and protected against splashing water. The equipment casing is not certified as protected against water jets, and is not suitable for immersion in water.

- Do not connect to the DataTrac PC interface port whilst in a hazardous location.
- The maximum input voltage, U_m , at the DataTrac PC interface port is 6V. The safe area apparatus that is to be connected to the DataTrac PC Interface port must be a Safety Extra Low Voltage (SELV) or Protective Extra Low Voltage (PELV) circuit, e.g. the serial (RS232) interface or USB interface of a PC.
- Do not charge the battery pack whilst in a hazardous location.
- Do not disconnect the battery pack from the pump whilst in a hazardous location. Fit the battery pack to the pump only when in a clean, dust free environment.
- Use only SKC approved chargers designated for this pump model.
- Do not subject the equipment to intense sunlight for long periods.
- The equipment has not been assessed as a safety related device (as referred to in Directive 2014/34/EU Annex II, clause 1.5).
- The recessed LCD screen window could potentially store an electrostatic charge if rubbed. Precautions must be taken to prevent the build up of electrostatic charge, particularly if the pump is used in a zone 0 location. Clean the LCD screen window only with a damp cloth.
- The equipment should not be used if damaged in a way that could invalidate intrinsic safety. Such defects might include cracking of the pump or battery pack enclosure and internal encapsulant such that internal components or cells are exposed.
- Substitution of components with non-SKC approved components may invalidate the intrinsic safety certification of the pump.

Important note about intrinsic safety

If you are unsure as to whether the air sampling pump you have purchased is suitable for your environment, check with your site manager or responsible person BEFORE USE that the intrinsic safety rating on the product meets your site requirements. SKC personnel are unable to recommend the appropriate safety rating for your site.

Specifications

- Weight: 580 g
- Casing IP rating: IP64 (dust and rain proof)
- Flow range:
1000 - 3250 ml/min (constant flow operation)
5 - 500 ml/min with adapter (constant pressure operation)
- Flow control: ± 5 % of set point constant flow
- Compensation range:

Flow rate (ml/min)	Back Pressure	
	(kPa)	(" H ₂ O)
1000	0 - 8.7	0 - 35
1500	0 - 7.5	0 - 30
2000	0 - 7.5	0 - 30
2500	0 - 6.2	0 - 25
3000	0 - 5.0	0 - 20
3250	0 - 3.7	0 - 15

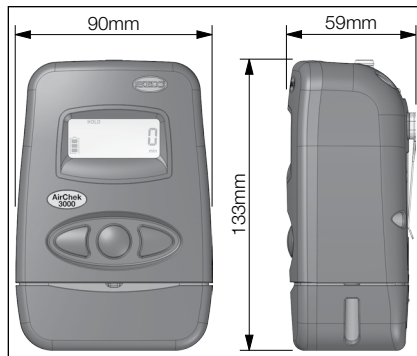

- Battery pack: NiMH rechargeable, 2.0 Ah, 4.8 V
- Charging time:
Up to 3 hours using 223-240A single fast charger
16 hours using 223-109A five station charger
- Storage & charging temperature: 0 °C to +45 °C
- Operating temperature: 0 °C to +40 °C (limited by Intrinsic Safety Certification)

- Operating humidity: 0 to 95 % RH non-condensing
- Operating altitude: 2285 metres (7500 ft) maximum
- Timing accuracy: 1 minute per month at 25 °C
- Atmospheric pressure accuracy: ± 10 mbar (± 0.3 " H_g)
- Temperature accuracy: ± 5 % of reading
- Typical run times:

Back Pressure		Run Time at Stated Flow Rate (hours)					
kPa	" H ₂ O	1.0 l/min	1.5 l/min	2.0 l/min	2.5 l/min	3.0 l/min	3.25 l/min
1.2	5	28	24	20	18	16	15
2.5	10	19	17	14	14	13	12
3.7	15	15	14	12	11	11	10
5.0	20	12	11	10	10	9	-
6.2	25	10	10	9	8	-	-
7.5	30	9	9	8	-	-	-
8.7	35	8	-	-	-	-	-

Note: Run times quoted are based on a new, fully charged battery, do not take account of increasing back pressure due to filter loading and are rounded down to the nearest full hour. Pump performance may vary.

Pump Features	
Battery charging options	SKC offer two battery charger options for the AirChek 3000 pump, a single fast charger (Part No. 223-240A) providing a charging time up to 3 hours, and a five station charger (Part No. 223-109A) providing a charging time of 16 hours.
Mains power option	The AirChek 3000 pump can also be powered from the electrical mains supply using a 'battery eliminator' (Part Nos. 223-330B - Euro 2 pin plug, 223-330C UK 3 pin plug). This accessory comprises a mains adaptor and dummy battery pack which is fitted to the pump in place of the standard battery pack. Please note that the pump's ATEX / IECEx certification is invalidated when using the battery eliminator, and therefore must not be used in hazardous areas when the battery eliminator is fitted.
LCD screen	LCD screen indicates run-time data, operating and fault modes and battery charge state.
Sample hold function	Enables pausing and restarting of the pump during a sample without loss of run time data .
Low battery shutdown	Automatic pump shutdown in the event of a low battery condition. The low battery shutoff voltage is selected to prevent over-discharge of the battery which can cause degradation of the battery performance. The pump retains the run-time data in the event of a low battery shutdown.

Pump Features

Flow fault function	Indicates flow fault due to obstructed tubing or excessive filter loading. Shuts the pump down and enters 'HOLD' mode if the condition persists for longer than 15 seconds. Automatically attempts to restart every five minutes (up to a maximum of 10 restarts), until the flow fault condition clears in which case normal running will resume.
Programmable run time	Sample run time programmable in minutes, via keypad and LCD screen. Pump automatically shuts down at end of sample and retains run time data.
Programmable delayed start time	Sample start delay time programmable in hours and minutes, via keypad and LCD screen.
Particulate trap	Built in replaceable filter to trap particles that would otherwise contaminate the pump mechanism.
Automatic air flow rate calibration	With optional Defender primary calibrator and CalChek Communicator cable. Enables automatic calibration of the sample air flow rate to the required level.
PC Connectivity	With optional DataTrac USB adapter cable and PC software. Enables programming of timed sample runs, delayed starts and intermittent sampling. Enables retrieval of pump run-time data and history to the PC.

1) Pump Models

210-3311	Deluxe ATEX / IECEx certified pump with NiMH battery pack
----------	---

2) Care of the AirChek 3000 Pump

- Always use the correct SKC battery pack and battery chargers designated for the AirChek 3000 pump.
- The battery pack charging socket is of the mini-USB type, however it is not a USB interface port and must not be connected to a computer USB port. Damage to the battery pack and/or the computer may result.
- Never run the pump long term without a tube or filter medium in place.
- When carrying out sampling using long term colour change tubes always use a tandem tube holder with trap tube (Part No. 222-3D-2 and cover 224-29T). This will prevent the aggressive fumes generated by these tubes from entering and damaging the pump mechanism.
- When carrying out sampling using impingers always fit a trap between the impinger and pump inlet. This will prevent the possibility of the fluid used in the impinger from entering and damaging the pump mechanism. As a further precaution always ensure that the pump flow rate is set to below 1 litre/min before connecting the trap and impinger to the pump inlet.
- The AirChek 3000 pump case is IP64 rated, and therefore must not be used where it may be subjected to water jets or complete immersion in water. The pump can be used where it may be subjected to rain or splashing water, but care must be taken to ensure that water cannot enter the pump air inlet port.
- The AirChek 3000 pump is fitted with a particulate filter which is easy to replace. Simply unscrew the inlet filter cover (use a 13mm A/F spanner to loosen the cover if required), remove the O ring and lift out the filter. Fit the new filter, taking care not to crease it when inserting, fit the O ring and screw on the inlet filter cover hand tight only. For general maintenance replace the filter every 2 - 3 months or if it appears dirty. New filters are white in colour (order Part No. P40011).

Warning - Failure to follow these guidelines will void the product warranty.

3) Non ATEX / IECEx Certified Variants of the AirChek 3000 Pump

The AirChek 3000 pump is also produced as a variant model which is certified for intrinsic safety for use in North America and Canada, and these pumps are therefore not suitable for use in potentially explosive atmospheres in Europe where ATEX certification is mandatory.

Pump components vary between the North American / Canadian and ATEX / IECEx certified variants, therefore components must not be interchanged between these pumps. If in any doubt please contact SKC Ltd customer services for advice.

4) Sampling Methods

This instruction manual provides the necessary information to set up and operate the AirChek 3000 pump. For more detailed information on specific sampling methods please refer to SKC's Step-By-Step Guide to Air Sampling (Part No. 224-G1). To obtain a free copy please contact SKC Ltd customer services on +44 (0) 1258 480188 or download at www.skcltd.com.

5) The WEEE Directive



This product is marked with the crossed out wheeled bin symbol, which identifies that it falls within the scope of the EC Directive 2002/96/EC on waste electrical and electronic equipment (WEEE). At the end of its useful life, this product must be disposed of in an environmentally sound way as detailed in the Directive. Note that the battery pack must be separated from the pump and disposed of as detailed in the Batteries Directive (see below). Please contact your local distributor or SKC Ltd for further details on how to comply with the requirements of the WEEE Directive. SKC Ltd's producer registration number is WEE/KH0054TQ.

6) The Batteries Directive

The NiMH battery pack supplied with this pump and any spare battery packs purchased for it, fall within the scope of the EC Directive 2006/66/EC on batteries and accumulators and waste batteries and accumulators. At the end of the battery pack's life it must be disposed of in an environmentally sound way as detailed in the Directive. Please contact your local distributor or SKC Ltd for further details on how to comply with the requirements of the Batteries Directive. SKC Ltd's batteries producer registration number is BPRN00454.

Diagram of the AirChek 3000 Pump

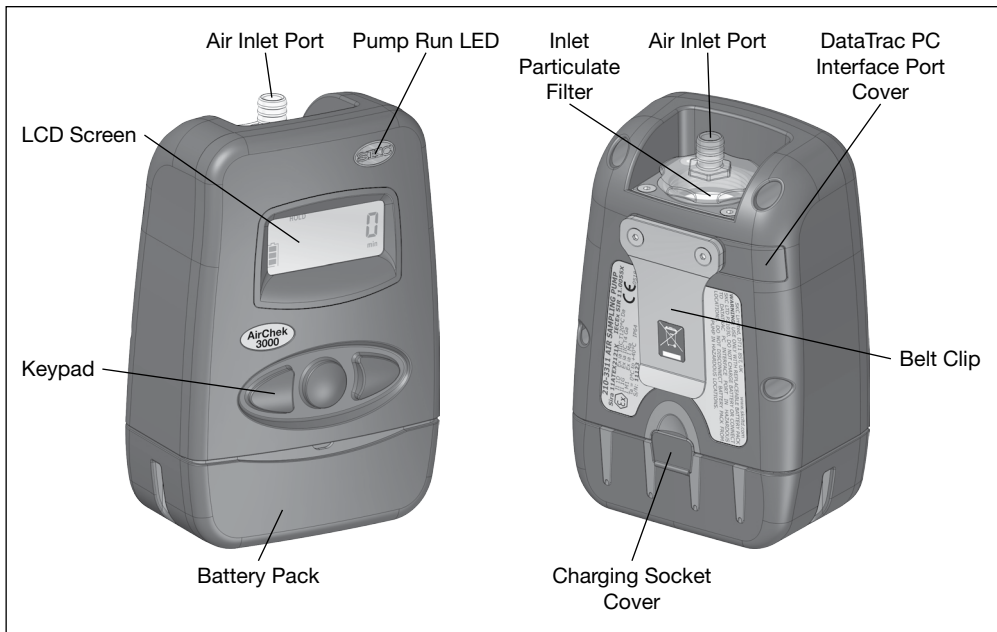

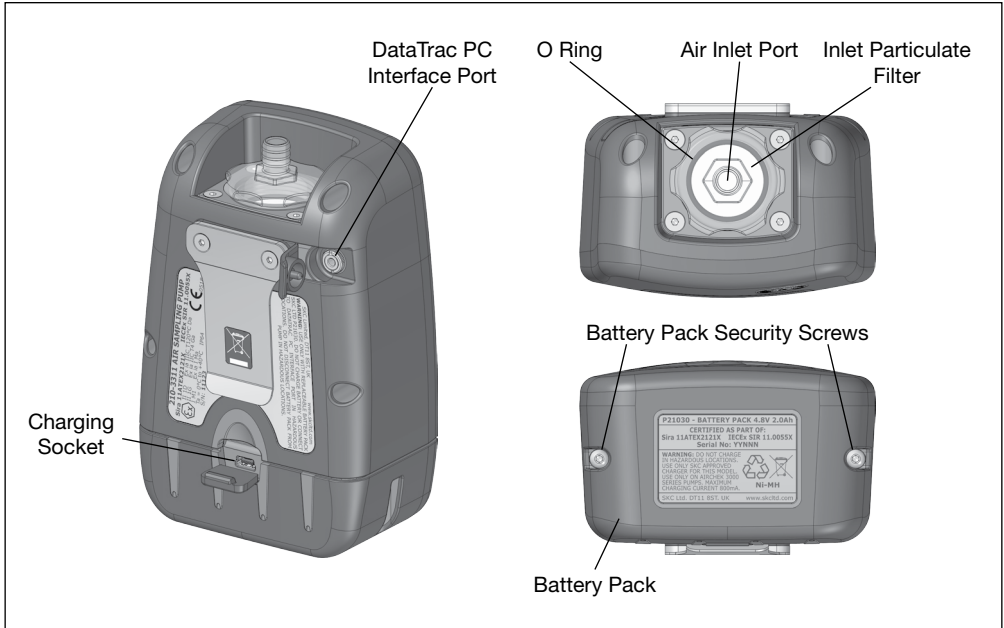

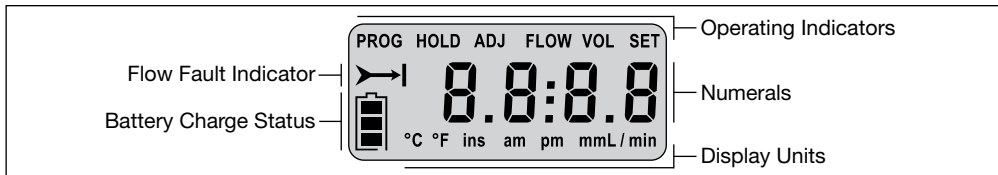

Operating Indicators





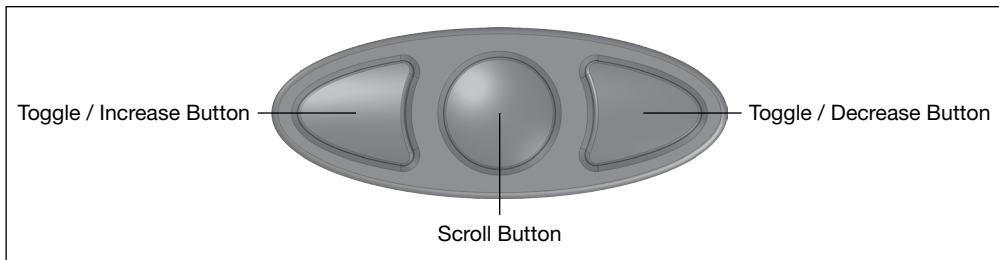

PROG	Active when a sample program is loaded into the pump memory.
HOLD	Flashes when the pump is in HOLD mode.
ADJ	Flashes when adjusting the pump flow rate during flow calibration.
FLOW	Active when the pump LCD screen displays the flow rate.
VOL	Active when the pump LCD screen displays the volume of air sampled.
SET	Flashes when setting the pump flow rate, display units, clock time and delayed start time.

Display Units

°C or °F	Sample air temperature in degrees Centigrade or Fahrenheit.
ins, mm or m	Atmospheric pressure in inches of mercury, millimetres of mercury or millibars.
mL/min	Pump flow rate in millilitres per minute.
mL or L	Total volume of air sampled in millilitres or litres since last reset.
min	Run time in minutes since last reset.
am and/or pm	Time of day in hours and minutes (12 or 24 hour clock).



Keypad Operation

	Scrolls through run time data in RUN and HOLD modes. Scrolls through sampling parameters and display options when navigating the User Interface.
	Toggles between options and increases values when navigating the User Interface.
	Toggles between options and decreases values when navigating the User Interface.
	To wake the pump from SLEEP mode and activate the LCD screen press any of the three buttons.
	Press buttons simultaneously. Switches between HOLD and RUN modes. When navigating the User Interface selects or enters the displayed item.
	Security code that must be pressed in sequence within 10 seconds after changing operating mode (from HOLD to RUN mode, or RUN to HOLD mode) to enter the User Interface. If the 10 second time limit is exceeded, the pump will remain in its current (HOLD or RUN) mode.

1) Charging the Battery Pack

Prior to first use the battery pack should be fully charged, ideally overnight. Note that a new battery pack may require 2 - 3 charge / discharge cycles to achieve full capacity.

The AirChek 3000 pump must only be charged using the correct SKC chargers (Part Nos. 223-240A - single fast charger, 223-109A - five station charger).

The chargers are supplied with mains input plugs suitable for use in the UK, Europe, USA and Australia / New Zealand. Select the correct mains input plug and fit it to the charger as detailed in the instructions supplied with the charger.

Use a finger nail to flick open the battery pack charging socket cover at the rear of the pump. Alternatively use the large bladed screwdriver attachment of the supplied toolkit to flick open the cover.

Plug the charger output plug into the mating socket revealed behind the charging socket cover. Plug the charger into the electrical mains supply and switch on the power. The LED indicator on the charger will illuminate to indicate that the battery pack is connected and charging has commenced.



Refer to the instructions supplied with the specific charger model for details of the charging sequence.

When fully charged disconnect the charger plug from the battery pack and close the charging socket cover.

To check the battery charge state wake the pump from SLEEP mode by pressing any of the three buttons on the keypad and the LCD screen will activate, displaying the battery status indicator.

2) Battery Status Indicator

The battery status indicator on the pump LCD screen shows the current battery charge level:

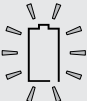
	<p>Fully charged. Three bars displayed from approximately 100% to 75% capacity. Note: It is strongly recommended to ensure that the battery is fully charged before starting a sample run.</p>
	<p>Two bars displayed from approximately 75% to 25% capacity.</p>
	<p>One bar displayed below approximately 25% capacity.</p>
	<p>Low battery. No bars and flashing outline indicates low battery. Pump automatically switches to HOLD mode, and then SLEEP mode within 10 seconds.</p> <p>Note: When the pump stops due to a low battery and is left to stand for a period of time, one bar may appear on the battery status indicator when the LCD screen is activated. This false “recovery” will fall quickly if the pump is operated without recharging it. RECHARGE THE PUMP BEFORE SAMPLING.</p>

3) SLEEP Mode

If the pump is left in HOLD mode for longer than five minutes the pump will automatically set itself to a low power SLEEP mode, with the LCD screen switched off. To wake the pump from SLEEP mode simply press any of the three buttons and the pump LCD screen will activate and display the last four digits of the pump serial number followed by the internal software version number before switching to HOLD mode.

The pump will also automatically wake from SLEEP mode when the battery charger is connected.

4) HOLD and RUN Modes

To switch from HOLD mode to RUN mode press [◀▶]. The pump will start to run and the run time data will be updated continuously in memory. The LCD screen will display the real-time run time data. Press the ● button to scroll through the run time data. The sample run time and sample air volume will continue to accumulate unless reset - refer User Interface Level Two 7) on page 37.

To switch from RUN mode to HOLD mode press [◀▶]. The pump will stop and retain the run-time data in memory. The temperature, atmospheric pressure and clock time readings remain active in HOLD mode, and can be displayed on the LCD screen, along with the accumulated sample run time and sample air volume by scrolling through the run time data screens by pressing the ● button.

5) Pump Run LED Indicator

When the pump is in RUN mode the blue pump run LED indicator will flash on and off to indicate that the pump is running.

6) Flow Fault

If pump operation is interrupted due to blocked or restricted air flow, the flow fault indicator ►| will flash. If the flow fault persists for 15 seconds the pump will stop and switch to HOLD mode, with the flow fault indicator on continuously. The pump will then wait 5 minutes before automatically switching to RUN mode to continue sampling. If the flow remains restricted the pump will return to HOLD mode, and attempt to restart every 5 minutes up to a maximum of 10 restarts. The maximum number of restart attempts can be changed using a PC and the optional DataTrac Interface and Software.

The accumulated sample run time and sample air volume readings are retained but not updated whilst the pump is in flow fault.

7) Entering and Navigating the User Interface

The AirChek 3000 pump User Interface features two security code protected levels:

- Level One - Accessed from RUN mode, allows the user to change the air flow rate, adjust the air flow rate to a calibrated air flow meter, and calibrate the pump automatically using the CalChek feature.

To enter the Level One User Interface, with the pump in HOLD mode, press [◀▶] to switch to RUN mode and within 10 seconds press the security code sequence ○▶▶○.

- Level Two - Accessed from HOLD mode, allows the user to change the display units for the temperature and atmospheric pressure, set a sample run time, select 12 or 24 hour clock display, set a delayed start time, set the clock time, and clear the accumulated run time data.







To enter the Level Two User Interface, with the pump in RUN mode, press [◀▶] to switch to HOLD mode and within 10 seconds press the security code sequence ○▶▶○.

To navigate the User Interface, press the ○ button to scroll through the different parameters on the LCD screen.

To exit the User Interface, press the ○ button to scroll through the different parameter screens until the LCD screen displays 'End'. Press [◀▶] to exit. Any changes made to the parameters will be saved and the pump will continue in its current (HOLD or RUN) mode.

The Level Two User Interface also includes the option to exit without saving changes to the parameters. Press the ○ button to scroll through the different parameter screens until the LCD screen displays "ESC". Press [◀▶] to exit without saving.



When in HOLD or RUN modes press the  button to scroll through the available run-time data screens:

	Elapsed run time since last reset in minutes up to 9999 minutes (approximately 1 week). Above 9999 minutes display reverts to 0 minutes and continues to count.
	Flow rate in millilitres/minute.
	Accumulated sample air volume since last reset in millilitres or litres up to 9999 litres. Above 9999 litres display reverts to 0 litres and continues to count.
	Real time sample air temperature in °C or °F.
	Clock time in 12 or 24 hour format with AM and PM indicators.
	Real time atmospheric pressure in mbar, mm H _g or " H _g .

The flow rate displayed on the pump LCD screen is the flow rate to which the pump has been calibrated. To maintain the flow rate as displayed, the pump automatically adjusts its operation during sampling for changes in temperature and atmospheric pressure that may differ from the temperature and atmospheric pressure present at the time of calibration. The flow rate display does not change from the calibrated flow rate. The pump will flow fault if it is unable to maintain the calibrated flow rate to within $\pm 5\%$.

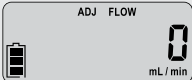
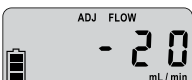

The accumulated sample air volume displayed on the pump LCD screen is "corrected" in that it is the result of a continuous calculation of corrected flow rate multiplied by sample time.

1) Setting and Manual Calibration of the Pump Flow Rate



1. Set up the sample train as specified in the sampling method and connect to the pump air inlet port. Connect a calibrated flow meter such as a Defender primary flow calibrator to the inlet of the sample train.
2. With the pump in HOLD mode, press [◀▶] to switch to RUN mode, and allow the pump to run for at least 5 minutes before commencing setting and calibration of the flow rate.
3. Enter User Interface Level One as detailed in Getting Started 7) on page 19.
4. The first User Interface screen displayed is the flow setting screen, with 'SET' flashing.
5. Use the ◀ and ▶ buttons to increase or decrease the flow setting, in steps of 10 ml/min, to the required flow rate on the LCD screen.
6. When the required flow rate is set press the ○ button to display the flow rate adjust screen, with 'ADJ' flashing.
7. Set the calibrated flow meter to take continuous readings, and observe the indicated flow rate. Use the ◀ and ▶ buttons to adjust the pump flow rate up or down in steps of 10 ml/min, until the calibrated flow meter indicates the required flow rate to within ± 10 ml/min.

8. Press the  button twice to display the 'End' screen.



9. Press [ ] to exit to RUN mode. The pump will now maintain the calibrated flow rate to within $\pm 5\%$.



10. Press [ ] to switch to HOLD mode. Before commencing sampling it is recommended to reset the accumulated run time data. Refer to User Interface Level Two 7) on page 37.

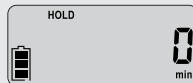

2) Setting and Automatic Calibration of the Pump Flow Rate Using CalChek

The optional CalChek Communicator cable provides direct communication between the AirChek 3000 pump and a Defender primary calibrator. This communication enables automatic adjustment and calibration of the pump flow rate. Refer to the Accessories Table on pages 49 - 51 for Defender and CalChek accessory part numbers.

Note: Do not perform a calibration until the pump has remained at ambient temperature for at least 2 hours.

1. Set up the sample train as specified in the sampling method and connect to the pump air inlet port. Connect the Defender primary flow calibrator air outlet port to the inlet of the sample train. Connect the CalChek Communicator cable between the serial interface (RS-232) port on the rear of the Defender primary calibrator and the PC interface socket on the rear of the AirChek 3000 pump.

2. With the pump in HOLD mode, press [◀▶] to switch to RUN mode, and allow the pump to run for at least 5 minutes before commencing setting and calibration of the flow rate.
3. On the Defender calibrator, ensure that the 'Data Port' parameter on the Setup - Preferences screen is set to the 'SKC' option. Set the Defender to take continuous readings. Refer to the Defender instructions for further information.
4. On the pump enter User Interface Level One as detailed in Getting Started 7) on page 19.

5. The first User Interface screen displayed is the flow setting screen, with 'SET' flashing.



6. Use the ◀ and ▶ buttons to increase or decrease the flow setting, in steps of 10 ml/min, to the required flow rate on the LCD screen.



7. When the required flow rate is set press the ○ button until the 'CAL' screen is displayed.



8. Press [◀▶] to initiate an automatic single point flow calibration.

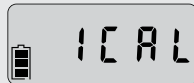

9. After a number of Defender readings the pump LCD screen will briefly display a pre-calibration flow rate.



10. The pump will then automatically adjust the flow rate to the required setting, and after a number of Defender readings the pump LCD screen will briefly display a post-calibration flow rate.

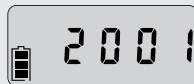

11. At the end of a successful single point calibration the pump will automatically display the 'End' screen.



12. Press [◀] to exit to RUN mode. The pump will now maintain the calibrated flow rate to within $\pm 5\%$.

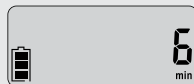

13. Press [◀] to switch to HOLD mode. The calibration data is written into the pump memory when the pump switches to SLEEP mode, therefore leave the pump in HOLD mode for five minutes after which it will switch to SLEEP mode. Before commencing sampling it is recommended to reset the accumulated run time data. Refer to User Interface Level Two 7) on page 37.

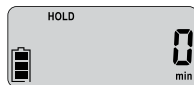

14. If a problem was encountered during the single point calibration, an error code will be displayed. Refer to the CalChek Error Code Table on pages 42 and 43. Press the O button to clear the error code screen and revert to RUN mode.



Both the pre-calibration and post-calibration flow rates with the time and date are recorded in the pump history memory and can be accessed using the optional DataTrac Interface and Software and a PC.

The single point calibration function can also be used to provide an automatic post sampling calibration check. However, as the function may adjust the flow rate, this is only recommended if the DataTrac Interface and Software are available. Otherwise a manual post sampling calibration check is recommended.

3) Full (Multiple Point) Flow Calibration Using CalChek

This type of automatic calibration provides flow correction across the operating range of the AirChek 3000 pump in approximately 4 minutes. The operation calibrates each flow rate to a Defender primary standard. It can also provide a record of calibration for maintenance and quality purposes if the optional DataTrac Interface and Software is used. SKC recommends that a full calibration be performed during pump maintenance and after non-factory repairs.

Note:

- Full calibration clears the pump history, run time parameters, and the Scheduler in the DataTrac Software.
- Ensure that the battery pack is fully charged before starting a full calibration.
- Do not perform a full calibration until the pump has remained at ambient temperature for at least 2 hours.
- Full calibration is carried out with no sample media in line.

1. Connect the Defender primary flow calibrator air outlet port directly to the pump air inlet port. Connect the CalChek Communicator cable between the serial interface (RS-232) port on the rear of the Defender primary calibrator and the PC interface socket on the rear of the AirChek 3000 pump.
2. With the pump in HOLD mode, press [⏪] to switch to RUN mode, and allow the pump to run for at least 5 minutes before commencing full calibration.

3. On the Defender calibrator, ensure that the 'Data Port' parameter on the Setup - Preferences screen is set to the 'SKC' option. Set the Defender to take continuous readings. Refer to the Defender instructions for further information.

4. On the pump enter User Interface Level One as detailed in Getting Started 7) on page 19.

5. Press the  button until the 'CAL' screen is displayed.



6. Press the  button seven times to initiate a full calibration, the LCD screen will show 'FCAL'.



7. At each calibration point the LCD screen will display the calibration point number.



8. After a number of Defender readings the pump LCD screen will briefly display the calibration flow rate.





9. The pump LCD screen will then display the next calibration point number, and the process repeats across the operating flow range of the pump.

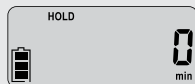

Note: The flow rate may be zero or very low at the first few calibration points, and the Defender piston may move very slowly. This is normal; do not interrupt the calibration.

10. At the end of a successful full calibration the pump will automatically switch to HOLD mode. The full calibration data is written into the pump memory when the pump switches to SLEEP mode, therefore leave the pump in HOLD mode for five minutes after which it will switch to SLEEP mode.



11. If a problem was encountered during the full calibration, an error code will be displayed. Refer to the CalChek Error Code Table on pages 42 and 43. Press the  button to clear the error code screen and revert to HOLD mode.



The full calibration process can be aborted at any stage by pressing . The pump will automatically switch to HOLD mode.

The full calibration data can be viewed and printed using the optional DataTrac Interface and Software and a PC. Access the DataTrac Software Pump Manager window, click on the View menu and select the Calibration Info option. A new window will display the calibration results, pump serial number and date of the last full calibration. A button on this window allows the data to be printed. The printed report also includes the pump internal software version, the date printed and a validation code.

To ensure that the printed calibration data has not been tampered with, in the DataTrac Software click on the Tools menu and select Confirm Validation Code. Enter the data from the printed report, including the validation code. The date is entered in the format mmm dd, yyyy (e.g. Mar 12, 2011). The DataTrac Software will indicate whether the information is completely valid or if a parameter has been changed.



Note: Clearing the pump history from memory will not clear the full calibration data. This data can only be cleared by performing another full calibration or by obtaining more than 36 pump history records.

1) Changing the Display Units

1. On the pump enter User Interface Level Two as detailed in Getting Started 7) on page 19.

2. Press the  button until the temperature units setting screen is displayed with 'SET' and the current display units flashing. The display shows the current air temperature.





3. Use the  and  buttons to toggle between the '°F' and '°C' temperature units options.





4. Press the  button until the atmospheric pressure units setting screen is displayed with 'SET' and the current display units flashing. The display shows the current atmospheric pressure.





5. Use the  and  buttons to toggle between the 'ins' (" H_g), 'm' (mbar) and 'mm' (mm H_g) atmospheric pressure units options.

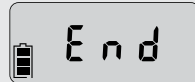

6. To save the new display units settings, press the  button until the 'End' screen is displayed. Press [ ] to save the settings and switch to HOLD mode.



- Alternatively to exit the User Interface without saving the changes, press the  button until the 'ESC' screen is displayed. Press [ ] to switch to HOLD mode without saving the changes.





2) Setting the Clock Time

- On the pump enter User Interface Level Two as detailed in Getting Started 7) on page 19.

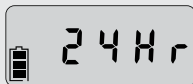
- Press the  button until the 12/24 hour clock setting screen is displayed.





- Use the  and  buttons to toggle between the 12 hour and 24 hour clock options.

Note: This screen also provides access to the delayed start time option - refer to User Interface Level Two 5) on page 34.





- Press the  button until the clock time setting screen is displayed with 'SET' and the current clock hours value flashing.





- Use the  and  buttons to enter the correct clock hours.





6. Press the  button once and the clock time minutes value will start to flash. Use the  and  buttons to enter the correct clock minutes.



7. To save the new clock settings, press the  button until the 'End' screen is displayed. Press [ >] to save the settings and switch to HOLD mode.



8. Alternatively to exit the User Interface without saving the changes, press the  button until the 'ESC' screen is displayed. Press [ >] to switch to HOLD mode without saving the changes.

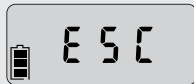



3) Setting a Sample Run Time

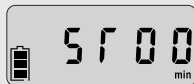

1. On the pump enter User Interface Level Two as detailed in Getting Started 7) on page 19.

2. Press the  button until the sample run time setting screen is displayed with the currently set sample run time flashing. The run time is displayed in minutes.





3. Use the  and  buttons to enter the required sample run time in minutes. The sample run time can be set to any value between 1 and 999 minutes, for example 480 minutes (8 hours) as shown.



4. To save the new sample run time setting, press the  button until the 'End' screen is displayed. Press [ ] to save the setting and switch to HOLD mode.



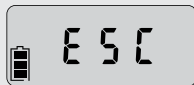

5. Alternatively to exit the User Interface without saving the changes, press the  button until the 'ESC' screen is displayed. Press [ ] to switch to HOLD mode without saving the changes.



6. Having successfully saved a sample run time and switched to HOLD mode, the elapsed run time screen will show a flashing 'S' and the programmed sample run time in minutes.



7. Press [ ] to switch to RUN mode and start the sampling operation. The sample run time will count down in one minute steps.

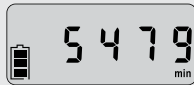

8. At the end of the sample run time the pump will automatically switch to HOLD mode, and the display will revert to showing the set sample run time.



Note:

- After cancelling a previously set sample run time, the elapsed run time screen will display the total sample run time since the run time data was last reset.
- If a sample run time has been set on the pump, a DataTrac program cannot be entered into the pump

memory without deleting the sample run time first. Likewise, if a DataTrac program is present in the pump memory, the sample run time setting in the User Interface cannot be selected until the DataTrac program is deleted - refer to User Interface Level Two 6) on page 36.

- When entering a DataTrac program using the optional DataTrac Interface and Software and a PC, it is possible to enter a sample run time of up 43,200 minutes (30 days). When a DataTrac program is present in the pump memory the LCD screen will display the 'PROG' icon. The elapsed run time screen will display the elapsed run time rather than counting down the sample run time as with a sample run time set on the pump.

4) Deleting a Sample Run Time



1. To delete a previously set sample run time, enter User Interface Level Two as detailed in Getting Started 7) on page 19.

2. Press the  button until the sample run time setting screen is displayed with the currently set sample run time flashing.



3. To delete the sample run time use the  button to reduce the sample run time setting to zero.



4. To save the zero sample run time setting, press the  button until the 'End' screen is displayed. Press [ >] to save the setting and switch to HOLD mode.





5) Setting a Delayed Start Time

The delayed start time is the 12 hour clock time at which the pump will automatically switch from HOLD mode to RUN mode and commence sampling. The delayed start time set has no AM or PM designation, and the actual start time will be the next occurrence of this time in the 12 hour clock, either in the AM or PM. The delayed start time must be set in conjunction with a sample run time.

1. On the pump enter User Interface Level Two as detailed in Getting Started 7) on page 19.
2. Enter a sample run time as detailed in User Interface Level Two 3) on page 31. This is required to set a delayed start time.

3. Press the  button until the 12/24 hour clock setting screen is displayed.



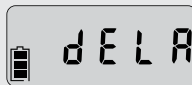

4. Use the  and  buttons to select the delayed start option, with 'dELA' flashing on the LCD screen.



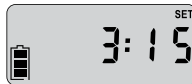

5. Press the  button once to display the delayed start time screen, with 'SET' and the current delayed start time hours value flashing.



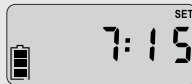

6. Use the  and  buttons to enter the required delayed start time hours value.





7. Press the  button once and the delayed start time minutes value will start to flash. Use the  and  buttons to enter the required delayed start time minutes value.



8. To save the new sample run time and delayed start time settings, press the  button until the 'End' screen is displayed. Press [] to save the setting and switch to HOLD mode.



9. Alternatively to exit the User Interface without saving the changes, press the  button until the 'ESC' screen is displayed. Press [] to switch to HOLD mode without saving the changes.



10. Having successfully saved a sample run time and start delay time, and switched to HOLD mode, the run time screens will show the '**PROG**' icon. If the elapsed run time is not showing zero, it is recommended to reset the accumulated run time data. Refer to User Interface Level Two 7) on page 37.

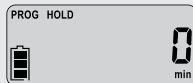

11. At the next occurrence of the programmed delayed start time the pump will automatically switch to RUN mode and commence sampling. The elapsed run time screen will display the accumulated sample run time.

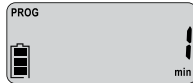

12. At the end of the sample run time the pump will automatically switch to HOLD mode, and the '**PROG**' icon will no longer be displayed on the run time data screens.



6) Deleting a Delayed Start Time or DataTrac Program



The following procedure is used to delete a delayed start time setting. If a DataTrac sampling program has been entered into the pump memory using the optional DataTrac Interface and Software and a PC, the same procedure is used to delete the DataTrac program from the pump memory.

1. Enter User Interface Level Two as detailed in Getting Started 7) on page 19.

2. Press the  button until the flashing 'Off' screen is displayed.

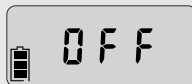
Note: This screen is only displayed if a delayed start time is set or a DataTrac program is present in the pump memory.





3. To delete the sample run time or DataTrac program press [ ]. The 12/24 hour clock setting screen will be displayed.



4. Press the  button until the 'End' screen is displayed.



5. Press [ ] to save the setting and switch to HOLD mode. The '**PROG**' icon will no longer be displayed on the run time data screens.



7) Resetting the Run Time Data

1. To reset the accumulated sample air volume and sample run time data, enter User Interface Level Two as detailed in Getting Started 7) on page 19.

2. Press the  button until the flashing 'CLr' screen is displayed.



3. To reset the run time data press [ ]. The 'ESC' screen will be displayed.



4. Press the  button until the 'End' screen is displayed.



5. Press [ ] to switch to HOLD mode.

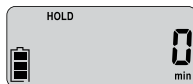

The standard compensated flow range of the AirChek 3000 pump is 1000 to 3250 ml/min. To operate at flows in the range 5 to 500 ml/min an optional low flow adapter / tube holder and a constant pressure controller (CPC) are required.

Low flow adapters are available for simultaneous sampling using one, two, three or four sample tubes (refer to the sampling accessories guide on pages 49 - 51 for details). The low flow adapters incorporate throttle valve(s) to set the low flow rate.

The CPC is a device that when connected to the pump inlet hoesetail provides a constant suction at the outlet of the low flow adapter, ensuring stable airflow through the sample tube(s) once the air flow rate has been set using the throttle valve(s).

To Set Up For Low Flow Sampling -

Before connecting the sample train to the pump set the pump flow rate to 1500 ml/min - refer to User Interface Level One 1) on page 22. There is no need to accurately calibrate the pump flow rate as only approximate flow rate setting is required for correct operation of the CPC. Switch the pump to HOLD mode.

Connect the CPC to the pump air inlet port hoesetail - the short length of tubing supplied connected to the CPC is connected to the pump hoesetail. Ensure that the CPC is connected correctly, the side of the CPC with the label should be pointing away from the pump.

The low flow adapter can now be connected to the CPC inlet hoesetail with a length of tubing, and the sorbent tube fitted into the short length of tubing attached to the low flow adapter. Set the required low flow rate by adjusting the throttle valve on the low flow adjuster, using a suitable calibrated flow meter (such as a Defender primary calibrator).

Note: If carrying out high flow sampling subsequent to low flow sampling with the same pump, ensure that the CPC is disconnected.

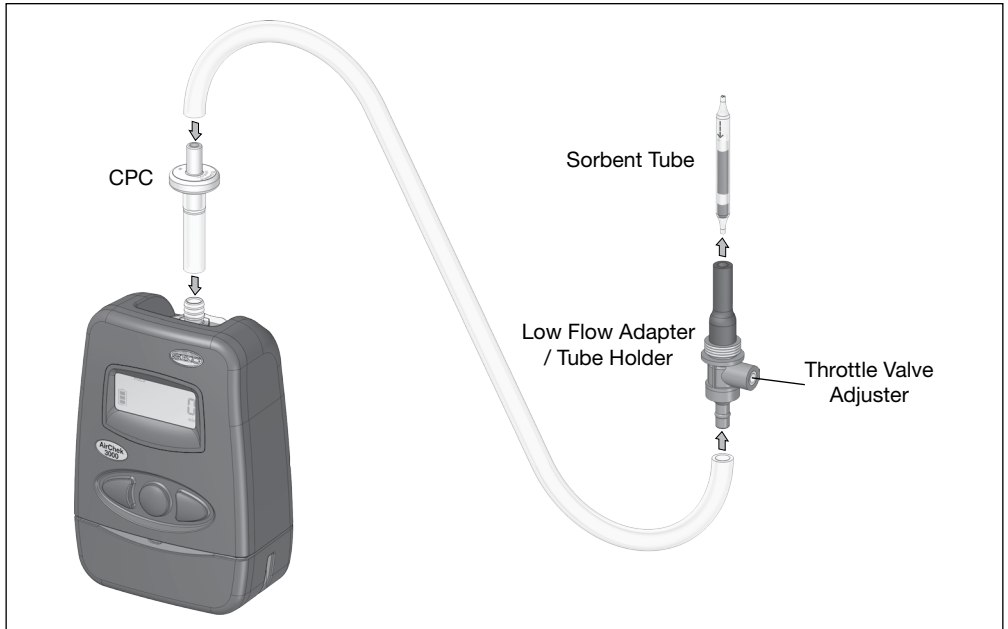

Possible Fault	Corrective Action
Battery pack will not charge	<ul style="list-style-type: none"> • Check the battery charger by trying it with a different battery pack. Replace the battery charger if required. • Check the battery pack by connecting it to a known good battery charger. If the battery pack still will not charge replace the battery pack.
Pump will not operate	<ul style="list-style-type: none"> • Check for faulty battery pack by trying a known good battery pack. Replace the battery pack if required.
Pump flow faults continuously	<ul style="list-style-type: none"> • Sample media back pressure too high. Try a lower flow rate and/or a less restrictive sample media if the sampling method being used allows this. • Pump particulate filter is blocked (appears black). Replace the particulate filter. • Tubing blocked or crimped. Replace tubing.
Pump cannot achieve required flow rate	<ul style="list-style-type: none"> • Battery pack voltage low. Fully charge the battery pack. • Sample media back pressure too high. Try a lower flow rate and/or a less restrictive sample media if the sampling method being used allows this. • Inlet filter cover / hosetail not screwed on tightly enough. Ensure filter cover is tightly fitted. • Pump mechanism leaking. Contact SKC Ltd customer services for assistance.

Possible Fault	Corrective Action
Pump stops due to low battery before the end of the required sample period	<ul style="list-style-type: none">• Battery pack not fully charged before starting sample run. Ensure battery pack is fully charged before starting a sample run.• Battery pack has reduced capacity as it nears end of life. Replace the battery pack.• Sample media back pressure too high. Try a lower flow rate and/or a less restrictive sample media if the sampling method being used allows this.

Error Code	Problem	Corrective Action
E 41	Single point calibration flow correction required is too high. The difference between the pre-calibration Defender flow rate reading and the required flow rate is greater than 360 ml/min.	Perform a full calibration. If this does not resolve the problem contact SKC Ltd customer services for assistance.
E 42	Unstable average flow rate reading. The variation between individual Defender flow rate readings is too high.	Repeat the calibration. If this does not resolve the problem contact SKC Ltd customer services for assistance.
E 43	Serial communication time out. The Defender calibrator is not communicating with the pump.	Check that the 'Data Port' setting on the Defender calibrator is set to the 'SKC' option. Check that the CalChek cable connections are secure.
E 44	Full calibration - The first calibration point flow reading is greater 750 ml/min. The pump air flow rate is higher than it should be.	Check the internal flow pressure sensor tubing is not pinched or blocked - contact SKC Ltd customer services for assistance.
E 45	Full calibration - The pump is unable to achieve a flow rate of 3000 ml/min.	Check the pump flow outlet tube for blockages. Check the pump stack for leakage - contact SKC Ltd customer services for assistance.

Error Code	Problem	Corrective Action
E 46	Full calibration - data analysis error.	Repeat the full calibration. If this does not resolve the problem contact SKC Ltd customer services for assistance.
E 47	Full calibration - Battery charge level is too low. Less than two bars displayed on the battery status indicator.	Fully charge the battery before repeating the full calibration.
E 48	Single point calibration - Pump could not achieve a successful calibration within 5 Defender flow readings.	Repeat the calibration. If the problem repeats perform a full calibration.

Battery Charging

- Charge battery pack fully before first use to ensure optimum performance.
- Full battery capacity will be achieved after 2 to 3 full charge / discharge cycles.
- Use only SKC approved charger designated for this battery pack. Use of a non-SKC approved charger may impair battery performance or even cause irreparable damage, and will invalidate the battery pack warranty.

Battery Performance

- Charging temperature - For optimum performance charge NiMH batteries between 0 and +45°C.
- Do not overcharge - For optimum performance disconnect battery pack from charger after 24 hours.
- Discharge temperature - For optimum performance discharge NiMH batteries between -10 and +45°C (refer also to pump specifications on pages 6 and 7 for other limitations on operating temperature for intrinsically safe applications).

Battery Maintenance

- Battery cycling during regular use - To maintain optimum capacity during regular battery use, cycle battery once a month. Run pump until low battery shutdown occurs, then fully charge battery.
- Long term storage and highly infrequent use -
 1. Charge battery fully prior to long term storage. Disconnect battery pack from pump.
 2. Store in a cool, dry place at temperature between 0 and 30°C.
 3. Recharge battery at least once a year (or more frequently if stored at temperature above 30°C).
 4. Cycle battery 2 to 3 times after long term storage to restore optimum capacity.

Battery Testing

1. Connect SKC approved charger to battery pack. If charger indicator LED illuminates, battery pack charger input is ok. If charger LED does not illuminate, battery pack input fuse is blown - Replace battery pack.
2. Leave battery pack connected to charger to fully charge.
3. If pump does not function at all after full charge of battery pack, battery pack output fuse has blown, or battery cells have failed or are at end of life - Replace battery pack.
4. If pump functions after full charge of battery pack but gives significantly reduced run times before low battery shutdown, battery cells are failing or are at end of life - Replace battery pack.

Battery Replacement

Refer to the pump component diagram on page 46. Unfasten the two security screws securing the battery pack to the pump using the supplied 2mm A/F Allen key. Carefully pull the battery pack downwards to disconnect from the pump case.

Fit the replacement battery pack to the pump, taking care to ensure that the battery output connector engages with the socket in the base of the pump case. Secure the battery pack with the two security screws. Charge the new battery pack fully before use.

Battery Disposal

- The EC Battery Directive and equivalent legislation in other countries requires that all batteries and battery packs are disposed of correctly at the end of their working life. This means that they must be collected and treated separately from other waste.
- Please ensure that any end-of-life SKC battery packs are collected and recycled or disposed of correctly.

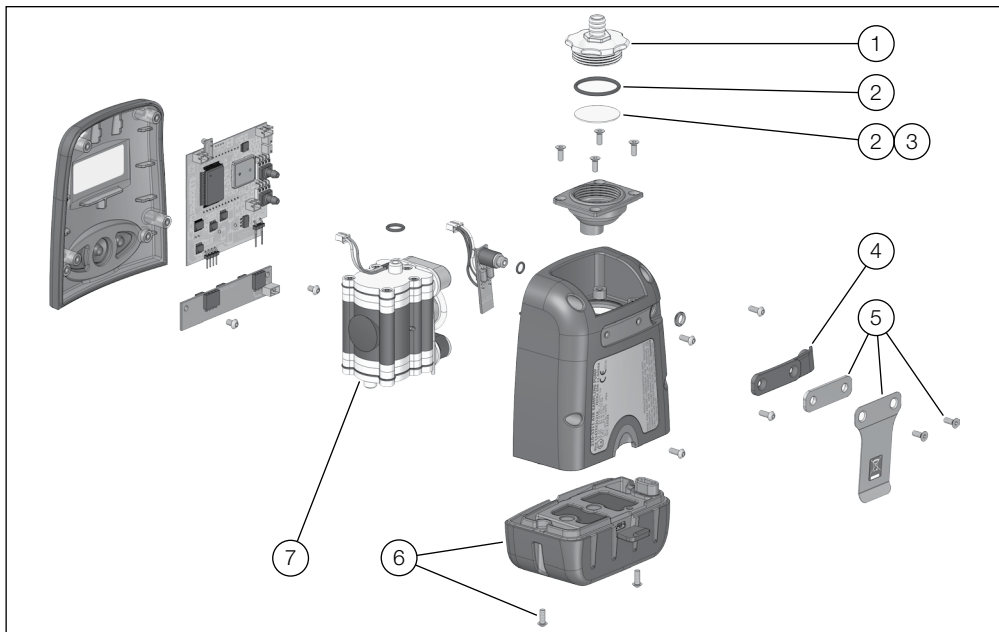

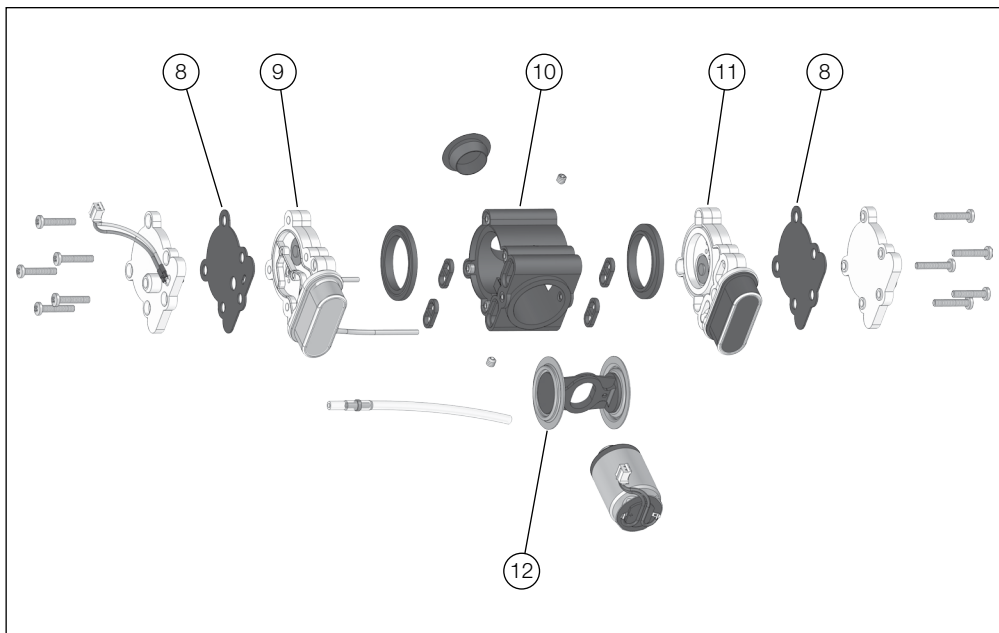

Item	Part No.	Description
1	P210301	Inlet filter cover / hosetail
2	P210308	Inlet filter and O ring (set of 3 filters and 3 O rings)
3	P40011	Inlet filter (pack of 50)
4	P210303	DataTrac PC interface port cover
5	P210304	Belt clip and spacer
6	P21030	Battery pack 4.8V 2.0Ah NiMH
7	P210305	Stack assembly (without motor)
8	P21273	Stack gaskets (set of 2)
9	P21322	Top valve plate assembly
10	P22417G	Pump body
11	P21272	Bottom valve plate assembly
12	P22417HC	Yoke and diaphragm assembly
13	P210302	Toolkit for AirChek 3000 Pump (2mm A/F Allen key)

SKC recommend that our air sampling pumps are regularly serviced by one of our Authorised Service Centres.

Due to the safety implications associated with the incorrect repair of ATEX / IECEx certified intrinsically safe products for use in potentially explosive atmospheres, it is our policy to only supply the complete range of replacement parts to our Authorised Service Centres who are trained in the service and repair of these products.

The range of replacement parts listed above is available to all customers. If the required part is not listed, contact SKC customer care on +44 (0) 1258 480188.

Note: Table item numbers correspond to the ringed numbers shown in the figures on pages 46 and 47 of this manual.

Part No.	Description
Key Accessories	
223-240A	Single fast charger 100-240V ~ 50/60Hz supply with UK/EU/US/AUS mains plugs
223-109A	Five station battery charger 100-240V ~ 50/60Hz supply with UK/EU/US/AUS mains plugs
223-330B	Battery eliminator 230V ~ 50Hz supply with EU 2 pin mains plug
223-330C	Battery eliminator 230V ~ 50Hz supply with UK 3 pin mains plug
224-88	Protective pouch in black
224-96A	High visibility protective pouch in red
224-96C	Noise reducing pouch in black
717-510LA	Defender primary calibrator 5 - 500 ml/min accuracy $\pm 1\%$ of reading
717-510MA	Defender primary calibrator 50 - 5000 ml/min accuracy $\pm 1\%$ of reading
210-502	CalChek Communicator cable
877-91K	DataTrac software package including software CD, PC adapter and cable
Dust Sampling Accessories	
225-70A	I.O.M. sampler in plastic complete with two part plastic filter cassette and clip
225-76A	I.O.M. sampler in stainless steel complete with two part stainless steel filter cassette and clip

Part No.	Description
225-79A	I.O.M. sampler in plastic complete with two part stainless steel filter cassette and clip
225-71A	I.O.M. two part plastic filter cassette with cap and clip
225-75A	I.O.M. two part stainless steel filter cassette with cap and clip
391-01	'Calidaptor' flow calibration adapter for I.O.M. sampler
225-772	I.O.M. foam plug for respirable and multi-dust sampling (pack of 10)
225-772-50	I.O.M. foam plug for respirable and multi-dust sampling (pack of 50)
225-69	Cyclone sampler in plastic with plastic cassette for 25mm diameter filters
225-69-37	Cyclone sampler in plastic with plastic cassette for 37mm diameter filters
225-62	Cyclone plastic cassette for 25mm diameter filters with clip
225-62-37	Cyclone plastic cassette for 37mm diameter filters with clip
225-67	Filter transport cassette for 25mm diameter filters
225-58F	Glass fibre binder free (GFA) filter 25mm diameter 1.6µm pore size (pack of 100)
225-19	Mixed cellulose ester (MCE) filter 25mm diameter 0.8µm pore size with support pad (pack of 100)
225-8-01	PVC GLA-5000 filter 37mm diameter 5.0µm pore size with support pad (pack of 50)

Part No.	Description
Gas / Vapour Sampling Accessories	
210-500	Low flow adapter kit (includes constant pressure controller (CPC), single adjustable low flow adapter / tube holder and type A protective cover)
224-26-CPC	Constant pressure controller (CPC) 20 inches of water
224-26-01	Single adjustable low flow adapter / tube holder
224-26-02	Double adjustable low flow adapter / tube holder
224-26-03	Treble adjustable low flow adapter / tube holder
224-26-04	Quadruple adjustable low flow adapter / tube holder
224-29A	Protective cover type A 6mm diameter x 70mm
224-29B	Protective cover type B 8mm diameter x 110mm
800-01200	Tube tip breaker
226-01	Anasorb CSC coconut charcoal tube 2 part 6mm diameter x 70mm GS (pack of 50)
226-119	Silica gel tube 2 part 6mm diameter x 110mm GS (pack of 100)

If the required item is not listed, contact your supplier or SKC sales on +44 (0) 1258 480188.

SKC provide an extensive range of sampling media, including filters, sorbent tubes and impingers. A full selection can be found in the current SKC catalogue and at www.skcltd.com

With the optional DataTrac Software accessory, the AirChek 3000 pump is programmable using a PC. DataTrac simplifies chain-of-custody reporting by allowing users the option of programming a complete running sequence, delayed start, timed stop, and intermittent sampling, all at different flow rates. Time and sample volume are continuously updated in memory. There is no need to perform lengthy calculations; DataTrac does it for you. The advanced information retrieval system is specifically designed to store data and provide chain-of-custody information. Fault features allow storage of historical data in memory that can be retrieved days after shutdown as long as the battery pack is not completely discharged. The full DataTrac user's manual is included on the software CDROM.

Features

- Program a sampling operation from a PC.
- Calibrate the AirChek 3000 pump's flow rate to a primary standard.
- Display the operating mode including flow rate, temperature, run-time, and battery status.
- Create and save an AirChek 3000 program without the pump being connected to a PC.
- Program up to ten sampling sequences, each with different flow rates.

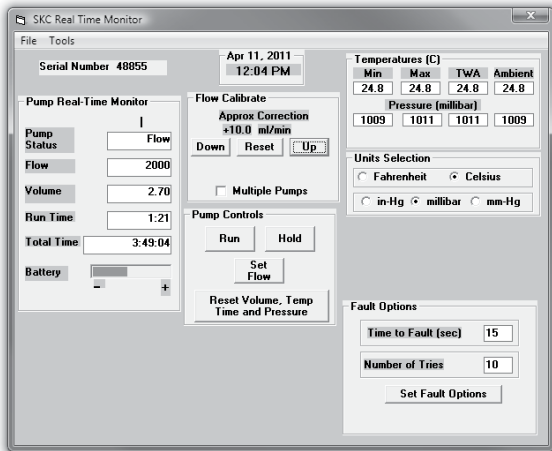

- Download pump run-time data and history to a PC.
- Create chain of custody information using the sample set-up feature.
- Print a history file containing pump run-time data.
- Print a worker exposure profile containing run-time data and the pump's history.
- Document date of pump calibration and validate information when using the CalChek automatic calibration feature.

DataTrac PC System Requirements

- Hard drive with minimum 20MB free space
- CDROM drive
- Available USB port
- Microsoft® Windows® XP or higher including 64bit versions
- Internet access for DataTrac USB adapter cable driver installation

Ordering information:

Includes software CD and DataTrac USB adapter cable.

Catalogue number 877-91K

SKC Sample Sheet Set-Up

File Options

SKC AirChek 2000 Sample Sheet

Worker (last name) Smith first John Worker ID 136

Sampling Site Unit A

Sampling Media 225-58F GFA 25mm 1.6um Sample ID 36219

Method Followed NDHS 14/3

Chemicals of Interest Total inhalable dust

Job Description Machine Shop

Pre-Sample Calib SN 46819 Post-Sample Calib. SN 46823

Environmental Conditions

Humidity % 45 Atm. Pressure 1009

Analysis

Date Sent To Lab 16 Mar 2011 Analyzed By Sally Jones

Date Returned From Lab 18 Mar 2011 Results 1.2 mg/m3

Sampled By Alice Rose Date 16 Mar 2011 Signature

Audited By Paul Rogers Date 18 Mar 2011 Signature

Comments Extraction fan to 80% in PM.



EC TYPE-EXAMINATION CERTIFICATE

- 1
- 2 Equipment intended for use in Potentially Explosive Atmospheres Directive 94/9/EC
- 3 Certificate Number: **Sira 11ATEX2121X** Issue: **3**
- 4 Equipment: **210-3311 AirChek 3000 Air Sampling Pump**
- 5 Applicant: **SKC Limited**
- 6 Address: **Sumrise Park
Higher Shaftesbury Road
Blanford Forum
Dorset DT11 8ST
UK**

7 This equipment and any acceptable variation thereto is specified in the schedule to this certificate and the documents therein referred to.

8 Sira Certification Service, notified body number 0518 in accordance with Article 9 of Directive 94/9/EC of 23 March 1994, certifies that this equipment has been found to comply with the Essential Health and Safety Requirements relating to the design and construction of equipment intended for use in potentially explosive atmospheres given in Annex II to the Directive.

The examination and test results are recorded in the confidential reports listed in Section 14.2.

9 Compliance with the Essential Health and Safety Requirements, with the exception of those listed in the schedule to this certificate, has been assured by compliance with the following documents:

EN 60079-0:2006 EN 60079-11:2007 EN 60079-26:2006 EN 50303:2000 EN 61241-11:2006
EN 60079-0:2009 (used for guidance in respect of marking)

The above list of documents may detail standards that do not appear on the UKAS Scope of Accreditation, but have been added through Sira's flexible scope of accreditation, which is available on request.

10 If the sign 'X' is placed after the certificate number, it indicates that the equipment is subject to special conditions for safe use specified in the schedule to this certificate.

11 This EC type-examination certificate relates only to the design and construction of the specified equipment. If applicable, further requirements of this Directive apply to the manufacture and supply of this equipment.

12 The marking of the equipment shall include the following:

 I M1
Ex Ia I Ma
Ta = 0°C;T_{st}+40°C

 II 1G
Ex Ia IIC T4 G
Ta = 0°C;T_{st}+40°C

 II ID
Ex Ia IIIC T1 20°C Da
Ta = 0°C;T_{st}+40°C



Project Number 70005202

C Ellaby
Deputy Certification Manager

This certificate and its schedules may only be reproduced in its entirety and without change.

Sira Certification Service

Raise Lane, Eccleston, Chester, CH1 9UN, England
Tel: +44 (0) 1244 670900
Fax: +44 (0) 1244 681330
Email: info@sira-certification.com
Web: www.sira-certification.com

Page 1 of 3

Form 9400 Issue 2



SCHEDULE

EC TYPE-EXAMINATION CERTIFICATE

Sira 11ATEX2121X
Issue 3

13

DESCRIPTION OF EQUIPMENT

The 210-3311 AirChek 3000 Air Sampling Pump is a portable device designed to pump air at a constant flow rate. When used in conjunction with a suitable air sampling device and collection substrate, it is used to determine the amount of particulate and/or gaseous contaminants in a given volume of air. The equipment comprises a removable, rechargeable, encapsulated battery pack, a battery operated, motor-driven, pump mechanism and an electronic circuit to control the rotational speed of the motor to maintain a constant air flow rate. The electronic circuit also provides a low battery shutdown function, detection of blockage of the airflow and control and monitoring of the duration of the sampling period. This circuit also provides a serial data interface port providing connection to a computer in the safe area for programming of the pump air flow rate and sample period duration, and retrieval of logged sample performance data. The motor, pump mechanism and electronic circuit are housed in a plastic enclosure and may use different filter covers/pump inlet arrangements to suit the application.

Variation 1 - This variation introduced the following changes:

- The introduction of Special Condition for Safe Use 15.6 relating to the Liquid Crystal Display.
- Corrections and modifications of the circuit capacitance were approved.

Variation 2 - This variation introduced the following changes:

- The value of safety resistor R39 was reduced from a minimum of 71R to 37R.
- A non-safety resistor was introduced in series with the pump.

Variation 3 - This variation introduced the following changes:

- The introduction of alternative TPE plastic materials that are used for the product case overmould.

14

DESCRIPTIVE DOCUMENTS

14.1

Drawings

Refer to Certificate Annexes.

14.2

Associated Sira Reports and Certificate History

Issue	Date	Report no.	Comment
0	05 May 2011	R21244A/00	The release of the prime certificate.
1	13 June 2012	R27899A/00	The introduction of Variation 1.
2	7 June 2013	R29351A/00	The introduction of Variation 2.
3	25 June 2014	R70005202A	The introduction of Variation 3.

15 **SPECIAL CONDITIONS FOR SAFE USE** (denoted by X after the certificate number)

15.1 Use only with Replaceable Battery Pack SKC LTD P21030. Do not disconnect battery pack from the pump in hazardous locations.

15.2 The battery pack shall only be fitted in a clean environment.

15.3 Do not charge battery or connect to Datastrac PC Interface port in hazardous locations.

This certificate and its schedules may only be reproduced in its entirety and without change.

Form 9400 Issues2

Page 2 of 3

Sira Certification Service

Rake Lane, Eccleston, Chester, CH4 9JN, England

Tel: +44 (0) 1244 670900

Fax: +44 (0) 1244 681330

Email: info@sira-certification.com

Web: www.sira-certification.com

Full size copies of the ATEX and IECEx certificate can be obtained from SKC customer service on request, for which a nominal charge may be levied.



SCHEDULE

EC TYPE-EXAMINATION CERTIFICATE

Sira 11ATEX2121X
Issue 3

- 15.4 The maximum input voltage, U_m , at the the Datatrac PC Interface port of the 210-3311 AirChek 3000 Air Sampling Pump is 6 V. The safe area apparatus that is to be connected to the Datatrac PC Interface port shall be a Safety Extra Low Voltage (SELV) or Protective Extra Low Voltage (PELV) circuit.
- 15.5 The equipment shall not be subjected to intense sunlight for long periods.
- 15.6 The window associated with the Liquid Crystal Display could possibly store an electrostatic charge if rubbed. Therefore, the user shall implement precautions to prevent the build up of electrostatic charge. This is particularly important if the equipment is installed in a zone 0 location. In addition, the equipment shall only be cleaned with a damp cloth.
- 16 **ESSENTIAL HEALTH AND SAFETY REQUIREMENTS OF ANNEX II (EHSRs)**
The relevant EHSRs that are not addressed by the standards listed in this certificate have been identified and individually assessed in the reports listed in Section 14.2.
- 17 **CONDITIONS OF CERTIFICATION**
17.1 The use of this certificate is subject to the Regulations Applicable to Holders of Sira Certificates.
17.2 Holders of EC type-examination certificates are required to comply with the production control requirements defined in Article 8 of directive 94/9/EC.

This certificate and its schedules may only be reproduced in its entirety and without change.

Form 9400 Issues2

Page 3 of 3

Sira Certification Service

Rake Lane, Eccleston, Chester, CH1 9UN, England

Tel: +44 (0) 1244 670900

Fax: +44 (0) 1244 681330

Email: info@siracertification.com

Web: www.siracertification.com

Certificate Annexe

Certificate Number: Sira 11ATEX2121X
Equipment: 210-3311 AirChek 3000 Air Sampling Pump
Applicant: SKC Limited



Issue 0

Drawing No.	Sheets	Rev.	Date (Sira stamp)	Title
SKC-15-0060	1 of 1	1	28 Apr 11	Block diagram
SKC-15-0039	1 of 1	2	28 Apr 11	Battery Pack PCB Assembly
SKC-15-0040	1 of 1	2	28 Apr 11	Battery Pack Schematic
SKC-15-0041	1 of 1	2	28 Apr 11	Battery Pack PCB Layout
SKC-15-0042	1 of 1	2	28 Apr 11	Battery Pack PCB Parts List
SKC-15-0043	1 of 1	3	28 Apr 11	Interface PCB Assembly
SKC-15-0044	1 of 1	1	28 Apr 11	Interface Circuit Schematic
SKC-15-0045	1 of 1	3	28 Apr 11	Interface PCB Layout
SKC-15-0046	1 of 1	2	28 Apr 11	Interface PCB Parts List
SKC-15-0047	1 of 1	1	28 Apr 11	Keypad PCB Assembly
SKC-15-0048	1 of 1	1	28 Apr 11	Keypad Circuit Schematic
SKC-15-0049	1 of 1	2	28 Apr 11	Keypad PCB Layout
SKC-15-0050	1 of 1	1	28 Apr 11	Keypad PCB Parts List
SKC-15-0051	1 of 1	1	28 Apr 11	Main PCB Assembly
SKC-15-0052	1 & 2	2	28 Apr 11	Main Circuit Schematic
SKC-15-0053	1 of 1	2	28 Apr 11	Main PCB Layout
SKC-15-0054	1 of 1	2	28 Apr 11	Pump Run PCB Layout
SKC-15-0055	1 to 3	1	28 Apr 11	Main PCB Parts List
SKC-15-0056	1 of 1	2	28 Apr 11	Pump Motor Specification
SKC-15-0057	1 of 1	1	28 Apr 11	Battery Pack Assembly
SKC-15-0058	1 & 2	1	28 Apr 11	210-3311 AirChek 3000 Pump Assembly
SKC-15-0059	1 of 1	1	28 Apr 11	Certification Labels
SKC-15-0061	1 of 1	1	28 Apr 11	Sensor details

Issue 1

Drawing no.	Sheets	Rev.	Date (Sira stamp)	Title
SKC-15-0055	1 to 3	2	24 May 12	Main PCB Parts List

Issue 2

Drawing no.	Sheets	Rev.	Date (Sira stamp)	Title
SKC-15-0055	1 to 3	3	17 May 13	Main PCB Parts List
SKC-15-0056	1 of 1	4	17 May 13	Pump Motor Specification

Issue 3

Drawing no.	Sheets	Rev.	Date (Sira stamp)	Title
SKC-15-0057	1 of 1	2	17 Jun 14	Battery Pack Assembly Aircheck 3000 Pump
SKC-15-0058	1 of 1	3	17 Jun 14	210-3311 Aircheck 3000 Pump Assembly

This certificate and its schedules may only be reproduced in its entirety and without change.



Form 9400 Issues2

Page 1 of 1

Sira Certification Service

Rake Lane, Eccleston, Chester, CH1 9UN, England
 Tel: +44 (0) 1244 670900
 Fax: +44 (0) 1244 681330
 Email: info@siracertification.com
 Web: www.siracertification.com

Full size copies of the ATEX and IECEx certificate can be obtained from SKC customer service on request, for which a nominal charge may be levied.

 <h2 style="text-align: center;">IECEX Certificate of Conformity</h2>	
<h3 style="text-align: center;">INTERNATIONAL ELECTROTECHNICAL COMMISSION</h3> <h3 style="text-align: center;">IEC Certification Scheme for Explosive Atmospheres</h3> <p style="text-align: center;">for rules and details of the IECEx Scheme visit www.iecex.com</p>	
Certificate No.:	IECEX SIR 11.0065X
Status:	Current
Date of Issue:	2014-06-25
Applicant:	SKC Limited 11 Surrindie Park Higher Sharnbury Road Barnby, Leicestershire DN11 8ST United Kingdom
Electrical Apparatus:	210-3311 AirChek 3000 Air Sampling Pump
Optional accessory:	
Type of Protection:	Intrinsic Safety and Dust
Marking:	Ex ia IIC T4 Ga Ex ia IIMb Ex ia IIC T120°C Da T4 T5 T6 T7 T8 T9 T10 T11 T12 T13 T14 T15 T16 T17 T18 T19 T20 T21 T22 T23 T24 T25 T26 T27 T28 T29 T30 T31 T32 T33 T34 T35 T36 T37 T38 T39 T40 T41 T42 T43 T44 T45 T46 T47 T48 T49 T50 T51 T52 T53 T54 T55 T56 T57 T58 T59 T60 T61 T62 T63 T64 T65 T66 T67 T68 T69 T70 T71 T72 T73 T74 T75 T76 T77 T78 T79 T80 T81 T82 T83 T84 T85 T86 T87 T88 T89 T90 T91 T92 T93 T94 T95 T96 T97 T98 T99 T100 T101 T102 T103 T104 T105 T106 T107 T108 T109 T110 T111 T112 T113 T114 T115 T116 T117 T118 T119 T120 T121 T122 T123 T124 T125 T126 T127 T128 T129 T130 T131 T132 T133 T134 T135 T136 T137 T138 T139 T140 T141 T142 T143 T144 T145 T146 T147 T148 T149 T150 T151 T152 T153 T154 T155 T156 T157 T158 T159 T160 T161 T162 T163 T164 T165 T166 T167 T168 T169 T170 T171 T172 T173 T174 T175 T176 T177 T178 T179 T180 T181 T182 T183 T184 T185 T186 T187 T188 T189 T190 T191 T192 T193 T194 T195 T196 T197 T198 T199 T200
Approved for issue on behalf of the IECEx Certification Body:	C Ellaby Deputy Certification Manager
Signature: (for printed version)	
Date:	2014-06-25
<p>1. This certificate and schedule may only be reproduced in full</p> <p>2. This certificate is not transferable and remains the property of the issuing body.</p> <p>3. The Status and authenticity of this certificate may be verified by visiting the Official IECEx Website.</p>	
Certificate issued by:	<p>SIRA Certification Service Rake Lane Ecclestone Chester CH4 5JN United Kingdom</p> 

Certificate history:
Issue No. 3 (2011-6-25)
Issue No. 2 (2011-6-7)
Issue No. 1 (2012-6-13)
Issue No. 0 (2011-5-23)

Page 1 of 4

IECEx Certificate of Conformity



Certificate No.:

IECEX SIR 11.0055X

Date of Issue:

2014-06-25

Issue No.: 3

Page 2 of 4

Manufacturer:

SKC Limited
11 Sunrise Park
Higher Shaftesbury Road
Blandford Forum
Dorset DT11 8ST
United Kingdom

Additional Manufacturing location
(8):

This certificate is issued as verification that a sample(s), representative of production, was assessed and tested and found to comply with the IECEx Scheme Rules. IECEx SIR 11.0055X is a certificate of conformity for the products covered by this certificate, was assessed and found to comply with the IECEx Quality System requirements. This certificate is granted subject to the conditions as set out in IECEx Scheme Rules, IECEx 02 and Operational Documents as amended.

STANDARDS:

The electrical apparatus and any acceptable variations to it specified in the schedule of this certificate and the identified documents, was found to comply with the following standards:

- IEC 60079-0 : 2004 Electrical apparatus for explosive gas atmospheres - Part 0: General requirements
Edition: 4.0
- IEC 60079-11 : 2006 Explosive atmospheres - Part 11: Equipment protection by intrinsic safety "i"
Edition: 5
- IEC 60079-26 : 2006 Explosive atmospheres - Part 26: Equipment with equipment protection level (EPL) Ga
Edition: 2
- IEC 61241-11 : 2005 Electrical apparatus for use in the presence of combustible dusts - Part 11: Protection by intrinsic safety 'ID'
Edition: 1

This Certificate does not indicate compliance with electrical safety and performance requirements other than those expressly included in the Standards listed above.

TEST & ASSESSMENT REPORTS:

A sample(s) of the equipment listed has successfully met the examination and test requirements as recorded in

Test Report:
GB/SIR/EXTR11.0111/00
GB/SIR/EXTR14.0153/00

GB/SIR/EXTR12.0152/00

GB/SIR/EXTR13.0155/00

Quality Assessment Report:

GB/SIR/QAR07.0024/03

GB/SIR/QAR07.0024/04

GB/SIR/QAR07.0024/05

Full size copies of the ATEX and IECEx certificate can be obtained from SKC customer service on request, for which a nominal charge may be levied.

IECEx Certificate of Conformity



Certificate No.:

IECEX SIR 11.0055X

Date of issue:

2014-06-25

Issue No.: 3

Page 3 of 4

Schedule

EQUIPMENT:
Equipment and systems covered by this certificate are as follows:

The 210-3311 Ai/Chek 3000 Air Sampling Pump is a portable device designed to pump air at a constant flow rate. When used in conjunction with a suitable air sampling device and collection substrate, it is used to determine the amount of particulate and/or gaseous contaminants in a given volume of air. The equipment comprises a removable, rechargeable, encapsulated battery pack, a battery operated, motor driven, pump mechanism and an electronic circuit to control the rotational speed of the motor to maintain a constant air flow rate. The electronic circuit also provides a low battery shutdown function, detection of blockage of the airflow, and control and monitoring of the duration of the sampling process. The equipment is designed for long periods of operation and monitoring of the concentration of the sample for concentrations of the pump air flow rate and sample period duration, and retrieval of logged sample performance data. The motor, pump mechanism and electronic circuit are housed in a plastic enclosure and may use different filter covers/pump inlet arrangements to suit the application.

CONDITIONS OF CERTIFICATION: YES as shown below:

- 1 Use only with Replaceable Battery Pack SKC LTD P21030. Do not disconnect battery pack from the pump in hazardous locations.
- 2 The battery pack shall only be fitted in a clean environment.
- 3 Do not charge battery or connect to Datarac PC Interface port in hazardous locations.
- 4 Do not pump into the equipment, as the Datarac PC Interface port is not certified for hazardous locations. The pump shall be a Safety Extra Low Voltage (SELV) or Protective Extra Low Voltage (PELV) circuit.
- 5 Do not subject the equipment to intense sunlight for long periods.
- 6 The window associated with the Liquid Crystal Display could possibly store an electrostatic charge if rubbed. Therefore, the user shall implement precautions to prevent the build up of electrostatic charge. This is particularly important if the equipment is installed in a zone 0 location. In addition, the equipment shall only be cleaned with a damp cloth.

IECEx Certificate of Conformity



Certificate No.:

IECEX SIR 11.0055X

Date of issue:

2014-06-25

Issue No.: 3

Page 4 of 4

DETAILS OF CERTIFICATE CHANGES (for issues 1 and above):

Issue 1	- this issue introduced the following changes: 1. The introduction of Condition of Certification 6 relating to the Liquid Crystal Display 2. Corrections and modifications of the circuit capacitance were approved.
Issue 2	- this issue introduced the following changes: 1. The value of safety resistor R39 was reduced from a minimum of 71R to 37R. 2. A non-safety resistor was introduced in series with the pump.
Issue 3	- this issue introduced the following changes: 1. The introduction of alternative TPE plastic materials that are used for the product case overmould.

Full size copies of the ATEX and IECEx certificate can be obtained from SKC customer service on request, for which a nominal charge may be levied.

Limited One Year Warranty

1. SKC warrants that this instrument, and each of its component parts, provided for occupational health and safety applications is free from defects in workmanship and materials under normal use for a period of one (1) year. This warranty DOES NOT cover any claims due to abuse, misuse, neglect, alteration, or accident, or use in application for which the instrument was either not designed or not approved by SKC, or, due to the buyer's failure to maintain normal maintenance, improper selection or misapplication. The warranty also DOES NOT cover any claims due to the use of a non-SKC approved charger to charge the battery pack. This warranty shall further be void if changes or adjustments to the instrument are made by a person other than an employee of the seller or, if the operating instructions furnished at the time of installation are not complied with.

2. SKC hereby expressly disclaims all warranties either expressed or implied, including any implied warranties of merchantability or fitness for a particular purpose and neither assumes nor authorises any person to assume for it any liability in connection with the sale of these instruments. No description of the goods being sold has been made a part of the basis of the bargain or has created or amounted to an express warranty that the goods will conform to any such description. Buyer shall not be entitled to recover from SKC any consequential damages; damages to property, damages for loss of use, loss of time, loss of profits or income or any other incidental damages. Nor shall the Buyer be entitled to recover from SKC any consequential damages resulting from defect of the instrument.

3. This warranty extends only to the original purchaser of the warranted instrument during the term of the warranty, the buyer may be required to present proof of purchase in the form of a paid receipt for the instrument.

4. In the event of a defect, malfunction, or other failure of the instrument not caused by any misuse or damage to the instrument while in the possession of the Buyer, SKC will remedy the failure or defect without charge

to the buyer. The remedy will consist of service or replacement of the instrument, or refund of the purchase price, at the option of SKC. However, SKC will not elect refund unless it is unable to provide replacement and repair is not commercially practicable.

5. The terms of this warranty begin on the date the instrument is delivered to the Buyer and continue for a period of one (1) year.

6(a) To obtain performance of any obligation under this warranty, the buyer shall return the instrument, freight prepaid to SKC at the following address:-

SKC Limited
11 Sunrise Park
Higher Shaftesbury Road
Blandford Forum
Dorset DT11 8ST
t: 44 (0) 1258 480188
f: 44 (0) 1258 480184

6(b) To obtain further information on the warranty performance contact SKC.

7. This warranty is provided under English law.

8. No other warranty is given by SKC in conjunction with this sale.

The disclaimers and limitations shall not affect the statutory rights of a consumer.







A member of the SKC global group of companies