

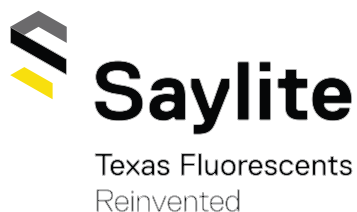

# Lighting done right.

This is an amazing time in lighting. It can enhance life and work in powerful ways, with technology creating new opportunities every day. It's also more complex than ever, blurring the lines between what's possible and what's practical.

At Saylite, we know what lighting means to you. That's why we work with you to deliver a solution that's just right: the lighting you want, at the speed and value you need, from an expert team with a factory at your fingertips.



# Table of Contents

Recessed Linear	4
Linear Pendants	22
Acoustical Lighting	47
Surface Mount	50
LED Strips	58
Linear Wall	70
High Bay	80
Retrofit Kits	88
LED CTC/Wall	96
Outdoor	102
Recessed Linear	122
Linear Pendants	126
Surface Mount	128
LED Strips	132
High Bay	134
Retrofit Kits	136
Linear Wall	139
Savegreen Lamps	143
Exit & Emergency	146
Reference (Options)	153
Index	158

X1LED

Saylite delivers lighting solutions for businesses nationwide, featuring one of the most comprehensive LED selections in the industry. As a privately held business with a state-of-the-art facility right here in the US, we're uniquely capable of getting you just the lighting you need from a team of experts you can trust.

### The Simple Choice

We'll take the complexity out of lighting, helping you navigate challenges in a rapidly shifting marketplace.

### The Right Lighting

Commodity to custom: choose from a broad selection, or design your own at our state-of-the-art facility.

### The Best Value

Find practical lighting at any price point or have it value engineered at a fraction of the cost.

### The Shortest Leadtime

Quick turnaround, often half the time of our competition. We design and build products to hit your deadlines.

### Your Reliable Partner

People you can reach and count on, with the experience and attitude to do what's right for your business.

# Recessed Linear

Recess in T Bar ceilings, hard ceilings, or special ceilings.

Saylite offers a recessed linear LED fixture for every lighting design and every application, from traditional 2X2 and 2X4 fixtures, to the slimmest channels, to wall wash and cove fixtures to complete the layout. Many are also offered in traditional fluorescent (see fluorescent icons) for maximum flexibility. If you don't see exactly what you are looking for, please ask. Saylite is your factory at your fingertips!





## LED CENTER BASKET

This spec-grade, low-profile, linear-ribbed, center basket (lensed) fixture is designed to maximize efficiency and minimize LED glare, creating a soft “sky light” appearance for modern spaces. Full family of sizes and lumen options available.



Surface mount any recessed by adding "SH" to prefix.



ITEM NO.	DESCRIPTION
UCLL22LJ28W3150LDMV40K	2x2 / 28W, 3150L / 0-10V Dim / 4000K
UCLL22LJ32W3600LDMV40K	2x2 / 32W, 3600L / 0-10V Dim / 4000K
UCLL22LJ42W4300LDMV30K	2x2 / 42W, 4300L / 0-10V Dim / 4000K
UCLL14LJ32W4300LDMV40K	1x4 / 32W, 4300L / 0-10V Dim / 4000K
UCLL14LJ48W6000LDMV30K	1x4 / 48W, 6000L / 0-10V Dim / 4000K
UCLL24LJ32W4350LDMV40K	2x4 / 32W, 4350L / 0-10V Dim / 4000K
UCLL24LJ48W6100LDMV40K	2x4 / 48W, 6100L / 0-10V Dim / 4000K
UCLL24LJ57W6800LDMV40K	2x4 / 57W, 6800L / 0-10V Dim / 4000K

EM4 G120 OS1 D1MV 90CRI CCT1 SURF X1LED FLUOR

Consult for 1x1 and 1x2. For perforated basket change LL to PF. See specification sheet for more DLC item options.

## LED CENTER BASKET WITH AIR RETURN

Same as UCLL, above, but with an Air Return option for a cleaner, less-cluttered, ceiling appearance.



ITEM NO.	DESCRIPTION
UCRLL22LJ28W3150LDMV40K	2x2 / 28W, 3150L / 0-10V Dim / 4000K
UCRLL22LJ42W4300LDMV40K	2x2 / 42W, 4300L / 0-10V Dim / 4000K
UCRLL24LJ48W6100LDMV40K	2x4 / 48W, 6100L / 0-10V Dim / 4000K
UCRLL24LJ57W6800LDMV40K	2x4 / 57W, 6800L / 0-10V Dim / 4000K

EM4 G120 OS1 D1MV 90CRI CCT1 SURF X1LED FLUOR

Consult for 1x1 and 1x2. For perforated basket change LL to PF.

## LED VOLUMETRIC CENTER BASKET

A value-priced, spec-grade, center basket (frosted smooth lens) fixture with a volumetric distribution to create even illumination from floor to ceiling, while still providing a soft “sky light” appearance. Ideal for modern offices with recessed configurations, where value is a priority.



ITEM NO.	DESCRIPTION
CBF22LF28W3200LDMV40K	2x2 / 28W, 3200L / 0-10V Dim / 4000K
CBF22LF35W4200LDMV40K	2x2 / 35W, 4200L / 0-10V Dim / 4000K
CBF22LF45W5100LDMV40K	2x2 / 45W, 5100L / 0-10V Dim / 4000K
CBF14LF35W4600LDMV40K	1x4 / 35W, 4600L / 0-10V Dim / 4000K
CBF14LF48W6000LDMV40K	1x4 / 48W, 6000L / 0-10V Dim / 4000K
CBF24LF35W4500LDMV40K	2x4 / 35W, 4500L / 0-10V Dim / 4000K
CBF24LF48W6200LDMV40K	2x4 / 48W, 6200L / 0-10V Dim / 4000K
CBF24LF57W7200LDMV40K	2x4 / 57W, 7200L / 0-10V Dim / 4000K

EM2 G120 OS1 D1MV 90CRI CCT1 SURF

See specification sheet for more DLC item options.

### Options to Make It “Your Way”

EM1 SURF X1LED

The icons listed under every series identifies all of the options available for that series, including color temperatures, emergencies, sensors/controls, coordinating applications and more. See pages 154 and 155 for full explanations of each icon.

# Recessed Linear



## LED CENTER SQUARE LENS

This spec-grade fixture has a unique, square lens for a sleek, more architectural look, and a volumetric distribution to create even illumination from floor to ceiling. Maintain a soft “sky light” appearance with a choice of frosted or perforated side lenses.

ITEM NO.	DESCRIPTION
SCB22LS22W2200LDMV40K	2x2 / 22W, 2200L / 0-10V Dim / 4000K
SCB22LS30W3000LDMV40K	2x2 / 30W, 3000L / 0-10V Dim / 4000K
SCB14LS37W3300LDMV40K	1x4 / 37W, 3300L / 0-10V Dim / 4000K
SCB14LS57W4700LDMV40K	1x4 / 57W, 4700L / 0-10V Dim / 4000K
SCB24LS46W4000LDMV40K	2x4 / 46W, 4000L / 0-10V Dim / 4000K
SCB24LS57W4800LDMV40K	2x4 / 57W, 4800L / 0-10V Dim / 4000K

EM2 G120 D1MV 90CRI CCT1 SURF

Add “PF” and \$5.00 after SCB for perforated sided center basket.

## LED DECORATIVE CENTER BASKET

An extruded, optically-designed, acrylic center lens with a softening mesh overlay provides a low glare glow, but with all the benefits of LED. In addition to offices, this fixture is ideal for hospitals and schools.



ITEM NO.	DESCRIPTION
LXT22LZ24W3000LDMV40K	2x2 / 24W, 3000L / 0-10V Dim / 4000K
LXT22LZ36W4200LDMV40K	2x2 / 36W, 4200L / 0-10V Dim / 4000K
LXT24LZ45W5800LDMV40K	2x4 / 45W, 5800L / 0-10V Dim / 4000K
LXT24LZ50W6450LDMV40K	2x4 / 50W, 6450L / 0-10V Dim / 4000K
LXT24LZ60W7350LDMV40K	2x4 / 60W, 7350L / 0-10V Dim / 4000K

EM2 G120 D1MV 90CRI CCT1 SURF

See specification sheet for more DLC item options.

## LED CENTER DIFFUSER WITH DUAL LIT CURVED SIDE LENSES

This spec-grade fixture features a center diffuser (choice of perforated basket or linear ribbed lens), and unique dual lit curved side lenses, creating a luminous housing with excellent visual comfort and eliminating the “cave effect.”



Lit acrylic sides add premium look over standard Center Basket fixtures.

ITEM NO.	DESCRIPTION
CRVRL22LJ28W3500LDMV40K	2x2 / 28W, 3500L / 0-10V Dim / 4000K
CRVRL22LJ35W4200LDMV40K	2x2 / 35W, 4200L / 0-10V Dim / 4000K
CRVRL24LJ32W4000LDMV40K	2x4 / 32W, 4000L / 0-10V Dim / 4000K
CRVRL24LJ48W6100LDMV40K	2x4 / 48W, 6100L / 0-10V Dim / 4000K
CRVRL24LJ57W7200LDMV40K	2x4 / 57W, 7200L / 0-10V Dim / 4000K

EM2 G120 OS1 D1MV 90CRI CCT1 SURF X1LED FLUOR

## LED DUAL BASKET

This low-profile, dual-basket (linear ribbed lenses) fixture offers an ever-pleasing aesthetic and is designed to maximize efficiency and minimize LED glare, creating a soft “sky light” appearance for modern spaces. Dual baskets yield a slightly wider distribution.



ITEM NO.	DESCRIPTION
UDLL22LJ28W3200LDMV40K	2x2 / 28W, 3200L / 0-10V Dim / 4000K
UDLL22LJ35W4200LDMV40K	2x2 / 35W, 4200L / 0-10V Dim / 4000K
UDLL24LJ48W6000LDMV40K	2x4 / 48W, 6000L / 0-10V Dim / 4000K
UDLL24LJ57W7100LDMV40K	2x4 / 57W, 7100L / 0-10V Dim / 4000K

EM5 G120 OS1 D1MV 90CRI CCT1 SURF XILED FLUOR

For perforated basket change LL to PF.

## LED DUAL CONCAVE LENSES

A contemporary, dual concave-lensed fixture featuring extruded acrylic lenses with softening overlays designed to maximize efficiency and minimize LED glare, creating a soft “sky light” appearance for modern spaces. Ideal for integrated sensors.



ITEM NO.	DESCRIPTION
VLT22LJ24W2500LDMV40K	2x2 / 24W, 2500L / 0-10V Dim / 4000K
VLT22LJ36W3700LDMV40K	2x2 / 36W, 3700L / 0-10V Dim / 4000K
VLT24LJ48W5500LDMV40K	2x4 / 48W, 5500L / 0-10V Dim / 4000K
VLT24LJ52W6000LDMV40K	2x4 / 52W, 6000L / 0-10V Dim / 4000K

EM2 G120 OS1 D1MV 90CRI CCT1 SURF

## FLAT CENTER TROFFER **NEW**

An affordable upgrade to a standard troffer. Matte White lens has angled sides with a seamless flat center to provide an architectural look, low glare, and high efficiency at affordable pricing.



ITEM NO.	DESCRIPTION
FCT22LF24W2600LDMV40K	2x2 / 24W, 2600L / 0-10V Dim / 4000K
FCT22LF35W3600LDMV40K	2x2 / 35W, 3600L / 0-10V Dim / 4000K
FCT24LF35W3900LDMV40K	2x4 / 35W, 3900L / 0-10V Dim / 4000K
FCT24LF48W5200LDMV40K	2x4 / 48W, 5200L / 0-10V Dim / 4000K

EM2 G120 D1MV 90CRI CCT1 SURF

# Recessed Linear

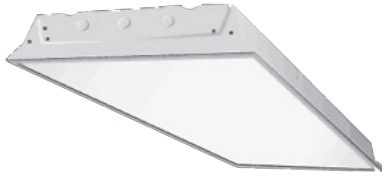

## LED LENSED TROFFER

This spec-grade, low-profile, best seller offers almost unlimited options including four color temperatures, ten diffuser options, and three size configurations. Post-painted powder-coated finish, perfect for all general illumination applications.

ITEM NO.	DESCRIPTION
131A22LJ28W3200LDMV40K	2x2 / 28W, 3200L / 0-10V Dim / 4000K
131A22LJ35W3900LDMV40K	2x2 / 35W, 3900L / 0-10V Dim / 4000K
131A22LJ40W4500LDMV40K	2x2 / 40W, 4500L / 0-10V Dim / 4000K
131A14LJ35W4300LDMV40K	1x4 / 35W, 4300L / 0-10V Dim / 4000K
131A14LJ48W5800LDMV40K	1x4 / 48W, 5800L / 0-10V Dim / 4000K
131A24LV37W4750LDMV40K	2x4 / 37W, 4750L / 0-10V Dim / 4000K
131A24LJ35W4600LDMV40K	2x4 / 35W, 4600L / 0-10V Dim / 4000K
131A24LJ48W6300LDMV40K	2x4 / 48W, 6300L / 0-10V Dim / 4000K
131A24LJ57W7100LDMV40K	2x4 / 57W, 7100L / 0-10V Dim / 4000K
131A24LF95W12000LDMV40K	2x4 / 95W, 12000L / 0-10V Dim / 4000K

EM7 G120 OS1 D1MV 90CRI CCT1 AIR RET SURF X1LED FLUOR

Change lens to Frosted (FR). Add "R" after 131A for Air Return.  
See specification sheet for more DLC item options.

### Door & Gasketing Options

CODE	DESCRIPTION
Blank	Flush steel door
AW	Regressed AL door, white
AB	Regressed AL door, black
GK1	Single gasketed door - Single (lens to door frame)
GK2	Double gasketed door - (lens/frame + frame to troffer)
GK3	Triple gasketed (lens/frame + frame/troffer + troffer to T-bar grid)

### Lens Options

CODE	DESCRIPTION
A	A12 0.10" thick lens
A125	A12 0.125" thick lens
A19	A19 0.156" thick lens
CL	Clear 0.10" thick lens
CL125	Clear 0.125" thick lens
FR	Frosted lens
MW	Matte White 0.10" thick lens
PLA	White Grid 0.5Sq x 0.38Dp
SP1	Spec para grid 0.5Sq x 0.38D
SP2	Spec para grid 1.5Sq x 1.0D
SP4	Spec para grid 0.75Sq x 0.50D

Consult for pricing on options.

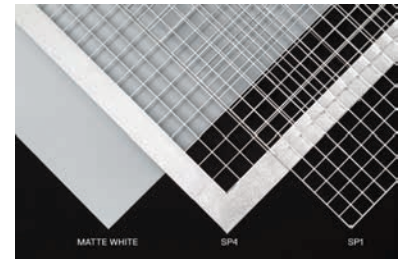
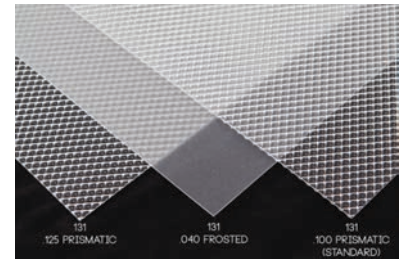

Make Your Fixtures "Smarter" and More Efficient with Sensors

#### FOR SENSOR OPTIONS (See page 157 for more detail):

ADD PREFIX	DESCRIPTION
SS	On / Off
SD	On / Off, Daylight Harvesting
SV	On / Variable Setting (DMVXX - XX is % of intensity when dim)
SM	Microwave Sensor, On / Off - Consult for specific adder for your fixture.

## LED PARABOLIC

When glare control and cut-off are important, this spec-grade deep-cell parabolic troffer delivers, while also offering a choice of four color temperatures. Black perimeter “reveal” provides “floating” louver facade.



ITEM NO.	DESCRIPTION
PARA9C22LJ30W2600LDMV40K	2x2 / 9 Cell / 30W, 2600L / 0-10V Dim / 4000K
PARA9C22LJ42W3300LDMV40K	2x2 / 9 Cell / 42W, 3300L / 0-10V Dim / 4000K
PARA18C24LJ48W4500LDMV40K	2x4 / 18 Cell / 48W, 4500L / 0-10V Dim / 4000K
PARA18C24LJ60W5000LDMV40K	2x4 / 18 Cell / 60W, 5000L / 0-10V Dim / 4000K
PARA18C24LJ85W7400LDMV40K	2x4 / 18 Cell / 85W, 7400L / 0-10V Dim / 4000K

EM7 G120 OS3 D1MV 90CRI CCT1 SURF XILED FLUOR

Add Frosted Overlay to Hide LED's. Add FR after PARA.

## LED HIGH-EFFICIENCY PARABOLIC WITH WHITE OR SEMI SPECULAR LOUVER

This shallow (less than 4”) parabolic fixture offers greater efficiency and energy savings than a standard parabolic. Offered with a (PEW) white louver for broader, balanced brightness, or an optional (PES) semi-specular louver.



ITEM NO.	DESCRIPTION
PEW9C22LJ24W3000LDMV40K	2x2 / 9 Cell / 24W, 3000L / 0-10V Dim / 4000K
PEW9C22LJ30W3600LDMV40K	2x2 / 9 Cell / 30W, 3600L / 0-10V Dim / 4000K
PEW18C24LJ48W6000LDMV40K	2x4 / 18 Cell / 48W, 6000L / 0-10V Dim / 4000K
PEW18C24LJ60W7300LDMV40K	2x4 / 18 Cell / 60W, 7300L / 0-10V Dim / 4000K

EM7 G120 OS1 D1MV 90CRI CCT1 SURF XILED FLUOR

Add Frosted Overlay to Hide LED's. Add FR after PARA.  
Consult for Louver Options. For semi-specular louver change PEW to PES.

**Smart lighting enhances performance and energy savings.**

Most Saylite recessed fixtures can accommodate various sensors to provide new levels of control, energy savings and performance.

See page 157 for more details.



# Recessed Linear



## LED RECESSED SKY BOX – EDGE-LIT FLAT PANEL WITH INNOVATIVE SHROUD

This slim, elegant, sky box with its unobtrusive white shroud offers a refined skylight appearance at a value-engineered price with standard Flat Panel. Available in 1x4, 2X2 and 2X4 configurations, and in multiple color temperatures with 0 to 10 Volt dimming.

ITEM NO.	DESCRIPTION
SBX22LED40DMVWH40	SBX 2x2 LED40 DMV WH 40K
SBX14LED40DMVWH40	SBX 1x4 LED40 DMV WH 40K
SBX24LED50DMVWH40	SBX 2x4 LED50 DMV WH 40K

EM3 CCT2 SURF



### SKYBOX ACCESSORY



Transform any LED Edge-Lit Flat Panel (ours, or by others) into a specification-grade fixture with the addition of this sleek shroud. Specify a custom color to add visual interest or to support corporate branding.

ITEM NO.	DESCRIPTION
SBX22	SKY BOX (SBX) SHROUD FOR 2x2 FLAT PANEL
SBX14	SKY BOX (SBX) SHROUD FOR 1x4 FLAT PANEL
SBX24	SKY BOX (SBX) SHROUD FOR 2x4 FLAT PANEL

## Customize your Skybox to compliment your application.

Choose the powder coated finish that suits your application. Do you love the Texas Longhorns? See page 156 for more options.

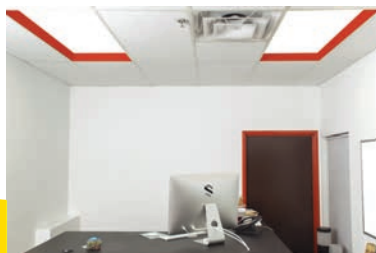



## LED BACK LIT FLAT PANEL **NEW**

The popular Flat Panel is now available in a back lit version that maintains the appearance, shallow depth and great value of the Edge Lit but utilizes a longer life diffuser. Available in multiple sizes and color temperatures.



ITEM NO.	DESCRIPTION
BFP22L30W3750LDMV40K	23.78"L x 23.78"W x 1.38"H / 30W, 3750L / 0-10V Dim / 4000K / White
BFP24L40W5000LDMV40K	47.80"L x 23.78"W x 1.38"H / 40W, 5000L / 0-10V Dim / 4000K / White

**EM3** **CCT2** **SURF**

Coming Soon - Multiple wattages and CCT from one fixture with Dip Switches.

## LED EDGE-LIT FLAT PANEL

A popular look for many applications including offices, circulation spaces, retail and residential kitchens (for a skylight appearance), this fixture provides comfortable, abundant lighting with a thin, modern profile. Accessories available to pendant or surface Mount.



ITEM NO.	DESCRIPTION
FPELP22LED40DMVWH40	2X2 / 40W, 5000L / 0-10V Dim / 4000K
FPELP14LED40DMVWH40	1X4 / 40W, 5000L / 0-10V Dim / 4000K
FPELP24LED50DMVWH40	2X4 / 50W, 6250L / 0-10V Dim / 4000K
FPELP24LED75DMVWH40	2X4 / 75W, 9375L / 0-10V Dim / 4000K

**EM3** **CCT2** **SURF**

Frame-in-kits available to mount in hard ceilings: FIK2X2, FIK1X4, FIK2X4.  
See specification sheet for more DLC item options.

## Pendant Mount Flat Panels in **NEW** Configurations FPHK Series

Saylite has developed a unique accessory to align pendant mounted Flat Panels in a variety of configurations. Mix 1x4, 2x2 and 2x4 flat panels each individually pendant mounted in a unique configuration to compliment your interior architecture. The Flat Panel Aligner Mounting System can be made for a variety of angles or straight configurations and finished in an accent color. A high impact look at a great value.

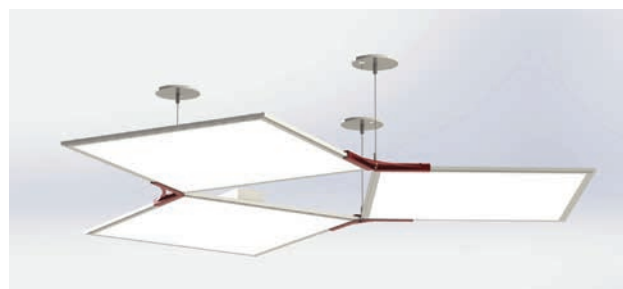

Consult Factory for Your Configuration.  
See other option on page 23.

## LED LINEAR OPEN CHANNEL

This value-priced recessed channel outperforms typical troffers and strip fixtures by maximizing comfortable, glare-free light levels for general merchandising environments. Available for individual or continuous run (with no additional parts required).



ITEM NO.	DESCRIPTION
ITB48LT23W3000LDMV40K	47.96"L x 11.71"W x 5.45"H / Recessed Linear / 23W, 3000L / 0-10V Dim / 4000K
ITB48LT48W6300LDMV40K	47.96"L x 11.71"W x 5.45"H / Recessed Linear / 48W, 6300L / 0-10V Dim / 4000K
ITB96LT48W6300LDMV40K	95.92"L x 11.71"W x 5.45"H / Recessed Linear / 48W, 6300L / 0-10V Dim / 4000K
ITB96LT85W11000LDMV40K	95.92"L x 11.71"W x 5.45"H / Recessed Linear / 85W, 11000L / 0-10V Dim / 4000K

**EM3** **G120** **D1MV** **90CRI** **CCT1** **X1LED** **FLUOR**

# Recessed Linear Lines of Light

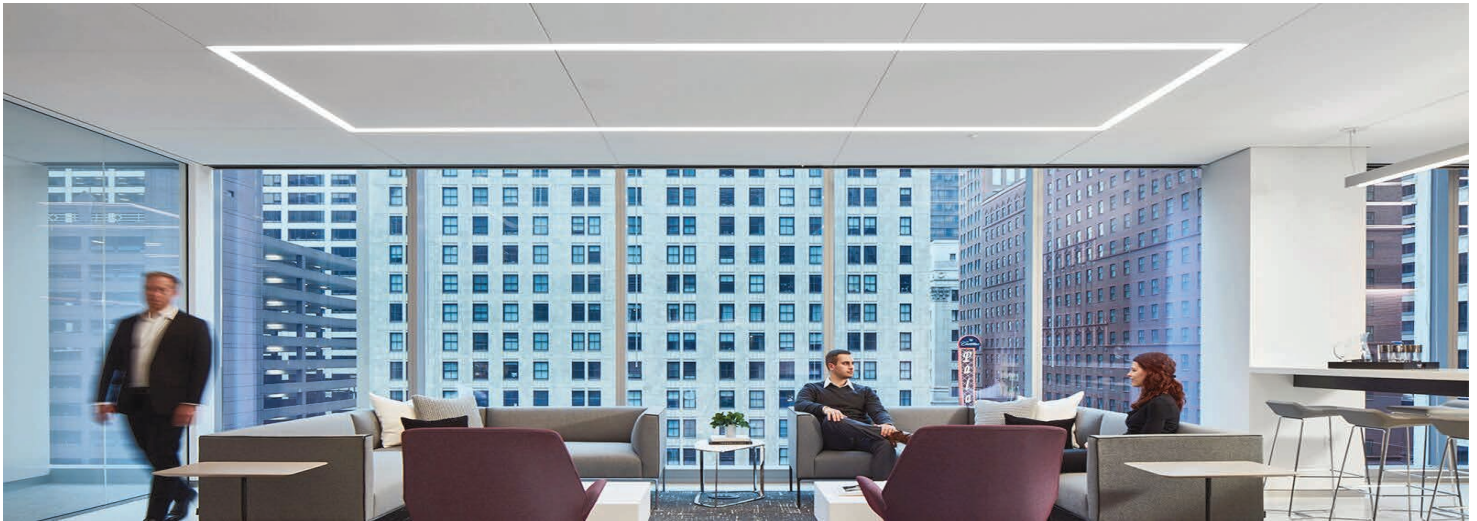

LED technology allows for maximum light output in a minimal package, perfect for modern interiors. Saylite offers LED, recessed, linear lines of light for every specification. Available for individual, continuous, or configurations, and for T-bar and Hard (flanged or flangeless) ceilings. If the design calls for a minimal profile, Saylite has the fixture.

**Specify the right Line of Light for your application with these options.**

- Type of ceiling to recess – T Bar, Hard Ceiling or Other.
- Individual, continuous or configurations (patterns).
- Width of the line of light from 1 inch to 6 inches.
- Integral driver or remote driver.

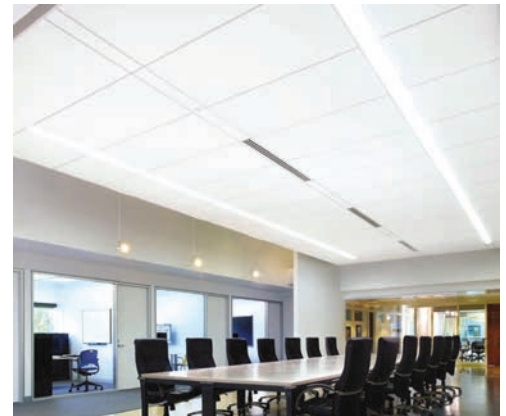

## Choose from three Recessed Mounting and Looks

### T Bar Grid Ceiling Specify "R"

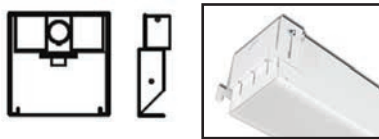

End is slightly shorter to accommodate the T Bar Grid.

### Hard Ceiling - Sheetrock Flanged Version Specify "RF"



### Hard Ceiling - Sheetrock Flangeless Version

Option 1: Install before sheetrock  
Specify "RRXXX"  
XXX - Depth of Sheetrock (consult)  
Option 2: Install after sheetrock  
RRPF - Perforated Flange to mud to



New Perforated Flange 1/4" below ceiling to mud to (RRPF)



## LED LINEAR LINES 2" X 3" FOR T BAR CEILING



**T Bar  
L23R**



**Flangeless  
L23RRXXX**

Specify the right mounting  
**L23R** - For T Bar  
**L23RF** - For Hard Ceiling with Flange  
**L23RRXXX** - For Hard Ceilings Flangeless  
 See page 12 for more information.

This popular 2" fixture is available with a wide variety of options and is USA-manufactured to your specified length. The narrow width packs a large punch of light and allows for application specific customization in T Bar, hard deck, or specialty ceilings. Designed for direct lighting with a snap-in lens and ideal for corridors, lobbies, and office areas.

ITEM NO.	DESCRIPTION
L23RSF24LT13W1300LDMV40KWH	24"L x 2"W x 3"H Recessed Grid Ceiling / Frosted Lens / 13W, 1300L / 0-10V Dim / 4000K
L23RSF24LT22W2200LDMV40KWH	24"L x 2"W x 3"H Recessed Grid Ceiling / Frosted Lens / 22W, 2200L / 0-10V Dim / 4000K
L23RSF48LT26W2600LDMV40KWH	48"L x 2"W x 3"H Recessed Grid Ceiling / Frosted Lens / 26W, 2600L / 0-10V Dim / 4000K
L23RSF48LT38W3800LDMV40KWH	48"L x 2"W x 3"H Recessed Grid Ceiling / Frosted Lens / 38W, 3800L / 0-10V Dim / 4000K
L23RSF48LT45W4500LDMV40KWH	48"L x 2"W x 3"H Recessed Grid Ceiling / Frosted Lens / 45W, 4500L / 0-10V Dim / 4000K
L23RSF96LT52W5200LDMV40KWH	96"L x 2"W x 3"H Recessed Grid Ceiling / Frosted Lens / 52W, 5200L / 0-10V Dim / 4000K
L23RSF96LT76W7600LDMV40KWH	96"L x 2"W x 3"H Recessed Grid Ceiling / Frosted Lens / 76W, 7600L / 0-10V Dim / 4000K
L23RSF96LT90W9000LDMV40KWH	96"L x 2"W x 3"H Recessed Grid Ceiling / Frosted Lens / 90W, 9000L / 0-10V Dim / 4000K

EM3 G120 OS2 D1MV 90CRI CCT1 SURF PEND WALL

## LED LINEAR LINES 2.5" X 3" FOR T BAR OR HARD CEILINGS **NEW**



Specify the right mounting  
**L34R** - For T Bar  
**L34RF** - For Hard Ceiling with Flange  
**L34RRXXX** - For Hard Ceilings Flangeless  
 See page 12 for more information.

This popular 2.5" fixture is available with a wide variety of options and is USA-manufactured to your specified length. The narrow width packs a large punch of light and allows for application specific customization in a T Bar Ceiling. Designed for direct lighting with a snap-in lens and ideal for corridors, lobbies, and office areas.

ITEM NO.	DESCRIPTION
L34RSF24LT13W1300LDMV40KWH	23.75"L x 2.5"W x 3"H Recessed Grid Ceiling / Frosted Lens / 13W, 1300L / 0-10V Dim / 4000K
L34RSF24LT22W2200LDMV40KWH	23.75"L x 2.5"W x 3"H Recessed Grid Ceiling / Frosted Lens / 22W, 2200L / 0-10V Dim / 4000K
L34RSF48LT26W2600LDMV40KWH	47.32"L x 2.5"W x 3"H Recessed Grid Ceiling / Frosted Lens / 26W, 2600L / 0-10V Dim / 4000K
L34RSF48LT38W3800LDMV40KWH	47.32"L x 2.5"W x 3"H Recessed Grid Ceiling / Frosted Lens / 38W, 3800L / 0-10V Dim / 4000K
L34RSF48LT45W4500LDMV40KWH	47.32"L x 2.5"W x 3"H Recessed Grid Ceiling / Frosted Lens / 45W, 4500L / 0-10V Dim / 4000K
L34RSF96LT52W5200LDMV40KWH	95.50"L x 2.5"W x 3"H Recessed Grid Ceiling / Frosted Lens / 52W, 5200L / 0-10V Dim / 4000K
L34RSF96LT76W7600LDMV40KWH	95.50"L x 2.5"W x 3"H Recessed Grid Ceiling / Frosted Lens / 76W, 7600L / 0-10V Dim / 4000K
L34RSF96LT90W9000LDMV40KWH	95.50"L x 2.5"W x 3"H Recessed Grid Ceiling / Frosted Lens / 90W, 9000L / 0-10V Dim / 4000K

EM6 G120 OS2 RGBW D1MV 90CRI CCT1 SURF PEND WALL

**Specify Continuous Runs**  
 To specify continuous runs, identify the fixtures for the beginning ("B"), for the joiner(s) ("J") and for the end of run ("E") with these letter designations at the end of the item number. The fixtures will include the necessary electrical harnesses and mechanical accessories for the joining of multiple fixtures.

# Recessed Linear Lines of Light



Shown with Flange  
SES25RFSF



Consult for Smart Censored Version.

Specify the right mounting  
**SES25R** - For T Bar  
**SES25RF** - For Hard Ceiling with Flange  
**SES25RRXXX** - For Hard Ceilings  
 Flangeless  
 See page 12 for more information.

## LED RECESSED LINEAR LINES OF LIGHT 2.5" X 3" (VALUE PURCHASE)

This value version uses discreet 22 inch LED arrays with metal inserts in the lens to mask dark spots on the ends. Use only for individual run lengths. Choose the right version for T Bar or Hard Ceilings. Use L34 for full featured 2.5" width line of light, for specifications that require a 2.5" fixture width.

ITEM NO.	DESCRIPTION
SES25RFR24LJ20W2000LDMV40KWH	23.75"L x 2.5"W x 3"H Recessed Grid Ceiling / Frosted Lens / 20W, 2000L / 0-10V Dim / 4000K
SES25RFR48LJ31W3100LDMV40KWH	47.32"L x 2.5"W x 3"H Recessed Grid Ceiling / Frosted Lens / 31W, 3100L / 0-10V Dim / 4000K
SES25RFR48LJ45W4500LDMV40KWH	47.32"L x 2.5"W x 3"H Recessed Grid Ceiling / Frosted Lens / 45W, 4500L / 0-10V Dim / 4000K
SES25RFR96LJ62W6200LDMV40KWH	95.50"L x 2.5"W x 3"H Recessed Grid Ceiling / Frosted Lens / 62W, 6200L / 0-10V Dim / 4000K
SES25RFR96LJ90W9000LDMV40KWH	95.50"L x 2.5"W x 3"H Recessed Grid Ceiling / Frosted Lens / 90W, 9000L / 0-10V Dim / 4000K

EM6 G120 OS2 RGBW D1MV 90CRI CCT1 SURF PEND X1LED FLUOR

## LED RECESSED LINEAR LINES OF LIGHT 4" X 4" FOR T BAR CEILINGS

The 44 Series provides a higher output in a fully configurable 4" fixture for individual, continuous or patterns. This steel fixture is value-engineered and manufactured in the USA. Designed for direct lighting with a snap-in lens that is specially engineered for T Bar Ceiling.

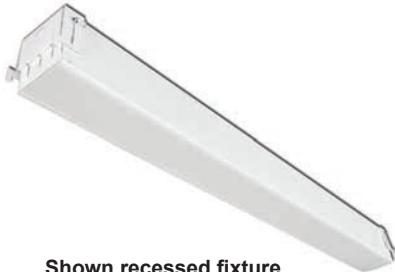

Shown recessed fixture for T Bar / Grid ceiling.

ITEM NO.	DESCRIPTION
44RSF24LR12W1200LDMV40KWH	24"L x 4"W x 4"H Recessed Grid Ceiling / Frosted Lens / 12W, 1200L / 0-10V Dim / 4000K
44RSF24LR24W2400LDMV40KWH	24"L x 4"W x 4"H Recessed Grid Ceiling / Frosted Lens / 24W, 2400L / 0-10V Dim / 4000K
44RSF48LR24W2400LDMV40KWH	48"L x 4"W x 4"H Recessed Grid Ceiling / Frosted Lens / 24W, 2400L / 0-10V Dim / 4000K
44RSF48LR48W4800LDMV40KWH	48"L x 4"W x 4"H Recessed Grid Ceiling / Frosted Lens / 48W, 4800L / 0-10V Dim / 4000K
44RSF96LR48W4800LDMV40KWH	96"L x 4"W x 4"H Recessed Grid Ceiling / Frosted Lens / 48W, 4800L / 0-10V Dim / 4000K
44RSF96LR96W9600LDMV40KWH	96"L x 4"W x 4"H Recessed Grid Ceiling / Frosted Lens / 96W, 9600L / 0-10V Dim / 4000K

EM6 G120 RGBW D1MV 90CRI CCT1 SURF PEND X1LED FLUOR

## LED RECESSED LINEAR LINES OF LIGHT 4" X 4" FOR HARD CEILINGS

The 44 Series provides a higher output in a fully configurable 4" fixture for individual, continuous or patterns in hard ceilings (sheetrock). Choose either a flanged appearance or a flangeless mud-in. The 4" width is ideal to make a statement.



Shown with Parabolic Grid (SP1)

ITEM NO.	DESCRIPTION
44RFSF24LR12W1200LDMV40KWH	24"L x 4"W x 4"H Recessed Hard Ceiling / Frosted Lens / 12W, 1200L / 0-10V Dim / 4000K
44RFSF24LR24W2400LDMV40KWH	24"L x 4"W x 4"H Recessed Hard Ceiling / Frosted Lens / 24W, 2400L / 0-10V Dim / 4000K
44RFSF48LR24W2400LDMV40KWH	48"L x 4"W x 4"H Recessed Hard Ceiling / Frosted Lens / 24W, 2400L / 0-10V Dim / 4000K
44RFSF48LR48W4800LDMV40KWH	48"L x 4"W x 4"H Recessed Hard Ceiling / Frosted Lens / 48W, 4800L / 0-10V Dim / 4000K
44RFSF96LR48W4800LDMV40KWH	96"L x 4"W x 4"H Recessed Hard Ceiling / Frosted Lens / 48W, 4800L / 0-10V Dim / 4000K
44RFSF96LR96W9600LDMV40KWH	96"L x 4"W x 4"H Recessed Hard Ceiling / Frosted Lens / 96W, 9600L / 0-10V Dim / 4000K

EM6 G120 RGBW D1MV 90CRI CCT1 SURF PEND X1LED FLUOR

For Flangeless use 44RRPF.  
 See page 12 for more information.

## LED RECESSED LINEAR LINES OF LIGHT 6" X 6" FOR T BAR OR HARD CEILINGS

Make a big, bold statement with the 66 series. This steel fixture is value-engineered and manufactured in the USA. Designed for direct lighting for individual, continuous or patterns with a snap-in lens and ideal for corridors, lobbies, and office areas.

### T Bar Ceilings

ITEM NO.	DESCRIPTION
66RSF24LR12W1200LDMV40KWH	24"L x 6"W x 6"H Recessed Grid Ceiling / Frosted Lens / 12W, 1200L / 0-10V Dim / 4000K
66RSF24LR24W2400LDMV40KWH	24"L x 6"W x 6"H Recessed Grid Ceiling / Frosted Lens / 24W, 2400L / 0-10V Dim / 4000K
66RSF48LR24W2400LDMV40KWH	48"L x 6"W x 6"H Recessed Grid Ceiling / Frosted Lens / 24W, 2400L / 0-10V Dim / 4000K
66RSF48LR48W4800LDMV40KWH	48"L x 6"W x 6"H Recessed Grid Ceiling / Frosted Lens / 48W, 4800L / 0-10V Dim / 4000K
66RSF96LR48W4800LDMV40KWH	96"L x 6"W x 6"H Recessed Grid Ceiling / Frosted Lens / 48W, 4800L / 0-10V Dim / 4000K
66RSF96LR96W9600LDMV40KWH	96"L x 6"W x 6"H Recessed Grid Ceiling / Frosted Lens / 96W, 9600L / 0-10V Dim / 4000K

### Hard Ceiling

ITEM NO.	DESCRIPTION
66RFSF24LR12W1200LDMV40KWH	24"L x 6"W x 6"H Recessed Hard Ceiling / Frosted Lens / 12W, 1200L / 0-10V Dim / 4000K
66RFSF24LR24W2400LDMV40KWH	24"L x 6"W x 6"H Recessed Hard Ceiling / Frosted Lens / 24W, 2400L / 0-10V Dim / 4000K
66RFSF48LR24W2400LDMV40KWH	48"L x 6"W x 6"H Recessed Hard Ceiling / Frosted Lens / 24W, 2400L / 0-10V Dim / 4000K
66RFSF48LR48W4800LDMV40KWH	48"L x 6"W x 6"H Recessed Hard Ceiling / Frosted Lens / 48W, 4800L / 0-10V Dim / 4000K
66RFSF96LR48W4800LDMV40KWH	96"L x 6"W x 6"H Recessed Hard Ceiling / Frosted Lens / 48W, 4800L / 0-10V Dim / 4000K
66RFSF96LR96W9600LDMV40KWH	96"L x 6"W x 6"H Recessed Hard Ceiling / Frosted Lens / 96W, 9600L / 0-10V Dim / 4000K

EM6 G120 RGBW D1MV 90CRI CCT1 SURF PEND WALL X1LED FLUOR

## LED INDIRECT RADIUS LINEAR LINES OF LIGHT 4" X 4" **NEW**

This linear line of light provides soft, indirect lighting reflected off a barrel styled reflector. Eliminating the lens prevents unsightly dirt and bugs that can build up in some applications. Choose the right version for T Bar or Hard Ceilings.

ITEM NO.	DESCRIPTION
RIGR24LC24W2000LDMV40KWH	24"L x 4"W x 4"H / 22W, 2000L / 0-10V Dim / 4000K / White / RECESSED T BAR
RIGR48LC48W4000LDMV40KWH	48"L x 4"W x 4"H / 48W, 4000L / 0-10V Dim / 4000K / White / RECESSED T BAR
RIGR72LC72W6000LDMV40KWH	72"L x 4"W x 4"H / 72W, 6000L / 0-10V Dim / 4000K / White / RECESSED T BAR
RIGR96LC96W8000LDMV40KWH	96"L x 4"W x 4"H / 96W, 8000L / 0-10V Dim / 4000K / White / RECESSED T BAR

EM3 G120 D1MV 90CRI CCT1 SURF PEND WALL



Shown "RF" recessed flange fixture.

Consult for Custom Lengths



For Flangeless use 44RRPF. See page 12 for more information.



Specify the right mounting  
RIGR - For T Bar  
RIGRF - For Hard Ceiling with Flange  
RIGRRXXX - For Hard Ceilings Flangeless  
See page 12 for more information.

# Recessed Linear Lines of Light



## LED RECESSED LINEAR LINES OF LIGHT 1.5" FOR HARD CEILINGS (SHEETROCK ONLY)

Series CLF provides an elegant and uniform line of light only 1.5 inches wide to seamlessly blend into a hard ceiling. Choice of white flange that can be painted to match any surface or a flangeless appearance with only the narrow lens showing. Flangeless version includes a specially designed mud-in flange adjustable to accommodate different sheetrock thicknesses and installation methods. Mud-in flange can be adjusted to 1/8", 1/2" or 5/8" to match sheetrock thicknesses and mud-in methods. The Series CLF is available in 4 or 8 foot sections that can be used individually or joined together for a longer run. A uniquely designed kit that includes a 3 foot, 2 foot and 1 foot channel can be used together to make one six foot channel or used individually for a unique look with three cascading sizes of 1, 2 and 3 foot channels. The 3, 4 and 8 foot channels have integral drivers and the 3 foot has a unique plug and play wiring system with its integral driver to power the 1ft and 2ft channels with a 6 ft cord (consult for longer cords).



CLF Kit with 3FT, 2FT and 1FT combined with 4FT and 8FT lengths allow special designs.

### MULTIPLE SIZES TO CREATE INFINITE LAYOUTS

Flanged or flangeless appearance available in 4ft or 8ft lengths that can be used individually or together, and an innovative 6ft kit can be used together or separated into 1ft, 2ft and 3ft lengths.



4 FT FLANGED



8 FT FLANGED



### ROUGH IN AND TRIM SYSTEM

Separate housing installs easily during rough-in. LED trim installs quickly during trim out with innovative magnetic system.

## LED RECESSED LINEAR LINES OF LIGHT 1.5" **NEW** FOR HARD CEILINGS (SHEETROCK ONLY)

This elegant 1.5" extruded aluminum lighting channel blends seamlessly into hard ceilings. Upgrade from the tired look of round downlights in typical sheetrock applications for general lighting. The new CLF series allows for exciting new looks with a 1.5" line of light. Choose white flange or flangeless (mud-in flange available) in multiple sizes to create infinite configurations. Value-engineered for easy installation.

### Flangeless

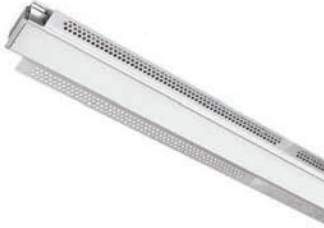

ITEM NO.	DESCRIPTION
CLFRRKITDMV30KSA	Recessed Flangeless 3 Piece Set (36.4", 24.4" & 12.4")L x 1.48"W x 2.6"H with Frosted Lens, 45W (total), 4200 Lumens (total), Mult-Volt 0-10V Dimming, 3000K, Satin Aluminum
CLFRR48L30W2800LDMV30KSA	Recessed Flangeless Fixture 48.4"L x 1.48"W x 2.6"H with Frosted Lens, 30W, 2800 Lumens, Mult-Volt 0-10V Dimming, 3000K, Satin Aluminum
CLFRR96L60W5600LDMV30KSA	Recessed Flangeless Fixture 96.4"L x 1.48"W x 2.6"H with Frosted Lens, 60W, 5600 Lumens, Mult-Volt 0-10V Dimming, 3000K, Satin Aluminum

### Flanged



ITEM NO.	DESCRIPTION
CLFRFKITDMV30KSA	Recessed Flanged 3 Piece Set 3.2"W x 1.4"H [38.1", 26.1" & 14.1" lengths] w/ Frst 1.5"W Lens, 45W (total), 4200 Lumens (total), Mult-Volt 0-10V Dimming, 3000K, Satin Aluminum
CLFRF48L30W2800LDMV30KSA	Recessed Flanged Fixture 50.0"L x 3.2"W x 1.4"H w/ Frst 1.5"W Lens, 30W, 2800 Lumens, Multi-Volt 0-10V Dimming, 3000K, Satin Aluminum
CLFRF96L60W5600LDMV30KSA	Recessed Flanged Fixture 99.1"L x 3.2"W x 1.4"H Extrusion w/ Frst 1.5"W /Lens, 60W, 5600 Lumens, Multi-Volt 0-10 Dimming, 3000K, Satin Aluminum

EM3 CCT4

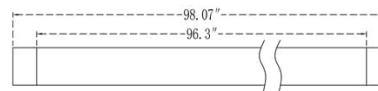
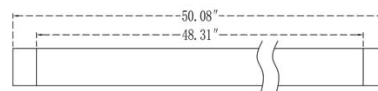
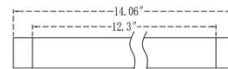
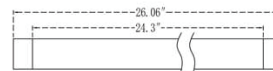
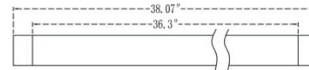

## Flangeless Appearance

A popular look with a sleek appearance.  
Fixture comes with mud-in flange.





# Recessed Linear Lines of Light

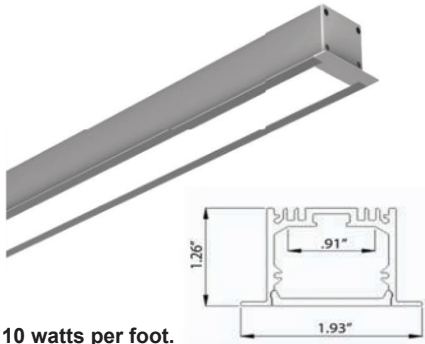

10 watts per foot.

## LED RECESSED LINEAR LINES OF LIGHT 1.93" WITH FLANGE FOR HARD CEILING

For micro-illumination applications, when you need to place light precisely. This slim, shallow, aluminum-extruded, recessed fixture does the job. Available in four or eight foot lengths and custom sizes.

ITEM NO.	DESCRIPTION
LLLSR47L42W2488L30KSA	47"L x 1.93"W x 1.26"H, Recessed Flanged SR Channel, Frosted Lens, 42W, 2488 Lumens, 3000K, 10' clear wire, Satin Aluminum
LLLSR96L83W4976L30KSA	96"L x 1.93"W x 1.26"H, Recessed Flanged SR Channel, Frosted Lens, 83W, 4976 Lumens, 3000K, 10' clear wire, Satin Aluminum

EM3 CCT4

Specify Remote Driver separately, see below.

Ideal Choice for Customized Lengths. Available from Factory in Any Length at Value Pricing. Call for Pricing.

## LED LINEAR LINES OF LIGHT 2.16" WITH FLANGE FOR HARD CEILING

This fixture has all the benefits of the LLLSR, but with a slightly wider (2.16") profile and additional flange and pattern accessories for straight, L-, T-, and X- configurations, for walls or ceilings.

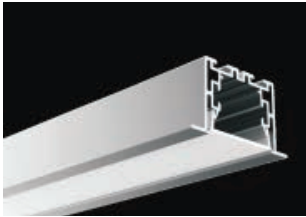

Consult for configurations and ordering.

ITEM NO.	DESCRIPTION
LLLFR48L24W2125L40KSA	47.24"L x 2.17"W x 1.38"H, Recessed Flanged FR Channel, Frosted Lens, 24W, 2125 Lumens, 4000K, 10' clear wire, Satin Aluminum
LLLFR96L49W4335L40KSA	96.46"L x 2.17"W x 1.38"H, Recessed Flanged FR Channel, Frosted Lens, 49W, 4335 Lumens, 4000K, 10' clear wire, Satin Aluminum

EM3 CCT4

Available in 3000K and 4000K. Specify Remote Driver separately, see below.

## LLLFR ACCESORIES

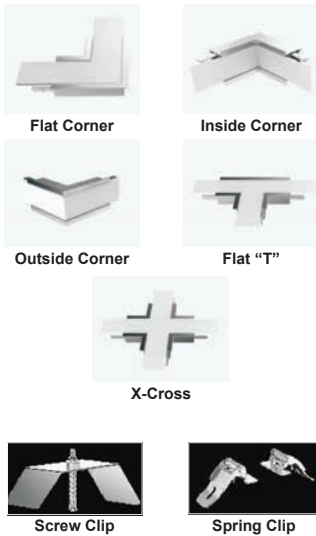

ITEM NO.	DESCRIPTION
LLLFRCORNER30K	LLLFR 90 DEGREE FLAT CORNER 3000K
LLLFRCORNER40K	LLLFR 90 DEGREE FLAT CORNER 4000K
LLLFRCROSS30K	LLLFR FLAT X-CROSS 3000K
LLLFRCROSS40K	LLLFR FLAT X-CROSS 4000K
LLLFRIS9030K	LLLFR 90 DEGREE INSIDE CORNER 3000K
LLLFRIS9040K	LLLFR 90 DEGREE INSIDE CORNER 4000K
LLLFRJOINER	Joiner Spline for LLL FR Extrusion
LLLFRS9030K	LLLFR 90 DEGREE OUTSIDE CORNER 3000K
LLLFRS9040K	LLLFR 90 DEGREE OUTSIDE CORNER 4000K
LLLFRRECLIP	LLLFR RECESSED SCREW CLIP
LLLFRSPRINGCLIP	LLLFR BUTTERFLY SPRING CLIP SET(2)
LLLFRTEE30K	LLLFR FLAT "T" 3000K
LLLFRTEE40K	LLLFR FLAT "T" 4000K

## REMOTE DRIVERS FOR LLLSR AND LLLFR SERIES ABOVE

ITEM NO.	DESCRIPTION
MTIM60L24DC	Constant Voltage DRIVER 60W 24VDC USE MAGNETIC LV CONTROL
MTIM100L24DC	Constant Voltage DRIVER 100W 24VDC USE MAGNETIC LV CONTROL
MTIM150L24DC	Constant Voltage DRIVER 150W 24VDC USE MAGNETIC LV CONTROL



## LED LINEAR LINES OF LIGHT WALL WASH 4" X 4"

This economical 4" recessed wall wash provides an asymmetrical light distribution and is ideal for corners, offices, or lobby areas. Available with optional Snap Fit Lens.



Now Available with Snap Fit Lens (SF).  
Shown without lens.  
Available in 44 and 66 series.

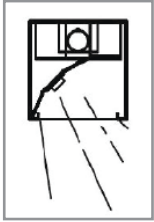

Specially designed reflector provides asymmetrical light distribution ideal for economical wall washing.

ITEM NO.	DESCRIPTION
44RWSF24LR12W1200LDMV40KWH	24"L x 4"W x 4"H Recessed Grid Ceiling / Wall Wash / Frosted Lens / 12W, 1200L / 0-10V Dim / 4000K
44RWSF24LR24W2400LDMV40KWH	24"L x 4"W x 4"H Recessed Grid Ceiling / Wall Wash / Frosted Lens / 24W, 2400L / 0-10V Dim / 4000K
44RWSF48LR24W2400LDMV40KWH	48"L x 4"W x 4"H Recessed Grid Ceiling / Wall Wash / Frosted Lens / 24W, 2400L / 0-10V Dim / 4000K
44RWSF48LR48W4800LDMV40KWH	48"L x 4"W x 4"H Recessed Grid Ceiling / Wall Wash / Frosted Lens / 48W, 4800L / 0-10V Dim / 4000K
44RWSF96LR48W4800LDMV40KWH	96"L x 4"W x 4"H Recessed Grid Ceiling / Wall Wash / Frosted Lens / 48W, 4800L / 0-10V Dim / 4000K
44RWSF96LR96W9600LDMV40KWH	96"L x 4"W x 4"H Recessed Grid Ceiling / Wall Wash / Frosted Lens / 96W, 9600L / 0-10V Dim / 4000K

EM6 G120 OS2 D1MV 90CRI CCT1 SURF PEND

For T Bar or Hard Ceiling Options, See Page 12.

## LED LINEAR LINES OF LIGHT WALL WASH 6" X 6"

This economical 6" recessed wall wash provides an asymmetrical light distribution and is ideal for corners, offices, or lobby areas. Available with optional Snap Fit Lens.



Shown without lens.

For T Bar or Hard Ceiling Options, See Page 12.

ITEM NO.	DESCRIPTION
66RWSF24LR12W1200LDMV40KWH	24"L x 6"W x 6"H Recessed Grid Ceiling / Wall Wash / Frosted Lens / 12W, 1200L / 0-10V Dim / 4000K
66RWSF24LR24W2400LDMV40KWH	24"L x 6"W x 6"H Recessed Grid Ceiling / Wall Wash / Frosted Lens / 24W, 2400L / 0-10V Dim / 4000K
66RWSF48LR24W2400LDMV40KWH	48"L x 6"W x 6"H Recessed Grid Ceiling / Wall Wash / Frosted Lens / 24W, 2400L / 0-10V Dim / 4000K
66RWSF48LR48W4800LDMV40KWH	48"L x 6"W x 6"H Recessed Grid Ceiling / Wall Wash / Frosted Lens / 48W, 4800L / 0-10V Dim / 4000K
66RWSF96LR48W4800LDMV40KWH	96"L x 6"W x 6"H Recessed Grid Ceiling / Wall Wash / Frosted Lens / 48W, 4800L / 0-10V Dim / 4000K
66RWSF96LR96W9600LDMV40KWH	96"L x 6"W x 6"H Recessed Grid Ceiling / Wall Wash / Frosted Lens / 96W, 9600L / 0-10V Dim / 4000K

EM6 G120 OS2 D1MV 90CRI CCT1 SURF PEND

## LED RECESSED ELLIPTICAL WALL WASH COFFER

The EWW offers spec-grade uniform vertical surface lighting to highlight wall- and shelf-mounted goods in commercial and retail environments.



ITEM NO.	DESCRIPTION
EWW24LJ24W1600LDMV40K	24"L x 10.62"W x 4.5"H / Wall Wash / 24W, 1600L / 0-10V Dim / 4000K
EWW24LZ35W2500LDMV40K	24"L x 10.62"W x 4.5"H / Wall Wash / 35W, 2500L / 0-10V Dim / 4000K
EWW48LJ48W3500LDMV40K	48"L x 10.62"W x 4.5"H / Wall Wash / 48W, 3500L / 0-10V Dim / 4000K
EWW48LZ57W4000LDMV40K	48"L x 10.62"W x 4.5"H / Wall Wash / 57W, 4000L / 0-10V Dim / 4000K

EM6 G120 D1MV 90CRI CCT1 X1LED FLUOR

# Perimeter Lighting



Specify the depth of drop shield in the item number.

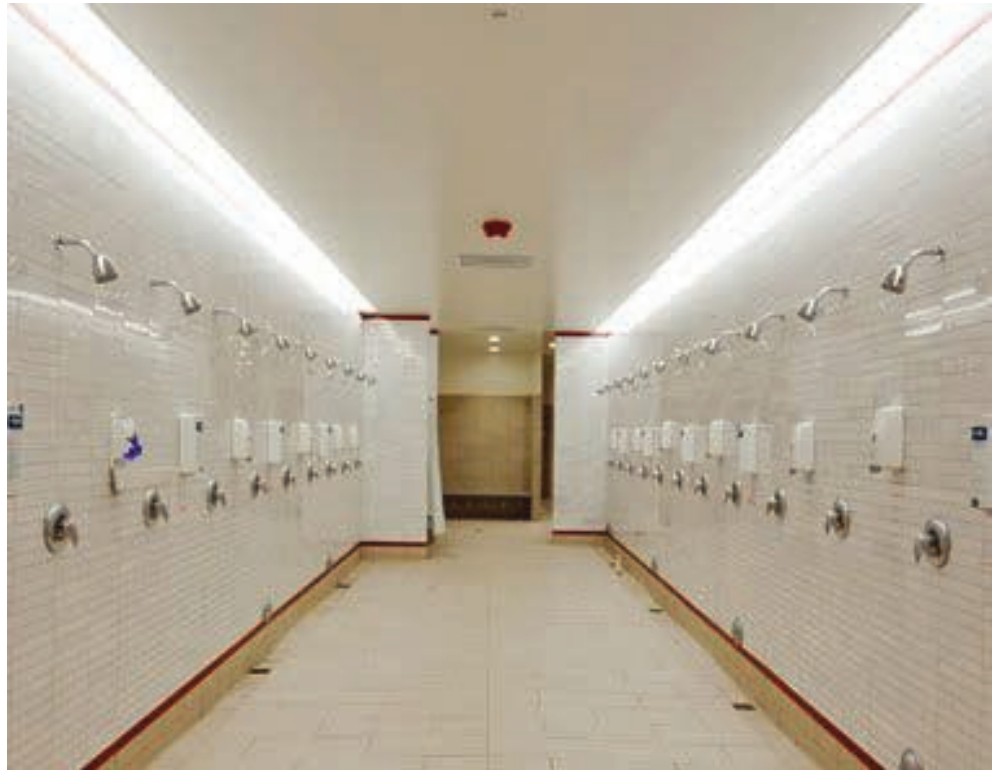

## LED PERIMETER COVE LIGHTING SYSTEM **NEW**

The PRL is a cost-effective solution where cove lighting is desired. Create an elegant wash of ambient and vertical illumination between the wall and ceiling planes in offices, hallways, conference rooms, and medical facilities. Available in 2, 4, 6 or 8 foot sections along with telescoping and corner options that can all be combined for longer runs and 4" regressed optics. This Perimeter Lighting System eliminates the need for a more costly "built-in-place" solution.

ITEM NO.	DESCRIPTION
PRLW44RSF24LR16W1600LDMV40K	4"W x 24"L x 4"H / 16W, 1600L / 0-10V Dim / 4000K / White
PRLW44RSF48LR32W3200LDMV40K	4"W x 48"L x 4"H / 32W, 3200L / 0-10V Dim / 4000K / White
PRLW44RSF72LR48W4800LDMV40K	4"W x 72"L x 4"H / 48W, 4800L / 0-10V Dim / 4000K / White
PRLW44RSF96LR64W6400LDMV40K	4"W x 96"L x 4"H / 64W, 6400L / 0-10V Dim / 4000K / White
PRLW46RSF24LR16W1600LDMV40K	4"W x 24"L x 6"H / 16W, 1600L / 0-10V Dim / 4000K / White
PRLW46RSF48LR32W3200LDMV40K	4"W x 48"L x 6"H / 32W, 3200L / 0-10V Dim / 4000K / White
PRLW46RSF72LR48W4800LDMV40K	4"W x 72"L x 6"H / 48W, 4800L / 0-10V Dim / 4000K / White
PRLW46RSF96LR64W6400LDMV40K	4"W x 96"L x 6"H / 64W, 6400L / 0-10V Dim / 4000K / White

EM3 G120 RGBW D1MV 90CRI CCT1



Telescoping Version for Wall to Wall Application. Consult to Specify.



## Add Drama and Personality to Your Space



Whether you want to accentuate the architecture, provide wayfinding, create visual interest or make your space stand out, Saylite's L23 series as well as others can be configured in patterns. Custom sizes, angles and configurations are available and manufactured in our USA factory. Contact your local sales representative or [sales@saylite.com](mailto:sales@saylite.com) for help with your project.

# Linear Pendants

Saylite offers a wide range of linear pendant LED fixtures in all the most popular profiles, from Flat Panels to geometric rectangles, to clouds, with many also available as companion recessed or surface mounted. We offer the most competitive lead times and custom capabilities in the industry. Steel fixtures are manufactured in our USA factory allowing for custom capabilities, faster lead times and cost-effective solutions.

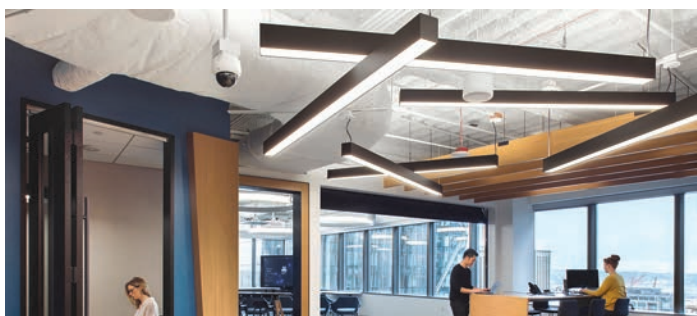

## LED LINEAR RADIUS INDIRECT **NEW**

This refreshing style features an open aperture design with fully luminous interior channel. The construction with no horizontal lenses or diffusers differentiates this series and provides the eye appeal. Specially engineered LED arrays are discreetly placed on the bottom edge of the linear channel to brightly illuminate the barreled bright white reflector to provide a gentle, soft downward spread of light. The aperture glows brilliantly and seamlessly while the light output is ideal for corridors, offices and other circulation and task areas. Bold, machined ends cap the fixture available in 2, 4, 6 or 8 foot lengths that can be used individually or joined together for longer run. Custom sizes and custom powder coat finishes are available. Pendant or surface mount.



ITEM NO.	DESCRIPTION
RIGP24LC24W2000LDMV40KWHHC421WH	24"L x 4"W x 4"H / 22W, 2000L / 0-10V Dim / 4000K / White / 4ft WH Canopy Kit with 5 Wire Cord
RIGP48LC48W4000LDMV40KWHHC421WH	48"L x 4"W x 4"H / 48W, 4000L / 0-10V Dim / 4000K / White / 4ft WH Canopy Kit with 5 Wire Cord
RIGP72LC72W6000LDMV40KWHHC421WH	72"L x 4"W x 4"H / 72W, 6000L / 0-10V Dim / 4000K / White / 4ft WH Canopy Kit with 5 Wire Cord
RIGP96LC96W8000LDMV40KWHHC421WH	96"L x 4"W x 4"H / 96W, 8000L / 0-10V Dim / 4000K / White / 4ft WH Canopy Kit with 5 Wire Cord

EM3 G120 D1MV 90CRI CCT1 SURF RECE WALL

## Pendant Mount Flat Panels in **NEW** Configurations FPHK Series

Saylite has developed a unique accessory to align pendant mounted Flat Panels in a variety of configurations. Mix 1x4, 2x2 and 2x4 Flat Panels each individually pendant mounted in a unique configuration to compliment your interior architecture. The Flat Panel Aligner Mounting System can be made for a variety of angles or straight configurations and finished in an accent color. A high impact look at a great value.

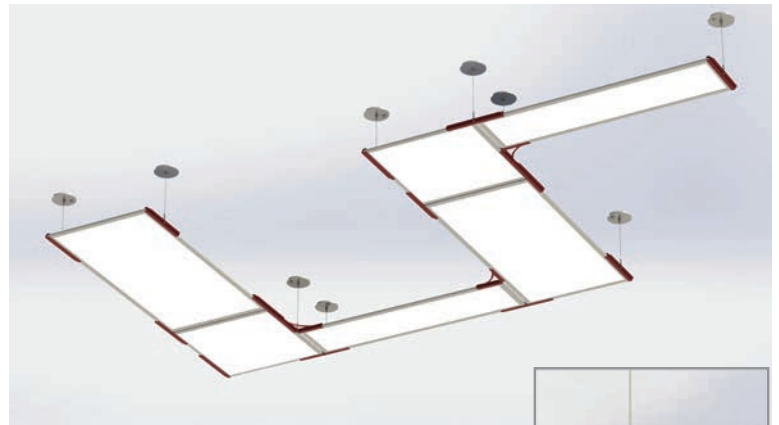

Consult Factory for Your Configuration.  
See other option on page 11.

## Convert a Linear Pendant to a Surface Mount

Most of the Linear Pendants on the next several pages can be surface mounted. Simply remove the hanging kit starting with "HC."



# Linear Pendants

Saylite offers a complete palette of linear pendant channel fixtures for every project, in 0.7, 1.3, 2, 2.5, 4, and 6" widths, individual or continuous run, direct/indirect, and direct only, and pendant, surface or wall mounted. Still don't see exactly what you want? Please ask us. We design and build to specification every day. Saylite is your factory at your fingertips!

## LED LINEAR PENDANT 2" X 3" DIRECT OR INDIRECT ONLY

Our signature micro pendant (2" wide, Direct or Indirect only) is suitable for modern corridors, lobbies and offices and can be installed individually or in continuous run. Snap-in lens hides LED arrays and provides excellent glare control. Consult for custom sizes or configured in patterns.



ITEM NO.	DESCRIPTION
L23PSF24LT13W1300LDMV40KWHHC605WH	24"L x 2"W x 3"H / Frosted Lens / 13W, 1300L / 0-10V Dim / 4000K / White / 6ft WH Canopy Kit with 5 Wire Cord
L23PSF24LT19W1900LDMV40KWHHC605WH	24"L x 2"W x 3"H / Frosted Lens / 19W, 1900L / 0-10V Dim / 4000K / White / 6ft WH Canopy Kit with 5 Wire Cord
L23PSF48LT26W2600LDMV40KWHHC605WH	48"L x 2"W x 3"H / Frosted Lens / 26W, 2600L / 0-10V Dim / 4000K / White / 6ft WH Canopy Kit with 5 Wire Cord
L23PSF48LT38W3800LDMV40KWHHC605WH	48"L x 2"W x 3"H / Frosted Lens / 38W, 3800L / 0-10V Dim / 4000K / White / 6ft WH Canopy Kit with 5 Wire Cord
L23PSF48LT45W4500LDMV40KWHHC605WH	48"L x 2"W x 3"H / Frosted Lens / 45W, 4500L / 0-10V Dim / 4000K / White / 6ft WH Canopy Kit with 5 Wire Cord
L23PSF96LT52W5200LDMV40KWHHC605WH	96"L x 2"W x 3"H / Frosted Lens / 52W, 5200L / 0-10V Dim / 4000K / White / 6ft WH Canopy Kit with 5 Wire Cord
L23PSF96LT76W7600LDMV40KWHHC605WH	96"L x 2"W x 3"H / Frosted Lens / 76W, 7600L / 0-10V Dim / 4000K / White / 6ft WH Canopy Kit with 5 Wire Cord
L23PSF96LT90W9000LDMV40KWHHC605WH	96"L x 2"W x 3"H / Frosted Lens / 90W, 9000L / 0-10V Dim / 4000K / White / 6ft WH Canopy Kit with 5 Wire Cord

EM3 G120 OS2 D1MV 90CRI CCT1 SURF REC WALL

Ordering is for Direct lighting. For Indirect Lighting Add U after the "L" after the length. To surface mount, remove HC605WH.

## LED LINEAR PENDANT 2" X 3" DIRECT & INDIRECT

Our signature micro pendant (2" wide, Uplight and Downlight) is suitable for modern corridors, lobbies and offices and can be installed individually or in continuous run. Snap-in lens hides LED arrays and provides excellent glare control.



ITEM NO.	DESCRIPTION
L23PSF24LUV6WDT12WDMV40KWHHC605WH	24"L x 2"W x 3"H / Frosted Lens / Up 6W, Dn 12, 1800L / 0-10V Dim / 4000K / White / 6ft WH Canopy Kit with 5 Wire Cord
L23PSF24LUV9WDT18WDMV40KWHHC605WH	24"L x 2"W x 3"H / Frosted Lens / Up 9W, Dn 18, 2700L / 0-10V Dim / 4000K / White / 6ft WH Canopy Kit with 5 Wire Cord
L23PSF48LUV12WDT24WDMV40KWHHC605WH	48"L x 2"W x 3"H / Frosted Lens / Up 12W, Dn 24, 3600L / 0-10V Dim / 4000K / White / 6ft WH Canopy Kit with 5 Wire Cord
L23PSF48LUV18WDT36WDMV40KWHHC605WH	48"L x 2"W x 3"H / Frosted Lens / Up 18W, Dn 36W, 5400L / 0-10V Dim / 4000K / White / 6ft WH Canopy Kit with 5 Wire Cord
L23PSF96LUV24WDT48WDMV40KWHHC605WH	96"L x 2"W x 3"H / Frosted Lens / Up 24W, Dn 48W, 7200L / 0-10V Dim / 4000K / White / 6ft WH Canopy Kit with 5 Wire Cord
L23PSF96LUV36WDT72WDMV40KWHHC605WH	96"L x 2"W x 3"H / Frosted Lens / Up 36W, Dn 72W, 10800L / 0-10V Dim / 4000K / White / 6ft WH Canopy Kit with 5 Wire Cord

EM6 G120 D1MV 90CRI CCT1 SURF REC WALL

## LED LINEAR PENDANT 2.5" X 3.5" DIRECT OR INDIRECT

This fixture series delivers maximum light output in a narrow body and it is the smallest fixture that accepts an integral emergency. Our US factory can fabricate this fixture to your exact specifications – length, finish, output, and configuration. For individual or continuous run. Consult for direct/indirect combination.



ITEM NO.	DESCRIPTION
L34PSF24LT13W1300LDMV40KWHHC3015WWH	24"L x 2.5"W x 3.25"H / Frosted Lens / 13W, 1300L / 0-10V Dim / 4000K / White / 4ft WH Canopy Kit with 5 Wire Cord
L34PSF24LT22W2200LDMV40KWHHC3015WWH	24"L x 2.5"W x 3.25"H / Frosted Lens / 22W, 2200L / 0-10V Dim / 4000K / White / 4ft WH Canopy Kit with 5 Wire Cord
L34PSF48LT26W2600LDMV40KWHHC3015WWH	48"L x 2.5"W x 3.25"H / Frosted Lens / 26W, 2600L / 0-10V Dim / 4000K / White / 4ft WH Canopy Kit with 5 Wire Cord
L34PSF48LT45W4500LDMV40KWHHC3015WWH	48"L x 2.5"W x 3.25"H / Frosted Lens / 45W, 4500L / 0-10V Dim / 4000K / White / 4ft WH Canopy Kit with 5 Wire Cord
L34PSF96LT52W5200LDMV40KWHHC3015WWH	96"L x 2.5"W x 3.25"H / Frosted Lens / 52W, 5200L / 0-10V Dim / 4000K / White / 4ft WH Canopy Kit with 5 Wire Cord
L34PSF96LT90W9000LDMV40KWHHC3015WWH	96"L x 2.5"W x 3.25"H / Frosted Lens / 90W, 9000L / 0-10V Dim / 4000K / White / 4ft WH Canopy Kit with 5 Wire Cord

EM6 G120 OS2 RGBW D1MV 90CRI CCT1 SURF REC WALL

Ordering is for Direct lighting. For Indirect Lighting Add U after the "L" after the length.  
To surface mount, remove HC3015WWH.

## LED LINEAR PENDANT 2.5" X 3.5" DIRECT ONLY

This value version uses discreet 22 inch LED arrays with metal inserts in the lens to mask dark spots on the ends. Use only for individual run lengths. Pendant or surface mount versions. Use L34 for full-featured 2.5" width line of light for specifications that require a 2.5" fixture width.



ITEM NO.	DESCRIPTION
SES25PFR24LJ15W1500LDMV40KWHHC3015WWH	24"L x 2.5"W x 3.25"H / Frosted Lens / 15W, 1500L / 0-10V Dim / 4000K / White / 4ft WH Canopy Kit with 5 Wire Cord
SES25PFR24LJ20W2000LDMV40KWHHC3015WWH	24"L x 2.5"W x 3.25"H / Frosted Lens / 20W, 2000L / 0-10V Dim / 4000K / White / 4ft WH Canopy Kit with 5 Wire Cord
SES25PFR48LJ31W3100LDMV40KWHHC3015WWH	48"L x 2.5"W x 3.25"H / Frosted Lens / 31W, 3100L / 0-10V Dim / 4000K / White / 4ft WH Canopy Kit with 5 Wire Cord
SES25PFR48LJ45W4500LDMV40KWHHC3015WWH	48"L x 2.5"W x 3.25"H / Frosted Lens / 45W, 4500L / 0-10V Dim / 4000K / White / 4ft WH Canopy Kit with 5 Wire Cord
SES25PFR96LJ62W6200LDMV40KWHHC3015WWH	96"L x 2.5"W x 3.25"H / Frosted Lens / 62W, 6200L / 0-10V Dim / 4000K / White / 4ft WH Canopy Kit with 5 Wire Cord
SES25PFR96LJ90W9000LDMV40KWHHC3015WWH	96"L x 2.5"W x 3.25"H / Frosted Lens / 90W, 9000L / 0-10V Dim / 4000K / White / 4ft WH Canopy Kit with 5 Wire Cord

EM6 G120 OS2 RGBW D1MV 90CRI CCT1 SURF REC WALL X1LED FLUOR

To surface mount, remove HC3015WWH.

## LED LINEAR PENDANT 2.5" X 3" DIRECT ONLY

The L25 is value-engineered for easy specification in 2-, 4-, and 8 foot individual pendants and a variety of colors for bold design statements. Ideal for corridors and lobbies and to emphasize directional layouts.

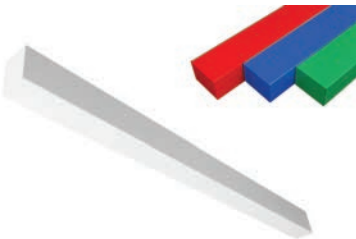

ITEM NO.	DESCRIPTION
L25PSF24LT18W1800LDMV40KWHHC3015WWH	48"L x 2.5"W x 3"H / Frosted Lens / 18W, 1800L / 0-10V Dim / 4000K / White
L25PSF48LT37W3770LDMV40KWHHC3015WWH	48"L x 2.5"W x 3"H / Frosted Lens / 37W, 3700L / 0-10V Dim / 4000K / White
L25PSF96LT74W7400LDMV40KWHHC3015WWH	96"L x 2.5"W x 3"H / Frosted Lens / 74W, 7400L / 0-10V Dim / 4000K / White

EM6 G120 OS2 RGBW D1MV 90CRI CCT1 SURF REC WALL

To surface mount any of these see bottom of page 23.

# Linear Pendants



## LED LINEAR PENDANT 4" X 4" DIRECT OR INDIRECT ONLY

The 4" x 4" steel profile provides a bold architectural look used individually or in continuous lengths to provide comfortable, bright general lighting. Snap fit frosted lens hides the LED arrays and provides excellent glare control. Easy to join, and easy to install. Available in standard sizes, outputs and finishes with a vast array of custom options.

ITEM NO.	DESCRIPTION
44PSF24LR12W1200LDMV40KWH-HC3015WWH	24"L x 4"W x 4"H / Frosted Lens / 12W, 1200L / 0-10V Dim / 4000K / White / 4ft WH Canopy Kit with 5 Wire Cord
44PSF24LR24W2400LDMV40KWH-HC3015WWH	24"L x 4"W x 4"H / Frosted Lens / 24W, 2400L / 0-10V Dim / 4000K / White / 4ft WH Canopy Kit with 5 Wire Cord
44PSF48LR24W2400LDMV40KWH-HC3015WWH	48"L x 4"W x 4"H / Frosted Lens / 24W, 2400L / 0-10V Dim / 4000K / White / 4ft WH Canopy Kit with 5 Wire Cord
44PSF48LR48W4800LDMV40KWH-HC3015WWH	48"L x 4"W x 4"H / Frosted Lens / 48W, 4800L / 0-10V Dim / 4000K / White / 4ft WH Canopy Kit with 5 Wire Cord
44PSF96LR48W4800LDMV40KWH-HC3015WWH	96"L x 4"W x 4"H / Frosted Lens / 48W, 4800L / 0-10V Dim / 4000K / White / 4ft WH Canopy Kit with 5 Wire Cord
44PSF96LR96W9600LDMV40KWH-HC3015WWH	96"L x 4"W x 4"H / Frosted Lens / 96W, 9600L / 0-10V Dim / 4000K / White / 4ft WH Canopy Kit with 5 Wire Cord

EM6 G120 OS2 RGBW D1MV 90CRI CCT1 SURF REC WALL X1LED FLUOR

Ordering is for Direct lighting. For Indirect Lighting Add "U" after the "L."  
To surface mount, remove HC3015WWH.



## LED LINEAR PENDANT 4" X 5" UPLIGHT AND DOWNLIGHT

Designed for distinctive architectural lighting plans, this linear 4" X 5" pendant (direct and indirect) can be installed individually or in group patterns. The snap fit lens provides excellent lighting and the five inch height makes a bold statement.

ITEM NO.	DESCRIPTION
45PSF24LUR6WD12WDMV40KWH-HC3015WWH	24"L x 4"W x 5"H / Frosted Lens / Up 6W, Dn 12W, 1800L / 0-10V Dim / 4000K / White / 4ft WH Canopy Kit with 5 Wire Cord
45PSF24LUR9WD18WDMV40KWH-HC3015WWH	24"L x 4"W x 5"H / Frosted Lens / Up 9W, Dn 18W, 2700L / 0-10V Dim / 4000K / White / 4ft WH Canopy Kit with 5 Wire Cord
45PSF48LUR12WD24WDMV40KWH-HC3015WWH	48"L x 4"W x 5"H / Frosted Lens / Up 12W, Dn 24, 3600L / 0-10V Dim / 4000K / White / 4ft WH Canopy Kit with 5 Wire Cord
45PSF48LUR18WD36WDMV40KWH-HC3015WWH	48"L x 4"W x 5"H / Frosted Lens / Up 18W, Dn 36W, 5400L / 0-10V Dim / 4000K / White / 4ft WH Canopy Kit with 5 Wire Cord
45PSF96LUR24WD48WDMV40KWH-HC3015WWH	96"L x 4"W x 5"H / Frosted Lens / Up 24W, Dn 48W, 7200L / 0-10V Dim / 4000K / White / 4ft WH Canopy Kit with 5 Wire Cord
45PSF96LUR36WD72WDMV40KWH-HC3015WWH	96"L x 4"W x 5"H / Frosted Lens / Up 36W, Dn 72W, 10800L / 0-10V Dim / 4000K / White / 4ft WH Canopy Kit with 5 Wire Cord

EM6 G120 OS2 RGBW WALL X1LED FLUOR

Ordering is for Direct lighting. For Indirect Lighting Add "U" after the "L."  
For size 4"W x 4"H, change 45 to 44.

## LED LINEAR PENDANT 6" X 6" DIRECT OR INDIRECT ONLY

This spec-grade geometric (6" X 6" Direct or Indirect only) fixture is ideal for general or perimeter lighting applications where a bolder size is required and can be installed individually or in group patterns.



ITEM NO.	DESCRIPTION
66PSF24LR12W1200LDMV40KWH-HC3015WWH	24"L x 6"W x 6"H / Frosted Lens / 12W, 1200L / 0-10V Dim / 4000K / White / 4ft WH Canopy Kit with 5 Wire Cord
66PSF24LR24W2400LDMV40KWH-HC3015WWH	24"L x 6"W x 6"H / Frosted Lens / 24W, 2400L / 0-10V Dim / 4000K / White / 4ft WH Canopy Kit with 5 Wire Cord
66PSF48LR24W2400LDMV40KWH-HC3015WWH	48"L x 6"W x 6"H / Frosted Lens / 24W, 2400L / 0-10V Dim / 4000K / White / 4ft WH Canopy Kit with 5 Wire Cord
66PSF48LR48W4800LDMV40KWH-HC3015WWH	48"L x 6"W x 6"H / Frosted Lens / 48W, 4800L / 0-10V Dim / 4000K / White / 4ft WH Canopy Kit with 5 Wire Cord
66PSF96LR48W4800LDMV40KWH-HC3015WWH	96"L x 6"W x 6"H / Frosted Lens / 48W, 4800L / 0-10V Dim / 4000K / White / 4ft WH Canopy Kit with 5 Wire Cord
66PSF96LR96W9600LDMV40KWH-HC3015WWH	96"L x 6"W x 6"H / Frosted Lens / 96W, 9600L / 0-10V Dim / 4000K / White / 4ft WH Canopy Kit with 5 Wire Cord

EM6 G120 OS2 RGBW D1MV 90CRI CCT1 SURF REC WALL X1LED FLUOR

Ordering is for Direct lighting. For Indirect Lighting Add "U" after the "L."  
To surface mount, remove HC3015WWH.

## LED LINEAR PENDANT 6" X 6" DIRECT AND INDIRECT

This spec-grade geometric (6" X 6" Uplight and Downlight) fixture is ideal for general or perimeter lighting applications where a bolder size is required and can be installed individually or in group patterns.



ITEM NO.	DESCRIPTION
66PSF24LUR6WD12WDMV40KWH-HC3015WWH	24"L x 6"W x 6"H / Frosted Lens / Up 6W, Dn 12W, 1800L / 0-10V Dim / 4000K / White / 4ft WH Canopy Kit with 5 Wire Cord
66PSF24LUR12WD24WDMV40KWH-HC3015WWH	24"L x 6"W x 6"H / Frosted Lens / Up 12W, Dn 24W, 3600L / 0-10V Dim / 4000K / White / 4ft WH Canopy Kit with 5 Wire Cord
66PSF48LUR12WD24WDMV40KWH-HC3015WWH	48"L x 6"W x 6"H / Frosted Lens / Up 12W, Dn 24W, 3600L / 0-10V Dim / 4000K / White / 4ft WH Canopy Kit with 5 Wire Cord
66PSF48LUR24WD48WDMV40KWH-HC3015WWH	48"L x 6"W x 6"H / Frosted Lens / Up 18W, Dn 36W, 5400L / 0-10V Dim / 4000K / White / 4ft WH Canopy Kit with 5 Wire Cord
66PSF96LUR24WD48WDMV40KWH-HC3015WWH	96"L x 6"W x 6"H / Frosted Lens / Up 24W, Dn 48W, 7200L / 0-10V Dim / 4000K / White / 4ft WH Canopy Kit with 5 Wire Cord
66PSF96LUR36WD72WDMV40KWH-HC3015WWH	96"L x 6"W x 6"H / Frosted Lens / Up 36W, Dn 72W, 10800L / 0-10V Dim / 4000K / White / 4ft WH Canopy Kit with 5 Wire Cord

EM6 G120 OS2 RGBW D1MV 90CRI CCT1 WALL X1LED FLUOR

## PENDANT CANOPY KITS See page 153 for more information on hanging kits.



Pendant Canopy Kit (HC301WH/HC401WH are 5FT Length) & (HC302WH/HC402WH are 12FT Length).  
Standard Power Cords are 3 Wire for 5 Wire or 6 Wire Cords add 5W or 6W after number.



Power Feed Canopy Kit



Non Power Feed Kit

Both come in complete kit.

# Linear Pendants

JUST RIGHT,  
RIGHT NOW.

Choice of 2.2" or 3.5" Wide Linear Aluminum Channel available in 4ft and 8ft or join for longer runs for direct lighting. 2.2" is also available in direct and indirect output. Ships in less than 48 hours.



Based on your feedback, our brand new All-In-One LED Linear Channel is new and improved to provide the easiest channel in the industry to specify, order, and install. This integral driver channel in two different profiles provides the ideal solution for both individuals fixtures (in 4 or 8 foot), and to join multiple channels for longer, continuous runs (in 4 or 8 foot multiples). This beautifully finished aluminum channel is so easy to install that the "do-it-yourselfer" can install in minutes; and professional installers will appreciate not only the reduction in cost, but also the speed in which installation can be completed. A specially designed integral wiring harness (ordered separately) makes joining two channels electronically simple and efficient. A unique, mechanical joiner bracket in conjunction with our special joiner tool allows for joining two or more channels together with no light leak and a clean connection.

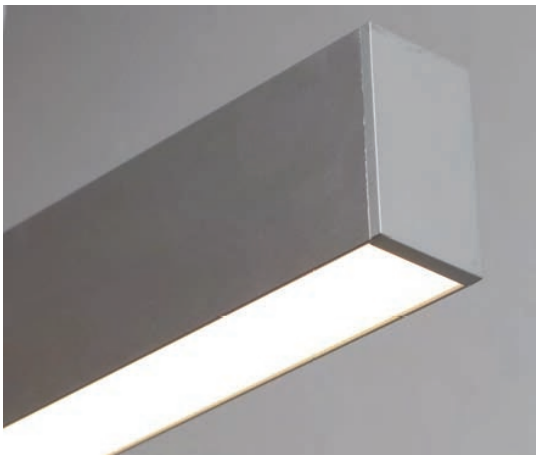

2 SIZES READY TO SHIP  
Satin Aluminum or White Finishes

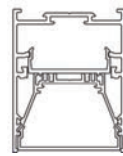

LLLSF

2.16" Wide, 2.75" Tall

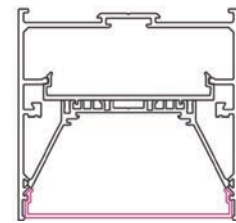

LLLSG

3.54" Wide, 3.38" Tall

## FEATURES INCLUDE:

- Aluminum Channel
- Integral Driver
- Snap Fit Lens
- Magnetic Light Leak Block
- Integral Wire Harness

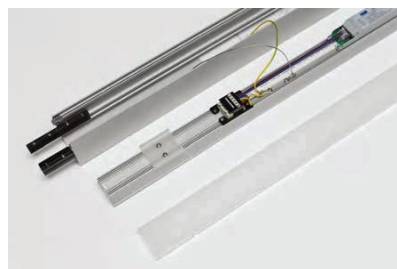

Three-part system allows for easy wiring with prewired harnesses and allows for custom finishes on channel (Consult).

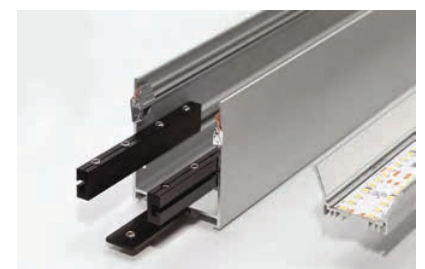

Joins easily with a mechanical spline.



## LED LINEAR PENDANT CHANNEL 2.2" X 2.80" **NEW** DIRECT AND INDIRECT

Aluminum 2.2" profile with the perfect ratio direct and indirect light. Frosted lens housed in Satin Aluminum or white finished channel. Ideal for open office plans, it comes in 4- or 8- foot individual fixtures or join multiple fixtures for continuous runs. Dubbed "the easiest LED channel in the industry", the CLLBF is easy to specify, order, and install, and ships in less than 48 hours.



ITEM NO.	DESCRIPTION
CLLLBF48LU18WD27WDMV30KSAHC705WH	2.2"W X 2.8"H X 48.43"L / LED Direct/Indirect Pend / Up 18W, Dn 27W, 4500L Total / 0-10V Dim / 3000K / Satin Aluminum / 5FT Cable Kit
CLLLBF96LU36WD54WDMV30KSAHC705WH	2.2"W X 2.8"H X 96.42"L / LED Direct/Indirect Pend / Up 36W, Dn 54W, 9000L Total / 0-10V Dim / 3000K / Satin Aluminum / 5FT Cable Kit
CLLLBF144LU54WD81WDMV30KSAHC705WH	144"L x 2.2"W x 2.8"H / LED Direct/Indirect Pend / Up 54W, Dn 81W, 13500L Total / 0-10V Dim / 3000K / Satin Aluminum / 5FT Cable Kit
CLLLBF192LU72WD108WDMV30KSAHC705WH	192"L x 2.2"W x 2.8"H / LED Direct/Indirect Pend / Up 72W, Dn 108W, 18000L Total / 0-10V Dim / 3000K / Satin Aluminum / 5FT Cable Kit

**OS3** **CCT4**

For White Finish Change SA to WH. For 12ft Mounting cable change HC705WH to HC712WH.

2 LED Strips provides uplight. 40% uplight and 60% downlight is ideal for most applications.

This series, as well as the other CLLL series ship from stock within 48 hours.



2.2" Wide Silhouette x 3.2" Height with Integral Driver for 0-10V Dimming.

Saylite has a library of videos that provide step by step Installations, "How we Build it," and application shots. Go to [www.saylite.com/support/videos](http://www.saylite.com/support/videos).

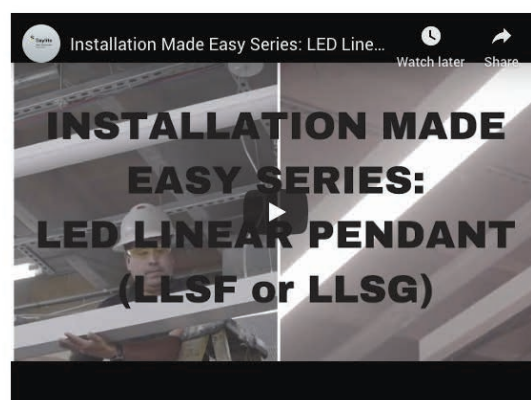
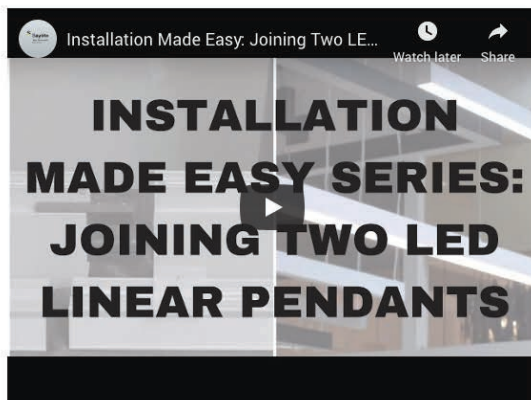

# Linear Pendants



Sensor option.  
Consult Factory.

For White Finish, Change SA to WH. For 12ft cable kit change HC605WH to HC612WH.

## LED LINEAR PENDANT CHANNEL 2.2" X 3.15" DOWNLIGHT ONLY

Aluminum 2.2" profile with the perfect amount of smooth downlight. Frosted lens housed in Satin Aluminum or white finished channel. Ideal for open office plans, it comes in 4 or 8 foot individual fixtures or join multiple fixtures for continuous runs. Dubbed "the easiest LED channel in the industry", the CLLLSF is easy to specify, order, and install, and ships in less than 48 hours.

### Surface

ITEM NO.	DESCRIPTION
CLLLSF48L31WCDMV30KSASURF	Aluminum Channel / 48"L x 2.2"W x 2.8"H / 31W 3100L / 0-10V Dim / 3000K / Satin Aluminum / Surface Mount
CLLLSF96L62WCDMV30KSASURF	Aluminum Channel / 96"L x 2.2"W x 2.8"H / 62W 6200L / 0-10V Dim / 3000K / Satin Aluminum / Surface Mount
CLLLSF144L93WCDMV30KSASURF	Aluminum Channel / 144"L x 2.2"W x 2.8"H / 93W 9300L / 0-10V Dim / 3000K / Satin Aluminum / Surface Mount
CLLLSF192L124WCDMV30KSASURF	Aluminum Channel / 192"L x 2.2"W x 2.8"H / 124W 12400L / 0-10V Dim / 3000K / Satin Aluminum / Surface Mount

### Pendant

ITEM NO.	DESCRIPTION
CLLLSF48L31WCDMV30KSAHC605WH	Aluminum Channel / 48"L x 2.2"W x 2.8"H / 31W 3100L / 0-10V Dim / 3000K / Satin Aluminum / 5' WH Canopy Kit
CLLLSF96L62WCDMV30KSAHC605WH	Aluminum Channel / 96"L x 2.2"W x 2.8"H / 62W 6200L / 0-10V Dim / 3000K / Satin Aluminum / 5' WH Canopy Kit
CLLLSF144L93WCDMV30KSAHC605WH	Aluminum Channel / 144"L x 2.2"W x 2.8"H / 93W 9300L / 0-10V Dim / 3000K / Satin Aluminum / 5' WH Canopy Kit
CLLLSF192L124WCDMV30KSAHC605WH	Aluminum Channel / 192"L x 2.2"W x 2.8"H / 124W 12400L / 0-10V Dim / 3000K / Satin Aluminum / 5' WH Canopy Kit

OS3 CCT3 SURF

## LED LINEAR PENDANT CHANNEL 3.25" X 2.8" DOWNLIGHT ONLY

Aluminum 3.5" profile with the perfect amount of smooth downlight. See description above.

### Surface

ITEM NO.	DESCRIPTION
CLLLSG48L45WCDMV30KSASURF	Aluminum Channel / 48"L x 3.5"W x 2.8"H / 45W 5000L / 0-10V Dim / 3000K / Satin Aluminum / Surface Mount
CLLLSG96L90WCDMV30KSASURF	Aluminum Channel / 96"L x 3.5"W x 2.8"H / 90W 1000L / 0-10V Dim / 3000K / Satin Aluminum / Surface Mount
CLLLSG144L135WCDMV30KSASURF	Aluminum Channel / 144"L x 3.5"W x 2.8"H / 135W 13500L / 0-10V Dim / 3000K / Satin Aluminum / Surface Mount
CLLLSG192L180WCDMV30KSASURF	Aluminum Channel / 192"L x 3.5"W x 2.8"H / 180W 18000L / 0-10V Dim / 3000K / Satin Aluminum / Surface Mount

### Pendant

CLLLSG48L45WCDMV30KSAHC605WH	Aluminum Channel / 48"L x 3.5"W x 2.8"H / 45W 5000L / 0-10V Dim / 3000K / Satin Aluminum / 5' WH Canopy Kit
CLLLSG96L90WCDMV30KSAHC605WH	Aluminum Channel / 96"L x 3.5"W x 2.8"H / 90W 1000L / 0-10V Dim / 3000K / Satin Aluminum / 5' WH Canopy Kit
CLLLSG144L135WCDMV30KSAHC605WH	Aluminum Channel / 144"L x 3.5"W x 2.8"H / 135W 13500L / 0-10V Dim / 3000K / Satin Aluminum / 5' WH Canopy Kit
CLLLSG192L180WCDMV30KSAHC605WH	Aluminum Channel / 192"L x 3.5"W x 2.8"H / 180W 18000L / 0-10V Dim / 3000K / Satin Aluminum / 5' WH Canopy Kit

CCT3 SURF

## LED LINEAR CHANNEL IN 2 SIZES w/ INTEGRAL DRIVER

Above fixtures are complete with hanging hardware and power cords. These fixtures are sold a la carte with accessories on the bottom of the following page.

ITEM NO.	DESCRIPTION
<b>LLLSF - Alum. Channel 2.2"W x (48"L or 96"L) x 2.8"H</b>	
LLLSF48L30W3000LDMV40KSA	30W 3000L, 4000K 0-10V Dimming Multi-Volt
LLLSF96L60W6000LDMV40KSA	60W 6000L, 4000K 0-10V Dimming Multi-Volt
<b>LLLSG - Alum. Channel 3.5"W x (48"L or 96"L) x 3.3"H</b>	
LLLSG48L45W5000LDMV40KSA	45W 5000L, 4000K 0-10V Dimming Multi-Volt
LLLSG96L90W10000LDMV40KSA	90W 10000L, 4000K 0-10V Dimming Multi-Volt

CCT4 SURF PEND REC



LLLSF  
2.16" Wide, 2.75" Tall



LLLSG  
3.54" Wide, 3.38" Tall

## LED LINEAR PENDANT CHANNEL 1.57" LED TAPE



1.57" Wide x 2.54" High Satin Aluminum. Requires Remote Driver, see page 33.

Utilizing the latest LED high-powered 24-volt tape, the LLLSH provides powerful micro-illumination and stylish lines of light in 4- and 8-foot lengths or continuous runs. Available in custom sizes and patterns. Snap-in lens provides 527 lumens per foot using less than 8.78 watts.

ITEM NO.	DESCRIPTION
LLLSH48L24W2125L30KSA	LLLSH Pendant 47.24"L x 1.57"W x 2.5"H / 24W, 2125L / 3000K / Satin Aluminum
LLLSH48L24W2125L40KSA	LLLSH Pendant 47.24"L x 1.57"W x 2.5"H / 24W, 2125L / 4000K / Satin Aluminum
LLLSH96L49W4335L30KSA	LLLSH Pendant 96.46"L x 1.57"W x 2.5"H / 49W, 4335L / 3000K / Satin Aluminum
LLLSH96L49W4335L40KSA	LLLSH Pendant 96.46"L x 1.57"W x 2.5"H / 49W, 4335L / 4000K / Satin Aluminum

CCT4 SURF WALL

Order driver and accessories separately.

## LLLSH PATTERN OPTIONS

Join individual fixtures together to create endless patterns and variations.



ITEM NO.	DESCRIPTION
LLLSHCAP	LLLSH END CAP
LLLSHLOCKER	LLLSH Internal Locker for GEAR TRAY
LLLSHRECLIP	LLLSH RECESSED SCREW CLIP
LLLSHWALLCLIP	LLLSH WALL MOUNT ELL CLIP
LLLSHJOINER	Joiner Spline for LLL SH Extrusion
LLLSHCORNER30K	LLLSH 90° FLAT CORNER 3000K
LLLSHCORNER40K	LLLSH 90° FLAT CORNER 4000K
LLLSHTEE30K	LLLSH FLAT TEE 3000K
LLLSHTEE40K	LLLSH FLAT TEE 4000K
LLLSHCROSS30K	LLLSH FLAT X-CROSS 3000K
LLLSHCROSS40K	LLLSH FLAT X-CROSS 4000K
LLLSHHC601WH	LLLSH LLLSH Pendant parts Kit 2M
LLLSHHC602WH	LLLSH LLLSH Pendant parts Kit 4M

## Accessories for CLLLSF and CLLLSG on Preceding Page

### JOIN TWO OR MORE CHANNELS TOGETHER



ITEM NO.	DESCRIPTION
LLLSFJOINER	Mechanical Joiner to Join 2 LLLSF Channe
LLLSGJOINER	Mechanical Joiner to Join 2 LLLSG Channe
LLLSGJOINERTOOL	Tool Required to Use Mechanical Joiner (1 per installation)
LLLSFLENSTOOL	Lens Removal Tool for LLLSF

### 3 MOUNTING OPTIONS (SURFACE, PENDANT AND RECESSED)

Mounting options and accessories make installation a breeze for both "do-it-yourselfers" and professionals.



ITEM NO.	DESCRIPTION
LLLSFSURFKIT	Surface Mount Screw and Toggle Set of 3
LLLSFRECKIT**	Recessed Mounting Brackets for LLLSF (Set of 2) (Includes 24 inch power cord)
LLLSGRECKIT*	Recessed Mounting Brackets for LLLSG (Set of 2) (Includes 24 inch power cord)
LLLSFHCPNF605WH	Pendant Mounting Non-Power Canopy Kit, 6FT Cable w/Canopy
LLLSFHCPNF612WH	Pendant Mounting Non-Power Canopy Kit, 12FT Cable w/Canopy
LLLSFHCFPF605WH	Pendant Mounting Power Feed Canopy Kit 5 Wire for up to 6FT Drop
LLLSFHCFPF612WH	Pendant Mounting Power Feed Canopy Kit 5 Wire for up to 12FT Drop

\* Aluminum Channel has no flange so review Recessed Application to ensure this will work.

\*\*Use One Power Feed Canopy Kit every place mounting to Power. Non Power Feed Version Order Separately for Mounting where No Power Feed is Required.

# Linear Pendants



## LED LINEAR PENDANT CHANNEL WITH REMOTE DRIVERS

Utilizing the latest LED high-powered 24-volt tape, the LLL Series provides powerful micro-illumination and can be ordered in multiple ways providing maximum flexibility for every specification. Choose from a variety of aluminum channels that can be cut to size, painted a variety of colors and mounted as an individual fixture, a continuous run, concealed behind fascias, clustered in multiples and mounted as pendant or surface mounted on wall or ceiling. Each aluminum profile utilizes a specially designed 24 volt LED tape that can be cut to size and requires a separate 24 Volt driver. Remote drivers can be specified per fixture or for a group of fixtures. Specify mounting and joining accessories to complete the fixture.



### LED Linear Pendant Channel 1.38" Dia. Round Body (Pendant Only)

ITEM NO.	DESCRIPTION
LLLRA48L35W2246L30KSA	47.75" Round 1.6" Dia. RA Channel w/Lens and 2 End Caps and Tape 30K Installed with 10' Clear Wire
LLLRA97L69W4492L30KSA	92" Round 1.6" Dia. RA Channel w/Lens and 2 End Caps and Tape 30K Installed with 10' Clear Wire

CCT4



### LED Linear Pendant Channel 2.36" Dia. Round Body (Pendant Only)

ITEM NO.	DESCRIPTION
LLLRB47L42W2488L30KSA	47.75" Round 2.36" Dia. RB Extrusion w/Lens and 2 End Caps and Tape 30K Installed with 10' Clear Wire
LLLRB99L96W4976L30KSA	96" Round 2.36" Dia. RB Extrusion w/Lens and 2 End Caps and Tape 30K Installed with 10' Clear Wire

CCT4



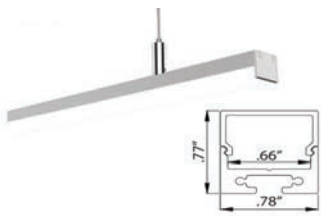

## LED LINEAR PENDANT CHANNEL 0.78" SQUARE BODY

ITEM NO.	DESCRIPTION
LLLSA48L23W1500L30KSA	47.75" Square 0.77" SA Channel w/Lens and 2 End Caps and Tape 30K Installed with 10' Clear Wire
LLLSA97L46W3000L30KSA	97" Square 0.77" SA Channel w/Lens and 2 End Caps and Tape 30K Installed with 10' Clear Wire

**CCT4** **SURF**

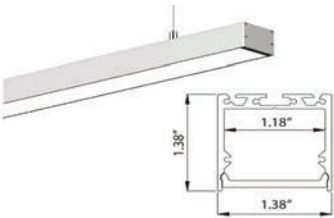

## LED LINEAR PENDANT CHANNEL 1.18" SQUARE BODY

ITEM NO.	DESCRIPTION
LLLSB47L42W2488L30KSA	47" Square 1.38" SB Channel w/Lens and 2 End Caps and Tape 30K Installed with 10' Clear Wire
LLLSB96L83W4976L30KSA	96" Square 1.38" SB Channel w/Lens and 2 End Caps and Tape 30K Installed with 10' Clear Wire

**CCT4** **SURF**

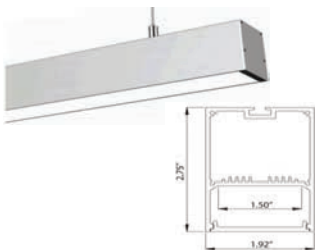

## LED LINEAR PENDANT CHANNEL 2" RECTANGULAR BODY

ITEM NO.	DESCRIPTION
LLLSC48L58W3456L30KSA	47.75" Rect. 1.92W" x 2.75H" SC Extrusion w/Lens and 2 End Caps and Tape 30K Installed with 10' Clear Wire
LLLSC97L115W6912L30KSA	97" Rect. 1.92W" x 2.75H" SC Extrusion w/Lens and 2 End Caps and Tape 30K Installed with 10' Clear Wire

**CCT4** **SURF**

## DRIVERS AND ACCESSORIES (Max driver utilization 80%)

ITEM NO.	DESCRIPTION
MTIM40L24DC	Constant Voltage DRIVER 40W 24VDC USE MAGNETIC LV CONTROL
MTIM60L24DC	Constant Voltage DRIVER 60W 24VDC USE MAGNETIC LV CONTROL
MTIM100L24DC	Constant Voltage DRIVER 100W 24VDC USE MAGNETIC LV CONTROL
MTIM150L24DC	Constant Voltage DRIVER 150W 24VDC USE MAGNETIC LV CONTROL
<b>Cable Kits</b>	
HC601WH	Cable kit with 6' cable and power feed/cable incl. and white canopy
HC602WH	Cable kit with 12' cable and power feed/cable incl. and white canopy
<b>Joiners</b>	
LLLRAJOIN	LLL RA JOINER METAL
LLLSAJJOIN	LINEAR SA JOINER METAL

Change 30K to 40K for 4000 color temperature. Consult for surface mount to order channel and tape separately.



Consult for accessories to make patterns

# Linear Pendants



## LINEAR CONFIGURATIONS AND PATTERNS

Saylite's Factory at Your Fingertips is able to configure a linear pattern to your specifications. Choose from our pre-configured patterns below or specify your own patterns at affordable pricing.



Lit corners

Consult for Different Configurations

(Squares or Rectangles, Up and Downlight Versions, or Different Shapes of Lit Patterns)

## LED LINEAR PENDANT SQUARE 4" X 4", 4-FOOT AND 8-FOOT SQUARES

Create dramatic geometric lines of light in 4-foot or 8-foot squares or consult for custom lit configurations. Lit corners, shadowless LED and energy-efficient performance provide excellent general lighting. Ideal for circulation spaces, lobbies, retail and conference rooms with high ceilings, a desire for industrial feel and a compliment to the architectural style.

ITEM NO.	DESCRIPTION
44PSF4X4R96WDMV40KWH-HC4015WWH	4"x4" 4ft. Sq / 96W, 9600L / 0-10V Dim / 4000K / White / 4ft WH Canopy Kit with 5 Wire Cord
44PSF4X4R128WDMV40KWH-HC4015WWH	4"x4" 4ft. Sq / 128W, 12800L / 0-10V Dim / 4000K / White / 4ft WH Canopy Kit with 5 Wire Cord
44PSF8X8R192WDMV40KWH-HC4015WH	4"x4" 8ft. Sq / 192W, 19200L / 0-10V Dim / 4000K / White / 4ft WH Canopy Kit with 5 Wire Cord
44PSF8X8R256WDMV40KWH-HC4015WWH	4"x4" 8ft. Sq / 256W, 25600L / 0-10V Dim / 4000K / White / 4ft WH Canopy Kit with 5 Wire Cord

EM2 G120 RGBW D1MV 90CRI CCT1 SURF

## LED LINEAR PENDANT SQUARE DIRECT/INDIRECT

The 45 Series offers all the benefits of the 44 Series but is specifically designed for direct/indirect lighting with a snap-in lens to hide the lamps or LED arrays. Ideal where downlight and uplight are required.



ITEM NO.	DESCRIPTION
45PSF4X4UR24WD96WDMV40KWHHC4015WWH	4"x5" 4ft. Sq / Up 24W, Dn 96W, 12000L / 0-10V Dim / 4000K / White / 4ft WH Canopy Kit with 5 Wire Cord
45PSF4X4UR32WD128WDMV40KWHHC4015WWH	4"x5" 4ft. Sq / Up 32W, Dn 128W, 16000L / 0-10V Dim / 4000K / White / 4ft WH Canopy Kit with 5 Wire Cord
45PSF8X8UR48WD192WDMV40KWHHC4015WH	4"x5" 8ft. Sq / Up 48W, Dn 192W, 24000L / 0-10V Dim / 4000K / White / 4ft WH Canopy Kit with 5 Wire Cord
45PSF8X8UR64WD256WDMV40KWHHC4015WWH	4"x5" 8ft. Sq / Up 64W, Dn 256W, 32000L / 0-10V Dim / 4000K / White / 4ft WH Canopy Kit with 5 Wire Cord

EM2 G120 RGBW D1MV 90CRI CCT1 **NEW**



ITEM NO.	DESCRIPTION
YFXSF49LRGBW36WMVWHILHC3301WH	Y Shape Pendant / 49"L x 5.85"W x 4"H / 36W / RGBW / 120V-277V / White / Illumi Wireless Control / 4ft WH Canopy Kit with 5 Wire Cord
YFXSF49LRGBW72WMVWHILHC3301WH	Y Shape Pendant / 49"L x 5.85"W x 4"H / 72W / RGBW / 120V-277V / White / Illumi Wireless Control / 4ft WH Canopy Kit with 5 Wire Cord
YFXSF49LR36W3600LDMVWHHC3301WH	Y Shape Pendant / 49"L x 5.85"W x 4"H / 36W, 3600L / 0-10V Dim / White / 4ft WH Canopy Kit with 5 Wire Cord
YFXSF49LR72W7200LDMVWHHC3301WH	Y Shape Pendant / 49"L x 5.85"W x 4"H / 72W, 7200L / 0-10V Dim / White / 4ft WH Canopy Kit with 5 Wire Cord

EM2 G120 D1MV 90CRI CCT1

Consult for other wattage and finish options.

## RGB, CUSTOM PATTERNS & CUSTOM FINISHES



Add RGBW option to your pattern to add dramatic effects with controls that make programming easy.



Custom simulated wood finishes, rust finishes or other powder coat finishes available, see page 156.



Shown custom finish.

## LED LINEAR PENDANT 4" X 4", "X"

Utilizing the popular 4" X 4" profile, create dramatic "X"-shaped effects. A center joiner box provides a sleek and modern solution for joining multiple linear fixtures to create interesting configurations.

ITEM NO.	DESCRIPTION
X44PSF2X2R48WDMV40KWHHC4015WWH	2 FT CROSS / 4" X 4" / 48W 4800L / 0-10V Dim / White / 4ft WH Canopy Kit with 5 Wire Cord
X44PSF4X4R96WDMV40KWHHC4015WWH	4 FT CROSS / 4" X 4" / 96W 9600L / 0-10V Dim / White / 4ft WH Canopy Kit with 5 Wire Cord

EM7 G120 RGBW D1MV 90CRI CCT1 SURF



## LED LINEAR PENDANT 4" X 4" DOWNLIGHT ONLY UNLIT CORNERS

Linear configurations with unlit corner options provide a dramatic look and lighting effect at great value and simpler installation. If you can dream it, we can make it! Designed to create distinctive architectural lighting plans at a value price point, this linear 4" X 4" pendant can be installed with a joiner box, create straight runs, or "L", "T" or "X" configurations.



Joiner Box

ITEM NO.	DESCRIPTION
44PSF24LR12W1200LDMV40KWHHC3015WWH-B	24"L x 4"W x 4"H / Frosted Lens / 12W, 1200L / 0-10V Dim / 4000K / White / 4ft WH Canopy Kit with 5 Wire Cord
44PSF24LR24W2400LDMV40KWHHC3015WWH-E	24"L x 4"W x 4"H / Frosted Lens / 24W, 2400L / 0-10V Dim / 4000K / White / 4ft WH Canopy Kit with 5 Wire Cord
44PSF48LR24W2400LDMV40KWHHC3015WWH-B	48"L x 4"W x 4"H / Frosted Lens / 24W, 2400L / 0-10V Dim / 4000K / White / 4ft WH Canopy Kit with 5 Wire Cord
44PSF48LR48W4800LDMV40KWHHC3015WWH-E	48"L x 4"W x 4"H / Frosted Lens / 48W, 4800L / 0-10V Dim / 4000K / White / 4ft WH Canopy Kit with 5 Wire Cord
44PSF96LR48W4800LDMV40KWHHC3015WWH-B	96"L x 4"W x 4"H / Frosted Lens / 48W, 4800L / 0-10V Dim / 4000K / White / 4ft WH Canopy Kit with 5 Wire Cord
44PSF96LR96W9600LDMV40KWHHC3015WWH-E	96"L x 4"W x 4"H / Frosted Lens / 96W, 9600L / 0-10V Dim / 4000K / White / 4ft WH Canopy Kit with 5 Wire Cord
44JB1WAYWH	44P Straight Joiner
44JB2WAYWH	44P 90 Degree Joiner
44JB3WAYWH	44 SERIES 3WAY JOINER T CONNECT WH UNLIT
44JB4WAYWH	44 SERIES 4WAY JOINER BOX WHITE UNLIT
44E10WAYWH	44P End of Run

EM6 G120 OS2 RGBW D1MV 90CRI CCT1 SURF

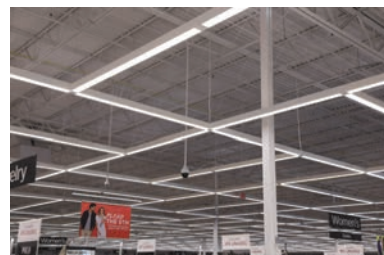
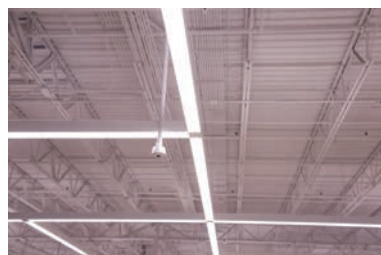



# Linear Pendants



## LED LINEAR PENDANT FIXED RECTANGULAR CHANNEL

Make a bold design statement with this geometric-shaped line of light. The CLLLSF4X8 is easy to specify, order, and install, making it ideal for both residential and commercial general lighting applications. This 4 x 8 foot rectangle with 2.2" wide linear channel with center lit channel is available for quick ship and economical applications to fill a large space without impairing visibility. See [www.saylite.com](http://www.saylite.com) for video on how to install.



ITEM NO.	DESCRIPTION
CLLLSF4X8T210WDMV35KALHC705WH	4' x 8' / 2.2"W x 2.7"H / 210W, 21000L / 0-10V Dim / 3500K / Silver / 6ft WH Canopy Kit with 5 Wire Cord
CLLLSF4X8T210WDMV35KWHHC705WH	4' x 8' / 2.2"W x 2.7"H / 210W, 21000L / 0-10V Dim / 3500K / White / 6ft WH Canopy Kit with 5 Wire Cord
CLLLSF4X8T210WDMV40KALHC705WH	4' x 8' / 2.2"W x 2.7"H / 210W, 21000L / 0-10V Dim / 4000K / Silver / 6ft WH Canopy Kit with 5 Wire Cord
CLLLSF4X8T210WDMV40KWHHC705WH	4' x 8' / 2.2"W x 2.7"H / 210W, 21000L / 0-10V Dim / 4000K / White / 6ft WH Canopy Kit with 5 Wire Cord

**CCT5**

Custom Configurations Available.

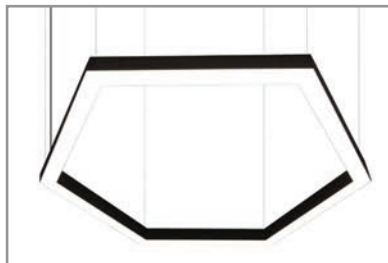

Consult for hexagon and other shapes.



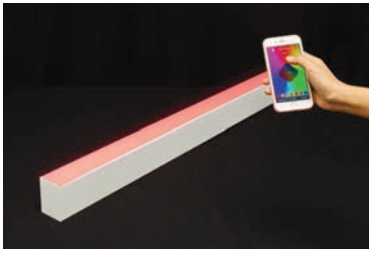

## LED RGBW LINEAR CHANNELS 2.5" WIDE

Add RGBW capabilities to 2.5" wide linear channel to change the mood, atmosphere and look of the application. Ideal for behind covers or fascias to create a "horizon or accent of color" that psychologists have concluded can change your mood. Fixtures wire with standard 2 wires installation and control with a free phone App or choose wireless or wired controllers. RGB allows 1000's of color choices or choose from a variety of white colors. App or controller allows scheduling, white tuning and other special lighting effects.

ITEM NO.	DESCRIPTION
L25PSF48LRGBW27WMVWHIL-HC301WH	48"L x 2.5"W x 3"H / RGBW Integrated Control / Ilumi App / 120-277V / 27 Watts / White / 4ft WH Canopy Kit with 3 Wire Cord
L25PSF48LRGBW54WMVWHIL-HC301WH	48"L x 2.5"W x 3"H / RGBW Integrated Control / Ilumi App / 120-277V / 54 Watts / White / 4ft WH Canopy Kit with 3 Wire Cord
L25PSF96LRGBW54WMVWHIL-HC301WH	96"L x 2.5"W x 3"H / RGBW Integrated Control / Ilumi App / 120-277V / 54 Watts / White / 4ft WH Canopy Kit with 3 Wire Cord
L25PSF96LRGBW108WMVWHIL-HC301WH	96"L x 2.5"W x 3"H / RGBW Integrated Control / Ilumi App / 120-277V / 108 Watts / White / 4ft WH Canopy Kit with 3 Wire Cord

EM3 G120 OS2 D1MV 90CRI CCT1 SURF

For Surface Mount, delete HC301WH. Consult for other control options.



Change the mood of your room with an RGBW linear channel.

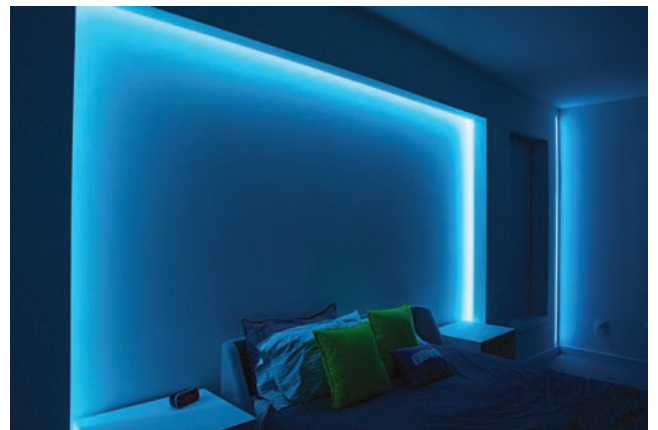

# Linear Pendants



## LED LINEAR MICRO TAPERED PENDANT

The SAR series is the right choice for merchandising, safety, security, or just general lighting. Easily accomplish continuous runs with the specially engineered joiner accessory for perfect installation.

ITEM NO.	DESCRIPTION
SARFR24LT15W1575LDMV40KWH-HC3015WWH	24"L x 3"W x 3"H / Frosted Lens / 15W, 1575L / 0-10V Dim / 4000K / White / 4ft WH Canopy Kit with 5 Wire Cord
SARFR24LT19W1950LDMV40KWH-HC3015WWH	24"L x 3"W x 3"H / Frosted Lens / 19W, 1950L / 0-10V Dim / 4000K / White / 4ft WH Canopy Kit with 5 Wire Cord
SARFR48LT30W3150LDMV40KWH-HC3015WWH	48"L x 3"W x 3"H / Frosted Lens / 30W, 3150L / 0-10V Dim / 4000K / White / 4ft WH Canopy Kit with 5 Wire Cord
SARFR48LT38W3990LDMV40KWH-HC3015WWH	48"L x 3"W x 3"H / Frosted Lens / 38W, 3990L / 0-10V Dim / 4000K / White / 4ft WH Canopy Kit with 5 Wire Cord
SARFR48LT45W4700LDMV40KWH-HC3015WWH	48"L x 3"W x 3"H / Frosted Lens / 45W, 4700L / 0-10V Dim / 4000K / White / 4ft WH Canopy Kit with 5 Wire Cord
SARFR96LT60W6300LDMV40KWH-HC3015WWH	96"L x 3"W x 3"H / Frosted Lens / 60W, 6300L / 0-10V Dim / 4000K / White / 4ft WH Canopy Kit with 5 Wire Cord
SARFR96LT75W7900LDMV40KWH-HC3015WWH	96"L x 3"W x 3"H / Frosted Lens / 75W, 7900L / 0-10V Dim / 4000K / White / 4ft WH Canopy Kit with 5 Wire Cord
SARFR96LT90W9450LDMV40KWH-HC3015WWH	96"L x 3"W x 3"H / Frosted Lens / 90W, 9450L / 0-10V Dim / 4000K / White / 4ft WH Canopy Kit with 5 Wire Cord

EM6 G120 D1MV 90CRI CCT1 SURF

For continuous run, order beginner, joiner and end as shown on bottom of page 39.

## LED LINEAR PENDANT CORISCO

Slim (2.8" wide) and architecturally interesting with clean styling, this fixture is available with colored end caps (blue, black, or white) and joiner brackets. Features a technical frosted diffuser with 80% light transmission.



ITEM NO.	DESCRIPTION
CORFR48LJ24W2050LDMV40KWHHC3015WWH	4 ft x 2.8"W x 2.8"H / 24W, 2050L / Matt White Lens / Color Temp - 30, 35, 40, 50 / White End Cap
CORFR48LJ34W3150LDMV40KWHHC3015WWH	4 ft x 2.8"W x 2.8"H / 34W, 3150L / Matt White Lens / Color Temp - 30, 35, 40, 50 / White End Cap
CORFR48LZ43W5000LDMV40KWHHC3015WWH	4 ft x 2.8"W x 2.8"H / 43W, 5000L / Matt White Lens / Color Temp - 30, 35, 40, 50 / White End Cap
CORFR48LZ57W5100LDMV40KWHHC3015WWH	4 ft x 2.8"W x 2.8"H / 57W, 5100L / Matt White Lens / Color Temp - 30, 35, 40, 50 / White End Cap
CORJOINBK	CORISCO Joiner - Black Finish
CORJOINBL	CORISCO Joiner - Blue Finish
CORJOINWH	CORISCO Joiner - White Finish

EM2 G120 D1MV 90CRI CCT1 SURF

For black fixtures, change first WH to BK or BL for blue fixtures.

### Options to Make It "Your Way"

EM1 SURF X1LED

The icons listed under every series identifies all of the options available for that series, including color temperatures, emergencies, sensors/controls, coordinating applications and more. See pages 154 and 155 for full explanations of each icon.

## LED LINEAR CONTOURED STRIP

A versatile workhorse with great lighting in all directions out of the lens specifically designed for LED. Can be wall, ceiling, surface or pendant mounted. Standard in white, but with a variety of finish options. Available in 3 sizes for individual or continuous run.



ITEM NO.	DESCRIPTION
SERFR24LT14W1400LDMV40KWH	24"L x 3.79"W x 3.93"H / Frosted Lens / 14W, 1400L / 0-10V Dim / 4000K
SERFR24LT20W2000LDMV40KWH	24"L x 3.79"W x 3.93"H / Frosted Lens / 20W, 2000L / 0-10V Dim / 4000K
SERFR48LT28W2800LDMV40KWH	48"L x 3.79"W x 3.93"H / Frosted Lens / 28W, 2800L / 0-10V Dim / 4000K
SERFR48LT40W4000LDMV40KWH	48"L x 3.79"W x 3.93"H / Frosted Lens / 40W, 4000L / 0-10V Dim / 4000K
SERFR96LT56W5600LDMV40KWH	96"L x 3.79"W x 3.93"H / Frosted Lens / 56W, 5600L / 0-10V Dim / 4000K
SERFR96LT80W8000LDMV40KWH	96"L x 3.79"W x 3.93"H / Frosted Lens / 80W, 8000L / 0-10V Dim / 4000K

EM6 G120 OS3 RGBW D1MV 90CRI CCT1 SURF X1LEDT5 FLUORT5

Specify pendant cable kit separately, see page 153.

## LED LINEAR CONTOURED STRIP WITH SENSOR

Specify SS to add an Occupancy Sensor to the SER Series.



Add this sensor box for a variety of sensor options. See page 157 for more information.

ITEM NO.	DESCRIPTION
SSSERFR24LT14W1400LDMV40KWH	24"L x 3.79"W x 3.93"H / Occ Sensor / Frosted Lens / 14W, 1400L / 0-10V Dim / 4000K
SSSERFR24LT20W2000LDMV40KWH	24"L x 3.79"W x 3.93"H / Occ Sensor / Frosted Lens / 20W, 2000L / 0-10V Dim / 4000K
SSSERFR48LT28W2800LDMV40KWH	48"L x 3.79"W x 3.93"H / Occ Sensor / Frosted Lens / 28W, 2800L / 0-10V Dim / 4000K
SSSERFR48LT40W4000LDMV40KWH	48"L x 3.79"W x 3.93"H / Occ Sensor / Frosted Lens / 40W, 4000L / 0-10V Dim / 4000K
SSSERFR96LT56W5600LDMV40KWH	96"L x 3.79"W x 3.93"H / Occ Sensor / Frosted Lens / 56W, 5600L / 0-10V Dim / 4000K
SSSERFR96LT80W8000LDMV40KWH	96"L x 3.79"W x 3.93"H / Occ Sensor / Frosted Lens / 80W, 8000L / 0-10V Dim / 4000K

EM6 G120 OS3 RGBW D1MV 90CRI CCT1 SURF X1LEDT5 FLUORT5

Specify pendant cable kit separately, see page 153.

## Continuous Runs

Saylite engineers most of their pendants for continuous runs with specially designed mechanical connections and wiring harnesses for plug and play electrical connections. Add -B, -J and -E to end of Item Number to designate where the fixture goes in the continuous run (beginning, joiner or end) and ensure it comes with the right mechanical and electrical components for easy joining.



# Linear Pendants



Consult for other finishes and adder.

## LED LINEAR 2" LOW PROFILE

Featuring a micro silhouette, the frosted diffuser is scaled to the LED module and surrounds the LEDs for soft lighting.

ITEM NO.	DESCRIPTION
SKDFR24LJ12W1200LDMV40KWH	22.50"L x 2"W x 2.60"H / Frosted Lens / 12W, 1200L / 0-10V Dim / 4000K
SKDFR48LJ28W2800LDMV40KWH	46.00"L x 2"W x 2.60"H / Frosted Lens / 28W, 2800L / 0-10V Dim / 4000K
SKDFR48LJ35W3400LDMV40KWH	46.00"L x 2"W x 2.60"H / Frosted Lens / 35W, 3400L / 0-10V Dim / 4000K
SKDFR96LJ57W5400LDMV40KWH	92.00"L x 2"W x 2.60"H / Frosted Lens / 57W, 5400L / 0-10V Dim / 4000K
SKDFR96LJ72W7000LDMV40KWH	92.00"L x 2"W x 2.60"H / Frosted Lens / 72W, 7000L / 0-10V Dim / 4000K

EM3 G120 OS2 RGBW D1MV 90CRI CCT1 SURF WALL X1LEDT5 FLUORT5

## LED LINEAR 3" LOW PROFILE

A slightly wider profile allowing for higher output in shorter runs and integral emergency driver.



Vented body is for Emergency Version.



ITEM NO.	DESCRIPTION
SKDWBFR24LJ35W3400LDMV40KWH	23.84"L x 3"W x 3"H / Frosted Lens / 35W, 3400L / 0-10V Dim / 4000K
SKDWBFR48LJ40W4000LDMV40KWH	46.00"L x 3"W x 3"H / Frosted Lens / 40W, 4000L / 0-10V Dim / 4000K
SKDWBFR48LZ72W7000LDMV40KWH	46.00"L x 3"W x 3"H / Frosted Lens / 72W, 7000L / 0-10V Dim / 4000K
SKDWBFR96LJ80W8000LDMV40KWH	92.00"L x 3"W x 3"H / Frosted Lens / 80W, 8000L / 0-10V Dim / 4000K
SKDWBFR96LZ114W10800LDMV40KWH	92.00"L x 3"W x 3"H / Frosted Lens / 114W, 10800L / 0-10V Dim / 4000K

EM3 G120 OS2 RGBW D1MV 90CRI CCT1 SURF WALL X1LEDT5 FLUORT5

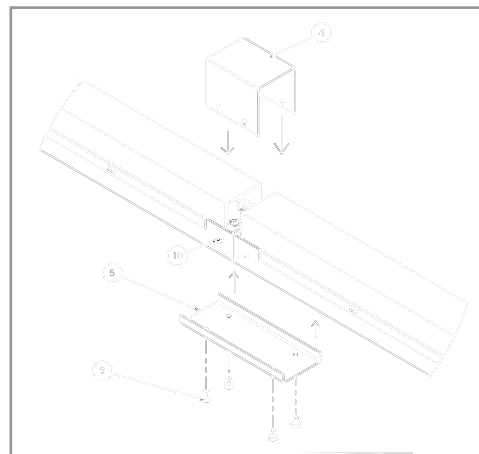

Continuous run SKD and SKDWB are easy with 2 piece joiner. Consult for custom run lengths.



## SLOTTED LOW PROFILE LED LINEAR PENDANT

The clean SLP's lines are ideal for general lighting for circulation spaces, high impact areas, kitchen islands, and offices. Can be pendant-mounted individually or in continuous runs. Add sensors. Smart sensors available.

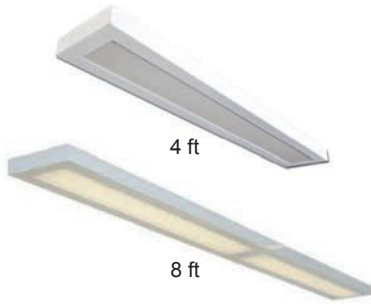

ITEM NO.	DESCRIPTION
<b>Downlight</b>	
SLPFR48LS48W5400LDMV40KWHHC4015WWH	48"L x 7.70"W x 2"W / Frosted Lens / 48W, 5400L / 0-10V Dim / 4000K / White / 4ft WH Canopy Kit with 5 Wire Cord
SLPFR96LS96W10800LDMV40KWHHC4015WWH	96"L x 7.70"W x 2"W / Frosted Lens / 96W, 10800L / 0-10V Dim / 4000K / White / 4ft WH Canopy Kit with 5 Wire Cord
<b>Up and Downlight</b>	
SLPFR48LUS12WD24WDMV40KWHHC4015WWH	48"L x 7.70"W x 2"W / Frosted Lens / Up 12W, Dn 24W, 3600L / 0-10V Dim / 4000K / White / 4ft WH Canopy Kit with 5 Wire Cord
SLPFR48LUS18WD36WDMV40KWHHC4015WWH	48"L x 7.70"W x 2"W / Frosted Lens / Up 18W, Dn 36W, 5400L / 0-10V Dim / 4000K / White / 4ft WH Canopy Kit with 5 Wire Cord
SLPFR96LUS24WD48WDMV40KWHHC4015WWH	96"L x 7.70"W x 2"W / Frosted Lens / Up 24W, Dn 48W, 7200L / 0-10V Dim / 4000K / White / 4ft WH Canopy Kit with 5 Wire Cord
SLPFR96LUS36WD72WDMV40KWHHC4015WWH	96"L x 7.70"W x 2"W / Frosted Lens / Up 36W, Dn 72W, 10800L / 0-10V Dim / 4000K / White / 4ft WH Canopy Kit with 5 Wire Cord

EM6 G120 OS2 RGBW D1MV 90CRI CCT1 SURF WALL X1LEDT5 FLUORT5

Consult for special size EM adder.

## White Tuning

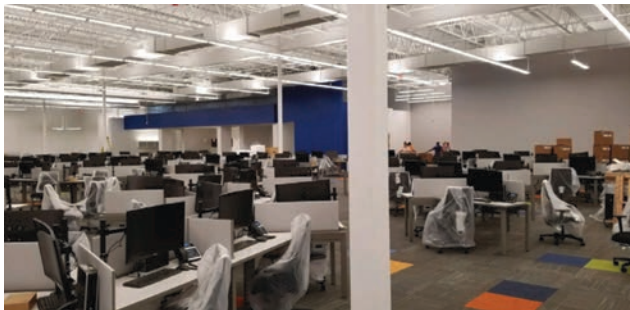

Whether interested in white tuning for the health benefits of circadian rhythms or to enhance students efforts at school to energize, relax and motivate, Saylite has the right LED arrays, controls and engineering to make it a cost-effective solution. SLP series above is a great choice for white tuning.

# Linear Pendants



For continuous runs, see ordering on page 39.

## LED LINEAR LOW PROFILE ELLIPSOIDAL DIRECT/INDIRECT

When suspended, this sleek and compact, low profile ellipsoidal fixture appears to float in the space and is especially designed for direct/indirect lighting. Available in 96" and 48" modular lengths for individual or row configurations.

ITEM NO.	DESCRIPTION
<b>Downlight</b>	
LPLINFR48LF48W5900LDMV40KWHHC4015WWH	48"L x 10.80"W x 3.50"W / Dn 48W, 5900L / 0-10V Dim / 4000K / White / 4ft WH Canopy Kit with 5 Wire Cord
LPLINFR96LF96W11850LDMV40KWHHC4015WWH	96"L x 10.80"W x 3.50"W / Dn 96W, 11850L / 0-10V Dim / 4000K / White / 4ft WH Canopy Kit with 5 Wire Cord
<b>Up and Downlight</b>	
LPLINFR48LUF12WD24WDMV40KWHHC4015WWH	48"L x 10.80"W x 3.50"W / Up 12W, Dn 24W, 4790L / 0-10V Dim / 4000K / White / 4ft WH Canopy Kit with 5 Wire Cord
LPLINFR48LUF16WD32WDMV40KWHHC4015WWH	48"L x 10.80"W x 3.50"W / Up 16W, Dn 32W, 6470L / 0-10V Dim / 4000K / White / 4ft WH Canopy Kit with 5 Wire Cord
LPLINFR48LUF30WD60WDMV40KWHHC4015WWH	48"L x 10.80"W x 3.50"W / Up 30W, Dn 60W, 10820L / 0-10V Dim / 4000K / White / 4ft WH Canopy Kit with 5 Wire Cord
LPLINFR96LUF24WD48WDMV40KWHHC4015WWH	96"L x 10.80"W x 3.50"W / Up 24W, Dn 48W, 9580L / 0-10V Dim / 4000K / White / 4ft WH Canopy Kit with 5 Wire Cord
LPLINFR96LUF32WD64WDMV40KWHHC4015WWH	96"L x 10.80"W x 3.50"W / Up 32W, Dn 64W, 12940L / 0-10V Dim / 4000K / White / 4ft WH Canopy Kit with 5 Wire Cord
LPLINFR96LUF60WD120WDMV40KWHHC4015WWH	96"L x 10.80"W x 3.50"W / Up 60W, Dn 120W, 21640L / 0-10V Dim / 4000K / White / 4ft WH Canopy Kit with 5 Wire Cord



EM3 G120 OS1 RGBW D1MV 90CRI CCT1

See specification sheet for more DLC item options.

## LOW PROFILE LINEAR LIGHTING

A popular version in fluorescent and X1LED, this sleek low profile with baffled louvered is available in LED where bright downlight is required. Love this look but need to add indirect light? Choose the LPL series.



ITEM NO.	DESCRIPTION
PLIN48LS48W5900LDMV40KWHHC4015WWH	48.14"L x 10.81"W x 9.56"H / Baffled Louver with Lens / Dn 48W, 5900L / 0-10V Dim / 4000K / White / 4ft WH Canopy Kit with 5 Wire Cord
PLIN48LS57W6400LDMV40KWHHC4015WWH	48.14"L x 10.81"W x 9.56"H / Baffled Louver with Lens / Dn 57W, 6400L / 0-10V Dim / 4000K / White / 4ft WH Canopy Kit with 5 Wire Cord
PLIN96LS97W11850LDMV40KWHHC4015WWH	96.30"L x 10.80"W x 9.56"H / Baffled Louver with Lens / Dn 96W, 11850L / 0-10V Dim / 4000K / White / 4ft WH Canopy Kit with 5 Wire Cord
PLIN96LS114W12800LDMV40KWHHC4015WWH	96.30"L x 10.80"W x 9.56"H / Baffled Louver with Lens / Dn 114W, 12800L / 0-10V Dim / 4000K / White / 4ft WH Canopy Kit with 5 Wire Cord

EM3 G120 OS4 D1MV 90CRI CCT1 X1LED FLUOR

Consult for door frame and lens in lieu of baffled louver.

## LED LINEAR PENDANT INDIRECT ONLY

This sleek, graceful, low profile (2.1" high and 7.9" wide) fixture features a choice of die-cast end caps as well as three choices of diffusers. Available in 4-foot and 8-foot lengths or continuous run. High efficiency optics include a specular aluminum reflector that is designed to provide a wide distribution for 100% uplight and just a hint of downlight.

Bullnose is standard. Shown below with spade endcap.



LINMW  
Matte White Lens



LINLV  
Louvered

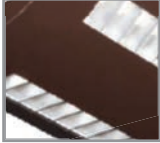

LINPF  
Perforated



ITEM NO.	DESCRIPTION
LINMW48LUS24WD12WDMV40KWHHC3015WWH	48"L x 7"W x 2"H / Matt White Lens / Up 24W Dn 12W, 3600L / 0-10V Dim / 4000K / White / 4ft WH Canopy Kit with 5 Wire Cord
LINMW48LUS36WD18WDMV40KWHHC3015WWH	48"L x 7"W x 2"H / Matt White Lens / Up 36W Dn 18W, 5400L / 0-10V Dim / 4000K / White / 4ft WH Canopy Kit with 5 Wire Cord
LINMW96LUS48WD24WDMV40KWHHC3015WWH	96"L x 7"W x 2"H / Matt White Lens / Up 48W Dn 24W, 7200L / 0-10V Dim / 4000K / White / 4ft WH Canopy Kit with 5 Wire Cord
LINMW96LUS72WD36WDMV40KWHHC3015WWH	96"L x 7"W x 2"H / Matt White Lens / Up 72W Dn 36W, 10800L / 0-10V Dim / 4000K / White / 4ft WH Canopy Kit with 5 Wire Cord

EM3 G120 D1MV 90CRI CCT1 WALL X1LED FLUOR

Change WH to BN for Brushed Nickel.  
For Louver, change MW to LV.  
For Perforated, change MW to PF.



Matching wall version.  
See WLIN series on page 73.

## Choose Your Finish

Saylite's Factory at Your Fingertips enables you to pick the right powder coat finish, wood finish or custom finish for your application. Some companies charge a small fortune for a custom finish but not Saylite. See page 156 for complete options.



Silver (SL)



Black (BK)



Iron (IN)



Red (RD)



Bronze (BZ)

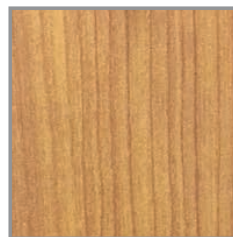

# Linear Pendants



New Door Frame and Lens is a high style option for LED.

Consult for finish options.

## LED LINEAR PENDANT HIGH BAY WITH LENS

FHBFR features a frosted lens, ideal for office and retail applications. Premium full specular white reflectors are standard for high efficiency lighting.

ITEM NO.	DESCRIPTION
FHBFR48LS32W4050LW30DMV40K	48"L x 11.25"W x 4.25"H / Frosted Lens / 32W, 4050L / 0-10V Dim / 4000K
FHBFR48LS48W5650LW30DMV40K	48"L x 11.25"W x 4.25"H / Frosted Lens / 48W, 5650L / 0-10V Dim / 4000K
FHBFR48LS57W6400LW30DMV40K	48"L x 11.25"W x 4.25"H / Frosted Lens / 57W, 6400L / 0-10V Dim / 4000K
FHBFR48LH72W8200LW30DMV40K	48"L x 11.25"W x 4.25"H / Frosted Lens / 72W, 8200L / 0-10V Dim / 4000K
FHBFR96LS97W11300LW30DMV40K	96"L x 11.25"W x 4.25"H / Frosted Lens / 97W, 11300L / 0-10V Dim / 4000K
FHBFR96LS114W12800LW30DMV40K	96"L x 11.25"W x 4.25"H / Frosted Lens / 114W, 12800L / 0-10V Dim / 4000K

EM2 G120 RGBW D1MV 90CRI CCT1 X1LED FLUOR

## LED LINEAR PENDANT HIGH BAY WITH BAFFLE

FHB features a specially designed baffle to reduce glare. Premium full specular white reflectors are standard for high efficiency lighting. Ideal for retail applications.



ITEM NO.	DESCRIPTION
FHBL48LS32W4050LW30DMV40K	48"L x 11.25"W x 4.25"H / Baffle / 32W, 4050L / 0-10V Dim / 4000K
FHBL48LS48W5400LW30DMV40K	48"L x 11.25"W x 4.25"H / Baffle / 48W, 5400L / 0-10V Dim / 4000K
FHBL48LS57W6000LW30DMV40K	48"L x 11.25"W x 4.25"H / Baffle / 57W, 6000L / 0-10V Dim / 4000K
FHBL48LH72W7600LW30DMV40K	48"L x 11.25"W x 4.25"H / Baffle / 72W, 7600L / 0-10V Dim / 4000K
FHBL96LS97W10800LW30DMV40K	96"L x 11.25"W x 4.25"H / Baffle / 97W, 10800L / 0-10V Dim / 4000K
FHBL96LS114W12000LW30DMV40K	96"L x 11.25"W x 4.25"H / Baffle / 114W, 12000L / 0-10V Dim / 4000K

EM2 G120 RGBW D1MV 90CRI CCT1 X1LED FLUOR

Consult for Inlay Lens.

For Continuous Runs, see page 39. For Wiring Harnesses, see page 153.



Saylite manufactures and assembles in their two USA factories which allows many items to meet Buy American Act (BAA) Criteria.



## LED LINEAR PENDANT LOUVERED INDUSTRIAL 6"

This direct, louvered, industrial strip makes a bold statement perfect for a modern industrial aesthetic. Louver is matte silver anodized parabolic.



ITEM NO.	DESCRIPTION
LVS648LJ48W4000LDMV40KWHHC3015WWH	48"L x 6"W x 5.12"H / Louver / 48W, 3800L / 0-10V Dim / 4000K / White / 4ft WH Canopy Kit with 5 Wire Cord
LVS648LZ57W4800LDMV40KWHHC3015WWH	48"L x 6"W x 5.12"H / Louver / 57W, 4800L / 0-10V Dim / 4000K / White / 4ft WH Canopy Kit with 5 Wire Cord
LVS648LZ72W6000LDMV40KWHHC3015WWH	48"L x 6"W x 5.12"H / Louver / 72W, 6000L / 0-10V Dim / 4000K / White / 4ft WH Canopy Kit with 5 Wire Cord
LVS696LJ48W4000LDMV40KWHHC3015WWH	96"L x 6"W x 5.12"H / Louver / 48W, 4000L / 0-10V Dim / 4000K / White / 4ft WH Canopy Kit with 5 Wire Cord
LVS696LJ96W8000LDMV40KWHHC3015WWH	96"L x 6"W x 5.12"H / Louver / 96W, 8000L / 0-10V Dim / 4000K / White / 4ft WH Canopy Kit with 5 Wire Cord
LVS696LZ114W9600LDMV40KWHHC3015WWH	96"L x 6"W x 5.12"H / Louver / 114W, 9600L / 0-10V Dim / 4000K / White / 4ft WH Canopy Kit with 5 Wire Cord
LVS696LZ144W12000LDMV40KWHHC3015WWH	96"L x 6"W x 5.12"H / Louver / 144W, 12000L / 0-10V Dim / 4000K / White / 4ft WH Canopy Kit with 5 Wire Cord

EM2 G120 RGBW D1MV 90CRI CCT1 SURF X1LED FLUOR

For Inlay Lens add MW after LVS.  
Available in Black (BK), Silver (SL), Bronze (BZ) or Galvanized (GV).  
Consult for lensed version.

## In House Photometric Lab

Saylite's photometric lab allows us to quickly provide IES files for our custom engineered fixtures. Bring your project to us and find out what A Factory at Your Fingertips can do for you!



# Linear Pendants



## BATWING INDIRECT LINEAR **NEW**

This new series feels like a “batwing” floating in space providing soft, general and directed light from a specially designed indirect source. Available in 4 and 8 foot individual runs as well as longer continuous runs. Ideal for merchandising applications as well as open offices and circulation spaces. Consult for custom finishes to add to the visual appeal.

ITEM NO.	DESCRIPTION
ISSST48LQ42W5000LDMV40KWHHC804WH	48"L x 11"W x 8.21"H / 42W, 5000L / 0-10V Dim / 4000K / White / 4ft WH Canopy Kit with 5 Wire Cord
ISSST96LQ90W10000LDMV40KWHHC804WH	96"L x 11"W x 8.21"H / 90W, 10000L / 0-10V Dim / 4000K / White / 4ft WH Canopy Kit with 5 Wire Cord

EM2 G120 RGBW DIMV 90CRI CCT1



## WET LOCATION LINEAR PENDANT **NEW**

Now bring your exterior applications to life with a special designed wet location linear pendant. This aluminum extrusion is 3.5” wide for a bold yet minimal look with a sealed lens to keep out moisture and bugs. Specially designed power cord and mounting kits allows the fixture to be pendant or surface mounted. Choose individual fixtures or fixtures made especially for continuous runs. Both versions complete with all mounting brackets and joiner accessories. Available in satin aluminum and in 4000 and 5000 kelvin or consult for other custom options.

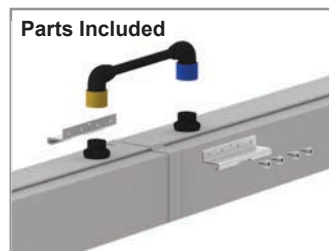
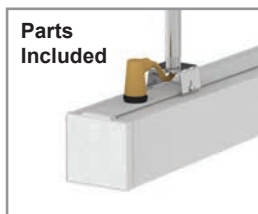

ITEM NO.	DESCRIPTION
Individual Fixtures	
CWLLL48L45W4900LDMV40KSA	48.7"L x 3.58"W x 3.58"H / Frosted Lens / 45W, 4900L / 0-10V Dim / 4000K / Satin Aluminum / Included 1xWLLLPF6, 1xWLLLMT
CWLLL96L90W9800LDMV40KSA	96.7"L x 3.58"W x 3.58"H / Frosted Lens / 90W, 10000L / 0-10V Dim / 4000K / Satin Aluminum / Included 1xWLLLPF6, 1xWLLLMT
Longer Run - Specify Beginner (-B), Joiner (-J) and Ender (-E)	
CWLLL48L45W4900LDMV40KSA-B	48.7"L x 3.58"W x 3.58"H / Frosted Lens / 45W, 4900L / 0-10V Dim / 4000K / Satin Aluminum / Beginner / Included 1xWLLLPF6, 1xWLLLMT
CWLLL96L90W9800LDMV40KSA-B	96.7"L x 3.58"W x 3.58"H / Frosted Lens / 90W, 10000L / 0-10V Dim / 4000K / Satin Aluminum / Beginner / Included 1xWLLLPF6, 1xWLLLMT
CWLLL48L45W4900LDMV40KSA-J	48.7"L x 3.58"W x 3.58"H / Frosted Lens / 45W, 4900L / 0-10V Dim / 4000K / Satin Aluminum / Joiner / Included 1xWLLLMT, 1xWLLLJB, WLLJN8
CWLLL96L90W9800LDMV40KSA-J	96.7"L x 3.58"W x 3.58"H / Frosted Lens / 90W, 10000L / 0-10V Dim / 4000K / Satin Aluminum / Joiner / Included 1xWLLLMT, 1xWLLLJB, WLLJN8
CWLLL48L45W4900LDMV40KSA-E	48.7"L x 3.58"W x 3.58"H / Frosted Lens / 45W, 4900L / 0-10V Dim / 4000K / Satin Aluminum / Ender / Included 1xWLLLMT, 1xWLLLJB, WLLJN8
CWLLL96L90W9800LDMV40KSA-E	96.7"L x 3.58"W x 3.58"H / Frosted Lens / 90W, 10000L / 0-10V Dim / 4000K / Satin Aluminum / Ender / Included 1xWLLLMT, 1xWLLLJB, WLLJN8
Accessories (only for specials)	
WLLLPF6	6ft black 5 wires dimming power feed with fast connector one side
WLLLJN8	8.67" black dimming wiring harness with fast connector both side
WLLLMT	Fix Clips for surface mounted and pendant bracket / 2 pieces per set
WLLLJB	180° Straight connector / 2 pieces per set

CCT6 WET

# Acoustical Lighting

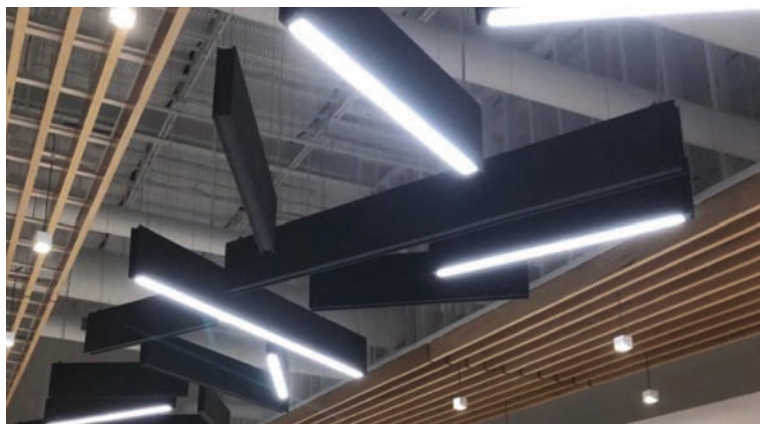

The industrial look, open ceilings, concrete floors and wide open spaces, is all the rage in interior design. The only downside can be the hard surfaces that make the space attractive also makes it loud and without any sound absorption. Saylite's new Acoustical Lighting series utilizes an eco-friendly highly sound absorbing material (PET), that can be formed in a variety of styles and integrated with lighting

called Acoustical Lighting. Acoustical Lighting combines the performance of LED lighting with specially crafted sound absorption material to develop a “multi-function” architectural lighting fixture. Saylite has teamed up with Frasch that specializes in forming PET to develop off-the-shelf and custom acoustical lighting fixtures and baffles.

## CUSTOM ACOUSTICAL FIXTURES

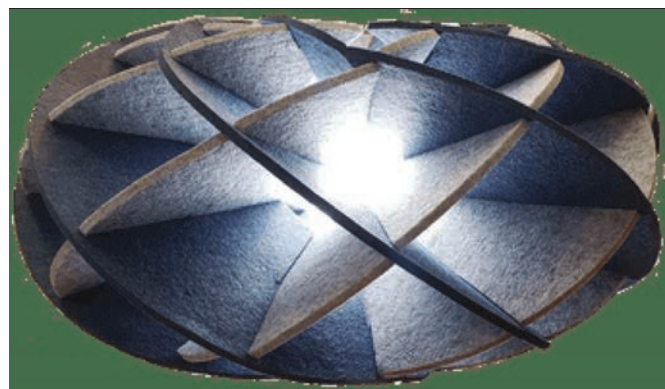

Saylite can provide custom acoustical fixtures and baffles to provide the sound absorption and lighting for your project. Whatever you need, you get experienced acoustic designers from Frasch to bring it to life while Saylite adds the lighting components to maximize form and function for your space. Best of all, the custom creation is at a price you can afford.

# Acoustical Lighting NEW



Your open architecture demands it. The design is incomplete without it. Acoustic lighting is the perfect solution, and it doesn't have to break the bank. When you have a vision that surpasses the project budget, you come to Saylite to make it right.

The LAB series is designed from 100% PET with at least 40% post consumer recycled content. Available in lit and acoustic only version. Saylite can help complete your total noise reduction and lighting project.

## COLOR OPTIONS

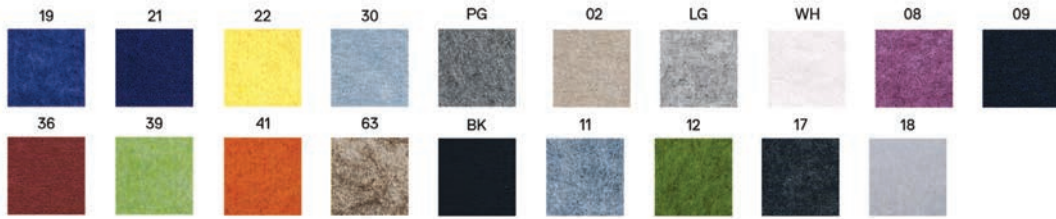

## END CAP OPTIONS



Wood End (W)



Metal Seam (M)

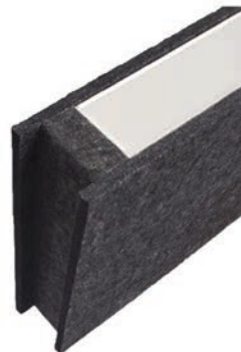

Regressed (Standard)





This highly customizable fixture seamlessly integrates quality lighting with sound absorbing technology. With four different length options, four different height options, and three different end styles, the creative possibilities are endless for your unique space. It is functional as a stand alone fixture or as part of a matching baffle system.

SERIES	LENGTH	HEIGHT	DIRECT/INDIRECT	WATTAGE & LUMENS	DRIVER	COLOR TEMP	COLOR
<b>LAB</b> Light Acoustical Baffle	<b>24L</b> 24.00"	<b>6H</b> 6.00"	<b>Blank</b> Down Light	<b>J13W1300L</b> 13 Watts 1300 Lumens	<b>DMV G120</b> 0-10V dimming Triac or ELV dimming at 120V only	<b>30K</b> 3000K <b>35K</b> 3500K <b>40K</b> 4000K <b>50K</b> 5000K	<b>WH**</b> White <b>BK**</b> Black <b>LG**</b> Light Gray <b>PG**</b> Pure Gray
		<b>12H</b> 12.00"		<b>U</b> Up Light			
		<b>16H</b> 16.00"	<b>J26W2600L</b> 26 Watts 2600 Lumens				
		<b>24H</b> 24.00"		<b>J45W4500L</b> 45 Watts 4500 Lumens			
	<b>48L</b> 48.00"	Consult for other height options		<b>J39W3900L</b> 39 Watts 3900 Lumens		Mix Lit and Unlit Baffles. To order unlit simply provide Series, Length, Height, Color and Mounting.	
		<b>72L</b> 72.00"	<b>J68W6800L</b> 68 Watts 6800 Lumens				
			<b>96L</b> 96.00"	<b>J52W5200L</b> 52 Watts 5200 Lumens			
				<b>J90W9000L</b> 90 Watts 9000 Lumens			
			-----*				

ENDS	CONFIGURATION	MOUNTING OPTIONS
<b>Blank</b> <b>W</b> Wood Ends <b>M</b> Metal Seam	<b>Blank</b> Individual	<b>HC605WH</b> Cable kit with 6' cable & 5 wires power feed/cable incl., clear cord and white canopy (included power feed and non-power feed) <b>HC605WHNPF</b> Cable kit with 6' cable & white canopy, non power feed (non-power feed only) <b>HC612WH</b> Cable kit with 12' cable & 5 wires power feed/cable incl., clear cord and white canopy (included power feed and non-power feed) <b>HC612WHNPF</b> Cable kit with 12' cable & white canopy, non power feed (non-power feed only)
	<b>-B</b> Beginner Run	
	<b>-E</b> Ender Run	
	<b>-J</b> Joiner	

# Surface Mount



Most of our linear pendants like our 44 Series can be surface mounted. See pages 22 to 49 for other options.



Saylite has a wide selection of surface-mounted LED fixtures for every application, and many are companion fixtures to our extensive recessed and pendant-mounted fixtures. An extensive selection of linear channels are available from less than 1 inch wide to more than 6 inches wide (See Linear Pendant Section). From Flat Panels to wraparounds, to specialty corridor and wall wash fixtures, to low profile “clouds”, there is a fixture for every lighting design and every application. Each surface mount is available in a variety of sizes, wattages and lumen outputs. Choose the color temperature and fixture color that works for the application. Consult our “Factory at Your Fingertips” if you don’t see what you need.

## Sales Illuminated Shadow Box

Saylite manufactures a variety of Illuminated Shadow Boxes for signage, displays or lit designs. Vinyl graphics can be custom printed and is illuminated by dimmable LED arrays.

## LED SURFACE PREMIUM LOW-PROFILE WELDED FLAT PANEL

This sleek, ultra-thin, LED flat panel is only 2.5" in height and available in three sizes housed in low profile welded steel frame. Ideal for offices, circulation spaces, retail, and residential kitchens where a "skylight" appearance is desired.



ITEM NO.	DESCRIPTION
SHPFPELP22LED40DMVWH40	2x2 / 40W, 5000L / 0-10V Dim / 4000K
SHPFPELP14LED40DMVWH40	1x4 / 40W, 5000L / 0-10V Dim / 4000K
SHPFPELP24LED50DMVWH40	2x4 / 50W, 6250L / 0-10V Dim / 4000K

EM3 CCT2 REC

## LED SURFACE SHROUD KIT FOR FLAT PANELS

Specially made for surface-mounting flat panels, this shroud kit works with most ultra-thin LED flat panels. There are no visible fasteners or seams for an upscale appearance in demanding applications. 2.5 inches height.



Shroud Only. Specify Flat Panel Separately.

ITEM NO.	DESCRIPTION
SHFPELP2X2WH	2x2 SHROUD FOR FLAT PANEL
SHFPELP1X4WH	1x4 SHROUD FOR FLAT PANEL
SHFPELP2X4WH	2x4 SHROUD FOR FLAT PANEL

EM3 CCT2 REC

For economy shroud see page 5.

For Wet Location Surface Linear See Page 46.



## ILLUMINATED SHADOW BOX **NEW**

Illuminated Shadow Boxes illuminate custom vinyl art that can be printed to your exact specifications. Vinyl adheres easily to the backlit box for a great look. Consult for Factory for the exact dimensions and specifications.

## Family Affair

Many Saylite LED fixtures are part of a family of products that have matching Pendants, Surface, and Wall mounting allowing a coordinated look through an entire building or even a smaller area. Coordinate style, finish, lumens and color temperature.



# Surface Mount

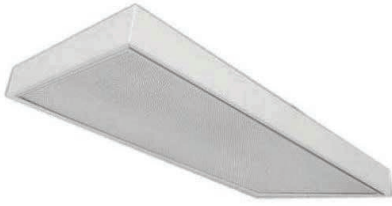

## LED SURFACE TROFFER WITH WELDED SEAMLESS BODY

This spec-grade, low-profile troffer with welded seamless body provides almost limitless flexibility where surface mounting is required. Ideal for all commercial and industrial buildings.

ITEM NO.	DESCRIPTION
153A22LJ24W2700LDMV40K	24"L x 24"W x 3.75"H / 24W, 2700L / 0-10V Dim / 4000K
153A22LJ28W3200LDMV40K	24"L x 24"W x 3.75"H / 28W, 3200L / 0-10V Dim / 4000K
153A22LJ35W3900LDMV40K	24"L x 24"W x 3.75"H / 35W, 3900L / 0-10V Dim / 4000K
153A14LJ35W4300LDMV40K	48"L x 12"W x 3.75"H / 35W, 4300L / 0-10V Dim / 4000K
153A14LJ48W5800LDMV40K	48"L x 12"W x 3.75"H / 48W, 5800L / 0-10V Dim / 4000K
153A24LJ35W4600LDMV40K	48"L x 24"W x 3.75"H / 35W, 4600L / 0-10V Dim / 4000K
153A24LJ48W6300LDMV40K	48"L x 24"W x 3.75"H / 48W, 6300L / 0-10V Dim / 4000K
153A24LJ57W7100LDMV40K	48"L x 24"W x 3.75"H / 57W, 7100L / 0-10V Dim / 4000K

EM7 G120 OS1 RGBW D1MV 90CRI CCT1 REC X1LED FLUOR

Dress up with higher efficient Frosted Lens made special for LED.  
Replace "A" with "FR."

## SLOTTED LOW PROFILE LED LINEAR

The shallow, spec-grade SLP offers clean rectilinear lines, ideal for commercial or residential general lighting and for circulation spaces, high impact areas, kitchen islands, and offices.



ITEM NO.	DESCRIPTION
SLFFR48LS24W2700LDMV40KWH	48"L x 7.70"W x 2"H / Frosted Lens / 24W, 2700L / 0-10V Dim / 4000K / White
SLFFR48LS48W5400LDMV40KWH	48"L x 7.70"W x 2"H / Frosted Lens / 48W, 5400L / 0-10V Dim / 4000K / White
SLFFR96LS48W5400LDMV40KWH	96"L x 7.70"W x 2"H / Frosted Lens / 48W, 5400L / 0-10V Dim / 4000K / White
SLFFR96LS96W10800LDMV40KWH	96"L x 7.70"W x 2"H / Frosted Lens / 96W, 10800L / 0-10V Dim / 4000K / White

EM6 G120 OS2 RGBW D1MV 90CRI CCT1 PEND WALL X1LEDT5 FLUORT5

Consult for special size EM adder.

## LED ENGINEERED HEAVY-DUTY WRAPAROUND WITH SOLID ENDS

This industrial grade wrap is ideal for individual or continuous runs with solid ends for demanding applications. This high efficiency luminaire delivers excellent brightness control, featuring a high-performance clear acrylic lens.



ITEM NO.	DESCRIPTION
EWPLR48LS32W4200LDMV40K	48.0"L x 9.56"W x 3.19"H / 32W, 4200L / 0-10V Dim / 4000K
EWPLR48LS48W5800LDMV40K	48.0"L x 9.56"W x 3.19"H / 48W, 5800L / 0-10V Dim / 4000K
EWPLR48LH72W8700LDMV40K	48.0"L x 9.56"W x 3.19"H / 72W, 8700L / 0-10V Dim / 4000K
EWPLR96LS48W5800LDMV40K	96.0"L x 9.56"W x 3.19"H / 48W, 5800L / 0-10V Dim / 4000K
EWPLR96LS65W8400LDMV40K	96.0"L x 9.56"W x 3.19"H / 65W, 8400L / 0-10V Dim / 4000K
EWPLR96LS97W11600LDMV40K	96.0"L x 9.56"W x 3.19"H / 97W, 11600L / 0-10V Dim / 4000K

EM2 G120 OS2 RGBW D1MV 90CRI CCT1 X1LED FLUOR

## LED SPEC-GRADE WIDE WRAPAROUND

All the benefits of a wraparound, but with a sleek low profile, comfortable brightness values, an upright component, and the flexibility of two-, four-, and eight-foot lengths. This spec-grade fixture is ideal for schools, stores, and offices.



8 FT Size Available

ITEM NO.	DESCRIPTION
200A224LS28W3300LDMV40K	24"L x 11.25"W x 3.4"H / Acrylic Lens / 28W, 3300L / 0-10V Dim / 4000K
200A424LS48W6000LDMV40K	24"L x 15.80"W x 3.4"H / Acrylic Lens / 48W, 6000L / 0-10V Dim / 4000K
200A248LS48W5600LDMV40K	48"L x 11.25"W x 3.4"H / Acrylic Lens / 48W, 5600L / 0-10V Dim / 4000K
200A248LS57W6500LDMV40K	48"L x 11.25"W x 3.4"H / Acrylic Lens / 57W, 6500L / 0-10V Dim / 4000K
200A448LS72W9500LDMV40K	48"L x 15.80"W x 3.4"H / Acrylic Lens / 72W, 9500L / 0-10V Dim / 4000K
200A296LS97W11200LDMV40K	96"L x 11.25"W x 3.4"H / Acrylic Lens / 97W, 11200L / 0-10V Dim / 4000K
200A296LS114W13000LDMV40K	96"L x 11.25"W x 3.4"H / Acrylic Lens / 114W, 13000L / 0-10V Dim / 4000K

EM3 G120 OS1 RGBW D1MV 90CRI CCT1 X1LED FLUOR

## LED LOW-PROFILE 9" ECONOMY WRAPAROUND

This 9" wide, low-profile, low cost, maintenance-free fixture delivers high efficiency and brightness control in either two- or four-foot lengths.



ITEM NO.	DESCRIPTION
209A24LF18W2400LDMV40K	24"L x 9.375"W x 3"H / Acrylic Lens / 18W, 2400L / 0-10V Dim / 4000K
209A24LF30W3600LDMV40K	24"L x 9.375"W x 3"H / Acrylic Lens / 30W, 3600L / 0-10V Dim / 4000K
209A48LF32W3450LDMV40K	48"L x 9.375"W x 3"H / Acrylic Lens / 32W, 3450L / 0-10V Dim / 4000K
209A48LF48W4800LDMV40K	48"L x 9.375"W x 3"H / Acrylic Lens / 48W, 5100L / 0-10V Dim / 4000K
209FR48LF48W5700LDMV40K	48"L x 9.375"W x 3"H / Frosted Lens / 48W, 5700L / 0-10V Dim / 4000K
209FR48LF57W6700LDMV40K	48"L x 9.375"W x 3"H / Frosted Lens / 57W, 6700L / 0-10V Dim / 4000K

EM3 G120 OS1 RGBW D1MV 90CRI CCT1 X1LED FLUOR

See specification sheet for more DLC item options.

## LED LOW-PROFILE 7" OR 13" ECONOMY WRAPAROUND

This 7" wide, low-profile, low initial cost, maintenance-free fixture delivers high efficiency in either 2FT or 4FT lengths and two widths for multiple lumen packages.



Consult for 8ft. LED Wrap.

ITEM NO.	DESCRIPTION
207FR224LS24W2800LDMV40K	24"L x 7.625"W x 3"H / Frosted Lens / 24W, 2800L / 0-10V Dim / 4000K
207FR224LS30W3300LDMV40K	24"L x 7.625"W x 3"H / Frosted Lens / 30W, 3300L / 0-10V Dim / 4000K
207FR248LS32W4000LDMV40K	48"L x 7.625"W x 3"H / Frosted Lens / 32W, 4000L / 0-10V Dim / 4000K
207FR248LS48W5500LDMV40K	48"L x 7.625"W x 3"H / Frosted Lens / 48W, 5500L / 0-10V Dim / 4000K
207FR248LS57W6300LDMV40K	48"L x 7.625"W x 3"H / Frosted Lens / 57W, 6300L / 0-10V Dim / 4000K
207FR448LS65W8100LDMV40K	48"L x 13"W x 3"H / Frosted Lens / 65W, 8100L / 0-10V Dim / 4000K
207FR448LS97W11200LDMV40K	48"L x 13"W x 3"H / Frosted Lens / 97W, 11200L / 0-10V Dim / 4000K

EM3 G120 OS1 RGBW D1MV 90CRI CCT1 X1LED FLUOR



# Surface Mount



## LED NARROW 5.75" WIDE WRAPAROUND

Narrow cross-section and a full wireway for more uniform light distribution, this wraparound fixture is ideal for corners, hallways, and smaller spaces. Chaise nipple end caps for continuous run layouts.

ITEM NO.	DESCRIPTION
201A48LS24W2800LDMV40K	48"L x 5.75"W x 4.6"H / Acrylic Lens / 24W, 2800L / 0-10V Dim / 4000K
201A48LS32W4000LDMV40K	48"L x 5.75"W x 4.6"H / Acrylic Lens / 32W, 4000L / 0-10V Dim / 4000K
201A48LS48W5700LDMV40K	48"L x 5.75"W x 4.6"H / Acrylic Lens / 48W, 5700L / 0-10V Dim / 4000K
201A48LH72W8700LDMV40K	48"L x 5.75"W x 4.6"H / Acrylic Lens / 72W, 8700L / 0-10V Dim / 4000K
201A96LS48W5600LDMV40K	96"L x 5.75"W x 4.6"H / Acrylic Lens / 48W, 5600L / 0-10V Dim / 4000K
201A96LS65W8000LDMV40K	96"L x 5.75"W x 4.6"H / Acrylic Lens / 65W, 8000L / 0-10V Dim / 4000K
201A96LS97W11400LDMV40K	96"L x 5.75"W x 4.6"H / Acrylic Lens / 97W, 11400L / 0-10V Dim / 4000K

EM2 G120 OS1 RGBW D1MV 90CRI CCT1 X1LED FLUOR

## LED LINEAR CORRIDOR LIGHT

This linear acrylic diffuser fixture can be ceiling or wall mounted and is available in a variety of LED combinations and sizes. A stylish solution for baths, kitchens, or rec rooms, and for corridors, aisles, or stairwells.



ITEM NO.	DESCRIPTION
159A24LS24W1900LDMV40K	24"L x 4.62"W x 4.5"H / Acrylic Lens / 24W, 1900L / 0-10V Dim / 4000K
159A24LS31W2300LDMV40K	24"L x 4.62"W x 4.5"H / Acrylic Lens / 31W, 2300L / 0-10V Dim / 4000K
159A48LS48W3900LDMV40K	4.62"W x 48"L x 4.5"H / Acrylic Lens / 48W, 3900L / 0-10V Dim / 4000K
159A48LS62W4700LDMV40K	4.62"W x 48"L x 4.5"H / Acrylic Lens / 62W, 4700L / 0-10V Dim / 4000K

EM2 G120 RGBW D1MV 90CRI CCT1 WALL X1LED FLUOR

## More Choices for Surface Mount Applications

In addition to all the Surface Mount fixtures in this section, many of the fixtures in the recessed section can be surface mounted with a shroud. Also many of the fixtures in the Linear Pendant and Linear Strip section to come are ideal choices for Surface Mounting applications.



A clean and simple surface shroud easily transforms recessed fixtures to Surface Mounts to match appearances or provide a specification grade appearance.

## LED LINEAR WALL WASH

Lit walls expand the space and draw the eye. This architectural linear wall wash solution does it in a sleek, inconspicuous form factor. Ideal for lobbies, circulation spaces, and office environments. Available in two-, four-, and eight- foot lengths, individual or group patterns with asymmetrical light output.



ITEM NO.	DESCRIPTION
W4ASSF48LR24W2400LDMV40KWH	48"L x 4"W x 4"H / Frosted Lens / 24W, 2400L / 0-10V Dim / 4000K
W4ASSF48LR48W4800LDMV40KWH	48"L x 4"W x 4"H / Frosted Lens / 48W, 4800L / 0-10V Dim / 4000K
W4ASSF96LR48W4800LDMV40KWH	96"L x 4"W x 4"H / Frosted Lens / 48W, 4800L / 0-10V Dim / 4000K
W4ASSF96LR96W9600LDMV40KWH	96"L x 4"W x 4"H / Frosted Lens / 96W, 9600L / 0-10V Dim / 4000K

EM1 G120 OS1 RGBW D1MV 90CRI CCT1

## LED SURFACE VANDAL-PROOF

Ideal for locker rooms, or any high-abuse, vandal-prone application. Suitable for damp location, five-year warranty. This heavy duty steel welded body will withstand a celebration after a big win or a devastating defeat.



ITEM NO.	DESCRIPTION
LRSFR24LS25W2800LDMV40KWH	24"L x 12"W x 6"H / Frosted Lens / 25W, 2800L / 0-10V Dim / 4000K / White
LRSFR48LS50W5600LDMV40KWH	48"L x 12"W x 6"H / Frosted Lens / 50W, 5600L / 0-10V Dim / 4000K / White

EM3 G120 RGBW D1MV 90CRI CCT1

Available with Clear Lens change FR to CL.



Linear narrow channels are ideal for Surface Mount applications. Choose from a variety of widths, lengths and light outputs.



Most linear pendants like this square geometric version adapt beautifully to surface mounting.



Looking for more utilitarian Surface Mount fixtures like the FSF series? Check out the LED Strip section coming up for a variety of options.

# Surface Mount



## LED SURFACE LOWEST PROFILE CLOUD

A 3.2" deep, contemporary, opal acrylic diffuser, softly and evenly distributes light and creates a subtle "cloud" effect on the ceiling. Ideal for modern, upscale, dry or damp applications.

ITEM NO.	DESCRIPTION
LPCMW24LS20W2250LG12040K*	24"L x 11"W x 3"H / Matt White Lens / 20W, 2250L / Triac Dim / 4000K
LPCMW48LS40W4550LG12040K*	48"L x 11"W x 3"H / Matt White Lens / 40W, 4550L / Triac Dim / 4000K
<b>(0-10V DIMMING)</b>	
LPCMW24LS20W2250LDMV40K	24"L x 11"W x 3"H / Matte White Lens / 20W, 2250L / 0-10V Dim / 4000K
LPCMW24LS24W2600LDMV40K	24"L x 11"W x 3"H / Matte White Lens / 24W, 2600L / 0-10V Dim / 4000K
LPCMW24LS28W3000LDMV40K	24"L x 11"W x 3"H / Matte White Lens / 28W, 3000L / 0-10V Dim / 4000K
LPCMW48LS40W4550LDMV40K	48"L x 11"W x 3"H / Matte White Lens / 40W, 4550L / 0-10V Dim / 4000K
LPCMW48LS48W5200LDMV40K	48"L x 11"W x 3"H / Matte White Lens / 48W, 5200L / 0-10V Dim / 4000K
LPCMW48LS57W6050LDMV40K	48"L x 11"W x 3"H / Matte White Lens / 57W, 6050L / 0-10V Dim / 4000K

EM3 G120 RGBW D1MV 90CRI CCT1

\*120V only and 2 wire dimming.

## LED SURFACE WRAPAROUND CLOUD

This premium-grade, 3.75" deep, designer wraparound fixture has a regressed housing for a floating appearance ideal for kitchens, rec rooms, nursing homes, retail and office applications.



ITEM NO.	DESCRIPTION
CLMMW248LS32W3450LDMV40K	50"L x 9.5"W x 3.375"H / Matte White Lens / 32W, 3450L / 0-10V Dim / 4000K
CLMMW248LS48W4800LDMV40K	50"L x 9.5"W x 3.375"H / Matte White Lens / 48W, 4800L / 0-10V Dim / 4000K
CLMMW248LS57W5400LDMV40K	50"L x 9.5"W x 3.375"H / Matte White Lens / 57W, 5400L / 0-10V Dim / 4000K
CLMMW448LS72W7000LDMV40K	50"L x 13.75"W x 3.375"H / Matte White Lens / 72W, 7000L / 0-10V Dim / 4000K
CLMMW448LS97W9600LDMV40K	50"L x 13.75"W x 3.375"H / Matte White Lens / 97W, 9600L / 0-10V Dim / 4000K

EM3 G120 RGBW D1MV 90CRI CCT1 X1LED FLUOR

## LED SURFACE CLOUD

A shallow, contemporary opal acrylic diffuser softly and evenly distributes light at comfortable levels. Specify this fixture for a "puff" of light in discriminating homes or offices.



ITEM NO.	DESCRIPTION
PUF22LS24W1800LDMV40K	26.5"L x 26.5"W x 6"H / Matte White Lens / 24W, 1800L / 0-10V Dim / 4000K
PUF22LH36W2900LDMV40K	26.5"L x 26.5"W x 6"H / Matte White Lens / 36W, 2900L / 0-10V Dim / 4000K
PUF248LS32W2600LDMV40K	50.5"L x 11.75"W x 6"H / Matte White Lens / 32W, 2600L / 0-10V Dim / 4000K
PUF248LS48W3500LDMV40K	50.5"L x 11.75"W x 6"H / Matte White Lens / 48W, 3500L / 0-10V Dim / 4000K
PUF248LS57W4200LDMV40K	50.5"L x 11.75"W x 6"H / Matte White Lens / 57W, 4200L / 0-10V Dim / 4000K
PUF248LH72W5400LDMV40K	50.5"L x 11.75"W x 6"H / Matte White Lens / 72W, 5400L / 0-10V Dim / 4000K
PUF424LS32W2600LDMV40K	26.5"L x 17"W x 6"H / Matte White Lens / 32W, 2600L / 0-10V Dim / 4000K
PUF424LS48W3500LDMV40K	26.5"L x 17"W x 6"H / Matte White Lens / 48W, 3500L / 0-10V Dim / 4000K
PUF448LS65W5200LDMV40K	50.5"L x 17"W x 6"H / Matte White Lens / 65W, 5200L / 0-10V Dim / 4000K
PUF448LS97W7000LDMV40K	50.5"L x 17"W x 6"H / Matte White Lens / 97W, 7000L / 0-10V Dim / 4000K
PUF448LS114W8400LDMV40K	50.5"L x 17"W x 6"H / Matte White Lens / 114W, 8400L / 0-10V Dim / 4000K

EM6 G120 OS3 RGBW D1MV 90CRI CCT1 X1LED FLUOR

Consult for full size 2x4 version.

## LED SURFACE ROUNDED SILHOUETTE

The softly rounded Eclipse profile adds a pleasant architectural element to any commercial environment. Featuring a choice of decorative end cap finishes, both luminous and opaque, to coordinate with the most popular interior finishes.

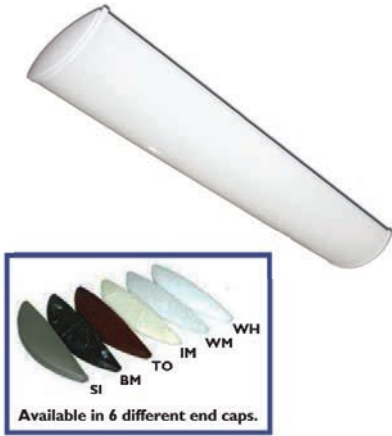

ITEM NO.	DESCRIPTION
ECLMW224LS24W2000DMV40KWH	25.75"L x 9.5"W x 4.5"H / Matte White Lens / 24W, 2000L / 0-10V Dim / 4000K / WH End Caps
ECLMW224LH36W2900LDMV40KWH	25.75"L x 9.5"W x 4.5"H / Matte White Lens / 36W, 2900L / 0-10V Dim / 4000K / WH End Caps
ECLMW248LS32W2900LDMV40KWH	51.25"L x 9.5"W x 4.5"H / Matte White Lens / 32W, 2900L / 0-10V Dim / 4000K / WH End Caps
ECLMW248LS48W4000LDMV40KWH	51.25"L x 9.5"W x 4.5"H / Matte White Lens / 48W, 4000L / 0-10V Dim / 4000K / WH End Caps
ECLMW248LS57W4500LDMV40KWH	51.25"L x 9.5"W x 4.5"H / Matte White Lens / 57W, 4500L / 0-10V Dim / 4000K / WH End Caps
ECLMW424LS48W4000LDMV40KWH	25.75"L x 16.5"W x 4.5"H / Matte White Lens / 48W, 4000L / 0-10V Dim / 4000K / WH End Caps
ECLMW448LS96W8000LDMV40KWH	51.25"L x 16.5"W x 4.5"H / Matte White Lens / 96W, 8000L / 0-10V Dim / 4000K / WH End Caps

EM3 G120 OS3 RGBW D1MV 90CRI CCT1 X1LED FLUOR

Finishes for End Caps: SL-Silver, BM-Black Marble, TO- Tortoise, IM-Ivory, WM-White Marble, WH-White

## LED SURFACE SPILL RING

Brushed nickel end caps and white bull-nosed diffuser add deco contemporary style for any commercial or residential application.



See matching close-to-ceiling, wall, and bath on pages 78, 96 and 101.

ITEM NO.	DESCRIPTION
FL48L45W3700LMVSNMCT	48.25"L *11.5"W*4.5"H / 45W, 3700L / 120-277V / Available in 3000K, 3500K or 4000K / Satin Nickel Spill Ring / No Dim
FL48LS57W5400LDMV40KSN	48.25"L x 11.5"W x 4.5"H / 57W, 5400L / 0-10V Dim / 4000K / Satin Nickel Spill Ring

EM3 G120 OS3 RGBW 90CRI CCT1 X1LED FLUOR

Consult for Bronze. Consult for 24 inches.

## LED SURFACE WITH CROWN MOLDING FRAME

This versatile fixture provides excellent, even, general illumination, with the stylish addition of a crown molding frame available in Golden Oak or white finish. Widely useful for residential, institutional, or commercial applications. Consult for unfinished version that can be stained.



Shown in Golden Oak finish (GO)

ITEM NO.	DESCRIPTION
CRWNMW22LS24W2400LDMV40KWH	25"L x 25"W x 4.125"H / Matte White Lens / 24W, 2400L / 0-10V Dim / 4000K / White
CRWNMW22LS28W2700LDMV40KWH	25"L x 25"W x 4.125"H / Matte White Lens / 28W, 2700L / 0-10V Dim / 4000K / White
CRWNMW22LS35W3200LDMV40KWH	25"L x 25"W x 4.125"H / Matte White Lens / 35W, 3200L / 0-10V Dim / 4000K / White
CRWNMW14LS48W4800LDMV40KWH	48"L x 11.5"W x 4.125"H / Matte White Lens / 48W, 4800L / 0-10V Dim / 4000K / White
CRWNMW14LS57W5700LDMV40KWH	48"L x 11.5"W x 4.125"H / Matte White Lens / 57W, 5700L / 0-10V Dim / 4000K / White
CRWNMW24LS48W4800LDMV40KWH	48"L x 16.27"W x 4.125"H / Matte White Lens / 48W, 4800L / 0-10V Dim / 4000K / White
CRWNMW24LS57W5700LDMV40KWH	48"L x 16.27"W x 4.125"H / Matte White Lens / 57W, 5700L / 0-10V Dim / 4000K / White

EM7 G120 OS3 RGBW D1MV 90CRI CCT1 X1LED FLUOR

Finishes: WH - White, GO - Golden Oak, UF - Unfinished.



# LED Strips



Saylite LED strips are easy to join in a continuous configuration with both mechanical and electrical joining well thought out.



Saylite's in-house Powder Coat capabilities allow the exact finish for the project. Choose from standard options or send in a color to match.



Orange (OR)



Red (RD)



Matte White (WH)



Black (BK)

See color chart on pg 156.

## Add Style, Performance, Flexibility and Color to Your Next Project.

Linear Strips continue to be an important application in commercial, industrial and residential applications. In the new LED era, choices for these utilitarian applications have expanded to provide the exact style, light output, size, and finish required. Don't settle anymore for "just a strip" and instead specify a Saylite LED strip that will say, "the right light matters" in every application.



Using multiple of Saylite LED strips to make visual impact. Surface mount, wall mount, and pendant mount depending on the application.

## LED CONTOURED STRIP

Wall or Ceiling mount, surface or pendant mount, vertical or horizontal this fixture, available standard in 3 sizes, can be used individually or joined together for a continuous run. Standard in white but with a variety of finish options. One piece lens for a great look.



ITEM NO.	DESCRIPTION
SERFR24LT14W1400LDMV40KWH	24"L x 3.79"W x 3.93"H / Frosted Lens / 14W, 1400L / 0-10V Dim / 4000K / White
SERFR24LT20W2000LDMV40KWH	24"L x 3.79"W x 3.93"H / Frosted Lens / 20W, 2000L / 0-10V Dim / 4000K / White
SERFR48LT28W2800LDMV40KWH	48"L x 3.79"W x 3.93"H / Frosted Lens / 28W, 2800L / 0-10V Dim / 4000K / White
SERFR48LT40W4000LDMV40KWH	48"L x 3.79"W x 3.93"H / Frosted Lens / 40W, 4000L / 0-10V Dim / 4000K / White
SERFR96LT56W5600LDMV40KWH	96"L x 3.79"W x 3.93"H / Frosted Lens / 56W, 5600L / 0-10V Dim / 4000K / White
SERFR96LT80W8000LDMV40KWH	96"L x 3.79"W x 3.93"H / Frosted Lens / 80W, 8000L / 0-10V Dim / 4000K / White

with SENSOR

SSSERFR24LT14W1400LDMV40KWH	24"L x 3.79"W x 3.93"H / Occ Sensor / Frosted Lens / 14W, 1400L / 0-10V Dim / 4000K / White
SSSERFR24LT20W2000LDMV40KWH	24"L x 3.79"W x 3.93"H / Occ Sensor / Frosted Lens / 20W, 2000L / 0-10V Dim / 4000K / White
SSSERFR48LT28W2800LDMV40KWH	48"L x 3.79"W x 3.93"H / Occ Sensor / Frosted Lens / 28W, 2800L / 0-10V Dim / 4000K / White
SSSERFR48LT40W4000LDMV40KWH	48"L x 3.79"W x 3.93"H / Occ Sensor / Frosted Lens / 40W, 4000L / 0-10V Dim / 4000K / White
SSSERFR96LT56W5600LDMV40KWH	96"L x 3.79"W x 3.93"H / Occ Sensor / Frosted Lens / 56W, 5600L / 0-10V Dim / 4000K / White
SSSERFR96LT80W8000LDMV40KWH	96"L x 3.79"W x 3.93"H / Occ Sensor / Frosted Lens / 80W, 8000L / 0-10V Dim / 4000K / White

EM6 G120 OS2 RGBW D1MV 90CRI CCT1 PEND X1LEDT5 FLUORT5

Add this sensor box for a variety of sensor options. See page 157 for more information.



## LED LINEAR LINES OF LIGHT 2.5" X 3" (VALUE PURCHASE)

This value version uses discreet 22 inch LED arrays with metal inserts in the lens to mask dark spots on the ends. Use only for individual run lengths. Pendant or surface mount versions. Use L34 for full-featured 2.5" width line of light for specifications that require a 2.5" fixture width.



ITEM NO.	DESCRIPTION
SES25FR24LJ20W2000LDMV40KWH	24"L x 2.375"W x 3.25"H / Frosted Lens / 20W, 2000L / 0-10V Dim / 4000K / White
SES25FR48LJ31W3100LDMV40KWH	48"L x 2.375"W x 2.83"H / Frosted Lens / 31W, 3100L / 0-10V Dim / 4000K / White
SES25FR48LJ40W4000LDMV40KWH	48"L x 2.375"W x 2.83"H / Frosted Lens / 40W, 4000L / 0-10V Dim / 4000K / White
SES25FR96LJ62W6200LDMV40KWH	96"L x 2.375"W x 2.83"H / Frosted Lens / 62W, 6200L / 0-10V Dim / 4000K / White
SES25FR96LJ80W8000LDMV40KWH	96"L x 2.375"W x 2.83"H / Frosted Lens / 80W, 8000L / 0-10V Dim / 4000K / White

EM6 G120 OS2 RGBW D1MV 90CRI CCT1 PEND REC WALL X1LED FLUOR

Pendant mount available. For Side Mount version with downlight change SES to SESW.

## LED LINEAR LINES OF LIGHT W/SMARTSENSE

Fixture on when occupied, off when vacant.



ITEM NO.	DESCRIPTION
SSSES25FR24LJ20W2000LDMV40KWH	24"L x 2.375"W x 3.25"H / Occ Sensor / Frosted Lens / 20W, 2000L / 0-10V Dim / 4000K / White
SSSES25FR48LJ31W3100LDMV40KWH	48"L x 2.375"W x 3.25"H / Occ Sensor / Frosted Lens / 31W, 3100L / 0-10V Dim / 4000K / White
SSSES25FR96LJ62W6200LDMV40KWH	96"L x 2.375"W x 3.25"H / Occ Sensor / Frosted Lens / 62W, 6200L / 0-10V Dim / 4000K / White

EM6 G120 OS2 RGBW D1MV 90CRI CCT1 PEND REC WALL X1LED FLUOR

Pendant mount available. For Side Mount version with downlight change SES to SESW.

# LED Strips



## LED LINEAR MICRO TAPERED SURFACE OR PENDANT

The SAR series is the right choice for merchandising, safety, security, or just general lighting. Easily accomplish continuous runs with the specially engineered joiner accessory for perfect installation.

ITEM NO.	DESCRIPTION
SARFR24LT15W1575LDMV40KWH	24"L x 3"W x 3"H / Frosted Lens / 15W, 1575L / 0-10V Dim / 4000K / White
SARFR24LT19W1950LDMV40KWH	24"L x 3"W x 3"H / Frosted Lens / 19W, 1950L / 0-10V Dim / 4000K / White
SARFR48LT30W3150LDMV40KWH	48"L x 3"W x 3"H / Frosted Lens / 30W, 3150L / 0-10V Dim / 4000K / White
SARFR48LT38W3990LDMV40KWH	48"L x 3"W x 3"H / Frosted Lens / 38W, 3990L / 0-10V Dim / 4000K / White
SARFR48LT45W4700LDMV40KWH	48"L x 3"W x 3"H / Frosted Lens / 45W, 4700L / 0-10V Dim / 4000K / White
SARFR96LT60W6300LDMV40KWH	96"L x 3"W x 3"H / Frosted Lens / 60W, 6300L / 0-10V Dim / 4000K / White
SARFR96LT75W7900LDMV40KWH	96"L x 3"W x 3"H / Frosted Lens / 75W, 7900L / 0-10V Dim / 4000K / White
SARFR96LT90W9450LDMV40KWH	96"L x 3"W x 3"H / Frosted Lens / 90W, 9450L / 0-10V Dim / 4000K / White

EM6 G120 OS2 RGBW D1MV 90CRI CCT1 PEND

## LINEAR 2" ROUND STRIP

Featuring a micro silhouette scaled to the LED module. The matte white diffuser surrounds the LEDs for soft lighting. Available with smooth frosted lens. New designer matching ends ideal for a variety of applications.



New Designer White Ends ideal for variety of applications.

ITEM NO.	DESCRIPTION
DKSMW24LZ18W1900LDMV40KWH	22.50"L x 2"W x 2.60"H / Matte White Lens / 18W, 1900L / 0-10V Dim / 4000K / White
DKSMW48LZ35W3800LDMV40KWH	46.25"L x 2"W x 2.60"H / Matte White Lens / 35W, 3800L / 0-10V Dim / 4000K / White
DKSMW96LZ70W7000LDMV40KWH	92.00"L x 2"W x 2.60"H / Matte White Lens / 70W, 7000L / 0-10V Dim / 4000K / White

EM3 G120 RGBW D1MV 90CRI CCT1 PEND XILED FLUOR

Consult for other wattages & lumens.

## LINEAR 3" ROUND STRIP

Featuring a rounded, full body (3"x3") low-profile silhouette and a matte white diffuser for higher output than the standard DKS. Integral EM driver available.



ITEM NO.	DESCRIPTION
DKSWBMW24LZ20W2000LDMV40KWH	24.50"L x 3"W x 3.00"H / Matte White Lens / 20W, 2000L / 0-10V Dim / 4000K / White
DKSWBMW48LZ40W4000LDMV40KWH	46.25"L x 3"W x 3.00"H / Matte White Lens / 40W, 4000L / 0-10V Dim / 4000K / White
DKSWBMW96LZ80W8000LDMV40KWH	92.00"L x 3"W x 3.00"H / Matte White Lens / 80W, 8000L / 0-10V Dim / 4000K / White

EM3 G120 RGBW D1MV 90CRI CCT1 PEND XILED FLUOR

Consult for other wattages & lumens.

## LED LINEAR 3" LOW PROFILE STRIP

A slightly wider profile allowing for higher output in shorter runs and integral emergency driver.



Vented body is for Emergency Version.

ITEM NO.	DESCRIPTION
SKDWBFR24LJ35W3400LDMV40KWH	23.84"L x 3"W x 3"H / Frosted Lens / 35W, 3400L / 0-10V Dim / 4000K / White
SKDWBFR48LJ40W4000LDMV40KWH	46.00"L x 3"W x 3"H / Frosted Lens / 40W, 4000L / 0-10V Dim / 4000K / White
SKDWBFR48LZ72W7000LDMV40KWH	46.00"L x 3"W x 3"H / Frosted Lens / 72W, 7000L / 0-10V Dim / 4000K / White
SKDWBFR96LJ80W8000LDMV40KWH	92.00"L x 3"W x 3"H / Frosted Lens / 80W, 8000L / 0-10V Dim / 4000K / White
SKDWBFR96LZ114W10800LDMV40KWH	92.00"L x 3"W x 3"H / Frosted Lens / 114W, 10800L / 0-10V Dim / 4000K / White

EM3 G120 OS2 RGBW D1MV 90CRI CCT1 PEND X1LED FLUOR

## LED LINEAR 3" LOW PROFILE STRIP W/ SMARTSENSE

Fixture on when occupied, off when vacant.



ITEM NO.	DESCRIPTION
SSSKDWBFR24LZ35W3400LDMV40KWH	23.84"L x 3"W x 3"H / Occ Sensor / Frosted Lens / 35W, 3400L / 0-10V Dim / 4000K / White
SSSKDWBFR48LZ40W4000LDMV40KWH	46.00"L x 3"W x 3"H / Occ Sensor / Frosted Lens / 40W, 4000L / 0-10V Dim / 4000K / White
SSSKDWBFR48LZ72W7000LDMV40KWH	46.00"L x 3"W x 3"H / Occ Sensor / Frosted Lens / 72W, 7000L / 0-10V Dim / 4000K / White
SSSKDWBFR96LZ80W8000LDMV40KWH	92.00"L x 3"W x 3"H / Occ Sensor / Frosted Lens / 80W, 8000L / 0-10V Dim / 4000K / White
SSSKDWBFR96LZ114W10800LDMV40KWH	92.00"L x 3"W x 3"H / Occ Sensor / Frosted Lens / 114W, 10800L / 0-10V Dim / 4000K / White

EM3 G120 OS2 RGBW D1MV 90CRI CCT1 PEND X1LED FLUOR

Consult for other finishes. See page 157 for other sensor options.

## LED LINEAR 2" LOW PROFILE STRIP

Featuring a micro silhouette, the frosted diffuser is scaled to the LED module and surrounds the LEDs for soft lighting.



Shown in SL. Consult for other finishes and adder.

ITEM NO.	DESCRIPTION
SKDFR24LJ12W1200LDMV40KWH	22.50"L x 2"W x 2.60"H / Frosted Lens / 12W, 1200L / 0-10V Dim / 4000K / White
SKDFR48LJ28W2800LDMV40KWH	46.00"L x 2"W x 2.60"H / Frosted Lens / 28W, 2800L / 0-10V Dim / 4000K / White
SKDFR48LJ35W3400LDMV40KWH	46.00"L x 2"W x 2.60"H / Frosted Lens / 35W, 3400L / 0-10V Dim / 4000K / White
SKDFR96LJ57W5400LDMV40KWH	92.00"L x 2"W x 2.60"H / Frosted Lens / 57W, 5400L / 0-10V Dim / 4000K / White
SKDFR96LJ72W7000LDMV40KWH	92.00"L x 2"W x 2.60"H / Frosted Lens / 72W, 7000L / 0-10V Dim / 4000K / White

EM3 G120 OS2 RGBW D1MV 90CRI CCT1 PEND X1LED FLUOR



# LED Strips



Pendant mount available.

## LINEAR STRIP WORKHORSE

Ideal for continuous runs, this medium body strip with a frosted lens is sleek and stylized, yet economical. Ideal for many retail and industrial applications as well as mezzanine low-ceiling installations where a wide distribution is needed.

ITEM NO.	DESCRIPTION
FSFFR48LJ31W3400LDMV40KWH	48"L x 4.25"W x 3.25"H / Frosted Lens / 31W, 3400L / 0-10V Dim / 4000K / White
FSFFR48LZ57W6300LDMV40KWH	48"L x 4.25"W x 3.25"H / Frosted Lens / 57W, 6300L / 0-10V Dim / 4000K / White
FSFFR96LJ62W6600LDMV40KWH	96"L x 4.25"W x 3.25"H / Frosted Lens / 62W, 6600L / 0-10V Dim / 4000K / White
FSFFR96LZ114W12600LDMV40KWH	96"L x 4.25"W x 3.25"H / Frosted Lens / 114W, 12600L / 0-10V Dim / 4000K / White

EM6 G120 OS1 RGBW D1MV 90CRI CCT1

For Sensor Option add SM in front or MDT4. See Retrofit Kit on page 92.

## LED PREMIUM STRIP - ROUND OR FLAT LENS

For a high-end aesthetic, with a fully luminous lens from end to end, at an economical price, choose the CRS. Available with a round lens (SR) or a flat lens (SF). Ideal for schools, retail, and warehouse applications. Specially engineered for continuous runs.



Fully luminous lens from end to end. Shown is the CRSR with rounded lens. CRSF has flat lens.

ITEM NO.	DESCRIPTION
CRSF48LT30W3500LDMV40K	48"L x 4.36"W x 3.90"H / FLAT LENS / 30W, 3500L / 0-10V Dim / 4000K
CRSF48LT41W4300LDMV40K	48"L x 4.36"W x 3.90"H / FLAT LENS / 41W, 4300L / 0-10V Dim / 4000K
CRSF48LT58W6700LDMV40K	48"L x 4.36"W x 3.90"H / FLAT LENS / 58W, 6700L / 0-10V Dim / 4000K
CRSF96LT60W6900LDMV40K	96"L x 4.36"W x 3.90"H / FLAT LENS / 60W, 6900L / 0-10V Dim / 4000K
CRSF96LT82W8900LDMV40K	96"L x 4.36"W x 3.90"H / FLAT LENS / 82W, 8900L / 0-10V Dim / 4000K
CRSF96LT116W13400LDMV40K	96"L x 4.36"W x 3.90"H / FLAT LENS / 116W, 13400L / 0-10V Dim / 4000K
CRSR48LT30W3500LDMV40K	48"L x 4.36"W x 3.90"H / ROUND LENS / 30W, 3500L / 0-10V Dim / 4000K
CRSR48LT41W4300LDMV40K	48"L x 4.36"W x 3.90"H / ROUND LENS / 41W, 4300L / 0-10V Dim / 4000K
CRSR48LT58W6700LDMV40K	48"L x 4.36"W x 3.90"H / ROUND LENS / 58W, 6700L / 0-10V Dim / 4000K
CRSR96LT60W6900LDMV40K	96"L x 4.36"W x 3.90"H / ROUND LENS / 60W, 6900L / 0-10V Dim / 4000K
CRSR96LT82W8900LDMV40K	96"L x 4.36"W x 3.90"H / ROUND LENS / 82W, 8900L / 0-10V Dim / 4000K
CRSR96LT116W13400LDMV40K	96"L x 4.36"W x 3.90"H / ROUND LENS / 116W, 13400L / 0-10V Dim / 4000K



EM6 G120 OS1 RGBW D1MV 90CRI CCT1

See specification sheet for more DLC item options.



Continuous 8ft lens for great look.



## LINEAR STRIP

Designed for commercial (warehouse, office, garage, display shop) applications. The 8 foot fixture features one lens, for a clean, continuous appearance and an ideal replacement for fluorescent strips.

ITEM NO.	DESCRIPTION
JSR48L40W5400LDMV40K	42.44"L x 3.25"W x 3.75"H / Matt White Lens / 40W, 5400L / 0-10V Dim / 4000K
JSR96L68W9400LDMV40K	90.47"L x 3.25"W x 3.75"H / Matt White Lens / 68W, 9400L / 0-10V Dim / 4000K

EM1 CCT2

## ECONOMY LENSED STRIP

Ideal for cove lighting, this sleek, enclosed strip is highly engineered for quick installation, low maintenance, and long life. Available in 2', 4', and 8' lengths for individual or continuous run.



ITEM NO.	DESCRIPTION
RKDFR24LJ12W1200LDMV40KWH	24"L x 1.96"W x 2.93"H / Frosted Lens / 12W, 1200L / 0-10V Dim / 4000K
RKDFR24LJ24W2400LDMV40KWH	24"L x 1.96"W x 2.93"H / Frosted Lens / 24W, 2400L / 0-10V Dim / 4000K
RKDFR48LJ28W2800LDMV40KWH	48"L x 1.96"W x 2.93"H / Frosted Lens / 28W, 2800L / 0-10V Dim / 4000K
RKDFR48LZ48W4800LDMV40KWH	48"L x 1.96"W x 2.93"H / Frosted Lens / 48W, 4800L / 0-10V Dim / 4000K
RKDFR96LJ57W5700LDMV30KWH	48"L x 1.96"W x 2.93"H / Frosted Lens / 57W, 5700L / 0-10V Dim / 4000K
RKDFR96LZ96W9600LDMV40KWH	48"L x 1.96"W x 2.93"H / Frosted Lens / 96W, 9600L / 0-10V Dim / 4000K

EM3 G120 RGBW D1MV 90CRI CCT1

For Continuous runs, add PI1 or PI3D after DMV for Electrical Connector, see page 153.

## LED CONTINUOUS RUN LINEAR STRIP COVE LIGHTING

Energy savings, easy installation, and soft, wide light distribution are all available with this economical plug and play system. Ideal for general illumination for almost any lighting environment. Plug and play system with cord, plug and butt connector.



Adjustable and locking mounting bracket aims the light.

ITEM NO.	DESCRIPTION
LCR48L18W2400LMV50K	1" x 48" 18 / 2400 5000K
LCR96L40W5200LMV50K	1" x 96" 40 / 5200 5000K
LCRADJMT	Set of 3

\* Standard brackets included. Not dimmable.

## LINKABLE LED STRIP

This sub-miniature (1") strip is ideal for illuminating tight spaces for display, cove and shelf lighting. Fixtures may be used individually, or linked (plugged directly one into another), end to end, without cords, for continuous runs. Each fixture comes with 3ft cord & plug, mini coupler and mounting clips.



ITEM NO.	DESCRIPTION
LDED13L4W360L50K	STRIP LED DED 4W 360 LUMENS 5000K
LDED22L7W630L50K	STRIP LED DED 7W 630 LUMENS 5000K
LDED23L8W720L50K	STRIP LED DED 8W 720 LUMENS 5000K
LDED35L14W1260L50K	STRIP LED DED 14W 1260 LUMENS 5000K
LDED47L18W1550L50K	STRIP LED DED 18W 1550 LUMENS 5000K
LDED12JOIN	STRIP LED DED 12in JOINER
LDED24JOIN	STRIP LED DED 24in JOINER
LDED6JOIN	STRIP LED DED 6in JOINER
LDEDJBOX	STRIP LED DED HARDWIRE JBOX

# LED Strips

## LED OPEN STRIP (1.62" WIDE)

KDS is a spec-grade, mini body open strip, ideal for size-critical applications such as display cabinets or coves.



KDS48LJ24W2800LDMV40K	48"L x 1.62"W x 1.62"H / 24W, 2800L / 0-10V Dim / 4000K
KDS48LJ28W3200LDMV40K	48"L x 1.62"W x 1.62"H / 28W, 3200L / 0-10V Dim / 4000K
KDS48LJ35W4000LDMV40K	48"L x 1.62"W x 1.62"H / 35W, 4000L / 0-10V Dim / 4000K
KDS96LJ48W5650LDMV40K	96"L x 1.62"W x 1.62"H / 48W, 5650L / 0-10V Dim / 4000K
KDS96LJ57W6400LDMV40K	96"L x 1.62"W x 1.62"H / 57W, 6400L / 0-10V Dim / 4000K
KDS96LJ72W8000LDMV40K	96"L x 1.62"W x 1.62"H / 72W, 8000L / 0-10V Dim / 4000K

EM3 G120 RGBW D1MV 90CRI CCT1 X1LED FLUOR

For Wire Guard add WG.

## LED OPEN STRIP (2.75" WIDE)

This narrow open strip is ideal for warehouses, retail, and utility areas requiring general illumination with a commercial narrow strip configuration, low maintenance, and maximum flexibility to quickly change wattage, lumens, or color temperature, simply by changing the lamp. Frosted lens accessory available.



Frosted lens accessory reduces LED glare.

ITEM NO.	DESCRIPTION
S24LJ22W2800LDMV40K	24"L x 2.75"W x 2"H / Open / 22W, 2800L / 0-10V Dim / 4000K
S48LJ37W5000LDMV40K	48"L x 2.75"W x 2"H / Open / 37W, 5000L / 0-10V Dim / 4000K
S96LJ74W10050LDMV40K	96"L x 2.75"W x 2"H / Open / 74W, 10050L / 0-10V Dim / 4000K

### Frosted Lens

S24LFRJ22W2600LDMV40K	24"L x 2.75"W x 2"H / Frosted Lens / 22W, 2600L / 0-10V Dim / 4000K
S48LFRJ37W4600LDMV40K	48"L x 2.75"W x 2"H / Frosted Lens / 37W, 4600L / 0-10V Dim / 4000K
S96LFRJ74W9300LDMV40K	96"L x 2.75"W x 2"H / Frosted Lens / 74W, 9300L / 0-10V Dim / 4000K

EM6 G120 OS1 RGBW D1MV 90CRI CCT1 X1LED FLUOR

## Continuous Run Made Easy

Saylite provides simple methods to install strips in continuous runs to ensure ease of installation, straight and uniform joining and continuous power with one electrical feed. Mechanical joining includes end caps that transform into joiners, holes and knockout for easy nut and bolt installation and brackets for easy joining on top. Wiring harnesses in a variety of wire options make electrical joining from one power feed plug and play.



Wiring harnesses are provided in continuous run fixtures designated by -B, -J, -E for beginners, joiners and Enders. See page 153 for options.

## LED LENSED STRIP (4.25" WIDE)

Low profile economy linear strip provides light where you need it. End cap and lens finish the look and provides low glare lighting.



ITEM NO.	DESCRIPTION
C24LFRF24W3000LDMV40K	24"L x 4.25"W x 2.95"H / Frosted Lens / 24W, 3000L / 0-10V Dim / 4000K
C24LFRF30W3400LDMV40K	24"L x 4.25"W x 2.95"H / Frosted Lens / 30W, 3400L / 0-10V Dim / 4000K
C48LFRF35W4500LDMV40K	48"L x 4.25"W x 2.95"H / Frosted Lens / 35W, 4500L / 0-10V Dim / 4000K
C48LFRF48W6000LDMV40K	48"L x 4.25"W x 2.95"H / Frosted Lens / 48W, 6000L / 0-10V Dim / 4000K
C48LFRF57W7100LDMV40K	48"L x 4.25"W x 2.95"H / Frosted Lens / 57W, 7100L / 0-10V Dim / 4000K
C96LFRF70W9100LDMV40K	96"L x 4.25"W x 2.95"H / Frosted Lens / 70W, 9100L / 0-10V Dim / 4000K
C96LFRF97W11900LDMV40K	96"L x 4.25"W x 2.95"H / Frosted Lens / 97W, 11900L / 0-10V Dim / 4000K
C96LFRF118W14200LDMV40K	96"L x 4.25"W x 2.95"H / Frosted Lens / 118W, 14200L / 0-10V Dim / 4000K

EM6 G120 OS1 RGBW D1MV 90CRI CCT1 X1LED FLUOR

For Wire Guard add WG.  
See specification sheet for more DLC item options.

## LED OPEN STRIP (4.25" WIDE)

This medium-body open strip is ideal for warehouses, retail, and utility areas requiring general illumination with a commercial wide strip configuration, low maintenance, and maximum flexibility to quickly change wattage, lumens, or color temperature, simply by changing the lamp. Frosted lens accessory available. Consult to add reflectors.



ITEM NO.	DESCRIPTION
C24LF24W3350LDMV40K	24"L x 4.25"W x 2"H / Open / 24W, 3350L / 0-10V Dim / 4000K
C24LF30W3900LDMV40K	24"L x 4.25"W x 2"H / Open / 30W, 3900L / 0-10V Dim / 4000K
C48LF35W4900LDMV40K	48"L x 4.25"W x 2"H / Open / 35W, 4900L / 0-10V Dim / 4000K
C48LF48W6500LDMV40K	48"L x 4.25"W x 2"H / Open / 48W, 6500L / 0-10V Dim / 4000K
C48LF57W7800LDMV40K	48"L x 4.25"W x 2"H / Open / 57W, 7800L / 0-10V Dim / 4000K
C96LF70W9800LDMV40K	96"L x 4.25"W x 2"H / Open / 70W, 9800L / 0-10V Dim / 4000K
C96LF97W13000LDMV40K	96"L x 4.25"W x 2"H / Open / 97W, 13000L / 0-10V Dim / 4000K
C96LF118W15500LDMV40K	96"L x 4.25"W x 2"H / Open / 118W, 15500L / 0-10V Dim / 4000K

EM6 G120 OS1 RGBW D1MV 90CRI CCT1 X1LED FLUOR

See specification sheet for more DLC item options.

## INDUSTRIAL STRIP W/REFLECTOR AND LENS



ITEM NO.	DESCRIPTION
CIND48LJ32W5000LW30DMV40K	48"L x 8.06"W x 4.25"H/ Frosted Lens and White Reflector / 32W, 5000L / 0-10V Dim / 4000K
CIND48LJ48W6900LW30DMV40K	48"L x 8.06"W x 4.25"H/ Frosted Lens and White Reflector / 48W, 6900L / 0-10V Dim / 4000K
CIND48LJ57W7800LW30DMV40K	48"L x 8.06"W x 4.25"H/ Frosted Lens and White Reflector / 57W, 7800L / 0-10V Dim / 4000K
CIND96LJ57W7800LW30DMV40K	96"L x 8.06"W x 4.25"H/ Frosted Lens and White Reflector / 57W, 7800L / 0-10V Dim / 4000K
CIND96LJ97W12400LW30DMV40K	96"L x 8.06"W x 4.25"H/ Frosted Lens and White Reflector / 97W, 12400L / 0-10V Dim / 4000K
CIND96LJ114W14000LW30DMV40K	96"L x 8.06"W x 4.25"H/ Frosted Lens and White Reflector / 114W, 14000L / 0-10V Dim / 4000K

EM1 G120 OS1 RGBW D1MV 90CRI CCT1

# Industrial Strips

Your Choice for Industrial Lighting with LED.

LED Industrials provide more light on the cartons on each side of the aisle.



BEFORE  
(fluorescent)



AFTER  
(LED)



## INDUSTRIAL STRIP FAMILY

One style offered three ways to meet any industrial application – cost effective and high output - Open Strip, Frosted Lens, or a highly focused Narrow Reflector. Available surface or pendant mount.



Lens



Multiple sensor options available.



Reflector (Narrow Spread)

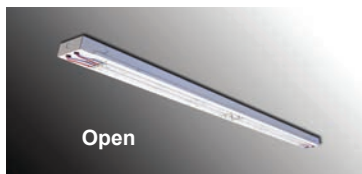

Open

ITEM NO.	DESCRIPTION
<b>Enclosed with Hinged Frosted Lens</b>	
RRSFR48LE28W2700LDMV40K	48"L x 2.925"W x 3.395"H / Frosted Lens / 28W, 2700L / 0-10V Dim / 4000K
RRSFR48LE48W4600LDMV40K	48"L x 2.925"W x 3.395"H / Frosted Lens / 48W, 4600L / 0-10V Dim / 4000K
RRSFR48LE57W5400LDMV40K	48"L x 2.925"W x 3.395"H / Frosted Lens / 57W, 5400L / 0-10V Dim / 4000K
RRSFR96LE57W5400LDMV40K	96"L x 2.925"W x 3.395"H / Frosted Lens / 57W, 5400L / 0-10V Dim / 4000K
RRSFR96LE96W9200LDMV40K	96"L x 2.925"W x 3.395"H / Frosted Lens / 96W, 9200L / 0-10V Dim / 4000K
RRSFR96LE114W10400LDMV40K	96"L x 2.925"W x 3.395"H / Frosted Lens / 114W, 10400L / 0-10V Dim / 4000K
<b>Enhanced White Reflector</b>	
RRS48LE28W4600LW30DMV40K	48"L x 4.70"W x 6.20"H / White Reflector / 28W, 4600L / 0-10V Dim / 4000K
RRS48LE48W5650LW30DMV40K	48"L x 4.70"W x 6.20"H / White Reflector / 48W, 5650L / 0-10V Dim / 4000K
RRS48LE57W6400LW30DMV40K	48"L x 4.70"W x 6.20"H / White Reflector / 57W, 6400L / 0-10V Dim / 4000K
RRS96LE57W6400LW30DMV40K	96"L x 4.70"W x 6.20"H / White Reflector / 57W, 6400L / 0-10V Dim / 4000K
RRS96LE96W11300LW30DMV40K	96"L x 4.70"W x 6.20"H / White Reflector / 96W, 11300L / 0-10V Dim / 4000K
RRS96LE114W12800LW30DMV40K	96"L x 4.70"W x 6.20"H / White Reflector / 114W, 12800L / 0-10V Dim / 4000K
<b>Open Strip</b>	
RRS48LE28W4300LDMV40K	48"L x 2.925"W x 1.778"H / Open / 28W, 4300L / 0-10V Dim / 4000K
RRS48LE48W7000LDMV40K	48"L x 2.925"W x 1.778"H / Open / 48W, 7000L / 0-10V Dim / 4000K
RRS48LE57W8000LDMV40K	48"L x 2.925"W x 1.778"H / Open / 57W, 8000L / 0-10V Dim / 4000K
RRS96LE57W8000LDMV40K	96"L x 2.925"W x 1.778"H / Open / 57W, 8000L / 0-10V Dim / 4000K
RRS96LE96W12000LDMV40K	96"L x 2.925"W x 1.778"H / Open / 96W, 12000L / 0-10V Dim / 4000K
RRS96LE114W13800LDMV40K	96"L x 2.925"W x 1.778"H / Open / 114W, 13800L / 0-10V Dim / 4000K

EM6 G120 OS2 RGBW D1MV 90CRI CCT1



## INDUSTRIAL STRIP W/LENS

The popular Industrial series has a new look in LED with a diffuser to hide the LED's and provide smooth, even illumination directed by the formed reflector. Ideal for lower ceiling applications.

Add SS at beginning for SMARTSENSE sensor.



Consult for dropped lens version

ITEM NO.	DESCRIPTION
SES25FR48LJ24W2400LW30DMV40K	48"L x 9.50"W x 4.25"H/ Frosted Lens and White Reflector / 24W, 2400L / 0-10V Dim / 4000K
SES25FR48LJ31W3100LW30DMV40K	48"L x 9.50"W x 4.25"H/ Frosted Lens and White Reflector / 31W, 3100L / 0-10V Dim / 4000K
SES25FR48LJ45W4500LW30DMV40K	48"L x 9.50"W x 4.25"H/ Frosted Lens and White Reflector / 45W, 4500L / 0-10V Dim / 4000K
SES25FR48LJ48W4800LW30DMV40K	48"L x 9.50"W x 4.25"H/ Frosted Lens and White Reflector / 48W, 4800L / 0-10V Dim / 4000K
SES25FR96LJ62W6200LW30DMV40K	96"L x 9.50"W x 4.25"H/ Frosted Lens and White Reflector / 62W, 6200L / 0-10V Dim / 4000K
SES25FR96LJ90W9000LW30DMV40K	96"L x 9.50"W x 4.25"H/ Frosted Lens and White Reflector / 90W, 9000L / 0-10V Dim / 4000K

EM6 G120 OS2 RGBW D1MV 90CRI CCT1 PEND X1LED FLUOR

## INDUSTRIAL LED

Ideal for Ceilings Between 10 and 18 feet this workhorse provides concentrated illumination in a commercial quality configuration for interior warehouse, retail, and utility areas. Offered with a variety of distributions and reflector attributes for maximum versatility.



See bottom of page 65 for Industrial Strip with rounded lens (CIND).

ITEM NO.	DESCRIPTION
IND48LJ32W5000LW30DMV40K	48"L x 8.06"W x 4.25"H/ White Reflector / 32W, 5000L / 0-10V Dim / 4000K
IND48LJ48W6900LW30DMV40K	48"L x 8.06"W x 4.25"H/ White Reflector / 48W, 6900L / 0-10V Dim / 4000K
IND48LJ57W7800LW30DMV40K	48"L x 8.06"W x 4.25"H/ White Reflector / 57W, 7800L / 0-10V Dim / 4000K
IND96LJ57W7800LW30DMV40K	96"L x 8.06"W x 4.25"H/ White Reflector / 57W, 7800L / 0-10V Dim / 4000K
IND96LJ97W12400LW30DMV40K	96"L x 8.06"W x 4.25"H/ White Reflector / 97W, 12400L / 0-10V Dim / 4000K
IND96LJ114W14000LW30DMV40K	96"L x 8.06"W x 4.25"H/ White Reflector / 114W, 14000L / 0-10V Dim / 4000K

EM6 G120 OS1 RGBW D1MV 90CRI CCT1 X1LED FLUOR

Add wire guard IND48WGW.

## MEZZANINE LED FIXTURE

Specially designed for dense mezzanine applications, this shallow, robust linear fixture features a remote driver to easily install to the bottom of the floor above and to withstand the vibration of overhead activity.



ITEM NO.	DESCRIPTION
MIND24LF24W3350LDMV40K	24"L x 4.25"W x 2"H / 24W, 3350L / 0-10V Dim / 4000K
MIND24LF30W3900LDMV40K	24"L x 4.25"W x 2"H / 30W, 3900L / 0-10V Dim / 4000K
MIND48LF35W4900LDMV40K	48"L x 4.25"W x 2"H / 35W, 4900L / 0-10V Dim / 4000K
MIND48LF48W6500LDMV40K	48"L x 4.25"W x 2"H / 48W, 6500L / 0-10V Dim / 4000K
MIND48LF57W7800LDMV40K	48"L x 4.25"W x 2"H / 57W, 7800L / 0-10V Dim / 4000K
MIND96LF70W9800LDMV40K	96"L x 4.25"W x 2"H / 70W, 9800L / 0-10V Dim / 4000K
MIND96LF97W13000LDMV40K	96"L x 4.25"W x 2"H / 97W, 13000L / 0-10V Dim / 4000K
MIND96LF118W15500LDMV40K	96"L x 4.25"W x 2"H / 118W, 15500L / 0-10V Dim / 4000K

EM3 G120 RGBW D1MV 90CRI CCT1

# Asymmetrical Strips



Asymmetrical reflector provides wall wash (W35 Reflector).

## LED STRIP WITH REFLECTOR

Enlarge a space, highlight the perimeter and wash the walls with this cost-effective linear strip with asymmetrical reflector. See the PRL on page 20 for more spec-grade applications.

ITEM NO.	DESCRIPTION
S24LT15W1600LW35DMV40K	24"L x 4.875"W x 3.36"H / Asymmetrical Reflector / 15W, 1600L / 0-10V Dim / 4000K
S48LT29W3200LW35DMV40K	48"L x 4.875"W x 3.36"H / Asymmetrical Reflector / 29W, 3200L / 0-10V Dim / 4000K
S60LT38W4070LW35DMV40K	60"L x 4.875"W x 3.36"H / Asymmetrical Reflector / 38W, 4070L / 0-10V Dim / 4000K
S96LT57W6400LW35DMV40K	96"L x 4.875"W x 3.36"H / Asymmetrical Reflector / 57W, 6400L / 0-10V Dim / 4000K

EM6 G120 OS1 RGBW D1MV 90CRI CCT1

For continuous run, see information on page 39.

## ANGLED LINEAR OPEN PERIMETER LIGHT

Specially engineered to fit in a corner to provide general illumination and perimeter lighting. Ideal for narrow corridors and storage facilities for maximum lighting and minimum maintenance.



ITEM NO.	DESCRIPTION
CU4548LS35W4500LDMV40K	48"L x 4.25"W x 2"H / 35W, 4500L / 0-10V Dim / 4000K
CU4548LS48W6000LDMV40K	48"L x 4.25"W x 2"H / 48W, 6000L / 0-10V Dim / 4000K
CU4548LS57W7100LDMV40K	48"L x 4.25"W x 2"H / 57W, 7100L / 0-10V Dim / 4000K
CU4596LS70W9100LDMV40K	96"L x 4.25"W x 2"H / 70W, 9100L / 0-10V Dim / 4000K
CU4596LS97W11900LDMV40K	96"L x 4.25"W x 2"H / 97W, 11900L / 0-10V Dim / 4000K
CU4596LS118W14200LDMV40K	96"L x 4.25"W x 2"H / 118W, 14200L / 0-10V Dim / 4000K

EM3 G120 RGBW D1MV 90CRI CCT1





## LINEAR FIXTURE w/ SENSOR

This value version uses discreet 22 inch LED arrays with metal inserts in the lens to mask dark spots on the ends. Use only for individual run lengths. Sensor provides control based on occupancy.

ITEM NO.	DESCRIPTION
SSSES25FR24LJ20W2000LDMV40KWH	24"L x 2.375"W x 3.25"H / Occ Sensor / Frosted Lens / 20W, 2000L / 0-10V Dim / 4000K
SSSES25FR48LJ31W3100LDMV40KWH	48"L x 2.375"W x 3.25"H / Occ Sensor / Frosted Lens / 31W, 3100L / 0-10V Dim / 4000K
SSSES25FR96LJ62W6200LDMV40KWH	96"L x 2.375"W x 3.25"H / Occ Sensor / Frosted Lens / 62W, 6200L / 0-10V Dim / 4000K
SSSES25FR24LJ20W2000LSTMV40KWH	24"L x 2.375"W x 3.25"H / Occ Sensor with 50% Step Dim / Frosted Lens / 20W, 2000L / 0-10V Dim / 4000K
SSSES25FR48LJ31W3100LSTMV40KWH	48"L x 2.375"W x 3.25"H / Occ Sensor with 50% Step Dim / Frosted Lens / 31W, 3100L / 0-10V Dim / 4000K
SSSES25FR96LJ62W6200LSTMV40KWH	96"L x 2.375"W x 3.25"H / Occ Sensor with 50% Step Dim / Frosted Lens / 62W, 6200L / 0-10V Dim / 4000K

EM6 G120 OS1 RGBW D1MV 90CRI CCT1 X1LED FLUOR

Step Dim w/Sensor (Fixture ON when occupied, 50% when vacant). Consult for other finishes. Pendant mount available. See Page 157.

## LED ROUND LENS W/ SMARTSENSE

Featuring a micro silhouette scaled to the LED module. The matte white diffuser surrounds the LEDs for soft lighting. Sensor in center of fixture provides control based on occupancy.



ITEM NO.	DESCRIPTION
SSFSFFR48LJ31W3400LDMV40KWH	48"L x 4.25"W x 3.25"H / Frosted Lens / Occ Sensor / 31W, 3400L / 0-10V Dim / 4000K / White
SSFSFFR48LZ57W6300LDMV40KWH	48"L x 4.25"W x 3.25"H / Frosted Lens / Occ Sensor / 57W, 6300L / 0-10V Dim / 4000K / White
SSFSFFR96LJ62W6600LDMV40KWH	96"L x 4.25"W x 3.25"H / Frosted Lens / Occ Sensor / 62W, 6600L / 0-10V Dim / 4000K / White
SSFSFFR96LZ114W12600LDMV40KWH	96"L x 4.25"W x 3.25"H / Frosted Lens / Occ Sensor / 114W, 12600L / 0-10V Dim / 4000K / White

EM6 G120 OS1 RGBW D1MV 90CRI CCT1 X1LED FLUOR

## LED LINEAR 3" LOW PROFILE STRIP W/ SMARTSENSE

Fixture on when occupied, off when vacant.



ITEM NO.	DESCRIPTION
SSSKDWBFR24LZ35W3400LDMV40KWH	23.84"L x 3"W x 3"H / Occ Sensor / Frosted Lens / 35W, 3400L / 0-10V Dim / 4000K
SSSKDWBFR48LZ40W4000LDMV40KWH	46.00"L x 3"W x 3"H / Occ Sensor / Frosted Lens / 40W, 4000L / 0-10V Dim / 4000K
SSSKDWBFR48LZ72W7000LDMV40KWH	46.00"L x 3"W x 3"H / Occ Sensor / Frosted Lens / 72W, 7000L / 0-10V Dim / 4000K
SSSKDWBFR96LZ80W8000LDMV40KWH	92.00"L x 3"W x 3"H / Occ Sensor / Frosted Lens / 80W, 8000L / 0-10V Dim / 4000K
SSSKDWBFR96LZ114W10800LDMV40KWH	92.00"L x 3"W x 3"H / Occ Sensor / Frosted Lens / 114W, 10800L / 0-10V Dim / 4000K

EM6 G120 OS2 RGBW D1MV 90CRI CCT1 X1LED FLUOR

## Sensor Switch SFOD 7 in Detail

The SFOD 7 ODP Series sensors provide both Motion and Daylight based control of a 0-10 VDC dimmable outdoor or wet location luminaire. The SFOD 7 ODP can dim and turn on/off its connected lighting. For motion detection, the sensors utilize 100% Digital Passive Infrared (PIR) technology that is tuned for walking size motion while preventing false tripping from the environment. The SFOD 7 ODP's integrated photocell enables additional energy savings during daytime periods when there is sufficient daylight.

### SPECIAL FEATURES

- Adjustable Time Delays, Max/Min Dim Levels, and Ramp Rates
- Programming Button Accessible w/o Opening Sensor or Removing Gasketing for Outdoor/Wet locations
- No Field Calibration or Sensitivity Adjustments Required
- Non-Volatile Settings Memory
- Convenient Test Mode



# Linear Wall

Saylite offers a full palette of complementary wall fixtures for every application, in 2", 2.5", 4", and 6" wide profiles. Whether the plan calls for a sleek architectural form or a linear strip, we manufacture it to your specifications.



See Matching Pendants on page 24.

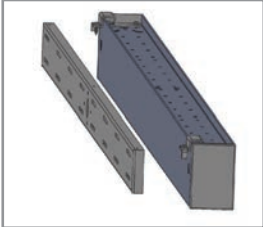

Mounting brackets allows easy installation and floating look.

Ordering is for Direct lighting. For Indirect Lighting Add U after the "L" after the length.



## WALL LINEAR 2" X 3.5" DIRECT ONLY OR INDIRECT ONLY

Our signature micro pendant (2" wide, Direct or Indirect only) is suitable for modern corridors, lobbies and offices and can be installed individually or in continuous run. Snap-in lens hides LED arrays and provides excellent glare control. Consult for custom sizes or configured in patterns.

ITEM NO.	DESCRIPTION
L23WSF24LT13W1300LDMV40KWH	24"L x 2"W x 3"H / Frosted Lens / 13W, 1300L / 0-10V Dim / 4000K / White / Wall Mount Bracket
L23WSF24LT19W1900LDMV40KWH	24"L x 2"W x 3"H / Frosted Lens / 19W, 1900L / 0-10V Dim / 4000K / White / Wall Mount Bracket
L23WSF24LT23W2300LDMV40KWH	24"L x 2"W x 3"H / Frosted Lens / 23W, 2300L / 0-10V Dim / 4000K / White / Wall Mount Bracket
L23WSF48LT26W2600LDMV40KWH	48"L x 2"W x 3"H / Frosted Lens / 26W, 2600L / 0-10V Dim / 4000K / White / Wall Mount Bracket
L23WSF48LT38W3800LDMV40KWH	48"L x 2"W x 3"H / Frosted Lens / 38W, 3800L / 0-10V Dim / 4000K / White / Wall Mount Bracket
L23WSF48LT45W4500LDMV40KWH	48"L x 2"W x 3"H / Frosted Lens / 45W, 4500L / 0-10V Dim / 4000K / White / Wall Mount Bracket
L23WSF96LT52W5200LDMV40KWH	96"L x 2"W x 3"H / Frosted Lens / 52W, 5200L / 0-10V Dim / 4000K / White / Wall Mount Bracket
L23WSF96LT76W7600LDMV40KWH	96"L x 2"W x 3"H / Frosted Lens / 76W, 7600L / 0-10V Dim / 4000K / White / Wall Mount Bracket
L23WSF96LT90W9000LDMV40KWH	96"L x 2"W x 3"H / Frosted Lens / 90W, 9000L / 0-10V Dim / 4000K / White / Wall Mount Bracket

EM3 G120 OS2 D1MV 90CRI CCT1 SURF PEND REC

## WALL LINEAR 2" X 3.5" DIRECT/INDIRECT

Our signature micro pendant (2" wide, Uplight and Downlight) is suitable for modern corridors, lobbies and offices and can be installed individually or in continuous run. Snap-in lens hides LED arrays and provides excellent glare control.

L23WSF24LUV6WDT12WDMV40KWH	24"L x 2"W x 3"H / Frosted Lens / Up 6W, Dn 12W, 1800L / 0-10V Dim / 4000K / White / Wall Mount Bracket
L23WSF24LUV9WDT18WDMV40KWH	24"L x 2"W x 3"H / Frosted Lens / Up 9W, Dn 18W, 2700L / 0-10V Dim / 4000K / White / Wall Mount Bracket
L23WSF48LUV12WDT24WDMV40KWH	48"L x 2"W x 3"H / Frosted Lens / Up 12W, Dn 24W, 3600L / 0-10V Dim / 4000K / White / Wall Mount Bracket
L23WSF48LUV18WDT36WDMV40KWH	48"L x 2"W x 3"H / Frosted Lens / Up 18W, Dn 36W, 5400L / 0-10V Dim / 4000K / White / Wall Mount Bracket
L23WSF96LUV24WDT48WDMV40KWH	96"L x 2"W x 3"H / Frosted Lens / Up 24W, Dn 48W, 7200L / 0-10V Dim / 4000K / White / Wall Mount Bracket
L23WSF96LUV36WDT72WDMV40KWH	96"L x 2"W x 3"H / Frosted Lens / Up 36W, Dn 72W, 10800L / 0-10V Dim / 4000K / White / Wall Mount Bracket

EM3 G120 OS2 D1MV 90CRI CCT1 SURF PEND REC

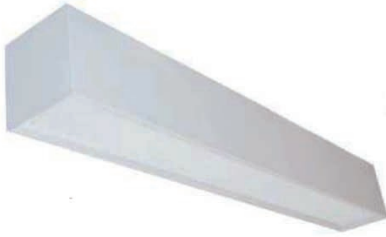

## WALL LED LINEAR 4" X 4" DIRECT OR INDIRECT ONLY

The 4" x 4" steel profile provides a bold architectural look used individually or in continuous lengths to provide comfortable, bright general lighting. Snap fit frosted lens hides the LED arrays and provides excellent glare control. Easy to join, and easy to install. Available in standard sizes, outputs and finishes with a vast array of custom options.

ITEM NO.	DESCRIPTION
<b>Direct</b>	
44WSF48LR24W2400LDMV40KWH	48"L x 4"W x 4"H / Frosted Lens / 24W, 2400L / 0-10V Dim / 4000K / White
44WSF48LR48W4800LDMV40KWH	48"L x 4"W x 4"H / Frosted Lens / 48W, 4800L / 0-10V Dim / 4000K / White
44WSF96LR48W4800LDMV40KWH	96"L x 4"W x 4"H / Frosted Lens / 48W, 4800L / 0-10V Dim / 4000K / White
44WSF96LR96W9600LDMV40KWH	96"L x 4"W x 4"H / Frosted Lens / 96W, 9600L / 0-10V Dim / 4000K / White

EM6 G120 OS2 RGBW D1MV 90CRI CCT1 SURF PEND REC X1LED FLUOR



## WALL LED LINEAR 4" X 4" DIRECT/INDIRECT ONLY

The 4" x 4" steel profile provides a bold architectural look used individually or in continuous lengths to provide comfortable, bright general lighting. Snap fit frosted lens hides the LED arrays and provides excellent glare control. Easy to join, and easy to install. Available in standard sizes, outputs and finishes with a vast array of custom options.

ITEM NO.	DESCRIPTION
<b>Direct</b>	
44WSF48LUR12WD24WDMV40KWH	48"L x 4"W x 4"H / Frosted Lens / Up 12W, Dn 24W, 3600L / 0-10V Dim / 4000K / White
44WSF48LUR18WD36WDMV40KWH	48"L x 4"W x 4"H / Frosted Lens / Up 18W, Dn 36W, 5400L / 0-10V Dim / 4000K / White
44WSF96LUR24WD48WDMV40KWH	96"L x 4"W x 4"H / Frosted Lens / Up 24W, Dn 48W, 7200L / 0-10V Dim / 4000K / White
44WSF96LUR36WD72WDMV40KWH	96"L x 4"W x 4"H / Frosted Lens / Up 36W, Dn 72W, 10800L / 0-10V Dim / 4000K / White

EM6 G120 OS2 RGBW D1MV 90CRI CCT1 SURF PEND REC X1LED FLUOR



## WALL LED LINEAR 4" X 5" DIRECT/INDIRECT ONLY

Designed for distinctive architectural lighting plans, this linear 4" X 5" pendant (direct and indirect) can be installed individually or in group patterns. The snap fit lens provides excellent lighting and the five inch height makes a bold statement.

ITEM NO.	DESCRIPTION
45WSF48LUR12WD24WDMV40KWH	48"L x 4"W x 5"H / Frosted Lens / Up 12W, Dn 24W, 3600L / 0-10V Dim / 4000K / White
45WSF48LUR18WD36WDMV40KWH	48"L x 4"W x 5"H / Frosted Lens / Up 18W, Dn 36W, 5400L / 0-10V Dim / 4000K / White
45WSF96LUR24WD48WDMV40KWH	96"L x 4"W x 5"H / Frosted Lens / Up 24W, Dn 48W, 7200L / 0-10V Dim / 4000K / White
45WSF96LUR36WD72WDMV40KWH	96"L x 4"W x 5"H / Frosted Lens / Up 36W, Dn 72W, 10800L / 0-10V Dim / 4000K / White

EM6 G120 OS2 RGBW D1MV 90CRI CCT1 PEND



# Linear Wall



See Matching Pendants or Surface Mounts on page 27.

Shown with baffled louvre. Change SF to BL.

## WALL LINEAR 6" X 6" DIRECT ONLY OR INDIRECT ONLY

This geometric 6" fixture adds a distinctive architectural element to any layout and is ideal for corridors, lobbies, and office areas. The efficient LED T8 lamps provide high lumen output with significant energy savings.

ITEM NO.	DESCRIPTION
66WSF48LR24W2400LDMV40KWH	48"L x 6"W x 6"H / Frosted Lens / 24W, 2400L / 0-10V Dim / 4000K / White
66WSF48LR48W4800LDMV40KWH	48"L x 6"W x 6"H / Frosted Lens / 48W, 4800L / 0-10V Dim / 4000K / White
66WSF96LR48W4800LDMV40KWH	96"L x 6"W x 6"H / Frosted Lens / 48W, 4800L / 0-10V Dim / 4000K / White
66WSF96LR96W9600LDMV40KWH	96"L x 6"W x 6"H / Frosted Lens / 96W, 9600L / 0-10V Dim / 4000K / White

EM6 G120 OS2 RGBW D1MV 90CRI CCT1 SURF PEND REC X1LED FLUOR

Change SF to MW for Matte White Lens.

## WALL LINEAR 6" X 6" DIRECT/INDIRECT

This geometric 6" fixture adds a distinctive architectural element to any layout and is ideal for corridors, lobbies, and office areas. The efficient LED T8 lamps provide high lumen output with significant energy savings.



ITEM NO.	DESCRIPTION
66WSF48LUR12WD24WDMV40KWH	48"L x 6"W x 6"H / Frosted Lens / Up 12W, Dn 24W, 3600L / 0-10V Dim / 4000K / White
66WSF48LUR24WD48WDMV40KWH	48"L x 6"W x 6"H / Frosted Lens / Up 18W, Dn 36W, 5400L / 0-10V Dim / 4000K / White
66WSF96LUR24WD48WDMV40KWH	96"L x 6"W x 6"H / Frosted Lens / Up 24W, Dn 48W, 7200L / 0-10V Dim / 4000K / White
66WSF96LUR36WD72WDMV40KWH	96"L x 6"W x 6"H / Frosted Lens / Up 36W, Dn 72W, 10800L / 0-10V Dim / 4000K / White

EM6 G120 OS2 RGBW D1MV 90CRI CCT1 PEND

Change SF to MW for Matte White Lens.

## BED LIGHT DIRECT/INDIRECT

A sleek light provides both great light to read and functional light for an exam as well as softer indirect light for comfort and relaxation. Available with dual control options for wall or pull chain.



ITEM NO.	DESCRIPTION
STWFR24LY13W1300LDMV40K	24"L x 5.60"W x 4.58"H / Frosted Lens / 13W, 1300L / 0-10V Dim / 4000K / White
STWFR24LY23W2300LDMV40K	24"L x 5.60"W x 4.58"H / Frosted Lens / 23W, 2300L / 0-10V Dim / 4000K / White
STWFR48LY26W2600LDMV40K	48"L x 5.60"W x 4.58"H / Frosted Lens / 26W, 2600L / 0-10V Dim / 4000K / White
STWFR48LY45W4500LDMV40K	48"L x 5.60"W x 4.58"H / Frosted Lens / 45W, 4500L / 0-10V Dim / 4000K / White
STWFR24LUY12WD24WDMV40K	24"L x 5.60"W x 4.58"H / Frosted Lens / Up 12W, Dn 24W, 3600L / 0-10V Dim / 4000K / White
STWFR48LUY24WD48WDMV40K	48"L x 5.60"W x 4.58"H / Frosted Lens / Up 24W, Dn 48W, 7200L / 0-10V Dim / 4000K / White

EM6 G120 OS4 RGBW D1MV 90CRI CCT1

For separately switching, add 11 after DMV. For 4 way pull chain, add PC4.

## SLOTTED LOW PROFILE LED LINEAR PENDANT

The clean SLW's lines are ideal for general lighting for circulation spaces, high impact areas, kitchen islands, and offices. Can be pendant-mounted individually or in continuous runs. Add sensors. Smart sensors available.



Shown with wall mount brackets.

ITEM NO.	DESCRIPTION
<b>Downlight Only</b>	
SLWFR48LS48W4800LDMV40KWH	48"L x 7.70"W x 2"W / Frosted Lens / 48W, 4800L / 0-10V Dim / 4000K / White
SLWFR96LS96W9600LDMV40KWH	96"L x 7.70"W x 2"W / Frosted Lens / 96W, 9600L / 0-10V Dim / 4000K / White
<b>Direct/Indirect</b>	
SLWFR48LUS12WD24WDMV40KWH	48"L x 7.70"W x 2"W / Frosted Lens / Up 12W, Dn 24W, 3600L / 0-10V Dim / 4000K / White
SLWFR48LUS18WD36WDMV40KWH	48"L x 7.70"W x 2"W / Frosted Lens / Up 18W, Dn 36W, 5400L / 0-10V Dim / 4000K / White
SLWFR96LUS24WD48WDMV40KWH	96"L x 7.70"W x 2"W / Frosted Lens / Up 24W, Dn 48W, 7200L / 0-10V Dim / 4000K / White
SLWFR96LUS36WD72WDMV40KWH	96"L x 7.70"W x 2"W / Frosted Lens / Up 36W, Dn 72W, 10800L / 0-10V Dim / 4000K / White

EM6 G120 OS2 RGBW D1MV 90CRI CCT1 SURF WALL X1LEDT5 FLUORT5

Special size EM adder \$130.00

## WALL LED LINEAR INDIRECT ONLY

This sleek, graceful, low profile (2.1" high and 7.9" wide) fixture features a choice of die-cast end caps as well as three choices of diffusers. Available in 4-foot and 8-foot lengths or continuous run. High efficiency optics include a specular aluminum reflector that is designed to provide a wide distribution for 100% uplight and just a hint of downlight.



Louvered (LV)

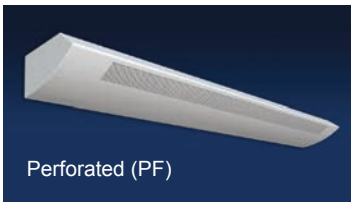

Perforated (PF)



Matte White Lens (MV)

ITEM NO.	DESCRIPTION
WLINMW48LUJ24WD12WDMV40KWH	48"L x 5.03"W x 2.68"H / Perforated / Up 24W, Dn 12W, 3600L / 0-10V Dim / 4000K / White / 4ft WH Canopy Kit with 5 Wire Cord
WLINMW48LUJ36WD18WDMV40KWH	48"L x 5.03"W x 2.68"H / Perforated / Up 36W, Dn 18W, 5400L / 0-10V Dim / 4000K / White / 4ft WH Canopy Kit with 5 Wire Cord
WLINMW96LUJ48WD24WDMV40KWH	96"L x 5.03"W x 2.68"H / Perforated / Up 48W, Dn 24W, 7200L / 0-10V Dim / 4000K / White / 4ft WH Canopy Kit with 5 Wire Cord
WLINMW96LUJ72WD36WDMV40KWH	96"L x 5.03"W x 2.68"H / Perforated / Up 72W, Dn 36W, 10800L / 0-10V Dim / 4000K / White / 4ft WH Canopy Kit with 5 Wire Cord

EM3 G120 RGBW D1MV 90CRI CCT1

Consult for other Direct/Indirect Options. Change WH to BN for Brushed Nickel.  
For Louver, change MW to LV.  
For Perforated, change MW to PF.

Most fixtures are available in a range of finishes, see page 156.

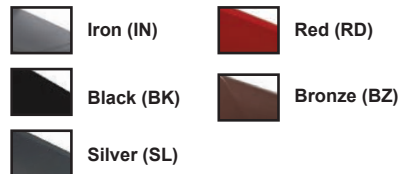

# Linear Wall



## 4" WALL LINEAR

A stylish luminaire with a variety of LED combinations and sizes enhanced by a linear-sided acrylic diffuser. Designed for baths, kitchens, rec rooms, corridors, aisles, stairwells, and over mirrors and displays.

ITEM NO.	DESCRIPTION
555A24LF24W2900LDMV40KWH	24"L x 5.62"W x 4.5"H / Prismatic Acrylic Lens / 24W, 2900L / 0-10V Dim / 4000K / White
555A24LF28W3200LDMV40KWH	24"L x 5.62"W x 4.5"H / Prismatic Acrylic Lens / 28W, 3200L / 0-10V Dim / 4000K / White
555A24LF35W4000LDMV40KWH	24"L x 5.62"W x 4.5"H / Prismatic Acrylic Lens / 35W, 4000L / 0-10V Dim / 4000K / White
555A48LF30W4100LDMV40KWH	48"L x 5.62"W x 4.5"H / Prismatic Acrylic Lens / 30W, 4100L / 0-10V Dim / 4000K / White
555A48LF48W6000LDMV40KWH	48"L x 5.62"W x 4.5"H / Prismatic Acrylic Lens / 48W, 6000L / 0-10V Dim / 4000K / White
555A48LF57W6900LDMV40KWH	48"L x 5.62"W x 4.5"H / Prismatic Acrylic Lens / 57W, 6900L / 0-10V Dim / 4000K / White
555A48LH72W8800LDMV40KWH	48"L x 5.62"W x 4.5"H / Prismatic Acrylic Lens / 72W, 8800L / 0-10V Dim / 4000K / White

EM1 G120 RGBW D1MV 90CRI CCT1 X1LED FLUOR

For Matt White Lens, change "A" to "MW".

## DIRECT/INDIRECT WALL FIXTURE

This clean, crisp, spec-grade fixture is designed for "over the bed" applications and may also be used in bath, stairwells, and office applications. Up and down light may be controlled with optional dividers, front baffles, and dual drivers. Also available with pull chain.

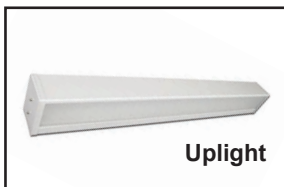

ITEM NO.	DESCRIPTION
215A24L1U1DS24W2400LDFDMV40K	24"L x 5.62"W x 4.50"H / Prismatic Acrylic / 1U1D / 24W, 2400L / 0-10V Dim / 4000K
215A24L1U2DS36W3600LDFDMV40K	24"L x 5.62"W x 4.50"H / Prismatic Acrylic / 1U2D / 36W, 3600L / 0-10V Dim / 4000K
215A24L2U1DS36W3600LDFDMV40K	24"L x 5.62"W x 4.50"H / Prismatic Acrylic / 2U1D / 36W, 3600L / 0-10V Dim / 4000K
215A24L2U2DS48W4800LDFDMV40K	24"L x 5.62"W x 4.50"H / Prismatic Acrylic / 2U2D / 48W, 4800L / 0-10V Dim / 4000K
215A48L1U1DS48W4800LDFDMV40K	48"L x 5.62"W x 4.50"H / Prismatic Acrylic / 1U1D / 48W, 4800L / 0-10V Dim / 4000K
215A48L1U2DS73W7200LDFDMV40K	48"L x 5.62"W x 4.50"H / Prismatic Acrylic / 1U2D / 73W, 7200L / 0-10V Dim / 4000K
215A48L2U1DS73W7200LDFDMV40K	48"L x 5.62"W x 4.50"H / Prismatic Acrylic / 2U1D / 73W, 7200L / 0-10V Dim / 4000K
215A48L2U2DS97W9600LDFDMV40K	48"L x 5.62"W x 4.50"H / Prismatic Acrylic / 2U2D / 97W, 9600L / 0-10V Dim / 4000K

EM1 G120 RGBW D1MV 90CRI CCT1 X1LED FLUOR

For separately switching, add 11 after DMV.. For 4 way pull chain, add PC4.

## LINEAR WALL DOWNLIGHT

This wall-mounted downlight is ideal for lobbies, bathrooms, and office areas and may be installed individually or in group patterns.



ITEM NO.	DESCRIPTION
LWDFR48LS30W2400LDMV40KWH	48"L x 4.43"W x 5.98"H / Frosted Lens / 30W, 2400L / 0-10V Dim / 4000K / White
LWDFR48LS48W3500LDMV40KWH	48"L x 4.43"W x 5.98"H / Frosted Lens / 48W, 3500L / 0-10V Dim / 4000K / White
LWDFR48LS57W4000LDMV40KWH	48"L x 4.43"W x 5.98"H / Frosted Lens / 57W, 4000L / 0-10V Dim / 4000K / White

EM3 G120 RGBW D1MV 90CRI CCT1

## LED LINEAR 3" LOW PROFILE

A slightly wider profile allowing for higher output in shorter runs and integral emergency driver.

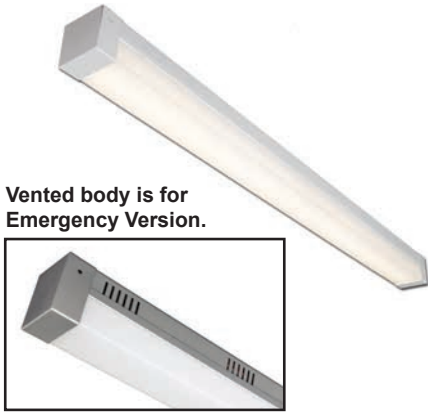

Vented body is for Emergency Version.

For Silver, Change WH to SL. For Bronze, Change WH to BZ. Sensor options available. See pg 157.

ITEM NO.	DESCRIPTION
SKDWBFR24LJ35W3400LDMV40KWH	23.84"L x 3"W x 3"H / Frosted Lens / 35W, 3400L / 0-10V Dim / 4000K
SKDWBFR48LJ40W4000LDMV40KWH	46.00"L x 3"W x 3"H / Frosted Lens / 40W, 4000L / 0-10V Dim / 4000K
SKDWBFR48LZ72W7000LDMV40KWH	46.00"L x 3"W x 3"H / Frosted Lens / 72W, 7000L / 0-10V Dim / 4000K
SKDWBFR96LJ80W8000LDMV40KWH	92.00"L x 3"W x 3"H / Frosted Lens / 80W, 8000L / 0-10V Dim / 4000K
SKDWBFR96LZ114W10800LDMV40KWH	92.00"L x 3"W x 3"H / Frosted Lens / 114W, 10800L / 0-10V Dim / 4000K

EM3 G120 OS2 RGBW D1MV 90CRI CCT1 X1LED FLUOR

## LED LINEAR 2" LOW PROFILE

Featuring a micro silhouette, the frosted diffuser is scaled to the LED module and surrounds the LEDs for soft lighting.



Shown in Silver. Change WH to SL and. See pg 156 for additional finishes.

ITEM NO.	DESCRIPTION
SKDFR24LJ12W1200LDMV40KWH	24.00"L x 2"W x 2.60"H / Frosted Lens / 12W, 1200L / 0-10V Dim / 4000K
SKDFR48LJ28W2800LDMV40KWH	46.00"L x 2"W x 2.60"H / Frosted Lens / 28W, 2800L / 0-10V Dim / 4000K
SKDFR48LJ35W3400LDMV40KWH	46.00"L x 2"W x 2.60"H / Frosted Lens / 35W, 3400L / 0-10V Dim / 4000K
SKDFR96LJ57W5400LDMV40KWH	92.00"L x 2"W x 2.60"H / Frosted Lens / 57W, 5400L / 0-10V Dim / 4000K
SKDFR96LJ72W7000LDMV40KWH	92.00"L x 2"W x 2.60"H / Frosted Lens / 72W, 7000L / 0-10V Dim / 4000K

EM3 G120 OS2 RGBW D1MV 90CRI CCT1 X1LED FLUOR

## LINEAR 2" ROUND STRIP

Featuring a micro silhouette scaled to the LED module. The matte white diffuser surrounds the LEDs for soft lighting. Available with smooth frosted lens. New designer matching ends ideal for a variety of applications.

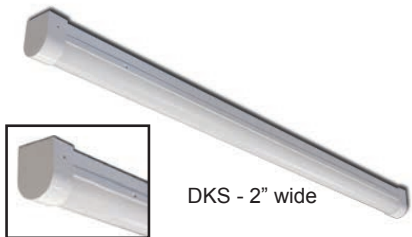

DKSWB - 3" wide

New Designer matching ends for high-end aesthetic.

ITEM NO.	DESCRIPTION
DKSMW24LZ18W1900LDMV40KWH	24.00"L x 2"W x 2.60"H / Matt White Lens / 18W, 1900L / 0-10V Dim / 4000K
DKSMW48LZ35W3800LDMV40KWH	46.25"L x 2"W x 2.60"H / Matt White Lens / 35W, 3800L / 0-10V Dim / 4000K
DKSWBMW48LZ40W4000LDMV40KWH	46.25"L x 3"W x 3.00"H / Matt White Lens / 40W, 4000L / 0-10V Dim / 4000K
DKSWBMW96LZ80W8000LDMV40KWH	92.00"L x 3"W x 3.00"H / Matt White Lens / 80W, 8000L / 0-10V Dim / 4000K
DKSWBMW96LZ114W10800LDMV40KWH	92.00"L x 3"W x 3.00"H / Matt White Lens / 114W, 10800L / 0-10V Dim / 4000K

EM3 G120 RGBW D1MV 90CRI CCT1 X1LED FLUOR

Available in BN, BK or BZ and consult for adder. Consult for other wattages & lumens.

# Stairwell Lighting

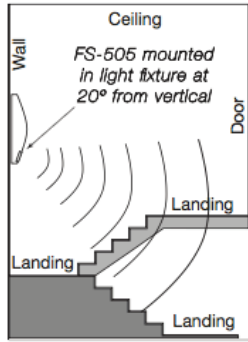

FS-505 Mounted in Stairwell

**Ultrasonic technology for open area detection and line of sight obstructions.**

Choose the percentage of light output (XX) that you want when space is unoccupied.

Saylite SMARTSENSE is an integral ultrasonic occupancy sensor to sense motion within a space and automatically turn on lights even when the sensor has no direct line of sight to occupants. After the area is vacated and the time delay has elapsed, the sensors automatically turn the lights off. Ultrasonic detection operates by transmitting sound waves throughout an area and measuring the speed at which they return. Movement increases the return frequency which indicates occupancy. Saylite Ultrasonic smart sensors provide functions for testing, overriding the fixture "ON."

## STAIRWELL STANDARD

This sleek, spec-grade, wall-mounted fixture with SMARTSENSE and forward throw optics is ideal for brightening the perimeters of offices or when used as a wall lighting system for corridors.



ITEM NO.	DESCRIPTION
SSSTWFR24LE15W2050LDMV(XX)40K	24"L x 5.62"W x 4.5"H / Frosted Lens / 15W, 2050L / 0-10V Dim / 4000K / White
SSSTWFR24LE24W3000LDMV(XX)40K	24"L x 5.62"W x 4.5"H / Frosted Lens / 24W, 3000L / 0-10V Dim / 4000K / White
SSSTWFR48LE48W6000LDMV(XX)40K	48"L x 5.62"W x 4.5"H / Frosted Lens / 46W, 5500L / 0-10V Dim / 4000K / White
SSSTWFR48LE57W6900LDMV(XX)40K	48"L x 5.62"W x 4.5"H / Frosted Lens / 46W, 5500L / 0-10V Dim / 4000K / White

EM4 G120 OS4 D1MV 90CRI CCT1

(XX) for Percentage of light output when it is not occupied.

## STAIRWELL LINEAR LED W/ 20% OUTPUT AND EMERGENCY UNIT

This sleek, spec-grade, wall-mounted fixture with SMARTSENSE and forward throw optics is preset for 20% output in standby mode and has an integrated emergency backup.



ITEM NO.	DESCRIPTION
SSSTWFR48LY46W5500LDMV(20)40KEM	48"L x 5.62"W x 4.5"H / Frosted Lens / 46W, 5500L / 0-10V Dim / 4000K / White / 10W EM

EM4 G120 OS4 D1MV 90CRI CCT1

Fixed output driver. No variations.

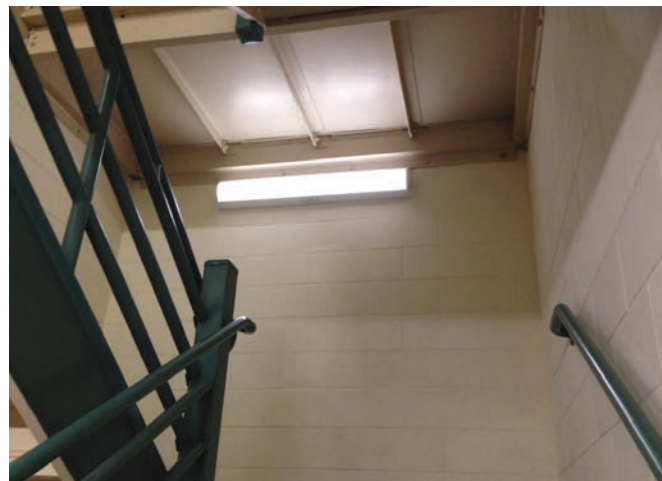



## LED STAIRWELL LINEAR WITH ROUND OR FLAT LENS

A spec-grade wall-mounted fixture for “over the bed” applications, as well as bath, stairwell and office applications. Offered with a choice of round or flat lens. Features Saylite SMARTSENSE technology.



SSSTR



SSSTS

ITEM NO.	DESCRIPTION
SSSTRMW24LE27W2000LDMV(XX)40K	24.25"L x 4.31"W x 3.44"H / Half Moon Matt WH Lens / 27W, 2000L / 0-10V Dim / 4000K / White
SSSTRMW48LE36W2800LDMV(XX)40K	46.25"L x 4.31"W x 3.44"H / Half Moon Matt WH Lens / 36W, 2800L / 0-10V Dim / 4000K / White
SSSTSMW24LE27W2000LDMV(XX)40K	24.25"L x 4.47"W x 3.16"H / Rectangular Matt WH Lens / 27W, 2000L / 0-10V Dim / 4000K / White
SSSTSMW48LE36W2800LDMV(XX)40K	46.25"L x 4.47"W x 3.16"H / Rectangular Matt WH Lens / 36W, 2800L / 0-10V Dim / 4000K / White

EM1 G120 OS4 D1MV 90CRI CCT1

(XX) for Percentage of Light Output When it is not Occupied.

## LED STAIRWELL LINEAR 4" SQUARE

This clean, crisp, spec-grade fixture is designed for “over the bed” applications and may also be used in bath, stairwells, and office applications. Up and down light may be controlled with optional dividers, front baffles, and dual drivers. Features Saylite SMARTSENSE technology.



All SMARTSENSE fixtures are available with multiple sensor options. See pg 157 for sensor options.

ITEM NO.	DESCRIPTION
SS213A24LE15W1500LDMV(XX)40K	24.25"L x 4.4"W x 4.5"H / Prismatic Acrylic Frosted Lens / 15W, 1500L / 0-10V Dim / 4000K / White
SS213A24LE24W2700LDMV(XX)40K	24.25"L x 4.4"W x 4.5"H / Prismatic Acrylic Frosted Lens / 24W, 2400L / 0-10V Dim / 4000K / White
SS213A48LE48W4800LDMV(XX)40K	48.25"L x 4.4"W x 4.5"H / Prismatic Acrylic Frosted Lens / 48W, 4800L / 0-10V Dim / 4000K / White
SS213A48LE57W5700LDMV(XX)40K	48.25"L x 4.4"W x 4.5"H / Prismatic Acrylic Frosted Lens / 57W, 5700L / 0-10V Dim / 4000K / White
SS213A48LY45W4500LDMV(20)40KEM	48.25"L x 4.4"W x 4.5"H / Prismatic Acrylic Frosted Lens / 45W, 4500L / 0-10V Dim / 4000K / White / 10W EM

EM1 G120 OS4 D1MV 90CRI CCT1 X1LED FLUOR

(XX) for Percentage of light output when it is not occupied.

## DLC Qualified

Saylite tests all its LED products against DLC performance criteria for the applicable product category. Most, if not all, Saylite products meet DLC criteria. Saylite submits, on a continuing basis, the test results to DLC to add their products to the list.

Saylite focuses its product line and DLC submittals to maximize the value to our customers. In cases where utility rebates aren't plentiful, we make sure we offer the full performance criteria without the unnecessary mark-up required to pay for the DLC listing.

Search our latest DLC Listings at <https://www.designlights.org/search>



# Linear Wall



**MCT** - Provides choice of 3000, 3500 or 4000 kelvin from the same fixture with a dip switch.

## LED SPILL RING BATH

Linear-sided acrylic lens distributes light evenly while reducing glare and providing visual comfort. Ideal for over-vanity bath applications.

ITEM NO.	DESCRIPTION
HOTBD24L23W2195LMVSNMCT	24.6"L x 5.7"W x 4.4"E / 23W, 2195L / 120-277V / Satin Nickel / Dip Switch for 3000K, 3500K or 4000K / Non Dim
HOTBD36L34W3260LMVSNMCT	36.75"L x 6"W x 4.25"E / 34W, 3265L / 120-277V / Satin Nickel / Dip Switch for 3000K, 3500K or 4000K / Non Dim
HOTBD48L48W4590LMVSN30K	48.75"L x 6"W x 4.3"E / 48W, 4590L / 120-277V / Satin Nickel / 3000K or 4000K / Non Dim

EM3 G120 90CRI CCT4 SURF X1LED FLUOR

Consult for Bronze ends.

## LED ROUND LINEAR WITH CHOICE OF END CAPS

This end cap bath bar series provides a choice of cost-effective stylish lighting solutions. Specify solid white, clear fluted, or white fluted diffuser.



ITEM NO.	DESCRIPTION
VAN24LS24W1800LDMV40KSW	25.5"L x 4.75"W x 4.00"E / 24W, 1800L / 0-10V Dim / 4000K / Solid White
VAN24LS28W2000LDMV40KSW	25.5"L x 4.75"W x 4.00"E / 28W, 2000L / 0-10V Dim / 4000K / Solid White
VAN48LS32W2850LDMV40KSW	49.5"L x 4.75"W x 4.00"E / 32W, 2850L / 0-10V Dim / 4000K / Solid White
VAN48LS48W4000LDMV40KSW	49.5"L x 4.75"W x 4.00"E / 48W, 4000L / 0-10V Dim / 4000K / Solid White
VAN48LS57W4500LDMV40KSW	49.5"L x 4.75"W x 4.00"E / 57W, 4500L / 0-10V Dim / 4000K / Solid White

EM3 G120 D1MV 90CRI CCT1 SURF X1LED FLUOR

Change SW to BM (Black Marble), IV (Ivory Marble), etc for end cap in different finish. See specification for more end cap choices. Add after VAN, WR for White Ribbed, CR - Clear Ribbed, FR - For Frosted Ribbed.

## LED WALL PUFF

A contemporary, narrow white cloud. The diffuser fully encloses the fixture, providing a clean appearance. Can be mounted vertically or horizontally.



ITEM NO.	DESCRIPTION
WPU24LS24W2250LDMV40K	27"L x 6"W x 2.75"E / 24W, 2250L / 0-10V Dim / 4000K
WPU48LS48W4500LDMV40K	51"L x 6"W x 2.75"E / 48W, 4500L / 0-10V Dim / 4000K

EM3 G120 D1MV 90CRI CCT1 SURF X1LED FLUOR

### Options to Make It "Your Way"

EM1 SURF X1LED

The icons listed under every series identifies all of the options available for that series, including color temperatures, emergencies, sensors/controls, coordinating applications and more. See pages 154 and 155 for full explanations of each icon.

## LED Linkable Undercabinet

Acrylic prismatic lens distributes light evenly while reducing glare and providing visual comfort.



**MCT** - Provides choice of 3000, 3500 or 4000 kelvin from the same fixture with a dip switch.

ITEM NO.	DESCRIPTION
LUC9L5WD120MCT	9"L x 5"W x 1"H / 5W, 250L / D120V / Color Selectable 30/35/40K / Finish: White
LUC12L6WD120MCT	12"L x 5"W x 1"H / 6W, 450L / D120V / Color Selectable 30/35/40K / Finish: White
LUC18L9WD120MCT	18"L x 5"W x 1"H / 9W, 675L / D120V / Color Selectable 30/35/40K / Finish: White
LUC24L11WD120MCT	24"L x 5"W x 1"H / 11W, 825L / D120V / Color Selectable 30/35/40K / Finish: White
LUC33L13WD120MCT	33"L x 5"W x 1"H / 13W, 975L / D120V / Color Selectable 30/35/40K / Finish: White
LUC42L16WD120MCT	42"L x 5"W x 1"H / 16W, 1200L / D120V / Color Selectable 30/35/40K / Finish: White

### SURF

Undercabinets come with power cord, joiner cable, butt connector and a BX connector.

## LED Dimmable Undercabinet Task Lighting

Choose from three sizes with integral LEDs and driver that can be used individually with a cord and plug and on/off switch provided or joined together with a mini coupler or 15" joiner cord also supplied with every fixture. An optional Hardwire Junction Box is available for hardwire applications. Less than 3/4" in height makes it one of the shallowest fixtures on the market.



ITEM NO.	DESCRIPTION
LEDDUCL12WH30	12"L x 2"W x 0.63"H / 5W, 250L / 120V / White / 3000K
LEDDUCL18WH30	17.8"L x 2"W x 0.63"H / 8W, 400L / 120V / White / 3000K
LEDDUCL24WH30	24"L x 2"W x 0.63"H / 11W, 550L / 120V / White / 3000K
LEDDUCLJBOXWH	HARDWIRE JUNCTION BOX / 4.25"L x 1.875"W x 1"H / White

### SURF

Each fixture comes with mini coupler and 15" joiner cord, 42" cord and plug with integral on/off switch. Change WH to BZ for Bronze finish.

## LED HIGH LUMEN TAPE

LED tape lighting allows you to easily and inexpensively put light exactly where you need it. Available in warm white, natural, and white.



ITEM NO.	DESCRIPTION
T5050L24V27K*	LED HIGH LUMEN TAPE 1ft PIECES 24v 27K
T5050L24V30K	LED HIGH LUMEN TAPE 1ft PIECES 24v 30K
T5050L24V40K	LED HIGH LUMEN TAPE 1ft PIECES 24v 40K
TCON4M4M	LED 4 PIN TAPE MALE to MALE CONNECTOR
TEXT12IN	LED 12 inch 4 PIN TAPE JUMPER CABLE MtoF
TEXT36IN	LED 36 inch 4 PIN TAPE JUMPER CABLE MtoF
TEXT4IN	LED 4 inch 4 PIN TAPE JUMPER CABLE MtoF
THWCON10	LED 10 foot HARDWIRE CONNECTOR
TTCON	LED 4 PIN TAPE MALE to MALE T CONNECTOR

\*Priced per Foot, 16ft/Reel. Specify remote driver.

## REMOTE DRIVER (Dimmable with any standard MLV Triac (leading edge) control)

ITEM NO.	DESCRIPTION
MTIM20L24DC	Constant Voltage DRIVER 20W 24VDC USE MAGNETIC LV CONTROL
MTIM40L24DC	Constant Voltage DRIVER 40W 24VDC USE MAGNETIC LV CONTROL
MTIM60L24DC	Constant Voltage DRIVER 60W 24VDC USE MAGNETIC LV CONTROL
MTIM96L24DC	Constant Voltage DRIVER 96W 24VDC USE MAGNETIC LV CONTROL
MTIM150L24DC	Constant Voltage DRIVER 150W 24VDC USE MAGNETIC LV CONTROL



Consult for other drivers and wattages.

# High Bays



Saylite offers high-efficiency LED high bay fixtures for warehouse, manufacturing, and commercial facilities – anywhere you need exceptional light distribution for mounting heights up to 40 feet. The LED high bay’s superior lumen package is ideal for replacing traditional metal halide and linear fluorescent high bay systems. The benefits include high efficiency, excellent color rendering, long life, instant on, and improved uniformity. Saylite heavy-duty high bay housings are manufactured from steel for long-lasting performance. Choose from linear or round, lensed or open, and with a wide range of sensors and controls.



**Saylite’s specially engineered High Bays for Aisles provide light in the racks to illuminate the carton labels for greater visibility and energy savings.**



## HIGH BAY WITH AIMABLE AND MODULAR ARRAYS

This industrial open frame unit is the ideal warehouse fixture. Premium full specular mirrored reflectors provide efficient lighting and maximum throw. Available in downlight and uplight configurations, in 2-row, 4-row, and larger. Adjusts 15% for aiming and can be mounted indirect with special accessory clips.



ITEM NO.	DESCRIPTION
HBG48LD104W15000LDMV50K	46.26"L x 12.74"W x 3.62"H / High Bay / 104W, 15000L / 0-10V Dim / 5000K
HBG48LD132W20000LDMV50K	46.26"L x 12.74"W x 3.62"H / High Bay / 132W, 20000L / 0-10V Dim / 5000K
HBG48LD175W25000LDMV50K	46.26"L x 12.74"W x 3.62"H / High Bay / 175W, 25000L / 0-10V Dim / 5000K
HBG48LD215W30000LDMV50K	46.26"L x 19.87"W x 3.62"H / High Bay / 215W, 30000L / 0-10V Dim / 5000K
HBG48LD280W40000LDMV50K	46.26"L x 19.87"W x 3.62"H / High Bay / 280W, 40000L / 0-10V Dim / 5000K
HBG48LD355W50000LDMV50K	46.26"L x 19.87"W x 3.62"H / High Bay / 355W, 50000L / 0-10V Dim / 5000K

EM1 OS2 D1MV 90CRI CCT1 SURF PEND X1LED FLUOR

with Lens



Shown in Black. Add BK to end of item number.

Each of the Four Linear LEDs are Separately Enclosed and Aimable.



ITEM NO.	DESCRIPTION
HBG48LFRD104W13000LDMV50K	46.26"L x 12.74"W x 3.62"H / High Bay / Frosted Lens / 104W, 13000L / 0-10V Dim / 5000K
HBG48LFRD132W16500LDMV50K	46.26"L x 12.74"W x 3.62"H / High Bay / Frosted Lens / 132W, 16500L / 0-10V Dim / 5000K
HBG48LFRD175W21000LDMV50K	46.26"L x 12.74"W x 3.62"H / High Bay / Frosted Lens / 175W, 21000L / 0-10V Dim / 5000K
HBG48LFRD215W27000LDMV50K	46.26"L x 19.87"W x 3.62"H / High Bay / Frosted Lens / 215W, 27000L / 0-10V Dim / 5000K
HBG48LFRD280W35000LDMV50K	46.26"L x 19.87"W x 3.62"H / High Bay / Frosted Lens / 280W, 35000L / 0-10V Dim / 5000K
HBG48LFRD355W40000LDMV50K	46.26"L x 19.87"W x 3.62"H / High Bay / Frosted Lens / 355W, 40000L / 0-10V Dim / 5000K

EM1 OS2 D1MV 90CRI CCT1 SURF PEND X1LED FLUOR

Consult for 2 Row Version.

with Sensor



SSHBG48LD104W15000LDMV50K	46.26"L x 12.74"W x 3.62"H / High Bay / Occ Sensor / 104W, 15000L / 0-10V Dim / 5000K
SSHBG48LD132W20000LDMV50K	46.26"L x 12.74"W x 3.62"H / High Bay / Occ Sensor / 132W, 20000L / 0-10V Dim / 5000K
SSHBG48LD175W25000LDMV50K	46.26"L x 12.74"W x 3.62"H / High Bay / Occ Sensor / 175W, 25000L / 0-10V Dim / 5000K
SSHBG48LD215W30000LDMV50K	46.26"L x 19.87"W x 3.62"H / High Bay / Occ Sensor / 215W, 30000L / 0-10V Dim / 5000K
SSHBG48LD280W40000LDMV50K	46.26"L x 19.87"W x 3.62"H / High Bay / Occ Sensor / 280W, 40000L / 0-10V Dim / 5000K
SSHBG48LD355W50000LDMV50K	46.26"L x 19.87"W x 3.62"H / High Bay / Occ Sensor / 355W, 50000L / 0-10V Dim / 5000K

EM1 OS2 D1MV 90CRI CCT1 SURF PEND X1LED FLUOR

Consult for DLC Versions

The Next Generation of High Bays is Here!



# High Bays



Slim profile with an integrated lens.

## LENSED HIGH BAY NEW

An economical lensed high bay provides the high light output, glare-free operation and long life required for the most demanding applications.

ITEM NO.	DESCRIPTION
HBCL48LN127W18000LA10DMV50K	48.10"L x 16.39"W x 3.62"H / High Bay / Wrap Around Frosted Lens / 127W, 18000L / 0-10V Dim / 5000K
HBCL48LN162W24000LA10DMV50K	48.10"L x 16.39"W x 3.62"H / High Bay / Wrap Around Frosted Lens / 162W, 24000L / 0-10V Dim / 5000K
HBCL48LN216W30000LA10DMV50K	48.10"L x 16.39"W x 3.62"H / High Bay / Wrap Around Frosted Lens / 216W, 30000L / 0-10V Dim / 5000K
HBCL48LN272W36000LA10DMV50K	48.10"L x 16.39"W x 3.62"H / High Bay / Wrap Around Frosted Lens / 272W, 36000L / 0-10V Dim / 5000K
HBCL48LN305W40000LA10DMV50K	48.10"L x 16.39"W x 3.62"H / High Bay / Wrap Around Frosted Lens / 305W, 40000L / 0-10V Dim / 5000K
HBCL48LN380W50000LA10DMV50K	48.10"L x 16.39"W x 3.62"H / High Bay / Wrap Around Frosted Lens / 380W, 50000L / 0-10V Dim / 5000K
HBCL48LN433W60000LA10DMV50K	48.10"L x 20"W x 3.62"H / High Bay / Wrap Around Frosted Lens / 433W, 60000L / 0-10V Dim / 5000K

EM1 OS2 D1MV 90CRI CCT1 SURF PEND X1LED FLUOR

## HIGH BAY

This workhorse features a precision-formed reflector system available in highly reflective enhanced white to achieve maximum light output for warehouses, manufacturing plants, sports facilities and retail spaces. With surface, pendant, chain or stem mounting options.

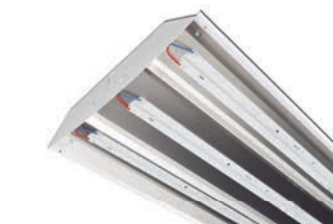

ITEM NO.	DESCRIPTION
HBC48LN127W18000LA10DMV50K	48.10"L x 16.39"W x 3.62"H / High Bay / 127W, 18000L / 0-10V Dim / 5000K
HBC48LN144W20000LA10DMV40K	48.10"L x 16.39"W x 3.62"H / High Bay / 144W, 20000L / 0-10V Dim / 5000K
HBC48LN162W24000LA10DMV50K	48.10"L x 16.39"W x 3.62"H / High Bay / 162W, 24000L / 0-10V Dim / 5000K
HBC48LN216W30000LA10DMV50K	48.10"L x 16.39"W x 3.62"H / High Bay / 216W, 30000L / 0-10V Dim / 5000K
HBC48LN272W36000LA10DMV50K	48.10"L x 16.39"W x 3.62"H / High Bay / 272W, 36000L / 0-10V Dim / 5000K
HBC48LN380W50000LA10DMV50K	48.10"L x 16.39"W x 3.62"H / High Bay / 380W, 50000L / 0-10V Dim / 5000K
HBC48LN433W60000LA10DMV50K	48.10"L x 20"W x 3.62"H / High Bay / 433W, 60000L / 0-10V Dim / 5000K

EM1 OS2 D1MV 90CRI CCT1 SURF PEND X1LED FLUOR

## LOW BAY

Same great version with lower output for low ceiling applications.



ITEM NO.	DESCRIPTION
HBC48LS61W7040LW30DMV40K	48.10"L x 11.39"W x 3.62"H / Low Bay / 61W, 7040L / 0-10V Dim / 4000K
HBC48LF97W11900LW30DMV40K	48.10"L x 11.39"W x 3.62"H / Low Bay / 97W, 11900L / 0-10V Dim / 4000K
HBC48LH118W13500LW30DMV50K	48.10"L x 11.39"W x 3.62"H / Low Bay / 118W, 13500L / 0-10V Dim / 5000K

EM1 OS2 D1MV 90CRI CCT1 SURF PEND X1LED FLUOR

Consult for Door Frame and Lens.



## MINI HIGH BAY

High efficiency LED high bay engineered for premium performance in low and medium ceiling applications ideally suited for warehouses, manufacturing plants, sports facilities and retail spaces. A precision-formed reflector system, available in highly reflective enhanced white achieves maximum light output for ceilings from 10 feet to 20 feet. The unique arrangement is ideal for wide area lighting and putting the light exactly where you need it with fewer fixtures. Surface, pendant, chain or stem mounting options.

ITEM NO.	DESCRIPTION
HBC22LN63W9000LA10DMV50K	24"L x 20.39"W x 3.62"H / Mini High Bay / 63W, 9000L / 0-10V Dim / 5000K
HBC22LZ110W16000LA10DMV50K	24"L x 20.39"W x 3.62"H / Mini High Bay / 110W, 16000L / 0-10V Dim / 5000K
HBC22LZ144W20000LA10DMV50K	24"L x 20.39"W x 3.62"H / Mini High Bay / 144W, 20000L / 0-10V Dim / 5000K

EM1 OS2 D1MV 90CRI CCT1 SURF PEND

For Door Frame and Lens add DFFR.

## LED HIGH BAY

This premium high bay is architecturally savvy and engineered for high performance, featuring a precision-formed reflector system available in highly reflective enhanced white to achieve maximum light output for warehouses, manufacturing plants, sports facilities and retail spaces. With surface, pendant, chain or stem mounting options.



For lensed version add FR after HIL.



ITEM NO.	DESCRIPTION
HIL24LY80W10000LDMV50K	23.38"L x 15.58"W x 4.30"H / High Bay / 80W, 10000L / 0-10V Dim / 5000K
HIL48LY80W10000LDMV50K	45.16"L x 15.58"W x 4.30"H / High Bay / 80W, 10000L / 0-10V Dim / 5000K
HIL48LY122W15000LDMV50K	45.16"L x 15.58"W x 4.30"H / High Bay / 122W, 15000L / 0-10V Dim / 5000K
HIL48LA149W20000LDMV50K	45.16"L x 15.58"W x 4.30"H / High Bay / 149W, 20000L / 0-10V Dim / 5000K
HIL48LA175W25000LDMV50K	45.16"L x 15.58"W x 4.30"H / High Bay / 175W, 25000L / 0-10V Dim / 5000K
HIL48LA215W30000LDMV50K	45.16"L x 15.58"W x 4.30"H / High Bay / 215W, 30000L / 0-10V Dim / 5000K
HIL48LA260W35000LDMV50K	45.16"L x 15.58"W x 4.30"H / High Bay / 260W, 35000L / 0-10V Dim / 5000K
HIL48LA280W40000LDMV50K	45.16"L x 15.58"W x 4.30"H / High Bay / 280W, 40000L / 0-10V Dim / 5000K
HIL48LA315W45000LDMV50K	45.16"L x 15.58"W x 4.30"H / High Bay / 315W, 45000L / 0-10V Dim / 5000K
HIL48LA355W50000LDMV50K	45.16"L x 15.58"W x 4.30"H / High Bay / 355W, 50000L / 0-10V Dim / 5000K
HIL48LA433W60000LDMV50K	45.16"L x 15.58"W x 4.30"H / High Bay / 433W, 60000L / 0-10V Dim / 5000K



EM1 OS2 D1MV 90CRI CCT1 SURF PEND

For Frosted Lens add "FR" after HIL. For Clear Lens change FR to CL For Wireguard add WG after FR and. For Occupancy Sensor on End add MDT4.

## UPLIGHT ACCESSORY FOR HIL

Saylite engineered a unique uplight accessory for the HIL Series Linear High Bay above. Avoid the tunnel effect by adding this unique accessory to create some surface brightness to compliment the high impact downlight.

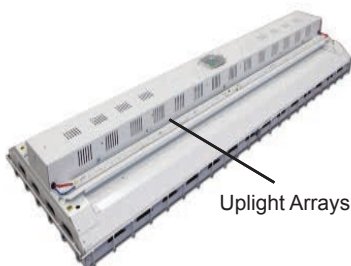

Uplight Arrays

ITEM NO.	DESCRIPTION
UV45W	HIL Uplight Accessory Module 45W and 550

EM3 OS6 D1MV 90CRI CCT1 SURF PEND

LED Arrays don't provide the 360 degrees light output of fluorescent lamps. For applications that require uplight, this accessory is ideal. Consult for other wattages and lumens.

# High Bays



## LED PREMIUM HIGH BAY w/OPTIONAL ACCESSORIES

This high-efficiency LED high bay is engineered for premium performance. A precision-formed highly reflective mirrored reflector system is designed to achieve maximum light output for warehouses, manufacturing plants, sports facilities and retail spaces. With surface, pendant, chain or stem mounting options.

ITEM NO.	DESCRIPTION
HBIP12L110W14680LMV50K	21.5"L x 11.8"W x 2 "H / High Bay / 110W, 14680L / 120-277V / 5000K
HBIP22L165W22000LMV50K	21.5"L x 16"W x 2 "H / High Bay / 165W, 22000L / 120-277V / 5000K
HBIP24L220W29370LMV50K	43"L x 11.8"W x 2 "H / High Bay / 220W, 29370L / 120-277V / 5000K

EM3 OS6 SURF PEND

For Occupancy Sensor, add MDT4. Fixtures include chain kits. Consult for different wattage, color temperature, and higher lumens.



Add accessories, sensor, chain kit or lens to any high bay for optimum performance for your application.

## ACCESSORIES

Fine tune your High Bay to your application.



Door Frame Lens options.

ITEM NO.	DESCRIPTION
HBI12DFMW	HBI 1x2 DOOR FRAME SET WHITE / MW LENS
HBI22DFMW	HBI 2x2 DOOR FRAME SET WHITE / MW LENS
HBI24DFMW	HBI 2x4 DOOR FRAME SET WHITE / MW LENS
HBI12WG	HBIP 1x2 Wire Guard White
HBI22WG	HBIP 2x2 Wire Guard White
HBI24WG	HBIP 2x4 Wire Guard White
HBIFMK	Flush Mounting Clips for HBI LED Hi-Bay
HBIPDMK	Pendant Mounting Kit 3.4"L x 2.3"W x 2"H

## HIGH OUTPUT PREMIUM LED HIGH BAY

This high-efficiency LED high bay is engineered for premium performance. A precision-formed highly reflective mirrored reflector system is designed to achieve maximum light output for warehouses, manufacturing plants, sports facilities and retail spaces.



ITEM NO.	DESCRIPTION
HBIHO14L200W27800LDMV50K	44.9L x 16.0W x 1.5H / High Output High Bay / 200W, 27800L / 0-10V Dim / 5000K
HBIHO24L245W34300LDMV50K	43"L x 20"W x 1.5"H / High Output High Bay / 245W, 34300L / 0-10V Dim / 5000K
HBIHO24L325W45500LDMV50K	43"L x 20"W x 1.5"H / High Output High Bay / 325W, 45500L / 0-10V Dim / 5000K

EM3 OS6 SURF PEND

## AISLE LIGHT

This high-efficiency LED high bay is engineered for premium performance in aisle lighting. A precision-formed highly reflective enhanced aluminum reflector system is designed to achieve maximum light output.



Shown with Optional Wire Guard



ITEM NO.	DESCRIPTION
4FT	
HBCA48LN110W14000LA10DMV50K	48"L x 7.90"W x 4.30"H / High Bay / 110W, 14000L / 0-10V Dim / 5000K
HBCA48LN144W20000LA10DMV50K	48"L x 7.90"W x 4.30"H / High Bay / 144W, 20000L / 0-10V Dim / 5000K
8FT	
HBCA96LN162W22000LA10DMV50K	96"L x 7.90"W x 4.30"H / High Bay / 162W, 22000L / 0-10V Dim / 5000K
HBCA96LN220W27000LA10DMV50K	96"L x 7.90"W x 4.30"H / High Bay / 220W, 27000L / 0-10V Dim / 5000K
HBCA96LN288W35000LA10DMV50K	96"L x 7.90"W x 4.30"H / High Bay / 288W, 35000L / 0-10V Dim / 5000K

EM1 OS6 D1MV 90CRI CCT1 SURF PEND

For Wire Guard Add WG. Consult for other wattage and lumen packages.



Notice how well lit the labels on the cartons are from the Saylite Aisle Light. Don't put light in the aisle put it on the labels.

## INDUSTRIAL LED

This industrial strip is ideally suited for interior warehouse, retail, and utility areas requiring concentrated illumination in a commercial quality configuration. Features economical white steel reflectors for abusive locations, with a variety of options to fine tune for specific locations.



ITEM NO.	DESCRIPTION
IND48LJ32W5000LW30DMV40K	48"L x 8.06"W x 4.25"H / White Reflector / 32W, 5000L / 0-10V Dim / 4000K
IND48LJ48W6900LW30DMV40K	48"L x 8.06"W x 4.25"H / White Reflector / 48W, 6900L / 0-10V Dim / 4000K
IND48LJ57W7800LW30DMV40K	48"L x 8.06"W x 4.25"H / White Reflector / 57W, 7800L / 0-10V Dim / 4000K
IND96LJ57W7800LW30DMV40K	96"L x 8.06"W x 4.25"H / White Reflector / 57W, 7800L / 0-10V Dim / 4000K
IND96LJ97W12400LW30DMV40K	96"L x 8.06"W x 4.25"H / White Reflector / 97W, 12400L / 0-10V Dim / 4000K
IND96LJ114W14000LW30DMV40K	96"L x 8.06"W x 4.25"H / White Reflector / 114W, 14000L / 0-10V Dim / 4000K

EM6 G120 OS1 RGBW D1MV 90CRI CCT1 SURF PEND XILED FLUOR

Add wire guard IND48WGW.



# High Bays



## VAPOR TIGHT HIGH BAY WET LOCATION

Demanding environments call for this tough, enclosed and gasketed, high bay fixture. For use in both indoor and outdoor applications, appropriate for damp and wet locations, as well as for protection against dust and other non-hazardous contaminants. Ideal for food industry, cold storage, warehouses, parking garages, commercial kitchens, car washes, utility tunnels, laundries and industrial facilities. IP67, NEMA 4X.

ITEM NO.	DESCRIPTION
CITACL48LV80W9700LDMV50K	51.87"L x 14.44"W x 4.63"H / Clear with Matte White Ends Lens / 80W, 9700L / 0-10V Dim / 5000K
CITACL48LA120W15500LDMV50K	51.87"L x 14.44"W x 4.63"H / Clear with Matte White Ends Lens / 120W, 15500L / 0-10V Dim / 5000K
CITACL48LA140W18000LDMV50K	51.87"L x 14.44"W x 4.63"H / Clear with Matte White Ends Lens / 140W, 18000L / 0-10V Dim / 5000K
CITACL48LA150W19500LDMV50K	51.87"L x 14.44"W x 4.63"H / Clear with Matte White Ends Lens / 150W, 19500L / 0-10V Dim / 5000K
CITACL48LA180W23200LDMV50K	51.87"L x 14.44"W x 4.63"H / Clear with Matte White Ends Lens / 180W, 23200L / 0-10V Dim / 5000K

EM6 G120 OS1 RGBW DIMV 90CRI CCT1 X1LED FLUOR

See specification sheet for mounting options and accessories. CL is Clear Acrylic Lens, change to FR for Frosted Acrylic Lens. For Polycarbonate Versions add PC after CL or FR.

## VAPOR TIGHT LOW BAY WET LOCATION

A low bay version and lower output of the above fixture. IP67, NEMA 4X.



ITEM NO.	DESCRIPTION
CITACL24LV80W8000LDMV50K	26.6"L x 14.5"W x 5.8"H / Clear with Matte White Ends Lens / 80W, 8000L / 0-10V Dim / 5000K
CITACL24LV100W10000LDMV50K	26.6"L x 14.5"W x 5.8"H / Clear with Matte White Ends Lens / 100W, 10000L / 0-10V Dim / 5000K
CITACL24LV140W14000LDMV50K	26.6"L x 14.44"W x 5.8"H / Clear with Matte White Ends Lens / 140W, 14000L / 0-10V Dim / 5000K

EM3 G120 OS6 RGBW DIMV CCT1 SURF PEND

See specification sheet for mounting options and accessories. CL is Clear Acrylic Lens, change to FR for Frosted Acrylic Lens. For Polycarbonate Versions add PC after CL or FR.

Frosted Lens option (FR) provides soft, glare-free lighting.

Citadel High Bay is ideal for food processing areas where a wash down fixture with abundant lighting is required.





## ROUND HIGH BAY

A sleek, round high bay available in 14000 or 25000 Lumen versions makes designing in challenging environments like warehouses, gymnasiums, retail centers and manufacturing facilities easy and provides a fresh appearance.

This LED High Bay Pendant saves 60 percent energy vs. HID and fluorescent fixtures, and delivers 100,000 hours of lumen maintenance for a wide range of commercial and industrial lighting applications. Engineered to withstand significant voltage surges common in these large venues, ambient temperatures up to 55 degree Celsius (131 degree Fahrenheit) and dust, moisture and airborne contaminants with IP65 rating. A superior optical design and efficient illumination gives an ideal lighting distribution and glare control. The lens provides the right amount of illumination and glare control. A knockout in the center of the body allows adding a sensor easily and economically for enhanced energy savings and performance.



LED High Bay 15 inch  
Diameter 14000 Lumens or  
25000 Lumens



Optional Integral Sensor



Engineered for long life in ambient  
temperatures up to 55° centigrade,  
IP65, and simple hook installation.



ITEM NO.	DESCRIPTION
RHB15L100W14000LDMV50K	15.56" Dia x 7.08"H / Clear Polycarbonate Lens / 100W, 14000L / 0-10V Dim / 5000K / White
RHB15L140W20500LD48050K	15.56" Dia x 7.08"H / Clear Polycarbonate Lens / 140W, 20500L / 480V / 5000K / White
RHB15L180W25000LDMV50K	15.56" Dia x 7.08"H / Clear Polycarbonate Lens / 180W, 25000L / 0-10V Dim / 5000K / White

with Sensor

SVRHB15L100W14000LDMV50K	15.56"Dia x 7.08"H / Clear Polycarbonate Lens / Photo/ Motion Sensor / 100W, 14000L / 0-10V Dim / 5000K / Hook Mount / White
SVRHB15L180W25000LDMV50K	15.56"Dia x 7.08"H / Clear Polycarbonate Lens / Photo/ Motion Sensor / 100W, 14000L / 0-10V Dim / 5000K / Hook Mount / White

## LRH ROUND HIGH BAY

The LRH is perfect for replacing old, inefficient MH high bays. Consult for DLC Premium version.



ITEM NO.	DESCRIPTION
LRH15L135W19800LDMV50KBZ	15.35" Dia x 8.67"H / 135W, 19800L / 0-10V DIM / 5000K / BRONZE
LRH15L175W25600LMV50KBZ	15.35" Dia x 8.67"H / 175W, 25600L / 120-277V / 5000K / BRONZE
LRH15L200W29700LMV50KBZ	15.35" Dia x 8.67"H / 200W, 29700L / 120-277V / 5000K / BRONZE
LRHALREFLECTOR	Aluminum Reflector

## LINEAR HIGH BAY ACCESSORY OPTIONS

ITEM NO.	DESCRIPTION
MDT4	External Mounted Occupancy Sensor
WG	Wire Guard for HBC Full Size
GT310	Gripple Style Cable Kit 10 FT
HC101	Chain Kit - 4 "S" Hooks & 20 FT Chain
EM	Emergency Driver
HBC7	Center Hub for 3/4" Pipe
WP	6 FT Whip
W10	10 FT Whip
C6	6 FT Cord



GT310

MDT4 for sensor



# Retrofit Kits



If you are looking for retrofitting expertise, you've come to the right place. Saylite offers a comprehensive assortment of LED retrofit products and we package and ship kits in ways that reduce time for storage, unpacking and installing, even pre-wiring kits in the factory to minimize time in the field. We also make custom-configured kits in a way that eliminates 15% of unnecessary costs associated with the "universal" kits from our competitors.



Saylite offers a full assortment of Savegreen Linear LED lamps and X1LED retrofit kits to change any fluorescent fixture to accept LED linear lamps. See Savegreen Lamps on pages 142-145.

## X1LED

At [www.saylite.com/support/videos](http://www.saylite.com/support/videos) you can view simple "how to" solutions for retrofitting strips and troffers.

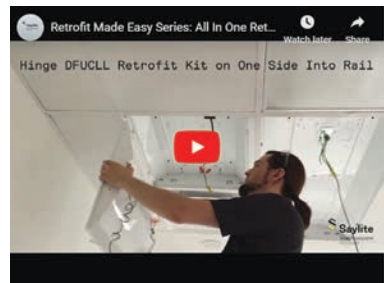
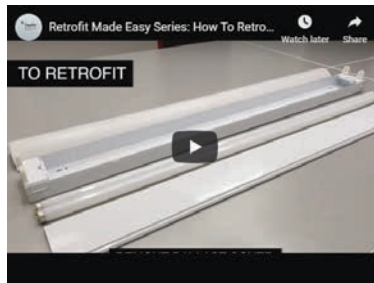

# Troffer Retrofit Kits

## All-In-One Retrofit Troffer Kits

Convert an existing linear fluorescent fixture to a state-of-the-art Linear LED fixture in minutes with these LED All-In-One Retrofit Kits. Increase lighting performance, save energy, reduce maintenance, and welcome a fresh new look to any space. Each kit mounts in minutes with all the LED components neatly engineered in one simple frame that mounts to two side rails that mount between the existing fixture body and the T-bar.

### CENTER BASKET

This retrofit fixture provides the look of a popular indirect/direct linear fixture but with a specially designed LED reflector and lens and provides comfortable, abundant lighting. Available in 1X4, 2X2 or 2X4 configurations and a variety of wattages, lumens, and color temperature



**Install in Minutes:**  
Place Rails between fixture and T-Bar on each side. Then latch and secure All-In-One-LED-Retrofit into place.



ITEM NO.	DESCRIPTION
DFUCLL22LF24W3000LDMV40K	23.90"L x 23.85"W x 3.65"H / Frosted Lens / 24W, 3000L / 0-10V Dim / 4000K
DFUCLL22LF28W3350LDMV40K	23.90"L x 23.85"W x 3.65"H / Frosted Lens / 28W, 3350L / 0-10V Dim / 4000K
DFUCLL22LF35W4300LDMV40K	23.90"L x 23.85"W x 3.65"H / Frosted Lens / 35W, 4300L / 0-10V Dim / 4000K
DFUCLL24LF32W4650LDMV40K	47.90"L x 23.85"W x 3.65"H / Frosted Lens / 32W, 4650L / 0-10V Dim / 4000K
DFUCLL24LF48W6750LDMV40K	47.90"L x 23.85"W x 3.65"H / Frosted Lens / 48W, 6750L / 0-10V Dim / 4000K
DFUCLL24LF57W7800LDMV40K	47.90"L x 23.85"W x 3.65"H / Frosted Lens / 57W, 7800L / 0-10V Dim / 4000K
DFUCLL24LF62W8100LDMV40K	47.90"L x 23.85"W x 3.65"H / Frosted Lens / 62W, 8100L / 0-10V Dim / 4000K

EM2 G120 OS2 RGBW D1MV CCT1

### CHICKLET FROSTED LENS

This retrofit fixture offers a dramatic “luminous pillow” styled lens with a high level of lighting. Available in 1X4, 2X2 or 2X4 configurations and a variety of wattages, lumens, and color temperature.



**Watch Installation Videos**  
<https://www.saylite.com/support/videos>

ITEM NO.	DESCRIPTION
DFCKFR22LF24W2400LDMV40K	23.50"L x 23.68"W x 3.65"H / Frosted Lens / 24W, 2400L / 0-10V Dim / 4000K
DFCKFR22LF28W2800LDMV40K	23.50"L x 23.68"W x 3.65"H / Frosted Lens / 28W, 2800L / 0-10V Dim / 4000K
DFCKFR22LF35W3500LDMV40K	23.50"L x 23.68"W x 3.65"H / Frosted Lens / 35W, 3500L / 0-10V Dim / 4000K
DFCKFR24LF32W3200LDMV40K	47.00"L x 23.68"W x 3.65"H / Frosted Lens / 32W, 3200L / 0-10V Dim / 4000K
DFCKFR24LF40W4000LDMV40K	47.00"L x 23.68"W x 3.65"H / Frosted Lens / 40W, 4000L / 0-10V Dim / 4000K
DFCKFR24LF48W4800LDMV40K	47.00"L x 23.68"W x 3.65"H / Frosted Lens / 48W, 4800L / 0-10V Dim / 4000K
DFCKFR24LF57W5700LDMV40K	47.00"L x 23.68"W x 3.65"H / Frosted Lens / 57W, 5700L / 0-10V Dim / 4000K

EM3 G120 OS2 RGBW D1MV CCT1

## Retrofit Your Store to Stand Out and Save Energy



### LED Troffer Retrofit Kit Makes Sally Beauty Stand Out



Consult for  
Parabolic Retrofit Kit

Installs In Fluorescent  
Troffer In Under 5 Minutes



#### LED TROFFER RETROFIT KIT

Designed to quickly convert a fluorescent troffer to a highly efficient LED light fixture. A durable gear tray installs quickly with four screws in minutes. LED arrays and drivers optimize performance and life with the heat sink of the gear tray.

ITEM NO.	DESCRIPTION
22CJ24W2700LW10DMV40K	22.6"L x 14.73"W x 1.74"H / 24W, 2700L / 0-10V Dim / 4000K
22CJ28W3200LW10DMV40K	22.6"L x 14.73"W x 1.74"H / 28W, 3200L / 0-10V Dim / 4000K
22CJ35W3900LW10DMV40K	22.6"L x 14.73"W x 1.74"H / 35W, 3900L / 0-10V Dim / 4000K
24CJ35W4600LW10DMV40K	46"L x 14.54"W x 1.85"H / 35W, 4600L / 0-10V Dim / 4000K
24CJ48W6300LW10DMV40K	46"L x 14.54"W x 1.85"H / 48W, 6300L / 0-10V Dim / 4000K
24CJ57W7100LW10DMV40K	46"L x 14.54"W x 1.85"H / 57W, 7100L / 0-10V Dim / 4000K

EM7 G120 OS1 D1MV 90CRI CCT1 SMART

#### LED TROFFER RETROFIT KIT w/SMARTSENSE

Add a sensor to your troffer for added energy savings.



ITEM NO.	DESCRIPTION
SM22CLY28W2850LVDMV40K	22.6"L x 14.73"W x 1.74"H / Occupancy Sensor / 28W, 2850L / 0-10V Dim / 4000K
SM24CLY56W5650LVDMV40K	46"L x 14.54"W x 1.85"H / Occupancy Sensor / 56W, 5650L / 0-10V Dim / 4000K

EM7 CCT1 SMART



# High Bay Retrofit Kits

Saylite's Factory at Your Fingertips can retrofit your existing Fluorescent High Bays with specially designed LED High Bay Retrofit Kits to preserve expensive modular wiring systems and difficult to access applications. Engineered for a simple plug and play installation utilizing the existing high bay's construction to allow retrofitting in minutes.

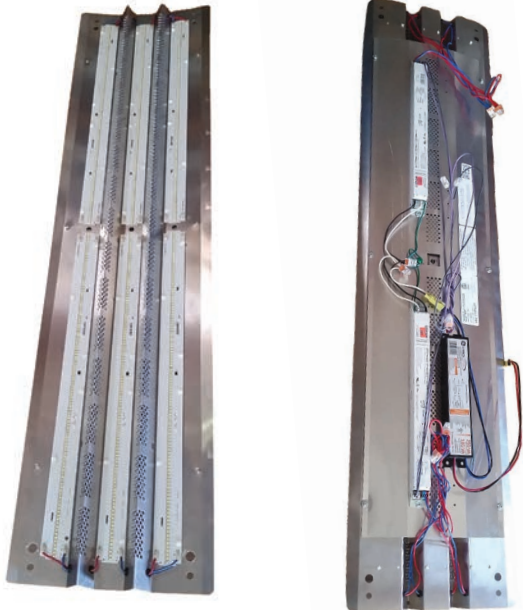

Saylite's engineering team constructed an LED retrofit kit utilizing a specular aluminum reflector and high powered LED's to convert these fluorescent high bays to save over 40% of the energy and increase life by 5 times. Our engineering team can make a custom retrofit for your High Bay.



LED T5HO or T8 linear LED lamps are ideal to retrofit fluorescent high bays with minimum investment and maximum benefit. See X1LED Retrofit section on pages 136 to 138 for more information.



# Retrofit Kits

## Linear Strip Retrofit Kits



**WARNING:** If you have this fixture in 4 or 8 Foot, You can Retrofit Them and Save over 40% Energy and Reduce Maintenance.

### ENCLOSED STRIP RETROFIT KIT

This workhorse Retrofit solution is now available with a lens. It provides an economical and versatile solution for many applications including retail, industrial, and mezzanine low-ceilinged applications where a wide light distribution is needed.



ITEM NO.	DESCRIPTION
RFSFFR24LJ12W1200LDMV40K	24.00"L x 4.25"W x 3.25"H / Frosted Lens / 12W, 1200L / 0-10V Dim / 4000K
RFSFFR48LJ24W2600LDMV40K	48.00"L x 4.25"W x 3.25"H / Frosted Lens / 24W, 2600L / 0-10V Dim / 4000K
RFSFFR48LJ48W5400LDMV40K	48.00"L x 4.25"W x 3.25"H / Frosted Lens / 48W, 5400L / 0-10V Dim / 4000K
RFSFFR48LZ57W6200LDMV40K	48.00"L x 4.25"W x 3.25"H / Frosted Lens / 57W, 6200L / 0-10V Dim / 4000K
RFSFFR96LJ62W6600LDMV40K	96.00"L x 4.25"W x 3.25"H / Frosted Lens / 62W, 6600L / 0-10V Dim / 4000K
RFSFFR96LZ114W12400LDMV40K	96.00"L x 4.25"W x 3.25"H / Frosted Lens / 114W, 12400L / 0-10V Dim / 4000K

EM6 G120 OS1 RGBW D1MV 90CRI CCT1

Consult to retrofit 5" strip. See complete fixture on page 62.

### LED STRIP RETROFIT KIT ROUND PROFILE

This designer Retrofit solution with a rounded lens, provides both a sleek new look and an energy-saving alternative to traditional T12 or T8 linear strips. Ideal for schools, retail, and warehouses.



ITEM NO.	DESCRIPTION
RSR48LT20W2200LDMV40K	48"L x 4.25"W x 3.9"H / Round Frost Lens / 20W, 2200L / 0-10V Dim / 4000K
RSR48LT30W3500LDMV40K	48"L x 4.25"W x 3.9"H / Round Frost Lens / 30W, 3500L / 0-10V Dim / 4000K
RSR48LT41W4300LDMV40K	48"L x 4.25"W x 3.9"H / Round Frost Lens / 41W, 4300L / 0-10V Dim / 4000K
RSR48LT58W6700LDMV40K	48"L x 4.25"W x 3.9"H / Round Frost Lens / 58W, 6700L / 0-10V Dim / 4000K
RSR96LT40W4400LDMV40K	96"L x 4.25"W x 3.9"H / Round Frost Lens / 40W, 4400L / 0-10V Dim / 4000K
RSR96LT60W6900LDMV40K	96"L x 4.25"W x 3.9"H / Round Frost Lens / 60W, 6900L / 0-10V Dim / 4000K
RSR96LT82W8900LDMV40K	96"L x 4.25"W x 3.9"H / Round Frost Lens / 82W, 8900L / 0-10V Dim / 4000K
RSR96LT116W13400LDMV40K	96"L x 4.25"W x 3.9"H / Round Frost Lens / 116W, 13400L / 0-10V Dim / 4000K

EM6 G120 OS1 RGBW D1MV 90CRI CCT1

Complete fixture available. Add "C" in front of item number.

## LED STRIP RETROFIT KIT FLAT PROFILE



Complete fixture available. Add "C" in front of item number.

ITEM NO.	DESCRIPTION
RSF48LT20W2000LDMV40K	48"L x 4.25"W x 2.78"H / Flat Frost Lens / 20W, 2000L / 0-10V Dim / 4000K
RSF48LT30W3000LDMV40K	48"L x 4.25"W x 2.78"H / Flat Frost Lens / 30W, 3000L / 0-10V Dim / 4000K
RSF48LT41W4100LDMV40K	48"L x 4.25"W x 2.78"H / Flat Frost Lens / 41W, 4100L / 0-10V Dim / 4000K
RSF48LT58W5800LDMV40K	48"L x 4.25"W x 2.78"H / Flat Frost Lens / 58W, 5800L / 0-10V Dim / 4000K
RSF96LT40W4000LDMV40K	96"L x 4.25"W x 2.78"H / Flat Frost Lens / 40W, 4000L / 0-10V Dim / 4000K
RSF96LT60W6000LDMV40K	96"L x 4.25"W x 2.78"H / Flat Frost Lens / 60W, 6000L / 0-10V Dim / 4000K
RSF96LT82W8200LDMV40K	96"L x 4.25"W x 2.78"H / Flat Frost Lens / 82W, 8200L / 0-10V Dim / 4000K
RSF96LT116W11600LDMV40K	96"L x 4.25"W x 2.78"H / Flat Frost Lens / 116W, 11600L / 0-10V Dim / 4000K

EM6 G120 OS1 RGBW D1MV 90CRI CCT1 SMART

Consult to retrofit 5" strip.

## LED STRIP BALLAST COVER RETROFIT KIT (FOR 4.25" OR 5" STRIPS)

This economical Retrofit Kit provides enhanced output for an existing strip and is available in 48" and 96" lengths and with a frosted lens accessory to reduce LED brightness.



Frosted lens accessory reduces LED glare. C48FRLN



ITEM NO.	DESCRIPTION
4RB421F24W3500LDMV40K	48"L x 4.25"W x 0.5"H / 24W, 3500L / 0-10V Dim / 4000K
4RB421F48W6500LDMV40K	48"L x 4.25"W x 0.5"H / 48W, 6500L / 0-10V Dim / 4000K
4RB421F57W7900LDMV40K	48"L x 4.25"W x 0.5"H / 57W, 7900L / 0-10V Dim / 4000K
4RB501F24W3500LDMV40K	48"L x 5"W x 0.5"H / 24W, 3500L / 0-10V Dim / 4000K
4RB501F48W6500LDMV40K	48"L x 5"W x 0.5"H / 48W, 6500L / 0-10V Dim / 4000K
4RB501F57W7900LDMV40K	48"L x 5"W x 0.5"H / 57W, 7900L / 0-10V Dim / 4000K
8RB421F48W6950LDMV40K	96"L x 4.25"W x 0.5"H / 48W, 6950L / 0-10V Dim / 4000K
8RB421F97W13100LDMV40K	96"L x 4.25"W x 0.5"H / 97W, 13100L / 0-10V Dim / 4000K
8RB421F118W15800LDMV40K	96"L x 4.25"W x 0.5"H / 118W, 15800L / 0-10V Dim / 4000K
8RB501F48W6950LDMV40K	96"L x 5"W x 0.5"H / 48W, 6950L / 0-10V Dim / 4000K
8RB501F97W13100LDMV40K	96"L x 5"W x 0.5"H / 97W, 13100L / 0-10V Dim / 4000K
8RB501F118W15800LDMV40K	96"L x 5"W x 0.5"H / 118W, 15800L / 0-10V Dim / 4000K

EM6 G120 OS1 RGBW D1MV 90CRI CCT1 X1LED FLUOR

## LINEAR WALL RETROFIT

Specially engineered to retrofit perimeter lighting fluorescent systems to a highly efficient, LED fixture that will provide even illumination on the wall. Ideal for merchandising and to enhance a space by increasing the light on the perimeter. Easy installation in most applications.



Ideal To Retrofit Perimeter Wall Lighting

ITEM NO.	DESCRIPTION
RLWDFR48LT30W4100LDMV40K	48"L x 4.25"W x 5.98"H / Frosted Lens / 30W, 4100L / 0-10V Dim / 4000K
RLWDFR48LT48W6000LDMV40K	48"L x 4.25"W x 5.98"H / Frosted Lens / 48W, 6000L / 0-10V Dim / 4000K
RLWDFR48LT57W6900LDMV40K	48"L x 4.25"W x 5.98"H / Frosted Lens / 57W, 6900L / 0-10V Dim / 4000K

EM6 G120 OS1 RGBW D1MV 90CRI CCT1

See complete fixture on page 74.

## LINEAR RECESSED LED RETROFIT KIT

Retrofit linear recessed open strips commonly used in grocery and drug stores.



ITEM NO.	DESCRIPTION
RKITB48LT48W5400LDMV40K	48.00"L x 4.25"W x 3.25"H / Frosted Lens / 48W, 5400L / 0-10V Dim / 4000K
RKITB48LT57W6200LDMV40K	48.00"L x 4.25"W x 3.25"H / Frosted Lens / 57W, 6200L / 0-10V Dim / 4000K
RKITB96LT62W6600LDMV40K	96.00"L x 4.25"W x 3.25"H / Frosted Lens / 62W, 6600L / 0-10V Dim / 4000K
RKITB96LT114W12400LDMV40K	96.00"L x 4.25"W x 3.25"H / Frosted Lens / 114W, 12400L / 0-10V Dim / 4000K

EM6 G120 OS1 RGBW D1MV 90CRI CCT1

# Retrofit Kits

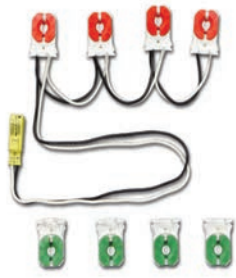

UL Listed kit to bypass Fluorescent Ballast w/LED tubes.

Add "8" after RLK for tandem version.

To wire for Troffer Retrofit, add "TR" after "RLK".

## RETROFIT LED T8 LAMP KIT (Convert Existing Fluorescent Fixtures to LED)

Prewired UL socket kits to allow quick change from fluorescent to LED T8 Lamps.

ITEM NO.	DESCRIPTION
RLK1X1WR	Retrofit Lamp Kit Prewired Unshunted Sockets For 1 LED T8 Lamp Includes Companion Sockets
RLK2X1WR	Retrofit Lamp Kit Prewired Unshunted Sockets For 2 LED T8 Lamps Includes Companion Sockets
RLK3X1WR	Retrofit Lamp Kit Prewired Unshunted Sockets For 3 LED T8 Lamps Includes Companion Sockets
RLK4X1WR	Retrofit Lamp Kit Prewired Unshunted Sockets For 4 LED T8 Lamps Includes Companion Sockets
RLK1X1WRLI18W40	Retrofit Lamp Kit Prewired Unshunted Sockets For 1 LED T8 Lamp Included Plus Companion Sockets
RLK2X1WRLI18W40	Retrofit Lamp Kit Prewired Unshunted Sockets For 2 LED T8 Lamps Included Plus Companion Sockets
RLK3X1WRLI18W40	Retrofit Lamp Kit Prewired Unshunted Sockets For 3 LED T8 Lamps Included Plus Companion Sockets
RLK4X1WRLI18W40	Retrofit Lamp Kit Prewired Unshunted Sockets For 4 LED T8 Lamps Included Plus Companion Sockets

TB8 X1LEDT8D

## RETROFIT REFLECTOR KIT FOR PARABOLICS/TROFFERS

Convert a fluorescent troffer to LED T8 Lamps with reflectors to reduce the number of lamps.



ITEM NO.	DESCRIPTION
22C2W10BL11X1LI15W40	2x2 Retrofit Kit 4200 Lumen Enhanced White Reflector Includes 2x15W 4000K Lamps
22C3W10BL11X1LI15W40	2x2 Retrofit Kit 6300 Lumen Enhanced White Reflector Includes 3x15W 4000K Lamps
24C2W10BL11X1LI18W40	2x4 Retrofit Kit 4200 Lumen Enhanced White Reflector Includes 2x18W 4000K Lamps
24C3W10BL11X1LI18W40	2x4 Retrofit Kit 6300 Lumen Enhanced White Reflector Includes 3x18W 4000K Lamps

TB8 EM8 LED FLUOR X1LEDT8D

## BALLAST COVER REFIT KIT (Ideal to change 8ft Lamps to 4ft Tandem)

Convert a fluorescent strip to LED T8 Lamps.



ITEM NO.	DESCRIPTION
4RB421T8L11X1LI18W40	4.25" Strip Retrofit Kit 48 In. 2100 Lumen Included 1x18W 4000K Lamp
4RB422T8L11X1LI18W40	4.25" Strip Retrofit Kit 48 In. 4200 Lumen Included 2x18W 4000K Lamp
8RB421X2T8L11X1LI18W40	4.25" Strip Retrofit Kit 96 In. 4200 Lumen Included 2x18W 4000K Lamp
8RB422X2T8L11X1LI18W40	4.25" Strip Retrofit Kit 96 In. 8400 Lumen Included 4x18W 4000K Lamp

TB8 EM8 LED FLUOR X1LEDT8D

See pages 136-138 for full selections of X1LED retrofits.

# Wall or Ceiling Retrofit Kits

Convert fluorescent or incandescent fixtures into energy-efficient LED systems with these pre-packaged drivers, LED modules, and mounting accessories, so that the LED retrofit can be installed quickly and easily. Upgrading to LED is as easy as screwing in these clever LED kits. Below are some standard kits but don't see what you need? Ask us for the version ideal for your retrofit.



## CTC / WALL FIXTURE RETROFITS

The EOS features driver-on-board technology and heat sink for excellent light output. These Retrofit units are low maintenance and easy to install. Perfect for many applications including damp location.



ITEM NO.	DESCRIPTION
EOS12W900LD12030KSQ	EOS Array w/6" Sq Alum Heat Sink / 12W, 900L / Triac Dim / 3000K / 80CRI
EOS12W1000LD12040KSQ	EOS Array w/6" Sq Alum Heat Sink / 12W, 1000L / Triac Dim / 4000K / 80CRI
EOS15W1350LD12030KSQ	EOS Array w/8" Sq Alum Heat Sink / 15W, 1350L / Triac Dim / 3000K / 80CRI
EOS15W1400LD12040KSQ	EOS Array w/8" Sq Alum Heat Sink / 15W, 1400L / Triac Dim / 4000K / 80CRI
EOS22W1850LD12030KSQ	EOS Array w/8" Sq Alum Heat Sink / 22W, 1850L / Triac Dim / 3000K / 80CRI
EOS22W1900LD12040KSQ	EOS Array w/8" Sq Alum Heat Sink / 22W, 1900L / Triac Dim / 4000K / 80CRI
EOS32W2700LD12030KRD	EOS Array w/10" round Alum Heat Sink / 32W, 2700L / Triac Dim / 3000K/80CRI
EOS32W2700LD12040KRD	EOS Array w/10" round Alum Heat Sink / 32W, 2750L / Triac Dim / 4000K/80CRI

EOS12W900LD12030KSQ90	EOS Array w/6" Sq Alum Heat Sink / 12W, 900L / Triac Dim / 3000K/90CRI
EOS12W1000LD12040KSQ90	EOS Array w/6" Sq Alum Heat Sink / 12W, 1000L / Triac Dim / 4000K/90CRI
EOS15W1350LD12030KSQ90	EOS Array w/8" Sq Alum Heat Sink / 15W, 1350L / Triac Dim / 3000K/90CRI
EOS15W1400LD12040KSQ90	EOS Array w/8" Sq Alum Heat Sink / 15W, 1400L / Triac Dim / 4000K/90CRI
EOS22W1850LD12030KSQ90	EOS Array w/8" Sq Alum Heat Sink / 22W, 1850L / Triac Dim / 3000K/90CRI
EOS22W1900LD12040KSQ90	EOS Array w/8" Sq Alum Heat Sink / 22W, 1900L / Triac Dim / 4000K/90CRI
EOS32W2700LD12030KRD90	EOS Array w/10" round Alum Heat Sink / 31W, 2750L / Triac Dim / 3000K/90CRI
EOS32W2700LD12040KRD90	EOS Array w/10" round Alum Heat Sink / 31W, 2850L / Triac Dim / 4000K/90CRI

### CCT4

Dimmable with standard dimmer. UL Classified for retrofit.

## CTC RETROFIT FOR 11" OR 14" WITH HEAT SINK

(DIMMABLE W/STANDARD DIMMER)

This Retrofit unit is dimmable with a standard dimmer and is available in 11" (15 watt) or 14" (25 watt), with heat sink.



ITEM NO.	DESCRIPTION
DAC15W1350LD12040K	LED Array 120V / 11" Dia / 15W, 1350L / Triac Dim / 4000K
DAC15W1350LD12050K	LED Array 120V / 11" Dia / 15W, 1350L / Triac Dim / 5000K
DAC25W1850LD12030K	LED Array 120V / 14" Dia / 25W, 1850L / Triac Dim / 3000K
DAC25W1850LD12050K	LED Array 120V / 14" Dia / 25W, 1850L / Triac Dim / 5000K

## Surface or Wall High Lumen, Larger Size Retrofit Kits

Whether you need a 4000 lumen package or a retrofit for a custom surface mount fixture, Saylite has a vast assortment of retrofit kits for your legacy fixture. Choose the diameter, light output and mounting method and let us make a retrofit kit.

# CLOSE-TO-CEILING LED

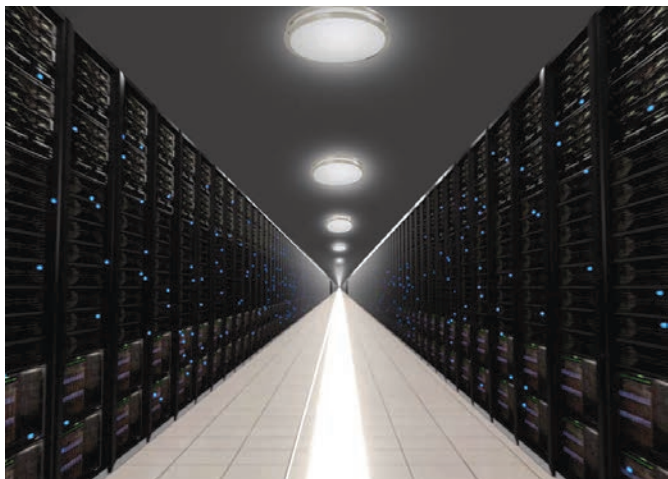

Saylite offers a comprehensive selection of energy-efficient LED close-to-ceiling fixtures, and we offer them with a lead time that will feel like off-the-shelf. We offer many customizable options including sensors, lamps, diffusers and finishes. Need something that you don't see here? Just ask!

## LED SPILL RING CLOSE-TO-CEILING

This stylish ceiling fixture is offered in satin nickel or bronze (special order) and is available in multiple sizes from 10" to 32" to meet a wide variety of applications. Matching wall, bath, and linear versions make this fixture ideal for multi-family or hospitality applications.



ITEM NO.	DESCRIPTION
HOTCD10L18W1300LD120SN30K	9.8"D x 4.2"H / Matt White Lens / 18W, 1300L / Triac Dimming / 3000K / Satin Nickel
HOTCD12L17W1200LD120SN30K	11.8"D x 4.2"H / Matt White Lens / 17W, 1200L / Triac Dimming / 3000K / Satin Nickel
HOTCD12L18W1400LMVSNMCT	11.75"D x 4.2"H / Matt White Lens / 18W, 1400L / 120-277V / Available in 3000K, 3500K or 4000K / Non Dim
HOTCD14L24W2250LMVSNMCT	14.5"D x 4.75"H / Matt White Lens / 24W, 2260L / 120-277V / Available in 3000K, 3500K or 4000K / Non Dim
HOTCD16L30W2600LMVSNMCT	16"D x 5"H / Matt White Lens / 30W, 2600L / 120-277V / Available in 3000K, 3500K or 4000K / Non Dim
HOTCD18L33W3300LMVSNMCT	17.75"D x 5"H / Matt White Lens / 35W, 3300L / 120-277V / Available in 3000K, 3500K or 4000K / Non Dim

### CCT3

MCT - Provides choice of 3000, 3500 or 4000 kelvin from the same fixture with a dip switch. Consult for 16 inch Version. For 4000K change 30K to 40K



## LED MUSHROOM FIXTURE



TFC features a circular “puff” diffuser suitable for closets, laundry areas, and pantries in residential or light commercial applications.

ITEM NO.	DESCRIPTION
TFC11L13W900LD12030K	11"Dia x 3"E / Mushroom / 13W 900L / Triac Dim / 3000K
TFC11L14W1350LD12030K	11"Dia x 3"E / Mushroom / 14W 1350L / Triac Dim / 3000K
TFC14L14W1350LD12030K	14"Dia x 3"E / Mushroom / 14W 1350L / Triac Dim / 3000K
TFC14L23W1850LD12030K	14"Dia x 3"E / Mushroom / 23W 1850L / Triac Dim / 3000K

**CCT4**

Change 30K to 40K for 4000K. Consult for multi-volt and other wattage and lumen options.

## LED DRUM FIXTURE



CIRDC offers a clean, contemporary look, perfect for kitchens, hallways, laundry rooms, pantries, bathrooms, and general work areas.

ITEM NO.	DESCRIPTION
CIRDC11L13W900LD12030K	11"Dia x 3"E / Drum / 13W 900L / Triac Dim / 3000K
CIRDC11L14W1350LD12030K	11"Dia x 3"E / Drum / 14W 1350L / Triac Dim / 3000K
CIRDC14L14W1350LD12030K	14"Dia x 3"E / Drum / 14W 1350L / Triac Dim / 3000K
CIRDC14L23W1850LD12030K	14"Dia x 3"E / Drum / 23W 1850L / Triac Dim / 3000K

**CCT4**

Consult for multi-volt and other wattage and lumen options.

## LED DOME FIXTURE



HOTCE is a clean, stylized dome, suitable for a wide variety of residential and light commercial applications.

ITEM NO.	DESCRIPTION
HOTCE11L13W900LD12030K	11"Dia x 3.875"E / Dome / 13W 900L / Triac Dim / 3000K
HOTCE11L14W1350LD12030K	11"Dia x 3.875"E / Dome / 14W 1350L / Triac Dim / 3000K
HOTCE14L14W1350LD12030K	14"Dia x 4.25"E / Dome / 14W 1350L / Triac Dim / 3000K
HOTCE14L23W1850LD12030K	14"Dia x 4.25"E / Dome / 23W 1850L / Triac Dim / 3000K

**CCT4**

Change 30K to 40K for 4000K. Consult for multi-volt and other wattage and lumen options.

## LED SPILL RING CTC w/ SMARTSENSE



Shown without lens to see sensor. Complete Fixture looks like HOTCD on left.

Provides adjustable soft illumination with dimming capability and occupancy sensing technology to fully illuminate areas when occupied and provide maximum cost savings when areas are not in use. The advanced microwave sensor technology has multiple sensor options available, including on/off sensor controlled, bi-level or adjustable standby, and even daylight sensing technology to ensure no is ever left in dark.

ITEM NO.	DESCRIPTION
SMHOTCD18L35W3300LMVSN(50)MCT	17.75"D x 5"H / 35W, 3300L / 0-10V Dim / Occupancy and Daylight Harvesting Sensor / Available in 3000K, 3500K or 4000K

**CCT3**

## User Friendly Color Temperature

Now some Saylite fixtures have “MCT” for color temperature which features a Dip Switch to change color from 3000, 3500 and 4000 kelvin.

# CLOSE-TO-CEILING / DISK LIGHTS LED



These Micro LED Close-to-Ceiling fixtures are particularly a good solution in wet location applications where normally a much larger and usually simple utilitarian look is used like in outdoor breezeways and showers/bathroom applications. They are also stylish substitutes for recessed downlights especially where ceiling obstructions or codes make a surface mount a good solution. It is ideal for applications that require expensive fire rated boxes for recessed fixtures since these mount simply to a surface mounted junction box.

## ULTRA THIN EDGELIT DOWNLIGHT (WET LOCATION)

Choose either a round or square silhouette in two sizes and two finishes, white and brushed nickel with a special regressed lens to provide even, comfortable illumination from these edge-lit fixtures. Wet location for indoor and outdoor use. 120V only. Dims to 10% with standard dimmers.



ITEM NO.	DESCRIPTION
RCR5L10W660L30KBN	5.5"Dia x 0.625"H / LED Regressed Round Lens/ 10W, 660L / 120V Dim / 3000K / Brushed Nickel
RCR5L10W660L30KWH	5.5"Dia x 0.625"H / LED Regressed Round Lens/ 10W, 660L / 120V Dim / 3000K / White
RCR7L15W1000L30KBN	7"Dia x 0.625"H / LED Regressed Round Lens/ 15W, 1000L / 120V Dim / 3000K / Brushed Nickel
RCR7L15W1000L30KWH	7"Dia x 0.625"H / LED Regressed Round Lens/ 15W, 1000L / 120V Dim / 3000K / White
RCS5L10W660L30KBN	6.28"L x 0.625"H / LED Regressed Square Lens / 10W, 660L / 120V Dim / 3000K / Brushed Nickel
RCS5L10W660L30KWH	6.28"L x 0.625"H / LED Regressed Square Lens / 10W, 660L / 120V Dim / 3000K / White
RCS7L15W1000L30KBN	8"L x 0.625"H / LED Regressed Square Lens / 15W, 1000L / 120V Dim / 3000K / Brushed Nickel
RCS7L15W1000L30KWH	8"L x 0.625"H / LED Regressed Square Lens / 15W, 1000L / 120V Dim / 3000K / White

Lumens shown are gross lumens. Net lumens is 20% less.

## MICRO LED SURFACE MOUNT (WET LOCATION)

Low profile LED disc mounts directly to junction box or to 4" or 6" recessed housing to provide uniform look throughout your project. Easy dimming with standard dimmer. Wet location.



ITEM NO.	DESCRIPTION
SMC4L12W900L30KWH	4"(5.9"OD) x 1.2"H / Surface Mount / White Opal Acrylic Lens / 12W, 900L / 120V Dim / 3000K / White
SMC6L15W1100L30KWH	6"(7.4"OD) x 1.2"H / Surface Mount / White Opal Acrylic Lens / 15W, 1095L / 120V Dim / 3000K / White
SMC9L26W2100L30KWH	9"(9.5"OD) x 1.2"H / Surface Mount / White Opal Acrylic Lens / 26W, 1700L / 120V Dim / 3000K / White
SMC4RECACC	4in TORTIONITE ACCESSORY
SMC6RECACC	6in TORTIONITE ACCESSORY

Consult for bronze and satin nickel.

## SMC EMERGENCY AND 277V VERSION (WET LOCATION)

EM disc for low plenum locations and affordable solution to hiding EM fixtures. Includes specially designed junction box for install before drywall. Wet rated.



Emergency Version

ITEM NO.	DESCRIPTION
SMC6L15W1100L30K-WH-277V	6"(7.4"OD) x 1.2"H / Surface Mount / White Opal Acrylic Lens / 15W, 1100L / 277V / 3000K / White / Non Dim
SMC6L15W1100L30KWH-EM	6"(7.4" OD ) x 1.2"H / Integral EM in recessed 4"H junction Box / 15W, 1100L / 120V / 3000K / White / EM mode 6W 400L / Non Dim

Emergency version comes with junction box.

## SURFACE DISCS 11" AND 15" (WET LOCATION)

Large LED discs provide a sleek modern look to replace oversized flushmounts. These sealed fixtures are a great option for outdoor to prevent bug build up.



ITEM NO.	DESCRIPTION
SMC11L28W1700LD12030KWH	11"D x 1.2"H / Surface Mount / White Opal Acrylic Lens / 28W, 1700L / 120V Dim / 3000K / White
SMC11L28W1700LD12030KBN	11"D x 1.2"H / Surface Mount / White Opal Acrylic Lens / 28W, 1700L / 120V Dim / 3000K / Brush Nickel
SMC15L40W2500LD12030KWH	15"D x 1.2"H / Surface Mount / White Opal Acrylic Lens / 40W, 2500L / 120V Dim / 3000K / White
SMC15L40W2500LD12030KBN	15"D x 1.2"H / Surface Mount / White Opal Acrylic Lens / 40W, 2500L / 120V Dim / 3000K / Brush Nickel

## MULTI-FAMILY DISC (WET LOCATION) **NEW**

The right value when using hundreds of discs on your project. Driver on board LED technology in 120V only makes it the right light for many projects.



ITEM NO.	DESCRIPTION
IRCR5L11W600L30KWH	Regressed CTC / 5.0in Dia / 11W, 600L / 120V Dim / 3000K / White
IRCR7L16W1000L30KWH	Regressed CTC/ 7.0in Dia / 16W, 1000L / 120V Dim / 3000K / White

# CLOSE-TO-CEILING / DISK LIGHTS LED



## LED TAPERED DISK (WET LOCATION)

This new tapered Disk Light provides bright general illumination in a sleek, small, package, providing 75% energy savings while lasting 10X longer than conventional recessed downlights. Available in 3 finishes, and dimmable. Ideal for wet location applications.

ITEM NO.	DESCRIPTION
TDL6L15W1100L30KBA	7.375"D x 1.5"H / Tapered LED Disk / 15W, 1100L / 120V Dim / 3000K / Brushed Alum.
TDL6L15W1100L30KBZ	7.375"D x 1.5"H / Tapered LED Disk / 15W, 1100L / 120V Dim / 3000K / Bronze
TDL6L15W1100L30KWH	7.375"D x 1.5"H / Tapered LED Disk / 15W, 1100L / 120V Dim / 3000K / Matte White
TDL6RECACC	6in RECESSED CAN ACCESSORY

### CCT3

Change 30K to 40K

## LED TAPERED DISK WITH PULL CHAIN **NEW**

The popular low profile LED disk lights now available with a pull chain for those applications that require an integral on/off switch. Ideal for retrofit applications especially in closet and storage areas.



ITEM NO.	DESCRIPTION
TDL6L15W1100L30KBA-SW	7.375"D x 1.5"H / Tapered LED Disk / 15W, 1100L / 120V Dim / 3000K / Brushed Alum. with Pull Chain Switch
TDL6L15W1100L30KBZ-SW	7.375"D x 1.5"H / Tapered LED Disk / 15W, 1100L / 120V Dim / 3000K / Bronze with Pull Chain Switch
TDL6L15W1100L30KWH-SW	7.375"D x 1.5"H / Tapered LED Disk / 15W, 1100L / 120V Dim / 3000K / Matte White with Pull Chain Switch

## MICRO LED SURFACE MOUNT (WET LOCATION)

Low profile LED disc mounts directly to junction box or to 4" or 6" recessed housing to provide uniform look throughout your project. Easy dimming with standard dimmer. Wet location.



ITEM NO.	DESCRIPTION
LMD6L15W1100LD12030KWH	Disk LED 15W 1100L, Dimmable. 35000 Hours. 7.5"OD x 1.5"H, White
LMD6L15W1100LD12030KBA	Disk LED 15W 1100L, Dimmable. 35000 Hours. 7.5"OD x 1.5"H, Brushed Aluminum



Latest LED driver on board technology allows all the benefits of LED lighting including simple, cost effective triac, low voltage dimming without the size of an external driver.

## LED DISK W/INTEGRAL SENSOR **NEW**

This wet location LED disk light not only provide bright, comfortable lighting with great energy efficiency but also incorporates an integral motion sensor with 15 foot range from eight foot ceiling to conserve energy when area is not occupied.



ITEM NO.	DESCRIPTION
CLS12W1000LD12030KWH	7" LED MOTION FIXTURE WHITE W/ FROSTED LENS 12W 1000L/TRIAC DIMMING/ 3000K





## CONTEMPO CEILING AND PENDANT **NEW**

Rich, Brushed Nickel metal band adorns a special formulated acrylic lens to provide a soft, comfortable LED light. Low profile Close-to-ceiling or matching ceiling and pendant can dress up circulation and living spaces.

ITEM NO.	DESCRIPTION
CBA24W1850LD12030KBN	CEILING MUSHROOM W/ BRUSHED NICKEL BAND 15"W X 3.75"H AND WHITE LENS 24W 1850L / 3000K
CBB24W1850LD12030KBN	CEILING BRUSH NICKEL BASE W/ WHITE LENS BAND 13.75"W X 4.625"H / 24W 1850L / 3000K & 4000K
CBC24W1850LD12030KBN	CEILING BRUSH NICKEL BASE W/ WHITE LENS BAND 13.75"W X 4.625"H / 24W 1850L / 3000K & 4000K

## LED SPILL RING WALL BRACKET

ADA wall bracket is ideal for corridors and entries. Acrylic diffuser is easy to maintain. Spill ring design matches close-to-ceiling and linear fixtures.



ITEM NO.	DESCRIPTION
HOTWDL24W1200LMV30KSN	4"E x 9.25"W x 10.5"H / Acrylic / 24W, 1200L / 120V - 277V / 3000K / Satin Nickel / Non Dim

## LED CUFF LINK WALL BRACKET

Curved Bent glass diffuser held by satin nickel decorative hardware meets ADA and provide comfortable lighting for corridors and circulation spaces. Open top and bottom doesn't collect debris.



ITEM NO.	DESCRIPTION
HOTWFL15W1100LD120SN30K	4.25"E x 10.5"W x 11.5"H / Frost Acrylic / 15W, 1100L / 120V Dim / 3000K / Satin Nickel / Non Dim

## LED WALL BRACKET

High transmission acrylic diffuser provides comfortable lighting and is surrounded by distinctive satin nickel hardware. Closed top and bottom are ideal for locations wanting to minimize cleaning issues.



ITEM NO.	DESCRIPTION
HOTWVL12W800LD12030KBZ	4"E x 7"W x 10"H / Frost Acrylic / 12W, 800L / 120V Dim / 3000K / Satin Nickel

# Outdoor



Saylite offers a comprehensive selection of LED fixtures to meet all your exterior applications from Site Lighting to decorative attached to the building, to the more utilitarian. Saylite's linear enclosures offer the performance, reliability and options to address rough service, wet and other demanding applications. Exterior fixtures include LED, X1LED and even legacy fluorescent and HID options. All of the exterior fixtures are focused on delivering safety, security and sustainability. Wall packs, flood and wide area lighting are available to meet today's demanding specifications in a range of lumen outputs and energy requirements including meeting Dark Sky codes and maintenance targets.



See wet location linear CWLL on page 46.

## ENCLOSED LOW BAY (WET LOCATION)

Engineered LED lighting system designed for exterior applications where weatherproof lighting is required. Tough diffuser resists breakage while providing excellent light transmission with minimal glare. Wet location.



ITEM NO.	DESCRIPTION
CITE24LRFV22W2500LLBDMV40K	27.68"L x 7.33"W x 4.13"H / Ribbed Lens / 22W, 2500L / Lowbay / 0-10V Dim / 4000K
CITE24LFRF24W2700LLBDMV40K	27.68"L x 7.33"W x 4.13"H / Frosted Lens / 24W, 3000L / Lowbay / 0-10V Dim / 4000K
CITE24LFRF28W3300LLBDMV40K	27.68"L x 7.33"W x 4.13"H / Frosted Lens / 28W, 3500L / Lowbay / 0-10V Dim / 4000K
CITE48LRFV37W4600LLBDMV40K	51.81"L x 7.33"W x 4.13"H / Ribbed Lens / 37W, 4600L / Lowbay / 0-10V Dim / 4000K
CITE48LFRF48W5600LLBDMV40K	51.81"L x 7.33"W x 4.13"H / Frosted Lens / 48W, 6200L / Lowbay / 0-10V Dim / 4000K
CITE48LFRF57W6800LLBDMV40K	51.81"L x 7.33"W x 4.13"H / Frosted Lens / 57W, 7100L / Lowbay / 0-10V Dim / 4000K
CITE96LRFV74W9200LLBDMV40K	98.51"L x 7.33"W x 4.13"H / Ribbed Lens / 74W, 9200L / Lowbay / 0-10V Dim / 4000K
CITE96LFRF97W11200LLBDMV40K	98.51"L x 7.33"W x 4.13"H / Frosted Lens / 97W, 11200L / Lowbay / 0-10V Dim / 4000K
CITE96LFRF114W13600LLBDMV40K	98.51"L x 7.33"W x 4.13"H / Frosted Lens / 114W, 13600L / Lowbay / 0-10V Dim / 4000K

Consult for sensors. Consult for stainless steel latches.

**Consult for New Narrow Economy Version 48 inch.**

## ENCLOSED PARKING GARAGE (WET LOCATION)

A highly engineered LED lighting system designed for parking garages and other applications where weatherproof wide area lighting is required. Specially designed reflector provides wide spread light transmission with minimal glare.



ITEM NO.	DESCRIPTION
CITE48LFRJ48W4800LPGDMV40K	51.81"L x 7.33"W x 4.13"H / Frosted Shallow Lens / 48W, 4800L / Parking Garage / 0-10V Dim / 4000K
CITE48LFRJ57W5700LPGDMV40K	51.81"L x 7.33"W x 4.13"H / Frosted Shallow Lens / 57W, 5700L / Parking Garage / 0-10V Dim / 4000K
CITE48LFRZ72W7000LPGDMV40K	51.81"L x 7.33"W x 4.13"H / Frosted Shallow Lens / 72W, 7000L / Parking Garage / 0-10V Dim / 4000K
CITE96LFRJ57W5700LPGDMV40K	98.5"L x 7.33"W x 4.13"H / Frosted Shallow Lens / 57W, 5700L / Parking Garage / 0-10V Dim / 4000K
CITE96LFRJ97W9700LPGDMV40K	98.5"L x 7.33"W x 4.13"H / Frosted Shallow Lens / 97W, 9700L / Parking Garage / 0-10V Dim / 4000K

**EM3 G120 OS5 RGBW D1MV CCT1 SURF PEND WET**

Consult for sensors. For stainless steel latches, add SL.



Ribbed Lens



Smooth Lens



Deep Lens

## LED VAPORTIGHT (WET LOCATION)

ITEM NO.	DESCRIPTION
CITN48LRFJ48W5000LLBDMV40K	51.81"L x 4.4"W x 4.13"H / Ribbed Lens / 48W, 5000L / Lowbay / 0-10V Dim / 4000K

**EM3 G120 OS6 RGBW D1MV CCT1 SURF PEND WET**

Acrylic Lens Options	2ft	4ft	8ft
<b>RF</b> Ribbed Frosted	*✓	*✓	✓
<b>LB</b> Linear Ribbed	*✓	*✓	✓
<b>CL</b> Clear Shallow		*✓	
<b>FR</b> Frosted Shallow		*✓	
<b>OL</b> Clear Deep Lens	✓	✓	✓
<b>FL</b> Frosted Deep Lens	✓	✓	✓

\*Add "P" in front of Lens options above for Polycarbonate. Consult for pricing adders on these.



Deep Lens not available for CITN.

For the Icon Legend, see pages 154-155. Item numbers highlighted in gray are DLC Listed.

# Outdoor



Standard 3/4" hub allows standard electrical accessories for installation.

## OUTDOOR SIGN LIGHTER 3/4" HUB (WET LOCATION)

This spec-grade sign lighter rotates up to 360° and is constructed from sealed, powder-coated aluminum extrusion with a lens, suitable for parking and commercial/retail outdoor areas, for sign and walkway lighting. 3/4" Hub. Wet location.

ITEM NO.	DESCRIPTION
OSL48LS48W5900LDMV40K	54.5"L x 5.25"W x 3.06"H / Clear Lens / 48W, 5900L / 0-10V Dim / 4000K
OSL48LS57W6500LDMV40K	54.5"L x 5.25"W x 3.06"H / Clear Lens / 57W, 6500L / 0-10V Dim / 4000K
OSL96LS114W13000LDMV40K	102.5"L x 5.25"W x 3.06"H / Clear Lens / 114W, 13000L / 0-10V Dim / 4000K
OSL96LS96W11800LDMV40K	102.5"L x 5.25"W x 3.06"H / Clear Lens / 96W, 11800L / 0-10V Dim / 4000K

EM3 G120 RGBW D1MV CCT1 SURF PEND WET

## LINEAR VANDAL RESISTANT (DAMP LOCATION)

This wraparound LED fixture is designed for high-abuse areas such as parking garages and school corridors and features an injection-molded UV-stabilized 100% clear, polycarbonate, prismatic lens.



ITEM NO.	DESCRIPTION
CV800LJ48W4800LDMV50K	50.25"L X 8.25"W X 4.5"H / Clear Polycarbonate Lens / 48W, 4800L / 0-10V Dim / 5000K
CV800LZ72W7200LDMV50K	50.25"L X 8.25"W X 4.5"H / Clear Polycarbonate Lens / 72W, 7200L / 0-10V Dim / 5000K

EM3 G120 RGBW D1MV CCT1 SURF WET

## PROFILE (WET LOCATION) **NEW**

The new Profile series is ideal for low bay area lighting where wet rated enclosures are required. Co-extruded 5VA plastic housing and lens ensure a fully encapsulated enclosure for garden centers, food processing, supermarkets or anywhere that general lighting is required in a wet location application. Ideal for wash down and where chemicals are present. IP66.



Consult for clear frosted end caps.

ITEM NO.	DESCRIPTION
PRO24LZ16W1700LDMV40KBK	24"L x 4.16"W x 4.44"H / Matte White Lens / 16W, 1700L / 0-10V Dim / 4000K / Black End Caps / Grey Housing
PRO24LZ24W2500LDMV40KBK	24"L x 4.16"W x 4.44"H / Matte White Lens / 24W, 2500L / 0-10V Dim / 4000K / Black End Caps / Grey Housing
PRO48LZ32W3300LDMV40KBK	48"L x 4.16"W x 4.44"H / Matte White Lens / 32W, 3300L / 0-10V Dim / 4000K / Black End Caps / Grey Housing
PRO48LZ48W5000LDMV40KBK	48"L x 4.16"W x 4.44"H / Matte White Lens / 48W, 5000L / 0-10V Dim / 4000K / Black End Caps / Grey Housing
PRO96LZ64W6600LDMV40KBK	96"L x 4.16"W x 4.44"H / Matte White Lens / 64W, 6600L / 0-10V Dim / 4000K / Black End Caps / Grey Housing
PRO96LZ96W10000LDMV40KBK	96"L x 4.16"W x 4.44"H / Matte White Lens / 96W, 10000L / 0-10V Dim / 4000K / Black End Caps / Grey Housing

EM3 G120 OS6 RGBW D1MV CCT1 SURF PEND WET

### Options to Make It "Your Way"

EM1 SURF X1LED

The icons listed under every series identifies all of the options available for that series, including color temperatures, emergencies, sensors/controls, coordinating applications and more. See pages 154 and 155 for full explanations of each icon.



## LED CANOPY (WET LOCATION)

The economical CPY is a sealed, die-cast, low profile for indoor and outdoor applications. Ideal for parking garages but also works well for storage areas, shopping area walkways and other low security applications.



ITEM NO.	DESCRIPTION
CPY10L27W3800LDMV50K	9.52"L x 9.52"W x 3.19"H / Clear Polycarbonate Lens / 27W, 3800L / 0-10V Dim / 5000K / Bronze
CPY10L40W5400LDMV50K	9.52"L x 9.52"W x 3.19"H / Clear Polycarbonate Lens / 40W, 5400L / 0-10V Dim / 5000K / Bronze
CPY10L60W8000LDMV50K	9.52"L x 9.52"W x 3.19"H / Clear Polycarbonate Lens / 60W, 8000L / 0-10V Dim / 5000K / Bronze

## LED LOW PROFILE WALL OR CEILING (WET LOCATION)

This wall or ceiling light has a slim and low profile design which provides safe and a visually appealing lighting experience. Quick mount structure for fast installation. Wet rated.



VPYMGUARD



VPYCGUARD

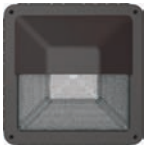

VPYHGUARD

ITEM NO.	DESCRIPTION
VPY9L20W2600LMV50K	8.8"L x 8.8"W x 3.3"H / 20W, 2616L / 120-277V / 5000K / Bronze
VPY9L40W4500LMV50K	8.8"L x 8.8"W x 3.3"H / 40W, 4476L / 120-277V / 5000K / Bronze
VPY11L60W7000LMV50K	10.6"L x 10.6"W x 3.3"H / 60W, 7018L / 120-277V / 5000K / Bronze
VPY13L80W10000LMV50K	12.8"L x 12.8"W x 3.3"H / 80W, 10093L / 120-277V / 5000K / Bronze
VPYMGUARD	M-Guard with reflector for 11L housing only / 10.6"L x 10.6"W x 3.3"H / Bronze
VPYCGUARD	C-Guard with reflector for 11L housing only / 10.6"L x 10.6"W x 3.3"H / Bronze
VPYHGUARD	H-Guard with reflector for 11L housing only / 10.6"L x 10.6"W x 3.3"H / Bronze

## LED LARGE CANOPY

The large, 12" square, CV300 Canopy features heavy-duty die-cast aluminum powder-coated construction and a high-impact polycarbonate lens. Ideal for parking garages, walkways, and other harsh environments.



ITEM NO.	DESCRIPTION
CV30012L53W6250LDMV50KBZ	12Inch Square , Clear Lens, 53W / 6267Lm, 50K, Bronze Finish

## LED ROUND CANOPY (WET LOCATION)

Wet location round canopy with high efficacy (up to 127lm/W) and sensor available for greater energy savings.



ITEM NO.	DESCRIPTION
RCP12L30W3600LDMV50KBZ	12"Dia x 3.32"H / 30W, 3600L / 0-10 Dim / 5000K / Bronze
RCP12L45W5000LDMV50KBZ	12"Dia x 3.32"H / 45W, 5000L / 0-10 Dim / 5000K / Bronze
RCP12L60W7100LDMV50KBZ	12"Dia x 3.32"H / 60W, 7100L / 0-10 Dim / 5000K / Bronze

# Outdoor



F1303 - Round



F1302 - Square

## WET LOCATION CLOSE-TO-CEILING

This wet location fixture is available Round (1303) or Square (1302), with black or white housing and white lens. Is ideal for lighting residential exteriors, entry ways, stairways, walkways, perimeters, parking garages, storage areas, and warehouses.

ITEM NO.	DESCRIPTION
F13032INCLPLEDWH	ROUND CEILING WET / 9.375" Dia x 4.5"H / 2 x LED Lamp 9.5W A19 30K Incl. / 120V Dim / White
F1303L22W1824LMVWH40K	ROUND CEILING WET / 9.375" Dia x 4.5"H / 22W, 1824L / 120-277V / 4000K / White
F1303L23W1900LD120WH40K	ROUND CEILING WET / 9.375" Dia x 4.5"H / 23W, 1900L / 120V Dim / 4000K / White
F13022INCLPLEDWH	SQUARE CEILING WET / 10"L x 10"W x 4.5"H / 2 x LED Lamp 9.5W A19 30K Incl. / 120V Dim / White
F1302L22W1824LMVWH40K	SQUARE CEILING WET / 10"L x 10"W x 4.5"H / 22W, 1824L / 120-277V / 4000K / White
F1302L23W1900LD120WH40	SQUARE CEILING WET / 10"L x 10"W x 4.5"H / 23W, 1900L / 120V Dim / 4000K / White

For 3000K change 40K to 30K. For Black body, change WH to BK. See LED Lamp spec on page 114.

## UTILITY LED



ITEM NO.	DESCRIPTION
SWPFRACINCLPLED	Small Wall Pack 5" x 8" Incand. socket & LED Lamp 9.5W A19 30K Incl. White Dimmable 120V
SWPFRACL13W1000LD12040K	Small Wall Pack 13W 1000L White Dimmable 120V
MWPFRACINCLPLED	Medium Wall Pack, Incand. socket & LED Lamp 9.5W A19 30K Incl. White 6" x 10.8" Dimmable 120V
MWPFRACL13W1000LD12040K	Medium Wall Pack 13W 1000L White Dimmable 120V
LWPFR15W1500LMV40K	Large Wall Pack Clear Lens 15W 1500L Multi-Volt 40K

For 3000K change 40K to 30K.

## UTILITY CEILING FIXTURE

This utilitarian workhorse is damp location and ideal for circulation spaces in commercial or multi-family applications. Consult factory for tamper-proof and other lens options.



ITEM NO.	DESCRIPTION
F1010CLAC2INCLPLED	SQUARE SENTINEL / 10"L x 10"W x 4"H / 2 x LED Lamp 9.5W A19 30K Incl. / 120V Dim / White
F1010CLAC10L14W1400LD12040K	SQUARE SENTINEL / 10"L x 10"W x 4"H / 14W, 1400L / 120V Dim / 4000K / White
F1010CLAC10L23W1900LD12040K	SQUARE SENTINEL / 10"L x 10"W x 4"H / 23W, 1900L / 120-277V / 4000K / White

## SQUARE CEILING LED

Traditional design, surface-mounted porch light is 10.25" square and commercial grade wet location with a galvanized steel base in white or black.



ITEM NO.	DESCRIPTION
CBPINCLPLEDWH	8.25"L x 8.25"W x 4.75"H / Frosted Lens / LED Lamp 9.5W A19 30K Incl. / 120V Dim / White
CBPL11W912LMVWH40K	8.25"L x 8.25"W x 4.75"H / Frosted Lens / 11.3W, 912L / 120-277V / 4000K / White
CBPL13W1000LD120WH40K	8.25"L x 8.25"W x 4.75"H / Frosted Lens / 13W, 1000L / 120V Dim / 4000K / White

## OUTDOOR WET LOCATION WALL/CEILING

The new OUT general-use, wet-location ceiling and wall fixture provides maintenance-free and bug-free illumination for commercial and residential applications. Its simple, sleek design, die-cast backplate, and rugged acrylic lens makes it the ideal solution for almost any outdoor application. Bug Proof. IP65. Eyelid version provides direct light only.



ITEM NO.	DESCRIPTION
OUTMW15W1200LD120WH40K	Round 12" Dia x 3.61"Depth / White Acrylic Lens / 15W, 1200L / 120V Dim / 4000K / White
OUTMW15W1200LD120BK40K	Round 12" Dia x 3.61"Depth / White Acrylic Lens / 15W, 1200L / 120V Dim / 4000K / Black
OUTEYMW15W1200LD120WH40K	Round EYELID 12" Dia x 3.61"Depth / White Acrylic Lens / 15W, 1200L / 120V Dim / 4000K / White
OUTEYMW15W1200LD120BK40K	Round EYELID 12" Dia x 3.61"Depth / White Acrylic Lens / 15W, 1200L / 120V Dim / 4000K / Black

## CEILING GLOBES (WET LOCATION)

Classic balls and jars for a wide variety of applications. Additional style balls and jars available. Consult factory for more information.



ITEM NO.	DESCRIPTION
BCCINCLPLEDWHCAG	SCREW NECK GLOBE / 6"Dia x 7.25"H / Clear Acrylic Globe / LED Lamp 9.5W A19 27K Incl. / 120V Dim / White
BPCINCLPLEDWHWAG	SCREW NECK GLOBE TAPER / 6"Dia x 7.25"H / White Acrylic Globe / LED Lamp 9.5W A19 27K Incl. / 120V Dim / White

For Black base lamp change WH to BK

## CYLINDER CLASSIC GLOBES (WET LOCATION)

Economical and versatile, these classic cylinder ceiling globes are ideal for any wet location application. Ceiling-mount available in black or white, and with clear or white diffuser



ITEM NO.	DESCRIPTION
BCCINCLPLEDWHWSJ	HARBOR SCREW NECK / 8.5"L x 4.25"Dia / White Diffuser / LED Lamp 9.5W A19 27K Incl. / 120V Dim / White
WPCINCLPLEDWHCSJ	HARBOR SCREW NECK TAPER / 8.5"L x 4.25"Dia / Clear Diffuser / LED Lamp 9.5W A19 27K Incl. / 120V Dim / White
BPCINCLPLEDWHWPJ	LONG BEACH TAPER / 8.25"H x 4.25" Dia / White Polycarbonate Jar / LED Lamp 9.5W A19 27K Incl. / 120V Dim / White

For Black base lamp change WH to BK. For other lens options, consult factory.

## OUTDOOR OCTAGON SERIES

Where you need a more stylized fixture, choose this durable damp location LED fixture, molded of non-corrosive and UV-resistant resins.



ITEM NO.	DESCRIPTION
OCLINCLPLEDWH	OCTAGON CEILING / Frosted Lens / 10.25"W x 5.75"H / LED Lamp 9.5W A19 30K Incl. / 120V Dim / White
OCL10L14W1400LD120WH40K	OCTAGON CEILING / Frosted Lens / 10.25"W x 5.75"H / 14W, 1400L / 120V Dim / 4000K / White
OCL10L23W1900LD120WH40K	OCTAGON CEILING / Frosted Lens / 10.25"W x 5.75"H / 23W, 1900L / 120V Dim / 4000K / White

For 3000K change 40K to 30K. For Black, change WH to BK

# Outdoor

## LED NAUTICAL WALL OR CEILING (WET LOCATION)

The CEO is an oval, commercial-grade wall or ceiling mounted fixture available in black or white, with frosted lens. Available with plain, grill, or eyelid lenses. Ideal for nautical applications. Wet location.



CEO



CEOG



CEOS



CEOC



ITEM NO.	DESCRIPTION
EOINCLPLEDWH	Euro Oval Wall or Ceiling / 10.625"W x 6"H x 4.25"Dp / Frosted Lens / LED Lamp 9.5W A19 30K Incl. / 120V Dim / White
CEOL11W912LMVWH40K	Euro Oval Wall or Ceiling / 10.625"W x 6"H x 4.25"Dp / Frosted Lens / 11W, 912L / 120-277V / 4000K / White
CEOL13W1000LD120WH40K	Euro Oval Wall or Ceiling / 10.625"W x 6"H x 4.25"Dp / Frosted Lens / 13W, 1000L / 120V Dim / 4000K / White
EOGINCLPLEDWH	Euro Oval Wall or Ceiling w/Grill / 10.625"W x 6"H x 4.25"Dp / Frosted Lens / LED Lamp 9.5W A19 30K Incl. / 120V Dim / White
CEOGL11W912LMVWH40K	Euro Oval Wall or Ceiling w/Grill / 10.625"W x 6"H x 4.25"Dp / Frosted Lens / 11W, 912L / 120-277V / 4000K / White
CEOGL13W1000LD120WH40K	Euro Oval Wall or Ceiling w/Grill / 10.625"W x 6"H x 4.25"Dp / Frosted Lens / 13W, 1000L / 120V Dim / 4000K / White
EOSINCLPLEDWH	Euro Oval Wall or Ceiling w/Eyelid / 10.625"W x 6"H x 4.25"Dp / Frosted Lens / LED Lamp 9.5W A19 30K Incl. / 120V Dim / White
CEOSL11W912LMVWH40K	Euro Oval Wall or Ceiling w/Eyelid / 10.625"W x 6"H x 4.25"Dp / Frosted Lens / 11W, 912L / 120-277V / 4000K / White
CEOSL13W1000LD120WH40K	Euro Oval Wall or Ceiling w/Eyelid / 10.625"W x 6"H x 4.25"Dp / Frosted Lens / 13W, 1000L / 120V Dim / 4000K / White

For Full Grill change EOS to EOC and CEO to CEOC

The CER is a round, commercial-grade wall or ceiling mounted fixture available in black or white, with frosted lens. Available with plain, grill, or eyelid lenses. Ideal for nautical applications. Wet location.

CER



CERG



CERC



ITEM NO.	DESCRIPTION
ERLINCLPLEDWH	Euro Round Wall or Ceiling / 10.3"Dia x 5.25"Dp / Frosted Lens / LED Lamp 9.5W A19 30K Incl. / 120V Dim / White
CERL22W1824LMVWH40K	Euro Round Wall or Ceiling / 10.3"Dia x 5.25"Dp / Frosted Lens / 22W, 1824L / 120-277V / 4000K / White
CERL23W1900LD120WH40K	Euro Round Wall or Ceiling / 10.3"Dia x 5.25"Dp / Frosted Lens / 23W, 1900L / 120V Dim / 4000K / White
ERGINCLPLEDWH	Euro Round Wall or Ceiling w/Grill / 10.3"Dia x 5.25"Dp / Frosted Lens / LED Lamp 9.5W A19 30K Incl. / 120V Dim / White
CERGL22W1824LMVWH40K	Euro Round Wall or Ceiling w/Grill / 10.3"Dia x 5.25"Dp / Frosted Lens / 22W, 1824L / 120-277V / 4000K / White
CERGL23W1900LD120WH40K	Euro Round Wall or Ceiling w/Grill / 10.3"Dia x 5.25"Dp / Frosted Lens / 23W, 1900L / 120V Dim / 4000K / White
ERCINCLPLEDWH	Euro Round Wall or Ceiling w/Mask / 10.3"Dia x 5.25"Dp / Frosted Lens / LED Lamp 9.5W A19 30K Incl. / 120V Dim / White
CERCL22W1824LMVWH40K	Euro Round Wall or Ceiling w/Mask / 10.3"Dia x 5.25"Dp / Frosted Lens / 22W, 1824L / 120-277V / 4000K / White
CERCL23W1900LD120WH40K	Euro Round Wall or Ceiling w/Mask / 10.3"Dia x 5.25"Dp / Frosted Lens / 23W, 1900L / 120V Dim / 4000K / White

## ROUND WALL CYLINDER (WET LOCATION)

For sensitive outdoor applications, specify the WCD turtle- and dark sky-friendly wall cylinders. Molded of durable non-corrosive UV-resistant resins and listed for wet locations.



(Turtle Friendly)



ITEM NO.	DESCRIPTION
WCD8LINCWH	5"Dia x 8"H / 2.75" Arm / Medium Socket / 120V / White
WCD10LINCWH	5"Dia x 12"H / 2.75" Arm / Medium Socket / 120V / White

For Black change WH to BK. Lamps sold separately. Ideal for LED Par 30 Lamp



## SQUARE WALL CYLINDER (WET LOCATION)



These aluminum and glass Wet location square cylinders are ideal where a sleek, modern look meets wet location and dark sky friendly lighting. Ideal for wayfinding and outdoor circulation spaces. Available in two sizes.

ITEM NO.	DESCRIPTION
WCD4SL9W750LMV40K BK	6.5"E x 4.5"W x 6.3"H / 9W, 750L / 4000K / 120-277V / Down Only / Black
WCD4LL15W1500LMV40K BK	6.5"E x 4.5"W x 12"H / 15W, 1500L / 4000K / 120-277V / Up and Down / Black

## NAUTICAL LANTERNS AND POST TOPS (WET LOCATION)

These nautically styled fixtures are made of durable plastic in a choice of black or white, and with clear prismatic or white diffusers. Choose from wall-mounted, post-top, or bollard.



NOB



ITEM NO.	DESCRIPTION
NOBINCLPLEDWH	Nautical Bollard Top / 10.06"W x 10"H / Clear Lens / LED Lamp 9.5W A19 30K Incl. / 120V Dim / White
NOBL13W1000LD120WH40K	Nautical Bollard Top / 10.06"W x 10"H / Clear Lens / 13W, 1000L / 120V Dim / 4000K / White



NOP



NOPINCLPLEDWH	Single Nautical Post Top / 10.06"W x 13"H / Clear Lens / LED Lamp 9.5W A19 30K Incl. / 120V Dim / White
NOPL11W912LMVWH40K	Single Nautical Post Top / 10.06"W x 13"H / Clear Lens / 11W, 912L / 120-277V / 4000K / White
NOPL13W1000LD120WH40K	Single Nautical Post Top / 10.06"W x 13"H / Clear Lens / 13W, 1000L / 120V Dim / 4000K / White
NOP2INCLPLEDWH	Double Nautical Post Top / 23.375"W x 13"H / Clear Lens / LED Lamp 9.5W A19 30K Incl. / 120V Dim / White
NOP2L22W1824LMVWH40K	Double Nautical Post Top / 23.375"W x 13"H / Clear Lens / 22W, 1824L / 120-277V / 4000K / White
NOP2L26W2000LD120WH40K	Double Nautical Post Top / 23.375"W x 13"H / Clear Lens / 26W, 2000L / 120V Dim / 4000K / White



NOW



NOWINCLPLEDWH	Nautical Wall / 11"W x 13"H / Clear Lens / LED Lamp 9.5W A19 30K Incl. / 120V Dim / White
NOWL11W912LMVWH40K	Nautical Wall / 11"W x 13"H / Clear Lens / 11W, 912L / 120-277V / 4000K / White
NOWL13W1000LD120WH40K	Nautical Wall / 11"W x 13"H / Clear Lens / 13W, 1000L / 120V Dim / 4000K / White

For 3000K change 40K to 30K. For Black, change WH to BK  
**Energy Star not available on Post Lanterns**

## LED GLOBE LANTERNS AND POST TOPS (WET LOCATION)

This classic globe fixture is available in four sizes and is made of durable plastic in choice of black or white fitters with white globes. Matching post-top and wall-mounted versions available.



GP12

GOW

GP10



ITEM NO.	DESCRIPTION
GOWINCLPLEDWH	8" Globe Wall Mount / LED Lamp 9.5W A19 30K incl. / 120V Dim / White
GP10INCLPLEDWH	10" Globe Post Top / LED Lamp 9.5W A19 30K incl. / 120V Dim / White
GP12INCLPLEDWH	12" Globe Post Top / LED Lamp 9.5W A19 30K incl. / 120V Dim / White
GP14INCLPLEDWH	14" Globe Post Top / LED Lamp 9.5W A19 30K incl. / 120V Dim / White
GP16INCLPLEDWH	16" Globe Post Top / LED Lamp 9.5W A19 30K incl. / 120V Dim / White

For 3000K change 40K to 30K. For Black, change WH to BK  
**Energy Star not available on Post Lanterns**

Consult for traditional Acorn and Flame Top Post Tops in clear or frosted finishes.

# Outdoor

## HORIZON LED LANTERNS AND POST TOPS **NEW**

Modern style in a fade and rust resistant composite construction. Available in black, white and bronze. Wall mount accepts optional photocell and post top fits most 3 inch diameter poles.



ITEM NO.	DESCRIPTION
HZWINCLPLEDBZ	HORIZON WALL MOUNT 12.2"H x 10.5"D x 9"W / LED Lamp 9.5W A19 30K Incl. / 120V Dim / Bronze
HZWL13W1000LD120BZ40K	HORIZON WALL MOUNT 12.2"H x 10.5"D x 9"W / 13W 80CRI 1280L / 120V / 4000K / Bronze
HZPINCLPLEDBZ	HORIZON POST TOP 14"H x 9" Dia. / LED Lamp 9.5W A19 30K Incl. / 120V Dim / Bronze
HZPL13W1000LD120BZ40K	HORIZON POST TOP 14"H x 9" Dia. / 13W 80CRI 1280L / 120V / 4000K / Bronze

For White finish change BZ to WH or for Black change BZ to BK.

## HIGHLAND LED LANTERNS AND POST TOPS **NEW**

Sleek style in a fade and rust resistant composite construction. Available in black, white and bronze. Wall mount accepts optional photocell and post top fits most 3 inch diameter poles.



ITEM NO.	DESCRIPTION
HIWINCLPLEDBZ	HIGHLAND SMALL WALL MOUNT 12.75"H x 7.1"D x 5.75"W / LED Lamp 9.5W A19 30K Incl. / 120V Dim / Bronze
HIWL13W1000LD120BZ40K	HIGHLAND SMALL WALL MOUNT 12.75"H x 7.1"D x 5.75"W / 13W 80CRI 1280L / 120V / 4000K / Bronze
HILINCLPLEDBZ	HIGHLAND LARGE WALL MOUNT 15.25"H x 9"D x 7.4"W / LED Lamp 9.5W A19 30K Incl. / 120V Dim / Bronze
HILL13W1000LD120BZ40K	HIGHLAND LARGE WALL MOUNT 15.25"H x 9"D x 7.4"W / 13W 80CRI 1280L / 120V / 4000K / Bronze
HIPINCLPLEDBZ	HIGHLAND POST TOP 17.25"H x 7.25"Dia. / LED Lamp 9.5W A19 30K Incl. / 120V Dim / Bronze
HIPL13W1000LD120BZ40K	HIGHLAND POST TOP 17.25"H x 7.25"Dia. / 13W 80CRI 1280L / 120V / 4000K / Bronze

For White finish change BZ to WH or for Black change BZ to BK.

## HUTTON LED LANTERNS AND POST TOPS **NEW**

Square style in a fade and rust resistant composite construction. Available in black, white and bronze. Wall mount accepts optional photocell and post top fits most 3 inch diameter poles.



ITEM NO.	DESCRIPTION
HUWINCLPLEDBZ	HUTTON SMALL WALL MOUNT 11.6"H x 6.8"D x 5"W / LED Lamp 9.5W A19 30K Incl. / 120V Dim / Bronze
HUWL13W1000LD120BZ40K	HUTTON SMALL WALL MOUNT 11.6"H x 6.8"D x 5"W / 13W 80CRI 1280L / 120V / 4000K / Bronze
HULINCLPLEDBZ	HUTTON LARGE WALL MOUNT 14.4"H x 8.5"D x 6.4"W / LED Lamp 9.5W A19 30K Incl. / 120V Dim / Bronze
HULL13W1000LD120BZ40K	HUTTON LARGE WALL MOUNT 14.4"H x 8.5"D x 6.4"W / 13W 80CRI 1280L / 120V / 4000K / Bronze
HUPINCLPLEDBZ	HUTTON POST TOP 15"H x 6.35"W / LED Lamp 9.5W A19 30K Incl. / 120V Dim / Bronze
HUPL13W1000LD120BZ40K	HUTTON POST TOP 15"H x 6.35"W / 13W 80CRI 1280L / 120V / 4000K / Bronze

For White finish change BZ to WH or for Black change BZ to BK.



## COLONIAL LED LANTERNS AND POST TOPS

ITEM NO.	DESCRIPTION
COLINCLPLEDWH	Colonial Long Wall / 8"W x 17.5"H / Flemish Lens / LED Lamp 9.5W A19 30K incl. / 120V Dim / White
COLL13W1000LD120WH40K	Colonial Long Wall / 8"W x 17.5"H / Flemish Lens / 13W, 1000L / 120V Dim / White
COPINCLPLEDWH	Colonial Post Top / 8"W x 8"H / Flemish Lens / LED Lamp 9.5W A19 30K incl. / 120V Dim / White
COPL13W1000LD120WH40K	Colonial Post Top / 8"W x 8"H / Flemish Lens / 13W, 1000L / 120V Dim / White
COWINCLPLEDWH	Colonial Short Wall / 8"W x 13.25"H / Flemish Lens / LED Lamp 9.5W A19 30K incl. / 120V Dim / White
COWL13W1000LD120WH40K	Colonial Short Wall / 8"W x 13.25"H / Flemish Lens / 13W, 1000L / 120V Dim / White
HTLL13W1000LD120WH40K	Long Hatch / 8"W x 21.25"H / Clear Lens / 13W, 1000L / 120V Dim / White

For Black, change WH to BK. See A Lamp specs on page 114. **Energy Star not available on Post Lanterns**

## STAGECOACH LED LANTERN

Available in LED, Incandescent, GU24 or with LED lamp. Molded in durable non-corrosive UV resistant resin. Post top fits 3" diameter posts.

ITEM NO.	DESCRIPTION
SCWINCLPLEDWH	Wall Mount Stage Coach / 8"W x 17.5"H / Clear Lens / LED Lamp 9.5W A19 30K incl. / 120V Dim / White
SCWL13W1000LD120WH40K	Wall Mount Stage Coach / 8"W x 13.5"H / Clear Lens / 13W, 1000L / 120V Dim / White

## TUDOR LED POST TOPS

Available in LED, Incandescent, GU24 or with LED lamp. Molded in durable non-corrosive UV resistant resin. Post top fits 3" diameter posts.

ITEM NO.	DESCRIPTION
TOLINCLPLEDBK	Tudor Long Wall / 7.75"W x 17"H / Clear Lens / LED Lamp 9.5W A19 30K incl. / 120V Dim / Black
TOLL13W1000LD120BK40K	Tudor Long Wall / 7.75"W x 17"H / Clear Lens / 13W, 1000L / 120V Dim / 4000K / Black
TOPINCLPLEDWH	Tudor Post Top / 7.75"W x 12.5"H / Clear Lens / LED Lamp 9.5W A19 30K incl. / 120V Dim / White
TOPL13W1000LD120WH40K	Tudor Post Top / 7.75"W x 12.5"H / Clear Lens / 13W, 1000L / 120V Dim / 4000K / White
TOP10INCLPLEDWH	IMPERIAL POST TOP / 10.5"W x 18"H / Clear Lens / LED Lamp 9.5W A19 30K incl. / 120V Dim / White
TOP10L23W1900LD120WH40K	IMPERIAL POST TOP / 10.5"W x 18"H / Clear Lens / 13W, 1000L / 120V Dim / 4000K / White
TOP13INCLPLEDWH	IMPERIAL POST TOP / 13"W x 18"H / Clear Lens / LED Lamp 9.5W A19 30K incl. / 120V Dim / White
TOP13L23W1900LD120WH40K	IMPERIAL POST TOP / 13"W x 18"H / Clear Lens / 13W, 1000L / 120V Dim / 4000K / White
LTOLINCLPLEDBK	LARGE TUDOR WALL / 10"W x 18"H / Clear Lens / LED Lamp 9.5W A19 30K incl. / 120V Dim / Black
LTOLL13W1000LD120BK40K	LARGE TUDOR WALL / 10"W x 18"H / Clear Lens / 13W, 1000L / 120V Dim / 4000K / Black
LTOPINCLPLEDBK	LARGE TUDOR POST TOP / 10"W x 17"H / Clear Lens / LED Lamp 9.5W A19 30K incl. / 120V Dim / Black
LTOPL13W1000LD120BK40K	LARGE TUDOR POST TOP / 10"W x 17"H / Clear Lens / 13W, 1000L / 120V Dim / 4000K / Black

## ECONOMY WALL

Available in LED, Incandescent, GU24 or with LED lamp. Molded in durable non-corrosive UV resistant resin.

ITEM NO.	DESCRIPTION
APWINCLPLEDWH	Wall Mount Small Acorn / 6"W x 9"H / White Lens / LED Lamp 9.5W A19 30K incl. / 120V Dim / White
APWL11W912LMVWH40K	Wall Mount Small Acorn / 6"W x 9"H / White Lens / 11W, 912L / 120-277V / White
APWL13W1000LD120WH40K	Wall Mount Small Acorn / 6"W x 9"H / White Lens / 13W, 1000L / 120V Dim / White
DHINCLPLEDWH	Wall Mount Cottage / 5"W x 9.12"H / White Lens / LED Lamp 9.5W A19 30K incl. / 120V Dim / White
DHL13W1000LD120WH40K	Wall Mount Cottage / 5"W x 9.12"H / White Lens / 13, 1000L / 120V Dim / White



\*Not available in White



# Outdoor



## BRADFORD LED LANTERNS AND POST TOPS

Traditional Bradford Lanterns and Post-tops are available in black or white, with clear or white lenses, wall-mounted in short and long tail, and post-top and with a variety of lamp configurations.

ITEM NO.	DESCRIPTION
BRLINCLPLEDWH	Bradford Long Wall / 8"W x 21"H / Clear Lens / LED Lamp 9.5W A19 30K incl. / 120V Dim / White
BRL13W1000LD120WH40K	Bradford Long Wall / 8"W x 21"H / Clear Lens / 13W, 1000L / 120V Dim / White
BRPINCLPLEDWH	Bradford Post Top / 8"W x 21"H / Clear Lens / LED Lamp 9.5W A19 30K incl. / 120V Dim / White
BRPL13W1000LD120WH40K	Bradford Post Top / 8"W x 21"H / Clear Lens / 13W, 1000L / 120V Dim / White
BRWINCLPLEDWH	Bradford Short Wall / 8"W x 15"H / Clear Lens / LED Lamp 9.5W A19 30K incl. / 120V Dim / White
BRWL13W1000LD120WH40K	Bradford Short Wall / 8"W x 15"H / Clear Lens / 13W, 1000L / 120V Dim / White

**Energy Star not available on Post Lanterns**



## PRINCETON LED LANTERNS AND POST TOPS

Classic Princeton Lanterns and Post-tops are available in black or white, with clear or white lenses, wall-mounted in short and long tail, and post-top and with a variety of lamp configurations.

ITEM NO.	DESCRIPTION
PRLINCLPLEDWH	Princeton Long Wall / 8"W x 17.5"H / Clear Lens / LED Lamp 9.5W A19 30K incl. / 120V Dim / White
PRL13W1000LD120WH40K	Princeton Long Wall / 8"W x 17.5"H / Clear Lens / 13W, 1000L / 120V Dim / White
PRPINCLPLEDWH	Princeton Post Top / 8"W x 13.5"H / Clear Lens / LED Lamp 9.5W A19 30K incl. / 120V Dim / White
PRPL13W1000LD120WH40K	Princeton Post Top / 8"W x 13.5"H / Clear Lens / 13W, 1000L / 120V Dim / White
PRWINCLPLEDWH	Princeton Short Wall / 8"W x 13.5"H / Clear Lens / LED Lamp 9.5W A19 30K incl. / 120V Dim / White
PRWL13W1000LD120WH40K	Princeton Short Wall / 8"W x 13.5"H / Clear Lens / 13W, 1000L / 120V Dim / White

For 3000K change 40K to 30K. For Black, change WH to BK. See A Lamp specs on page 114.

**Energy Star not available on Post Lanterns**



## KINGSTON LED LANTERNS AND POST TOPS

The highly styled Kingston Lanterns and Post-tops are available in black or white, with clear or white lenses, wall-mounted in short and long tail, and post-top and with a variety of lamp configurations.

ITEM NO.	DESCRIPTION
KRLINCLPLEDWH	Kingston Long Wall / 8"W x 21.125"H / Clear Lens / LED Lamp 9.5W A19 30K incl. / 120V Dim / White
KRL13W1000LD120WH40K	Kingston Long Wall / 8"W x 21.125"H / Clear Lens / 13W, 1000L / 120V Dim / White
KRPINCLPLEDWH	Kingston Post Top / 8"W x 14.75"H / Clear Lens / LED Lamp 9.5W A19 30K incl. / 120V Dim / White
KRPL13W1000LD120WH40K	Kingston Post Top / 8"W x 14.75"H / Clear Lens / 13W, 1000L / 120V Dim / White
KRWINCLPLEDWH	Kingston Short Wall / 8"W x 15.5"H / Clear Lens / LED Lamp 9.5W A19 30K incl. / 120V Dim / White
KRWL13W1000LD120WH40K	Kingston Short Wall / 8"W x 15.5"H / Clear Lens / 13W, 1000L / 120V Dim / White

For 3000K change 40K to 30K. For Black, change WH to BK. See A Lamp specs on page 114.

**Energy Star not available on Post Lanterns**





## AMHERST LED LANTERNS AND POST TOPS

The stylish Amherst Lanterns and Post-tops are available in black or white, with clear or white lenses, wall-mounted in short and long tail, and post-top and with a variety of lamp configurations.

ITEM NO.	DESCRIPTION
AOLINCLPLEDWH	Amherst Long Wall / 8"W x 25"H/ Clear Lens / LED Lamp 9.5W A19 30K incl. / 120V Dim / White
AOLL13W1000LD120WH40K	Amherst Long Wall / 8"W x 25"H/ Clear Lens / 13W, 1000L / 120V Dim / White
AOPINCLPLEDWH	Amherst Post Top / 8"W x 18"H/ Clear Lens / LED Lamp 9.5W A19 30K incl. / 120V Dim / White
AOPL13W1000LD120WH40K	Amherst Post Top / 8"W x 18"H/ Clear Lens / 13W, 1000L / 120V Dim / White
AOWINCLPLEDWH	Amherst Short Wall / 8"W x 20"H/ Clear Lens / LED Lamp 9.5W A19 30K incl. / 120V Dim / White
AOWL13W1000LD120WH40K	Amherst Short Wall / 8"W x 20"H/ Clear Lens / 13W, 1000L / 120V Dim / White

For 3000K change 40K to 30K. For Black, change WH to BK. See A Lamp specs on page 114.  
**Energy Star not available on Post Lanterns**

## HEXAGON LED LANTERNS AND POST TOPS

Hexagon Lanterns and Post-tops are available in black or white, with clear or white lenses, wall-mounted in short and long tail, and post-top and with a variety of lamp configurations.



ITEM NO.	DESCRIPTION
HOPINCLPLEDWH	Hexagon Post Top / 9"W x 21.5"H/ Clear Lens / LED Lamp 9.5W A19 30K incl. / 120V Dim / White
HOPL13W1000LD120WH40K	Hexagon Post Top / 9"W x 21.5"H / Clear Lens / 13W, 1000L / 120V Dim / White
HOWINCLPLEDWH	Hexagon Short Wall / 9"W x 15.5"H / Clear Lens / LED Lamp 9.5W A19 30K incl. / 120V Dim / White
HOWL13W1000LD120WH40K	Hexagon Short Wall / 9"W x 15.5"H / Clear Lens / 13W, 1000L / 120V Dim / White
HOLINCLPLEDWH	Hexagon Long Wall / 9"W x 16"H / Clear Lens / LED Lamp 9.5W A19 30K incl. / 120V Dim / White
HOLL13W1000LD120WH40K	Hexagon Long Wall / 9"W x 16"H / Clear Lens / 13W, 1000L / 120V Dim / White

For 3000K change 40K to 30K. For Black, change WH to BK. See A Lamp specs on page 114.  
**Energy Star not available on Post Lanterns**

## HATCH LED LANTERNS AND POST TOPS

Hatch Lanterns and Post-tops are available in black or white, with clear or white lenses, wall-mounted in short and long tail, and post-top. Available in LED, Incandescent, GU24 or with LED lamp.



ITEM NO.	DESCRIPTION
HTPINCLPLEDWH	Post Top Hatch / 8"W x 16"H / Clear Lens / LED Lamp 9.5W A19 30K incl. / 120V Dim / White
HTPL13W1000LD120WH40K	Post Top Hatch / 8"W x 16"H / Clear Lens / 13W, 1000L / 120V Dim / White
HTWINCLPLEDWH	Petite Hatch / 6.5"W x 10.5"H / Clear Lens / LED Lamp 9.5W A19 30K incl. / 120V Dim / White
HTWL13W1000LD120WH40K	Petite Hatch / 6.5"W x 10.5"H / Clear Lens / 13W, 1000L / 120V Dim / White
HTSINCLPLEDWH	Short Hatch / 8"W x 16"H / Clear Lens / LED Lamp 9.5W A19 30K incl. / 120V Dim / White
HTSL13W1000LD120WH40K	Short Hatch / 8"W x 16"H / Clear Lens / 13W, 1000L / 120V Dim / White
HTLINCLPLEDWH	Long Hatch / 8"W x 21.25"H / Clear Lens / LED Lamp 9.5W A19 30K incl. / 120V Dim / White
HTLL13W1000LD120WH40K	Long Hatch / 8"W x 21.25"H / Clear Lens / 13W, 1000L / 120V Dim / White

For 3000K change 40K to 30K. For Black, change WH to BK. See A Lamp specs on page 114.  
**Energy Star not available on Post Lanterns**

# Outdoor

## HARBOUR LED WALL MOUNT

Available in LED, Incandescent, GU24 or with LED lamp. Molded in durable non-corrosive UV resistant resin.



ITEM NO.	DESCRIPTION
BPWINCLPLEDWHWSJ	WALL MOUNT HARBOR / 5.75"W x 8"H / White Lens / LED Lamp 9.5W A19 30K incl. / 120V Dim / White
BPWL11W912LMVWH40KWSJ	WALL MOUNT HARBOR / 5.75"W x 8"H / White Lens / 11W, 912L / 120-277V / 4000K / White
BPWL13W1000LD120WH40KWSJ	WALL MOUNT HARBOR / 5.75"W x 8"H / White Lens / 13W, 1000L / 120V Dim / 4000K / White

For 3000K change 40K to 30K. For Black, change WH to BK. See LED A19 Specs on page 114.

## LONG BEACH LED WALL MOUNT

Available in LED, Incandescent, GU24 or with LED lamp. Molded in durable non-corrosive UV resistant resin.



ITEM NO.	DESCRIPTION
BPWINCLPLEDWHWPJ	WALL MOUNT BPW INC BLK WPJ w/ LED lamp
BPWL11W912LMVWH40KWPJ	WALL MOUNT LONG BEACH / 5.75"W x 9.25"H / White Lens / 11W, 912L / 120-277V / 4000K / White
BPWL13W1000LD120WH40KWPJ	WALL MOUNT LONG BEACH / 5.75"W x 9.25"H / White Lens / 13W, 1000L / 120V Dim / 4000K / White

For 3000K change 40K to 30K. For Black, change WH to BK. See LED A19 Specs on page 114.

## CLASSIC LED WALL POCKET

Available in LED, Incandescent, GU24 or with LED lamp. Molded in durable non-corrosive UV resistant resin.



ITEM NO.	DESCRIPTION
WPWINCLPLEDWHWAG	WALL MOUNT GLOBE / 6"Dia x 8"H / White Lens / LED Lamp 9.5W A19 30K incl. / 120V Dim / White
WPWL11W912LMVWH40KWAG	WALL MOUNT GLOBE / 6"Dia x 8"H / White Lens / 11W, 912L / 120-277V / 4000K / White
WPWL13W1000LD120WH40KWAG	WALL MOUNT GLOBE / 6"Dia x 8"H / White Lens / 13W, 1000L / 120V Dim / 4000K / White

For 3000K change 40K to 30K. For Black, change WH to BK. See LED A19 Specs on page 114.

**Add Photocell to all LED wall versions - PC120 at \$7.50**

## LED VAPOR PROOF

Available for wall- or ceiling-mount, this utility fixture features a sturdy die-cast housing, and is ideal for parking lots, warehouses, farm and residential areas, walkways, underpasses, gas stations, factories, and loading docks.



ITEM NO.	DESCRIPTION
VPC18W1500LMV50K	Vaporproof / 11.3"H x 6"W / 18W, 1500L / 120-277V / 5000K / Silver
VPW18W1500LMV50K	Vaporproof / 12.3"H x 8.8"W / 18W, 1500L / 120-277V / 5000K / Silver

### LED A19/E26

- 10W
- 800 Lumens 120V 3000K
- Replaces 60W Incandescent or 13W CFL
- CRI 80
- 15,000 Hour Life
- 270 Beam Angle, Dimmable

Consult for 4000K

**NOTE: Now fixtures with LED A Lamps can qualify for Energy Star**





## HOTEL OUTDOOR SERIES (WET LOCATION)

High style wet location bracket with black or silver bands across acrylic diffuser.

ITEM NO.	DESCRIPTION
HOTOA16W1000LD120BK30K	14.12"L x 14.18"W x 5.5"D / White acrylic lens / 16W, 1000L / 3000K / Black
HOTOA16W1000LD120SI30K	14.12"L x 14.18"W x 5.5"D / White acrylic lens / 16W, 1000L / 3000K / Silver



## DUSK TO DAWN

Built in photocell and included arm mount make for low initial cost and ongoing savings.

ITEM NO.	DESCRIPTION
D2D12L45W4900LMV50K	20.69"L x 8.98"Dia x 17.73"H / 45W, 4900L / 120-277V / 5000K / Bronze

## DIRECT BURIAL ALUMINUM POST

These residential lamp posts fit most 3" Post Top Fixtures including all Post Tops on the preceding pages. Texture Powder coated aluminum finish holds up to the elements and available in Black (BK), White (WH) and Bronze (BZ). Optional crossarms, convenience outlet and photocontrols are available. Consult for custom versions.



ITEM NO.	DESCRIPTION
DBP7X3BZ	7' DIRECT BURIAL ALUMINUM POST - 0.050" WALL; 3" DIA - POWDERCOATED BRONZE (ALSO AVAILABLE IN WHITE OR BRONZE)
DBP8X3BZ	8' DIRECT BURIAL ALUMINUM POST - 0.050" WALL; 3" DIA - POWDERCOATED BRONZE (ALSO AVAILABLE IN WHITE OR BRONZE)
DBP10X3BZ**	10' DIRECT BURIAL ALUMINUM POST - 0.050" WALL; 3" DIA - POWDERCOATED BRONZE (ALSO AVAILABLE IN WHITE OR BRONZE)
DBP12X3BZ**	12' DIRECT BURIAL ALUMINUM POST - 0.072" WALL; 3" DIA - HANDHOLE INCLUDED - POWDERCOATED BRONZE (ALSO AVAILABLE IN WHITE OR BRONZE)
DBP14X3BZ**	14' DIRECT BURIAL ALUMINUM POST - 0.072" WALL; 3" DIA - HANDHOLE INCLUDED - POWDERCOATED BRONZE (ALSO AVAILABLE IN WHITE OR BRONZE)

## Accessories



DBPCABK	CROSS ARM ACCESSORY FOR DBP7X3, DBP8X3 OR DBP10X3 (BK OR WH ONLY)
DBPPCBK	PHOTO CELL ACCESSORY FOR DBP7X3, DBP8X3 OR DBP10X3 (BK OR WH ONLY)
DBPCOBK	CONVENIENCE OUTLET ACCESSORY FOR DBP7X3, DBP8X3 OR DBP10X3 (BK OR WH ONLY)

Available in Black (BK), White (WH), Bronze (BZ).

\*\*MUST SHIP FREIGHT

# Exterior Wall Packs & Floods



LED wall packs and floods are perfect for illuminating pathways and perimeters, giving people a greater sense of security. And whether you're looking for a traditional non-cut off, high-output, fixed-cutoff, architectural, or slim-sized fixture, we've got them all. Each is so easy to install with a full assortment of accessories for most applications. Energy efficiency, durability, optics and fresh aesthetics distinguish our offering. Poles available for certain markets along with bollards and other specialty commercial exterior fixtures to illuminate your next exterior project.

## LED CUTOFF WALL PACK

Full cutoff LED wall pack. DLC listed. Photocell and EM available (most models).



ITEM NO.	DESCRIPTION
DCC150SR45W4900LMV50K	14.21"L x 9.25"W x 8.78"Dp / 45W, 4900L / 0-10V Dim / 5000K / Bronze
DCC150SR70W7500LMV50K	14.21"L x 9.25"W x 8.78"Dp / 70W, 7500L / 0-10V Dim / 5000K / Bronze
DCC200SR90W9700LMV50K	18.10"L x 10.81"W x 11.24"Dp / 90W, 9700L / 0-10V Dim / 5000K / Bronze
DCC200SR135W14500LMV50K	18.10"L x 10.81"W x 11.24"Dp / 135W, 14500L / 0-10V Dim / 5000K / Bronze

**CCT6**

Available in 4000K. Consult factory for EM options.

## DECORATIVE CUT-OFF WALL PACK

A stylish alternative to standard wall packs. Available with up light or in full cutoff versions.



ITEM NO.	DESCRIPTION
SM302L35W3456LMV50KBZ	Half Moon LED / Downlight / 18"L x 9"E x 7.25"H / 35W, 3456L / 120-277V / 5000K / Bronze
SM302LU5WD35WMV50KBZ	Half Moon LED / 18"L x 9"E x 7.25"H / Up 5w, 480L / Down 35w, 3456L / 120-277V / 5000K / Bronze
SM302LU5WD70WMV50KBZ	Half Moon LED / 18"L x 9"E x 7.25"H / Up 5w, 480L / Down 70w, 6735L / 120-277V / 5000K / Bronze

Consult factory for EM options.



## ECONOMY WALL PACK

Great value wall pack with shields, photocell, and em options.



ITEM NO.	DESCRIPTION
DC150SR45W4900LMV50K	14.21"L x 7.95"E x 9.25"H / 45W, 4950L / 0-10V Dim / 5000K / Bronze
DC150SR70W7900LMV50K	14.21"L x 7.95"E x 9.25"H / 70W, 7900L / 0-10V Dim / 5000K / Bronze
DC200SR90W9900LMV50K	18"L x 9.75"W x 9.22"H / 90W, 9900L / 0-10V Dim / 5000K / Bronze
DC200SR135W15400LMV50K	18"L x 9.75"W x 9.22"H / 135W, 15400L / 0-10V Dim / 5000K / Bronze
DC150SRSHIELD	Shield for DC150SR / 13"L x 10"W x 9.25"H
DC200SRSHIELD	Shield for DC200SR / 17"L x 10"W x 9.25"H

CCT6

Available in 4000K. Consult factory for EM options.

## MINI LED WALL PACK

2 lumen packages for just right light. High efficacy and available photocell for greater savings.



ITEM NO.	DESCRIPTION
DC056L17W2000LMV50K	5.484"W x 3.523"E x 8.384"H / 17W, 2000L / 120-277V / 5000K / Bronze
DC056L17W2000LMV50KPC	5.484"W x 3.523"E x 8.384"H / 17W, 2000L / 120-277V / 5000K / Bronze / Photocell
DC056L25W2700LMV50K	5.484"W x 3.523"E x 8.384"H / 25W, 2700L / 120-277V / 5000K / Bronze
DC056L25W2700LMV50KPC	5.484"W x 3.523"E x 8.384"H / 25W, 2700L / 120-277V / 5000K / Bronze / Photocell

## MINI WALL PACK

Sleek, low profile cutoff wall pack, ideal for low level area lighting and security. IP66 wet listed with optional photocell.



ITEM NO.	DESCRIPTION
MLW6L14W750LMV50KBZ	LED Surface Mount Light 5000K

## LED ADJUSTABLE WALL PACK

The AWP series of luminaries provides a low profile architectural style with the power of bright, energy efficient LEDs. It has a rugged aluminum construction with multi-mount capabilities.



ITEM NO.	DESCRIPTION
AWP7L27W3600LDMV50KBZ	7.29"L x 9.13"W x 4.2"H / 27W, 3600L / 0-10V Dim / 5000K / Bronze
AWP7L40W5400LDMV50KBZ	7.29"L x 9.13"W x 4.2"H / 40W, 5400L / 0-10V Dim / 5000K / Bronze
AWP10L67W8800LDMV50KBZ	10.06"L x 11.02"W x 5.09"H / 67W, 8800L / 0-10V Dim / 5000K / Bronze
AWP10L80W10500LDMV50KBZ	10.06"L x 11.02"W x 5.09"H / 80W, 10500L / 0-10V Dim / 5000K / Bronze

Consult to add Photocontrols, Emergency and 480V options.

# Outdoor



## AREA LIGHT

Outstanding photometric performance, uniform illumination and low profile form providing a 100,000+ L70 lifespan.

ITEM NO.	DESCRIPTION
PLF12L70W9000LDMV50K	11.26"L x 12.4"W x 3.07"D / 70W, 9000L / 120-277V / 0-10V Dim / 5000K / Bronze
PLF12L105W13400LDMV50K	11.26"L x 12.4"W x 3.07"D / 105W, 13400L / 120-277V / 0-10V Dim / 5000K / Bronze

## PPF LARGE AREA LIGHT



PPF15L150W19500LDMV50K	14.61"L x 12.4"W x 3.07"D / 150W, 19500L / 0-10V Dim / 120-277V / 5000K / Bronze / Type III Distribution
PPF15L200W26000LDMV50K	14.61"L x 12.4"W x 3.07"D / 200W, 26000L / 0-10V Dim / 120-277V / 5000K / Bronze / Type III Distribution
PPF23L250W33250LDMV50K	22.81"L x 12.4"W x 3.54"D / 250W, 33250L / 0-10V Dim / 120-277V / 5000K / Bronze / Type III Distribution
PPF23L300W39000LDMV50K	22.81"L x 12.4"W x 3.54"D / 300W, 39000L / 0-10V Dim / 120-277V / 5000K / Bronze / Type III Distribution
PPF15L150W19500LD48050K	14.61"L x 12.4"W x 3.07"D / 150W, 19500L / 0-10V Dim / 480V / 5000K / Bronze / Type III Distribution
PPF23L300W39000LD48050K	22.81"L x 12.4"W x 3.54"D / 300W, 39000L / 0-10V Dim / 480V / 5000K / Bronze / Type III Distribution
PPFT415L150W19500LDMV50K	14.61"L x 12.4"W x 3.07"D / 150W, 19500L / 0-10V Dim / 120-277V / 5000K / Bronze / Type IV Distribution
PPFT415L200W26000LDMV50K	14.61"L x 12.4"W x 3.07"D / 200W, 26000L / 0-10V Dim / 120-277V / 5000K / Bronze / Type IV Distribution
PPFT423L300W39000LDMV50K	22.81"L x 12.4"W x 3.54"D / 300W, 39000L / 0-10V Dim / 120-277V / 5000K / Bronze / Type IV Distribution



**CCT6**

Mounting sold separately. Type III distribution standard. Type IV and VS available. Consult for integral back light control.

## ACCESSORIES FOR AREA LIGHT



ITEM NO.	DESCRIPTION
PLFRARM	Round Pole Mounting Arm Bronze
PLFSARM	Square Pole Mounting Arm Bronze
PLFSW	Slip Fitter Mounting Bronze
PLF15YK	Yoke Mount for PPF15 Series Bronze
PLF23TR	Trunnion Fitter for PPF23 Bronze
PLFWARM	Wall mounting Bronze

## SMALL FLOOD LIGHT



ITEM NO.	DESCRIPTION
SFL10L50W5562LMV50KBZ	LED Small Flood Light 50W 5562lm 5000K
SFL10L75W8645LMV50KBZ	LED Small Flood Light 75W 8645lm 5000K

Consult for different finish options.

## SQUARE FLOOD LIGHT



ITEM NO.	DESCRIPTION
LFS45L24W2200L40KBZ	Rectangular Flood / 6.125"W x 4.75"H x 6"Dp / 24W, 2200L / 4000K / Bronze
LFS57L33W3700LMV40KWH	LED FLOOD SQ 33W 3700L MV 40K WH

## LED BULLET FLOOD

Available in white.



ITEM NO.	DESCRIPTION
LFS4L12W1000L40KBZ	Round Flood / 4"Dia x 5.8"Dp / 12W, 1000L / 4000K / Bronze

CCT6

## MINI FLOOD LIGHT

DLC listed mini flood light. Wet rated, knuckle mount in various sizes and lumen outputs.



ITEM NO.	DESCRIPTION
MFL4L15W1500LMV40K	4.72"L x 2.95"W x 1.27"H / 15W, 1500L / 120-277V / 4000K
MFL7L30W3000LMV40K	7.08"L x 4.42"W x 1.61"H / 15W, 1500L / 120-277V / 4000K
MFL8L45W5400LMV40K	8.26"L x 5.15"W x 2"H / 15W, 1500L / 120-277V / 4000K

## MEDIUM AND LARGE LED FLOOD

High performance LED floods with multiple mounting options. Wet rated housing with scalable lumen packages allows for full project uniformity.



ITEM NO.	DESCRIPTION
MDF8L60W7 450LMV50KKN	Medium Flood / 7.87"L x 3.12"W x 4.8"H / 60W, 7450L / 120V-277V / 5000K / Bronze / Knuckle
MDF8L60W7 450LMV50KTR	Medium Flood / 7.87"L x 3.12"W x 4.8"H / 60W, 7450L / 120V-277V / 5000K / Bronze / Trunnion
LDF11L70W8900LDMV50KSF	Large Flood / 11"L x 4.9"W x 6"H / 70W, 8900L / 0-10 Dim 120V-277V / 5000K / Bronze / Slip Fitter
LDF11L 100W13300LMV50KSF	Large Flood / 11"L x 4.9"W x 6"H / 100W, 13300L / 0-10 Dim 120V-277V / 5000K / Bronze / Slip Fitter
LDF15L 135W18000LMV50KSF	Large Flood / 14.53"L x 4.37"W x 8.98"H / 135W, 18000L / 0-10 Dim / 120V-277V / 5000K / Bronze I Slip fitter
LDF15L200W26200LMV50KSF	Large Flood / 14.53"L x 4.37"W x 8.98"H / 200W, 26200L / 0-10 Dim / 120V-277V / 5000K / Bronze I Slip fitter

For Yoke mount, change SF to YK.

# Outdoor



Pole does not include tenon.  
Poles can be cut to any length.

## STEEL POLES

- 12 top holes w/polyarbonate lexan brushings
- Reinforced hand hold cover
- Anchor Bolts and Template Included
- Easily Secured base cover
- Bronze polyester powder-coat finish
- Meets ASTM 500 standard
- Pole cap is included

ITEM NO.	DESCRIPTION
SPS16411	STEEL POLE SPS 16ft 4in SQ 11 GAUGE BZ
SPS20411	STEEL POLE SPS 20ft 4in SQ 11 GAUGE BZ
SPS25411	STEEL POLE SPS 25ft 4in SQ 11 GAUGE BZ
SPS30511	STEEL POLE SPS 30ft 5in SQ 11 GAUGE BZ

### Template 4" Poles

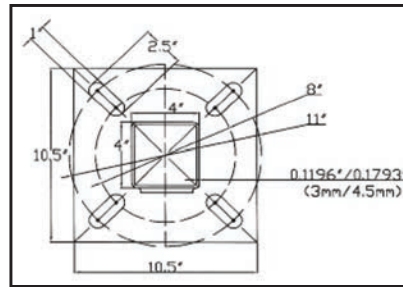

### Template 5" Poles

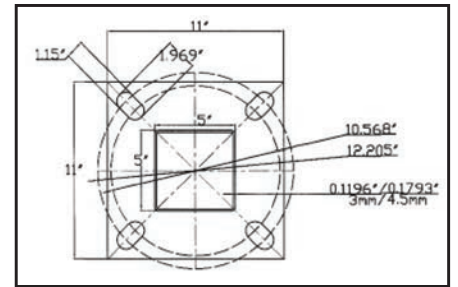

Tenon Top Adapter  
TEN4  
TEN5

2 Light Square Bullhorn



TB180\*

4 Light Square Bullhorn



TB490\*

\*Requires TEN4 or TEN5

Pole Top Cap



TC4  
TC5

Pole Base Cover



BC4  
BC5

Anchor Bolts



AB3/4X30  
AB1X36

Wall Mount Vertical



WMV

ITEM NO.	DESCRIPTION
TEN4	TENON TOP ADAPTER 4inX4in
TEN5	TENON TOP ADAPTER 5inX5in
TB2180	2 Light Straight Square Bullhorn / 43" Wide / 2.375" Tenon mount / Bronze
TB490	4" X 4" / 4 Light Square Bullhorn / Bronze
TC4	4" X 4" Square Pole Top Cap
TC5	5" X 5" Square Pole Top Cap
BC4	Anchor Bolt Cover for 4" x 4" Square Pole
BC5	Anchor Bolt Cover for 5" x 5" Square Pole
AB3/4X30	Anchor Bolt 0.75" x 30" X 0.75" with Nut and Washers (4 per pole)
AB1X36	Anchor Bolt 1" x 36" X 4" with Nut and Washers (4 per pole)
WMV	Wall Mount Vertical

## LED ROUND POST TOP **NEW**

A more contemporary and attractive look with high efficiency light output. DLC listed, PIR and photocell available.



ITEM NO.	DESCRIPTION
PTR53W6800LMV40KBZ	LED Round Post Top / 17.3"Dia x 22.3"H / 53W, 6814L / 120-277V / 4000K / Bronze / Type VS Distribution
PTR78W9500LMV40KBZ	LED Round Post Top / 17.3"Dia x 22.3"H / 78W, 9506L / 120-277V / 4000K / Bronze / Type VS Distribution
PTR143W15400LMV40KBZ	LED Round Post Top / 17.3"Dia x 22.3"H / 143W, 15408L / 120-277V / 4000K / Bronze / Type VS Distribution

## MINI BOLLARD W/ GFCI OUTLET (WET LOCATION) **NEW**

Ideal for pool decks, landscape, and park areas where dual GFCI outlet could be useful for device charging, event power, and walkway lighting.



ITEM NO.	DESCRIPTION
BOLEICB300LMGFCI40KGY	LED Flat Top Bollard / 6W, 300L / 4000K / 120V / Silver



## LED COMMERCIAL BOLLARDS

This attractive, newly redesigned heavy-duty bollard features full proof aluminum construction housing, providing corrosion and vandal resistance ideal for lighting pedestrian walkways, as well as accenting the exterior grounds of office and apartment buildings, hotel and parks. A solid foundation withstands the elements, driver options work in even the worst weather conditions.



ITEM NO.	DESCRIPTION
BOLPF18W2000LMV40KBZ	LED Flat Top Bollard / 18W, 2035L / 120V-277V / 4000 / Bronze
BOLPF36W4000LMV40KBZ	LED Flat Top Bollard / 36W, 4000L / 120V-277V / 4000 / Bronze
BOLPR18W2000LMV40KBZ	LED Round Top Bollard / 18W, 2035L / 120V-277V / 4000K / Bronze
BOLPR36W4000LMV40KBZ	LED Round Top Bollard / 36W, 4000L / 120V-277V / 4000K / Bronze
BOLPFH36W2500LMV40KBZ	LED Flat Top Bollard with Half lens / 8"Dia x 36"L / 36W, 2500L / 120-277V / 4000K / Bronze
BOLPFC36W2500LMV40KBZ	LED Flat Top Bollard with Cone Lens / 8"Dia x 36"L / 36W, 2500L / 120-277V / 4000K / Bronze
BOLPFL20W1500LMV40KBZ	LED Flat Top Bollard with Lovuer / 8"Dia x 36"L / 20W, 1500L / 120-277V / 4000K / Bronze
BOLPFO20W2000LMV40KBZ	LED Flat Top Bollard with Round Lens / 8"Dia x 36"L / 20W, 2000L / 120-277V / 4000K / Bronze

## ARCHITECTURAL TALL BOLLARDS **NEW**

This new Architectural Tall Bollard is the latest in LED design for Site and Architectural Lighting. Almost 12 feet tall with 4 feet of durable acrylic diffuser makes a bold statement. This luminaire is bolted with a mounting plate onto a foundation provided by the customer or an anchorage unit made of hot-dep galvanized steel. Consult for RGB and with custom text on the galvanized bollard.



ITEM NO.	DESCRIPTION
ATBL80WMV40K	LED Cassiopeia Architectural Tall Bollard / 7" Dia x 137.8"L / 80W / 120-277V / 4000K / Aluminum Galvanized

Architectural Tall Bollard adds style to Strip Centers and Multi-Family exteriors.



The Simple LED Solution

# X1LED

The Benefits of LED with  
Ease, Practicality and Flexibility

## THE SIMPLE LED SOLUTION

**X1LED** is the most economical, practical and user friendly series of LED fixtures, with the energy savings, quality of light, long life and hassle-free maintenance you have been searching for. X1 LED fixtures are UL Listed with the latest LED T8 Bypass lamps. Fixtures provide over 40% energy savings over comparable fluorescent fixtures utilizing less expensive fixtures than the fluorescent version and have flexibility to change wattage and color temperature any time. Fixture performance will evolve over time with the evolution of the T8 LED lamp technology. Concerned about maintenance with an LED array and driver fixture, X1LED solves that by utilizing LED T8 lamps that fit into the fixture just like a fluorescent lamp.



**LED System**

A complete UL Listed LED fixture with no ballast or driver to fail. Special red sockets to identify fixtures made for LED T8 lamps.



**Flexibility and Long Life**

Change the LED T8 lamp any time to different wattage, color temperature or lumens.



**Premium LED T8 Lamps**

Saylite uses top quality LED T8 lamps that are field tested for demanding applications and up to a 10 year warranty.

### TROFFER

ITEM NO.	DESCRIPTION
131A23212X1LN18W40	1x4 4200 Lumen Troffer w/2x18W LED T8 4000K Lamps included
131A217X1LN15W40	2x2 3400 Lumen Troffer w/2x15W LED T8 4000K Lamps included
131A317X1LN15W40	2x2 5100 Lumen Troffer w/3x15W LED T8 4000K Lamps included
131A417X1LN15W40	2x2 6800 Lumen Troffer w/4x15W LED T8 4000K Lamps included
131A232X1LN18W40	2x4 4200 Lumen Troffer w/2x18W LED T8 4000K Lamps included
131A332X1LN18W40	2x4 6300 Lumen Troffer w/3x18W LED T8 4000K Lamps included
131A432X1LN18W40	2x4 8400 Lumen Troffer w/4x18W LED T8 4000K Lamps included

EM8 OS5 CCT2 SURF AIR RET LED FLUOR X1LEDT8D



## PARABOLIC



ITEM NO.	DESCRIPTION
PARA8C23212X1LN18W40	1x4 4200 Lumen Parabolic 8C w/2x18W LED T8 4000K Lamps included
PARA9C217X1LN15W40	2x2 3400 Lumen Parabolic 9C w/2x15W LED T8 4000K Lamps included
PARA9C317X1LN15W40	2x2 5100 Lumen Parabolic 9C w/3x15W LED T8 4000K Lamps included
PARA9C417X1LN15W40	2x2 6800 Lumen Parabolic 9C w/4x15W LED T8 4000K Lamps included
PARA12C232X1LN18W40	2x4 4200 Lumen Parabolic 12C w/2x18W LED T8 4000K Lamps included
PARA18C232X1LN18W40	2x4 4200 Lumen Parabolic 18C w/2x18W LED T8 4000K Lamps included
PARA18C332X1LN18W40	2x4 6300 Lumen Parabolic 18C w/3x18W LED T8 4000K Lamps included
PARA18C432X1LN18W40	2x4 8400 Lumen Parabolic 18C w/4x18W LED T8 4000K Lamps included
PARA32C432X1LN18W40	2x4 8400 Lumen Parabolic 32C w/4x18W LED T8 4000K Lamps included

EM8 OS5 CCT2 SURF AIR RET LED FLUOR X1LEDT8D

## SHALLOW, HIGH EFFICIENT PARABOLIC



ITEM NO.	DESCRIPTION
PES9C217X1LN15W40	2x2 3400 Lumen Parabolic 9C w/2x15W LED T8 4000K Lamps Included
PES9C317X1LN15W40	2x2 5100 Lumen Parabolic 9C w/3x15W LED T8 4000K Lamps Included
PES9C417X1LN15W40	2x2 6800 Lumen Parabolic 9C w/4x15W LED T8 4000K Lamps Included
PES12C232X1LN18W40	2x4 4200 Lumen Parabolic 12C w/2x18W LED T8 4000K Lamps Included
PES18C232X1LN18W40	2x4 4200 Lumen Parabolic 18C w/2x18W LED T8 4000K Lamps Included
PES18C332X1LN18W40	2x4 6300 Lumen Parabolic 18C w/3x18W LED T8 4000K Lamps Included
PES18C432X1LN18W40	2x4 8400 Lumen Parabolic 18C w/4x18W LED T8 4000K Lamps Included

EM8 OS5 CCT2 SURF LED FLUOR X1LEDT8D

Change PES to PEW for White Louver

**Frame-In-Kits Available for Recessed Fixtures to mount in hard ceilings**

FIK 1x4

FIK 2x2

FIK 2x4

See full selection of LED T8 Lamps on pages 142 to 145.

Consult for Fixtures Wired for LED T8 Lamps with Lamps Sold Separately



For Large Quantities, Call For Quote

# X1LED Recessed



## CENTER BASKET

ITEM NO.	DESCRIPTION
UCPF23212X1LN18W40	1x4 4200 Lumen Center Basket w/2x18W LED T8 4000K Lamps Included
UCPF217X1LN15W40	2x2 3400 Lumen Center Basket w/2x15W LED T8 4000K Lamps Included
UCPF317X1LN15W40	2x2 5100 Lumen Center Basket w/3x15W LED T8 4000K Lamps Included
UCPF232X1LN18W40	2x4 4200 Lumen Center Basket w/2x18W LED T8 4000K Lamps Included
UCPF332X1LN18W40	2x4 6300 Lumen Center Basket w/3x18W LED T8 4000K Lamps Included

EM8 OS5 CCT2 SURF AIR RET LED FLUOR X1LEDT8D

Change PF to LL for Linear Ribbed Lens



## DUAL BASKET

ITEM NO.	DESCRIPTION
UDPF217X1LN15W40	2x2 3400 Lumen Troffer w/2x15W LED T8 4000K Lamps Included
UDPF232X1LN18W40	2x4 4200 Lumen Dual Basket w/2x18W LED T8 4000K Lamps Included

EM8 OS5 CCT2 SURF LED FLUOR X1LEDT8D

Change PF to LL for Linear Ribbed Lens



## DEEP CENTER BASKET

ITEM NO.	DESCRIPTION
RDI217X1LN15W40	2x2 3400 Lumen Center Basket w/2x15W LED T8 4000K Lamps Included
RDI317X1LN15W40	2x2 5100 Lumen Center Basket w/3x15W LED T8 4000K Lamps Included
RDI232X1LN18W40	2x4 4200 Lumen Center Basket w/2x18W LED T8 4000K Lamps Included
RDI332X1LN18W40	2x4 6300 Lumen Center Basket w/3x18W LED T8 4000K Lamps Included

EM8 OS5 CCT2 SURF AIR RET LED FLUOR X1LEDT8D

See full selection of LED T8 Lamps on pages 142 to 145.



For Large Quantities, Call For Quote



## 4X4 RECESSED LINEAR (FOR T-BAR CEILING)



Special red sockets to identify fixtures made for LED T8 lamps.

ITEM NO.	DESCRIPTION
44RSF117X1WHLN15W40K	4" x 24" 1700 Lumen Recessed TBAR 1x 15W LED T8 4000K Lamps Included
44RSF217X1WHLN15W40K	4" x 24" 3400 Lumen Recessed TBAR 2x 15W LED T8 4000K Lamps Included
44RSF132X1WHLN18W40K	4" x 48" 2100 Lumen Recessed TBAR 1x 18W LED T8 4000K Lamps Included
44RSF232X1WHLN18W40K	4" x 48" 4200 Lumen Recessed TBAR 2x 18W LED T8 4000K Lamps Included
44RSF1328X1WHLN18W40K	4" x 96" 4200 Lumen Recessed TBAR 2x 18W LED T8 4000K Lamps Included
44RSF2328X1WHLN18W40K	4" x 96" 8400 Lumen Recessed TBAR 4x 18W LED T8 4000K Lamps Included

EM8 OS5 CCT2 SURF PEND WALL LED FLUOR X1LEDT8D

Change SF (Snap Fit Frosted Lens) to MW for Matte White Regressed Lens  
 Change 44R to 44RF for Recessed Flanged or 44RRXX for Recessed Flangeless for XX" sheetrock depth.  
 For Baffled Louver, change MW to BL.

## 6X6 RECESSED LINEAR (FOR T-BAR CEILING)



ITEM NO.	DESCRIPTION
66RMW117X1WHLN15W40K	6" x 26" 1700 Lumen Recessed TBAR 1x 15W LED T8 4000K Lamps Included
66RMW217X1WHLN15W40K	6" x 26" 3400 Lumen Recessed TBAR 2x 15W LED T8 4000K Lamps Included
66RMW132X1WHLN18W40K	6" x 48" 2100 Lumen Recessed TBAR 1x 18W LED T8 4000K Lamps Included
66RMW232X1WHLN18W40K	6" x 48" 4200 Lumen Recessed TBAR 2x 18W LED T8 4000K Lamps Included
66RMW1328X1WHLN18W40K	6" x 96" 4200 Lumen Recessed TBAR 2x 18W LED T8 4000K Lamps Included
66RMW2328X1WHLN18W40K	6" x 96" 8400 Lumen Recessed TBAR 4x 18W LED T8 4000K Lamps Included

EM8 OS5 CCT2 SURF PEND WALL LED FLUOR X1LEDT8D

Change 66R to 66RF for Recessed Flanged or 66RRXX for Recessed Flangeless for XX" sheetrock depth.  
 For Baffled Louver, change MW to BL.

## 2.5 RECESSED LINEAR (FLANGED FOR HARD CEILINGS)



Shown with Flange  
SES25RFSF

ITEM NO.	DESCRIPTION
SES25RFSF117X1WHLN15W40K	4"x24" 1700 Lumen Recessed 2.5" Flanged 1x15W LED T8 4000K Lamps Included
SES25RFSF132X1WHLN18W40K	4"x48" 2100 Lumen Recessed 2.5" Flanged 1x18W LED T8 4000K Lamps Included
SES25RFSF1328X1WHLN18W40K	4"x96" 4200 Lumen Recessed 2.5" Flanged 2x18W LED T8 4000K Lamps Included

EM8 OS5 CCT2 SURF PEND WALL LED FLUOR X1LEDT8D

Change SES25RFSF to 44R for Recessed TBAR or SES25RRXX for Recessed Flangeless for XX" sheetrock depth.



For Large Quantities, Call For Quote

# X1LED Linear Pendant



## PLIN LOUVER BLADE LINEAR PENDANT

ITEM NO.	DESCRIPTION
PLIN232X1WHLN18W40-HC401WH	48" PLIN 90% DOWN 4200 Lumen 2x18W LED T8 4000K Lamps included w/5 ft cable kit
PLIN2328X1WHLN18W40-HC401WH	96" PLIN 90% DOWN 8400 Lumen 4x18W LED T8 4000K Lamps included w/5 ft cable kit

EM10 OS5 CCT2 LED FLUOR X1LEDT8D

Change WH TO BK (Black), RD (Red), IR (Iron), SL (Silver) or BR (Bronze)

## 4X4 LINEAR PENDANT



ITEM NO.	DESCRIPTION
44PSF117X1WHLN15W40-HC301WH	4" x 24" 1700 Lumen Pendant w/Cable Kit 1x15W LED T8 4000K Lamps Included
44PSF217X1WHLN15W40-HC301WH	4" x 24" 3400 Lumen Pendant w/Cable Kit 2x15W LED T8 4000K Lamps Included
44PSF132X1WHLN18W40-HC301WH	4" x 48" 2100 Lumen Pendant w/Cable Kit 1x18W LED T8 4000K Lamps Included
44PSF232X1WHLN18W40-HC301WH	4" x 48" 4200 Lumen Pendant w/Cable Kit 2x18W LED T8 4000K Lamps Included
44PSF1328X1WHLN18W40-HC301WH	4" x 96" 4200 Lumen Pendant w/Cable Kit 2x18W LED T8 4000K Lamps Included
44PSF2328X1WHLN18W40-HC301WH	4" x 96" 8400 Lumen Pendant w/Cable Kit 4x18W LED T8 4000K Lamps Included

EM8 OS5 CCT2 SURF PEND WALL LED FLUOR X1LEDT8D

Change SF (Snap Fit Frosted Lens) to MW for Matte White Regressed Lens  
 Change HC301WH to HC302WH for 10" Cable Kit  
 Change WH to BK (Black), IR (Iron), SL (Silver) or BR (Bronze)  
 For surface mount, remove HC301WH

## 6X6 LINEAR PENDANT



ITEM NO.	DESCRIPTION
66PMW117X1WHLN15W40-HC301WH	6" x 26" 1700 Lumen Pendant w/Cable Kit 1x15W LED T8 4000K Lamps Included
66PMW217X1WHLN15W40-HC301WH	6" x 26" 3400 Lumen Pendant w/Cable Kit 2x15W LED T8 4000K Lamps Included
66PMW132X1WHLN15W40-HC301WH	6" x 48" 2100 Lumen Pendant w/Cable Kit 1x18W LED T8 4000K Lamps Included
66PMW232X1WHLN15W40-HC301WH	6" x 48" 4200 Lumen Pendant w/Cable Kit 2x18W LED T8 4000K Lamps Included
66PMW1328X1WHLN15W40-HC301WH	6" x 96" 4200 Lumen Pendant w/Cable Kit 2x18W LED T8 4000K Lamps Included
66PMW2328X1WHLN15W40-HC301WH	6" x 96" 8400 Lumen Pendant w/Cable Kit 4x18W LED T8 4000K Lamps Included

EM8 OS5 SURF PEND WALL LED FLUOR X1LEDT8D

Change HC301WH to HC302WH for 10" Cable Kit  
 Change WH to BK (Black), IR (Iron), SL (Silver) or BR (Bronze)  
 For surface mount, remove HC301WH  
 For Baffled Louver, change MW to BL



For Large Quantities, Call For Quote



## LED T8 PENDANT (SUSPENDED ONLY - COMES W/ PENDANT)

ITEM NO.	DESCRIPTION
LTX132X1CHLN18W40K	48" Linear Pendant 2100 Lumens 1x18W LED T8 Chrome
LTX132X1WHLN18W40K	48" Linear Pendant 2100 Lumens 1x18W LED T8 White

**CCT2** **X1LEDT8D**

Comes with 5ft Cable Kit.

## LOUVERED 8" DECORATIVE LINEAR



Shown in Black (BK).

ITEM NO.	DESCRIPTION
LVS232X1WHLN18W40-HC301WH	48" LVS WHITE 4200 Lumen 2x18W LED T8 4000K Lamps included w/5 ft cable kit
LVS2328X1WHLN18W40-HC401WH	96" LVS WHITE 8400 Lumen 4x18W LED T8 4000K Lamps included w/5 ft cable kit

**EM10** **CCT2** **SURF** **PEND** **LED** **FLUOR** **X1LEDT8D**

Change WH TO BK (Black), IR (Iron), SL (Silver) or BR (Bronze)

## LOUVERED 6" DECORATIVE LINEAR



ITEM NO.	DESCRIPTION
LVS6232X1WHLN18W40-HC301WH	48" LVS WHITE 4200 Lumen 2x18W LED T8 4000K Lamps included w/5 ft cable kit
LVS62328X1WHLN18W40-HC401WH	96" LVS WHITE 8400 Lumen 4x18W LED T8 4000K Lamps included w/5 ft cable kit

**EM10** **CCT2** **SURF** **PEND** **LED** **FLUOR** **X1LEDT8D**

Change WH TO BK (Black), IR (Iron), SL (Silver) or BR (Bronze)

## 1 LIGHT 2.5 IN. ENCLOSED STRIP



Detail View

ITEM NO.	DESCRIPTION
SES25FR132X1LN18W40-HC301WH	2.5"x48" PENDANT or SURFACE LINEAR 2100 Lumen 1x18W LED T8 4000K Lamps included
SES25FR1328X1LN18W40-HC301WH	2.5"x96" PENDANT or SURFACE LINEAR 4200 Lumen 2x18W LED T8 4000K Lamps included

**EM8** **OS5** **CCT2** **SURF** **PEND** **LED** **FLUOR** **X1LEDT8D**

Change WH TO BK (Black), IR (Iron), SL (Silver) or BR (Bronze)



For Large Quantities, Call For Quote

# X1LED Surface



## SURFACE TROFFER

ITEM NO.	DESCRIPTION
153A23212X1LN18W40	1x4 4200 Lumen Troffer w/2x18W LED T8 4000K Lamps Included
153A217X1LN18W40	2x2 3400 Lumen Troffer w/2x15W LED T8 4000K Lamps Included
153A317X1LN18W40	2x2 5100 Lumen Troffer w/3x15W LED T8 4000K Lamps Included
153A417X1LN18W40	2x2 6800 Lumen Troffer w/4x15W LED T8 4000K Lamps Included
153A232X1LN18W40	2x4 4200 Lumen Troffer w/2x18W LED T8 4000K Lamps Included
153A332X1LN18W40	2x4 6300 Lumen Troffer w/3x18W LED T8 4000K Lamps Included
153A432X1LN18W40	2x4 8400 Lumen Troffer w/4x18W LED T8 4000K Lamps Included

EM8 OS5 CCT2 REC LED FLUOR X1LEDT8D

For Frosted Lens change A to FR

## SURFACE PARABOLIC



Special red sockets to identify fixtures made for LED T8 lamps.

ITEM NO.	DESCRIPTION
SHPARA8C23212X1LN18W40	1x4 4200 Lumen Parabolic 8C w/2x18W LED T8 4000K Lamps Included
SHPARA9C217X1LN15W40	2x2 3400 Lumen Parabolic 9C w/2x15W LED T8 4000K Lamps Included
SHPARA9C317X1LN15W40	2x2 5100 Lumen Parabolic 9C w/3x15W LED T8 4000K Lamps Included
SHPARA9C417X1LN15W40	2x2 6800 Lumen Parabolic 9C w/4x15W LED T8 4000K Lamps Included
SHPARA12C232X1LN18W40	2x4 4200 Lumen Parabolic 12C w/2x18W LED T8 4000K Lamps Included
SHPARA18C232X1LN18W40	2x4 4200 Lumen Parabolic 18C w/2x18W LED T8 4000K Lamps Included
SHPARA18C332X1LN18W40	2x4 6300 Lumen Parabolic 18C w/3x18W LED T8 4000K Lamps Included
SHPARA18C432X1LN18W40	2x4 8400 Lumen Parabolic 18C w/4x18W LED T8 4000K Lamps Included
SHPARA32C432X1LN18W40	2x4 8400 Lumen Parabolic 32C w/4x18W LED T8 4000K Lamps Included

EM8 OS5 CCT2 REC LED FLUOR X1LEDT8D

See full selection of LED T8 Lamps on pages 142 to 145.



For Large Quantities, Call For Quote



## SURFACE HIGH EFFICIENT PARABOLIC



(Surface Mount has shroud)

ITEM NO.	DESCRIPTION
SHPES9C217X1LN15W40	2x2 3400 Lumen Parabolic 9C w/2x15W LED T8 4000K Lamps Included
SHPES9C317X1LN15W40	2x2 5100 Lumen Parabolic 9C w/3x15W LED T8 4000K Lamps Included
SHPES9C417X1LN15W40	2x2 6800 Lumen Parabolic 9C w/4x15W LED T8 4000K Lamps Included
SHPES12C232X1LN18W40	2x4 4200 Lumen Parabolic 12C w/2x18W LED T8 4000K Lamps Included
SHPES18C232X1LN18W40	2x4 4200 Lumen Parabolic 18C w/2x18W LED T8 4000K Lamps Included
SHPES18C332X1LN18W40	2x4 6300 Lumen Parabolic 18C w/3x18W LED T8 4000K Lamps Included
SHPES18C432X1LN18W40	2x4 8400 Lumen Parabolic 18C w/4x18W LED T8 4000K Lamps Included

EM8 OS5 CCT2 REC LED FLUOR X1LEDT8D

Change PES to PEW for White Louver

## SURFACE CENTER BASKET



ITEM NO.	DESCRIPTION
SHUCPF23212X1LN18W40	1x4 4200 Lumen Center Basket w/2x18W LED T8 4000K Lamps Included
SHUCPF217X1LN18W40	2x2 3400 Lumen Center Basket w/2x15W LED T8 4000K Lamps Included
SHUCPF317X1LN18W40	2x2 5100 Lumen Center Basket w/3x15W LED T8 4000K Lamps Included
SHUCPF232X1LN18W40	2x4 4200 Lumen Center Basket w/2x18W LED T8 4000K Lamps Included
SHUCPF332X1LN18W40	2x4 6300 Lumen Center Basket w/3x18W LED T8 4000K Lamps Included

EM8 OS5 CCT2 REC LED FLUOR X1LEDT8D

Change PF to LL for Linear Ribbed Lens

Consult for Wired for LED T8 Lamps with Lamps Sold Separately

## SURFACE DUAL BASKET



ITEM NO.	DESCRIPTION
SHUDPF217X1LN15W40	2x2 3400 Lumen Dual Basket w/2x15W LED T8 4000K Lamps Included
SHUDPF232X1LN18W40	2x4 4200 Lumen Dual Basket w/2x18W LED T8 4000K Lamps Included

EM8 OS5 CCT2 REC LED FLUOR X1LEDT8D

Change PF to LL for Linear Ribbed Lens



For Large Quantities, Call For Quote

# X1LED Linear



## ECLIPSE

ITEM NO.	DESCRIPTION
ECLMW217X1WHLN15W40K (TO, BM, IM, SI, WM)	9"x24" 3400 Lumen w/2x15W LED T8 4000K Lamps Included
ECLMW232X1WHLN18W40K (TO, BM, IM, SI, WM)	9"x48" 4200 Lumen w/2x18W LED T8 4000K Lamps Included
ECLMW417X1WHLN15W40K (TO, BM, IM, SI, WM)	17"x24" 6800 Lumen w/4x15W LED T8 4000K Lamps Included
ECLMW432X1WHLN18W40K (TO, BM, IM, SI, WM)	17"x48" 8400 Lumen w/4x18W LED T8 4000K Lamps Included

EM9 OS3 CCT2 REC LED FLUOR X1LEDT8D

## PUF SURFACE LINEAR



ITEM NO.	DESCRIPTION
PUF23211X1LN18W40K	11x48 inches 4200 Lumen w/2x18W LED T8 4000K Lamps Included
PUF41717X1LN15W40K	17x24 inches 6800 Lumen w/4x15W LED T8 4000K Lamps Included
PUF43217X1LN18W40K	17x48 inches 8400 Lumen w/4x18W LED T8 4000K Lamps Included

EM8 OS3 CCT2 REC WALL LED FLUOR X1LEDT8D

## CROWN



ITEM NO.	DESCRIPTION
CRWNMW217X1WHLN15W40K	9x24 inches 3400 Lumen w/2x15W LED T8 4000K Lamps Included
CRWNMW417X1WHLN15W40K	17x24 inches 6800 Lumen w/4x15W LED T8 4000K Lamps Included
CRWNMW232X1WHLN18W40K	9x48 inches 4200 Lumen w/2x18W LED T8 4000K Lamps Included
CRWNMW432X1WHLN18W40K	17x48 inches 8400 Lumen w/4x18W LED T8 4000K Lamps Included

EM8 OS3 CCT2 REC WALL LED FLUOR X1LEDT8D

Consult for Alternate Wood Finishes



For Large Quantities, Call For Quote



Ideal for Residential Use

## WRAPAROUND 7"

ITEM NO.	DESCRIPTION
207A217X1LN15W40	7" x 24" 3400 Lumen 2 Light Wraparound w/2x15W LED T8 4000K Lamps Included
207A232X1LN18W40	7" x 48" 4200 Lumen 2 Light Wraparound w/2x18W LED T8 4000K Lamps Included
207A332X1LN18W40	13" x 48" 6300 Lumen 3 Light Wraparound w/3x18W LED T8 4000K Lamps Included
207A432X1LN18W40	13" x 48" 8400 Lumen 4 Light Wraparound w/4x18W LED T8 4000K Lamps Included

EM9 OS3 CCT2 LED FLUOR X1LEDT8D

## WRAPAROUND 9"

ITEM NO.	DESCRIPTION
209A232X1LN18W40	9" x 48" 4200 Lumen 2 Light Wraparound w/2x18W LED T8 4000K Lamps Included

EM9 OS3 CCT2 LED FLUOR X1LEDT8D



## WRAPAROUND SPECIFICATION GRADE

ITEM NO.	DESCRIPTION
200A217X1LN15W40	11" x 24" 3400 Lumen 2 Light Wraparound w/2x15W LED T8 4000K Lamps Included
200A232X1LN18W40	11" x 48" 4200 Lumen 2 Light Wraparound w/2x18W LED T8 4000K Lamps Included
200A2328X1LN18W40	11" x 96" 8400 Lumen 4 Light Wraparound w/4x18W LED T8 4000K Lamps Included
200A432X1LN18W40	16" x 48" 8400 Lumen 4 Light Wraparound w/4x18W LED T8 4000K Lamps Included
200A4328X1LN18W40	16" x 96" 16800 Lumen 8 Light Wraparound w/8x18W LED T8 4000K Lamps Included

EM9 OS3 CCT2 LED FLUOR X1LEDT8D

## NARROW WRAPAROUND

ITEM NO.	DESCRIPTION
201A117X1LN18W40	5" x 24" 1700 Lumen 1 Light Wraparound w/1x15W LED T8 4000K Lamps Included
201A132X1LN18W40	5" x 48" 2100 Lumen 1 Light Wraparound w/1x18W LED T8 4000K Lamps Included

EM9 OS3 CCT2 LED FLUOR X1LEDT8D



## CORRIDOR LINEAR

ITEM NO.	DESCRIPTION
159A117X1LN18W40	5" x 24" 1700 Lumen 1 Light Wraparound w/1x15W LED T8 4000K Lamps Included
159A132X1LN18W40	5" x 48" 2100 Lumen 1 Light Wraparound w/1x18W LED T8 4000K Lamps Included
159A1328X1LN18W40	5" x 96" 4200 Lumen 1 Light Wraparound w/2x18W LED T8 4000K Lamps Included

EM9 OS3 CCT2 LED FLUOR X1LEDT8D



Consult for Fixtures Wired for LED T8 Lamps with Lamps Sold Separately



For Large Quantities, Call For Quote

# X1LED Linear Strip



**BEST SELLER**

## 2 OR 3 LIGHT STRIP 4.25"

ITEM NO.	DESCRIPTION
C217X1LI18W40	2ft. Strip 3400 Lumen 2x15W LED T8 4000K Lamps Included
C317X1LI18W40	2ft. Strip 5400 Lumen 3x15W LED T8 4000K Lamps Included
C232X1LI18W40	4ft. Strip 4200 Lumen 2x18W LED T8 4000K Lamps Included
C332X1LI18W40	4ft. Strip 6300 Lumen 3x18W LED T8 4000K Lamps Included
C2328X1LI18W40	8ft. Tandem Strip 8400 Lumen 4x18W LED T8 4000K Lamps Included

EM9 OS5 CCT2 LED FLUOR X1LEDT8D

## 1 LIGHT STRIP 2.75"



ITEM NO.	DESCRIPTION
S117X1LI18W40	2ft. Strip 1700 Lumen 1x15W LED T84000K Lamps Included
S132X1LI18W40	4ft. Strip 2100 Lumen 1x18W LED T84000K Lamps Included
S1328X1LI18W40	8ft. Tandem Strip 4200 Lumen 2x18W LED T8 4000K Lamps Included

EM9 OS5 CCT2 LED FLUOR X1LEDT8D

## MINI STRIP (1.6 IN.) 1 LIGHT



ITEM NO.	DESCRIPTION
KDST8117X1LI18W40	1.6 " 2 ft. Strip 1700 Lumen 1x15W LED T84000K Lamps Included
KDST8132X1LI18W40	1.6 " 4 ft. Strip 2100 Lumen 1x18W LED T84000K Lamps Included

EM3 CCT2 LED FLUOR X1LEDT8D

## 1 LIGHT LOW PROFILE STRIP



ITEM NO.	DESCRIPTION
LLS132X1LI18W40	49.5"L x 1.38"W . 1.69" 1 Light Strip w/LED T8 18W Lamp Included

EM3 CCT2 LED FLUOR X1LEDT8D

See full selection of LED T8 Lamps on pages 142 to 145.



For Large Quantities, Call For Quote





## SIDE MOUNT STRIP

ITEM NO.	DESCRIPTION
SM117X1L115W40	2ft. Strip 1700 Lumen 1x15W LED T8 4000K Lamps Included
SM217X1L118W40	2ft. Strip 3400 Lumen 2x15W LED T8 4000K Lamps Included
SM132X1L118W40	4ft. Strip 2100 Lumen 1x18W LED T8 4000K Lamps Included
SM232X1L118W40	4ft. Strip 4200 Lumen 2x18W LED T8 4000K Lamps Included

EM3 CCT2 LED FLUOR X1LEDT8D

## INDUSTRIAL



ITEM NO.	DESCRIPTION
IND232W30X1L118W40	4ft. Industrial 4200 Lumen 2x18W LED T8 4000K Lamps Included
IND332W30X1L118W40	4ft. Industrial 6300 Lumen 3x18W LED T8 4000K Lamps Included
IND2328W30X1L118W40	8ft. Tandem Industrial 8400 Lumen 4x18W LED T8 4000K Lamps Included
IND3328W30X1L118W40	8ft. Tandem Industrial 12600 Lumen 6x18W LED T8 4000K Lamps Included

EM9 OS5 CCT2 LED FLUOR X1LEDT8D



Order IND48WG  
for Wire guard.

## RECESSED STRIP ITB



ITEM NO.	DESCRIPTION
ITB132X1L118W40	4ft. Industrial 2100 Lumen 1x18W LED T8 4000K Lamps Included
ITB232X1L118W40	4ft. Recessed Linear 4200 Lumen 2x18W LED T8 4000K Lamps Included
ITB1328X1L118W40	8ft. Tandem Recessed Linear 4200 Lumen 2x18W LED T8 4000K Lamps Included
ITB2328X1L118W40	8ft. Tandem Recessed Linear 8400 Lumen 4x18W LED T8 4000K Lamps Included

EM3 CCT2 LED FLUOR X1LEDT8D

### Options to Make It “Your Way”

EM1

SURF

X1LED

The icons listed under every series identifies all of the options available for that series, including color temperatures, emergencies, sensors/controls, coordinating applications and more. See pages 154 and 155 for full explanations of each icon.



For Large Quantities, Call For Quote

# X1LED High Bays



## PREMIERE HIGH BAY

ITEM NO.	DESCRIPTION
HBC432M23X1LN18W50	High Bay 48 inch 8400 Lumens w/4x18W LED T8 5000K Lamps Included
HBC632M23X1LN18W50	High Bay 48 inch 12600 Lumens w/6x18W LED T8 5000K Lamps Included
HBC832M23X1LN18W50	High Bay 48 Inches 16800 Lumens w/8x18W LED T8 5000K Lamps Included
HBC1032M23X1LN18W50	High Bay 48 Inches 21000 Lumens w/10x18W LED T8 5000K Lamps Included
HBC1232M23X1LN18W50	High Bay 48 Inches 25200 Lumens w/12x18W LED T8 5000K Lamps Included

EM8 OS5 CCT2 LED FLUOR X1LEDT8D

## INDUSTRIALIZED GALVANIZED HIGH BAY



ITEM NO.	DESCRIPTION
HBG432M23X1LN18W50	High Bay 48 Inches 8400 Lumens w/4x18W LED T8 5000K Lamps Included
HBG632M23X1LN18W50	High Bay 48 Inches 12600 Lumens w/6x18W LED T8 5000K Lamps Included
HBG832M23X1LN18W50	High Bay 48 Inches 16800 Lumens w/8x18W LED T8 5000K Lamps Included
HBG1032M23X1LN18W50	High Bay 48 Inches 21000 Lumens w/10x18W LED T8 5000K Lamps Included
HBG1232M23X1LN18W50	High Bay 48 Inches 25200 Lumens w/12x18W LED T8 5000K Lamps Included

EM8 OS5 CCT2 LED FLUOR X1LEDT8D

## H6L SERIES



ITEM NO.	DESCRIPTION
H6L4328M23X1LN18W50	High Bay 96 Inches Tandem 16800 Lumens w/8x18W LED T8 5000K Lamps Included
H6L432M23X1LN18W50	High Bay 48 Inches Tandem 8400 Lumens w/4x18W LED T8 5000K Lamps Included
H6L6328M23X1LN18W50	High Bay 96 Inches Tandem 21000 Lumens w/10x18W LED T8 5000K Lamps Included
H6L632M23X1LN18W50	High Bay 48 Inches Tandem 12600 Lumens w/6x18W LED T8 5000K Lamps Included

EM8 CCT2 LED FLUOR X1LEDT8D



For Large Quantities, Call For Quote



## H2L SERIES

ITEM NO.	DESCRIPTION
H2L132M23X1LN18W50	High Bay 48 Inches 2100 Lumens w/1x18W LED T8 5000K Lamps Included
H2L232M23X1LN18W50	High Bay 48 Inches 4200 Lumens w/2x18W LED T8 5000K Lamps Included

EM3 CCT2 LED FLUOR X1LEDT8D



Special red sockets to identify fixtures made for LED T8 lamps.

## BAFFLED HIGH BAY

ITEM NO.	DESCRIPTION
FHBL232X1LN18W50	Linear Louvered 48 Inches 4200 Lumens w/2x18W LED T8 5000K Lamps Included
FHBL332X1LN18W50	Linear Louvered 48 Inches 6300 Lumens w/3x18W LED T8 5000K Lamps Included
FHBL432X1LN18W50	Linear Louvered 48 Inches 8400 Lumens w/4x18W LED T8 5000K Lamps Included
FHBL2328X1LN18W50	Linear Baffled Louver 96 Inches Tandem 8400 Lumens w/4x18W LED T8 5000K Lamps Included
FHBL3328X1LN18W50	Linear Baffled Louver 96 Inches Tandem 12600 Lumens w/6x18W LED T8 5000K Lamps Included
FHBL4328X1LN18W50	Linear Baffled Louver 96 Inches Tandem 16800 Lumens w/8x18W LED T8 5000K Lamps Included

EM9 CCT2 LED FLUOR X1LEDT8D

## VAPOR TIGHT HIGH BAY WET LOCATION

(IDEAL FOR COLD STORAGE AND WASH DOWN) IP65, IP66 IP67, NEMA 4X



ITEM NO.	DESCRIPTION
CITA432X1LN18W40	14.61" x 51.91" Enclosure w/Clear Lens 8400 Lumen 4x18W LED T8 4000K Lamps Included
CITA632X1LN18W40	14.61" x 51.91" Enclosure w/Clear Lens 12600 Lumen 6x18W LED T8 4000K Lamps Included

EM3 OS6 CCT2 LED FLUOR X1LEDT8D

See specification sheet for mounting options and accessories. CL is Clear Acrylic Lens, change to FR for Frosted Acrylic Lens. For Polycarbonate Versions add PC after CL or FR.



For Large Quantities, Call For Quote

# X1LED Retrofit Kits



UL Listed kit to bypass Fluorescent Ballast w/LED tubes.

Add "8" after RLK for tandem version

To wire for Troffer Retrofit, add "TR" after "RLK".

## RETROFIT LED T8 LAMP KIT (Convert Existing Fluorescent Fixtures to LED)

ITEM NO.	DESCRIPTION
RLK1X1WR	Retrofit Lamp Kit Prewired Unshunted Sockets For 1 LED T8 Lamp Includes Companion Sockets
RLK2X1WR	Retrofit Lamp Kit Prewired Unshunted Sockets For 2 LED T8 Lamp Includes Companion Sockets
RLK3X1WR	Retrofit Lamp Kit Prewired Unshunted Sockets For 3 LED T8 Lamp Includes Companion Sockets
RLK4X1WR	Retrofit Lamp Kit Prewired Unshunted Sockets For 4 LED T8 Lamp Includes Companion Sockets
RLK1X1WRLI18W40	Retrofit Lamp Kit Prewired Unshunted Sockets For 1 LED T8 Lamp Included Plus Companion Sockets
RLK2X1WRLI18W40	Retrofit Lamp Kit Prewired Unshunted Sockets For 2 LED T8 Lamp Included Plus Companion Sockets
RLK3X1WRLI18W40	Retrofit Lamp Kit Prewired Unshunted Sockets For 3 LED T8 Lamp Included Plus Companion Sockets
RLK4X1WRLI18W40	Retrofit Lamp Kit Prewired Unshunted Sockets For 4 LED T8 Lamp Included Plus Companion Sockets

CCT2

X1LEDT8D

### Consult for Dimmable LED Lamps Retrofit Kit



#### 4 Ft. Dimming Kit

(This kit will change a two lamp fluorescent to a dimmable two lamp with LED T8 lamps)



#### LED Dimming Kit for 8 FT. Tandem 1 Light Strip

(Shown w/Optional Wiring Harness for Continuous Run)

## RETROFIT REFLECTOR KIT FOR PARABOLICS/TROFFERS



To wire for Troffer Retrofit.

ITEM NO.	DESCRIPTION
22C2M20BL11X1LI15W40	2x2 Retrofit Kit 4200 Lumen Mirrored Reflector Includes 2x15W 4000K Lamps
22C2W10BL11X1LI15W40	2x2 Retrofit Kit 4200 Lumen Enhanced White Reflector Includes 2x15W 4000K Lamps
22C3M20BL11X1LI15W40	2x2 Retrofit Kit 6300 Lumen Mirrored Reflector Includes 3x15W 4000K Lamps
22C3W10BL11X1LI15W40	2x2 Retrofit Kit 6300 Lumen Enhanced White Reflector Includes 3x15W 4000K Lamps
24C2M20BL11X1LI18W40	2x4 Retrofit Kit 4200 Lumen Mirrored Reflector Includes 2x18W 4000K Lamps
24C2W10BL11X1LI18W40	2x4 Retrofit Kit 4200 Lumen Enhanced White Reflector Includes 2x18W 4000K Lamps
24C3M20BL11X1LI18W40	2x4 Retrofit Kit 6300 Lumen Mirrored Reflector Includes 3x18W 4000K Lamps
24C3W10BL11X1LI18W40	2x4 Retrofit Kit 6300 Lumen Enhanced White Reflector Includes 3x18W 4000K Lamps

EM8

OS5

CCT2

LED

FLUOR

X1LEDT8D



For Large Quantities, Call For Quote

## BALLAST COVER REFIT KIT (Ideal to change 8ft Lamps to 4ft Tandem)



ITEM NO.	DESCRIPTION
4RB421T8L11X1LI18W40	4.25" Strip Retrofit Kit 48 In. 2100 Lumen Included 1x18W 4000K Lamp
4RB422T8L11X1LI18W40	4.25" Strip Retrofit Kit 48 In. 4200 Lumen Included 2x18W 4000K Lamp
4RB501T8L11X1LI18W40	5" Strip Retrofit Kit 48 In. 2100 Lumen Included 1x18W 4000K Lamp
4RB502T8L11X1LI18W40	5" Strip Retrofit Kit 48 In. 4200 Lumen Included 2x18W 4000K Lamp
8RB421X2T8L11X1LI18W40	4.25" Strip Retrofit Kit 96 In. 4200 Lumen Included 2x18W 4000K Lamp
8RB422X2T8L11X1LI18W40	4.25" Strip Retrofit Kit 96 In. 8400 Lumen Included 4x18W 4000K Lamp
8RB501X2T8L11X1LI18W40	5" Strip Retrofit Kit 96 In. 4200 Lumen Included 2x18W 4000K Lamp
8RB502X2T8L11X1LI18W40	5" Strip Retrofit Kit 96 In. 8400 Lumen Included 4x18W 4000K Lamp

EM9 OS5 CCT2 LED FLUOR X1LEDT8D

See full selection of LED T8 Lamps on pages 142 to 145.

Consult for Fixtures Wired for LED T8 Lamps with Lamps Sold Separately

### How To Add Emergency to X1LED

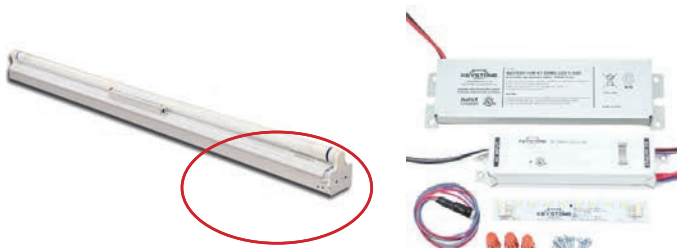

Separate LED Array added for Emergency.

#### KEYSTONE KT-EMERG-LED-12-1200-K1 LED EMERGENCY LIGHTING KIT

12W Constant Wattage - Ballast Battery Backup - Damp Location  
- 120-277V

Includes driver, separately housed 1200mAh Ni-Cd battery and 0.7" x 8" 1200 Lumen LED module for complete emergency lighting installations. When AC power fails, the driver will power the LED for a minimum of 90 minutes emergency illumination. Easy installation in existing LED or fluorescent fixtures with wiring diagrams and labels on all parts. Mounting hardware included. Full 5 year warranty on all components. Output Current 1000 mA-200mA - Output Voltage 12 ~41 Vdc

To order, add EMKT12 to end of X1LED item number.

### How To Add an Inverter to X1LED



#### KT-EMRG-LED-5-500-AC CONSTANT WATTAGE LED EMERGENCY BACK-UP

LED Emergency Back-Up Driver | Standard Side Exit Wire Leads |  
5W Output

DRIVER TYPE: Constant Wattage LED Emergency

MAX. OUTPUT POWER: 5W

INPUT VOLTAGE: 120-277Vac ±10%

OUTPUT VOLTAGE: 40-300Vdc

OUTPUT CURRENT: Load Dependant

WARRANTY: 5 Years

PRODUCT FEATURES

- Illuminates entire LED load at reduced output under emergency mode
- One Piece Design with Metal Housing
- 2 -in- 1 LED test switch and indicator light included
- Evaluated to UL 924 requirements

To order, add INV5 to end of X1LED item number.



# X1LED Retrofit Kits

## Choice of Reflectors or Ballast Cover

For ballast cover,  
choose strip width 4.25" or 5"

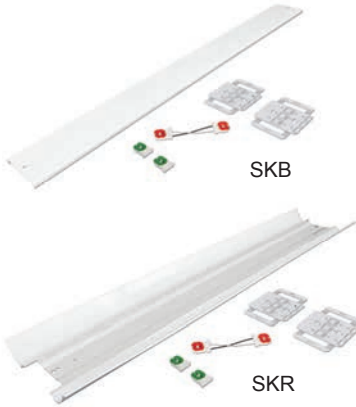

For enhanced light output add a mirrored specular reflector (M20) or white reflector (W10).

Universal socket bar SKRUSB is ideal to retrofit 4.25" to 5" strips with either reflector or ballast cover.



## UNIVERSAL STRIP RETROFIT KIT

ITEM NO.	DESCRIPTION
SKB132B4L11X1LI18W40	4.25" Strip Retrofit Kit 48". 2100 Lumen Included 1x18W 4000K Lamps
SKB232B4L11X1LI18W40	4.25" Strip Retrofit Kit 48". 4200 Lumen Included 2x18W 4000K Lamps
SKB1328B4L11X1LI18W40	4.25" Strip Retrofit Kit 96". 4200 Lumen Included 2x18W 4000K Lamps
SKB2328B4L11X1LI18W40	4.25" Strip Retrofit Kit 96". 8400 Lumen Included 4x18W 4000K Lamps
SKB132B5L11X1LI18W40	5" Strip Retrofit Kit 48". 2100 Lumen Included 1x18W 4000K Lamps
SKB232B5L11X1LI18W40	5" Strip Retrofit Kit 48". 4200 Lumen Included 2x18W 4000K Lamps
SKB1328B5L11X1LI18W40	5" Strip Retrofit Kit 96". 8400 Lumen Included 2x18W 4000K Lamps
SKB2328B5L11X1LI18W40	5" Strip Retrofit Kit 96". 4200 Lumen Included 4x18W 4000K Lamps
SKR132W10L11X1LI18W40	Strip Reflector Enhanced White Kit 48" 2100 Lumen Included 1x18W 4000K Lamp
SKR232W10L11X1LI18W40	Strip Reflector Enhanced White Kit 48" 4100 Lumen Included 2x18W 4000K Lamp
SKR1328W10L11X1LI18W40	Strip Reflector Enhanced White Kit 96" 4200 Lumen Included 2x18W 4000K Lamp
SKR2328W10L11X1LI18W40	Strip Reflector Enhanced White Kit 96" 8400 Lumen Included 4x18W 4000K Lamp
SKR132M20L11X1LI18W40	Strip Reflector Mirror Kit 48" 2100 Lumen Included 1x18W 4000K Lamp
SKR232M20L11X1LI18W40	Strip Reflector Mirror Kit 48" 4100 Lumen Included 2x18W 4000K Lamp
SKR1328M20L11X1LI18W40	Strip Reflector Mirror Kit 96" 4200 Lumen Included 2x18W 4000K Lamp
SKR2328M20L11X1LI18W40	Strip Reflector Mirror Kit 96" 8400 Lumen Included 4x18W 4000K Lamp
SKRUSB	

CCT2 LED FLUOR X1LEDT8D

**UL Listed with all Options and Accessories.**

### Optional Dimming Options

The 4 FT. lamps are available with a dimming option. Specially designed dimming lamps require an external driver that runs up to 4 lamps. Dimming driver is installed in the fixture with dimming lamps to dim with 0-10V to 10% or choose integral dimming driver lamps, see page 144.



For Large Quantities, Call For Quote

# X1LED Wall Fixtures

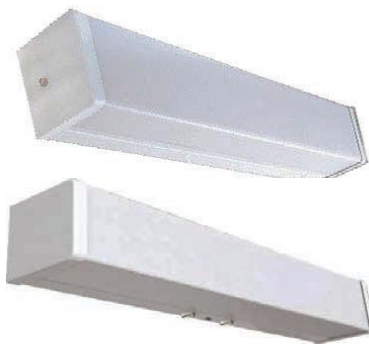

## WALL FIXTURE 4 FT.

ITEM NO.	DESCRIPTION
555MW232X1LN18W40	4ft. Wall 4200 Lumen 2x18W LED T8 4000K Lamps Included

EM8 OS4 CCT2 LED FLUOR X1LEDT8D

## STAIRWELL 4FT. WITH ULTRASONIC SENSOR

ITEM NO.	DESCRIPTION
SS213A232X1LN18W40	4ft. Wall 4200 Lumen 2x18W LED T8 4000K Lamps Included

EM8 OS4 CCT2 LED FLUOR X1LEDT8D

1 Light on Always, 1 Light on Sensor

## 4X4 LINEAR WALL



ITEM NO.	DESCRIPTION
44WSF117X1WHLN15W40	4" x 24" 1700 Lumen Pendant w/Cable Kit 1x15W LED T8 4000 Lamps Included
44WSF217X1WHLN15W40	4" x 24" 3400 Lumen Pendant w/Cable Kit 2x15W LED T8 4000 Lamps Included
44WSF132X1WHLN18W40	4" x 48" 2100 Lumen Pendant w/Cable Kit 1x18W LED T8 4000 Lamps Included
44WSF232X1WHLN18W40	4" x 48" 4200 Lumen Pendant w/Cable Kit 2x18W LED T8 4000 Lamps Included
44WSF1328X1WHLN18W40	4" x 96" 4200 Lumen Pendant w/Cable Kit 2x18W LED T8 4000 Lamps Included
44WSF2328X1WHLN18W40	4" x 96" 8400 Lumen Pendant w/Cable Kit 4x18W LED T8 4000 Lamps Included

EM8 OS5 CCT2 SURF PEND REC LED FLUOR X1LEDT8D

Change SF (Snap Fit Frosted Lens) to MW for Matte White Regressed Lens  
Change WH to BK (Black), IR (Iron), SL (Silver) or BR (Bronze)  
For Baffled Louver, Change MW to BL

## 6X6 LINEAR WALL



ITEM NO.	DESCRIPTION
66WMW117X1WHLN15W40	6" x 26" 1700 Lumen Pendant w/Cable Kit 1x15W LED T8 4000 Lamps Included
66WMW217X1WHLN15W40	6" x 26" 3400 Lumen Pendant w/Cable Kit 2x15W LED T8 4000 Lamps Included
66WMW132X1WHLN18W40	6" x 48" 2100 Lumen Pendant w/Cable Kit 1x18W LED T8 4000 Lamps Included
66WMW232X1WHLN18W40	6" x 48" 4200 Lumen Pendant w/Cable Kit 2x18W LED T8 4000 Lamps Included
66WMW1328X1WHLN18W40	6" x 96" 4200 Lumen Pendant w/Cable Kit 4x18W LED T8 4000 Lamps Included
66WMW2328X1WHLN18W40	6" x 96" 8400 Lumen Pendant w/Cable Kit 4x18W LED T8 4000 Lamps Included

EM8 OS5 CCT2 SURF PEND REC LED FLUOR X1LEDT8D

Change WH to BK (Black), IR (Iron), SL (Silver) or BR (Bronze)  
For Baffled Louver, Change MW to BL



For Large Quantities, Call For Quote

# X1LED Wall Fixtures

Special red sockets to identify fixtures made for LED T8 lamps.

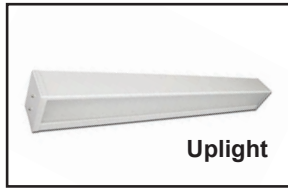

Add PC4 to switch up and down separately.



## BED LIGHT (Direct and Indirect Light)

ITEM NO.	DESCRIPTION
215A1U1D17DFX1LN15W40	24" Direct/Indirect 3400 Lumens 2x15W LED T8 4000K Lamps Included
215A1U1D32DFX1LN18W40	48" Direct/Indirect 3400 Lumens 2x18W LED T8 4000K Lamps Included
215A1U2D17DFX1LN15W40	24" Direct/Indirect 5100 Lumens 3x15W LED T8 4000K Lamps Included
215A1U2D32DFX1LN18W40	48" Direct/Indirect 6300 Lumens 3x18W LED T8 4000K Lamps Included
215A2U1D17DFX1LN15W40	24" Direct/Indirect 5100 Lumens 3x15W LED T8 4000K Lamps Included
215A2U1D32DFX1LN18W40	48" Direct/Indirect 6300 Lumens 3x18W LED T8 4000K Lamps Included
215A2U2D17DFX1LN15W40	24" Direct/Indirect 6800 Lumens 4x15W LED T8 4000K Lamps Included
215A2U2D32DFX1LN18W40	48" Direct/Indirect 8400 Lumens 4x18W LED T8 4000K Lamps Included

EM8 CCT2 LED FLUOR X1LEDT8D

Add SW4 for 4 Way Switch.

**Consult for Fixtures Wired for LED T8 Lamps with Lamps Sold Separately**

## CITADEL ENCLOSURES

ITEM NO.	DESCRIPTION
CITCL232X1LN18W40	4ft. Enclosure w/Clear Lens 4200 Lumen 2x18W LED T8 4000K Lamps Included
CITCL332X1LN18W40	4ft. Enclosure w/Clear Lens 6300 Lumen 2x18W LED T8 4000K Lamps Included
CITLB2328X1LN18W40	8ft. Enclosure w/Linear Ribbed Lens 8200 Lumen 4x18W LED T8 4000K Lamps Included

EM9 OS6 CCT2 LED FLUOR X1LEDT8D

Consult for different lens options and sensors.  
Change CL lens on 4ft to LB (linear ribbed) to match 8 ft. lens

## WIDE BODY GARAGE LIGHT

ITEM NO.	DESCRIPTION
CITOL332 SBA3X1LN18W40	4 FT Deep Clear Enclosure 6300 Lumens with 4200 lumens for wide distribution and 2100 lumens for downlight. 3x18W LED T8 4000K lamps included. Surface Mounting brackets.
CITOL332 SBA3X1LN18W40MDT4(21) (Pictured)	4 Ft Deep Clear Enclosure 6300 Lumens with 4200 lumens for wide distribution and 2100 lumens for downlight. 3x18W LED T8 4000K lamps included. Surface Mounting brackets and Occupancy Sensor included. Occupancy sensor wired to two wide area lamps.

EM9 OS6 CCT2 LED FLUOR X1LEDT8D

MDT4 is for Standard Indoor Occupancy Sensor. For Wet Location change to MDT4W or for Cold Weather Sensor change to MDT4C. Change 40 to 35 or 50 for different Kelvin. Change Lamp to 15W on 4FT. Consult for different lens and mounting options.



For Large Quantities, Call For Quote



## SPILL RING BATH

ITEM NO.	DESCRIPTION
HOTBD217X1SNLN15W40	2ft. Wall 3400 Lumen 2x15W LED T8 4000K Lamps Included
HOTBD232X1SNLN18W40	4ft. Wall 4200 Lumen 2x18W LED T8 4000K Lamps Included

**CCT2** **LED** **FLUOR** **X1LEDT8D**



## END CAP BATH

ITEM NO.	DESCRIPTION
VAN217X1LN15W40 (AL, SW, IV, BM, TO, WM)	2ft. Wall 3400 Lumen 2x15W LED T8 4000K Lamps Included
VAN232X1LN18W40 (AL, SW, IV, BM, TO, WM)	4ft. Wall 4200 Lumen 2x18W LED T8 4000K Lamps Included

**CCT2** **LED** **FLUOR** **X1LEDT8D**



## WALL PUFF

ITEM NO.	DESCRIPTION
WPU217X1LN15W40	2ft. Wall 3400 Lumen 2x15W LED T8 4000K Lamps Included
WPU232X1LN18W40	4ft. Wall 4200 Lumen 2x18W LED T8 4000K Lamps Included

**CCT2** **LED** **FLUOR** **X1LEDT8D**

See full selection of LED T8 Lamps on pages 142 to 145.



For Large Quantities, Call For Quote

# SG Savegreen

## LED LINEAR LAMPS: THE SMART WAY TO LED

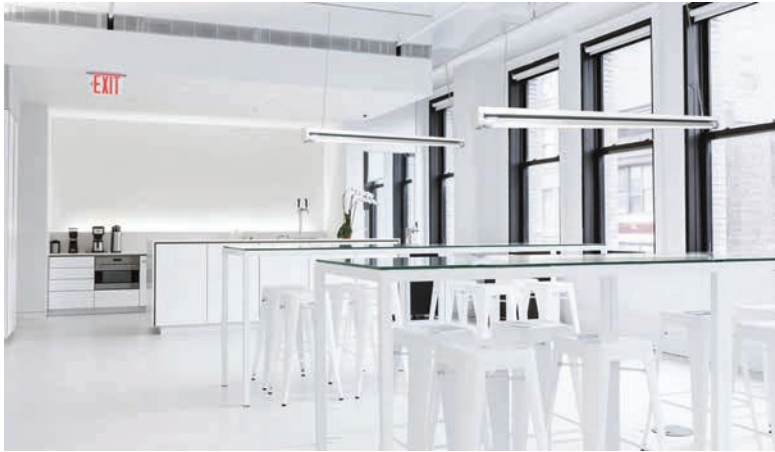

LED T8 and T5 lamps are fast becoming one of the best options to enjoy the benefits of LED. Savegreen Lamps are manufactured to strict specifications providing the highest quality, consistency, performance and life. Higher efficiencies, lumens per watt, higher output options, more product options and industry leading warranty options, makes it a great choice to light your next job.

### Practical LED T8 Bypass Type B Linear Lamps

Start enjoying the benefits of LED lighting. Bypass Type B Linear Lamps are perfect for both new construction and retrofit installations. Savegreen Bypass Lamps eliminate the need for an external driver or ballast. Simply connect the 120-277V line directly to the new safety sockets and achieve long life, energy savings and flexibility for years to come.

### Industry-leading, 10-year Limited Warranty

Savegreen offers a premium line of LED T8 Bypass Lamps designed to provide higher efficiency, better performance and longer life. As the industry leader, we are willing to offer a 10-year warranty on these products. Simply register your project and purchase of L10T8 lamps, and you'll receive replacements or credit towards other Savegreen LED T8 Lamps—no questions asked.

### Reliable and Easy to Replace

Now you can combine the performance, long life, and energy efficiency of LED's with no maintenance crisis. It's as easy as changing a light bulb or fluorescent tube. Just twist out the old lamp and put in an affordable Savegreen lamp—no wiring, ballast or electrician required.



**X1LED** 



**POPULAR BYPASS SINGLE ENDED (MOST COST EFFECTIVE LAMP)**



SAVEGREEN ITEM NO.	DESCRIPTION	Savegreen Inside Short Code*	WAR
LT8BG48L15W1740L40K	Frosted Glass Single Ended Bypass T8 Lamp 48 Inch 15W 1740 Lumens 4000K	SGB15W40	5 Yrs

**STANDARD BYPASS SINGLE ENDED (AVAILABLE IN 24,36 AND 48 INCHES)**



SAVEGREEN ITEM NO.	DESCRIPTION	Savegreen Inside Short Code*	WAR
LT8BGC24L9W1050L40K	Plastic Coated Glass Single Ended Bypass T8 Lamp 24 Inch 9W 1050 Lumens 4000K	SGS29W40	5 Yrs
LT8BGC36L12W1200L40K	Plastic Coated Glass Single Ended Bypass T8 Lamp 36 Inch 12W 1200 Lumens 4000K	SGS312W40	5 Yrs
LT8BGC48L15W1740L40K	Plastic Coated Glass Single Ended Bypass T8 Lamp 48 Inch 15W 1740 Lumens 4000K	SGS15W40	5 Yrs

**PREMIUM BYPASS SINGLE ENDED (10 YEAR WARRANTY AND HIGHER LUMEN/WATT)**



SAVEGREEN ITEM NO.	DESCRIPTION	Savegreen Inside Short Code*	WAR
L10T8BGC48L12W1750L40K	Premium Singled Ended Bypass T8 Lamp Plastic Coated Glass 48 Inch 12W 1750 Lumens 4000K 10 Yr	SGP12W40	10 Yrs
L10T8BGC48L15W2000L40K	Premium Singled Ended Bypass T8 Lamp Plastic Coated Glass 48 Inch 15W 2000 Lumens 4000K 10 Yr	SGP15W40	10 Yrs
L10T8BGC48L18W2500L40K	Premium Singled Ended Bypass T8 Lamp Plastic Coated Glass 48 Inch 18W 2500 Lumens 4000K 10 Yr	SGP18W40	10 Yrs

**HIGH OUTPUT BYPASS SINGLE ENDED (3500 LUMENS PER LAMP)**



SAVEGREEN ITEM NO.	DESCRIPTION	Savegreen Inside Short Code*	WAR
LT8BGC48L26W3500L40K	High Output Singled Ended Bypass T8 Lamp Plastic Coated Glass 48 Inch 26W 3500 Lumens 4000K	SGH26W40	5 Yrs

**BYPASS DOUBLE ENDED OR SINGLE ENDED (EASY RETROFIT OPTION)**



SAVEGREEN ITEM NO.	DESCRIPTION	Savegreen Inside Short Code*	WAR
LT8BDGC48L18W2100L40K	Double & Singled Ended Bypass T8 Lamps Plastic Coated Glass 48 Inch 18W 2100 Lumens 4000K	SGD18W40	5 Yrs
L10T8BDGC48L12W1750L40K	Premium Double & Singled Ended Bypass T8 Lamps Plastic Coated Glass 48 Inch 12W 1750 Lumens 4000K	SGPD12W40	10 Yrs
L10T8BDGC48L18W2500L40K	Premium Double & Singled Ended Bypass T8 Lamps Plastic Coated Glass 48 Inch 18W 2500 Lumens 4000K	SGPD18W40	10 Yrs

\*Add Savegreen Inside Short Code to any X1LED fixture in lieu of "LN" or "LI" and change price of complete fixture by the "Add/Deduct" columns per lamp.

# Savegreen Lamps



## DUAL TYPE A OR TYPE B - MAGIC (WORK WITH OR WITHOUT BALLAST)

SAVEGREEN ITEM NO.	DESCRIPTION	Savegreen Inside Short Code*	WAR
LT8ABP48L18W2250L40K	Type A & B Plastic T8 Lamp Singled Ended 48 Inch 18W 2250 Lumens 4000K	SGM18W40K	5 Yrs
LT8ABP48L15W1875L40K	Type A & B Plastic T8 Lamp Singled Ended 48 Inch 15W 1875 Lumens 4000K	SGM15W40K	5 Yrs
LT8ABP24L15W1875L40K	Type A & B Plastic T8 Lamp Singled Ended 24 Inch 15W 1875 Lumens 4000K	SGM215W40K	5 Yrs

## DIMMING - BYPASS SINGLE ENDED (SIMPLE 2 WIRE DIMMING)



SAVEGREEN ITEM NO.	DESCRIPTION	Savegreen Inside Short Code*	WAR
LD2T8BGC48L18W2200L40K	2 Wire Dimming Plastic Coated Glass Single Ended Bypass T8 Lamps 48 Inch 18W 2200 Lumens 4000K	LD218W40K	5 Yrs

## DIMMING - TYPE C (DRIVER & TUBES) (0-10V DIMMING)



SAVEGREEN ITEM NO.	DESCRIPTION	Savegreen Inside Short Code*	WAR
JIGZYDRWG192	3 Light 60W 0-10V Dimmable Driver	--	5 Yrs
JIGZDRWG211	2 Light 40W 0-10V Dimmable Driver	--	5 Yrs
JIGZYT810W600BOT40K	LED T8 DIM 2FT 10W 1200 Lumens 4000K	--	5 Yrs
JIGZYT8181200BONT40KFUS	LED T8 DIM 4FT 18W 2100 Lumens 4000K	--	5 Yrs

## T5HO BYPASS SINGLE ENDED (3300 LUMENS WITH DARK SPOT ON ONE END)



SAVEGREEN ITEM NO.	DESCRIPTION	Savegreen Inside Short Code*	WAR
LT5BG46L25W3300L40K	Frosted Glass T5HO Single Ended Bypass T5 Lamp 46 Inch 25W 3300 Lumens 4000K	SGT525W40	5 Yrs

## TYPE A BALLAST COMPATIBLE

These lamps work with most instant start ballasts for simple retrofit. No rewiring required.



SAVEGREEN ITEM NO.	DESCRIPTION	Savegreen Inside Short Code*	WAR
LT8AG48L13W1900L40K	Glass 4ft T8 Ballast Compatible 13W 1900 Lumens 4000K	--	5 Yrs

\*Add Savegreen Inside Short Code to any X1LED fixture in lieu of "LN" or "LI" and change price of complete fixture by the "Add/Deduct" columns per lamp.

# Versa Lamp NEW



## The Simplest Way to Create Architainment

**RGBW Single Ended LED Lamps That Work with DMX Control. Create Architainment with X1LED.**

The patented VersaLamp LED lamp is the first Single Ended LED Linear Lamp that fits in standard T8 fixtures either retrofit or X1LED fixtures that provides RGB, ultraviolet\*, and white lighting from a single lamp controlled by DMX controllers. The lamp is ideal for creating architainment which is not only popular in entertainment applications but now creating an experience in hospitality, retail and living applications. A simple digital lighting control easily switches environments. The lamp includes long life LED lamp sources that can be addressed in sections, energy efficiency, simplicity of installation, and maintenance free operation. It can be used in new and retrofit applications. You must see it to believe how it can change your next project.



ITEM NO.	DESCRIPTION
VER485BLBRGBWUV	4FT LED Linear Lamp Red, Green, Blue, White, Ultraviolet
VER485WX2RGBW	4FT LED Linear Lamp Red, Green, Blue, 2xWhite
VER485UVX2RGBUV	4FT LED Linear Lamp Red, Green, Blue 2xUltraviolet
VER485WWWRGBW	4FT LED Linear Lamp Red, Green, Blue, White 2700 & 4000°K
Chroma 1SD Keypad	*Lighting Control Provides multiple programmed lights shows.

Consult for More options, Programming and DMX Cabling.

# Exit Signs



## COMPACT LED EXIT SIGN

ITEM NO.	DESCRIPTION
EZRXTU2GWEM	Rounded EXIT, SF/DF, Green, Backup
EZRXTU2RWEM	Rounded EXIT, SF/DF, Red, Battery Backup

## THIN THERMOPLASTIC EXIT SIGN

ITEM NO.	DESCRIPTION
ETXTU-Thin	Injection-molded sign with EZ snap-out Chevron indicators

## THIN THERMOPLASTIC EXIT SIGN

ITEM NO.	DESCRIPTION
EZXTEU2GW	LED Exit AC Only Sgl/Dbf Face Univ. Green Letters, White Housing, 120/277V
EZXTEU2GWEM	LED Exit w/Battery Backup Sgl/Dbf Face Univ. Green Letters White Housing, 120/277V
EZXTEU2GWEMRC	LED Exit w/Battery Backup Sgl/Dbf Face Univ. Green Letters White Housing, Remote Capable 120/277V
EZXTEU2RW	LED Exit AC Only Sgl/Dbf Face Univ. Red Letters, White Housing, 120/277V
EZXTEU2RWEM	LED Exit w/Battery Backup Sgl/Dbf Face Univ. Red Letters, White Housing, 120/277V
EZXTEU2RWEMRC	LED Exit w/Battery Backup Sgl/Dbf Face Univ. Red Letters, White Housing, Remote Capable 120/277V

## THIN DIE-CAST LED EXIT SIGN

ITEM NO.	DESCRIPTION
KZXTEU1GAEM	Thin Die Cast, SF, Green, Battery Backup, Al face, Al body
KZXTEU1RAEM	Thin Die Cast, SF, Red, Battery Backup, Al face, Al body

## THERMOPLASTIC LED EDGELIT EXIT SIGN

ITEM NO.	DESCRIPTION
PLELRXTU1RCAEM	Plastic Edge-Lit, SF, Red, Clear, Silver Housing, Battery Backup
PLELRXTU1RCWEM	Plastic Edge-Li, SF, Red, White Housing, Battery Backup

## ALUMINUM LED EDGELIT EXIT SIGN

ITEM NO.	DESCRIPTION
ELXTEU1GCAEM	Edge-Lit LED Exit Battery Backup, Single Face Green/Clear, 120/277V
ELXTEU1RCAEM	Edge-Lit LED Exit Battery Backup, Single Face Red/Clear, 120/277V
ELXTERPANEL ELXTEGPANEL	Edge-Lit LED Exit Single Face Green/Clear, 120/277V

**Consult for Made in USA versions.**



## RECESSED ALUMINUM LED EDGELIT EXIT SIGN



ITEM NO.	DESCRIPTION
RELZXTE1GCAEM	Recessed Edge-Lit Exit Sign, Battery Backup, Single Face, BELOW ACCESS, Green/Clear, 120/277V
RELZXTE1RCAEM	Recessed Edge-Lit Exit Sign, Battery Backup, Single Face, BOTTOM ACCESS, Red/Clear, 120/277V
RELZXTE2GMAEM	Recessed Edge-Lit Exit Sign, Battery Backup, Double Face, BELOW ACCESS, Green/Mirror, 120/277V
RELZXTE2RMAEM	Recessed Edge-Lit Exit Sign, Battery Backup, Double Face, BOTTOM ACCESS, Red/Mirror, 120/277V

## COMPACT WET LOCATION LED EXIT SIGN



ITEM NO.	DESCRIPTION
WLEZXTEU1GGEMCW	Wet location Exit sign, single face, green letters, gray housing, white face plate, battery back up, cold weather incl'd
WLEZXTEU1RGEMCW	Wet location Exit sign, single face, red letters, gray housing, white face plate, battery back up, cold weather incl'd
WLEZXTEU2GGEMCW	Wet location Exit sign, double face, green letters, gray housing, white face plate, battery back up, cold weather incl'd
WLEZXTEU2RGEMCW	Wet location Exit sign, double face, red letters, gray housing, white face plate, battery back up, cold weather incl'd



## NEMA4X/NSF EXIT SIGN

ITEM NO.	DESCRIPTION
INDWLEZU1RBEM	NEMA 4X/NSF Exit, SF, Red Letters, Black Housing, Battery Back Up
INDWLEZU2RBEM	NEMA 4X/NSF Exit, SF, Red Letters, Double Face, Black Housing, Battery Back Up



## HAZARDOUS LOCATION EXIT SIGN

ITEM NO.	DESCRIPTION
HLWLEZU1RGEM	Hazardous Location, Exit, SF, Red Letters, Gray Housing, Battery Backup
HLWLEZU2RGEM	Hazardous Location, Exit, SF, Red Letters, Double Face, Gray Housing, Battery Backup

Consult for specially made Exits for New York City and Chicago.

**Consult for Made in USA versions.**



# Combos (Exit and Emergency)

## ALL LED EXIT & EMERGENCY COMBO



ITEM NO.	DESCRIPTION
LEDCXTEU2RW	White LED Combo, SF/DF, Red, White
LEDCXTEU2RWRC	White LED Combo, SF/DF, Red, White, Remote Capable

## LED EXIT & INCANDESCENT EMERGENCY COMBO



ITEM NO.	DESCRIPTION
CXTEU2GW	COMBO LED Exit/Emerg. Light Sgl/Dbf Face Green Letters White Housing, 120/277V
CXTEU2GWRC	COMBO LED Exit/Emerg. Light Sgl/Dbf Green Letters, white housing, w/Remote Capability, 120/277V
CXTEU2RW	COMBO LED Exit/Emerg. Light Sgl/Dbf Face Red Letters White Housing, 120/277V
CXTEU2RW-RC	COMBO LED Exit/Emerg. Light Sgl/Dbf Red Letters, white housing, w/Remote Capability, 120/277v

## THIN ALL LED THERMOPLASTIC EXIT & EMERGENCY COMBO



ITEM NO.	DESCRIPTION
CTXTEU3R	Injection-moded with a thin sleek 1-5/8" profile

## LOW PROFILE ALL LED EXIT & EMERGENCY COMBO



ITEM NO.	DESCRIPTION
CEU3RW	Low Profile All LED Exit & Emergency Combo, Red, White Housing
CEU3GW	Low Profile All LED Exit & Emergency Combo, Green, White Housing
CEU3RWRC	1-15/16" low profile Injection-moded exit sign

## LIGHTPIPE LED EXIT & EMERGENCY COMBO



ITEM NO.	DESCRIPTION
CLPU2GWRC	Pipe Combo, SF/DF, Green, White, Remote Capable
CLPU2RWRC	Pipe Combo, SF/DF, Red, White, Remote Capable

## LIGHTPIPE LED EXIT & EMERGENCY COMBO



ITEM NO.	DESCRIPTION
LCTXTEU	patent pending low level exit sign when visibility is an issue

**Consult for Made in USA versions.**



## WET LOCATION ALL LED THERMOPLASTIC EXIT & EMERGENCY COMBO

ITEM NO.	DESCRIPTION
CWLEZXTEU1R	Wet Location LED Combo, SF, Red letters, White, Black or Gray housing
CWLEZXTEU2R	Wet Location LED Combo, DF, Red letters, White, Black or Gray housing

Consult for Cold Weather, SDT and Tamper Proof screws adder. For Green lettering, change R to G.



## ALL LED NEMA4X/NSF EXIT & EMERGENCY COMBO

ITEM NO.	DESCRIPTION
INDCWLEZU1R	NEMA4X/NSF LED COMBO, SF, Red letters, White or Black housing
INDCWLEZU2R	NEMA4X/NSF LED COMBO, DF, Red letters, White or Black housing

Consult for Cold Weather, SDT and Tamper Proof screws adder. For Green lettering, change R to G.



## ALL LED HAZARDOUS EXIT & EMERGENCY COMBO

ITEM NO.	DESCRIPTION
HLCWLEZU1RG	HAZARDOUS LED COMBO, SF, Red letters, 15 or 28 Watts, Gray housing
HLCWLEZU2R12G	HAZARDOUS LED COMBO, SF, Red letters, 12 Watts, Gray housing

For Green lettering, change R to G.

## Unit Equipment



## LED LOW PROFILE THERMOPLASTIC EMERGENCY UNIT

ITEM NO.	DESCRIPTION
E1	Low Profile LED Emergency, White housing
E1RC	Low Profile LED Emergency, White housing, Remote capable

Add B to end of item number for black.



## LED HAZARDOUS LOCATION EMERGENCY UNIT

ITEM NO.	DESCRIPTION
INDEMR16615*	LED NEMA4X/ NSF Emergency, 6 Volts, 15 Watts, White or Black housing
INDEMR16636*	LED NEMA4X/ NSF Emergency, 6 Volts, 36 Watts, White or Black housing

Consult for Cold Weather, SDT and Tamper Proof screws adder.



## LED NEMA4X/NSF EMERGENCY UNIT

ITEM NO.	DESCRIPTION
HLEMR16615*	LED Class 1, Division 2 Emergency, 6 Volts, 15 Watts, Gray housing
HLEMR16636*	LED Class 1 Division Emergency, 6 Volts, 36 Watts, Gray housing

Consult for Cold Weather, SDT and Tamper Proof screws adder.

# Emergency



## LED EMERGENCY UNIT

ITEM NO.	DESCRIPTION
LEDR1	LED Emergency Light, White
LEDR1B	LED Emergency Light, black
LEDR1SDT	LED Emergency Light, White, SDT



## REMOTE CAPABLE LED EMERGENCY UNIT

ITEM NO.	DESCRIPTION
LEDR5HO	LED Emergency Light, White, Remote Capable
LEDR5HOSDT	LED Emergency Light, White, Remote Capable, SDT



## ADJUSTABLE OPTICS LED EMERGENCY UNIT

ITEM NO.	DESCRIPTION
LEDR2	LED Emergency Light, White, 120/277
LEDR2B	LED Emergency Light, Black, 120/277



## SEMI-RECESSED MR-16 EMERGENCY UNIT

ITEM NO.	DESCRIPTION
RMR16	2 Lamp Emergency Fixture, White Housing, 120/277V, Ultra bright MR-16 lamps
RMR16LED	2 Lamp Emergency Fixture, White Housing, 120/277V, High Output 3.3w LED lamps



## R-1 EMERGENCY UNIT

ITEM NO.	DESCRIPTION
R1	2 Head Emergency Fixture w/Battery, White Housing, 120/277V



## R-2 EMERGENCY UNIT

ITEM NO.	DESCRIPTION
R2	Twin Lens Emergency Fixture w/Battery, White Housing, 120/277V



## DXR EMERGENCY UNIT

ITEM NO.	DESCRIPTION
DXR125	50 watt 12 Volt Heavy duty emergency lighting unit with remote capacity. (50 watts for 90 min.), 120/277V
DXR610	100 watt 6 Volt Heavy duty emergency lighting unit with remote capacity. (100 watts for 90 min.), 120/277V

**Consult for Made in USA versions.**

# Emergency Wet Location



RH2



RHLED1



RHLED1PWP



RHLED2



RHLED2PWP

## WET LOCATION SEMIRECESSED MR-16 EMERGENCY UNIT

ITEM NO.	DESCRIPTION
RMR16WP	2 Lamp, Weatherproof Emergency Fixture, Gray Housing, 120/277V, Ultra bright MR-16 lamps
RMR16WPLED	2 Lamp, Weatherproof Emergency Fixture, Gray Housing, 120/277V, High Output 3.3w LED lamps

## DECORATIVE OUTDOOR LED AC/EMERGENCY UNIT

ITEM NO.	DESCRIPTION
DBELACEMHLBRSDTPC	Outdoor teardrop LED Die Cast , AC and EM operation, High lumen output, SDT (standard), includes photo cell, Bronze
DBELACEMHLBRSDTCWPC	Outdoor teardrop LED Die Cast , AC and EM operation, High lumen output, SDT (standard), includes photo cell, Cold Weather, Bronze

## WET LOCATION REMOTE CAPABLE LED EMERGENCY UNIT

ITEM NO.	DESCRIPTION
LEDTFX2	LED Wet Location 2 Head Emergency Light Unit, COLD WEATHER HEATER INCLUDED, 120/277V

## REMOTE HEADS FOR EXITS & EMERGENCY

(See Spec Sheet for the Right Item for Your Application)

ITEM NO.	DESCRIPTION
RH26V5.W	Dual head Indoor remote 5.4 Watts
RH2WP6V7.2W	Double head weather proof remote 5.4 Watts
RHLED1MV	LED Multi-Volt (3.6v/6v/9.6v/12v) Remote Head, Single, Indoor
RHLED1PWPMV	LED Combo Remote Head, Plastic, Single, Wet Location
RHLED1WPMV	LED Combo Remote Head, Single, Wet Location
RHLED2MV	LED Multi-Volt (3.6v/6v/9.6v/12v) Remote Head, Dual, Indoor
RHLED2PWPMV	LED Combo Remote Head, Plastic, Double, Wet Location
RHLED2WPMV	LED Combo Remote Head, Double, Wet Location

For other options and accessories, see specification sheets.

**Consult for Made in USA versions.**

# Inverters

## INVERTERS - EMERGENCY LIGHTING BACKUP SYSTEMS

A battery backup inverter can provide power to your emergency LED T8 lamps and fixtures for 90 minutes. We carry interruptible and uninterruptible backup power inverters in surface mount and ceiling grid mount options. These battery backup inverters are compatible with a variety of lamps, ranging from fluorescent to LED lights including X1LED. They can provide power at a distance of up to 1,000 feet to multiple emergency lamps and fixtures. A three-year warranty is standard, along with the 90-minute operation timespan.

### MPS EMERGENCY POWER SYSTEMS



ITEM NO.	DESCRIPTION
MPS-20-S	Micro-electrical inverter system which powers 32 W/VA of incandescent, fluorescent, or LED lighting loads
MPS-32-S	Micro-electrical inverter system which powers 55W/VA of incandescent, fluorescent, or LED lighting loads
MPS-35-S	Micro-electrical inverter system which powers 20W/VA of incandescent, fluorescent, or LED lighting loads
MPS-55-S	Micro-electrical inverter system which powers 35W/VA of incandescent, fluorescent, or LED lighting loads

### SPS EMERGENCY POWER SYSTEMS



ITEM NO.	DESCRIPTION
SPS-55/125	Mini-electrical inverter system which powers 55 Watts / 125 VA of incandescent, fluorescent, induction or LED lighting loads
SPS-110/125	Mini-electrical inverter system which powers 110 Watts / 125 VA of incandescent, fluorescent, induction or LED lighting loads
SPS-110/250	Mini-electrical inverter system which powers 110 Watts / 250 VA of incandescent, fluorescent, induction or LED lighting loads
SPS-220/250	Mini-electrical inverter system which powers 220 Watts / 250 VA of incandescent, fluorescent, induction or LED lighting loads

### LPS EMERGENCY POWER SYSTEMS



ITEM NO.	DESCRIPTION
LPS-375	Large-electrical inverter system which powers 375 watts/VA of Incandescent, florescent, induction, or LED lighting loads
LPS-600	Large-electrical inverter system which powers 600 watts/VA of Incandescent, florescent, induction, or LED lighting loads



# Hanging Kits

Chain



S Hook



Tong Hangers



G310



G315



HC401



HC605



HC301



ITEM NO.	DESCRIPTION
<b>For ALL HIGHBAY</b>	
HC101	Chain kit with 20' chain & (4) S Hooks
HC102	Jack chain (per foot)
HC103	S Hook, Set of 2
HC202	Tong hangers only, End mount (Tong Hooks Pointed Forward), Set of 2
HC203	Tong hangers only, Side mount (Tong Hooks Pointed to Center), Set of 2
HC204	Chain kit with (2) 10' Chain and (1) HC202
GT310	Cable kit with (2) 10' aircraft cable, (1) 3 wires white power feed
GT315	Cable kit with (2) 15' aircraft cable, (1) 3 wires white power feed
<b>For LPLIN, PLIN, SLP</b>	
SCS24WH	One stem white kit with (1) 24" stem, (1) canopy and mounting hardware for a 4' fixture
2SCS24WH	Two stems white kit with (2) 24" stem, (2) canopy and mounting hardware for a 4' fixture
<b>For RIG</b>	
HC401WH	Cable kit with (2) 4' aircraft cable, (1) 3 wires white power feed and (2) white canopy
HC402WH	Cable kit with (2) 12' aircraft cable, (1) 3 wires white power feed and (2) white canopy
HC4015WWH	Cable kit with (2) 4' aircraft cable, (1) 5 wires white power feed and (2) white canopy
HC4025WWH	Cable kit with (2) 12' aircraft cable, (1) 5 wires white power feed and (2) white canopy
HC401WHNPF	Cable kit with (1) 4' cable & (1) white canopy (non-power feed only)
HC402WHNPF	Cable kit with (1) 12' cable & (1) white canopy (non-power feed only)
<b>For LLL</b>	
HC601WH	Cable kit with (2) 6' aircraft cable, (1) 5 wires clear power feed and (2) white canopy
HC601WH	Cable kit with (2) 12' aircraft cable, (1) 5 wires clear power feed and (2) white canopy
<b>For L23, LAB, LLLSF, LLLSG</b>	
HC605WH	Cable kit with (2) 6' aircraft cable, (1) 5 wires clear power feed and (2) white canopy
HC612WH	Cable kit with (2) 12' aircraft cable, (1) 5 wires clear power feed and (2) white canopy
HC605WHNPF	Cable kit with (1) 4' cable & (1) white canopy (non-power feed only)
HC612WHNPF	Cable kit with (1) 12' cable & (1) white canopy (non-power feed only)
<b>For ISS</b>	
HC804WH	Cable kit with (2) 4' cable, (1) 5 wires white power feed and (2) white canopy
HC812WH	Cable kit with (2) 12' cable, (1) 5 wires white power feed and (2) white canopy
HC804WHNPF	Cable kit with (1) 4' cable and (1) white canopy
HC812WHNPF	Cable kit with (1) 12' cable and (1) white canopy
<b>For the Others</b>	
HC301WH	Cable kit with (2) 4' aircraft cable, (1) 3 wires white power feed and (2) white canopy
HC302WH	Cable kit with (2) 12' aircraft cable, (1) 3 wires white power feed and (2) white canopy
HC3015WWH	Cable kit with (2) 4' aircraft cable, (1) 5 wires white power feed and (2) white canopy
HC3025WWH	Cable kit with (2) 12' aircraft cable, (1) 5 wires white power feed and (2) white canopy
HC301WHNPF	Cable kit with (1) 4' cable & (1) white canopy (non-power feed only)
HC302WHNPF	Cable kit with (1) 12' cable & (1) white canopy (non-power feed only)
<b>Harness - Use for all, except L23 and LLL series</b>	
PI1	3 wires harness, including white, black and green
PI2	4 wires harness, including white, black, green and blue for emergency battery backup
PI3D	5 wires harness, including white, black, green, violet and gray
PI4D	6 wires harness, including white, black, green, violet and gray and blue for emergency battery backup

# Icon Legend

<b>EM1</b>	Integrated 10 Watt( <b>EM</b> ) or 12 Watt( <b>EM12</b> ), External 20 Watt( <b>EM20</b> ), 90 mins Battery Backup
<b>EM2</b>	Integrated 10 Watt( <b>EM</b> ), External 12 Watt( <b>EM12</b> ) or 20 Watt( <b>EM20</b> ), 90 mins Battery Backup
<b>EM3</b>	External Battery Backup
<b>EM4</b>	Integrated 10 Watt( <b>EM</b> ) or 12 Watt( <b>EM12</b> ) (excludes 1x4 or less than 4ft), External 20 Watt( <b>EM20</b> ), 90 mins Battery Backup
<b>EM5</b>	Integrated 10 Watt( <b>EM</b> ) or 12 Watt( <b>EM12</b> ) (excludes 2x2 or less than 4ft), External 20 Watt( <b>EM20</b> ), 90 mins Battery Backup
<b>EM6</b>	Integrated 10 Watt( <b>EM</b> ) (excludes 1x4 or less than 4ft), External 12 Watt( <b>EM12</b> ) or 20 Watt( <b>EM20</b> ), 90 mins Battery Backup
<b>EM7</b>	Integrated 10 Watt( <b>EM</b> ) (excludes 2x2 or less than 4ft), External 12( <b>EM12</b> ) or 20 Watt( <b>EM20</b> ), 90 mins Battery Backup
<b>EM8</b>	Integrated 5 Watt Inverter ( <b>INV5</b> ), 12 Watt Inverter( <b>INV12</b> ) 90 mins Battery Backup or 12 Watt( <b>EMKT12</b> ), 90 mins Battery Backup, 1200 lumens LED array (excludes 2x2 or less than 4ft)
<b>EM9</b>	Integrated 5 Watt Inverter ( <b>INV5</b> ) or 12 Watt ( <b>EMKT12</b> ) 90 mins Battery Backup, 1200 lumens LED array (excludes 2x2 or less than 4ft)
<b>EM10</b>	Integrated 12 Watt( <b>EMKT12</b> ), 90 mins Battery Backup, 1200 lumens LED array
<b>G120</b>	ELV/Triac dimming at 120V only (Change <b>DMV</b> to <b>G120</b> )
<b>OS1</b>	<b>SS</b> -On/Off Sensor, <b>SV</b> -Bi-level Sensor, <b>SD</b> -Daylight Harvesting Sensor, <b>SM</b> -Microwave Sensor
<b>OS2</b>	<b>SS</b> -On/Off Sensor, <b>SV</b> -Bi-level Sensor, <b>SD</b> -Daylight Harvesting Sensor
<b>OS3</b>	<b>SM</b> -Microwave Sensor only
<b>OS4</b>	<b>SS</b> -On/Off Sensor for stairwell
<b>OS5</b>	<b>SS</b> -On/Off Sensor for stairwell and <b>SM</b> -Microwave Sensor only
<b>OS6</b>	<b>MDT4</b> -On/Off Sensor for indoor highbay
<b>D1MV</b>	0-10V, Dim to 1%, 120V-277V (Change <b>DMV</b> to <b>D1MV</b> )

**90CRI** 90CRI, 2700K, 3000K, 3500K, 4000K, 5000K

**CCT1** 3000K, 3500K, 4000K, 5000K

**CCT2** 3500K, 4000K, 5000K

**CCT3** 3000K, 3500K, 4000K

**CCT4** 3000K, 4000K

**CCT5** 3500K, 4000K

**CCT6** 4000K, 5000K (Consult factory for 3000K)

**RGBW** Color Changing

**WET** Wet Location

**SURF** Surface Mount (some may require shroud) (See index for page number)

**REC** Recessed Mount (See index for page number)

**PEND** Pendant Mount (See index for page number)

**WALL** Wall Mount (See index for page number)

**AIR RET** Air Return

**X1LED** X1 LED Series T8 or T5

**X1LEDT5** X1 LED Series LED T5 Lamp only

**X1LEDT8D** X1 LED Series T8 Dimming

**FLUOR** Fluorescent T8 or T5 (Consult factory for ordering info)

**FLUORT5** Fluorescent T5 Lamp only (Consult factory for ordering info)

# Finishes

While white is standard, Saylite offers a variety of finishes, including any RAL finish. From classic colors to unique woodgrain finishes, Saylite can make an eye catching display of your lighting. Can we match your company color? Contact us for info!



Gloss Black  
(GB)



Matte Black  
(BK)



Matte Silver  
(SL)



Statuary Bronze  
(BZ)



Glimmer (Iron)  
(IR)

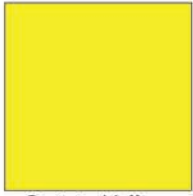

Safety Yellow  
(YL)



Safety Orange  
(OR)



Red 3003  
(RD)



Fire Engine Red  
(FR)



Bengal Blue  
(BL)

Did you know that Saylite developed its High Reflectivity Matte White over years of development to make it the most reflective white on the market today? See why our standard white fixtures outperform most other manufacturers fixtures for yourself!

Consult factory for other finishes.

## “Real Wood” Finishes



Barnwood  
(BW)



Lighter Maple  
(LM)



Maple  
(MP)



Straight Cherry  
(SC)



Cordoba Cherry  
(CC)



Dark Walnut  
(DW)



Light Walnut  
(LW)



Mahogany Cherrywood  
(MC)



Burled Mahogany  
(BM)



Straight Mahogany  
(SM)



Mediterranean  
(ME)



Oak  
(OA)

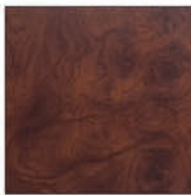

Walnut  
(WA)



Cherry  
(CH)



Douglas Fir  
(DF)

# Sensors



**MDT**



**MDD**



**MDF**



**MDB**

## External Sensor

Sensor Code	Lens Code	Lens Option	Sensor Description	Part Number*	Supplier
<b>MDT</b>	1	Isle Lens	On/Off	OSFLAITW	Leviton
				HBP112L7EM1OEM	Watt Stopper
<b>MDD</b>	3	Low Mount Lens	Daylight Harvesting	HB011BDX	Leviton
<b>MDF</b>	4	High Mount Lens	Photocell	HBP112L7EM1OEM	Watt Stopper
<b>MDB</b>			Bi Level (xx)	LSXR610HL(xx)	Sensor Switch



**SS / SD / SV**



**SM**

## Internal Sensor

Sensor Code	Sensor Description	Part Number*	Supplier
<b>SS</b>	On/Off	SFR30J180	Sensor Switch
<b>SD</b>	Daylight Harvesting	SNS200	Philips
<b>SV</b>	Bi Level (xx)	SFD7ADCWH(xx)	Sensor Switch
<b>SM</b>	Microwave	OSM3DV1W	Leviton
		SSTMS2B	Interglobal

\*Saylite may change to similar specification versions.



# Index

Series	Page #	Series	Page #	Series	Page #	Series	Page #
4RB.....	93,94,137	CIRDC.....	97	ETXTEU....	146	KZXTE.....	146
8RB.....	93,94,137	CIT.....	140	EWPLR.....	52	L23P.....	24
22C.....	90,94,136	CITA.....	86, 135	EWV.....	19	L23R.....	13
24C.....	90, 94,136	CITE.....	103	EZRXTU....	146	L23W.....	70
44P.....	26,35,126	CITN.....	103	EZXTEU....	146	L25P.....	25
44PSF4X4...	34	CITOL.....	140	F1010.....	106	L25S.....	25
44PSF8X8...	34	CLF.....	16,17	F1302.....	106	L34P.....	25
44R.....	14, 125	CLLLBF.....	29	F1303.....	106	L34R.....	13
44RW.....	19	CLLLSF.....	30	FCT.....	7	LAB.....	47,48,49
44W.....	71, 139	CLLLSF4X8.	36	FHBFR.....	44	LCR.....	63
45P.....	26	CLLLSG....	30	FHBL.....	44, 135	LCT.....	148
45PSF4X4...	34	CLM.....	56	FL.....	57	LDED.....	63
45PSF8X8...	34	CLPU.....	148	FPERP.....	11	LDF.....	119
45W.....	71	CLS.....	100	FPHK.....	11, 23	LEDCXTEU..	148
66P.....	27, 126	CO.....	111	FSF.....	62	LEDDUCL...	79
66R.....	15	COR.....	38	GO.....	109	LEDR.....	150
66RW.....	19	CPY.....	105	GP.....	109	LEDTFX....	151
66W.....	72, 139	CRSF.....	62	H2L.....	135	LFS.....	119
131.....	8, 122	CRSR.....	62	H6L.....	134	LIN.....	43
153.....	52, 128	CRVR.....	7	HBC.....	82, 134	LLLFR.....	18
159.....	54, 131	CRWN.....	57, 130	HBCA.....	85	LLLRA.....	32
200.....	53, 131	CTXTEU....	148	HBG.....	81, 134	LLLRB.....	32
201.....	54, 131	CU45.....	68	HBIHO.....	84	LLLSA.....	33
207.....	53, 131	CV300.....	105	HBIP.....	84	LLLSB.....	33
209.....	53, 131	CV800.....	104	HI.....	110	LLLSC.....	33
215.....	74, 140	CWLEZXT...	149	HIL.....	83	LLLSF.....	28,30
555.....	74, 139	CWLLL.....	46	HLCWLEZ...	149	LLLSG.....	28,30
AO.....	113	CXTEU....	148	HLEMR16...	149	LLLSH.....	31
APW.....	111	D2D.....	115	HLWLEZ...	147	LLLSR.....	18
ATB.....	121	DAC.....	95	HO.....	113	LLS.....	132
AWP.....	117	DBEL.....	151	HOTBD.....	78, 141	LMD.....	100
BCC.....	107	DBP.....	115	HOTCD.....	96	LPC.....	56
BFP.....	11	DC056.....	117	HOTCE.....	97	LPLIN.....	42
BOL.....	121	DC150.....	117	HOTTOA....	115	LPS.....	152
BPC.....	107	DC200.....	117	HT.....	113	LRH.....	87
BPW.....	114	DCC.....	116	HU.....	110	LRS.....	55
BR.....	112	DFCK.....	89	HZ.....	110	LTX.....	127
C.....	65, 132	DFUCLL....	89	IND.....	67,85,133	LUC.....	79
CBA.....	101	DH.....	111	INDCWLEZ..	149	LVS.....	127
CBB.....	101	DKS.....	60, 75	INDEM16..	149	LVS6.....	45, 127
CBC.....	101	DKSWB.....	60, 75	INDWLEZ...	147	LWD.....	74
CBF.....	5	DXR.....	150	IRCR7.....	99	LWP.....	106
CBP.....	106	E1.....	149	ISS.....	46	LXT.....	6
CEO.....	108	ECL.....	57, 130	ITB.....	11, 133	MDF.....	119
CER.....	108	ELXTE.....	146	JSR.....	62	MFL.....	119
CEU.....	148	EO.....	108	KDS.....	64, 132	MIND.....	67
CIND.....	65	EOS.....	95	KR.....	112	MLW.....	117
		ER.....	108				

Series	Page #	Series	Page #	Series	Page #
MPS	152	SES25	14,59,67,125	WLIN	73
MTIM	18,33,79	SES25P	25, 127	WPC	107
MWP	106	SFL	119	WPU	78, 141
NOB	109	SHFP	51	X44	35
NOP	109	SHFPPELP	51	YFX	34
NOW	109	SHPARA	128		
OCL	107	SHPES	129	HANGING	153
OSL	104	SHPFPELP	51	KITS	
OUT	107	SHUC	129	ICONS	154
PARA	9, 123	SHUD	129	FINISHES	156
PES	9, 123	SKB	138	SENSORS	157
PEW	9, 123	SKD	40,61,75		
PLELXTEU	146	SKDWB	40,61,75		
PLF	118	SKR	138		
PLIN	42, 126	SLP	41, 52		
PPF	118	SLW	73		
PR	112	SM	133		
PRL	20	SM302	116		
PRO	104	SMC	99		
PTR	120	SMHOTCD	97		
PUF	56, 130	SPS	120, 152		
R1	150	SSHBG	81		
R2	150	SSSER	39, 59		
RCP	105	SSSES	59, 69		
RCR	98	SSSKDWB	61, 69		
RCS	98	SSSTR	77		
RDI	124	SSSTS	77		
RELZXTE	147	SSSTW	76		
RFSF	92	STW	72		
RH	151	SWP	106		
RHB	87	T5050	79		
RIGP	23	TDL	100		
RIGR	15	TFC	97		
RKD	63	TO	111		
RKIT	93	UCLL	5, 124		
RLK	94, 136	UCPF	5, 124		
RLWD	93	UCRLL	5		
RMR	150, 151	UDLL	7, 70		
RRS	66	UDPF	7, 70		
RSF	93	VAN	78, 141		
RSR	92	VER	145		
S	64,68,132	VLT	7		
SAR	38, 60	VP	114		
SBX	10	VPY	105		
SCB	6	W4	55		
SCW	111	WCD	108, 109		
SER	39, 59	WLEZXTEU	147		

In addition to lenses for all Saylite fixtures, we now offer a wide variety of lenses for other manufacturer's fixtures. Contact our in-house lens department for expert help on getting the right lens for any light fixture.

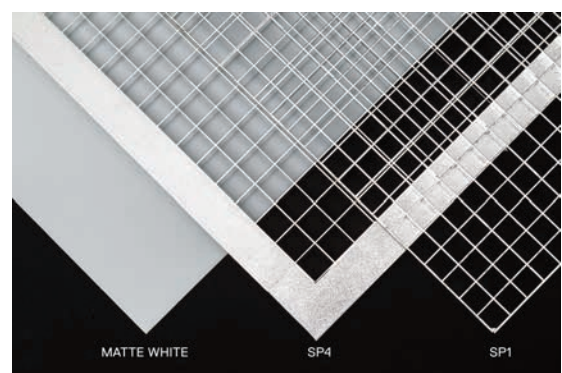
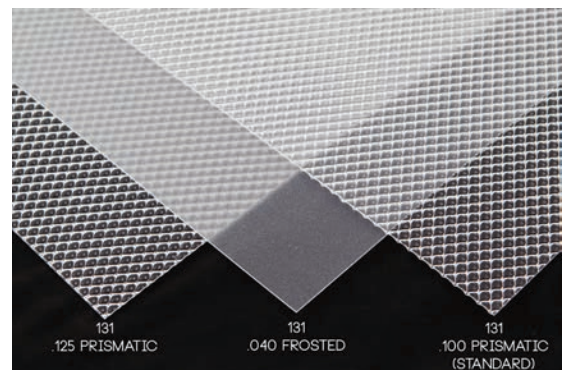



**Lighting** done right.

**Dallas**

2055 Luna Rd., Ste. 142  
Carrollton, TX 75006  
972-247-3171  
Fax: 972-247-0200

**Houston**

4205 Pinemont Dr.  
Houston, TX 77018  
713-686-5899  
Fax: 713-686-5899

**Maryland**

8200 Stayton Dr., Ste. 500  
Jessup, MD 20794  
301-953-2960  
Fax: 301-953-9310

Scan to Call Us



[www.saylite.com](http://www.saylite.com)

[sales@saylite.com](mailto:sales@saylite.com)