

S.&A.S. Ltd.
 Jieh Chouf
 Lebanon
 support@sascontrollers.com

MICROZED AR WIRING DIAG: VVVF - SUPPLY & OUTPUTS

Size B	FCSM No. -	DWG No. BR310W1_VX2_SUPPLY.Sch	Rev 1
Scale -	Sheet 1 of 7		

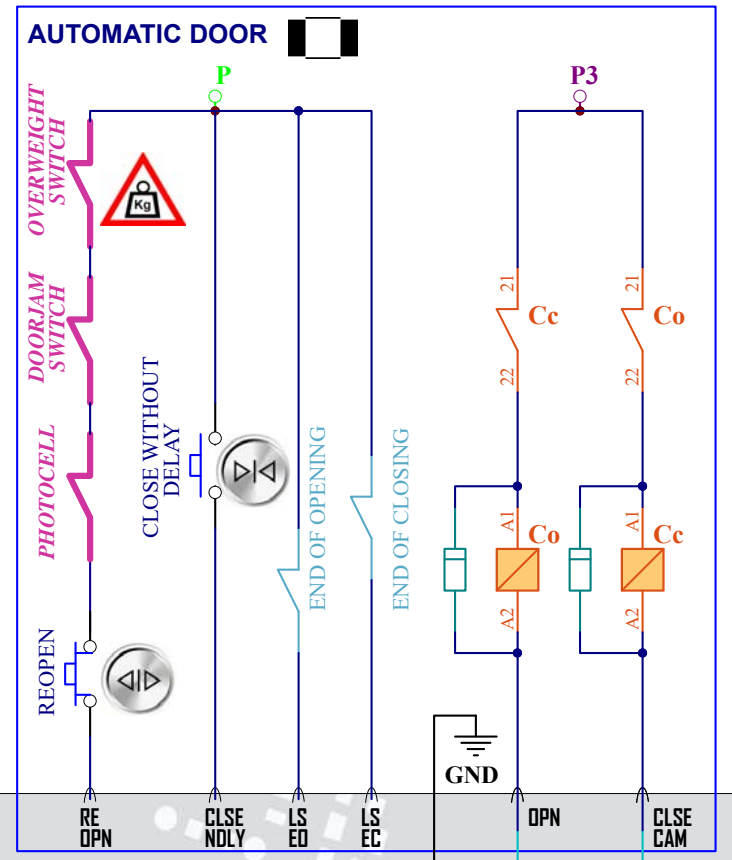
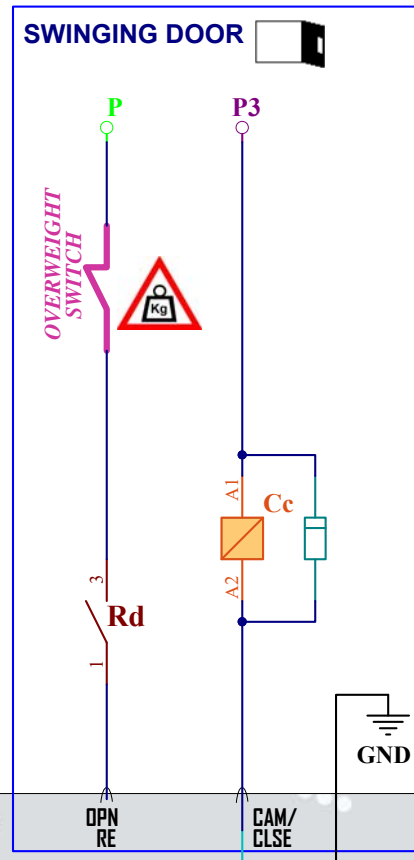
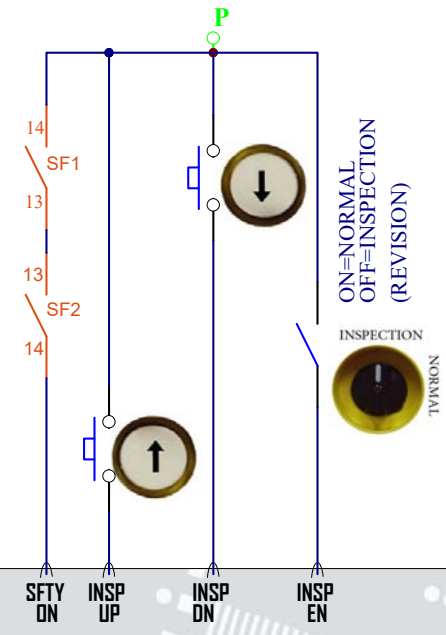
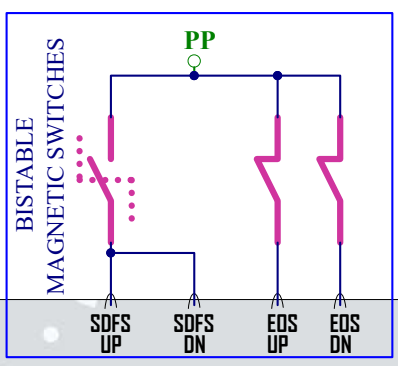
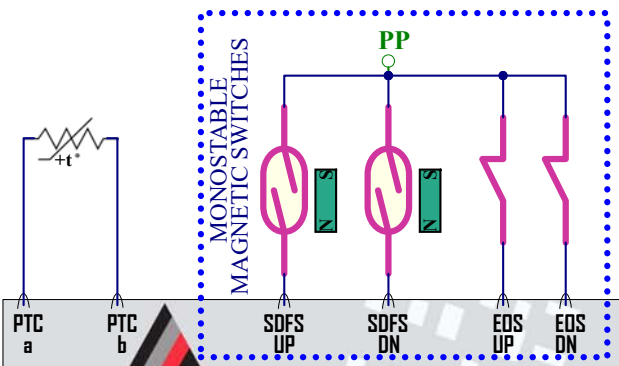
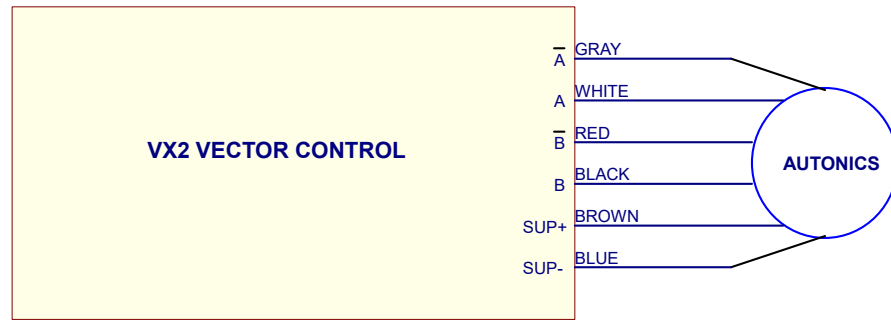
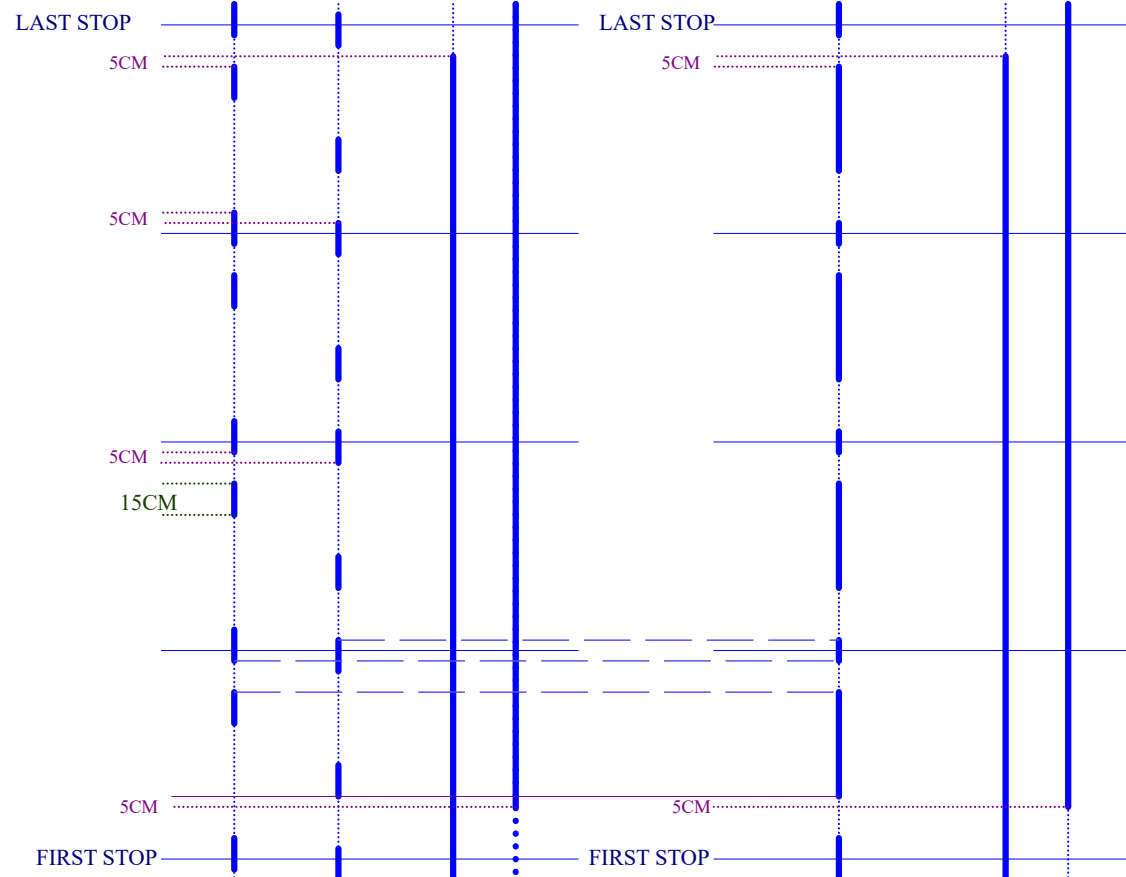

MICROZED AR V3.1 BOARD



Note:
1- Use the Monostable Magnetic Switches configuration for Automatic door.

S.&A.S. Ltd.
Jieh Chouf
Lebanon
support@sascontrollers.com

MICROZED AR WIRING DIAG:INPUTS/DOOR INFO

Size B	FCSM No.	DWG No. BR310VX2_V1W2_INPUTS	Rev 1
Scale	Sheet 2 of 7		

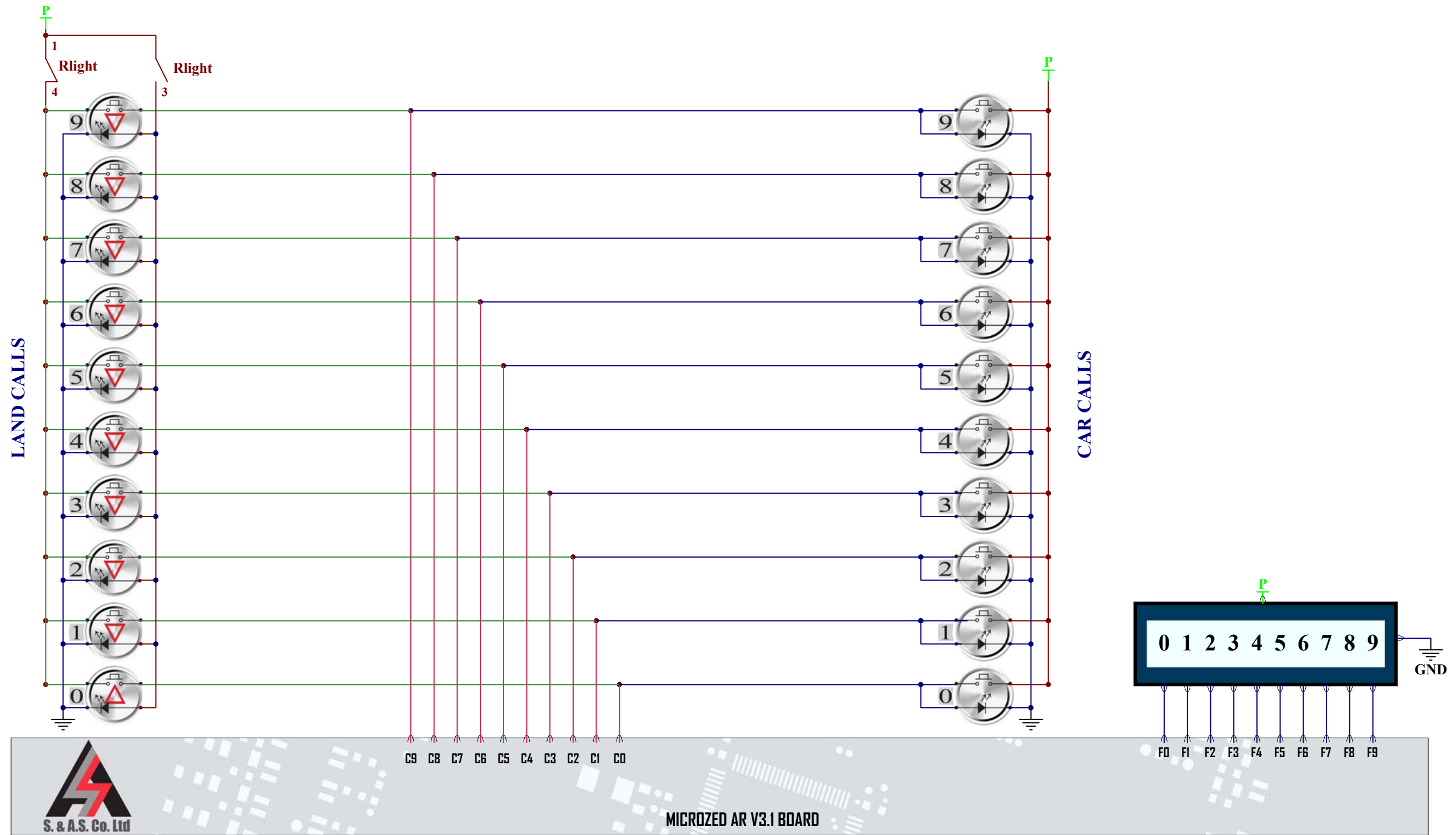

MICROZED AR V3.1 BOARD

INDICATR="DECIMAL"

S.&A.S. Ltd.
Jieh Chouf
Lebanon
support@sascontrollers.com

MICROZED AR WIRING DIAG:CALLS / FLOOR INFORMATION

Decimal Indicator - No Call Register

Size B	FCSM No.	DWG No. BR310AVX2W3_Calls	Rev 1
Scale	Sheet		3 of 7

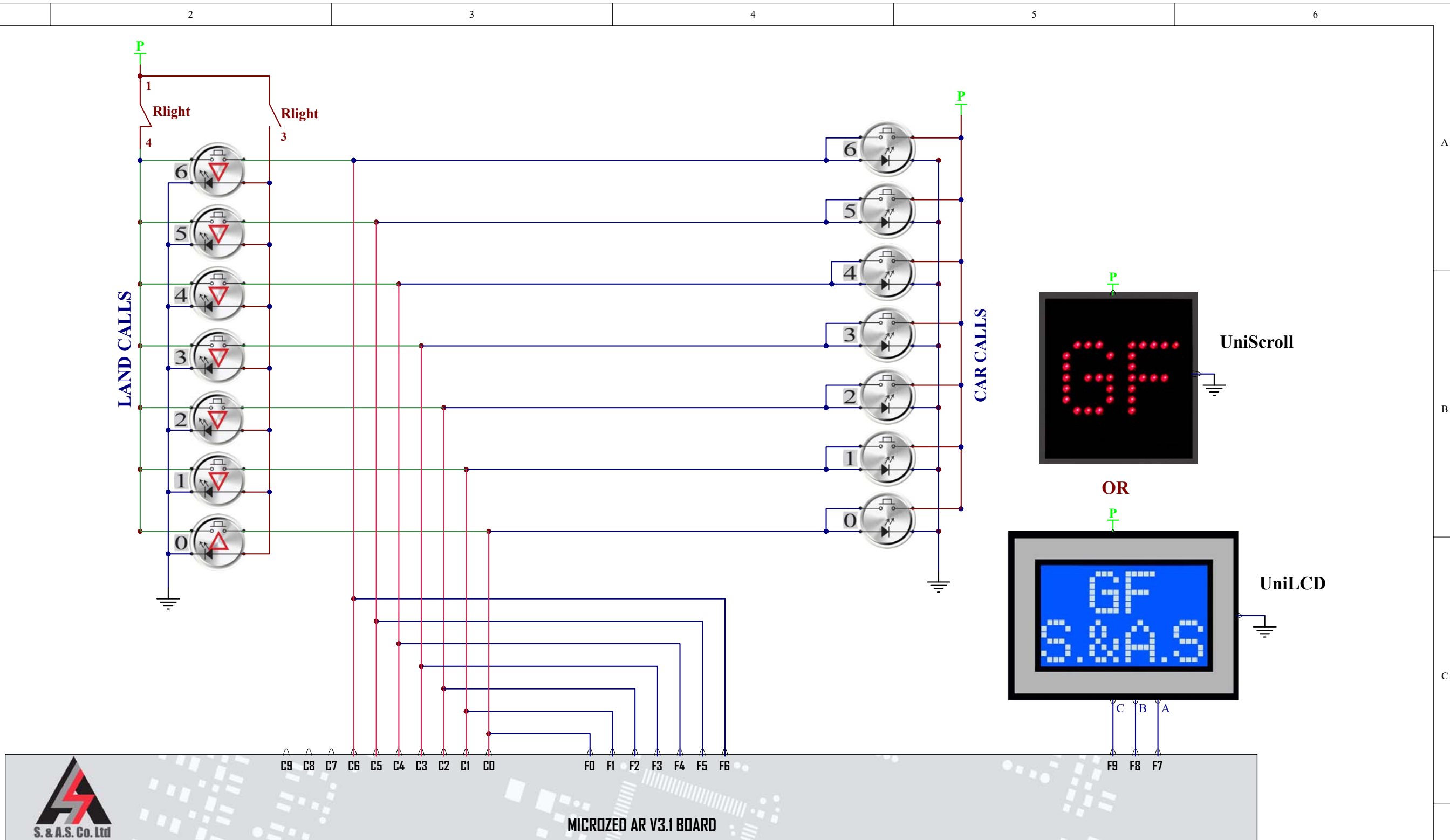

INDICATR="COLLECT7" or
 INDICATR="GRAY R" or
 INDICATR="BINARY R"

S.&A.S. Ltd.
 Jieh Chouf
 Lebanon
 support@sascontrollers.com

MICROZED AR WIRING DIAG:CALLS / FLOOR INFORMATION
 Gray/ Binary/ Collective with Call Register

Size B	FCSM No.	DWG No. BR310AVX2W4_Calls	Rev 1
Scale	Sheet		4 of 7

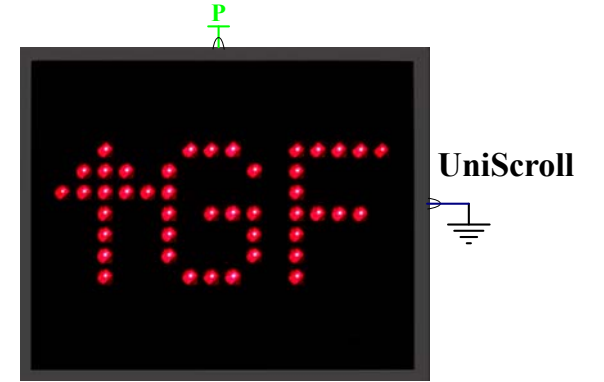
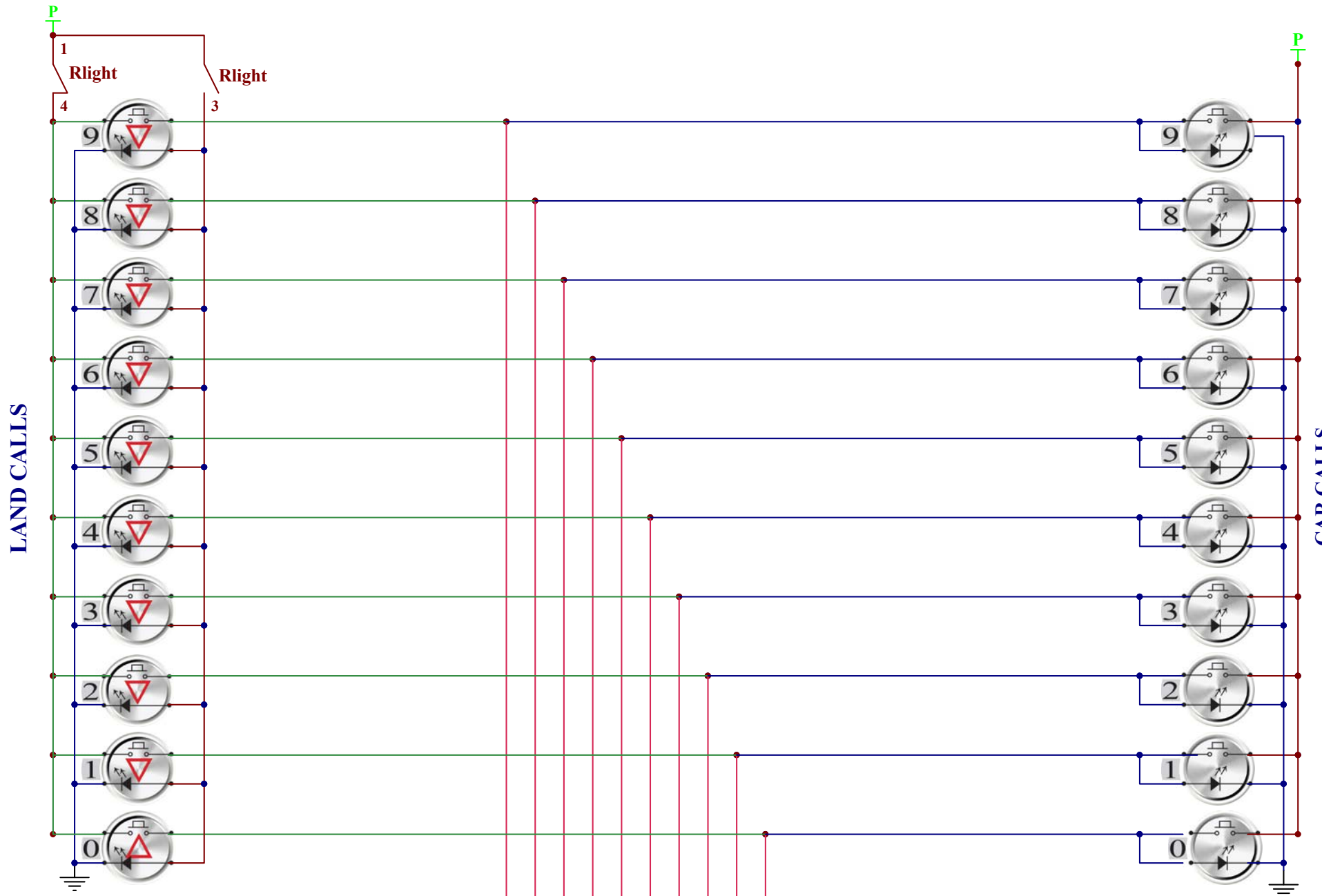

OR

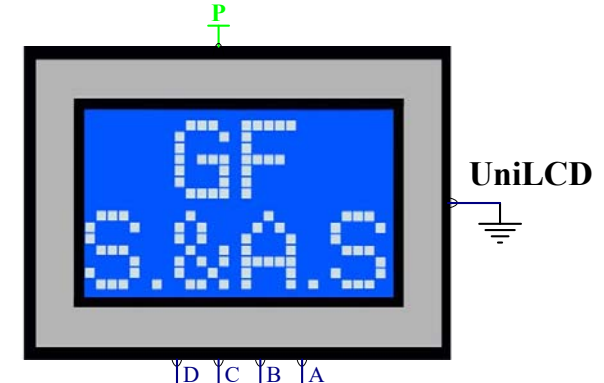



S. & A.S. Co. Ltd

MICROZED AR V3.1 BOARD

C9 C8 C7 C6 C5 C4 C3 C2 C1 C0 F9 F8 F7 F6

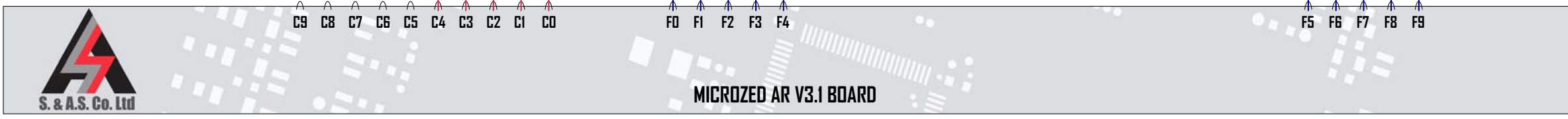
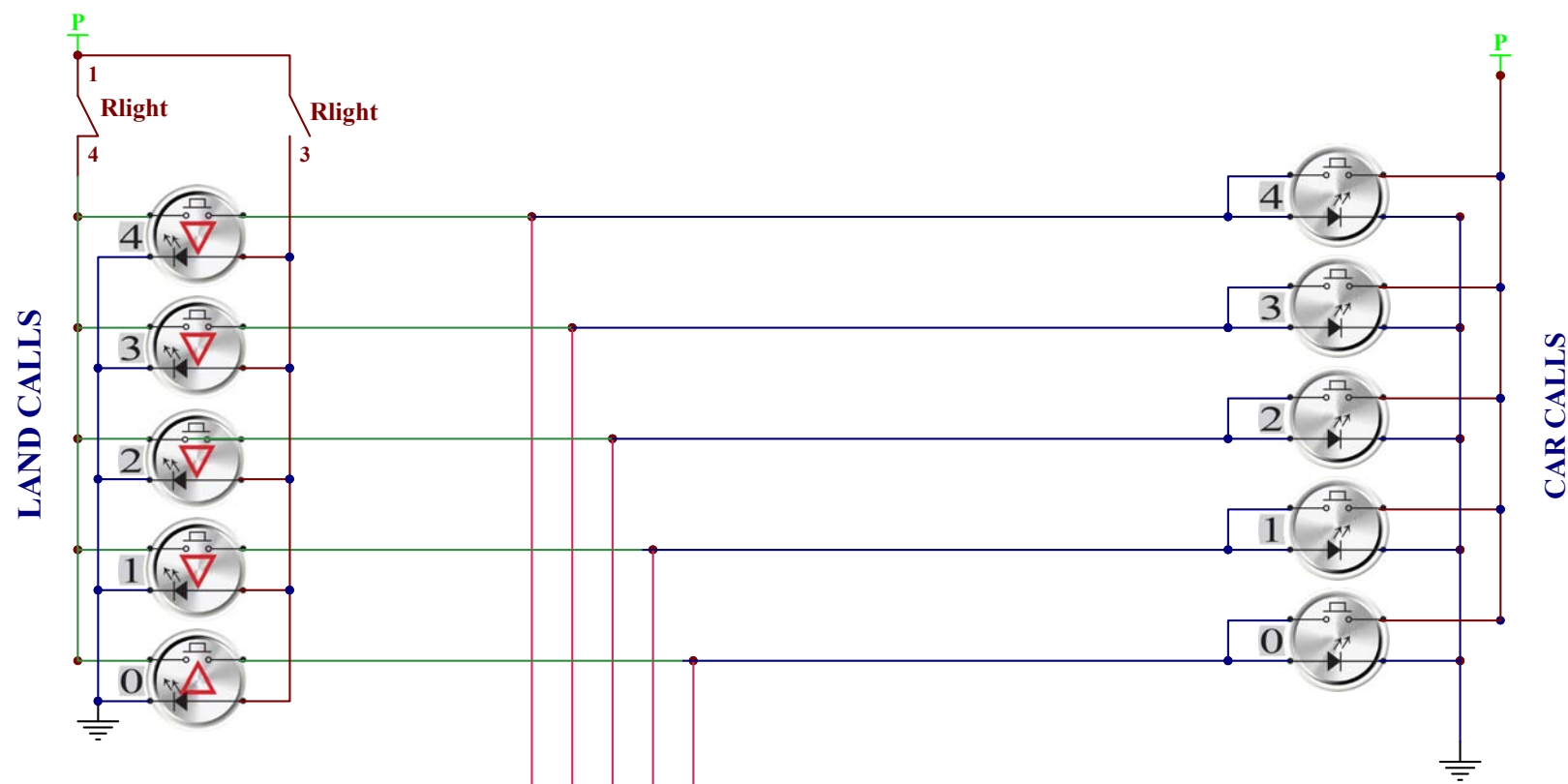
INDICATR="GRAY NR" or INDICATR="BINARY NR"		S.&A.S. Ltd. Jieh Chouf Lebanon support@sascontrollers.com		
MICROZED AR WIRING DIAG:CALLS / FLOOR INFORMATION Binary/Gray Indicator - No Call Register				
Size B	FCSM No.	DWG No. BR310AVX2W5_Calls	Rev 1	
Scale		Sheet		5 of 7



MICROZED AR V3.1 BOARD

INDICATR="COLLECTD"

S.&A.S. Ltd.
Jieh Chouf
Lebanon
support@sascontrollers.com

MICROZED AR WIRING DIAG:CALLS / FLOOR INFORMATION

Decimal Indicator with Call Register

Size B	FCSM No. -	DWG No. BR310AVX2W6_Calls	Rev 1
Scale -	Sheet 6 of 7		

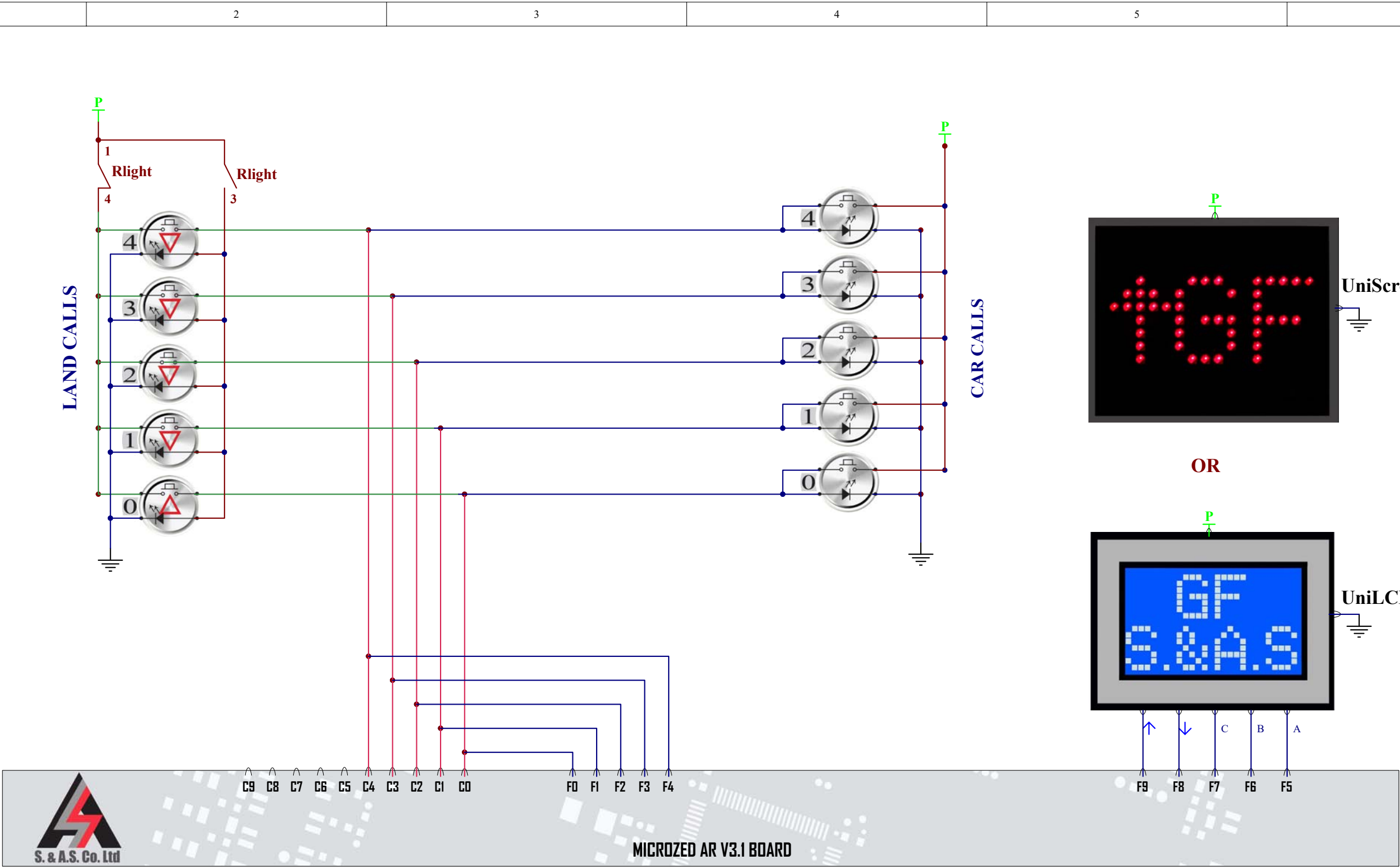

MICROZED AR V3.1 BOARD

INDICATR="ENHANCED"		S.&A.S. Ltd. Jieh Chouf Lebanon support@sascontrollers.com	
MICROZED AR WIRING DIAG:CALLS / FLOOR INFORMATION			
S.&A.S. Indicator with Call Register			
Size B	FCSM No.	DWG No. BR310AVX2W7_Calls	Rev 1
Scale	Sheet		7 of 7