

ELEKTROTEK KABEL® **GROUP**



**AMERICAN INDUSTRIAL
AND MINING CABLES**



ELETTROTEK KABEL® **GROUP**

Elettrotek Kabel was founded in Italy at the end of 2001.

We are focused in offering electrical wire & cable for SPECIAL applications in several different sectors, Industrial Automation in particular.

Through the years, the company expanded and created a network of branches and subsidiaries that exports to over 45 different countries all around the globe.

Elettrotek Kabel has warehouses in Italy, Switzerland, Germany, USA, Dubai, Abu Dhabi and Canada.

We are one of the first companies in the world that produces and distributes SPECIAL cables for use in the following industries: Industrial Automation, Iron & Steel, Mining, Port & Cranes, Marine and Oil & Gas.

This rapid expansion has been possible thanks to the competence of Elettrotek Kabel Group's management team and their constant focus on using only the highest quality products.

Elettrotek Kabel continues investing in the quality of our product lines and the customer care experience.

These elements have helped the company grow swiftly in a short period and have contributed in establishing Elettrotek Kabel's worldwide partnerships.



Roberto Gallingani
General manager

WORLDWIDE PRESENCE

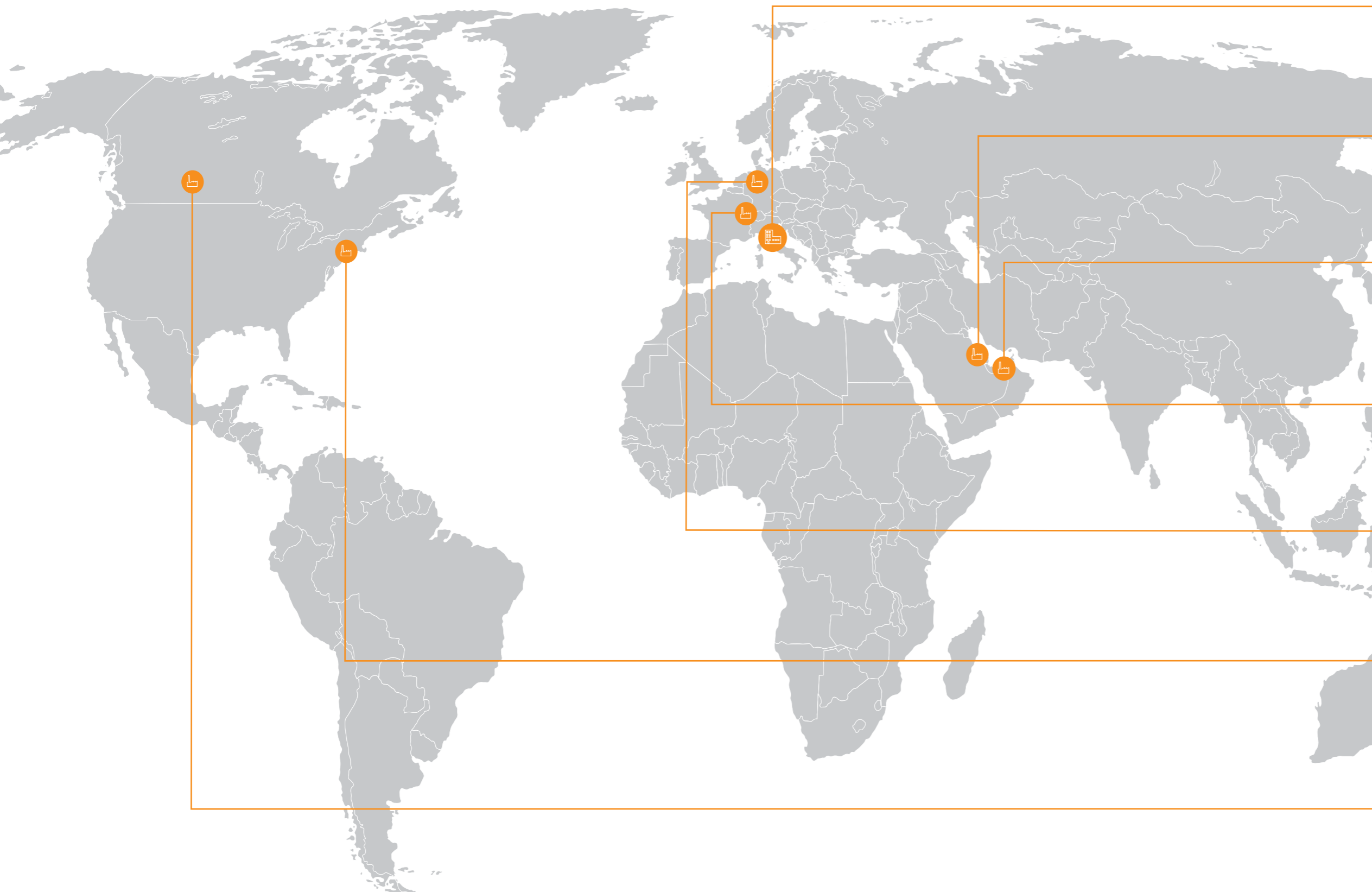

ELETTROTEK KABEL[®]

ELETTROTEK KABEL S.p.A.
Headquarter
Via Imerio Tondelli, 10
42011 Bagnolo in Piano - RE - Italy
Phone: +39 0522 956 001
Fax: +39 0522 953 655
Email: info@eletrotekkabel.com

ELETTROTEK KABEL[®] **ABU DHABI**

ELETTROTEK KABEL Middle East Electrical Equipment trading L.L.C.
Beside TRA Building, Al Salam Street, Abu Dhabi,
United Arab Emirates, PO Box: 48238
Phone: +971 2 67 999 19
Fax: +971 2 67 999 29
Email: info@eletrotekkabel.ae

ELETTROTEK KABEL[®] **MIDDLE EAST**

ELETTROTEK KABEL Middle East DMCC
Unit 602, JBC2, plot JLT-PH2-V1A, Cluster V,
Jumeirah Lakes Towers, Dubai
United Arab Emirates PO Box 337077
Phone: +971 4 447 2551
Fax: +971 4 447 3690
Email: info@eletrotekkabel.ae

ELETTROTEK KABEL[®] **SWISS**

ELETTROTEK KABEL SWISS GmbH
Industriestrasse 18
8910 Affoltern am Albis - ZH - Switzerland
Phone: +41 (0) 44 760 36 80
Fax: +41 (0) 44 760 36 81
Email: contact@eletrotekkabel.ch

ELETTROTEK KABEL[®] **GERMANY**

ELETTROTEK KABEL GmbH
Erik-Geiershoefer-Str. 7
90584 Allersberg - Germany
Phone: +49 (0) 9176 36 797 46
Fax: +49 (0) 9176 36 797 47
Email: kontakt@eletrotekkabel.de

ELETTROTEK KABEL[®] **NORTH AMERICA**

ELETTROTEK KABEL NORTH AMERICA Inc.
2 Cranberry Road - Unit 5A
Parsippany, NJ - 07054 - USA
Phone: +1 973 265 0850
Fax: +1 973 265 0854
Email: info@eletrotekkabel.us

ELETTROTEK KABEL[®] **CANADA**

ELETTROTEK KABEL CANADA Inc.
1201 - 5th street SW - Suite 200
Calgary, AB T2R 0Y6 - Canada
Phone: +1 403 817 2050
Email: info@eletrotekkabel.ca

The Business Units:

STOCKS:



FACTORY:

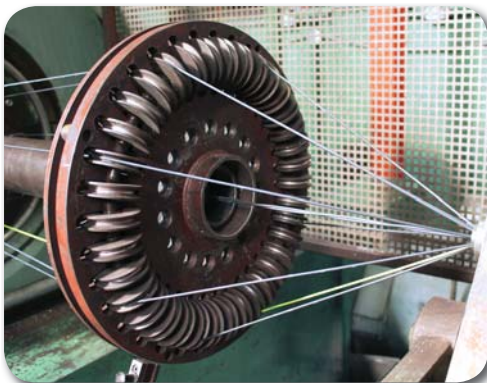
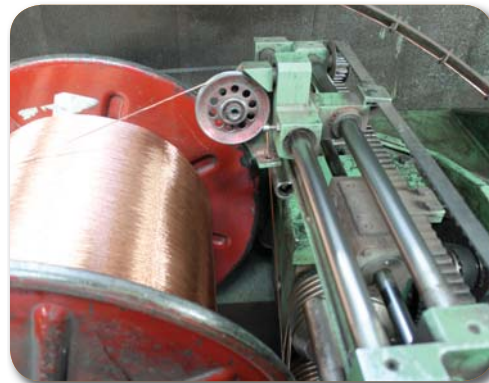

Certifications:

GOST-EAC



ISO 9001:2008



UL



CSA



Power and control cables:

GAALFLEX® CONTROL H05V2-K / H07V2-K.....	8
GAALFLEX® CONTROL THHN / THWN.....	9
GAALFLEX® CONTROL XHHW-2.....	10
GAALFLEX® CONTROL 600.....	11/13
GAALFLEX® CONTROL 600 CY Lean.....	14/16
GAALFLEX® TRAY 600.....	17/18
GAALFLEX® TRAY 600 R.....	19/20
GAALFLEX® TRAY 1002.....	21/22
GAALFLEX® TRAY 600 XR.....	23/26
GAALFLEX® TRAY 600 CY Lean.....	27/28
GAALFLEX® TRAY 600 R CY.....	29/30
GAALFLEX® TRAY 1002 CY Lean.....	31/32

Data and Instrumentation cables:

GAALFLEX® DATA LiYY UL.....	34/35
GAALFLEX® DATA LiYCY UL.....	36/37
GAALFLEX® DATA LiYCY (B) TP UL.....	38/39
GAALFLEX® TRAY INSTRUMENTATION ITC-PLTC 300 POS.....	40/41
GAALFLEX® TRAY INSTRUMENTATION ITC-PLTC 300 SPOS.....	42/43
GAALFLEX® TRAY INSTRUMENTATION ITC-PLTC 300 TOS.....	44/45
GAALFLEX® TRAY INSTRUMENTATION ITC-PLTC 300 STOS.....	46/47
GAALFLEX® TRAY INSTRUMENTATION 600 POS PVC.....	48/49
GAALFLEX® TRAY INSTRUMENTATION 600 SPOS PVC.....	50/51
GAALFLEX® TRAY INSTRUMENTATION 600 TOS PVC.....	52/53
GAALFLEX® TRAY INSTRUMENTATION 600 STOS PVC.....	54/55
GAALFLEX® TRAY INSTRUMENTATION 600 POS.....	56
GAALFLEX® TRAY INSTRUMENTATION 600 SPOS.....	57
GAALFLEX® TRAY INSTRUMENTATION 600 TOS.....	58
GAALFLEX® TRAY INSTRUMENTATION 600 STOS.....	59

Gaalflex VFD cables:

GAALFLEX® TRAY VFD I500 T.....	62/63
GAALFLEX® TRAY VFD I510 T.....	64/65
GAALFLEX® TRAY VFD I520.....	66/67
GAALFLEX® TRAY VFD I400.....	68/69
SPECIAL GAALFLEX® TRAY VFD I400.....	70
GAALFLEX® TRAY VFD I405 600 V.....	71/72
GAALFLEX® TRAY VFD I405 2000 V.....	73
GAALFLEX® TRAY VFD I410 600 V.....	74/75
GAALFLEX® TRAY VFD I410 2000 V.....	76/77
GAALFLEX® TRAY VFD I420.....	78
SPECIAL GAALFLEX® TRAY VFD I420 1000 V.....	79/80
SPECIAL GAALFLEX® TRAY VFD I420 2000 V.....	81
GAALFLEX® VFD 600.....	82
GAALFLEX® VFD 600 Type MC HL.....	83/84

Medium Voltage cables:

GAALFLEX® MEDIUM IC Type MV-105.....	86/89
GAALFLEX® MEDIUM 3C+1G Type MV-105.....	90/93

Portable cord & Mining:

Festoon:

FLEXIFESTOON® SOOW.....	96/97
FLEXIFESTOON® SEOOW.....	98
FLEXIFESTOON® DLO.....	99
FLEXIFESTOON® PV FLAT UL.....	100

Pendant cables:

LIFT-1S UL CENTRAL PENDANT.....	101
LIFT-1S UL.....	102
LIFT-2S UL.....	103

Lift cables:

PENDANT ROUND LIFT 733 UL.....	104
--------------------------------	-----

Mining:

FLEXIMINING® Type W.....	105/106
FLEXIDRUM® MEDIUM SHD GC.....	107/108

High temperature cables:

GAALTHERM® SiAF/POL UL, I, I up to 13,8/15 kV.....	110/112
--	---------

Technical data:

.....	115/149
-------	---------

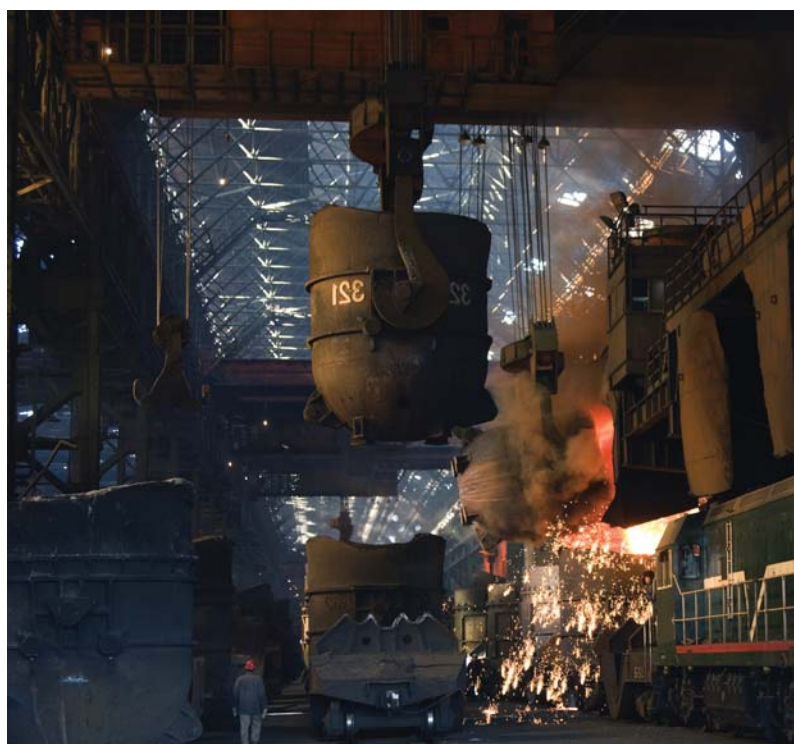
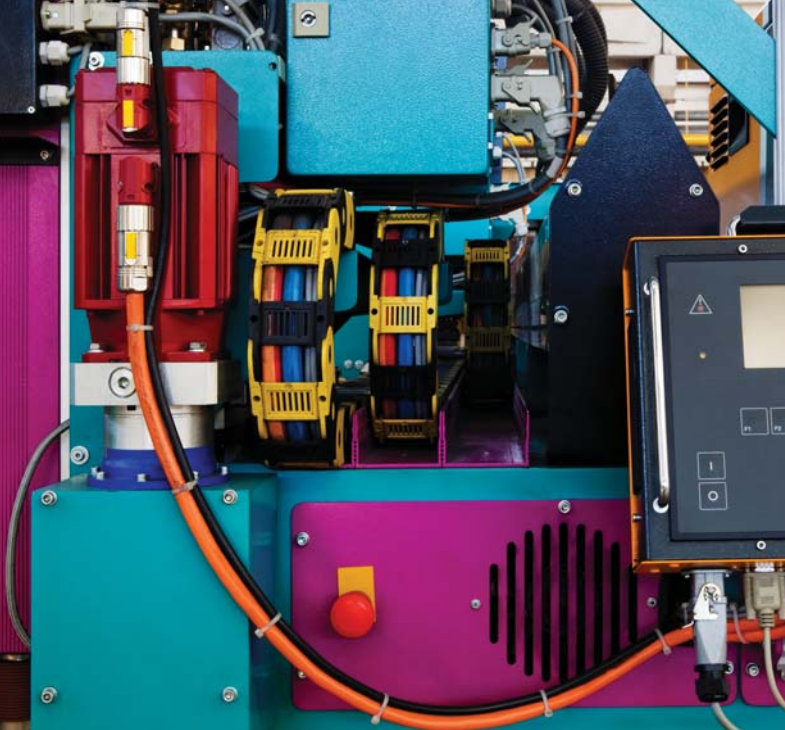

POWER AND CONTROL CABLES

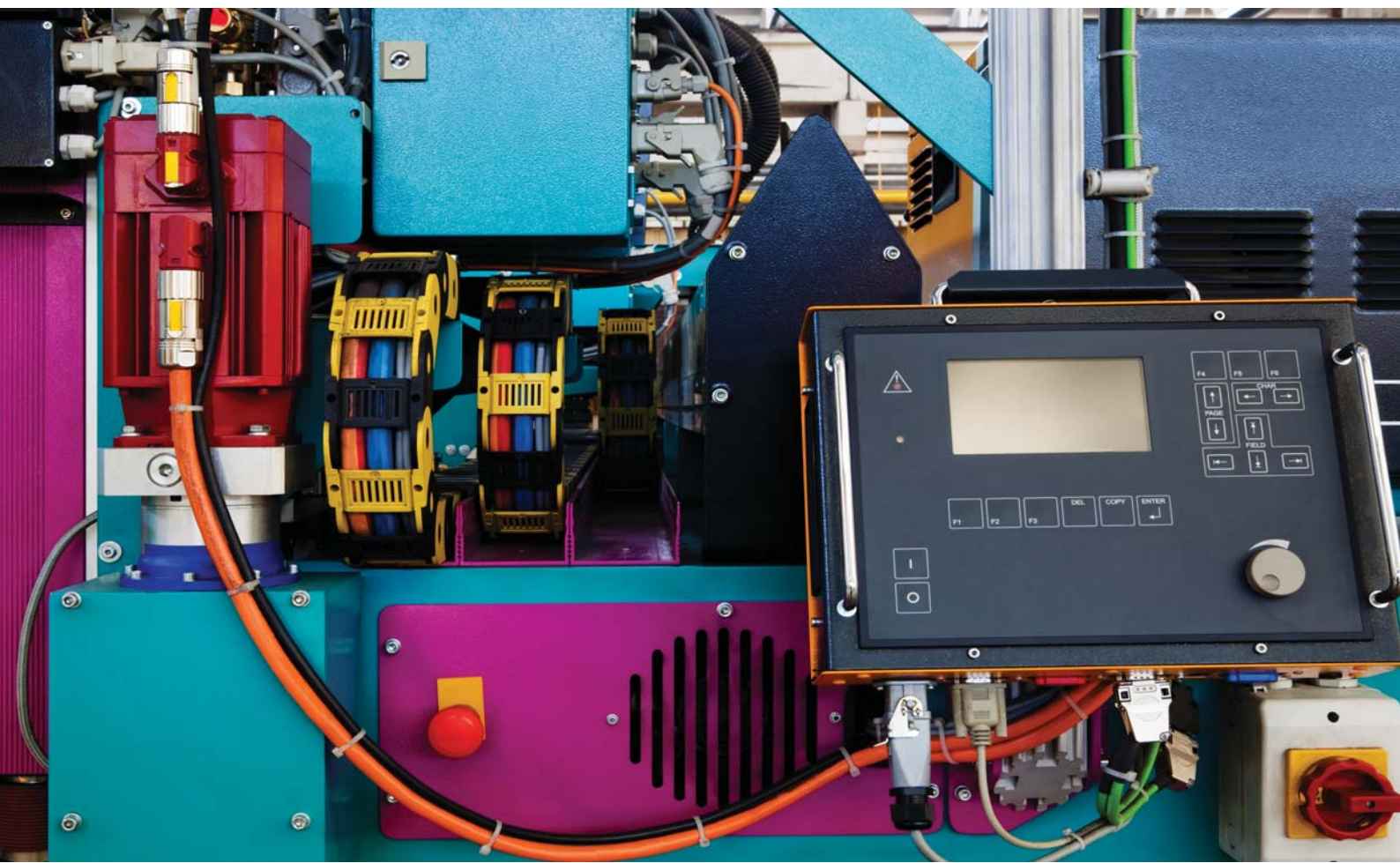

POWER AND CONTROL CABLES

GAALFLEX® CONTROL H05V2-K GAALFLEX® CONTROL H07V2-K

PVC insulated single conductor 300/500V, 450/750V and 600V for UL/CSA



ELETTROTEK KABEL® GAALFLEX® CONTROL H05V2-K

Construction:

Conductor: flexible tinned copper conductor Cl. 5, acc to IEC 60228, DIN VDE 0295

Outer sheath: black (RAL 9005), PVC type T13 for the other coloration, see technical data (PAG.462)

Technical data:

Nominal voltage:

DIN VDE:

H052V-K: U₀/U 300/500 V

H07V2-K: U₀/U 450/750 V

UL/CSA: 600 V

Test voltage: 2,5 kV

Temperature range

Fixed laying: **DIN VDE:** -20°C up to +90°C

UL/CSA: up to +105°C

Flexible application: **DIN VDE:** -5° Cup to +90°C

UL/CSA: up to +105°C

Min. bending radius: 4 x d

Resistance:



Flame retardant acc. to:

DIN VDE 0482 part 265-2-1
EN 50265-2-1
IEC 60332-1-2
UL1581 UL VW-1, CSA FT 1

Features:

flexible conductor

harmonized acc. to European standards

<HAR> H052V-K, H07V2-K

AWM style 1015 105°C 600 V
CSA type TEW 105°C 600 V FT1 CE

on request AWM style 1569 105°C 300 V
CSA type TEW 105°C 300 V FT1 CE

on request AWM style 1007 80°C 300 V
CSA type TEW 80°C 300 V FT1 CE

RoHS and CE approval



H05V2-K UL/CSA/CE

Part no.	No. of cores x cross section n x mm ²	Outer-Ø ca. mm ± 10%	Copper weight kg/km	Cable weight approx. kg/km	AWG no. *)
31330F01010A20	0,5	2,5	5,1	11	20
31330F01010A19	0,75	2,7	7,2	14	19
31330F01010A18	1	2,8	9,6	16	18

H07V2-K UL/CSA/CE

Part no.	No. of cores x cross section n x mm ²	Outer-Ø ca. mm ± 10%	Copper weight kg/km	Cable weight approx. kg/km	AWG no. *)
31330F01010A16	1,5	3,1	14,4	20	16
31330F01010A14	2,5	3,7	24	32	14
31330F01010A12	4	4,3	38,4	50	12
31330F01010A10	6	4,8	57,6	66	10
31330F01010A08	10	6,8	96	121	8
31330F01010A06	16	9,1	153,6	211	6
31330F01010A04	25	10,6	240	303	4
31330F01010A02	35	11,8	336	407	2

07V2-K UL/CSA/CE

Part no.	No. of cores x cross section n x mm ²	Outer-Ø ca. mm ± 10%	Copper weight kg/km	Cable weight approx. kg/km	AWG no. *)
31330F01010A01	50	14,2	480	600	1
31330F01010A2C	70	16,2	672	790	2/0
31330F01010A3C	95	17,3	912	1067	3/0
31330F01010A4C	120	19,2	1152	1277	4/0

Other dimensions and colors available on request.

POWER AND CONTROL CABLES

GAALFLEX® CONTROL THHN/THWN

PVC/Nylon insulated single conductor, UL 600 V THHN, 1000 THWN



ELETTROTEK KABEL® GAALFLEX® CONTROL THHN/THWN

Construction:

Conductor: Stranded red copper conductor similar Cl. 2, acc. to ASTM B3 and B787 and B8

Insulation: black (RAL 9005), PVC/Nylon compound, acc. to UL 83, (other color on request)

Resistance:



Flame retardant and self-extinguishing:
acc. to DIN VDE 0482 part 265-2-1 / EN 50265-2-1 / IEC 60332-1-2, UL VW-1, CSA FT 2



Oil resistance:
DIN VDE 0473 part 811-2-1, IEC EN 60811-2 and UL 758 80°C

Technical data:

Nominal voltage UL:
THHN: 600 V
THWN: 1000 V

Test Voltage:
AWG 14 to AWG 10: 7,5 kV
AWG 8 to AWG 2/0: 10 kV
AWG 4/0: 12,5 kV

Temperature range UL:
THHN: up to +105°C
THWN: up to +90°C

Min. bending radius: 8 x d

Features:

Flexible conductors
UV resistant
Abrasion resistant
MTW (machine tool wire)



UL Standards:

THHN AWM UL 1316 to 1321 105°C dry 80°C in oil 600 V
THWN AWM UL 1452, 1453 90°C dry 80° in oil 1000 V
MTW UL style 1408 to 1414 90°C dry 80°C in oil 600 V

Part no. THHN	Part no. THWN	cross section mm ²	Outer-Ø ca.mm ± 10%	Cable weight approx. kg/km	Cable weight approx. kg/km	AWG no. *)
31360F01010A14	31360H01010A14	2,5	3	20,7	25	14
31360F01010A12	31360H01010A12	4	3,4	33	37	12
31360F01010A10	31360H01010A10	6	4,3	51,6	60	10
31360F01010A08	31360H01010A08	10	5,5	80,6	95	8
31360F01010A06	31360H01010A06	16	6,6	125	143	6
31360F01010A04	31360H01010A04	25	8,4	201	229	4
31360F01010A02	31360H01010A02	35	10	317	349	2
31360F01010A01	31360H01010A01	50	11,4	399	449	1
31360F01010A2C	31360H01010A2C	70	13,7	631	691	2/0
31360F01010A3C	31360H01010A3C	95	15	792	861	3/0
31360F01010A4C	31360H01010A4C	120	16,5	996	1069	4/0
31360F01010A5C	31360H01010A5C	150	18,3	1440	1257	250
31360F01010AAC	31360H01010AAC	240 (253)	23,4	2428	2440	500

Other dimension and colours available on request.

POWER AND CONTROL CABLES

GAALFLEX® CONTROL XHHW-2

XLPE insulated single conductor, UL 600V, 90°C Dry or Wet, LEAD FREE



ELETTROTEK KABEL® GAALFLEX® CONTROL XHHW-2

Construction:

- Conductor:** Stranded red copper conductor similar Cl. 2, acc. to ASTM B3 and B787 and B8
- Insulation:** XLPE compound acc. to UL 44
- Colour core:** 14 AWG up to 10 AWG available: Black, White, Red, Blue, Green, Yellow, Brown, Orange, Gray, Purple
8 AWG and larger available only in Black

Resistance:



Fire performance acc. to:
IEEE 1202 or UL 1685

Technical data:

- Nominal voltage UL:** 600 V
- Test voltage:** 4 kV
- Temperature range UL:** up to +90°C

Features:

acc. to Standard ICEA S-95-658 and UL 44: Thermoset-Insulated Wire and Cables

NEMA WC70 / ICEA S-95-658: Power Cables Rated 2000 Volts or Less for the Distribution of Electrical Energy

suitable for use conduit and other raceways for services, feeders and other applications recognized by the NEC 2008 and NEC 2011

sizes 14 AWG to 4/0 AWG are approved as Type SIS

sizes 1/0 AWG and larger (4 AWG and larger in green) in all colors are cable tray (CT) rated

Federal Specification a-A-59544 and the requirements of the NEC

LEAD FREE

UV resistant for black version 8 AWG and larger

14 to 10 AWG are available in 10 distinct colors for identification purposes

Part no.	No. of cores x cross section n x AWG/MCM	Outer-Ø Inches/mm ± 10%	Cable weight approx. Lbs/Mft - kg/km
31780F01010A14	1x14	0,13 - 3,4	18 - 27
31780F01010A12	1x12	0,15 - 3,8	26 - 39
31780F01010A10	1x10	0,17 - 4,5	40 - 60
31780F01010A08	1x8	0,24 - 6	64 - 95
31780F01010A06	1x6	0,27 - 6,9	97 - 144
31780F01010A04	1x4	0,32 - 8,2	149 - 222
31780F01010A02	1x2	0,38 - 9,6	230 - 342
31780F01010A01	1x1	0,43 - 10,9	288 - 429
31780F01010A1C	1x1/0	0,48 - 12,1	360 - 536
31780F01010A2C	1x2/0	0,52 - 13,2	456 - 679
31780F01010A3C	1x3/0	0,56 - 14,2	563 - 838
31780F01010A4C	1x4/0	0,61 - 15,6	703 - 1046
31780F01010A5C	1x250	0,680 - 17,1	837 - 1245
31780F01010A6C	1x300	0,75 - 18,9	995 - 1481
31780F01010A7C	1x350	0,8 - 20,2	1155 - 1719
31780F01010A8C	1x400	0,84 - 21,4	1324 - 1970
31780F01010AAC	1x500	0,93 - 23,5	1643 - 2445
31780F01010ACC	1x600	1,04 - 26,3	1986 - 2955
31780F01010AEC	1x700	1,1 - 26,3	2283 - 3397
31780F01010AFC	1x750	1,14 - 28,8	2467 - 3671
31780F01010AJC	1x1000	1,29 - 32,7	3230 - 4806

Other dimension and colours available on request.

POWER AND CONTROL CABLES

GAALFLEX® CONTROL 600

PVC control cable, IEC/DIN VDE 450/750 V, UL 600 V



ELETTROTEK KABEL® GAALFLEX® CONTROL 600



Construction:

- Conductor:** flexible red copper conductor Cl.5, acc.to IEC 60228, DIN VDE 0295
- Insulation:** PVC type T11 class 43 acc. to UL 1581
- Colour cores:** black cores with consecutive numbers acc. to EN 50334, green-yellow from 3 cores
- Stranding:** in layers
- Outer sheath:** grey (RAL 7001)
PVC type TM5, acc.to DIN VDE 0281 part 1 + HD 21.1 and class 43 acc. to UL 1581

Resistance:



Self-extinguishing and flame retardant acc. to:
DIN VDE 0482 part 265-2-1
EN 50265-2-1
IEC 60332-1-2,
DIN VDE 0482 part 265-2-5
EN 50265-2-5
IEC 60332-3C
UL VW-1, CSA FT1 FT2



Oil resistance:
acc. to DIN EN 50290-2-22 resp. VDE 0819-102, TM54

Technical data:

- Nominal voltage:** **IEC/DIN VDE**
UoU 450/750 V
UL/CSA
600V
- Test voltage:** 3 kV acc.to DIN VDE 0281 part 2 + HD 21.2
- Temperature range** **DIN VDE** **UL/CSA**
Fixed laying: -40°C up to +70°C up to +90°C
Flexible installation: +5°C up to +70°C up to +90°C
- Min. bending radius** 7,5 x d

Features:

- small bending radius
- on request black
- UL recognized AWM style 2587 90°C 600 V
or style 21179 105°C 600 V,
on request style 21216 90°C Oil 60°C 600V
CSA AWM I/II A/B 90°C 600 V FT1 FT2 CE

RoHS and CE approval



Part no.	No.of cores x cross section n x mm ²	Outer-Ø ca.mm ± 10%	Copper weight kg/km	Cable weight approx. kg/km	AWG no.*)
31150F51020A20	2 x 0,5	5,8	9,6	45,4	20
31150F50031A20	3 G 0,5	6,2	14,4	54,4	20
31150F50041A20	4 G 0,5	6,7	19,2	65,3	20
31150F50051A20	5 G 0,5	7,3	24	78,5	20
31150F50061A20	6 G 0,5	8	28,8	94,4	20
31150F50071A20	7 G 0,5	8	33,6	97,8	20
31150F50081A20	8 G 0,5	9,3	38,4	127,5	20
31150F50091A20	9 G 0,5	10	43,2	142	20
31150F50101A20	10 G 0,5	10,2	48	150,1	20
31150F50121A20	12 G 0,5	10,5	57,6	164	20
31150F50141A20	14 G 0,5	11	67,2	183,2	20
31150F50161A20	16 G 0,5	11,6	76,8	205,6	20
31150F50181A20	18 G 0,5	12,6	86,4	234,6	20
31150F50191A20	19 G 0,5	12,6	91,2	238	20
31150F50211A20	21G 0,5	13,7	100,8	277,6	20
31150F50251A20	25 G 0,5	14,6	120	313,7	20
31150F50271A20	27 G 0,5	15,4	129,6	347,5	20
31150F50301A20	30 G 0,5	15,7	144	368,3	20
31150F50321A20	32 G 0,5	16,1	153,6	389,5	20
31150F50341A20	34 G 0,5	17,2	163,2	418,5	20
31150F50351A20	35 G 0,5	17,2	168	433,4	20
31150F50371A20	37 G 0,5	17,2	177,6	440,2	20
31150F50401A20	40 G 0,5	18,2	192	490,1	20
31150F50411A20	41 G 0,5	18,7	196,8	505,8	20
31150F50421A20	42 G 0,5	18,7	201,6	509,3	20
31150F50501A20	50 G 0,5	20,3	240	606	20
31150F50561A20	56 G 0,5	21,9	268,8	748,1	20
31150F50611A20	61 G 0,5	22,2	292,8	780,7	20

POWER AND CONTROL CABLES

GAALFLEX® CONTROL 600

PVC control cable, IEC/DIN VDE 450/750 V, UL 600 V



ELETTROTEK KABEL® GAALFLEX® CONTROL 600



Part no.	No. of cores x cross section n x mm ²	Outer-Ø ca. mm ± 10%	Copper weight kg/km	Cable weight approx. kg/km	AWG no. *)
31150F51020A19	2 x 0,75	6,2	14,4	54,4	19
31150F50031A19	3 G 0,75	6,6	21,6	65,5	19
31150F50041A19	4 G 0,75	7,2	28,8	80,2	19
31150F50051A19	5 G 0,75	7,9	36	97,7	19
31150F50061A19	6 G 0,75	8,6	43,2	116,3	19
31150F50071A19	7 G 0,75	8,6	50,4	121,4	19
31150F50081A19	8 G 0,75	10,2	57,6	156,9	19
31150F50091A19	9 G 0,75	10,8	64,8	176,5	19
31150F50101A19	10 G 0,75	11	72	186,6	19
31150F50121A19	12 G 0,75	11,3	86,4	204,6	19
31150F50141A19	14 G 0,75	12,1	100,8	230,8	19
31150F50151A19	15 G 0,75	12,5	108	247,1	19
31150F50161A19	16 G 0,75	12,7	115,2	257,9	19
31150F50181A19	18 G 0,75	13,5	129,6	292	19
31150F50191A19	19 G 0,75	13,5	136,8	297,1	19
31150F50211A19	21 G 0,75	15	151,2	349,2	19
31150F50241A19	24 G 0,75	15,7	172,8	388,8	19
31150F50251A19	25 G 0,75	15,8	180	397,5	19
31150F50261A19	26 G 0,75	16,2	187,2	417,1	19
31150F50271A19	27 G 0,75	16,9	194,4	440,8	19
31150F50301A19	30 G 0,75	17,2	216	467,6	19
31150F50321A19	32 G 0,75	17,6	230,4	493,4	19
31150F50341A19	34 G 0,75	18,8	244,8	531,8	19
31150F50361A19	36 x 0,75	18,8	259,2	554,5	19
31150F50371A19	37 x 0,75	18,8	266,4	559,6	19
31150F50421A19	42 x 0,75	20,2	302,4	646	19
31150F50451A19	45 x 0,75	22	324	792,6	19
31150F50501A19	50 x 0,75	22,5	360	844,3	19
31150F50611A19	61 G 0,75	24	439,2	982,3	19
31150F51020A18	2 x 1	6,5	19,2	62,2	18
31150F50031A18	3 G 1	6,9	28,8	75,3	18
31150F50041A18	4 G 1	7,5	38,4	92,2	18
31150F50051A18	5 G 1	8,3	48,0	113,8	18
31150F50061A18	6 G 1	9	57,6	134,7	18
31150F50071A18	7 G 1	9	67,2	141,6	18
31150F50081A18	8 G 1	10,8	76,8	185,1	18
31150F50091A18	9 G 1	11,3	86,4	204,6	18
31150F50101A18	10 G 1	11,6	96,0	219,3	18
31150F50121A18	12 G 1	12,2	115,2	243,9	18
31150F50141A18	14 G 1	12,8	134,4	274,5	18
31150F50161A18	16 G 1	13,4	153,6	306	18
31150F50181A18	18 G 1	15,3	172,8	348,1	18
31150F50191A18	19 G 1	14,5	182,4	354,9	18
31150F50201A18	20 G 1	15,3	192	388,5	18
31150F50211A18	21 G 1	15,9	201,6	416,5	18
31150F50241A18	24 G 1	16,8	230,4	462,7	18
31150F50251A18	25 G 1	16,8	240	469,5	18
31150F50261A18	26 G 1	17,3	249,6	495,4	18
31150F50271A18	27 G 1	17,8	259,2	521,9	18
31150F50301A18	30 G 1	18,2	288	558,5	18
31150F50321A18	32 G 1	18,8	307,2	588,7	18
31150F50341A18	34 G 1	19,9	326,4	632,2	18
31150F50361A18	36 G 1	19,9	345,6	663,4	18
31150F50371A18	37 G 1	19,9	355,2	670,2	18
31150F50411A18	41 G 1	22	393,6	842,2	18
31150F50421A18	42 G 1	22	403,2	849	18
31150F50501A18	50 G 1	23,8	480	1000,2	18
31150F50561A18	56 G 1	25	537,6	1109,7	18
31150F50611A18	61 G 1	25,3	585,6	1161,6	18

POWER AND CONTROL CABLES

GAALFLEX® CONTROL 600

PVC control cable, IEC/DIN VDE 450/750 V, UL 600 V



ELETTROTEK KABEL® GAALFLEX® CONTROL 600



Part no.	No. of cores x cross section n x mm ²	Outer-Ø ca. mm ± 10%	Copper weight kg/km	Cable weight approx. kg/km	AWG no. *)
31150F51020A16	2 x 1,5	7,1	28,8	85,8	16
31150F50031A16	3 G 1,5	7,5	43,2	105,3	16
31150F50041A16	4 G 1,5	8,2	57,6	129,4	16
31150F50051A16	5 G 1,5	9,1	72	159	16
31150F50061A16	6 G 1,5	10,1	86,4	190,6	16
31150F50071A16	7 G 1,5	10,1	100,8	201,1	16
31150F50081A16	8 G 1,5	12	115,2	259,5	16
31150F50091A16	9 G 1,5	12,7	129,6	290,7	16
31150F50101A16	10 G 1,5	12,9	144	310,4	16
31150F50111A16	11 G 1,5	13	158,4	324	16
31150F50121A16	12 G 1,5	13,4	172,8	347,2	16
31150F50141A16	14 G 1,5	14,2	201,6	391,3	16
31150F50161A16	16 G 1,5	15	230,4	440,2	16
31150F50181A16	18 G 1,5	15,9	259,2	498,1	16
31150F50191A16	19 G 1,5	15,9	273,6	508,6	16
31150F50201A16	20 G 1,5	17,1	288	558,4	16
31150F50211A16	21 G 1,5	17,7	302,4	597,9	16
31150F50241A16	24 G 1,5	18,7	345,6	668,2	16
31150F50251A16	25 G 1,5	18,8	360	678,7	16
31150F50261A16	26 G 1,5	19,3	374,4	788,4	16
31150F50271A16	27 G 1,5	19,8	388,8	828,9	16
31150F50301A16	30 G 1,5	20,2	432	880,7	16
31150F50321A16	32 G 1,5	21,3	460,8	927,8	16
31150F50341A16	34 G 1,5	22,5	489,6	997,2	16
31150F50371A16	37 G 1,5	22,5	532,8	1050,8	16
31150F50411A16	41 G 1,5	24,2	590,4	1197,1	16
31150F50421A16	42 G 1,5	24,2	604,8	1207,6	16
31150F50501A16	50 G 1,5	26,2	720	1429,3	16
31150F50561A16	56 G 1,5	27,8	806,4	1657,1	16
31150F50611A16	61 G 1,5	28,2	878,4	1745,2	16
31150F51020A14	2 x 2,5	8,1	48	99,8	14
31150F50031A14	3 G 2,5	8,6	72	126,3	14
31150F50041A14	4 G 2,5	9,4	96	157,5	14
31150F50051A14	5 G 2,5	10,6	120	194,2	14
31150F50071A14	7 G 2,5	11,6	168	250,3	14
31150F50081A14	8 G 2,5	13,8	192	315,8	14
31150F50091A14	9 G 2,5	14,8	216	354	14
31150F50101A14	10 G 2,5	15,1	240	380,7	14
31150F50121A14	12 G 2,5	15,6	288	431,5	14
31150F50141A14	14 G 2,5	16,6	336	489,7	14
31150F50161A14	16 G 2,5	17,5	384	552,6	14
31150F50181A14	18 G 2,5	18,8	432	624,6	14
31150F50241A14	24 G 2,5	22,2	576	836,8	14
31150F50251A14	25 G 2,5	22,2	600	854,3	14
31150F50341A14	34 G 2,5	26,0	816	1236,1	14
31150F51020A12	2 x 4	9,3	76,8	145,3	12
31150F50031A12	3 G 4	10,2	115,2	183,8	12
31150F50041A12	4 G 4	11,2	153,6	234,5	12
31150F50051A12	5 G 4	12,5	192	287,7	12
31150F50071A12	7 G 4	13,7	268,8	373,9	12
31150F50111A12	11 G 4	17,9	422,4	601,5	12
31150F50121A12	12 G 4	18,6	460,8	648,3	12
31150F51020A10	2 x 6	10,6	115,2	204,3	10
31150F50031A10	3 G 6	11,3	172,8	263,4	10
31150F50041A10	4 G 6	12,7	230,4	334,6	10
31150F50051A10	5 G 6	14,2	288	415	10
31150F50071A10	7 G 6	15,6	403,2	544,5	10
31150F51020A08	2 x 10	13,0	192	323,7	8
31150F50031A08	3 G 10	13,9	288	420,7	8
31150F50041A08	4 G 10	15,5	384	536,9	8
31150F50051A08	5 G 10	17,4	480	669,1	8
31150F50071A08	7 G 10	19,2	672	873,5	8

Other dimension and colours available on request.

POWER AND CONTROL CABLES

GAALFLEX® CONTROL 600 CY Lean

PVC control cable with overall copper screen, IEC/DIN VDE 450/750 V, UL 600 V



ELETTROTEK KABEL® GAALFLEX® CONTROL 600 CY Lean

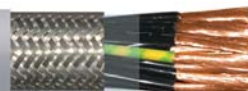

Construction:

Conductor:	flexible red copper conductor Cl.5, acc.to IEC 60228, DIN VDE 0295
Insulation:	PVC type T11 class 43 acc. to UL 1581
Colour cores:	black cores with consecutive numbers acc. to EN 50334, green-yellow from 3 cores
Stranding:	in layers
Wrapping	PETP foil
Screen:	tinned copper braid
Outer sheath:	grey (RAL 7001) PVC type TM5, acc.to DIN VDE 0281 part 1 + HD 21.1 and class 43 acc. to UL 1581

Resistance:



Self-extinguishing and flame retardant acc. to:
DIN VDE 0482 part 265-2-1
EN 50265-2-1
IEC 60332-1-2,
UL VW-1, CSA FT1 FT2



Oil resistance:
acc. to DIN EN 50290-2-22 resp. VDE 0819-102, TM54

Technical data:

Nominal voltage:	IEC/DIN VDE UoU 450/750 V UL/CSA 600V
Test voltage:	3 kV acc.to DIN VDE 0281 part 2 + HD 21.2
Temperature range	DIN VDE UL/CSA
<i>Fixed laying:</i>	-40°C up to +70°C up to +90°C
<i>Flexible installation:</i>	+5°C up to +70°C up to +90°C
Min. bending radius	7,5 x d

Features:

high mechanical loading capacity
UL recognized AWM style 2587 90°C 600 V or style 21179 105°C 600 V, on request style 21216 90°C Oil 60°C 600V CSA AWM I/II A/B 90°C 600 V FT1 FT2 CEE

RoHS and CE approval



Part no.	No.of cores x cross section n x mm ²	Outer-Ø ca.mm ± 10%	Copper weight kg/km	Cable weight approx. kg/km	AWG no.*)
31190F51020A20	2 x 0,5	6,4	27	59,2	20
31190F50031A20	3 G 0,5	6,8	32	67,6	20
31190F50041A20	4 G 0,5	7,3	41,6	84,2	20
31190F50051A20	5 G 0,5	7,9	46,9	98,1	20
31190F50061A20	6 G 0,5	8,6	56,7	117,1	20
31190F50071A20	7 G 0,5	8,6	61,5	120,5	20
31190F50081A20	8 G 0,5	10,1	70,9	157,4	20
31190F50091A20	9 G 0,5	10,6	80,4	179,2	20
31190F50101A20	10 G 0,5	10,8	85,2	169,4	20
31190F50121A20	12 G 0,5	11,1	94,8	188,7	20
31190F50141A20	14 G 0,5	11,6	104,4	209,5	20
31190F50161A20	16 G 0,5	12,4	118,6	241,9	20
31190F50181A20	18 G 0,5	13,4	132,9	270,8	20
31190F50191A20	19 G 0,5	13,4	137,7	274,2	20
31190F50211A20	21G 0,5	14,7	151,9	321,2	20
31190F50251A20	25 G 0,5	15,4	171,1	348,1	20
31190F50271A20	27 G 0,5	16,4	185,4	374,7	20
31190F50301A20	30 G 0,5	16,7	199,8	411,9	20
31190F50321A20	32 G 0,5	17,1	214	438	20
31190F50341A20	34 G 0,5	18	228,3	468,5	20
31190F50351A20	35 G 0,5	18	233,1	477,4	20
31190F50371A20	37 G 0,5	18	242,7	489,6	20
31190F50401A20	40 G 0,5	19,2	257,1	542,7	20
31190F50411A20	41 G 0,5	19,5	266,5	562,1	20
31190F50421A20	42 G 0,5	19,5	271,3	570,9	20
31190F50501A20	50 G 0,5	21,7	314,4	671,5	20
31190F50561A20	56 G 0,5	21,7	347,8	737,2	20
31190F50611A20	61 G 0,5	21,7	421,9	837,1	20

POWER AND CONTROL CABLES

GAALFLEX® CONTROL 600 CY Lean

PVC control cable with overall copper screen, IEC/DIN VDE 450/750 V, UL 600 V



ELETTROTEK KABEL® GAALFLEX® CONTROL 600 CY Lean

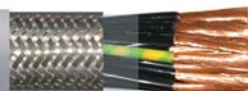

Part no.	No. of cores x cross section n x mm ²	Outer-Ø ca. mm ± 10%	Copper weight kg/km	Cable weight approx. kg/km	AWG no. *)
31190F51020A19	2 x 0,75	6,8	32	66,9	19
31190F50031A19	3 G 0,75	7,2	43,9	82,3	19
31190F50041A19	4 G 0,75	7,8	51,5	97,9	19
31190F50051A19	5 G 0,75	8,5	63,9	119,4	19
31190F50061A19	6 G 0,75	9,2	71,1	137	19
31190F50071A19	7 G 0,75	9,2	78,3	142,2	19
31190F50081A19	8 G 0,75	10,8	94,8	189,8	19
31190F50091A19	9 G 0,75	11,4	102	211,5	19
31190F50101A19	10 G 0,75	11,6	109,2	200,6	19
31190F50121A19	12 G 0,75	12,1	128,2	235,7	19
31190F50141A19	14 G 0,75	12,9	142,6	262,7	19
31190F50151A19	15 G 0,75	13,3	154,5	282,4	19
31190F50161A19	16 G 0,75	13,5	161,7	296	19
31190F50181A19	18 G 0,75	14,5	180,7	337,7	19
31190F50191A19	19 G 0,75	14,5	187,9	342,8	19
31190F50211A19	21 G 0,75	15,8	207	392,3	19
31190F50241A19	24 G 0,75	16,7	228,6	424,1	19
31190F50251A19	25 G 0,75	16,8	235,8	436	19
31190F50261A19	26 G 0,75	17,2	247,6	454,7	19
31190F50271A19	27 G 0,75	17,7	254,8	469	19
31190F50301A19	30 G 0,75	18	281,1	511,6	19
31190F50321A19	32 G 0,75	18,4	295,5	539,4	19
31190F50341A19	34 G 0,75	19,6	314,5	585,6	19
31190F50361A19	36 x 0,75	19,6	328,9	608,8	19
31190F50371A19	37 x 0,75	19,6	336,1	614	19
31190F50421A19	42 x 0,75	21,6	376,8	734,3	19
31190F50451A19	45 x 0,75	22,8	403	764,2	19
31190F50501A19	50 x 0,75	23,3	502	893,5	19
31190F50561A19	61 G 0,75	23,3	581,2	1032,7	19
31190F51020A18	2 x 1	7,1	37	73,7	18
31190F50031A18	3 G 1	7,5	51,3	91,4	18
31190F50041A18	4 G 1	8,1	61,4	110	18
31190F50051A18	5 G 1	8,9	75,9	134,2	18
31190F50061A18	6 G 1	9,8	90,1	164,5	18
31190F50071A18	7 G 1	9,8	99,7	171,3	18
31190F50081A18	8 G 1	11,4	114	215	18
31190F50091A18	9 G 1	12,1	128,2	250,4	18
31190F50101A18	10 G 1	12,4	137,8	239,2	18
31190F50121A18	12 G 1	13	157	269,4	18
31190F50141A18	14 G1	13,6	180,9	306,7	18
31190F50161A18	16 G 1	14,4	200,1	347,4	18
31190F50181A18	18 G 1	15,3	223,9	388,8	18
31190F50191A18	19 G 1	15,3	233,5	395,7	18
31190F50201A18	20 G 1	16,1	247,8	432,6	18
31190F50211A18	21 G 1	16,9	262	465,1	18
31190F50241A18	24 G 1	17,6	290,8	495,3	18
31190F50251A18	25 G 1	17,6	300,4	509,7	18
31190F50261A18	26 G 1	18,1	314,7	531,1	18
31190F50271A18	27 G 1	18,8	324,3	548,4	18
31190F50301A18	30 G 1	19,2	353,1	603,2	18
31190F50321A18	32 G 1	19,6	376,9	641,1	18
31190F50341A18	34 G 1	21,3	400,8	714,3	18
31190F50361A18	36 G 1	21,3	420	742,7	18
31190F50371A18	37 G 1	21,3	429,6	749,5	18
31190F50411A18	41 G 1	22,8	472,6	843,8	18
31190F50421A18	42 G 1	22,8	482,2	858	18
31190F50501A18	50 G 1	24,6	622	1031,6	18
31190F50561A18	56 G 1	24,6	692,5	1138,8	18
31190F50611A18	61 G 1	24,6	740,5	1212,6	18

POWER AND CONTROL CABLES

GAALFLEX® CONTROL 600 CY Lean

PVC control cable with overall copper screen, IEC/DIN VDE 450/750 V, UL 600V



ELETTROTEK KABEL® GAALFLEX® CONTROL 600 CY Lean

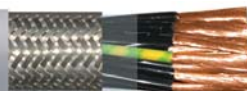

Part no.	No. of cores x cross section n x mm ²	Outer-Ø ca. mm ± 10%	Copper weight kg/km	Cable weight approx. kg/km	AWG no. *)
31190F51020A16	2 x 1,5	7,7	51,8	97,2	16
31190F50031A16	3 G 1,5	8,1	71,1	121	16
31190F50041A16	4 G 1,5	8,8	90,1	151,4	16
31190F50051A16	5 G 1,5	9,9	104,5	183,9	16
31190F50061A16	6 G 1,5	10,7	123,6	218,9	16
31190F50071A16	7 G 1,5	10,7	138	229,1	16
31190F50081A16	8 G 1,5	12,8	161,7	299,7	16
31190F50091A16	9 G 1,5	13,5	176,1	342,6	16
31190F50101A16	10 G 1,5	13,7	195,1	331,4	16
31190F50101A16	11 G 1,5	13,8	209,5	363,4	16
31190F50121A16	12 G 1,5	14,4	223,9	375,7	16
31190F50141A16	14 G 1,5	15	257,4	427,5	16
31190F50161A16	16 G 1,5	15,8	290,8	489,3	16
31190F50181A16	18 G 1,5	16,9	324,3	546,8	16
31190F50191A16	19 G 1,5	16,9	338,7	557	16
31190F50201A16	20 G 1,5	17,9	353,1	612,5	16
31190F50211A16	21 G 1,5	18,7	372,1	646	16
31190F50241A16	24 G 1,5	19,5	420	724,2	16
31190F50251A16	25 G 1,5	19,6	434,4	745,5	16
31190F50261A16	26 G 1,5	20,1	448,8	770,4	16
31190F50271A16	27 G 1,5	21,2	467,8	800,7	16
31190F50301A16	30 G 1,5	21,6	511	868,3	16
31190F50321A16	32 G 1,5	22,1	602,8	983,1	16
31190F50341A16	34 G 1,5	23,3	631,6	1040,4	16
31190F50371A16	37 G 1,5	23,3	674,8	1092,3	16
31190F50411A16	41 G 1,5	25	745,3	1233,1	16
31190F50421A16	42 G 1,5	25	759,7	1253,9	16
31190F50501A16	50 G 1,5	27	900,8	1503,8	16
31190F50561A16	56 G 1,5	27	987,2	1642,8	16
31190F50611A16	61 G 1,5	27	1.072,1	1764,6	16
31190F51020A14	2 x 2,5	8,7	75,9	123,3	14
31190F50031A14	3 G 2,5	9,2	99,9	150,6	14
31190F50041A14	4 G 2,5	10,2	128,5	199,2	14
31190F50051A14	5 G 2,5	11,2	157,2	238,7	14
31190F50071A14	7 G 2,5	12,4	209,8	306,9	14
31190F50081A14	8 G 2,5	14,8	243,1	394,6	14
31190F50091A14	9 G 2,5	15,6	271,8	447,8	14
31190F50101A14	10 G 2,5	15,9	295,8	433,2	14
31190F50121A14	12 G 2,5	16,6	343,8	495,9	14
31190F50141A14	14 G 2,5	17,4	396,4	574,6	14
31190F50161A14	16 G 2,5	18,3	449,1	648,7	14
31190F50181A14	18 G 2,5	19,6	501,7	735,2	14
31190F50241A14	24 G 2,5	23	655	960,6	14
31190F50251A14	25 G 2,5	23	729,1	1044,2	14
31190F50341A14	34 G 2,5	26,8	983,9	1393,9	14
31190F51020A12	2 x 4	10,1	109,3	171,2	12
31190F50031A12	3 G 4	10,8	152,4	218,0	12
31190F50041A12	4 G 4	11,8	195,4	280,8	12
31190F50051A12	5 G 4	13,3	238,5	343,8	12
31190F50071A12	7 G 4	14,7	319,9	443,4	12
31190F50111A12	11 G 4	18,9	487,5	696,9	12
31190F50121A12	12 G 4	19,4	530,5	732,1	12
31190F51020A10	2 x 6	11,2	152,4	221,1	10
31190F50031A10	3 G 6	12,1	214,6	291	10
31190F50041A10	4 G 6	13,5	276,9	376,3	10
31190F50051A10	5 G 6	15	339,1	461	10
31190F50071A10	7 G 6	16,6	459	590,9	10
31190F50031A08	3 G 10	14,9	339,1	450,2	8
31190F50041A08	4 G 10	16,5	444,4	600,8	8
31190F50051A08	5 G 10	18,2	545,1	734,3	8
31190F50071A08	7 G 10	20	746,4	980,5	8

Other dimension and colours available on request.

GAALFLEX® TRAY 600

Special PVC UV and oil resistant, flexible tray cable, Machine-Tool cable,
UL-AWM / (UL) / c(UL): 600V, (UL) WTTC: 1000 V



ELETTROTEK KABEL® GAALFLEX® TRAY 600



Construction:

Conductor:	flexible red copper conductor Cl. 5, acc to IEC 60228, DIN VDE 0295 and UL standard 83 + UL 1581 table 20.1.1
Insulation:	special PVC/Nylon compound: from 1 sqmm up to 1,5 sqmm: UL TFFN > 1,5 sqmm: UL THHN
Colour cores:	black cores with consecutive numbers acc. to EN 50334, green-yellow from 3 cores
Stranding:	in layers
Outer sheath:	black (RAL 9005), special PVC oil resistant compound

Resistance:



Fire performance acc. to:
(UL) FT4 and c(UL) FT1 FT2 FT4

Technical data:

Nominal voltage:	UL-AWM / (UL) / c(UL): 600V (UL) WTTC: 1000V
Test voltage:	2 kV
Temperature range	(UL) / c(UL): up to +90°C
<i>Fixed laying:</i>	- 40°C
Radiation resistance:	8 x 10 ⁷ cJ/kg
Min. bending radius:	
<i>Fixed laying:</i>	5 x d
<i>Flexible installation:</i>	15 x d

Features:

UL AWM style 2587 90°C 600 V
(UL) type TC-ER 90°C 600 V
FT4 (UL) WTTC 90°C 1000 V (UL)
MTW 600 V flexing
Type CIC 90°C dry 600 V FT1 FT2 FT4 CE

New: improved with WTTC approval

WTTC: UL subject 2277

TC: UL Standard 1277

exposed runs

cable for tray use

UV resistance

RoHS and CE approval



POWER AND CONTROL CABLES

GAALFLEX® TRAY 600

Special PVC UV and oil resistant, flexible tray cable, Machine-Tool cable,
UL-AWM / (UL) / c(UL): 600V, (UL) WTTC: 1000 V



ELETTROTEK KABEL® GAALFLEX® TRAY 600



Part no.	No. of cores x cross section n x mm ²	Outer-Ø ca. mm ± 10%	Copper weight kg/km	Cable weight approx. kg/km	AWG no. *)
32010G71020A18	2 x 1	6,9	19	76	18
32010G70031A18	3 G 1	7,3	29	89	18
32010G70041A18	4 G 1	7,9	38	107	18
32010G70051A18	5 G 1	8,5	48	126	18
32010G70071A18	7 G 1	9,2	67	155	18
32010G70091A18	9 G 1	11,3	86,4	196,5	18
32010G70121A18	12 G 1	12	115	244	18
32010G70161A18	16 G 1	13,9	153,6	333,5	18
32010G70181A18	18 G 1	14,6	173	372	18
32010G70191A18	19 G 1	14,6	182,4	384	18
32010G70251A18	25 G 1	17,4	240	496	18
32010G70271A18	27 G 1	17,4	259,2	521	18
32010G70371A18	37 G 1	19,6	355,2	695	18
32010G70501A18	50 G 1	23,6	480	943	18
32010G71020A16	2 x 1,5	7,5	29	93,5	16
32010G70031A16	3 G 1,5	7,9	43	110	16
32010G70041A16	4 G 1,5	8,5	58	133	16
32010G70051A16	5 G 1,5	9,3	72	160	16
32010G70071A16	7 G 1,5	10,1	101	199	16
32010G70081A16	8 G 1,5	11,7	115,2	230	16
32010G70091A16	9 G 1,5	12,5	129,6	256	16
32010G70121A16	12 G 1,5	13,9	173	341	16
32010G70161A16	16 G 1,5	15,4	230,4	435	16
32010G70181A16	18 G 1,5	16,2	259,5	486	16
32010G70191A16	19 G 1,5	16,2	273,6	501	16
32010G70251A16	25 G 1,5	19,2	360	644	16
32010G70271A16	27 G 1,5	19,2	388,8	675,4	16
32010G70371A16	37 G 1,5	22,4	532,8	942	16
32010G70411A16	41 G 1,5	24,0	590,4	1023	16
32010G70501A16	50 G 1,5	26,5	720	1253	16
32010G70611A16	61 G 1,5	27,8	878,4	1460	16
32010G70031A14	3 G 2,5	8,8	72	148	14
32010G70041A14	4 G 2,5	9,5	96	182	14
32010G70051A14	5 G 2,5	10,3	120	219	14
32010G70071A14	7 G 2,5	11,4	168	280	14
32010G70091A14	9 G 2,5	14,1	216	349	14
32010G70121A14	12 G 2,5	15,6	288	470	14
32010G70181A14	18 G 2,5	18,3	432	682	14
32010G70251A14	25 G 2,5	22,7	600	942	14
32010G70031A12	3 G 4	10,2	115	216	12
32010G70041A12	4 G 4	11	154	266	12
32010G70051A12	5 G 4	12,1	192	326	12
32010G70061A12	6 G 4	13,2	230,4	371	12
32010G70071A12	7 G 4	13,2	268,8	415	12
32010G70031A10	3 G 6	12,8	173	329	10
32010G70041A10	4 G 6	14	230	408	10
32010G70051A10	5 G 6	15,4	288	497	10
32010G70071A10	7 G 6	16,8	403,2	625	10
32010G70031A08	3 G 10	17	288	568	8
32010G70041A08	4 G 10	18,7	384	705	8
32010G70051A08	5 G 10	21,5	480	880	8
32010G70071A08	7 G 10	23,5	672	1134	8
32010G70031A06	3 G 16	19,4	461	796	6
32010G70041A06	4 G 16	22,4	614	1056	6
32010G70051A06	5 G 16	24,3	768	1243	6
32010G70041A04	4 G 25	27,2	960	1648	4
32010G70051A04	5 G 25	29,7	1200	1535	4
32010G70041A02	4 G 35	31,3	1344	2260	2
32010G70051A02	5 G 35	34,7	1680	2731	2

Other dimension and colours available on request.

GAALFLEX® TRAY 600 R

Special PVC UV and oil resistant,
type TFN or THHN/THWN-2, UL type TC 600V, 90°C wet and dry, exposed run (ER)*



ELETTROTEK KABEL® GAALFLEX® TRAY 600 R



Construction:

Conductor: stranded red copper conductor similar Cl. 2, acc. to ASTM B3 and class B, stranded acc. to ASTM B8

Insulation: special PVC/Nylon compound: from 1 sqmm up to 1,5 sqmm: UL 62 type TFN from 2,5 sqmm: UL 83 typE THHN/THWN-2

Colour cores: acc. to ICEA S-73-532 table E2

Ground-Conductor insulation*:
14 AWG up to 6 AWG: insulated green ground.
4 AWG up to 750 MCM: uninsulated
acc. to UL 1277

Stranding:
construction 2x: cores parallel
construction from 3 cores and overall: in layers + fillers:
construction 3x+1G: cores twisted together + fillers:

Wrapping: synthetic tape

Ripcord: nylon ripcord under outer sheath

Outer sheath: black (RAL 9005), special PVC oil and UV resistance compound, flame retardant acc. to UL 1277

Features:

type THHN/THWN-2: UL type TC, 600, rated 90°C, wet and dry LEAD FREE, exposed runs (ER)*

TC: UL Standard 1277

wet and dry use

cable for tray use

UV resistance

weather resistance, direct burial class I, Div. 2 (also Zone 2), and class II, Div. 2 hazardous location acc. to NEC 2008/2011, as for Class III. Div 1&2 hazardous location acc. to NEC 2011

*Cables with 3 or more conductors are UL listed for exposed runs (ER) when installed in accordance with NEC 336.10

*ground conductor standard for sections 3x...+1G..., on request green-ground conductors for other sections

RoHS approval



Technical data:

Nominal voltage UL: 600V

Test voltage: 4 kV

Temperature range UL: up to +90°C

Fixed laying: - 25°C

Min. bending radius:

Fixed laying:

Section up to 2 inch (51 mm) outer Ø: 5 x d

Section over 2 inch (51 mm) outer Ø: 6 x d

Flexible installation: 8 x d

Part no.	No. of cores x cross section n x mm ²	Outer-Ø ca. mm ± 10%	Copper weight kg/km	Cable weight approx. kg/km	AWG no. (*)
32020F7T030A18	3 x 1	7,31	23,7	52	18
32020F7T030A16	3 x 1,5	7,77	37,44	86	16
32020F7T020A14	2 x 2,5 (flat)	5,3 x 8,1	48	95	14
32020F7T030A14	3 x 2,5	8,8	72	120	14
32020F7T040A14	4 x 2,5	9,6	96	150	14
32020F7T050A14	5 x 2,5	10,4	120	180	14
32020F7T060A14	6 x 2,5	11,3	144	215	14
32020F7T070A14	7 x 2,5	11,3	168	240	14
32020F7T080A14	8 x 2,5	12,1	192	270	14
32020F7T090A14	9 x 2,5	13	216	300	14
32020F7T100A14	10 x 2,5	14,7	240	360	14
32020F7T110A14	11 x 2,5	14,9	264	380	14
32020F7T120A14	12 x 2,5	15,4	288	410	14
32020F7T130A14	13 x 2,5	15,7	312	440	14
32020F7T140A14	14 x 2,5	16	336	470	14
32020F7T150A14	15 x 2,5	16,5	360	500	14
32020F7T160A14	16 x 2,5	17,3	384	520	14
32020F7T190A14	19 x 2,5	17,8	428	600	14
32020F7T200A14	20 x 2,5	18,2	480	630	14
32020F7T250A14	25 x 2,5	20,4	600	780	14
32020F7T300A14	30 x 2,5	22,8	720	960	14
32020F7T370A14	37 x 2,5	24,7	888	1160	14
32020F7T400A14	40 x 2,5	25,5	960	1250	14
32020F7T450A14	45 x 2,5	26,8	1080	1390	14
32020F7T500A14	50 x 2,5	27,8	1200	1450	14
32020F7T020A12	2 x 4 (flat)	5,8 x 9,2	77	130	12
32020F7T030A12	3 x 4	9,8	115	170	12
32020F7T040A12	4 x 4	10,6	154	200	12
32020F7T050A12	5 x 4	11,7	192	260	12

POWER AND CONTROL CABLES

GAALFLEX® TRAY 600 R

Special PVC UV and oil resistant, rigid tray cable,
type TFN or THHN/THWN-2, UL type TC 600V, 90°C wet and dry, exposed run (ER)*



ELETTROTEK KABEL® GAALFLEX® TRAY 600 R



Part no.	No. of cores x cross section n x mm ²	Outer-Ø ca. mm ± 10%	Copper weight kg/km	Cable weight approx. kg/km	AWG/MCM no. *)
32020F7T060A12	6 x 4	12,7	230	300	12
32020F7T070A12	7 x 4	12,7	269	330	12
32020F7T080A12	8 x 4	14,5	307	390	12
32020F7T090A12	9 x 4	15,7	346	450	12
32020F7T100A12	10 x 4	16,7	384	500	12
32020F7T110A12	11 x 4	16,9	422	540	12
32020F7T120A12	12 x 4	17,4	461	570	12
32020F7T130A12	13 x 4	17,7	499	630	12
32020F7T140A12	14 x 4	18,2	538	660	12
32020F7T150A12	15 x 4	18,8	576	710	12
32020F7T160A12	16 x 4	19,2	614	740	12
32020F7T190A12	19 x 4	20,3	730	860	12
32020F7T200A12	20 x 4	20,8	768	880	12
32020F7T250A12	25 x 4	24,3	960	1160	12
32020F7T300A12	30 x 4	25,9	1152	1380	12
32020F7T370A12	37 x 4	27,9	1421	1660	12
32020F7T400A12	40 x 4	28,9	1536	1830	12
32020F7T450A12	45 x 4	30,7	1728	2040	12
32020F7T500A12	50 x 4	31,8	1920	2240	12
32020F7T020A10	2 x 6 (flat)	6,7 x 11	115	180	10
32020F7T030A10	3 x 6	11,7	173	250	10
32020F7T040A10	4 x 6	12,7	230	295	10
32020F7T050A10	5 x 6	14,7	288	400	10
32020F7T060A10	6 x 6	16	347	490	10
32020F7T070A10	7 x 6	16	403	530	10
32020F7T080A10	8 x 6	17,2	461	600	10
32020F7T090A10	9 x 6	18,6	518	690	10
32020F7T100A10	10 x 6	19,9	576	740	10
32020F7T110A10	11 x 6	20,2	637	800	10
32020F7T120A10	12 x 6	20,8	691	870	10
32020F7T130A10	13 x 6	22,4	750	980	10
32020F7T140A10	14 x 6	22,9	806	1110	10
32020F7T150A10	15 x 6	23,5	864	1180	10
32020F7T160A10	16 x 6	24,2	922	1200	10
32020F7T190A10	19 x 6	25,4	1095	1380	10
32020F7T200A10	20 x 6	26,1	1152	1440	10
32020F7T250A10	25 x 6	29,3	1440	1770	10
32020F7T300A10	30 x 6	31,5	1728	2100	10
32020F7T370A10	37 x 6	33,9	2131	2550	10
32020F7T400A10	40 x 6	35,2	2304	2740	10
32020F7T450A10	45 x 6	37,2	2592	3050	10
32020F7T500A10	50 x 6	38,6	2880	3370	10
32020F7T041A14	3x2,5+1G2,5	9,3	96	135	14/14
32020F7T041A12	3x4+1G4	10,4	153,6	188	12/12
32020F7T041A10	3x6+1G6	11,7	230,4	284	10/10
32020F7T035A08	3x10+1G6	15,5	345,6	450	8/10
32020F7T035A06	3x16+1G10	18,4	556,8	630	6/8
32020F7T035A04	3x25+1G10	21,8	816	960	4/8
32020F7T035A02	3x35+1G16	25,3	1162	1430	2/6
32020F7T035A01	3x50 (42)+1G16	28,1	1221,12	1720	1/6
32020F7T035A1C	3x50 (53)+1G16	30,7	1375	2160	1/0 /6
32020F7T035A2C	3x70+1G16	32,9	2016	2590	2/0 /6
32020F7T035A3C	3x95+1G25	35,8	2170	3160	3/0 /4
32020F7T035A4C	3x120+1G25	38,9	3696	3835	4/0 /4
32020F7T035A5C	3x150+1G25	42,1	4560	4510	250/4
32020F7T035A7C	3x185+1G25 (27)	49,8	5584	6470	350/3
32020F7T035AAC	3x240 (253)+1G35	56,7	7622	8660	500/2
32020F7T045A08	4x10+1G6	17,2	442	560	8/10
32020F7T045A06	4x16+1G10	19,8	403	815	6/8
32020F7T045A04	4x25+1G10	23,9	1056	1220	4/8
32020F7T045A02	4x35+1G16	27,5	1498	1825	2/6
32020F7T045A01	4x50 (42)+1G16	31,7	1782	2260	1/6
32020F7T045A1C	4x50 (53)+1G16	33,4	2204	2695	1/0 /6
32020F7T045A2C	4x70+1G16	36,9	2842	3405	2/0 /6
32020F7T045A3C	4x95+1G25	40	3660	4100	3/0 /4
32020F7T045A4C	4x120+1G25	44,9	4848	5115	4/0 /4
32020F7T045A5C	4x150+1G25	49,2	6000	6020	250/4
32020F7T045A7C	4x185+1G25 (27)	55,4	7360	8155	350/3
32020F7T045AAC	4x240 (253)+1G35	63,3	10051	11271	500/2
32020F7T045AFC	4x400 (380)+1G50 (42)	78,6	15000	16910	750/1

Other dimension and colours available on request.

GAALFLEX® TRAY 1002

Special PVC oil resistant, flexible tray cable, Machine-Tool cable,
acc. to UL 1277 (TC-ER) and UL 1063 (MTW), 600V TC & MTW, 1000V AWM & IEC



ELETTROTEK KABEL® GAALFLEX® TRAY 1002



Construction:

Conductor:	flexible red copper conductor Cl. 5, acc to IEC 60228, DIN VDE 0295 and UL standard 83 from 18 to 16 AWG: cores type TFF from 14 AWG and over: cores type THHW
Insulation:	GAALTHERM® 522
Colour cores:	black cores with consecutive numbers acc. to EN 50334, green-yellow from 3 cores
Stranding:	in layers
Outer sheath:	black (RAL 9005), special PVC oil resistant compound acc. to UL 1277 and UL 1063

Resistance:



Fire performance acc. to:
(UL) FT4/IEEE, UL 1685



Oil resistance acc. to:
to UL OIL RES I



UV resistant / Sunlight resistant:
acc. to EN 50396 and HD 605 A1, UL 1581

Technical data:

Nominal voltage:	UL-TC/MTW 600 V
Nominal voltage:	IEC / UL-AWM 1000 V
Test voltage:	4 kV
Temperature range	
<i>Fixed laying:</i>	- 40°C up to +90°C (UL-AWM up to +105°C)
<i>Flexible application:</i>	- 5°C up to +90°C (UL-AWM up to +105°C)
Min. bending radius:	
<i>Fixed laying:</i>	4 x d
<i>Flexible installation:</i>	13 x d

Features:

UL AWM style 10012/21179 90°C 600 or 1000 V, CSA AWM I/II A/B
acc. to UL 1063 UL(MTW) and UL 1277 (TC-ER)
oil resistant acc. to UL OIL RES I,
water resistance and UL Wet approval 75°C
acc. to UL 2277: Flexible Motor Supply Lead Cable
and Wind Turbine Tray Cable (WTTC)
acc. to NFPA 79 2007 and NEC 336.10(7)
class 1 Div. 2 art 336, 392, 501
Direct burial acc. to UL 1277 part. 5.2. (wet location insulations)
and 18.1 - 18.6 (crushing test)
outdoor use
exposed runs
cable for tray use
oil resistance
water resistance
RoHS and CE approval



POWER AND CONTROL CABLES

GAALFLEX® TRAY 1002

Special PVC oil resistant, flexible tray cable, Machine-Tool cable,
acc. to UL 1277 (TC-ER) and UL 1063 (MTW), 600V TC & MTW, 1000V AWM & IEC



ELETTROTEK KABEL® GAALFLEX® TRAY 1002



Part no.	No. of cores x cross section n x mm ²	Outer-Ø ca. mm ± 10%	Copper weight kg/km	Cable weight approx. kg/km	AWG no. *)
32230H71020A18	2 x 1	8	19,2	90	18
32230H70031A18	3 G 1	8,4	28,8	105	18
32230H70041A18	4 G 1	9,2	38,4	125	18
32230H70051A18	5 G 1	10	48	150	18
32230H70071A18	7 G 1	10,9	67,2	185	18
32230H70081A18	8 G 1	12,8	76,8	245	18
32230H70101A18	10 G 1	14,2	96	305	18
32230H70121A18	12 G 1	14,7	115,2	335	18
32230H70181A18	18 G 1	17,1	172,8	470	18
32230H70251A18	25 G 1	19,5	240	620	18
32230H71020A16	2 x 1,5	8,7	28,8	110	16
32230H70031A16	3 G 1,5	9,2	43,2	130	16
32230H70041A16	4 G 1,5	10	57,6	150	16
32230H70051A16	5 G 1,5	10,9	72	190	16
32230H70071A16	7 G 1,5	11,9	100,8	240	16
32230H70081A16	8 G 1,5	14,6	115,2	335	16
32230H70121A16	12 G 1,5	16,1	172,8	430	16
32230H70181A16	18 G 1,5	18,8	259,2	600	16
32230H70251A16	25 G 1,5	22,7	360	860	16
32230H71020A14	2 x 2,5	9,5	48	150	14
32230H70031A14	3 G 2,5	10	72	170	14
32230H70041A14	4 G 2,5	10,9	96	210	14
32230H70051A14	5 G 2,5	12	120	255	14
32230H70071A14	7 G 2,5	13,1	168	325	14
32230H70081A14	8 G 2,5	16,1	192	440	14
32230H70121A14	12 G 2,5	17,8	288	580	14
32230H70181A14	18 G 2,5	20,9	432	820	14
32230H70031A12	3 G 4	11,4	115,2	235	12
32230H70041A12	4 G 4	12,5	153,6	295	12
32230H70051A12	5 G 4	14,5	192	385	12
32230H70071A12	7 G 4	15,8	268,8	485	12
32230H70031A10	3 G 6	12,6	172,8	310	10
32230H70041A10	4 G 6	14,6	230,4	415	10
32230H70051A10	5 G 6	16	288	510	10
32230H70031A08	3 G 10	17,1	288	550	8
32230H70041A08	4 G 10	18,7	384	685	8
32230H70051A08	5 G 10	20,7	480	850	8
32230H70031A06	3 G 16	20,8	460,8	840	6
32230H70041A06	4 G 16	23,9	614,4	1115	6
32230H70051A06	5 G 16	26,4	768	1375	6
32230H70041A04	4 G 25	27,4	960	1580	4
32230H70041A02	4 G 35	30,1	1344	2050	2
32230H70041A01	4 G 50	36,8	1920	2980	1
32230H70041A2C	4 G 70	41,8	2688	3975	2/0
32230H70041A3C	4 G 95	46,8	3648	5200	3/0
32230H70041A4C	4 G 120	49,4	4608	6330	4/0
32230H70041A5C	4 G 150	55	5760	7660	250 MCM

Other dimension and colours available on request.

GAALFLEX® TRAY 600 XR

Special XLPE UV and oil resistant, rigid tray cable,
UL Type TC/TC-ER 600 V, 90°C dry or wet



ELETTROTEK KABEL® GAALFLEX® TRAY 600 XR



Construction:

Conductor:	Stranded red copper conductor similar Cl. 2, acc. to ASTM B3 and B8
Insulation:	special XLPE type XHHW-2, flame retardant, acc. to UL 44 and ICEA S-95-658
Colour cores:	14 AWG up to 10 AWG from 2 up to 37 conductors, acc. to ICEA S-73-532 table E2 method 1 over 38 conductors, acc. to ICEA S-73-532 method 4, black numbered 8 AWG up to 750 MCM, acc. to ICEA S-73-532 method 4, black numbered
Ground-Conductor insulation:	14 AWG up to 6 AWG, green insulation, acc. to UL 1277 4 AWG and Larger, uninsulated, acc. to UL 1277
Stranding:	in layers + fillers
Wrapping:	synthetic tape
Ripcord:	nylon ripcord under outer sheath
Outer sheath:	black (RAL 9005), special PVC oil and UV resistance compound, flame retardant acc. to UL 1277

Technical data:

Nominal voltage UL:	600 V
Test voltage:	4 kV
Temperature range UL:	up to +90°C
<i>Fixed laying:</i>	- 25°C
Radiation resistance:	8×10^7 cJ/kg
Min. bending radius:	
<i>Fixed laying:</i>	5 x d
<i>Fixed Installation:</i>	8 x d

Resistance:



Fire performance acc. to:
acc. to UL 1685 and IEEE 383
vertical fire tests at 70,000 BTU/hr
acc. to IEEE 1202 and FT4,
70,000 BTU/hr flame test
acc. to ICEA T-29-520,
210,000 BTU/hr flame test
14 AWG up to 8 AWG acc. to VW-1
6 AWG and larger are not acc. to VW-1

Features:

cable for tray use
outdoor use
sunlight and moisture and weather resistance
DIRECT BURIAL
LEAD FREE
UL listed for Exposed Run (ER), acc. to NEC 2008
and NEC 2011 Article 336.10(7)
acc. to ICEA S-95-658, NEMA publication No. WC-70
suitable in class I Division 2 and Class 2 Division 2
Hazardous Locations and intrinsically safe application
acc. to NEC 2008 and NEC 2011 articles 392, 501, 502, 503, 505
acc. to NEC 2008 and NEC 2011 articles 336.10 and 725
for class 1 circuits
acc. to NEC 2008 and NEC 2011 articles 336.10 and 760.27
for non-power-limited- alarm circuit
on request cables sized 4 AWG and larger
with green insulation ground conductor
on request ground conductor for *Multiconductor sections*:
identified with "1" on the 11th number, of the Part. no,
for sections from 3 up to 37 conductors,
identified with "0" on the 8th number, and "1" on the 11th number
of the Part. no, for sections over 38 conductors
on request aluminium conductors for size 12 AWG
up to 1000 kcmil
on request aluminium/mylar tape screen
(with or without tinned copper drain wire)
on request Oil resisant I or Oil resistant II outer sheath
on request 2000 V cables with RHH/RHW-2 insulated conductors
RoHS approval



UL Standards

TC TC/ER: UL Standard 1277 Dry or Wet 90°C 600 V
UL 44 thermoset insulation

POWER AND CONTROL CABLES

GAALFLEX® TRAY 600 XR

Special XLPE UV and oil resistant, rigid tray cable,
UL Type TC/TC-ER 600V, 90°C dry or wet



ELETTROTEK KABEL® GAALFLEX® TRAY 600 XR



2/3 or 4 CONDUCTORS + 1 GROUND:

Part no.	No. of cores x cross section n x AWG/MCM	Outer-Ø inches/mm ± 10%		Cable weight approx. lbs/ft - kg/km	
32030F7T025A4C	2 x 4/0 + 1 G 4	1,409	35,8	1815	2700
32030F7T035A12	3 x 12 + 1 G 12	0,472	12	154	230
32030F7T035A10	3 x 10 + 1 G 10	0,531	13,5	215	320
32030F70035A08	3 x 8 + 1 G 10	0,673	17,1	336	500
32030F70035A06	3 x 6 + 1 G 8	0,775	19,7	464	690
32030F70035A04	3 x 4 + 1 G 8	0,826	21	625	930
32030F70035A03	3 x 3 + 1 G 6	0,925	23,5	853	1270
32030F70035A02	3 x 2 + 1 G 6	0,996	25,3	954	1420
32030F70035A01	3 x 1 + 1 G 6	1,102	28	1230	1830
32030F70035A1C	3 x 1/0 + 1 G 6	1,189	30,2	1398	2080
32030F70035A2C	3 x 2/0 + 1 G 6	1,279	32,5	1700	2530
32030F70035A3C	3 x 3/0 + 1 G 4	1,409	35,8	2184	3250
32030F70035A4C	3 x 4/0 + 1 G 4	60,8	39,3	2540	3780
32030F70035A5C	3 x 250 + 1 G 4	1,642	41,7	2984	4440
32030F70035A6C	3 x 300 + 1 G 3	1,807	45,9	3447	5130
32030F70035A7C	3 x 350 + 1 G 3	1,941	49,3	4119	6130
32030F70035A8C	3 x 400 + 1 G 3	2,027	51,5	4865	7240
32030F70035AAC	3 x 500+ 1 G 2	2,197	55,8	5719	8510
32030F70035AFC	3 x 750 + 1 G 1	2,578	65,5	8620	12825
32030F7T045A10	4 x 10 + 1 G 10	0,610	15,5	282	420
32030F70045A08	4 x 8 + 1 G 10	0,740	18,8	403	600
32030F70045A06	4 x 6 + 1 G 8	0,897	22,8	605	900
32030F70045A04	4 x 4 + 1 G 8	0,956	24,3	826	1230
32030F70045A03	4 x 3 + 1 G 6	1,043	26,5	1055	1570
32030F70045A02	4 x 2 + 1 G 6	1,102	28	1210	1800
32030F70045A01	4 x 1 + 1 G 6	1,232	31,3	1498	2230
32030F70045A1C	4 x 1/0 + 1 G 6	1,319	33,5	1808	2690
32030F70045A2C	4 x 2/0 + 1 G 6	1,425	36,2	2184	3250
32030F70045A3C	4 x 3/0 + 1 G 6	1,543	39,2	2701	4020
32030F70045A4C	4 x 4/0 + 1 G 4	1,665	42,3	3279	4880
32030F70045A5C	4 x 250 + 1 G 4	1,890	48	3978	5920
32030F70045A6C	4 x 300 + 1 G 3	2,019	51,3	4690	6980
32030F70045A7C	4 x 350 + 1 G 3	2,126	54	5362	7980
32030F70045A8C	4 x 400 + 1 G 3	2,240	56,9	6075	9040
32030F70045AAC	4 x 500+ 1 G 2	2,433	61,8	7459	11100
32030F70045AFC	4 x 750 + 1 G 1	2,92	74,2	11390	16950

POWER AND CONTROL CABLES

GAALFLEX® TRAY 600 XR

Special XLPE UV and oil resistant, rigid tray cable,
UL Type TC/TC-ER 600 V, 90°C dry or wet



ELETTROTEK KABEL® GAALFLEX® TRAY 600 XR



MULTICONDUCTOR:

Part no.	No. of cores x cross section n x AWG/MCM	Outer-Ø inches/mm ± 10%	Cable weight approx. lbs/mft - kg/km	
32030F7T020A14	2 x 14	0,386	9,8	77 115
32030F7T030A14	3 x 14	0,406	10,3	97 145
32030F7T040A14	4 x 14	0,445	11,3	121 180
32030F7T050A14	5 x 14	0,488	12,4	148 220
32030F7T060A14	6 x 14	0,528	13,4	175 260
32030F7T070A14	7 x 14	0,528	13,4	188 280
32030F7T080A14	8 x 14	0,602	15,3	218 325
32030F7T090A14	9 x 14	0,646	16,4	242 360
32030F7T100A14	10 x 14	0,689	17,5	269 400
32030F7T110A14	11 x 14	0,697	17,7	289 430
32030F7T120A14	12 x 14	0,717	18,2	309 460
32030F7T130A14	13 x 14	0,732	18,6	329 490
32030F7T140A14	14 x 14	0,756	19,2	349 520
32030F7T150A14	15 x 14	0,772	19,6	370 550
32030F7T190A14	19 x 14	0,858	21,8	457 680
32030F7T200A14	20 x 14	0,866	22	477 710
32030F7T250A14	25 x 14	1,012	25,7	618 920
32030F7T300A14	30 x 14	1,079	27,4	726 1080
32030F7T350A14	35 x 14	1,142	29	827 1230
32030F7T370A14	37 x 14	1,181	30	874 1300
32030F71400A14	40 x 14	1,201	30,5	934 1390
32030F71450A14	45 x 14	1,272	32,3	1035 1540
32030F71500A14	50 x 14	1,323	33,6	1136 1690
32030F7T020A12	2 x 12	0,421	10,7	94 140
32030F7T030A12	3 x 12	0,445	11,3	128 190
32030F7T040A12	4 x 12	0,488	12,4	161 240
32030F7T050A12	5 x 12	0,539	13,7	198 295
32030F7T060A12	6 x 12	0,614	15,6	249 370
32030F7T070A12	7 x 12	0,614	15,6	276 410
32030F7T080A12	8 x 12	0,661	16,8	296 440
32030F7T090A12	9 x 12	0,713	18,1	343 510
32030F7T100A12	10 x 12	0,756	19,2	363 540
32030F7T110A12	11 x 12	0,772	19,6	390 580
32030F7T120A12	12 x 12	0,799	20,3	420 625
32030F7T130A12	13 x 12	0,815	20,7	450 670
32030F7T120A12	12 x 12	0,839	21,3	480 715
32030F7T150A12	15 x 12	0,862	21,9	511 760
32030F7T190A12	19 x 12	0,957	24,3	659 980
32030F7T200A12	20 x 12	0,996	25,3	692 1030
32030F7T250A12	25 x 12	1,118	28,4	853 1270
32030F7T300A12	30 x 12	1,193	30,3	1001 1490
32030F7T350A12	35 x 12	1,268	32,2	1149 1710
32030F7T370A12	37 x 12	1,268	32,2	1284 1910
32030F71400A12	40 x 12	1,339	34	1297 1930
32030F71450A12	45 x 12	1,417	36	1445 2150
32030F71500A12	50 x 12	1,469	37,3	1586 2360
32030F7T020A10	2 x 10	0,472	12	131 195
32030F7T030A10	3 x 10	0,496	12,6	178 265
32030F7T040A10	4 x 10	0,547	13,9	228 340
32030F7T050A10	5 x 10	0,634	16,1	296 440
32030F7T060A10	6 x 10	0,689	17,5	346 515
32030F7T070A10	7 x 10	0,689	17,5	386 575
32030F7T080A10	8 x 10	0,744	18,9	417 620
32030F7T090A10	9 x 10	0,803	20,4	484 720
32030F7T100A10	10 x 10	0,858	21,8	511 760
32030F7T110A10	11 x 10	0,913	23,2	588 875
32030F7T120A10	12 x 10	0,937	23,8	632 940
32030F7T130A10	13 x 10	0,953	24,2	672 1000
32030F7T120A10	14 x 10	0,984	25	726 1080
32030F7T150A10	15 x 10	1,016	25,8	766 1140
32030F7T200A10	20 x 10	1,130	28,7	988 1470
32030F7T250A10	25 x 10	1,264	32,1	1216 1810
32030F7T300A10	30 x 10	1,346	34,2	1431 2130
32030F7T350A10	35 x 10	1,433	36,4	1653 2460
32030F71400A10	40 x 10	1,512	38,4	1868 2780
32030F71450A10	45 x 10	1,606	40,8	2090 3110
32030F71500A10	50 x 10	1,665	42,3	2305 3430

POWER AND CONTROL CABLES

GAALFLEX® TRAY 600 XR

Special XLPE UV and oil resistant, rigid tray cable,
UL Type TC/TC-ER 600V, 90°C dry or wet



ELETTROTEK KABEL® GAALFLEX® TRAY 600 XR



MULTICONDUCTOR:

Part no.	No. of cores x cross section n x AWG/MCM	Outer-Ø inches/mm ± 10%		Cable weight approx. lbs/mft - kg/km
32030F7T050A08	5 x 8	0,778	19,8	407 605
32030F7T070A08	7 x 8	0,891	22,6	577 858
32030F7T120A08	12 x 8	1,171	29,7	948 1410

Other dimension and colours available on request.

GAALFLEX® TRAY 600 CY Lean

Special PVC UV and oil resistant, flexible tray cable, Machine-Tool cable
with overall copper screen, UL-AWM / (UL) / c(UL): 600V, (UL) WTTC: 1000 V



ELETTROTEK KABEL® GAALFLEX® TRAY 600 CY lean

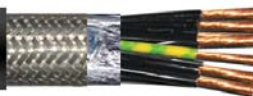

Construction:

Conductor:	flexible red copper conductor Cl. 5, acc to IEC 60228, DIN VDE 0295 and UL standard 758 table 5.1 + UL 1518 table 20.1
Insulation:	special PVC/Nylon compound: from 1 sqmm up to 1,5 sqmm: UL TFFN > 1,5 sqmm: UL THHN
Colour cores:	black cores with consecutive numbers acc. to EN 50334, green-yellow from 3 cores
Stranding:	in layers
Screen:	aluminium tape and tinned copper braid + tinned copper drain wire
Outer sheath:	black (RAL 9005), special PVC oil resistant compound

Resistance:



Fire performance acc. to:
(UL) FT4 and c(UL) FT1 FT2 FT4

Technical data:

Nominal voltage:	UL-AWM / (UL) / c(UL): 600V (UL) WTTC: 1000V
Test voltage:	2 kV
Temperature range	(UL) / c(UL): up to +90°C
<i>Fixed laying:</i>	- 40°C
Radiation resistance:	8 x 10 ⁷ cJ/kg
Min. bending radius:	
<i>Fixed laying:</i>	6 x d
<i>Flexible installation:</i>	20 x d

Features:

UL AWM style 2587 90°C 600 V
(UL) Type TC-ER 90°C 600 V,
FT4 (UL) WTTC 90°C 1000 V (UL)
MTW 600 V flexing
Type CIC SCREENED 90°C dry 600 V FT1 FT2 FT4 CE

flexible cable for cable tray use
new: improved with WTTC approval
WTTC:UL subject 2277
TC: UL Standard 1277
exposed runs
UV resistance
RoHS and CE approval



POWER AND CONTROL CABLES

GAALFLEX® TRAY 600 CY Lean

Special PVC UV and oil resistant, flexible tray cable, Machine-Tool cable
with overall copper screen, UL-AWM / (UL) / c(UL): 600V, (UL) WTTC: 1000V



ELETTROTEK KABEL® GAALFLEX® TRAY 600 CY lean

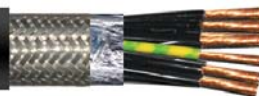

Part no.	No. of cores x cross section n x mm ²	Outer-Ø ca. mm ± 10%	Copper weight kg/km	Cable weight approx. kg/km	AWG no. *)
32060G70031A18	3 G 1	8,1	51	110	18
32060G70041A18	4 G 1	8,5	64	119	18
32060G70051A18	5 G 1	9,3	77	152	18
32060G70071A18	7 G 1	10,1	101	186	18
32060G70031A16	3 G 1,5	8,6	71	118	16
32060G70041A16	4 G 1,5	9,2	89	155	16
32060G70051A16	5 G 1,5	10,1	108	183	16
32060G70071A16	7 G 1,5	10,9	143	226	16
32060G70121A16	12 G 1,5	14,8	240	384	16
32060G70181A16	18 G 1,5	17,2	346	557	16
32060G70251A16	25 G 1,5	20,2	472	727	16
32060G70031A14	3 G 2,5	9,6	106	169	14
32060G70041A14	4 G 2,5	10,5	136	214	14
32060G70051A14	5 G 2,5	11,2	166	246	14
32060G70071A14	7 G 2,5	12,4	223	313	14
32060G70121A14	12 G 2,5	16,6	311,7	531	14
32060G70181A14	18 G 2,5	19,4	496,5	725	14
32060G70251A14	25 G 2,5	23,8	634	1062	14
32060G70041A14	4 G 2,5	10,5	136	214	14
32060G70051A14	5 G 2,5	11,2	166	246	14
32060G70071A14	7 G 2,5	12,4	223	313	14
32060G70121A14	12 G 2,5	16,6	311,7	531	14
32060G70181A14	18 G 2,5	19,4	496,5	725	14
32060G70251A14	25 G 2,5	23,8	634	1062	14
32060G70031A12	3 G 4	11,0	140	231	12
32060G70041A12	4 G 4	11,6	205	279	12
32060G70051A12	5 G 4	13,0	175,5	340	12
32060G70071A12	7 G 4	14,8	294,2	468	12
32060G70031A10	3 G 6	13,1	232	345	10
32060G70041A10	4 G 6	14,9	306	443	10
32060G70051A10	5 G 6	16,4	320	547	10
32060G70071A10	7 G 6	17,7	408	677	10
32060G70031A08	3 G 10	18,2	388	531	8
32060G70041A08	4 G 10	21,2	517	816	8
32060G70051A08	5 G 10	23,3	555	1005	8
32060G70071A08	7 G 10	25,5	750	1252	8
32060G70031A06	3 G 16	21,2	570	882	6
32060G70041A06	4 G 16	23,4	789	1107	6
32060G70051A06	5 G 16	26,2	799	1305	6
32060G70071A06	7 G 16	28,4	1216,5	1718	6
32060G70041A04	4 G 25	28,3	1101,5	1636	4
32060G70041A02	4 G 35	32,6	1505	2217	2

Other dimension and colours available on request.

GAALFLEX® TRAY 600 R CY

Special PVC UV and oil resistant tray cable, with overall Aluminium tape screen, type TFN or THHN/THWN-2, UL type TC 600V, 90°C wet and dry, exposed run (ER)*



ELETTROTEK KABEL® GAALFLEX® TRAY 600 R CY



Construction:

Conductor:	stranded red copper conductor similar Cl. 2, acc. to ASTM B3 and class B, stranded acc. to ASTM B8
Insulation:	special PVC/Nylon compound: from 1 sqmm up to 1,5 sqmm: UL 66 type TFN from 2,5 sqmm: UL 83 typE THHN/ THWN-2
Colour cores:	acc. to ICEA S-73-532 table E2
Stranding:	<i>construction 2x:</i> cores parallel <i>construction from 3 cores and overall:</i> in layers + fillers
Wrapping:	synthetic tape
Screen:	aluminium tape + tinned copper drain wire
Ripcord:	nylon ripcord under outer sheath
Outer sheath:	black (RAL 9005), special PVC oil and UV resistance compound, flame retardant acc. to UL 1277

Features:

type THHN/THWN-2: UL type TC, 600, rated 90°C, wet and dry LEAD FREE, exposed runs (ER)*
TC: UL Standard 1277
wet and dry use
cable for tray use
UV resistance
weather resistance, direct burial class I, Div. 2 (also Zone 2), and class II, Div. 2 hazardous location acc. to NEC
*Cables with 3 or more conductors are UL listed for exposed runs (ER) when installed in accordance with NEC 336.10
on request green-ground conductor
RoHS approval



Technical data:

Nominal voltage UL:	600V
Test voltage:	4 kV
Temperature range UL:	up to +90°C
<i>Fixed laying:</i>	- 25°C
Min. bending radius:	
<i>Fixed laying:</i>	5 x d
<i>Flexible installation:</i>	8 x d

Part no.	No. of cores x cross section n x mm ²	Outer-Ø ca. mm ± 10%	Copper weight kg/km	Cable weight approx. kg/km	AWG no. (*)
32070F7T030A18	3 x 1	7,47	28,7	73	18
32070F7T030A16	3 x 1,5	7,98	45,63	100	16
32070F7T020A14	2 x 2,5	8,5	48	115	14
32070F7T030A14	3 x 2,5	9	72	140	14
32070F7T040A14	4 x 2,5	9,7	96	170	14
32070F7T050A14	5 x 2,5	10,6	120	200	14
32070F7T060A14	6 x 2,5	11,5	144	230	14
32070F7T070A14	7 x 2,5	11,5	168	250	14
32070F7T080A14	8 x 2,5	12,6	192	290	14
32070F7T090A14	9 x 2,5	13,5	216	320	14
32070F7T100A14	10 x 2,5	15	240	380	14
32070F7T110A14	11 x 2,5	15,2	264	400	14
32070F7T120A14	12 x 2,5	15,7	288	440	14
32070F7T130A14	13 x 2,5	16	312	460	14
32070F7T140A14	14 x 2,5	16,4	336	490	14
32070F7T150A14	15 x 2,5	16,8	360	510	14
32070F7T160A14	16 x 2,5	17,3	384	550	14
32070F7T190A14	19 x 2,5	18,1	428	630	14
32070F7T200A14	20 x 2,5	18,6	480	660	14

POWER AND CONTROL CABLES

GAALFLEX® TRAY 600 R CY

Special PVC UV and oil resistant tray cable, with overall Aluminium tape screen, type TFN or THHN/THWN-2, UL type TC 600V, 90°C wet and dry, exposed run (ER)*



ELETTROTEK KABEL® GAALFLEX® TRAY 600 R CY



Part no.	No. of cores x cross section n x mm ²	Outer-Ø ca. mm ± 10%	Copper weight kg/km	Cable weight approx. kg/km	AWG no. *)
32070F7T250A14	25 x 2,5	20,7	600	800	14
32070F7T300A14	30 x 2,5	23,2	720	990	14
32070F7T370A14	37 x 2,5	24,8	888	1200	14
32070F7T400A14	40 x 2,5	25,7	960	1280	14
32070F7T450A14	45 x 2,5	27,2	1080	1420	14
32070F7T500A14	50 x 2,5	28,2	1200	1550	14
32070F7T020A12	2 x 4	9,7	77	150	12
32070F7T030A12	3 x 4	10,2	115	190	12
32070F7T040A12	4 x 4	11	154	230	12
32070F7T050A12	5 x 4	11,9	192	290	12
32070F7T060A12	6 x 4	13	230	330	12
32070F7T070A12	7 x 4	13	269	360	12
32070F7T080A12	8 x 4	14,8	307	420	12
32070F7T090A12	9 x 4	15,9	346	500	12
32070F7T100A12	10 x 4	16,9	384	530	12
32070F7T110A12	11 x 4	17,1	422	570	12
32070F7T120A12	12 x 4	17,7	461	620	12
32070F7T130A12	13 x 4	18	499	650	12
32070F7T140A12	14 x 4	18,5	538	690	12
32070F7T150A12	15 x 4	19	576	730	12
32070F7T160A12	16 x 4	19,3	614	770	12
32070F7T190A12	19 x 4	20,5	730	880	12
32070F7T200A12	20 x 4	21	768	950	12
32070F7T250A12	25 x 4	24,7	960	1190	12
32070F7T300A12	30 x 4	26,7	1152	1390	12
32070F7T370A12	37 x 4	28,4	1421	1680	12
32070F7T400A12	40 x 4	29,3	1536	1840	12
32070F7T450A12	45 x 4	31	1728	2050	12
32070F7T500A12	50 x 4	32	1920	2260	12
32070F7T020A10	2 x 6	11,2	115	200	10
32070F7T030A10	3 x 6	11,8	173	270	10
32070F7T040A10	4 x 6	12,9	230	300	10
32070F7T050A10	5 x 6	14,8	288	430	10
32070F7T060A10	6 x 6	16	347	500	10
32070F7T070A10	7 x 6	16	403	560	10
32070F7T080A10	8 x 6	17,7	461	630	10
32070F7T090A10	9 x 6	19	518	700	10
32070F7T100A10	10 x 6	20,3	576	760	10
32070F7T110A10	11 x 6	20,5	637	830	10
32070F7T120A10	12 x 6	22,3	691	950	10
32070F7T130A10	13 x 6	22,6	750	1000	10
32070F7T140A10	14 x 6	23,4	806	1130	10
32070F7T150A10	15 x 6	23,7	864	1200	10
32070F7T160A10	16 x 6	24,6	922	1290	10
32070F7T190A10	19 x 6	25,8	1095	1400	10
32070F7T200A10	20 x 6	26,6	1152	1470	10
32070F7T250A10	25 x 6	29,9	1440	1780	10
32070F7T300A10	30 x 6	31,7	1728	2120	10
32070F7T370A10	37 x 6	34,2	2131	2570	10
32070F7T400A10	40 x 6	35,4	2304	2760	10
32070F7T450A10	45 x 6	37,6	2592	3070	10
32070F7T500A10	50 x 6	39	2880	3400	10

Other dimension and colours available on request.

GAALFLEX® TRAY 1002 CY Lean

Special PVC oil resistant, flexible tray cable, Machine-Tool cable, with overall copper screen, acc. to UL 1277 (TC-ER) and UL 1063 (MTW), 600 V TC & MTW, 1000 V AWM & IEC



ELETTROTEK KABEL® GAALFLEX® TRAY 1002 CY lean

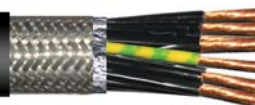

Construction:

Conductor:	flexible red copper conductor Cl. 5, acc. to IEC 60228, DIN VDE 0295 and UL standard 83 from 18 to 16 AWG: cores type TFF from 14 AWG and over: cores type THHW
Insulation:	GAALTHERM® 522
Colour cores:	black cores with consecutive numbers acc. to EN 50334, green-yellow from 3 cores
Stranding:	in layers
Screen:	aluminium tape and tinned copper braid
Outer sheath:	black (RAL 9005), special PVC oil resistant compound acc. to UL 1277 and UL 1063

Technical data:

Nominal voltage:	UL-TC/MTW 600 V
Nominal voltage:	IEC / UL-AWM 1000 V
Test voltage:	4 kV
Temperature range	
<i>Fixed laying:</i>	- 40°C up to +90°C (UL-AWM up to +105°C)
<i>Flexible application:</i>	- 5°C up to +90°C (UL-AWM up to +105°C)
Min. bending radius:	
<i>Fixed laying:</i>	6 x d
<i>Flexible installation:</i>	20 x d

Resistance:



Fire performance acc. to:
(UL) FT4/IEEE, UL 1685



Oil resistance acc. to:
to UL OIL RES I



UV resistant / Sunlight resistant:
acc. to EN 50396 and HD 605 A1, UL 1581

Features:

UL AWM style 10012/21179 90°C 600 or 1000 V, CSA AWM I/II A/B acc. to UL 1063 UL(MTW) and UL 1277 (TC-ER) oil resistant acc. to UL OIL RES I, water resistance and UL Wet approval 75°C

acc. to UL 2277: Flexible Motor Supply Lead Cable (Flexible VFD Servo Cable) and Wind Turbine Tray Cable (WTTC)

acc. to NFPA 79 2007 and NEC 336.10(7) class 1 Div. 2 art 336, 392, 501

Direct burial acc. to UL 1277 part. 5.2. (wet location insulations) and 18.1 - 18.6 (crushing test)

outdoor use
exposed runs
cable for tray use
oil resistance
water resistance
RoHS and CE approval



POWER AND CONTROL CABLES

GAALFLEX® TRAY 1002 CY Lean

Special PVC oil resistant, flexible tray cable, Machine-Tool cable,
with overall copper screen, acc. to UL 1277 (TC-ER) and UL 1063 (MTW), 600 VTC & MTW, 1000 V AWM & IEC



ELETTROTEK KABEL® GAALFLEX® TRAY 1002 CY lean

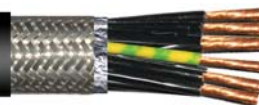

Part no.	No. of cores x cross section n x mm ²	Outer-Ø ca. mm ± 10%	Copper weight kg/km	Cable weight approx. kg/km	AWG no. *)
32240H71020A18	2 x 1	8,5	44,0	100	18
32240H70031A18	3 G 1	8,9	58,4	122	18
32240H70041A18	4 G 1	9,7	67,9	145	18
32240H70051A18	5 G 1	10,5	82,6	175	18
32240H70071A18	7 G 1	11,4	106,7	212	18
32240H70121A18	12 G 1	15,5	185,2	350	18
32240H70181A18	18 G 1	17,9	260,5	485	18
32240H70251A18	25 G 1	20,3	336,3	610	18
32240H71020A16	2 x 1,5	9,2	58,4	125	16
32240H70031A16	3 G 1,5	9,7	72,7	145	16
32240H70041A16	4 G 1,5	10,5	92,2	185	16
32240H70051A16	5 G 1,5	11,4	111,5	220	16
32240H70071A16	7 G 1,5	12,4	145,3	270	16
32240H70121A16	12 G 1,5	16,9	251,8	450	16
32240H70181A16	18 G 1,5	19,6	355,6	630	16
32240H70251A16	25 G 1,5	23,4	474,0	770	16
32240H71020A14	2 x 2,5	10,0	82,5	158	14
32240H70031A14	3 G 2,5	10,5	106,6	190	14
32240H70041A14	4 G 2,5	11,4	135,6	240	14
32240H70051A14	5 G 2,5	12,5	164,4	290	14
32240H70071A14	7 G 2,5	14,6	229,6	390	14
32240H70121A14	12 G 2,5	18,5	375,9	610	14
32240H70181A14	18 G 2,5	22,6	537,5	850	14
32240H70031A12	3 G 4	11,9	154,6	260	12
32240H70041A12	4 G 4	13,0	198,1	335	12
32240H70051A12	5 G 4	15,2	262,1	435	12
32240H70071A12	7 G 4	16,5	348,0	550	12
32240H70031A10	3 G 6	13,9	217,2	355	10
32240H70041A10	4 G 6	15,3	300,7	480	10
32240H70051A10	5 G 6	16,7	367,0	570	10
32240H70041A08	4 G 10	19,4	480,8	770	8
32240H70051A08	5 G 10	22,4	585,4	960	8
32240H70041A06	4 G 16	24,6	737,3	1210	6
32240H70051A06	5 G 16	27,1	899,7	1450	6
32240H70041A04	4 G 25	28,1	1100,6	1700	4
32240H70041A02	4 G 35	31,0	1502,0	2210	2
32240H70041A01	4 G 50	37,7	2166,7	3210	1
32240H70041A2C	4 G 70	44,2	2976,1	4400	2/0
32240H70041A3C	4 G 95	47,7	3963,5	5570	3/0
32240H70041A4C	4 G 120	50,3	4937,2	6660	4/0
32240H70041A5C	4 G 150	55,9	6130,5	8260	250 MCM

Other dimension and colours available on request.

DATA AND INSTRUMENTATION CABLES



GAALFLEX® DATA LiYY UL

PVC data cable, 300 V UL/CSA



ELETTROTEK KABEL® GAALFLEX® DATA LiYY UL



Construction:

Conductor:	flexible red copper conductor acc. to ASTM B 286
Insulation:	PVC semi-rigid compound
Colour cores:	acc. to US 2
Stranding:	in layers
Outer sheath:	grey, (RAL 7032), PVC type YM1, acc. to DIN VDE 0207 part. 5

Resistance:



Self-extinguishing and flame retardant acc. to:
DIN VDE 0482 part 265-2-1
EN 50265-2-1
IEC 60332-1-2,
CSA FT1 FT2



Oil resistance acc. to:
DIN VDE 0473 part 811-2-1
IEC EN 60811-2-1

Technical data:

Nominal voltage:	300 V
Test voltage:	1,5 kV
Temperature range	DIN VDE: UL/CSA: up to + 80°C
<i>Fixed laying:</i>	- 30°C up to +70°C
<i>Flexible installation:</i>	- 5°C up to + 70°C
Min. bending radius	
<i>Fixed laying:</i>	5 x d
<i>Flexible installation:</i>	10 x d

Features:

on request color cores acc. to DIN 47100

 AWM style 2464 80°C 300 V CSA AWM I/II A/B 80°C 300 V FT1 FT2 CE

flexible

small outer diameter

small bending radius

RoHS and CE approval



DATA AND INSTRUMENTATION CABLES

GAALFLEX® DATA LiYY UL

PVC data cable, 300 V UL/CSA



ELETTROTEK KABEL® GAALFLEX® DATA LiYY UL



Part no.	No. of cores x cross section n x mm ²	Outer-Ø ca. mm ± 10%	Copper weight kg/km	Cable weight approx. kg/km	AWG no. *)
35070C66020A26	2 x 0,14	3,6	2,7	16	26
35070C66030A26	3 x 0,14	3,8	4	19	26
35070C66040A26	4 x 0,14	4	5,4	21	26
35070C66050A26	5 x 0,14	4,3	6,7	25	26
35070C66070A26	7 x 0,14	4,7	9,4	30	26
35070C66080A26	8 x 0,14	5,2	10,8	36	26
35070C66120A26	12 x 0,14	5,7	16,1	45	26
35070C66160A26	16 x 0,14	6,3	21,5	56	26
35070C66180A26	18 x 0,14	6,6	24,2	61	26
35070C66250A26	25 x 0,14	7,8	33,6	80	26
35070C66020A24	2 x 0,25	3,9	4,4	20	24
35070C66030A24	3 x 0,25	4,1	6,6	23	24
35070C66040A24	4 x 0,25	4,3	8,8	27	24
35070C66050A24	5 x 0,25	4,7	11	32	24
35070C66070A24	7 x 0,25	5	15,5	39	24
35070C66080A24	8 x 0,25	5,7	17,7	45	24
35070C66120A24	12 x 0,25	6,3	26,5	59	24
35070C66160A24	16 x 0,25	6,9	35,3	74	24
35070C66180A24	18 x 0,25	7,2	39,7	82	24
35070C66250A24	25 x 0,25	8,5	55,2	107	24
35070C66020A22	2 x 0,34	4,2	6	24	22
35070C66030A22	3 x 0,34	4,4	10,4	29	22
35070C66040A22	4 x 0,34	4,7	13,8	34	22
35070C66050A22	5 x 0,34	5,1	17,3	41	22
35070C66070A22	7 x 0,34	5,5	24,2	51	22
35070C66080A22	8 x 0,34	6,2	27,6	60	22
35070C66120A22	12 x 0,34	6,9	41,5	78	22
35070C66160A22	16 x 0,34	7,6	55,3	100	22
35070C66180A22	18 x 0,34	8	62,2	110	22
35070C66250A22	25 x 0,34	9,4	86,4	146	22
35070C66020A20	2 x 0,5	4,7	11,9	33	20
35070C66030A20	3 x 0,5	4,9	17,9	40	20
35070C66040A20	4 x 0,5	5,3	23,8	48	20
35070C66050A20	5 x 0,5	5,7	29,8	57	20
35070C66070A20	7 x 0,5	6,2	41,7	73	20
35070C66120A20	12 x 0,5	7,9	71,4	115	20
35070C66180A20	18 x 0,5	9,2	107,1	164	20
35070C66250A20	25 x 0,5	12,4	148,8	228	20
35070C66020A18	2 x 1	5,2	18,4	43	18
35070C66030A18	3 x 1	5,4	27,6	53	18
35070C66040A18	4 x 1	5,9	36,9	66	18
35070C66050A18	5 x 1	6,4	46,1	79	18
35070C66070A18	7 x 1	6,9	64,5	102	18
35070C66120A18	12 x 1	8,9	110,6	164	18
35070C66180A18	18 x 1	10,6	165,9	238	18
35070C66250A18	25 x 1	13,1	230,4	321	18
35070C66020A16	2 x 1,5	5,5	23,6	51	16
35070C66030A16	3 x 1,5	5,8	35,4	64	16
35070C66040A16	4 x 1,5	6,2	47,2	78	16
35070C66050A16	5 x 1,5	6,8	59	92	16
35070C66070A16	7 x 1,5	7,4	82,7	123	16

Other dimension and colours available on request.

GAALFLEX® DATA LiYCY UL

PVC data cable with overall copper screen, 300 V UL/CSA



ELETTROTEK KABEL® GAALFLEX® DATA LiYCY UL



Construction:

Conductor:	flexible red copper conductor acc. to ASTM B 286
Insulation:	PVC semi-rigid compound
Colour cores:	acc. to US 2
Stranding:	in layers
Wrapping:	PETP foil
Screen:	tinned copper braid
Outer sheath:	grey, (RAL 7032), PVC type YM1, acc. to DIN VDE 0207 part. 5

Resistance:



Self-extinguishing and flame retardant acc. to:
 DIN VDE 0482 part 265-2-1
 EN 50265-2-1
 IEC 60332-1-2,
 CSA FT1 FT2



Oil resistance acc. to:
 DIN VDE 0473 part 811-2-1
 IEC EN 60811-2-1

Technical data:

Nominal voltage:	300 V
Test voltage:	1,5 kV
Temperature range	DIN VDE: UL/CSA: up to + 80°C
<i>Fixed laying:</i>	- 30°C up to +70°C
<i>Flexible installation:</i>	- 5°C up to + 70°C
Min. bending radius	
<i>Fixed laying:</i>	5 x d
<i>Flexible installation:</i>	10 x d

Features:

on request color cores acc. to DIN 47100

 AWM style 2464 80°C 300 V CSA AWM I/II A/B 80°C 300 V FT1 FT2 CE

flexible

small outer diameter

small bending radius

good EMC characteristics

RoHS and CE approval



DATA AND INSTRUMENTATION CABLES

GAALFLEX® DATA LiYCY UL

PVC data cable with overall copper screen, 300V UL/CSA



ELETTROTEK KABEL® GAALFLEX® DATA LiYCY UL



Part no.	No. of cores x cross section n x mm ²	Outer-Ø ca. mm ± 10%	Copper weight kg/km	Cable weight approx. kg/km	AWG no. *)
35080C66020A26	2 x 0,14	4,1	9,5	22	26
35080C66030A26	3 x 0,14	4,3	10,8	24	26
35080C66040A26	4 x 0,14	4,5	12,2	26	26
35080C66050A26	5 x 0,14	4,8	15,3	31	26
35080C66070A26	7 x 0,14	5,1	18	36	26
35080C66080A26	8 x 0,14	5,7	21,2	44	26
35080C66120A26	12 x 0,14	6,2	26,6	52	26
35080C66160A26	16 x 0,14	6,8	33,9	64	26
35080C66180A26	18 x 0,14	7,1	38,4	71	26
35080C66250A26	25 x 0,14	8,2	50	91	26
35080C66020A24	2 x 0,25	4,4	11,2	25	24
35080C66030A24	3 x 0,25	4,6	13,4	28	24
35080C66040A24	4 x 0,25	4,9	17,4	33	24
35080C66050A24	5 x 0,25	5,2	19,6	38	24
35080C66070A24	7 x 0,25	5,5	25,8	46	24
35080C66080A24	8 x 0,25	6,2	28,2	55	24
35080C66100A24	10 x 0,25	6,6	34,4	60	24
35080C66120A24	12 x 0,25	6,8	38,9	67	24
35080C66160A24	16 x 0,25	7,4	49,7	84	24
35080C66180A24	18 x 0,25	7,8	54,2	92	24
35080C66250A24	25 x 0,25	9,2	73,8	123	24
35080C66020A22	2 x 0,34	4,7	13,7	28	22
35080C66030A22	3 x 0,34	4,9	18,9	34	22
35080C66040A22	4 x 0,34	5,2	22,4	40	22
35080C66050A22	5 x 0,34	5,6	27,7	47	22
35080C66070A22	7 x 0,34	6	34,6	57	22
35080C66080A22	8 x 0,34	6,7	40	68	22
35080C66100A22	10 x 0,34	7,2	48,8	78	22
35080C66120A22	12 x 0,34	7,4	55,8	87	22
35080C66160A22	16 x 0,34	8,1	71,7	107,4	22
35080C66180A22	18 x 0,34	8,7	78,8	117,4	22
35080C66250A22	25 x 0,34	10,1	107,4	147,4	22
35080C66020A20	2 x 0,5	5,2	20,5	37	20
35080C66030A20	3 x 0,5	5,4	26,5	44	20
35080C66040A20	4 x 0,5	5,8	34,2	54	20
35080C66050A20	5 x 0,5	6,2	40,3	63	20
35080C66060A20	6 x 0,5	6,7	48,1	74	20
35080C66070A20	7 x 0,5	6,7	54	80	20
35080C66100A20	10 x 0,5	8,2	76	109	20
35080C66120A20	12 x 0,5	8,5	87,9	127	20
35080C66180A20	18 x 0,5	9,9	126,1	179	20
35080C66250A20	25 x 0,5	11,6	172,8	238	20
35080C66020A18	2 x 1	5,6	28,8	47	18
35080C66030A18	3 x 1	5,9	38,1	57	18
35080C66040A18	4 x 1	6,3	49,1	71	18
35080C66050A18	5 x 1	6,9	60,3	86	18
35080C66070A18	7 x 1	7,4	78,8	108	18
35080C66080A18	8 x 1	8,6	90,2	131	18
35080C66120A18	12 x 1	9,6	129,4	176	18
35080C66180A18	18 x 1	11,1	189,5	251	18
35080C66250A18	25 x 1	13,4	258,9	346	18
35080C66020A16	2 x 1,5	6	34,1	54	16
35080C66030A16	3 x 1,5	6,2	45,9	67	16
35080C66040A16	4 x 1,5	6,7	59,6	83	16
35080C66050A16	5 x 1,5	7,3	73,3	101	16
35080C66070A16	7 x 1,5	7,9	99	130	16
35080C66080A16	8 x 1,5	9,1	113,1	157	16
35080C66120A16	12 x 1,5	10,2	162,8	212	16

Other dimension and colours available on request.

GAALFLEX® DATA LiYCY (B) TP UL

paired PVC data cable with drain wire, overall copper screen, 300V UL/CSA



ELETTROTEK KABEL® GAALFLEX® DATA LiYCY B TP UL



Construction:

Conductor:	flexible red copper conductor acc. to ASTM B 286
Insulation:	PVC semi-rigid compound
Colour cores:	acc. to US 3 (on request DIN 47100)
Stranding:	cores twisted to pairs, pairs stranded in layers
Wrapping:	PETP foil
Screen:	tinned copper braid + tinned copper drain wire
Outer sheath:	grey, (RAL 7032), PVC type YM1, acc. to DIN VDE 0207 part. 5

Resistance:



Self-extinguishing and flame retardant acc. to:
 DIN VDE 0482 part 265-2-1
 EN 50265-2-1
 IEC 60332-1-2,
 CSA FT1 FT2



Oil resistance acc. to:
 DIN VDE 0473 part 811-2-1
 IEC EN 60811-2-1

Technical data:

Nominal voltage:	300 V
Test voltage:	1,5 kV
Temperature range	DIN VDE: UL/CSA: up to + 80°C
<i>Fixed laying:</i>	- 30°C up to +70°C
<i>Flexible installation:</i>	- 5°C up to + 70°C
Min. bending radius	
<i>Fixed laying:</i>	5 x d
<i>Flexible installation:</i>	10 x d

Features:

AWM style 2464 80°C 300 V CSA AWM I/II A/B 80°C
 300 V FT1 FT2 CE

flexible

small outer diameter

small bending radius

good EMC characteristics

RoHS and CE approval



DATA AND INSTRUMENTATION CABLES

GAALFLEX® DATA LiYCY (B) TP UL

paired PVC data cable with drain wire, overall copper screen, 300V UL/CSA



ELETTROTEK KABEL® GAALFLEX® DATA LiYCY B TP UL



Part no.	No. of cores x cross section n x mm ²	Outer-Ø ca. mm ± 10%	Copper weight kg/km	Cable weight approx. kg/km	AWG no. *)
35090C67022A26	2 x 2 x 0,14	5,5	14,9	34	26
35090C67032A26	3 x 2 x 0,14	6,1	19,2	43	26
35090C67042A26	4 x 2 x 0,14	6,8	23,5	49	26
35090C67052A26	5 x 2 x 0,14	7,3	26,3	56	26
35090C67062A26	6 x 2 x 0,14	7,6	33,3	66	26
35090C67082A26	8 x 2 x 0,14	8,1	36,1	72	26
35090C67102A26	10 x 2 x 0,14	9	43,3	89	26
35090C67122A26	12 x 2 x 0,14	9,8	50,6	102	26
35090C67162A26	16 x 2 x 0,14	10,6	63,4	125	26
35090C67182A26	18 x 2 x 0,14	10,9	70,6	136	26
35090C67252A26	25 x 2 x 0,14	12,7	90,3	182	26
35090C67262A26	26 x 2 x 0,14	12,6	92,9	185	26
35090C67022A24	2 x 2 x 0,25	5,9	19,9	42	24
35090C67032A24	3 x 2 x 0,25	6,6	24,4	51	24
35090C67042A24	4 x 2 x 0,25	7,4	30,5	59	24
35090C67052A24	5 x 2 x 0,25	7,9	36,6	69	24
35090C67072A24	7 x 2 x 0,25	8,5	47,2	87	24
35090C67082A24	8 x 2 x 0,25	9	51,7	95	24
35090C67102A24	10 x 2 x 0,25	9,8	62,5	113	24
35090C67122A24	12 x 2 x 0,25	10,7	73,4	130	24
35090C67162A24	16 x 2 x 0,25	11,6	93,3	161	24
35090C67182A24	18 x 2 x 0,25	12,4	102,4	189	24
35090C67252A24	25 x 2 x 0,25	14	137,3	239	24
35090C67262A24	26 x 2 x 0,25	14,3	141,9	247	24
35090C67022A22	2 x 2 x 0,34	6,4	25	50	22
35090C67032A22	3 x 2 x 0,34	7,1	33,5	62	22
35090C67042A22	4 x 2 x 0,34	8	42,2	74	22
35090C67052A22	5 x 2 x 0,34	8,8	50,9	91	22
35090C67072A22	7 x 2 x 0,34	9,3	64,9	110	22
35090C67122A22	12 x 2 x 0,34	11,8	105,7	170	22
35090C67182A22	18 x 2 x 0,34	13,7	151,2	246	22
35090C67252A22	25 x 2 x 0,34	15,8	203	332	22
35090C67022A20	2 x 2 x 0,5	7	36,6	64	20
35090C67032A20	3 x 2 x 0,5	7,6	50,3	80	20
35090C67042A20	4 x 2 x 0,5	9,2	64,1	104	20
35090C67052A20	5 x 2 x 0,5	9,9	77,9	124	20
35090C67072A20	7 x 2 x 0,5	10,4	103,6	155	20
35090C67122A20	12 x 2 x 0,5	13,9	169,7	255	20
35090C67182A20	18 x 2 x 0,5	16	244,6	368	20
35090C67252A20	25 x 2 x 0,5	18,1	336,9	484	20
35090C67022A18	2 x 2 x 1	7,8	51,4	81	18
35090C67032A18	3 x 2 x 1	9	71,7	114	18
35090C67042A18	4 x 2 x 1	10,2	92,3	138	18
35090C67052A18	5 x 2 x 1	11,1	112,8	166	18
35090C67072A18	7 x 2 x 1	11,7	151,7	211	18
35090C67122A18	12 x 2 x 1	16	251,6	365	18
35090C67182A18	18 x 2 x 1	18	366,1	511	18
35090C67252A18	25 x 2 x 1	20,6	521,4	692	18
35090C67022A16	2 x 2 x 1,5	8,2	61,9	96	16
35090C67032A16	3 x 2 x 1,5	9,6	89,1	133	16
35090C67042A16	4 x 2 x 1,5	10,9	115	164	16
35090C67052A16	5 x 2 x 1,5	11,8	140,8	198	16
35090C67072A16	7 x 2 x 1,5	12,9	188,5	264	16
35090C67082A16	8 x 2 x 1,5	13,8	215,8	297	16

Other dimension and colours available on request.

DATA AND INSTRUMENTATION CABLES

GAALFLEX® TRAY INSTRUMENTATION ITC-PLTC 300 POS

Special paired PVC/PVC UV resistant, with overall Aluminium tape screen,
ITC-PLTC 105°C 300V, UL 2250 and UL 13



ELETTROTEK KABEL® GAALFLEX® TRAY INSTRUMENTATION ITC-PLTC 300 POS



Construction:

Conductor:	Stranded red copper, acc.to ASTM B-3, Class B and ASTM B-8
Insulation:	special PVC compound acc. to UL 66 and UL 2250, flame-retardant 105°C
Colour cores:	acc. to ICEA table E1: pairs: black and white numbered
Stranding:	in pairs
Communication wire:	orange communication wire provided for calibration from 4 pairs and higher
Screen:	aluminium tape + PETP foil, + tinned copper drain wire
Ripcord:	nylon ripcord under outer sheath
Outer sheath:	black (RAL 9005), special PVC compound, flame retardant and UV resistance

Technical data:

Nominal voltage UL:	300 V
Test voltage:	1,5 kV
Temperature range UL:	up to +105°C
Min. bending radius:	
<i>Fixed laying:</i>	5 x d
<i>Flexible installation:</i>	8 x d

Resistance:



Fire performance acc. to:
UL 1685 / FT4 / IEEE 1202
vertical fire test at 70.000 BTU/hr

Features:

- cable for tray use
- outdoor use
- sunlight and moisture resistance
- LEAD FREE
- suitable for installations acc. to NEC 2008 and NEC 2011 Article 725 for Type PLTC cables and NEC 2008 and NEC 2011 Article 727 for Type ITC cables
- suitable substitute for General purpose Class 2 (CL2X) and Class 3 (CL3) wiring, as well as Dwelling unit Class 2 (CL2X) and Class 3 (CL3X) wiring as per NEC 2008 and NEC 2011 Article 725
- or request DIRECT BURIAL
- on request tinned copper conductors
with "0" on fifth digit of the part number
- on request welded and corrugated aluminium armor
and PVC outer sheath
- on request interlocked aluminium armour with or without PVC
outer sheath
- RoHS approval



UL Standards

PLTC: acc. to UL 13, ITC: acc. to UL 2250

DATA AND INSTRUMENTATION CABLES

GAALFLEX® TRAY INSTRUMENTATION ITC-PLTC 300 POS

Special paired PVC/PVC UV resistant, with overall Aluminium tape screen,
ITC-PLTC 105°C 300V, UL 2250 and UL 13



ELETTROTEK KABEL® GAALFLEX® TRAY INSTRUMENTATION ITC-PLTC 300 POS



Part no.	No. of pair(s) x cross section n x AWG	Outer-Ø Inches/mm ± 10%	Copper weight Lbs/Mft - kg/km	Cable weight approx. Lbs/Mft - kg/km
32141C7K012A20	1 x 2 x 20	0,212 - 5,38	-	27 - 40
32141C7K022A20	2 x 2 x 20	0,264 - 6,71	-	49 - 73
32141C7K042A20	4 x 2 x 20	0,353 - 8,97	-	74 - 110
32141C7K082A20	8 x 2 x 20	0,485 - 12,32	-	133 - 198
32141C7K102A20	10 x 2 x 20	0,529 - 13,44	-	158 - 235
32141C7K122A20	12 x 2 x 20	0,57 - 14,48	-	182 - 271
32141C7K162A20	16 x 2 x 20	0,662 - 16,81	-	243 - 362
32141C7K202A20	20 x 2 x 20	0,726 - 18,44	-	291 - 433
32141C7K242A20	24 x 2 x 20	0,783 - 19,89	-	338 - 503
32141C7K362A20	36 x 2 x 20	0,951 - 24,16	-	495 - 737
32141C7K502A20	50 x 2 x 20	1,095 - 27,81	-	658 - 979
32141C7K012A18	1 x 2 x 18	0,23 - 5,84	-	34 - 51
32141C7K022A18	2 x 2 x 18	0,302 - 7,67	-	67 - 100
32141C7K042A18	4 x 2 x 18	0,413 - 10,49	-	105 - 156
32141C7K082A18	8 x 2 x 18	0,541 - 13,74	-	176 - 262
32141C7K102A18	10 x 2 x 18	0,592 - 15,04	-	211 - 314
32141C7K122A18	12 x 2 x 18	0,67 - 17,02	-	258 - 384
32141C7K162A18	16 x 2 x 18	0,742 - 18,85	-	326 - 485
32141C7K202A18	20 x 2 x 18	0,851 - 21,62	-	393 - 585
32141C7K242A18	24 x 2 x 18	0,901 - 22,89	-	476 - 708
32141C7K362A18	36 x 2 x 18	1,071 - 27,2	-	675 - 1005
32141C7K502A18	50 x 2 x 18	1,236 - 31,39	-	901 - 1341
32141C7K012A16	1 x 2 x 16	0,254 - 6,45	-	47 - 70
32141C7K022A16	2 x 2 x 16	0,339 - 8,61	-	91 - 135
32141C7K042A16	4 x 2 x 16	0,464 - 11,79	-	142 - 211
32141C7K082A16	8 x 2 x 16	0,633 - 16,08	-	256 - 381
32141C7K102A16	10 x 2 x 16	0,693 - 17,6	-	307 - 457
32141C7K122A16	12 x 2 x 16	0,748 - 19	-	357 - 531
32141C7K162A16	16 x 2 x 16	0,844 - 21,44	-	454 - 676
32141C7K202A16	20 x 2 x 16	0,949 - 24,1	-	570 - 848
32141C7K242A16	24 x 2 x 16	1,026 - 26,06	-	667 - 993
32141C7K362A16	36 x 2 x 16	1,224 - 31,09	-	956 - 1423
32141C7K502A16	50 x 2 x 16	1,437 - 36,5	-	1314 - 1955

Other dimensions and colors available on request.

DATA AND INSTRUMENTATION CABLES

GAALFLEX® TRAY INSTRUMENTATION ITC-PLTC 300 SPOS

Special paired PVC/PVC UV resistant, with individual and overall Aluminium tape screen, ITC-PLTC 105°C 300V, UL 2250 and UL 13



ELETTROTEK KABEL® GAALFLEX® TRAY INSTRUMENTATION ITC-PLTC 300 SPOS



Construction:

Conductor:	Stranded red copper, acc.to ASTM B-3, Class B and ASTM B-8
Insulation:	special PVC compound acc. to UL 66 and UL 2250, flame-retardant 105°C
Colour cores:	acc. to ICEA table E1: pairs: black and white numbered
Stranding:	in pairs
Screen:	
<i>Individual:</i>	aluminium tape + PETP foil, + tinned copper drain wire
<i>Overall:</i>	aluminium tape + PETP foil, + tinned copper drain wire
Ripcord:	nylon ripcord under outer sheath
Outer sheath:	black (RAL 9005), special PVC compound, flame retardant and UV resistance

Resistance:



Fire performance acc. to:
UL 1685 / FT4 / IEEE 1202
vertical fire test at 70.000 BTU/hr

Technical data:

Nominal voltage UL:	300 V
Test voltage:	1,5 kV
Temperature range UL:	up to +105°C
Min. bending radius:	
<i>Fixed laying:</i>	5 x d
<i>Flexible installation:</i>	8 x d

Features:

cable for tray use
outdoor use
sunlight and moisture resistance
LEAD FREE
suitable for installations acc. to NEC 2008 and NEC 2011
Article 725 for Type PLTC cables and NEC 2008 and NEC 2011
Article 727 for Type ITC cables
suitable substitute for General purpose Class 2 (CL2X) and Class
3 (CL3) wiring, as well as Dwelling unit Class 2 (CL2X) and Class
3 (CL3X) wiring as per NEC 2008 and NEC 2011 Article 725
or request DIRECT BURIAL
on request tinned copper conductors
with "0" on fifth digit of the part number
on request welded and corrugated aluminium armor
and PVC outer sheath
on request interlocked aluminium armour with or without PVC
outer sheath
RoHS approval



UL Standards

PLTC: acc. to UL 13, ITC: acc. to UL 2250

DATA AND INSTRUMENTATION CABLES

GAALFLEX® TRAY INSTRUMENTATION ITC-PLTC 300 SPOS

Special paired PVC/PVC UV resistant, with individual and overall Aluminium tape screen, ITC-PLTC 105°C 300V, UL 2250 and UL 13



ELETTROTEK KABEL® GAALFLEX® TRAY INSTRUMENTATION ITC-PLTC 300 SPOS



Part no.	No. of pair(s) x cross section n x AWG	Outer-Ø Inches/mm ± 10%	Copper weight Lbs/Mft - kg/km	Cable weight approx. Lbs/Mft - kg/km
32151C7K022A20	2 x 2 x 20	0,349 - 8,86	-	66 - 98
32151C7K042A20	4 x 2 x 20	0,423 - 10,74	-	101 - 150
32151C7K082A20	8 x 2 x 20	0,543 - 13,79	-	170 - 253
32151C7K102A20	10 x 2 x 20	0,654 - 16,61	-	220 - 327
32151C7K122A20	12 x 2 x 20	0,674 - 17,12	-	250 - 372
32151C7K162A20	16 x 2 x 20	0,747 - 18,97	-	316 - 470
32151C7K202A20	20 x 2 x 20	0,827 - 21,01	-	382 - 568
32151C7K242A20	24 x 2 x 20	0,939 - 23,85	-	466 - 693
32151C7K362A20	36 x 2 x 20	1,071 - 27,2	-	655 - 975
32151C7K502A20	50 x 2 x 20	1,278 - 32,46	-	902 - 1342
32151C7K022A18	2 x 2 x 18	0,382 - 9,7	-	84 - 125
32151C7K042A18	4 x 2 x 18	0,443 - 11,25	-	121 - 180
32151C7K082A18	8 x 2 x 18	0,577 - 14,66	-	211 - 314
32151C7K102A18	10 x 2 x 18	0,72 - 18,29	-	285 - 424
32151C7K122A18	12 x 2 x 18	0,743 - 18,87	-	327 - 487
32151C7K162A18	16 x 2 x 18	0,824 - 20,93	-	415 - 618
32151C7K202A18	20 x 2 x 18	0,935 - 23,75	-	521 - 775
32151C7K242A18	24 x 2 x 18	1,038 - 26,37	-	614 - 914
32151C7K362A18	36 x 2 x 18	1,187 - 30,15	-	870 - 1295
32151C7K502A18	50 x 2 x 18	1,417 - 35,99	-	1201 - 1787
32151C7K022A16	2 x 2 x 16	0,446 - 11,33	-	120 - 179
32151C7K042A16	4 x 2 x 16	0,516 - 13,11	-	174 - 259
32151C7K082A16	8 x 2 x 16	0,69 - 17,53	-	317 - 472
32151C7K102A16	10 x 2 x 16	0,808 - 20,52	-	388 - 577
32151C7K122A16	12 x 2 x 16	0,834 - 21,18	-	449 - 668
32151C7K162A16	16 x 2 x 16	0,948 - 24,08	-	592 - 881
32151C7K202A16	20 x 2 x 16	1,053 - 26,75	-	721 - 1073
32151C7K242A16	24 x 2 x 16	1,171 - 29,74	-	852 - 1268
32151C7K362A16	36 x 2 x 16	1,362 - 34,59	-	1245 - 1853
32151C7K502A16	50 x 2 x 16	1,603 - 40,72	-	1684 - 2506

Other dimensions and colors available on request.

DATA AND INSTRUMENTATION CABLES

GAALFLEX® TRAY INSTRUMENTATION ITC-PLTC 300 TOS

Special triads PVC/PVC UV resistant, with overall Aluminium tape screen,
ITC-PLTC 105°C 300V, UL 2250 and UL 13



ELETTROTEK KABEL® GAALFLEX® TRAY INSTRUMENTATION ITC-PLTC 300 TOS



Construction:

Conductor:	Stranded red copper, acc.to ASTM B-3, Class B and ASTM B-8
Insulation:	special PVC compound acc. to UL 66 and UL 2250, flame-retardant 105°C
Colour cores:	acc. to ICEA table E1: traids: black, white and red numbered
Stranding:	in triads
Screen:	aluminium tape + PETP foil, + tinned copper drain wire
Ripcord:	nylon ripcord under outer sheath
Outer sheath:	black (RAL 9005), special PVC compound, flame retardant and UV resistance

Technical data:

Nominal voltage UL:	300 V
Test voltage:	1,5 kV
Temperature range UL:	up to +105°C
Min. bending radius:	
<i>Fixed laying:</i>	5 x d
<i>Flexible installation:</i>	8 x d

Resistance:



Fire performance acc. to:
UL 1685 / FT4 / IEEE 1202
vertical fire test at 70.000 BTU/hr

Features:

cable for tray use
outdoor use
sunlight and moisture resistance
LEAD FREE
suitable for installations acc. to NEC 2008 and NEC 2011
Article 725 for Type PLTC cables and NEC 2008 and NEC 2011
Article 727 for Type ITC cables
suitable substitute for General purpose Class 2 (CL2X) and Class
3 (CL3) wiring, as well as Dwelling unit Class 2 (CL2X) and Class
3 (CL3X) wiring as per NEC 2008 and NEC 2011 Article 725
or request DIRECT BURIAL
on request tinned copper conductors
with "0" on fifth digit of the part number
on request welded and corrugated aluminium armor
and PVC outer sheath
on request interlocked aluminium armour with or without PVC
outer sheath
RoHS approval



UL Standards

PLTC: acc. to UL 13, ITC: acc. to UL 2250

DATA AND INSTRUMENTATION CABLES

GAALFLEX® TRAY INSTRUMENTATION ITC-PLTC 300 TOS

Special triads PVC/PVC UV resistant, with overall Aluminium tape screen, ITC-PLTC 105°C 300V, UL 2250 and UL 13



ELETTROTEK KABEL® GAALFLEX® TRAY INSTRUMENTATION ITC-PLTC 300 TOS



Part no.	No. of triad(s) x cross section n x AWG	Outer-Ø Inches/mm ± 10%	Copper weight Lbs/Mft - kg/km	Cable weight approx. Lbs/Mft - kg/km
32161C7K012A20	1 x 3 x 20	0,222 - 5,64	-	33 - 49
32161C7K022A20	2 x 3 x 20	0,357 - 9,07	-	70 - 104
32161C7K042A20	4 x 3 x 20	0,433 - 11	-	107 - 159
32161C7K082A20	8 x 3 x 20	0,556 - 14,12	-	181 - 269
32161C7K102A20	10 x 3 x 20	0,67 - 17,02	-	233 - 347
32161C7K122A20	12 x 3 x 20	0,69 - 17,53	-	266 - 396
32161C7K162A20	16 x 3 x 20	0,765 - 19,43	-	336 - 500
32161C7K202A20	20 x 3 x 20	0,849 - 21,56	-	406 - 604
32161C7K242A20	24 x 3 x 20	0,963 - 24,46	-	496 - 738
32161C7K362A20	36 x 3 x 20	1,099 - 27,91	-	698 - 1039
32161C7K502A20	50 x 3 x 20	1,312 - 33,32	-	961 - 1430
32161C7K012A18	1 x 3 x 18	0,242 - 6,15	-	42 - 63
32161C7K022A18	2 x 3 x 18	0,413 - 10,49	-	96 - 143
32161C7K042A18	4 x 3 x 18	0,476 - 12,09	-	141 - 210
32161C7K082A18	8 x 3 x 18	0,635 - 16,13	-	254 - 378
32161C7K102A18	10 x 3 x 18	0,741 - 18,82	-	311 - 463
32161C7K122A18	12 x 3 x 18	0,764 - 19,41	-	358 - 533
32161C7K162A18	16 x 3 x 18	0,849 - 21,56	-	454 - 676
32161C7K202A18	20 x 3 x 18	0,963 - 24,46	-	571 - 850
32161C7K242A18	24 x 3 x 18	1,07 - 27,18	-	674 - 1003
32161C7K362A18	36 x 3 x 18	1,224 - 31,09	-	958 - 1426
32161C7K502A18	50 x 3 x 18	1,462 - 37,13	-	1321 - 1966
32161C7K012A16	1 x 3 x 16	0,267 - 6,78	-	58 - 86
32161C7K022A16	2 x 3 x 16	0,460 - 11,68	-	126 - 188
32161C7K042A16	4 x 3 x 16	0,533 - 13,54	-	192 - 286
32161C7K082A16	8 x 3 x 16	0,713 - 18,11	-	352 - 524
32161C7K102A16	10 x 3 x 16	0,836 - 21,23	-	432 - 643
32161C7K122A16	12 x 3 x 16	0,863 - 21,92	-	500 - 744
32161C7K162A16	16 x 3 x 16	0,981 - 24,92	-	661 - 984
32161C7K202A16	20 x 3 x 16	1,089 - 27,66	-	807 - 1201
32161C7K242A16	24 x 3 x 16	1,212 - 30,78	-	954 - 1420
32161C7K362A16	36 x 3 x 16	1,41 - 35,81	-	1396 - 2077
32161C7K502A16	50 x 3 x 16	1,681 - 42,7	-	1923 - 2862

Other dimensions and colors available on request.

DATA AND INSTRUMENTATION CABLES

GAALFLEX® TRAY INSTRUMENTATION ITC-PLTC 300 STOS

Special triads PVC/PVC UV resistant, with individual and overall Aluminium tape screen, ITC-PLTC 105°C 300V, UL 2250 and UL 13



ELETTROTEK KABEL® GAALFLEX® TRAY INSTRUMENTATION ITC-PLTC 300 STOS



Construction:

Conductor:	Stranded red copper, acc.to ASTM B-3, Class B and ASTM B-8
Insulation:	special PVC compound acc. to UL 66 and UL 2250, flame-retardant 105°C
Colour cores:	acc. to ICEA table E1: triads: black, white and red numbered
Stranding:	in triads
Screen:	
<i>Individual:</i>	aluminium tape + PETP foil, + tinned copper drain wire
<i>Overall:</i>	aluminium tape + PETP foil, + tinned copper drain wire
Ripcord:	nylon ripcord under outer sheath
Outer sheath:	black (RAL 9005), special PVC compound, flame retardant and UV resistance

Technical data:

Nominal voltage UL:	300 V
Test voltage:	1,5 kV
Temperature range UL:	up to +105°C
Min. bending radius:	
<i>Fixed laying:</i>	5 x d
<i>Flexible installation:</i>	8 x d

Features:

- cable for tray use
- outdoor use
- sunlight and moisture resistance
- LEAD FREE
- suitable for installations acc. to NEC 2008 and NEC 2011 Article 725 for Type PLTC cables and NEC 2008 and NEC 2011 Article 727 for Type ITC cables
- suitable substitute for General purpose Class 2 (CL2X) and Class 3 (CL3) wiring, as well as Dwelling unit Class 2 (CL2X) and Class 3 (CL3X) wiring as per NEC 2008 and NEC 2011 Article 725
- or request DIRECT BURIAL
- on request tinned copper conductors with "0" on fifth digit of the part number
- on request welded and corrugated aluminium armor and PVC outer sheath
- on request interlocked aluminium armour with or without PVC outer sheath
- RoHS approval



UL Standards

PLTC: acc. to UL 13, ITC: acc. to UL 2250

DATA AND INSTRUMENTATION CABLES

GAALFLEX® TRAY INSTRUMENTATION ITC-PLTC 300 STOS

Special triads PVC/PVC UV resistant, with individual and overall Aluminium tape screen, ITC-PLTC 105°C 300V, UL 2250 and UL 13



ELETTROTEK KABEL® GAALFLEX® TRAY INSTRUMENTATION ITC-PLTC 300 STOS



Part no.	No. of triad(s) x cross section n x AWG	Outer-Ø Inches/mm ± 10%	Copper weight Lbs/Mft - kg/km	Cable weight approx. Lbs/Mft - kg/km
32171C7K022A20	2 x 3 x 20	0,357 - 9,07	-	77 - 115
32171C7K042A20	4 x 3 x 20	0,433 - 11	-	122 - 182
32171C7K082A20	8 x 3 x 20	0,556 - 14,12	-	212 - 315
32171C7K102A20	10 x 3 x 20	0,670 - 17,02	-	272 - 405
32171C7K122A20	12 x 3 x 20	0,690 - 17,53	-	313 - 466
32171C7K162A20	16 x 3 x 20	0,765 - 19,43	-	399 - 594
32171C7K202A20	20 x 3 x 20	0,849 - 21,56	-	485 - 722
32171C7K242A20	24 x 3 x 20	0,963 - 24,46	-	591 - 880
32171C7K362A20	36 x 3 x 20	1,099 - 27,91	-	841 - 1252
32171C7K502A20	50 x 3 x 20	1,275 - 32,39	-	1155 - 1719
32171C7K022A18	2 x 3 x 18	0,431 - 10,95	-	108 - 161
32171C7K042A18	4 x 3 x 18	0,476 - 12,09	-	160 - 238
32171C7K082A18	8 x 3 x 18	0,635 - 16,13	-	293 - 436
32171C7K102A18	10 x 3 x 18	0,741 - 18,82	-	360 - 536
32171C7K122A18	12 x 3 x 18	0,764 - 19,41	-	416 - 619
32171C7K162A18	16 x 3 x 18	0,849 - 21,56	-	533 - 793
32171C7K202A18	20 x 3 x 18	0,963 - 24,46	-	671 - 999
32171C7K242A18	24 x 3 x 18	1,070 - 27,18	-	793 - 1180
32171C7K362A18	36 x 3 x 18	1,224 - 31,09	-	1137 - 1692
32171C7K502A18	50 x 3 x 18	1,420 - 36,07	-	1565 - 2329
32171C7K022A16	2 x 3 x 16	0,460 - 11,68	-	146 - 217
32171C7K042A16	4 x 3 x 16	0,533 - 13,53	-	221 - 329
32171C7K082A16	8 x 3 x 16	0,713 - 18,11	-	410 - 610
32171C7K102A16	10 x 3 x 16	0,836 - 21,23	-	504 - 750
32171C7K122A16	12 x 3 x 16	0,863 - 21,92	-	587 - 874
32171C7K162A16	16 x 3 x 16	0,981 - 24,92	-	777 - 1156
32171C7K202A16	20 x 3 x 16	1,089 - 27,66	-	953 - 1418
32171C7K242A16	24 x 3 x 16	1,212 - 30,78	-	1130 - 1682
32171C7K362A16	36 x 3 x 16	1,410 - 35,81	-	1660 - 2470
32171C7K502A16	50 x 3 x 16	1,613 - 40,97	-	2252 - 3351

Other dimensions and colors available on request.

DATA AND INSTRUMENTATION CABLES

GAALFLEX® TRAY INSTRUMENTATION 600 POS PVC

Special paired PVC-Nylon/PVC UV and oil resistant, with overall Aluminium tape screen, TC 90°C 600V Dry or wet, UL 1277 type TC



ELETTROTEK KABEL® GAALFLEX® INSTRUMENTATION 600 POS PVC



Construction:

Conductor:	Stranded red copper, acc.to ASTM B-3, Class B and ASTM B-8
Insulation:	special PVC/Nylon type TFN acc. to UL 66, flame-retardant 90°C
Colour cores:	acc. to ICEA table E1: pairs: black and white numbered
Stranding:	in pairs
Screen:	aluminium tape + PETP foil, + tinned copper drain wire
Ripcord:	nylon ripcord under outer sheath
Outer sheath:	black (RAL 9005), special PVC compound, flame retardant and UV resistance

Technical data:

Nominal voltage UL:	600 V
Test voltage:	4 kV
Temperature range UL:	
<i>Dry:</i>	up to +90°C
<i>Wet:</i>	up to +75°C
Min. bending radius:	
<i>Fixed laying:</i>	5 x d
<i>Flexible installation:</i>	8 x d

Resistance:



Fire performance acc. to:
UL 1685 / IEEE 383
vertical fire test at 70.000 BTU/hr

Features:

cable for tray use
outdoor use
sunlight moisture and weather resistance
oil and gasoline resistance due to PVC/Nylon insulation
DIRECT BURIAL
LEAD FREE
suitable for use in cable trays, raceways, conduit or for aerial applications where installed with a messenger
type TC acc. to NEC 2008 and NEC 2011 Article 336
suitable in class I Division 2 and Class 2 Division 2 Hazardous Locations and intrinsically safe application
acc. to NEC 2008 and NEC 2011 articles 392, 501, 502, 503, 505
suitable in class 1 circuits, acc. to NEC 2008 and NEC 2011 articles 336.10 and 725 for type TC cables
suitable for nonpower-limited alarm circuits
acc. to NEC 2008 and NEC 2011 articles 336.10 and 760.46
on request tinned copper conductors
on request welded and corrugated aluminium armor and PVC outer sheath
on request interlocked aluminium armour with or without PVC outer sheath
RoHS approval



UL Standards

TC: UL Standard 1277 Dry or Wet 90°C 600 V
UL 66: fixture for 18/16 AWG, type TFN 90°C 600 V

DATA AND INSTRUMENTATION CABLES

GAALFLEX® TRAY INSTRUMENTATION 600 POS PVC

Special paired PVC-Nylon/PVC UV and oil resistant, with overall Aluminium tape screen,
TC 90°C 600V Dry or wet, UL 1277 type TC



ELETTROTEK KABEL® GAALFLEX® INSTRUMENTATION 600 POS PVC



Part no.	No. of pair(s) x cross section n x AWG	Outer-Ø Inches/mm ± 10%	Copper weight Lbs/Mft - kg/km	Cable weight approx. Lbs/Mft - kg/km
32141F7K012A18	1 x 2 x 18	0,27 - 6,86	-	42 - 63
32141F7K022A18	2 x 2 x 18	0,34 - 8,64	-	77 - 115
32141F7K042A18	4 x 2 x 18	0,442 - 11,23	-	114 - 170
32141F7K062A18	6 x 2 x 18	0,557 - 14,15	-	162 - 241
32141F7K082A18	8 x 2 x 18	0,617 - 15,67	-	208 - 310
32141F7K102A18	10 x 2 x 18	0,675 - 17,15	-	248 - 369
32141F7K122A18	12 x 2 x 18	0,728 - 18,49	-	286 - 426
32141F7K162A18	16 x 2 x 18	0,821 - 20,85	-	361 - 537
32141F7K202A18	20 x 2 x 18	0,943 - 23,95	-	469 - 698
32141F7K242A18	24 x 2 x 18	1,018 - 25,86	-	544 - 810
32141F7K362A18	36 x 2 x 18	1,209 - 30,71	-	765 - 1138
32141F7K502A18	50 x 2 x 18	1,396 - 35,46	-	1017 - 1513
32141F7K012A16	1 x 2 x 16	0,294 - 7,47	-	55 - 82
32141F7K022A16	2 x 2 x 16	0,377 - 9,58	-	103 - 153
32141F7K042A16	4 x 2 x 16	0,494 - 12,55	-	152 - 226
32141F7K082A16	8 x 2 x 16	0,69 - 17,53	-	279 - 415
32141F7K102A16	10 x 2 x 16	0,756 - 19,2	-	334 - 497
32141F7K122A16	12 x 2 x 16	0,817 - 20,75	-	388 - 577
32141F7K162A16	16 x 2 x 16	0,964 - 24,49	-	528 - 786
32141F7K202A16	20 x 2 x 16	1,058 - 26,87	-	636 - 946
32141F7K242A16	24 x 2 x 16	1,144 - 29,06	-	745 - 1109
32141F7K362A16	36 x 2 x 16	1,354 - 34,39	-	1057 - 1573
32141F7K502A16	50 x 2 x 16	1,578 - 40,08	-	1417 - 2109
32141F7K012A14	1x 2 x 14	0,313 - 7,95	-	73 - 106

Other dimensions and colors available on request.

GAALFLEX® TRAY INSTRUMENTATION 600 SPOS PVC

Special paired PVC-Nylon/PVC UV and oil resistant, with individual and overall Aluminium tape screen, TC-ER 90°C 600V Dry or wet, UL 1277 type TC



ELETTROTEK KABEL® GAALFLEX® INSTRUMENTATION 600 SPOS PVC



Construction:

Conductor:	Stranded red copper, acc.to ASTM B-3, Class B and ASTM B-8
Insulation:	special PVC/Nylon type TFN acc. to UL 66, flame-retardant 90°C
Colour cores:	acc. to ICEA table E1: pairs: black and white numbered
Stranding:	in pairs
Screen:	
<i>Individual:</i>	aluminium tape + PETP foil, + tinned copper drain wire
<i>Overall:</i>	aluminium tape + PETP foil, + tinned copper drain wire
Ripcord:	nylon ripcord under outer sheath
Outer sheath:	black (RAL 9005), special PVC compound, flame retardant and UV resistance

Technical data:

Nominal voltage UL:	600 V
Test voltage:	4 kV
Temperature range UL:	
<i>Dry:</i>	up to +90°C
<i>Wet:</i>	up to +75°C
Min. bending radius:	
<i>Fixed laying:</i>	5 x d
<i>Flexible installation:</i>	8 x d

Resistance:



Fire performance acc. to:
UL 1685 / IEEE 383
vertical fire test at 70.000 BTU/hr

Features:

cable for tray use
outdoor use
sunlight moisture and weather resistance
oil and gasoline resistance due to PVC/Nylon insulation
DIRECT BURIAL
LEAD FREE
suitable for use in cable trays, raceways, conduit or for aerial applications where installed with a messenger
type TC acc. to NEC 2008 and NEC 2011 Article 336
suitable in class I Division 2 and Class 2 Division 2 Hazardous Locations and intrinsically safe application
acc. to NEC 2008 and NEC 2011 articles 392, 501, 502, 503, 505
suitable in class 1 circuits, acc. to NEC 2008 and NEC 2011 articles 336.10 and 725 for type TC cables
suitable for nonpower-limited alarm circuits
acc. to NEC 2008 and NEC 2011 articles 336.10 and 760.46
on request tinned copper conductors
on request welded and corrugated aluminium armor and PVC outer sheath
on request interlocked aluminium armour with or without PVC outer sheath
RoHS approval



UL Standards

TC: UL Standard 1277 Dry or Wet 90°C 600 V
UL 66: fixture for 18/16 AWG, type TFN 90°C 600 V

DATA AND INSTRUMENTATION CABLES

GAALFLEX® TRAY INSTRUMENTATION 600 SPOS PVC

Special paired PVC-Nylon/PVC UV and oil resistant, with individual and overall Aluminium tape screen, TC-ER 90°C 600V Dry or wet, UL 1277 type TC



ELETTROTEK KABEL® GAALFLEX® INSTRUMENTATION 600 SPOS PVC



Part no.	No. of pair(s) x cross section n x AWG	Outer-Ø Inches/mm ± 10%	Copper weight Lbs/Mft - kg/km	Cable weight approx. Lbs/Mft - kg/km
32151F7K022A18	2 x 2 x 18	0,429 - 10,9	-	96 - 143
32151F7K042A18	4 x 2 x 18	0,498 - 12,65	-	139 - 207
32151F7K062A18	6 x 2 x 18	0,595 - 15,11	-	194 - 288
32151F7K082A18	8 x 2 x 18	0,678 - 17,22	-	257 - 382
32151F7K102A18	10 x 2 x 18	0,794 - 20,17	-	314 - 467
32151F7K122A18	12 x 2 x 18	0,819 - 20,8	-	359 - 534
32151F7K162A18	16 x 2 x 18	0,951 - 24,16	-	490 - 729
32151F7K202A18	20 x 2 x 18	1,053 - 26,75	-	592 - 881
32151F7K242A18	24 x 2 x 18	1,169 - 29,69	-	695 - 1034
32151F7K362A18	36 x 2 x 18	1,336 - 33,93	-	987 - 1469
32151F7K502A18	50 x 2 x 18	1,572 - 39,93	-	1314 - 1955
32151F7K022A16	2 x 2 x 16	0,48 - 12,19	-	127 - 189
32151F7K032A16	3 x 2 x 16	0,514 - 13,06	-	145 - 216
32151F7K042A16	4 x 2 x 16	0,59 - 14,99	-	201 - 299
32151F7K062A16	6 x 2 x 16	0,694 - 17,63	-	270 - 402
32151F7K082A16	8 x 2 x 16	0,763 - 19,38	-	344 - 512
32151F7K102A16	10 x 2 x 16	0,937 - 23,8	-	455 - 677
32151F7K122A16	12 x 2 x 16	0,966 - 24,54	-	521 - 775
32151F7K162A16	16 x 2 x 16	1,072 - 27,23	-	660 - 982
32151F7K202A16	20 x 2 x 16	1,19 - 30,23	-	801 - 1192
32151F7K242A16	24 x 2 x 16	1,323 - 33,60	-	944 - 1405
32151F7K362A16	36 x 2 x 16	1,536 - 39,01	-	1370 - 2039
32151F7K502A16	50 x 2 x 16	1,849 - 46,96	-	1914 - 2848

Other dimensions and colors available on request.

GAALFLEX® TRAY INSTRUMENTATION 600 TOS PVC

Special triads PVC-Nylon/PVC UV and oil resistant, with overall Aluminium tape screen, TC-ER 90°C 600V Dry or wet, UL 1277 type TC



ELETTROTEK KABEL® GAALFLEX® INSTRUMENTATION 600 TOS PVC



Construction:

Conductor:	Stranded red copper, acc.to ASTM B-3, Class B and ASTM B-8
Insulation:	special PVC/Nylon type TFN acc. to UL 66, flame-retardant 90°C
Colour cores:	acc. to ICEA table E1: traids: black, white and red numbered
Stranding:	in triads
Screen:	aluminium tape + PETP foil, + tinned copper drain wire
Ripcord:	nylon ripcord under outer sheath
Outer sheath:	black (RAL 9005), special PVC compound, flame retardant and UV resistance

Technical data:

Nominal voltage UL:	600 V
Test voltage:	4 kV
Temperature range UL:	
<i>Dry:</i>	up to +90°C
<i>Wet:</i>	up to +75°C
Min. bending radius:	
<i>Fixed laying:</i>	5 x d
<i>Flexible installation:</i>	8 x d

Resistance:



Fire performance acc. to:
UL 1685 / IEEE 383
vertical fire test at 70.000 BTU/hr

Features:

cable for tray use
outdoor use
sunlight moisture and weather resistance
oil and gasoline resistance due to PVC/Nylon insulation
DIRECT BURIAL
LEAD FREE
suitable for use in cable trays, raceways, conduit or for aerial applications where installed with a messenger
type TC acc. to NEC 2008 and NEC 2011 Article 336
suitable in class I Division 2 and Class 2 Division 2 Hazardous Locations and intrinsically safe application acc. to NEC 2008 and NEC 2011 articles 392, 501, 502, 503, 505
suitable in class 1 circuits, acc. to NEC 2008 and NEC 2011 articles 336.10 and 725 for type TC cables
suitable for nonpower-limited alarm circuits acc. to NEC 2008 and NEC 2011 articles 336.10 and 760.46
on request tinned copper conductors
on request welded and corrugated aluminium armor and PVC outer sheath
on request interlocked aluminium armour with or without PVC outer sheath
RoHS approval



UL Standards

TC: UL Standard 1277 Dry or Wet 90°C 600 V
UL 66: fixture for 18/16 AWG, type TFN 90°C 600 V

DATA AND INSTRUMENTATION CABLES

GAALFLEX® TRAY INSTRUMENTATION 600 TOS PVC

Special triads PVC-Nylon/PVC UV and oil resistant, with overall Aluminium tape screen, TC-ER 90°C 600V Dry or wet, UL 1277 type TC



ELETTROTEK KABEL® GAALFLEX® INSTRUMENTATION 600 TOS PVC



Part no.	No. of triad(s) x cross section n x AWG	Outer-Ø Inches/mm ± 10%	Copper weight Lbs/Mft - kg/km	Cable weight approx. Lbs/Mft - kg/km
32161F7K013A18	1 x 3 x 18	0,283 - 7,19	-	51 - 76
32161F7K023A18	2 x 3 x 18	0,442 - 11,23	-	90 - 134
32161F7K043A18	4 x 3 x 18	0,513 - 13,03	-	153 - 228
32161F7K083A18	8 x 3 x 18	0,700 - 17,78	-	282 - 420
32161F7K103A18	10 x 3 x 18	0,820 - 20,83	-	345 - 513
32161F7K123A18	12 x 3 x 18	0,886 - 22,50	-	427 - 635
32161F7K163A18	16 x 3 x 18	0,982 - 24,94	-	538 - 801
32161F7K203A18	20 x 3 x 18	1,088 - 27,64	-	651 - 969
32161F7K243A18	24 x 3 x 18	1,208 - 30,68	-	765 - 1138
32161F7K363A18	36 x 3 x 18	1,382 - 35,10	-	1080 - 1607
32161F7K503A18	50 x 3 x 18	1,628 - 41,35	-	1451 - 2159
32161F7K013A16	1 x 3 x 16	0,309 - 7,85	-	68 - 101
32161F7K023A16	2 x 3 x 16	0,490 - 12,45	-	120 - 179
32161F7K043A16	4 x 3 x 16	0,601 - 15,27	-	222 - 330
32161F7K083A16	8 x 3 x 16	0,779 - 19,79	-	383 - 570
32161F7K103A16	10 x 3 x 16	0,955 - 24,26	-	503 - 749
32161F7K123A16	12 x 3 x 16	0,985 - 25,02	-	578 - 860
32161F7K163A16	16 x 3 x 16	1,094 - 27,79	-	735 - 1094
32161F7K203A16	20 x 3 x 16	1,214 - 30,84	-	893 - 1329
32161F7K243A16	24 x 3 x 16	1,351 - 34,32	-	1055 - 1570
32161F7K363A16	36 x 3 x 16	1,549 - 39,34	-	1505 - 2240
32161F7K503A16	50 x 3 x 16	1,887 - 47,93	-	2142 - 3188
32161F7K013A14	1 x 3 x 14	0,336 - 8,53	-	91 - 135

Other dimensions and colors available on request.

DATA AND INSTRUMENTATION CABLES

GAALFLEX® TRAY INSTRUMENTATION 600 STOS PVC

Special triads PVC-Nylon/PVC UV and oil resistant, with individual and overall Aluminium tape screen, TC-ER 90°C 600V Dry or wet, UL 1277 type TC



ELETTROTEK KABEL® GAALFLEX® INSTRUMENTATION 600 STOS PVC



Construction:

Conductor:	Stranded red copper, acc.to ASTM B-3, Class B and ASTM B-8
Insulation:	special PVC/Nylon type TFN acc. to UL 66, flame-retardant 90°C
Colour cores:	acc. to ICEA table E1: pairs: black, white and red numbered
Stranding:	in triads
Screen:	
<i>Individual:</i>	aluminium tape + PETP foil, + tinned copper drain wire
<i>Overall:</i>	aluminium tape + PETP foil, + tinned copper drain wire
Ripcord:	nylon ripcord under outer sheath
Outer sheath:	black (RAL 9005), special PVC compound, flame retardant and UV resistance

Technical data:

Nominal voltage UL:	600 V
Test voltage:	4 kV
Temperature range UL:	
<i>Dry:</i>	up to +90°C
<i>Wet:</i>	up to +75°C
Min. bending radius:	
<i>Fixed laying:</i>	5 x d
<i>Flexible installation:</i>	8 x d

Resistance:



Fire performance acc. to:
UL 1685 / IEEE 383
vertical fire test at 70.000 BTU/hr

Features:

cable for tray use
outdoor use
sunlight moisture and weather resistance
oil and gasoline resistance due to PVC/Nylon insulation
DIRECT BURIAL
LEAD FREE
suitable for use in cable trays, raceways, conduit or for aerial applications where installed with a messenger
type TC acc. to NEC 2008 and NEC 2011 Article 336
suitable in class I Division 2 and Class 2 Division 2 Hazardous Locations and intrinsically safe application acc. to NEC 2008 and NEC 2011 articles 392, 501, 502, 503, 505
suitable in class 1 circuits, acc. to NEC 2008 and NEC 2011 articles 336.10 and 725 for type TC cables
suitable for nonpower-limited alarm circuits acc. to NEC 2008 and NEC 2011 articles 336.10 and 760.46
on request tinned copper conductors
on request welded and corrugated aluminium armor and PVC outer sheath
on request interlocked aluminium armour with or without PVC outer sheath
RoHS approval



UL Standards

TC: UL Standard 1277 Dry or Wet 90°C 600 V

UL 66: fixture for 18/16 AWG, type TFN 90°C 600 V

DATA AND INSTRUMENTATION CABLES

GAALFLEX® TRAY INSTRUMENTATION 600 STOS PVC

Special triads PVC-Nylon/PVC UV and oil resistant, with individual and overall Aluminium tape screen, TC-ER 90°C 600V Dry or wet, UL 1277 type TC



ELETTROTEK KABEL® GAALFLEX® INSTRUMENTATION 600 STOS PVC



Part no.	No. of triad(s) x cross section n x AWG	Outer-Ø Inches/mm ± 10%	Copper weight Lbs/Mft - kg/km	Cable weight approx. Lbs/Mft - kg/km
32171F7K023A18	2 x 3 x 18	0,453 - 11,51	-	117 - 170
32171F7K043A18	4 x 3 x 18	0,557 - 14,15	-	190 - 283
32171F7K083A18	8 x 3 x 18	0,718 - 18,24	-	327 - 487
32171F7K103A18	10 x 3 x 18	0,882 - 22,4	-	432 - 643
32171F7K123A18	12 x 3 x 18	0,909 - 23,09	-	495 - 737
32171F7K163A18	16 x 3 x 18	1,008 - 25,6	-	628 - 935
32171F7K203A18	20 x 3 x 18	1,118 - 28,4	-	762 - 1134
32171F7K243A18	24 x 3 x 18	1,242 - 31,55	-	899 - 1338
32171F7K363A18	36 x 3 x 18	1,421 - 36,09	-	1279 - 1903
32171F7K503A18	50 x 3 x 18	1,734 - 44,04	-	1826 - 2717
32171F7K023A16	2 x 3 x 16	0,509 - 12,93	-	156 - 232
32171F7K043A16	4 x 3 x 16	0,624 - 15,85	-	253 - 377
32171F7K083A16	8 x 3 x 16	0,81 - 20,57	-	444 - 661
32171F7K103A16	10 x 3 x 16	0,993 - 25,22	-	581 - 865
32171F7K123A16	12 x 3 x 16	1,024 - 26,01	-	671 - 999
32171F7K163A16	16 x 3 x 16	1,138 - 28,91	-	858 - 1277
32171F7K203A16	20 x 3 x 16	1,265 - 32,13	-	1046 - 1557
32171F7K243A16	24 x 3 x 16	1,408 - 35,76	-	1238 - 1842
32171F7K363A16	36 x 3 x 16	1,615 - 41,02	-	1777 - 2644
32171F7K503A16	50 x 3 x 16	1,967 - 49,96	-	2523 - 3755

Other dimensions and colors available on request.

DATA AND INSTRUMENTATION CABLES

GAALFLEX® TRAY INSTRUMENTATION 600 POS

Special paired XLPE/PVC UV and oil resistant, with overall Aluminium tape screen, TC-ER 90°C 600V Dry or wet, UL 1277 type TC



ELETTROTEK KABEL® GAALFLEX® INSTRUMENTATION 600 POS



Construction:

Conductor:	stranded red copper conductor similar Cl. 2, acc. to IEC 60228, ASTM B33 and B8
Insulation:	special XLPE compound flame-retardant
Colour cores:	acc. to ICEA table E1: pairs: black and white numbered
Stranding:	in pairs
Screen:	aluminium tape + PETP foil
Outer sheath:	black (RAL 9005), special PVC oil and UV resistance compound

Technical data:

Nominal voltage:	UL: 600V
Test voltage:	4 kV
Temperature range	UL: - 40°C up to +90°C
Min. bending radius:	
<i>Fixed laying:</i>	5 x d
<i>Flexible installation:</i>	8 x d

Resistance:



Fire performance acc. to:
UL 1581 / IEEE 383



Low smoke emission acc. to:
UL 1685

Features:

- on request tinned copper conductor
- on request flexible conductors
- on request Method 4 color code
- on request fire performance acc. to FT4 and IEEE 1202

UV and weather resistance
abrasion and chemical resistance

Type TC-ER UL 600V 90°C dry or wet
sunlight resistant oil resistant I direct burial

TC: UL Standard 1277

acc. to UL 1581

acc. to EPA 40 CFR, Part 261, Subpart C,
heavy metals per table 1, TCLP method

acc. to ICEA S-95-658 (WC70)

approved for class 1 div 2 hazardous location
acc. to NEC article 501 (TC)

acc. to NEC article 336 applications

RoHS and CE approval



Part no.	No. of pair(s) x cross section n x AWG	Outer-Ø ca. mm ± 10%	Copper weight Lbs/Mft - kg/km	Cable weight approx. Lbs/Mft - kg/km
32090F7T012A18	1 x 2 x 18	0,314 - 7,98	-	45 - 67
32090F7T022A18	2 x 2 x 18	0,476 - 12,09	-	89 - 132
32090F7T042A18	4 x 2 x 18	0,582 - 14,78	-	156 - 132
32090F7T082A18	8 x 2 x 18	0,733 - 18,61	-	255 - 380
32090F7T122A18	12 x 2 x 18	0,902 - 22,91	-	383 - 570
32090F7T242A18	24 x 2 x 18	1,198 - 30,43	-	665 - 990
32090F7T362A18	36 x 2 x 18	1,360 - 34,54	-	909 - 1353
32090F7T012A16	1 x 2 x 16	0,338 - 8,59	-	56 - 83
32090F7T022A16	2 x 2 x 16	0,548 - 13,92	-	184 - 274
32090F7T042A16	4 x 2 x 16	0,632 - 16,05	-	218 - 324
32090F7T082A16	8 x 2 x 16	0,800 - 20,32	-	328 - 488
32090F7T122A16	12 x 2 x 16	0,988 - 25,10	-	496 - 738
32090F7T162A16	16 x 2 x 16	1,108 - 28,14	-	625 - 930
32090F7T242A16	24 x 2 x 16	1,312 - 33,32	-	869 - 1293
32090F7T362A16	36 x 2 x 16	1,530 - 38,86	-	1258 - 1872

Other dimension and colours available on request.

DATA AND INSTRUMENTATION CABLES

GAALFLEX® TRAY INSTRUMENTATION 600 SPOS

Special paired XLPE/PVC UV and oil resistant, with individual and overall Aluminium tape screen, TC-ER 90°C 600V Dry or wet, UL 1277 type TC



ELETTROTEK KABEL® GAALFLEX® INSTRUMENTATION 600 SPOS



Construction:

Conductor:	stranded red copper conductor similar Cl. 2, acc. to IEC 60228, ASTM B33 and B8
Insulation:	special XLPE compound flame-retardant
Colour cores:	acc. to ICEA table E1: pairs: black and white numbered
Stranding:	in pairs
Screen	
<i>Individual:</i>	aluminium tape + PETP foil on each pair
<i>Overall:</i>	aluminium tape + PETP foil
Outer sheath:	black (RAL 9005), special PVC oil and UV resistance compound

Resistance:



Fire performance acc. to:
UL 1581 / IEEE 383



Low smoke emission acc. to:
UL 1685

Technical data:

Nominal voltage:	UL: 600V
Test voltage:	4 kV
Temperature range	UL: - 40°C up to +90°C
Min. bending radius:	
<i>Fixed laying:</i>	5 x d
<i>Flexible installation:</i>	8 x d

Features:

on request tinned copper conductor
on request flexible conductors
on request Method 4 color code
on request fire performance acc. to FT4 and IEEE 1202
UV and weather resistance
abrasion and chemical resistance
Type TC-ER UL 600V 90°C dry or wet
sunlight resistant oil resistant I direct burial
TC: UL Standard 1277
acc. to UL 1581
acc. to EPA 40 CFR, Part 261, Subpart C,
heavy metals per table 1, TCLP method
acc. to ICEA S-95-658 (WC70)
approved for class 1 div 2 hazardous location
acc. to NEC article 501 (TC)
acc. to NEC article 336 applications
RoHS and CE approval



Part no.	No. of triads x cross section n x AWG	Outer-Ø ca. mm ± 10%	Copper weight Lbs/Mft - kg/km	Cable weight approx. Lbs/Mft - kg/km
32100F7T022A18	2 x 2 x 18	0,490 - 12,45	-	98 - 146
32100F7T042A18	4 x 2 x 18	0,598 - 15,19	-	176 - 262
32100F7T082A18	8 x 2 x 18	0,755 - 19,18	-	290 - 432
32100F7T122A18	12 x 2 x 18	0,930 - 23,62	-	438 - 652
32100F7T242A18	24 x 2 x 18	1,254 - 31,85	-	796 - 1185
32100F7T362A18	36 x 2 x 18	1,442 - 36,63	-	968 - 1440
32100F7T022A16	2 x 2 x 16	0,562 - 14,27	-	140 - 208
32100F7T042A16	4 x 2 x 16	0,674 - 17,07	-	227 - 338
32100F7T082A16	8 x 2 x 16	0,800 - 20,32	-	375 - 558
32100F7T122A16	12 x 2 x 16	1,015 - 25,78	-	571 - 850
32100F7T242A16	24 x 2 x 16	1,368 - 34,75	-	1044 - 1554
32100F7T362A16	36 x 2 x 16	1,574 - 39,98	-	1477 - 2198

Other dimension and colours available on request.

DATA AND INSTRUMENTATION CABLES

GAALFLEX® TRAY INSTRUMENTATION 600 TOS

Special triads XLPE/PVC UV and oil resistant, with overall Aluminium tape screen, TC-ER 90°C 600V Dry or wet, UL 1277 type TC



ELETTROTEK KABEL® GAALFLEX® INSTRUMENTATION 600 TOS



Construction:

Conductor:	stranded red copper conductor similar Cl. 2, acc. to IEC 60228, ASTM B33 and B8
Insulation:	special XLPE compound flame-retardant
Colour cores:	acc. to ICEA table E1: triads: black, white and red numbered
Stranding:	in triads
Screen:	aluminium tape + PETP foil
Outer sheath:	black (RAL 9005), special PVC oil and UV resistance compound

Resistance:



Fire performance acc. to:
UL 1581 / IEEE 383



Low smoke emission acc. to:
UL 1685

Technical data:

Nominal voltage:	UL: 600V
Test voltage:	4 kV
Temperature range	UL: - 40°C up to +90°C
Min. bending radius:	
<i>Fixed laying:</i>	5 x d
<i>Flexible installation:</i>	8 x d

Features:

- on request tinned copper conductor
- on request flexible conductors
- on request acc. to Method 4 color coded
- on request fire performance acc. to FT4 and IEEE 1202
- UV and weather resistance
abrasion and chemical resistance
- Type TC-ER UL 600V 90°C dry or wet
sunlight resistant oil resistant | direct burial
- TC: UL Standard 1277
- acc. to UL 1581
- acc. to EPA 40 CFR, Part 261, Subpart C,
heavy metals per table 1, TCLP method
- acc. to ICEA S-95-658 (WC70)
- approved for class 1 div 2 hazardous location
acc. to NEC article 501 (TC)
- acc. to NEC article 336 applications
- RoHS and CE approval



Part no.	No. of triads x cross section n x AWG	Outer-Ø ca. mm ± 10%	Copper weight Lbs/Mft - kg/km	Cable weight approx. Lbs/Mft - kg/km
32110F7T023A18	2 x 3 x 18	0,604 - 15,34	-	138 - 206
32110F7T043A18	4 x 3 x 18	0,703 - 17,86	-	228 - 339
32110F7T083A18	8 x 3 x 18	0,903 - 22,91	-	388 - 577
32110F7T123A18	12 x 3 x 18	1,142 - 29,01	-	596 - 887
32110F7T163A18	16 x 3 x 18	1,330 - 33,78	-	807 - 1200
32110F7T243A18	24 x 3 x 18	1,632 - 41,45	-	1133 - 1685
32110F7T363A18	36 x 3 x 18	1,869 - 47,47	-	1586 - 2360
32110F7T023A16	2 x 3 x 16	0,656 - 16,66	-	156 - 232
32110F7T043A16	4 x 3 x 16	0,780 - 19,81	-	291 - 433
32110F7T083A16	8 x 3 x 16	1,028 - 26,11	-	545 - 811
32110F7T123A16	12 x 3 x 16	1,271 - 32,28	-	735 - 1094
32110F7T163A16	16 x 3 x 16	1,452 - 36,88	-	973 - 1448
32110F7T243A16	24 x 3 x 16	1,808 - 45,92	-	1516 - 2256
32110F7T363A16	36 x 3 x 16	2,071 - 52,60	-	2136 - 3178

Other dimension and colours available on request.

DATA AND INSTRUMENTATION CABLES

GAALFLEX® TRAY INSTRUMENTATION 600 STOS

Special triads XLPE/PVC UV and oil resistant, with individual and overall Aluminium tape screen, TC-ER 90°C 600V Dry or wet, UL 1277 type TC



ELETTROTEK KABEL® GAALFLEX® INSTRUMENTATION 600 STOS



Construction:

Conductor:	stranded red copper conductor similar Cl. 2, acc. to IEC 60228, ASTM B33 and B
Insulation:	special XLPE compound flame-retardant
Colour cores:	acc. to ICEA table E1: triads: black, white and red numbered
Stranding:	in triads
Screen	
<i>Individual:</i>	aluminium tape + PETP foil on each pair
<i>Overall:</i>	aluminium tape + PETP foil
Outer sheath:	black (RAL 9005), special PVC oil and UV resistance compound

Resistance:



Fire performance acc. to:
UL 1581 / IEEE 383



Low smoke emission acc. to:
UL 1685

Technical data:

Nominal voltage:	UL: 600V
Test voltage:	4 kV
Temperature range	UL: - 40°C up to +90°C
Min. bending radius:	
<i>Fixed laying:</i>	5 x d
<i>Flexible installation:</i>	8 x d

Features:

- on request tinned copper conductor
- on request flexible conductors
- on request Method 4 color code
- on request fire performance acc. to FT4 and IEEE 1202

UV and weather resistance
abrasion and chemical resistance

Type TC-ER UL 600V 90°C dry or wet
sunlight resistant oil resistant I direct burial

TC: UL Standard 1277

acc. to UL 1581

acc. to EPA 40 CFR, Part 261, Subpart C,
heavy metals per table 1, TCLP method

acc. to ICEA S-95-658 (WC70)

approved for class 1 div 2 hazardous location
acc. to NEC article 501 (TC)

acc. to NEC article 336 applications

RoHS and CE approval



Part no.	No. of triads x cross section n x AWG	Outer-Ø ca. mm ± 10%	Copper weight Lbs/Mft - kg/km	Cable weight approx. Lbs/Mft - kg/km
32120F7T013A18	1 x 3 x 18	0,331 - 8,41	-	59 - 75
32120F7T013A16	1 x 3 x 16	0,357 - 9,07	-	75 - 94
32120F7T013A14	1 x 3 x 14	0,387 - 9,83	-	98 - 146

Other dimension and colours available on request.

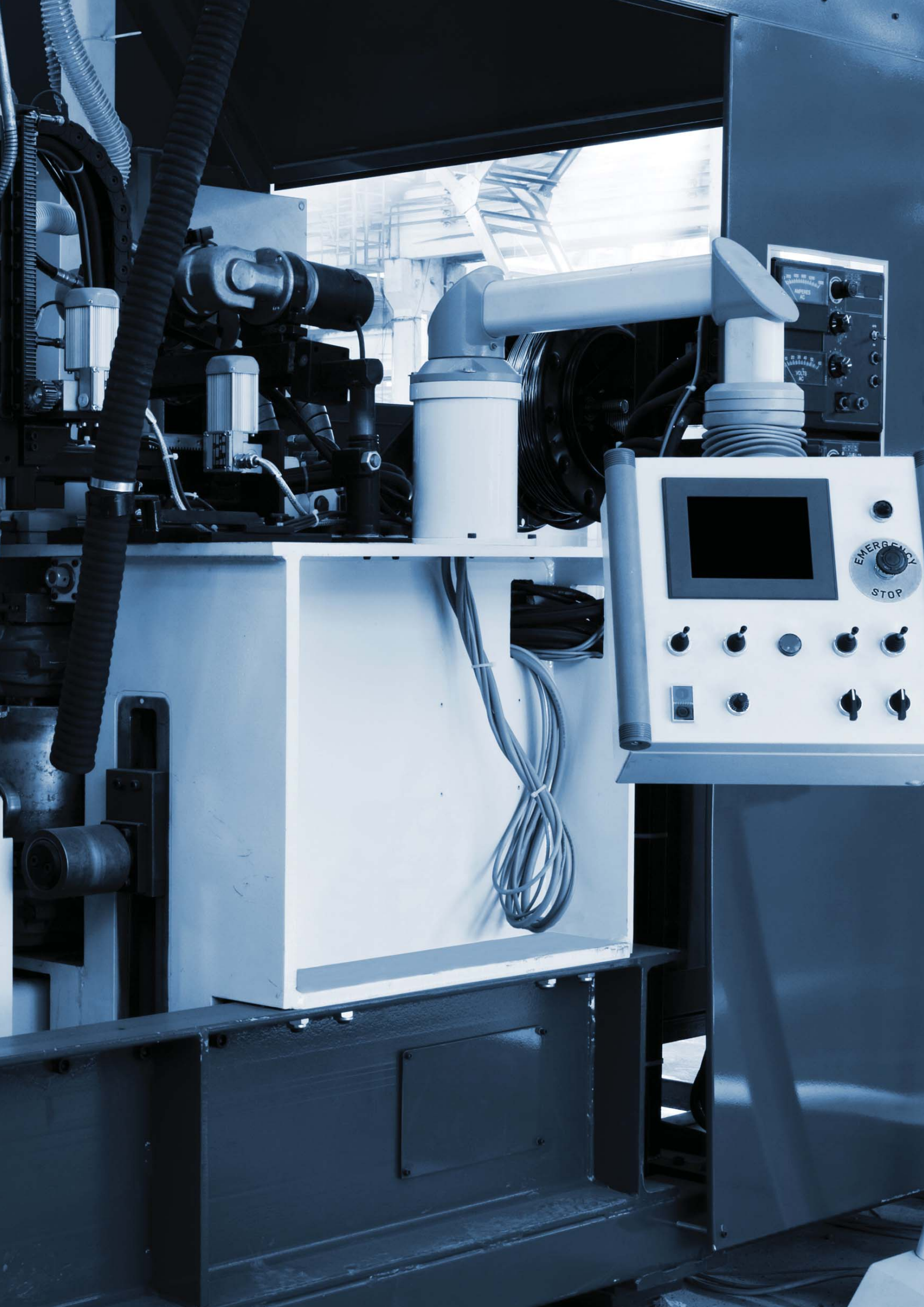

GAALFLEX® VFD CABLES

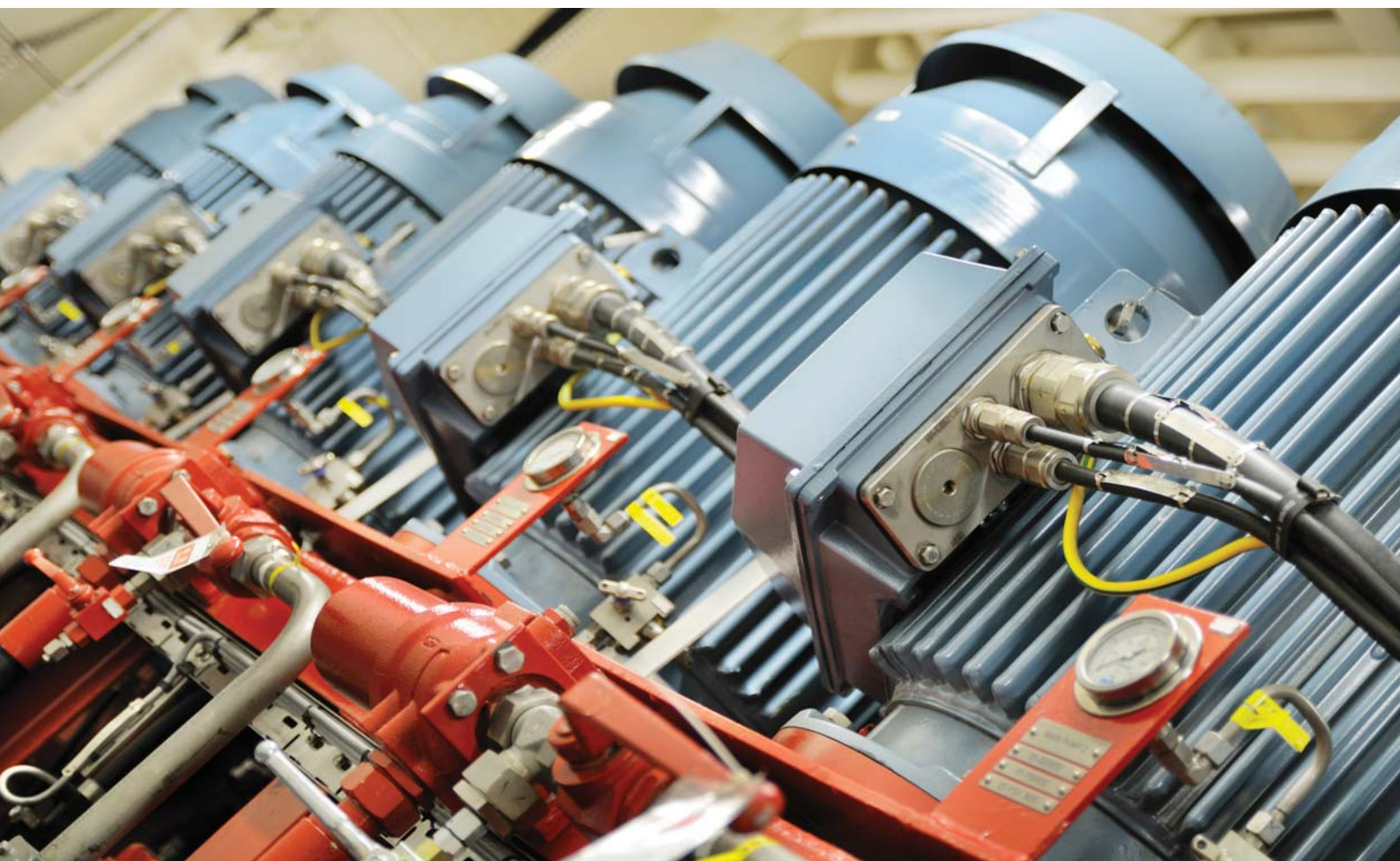

GAALFLEX® TRAY VFD I 500 T

Inverter, connection to frequency converters, UV Resistant, UL 2277 WTTC 1000 V 90°C Dry 75°C Wet



ELETTROTEK KABEL® GAALFLEX® TRAY VFD 1500 T

UL Type TC-ER c(UL) Type CIC FT4, Sun Res, Oil Res I
UL style 1277 60°C 600 V WTTC and
UL 1277, UL type TC-ER for 600 V on request
UL style 2277 WTTC 1000 V 90°C dry



ELETTROTEK KABEL® GAALFLEX® TRAY VFD 1500 T

UL Type TC-ER c(UL) Type CIC FT4, Sun Res, Oil Res I
UL style 1277 60°C 500 V WTTC and
UL 1277, UL type TC-ER for 600 V on request
UL style 2277 WTTC 1000 V 90°C dry

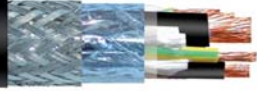

Construction:

Conductor:	finely stranded red copper, acc.to ASTM B-3 or ASTM B-33 and B-172 or B-174
Insulation:	special PVC/Nylon compound
Cores color:	4 conductors: black conductors and green/yellow or 3 black conductors + 3 earth conductors
Stranding:	in layers
Screen:	aluminium tape + PETP foil and tinned copper braid + tinned copper drain wire
Ripcord:	high strenght ripcord under outer sheath
Outer Sheath:	black (similar RAL 9005), special TPE compound

Technical data:

Nominal voltage UL:	1000 V
Temperature range	
<i>Fixed laying:</i>	- 25 °C up to + 90 °C
<i>Flexible installation:</i>	- 25 °C up to + 90 °C
Min. bending radius	6 x D

Resistance:



Fire performance acc. to:
c(UL) FT4

Features:

- UV resistant
- outdoor use
- installation in hazardous areas
- UL Type TC-ER c(UL) Type CIC FT4, Sun Res, Oil Res I
- UL 1277 60°C 600 V WTTC and
- UL 1277, UL type TC-ER for 600 V on request
- UL 2277 WTTC 1000 V 90°C dry
- RoHS approval
- tinned copper on request
- on request MSHA approved



UL/CSA Standards:

- ASTM B-3
- ASTM B-33
- ASTM B-172
- ASTM B-174
- UL 66 basic construction, test and marking
- UL 83 600 V thermoplastic insulation
- UL 1277 60°C for Oil Res I
- CSA C22.2 No 230 for tray cable
- CSA C22.2 No 239 for control and instrumentation cable

GAALFLEX® VFD CABLES

GAALFLEX® TRAY VFD I 500 T

Inverter, connection to frequency converters, UV Resistant, UL 2277 WTTTC 1000 V 90°C Dry 75°C Wet



ELETTROTEK KABEL® GAALFLEX® TRAY VFD 1500 T

UL Type TC-ER c(UL) Type C1C FT4, Sun Res, Oil Res I
UL style 1277 60°C 600 V WTTTC and
UL 1277, UL type TC-ER for 600 V on request
UL style 2277 WTTTC 1000 V 90°C dry

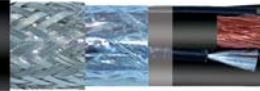

ELETTROTEK KABEL® GAALFLEX® TRAY VFD 1500 T

UL Type TC-ER c(UL) Type C1C FT4, Sun Res, Oil Res I
UL style 1277 60°C 600 V WTTTC and
UL 1277, UL type TC-ER for 600 V on request
UL style 2277 WTTTC 1000 V 90°C dry

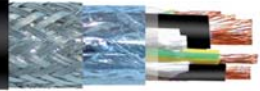

Part no.	No. of cores x cross section n x AWG/MCM	Outer Ø inches/mm ±10%	Cable weight approx. Lbs/Mft - kg/km
33070H70041A16	4 G 16	0,395 - 10	121 - 180
33070H70041A14	4 G 14	0,435 - 11	153 - 228
33070H70041A12	4 G 12	0,475 - 12,1	197 - 293
33070H70041A10	4 G 10	0,595 - 15,1	296 - 441
33070H70041A08	4 G 8	0,73 - 18,5	440 - 654
33070H70041A06	4 G 6	0,825 - 21	609 - 907
33070H70041A04	4 G 4	1,045 - 26,5	940 - 1399
33070H70041A02	4 G 2	1,19 - 30,2	1328 - 1976
33070H70041A01	4 G 1	1,33 - 33,8	1651 - 2457
33070H70041A1C	4 G 1/0	1,425 - 36,2	1986 - 2955
33070H70041A2C	4 G 2/0	1,545 - 39,2	2405 - 3579
33070H70041A3C	4 G 3/0	1,665 - 42,3	2917 - 4340
33070H70041A4C	4 G 4/0	1,915 - 48,6	3721 - 5536
33070H70041A5C	4 G 250 MCM	2,09 - 53,1	4336 - 6452
33070H70041A6C	4 G 300 MCM	2,195 - 55,8	5036 - 7494
33070H70041A7C	4 G 350 MCM	2,33 - 59,2	5809 - 8644
33070H70041A8C	4 G 400 MCM	2,4 - 61	6442 - 9586
33070H70041AAC	4 G 500 MCM	2,615 - 66,4	7886 - 11705
33070H70037A08	3x8+3G14	0,7 - 17,8	401 - 597
33070H70037A02	3x6+3G12	0,785 - 19,9	554 - 824
33070H70037A04	3x4+3G12	0,975 - 24,8	809 - 1204
33070H70037A02	3x2+3G10	1,105 - 28,1	1147 - 1707
33070H70037A01	3x1+3G8	1,235 - 31,4	1471 - 2189
33070H70037A1C	3x1/0+3G8	1,315 - 33,4	1719 - 2558
33070H70037A2C	3x2/0+3G8	1,42 - 36,1	2032 - 3024
33070H70037A3C	3x3/0+3G6	1,53 - 38,9	2521 - 3751
33070H70037A4C	3x4/0+3G6	1,76 - 44,7	3139 - 4671
33070H70037A5C	3x250 MCM+3G6	1,915 - 48,6	3596 - 5351
33070H70037A6C	3x300 MCM+3G4	2,01 - 51,1	4296 - 6392
33070H70037A7C	3x350 MCM+3G4	2,13 - 54,1	4873 - 7521
33070H70037A8C	3x400 MCM+3G4	2,195 - 55,8	5347 - 7956
33070H70037AAC	3x500 MCM+3G2	2,39 - 60,7	6653 - 9900

Other dimension and colours available on request.

GAALFLEX® TRAY VFD 1510 T

Inverter, connection to frequency converters, UV Resistant, UL 2277 WTTC 1000 V 90°C Dry 75°C Wet



ELETTROTEK KABEL® GAALFLEX® TRAY VFD 1510 T
 UL Type TC-ER c(UL) Type CIC FT4, Sun Res, Oil Res I
 UL style 1277 60°C 600 V WTTC and
 UL 1277, UL type TC-ER for 600 V on request
 UL style 2277 WTTC 1000 V 90°C dry

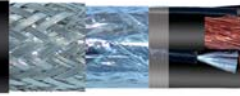

ELETTROTEK KABEL® GAALFLEX® TRAY VFD 1510 T
 UL Type TC-ER c(UL) Type CIC FT4, Sun Res, Oil Res I
 UL style 1277 60°C 600 V WTTC and
 UL 1277, UL type TC-ER for 600 V on request
 UL style 2277 WTTC 1000 V 90°C dry

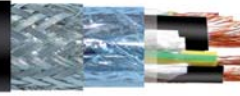

Construction:

- Conductor:** flexible red copper conductor Cl. 5, acc to IEC 60228, DIN VDE 0295
- Insulation:** special PVC/Nylon compound
- Cores color:** 4 conductors: black conductors and green/yellow or 3 black conductors + 3 earth conductors
- Stranding:** in layers
- Screen:** aluminium tape + PETP foil and tinned copper braid + tinned copper drain wire
- Ripcord:** high strenght ripcord under outer sheath
- Outer Sheath:** black (similar RAL 9005), special TPE compound

Technical data:

- Nominal voltage UL:** 1000 V
- Temperature range**
- Fixed laying:* - 25 °C up to + 90 °C
- Flexible installation:* - 25 °C up to + 90 °C
- Min. bending radius** 6 x D

Resistance:



Fire performance acc. to:
 c(UL) FT4

Features:

- UV resistant
- outdoor use
- installation in hazardous areas
- UL Type TC-ER c(UL) Type CIC FT4, Sun Res, Oil Res I
- UL 1277 60°C 600 V WTTC and
- UL 1277, UL type TC-ER for 600 V on request
- UL 2277 WTTC 1000 V 90°C dry
- RoHS approval
- tinned copper on request
- on request MSHA approved



UL/CSA Standards:

- ASTM B-3
- ASTM B-33
- ASTM B-172
- ASTM B-174
- UL 66 basic construction, test and marking
- UL 83 600 V thermoplastic insulation
- UL 1277 60°C for Oil Res I
- CSA C22.2 No 230 for tray cable
- CSA C22.2 No 239 for control and instrumentation cable

GAALFLEX® TRAY VFD 1510 T

Inverter, connection to frequency converters, UV Resistant, UL 2277 WTTC 1000 V 90°C Dry 75°C Wet



ELETTROTEK KABEL® GAALFLEX® TRAY VFD 1510 T

UL Type TC-ER c(UL) Type C1C FT4, Sun Res, Oil Res I
UL style 1277 60°C 600 V WTTC and
UL 1277, UL type TC-ER for 600 V on request
UL style 2277 WTTC 1000 V 90°C dry

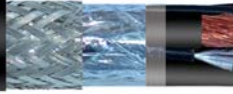

ELETTROTEK KABEL® GAALFLEX® TRAY VFD 1510 T

UL Type TC-ER c(UL) Type C1C FT4, Sun Res, Oil Res I
UL style 1277 60°C 600 V WTTC and
UL 1277, UL type TC-ER for 600 V on request
UL style 2277 WTTC 1000 V 90°C dry

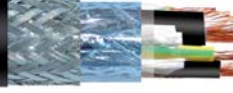

Part no.	No. of cores x cross section n x mm ²	Outer Ø inches/mm ±10%	Cable weight approx. Lbs/Mft - kg/km	AWG no.)*
33080H70041A16	4 G 1,5	0,395 - 10	121 - 180	16
33080H70041A14	4 G 2,5	0,435 - 11	153 - 228	14
33080H70041A12	4 G 4	0,475 - 12,1	197 - 293	12
33080H70041A10	4 G 6	0,595 - 15,1	296 - 441	10
33080H70041A08	4 G 10	0,73 - 18,5	440 - 654	8
33080H70041A06	4 G 16	0,825 - 21	609 - 907	6
33080H70041A04	4 G 25	1,045 - 26,5	940 - 1399	4
33080H70041A02	4 G 35	1,19 - 30,2	1328 - 1976	2
33080H70041A01	4 G 50	1,33 - 33,8	1651 - 2457	1
33080H70041A2C	4 G 70	1,545 - 39,2	2405 - 3579	2/0
33080H70041A3C	4 G 95	1,665 - 42,3	2917 - 4340	3/0
33080H70041A4C	4 G 120	1,915 - 48,6	3721 - 5536	4/0
33080H70041A5C	4 G 150	2,09 - 53,1	4336 - 6452	250 MCM
33080H70041A7C	4 G 185	2,33 - 59,2	5809 - 8644	350 MCM
33080H70041A9C	4 G240	2,5 - 63,7	7437 - 11100	450 MCM
33080H70037A08	3x10+3G2,5	0,7 - 17,8	401 - 597	8 / 14
33080H70037A06	3x16+3G4	0,785 - 19,9	554 - 824	6 / 12
33080H70037A04	3x25+3G4	0,975 - 24,8	809 - 1204	4 / 12
33080H70037A02	3x35+3G6	1,105 - 28,1	1147 - 1707	2 / 10
33080H70037A01	3x50+3G10	1,235 - 31,4	1471 - 2189	1 / 8
33080H70037A2C	3x70+3G10	1,42 - 36,1	2032 - 3024	2/0 / 8
33080H70037A3C	3x95+3G16	1,53 - 38,9	2521 - 3751	3/0 / 6
33080H70037A4C	3x120+3G16	1,76 - 44,7	3139 - 4671	4/0 / 6
33080H70037A5C	3x150+3G16	1,915 - 48,6	3596 - 5351	250 MCM / 6
33080H70037A7C	3x185+3G25	2,13 - 54,1	4873 - 7521	350 MCM / 6
33080H70037A9C	3x240+3G35	2,26 - 57,3	6378 - 9520	450 MCM / 2

Other dimension and colours available on request.

GAALFLEX® VFD CABLES

GAALFLEX® TRAY VFD I 520

Inverter, connection to frequency converters, UV Resistant, UL 2277 WTTC 1000 V 90°C Dry 75°C Wet



ELETTROTEK KABEL® GAALFLEX® TRAY VFD 1520
UL Type TC-ER c(UL) Type CIC FT4, Sun Res, Oil Res I
UL style 1277 60°C 600 V WTTC and
UL 1277, UL type TC-ER for 600 V on request
UL style 2277 WTTC 1000 V 90°C dry

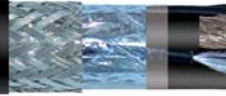

ELETTROTEK KABEL® GAALFLEX® TRAY VFD 1520
UL Type TC-ER c(UL) Type CIC FT4, Sun Res, Oil Res I
UL style 1277 60°C 600 V WTTC and
UL 1277, UL type TC-ER for 600 V on request
UL style 2277 WTTC 1000 V 90°C dry

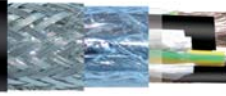

Construction:

Conductor:	flexible tinned copper conductor Cl. 5, acc. to IEC 60228, DIN VDE 0295
Insulation:	GAALTHERM® 530
Cores color:	4 conductors: black conductors and green/yellow or 3 black conductors + 3 earth conductors
Stranding:	in layers
Screen:	aluminium tape + PETP foil and tinned copper braid + tinned copper drain wire
Ripcord:	high strength ripcord under outer sheath
Outer Sheath:	black (similar RAL 9005), special CPE compound

Resistance:



Fire performance acc. to:
c(UL) FT4

Features:

MSHA APPROVED
UV resistant
outdoor use
installation in hazardous areas
UL TC-ER c(UL) Type CIC FT4, Sun Res, Oil Res I
UL 1277 60°C 600 V WTTC and
UL 1277, UL type TC-ER for 600 V on request
UL 2277 WTTC 1000 V 90°C dry
RoHS approval



Technical data:

Nominal voltage UL:	1000 V
Temperature range	
<i>Fixed laying:</i>	- 25 °C up to + 90 °C
<i>Flexible installation:</i>	- 25 °C up to + 90 °C
Min. bending radius	6 x D

UL/CSA Standards:

ASTM B-3
ASTM B-33
ASTM B-172
ASTM B-174
UL 66 basic construction, test and marking
UL 83 600 V thermoplastic insulation
UL 1277 60°C for Oil Res I
CSA C22.2 No 230 for tray cable
CSA C22.2 No 239 for control and instrumentation cable

GAALFLEX® VFD CABLES

GAALFLEX® TRAY VFD I 520

Inverter, connection to frequency converters, UV Resistant, UL 2277 WTTC 1000 V 90°C Dry 75°C Wet



ELETTROTEK KABEL® GAALFLEX® TRAY VFD 1520
 UL Type TC-ER c(UL) Type CIC FT4, Sun Res, Oil Res I
 UL style 1277 60°C 600 V WTTC and
 UL 1277, UL type TC-ER for 600 V on request
 UL style 2277 WTTC 1000 V 90°C dry

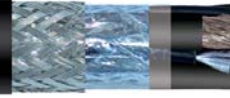

ELETTROTEK KABEL® GAALFLEX® TRAY VFD 1520
 UL Type TC-ER c(UL) Type CIC FT4, Sun Res, Oil Res I
 UL style 1277 60°C 600 V WTTC and
 UL 1277, UL type TC-ER for 600 V on request
 UL style 2277 WTTC 1000 V 90°C dry

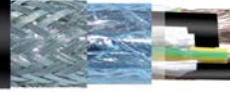

Part no.	No. of cores x cross section n x mm ²	Outer Ø inches/mm ±10%	Cable weight approx. Lbs/Mft - kg/km	AWG no.)*
33090H70041A16	4 G 1,5	0,395 - 10	121 - 180	16
33090H70041A14	4 G 2,5	0,435 - 11	153 - 228	14
33090H70041A12	4 G 4	0,475 - 12,1	197 - 293	12
33090H70041A10	4 G 6	0,595 - 15,1	296 - 441	10
33090H70041A08	4 G 10	0,73 - 18,5	440 - 654	8
33090H70041A06	4 G 16	0,825 - 21	609 - 907	6
33090H70041A04	4 G 25	1,045 - 26,5	940 - 1399	4
33090H70041A02	4 G 35	1,19 - 30,2	1328 - 1976	2
33090H70041A01	4 G 50	1,33- 33,8	1651 - 2457	1
33090H70041A2C	4 G 70	1,545 - 39,2	2405 - 3579	2/0
33090H70041A3C	4 G 95	1,665 - 42,3	2917 - 4340	3/0
33090H70041A4C	4 G 120	1,915 - 48,6	3721 - 5536	4/0
33090H70041A5C	4 G 150	2,09 - 53,1	4336 - 6452	250 MCM
33090H70041A7C	4 G 185	2,33 - 59,2	5809 - 8644	350 MCM
33090H70041A9C	4 G240	2,5 - 63,7	7437 - 11100	450 MCM
33090H70037A08	3x10+3G2,5	0,7 - 17,8	401 - 597	8 / 14
33090H70037A06	3x16+3G4	0,785 - 19,9	554 - 824	6 / 12
33090H70037A04	3x25+3G4	0,975 - 24,8	809 - 1204	4 / 12
33090H70037A02	3x35+3G6	1,105 - 28,1	1147 - 1707	2 / 10
33090H70037A01	3x50+3G10	1,235 - 31,4	1471 - 2189	1 / 8
33090H70037A2C	3x70+3G10	1,42 - 36,1	2032 - 3024	2/0 / 8
33090H70037A3C	3x95+3G16	1,53 - 38,9	2521 - 3751	3/0 / 6
33090H70037A4C	3x120+3G16	1,76 - 44,7	3139 - 4671	4/0 / 6
33090H70037A5C	3x150+3G16	1,915 - 48,6	3596 - 5351	250 MCM / 6
33090H70037A7C	3x185+3G25	2,13 - 54,1	4873 - 7521	350 MCM / 6
33090H70037A9C	3x240+3G35	2,26 - 57,3	6378 - 9520	450 MCM / 2

Other dimension and colours available on request.

GAALFLEX® TRAY VFD I 400

Inverter, connection to frequency converters, UV Resistant, UL 2277 WTTC 1000 V 90°C Dry 75°C Wet



ELETTROTEK KABEL® GAALFLEX® TRAY VFD 1400
 UL Type TC-ER c(UL) Type CIC FT4, Sun Res, Oil Res I
 UL style 1277 60°C 600 V WTTC and
 UL 1277, UL type TC-ER for 600 V on request
 UL style 2277 WTTC 1000 V 90°C dry

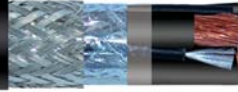

ELETTROTEK KABEL® GAALFLEX® TRAY VFD 1400
 UL Type TC-ER c(UL) Type CIC FT4, Sun Res, Oil Res I
 UL style 1277 60°C 600 V WTTC and
 UL 1277, UL type TC-ER for 600 V on request
 UL style 2277 WTTC 1000 V 90°C dry

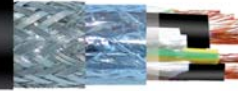

Construction:

- Conductor:** flexible red copper conductor Cl. 5, acc. to IEC 60228, DIN VDE 0295
- Insulation:** special PVC/Nylon compound
- Cores color:** 4 conductors: black conductors and green/yellow or 3 black conductors + 3 earth conductors
- Stranding:** in layers
- Screen:** aluminium tape + PETP foil and tinned copper braid + tinned copper drain wire
- Ripcord:** high strength ripcord under outer sheath
- Outer Sheath:** black (similar RAL 9005), special PVC compound

Technical data:

- Nominal voltage UL:** 1000 V
- Temperature range**
- Fixed laying:* - 25 °C up to + 90 °C
- Flexible installation:* - 25 °C up to + 90 °C
- Min. bending radius** 6 x D

Resistance:



Fire performance acc. to:
 c(UL) FT4

Features:

- UV resistant
- outdoor use
- installation in hazardous areas
- UL Type TC-ER c(UL) Type CIC FT4, Sun Res, Oil Res I
- UL 1277 60°C 600 V WTTC and
- UL 1277, UL type TC-ER for 600 V on request
- UL 2277 WTTC 1000 V 90°C dry
- RoHS approval
- tinned copper on request
- on request MSHA approved



UL/CSA Standards:

- ASTM B-3
- ASTM B-33
- ASTM B-172
- ASTM B-174
- UL 66 basic construction, test and marking
- UL 83 600 V thermoplastic insulation
- UL 1277 60°C for Oil Res I
- CSA C22.2 No 230 for tray cable
- CSA C22.2 No 239 for control and instrumentation cable

GAALFLEX® VFD CABLES

GAALFLEX® TRAY VFD I 400

Inverter, connection to frequency converters, UV Resistant, UL 2277 WTTC 1000V 90°C Dry 75°C Wet



ELETTROTEK KABEL® GAALFLEX® TRAY VFD 1400

UL Type TC-ER c(UL) Type CIC FT4, Sun Res, Oil Res I
UL style 1277 80°C 600 V WTTC and
UL 1277, UL type TC-ER for 600 V on request
UL style 2277 WTTC 1000 V 90°C dry

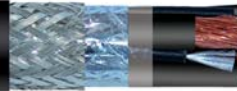

ELETTROTEK KABEL® GAALFLEX® TRAY VFD 1400

UL Type TC-ER c(UL) Type CIC FT4, Sun Res, Oil Res I
UL style 1277 80°C 600 V WTTC and
UL 1277, UL type TC-ER for 600 V on request
UL style 2277 WTTC 1000 V 90°C dry

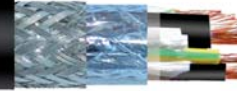

Part no.	No. of cores x cross section n x mm ²	Outer Ø inches/mm ±10%	Cable weight approx. Lbs/Mft - kg/km	AWG no.)*
33100H70041A16	4 G 1,5	0,395 - 10	121 - 180	16
33100H70041A14	4 G 2,5	0,435 - 11	153 - 228	14
33100H70041A12	4 G 4	0,475 - 12,1	197 - 293	12
33100H70041A10	4 G 6	0,595 - 15,1	296 - 441	10
33100H70041A08	4 G 10	0,73 - 18,5	440 - 654	8
33100H70041A06	4 G 16	0,825 - 21	609 - 907	6
33100H70041A04	4 G 25	1,045 - 26,5	940 - 1399	4
33100H70041A02	4 G 35	1,19 - 30,2	1328 - 1976	2
33100H70041A01	4 G 50	1,33- 33,8	1651 - 2457	1
33100H70041A2C	4 G 70	1,545 - 39,2	2405 - 3579	2/0
33100H70041A3C	4 G 95	1,665 - 42,3	2917 - 4340	3/0
33100H70041A4C	4 G 120	1,915 - 48,6	3721 - 5536	4/0
33100H70041A5C	4 G 150	2,09 - 53,1	4336 - 6452	250 MCM
33100H70041A7C	4 G 185	2,33 - 59,2	5809 - 8644	350 MCM
33100H7004A9C	4 G240	2,5 - 63,7	7437 - 11100	450 MCM
33100H70037A08	3x10+3G2,5	0,7 - 17,8	1651 - 2457	8 / 14
33100H70037A06	3x16+3G4	0,785 - 19,9	2405 - 3579	6 / 12
33100H70037A04	3x25+3G4	0,975 - 24,8	2917 - 4340	4 / 12
33100H70037A02	3x35+3G6	1,105 - 28,1	3721 - 5536	2 / 10
33100H70037A01	3x50+3G10	1,235 - 31,4	4336 - 6452	1 / 8
33100H70037A2C	3x70+3G10	1,42 - 36,1	5809 - 8644	2/0 / 8
33100H70037A3C	3x95+3G16	1,53 - 38,9	7437 - 11100	3/0 / 6
33100H70037A4C	3x120+3G16	1,76 - 44,7	3139 - 4671	4/0 / 6
33100H70037A5C	3x150+3G16	1,915 - 48,6	3596 - 53 51	250 MCM / 6
33100H70037A7C	3x185+3G25	2,13 - 54,1	4873 - 7521	350 MCM / 6
33100H70037A9C	3x240+3G35	2,26 - 57,3	6378 - 9520	450 MCM / 2

Other dimension and colours available on request.

GAALFLEX® VFD CABLES

SPECIAL GAALFLEX® TRAY VFD I 400

Inverter, connection to frequency converters, UV Resistant,
(UL)/c(UL) 600 V, UL 2277 WTTTC 1000 V 90°C Dry or wet



ELETTROTEK KABEL® SPECIAL GAALFLEX® TRAY VFD 1400
THHN (UL) TYPE TC-ER 90°C 600 V, OIL 1, SUNLIGHT RES, DIRECT BURIAL
FT4 (UL) WTTTC 90°C 1000 V (UL) MTW .AWG/4 c 600 V
AWM STYLE 21179 1000 V (UL) TYPE CIG SHIELDED .AWG/4C 90°C DRY 600 V FT1, FT2, FT4
CSA AWM III A/B 90°C 1000 V FT1 FT2 CE

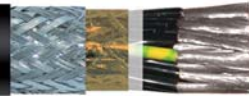

Construction:

- Conductor:** From 18 AWG to 12 AWG:
flexible tinned copper conductor Cl. 5,
acc. to IEC 60228, DIN VDE 0295
From 10 AWG to 2 AWG:
acc. to ASTM B 172 class K
- Insulation:** special PVC/Nylon compound
- Cores color:** black cores with consecutive numbers
acc. to EN 50334 + green-yellow
- Stranding:** in layers
- Wrapping:** non-woven tape
- Screen:** aluminium tape + PETP foil
and tinned copper braid
- Outer Sheath:** black (similar RAL 9005),
special PVC compound

Technical data:

- Nominal voltage:**
- (UL)/c(UL): 600 V
- UL-AWM/CSA-AWM: 1000 V
- (UL)WTTTC: 1000 V
- Test voltage:**
- Cond./Cond: 7,5 kV
- Cond./Screen: 3 kV
- Temperature range**
- UL AWM: up to + 105 °C
- (UL)/c(UL) / CSA-AWM: up to + 90 °C
- Fixed laying: up to - 25 °C
- Min. bending radius:**
- Fixed laying: 12 x D
- Flexible application: /

Resistance:



Fire performance acc. to:
(UL) / c(UL) FT4, c(UL) / CSA-AWM FT1, FT2

Features:

- UV resistant
- indoor/outdoor use
- suitable in wet/dry location
- Oil resistant
- Sunlight resistant
- Exposed runs
- Direct burial
- Machinery area
- NFPA 79 For industrial machinery area
- MTW listed cables can be used in
NFPA 79 For industrial machinery area
- suitable for use in hazardous (classified) locations class I,
division 2 per NEC article 501,4 (B)
- WTTTC: UL subject 2277
- TC: UL subjectt 1277 and acc. to NEC article 336 (392, 501)
- (UL)/(cUL) Listed



UL Standards:

- UL 1277 TC-ER
- UL 2277 WTTTC

Part no.	No. of cores x cross section n x AWG/MCM	Outer Ø inches/mm ±10%	Cable weight approx. Lbs/Mft - kg/km
33101F70041A12	4 x 12	0,472 - 12	177 - 263

GAALFLEX® TRAY VFD I 405 600 V

Inverter, connection to frequency converters, UV Resistant, UL 2277 WTTC 1000 V, c(UL) 1277 TC-ER 600 V 75 °C Wet



ELETTROTEK KABEL® GAALFLEX® TRAY VFD 1405 600 V
 UL 2277 WTTC or Flexible Motor Supply
 c(UL) 1277 TC-ER (Oil-resistant according to UL OIL RES I and Water-resistant, UL Wet Approval 75 °C
 Direct Burial according UL 1277

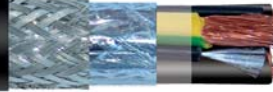

Construction:

- Conductor:** flexible red copper conductor Cl. 5, acc. to IEC 60228, DIN VDE 0295 and UL standard 83
- Insulation:** from 18 AWG up to 16 AWG: GAALTHERM® 520
 from 14 AWG and over: GAALTHERM® 591
- Cores color:** 3x..+3g..
 3 black conductors numbered + 3 green-yellow conductors divided in 3 inertstices
 3x..+1g.. / 4g..+(2x..) or 4g..+(2x..+2x..): black cores with consecutive numbers acc. to EN 50334 + green/yellow
- Stranding:** 3x..+1g..
 cores twisted together + fillers
 3x..+3g..
 phase units laid up with earth-conductors in interstices
 4g..+(2x..) or 4g..+(2x..+2x..): control cores twisted in pair(s) and screened, supply cores and control screened pair(s) twisted together
- Individual screen:** 4g..+(2x..) or 4g..+(2x..+2x..): aluminium tape + PETP foil and tinned copper braid 85% coverage +/- 5%
- Overall screen:** aluminium tape + PETP foil and tinned copper braid 85% coverage +/- 5%
- Outer Sheath:** black (similar RAL 9005), GAALTHERM® 520

Resistance:



Flame retardant and self-extinguishing:
 c(UL) FT4/IEEE 1202
 UL 1685



UV resistant / Sunlight resistant:
 according to EN 50396 and HD 605 A1,
 UL 1581

Features:

- UV resistant
- outdoor use
- installation in hazardous areas
- acc. to UL 2277 WTTC or Flexible Motor Supply
- Direct Burial according UL 1277 part 5.2 (wet-locations insulation) and 18.1 - 18.6 (crushing test)
- acc. to UL 1277 (Oil-resistant according to UL OIL RES I and Water-resistant, UL Wet Approval 75 °C)
- c(UL) only for TC-ER use
- acc. to NFPA 79 2007 and NEC 336.10(7) Class 1, Div. 2 Art. 336, 392, 501
- RoHS and CE approval



Technical data:

- Nominal voltage:** c(UL) 1277 TC-ER 600 V
 UL 2277 WTTC 1000 V
- Temperature range:** UL: up to 90°C
- Fixed laying:* - 40 °C up to + 105 °C
- Flexible installation:* - 5 °C up to + 105 °C
- Min. bending radius**
- Fixed laying:* 6 x d
- Flexible application:* 20 x d

UL Standards:

- UL 1277
- UL 2277

GAALFLEX® VFD CABLES

GAALFLEX® TRAY VFD 1405 600 V

Inverter, connection to frequency converters, UV Resistant, UL 2277 WTTC 1000V, c(UL) 1277 TC-ER 600 V 75°C Wet



ELETTROTEK KABEL® GAALFLEX® TRAY VFD 1405 600 V

UL 2277 WTTC or Flexible Motor Supply
c(UL) 1277 TC-ER (Oil-resistant according to UL OIL RES I and Water-resistant, UL Wet Approval 75 °C
Direct Burial according UL 1277

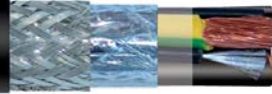

Part no.	No. of cores x cross section n x AWG/MCM	Outer Ø inches/mm ±10%	Copper weight Lbs/Mft - kg/km	Cable weight approx. Lbs/Mft - kg/km
33290F70041A14	4 G 14	0,456 - 11,4	91,4 - 136	150,5 - 224
33290F70041A12	4 G 12	0,52 - 13	136,4 - 203	209,7 - 312
33290F70041A10	4 G 10	0,612 - 15,3	202,3 - 301	301,1 - 448
33290F70041A08	4 G 8	0,776 - 19,4	323,2 - 481	479,8 - 714
33290F70041A06	4 G 6	0,912 - 22,8	489,2 - 728	702,2 - 1045
33290F70041A04	4 G 4	1,052 - 26,3	733,8 - 1092	1004 - 1494
33290F70041A02	4 G 2	1,168 - 29,2	1009,3 - 1502	1323,9 - 1970
33290F70041A01	4 G 1	1,384 - 34,6	1446,8 - 2153	1872,9 - 2787
33290F70041A2C	4 G 2/0	1,584 - 39,6	1990,5 - 2962	2526,7 - 3760
33290F70041A3C	4 G 3/0	1,784 - 44,6	2651 - 3945	3332,4 - 4959
33290F70041A4C	4 G 4/0	1,936 - 48,4	3317,7 - 4937	4085,1 - 6079
33290F70041A5C	4 G 250	2,088 - 52,2	4110,6 - 6117	4961,4 - 7383
33290F70041A7C	4 G 350	2,26 - 56,5	5041,3 - 7502	5999 - 8927
33290F70037A10	3 x 10 + 3 G 18	0,608 - 15,2	179,4 - 267	252 - 375
33290F70037A08	3 x 8 + 3 G 16	0,724 - 18,1	277,5 - 413	378,3 - 563
33290F70037A06	3 x 6 + 3 G 14	0,804 - 20,1	428,7 - 638	552,4 - 822
33290F70037A04	3 x 4 + 3 G 12	0,976 - 24,4	643,8 - 958	824,5 - 1227
33290F70037A02	3 x 2 + 3 G 10	1,08 - 27	887,7 - 1321	1077,9 - 1604
33290F70037A01	3 x 1 + 3 G 8	1,28 - 32	1308,4 - 1947	1560,4 - 2322
33290F70037A2C	3 x 2/0 + 3 G 8	1,46 - 36,5	1714,3 - 2551	1992,5 - 2965
33290F70037A3C	3 x 3/0 + 3 G 6	1,592 - 39,8	2332,5 - 3471	2598 - 3866
33290F70037A4C	3 x 4/0 + 3 G 6	1,788 - 44,7	2835,2 - 4219	3198,7 - 4760
33290F70037A5C	3 x 250 + 3 G 4	1,928 - 48,2	3608,6 - 5370	3972,9 - 5912
33290F70037A7C	3 x 350 + 3 G 2	2,084 - 52,1	4497,7 - 6693	4831,7 - 7190
33290F7004BA14	4 G 14 + (2 x 18)C	0,608 - 15,2	135,7 - 202	229,2 - 341
33290F7004BA12	4 G 12 + (2 x 18)C	0,66 - 16,5	179,4 - 267	284,2 - 423
33291F7004BA14	4 G 14 + (2 x 16)C	0,63 - 15,7	149,9 - 223	246 - 366
33291F7004BA12	4 G 12 + (2 x 16)C	0,68 - 17	193,5 - 288	302,4 - 450
33291F7004BA10	4 G 10 + (2 x 16)C	0,72 - 18	245,3 - 365	359,6 - 535
33291F7004BA08	4 G 8 + (2 x 16)C	0,912 - 22,8	366,9 - 546	567,9 - 845
33291F7004BA06	4 G 6 + (2 x 16)C	1 - 25	528,9 - 787	747,9 - 1113
33292F7004BA14	4 G 14 + (2 x 14)C	0,638 - 16,2	162,6 - 242	256,7 - 382
33292F7004BA12	4 G 12 + (2 x 14)C	0,697 - 17,7	207 - 308	309,8 - 461
33292F7004BA10	4 G 10 + (2 x 14)C	0,744 - 18,9	264,1 - 393	323,9 - 482
33292F7004BA08	4 G 8 + (2 x 14)C	0,913 - 23,2	384,4 - 572	514,8 - 766
33292F7004BA06	4 G 6 + (2 x 14)C	1,012 - 25,7	545 - 811	708,3 - 1054
33292F7004BA04	4 G 4 + (2 x 14)C	1,138 - 28,9	788,9 - 1174	992,5 - 1477
33292F7004BA02	4 G 2 + (2 x 14)C	1,268 - 32,2	1058,4 - 1575	1297 - 1930
33292F7004BA01	4 G 1 + (2 x 14)C	1,504 - 38,2	1493,9 - 2223	1842,6 - 2742
33292F7004BA2C	4 G 2/0 + (2 x 14)C	1,72 - 43,7	2036,8 - 3031	2483 - 3695
33290F7004B900	4 G 14 + (2 x 18)C + (2 x 18)C	0,692 - 17,3	173,4 - 258	287,6 - 428
33290F7004B901	4 G 12 + (2 x 18)C + (2 x 18)C	0,74 - 18,5	216,4 - 322	346,1 - 515
33290F7004B902	4 G 12 + (2 x 18)C + (2 x 16)C	0,76 - 19	224,4 - 334	358,2 - 533
33290F7004B903	4 G 10 + (2 x 18)C + (2 x 16)C	0,8 - 20	283,6 - 422	424,7 - 632
33290F7004B904	4 G 8 + (2 x 18)C + (2 x 16)C	0,98 - 24,4	401,2 - 597	633 - 942
33290F7004B905	4 G 6 + (2 x 16)C + (2 x 16)C	1,08 - 27	571,9 - 851	826,6 - 1230
33290F7004B906	4 G 12 + (2 x 14)C + (2 x 14)C	0,78 - 19,8	266,1 - 396	396,5 - 590
33290F7004B907	4 G 10 + (2 x 14)C + (2 x 14)C	0,87 - 22,1	317,9 - 473	494,6 - 736
33290F7004B908	4 G 8 + (2 x 14)C + (2 x 14)C	1,004 - 25,5	435,5 - 648	665,3 - 990
33290F7004B909	4 G 6 + (2 x 14)C + (2 x 14)C	1,138 - 28,9	608,8 - 906	905,2 - 1347
33290F7004B910	4 G 4 + (2 x 14)C + (2 x 14)C	1,268 - 32,2	883,7 - 1315	1210,9 - 1802
33290F7004B911	4 G 2 + (2 x 14)C + (2 x 14)C	1,362 - 34,6	1141,7 - 1699	1485,8 - 2211

Other dimension and colours available on request.

GAALFLEX® TRAY VFD 1405 2000 V

Inverter, connection to frequency converters, UV Resistant, UL 2277 WTTC 1000 V 90°C Dry or 90°C Wet
or UL 2277 Flexible Motor Supply Cable 2000 V 90°C Dry up to 4/0 AWG or UL 1277 TC-ER 2000 V 90°C Dry or 90°C Wet



ELETTROTEK KABEL® GAALFLEX® TRAY VFD 1405 2000 V
UL style 2277 WTTC 1000 V 90°C Dry or 90°C Wet or UL 2277 Flexible Motor Supply Cable 2000 V 90°C Dry up to 4/0 AWG
or UL Listed Type TC-ER, 90°C DRY or WET, 2000 V, SUN RES, DIR BUR, FT4 acc. to UL 1277,
c(UL) Listed Type CIC, FT4 acc. to CSA C22.2 No. 239

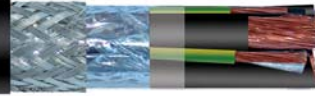

Construction:

- Conductor:** finely stranded red copper,
acc.to ASTM B-3 and B-172
6 AWG and smaller
acc.to ASTM B-3 and B-174
- Insulation:** GAALTHERM® 590
- Cores color:** 3 black conductors + 3 earth conductors
- Stranding:** in layers
- Screen:** aluminium tape + PETP foil
and tinned copper braid +
tinned copper drain wire
- Ripcord:** high strenght ripcord under outer sheath
- Outer Sheath:** black (similar RAL 9005),
GAALTHERM® 520

Technical data:

- Nominal voltage UL:** 2000 V
- Max. permissible Peak. voltage:** 2828 V A.C.
- Test voltage (acc. to UL 1277):**
- 14 AWG up to 8 AWG: 6000 V
- 6 AWG up to 2 AWG: 7500 V
- 1 AWG up to 4/0 AWG: 9000 V
- 250 MCM up to 500 MCM: 10000 V
- Temperature range**
- Fixed laying: - 25 °C up to + 90 °C
- Flexible installation: - 25 °C up to + 90 °C
- Min. bending radius** 6 x d

Resistance:



Fire performance acc. to:
IEEE 1202, c(UL) FT4

Features:

- UV resistant
- outdoor use
- oil resistant
- installation in hazardous areas
- DIRECT BURIAL
- UL Listed Type TC-ER, 90°C DRY or WET, 2000V,
SUN RES, DIR BUR, FT4 acc. to UL 1277,
c(UL) Listed Type CIC, FT4 acc. to CSA C22.2 No. 239
- UL 2277 WTTC 1000 V 90°C Dry or 90°C Wet
- UL 2277 Flexible Motor Supply Cable 2000 V
90°C Dry up to 4/0 AWG
- on request MSHA approved
- on request tinned copper acc. to ASTM B-33
- RoHS approval



UL Standards:

- UL 44 2000 V thermoset insulation
- UL 2277 WTTC 1000 V 90°C Dry or 90°C Wet
- UL 2277 Flexible Motor Supply Cable 2000 V
90°C Dry up to 4/0 AWG
- UL 1277 Type TC-ER 2000 V 90°C Dry or 90°C Wet

Part no.	No. of cores x cross section n x AWG/MCM	Outer Ø inches/mm ±10%	Cable weight approx. Lbs/Mft - kg/km
33290170037A14	3 x 14 + 3 x 18	0,80 - 20	375- 558
33290170037A12	3 x 12 + 3 x 16	0,82 - 20,8	410 - 610
33290170037A10	3 x 10 + 3 x 14	0,90 - 22,9	505 - 752
33290170037A08	3 x 8 + 3 x 14	0,97 - 24,63	615 - 915
33290170037A06	3 x 6 + 3 x 12	1,005 - 25,5	716 - 1065
33290170037A04	3 x 4 + 3 x 12	1,115 - 28,3	923 - 1373
33290170037A02	3 x 2 + 3 x 10	1,25 - 31,8	1273 - 1894
33290170037A01	3 x 1 + 3 x 10	1,42 - 36,1	1579 - 2350
33290170037A1C	3 x 1/0 + 3 x 10	1,515 - 38,5	1847 - 2748
33290170037A2C	3 x 2/0 + 3 x 10	1,62 - 41,1	2183 - 3248
33290170037A3C	3 x 3/0 + 3 x 8	1,735 - 44,1	2662 - 3961
33290170037A4C	3 x 4/0 + 3 x 8	1,975 - 50,2	3283 - 4885
33290170037A5C	3 x 250 + 3 x 6	2,16 - 54,9	3952 - 5881
33290170037A6C	3 x 300 + 3 x 6	2,255 - 57,3	4507 - 6706
33290170037A7C	3 x 350 + 3 x 6	2,38 - 60,5	5119 - 7617
33290170037A8C	3 x 400 + 3 x 6	2,45 - 62,2	5612 - 8351
33290170037AAC	3 x 500 + 3 x 6	2,645 - 67,2	6733 - 10019

Other dimension and colours available on request.

GAALFLEX® VFD CABLES

GAALFLEX® TRAY VFD 1410 600 V

Inverter, connection to frequency converters, UV Resistant, UL 1277 type TC-ER 600 V 90°C Dry 90°C Wet



ELETTROTEK KABEL® GAALFLEX® TRAY VFD 1410 600 V
UL 1277 Type TC-ER, 600 V
CSA: c (UL) CIC/TC FT4



Construction:

Conductor:	stranded red copper, acc.to ASTM B-8, B496
Insulation:	XLPE compound (VW-1 / XHWW-2)
Cores color:	acc. to ICEA S-58 679 method 4 black conductors with number printed
Earth conductor:	stranded red copper, acc.to ASTM B-8 and ASTM B-8, B496
Earth conductor insulation:	uninsulated
Stranding:	in layers
Screen:	Copper tape
Outer Sheath:	black (similar RAL 9005), PVC compound

Technical data:

Nominal voltage UL:	600 V
Temperature range:	
<i>Fixed laying:</i>	- 40 °C up to + 90 °C
<i>Flexible application:</i>	- 25 °C up to + 90 °C

Resistance:



Flame test acc. to:

UL 1581,
UL 2556 VW-1,
CSA FT4,
UL 1685 vertical flame test,
IEEE 383, IEEE 1202 vertical tray flame test,
ICEA T-29-520

Features:

UV resistant, Direct Burial
Outdoor use
Installation in hazardous areas Class I Zone 2, Zone 22 (Class II Div 2)
On request special EPR compound insulation version
On request 4 conductor version
UL 1277 Type TC-ER, 600 V
CSA: c (UL) CIC/TC FT4
RoHS approval
OSHA and MSHA on request



UL/CSA Standards:

UL 44 thermoplastic insulation
UL 1277
CSA C22.2 No 38

GAALFLEX® VFD CABLES

GAALFLEX® TRAY VFD 1410 600 V

Inverter, connection to frequency converters, UV Resistant, UL 1277 type TC-ER 600 V 90°C Dry 90°C Wet



ELETTROTEK KABEL® GAALFLEX® TRAY VFD 1410 600 V
UL 1277 Type TC-ER, 600 V
CSA: c (UL) C1C/TC FT4



Part no.	No. of cores x cross section n x AWG/MCM	Outer Ø inches/mm ±10%	Copper weight Lbs/Mft - kg/km	Cable weight approx. Lbs/Mft - kg/km
33110F71037A14	3 x 14 + 3 x 18	0,40 - 10,26	71 - 105	126 - 188
33110F71037A12	3 x 12 + 3 x 16	0,45 - 11,3	103 - 153	167 - 249
33110F71037A10	3 x 10 + 3 x 14	0,49 - 12,6	155 - 231	229 - 341
33110F71037A08	3 x 8 + 3 x 14	0,66 - 16,76	220 - 327	355 - 529
33110F71037A06	3 x 6 + 3 x 12	0,74 - 18,85	336 - 500	501 - 746
33110F71037A04	3 x 4 + 3 x 12	0,89 - 22,5	485 - 722	717 - 1067
33110F71037A02	3 x 2 + 3 x 10	0,96 - 24,49	766 - 1140	1004 - 1494
33110F71037A1C	3 x 1/0 + 3 x 10	1,15 - 29,31	1136 - 1691	1472 - 2191
33110F71037A2C	3 x 2/0 + 3 x 10	1,24 - 31,50	1402 - 2086	1763 - 2623
33110F71037A4C	3 x 4/0 + 3 x 8	1,47 - 37,21	2206 - 3283	2658 - 3955

Other dimension and colours available on request.

GAALFLEX® TRAY VFD 1410 2000 V

Inverter, connection to frequency converters, UV Resistant, UL 1277 type TC-ER 2000 V 90°C Dry 90°C Wet



ELETTROTEK KABEL® GAALFLEX® TRAY VFD 1410 2000 V
 UL 1277 Type TC-ER, 2000 V
 UL type RHH or RHW-2 conductors per UL 44
 and ICEA S-95-658, NEMA WC 70
 CSA: c (UL) CIC/TC FT4



Construction:

Conductor:	stranded red copper, acc.to ASTM B-3 and ASTM B-8
Insulation:	special XLPE compound
Cores color:	acc. to ICEA S-58 679 method 4 black conductors whit number printed
Earth conductor:	stranded red copper, acc.to ASTM B-3 and ASTM B-8
Earth conductor insulation:	uninsulated
Stranding:	in layers
Screen:	red copper tape
Outer Sheath:	black (similar RAL 9005), special PVC compound

Resistance:



Flame test acc. to:

UL 1581,
 UL 2556 VW-1,
 CSA FT4,
 UL 1685 vertical flame test,
 IEEE 383, IEEE 1202 vertical tray flame test,
 ICEA T-29-520

Technical data:

Nominal voltage UL:	2000 V
Temperature range	
<i>Fixed laying:</i>	- 25 °C up to + 90 °C
<i>Flexible application:</i>	- 25 °C up to + 90 °C
Min. bending radius:	12 x d

Features:

UV resistant
 outdoor use
 installation in hazardous areas
 on request special EPR compound insulation version
 on request 4 conductor version
 UL 1277 Type TC-ER, 2000 V
 UL: type RHH or RHW-2 conductors per UL 44
 and ICEA S-95-658, NEMA WC 70
 CSA: c (UL) CIC/TC FT4
 RoHS approval
 EPA 40 CFR, part 261
 OSHA and MSHA on request



UL/CSA Standards:

UL 44 2000 V thermoplastic insulation
 UL 1277 60°C for Oil Res I
 CSA C22.2 No 230 for tray cable
 CSA C22.2 No 239 for control and instrumentation cable

GAALFLEX® VFD CABLES

GAALFLEX® TRAY VFD 1410 2000 V

Inverter, connection to frequency converters, UV Resistant, UL 1277 type TC-ER 2000 V 90°C Dry 90°C Wet



ELETTROTEK KABEL® GAALFLEX® TRAY VFD 1410 2000 V
 UL 1277 Type TC-ER, 2000 V
 UL: type RHH or RHW-2 conductors per UL 44
 and ICEA S-95-658, NEMA WC 70
 CSA: c (UL) CIG/TC FT4



Part no.	No. of cores x cross section n x AWG/MCM	Outer Ø inches/mm ±10%	Copper weight Lbs/Mft - kg/km	Cable weight approx. Lbs/Mft - kg/km
33110171037A14	3 x 14 + 3 x 18	0,58 - 14,73	91 - 135	212 - 315
33110171037A12	3 x 12 + 3 x 16	0,615 - 15,37	127 - 189	260 - 387
33110171037A10	3 x 10 + 3 x 14	0,67 - 24,8	183 - 272	329 - 490
33110171037A08	3 x 8 + 3 x 14	0,77 - 28,1	246 - 366	441 - 656
33110171037A06	3 x 6 + 3 x 12	0,895 - 31,4	368 - 548	618 - 920
33110171037A04	3 x 4 + 3 x 12	0,995 - 36,1	522 - 777	830 - 1235
33110171037A02	3 x 2 + 3 x 10	1,125 - 38,9	801 - 1192	1152 - 1714
33110171037A1C	3 x 1/0 + 3 x 6	1,385 - 35,18	1348 - 2006	1853 - 2757
33110171037A2C	3 x 2/0 + 3 x 6	1,48 - 37,59	1616 - 2405	2169 - 3227
33110171037A3C	3 x 3/0 + 3 x 5	1,59 - 40,39	2010 - 2991	2619 - 3897
33110171037A4C	3 x 4/0 + 3 x 4	1,78 - 45,21	2517 - 3745	3241 - 4823
33110171037A5C	3 x 250 + 3 x 4	1,94 - 49,28	2895 - 4308	3763 - 5599
33110171037A7C	3 x 350 + 3 x 2	2,16 - 54,86	4089 - 6084	5109 - 7602
33110171037AAC	3 x 500 + 3 x 1	2,45 - 62,36	5693 - 8471	6933 - 10316

Other dimension and colours available on request.

GAALFLEX® TRAY VFD 1420

Inverter, connection to frequency converters, UV Resistant,

UL 1277, WTTC 90°C DRY 1000 V, UL type TC-ER 2000 V 90°C Dry 90°C wet, cUL type CIC/TC FT4



ELETTROTEK KABEL* SPECIAL GAALFLEX® TRAY VFD 1420 2000 V
 UL 1277 Type TC-ER, 2000 V, 90°C Dry 90°C Wet, SUN RES, DIR BUR
 UL: type RHW-2 conductors per UL 44
 CSA: c (UL) CIC/TC FT4



Construction:

- Conductor:** finely stranded red copper, acc.to ASTM B-3 and ASTM B-174
- Insulation:** special XLPE compound
- Cores color:** acc. to ICEA S-58 679 method 4 black conductors whit number printed
- Earth conductor:** finely stranded red copper acc.to ASTM B-3 or ASTM B-174
- Earth conductor insulation:** uninsulated
- Stranding:** in layers
- Screen:** red copper tape
- Outer Sheath:** black (similar RAL 9005), special PVC compound

Technical data:

- Nominal voltage UL:** 2000 V
- Temperature range**
- Fixed laying:* - 25 °C up to + 90 °C
- Flexible installation:* - 25 °C up to + 90 °C
- Min. bending radius** 12 x d

Resistance:



Flame test acc. to:
 UL 1581 / UL 2556 VW-1, CSA FT4,
 UL 1685 vertical flame test,
 IEEE 383, IEEE 1202 vertical tray flame test,
 ICEA T-29-520

Features:

- UV resistant
- outdoor use
- installation in hazardous areas
- UL 1277 type TC-ER 2000 V, 90°C Dry 90°C Wet
- WTTC 90°C DRY 1000 V
- UL: type RHH or RHW-2 conductors per UL 44 and ICEA S-95-658, NEMA WC 70
- on request UL type TC-ER 600 V 90°C Dry 90°C Wet
- CSA: c (UL) CIC/TC FT4
- RoHS approval
- EPA 40 CFR, part 261
- OSHA and MSHA on request
- on request special EPR compound insulation version
- tinned copper on request



UL/CSA Standards:

- UL 44 2000 V thermoplastic insulation
- UL 1277 60°C for Oil Res I
- CSA C22.2 No 230 for tray cable
- CSA C22.2 No 239 for control and instrumentation cable

Part no.	No. of cores x cross section n x AWG/MCM	Outer Ø inches/mm ±10%	Copper weight Lbs/Mft - kg/km	Cable weight approx. Lbs/Mft - kg/km
33120171037A14	3 x 14 + 3 G 18	0,58 - 14,73	91 - 135	212 - 315
33120171037A12	3 x 12 + 3 G 16	0,615 - 15,37	127 - 189	260 - 387
33120171037A10	3 x 10 + 3 G 14	0,67 - 24,8	183 - 272	329 - 490
33120171037A08	3 x 8 + 3 G 14	0,77 - 28,1	246 - 366	441 - 656
33120171037A06	3 x 6 + 3 G 12	0,895 - 31,4	368 - 548	618 - 920
33120171037A04	3 x 4 + 3 G 12	0,995 - 36,1	522 - 777	830 - 1235
33120171037A02	3 x 2 + 3 G 10	1,125 - 38,9	801 - 1192	1152 - 1714
33120171037A1C	3 x 1/0 + 3 G 6	1,385 - 35,18	1348 - 2006	1853 - 2757
33120171037A2C	3 x 2/0 + 3 G 6	1,48 - 37,59	1616 - 2405	2169 - 3227
33120171037A3C	3 x 3/0 + 3 G 5	1,59 - 40,39	2010 - 2991	2619 - 3897
33120171037A4C	3 x 4/0 + 3 G 4	1,78 - 45,21	2517 - 3745	3241 - 4823
33120171037A5C	3 x 250 + 3G 4	1,94 - 49,28	2895 - 4308	3763 - 5599
33120171037A7C	3 x 350 + 3 G 2	2,16 - 54,86	4089 - 6084	5109 - 7602
33120171037AAC	3 x 500 + 3 G 1	2,45 - 62,36	5693 - 8471	6933 - 10316

Other dimension and colours available on request.

SPECIAL GAALFLEX® TRAY VFD 1420 1000 V

Inverter, connection to frequency converters, UV Resistant,
UL listed 1000 V Flexible Motor Supply Cables, UL listed 600 V Type TC/ER, 90°C



ELETTROTEK KABEL® SPECIAL GAALFLEX® TRAY VFD 1420 1000 V
UL listed 1000 V Flexible Motor supply cables, UL Listed 600 V Type TC/ER,
90°C FT-4 and IEEE 1202, sunlight resistant, direct burial

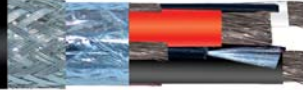

ELETTROTEK KABEL® SPECIAL GAALFLEX® TRAY VFD 1420 1000 V
UL listed 1000 V Flexible Motor supply cables, UL Listed 600 V Type TC/ER,
90°C FT-4 and IEEE 1202, sunlight resistant, direct burial

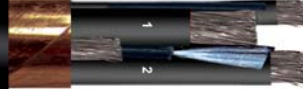

Construction:

Conductor:	finely stranded tinned copper, acc.to ASTM B-3 and ASTM B-174
Insulation:	special XLPE compound
Cores color:	from 14 AWG to 4/0 AWG: acc. to US 1 from 262 MCM to 777 MCM: black cores with consecutive numbers
Earth conductor:	finely stranded tinned copper, acc.to ASTM B-3 and ASTM B-174
Earth conductor insulation:	uninsulated
Stranding:	in layers
Screen:	from 14 AWG to 10 AWG: aluminium tape + PETP foil and tinned copper braid + tinned copper drain wire from 8 AWG to 777 MCM: red copper tape
Outer Sheath:	black (similar RAL 9005), special PVC compound

Resistance:



Fire performance acc. to:
FT-4 and IEEE 1202

Technical data:

Nominal voltage:	
<i>UL listed</i>	
<i>Flexible Motor Supply Cable</i>	1000 V
<i>(Up to AWG 2)</i>	
<i>UL listed type TC-ER</i>	600 V
Temperature range	
<i>Fixed laying:</i>	up to + 90°C
<i>Flexible application:</i>	/
Min. bending radius:	
<i>Fixed laying:</i>	12 x D
<i>Flexible application:</i>	/

Features:

- UV resistant
- Sunlight resistant
- Direct burial
- Exposed runs (use acc. to NEC)
- Crush and Impact resistance acc. to Type MC cable
- suitable for use in hazardous (classified) locations class I, division 2 and Zone 2 per NEC
- UL listed 1000 V Flexible Motor supply cable (Up to AWG 2)
- UL listed 600 V Type TC/ER
- (UL)/(cUL) Listed



SPECIAL GAALFLEX® TRAY VFD I 420 I 000 V

Inverter, connection to frequency converters, UV Resistant,
UL listed 1000 V Flexible Motor Supply Cables, UL listed 600 V Type TC/ER, 90°C



ELETTROTEK KABEL® SPECIAL GAALFLEX® TRAY VFD 1420 1000 V
UL listed 1000 V Flexible Motor supply cables, UL Listed 600 V Type TC/ER,
90°C FT-4 and IEEE 1202, sunlight resistant, direct burial

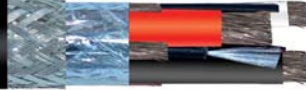

ELETTROTEK KABEL® SPECIAL GAALFLEX® TRAY VFD 1420 1000 V
UL listed 1000 V Flexible Motor supply cables, UL Listed 600 V Type TC/ER,
90°C FT-4 and IEEE 1202, sunlight resistant, direct burial



Part no.	No. of cores x cross section n x AWG/MCM	Outer Ø inches/mm ±10%	Cable weight approx. Lbs/Mft - kg/km
33121F75037A14	3 x 14 + 3 x 18	0,466 - 11,8	158 - 235
33121F75037A12	3 x 12 + 3 x 18	0,509 - 12,9	199 - 296
33121F75037A10	3 x 10 + 3 x 14	0,522 - 13,2	258 - 384
33121F75037A08	3 x 8 + 3 x 14	0,653 - 16,6	368 - 548
33121F75037A06	3 x 6 + 3 x 12	0,737 - 18,7	517 - 769
33121F75037A04	3 x 4 + 3 x 12	0,956 - 24,3	814 - 1211
33121H75037A02	3 x 2 + 3 x 10	1,103 - 28	1178 - 1753
33121H75037A01	3 x 1 + 3 x 10	1,221 - 31	1462 - 2176
33121H75037A1C	3 x 1/0 + 3 x 10	1,447 - 36,7	1714 - 2551
33121H75037A2C	3 x 2/0 + 3 x 10	1,538 - 39,1	1951 - 2903
33121H75037A4C	3 x 4/0 + 3 x 8	1,883 - 47,8	3102 - 4616
33121H71037APC	3 x 262 + 3 x 6	1,981 - 50,3	3642 - 5420
33121H71037AQC	3 x 313 + 3 x 6	2,082 - 52,9	4185 - 6228
33121H71037ANC	3 x 373 + 3 x 6	2,215 - 56,3	4834 - 7193
33121H71037ARC	3 x 444 + 3 x 6	2,371 - 60,2	5634 - 8384
33121H71037AOC	3 x 535 + 3 x 6	2,616 - 66,4	7592 - 11298
33121H71037ASC	3 x 646 + 3 x 4	2,878 - 73,1	9183 - 13665
33121H71037ATC	3 x 777 + 3 x 4	3,089 - 78,46	10834 - 16122

SPECIAL GAALFLEX® TRAY VFD I 420 2000 V

Inverter, connection to frequency converters, UV Resistant,

UL style 1277, UL type TC-ER 2000 V 90°C Dry 90°C Wet, SUN RES, DIR BUR, cUL type CIC/FT4



ELETTROTEK KABEL® SPECIAL GAALFLEX® TRAY VFD 1420 2000 V
 UL 1277 Type TC-ER, 2000 V, 90°C Dry 90°C Wet, SUN RES, DIR BUR
 UL: type RHW-2 conductors per UL 44
 CSA: c (UL) CIC/TC FT4



Construction:

Conductor:	finely stranded red copper, acc.to ASTM B-3 and ASTM B-172
Insulation:	special XLPE compound
Cores color:	black conductors whit number printed
Earth conductor:	finely stranded red copper acc.to ASTM B-3 or ASTM B-174
Earth conductor insulation:	uninsulated
Stranding:	in layers + fillers + 3 earth conductor in interstices
Screen:	red copper tape
Ripcord:	High strenght ripcord under sheath
Outer Sheath:	black (similar RAL 9005), special PVC compound

Resistance:



Flame test acc. to:

UL 1581 / UL 2556 VW-1,
 CSA FT4,
 UL 1685 vertical flame test,
 IEEE 383, IEEE 1202 vertical tray flame test,
 ICEA T-29-520

Technical data:

Nominal voltage UL:	2000 V
Temperature range	
<i>Fixed laying:</i>	- 25 °C up to + 90 °C
<i>Flexible installation:</i>	- 25 °C up to + 90 °C
Min. bending radius:	
<i>From 6 AWG up to 4/0 AWG:</i>	10 x d
<i>From 350 MCM up to 500 MCM</i>	16 x d

Features:

UV resistant
 outdoor use
 installation in hazardous areas
 DIRECT BURIAL
 UL 1277 type TC-ER 2000 V, 90°C dry and wet
 UL: type RHW-2 conductors per UL 44
 CSA: c (UL) CIC/FT4
 CSA C22.2 No. 239



Part no.	No. of cores x cross section n x AWG/MCM	Outer Ø inches/mm ±10%	Cable weight approx. Lbs/Mft - kg/km
33125171037A06	3 x 6 + 3 G 12	0,93 - 23,6	665 - 990
33125171037A04	3 x 4 + 3 G 12	1,04 - 26,4	875 - 1300
33125171037A02	3 x 2 + 3 G 10	1,17 - 29,7	1235 - 1840
33125171037A4C	3 x 4/0 + 3 G 8	1,87 - 47,5	3425 - 5100
33125171037A7C	3 x 350 + 3 G 6	2,26 - 57,4	5400 - 8100
33125171037AAC	3 x 500 + 3 G 6	2,51 - 63,8	7120 - 10680

Other dimension and colours available on request.

GAALFLEX® VFD 600

XLPE/PVC, Low voltage variable frequency drive systems, 600 V



ELETTROTEK KABEL® GAALFLEX® VFD 600

UL standard 44
UL standard 1277

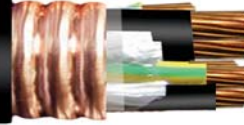

Construction:

Conductor:	stranded red copper, acc.to ASTM B-3 and ASTM B-8
Insulation:	XLPE compound, acc. to UL 44 and VW-1 flame test
Earth conductor:	stranded red copper, acc.to ASTM B-3 and ASTM B-8
Cores color:	acc. to ICEA S-73-352 (NEMA WC 57) black conductors with number print
Stranding:	in layers + fillers + 3 earth conductor in interstices
Screen :	corrugated red copper tape
Outer Sheath:	black (similar RAL 9005), PVC compound, heat and moisture resistant acc. to UL1581 and UL 1277

Technical data:

Nominal voltage UL:	600 V
Temperature range	
<i>Fixed laying:</i>	- 40 °C up to + 90 °C
<i>Flexible installation:</i>	- 5 °C up to + 90 °C
Min. bending radius:	12 x d

Resistance:



Flame test acc. to:
IEEE 1202 , Flame test
ICEA T-29-520, Flame test

Features:

MSHA APPROVED

On request is possible:
2000 V nominal voltage version

Optional features are:

1. EPR insulation
2. CPE, LSZH or TPE Outer sheath

RoHS approval



UL Standards:

UL standard 44

UL standard 1277

Applications:

these cables are designed for use with low voltage (600 V) AC motors controlled for speed by modern PWM inverters.

Part no.	No. of cores x cross section n x AWG/MCM	Outer Ø Inches/mm ±10%	Cable weight approx. Lbs/Mft-kg/km
33230F70037A16	3 x 16 + 3 x 18	0,43 - 10,9	92 - 136
33230F70037A14	3 x 14 + 3 x 18	0,46 - 11,7	144 - 213
33230F70037A12	3 x 12 + 3 x 18	0,519 - 13	176 - 260
33230F70037A10	3 x 10 + 3 x 16	0,59 - 15	254 - 376
33230F70037A08	3 x 8 + 3 x 14	0,73 - 18,5	390 - 577
33230F70037A06	3 x 6 + 3 x 12	0,78 - 19,8	263 - 389
33230F70037A04	3 x 4 + 3 x 10	0,93 - 23,6	769 - 1138
33230F70037A02	3 x 2 + 3 x 8	1,11 - 28,2	1154 - 1655
33230F70037A01	3 x 1 + 3 x 8	1,28 - 32,5	1427 - 2112
33230F70037A1C	3 x 1/0 + 3 x 6	1,37 - 34,8	1764 - 2611)
33230F70037A2C	3 x 2/0 + 3 x 6	1,43 - 36,3	2077 - 3074
33230F70037A3C	3 x 3/0 + 3 x 4	1,55 - 39,4	2599 - 3847
33230F70037A4C	3 x 4/0 + 3 x 4	1,66 - 42,2	3093 - 4578
33230F70037A5C	3 x 250 MCM+ 3 x 4	1,88 - 47,8	3791 - 5611
33230F70037A7C	3 x 350 MCM + 3 x 2	2 - 50,8	5020 - 7430
33230F70037AAC	3 x 500 MCM + 3 x 1	2,3 - 58,4	7012 - 10378

Other dimension and colours available on request.

GAALFLEX® VFD 600 Type MC HL

XLPE/PVC, Low voltage variable frequency drive systems, UL 1569 type MC, UL 2225 HL 600V 90°C Dry or wet



ELETTROTEK KABEL® GAALFLEX® VFD Type MC HL
 UL approved Type MC 600 V
 UL 44, UL 1569, UL 2225, ICEA S-73-532,
 CSA C 22.2 No. 123-08, CSA C 22.2 No. 174-M1984

Construction:

Conductor:	stranded red copper, acc.to ASTM B-3 and ASTM B-8
Insulation:	special XLPE type XHHW-2, acc. to UL 44
Ground conductor:	stranded red copper, acc.to ASTM B-3 and ASTM B-8
Ground conductor insulation:	uninsulated
Cores color:	from 14 AWG to 2 AWG: acc. to ICEA S-73 532 table E2 method #1 from 1 AWG to 500 MCM: acc. to ICEA S-73 532 method #4
Stranding:	phase units laid up with uninsulated ground-conductors + non hygroscopic filler (if necessary) in interstices
Wrapping:	synthetic tape
Armour:	corrugated and welded aluminium tape
Outer Sheath:	black (similar RAL 9005), special PVC compound, acc. to UL1569

Resistance:



Flame test acc. to:

acc. to UL 1685 and IEEE 383 vertical tray fire test
 at 70,000 BTU/hr IVEA T-29-520 210,000 BTU/hr
 acc. to IEC 60332-3-22,
 IEEE 1202 and CSA FT4

Technical data:

Nominal voltage UL:	600 V
Temperature range UL:	
<i>Fixed laying:</i>	- 25 °C up to + 90 °C (- 40°C bend, with precautions)
<i>Max. operating temp:</i>	up to +130°C
<i>Short circuit temp:</i>	up to +250°C
Min. bending radius:	
<i>Fixed laying:</i>	7 x d
<i>Flexible application:</i>	12 x d

Features:

- LEAD FREE
- UL approval cables Type MC, 600 V
- UL approval for insulation conductors
- Designed type MC acc. to NEC 2008 and NEC 2011 Article 330
- American Bureau of Shipping (ABS) listed as CWC MC Type MC
- corrugated and welded aluminium tape protect from moisture, gases and liquids
- UV resistant
- direct burial
- suitable for cable tray
- high mechanical resistance
- On request is possible:
UL 1309 approval

UL Standards:

- UL standard 44, XHHW-2 600 V conductors
- UL standard 1569, type MC cables
- UL standard 2225, for Hazardous locations

CSA Standards:

- CSA C22.2 No. 123-08 for Aluminium sheathed cable
- CSA C22.2 No. 174-M1984 for Hazardous location

GAALFLEX® VFD CABLES

GAALFLEX® VFD 600 Type MC HL

XLPE/PVC, Low voltage variable frequency drive systems, UL 1569 type MC, UL 2225 HL 600V 90°C Dry or wet



ELETTROTEK KABEL® GAALFLEX® VFD Type MC HL
 UL approved Type MC 600 V
 UL 44, UL 1569, UL 2225, ICEA S-73-532,
 CSA C 22.2 No. 123-08, CSA C 22.2 No. 174-M1984

Part no.	No. of cores x cross section n x AWG/MCM	Outer Ø Inches/mm ±10%	Cable weight approx. Lbs/Mft-kg/km
46450F7T037A14	3 x 14 + 3 x 18	0,67 - 17	201 - 299
46450F7T037A12	3 x 12 + 3 x 16	0,67 - 17	227 - 338
46450F7T037A10	3 x 10 + 3 x 14	0,73 - 18,5	313 - 466
46450F7T037A08	3 x 8 + 3 x 14	0,84 - 21,3	414 - 616
46450F7T037A06	3 x 6 + 3 x 12	0,91 - 23,1	543 - 808
46450F7T037A04	3 x 4 + 3 x 12	1,04 - 26,4	736 - 1095
46450F7T037A02	3 x 2 + 3 x 10	1,23 - 31,2	1098 - 1634
46450F71037A01	3 x 1 + 3 x 10	1,32 - 33,5	1331 - 1981
46450F71037A1C	3 x 1/0 + 3 x 10	1,47 - 37,3	1593 - 2370
46450F71037A2C	3 x 2/0 + 3 x 10	1,5 - 38,1	1883 - 2802
46450F71037A3C	3 x 3/0 + 3 x 8	1,74 - 44,2	2400 - 3571
46450F71037A4C	3 x 4/0 + 3 x 8	1,87 - 47,5	2910 - 4330
46450F71037A5C	3 x 250 MCM+ 3 x 8	2,06 - 52,3	3317 - 4936
46450F71037A7C	3 x 350 MCM+ 3 x 6	2,16 - 54,9	4375 - 6510
46450F71037AAC	3 x 500 MCM + 3 x 6	2,5 - 63,5	6027 - 8969

Other dimension and colours available on request.

MEDIUM VOLTAGE CABLES



GAALFLEX® MEDIUM 1C Type MV-105

single-core, EPR/PVC, 5-35 kV, 100% & 133% Insulation level



ELETTROTEK KABEL® GAALFLEX® MEDIUM 1C Type MV-105



Construction:

Conductor:	compacted concentric soft drawn bare copper Class B acc. to ASTM
Inner semi-conductive layer:	semi-conductive extruded thermosetting polymeric layer
Insulation:	special rubber EPR compound
Outer semi-conductive layer:	semi-conductive extruded thermosetting polymeric layer
Screen:	red copper tape
Outer Sheath:	black (RAL 9005), special PVC compound

Resistance:



Self-extinguishing and flame retardant:
IEEE 383 flame test: (1/0 AWG and larger)
IEEE 1202 flame test: (250 MCM and larger)

Technical data:

Nominal voltage:	5 kV 100%, 133% 8 kV 100%, 133% 15 kV 100%, 133% 25 kV 100%, 133% 35 kV 100%, 133%
Temperature range:	
<i>operating:</i>	up to +105°C
<i>emergency overload:</i>	up to +140°C
<i>On short-circuit:</i>	up to +250°C
Min. bending radius:	12 x d

Features:

Suitable for Direct buried, aerial installation, cable trays (CT)*, troughs or raceways
*(CT use 1/0 AWG and larger)

suitable for wet or dry locations

sunlight resistant

on request compressed or compacted stranded conductors

on request compacted concentric stranded aluminium conductor Class B acc. to ASTM

on request LLDPE*, CPE or Halogen-free insulation
*(UL does not recognize LLDPE AS MV.105)

on request red copper wires screen

on request oil resistant outer sheath

on request low coefficient PVC outer sheath

on request acc. to CSA C68.10 (FT4 250 MCM and larger, -40°C cold impact and cold bend)

acc. to AIEC CS-8

RoHS approval



UL/ICEA standards:

UL 1072
ICEA S-97-682
ICEA S-93-639

MEDIUM VOLTAGE CABLES

GAALFLEX® MEDIUM 1C Type MV-105

single-core, EPR/PVC, 5-35 kV, 100% & 133% Insulation level



ELETTROTEK KABEL® GAALFLEX® MEDIUM 1C Type MV-105

5 kV 100 %, insulation level

Part no.	Cross section AWG/MCM	Outer Ø Inch/mm ±10%	Cable weight approx. Lbs/Mft - kg/km
4832027L010A04	1 x 4	0,63-16	316-470
4832027L010A02	1 x 2	0,68-17,3	414-616
4832027L010A01	1 x 1	0,72-18,3	480-714
4832027L010A1C	1x 1/0	0,76-19,3	566-842
4832027L010A2C	1x 2/0	0,79-20,1	665-990
4832027L010A3C	1 x 3/0	0,84-21,3	792-933
4832027L010A4C	1 x 4/0	0,93-23,6	974-1449
4832027L010A5C	1 x 250	0,98-24,9	1116-1661
4832027L010A7C	1 x 350	1,08-27,4	1468-2185
4832027L010AAC	1 x 500	1,2-30,5	1982-2949
4832027L010AFC	1 x 750	1,38-35,1	2861-4257
4832027L010AJC	1 x 1000	1,53-38,9	3676-5470

5/8 kV 133 %/100%, insulation level

Part no.	Cross section AWG/MCM	Outer Ø Inch/mm ±10%	Cable weight approx. Lbs/Mft - kg/km
48320P7L010A04	1 x 4	0,68-17,3	347-516
48320P7L010A02	1 x 2	0,73-18,6	424-631
48320P7L010A01	1 x 1	0,77-19,6	514-765
48320P7L010A1C	1x 1/0	0,81-20,6	577-859
48320P7L010A2C	1x 2/0	0,84-21,3	675-1004
48320P7L010A3C	1 x 3/0	0,92-23,4	857-1275
48320P7L010A4C	1 x 4/0	0,97-24,6	982-1461
48320P7L010A5C	1 x 250	1,02-20,5	1126-1676
48320P7L010A7C	1 x 350	1,12-28,4	1475-2195
48320P7L010AAC	1 x 500	1,24-31,5	1988-2958
48320P7L010AFC	1 x 750	1,43-36,3	2863-4260
48320P7L010AJC	1 x 1000	1,59-40,4	3681-5478

8 kV 133 %, insulation level

Part no.	Cross section AWG/MCM	Outer Ø Inch/mm ±10%	Cable weight approx. Lbs/Mft - kg/km
48321P7L010A02	1 x 2	0,8-20,3	489-728
48321P7L010A01	1 x 1	0,82-20,8	549-817
48321P7L010A1C	1x 1/0	0,86-21,8	638-949
48321P7L010A2C	1x 2/0	0,93-23,6	767-1141
48321P7L010A3C	1 x 3/0	0,97-24,6	899-1338
48321P7L010A4C	1 x 4/0	1,03-26,2	1060-1577
48321P7L010A5C	1 x 250	1,08-27,4	1206-1795
48321P7L010A7C	1 x 350	1,18-30	1566-2330
48321P7L010AAC	1 x 500	1,3-33	2089-3109
48321P7L010AFC	1 x 750	1,48-37,6	2983-4439
48321P7L010AJC	1 x 1000	1,6-40,6	3810-5670

MEDIUM VOLTAGE CABLES

GAALFLEX® MEDIUM 1C Type MV-105

single-core, EPR/PVC, 5-35 kV, 100% & 133% Insulation level



ELETTROTEK KABEL® GAALFLEX® MEDIUM 1C Type MV-105



15 kV 100 %, insulation level

Part no.	Cross section AWG/MCM	Outer Ø Inch/mm ±10%	Cable weight approx. Lbs/Mft - kg/km
48320T7L010A02	1 x 2	0,84-21,3	525-781
48320T7L010A01	1 x 1	0,91-23,1	621-924
48320T7L010A1C	1x 1/0	0,95-24,1	713-1061
48320T7L010A2C	1x 2/0	0,98-24,9	818-1217
48320T7L010A3C	1 x 3/0	1,03-26,2	952-1417
48320T7L010A4C	1 x 4/0	1,09-27,7	1115-1659
48320T7L010A5C	1 x 250	1,14-29	1264-1881
48320T7L010A7C	1 x 350	1,24-31,5	1629-2424
48320T7L010AAC	1 x 500	1,36-34,5	2157-3210
48320T7L010AFC	1 x 750	1,54-39,1	3060-4554
48320T7L010AJC	1 x 1000	1,69-42,9	3894-5929

15 kV 133 %, insulation level

Part no.	Cross section AWG/MCM	Outer Ø Inch/mm ±10%	Cable weight approx. Lbs/Mft - kg/km
48321T7L010A02	1 x 2	0,96-24,4	590-878
48321T7L010A01	1 x 1	1-25,4	696-1036
48321T7L010A1C	1x 1/0	1,04-26,4	762-1134
48321T7L010A2C	1x 2/0	1,07-27,2	863-1284
48321T7L010A3C	1 x 3/0	1,12-28,4	1036-1542
48321T7L010A4C	1 x 4/0	1,17-29,7	1161-1728
48321T7L010A5C	1 x 250	1,22-31	1314-1955
48321T7L010A7C	1 x 350	1,32-33,5	1676-2494
48321T7L010AAC	1 x 500	1,44-36,6	2204-3280
48321T7L010AFC	1 x 750	1,63-41,4	3110-4628
48321T7L010AJC	1 x 1000	1,84-46,7	4056-6036

25 kV 100 %, insulation level

Part no.	Cross section AWG/MCM	Outer Ø Inch/mm ±10%	Cable weight approx. Lbs/Mft - kg/km
48320W7L010A01	1 x 1	1,07-27,2	760-1131
48320W7L010A1C	1x 1/0	1,11-28,2	857-1275
48320W7L010A2C	1x 2/0	1,14-29	967-1439
48320W7L010A3C	1 x 3/0	1,19-30,2	1106-1646
48320W7L010A4C	1 x 4/0	1,25-31,7	1277-1900
48320W7L010A5C	1 x 250	1,3-33	1432-2131
48320W7L010A7C	1 x 350	1,4-35,6	1809-2962
48320W7L010AAC	1 x 500	1,52-38,6	2353-3501
48320W7L010AFC	1 x 750	1,76-44,7	3379-5028
48320W7L010AJC	1 x 1000	1,91-48,5	4242-6313

25 kV 133 %, insulation level

Part no.	Cross section AWG/MCM	Outer Ø Inch/mm ±10%	Cable weight approx. Lbs/Mft - kg/km
48321W7L010A01	1 x 1	1,2-30,5	894-1330
48321W7L010A1C	1x 1/0	1,24-31,5	994-1479
48321W7L010A2C	1x 2/0	1,28-32,5	1109-1650
48321W7L010A3C	1 x 3/0	1,33-33,8	1254-1866
48321W7L010A4C	1 x 4/0	1,38-35,1	1430-2128
48321W7L010A5C	1 x 250	1,43-36,3	1591-2368
48321W7L010A7C	1 x 350	1,53-38,9	1979-2945
48321W7L010AAC	1 x 500	1,65-41,9	2535-3772
48321W7L010AFC	1 x 750	1,9-48,3	3588-5339
48321W7L010AJC	1 x 1000	2,05-52,1	4468-6649

MEDIUM VOLTAGE CABLES

GAALFLEX® MEDIUM 1C Type MV-105

single-core, EPR/PVC, 5-35 kV, 100% & 133% Insulation level



ELETTROTEK KABEL® GAALFLEX® MEDIUM 1C Type MV-105

35 kV 100 %, insulation level

Part no.	Cross section AWG/MCM	Outer Ø Inch/mm ±10%	Cable weight approx. Lbs/Mft - kg/km
48320Y7L010A1C	1x 1/0	1,29-32,8	1011-1504
48320Y7L010A2C	1x 2/0	1,33-33,8	1165-1734
48320Y7L010A3C	1 x 3/0	1,38-35,1	1312-1952
48320Y7L010A4C	1 x 4/0	1,43-36,3	1443-2147
48320Y7L010A5C	1 x 250	1,48-37,6	1653-2460
48320Y7L010A7C	1 x 350	1,58-40,1	1989-2960
48320Y7L010AAC	1 x 500	1,7-43,2	2542-3783
48320Y7L010AFC	1 x 750	1,95-49,5	3670-5461
48320Y7L010AJC	1 x 1000	2,1-53,3	4555-6778

35 kV 133 %, insulation level

Part no.	Cross section AWG/MCM	Outer Ø Inch/mm ±10%	Cable weight approx. Lbs/Mft - kg/km
48321Y7L010A1C	1x 1/0	1,43-36,3	1214-1807
48321Y7L010A2C	1x 2/0	1,47-37,3	1279-1903
48321Y7L010A3C	1 x 3/0	1,52-38,6	1428-2125
48321Y7L010A4C	1 x 4/0	1,57-39,9	1669-2484
48321Y7L010A5C	1 x 250	1,62-41,1	1837-2734
48321Y7L010A7C	1 x 350	1,78-45,2	2342-3485
48321Y7L010AAC	1 x 500	1,9-48,3	2924-4351
48321Y7L010AFC	1 x 750	2,09-53,1	3906-5813
48321Y7L010AJC	1 x 1000	2,24-56,9	4808-7155

Other dimensions and colors available on request.

MEDIUM VOLTAGE CABLES

GAALFLEX® MEDIUM 3C+1G Type MV-105

Three-cores + 1 ground, 5-35 kV, 100% & 133% Insulation level



ELETTROTEK KABEL® GAALFLEX® MEDIUM 3C+1G Type MV-105

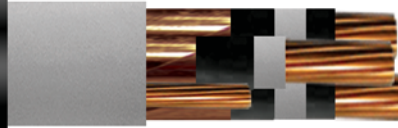

Construction:

Conductor:	Compressed concentric stranded bare copper Class B acc. to ASTM B3 and B8
Inner semi-conductive layer:	semi-conductive extruded thermosetting polymeric layer
Insulation:	EPR compound
Outer semi-conductive layer:	semi-conductive extruded thermosetting polymeric layer
Screen:	red copper tape
Earth conductor:	Compressed concentric stranded bare copper Class B acc. to ASTM B3 and B8
Fillers:	in interstices
Wrapping:	binder tape
Outer Sheath:	black (RAL 9005), PVC compound

Technical data:

Nominal voltage:	5 kV 100%, 133% 5/8 kV 133%, 100% 15 kV 100%, 133% 25 kV 100%, 133% 28 kV 100%, 133% 35 kV 100%, 133%
Temperature range:	
<i>operating:</i>	up to +105°C
<i>emergency overload:</i>	up to +140°C
<i>On short-circuit:</i>	up to +250°C

Resistance:



Self-extinguishing and flame retardant:

UL 1685 flame exposure test, and IEEE 1202/FT4 Flame test (70000 Btu/hr Vertical Tray Test)

Features:

Suitable for Direct buried, aerial installation, cable trays (CT), troughs or raceways

suitable for wet or dry locations

Sunlight resistant

on request CPE or Halogen-free compound outer sheath

acc. to AIEC CS-8

RoHS approval



UL/ICEA standards:

UL standard 1072 and ICEA S-93-639 (NEMA WC 74) 5-46 kV

ICEA S-97-682 when requested

MEDIUM VOLTAGE CABLES

GAALFLEX® MEDIUM 3C+1G Type MV-105

Three-cores + 1 ground, 5-35 kV, 100% & 133% Insulation level



ELETTROTEK KABEL® GAALFLEX® MEDIUM 3C+1G Type MV-105

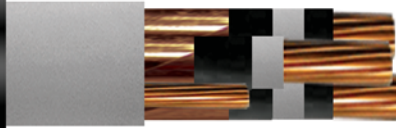

5 kV 100 %, insulation level

Part no.	Cross section AWG/MCM	Outer Ø Inch/mm ±10%	Cable weight approx. Lbs/Mft - kg/km
48320271035A02	3 x 2 + 6	1,443 - 38,6	1447 - 2153
48320271035A01	3 x 1 + 4	1,529 - 38,8	1730 - 2575
48320271035A1C	3 x 1/0 + 4	1,616 - 41	1987 - 2957
48320271035A2C	3 x 2/0 + 4	1,765 - 44,8	2421 - 3602
48320271035A3C	3 x 3/0 + 3	1,873 - 47,6	2869 - 4269
48320271035A4C	3 x 4/0 + 3	1,992 - 50,6	3384 - 5036
48320271035A5C	3 x 250 + 2	2,123 - 53,9	3911 - 5819
48320271035A7C	3 x 350 + 2	2,349 - 59,7	5056 - 7524
48320271035AAC	3 x 500 + 1	2,619 - 66,5	6770 - 10074
48320271035AFC	3 x 750 + 1/0	3,077 - 78,2	9722 - 14466

5 kV 133 %, insulation level

Part no.	Cross section AWG/MCM	Outer Ø Inch/mm ±10%	Cable weight approx. Lbs/Mft - kg/km
48321271035A02	3 x 2 + 6	1,443 - 38,6	1447 - 2153
48321271035A01	3 x 1 + 4	1,529 - 38,8	1730 - 2575
48321271035A1C	3 x 1/0 + 4	1,616 - 41	1987 - 2957
48321271035A2C	3 x 2/0 + 4	1,765 - 44,8	2421 - 3602
48321271035A3C	3 x 3/0 + 3	1,873 - 47,6	2869 - 4269
48321271035A4C	3 x 4/0 + 3	1,992 - 50,6	3384 - 5036
48321271035A5C	3 x 250 + 2	2,123 - 53,9	3911 - 5819
48321271035A7C	3 x 350 + 2	2,349 - 59,7	5056 - 7524
48321271035AAC	3 x 500 + 1	2,619 - 66,5	6770 - 10074
48321271035AFC	3 x 750 + 1/0	3,077 - 78,2	9722 - 14466

5/8 kV 133 %/100%, insulation level

Part no.	Cross section AWG/MCM	Outer Ø Inch/mm ±10%	Cable weight approx. Lbs/Mft - kg/km
48320P71035A06	3 x 6 + 6	1,329 - 33,8	1007 - 1498
48320P71035A04	3 x 4 + 6	1,427 - 36,2	1234 - 1836
48320P71035A02	3 x 2 + 6	1,55 - 39,4	1558 - 2319
48320P71035A01	3 x 1 + 4	1,637 - 41,6	1836 - 2732
48320P71035A1C	3 x 1/0 + 4	1,787 - 45,4	2208 - 3286
48320P71035A2C	3 x 2/0 + 4	1,663 - 42,22	2207 - 3285
48320P71035A3C	3 x 3/0 + 3	1,981 - 50,3	3006 - 4473
48320P71035A4C	3 x 4/0 + 3	2,1 - 53,3	3516 - 5232
48320P71035A5C	3 x 250 + 2	2,236 - 56,8	4055 - 6033
48320P71035A7C	3 x 350 + 2	2,457 - 62,4	5202 - 7740
48320P71035AAC	3 x 500 + 1	2,78 - 70,6	7058 - 10502
48320P71035AFC	3 x 750 + 1/0	3,185 - 80,9	9905 - 14738

MEDIUM VOLTAGE CABLES

GAALFLEX® MEDIUM 3C+1G Type MV-105

Three-cores + 1 ground, 5-35 kV, 100% & 133% Insulation level



15 kV 100 %, insulation level

Part no.	Cross section AWG/MCM	Outer Ø Inch/mm ±10%	Cable weight approx. Lbs/Mft - kg/km
48320T71035A02	3 x 2 + 6	1,89 - 48	2025 - 3013
48320T71035A01	3 x 1 + 4	1,95 - 49,5	2310 - 3438
48320T71035A1C	3 x 1/0 + 4	2,03 - 51,6	2600 - 3869
48320T71035A2C	3 x 2/0 + 4	2,12 - 53,8	2960 - 4405
48320T71035A3C	3 x 3/0 + 3	2,22 - 56,4	3430 - 5104
48320T71035A4C	3 x 4/0 + 3	2,33 - 59,2	3975 - 5915
48320T71035A5C	3 x 250 + 2	2,43 - 61,7	4490 - 6682
48320T71035A7C	3 x 350 + 2	2,64 - 67,1	5680 - 8452
48320T71035AAC	3 x 500 + 1	2,96 - 75,2	7925 - 11793
48320T71035AFC	3 x 750 + 1/0	3,33 - 84,6	10540 - 15684
48320T71035AJC	3 x 1000 + 2/0	3,82 - 97	13700 - 20386

15 kV 133 %, insulation level

Part no.	Cross section AWG/MCM	Outer Ø Inch/mm ±10%	Cable weight approx. Lbs/Mft - kg/km
48321T71035A02	3 x 2 + 6	2,057 - 52,2	2252 - 3350
48321T71035A01	3 x 1 + 4	2,143 - 54,4	2566 - 3818
48321T71035A1C	3 x 1/0 + 4	2,229 - 56,6	2881 - 4286
48321T71035A2C	3 x 2/0 + 4	2,316 - 58,8	3244 - 4827
48320T71035A3C	3 x 3/0 + 3	2,424 - 61,6	3724 - 5541
48321T71035A4C	3 x 4/0 + 3	2,543 - 64,6	4283 - 6373
48321T71035A5C	3 x 250 + 3	2,673 - 67,9	4807 - 7152
48321T71035A7C	3 x 350 + 2	2,953 - 75	6232 - 9273
48321T71035AAC	3 x 500 + 1	3,223 - 81,9	8056 - 11987
48321T71035AFC	3 x 750 + 1/0	3,628 - 92,2	11025 - 16405

25 kV 100 %, insulation level

Part no.	Cross section AWG/MCM	Outer Ø Inch/mm ±10%	Cable weight approx. Lbs/Mft - kg/km
48320W71035A01	3 x 1 + 4	2,28 - 57,9	2800 - 5167
48320W71035A1C	3 x 1/0 + 4	2,36 - 59,9	3110 - 4628
48320W71035A2C	3 x 2/0 + 4	2,44 - 62	3485 - 5186
48320W71035A3C	3 x 3/0 + 3	2,55 - 64,8	3980 - 5923
48320W71035A4C	3 x 4/0 + 3	2,66 - 67,6	4545 - 6763
48320W71035A5C	3 x 250 + 2	2,76 - 70,1	5080 - 7760
48320W71035A7C	3 x 350 + 2	3,02 - 77,7	6485 - 9650
48320W71035AAC	3 x 500 + 1	3,28 - 83,3	8335 - 12403
48320W71035AFC	3 x 750 + 1/0	3,65 - 92,7	11325 - 16853
48320W71035AJC	3 x 1000 + 2/0	4,15 - 105,4	14590 - 21711

25 kV 133 %/100%, insulation level

Part no.	Cross section AWG/MCM	Outer Ø Inch/mm ±10%	Cable weight approx. Lbs/Mft - kg/km
48320W71035A01	3 x 1 + 4	2,56 - 65	3280 - 4881
48320W71035A1C	3 x 1/0 + 4	2,64 - 1	3605 - 5365
48320W71035A2C	3 x 2/0 + 4	2,73 - 69,3	3995 - 5945
48320W71035A3C	3 x 3/0 + 3	2,83 - 71,9	4510 - 6711
48320W71035A4C	3 x 4/0 + 3	3 - 76,2	5265 - 7835
48320W71035A5C	3 x 250 + 2	3,1 - 78,7	5825 - 8668
48320W71035A7C	3 x 350 + 2	3,3 - 83,8	7105 - 10753
48320W71035AAC	3 x 500 + 1	3,56 - 90,4	9005 - 13400
48320W71035AFC	3 x 750 + 1/0	3,93 - 99,8	12060 - 17946
48320W71035AJC	3 x 1000 + 2/0	4,43 - 112,5	15415 - 22939,1

MEDIUM VOLTAGE CABLES

GAALFLEX® MEDIUM 3C+1G Type MV-105

Three-cores + 1 ground, 5-35 kV, 100% & 133% Insulation level



ELETTROTEK KABEL® GAALFLEX® MEDIUM 3C+1G Type MV-105

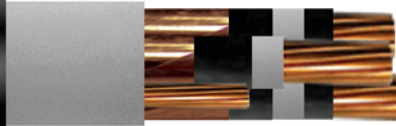

28 kV 100 %, insulation level

Part no.	Cross section AWG/MCM	Outer Ø Inch/mm ±10%	Cable weight approx. Lbs/Mft - kg/km
48320X71035A01	3 x 1 + 4	2,36 - 59,9	2945 - 4382
48320X71035A1C	3 x 1/0 + 4	2,44 - 62	3260 - 4851
48320X71035A2C	3 x 2/0 + 4	2,53 - 64,3	3635 - 5409
48320X71035A3C	3 x 3/0 + 3	2,63 - 66,8	4140 - 6161
48320X71035A4C	3 x 4/0 + 3	2,75 - 69,8	4710 - 7009
48320X71035A5C	3 x 250 + 2	2,84 - 72,1	5250 - 7812
48320X71035A7C	3 x 350 + 2	3,11 - 79	6670 - 9926
48320X71035AAC	3 x 500 + 1	3,37 - 85,6	8535 - 12701
48320X71035AFC	3 x 750 + 1/0	3,74 - 95	11545 - 17180
48320X71035AJC	3 x 1000 + 2/0	4,23 - 107,4	14835 - 22076

28 kV 133 %, insulation level

Part no.	Cross section AWG/MCM	Outer Ø Inch/mm ±10%	Cable weight approx. Lbs/Mft - kg/km
48320X71035A01	3 x 1 + 4	2,67 - 67,8	3480 - 5179
48320X71035A1C	3 x 1/0 + 4	2,75 - 69,8	3810 - 5670
48320X71035A2C	3 x 2/0 + 4	2,83 - 71,9	4205 - 6257
48320X71035A3C	3 x 3/0 + 3	3 - 76,2	4895 - 7284
48320X71035A4C	3 x 4/0 + 3	3,11 - 79	5495 - 8177
48320X71035A5C	3 x 250 + 2	3,2 - 81,3	6065 - 9025
48320X71035A7C	3 x 350 + 2	3,41 - 86,6	7360 - 10952
48320X71035AAC	3 x 500 + 1	3,67 - 93,2	9275 - 14472
48320X71035AFC	3 x 750 + 1/0	4,04 - 102,6	12355 - 18385

35 kV 100 %, insulation level

Part no.	Cross section AWG/MCM	Outer Ø Inch/mm ±10%	Cable weight approx. Lbs/Mft - kg/km
48320Y71035A1C	3 x 1/0 + 4	2,75 - 69,8	3810 - 5670
48320Y71035A2C	3 x 2/0 + 4	2,83 - 71,9	4205 - 6257
48320Y71035A3C	3 x 3/0 + 3	3 - 76,2	4895 - 7284
48320Y71035A4C	3 x 4/0 + 3	3,11 - 79	5495 - 8177
48320Y71035A5C	3 x 250 + 2	3,2 - 81,3	6065 - 9025
48320Y71035A7C	3 x 350 + 2	3,41 - 86,6	7360 - 10952
48320Y71035AAC	3 x 500 + 1	3,67 - 93,2	9275 - 14472
48320Y71035AFC	3 x 750 + 1/0	4,04 - 102,6	12355 - 18385

35 kV 133 %/100%, insulation level

Part no.	Cross section AWG/MCM	Outer Ø Inch/mm ±10%	Cable weight approx. Lbs/Mft - kg/km
48320Y71035A1C	3 x 1/0 + 4	3,13 - 79,5	4645 - 6912
48320Y71035A2C	3 x 2/0 + 4	3,22 - 81,8	5065 - 7537
48320Y71035A3C	3 x 3/0 + 3	3,32 - 84,3	5610 - 8348
48320Y71035A4C	3 x 4/0 + 3	3,43 - 87,1	6235 - 9728
48320Y71035A5C	3 x 250 + 2	3,53 - 89,7	6820 - 10149
48320Y71035A7C	3 x 350 + 2	3,74 - 96,1	8160 - 12143
48320Y71035AAC	3 x 500 + 1	4 - 101,6	10130 - 15074
48320Y71035AFC	3 x 750 + 1/0	4,37 - 111	13290 - 19777

Other dimensions and colors available on request.

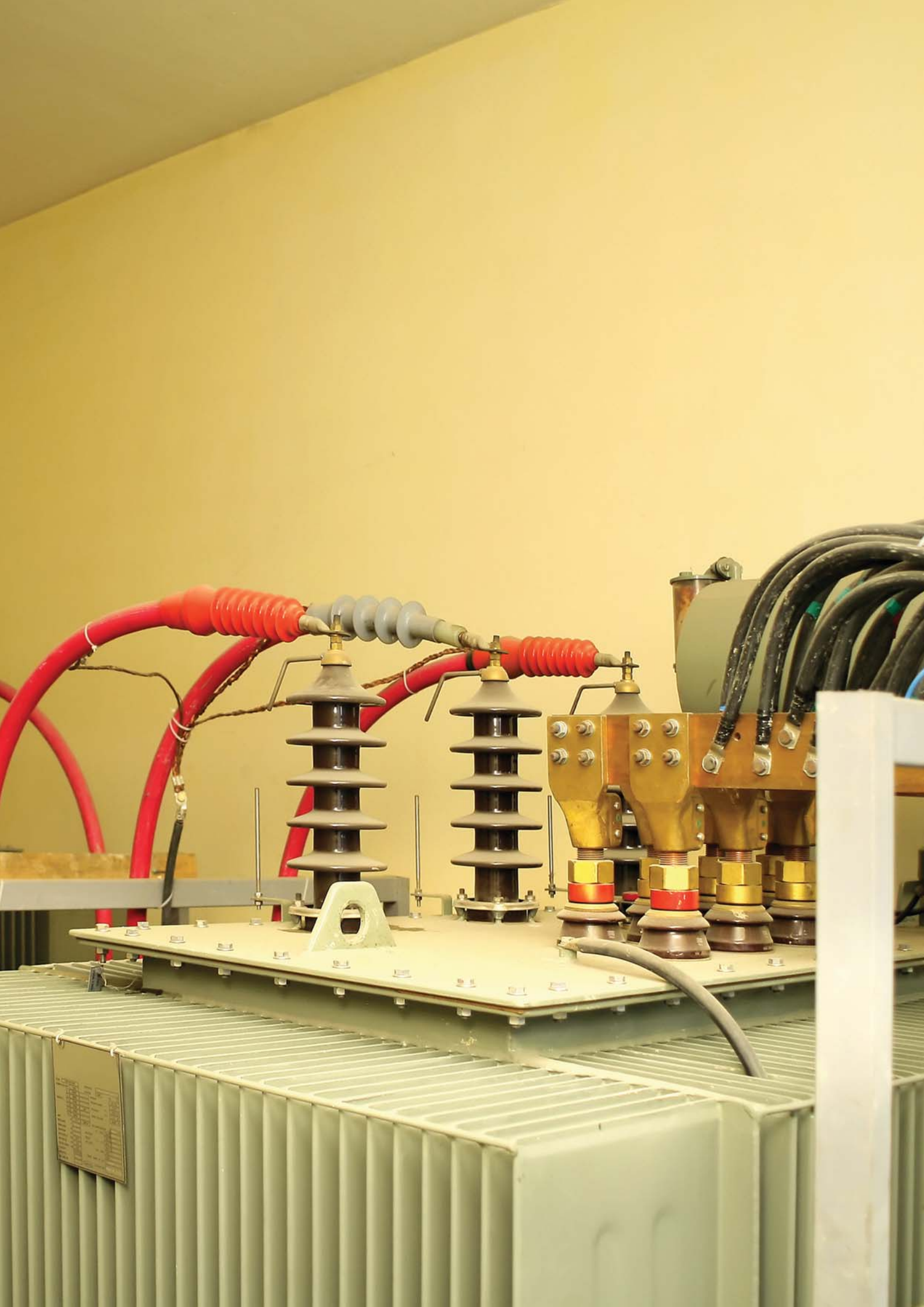

PORTABLE CORD AND MINING



FESTOON CABLES

FLEXIFESTOON® SOOW

EPDM/CPE cable, UL 600 V -40°C up to 90°C - CSA SOOW 600 V -40°C up to +90°C FT2 Water resistant, MSHA



ELETTROTEKKABEL® FLEXIFESTOON® SOOW
UL 600 V -40°C up to 90°C - CSA SOOW 600 V
-40°C up to 90°C FT2 Water resistant, MSHA



Construction:

Conductor:	finely stranded red copper acc.to Cl. K, acc. to ASTM B-174
Insulation:	rubber EPDM compound
Cores color:	acc. to ICEA Method 1-E1 (K-1)
Stranding:	in layers
Outer sheath:	black (similar to RAL 9005), rubber CPE compound

Resistance:



Flame test acc. to:
CSA FT 2

Technical data:

Nominal voltage:	600 V
Test voltage:	2 kV
Temperature range:	
<i>Fixed laying:</i>	-40°C up to +90°C
<i>Flexible application:</i>	-40°C up to +90°C
Min. bending radius:	
<i>Fixed laying:</i>	4 x D
<i>Flexible application:</i>	4 x D

Features:

UV, ozone, water, oil and abrasion resistant

flexible in cold weather

on request tinned copper conductor

on request screened version

(UL) 600 V -40°C up to 90°C
CSA 600 V -40°C up to 90°C FT2

acc. to UL standard 62

acc. to CSA 22.2 No. 49

acc. to NEC 501.140 Class I, Division. 1 and 2

acc. to NEC Article 400

MSHA approval

for MINIMUM BENDING RADIUS see pages from 5 to 8
of catalogue

RoHS approval



FESTOON CABLES

FLEXIFESTOON® SOOW

EPDM/CPE cable, UL 600 V -40°C up to 90°C - CSA SOOW 600 V -40°C up to +90°C FT2 Water resistant, MSHA



ELETTROTEKKABEL® FLEXIFESTOON® SOOW
UL 600 V -40°C up to 90°C - CSA SOOW 600 V
-40°C up to 90°C FT2 Water resistant, MSHA



Part no.	No. of cores x cross section n x AWG	Outer-Ø inches/mm ± 10%	Cable weight approx. Lbs/Mft-kg/km	Current capacity at +30°C Amps
03200F7K020A18	2 x 18	0,346 - 7,6	67 - 100	10
03200F7K030A18	3 x 18	0,365 - 9,27	84 - 125	10
03200F7K040A18	4 x 18	0,39 - 9,91	98 - 146	7
03200F7K050A18	5 x 18	0,465 - 11,81	116 - 173	5
03200F7K020A16	2 x 16	0,37 - 9,4	81 - 121	13
03200F7K030A16	3 x 16	0,39 - 9,91	94 - 140	13
03200F7K040A16	4 x 16	0,415 - 10,54	118 - 176	10
03200F7K050A16	5 x 16	0,495 - 12,57	143 - 213	8
03200F7K080A16	8 x 16	0,575 - 14,6	222 - 331	-
03200F7K100A16	10 x 16	0,62 - 15,8	278 - 414	-
03200F7K120A16	12 x 16	0,66 - 16,8	305 - 454	-
03200F7K020A14	2 x 14	0,5 - 12,7	134 - 199	18
03200F7K030A14	3 x 14	0,525 - 13,34	169 - 252	18
03200F7K040A14	4 x 14	0,57 - 14,48	201 - 299	15
03200F7K050A14	5 x 14	0,668 - 16,97	272 - 405	12
03200F7K080A14	8 x 14	0,74 - 18,9	324 - 480	32
03200F7K020A12	2 x 12	0,57 - 14,48	184 - 274	25
03200F7K030A12	3 x 12	0,595 - 15,11	224 - 333	25
03200F7K040A12	4 x 12	0,650 - 16,51	276 - 411	20
03200F7K050A12	5 x 12	0,713 - 18,11	318 - 473	16
03200F7K080A12	8 x 12	0,80 - 20,2	408 - 607	14
03200F7K200A12	20 x 12	1,22 - 31	971 - 1445	10
03200F7K020A10	2 x 10	0,615 - 15,62	225 - 335	30
03200F7K030A10	3 x 10	0,66 - 16,76	299 - 445	30
03200F7K040A10	4 x 10	0,71 - 18,03	360 - 536	25
03200F7K050A10	5 x 10	0,77 - 19,56	409 - 609	20
03200F7K030A08	3 x 8	0,88 - 22,35	485 - 722	40
03200F7K040A08	4 x 8	0,953 - 24,21	619 - 921	35
03200F7K050A08	5 x 8	1,034 - 26,26	722 - 1074	28
03200F7K030A06	3 x 6	1,04 - 26,42	700 - 1042	55
03200F7K040A06	4 x 6	1,125 - 28,58	837 - 1246	45
03200F7K050A06	5 x 6	1,185 - 30,1	979 - 1457	36
03200F7K030A04	3 x 4	1,315 - 28,83	902 - 1342	70
03200F7K040A04	4 x 4	1,255 - 31,88	1144 - 1702	60
03200F7K050A04	5 x 4	1,348 - 34,24	1320 - 1964	48
03200F7K020A02	3 x 2	1,305 - 33,15	1277 - 1900	95
03200F7K040A02	4 x 2	1,455 - 36,96	1639 - 2439	80
03200F7K050A02	5 x 2	1,556 - 39,52	1925 - 2439	64

Other dimensions and colors available on request.

FESTOON CABLES

FLEXIFESTOON® SEOOOW YELLOW

TPE/TPE cable, UL 600 V -60°C up to 105°C - CSA SEOOOW 600 V -60°C up to +105°C FT2 Water resistant, MSHA



ELETTROTEKKABEL® FLEXIFESTOON® SEOOOW YELLOW
UL 600 V -60°C up to 105°C - CSA SEOOOW 600 V
-60°C up to 105°C FT2 Water resistant, MSHA



Construction:

Conductor:	finely stranded red copper acc.to Cl. K, acc. to ASTM B-174
Insulation:	TPE compound
Cores color:	acc. to ICEA Method 1-E1 (K-1)
Stranding:	in layers
Outer sheath:	yellow (similar to RAL 1021) TPE compound

Resistance:



Flame test acc. to:
CSA FT 2

Technical data:

Nominal voltage:	600 V
Test voltage:	2 kV
Temperature range:	
<i>Fixed laying:</i>	-60°C up to +105°C
<i>Flexible application:</i>	-60°C up to +105°C
Min. bending radius:	
<i>Fixed laying:</i>	4 x D
<i>Flexible application:</i>	4 x D

Features:

UV, ozone, water, oil and abrasion resistant
flexible in cold weather
on request tinned copper conductor
on request screened version
on request black outer sheath version

(UL) 600 V -50°C up to 105°C
CSA 600 V -50°C up to 105°C FT2

acc. to UL standard 62

acc. to CSA 22.2 No. 49

acc. to NEC 501.140 Class I, Division. 1 and 2

acc. to NEC Article 400

acc. to Federal Spec JC580

acc. to EPA 40 CFR part 26-C,

heavy metals per table 1, TCLP method

MSHA approval

for MINIMUM BENDING RADIUS see pages from 5 to 8 of catalogue

RoHS approval



Part no.	No. of cores x cross section n x AWG	Outer-Ø inches/mm ± 10%	Cable weight approx. Lbs/Mft-kg/km	Current capacity at +30°C Amps
03210FYK020A18	2 x 18	0,342 - 8,69	53 - 79	10
03210FYK030A18	3 x 18	0,362 - 9,19	63 - 94	10
03210FYK040A18	4 x 18	0,387 - 9,83	79 - 118	7
03210FYK020A16	2 x 16	0,367 - 9,32	64 - 95	13
03210FYK030A16	3 x 16	0,387 - 9,83	78 - 116	13
03210FYK040A16	4 x 16	0,412 - 10,46	93 - 138	10
03210FYK020A14	2 x 14	0,497 - 12,62	115 - 171	18
03210FYK030A14	3 x 14	0,522 - 13,26	138 - 205	18
03210FYK040A14	4 x 14	0,562 - 14,27	166 - 247	15
03210FYK020A12	2 x 12	0,567 - 14,4	151 - 225	25
03210FYK030A12	3 x 12	0,595 - 15,11	185 - 275	25
03210FYK040A12	4 x 12	0,642 - 16,31	227 - 338	20
03210FYK020A10	2 x 10	0,617 - 15,67	192 - 286	30
03210FYK030A10	3 x 10	0,652 - 16,56	244 - 363	30
03210FYK040A10	4 x 10	0,702 - 17,83	300 - 446	25

Other dimensions and colors available on request.

FLEXIFESTOON® DLO



ELETTROTEK KABEL® FLEXIFESTOON® DLO

Construction:

Conductor:	annealed stranded tinned copper, acc. to ASTM B-33, AAR-598
Insulation:	special EPR compound
Core color:	black
Stranding:	in layers
Outer sheath:	black (similar to RAL 9005), special rubber CPE compound

Resistance:



Flame test acc. to:
FT4, FT1, UL VW-1

Technical data:

Nominal voltage:	U ₀ /U DLO 2000 V
Test voltage:	4 kV
Temperature range:	-40°C up to +90°C
Min. bending radius:	
<i>Fixed laying:</i>	4 x D
<i>Flexible application:</i>	6 x D

Features:

UV, wet, oils and chemical resistant

UL: 90°C, 600 V for CT use, VW-1 CSA RW 90°C DRY/WET 600 V -40°C FT1, MSHA DLO Type 2000 V

UL44 Type RHH/RHW-2,

1000 V CSA Type RW-90

ICEA S-95-685/ NEMA WC 70

90°C WET/DRY for continuous exposure

approved for CT use

for MINIMUM BENDING RADIUS see pages from 5 to 8 of catalogue

RoHS approval



Part no.	No. of cores x cross section n x AWG	Outer-Ø inches/mm ± 10%	Cable weight approx. Lbs/Mft-kg/km	Current capacity at +30°C Amps
0325017L010A08	1x8	0,348-8,84	105-156	80
0325017L010A06	1x6	0,386-9,8	146-217	105
0325017L010A04	1x4	0,438-11,1	206-307	140
0325017L010A02	1x2	0,500-12,7	293-436	190
0325017L010A01	1x1	0,613-15,6	392-584	220
0325017L010A1C	1x1/0	0,620-15,8	462-688	260
0325017L010A2C	1x2/0	0,680-17,3	558-830	300
0325017L010A3C	1x3/0	0,752-19,1	673-1003	350
0325017L010A4C	1x4/0	0,780-19,8	833-1240	405
0325017L010A5C	1x262	0,920-23,4	1077-1603	467
0325017L010A6C	1x313	0,968-24,6	1225-1823	518
0325017L010A7C	1x373	1,065-27	1485-2210	588
0325017L010A9C	1x444	1,132-28,8	1913-2847	649
0325017L010ABC	1x535	1,240-31,5	2023-3010	7L5
0325017L010ADC	1x646	1,359-34,5	2515-3742	814
0325017L010AFC	1x777	1,382-35,1	3050-4538	900

Other dimensions and colors available on request.

FESTOON CABLES

FLEXIFESTOON® PV-FLAT UL



ELETTROTEK KABEL® FLEXIFESTOON® PV-FLAT UL
UL Festoon and AWM 105°C 600 V, CSA Festoon 105°C 600 V

ELETTROTEK KABEL® FLEXIFESTOON® PV-FLAT UL
UL Festoon and AWM 105°C 600 V, CSA Festoon 105°C 600 V

Construction:

- Conductor:** flexible red copper conductor class M from 16 AWG up to 14 AWG
flexible red copper conductor class K from 12 AWG and larger
- Insulation:** special PVC compound 105°C
- Cores color:** acc. to ICEA Method 1-E2 (K-2)*
*5 conductors:
1 green, 2 white, 3 black, 4 red and blue
- Stranding:** cores laying parallel
- Outer sheath:** yellow (similar to RAL 1021),
special PVC compound 105°C
black (similar to RAL 9005), on request

Resistance:



Self-extinguishing and flame retardant acc. to:
UL VW-1, CSA FT4

Technical data:

- Nominal voltage:** 600 V
- Max. operating voltage:** 2000 V
- Test voltage:** 2 kV
- Temperature range:** -40°C up to +105°C
- Max. temp on conductor:**
In service: up to +90°C (105°C)
In short circuit: up to +150°C
- Min. bending radius:** 5 x d
- Max. temp on conductor:**
In service: up to +90°C (105°C)
In short circuit: up to +150°C
- Tensile strenght:**
Static: 15 n/mm²
Dynamic: 30 n/mm²
- Max speed (main application):** 120 m/min

Features:

- oil resistant outer sheath
- UV resistant
- cold resistant
- Indoor/outdoor use
- high flexibility
- minimum waste of space
- acc. to NEC approval
- UL festoon and AWM 105°C 600 V
- CSA festoon 105°C 600 V
- for SPEEDS and MINIMUM BENDING RADIUS
see pages from 2 to 8 of catalogue

Part no.	No. of cores x cross section n x AWG	Outer Ø inches/mm ±10%	Copper weight Lbs/Mft - kg/km	Cable weight approx. Lbs/Mft - kg/km
03220FYU040A16	4x16	0,6x0,2 - 15,2x5,1	33,8 - 50,3	87,4 - 130
03220FYU080A16	8x16	1,12x0,2 - 28,5x5,1	67,6 - 100,6	174,7 - 260
03220FYU120A16	12x16	1,68x0,2 - 41,5x5,1	101,4 - 150,9	268,8 - 400
03220FYU040A14	4x14	0,69x0,24 - 17,5x6,2	53,7 - 79,9	141,1 - 210
03220FYU080A14	8x14	1,34x0,24 - 34x6,2	107,3 - 159,7	255,4 - 380
03220FYU120A14	12x14	1,97x0,24 - 50x6,2	161,3 - 240	362,9 - 540
03220FYU040A12	4x12	0,71x0,24 - 18,1x6	85,4 - 127,1	168 - 250
03220FYU050A12	5x12	0,85x0,22 - 21,5x5,6	106,8 - 158,9	201,6 - 300
03220FYU080A12	8x12	1,34x0,24 - 34x6	170,8 - 254,2	315,8 - 470
03220FYU120A10	4x10	0,89x0,27 - 22,5x6,9	135,7 - 202	255,4 - 380
03220FYU050A10	5x10	1,08x0,27 - 27,5x6,9	169,7 - 252,5	302,4 - 450
03220FYU040A08	4x8	1,2x0,37 - 30,5x9,4	215,2 - 320,2	403,2 - 600
03220FYU040A06	4x6	1,45x0,43 - 36,8x10,9	343 - 510,7	618,2 - 920
03220FYU040A04	4x4	1,68x0,49 - 42,6x12,5	547,1 - 814,1	873,6 - 1300
03220FYU040A02	4x2	1,97x0,57 - 50x14,5	867 - 1290,2	1276,8 - 1900
03220FYU040A1C	4x1/0	2,6x0,75 - 66x19,1	1378 - 2050,6	2221 - 3305
03220FYU040A2C	4x2/0	2,72x0,79 - 69x20	1739,1 - 2588,2	2587,2 - 3850

Other dimensions and colors available on request.

PENDANT CABLES

LIFT-IS UL Central

UL Type STOOW Cable / CSA STOOW AWM / 600V 105°C / FTI



ELETTROTEK KABEL® LIFT-IS UL Central
UL Pendant 600V 90°C; UL
Type MTW; CSA AWM 600V 90°C

Construction:

- Conductor:** Flexible red copper
- Insulation:** PVC compound
- Cores color:**
1st core: yellow
2nd core: blue
3rd core: brown
4th core: red
5th core: orange
6th core: white
7th core: purple
- Central supporting unit:** central galvanized steel core
A 1/16" (7x7)
- Stranding:** in layers around central supporting unit
- Outer sheath:** yellow (similar to RAL 1021),
PVC compound, oil resistant

Resistance:



Self-extinguishing and flame retardant acc. to:
DIN VDE 0482 part 265-2-1
EN 50265-2-1
IEC 60332-1-2
UL type MTW, VW-1,
CSA AWM, FT-1

Technical data:

- Nominal voltage:** Uo/U 600 V
- Test voltage:** 2 kV
- Temperature range:**
Fixed laying: up to +105°C **UL/CSA:** +90°C
Flexible application: up to +105°C **UL/CSA:** +90°C
- Min. bending radius:** 10 x D

Features:

- UV, ozone and moisture resistance
 - low abrasion
 - high notch resistant
- UL Pendant 600 V 90°C**
UL type MTW
CSA AWM 600 V 90°C

Part no.	No. of cores x cross section n x AWG	Outer-Ø inches/mm ± 10%	Cable weight approx. Lbs/Mft-kg/km
03300FYK030A16	3x16	0,514 - 13,1	100 - 149
03300FYK050A16	5x16	0,554 - 14,1	173 - 257
03300FYK070A16	7x16	0,592 - 15	185 - 275

Other dimensions and colors available on request.

PENDANT CABLES

LIFT- 1S UL



ELETTROTEK KABEL® LIFT 1S UL
 UL subject 2562 for pendant cable,
 UL 105°C 600 V, CSA AWM I/II A/B 105°C 600 V



Construction:

- Conductor:** finely stranded red copper
 acc.to ASTM B-3 or ASTM B-174
- Insulation:** PVC compound 105°C
 acc. to UL 62, CSA C22.2 No.210.2
- Cores color:** acc. to ICEA Method 1-E1 (K-1)
- Stranding:** in layer with fibrillated polypropylene filler
- Wrapping:** polyester tape
- Supporting unit:** one galvanized steel core + black nylon covering, laying parallel with the cable
- Outer sheath:** black (similar to RAL 9005),
 PVC compound
 acc. to UL 62, CSA C22.2 No.210.2

Resistance:



Self-extinguishing and flame retardant acc. to:
 DIN VDE 0482 part 265-2-1
 EN 50265-2-1
 IEC 60332-1-2
 UL type MTW, VW-1,
 CSA AWM, FT-1

Technical data:

- Nominal voltage:** Uo/U 600 V
- Test voltage:** 2 kV
- Temperature range:** **(UL) / c(UL)**
- Fixed laying:* -25°C up to +105°C
- Flexible application:* -25°C up to +105°C
- Min. bending radius:** 10 x D

Features:

- UV, ozone and moisture resistance
- low abrasion
- high notch resistant
- UL subject 2562 for pendant cables**
- UL 105°C 600 V**
- CSA AWM I/II A/B 105°C 600 V**

Part no.	No. of cores x cross section n x mm ²	Outer-Ø inches/mm ± 10%	Cable weight approx. Lbs/Mft-kg/km	Tensile strength N	AWG no. ³⁾
03170F7K041A16	4 G1,5	0,675 x 0,445 - 17,1 x 11,3	134 - 199,4	1000	16
03170F7K061A16	6 G 1,5	0,75 x 0,52 - 19 x 13,2	171 - 254,4	1000	16
03170F7K081A16	8 G1,5	0,845 x 0,615 - 21,5 x 15,6	213 - 317	1000	16

Other dimensions and colors available on request.

PENDANT CABLES

LIFT-2S UL



ELETTROTEK KABEL® LIFT-2S UL
UL subject 2562 for pendant cables,
UL 90°C 600 V, CSA AWM I/II A/B 90°C 600 V

Construction:

Conductor:	finely stranded red copper acc.to ASTM B-3 or ASTM B-174
Insulation:	PVC/Nylon special compound
Cores color:	acc. to ICEA Method 1-E2 (K-2)
Central unit:	PVC filler (if necessary)
Stranding:	in layers
Wrapping:	mylar tape
Supporting unit:	two galvanized steel core + black nylon covering, laying parallel with the cable
Outer sheath:	yellow (similar to RAL 1021), PVC compound

Resistance:



Self-extinguishing and flame retardant acc. to:

DIN VDE 0482 part 265-2-1
EN 50265-2-1
IEC 60332-1-2
UL type MTW, VW-1,
CSA AWM, FT-1

Technical data:

Nominal voltage:	Uo/U 600 V
Test voltage:	2 kV
Temperature range:	(UL) / c(UL)
<i>Fixed laying:</i>	-25°C up to +90°C
<i>Flexible application:</i>	-25°C up to +90°C
Min. bending radius:	10 x D

Features:

UV, ozone and moisture resistance
low abrasion
high notch resistant
UL subject 2562 for pendant cables
UL 90°C 600 V
CSA AWM I/II A/B 90°C 600 V

Part no.	No. of cores x cross section n x mm ²	Outer-Ø inches/mm ± 10%	Cable weight approx. Lbs/Mft-kg/km	Tensile strength N	AWG no.®)
03180FYU081A16	8G1,5	0,895 x 0,490 - 22,7 x 12,4	219 - 325,9	1000	16
03180FYU121A16	12G1,5	0,972 x 0,546 - 24,7 x 13,9	263 - 391,4	1000	16
03180FYU161A16	16G1,5	1,030 x 0,624 - 26,2 x 15,8	318 - 473,2	1000	16
03180FYU241A16	24G1,5	1,195 x 0,760 - 30,3 x 19,3	430 - 640	1000	16

Other dimensions and colors available on request.

LIFT CABLES

PENDANT ROUND LIFT 733 UL

pendant control cable up to 60 mt.



ELETTROTEK KABEL® PENDANT ROUND LIFT 733 UL
UL type MTW VW-1, UL 90°C 600 V,
CSA AWM I/II A/B 90°C 600 V FT1

Construction:

- Conductor:** finely stranded red copper
acc. to ASTM B-3 or ASTM B-174
- Insulation:** PVC/Nylon special compound
- Cores color:** acc. to ICEA Method 1-E2 (K-2)
- Central unit:** PVC filler
- Stranding:** in layers
- Wrapping:** mylar tape
- Outer sheath:** yellow (similar to RAL 1021),
PVC compound

Resistance:



Self-extinguishing and flame retardant acc. to:
 DIN VDE 0482 part 265-2-1
 EN 50265-2-1
 IEC 60332-1-2
 UL type MTW, VW-1,
 CSA AWM, FT-1

Technical data:

- Nominal voltage:** U₀/U 600 V
- Test voltage:** 2 kV
- Temperature range:** **(UL) / c(UL)**
- Fixed laying:* -25°C up to +90°C
- Flexible application:* -25°C up to +90°C
- Min. bending radius:** 10 x D

Features:

- UL 90°C 600 V**
- CSA AWM I/II A/B 90°C 600 V**

Part no.	No. of cores x cross section n x mm ²	Outer-Ø inches/mm ± 10%	Cable weight approx. Lbs/Mft-kg/km	Max. tensile strength N	AWG no.®)
07050FYU081A16	8G1,5	0,479 - 12,2	158 - 235	1000	16
07050FYU121A16	12G1,5	0,566 - 14,4	217 - 323	1000	16
07050FYU161A16	16G1,5	0,605 - 15,4	255 - 380	1000	16
07050FYU241A16	24G1,5	0,755 - 19,2	-	1000	16
07050FYU301A16	30G1,5	0,803 - 20,4	-	1000	16
07050FYU361A16	36G 1,5	0,905 - 23	-	1000	16

Other dimensions and colors available on request.

MINING CABLES

FLEXIMINING® Type W

EPR/CPE portable power cable, UL C(UL) 2000 V, -40°C up to 90°C, FTI, FT5, SUN RES OIL RES 90°C WET or DRY, MSHA



ELETTROTEK KABEL® FLEXIMINING® Type W

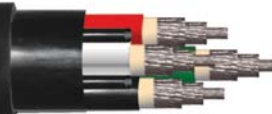

Construction:

Conductor:	finely stranded tinned copper acc. to ASTM B-172 and ICEA S-75-381/NEMA WC58
Separator:	tape separator
Insulation:	rubber EPR compound
Cores color:	acc. to ICEA S-75-381 sec 3.18, 2 cores: black, white 3 cores: black, white, green, 4 cores: black, white, green, red 5 cores: black, white, green, red, orange
Stranding:	in layers + fillers
Wrapping:	binder tape
Outer sheath:	black (similar to RAL 9005), rubber CPE compound

Resistance:



Flame test acc. to:
c(UL) FT 1, FT 5

Technical data:

Nominal voltage:	2 kV
Temperature range:	
<i>Fixed laying:</i>	- 40°C up to +90°C
<i>Flexible application:</i>	- 40°C up to +90°C
Min. bending radius:	6 x D

Features:

UV, ozone, water, weather, oil, grease and chemical resistant
excellent flexibility
excellent impact and abrasion resistant
on request CSA approval
acc. to ICEA S-75-381/NEMA WC58
acc. to ICEA S-95-658/NEMA WC70
acc. to ASTM B 33
acc. to ASTM B 33
MSHA approval
RoHS and CE approval



UL/CSA Standards:

UL 44

MINING CABLES

FLEXIMINING® Type W

EPR/CPE portable power cable, UL C(UL) 2000V, -40°C up to 90°C , FT5, SUN RES OIL RES 90°C WET or DRY, MSHA



ELETTROTEK KABEL® FLEXIMINING® Type W

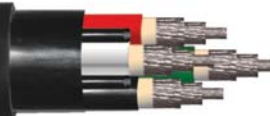

Part no.	No. of cores x cross section n x AWG / MCM	Outer-Ø inches/mm ± 10%	Cable weight approx. Lbs/Mft-kg/km		
0510017L010A08	1 x 8	0,44	11,2	129	192
0510017L010A06	1 x 6	0,51	13	188	280
0510017L010A04	1 x 4	0,55	14	249	371
0510017L010A02	1x 2	0,64	16,2	363	540
0510017L010A01	1 x 1	0,72	18,3	439	654
0510017L010A1C	1x 1/0	0,77	19,5	526	783
0510017L010A2C	1 x 2/0	0,79	20	625	930
0510017L010A3C	1 x 3/0	0,87	22,1	757	1126
0510017L010A4C	1 x 4/0	0,88	22,5	897	1335
0510017L010A5C	1 x 250	1,03	26,2	1088	1619
0510017L010A7C	1 x 350	1,15	29,1	1444	2149
0510017L010AAC	1 x 500	1,25	31,9	1913	2846
0510017L010AFC	1 x 750	1,58	40,1	2916	4341
0510017L010AGC	1 x 800	1,61	41	3071	4570
0510017K020A08	2 x 8	0,83	21,1	391	581
0510017K020A06	2 x 6	0,94	23,9	571	849
0510017K020A04	2 x 4	1,07	27,3	793	1180
0510017K020A02	2 x 2	1,26	32,1	1142	1699
0510017K020A01	2 x 1	1,41	35,9	1357	2019
0510017K020A1C	2 x 1/0	1,51	38,3	1693	2520
0510017K020A2C	2 x 2/0	1,65	41,9	1908	2840
0510017K020A3C	2 x 3/0	1,77	45,0	2600	3870
0510017K020A4C	2 x 4/0	1,92	48,8	2675	3980
0510017K020A5C	2 x 250	2,10	53,3	3434	5110
0510017K030A08	3 x 8	0,91	23,1	541	805
0510017K030A06	3 x 6	1,01	25,7	715	1064
0510017K030A04	3 x 4	1,05	26,5	1010	1503
0510017K030A02	3 x 2	1,32	33,6	1405	2091
0510017K030A01	3 x 1	1,51	38,4	1734	2581
0510017K030A1C	3 x 1/0	1,63	41,4	2030	3010
0510017K030A2C	3 x 2/0	1,73	44,0	2566	3818
0510017K030A3C	3 x 3/0	1,85	47,0	2885	4293
0510017K030A4C	3 x 4/0	1,99	50,6	3479	5177
0510017K030A5C	3 x 250	2,39	60,7	4368	6500
0510017K030A7C	3 x 350	2,66	67,5	5895	8772
0510017K030AAC	3 x 500	2,98	75,8	7820	11638
0510017K040A08	4 x 8	0,97	24,6	656	976
0510017K040A06	4 x 6	1,11	28,3	908	1352
0510017K040A04	4 x 4	1,26	32,1	1262	1878
0510017K040A02	4 x 2	1,43	36,3	1759	2618
0510017K040A01	4 x 1	1,71	43,4	2322	3456
0510017K040A1C	4 x 1/0	1,78	45,2	2721	4050
0510017K040A2C	4 x 2/0	1,89	48,0	3293	4901
0510017K040A3C	4 x 3/0	2,02	51,4	3849	5729
0510017K040A4C	4 x 4/0	2,22	56,3	4765	7092
0510017K040A5C	4 x 250	2,61	66,2	5579	8303
0510017K040A7C	4 x 350	2,92	74,2	7329	10908
0510017K040AAC	4 x 500	3,36	85,3	9896	14729
0510017K050A10	5 x 10*	0,93	23,7	568	837
0510017K050A08	5 x 8	1,07	27,2	776	1154
0510017K050A06	5 x 6	1,24	31,5	1024	1524
0510017K050A04	5 x 4	1,36	35,2	1432	2131
0510017K050A02	5 x 2	1,56	39,8	2051	3052
0510017K050A01	5 x 1	1,85	47,1	2665	3967
0510017K050A1C	5 x 1/0	1,98	50,4	3406	5069
0510017K050A2C	5 x 2/0	2,13	54,1	3596	5351
0510017K050A3C	5 x 3/0	2,27	57,6	4728	7035
0510017K050A4C	5 x 4/0	2,46	62,6	5512	8203
0510017K050A5C	5 x 250*	2,72	69,0	6333	9425
0510017K050AAC	5 x 500*	3,50	88,9	-	17300

* Based on ICEA S-75-381/NEMA WC-58, without approvals

Other dimensions and colors available on request.



FLEXIDRUM® MEDIUM SHD GC

From 2 Kv up to 15 Kv



Construction:

Power conductor:	flexible tinned copper conductor, acc. to ASTM B-172
Inner semi-conductive layer:	semi-conducting compound
Insulation:	rubber EPR compound
Power screen:	tinned copper braid with overall colored nylon and semi-conducting compound (non-conducting for 2 and 5 kV)
Outer semi-conductive layer:	semi-conducting compound
Earth conductors:	two finely stranded tinned copper acc. to ASTM B-172 uninsulated
Monitoring conductor:	finely stranded tinned copper acc. to ASTM B-172
Monitoring insulation:	PP compound
Cores color:	Power: natural color with Polyamide braid black, white, red acc. to ICEA S-75-381 Monitoring: yellow semi-conducting compound acc. to ICEA S-75-381 Tab. 3-22
Outer sheath:	black (similar to RAL 9005), rubber CPE compound

Features:

others colour on request
mechanical and water protection
MSHA, CSA and other approvals on request
two Earth conductors are used giving a total cross sectional area equal to at least 60% of the power conductor

for MINIMUM BENDING RADIUS
see pages from 5 to 8 of catalogue

RoHS approval



Technical data:

Nominal voltage:	2 kV up to 15 kV
Temperature range:	
<i>Flexible installation:</i>	-50°C up to +90°C
Min. bending radius:	8 x D

Applications:

FLEXIDRUM® MEDIUM cables are designed to provide safe, reliable performance on cable reelers and festoons at temperatures from -50°C to +50°C at speed up to 750 feet/minute. These cables are designed for use on gantry cranes, stacker/reclaimers and other equipment.

MINING CABLES

FLEXIDRUM® MEDIUM SHD GC

From 2 Kv up to 15 Kv



2 kV		POWER	GROUND/MONITORING			
Part no.	AWG no.*)		AWG no.*) Kcmil	Nominal outside diameter (In) ± 10%	Weight approx. lbs. x 1000 ft	Maximum tensile load (lbs)
02110170037A06	6		10/10	1,29	1160	-
02110170037A04	4		8/10	1,4	1490	293
02110170037A02	2		6/10	1,59	2000	466
02110170037A01	1		5/8	1,76	2450	587
02110170037A1C	1/0		4/8	1,86	2840	741
02110170037A2C	2/0		3/8	2	3400	934
02110170037A3C	3/0		2/8	2,13	3680	1178
02110170037A4C	4/0		1/8	2,31	4860	1178
02110170037A5C	250 MCM		1/0 - 6	2,51	5950	1178
02110170037A7C	350 MCM		2/0 - 6	2,81	7400	1178
02110170037AAC	500 MCM		3/0 - 6	3,19	10100	1178
5 kV		POWER	GROUND/MONITORING			
Part no.	AWG no.*)		AWG no.*) Kcmil	Nominal outside diameter (In) ± 10%	Weight approx. lbs. x 1000 ft	Maximum tensile load (lbs)
02110270037A06	6		10/8	1,56	1565	-
02110270037A04	4		8/8	1,7	1920	293
02110270037A02	2		6/8	1,9	2500	466
02110270037A01	1		5/8	1,95	2860	587
02110270037A1C	1/0		4/8	2	3390	741
02110270037A2C	2/0		3/8	2,2	3830	934
02110270037A3C	3/0		2/8	2,35	4418	1178
02110270037A4C	4/0		1/8	2,5	5300	1178
02110270037A5C	250 MCM		1/0 - 6	2,7	6450	1178
02110270037A7C	350 MCM		2/0 - 6	2,95	7880	1178
02110270037AAC	500 MCM		3/0 - 6	3,3	10440	1178
8 kV		POWER	GROUND/MONITORING			
Part no.	AWG no.*)		AWG no.*) Kcmil	Nominal outside diameter (In) ± 10%	Weight approx. lbs. x 1000 ft	Maximum tensile load (lbs)
02110P70037A04	4		8/8	2	2200	293
02110P70037A02	2		6/8	2,2	2850	466
02110P70037A01	1		5/8	2,3	3370	587
02110P70037A1C	1/0		4/8	2,4	3600	741
02110P70037A2C	2/0		3/8	2,5	4200	934
02110P70037A3C	3/0		2/8	2,7	5100	1178
02110P70037A4C	4/0		1/8	2,6	5680	1178
02110P70037A5C	250 MCM		1/0 - 6	2,9	6750	1178
02110P70037A7C	350 MCM		2/0 - 6	3,3	8480	1178
02110P70037AAC	500 MCM		3/0 - 6	3,6	10720	1178
15 kV		POWER	GROUND/MONITORING			
Part no.	AWG no.*)		AWG no.*) Kcmil	Nominal outside diameter (In) ± 10%	Weight approx. lbs. x 1000 ft	Maximum tensile load (lbs)
02110T70037A02	2		6/8	2,5	3520	466
02110T70037A01	1		5/8	2,6	4100	587
02110T70037A1C	1/0		4/8	2,7	4630	741
02110T70037A2C	2/0		3/8	2,9	4900	934
02110T70037A3C	3/0		2/8	3	5600	1178
02110T70037A4C	4/0		1/8	3,1	6830	1178

Other dimensions and colors available on request.

HIGH TEMPERATURE CABLES

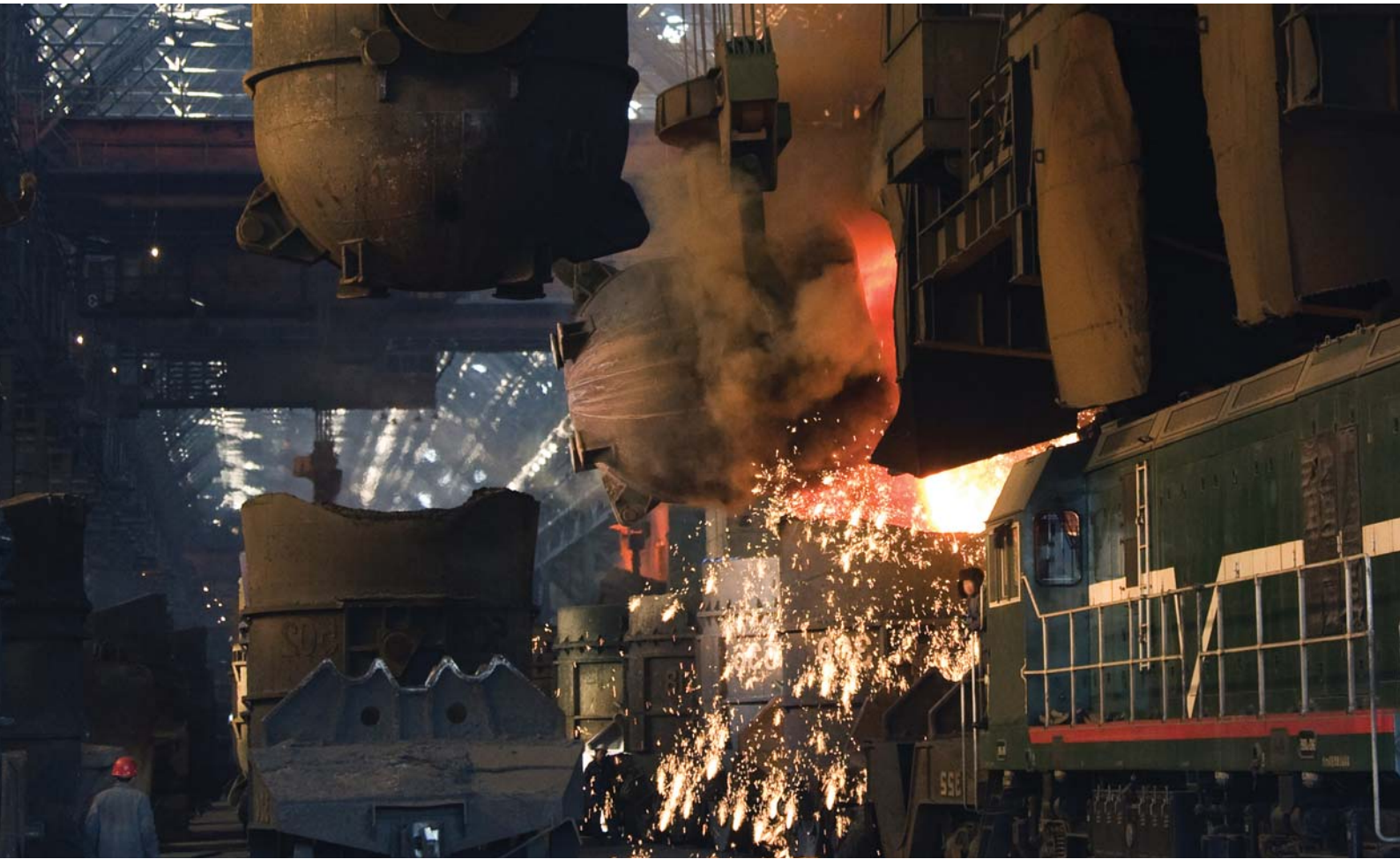

HIGH TEMPERATURE CABLES

GAALTHERM® SiAF/POL UL

Silicone insulated single core flexible, with silicone impregnated polyester fiber braiding, I, I up to 13,8/15 kV

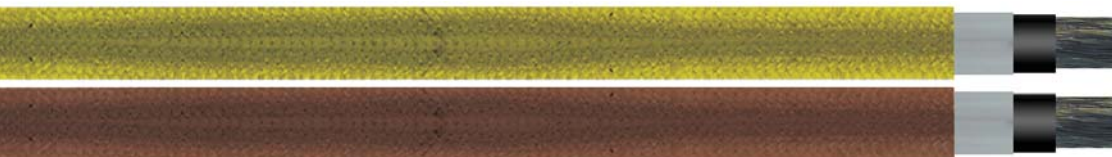

Construction:

Conductor:	flexible tinned copper conductor Cl. 5, acc. to IEC 60228 and UL 758
Semi-conductive layer:	semi-conducting tape (for section ≥ 10 sqmm (AWG 8) for 1,1 kV version)
Insulation:	silicone-rubber compound
Outer sheath:	yellow (similar RAL 1021), silicone impregnated polyester fiber braiding (1,1 kV version) brown (similar RAL 8003), silicone impregnated polyester fiber braiding (3,3/4,2 kV version) grey (similar RAL 7001), silicone impregnated polyester fiber braiding, (6,9/7,2 kV version) black (similar RAL 9005), silicone impregnated polyester fiber braiding, (13,8/15 kV version)

Resistance:



Fire resistant acc. to:
IEC 60331



Flame and fire retardant acc. to:
IEC 60332-1,
IEC 60332-3-24,
VW1, FT1, FT2



Halogen free acc. to:
IEC 60754-1



Corrosiveness of conflagration gases acc. to:
IEC 60754-2



Smoke emission properties acc. to:
IEC 61034

Technical data:

Nominal voltage:	1,1 kV up to 13,8/15 kV
Test Voltage A.C.:	1,1 kV = 4 kV 3,3/4,2 kV = 9,4 kV 6,9/7,2 kV = 15,4 kV 13,8/15 kV = 31 kV
Temperature range:	-55°C up to +180°C (UL up to + 150°C)
Peaks:	up to + 210°C
Min. bending radius:	
Fixed laying:	10 x D

Features:

- very good flexibility
- high temperature resistance
- excellent dielectric strength
- excellent mechanical protection
- Ozone, and UV resistance
- oil resistance
- good chemical resistance
- on request version with PUR impregnated polyester fiber braiding with "5" on the 5th number of the Part no.
- RoHS, REACH approval



UL/CSA standards:

- UL AWM Style 3640 150°C, 180°C 1100 V / 3988 150°C 1100 V
- UL AWM Style 3641 150°C, 180°C 3300 V / 3989 150°C, 4200 V
- UL AWM Style 3642 150°C, 180°C 6900 V / 3990 150°C, 7200 V
- UL AWM Style 3643 150°C, 180°C 13800 V / 3991 150°C, 15000 V

acc. to UL 758

acc. to CSA C 22.2 N° 210-11

HIGH TEMPERATURE CABLES

GAALTHERM® SiAF/POL UL

Silicone insulated single core flexible, with silicone impregnated polyester fibre braiding, I, I up to 13,8/15 kV

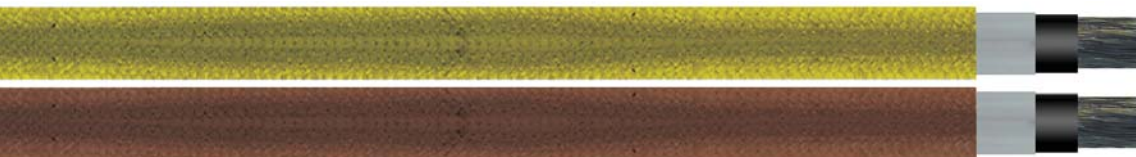

1,1 kV

Part no.	No. of cores x cross section n x mm ²	Outer-Ø ca. mm ± 10%	Copper weight kg/km	Cable weight approx. kg/km	AWG no. *)
52340HYH01A16	1 x 1,5	5,3	14,4	20	16
52340HYH01A14	1 x 2,5	5,7	24	25	14
52340HYH01A12	1 x 4	6,4	38,4	28	12
52340HYH01A10	1 x 6	7	57,6	42	10
52340HYH01A08	1 x 10	8,2	96	55	8
52340HYH01A06	1 x 16	9,3	153,6	60	6
52340HYH01A04	1 x 25	10,8	240	75	4
52340HYH01A02	1 x 35	12,4	336	95	2
52340HYH01A01	1 x 50	14,1	480	115	0
52340HYH01A2C	1 x 70	16	672	130	2/0
52340HYH01A3C	1 x 95	18,3	912	160	3/0
52340HYH01A4C	1 x 120	19,8	1152	185	4/0
52340HYH01A5C	1x 150	22	1440	220	250 MCM
52340HYH01A7C	1 x 185	24,4	1776	260	350 MCM
52340HYH01A9C	1x 240	27,2	2304	315	450 MCM
52340HYH01ABC	1 x 300	30,2	2880	375	550 MCM

3,3/4,2 kV

Part no.	No. of cores x cross section n x mm ²	Outer-Ø ca. mm ± 10%	Copper weight kg/km	Cable weight approx. kg/km	AWG no. *)
52340LMH01A16	1 x 1,5	7,3	14,4	40	16
52340LMH01A14	1 x 2,5	7,7	24	45	14
52340LMH01A12	1 x 4	8,3	38,4	50	12
52340LMH01A10	1 x 6	9,5	57,6	65	10
52340LMH01A08	1 x 10	10,2	96	80	8
52340LMH01A06	1 x 16	11,3	153,6	90	6
52340LMH01A04	1 x 25	12,7	240	110	4
52340LMH01A02	1 x 35	13,7	336	120	2
52340LMH01A01	1 x 50	15,3	480	135	0
52340LMH01A2C	1 x 70	17,2	672	155	2/0
52340LMH01A3C	1 x 95	19,4	912	190	3/0
52340LMH01A4C	1 x 120	21,3	1152	225	4/0
52340LMH01A5C	1x 150	23,4	1440	260	250 MCM
52340LMH01A7C	1 x 185	25,3	1776	290	350 MCM
52340LMH01A9C	1x 240	27,7	2304	325	450 MCM
52340LMH01ABC	1 x 300	31,3	2880	425	550 MCM

6,9/7,2 kV

Part no.	No. of cores x cross section n x mm ²	Outer-Ø ca. mm ± 10%	Copper weight kg/km	Cable weight approx. kg/km	AWG no. *)
52340N5H01A12	1 x 1,5	8	14,4	60	
52340N5H01A14	1 x 2,5	8,3	24	80	
52340N5H01A12	1 x 4	9	38,4	100	12
52340N5H01A10	1 x 6	10	57,6	140	10
52340N5H01A08	1 x 10	10,8	96	190	8
52340N5H01A06	1 x 16	12	153,6	260	6
52340N5H01A04	1 x 25	14	240	380	4
52340N5H01A02	1 x 35	15	336	490	2
52340N5H01A01	1 x 50	16,5	480	660	0
52340N5H01A2C	1 x 70	18,3	672	875	2/0
52340N5H01A3C	1 x 95	21	912	1165	3/0
52340N5H01A4C	1 x 120	22	1152	1420	4/0
52340N5H01A5C	1x 150	24	1440	1750	250 MCM
52340N5H01A7C	1 x 185	26	1776	2115	350 MCM
52340N5H01A9C	1x 240	28,7	2304	2700	450 MCM
52340N5H01ABC	1 x 300	32,5	2880	3370	550 MCM

HIGH TEMPERATURE CABLES

GAALTHERM® SiAF/POL UL

Silicone insulated single core flexible, with silicone impregnated polyester fibre braiding, I, I up to 13,8/15 kV

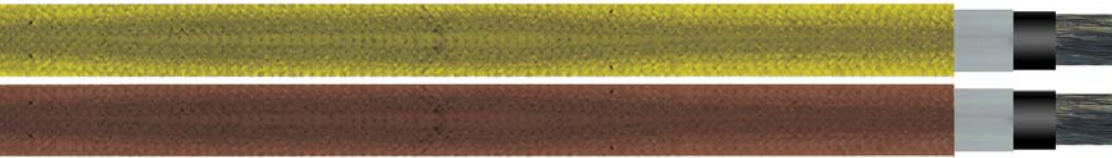

13,8/15 kV

Part no.	No. of cores x cross section n x mm ²	Outer-Ø ca. mm ± 10%	Copper weight kg/km	Cable weight approx. kg/km	AWG no. *)
52340R7H01A16	1 x 1,5	10,7	14,4	110	16
52340R7H01A14	1 x 2,5	11,1	24	130	14
52340R7H01A12	1 x 4	11,7	38,4	150	12
52340R7H01A10	1 x 6	12,9	57,6	200	10
52340R7H01A08	1 x 10	13,6	96	255	8
52340R7H01A06	1 x 16	14,7	153,6	330	6
52340R7H01A04	1 x 25	16,1	240	445	4
52340R7H01A02	1 x 35	17,1	336	560	2
52340R7H01A01	1 x 50	18,7	480	730	0
52340R7H01A2C	1 x 70	20,5	672	955	2/0
52340R7H01A3C	1 x 95	22,5	912	1230	3/0
52340R7H01A4C	1 x 120	23,6	1152	1490	4/0
52340R7H01A5C	1x 150	25,7	1440	1825	250 MCM
52340R7H01A7C	1 x 185	27,7	1776	2200	350 MCM
52340R7H01A9C	1x 240	30	2304	2765	450 MCM
52340R7H01ABC	1 x 300	33,6	2880	3440	550 MCM

Other dimensions and colors available on request.

TECHNICAL DATA

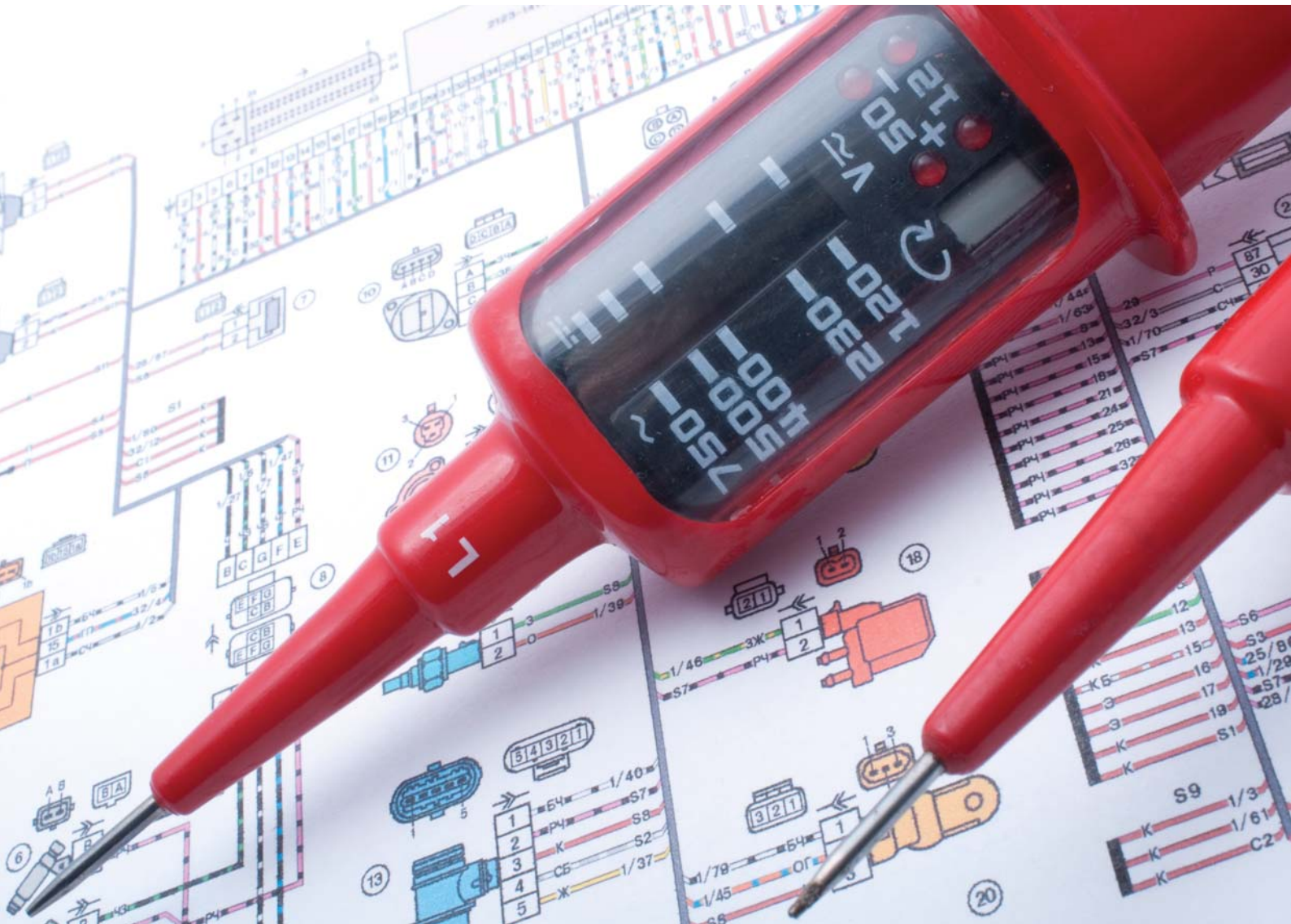

TECHNICAL DATA INDEX

RESISTANCE SYMBOLS LEGEND	115
STRANDING COMPOSITION.....	116/118
CONVERSION FROM AWG TO MM ²	119
ADDITIONAL CONVERSION.....	120
COLOR CODE.....	121/128
LOW VOLTAGE CURRENT CARRYING CAPACITY	129/130
LOW VOLTAGE PHASE SPLITTING - RESISTANCE AND REACTANCE.....	131
LOW VOLTAGE RESISTANCE AND REACTANCE.....	132
LOW VOLTAGE RESISTANCE AND REACTANCE - VOLTAGE DROP	133
LOW VOLTAGE -VOLTAGE DROP.....	134
LOW VOLTAGE - SHORT-CIRCUIT	135/136
MEDIUM VOLTAGE CURRENT CARRYING CAPACITY.....	137
MEDIUM VOLTAGE CORRECTION FACTORS.....	138
MEDIUM VOLTAGE CORRECTION FACTORS AND PHASE SPLITTING	139
MEDIUM VOLTAGE RESISTANCE.....	140
MEDIUM VOLTAGE REACTANCE.....	141
MEDIUM VOLTAGE REACTANCE - SHORT CIRCUIT CURRENT CAPACITY.....	142
MINIMUM BENDING RADIUS.....	143
FLAMABILITY TEST	144/147
DRUMS CAPACITY	148
DRUM TYPE AND DRUM SIZE	149

RESISTANCE SYMBOLS LEGEND



Fire performance
Fire resistant

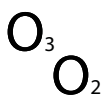

Ozone-Oxygene resistance



mud resistant



Flame retardant and
self-extinguishing

F

flourine resistance



microbe resistant



Halogen-free



weather/atmospheric
resistance



Railway network stability



Smoke density/
low smoke emission



impact-crushing
resistance



Corrosiveness of
combustion gases



Mechanical resistance



Chem. resistance



water and cold
resistance



Abrasion
notch resistant

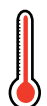

high temperature/
heat resistance



UV resistant/
Sunlight resistant



electro magnetic
resistance



Ozone resistance



ageing resistance



Oil resistance



water resistant

STRANDING COMPOSITION

STRAND MAKE-UP ACCORDING TO DIN VDE 0295 and IEC 60228

Cross section mm ²	Stranded wires	Multi-Stranded wires	Fine wires	Extra-fine wires
	Class 2 DIN VDE 0295		Class 5 DIN VDE 0295	Class 6 DIN VDE 0295
	1	2	3	4
	Number of single wires x wire Ø mm	Number of single wires x wire Ø mm	Number of single wires x wire Ø mm	Number of single wires x wire Ø mm
0,05				
0,08				
0,09				
0,14			± 18x0,1	± 18x0,1
0,25			± 14x0,15	± 32x0,1
0,34		7x0,25	± 19x0,15	± 42x0,1
0,38		7x0,27	± 12x0,2	± 21x0,15
0,5	7x0,30	7x0,30	± 16x0,2	± 28x0,15
0,75	7x0,37	7x0,37	± 24x0,2	± 42x0,15
1,0	7x0,43	7x0,43	± 32x0,2	± 56x0,15
1,5	7x0,52	7x0,52	± 30x0,25	± 84x0,15
2,5	7x0,67	19x0,41	± 50x0,25	± 140x0,15
4	7x0,85	19x0,52	± 56x0,3	± 224x0,15
6	7x1,05	19x0,64	± 84x0,3	± 192x0,2
10	7x1,35	49x0,51	± 80x0,4	± 320x0,2
16	7x1,70	49x0,65	± 128x0,4	± 512x0,2
25	7x2,13	84x0,62	± 200x0,4	± 800x0,2
35	7x2,52	133x0,58	± 280x0,4	± 1120x0,2
50	19x1,83	133x0,69	± 400x0,4	± 705x0,3
70	19x2,17	189x0,69	± 356x0,5	± 990x0,3
95	19x2,52	259x0,69	± 485x0,5	± 1340x0,3
120	37x2,03	336x0,67	± 614x0,5	± 1690x0,3
150	37x2,27	392x0,69	± 765x0,5	± 2123x0,3
185	37x2,52	494x0,69	± 944x0,5	1470x0,4
240	61x2,24	627x0,70	± 1225x0,5	± 1905x0,4
300	61x2,50	790x0,70	± 1530x0,5	± 2385x0,4
400	61x2,89		± 2035x0,5	
500	61x3,23		± 1768x0,6	
630	91x2,97		± 2228x0,6	

allowable maximal diameter of single wire	
nominal value mm	maximum value mm
0,2	0,21
0,25	0,26
0,3	0,31
0,4	0,41
0,5	0,51
0,6	0,51

STRANDING COMPOSITION

COPPER CONDUCTOR AND STRANDING COMPOSITION DATA

Approx outer Ø	Pounds per 1000 ft.	Circular Mils	Size AWG/CM	CONCENTRIC STRAND					ROPE LAY Concentric Strand		ROPE LAY Bunch Strand	
				Class AA	Class A	Class B	Class C	Class D	Class G	Class H	Class K 30AWG (.010")	Class M 34AWG (.0063")
.0050	.0757	25.00	36									
.0056	.0954	31.52	35									
.0063	.1203	39.75	34									
.0071	.1517	50.13	33									
.0080	.1913	63.21	32									
.0089	.2413	79.70	30									
.0100	.3042	100.5	30									
.0113	.3836	126.7	29									
.0126	.4837	159.8	28									
.0142	.6100	201.5	27									
.0159	.7692	254.1	26									
.0179	.9699	320.4	25									
.0201	1.223	404.0	24									
.0226	1.542	509.5	23									
.0254	1.945	642.4	22									
.0285	2.452	810.1	21									
.0363	3.154	1,020	20			7	19				10	26
.0456	5.015	1,620	18			7	19				16	41
.0576	7.974	2,580	16			7	19				26	65
.0726	12.68	4,110	14			7	19	37	49		41	104
.0915	20.16	6,530	12			7	19	37	49		65	186
.1160	32.06	10,380	10			7	19	37	49		104	259
.1600	40.42	13,090	9			7	19	37	49	133		
.1460	51.0	16,510	8			7	19	37	49	133	168	420
.1840	80.9	26,240	6			7	19	37	49	133	266	665
.2320	129	41,740	4	3	7	7	19	37	49	133	420	1064
.2600	162	52,620	3	3	7	7	19	37	49	133	532	1323
.2990	205	66,630	2	3	7	7	19	37	49	133	665	1666
.3320	259	83,690	1	3	7	19	37	61	133	259	836	2107
.3730	326	105,600	1/0	7	7	19	37	61	133	259	1064	2646
.4190	411	133,100	2/0	7	7	19	37	61	133	259	1323	3325
.4700	518	167,800	3/0	7	7	19	37	61	133	259	1666	4256
.5280	653	211,600	4/0	7	7	19	37	61	133	259	2107	5320
.5750	772	250,000	250,000	12	19	37	61	91	259	427	2499	6384
.6300	925	300,000	300,000	12	19	37	61	91	259	427	2989	7581
.6810	1080	350,000	350,000	12	19	37	61	91	259	427	3458	8806
.7280	1236	400,000	400,000	19	19	37	61	91	259	427	3990	10,101
.8130	1542	500,000	500,000	19	37	37	61	91	259	427	5054	12,691
.8930	1850	600,000	600,000	37	37	61	91	127	427	703	5985	14,945
.9980	2316	750,000	750,000	37	61	61	91	127	427	703	7581	18,788
1.152	3086	1,000,000	1,000,000	37	61	61	91	127	427	703	10,101	25,193

STRANDING COMPOSITION

DIMENSION AND WEIGHTS OF SOLID COPPER WIRE

Size AWG	Approximate Diameter	Circular Mils	Square Inches	Approximate Lbs/Mft
34	0,00063	39,7	0,0000312	0,120
32	0.0080	64.0	0.0000503	0.194
30	0.0100	100	0.0000785	0.303
29	0.0113	128	0.000100	0.387
28	0.0126	159	0.000125	0.481
27	0.0142	202	0.000158	0.610
26	0.0159	253	0.000199	0.765
25	0.0179	320	0.000252	0.970
24	0.0201	404	0.000317	1.22
23	0.0226	511	0.000401	1.55
22	0.0253	640	0.000503	1.94
21	0.0285	812	0.000638	2.46
20	0.0320	1020	0.000804	3.10
18	0.0403	1620	0.00128	4.92
16	0.0508	2580	0.00203	7.81
14	0.0641	4110	0.00323	12.4
12	0.0808	6530	0.00513	19.8
10	0.1019	10,380	0.00815	31.43
9	0.1144	13,090	0.01028	39.62
8	0.1285	16,510	0.01297	49.98
7	0.1443	20,820	0.01635	63.03
6	0.1620	26,240	0.02061	79.44
5	0.1819	33,090	0.02599	100.2
4	0.2043	41,740	0.03278	130.3
3	0.2294	52,620	0.04133	159.3
2	0.2576	66,360	0.05212	200.9

STRANDING-CLASS CONSTRUCTION AND USES

Concentric-lay Conductors	
Class B	Power cables
Class C	Power cables where more flexible stranding than Class B is desired
Class D	Power cables where extra flexible stranding is desired
Rope-lay and Bunch-stranded Conductors	
Class G	All cables for portable use
Class H	All cables where extreme flexibility is required, e.g. take-up reels
Class I	Apparatus cable and motor leads
Class K	Cords and cables 30 AWG copper wires - Stationary service
Class M	Cords and cables 34 AWG copper wires - Constant service

Note: Class G and H shall have concentric-lay stranded members and Class I, K and M shall have bunched stranded members.

CONVERSION FROM AWG TO MM²

AMERICAN/EUROPEAN CONVERSION TABLE FROM AWG TO mm²

AWG Number	Cross section mm ² (AMERICAN COMPARISON)	Cross section mm ² (EUROPEAN COMPARISON)	Ø mm	Conductor resistance Ω/km
1000 MCM	507	500	29,3	0,036
900	456	-	27,8	0,04
750	380	400	25,4	0,048
600	304	300	22,7	0,061
550	279	-	21,7	0,066
500	253	240	20,7	0,07
450	228	-	19,6	0,08
400	203	-	18,5	0,09
350	177	185	17,3	0,1
300	152	150	16	0,12
250	127	-	14,6	0,14
4/0	107,2	120	11,68	0,18
3/0	85	95	10,4	0,23
2/0	67,4	70	9,27	0,29
0	53,4	-	8,25	0,37
1	42,4	50	7,35	0,47
2	33,6	35	6,54	0,57
3	26,7	-	5,83	0,71
4	21,2	25	5,19	0,91
5	16,8	-	4,62	1,12
6	13,3	16	4,11	1,44
7	10,6	-	3,67	1,78
8	8,34	10	3,26	2,36
9	6,62	-	2,91	2,77
10	5,26	6	2,59	3,64
11	4,15	-	2,3	4,44
12	3,31	4	2,05	5,41
13	2,63	-	1,83	7,02
14	2,08	2,5	1,63	8,79
15	1,65	-	1,45	11,2
16	1,31	1,5	1,29	14,7
17	1,04	-	1,15	17,8
18	0,823	1	1,024	23
19	0,653	0,75	0,912	28,3
20	0,519	0,5	0,812	34,5
21	0,412	0,38	0,723	44
22	0,324	0,34	0,644	54,8
23	0,259	-	0,573	70,1
24	0,205	0,25	0,511	89,2
25	0,163	-	0,455	111
26	0,128	0,14	0,405	146
27	0,102	-	0,361	176
28	0,0804	0,08	0,321	232
29	0,0646	-	0,286	282
30	0,0503	0,05	0,255	350
31	0,04	-	0,227	446
32	0,032	-	0,202	578
33	0,0252	-	0,18	710
34	0,0200	-	0,16	899
35	0,0161	-	0,143	1125
36	0,0123	-	0,127	1426
37	0,01	-	0,113	1800
38	0,00795	-	0,101	2255
39	0,00632	-	0,0897	2860

4/0 is also known as 0000; 1 mil = inch = 0.0254 mm
*Shown in MCM (circular mills) for bigger cross sections

1 CM = 1 Circ. mil = 0.0005067 mm²
1 MCM = 1000 Circ. mils = 0.5067 mm²

1 CM = 1 Circ. mil = 0.0005067 mm²
1 MCM = 1000 Circ. mils = 0.5067 mm²

ADDITIONAL CONVERSION

ADDITIONAL CONVERSION TABLE

LENGHT		
From	to	Formula
Inch (In)	millimeter (mm)	$In \times 25,4 = mm$
millimeter (mm)	Inch (In)	$mm \times 0,03937 = In$
foot (ft)	meter (m)	$ft \times 0,3048 = m$
meter (m)	foot (ft)	$mt \times 3,218 = ft$
mile (mi)	kilometer (km)	$mi \times 1,609 = km$
kilometer (km)	mile (mi)	$km \times 0,662 = mi$

WEIGHTS		
From	to	Formula
pound (lb)	kilogram (kg)	$lb \times 2,205 = kg$
kilogram (kg)	pound (lb)	$kg : 2,205 = lb$

TEMPERATURE		
From	to	Formula
Fahrenheit (F)	Celsius (C)	$(F-32) \times 0,56 = C$
Celsius (C)	Fahrenheit (F)	$C \times 1,8 + 32 = F$

COLOR CODE

ELETTROTEK KABEL SINGLE WIRE COLOR IDENTIFICATION

Core.no	Basic color	RAL
01	BLACK / NERO	9005
02	DARK BLUE / BLU SCURO (RAL 5010)	5010
03	BROWN / MARRONE	8003
04	GREY / GRIGIO	7000
05	YELLOW / GIALLO	1021
06	GREEN / VERDE	6018
07	VIOLET/ VIOLA	4005
08	WHITE / BIANCO	9003
09	ORANGE / ARANCIONE	2003
10	RED / ROSSO	3000
11	LIGHT BLUE / BLU CHIARO (RAL 5015)	5015
12	LIGHT BLUE / BLU CHIARO (RAL 5012)	5012
13	PINK / ROSA	3015
14	SKY BLUE/BLU SKY	5024
15	YELLOW-GREEN / GIALLO-VERDE	1021/6018
16	WHITE-DARK BLUE / BIANCO-BLU SCURO	9003/5010
17	DARK BLUE-WHITE / BLU-BIANCO	5010/9003
18	WHITE-GREY / BIANCO-GRIGIO	9003/7000
19	BLACK-GREEN / NERO-VERDE	9005/6018
20	BLACK-DARK BLUE / NERO-BLU SCURO	9005/5010
21	BLACK-WHITE / NERO-BIANCO	9005/9003
22	BLACK-VIOLET / NERO-VIOLA	9005/4005
23	BLACK-RED / NERO-ROSSO	9005/3000
24	WHITE-RED / BIANCO-ROSSO	9003/3000
25	WHITE-BROWN / BIANCO- MARRONE	9003/8003
26	DARK BLUE-RED / BLU SCURO-ROSSO	5010/3000
27	WHITE-VIOLET / BIANCO-VIOLA	9003/4005
28	WHITE-YELLOW / BIANCO-GIALLO	9003/1021
29	WHITE-GREEN / BIANCO-VERDE	9003/6018
30	WHITE-ORANGE / BIANCO-ARANCIONE	9003/2003
31	OFF WHITE GREY	9002
32	REDDISH BROWN	3016
33	BEIGE	1001
34		
35		
36		
37		
38		
39		

HD 308 S2

no. of cores	Cores with green-yellow protective conductor (-J)	Cores without green-yellow protective conductor (-O)
2	-	BLUE-BROWN
3	GREEN/YELLOW-BLUE-BROWN	BROWN-BLACK-GREY
4	GREEN/YELLOW-BROWN-BLACK-GREY	BLUE-BROWN-BLACK-GREY
5	GREEN/YELLOW-BLUE-BROWN-BLACK-GREY	BLUE-BROWN-BLACK-GREY-BLACK
6	GREEN-YELLOW/BLACK + WHITE PRINTED NUMBERS	BLACK + WHITE PRINTED NUMBERS

Core identification with numbers acc. to EN 50334

Number Printing used as the marking inscription for identifying the of cores of electrical cables.
Other core colors are allowed except green and yellow.

COLOR CODE

DIN 47100

Number	Colour	Number	Colour
1	WHITE	32	YELLOW - blue
2	BROWN	33	GREEN - red
3	GREEN	34	YELLOW - red
4	YELLOW	35	GREEN - black
5	GREY	36	YELLOW - black
6	PINK	37	GREY - blue
7	BLUE	38	PINK - blue
8	RED	39	GREY - red
9	BLACK	40	PINK - red
10	VIOLET	41	GREY - black
11	GREY - pink	42	PINK - black
12	RED - blue	43	BLUE - black
13	WHITE - green	44	RED - black
14	BROWN - green	45	WHITE - brown - black
15	WHITE - yellow	46	YELLOW - green - black
16	YELLOW - brown	47	GREY - pink - black
17	WHITE - grey	48	RED - blue - black
18	GREY - brown	49	WHITE - green - black
19	WHITE - pink	50	BROWN - green- black
20	PINK - brown	51	WHITE - yellow - black
21	WHITE - blue	52	YELLOW - brown - black
22	BROWN - blue	53	WHITE - grey - black
23	WHITE - red	54	GRAY - brown - black
24	BROWN - red	55	WHITE - pink - black
25	WHITE - black	56	PINK - brown - black
26	BROWN - black	57	WHITE - blue - black
27	GREY - green	58	BROWN - blue - black
28	YELLOW - grey	59	WHITE - red - black
29	PINK - green	60	BROWN- red - black
30	YELLOW - pink	61	BLACK - white
31	GREEN - blue		

COLOR CODE

COLOR CODE US I

Core. no	Basic color	1 st ring	2nd ring
1	BLACK	-	-
2	WHITE	-	-
3	RED	-	-
4	GREEN	-	-
5	BROWN	-	-
6	BLUE	-	-
7	ORANGE	-	-
8	YELLOW	-	-
9	VIOLET	-	-
10	GREY	-	-
11	PINK	-	-
12	BEIGE	-	-

COLOR CODE

COLOR CODE US2

Comparable with IEEE 1580 table 22 and K1 color code (for multi-conductor cables and per ICEA and NEC code)

Core. no	Basic color	1st stripe	2nd stripe
1	BLACK	-	-
2	WHITE	-	-
3	RED	-	-
4	GREEN	-	-
5	ORANGE	-	-
6	BLUE	-	-
7	WHITE	BLACK	-
8	RED	BLACK	-
9	GREEN	BLACK	-
10	ORANGE	BLACK	-
11	BLUE	BLACK	-
12	BLACK	WHITE	-
13	RED	WHITE	-
14	GREEN	WHITE	-
15	BLUE	WHITE	-
16	BLACK	RED	-
17	WHITE	RED	-
18	ORANGE	RED	-
19	BLUE	RED	-
20	RED	GREEN	-
21	ORANGE	GREEN	-
22	BLACK	WHITE	RED
23	WHITE	BLACK	RED
24	RED	BLACK	WHITE
25	GREEN	BLACK	WHITE
26	ORANGE	BLACK	WHITE
27	BLUE	BLACK	WHITE
28	BLACK	RED	GREEN
29	WHITE	RED	GREEN
30	RED	BLACK	GREEN
31	GREEN	BLACK	ORANGE
32	ORANGE	BLACK	GREEN
33	BLUE	WHITE	ORANGE
34	BLACK	WHITE	ORANGE
35	WHITE	RED	ORANGE
36	ORANGE	WHITE	BLUE
37	WHITE	RED	BLUE
38	BLACK	WHITE	GREEN
39	WHITE	BLACK	GREEN
40	RED	WHITE	GREEN
41	GREEN	WHITE	BLUE
42	ORANGE	RED	GREEN

COLOR CODE

Core. no	Basic color	1 st stripe	2nd stripe
43	BLUE	RED	GREEN
44	BLACK	WHITE	BLUE
45	WHITE	BLACK	BLUE
46	RED	WHITE	BLUE
47	GREEN	ORANGE	RED
48	ORANGE	RED	BLUE
49	BLUE	RED	ORANGE
50	BLACK	ORANGE	RED
51	WHITE	BLACK	ORANGE
52	RED	ORANGE	BLACK
53	GREEN	RED	BLUE
54	ORANGE	BLACK	BLUE
55	BLUE	BLACK	ORANGE
56	BLACK	ORANGE	GREEN
57	WHITE	ORANGE	GREEN
58	RED	ORANGE	GREEN
59	GREEN	BLACK	BLUE
60	ORANGE	GREEN	BLUE
61	BLUE	GREEN	ORANGE
62	BLACK	RED	BLUE
63	WHITE	ORANGE	BLUE
64	RED	BLACK	BLUE
65	GREEN	ORANGE	BLUE
66	ORANGE	WHITE	RED
67	BLUE	WHITE	RED
68	BLACK	GREEN	BLUE
69	WHITE	GREEN	BLUE
70	RED	GREEN	BLUE
71	GREEN	WHITE	RED
72	ORANGE	RED	BLACK
73	BLUE	RED	BLACK
74	BLACK	ORANGE	BLUE
75	RED	ORANGE	BLUE
76	GREEN	RED	BLACK
77	ORANGE	WHITE	GREEN
78	BLUE	WHITE	GREEN
79	RED	WHITE	ORANGE
80	GREEN	WHITE	ORANGE
81	BLUE	BLACK	GREEN
82	ORANGE	WHITE	-
83	GREEN	RED	-
84	BLACK	GREEN	-
85	WHITE	GREEN	-
86	BLUE	GREEN	-
87	BLACK	ORANGE	-
88	WHITE	ORANGE	-
89	RED	ORANGE	-
90	GREEN	ORANGE	-
91	BLUE	ORANGE	-
92	BLACK	BLUE	-

COLOR CODE

COLOR CODE US 3

Core. no	Basic color	Color combination
1	BLACK	PAIRED WITH RED
2	BLACK	PAIRED WITH WHITE
3	BLACK	PAIRED WITH GREEN
4	BLACK	PAIRED WITH BLUE
5	BLACK	PAIRED WITH YELLOW
6	BLACK	PAIRED WITH BROWN
7	BLACK	PAIRED WITH ORANGE
8	RED	PAIRED WITH WHITE
9	RED	PAIRED WITH GREEN
10	RED	PAIRED WITH BLUE
11	RED	PAIRED WITH YELLOW
12	RED	PAIRED WITH BROWN
13	RED	PAIRED WITH ORANGE
14	GREEN	PAIRED WITH WHITE
15	GREEN	PAIRED WITH BLUE
16	GREEN	PAIRED WITH YELLOW
17	GREEN	PAIRED WITH BROWN
18	GREEN	PAIRED WITH ORANGE
19	WHITE	PAIRED WITH BLUE
20	WHITE	PAIRED WITH YELLOW
21	WHITE	PAIRED WITH BROWN
22	WHITE	PAIRED WITH ORANGE
23	BLUE	PAIRED WITH YELLOW
24	BLUE	PAIRED WITH BROWN
25	BLUE	PAIRED WITH ORANGE
26	BROWN	PAIRED WITH YELLOW
27	BROWN	PAIRED WITH ORANGE
28	ORANGE	PAIRED WITH YELLOW
29	VIOLET	PAIRED WITH ORANGE
30	VIOLET	PAIRED WITH RED
31	VIOLET	PAIRED WITH WHITE
32	VIOLET	PAIRED WITH GREEN
33	VIOLET	PAIRED WITH BLUE
34	VIOLET	PAIRED WITH YELLOW
35	VIOLET	PAIRED WITH BROWN
36	VIOLET	PAIRED WITH BLACK
37	GREY PAIRED WITH WHITE	

COLOR CODE

K2 Color code (with printed numbers)

Chart 12: ICEA S-66-524 NEMA WC-7

Core. no	Basic color	Stripe
1	BLACK	-
2	RED	-
3	BLUE	-
4	ORANGE	-
5	YELLOW	-
6	BROWN	-
7	RED	BLACK
8	BLUE	BLACK
9	ORANGE	BLACK
10	YELLOW	BLACK
11	BROWN	BLACK
12	BLACK	RED
13	BLUE	RED
14	ORANGE	RED
15	YELLOW	RED
16	BROWN	RED
17	BLACK	BLUE
18	RED	BLUE
19	ORANGE	BLUE
20	YELLOW	BLUE
21	BROWN	BLUE
22	BLACK	ORANGE
23	RED	ORANGE
24	BLUE	ORANGE
25	YELLOW	ORANGE
26	BROWN	ORANGE
27	BLACK	YELLOW
28	RED	YELLOW
29	BLUE	YELLOW
30	ORANGE	YELLOW
31	BROWN	YELLOW
32	BLACK	BROWN
33	RED	BROWN
34	BLUE	BROWN
35	ORANGE	BROWN
36	YELLOW	BROWN

COLOR CODE

ICEA Table E2 (acc. to ICEA S-73-532)

Core.no	Basic color	Tracer
1	BLACK	-
2	RED	-
3	BLUE	-
4	ORANGE	-
5	YELLOW	-
6	BROWN	-
7	RED	BLACK
8	BLUE	BLACK
9	ORANGE	BLACK
10	YELLOW	BLACK
11	BROWN	BLACK
12	BLACK	RED
13	BLUE	RED
14	ORANGE	RED
15	YELLOW	RED
16	BROWN	RED
17	BLACK	BLUE
18	RED	BLUE
19	ORANGE	BLUE
20	YELLOW	BLUE
21	BROWN	BLUE
22	BLACK	ORANGE
23	RED	ORANGE
24	BLUE	ORANGE
25	YELLOW	ORANGE
26	BROWN	ORANGE
27	BLACK	YELLOW
28	RED	YELLOW
29	BLUE	YELLOW
30	ORANGE	YELLOW
31	BROWN	YELLOW
32	BLACK	BROWN
33	RED	BROWN
34	BLUE	BROWN
35	ORANGE	BROWN
36	YELLOW	BROWN

Pair cables are Black, Red and numbered. Triad cables are Black, Red, Blue and numbered. Colors repeat after 36 conductors. There are no Green or White conductors stripes.

LOW VOLTAGE CURRENT CARRYING CAPACITY

Acc. to IEC 60364-5-52 table A.52-10 and B.52.14 (acc. to VDE 0298 T4 08/03)

Current carrying capacities listed in amperes and Correction factors for ambient air temperature other than 30°C

PVC insulation / Copper conductor 70°C

Conductor temperature +70°C, Ambient temperature: +30°C

Installation methods - table A.52-1					
Nominal cross sectional area of conductor mm ²	Multi core cables	Single core cables			
	Three loaded conductors	Three loaded conductors trefoil	Three loaded conductors flat		
			Touching	Spaced	
				Horizontal	Vertical
1,5	18,5	-	-	-	-
2,5	25	-	-	-	-
4	34	-	-	-	-
6	43	-	-	-	-
10	60	-	-	-	-
16	80	-	-	-	-
25	101	110	114	146	130
35	126	137	143	181	162
50	153	167	174	219	197
70	196	216	225	281	254
95	238	264	275	341	311
120	276	308	321	396	362
150	319	356	372	456	419
185	364	409	427	521	480
240	430	485	507	615	569
300	497	561	587	709	659
400	-	656	689	852	795
500	-	749	789	982	920
600	-	855	905	1138	1070

Correction factors - table B.52.14.																		
Ambient temperature °C	10	15	20	25	30	35	40	45	50	55	60	65	70	75	80	85	90	95
Insulation material PVC	1,22	1,17	1,12	1,06	1	0,94	0,87	0,79	0,71	0,61	0,50	-	-	-	-	-	-	-

NOTE:
Circular conductors are estimated for sizes up to and including 16 mm².
Values for larger sizes relate to shaped conductors and may safely be applied to circular conductor

LOW VOLTAGE CURRENT CARRYING CAPACITY

Acc.to IEC 60364-5-52 table B.52-12 and B.52.14 (acc. to VDE 0298 T4 08/03)

Current carrying capacities listed in amperes and Correction factors for ambient air temperature other than 30°C

XLPE or HEPR insulation / Copper conductor

Conductor temperature +90°C, Ambient temperature: +30°C

Installation methods - table B.52-1					
Nominal cross sectional area of conductor mm ²	Multi core cables		Single core cables		
	Three loaded conductors	Three loaded conductors trefoil	Three loaded conductors flat		
			Touching	Spaced	
				Horizontal	Vertical
1,5	23	-	-	-	-
2,5	32	-	-	-	-
4	42	-	-	-	-
6	54	-	-	-	-
10	75	-	-	-	-
16	100	-	-	-	-
25	127	135	141	182	161
35	158	169	176	226	201
50	192	207	216	275	246
70	246	268	279	353	318
95	298	328	342	430	389
120	346	383	400	500	454
150	399	444	464	577	527
185	456	510	533	661	605
240	538	607	634	781	719
300	621	703	736	902	833
400	-	823	868	1085	1008
500	-	946	998	1253	1169
600	-	1088	1151	1454	1362

Correction factors - table B.52.14.																		
Ambient temperature °C	10	15	20	25	30	35	40	45	50	55	60	65	70	75	80	85	90	95
Insulation material XLPE or HEPR	1,15	1,12	1,08	1,04	1	0,96	0,91	0,87	0,82	0,76	0,71	0,65	0,58	0,50	0,41	-	-	-

NOTE:
Circular conductors are estimated for sizes up to and including 16 mm².
Values for larger sizes relate to shaped conductors and may safely be applied to circular conductor

LOW VOLTAGE PHASE SPLITTING - RESISTANCE AND REACTANCE

PHASE SPLITTING

Single core cables laying in line

Cables laying in trefoil formation

Number 3 core units in the same layer									
2			3			4			
T	T		T	T	T	T	T	T	T
RS	SR		RS	SR	RS	RS	SR	RS	SR

Cables laying in line: horizontally or vertically

Number 3 core units in the same layer(*)							
2				4			
RST		TSR		RST		TSR	

(*) For cables installed in layers, the indicated arrangements are repeated for each layer

RESISTANCE AND REACTANCE

Cables insulated with thermoplastic compounds

Apparent resistance of flexible red copper conductor at 70°C and reactance at 50 Hz (for 0,6/1 Kv voltage rates)

Power cables

Conductor cross-section (mm ²)	Resistance at 70 °C		Reactance at 50 Hz	
	c.c. / DC (Ohm/km)	c a. / AC (Ohm/km)	single cores (Ohm/km)	multi-cores (Ohm/km)
1,5	15,9	15,9	0,147	0,106
2,5	9,55	9,55	0,186	0,098
4	5,92	5,92	0,129	0,097
6	3,95	3,95	0,121	0,092
10	2,29	2,29	0,111	0,086
16	1,45	1,45	0,103	0,081
25	0,93	0,93	0,097	0,080
35	0,66	0,66	0,093	0,077
50	0,46	0,46	0,090	0,076
70	0,33	0,33	0,086	0,074
95	0,25	0,25	0,085	0,074
120	0,193	0,194	0,081	-
150	0,154	0,156	0,081	-
185	0,127	0,129	0,081	-
240	0,096	0,099	0,080	-

LOW VOLTAGE RESISTANCE AND REACTANCE

Cables insulated with thermoplastic compounds

Control and signal cables

number of conductors	conductor cross-section (mm ²)	resistance at 70 °C c.c / DC (Ohm/km)	c.c / DC (Ohm/km)	reactance at 50 Hz (Ohm/km)
5	1,5	15,9	15,9	0,106
7	1,5	15,9	15,9	0,106
7	2,5	9,55	9,55	0,098
from 10 to 19	1,5	16	16	0,106
from 10 to 19	2,5	9,65	9,65	0,098
24	1,5	16,1	16,1	0,106
24	2,5	9,7	9,7	0,098

Cables insulated with elastomeric compounds

Resistance at 70°C

Conductor cross-section (mm ²)	Fexible red copper conductor		Rigid red copper conductor	
	c.c. / DC (Ohm/km)	c.a. / AC (Ohm/km)	c.c. / DC (Ohm/km)	c.a. / AC (Ohm/km)
1,5	16,95	16,95	15,4	15,4
2,5	10,17	10,17	9,45	9,45
4	6,31	6,31	5,88	5,88
6	4,20	4,20	3,93	3,93
10	2,43	2,43	2,33	2,33
16	1,54	1,54	1,47	1,47
25	0,99	0,99	0,93	0,93
35	0,71	0,71	0,67	0,67
50	0,49	0,50	0,49	0,49
70	0,34	0,35	0,34	0,34
95	0,26	0,27	0,25	0,25
120	0,20	0,21	0,20	0,20
150	0,16	0,17	0,16	0,16
185	0,13	0,14	0,13	0,13
240	0,102	0,104	0,96	0,99
300	0,081	0,085	0,076	0,080
400	0,062	0,065	0,060	0,064
500	-	-	0,047	0,052
630	-	-	0,037	0,043

LOW VOLTAGE RESISTANCE AND REACTANCE - VOLTAGE DROP

Cables insulated with elastomeric compounds

Reactance at 50 Hz

Conductor cross-section (mm ²)	Rigid red copper conductor		Flexible red copper conductor	
	Single core (Ohm/km)	Multi cores (Ohm/km)	Single core (Ohm/km)	Multi cores (Ohm/km)
1,5	0,146	0,103	0,144	0,100
2,5	0,135	0,095	0,132	0,094
4	0,126	0,090	0,122	0,087
6	0,118	0,085	0,114	0,083
10	0,106	0,079	0,105	0,078
16	0,099	0,076	0,098	0,075
25	0,095	0,076	0,093	0,075
35	0,091	0,074	0,089	0,072
50	0,088	0,073	0,085	0,071
70	0,087	0,072	0,084	0,070
95	0,085	0,070	0,083	0,069
120	0,084	0,070	0,080	0,069
150	0,084	0,070	0,080	0,069
185	0,083	0,070	0,080	0,069
240	0,081	0,070	0,078	0,069
300	0,079	0,069	0,076	0,068
400	0,079	0,069	0,076	0,068
500	0,077	-	0,074	-
630	0,076	-	0,073	-

VOLTAGE DROP

For alternate currents, voltage drop is calculated (Volts) as follows:
$$\phi V = \frac{C_t \cdot I \cdot L}{1000}$$

Where:

C_t (V/A km) = $K \cdot (R \cdot \cos j + X \cdot \sin j)$

L (m) = length of line

I (A) = current

R (ohm/km) = conductor resistance at maximum operating temperature

X (ohm/km) = phase reactance

j = power factor

K = 2 for single-phase system

K = 1,73 for three-phase system

The formula is valid direct currents too

LOW VOLTAGE -VOLTAGE DROP

Voltage drop coefficients (Ct) in AC

Flexible PVC cables at 70 °C

Cross-section	single-phase system single core				three-phase system single core				single-phase system multi-core				three-phase system multi-core			
	cos φ 0,7	cos φ 0,8	cos φ 0,9	cos φ 1	cos φ 0,7	cos φ 0,8	cos φ 0,9	cos φ 1	cos φ 0,7	cos φ 0,8	cos φ 0,9	cos φ 1	cos φ 0,7	cos φ 0,8	cos φ 0,9	cos φ 1
1,5	22,49	25,63	28,77	31,83	19,45	22,17	24,89	27,53	22,43	25,59	28,73	31,83	19,40	22,1	24,86	27,53
2,5	13,56	15,43	17,30	19,10	11,73	13,35	14,97	16,52	13,50	15,39	17,27	19,10	11,68	13,31	14,94	16,52
4	8,47	9,63	10,77	11,84	7,33	8,33	9,32	10,25	8,43	9,59	10,74	11,84	7,29	8,30	9,29	10,25
6	5,70	6,46	7,21	7,90	4,93	5,59	6,24	6,83	5,66	6,43	7,19	7,90	4,89	5,56	6,22	6,83
10	3,36	3,79	4,21	4,57	2,90	3,28	3,64	3,95	3,32	3,76	4,19	4,57	2,87	3,25	3,62	3,95
16	2,17	2,44	2,69	2,90	1,88	2,11	2,33	2,50	2,14	2,41	2,69	2,90	1,85	2,09	2,31	2,50
25	1,45	1,61	1,76	1,87	1,25	1,39	1,53	1,61	1,42	1,59	1,74	1,87	1,23	1,37	1,51	1,61
35	1,06	1,17	1,27	1,33	0,29	1,01	1,10	1,15	1,04	1,15	1,26	1,33	0,90	1	1,09	1,15
50	0,77	0,85	0,91	0,92	0,67	0,73	0,79	0,80	0,76	0,83	0,90	0,92	0,65	0,72	0,78	0,80
70	0,58	0,62	0,66	0,65	0,50	0,54	0,57	0,56	0,56	0,61	0,65	0,65	0,49	0,53	0,56	0,56
95	0,47	0,50	0,52	0,50	0,41	0,43	0,45	0,43	-	-	-	-	0,39	0,42	0,44	0,43
120	0,39	0,41	0,42	0,39	0,34	0,34	0,36	0,34	-	-	-	-	-	-	-	-
150	0,34	0,35	0,35	0,31	0,29	0,30	0,30	0,27	-	-	-	-	-	-	-	-
185	0,30	0,30	0,30	0,26	0,26	0,26	0,26	0,22	-	-	-	-	-	-	-	-
240	0,25	0,25	0,25	0,20	0,22	0,22	0,21	0,17	-	-	-	-	-	-	-	-

Flexible HEPR cables at 90 °C

Cross-section	single-phase system single core				three-phase system single core				single-phase system multi-core				three-phase system multi-core			
	cos φ 0,7	cos φ 0,8	cos φ 0,9	cos φ 1	cos φ 0,7	cos φ 0,8	cos φ 0,9	cos φ 1	cos φ 0,7	cos φ 0,8	cos φ 0,9	cos φ 1	cos φ 0,7	cos φ 0,8	cos φ 0,9	cos φ 1
1,5	23,95	27,31	30,65	33,92	20,71	23,62	26,51	29,34	23,88	27,25	30,61	33,92	20,66	23,57	26,48	29,34
2,5	14,43	16,44	18,43	20,35	12,48	14,22	15,94	17,6	14,38	16,39	18,40	20,35	12,44	14,18	15,91	17,60
4	9,01	10,24	11,47	12,62	7,79	8,86	9,92	10,92	8,96	10,2	11,44	12,62	7,75	8,83	9,89	10,92
6	6,05	6,87	7,67	8,42	5,24	5,94	6,64	7,28	6,01	6,83	7,65	8,42	5,20	5,91	6,61	7,28
10	3,56	4,02	4,48	4,87	3,08	3,48	3,87	4,21	3,52	3,99	4,45	4,87	3,05	3,45	3,85	4,21
16	2,30	2,59	2,86	3,09	1,99	2,24	2,48	2,67	2,27	2,56	2,84	3,09	1,96	2,21	2,46	2,67
25	1,53	1,70	1,87	1,99	1,32	1,47	1,62	1,72	1,5	1,68	1,85	1,99	1,30	1,45	1,60	1,72
35	1,12	1,24	1,35	1,41	0,97	1,07	1,17	1,22	1,09	1,22	1,33	1,41	0,94	1,05	1,15	1,22
50	0,81	0,89	0,96	0,99	0,70	0,77	0,83	0,85	0,79	0,87	0,95	0,99	0,68	0,76	0,82	0,85
70	0,61	0,66	0,70	0,70	0,53	0,57	0,61	0,60	0,59	0,64	0,69	0,70	0,51	0,55	0,59	0,60
95	0,49	0,52	0,55	0,53	0,42	0,45	0,47	0,46	0,47	0,51	0,54	0,53	0,40	0,44	0,46	0,46
120	0,40	0,43	0,44	0,41	0,35	0,37	0,38	0,36	0,39	0,41	0,43	0,41	0,34	0,36	0,37	0,36
150	0,35	0,36	0,37	0,33	0,30	0,31	0,32	0,29	0,33	0,35	0,36	0,33	0,29	0,30	0,31	0,29
185	0,31	0,32	0,32	0,27	0,26	0,27	0,27	0,24	-	-	-	-	0,25	0,26	0,27	0,24
240	0,26	0,26	0,26	0,21	0,22	0,23	0,22	0,18	-	-	-	-	0,21	0,22	0,22	0,18
300	0,23	0,23	0,22	0,17	0,20	0,20	0,19	0,15	-	-	-	-	0,19	0,19	0,18	0,15
400	0,20	0,20	0,19	0,13	0,18	0,17	0,16	0,12	-	-	-	-	0,17	0,16	0,16	0,12
500	0,18	0,17	0,16	0,11	0,16	0,15	0,14	0,091	-	-	-	-	-	-	-	-
630	0,16	0,16	0,14	0,09	0,14	0,14	0,12	0,075	-	-	-	-	-	-	-	-

LOW VOLTAGE - SHORT-CIRCUIT

Protection devices must take into consideration the maximum and the minimum short-circuit currents that are reported below

MAXIMUM SHORT-CIRCUIT CURRENT

Voltage Calculation for Alternative Current:

$$S \geq = \frac{I_{cc} \sqrt{T}}{C}$$

The maximum short circuit current accepted by a conductor:
S is calculated with the following formula:

$$I_{cc} (\max) = \frac{S \cdot C}{\sqrt{T}}$$

Key:

T = short circuit duration (seconds)

S = cross-section of copper conductor (mm²)

I_{cc} = short circuit current (A)

C = 115 for PVC copper cables (160 °C)

143 for G7 rubber copper cables (250 °C)

NOTE:

The formula above is valid for intermediate breaks (a maximum of 5 sec.).

For calculating effective short-circuit current allowed by shielding, see the CEI 64-8 standard, appendix D

Celsius coefficient values for copper conductors dependent on the difference in temperature between start and end of short-circuit acc. to the table 2.02.02 of the CEI 11-17 standard.

Starting temperature Θ _o °C	Ending temperature Θ _o °C					
	140	160	180	200	220	250
90	86	100	112	122	131	143
85	90	104	115	125	134	146
80	94	108	119	129	137	149
75	99	111	122	132	140	151
70	103	115	125	135	143	154
65	107	119	129	138	146	157
60	111	122	132	141	149	160
50	118	129	139	147	155	165
40	126	136	145	153	161	170
30	133	143	152	159	166	176

LOW VOLTAGE - SHORT-CIRCUIT

MINIMUM SHORT-CIRCUIT CURRENT

Minimum short-circuit current happens during a short-circuit between phase and neutral (or between phase and phase, for a non distributed neutral), at the farthest point of the conduit. In a system powered by multiple origins, the only source to be taken into consideration is the one corresponding to the minimum value.

The minimum short-circuit current can be calculated using the formulas a) and b), considering: 50% resistance increase at 20 °C (due to the heating of conductors) and 80% rated voltage reduction, due to the effect of the short-circuit on the current carrying capacities.

If the impedance of the incoming circuit is well-known, the coefficient 0,8 must be replaced by a specific value.

$$\text{a) } I_{cc} = \frac{0,8 U}{1,5 \rho \frac{2 L}{S}} \quad \text{b) } I_{cc} = \frac{0,8 U_0}{1,5 \rho (1+m) \frac{L}{S}}$$

Key:

a) for a neutral not distributed conductor, where:

U = line voltage supplied, linked rated voltage volts

ρ = resistivity of the conductor compounds at 20 °C, ohm • mm² (0,018 for copper - 0,027 for aluminum)

L = length of protected conductor in meters

S = conductor cross-section in mm²

I_{cc} = short-circuit current

b) for a neutral distributed conductor, where:











U₀ = phase rating voltage, volts

m = ratio of the neutral conductor resistance and the phase conductor resistance
(if composed of the same material, the ratio is the result between the phase conductor cross-section and the neutral conductor cross-section)

MEDIUM VOLTAGE CURRENT CARRYING CAPACITY

CURRENT CARRYING CAPACITY

Current carrying capacities in amperes with correction factors for ambient air temperature other than 30°C

Cross-section mm ²	PVC insulation	Rubber up to 10 kV								
										
	Three loaded conductors	Stretched laying A factor 1	Suspended freely in air A 1,05	Reeled in 1 layer A 0,8	2 layers A 0,61	3 layers* A 0,49	4 layers A 0,42	5 layers A 0,38	6 layers A 0,27	7 layers A 0,22
1	18,5	18	19	14	11	9	8	7	5	4
1,5	25	23	24	18	14	11	10	9	6	5
2,5	34	30	2	24	18	15	13	11	8	7
4	43	41	43	33	25	20	17	16	11	9
6	60	53	56	42	32	26	22	20	14	12
10	80	74	78	59	45	36	31	28	20	16
16	101	99	104	79	60	49	42	38	27	22
25	126	131	138	105	80	64	55	50	35	29
35	153	162	170	130	99	79	68	62	44	36
50	196	202	22	162	123	99	85	78	55	44
70	238	250	263	200	153	123	105	95	68	55
95	276	301	316	241	184	147	126	114	81	66
120	319	352	370	282	215	172	148	134	95	77
150	364	404	424	323	246	198	170	154	109	89
185	430	461	484	369	281	226	194	175	124	101
240	497	540	567	432	329	265	227	205	146	119
300	-	620	651	496	378	304	260	236	167	136
Rubber - starting at 15 kV										
16	101	105	-	84	64	51	44	40	28	23
25	126	139	-	111	85	68	58	53	38	31
35	153	172	-	138	105	84	72	65	46	38
50	196	216	-	172	131	105	90	82	58	47
70	238	265	-	212	162	130	111	101	72	58
95	276	319	-	255	195	156	134	121	86	70
120	319	371	-	297	226	182	156	141	100	82
150	364	428	-	342	261	210	180	163	116	94
185	430	488	-	390	298	239	205	185	132	107
240	497	574	-	459	350	281	241	218	155	126
300	-	660	-	528	403	323	277	251	178	145

* The reduction factor is also valid for flat reeling cables (spirally)

Current carrying capacities in A are calculated according to the IEC 60287 standard.

They are calculated assuming the following values:

Ambient temperature for installation in open air : 30 °C

Ambient temperature for underground burial : 20 °

Laying depths: U = 3÷10 kV 0,8 m
 U = 15÷30 kV 1,0 m
 U = 45 kV 1,2 m

Metallic screens interconnected and grounded at both ends

MEDIUM VOLTAGE CORRECTION FACTORS

CORRECTION FACTORS

Insulation	Conductor temperature °C	Cables type	Ambient temperature °C											
			10	15	20	25	30	35	40	45	50	55	60	65
PVC	70	in air cables*	1,22	1,17	1,12	1,06	1	0,94	0,87	0,79	0,71	0,61	0,50	-
EPR / RUBBER	90	in air cables*	1,15	1,12	1,08	1,04	1	0,96	0,91	0,87	0,82	0,76	0,71	0,65
	90	buried cables	1,07	1,04	1	0,96	0,93	0,89	0,85	0,80	0,76	-	-	-

* Not directly exposed to the sun

THREE-CORE CABLES GROUNDED LAYING or single-core cables enclosed in trefoil

Number of cables or trefoil-set (horizontally)	2	3	4	6	
Empty space between cables or trefoil-set	7 cm	0.84	0.74	0.67	0.60
	25 cm	0.86	0.78	0.74	0.69

THREE-CORE CABLES GROUNDED PIPE LAYING

Number of cables (horizontally)	1	2	3
	0.82	0.69	0.61



THREE-CORE CABLES SUSPENDED FREELY IN AIR

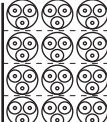

Number of sets of three (horizontally)	1	2	3	6	9	
Single layer	0,95	0,9	0,88	0,85	0,84	
Layers number (vertical)	1	1	0,98	0,96	0,93	0,92
	2	1	0,95	0,93	0,9	0,89
	3	1	0,94	0,92	0,89	0,88
	6	1	0,93	0,9	0,87	0,86

Number of sets of three (vertical)	1	2	3	6	9
	1	0,93	0,9	0,87	0,86



Cables number (horizontally)	1	2	3	6	9	
Layers number (vertical)	1	0,95	0,84	0,8	0,75	0,73
	2	0,95	0,8	0,76	0,71	0,69
	3	0,95	0,78	0,74	0,7	0,68
	6	0,95	0,76	0,72	0,68	0,66

Cables number (horizontally)	1	2	3	6	9
	0,95	0,78	0,73	0,68	0,66



MEDIUM VOLTAGE CORRECTION FACTORS AND PHASE SPLITTING

SINGLE CORE TREFOIL CORES CABLES SUSPENDED FREELY IN AIR

Number of sets of three (horizontally)		1	2	3	6	9
Single layer		0,95	0,9	0,88	0,85	0,84
Layers number (vertical)	1	1	0,98	0,96	0,93	0,92
	2	1	0,95	0,93	0,9	0,89
	3	1	0,94	0,92	0,89	0,88
	4	1	0,93	0,9	0,87	0,86

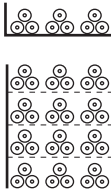

Number of sets of three (vertical)	1	2	3
	0,89	0,86	0,84

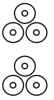

Number of single core (horizontally)		1	2	3
Single layer		0,92	0,89	0,88
Layers number (vertical)	1	1	0,97	0,96
	2	0,97	0,94	0,93
	3	0,96	0,93	0,92
	6	0,94	0,91	0,9

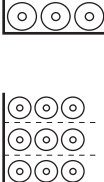

Number of single core (vertical)	1	2	3
	0,94	0,91	0,89



PHASE SPLITTING

Single core cables assembled in line

Cables lying in trefoil formation

Number 3 core units in the same layer								
2			3			4		
T	T	T	T	T	T	T	T	T
RS	SR	RS	SR	RS	RS	SR	RS	SR

Cables lying in line horizontally or vertically

Number 3 core units in the same layer(*)			
2		4	
RST	TSR	RST	TSR

(*) Cables installed in layers: indicated arrangements are repeated for each layer

MEDIUM VOLTAGE RESISTANCE

RESISTANCE

Cables insulated with elastomeric compounds

Observable resistance of red copper conductor and aluminum at 90°C and at 50 Hz

Conductor cross-section (mm ²)	Single core cables (copper-aluminum conductor)								Single core cables (copper-aluminum conductor any rated voltage)		three core cables (copper-aluminum conductor any rated voltage)	
	1,8/3 kV - 3,6/6 kV (Ohm/km)		6/10 kV - 8,7/15 kV (Ohm/km)		12/20 kV - 18/30 kV (Ohm/km)		26/45 kV (Ohm/km)		(Ohm/km)		(Ohm/km)	
	Cu	Al	Cu	Al	Cu	Al	Cu	Al	Cu	Al	Cu	Al
10	2,33	3,91	2,33	3,91	-	-	-	-	2,33	3,91	2,33	3,91
16	1,47	2,47	1,47	2,47	-	-	-	-	1,47	2,47	1,47	2,47
25	0,92	1,56	0,929	1,56	0,929	1,56	-	-	0,929	1,56	0,929	1,56
35	0,67	1,12	0,671	1,13	0,671	1,13	-	-	0,67	1,13	0,669	1,12
50	0,495	0,832	0,495	0,832	0,495	0,832	-	-	0,495	0,832	0,494	0,83
70	0,347	0,583	0,344	0,58	0,344	0,58	0,344	0,58	0,344	0,58	0,343	0,57
95	0,248	0,416	0,248	0,416	0,248	0,416	0,248	0,416	0,248	0,416	0,247	0,415
120	0,198	0,333	0,198	0,333	0,198	0,333	0,198	0,333	0,198	0,333	0,196	0,329
150	0,161	0,27	0,161	0,27	0,161	0,27	0,161	0,27	0,161	0,27	0,160	0,269
185	0,130	0,218	0,130	0,218	0,130	0,218	0,130	0,218	0,130	0,218	0,129	0,217
240	0,0984	0,165	0,0983	0,165	0,0982	0,165	0,0981	0,165	0,1	0,168	0,1	0,168
300	0,0789	0,132	0,0788	0,132	0,0787	0,132	0,0786	0,132	0,081	0,136	0,08	0,134
400	0,0625	0,105	0,0624	0,105	0,0623	0,105	0,0622	0,105	0,065	0,109	0,065	0,109
500	0,0496	0,0833	0,0494	0,0830	0,0493	0,0828	0,0491	0,0825	0,053	0,0890	0,0536	0,09
630	0,0396	0,0665	0,0394	0,0662	0,0393	0,0662	0,0391	0,0657	0,044	0,0739	-	-

Insulation resistance per phase (MOhm/km)

Conductor cross-section (mm ²)	Nominal voltage						
	1,8/3 kV	3,6/6 kV	6/10 kV	8,7/15 kV	12/20 kV	18/30 kV	26/45 kV
10	1590	-	-	-	-	-	-
16	1360	1505	1645	1990	-	-	-
25	1140	1315	1445	1760	2130	-	-
35	995	1180	1300	1595	1830	2455	-
50	885	1075	1185	1460	1680	2155	-
70	755	945	1045	1300	1505	1950	2105
95	655	835	925	1155	1345	1760	1905
120	595	770	855	1070	1250	1645	1785
150	540	705	785	990	1160	1535	1665
185	485	645	720	910	1070	1420	1550
240	430	580	645	820	965	1295	1415
300	390	530	590	755	890	1200	1310
400	350	470	520	670	790	1070	1165
500	340	450	470	600	720	980	1065
630	330	400	420	540	650	890	970

MEDIUM VOLTAGE REACTANCE

REACTANCE

Single core cables phase reactance at 50 Hz

Conductor cross-section (mm ²)	Single core cables (average values)						
	1,8/3 kV (Ohm/km)	3,6/6 kV (Ohm/km)	6/10 kV (Ohm/km)	8,7/15 kV (Ohm/km)	12/20 kV (Ohm/km)	18/30 kV (Ohm/km)	26/45 kV (Ohm/km)
10	0,19	0,20	0,21	-	-	-	-
16	0,18	0,19	0,20	0,21	-	-	-
25	0,18	0,18	0,19	0,20	0,21	-	-
35	0,17	0,18	0,19	0,19	0,20	0,21	-
50	0,16	0,17	0,18	0,19	0,19	0,20	-
70	0,16	0,17	0,17	0,18	0,19	0,20	0,21
95	0,16	0,16	0,17	0,17	0,18	0,19	0,20
120	0,15	0,16	0,16	0,17	0,18	0,18	0,19
150	0,15	0,16	0,16	0,17	0,17	0,18	0,19
185	0,14	0,15	0,16	0,16	0,17	0,18	0,18
240	0,14	0,15	0,16	0,16	0,16	0,17	0,18
300	0,14	0,15	0,15	0,16	0,16	0,17	0,17
400	0,14	0,15	0,15	0,15	0,16	0,16	0,17
500	0,14	0,14	0,15	0,5	0,15	0,16	0,17
630	0,14	0,14	0,15	0,15	0,15	0,16	0,16

NOTE:
Valid for copper and aluminum cables

For single core cables in trefoil formation with phase reactance at 50 Hz

Conductor cross-section (mm ²)	Single core cables						
	1,8/3 kV (Ohm/km)	3,6/6 kV (Ohm/km)	6/10 kV (Ohm/km)	8,7/15 kV (Ohm/km)	12/20 kV (Ohm/km)	18/30 kV (Ohm/km)	26/45 kV (Ohm/km)
10	0,14	0,16	0,16	-	-	-	-
16	0,13	0,14	0,15	0,16	-	-	-
25	0,12	0,13	0,14	0,15	0,15	-	-
35	0,11	0,12	0,13	0,14	0,14	0,16	-
50	0,11	0,12	0,12	0,13	0,13	0,15	-
70	0,1	0,11	0,12	0,12	0,13	0,14	0,15
95	0,098	0,11	0,11	0,12	0,12	0,13	0,14
120	0,097	0,1	0,11	0,11	0,12	0,13	0,14
150	0,092	0,099	0,1	0,11	0,11	0,12	0,13
185	0,089	0,096	0,1	0,11	0,11	0,12	0,12
240	0,086	0,093	0,096	0,1	0,1	0,11	0,12
300	0,084	0,092	0,094	0,098	0,1	0,11	0,12
400	0,082	0,090	0,092	0,095	0,099	0,11	0,11
500	0,081	0,088	0,089	0,092	0,095	0,1	0,11
630	0,079	0,086	0,087	0,090	0,093	0,099	0,10

NOTE:
Valid for copper and aluminum cables

MEDIUM VOLTAGE REACTANCE - SHORT CIRCUIT CURRENT CAPACITY

Three core cables phase reactance at 50 Hz

Conductor cross-section (mm ²)	Three core cables						
	1,8/3 kV (Ohm/km)	3,6/6 kV (Ohm/km)	6/10 kV (Ohm/km)	8,7/15 kV (Ohm/km)	12/20 kV (Ohm/km)	18/30 kV (Ohm/km)	26/45 kV (Ohm/km)
10	0,11	0,13	0,14	-	-	-	-
16	0,1	0,12	0,13	0,14	-	-	-
25	0,096	0,11	0,12	0,13	0,14	-	-
35	0,091	0,1	0,11	0,12	0,13	0,14	-
50	0,086	0,1	0,11	0,11	0,12	0,13	-
70	0,083	0,095	0,1	0,11	0,11	0,13	0,14
95	0,080	0,091	0,096	0,1	0,11	0,12	0,13
120	0,078	0,088	0,093	0,099	0,1	0,12	0,13
150	0,076	0,086	0,091	0,096	0,1	0,11	0,12
185	0,075	0,083	0,088	0,093	0,098	0,11	0,12
240	0,073	0,081	0,085	0,09	0,094	0,1	-
300	0,071	0,081	0,083	0,088	0,092	0,1	-
400	0,07	0,08	0,081	0,086	-	-	-
500	0,07	0,08	0,081	-	-	-	-

NOTE:

Valid both for copper and aluminium cables

MAX CURRENT CARRYING (kA) IN SHORT CIRCUIT

Conditions: 1 second duration; temperature 90°C

Conductor	Sections-mm														
	10	15	25	35	50	70	95	120	150	185	240	300	400	500	630
Copper	1,4	2,3	3,6	5	7,1	10	14	17	21	26	34	43	57	72	90
Alluminium	0,92	1,5	2,3	3,2	4,6	6,4	8,7	11	14	17	22	28	37	46	58

MINIMUM BENDING RADIUS

Minimum Bending Radius acc. to DIN VDE 0298 part. 3

Cables for fixed laying:				
Cable type:	Voltage up to 0,6/1 kV			Voltage above to 0,6/1 kV
	Outer diameter of cable (or thickness of flat cables) in mm			
	up to 10	above 10 up to 25	above 25	
Fixed laying:	4 x D*	4 x D	4 x D	6 x D
Single bended installation:	1 x D	2 x D	3 x D	4 x D

Flexible cables:					
Cable type:	Voltage up to 0,6/1 kV				Voltage above to 0,6/1 kV
	Outer diameter of round cable (or thickness of flat cables) in mm				
	up to 8	above 8 up to 12	above 12 up to 20	above 20	
Fixed laying:	3 x D	3 x D	4 x D	4 x D	6 x D
Freely movable:	3 x D	4 x D	5 x D	5 x D	10 x D
Cable entry/gland	3 x D	4 x D	5 x D	5 x D	10 x D
Mechanical restraint ¹⁾					
Cable-drum mode	5 x D	5 x D	5 x D	6 x D	12 x D
Festoon mode:	3 x D	4 x D	5 x D	5 x D	10 x D
Drag-chain mode:	4 x D	4 x D	5 x D	5 x D	10 x D
Roller reversing:	7,5 x D	7,5 x D	7,5 x D	7,5 x D	15 x D

NOTES:

D* = Outer diameter of cable

¹⁾ = Special structural support is required for suitability in the application

FLAMABILITY TEST

Examination of the vertical flame length, test method I kV - flame with gas/air mixture

Description	VDE 0482 part. 265-2-1, EN 50265-2-1 and IEC 60332-1	VDE 0482 part. 265-2-2, EN 50265-2-2 and IEC 60332-2
Length of sample	600 mm	600 mm
Burner	Acc. to EN 60695-2-4-1	Acc. to VDE 0482 part. 265-1 and EN 50265-1
Test temperature	1 kW flame	Defined by the stipulated setting of the Flame length
Position of sample	Vertical	Vertical
Position of flame	45° to vertical sample	45° to vertical sample
Duration of flame	See table 1	20 seconds
Conditions	Cable must be self-extinguishing. The damage or carbonization may only reach max. 50 mm under the upper fixing clamp.	Cable must be self-extinguishing. The damage or carbonization may only reach max. 10 mm under the upper fixing clamp.

Table I

outer diameter * of sample in mm	
Nominal value	Duration of flame test in seconds
$D \leq 25$	60
$25 < D \leq 50$	120
$50 < D \leq$	240
$D > 75$	480

* If the insulated cables are not round (i.e. flat cables), dimensions must be measured to determine an equivalent diameter.



FLAMABILITY TEST

Description	UL 1581 section 1080 (VW-I Flame test)
Length of sample	455 mm
Burner	Bunsen burner with added air supply Ø 9,5 mm
Test temperature	500 W flame
Position of sample	Vertical
Position of flame	20° to vertical sample
Duration of flame	Five 15 second trials with 15 seconds between each flame test
Conditions	Paper (25% carbonized) The sample may keep on burning for a maximum of 1 minute after any application. Material droppings must not ignite the cotton lying under the sample.

Description	UL 1581 section 1061 (Cable Flame Test)
Length of sample	455 mm
Burner	Bunsen burner with added air supply Ø 9,5 mm
Test temperature	500 W flame
Position of sample	Vertical
Position of flame	20° to vertical sample
Duration of flame	Three 60 seconds trials with 30 seconds between each flame test
Conditions	Paper (25% carbonized) The sample may keep on burning for a maximum of 1 minute after any application. Material droppings must not ignite the cotton lying under the sample.

Description	UL 1581 section 1060 (Vertical Flame and FT I Test)
Length of sample	455 mm
Burner	Bunsen burner with added air supply Ø 9,5 mm
Test temperature	500 W flame
Position of sample	Vertical
Position of flame	20° to vertical sample
Duration of flame	Five 15 seconds trials with 15 seconds between each flame test
Conditions	Paper (25% carbonized) The sample may keep on burning for a maximum of 1 minute after any application.

FLAMABILITY TEST

Assessment of the vertical flame length for vertical extended bundle of insulated cables

Description	IEC 60332-3, EN 50266, DIN VDE 0482 part. 266
Length of sample	3500 mm
Burner	Flat burner (Ribbon gas burner)
Test temperature	500 W flame
Position of sample	Vertical
Position of flame	Horizontal
Duration of flame	Category A, B: 40 minutes Category C, D: 20 minutes
Conditions	The burned portion of the sample must be shorter than 2,5 m measured from the bottom edge of the burner, unless specified otherwise.

	EN 60332-	IEC 60332-
Category A-7 l/m	3/22	3/22
Category B-3,5 l/m	3/23	3/23
Category C-1,5 l/m > 12 mm cable-ø	3/24	3/24
Category D-0,5 l/m ≤ 12 mm cable-ø	3/25	3/25
Volume % of non metallic material x meter		



FLAMABILITY TEST

Tests for electric cables under fire conditions - Circuits integrity

Description:	IEC 60331, CEI 20-36
	This test serves to verify the circuit can remain integral even during a fire. A sample of cable is held on an open flame at 750°C for a minimum period of 90 min, under the rated voltage. No break or short circuit should occur during the test in order to receive the rating. The test can also be performed with temperatures up to 1100 °C. Likewise, fibre optic cables can be tested in the same conditions while monitoring the attenuation of the signal of one or more fibres.
Classification:	IEC 60331-21 - CEI 20-36/2-1 - Electrical cables up to 0,6/1 kV IEC 60331-23 - CEI 20-36/2-3 - Data cables IEC 60331-25 - CEI 20-36/2-5 - Fibre optic cables

Tests for electric cables under fire conditions - Circuits integrity - part.2

Description:	IEC 60331-2
	Test method for fire with shock at a temperature of at least 830 °C for cables of rated voltage up to 0,6/1 kV and with an overall diameter not exceeding 20 mm
Test temperature:	830°C (+40/-0°C)
Duration:	30*, 60, 90, 120 min (*with water spray BS EN 50200 annex E)
Mechanical shocks:	every 5 min.
Water spray:	0,8 lt/min. (last 15 min.) (with water spray BS EN 50200 annex E)

Tests for electric cables under fire conditions - Circuits integrity - part.1

Description:	IEC 60331-1
	Test method for fire with shock at a temperature of at least 830 °C for cables of rated voltage up to 0,6/1 kV and with an overall diameter exceeding 20 mm
Test temperature:	830°C (+40/-0°C)
Duration:	60, 90, 120 min
Mechanical shocks:	every 5 min.

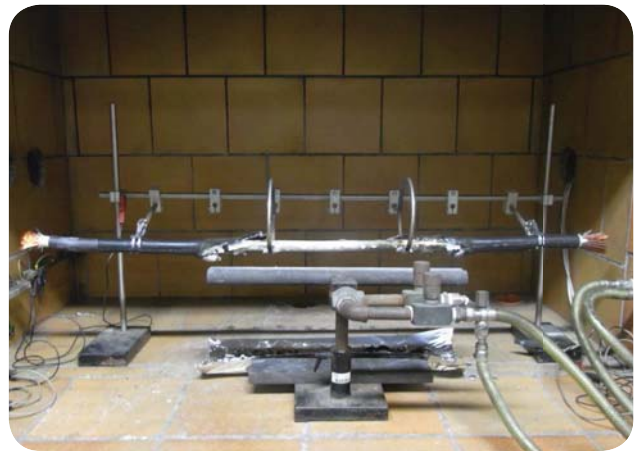

Fire Resistance

Description:	BS EN 50200
	This test serves to verify the circuit integrity of cables while exposed to fire at 830°C as well as mechanical shocks.
Classification:	PH 15 - flame exposure for 15 min. PH 30 - flame exposure for 30 min. PH 60 - flame exposure for 60 min. PH 90 - flame exposure for 90 min. PH 120 - flame exposure for 120 min.

Description	NF C 32-070 "CI"
Length of sample	1600 mm
Test temperature	+ 830°C +/- 50°C
Position of sample	Vertical in the chimney
Duration of test	30 minutes
Conditions	The outstanding cable above the chymney may not be damaged

DRUMS CAPACITY

WOODEN DRUMS

Drum Type	Flange diameter D1 (mm)	Barrel diameter D2 (mm)	Overall width L1 (mm)	Winding width L2 (mm)	Maximum carrying capacity (kg)	Standard wooden drum weight (kg)
051	500	150	470	410	100	8
061	630	315	415	315	250	17
071	710	355	520	400	250	25
081	800	400	520	400	400	31
091	900	450	690	560	750	47
101	1000	500	710	560	900	71
121	1250	630	890	670	1700	144
141	1400	710	890	670	2000	175
161	1600	800	1100	850	3000	280
181	1800	1000	1100	840	4000	380
201	2000	1250	1350	1045	5000	550
221	2240	1400	1450	1140	6000	710
250	2500	1400	1450	1140	7500	875
251	2500	1600	1450	1130	7500	900
281	2800	1800	1635	1280	10000	1175

PLASTIC DRUMS

Drum Type	Flange diameter D1 (mm)	Barrel diameter D2 (mm)	Overall width L1 (mm)	Winding width L2 (mm)	Maximum carrying capacity (kg)	Standard plastic drum weight (kg)
050	500	150	456	404	100	4
070	710	355	510	400	250	15
080	800	400	510	400	350	16
090	900	450	680	560	400	23
100	1000	500	704	560	500	32

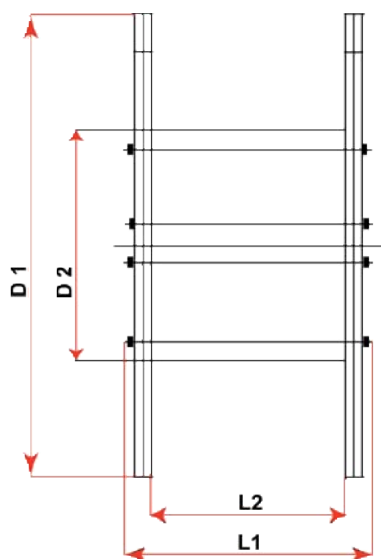

DRUM TYPE AND DRUM SIZE

Cable diameter mm	051	061	071	081	091	101	121	141	161	181	201	221	250	251	281	Cable diameter mm
6	1130	1110	2024	2755												6
7	815	840	1480	2340												7
8	630	640	1064	1463	2730											8
9	460	470	890	1152	2202	2866										9
10	390	388	680	980	1768	2349										10
11	320	315	564	760	1404	1910										11
12	260	254	470	643	1206	1540										12
13	220	238	385	542	1032	1339	2727									13
14	190	190	360	454	880	1159	2265	2967								14
15	170	180	300	430	749	1000	1990	2480								15
16	150	140	239	358	632	860	1756	2205								16
17	130	134	228	294	603	736	1545	1960								17
18	110	102	218	280	505	705	1355	1737								18
19	105	96	172	228	485	599	1184	1535	2722							19
20	100	92	165	220	402	576	1139	1352	2435	2830						20
21	80	90	159	210	387	485	990	1304	2172	2527						21
22		65	122	167	315	468	856	1145	1930	2248						22
23		62	117	160	304	389	827	999	1870	2172	2954					23
24		60	113	156	294	377	709	967	1657	1927	2608					24
25		58	110	150	285	365	688	839	1608	1867	2522					25
26		56	80	116	226	299	668	814	1420	1650	2218					26
27			78	113	220	290	567	700	1244	1450	2150	2860				27
28			76	109	215	282	550	680	1210	1410	1880	2777				28
29			73	106	209	226	462	663	1180	1370	1826	2450		2976		29
30			70	103	165	220	450	564	1028	1200	1583	2383			2893	30
31				76	157	214	438	550	1003	1166	1540	2089			2558	31
32				74	153	209	428	537	866	1009	1500	2035		2978	2490	32
33				72	150	204	352	450	846	985	1289	1984	2908		2428	33
34					146	158	344	440	828	962	1257	1726	2605	2134		34
35					108	154	336	430	710	824	1227	1685	2547	2083	2890	35
36					105	150	329	422	692	806	1040	1646	2270	2035	2820	36
37					103	148	265	348	678	788	1017	1418	2223	1774	2760	37
38						144	259	340	664	772	994	1386	1969	1735	2432	38
39						110	254	334	560	653	972	1356	1930	1697	2380	39
40						105	249	327	549	640	812	1328	1892	1486	2330	40
41						102	244	264	539	627	795	1130	1664	1435	2036	41
42						100	190	259	529	615	779	1107	1633	1406	1995	42
43							187	254	437	510	763	1085	1603	1199	1956	43
44							183	249	430	502	750	1065	1574	1175	1692	44
45							180	245	422	492	610	890	1373	1153	1660	45
46							177	240	415	484	600	874	1349	1130	1630	46
47							174	187	408	475	589	858	1326	1110	1600	47
48							130	184	330	386	578	878	1144	990	1366	48
49							127	180	325	380	568	848	1125	914	1362	49
50							125	178	319	373	558	828	1107	898	1320	50
51							123	175	314	367	442	666	1089	883	1298	51
52							120	172	310	360	435	655	1072	869	1276	52
53								170	305	356	428	644	912	715	1072	53
54								126	235	280	420	634	898	700	1056	54
55								124	232	276	414	624	885	690	1040	55
56								122	230	270	408	614	872	680	1022	56
57								121	228	267	400	488	860	668	1006	57
58								119	225	263	304	480	720	658	990	58
59									222	260	300	473	710	649	815	59
60									220	256	295	466	700	640	803	60
61									216	252	290	460	690	610	790	61
62									160	190	287	453	680	500	780	62
63									158	187	282	448	670	494	770	63
64									156	184	280	440	662	487	760	64
65									154	182	275	435	640	480	748	65
66									152	180	270	430	634	474	738	66
67									150	178	266	426	628	468	728	67
68										174	264	420	620	462	720	68
69										172	262	418	618	460	718	69
70										170	260	416	616	458	716	70
71										168	258	414	614	456	714	71
72										166	256	412	612	454	712	72
73										164	254	410	610	452	710	73
74										162	252	408	608	450	708	74
75										160	250	406	606	448	706	75
76										112	170	291	380	322	526	76
77										110	168	287	375	318	520	77
78										109	166	284	370	314	514	78
79										108	164	281	367	310	508	79
80										107	163	278	363	306	502	80
81										106	161	276	360	304	496	81
82										105	158	273	356	300	490	82
83										103	156	269	352	297	484	83
84											155	190	349	294	478	84
85											154	188	345	290	472	85
86											152	186	342	288	466	86
87											150	184	338	285	460	87
88											149	182	335	282	454	88
89											147	180	332	280	448	89
90											146	178	329	278	442	90
91											144	176	326	276	436	91
92											90	175	325	275	430	92

min. drum barrel $\varnothing \leq 40 \times D$ (cable \varnothing)
min. drum barrel $\varnothing \leq 30 \times D$ (cable \varnothing)
min. drum barrel $\varnothing \leq 25 \times D$ (cable \varnothing)

min. drum barrel $\varnothing \leq 20 \times D$ (cable \varnothing)
min. drum barrel $\varnothing \leq 15 \times D$ (cable \varnothing)

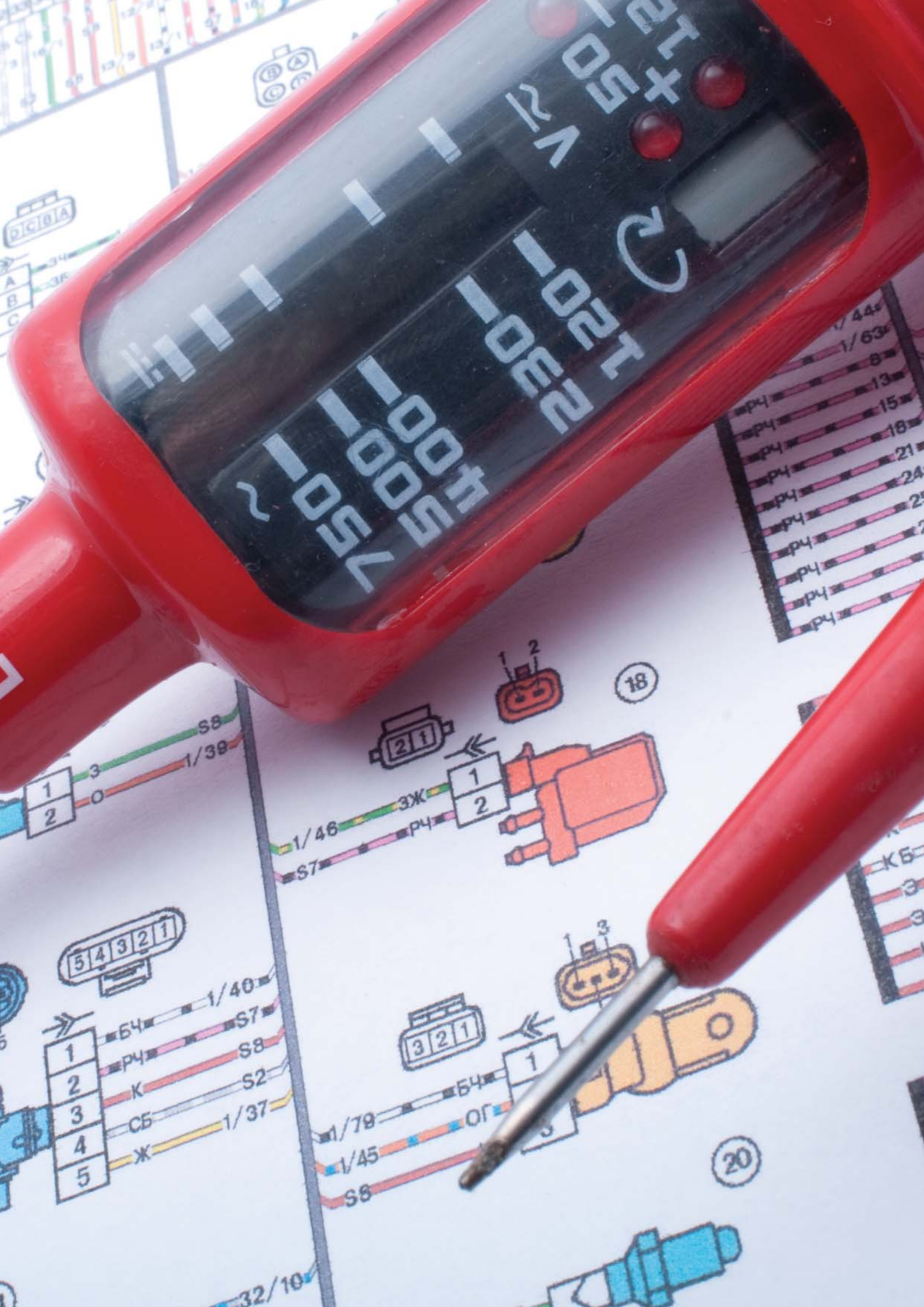

~ 1.000
V~ 1000
V- 100
K 10
1000

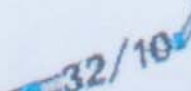
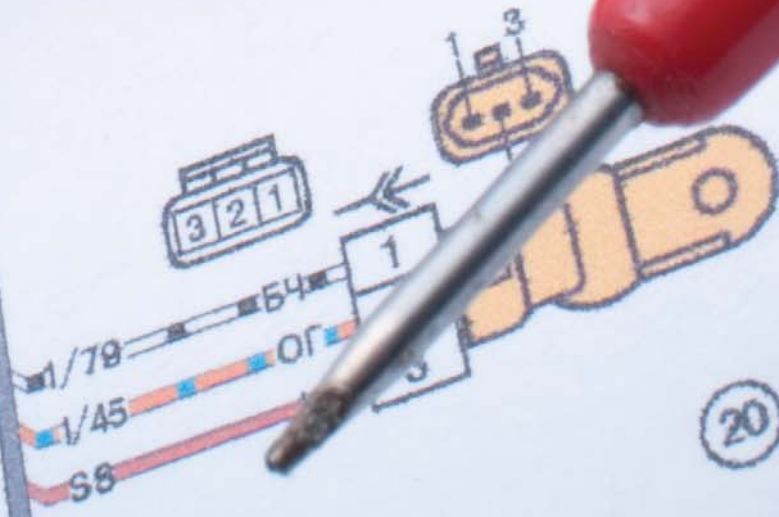
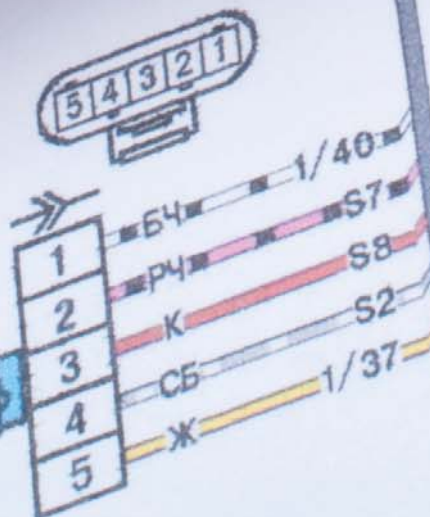
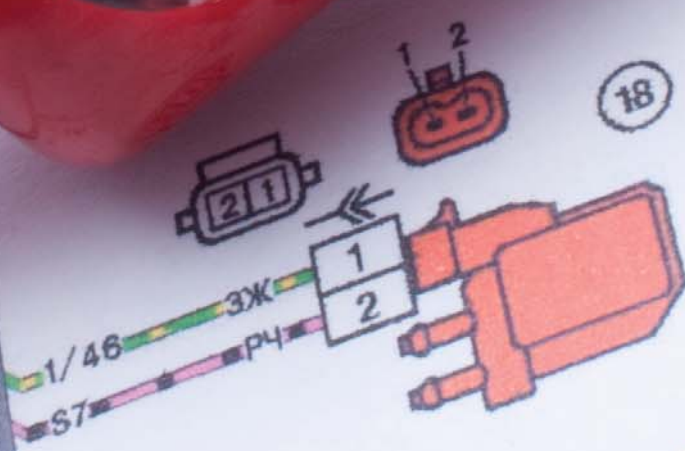
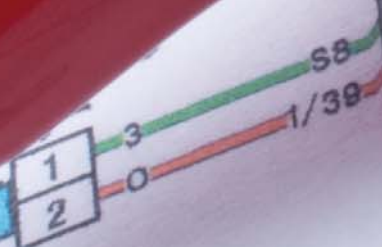

Subject to errors, modifications and amendments

All pictures, texts technical data and other representations of the Elettrotek Kabel® products shown in this catalogue are valid at the time of issuance. All information is non-binding and subject to change. In case of errors, the company Elettrotek Kabel® do not assume liability. The company Elettrotek Kabel® is excluded from liability for damages that are incurred either directly or indirectly from the use of this catalogue, to the extent that they may be caused by demonstrably false intentions or grave negligence by the company Elettrotek Kabel®. All rights for reprinting or reproduction of text and illustrations, in whole or in part, are reserved. Transfers or copyrights must be allowed through the written permission of Elettrotek Kabel®

Elettrotek Kabel Group
www.elettrotekkabel.com info@elettrotekkabel.com