

# SIGNUM™ encoder system



## Renishaw's SR readhead and Si interface are part of the **SIGNUM** range of optical encoders.

They have been designed for use with Renishaw's range of high accuracy RESM and REXM angle encoders and RSLM and RELM linear encoders which incorporate the *IN-TRAC*™ bi-directional reference mark.

Like all Renishaw encoders, the **SIGNUM** range offers high speed, reliable operation and open, non-contact performance with excellent immunity to dirt and electrical noise.

The interface incorporates dynamic signal control which, combined with the patented filtering optics, ensure excellent signal integrity and exceptionally low cyclic error.

The Si interface can be mounted remotely and a small connector on the readhead cable allows it to be fed easily through machines where access is restricted.

### Readhead (SR)

SR005A – 0.5 m cable
SR010A – 1.0 m cable
SR015A – 1.5 m cable
SR030A – 3.0 m cable
SR050A – 5.0 m cable
SR100A – 10.0 m cable

### Interface unit (Si)

Si-NN-0004 – 5 µm
Si-NN-0020 – 1 µm
Si-NN-0040 – 0.5 µm
Si-NN-0100 – 0.2 µm
Si-NN-0200 – 0.1 µm
Si-NN-0400 – 50 nm
Si-NN-1000 – 20 nm
Si-HN-2000 – 10 nm
Si-HN-4000 – 5 nm
Si-NN-0000 – Analogue
Si-NN-0001 – Low noise analogue

- *IN-TRAC* bi-directional reference mark and on-scale dual limit outputs
- Compatible with RESM, REXM (rotary) and RELM and RSLM (linear) scales
- Operating temperature up to 85 °C
- Speeds up to 12.5 m/s (4591 rev/min @ Ø52 mm)
- Dynamic signal control to give cyclic error of typically ±30 nm
- **SIGNUM** software for easy installation and system diagnostics
- Integral LEDs for optimum set-up and system diagnostics
- Industry standard analogue and digital outputs with resolutions from 5 µm to 5 nm (40 to 0.0038 arc seconds)
- Non-contact open optical system
- Filtering optics provide excellent dirt immunity
- High flex, UL approved cable

## SR installation drawing

Dimensions and tolerances in mm

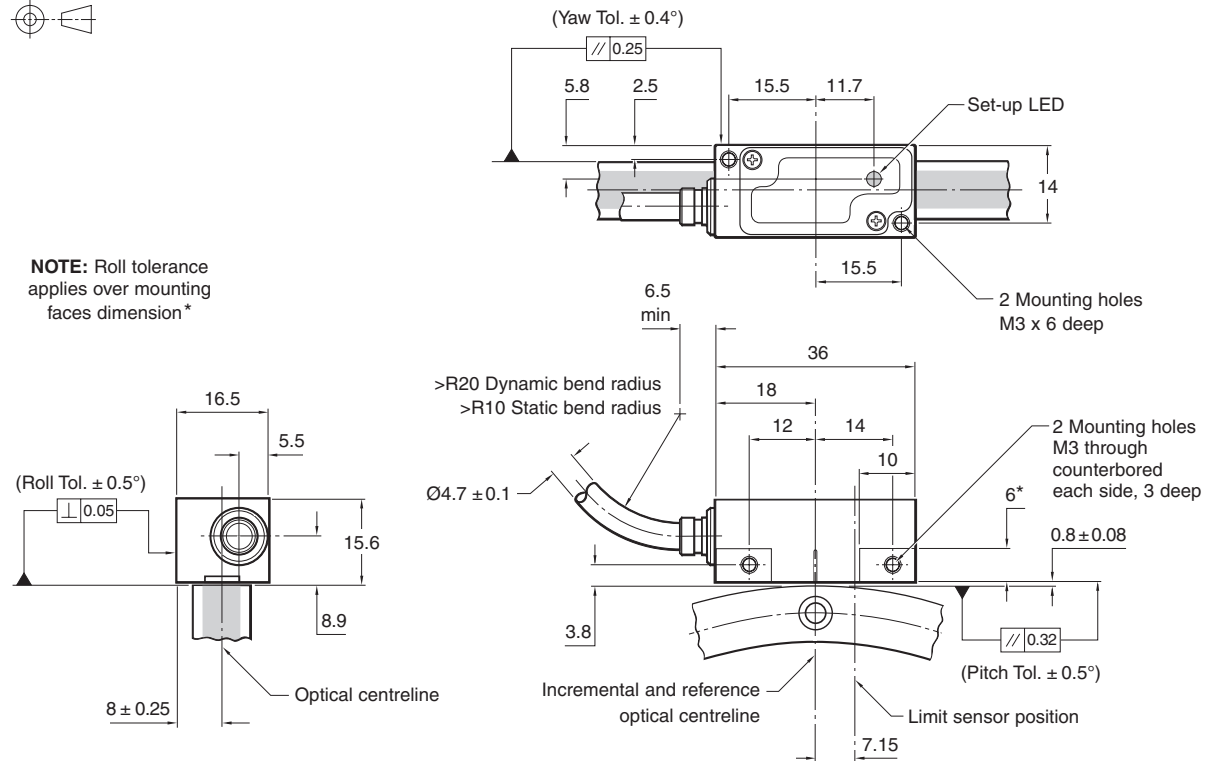

**NOTE:** Roll tolerance applies over mounting faces dimension\*

**NOTE:** RESM only shown.

For detailed installation drawings, refer to RSLM/RELM (M-9572-9110), RESM (M-9590-9106) and REXM (M-9671-0021) Installation guides. For scale information refer to RESM (L-9517-9154), REXM (L-9517-9318), RSLM (L-9517-9305) and RELM (L-9517-9219) Data sheets.

## Si installation drawing

Dimensions and tolerances in mm

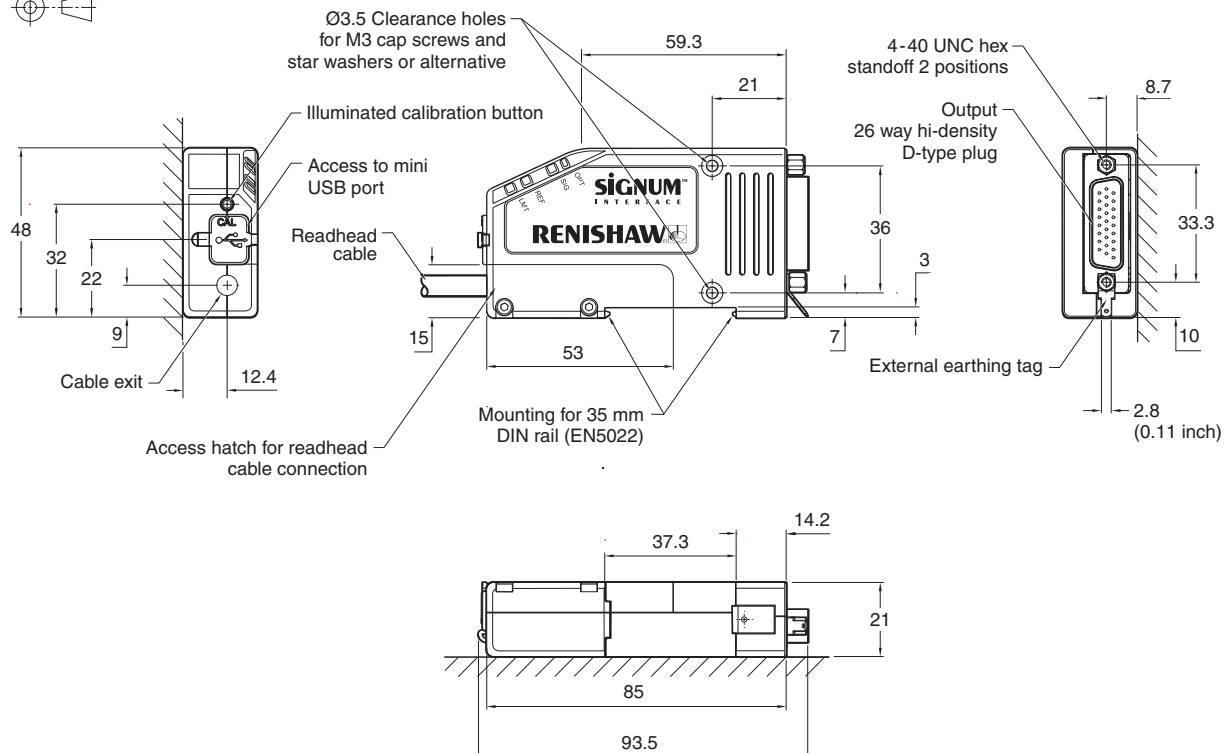

## Operating and electrical specifications

<b>Power supply</b>	5 V ±10%	<250 mA (typical)
	Ripple	200 mVpp maximum @ frequency up to 500 kHz maximum
<b>Temperature (system) (readhead) (interface)</b>	Storage	-20 °C to +70 °C
	Operating	0 °C to +85 °C
	Operating	0 °C to +70 °C
<b>Humidity</b>	Storage	95% maximum relative humidity (non-condensing)
	Operating	80% maximum relative humidity (non-condensing)
<b>Sealing (readhead) (interface)</b>		IP64
		IP30
<b>Acceleration (readhead)</b>	Operating	500 m/s <sup>2</sup> BS EN 60068-2-7:1993 (IEC 68-2-7:1983)
<b>Shock (system)</b>	Non-operating	1000 m/s <sup>2</sup> , 6 ms, ½ sine BS EN 60068-2-27:1993 (IEC 68-2-27:1987)
<b>Vibration (system)</b>	Operating	100 m/s <sup>2</sup> max @ 55 Hz to 2000 Hz BS EN 60068-2-6:1996 (IEC 68-2-6:1995)
<b>Mass</b>	Readhead	15 g
	Interface	205 g
	Cable	35 g/m
<b>EMC compliance (system)</b>	The <b>SIGNUM</b> encoder system conforms to the relevant harmonised European standards for electromagnetic compatibility	
<b>Readhead cable</b>	Double-shielded, outside diameter 4.7 ±0.1 mm maximum Flex life >20 x 10 <sup>6</sup> cycles at 20 mm bend radius UL recognised component 	

**NOTE: Class 1M LED product. LED radiation. Do not view directly with optical instruments.**

## Speed

Minimum counter clock frequency (MHz)*	Maximum speed (m/s)								
	Si-NN-0004 5 µm	Si-NN-0020 1 µm	Si-NN-0040 0.5 µm	Si-NN-0100 0.2 µm	Si-NN-0200 0.1 µm	Si-NN-0400 50 nm	Si-NN-1000 20 nm	Si-HN-2000 10 nm	Si-HN-4000 5 nm
40	12.5	12.5	12.5	5	2.5	1.25	0.5	0.27	0.135
20	12.5	12.5	6.5	2.7	1.25	0.6	0.25	0.135	0.068
12	12.5	8	4	1.5	0.8	0.4	0.15	0.09	0.045
10	12.5	6.5	3	1.25	0.6	0.3	0.12	0.068	0.034
8	12.5	5	2.5	1	0.5	0.25	0.1	0.054	0.027
6	12.5	4	2	0.8	0.4	0.2	0.08	0.045	0.023
4	12.5	3	1.5	0.6	0.3	0.15	0.06	0.034	0.017
1	4	0.8	0.4	0.15	0.075	0.04	0.02	0.008	0.004
<b>Analogue output</b>	12.5 m/s					3.0 m/s			

\*Digital only

Analogue systems: Si-NN-0000 – 12.5 m/s Si-NN-0001 (bandwidth limited for lower noise) – 3.0 m/s.

Additional decimal and binary interpolation factors are available on request.

Angular speed depends on ring diameter - use the following equation to convert to rev/min.

$$\text{Angular speed (rev/min)} = \frac{V \times 1000 \times 60}{\pi D} \quad \text{Where } V = \text{maximum linear speed (m/s) and } D = \text{external diameter of RESM (mm)}$$

## System features



### IN-TRAC optical reference mark

- Integrated within the graduation for compact dimensions and simplified alignment
- Electronically phased, requiring no physical adjustment
- Sub micron repeatability in both directions of travel over full operating temperature and speed range
- Mid point (RELM and RSLM), end point (RELE and RSLE), customer selectable (RSLC) or distance coded\* (RSLD) location on linear scale system

\*Distance coded only available for Digital systems with a resolution of 1  $\mu$ m or finer.  
The maximum speed for referencing is as per the speed table or 5 m/s whichever is the lowest

### Dynamic signal control

- Real time signal conditioning for optimised performance across a range of operating conditions
- Includes Auto Gain Control (AGC), Auto Offset Control (AOC) and Auto Balance Control (ABC)
- Ultra low cyclic errors, typically  $\pm 30$  nm

### Calibration at the touch of a button

- Click of a mouse via **siGNUM** software or CAL button on Si interface
- Optimization for all output signals

### Integrated LED diagnostics

- Simplifies initial alignment and set-up
- Reference mark and limit status



### Dual optical limit switch

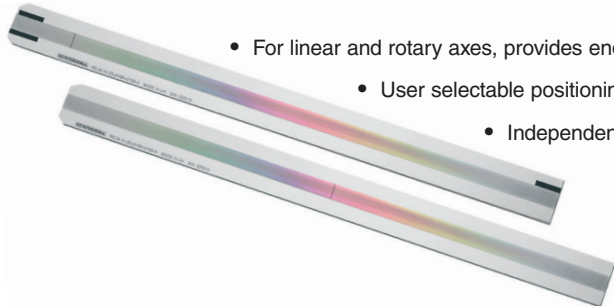

- For linear and rotary axes, provides end-of-travel indication
- User selectable positioning
- Independent output for each limit position
- Ideal for linear and partial arc rotary applications

### In-line connector (option)

- In-line connector between readhead and interface for easy connectivity
- IP68
- Protective caps available



### siGNUM software

- PC based, providing real-time set-up, calibration and diagnostics
- USB connection to **siGNUM** Si interface
- Simultaneous multiple axis connectivity
- Can be connected during full servo-loop operation
- Latest version of software available for download from [www.renishaw.com](http://www.renishaw.com)

Recommended minimum PC requirements for the software:

- USB1.1
- .NET Framework 1.1 (redistributable version included with the software)
- Microsoft® Windows® Millennium edition (Me), XP or Windows® 7
- Microsoft® Internet Explorer 5.01 or later
- Pentium® II processor
- 128 MB RAM
- Screen resolution 800 x 600, 16-bit colours



### Connections Si output (analogue and digital versions)

Function	Output type	Signal	Pin	
Power		5 V Power	26	
		5 V Sense	18	
		0 V Power	9	
		0 V Sense	8	
Incremental signals	RS422A digital	A+	24	
		A-	6	
		B+	7	
		B-	16	
	Analogue	Cosine	V <sub>1+</sub>	1
		Sine	V <sub>2+</sub>	2
Reference mark	RS422A digital	Z+	15	
		Z-	23	
	Analogue	V <sub>0+</sub>	12	
		V <sub>0-</sub>	20	
Customer selected reference mark	RS422A digital	S+	5	
		S-	14	
	Analogue	V <sub>0</sub> S+	21	
		V <sub>0</sub> S-	3	
Alarm	RS422A digital	E+	25	
		E-	17	
Limits	Open collector	P	4	
		Q	13	
Warning	Open collector	W	22	
Readhead pitch adjustment	-	XS	10	
Shield	-	Inner shield	Not connected	
	-	Outer shield	Case	

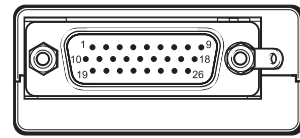

26 pin high density D type plug

### Electrical connections

#### Si and SR grounding and shielding

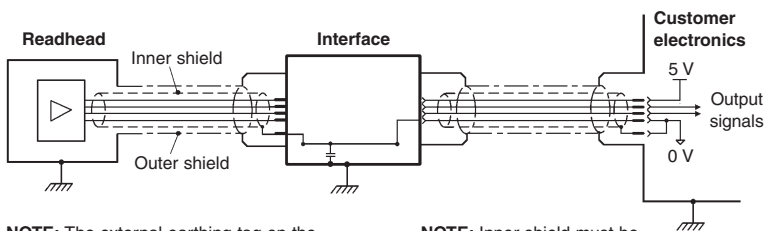

**NOTE:** The external earthing tag on the interface should be used when mounting the interface on a DIN rail

**NOTE:** Inner shield must be connected to 0 V at customer electronics only

#### Maximum cable length

Readhead to interface: 10 m

Interface to controller: Dependent on output frequency. See table below for details.

Output frequency (MHz)	Maximum cable length (m)
21 to 40	10
13 to 20	25
≤ 12	50
analogue	50

#### Recommended signal termination

##### Digital outputs

- all Si interfaces except Si-NN-0000 and Si-NN-0001

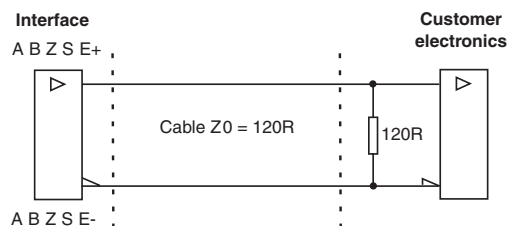

Standard RS422A line receiver circuitry

##### Limits and warning outputs

- all Si interfaces

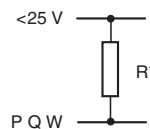

\*Select R so max. current does not exceed 20 mA

Alternatively, use a suitable relay or opto-isolator

##### Analogue outputs

- all Si interfaces

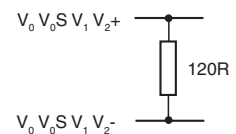

## Output specifications

Digital output signals - available from all Si interfaces  
 except Si-NN-0000 and Si-NN-0001

All digital **SiGNUM** interfaces also offer analogue outputs as standard  
 Form - Square wave differential line driver to EIA RS422A  
 (except limits P and Q and warning W)

Analogue output signals - available from all  
 Si interfaces

**Incremental** 2 channels A and B in quadrature  
 (90° phase shifted)<sup>†</sup>

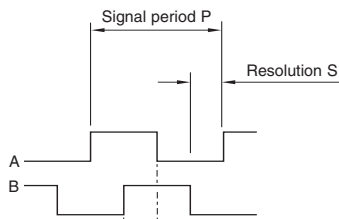

Model	P (μm)	S (μm)
Si-NN-0004	20	5
Si-NN-0020	4	1
Si-NN-0040	2	0.5
Si-NN-0100	0.8	0.2
Si-NN-0200	0.4	0.1
Si-NN-0400	0.2	0.05
Si-NN-1000	0.08	0.02
Si-HN-2000	0.04	0.01
Si-HN-4000	0.02	0.005

**Incremental** 2 channels V<sub>1</sub> and V<sub>2</sub> differential sinusoids in quadrature  
 (90° phase shifted)<sup>†</sup>

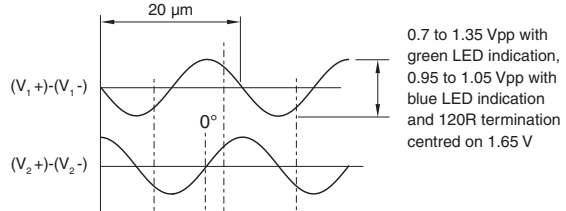

**Reference**<sup>†</sup>

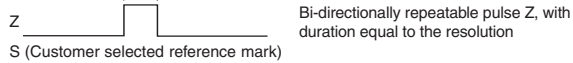

**Reference**<sup>†</sup>

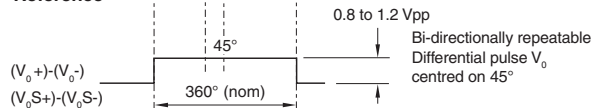

### All units

End of travel limit and warning outputs can be selected as 'active high' or 'active low' at time of ordering.  
 The alarm signal can be output as a differential line driven signal or 3-state. Again, please select the preferred option at time of ordering.

**Limits** Open collector output, asynchronous pulse

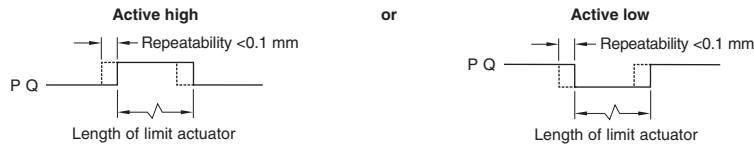

**Warning** Open collector output, asynchronous pulse

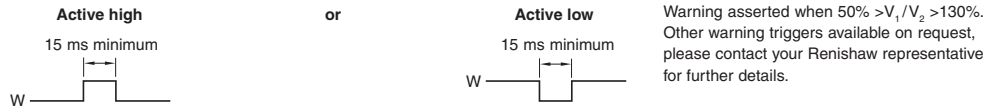

**Alarm**<sup>†</sup> Asynchronous pulse

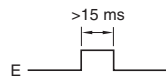

Alarm asserted when signal level is less than 20% or greater than 135% and overspeed. Alarm is also asserted if readhead speed is too high for reliable operation.  
 Other alarm triggers available on request, please contact your Renishaw representative for further details.

**or 3-state alarm**

Differentially transmitted signals forced open circuit for >15 ms when alarm conditions valid.

<sup>†</sup>**Note:** Inverse signals not shown for clarity

## SiGNUM readhead

Readhead part number **SR-005-A**

Readhead series

Cable length

005 = 0.5 m

010 = 1 m

015 = 1.5 m

030 = 3 m

050 = 5 m

100 = 10 m

Type

A - standard

## SiGNUM interface

Interface part number

**Si-NN-0000-00-0-0N-003-003-3**

Interface series

Si-NN – Standard digital, analogue and low noise analogue interfaces

Si-HN – High resolution interfaces

Interpolation factor and resolution

0000 - Analogue

0001 - Low noise analogue

0004 - x 4 interpolation, 5 µm resolution

0016 - x 16 interpolation, 1.25 µm resolution

0020 - x 20 interpolation, 1µm resolution

0032 - x 32 interpolation, 0.625 µm resolution

0040 - x 40 interpolation, 0.5 µm resolution

0064 - x 64 interpolation, 0.3125 µm resolution

0100 - x 100 interpolation, 0.2 µm resolution

0128 - x 128 interpolation, 0.15625 µm resolution

0200 - x 200 interpolation, 0.1 µm resolution

0400 - x 400 interpolation, 50 nm resolution

0512 - x 512 interpolation, 39.062 nm resolution

1000 - x 1000 interpolation, 20 nm resolution

2000 - x 2000 interpolation, 10 nm resolution (Si-HN only)

4000 - x 4000 interpolation, 5 nm resolution (Si-HN only)

Counter clock frequency

00 - Analogue 1 Vpp

01 - 1 MHz customer clock

04 - 4 MHz customer clock

06 - 6 MHz customer clock

08 - 8 MHz customer clock

10 - 10 MHz customer clock

12 - 12 MHz customer clock

20 - 20 MHz customer clock

40 - 40 MHz customer clock

Alarm, warning and limit outputs

0 - 3 state alarm, active high warning output, active high limit output

1 - Line driven alarm, active high warning output, active high limit output

Count direction and readhead mounting

0N - Normal mounting (analogue only)

FN - Forward counting, normal mounting (digital only)

Alarms

003 - High signal & low signal alarms (analogue only)

403 - High signal, low signal & over speed alarms (digital only)

Warnings

003 - High signal & low signal warnings

ABC / AOC / Limits

3 - All enabled

## SIGNUM compatible products:

### SIGNUM



#### RELM



Installation guide M-9572-9110  
Data sheet L-9517-9219

#### RSLM



Installation guide M-9572-9110  
Data sheet L-9517-9305

#### RESM

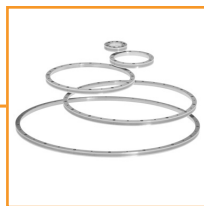

Installation guide M-9572-9106  
Data sheet L-9517-9154

#### REXM

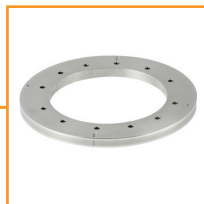

Installation guide M-9671-0021  
Data sheet L-9517-9318

#### DSi



Installation guide M-9568-0200  
Data sheet L-9517-9231

For worldwide contact details, please visit our  
main website at [www.renishaw.com/contact](http://www.renishaw.com/contact)

RENISHAW HAS MADE CONSIDERABLE EFFORTS TO ENSURE THE CONTENT OF THIS DOCUMENT IS CORRECT AT THE DATE OF PUBLICATION BUT MAKES NO WARRANTIES OR REPRESENTATIONS REGARDING THE CONTENT. RENISHAW EXCLUDES LIABILITY, HOWSOEVER ARISING, FOR ANY INACCURACIES IN THIS DOCUMENT.

RENISHAW® and the probe emblem used in the RENISHAW logo are registered trademarks of Renishaw plc in the UK and other countries. apply innovation is a trademark of Renishaw plc.

