

# optronics®

HEAVY DUTY LIGHTING CATALOG







Founded in 1972, Optronics has been a leading supplier of 12-volt lighting to the automotive, trailer, and recreational markets for over 35 years. In 2010 Optronics acquired the Panelite® Millennium Series™ line of lighting products to further expand its product line. With extensive engineering and design capabilities and manufacturing facilities in the US and Asia (ISO/TS-16949), Optronics produces lighting to meet the industry's evolving needs using the latest in technological advances. Photometric and mechanical testing both at point of manufacture and distribution ensures consistent quality and FMVSS 108 compliance of our safety lighting products, and three North American distribution centers contribute to our exemplary on-time shipping performance. Optronics offers customers the best of both worlds—lighting expertise resulting from over three decades of manufacturing experience combined with the cost savings of an import program. And while others may supply only a few items, Optronics offers complete lighting programs to cover interiors as well as exterior safety lighting in the marine, RV, cargo trailer, heavy duty and transit vehicle markets.



All products conform to DOT/SAE/FMVSS/CMVSS 108 requirements where applicable.







**MILLENNIUM SERIES™** ..... 2-5  
*Most popular panel light in the heavy duty market*



**Opti-Brite Cargo Lights** ..... 6  
*Durable lighting for harsh applications using latest LED technology*



**Miro-Flex LED Safety Lighting**..... 7-9  
*Faceted, mirrored reflectors and clear lenses provide increased light output and a high end appearance*



**Hyper X LED Safety Lighting** ..... 10-11  
*Engineered optics multiply light output and provide contemporary automotive styling*



**FLEET Count LED Safety Lighting** ..... 12-13  
*Low diode count combined with engineered optics provide DOT compliant, entry level LED lights*



**Optronics LED Safety Lighting**..... 14-22  
*Select from mid-range and high diode count to find lighting for any application*



**Optronics Incandescent Lighting, Conspicuity Tape**..... 23-31  
**and Accessories**  
*Optronics supplies a complete line of DOT compliant, durable lighting for trucks and trailers*



**Optronics LED POP Displays**..... 32  
*Illuminated displays illustrate benefits of LED lighting and increase sales*

**Index**..... 33



# MILLENNIUM SERIES



## M1 MARKER/CLEARANCE LIGHTS

### 180 BULLETS + BEZEL

PRODUCT	POLYPACK	QTY	BULK	QTY
M1-AMBER-12V	00212331	20	00212331B	20
M1-AMBER-24V	00212031	20	00212031B	20
M1-AMBER-LED	00212335	10	-	-
M1-AMBER-LED-CLEAR	00212336	10	-	-
M1-RED-12V	00212333	20	00212333B	20
M1-RED-LED	00212337	10	-	-
M1-RED-LED-CLEAR	00212338	10	-	-

### 180 BULLETS - NO BEZEL

PRODUCT	POLYPACK	QTY	BULK	QTY
M1-AMBER-12V	00212351	20	00212351B	20
M1-AMBER-24V	00212051	20	00212051B	20
M1-AMBER-LED	00212355	10	00212307	10
M1-AMBER-LED-CLEAR	00212356	10	00212376	10
M1-RED-12V	00212353	20	00212353B	20
M1-RED-LED	00212357	10	00212309	10
M1-RED-LED-CLEAR	00212358	10	00212378	10

### METRIPACK + BEZEL

PRODUCT	POLYPACK	QTY	BULK	QTY
M1-AMBER-INC	00212342	20	00212342B	20
M1-AMBER-LED	00212345	10	-	-
M1-AMBER-LED-CLEAR	00212346	10	-	-
M1-RED-INC	00212344	20	00212344B	20
M1-RED-LED	00212347	10	-	-
M1-RED-LED-CLEAR	00212348	10	-	-

### METRIPACK - NO BEZEL

PRODUCT	POLYPACK	QTY	BULK	QTY
M1-AMBER-INC	00212362	20	00212362B	20
M1-AMBER-LED	00212365	10	00212315	10
M1-AMBER-LED-CLEAR	00212366	10	00212384	10
M1-RED-INC	00212364	20	00212364B	20
M1-RED-LED	00212367	10	00212316	10
M1-RED-LED-CLEAR	00212368	10	00212386	10

## M1 ACCESSORIES

PRODUCT	POLYPACK	QTY	BULK	QTY
M1-RED-LENS	00212392	20	00212322	100
M1-AMBER-LENS	00212393	20	00212323	100
M1-SOCKET ASSY-BULLETS	00212005	20	00212011	100
M1-SOCKET ASSY METRIPACK	00212006	20	00212012	100
M1-BEZEL-CHROME	00212327	20	00212317	100
M1-BASE KIT	00212391	20	00212321	100
M1-BULB-12V	-	-	00212007	100
M1-BULB-24V	-	-	00212010	100



**M1**  
Amber Lens - Incandescent Bulb



**M1-LED**  
Amber Lens - LED



**M1-AMBER-LED-CLEAR**  
Clear Lens - Amber LED



**M1-RED**  
Red Lens - Incandescent Bulb



**M1-RED-LED**  
Red Lens - LED

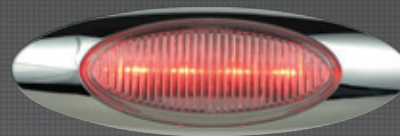

**M1-RED-LED-CLEAR**  
Clear Lens - Red LED



**UNLIT**  
M1-Clear Lens-LED

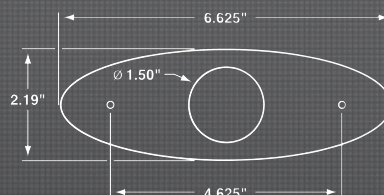

### TECHNICAL SPECIFICATIONS

POLYCARBONATE LENS  
FMVSS SAE CODE: P2

POLYCARBONATE BEZEL W/ CHROME-PLATING  
ASTM B 604-91: SC2  
GENERAL MOTORS SPEC: GM4372M

M1 LED  
12V / 0.12 AMP

M1 INCANDESCENT  
#193 BULB #464E BULB  
12V / 0.33 AMP 24V / 0.17 AMP



## M3 Panelite MILLENNIUM SERIES™



### M3 MARKER/CLEARANCE LIGHTS

#### 180 BULLETS + BEZEL

PRODUCT	POLYPACK	QTY	BULK	QTY
M3-AMBER-INC	00212231	20	00212231B	20
M3-AMBER-LED	00212235	10	-	-
M3-AMBER-LED-CLEAR	00212236	10	-	-
M3-RED-INC	00212233	20	00212233B	20
M3-RED-LED	00212237	10	-	-
M3-RED-LED-CLEAR	00212238	10	-	-
M3-CLEAR-INC	00212239	20	00212239B	20

#### 180 BULLETS – NO BEZEL

PRODUCT	POLYPACK	QTY	BULK	QTY
M3-AMBER-INC	00212251	20	00212251B	20
M3-AMBER-LED	00212255	10	00212207	10
M3-AMBER-LED-CLEAR	00212256	10	00212276	10
M3-RED-INC	00212253	20	00212253B	20
M3-RED-LED	00212257	10	00212209	10
M3-RED-LED-CLEAR	00212258	10	00212278	10
M3-CLEAR-INC	00212259	20	00212259B	20

### M1 ACCESSORIES

PRODUCT	POLYPACK	QTY	BULK	QTY
M3-RED-LENS	00212292	20	00212222	100
M3-AMBER-LENS	00212293	20	00212223	100
M3-CLEAR-LENS	00212294	20	00212224	100
M3-BEZEL-CHROME	00212227	20	00212217	100
M3-BASE KIT	00212291	20	00212221	100
M1-SOCKET ASSY-BULLETS	00212005	20	00212011	100
M1-SOCKET ASSY METRIPACK	00212006	20	00212012	100

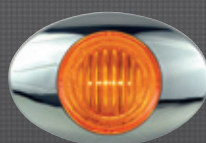

**M3**  
Amber Lens - Incandescent Bulb



**M3-LED**  
Amber Lens - LED

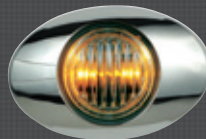

**M3-LED-CLEAR**  
Clear Lens - Amber LED



**M3-RED**  
Red Lens - Incandescent Bulb



**M3-RED-LED**  
Red Lens - LED



**M3-RED-LED-CLEAR**  
Clear Lens - Red LED



**M3-CLEAR**  
Clear Lens - Bulb

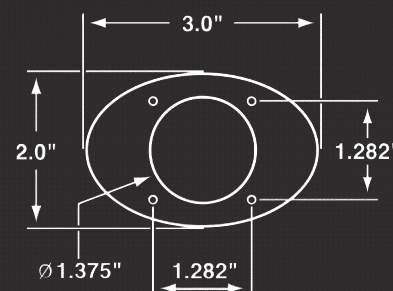

### TECHNICAL SPECIFICATIONS

POLYCARBONATE LENS  
FMVSS SAE CODE: P2

POLYCARBONATE BEZEL W/ CHROME-PLATING  
ASTM B 604-91: SC2  
GENERAL MOTORS SPEC: GM4372M

M3 LED  
12V / 0.06 AMP

M3 INCANDESCENT  
#193 BULB  
12V / 0.33 AMP



# MILLENNIUM SERIES



# M4

## M4 LIGHTS

### STOP/TURN/TAIL - AMP CONNECTOR

PRODUCT	POLYPACK	QTY	BULK	QTY
M4-RED-LED	00212110	10	00212100	10
M4-RED-LED-CLEAR	00212111	10	00212101	10

### BACK-UP - AMP CONNECTOR

PRODUCT	POLYPACK	QTY	BULK	QTY
M4-CLEAR-LED	00212220	10	00212120	10

### MARKER/CLEARANCE - 180 BULLETS

PRODUCT	POLYPACK	QTY	BULK	QTY
M4-RED-LED-BEZEL	00212137	10	-	-
M4-AMBER-LED-BEZEL	00212135	10	-	-
M4-RED-LED	00212157	10	00212108	10
M4-AMBER-LED	00212155	10	00212104	10

## M4 ACCESSORIES

PRODUCT	POLYPACK	QTY	BULK	QTY
M4-BEZEL-CHROME	00212127	20	00212117	100

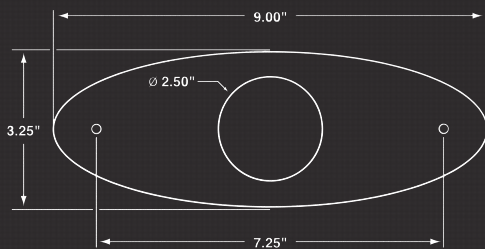

**M4-RED-LED**  
Red Lens - LED



**M4-RED-LED**  
Clear Lens - Red LED

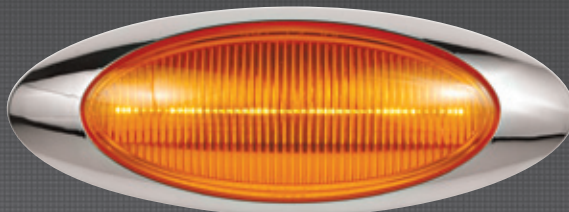

**M4-AMBER-LED**  
Amber Lens - 6 LEDs



**M4-RED-LED**  
Red Lens - 6 LEDs

### TECHNICAL SPECIFICATIONS

POLYCARBONATE LENS

POLYCARBONATE BEZEL W/ CHROME-PLATING

M4 LED

ASTM B 604-91:

SC2

12V / 0.12 AMP

GENERAL MOTORS SPEC:

GM4372M





## M5 Panelite<sup>®</sup> MILLENNIUM SERIES™

### M5 MARKER/CLEARANCE LIGHTS

#### 180 BULLETS + BEZEL

PRODUCT	POLYPACK	QTY	BULK	QTY
M45-AMBER-LED	00212704	10	-	-
M5-AMBER-LED-CLEAR	00212706	10	-	-
M5-RED-LED	00212705	10	-	-
M5-RED-LED-CLEAR	00212707	10	-	-

#### 180 BULLETS – NO BEZEL

PRODUCT	POLYPACK	QTY	BULK	QTY
M5-LED	00212708	10	00212700	10
M5-LED-CLEAR	00212710	10	00212702	10
M5-RED-LED	00212709	10	00212701	10
M5-RED-LED-CLEAR	00212711	10	00212703	10

#### METRIPACK - NO BEZEL

PRODUCT	POLYPACK	QTY	BULK	QTY
M5-AMBER-LED	00212713	10	00212712	10
M5-RED-LED-CLEAR	00212714	10	-	-

### M5 ACCESSORIES

PRODUCT	POLYPACK	QTY	BULK	QTY
M5-BEZEL-CHROME	00212727	20	00212717	100



**M5-LED**  
Amber Lens - LED



**M4-LED-CLEAR**  
Clear Lens - Amber LED



**M4-RED**  
Red Lens - LED



**M4-RED-LED**  
Clear Lens - Red LED



**UNLIT**  
M5 Clear-Lens-LED

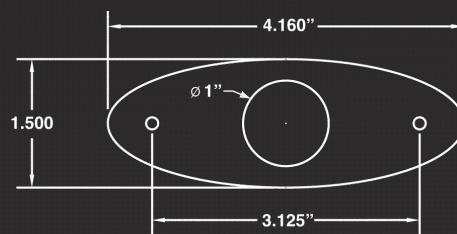

### TECHNICAL SPECIFICATIONS

POLYCARBONATE LENS  
FMVSS SAE CODE: P2

POLYCARBONATE BEZEL W/ CHROME-PLATING  
ASTM B 604-91: SC2  
GENERAL MOTORS SPEC: GM4372M

M5 LED  
12V / 0.09 AMP





**INTERIOR LED LIGHTS**

**RECTANGULAR FLANGE MOUNT, 7-30VDC**

PRODUCT	DESCRIPTION	DIODES	AMP/VOLTAGE	PKG	QTY
ILL-08COB	INTERIOR - LED	8	1.61A / 12VDC 0.80A / 24VDC	BULK	6

**ROUND FLANGE MOUNT**

PRODUCT	DESCRIPTION	DIODES	AMP/VOLTAGE	PKG	QTY
ILL-42CB	INTERIOR - LED	3	.582A / 12.8VDC	BULK	10

**COMPACT FLUSH MOUNT**

PRODUCT	DESCRIPTION	DIODES	AMP/VOLTAGE	PKG	QTY
ILL-31CB	INTERIOR - LED	10	.107A / 12.8VDC	BULK	20

**4" ROUND SEALED LED UTILITY**

PRODUCT	DESCRIPTION	DIODES	AMP/VOLTAGE	PKG	QTY
BUL-43CB	UTILITY - LED	10	.080A / 12.8VDC	BULK	10

**6" OVAL SEALED LED UTILITY**

PRODUCT	DESCRIPTION	DIODES	AMP/VOLTAGE	PKG	QTY
BUL-72CB	UTILITY - LED	10	.080A / 12.8VDC	BULK	10

**ULTRA THINLINE SEALED LED UTILITY**

PRODUCT	DESCRIPTION	DIODES	AMP/VOLTAGE	PKG	QTY
BUL-69CB	UTILITY - LED	11	.100A / 12.8VDC	BULK	10



**ILL-08COB**  
Clear Lens - LED

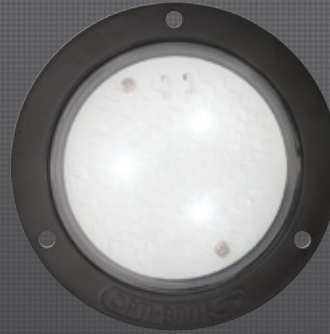

**ILL-42CB**  
Clear Lens - LED



**ILL-31CB**  
Clear Lens - LED



**BUL-43CB**  
Clear Lens - LED



**BUL-72CB**  
Clear Lens - LED



**BUL-69CB**  
Clear Lens - LED

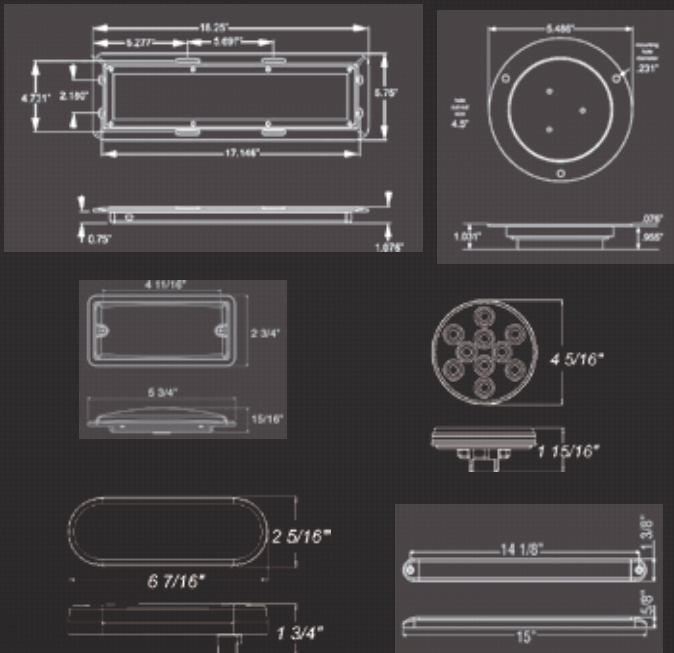





**STL-22AB**  
Amber Lens - LED

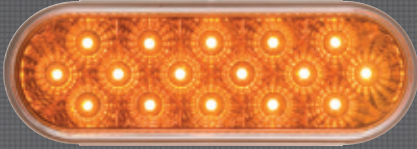

**STL-22CCAB**  
Clear Lens - Amber LED  
Amber Reflector

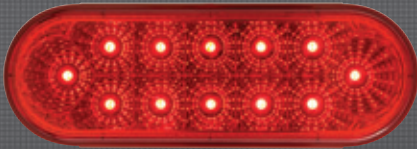

**STL-22RB**  
Red Lens - LED

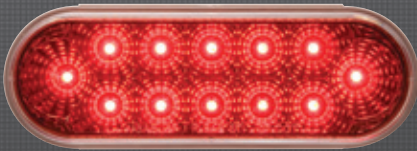

**STL-22CCRB**  
Clear Lens - Red LED  
Red Reflector

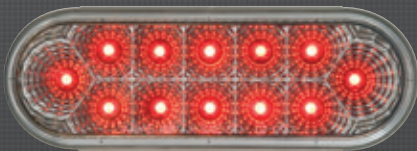

**STL-22RCB**  
Clear Lens - Red LED

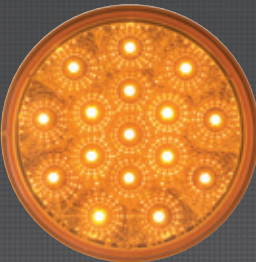

**STL-23AB**  
Amber Lens - LED

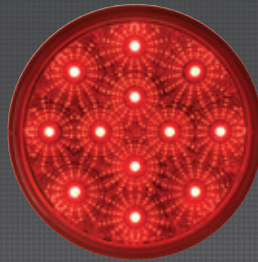

**STL-23RB**  
Red Lens - LED



**STL-23CCRB**  
Clear Lens - Red LED  
Red Reflector

**STOP/TURN/TAIL & PARKING/REAR/TURN SIGNAL LIGHTS**

**6" OVAL AMBER SEALED LED**

PRODUCT	DESCRIPTION	DIODES	DRAW AT 12V	PKG	QTY
STL-22AB	AMBER	12	.181 / .023A	BULK	10
STL-22CCAB	AMBER LEDS - CLEAR LENS AMBER REFLECTOR	12	.181 / .023A	BULK	10

**6" OVAL RED SEALED LED**

PRODUCT	DESCRIPTION	DIODES	DRAW AT 12V	PKG	QTY
STL-22RB	RED	12	.161 / .009A	BULK	10
STL-22RBH	RED, 3-WAY PLUG	12	.161 / .009A	BULK	10
STL-22RCB	RED LEDS - CLEAR LENS	12	.161 / .009A	BULK	10
STL-22CCRB	RED LEDS - CLEAR LENS RED REFLECTOR	12	.161 / .009A	BULK	10

**4" ROUND AMBER SEALED LED**

PRODUCT	DESCRIPTION	DIODES	DRAW AT 12V	PKG	QTY
STL-23AB	AMBER - 12V	16	.181 / .023A	BULK	10
STL-23A24B	AMBER - 24V	16	.157 / .038A	BULK	10

**4" ROUND RED SEALED LED**

PRODUCT	DESCRIPTION	DIODES	DRAW AT 12V	PKG	QTY
STL-23RB	RED - 12V	12	.181 / .023A	BULK	10
STL-23R24B	RED - 24V	12	.121 / .038A	BULK	10
STL-23CCRB	RED LEDS - CLEAR LENS RED REFLECTOR	12	.181 / .023A	BULK	10

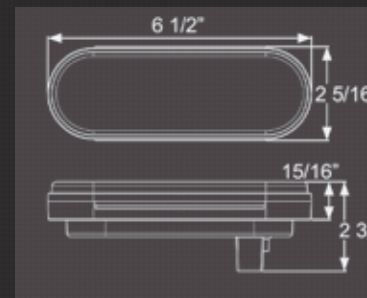





**MARKER/CLEARANCE LIGHTS**

**MCL-50 SERIES 2" ROUND SEALED LED**

PRODUCT	DESCRIPTION	DIODES	AMP/VOLTAGE	PKG	QTY
MCL-50AB	AMBER	9	.187A / 12.8V	BULK	20
MCL-50RB	RED	9	.187A / 12.8V	BULK	20
MCL-502AB	AMBER	3	.054A / 12.8V	BULK	20
MCL-502RB	RED	3	.054A / 12.8V	BULK	20

**MCL-51 SERIES 2.5" ROUND SEALED LED**

PRODUCT	DESCRIPTION	DIODES	AMP/VOLTAGE	PKG	QTY
MCL-51AB	AMBER	3	.040A / 12.8V	BULK	20
MCL-51RB	RED	3	.033A / 12.8V	BULK	20

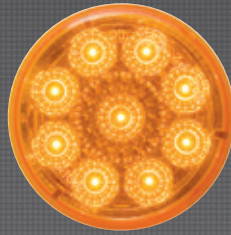
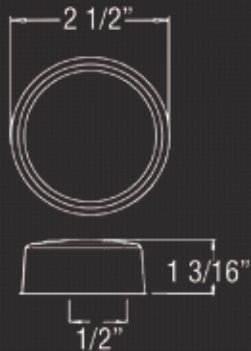
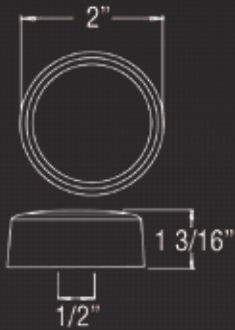

**MCL-50AB**  
Amber Lens - LED

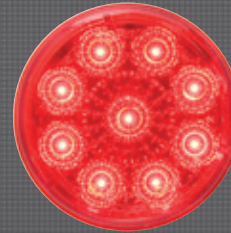

**MCL-50RB**  
Red Lens - LED

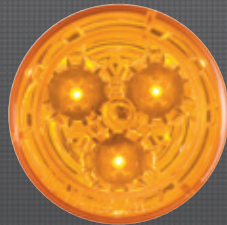

**MCL-502AB**  
Amber Lens - LED

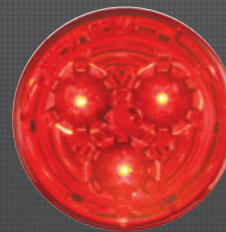

**MCL-502RB**  
Red Lens - LED



**MCL-51AB**  
Amber Lens - LED



**MCL-51RB**  
Red Lens - LED





**MCL-63AB**  
Amber Lens - LED



**MCL-63CAB**  
Clear Lens - Amber LEDs



**MCL-63RB**  
Red Lens - LED



**MCL-63CRB**  
Clear Lens - Red LEDs



**AL-191AB**  
Amber Lens - LED



**AL-191CAB**  
Clear Lens - Amber LEDs



**AL-191RB**  
Red Lens - LED



**AL-191CRB**  
Clear Lens - Red LEDs

**MARKER/CLEARANCE LIGHTS**

**MCL-63 SERIES THIN LINE SEALED LED**

PRODUCT	DESCRIPTION	DIODES	AMP/VOLTAGE	PKG	QTY
MCL-63AB	AMBER	4	.086A / 12.8V	BULK	20
MCL-63RB	RED	4	.086A / 12.8V	BULK	20
MCL-63CAB	AMBER LEDES - CLEAR LENS	4	.086A / 12.8V	BULK	20
MCL-63CRB	RED LEDES - CLEAR LENS	4	.086A / 12.8V	BULK	20

**AL-191 SERIES MINI THIN LINE SEALED LED**

PRODUCT	DESCRIPTION	DIODES	AMP/VOLTAGE	PKG	QTY
AL-191AB	AMBER	3	.051A / 12.8V	BULK	50
AL-191RB	RED	3	.051A / 12.8V	BULK	50
AL-191CAB	AMBER LEDES - CLEAR LENS	3	.051A / 12.8V	BULK	50
AL-191CRB	RED LEDES - CLEAR LENS	3	.051A / 12.8V	BULK	50

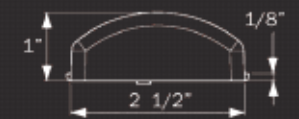
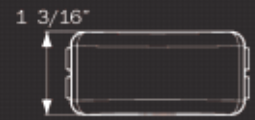
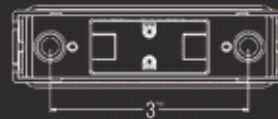
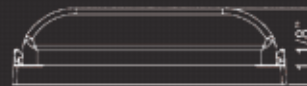
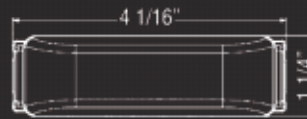



# HYPER X<sup>®</sup>

## STOP/TURN/TAIL & PARKING/REAR/TURN SIGNAL LIGHTS

### 4" ROUND SEALED LED

PRODUCT	DESCRIPTION	DIODES	DRAW AT 12V	PKG	QTY
STL-543AB	AMBER	12	.208 / .013A	BULK	10
STL-543RB	RED	12	.208 / .013A	BULK	10

### 6" OVAL SEALED LED

PRODUCT	DESCRIPTION	DIODES	DRAW AT 12V	PKG	QTY
STL-572AB	AMBER	12	.214 / .013A	BULK	10
STL-572RB	RED	12	.214 / .013A	BULK	10

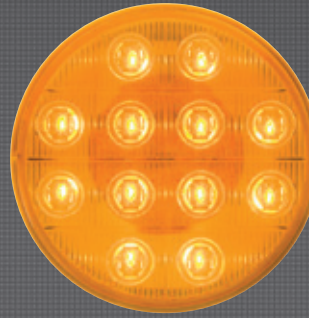
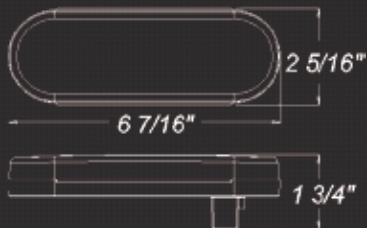
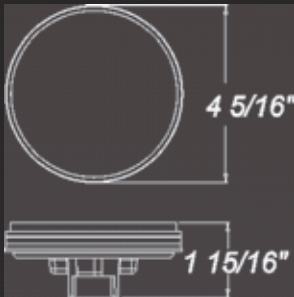

**STL-543AB**  
Amber Lens - LED

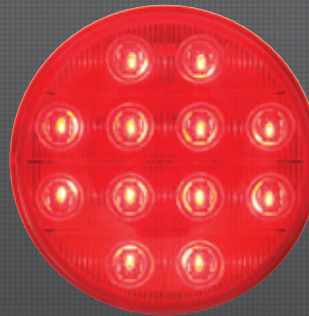

**STL-543RB**  
Red Lens - LED

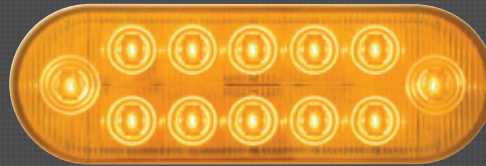

**STL-572AB**  
Amber Lens - LED



**STL-572RB**  
Red Lens - LED

**LIFETIME LED WARRANTY**



# HYPER X<sup>®</sup>



**MCL-553AB**  
Amber Lens - LED



**MCL-553RB**  
Red Lens - LED



**MCL-557AB**  
Amber Lens - LED



**MCL-557RB**  
Red Lens - LED



**MCL-565AB**  
Amber Lens - LED



**MCL-565RB**  
Red Lens - LED



**AL-591AB**  
Amber Lens - LED



**AL-591RB**  
Red Lens - LED

## MARKER/CLEARANCE LIGHTS

### MCL-553 SERIES 2" ROUND SEALED LED

PRODUCT	DESCRIPTION	DIODES	AMP/VOLTAGE	PKG	QTY
MCL-553AB	AMBER	7	.161A / 12.8V	BULK	20
MCL-553RB	RED	7	.161A / 12.8V	BULK	20

### MCL-557 SERIES 2.5" ROUND SEALED LED

PRODUCT	DESCRIPTION	DIODES	AMP/VOLTAGE	PKG	QTY
MCL-557AB	AMBER	7	.034A / 12.8V	BULK	20
MCL-557RB	RED	7	.034A / 12.8V	BULK	20

### MCL-565 SERIES THIN LINE SEALED LED

PRODUCT	DESCRIPTION	DIODES	AMP/VOLTAGE	PKG	QTY
MCL-565AB	AMBER	3	.013A / 12.8V	BULK	20
MCL-565RB	RED	3	.013A / 12.8V	BULK	20

### AL-591 SERIES MINI THIN LINE SEALED LED

PRODUCT	DESCRIPTION	DIODES	AMP/VOLTAGE	PKG	QTY
AL-591AB	AMBER	3	.051A / 12.8V	BULK	50
AL-591RB	RED	3	.051A / 12.8V	BULK	50

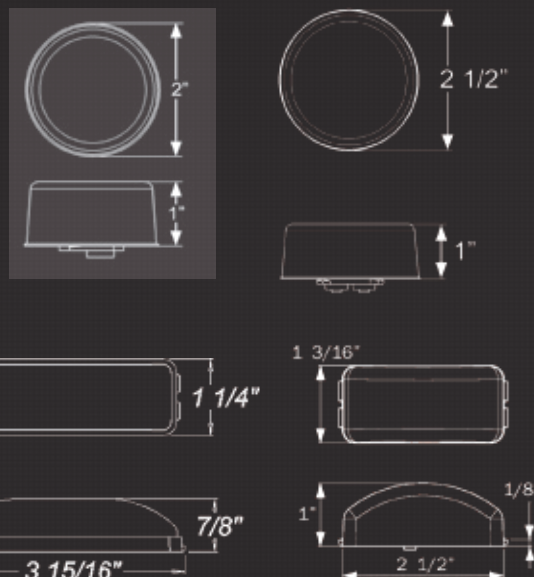



# FLEET COUNT SERIES



## STOP/TURN/TAIL LIGHTS

### STL-12 SERIES 6" OVAL SEALED LED

PRODUCT	DESCRIPTION	DIODES	DRAW AT 12V	PKG	QTY
STL-12RB	RED	6	.161 / .007A	BULK	10
STL-12RBP	RED	6	.161 / .007A	POLY	10

### STL-13 SERIES 4" ROUND SEALED LED

PRODUCT	DESCRIPTION	DIODES	DRAW AT 12V	PKG	QTY
STL-13RB	RED	7	.033 / .234A	BULK	10
STL-13RBP	RED	7	.033 / .234A	POLY	10

## BACK-UP LIGHTS

### BUL-10 6" OVAL CLEAR D.O.T. SEALED LED

PRODUCT	DESCRIPTION	DIODES	DRAW AT 12.8V	PKG	QTY
BUL-10CB	CLEAR	10	.260A	BULK	10
BUL-10CBP	CLEAR	10	.260A	POLY	10

### BUL-11 SERIES 4" ROUND CLEAR D.O.T. SEALED LED

PRODUCT	DESCRIPTION	DIODES	DRAW AT 12.8V	PKG	QTY
BUL-11CB	CLEAR - 12V	10	.260A	BULK	10
BUL-11CBP	CLEAR - 12V	10	.260A	POLY	10
BUL-11CKB	CLEAR - 12V GROMMET & PLUG	10	.260A	BULK	10
BUL-11CMB	CLEAR - 12V WEATHERTIGHT	10	.260A	BULK	10
BUL-11CM24B	CLEAR - 24V WEATHERTIGHT	10	.260A	BULK	10



**STL-12RB**  
Red Lens - LED

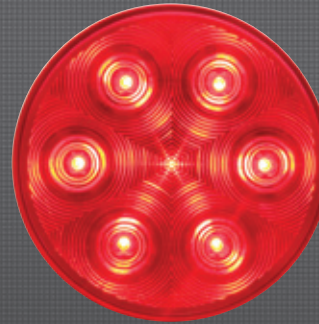

**STL-13RB**  
Red Lens - LED



**BUL-10CB**  
Clear Lens - LED



**BUL-11CB**  
Clear Lens - LED

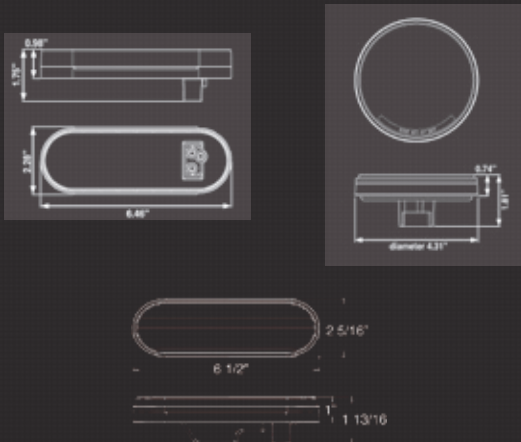





**MCL-56AB**  
Amber Lens - LED



**MCL-56RB**  
Red Lens - LED



**MCL-527AB**  
Amber Lens - LED



**MCL-527RB**  
Red Lens - LED



**MCL-61AB**  
Amber Lens - LED



**MCL-61RB**  
Red Lens - LED

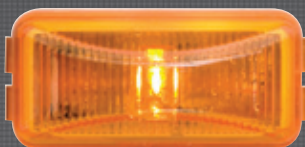

**AL-90AB**  
Amber Lens - LED

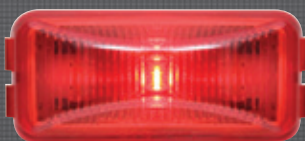

**AL-90RB**  
Red Lens - LED

## MARKER/CLEARANCE LIGHTS

### MCL-56 SERIES 2" ROUND SEALED LED

PRODUCT	DESCRIPTION	DIODES	AMP/VOLTAGE	PKG	QTY
MCL-56AB	AMBER	1	.045A / 12.8V	BULK	20
MCL-56RB	RED	1	.045A / 12.8V	BULK	20
MCL-56ABP	AMBER	1	.045A / 12.8V	POLY	20
MCL-56RBP	RED	1	.045A / 12.8V	POLY	20

### MCL-527 SERIES 2.5" ROUND SEALED LED

PRODUCT	DESCRIPTION	DIODES	AMP/VOLTAGE	PKG	QTY
MCL-527AB	AMBER	2	.034A / 12.8V	BULK	20
MCL-527RB	RED	2	.034A / 12.8V	BULK	20
MCL-527ABP	AMBER	2	.034A / 12.8V	POLY	20
MCL-527RBP	RED	2	.034A / 12.8V	POLY	20

### MCL-61 SERIES THIN LINE SEALED LED

PRODUCT	DESCRIPTION	DIODES	DRAW AT 12V	PKG	QTY
MCL-61AB	AMBER	2	.047A / 12.8V	BULK	20
MCL-61RB	RED	2	.047A / 12.8V	BULK	20
MCL-61ABP	AMBER	2	.047A / 12.8V	POLY	20
MCL-61RBP	RED	2	.047A / 12.8V	POLY	20

### AL-90 SERIES MINI THIN LINE SEALED LED

PRODUCT	DESCRIPTION	DIODES	AMP/VOLTAGE	PKG	QTY
AL-90AB	AMBER	1	.050A / 12.8V	BULK	50
AL-90RB	RED	1	.050A / 12.8V	BULK	50
AL-90ABP	AMBER	1	.050A / 12.8V	POLY	50
AL-90RBP	RED	1	.050A / 12.8V	POLY	50

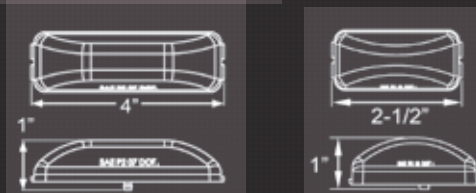
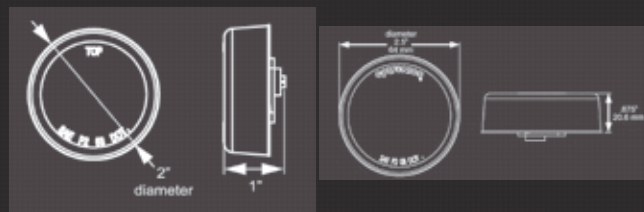



# OPTRONICS LED SERIES



## STOP/TURN/TAIL & PARKING/REAR TURN SIGNAL LIGHTS

### STL-43 SERIES 4" ROUND SEALED LED

PRODUCT	DESCRIPTION	DIODES	DRAW AT 12V/28V	PKG	QTY
STL-43AB	AMBER - 12V	10	.310 / .046A	BULK	10
STL-43ABP	AMBER - 12V	10	.310 / .046A	POLY	10
STL-43A24B	AMBER - 24V	10	.171 / .061A	BULK	10
STL-43AKB	AMBER - 12V, GROMMET & PLUG	10	.310 / .046A	BULK	10
STL-43AMB	AMBER - 12V WEATHERTIGHT	10	.310 / .046A	BULK	10
STL-43AMB P	AMBER - 12V WEATHERTIGHT	10	.310 / .046A	POLY	10
STL-43RB	RED - 12V	10	.208 / .013A	BULK	10
STL-43RBP	RED - 12V	10	.208 / .013A	POLY	10
STL-43RKB	RED - 12V - KIT	10	.208 / .013A	BULK	10
STL-43R24B	RED - 24V	10	.171 / .061A	BULK	10
STL-43R24BP	RED - 24V	10	.171 / .061A	POLY	10
STL-43RMB	RED - 12V WEATHERTIGHT	10	.208 / .013A	BULK	10
STL-43RMB P	RED - 12V WEATHERTIGHT	10	.208 / .013A	POLY	10
STL-43RM24B	RED - 24V WEATHERTIGHT	10	.171 / .061A	BULK	10

### STL-43 X SERIES 4" ROUND SEALED LED

PRODUCT	DESCRIPTION	DIODES	DRAW AT 12V	PKG	QTY
STL-43ABX	AMBER, REFLEX FLANGE	10	.310 / .046A	BULK	10
STL-43RBX	RED, REFLEX FLANGE	10	.413 / .026A	BULK	10

### STL-55 SERIES 4" ROUND SEALED LED

PRODUCT	DESCRIPTION	DIODES	DRAW AT 12.8V	PKG	QTY
STL-55AB	AMBER	21	.428 / .047A	BULK	10
STL-55ABP	AMBER	21	.428 / .047A	POLY	10
STL-55RB	RED	21	.274 / .027A	BULK	10
STL-55RBP	RED	21	.274 / .027A	POLY	10

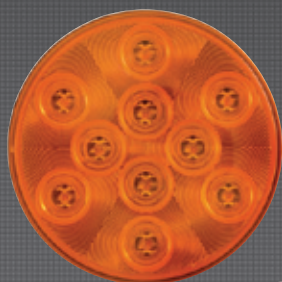
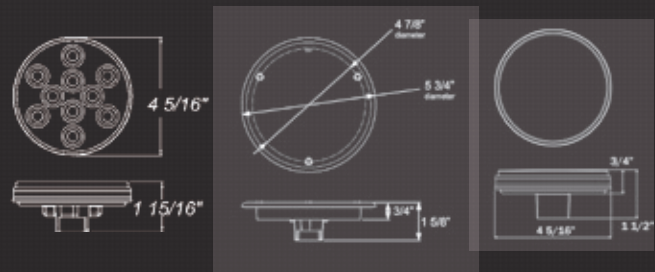

**STL-43AB**  
Amber Lens - LED

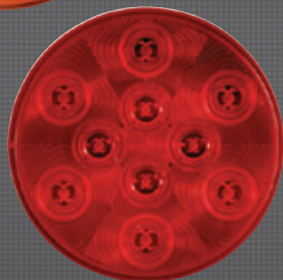

**STL-43RB**  
Red Lens - LED



**STL-43ABX**  
Amber Lens - LED,  
Amber Reflex Flange



**STL-43RBX**  
Red Lens - LED,  
Red Reflex Flange



**STL-55AB**  
Amber Lens - LED



**STL-55RB**  
Red Lens - LED





**STL-72AB**  
Amber Lens - LED

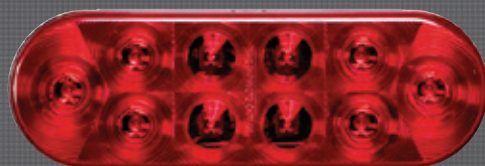

**STL-72RB**  
Red Lens - LED



**STL-82RCB**  
Clear Lens - Red LEDs



**STL-70AB**  
Amber Lens - LED



**STL-70RB**  
Red Lens - LED



**STL-75AB**  
Amber Lens - LED

## STOP/TURN/TAIL LIGHTS & PARKING/REAR TURN SIGNAL LIGHTS

### STL-72 SERIES 6" OVAL SEALED LED

PRODUCT	DESCRIPTION	DIODES	AMP DRAW	PKG	QTY
STL-72AB	AMBER - 12V	10	.275 / .042A	BULK	10
STL-72ABP	AMBER - 12V	10	.275 / .042A	POLY	10
STL-72AMB	AMBER - 12V WEATHERTIGHT	10	.275 / .042A	BULK	10
STL-72AMB	AMBER - 12V WEATHERTIGHT	10	.275 / .042A	POLY	10
STL-72AM24B	AMBER - 24V WEATHERTIGHT	10	.275 / .042A	BULK	10
STL-72RB	RED	10	.243 / .046A	BULK	10
STL-72RBP	RED	10	.243 / .046A	POLY	10
STL-72RMB	RED - WEATHERTIGHT	10	.243 / .046A	BULK	10
STL-72RMBP	RED - WEATHERTIGHT	10	.243 / .046A	POLY	10
STL-82RCB	RED LEDs - CLEAR LENS	10	.243 / .046A	BULK	10

### STL-70 SERIES 6" OVAL SEALED LED

PRODUCT	DESCRIPTION	DIODES	DRAW AT 12.8V	PKG	QTY
STL-70AB	AMBER	56	.288 / .040A	BULK	10
STL-70ABP	AMBER	56	.288 / .040A	POLY	10
STL-70RB	RED	48	.362 / .054A	BULK	10
STL-70RBP	RED	48	.362 / .054A	POLY	10

### STL-75 SERIES 6" OVAL SEALED LED - MID-SHIP

PRODUCT	DESCRIPTION	DIODES	DRAW AT 12.8V	PKG	QTY
STL-75AB	AMBER	9	.141 / .060A	BULK	10
STL-75ABP	AMBER	9	.141 / .060A	POLY	10
STL-75AMB	AMBER - WEATHERTIGHT	9	.141 / .060A	BULK	10
STL-75AMB	AMBER - WEATHERTIGHT	9	.141 / .060A	POLY	10

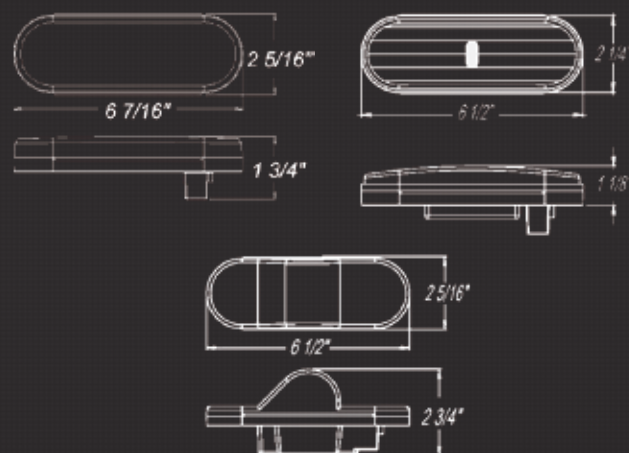





**PEDESTAL MOUNT LIGHTS**

**STL-51 SINGLE FACE SEALED LED**

PRODUCT	DESCRIPTION	DIODES	DRAW AT 12.8V	PKG	QTY
STL-51AB	AMBER	21	.476 / .027A	BULK	10
STL-51RB	RED	21	.252 / .019A	BULK	10

**STL-52 DUAL FACE SEALED LED**

PRODUCT	DESCRIPTION	DIODES	DRAW AT 12.8V	PKG	QTY
STL-52ARB	RED / AMBER	42	.476 / .027A .252 / .019A	BULK	10

**STL-53 DUAL FACE SEALED LED, SIDE MARKER, REFLEX**

PRODUCT	DESCRIPTION	DIODES	DRAW AT 12.8V	PKG	QTY
STL-53ARP	RED / AMBER, SIDE MARKER, REFLEX PASSENGER SIDE	42	.182 / .012A .215 / .013A	BULK	10
STL-53ARB	RED / AMBER, SIDE MARKER, REFLEX DRIVER SIDE	42	.182 / .012A .215 / .013A	BULK	10

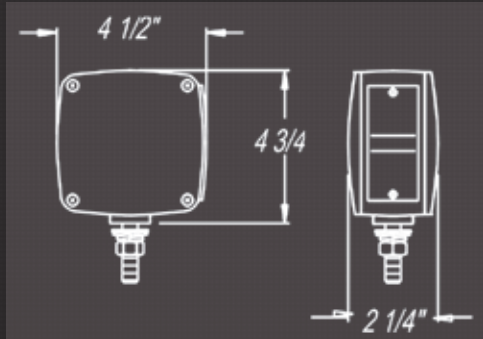
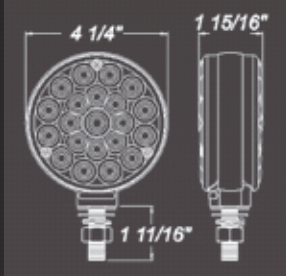
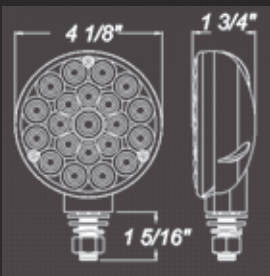

**STL-51AB**  
Amber Lens - LED



**STL-51RB**  
Red Lens - LED



**STL-52ARB**  
Red Lens, Amber Lens, LED

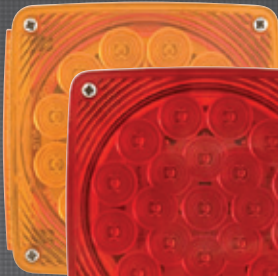

**STL-53ARP**  
**STL-53ARB**  
Red/Amber Lens,  
Side Marker with Reflex, LED





**MCL-11AKB**  
Amber Lens - LED **PC Rated**



**MCL-11RKB**  
Red Lens - LED **PC Rated**



**UCL-11CKB**  
Clear Lens - LED **PC Rated**



**MCL-21AB**  
Amber Lens - LED



**MCL-21RB**  
Red Lens - LED



**MCL-23AB**  
Amber Lens - LED



**MCL-23RB**  
Red Lens - LED

## MARKER/CLEARANCE LIGHTS

### MCL-11 SERIES UNI-LITE™ SEALED LED LIGHT ONLY

PRODUCT	DESCRIPTION	DIODES	AMP/VOLTAGE	PKG	QTY
MCL-11AB	AMBER	2	.047 A / 12.0V	BULK	50
MCL-11RB	RED	2	.047 A / 12.0V	BULK	50
MCL-11CAB	AMBER - CLEAR LENS	2	.047 A / 12.0V	BULK	50
MCL-11CRB	RED - CLEAR LENS	2	.047 A / 12.0V	BULK	50
UCL-11CB	CLEAR	2	.047 A / 12.0V	BULK	50

### LIGHT + GROMMET

PRODUCT	DESCRIPTION	DIODES	AMP/VOLTAGE	PKG	QTY
MCL-11AKB	AMBER	2	.047 A / 12.0V	BULK	50
MCL-11AKBP	AMBER	2	.047 A / 12.0V	POLY	50
MCL-11RKB	RED	2	.047 A / 12.0V	BULK	50
MCL-11RKBP	RED	2	.047 A / 12.0V	POLY	50
MCL-11CAKB	AMBER - CLEAR LENS	2	.047 A / 12.0V	BULK	50
MCL-11CRKB	RED - CLEAR LENS	2	.047 A / 12.0V	BULK	50
UCL-11CKB	CLEAR - KIT	2	.047 A / 12.0V	BULK	50

### 180 MALE BULLETS - NO GROMMET

PRODUCT	DESCRIPTION	DIODES	AMP/VOLTAGE	PKG	QTY
MCL-11APG	AMBER	2	.047 A / 12.0V	BULK	50
MCL-11RPG	RED	2	.047 A / 12.0V	BULK	50

### 156 FEMALE BARRELS + GROMMET

PRODUCT	DESCRIPTION	DIODES	AMP/VOLTAGE	PKG	QTY
MCL-11AKAB	AMBER - WEATHERTIGHT	2	.047 A / 12.0V	BULK	50
MCL-11RKAB	RED - WEATHERTIGHT	2	.047 A / 12.0V	BULK	50
MCL-11AKBF	AMBER	2	.047 A / 12.0V	BULK	50
MCL-11RKBF	RED - BARREL / RING TERMINAL	2	.047 A / 12.0V	BULK	50

### MCL-21 SERIES 2" BEEHIVE SEALED LED

PRODUCT	DESCRIPTION	DIODES	AMP/VOLTAGE	PKG	QTY
MCL-21AB	AMBER	8	.061A / 12.8V	BULK	20
MCL-21RB	RED	8	.061A / 12.8V	BULK	20

### MCL-23 SERIES 2.5" BEEHIVE SEALED LED

PRODUCT	DESCRIPTION	DIODES	AMP/VOLTAGE	PKG	QTY
MCL-23AB	AMBER	8	.051A / 12.8V	BULK	20
MCL-23RB	RED	8	.051A / 12.8V	BULK	20

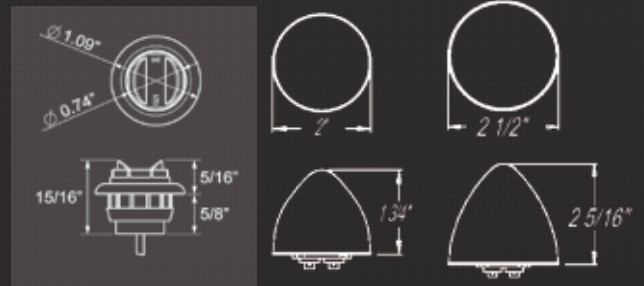



# OPTRONICS LED SERIES



## MARKER/CLEARANCE LIGHTS

### MCL-54 2" ROUND SEALED LED

PRODUCT	DESCRIPTION	DIODES	AMP/VOLTAGE	PKG	QTY
MCL-54AB	AMBER	5	.114A / 12.8V	BULK	20
MCL-54RB	RED	5	.174A / 12.8V	BULK	20
MCL-54ABP	AMBER	5	.114A / 12.8V	POLY	20
MCL-54RBP	RED	5	.174A / 12.8V	POLY	20

### MCL-55 2" ROUND SEALED LED

PRODUCT	DESCRIPTION	DIODES	AMP/VOLTAGE	PKG	QTY
MCL-55AB	AMBER - 12V	4	.097A / 12.8V	BULK	20
MCL-55RB	RED - 12V	4	.108A / 12.8V	BULK	20
MCL-55ABP	AMBER - 12V	4	.097A / 12.8V	POLY	20
MCL-55RBP	RED - 12V	4	.108A / 12.8V	POLY	20
MCL-55A1224B	AMBER - 12-24V	4	.027A / 12.8V	BULK	20
MCL-55R1224B	RED - 12-24V	4	.067A / 12.8V	BULK	20
MCL-55A24B	AMBER - 24V	4	.097A / 12.8V	BULK	20
MCL-55R24B	RED - 24V	4	.108A / 12.8V	BULK	20
MCL-55ACB	AMBER - CLEAR - 12V	4	.097A / 12.8V	BULK	20
MCL-55RCB	RED - CLEAR - 12V	4	.108A / 12.8V	BULK	20

### MCL-57 SERIES 2.5" ROUND SEALED LED

PRODUCT	DESCRIPTION	DIODES	AMP/VOLTAGE	PKG	QTY
MCL-57AB	AMBER - 12V	4	.047A / 12.8V	BULK	20
MCL-57RB	RED - 12V	4	.047A / 12.8V	BULK	20
MCL-57ABP	AMBER - 12V	4	.047A / 12.8V	POLY	20
MCL-57RBP	RED - 12V	4	.047A / 12.8V	POLY	20
MCL-57A1224B	AMBER - 12-24V	4	.047A / 12.8V	BULK	20
MCL-57R1224B	RED - 12-24V	4	.047A / 12.8V	BULK	20
MCL-57A24B	AMBER - 24V	4	.047A / 12.8V	BULK	20
MCL-57R24B	RED - 24V	4	.047A / 12.8V	BULK	20
MCL-57ACB	AMBER - CLEAR - 12V	4	.047A / 12.8V	BULK	20
MCL-57RCB	RED - CLEAR - 12V	4	.047A / 12.8V	BULK	20

### MCL-58 SERIES 2.5" ROUND SEALED LED

PRODUCT	DESCRIPTION	DIODES	AMP/VOLTAGE	PKG	QTY
MCL-58AB	AMBER	7	0.18A / 12.8V	BULK	20
MCL-58RB	RED	7	0.18A / 12.8V	BULK	20
MCL-58ABP	AMBER	7	0.18A / 12.8V	POLY	20
MCL-58RBP	RED	7	0.18A / 12.8V	POLY	20

### MCL-59 SERIES 2.5" ROUND SEALED LED, REFLECTORIZED LENS

PRODUCT	DESCRIPTION	DIODES	AMP/VOLTAGE	PKG	QTY
MCL-59AB	AMBER	8	.045A / 12.8V	BULK	20
MCL-59RB	RED	8	.045A / 12.8V	BULK	20

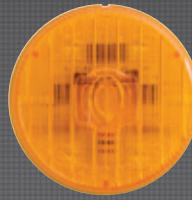

**MCL-54AB**  
Amber Lens - LED



**MCL-54RB**  
Red Lens - LED



**MCL-55AB**  
Amber Lens - LED



**MCL-55RB**  
Red Lens - LED



**MCL-55ACB**  
**MCL-55RCB**  
Clear Lens



**MCL-57AB**  
Amber Lens - LED



**MCL-57RB**  
Red Lens - LED



**MCL-57ACB**  
**MCL-57RCB**  
Clear Lens



**MCL-58AB**  
Amber Lens - LED

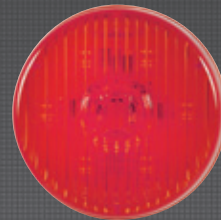

**MCL-58RB**  
Red Lens - LED

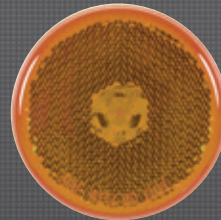

**MCL-59AB**  
Amber Lens - LED



**MCL-59RB**  
Red Lens - LED





**MCL-65AB**  
Amber Lens - LED



**MCL-65RB**  
Red Lens - LED



**MCL-65CAB**  
**MCL-65CRB**  
Clear Lens

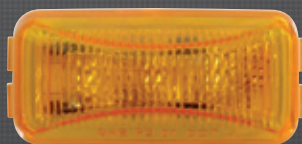

**AL-91AB**  
Amber Lens - LED



**AL-91RB**  
Red Lens - LED



**AL-91CAB / AL-91CRB**  
Clear Lens



## MARKER/CLEARANCE LIGHTS

### MCL-65 SERIES THIN LINE SEALED LED

PRODUCT	DESCRIPTION	DIODES	AMP/VOLTAGE	PKG	QTY
MCL-65AB	AMBER	6	.048A / 12.8V	BULK	20
MCL-65RB	RED	6	.048A / 12.8V	BULK	20
MCL-65ABP	AMBER	6	.048A / 12.8V	POLY	20
MCL-65RBP	RED	6	.048A / 12.8V	POLY	20
MCL-65CAB	AMBER - CLEAR	6	.048A / 12.8V	BULK	20
MCL-65CRB	RED - CLEAR	6	.048A / 12.8V	BULK	20
MCL-65A24B	AMBER - 24V	6	.048A / 12.8V	BULK	20
MCL-65R24B	RED - 24V	6	.048A / 12.8V	BULK	20

### AL-91 SERIES MINI THIN LINE SEALED LED

PRODUCT	DESCRIPTION	DIODES	AMP/VOLTAGE	PKG	QTY
AL-91AB	AMBER	3	.051A / 12.8V	BULK	50
AL-91RB	RED	3	.051A / 12.8V	BULK	50
AL-91CAB	AMBER - CLEAR	3	.051A / 12.8V	BULK	50
AL-91CRB	RED - CLEAR	3	.051A / 12.8V	BULK	50

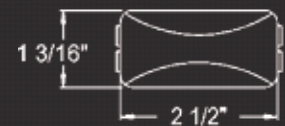
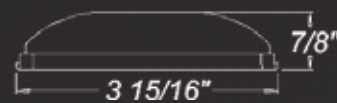



# OPTRONICS LED SERIES



## MARKER/CLEARANCE LIGHTS

### MCL-46 SERIES BULLSEYE SEALED LED

PRODUCT	DESCRIPTION	DIODES	AMP/VOLTAGE	PKG	QTY
MCL-46AB	AMBER, TWO-WIRE	6	.087A / 12.8V	BULK	20
MCL-46RB	RED, TWO-WIRE	6	.087A / 12.8V	BULK	20
MCL-46ABP	AMBER, TWO-WIRE	6	.087A / 12.8V	POLY	20
MCL-46RBP	RED, TWO-WIRE	6	.087A / 12.8V	POLY	20

### MCL-49 SERIES RECTANGULAR SEALED LED

PRODUCT	DESCRIPTION	DIODES	AMP/VOLTAGE	PKG	QTY
MCL-49AB	AMBER	14	.115A / 12.8V	BULK	20

### MCL-76 SERIES RECTANGULAR SEALED LED

PRODUCT	DESCRIPTION	DIODES	AMP/VOLTAGE	PKG	QTY
MCL-76AB	AMBER	4	.063A / 12.8V	BULK	20
MCL-76RB	RED	4	.063A / 12.8V	BULK	20
MCL-76ABP	AMBER	4	.063A / 12.8V	POLY	20
MCL-76RBP	RED	4	.063A / 12.8V	POLY	20

## CAB AND LICENSE PLATE LIGHTS

### CBL-22 SERIES TRIANGULAR SEALED LED

PRODUCT	DESCRIPTION	DIODES	AMP/VOLTAGE	PKG	QTY
CBL-22AB	AMBER	15	.109A / 12.8V	BULK	50
CBL-22RB	RED	15	.109A / 12.8V	BULK	50

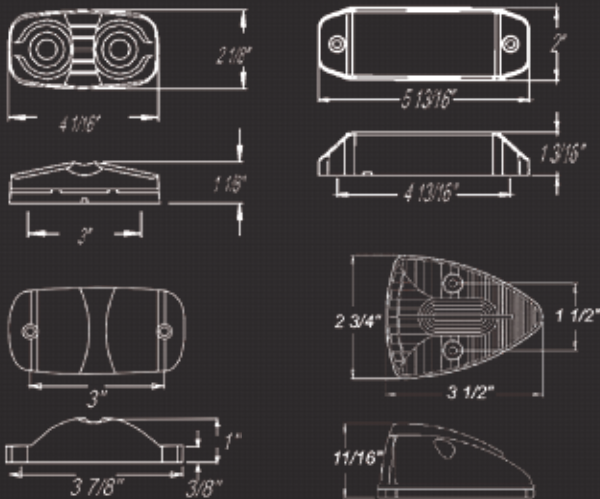

**MCL-46AB**  
Amber Lens - LED



**MCL-46RB**  
Red Lens - LED

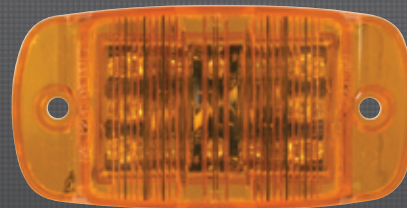

**MCL-49AB**  
Amber Lens - LED

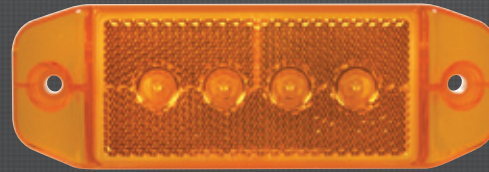

**MCL-76AB**  
Amber Lens - LED

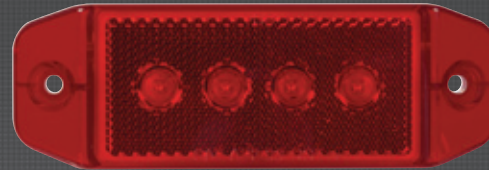

**MCL-76RB**  
Red Lens - LED



**CBL-22AB**  
Amber Lens - LED



**CBL-22RB**  
Red Lens - LED







**LPL-91CB**  
Clear Lens - LED



**BUL-11CBX**  
Clear Lens - LED  
Reflex Flange



**BUL-22CB**  
Clear Lens - LED



**BUL-23CB**  
Clear Lens - LED



**LICENSE PLATE LIGHTS**

**LPL-91 SERIES MINI SEALED LED**

PRODUCT	DESCRIPTION	DIODES	DRAW AT 12.8V	PKG	QTY
LPL-91CB	CLEAR	2	.027A	BULK	50

**BACK-UP LIGHTS**

**BUL-11 X SERIES 4" ROUND CLEAR D.O.T. SEALED LED**

PRODUCT	DESCRIPTION	DIODES	DRAW AT 12.8V	PKG	QTY
BUL-11CBX	CLEAR - 12V, AUX REFLEX FLANGE	10	.260A	BULK	10

**BUL-22 6" OVAL CLEAR D.O.T. SEALED LED**

PRODUCT	DESCRIPTION	DIODES	DRAW AT 12.8V	PKG	QTY
BUL-22CB	CLEAR	27	.161A	BULK	10
BUL-22CBP	CLEAR	27	.161A	POLY	10

**BUL-23 4" ROUND CLEAR D.O.T. SEALED LED**

PRODUCT	DESCRIPTION	DIODES	AMP/VOLTAGE	PKG	QTY
BUL-23CB	CLEAR - 12V	27	.154A / 12.8V	BULK	10
BUL-23C24B	CLEAR - 24V	27	.108A / 28V	BULK	10
BUL-23C24BP	CLEAR - 24V	27	.108A / 28V	POLY	10

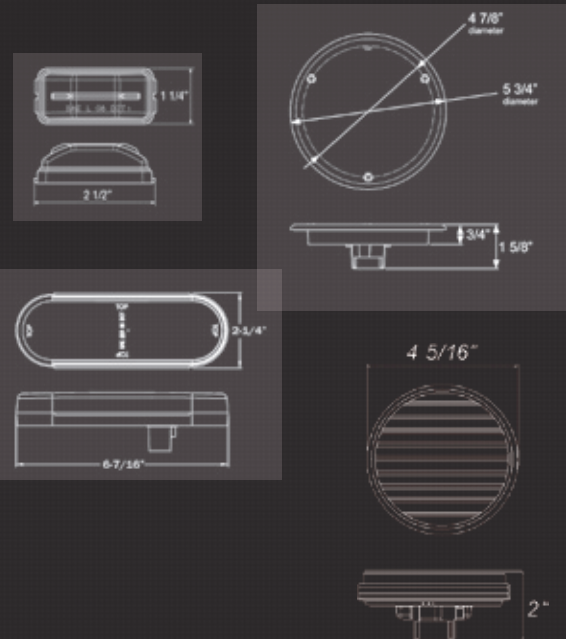





**STROBE/WARNING LIGHTS**

**SLL-43 AMBER SERIES 4" ROUND SEALED LED**

PRODUCT	DESCRIPTION	DIODES	DRAW AT 12.8V	PKG	QTY
SLL-43AB1	FUNCTION 1	24	.448A	BULK	10
SLL-43AB2	FUNCTION 2	24	.448A	BULK	10
SLL-43AB1P	FUNCTION 1	24	.448A	POLY	10
SLL-43AB2P	FUNCTION 2	24	.448A	POLY	10
SLL-43AKB1	FUNCTION 1 - KIT, GROMMET & PLUG	24	.448A	BULK	10
SLL-43AKB2	FUNCTION 2 - KIT, GROMMET & PLUG	24	.448A	BULK	10
SLL-43AKB1P	FUNCTION 1 - KIT, GROMMET & PLUG	24	.448A	POLY	10
SLL-43AKB2P	FUNCTION 2 - KIT, GROMMET & PLUG	24	.448A	POLY	10

**SLL-72 AMBER SERIES 6" OVAL SEALED LED**

PRODUCT	DESCRIPTION	DIODES	DRAW AT 12.8V	PKG	QTY
SLL-72AB1	FUNCTION 1	24	.448A	BULK	10
SLL-72AB2	FUNCTION 2	24	.448A	BULK	10
SLL-72AB1P	FUNCTION 1	24	.448A	POLY	10
SLL-72AB2P	FUNCTION 2	24	.448A	POLY	10
SLL-72AKB1	FUNCTION 1 - KIT, GROMMET & PLUG	24	.448A	BULK	10
SLL-72AKB2	FUNCTION 2 - KIT, GROMMET & PLUG	24 <td .448A	BULK	10	
SLL-72AKB1P	FUNCTION 1 - KIT, GROMMET & PLUG	24	.448A	POLY	10
SLL-72AKB2P	FUNCTION 2 - KIT, GROMMET & PLUG	24	.448A	POLY	10



**SLL-43AB1**  
Amber Lens - LED



**SLL-72AB1**  
Amber Lens - LED

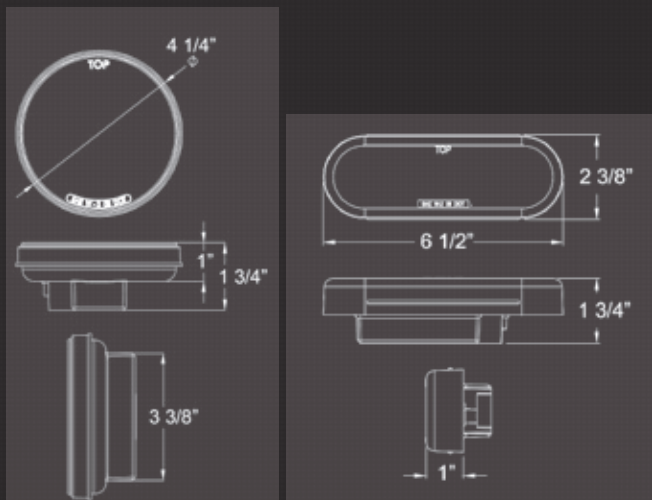





**ST-45AB**  
Amber Lens

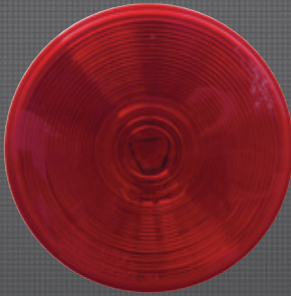

**ST-45RB**  
Red Lens



**ST-47RB**  
Red Lens



**ST-70AB**  
Amber Lens



**ST-70RB**  
Red Lens



**ST-75AB**  
Amber Lens

## STOP/TURN/TAIL AND PARKING/REAR TURN SIGNAL LIGHTS

### ST-45 SERIES 4" ROUND SEALED, RECESS MOUNT

PRODUCT	DESCRIPTION	PKG	QTY
ST-45AB	AMBER	BULK	50
ST-45ABP	AMBER	POLY	50
ST-44AB	AMBER - KIT, GROMMET & PLUG	BULK	10
ST-44ABP	AMBER - KIT, GROMMET & PLUG	POLY	10
ST-45RB	RED	BULK	50
ST-45RBP	RED	POLY	50
ST-44RB	RED - KIT, GROMMET & PLUG	BULK	10
ST-44RBP	RED - KIT, GROMMET & PLUG	POLY	10
ST-49RB	RED - KIT, GROMMET	BULK	10
ST-46RB	RED - REFLEX LENS	BULK	50
ST-46RBP	RED - REFLEX LENS	POLY	50
ST-46RKB	RED - KIT, REFLEX LENS, GROMMET & PLUG	BULK	50
ST-46RKBP	RED - KIT, REFLEX LENS, GROMMET & PLUG	POLY	50

### ST-47 SERIES 4" ROUND SEALED, FLANGE MOUNT

PRODUCT	DESCRIPTION	PKG	QTY
ST-47RB	RED	BULK	50
ST-47RBP	RED	POLY	50

### ST-70 SERIES 6" OVAL SEALED, RECESS MOUNT

PRODUCT	DESCRIPTION	PKG	QTY
ST-70AB	AMBER	BULK	50
ST-70ABP	AMBER	POLY	50
ST-70RB	RED	BULK	50
ST-70RBP	RED	POLY	50

### ST-75 SERIES 6" OVAL SEALED, RECESS MOUNT, MID-SHIP

PRODUCT	DESCRIPTION	PKG	QTY
ST-75AB	AMBER	BULK	50
ST-75ABP	AMBER	POLY	50

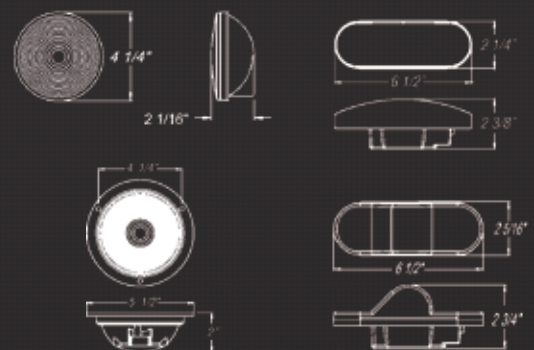



# OPTRONICS INCANDESCENT SERIES



## STOP/TURN/TAIL LIGHTS

### ST-51 SERIES PEDESTAL MOUNT - 3-FUNCTION

PRODUCT	DESCRIPTION	PKG	QTY
ST-51RB	RED - STOP/TURN/TAIL	BULK	10
ST-51RBP	RED - STOP/TURN/TAIL	POLY	10

### ST-52 SERIES PEDESTAL MOUNT - DUAL FACE

PRODUCT	DESCRIPTION	PKG	QTY
ST-52RB	AMBER/RED - STOP/TURN/TAIL	BULK	10
ST-52RBP	AMBER/RED - STOP/TURN/TAIL	POLY	10

## BACK-UP LIGHTS

### BU-45 CLEAR SERIES 4" ROUND

PRODUCT	DESCRIPTION	PKG	QTY
BU-45CB	CLEAR	BULK	50
BU-45CBP	CLEAR	POLY	50

### BU-70 CLEAR SERIES 6" OVAL

PRODUCT	DESCRIPTION	PKG	QTY
BU-70CB	CLEAR	BULK	50
BU-70CBP	CLEAR	BULK	50

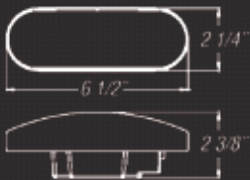
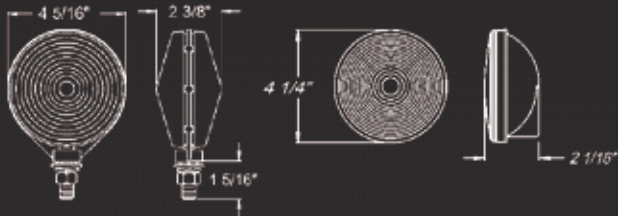

**ST-51RB**  
Red Lens



**ST-52RB**  
Amber Lens  
Red Lens



**BU-45CB**  
Clear Lens



**BU-70CB**  
Clear Lens





**MC-25AB**  
Amber Lens  
**PC Rated**



**MC-25RB**  
Red Lens  
**PC Rated**



**MC-27AB**  
Amber Lens  
**PC Rated**



**MC-27RB**  
Red Lens  
**PC Rated**



**MC-505AB**  
Amber Lens, Flange  
**PC Rated**



**MC-505RB**  
Red Lens, Flange  
**PC Rated**



**MC-53AB**  
Amber Lens  
**PC Rated**



**MC-53RB**  
Red Lens  
**PC Rated**



**MC-53ABSB**  
Amber Lens - ABS

## MARKER/CLEARANCE LIGHTS

### MC-25 SERIES 2" BEEHIVE SEALED

PRODUCT	DESCRIPTION	PKG	QTY
MC-25AB	AMBER	BULK	20
MC-25ABP	AMBER	POLY	20
MC-25RB	RED	BULK	20
MC-25RBP	RED	POLY	20

### MC-27 SERIES 2.5" BEEHIVE SEALED

PRODUCT	DESCRIPTION	PKG	QTY
MC-27AB	AMBER	BULK	20
MC-27RB	RED	BULK	20

### MC-505 SERIES 2" ROUND SEALED FLANGE-MOUNT

PRODUCT	DESCRIPTION	PKG	QTY
MC-505AB	AMBER	BULK	50
MC-505RB	RED	BULK	50

### MC-53 SERIES 2" ROUND SEALED

PRODUCT	DESCRIPTION	PKG	QTY
MC-53AB	AMBER	BULK	50
MC-53RB	RED	BULK	50
MC-53ABP	AMBER	POLY	50
MC-53RBP	RED	POLY	50
MC-53ABSB	AMBER - ABS	BULK	50

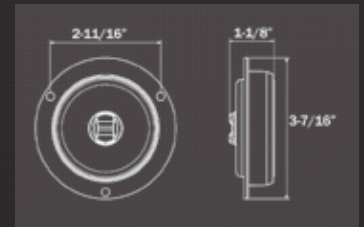
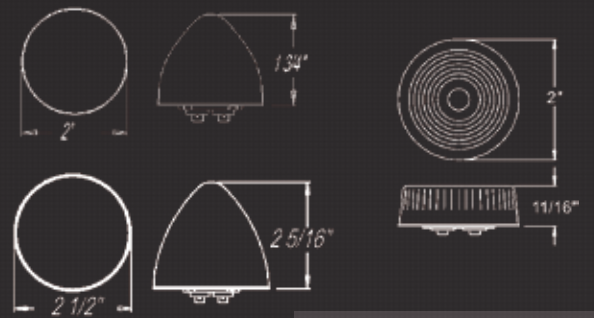



# OPTRONICS INCANDESCENT SERIES



## MARKER/CLEARANCE LIGHTS

### MC-52 SERIES 2" ROUND SEALED FLANGE-MOUNT

PRODUCT	DESCRIPTION	PKG	QTY
MC-52AB	AMBER	BULK	50
MC-52RB	RED	BULK	50

### MC-54 SERIES 2" ROUND SEALED FLANGE-MOUNT, PC RATED

PRODUCT	DESCRIPTION	PKG	QTY
MC-54AB	AMBER	BULK	50
MC-54RB	RED	BULK	50

### MC-55 SERIES 2.5" ROUND SEALED, PC RATED

PRODUCT	DESCRIPTION	PKG	QTY
MC-55AB	AMBER	BULK	50
MC-55RB	RED	BULK	50
MC-55ABP	AMBER	POLY	50
MC-55RBP	RED	POLY	50

### MC-56 SERIES 2.5" ROUND SEALED FLANGE-MOUNT, PC RATED

PRODUCT	DESCRIPTION	PKG	QTY
MC-56AB	AMBER	BULK	50
MC-56RB	RED	BULK	50

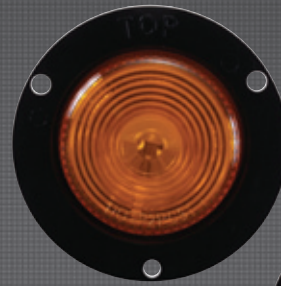
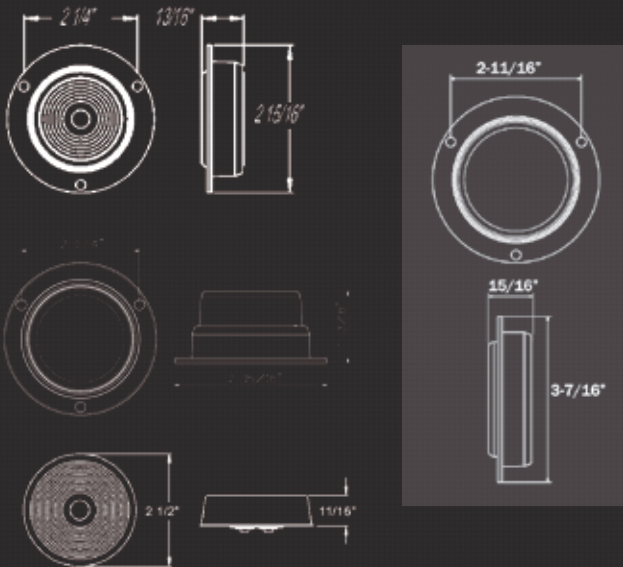

**MC-52AB**  
Amber Lens, Flange



**MC-52RB**  
Red Lens, Flange



**MC-54AB**  
Amber Lens, Flange



**MC-54RB**  
Red Lens, Flange

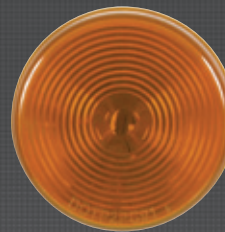

**MC-55AB**  
Amber Lens



**MC-55RB**  
Red Lens



**MC-56AB**  
Amber Lens, Flange



**MC-56RB**  
Red Lens, Flange





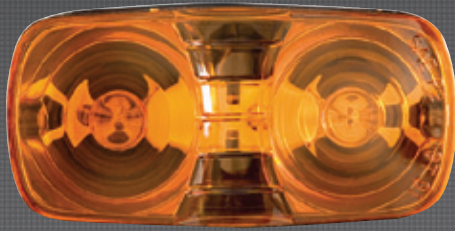

**MC-42AB**  
Amber Lens

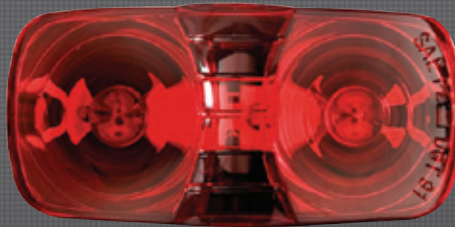

**MC-42RB**  
Red Lens

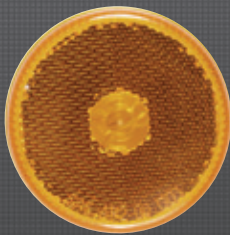

**MC-57AB**  
Amber Lens

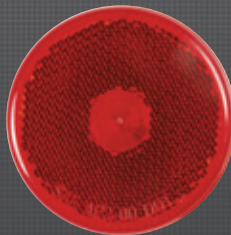

**MC-57RB**  
Red Lens



**MC-65AB**  
Amber Lens



**MC-65RB**  
Red Lens



**A-91AB**  
Amber Lens



**A-91RB**  
Red Lens



## MARKER/CLEARANCE LIGHTS

### MC-42 SERIES DOUBLE BULLSEYE

PRODUCT	DESCRIPTION	PKG	QTY
MC-42AB	AMBER	BULK	50
MC-42RB	RED	BULK	50
MC-42ABP	AMBER	POLY	50
MC-42RBP	RED	POLY	50

### MC-57 SERIES 2.5" ROUND SEALED WITH REFLEX

PRODUCT	DESCRIPTION	PKG	QTY
MC-57AB	AMBER	BULK	50
MC-57RB	RED	BULK	50
MC-57ABP	AMBER	POLY	50
MC-57RBP	RED	POLY	50

### MC-65 SERIES TWO BULB SEALED

PRODUCT	DESCRIPTION	PKG	QTY
MC-65AB	AMBER	BULK	50
MC-65RB	RED	BULK	50
MC-65ABP	AMBER	POLY	50
MC-65RBP	RED	POLY	50

### A-91 SERIES SEALED

PRODUCT	DESCRIPTION	PKG	QTY
A-91AB	AMBER	BULK	100
A-91RB	RED	BULK	100
A-91ABP	AMBER	POLY	100
A-91RBP	RED	POLY	100

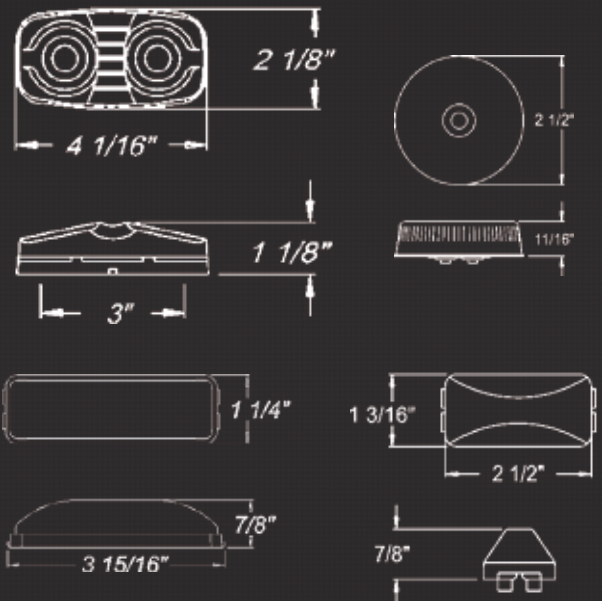



# OPTRONICS INCANDESCENT SERIES



## MARKER/CLEARANCE LIGHTS

### MC-66 SERIES OVAL TWO-BULB

PRODUCT	DESCRIPTION	PKG	QTY
MC-66AB	AMBER	BULK	50
MC-66RB	RED	BULK	50
MC-66ABP	AMBER	POLY	50
MC-66RBP	RED	POLY	50
MC-66HAB	AMBER, SINGLE WIRE	BULK	50

### MC-70 SERIES RECTANGULAR REFLECTOR

PRODUCT	DESCRIPTION	PKG	QTY
MC-70AB	AMBER	BULK	50
MC-70RB	RED	BULK	50
MC-70ABP	AMBER	POLY	50
MC-70RBP	RED	POLY	50

### CB-20 SERIES TRIANGULAR CAB

PRODUCT	DESCRIPTION	PKG	QTY
CB-20AB	AMBER	BULK	50
CB-20ABP	AMBER	POLY	50

### CB-22 SERIES TRIANGULAR CAB

PRODUCT	DESCRIPTION	PKG	QTY
CB-22AB	AMBER	BULK	50
CB-22RB	RED	BULK	50

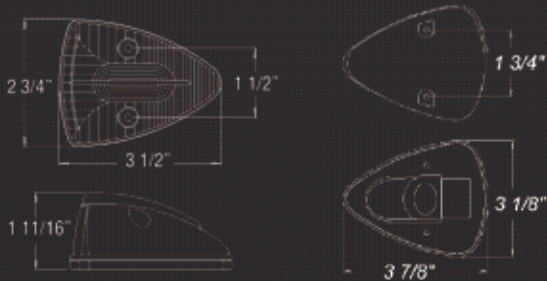
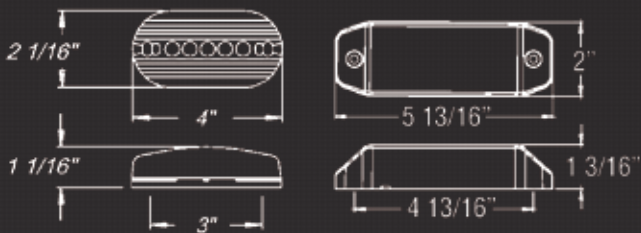

**MC-66AB**  
Amber Lens



**MC-66RB**  
Red Lens

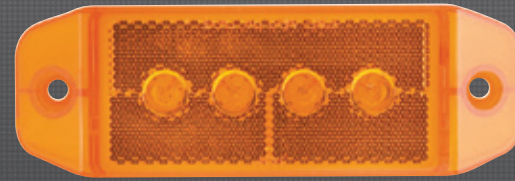

**MC-70AB**  
Amber Lens



**MC-70RB**  
Red Lens



**CB-20AB**  
Amber Lens



**CB-22AB**  
Amber Lens



**CB-22RB**  
Red Lens







## UTILITY LIGHTS

### TL-10CB 5" TRACTOR LIGHT

PRODUCT	DESCRIPTION	PKG	QTY
TL-10CB	UTILITY/TRACTOR	BULK	25
TL-10CBP	UTILITY/TRACTOR	POLY	25

### HB SERIES MAGNETIC MOUNT SPOTLIGHTS, SEALED BEAM

PRODUCT	DESCRIPTION	PKG	QTY
HB-2010	200K / 100K CP	BOX	6
HB-2002	200K CP	BOX	6
HB-2100	200K CP	BOX	6



**TL-10CB**  
Utility / Tractor Light



**HB-2010**  
Magnet Mount  
Spotlight

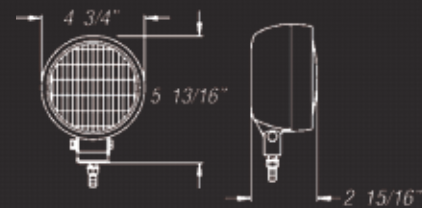



# OPTRONICS CONSPICUITY TAPE & REFLECTORS



## CONSPICUITY TAPE

### RED/SILVER - 11"RED/7"SILVER

PRODUCT	DESCRIPTION	PKG	QTY
RT-150711B	CONTINUOUS	ROLL	1
RT-150711PB	PERFORATED	ROLL	1

### RED/SILVER - 6"RED/6"SILVER

PRODUCT	DESCRIPTION	PKG	QTY
RT-15066B	CONTINUOUS	ROLL	1
RT-15066PB	PERFORATED	ROLL	1

### WHITE

PRODUCT	DESCRIPTION	PKG	QTY
RT-150WBD	CONTINUOUS	ROLL	1

## REFLECTORS

### CENTER MOUNT - ROUND

PRODUCT	DESCRIPTION	PKG	QTY
RE-13AB	3 3/16" CENTER MOUNT	BULK	50
RE-13RB	3 3/16" CENTER MOUNT	BULK	50
RE-35AB	2 3/16" CENTER MOUNT	BULK	100
RE-35RB	2 3/16" CENTER MOUNT	BULK	100

### ARMORED - ROUND

PRODUCT	DESCRIPTION	PKG	QTY
RE-31AB	3 15/16" ARMORED	BULK	50
RE-31RB	3 15/16" ARMORED	BULK	50

### ADHESIVE MOUNT

PRODUCT	DESCRIPTION	PKG	QTY
RE-10AB	3 3/16" X 1 7/16"	BULK	100
RE-10RB	3 3/16" X 1 7/16"	BULK	100
RE-21AB	3 3/16" DIAMETER	BULK	50
RE-21RB	3 3/16" DIAMETER	BULK	50
RE-37AB	2 3/16" DIAMETER	BULK	100
RE-37RB	2 3/16" DIAMETER	BULK	100

### ADHESIVE/SCREW MOUNT

PRODUCT	DESCRIPTION	PKG	QTY
RE-11AB	4 7/16" X 1 15/16"	BULK	100
RE-11RB	4 7/16" X 1 15/16"	BULK	100
RE-15AB	4 3/8" X 1 1/8"	BULK	100
RE-15RB	4 3/8" X 1 1/8"	BULK	100

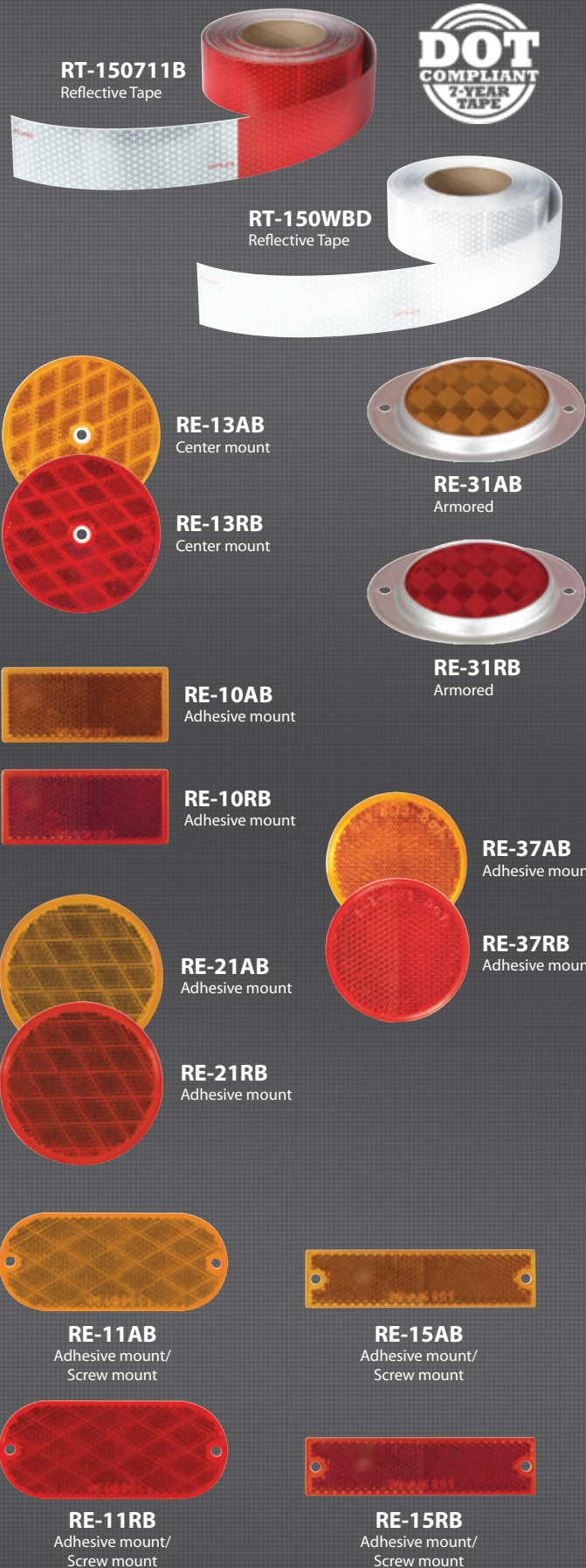





## MOUNTING ACCESSORIES

### GROMMETS & FLANGES

PRODUCT	DESCRIPTION	PKG	QTY
A-11GB	GROMMET, MCL-11 SERIES	BULK	100
A-11GBP	GROMMET, MCL-11 SERIES	POLY	100
A-12GB	SEALING GROMMET, .070"-.125", MCL-11	BULK	100
A-14GB	SEALING GROMMET, .125"-.250", MCL-11	BULK	100
A-45GB	RUBBER GROMMET, 4" ROUND	BULK	50
A-45GBP	RUBBER GROMMET, 4" ROUND	POLY	50
A-54GB	RUBBER GROMMET, 2" ROUND	BULK	100
A-54GBP	RUBBER GROMMET, 2" ROUND	POLY	100
A-54GK	GROMMET, PLUG, SCREW, 2" ROUND	BULK	100
A-54GKP	GROMMET, PLUG, SCREW, 2" ROUND	POLY	100
A-55GB	GROMMET - FLUSH MOUNT, 2.5" ROUND	BULK	50
A-55GBP	GROMMET - FLUSH MOUNT, 2.5" ROUND	POLY	50
A-55GK	GROMMET, PLUG, SCREW, 2.5" ROUND	BULK	100
A-55GKP	GROMMET, PLUG, SCREW, 2.5" ROUND	POLY	100
A-56GB	GROMMET - CLOSED BACK, 2.5" ROUND	BULK	100
A-56GBP	GROMMET - CLOSED BACK, 2.5" ROUND	POLY	100
A-57GB	GROMMET - RECESSED MOUNT, 2.5" ROUND	BULK	50
A-57GBP	GROMMET - RECESSED MOUNT, 2.5" ROUND	POLY	50
A-57GK	GROMMET, PLUG, SCREW, 2.5" ROUND	BULK	100
A-57GKP	GROMMET, PLUG, SCREW, 2.5" ROUND	POLY	100
A-70GB	RUBBER GROMMET, 6" OVAL	BULK	50
A-70GBP	RUBBER GROMMET, 6" OVAL	POLY	50
A-91GB	GROMMET, MINI THINLINE	BULK	100

### BASES & BRACKETS

PRODUCT	DESCRIPTION	PKG	QTY
BK-45BB	BLACK BRACKET, 4" ROUND	BULK	10
BK-45BBP	BLACK BRACKET, 4" ROUND	POLY	10
BK-55BB	BLACK BRACKET, 2.5" ROUND	BULK	50
BK-70BB	BLACK BRACKET, 6" OVAL	BULK	10
BK-70BBP	BLACK BRACKET, 6" OVAL	POLY	10
BK-53BB	DEFLECTOR BRACKET, 2" ROUND	BULK	50
BK-53BBP	DEFLECTOR BRACKET, 2" ROUND	POLY	50
BK-57BB	DEFLECTOR BRACKET, 2.5" ROUND	BULK	50
BK-57BBP	DEFLECTOR BRACKET, 2.5" ROUND	POLY	50
BK-5557GB	CAM-ON BRACKET, 2"/2.5" ROUND	BULK	50
BK-5557GBP	CAM-ON BRACKET, 2"/2.5" ROUND	POLY	50
A-65B	BLACK BRACKET, MC/MCL-65 SERIES	BULK	50
A-65TB	BLACK BRACKET - THICK, MC/MCL-65 SERIES	BULK	50
BK-66DB	ARMORED BASE, MCL-66 SERIES	BULK	50
BK-66DBP	ARMORED BASE, MCL-66 SERIES	POLY	50
A-82BB	BLACK BASE, A/AL-91 SERIES	BULK	100
A-91BB	BLACK BASE, SELF GROUND, A/AL-91 SERIES	BULK	100
A-91BOB	BLACK BASE, A/AL-91 SERIES	BULK	100
A-91BOBP	BLACK BASE, A/AL-91 SERIES	POLY	100
A-91CB	CHROME BASE, SELF GROUND, A/AL-91 SERIES	BULK	100
A-91OB	CHROME BASE, A/AL-91	BULK	100

## WIRING ACCESSORIES

### PIGTAILS

PRODUCT	DESCRIPTION	PKG	QTY
A-45PB	PIGTAIL, 3-WIRE, STRAIGHT	BULK	100
A-45PBP	PIGTAIL, 3-WIRE, STRAIGHT	POLY	100
A-47PB	PIGTAIL, 3-WIRE, RIGHT ANGLE	BULK	100
A-47PBP	PIGTAIL, 3-WIRE, RIGHT ANGLE	POLY	100
A-47P10B	PIGTAIL, 3-WIRE, 10' LEADS, RIGHT ANGLE	BULK	50
A-45CB	PIGTAIL, 2-WIRE, STRAIGHT	BULK	100
A-45CBP	PIGTAIL, 2-WIRE, STRAIGHT	POLY	100
A-49PB	PIGTAIL, 2-WIRE, RIGHT ANGLE	BULK	100
A-49PBP	PIGTAIL, 2-WIRE, RIGHT ANGLE	POLY	100
A-46PB	PIGTAIL, 2-WIRE, MC/MCL	BULK	100
A-46PBP	PIGTAIL, 2-WIRE, MC/MCL	POLY	100
A-65P	PLUG, SINGLE WIRE, MC/MCL-65	BULK	50
A-91LW	PLUG, SINGLE WIRE, A/AL-91	BULK	100

### TRIM RINGS

PRODUCT	DESCRIPTION	PKG	QTY
A-3TRSSB	STAINLESS STEEL, 2" FLANGE	BULK	100
A-5TRSSB	STAINLESS STEEL, 4" FLANGE	BULK	100
A-42FCB	CHROME, 4" FLANGE	BULK	50
A-45CGB	CHROME, 4" GROMMETS	BULK	20
A-45CGBP	CHROME, 4" GROMMETS	POLY	20
A-55CB	CHROME, 2" GROMMETS	BULK	20
A-55CBP	CHROME, 2" GROMMETS	POLY	20
A-57CB	CHROME 2.5" GROMMETS	BULK	20



# OPTRONICS POP DISPLAYS



## POP DISPLAYS

### POP PANEL DISPLAYS

PRODUCT	DESCRIPTION	QTY
Z-2035	DIAMOND PLATE: STL-72RB, STL-72AB, STL-43RB, MCL-55AB, MCL-57RB, MCL-67AB, MCL-31AB, MCL-91AB, MCL-46RB, & MCL-93RB	1
Z-2040	DIAMOND PLATE - HEAVY DUTY: STL-75AB, STL-42RB, STL-43RB, STL-72AB, STL-72RB, MCL-55AB, MCL-57RB, MCL-65RB, & MCL-66AB	1
Z-2045	MIRO-FLEX™ DIAMOND PLATE: STL-23RB, STL-23CCRB, STL-22RB, STL-CCRB, MCL-50AB, AL-191CRB, MCL-51AB, AL-191AB, MCL-502AB, MCL-19AB, MCL-63CRB, & MCL-63AB	1

### POP TABLE TOP DISPLAYS

PRODUCT	DESCRIPTION	QTY
Z-2025	COUNTER TOP: STL-43RB, MCL-57RB, & MCL-58AB	1
Z-2025FC	COUNTER TOP: STL-13RB, MCL-527AB, & MCL-527RB	1



**Z-2035**  
Diamond Plate Panel



**Z-2040**  
Diamond Plate Panel



**Z-2045**  
Diamond Plate Panel

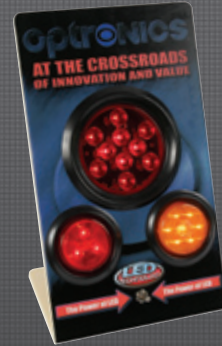

**Z-2025**  
Counter Top

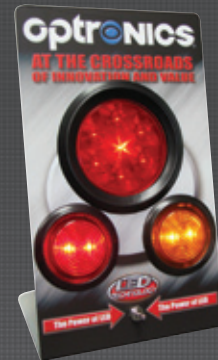

**Z-2025FC**  
FLEET Count Counter Top



00212005.....2	00212355.....2	A-55CB.....31	BUL-43CB.....6	MCL-11RKAB.....17	MCL-65AB.....19	STL-13RB.....12
00212006.....2	00212356.....2	A-55CBP.....31	BUL-69CB.....6	MCL-11RKB.....17	MCL-65ABP.....19	STL-13RBP.....12
00212007.....2	00212357.....2	A-55GB.....31	BUL-72CB.....6	MCL-11RKBF.....17	MCL-65CAB.....19	STL-22AB.....7
00212010.....2	00212358.....2	A-55GBP.....31	CB-20AB.....28	MCL-11RKB.....17	MCL-65CRB.....19	STL-22CCAB.....7
00212011.....2	00212362.....2	A-55GK.....31	CB-20ABP.....28	MCL-11RKPG.....17	MCL-65R24B.....19	STL-22CCRB.....7
00212011.....3	00212364.....2	A-55GKP.....31	CB-22AB.....28	MCL-11RKPG5W.....17	MCL-65RB.....19	STL-22RB.....7
00212012.....2	00212365.....2	A-56GB.....31	CB-22RB.....28	MCL-11RPG.....17	MCL-65RBP.....19	STL-22RBH.....7
00212012.....3	00212366.....2	A-56GBP.....31	CB-22RBP.....28	MCL-21AB.....17	MCL-76AB.....20	STL-22RCB.....7
00212031.....2	00212367.....2	A-57CB.....31	CBL-22AB.....20	MCL-21RB.....17	MCL-76ABP.....20	STL-23A24B.....7
00212051.....2	00212368.....2	A-57GB.....31	CBL-22RB.....20	MCL-23AB.....17	MCL-76RB.....20	STL-23AB.....7
00212100.....4	00212376.....2	A-57GBP.....31	HB-2002.....29	MCL-23RB.....17	MCL-76RBP.....20	STL-23CCRB.....7
00212101.....4	00212378.....2	A-57GK.....31	HB-2010.....29	MCL-46AB.....20	RE-10AB.....30	STL-23RCB.....7
00212104.....4	00212384.....2	A-57GKP.....31	HB-2100.....29	MCL-46ABP.....20	RE-10RB.....30	STL-23RB.....7
00212108.....4	00212386.....2	A-57R5SB.....31	ILL-08COB.....6	MCL-46RBP.....20	RE-11AB.....30	STL-43A24B.....14
00212110.....4	00212391.....2	A-65B.....31	ILL-31CB.....6	MCL-46RBP.....20	RE-11RB.....30	STL-43AB.....14
00212111.....4	00212392.....2	A-65P.....31	ILL-42CB.....6	MCL-49AB.....20	RE-13AB.....30	STL-43ABP.....14
00212117.....4	00212393.....2	A-65TB.....31	LPL-91CB.....21	MCL-502AB.....8	RE-13RB.....30	STL-43ABX.....14
00212120.....4	00212700.....5	A-70GB.....31	MC-25AB.....25	MCL-502RB.....8	RE-15AB.....30	STL-43AKB.....14
00212127.....4	00212701.....5	A-70GBP.....31	MC-25ABP.....25	MCL-50AB.....8	RE-15RB.....30	STL-43AMB.....14
00212135.....4	00212702.....5	A-82BB.....31	MC-25RB.....25	MCL-50RB.....8	RE-21AB.....30	STL-43AMB.....14
00212137.....4	00212703.....5	A-91AB.....27	MC-25RBP.....25	MCL-51AB.....8	RE-21RB.....30	STL-43R24B.....14
00212155.....4	00212704.....5	A-91ABP.....27	MC-27AB.....25	MCL-51RB.....8	RE-31AB.....30	STL-43R24BP.....14
00212157.....4	00212705.....5	A-91BB.....31	MC-27RB.....25	MCL-527AB.....13	RE-31RB.....30	STL-43RB.....14
00212207.....3	00212706.....5	A-91BOB.....31	MC-42AB.....27	MCL-527ABP.....13	RE-35AB.....30	STL-43RBP.....14
00212209.....3	00212707.....5	A-91BOBP.....31	MC-42ABP.....27	MCL-527RB.....13	RE-35RB.....30	STL-43RBX.....14
00212217.....3	00212708.....5	A-91CB.....31	MC-42RB.....27	MCL-527RBP.....13	RE-37AB.....30	STL-43RKB.....14
00212220.....4	00212709.....5	A-91GB.....31	MC-42RBP.....27	MCL-54AB.....18	RE-37RB.....30	STL-43RM24B.....14
00212221.....3	00212710.....5	A-91LW.....31	MC-505AB.....25	MCL-54ABP.....18	RT-15066B.....30	STL-43RMB.....14
00212222.....3	00212711.....5	A-91OB.....31	MC-505RB.....25	MCL-54RB.....18	RT-15066PB.....30	STL-43RMBP.....14
00212223.....3	00212712.....5	A-91RB.....27	MC-52AB.....26	MCL-54RBP.....18	RT-150711B.....30	STL-51AB.....16
00212224.....3	00212713.....5	A-91RBP.....27	MC-52RB.....26	MCL-553AB.....11	RT-150711PB.....30	STL-51RB.....16
00212227.....3	00212714.....5	AL-191AB.....9	MC-53AB.....25	MCL-553RB.....11	RT-150WBD.....30	STL-53ARB.....16
00212231.....3	00212717.....5	AL-191CAB.....9	MC-53ABP.....25	MCL-557AB.....11	SLL-43AB1.....22	STL-53ARDB.....16
00212233.....3	00212727.....5	AL-191CRB.....9	MC-53ABSP.....25	MCL-557RB.....11	SLL-43AB1P.....22	STL-53ARP.....16
00212235.....3	00212031B.....2	AL-191RB.....9	MC-53R.....25	MCL-55A1224B.....18	SLL-43AB2.....22	STL-53AB.....10
00212236.....3	00212051B.....2	AL-591AB.....11	MC-53RBP.....25	MCL-55A24B.....18	SLL-43AB2P.....22	STL-53ARB.....10
00212237.....3	00212231B.....3	AL-591RB.....11	MC-54AB.....26	MCL-55AB.....18	SLL-43AKB1.....22	STL-55AB.....14
00212238.....3	00212233B.....3	AL-90AB.....13	MC-54RB.....26	MCL-55ABP.....18	SLL-43AKB1P.....22	STL-55ABP.....14
00212239.....3	00212239B.....3	AL-90ABP.....13	MC-54RBP.....26	MCL-55ACB.....18	SLL-43AKB2.....22	STL-55RB.....14
00212251.....3	00212251B.....3	AL-90RB.....13	MC-55AB.....26	MCL-55A1224B.....18	SLL-43AKB2P.....22	STL-55RBP.....14
00212253.....3	00212253B.....3	AL-90RBP.....13	MC-55ABP.....26	MCL-55R24B.....18	SLL-72AB1.....22	STL-572AB.....10
00212255.....3	00212259B.....3	AL-91AB.....19	MC-55RB.....26	MCL-55RB.....18	SLL-72AB1P.....22	STL-572RB.....10
00212256.....3	00212331B.....2	AL-91CAB.....19	MC-55RBP.....26	MCL-55RBP.....18	SLL-72AB2.....22	STL-70AB.....15
00212257.....3	00212333B.....2	AL-91CRB.....19	MC-56AB.....26	MCL-55RCB.....18	SLL-72AB2P.....22	STL-70ABP.....15
00212258.....3	00212342B.....2	AL-91RB.....19	MC-56RB.....26	MCL-565AB.....11	SLL-72AKB1.....22	STL-70RB.....15
00212259.....3	00212344B.....2	BK-45BB.....31	MC-56RBP.....26	MCL-565RB.....11	SLL-72AKB1P.....22	STL-70RBP.....15
00212276.....3	00212351B.....2	BK-45BBP.....31	MC-57AB.....27	MCL-56AB.....13	SLL-72AKB2.....22	STL-72AB.....15
00212278.....3	00212353B.....2	BK-53BB.....31	MC-57ABP.....27	MCL-56ABP.....13	SLL-72AKB2P.....22	STL-72ABP.....15
00212291.....3	00212362B.....2	BK-53BBP.....31	MC-57RB.....27	MCL-56RB.....13	ST-44AB.....23	STL-72AM24B.....15
00212292.....3	00212364B.....2	BK-5557GB.....31	MC-57RBP.....27	MCL-56RBP.....13	ST-44ABP.....23	STL-72AMB.....15
00212293.....3	A-11GB.....31	BK-5557GBP.....31	MC-65AB.....27	MCL-57A124B.....18	ST-44RB.....23	STL-72AMB.....15
00212294.....3	A-11GBP.....31	BK-55BB.....31	MC-65ABP.....27	MCL-57A24B.....18	ST-44RBP.....23	STL-72AMP.....15
00212307.....2	A-12GB.....31	BK-57BB.....31	MC-65RB.....27	MCL-57AB.....18	ST-45AB.....23	STL-72RBP.....15
00212309.....2	A-14GB.....31	BK-57BBP.....31	MC-65RBP.....27	MCL-57ABP.....18	ST-45ABP.....23	STL-72RMB.....15
00212315.....2	A-3TR5SB.....31	BK-66DB.....31	MC-66AB.....28	MCL-57ACB.....18	ST-45RB.....23	STL-72RMBP.....15
00212316.....2	A-42FCB.....31	BK-66DBP.....31	MC-66ABP.....28	MCL-57R1224B.....18	ST-45RBP.....23	STL-75AB.....15
00212317.....2	A-45CB.....31	BK-70BB.....31	MC-66HAB.....28	MCL-57R24B.....18	ST-46RB.....23	STL-75ABP.....15
00212321.....2	A-45CBP.....31	BK-70BBP.....31	MC-66RB.....28	MCL-57RB.....18	ST-46RBP.....23	STL-75AMB.....15
00212322.....2	A-45CGB.....31	BU-45CB.....24	MC-66RBP.....28	MCL-57RBP.....18	ST-46RKB.....23	STL-75AMP.....15
00212323.....2	A-45CGBP.....31	BU-45CBP.....24	MC-70AB.....28	MCL-57RCB.....18	ST-46RKBP.....23	STL-82RCB.....15
00212327.....2	A-45GB.....31	BU-70CB.....24	MC-70ABP.....28	MCL-58AB.....18	ST-47RB.....23	TL-10CB.....29
00212331.....2	A-45GBP.....31	BU-70CBP.....24	MC-70RB.....28	MCL-58ABP.....18	ST-47RBP.....23	TL-10CBP.....29
00212333.....2	A-45PB.....31	BUL-10CB.....12	MC-70RBP.....28	MCL-58RB.....18	ST-49RB.....23	UCL-11CB.....17
00212335.....2	A-45PBP.....31	BUL-10CBP.....12	MCL-11AB.....17	MCL-58RBP.....18	ST-51RB.....24	UCL-11CKB.....17
00212336.....2	A-46PB.....31	BUL-11CB.....12	MCL-11AHPG.....17	MCL-59AB.....18	ST-51RBP.....24	Z-2025.....32
00212337.....2	A-46PBP.....31	BUL-11CBP.....12	MCL-11AKAB.....17	MCL-59RB.....18	ST-52RB.....24	Z-2025FC.....32
00212338.....2	A-47P10B.....31	BUL-11CBX.....21	MCL-11AKB.....17	MCL-61AB.....13	ST-52RBP.....24	Z-2035.....32
00212342.....2	A-47PB.....31	BUL-11CBB.....12	MCL-11AKBF.....17	MCL-61ABP.....13	ST-70AB.....23	Z-2040.....32
00212344.....2	A-47PBP.....31	BUL-11CM24B.....12	MCL-11AKBP.....17	MCL-61RB.....13	ST-70ABP.....23	Z-2045.....32
00212345.....2	A-49PB.....31	BUL-11CMB.....12	MCL-11APG.....17	MCL-61RBP.....13	ST-70RB.....23	
00212346.....2	A-49PBP.....31	BUL-22CB.....21	MCL-11CAB.....17	MCL-63AB.....9	ST-70RBP.....23	
00212347.....2	A-54GB.....31	BUL-22CBP.....21	MCL-11CAKB.....17	MCL-63CAB.....9	ST-75AB.....23	
00212348.....2	A-54GBP.....31	BUL-23C24B.....21	MCL-11CRB.....17	MCL-63CRB.....9	ST-75ABP.....23	
00212351.....2	A-54GK.....31	BUL-23C24BP.....21	MCL-11CRKB.....17	MCL-63RB.....9	STL-12RB.....12	
00212353.....2	A-54GKP.....31	BUL-23CB.....21	MCL-11RB.....17	MCL-65A24B.....19	STL-12RBP.....12	





**Optronics International**

401 South 41st Street East

Muskogee, OK 74403

800-364-5483

918-683-9514

918-683-9517 fax

**H-848**

©2010 Optronics International

[www.optronicsinc.com](http://www.optronicsinc.com)