

OUTDOOR UNITS

Maxi Series MVD V6R 3 pipes

Super DC Inverter (up to 150 kW)



R410A



OPTIONAL ACCESSORIES

More information on optional accessories in "MUNDOCLIMA CONTROL SYSTEMS"

Centralized controller

Software control



CCM-180A/WS
(CL 97 800)



CCM-270B/WS(A)
(CL 97 802)



IMMP-BAC(A)
(CL 97 826)



IMMP-S(A)
(CL 97 825)



BMS

Wattmeter



GW-MOD(A)
(CL 97 828)



GW-LON(A)
(CL 97 829)



DTS343-3
(CL 97 827)

MINI MVD V6R SERIES



WIDE RANGE

Up to 6 modules

The Super DC Inverter Maxi MVD V6R modular system, consists of 6 basic modules that can be combined with up to 3 modules, therefore adapting to the installation needs. They make up a total system capacity that can go from 8 up to 54 HP (150 kW), in increments of 2 HP.



8 / 10 / 12 HP



14 / 16 / 18 HP

8/10/12/14/16/18 HP ... Max. 54 HP (150 kW)



MINI MVD V6R SERIES



HIGH EFFICIENCY

Independent exchanger and compressor control

When cooling or heating with a modular system, the outdoor heat exchanger and the compressor are controlled independently to improve energy efficiency, which means that even in the non-functioning outdoor unit, the heat exchanger can be used while the compressor remains interrupted. This function maximizes heat exchanging efficiency.

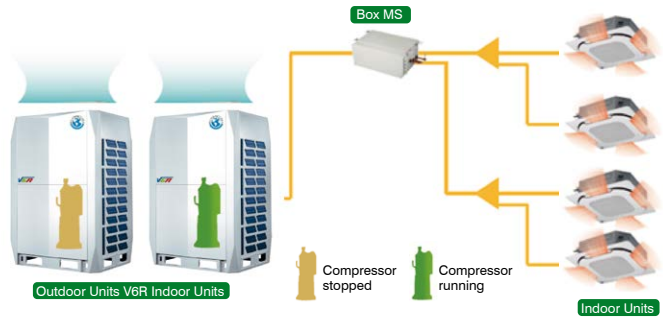

DC Inverter EVI Scroll Compressor (Enhanced Steam Injection)

The EVI compressor allows the unit to operate in heating mode as far as -25°C thanks to the 2 stages of compression and the wide frequency range of 15 - 140Hz.

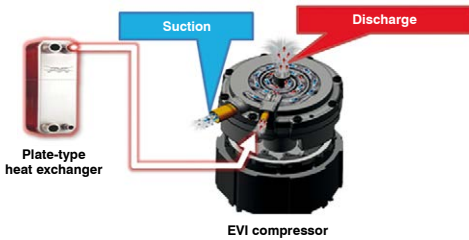
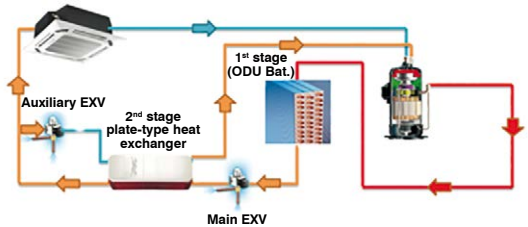

Plate-type heat exchanger

The plate heat exchanger increases the subcooling of the refrigerant, resulting in a 10% improvement in energy efficiency and a reduction in refrigerant flow noise.



EER up to 7.8

The V6R heat recovery system can provide cooling and heating simultaneously. Heat recovery is achieved by diverting exhaust heat from indoor units in cooling mode to areas that require heating. As a result, energy efficiency is maximized and energy consumption is reduced. Efficiency with partial load is very high (up to 7.8 in the 8 HP unit).

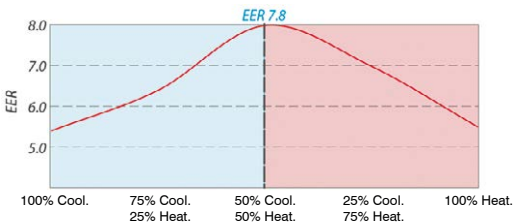

Note: EER at 50% in simultaneous cooling and heating operation, based on the following conditions: Outdoor temperature 7°C DB, 6°C WB; indoor temperature 27°C DB, 19°C WB for cooling and 20°C DB for heating.

Evaporation/floating condensation temperature

The evaporation temperature (in cooling) and the condensation temperature (in heating) are automatically adjusted according to the indoor and outdoor temperature to balance comfort and energy efficiency.

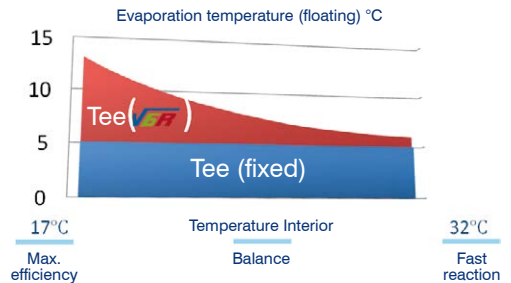

MINI MVD V6R SERIES



CONFORT

WIDE WORKING TEMPERATURE RANGE

The V6R series, among other mixed modes, can stably operate in only heating mode between -25°C and 19°C, with 100% efficiency down to -5°C, and in only cooling mode between -15°C and 52°C.

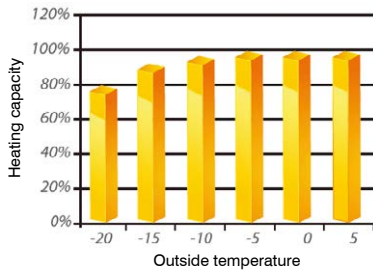
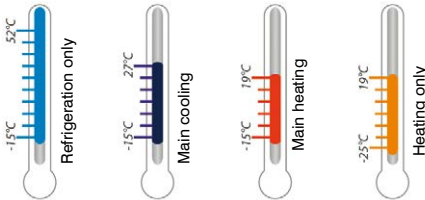

Note: Cooling mode operation with low outdoor temperature (-15°C ~ to -5°C) is only available for indoor units connected to the MS01 distribution box.

Multiple silent modes

The silent mode includes several reduced noise programming options that can be used when low noise operations are required.

In total there are: 4 night silent modes, 3 silent modes and 4 super silent modes.



In super silent mode, both the maximum fan speed and the frequency of the compressor are limited.



In night and silent mode, only the maximum fan speed is limited.

The nightly silent mode is activated "X" hours after the maximum temperature peak is recorded by the outdoor unit, and deactivated "Y" hours later.

Mode 1 → X = 6h; Y = 10h

Mode 2 → X = 8h; Y = 10h

Mode 3 → X = 6h; Y = 12h

Mode 4 → X = 8h; Y = 8h

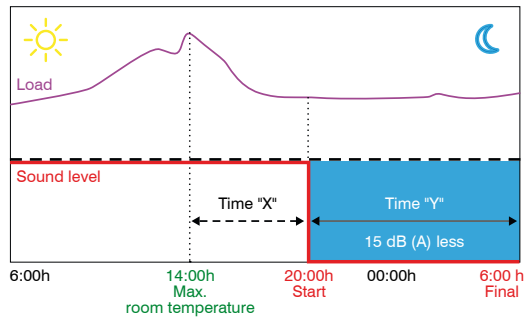

Note: The curve shown in the graph is an example.

Continuous heating

Usually, it is necessary to disable heating operation during defrost. However in a modular installation, the continuous heating operation mode makes it possible to perform defrosting while heating continues. The units defrost alternately, so while one unit is defrosting, the other one continues to heat.



Normal heating operation



Stage 1: Operation in continuous heating mode



Stage 2: Operation in continuous heating mode

MINI MVD V6R SERIES



HIGH RELIABILITY

ROTATION FUNCTION

This function matches the running time of the outdoor units in a multiple system, extending significantly the life of the compressors.



Backup function

In a modular installation, in case one of the modules fails, the one that was in standby mode will be started automatically.



Compressor ON Compressor OFF Damaged compressor

Fewer components

Integration of different components within the same electronic board, and communication between RS485 bus type boards, thus minimizing the risk of failure.

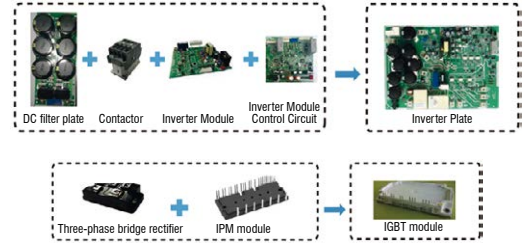

Cooling liquid

The electric panel is kept cold by a cooling liquid, the liquid pipe runs through the heat dissipator. When comparing with the air cooling method, the temperature of the PCB is 10°C lower.



Detection of lack/excess of gas

The V6R series can detect if the system lacks refrigerant or if there is an excess.

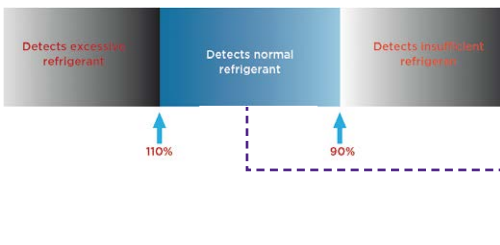

Leak detection

The V6R system can detect in real time if there is a refrigerant leak in any room and thus automatically shuts off the MS box valves to prevent all the refrigerant from leaking, while simultaneously sending an activation signal to the air extraction systems, ensuring system safety.

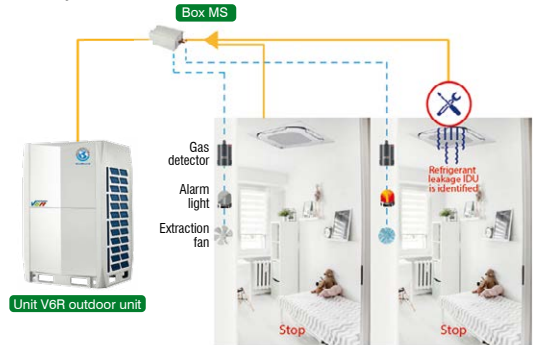

Note: This function is only available using the MS01/N1-D distribution box. An external gas detector must be connected to it.

MINI MVD V6R SERIES



Easier installation

Automatic refrigerant gas charging

The V6R series charges the refrigerant gas automatically without having to perform the additional charge calculation.

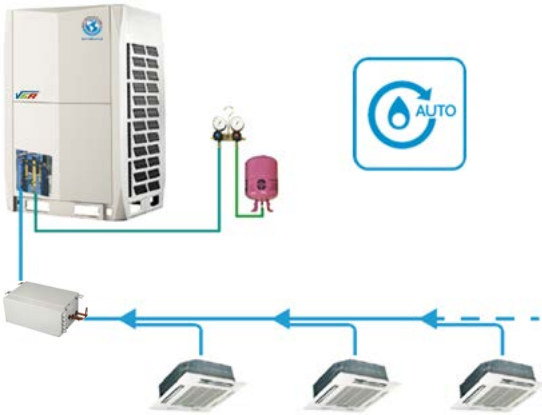

Energy management system

For projects with temporary power supply restrictions, the V6R series can be set up to limit its capacity to 40 ~ 100%.



High static pressure

The available static fan pressure can be increased up to 80 Pa by simply activating a micro-switch on the control board of the outdoor unit.



Triple set up possibility

The parameters of the external unit can be set up and checked out in 3 ways:

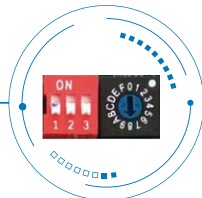

Locally through micro-switches on the outdoor unit.



From the wired WDC and centralized controls CCM-180 and CCM-270.



From a computer using the IMMP-S software.

Up to 1 km of pipe

- Total pipe length/ vertical: **1 km**
- Pipe length of the furthest indoor unit (equivalent): **175 m (200 m)**
- Pipe length between the first distributor and the furthest indoor unit (when certain conditions are met): **40 m (90 m)**
- Pipe length between the first distribution box and the furthest indoor unit: **40 m**
- Height difference between indoor and outdoor units: **110 m**
- Height difference between indoor units: **30 m**

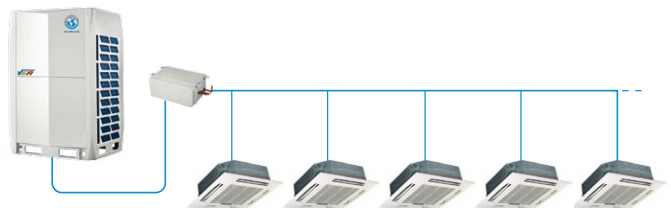

MINI MVD V6R SERIES



Easier installation

Automatic addressing

By default, the first time the power supply to the entire system is activated, the outdoor unit automatically assigns the address to each indoor unit. It is also possible to check and modify the address of each indoor unit from your controller.



Without oil balance pipe

Thanks to the new oil management technology within the modular systems, there is no need to install an oil balance pipe.



Distribution boxes with up to 12 outlets

The V6R system distribution boxes have up to 12 outlets. Up to 5 or 8 indoor units can be connected to each outlet, depending on the model of each box.

Indoor units up to 28 kW can be connected by combining 2 outputs from the same box.



Model			MS01/N1-D ⁽¹⁾	MS04 / N1-D	MS06 / N1-D	MS08 / N1-D	MS10 / N1-D	MS12 / N1-D
Code			CL 23 630	CL 23 631	CL 23 632	CL 23 633	CL 23 634	CL 23 635
Power supply		Ph, V, Hz	1N~, 230, 50	1N~, 230, 50	1N~, 230, 50	1N~, 230, 50	1N~, 230, 50	1N~, 230, 50
Max. quantity of indoor unit groups (outlets)			1	4	6	8	10	12
Max. quantity of indoor units per group			8	5	5	5	5	5
Max. quantity of indoor units total			8	20	40	/	47	47
Maximum capacity of each indoor unit group		kW	32	16	16	16	16	16
Indoor unit max. total capacity		kW	32	49	63	85	85	85
Sound pressure ⁽²⁾		dB(A)	/	44	45	47	47	47
Sound power ⁽²⁾		dB(A)	60	63	40	40	40	40
Connection pipes	Outdoor unit side	Liquid	mm (inches)	9.5 (3/8")	15.9 (5/8")	15.9 (5/8")	15.9 (5/8")	15.9 (5/8")
		Low pressure gas	mm (inches)	15.9 (5/8")	28.6 (1 1/8")	28.6 (1 1/8")	28.6 (1 1/8")	28.6 (1 1/8")
		High pressure gas	mm (inches)	12.7 (1/2")	22.2 (7/8")	22.2 (7/8")	22.2 (7/8")	22.2 (7/8")
	Inner side	Liquid	mm (inches)	9.5 (3/8")	9.5 (3/8")	9.5 (3/8")	9.5 (3/8")	9.5 (3/8")
		Gas	mm (inches)	15.9 (5/8")	15.9 (5/8")	15.9 (5/8")	15.9 (5/8")	15.9 (5/8")
	Drain connection		mm	Ø25	Ø25	Ø25	Ø25	Ø25
Dimensions (W x H x D)		mm	440 x 195 x 296	668 x 250 x 574	668 x 250 x 574	974 x 250 x 574	974 x 250 x 574	974 x 250 x 574
Weight		kg	10.5	33	36	48	51	54

Notes: ⁽¹⁾ The MS01/N1-D box is used for cooling operation in low outdoor temperatures (-15°C ~ to -5°C).

⁽²⁾ Sound pressure measured in a semi-anechoic chamber at a distance of 1m from the bottom of the MS box while it is changing operating mode.

MINI MVD V6R SERIES



EASIER MAINTENANCE

Maintenance mode

When the maintenance mode is activated, the outdoor unit does not check the number of indoor units connected, so that the system can continue to operate without them.

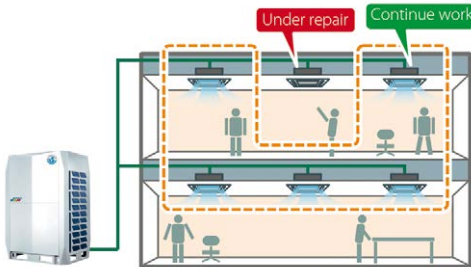

Settings menu

The main board incorporates the new parameter settings menu that allows us to adjust most of the equipment's functions.

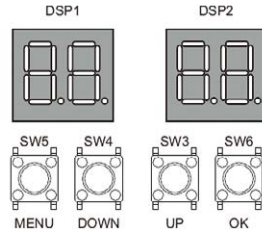

Black box

As standard, the equipment incorporates a "Black Box" multifunction board that allows the equipment's operating parameters to be checked without practically opening its front panel. It also allows you to record operating parameters from the last 30 minutes.

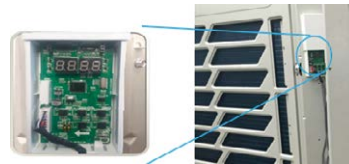

VERSATILITY

Up to 200% connectivity rate

Under certain conditions, the V6R system allows the connection of up to 200% of the outdoor unit capacity.

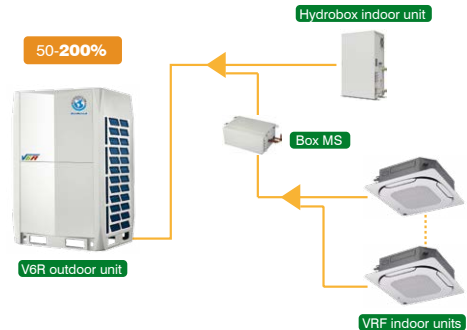

System type	Number of outdoor units joined together	Total pluggable capacity	Connectable capacity of each indoor unit type		
			VRF outdoor units	Hydrobox indoor units	100% exterior air indoor units
Only VRF indoor units	1	50% ~ 200%	50% ~ 200%	–	–
	2	50% ~ 150%	50% ~ 150%	–	–
	3	50% ~ 130%	50% ~ 130%	–	–
VRF indoor units + Hydrobox indoor units	1, 2 or 3	50% ~ 200%	50% ~ 130%	0% ~ 100%	–
VRF indoor units + 100% exterior air indoor units	1, 2 or 3	50% ~ 100%	50% ~ 100%	–	0% ~ 30%

MINI MVD V6R SERIES



VERSATILITY

Multiple applications

With the Maxi MVD V6R heat recovery 3-pipe system, we can cool, heat and produce hot water (up to 80°C) simultaneously with one single system.

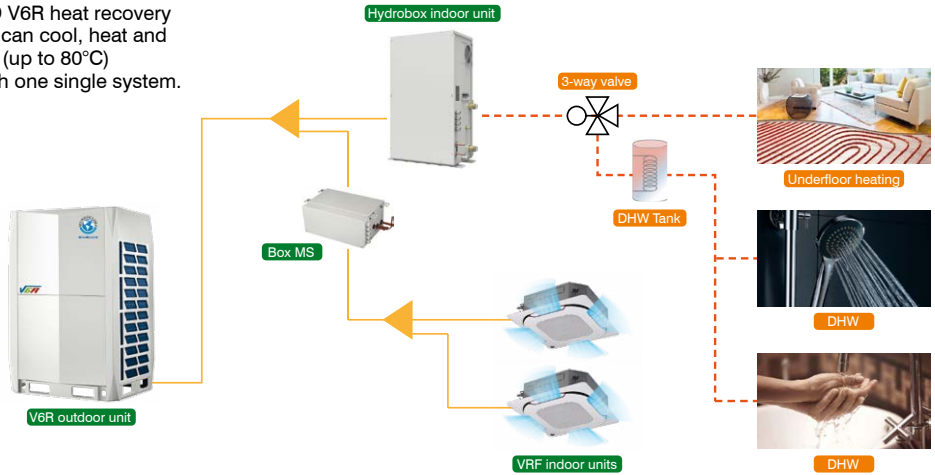

Hydrobox indoor unit for hot water production

Hydrobox indoor unit for high temperature hot water production. When connected to a Maxi MVD V6R system it allows to produce hot water for heating and DHW, with a temperature range between 25°C and 80°C, thanks to the incorporation of a R134a compressor for producing high temperature water.



- In low temperature operation mode: a system with R410A refrigerant absorbs heat from the environment and transfers it to the Hydrobox unit's plate heat exchanger.
- In high temperature operation mode: a system with R134a refrigerant absorbs heat from the R410A circuit and transfers it to the Hydrobox unit's plate heat exchanger.

Ability to connect up to 10 Hydrobox indoor units modularly, making it possible to achieve 140kW in hot water production.

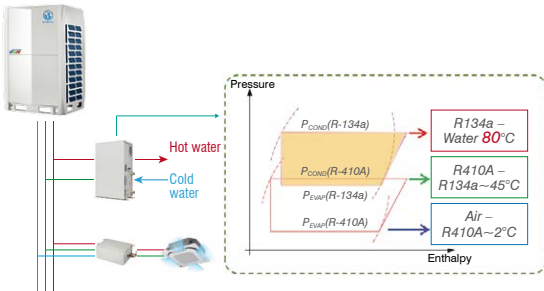
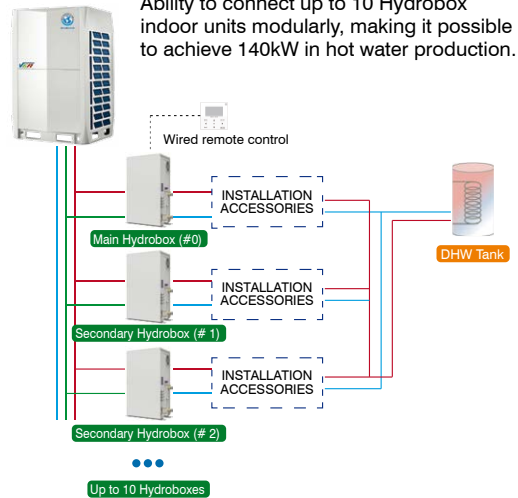

Hydrobox indoor units are connected directly to the main pipe without the need for an MS distribution box.

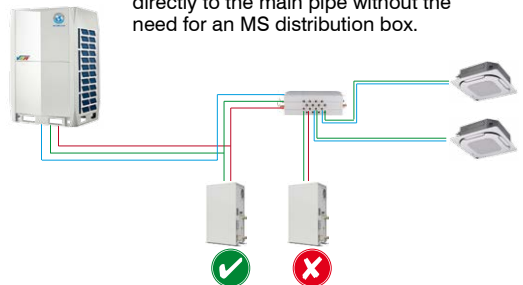

MINI MVD V6R SERIES



HYDROBOX UNIT TECHNICAL SPECIFICATIONS

Model		MVD-W140RN3	
Code		CL 23 636	
Power supply		Ph, V, Hz	1N~, 230, 50
Outdoor air: 7°C DB, 6°C WB; Water (in/out): 40°C / 45°C; Water flow rate: 2.4 m³/h	Capacity	kW	14
	Consumption	kW	1.59
Exterior air: 7°C DB, 6°C WB; Water (in/out): 80°C / 82.5°C; Water flow rate: 2.4 m³/h	Capacity	kW	7.1
	Consumption	kW	2.98
Nominal intensity / max.		A	16 / 20
Water outlet temperature range		°C	25~ 80
Water flow	Nominal (min. - max.)	m³/h	2.4 (1.2 - 2.9)
Heat exchanger pressure drop at nominal flow rate		kPa	20
Allowed water pressure	min. ~ max.	Bar	1~ 3
Water inlet temperature range	min. ~ max.	°C	5 ~ 80
Sound pressure		dB(A)	43
Sound power		dB(A)	54
Connection pipes	Type	Welding	
	Liquid	mm (inches)	9.5 (3/8")
	Gas	mm (inches)	12.7 (1/2")
Water connections	Type	Male Thread	
	Diameter	mm (inches)	Ø 25 (1")
Compressor	Brand	Mitsubishi	
	Type	DC Inverter Twin Rotary	
	Number	1	
	Model	SBB220FAMEC	
Internal refrigerant	Type / PCA	R134a / 143	
	Number	kg / TCO ₂ eq	1.2 / 1.716
Electrical connections ⁽¹⁾	Power wiring	mm²	2 x 2.5 + T
	Communication wiring	mm²	3 x 0,75 (shielded)
Dimensions (W x H x D)		mm	450 x 795 x 300
Weight		kg	63
Working temperature range	Heating	°C	-20 ~ 30
	DHW	°C	-20 ~ 43

Notes:

⁽¹⁾ Recommended power wiring for L < 20m should be calculated according to the conditions of each installation.

* Recirculation pump not included.

MINI MVD V6R SERIES



OUTDOOR UNITS TECHNICAL SPECIFICATIONS

Model			MVD-V6R252W V2GN1	MVD-V6R280W V2GN1	MVD-V6R335W V2GN1	MVD-V6R400W V2GN1	MVD-V6R450W V2GN1	MVD-V6R500W V2GN1
Code			CL 23 620	CL 23 621	CL 23 622	CL 23 623	CL 23 624	CL 23 625
Power supply			Ph. V. Hz 3N~, 400, 50	3N~, 400, 50	3N~, 400, 50	3N~, 400, 50	3N~, 400, 50	3N~, 400, 50
Cooling ⁽¹⁾	Nominal capacity	kW	22.4	40	33.5	/	45	50
	Nominal rating	kW	5.25	7.15	8.64	9.83	12	13.81
	EER ⁽⁷⁾		4.27	3.9	3.88	4.07	3.75	3.62
	Prated,c (design capacity)	kW	22.4	40	33.5	/	45	50
	SEER		7.73	7.55	7.30	6.70	6.68	6.88
	ηs,c (Seasonal energy efficiency)	%	306	299	289	265	264	272
Heating ⁽²⁾	Nominal capacity / max.	kW	22.4 / 25	28 / 31.5	33.5 / 37.5	40 / 45	45 / 50	50 / 56
	Nominal consumption / max.	kW	3.96 / 4.69	5.46 / 7.12	6.57 / 9.48	8.26 / 9.78	9.78 / 12.26	11.9 / 14.77
	Nominal COP / max.		5.66 / 5.33	5.13 / 4.43	5.1 / 3.95	4.84 / 4.6	4.6 / 4.08	4.2 / 3.79
	Prated,h (design capacity)	kW	22.4	40	33.5	/	45	50
	SCOP		4.18	4.25	4.60	4.35	4.33	4.20
	ηs,h (Seasonal energy efficiency)	%	164	167	181	171	170	165
Tbiv (Bivalent temperature)		°C	-10	-10	-10	-10	-10	-10
Nominal intensity / max.		A	18 / 20	22 / 25	24 / 25	28 / 30	34 / 35	36 / 40
Connectivity	Pluggable capacity ⁽³⁾	%	50 - 200	50 - 200	50 - 200	50 - 200	50 - 200	50 - 200
	Max. quantity of indoor units		64	64	64	64	64	64
Compressor	Brand		Hitachi	Hitachi	Hitachi	Hitachi	Hitachi	Hitachi
	Type		Scroll DC Inverter EVI					
	Number		1	1	1	1	1	1
	Model		AA55PHDG-D1Y2			DC80PHDG-D1Y2		
Fan	Type		DC	DC	DC	DC	DC	DC
	Number		1	1	1	2	2	2
	Flow rate	m³/h	9,000	9,500	10,000	14,000	14,900	15,800
	Static pressure	Standard	Pa	0 - 20	0 - 20	0 - 20	0 - 20	0 - 20
Adjustable		Pa	20/40/60/80	20/40/60/80	20/40/60/80	20/40/60/80	20/40/60/80	20/40/60/80
Sound pressure ⁽⁴⁾		dB(A)	58	58	60	61	64	40
Sound power (LWA) ⁽⁴⁾		dB(A)	78	78	81	85	88	88
Dimensions (W x H x D)		mm	990 x 1635 x 790	990 x 1635 x 790	990 x 1635 x 790	1340 x 1635 x 850	1340 x 1635 x 850	1340 x 1635 x 825
Weight		kg	232	232	232	300	300	300
Refrigerant	Type / PCA		R410A / 2088	R410A / 2088	R410A / 2088	R410A / 2088	R410A / 2088	R410A / 2088
	Number	kg / TCO ₂ eq	8 / 16.7	8 / 16.7	8 / 16.7	10 / 20.88	10 / 20.88	10 / 20.88
Pipe length	Max. vertical	Outdoor unit upward	m	110	110	110	110	110
		Lower outdoor unit	m	110	110	110	110	110
	Total	m	1.000	1.000	1.000	1.000	1.000	1.000
Connection pipes ⁽⁵⁾	Liquid	mm (inches)	12.7 (1/2")	12.7 (1/2")	12.7 (1/2")	15.9 (5/8")	15.9 (5/8")	15.9 (5/8")
	Low pressure gas	mm (inches)	25.4 (1")	25.4 (1")	25.4 (1")	28.6 (1 1/8")	28.6 (1 1/8")	28.6 (1 1/8")
	High pressure gas	mm (inches)	19.1 (3/4")	19.1 (3/4")	19.1 (3/4")	22.2 (7/8")	22.2 (7/8")	22.2 (7/8")
Electrical connections ⁽⁶⁾	Power wiring / ICP	mm²	4x4 + T/20	4x4 + T/25	4x4 + T/25	4x6 + T/32	4x10 + T/40	4x10 + T/50
	Communication wiring	mm²	3 x 0,75 (shielded)	3 x 0,75 (shielded)	3 x 0,75 (shielded)	3 x 0,75 (shielded)	3 x 0,75 (shielded)	3 x 0,75 (shielded)
Working temperature range	VRF indoor units	Cooling only ⁽⁷⁾	°C	-15 ~ 52	-15 ~ 52	-15 ~ 52	-15 ~ 52	-15 ~ 52
		Main cooling ⁽⁷⁾	°C	-15 ~ 27	-15 ~ 27	-15 ~ 27	-15 ~ 27	-15 ~ 27
		Heating only	°C	-25 ~ 19	-25 ~ 19	-25 ~ 19	-25 ~ 19	-25 ~ 19
		Main heating	°C	-15 ~ 19	-15 ~ 19	-15 ~ 19	-15 ~ 19	-15 ~ 19
	Hydrobox indoor units	Heating	°C	-20 - 30	-20 - 30	-20 - 30	-20 - 30	-20 - 30
	SHW	°C	-20 - 43	-20 - 43	-20 - 43	-20 - 43	-20 - 43	

Notes: (1) Nominal cooling conditions : Indoor 27°C DB, 19°C WB and outdoor 35°C DB, 24°C WB for a pipe length of 7.5 m and a height difference of 0 m.

(2) Nominal heating conditions: Indoor 20°C DB, 15°C WB and outdoor 7°C DB, 6°C WB for a pipe length of 7.5 m and a height difference of 0 m.

(3) The connectable capacity may vary according to the type of indoor units used, to obtain the permitted connectivity in each case please refer to the "Connectivity Table".

(4) Sound pressure measured in anechoic chamber at 1m frontal distance and 1.3m height.

(5) The specified diameters are for the service valves, this does not mean that the pipe must have this diameter.

(6) Recommended power wiring for L < 20m should be calculated according to the conditions of each installation.

(7) Cooling mode operation with low outdoor temperature (-15°C ~ to -5°C) is only available for indoor units connected to the MS01 distribution box.

* Data measured under EUROVENT EN 14825 conditions, at 100% simultaneity with high pressure duct-type indoor units.

** Data and specifications can be changed without previous notice.

MINI MVD V6R SERIES



COMBINATIONS

Capacity		Combination	Quantity of ODU's	Max. quantity of IDU's
kW	HP	HP		
22.4	8	8	1	64
40	10	10	1	64
33.5	12	12	1	64
/	14	14	1	64
45	16	16	1	64
50	18	18	1	64
56	20	10+10	2	64
61.5	22	10+12	2	64
68	24	10+14	2	64
73.5	26	12+14	2	64
78.5	40	12+16	2	64
83.5	40	12+18	2	64
90	32	16+16	2	64
95	34	16+18	2	64
100	36	18+18	2	64
107	38	12+12+14	3	64
112	/	12+12+16	3	64
118	42	12+14+16	3	64
123.5	44	12+16+16	3	64
130	46	14+16+16	3	64
135	48	16+16+16	3	64
140	50	16+16+18	3	64
145	52	16+18+18	3	64
150	54	18+18+18	3	64

Note:

- ⁽¹⁾ In systems consisting of several modules, the power wiring and the electrical protections must be recalculated for each module.
- ⁽²⁾ Standard combinations, any other combination is possible (max. 3 units).
- ⁽³⁾ In systems formed by 2 modules, it is necessary to acquire the external unit distributor FQZHW-02SB or if it is formed by 3 modules, the FQZHW-03SB.

MINI MVD V6R SERIES



REFRIGERANT PIPES SELECTION FOR THE MINI MVD V6R SYSTEM

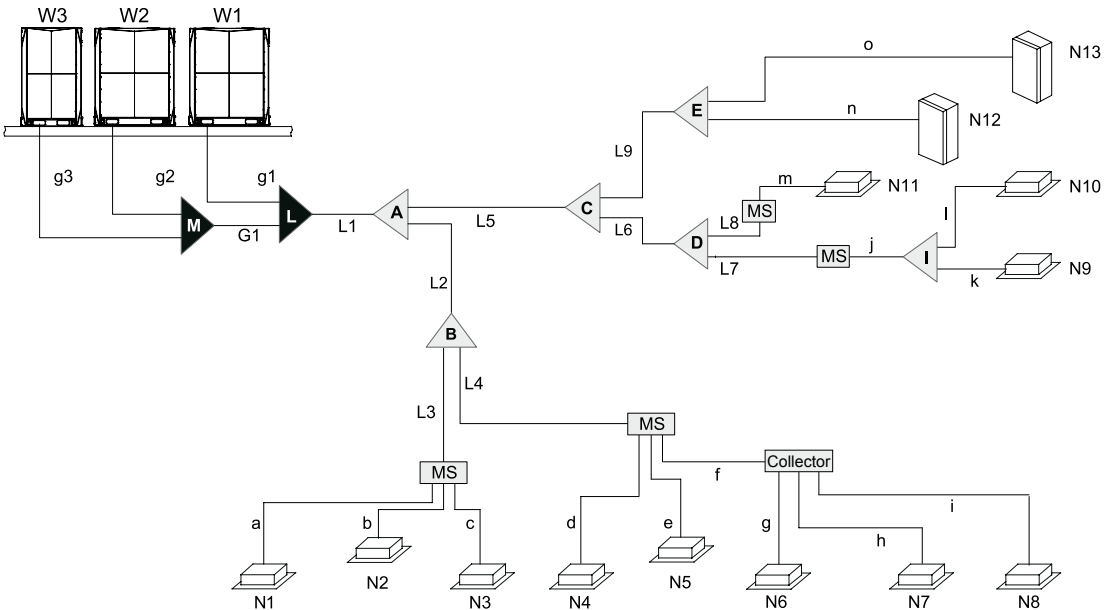

Table 1. LEGEND

Names	Description
g1, g2, g3, G1	Connecting pipes between outdoor units
L, M	Outdoor units distributors
L1	Main pipe
L2~ L9	Secondary pipe
A ~ E	Distributors between the main pipe and the MS boxes or the Hydrobox indoor units
I	Indoor units distributor, between the MS box and the indoor units
a ~ o	Piping between the MS boxes and the indoor units
N1 ~ N11	VRF indoor units
N12, N13	Hydrobox indoor units
W1 ~ W3	Outdoor units

Table 2. MAIN PIPE (L1) AND FIRST DISTRIBUTOR (A) DIAMETERS

Outdoor unit capacity		Main pipe (L1)			
(kW)	(HP)	Liquid	Low pressure gas	High pressure gas	First distributor (A)
22.5	8	9.5 (3/8")	19.1 (3/4")	15.9 (5/8")	FQZHN-02SB
28	10	9.5 (3/8")	22.2 (7/8")	19.1 (3/4")	FQZHN-02SB
33.5	12	12.7 (1/2")	28.6 (1 1/8")	19.1 (3/4")	FQZHN-03SB
40 - 45	14 - 16	12.7 (1/2")	28.6 (1 1/8")	22.2 (7/8")	FQZHN-03SB
50	18	15.9 (5/8")	28.6 (1 1/8")	22.2 (7/8")	FQZHN-03SB
56 - 61.5	20 - 22	15.9 (5/8")	28.6 (1 1/8")	28.6 (1 1/8")	FQZHN-03SB
68	24	15.9 (5/8")	34.9 (1 3/8")	28.6 (1 1/8")	FQZHN-04SB
73.5 - 95	26 - 34	19.1 (3/4")	34.9 (1 3/8")	28.6 (1 1/8")	FQZHN-04SB
100	36	19.1 (3/4")	41.3 (1 5/8")	28.6 (1 1/8")	FQZHN-05SB
107 - 150	38 - 54	19.1 (3/4")	41.3 (1 5/8")	34.9 (1 3/8")	FQZHN-05SB

Notes:

⁽¹⁾ When the pipe length from the outdoor unit to the farthest indoor unit exceeds 90 m, or the difference in height is more than 50 m (higher outdoor unit) or 40 m (lower outdoor unit), the liquid pipe of the main line (L1) must be increased by one diameter.

MINI MVD V6R SERIES



Table 3. PIPE DIAMETERS (L2 ~ L8) AND DISTRIBUTORS (A ~ e)

Capacity (kW)	Pipe (L2 ~ L8)			Distributor (A ~ D)
	Liquid	Low pressure gas	High pressure gas	
A < 16.8	9.5 (3/8")	15.9 (5/8")	12.7 (1/2")	FQZHN-01SB
16.8 ≤ A < 22.4	9.5 (3/8")	19.1 (3/4")	15.9 (5/8")	FQZHN-02SB
22.4 ≤ A < 33	9.5 (3/8")	22.2 (7/8")	19.1 (3/4")	FQZHN-02SB
33 ≤ A < 47	12.7 (1/2")	28.6 (1 1/8")	19.1 (3/4")	FQZHN-03SB
47 ≤ A < 71	15.9 (5/8")	28.6 (1 1/8")	28.6 (1 1/8")	FQZHN-03SB
71 ≤ A < 104	19.1 (3/4")	34.9 (1 3/8")	28.6 (1 1/8")	FQZHN-04SB
104 ≤ A	19.1 (3/4")	41.3 (1 5/8")	28.6 (1 1/8")	FQZHN-05SB

Notes: (1) A = Total capacity (kW) of the VRF indoor units connected downstream from that distributor, not including Hydrobox indoor units.

(2) When there are Hydrobox indoor units, the sizing of the pipes (L9, n, o) must be done according to Table 4.

Table 4. PIPE DIAMETERS (L9, n, o) AND DISTRIBUTORS (E)

Capacity (kW)	Pipe (L9, n, o)		Distributor (E)
	Liquid	Gas	
B < 16.8	9.5 (3/8")	12.7 (1/2")	FQZHN-01SB
16.8 ≤ B < 22.4	9.5 (3/8")	15.9 (5/8")	FQZHN-02SB
22.4 ≤ B < 33	9.5 (3/8")	19.1 (3/4")	FQZHN-02SB
33 ≤ B < 47	12.7 (1/2")	19.1 (3/4")	FQZHN-03SB
47 ≤ B < 71	15.9 (5/8")	28.6 (1 1/8")	FQZHN-03SB
71 ≤ B < 104	19.1 (3/4")	28.6 (1 1/8")	FQZHN-04SB
104 ≤ B	19.1 (3/4")	28.6 (1 1/8")	FQZHN-05SB

Notes: (1) Total Capacity (kW) of Hydrobox indoor units connected downstream from that distributor.

(2) The Hydrobox indoor units should be connected to the main pipe (L1) or to the secondary pipes (L2 ~ L9) but never to a MS box.

Table 5. PIPE DIAMETERS (a ~ m) FOR INDOOR UNITS AND DISTRIBUTOR (I)

Capacity (kW)	Pipe (a ~ m)		Distributor (I)
	Liquid	Gas	
A < 5.6	6.4 (1/4")	12.7 (1/2")	FQZHN-01D
5.6 ≤ A < 16	9.5 (3/8")	15.9 (5/8")	FQZHN-01D
16 ≤ A < 22.4	9.5 (3/8")	19.1 (3/4")	FQZHN-01D
22.4 ≤ A ≤ 28	9.5 (3/8")	22.2 (7/8")	FQZHN-02D

Notes: (1) A = Total capacity (kW) of downstream connected VRF indoor units.

(2) The indoor distributors between the MS box and the indoor units are only necessary if several indoor units are connected to the same MS box outlet.

(3) Indoor units with a capacity of more than 16 kW must be connected to 2 outputs of the MS box via a distributor FWZHN-09A (LC23227). Port combinations should begin with an odd number and the next even number in sequence (i.e.: 1, 2 or 3, 4, etc.). If the MS01 box is being used, downstream indoor units can have a maximum capacity of 32 kW.

Table 6. PIPE DIAMETERS (g1, g2, g3, G1) FOR OUTDOOR UNITS

Amount of outdoor units	Pipe	Outdoor unit capacity (kW)	Pipe (g1, g1, g2, G1)		
			Liquid	Low pressure gas	High pressure gas
2	g1, g2, g3	22.4	9.5 (3/8")	19.1 (3/4")	15.9 (5/8")
		28	9.5 (3/8")	22.2 (7/8")	19.1 (3/4")
		33.5	12.7 (1/2")	28.6 (1 1/8")	19.1 (3/4")
		40 - 455	12.7 (1/2")	28.6 (1 1/8")	22.2 (7/8")
		50	15.9 (5/8")	28.6 (1 1/8")	22.2 (7/8")
3	G1	≤ 68	15.9 (5/8")	34.9 (1 3/8")	28.6 (1 1/8")
		73.5 - 95	19.1 (3/4")	34.9 (1 3/8")	28.6 (1 1/8")
		100	19.1 (3/4")	41.3 (1 5/8")	28.6 (1 1/8")
		≥ 107	19.1 (3/4")	41.3 (1 5/8")	34.9 (1 3/8")

Table 7. DISTRIBUTORS (M, L) FOR OUTDOOR UNITS

Amount of outdoor units	Branch Pipe	Distributor model
2	L	FQZHW-02SB
3	L + M	FQZHW-03SB

Note: *When a pipe diameter is not available for sale, the pipe can be increased by one diameter.