

EFFBE Elastomer Springs and Component Parts

Permanently elastic, unbreakable,
customer-specific

Design information, product range
www.effbe.de

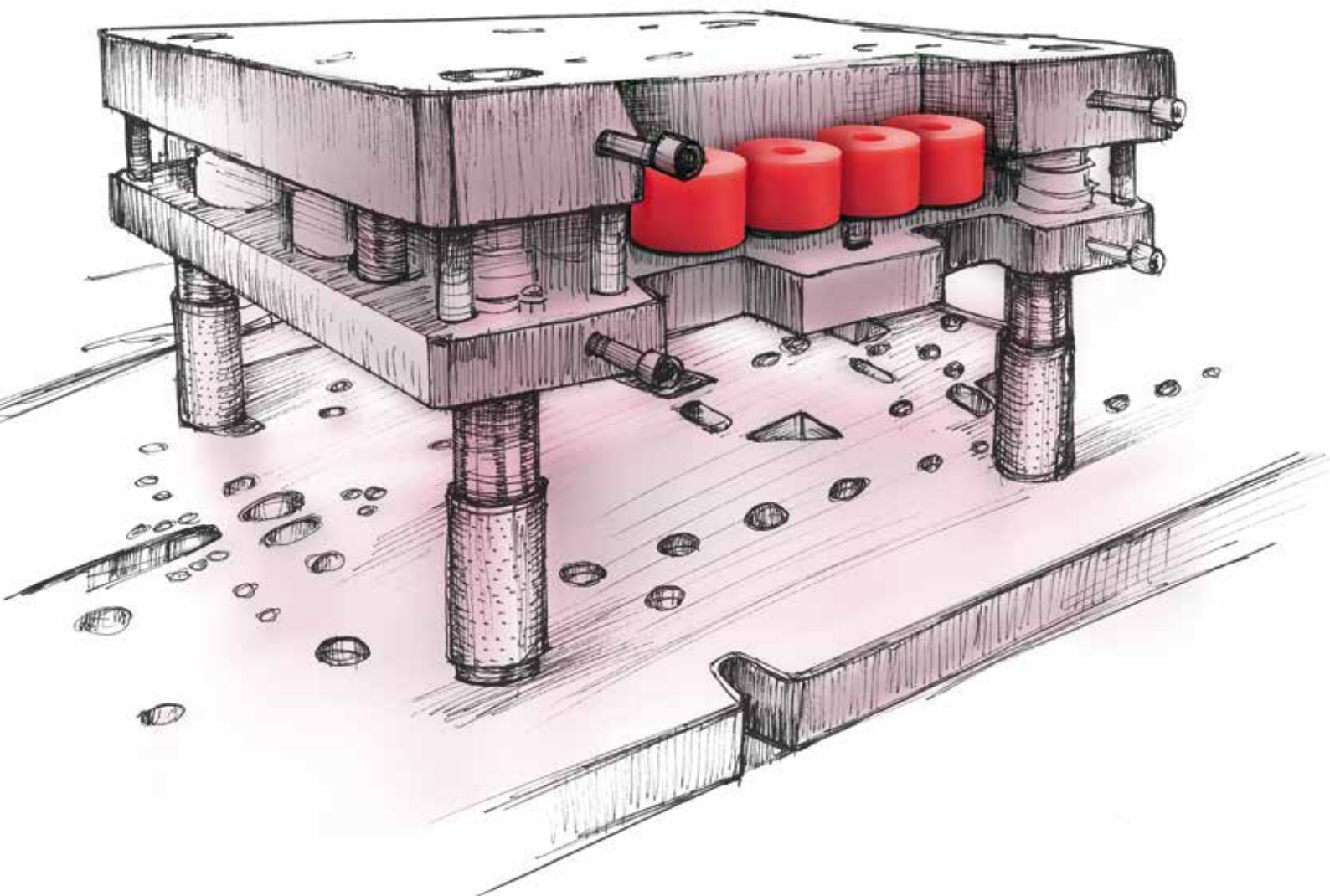

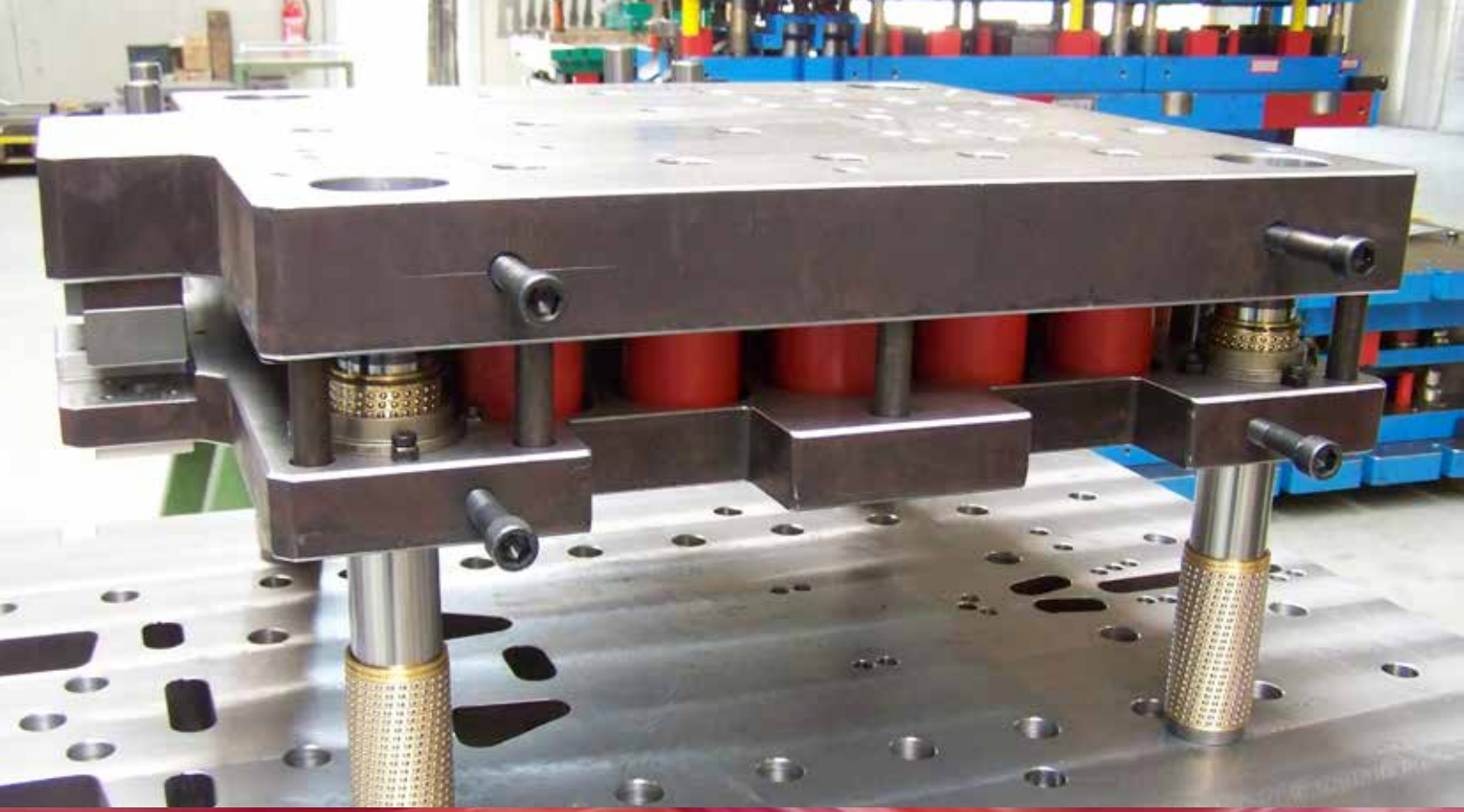

EFFBE elastomer springs and component parts have long been synonymous with quality

Extremely long service life, defined spring characteristics after long use, oil resistance, abrasion resistance, high elongation at break and additional features characterize these high-quality EFFBE elastomer materials. Above all, the breakage resistance and material damping are the special advantages over steel springs. The possibility of tool damage due to fatigued, broken steel springs is excluded.

Our engineers and designers in Development and Production solve your varied spring and damping problems. Modern work methods and knowledge of customer-specific requirements supplement the experience gained in applications and process engineering of elastomers for optimal use of the spring qualities EFFBE 295 and EFFBE Urelast.

Extensive measurement methods and testing measures for EFFBE elastomer springs assure uniform high quality standards. This product performance is the basis of long-term customer confidence and partnership. Our engineers have played an important role in the DIN standardization and ISO standards.

Solving your problem is the central focus of our work, whether with series production parts or component parts designed especially for you.

Our know-how and service, expert consulting and flexibility, as well as the direct contact with our customers are performance characteristics that we fulfill every day.

Contents

Material properties	4
Design information	6
<hr/>	
Elastomer Springs	9
Stock List	9
EFFBE 295 CR, 70 Shore A	10
EFFBE UN 80, 80 Shore A	11
EFFBE U 90, 92 Shore A	12
<hr/>	
Standardized Parts	13
Guide Bolts and Spring Collars	13
Load Relief Elements	14
Ejectors/Strippers	16
<hr/>	
Semi-Finished Products	17
Stripper Bars	17
Hollow Bars and Solid Bars	18
Sheets	19
Component Parts	20
<hr/>	
Processing Information	21
Forming with Elastomers	22
Areas of Application	23

The information in this brochure is the result of extensive product and application experience. It does not constitute a description or identification of assured properties. Subject to technical changes in the course of product development.



Material properties

Product description

In their physical properties and through their geometric dimensions, EFFBE spring elements and component parts meet a defined spring behavior through selected elastomers.

Elastomer compression springs are standardized in DIN ISO 10069-1. Our qualities EFFBE 295 and EFFBE Urelast exceed these standards in many cases.

For the production of EFFBE spring elements, three different elastomer types are offered, in accordance with application criteria.

- **EFFBE 295 CR** – spring quality on the basis of chloroprene-rubber (CR), 70 Shore A, in accordance with the specifications of DIN ISO 10069-1.
- **EFFBE Urelast UN 80** – tempered polyurethane rubber 80 Shore A.
- **EFFBE Urelast U 90** – tempered polyurethane rubber, highly resistant to dynamic load, 92 Shore A, in accordance with the specifications of DIN ISO 10069-1.

With these qualities, the limits relative to degree of deformation, spring stroke, load absorption and temperature are optimally matched.

The essential Material properties

	Unit	EFFBE 295	EFFBE Urelast	
		Chloroprene rubber CR 70 / DIN ISO 10069-1	Polyurethane rubber UN 80	Polyurethane rubber U 90 / DIN ISO 10069-1
Color		Black	Natural	Red
Hardness in accordance with DIN ISO 7619 *	Shore A	70	80	92
Tensile strength in accordance with DIN 53 504	N / mm ²	≥ 12	≤ 50	≤ 40
Elongation at break in accordance with DIN 53 504	%	≥ 250	≥ 640	≥ 550
Tear propagation resistance in acc. with DIN ISO 34-1	N / mm	4	≤ 50	≤ 50
Rebound resilience in accordance with DIN 53 512	%	30	48	43
Abrasion in accordance with DIN ISO 4649	mm ³	≤ 150	≥ 40	≤ 40
Compression set in accordance with DIN ISO 815-1	%	≤ 20	≤ 30	≤ 30
Bulk density in accordance with DIN EN ISO 1183	g / cm ³	1.37	1.24	1.27
Temperature application area	°C	–20°C to +80°C Briefly from –40°C to +120°C	–20°C to +80°C Briefly from –40°C to +120°C	–20°C to +80°C Briefly from –40°C to +120°C
Resistant to				
Oil (lubricating oil)		0	+	+
Grease		0	+	+
Alcohol		+	+	+
Benzene		0	+	+
Water		+	– ¹⁾	– ¹⁾
Humidity		+	– ¹⁾	– ¹⁾
Ozone		+	+	+
Alkaline solutions		0	–	–
Acids		0 / –	–	–

+ = good, 0 = adequate, – = conditionally, use must be checked relative to duration, temperature and/or concentration.

* Shore hardness measured on the test sheet in accordance with DIN ISO 7619.

¹⁾ Hydrolysis-resistant material on request.

Material properties

Service life

If the design criteria are complied with more than 2×10^6 load changes are possible.

Other advantages

- Progressive characteristic curve and high load absorption, no danger of "bottoming out" as is the case with steel springs.
- Excellent operational reliability through emergency running characteristics, consequently there is no tool damage at overload.
- Complete freedom from maintenance offers profitability in continuous operation.
- Structure-borne noise insulation and shock absorption, airborne noise reduction, abrupt excitations quickly subside.
- Favorable price-performance ratio compared to other spring systems.

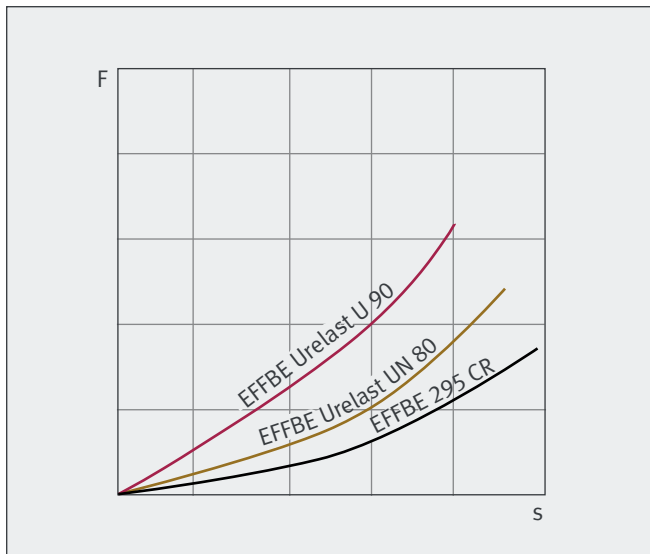

Diagram 1

Temperature resistance

The operating temperature range is between -20°C and $+80^{\circ}\text{C}$; short-term temperatures -40°C and $+120^{\circ}\text{C}$ are possible. The determining factors are self-warming and ambient temperature.

Diagram 2 shows the elastic behavior depending on temperature. The spring characteristic is determined by the temperature-dependent modulus of elasticity, by the geometric shape and the type and size of deformation.

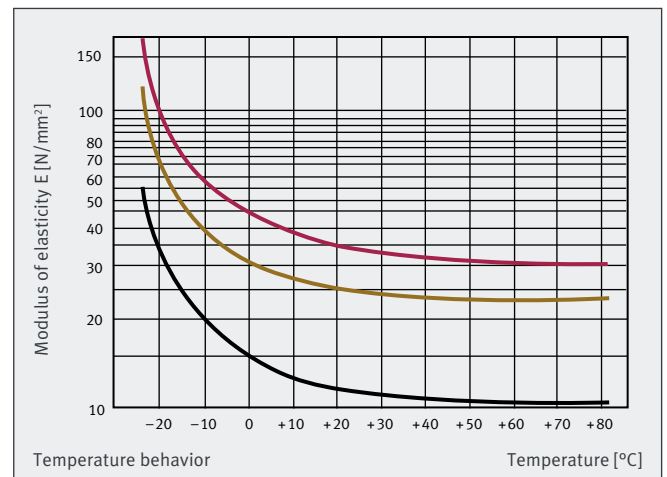

Diagram 2



Design information

Spring stroke (s)

The values of the table apply (see Diagram 6, page 7) as maximum spring stroke based on the original spring height (l) of the spring, dependent on the stroke rate.

EFFBE elastomer springs	EFFBE 295	EFFBE Urelast	
	Chloroprene rubber CR 70	Polyurethane rubber UN 80	Polyurethane rubber U 90
Spring deflection (s) max.	40%	35%	30%
Bottoming tendency (s_b) from original height	3 - 5%	5 - 7%	5 - 8%

Settling distance (s_s)

In addition to the type of deformation, its size and the temperature, the spring material determines the settling distance. The information is based on values recorded in practice that are reached in dynamic application after 10^3 load changes at 90% (see Diagram 4).

The initial drop in force can be compensated through an increase in the force specification by F_v . At high dynamic stress the practical increase values for quality are:

- **EFFBE 295 CR 70** by approx. 10%
(factor 1.1, i.e. nominal load x 1.1)
- **EFFBE Urelast UN 80** by approx. 20%
(factor 1.2, i.e. nominal load x 1.2)
- **EFFBE Urelast U 90** by approx. 30%
(factor 1.3, i.e. nominal load x 1.3)

Preload (s_v)

The preload deflection must be selected greater than the settling distance (see Diagram 3) due to the bottoming tendency and to ensure positive-locking spring application.

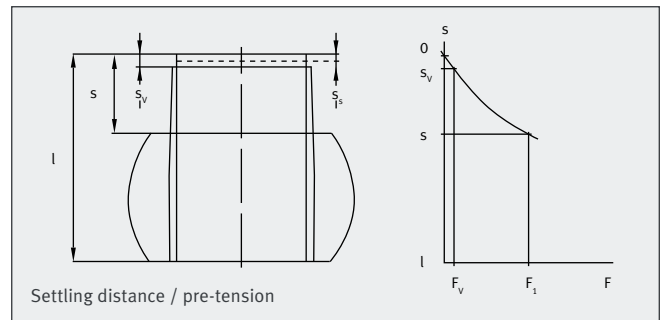

Diagram 3

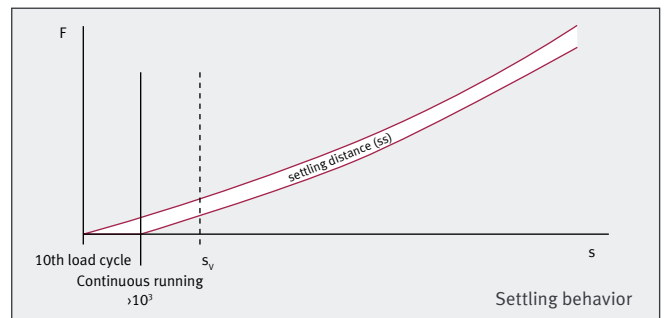

Diagram 4

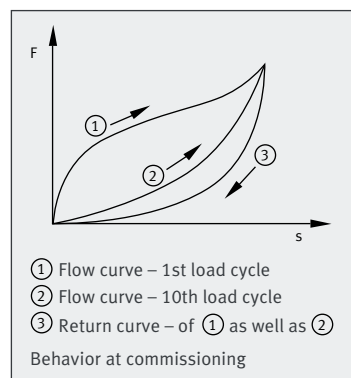

Diagram 5



Design information

Stroke rate

For dynamic continuous use, the stroke rate in conjunction with the deformation must always be considered. If the limit values are underranged the service life increases due to lower self-warming (see Diagram 6).

Tolerances

Dimensional tolerances in accordance with DIN ISO 3302-1 M3 apply at a reference temperature of +20°C.

Hardness tolerances in accordance with DIN ISO 10069-1 apply with the tolerance range of ± 3 Shore A.

Commissioning

Prior to the final dynamic stress, the springs should be loaded and unloaded several times (up to 10 times, Diagram 5). All subsequent diagrams present the 10th load change of quasi-static deformation. They correspond to DIN ISO 10069-1.

Tolerance table

Permissible dimensional deviations in accordance with DIN ISO 3302-1 M3

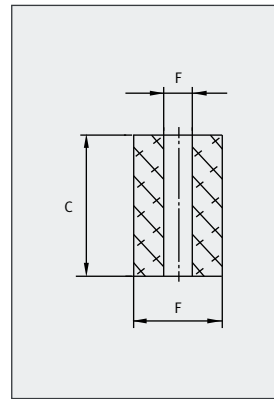

Nominal dimension range mm	Permissible dimensional deviation	
	F ± mm	C ± mm
To 6.3	0.25	0.4
Greater than 6.3 to 10	0.3	0.5
Greater than 10 to 16	0.4	0.6
Greater than 16 to 25	0.5	0.8
Greater than 25 to 40	0.6	1.0
Greater than 40 to 63	0.8	1.3
Greater than 63 to 100	1.0	1.6
Greater than 100 to 160	1.3	2.0
Greater than 160	0.8%	1.3%

F = fixed dimension
C = closure dimension

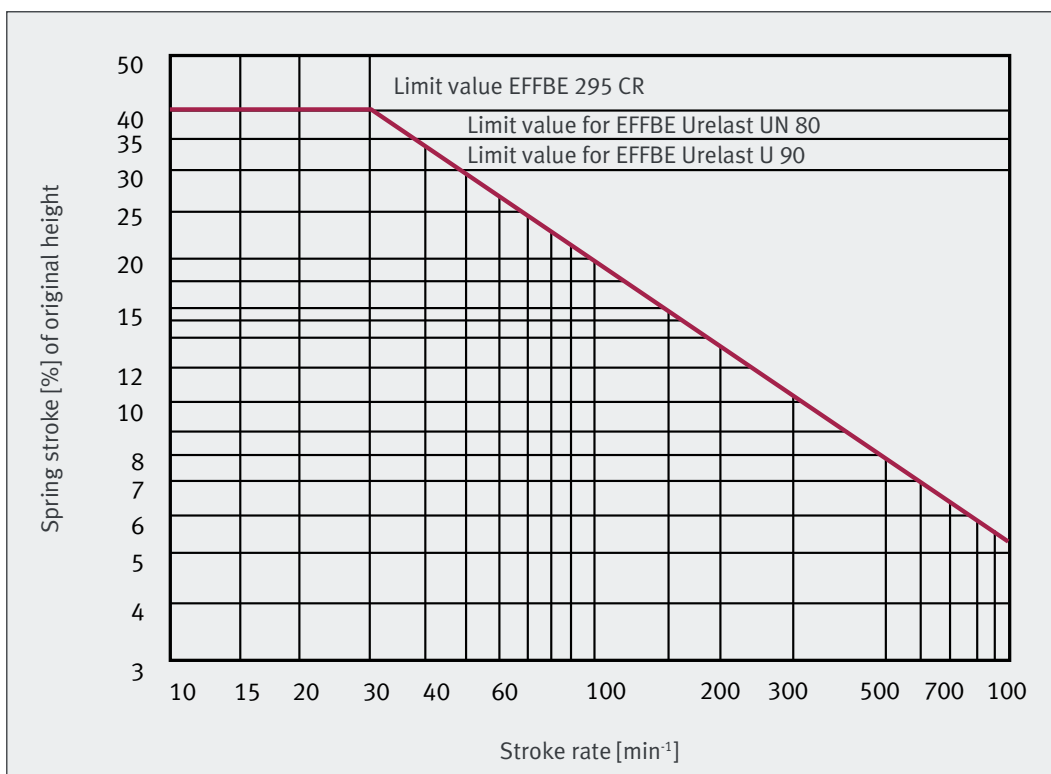

Diagram 6

Design information

Installation information

Elastomer springs can be used in single, parallel or row arrangement. Their force-distance behavior corresponds to the familiar laws governing spring behavior. For optimum application of elastomer springs, the following installation information must be complied with:

Space requirements

EFFBE elastomer materials are incompressible. Consequently, for installation dimensions, clearances, such as distances for the bulging out of the springs must be taken into account. The crucial factor is the spring stroke; simplified, the bulging percentage equals the compression percentage. A safety margin must also be provided (see Diagram 7).

Contact faces

The contact faces of the spring should be R_2 25 to R_2 40 in accordance with DIN ISO 10069-1. They can be flat, elevated or in a recess. When mounted at a raised level, the diameter must at least equal the dimension of the spring collar (see page 13). If mounted in a recess, the clearance must be adapted to the bulge factor (see Diagram 7).

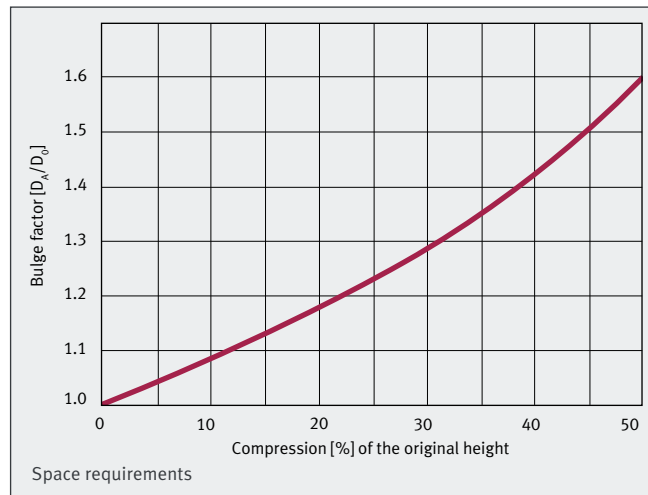

Diagram 7

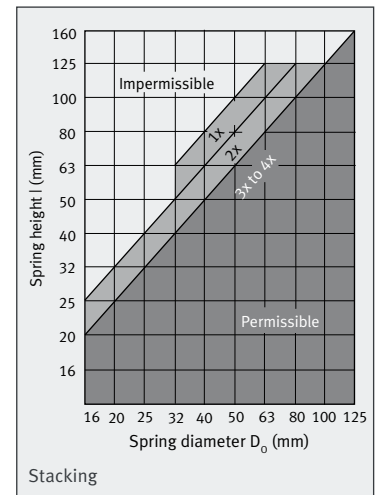

Diagram 8

Guidance

Guidance and centering of the springs is ideally achieved with Guide bolts (DIN ISO 10069-1). They are required for unfavorable spring geometry and in order to avoid buckling of the spring stacks (see page 13).

Stacking

For greater spring strokes, elastomer springs are stacked in rows; in this regard the geometry must be complied with (see Diagram 8). The individual springs must be separated from each other by spring washers. At equal spring forces, the individual spring strokes are added together. The spring stacks must always be guided (see page 13).

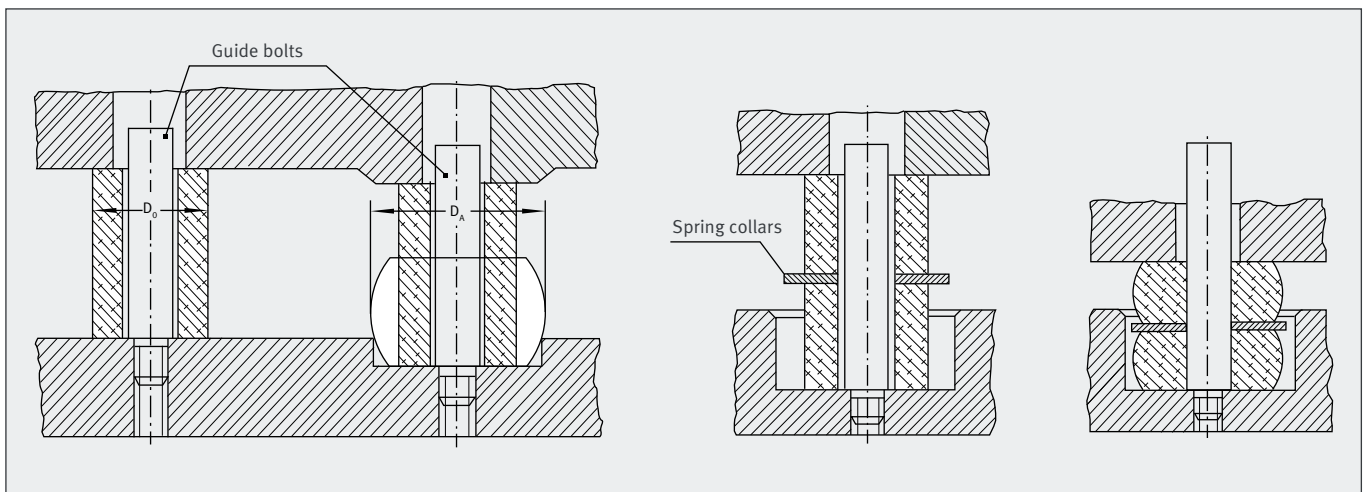

Elastomer Springs

Stock list

D	d	l	EFFBE 295 CR 70, DIN ISO 10069-1 Designation	Part no.	EFFBE Urelast UN 80 Designation	Part no.	EFFBE Urelast U 90, DIN ISO 10069-1 Designation	Part no.
16	6.5	12	1612 CR	FB70016120	1612 UN 80	FB72016128	1612 U 90	FB72016120
16	6.5	16	1616 CR	FB70016160	1616 UN 80	FB72016168	1616 U 90	FB72016160
16	6.5	20	1620 CR	FB70016200	1620 UN 80	FB72016208	1620 U 90	FB72016200
16	6.5	25	1625 CR	FB70016250	1625 UN 80	FB72016258	1625 U 90	FB72016250
20	8.5	16	2016 CR	FB70020160	2016 UN 80	FB72020168	2016 U 90	FB72020160
20	8.5	20	2020 CR	FB70020200	2020 UN 80	FB72020208	2020 U 90	FB72020200
20	8.5	25	2025 CR	FB70020250	2025 UN 80	FB72020258	2025 U 90	FB72020250
20	8.5	32	2032 CR	FB70020320	2032 UN 80	FB72020328	2032 U 90	FB72020320
25	10.5	20	2520 CR	FB70025200	2520 UN 80	FB72025208	2520 U 90	FB72025200
25	10.5	25	2525 CR	FB70025250	2525 UN 80	FB72025258	2525 U 90	FB72025250
25	10.5	32	2532 CR	FB70025320	2532 UN 80	FB72025328	2532 U 90	FB72025320
25	10.5	40	2540 CR	FB70025400	2540 UN 80	FB72025408	2540 U 90	FB72025400
32	13.5	32	3232 CR	FB70032320	3232 UN 80	FB72032328	3232 U 90	FB72032320
32	13.5	40	3240 CR	FB70032400	3240 UN 80	FB72032408	3240 U 90	FB72032400
32	13.5	50	3250 CR	FB70032500	3250 UN 80	FB72032508	3250 U 90	FB72032500
32	13.5	63	3263 CR	FB70032630	3263 UN 80	FB72032638	3263 U 90	FB72032630
40	13.5	32	4032 CR	FB70040320	4032 UN 80	FB72040328	4032 U 90	FB72040320
40	13.5	40	4040 CR	FB70040400	4040 UN 80	FB72040408	4040 U 90	FB72040400
40	13.5	50	4050 CR	FB70040500	4050 UN 80	FB72040508	4050 U 90	FB72040500
40	13.5	63	4063 CR	FB70040630	4063 UN 80	FB72040638	4063 U 90	FB72040630
40	13.5	80	4080 CR	FB70040800	4080 UN 80	FB72040808	4080 U 90	FB72040800
50	17	32	5032 CR	FB70050320	5032 UN 80	FB72050328	5032 U 90	FB72050320
50	17	40	5040 CR	FB70050400	5040 UN 80	FB72050408	5040 U 90	FB72050400
50	17	50	5050 CR	FB70050500	5050 UN 80	FB72050508	5050 U 90	FB72050500
50	17	63	5063 CR	FB70050630	5063 UN 80	FB72050638	5063 U 90	FB72050630
50	17	80	5080 CR	FB70050800	5080 UN 80	FB72050808	5080 U 90	FB72050800
50	17	100	50100 CR	FB70050100	50100 UN 80	FB72050108	50100 U 90	FB72050100
63	17	32	6332 CR	FB70063320	6332 UN 80	FB72063328	6332 U 90	FB72063320
63	17	40	6340 CR	FB70063400	6340 UN 80	FB72063408	6340 U 90	FB72063400
63	17	50	6350 CR	FB70063500	6350 UN 80	FB72063508	6350 U 90	FB72063500
63	17	63	6363 CR	FB70063630	6363 UN 80	FB72063638	6363 U 90	FB72063630
63	17	80	6380 CR	FB70063800	6380 UN 80	FB72063808	6380 U 90	FB72063800
63	17	100	63100 CR	FB70063100	63100 UN 80	FB72063108	63100 U 90	FB72063100
63	17	125	63125 CR	FB70063125	63125 UN 80	FB72063128	63125 U 90	FB72063125
80	21	32	8032 CR	FB70080320	8032 UN 80	FB72080328	8032 U 90	FB72080320
80	21	40	8040 CR	FB70080400	8040 UN 80	FB72080408	8040 U 90	FB72080400
80	21	50	8050 CR	FB70080500	8050 UN 80	FB72080508	8050 U 90	FB72080500
80	21	63	8063 CR	FB70080630	8063 UN 80	FB72080638	8063 U 90	FB72080630
80	21	80	8080 CR	FB70080800	8080 UN 80	FB72080808	8080 U 90	FB72080800
80	21	100	80100 CR	FB70080100	80100 UN 80	FB72080108	80100 U 90	FB72080100
80	21	125	80125 CR	FB70080125	80125 UN 80	FB72080128	80125 U 90	FB72080125
100	21	32	10032 CR	FB70100320	10032 UN 80	FB72100328	10032 U 90	FB72100320
100	21	40	10040 CR	FB70100400	10040 UN 80	FB72100408	10040 U 90	FB72100400
100	21	50	10050 CR	FB70100500	10050 UN 80	FB72100508	10050 U 90	FB72100500
100	21	63	10063 CR	FB70100630	10063 UN 80	FB72100638	10063 U 90	FB72100630
100	21	80	10080 CR	FB70100800	10080 UN 80	FB72100808	10080 U 90	FB72100800
100	21	100	100100 CR	FB70100100	100100 UN 80	FB72100108	100100 U 90	FB72100100
100	21	125	100125 CR	FB70100125	100125 UN 80	FB72100128	100125 U 90	FB72100125
125	27	32	12532 CR	FB70125320	12532 UN 80	FB72125328	12532 U 90	FB72125320
125	27	40	12540 CR	FB70125400	12540 UN 80	FB72125408	12540 U 90	FB72125400
125	27	50	12550 CR	FB70125500	12550 UN 80	FB72125508	12550 U 90	FB72125500
125	27	63	12563 CR	FB70125630	12563 UN 80	FB72125638	12563 U 90	FB72125630
125	27	80	12580 CR	FB70125800	12580 UN 80	FB72125808	12580 U 90	FB72125800
125	27	100	125100 CR	FB70125100	125100 UN 80	FB72125108	125100 U 90	FB72125100
125	27	125	125125 CR	FB70125125	125125 UN 80	FB72125128	125125 U 90	FB72125125
125	27	160	125160 CR	FB70125160	125160 UN 80	FB72125168	125160 U 90	FB72125160

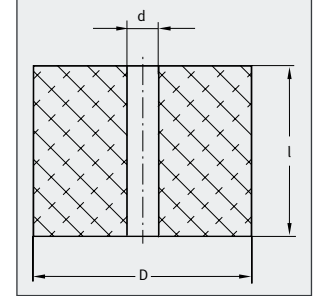

The quality UN 80 is not available from stock, delivery time on request.

Non-standard spring dimensions (with or without center bore) are available on request.

Elastomer Springs

EFFBE 295 CR, 70 Shore A
DIN ISO 10069-1

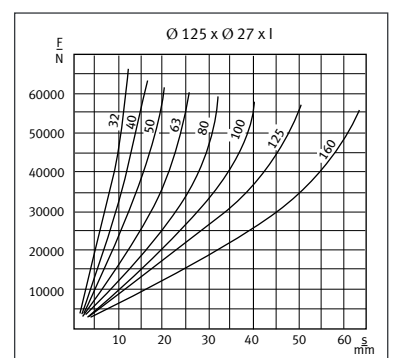
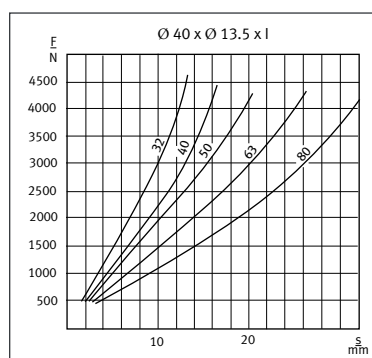
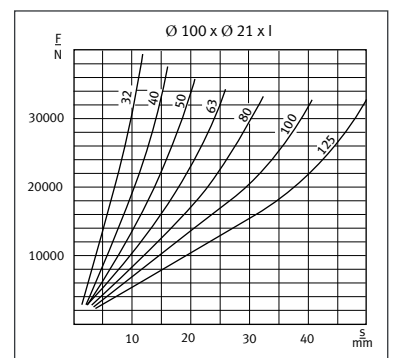
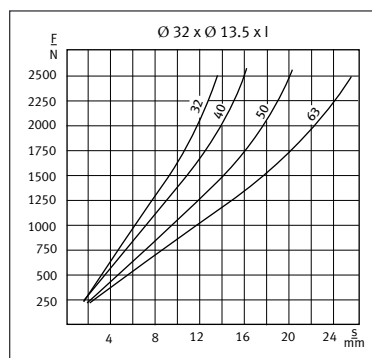
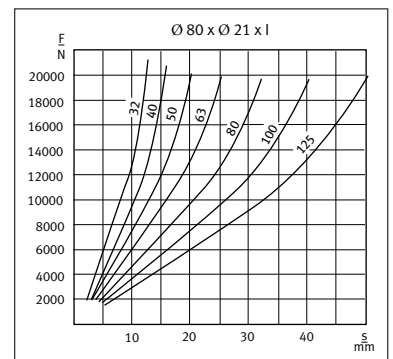
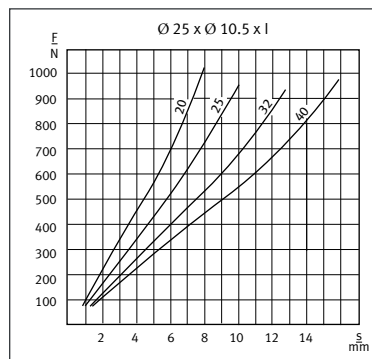
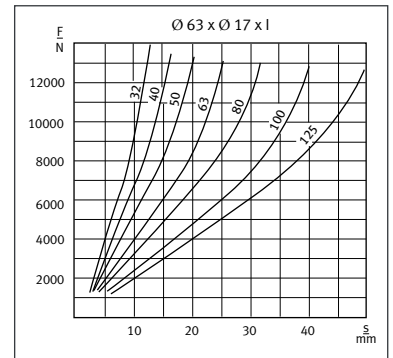
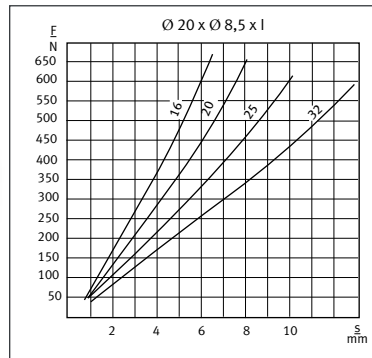
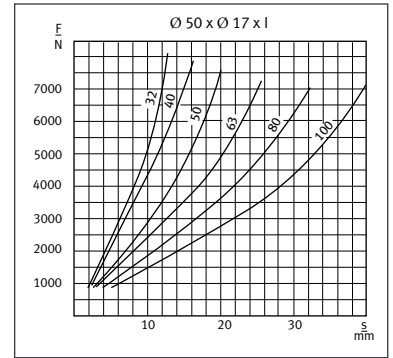
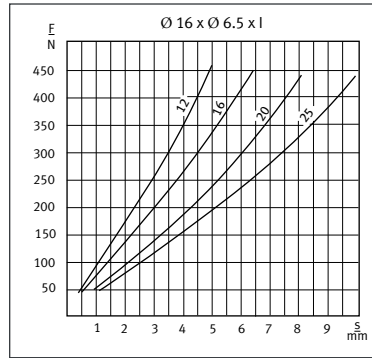

Elastomer Springs

EFFBE UN 80, 80 Shore A
Dimensions correspond to
DIN ISO 10069-1

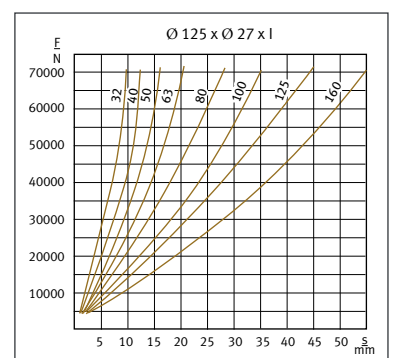
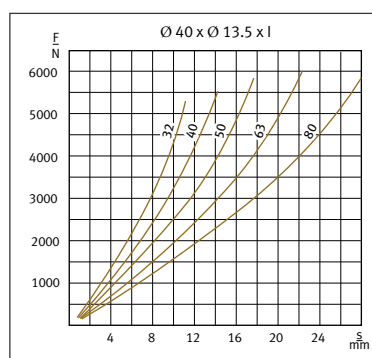
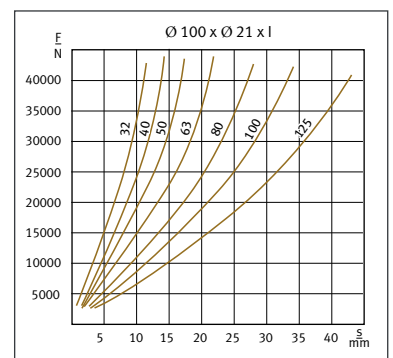
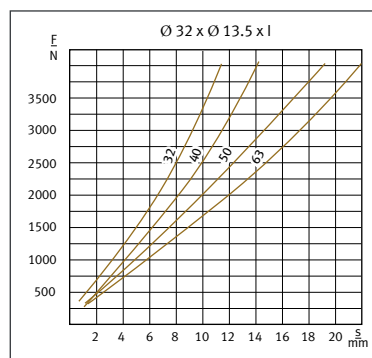
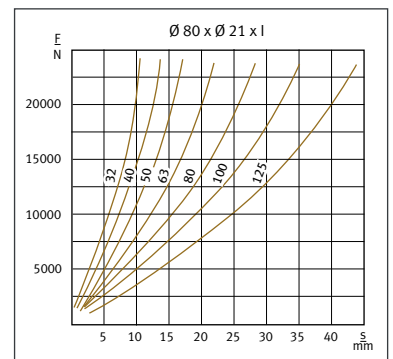
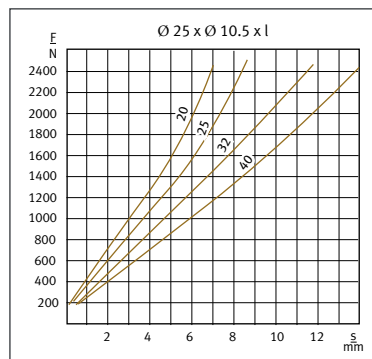
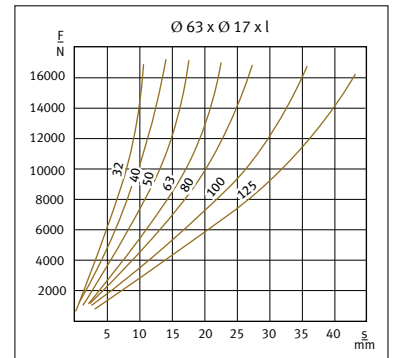
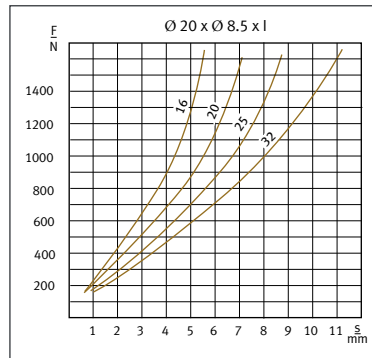
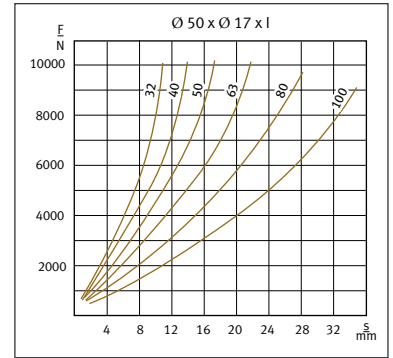
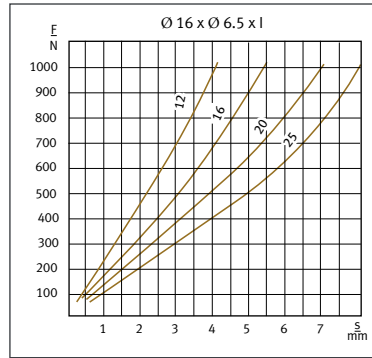
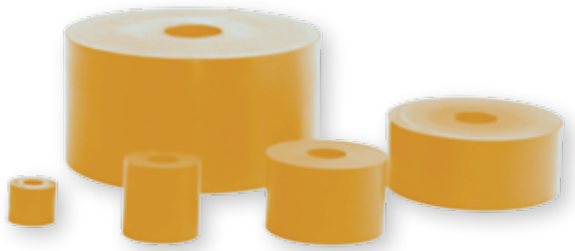

Elastomer Springs

EFFBE U 90, 92 Shore A
DIN ISO 10069-1

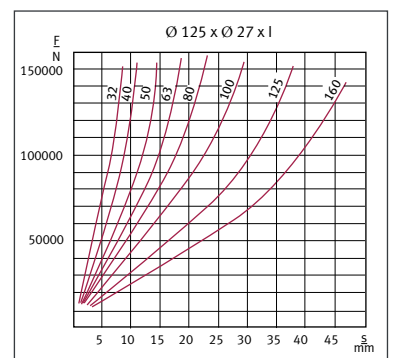
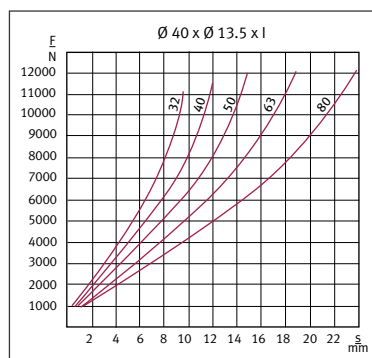
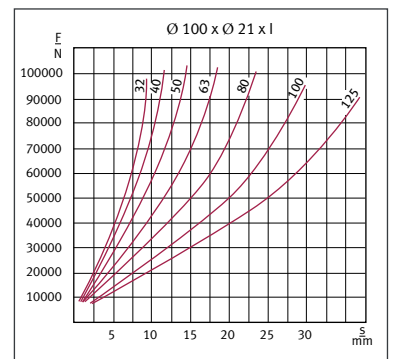
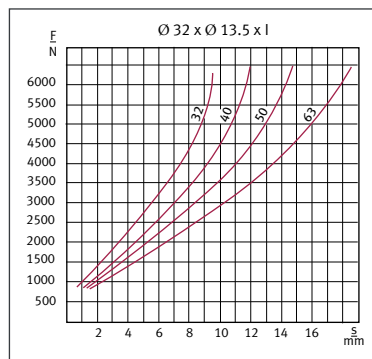
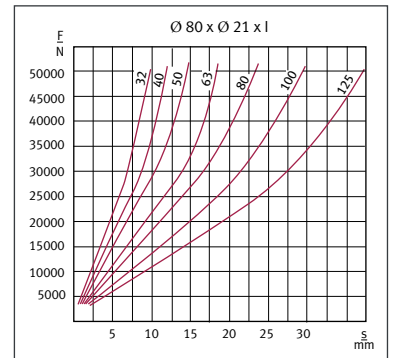
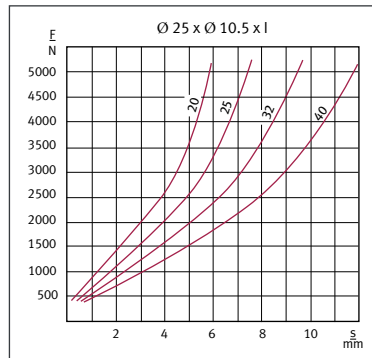
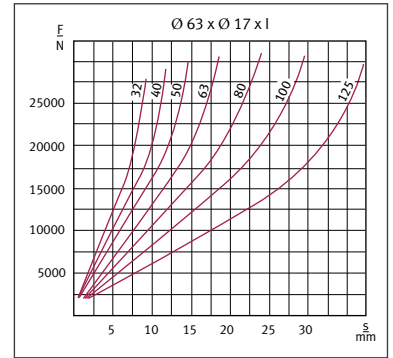
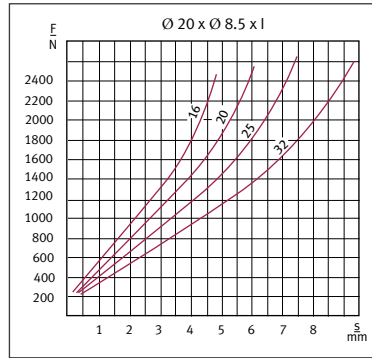
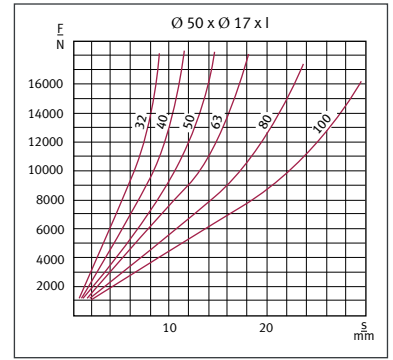
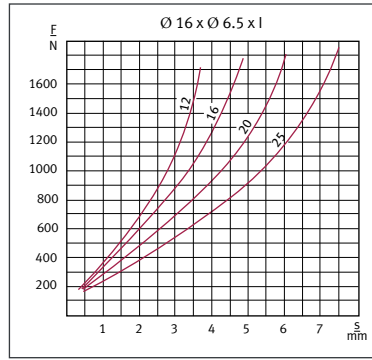

Guide Bolts and Spring Collars



Table and stock list – Guide bolts (DIN ISO 10069-2, Form B)

	Designation						
	B 6xl	B 8xl	B 10xl	B 13xl	B 16xl	B 20xl	B 25xl
Nominal \varnothing d_1 h_{11}	6	8	10	13	16	20	25
d_2	M 4	M 6	M 8	M 10	M 12	M 16	M 20
l_1	6	9	15	15	18	25	30
SW	3	4	5	6	8	10	14
t	2.5	3	4	5	6	8	10
Length l	Stock sizes (subject to change)						
20	FB76062000	FB76082000	FB76102000				
25	FB76062500	FB76082500	FB76102500				
32	FB76063200	FB76083200	FB76103200	FB76133200	FB76163200	FB76203200	FB76253200
40	FB76064000	FB76084000	FB76104000	FB76134000	FB76164000	FB76204000	FB76254000
50		FB76085000	FB76105000	FB76135000	FB76165000	FB76205000	FB76255000
63			FB76106300	FB76136300	FB76166300	FB76206300	FB76256300
80				FB76138000	FB76168000	FB76208000	FB76258000
95				FB76139500	FB76169500	FB76209500	FB76259500
118					FB76161180	FB76201180	FB76251180
140					FB76161400	FB76201400	FB76251400
180							FB76251800

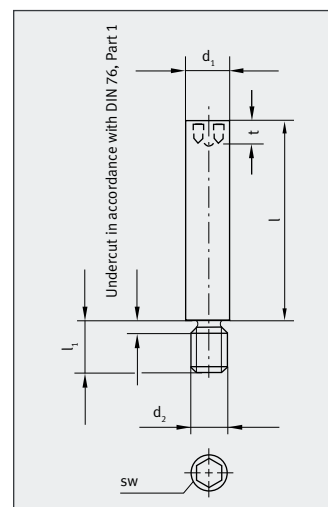
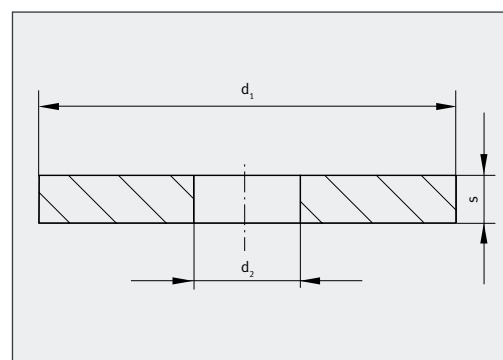

Table and stock list – spring collars (DIN ISO 10069-2, Form A)

	Designation									
	A 20	A 25	A 30	A 40	A 50	A 60	A 80	A 100	A 120	A 150
For springs	\varnothing 16	\varnothing 20	\varnothing 25	\varnothing 32	\varnothing 40	\varnothing 50	\varnothing 63	\varnothing 80	\varnothing 100	\varnothing 125
d_1	20	25	30	40	50	60	80	100	120	150
d_2	6.5	8.5	10.5	13.5	13.5	16.5	16.5	20.5	20.5	26
s	4	4	5	5	5	6	6	8	8	8
Part no.	FB76002010	FB76002510	FB76003010	FB76004010	FB76005010	FB76006010	FB76008010	FB76010010	FB76012010	FB76015010



EFFBE Load Relief Elements

EFFBE Urelast U 90 (92 Shore A)

EFFBE Urelast round springs are available in various sizes to enable damage-free storage and efficient setup of tools. They replace support bolts (shear bolts) and considerably reduce setup times.

Due to their permanent elasticity they can remain permanently in the tool. Installing and removing for setup or storage is dispensed with.

To prevent damage when storing the tool, support springs must be capable of supporting at least the weight of the upper part of the tool. If stacking is intended, the additional tool weight must be taken into account.

The installation of support springs can occur either with Guide bolts in accordance with DIN ISO 10069-2 (see page 13) or with a workholding bolts (see page 15).

Urelast spring with workholding bolts (cpl.), type M

D	D ₁	H	F _{max} (kN)	s _{max}	Part no.
63	12.5	75	16	20	FB73563750
80	12.5	75	28	20	FB73580750
100	12.5	75	40	20	FB73510750
125	12.5	75	68.5	20	FB73512750
140	12.5	75	123	20	FB73514750

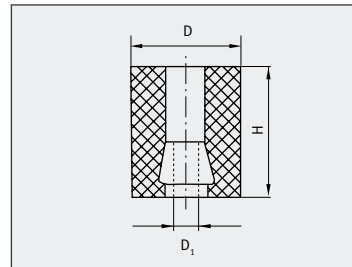

Damping washers type VN

D	D ₁	H	F _{max} (kN)	s _{max}	Part no.
34	17	8	0.5	3	FB73100341
47	21	8	1	3	FB73100471
55	32.5	15	1.1	3	FB73100551
58	50.2	10	4.5	3	FB73100581

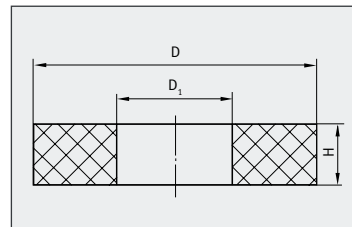

Round springs

D	D ₁	H	F _{max} (kN)	s _{max}	Part no.
63	17	105	40	31	FB73500630
80	21	105	65	31	FB73500800
100	21	105	100	31	FB73501000
125	27	105	140	31	FB73501250
140	27	105	200	31	FB73501400

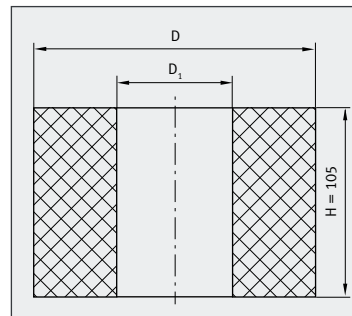

Workholding bolt, type ST

D	H	G	For spring bore Ø	Part no.
28	38	M 12	17	FB99000002
32	50	M 16	21	FB99000001
38	70	M 20	27	FB99000003

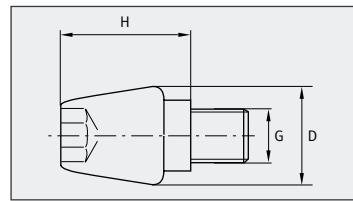

Workholding bolt, type B

D	D1	H	For spring bore Ø	Part no.
28	11	50	17	FB99000280
32	13.5	50	21	FB99000321
38	17.5	50	27	FB99000380

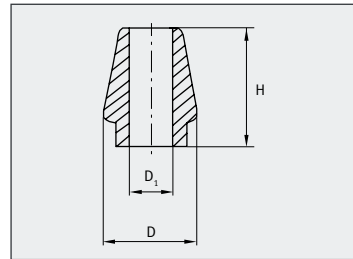

Workholding bolt, type N/H

D	H	G	For spring bore Ø	Part no.
16	35	M 10	13.5	FB05022469
16	47	M 10	13.5	FB05022470
20	38	M 12	17	FB05022471
20	50	M 12	17	FB05022472

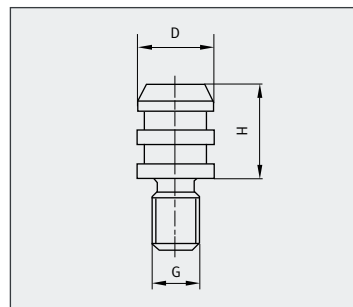

Damping pistons, EFFBE Urelast U 90 (92 Shore A)

D	l	Type	Designation	Part no.
25	50	ST	089.1	FB75208910
32	60	ST	089.2	FB75208920
40	60	ST	089.3	FB75208930
50	80	ST	089.4	FB75208940
63	80	ST	089.5	FB75208950
80	90	ST	089.6	FB75208960
40	60	M	81-40	FB75140600
50	80	M	81-50	FB75150800
63	80	M	81-63	FB75163800



Type M

EFFBE Ejectors and Strippers

Advantages of ejectors and self-adhesive strippers for punches with pressfit

- Punched part surface is not damaged
- High operating force at small installation dimensions
- Reduced noise level
- Long service life due to high resistance to abrasion

Use of EFFBE Urelast ejector pins

EFFBE Urelast ejector pins are used with preference in punching, drawing, and embossing tools for lifting off and ejecting the sheet metal parts.

Designation	D	H	h	d	r	D _L	t	F (N) max.	Part no.
80-06	06	9.5	4.5	3.6	–	6	8	100	FB74008006
80-10	10	15.5	7.5	6	1	10	13	450	FB74008010
80-16	16	25	12	9.5	1.5	16	21	1500	FB74008016
80-24	24	25	10	18	2	24	21	3000	FB74008024
80-30	30	35	19	20	2.5	30	30	3000	FB74008030
80-32	32	32	14	24	3	32	26	12000	FB74008032
80-40	39.5	40	16	30	3	39.5	34	25000	FB74008039

Installation

To accommodate ejector pins, a blind hole suffices; the contour (venting groove) facilitates press-in.

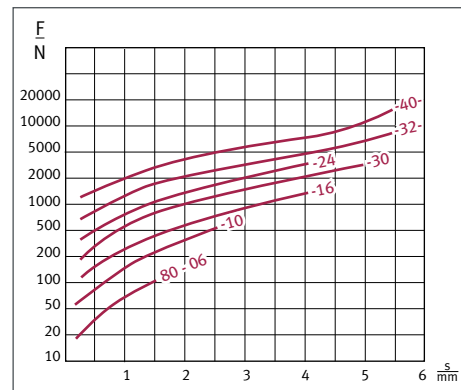
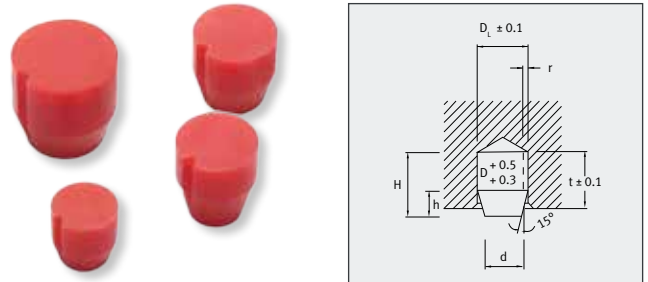

Diagram 9

When used with strippers

- Increased resistance to kinking of the punch
- No pull-in of the sheet metal element thanks to play-free seat on the punch

The strippers fit off-the-shelf punch shanks and punch retainers. The self-cut punch contour on the cutting shank as well as the dimension-adapted inner diameter guarantee self-adhering seat. The stripper length equals the largest installation dimension. It can be adapted if the dimensions underrange this size.

Stripper Designation	Nominal $\varnothing d^{-0.4}$	d_i	D	L_i	$L_D^{+1.6}$	Stripper force (N) At deformation of			Part no.
						3 mm	6 mm	9 mm	
80-04-45	4	1.6	17	7	45	600	1150	–	FB74800445
80-06-55	6	1.6	19	7	55	650	1200	1800	FB74800655
80-08-55	8	3	21	7	55	700	1300	2100	FB74800855
80-10-55	10	3	23	7	55	900	1600	2400	FB74801055
80-13-55	13	3	26	7	55	1100	1900	3000	FB74801355
80-16-55	16	3	30	7	55	1400	2300	3700	FB74801655
80-20-55	20	3	38	7	55	2100	3600	5500	FB74802055
80-25-55	25	3	50	7	55	3700	6500	10200	FB74802555

Installation

The length of the stripper should be 1 to 2 mm longer than the free punch length. When installing, ensure that there is sufficient space to accommodate bulging.

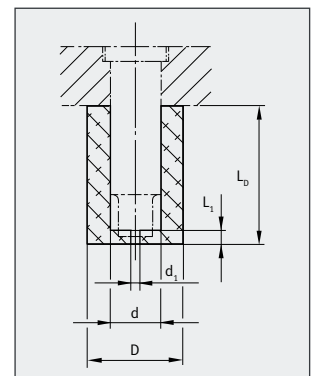

Stripper Bars

No.	W	H	L	D	Quality	Part no.	Number of segments
1	19	16.6	270	26	Perbun. 70 Shore A	FB75391177	9
2	15	11.5	270	26	Perbun. 70 Shore A	FB75391176	9
3	19	27	306	30	Perbun. 70 Shore A	FB75391178	9
4	19	27	306	26	PU 70 Shore A	FB75008400	9
5	32	65	400	40	Urelast U 90	FB75811002	8
6	19	27	306	26	PU 80 Shore A	FB75008500	9

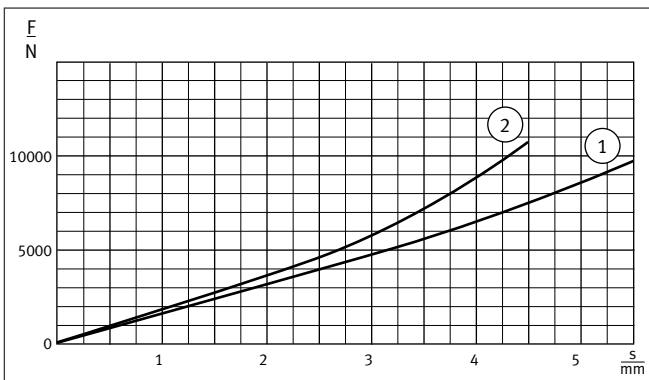

Diagram 10

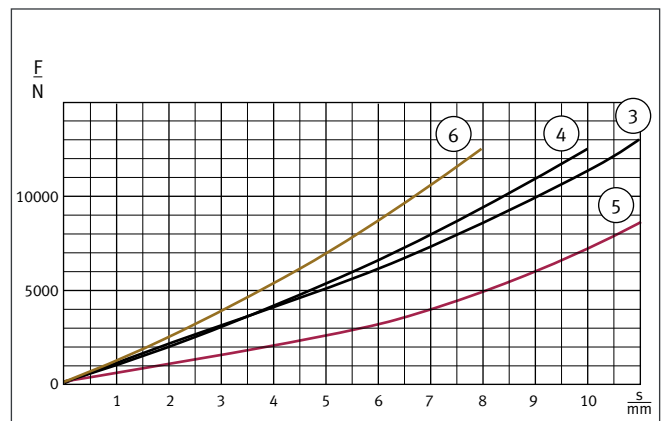
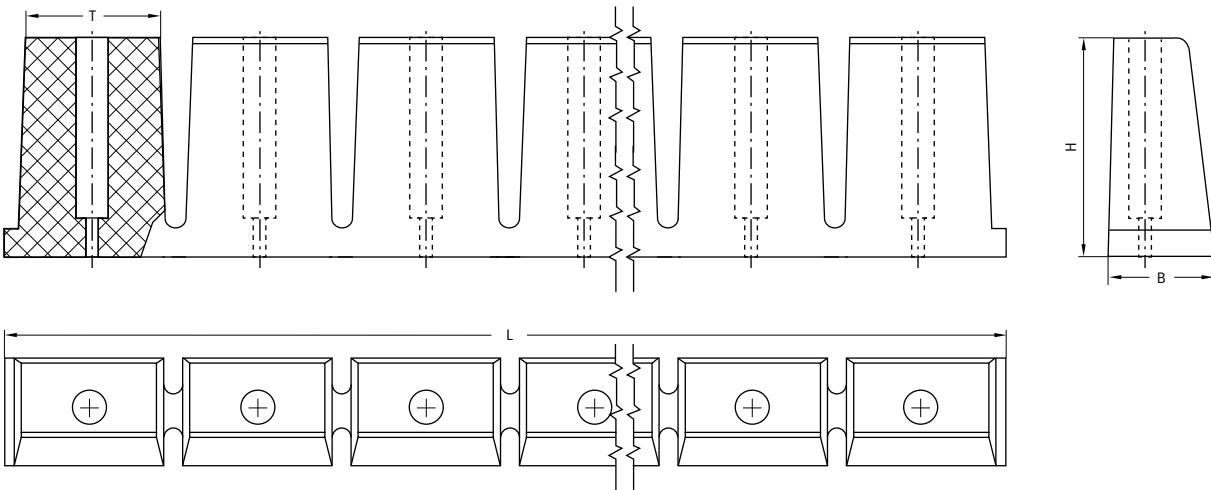

Diagram 11



EFFBE Hollow Bars and Solid Bars



Bars supplement the product range of standardized parts. Application descriptions and installation information apply. They are used in the areas of structural mechanical engineering, tool manufacturing and system engineering.

Hollow bars

EFFBE Urelast UN 80
(80 Shore A)

EFFBE Urelast U 90
(92 Shore A)

Base material for springs in non-standard lengths, damping washers, component parts and prototypes.

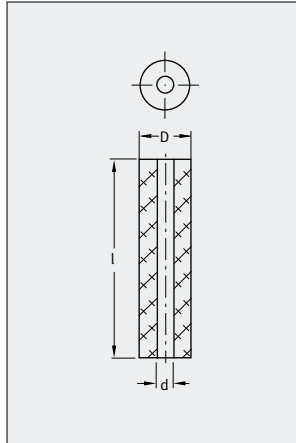

Hollow bars Designation	D	d	l	EFFBE UN 80 (80 Shore A)	EFFBE U 90 (90 Shore A)
16-300	16	6.5	300	FB73000168	FB73000160
20-300	20	8.5	300	FB73000208	FB73000200
25-300	25	10.5	300	FB73000258	FB73000250
32-300	32	13.5	300	FB73000328	FB73000320
40-300	40	13.5	300	FB73000408	FB73000400
50-400	50	17	400	FB73000508	FB73000500
63-400	63	17	400	FB73000638	FB73000630
80-400	80	21	400	FB73000808	FB73000800
100-300	100	21	300	FB73001008	FB73001000
125-300	125	27	300	FB73001258	FB73001250

Solid bars

EFFBE Urelast UN 80
(80 Shore A)

EFFBE Urelast U 90
(92 Shore A)

Base material for cylindrical spring bodies (higher forces relative to hollow springs), component parts and prototypes.

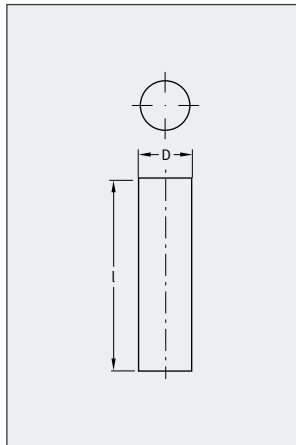

Solid bars Designation	D	l	EFFBE UN 80 (80 Shore A)	EFFBE U 90 (90 Shore A)
16 V-300	16	300	FB73001658	FB73001650
20 V-300	20	300	FB73002058	FB73002050
25 V-300	25	300	FB73002558	FB73002550
32 V-300	32	300	FB73003258	FB73003250
40 V-300	40	300	FB73004058	FB73004050
50 V-400	50	400	FB73005058	FB73005050
63 V-400	63	400	FB73006358	FB73006350
80 V-400	80	400	FB73008058	FB73008050
100 V-300	100	300	FB73010058	FB73010050
125 V-300	125	300	FB73012558	FB73012550

Square bars

EFFBE Urelast UN 80
(80 Shore A)

EFFBE Urelast U 90
(92 Shore A)

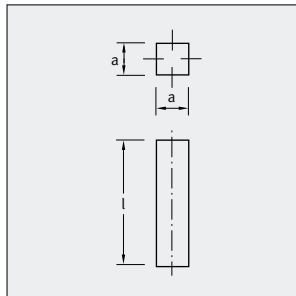

a	a	l	EFFBE UN 80 (80 Shore A)	EFFBE U 90 (90 Shore A)
25	25	1000	FB75000258	FB75000250
50	50	1000	–	FB75000500
75	75	1000	–	FB75000750
100	100	1000	FB75001008	FB75001000
125	125	1000	FB75001258	FB75001250

Sheets

Sheets supplement the product range of standardized parts. Application descriptions and installation information apply. They are used in the areas of structural mechanical engineering, tool manufacturing and system engineering.

Sheets

EFFBE CR/SBR 65 (65 Shore A)

EFFBE Urelast UN 80 (80 Shore A)

EFFBE Urelast U 90 (92 Shore A)

Sheet material for deep-drawing tasks, edging, bulging and cutting of sheet metal elements, among other tasks. Base material for component parts and prototypes. Sheet material is also delivered as a blank as specified by the customer.

EFFBE CR/SBR 65		EFFBE Urelast UN 80		EFFBE Urelast U 90	
h	Part no.	h	Part no.	h	Part no.
3	–	3	* FB78100031	3	* FB78100032
4	FB77000043	4	–	4	–
5	–	5	* FB78100051	5	* FB78100052
6	FB77000063	6	–	6	–
8	FB77000083	8	* FB78100081	8	* FB78100082
10	FB77000103	10	FB78000101	10	FB78000102
12.5	–	12.5	FB78000121	12.5	FB78000122
15	FB77000153	15	FB78000151	15	FB78000152
20	FB77000203	20	FB78000201	20	FB78000202
25	FB77000253	25	FB78000251	25	FB78000252
30	FB77000303	30	FB78000301	30	FB78000302
35	–	35	FB78000351	35	FB78000352
40	FB77000403	40	FB78000401	40	FB78000402
50	FB77000503	50	FB78000401	50	FB78000402
60	FB77000603	60	FB78000601	60	FB78000602
70	FB77000703	70	–	70	–
75	–	75	* FB78000751	75	* FB78000752

h in mm
 Format: 1000x1000 mm
 * 500x1000 mm

The most significant Material properties of quality EFFBE CR/SBR 65

Properties		
Hardness Shore A DIN ISO 7619-1	Shore A	65 ± 5
Color		Black
Density	g / cm ³	1.4
Temperature range	°C	–20 to +70
Tear resistance DIN 53 504	N / mm ²	5
Elongation at break DIN 53 504	%	250



Component Parts

EFFBE Urelast UN 80 (80 Shore A)

EFFBE Urelast U 90 (92 Shore A)

The high strength of EFFBE Urelast material provides physical properties and mechanical properties that extend and supplement the application possibilities of the usual elastomers.

The material can withstand extremely high stresses and is particularly well suited as an energy-absorbing component or force transmitting component. In many cases it enables use of non-reinforced Urelast component parts instead of rubber-metal connections. For design reasons, Urelast connections with metal or plastics are manufactured through vulcanization or bonding.

Application examples

Profiled damping sheets, damping rings, and damping strips, stop buffers, emergency stops, hold-down elements, ejectors, strippers, guides, couplings, rollers, drive rollers, drawing and bulging tasks, seals, plugs, assembly supports, bushings, nozzles.

Delivery type

EFFBE Urelast component parts are manufactured in molds according to the drawings. Small series and sample parts are manufactured through mechanical processes from bars, sheets, and other semi-finished products. This processability enables a wide range of designs. Dimension tolerances in accordance with DIN ISO 3302-1 M3 C.



Processing Information

Machining

Hard elastomers can be effectively machined. At softer qualities the material tends to give way or yields to the tool. In this case the workpieces must be cooled before processing.

All tools must be always be well-sharpened.

Rework impairs the surface tension and thus reduces the edge-cut resistance.

The table indicates which types of processing are possible.

Elastomer Shore A	EFFBE 295 CR 70 Shore A	EFFBE Urelast UN 80 80 Shore A	EFFBE Urelast U 90 92 Shore A
Sawing	0	+	+
Cutting	++	++	++
Drilling, spiral	-	0	+
Drilling, hollow	++	++	++
Turning	-	0	+
Milling	0	+	++
Grinding	+	+	+
Tapping	--	-	-

Explanation:
 ++ = excellent | + = good | 0 = satisfactory | - = conditional | -- = not possible

Bonding

EFFBE elastomers can be effectively bonded with off-the-shelf component adhesives on metals and plastics.

The guidelines provided by the manufacturer of the adhesive must be complied with.

Recommendations for storage

Storage conditions

- 20 ± 5°C
- Maximum relative humidity of 65 %
- Dark
- Dry
- Not outdoors
- Max. storage period: 5 years



	EFFBE Urelast	EFFBE Elastomer CR and CR/SBR 65
Storage area	The storage room should be cool and dry. Storage outdoors is not permitted!	
Sunlight	EFFBE Urelast products should not be exposed to direct sunlight over an extended period of time. After an extended period of exposure to sunlight a darkening of EFFBE Urelast products occurs. The physical properties are not influenced however.	EFFBE should not be exposed to direct sunlight over an extended period of time.
Temperature	The optimal storage temperature is 20 ± 5°C	
Humidity	Relative humidity should not exceed 65%. Under some circumstances the maximum storage periods are reduced if this value is exceeded.	
Interactions	Acids, bases, disinfectants or other chemicals must not be stored together with EFFBE Urelast products. Solvents, such as tetrachloroethylene, carbon tetrachloride, etc. must not be used for cleaning.	
Storage period	Storage period is highly dependent on humidity in conjunction with temperature. If optimal storage conditions are complied with, storage periods of up to 5 years are possible without significant changes in properties.	
Stock turnover	To optimally organize the storage period, proceed in accordance with the "first in, first out" principle for stock turnover.	

Forming with Elastomers

Forming

Elastomer can also be used as a shaping element in toolmaking applications.

Rubber or Urelast material can be used for elastomer dies, which for economic reasons are structured of multiple sheets, placed in a steel case. Both materials are resistant to oil and aging and can be used for deep-drawing, bulging, and cutting. The sheet material is available in Shore hardnesses 65, 80, and 92. While due to high elasticity, long penetration depths are possible using rubber sheets, Urelast sheets have a high load-bearing capacity and excellent abrasion-resistance.

Folding

Similar to deep-drawing, sheet metal elements can also be trimmed with elastomer dies. When pressing in the forming pin, the dispelled elastomer material forces the sheet metal element onto the punch until the desired fold or shape is achieved. The illustration provides information concerning the folding press die. Urelast sheets are generally used for these tasks. For a large penetration depth of the punch, rubber sheets are the most effective.

Cutting

Likewise, cutting and punching tasks can be executed with elastomer dies; the elastomer serves as cutting plate.

Bulging

Exploiting the property of incompressibility, elastomer can also be used for bulging hollow bodies. An elastomer punch is pressed together in the longitudinal direction and expands in the transverse direction. Thus the inserted cylindrical hollow body is pressed into the mold.

The size of the elastomer punch is determined based on the final volume of the desired hollow sheet metal body.

Deep-drawing

When deep-drawing with elastomer dies, deformation begins with penetration of the forming pin into the die. Through the all-side inclusion of the incompressible elastomer, the expelled material presses the sheet metal onto the forming pin. With the uniform contact pressure, a uniform elongation of the sheet metal is also achieved. Once released, the die takes on its original shape again. Bear in mind that only slow running presses are suitable for these types of tasks.

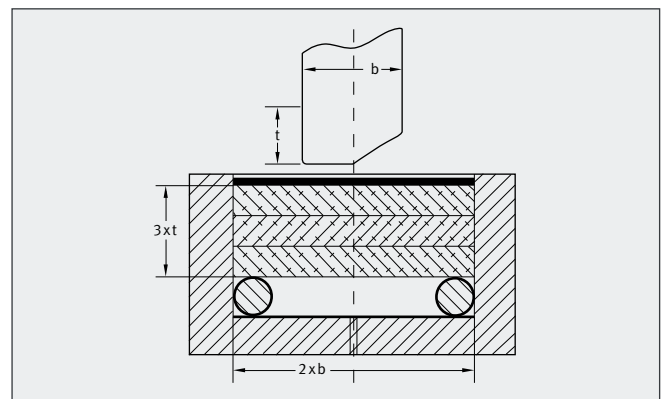

Forming with elastomer: Folding



Areas of Application

The areas of application of EFFBE products include a broad spectrum of material and design, such as

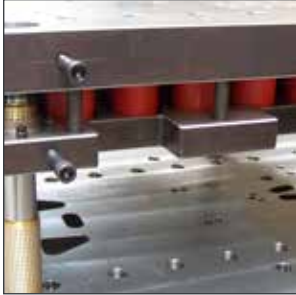

Cutting tools and die-cutting tools

- Hold-down devices
 - Stripper bars
 - Ejectors
 - Spring elements
-



Wind power

- Torque support arms
 - Preload elements
 - Spring elements
-



Machine tools

- Emergency stops
 - Limit stops
 - Preload elements
 - Spring elements
-



Sheet metal forming

- Hold-down devices
- Dies
- Spring elements

EFFBE GmbH

Hanauer Landstrasse 16 | 63628 Bad Soden-Salmünster | Germany

Phone +49 6056 78-7400 | Fax +49 6056 78-7966 | info@effbe.de | www.effbe.de

Member of Woco Group

www.wocogroup.com



EFFBE and Woco Group worldwide

LEVELMOUNT



PNEUMO



MEMBRANE BEARINGS



EFFBE – over 65 years of experience in the development and manufacturing of plastic and rubber products for industry

Access to Woco Group's production sites, development centers and partners in more than 14 countries worldwide puts us in a position to exploit development, production and sales synergies. Take advantage of a global and flexible competence network.