

# PRICE & SPECIFICATION GUIDE

SUPERSEDES ALL PRIOR VERSIONS

JULY 2018



**Diamond**<sup>®</sup>

VIBE™ SERIES



# Diamond®

## VIBE™ SERIES

### What's New

#### KEY PRODUCT ADDITIONS, REVISIONS, AND DELETIONS

##### DOOR STYLE ADDITIONS

Westburke expanded to PureStyle™ (see page 16)

##### FINISH AVAILABILITY

Standard matching laminate ends available in Moonstone (see page 17)

##### MODIFICATION EXPANSION

Roll Tray (\*RT) modification expanded to office and vanity cabinets (see page 30)

##### CABINET ADDITIONS

Diagonal Wall Cabinets with Cut for Glass availability: DW152424 L or R, DW152727 L or R, DW182727 L or R, DW242727 L or R, DW272727 L or R (see pages 88, 90)

Wall Box Column Pull-Out with Overlay, 33"-42" high: WBCPO3\*\*OL, WBCPO6\*\*OL (see page 110)

Overlay Filler, 5 1/2" wide, 30"-42" high expanded to partial overlay styles: OL6\*\* (see page 265)

Under Counter Drawer, 33" wide: UCD3321 (see pages 238, 258)

##### EMBELLISHMENTS & ACCESSORY ADDITIONS

8" Bar Corbel: BARCORBEL8 (see page 287)

12" Cove Corbel: COVECORBEL12 (see page 287)

Hinge Shim: HINGESHIM5 (see page 299)

##### PRODUCT REVISIONS

Cabinets and Finishes:

- 23 1/2" and 27 1/2" high wall cabinets transitioned to 24" and 27" heights
- Tall Cabinets and Panels with Doors will use AH (Aligned Height) nomenclature (see pages 178-220, 276)
- The names of seven existing finishes have changed to better align with Diamond Distinction™ Series (see pages 17-18, 298)
  - Alabaster to White
  - Bluff to Cloud
  - Brie to Coconut
  - Dark Ale to Chocolate
  - Riverwood to Thatch
  - Scone to Egret
  - Tuscan to Henna

Mouldings, Embellishments and Lighting:

- Dentil Moulding (DE8) - replaced with new design MDENTIL8 (see page 280)
- Egg & Dart Moulding (EGD8) - species availability change to Maple only (see page 280)
- Window Casing - Traditional (WCT4 and WCT7) - replaced with WCT8 (see page 282)
- Metro Bar Column Leg (METBARCOLUMN) - revised from a 3-piece design to a 1-piece design, with overall height change from 40 5/8" to 42 1/4" (see page 285)
- Battery Powered Drawer Strip Light (BATT30) - replaced with BATT1I (see page 288)

##### DISCONTINUATIONS

Finishes:

- Leather stain on all species and with glaze combinations
- Barn Wood and Brown Sugar glazes on Oak and Hickory (all styles)
- Barn Wood and Brown Sugar glazes on Keegan and Valero door styles only (all species)

Trim and Accessories:

- Bread Box Lids (BBX\*\*)
- Tiered Cutlery Dividers – Plastic (TCD\*\*)
- Cookbook Rack (CBR)
- Peg Hook / Backer Kit (PEGHKASSY)





# TABLE OF CONTENTS

Index	A-E
Characteristics	1
Humidification	2
Door Styles	3-16
Finish Availability Chart	17-18
Premium Color Palette	18
12-Step Finishing Process	19
Construction Features	20
Modification/Upgrade Compatibility Chart	21
Construction Upgrade	22
Drawer Front Upgrades	23
Smart Stop Options	24
Custom Modifications	25-34
Specialty Doors	35-36
Decorative Glass Inserts	37-40
Cabinet Dimensions	41-47
Policies & Installer Notes	48
Design Checklist	49
NKBA Guidelines	50-51
Logix® Reference Chart	52
Wall Cabinets	54-125
Base Cabinets	126-177
Tall Cabinets	178-221
Office & Furniture Cabinets	222-239
Vanity Cabinets	240-263
Fillers	264-266
Appliance Panels	266-267
Panels & Skins	268-278
Moulding	279-283
Valances	283-284
Embellishments	284-287
Lighting & Lighting Accessories	288-289
Decorative Hardware	290
Accessories	291-295
Roll Tray Kits	296
Guide Kits and Parts	296-297
Stain, Paint, & Touch-Up Tools	298
Hinges	299
Parts	300
Sales Support Tools	300
Stack Moulding Kits	301-305
Paint Finish Agreement	306

Description	Code	Page Number
Acanthus Moulding	ACAM	281
All Plywood w/Laminate Ends	VPL	22
Angled Corner Sinks	ACS	148
Angled Fluted/Plain Fillers	BLVDFF	265
Angled Furniture Toekick Valance	AVTOE	283
Arched Valance	AV	283
Art Corbel 9"	CORBELART9	287
Asymmetrical Base Easy Reach	BER	156
Asymmetrical Easy Reach Wall Corners	ER	94
Asymmetrical Solid Wood Super Lazy Susan	SLSW	158
Asymmetrical Super Susans	SLS	158
Authentic Ends	AUTHL, AUTHR	25
Back Panel Moulding	BPM	281
Bar Corbel	BARCORBEL	287
Bar Leg	BARLEG	284
Baseboard Moulding	BBM	282
Base Box Column w/Overlay	BBCPO	172
Base Built-In Microwave Cabinet w/Drawer	BBMWD	174
Base Cabinets	B	126
Base Cabinets Four Drawer	4DB	164
Base Cabinets Four Drawer w/Cutlery Insert Wood Organizer	4DB..CIW	166
Base Cabinets Four Drawer w/Wood Tiered Cutlery Divider Drawer	4DB..WTCD	166
Base Cabinets Three Drawer	3DB	164
Base Cabinets Three Drawer w/Deep Drawer	3DBDD	164
Base Cabinets Three Drawer w/Wood Tiered Cutlery Divider Drawer	3DB..WTCD	164
Base Cabinets Two Drawer	2DB	160
Base Cabinets Two Drawer w/Drop-In Range	2DB..DR	162
Base Cabinets Two Drawer w/Pegged Dish Organizer	2DB..PDO	162
Base Cabinets Two Drawer w/Roll Tray	2DB..RT	162
Base Cabinets Two Drawer w/Roll Tray & Pegged Dish Organizer	2DB..RTPDO	162
Base Cabinets w/Full Height Doors	B..FH	128
Base Corner Cabinets	BC	152
Base Corner Full Width Cabinets	BCFW	152
Base Corner Full Width Cabinets w/Pull-Out	BCFW..PO	154
Base Corner Peninsula	BPC	176
Base Corner Peninsula, Full Height Door	BPC..FH	176
Base Corner w/Pull-Out	BC..PO	152
Base Drawer Cabinets	DB	160-166
Base Drop-In Range Cabinet	B..DR	172
Base Easy Reach	BER	156
Base End Cabinet	BEC	160
Base Full Height w/Tray Divider	TD..FH	136
Base Lazy Susan Corner w/Center Hinge Door	BLS	154
Base Microwave Cabinets w/Deep Drawer	BMWD..DD	176
Base Microwave Cabinets w/Drawer	BMWD	174
Base Ovens	BO	174
Base Pan Storage	BPS	291
Base Panel w/Filler Attached & Authentic End	BEP..AEL, AER	271
Base Pantry Pull-Outs	BPP	170
Base Pots & Pans Pull-Out	BPPP	134
Base Spice Drawer	BSD	170
Base Transition Cabinets	BTC	160
Base Utensil Pantry Pull-Out	BUPP	170
Base Wastebasket	BWB	166
Base Wastebasket Full Height	BWB..FH	168
Base Wine Cubby	BWC	170
Baseboard Moulding	BBM	282
Baseboard - Shaker	BBMSH	282
Bases w/Cutlery Insert	B..CIW	128
Bases w/Roll-Out Tray Divider	B..TDRO	136
Bases w/Roll Trays	B..RT	132
Bases w/Tray Dividers	TD	136
Bases w/Wood Tiered Cutlery Divider Drawer	B..WTCD	128

Description	Code	Page Number
Bases w/Wood Cutlery Insert and Roll Trays	B..RTCIW	132
Bases w/Wood Tiered Cutlery Divider Drawer and Roll Trays	B..RTWTC	134
Bookcases Tall	T..BC	228-230
Bookcases Wall	W..BC	222-226
Box Column Fillers (Wall, Base, Tall)	BCF	265
Broom Clip	BRMCLP	291
Cabinet Box Only	CBO	27
Cabinet Case Only	CCO	27
Cabinet False Panel	CFP	27
Cabinet Frame Only	CFRMO	34
Cabinet Front Only	CFNTO	34
Cabinet Panel Edge Moulding	CPE	281
Cabinet w/No Door, w/Drawer	CND	27
CabMat™	CABMAT	291
CabMat™	CMAT	29
CabMat™ Vanity	CABMATV	291
Cap Moulding	CAPM	282
Classic Tall Crown Moulding	CLTCROWN	279
Cooking Utensil Divider	CUDD	291
Corner Door Cabinets	CD	108
Cornice Tall Crown Moulding	COTCROWN	279
Countertop Edge Moulding (Traditional)	TCM	281
Country Sink Bases	CNTYSB	150
Country Sink Base w/CabMat™	CNTYSB..CM	150
Cove Corbel	COVECORBEL	287
Cove Crown Moulding	COVECROWN	279
Cross Grain Veneer Back Skin 1/4" Panels	BP..CRSGR	269
Cut for Glass Doors	CG	35
Cutlery Dividers	CIW, WTCD	292
Decorative Appliance Panels	DAPNL	266
Decorative Door Panel Kits, Base End	BED	274
Decorative Door Panel Kits, Tall End	TED	276
Decorative Door Panel Kits, Wall End	WED	274
Decorative Split Turning End	SPRINGEND	287
Decorative Split Turning Spool	SPRINGSPPOOL	287
Dentil Moulding	MDENTIL	280
Desk Door Drawer Bases	DDO	232
Desk Double File Drawer Bases	DDFD	234
Desk Drawer Bases	DDR	232-234
Desk File Drawer Bases	DFD	234
Diagonal Base Cabinet w/Full Height Door	DAB..FS	154
Diagonal Base Cabinet w/Full Height Door & Lazy Susan	DAB..S	154
Diagonal Base Cabinet w/Full Height Door & Super Lazy Susan	DAB..SLS	156
Diagonal Wall Cabinets	DW	88
Diagonal Wall Cabinets w/Lazy Susan	DW..LS	90
Diagonal Wall Cabinets w/Plywood Lazy Susan	DW..S	92
Drawer Front Flat 5-Piece	DFF5PC	23
Drawer Front Slab	DFSLB	23
Drawer Guide Back Sockets	BKSOCKET	297
Drawer Guide Kits	DGK	296
Ductless Conversion Kit	CONVERSION	124
Easy Reach Wall Corner Cabinets	ER	92
Edgeband	EDGEBAND	292
Egg & Dart Moulding	EGD	280
End Panel/Base	BEP	269
End Panel/Tall	TEP	270
End Panel Skins/Base	BEPS	268
End Panel Skins/Tall	TEPS	268
End Panel Skins/Wall	WEPS	268
End Panels, Wall	W	269
English Bar Column	ENGBARCOLUMN	284
English Island Column	ENGISLCOLUMN	285
Estate Leg, Small	JESTATELEGS	285
Exterior Shelf	ES	292, 293

Description	Code	Page Number
False Panel Clips	FALSEPNLCLIP50, PFALSEPNLCLIP50	297
Fillers	F	264
Finished Back Skins	BP	269
Finished Ends	FB	25
Flat Scribe Moulding	SM	281
Floating Island Bases	FIC	170
Floating Shelves	FS	120
Flush Toekick	.FTK	31
Fluted/Beaded Fillers	FBF	265
Full Depth Shelf	.FD	29
Full Depth Shelving	SK	293
Furniture Drawer Window Bench	FDWB	238
Furniture Drawers	FD	238
Furniture Finished Plywood End Panels	.FPEB	25
Furniture Valance	FV	283
Glass Shelf Kits	GSK	294
Hardware Decorative Pulls and Knobs	KNOBH, PULLH	290
Heat Shields	ANGLHEATSHIELD, ANGLSHIELDSS, STRHEATSHIELD, STRTHSHIELDSS	294
Hinge Angle Restriction Clip	HINGERESCLIP	299
Hinge Shim	HINGESHIM	299
Hinges	HINGE	299
Increased Depth	ID	28
Insert Crown	INSCROWN	279
Inside Corner Moulding	ICM	283
Installed Roll Tray	RT, RTF	30
Island Leg	ISLEG	285
Island Leg Straight	ISLEGST	286
Island Leg Tapered	ISLEGTPRD	286
Large Corbel	LGCORBEL	287
Large Shaker Crown Moulding	LSHAKER	279
Large Square Foot	LGSQFOOT	286
Large Straight Angle Crown Moulding	LSACROWN	279
Library Moulding	LBRM	281
Lid Organizers	LO	294
Lidstay	.LIDSTAY	299
Lidstay, Heavy Duty	.LIDSTAYHD	299
Light Baffle Moulding	LB	283
Light Rail Moulding	LRM	283
Lighting & Lighting Accessories	—	288-289
Lille Foot	LIFOOT	286
Linen Closet	LC	258
Linen Closet w/Removable Hamper	LCRH	258
Matching Interior Plywood	MIP	26
Medicine Cabinets (Single)	MC	262
Medium Straight Angle Crown Moulding	MSACROWN	279
Metro Bar Column	METBARCOLUMN	285
Metro Island Column	METISLCOLUMN	285
Mirror Frame Moulding	WMF	281
Miscellaneous Parts	BRKOFFSCREW, BUMPERPADS, INSTALLSCR, INSTALLSCREWS, MCT16HDW/WCATCH, QCDM, RETCLIP.BAG, SHELFPEGS, TVHDW/WCATCH	300
Mission Leg	DLEGMISION	286
Mission Rosette	ROSETTEMIS	284
Mullion Doors	MD	36
Ogee Edge Moulding	OGEEM	281
Outside Corner 135° Moulding	OC135	283
Outside Corner Moulding	OCM	283
Oven Cabinets	OC	196-206

Description	Code	Page Number
Oven Cabinets Double	OCD	204-206
Oven Cabinets Double w/Deep Drawer	OCD..DD	208-210
Oven Cabinets Single	OCS	196-198
Oven Cabinets Single w/Deep Drawer	OCS..DD	200-202
Oven Installation Kit	OCINSTALLKIT	294
Oven Microwave Cabinets	OMC	214-216
Oven Microwave Cabinets w/Deep Drawer	OMC..DD	218-220
Overlay Fillers	OL	264
Panels w/Filler Attached	BEPF, TEP, WEP	270
Pegged Dish Organizer	PPO, PDOPOSTS	294
Peninsula	P	34
Pots & Pans Organizer Bases w/Drawer	B..PS	134
Power Pads	PWRPOD	295
Quarter Round Moulding	QRM	283
Quattro Dimming Receiver	QDIMREC	289
Quattro Wall Controller	Q4ZONECON	289
Raised Panel Arched Valance	RPV	284
Recessed Island Toekick	RECTKALL	32
Recessed Toekick on Back	RECTKBK	32
Recessed Toekick on Side	RECTKL, RECTKR	32
Reduced Depth	RD	28
Reed Leg	RDLEG	286
Roll Tray Kits	RT, RT..SP	296
Roll Tray Plug In Bracket	RTBK, RTBKXSXP	297
Rope Moulding	RPM	280
Rosette 3"	FFRC, BFRC	284
Sample Frame & Doors	DOORSAMPLE	300
Scooped Drawer	SCPDRW	29
Scroll Corbel 9"	CORBELSCR9	287
Shaker Crown Moulding	SHKRCRM	279
Shoe Moulding—Convex Inside Corner	SHM	283
Single Bead Edge Moulding	SBE	282
Single Door Medicine Cabinet	MC	262
Sink Base Caddy	SBCADDY	295
Sink Base SuperCabinet™	SB..S	144
Sink Base SuperCabinet™ w/CabMat™	SB..SCM	144
Sink Base SuperCabinet™ w/Caddy	SB..SCDY	144
Sink Base SuperCabinet™ w/Tilt-Out Trays	SB..STS	144
Sink Base SuperCabinet™ w/Tilt-Out Trays and CabMat™	SB..STSCM	146
Sink Base SuperCabinet™ w/Tilt-Out Trays & Caddy	SB..STSCDY	146
Sink Base w/CabMat™	SB..CM	140
Sink Base w/Caddy	SB..CDY	140
Sink Base w/Drawer Below and CabMat™	SB..DCM	146
Sink Base w/Tilt-Out Trays and CabMat™	SB..STCM	142
Sink Base w/Tilt-Out Trays & Caddy	SB..STCDY	144
Sink Bases	SB	138-142
Sink Bases w/Drawers Below	SB..D	146
Sink Bases w/Tilt-Out Trays	SB..ST	142
Sliding Towel Rack	STR	295
Small Corbel	SMCORBEL	287
Small Cove Crown Moulding	SMCOVECROWN	279
Small Crown Moulding	SCM	280
Small Light Rail Moulding	SMLR	283
Small Scribe Moulding	SSM8	282
Smart Stop Premium Drawer Guide	PG	24
Smart Stop Premium Hinge	INTGH	24
Smart Stop Premium Roll Tray Guide	SP	24
Snack Bar Support	SBS	287
Soffit Filler Moulding	SFM	281
Soffit Trim Moulding	TSTM	282
Solid Wood Crown Moulding	SWCRM	280
Solid Wood Large Crown Moulding	SWLCRM	280
Solid Wood Super Lazy Susan	SLSW	160
Solid Wood Tall Crown Moulding	SWTCRM	280
Solid Wood Victorian Crown Moulding	SWVCRM	280
Space Fillers	S96	264

Description	Code	Page Number
Spice Rack Pull Down	SPD	295
Spool Decorative Leg	SPLEG	286
Stack Moulding Kits	STKMLD	301-305
Stain	STAIN	298
Starter Moulding	STR8	281
Starter Moulding, Shaker	STRS	281
Straight Angle Crown Moulding	SACROWN	279
Straight Valance	VV	284
Super Susans	SLS	158
SuperCabinet™, 30"	BSC30PR, BSC30RP	130
SuperCabinet™, 36"	BSC36PRP	130
Tablet Holder	TABLEHLDR	295
Tall Built-In Microwave Cabinet	TBMWB	212
Tall Crown Moulding	MTCROWN	279
Tall Panel w/Filler Attached & Authentic End	TEP.AEL, AER	271
Tall Pantry Pull-Outs	TPP	194
Tapered Leg	TAPLG	286
Tapered Wood Hood Blower	TWHBLOWER	124
Tapered Wood Hoods	TWH	124
Tilt-Out Trays, Plastic	TOT	295
Tilt-Out Trays, Stainless Steel	TOTSS	29, 295
Toeboards	TB	282
Toekick Cap	TKC	282
Toekick Drawer	DRWTK	31
Toekick Tulip Foot	TKTLFOOT	287
Touch-Up Tools	TUK, MTUK, GLAZEPEN	298
Tray Divider Kit	CTDK	295
Triple Bead Edge Moulding	TBEM	282
Triple Bead Pilaster Moulding	TBP	282
Tri-View Medicine Cabinet	TV	262
Tulip Foot	TLFOOT	287
Under Counter Drawers	UCD	238, 258
Utility Cabinets	U	178-186
Utility Cabinets w/Roll Trays	U..RT	188-191
Utility Organizer Cabinets	UOC	192
Valley Forge Moulding	VFR	283
Vanity Desk Legs	VDL	278
Vanity Door Drawer Bases	VB	244
Vanity Drawer Bases	VDB	246
Vanity Mirror	VM	262
Vanity Pull-Out	VP	246
Vanity Sink Bases w/False Panel	VSF	240-242
Vanity Sink Bases SuperCabinet™ w/Tilt-Out Trays	VSSB	242
Vanity Sink Drawer Bases	2VSD	248
Vanity Sink Drawer Bases w/False Panel	VSD	252
Vanity Sink Drawer Bases w/Six Drawers & False Panel	VSD..FP	256
Vanity Sink Three Drawer Bases	VS3D	254
Vanity Utility Cabinets	VU	260
Vanity Wall Cabinets	W	260
Vanity Wall Mirror Cabinets	VWM	260
Vanity Wall Towel Bar	VWTB	260
Void Toekick	VTK	33
Wall Appliance Garage	WAGD	108
Wall Appliance Garage Vertical Lift Door	WAGVLD	108
Wall Box Column Pull-Outs w/Overlay	WBCPO	110
Wall China Display Cabinets	WCD	116
Wall Corner Cabinets	WC	84-88
Wall Corner Double Door Cabinets	WC	84-88
Wall Corner Single Door Cabinets	WC	84-88
Wall Double Door Cabinets	W	54-80
Wall End Cabinets	WEC	96
Wall Message Center	WMC	120
Wall Built-In Microwave Cabinet	WBMW	102-106
Wall Microwave Cabinets	MW	98
Wall Microwave Double Door Cabinets	MW	100
Wall Organizers	WO	118
Wall Quarter Round End Shelves	WQRES	96

Description	Code	Page Number
Wall Refrigerator Cabinets	W	56-72
Wall Refrigerator Vertical Lift	WVL	64, 68
Wall Single Door Cabinets	W	54-78
Wall Spice Drawers	WSD	118
Wall Spice Pull Down	W..SPD	112
Wall Spice Pull-Out	WSP	112
Wall Spice Rack Cabinets	WSR	114
Wall Three Drawer Cabinets	W3D	82
Wall Top Hinge Single Door Cabinets	WTH	54-62
Wall Transition Cabinets	WTC	98
Wall Vertical Lift	WVL	62-68
Wall Wine Cubbies	W	118
Wall Wine Racks	WNR	116
Window Casing—Traditional	WCT	282
Wine Glass Holders	WGH	295
Wine Storage Cabinet	WSC	116
Wood Hood Blower	BLOWER	124
Wood Hood Canopy Arched	WHCA	122
Wood Hood Canopy Square	WHCS	122
Wood Hood Chimney	WHC	122
Wood Hood Square	WHS	122
Wood Tops, One Sided	1TWT	236
Wood Tops, Three Sided	3TWT	236
Wood V-Grooved Beaded Skin 1/4" Panels	BP.VG	269

Code	Page Number
1TWT	236
2DB	160
2DB..DR	162
2DB..PDO	162
2DB..RT	162
2DB..RTPDO	162
2VSD	248
3DB	164
3DB..WTCD	164
3DBDD	164
3TWT	236
4DB	164
4DB..CIW	166
4DB..WTCD	166
ACAM	281
ACS	148
ANGLHEATSHIELD	294
ANGLHSHIELDSS	294
AUTHL, AUTHR	25
AV	283
AVTOE	283
B	126
B..CIW	128
B..DR	172
B..FH	128
B..PS	134
B..RT	132
B..RTCIW	132
B..RTWTCD	134
B..TDRO	136
B..WTCD	128
BARCORBEL	287
BARLEG	284
BATTLI	288
BB	282
BBCPO	172
BBM	282
BBMSH	282
BBMWD	174
BC	152
BC..PO	152
BCF	265
BCFW	152
BCFW..PO	154
BCP	176
BCP..FH	176
BEC	160
BED	274
BEP	269
BEP..AEL, AER	271
BEPF, TEP, WEP	270
BEPS	268
BER	156
BKSOCKET	297
BLOWER	124
BLS	154
BLVDF	265
BMWD	174
BMWD..DD	176
BO	174
BP	269
BP..CRSGR	269
BP..VG	269
BPM	281
BPP	170
BPPP	134
BPS	291
BRKOFFSCREW	300
BRMCLP	291
BSC3OPR	130
BSC3ORP	130
BSC36PRP	130
BSD	170
BTC	160
BUMPERPADS	300
BUPP	170
BWB	166
BWB..FH	168

Code	Page Number
BWC	170
CABL	289
CABLRIG	289
CABMAT	291
CABMATV	291
CAPM	282
CBO	27
CCO	27
CD	108
CFNTO	34
CFP	27
CFRMO	34
CG	35
CIW	291
CLTCROWN	279
CMAT	29
CND	27
CNTYSB	150
CNTYSB..CM	150
CONNFLX	289
CONVERSION	124
CORBELART9	287
CORBELSCR9	287
COTCROWN	279
COVECORBEL	287
COVECROWN	279
CPE	281
CTDK	295
CUDD	291
DAB..FS	154
DAB..S	154
DAB..SLS	156
DAPNL	266
DB	160-166
DDFD	234
DDO	232
DDR	232-234
DFD	234
DFFSPC	23
DFSLB	23
DGK	296
DIMM	289
DLEGMISSION	286
DOORSAMPLE	300
DRWTK	31
DW	88
DW..LS	90
DW..S	92
EDGEBAND	292
EGD	280
ENDRIG	289
ENGBARCOLUMN	284
ENGISLCOLUMN	285
ER	92
ES	292, 293
F	264
FALSEPNLCLIP50	297
FB	25
FBF	265
FD	29, 238
FDWB	238
FFRC, BFRC	284
FIC	170
FLEX	288
FPEB	25
FS	120
FTK	31
FV	283
GLAZEPEN	298
GSK	294
HINGE	299
HINGERESCLIP	299
HINGESHIM	299
ICM	283
ID	28
INSCROWN	279
INSTALLSCR, INSTALLSCREWS	300
INTGH	24

Code	Page Number
IR	289
ISLEG	285
ISLEGST	286
ISLEGTPRD	286
JESTATELEGS	285
KNOBH	290
LB	283
LBRM	281
LC	258
LCRH	258
LEADFLX	289
LEADRIC	289
LGCORBEL	287
LGSQFOOT	286
LIDSTAY	299
LIDSTAYHD	299
LIFOOT	286
LO	294
LRM	283
LSACROWN	279
LSHAKER	279
MC	262
MC16HDW/WCATCH	300
MD	36
MDENTIL	280
METBARCOLUMN	285
METISLCOLUMN	285
MIP	26
MSACROWN	279
MTCROWN	279
MTUK	298
MW	100
OC	196-206
OC135	283
OC	204-206
OC..DD	208-210
OCINSTALLKIT	294
OCM	283
OCS	196-198
OCS..DD	200-202
OGEEM	281
OL	264
OMC	214-216
OMC..DD	218-220
P	34
PDO, PDOPOSTS	294
PFALSEPNLCLIP50	297
PG	24
PUCK	288
PULLH	290
PWRPOD	295
Q4ZONECON	289
QCDM	300
QDIMREC	289
QRM	283
RD	28
RDLEG	286
RECTKALL	32
RECTKKB	32
RECTKL, RECTKR	32
RETCLIP..BAG	300
RIGID	288
ROSETTEMIS	284
RPM	280
RPV	284
RT, RTF	30
RT, RT..SP	296
RTBK, RTBKXSP	297
S96	264
SACROWN	279
SB	138-142
SB..CDY	140
SB..CM	140
SB..D	146
SB..DCM	146
SB..S	144
SB..SCDY	144
SB..SCM	144

Code	Page Number
SB..ST	142
SB..STCDY	144
SB..STCM	142
SB..STS	144
SB..STSCDY	146
SB..STSCM	146
SBCADDY	295
SBE	282
SBS	287
SCM	280
SCPRDW	29
SFM	281
SHELFPES	300
SHKRCRM	279
SHM	283
SK	293
SLS	158
SLSW	160
SM	281
SMCORBEL	287
SMCOVECROWN	279
SMLR	283
SP	24
SPD	295
SPLG	286
SPTRINGEND	287
SPTRINGSPool	287
SSM8	282
STAIN	298
STAND	288
STKMLD	301-305
STR	295
STR8	281
STRS	281
STRTHEATSHIELD	294
STRTHSHIELDSS	294
SWCRM	280
SWLCRM	280
SWVCRM	280
SWTCRM	280
T..BC	228-230
TABLETHLDR	295
TB	282
TBEM	282
TBMWB	212
TBP	282
TCM	281
TD	136
TD..FH	136
TED	276
TEP, TEP..AEL, TEP..AER	270, 271
TEPS	268
TKC	282
TKTLFOOT	287
TLFOOT	287
TOT	295
TOTSS	29, 295
TSTM	282
TPP	194
TUK	298
TV	262
TVHDW/WCATCH	300
TWH	124
TWHBLOWER	124
U	178-186
U..RT	188-191
UCD	238, 258
UOC	192
VB	244
VDB	246
VDL	278
VFR	283
VM	262
VP	246
VPL	22
VS3D	254
VS	240-242
VSD	252



Code	Page Number
VSD..FP .....	256
VSSB .....	242
VTK .....	33
VU .....	260
VV .....	284
VWM .....	260
VWTB .....	260
W .....	54-80, 118, 260
W..BC .....	222-226
W..SPD .....	112
W3D .....	82
WAGD .....	108
WAGVLD .....	108
WBCPO .....	110
WBMW .....	102-106
WC .....	84-88
WCD .....	116
WCT .....	282
WEC .....	96
WED .....	274
WEP .....	269
WEPS .....	268
WGH .....	295
WHC .....	122
WHCA .....	122
WHCS .....	122
WHS .....	122
WMC .....	120
WMF .....	281
WNR .....	116
WO .....	118
WQRES .....	96
WSC .....	116
WSP .....	112
WSR .....	114
WTC .....	98
WTCD .....	292
WTH .....	54-62
WWL .....	62-68

## CHARACTERISTICS OF LAMINATE

The surfaces of doors, drawer fronts, and overlay fillers feature laminate materials with an integrated top coat that provides superior beauty, durability, and performance while meeting or exceeding all of the KCMA performance standards. The core panel material is made of MDF to ensure a consistent and stable product.

A heat shield is required to separate all laminate products from heat producing units to be in compliance with cabinet warranty.

## CHARACTERISTICS OF PURESTYLE™ LAMINATE

PureStyle™ is the process of wrapping durable laminate materials around door frames resulting in products with crisp styling features and a surface that provides abrasion resistance and meets/exceeds all of the KCMA performance standards. PureStyle™ products are wrapped (versus form pressed onto a Medium Density Fiberboard (MDF) slab like thermofoil) and has a clear, integrated top coat for superior durability. The lineals and core panel material are made of MDF to ensure a consistent and stable product.

These doors offer the durability of a laminate and the beauty of paint and finished wood while bringing peace of mind to those who care about creating a better environment –both inside and outside of their homes.

PureStyle™ doors can be distinguished from painted cabinets by their picture perfect distribution of satin smooth color on a sleek surface with optimum durability. Trim items will feature a matching painted finish except where noted in product specifications.

## CHARACTERISTICS OF WOOD TYPES

No matter which species you choose for your new kitchen or bath cabinetry, please keep in mind that no two pieces of wood are exactly the same. Stains are likely to exaggerate the difference between open and closed grains and other markings in wood. Grain variation and color change should be expected. As hardwood ages, it will darken when exposed to different types of light. Color differences or changes in wood can also be caused by exposure to harsh chemicals, extreme heat or moisture. Additionally, wood species exhibit other defining characteristics, such as mineral deposits/streaks, knots, sap runs, pin holes and wormholes. These markings make the wood unique and contribute to its enduring beauty.



**Cherry** is characterized by its red undertones, but may vary in color from white to a deep, rich brown. Cherry is a close-grained wood with fairly uniform texture, revealing pin knots and curly graining. All wood will age with time and the finish will darken. This is especially true for cherry. This is a sought-after quality in cherry cabinetry, and those who select it expect this evolution.



**Hickory** is a strong, heavy hardwood known for distinctive graining patterns. Contributing to its dramatic appearance is a wide variation in color and streaking, ranging from white to dark brown. This contrast in color can appear in a single door panel. Hickory also contains random knots and wormholes that further contribute to a varied appearance. These exaggerated characteristics are to be expected and are considered desirable in Hickory cabinetry.



**Maple** is a close-grained hardwood that is predominately white to creamy-white in color, with occasional reddish-brown tones. While maple typically features uniform graining as compared to other wood species, characteristic markings may include fine brown lines, wavy or curly graining, bird pecks and mineral streaks. These traits are natural and serve to enhance maple's natural beauty.



**Oak** is a strong, open-grained hardwood that ranges in color from white to pink and reddish tones. Streaks of green, yellow and even black may appear due to mineral deposits. Oak may also contain wormholes and wild, varying grain patterns. This distinct graining is considered a desirable quality.

# HUMIDIFICATION

The natural response of wood to changes in humidity is much more dramatic than most people realize. Here is a table showing (a) how much a cabinet door panel is likely to shrink in an unhumidified house, (b) how much a cabinet door is likely to expand in excess humidity, and (c) the total potential range of dimension changes from a muggy summer to a cold dry winter.

## Total Potential Movement (inches) of solid wood panels

Species	Panel Dimension (inches)	(a) Winter	(b) Summer	(c) Annual Range
Cherry	19.75	-0.26	0.25	0.51
Maple	19.75	-0.49	0.10	0.59
Oak	19.75	-0.32	0.31	0.63
Hickory	19.75	-0.34	0.31	0.65

Notice the annual dimension change for a solid wood panel can approach three-quarters of an inch! For this reason, cabinet doors are typically manufactured at a targeted range of 40% – 50% relative humidity. This usually works very well because even unhumidified homes stay between 20% and 70% in normal years with typical cooking and washing activities.

In extremely cold, dry winters, some doors can be exposed to conditions that are below 20% relative humidity for weeks at a time. Exposure to sustained conditions such as these would cause panels to shrink and will not be considered defective. New construction makes the problem worse since the heat is on but no one is living in the home to raise the humidity levels. Conversely, where in-home humidity exceeds 70% relative humidity for extended periods of time, panels will swell and this will not be considered defective.

## Steps Consumers Can Take To Protect Real Wood Furnishings

- **Keep an eye on the humidity inside the home.** Reasonably accurate digital thermometers-hygrometer units are available to measure humidity.
- **Maintain the humidity at or above 20% when the temperature is below 20 degrees and over 35% when the temperature is above 20 degrees.** Some ways this may be accomplished are installing a whole-house humidifier on the furnace, running a portable humidifier in key rooms, or placing pans of water near the heat registers.
- **Don't over-do it.** Significant condensation on windows is a sign the humidity levels are too high for outside temperature conditions.
- **Recognize that finished wood responds to humidity over several days to several weeks.** It takes time before the wood returns to normal after any correction to the environment.

# Diamond®

## VIBE™ SERIES

### Door Style Reference Number Chart

Your Diamond Vibe price guide contains charts with prices for each cabinetry product, arranged according to a numerical code. Use the chart below to determine the price code for your preferred cabinetry style.

	Cherry	Hickory	Laminate	Maple	Oak	PureStyle™
<b>Adair</b>	17			15		15
<b>Antico</b>						14
<b>Brockway</b>	14			12	7	
<b>Bryant</b>	9	7		7		7
<b>Caito</b>	10			7	5	
<b>Cantrell</b>	12			8	5	
<b>Felix</b>	14	13		13		
<b>Forte</b>	14	13		13		13
<b>Hurley</b>	9	7		7		
<b>Kasper</b>	10			7	5	
<b>Keegan</b>	17			15		
<b>Kersey</b>	14	12		12	7	
<b>Klewin</b>	18	14		14	11	
<b>Loren</b>			4			
<b>Norris</b>	12			9		9
<b>Owens</b>	14			13		13
<b>Rensi</b>	10			7	5	7
<b>Tori</b>	4	3		3	1	
<b>Valero</b>	19			16		
<b>Westburke</b>	6	4		4	2	4

# FULL OVERLAY DOOR STYLES

4

DOOR STYLES

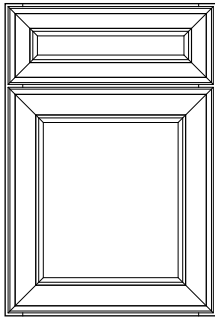

Adair  
(page 7)

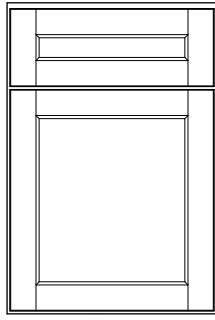

Antico  
(page 7)

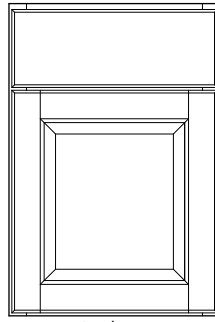

Brockway  
(page 8)

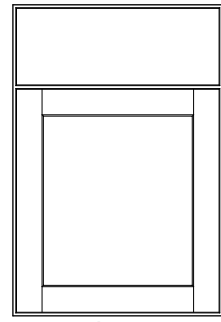

Bryant  
(page 8)

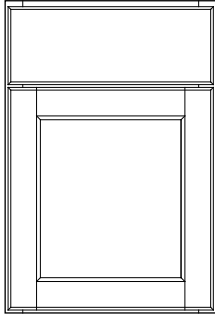

Caito  
(page 9)

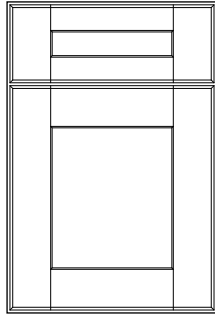

Felix  
(page 10)

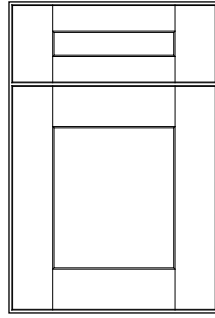

Forte  
(page 10)

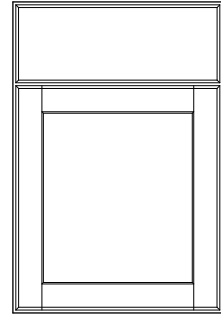

Hurley  
(page 11)

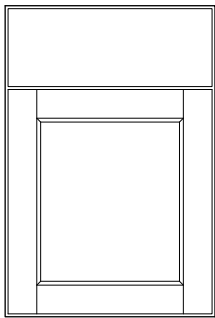

Kasper  
(page 11)

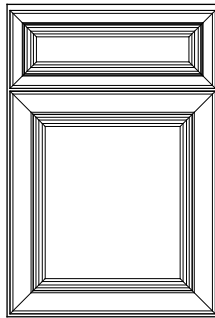

Keegan  
(page 12)

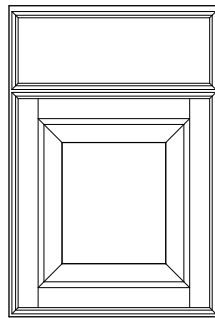

Klewin  
(page 13)

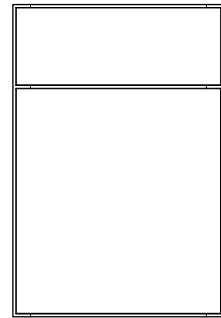

Loren  
(page 13)

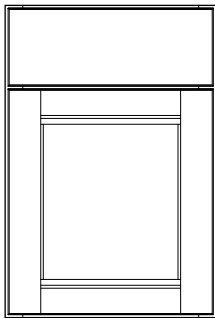

Owens  
(page 14)

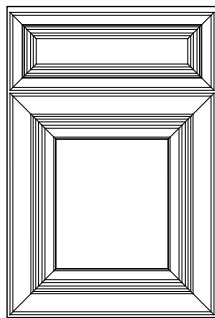

Valero  
(page 16)



## PARTIAL OVERLAY DOOR STYLES

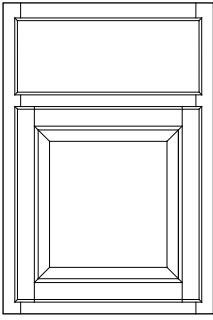

Cantrell  
(page 9)

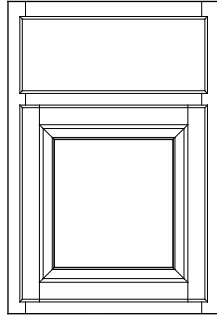

Kersey  
(page 12)

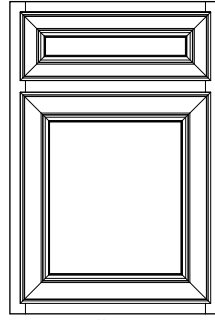

Norris  
(page 14)

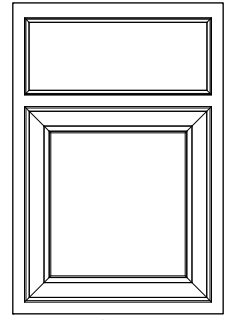

Rensi  
(page 15)

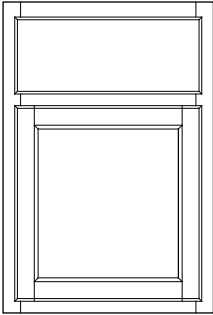

Tori  
(page 15)

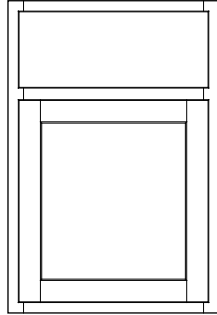

Westburke  
(page 16)

## FULL AND PARTIAL OVERLAY SPECIFICATIONS

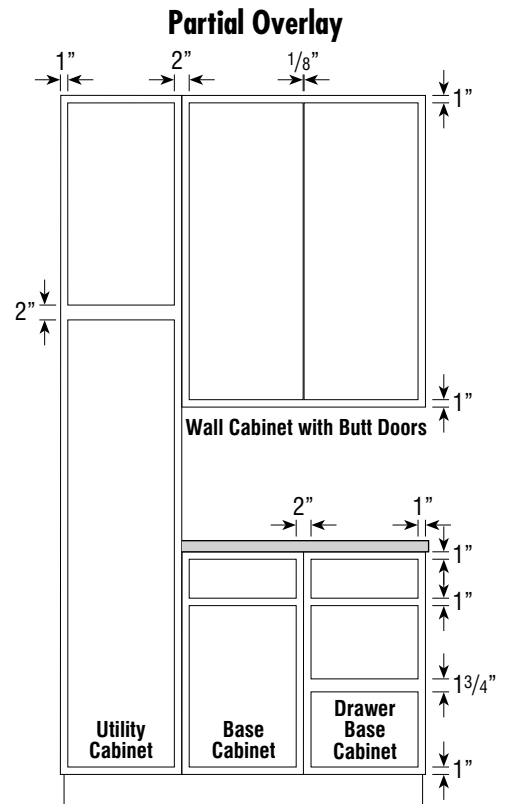
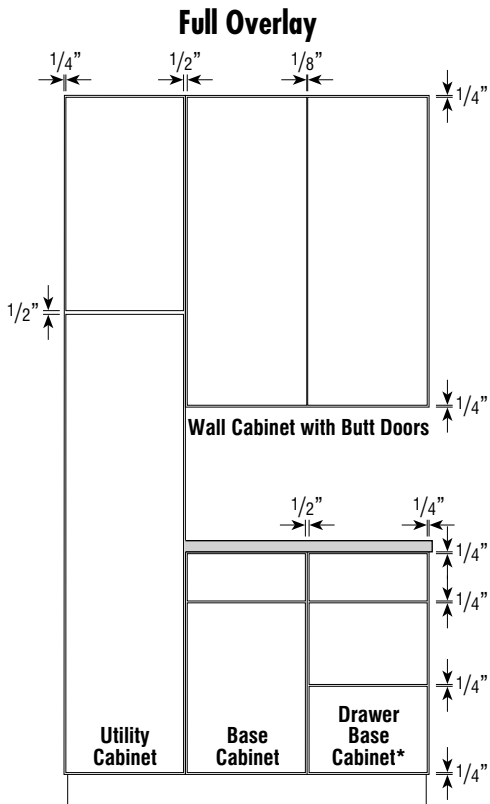

\*34 1/2" high application shown. On 32" high Full Overlay three drawer applications (drawer bases and sink bases with drawers), the reveal above the bottom drawer front is 1/2". On 29" high Full Overlay DDR\_\_ (Desk Drawer Base), the reveal above bottom drawer is 3/4".

- One double door center stile cabinet has the same reveal as two single door cabinets.

## DOOR STYLE SPECIFICATIONS

### Cherry

- When Cherry door styles are ordered, it is recommended to apply a finished end option or a veneer end panel for exposed ends due to the natural aging of Cherry.

### Maple

- When a Paint finish or Paint with Glaze finish is specified, select doors and/or drawer front center panels may be constructed of Medium Density Fiberboard (MDF). MDF provides a smoother finish when painted, and is more resistant to warping, expansion, and contraction.

### All Door Styles

- All doors and drawer fronts are 3/4" thick unless otherwise noted.

### Door and Drawer Front Side Profiles

- Veneer and MDF components are shown with gray shading on side profiles. Solid wood components do not have shading.

### Wood Grain

- See reference images for wood grain direction on all door styles.

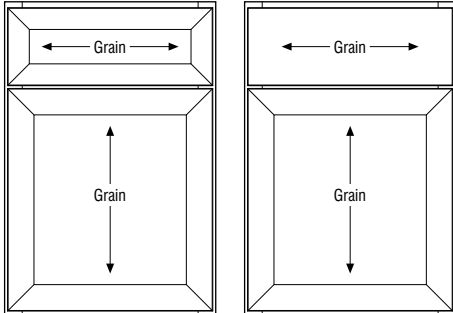

# DOOR STYLES

## Adair

	Cherry	Hickory	Laminate	Maple*	Oak	PureStyle™
Price Point	17	—	—	15	—	15

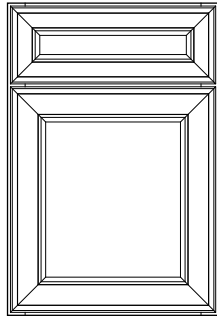

Base

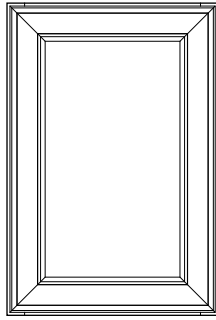

Wall

### Decorative Door Options

CG	MD
•	•

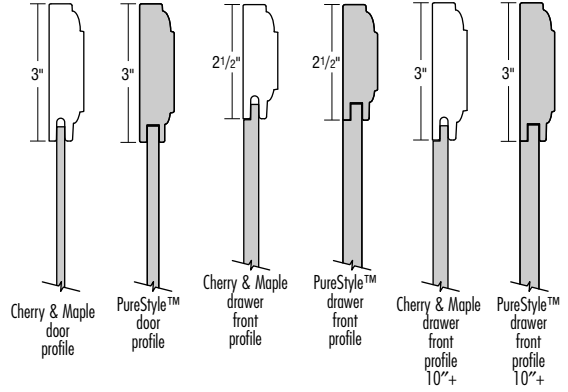
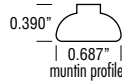

- Flat Center Panel
- Full Overlay, Miter

- 5-Piece Miter Drawer Front on all except WSD, BSD, UCD, and W3D (top drawer) will feature a slab drawer front.
- See page 45 for 5-piece drawer front dimensions when specifying decorative hardware.

\*When a Paint finish or Paint with Glaze finish is specified, the door and/or drawer front center panel may be constructed of Medium Density Fiberboard (MDF). MDF provides a smoother finish when painted, and is more resistant to warping, expansion, and contraction.

## Antico

	Cherry	Hickory	Laminate	Maple	Oak	PureStyle™
Price Point	—	—	—	—	—	14

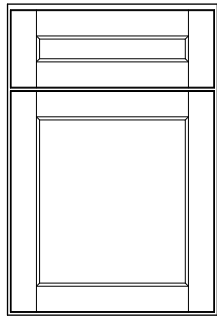

Base

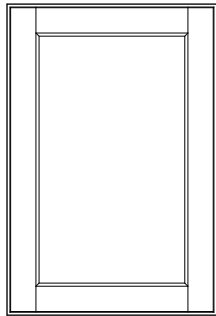

Wall

### Decorative Door Options

CG	MD
•	

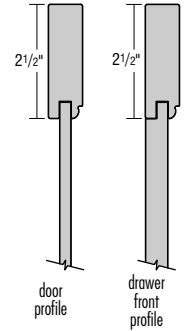

- Flat Center Panel
- 3/4" Thick Door Frame
- Full Overlay, French-Cut Miter

- 5-Piece French-Cut Miter Drawer Front on all except WSD, BSD, UCD, and W3D (top drawer) will feature a slab drawer front.
- See page 45 for 5-piece drawer front dimensions when specifying decorative hardware.

# DOOR STYLES

## Brockway

	Cherry	Hickory	Laminate	Maple*	Oak	PureStyle™
Price Point	14	—	—	12	7	—

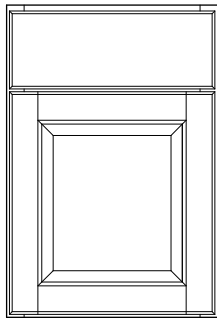

Base

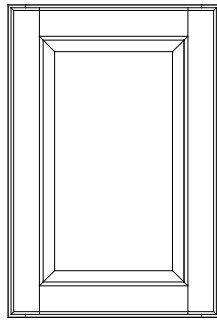

Wall

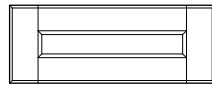

Optional Drawer Front:  
Flat 5-Piece (DFF5PC)

**Decorative Door Options**

CG	MD
•	•

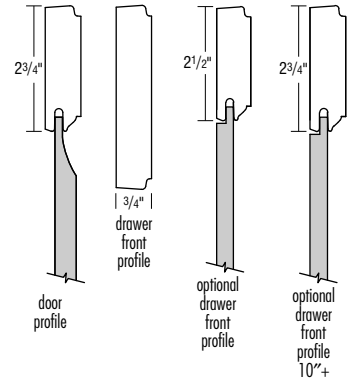
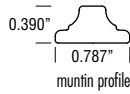

- Veneer Raised Center Panel
- 3/4" Thick Door Frame
- Full Overlay
- Profiled Slab Drawer Front

- See page 45 for 5-piece drawer front dimensions when specifying decorative hardware.

\*When a Paint finish or Paint with Glaze finish is specified, the door and/or drawer front center panel may be constructed of Medium Density Fiberboard (MDF). MDF provides a smoother finish when painted, and is more resistant to warping, expansion, and contraction.

## Bryant

	Cherry	Hickory	Laminate	Maple*	Oak	PureStyle™
Price Point	9	7	—	7	—	7

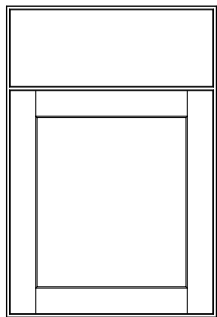

Base

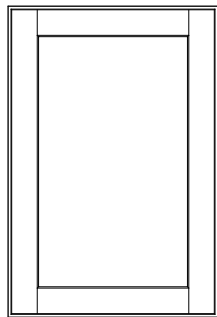

Wall

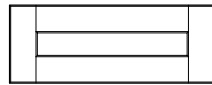

Optional Drawer Front:  
Flat 5-Piece (DFF5PC)

**Decorative Door Options**

CG	MD
•	•

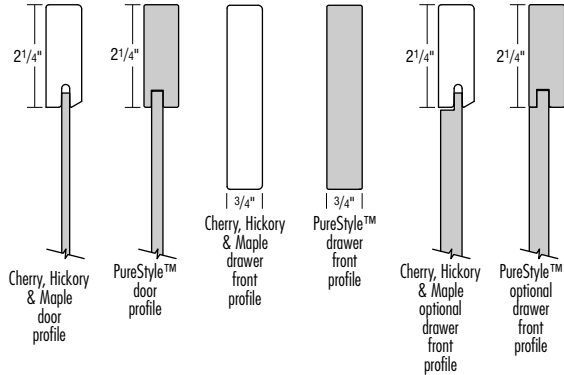
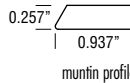

- Flat Center Panel
- 3/4" Thick Door Frame
- Full Overlay
- Slab Drawer Front

- See page 45 for 5-piece drawer front dimensions when specifying decorative hardware.

\*When a Paint finish or Paint with Glaze finish is specified, the door and/or drawer front center panel may be constructed of Medium Density Fiberboard (MDF). MDF provides a smoother finish when painted, and is more resistant to warping, expansion, and contraction.

# DOOR STYLES

## Caito

	Cherry	Hickory	Laminate	Maple*	Oak	PureStyle™
Price Point	10	—	—	7	5	—

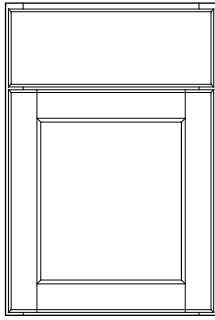

Base

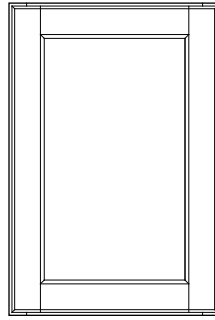

Wall

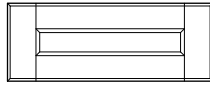

Optional Drawer Front:  
Flat 5-Piece (DFF5PC)

### Decorative Door Options

CG	MD
•	•

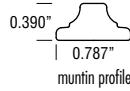

muntin profile

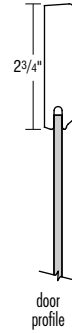

door profile



3/4" drawer front profile

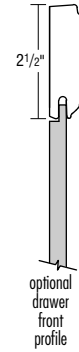

optional drawer front profile

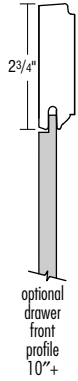

optional drawer front profile 10"+

- Veneer Flat Center Panel
- 3/4" Thick Door Frame
- Full Overlay
- Profiled Slab Drawer Front

- See page 45 for 5-piece drawer front dimensions when specifying decorative hardware.

\*When a Paint finish or Paint with Glaze finish is specified, the door and/or drawer front center panel may be constructed of Medium Density Fiberboard (MDF). MDF provides a smoother finish when painted, and is more resistant to warping, expansion, and contraction.

## Cantrell

	Cherry	Hickory	Laminate	Maple*	Oak	PureStyle™
Price Point	12	—	—	8	5	—

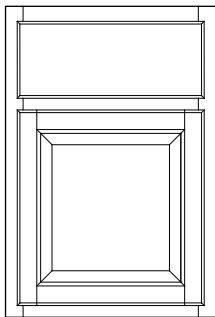

Base

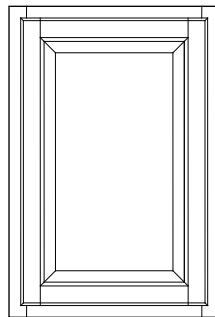

Wall

### Decorative Door Options

CG	MD
•	•

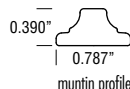

muntin profile

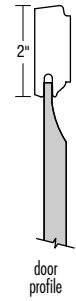

door profile



3/4" drawer front profile

- Veneer Raised Center Panel
- 3/4" Thick Door Frame
- Partial Overlay
- Profiled Slab Drawer Front

- Reverse Bevel Profile, Decorative Hardware Not Required

\*When a Paint finish or Paint with Glaze finish is specified, the door center panel may be constructed of Medium Density Fiberboard (MDF). MDF provides a smoother finish when painted, and is more resistant to warping, expansion, and contraction.



# DOOR STYLES

## Felix

	<b>Cherry</b>	<b>Hickory</b>	<b>Laminate</b>	<b>Maple*</b>	<b>Oak</b>	<b>PureStyle™</b>
<b>Price Point</b>	<b>14</b>	<b>13</b>	—	<b>13</b>	—	—

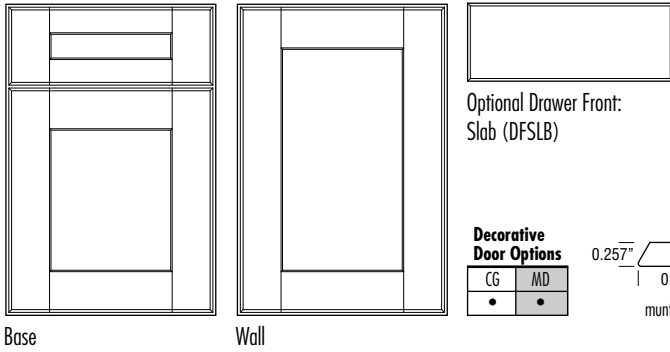

Base

Wall

**Decorative Door Options**

CG	MD
•	•

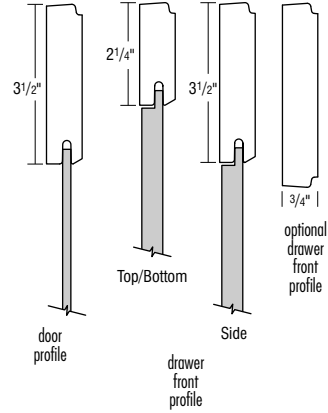
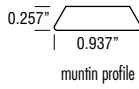

- Veneer Flat Center Panel
- 3/4" Thick Door Frame
- Full Overlay

- 5-Piece Drawer Front on all except WSD, BSD, UCD, and W3D (top drawer) will feature a slab drawer front.
- See page 45 for 5-piece drawer front dimensions when specifying decorative hardware.

\*When a Paint finish or Paint with Glaze finish is specified, the door and/or drawer front center panel may be constructed of Medium Density Fiberboard (MDF). MDF provides a smoother finish when painted, and is more resistant to warping, expansion, and contraction.

## Forte

	<b>Cherry</b>	<b>Hickory</b>	<b>Laminate</b>	<b>Maple*</b>	<b>Oak</b>	<b>PureStyle™</b>
<b>Price Point</b>	<b>14</b>	<b>13</b>	—	<b>13</b>	—	<b>13</b>

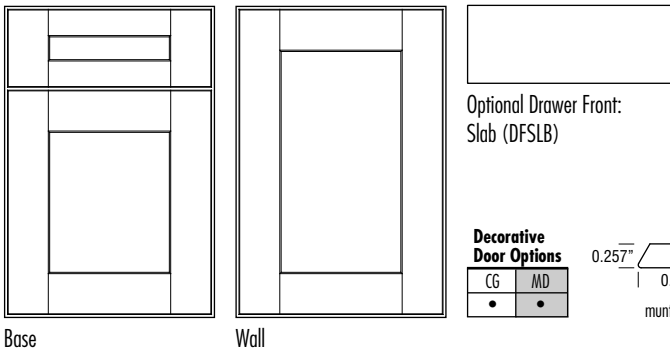

Base

Wall

**Decorative Door Options**

CG	MD
•	•

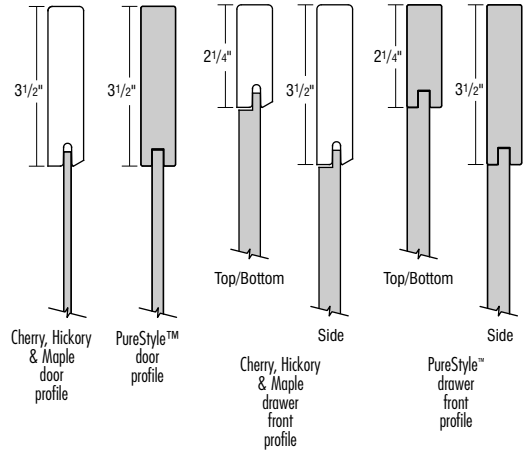
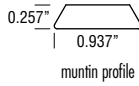

- Flat Center Panel
- 3/4" Thick Door Frame
- Full Overlay

- 5-Piece Drawer Front on all except WSD, BSD, UCD, and W3D (top drawer) will feature a slab drawer front.
- See page 45 for 5-piece drawer front dimensions when specifying decorative hardware.

\*When a Paint finish or Paint with Glaze finish is specified, the door and/or drawer front center panel may be constructed of Medium Density Fiberboard (MDF). MDF provides a smoother finish when painted, and is more resistant to warping, expansion, and contraction.

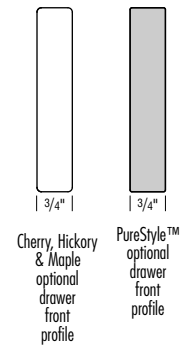

# DOOR STYLES

## Hurley

	Cherry	Hickory	Laminate	Maple*	Oak	PureStyle™
Price Point	9	7	—	7	—	—

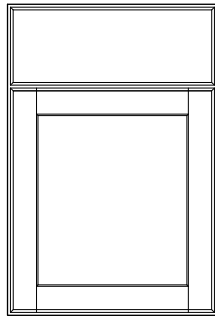

Base

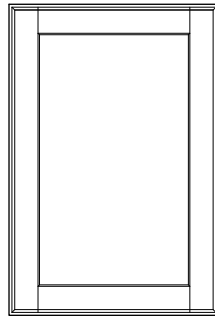

Wall

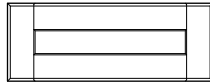

Optional Drawer Front:  
Flat 5-Piece (DFF5PC)

### Decorative Door Options

CG	MD
•	•

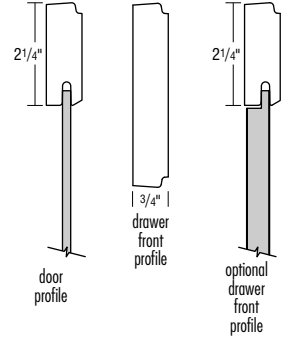
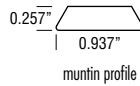

- Veneer Flat Center Panel
- 3/4" Thick Door Frame
- Full Overlay
- Profiled Slab Drawer Front

- See page 45 for 5-piece drawer front dimensions when specifying decorative hardware.

\*When a Paint finish or Paint with Glaze finish is specified, the door and/or drawer front center panel may be constructed of Medium Density Fiberboard (MDF). MDF provides a smoother finish when painted, and is more resistant to warping, expansion, and contraction.

## Kasper

	Cherry	Hickory	Laminate	Maple*	Oak	PureStyle™
Price Point	10	—	—	7	5	—

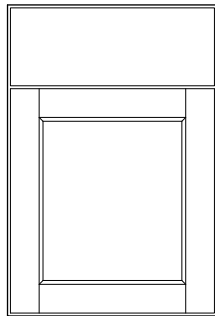

Base

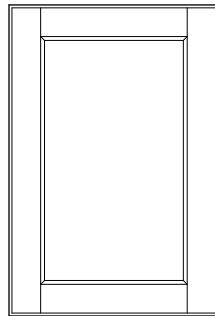

Wall

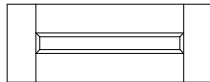

Optional Drawer Front:  
Flat 5-Piece (DFF5PC)

### Decorative Door Options

CG	MD
•	•

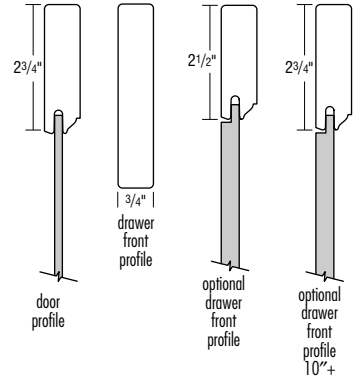
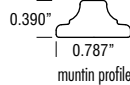

- Veneer Flat Center Panel
- 3/4" Thick Door Frame
- Full Overlay
- Slab Drawer Front

- See page 45 for 5-piece drawer front dimensions when specifying decorative hardware.

\*When a Paint finish or Paint with Glaze finish is specified, the door and/or drawer front center panel may be constructed of Medium Density Fiberboard (MDF). MDF provides a smoother finish when painted, and is more resistant to warping, expansion, and contraction.

# DOOR STYLES

12

DOOR STYLES

## Keegan

	Cherry	Hickory	Laminate	Maple*	Oak	PureStyle™
Price Point	17	—	—	15	—	—

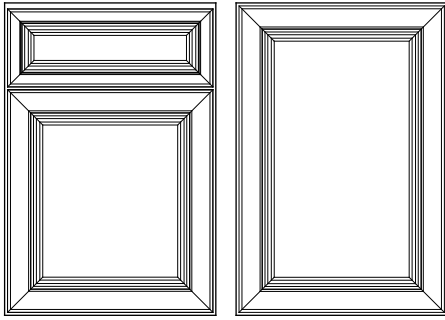

Base

Wall

### Decorative Door Options

CG	MD
•	•

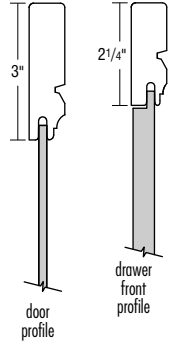

- Veneer Flat Center Panel
- 3/4" Thick Door Frame
- Full Overlay, Miter

- 5-Piece Miter Drawer Front on all except WSD, BSD, UCD, and W3D (top drawer) will feature a slab drawer front.
- See page 45 for 5-piece drawer front dimensions when specifying decorative hardware.

\*When a Paint finish is specified, the door and/or drawer front center panel may be constructed of Medium Density Fiberboard (MDF). MDF provides a smoother finish when painted, and is more resistant to warping, expansion, and contraction.

## Kersey

	Cherry	Hickory	Laminate	Maple*	Oak	PureStyle™
Price Point	14	12	—	12	7	—

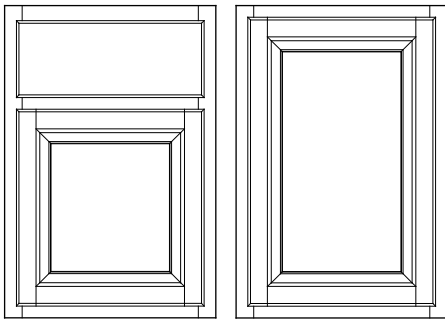

Base

Wall

### Decorative Door Options

CG	MD
•	•

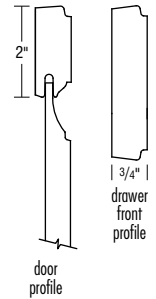
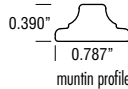

- Solid Raised Center Panel
- 3/4" Thick Door Frame
- Partial Overlay
- Profiled Slab Drawer Front

- Reverse Bevel Profile, Decorative Hardware Not Required

\*When a Paint finish or Paint with Glaze finish is specified, the door center panel may be constructed of Medium Density Fiberboard (MDF). MDF provides a smoother finish when painted, and is more resistant to warping, expansion, and contraction.

# DOOR STYLES

## Klewin

	Cherry	Hickory	Laminate	Maple*	Oak	PureStyle™
Price Point	18	14	—	14	11	—

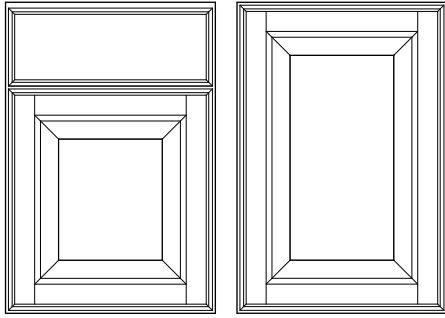

Base

Wall

**Decorative Door Options**

CG	MD
•	•

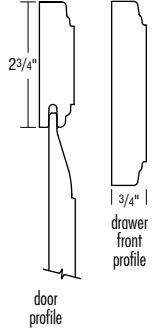
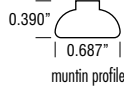

- Solid Raised Center Panel
- 3/4" Thick Door Frame
- Full Overlay
- Profiled Slab Drawer Front

\*When a Paint finish or Paint with Glaze finish is specified, the door center panel may be constructed of Medium Density Fiberboard (MDF). MDF provides a smoother finish when painted, and is more resistant to warping, expansion, and contraction.

## Loren

	Cherry	Hickory	Laminate	Maple	Oak	PureStyle™
Price Point	—	—	4	—	—	—

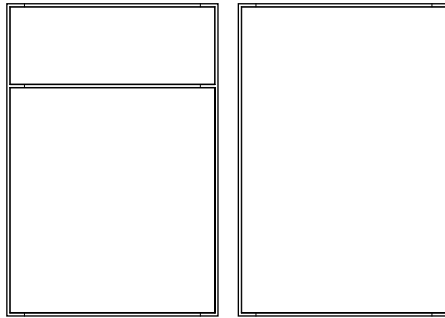

Base

Wall

**Decorative Door Options**

CG	MD

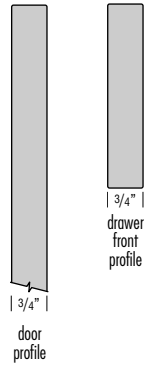

- Slab Door and Drawer Front with Matching or Metallic Edgebanding
- Full Overlay

- Backs of Doors, Drawer Fronts, and Overlays feature matching laminate
- A heat shield is required to separate Loren doors, drawer fronts, overlay fillers, and all laminate products from heat producing units to be in compliance with cabinet warranty.

# DOOR STYLES

## Norris

	Cherry	Hickory	Laminate	Maple*	Oak	PureStyle™
Price Point	12	—	—	9	—	9

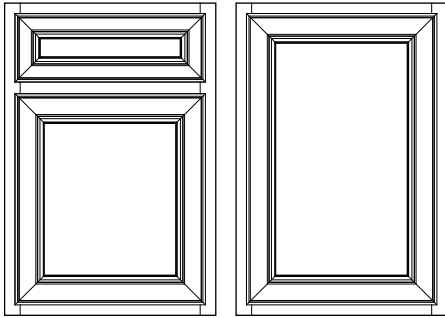

Base

Wall

**Decorative Door Options**

CG	MD
•	•

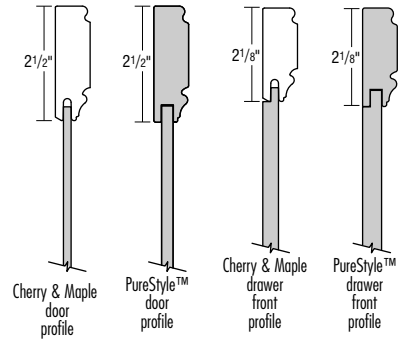
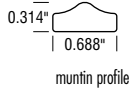

- Flat Center Panel
- Partial Overlay, Miter

- 5-Piece Miter Drawer Front on all except WSD, BSD, UCD, and W3D (top drawer) will feature a slab drawer front.
- See page 45 for 5-piece drawer front dimensions when specifying decorative hardware.

\*When a Paint finish or Paint with Glaze finish is specified, the door and/or drawer front center panel may be constructed of Medium Density Fiberboard (MDF). MDF provides a smoother finish when painted, and is more resistant to warping, expansion, and contraction.

## Owens

	Cherry	Hickory	Laminate	Maple*	Oak	PureStyle™
Price Point	14	—	—	13	—	13

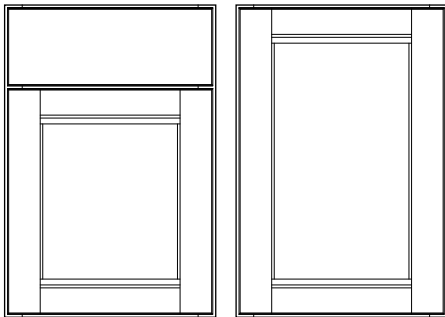

Base

Wall

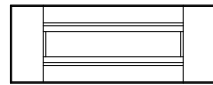

Optional Drawer Front:  
Flat 5-Piece (DFF5PC)

**Decorative Door Options**

CG	MD
•	

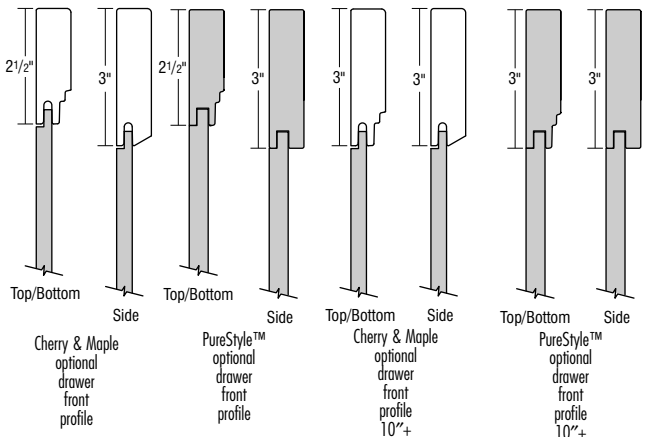
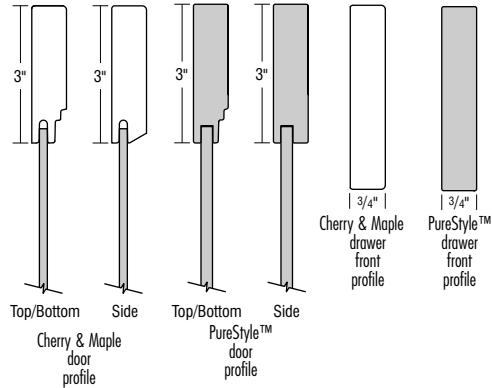

- Flat Center Panel
- Full Overlay
- Slab Drawer Front

- See page 45 for 5-piece drawer front dimensions when specifying decorative hardware.

\*When a Paint finish or Paint with Glaze finish is specified, the door and/or drawer front center panel may be constructed of Medium Density Fiberboard (MDF). MDF provides a smoother finish when painted, and is more resistant to warping, expansion, and contraction.

# DOOR STYLES

## Rensi

	Cherry	Hickory	Laminate	Maple*	Oak	PureStyle™
Price Point	10	—	—	7	5	7

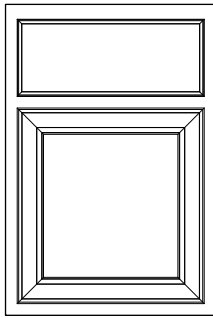

Base (Cherry, Maple, Oak)

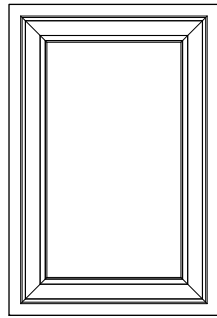

Wall

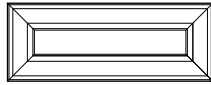

Cherry, Maple, Oak  
 Optional Drawer Front: Flat 5-Piece (DFF5PC)  
 PureStyle™: Standard 5-Piece Drawer Front

**Decorative Door Options**

CG	MD
•	•

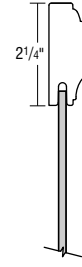
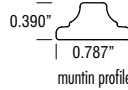

Cherry, Maple & Oak door profile

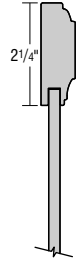

PureStyle™ door profile



Cherry, Maple & Oak drawer front profile

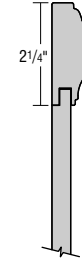

PureStyle™ drawer front profile

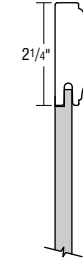

Cherry, Maple & Oak optional drawer front profile

- Flat Center Panel
- 3/4" Thick Door Frame
- Partial Overlay, Miter
- Profiled Slab Drawer Front on Cherry, Maple and Oak

- 5-Piece Miter Drawer Front on PureStyle™ on all except WSD, BSD, UCD, and W3D (top drawers) will feature a slab drawer front.
- See page 45 for 5-piece drawer front dimensions when specifying decorative hardware.

\*When a Paint finish or Paint with Glaze finish is specified, the door and/or drawer front center panel may be constructed of Medium Density Fiberboard (MDF). MDF provides a smoother finish when painted, and is more resistant to warping, expansion, and contraction.

## Tori

	Cherry	Hickory	Laminate	Maple*	Oak	PureStyle™
Price Point	4	3	—	3	1	—

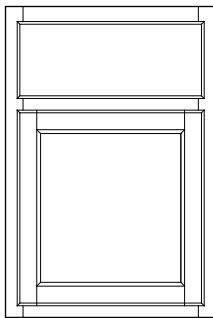

Base

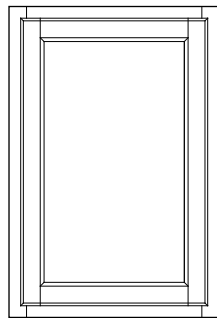

Wall

**Decorative Door Options**

CG	MD
•	•

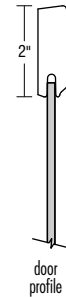
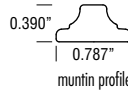

door profile



drawer front profile

- Veneer Flat Center Panel
- 3/4" Thick Door Frame
- Partial Overlay
- Profiled Slab Drawer Front

- Reverse Bevel Profile, Decorative Hardware Not Required

\*When a Paint finish or Paint with Glaze finish is specified, the door center panel may be constructed of Medium Density Fiberboard (MDF). MDF provides a smoother finish when painted, and is more resistant to warping, expansion, and contraction.

# DOOR STYLES

## Valero

	Cherry	Hickory	Laminate	Maple*	Oak	PureStyle™
Price Point	19	—	—	16	—	—

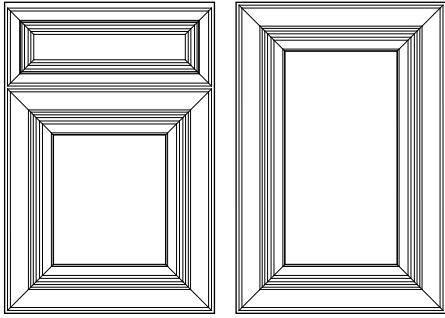

Base

Wall

**Decorative Door Options**

CG	MD
•	

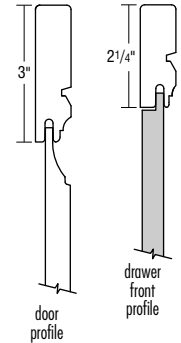

- Solid Raised Center Panel
- 3/4" Thick Door Frame
- Full Overlay, Miter
- 5-Piece Miter Drawer Front on all except WSD, BSD, UCD, and W3D (top drawer) will feature a slab drawer front.

- Cabinets with narrow doors may utilize flat center panels, see cabinet specification notes for more details.
- See page 45 for 5-piece drawer front dimensions when specifying decorative hardware.

\*When a Paint finish is specified, the door and/or drawer front center panel may be constructed of Medium Density Fiberboard (MDF). MDF provides a smoother finish when painted, and is more resistant to warping, expansion, and contraction.

## Westburke

	Cherry	Hickory	Laminate	Maple*	Oak	PureStyle™
Price Point	6	4	—	4	2	4

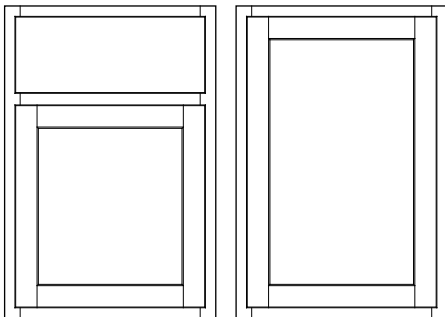

Base

Wall

**Decorative Door Options**

CG	MD
•	•

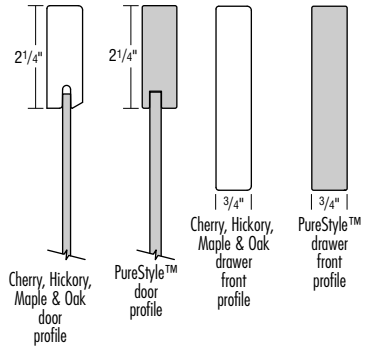
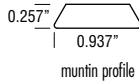

- Flat Center Panel
- 3/4" Thick Door Frame
- Partial Overlay
- Slab Drawer Front

\*When a Paint finish or Paint with Glaze finish is specified, the door center panel may be constructed of Medium Density Fiberboard (MDF). MDF provides a smoother finish when painted, and is more resistant to warping, expansion, and contraction.





## FINISH AVAILABILITY

				OAK								HICKORY						LAMINATE	PURESTYLE™ LAMINATE												
		Matching Laminate Ends	Upcharge	Brockway	Cairo	Cantrell	Kasper	Kersey	Klewin	Rensi	Tori	Westburke	Bryant	Felix	Forre	Hurley	Kersey	Klewin	Tori	Westburke	Loren	Adair	Antico	Bryant	Forre	Norris	Owens	Rensi	Westburke		
18	Stains	Buckskin	✓		✓	✓	✓	✓	✓	✓	✓	✓	✓	✓	✓	✓	✓	✓	✓												
		Cattail	✓		✓	✓	✓	✓	✓	✓	✓	✓	✓	✓	✓	✓	✓	✓	✓	✓											
		Chocolate	✓		✓	✓	✓	✓	✓	✓	✓	✓																			
		Morel	✓		✓	✓	✓	✓	✓	✓	✓	✓	✓	✓	✓	✓	✓	✓	✓	✓											
		Natural	✓		✓	✓	✓	✓	✓	✓	✓	✓	✓	✓	✓	✓	✓	✓	✓	✓											
		Sahara	✓		✓	✓	✓	✓	✓	✓	✓	✓	✓	✓	✓	✓	✓	✓	✓	✓											
		Thatch	✓		✓	✓	✓	✓	✓	✓	✓	✓	✓	✓	✓	✓	✓	✓	✓	✓											
		Tundra	✓		✓	✓	✓	✓	✓	✓	✓	✓	✓	✓	✓	✓	✓	✓	✓	✓											
		Unfinished*	✓	-5%	✓	✓	✓	✓	✓	✓	✓	✓	✓	✓	✓	✓	✓	✓	✓	✓											
Laminate Finishes	Cloud	✓																		✓	✓	✓	✓	✓	✓	✓	✓	✓	✓		
	Coconut	✓																		✓	✓	✓	✓	✓	✓	✓	✓	✓	✓		
	Egret	✓																		✓	✓	✓	✓	✓	✓	✓	✓	✓	✓		
	Limestone	✓																		✓	✓	✓	✓	✓	✓	✓	✓	✓	✓		
	White	✓																		✓	✓	✓	✓	✓	✓	✓	✓	✓	✓		

\*Requires VPL upgrade with FB option. Discount of 5% applied to all applicable products. When cabinets are finished by an outside source, finish is not covered under warranty. Interiors of cabinets will be natural Maple laminate. For finishable interiors, MIP must be specified.

## PREMIUM COLOR PALETTE

	OPTION NAME	DESCRIPTION/LIMITATIONS	MATCHING LAMINATE ENDS <sup>A</sup>	UPCHARGE <sup>**</sup>
Paints	<b>Black</b>	An opaque black finish which embodies a consistently dark and cool hue.	N/A	Cabinet list + 10%
	<b>Cloud</b>	A cool gray opaque finish.	✓	Cabinet list + 10%
	<b>Coconut</b>	An off-white opaque finish that gives a smooth appearance to the wood surface.	✓	Cabinet list + 10%
	<b>Egret</b>	A darker, off-white finish on the cooler gray side.	✓	Cabinet list + 10%
	<b>Heron</b>	A light gray opaque with blue undertones.	✓	Cabinet list + 10%
	<b>Limestone</b>	A gray opaque finish that gives a smooth appearance to the wood surface.	✓	Cabinet list + 10%
	<b>Maritime</b>	A dark, navy tone opaque.	N/A	Cabinet list + 10%
	<b>Moonstone</b>	A mid-gray opaque finish with cool, pale-blue undertones.	✓	Cabinet list + 10%
	<b>White</b>	A white opaque finish that gives a smooth appearance to the wood surface.	✓	Cabinet list + 10%
Panned Glazes	<b>Barn Wood</b>	A soft gray glaze that provides a subtle, pale shadow to light finishes and a highlight to darker finishes.	✓	Cabinet list + 15%
	<b>Brown Sugar</b>	A dark spicy brown glaze that helps define any profile with high contrast.	✓	Cabinet list + 15%

<sup>A</sup>In Standard construction, cabinets will have matching laminate ends. Where not available, ends will be Natural Maple laminate and a finished end treatment would be needed for an exposed end.

<sup>\*\*</sup>Cabinet list includes cabinet price plus any modifications except VPL.

## DIAMOND® VIBE™ CABINETS' 12-STEP FINISHING PROCESS

- 1. Wood Selection** – The selection of the finest woods including Cherry, Hickory, Maple, and Oak is the essential first step of Diamond Vibe's 12-step finishing process.
- 2. Sanded to Perfection** – Our sanding utilizes a fine grit paper, both with and against the wood grain. This process is completed on a vacuum table, allowing for a wood surface that is free of dust particles.
- 3. Achieving Natural Wood Tone** – Toner is applied to selected finishes, enhancing the naturalistic wood appearance.
- 4. Stain Application** – A hand-sprayed deep saturating stain is evenly applied to all surfaces for even coverage on all profiles.
- 5. Removal of Excess Stain** – The wood is hand-wiped to remove excess stain, emphasizing the cabinet's natural wood grain.
- 6. Catalyzed Sealer** – A tough, clear, catalyzed sealer is hand-sprayed on to protect the grain from moisture.
- 7. Drying Process** – For added durability, the sealed wood is oven cured to lock in the beauty of wood.
- 8. Hand-Sanded** – To achieve an ultra-smooth finish, we hand-sand the material one last time.
- 9. Dust Removal** – The resulting loose dust particles are removed from the surface of the wood.
- 10. Catalyzed Top-Coat** – A premium quality catalyzed top-coat is applied to protect the wood from environmental elements.
- 11. Final Top Coat Cure** – The top-coat is cured for a strong, beautiful finish.
- 12. Final Inspection** – This last inspection is very thorough, ensuring quality and beauty. Our gift to you is that every cabinet is crafted with care.

### CHARACTERISTICS OF GLAZING/PAIN

#### Characteristics of Glazing

A professional glaze can add another layer of beauty to your cabinets. The glazing is applied by hand, adding depth dimension and an understated sheen that's guaranteed to endure.

#### What to expect from glazed cabinetry...

- You should expect the result to yield a subtle to dramatic look based on the complexity of a cabinet door's design, as glazing may collect in the corners and grooves.
- Printed materials and online, electronic presentations can only do so much. It's important to both see and touch actual finished samples to ensure your satisfaction.

#### Characteristics of Paint

Paint may develop hairline cracks in the finish, most notable around the joints. This is a result of natural expansion and contraction of the genuine hardwoods used in the manufacturing of this product. Hairline cracks are not considered a defect in the cabinetry or finish.

## CONSTRUCTION FEATURES

	VIBE STANDARD (VIB)	ALL PLYWOOD WITH LAMINATE ENDS (VPL)*
<b>Doors &amp; Drawer Fronts</b>	See "Door Styles" pages 7-16 for door and drawer front configuration and construction details.	
<b>Face Frames</b>	3/4" solid hardwood.	
<b>I-Beam Braces</b>	1/2" furniture board dadoed into face frame, end panels and back panels.	1/2" plywood dadoed into face frame, end panels and back panels.
<b>Cabinet Sides</b>	3/8" furniture board with natural Maple laminate interiors and matching laminate exterior.	1/2" plywood with natural Maple laminate interior and matching laminate exterior.
<b>Cabinet Tops &amp; Bottoms (Wall &amp; Tall)</b>	1/2" furniture board with natural Maple laminate interior and exterior surfaces.	
<b>Cabinet Bottoms (Base &amp; Vanity)</b>	1/2" furniture board with natural Maple laminate interior surface.	
<b>Cabinet Backs</b>	3/8" furniture board with natural Maple laminate interior. Base cabinets have 3mm system holes for easy drawer and roll tray installation.	3/8" plywood with natural Maple laminate interior. Base cabinets have 3mm system holes for easy drawer and roll tray installation.
<b>Adjustable Shelves</b>	3/4" furniture board with natural Maple laminate to match interiors. Shelves are adjustable in wall and base cabinets unless otherwise noted.	3/4" plywood laminated to match interiors. Shelves are adjustable in wall and base cabinets unless otherwise noted.
<b>Finish</b>	Multi-step finishing process where the finished components are sanded, stained, and sealed before a catalyzed top coat is applied.	
<b>Hinges</b>	Partial 1/2" Overlay Doors: Fully concealed cup hinge; 6-way adjustable and self closing. Full 1 1/4" Overlay Doors: Fully concealed cup hinge; 6-way adjustable and self closing. Optional Integrated Smart Stop™ Premium Hinge (INTGH). Smart Stop fully concealed, integrated cup hinge with self-closing feature; 6-way adjustable and self closing. Hinge features deactivation option. Some cabinets utilize a 170° or 107° 4-way adjustable hinge. See page 299 for details.	
<b>Drawers</b>	Standard: 1/2" natural Maple laminated furniture board. Drawer bottom is 3/8" natural Maple furniture board. Features side mounted, epoxy coated guides.  Optional Smart Stop Premium Drawer Guide (PG): Double fully concealed, ball bearing, self-aligning, full extension guide with Smart Stop self-closing mechanism and fast clip removal system. Smart Stop engages when the drawer is approximately 2" from closing, applying resistance to the self-closing mechanism. Four-sided clear coated, solid hardwood drawer box with dovetailed construction. All guides have a 90 lb. weight capacity.	
<b>Roll Trays</b>	Standard: 1/2" natural Maple laminated furniture board. Roll tray bottom is 3/8" natural Maple furniture board. Features side mounted, epoxy coated guides.  Optional Smart Stop Premium Roll Tray Guide (SP): Double fully concealed, ball bearing, self-aligning, full extension guide with Smart Stop self-closing mechanism and fast clip removal system. Smart Stop engages when the roll tray is approximately 2" from closing, applying resistance to the self-closing mechanism. Four-sided clear coated, solid hardwood drawer box with dovetailed construction. All guides have a 90 lb. weight capacity.	
<b>Toekick</b>	3/8" Unfinished furniture board toekick to allow application of finished toeboard materials. A variety of laminate and wood toeboard skins and baseboard mouldings available in 8' lengths; see ACCESSORIES section.	3/8" Unfinished plywood toekick to allow application of finished toeboard materials. Toeboard skins and baseboard mouldings available in 8' lengths; see ACCESSORIES section.
<b>Warranty</b>	Lifetime limited warranty. Please see written warranty for detailed information.	
<b>Interior Cabinet Components</b>	A few interior components are manufactured from laminated furniture board because they provide for the most durable, aesthetic application.	

\*All plywood components meet ANSI/HPVA HP-1 standards and may contain MDF or particleboard.

### VIBE STANDARD BOX CONSTRUCTION

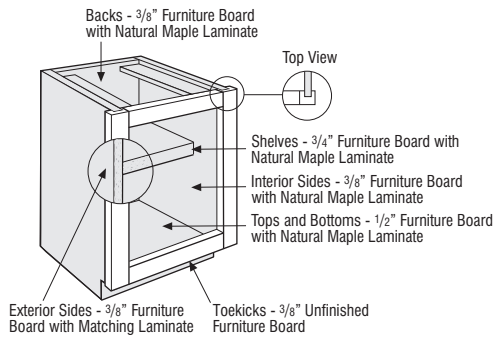

### VIBE STANDARD DRAWER BOX CONSTRUCTION

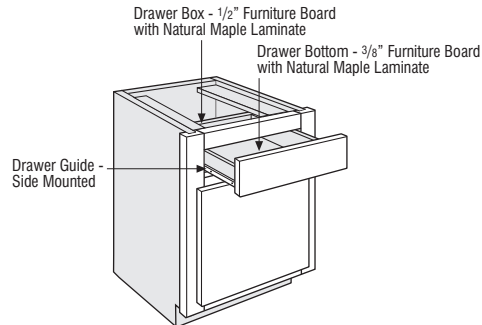

# MODIFICATION/UPGRADE COMPATIBILITY CHART

MODIFICATION/ UPGRADE		VPL	DF5PC	DFSLB	PG	SP	INTGH	AUTHL	AUTHR	FB	FPEB	MIP	CBO	CCO	CFP	CND	ID	RD	CMAT	FD	RT/RTF	SCPDRW	TOTSS	DRWTK	FTK	RECTKALL	RECTKBK	RECTKL	RECTKR	VTK	CFNTO	CFRMO	P	CG	MD	
<b>Construction Upgrades</b> (page 22)	VPL - All Plywood with Laminate Ends	✓	✓	✓	✓	✓	✓	✓	✓	✓	✓		✓	✓	✓	✓	✓	✓	✓	✓	✓	✓	✓	✓	✓	✓	✓	✓	✓	✓	✓	✓	✓	✓	✓	
<b>Drawer Front Upgrades</b> (page 23)	DF5PC - Drawer Front Flat 5-Piece	✓			✓	✓	✓	✓	✓	✓	✓	✓			✓	✓	✓	✓	✓	✓	✓	✓	✓	✓	✓	✓	✓	✓	✓	✓	✓	✓	✓	✓		
	DFSLB - Drawer Front Slab	✓			✓	✓	✓	✓	✓	✓	✓	✓			✓	✓	✓	✓	✓	✓	✓	✓	✓	✓	✓	✓	✓	✓	✓	✓	✓	✓	✓	✓	✓	
<b>Smart Stop Options</b> (page 24)	PG - Smart Stop Premium Drawer Guide	✓	✓	✓		✓	✓	✓	✓	✓	✓	✓	✓	✓	✓	✓	✓	✓	✓	✓	✓	✓	✓	✓	✓	✓	✓	✓	✓	✓	✓	✓	✓	✓		
	SP - Smart Stop Premium Roll Tray Guide	✓	✓	✓	✓		✓	✓	✓	✓	✓	✓	✓	✓	✓	✓	✓	✓	✓	✓	✓	✓	✓	✓	✓	✓	✓	✓	✓	✓	✓	✓	✓	✓	✓	
	INTGH - Smart Stop Premium Hinge	✓	✓	✓	✓	✓		✓	✓	✓	✓	✓	✓	✓	✓	✓	✓	✓	✓	✓	✓	✓	✓	✓	✓	✓	✓	✓	✓	✓	✓	✓	✓	✓	✓	
<b>End Panel Modifications</b> (page 25)	AUTHL - Authentic End Left	✓	✓	✓	✓	✓						✓	✓	✓	✓	✓	✓	✓	✓	✓	✓	✓	✓	✓	✓	✓	✓	✓	✓	✓	✓	✓	✓	✓		
	AUTHR - Authentic End Right	✓	✓	✓	✓	✓						✓	✓	✓	✓	✓	✓	✓	✓	✓	✓	✓	✓	✓	✓	✓	✓	✓	✓	✓	✓	✓	✓	✓		
	FB - Finished Ends	✓	✓	✓	✓	✓						✓	✓	✓	✓	✓	✓	✓	✓	✓	✓	✓	✓	✓	✓	✓	✓	✓	✓	✓	✓	✓	✓	✓		
	FPEB - Furniture Finished Plywood End Panels	✓	✓	✓	✓	✓						✓	✓	✓	✓	✓	✓	✓	✓	✓	✓	✓	✓	✓	✓	✓	✓	✓	✓	✓	✓	✓	✓	✓	✓	
<b>Finish Modification</b> (page 26)	MIP - Matching Interior Plywood		✓	✓	✓	✓	✓	✓	✓	✓	✓		✓	✓	✓	✓	✓	✓	✓	✓	✓	✓	✓	✓	✓	✓	✓	✓	✓	✓	✓	✓	✓	✓		
<b>Box Modifications</b> (pages 27-28)	CBO - Cabinet Box Only	✓			✓	✓	✓	✓	✓	✓	✓	✓					✓	✓	✓	✓	✓	✓	✓	✓	✓	✓	✓	✓	✓	✓	✓	✓	✓	✓		
	CCO - Cabinet Case Only	✓					✓	✓	✓	✓	✓	✓					✓	✓	✓	✓	✓	✓	✓	✓	✓	✓	✓	✓	✓	✓	✓	✓	✓	✓	✓	
	CFP - Cabinet False Panel	✓	✓	✓	✓	✓	✓	✓	✓	✓	✓	✓					✓	✓	✓	✓	✓	✓	✓	✓	✓	✓	✓	✓	✓	✓	✓	✓	✓	✓	✓	
	CND - Cabinet with No Door, with Drawer	✓	✓	✓	✓	✓	✓	✓	✓	✓	✓	✓					✓	✓	✓	✓	✓	✓	✓	✓	✓	✓	✓	✓	✓	✓	✓	✓	✓	✓	✓	
	ID - Increased Depth	✓	✓	✓	✓	✓	✓	✓	✓	✓	✓	✓	✓	✓	✓	✓	✓	✓	✓	✓	✓	✓	✓	✓	✓	✓	✓	✓	✓	✓	✓	✓	✓	✓	✓	
	RD - Reduced Depth	✓	✓	✓	✓	✓	✓	✓	✓	✓	✓	✓	✓	✓	✓	✓	✓	✓	✓	✓	✓	✓	✓	✓	✓	✓	✓	✓	✓	✓	✓	✓	✓	✓	✓	
<b>Installed Interior Modifications</b> (pages 29-30)	CMAT - CabMat™	✓	✓	✓	✓	✓	✓	✓	✓	✓	✓	✓	✓	✓	✓	✓	✓	✓	✓	✓	✓	✓	✓	✓	✓	✓	✓	✓	✓	✓	✓	✓	✓	✓		
	FD - Full Depth Shelf	✓	✓	✓	✓	✓	✓	✓	✓	✓	✓	✓	✓	✓	✓	✓	✓	✓	✓	✓	✓	✓	✓	✓	✓	✓	✓	✓	✓	✓	✓	✓	✓	✓	✓	
	RT/RTF - Installed Roll Tray	✓	✓	✓	✓	✓	✓	✓	✓	✓	✓	✓	✓	✓	✓	✓	✓	✓	✓	✓	✓	✓	✓	✓	✓	✓	✓	✓	✓	✓	✓	✓	✓	✓	✓	
	SCPDRW - Scooped Drawer	✓	✓	✓	✓	✓	✓	✓	✓	✓	✓	✓	✓	✓	✓	✓	✓	✓	✓	✓	✓	✓	✓	✓	✓	✓	✓	✓	✓	✓	✓	✓	✓	✓	✓	
	TOTSS - Tilt-Out Tray, Stainless Steel	✓	✓	✓	✓	✓	✓	✓	✓	✓	✓	✓	✓	✓	✓	✓	✓	✓	✓	✓	✓	✓	✓	✓	✓	✓	✓	✓	✓	✓	✓	✓	✓	✓	✓	
<b>Toekick Modifications</b> (pages 31-33)	DRWTK - Toekick Drawer	✓	✓	✓	✓	✓	✓	✓	✓	✓	✓	✓	✓	✓	✓	✓	✓	✓	✓	✓	✓	✓	✓	✓	✓	✓	✓	✓	✓	✓	✓	✓	✓	✓	✓	
	FTK - Flush Toekick	✓	✓	✓	✓	✓	✓	✓	✓	✓	✓	✓	✓	✓	✓	✓	✓	✓	✓	✓	✓	✓	✓	✓	✓	✓	✓	✓	✓	✓	✓	✓	✓	✓	✓	
	RECTKALL - Recessed Island Toekick	✓	✓	✓	✓	✓	✓	✓	✓	✓	✓	✓	✓	✓	✓	✓	✓	✓	✓	✓	✓	✓	✓	✓	✓	✓	✓	✓	✓	✓	✓	✓	✓	✓	✓	
	RECTKBK - Recessed Toekick Back	✓	✓	✓	✓	✓	✓	✓	✓	✓	✓	✓	✓	✓	✓	✓	✓	✓	✓	✓	✓	✓	✓	✓	✓	✓	✓	✓	✓	✓	✓	✓	✓	✓	✓	✓
	RECTKL - Recessed Toekick Left	✓	✓	✓	✓	✓	✓	✓	✓	✓	✓	✓	✓	✓	✓	✓	✓	✓	✓	✓	✓	✓	✓	✓	✓	✓	✓	✓	✓	✓	✓	✓	✓	✓	✓	✓
	RECTKR - Recessed Toekick Right	✓	✓	✓	✓	✓	✓	✓	✓	✓	✓	✓	✓	✓	✓	✓	✓	✓	✓	✓	✓	✓	✓	✓	✓	✓	✓	✓	✓	✓	✓	✓	✓	✓	✓	✓
	VTK - Void Toekick	✓	✓	✓	✓	✓	✓	✓	✓	✓	✓	✓	✓	✓	✓	✓	✓	✓	✓	✓	✓	✓	✓	✓	✓	✓	✓	✓	✓	✓	✓	✓	✓	✓	✓	✓
<b>Configuration Modifications</b> (page 34)	CFNTO - Cabinet Front Only		✓	✓		✓																			✓									✓	✓	
	CFRMO - Cabinet Frame Only																									✓									✓	✓
	P - Peninsula	✓	✓	✓	✓	✓	✓	✓	✓	✓	✓	✓	✓	✓	✓	✓	✓	✓	✓	✓	✓	✓	✓	✓	✓	✓	✓	✓	✓	✓	✓	✓	✓	✓	✓	
<b>Specialty Doors</b> (pages 35-36)	CG - Cut for Glass	✓	✓	✓	✓	✓	✓	✓	✓	✓	✓	✓	✓	✓	✓	✓	✓	✓	✓	✓	✓	✓	✓	✓	✓	✓	✓	✓	✓	✓	✓	✓	✓	✓	✓	
	MD - Mullion Door	✓	✓	✓	✓	✓	✓	✓	✓	✓	✓	✓	✓	✓	✓	✓	✓	✓	✓	✓	✓	✓	✓	✓	✓	✓	✓	✓	✓	✓	✓	✓	✓	✓	✓	

Orders for cabinets with non-compatible modifications will not be processed. Please contact customer service for more details.  
 ✓ Represents compatible modification(s) and upgrade(s).

# CONSTRUCTION UPGRADE

See page 21 for modification compatibility. Each modification will be priced accordingly.

OPTION NAME	APPLICABLE CABINET GROUP	DESCRIPTION/LIMITATIONS	PRICING
All Plywood with Laminate Ends (VPL)*	Most cabinets with sides	Replaces standard cabinet construction with: <ul style="list-style-type: none"> <li>• 3/8" laminated plywood back</li> <li>• 1/2" laminated plywood ends, top, and bottom</li> <li>• 3/8" unfinished plywood toekick</li> </ul> Matching laminate exterior with natural Maple laminate interior.	Cabinet list + 7%
	Shelf kits	Replaces standard shelf construction with: <ul style="list-style-type: none"> <li>• 3/4" laminated plywood shelves</li> </ul> Matching laminate exterior with natural Maple laminate interior.	Shelves: List + 7%

## ALL PLYWOOD WITH LAMINATE ENDS (VPL)\*

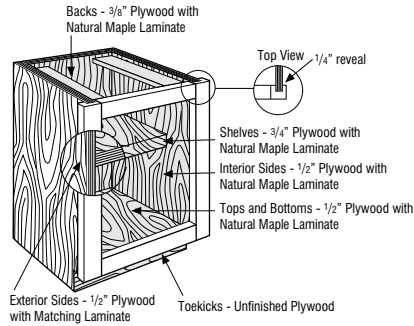

\*All plywood components meet ANSI/HPVA HP-1 standards and may contain MDF or particleboard.

# DRAWER FRONT UPGRADES

See page 21 for modification compatibility. Each modification will be priced accordingly.

OPTION NAME	APPLICABLE CABINET GROUP	DESCRIPTION/LIMITATIONS	PRICING
<b>Drawer Front Flat 5-Piece (DFF5PC)</b>	Base, tall, and vanity cabinets on Brockway, Bryant, Caito, Hurley, Kasper, Owens, and Rensi	Replaces the standard drawer front with a 5-piece drawer front (see images with applicable door styles). Must upgrade all drawer fronts on a cabinet where applicable.  Premium finish upcharges will apply where applicable.  See page 45 for 5-piece drawer front dimensions when specifying decorative hardware.	\$107 list per drawer
<b>Drawer Front Slab (DFS LB)</b>	Base, tall, and vanity cabinets on Felix and Forte	Replaces standard drawer front with slab drawer front. Must upgrade all drawer fronts on cabinet where applicable.  Premium finish upcharges will apply where applicable.	No Upcharge

## DRAWER FRONT FLAT 5-PIECE (DFF5PC)

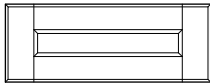

Brockway

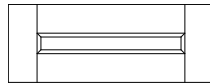

Kasper

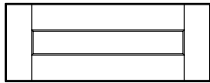

Bryant

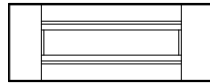

Owens

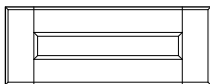

Caito

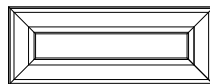

Rensi

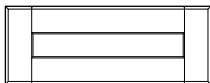

Hurley

## DRAWER FRONT SLAB (DFS LB)

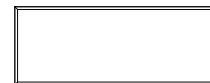

Felix



Forte

# SMART STOP OPTIONS

See page 21 for modification compatibility. Each modification will be priced accordingly.

OPTION NAME	APPLICABLE CABINET GROUP	DESCRIPTION/LIMITATIONS	PRICING
<b>Smart Stop Premium Hinge (INTGH)</b>	Most cabinets with doors	Replaces standard hinges with fully concealed, integrated Smart Stop cup hinges; 6-way adjustable and self closing. Hinges feature deactivation option.	\$13 list per door
<b>Smart Stop Premium Drawer Guide (PG)</b>	Most cabinets with drawers	Replaces standard 3/4 extension side mount guide with full extension, concealed, undermount guide with integrated Smart Stop which engages when the drawer is approximately 2" from closing, applying resistance to the self-closing mechanism. Also replaces the furniture board drawer box with a four-sided clear coated, solid hardwood box with dovetailed construction. Must upgrade all drawers in a cabinet, where applicable.	\$79 list per drawer
<b>Smart Stop Premium Roll Tray Guide (SP)</b>	Most cabinets with roll trays	Replaces standard 3/4 extension side mount guide with full extension, concealed, undermount guide with integrated Smart Stop which engages when the roll tray is approximately 2" from closing, applying resistance to the self-closing mechanism. Also replaces the furniture board roll tray box with a four-sided clear coated, solid hardwood box with dovetailed construction. Must upgrade all roll trays in a cabinet, where applicable.	\$79 list per roll tray

## SMART STOP PREMIUM HINGE (INTGH)

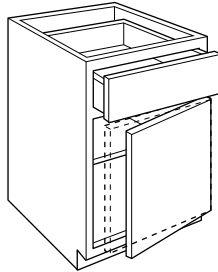

## SMART STOP PREMIUM DRAWER GUIDE (PG)

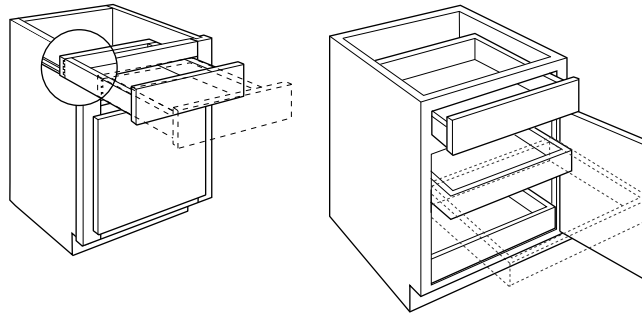

# END PANEL MODIFICATIONS

See page 21 for modification compatibility. Each modification will be priced accordingly.

OPTION NAME	APPLICABLE CABINET GROUP	DESCRIPTION/LIMITATIONS	PRICING
<b>Authentic Ends (AUTHL) (AUTHR)</b>	Most wall, base, tall, and vanity cabinets	<p>Modifies cabinet end panel(s) with applied decorative door(s) onto FPEB upgraded end panel(s).</p> <p>Includes FPEB modification — If AUTHL or AUTHR upgrades are specified, the opposite end panel is also FPEB.</p> <p>Available on most cabinets with depths of 9", 12", 15", 18", 21", and 24". 9" depth available on cabinets 30" high or taller.</p> <p>12" and 15" high wall cabinets will have double door configuration on 21" and 24" deep applications.</p> <p>For tall cabinets, non-miter doors have two panels on the bottom door.</p> <p>Decorative door for wall and tall cabinets will match style chosen on order, i.e., arch, cathedral or square.</p> <p>Office base cabinets (29" high) will have double door configuration when specified on 24" deep cabinets.</p>	<p>Wall: \$393 list per side                      Base &amp; Vanity: \$557 list per side                      Tall: \$1,330 list per side</p>
<b>Finished Ends (FB)</b>	Cabinets with VPL modification; both ends will be finished	Creates a matching finished 1/2" veneer plywood exterior.	<p>Wall: \$78 list                      Base: \$127 list                      Tall: \$323 list</p>
<b>Furniture Finished Plywood End Panels (FPEB)*</b>	Most wall, base, tall, office, and vanity cabinets	Replaces standard cabinet ends with 3/4" finished veneer end panels to achieve a Furniture End appearance. Both exterior sides are finished. Matching interior (MIP) is available.	<p>Wall: \$173 list                      Base &amp; Vanity: \$241 list                      Tall: \$415 list</p>

## AUTHENTIC ENDS (AUTHL/AUTHR)

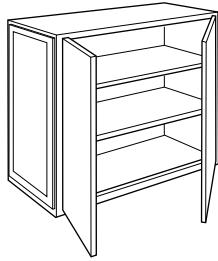

Wall cabinets

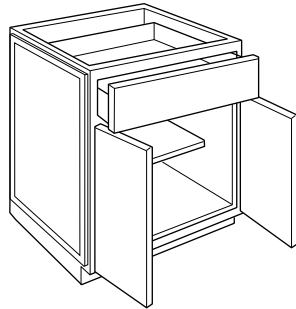

Base and Vanity cabinets

## FURNITURE FINISHED PLYWOOD END PANELS CONSTRUCTION UPGRADE (FPEB)\*

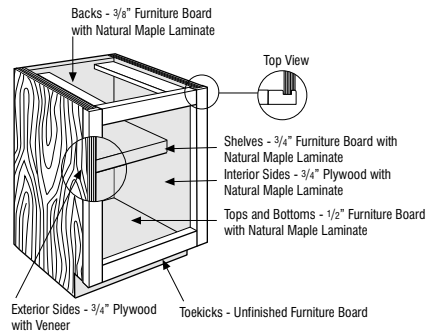

\*All plywood components meet ANSI/HPVA HP-1 standards and may contain MDF or particleboard.



# FINISH MODIFICATION

See page 21 for modification compatibility. Each modification will be priced accordingly.

OPTION NAME	APPLICABLE CABINET GROUP	DESCRIPTION/LIMITATIONS	PRICING
<b>Matching Interior Plywood (MIP)*</b>	Most cabinets	<p>Finishes the interior and exterior of the cabinet. Construction features hardwood veneered plywood with full depth shelves of hardwood veneer on a plywood core.</p> <p>Not available on open cabinets with standard matching interior.</p> <p>When a decorative door option is chosen in 20/20, Matching Interior Plywood (MIP) is a preselected option. If MIP is not desired, it can be deselected by choosing NOTMIP.</p>	<p>Wall: \$203 list                      Base: \$364 list                      Tall: \$669 list                      Shelves: List + 25%</p>

## MATCHING INTERIOR PLYWOOD (MIP)\*

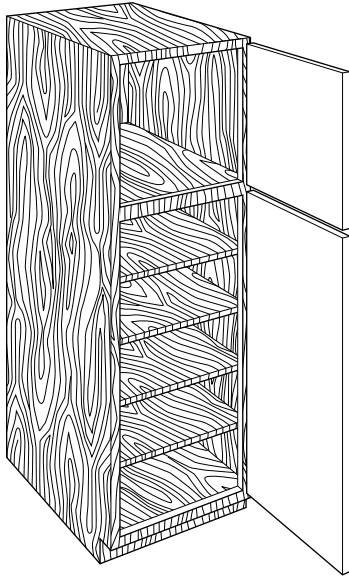

Tall cabinets

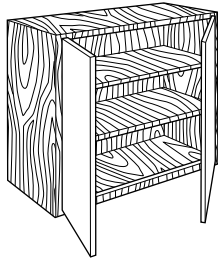

Wall cabinets

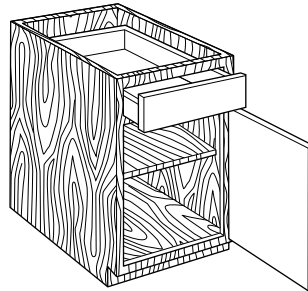

Base cabinets

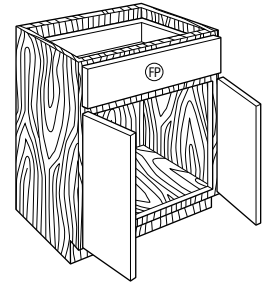

Vanity cabinets

\*All plywood components meet ANSI/HPVA HP-1 standards and may contain MDF or particleboard.

# BOX MODIFICATIONS

See page 21 for modification compatibility. Each modification will be priced accordingly.

OPTION NAME	APPLICABLE CABINET GROUP	DESCRIPTION/LIMITATIONS	PRICING
<b>Cabinet Box Only (CBO)</b>	Most wall, base, tall, and vanity cabinets	Removes doors, drawer fronts, and any accessory items attached to a door or drawer front. Drawer box and any interior components attached to the cabinet box will be included. Frames will not be drilled for hinges.	Cabinets without drawers: 85% of cabinet list Cabinets with drawers: 90% of cabinet list
<b>Cabinet Case Only (CCO)</b>	Most wall, base, tall, and vanity cabinets	Removes doors, drawer fronts, drawers, and interior components. Frames will not be drilled for hinges.	85% of cabinet list
<b>Cabinet False Panel (CFP)</b>	Most base and vanity cabinets with a top drawer	Replaces top drawer with false panel. Not available with deep drawers.	No Upcharge
<b>Cabinet with No Door, with Drawer (CND)</b>	Most wall, base, tall, and vanity cabinets with door(s) and drawer(s)	Removes door(s). Complete drawer(s) with drawer front(s) and interior components remain in cabinet. Frames will not be drilled for hinges.	90% of cabinet list

## CABINET BOX ONLY (CBO)

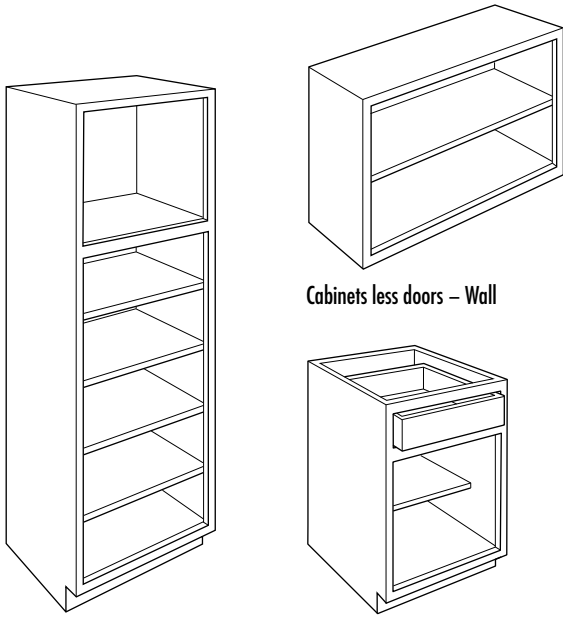

Cabinets less doors – Tall

Cabinets less doors – Wall

Cabinets less doors and drawer fronts – Base

## CABINET CASE ONLY (CCO)

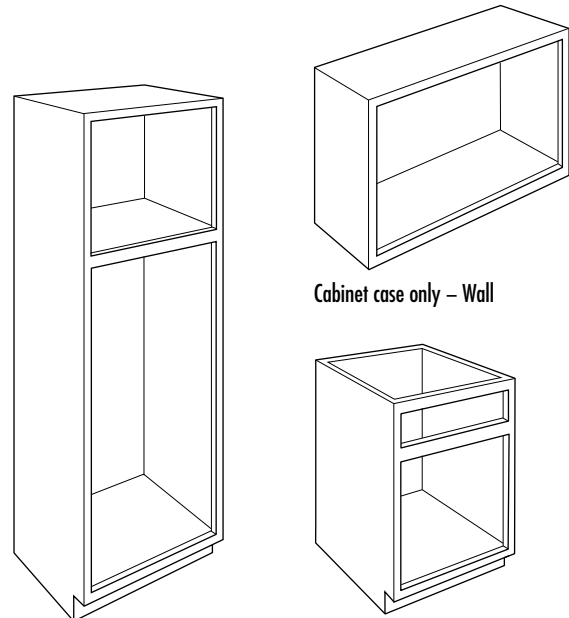

Cabinet case only – Tall

Cabinet case only – Wall

Cabinet case only – Base

## CABINET FALSE PANEL (CFP)

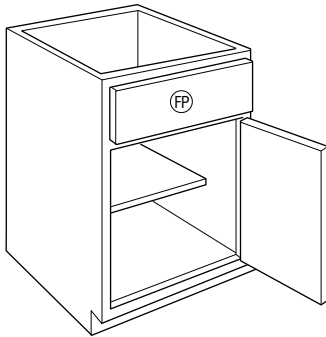

Base and Vanity cabinets

## CABINET WITH NO DOOR, WITH DRAWER (CND)

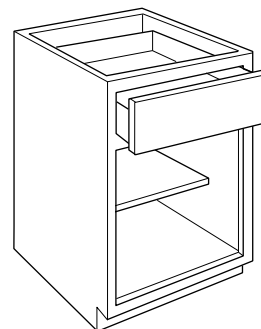

Base and Vanity cabinets

# BOX MODIFICATIONS (cont'd)

See page 21 for modification compatibility. Each modification will be priced accordingly.

OPTION NAME	APPLICABLE CABINET GROUP	DESCRIPTION/LIMITATIONS	PRICING
<b>Increased Depth (ID)</b>	Most wall, tall, and vanity cabinets with a frame	Increases the depth of wall and vanity cabinets in 1" increments to a maximum depth of 24". Available only on 12" deep wall cabinets. Vanity cabinets with a drawer only available in 3" increments. Increased depth wall cabinets should be either floor mounted or stacked to maintain stability. Shelf depths are increased on cabinets with increased depth. Not available on wall peninsula cabinets.	Wall: \$299 list Tall: \$412 list Vanity: \$359 list
	End panels	Increases the depth in 1" increments to a maximum depth of 36".	List + 40%
	Box column fillers	Increases the depth in 1" increments to a maximum depth of 27".	List + 40%
<b>Reduced Depth (RD)</b>	Most cabinets with drawers	Reduces the depth in 3" increments to a minimum depth of 18". Any specified shelving is included and is always full depth. The dimension is specified as the distance from the front of the face frame to the back of the cabinet.	Wall: \$299 list Base: \$359 list Tall: \$412 list Vanity: \$359 list (RD18 no charge)
	Most cabinets without drawers or roll trays	Reduces the depth in 1" increments to a minimum depth of 6". If reduced depth to 8" or less, toe-kick will not be included. Any specified shelving is included and is always full depth. The dimension is specified as the distance from the front of the face frame to the back of the cabinet.	
	Most cabinets with roll trays	Reduces the depth in 3" increments to a minimum depth of 18". Any specified shelving is included and is always full depth. The dimension is specified as the distance from the front of the face frame to the back of the cabinet.	
	Most wall cabinets	Reduces the depth in 1" increments to a minimum depth of 6". Any specified shelving is included and is always full depth. The dimension is specified as the distance from the front of the face frame to the back of the cabinet.	
	End panels, shelves, and box column fillers	Reduces the depth in 1" increments to a minimum depth of 6".	List + 30%
	Smart Stop premium kits	Reduces the depth in 3" increments to fit a minimum cabinet depth of 18".	

Cabinet Depth	Drawer Box and Roll Tray Exterior Depth			Clearance Behind Drawer Box or Roll Tray and Back Panel		
	Standard Guides	Premium Drawer Guide (PG) and Premium Roll Tray Guide (SP)	Heavy Duty Side-Mount Guides (DDFD)	Standard Guides	Premium Drawer Guide (PG) and Premium Roll Tray Guide (SP)	Heavy Duty Side-Mount Guides (DDFD)
24"	21"	21"	21"	2 3/4"	2 3/4"	2 3/4"
21"	18", 15" for roll trays	18"	18"	2 3/4"	2 3/4"	2 3/4"
18"	15"	15"	N/A	2 3/4"	2 3/4"	N/A

## INCREASED DEPTH (ID)

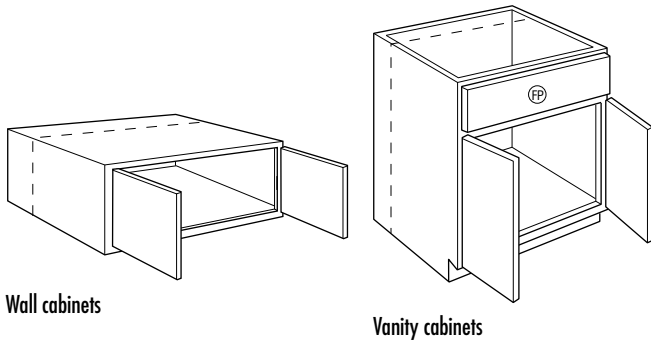

## REDUCED DEPTH (RD)

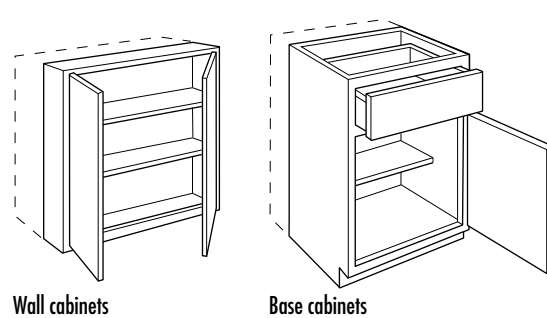

# INSTALLED INTERIOR MODIFICATIONS

See page 21 for modification compatibility. Each modification will be priced accordingly.

OPTION NAME	APPLICABLE CABINET GROUP	DESCRIPTION/LIMITATIONS	PRICING
<b>CabMat™ (CMAT1) (CMAT2)</b>	Most base and vanity cabinets	Installs removable CabMat™, size is determined by face frame opening width and cabinet depth. CMAT2 is only available on vanity cabinets with two face frame openings for sinks. Not available with Reduced Depth modification. When ordered with Increased Depth modification, CabMat™ size does not change. Vanity cabinets with face frame openings of 24" and 30" will utilize CabMats sized for 21" and 27" openings.	CMAT1: Cabinet list + \$290 CMAT2: Cabinet list + \$579
<b>Full Depth Shelf (FD)</b>	Base cabinets with standard half depth shelves	Replaces standard shelf with full depth shelf.	\$67 list per cabinet
<b>Scooped Drawer (SCPDRAW)</b>	Most base cabinets	Replaces top drawer box with a 2" high dovetail box with Smart Stop premium guides to allow for clearance of cooktops, etc. Available on cabinets 30"-36" wide with a top drawer. Only top drawer will be modified when specified on drawer bases. Increases clearance for cooktops from 2 1/2" to 3 7/8". When SCPDRW is selected on ZDB30 and ZDB36, top drawer will utilize a 6 3/8" high drawer box, creating a clearance of 6 5/8" for the cooktop. Not available on Adair PureStyle™, Antico PureStyle™, Bryant PureStyle™, Forte PureStyle™, Norris PureStyle™, Owens PureStyle™, and Rensi PureStyle™ with DFF5PC.	1 drawer: \$70 list
<b>Tilt-Out Tray, Stainless Steel (TOTSS)</b>	Cabinets with false panels	Installs one stainless steel tilt-out tray inside of each false panel. Trays are 2" deep and protrude 1 1/16" into cabinet.	\$279 list per cabinet

### CABMAT™ (CMAT1, CMAT2)

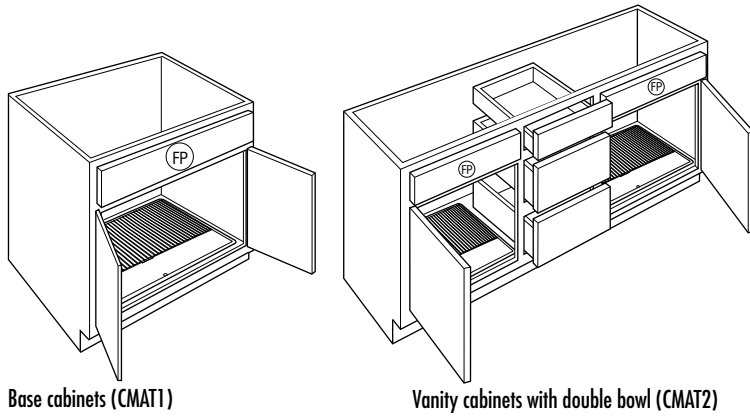

Base cabinets (CMAT1)

Vanity cabinets with double bowl (CMAT2)

### FULL DEPTH SHELF (FD)

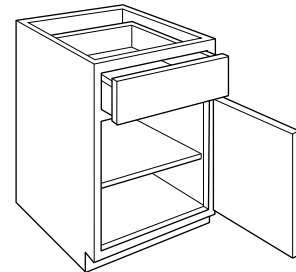

### SCOOPED DRAWER (SCPDRAW)

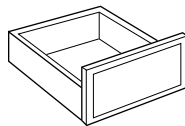

### TILT-OUT TRAY, STAINLESS STEEL (TOTSS)

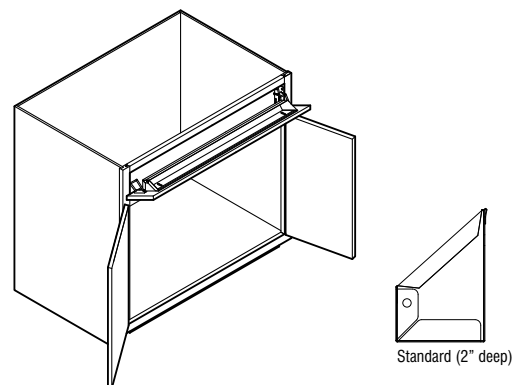

Standard (2" deep)

## INSTALLED INTERIOR MODIFICATIONS (cont'd)

See page 21 for modification compatibility. Each modification will be priced accordingly.

OPTION NAME	APPLICABLE CABINET GROUP	DESCRIPTION/LIMITATIONS	PRICING
<b>Installed Roll Tray with Smart Stop Premium Roll Tray Guide (RT)</b>	Select base, tall, office, and vanity cabinets	Installs specified number of roll trays (1-5 per side). Example, for two roll trays, specify 2RT. On cabinets with center stile, specify RTL for roll trays in left side and RTR for roll trays in right side. RTL and RTR should be selected for roll trays in both sides. Shelves will be replaced when Installed Roll Tray is specified. Maximum of 4 roll trays per opening for base cabinets. Maximum of 5 roll trays per opening for utility cabinets.	1RT: Cabinet list + \$230 2RT: Cabinet list + \$462 3RT: Cabinet list + \$693 4RT: Cabinet list + \$924 5RT: Cabinet list + \$1,154
<b>Installed Roll Tray Furniture Board (RTF)</b>	Select base and tall cabinets	Installs specified number of roll trays (1-5 per side). Example, for two roll trays, specify 2RTF. On cabinets with center stile, specify RTFL for roll trays in left side and RTFR for roll trays in right side. RTFL and RTFR should be selected for roll trays in both sides. Shelves will be replaced when Installed Roll Tray is specified. Maximum of 4 roll trays per opening for base cabinets. Maximum of 5 roll trays per opening for utility cabinets. Availability for RTF is shown in the modification charts with RT.	1RTF: Cabinet list + \$153 2RTF: Cabinet list + \$305 3RTF: Cabinet list + \$457 4RTF: Cabinet list + \$610 5RTF: Cabinet list + \$763

### INSTALLED ROLL TRAY WITH SMART STOP PREMIUM ROLL TRAY GUIDE (RT)

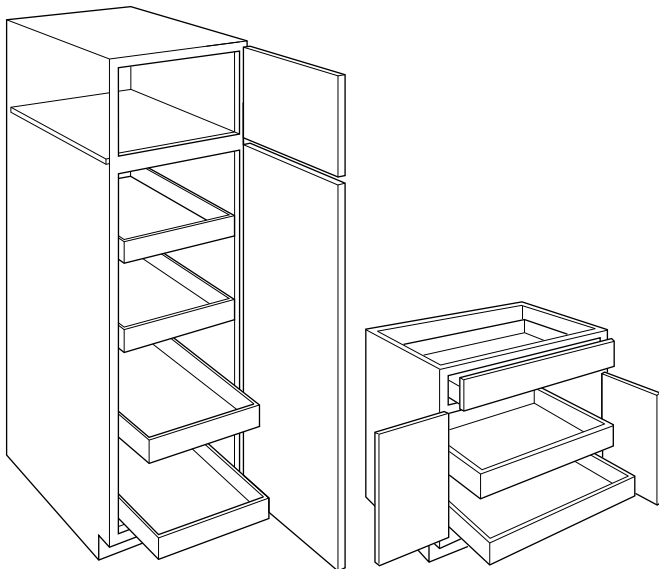

Tall cabinets

Base cabinets

### INSTALLED ROLL TRAY FURNITURE BOARD (RTF)

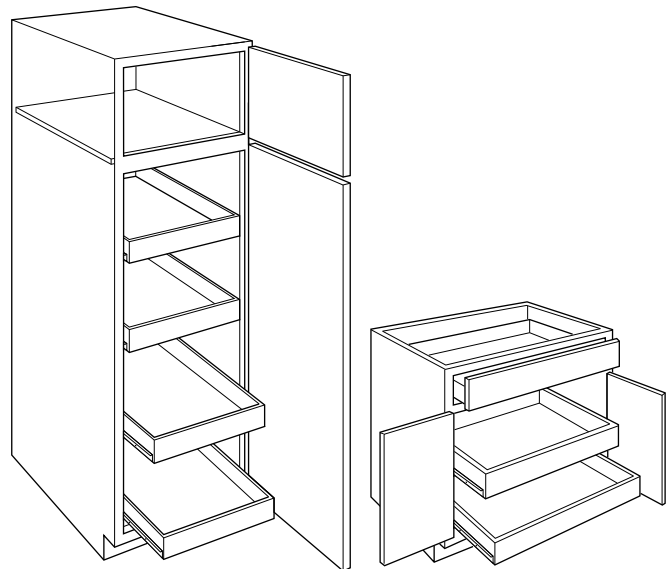

Tall cabinets

Base cabinets

# TOEKICK MODIFICATIONS

See page 21 for modification compatibility. Each modification will be priced accordingly.

OPTION NAME	APPLICABLE CABINET GROUP	DESCRIPTION/LIMITATIONS	PRICING
<b>Toekick Drawer (DRWTK)</b>	Most base and tall cabinets	Replaces standard toekick with a toekick drawer. Available on most 24" deep cabinets in 18", 21", 24", 27", 30", 33", and 36" widths that have standard toekick construction.  Front of toekick drawer is unfinished, allow enough toeboard to cover. 1" clearance below toekick drawer. Exterior dimensions of drawer are 3 3/8" tall and 15" or 18" deep.  Toekick drawer uses a push to open full extension guide, does not have soft-close feature.	\$549 list
<b>Flush Toekick (FTK)</b>	Most base, tall, and vanity cabinets	Extends the face frame to the floor eliminating the toe space. Not available on 93" or 96" tall cabinets due to separate pedestal base toekick.  When FTK is ordered with the Peninsula modification, only the working drawer side will receive a flush toekick.	\$135 list

## TOEKICK DRAWER (DRWTK)

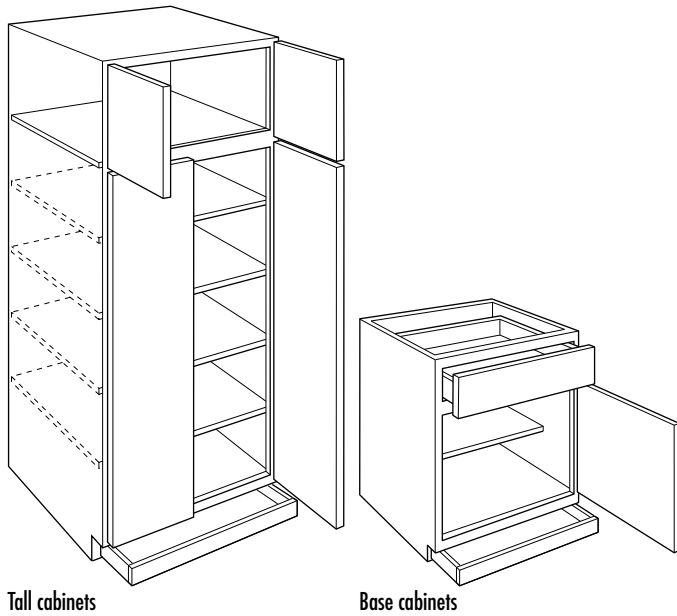

Tall cabinets

Base cabinets

## FLUSH TOEKICK (FTK)

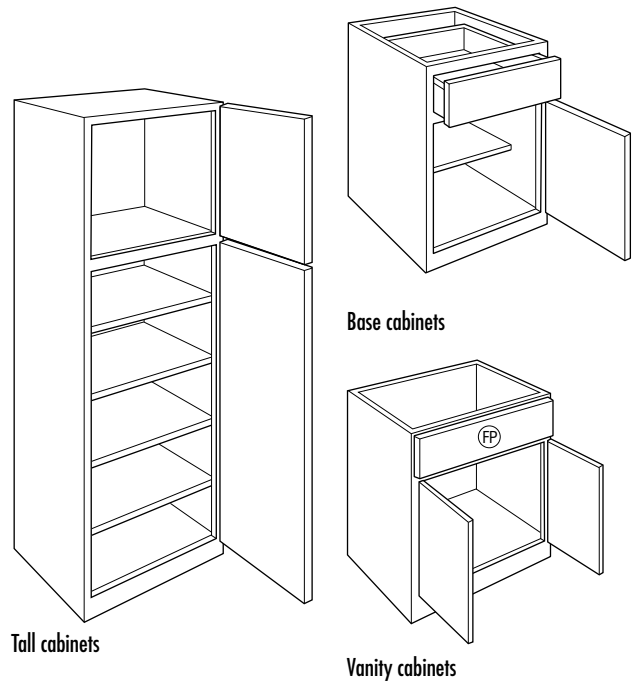

Base cabinets

Tall cabinets

Vanity cabinets

# TOEKICK MODIFICATIONS (cont'd)

See page 21 for modification compatibility. Each modification will be priced accordingly.

OPTION NAME	APPLICABLE CABINET GROUP	DESCRIPTION/LIMITATIONS	PRICING
<b>Recessed Island Toekick (RECTKALL)</b>	Most base and vanity cabinets	Creates a recessed toekick on the right, left, and back of cabinet. The entire toekick area will have non-matching material and requires any exposed toekick area to be covered.	\$389 list
<b>Recessed Toekick on Back or Side (RECTKBK) (RECTKL) (RECTKR)</b>	Most base and vanity cabinets	<p>Creates a recessed toekick on the back (RECTKBK), left (RECTKL), or right (RECTKR). When either the RECTKR or RECTKL are used, FTK is NOT available. The entire toekick will have non-matching material and requires any exposed toekick area to be covered. On RECTKL and RECTKR, the back will have a 3/8" recessed offset and non-specified side will have a 3/8" recessed offset to allow for application of toeboard material.</p> <p>93" and 96" tall cabinets have RECTKL or RECTKR standard on loose pedestal. For recess toekick applications of both left and right, order RECTKL.R. On 9" wide cabinets, only one side can be recessed.</p> <p>RECTKBK only available on cabinets at least 15" deep.</p>	\$130 list per side

### RECESSED ISLAND TOEKICK (RECTKALL)

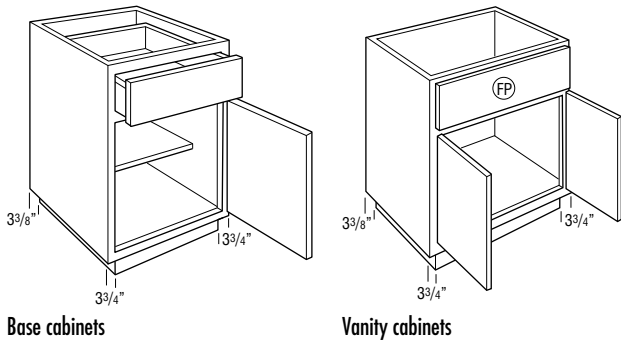

### CABINET BACK RECESSED TOEKICK (RECTKBK)

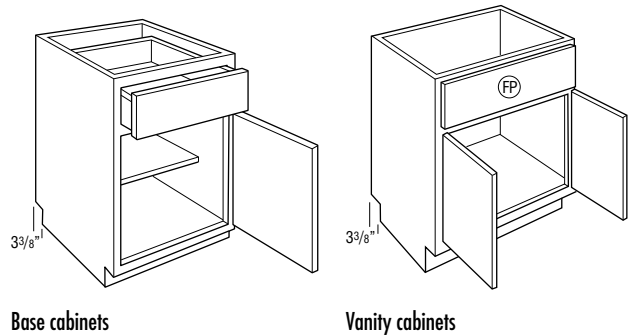

### CABINET LEFT RECESSED TOEKICK (RECTKL)

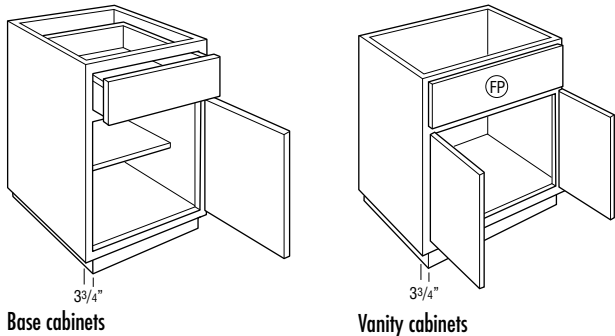

### CABINET RIGHT RECESSED TOEKICK (RECTKR)

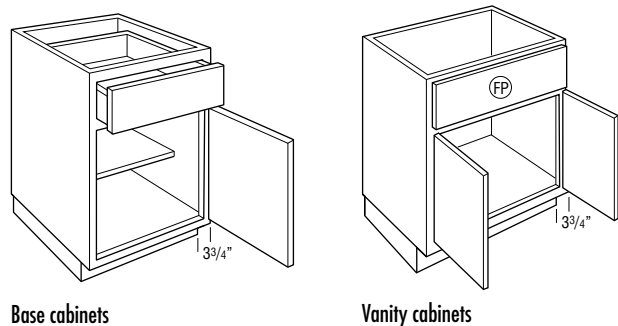

# TOEKICK MODIFICATIONS (cont'd)

See page 21 for modification compatibility. Each modification will be priced accordingly.

OPTION NAME	APPLICABLE CABINET GROUP	DESCRIPTION/LIMITATIONS	PRICING
<b>Void Toekick (VTK)</b>	Most base, tall, and vanity cabinets	Removes the toekick. Only available when the cabinet has a standard toekick (not available when flush toekick is standard or when cabinet has a separate pedestal base). When ordered on 84" or 90" tall cabinets, pedestal will not be included.	\$98 list

## VOID TOEKICK (VTK)

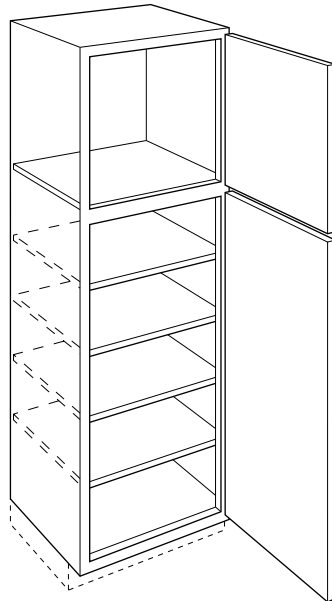

Tall cabinets

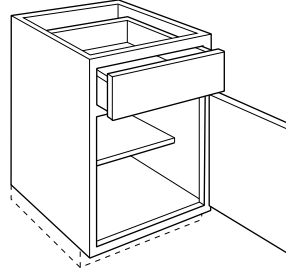

Base cabinets

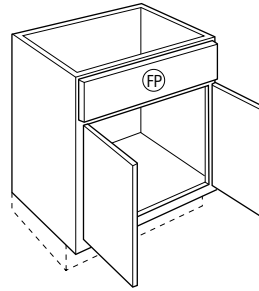

Vanity cabinets



# CONFIGURATION MODIFICATIONS

See page 21 for modification compatibility. Each modification will be priced accordingly.

OPTION NAME	APPLICABLE CABINET GROUP	DESCRIPTION/LIMITATIONS	PRICING
<b>Cabinet Front Only (CFNTO)</b>	Most cabinets with a face frame	Creates a door and/or drawer front assembled with a frame. Doors are attached with the specified hinges and drawer fronts are cleated.	80% of cabinet list
<b>Cabinet Frame Only (CFRMO)</b>	Most cabinets with a face frame	Creates a cabinet frame only. No box, doors, or drawer fronts are included.	25% of cabinet list
<b>Peninsula (P)</b>	Most wall and base cabinets	<p>Creates a 12 1/4" deep wall peninsula cabinet or 24 1/4" deep base peninsula cabinet.</p> <p>Not available on tall cabinets (oven, utility, and pantry), multi-drawer base cabinets, or increased depth wall cabinets.</p> <p>Cabinets with drawers or roll trays can only be reduced in 3" increments.</p> <p>Single door cabinets are hinged on the same cabinet end, for example a W1230L will feature a Left hinge on the front side and a Right hinge on the peninsula side.</p>	Cabinet list + 60%

### CABINET FRONT ONLY (CFNTO)

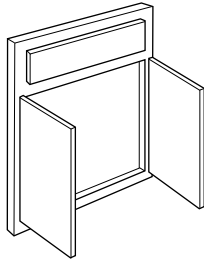

Cabinet front only – Wall, Base, and Tall

### CABINET FRAME ONLY (CFRMO)

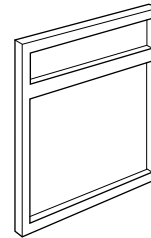

Cabinet frame only – Wall, Base, and Tall

### PENINSULA (P)

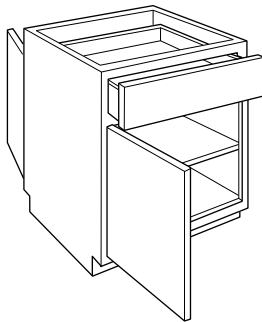

Base cabinets

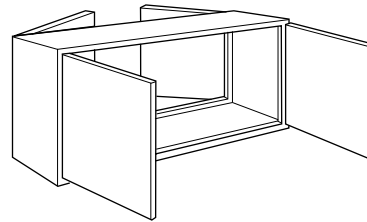

Wall cabinets

# CUT FOR GLASS DOORS (CG)

Glass not included in price, but can be ordered separately. See below for details.

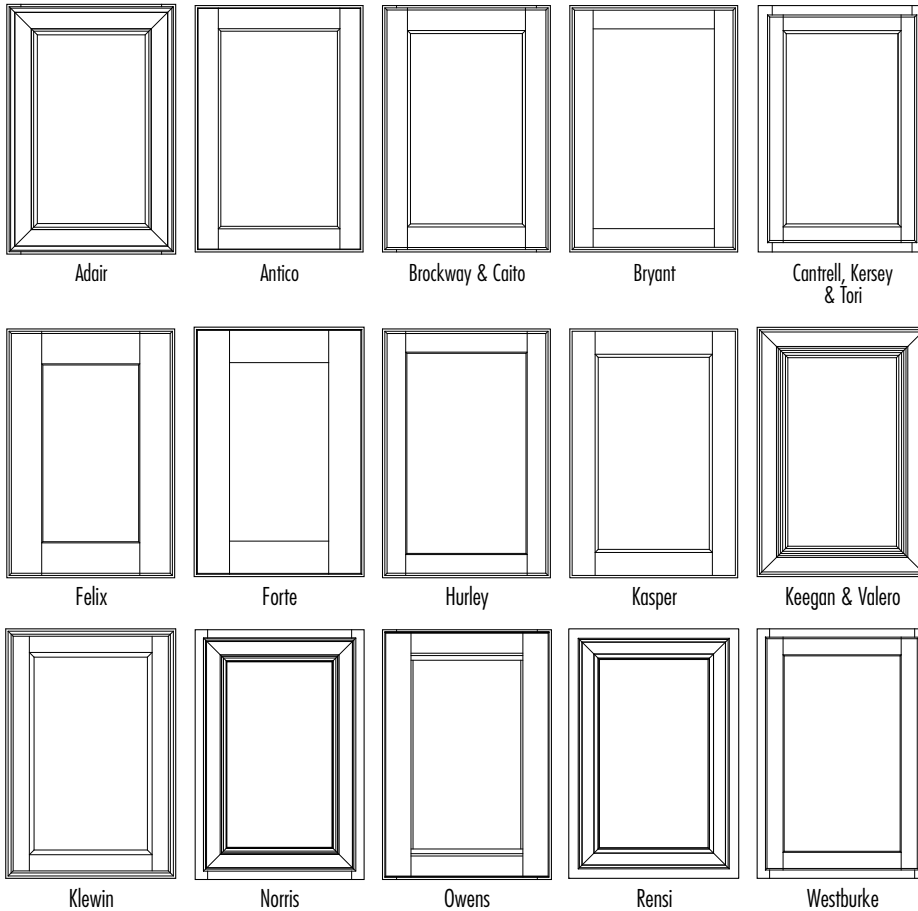

Cut for Glass Door To Fit:	PRICE
	List per Door
30" High or Shorter Wall Cabinet	102
33" High Wall Cabinet	102
36" High Wall Cabinet	102
39" High Wall Cabinet	102
42" High Wall Cabinet	102

To price Cut for Glass Doors attached to a cabinet, add the Door Only list price per door to the wall cabinet price (MIP modification upcharge will be applied to the cabinet price if matching interior is desired).

- Available on all standard wall corner (WC) cabinets.
- Not available on bifold doors.
- Specify Door Style and Finish when ordering Cut for Glass Doors.
- Custom door sizes not available.
- Glass available for order separately (see pages 37-40). If Clear glass is ordered with CG, glass will be shipped installed. All other glass styles will be drop shipped separately from the cabinet order.
- When a decorative door option is chosen in 20/20, Matching Interior Plywood (MIP) is a preselected option. If MIP is not desired, it can be deselected by choosing NOTMIP.

### STANDARD WALL CABINET AVAILABILITY\*

Cabinet Width	Cabinet Height										
	12"	15"	18"	21"	24"	27"	30"	33"	36"	39"	42"
W9							✓	✓	✓	✓	✓
W12	✓	✓	✓	✓	✓	✓	✓	✓	✓	✓	✓
W15	✓	✓	✓	✓	✓	✓	✓	✓	✓	✓	✓
W18	✓	✓	✓	✓	✓	✓	✓	✓	✓	✓	✓
W21		✓	✓	✓	✓	✓	✓	✓	✓	✓	✓
W24			✓	✓	✓	✓	✓	✓	✓	✓	✓
W24 (butt)	✓	✓	✓	✓	✓	✓	✓	✓	✓	✓	✓
W27 (butt)	✓	✓	✓	✓	✓	✓	✓	✓	✓	✓	✓
W30 (butt)	✓	✓	✓	✓	✓	✓	✓	✓	✓	✓	✓
W33 (butt)	✓	✓	✓	✓	✓	✓	✓	✓	✓	✓	✓
W36 (butt)	✓	✓	✓	✓	✓	✓	✓	✓	✓	✓	✓
W39	✓	✓	✓	✓	✓	✓	✓	✓	✓	✓	✓
W42	✓		✓		✓		✓	✓	✓	✓	✓
W45	✓	✓	✓	✓	✓	✓	✓	✓	✓	✓	✓
W48 (butt)			✓		✓		✓	✓	✓	✓	✓
DW							✓	✓	✓	✓	✓

\*For Specialty Wall Cabinet Availability, please see modification grid.  
 • For Cut for Glass Door availability, please see modification grid in Wall section.

# MULLION DOORS (MD)

Glass not included in price, but can be ordered separately. See below for details.

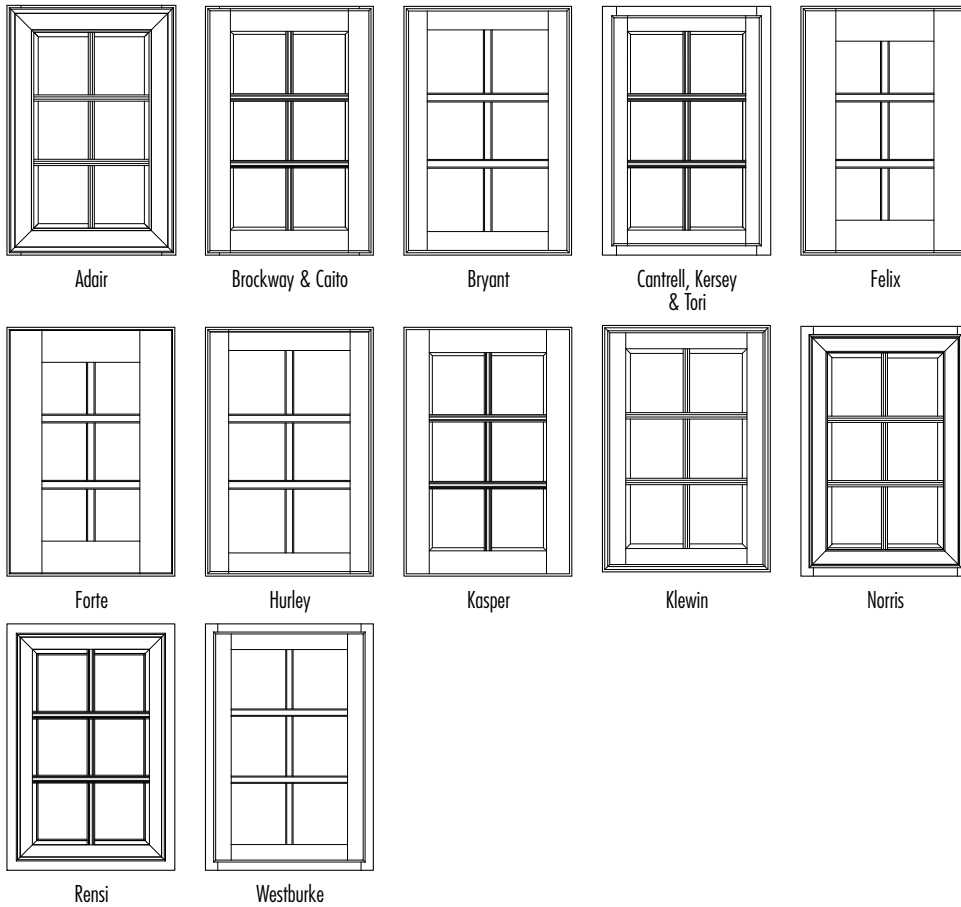

Mullion Door To Fit:	PRICE List per Door
18" High Wall Cabinet	411
24" High Wall Cabinet	411
30" High Wall Cabinet	411
33" High Wall Cabinet	445
36" High Wall Cabinet	445
39" High Wall Cabinet	445
42" High Wall Cabinet	445

To price Mullion Doors attached to a cabinet, add the Door Only list price per door to the wall cabinet price (MIP modification upcharge will be applied to the cabinet price if matching interior is desired).

- Compatible glass styles are Antique, Clear, Frost, Reeded, and Seeded glass.
- If Clear glass is ordered with MD, glass will be shipped installed. All other glass will be drop shipped separately from the cabinet order.
- Specify Door Style and Finish when ordering Mullion Doors.
- Custom door sizes not available.
- Shelves will not align with mullions.
- When a decorative door option is chosen in 20/20, Matching Interior Plywood (MIP) is a preselected option. If MIP is not desired, it can be deselected by choosing NOTMIP.

## MULLION LITES GRID

Cabinet Width	Cabinet Height						
	18"	24"	30"	33"	36"	39"	42"
W15	G		D	D	D	A	A
W18	G		D	D	D	A	A
W21			E	E	E	B	B
W24			E	E	E	B	B
W24 (butt)			D	D	D	A	A
W27 (butt)			D	D	D	A	A
W30 (butt)	G	G	D	D	D	A	A
W33 (butt)			D	D	D	A	A
W36 (butt)	G	G	D	D	D	A	A
W42			E	E	E	B	B
W45			E	E	E	B	B
W48 (butt)			D	D	D	A	A
DW30			D				
DW33				D			
DW36					D		
DW39						A	
DW42							A

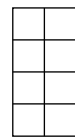

**A**  
2 x 4 Lites

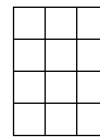

**B**  
3 x 4 Lites

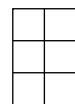

**D**  
2 x 3 Lites

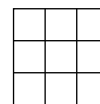

**E**  
3 x 3 Lites



**G**  
2 x 2 Lites

## TEXTURED GLASS PANELS



Antique



Bevel



Clear



Frost



Reeded

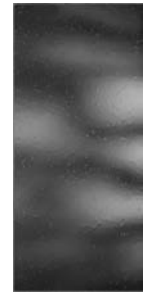

Seeded

- Cut for glass and mullion doors must be ordered separately. See pages 35-36.
- For glass shelf kits, see page 294.
- All glass is fully tempered or has a safety lamination.
- Clear glass panels will be factory installed when ordered with a CG or MD door. All other glass styles will be drop shipped separately from the cabinet order.
- When glass is shipped separately, on order acknowledgment, decorative glass nomenclature will be DECW, followed by cabinet width and height.
- When textured glass is ordered for use in wall top hinge cabinets (WTH), glass design will be turned horizontally and may not match desired pattern.
- Door frame may reduce amount of glass shown.

## TEXTURED GLASS PANELS PRICING

### TEXTURED GLASS PANELS

STYLE	PANEL THICKNESS	HEIGHT		
		12" – 18" TALL	21" – 30" TALL	33" – 42" TALL
Antique	1/8"	231	257	283
Bevel	1/4"	231	257	283
Clear	1/8"	196	217	238
Frost	5/32"	231	257	283
Reeded	5/32"	196	217	238
Seeded	9/32"	364	405	445

# TEXTURED GLASS PANELS

## Antique



- Glass type: Antique
- Panel thickness: 1/8"

38

GLASS INSERTS

### AVAILABILITY

Cabinet Width	Cabinet Height											
	12"	15"	18"	21"	24"	27"	30"	33"	36"	39"	42"	
W12		❖	✓	✓	✓	✓	✓	✓	✓	✓	✓	✓
W15	❖	✓	✓	✓	✓	✓	✓	✓	✓	✓	✓	✓
W18	✓	✓	✓	✓	✓	✓	✓	✓	✓	✓	✓	✓
W21			✓	✓	✓	✓	✓	✓	✓	✓	✓	✓
W24			✓	✓	✓	✓	✓	✓	✓	✓	✓	✓
W24 (butt)			✓	✓	✓	✓	✓	✓	✓	✓	✓	✓
W27 (butt)			✓	✓	✓	✓	✓	✓	✓	✓	✓	✓
W30 (butt)	✓	✓	✓	✓	✓	✓	✓	✓	✓	✓	✓	✓
W33 (butt)	✓	✓	✓	✓	✓	✓	✓	✓	✓	✓	✓	✓
W36 (butt)	✓	✓	✓	✓	✓	✓	✓	✓	✓	✓	✓	✓
W39	✓	✓	✓	✓	✓	✓	✓	✓	✓	✓	✓	✓
W42		❖	✓	✓	✓	✓	✓	✓	✓	✓	✓	✓
W45			✓	✓	✓	✓	✓	✓	✓	✓	✓	✓
W45 (butt)		❖										
W48 (butt)		❖	✓	✓	✓	✓	✓	✓	✓	✓	✓	✓
DW	✓	✓	✓		✓	✓	✓	✓	✓	✓	✓	✓

❖ Not available with Felix or Forte.

## Bevel

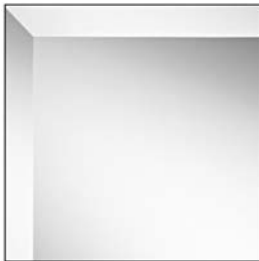

- Glass type: Clear
- Panel thickness: 1/4"
- Not available with Mullion Doors.

### AVAILABILITY

Cabinet Width	Cabinet Height											
	12"	15"	18"	21"	24"	27"	30"	33"	36"	39"	42"	
W12		❖	✓	✓	✓	✓	✓	✓	✓	✓	✓	✓
W15	❖	✓	✓	✓	✓	✓	✓	✓	✓	✓	✓	✓
W18	✓	✓	✓	✓	✓	✓	✓	✓	✓	✓	✓	✓
W21			✓	✓	✓	✓	✓	✓	✓	✓	✓	✓
W24			✓	✓	✓	✓	✓	✓	✓	✓	✓	✓
W24 (butt)			✓	✓	✓	✓	✓	✓	✓	✓	✓	✓
W27 (butt)			✓	✓	✓	✓	✓	✓	✓	✓	✓	✓
W30 (butt)	✓	✓	✓	✓	✓	✓	✓	✓	✓	✓	✓	✓
W33 (butt)	✓	✓	✓	✓	✓	✓	✓	✓	✓	✓	✓	✓
W36 (butt)	✓	✓	✓	✓	✓	✓	✓	✓	✓	✓	✓	✓
W39	✓	✓	✓	✓	✓	✓	✓	✓	✓	✓	✓	✓
W42		❖	✓	✓	✓	✓	✓	✓	✓	✓	✓	✓
W45			✓	✓	✓	✓	✓	✓	✓	✓	✓	✓
W45 (butt)		❖										
W48 (butt)		❖	✓	✓	✓	✓	✓	✓	✓	✓	✓	✓
DW	✓	✓	✓		✓	✓	✓	✓	✓	✓	✓	✓

❖ Not available with Felix or Forte.

# TEXTURED GLASS PANELS

## Clear

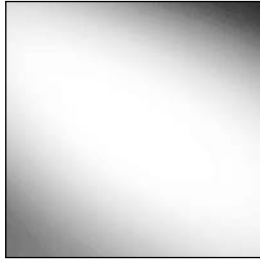

- Glass type: Clear
- Panel thickness: 1/8"

### AVAILABILITY

Cabinet Width	Cabinet Height										
	12"	15"	18"	21"	24"	27"	30"	33"	36"	39"	42"
W12		❖	✓	✓	✓	✓	✓	✓	✓	✓	✓
W15	❖	✓	✓	✓	✓	✓	✓	✓	✓	✓	✓
W18	✓	✓	✓	✓	✓	✓	✓	✓	✓	✓	✓
W21			✓	✓	✓	✓	✓	✓	✓	✓	✓
W24			✓	✓	✓	✓	✓	✓	✓	✓	✓
W24 (butt)			✓	✓	✓	✓	✓	✓	✓	✓	✓
W27 (butt)			✓	✓	✓	✓	✓	✓	✓	✓	✓
W30 (butt)	✓	✓	✓	✓	✓	✓	✓	✓	✓	✓	✓
W33 (butt)	✓	✓	✓	✓	✓	✓	✓	✓	✓	✓	✓
W36 (butt)	✓	✓	✓	✓	✓	✓	✓	✓	✓	✓	✓
W39	✓	✓	✓	✓	✓	✓	✓	✓	✓	✓	✓
W42		❖	✓	✓	✓	✓	✓	✓	✓	✓	✓
W45			✓	✓	✓	✓	✓	✓	✓	✓	✓
W45 (butt)		❖									
W48 (butt)		❖	✓	✓	✓	✓	✓	✓	✓	✓	✓
DW	✓	✓	✓		✓	✓	✓	✓	✓	✓	✓

❖ Not available with Felix or Forte.

## Frost

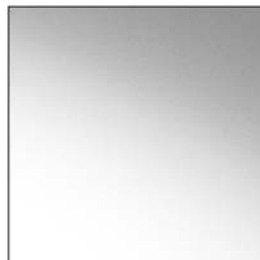

- Glass type: Frost
- Panel thickness: 5/32"

### AVAILABILITY

Cabinet Width	Cabinet Height										
	12"	15"	18"	21"	24"	27"	30"	33"	36"	39"	42"
W12		❖	✓	✓	✓	✓	✓	✓	✓	✓	✓
W15	❖	✓	✓	✓	✓	✓	✓	✓	✓	✓	✓
W18	✓	✓	✓	✓	✓	✓	✓	✓	✓	✓	✓
W21			✓	✓	✓	✓	✓	✓	✓	✓	✓
W24			✓	✓	✓	✓	✓	✓	✓	✓	✓
W24 (butt)			✓	✓	✓	✓	✓	✓	✓	✓	✓
W27 (butt)			✓	✓	✓	✓	✓	✓	✓	✓	✓
W30 (butt)	✓	✓	✓	✓	✓	✓	✓	✓	✓	✓	✓
W33 (butt)	✓	✓	✓	✓	✓	✓	✓	✓	✓	✓	✓
W36 (butt)	✓	✓	✓	✓	✓	✓	✓	✓	✓	✓	✓
W39	✓	✓	✓	✓	✓	✓	✓	✓	✓	✓	✓
W42		❖	✓	✓	✓	✓	✓	✓	✓	✓	✓
W45			✓	✓	✓	✓	✓	✓	✓	✓	✓
W45 (butt)		❖									
W48 (butt)		❖	✓	✓	✓	✓	✓	✓	✓	✓	✓
DW	✓	✓	✓		✓	✓	✓	✓	✓	✓	✓

❖ Not available with Felix or Forte.

# TEXTURED GLASS PANELS

## Reeded

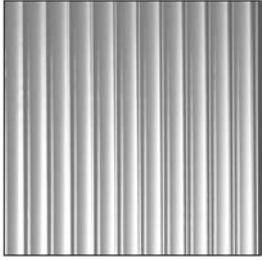

- Glass type: Reeded
- Panel thickness: 5/32"

40

GLASS INSERTS

### AVAILABILITY

Cabinet Width	Cabinet Height										
	12"	15"	18"	21"	24"	27"	30"	33"	36"	39"	42"
W12		❖	✓	✓	✓	✓	✓	✓	✓	✓	✓
W15	❖	✓	✓	✓	✓	✓	✓	✓	✓	✓	✓
W18	✓	✓	✓	✓	✓	✓	✓	✓	✓	✓	✓
W21			✓	✓	✓	✓	✓	✓	✓	✓	✓
W24			✓	✓	✓	✓	✓	✓	✓	✓	✓
W24 (butt)			✓	✓	✓	✓	✓	✓	✓	✓	✓
W27 (butt)			✓	✓	✓	✓	✓	✓	✓	✓	✓
W30 (butt)	✓	✓	✓	✓	✓	✓	✓	✓	✓	✓	✓
W33 (butt)	✓	✓	✓	✓	✓	✓	✓	✓	✓	✓	✓
W36 (butt)	✓	✓	✓	✓	✓	✓	✓	✓	✓	✓	✓
W39	✓	✓	✓	✓	✓	✓	✓	✓	✓	✓	✓
W42		❖	✓	✓	✓	✓	✓	✓	✓	✓	✓
W45			✓	✓	✓	✓	✓	✓	✓	✓	✓
W45 (butt)		❖									
W48 (butt)		❖	✓	✓	✓	✓	✓	✓	✓	✓	✓
DW	✓	✓	✓		✓	✓	✓	✓	✓	✓	✓

❖ Not available with Felix or Forte.

## Seeded



- Glass type: Seeded
- Panel thickness: 9/32"
- Not available with Mullion Doors.

### AVAILABILITY

Cabinet Width	Cabinet Height										
	12"	15"	18"	21"	24"	27"	30"	33"	36"	39"	42"
W12		❖	✓	✓	✓	✓	✓	✓	✓	✓	✓
W15	❖	✓	✓	✓	✓	✓	✓	✓	✓	✓	✓
W18	✓	✓	✓	✓	✓	✓	✓	✓	✓	✓	✓
W21			✓	✓	✓	✓	✓	✓	✓	✓	✓
W24			✓	✓	✓	✓	✓	✓	✓	✓	✓
W24 (butt)			✓	✓	✓	✓	✓	✓	✓	✓	✓
W27 (butt)			✓	✓	✓	✓	✓	✓	✓	✓	✓
W30 (butt)	✓	✓	✓	✓	✓	✓	✓	✓	✓	✓	✓
W33 (butt)	✓	✓	✓	✓	✓	✓	✓	✓	✓	✓	✓
W36 (butt)	✓	✓	✓	✓	✓	✓	✓	✓	✓	✓	✓
W39	✓	✓	✓	✓	✓	✓	✓	✓	✓	✓	✓
W42		❖	✓	✓	✓	✓	✓	✓	✓	✓	✓
W45			✓	✓	✓	✓	✓	✓	✓	✓	✓
W45 (butt)		❖									
W48 (butt)		❖	✓	✓	✓	✓	✓	✓	✓	✓	✓
DW	✓	✓	✓		✓	✓	✓	✓	✓	✓	✓

❖ Not available with Felix or Forte.

# CABINET DIMENSIONS

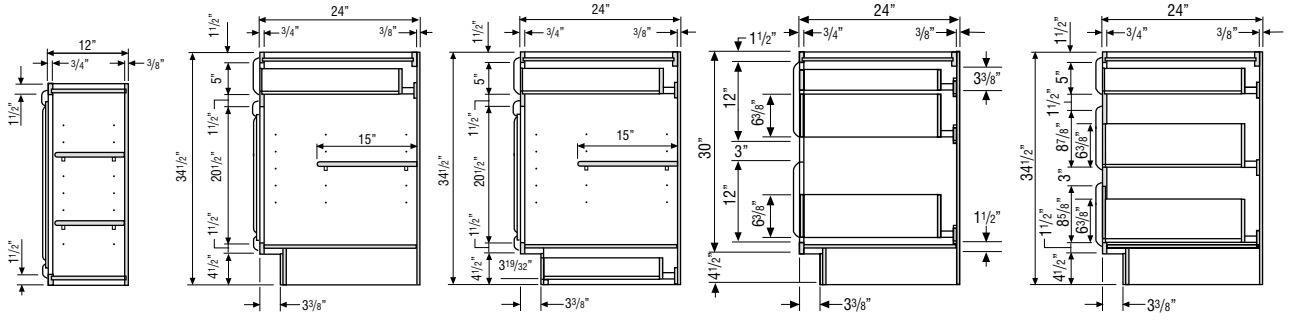

**WALL CABINET**

**BASE CABINET**

**BASE CABINET with TOEKICK DRAWER**

**TWO-DRAWER BASE CABINET with ROLL TRAY**

**THREE-DRAWER BASE CABINET**

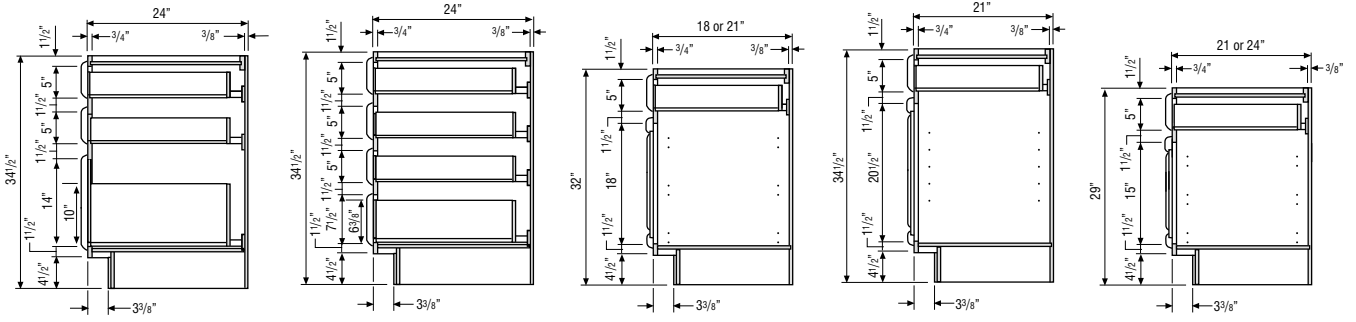

**THREE-DRAWER BASE CABINET with DEEP DRAWER**

**FOUR-DRAWER BASE CABINET**

**32" HIGH VANITY CABINET**

**34 1/2" HIGH VANITY CABINET**

**DESK BASE CABINET**

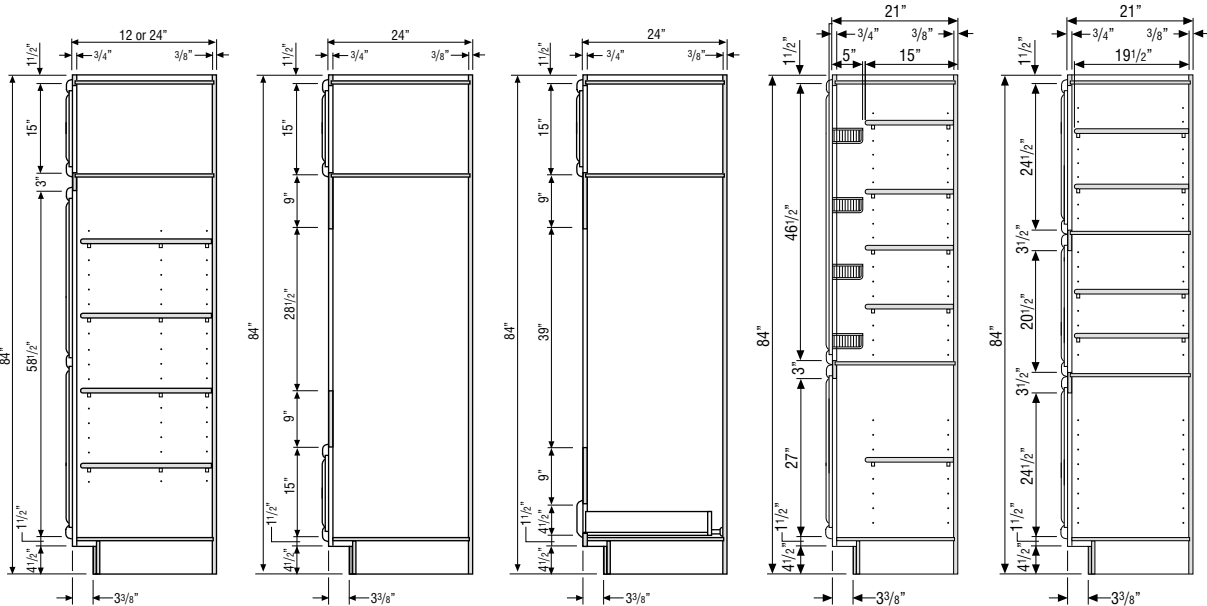

**UTILITY CABINET**

**SINGLE OVEN CABINET**

**DOUBLE OVEN CABINET**

**LC/LCRH**

**VANITY UTILITY**



# CABINET DIMENSIONS

## BASE AND 34 1/2" HIGH VANITY CABINET ROLL TRAY POSITIONS

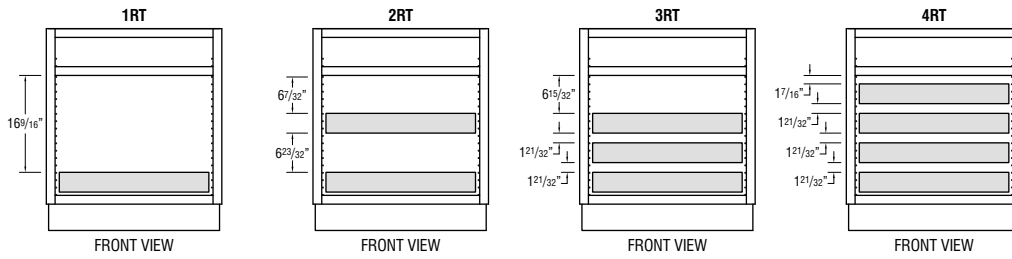

## FULL HEIGHT BASE CABINET ROLL TRAY POSITIONS

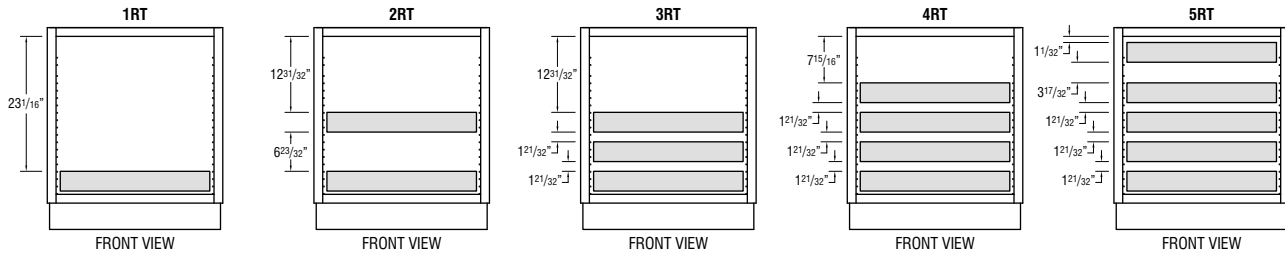

## UTILITY CABINET ROLL TRAY POSITIONS

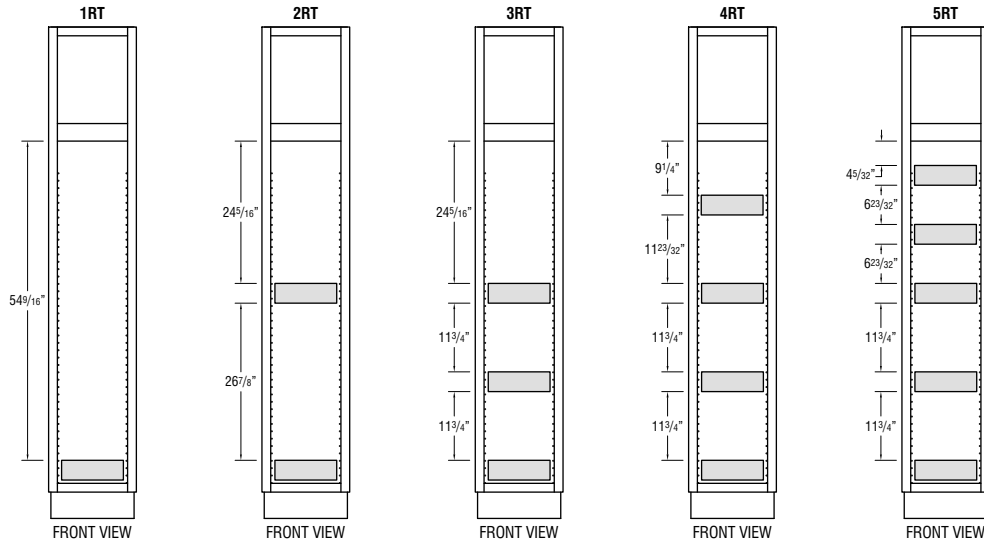

## 32" HIGH VANITY CABINET ROLL TRAY POSITIONS

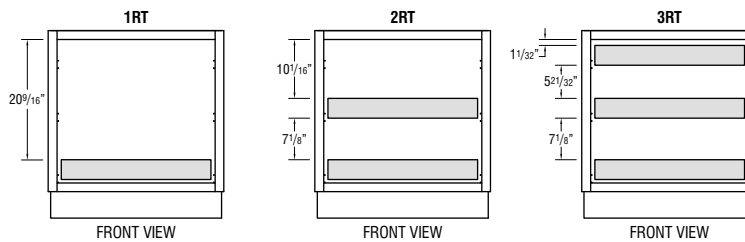

## DESK DOOR DRAWER BASE CABINET ROLL TRAY POSITIONS

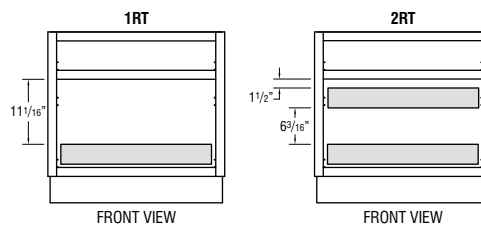

# CABINET DIMENSIONS

## 84" HIGH APPLICATION

Number after Wall Cabinet Represents Height of Cabinet

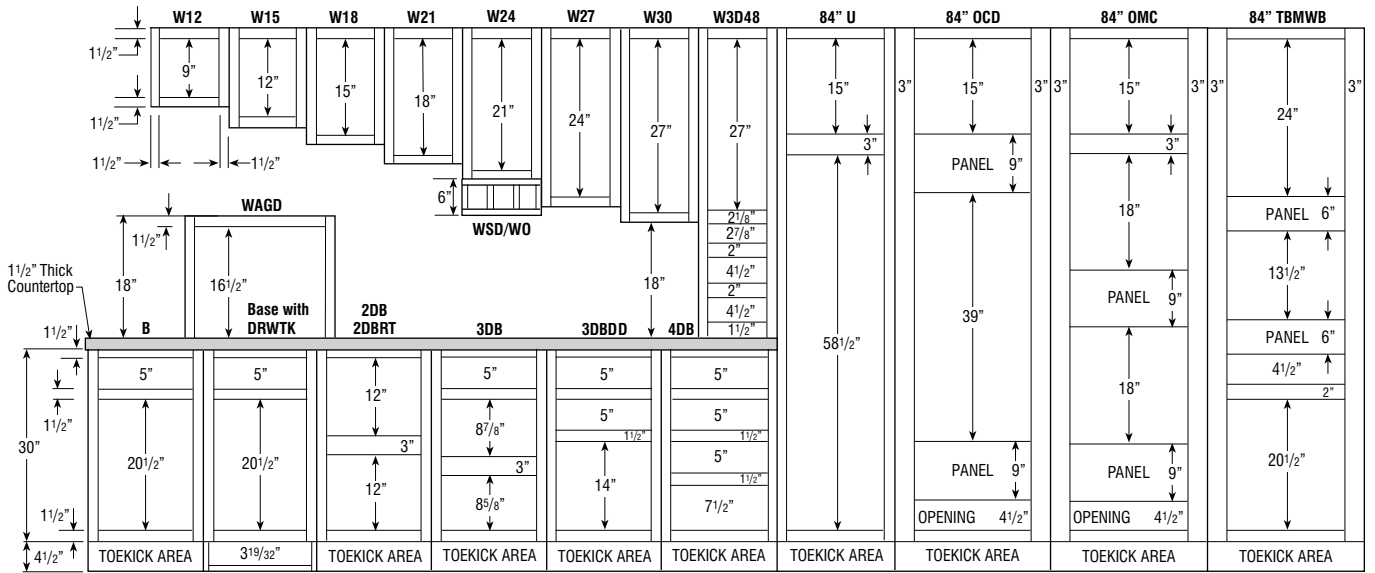

## 87" HIGH APPLICATION

Number after Wall Cabinet Represents Height of Cabinet

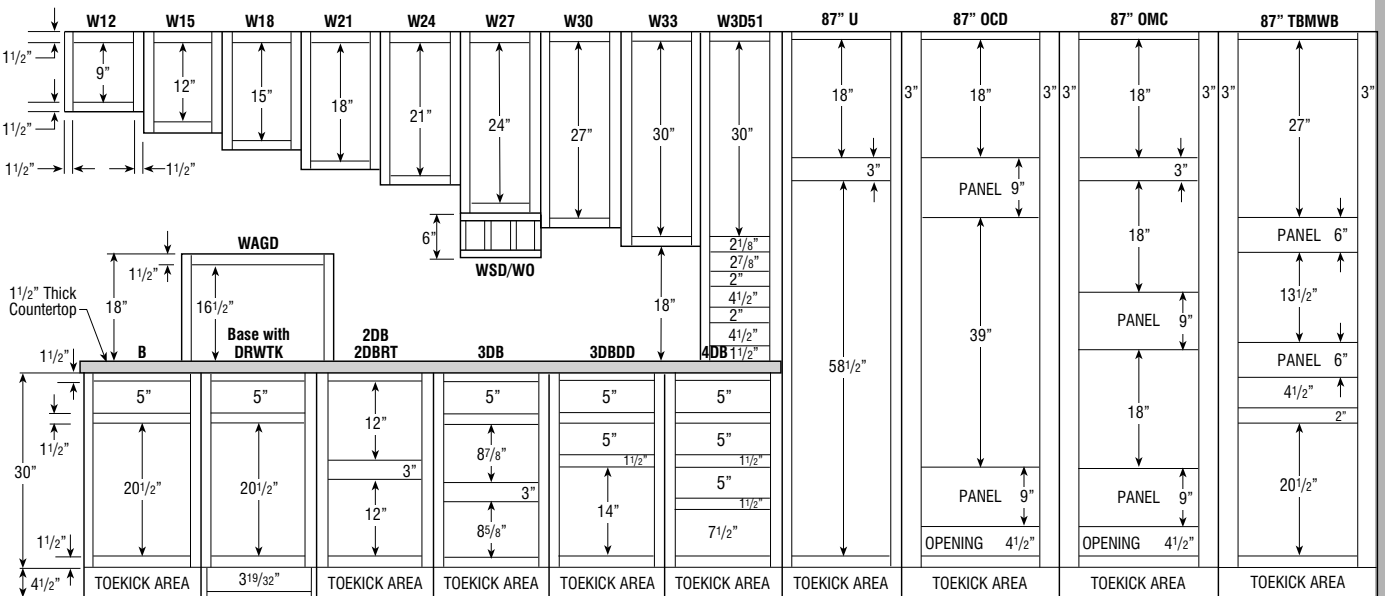

- 1 1/2" Top and Bottom Rails - Wall and Base Cabinets.
- 1 1/2" Vertical Stiles.
- 3" Center Vertical Rails on Wall and Base Cabinets to Divide Double Door Cabinets on 39" Wide and Over.

### Full Overlay Door Styles:

- 1/4" Reveal Around Doors (1/4" of Face Frame Shows).
- Frame Opening + 2 1/2" = Door Size for Base/Wall Cabinets.
- 4 1/2" or 5" High Drawer Opening = 6 1/4" Drawer Front.
- 7 1/2" High Drawer Opening = 10" Drawer Front.
- 8 5/8" and 8 7/8" Drawer Opening = 11 3/8" Drawer Front.
- 12" High Drawer Opening = 14 1/2" Drawer Front.
- 14" High Drawer Opening = 16 1/2" Drawer Front.

### 1/2" Overlay Door Styles:

- 1" Reveal Around Doors (1" of Face Frame Shows).
- Frame Opening + 1" = Door Size for Base/Wall Cabinets.
- 4 1/2" or 5" High Drawer Opening = 5 1/2" Drawer Front.
- 7 1/2" High Drawer Opening = 8 1/2" Drawer Front.
- 8 5/8" and 8 7/8" Drawer Opening = 9 7/8" Drawer Front.
- 12" High Drawer Opening = 13" Drawer Front.
- 14" High Drawer Opening = 15" Drawer Front.

# CABINET DIMENSIONS

## 90" HIGH APPLICATION

Number after Wall Cabinet Represents Height of Cabinet

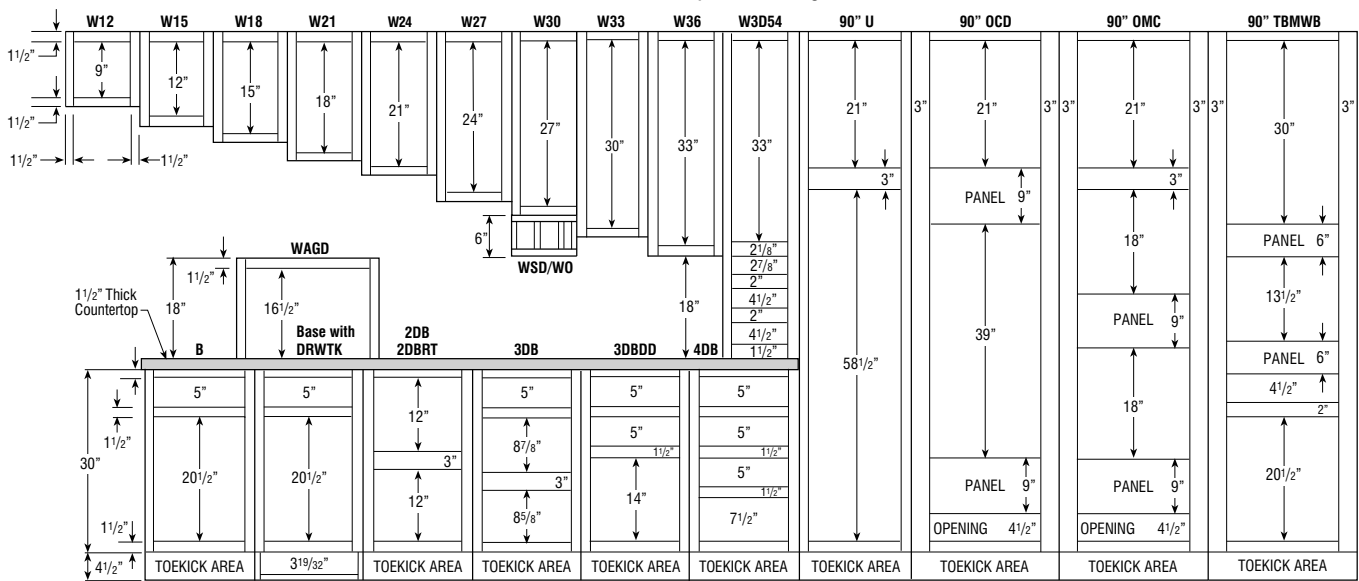

## 93" HIGH APPLICATION

Number after Wall Cabinet Represents Height of Cabinet

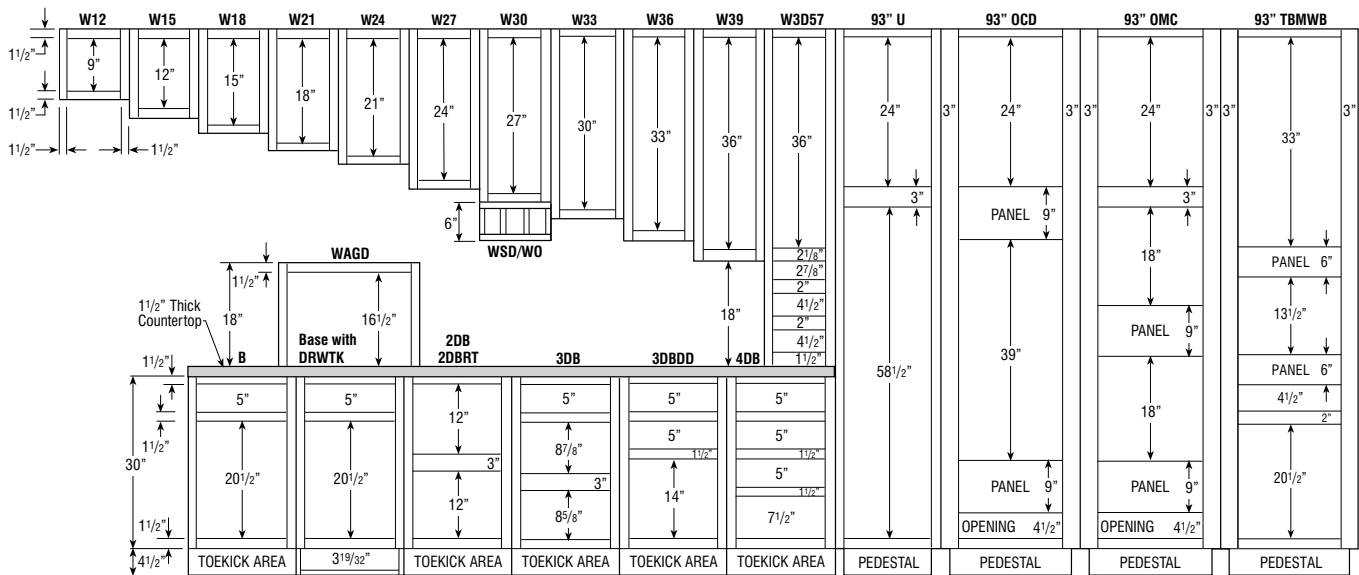

- 1 1/2" Top and Bottom Rails - Wall and Base Cabinets.
- 1 1/2" Vertical Stiles.
- 3" Center Vertical Rails on Wall and Base Cabinets to Divide Double Door Cabinets on 39" Wide and Over.

### Full Overlay Door Styles:

- 1/4" Reveal Around Doors (1/4" of Face Frame Shows).
- Frame Opening + 2 1/2" = Door Size for Base/Wall Cabinets.
- 4 1/2" or 5" High Drawer Opening = 6 1/4" Drawer Front.
- 7 1/2" High Drawer Opening = 10" Drawer Front.
- 8 5/8" and 8 7/8" Drawer Opening = 11 3/8" Drawer Front.
- 12" High Drawer Opening = 14 1/2" Drawer Front.
- 14" High Drawer Opening = 16 1/2" Drawer Front.

### 1/2" Overlay Door Styles:

- 1" Reveal Around Doors (1" of Face Frame Shows).
- Frame Opening + 1" = Door Size for Base/Wall Cabinets.
- 4 1/2" or 5" High Drawer Opening = 5 1/2" Drawer Front.
- 7 1/2" High Drawer Opening = 8 1/2" Drawer Front.
- 8 5/8" and 8 7/8" Drawer Opening = 9 7/8" Drawer Front.
- 12" High Drawer Opening = 13" Drawer Front.
- 14" High Drawer Opening = 15" Drawer Front.

# CABINET DIMENSIONS

## 96" HIGH APPLICATION

Number after Wall Cabinet Represents Height of Cabinet

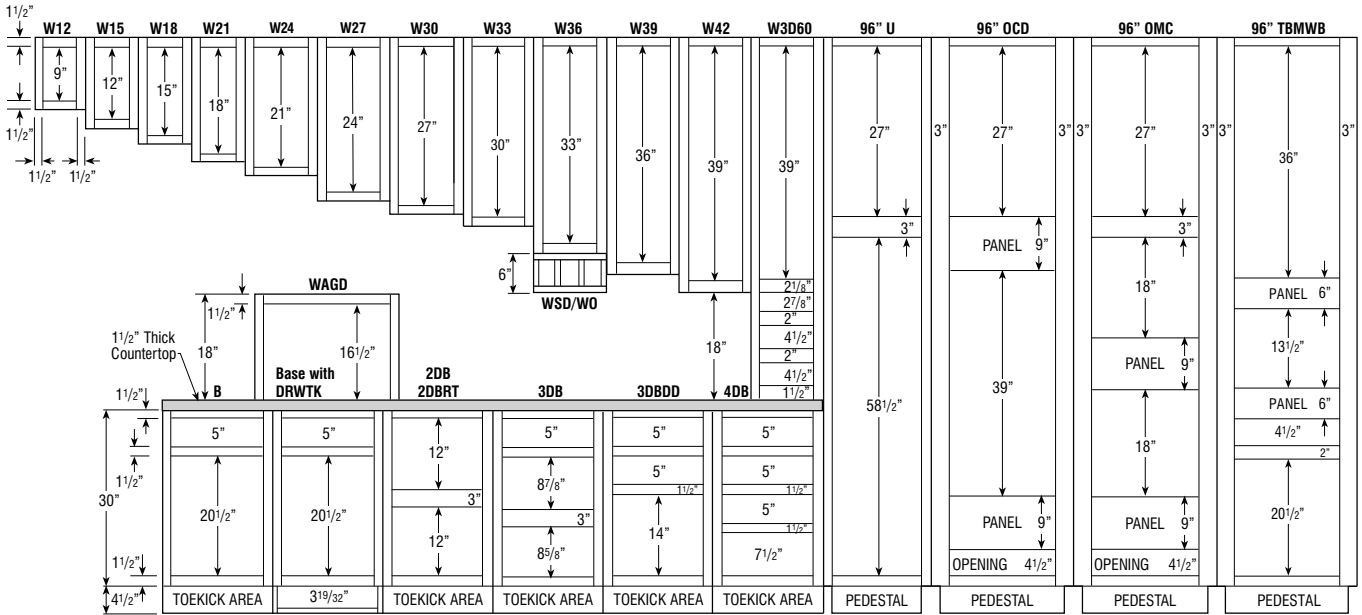

- 1 1/2" Top and Bottom Rails - Wall and Base Cabinets.
- 1 1/2" Vertical Stiles.
- 3" Center Vertical Rails on Wall and Base Cabinets to Divide Double Door Cabinets on 39" Wide and Over.

### Full Overlay Door Styles:

- 1/4" Reveal Around Doors (1/4" of Face Frame Shows).
- Frame Opening + 2 1/2" = Door Size for Base/Wall Cabinets.
- 4 1/2" or 5" High Drawer Opening = 6 1/4" Drawer Front.
- 7 1/2" High Drawer Opening = 10" Drawer Front.
- 8 5/8" and 8 7/8" Drawer Opening = 11 3/8" Drawer Front.
- 12" High Drawer Opening = 14 1/2" Drawer Front.
- 14" High Drawer Opening = 16 1/2" Drawer Front.

### 1/2" Overlay Door Styles:

- 1" Reveal Around Doors (1" of Face Frame Shows).
- Frame Opening + 1" = Door Size for Base/Wall Cabinets.
- 4 1/2" or 5" High Drawer Opening = 5 1/2" Drawer Front.
- 7 1/2" High Drawer Opening = 8 1/2" Drawer Front.
- 8 5/8" and 8 7/8" Drawer Opening = 9 7/8" Drawer Front.
- 12" High Drawer Opening = 13" Drawer Front.
- 14" High Drawer Opening = 15" Drawer Front.

## 5-PIECE DRAWER FRONT DIMENSIONS CHART

5-PIECE DRAWER FRONTS	DRAWER FRONT WIDTH	DRAWER FRONT HEIGHT	PANEL FLAT WIDTH	PANEL FLAT HEIGHT
Adair	8 1/2"	6 1/4"	3 1/2"	1 1/4"
Antico	8 1/2"	6 1/4"	3 1/2"	1 1/4"
Brockway	8 1/2"	6 1/4"	3"	1 1/4"
Bryant	8 1/2"	6 1/4"	4"	1 3/4"
Caito	8 1/2"	6 1/4"	3"	1 1/4"
Felix	8 1/2"	6 1/4"	1 1/2"	1 3/4"
Forte	8 1/2"	6 1/4"	1 1/2"	1 3/4"
Hurley	8 1/2"	6 1/4"	4"	1 3/4"
Kasper	8 1/2"	6 1/4"	3"	1 1/4"
Keegan	8 1/2"	6 1/4"	4"	1 3/4"
Norris	7"	5 1/2"	2 3/4"	1 1/4"
Owens	8 1/2"	6 1/4"	2 1/2"	1 1/4"
Rensi	7"	5 1/2"	2 1/2"	1"
Valero	8 1/2"	6 1/4"	4"	1 3/4"

Drawer front sizes are representative of a 9" wide base cabinet.

# CABINET DIMENSIONS

## 29" HIGH DESK CABINETS

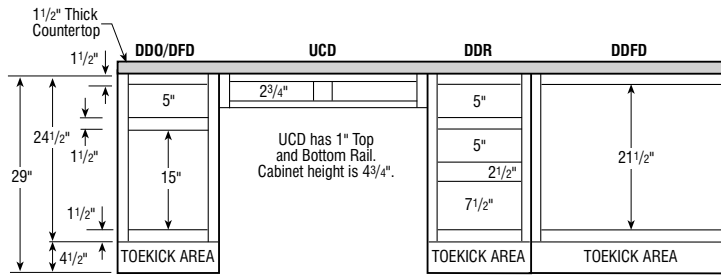

## 32" HIGH VANITY CABINETS

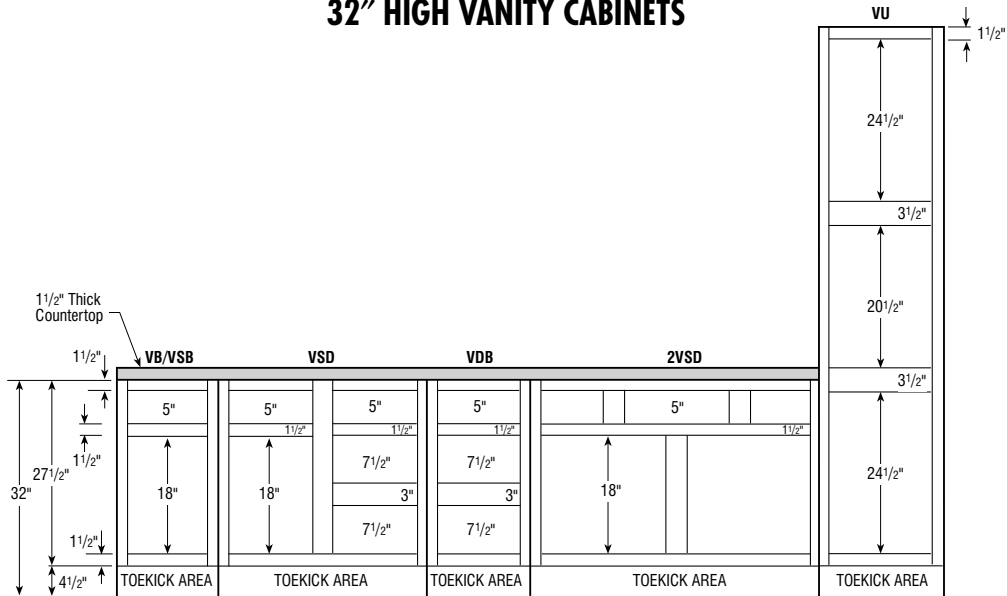

## 34 1/2" HIGH VANITY CABINETS

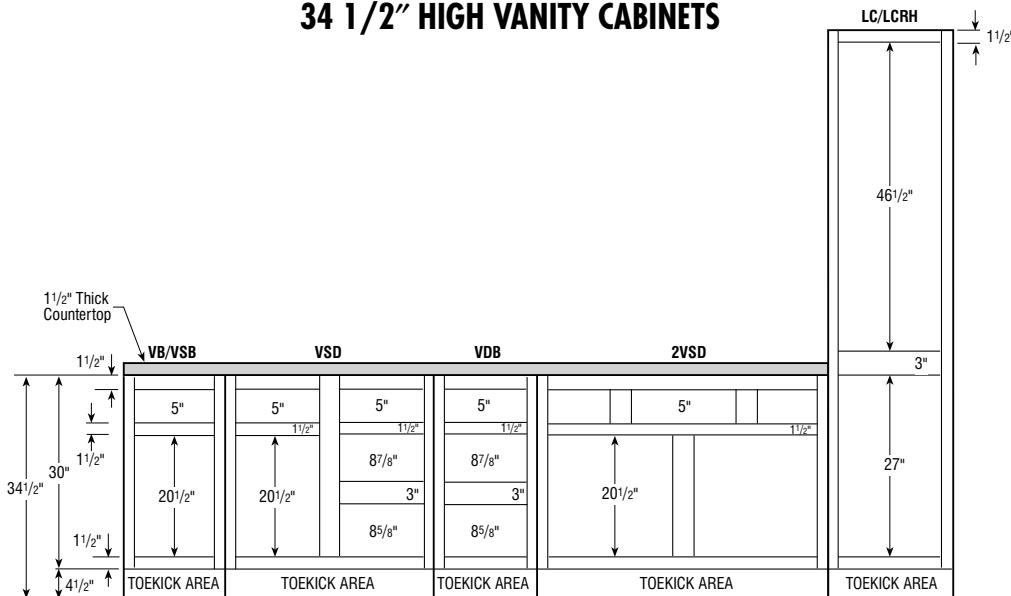

# CABINET DIMENSIONS

## DIMENSIONS FOR CORNER INSTALLATIONS (45° DIAGONAL)

### 12" DEEP CABINETS

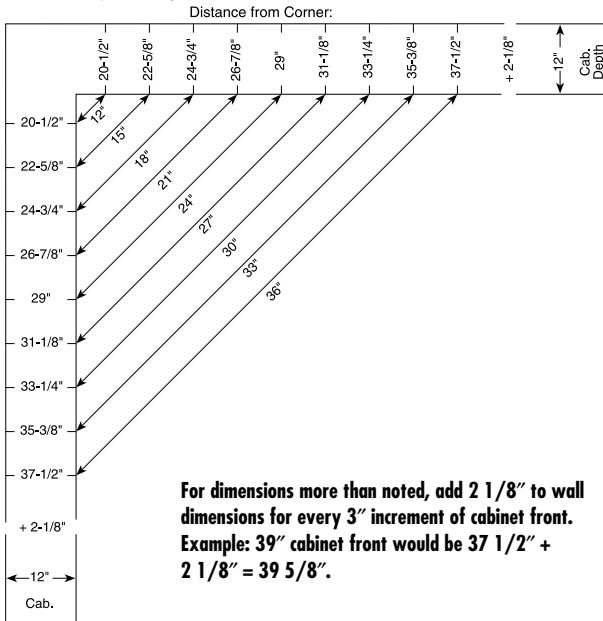

### 24" DEEP CABINETS

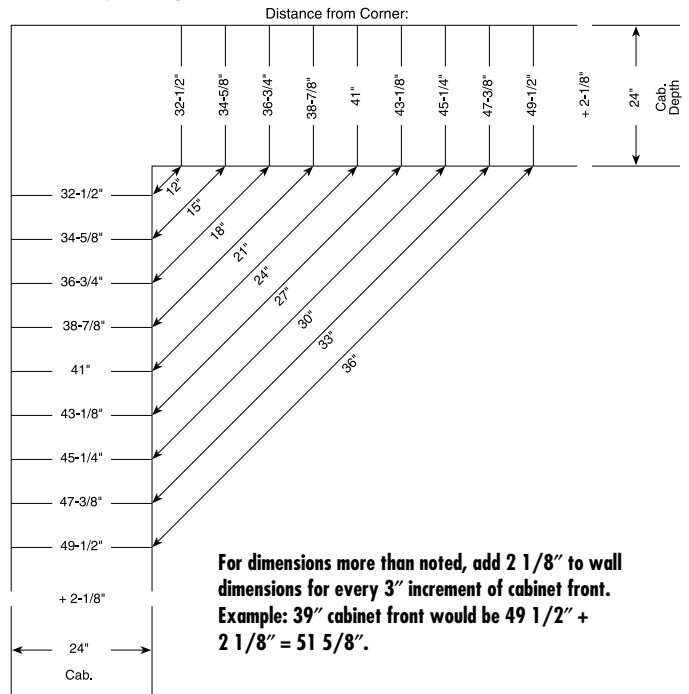

## INSTALLATION HEIGHT REQUIREMENTS

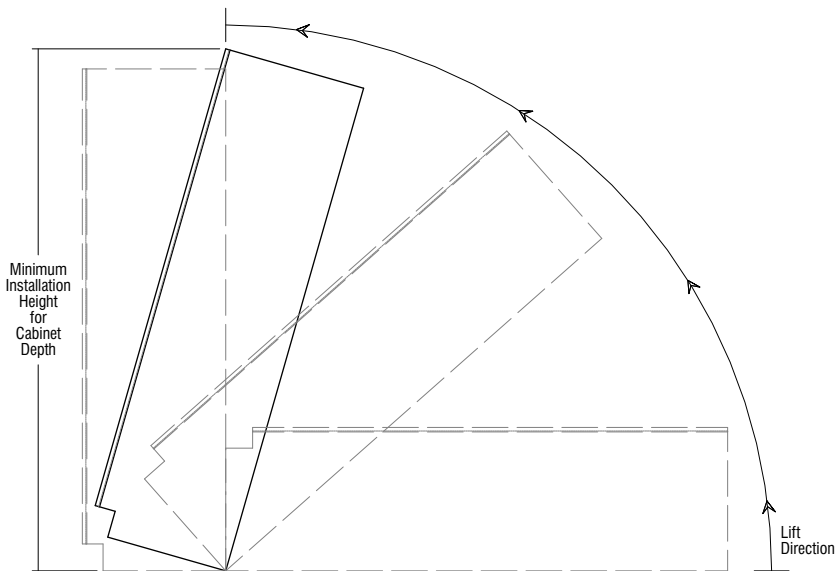

Height of ceiling needs to be considered for installation of tall cabinets. Cabinet height below includes toekick area:

Cabinet Height	Minimum Installation Height for Cabinet Depth		
	21"	24"	27"
84"	86 19/32"	87 3/8"	88 1/4"
87"	89 1/2"	90 1/4"	91 3/32"
90"	92 7/16"	93 5/32"	93 31/32"
93" *	90 31/32"	91 23/32"	92 17/32"
96" *	93 29/32"	94 5/8"	95 13/32"

\*Separate pedestal base included with cabinet to be installed after cabinet is in an upright position.

# POLICIES & INSTALLER NOTES

## DISCONTINUED PRODUCT POLICY

60 days minimum notice to reps and customers announcing the discontinuation of a product line.

Product will no longer be available for order after the discontinuation date. Only warranty orders will be considered. Even with warranty orders we will have the option to replace customer's defective product with the same discontinued product they originally purchased, or replace all doors originally ordered with a current product that is similar in appearance.

48

## EXPRESS RESPONSE™ POLICY

Diamond Vibe's Express Response program is designed to expedite orders when customers need product faster than normal lead times to correct problems with an existing order. Below is an overview of the program and what you can expect from Diamond Vibe's commitment to superior service.

### GUIDELINES

- Order must be associated with a previous order number.
- All orders received by 12 NOON E.T. Monday-Friday will be automatically scheduled for Express Response that same day. Orders received after the cutoff time will be processed on the next business day.
- Lead time calculation is based on receipt of a clean order on a credit-worthy account. Clean orders are orders in which all information is provided and accurate.
- There is no additional up-charge for Express Response.
- There are no cancellations or returns once order is received.
- Due to the special nature of Special Orders and Appliance Panels, they are excluded from the Express Response program and will be processed as a standard lead time order.
- Express Response is available within the continental United States. Should Alaska, Hawaii or international shipments be required, customer service representatives are ready to assist by providing shipping information and determining lead times.

### LEAD TIMES

#### 12 WORKING DAYS OR LESS FROM ORDER TO DELIVERY (channel partner or home delivery agent):

- Items shipped via LTL (via SuperPAC™) or truckload.
- Includes all catalog items except those that can be expedited through the 5-day program listed below.

#### 5 WORKING DAYS FROM ORDER TO DELIVERY

- Qualified items are designated in the Pricing/Specification Guide with an icon 
- Items will ship via parcel ground.
  - Lead time calculation allows for 2 days parcel ground shipping time. Some geographic areas may require additional shipping time.
- For orders containing both 12 day and 5 day items, the longer lead time applies.

## NOTES TO THE INSTALLER

#10 x 2 1/2" installation screws are furnished and packaged inside all cabinets. Proper wall stud or ceiling joist installation is essential for Wall and Peninsula cabinets to support weight. Whenever possible, cabinets should be attached to each other for additional strength. Excessive weight should not be put on cabinets hung by themselves. Shimming may be required to ensure proper alignment. Wallboard alone is not strong enough to support the cabinets.

Our Warranty does not cover damage caused by improper installation. Please be sure to install cabinets properly. If you have questions, please contact your representative or customer service.

### WOOD DUST WARNING:

When cutting, sanding, sawing, or shaping cabinets or wood products, you are likely to generate wood dust. For your own safety, we recommend that you wear a protective mask to prevent breathing wood dust. We also recommend eye protection to avoid injury by flying wood chips or sawdust during cabinet installation.

# DIAMOND VIBE CABINETS' DESIGN CHECKLIST

## CONSTRUCTION OPTIONS

Consider exposed end options:

- Modify exposed cabinet ends to FPFB.
- Apply 1/4" veneer skin to hide 1/4" reveal. This will allow the ends to age uniformly with the rest of the kitchen and will make it flush.
- Apply decorative door kit (BED, WED, TED). This kit includes 1/4" veneer skin, decorative doors, and screws for field installation.

## WOOD AND FINISH CHARACTERISTICS

Review specific details with the customer:

- Mineral Streaks, Birdseye Dots, Grain Variations, especially Hickory.
- Color Variations/Darkening.
- Finish Variations (Glazes are "consistently inconsistent"), hairline cracks may develop at frame joints on painted frame.
- Underside of cabinets are natural maple laminate. Use light rail or cabinet panel edge and skin to hide, especially when designing with peninsula wall cabinets.

## LOGIX®

Review storage and usage needs with Customer. See page 52 for complete chart.

- Cooking Solutions:
  - Wall Spice Rack Cabinet
- Storage Solutions:
  - SuperCabinet™
  - Pegged Dish Organizer
  - Wall Message Center
- Clean-up Center:
  - Base Waste Basket

## CLEARANCES

- Add fillers between end cabinets and walls on full overlay door styles.
- Allow space between door/window trim and end cabinets for countertop and top moulding overhang.
- Include refrigerator door hinges in overall refrigerator height when placing cabinets above it.

Maintain a minimum clearance of 3" by pulling blind corners as follows:

- Full Overlay: 1 1/4", Standard Overlay 1/2". (More is needed in certain situations such as when adjacent to an appliance or when using oversized pulls or knobs.)
- Allow sufficient clearance (3") on each side of accessory cabinets (such as roll-out trays, etc). Doors on these cabinets must open fully for accessories to be functional.
- Ensure the height between the cooktop and range hood is 24" to meet NKBA guidelines.

Qualify customer carefully on upper cabinet/microwave advantages/disadvantages as follows:

- Minimum of 18" from cooktop to upper cabinet/above the range microwave which allows for easy access to either, but less room over back burner.
- Minimum of 21" from cooktop to upper cabinet/microwave which allows for access to large pots on back burner of cooktop, but longer reach to microwave.

## FILLERS

- Place fillers toward end of run where least conspicuous if needed.
- Attach overlay fillers on top of the base, wall, or tall fillers when using full overlay door styles to maintain a consistent reveal. Don't forget to include blind corner fillers.
- Add a filler at least 6" wide to accommodate a decorative onlay when the filler is used as valance.

## VARYING HEIGHTS AND DEPTHS

- Also increase the depth of a wall cabinet run when you increase the height (so moulding on adjacent cabinet will kill into the side of the taller cabinet).
- Skin the sides of tall cabinets to 1) hide the seam between the toekick pedestal and the cabinet, 2) keep adjacent base and wall cabinets out from reveal of tall cabinet.
- Add increased depth (27"-36") on tall end panels for a built-in look for deep refrigerators.
- Account for the additional support needed for wall cabinets with a depth of 18" or greater. This can be achieved by installing a soffit or end panels.

## MATCHING INTERIOR CABINETS/GLASS OPTIONS

- Verify cut for glass or mullion door option is available on desired cabinet size. (See pages 35-36 for available cut for glass/mullion door sizes.)
- Verify glass insert option is available for desired cut for glass door size chosen.
- Verify matching interior option has been selected for all open or glass cabinets.
- Use light rail and skin to hide color variation between bottom of cabinets with and without matching interior.
- Verify mullion door lite grid matches customer expectations.

## MOULDINGS

- Verify correct amount of crown moulding has been ordered.
- Order toekick caps.
- Order extra scribe.

## ISLANDS AND PENINSULAS

- Consider standard height bars are 34 1/2" tall and require 19" knee space. Raised bars are 42" tall.
- Consider base peninsula cabinets (P) are 24 1/4" deep and require 12" of knee space. Use back panels/doors to flush non-P cabinets with P cabinets.
- Use outside corner moulding if a skin is exposed on the back of the island.

## APPLIANCES

- Note for all consumers, appliances are not included with any cabinetry product.
- Do not place dishwashers next to diagonal front cabinet (interference) or next to a range (no countertop support).
- Verify refrigerator door has enough clearance to open beyond 90 degrees so refrigerator drawers can be utilized. Refer to appliance manufacturer's specs.
- Add TF696FH, as it may be required to frame around built-in microwave ovens and other built-in items. Refer to appliance manufacturer's specs.
- Order appliance panels.

## SPECIAL CONSIDERATIONS

- Consider V-Groove skins and/or decorative doors on exposed cabinet sides in glazed kitchen.

## MISCELLANEOUS

- Order full size touch-up kit (mini touch-up kit included with standard sink base).



## kitchen planning guidelines

### DOOR/ENTRY

- Door opening should be at least 32" wide, requiring a minimum 2' 10" wide door.

### DOOR INTERFERENCE

- Entry door should not interfere with safe appliance operation or appliance doors.

### DISTANCE BETWEEN WORK CENTERS

- With three work centers, the total distance traveled should not be more than 26' with no single leg of the triangle less than 4' or more than 9'.
- With more than three work centers, each additional travel distance to another work center should be no less than 4' or more than 9'. Each leg is measured from the center-front of the appliance/sink. No work triangle leg should intersect an island/peninsula by more than 12".

### SEPARATING WORK CENTERS

- A tall obstacle should not separate two primary work centers. A properly recessed tall corner unit is acceptable.

### WORK TRIANGLE TRAFFIC

- Major traffic patterns should not cross through the basic work triangle.

### WORK AISLE

- The work aisle should be at least 42" for one cook and at least 48" for multiple cooks.

### WALKWAY

- The walkway width should be at least 36".

### TRAFFIC CLEARANCE AT SEATING

- Allow 32" of clearance from the table to wall/obstacle if no traffic passes behind a seated diner. If traffic passes behind the diner, allow at least 36" to edge past or 44" to walk past.

### SEATING CLEARANCE

- 30" high tables/counters should allow a 24" wide by 18" deep space for each seated diner and at least 18" knee space.
- 36" high counters should allow a 24" wide by 15" deep space for each seated diner and at least 15" kneespace.
- 42" high counters should allow a 24" wide by 12" deep space for each seated diner and at least 12" kneespace.

### CLEAN-UP/PREP SINK PLACEMENT

- With only one sink, locate it adjacent to or across from the cooking surface and refrigerator.

### CLEAN-UP/PREP SINK LANDING AREA

- Include at least a 24" wide landing space on one side of the sink and 18" on the other.
- If all the countertop at the sink is not the same height, plan a 24" landing space on one side of the sink and 3" of countertop frontage on the other, both at the same height of the sink.

### PREPARATION/WORK AREA

- Include a section of countertop at least 36" wide x 24" deep next to the sink for a work area.

### DISHWASHER PLACEMENT

- Nearest edge of dishwasher should be within 36" of nearest edge of sink. Provide at least 21" of standing space between the edge of the dishwasher and countertop frontage/appliances/cabinets which are placed at a right angle to the dishwasher.

### WASTE RECEPTACLES

- Include at least 2 waste receptacles, one near the sink and the other nearby for recycling.

### AUXILIARY SINK

- Provide at least 3" of countertop frontage on one side of the auxiliary sink and 18" on the other side, both at the same height as the sink.

### REFRIGERATOR LANDING AREA

- Include at least 15" of landing area on the handle side of the refrigerator, 15" on either side of a side-by-side refrigerator, 15" of landing space which is no more than 48" across from the front of the refrigerator, and 15" above or adjacent to any under-counter style refrigerator.

### COOKING SURFACE LANDING AREA

- Include a minimum of 12" of landing area on one side of the cooking surface and 15" on the other.
- If cooking surface is at a different countertop height than the rest of the kitchen, then the 12" and 15" landing areas must be the same height as the cooking surface.
- For safety reasons, in an island or peninsula situation, the countertop should extend a minimum of 9" behind the cooking surface if the counter height is the same height as the cooking surface.

### COOKING SURFACE CLEARANCE

- Allow 24" between the cooking surface and a protected noncombustible surface above it.
- At least 30" of clearance is required between the cooking surface and an unprotected/combustible surface above it.
- If a microwave/hood combination is used, then the manufacturer's specifications should be followed.

### COOKING SURFACE VENTILATION

- A correctly sized, ducted ventilation system is recommended for all cooking surface appliances. The recommended minimum is 150 CFM.
- Code requires that the manufacturer's specifications be followed. Minimum exhaust rate for a ducted hood is 100 CFM and must be ducted to the outside.
- Make-up air may need to be provided. Refer to local codes.

### COOKING SURFACE SAFETY

- Do not locate cooking surface under an operable window.
- Window treatments above cooking surface should not use flammable materials.
- Place a fire extinguisher near the kitchen exit away from cooking equipment.

### MICROWAVE OVEN PLACEMENT

- The ideal location for the bottom of the microwave is 3" below the principle user's shoulder, but no more than 54" above the floor.

### MICROWAVE LANDING AREA

- Provide at least 15" above, below, or adjacent to the handle side of a microwave oven.

### OVEN LANDING AREA

- Include at least 15" next to or above the oven.
- A 15" landing area that is not more than 48" away is also acceptable as long as the oven does not open into a walkway.

### COMBINING LANDING AREAS

- If two landing areas are adjacent to one another, determine a new minimum for the two by taking the longer of the two and adding 12".

*continued*

## kitchen planning guidelines (continued)

### COUNTERTOP SPACE

- A total of 158" of countertop frontage, 24" deep, with at least 15" clearance above is needed to accommodate all landing, preparation, work, and storage areas.

### COUNTERTOP EDGES

- Clipped or round corners, rather than sharp edges, are recommended on all counters.

### STORAGE

- The recommended total shelf/drawer frontage for a small kitchen (less than 150 square feet) is 1400", for a medium kitchen (151 to 350 square feet) is 1700", and for a large kitchen (greater than 350 square feet) is 2000".

Sizes:	S	M	L
Wall	300"	360"	360"
Base	520"	615"	660"
Drawer	360"	400"	525"
Pantry	180"	230"	310"
Misc.	40"	95"	145"

- The totals for wall, base, drawer, and pantry shelf/drawer frontage can be adjusted upward or downward as long as the recommended total stays the same.

### STORAGE AT CLEAN-UP/PREP SINK

- The recommended total for a small kitchen is 400", a medium kitchen is 480", a large kitchen is 560", and should be located within 72" of the centerline of the main clean-up/prep sink.

### CORNER CABINET STORAGE

- At least one corner cabinet should include a functional storage device.

### ELECTRICAL RECEPTACLES

- GFCI (Ground-Fault-Circuit-Interrupter) protection is required on all receptacles servicing countertop surfaces within the kitchen.

### LIGHTING

- Every work surface should be well illuminated. At least one wall switch-controlled light must be placed at the entrance.
- Window/skylight area, equal to at least 8% of the total square footage of the kitchen, or a total living space which includes a kitchen, is required.

## bathroom planning guidelines

### DOOR/ENTRY

- Doorway opening should be at least 32", requiring a minimum 2' 10" wide door.

### DOOR INTERFERENCE

- The door area should include clear floor space for maneuvering which varies according to the type of door and the direction of the approach.

### CEILING HEIGHT

- Bathroom floor to ceiling minimum height is 80". A shower or tub with a shower head shall have a minimum floor to ceiling height of 80" above a minimum area 30" x 30" at the shower head.

### CLEAR SPACE

- Plan a clear space of 30" from the front edge of all fixtures to any opposite bath fixture, wall, or obstacle.
- A minimum space of at least 21" is required in front of a lavatory, toilet, bidet, and tub, with a 24" minimum space in front of a shower entry.

### SINGLE LAVATORY PLACEMENT

- The distance from the centerline of the lavatory to the sidewall/tall obstacle should be at least 20".
- The minimum distance required is 15". The minimum distance required between a wall and the edge of a lavatory is 4".

### DOUBLE LAVATORY PLACEMENT

- The distance between the centerlines of two lavatories should be at least 36".
- The minimum distance required is 30".
- The minimum distance required between the edges of two lavatories is 4".

### LAVATORY/VANITY HEIGHT

- The height for a lavatory varies from 32" to 43" to fit the user.

### COUNTERTOP EDGES

- Clipped or round corners, rather than sharp edges, are recommended on all counters.

### SHOWER SIZE

- The interior shower size should be at least 36" x 36". The minimum interior shower size required is 30" x 30".

### STORAGE

- Provide adequate, accessible storage for toiletries, bath linens, grooming and general bathroom supplies.
- Storage of frequently used items should be 15" to 48" above floor.

### ELECTRICAL RECEPTACLES

- All GFCI receptacles should be located at electrical appliance points of use.

**Load bearing floors and shelves meet KCMA standards of 15 lbs. per square foot. Warranty does not cover overloading beyond this point.**

To view a complete and updated list of the NKBA Guidelines, visit <http://www.nkba.org/guidelines/default.aspx>

© Copyright 2007 National Kitchen & Bath Association

# LOGIX® REFERENCE CHART

Wall Cabinets	Description	3"	6"	9"	12"	15"	18"	21"	24"	27"	30"	33"	36"	39"	42"	45"	48"	Page	
W18 __ SPD	Wall Spice Pull Down						•											112	
WBCPO __ _OL	Wall Box Column Pull-Outs (Overlay)	•	•															110	
WMC12 __ _L or R	Wall Message Center	•																120	
WSC1818 __	Wine Storage Cabinet						•											116	
WSP __ _	Wall Spice Pull-Outs			•	•													112	
WSR __ _ L or R	Wall Spice Rack Cabinets						•	•										114	
<b>Base Cabinets</b>																			
2DB __ RT	Two Drawer Bases w/Roll Tray								•	•			•					162	
2DB36PDO	Two Drawer Bases w/Pegged Dish Organizer												•					162	
2DB36RTPDO	Two Drawer Base w/Roll Tray & Pegged Dish Organizer												•					162	
3DB __ WTC	Three Drawer Bases w/Wood Tiered Cutlery Divider Drawer					•	•	•	•									164	
3DBDD __	Three Drawer Bases w/Deep Drawer								•		•							164	
4DB __ CIW	Four Drawer Bases w/Cutlery Insert Wood Organizer					•	•	•	•									166	
4DB __ WTC	Four Drawer Bases w/Wood Tiered Cutlery Divider Drawer					•	•	•	•									166	
B __ CIW L or R, B24CIW	Bases w/Cutlery Insert Wood Organizer					•	•	•	•									128	
B __ RTCIW L or R, B24RTCIW	Bases w/Cutlery Insert Wood Organizer and Roll Tray					•	•	•	•									132	
B __ RTWTC L or R, B24RTWTC	Bases w/Wood Tiered Cutlery Divider Drawer and Roll Tray					•	•	•	•									134	
B __ TDRO L or R	Bases w/Roll-Out Tray Divider					•	•											136	
B __ WTC L or R, B24WTC	Bases w/Wood Tiered Cutlery Divider Drawer					•	•	•	•									128	
B24PS L or R, B __ PS	Pots & Pans Organizer Bases w/Drawer								•		•							134	
BBCPO _OL	Base Box Column Pull-Outs (Overlay)	•	•															172	
BC __ PO	Base Corner w/Pull-Out																•	•	152
BCFW __ PO	Base Corners Full Width w/Pull-Out																•	•	154
BPP __	Base Pantry Pull-Outs			•	•													170	
BPPP24 L or R, BPPP24	Base Pots & Pans Pull-Out								•									134	
BSC __ _	SuperCabinet™										•		•					130	
BUPP __	Base Utensil Pantry Pull-Out			•	•													170	
BWB __	Base Wastebasket						•	•	•									166	
BWB __ FH	Base Wastebasket Full Height						•	•	•									168	
CNTYSB __ CM	Country Sink Base w/CabMat™										•	•	•					150	
SB __ CM	Sink Base CabMat™										•	•	•					140	
SB __ STCM	Sink Base w/Tilt-Out Trays and CabMat™										•	•	•					142	
SB36CDY	Sink Base w/Caddy																•	140	
SB36D	Sink Base w/Drawer Below																•	146	
SB36DCM	Sink Base w/Drawer Below and CabMat™																•	146	
SB36S	Sink Base SuperCabinet™																•	144	
SB36SCDY	Sink Base SuperCabinet™ w/Caddy																•	144	
SB36SCM	Sink Base SuperCabinet™ w/CabMat™																•	144	
SB36STCDY	Sink Base w/Tilt-Out Trays & Caddy																•	144	
SB36STS	Sink Base SuperCabinet™ w/Tilt-Out Trays																•	144	
SB36STSCDY	Sink Base SuperCabinet™ w/Tilt-Out Trays & Caddy																•	146	
SB36STSCM	Sink Base SuperCabinet™ w/Tilt-Out Trays and CabMat™																•	146	
<b>Tall Cabinets</b>																			
TPP __ _24	Tall Pantry Pull-Outs				•	•	•											194	
UOC24 __ 6	Utility Organizer Cabinets		•															192	
<b>Vanity Cabinets</b>																			
LC188421 L or R	Linen Closet						•											258	
LCRH188421 L or R	Linen Closet w/Removable Hamper						•											258	
VP93421	Vanity Pull-Out			•														246	
VSSB __ 3421ST	Vanity Sink Base SuperCabinet™ w/Tilt-Out Trays										•		•					242	
<b>Modifications</b>																			
CMAT1 (Base)	CabMat™										•	•	•					29	
CMAT2 (Vanity)	CabMat™								•	•	•	•	•					29	
DRWTK	Toekick						•	•	•	•	•	•	•					31	

• Available widths

# NOTES

# Diamond®

## VIBE™ SERIES

### WALL CABINET NOMENCLATURE

All Wall Cabinets are 12" deep unless otherwise noted.

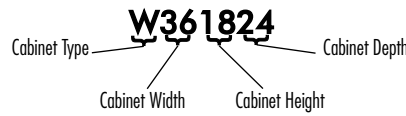

### MODIFICATIONS GRID KEY

- Available
- STD Standard on these cabinets
- L G I X Logix Organization Cabinet
- 5 DAY** 5 Day Express Response Item

54

### WALL SINGLE DOOR, 12" HIGH

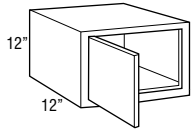

Model	Cubic Feet	Cabinet Depth						
		Tori Oak	Westbucke Oak	Tori Hickory Tori Maple	Loren Laminate Tori Cherry Westbucke Hickory Westbucke Maple Westbucke PureStyle™	Cairo Oak Cantrel Oak Kemper Oak Rena Oak	Westbucke Cherry	Brookway Oak Bryant Hickory Bryant Maple Bryant PureStyle™ Cairo Maple Haley Hickory Haley Maple Kemper Maple Kemper PureStyle™ Rena Maple Rena PureStyle™
		1	2	3	4	5	6	7
<b>W1212 L or R</b>	1.5	250	263	291	305	320	321	348
<b>W1512 L or R</b>	1.9	268	282	308	327	341	343	372
<b>W1812 L or R</b>	2.2	283	297	329	346	362	363	394

### WALL DOUBLE DOOR, 12" HIGH

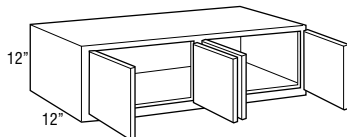
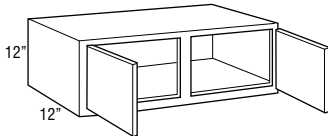
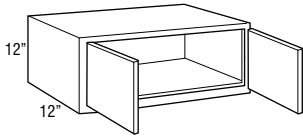

<b>W2412</b>	3.0	319	334	371	389	407	409	443
<b>W2712</b>	2.8	338	357	393	413	433	434	472
<b>W3012</b>	3.7	326	341	377	398	416	417	451
<b>W3312</b>	4.1	338	357	395	414	435	435	474
<b>W3412</b>	4.1	350	368	406	427	446	448	487
<b>W3612</b>	4.4	360	378	417	439	457	461	501
<b>W3712</b>	4.4	371	390	429	451	469	474	514
<b>W3912</b>	4.8	376	394	438	460	481	482	524
<b>W4212</b>	5.1	395	415	457	482	505	506	551
<b>W4512</b>	5.0	413	434	478	504	526	529	573
<b>W4812</b>	5.3	505	530	586	619	648	650	705

### WALL TOP HINGE SINGLE DOOR, 12" HIGH

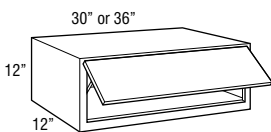

<b>WTH3012</b>	3.7	406	427	472	498	521	523	566
<b>WTH3612</b>	4.4	448	471	523	549	573	575	625

- Utilizes doors from 30" and 36" high wall cabinets. Grain on center panels will run horizontally and door rail configuration on non-miter doors will be unique from adjacent cabinet doors.
- Cabinet may utilize one or two lift mechanisms depending on door size and weight. Door lift mechanism tension can be field adjusted.
- Depth can be reduced to a minimum of 9".
- Lift mechanisms and mounting brackets will be visible if used with transparent textured glass.
- Lift mechanism not available for order for field installation, only available factory installed.

CUSTOM MODIFICATIONS			
Mod.	Description	Mod.	Description
AUTHL	Authentic End - Left	FB	Finished Ends
AUTHR	Authentic End - Right	FPEB	Furniture Finished Plywood
CBO	Cabinet Box Only		End Panels
CCO	Cabinet Case Only	ID	Increased Depth
CFNTO	Cabinet Front Only	MIP	Matching Interior Plywood
CFRMO	Cabinet Frame Only	P	Peninsula
CND	Cabinet with No Door, with Drawer	RD	Reduced Depth

CONSTRUCTION UPGRADES	
Mod.	Description
VPL	All Plywood with Laminate Ends

SMART STOP OPTIONS	
Mod.	Description
INTGH	Smart Stop Premium Hinge

DECORATIVE DOOR OPTIONS	
Mod.	Description
CG	Cut For Glass Doors
MD	Mullion Doors

Model	Cubic Feet	Central Maple	Bryant Cherry Hurley Cherry Morris Maple Morris PureStyle™	Cato Cherry Kasper Cherry Rena Cherry	Kevin Oak	Brookway Maple Central Cherry Kersey Hickory Kersey Maple Morris Cherry	Felix Hickory Felix Maple Forte Hickory Forte Maple Forte PureStyle™ Owens Maple Owens PureStyle™	AniRo PureStyle™ Brookway Cherry Felix Cherry Forte Cherry Kersey Cherry Kevin Hickory Kevin Maple Owens Cherry	Adira Maple Adira PureStyle™ Keegan Maple	Valero Maple	Adira Cherry Keegan Cherry	Kevin Cherry	Valero Cherry
		8	9	10	11	12	13	14	15	16	17	18	19
<b>W1212 L or R</b>	1.5	365	381	396	423	426	443	466	473	499	511	514	539
<b>W1512 L or R</b>	1.9	389	405	420	450	453	471	493	504	530	544	549	573
<b>W1812 L or R</b>	2.2	413	431	446	480	482	500	524	536	564	580	582	611

Custom Modifications	AUTHL AUTHR	CBO	CCO	CFNTO	CFRMO	CND	FB	FPEB	ID	MIP	P	RD
	•		•	•	•		•	•	•	•	•	•

Construction Upgrades	VPL	Decorative Door Options	CG	MD	Smart Stop Options	INTGH
	•		•			•

<b>W2412</b>	3.0	467	484	504	540	543	562	590	601	634	652	654	686
<b>W2712</b>	2.8	493	513	535	572	578	598	627	639	674	692	696	729
<b>W3012</b>	3.7	475	494	514	551	554	574	602	615	648	667	669	702
<b>W3312</b>	4.1	498	515	537	575	579	600	629	643	676	696	697	733
<b>W3412</b>	4.1	511	529	552	592	595	618	649	661	696	717	718	754
<b>W3612</b>	4.4	524	544	566	610	611	635	668	680	714	736	737	774
<b>W3712</b>	4.4	538	558	582	627	627	653	688	698	734	757	758	795

<b>W3912</b>	4.8	550	571	593	638	640	664	697	710	747	769	771	810
--------------	-----	-----	-----	-----	-----	-----	-----	-----	-----	-----	-----	-----	-----

<b>W4212</b>	5.1	578	599	623	669	673	699	733	747	787	807	810	850
<b>W4512</b>	5.0	600	624	650	697	702	729	764	778	819	844	846	887
<b>W4812</b>	5.3	738	768	798	855	859	893	937	957	1008	1034	1036	1090

Custom Modifications	AUTHL AUTHR	CBO	CCO	CFNTO	CFRMO	CND	FB	FPEB	ID	MIP	P	RD
	•		•	•	•		•	•	•	•	•	•

Construction Upgrades	VPL	Decorative Door Options	CG	MD	Smart Stop Options	INTGH
	•		•			•

<b>WTH3012</b>	3.7	594	619	645	687	692	718	752	769	810	833	837	877
<b>WTH3612</b>	4.4	655	681	708	762	763	794	834	849	894	920	921	966

Custom Modifications	AUTHL AUTHR	CBO	CCO	CFNTO	CFRMO	CND	FB	FPEB	ID	MIP	P	RD
	•		•		•		•	•	•	•		•

Construction Upgrades	VPL	Decorative Door Options	CG	MD	Smart Stop Options	INTGH
	•		•			•

**WALL REFRIGERATOR DOUBLE DOOR, 12" HIGH, 24" DEEP**

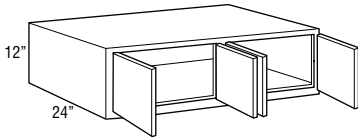
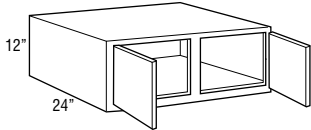
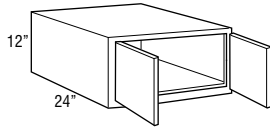

Model	Cubic Feet	Finish						
		Tori Oak	Westburke Oak	Tori Hickory Tori Maple	Loren Laminate Tori Cherry Westburke Hickory Westburke Maple Westburke PureStyle™	Cairo Oak Cantrell Oak Kesper Oak Renaist Oak	Westburke Cherry	Brookway Oak Bryant Hickory Bryant Maple Cairo Maple Hurley Hickory Hurley Maple Kesper Maple Kessy Oak Renaist Maple Renaist PureStyle™
		1	2	3	4	5	6	7
<b>W241224</b>	5.5	356	373	413	437	455	457	498
<b>W301224</b>	6.8	372	390	431	453	475	476	516
<b>W331224</b>	7.4	410	431	476	501	524	526	571
<b>W341224</b>	7.4	420	441	487	512	537	539	584
<b>W361224</b>	8.1	430	450	499	523	549	550	597
<b>W371224</b>	8.1	440	461	510	535	561	562	611
<b>W391224</b>	8.7	445	468	515	544	570	572	620
<b>W421224</b>	9.4	470	493	546	573	599	601	654
<b>W451224</b>	10.0	511	537	593	624	653	655	710
<b>W481224</b>	9.9	626	657	727	766	803	804	875

- 24" deep cabinets must be fully supported by screws installed in a structural member in the ceiling or soffit, and into adjacent cabinets.
- Load limit is 15 lbs. per square foot of load bearing surface.

**WALL TOP HINGE REFRIGERATOR SINGLE DOOR, 12" HIGH, 24" DEEP**

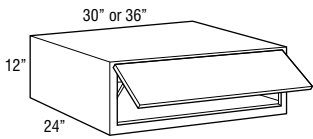

<b>WTH301224</b>	6.8	466	487	538	567	594	596	647
<b>WTH361224</b>	8.1	537	563	622	654	685	686	746

- Utilizes doors from 30" and 36" high wall cabinets. Grain on center panels will run horizontally and door rail configuration on non-miter doors will be unique from adjacent cabinet doors.
- 24" deep cabinets must be fully supported by screws installed in a structural member in the ceiling or soffit, and into adjacent cabinets.
- Load limit is 15 lbs. per square foot of load bearing surface.
- Cabinet may utilize one or two lift mechanisms depending on door size and weight. Door lift mechanism tension can be field adjusted.
- Depth can be reduced to a minimum of 9".
- Lift mechanisms and mounting brackets will be visible if used with transparent textured glass.
- Lift mechanism not available for order for field installation, only available factory installed.

**WALL SINGLE DOOR, 15" HIGH**

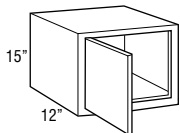

<b>W1215 L or R</b>	1.8	272	286	317	332	348	348	378
<b>W1515 L or R</b>	2.3	291	305	336	354	371	371	404
<b>W1815 L or R</b>	2.7	307	323	357	375	393	393	428

Model	Cubic Feet	Canthell Maple	Bryant Cherry Hurley Cherry Norris Maple Norris PureStyle™	Cairo Cherry Kesper Cherry Reist Cherry	Klewin Oak	Brookway Maple Canthell Cherry Kersey Hickory Kersey Maple Norris Cherry	Felix Hickory Felix Maple Forte Hickory Forte Maple Forte PureStyle™ Owens Maple Owens PureStyle™	Antico PureStyle™ Brookway Cherry Felix Cherry Forte Cherry Kersey Cherry Klewin Hickory Klewin Maple Owens Cherry	Adair Maple Adair PureStyle™ Keegan Maple	Valero Maple	Adair Cherry Keegan Cherry	Klewin Cherry	Valero Cherry
		8	9	10	11	12	13	14	15	16	17	18	19
W241224	5.5	519	540	560	603	605	627	658	674	709	729	731	766
W301224	6.8	541	562	585	627	629	654	687	702	738	760	761	798
W331224	7.4	598	621	647	693	696	723	760	774	815	838	841	881
W341224	7.4	612	636	662	710	713	740	777	793	834	858	860	903
W361224	8.1	625	651	677	727	730	758	795	810	852	878	879	924
W371224	8.1	638	666	693	744	747	775	812	829	871	898	898	946
W391224	8.7	651	675	703	752	758	787	824	842	886	911	912	958
W421224	9.4	685	711	740	795	798	830	871	887	933	960	962	1012
W451224	10.0	745	775	806	865	869	902	949	964	1015	1043	1048	1098
W481224	9.9	915	952	989	1062	1067	1106	1162	1186	1249	1283	1285	1350

Custom Modifications	AUTHL AUTHR	CBO	CCO	CFNTO	CFRMO	CND	FB	FPEB	ID	MIP	P	RD
	•		•	•	•		•	•		•		•

Construction Upgrades	VPL	Decorative Door Options	CG	MD	Smart Stop Options	INTGH
	•		•			•

WTH301224	6.8	676	704	732	786	788	818	859	877	923	950	951	998
WTH361224	8.1	782	813	847	908	912	948	994	1013	1066	1097	1098	1155

Custom Modifications	AUTHL AUTHR	CBO	CCO	CFNTO	CFRMO	CND	FB	FPEB	ID	MIP	P	RD
	•		•		•		•	•		•		•

Construction Upgrades	VPL	Decorative Door Options	CG	MD	Smart Stop Options	INTGH
	•		•			•

W1215 L or R	1.8	396	413	431	460	466	481	505	513	541	556	558	586
W1515 L or R	2.3	421	440	456	489	493	511	537	546	575	592	595	623
W1815 L or R	2.7	447	467	484	519	523	543	570	580	611	626	629	659

Custom Modifications	AUTHL AUTHR	CBO	CCO	CFNTO	CFRMO	CND	FB	FPEB	ID	MIP	P	RD
	•		•	•	•		•	•	•	•	•	•

Construction Upgrades	VPL	Decorative Door Options	CG	MD	Smart Stop Options	INTGH
	•		•			•



**WALL DOUBLE DOOR, 15" HIGH**

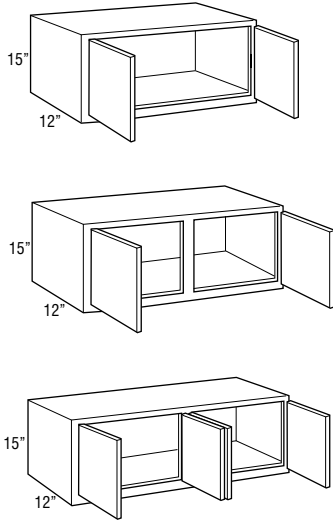

Model	Cubic Feet	Material Options						
		Tori Oak	Westburke Oak	Tori Hickory Tori Maple	Loren Laminate Tori Cherry Westburke Hickory Westburke Maple Westburke PureStyle™	Calvo Oak Gambrell Oak Kesper Oak Rensel Oak	Westburke Cherry	Brookway Oak Bryant Hickory Bryant Maple Calvo Maple Hurley Hickory Hurley Maple Kesper Maple Kessy Oak Rensel PureStyle™
		1	2	3	4	5	6	7
<b>W2115</b>	2.7	319	334	368	388	406	407	442
<b>W2415</b>	3.5	330	346	381	402	418	420	456
<b>W2715</b>	4.0	338	357	393	413	433	434	472
<b>W3015</b>	4.5	350	366	405	426	445	446	485
<b>W3315</b>	4.9	366	386	428	448	470	471	512
<b>W3415</b>	4.9	376	396	438	461	482	484	525
<b>W3615</b>	5.4	387	406	447	473	493	498	539
<b>W3715</b>	5.4	397	416	457	485	506	511	552
<b>W3915</b>	5.8	405	426	470	497	515	522	565
<b>W4215</b>	6.1	424	445	493	521	544	546	592
<b>W4515</b>	6.1	444	467	514	543	567	571	619
<b>W4815</b>	6.9	544	572	631	667	696	701	759

**WALL TOP HINGE SINGLE DOOR, 15" HIGH**

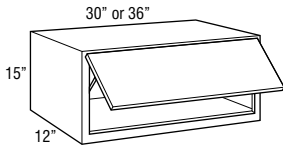

<b>WTH3015</b>	4.5	438	460	506	533	556	559	609
<b>WTH3615</b>	5.4	483	508	559	591	617	621	674

- Utilizes doors from 30" and 36" high wall cabinets. Grain on center panels will run horizontally and door rail configuration on non-miter doors will be unique from adjacent cabinet doors.
- Cabinet may utilize one or two lift mechanisms depending on door size and weight. Door lift mechanism tension can be field adjusted.
- Depth can be reduced to a minimum of 9".
- Lift mechanisms and mounting brackets will be visible if used with transparent textured glass.
- Lift mechanism not available for order for field installation, only available factory installed.

**WALL REFRIGERATOR DOUBLE DOOR, 15" HIGH, 24" DEEP**

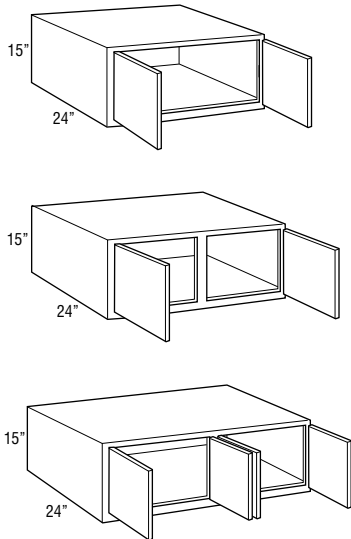

<b>W301524</b>	8.3	399	418	463	486	509	511	554
<b>W331524</b>	9.1	418	440	485	512	536	538	584
<b>W341524</b>	9.1	430	451	499	526	551	552	599
<b>W361524</b>	9.8	441	463	512	540	565	566	614
<b>W371524</b>	9.8	452	474	525	554	581	581	629
<b>W391524</b>	10.6	463	485	537	564	590	592	643
<b>W421524</b>	11.3	502	527	583	615	641	647	699
<b>W451524</b>	12.1	524	551	609	641	670	674	730
<b>W481524</b>	12.8	641	674	745	786	821	824	894

- 24" deep cabinets must be fully supported by screws installed in a structural member in the ceiling or soffit, and into adjacent cabinets.
- Load limit is 15 lbs. per square foot of load bearing surface.

Model	Cubic Feet	Carroll Maple	Bryant Cherry Hurley Cherry Norris Maple Norris PureStyle™	Cairo Cherry Kasper Cherry Reiss Cherry	Kevin Oak	Brockway Maple Carroll Cherry Conley Hickory Kersey Maple Norris Cherry	Felix Hickory Felix Maple Forte Hickory Forte Maple Forte PureStyle™ Owens Maple Owens PureStyle™	Amico PureStyle™ Brockway Cherry Felix Cherry Forte Cherry Kersey Cherry Kevin Hickory Kevin Maple Owens Cherry	Adair Maple Adair PureStyle™ Keegan Maple	Wilero Maple	Adair Cherry Keegan Cherry	Kevin Cherry	Wilero Cherry
		8	9	10	11	12	13	14	15	16	17	18	19
W2115	2.7	465	481	502	538	541	560	588	599	631	649	652	683
W2415	3.5	478	499	518	555	558	581	610	620	652	672	675	706
W2715	4.0	493	513	535	572	578	598	627	639	674	692	696	729
W3015	4.5	509	529	551	590	594	617	648	658	693	713	718	750
W3315	4.9	538	556	580	622	624	649	681	694	732	750	752	791
W3415	4.9	552	572	595	638	640	666	698	712	750	771	773	811
W3615	5.4	565	586	611	654	656	683	715	730	768	791	794	832
W3715	5.4	580	601	626	670	672	700	733	748	786	811	814	852

W3915	5.8	592	614	639	686	690	714	750	765	806	828	831	874
W4215	6.1	621	647	673	722	723	751	790	805	847	869	874	915
W4515	6.1	648	674	702	750	752	785	822	839	882	908	910	955
W4815	6.9	795	825	859	924	926	963	1012	1030	1085	1114	1118	1172

Custom Modifications	AUTHL AUTHR	CBO	CCO	CFNTO	CFRMO	CND	FB	FPEB	ID	MIP	P	RD
	•		•	•	•		•	•	•	•	•	•

Construction Upgrades	VPL	Decorative Door Options	CG	MD	Smart Stop Options	INTGH
	•		•			•

WTH3015	4.5	637	661	687	738	743	770	810	823	867	893	896	939
WTH3615	5.4	706	733	763	818	821	853	895	912	959	988	992	1039

Custom Modifications	AUTHL AUTHR	CBO	CCO	CFNTO	CFRMO	CND	FB	FPEB	ID	MIP	P	RD
	•		•		•		•	•	•	•		•

Construction Upgrades	VPL	Decorative Door Options	CG	MD	Smart Stop Options	INTGH
	•		•			•

W301524	8.3	582	602	626	674	676	704	738	751	792	815	817	856
W331524	9.1	612	635	659	709	711	740	777	793	834	856	859	902
W341524	9.1	628	653	676	728	731	760	798	813	856	879	883	926
W361524	9.8	645	669	694	746	749	778	818	834	879	901	906	950
W371524	9.8	661	687	711	765	769	798	839	854	902	923	929	975

W391524	10.6	674	702	729	782	783	817	856	875	920	944	948	993
W421524	11.3	733	762	793	852	853	887	930	949	998	1028	1030	1080
W451524	12.1	764	795	827	887	888	925	970	987	1039	1069	1074	1126
W481524	12.8	939	977	1015	1091	1094	1135	1194	1214	1278	1314	1319	1384

Custom Modifications	AUTHL AUTHR	CBO	CCO	CFNTO	CFRMO	CND	FB	FPEB	ID	MIP	P	RD
	•		•	•	•		•	•	•	•		•

Construction Upgrades	VPL	Decorative Door Options	CG	MD	Smart Stop Options	INTGH
	•		•			•

**WALL TOP HINGE REFRIGERATOR  
SINGLE DOOR, 15" HIGH, 24" DEEP**

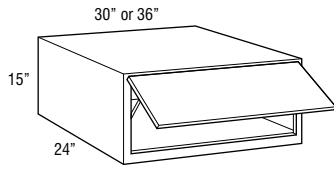

Model	Cubic Feet	Cabinet Feet					Cabinet Feet	
		Tori Oak	Westburke Oak	Tori Hickory Tori Maple	Loren Laminate Tori Cherry Westburke Hickory Westburke Maple Westburke PureStyle™	Calio Oak Gantrell Oak Kesper Oak Rensel Oak	Westburke Cherry	Brookway Oak Bryant Hickory Bryant Maple Bryant PureStyle™ Calio Maple Hurley Hickory Hurley Maple Kesper Maple Kessy Oak Rensel PureStyle™
<b>WTH301524</b>	8.3	500	525	579	610	637	639	692
<b>WTH361524</b>	9.8	551	579	640	675	706	708	768

- Utilizes doors from 30" and 36" high wall cabinets. Grain on center panels will run horizontally and door rail configuration on non-miter doors will be unique from adjacent cabinet doors.
- 24" deep cabinets must be fully supported by screws installed in a structural member in the ceiling or soffit, and into adjacent cabinets.
- Load limit is 15 lbs. per square foot of load bearing surface.
- Cabinet may utilize one or two lift mechanisms depending on door size and weight. Door lift mechanism tension can be field adjusted.
- Depth can be reduced to a minimum of 9".
- Lift mechanisms and mounting brackets will be visible if used with transparent textured glass.
- Lift mechanism not available for order for field installation, only available factory installed.

**WALL SINGLE DOOR, 18" HIGH**

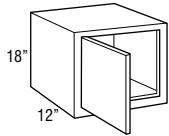

<b>W1218 L or R</b>	2.2	262	274	304	321	335	336	365
<b>W1518 L or R</b>	2.7	277	291	322	338	356	357	388
<b>W1818 L or R</b>	3.2	294	308	341	360	376	378	410
<b>W2118 L or R</b>	3.8	313	329	363	382	401	402	437
<b>W2418 L or R</b>	4.3	316	331	366	386	404	405	441

- MD not available on W1218 L or R, W2118 L or R, and W2418 L or R.

**WALL DOUBLE DOOR, 18" HIGH**

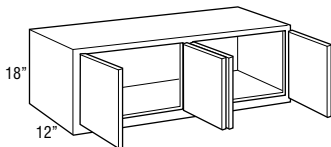
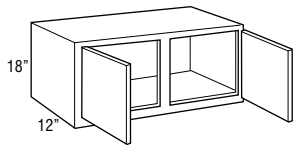
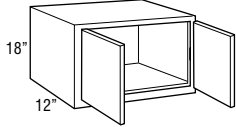

<b>W2418</b>	4.3	348	365	404	424	444	445	483
<b>W2718</b>	4.8	360	378	416	438	457	460	499
<b>W3018</b>	5.3	377	395	438	460	481	482	524
<b>W3318</b>	5.4	394	414	455	478	503	503	545
<b>W3418</b>	5.4	404	425	468	491	515	516	560
<b>W3618</b>	6.3	413	434	480	504	527	529	575
<b>W3718</b>	6.3	424	444	492	517	540	543	590
<b>W3918</b>	6.8	435	456	504	529	554	556	603
<b>W4218</b>	7.3	456	480	530	556	583	584	635
<b>W4518</b>	7.2	476	501	553	581	609	610	662
<b>W4818CS</b>	8.3	557	586	651	685	718	721	785
<b>W4818</b>	8.3	585	614	678	712	745	748	813

- MD available only on W3018 and W3618.

Model	Cubic Feet	Canthell Maple	Bryant Cherry Hurley Cherry Norris Maple Norris PureStyle™	Cairo Cherry Kasper Cherry Reist Cherry	Klewin Oak	Brookway Maple Canthell Cherry Kersey Hickory Kersey Maple Norris Cherry	Felix Hickory Felix Maple Forte Hickory Forte Maple Forte PureStyle™ Owens Maple Owens PureStyle™	Amico PureStyle™ Brookway Cherry Felix Cherry Forte Cherry Kersey Hickory Kersey Maple Klewin Hickory Klewin Maple Owens Cherry	Adair Maple Adair PureStyle™ Keegan Maple	Valero Maple	Adair Cherry Keegan Cherry	Klewin Cherry	Valero Cherry
	8	9	10	11	12	13	14	15	16	17	18	19	
WTH301524	8.3	728	752	783	842	846	879	923	941	989	1018	1021	1071
WTH361524	9.8	805	837	869	932	937	975	1022	1043	1098	1127	1131	1186

<b>Custom Modifications</b>	AUTHL AUTHR	CBO	CCO	CFNT0	CFRMO	CND	FB	FPEB	ID	MIP	P	RD
	•		•		•		•	•		•		•
<b>Construction Upgrades</b>	VPL	<b>Decorative Door Options</b>				CG	MD	<b>Smart Stop Options</b>			INTGH	
	•					•					•	

W1218 L or R	2.2	383	398	413	444	445	463	484	497	522	536	537	564
W1518 L or R	2.7	407	420	439	471	473	490	514	524	552	567	570	597
W1818 L or R	3.2	431	445	465	499	500	518	544	555	584	600	601	631
W2118 L or R	3.8	456	474	493	530	531	552	579	590	621	640	641	674
W2418 L or R	4.3	463	478	499	536	537	557	585	597	627	647	648	680

<b>Custom Modifications</b>	AUTHL AUTHR	CBO	CCO	CFNT0	CFRMO	CND	FB	FPEB	ID	MIP	P	RD
	•		•	•	•		•	•	•	•	•	•
<b>Construction Upgrades</b>	VPL	<b>Decorative Door Options</b>				CG	MD	<b>Smart Stop Options</b>			INTGH	
	•					•	•				•	

W2418	4.3	508	527	550	588	591	614	646	657	692	711	712	748
W2718	4.8	523	543	565	609	609	633	664	678	713	735	736	772
W3018	5.3	550	571	593	639	640	667	699	712	749	769	772	810
W3318	5.4	573	594	619	664	668	693	729	740	779	804	805	846
W3418	5.4	588	610	635	683	686	711	747	761	801	824	827	868
W3618	6.3	602	625	651	701	703	730	765	781	821	845	848	888
W3718	6.3	618	640	667	720	721	748	783	802	843	866	870	910

W3918	6.8	633	657	684	736	737	766	805	820	864	888	891	934
W4218	7.3	664	691	719	772	775	806	846	861	908	932	934	982
W4518	7.2	693	721	749	807	809	841	882	897	947	975	977	1024
W4818CS	8.3	823	856	893	960	964	1004	1056	1074	1133	1163	1170	1227

W4818	8.3	851	884	921	988	992	1032	1084	1102	1161	1190	1198	1255
-------	-----	-----	-----	-----	-----	-----	------	------	------	------	------	------	------

<b>Custom Modifications</b>	AUTHL AUTHR	CBO	CCO	CFNT0	CFRMO	CND	FB	FPEB	ID	MIP	P	RD
	•		•	•	•		•	•	•	•	•	•
<b>Construction Upgrades</b>	VPL	<b>Decorative Door Options</b>				CG	MD	<b>Smart Stop Options</b>			INTGH	
	•					•	•				•	

**WALL TOP HINGE SINGLE DOOR, 18" HIGH**

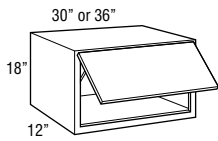

Model	Cubic Feet	Tori Oak		Westburke Oak	Tori Hickory Tori Maple	Loren Laminate Tori Cherry Westburke Hickory Westburke Maple Westburke PureStyle™	Calio Oak Gambrell Oak Kesper Oak Reins Oak	Westburke Cherry	Brockway Oak Bryant Hickory Bryant Maple Calio Maple Hurley Hickory Hurley Maple Kesper Oak Kessy Oak Reins Oak Reins PureStyle™
		1	2	3	4	5	6	7	
<b>WTH3018</b>	5.3	472	495	546	574	601	602	655	
<b>WTH3618</b>	6.3	516	542	600	629	659	661	720	

- Utilizes doors from 30" and 36" high wall cabinets. Grain on center panels will run horizontally and door rail configuration on non-miter doors will be unique from adjacent cabinet doors.
- Door stay tension can be field adjusted.
- Cabinet may utilize one or two lift mechanisms depending on door size and weight. Door lift mechanism tension can be field adjusted.
- Depth can be reduced to a minimum of 9".
- Lift mechanisms and mounting brackets will be visible if used with transparent textured glass.
- Lift mechanism not available for order for field installation, only available factory installed.

**WALL VERTICAL LIFT, 18" HIGH**

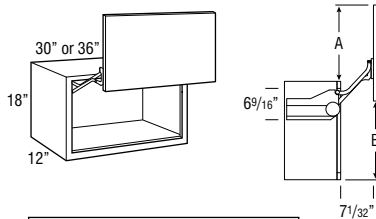

	Full Overlay	Partial Overlay
A	16 13/16"	16 1/16"
B	17 5/16"	18 1/16"

<b>WVL3018</b>	5.2	1413	1436	1487	1515	1542	1543	1596
<b>WVL3618</b>	6.1	1457	1483	1541	1570	1600	1602	1661

- Utilizes doors from 30" and 36" high wall cabinets. Grain on center panels will run horizontally and door rail configuration on non-miter doors will be unique from adjacent cabinet doors.
- Decorative hardware required.
- See side view drawing for required clearances.
- Lift mechanism features a single motion for up and out movement with Smart Stop, tension can be field adjusted.
- Lift mechanisms and mounting brackets will be visible if used with transparent textured glass.
- Lift mechanism not available for order for field installation, only available factory installed.
- Hardware extends 1" into opening on each side.
- Not available in Owens.

**WALL REFRIGERATOR DOUBLE DOOR, 18" HIGH, 24" DEEP**

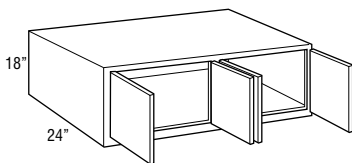
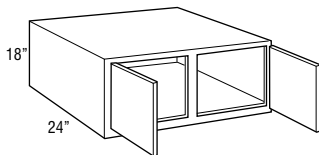
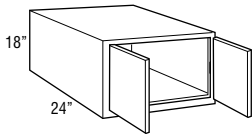

<b>W301824</b>	9.7	430	450	500	524	549	551	598
<b>W331824</b>	10.6	446	469	521	546	572	574	622
<b>W341824</b>	10.6	458	482	534	560	587	588	638
<b>W361824</b>	11.6	471	494	546	574	601	602	654
<b>W371824</b>	11.6	483	508	558	588	617	617	670

<b>W391824</b>	12.6	493	516	573	602	633	633	688
<b>W421824</b>	13.4	521	546	602	635	664	668	723
<b>W451824</b>	14.3	605	635	703	738	772	775	842
<b>W481824CS</b>	15.2	674	708	787	827	867	870	949

<b>W481824</b>	15.2	702	736	815	854	894	897	977
----------------	------	-----	-----	-----	-----	-----	-----	-----

- 24" deep cabinets must be fully supported by screws installed in a structural member in the ceiling or soffit, and into adjacent cabinets.
- Load limit is 15 lbs. per square foot of load bearing surface.
- MD available only on W301824 and W361824.

**WALL TOP HINGE REFRIGERATOR SINGLE DOOR, 18" HIGH, 24" DEEP**

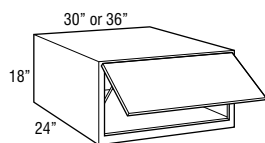

<b>WTH301824</b>	9.7	537	563	624	655	685	687	747
<b>WTH361824</b>	10.6	588	619	684	718	751	752	818

- Utilizes doors from 30" and 36" high wall cabinets. Grain on center panels will run horizontally and door rail configuration on non-miter doors will be unique from adjacent cabinet doors.
- 24" deep cabinets must be fully supported by screws installed in a structural member in the ceiling or soffit, and into adjacent cabinets.
- Load limit is 15 lbs. per square foot of load bearing surface.
- Cabinet may utilize one or two lift mechanisms depending on door size and weight. Door lift mechanism tension can be field adjusted.
- Depth can be reduced to a minimum of 9".
- Lift mechanisms and mounting brackets will be visible if used with transparent textured glass.
- Lift mechanism not available for order for field installation, only available factory installed.

Model	Cubic Feet	8	9	10	11	12	13	14	15	16	17	18	19
		8	9	10	11	12	13	14	15	16	17	18	19
<b>WTH3018</b>	5.3	686	713	741	798	799	833	874	891	937	960	965	1013
<b>WTH3618</b>	6.3	752	782	813	876	878	912	956	978	1028	1057	1061	1112

Custom Modifications	AUTHL AUTHR	CBO	CCO	CFNT0	CFRMO	CND	FB	FPEB	ID	MIP	P	RD
	•		•		•		•	•	•	•		•

Construction Upgrades	VPL	Decorative Door Options	CG	MD	Smart Stop Options	INTGH
	•		•			•

<b>WVL3018</b>	5.2	1627	1654	1682	1739	1740	1774	1815	1832	1878	1901	1906	1954
<b>WVL3618</b>	6.1	1693	1723	1754	1817	1819	1853	1897	1919	1969	1998	2002	2053

Custom Modifications	AUTHL AUTHR	CBO	CCO	CFNT0	CFRMO	CND	FB	FPEB	ID	MIP	P	RD
	•		•		•		•	•	•	•		

Construction Upgrades	VPL	Decorative Door Options	CG	MD	Smart Stop Options	INTGH
	•		•			•

<b>W301824</b>	9.7	625	651	677	729	730	759	796	810	852	878	881	924
<b>W331824</b>	10.6	653	678	706	760	760	792	830	847	891	916	919	963
<b>W341824</b>	10.6	669	696	724	778	779	812	852	869	914	940	943	989
<b>W361824</b>	11.6	686	712	741	796	799	832	874	889	935	963	966	1014
<b>W371824</b>	11.6	702	730	759	814	818	852	896	911	958	987	990	1039

<b>W391824</b>	12.6	722	749	779	839	841	876	920	934	984	1012	1014	1065
<b>W421824</b>	13.4	760	788	819	880	883	920	964	983	1034	1064	1066	1121
<b>W451824</b>	14.3	881	916	953	1024	1028	1067	1121	1142	1202	1237	1238	1301
<b>W481824CS</b>	15.2	994	1034	1075	1159	1161	1209	1271	1297	1367	1403	1408	1479

<b>W481824</b>	15.2	1022	1062	1103	1186	1188	1237	1298	1325	1395	1431	1436	1507
----------------	------	------	------	------	------	------	------	------	------	------	------	------	------

Custom Modifications	AUTHL AUTHR	CBO	CCO	CFNT0	CFRMO	CND	FB	FPEB	ID	MIP	P	RD
	•		•	•	•		•	•		•		•

Construction Upgrades	VPL	Decorative Door Options	CG	MD	Smart Stop Options	INTGH
	•		•	•		•

<b>WTH301824</b>	9.7	782	813	847	911	912	949	995	1013	1066	1097	1101	1155
<b>WTH361824</b>	10.6	858	891	926	995	1001	1039	1092	1113	1171	1205	1209	1266

Custom Modifications	AUTHL AUTHR	CBO	CCO	CFNT0	CFRMO	CND	FB	FPEB	ID	MIP	P	RD
	•		•		•		•	•		•		•

Construction Upgrades	VPL	Decorative Door Options	CG	MD	Smart Stop Options	INTGH
	•		•			•

**WALL REFRIGERATOR VERTICAL LIFT, 18" HIGH, 24" DEEP**

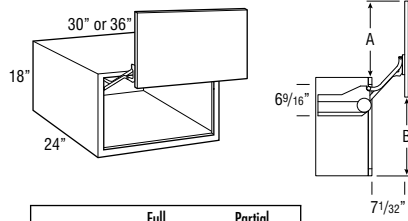

	Full Overlay	Partial Overlay
A	16 13/16"	16 1/16"
B	17 5/16"	18 1/16"

Model	Cubic Feet	Grain						
		Tori Oak	Westburne Oak	Tori Hickory Tori Maple	Loren Laminate Tori Cherry Westburne Hickory Westburne Maple Westburne PureStyle™	Chino Oak Gambrell Oak Kesper Oak Renaist Oak	Westburne Cherry	Brookway Oak Bryant Hickory Bryant Maple Chino Maple Hurley Hickory Hurley Maple Kesper Maple Kersey Oak Renaist PureStyle™ Renaist PureStyle™
		1	2	3	4	5	6	7
<b>WVL301824</b>	9.4	1478	1504	1565	1596	1626	1628	1688
<b>WVL361824</b>	11.2	1529	1560	1625	1659	1692	1693	1759

- Utilizes doors from 30" and 36" high wall cabinets. Grain on center panels will run horizontally and door rail configuration on non-miter doors will be unique from adjacent cabinet doors.
- Decorative hardware required.
- See side view drawing for required clearances.
- Lift mechanism features a single motion for up and out movement with Smart Stop, tension can be field adjusted.
- Lift mechanisms and mounting brackets will be visible if used with transparent textured glass.
- Lift mechanism not available for order for field installation, only available factory installed.
- Hardware extends 1" into opening on each side.
- Depth can be reduced to a minimum of 12".
- Not available in Owens.

**WALL SINGLE DOOR, 21" HIGH**

12", 15", 18", 21", or 24"

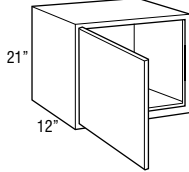

<b>W1221 L or R</b>	2.2	283	297	329	346	361	363	394
<b>W1521 L or R</b>	2.7	291	305	335	354	371	371	404
<b>W1821 L or R</b>	3.2	311	328	363	382	401	402	435
<b>W2121 L or R</b>	3.7	338	357	394	414	434	435	472
<b>W2421 L or R</b>	4.7	366	386	428	449	471	473	512

**WALL DOUBLE DOOR, 21" HIGH**

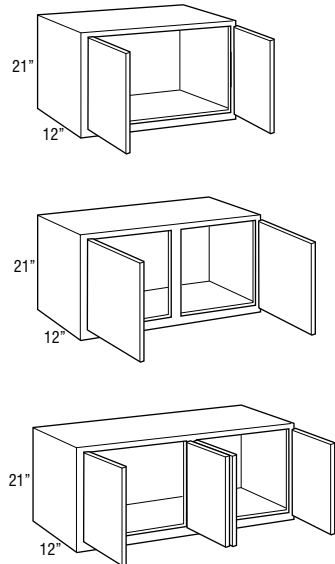

<b>W2421</b>	4.7	406	427	471	493	516	516	564
<b>W2721</b>	5.1	413	434	477	502	526	527	572
<b>W3021</b>	5.6	416	438	482	506	531	531	579
<b>W3321</b>	6.7	435	456	504	531	555	558	603
<b>W3421</b>	6.7	445	468	516	544	570	572	619
<b>W3621</b>	7.2	455	478	527	555	583	584	633
<b>W3721</b>	7.2	466	489	540	567	597	598	649
<b>W3921</b>	7.8	480	504	557	586	614	615	669
<b>W4221</b>	8.5	504	529	585	618	647	649	703
<b>W4521</b>	8.8	524	551	609	643	672	675	731
<b>W4821CS</b>	9.7	618	650	720	762	798	800	871
<b>W4821</b>	9.7	646	677	747	790	825	828	898

Model	Cubic Feet	Canterell Maple	Bryant Cherry Hurley Cherry Norris Maple Norris PureStyle™	Cairo Cherry Kasper Cherry Reist Cherry	Kevin Oak	Brockway Maple Canterell Cherry Kersey Hickory Kersey Maple Norris Cherry	Felix Hickory Felix Maple Forte Hickory Forte Maple Forte PureStyle™ Owens Maple Owens PureStyle™	Antico PureStyle™ Brockway Cherry Felix Cherry Forte Cherry Kersey Cherry Kevin Hickory Kevin Maple Owens Cherry	Adair Maple Adair PureStyle™ Keegan Maple	Valero Maple	Adair Cherry Keegan Cherry	Kevin Cherry	Valero Cherry
	8	9	10	11	12	13	14	15	16	17	18	19	
<b>WVL301824</b>	9.4	1723	1754	1788	1852	1853	1890	1936	1954	2007	2038	2042	2096
<b>WVL361824</b>	11.2	1799	1832	1867	1936	1942	1980	2033	2054	2112	2146	2150	2207

Custom Modifications	AUTHL AUTHR	CBO	CCO	CFNTO	CFRMO	CND	FB	FPEB	ID	MIP	P	RD
	•		•		•		•	•		•		•

Construction Upgrades	VPL	Decorative Door Options	CG	MD	Smart Stop Options	INTGH
	•		•			•

<b>W1221 L or R</b>	2.2	413	431	446	480	481	502	525	536	562	581	582	611
<b>W1521 L or R</b>	2.7	421	440	455	490	491	512	538	546	575	593	593	624
<b>W1821 L or R</b>	3.2	454	473	490	527	531	552	579	590	621	638	640	672
<b>W2121 L or R</b>	3.7	497	514	536	574	578	598	628	641	676	693	696	730
<b>W2421 L or R</b>	4.7	538	558	581	623	625	650	681	694	732	750	752	791

Custom Modifications	AUTHL AUTHR	CBO	CCO	CFNTO	CFRMO	CND	FB	FPEB	ID	MIP	P	RD
	•		•	•	•		•	•	•	•	•	•

Construction Upgrades	VPL	Decorative Door Options	CG	MD	Smart Stop Options	INTGH
	•		•			•

<b>W2421</b>	4.7	591	614	638	685	687	714	751	764	805	828	830	872
<b>W2721</b>	5.1	599	624	650	696	701	728	764	775	817	844	844	887
<b>W3021</b>	5.6	605	629	655	704	707	735	771	783	824	851	851	895
<b>W3321</b>	6.7	633	657	684	737	740	768	806	821	865	888	891	934
<b>W3421</b>	6.7	649	673	701	755	757	786	825	841	885	910	913	958
<b>W3621</b>	7.2	663	690	718	771	772	805	845	859	906	930	933	981
<b>W3721</b>	7.2	678	706	735	788	788	823	865	879	926	952	955	1004

<b>W3921</b>	7.8	702	729	758	815	817	849	891	908	955	982	985	1033
<b>W4221</b>	8.5	736	765	796	854	858	892	935	953	1003	1033	1035	1088
<b>W4521</b>	8.8	765	796	828	889	893	928	976	989	1042	1072	1076	1129
<b>W4821CS</b>	9.7	913	952	990	1067	1071	1114	1172	1190	1256	1294	1297	1363

<b>W4821</b>	9.7	941	980	1018	1095	1099	1142	1200	1218	1284	1322	1325	1391
--------------	-----	-----	-----	------	------	------	------	------	------	------	------	------	------

Custom Modifications	AUTHL AUTHR	CBO	CCO	CFNTO	CFRMO	CND	FB	FPEB	ID	MIP	P	RD
	•		•	•	•		•	•	•	•	•	•

Construction Upgrades	VPL	Decorative Door Options	CG	MD	Smart Stop Options	INTGH
	•		•			•



**WALL TOP HINGE SINGLE DOOR, 21" HIGH**

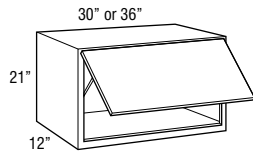

**WALL VERTICAL LIFT, 21" HIGH**

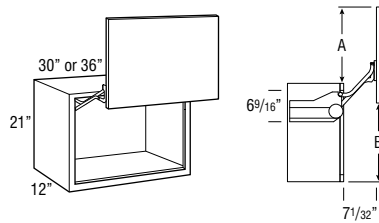

	Full Overlay	Partial Overlay
A	16 13/16"	16 1/16"
B	17 5/16"	18 1/16"

**WALL REFRIGERATOR DOUBLE DOOR, 21" HIGH, 24" DEEP**

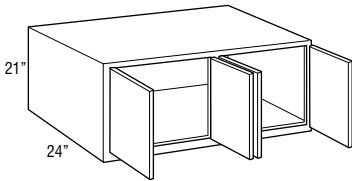
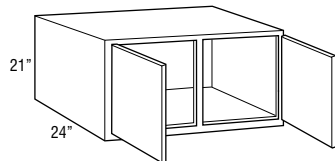
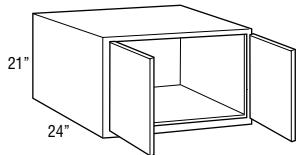

**WALL TOP HINGE REFRIGERATOR SINGLE DOOR, 21" HIGH, 24" DEEP**

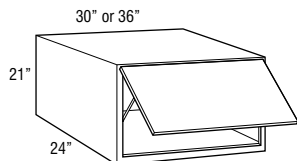

Model	Cubic Feet	Material						
		Tori Oak	Westburke Oak	Tori Hickory Tori Maple	Loren Laminate Tori Cherry Westburke Hickory Westburke Maple Westburke PureStyle™	Calio Oak Gantrell Oak Kesper Oak Rens Oak	Westburke Cherry	Brookway Oak Bryant Hickory Bryant Maple Bryant PureStyle™ Calio Maple Hurley Hickory Hurley Maple Kesper Maple Kessy Oak Rens Oak Rens PureStyle™
1	2	3	4	5	6	7		
<b>WTH3021</b>	5.6	602	634	700	735	770	770	838
<b>WTH3621</b>	7.2	661	694	765	804	845	845	919

- Utilizes doors from 30" and 36" high wall cabinets. Grain on center panels will run horizontally and door rail configuration on non-miter doors will be unique from adjacent cabinet doors.
- Lid stay hinge will be installed on the left side of the cabinet.
- Cabinet may utilize one or two lift mechanisms depending on door size and weight. Door lift mechanism tension can be field adjusted.
- Depth can be reduced to a minimum of 9".
- Lift mechanisms and mounting brackets will be visible if used with transparent textured glass.
- Lift mechanism not available for order for field installation, only available factory installed.

Model	5.9	1543	1575	1641	1676	1711	1711	1779
Model	7.1	1602	1635	1706	1745	1786	1786	1860
<b>WVL3021</b>								
<b>WVL3621</b>								

- Utilizes doors from 30" and 36" high wall cabinets. Grain on center panels will run horizontally and door rail configuration on non-miter doors will be unique from adjacent cabinet doors.
- Decorative hardware required.
- See side view drawing for required clearances.
- Lift mechanism features a single motion for up and out movement with Smart Stop, tension can be field adjusted.
- Lift mechanisms and mounting brackets will be visible if used with transparent textured glass.
- Lift mechanism not available for order for field installation, only available factory installed.
- Hardware extends 1" into opening on each side.
- Not available in Owens.

<b>W302124</b>	11.1	475	500	550	578	608	610	658
<b>W332124</b>	12.2	494	518	574	608	633	637	688
<b>W342124</b>	12.2	507	531	588	621	648	653	704
<b>W362124</b>	13.3	519	545	601	634	662	667	721
<b>W372124</b>	13.3	531	558	616	648	676	683	737

<b>W392124</b>	14.3	546	574	637	668	701	702	762
<b>W422124</b>	15.2	574	602	668	705	736	740	799
<b>W452124</b>	16.4	597	627	692	733	764	769	833
<b>W482124CS</b>	17.3	707	743	824	872	915	918	996

<b>W482124</b>	17.3	735	771	852	900	943	946	1024
----------------	------	-----	-----	-----	-----	-----	-----	------

- 24" deep cabinets must be fully supported by screws installed in a structural member in the ceiling or soffit, and into adjacent cabinets.
- Load limit is 15 lbs. per square foot of load bearing surface.

<b>WTH302124</b>	11.1	688	724	796	837	880	883	955
<b>WTH362124</b>	13.3	752	792	874	921	959	966	1044

- Utilizes doors from 30" and 36" high wall cabinets. Grain on center panels will run horizontally and door rail configuration on non-miter doors will be unique from adjacent cabinet doors.
- 24" deep cabinets must be fully supported by screws installed in a structural member in the ceiling or soffit, and into adjacent cabinets.
- Load limit is 15 lbs. per square foot of load bearing surface.
- Lid stay hinge will be installed on the left side of the cabinet.
- Cabinet may utilize one or two lift mechanisms depending on door size and weight. Door lift mechanism tension can be field adjusted.
- Depth can be reduced to a minimum of 9".
- Lift mechanisms and mounting brackets will be visible if used with transparent textured glass.
- Lift mechanism not available for order for field installation, only available factory installed.

Model	Cubic Feet	Canterl Maple	Bryant Cherry Hurley Cherry Norris Maple Norris PureStyle™	Cairo Cherry Kasper Cherry Reist Cherry	Kevin Oak	Brockway Maple Canterl Cherry Kersey Hickory Kersey Maple Norris Cherry	Felix Hickory Felix Maple Forte Hickory Forte Maple Forte PureStyle™ Owens Maple Owens PureStyle™	Amico PureStyle™ Brockway Cherry Felix Cherry Forte Cherry Kersey Cherry Kevin Hickory Kevin Maple Owens Cherry	Adair Maple Adair PureStyle™ Keegan Maple	Valero Maple	Adair Cherry Keegan Cherry	Kevin Cherry	Valero Cherry
		8	9	10	11	12	13	14	15	16	17	18	19
WTH3021	5.6	878	914	951	1021	1025	1066	1119	1135	1197	1235	1235	1297
WTH3621	7.2	962	1001	1040	1119	1122	1168	1224	1245	1313	1350	1353	1423

<b>Custom Modifications</b>	AUTHL AUTHR	CBO	CCO	CFNTO	CFRMO	CND	FB	FPEB	ID	MIP	P	RD
	•		•		•		•	•	•	•		•
<b>Construction Upgrades</b>	VPL	<b>Decorative Door Options</b>				CG	MD	<b>Smart Stop Options</b>			INTGH	
	•					•					•	

WVL3021	5.9	1819	1855	1892	1962	1966	2007	2060	2076	2138	2176	2176	2238
WVL3621	7.1	1903	1942	1981	2060	2063	2109	2165	2186	2254	2291	2294	2364

<b>Custom Modifications</b>	AUTHL AUTHR	CBO	CCO	CFNTO	CFRMO	CND	FB	FPEB	ID	MIP	P	RD
	•		•		•		•	•	•	•		
<b>Construction Upgrades</b>	VPL	<b>Decorative Door Options</b>				CG	MD	<b>Smart Stop Options</b>			INTGH	
	•					•					•	

W302124	11.1	690	719	747	803	806	838	879	894	941	968	970	1021
W332124	12.2	721	749	779	840	845	876	920	937	986	1012	1014	1065
W342124	12.2	739	769	799	859	862	897	942	959	1009	1036	1039	1092
W362124	13.3	758	787	818	879	880	918	962	981	1032	1061	1064	1117
W372124	13.3	776	807	838	898	900	940	984	1003	1056	1086	1090	1144

W392124	14.3	798	830	864	928	929	967	1016	1035	1091	1119	1124	1178
W422124	15.2	839	874	908	976	980	1017	1068	1087	1143	1178	1181	1239
W452124	16.4	874	908	944	1014	1018	1060	1113	1128	1187	1222	1227	1288
W482124CS	17.3	1043	1090	1132	1220	1226	1275	1339	1362	1434	1479	1482	1557

W482124	17.3	1071	1117	1160	1248	1254	1302	1367	1390	1462	1507	1510	1585
---------	------	------	------	------	------	------	------	------	------	------	------	------	------

<b>Custom Modifications</b>	AUTHL AUTHR	CBO	CCO	CFNTO	CFRMO	CND	FB	FPEB	ID	MIP	P	RD
	•		•	•	•		•	•		•		•
<b>Construction Upgrades</b>	VPL	<b>Decorative Door Options</b>				CG	MD	<b>Smart Stop Options</b>			INTGH	
	•					•					•	

WTH302124	11.1	1001	1041	1086	1163	1171	1214	1275	1296	1365	1405	1406	1480
WTH362124	13.3	1097	1142	1185	1275	1276	1330	1395	1423	1496	1538	1542	1620

<b>Custom Modifications</b>	AUTHL AUTHR	CBO	CCO	CFNTO	CFRMO	CND	FB	FPEB	ID	MIP	P	RD
	•	•			•		•	•		•		•
<b>Construction Upgrades</b>	VPL	<b>Decorative Door Options</b>				CG	MD	<b>Smart Stop Options</b>			INTGH	
	•					•					•	

**WALL REFRIGERATOR VERTICAL LIFT, 21" HIGH, 24" DEEP**

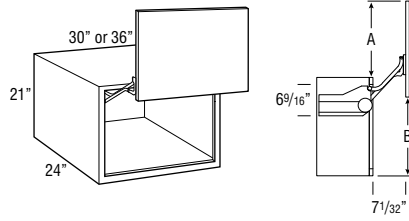

	Full Overlay	Partial Overlay
A	16 13/16"	16 1/16"
B	17 5/16"	18 1/16"

Model	Cubic Feet	Grain						
		Tori Oak	Westburke Oak	Tori Hickory Tori Maple	Loren Laminate Tori Cherry Westburke Hickory Westburke Maple Westburke PureStyle™	Chico Oak Gambrell Oak Kesper Oak Reist Oak	Westburke Cherry	Brookway Oak Bryant Hickory Bryant Maple Chico Maple Hurley Hickory Hurley Maple Kesper Maple Kesper Oak Reist PureStyle™ Reist PureStyle™
		1	2	3	4	5	6	7
<b>WVL302124</b>	10.9	1629	1665	1737	1778	1821	1824	1896
<b>WVL362124</b>	12.9	1693	1733	1815	1862	1900	1907	1985

- Utilizes doors from 30" and 36" high wall cabinets. Grain on center panels will run horizontally and door rail configuration on non-miter doors will be unique from adjacent cabinet doors.
- Decorative hardware required.
- See side view drawing for required clearances.
- Lift mechanism features a single motion for up and out movement with Smart Stop, tension can be field adjusted.
- Lift mechanisms and mounting brackets will be visible if used with transparent textured glass.
- Lift mechanism not available for order for field installation, only available factory installed.
- Hardware extends 1" into opening on each side.
- Depth can be reduced to a minimum of 12".
- Not available in Owens.

**WALL SINGLE DOOR, 24" HIGH**

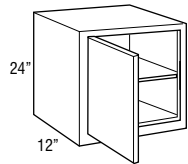

<b>W1224 L or R</b>	2.5	292	306	337	357	372	374	406
<b>W1524 L or R</b>	3.6	299	314	346	364	382	383	415
<b>W1824 L or R</b>	4.2	321	336	374	394	412	414	447
<b>W2124 L or R</b>	4.3	350	366	406	428	446	449	485
<b>W2424 L or R</b>	5.5	378	396	441	466	484	487	527

**WALL DOUBLE DOOR, 24" HIGH**

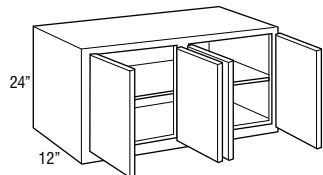
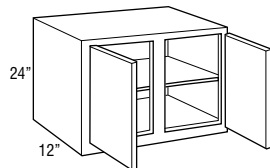
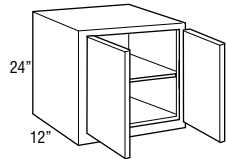

<b>W2424</b>	5.5	417	439	484	509	533	535	582
<b>W2724</b>	6.1	431	451	500	524	550	551	599
<b>W3024</b>	6.8	449	473	524	551	575	579	626
<b>W3324</b>	7.4	471	494	546	574	601	602	656
<b>W3424</b>	7.6	484	509	560	591	618	620	673
<b>W3624</b>	8.0	498	523	575	608	634	637	690
<b>W3724</b>	8.2	511	538	589	625	651	655	707
<b>W3924</b>	8.6	521	546	605	637	664	669	724
<b>W4224</b>	9.3	549	575	635	669	699	703	762
<b>W4524</b>	9.3	571	599	662	697	731	732	794
<b>W4824CS</b>	10.5	674	708	787	828	867	871	949
<b>W4824</b>	10.5	702	736	815	855	894	898	977

• MD available only on W3024 and W3624.

Model	Cubic Feet	8	9	10	11	12	13	14	15	16	17	18	19
		8	9	10	11	12	13	14	15	16	17	18	19
<b>WV1302124</b>	10.9	1942	1982	2027	2104	2112	2155	2216	2237	2306	2346	2347	2421
<b>WV1362124</b>	12.9	2038	2083	2126	2216	2217	2271	2336	2364	2437	2479	2483	2561

Custom Modifications	AUTHL AUTHR	CBO	CCO	CFNTO	CFRMO	CND	FB	FPEB	ID	MIP	P	RD
	•		•		•		•	•		•		•

Construction Upgrades	VPL	Decorative Door Options	CG	MD	Smart Stop Options	INTGH
	•		•			•

<b>W1224 L or R</b>	2.5	426	443	462	494	497	516	542	552	581	598	599	628
<b>W1524 L or R</b>	3.6	437	451	471	506	508	527	554	564	593	612	612	645
<b>W1824 L or R</b>	4.2	470	486	506	544	549	568	595	609	640	656	659	691
<b>W2124 L or R</b>	4.3	511	530	552	592	594	618	649	661	696	714	718	751
<b>W2424 L or R</b>	5.5	554	575	598	643	646	670	703	715	756	774	777	815

Custom Modifications	AUTHL AUTHR	CBO	CCO	CFNTO	CFRMO	CND	FB	FPEB	ID	MIP	P	RD
	•	•	•	•	•		•	•	•	•	•	•

Construction Upgrades	VPL	Decorative Door Options	CG	MD	Smart Stop Options	INTGH
	•		•			•

<b>W2424</b>	5.5	610	633	657	707	709	738	775	788	830	853	855	898
<b>W2724</b>	6.1	626	652	678	730	731	761	798	813	855	880	882	926
<b>W3024</b>	6.8	657	683	710	764	766	796	837	851	895	921	924	968
<b>W3324</b>	7.4	686	713	742	799	799	833	875	889	935	964	966	1015
<b>W3424</b>	7.6	704	732	762	819	821	855	898	914	961	989	992	1040
<b>W3624</b>	8.0	723	750	781	840	844	877	921	939	987	1013	1018	1066
<b>W3724</b>	8.2	741	769	801	860	867	900	945	963	1013	1037	1043	1092

<b>W3924</b>	8.6	761	790	820	882	884	921	965	984	1035	1065	1069	1122
<b>W4224</b>	9.3	798	830	864	926	929	965	1014	1033	1089	1121	1123	1179
<b>W4524</b>	9.3	832	865	898	966	968	1008	1059	1077	1133	1168	1172	1229
<b>W4824CS</b>	10.5	994	1035	1076	1158	1163	1208	1270	1295	1365	1405	1408	1481

<b>W4824</b>	10.5	1022	1063	1104	1185	1190	1236	1297	1323	1393	1433	1436	1509
--------------	------	------	------	------	------	------	------	------	------	------	------	------	------

Custom Modifications	AUTHL AUTHR	CBO	CCO	CFNTO	CFRMO	CND	FB	FPEB	ID	MIP	P	RD
	•	•	•	•	•		•	•	•	•	•	•

Construction Upgrades	VPL	Decorative Door Options	CG	MD	Smart Stop Options	INTGH
	•		•	•		•

**WALL REFRIGERATOR DOUBLE DOOR, 24" HIGH, 24" DEEP**

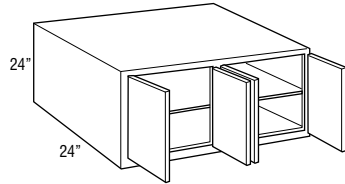
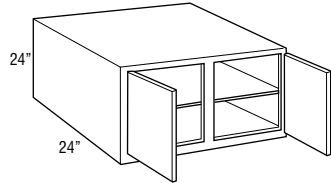
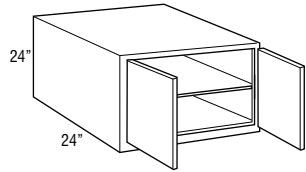

Model	Cubic Feet	Finish						
		Tori Oak	Westburke Oak	Tori Hickory Tori Maple	Loren Laminate Tori Cherry Westburke Hickory Westburke Maple Westburke PureStyle™	Galio Oak Camille Oak Kesper Oak Renaist Oak	Westburke Cherry	Brookway Oak Bryant Hickory Bryant Maple Tori PureStyle™ Galio Maple Hurley Hickory Hurley Maple Kesper Maple Kessy Oak Renaist PureStyle™
		1	2	3	4	5	6	7
<b>W242424</b>	10.5	476	501	553	581	609	610	662
<b>W302424</b>	12.4	490	514	568	597	626	627	683
<b>W332424</b>	13.6	513	539	597	626	656	657	714
<b>W342424</b>	13.9	540	567	627	659	689	692	751
<b>W362424</b>	14.7	566	595	656	691	721	727	787
<b>W372424</b>	15.1	593	623	686	724	754	762	824
<b>W392424</b>	15.9	593	623	690	727	760	762	825
<b>W422424</b>	17.1	624	655	723	762	796	799	868
<b>W452424</b>	18.2	651	683	757	796	832	837	906
<b>W482424CS</b>	19.6	771	812	900	949	991	996	1086
<b>W482424</b>	19.6	799	840	927	977	1019	1024	1113

- 24" deep cabinets must be fully supported by screws installed in a structural member in the ceiling or soffit, and into adjacent cabinets.
- Load limit is 15 lbs. per square foot of load bearing surface.
- MD available only on W302424 and W362424.

**WALL SINGLE DOOR, 27" HIGH**

12", 15", 18", 21", or 24"

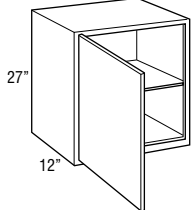

Model	Cubic Feet	Finish						
		Tori Oak	Westburke Oak	Tori Hickory Tori Maple	Loren Laminate Tori Cherry Westburke Hickory Westburke Maple Westburke PureStyle™	Galio Oak Camille Oak Kesper Oak Renaist Oak	Westburke Cherry	Brookway Oak Bryant Hickory Bryant Maple Tori PureStyle™ Galio Maple Hurley Hickory Hurley Maple Kesper Maple Kessy Oak Renaist PureStyle™
		1	2	3	4	5	6	7
<b>W1227 L or R</b>	2.8	301	317	348	367	383	387	417
<b>W1527 L or R</b>	3.4	322	337	373	393	411	413	447
<b>W1827 L or R</b>	4.0	345	362	402	419	443	445	481
<b>W2127 L or R</b>	4.7	376	394	438	462	482	484	524
<b>W2427 L or R</b>	6.0	413	434	480	506	529	531	575

Model	Cubic Feet	Canterell Maple	Bryant Cherry Hurley Cherry Norris Maple Norris PureStyle™	Cairo Cherry Kasper Cherry Reist Cherry	Klewin Oak	Brockway Maple Canterell Cherry Kersey Hickory Kersey Maple Norris Cherry	Felix Hickory Felix Maple Forte Hickory Forte Maple Forte PureStyle™ Owens Maple Owens PureStyle™	Amico PureStyle™ Brockway Cherry Felix Cherry Forte Cherry Kersey Cherry Klewin Hickory Klewin Maple Owens Cherry	Adair Maple Adair PureStyle™ Keegan Maple	Wilero Maple	Adair Cherry Keegan Cherry	Klewin Cherry	Wilero Cherry
		8	9	10	11	12	13	14	15	16	17	18	19
W242424	10.5	693	721	749	807	809	842	883	898	948	975	978	1024
W302424	12.4	714	742	772	831	833	867	910	926	977	1003	1007	1057
W332424	13.6	749	778	810	871	875	908	952	968	1021	1051	1053	1104
W342424	13.9	787	817	851	914	918	953	1000	1019	1073	1103	1106	1161
W362424	14.7	824	856	892	957	960	998	1048	1068	1125	1155	1159	1216
W372424	15.1	862	895	933	1000	1003	1043	1096	1118	1177	1208	1212	1273

W392424	15.9	867	900	935	1008	1009	1051	1101	1124	1182	1214	1217	1277
W422424	17.1	911	947	984	1059	1060	1101	1157	1179	1240	1275	1281	1342
W452424	18.2	950	985	1024	1101	1103	1150	1206	1227	1292	1329	1334	1399
W482424CS	19.6	1137	1184	1234	1324	1330	1382	1452	1480	1559	1606	1609	1691

W482424	19.6	1165	1212	1261	1352	1358	1409	1479	1508	1587	1633	1637	1719
---------	------	------	------	------	------	------	------	------	------	------	------	------	------

Custom Modifications	AUTHL AUTHR	CBO	CCO	CFNTO	CFRMO	CND	FB	FPEB	ID	MIP	P	RD
	•	•	•	•	•		•	•		•		•

Construction Upgrades	VPL	Decorative Door Options	CG	MD	Smart Stop Options	INTGH
	•		•	•		•

W1227 L or R	2.8	440	455	475	510	511	533	558	568	598	617	619	649
W1527 L or R	3.4	471	486	508	544	549	567	595	608	639	657	658	692
W1827 L or R	4.0	504	523	544	585	587	610	639	653	687	706	709	742
W2127 L or R	4.7	551	571	594	638	640	667	699	712	749	770	774	811
W2427 L or R	6.0	603	625	652	701	703	731	766	782	822	845	849	889

Custom Modifications	AUTHL AUTHR	CBO	CCO	CFNTO	CFRMO	CND	FB	FPEB	ID	MIP	P	RD
	•	•	•	•	•		•	•	•	•	•	•

Construction Upgrades	VPL	Decorative Door Options	CG	MD	Smart Stop Options	INTGH
	•		•			•

**WALL DOUBLE DOOR, 27" HIGH**

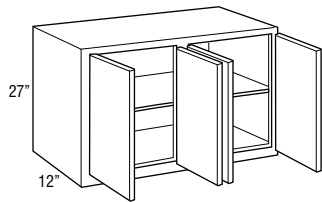
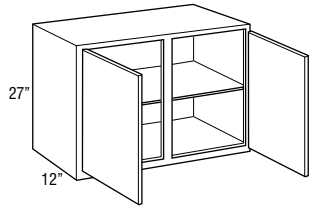
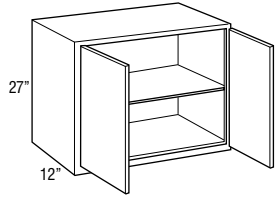

Model	Cubic Feet	Finish						
		Tori Oak	Westburke Oak	Tori Hickory Tori Maple	Loren Laminare Tori Cherry Westburke Hickory Westburke Maple Westburke PureStyle™	Calio Oak Gantrell Oak Kesper Oak Reinsl Oak	Westburke Cherry	Brockway Oak Bryant Hickory Bryant Maple Calio Maple Hurley Hickory Hurley Maple Kesper Oak Kessy Oak Reinsl PureStyle™
		1	2	3	4	5	6	7
<b>W2427</b>	6.0	449	473	522	551	575	579	626
<b>W2727</b>	6.8	466	487	538	567	593	596	646
<b>W3027</b>	7.5	476	501	553	581	609	610	662
<b>W3327</b>	8.3	499	524	578	609	635	638	693
<b>W3427</b>	8.5	512	538	593	625	653	656	711
<b>W3627</b>	9.0	524	551	609	640	670	673	729
<b>W3727</b>	9.2	538	564	624	657	688	691	747
<b>W3927</b>	9.7	550	578	639	672	703	705	765
<b>W4227</b>	10.4	578	605	672	706	738	741	804
<b>W4527</b>	11.1	599	629	697	733	766	769	837
<b>W4827CS</b>	11.8	711	748	831	874	918	920	1001
<b>W4827</b>	11.8	739	776	858	902	946	948	1029

**WALL REFRIGERATOR DOUBLE DOOR, 27" HIGH, 24" DEEP**

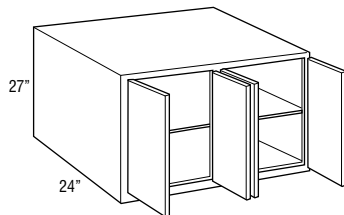
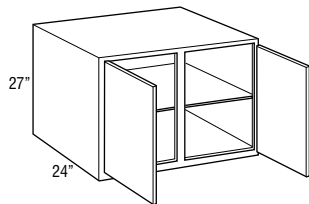
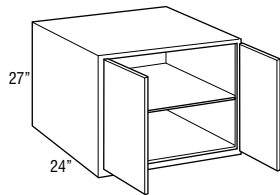

<b>W302724</b>	14.4	582	611	675	709	741	745	809
<b>W332724</b>	15.7	608	637	704	740	775	777	847
<b>W342724</b>	15.7	624	655	723	760	797	799	869
<b>W362724</b>	17.0	639	672	741	779	817	819	889
<b>W372724</b>	17.0	656	690	760	799	839	841	911
<b>W392724</b>	18.4	672	705	778	820	858	861	934
<b>W422724</b>	19.2	704	739	819	859	900	902	981
<b>W452724</b>	21.3	732	768	850	894	934	939	1019
<b>W482724CS</b>	22.6	805	845	935	983	1027	1033	1121
<b>W482724</b>	22.6	901	947	1047	1100	1152	1155	1254



- 24" deep cabinets must be fully supported by screws installed in a structural member in the ceiling or soffit, and into adjacent cabinets.
- Load limit is 15 lbs. per square foot of load bearing surface.

Model	Cubic Feet	Countertop Maple	Bryant Cherry Hurley Cherry Norris Maple Norris PureStyle™	Cairo Cherry Kasper Cherry Reiss Cherry	Klewin Oak	Brookway Maple Countertop Cherry Kersey Hickory Kersey Maple Norris Cherry	Felix Hickory Felix Maple Forte Hickory Forte Maple Forte PureStyle™ Owens Maple Owens PureStyle™	Antico PureStyle™ Brookway Cherry Felix Cherry Forte Cherry Kersey Cherry Klewin Hickory Klewin Maple Owens Cherry	Adair Maple Adair PureStyle™ Keegan Maple	Wilero Maple	Adair Cherry Keegan Cherry	Klewin Cherry	Wilero Cherry
		8	9	10	11	12	13	14	15	16	17	18	19
W2427	6.0	656	681	709	761	764	794	833	850	895	919	923	966
W2727	6.8	676	703	730	786	790	819	859	876	922	948	951	996
W3027	7.5	694	721	749	807	809	841	882	897	947	975	977	1024
W3327	8.3	724	756	785	844	846	878	922	940	988	1016	1021	1069
W3427	8.5	744	774	805	866	869	902	947	963	1014	1042	1048	1098
W3627	9.0	764	793	824	887	891	925	970	987	1039	1069	1074	1126
W3727	9.2	784	811	844	909	914	949	995	1011	1065	1096	1101	1154

W3927	9.7	803	832	866	930	933	970	1018	1038	1094	1124	1127	1183
W4227	10.4	844	876	910	980	982	1019	1070	1092	1149	1182	1184	1243
W4527	11.1	877	910	947	1018	1021	1062	1115	1134	1196	1231	1233	1294
W4827CS	11.8	1052	1093	1137	1226	1228	1278	1343	1369	1443	1484	1489	1566

W4827	11.8	1079	1121	1165	1254	1256	1306	1370	1397	1471	1512	1516	1593
-------	------	------	------	------	------	------	------	------	------	------	------	------	------

Custom Modifications	AUTHL AUTHR	CBO	CCO	CFNTO	CFRMO	CND	FB	FPEB	ID	MIP	P	RD
	•	•	•	•	•		•	•	•	•	•	•

Construction Upgrades	VPL	Decorative Door Options	CG	MD	Smart Stop Options	INTGH
	•		•			•

W302724	14.4	848	880	915	984	986	1025	1075	1096	1153	1187	1188	1250
W332724	15.7	884	921	957	1029	1031	1070	1124	1147	1206	1240	1245	1306
W342724	15.7	909	945	983	1057	1059	1099	1154	1177	1238	1273	1278	1339
W362724	17.0	932	968	1008	1084	1087	1128	1184	1207	1270	1305	1310	1373
W372724	17.0	957	992	1034	1111	1114	1157	1215	1237	1301	1337	1343	1407

W392724	18.4	981	1018	1060	1136	1143	1186	1245	1266	1333	1372	1376	1445
W422724	19.2	1029	1067	1112	1194	1198	1243	1306	1331	1401	1441	1445	1516
W452724	21.3	1068	1112	1154	1241	1245	1295	1359	1386	1458	1500	1503	1578
W482724CS	22.6	1175	1223	1269	1365	1370	1425	1495	1525	1604	1650	1653	1736

W482724	22.6	1318	1366	1422	1529	1533	1593	1672	1705	1796	1846	1851	1944
---------	------	------	------	------	------	------	------	------	------	------	------	------	------

Custom Modifications	AUTHL AUTHR	CBO	CCO	CFNTO	CFRMO	CND	FB	FPEB	ID	MIP	P	RD
	•	•	•	•	•		•	•	•	•	•	•

Construction Upgrades	VPL	Decorative Door Options	CG	MD	Smart Stop Options	INTGH
	•		•			•



**WALL SINGLE DOOR, 30" HIGH**

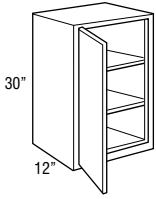

Model	Cubic Feet	Finish						
		Tori Oak	Westburke Oak	Tori Hickory Tori Maple	Loren Laminate Tori Cherry Westburke Hickory Westburke Maple Westburke PureStyle™	Galio Oak Gantrell Oak Kesper Oak Rensl Oak	Westburke Cherry	Brockway Oak Bryant Hickory Bryant Maple Calo Maple Hurley Hickory Hurley Maple Kesper Maple Kessy Oak Rensl PureStyle™
		1	2	3	4	5	6	7
<b>W930 L or R</b>	2.9	292	306	337	356	373	373	405
<b>W1230 L or R</b>	3.7	309	326	360	380	395	398	432
<b>W1530 L or R</b>	4.5	332	348	384	405	423	426	463
<b>W1830 L or R</b>	5.3	356	373	413	434	455	455	497
<b>W2130 L or R</b>	6.1	388	407	449	475	498	500	541
<b>W2430 L or R</b>	6.9	420	442	489	515	539	541	586

• MD not available on W930 L or R and W1230 L or R.

**WALL DOUBLE DOOR, 30" HIGH**

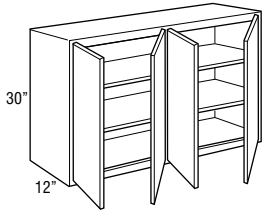
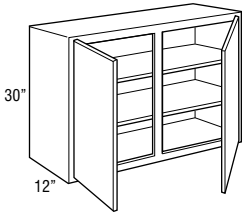
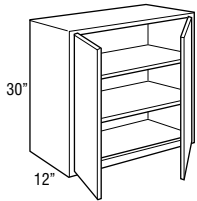

<b>W2430</b>	6.9	466	487	539	567	593	596	647
<b>W2730</b>	7.7	478	503	554	585	612	614	664
<b>W3030</b>	8.5	502	527	583	613	640	645	697
<b>W3330</b>	9.3	524	551	609	640	670	673	729
<b>W3630</b>	10.0	550	578	637	672	703	705	765
<b>W3930</b>	10.8	579	608	672	708	739	743	805
<b>W4230</b>	11.6	609	638	705	742	777	779	847
<b>W4530</b>	12.2	661	694	767	807	846	848	922
<b>W4830CS</b>	13.2	749	790	874	923	966	970	1058
<b>W4830</b>	13.2	777	817	902	951	994	998	1086

• MD not available on W3930.

Model	Cubic Feet	Cantrill Maple	Bryant Cherry Hurley Cherry Norris Maple Norris PureStyle™	Cairo Cherry Kasper Cherry Reist Cherry	Klewin Oak	Brockway Maple Cantrill Cherry Kersey Hickory Kersey Maple Norris Cherry	Felix Hickory Felix Maple Forte Hickory Forte Maple Forte PureStyle™ Owens Maple Owens PureStyle™	Amico PureStyle™ Brockway Cherry Felix Cherry Forte Cherry Kersey Cherry Klewin Hickory Klewin Maple Owens Cherry	Adair Maple Adair PureStyle™ Keegan Maple	Valero Maple	Adair Cherry Keegan Cherry	Klewin Cherry	Valero Cherry
		8	9	10	11	12	13	14	15	16	17	18	19
<b>W930 L or R</b>	2.9	424	442	460	493	494	513	540	550	579	595	597	626
<b>W1230 L or R</b>	3.7	451	471	489	525	526	550	575	586	618	635	638	669
<b>W1530 L or R</b>	4.5	484	503	523	560	565	585	614	625	658	678	680	713
<b>W1830 L or R</b>	5.3	519	540	560	602	605	627	658	674	709	728	731	765
<b>W2130 L or R</b>	6.1	567	588	613	657	659	686	720	735	772	794	797	837
<b>W2430 L or R</b>	6.9	615	638	662	711	714	742	779	795	838	859	861	906

Custom Modifications	AUTHL AUTHR	CBO	CCO	CFNT0	CFRMO	CND	FB	FPEB	ID	MIP	P	RD
	•	•	•	•	•		•	•	•	•	•	•

Construction Upgrades	VPL	Decorative Door Options	CG	MD	Smart Stop Options	INTGH
	•		•	•		•

<b>W2430</b>	6.9	677	703	731	785	788	819	859	877	923	948	952	996
<b>W2730</b>	7.7	697	723	751	810	813	845	886	902	951	978	981	1029
<b>W3030</b>	8.5	730	760	790	848	851	883	927	947	995	1024	1028	1077
<b>W3330</b>	9.3	764	793	824	887	891	925	970	987	1039	1069	1074	1126
<b>W3630</b>	10.0	803	832	866	930	933	970	1018	1037	1093	1124	1127	1183

<b>W3930</b>	10.8	846	878	912	981	984	1022	1072	1094	1151	1183	1186	1245
<b>W4230</b>	11.6	888	922	958	1031	1034	1074	1127	1149	1209	1242	1248	1309
<b>W4530</b>	12.2	965	1004	1042	1122	1126	1168	1226	1250	1316	1353	1358	1424
<b>W4830CS</b>	13.2	1107	1152	1200	1292	1296	1346	1415	1443	1520	1565	1570	1648

<b>W4830</b>	13.2	1135	1180	1227	1320	1324	1373	1442	1471	1548	1592	1598	1676
--------------	------	------	------	------	------	------	------	------	------	------	------	------	------

Custom Modifications	AUTHL AUTHR	CBO	CCO	CFNT0	CFRMO	CND	FB	FPEB	ID	MIP	P	RD
	•	•	•	•	•		•	•	•	•	•	•

Construction Upgrades	VPL	Decorative Door Options	CG	MD	Smart Stop Options	INTGH
	•		•	•		•

**WALL SINGLE DOOR, 33" HIGH**

9", 12", 15", 18", 21", or 24"

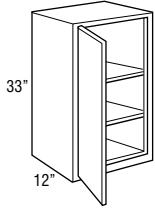

Model	Cubic Feet	Finish						
		Tori Oak	Westburke Oak	Tori Hickory Tori Maple	Loren Laminate Tori Cherry Westburke Hickory Westburke Maple Westburke PureStyle™	Galio Oak Gantrell Oak Kesper Oak Rensel Oak	Westburke Cherry	Brookway Oak Bryant Hickory Bryant Maple Calio Maple Hurley Hickory Hurley Maple Kesper Maple Kessy Oak Rensel PureStyle™
		1	2	3	4	5	6	7
<b>W933 L or R</b>	3.1	324	340	375	395	412	415	451
<b>W1233 L or R</b>	4.0	345	363	402	423	439	443	479
<b>W1533 L or R</b>	4.8	369	387	429	450	470	473	514
<b>W1833 L or R</b>	5.7	396	416	460	485	508	511	552
<b>W2133 L or R</b>	6.5	431	453	501	527	553	554	601
<b>W2433 L or R</b>	7.4	468	491	544	572	598	600	653

• MD not available on W933 L or R and W1233 L or R.

**WALL DOUBLE DOOR, 33" HIGH**

24", 27", 30", 33", or 36"

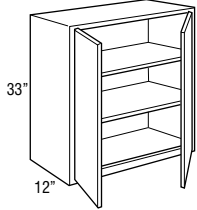

**W2433  
W2733  
W3033  
W3333  
W3633**

39", 42", 45", or 48"

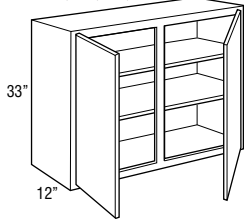

**W3933  
W4233  
W4533  
W4833CS**

48"

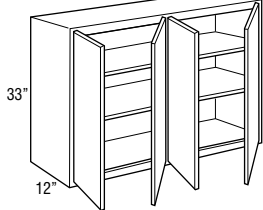

**W4833**

<b>W2433</b>	7.4	521	547	607	636	665	668	727
<b>W2733</b>	8.2	539	566	627	659	690	691	749
<b>W3033</b>	9.1	565	594	657	690	722	725	786
<b>W3333</b>	10.0	592	621	686	721	755	758	822
<b>W3633</b>	10.8	622	654	721	758	795	797	865
<b>W3933</b>	11.6	670	704	779	820	857	861	934
<b>W4233</b>	12.5	706	741	818	862	902	905	981
<b>W4533</b>	13.4	768	806	890	938	981	983	1067
<b>W4833CS</b>	14.2	875	921	1020	1076	1126	1130	1228
<b>W4833</b>	14.2	903	949	1048	1104	1153	1158	1256

• MD not available on W3933.

**WALL SINGLE DOOR, 36" HIGH**

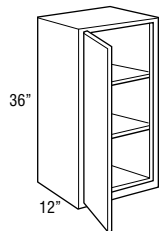

<b>W936 L or R</b>	3.5	332	348	384	405	423	426	463
<b>W1236 L or R</b>	4.4	355	372	412	433	450	454	491
<b>W1536 L or R</b>	5.3	378	396	440	462	482	484	526
<b>W1836 L or R</b>	6.3	406	427	471	499	521	524	566
<b>W2136 L or R</b>	7.2	442	465	513	541	566	567	617
<b>W2436 L or R</b>	8.2	480	504	557	586	613	615	669

• MD not available on W936 L or R and W1236 L or R.

Model	Cubic Feet	Canterel Maple	Bryant Cherry Hurley Cherry Norris Maple Norris PureStyle™	Cairo Cherry Kasper Cherry Reist Cherry	Klewin Oak	Brookway Maple Canterel Cherry Kersey Hickory Kersey Maple Norris Cherry	Felix Hickory Felix Maple Forte Hickory Forte Maple Forte PureStyle™ Owens Maple Owens PureStyle™	Anitico PureStyle™ Brookway Cherry Felix Cherry Forte Cherry Kersey Cherry Klewin Hickory Klewin Maple Owens Cherry	Adair Maple Adair PureStyle™ Keegan Maple	Valero Maple	Adair Cherry Keegan Cherry	Klewin Cherry	Valero Cherry
		8	9	10	11	12	13	14	15	16	17	18	19
W933 L or R	3.1	472	490	511	550	551	573	601	610	643	662	664	696
W1233 L or R	4.0	503	524	545	585	586	610	639	653	687	706	709	744
W1533 L or R	4.8	539	558	581	624	627	653	685	697	734	754	757	794
W1833 L or R	5.7	579	601	625	670	673	700	736	747	787	810	812	853
W2133 L or R	6.5	631	656	684	731	734	763	801	817	859	884	885	930
W2433 L or R	7.4	685	710	738	795	797	828	869	884	930	957	959	1007

Custom Modifications	AUTHL AUTHR	CBO	CCO	CFNTO	CFRMO	CND	FB	FPEB	ID	MIP	P	RD
	•	•	•	•	•		•	•	•	•	•	•

Construction Upgrades	VPL	Decorative Door Options	CG	MD	Smart Stop Options	INTGH
	•		•	•		•

W2433	7.4	762	791	822	884	885	923	967	986	1037	1066	1069	1122
W2733	8.2	787	817	850	914	917	954	1001	1018	1071	1101	1104	1160
W3033	9.1	824	856	890	957	959	1000	1048	1068	1124	1154	1158	1215
W3333	10.0	861	895	930	1001	1004	1042	1095	1115	1173	1207	1212	1271
W3633	10.8	907	941	980	1053	1056	1096	1151	1173	1235	1269	1273	1335

W3933	11.6	980	1018	1058	1137	1141	1185	1245	1270	1337	1371	1378	1444
W4233	12.5	1029	1068	1112	1196	1198	1248	1309	1332	1404	1441	1447	1518
W4533	13.4	1118	1163	1209	1301	1305	1356	1425	1451	1527	1570	1573	1652
W4833CS	14.2	1288	1339	1395	1504	1507	1569	1648	1679	1768	1820	1823	1916

W4833	14.2	1316	1367	1423	1532	1535	1596	1676	1706	1796	1847	1850	1944
-------	------	------	------	------	------	------	------	------	------	------	------	------	------

Custom Modifications	AUTHL AUTHR	CBO	CCO	CFNTO	CFRMO	CND	FB	FPEB	ID	MIP	P	RD
	•	•	•	•	•		•	•	•	•	•	•

Construction Upgrades	VPL	Decorative Door Options	CG	MD	Smart Stop Options	INTGH
	•		•	•		•

W936 L or R	3.5	484	503	523	564	565	587	617	625	658	678	681	713
W1236 L or R	4.4	516	538	558	600	601	625	656	669	704	724	727	763
W1536 L or R	5.3	552	573	595	640	643	669	702	714	752	772	776	813
W1836 L or R	6.3	593	617	641	688	691	719	756	766	807	831	833	876
W2136 L or R	7.2	647	673	701	749	752	782	821	838	881	907	908	954
W2436 L or R	8.2	702	728	757	815	817	849	891	907	954	982	984	1033

Custom Modifications	AUTHL AUTHR	CBO	CCO	CFNTO	CFRMO	CND	FB	FPEB	ID	MIP	P	RD
	•	•	•	•	•		•	•	•	•	•	•

  

Construction Upgrades	VPL	Decorative Door Options	CG	MD	Smart Stop Options	INTGH
	•		•	•		•

**WALL DOUBLE DOOR, 36" HIGH**

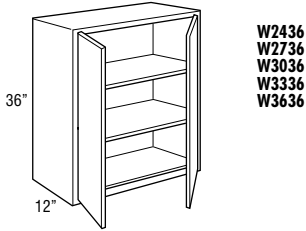

W2436  
W2736  
W3036  
W3336  
W3636

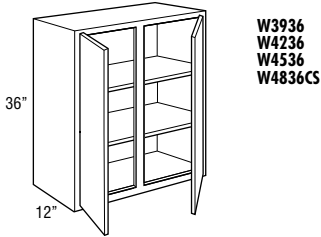

W3936  
W4236  
W4536  
W4836CS

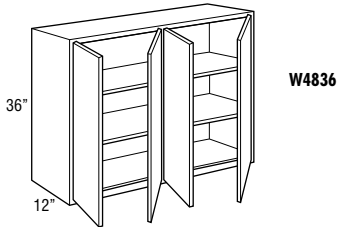

W4836

Model	Cubic Feet	Finish						
		Tori Oak	Westburke Oak	Tori Hickory Tori Maple	Loren Laminate Tori Cherry Westburke Hickory Westburke Maple Westburke PureStyle™	Calio Oak Cantrell Oak Kesper Oak Rensl Oak	Westburke Cherry	Brookway Oak Bryant Hickory Bryant Maple Calio Maple Hurley Hickory Hurley Maple Kesper Maple Kessy Oak Rensl PureStyle™
		1	2	3	4	5	6	7
W2436	8.2	536	562	623	654	684	686	746
W2736	9.0	554	582	646	677	709	710	771
W3036	9.9	582	611	675	709	742	745	809
W3336	10.9	609	638	705	741	776	778	846
W3636	11.8	639	672	741	779	817	819	889
W3936	12.7	693	729	806	848	887	891	966
W4236	13.7	731	767	847	892	932	937	1015
W4536	14.6	795	834	921	970	1015	1017	1103
W4836CS	15.6	907	954	1057	1114	1166	1170	1271
W4836	15.6	934	982	1085	1142	1194	1198	1298

- MD not available on W3936.
- P not available on W3936, W4236, W4536, W4836CS, and W4836.

**WALL SINGLE DOOR, 39" or 42" HIGH**

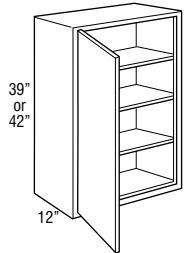

W939 L or R	3.7	353	368	410	431	449	451	490
W1239 L or R	4.7	376	394	438	460	480	482	523
W1539 L or R	5.7	402	420	467	489	513	513	558
W1839 L or R	6.8	432	453	500	526	552	553	599
W2139 L or R	7.8	471	494	545	574	600	602	655
W2439 L or R	8.8	510	536	592	623	651	654	709
W942 L or R	4.0	373	391	434	454	476	477	518
W1242 L or R	5.1	396	416	463	486	508	511	554
W1542 L or R	6.2	423	444	491	518	543	543	590
W1842 L or R	7.3	455	478	527	555	583	583	633
W2142 L or R	8.3	499	524	578	609	635	638	693
W2442 L or R	9.4	540	566	625	658	687	692	749

- MD not available on W939 L or R, W1239 L or R, W942 L or R, and W1242 L or R.

Model	Cubic Feet	Countertop Maple	Bryant Cherry Hurley Cherry Norris Maple Norris PureStyle™	Cairo Cherry Kasper Cherry Reist Cherry	Klewin Oak	Brockway Maple Countertop Cherry Kersey Hickory Kersey Maple Norris Cherry	Felix Hickory Felix Maple Forte Hickory Forte Maple Forte PureStyle™ Owens Maple Owens PureStyle™	Antico PureStyle™ Brockway Cherry Felix Cherry Forte Cherry Kersey Cherry Klewin Hickory Klewin Maple Owens Cherry	Adair Maple Adair PureStyle™ Keegan Maple	Wilero Maple	Adair Cherry Keegan Cherry	Klewin Cherry	Wilero Cherry
		8	9	10	11	12	13	14	15	16	17	18	19
<b>W2436</b>	8.2	782	812	845	909	910	949	994	1013	1066	1096	1099	1153
<b>W2736</b>	9.0	810	841	875	940	943	981	1030	1047	1101	1132	1135	1192
<b>W3036</b>	9.9	848	880	915	984	986	1029	1077	1098	1155	1187	1190	1250
<b>W3336</b>	10.9	886	921	957	1030	1032	1072	1126	1147	1207	1241	1247	1307
<b>W3636</b>	11.8	932	968	1008	1084	1087	1128	1184	1207	1270	1305	1310	1373

<b>W3936</b>	12.7	1014	1053	1095	1176	1180	1226	1288	1314	1384	1419	1426	1495
<b>W4236</b>	13.7	1064	1104	1150	1237	1239	1291	1354	1379	1453	1492	1497	1571
<b>W4536</b>	14.6	1157	1203	1250	1347	1350	1403	1474	1501	1579	1624	1626	1710
<b>W4836CS</b>	15.6	1333	1387	1443	1556	1559	1624	1706	1737	1830	1883	1886	1983

<b>W4836</b>	15.6	1361	1415	1471	1584	1587	1652	1734	1765	1858	1911	1914	2011
--------------	------	------	------	------	------	------	------	------	------	------	------	------	------

Custom Modifications	AUTHL AUTHR	CBO	CCO	CFNT0	CFRMO	CND	FB	FPEB	ID	MIP	P	RD
	•	•	•	•	•		•	•	•	•	•	•

Construction Upgrades	VPL	Decorative Door Options	CG	MD	Smart Stop Options	INTGH
	•		•	•		•

<b>W939 L or R</b>	3.7	514	535	555	597	599	623	654	664	702	720	723	759
<b>W1239 L or R</b>	4.7	549	571	593	638	639	664	697	709	746	769	771	810
<b>W1539 L or R</b>	5.7	586	610	633	680	682	709	743	760	798	820	823	864
<b>W1839 L or R</b>	6.8	628	653	680	731	732	762	799	813	855	881	883	927
<b>W2139 L or R</b>	7.8	685	713	742	796	799	830	872	888	934	960	964	1013
<b>W2439 L or R</b>	8.8	743	772	804	864	867	901	947	962	1013	1041	1044	1096

<b>W942 L or R</b>	4.0	543	565	587	629	633	657	691	705	741	762	765	803
<b>W1242 L or R</b>	5.1	580	602	626	674	676	704	738	749	790	812	816	854
<b>W1542 L or R</b>	6.2	620	645	670	719	721	749	787	803	845	868	872	914
<b>W1842 L or R</b>	7.3	663	690	718	771	772	805	845	859	906	930	933	981
<b>W2142 L or R</b>	8.3	724	756	785	844	846	878	922	940	988	1016	1021	1069
<b>W2442 L or R</b>	9.4	787	818	850	912	918	953	1000	1017	1070	1100	1104	1159

Custom Modifications	AUTHL AUTHR	CBO	CCO	CFNT0	CFRMO	CND	FB	FPEB	ID	MIP	P	RD
	•	•	•	•	•		•	•	•	•	•	•

  

Construction Upgrades	VPL	Decorative Door Options	CG	MD	Smart Stop Options	INTGH
	•		•	•		•

**WALL DOUBLE DOOR,  
39" or 42" HIGH**

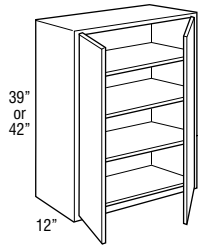

W2439 W2442  
W2739 W2742  
W3039 W3042  
W3339 W3342  
W3639 W3642

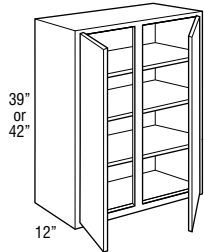

W3939 W3942  
W4239 W4242  
W4539 W4542  
W4839CS W4842CS

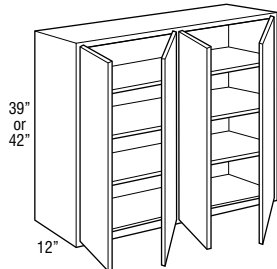

W4839  
W4842

Model	Cubic Feet	Finish						
		Tori Oak	Westburke Oak	Tori Hickory Tori Maple	Loren Laminate Tori Cherry Westburke Hickory Westburke Maple Westburke PureStyle™	Cairo Oak Gantrell Oak Kesper Oak Reinsl Oak	Westburke Cherry	Brookway Oak Bryant Hickory Bryant Maple Cairo Maple Hurley Hickory Hurley Maple Kesper Oak Kesper Maple Reinsl Oak Reinsl PureStyle™
		1	2	3	4	5	6	7
W2439	8.8	572	600	664	699	731	733	796
W2739	9.1	592	622	688	723	759	760	824
W3039	10.0	622	653	721	759	794	796	865
W3339	11.0	650	682	752	794	830	833	904
W3639	11.9	683	718	793	833	874	875	952
W2442	9.4	609	638	706	742	777	779	847
W2742	10.4	629	661	733	770	806	809	879
W3042	11.5	661	694	766	807	846	848	921
W3342	12.6	691	727	800	846	882	888	960
W3642	13.7	727	762	845	887	927	930	1013
W3939	11.8	738	775	856	901	944	947	1029
W4239	13.8	776	816	900	949	991	995	1079
W4539	15.6	845	886	980	1032	1076	1085	1174
W4839CS	16.9	965	1015	1125	1185	1240	1247	1353
W3942	14.8	782	821	908	954	998	1002	1089
W4242	15.9	821	864	953	1003	1048	1052	1143
W4542	17.0	894	939	1037	1092	1142	1147	1243
W4842CS	18.1	1024	1076	1192	1256	1314	1321	1434
W4839	16.9	993	1042	1152	1213	1268	1275	1381
W4842	18.1	1052	1104	1220	1284	1342	1349	1462

- MD not available on W3939 and W3942.
- P not available on W4539, W3642, W3942, W4242, W4542, W4842CS, and W4842.

Model	Cubic Feet	Cantrill Maple	Bryant Cherry Hurley Cherry Norris Maple Norris PureStyle™	Cairo Cherry Kasper Cherry Reist Cherry	Klewin Oak	Brockway Maple Cantrill Cherry Kersey Hickory Kersey Maple Norris Cherry	Felix Hickory Felix Maple Forte Hickory Forte Maple Forte PureStyle™ Owens Maple Owens PureStyle™	Antico PureStyle™ Brockway Cherry Felix Cherry Forte Cherry Kersey Cherry Klewin Hickory Klewin Maple Owens Cherry	Adair Maple Adair PureStyle™ Keegan Maple	Wilero Maple	Adair Cherry Keegan Cherry	Klewin Cherry	Wilero Cherry
		8	9	10	11	12	13	14	15	16	17	18	19
W2439	8.8	834	867	901	968	971	1012	1062	1080	1136	1170	1174	1232
W2739	9.1	866	898	934	1004	1008	1048	1100	1121	1179	1212	1216	1275
W3039	10.0	907	941	980	1052	1057	1098	1152	1174	1236	1270	1273	1337
W3339	11.0	949	984	1023	1099	1102	1148	1204	1226	1291	1327	1332	1398
W3639	11.9	996	1035	1076	1157	1160	1207	1266	1291	1359	1396	1400	1470
W2442	9.4	887	922	958	1030	1033	1074	1127	1148	1208	1241	1248	1307
W2742	10.4	921	956	994	1068	1071	1116	1172	1190	1254	1290	1295	1358
W3042	11.5	964	1002	1042	1119	1124	1168	1225	1249	1315	1352	1355	1424
W3342	12.6	1009	1047	1090	1171	1174	1220	1282	1305	1372	1414	1418	1488
W3642	13.7	1062	1100	1146	1232	1235	1285	1349	1372	1445	1486	1490	1565
W3939	11.8	1076	1119	1162	1250	1255	1304	1369	1396	1469	1508	1513	1589
W4239	13.8	1130	1175	1222	1315	1318	1370	1439	1466	1541	1585	1591	1668
W4539	15.6	1231	1278	1330	1429	1432	1491	1566	1593	1678	1725	1729	1815
W4839CS	16.9	1419	1477	1537	1654	1658	1726	1812	1846	1946	2003	2007	2108
W3942	14.8	1138	1183	1232	1324	1329	1381	1452	1477	1555	1598	1603	1681
W4242	15.9	1198	1243	1294	1391	1395	1452	1522	1549	1631	1679	1683	1768
W4542	17.0	1304	1354	1408	1513	1515	1578	1656	1687	1775	1827	1832	1921
W4842CS	18.1	1506	1566	1628	1752	1755	1829	1920	1956	2060	2120	2128	2233
W4839	16.9	1446	1505	1565	1682	1686	1754	1840	1874	1974	2030	2034	2136
W4842	18.1	1534	1593	1656	1779	1783	1857	1948	1984	2088	2147	2156	2261

Custom Modifications	AUTHL AUTHR	CBO	CCO	CFNTO	CFRMO	CND	FB	FPEB	ID	MIP	P	RD
	•	•	•	•	•		•	•	•	•	•	•

Construction Upgrades	VPL	Decorative Door Options	CG	MD	Smart Stop Options	INTGH
	•		•	•		•



**WALL THREE DRAWER SINGLE DOOR, 48", 51", 54", 57", or 60" HIGH**

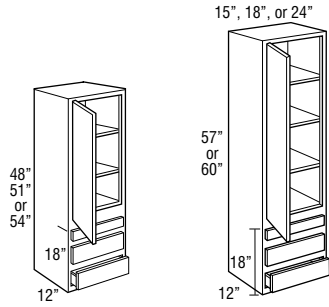

W3D1548 L or R  
W3D1848 L or R  
W3D2448 L or R

W3D1551 L or R  
W3D1851 L or R  
W3D2451 L or R

W3D1554 L or R  
W3D1854 L or R  
W3D2454 L or R

W3D1557 L or R  
W3D1857 L or R  
W3D2457 L or R

W3D1560 L or R  
W3D1860 L or R  
W3D2460 L or R

Model	Cubic Feet	Finish						
		Tori Oak	Westburke Oak	Tori Hickory Tori Maple	Loren Laminate Tori Cherry Westburke Hickory Westburke Maple Westburke PureStyle™	Galio Oak Gantrell Oak Kesper Oak Rensai Oak	Westburke Cherry	Brookway Oak Bryant Hickory Bryant Maple Rensai PureStyle™ Calio Maple Hurley Hickory Hurley Maple Kesper Maple Kessy Oak Rensai PureStyle™ Rensai PureStyle™
		1	2	3	4	5	6	7
W3D1548 L or R	6.5	1052	1104	1133	1161	1196	1218	1224
W3D1848 L or R	7.8	1091	1145	1178	1207	1243	1266	1275
W3D2448 L or R	10.4	1189	1250	1297	1333	1371	1400	1417
W3D1551 L or R	6.9	1109	1165	1201	1233	1268	1294	1305
W3D1851 L or R	8.2	1152	1210	1250	1286	1323	1351	1363
W3D2451 L or R	10.8	1263	1327	1382	1421	1464	1492	1517
W3D1554 L or R	7.2	1124	1180	1218	1250	1286	1313	1324
W3D1854 L or R	8.5	1168	1226	1268	1306	1344	1371	1386
W3D2454 L or R	11.1	1282	1347	1403	1442	1488	1514	1543
W3D1557 L or R	7.0	1159	1216	1261	1294	1332	1359	1372
W3D1857 L or R	8.3	1206	1265	1312	1352	1393	1421	1437
W3D2457 L or R	10.9	1327	1395	1456	1500	1545	1574	1607
W3D1560 L or R	7.9	1196	1255	1301	1337	1379	1403	1423
W3D1860 L or R	9.4	1243	1306	1355	1396	1440	1467	1489
W3D2460 L or R	12.3	1372	1442	1507	1556	1604	1633	1668

- Includes one shallow depth drawer and two standard drawers with undermount Smart Stop guides.
- Top drawer will be slab drawer front for all 5-piece drawer applications. Rensai PureStyle™ slab drawer front will be painted hardwood.
- Drawer front to face frame reveal is justified to the top to be consistent with both full and partial overlay. Bottom reveal is 7/8" for full overlay and 1" for partial overlay.
- ID15 not available.
- PG is standard.

**WALL THREE DRAWER DOUBLE DOOR, 48", 51", 54", 57", or 60" HIGH**

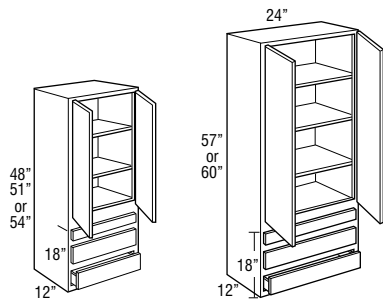

W3D2448  
W3D2451  
W3D2454

W3D2457  
W3D2460

W3D2448	10.4	1259	1322	1371	1414	1458	1483	1509
W3D2451	10.8	1347	1414	1476	1519	1571	1596	1633
W3D2454	11.1	1368	1436	1503	1546	1600	1624	1664
W3D2457	10.9	1425	1497	1568	1617	1672	1696	1742
W3D2460	12.3	1479	1552	1632	1686	1743	1770	1820

- Includes one shallow depth drawer and two standard drawers with undermount Smart Stop guides.
- Top drawer will be slab drawer front for all 5-piece drawer applications. Rensai PureStyle™ slab drawer front will be painted hardwood.
- Drawer front to face frame reveal is justified to the top to be consistent with both full and partial overlay. Bottom reveal is 7/8" for full overlay and 1" for partial overlay.
- ID15 not available.
- PG is standard.

Model	Cubic Feet	Central Maple	Byrant Cherry Hurley Cherry Norris Maple Norris PureStyle™	Calio Cherry Kesper Cherry Reist Cherry	Klewin Oak	Brookway Maple Central Cherry Kersey Hickory Kersey Maple Norris Cherry	Felix Hickory Felix Maple Forte Hickory Forte Maple Forte PureStyle™ Owens Maple Owens PureStyle™	Antico PureStyle™ Brookway Cherry Felix Cherry Forte Cherry Kersey Hickory Kersey Maple Klewin Hickory Klewin Maple Owens Cherry	Adair Maple Adair PureStyle™ Keegan Maple	Wilero Maple	Adair Cherry Keegan Cherry	Klewin Cherry	Wilero Cherry
		8	9	10	11	12	13	14	15	16	17	18	19
W3D1548 L or R	6.5	1259	1288	1338	1393	1407	1421	1490	1490	1562	1564	1585	1635
W3D1848 L or R	7.8	1312	1344	1398	1458	1472	1486	1562	1562	1637	1639	1665	1714
W3D2448 L or R	10.4	1460	1497	1556	1626	1640	1664	1747	1747	1835	1838	1870	1932

W3D1551 L or R	6.9	1342	1374	1430	1490	1504	1522	1599	1599	1677	1680	1705	1757
W3D1851 L or R	8.2	1404	1438	1497	1565	1577	1599	1679	1679	1758	1759	1795	1851
W3D2451 L or R	10.8	1568	1607	1671	1752	1767	1796	1884	1884	1981	1985	2020	2090

W3D1554 L or R	7.2	1362	1396	1453	1513	1529	1548	1625	1625	1705	1716	1735	1788
W3D1854 L or R	8.5	1427	1462	1521	1591	1604	1626	1708	1708	1789	1792	1827	1885
W3D2454 L or R	11.1	1594	1635	1699	1784	1799	1829	1918	1918	2018	2023	2058	2130

W3D1557 L or R	7.0	1415	1452	1508	1574	1590	1611	1692	1692	1776	1785	1808	1867
W3D1857 L or R	8.3	1481	1519	1580	1655	1666	1693	1777	1777	1865	1867	1903	1967
W3D2457 L or R	10.9	1661	1705	1773	1862	1875	1910	2004	2004	2107	2117	2154	2227

W3D1560 L or R	7.9	1468	1505	1565	1636	1650	1676	1758	1758	1846	1847	1883	1945
W3D1860 L or R	9.4	1537	1577	1640	1718	1731	1761	1846	1846	1941	1944	1980	2047
W3D2460 L or R	12.3	1726	1775	1845	1937	1952	1990	2088	2088	2196	2211	2247	2326

Custom Modifications	AUTHL AUTHR	CBO	CCO	CFNTO	CFRMO	CND	FB	FPEB	ID	MIP	P	RD
	•	•	•	•	•	•	•	•	•	•		

Construction Upgrades	VPL	Decorative Door Options	CG	MD	Smart Stop Options	INTGH
	•		•	•		•

W3D2448	10.4	1557	1595	1659	1738	1754	1780	1870	1870	1969	1971	2007	2075
W3D2451	10.8	1687	1733	1801	1893	1906	1940	2037	2037	2145	2154	2192	2268
W3D2454	11.1	1719	1767	1836	1932	1944	1980	2080	2080	2190	2200	2238	2316

W3D2457	10.9	1802	1852	1924	2024	2040	2080	2183	2186	2301	2313	2351	2435
W3D2460	12.3	1883	1937	2015	2118	2134	2178	2284	2289	2412	2426	2465	2554

Custom Modifications	AUTHL AUTHR	CBO	CCO	CFNTO	CFRMO	CND	FB	FPEB	ID	MIP	P	RD
	•	•	•	•	•	•	•	•	•	•		

Construction Upgrades	VPL	Decorative Door Options	CG	MD	Smart Stop Options	INTGH
	•		•	•		•

**Wall Corner Cabinets**

- Wall corner cabinets may be installed flush to the wall (left) or pulled 3" away from wall (right) to accommodate odd dimensions in a kitchen design. In either case, the adjoining run of 12" wall cabinets plus a 3" filler will butt against the solid wood panel.
- When a cabinet is "pulled" it will use proportionally more wall space, for example, a 30" wide WC pulled 2" will use 32" of space.
- The L or R in the cabinet's nomenclature indicates the location of cabinet void.
- Blind side of wall corner cabinets cannot be installed next to a range hood or microwave shelf unit due to door interference.

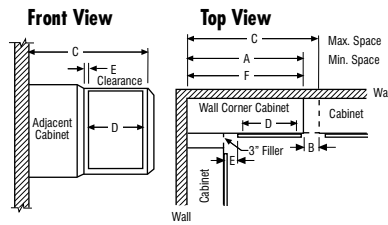

NOTE: All outside stiles are 1 1/2" wide

**WALL CORNER SINGLE DOOR, 30" HIGH**

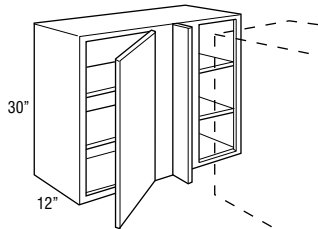

Model	Culic Feet	Cabinet Feet						
		Tori Oak	Westburke Oak	Tori Hickory Tori Maple	Levon Laminate Tori Cherry Westburke Hickory Westburke Maple Westburke PureStyle™	Carlo Oak Cannel Oak Kasper Oak Rensi Oak	Westburke Cherry	Brockway Oak Bryant Hickory Bryant Maple Bryant PureStyle™ Carlo Maple Haley Hickory Haley Maple Kasper Maple Rensi Oak Rensi Maple Rensi PureStyle™
WC2430 L or R	6.9	395	415	460	482	505	506	551
WC2730 L or R	7.7	420	442	486	513	539	539	586
WC3030 L or R	8.5	449	473	524	551	575	579	626
WC3330 L or R	9.5	484	509	562	591	619	621	675
WC3630 L or R	10.0	522	549	608	638	668	670	728

- Includes one 3" filler, shipped unattached.
- L or R indicates void. R (right) void shown.
- MD available only on WC3330 L or R and WC3630 L or R.

**WALL CORNER DOUBLE DOOR, 30" HIGH**

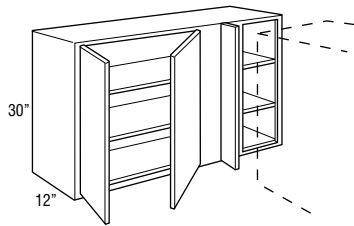

WC3930 L or R	10.8	566	595	657	691	724	727	790
WC4230 L or R	11.6	614	646	713	749	787	788	855
WC4530 L or R	11.6	667	701	775	813	853	853	928
WC4830 L or R	13.2	722	759	841	882	926	926	1008

- Includes one 3" filler, shipped unattached.
- L or R indicates void. R (right) void shown.

**WALL CORNER SINGLE DOOR, 33" HIGH**

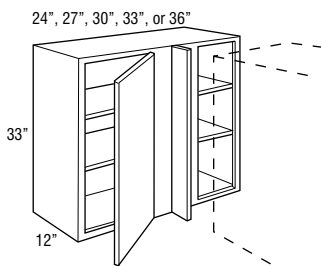

WC2433 L or R	7.4	443	466	514	541	567	567	617
WC2733 L or R	8.2	472	495	546	576	602	604	657
WC3033 L or R	9.1	505	530	586	617	644	647	702
WC3333 L or R	9.9	544	572	632	664	695	698	759
WC3633 L or R	10.8	584	613	680	714	746	749	815

- Includes one 3" filler, shipped unattached.
- L or R indicates void. R (right) void shown.
- MD available only on WC3333 L or R and WC3633 L or R.

Model	A	B	C	D	E*		E		F
	Min. Space	Max. Pull*	Max. Space	Cabinet Opening	Full Overlay At Min.	Full Overlay At Max.	Partial Overlay At Min.	Partial Overlay At Max.	Actual Cabinet
WC24..	24"	5"	29"	7 1/2"	1 3/4"	6 3/4"	2 1/2"	7 1/2"	24"
WC27..	27"	4 1/2"	31 1/2"	9"	3 1/4"	7 3/4"	4"	8 1/2"	27"
WC30..	30"	5"	35"	13 1/2"	1 3/4"	6 3/4"	2 1/2"	7 1/2"	30"
WC33..	33"	4 1/2"	37 1/2"	15"	3 1/4"	7 3/4"	4"	8 1/2"	33"
WC36..	36"	5"	41"	19 1/2"	1 3/4"	6 3/4"	2 1/2"	7 1/2"	36"
WC39..	39"	4 1/2"	43 1/2"	21"	3 1/4"	7 3/4"	4"	8 1/2"	39"
WC42..	42"	4 1/2"	46 1/2"	24"	3 1/4"	7 3/4"	4"	8 1/2"	42"
WC45..	45"	4 1/2"	49 1/2"	27"	3 1/4"	7 3/4"	4"	8 1/2"	45"
WC48..	48"	4 1/2"	52 1/2"	30"	3 1/4"	7 3/4"	4"	8 1/2"	48"

\*Minimum/maximum space between inside edge of door and face of filler/adjoining cabinet. If cabinet is pulled to maximum stated dimension, filler will need to be cleated for proper attachment.

Model	Cubic Feet	Central Maple	Bryant Cherry Hurley Cherry Norris Maple Norris PureStyle™	Galio Cherry Keeper Cherry Rensl Cherry	Klein Oak	Brookway Maple Central Cherry Kersey Hickory Kersey Maple Norris Cherry	Felix Hickory Felix Maple Fore Hickory Fore Maple Fore PureStyle™ Owens Maple Owens PureStyle™	Antico PureStyle™ Brookway Cherry Felix Cherry Fore Cherry Kersey Cherry Klein Hickory Klein Maple Owens Cherry	Adair Maple Adair PureStyle™ Kegon Maple	Valero Maple	Adair Cherry Kegon Cherry	Klein Cherry	Valero Cherry
		8	9	10	11	12	13	14	15	16	17	18	19
WC2430 L or R	6.9	579	599	623	672	674	702	736	747	787	809	811	851
WC2730 L or R	7.7	614	638	662	711	714	742	779	795	838	859	861	906
WC3030 L or R	8.5	657	683	710	764	766	796	837	851	895	921	924	968
WC3330 L or R	9.5	707	735	764	821	822	855	898	915	962	989	993	1042
WC3630 L or R	10.0	762	792	823	886	887	923	967	987	1038	1066	1070	1123

Custom Modifications	AUTHL AUTHR	CBO	CCO	CFNT0	CFRMO	CND	FB	FPEB	ID	MIP	P	RD
	•	•	•	•	•		•	•	•	•	•	•

Construction Upgrades	VPL	Decorative Door Options	CG	MD	Smart Stop Options	INTGH
	•		•	•		•

WC3930 L or R	10.8	825	858	894	960	962	1002	1051	1070	1127	1157	1161	1217
WC4230 L or R	11.6	896	930	970	1042	1044	1088	1141	1161	1222	1255	1261	1322
WC4530 L or R	11.6	975	1011	1053	1130	1132	1179	1237	1261	1326	1361	1368	1433
WC4830 L or R	13.2	1057	1096	1143	1226	1231	1278	1342	1368	1439	1477	1484	1556

Custom Modifications	AUTHL AUTHR	CBO	CCO	CFNT0	CFRMO	CND	FB	FPEB	ID	MIP	P	RD
	•	•	•	•	•		•	•	•	•	•	•

Construction Upgrades	VPL	Decorative Door Options	CG	MD	Smart Stop Options	INTGH
	•		•	•		•

WC2433 L or R	7.4	647	671	699	751	752	784	823	837	882	906	909	955
WC2733 L or R	8.2	688	714	742	798	801	832	874	891	938	963	966	1015
WC3033 L or R	9.1	737	766	796	854	858	892	935	954	1004	1032	1035	1087
WC3333 L or R	9.9	795	825	857	922	926	961	1009	1029	1084	1114	1118	1172
WC3633 L or R	10.8	853	886	922	991	994	1034	1086	1104	1163	1196	1200	1258

Custom Modifications	AUTHL AUTHR	CBO	CCO	CFNT0	CFRMO	CND	FB	FPEB	ID	MIP	P	RD
	•	•	•	•	•		•	•	•	•	•	•

Construction Upgrades	VPL	Decorative Door Options	CG	MD	Smart Stop Options	INTGH
	•		•	•		•

**WALL CORNER DOUBLE DOOR,  
33" HIGH**

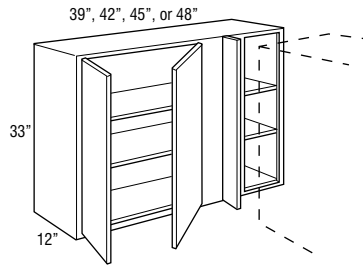

Model	Cubic Feet	Finish						
		Tori Oak	Westburke Oak	Tori Hickory Tori Maple	Loren Laminate Tori Cherry Westburke Hickory Westburke Maple Westburke PureStyle™	Chino Oak Gantrell Oak Kesper Oak Renaist Oak	Westburke Cherry	Brookway Oak Bryant Hickory Bryant Maple Chino Maple Hurley Hickory Hurley Maple Kesper Oak Renaist PureStyle™ Renaist PureStyle™
		1	2	3	4	5	6	7
<b>WC3933 L or R</b>	11.6	634	665	737	774	810	812	884
<b>WC4233 L or R</b>	12.5	688	722	800	841	879	882	959
<b>WC4533 L or R</b>	13.3	745	782	868	911	954	957	1040
<b>WC4833 L or R</b>	14.1	808	848	941	989	1035	1039	1129

- Includes one 3" filler, shipped unattached.
- L or R indicates void. R (right) void shown.

**WALL CORNER SINGLE DOOR,  
36" HIGH**

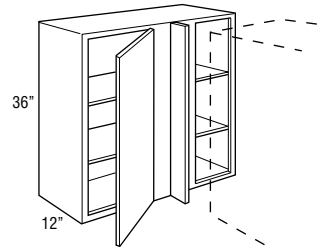

<b>WC2436 L or R</b>	8.2	455	478	527	555	583	583	633
<b>WC2736 L or R</b>	9.1	484	509	560	591	618	621	674
<b>WC3036 L or R</b>	10.0	519	545	601	633	661	664	722
<b>WC3336 L or R</b>	11.1	559	587	650	683	714	718	779
<b>WC3636 L or R</b>	11.9	599	629	697	733	766	769	837

- Includes one 3" filler, shipped unattached.
- L or R indicates void. R (right) void shown.
- MD available only on WC3336 L or R and WC3636 L or R.

**WALL CORNER DOUBLE DOOR,  
36" HIGH**

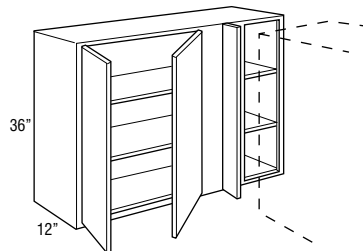

<b>WC3936 L or R</b>	11.8	651	683	758	795	832	834	908
<b>WC4236 L or R</b>	13.8	706	741	821	864	902	906	985
<b>WC4536 L or R</b>	13.8	765	803	891	935	980	983	1068
<b>WC4836 L or R</b>	14.5	830	871	965	1016	1063	1067	1159

- Includes one 3" filler, shipped unattached.
- L or R indicates void. R (right) void shown.

Model	Cubic Feet	8	9	10	11	12	13	14	15	16	17	18	19
		8	9	10	11	12	13	14	15	16	17	18	19
WC3933 L or R	11.6	925	961	999	1073	1077	1123	1176	1200	1261	1296	1302	1364
WC4233 L or R	12.5	1004	1042	1086	1167	1171	1217	1277	1301	1368	1406	1414	1481
WC4533 L or R	13.3	1090	1131	1176	1264	1270	1321	1386	1411	1485	1527	1532	1607
WC4833 L or R	14.1	1182	1228	1277	1372	1380	1433	1502	1531	1612	1657	1663	1742

Custom Modifications	AUTHL AUTHR	CBO	CCO	CFNTO	CFRMO	CND	FB	FPEB	ID	MIP	P	RD
	•	•	•	•	•		•	•	•	•	•	•

Construction Upgrades	VPL	Decorative Door Options	CG	MD	Smart Stop Options	INTGH
	•		•	•		•

WC2436 L or R	8.2	663	690	718	771	772	805	845	859	906	930	933	981
WC2736 L or R	9.1	706	733	763	819	822	854	897	915	962	989	992	1042
WC3036 L or R	10.0	757	786	817	877	881	916	960	980	1031	1060	1063	1116
WC3336 L or R	11.1	816	848	881	948	952	988	1037	1058	1114	1145	1149	1204
WC3636 L or R	11.9	876	910	947	1017	1021	1062	1115	1133	1194	1227	1233	1292

Custom Modifications	AUTHL AUTHR	CBO	CCO	CFNTO	CFRMO	CND	FB	FPEB	ID	MIP	P	RD
	•	•	•	•	•		•	•	•	•	•	•

Construction Upgrades	VPL	Decorative Door Options	CG	MD	Smart Stop Options	INTGH
	•		•	•		•

WC3936 L or R	11.8	950	987	1025	1102	1106	1152	1208	1232	1295	1331	1337	1401
WC4236 L or R	13.8	1031	1070	1114	1198	1203	1250	1311	1336	1405	1444	1452	1521
WC4536 L or R	13.8	1118	1161	1207	1298	1305	1357	1423	1449	1526	1568	1573	1650
WC4836 L or R	14.5	1213	1261	1310	1408	1417	1472	1542	1572	1655	1702	1708	1789

Custom Modifications	AUTHL AUTHR	CBO	CCO	CFNTO	CFRMO	CND	FB	FPEB	ID	MIP	P	RD
	•	•	•	•	•		•	•	•	•	•	•

Construction Upgrades	VPL	Decorative Door Options	CG	MD	Smart Stop Options	INTGH
	•		•	•		•

**WALL CORNER SINGLE DOOR,  
39" or 42" HIGH**

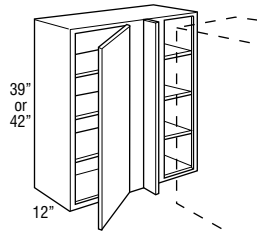

Model	Cubic Feet	Material						
		Tori Oak	Westburke Oak	Tori Hickory Tori Maple	Loren Laminate Tori Cherry Westburke Hickory Westburke Maple Westburke PureStyle™	Calio Oak Gantrell Oak Kesper Oak Rensel Oak	Westburke Cherry	Brookway Oak Bryant Hickory Bryant Maple Calio Maple Hurley Hickory Hurley Maple Kesper Maple Kessy Oak Rensel PureStyle™
		1	2	3	4	5	6	7
WC2439 L or R	8.8	485	510	562	592	620	622	675
WC2739 L or R	9.8	515	541	598	629	657	661	718
WC3039 L or R	10.8	553	581	641	675	706	708	769
WC3339 L or R	11.8	595	625	692	729	762	765	830
WC3639 L or R	12.5	639	672	742	781	817	820	891
WC2442 L or R	9.4	514	540	595	628	656	659	715
WC2742 L or R	10.5	546	574	634	669	699	703	761
WC3042 L or R	11.6	585	614	680	714	749	750	816
WC3342 L or R	12.7	631	663	735	772	809	812	880
WC3642 L or R	13.8	678	711	788	828	867	870	946

- Includes one 3" filler, shipped unattached.
- L or R indicates void. R (right) void shown.
- MD available only on WC3339 L or R, WC3639 L or R, WC3342 L or R and WC3642 L or R.

**WALL CORNER DOUBLE DOOR,  
39" or 42" HIGH**

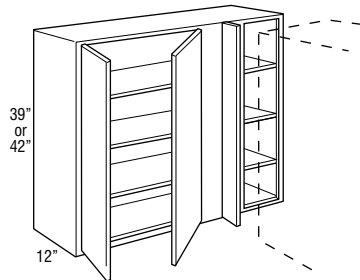

WC3939 L or R	11.8	692	728	806	848	886	891	965
WC4239 L or R	13.8	750	790	875	920	960	965	1048
WC4539 L or R	14.9	815	854	949	996	1042	1045	1136
WC4839 L or R	16.9	883	927	1029	1084	1130	1135	1235
WC3942 L or R	11.8	736	772	854	898	941	944	1024
WC4242 L or R	13.8	797	838	927	977	1021	1024	1113
WC4542 L or R	16.0	866	909	1007	1059	1106	1112	1206
WC4842 L or R	14.5	940	987	1093	1148	1203	1206	1309

- Includes one 3" filler, shipped unattached.
- L or R indicates void. R (right) void shown.

**DIAGONAL WALL, 12", 15", or 18"  
HIGH, 24" x 24"**

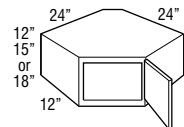

DW122424 L or R	6.8	478	506	570	602	633	637	699
DW152424 L or R	8.3	479	505	566	598	628	632	691
DW182424 L or R	9.7	499	526	590	623	654	658	720

- Cabinets require 24" x 24" of corner wall space.
- Full overlay styles use the same width doors as partial overlay styles (14 1/2" wide) with a partial overlay hinge (38NPOHINGE) to allow for proper door clearance with adjacent cabinets.

Model	Cubic Feet	Canterel Maple	Bryant Cherry Hurley Cherry Norris Maple Norris PureStyle™	Cairo Cherry Kasper Cherry Reist Cherry	Klewin Oak	Brookway Maple Canterel Cherry Kersey Hickory Kersey Maple Norris Cherry	Felix Hickory Felix Maple Forte Hickory Forte Maple Forte PureStyle™ Owens Maple Owens PureStyle™	Antico PureStyle™ Brookway Cherry Felix Cherry Forte Cherry Kersey Cherry Klewin Hickory Klewin Maple Owens Cherry	Adair Maple Adair PureStyle™ Keegan Maple	Valero Maple	Adair Cherry Keegan Cherry	Klewin Cherry	Valero Cherry
		8	9	10	11	12	13	14	15	16	17	18	19
WC2439 L or R	8.8	708	736	765	821	823	856	898	918	964	992	994	1043
WC2739 L or R	9.8	751	781	813	874	877	911	956	976	1025	1056	1059	1112
WC3039 L or R	10.8	805	838	871	933	939	977	1023	1043	1098	1129	1131	1188
WC3339 L or R	11.8	869	904	940	1009	1014	1053	1104	1126	1185	1218	1222	1283
WC3639 L or R	12.5	933	968	1008	1085	1089	1130	1186	1208	1271	1307	1312	1376

WC2442 L or R	9.4	750	781	812	872	875	910	954	975	1024	1052	1056	1105
WC2742 L or R	10.5	797	828	861	926	928	965	1014	1033	1089	1119	1123	1178
WC3042 L or R	11.6	853	888	924	991	995	1035	1087	1105	1165	1200	1202	1262
WC3342 L or R	12.7	923	958	996	1069	1074	1117	1173	1196	1259	1293	1296	1361
WC3642 L or R	13.8	991	1030	1069	1149	1153	1200	1259	1283	1350	1388	1393	1460

Custom Modifications	AUTHL AUTHR	CBO	CCO	CFNT0	CFRMO	CND	FB	FPEB	ID	MIP	P	RD
	•	•	•	•	•		•	•	•	•	•	•

Construction Upgrades	VPL	Decorative Door Options	CG	MD	Smart Stop Options	INTGH
	•		•	•		•

WC3939 L or R	11.8	1013	1052	1094	1175	1180	1226	1288	1311	1380	1419	1424	1495
WC4239 L or R	13.8	1098	1142	1186	1275	1281	1330	1397	1423	1498	1539	1543	1620
WC4539 L or R	14.9	1190	1238	1288	1385	1389	1443	1514	1542	1625	1669	1676	1758
WC4839 L or R	16.9	1293	1343	1397	1502	1507	1567	1644	1675	1764	1811	1816	1907

WC3942 L or R	11.8	1075	1117	1160	1247	1252	1299	1366	1391	1463	1506	1510	1584
WC4242 L or R	13.8	1168	1210	1260	1353	1358	1411	1481	1509	1589	1633	1639	1719
WC4542 L or R	16.0	1266	1314	1367	1468	1473	1531	1607	1637	1723	1772	1778	1865
WC4842 L or R	14.5	1373	1426	1482	1592	1599	1661	1743	1776	1870	1921	1932	2023

Custom Modifications	AUTHL AUTHR	CBO	CCO	CFNT0	CFRMO	CND	FB	FPEB	ID	MIP	P	RD
	•	•	•	•	•		•	•	•	•	•	•

Construction Upgrades	VPL	Decorative Door Options	CG	MD	Smart Stop Options	INTGH
	•		•	•		•

DW122424 L or R	6.8	737	768	801	869	871	909	957	978	1034	1065	1068	1125
DW152424 L or R	8.3	728	756	788	853	855	892	939	958	1013	1043	1045	1099
DW182424 L or R	9.7	758	788	821	889	891	929	978	998	1055	1086	1089	1145

Custom Modifications	AUTHL AUTHR	CBO	CCO	CFNT0	CFRMO	CND	FB	FPEB	ID	MIP	P	RD
	•	•	•	•	•		•	•	•	•	•	•

Construction Upgrades	VPL	Decorative Door Options	CG	MD	Smart Stop Options	INTGH
	•		•			•



**DIAGONAL WALL, 24" or 27" HIGH, 24" x 24"**

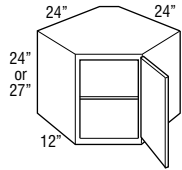

Model	Cubic Feet	Finish						
		Tori Oak	Westburke Oak	Tori Hickory Tori Maple	Loren Laminate Tori Cherry Westburke Hickory Westburke Maple Westburke PureStyle™	Calio Oak Gantrell Oak Kesper Oak Rena Oak	Westburke Cherry	Brookway Oak Bryant Hickory Bryant Maple Calio Maple Hurley Hickory Hurley Maple Kesper Maple Kessy Oak Rena Oak Rena PureStyle™
DW242424 L or R	12.7	519	547	611	644	674	678	740
DW272424 L or R	14.1	540	567	631	664	695	699	761

- Cabinets require 24" x 24" of corner wall space.
- Adjustable shelf cannot be removed/retrofitted.
- Full overlay styles use the same width doors as partial overlay styles (14 1/2" wide) with a partial overlay hinge (38NPOHINGE) to allow for proper door clearance with adjacent cabinets.

**DIAGONAL WALL, 30", 33", 36", 39", or 42" HIGH, 24" x 24"**

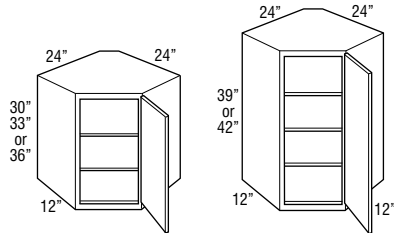

DW302424 L or R  
DW332424 L or R  
DW362424 L or R

DW392424 L or R  
DW422424 L or R

DW302424 L or R	12.5	560	588	652	685	715	720	781
DW332424 L or R	13.7	629	660	730	768	802	805	875
DW362424 L or R	14.9	647	678	749	788	823	827	898
DW392424 L or R	16.0	688	723	798	841	878	882	957
DW422424 L or R	17.2	731	767	847	892	930	937	1015

- Cabinets require 24" x 24" of corner wall space.
- Full overlay styles use the same width doors as partial overlay styles (14 1/2" wide) with a partial overlay hinge (38NPOHINGE) to allow for proper door clearance with adjacent cabinets.

**NEW DIAGONAL WALL, 15" or 18" HIGH, 27" x 27"**

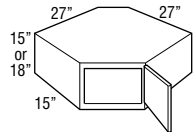

DW152727 L or R	8.3	438	459	508	534	558	559	608
DW182727 L or R	9.7	476	499	552	580	607	608	661

- Cabinets require 27" x 27" of corner wall space.
- Full overlay styles use the same width doors as partial overlay styles (14 1/2" wide) with a partial overlay hinge (38NPOHINGE) to allow for proper door clearance with adjacent cabinets.

**NEW DIAGONAL WALL, 24" or 27" HIGH, 27" x 27"**

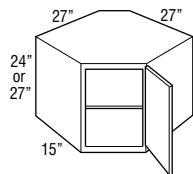

DW242727 L or R	12.7	517	542	600	630	660	661	719
DW272727 L or R	14.1	562	589	652	685	717	719	782

- Cabinets require 27" x 27" of corner wall space.
- Adjustable shelf cannot be removed/retrofitted.
- Full overlay styles use the same width doors as partial overlay styles (14 1/2" wide) with a partial overlay hinge (38NPOHINGE) to allow for proper door clearance with adjacent cabinets.

**DIAGONAL WALL, 30", 33", 36", 39", or 42" HIGH, 27" x 27"**

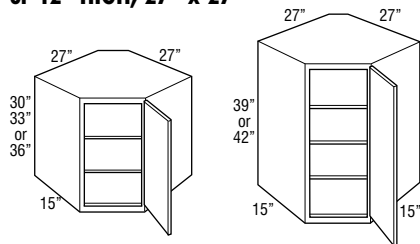

DW302727 L or R  
DW332727 L or R  
DW362727 L or R

DW392727 L or R  
DW422727 L or R

DW302727 L or R	14.7	611	640	709	745	779	782	850
DW332727 L or R	16.2	685	718	794	834	872	876	952
DW362727 L or R	17.6	703	737	815	856	895	900	978
DW392727 L or R	20.0	748	786	868	914	954	959	1041
DW422727 L or R	20.5	794	833	921	968	1013	1017	1103

- Cabinets require 27" x 27" of corner wall space.
- Full overlay styles use the same width doors as partial overlay styles (14 1/2" wide) with a partial overlay hinge (38NPOHINGE) to allow for proper door clearance with adjacent cabinets.

Model	Cubic Feet	Cantrill Maple	Bryant Cherry Hurley Cherry Norris Maple Norris PureStyle™	Cairo Cherry Kasper Cherry Reist Cherry	Klewin Oak	Brockway Maple Cantrill Cherry Kersey Hickory Kersey Maple Norris Cherry	Felix Hickory Felix Maple Forte Hickory Forte Maple Forte PureStyle™ Owens Maple Owens PureStyle™	Amico PureStyle™ Brockway Cherry Felix Cherry Forte Cherry Kersey Hickory Klewin Hickory Klewin Maple Owens Cherry	Adair Maple Adair PureStyle™ Keegan Maple	Valero Maple	Adair Cherry Keegan Cherry	Klewin Cherry	Valero Cherry
		8	9	10	11	12	13	14	15	16	17	18	19
DW242424 L or R	12.7	778	809	842	910	912	950	998	1019	1075	1106	1109	1166
DW272424 L or R	14.1	799	830	862	930	932	970	1019	1039	1096	1127	1130	1186

<b>Custom Modifications</b>	AUTHL AUTHR	CBO	CCO	CFNTO	CFRMO	CND	FB	FPEB	ID	MIP	P	RD
	•	•	•	•	•		•	•		•		
<b>Construction Upgrades</b>	VPL	<b>Decorative Door Options</b>				CG	MD	<b>Smart Stop Options</b>			INTGH	
	•					•					•	

DW302424 L or R	12.5	819	850	883	951	953	991	1039	1060	1116	1147	1150	1207
DW332424 L or R	13.7	918	953	990	1065	1068	1108	1165	1185	1250	1285	1289	1352
DW362424 L or R	14.9	943	979	1017	1094	1097	1138	1197	1217	1283	1319	1324	1388

DW392424 L or R	16.0	1003	1042	1086	1163	1170	1214	1275	1297	1367	1405	1409	1479
DW422424 L or R	17.2	1064	1104	1150	1235	1239	1290	1353	1378	1452	1491	1497	1570

<b>Custom Modifications</b>	AUTHL AUTHR	CBO	CCO	CFNTO	CFRMO	CND	FB	FPEB	ID	MIP	P	RD
	•	•	•	•	•		•	•		•		
<b>Construction Upgrades</b>	VPL	<b>Decorative Door Options</b>				CG	MD	<b>Smart Stop Options</b>			INTGH	
	•					•	•				•	

DW152727 L or R	8.3	638	661	687	740	742	772	811	824	868	893	897	939
DW182727 L or R	9.7	693	719	747	804	807	839	881	896	944	971	975	1021

<b>Custom Modifications</b>	AUTHL AUTHR	CBO	CCO	CFNTO	CFRMO	CND	FB	FPEB	ID	MIP	P	RD
	•	•	•	•	•		•	•		•		
<b>Construction Upgrades</b>	VPL	<b>Decorative Door Options</b>				CG	MD	<b>Smart Stop Options</b>			INTGH	
	•					•					•	

DW242727 L or R	12.7	753	782	812	874	877	912	958	974	1026	1055	1060	1110
DW272727 L or R	14.1	818	850	883	950	953	991	1041	1059	1115	1147	1152	1207

<b>Custom Modifications</b>	AUTHL AUTHR	CBO	CCO	CFNTO	CFRMO	CND	FB	FPEB	ID	MIP	P	RD
	•	•	•	•	•		•	•		•		
<b>Construction Upgrades</b>	VPL	<b>Decorative Door Options</b>				CG	MD	<b>Smart Stop Options</b>			INTGH	
	•					•					•	

DW302727 L or R	14.7	889	924	960	1033	1036	1077	1131	1151	1212	1247	1252	1312
DW332727 L or R	16.2	997	1035	1075	1157	1160	1206	1265	1290	1358	1397	1402	1470
DW362727 L or R	17.6	1024	1063	1104	1187	1190	1238	1299	1325	1395	1435	1439	1510

DW392727 L or R	20.0	1092	1132	1179	1266	1270	1321	1387	1412	1486	1529	1534	1608
DW422727 L or R	20.5	1158	1203	1250	1344	1349	1401	1471	1499	1577	1622	1626	1706

<b>Custom Modifications</b>	AUTHL AUTHR	CBO	CCO	CFNTO	CFRMO	CND	FB	FPEB	ID	MIP	P	RD
	•	•	•	•	•		•	•		•		
<b>Construction Upgrades</b>	VPL	<b>Decorative Door Options</b>				CG	MD	<b>Smart Stop Options</b>			INTGH	
	•					•	•				•	

**DIAGONAL WALL with PLYWOOD  
LAZY SUSAN, 30", 33", 36", 39", or  
42" HIGH, 24" x 24"**

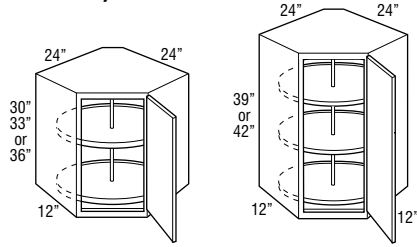

DW302424S L or R  
DW332424S L or R  
DW362424S L or R

DW392424S L or R  
DW422424S L or R

Model	Cubic Feet	Finish						
		Tori Oak	Westburke Oak	Tori Hickory Tori Maple	Loren Laminate Tori Cherry Westburke Hickory Westburke Maple Westburke PureStyle™	Calio Oak Gantrell Oak Kesper Oak Reist Oak	Westburke Cherry	Brookway Oak Bryant Hickory Bryant Maple Calio Maple Hurley Hickory Hurley Maple Kesper Maple Kesper Oak Reist Maple Reist PureStyle™
		1	2	3	4	5	6	7
DW302424S L or R	12.5	1091	1119	1183	1216	1246	1251	1312
DW332424S L or R	13.7	1160	1191	1261	1299	1333	1336	1406
DW362424S L or R	14.9	1178	1209	1280	1319	1354	1358	1429
DW392424S L or R	16.0	1292	1327	1402	1445	1482	1486	1561
DW422424S L or R	17.2	1335	1371	1451	1496	1534	1541	1619

- Cabinets require 24" x 24" of corner wall space.
- Plywood shelves are 18" in overall diameter with a 17" interior diameter and 1" high lip.
- Full overlay styles use the same width doors as partial overlay styles (14 1/2" wide) with a partial overlay hinge (38NPOHNGE) to allow for proper door clearance with adjacent cabinets.

**DIAGONAL WALL with LAZY SUSAN,  
30", 33", 36", 39", or 42" HIGH,  
24" x 24"**

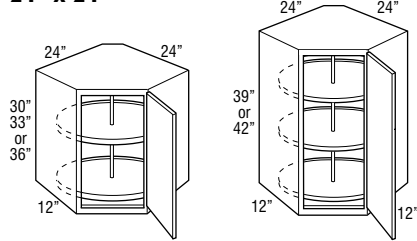

DW302424LS L or R  
DW332424LS L or R  
DW362424LS L or R

DW392424LS L or R  
DW422424LS L or R

DW302424LS L or R	12.5	775	803	867	900	930	935	996
DW332424LS L or R	13.7	844	875	945	983	1017	1020	1090
DW362424LS L or R	14.9	862	893	964	1003	1038	1042	1113
DW392424LS L or R	16.0	951	986	1061	1104	1141	1145	1220
DW422424LS L or R	17.2	994	1030	1110	1155	1193	1200	1278

- Cabinets require 24" x 24" of corner wall space.
- White 18" diameter plastic shelves.
- Full overlay styles use the same width doors as partial overlay styles (14 1/2" wide) with a partial overlay hinge (38NPOHNGE) to allow for proper door clearance with adjacent cabinets.

**EASY REACH WALL CORNER, 30",  
33", 36", 39", or 42" HIGH,  
24" x 24"**

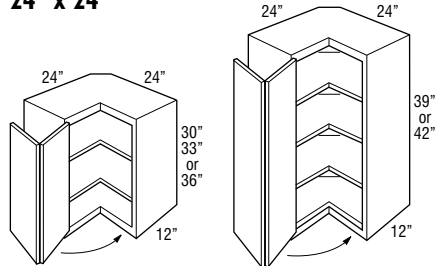

ER30 L or R	12.5	668	702	774	816	851	855	927
ER33 L or R	13.7	746	783	868	912	954	957	1039
ER36 L or R	14.9	766	804	891	935	980	983	1067
ER39 L or R	16.0	817	856	950	998	1044	1047	1136
ER42 L or R	17.2	867	910	1007	1061	1111	1114	1207

- Requires 24" x 24" of corner wall space.
- Due to the center hinge on Easy Reach doors, door options are not available.
- Decorative hardware screws must be countersunk to prevent scratching of adjacent cabinets and face frame of ER.

Model	Cubic Feet	Cantrill Maple	Bryant Cherry Hurley Cherry Norris Maple Norris PureStyle™	Cairo Cherry Kasper Cherry Reist Cherry	Klewin Oak	Brockway Maple Cantrill Cherry Kersey Hickory Kersey Maple Norris Cherry	Felix Hickory Felix Maple Forte Hickory Forte Maple Forte PureStyle™ Owens Maple Owens PureStyle™	Amico PureStyle™ Brockway Cherry Felix Cherry Forte Cherry Kersey Cherry Klewin Hickory Klewin Maple Owens Cherry	Adair Maple Adair PureStyle™ Keegan Maple	Valero Maple	Adair Cherry Keegan Cherry	Klewin Cherry	Valero Cherry
		8	9	10	11	12	13	14	15	16	17	18	19
DW302424S L or R	12.5	1350	1381	1414	1482	1484	1522	1570	1591	1647	1678	1681	1738
DW332424S L or R	13.7	1449	1484	1521	1596	1599	1639	1696	1716	1781	1816	1820	1883
DW362424S L or R	14.9	1474	1510	1548	1625	1628	1669	1728	1748	1814	1850	1855	1919
DW392424S L or R	16.0	1607	1646	1690	1767	1774	1818	1879	1901	1971	2009	2013	2083
DW422424S L or R	17.2	1668	1708	1754	1839	1843	1894	1957	1982	2056	2095	2101	2174

Custom Modifications	AUTHL AUTHR	CBO	CCO	CFNTO	CFRMO	CND	FB	FPEB	ID	MIP	P	RD
	•	•	•	•	•		•	•		•		

Construction Upgrades	VPL	Decorative Door Options	CG	MD	Smart Stop Options	INTGH
	•		•	•		•

DW302424LS L or R	12.5	1034	1065	1098	1166	1168	1206	1254	1275	1331	1362	1365	1422
DW332424LS L or R	13.7	1133	1168	1205	1280	1283	1323	1380	1400	1465	1500	1504	1567
DW362424LS L or R	14.9	1158	1194	1232	1309	1312	1353	1412	1432	1498	1534	1539	1603
DW392424LS L or R	16.0	1266	1305	1349	1426	1433	1477	1538	1560	1630	1668	1672	1742
DW422424LS L or R	17.2	1327	1367	1413	1498	1502	1553	1616	1641	1715	1754	1760	1833

Custom Modifications	AUTHL AUTHR	CBO	CCO	CFNTO	CFRMO	CND	FB	FPEB	ID	MIP	P	RD
	•	•	•	•	•		•	•		•		

Construction Upgrades	VPL	Decorative Door Options	CG	MD	Smart Stop Options	INTGH
	•		•	•		•

ER30 L or R	12.5	976	1011	1051	1130	1132	1179	1237	1260	1326	1364	1369	1435
ER33 L or R	13.7	1092	1132	1177	1264	1270	1320	1386	1410	1485	1527	1532	1607
ER36 L or R	14.9	1121	1162	1209	1298	1304	1355	1423	1448	1526	1568	1573	1650
ER39 L or R	16.0	1192	1239	1289	1385	1389	1443	1514	1543	1625	1669	1677	1759
ER42 L or R	17.2	1265	1315	1367	1469	1473	1533	1607	1639	1725	1773	1777	1866

Custom Modifications	AUTHL AUTHR	CBO	CCO	CFNTO	CFRMO	CND	FB	FPEB	ID	MIP	P	RD
	•	•	•				•	•		•		

Construction Upgrades	VPL	Decorative Door Options	CG	MD	Smart Stop Options	INTGH
	•					

**ASYMMETRICAL EASY REACH WALL  
CORNER, 30", 33", 36", 39", or 42"  
HIGH**

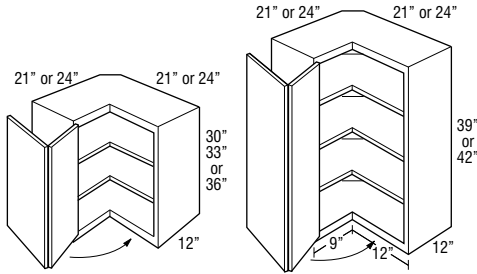

Model	Cubic Feet	Finish						
		Tori Oak	Westburke Oak	Tori Hickory Tori Maple	Loren Laminate Tori Cherry Westburke Hickory Westburke Maple Westburke PureStyle™	Galio Oak Gantrell Oak Kesper Oak Renaist Oak	Westburke Cherry	Brookway Oak Bryant Hickory Bryant Maple Calio Maple Hurley Hickory Hurley Maple Kesper Maple Kesper Oak Renaist PureStyle™ Renaist PureStyle™
		1	2	3	4	5	6	7
ER302124 L or R	12.5	668	702	774	816	851	855	927
ER302421 L or R	12.5	668	702	774	816	851	855	927
ER332124 L or R	13.3	746	783	868	912	954	957	1039
ER332421 L or R	13.3	746	783	868	912	954	957	1039
ER362124 L or R	14.9	766	804	891	935	980	983	1067
ER362421 L or R	14.9	766	804	891	935	980	983	1067
ER392124 L or R	16.0	817	856	950	998	1044	1047	1136
ER392421 L or R	16.0	817	856	950	998	1044	1047	1136
ER422124 L or R	17.2	867	910	1007	1061	1111	1114	1207
ER422421 L or R	17.2	867	910	1007	1061	1111	1114	1207

- Hinged door opens to 170°.
- Adjustable shelves.
- Legs at the front frames are 9" on 21" leg and 12" on 24" leg.
- Nomenclature for asymmetrical cabinets reads as follows:  
First set of numbers = height  
Second set of numbers = left side  
Third set of numbers = right side
- Decorative hardware screws must be countersunk to prevent scratching of adjacent cabinets and face frame of ER.
- ER\_\_2124L shown.

Model	Cubic Feet	Cantrill Maple	Bryant Cherry Hurley Cherry Norris Maple Norris PureStyle™	Cairo Cherry Kasper Cherry Reist Cherry	Klewin Oak	Brookway Maple Cantrill Cherry Kersey Hickory Kersey Maple Norris Cherry	Felix Hickory Felix Maple Forte Hickory Forte Maple Forte PureStyle™ Owens Maple Owens PureStyle™	Antico PureStyle™ Brookway Cherry Felix Cherry Forte Cherry Kersey Cherry Klewin Hickory Klewin Maple Owens Cherry	Adair Maple Adair PureStyle™ Keegan Maple	Valero Maple	Adair Cherry Keegan Cherry	Klewin Cherry	Valero Cherry
		8	9	10	11	12	13	14	15	16	17	18	19
ER302124 L or R	12.5	976	1011	1051	1130	1132	1179	1237	1260	1326	1364	1369	1435
ER302421 L or R	12.5	976	1011	1051	1130	1132	1179	1237	1260	1326	1364	1369	1435
ER332124 L or R	13.3	1092	1132	1177	1264	1270	1320	1386	1410	1485	1527	1532	1607
ER332421 L or R	13.3	1092	1132	1177	1264	1270	1320	1386	1410	1485	1527	1532	1607
ER362124 L or R	14.9	1121	1162	1209	1298	1304	1355	1423	1448	1526	1568	1573	1650
ER362421 L or R	14.9	1121	1162	1209	1298	1304	1355	1423	1448	1526	1568	1573	1650
ER392124 L or R	16.0	1192	1239	1289	1385	1389	1443	1514	1543	1625	1669	1677	1759
ER392421 L or R	16.0	1192	1239	1289	1385	1389	1443	1514	1543	1625	1669	1677	1759
ER422124 L or R	17.2	1265	1315	1367	1469	1473	1533	1607	1639	1725	1773	1777	1866
ER422421 L or R	17.2	1265	1315	1367	1469	1473	1533	1607	1639	1725	1773	1777	1866

Custom Modifications	AUTHL AUTHR	CBO	CCO	CFNTO	CFRMO	CND	FB	FPEB	ID	MIP	P	RD
	•	•	•				•	•		•		

Construction Upgrades	VPL	Decorative Door Options	CG	MD	Smart Stop Options	INTGH
	•					•

**WALL END CABINET SINGLE DOOR, 30", 33", 36", 39", or 42" HIGH, 12" x 12"**

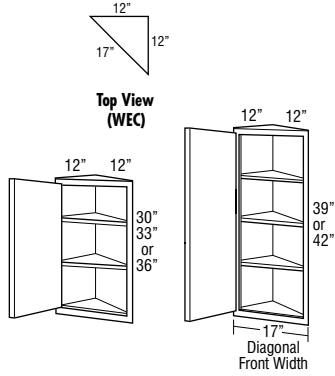

Model	Cubic Feet	Finish						
		Tori Oak	Westburke Oak	Tori Hickory Tori Maple	Loren Laminate Tori Cherry Westburke Hickory Westburke Maple Westburke PureStyle™	Calio Oak Gantrell Oak Kesper Oak Reins Oak	Westburke Cherry	Brookway Oak Bryant Hickory Bryant Maple Calio PureStyle™ Calio Maple Hurley Hickory Hurley Maple Kesper Maple Kessy Oak Reins PureStyle™ Reins PureStyle™
		1	2	3	4	5	6	7
WEC1230 L or R	3.7	512	538	594	625	655	656	712
WEC1233 L or R	4.1	575	603	666	701	735	736	800
WEC1236 L or R	4.4	590	620	684	720	756	757	821
WEC1239 L or R	4.7	627	658	729	766	803	804	875
WEC1242 L or R*	4.9	664	699	772	812	850	852	926

- Width at wall: 12" x 12".
- Cabinet features two unfinished back panels. Must be installed with one back panel adjacent to a cabinet of equal height with the other back panel attached to the wall.

\*When ordered with MD, shelves will not align with mullions.

**WALL END CABINET DOUBLE DOOR, 30", 33", 36", 39", or 42" HIGH, 12" x 12"**

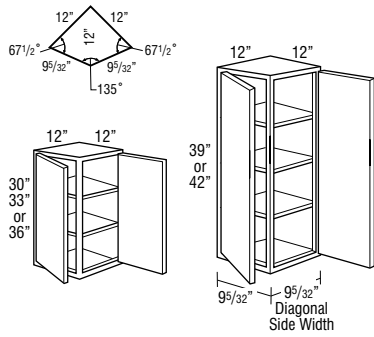

WEC1230D	3.7	682	708	764	795	825	826	882
WEC1233D	4.1	745	773	836	871	905	906	970
WEC1236D	4.4	760	790	854	890	926	927	991
WEC1239D	4.7	797	828	899	936	973	974	1045
WEC1242D	4.9	834	869	942	982	1020	1022	1096

- Width at wall: 12" x 12".
- Cabinet features two unfinished back panels. Must be installed with one back panel adjacent to a cabinet of equal height with the other back panel attached to the wall.
- Decorative glass inserts are not available.

**WALL QUARTER ROUND END SHELF, 30", 33", 36", 39", or 42" HIGH**

Square Top and Bottom Panels

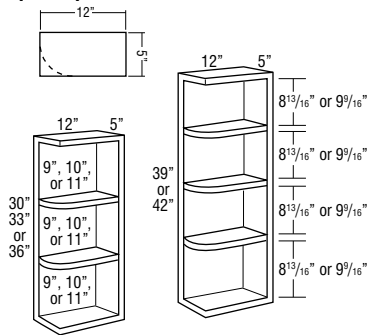

WQRES630STSB	1.8	321	321	321	321	321	321	321
WQRES633STSB	2.0	361	361	361	361	361	361	361
WQRES636STSB	2.2	371	371	371	371	371	371	371
WQRES639STSB	2.5	402	402	402	402	402	402	402
WQRES642STSB	2.9	433	433	433	433	433	433	433

- Units are reversible.
- Hardwood veneer on 3/4" furniture board core.
- Matching interior.
- Veneer construction, finished to match cabinet face frame.

Model	Cubic Feet	Cantrill Maple	Bryant Cherry Hurley Cherry Norris Maple Norris PureStyle™	Cairo Cherry Kasper Cherry Reist Cherry	Klewin Oak	Brookway Maple Cantrill Cherry Kersey Hickory Kersey Maple Norris Cherry	Felix Hickory Felix Maple Forte Hickory Forte Maple Forte PureStyle™ Owens Maple Owens PureStyle™	Amico PureStyle™ Brookway Cherry Felix Cherry Forte Cherry Kersey Hickory Klewin Hickory Klewin Maple Owens Cherry	Adair Maple Adair PureStyle™ Keegan Maple	Valero Maple	Adair Cherry Keegan Cherry	Klewin Cherry	Valero Cherry
		8	9	10	11	12	13	14	15	16	17	18	19
WEC1230 L or R	3.7	748	776	807	868	872	907	951	966	1018	1045	1052	1100
WEC1233 L or R	4.1	838	871	905	972	977	1016	1065	1087	1143	1174	1178	1235
WEC1236 L or R	4.4	860	894	929	998	1003	1042	1094	1116	1174	1206	1210	1269
WEC1239 L or R	4.7	916	952	989	1063	1067	1111	1163	1186	1249	1284	1289	1351
WEC1242 L or R	4.9	970	1009	1049	1126	1130	1176	1235	1258	1323	1360	1365	1431

Custom Modifications	AUTHL AUTHR	CBO	CCO	CFNTO	CFRMO	CND	FB	FPEB	ID	MIP	P	RD
		•	•	•	•			•		•		

Construction Upgrades	VPL	Decorative Door Options	CG	MD	Smart Stop Options	INTGH
	•		•	•		•

WEC1230D	3.7	918	946	977	1038	1042	1077	1121	1136	1188	1215	1222	1270
WEC1233D	4.1	1008	1041	1075	1142	1147	1186	1235	1257	1313	1344	1348	1405
WEC1236D	4.4	1030	1064	1099	1168	1173	1212	1264	1286	1344	1376	1380	1439
WEC1239D	4.7	1086	1122	1159	1233	1237	1281	1333	1356	1419	1454	1459	1521
WEC1242D	4.9	1140	1179	1219	1296	1300	1346	1405	1428	1493	1530	1535	1601

Custom Modifications	AUTHL AUTHR	CBO	CCO	CFNTO	CFRMO	CND	FB	FPEB	ID	MIP	P	RD
		•	•	•	•			•		•		

Construction Upgrades	VPL	Decorative Door Options	CG	MD	Smart Stop Options	INTGH
	•		•	•		•

WQRES630STSB	1.8	321	321	321	321	321	321	321	321	321	321	321	321
WQRES633STSB	2.0	361	361	361	361	361	361	361	361	361	361	361	361
WQRES636STSB	2.2	371	371	371	371	371	371	371	371	371	371	371	371
WQRES639STSB	2.5	402	402	402	402	402	402	402	402	402	402	402	402
WQRES642STSB	2.9	433	433	433	433	433	433	433	433	433	433	433	433

MODIFICATIONS
No modifications available for these products.



**WALL TRANSITION CABINET,  
30", 33", 36", 39", or 42" HIGH**

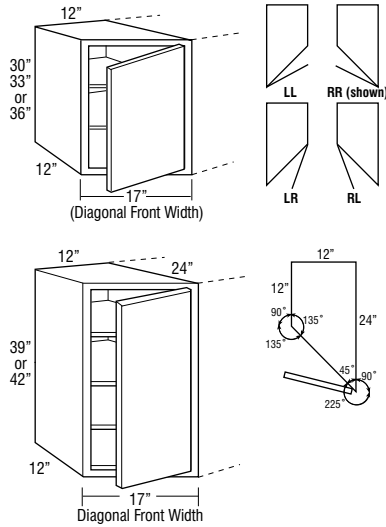

Model	Cubic Feet	Finish						
		Tori Oak	Westburke Oak	Tori Hickory Tori Maple	Loren Laminate Tori Cherry Westburke Hickory Westburke Maple Westburke PureStyle™	Cairo Oak Cantrell Oak Kesper Oak Renaist Oak	Westburke Cherry	Brookway Oak Bryant Hickory Bryant Maple Cairo Maple Hurley Hickory Hurley Maple Kesper Maple Kersey Oak Renaist PureStyle™
		1	2	3	4	5	6	7
WTC1230LL	6.9	444	467	514	542	568	570	620
WTC1230RL	6.9	444	467	514	542	568	570	620
WTC1230LR	6.9	444	467	514	542	568	570	620
WTC1230RR	6.9	444	467	514	542	568	570	620
WTC1233LL	7.5	495	519	574	603	632	633	689
WTC1233RL	7.5	495	519	574	603	632	633	689
WTC1233LR	7.5	495	519	574	603	632	633	689
WTC1233RR	7.5	495	519	574	603	632	633	689
WTC1236LL	8.1	508	533	588	619	648	650	706
WTC1236RL	8.1	508	533	588	619	648	650	706
WTC1236LR	8.1	508	533	588	619	648	650	706
WTC1236RR	8.1	508	533	588	619	648	650	706
WTC1239LL	8.7	539	565	624	656	687	688	748
WTC1239RL	8.7	539	565	624	656	687	688	748
WTC1239LR	8.7	539	565	624	656	687	688	748
WTC1239RR	8.7	539	565	624	656	687	688	748
WTC1242LL	9.4	568	597	658	693	729	729	791
WTC1242RL	9.4	568	597	658	693	729	729	791
WTC1242LR	9.4	568	597	658	693	729	729	791
WTC1242RR	9.4	568	597	658	693	729	729	791

- Specify door hinging. RR shown.
- Reduced Depth to 18" available.
- Full overlay styles use the same width doors as partial overlay styles (14 1/2" wide) with a partial overlay hinge (38NPOHINGE) to allow for proper door clearance with adjacent cabinets.

**WALL MICROWAVE CABINET,  
18" HIGH**

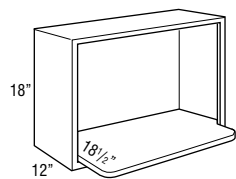

**MW2718**  
Opening: 24" w x 14 1/4" h  
Cabinet: 27" w x 18" h

**MW3018**  
Opening: 27" w x 14 1/4" h  
Cabinet: 30" w x 18" h

MW2718	4.6	526	526	526	526	526	526
MW3018	6.9	554	554	554	554	554	554

- Includes one 3/4" shelf with six mounting screws. Shelf is hardwood veneer plywood. Microwave shelf extends beyond the front of the cabinet by 6 1/2", for a total shelf depth of 18 1/2".
- Microwave cabinet must be attached to wall stud and adjacent cabinets on both sides for support.
- Cabinet interior finished to match cabinet face frame.

Model	Cubic Feet	Canterell Maple	Bryant Cherry Hurley Cherry Norris Maple Norris PureStyle™	Cairo Cherry Kesper Cherry Reist Cherry	Klewin Oak	Brookway Maple Canterell Cherry Kersey Hickory Kersey Maple Norris Cherry	Felix Hickory Felix Maple Forte Hickory Forte Maple Forte PureStyle™ Owens Maple Owens PureStyle™	Antico PureStyle™ Brookway Cherry Felix Cherry Forte Cherry Kersey Cherry Klewin Hickory Klewin Maple Owens Cherry	Adair Maple Adair PureStyle™ Keegan Maple	Valero Maple	Adair Cherry Keegan Cherry	Klewin Cherry	Valero Cherry
		8	9	10	11	12	13	14	15	16	17	18	19
WTC1230LL	6.9	650	674	702	750	757	785	822	840	883	910	910	957
WTC1230RL	6.9	650	674	702	750	757	785	822	840	883	910	910	957
WTC1230LR	6.9	650	674	702	750	757	785	822	840	883	910	910	957
WTC1230RR	6.9	650	674	702	750	757	785	822	840	883	910	910	957

WTC1233LL	7.5	722	749	778	835	839	873	916	934	984	1011	1013	1064
WTC1233RL	7.5	722	749	778	835	839	873	916	934	984	1011	1013	1064
WTC1233LR	7.5	722	749	778	835	839	873	916	934	984	1011	1013	1064
WTC1233RR	7.5	722	749	778	835	839	873	916	934	984	1011	1013	1064

WTC1236LL	8.1	739	768	798	856	859	894	940	958	1009	1035	1038	1091
WTC1236RL	8.1	739	768	798	856	859	894	940	958	1009	1035	1038	1091
WTC1236LR	8.1	739	768	798	856	859	894	940	958	1009	1035	1038	1091
WTC1236RR	8.1	739	768	798	856	859	894	940	958	1009	1035	1038	1091

WTC1239LL	8.7	785	816	848	910	914	950	996	1017	1070	1099	1102	1157
WTC1239RL	8.7	785	816	848	910	914	950	996	1017	1070	1099	1102	1157
WTC1239LR	8.7	785	816	848	910	914	950	996	1017	1070	1099	1102	1157
WTC1239RR	8.7	785	816	848	910	914	950	996	1017	1070	1099	1102	1157

WTC1242LL	9.4	830	861	896	962	966	1004	1056	1075	1131	1162	1168	1224
WTC1242RL	9.4	830	861	896	962	966	1004	1056	1075	1131	1162	1168	1224
WTC1242LR	9.4	830	861	896	962	966	1004	1056	1075	1131	1162	1168	1224
WTC1242RR	9.4	830	861	896	962	966	1004	1056	1075	1131	1162	1168	1224

<b>Custom Modifications</b>	AUTHL AUTHR	CBO	CCO	CFNT0	CFRMO	CND	FB	FPEB	ID	MIP	P	RD
	•	•	•	•	•		•	•		•		•
<b>Construction Upgrades</b>	VPL	<b>Decorative Door Options</b>				CG	MD	<b>Smart Stop Options</b>			INTGH	
	•					•	•				•	

MW2718	4.6	526	526	526	526	526	526	526	526	526	526	526	526
MW3018	6.9	554	554	554	554	554	554	554	554	554	554	554	554

<b>Custom Modifications</b>	AUTHL AUTHR	CBO	CCO	CFNT0	CFRMO	CND	FB	FPEB	ID	MIP	P	RD
	•	STD			•		STD	•		STD		
<b>Construction Upgrades</b>	VPL	<b>Decorative Door Options</b>				CG	MD	<b>Smart Stop Options</b>			INTGH	

**WALL MICROWAVE DOUBLE DOOR CABINET, 36" HIGH**

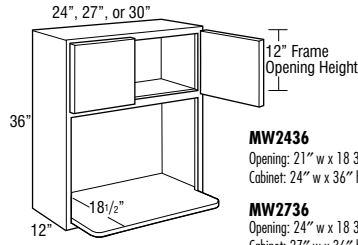

**MW2436**  
Opening: 21" w x 18 3/4" h  
Cabinet: 24" w x 36" h

**MW2736**  
Opening: 24" w x 18 3/4" h  
Cabinet: 27" w x 36" h

**MW3036**  
Opening: 27" w x 18 3/4" h  
Cabinet: 30" w x 36" h

Model	Cubic Feet	Finish						
		Tori Oak	Westburke Oak	Tori Hickory Tori Maple	Loren Laminate Tori Cherry Westburke Hickory Westburke Maple Westburke PureStyle™	Galio Oak Gantrell Oak Kesper Oak Reist Oak	Westburke Cherry	Brookway Oak Bryant Hickory Bryant Maple Cairo Maple Hurley Hickory Hurley Maple Kasper Maple Kessy Oak Reist PureStyle™ Reist PureStyle™
<b>MW2436</b>	6.6	1185	1251	1241	1256	1282	1324	1268
<b>MW2736</b>	6.8	1298	1364	1354	1369	1395	1437	1381
<b>MW3036</b>	10.0	1615	1695	1669	1683	1711	1768	1680

- Includes one 3/4" shelf with six mounting screws. Shelf is hardwood veneer plywood. Microwave shelf extends beyond the front of the cabinet by 6 1/2", for a total shelf depth of 18 1/2".
- Microwave cabinet must be attached to wall stud.
- Cabinet interior finished to match cabinet face frame.
- When ID is ordered, shelf will not be included with cabinet.

**WALL MICROWAVE DOUBLE DOOR CABINET, 39" HIGH**

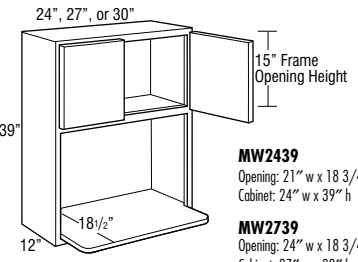

**MW2439**  
Opening: 21" w x 18 3/4" h  
Cabinet: 24" w x 39" h

**MW2739**  
Opening: 24" w x 18 3/4" h  
Cabinet: 27" w x 39" h

**MW3039**  
Opening: 27" w x 18 3/4" h  
Cabinet: 30" w x 39" h

<b>MW2439</b>	8.7	1298	1364	1354	1369	1395	1437	1381
<b>MW2739</b>	9.7	1411	1477	1467	1482	1508	1550	1494
<b>MW3039</b>	10.7	1728	1808	1783	1796	1824	1881	1793

- Includes one 3/4" shelf with six mounting screws. Shelf is hardwood veneer plywood. Microwave shelf extends beyond the front of the cabinet by 6 1/2", for a total shelf depth of 18 1/2".
- Microwave cabinet must be attached to wall stud.
- Cabinet interior finished to match cabinet face frame.
- When ID is ordered, shelf will not be included with cabinet.

**WALL MICROWAVE DOUBLE DOOR CABINET, 42" HIGH**

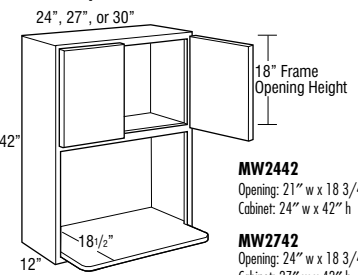

**MW2442**  
Opening: 21" w x 18 3/4" h  
Cabinet: 24" w x 42" h

**MW2742**  
Opening: 24" w x 18 3/4" h  
Cabinet: 27" w x 42" h

**MW3042**  
Opening: 27" w x 18 3/4" h  
Cabinet: 30" w x 42" h

<b>MW2442</b>	9.4	1411	1477	1467	1482	1508	1550	1494
<b>MW2742</b>	10.4	1525	1590	1580	1595	1621	1663	1607
<b>MW3042</b>	11.5	1841	1921	1896	1909	1937	1994	1906

- Includes one 3/4" shelf with six mounting screws. Shelf is hardwood veneer plywood. Microwave shelf extends beyond the front of the cabinet by 6 1/2", for a total shelf depth of 18 1/2".
- Microwave cabinet must be attached to wall stud.
- Cabinet interior finished to match cabinet face frame.
- When ID is ordered, shelf will not be included with cabinet.

Model	Cubic Feet	Cantrill Maple	Bryant Cherry Hurley Cherry Norris Maple Norris PureStyle™	Cairo Cherry Kasper Cherry Reist Cherry	Klewin Oak	Brookway Maple Cantrill Cherry Kersey Hickory Kersey Maple Norris Cherry	Felix Hickory Felix Maple Forte Hickory Forte Maple Forte PureStyle™ Owens Maple Owens PureStyle™	Antico PureStyle™ Brookway Cherry Felix Cherry Forte Cherry Kersey Cherry Klewin Hickory Klewin Maple Owens Cherry	Adair Maple Adair PureStyle™ Keegan Maple	Valero Maple	Adair Cherry Keegan Cherry	Klewin Cherry	Valero Cherry
		8	9	10	11	12	13	14	15	16	17	18	19
MW2436	6.6	1290	1312	1368	1399	1422	1408	1483	1448	1530	1485	1545	1569
MW2736	6.8	1403	1425	1481	1512	1535	1521	1596	1562	1643	1599	1658	1682
MW3036	10.0	1703	1723	1793	1820	1847	1823	1913	1862	1959	1894	1972	1992

Custom Modifications	AUTHL AUTHR	CBO	CCO	CFNT0	CFRMO	CND	FB	FPEB	ID	MIP	P	RD
	•		•	•	•		STD	•	•	STD		

Construction Upgrades	VPL	Decorative Door Options	CG	MD	Smart Stop Options	INTGH
			•			•

MW2439	8.7	1403	1425	1481	1512	1535	1521	1596	1562	1643	1599	1658	1682
MW2739	9.7	1516	1538	1594	1625	1648	1635	1710	1675	1756	1712	1771	1795
MW3039	10.7	1816	1836	1906	1933	1960	1936	2026	1975	2072	2007	2085	2105

Custom Modifications	AUTHL AUTHR	CBO	CCO	CFNT0	CFRMO	CND	FB	FPEB	ID	MIP	P	RD
	•		•	•	•		STD	•	•	STD		

Construction Upgrades	VPL	Decorative Door Options	CG	MD	Smart Stop Options	INTGH
			•			•

MW2442	9.4	1516	1538	1594	1625	1648	1635	1710	1675	1756	1712	1771	1795
MW2742	10.4	1629	1651	1708	1738	1761	1748	1823	1788	1869	1825	1884	1908
MW3042	11.5	1930	1949	2019	2046	2073	2049	2139	2088	2186	2120	2198	2218

Custom Modifications	AUTHL AUTHR	CBO	CCO	CFNT0	CFRMO	CND	FB	FPEB	ID	MIP	P	RD
	•		•	•	•		STD	•	•	STD		

Construction Upgrades	VPL	Decorative Door Options	CG	MD	Smart Stop Options	INTGH
			•			•

**WALL BUILT-IN MICROWAVE CABINET,  
18" or 21" HIGH**

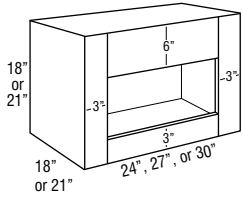

Model	Factory Opening	Maximum Cut Out
2418	18W x 9H	22 1/2W x 15H
2421	18W x 12H	22 1/2W x 18H
2718	21W x 9H	25 1/2W x 15H
2721	21W x 12H	25 1/2W x 18H
3018	24W x 9H	28 1/2W x 15H
3021	24W x 12H	28 1/2W x 18H

Model	Cubic Feet	Finish						
		Tori Oak	Westburke Oak	Tori Hickory Tori Maple	Loren Laminate Tori Cherry Westburke Hickory Westburke Maple Westburke PureStyle™	Galio Oak Gambrell Oak Kesper Oak Renaist Oak	Westburke Cherry	Brookway Oak Bryant Hickory Bryant Maple Bryant PureStyle™ Calio Maple Hurley Hickory Hurley Maple Kesper Maple Kessy Oak Renaist PureStyle™ Renaist PureStyle™
		1	2	3	4	5	6	7
<b>WBMW241818</b>	4.5	411	411	411	411	411	411	411
<b>WBMW271818</b>	4.6	434	434	434	434	434	434	434
<b>WBMW301818</b>	6.9	462	462	462	462	462	462	462
<b>WBMW242118</b>	5.3	467	467	467	467	467	467	467
<b>WBMW272118</b>	5.4	489	489	489	489	489	489	489
<b>WBMW302118</b>	8.0	516	516	516	516	516	516	516
<b>WBMW241821</b>	5.3	467	467	467	467	467	467	467
<b>WBMW271821</b>	6.8	489	489	489	489	489	489	489
<b>WBMW301821</b>	8.2	516	516	516	516	516	516	516
<b>WBMW242121</b>	6.1	522	522	522	522	522	522	522
<b>WBMW272121</b>	8.4	544	544	544	544	544	544	544
<b>WBMW302121</b>	9.5	572	572	572	572	572	572	572

- Microwave cabinet must be attached to wall stud and adjacent cabinets on both sides for support.
- When placed at a different height than adjacent cabinet, skins or FPEB option should be applied to taller cabinets in the run for correct reveal on each side.

Model	Cubic Feet	Cantrill Maple	Bryant Cherry Hurley Cherry Norris Maple Norris PureStyle™	Cairo Cherry Kesper Cherry Reist Cherry	Klewin Oak	Brookway Maple Cantrill Cherry Kersey Hickory Kersey Maple Norris Cherry	Felix Hickory Felix Maple Forte Hickory Forte Maple Forte PureStyle™ Owens Maple Owens PureStyle™	Amico PureStyle™ Brookway Cherry Felix Cherry Forte Cherry Kersey Hickory Klewin Hickory Owens Cherry	Adair Maple Adair PureStyle™ Keegan Maple	Valero Maple	Adair Cherry Keegan Cherry	Klewin Cherry	Valero Cherry
		8	9	10	11	12	13	14	15	16	17	18	19
WBMW241818	4.5	411	411	411	411	411	411	411	411	411	411	411	411
WBMW271818	4.6	434	434	434	434	434	434	434	434	434	434	434	434
WBMW301818	6.9	462	462	462	462	462	462	462	462	462	462	462	462
WBMW242118	5.3	467	467	467	467	467	467	467	467	467	467	467	467
WBMW272118	5.4	489	489	489	489	489	489	489	489	489	489	489	489
WBMW302118	8.0	516	516	516	516	516	516	516	516	516	516	516	516
WBMW241821	5.3	467	467	467	467	467	467	467	467	467	467	467	467
WBMW271821	6.8	489	489	489	489	489	489	489	489	489	489	489	489
WBMW301821	8.2	516	516	516	516	516	516	516	516	516	516	516	516
WBMW242121	6.1	522	522	522	522	522	522	522	522	522	522	522	522
WBMW272121	8.4	544	544	544	544	544	544	544	544	544	544	544	544
WBMW302121	9.5	572	572	572	572	572	572	572	572	572	572	572	572

Custom Modifications	AUTHL AUTHR	CBO	CCO	CFNTO	CFRMO	CND	FB	FPEB	ID	MIP	P	RD
	•	•	•		•		•	•	•	•		•

Construction Upgrades	VPL	Decorative Door Options	CG	MD	Smart Stop Options	INTGH
	•					

**WALL BUILT-IN MICROWAVE DOUBLE DOOR CABINET, 30" or 33" HIGH, 18" or 21" DEEP**

24", 27", or 30"

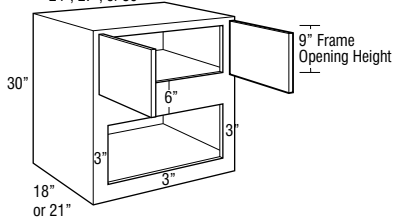

**WBMW243018**  
**WBMW273018**  
**WBMW303018**

**WBMW243021**  
**WBMW273021**  
**WBMW303021**

24", 27", or 30"

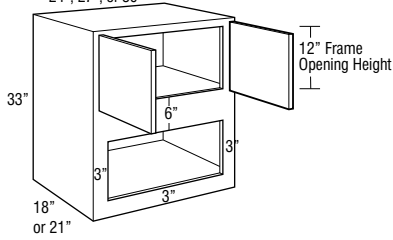

**WBMW243318**  
**WBMW273318**  
**WBMW303318**

**WBMW243321**  
**WBMW273321**  
**WBMW303321**

Model	Factory Opening	Maximum Cut Out
2430	18W x 10 1/2H	22 1/2W x 16 3/4H
2433	18W x 10 1/2H	22 1/2W x 16 3/4H
2730	21W x 10 1/2H	25 1/2W x 16 3/4H
2733	21W x 10 1/2H	25 1/2W x 16 3/4H
3030	24W x 10 1/2H	28 1/2W x 16 3/4H
3033	24W x 10 1/2H	28 1/2W x 16 3/4H

Model	Cubic Feet	Finish						
		Tori Oak	Westburke Oak	Tori Hickory Tori Maple	Loren Laminate Tori Cherry Westburke Hickory Westburke Maple Westburke PureStyle™	Calio Oak Gantrell Oak Kesper Oak Reins Oak	Westburke Cherry	Brookway Oak Bryant Hickory Bryant Maple Bryant PureStyle™ Calio Maple Hurley Hickory Hurley Maple Kesper Maple Kesper Oak Reins Maple Reins PureStyle™
<b>WBMW243018</b>	7.5	568	592	643	672	697	701	749
<b>WBMW273018</b>	10.5	583	608	657	688	714	718	768
<b>WBMW303018</b>	11.6	605	630	686	715	743	747	800
<b>WBMW243318</b>	8.3	625	652	710	741	770	773	830
<b>WBMW273318</b>	11.3	643	669	730	763	794	796	854
<b>WBMW303318</b>	12.5	669	697	760	794	827	829	889
<b>WBMW243021</b>	8.8	624	648	699	728	751	757	805
<b>WBMW273021</b>	9.8	638	662	712	743	770	772	823
<b>WBMW303021</b>	10.9	661	686	741	771	799	803	855
<b>WBMW243321</b>	9.7	680	706	766	796	825	829	885
<b>WBMW273321</b>	10.6	698	725	785	818	849	850	909
<b>WBMW303321</b>	13.4	725	752	815	849	881	884	945

- Microwave cabinet must be attached to wall stud and adjacent cabinets on both sides for support.
- When placed at a different height than adjacent cabinet, skins or FPEB option should be applied to taller cabinets in the run for correct reveal on each side.

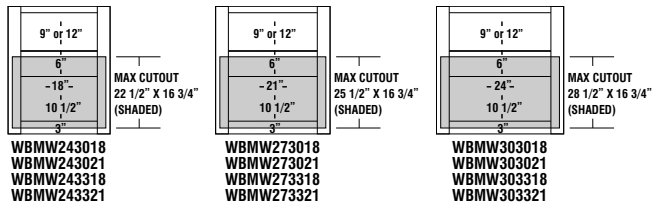

**WBMW243018**  
**WBMW243021**  
**WBMW243318**  
**WBMW243321**

**WBMW273018**  
**WBMW273021**  
**WBMW273318**  
**WBMW273321**

**WBMW303018**  
**WBMW303021**  
**WBMW303318**  
**WBMW303321**

Model	Cubic Feet	Cantrill Maple	Bryant Cherry Hurley Cherry Norris Maple Norris PureStyle™	Cairo Cherry Kasper Cherry Reist Cherry	Klewin Oak	Brockway Maple Cantrill Cherry Kersey Hickory Kersey Maple Norris Cherry	Felix Hickory Felix Maple Forte Hickory Forte Maple Forte PureStyle™ Owens Maple Owens PureStyle™	Amico PureStyle™ Brockway Cherry Felix Cherry Forte Cherry Kersey Cherry Klewin Hickory Klewin Maple Owens Cherry	Adair Maple Adair PureStyle™ Keegan Maple	Valero Maple	Adair Cherry Keegan Cherry	Klewin Cherry	Valero Cherry
		8	9	10	11	12	13	14	15	16	17	18	19
<b>WBMW243018</b>	7.5	781	806	834	888	892	923	963	981	1028	1051	1057	1100
<b>WBMW273018</b>	10.5	800	827	855	914	918	949	989	1006	1056	1080	1086	1131
<b>WBMW303018</b>	11.6	833	864	893	952	955	987	1032	1049	1099	1128	1130	1182
<b>WBMW243318</b>	8.3	866	894	926	988	989	1026	1071	1090	1142	1171	1174	1226
<b>WBMW273318</b>	11.3	891	922	954	1018	1020	1058	1103	1123	1176	1206	1209	1263
<b>WBMW303318</b>	12.5	928	960	993	1061	1064	1102	1152	1172	1228	1259	1262	1320
<b>WBMW243021</b>	8.8	837	861	889	944	948	979	1018	1036	1084	1105	1112	1155
<b>WBMW273021</b>	9.8	855	882	911	968	974	1004	1044	1062	1111	1135	1141	1186
<b>WBMW303021</b>	10.9	888	919	949	1007	1011	1042	1088	1104	1154	1183	1185	1238
<b>WBMW243321</b>	9.7	920	950	982	1043	1044	1080	1127	1145	1197	1225	1229	1281
<b>WBMW273321</b>	10.6	946	978	1009	1073	1075	1113	1159	1178	1232	1260	1264	1319
<b>WBMW303321</b>	13.4	984	1016	1049	1116	1119	1158	1208	1227	1283	1315	1318	1375

Custom Modifications	AUTHL AUTHR	CBO	CCO	CFNTO	CFRMO	CND	FB	FPEB	ID	MIP	P	RD
	•	•	•	•	•		•	•	•	•		•

Construction Upgrades	VPL	Decorative Door Options	CG	MD	Smart Stop Options	INTGH
	•		•			•



**WALL BUILT-IN MICROWAVE DOUBLE DOOR CABINET, 36", 39", or 42" HIGH, 18" or 21" DEEP**

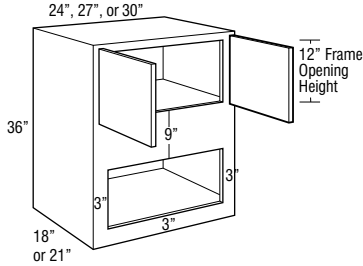

- WBMW243618**
- WBMW273618**
- WBMW303618**
- WBMW243621**
- WBMW273621**
- WBMW303621**

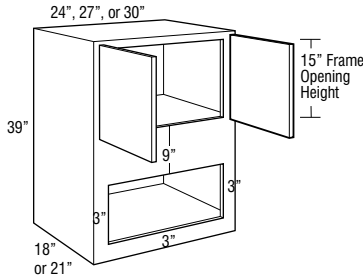

- WBMW243918**
- WBMW273918**
- WBMW303918**
- WBMW243921**
- WBMW273921**
- WBMW303921**

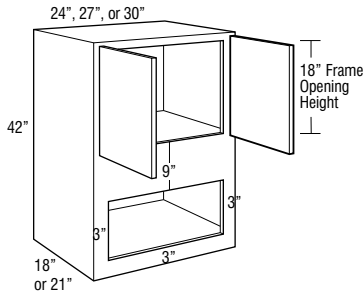

- WBMW244218**
- WBMW274218**
- WBMW304218**
- WBMW244221**
- WBMW274221**
- WBMW304221**

Model	Factory Opening	Maximum Cut Out
2436	18W x 10 1/2H	22 1/2W x 19 3/4H
2439	18W x 10 1/2H	22 1/2W x 19 3/4H
2442	18W x 10 1/2H	22 1/2W x 19 3/4H
2736	21W x 10 1/2H	25 1/2W x 19 3/4H
2739	21W x 10 1/2H	25 1/2W x 19 3/4H
2742	21W x 10 1/2H	25 1/2W x 19 3/4H
3036	24W x 10 1/2H	28 1/2W x 19 3/4H
3039	24W x 10 1/2H	28 1/2W x 19 3/4H
3042	24W x 10 1/2H	28 1/2W x 19 3/4H

Model	Cubic Feet	Material						
		Tori Oak	Westburke Oak	Tori Hickory Tori Maple	Loren Laminate Tori Cherry Westburke Hickory Westburke Maple Westburke PureStyle™	Calio Oak Gantrell Oak Kesper Oak Reins Oak	Westburke Cherry	Brookway Oak Bryant Hickory Bryant Maple Calio Maple Hurley Hickory Kesper Maple Kessy Oak Reins PureStyle™
<b>WBMW243618</b>	9.0	639	666	728	759	788	791	850
<b>WBMW273618</b>	12.1	657	685	748	781	813	815	876
<b>WBMW303618</b>	13.3	685	713	778	813	847	849	912

<b>WBMW243918</b>	9.8	676	705	768	802	834	837	900
<b>WBMW273918</b>	13.5	696	727	793	827	861	864	928
<b>WBMW303918</b>	14.9	727	758	824	861	897	900	967

<b>WBMW244218</b>	10.5	711	741	810	847	881	883	951
<b>WBMW274218</b>	14.0	734	765	837	875	910	912	983
<b>WBMW304218</b>	15.5	765	798	870	911	950	952	1024

<b>WBMW243621</b>	10.5	694	721	782	813	844	846	906
<b>WBMW273621</b>	11.4	712	740	804	837	869	870	930
<b>WBMW303621</b>	15.8	740	769	834	869	902	905	967

<b>WBMW243921</b>	11.4	732	761	823	856	889	892	955
<b>WBMW273921</b>	15.0	750	781	848	882	918	919	984
<b>WBMW303921</b>	18.4	781	812	880	918	953	955	1023

<b>WBMW244221</b>	12.3	767	797	866	902	937	939	1006
<b>WBMW274221</b>	13.2	790	820	892	929	965	967	1038
<b>WBMW304221</b>	17.1	820	853	925	966	1005	1007	1079

- Microwave cabinet must be attached to wall stud and adjacent cabinets on both sides for support.
- When placed at a different height than adjacent cabinet, skins or FPFB option should be applied to taller cabinets in the run for correct reveal on each side.
- When CG is specified, face frame will be visible through door if used with a translucent glass design.

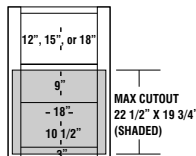

- WBMW243618**
- WBMW243621**
- WBMW243918**
- WBMW243921**
- WBMW244218**
- WBMW244221**

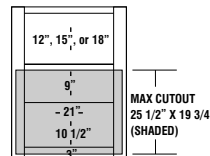

- WBMW273618**
- WBMW273621**
- WBMW273918**
- WBMW273921**
- WBMW274218**
- WBMW274221**

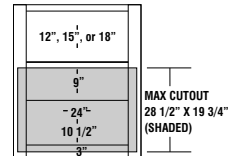

- WBMW303618**
- WBMW303621**
- WBMW303918**
- WBMW303921**
- WBMW304218**
- WBMW304221**

Model	Cubic Feet	Cantrill Maple	Bryant Cherry Hurley Cherry Norris Maple Norris PureStyle™	Cairo Cherry Kesper Cherry Reist Cherry	Klewin Oak	Brockway Maple Cantrill Cherry Kersey Hickory Kersey Maple Norris Cherry	Felix Hickory Felix Maple Forte Hickory Forte Maple Forte PureStyle™ Owens Maple Owens PureStyle™	Amico PureStyle™ Brockway Cherry Felix Cherry Forte Cherry Kersey Cherry Klewin Hickory Klewin Maple Owens Cherry	Adair Maple Adair PureStyle™ Keegan Maple	Valero Maple	Adair Cherry Keegan Cherry	Klewin Cherry	Valero Cherry
		8	9	10	11	12	13	14	15	16	17	18	19
WBMW243618	9.0	886	916	949	1013	1014	1052	1098	1117	1171	1201	1204	1258
WBMW273618	12.1	914	946	979	1043	1045	1086	1132	1151	1206	1237	1240	1296
WBMW303618	13.3	952	984	1018	1089	1091	1131	1182	1203	1260	1292	1295	1354
WBMW243918	9.8	938	970	1005	1072	1074	1116	1165	1184	1241	1272	1277	1334
WBMW273918	13.5	968	1003	1038	1106	1113	1152	1205	1224	1283	1316	1321	1379
WBMW303918	14.9	1011	1044	1085	1155	1159	1203	1256	1277	1339	1373	1378	1441
WBMW244218	10.5	991	1025	1063	1132	1135	1179	1232	1252	1312	1345	1352	1411
WBMW274218	14.0	1024	1061	1098	1173	1176	1218	1275	1295	1358	1394	1399	1461
WBMW304218	15.5	1068	1104	1147	1222	1227	1271	1329	1353	1419	1456	1459	1528
WBMW243621	10.5	941	971	1004	1068	1069	1106	1153	1173	1225	1255	1259	1313
WBMW273621	11.4	968	1001	1034	1099	1101	1141	1187	1207	1261	1292	1295	1352
WBMW303621	15.8	1007	1039	1073	1144	1146	1186	1238	1258	1315	1348	1351	1409
WBMW243921	11.4	993	1025	1061	1128	1130	1172	1220	1240	1296	1327	1332	1390
WBMW273921	15.0	1024	1059	1094	1162	1168	1208	1260	1280	1338	1371	1376	1433
WBMW303921	18.4	1066	1100	1138	1211	1214	1258	1312	1332	1395	1429	1432	1497
WBMW244221	12.3	1045	1080	1118	1187	1190	1235	1286	1307	1367	1400	1407	1467
WBMW274221	13.2	1079	1116	1153	1227	1232	1275	1330	1351	1414	1449	1455	1516
WBMW304221	17.1	1124	1160	1203	1278	1283	1326	1385	1408	1474	1511	1514	1583

Custom Modifications	AUTHL AUTHR	CBO	CCO	CFNTO	CFRMO	CND	FB	FPEB	ID	MIP	P	RD
	•	•	•	•	•		•	•	•	•		•

  

Construction Upgrades	VPL	Decorative Door Options	CG	MD	Smart Stop Options	INTGH
	•		•			•

**WALL APPLIANCE GARAGE, 18" HIGH**

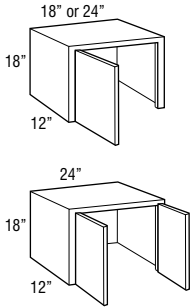

**WALL APPLIANCE GARAGE VERTICAL LIFT DOOR, 24" WIDE, 18" HIGH**

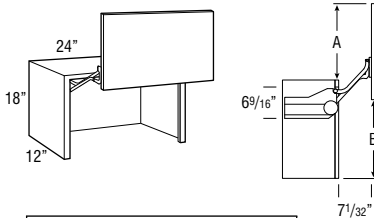

	Full Overlay	Partial Overlay
A	16 13/16"	16 1/16"
B	17 5/16"	18 1/16"

**CORNER DOOR, 18" HIGH**

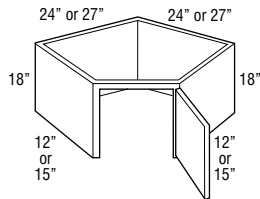

Model	Cubic Feet	Material						
		Tori Oak	Westburke Oak	Tori Hickory Tori Maple	Loren Laminate Tori Cherry Westburke Hickory Westburke Maple Westburke PureStyle™	Ohio Oak Gambrell Oak Kesper Oak Reist Oak	Westburke Cherry	Brookway Oak Bryant Hickory Bryant Maple PureStyle™ Ohio Maple Hurley Hickory Hurley Maple Kesper Maple Kesper Oak Reist Maple Reist PureStyle™
<b>WAGD18 L or R</b>	4.0	305	321	356	375	394	395	431
<b>WAGD24 L or R</b>	4.3	316	331	366	386	404	405	441
<b>WAGD24</b>	4.3	348	365	404	424	444	445	483

- Cabinet does not have a bottom (floor).
- Bottom edge is not trimmable.
- Standard cabinet interior, order MIP for matching interior.
- Cabinet is designed to fit beneath standard wall cabinets.
- Countertop back splash must end to set cabinet against wall.

<b>WAGVLD24</b>	4.3	1289	1306	1345	1365	1385	1386	1424
-----------------	-----	------	------	------	------	------	------	------

- Utilizes doors from 24" high wall cabinets. Grain on center panels will run horizontally and door rail configuration on non-miter doors will be unique from adjacent cabinet doors.
- Decorative hardware required.
- See side view drawing for required clearances.
- Lift mechanism features a single motion for up and out movement with Smart Stop, tension can be field adjusted.
- Lift mechanisms and mounting brackets will be visible if used with transparent textured glass.
- Lift mechanism not available for order for field installation, only available factory installed.
- Hardware extends 1" into opening on each side.
- Not available in Owens.

<b>CD2424 L or R</b>	7.8	447	470	522	549	573	575	624
<b>CD2727 L or R</b>	8.3	487	512	567	595	624	625	681

- CD2424 L or R requires 24" x 24" corner wall space.
- CD2727 L or R requires 27" x 27" corner wall space.
- Cabinet is designed to fit beneath Diagonal Wall Cabinets.
- Inside is maple laminate, and finished exterior.
- Does not have floor or top.
- Full overlay styles use the same width doors as partial overlay styles (14 1/2" wide) with a partial overlay hinge (38NPOHINGE) to allow for proper door clearance with adjacent cabinets.

Model	Cubic Feet	Cantrill Maple	Bryant Cherry Hurley Cherry Norris Maple Norris PureStyle™	Cairo Cherry Kasper Cherry Reist Cherry	Klewin Oak	Brockway Maple Cantrill Cherry Kersey Hickory Kersey Maple Norris Cherry	Felix Hickory Felix Maple Forte Hickory Forte Maple Forte PureStyle™ Owens Maple Owens PureStyle™	Amico PureStyle™ Brockway Cherry Felix Cherry Forte Cherry Kersey Hickory Klewin Hickory Klewin Maple Owens Cherry	Adair Maple Adair PureStyle™ Keegan Maple	Valero Maple	Adair Cherry Keegan Cherry	Klewin Cherry	Valero Cherry
		8	9	10	11	12	13	14	15	16	17	18	19
WAGD18 L or R	4.0	452	468	488	525	526	547	575	587	617	636	637	669
WAGD24 L or R	4.3	463	478	499	536	537	557	585	597	627	647	648	680
WAGD24	4.3	508	527	550	588	591	614	646	657	692	711	712	748

Custom Modifications	AUTHL AUTHR	CBO	CCO	CFNT0	CFRMO	CND	FB	FPEB	ID	MIP	P	RD
	•		•	•	•		•	•	•	•		•

Construction Upgrades	VPL	Decorative Door Options	CG	MD	Smart Stop Options	INTGH
	•					•

WAGVLD24	4.3	1449	1468	1491	1529	1532	1555	1587	1598	1633	1652	1653	1689
----------	-----	------	------	------	------	------	------	------	------	------	------	------	------

Custom Modifications	AUTHL AUTHR	CBO	CCO	CFNT0	CFRMO	CND	FB	FPEB	ID	MIP	P	RD
	•		•		•		•	•	•	•		

Construction Upgrades	VPL	Decorative Door Options	CG	MD	Smart Stop Options	INTGH
	•					•

CD2424 L or R	7.8	655	681	708	761	762	794	832	848	892	919	921	965
CD2727 L or R	8.3	711	739	769	825	830	861	906	921	968	998	1001	1051

Custom Modifications	AUTHL AUTHR	CBO	CCO	CFNT0	CFRMO	CND	FB	FPEB	ID	MIP	P	RD
	•		•	•	•		•	•		•		

Construction Upgrades	VPL	Decorative Door Options	CG	MD	Smart Stop Options	INTGH
	•					•

**WALL BOX COLUMN PULL-OUT with OVERLAY**

LOGIX™

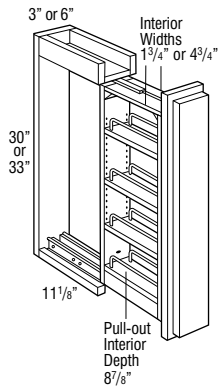

**WBCPO\_300L  
WBCPO\_330L**

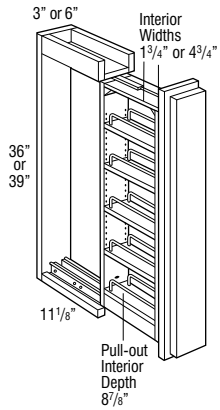
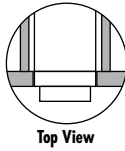

**WBCPO\_360L  
WBCPO\_390L**

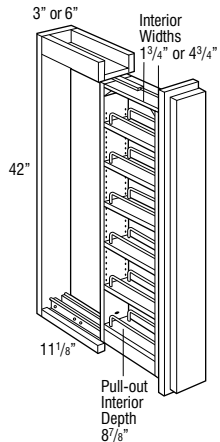

**WBCPO\_420L**

Model	Cubic Feet	Finish						
		Tori Oak	Westburke Oak	Tori Hickory Tori Maple	Loren Laminate Tori Cherry Westburke Hickory Westburke Maple Westburke PureStyle™	Calio Oak Gantrell Oak Kesper Oak Renaist Oak	Westburke Cherry	Brookway Oak Bryant Hickory Bryant Maple Bryant PureStyle™ Calio Maple Hurley Hickory Hurley Maple Kesper Maple Kersey Oak Renaist PureStyle™ Renaist PureStyle™
		1	2	3	4	5	6	7
<b>WBCPO3300L</b>	0.6	800	800	800	800	800	800	800
<b>NEW WBCPO3330L</b>	1.3	840	840	840	840	840	840	840
<b>NEW WBCPO3360L</b>	1.4	880	880	880	880	880	880	880
<b>NEW WBCPO3390L</b>	1.5	920	920	920	920	920	920	920
<b>NEW WBCPO3420L</b>	1.6	960	960	960	960	960	960	960
<b>WBCPO6300L</b>	1.3	1014	1014	1014	1014	1014	1014	1014
<b>NEW WBCPO6330L</b>	2.2	1054	1054	1054	1054	1054	1054	1054
<b>NEW WBCPO6360L</b>	2.4	1094	1094	1094	1094	1094	1094	1094
<b>NEW WBCPO6390L</b>	2.6	1134	1134	1134	1134	1134	1134	1134
<b>NEW WBCPO6420L</b>	2.7	1174	1174	1174	1174	1174	1174	1174

- Recommend installation between two cabinets. Can be installed on the end of a run with the use of a 3/4" thick end panel.
- Includes profiled full overlay filler.
- All styles feature a natural finish full extension wood pull-out with adjustable shelves and chrome rail sides.
- If used at the end of a run or next to an appliance, an End Panel must be installed on the pull-out adjacent to the end of run/appliance.
- In order to allow proper clearance for opening and closing, allow an additional 1/8" space between adjacent cabinet face frames. The 3" wide pull-outs require 3 1/8" space and the 6" wide pull-outs require 6 1/8" space. Spacers are included with the pull-outs to allow for proper installation.
- Not compatible with face mount moulding.

Model	Cubic Feet	Cantrill Maple	Bryant Cherry Hurley Cherry Norris Maple Norris PureStyle™	Cairo Cherry Kasper Cherry Reisat Cherry	Klewin Oak	Brookway Maple Cantrill Cherry Kersey Hickory Kersey Maple Norris Cherry	Felix Hickory Felix Maple Forte Hickory Forte Maple Forte PureStyle™ Owens Maple Owens PureStyle™	Amico PureStyle™ Brookway Cherry Felix Cherry Forte Cherry Kersey Cherry Klewin Hickory Klewin Maple Owens Cherry	Adair Maple Adair PureStyle™ Keegan Maple	Wilero Maple	Adair Cherry Keegan Cherry	Klewin Cherry	Wilero Cherry
		8	9	10	11	12	13	14	15	16	17	18	19
WBCPO3300L	0.6	800	800	800	800	800	800	800	800	800	800	800	800
WBCPO3330L	1.3	840	840	840	840	840	840	840	840	840	840	840	840
WBCPO3360L	1.4	880	880	880	880	880	880	880	880	880	880	880	880
WBCPO3390L	1.5	920	920	920	920	920	920	920	920	920	920	920	920
WBCPO3420L	1.6	960	960	960	960	960	960	960	960	960	960	960	960
WBCPO6300L	1.3	1014	1014	1014	1014	1014	1014	1014	1014	1014	1014	1014	1014
WBCPO6330L	2.2	1054	1054	1054	1054	1054	1054	1054	1054	1054	1054	1054	1054
WBCPO6360L	2.4	1094	1094	1094	1094	1094	1094	1094	1094	1094	1094	1094	1094
WBCPO6390L	2.6	1134	1134	1134	1134	1134	1134	1134	1134	1134	1134	1134	1134
WBCPO6420L	2.7	1174	1174	1174	1174	1174	1174	1174	1174	1174	1174	1174	1174

MODIFICATIONS
No modifications available for these products.

**WALL SPICE PULL-OUT, 30", 33", 36", 39", or 42" HIGH** L O G I X

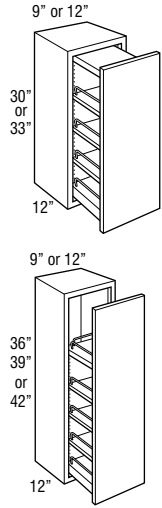

Model	Cubic Feet	Finish						
		Tori Oak	Westburke Oak	Tori Hickory Tori Maple	Loren Laminate Tori Cherry Westburke Hickory Westburke Maple Westburke PureStyle™	Calio Oak Gantrell Oak Kesper Oak Rens Oak	Westburke Cherry	Brookway Oak Bryant Hickory Bryant Maple Calio Maple Hurley Hickory Hurley Maple Kesper Maple Kessy Oak Rens PureStyle™
		1	2	3	4	5	6	7
WSP930	2.9	784	798	829	848	865	865	897
WSP1230	3.7	830	847	881	901	916	919	953
WSP933	3.2	816	832	867	887	904	907	943
WSP1233	4.1	866	884	923	944	960	964	1000
WSP936	3.5	824	840	876	897	915	918	955
WSP1236	4.4	876	893	933	954	971	975	1012
WSP939	3.7	845	860	902	923	941	943	982
WSP1239	4.7	897	915	959	981	1001	1003	1044
WSP942	4.0	865	883	926	946	968	969	1010
WSP1242	5.1	917	937	984	1007	1029	1032	1075

- 30" high units include a natural finish, full extension wood pull-out with three adjustable shelves, one fixed shelf, and chrome finish rail sides.
- Wood plugs for top of 30" high pull-out included for field installation.
- 36" to 42" high units include a natural finish, full extension wood pull-out with three adjustable shelves, two fixed shelves, and chrome finish rail sides.
- Wire for top rail on 36" to 42" high pull-out included separately for field installation.
- For full access from both sides of unit, do not install against a wall or next to deeper appliances and cabinets.
- Pull-out does not have Smart Stop feature.

**WALL SPICE PULL DOWN** L O G I X

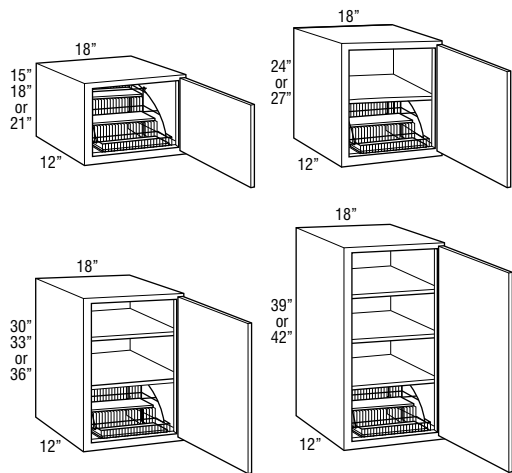

W1815SPD L or R	2.8	535	551	585	603	621	621	656
W1818SPD L or R	3.2	522	536	569	588	604	606	638
W1821SPD L or R	3.7	539	556	591	610	629	630	663
W1824SPD L or R	4.2	549	564	602	622	640	642	675
W1827SPD L or R	4.7	573	590	630	647	671	673	709
W1830SPD L or R	5.2	584	601	641	662	683	683	725
W1833SPD L or R	5.7	624	644	688	713	736	739	780
W1836SPD L or R	6.2	634	655	699	727	749	752	794
W1839SPD L or R	6.6	660	681	728	754	780	781	827
W1842SPD L or R	7.1	683	706	755	783	811	811	861

- Spice Rack Pull Down dimensions: 8 15/16" high x 14 13/16" wide x 10 5/16" deep.
- Interior dimensions of pull down trays: 11 3/4" wide x 3" deep.
- Maximum Weight Capacity for Spice Rack Pull Down: 15 lbs.
- When Increased Depth (ID) is ordered, insert will not increase in size.

Model	Cubic Feet	Canterell Maple	Bryant Cherry Hurley Cherry Norris Maple Norris PureStyle™	Cairo Cherry Kasper Cherry Reist Cherry	Klewin Oak	Brockway Maple Canterell Cherry Kersey Hickory Kersey Maple Norris Cherry	Falk Hickory Falk Maple Forte Hickory Forte Maple Forte PureStyle™ Owens Maple Owens PureStyle™	Antico PureStyle™ Brockway Cherry Falk Cherry Forte Cherry Kersey Cherry Klewin Hickory Klewin Maple Owens Cherry	Adair Maple Adair PureStyle™ Keegan Maple	Wilero Maple	Adair Cherry Keegan Cherry	Klewin Cherry	Wilero Cherry
		8	9	10	11	12	13	14	15	16	17	18	19
WSP930	2.9	916	934	952	985	986	1005	1032	1042	1071	1087	1089	1118
WSP1230	3.7	972	992	1010	1046	1047	1071	1096	1107	1139	1156	1159	1190
WSP933	3.2	964	982	1003	1042	1043	1065	1093	1102	1135	1154	1156	1188
WSP1233	4.1	1024	1045	1066	1106	1107	1131	1160	1174	1208	1227	1230	1265
WSP936	3.5	976	995	1015	1056	1057	1079	1109	1117	1150	1170	1173	1205
WSP1236	4.4	1037	1059	1079	1121	1122	1146	1177	1190	1225	1245	1248	1284
WSP939	3.7	1006	1027	1047	1089	1091	1115	1146	1156	1194	1212	1215	1251
WSP1239	4.7	1070	1092	1114	1159	1160	1185	1218	1230	1267	1290	1292	1331
WSP942	4.0	1035	1057	1079	1121	1125	1149	1183	1197	1233	1254	1257	1295
WSP1242	5.1	1101	1123	1147	1195	1197	1225	1259	1270	1311	1333	1337	1375

Custom Modifications	AUTHL AUTHR	CBO	CCO	CFNTO	CFRMO	CND	FB	FPEB	ID	MIP	P	RD
	•	•	•		•		•	•		•		

Construction Upgrades	VPL	Decorative Door Options	CG	MD	Smart Stop Options	INTGH
	•					

W1815SPD L or R	2.8	675	695	712	747	751	771	798	808	839	854	857	887
W1818SPD L or R	3.2	659	673	693	727	728	746	772	783	812	828	829	859
W1821SPD L or R	3.7	682	701	718	755	759	780	807	818	849	866	868	900
W1824SPD L or R	4.2	698	714	734	772	777	796	823	837	868	884	887	919
W1827SPD L or R	4.7	732	751	772	813	815	838	867	881	915	934	937	970
W1830SPD L or R	5.2	747	768	788	830	833	855	886	902	937	956	959	993
W1833SPD L or R	5.7	807	829	853	898	901	928	964	975	1015	1038	1040	1081
W1836SPD L or R	6.2	821	845	869	916	919	947	984	994	1035	1059	1061	1104
W1839SPD L or R	6.6	856	881	908	959	960	990	1027	1041	1083	1109	1111	1155
W1842SPD L or R	7.1	891	918	946	999	1000	1033	1073	1087	1134	1158	1161	1209

Custom Modifications	AUTHL AUTHR	CBO	CCO	CFNTO	CFRMO	CND	FB	FPEB	ID	MIP	P	RD
	•	•	•	•	•		•	•	•	•		

Construction Upgrades	VPL	Decorative Door Options	CG	MD	Smart Stop Options	INTGH
	•		•	•		•



**WALL SPICE RACK CABINET, 30", 33", 36", 39", or 42" HIGH**

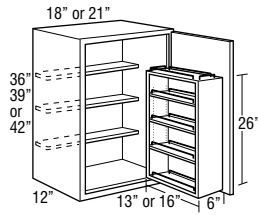
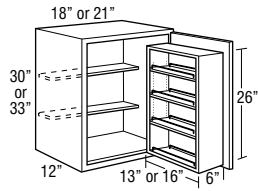

Model	Cubic Feet	Finish						
		Tori Oak	Westburke Oak	Tori Hickory Tori Maple	Loren Laminate Tori Cherry Westburke Hickory Westburke Maple Westburke PureStyle™	Galio Oak Gantrell Oak Kesper Oak Renaist Oak	Westburke Cherry	Brookway Oak Bryant Hickory Bryant Maple Cairo Maple Hurley Hickory Hurley Maple Kesper Maple Kesper Oak Renaist PureStyle™ Renaist PureStyle™
		1	2	3	4	5	6	7
<b>WSR1830 L or R</b>	5.3	1281	1298	1338	1359	1380	1380	1422
<b>WSR2130 L or R</b>	6.1	1313	1332	1374	1400	1423	1425	1466
<b>WSR1833 L or R</b>	5.8	1321	1341	1385	1410	1433	1436	1477
<b>WSR2133 L or R</b>	6.6	1356	1378	1426	1452	1478	1479	1526
<b>WSR1836 L or R</b>	6.3	1331	1352	1396	1424	1446	1449	1491
<b>WSR2136 L or R</b>	7.2	1367	1390	1438	1466	1491	1492	1542
<b>WSR1839 L or R</b>	6.8	1357	1378	1425	1451	1477	1478	1524
<b>WSR2139 L or R</b>	7.8	1396	1419	1470	1499	1525	1527	1580
<b>WSR1842 L or R</b>	7.3	1380	1403	1452	1480	1508	1508	1558
<b>WSR2142 L or R</b>	8.3	1424	1449	1503	1534	1560	1563	1618

- Adjustable shelves are 4 1/2" deep.
- Field installed swing-out has three adjustable and one fixed bottom shelf with chrome finish wire rail sides.
- Dimensions: WSR18 wood insert is 26" high x 13" wide x 6" deep. WSR21 wood insert is 26" high x 16" wide x 6" deep.
- When Increased Depth (ID) is ordered, wood insert will not increase in size.

Model	Cubic Feet	Cantrill Maple	Bryant Cherry Hurley Cherry Norris Maple Norris PureStyle™	Cairo Cherry Kasper Cherry Reist Cherry	Klewin Oak	Brockway Maple Cantrill Cherry Kersey Hickory Kersey Maple Norris Cherry	Felix Hickory Felix Maple Forte Hickory Forte Maple Forte PureStyle™ Owens Maple Owens PureStyle™	Antico PureStyle™ Brockway Cherry Felix Cherry Forte Cherry Kersey Cherry Klewin Hickory Klewin Maple Owens Cherry	Adair Maple Adair PureStyle™ Keegan Maple	Valero Maple	Adair Cherry Keegan Cherry	Klewin Cherry	Valero Cherry
		8	9	10	11	12	13	14	15	16	17	18	19
WSR1830 L or R	5.3	1444	1465	1485	1527	1530	1552	1583	1599	1634	1653	1656	1690
WSR2130 L or R	6.1	1492	1513	1538	1582	1584	1611	1645	1660	1697	1719	1722	1762
WSR1833 L or R	5.8	1504	1526	1550	1595	1598	1625	1661	1672	1712	1735	1737	1778
WSR2133 L or R	6.6	1556	1581	1609	1656	1659	1688	1726	1742	1784	1809	1810	1855
WSR1836 L or R	6.3	1518	1542	1566	1613	1616	1644	1681	1691	1732	1756	1758	1801
WSR2136 L or R	7.2	1572	1598	1626	1674	1677	1707	1746	1763	1806	1832	1833	1879
WSR1839 L or R	6.8	1553	1578	1605	1656	1657	1687	1724	1738	1780	1806	1808	1852
WSR2139 L or R	7.8	1610	1638	1667	1721	1724	1755	1797	1813	1859	1885	1889	1938
WSR1842 L or R	7.3	1588	1615	1643	1696	1697	1730	1770	1784	1831	1855	1858	1906
WSR2142 L or R	8.3	1649	1681	1710	1769	1771	1803	1847	1865	1913	1941	1946	1994

Custom Modifications	AUTHL AUTHR	CBO	CCO	CFNTO	CFRMO	CND	FB	FPEB	ID	MIP	P	RD
	•	•	•	•	•		•	•	•	•		

Construction Upgrades	VPL	Decorative Door Options	CG	MD	Smart Stop Options	INTGH
	•		•	•		•

**WALL CHINA DISPLAY, 15" HIGH**

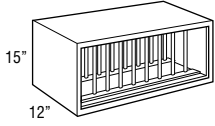

SKU	# of Plates
WCD3015	13
WCD3615	16

**WALL WINE RACK, 15", 18", or 30" HIGH**

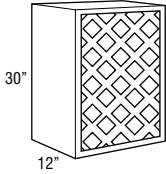
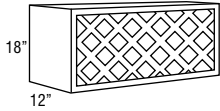
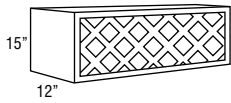

SKU	# of Bottles
WNR3015	11
WNR3615	13
WNR3018	11
WNR3618	13
WNR1530	11
WNR1830	11

**WINE STORAGE CABINET, 18" HIGH**

LOGIX

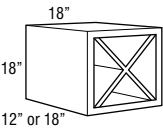

Model	Cubic Feet	Material					Westburke Cherry	Brookway Oak Bryant Hickory Bryant Maple Byram PureStyle™ Byram Maple Cala Maple Hurley Hickory Hurley Maple Kasper Maple Kessy Oak Rena PureStyle™ Rena PureStyle™
		Tori Oak	Westburke Oak	Tori Hickory Tori Maple	Loren Laminate Tori Cherry Westburke Hickory Westburke Maple Westburke PureStyle™	Cala Oak Gantrell Oak Kesper Oak Rena Oak		
WCD3015	4.5	762	762	762	762	762	762	762
WCD3615	6.0	844	844	844	844	844	844	844

- Vertical dowels are 3/8" diameter, 1 1/2" apart.
- Hardwood veneer plywood.
- Matching interior.
- Individual dowels are not removable. Complete rack assembly is removable.

WNR3015	4.5	690	690	690	690	690	690	690
WNR3615	5.4	751	751	751	751	751	751	751
WNR3018	5.3	711	711	711	711	711	711	711
WNR3618	6.3	766	766	766	766	766	766	766
WNR1530	4.5	690	690	690	690	690	690	690
WNR1830	5.3	711	711	711	711	711	711	711

- Cabinet interior finished to match cabinet face frame.
- Hardwood veneer plywood with solid wood lattice work.
- Matching interior.
- Wine bottle opening 4" x 4".

WSC181812	3.2	722	722	722	722	722	722	722
WSC181818	4.3	762	762	762	762	762	762	762

- Holds 18 standard 3 1/8" diameter wine bottles.
- WSC181818 must be installed between two cabinets, between a cabinet and a wall, or mounted to a horizontal surface.
- "X" shelf configuration cannot be removed.
- Reduced depth not recommended for safe wine bottle storage.

Model	Cubic Feet	Canterell Maple	Bryant Cherry Hurley Cherry Norris Maple Norris PureStyle™	Cairo Cherry Kasper Cherry Reist Cherry	Klewin Oak	Brockway Maple Canterell Cherry Kersey Hickory Kersey Maple Norris Cherry	Felix Hickory Felix Maple Forte Hickory Forte Maple Forte PureStyle™ Owens Maple Owens PureStyle™	Antico PureStyle™ Brockway Cherry Felix Cherry Forte Cherry Kersey Hickory Klewin Hickory Klewin Maple Owens Cherry	Adair Maple Adair PureStyle™ Keegan Maple	Valero Maple	Adair Cherry Keegan Cherry	Klewin Cherry	Valero Cherry
		8	9	10	11	12	13	14	15	16	17	18	19
WCD3015	4.5	762	762	762	762	762	762	762	762	762	762	762	762
WCD3615	6.0	844	844	844	844	844	844	844	844	844	844	844	844

Custom Modifications	AUTHL AUTHR	CBO	CCO	CFNTO	CFRMO	CND	FB	FPEB	ID	MIP	P	RD
		STD			•		STD	•		STD		

Construction Upgrades	VPL	Decorative Door Options	CG	MD	Smart Stop Options	INTGH

WNR3015	4.5	690	690	690	690	690	690	690	690	690	690	690	690
WNR3615	5.4	751	751	751	751	751	751	751	751	751	751	751	751
WNR3018	5.3	711	711	711	711	711	711	711	711	711	711	711	711
WNR3618	6.3	766	766	766	766	766	766	766	766	766	766	766	766
WNR1530	4.5	690	690	690	690	690	690	690	690	690	690	690	690
WNR1830	5.3	711	711	711	711	711	711	711	711	711	711	711	711

Custom Modifications	AUTHL AUTHR	CBO	CCO	CFNTO	CFRMO	CND	FB	FPEB	ID	MIP	P	RD
		STD			•		STD	•		STD		

Construction Upgrades	VPL	Decorative Door Options	CG	MD	Smart Stop Options	INTGH

WSC181812	3.2	722	722	722	722	722	722	722	722	722	722	722	722
WSC181818	4.3	762	762	762	762	762	762	762	762	762	762	762	762

Custom Modifications	AUTHL AUTHR	CBO	CCO	CFNTO	CFRMO	CND	FB	FPEB	ID	MIP	P	RD
							STD	•		STD		•

Construction Upgrades	VPL	Decorative Door Options	CG	MD	Smart Stop Options	INTGH

**WALL WINE CUBBY, 30", 36", or 42" WIDE, 6" HIGH**

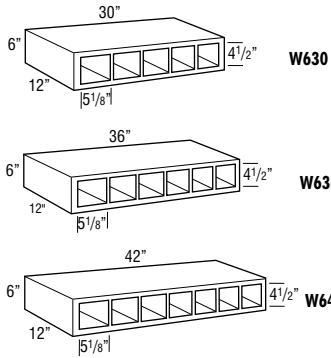

Model	Cubic Feet	Finish						
		Tori Oak	Westburke Oak	Tori Hickory Tori Maple	Loren Laminate Tori Cherry Westburke Hickory Westburke Maple Westburke PureStyle™	Calio Oak Gantrell Oak Kesper Oak Rensl Oak	Westburke Cherry	Brookway Oak Bryant Hickory Bryant Maple Calio Maple Hurley Hickory Hurley Maple Kesper Maple Kessy Oak Rensl PureStyle™ Rensl PureStyle™
<b>W630</b> (5 openings)	2.2	391	391	391	391	391	391	391
<b>W636</b> (6 openings)	2.7	430	430	430	430	430	430	430
<b>W642</b> (7 openings)	3.0	472	472	472	472	472	472	472

- Hardwood veneer on 3/4" furniture board core.
- Matching interior.
- Frameless construction.
- Increased Depth only available in 3" increments.

**WALL ORGANIZER, 30" or 36" WIDE, 6" HIGH**

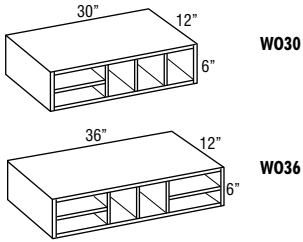

<b>W030</b>	2.2	762	762	762	762	762	762	762
<b>W036</b>	2.7	817	817	817	817	817	817	817

- Hardwood veneer on a 3/4" furniture board core.
- Frameless construction.
- Matching interior.
- Increased Depth only available in 3" increments.

**WALL SPICE DRAWER, 30", 36", or 42" WIDE, 6" HIGH**

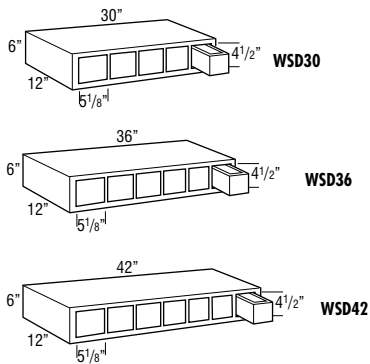

<b>WSD30</b> (5 drawers)	2.2	1077	1077	1077	1077	1077	1077	1077
<b>WSD36</b> (6 drawers)	2.7	1178	1178	1178	1178	1178	1178	1178
<b>WSD42</b> (7 drawers)	3.0	1414	1414	1414	1414	1414	1414	1414

- Drawer front is unique to item, and compatible with all existing profiles.
- Hardwood veneer on 3/4" furniture board core.
- 1/2" hardwood drawer with rabbet joint.
- Horizontal application only.
- Matching interior.
- Frameless construction.
- Increased Depth only available in 3" increments.
- Rensl PureStyle™ drawer fronts will be painted hardwood.

Model	Cubic Feet	Cantrill Maple	Bryant Cherry Hurley Cherry Norris Maple Norris PureStyle™	Cairo Cherry Kasper Cherry Reist Cherry	Klewin Oak	Brookway Maple Cantrill Cherry Kersey Hickory Kersey Maple Norris Cherry	Felix Hickory Felix Maple Forte Hickory Forte Maple Forte PureStyle™ Owens Maple Owens PureStyle™	Amico PureStyle™ Brookway Cherry Felix Cherry Forte Cherry Kersey Cherry Klewin Hickory Klewin Maple Owens Cherry	Adair Maple Adair PureStyle™ Keegan Maple	Valero Maple	Adair Cherry Keegan Cherry	Klewin Cherry	Valero Cherry
		8	9	10	11	12	13	14	15	16	17	18	19
<b>W630</b> (5 openings)	2.2	391	391	391	391	391	391	391	391	391	391	391	391
<b>W636</b> (6 openings)	2.7	430	430	430	430	430	430	430	430	430	430	430	430
<b>W642</b> (7 openings)	3.0	472	472	472	472	472	472	472	472	472	472	472	472

Custom Modifications	AUTHL AUTHR	CBO	CCO	CFNTO	CFRMO	CND	FB	FPEB	ID	MIP	P	RD
							STD		•			

Construction Upgrades	VPL	Decorative Door Options	CG	MD	Smart Stop Options	INTGH

<b>W030</b>	2.2	762	762	762	762	762	762	762	762	762	762	762	762
<b>W036</b>	2.7	817	817	817	817	817	817	817	817	817	817	817	817

Custom Modifications	AUTHL AUTHR	CBO	CCO	CFNTO	CFRMO	CND	FB	FPEB	ID	MIP	P	RD
							STD		•			

Construction Upgrades	VPL	Decorative Door Options	CG	MD	Smart Stop Options	INTGH

<b>WSD30</b> (5 drawers)	2.2	1077	1077	1077	1077	1077	1077	1077	1077	1077	1077	1077	1077
<b>WSD36</b> (6 drawers)	2.7	1178	1178	1178	1178	1178	1178	1178	1178	1178	1178	1178	1178
<b>WSD42</b> (7 drawers)	3.0	1414	1414	1414	1414	1414	1414	1414	1414	1414	1414	1414	1414

Custom Modifications	AUTHL AUTHR	CBO	CCO	CFNTO	CFRMO	CND	FB	FPEB	ID	MIP	P	RD
							STD		•			

Construction Upgrades	VPL	Decorative Door Options	CG	MD	Smart Stop Options	INTGH

**FLOATING SHELVES**

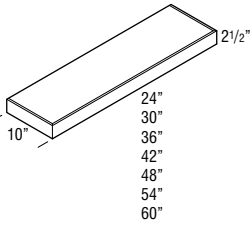

Model	Cubic Feet	Material Options						
		Tori Oak	Westburke Oak	Tori Hickory Tori Maple	Loren Laminate Tori Cherry Westburke Hickory Westburke Maple Westburke PureStyle™	Calio Oak Gantrell Oak Kesper Oak Reinsl Oak	Westburke Cherry	Brookway Oak Bryant Hickory Bryant Maple Calio Maple Hurley Hickory Hurley Maple Kesper Maple Kessy Oak Reinsl Maple Reinsl PureStyle™
		1	2	3	4	5	6	7
<b>FS24</b>	0.7	N/A	N/A	465	465	N/A	N/A	465
<b>FS30</b>	0.9	N/A	N/A	529	529	N/A	N/A	529
<b>FS36</b>	1.0	N/A	N/A	597	597	N/A	N/A	597
<b>FS42</b>	1.2	N/A	N/A	663	663	N/A	N/A	663
<b>FS48</b>	1.3	N/A	N/A	729	729	N/A	N/A	729
<b>FS54</b>	1.5	N/A	N/A	794	794	N/A	N/A	794
<b>FS60</b>	1.6	N/A	N/A	859	859	N/A	N/A	859

- Weight capacity per shelf:  
24 = 30 lbs.  
30 = 37.5 lbs.  
36 = 45 lbs.  
42 = 52.2 lbs.  
48 = 60 lbs.  
54 = 67.5 lbs.  
60 = 75 lbs.
- 3/4" thick solid wood front, back, and ends. 3/8" thick veneered plywood top and bottom. Front and ends are mitered together.

**WALL MESSAGE CENTER, 30", 33", 36", 39", or 42" HIGH, 3" DEEP**

LOGIX

Model	1.8	858	875	909	929	944	947	981
<b>WMC1230 L or R</b>	1.8	858	875	909	929	944	947	981
<b>WMC1233 L or R</b>	2.0	894	912	951	972	988	992	1028
<b>WMC1236 L or R</b>	2.2	904	921	961	982	999	1003	1040
<b>WMC1239 L or R</b>	2.5	925	943	987	1009	1029	1031	1072
<b>WMC1242 L or R</b>	2.9	945	965	1012	1035	1057	1060	1103

- Includes magnetic whiteboard on back of door, key hooks, pencil holder, and fixed plexi-glass fronted shelves.
- WMC1230, WMC1233, and WMC1236 have 2 fixed shelves. WMC1239 and WMC1242 have 3 fixed shelves.
- Not available next to a Peninsula Cabinet.
- Door will open 90° without decorative hardware.
- Cabinet should be hinged on wall side.
- For proper installation, adjacent cabinet must have FPEB or 1/4" skin applied.
- Embellishments or overlay fillers can be used on side of cabinet to add a decorative touch.

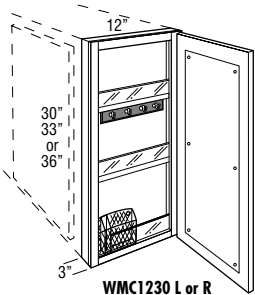

WMC1230 L or R  
WMC1233 L or R  
WMC1236 L or R

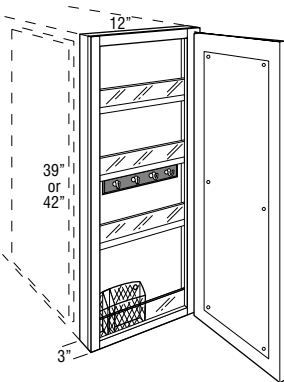

WMC1239 L or R  
WMC1242 L or R

Model	Cubic Feet	Carroll Maple	Bryant Cherry Hurley Cherry Norris Maple Norris PureStyle™	Cairo Cherry Kasper Cherry Reist Cherry	Klewin Oak	Brockway Maple Carroll Cherry Kersey Hickory Kersey Maple Norris Cherry	Felix Hickory Felix Maple Forte Hickory Forte Maple Forte PureStyle™ Owens Maple Owens PureStyle™	Amico PureStyle™ Brockway Cherry Felix Cherry Forte Cherry Kersey Cherry Klewin Hickory Klewin Maple Owens Cherry	Adair Maple Adair PureStyle™ Keegan Maple	Valero Maple	Adair Cherry Keegan Cherry	Klewin Cherry	Valero Cherry
		8	9	10	11	12	13	14	15	16	17	18	19
FS24	0.7	465	465	N/A	N/A	465	465	465	465	465	N/A	N/A	N/A
FS30	0.9	529	529	N/A	N/A	529	529	529	529	529	N/A	N/A	N/A
FS36	1.0	597	597	N/A	N/A	597	597	597	597	597	N/A	N/A	N/A
FS42	1.2	663	663	N/A	N/A	663	663	663	663	663	N/A	N/A	N/A
FS48	1.3	729	729	N/A	N/A	729	729	729	729	729	N/A	N/A	N/A
FS54	1.5	794	794	N/A	N/A	794	794	794	794	794	N/A	N/A	N/A
FS60	1.6	859	859	N/A	N/A	859	859	859	859	859	N/A	N/A	N/A

MODIFICATIONS
No modifications available for these products.

**Specie Availability**

Cherry	Hickory	Maple	Oak	Laminate	PureStyle™
		•		Maple	Maple

WMC1230 L or R	1.8	1000	1020	1038	1074	1075	1099	1124	1135	1167	1184	1187	1218
WMC1233 L or R	2.0	1052	1073	1094	1134	1135	1159	1188	1202	1236	1255	1258	1293
WMC1236 L or R	2.2	1065	1087	1107	1149	1150	1174	1205	1218	1253	1273	1276	1312
WMC1239 L or R	2.5	1098	1120	1142	1187	1188	1213	1246	1258	1295	1318	1320	1359
WMC1242 L or R	2.9	1129	1151	1175	1223	1225	1253	1287	1298	1339	1361	1365	1403

Custom Modifications	AUTHL AUTHR	CBO	CCO	CFNTO	CFRMO	CND	FB	FPEB	ID	MIP	P	RD
							STD	STD				

Construction Upgrades	VPL	Decorative Door Options	CG	MD	Smart Stop Options	INTGH
						•



**WOOD HOOD SQUARE,  
30" or 36" WIDE, 22 7/8" HIGH**

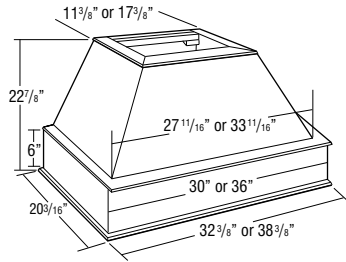

Model	Cubic Feet	Material					Westburke Cherry	7
		Tori Oak	Westburke Oak	Tori Hickory Tori Maple	Loren Laminate Tori Cherry Westburke Hickory Westburke Maple Westburke PureStyle™	Calio Oak Gantrell Oak Kesper Oak Rains Oak		
<b>WHS30</b>	10.8	3808	3808	3808	3808	3808	3808	3808
<b>WHS36</b>	13.0	3840	3840	3840	3840	3840	3840	3840

- Freestanding unit (must be properly secured to wall and cannot be attached to adjacent cabinets).
- Exhaust system not included. Compatible with all Diamond blowers.
- Chimney available (WHC...). See below.
- Check your local building code for installation heights above the range.
- Silver metallic liner included. Assembly required.
- Installation instructions and hardware included.
- Liner opening size: 10 1/4" deep by 19 1/2" wide.
- Wood hoods are designed for use with decorative overlays.

**WOOD HOOD CHIMNEY,  
23 1/2" HIGH**

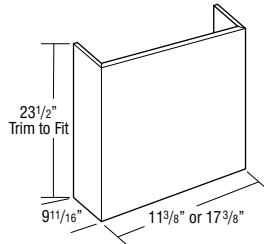

<b>WHC30</b>	2.5	692	692	692	692	692	692	692
<b>WHC36</b>	3.0	723	723	723	723	723	723	723

- 3/4" thick plywood.
- Trimmable.
- If trimmed, moulding is recommended to conceal any cut marks.
- Optional accessory for Wood Hood Square (WHS).
- WHC30 is not compatible with CONVERSION.

**WOOD HOOD CANOPY ARCHED,  
30" or 36" WIDE**

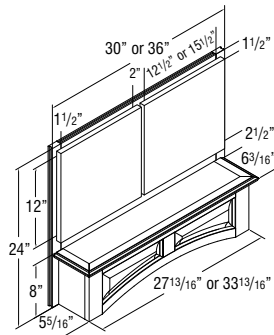

<b>WHCA30</b>	4.7	2499	2515	2554	2575	2594	2595	2634
<b>WHCA36</b>	5.6	2711	2730	2771	2797	2817	2822	2863

- Install Wood Hoods between adjacent cabinets.
- Exhaust system not included. Compatible with all Diamond Vibe blowers.
- Check your local building code for installation heights above the range.
- Silver metallic liner included. Assembly required. Interior bottom section is finished below liner. Liner is not arched.
- Installation instructions and hardware included.
- Liner opening size: 10 1/4" deep by 19 1/2" wide.

**WOOD HOOD CANOPY SQUARE,  
30" or 36" WIDE**

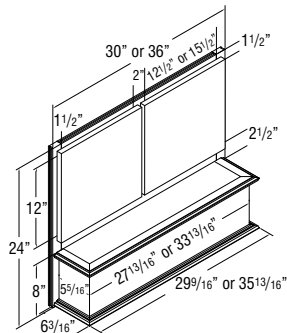

<b>WHCS30</b>	4.7	2173	2189	2228	2249	2268	2269	2308
<b>WHCS36</b>	5.6	2357	2376	2417	2443	2463	2468	2509

- Install Wood Hoods between adjacent cabinets.
- Exhaust system not included. Compatible with all Diamond Vibe blowers.
- Check your local building code for installation heights above the range.
- Square silver metallic liner included. Assembly required.
- Installation instructions and hardware included.
- Liner opening size: 10 1/4" deep by 19 1/2" wide.

Model	Cubic Feet	Cantrill Maple	Bryant Cherry Hurley Cherry Norris Maple Norris PureStyle™	Cairo Cherry Kasper Cherry Reist Cherry	Klewin Oak	Brockway Maple Cantrill Cherry Kersey Hickory Kersey Maple Norris Cherry	Felix Hickory Felix Maple Forte Hickory Forte Maple Forte PureStyle™ Owens Maple Owens PureStyle™	Amico PureStyle™ Brockway Cherry Felix Cherry Forte Cherry Kersey Hickory Klewin Hickory Klewin Maple Owens Cherry	Adair Maple Adair PureStyle™ Keegan Maple	Wilero Maple	Adair Cherry Keegan Cherry	Klewin Cherry	Wilero Cherry
		8	9	10	11	12	13	14	15	16	17	18	19
WHS30	10.8	3808	3808	3808	3808	3808	3808	3808	3808	3808	3808	3808	3808
WHS36	13.0	3840	3840	3840	3840	3840	3840	3840	3840	3840	3840	3840	3840

MODIFICATIONS
No modifications available for these products.

WHC30	2.5	692	692	692	692	692	692	692	692	692	692	692	692
WHC36	3.0	723	723	723	723	723	723	723	723	723	723	723	723

MODIFICATIONS
No modifications available for these products.

WHCA30	4.7	2658	2678	2700	2739	2743	2766	2797	2807	2842	2862	2867	2899
WHCA36	5.6	2889	2910	2935	2978	2980	3007	3039	3054	3092	3115	3118	3156

MODIFICATIONS
No modifications available for these products.

WHCS30	4.7	2332	2352	2374	2413	2417	2440	2471	2481	2516	2536	2541	2573
WHCS36	5.6	2535	2556	2581	2624	2626	2653	2685	2700	2738	2761	2764	2802

MODIFICATIONS
No modifications available for these products.

**TAPERED WOOD HOOD,  
30" or 36" WIDE, 24" HIGH**

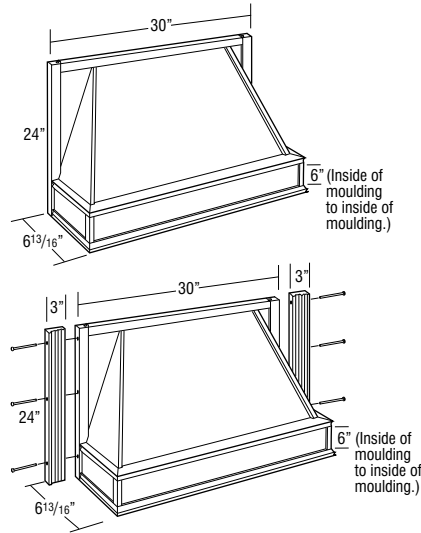

Model	Cubic Feet	Cabinet Material					7	
		Tori Oak	Westburke Oak	Tori Hickory Tori Maple	Loren Laminate Tori Cherry Westburke Hickory Westburke Maple Westburke PureStyle™	Chino Oak Gambrell Oak Kesper Oak Reins Oak		Westburke Cherry
<b>TWH30</b>	4.7	1283	1283	1283	1283	1283	1283	1283
<b>TWH36</b>	5.6	1378	1378	1378	1378	1378	1378	1378

- Wood hoods are designed for use with decorative overlays.
- Install Wood Hood between adjacent cabinets.
- Exhaust system not included. Compatible with all Diamond Vibe blowers.
- Check your local building code for installation heights above the range.
- Tapered design.
- Liner opening size: 10 1/4" deep x 19 1/2" wide.
- TWH36 has two plain/fluted fillers and metal wings included to extend hood to 36" width.
- Silver metallic liner included, not available for order separately.

**WOOD HOOD BLOWER, 500 CFM**



<b>BLOWER500</b>	4.0	4609	4609	4609	4609	4609	4609	4609
------------------	-----	------	------	------	------	------	------	------

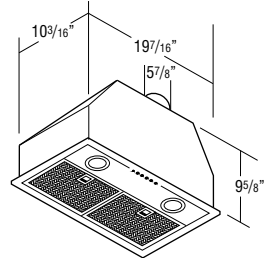

- 500 CFM.
- Two 20 watt (12 volt, G4 base) halogen lamps included.
- Installation instructions, warranty, and repair information included.
- Silver metallic finish.
- Three speed push button control.
- Includes two removable dishwasher safe grease filters.
- Compatible with all Wood Hoods.
- Designed for use in applications up to 60,000 BTUs.

**TAPERED WOOD HOOD BLOWER**



<b>TWHBLOWER390</b>	2.1	1324	1324	1324	1324	1324	1324	1324
---------------------	-----	------	------	------	------	------	------	------

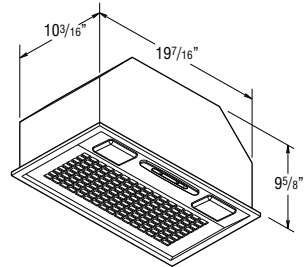

- Range Hood Component Package has 3-speed centrifugal fan and lighted filter control.
- 6" diameter vent.
- 1 year warranty.
- Sound rating is 6 sones.
- Uses 3.2 amps.
- Two 40 watt candelabra lights required, but not included.
- Compatible with all Wood Hoods.
- Silver metallic exterior finish.
- Includes removable dishwasher safe grease filter.

**WOOD HOOD DUCTLESS CONVERSION  
KIT AND FILTER KITS**



<b>CONVERSION</b>	2.0	291	291	291	291	291	291	291
<b>FILTER250/390</b>	0.2	48	48	48	48	48	48	48
<b>FILTER500</b>	0.2	280	280	280	280	280	280	280

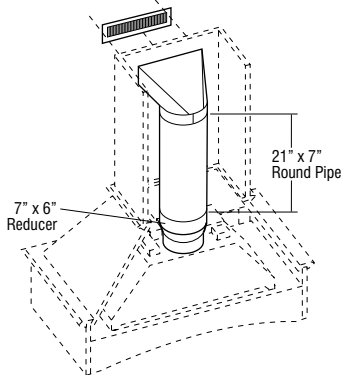

- Must order charcoal filter with CONVERSION kit for proper filtration to replace metal mesh filters included with blower unit.
- FILTER250/390 required when CONVERSION is used with TWHBLOWER390.
- FILTER500 required when CONVERSION is used with BLOWER500.
- CONVERSION includes: (1) 21" x 7" round pipe, (1) adjustable collar, (1) white metal soffit grille (11 3/8" x 3 5/8"), (1) adjustable boot, (1) 7" x 6" reducer, and installation instructions.
- CONVERSION is not compatible with WHC30.

Model	Cubic Feet	Centrell Maple	Bryant Cherry Hurley Cherry Norris Maple Norris PureStyle™	Cairo Cherry Kasper Cherry Reist Cherry	Klewin Oak	Brockway Maple Centrell Cherry Kersey Hickory Kersey Maple Norris Cherry	Felix Hickory Felix Maple Forte Hickory Forte Maple Forte PureStyle™ Owens Maple Owens PureStyle™	Amico PureStyle™ Brockway Cherry Felix Cherry Forte Cherry Kersey Cherry Klewin Hickory Klewin Maple Owens Cherry	Adair Maple Adair PureStyle™ Keegan Maple	Valero Maple	Adair Cherry Keegan Cherry	Klewin Cherry	Valero Cherry
		8	9	10	11	12	13	14	15	16	17	18	19
<b>TWH30</b>	4.7	1283	1283	1283	1283	1283	1283	1283	1283	1283	1283	1283	1283
<b>TWH36</b>	5.6	1378	1378	1378	1378	1378	1378	1378	1378	1378	1378	1378	1378

MODIFICATIONS
No modifications available for these products.

<b>BLOWER500</b>	4.0	4609	4609	4609	4609	4609	4609	4609	4609	4609	4609	4609	4609
------------------	-----	------	------	------	------	------	------	------	------	------	------	------	------

MODIFICATIONS
No modifications available for these products.

<b>TWHBLOWER390</b>	2.1	1324	1324	1324	1324	1324	1324	1324	1324	1324	1324	1324	1324
---------------------	-----	------	------	------	------	------	------	------	------	------	------	------	------

MODIFICATIONS
No modifications available for these products.

<b>CONVERSION</b>	2.0	291	291	291	291	291	291	291	291	291	291	291	291
<b>FILTER250/390</b>	0.2	48	48	48	48	48	48	48	48	48	48	48	48
<b>FILTER500</b>	0.2	280	280	280	280	280	280	280	280	280	280	280	280

MODIFICATIONS
No modifications available for these products.

# Diamond®

## VIBE™ SERIES

BASE CABINET NOMENCLATURE

All Base Cabinets are 34 1/2" high and 24" deep unless otherwise noted.

**B24**

Cabinet Type      Cabinet Width

- Heat Shields available for field installation. See page 294.

TOEKICKS

Base Cabinets are shipped with an unfinished toekick. Finished toekicks in matching wood veneer or laminate must be ordered separately and field installed.

BASE SINGLE DOOR

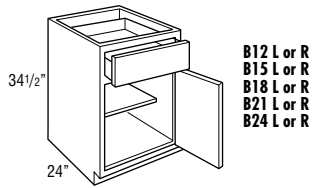

B12 L or R  
B15 L or R  
B18 L or R  
B21 L or R  
B24 L or R

Model	Cubic Feet	Toekicks						
		Tori Oak	Westburke Oak	Tori Hickory Tori Maple	Loren Laminate Tori Cherry Westburke Hickory Westburke Maple Westburke PureStyle™	Callo Oak Ginnell Oak Kasper Oak Reins Oak	Westburke Cherry	Brockway Oak Bryant Hickory Bryant Maple Bryant PureStyle™ Callo Maple Huney Hickory Huney Maple Kasper Maple Reins Maple Reins Oak Reins PureStyle™
B12 L or R	7.8	418	440	486	513	537	539	584
B15 L or R	9.4	449	473	524	551	575	579	626
B18 L or R	11.1	480	504	554	585	613	614	668
B21 L or R	12.8	512	538	593	624	653	655	711
B24 L or R	14.4	546	574	634	667	697	701	758

- Adjustable 15" deep shelves.
- DRWTK not available on B12 L or R and B15 L or R.

BASE DOUBLE DOOR

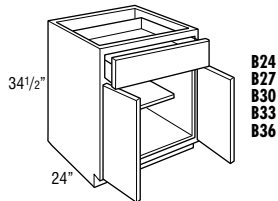

B24  
B27  
B30  
B33  
B36

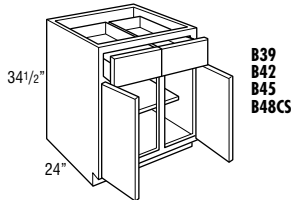

B39  
B42  
B45  
B48CS

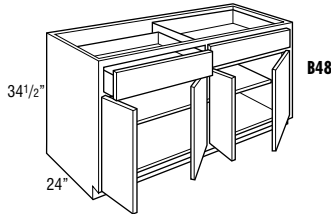

B48

B24	14.4	634	667	737	775	810	815	881
B27	16.1	662	696	771	811	847	851	923
B30	17.7	690	724	799	841	880	882	958
B33	19.6	721	758	838	881	922	925	1004
B36	21.1	756	793	877	922	964	967	1051
B39	22.7	792	831	920	965	1012	1014	1100
B42	24.4	827	869	960	1012	1058	1063	1152
B45	24.7	865	907	1005	1058	1103	1111	1204
B48CS	27.7	874	920	1019	1073	1126	1129	1228
B48	27.7	902	948	1047	1101	1153	1157	1256

- Adjustable 15" deep shelves.
- DRWTK not available on B39, B42, B45, B48CS, and B48.
- SCPDRW not available on B24, B27, B39, B42, B45, B48CS, and B48.

**CUSTOM MODIFICATIONS**

Mod.	Description	Mod.	Description
AUTHL	Authentic End - Left	FTK	Flush Toekick
AUTHR	Authentic End - Right	MIP	Matching Interior Plywood
CBO	Cabinet Box Only	P	Peninsula
CCO	Cabinet Case Only	RD	Reduced Depth
CFNTO	Cabinet Front Only	RECTKALL	Recessed Island Toekick
CFP	Cabinet False Panel	RECTKBK	Recessed Toekick Back
CFRMO	Cabinet Frame Only	RECTKL	Recessed Toekick Left
CMAT	CabMat™	RECTKR	Recessed Toekick Right
CND	Cabinet with No Door, with Drawer	RT	Installed Roll Tray
DRWTK	Toekick Drawer	SCPDRW	Scooped Drawer
FB	Finished Ends	TOTSS	Tilt-Out Tray, Stainless Steel
FD	Full Depth Shelf	VTK	Void Toekick
FPEB	Furniture Finished Plywood End Panels		

**CONSTRUCTION UPGRADES**

Mod.	Description
VPL	All Plywood with Laminate Ends

**SMART STOP OPTIONS**

Mod.	Description
INTGH	Smart Stop Premium Hinge
PG	Smart Stop Premium Drawer Guide and Dovetail Box
SP	Smart Stop Premium Roll Tray Guide

**MODIFICATIONS GRID KEY**

- Available
- STD Standard on these cabinets
- L O G I X Logix Organization Cabinet
-  5 Day Express Response Item

Model	Cubic Feet	Cantral Maple	Bryant Cherry Hurley Cherry Morris Maple Morris PureStyle™	Cairo Cherry Kasper Cherry Reins Cherry	Klein Oak	Brookway Maple Cantral Cherry Kersay Hickory Kersay Maple Morris Cherry	Felix Hickory Felix Maple Forte Hickory Forte Maple Forte PureStyle™ Owens Maple Owens PureStyle™	Anitico PureStyle™ Brookway Cherry Felix Cherry Forte Cherry Kersay Cherry Klein Hickory Klein Maple Owens Cherry	Adair Maple Adair PureStyle™ Keegan Maple	Valero Maple	Adair Cherry Keegan Cherry	Klein Cherry	Valero Cherry
		8	9	10	11	12	13	14	15	16	17	18	19
<b>B12 L or R</b>	7.8	615	638	662	710	712	741	778	793	834	856	859	902
<b>B15 L or R</b>	9.4	656	683	710	764	766	796	837	851	895	921	924	968
<b>B18 L or R</b>	11.1	701	724	752	812	813	848	889	907	954	981	984	1032
<b>B21 L or R</b>	12.8	746	775	806	866	871	902	949	965	1017	1044	1048	1099
<b>B24 L or R</b>	14.4	796	825	859	924	925	963	1012	1031	1086	1116	1121	1174

Custom Modifications	AUTHL AUTHR	CBO	CCO	CFNTO	CFP	CFRMO	CMAT	CND	DRWTK	FB	FD	FPEB	FTK	MIP	P	RD	RECTKALL RECTKBK	RECTKL RECTKR	RT	SCPDRW	TOTSS	VTK
	•	•	•	•	•	•	•	•	•	•	•	•	•	•	•	•	•	•	•			•

Construction Upgrades	VPL	Smart Stop Options	INTGH	PG	SP
	•		•	•	

<b>B24</b>	14.4	924	960	1000	1072	1076	1121	1176	1198	1261	1295	1299	1364
<b>B27</b>	16.1	966	1007	1047	1124	1127	1173	1231	1254	1320	1355	1360	1427
<b>B30</b>	17.7	1004	1044	1088	1166	1172	1216	1277	1302	1370	1407	1411	1481
<b>B33</b>	19.6	1053	1095	1138	1224	1227	1276	1338	1364	1435	1475	1481	1554
<b>B36</b>	21.1	1100	1145	1188	1277	1282	1333	1399	1425	1500	1541	1546	1623
<b>B39</b>	22.7	1154	1200	1247	1341	1344	1399	1469	1496	1573	1617	1624	1702
<b>B42</b>	24.4	1207	1255	1305	1401	1405	1461	1535	1564	1646	1691	1697	1778
<b>B45</b>	24.7	1262	1311	1364	1467	1471	1530	1605	1635	1720	1769	1774	1862
<b>B48CS</b>	27.7	1290	1341	1396	1501	1506	1568	1647	1678	1768	1818	1824	1915

<b>B48</b>	27.7	1318	1368	1424	1529	1534	1595	1675	1705	1796	1845	1851	1943
------------	------	------	------	------	------	------	------	------	------	------	------	------	------

Custom Modifications	AUTHL AUTHR	CBO	CCO	CFNTO	CFP	CFRMO	CMAT	CND	DRWTK	FB	FD	FPEB	FTK	MIP	P	RD	RECTKALL RECTKBK	RECTKL RECTKR	RT	SCPDRW	TOTSS	VTK
	•	•	•	•	•	•	•	•	•	•	•	•	•	•	•	•	•	•	•	•		•

Construction Upgrades	VPL	Smart Stop Options	INTGH	PG	SP
	•		•	•	

**BASE with CUTLERY INSERT WOOD ORGANIZER**

LOGIX

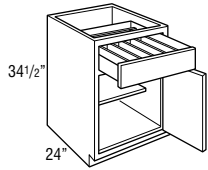

B15CIW L or R  
B18CIW L or R  
B21CIW L or R  
B24CIW L or R

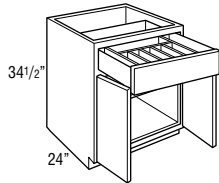

B24CIW

Model	Cubic Feet	Cabinet Feet						
		Tori Oak	Westburke Oak	Tori Hickory Tori Maple	Loren Laminate Tori Cherry Westburke Hickory Westburke Maple Westburke PureStyle™	Cairo Oak Gantrell Oak Kesper Oak Reins Oak	Westburke Cherry	Brookway Oak Bryant Hickory Bryant PureStyle™ Cairo Maple Hurley Hickory Hurley Maple Kesper Oak Kesper PureStyle™ Reins PureStyle™
		1	2	3	4	5	6	7
B15CIW L or R	9.4	635	659	710	737	761	765	812
B18CIW L or R	11.1	678	702	752	783	811	812	866
B21CIW L or R	12.8	769	795	850	881	910	912	968
B24CIW L or R	14.4	822	850	910	943	973	977	1034
<b>B24CIW</b>	<b>14.4</b>	<b>910</b>	<b>943</b>	<b>1013</b>	<b>1051</b>	<b>1086</b>	<b>1091</b>	<b>1157</b>

- Adjustable 15" deep shelf.
- Includes Cutlery Insert Wood Organizer.
- Cutlery Insert Wood Organizer is also available as an accessory. See page 291.
- DRWTK not available on B15CIW L or R.

**BASE with WOOD TIERED CUTLERY DIVIDER DRAWER**

LOGIX

15", 18", 21", or 24"

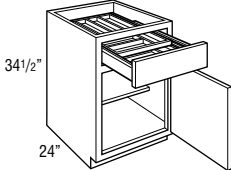

B15WTCD L or R  
B18WTCD L or R  
B21WTCD L or R  
B24WTCD L or R

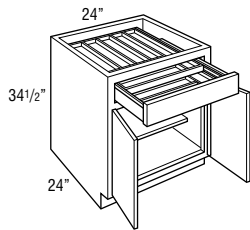

B24WTCD

B15WTCD L or R	9.4	947	971	1022	1049	1073	1077	1124
B18WTCD L or R	11.1	995	1019	1069	1100	1128	1129	1183
B21WTCD L or R	12.8	1048	1074	1129	1160	1189	1191	1247
B24WTCD L or R	14.4	1100	1128	1188	1221	1251	1255	1312
<b>B24WTCD</b>	<b>14.4</b>	<b>1188</b>	<b>1221</b>	<b>1291</b>	<b>1329</b>	<b>1364</b>	<b>1369</b>	<b>1435</b>

- Adjustable 15" deep shelf.
- Includes tiered wood cutlery divider drawer.
- Exterior WTCD drawer box height is 3 3/4", interior height of top tier is 1 5/8", and interior height of bottom tier is 1 3/8".
- Wood Tiered Cutlery Divider Drawer is also available as an accessory. See page 292.
- DRWTK not available on B15WTCD L or R.

**FULL HEIGHT BASE SINGLE DOOR, 6" WIDE**

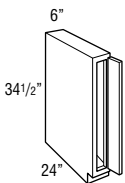

<b>B6FH L or R</b>	<b>4.1</b>	<b>363</b>	<b>382</b>	<b>420</b>	<b>443</b>	<b>465</b>	<b>466</b>	<b>506</b>
--------------------	------------	------------	------------	------------	------------	------------	------------	------------

- Frame opening is 3" wide.
- Cabinet has a full top panel.
- Utilizes a 5 1/2" wide overlay filler as a hinged door for full and partial overlay styles.

**FULL HEIGHT BASE SINGLE DOOR**

9", 12", 15", 18", 21", or 24"

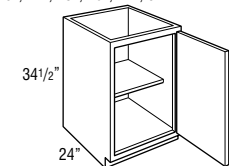

B9FH L or R  
B12FH L or R  
B15FH L or R  
B18FH L or R  
B21FH L or R  
B24FH L or R

<b>B9FH L or R</b>	<b>6.1</b>	<b>363</b>	<b>382</b>	<b>420</b>	<b>443</b>	<b>465</b>	<b>466</b>	<b>506</b>
<b>B12FH L or R</b>	<b>7.8</b>	<b>382</b>	<b>402</b>	<b>444</b>	<b>468</b>	<b>486</b>	<b>490</b>	<b>533</b>
<b>B15FH L or R</b>	<b>9.4</b>	<b>412</b>	<b>433</b>	<b>476</b>	<b>502</b>	<b>525</b>	<b>527</b>	<b>572</b>
<b>B18FH L or R</b>	<b>11.1</b>	<b>437</b>	<b>457</b>	<b>505</b>	<b>533</b>	<b>557</b>	<b>559</b>	<b>609</b>
<b>B21FH L or R</b>	<b>12.8</b>	<b>466</b>	<b>487</b>	<b>540</b>	<b>568</b>	<b>593</b>	<b>597</b>	<b>648</b>
<b>B24FH L or R</b>	<b>14.4</b>	<b>498</b>	<b>523</b>	<b>573</b>	<b>608</b>	<b>629</b>	<b>637</b>	<b>688</b>

- Adjustable 15" deep shelf.
- RECTKALL, RECTKBK, RT, and RTF not available on B9FH L or R.
- DRWTK not available on B9FH L or R, B12FH L or R, and B15FH L or R.

Model	Cubic Feet	Canterell Maple	Bryant Cherry Hurley Cherry Norris Maple Norris PureStyle™	Cairo Cherry Kasper Cherry Reist Cherry	Klewin Oak	Brockway Maple Canterell Cherry Kersey Hickory Kersey Maple Norris Cherry	Felix Hickory Felix Maple Forte Hickory Forte Maple Forte PureStyle™ Owens Maple Owens PureStyle™	Amico PureStyle™ Brockway Cherry Felix Cherry Forte Cherry Kersey Cherry Klewin Hickory Klewin Maple Owens Cherry	Adair Maple Adair PureStyle™ Keegan Maple	Wilero Maple	Adair Cherry Keegan Cherry	Klewin Cherry	Wilero Cherry
		8	9	10	11	12	13	14	15	16	17	18	19
B15CIW L or R	9.4	842	869	896	950	952	982	1023	1037	1081	1107	1110	1154
B18CIW L or R	11.1	899	922	950	1010	1011	1046	1087	1105	1152	1179	1182	1230
B21CIW L or R	12.8	1003	1032	1063	1123	1128	1159	1206	1222	1274	1301	1305	1356
B24CIW L or R	14.4	1072	1101	1135	1200	1201	1239	1288	1307	1362	1392	1397	1450

B24CIW	14.4	1200	1236	1276	1348	1352	1397	1452	1474	1537	1571	1575	1640
--------	------	------	------	------	------	------	------	------	------	------	------	------	------

Custom Modifications	AUTHL AUTHR	CBO	CCO	CFNTO	CFP	CFRMO	CMAT	CND	DRWTK	FB	FD	FPEB	FTK	MIP	P	RD	RECTKALL RECTKBK	RECTKL RECTKR	RT	SCPDRW	TOTSS	VTK
	•		•	•	•	•		•	•	•	•	•	•	•	•		•	•	•			•

Construction Upgrades	VPL	Smart Stop Options	INTGH	PG	SP
	•		•	STD	

B15WTCD L or R	9.4	1154	1181	1208	1262	1264	1294	1335	1349	1393	1419	1422	1466
B18WTCD L or R	11.1	1216	1239	1267	1327	1328	1363	1404	1422	1469	1496	1499	1547
B21WTCD L or R	12.8	1282	1311	1342	1402	1407	1438	1485	1501	1553	1580	1584	1635
B24WTCD L or R	14.4	1350	1379	1413	1478	1479	1517	1566	1585	1640	1670	1675	1728

B24WTCD	14.4	1478	1514	1554	1626	1630	1675	1730	1752	1815	1849	1853	1918
---------	------	------	------	------	------	------	------	------	------	------	------	------	------

Custom Modifications	AUTHL AUTHR	CBO	CCO	CFNTO	CFP	CFRMO	CMAT	CND	DRWTK	FB	FD	FPEB	FTK	MIP	P	RD	RECTKALL RECTKBK	RECTKL RECTKR	RT	SCPDRW	TOTSS	VTK
	•	•	•	•	•	•		•	•	•	•	•	•	•	•		•	•	•			•

Construction Upgrades	VPL	Smart Stop Options	INTGH	PG	SP
	•		•	STD	

B6FH L or R	4.1	529	550	571	615	618	641	674	685	721	740	743	779
-------------	-----	-----	-----	-----	-----	-----	-----	-----	-----	-----	-----	-----	-----

Custom Modifications	AUTHL AUTHR	CBO	CCO	CFNTO	CFP	CFRMO	CMAT	CND	DRWTK	FB	FD	FPEB	FTK	MIP	P	RD	RECTKALL RECTKBK	RECTKL RECTKR	RT	SCPDRW	TOTSS	VTK
			•	•		•		•	•	•	•	•	•	•	•							•

Construction Upgrades	VPL	Smart Stop Options	INTGH	PG	SP
	•				

B9FH L or R	6.1	529	550	571	615	618	641	674	685	721	740	743	779
B12FH L or R	7.8	556	579	600	648	650	676	709	721	760	779	782	820
B15FH L or R	9.4	599	622	648	694	697	724	761	776	817	840	844	883
B18FH L or R	11.1	637	661	687	739	741	771	810	824	868	892	895	939
B21FH L or R	12.8	680	706	735	788	792	822	864	879	925	952	955	1002
B24FH L or R	14.4	722	750	781	839	839	876	920	935	985	1013	1016	1066

Custom Modifications	AUTHL AUTHR	CBO	CCO	CFNTO	CFP	CFRMO	CMAT	CND	DRWTK	FB	FD	FPEB	FTK	MIP	P	RD	RECTKALL RECTKBK	RECTKL RECTKR	RT	SCPDRW	TOTSS	VTK
	•	•	•	•		•		•	•	•	•	•	•	•	•		•	•	•			•

Construction Upgrades	VPL	Smart Stop Options	INTGH	PG	SP
	•		•		



**FULL HEIGHT BASE DOUBLE DOOR**

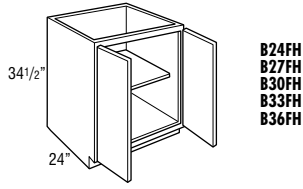

**B24FH  
B27FH  
B30FH  
B33FH  
B36FH**

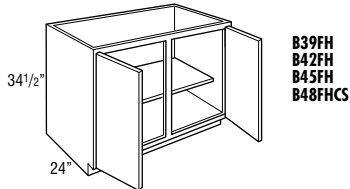

**B39FH  
B42FH  
B45FH  
B48FHCS**

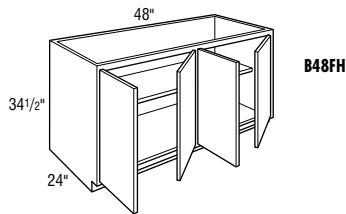

**B48FH**

Model	Cubic Feet							
	Tori Oak	Westburke Oak	Tori Hickory Tori Maple	Loren Laminate Tori Cherry Westburke Hickory Westburke Maple Westburke PureStyle™	Calio Oak Gantrell Oak Kesper Oak Reins Oak	Westburke Cherry	Brookway Oak Bryant Hickory Bryant Maple Calio Maple Hurley Hickory Hurley Maple Kesper Maple Kessy Oak Reins PureStyle™ Reins PureStyle™	
<b>B24FH</b>	14.4	599	629	696	733	765	769	833
<b>B27FH</b>	16.1	634	667	737	775	810	815	881
<b>B30FH</b>	17.7	647	678	749	788	824	827	897
<b>B33FH</b>	19.6	656	688	762	803	840	844	914
<b>B36FH</b>	21.1	687	722	798	840	879	881	956
<b>B39FH</b>	22.7	720	757	837	880	921	924	1003
<b>B42FH</b>	24.4	752	792	874	920	962	965	1047
<b>B45FH</b>	26.1	858	903	996	1050	1097	1101	1194
<b>B48FHCS</b>	27.7	937	985	1091	1150	1204	1209	1313
<b>B48FH</b>	27.7	964	1013	1118	1178	1232	1237	1341

- Adjustable 15" deep shelf.
- DRWTK not available on B39FH, B42FH, B45FH, B48FHCS, and B48FH.

**30" SUPERCABINET™**

L O G I X

<b>BSC30RP</b>	17.7	1537	1568	1639	1678	1714	1717	1787
<b>BSC30PR</b>	17.7	1537	1568	1639	1678	1714	1717	1787

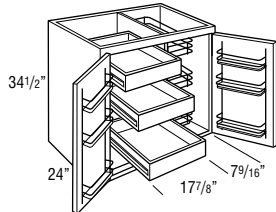

**BSC30RP**

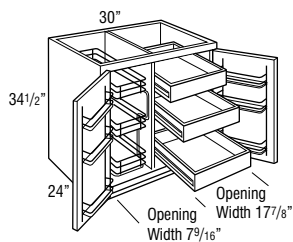

**BSC30PR**

- Nomenclature represents left to right order of interior components.  
Example: BSC30PR = Base SuperCabinet™ 30" Pull-Out Roll-Out.
- Shelves are adjustable and 20" deep.
- Roll trays are Full Extension side mounted with a solid hardwood dovetail box.
- Cabinets utilize 170° hinge. For sufficient pull-out clearance, 12" of adjacent space is required for door to open 170° when installed near a wall or corner.
- Both doors have chrome and wood three-tiered 3 1/4" deep racks.
- Door rack width is 10 7/8".
- Door rack depth is 3 1/2".
- Smart Stop Premium Hinge (INTGH) option not available, order a QCDM if a soft-close door is desired.

**36" SUPERCABINET™**

L O G I X

<b>BSC36PRP</b>	21.1	2067	2102	2178	2220	2259	2261	2336
-----------------	------	------	------	------	------	------	------	------

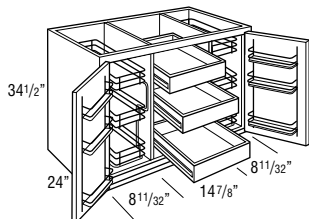

- Shelves are adjustable and 20" deep.
- Roll trays are Full Extension side mounted with a solid hardwood dovetail box.
- Cabinets utilize 170° hinge. For sufficient pull-out clearance, 12" of adjacent space is required for door to open 170° when installed near a wall or corner.
- Both doors have chrome and wood three-tiered 3 1/4" deep racks.
- Smart Stop Premium Hinge (INTGH) option not available, order a QCDM if a soft-close door is desired.

Model	Cubic Feet	Canterell Maple	Bryant Cherry Hurley Cherry Norris Maple Norris PureStyle™	Cairo Cherry Kasper Cherry Reist Cherry	Klewin Oak	Brookway Maple Canterell Cherry Kersey Hickory Kersey Maple Norris Cherry	Felix Hickory Felix Maple Forte Hickory Forte Maple Forte PureStyle™ Owens Maple Owens PureStyle™	Antico PureStyle™ Brookway Cherry Felix Cherry Forte Cherry Kersey Cherry Klewin Hickory Klewin Maple Owens Cherry	Adair Maple Adair PureStyle™ Keegan Maple	Wilero Maple	Adair Cherry Keegan Cherry	Klewin Cherry	Wilero Cherry
		8	9	10	11	12	13	14	15	16	17	18	19
B24FH	14.4	875	909	946	1015	1018	1060	1113	1130	1189	1225	1229	1290
B27FH	16.1	924	960	1000	1072	1076	1121	1176	1197	1260	1295	1298	1364
B30FH	17.7	943	980	1018	1094	1097	1141	1198	1218	1284	1320	1324	1389
B33FH	19.6	958	995	1035	1113	1117	1160	1217	1241	1307	1343	1349	1414
B36FH	21.1	1003	1041	1085	1162	1168	1214	1273	1298	1367	1405	1408	1479

B39FH	22.7	1051	1092	1134	1218	1224	1271	1333	1360	1431	1471	1477	1548
B42FH	24.4	1098	1142	1186	1275	1278	1330	1396	1423	1498	1539	1544	1620
B45FH	26.1	1252	1301	1353	1454	1458	1517	1591	1622	1708	1755	1761	1847
B48FHCS	27.7	1379	1433	1492	1605	1609	1676	1759	1793	1888	1943	1949	2047

B48FH	27.7	1406	1461	1519	1632	1637	1703	1787	1821	1916	1971	1977	2075
-------	------	------	------	------	------	------	------	------	------	------	------	------	------

Custom Modifications	AUTHL AUTHR	CBO	CCO	CFNTO	CFP	CFRMO	CMAT	CND	DRWTK	FB	FD	FPEB	FTK	MIP	P	RD	RECTKALL RECTKBK	RECTKL RECTKR	RT	SCPDRW	TOTSS	VTK
	•	•	•	•		•			•	•	•	•	•	•	•	•	•	•	•			•

Construction Upgrades	VPL	Smart Stop Options	INTGH	PG	SP
	•		•		

BSC30RP	17.7	1833	1870	1908	1984	1987	2031	2088	2108	2174	2210	2214	2279
---------	------	------	------	------	------	------	------	------	------	------	------	------	------

BSC30PR	17.7	1833	1870	1908	1984	1987	2031	2088	2108	2174	2210	2214	2279
---------	------	------	------	------	------	------	------	------	------	------	------	------	------

Custom Modifications	AUTHL AUTHR	CBO	CCO	CFNTO	CFP	CFRMO	CMAT	CND	DRWTK	FB	FD	FPEB	FTK	MIP	P	RD	RECTKALL RECTKBK	RECTKL RECTKR	RT	SCPDRW	TOTSS	VTK
	•	•	•	•		•			•	•	•	•	•	•	•	•	•	•				•

Construction Upgrades	VPL	Smart Stop Options	INTGH	PG	SP
	•				

BSC36PRP	21.1	2383	2421	2465	2542	2548	2594	2653	2678	2747	2785	2788	2859
----------	------	------	------	------	------	------	------	------	------	------	------	------	------

Custom Modifications	AUTHL AUTHR	CBO	CCO	CFNTO	CFP	CFRMO	CMAT	CND	DRWTK	FB	FD	FPEB	FTK	MIP	P	RD	RECTKALL RECTKBK	RECTKL RECTKR	RT	SCPDRW	TOTSS	VTK
	•	•	•	•		•			•	•	•	•	•	•	•	•	•	•				•

Construction Upgrades	VPL	Smart Stop Options	INTGH	PG	SP
	•				

**BASE SINGLE DOOR with ROLL TRAYS**

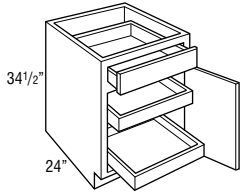

Model	Cubic Feet	Finish						
		Tori Oak	Westburke Oak	Tori Hickory Tori Maple	Loren Laminate Tori Cherry Westburke Hickory Westburke Maple Westburke PureStyle™	Chino Oak Gambrell Oak Kesper Oak Renaist Oak	Westburke Cherry	Brookway Oak Bryant Hickory Bryant Maple Chino Maple Hurley Hickory Hurley Maple Kesper Maple Kesper Oak Renaist PureStyle™ Renaist PureStyle™
		1	2	3	4	5	6	7
<b>B15RT L or R</b>	9.4	717	741	792	819	843	847	894
<b>B18RT L or R</b>	11.1	748	772	822	853	881	882	936
<b>B21RT L or R</b>	12.8	780	806	861	892	921	923	979
<b>B24RT L or R</b>	14.4	814	842	902	935	965	969	1026

- 2 roll trays standard.
- Cabinets may accommodate up to 4 roll trays, which may be purchased separately for field installation. See page 296.
- DRWTK not available on B15RT L or R.

**BASE DOUBLE DOOR with ROLL TRAYS**

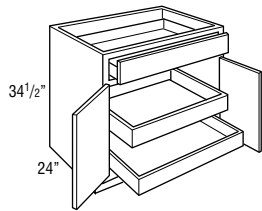

<b>B24RT</b>	14.4	902	935	1005	1043	1078	1083	1149
<b>B27RT</b>	16.1	930	964	1039	1079	1115	1119	1191
<b>B30RT</b>	17.7	958	992	1067	1109	1148	1150	1226
<b>B33RT</b>	19.6	989	1026	1106	1149	1190	1193	1272
<b>B36RT</b>	21.1	1024	1061	1145	1190	1232	1235	1319

- 2 roll trays standard.
- Top of drawer box is 2" from top of cabinet to accommodate installation of a cooktop.
- Cabinet has butt doors, no center stile.
- Cabinet may accommodate up to 4 roll trays, which may be purchased separately for field installation. See page 296.
- SCPDRW not available on B24RT and B27RT.

**BASE with CUTLERY INSERT WOOD ORGANIZER and ROLL TRAYS**

**L O G I X**

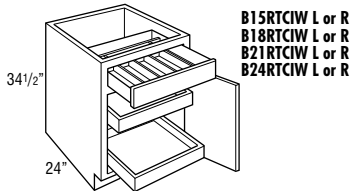

**B15RTCW L or R  
B18RTCW L or R  
B21RTCW L or R  
B24RTCW L or R**

<b>B15RTCW L or R</b>	9.4	903	927	978	1005	1029	1033	1080
<b>B18RTCW L or R</b>	11.1	946	970	1020	1051	1079	1080	1134
<b>B21RTCW L or R</b>	12.8	1037	1063	1118	1149	1178	1180	1236
<b>B24RTCW L or R</b>	14.4	1090	1118	1178	1211	1241	1245	1302

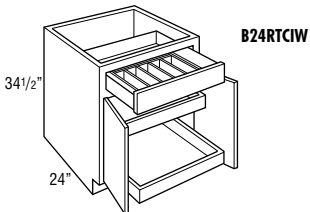

**B24RTCW**

<b>B24RTCW</b>	14.4	1178	1211	1281	1319	1354	1359	1425
----------------	------	------	------	------	------	------	------	------

- 2 roll trays standard.
- Cabinets may accommodate up to 4 roll trays, which may be purchased separately for field installation. See page 296.
- Includes Cutlery Insert Wood Organizer.
- Cutlery Insert Wood Organizer is also available as an accessory. See page 291.
- DRWTK not available on B15RTCW L or R.

Model	Cubic Feet	Canterell Maple	Bryant Cherry Hurley Cherry Norris Maple Norris PureStyle™	Cairo Cherry Kasper Cherry Reist Cherry	Klewin Oak	Brookway Maple Canterell Cherry Kersey Hickory Kersey Maple Norris Cherry	Felix Hickory Felix Maple Forte Hickory Forte Maple Forte PureStyle™ Owens Maple Owens PureStyle™	Amico PureStyle™ Brookway Cherry Felix Cherry Forte Cherry Kersey Cherry Klewin Hickory Klewin Maple Owens Cherry	Adair Maple Adair PureStyle™ Keegan Maple	Valero Maple	Adair Cherry Keegan Cherry	Klewin Cherry	Valero Cherry
		8	9	10	11	12	13	14	15	16	17	18	19
B15RT L or R	9.4	924	951	978	1032	1034	1064	1105	1119	1163	1189	1192	1236
B18RT L or R	11.1	969	992	1020	1080	1081	1116	1157	1175	1222	1249	1252	1300
B21RT L or R	12.8	1014	1043	1074	1134	1139	1170	1217	1233	1285	1312	1316	1367
B24RT L or R	14.4	1064	1093	1127	1192	1193	1231	1280	1299	1354	1384	1389	1442

Custom Modifications	AUTHL AUTHR	CBO	CCO	CFNT0	CFP	CFRMO	CMAT	CND	DRWTK	FB	FD	FPEB	FTK	MIP	P	RD	RECTKALL RECTKBK	RECTKL RECTKR	RT	SCPDRW	TOTSS	VTK
	•	•	•	•	•	•	•	•	•	•	•	•	•	•	•	•	•	•				•

Construction Upgrades	VPL	Smart Stop Options	INTGH	PG	SP
	•		•	•	•

B24RT	14.4	1192	1228	1268	1340	1344	1389	1444	1466	1529	1563	1567	1632
B27RT	16.1	1234	1275	1315	1392	1395	1441	1499	1522	1588	1623	1628	1695
B30RT	17.7	1272	1312	1356	1434	1440	1484	1545	1570	1638	1675	1679	1749
B33RT	19.6	1321	1363	1406	1492	1495	1544	1606	1632	1703	1743	1749	1822
B36RT	21.1	1368	1413	1456	1545	1550	1601	1667	1693	1768	1809	1814	1891

Custom Modifications	AUTHL AUTHR	CBO	CCO	CFNT0	CFP	CFRMO	CMAT	CND	DRWTK	FB	FD	FPEB	FTK	MIP	P	RD	RECTKALL RECTKBK	RECTKL RECTKR	RT	SCPDRW	TOTSS	VTK
	•	•	•	•	•	•	•	•	•	•	•	•	•	•	•	•	•	•		•		•

Construction Upgrades	VPL	Smart Stop Options	INTGH	PG	SP
	•		•	•	•

B15RTCW L or R	9.4	1110	1137	1164	1218	1220	1250	1291	1305	1349	1375	1378	1422
B18RTCW L or R	11.1	1167	1190	1218	1278	1279	1314	1355	1373	1420	1447	1450	1498
B21RTCW L or R	12.8	1271	1300	1331	1391	1396	1427	1474	1490	1542	1569	1573	1624
B24RTCW L or R	14.4	1340	1369	1403	1468	1469	1507	1556	1575	1630	1660	1665	1718

B24RTCW	14.4	1468	1504	1544	1616	1620	1665	1720	1742	1805	1839	1843	1908
---------	------	------	------	------	------	------	------	------	------	------	------	------	------

Custom Modifications	AUTHL AUTHR	CBO	CCO	CFNT0	CFP	CFRMO	CMAT	CND	DRWTK	FB	FD	FPEB	FTK	MIP	P	RD	RECTKALL RECTKBK	RECTKL RECTKR	RT	SCPDRW	TOTSS	VTK
	•	•	•	•	•	•	•	•	•	•	•	•	•	•	•	•	•	•				•

Construction Upgrades	VPL	Smart Stop Options	INTGH	PG	SP
	•		•	STD	•

**BASE with WOOD TIERED CUTLERY DIVIDER DRAWER and ROLL TRAYS**

LOGIX

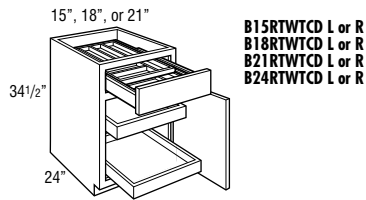

**B15RTWCD L or R  
B18RTWCD L or R  
B21RTWCD L or R  
B24RTWCD L or R**

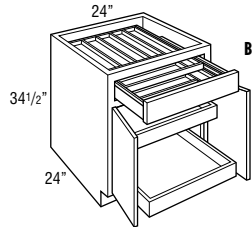

**B24RTWCD**

Model	Cubic Feet	Tori Oak		Westburke Oak	Tori Hickory Tori Maple	Loren Laminate Tori Cherry Westburke Hickory Westburke Maple Westburke PureStyle™	Calho Oak Gantrell Oak Kesper Oak Reins Oak	Westburke Cherry	Brockway Oak Bryant Hickory Bryant Maple Calho Maple Hurley Hickory Hurley Maple Kesper Maple Kessy Oak Reins PureStyle™ Reins PureStyle™
		1	2	3	4	5	6	7	
<b>B15RTWCD L or R</b>	9.4	1215	1239	1290	1317	1341	1345	1392	
<b>B18RTWCD L or R</b>	11.1	1263	1287	1337	1368	1396	1397	1451	
<b>B21RTWCD L or R</b>	12.8	1316	1342	1397	1428	1457	1459	1515	
<b>B24RTWCD L or R</b>	14.4	1368	1396	1456	1489	1519	1523	1580	
<b>B24RTWCD</b>	14.4	1456	1489	1559	1597	1632	1637	1703	

- 2 roll trays standard.
- Cabinets may accommodate up to 4 roll trays, which may be purchased separately for field installation. See page 296.
- Includes Wood Tiered Cutlery Divider Drawer.
- Exterior WTCD drawer box height is 3 3/4", interior height of top tier is 1 5/8", and interior height of bottom tier is 1 3/8".
- Wood Tiered Cutlery Divider Drawer is also available as an accessory. See page 292.
- DRWTK not available on B15RTWCD L or R.

**POTS & PANS ORGANIZER BASE with DRAWER**

LOGIX

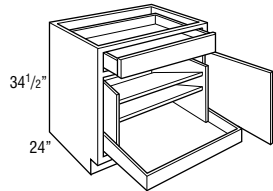

**B24PS L or R**

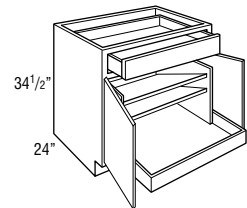

**B24PS  
B30PS  
B36PS**

<b>B24PS L or R</b>	14.4	968	996	1057	1090	1119	1124	1180
<b>B24PS</b>	14.4	1057	1090	1160	1198	1233	1238	1304
<b>B30PS</b>	17.7	1132	1166	1241	1283	1322	1324	1400
<b>B36PS</b>	21.1	1290	1327	1411	1457	1499	1502	1585

- Top of drawer box is 2" from top of cabinet to accommodate installation of a cooktop.
- Cabinet has butt doors, no center stile.
- Cabinet has sliding bottom shelf with double lid storage shelves above.
- Base Pan Storage unit is also available as an accessory for field installation. See page 291.
- SCPDRW not available on B24PS L or R and B24PS.

**BASE POTS & PANS PULL-OUT**

LOGIX

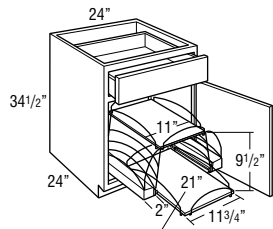

**BPPP24 L or R**

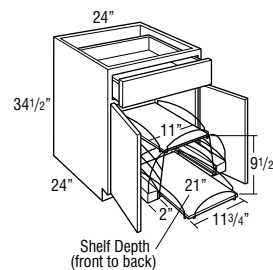

**BPPP24**

<b>BPPP24 L or R</b>	14.4	1191	1219	1279	1312	1342	1346	1403
<b>BPPP24</b>	14.4	1279	1312	1382	1420	1455	1460	1526

- Full Extension slide out shelves pull out independently.

Model	Cubic Feet	Canterell Maple	Bryant Cherry Hurley Cherry Norris Maple Norris PureStyle™	Cairo Cherry Kasper Cherry Reist Cherry	Klewin Oak	Brookway Maple Canterell Cherry Kersey Hickory Kersey Maple Norris Cherry	Felix Hickory Felix Maple Forte Hickory Forte Maple Forte PureStyle™ Owens Maple Owens PureStyle™	Antico PureStyle™ Brookway Cherry Felix Cherry Forte Cherry Kersey Cherry Klewin Hickory Klewin Maple Owens Cherry	Adair Maple Adair PureStyle™ Keegan Maple	Wilero Maple	Adair Cherry Keegan Cherry	Klewin Cherry	Wilero Cherry
		8	9	10	11	12	13	14	15	16	17	18	19
B15RTWTC L or R	9.4	1422	1449	1476	1530	1532	1562	1603	1617	1661	1687	1690	1734
B18RTWTC L or R	11.1	1484	1507	1535	1595	1596	1631	1672	1690	1737	1764	1767	1815
B21RTWTC L or R	12.8	1550	1579	1610	1670	1675	1706	1753	1769	1821	1848	1852	1903
B24RTWTC L or R	14.4	1618	1647	1681	1746	1747	1785	1834	1853	1908	1938	1943	1996

<b>B24RTWTC D</b>	14.4	1746	1782	1822	1894	1898	1943	1998	2020	2083	2117	2121	2186
-------------------	------	------	------	------	------	------	------	------	------	------	------	------	------

Custom Modifications	AUTHL AUTHR	CBO	CCO	CFNTO	CFP	CFRMO	CMAT	CND	DRWTK	FB	FD	FPEB	FTK	MIP	P	RD	RECTKALL RECTKBK	RECTKL RECTKR	RT	SCPDRW	TOTSS	VTK
	•	•	•	•	•	•	•	•	•	•	•	•	•	•	•	•	•	•	•	•	•	•

Construction Upgrades	VPL	Smart Stop Options	INTGH	PG	SP
	•		•	•	•

<b>B24PS L or R</b>	14.4	1218	1248	1282	1347	1348	1386	1434	1454	1508	1539	1543	1596
<b>B24PS</b>	14.4	1347	1383	1423	1495	1499	1543	1599	1620	1684	1718	1722	1787
<b>B30PS</b>	17.7	1446	1486	1530	1608	1614	1658	1719	1745	1812	1849	1853	1923
<b>B36PS</b>	21.1	1635	1680	1723	1811	1816	1868	1934	1959	2034	2076	2081	2158

Custom Modifications	AUTHL AUTHR	CBO	CCO	CFNTO	CFP	CFRMO	CMAT	CND	DRWTK	FB	FD	FPEB	FTK	MIP	P	RD	RECTKALL RECTKBK	RECTKL RECTKR	RT	SCPDRW	TOTSS	VTK
	•	•	•	•	•	•	•	•	•	•	•	•	•	•	•	•	•	•	•	•	•	•

Construction Upgrades	VPL	Smart Stop Options	INTGH	PG	SP
	•		•	•	•

<b>BPPP24 L or R</b>	14.4	1441	1470	1504	1569	1570	1608	1657	1676	1731	1761	1766	1819
<b>BPPP24</b>	14.4	1569	1605	1645	1717	1721	1766	1821	1843	1906	1940	1944	2009

Custom Modifications	AUTHL AUTHR	CBO	CCO	CFNTO	CFP	CFRMO	CMAT	CND	DRWTK	FB	FD	FPEB	FTK	MIP	P	RD	RECTKALL RECTKBK	RECTKL RECTKR	RT	SCPDRW	TOTSS	VTK
	•	•	•	•	•	•	•	•	•	•	•	•	•	•	•	•	•	•	•	•	•	•

Construction Upgrades	VPL	Smart Stop Options	INTGH	PG	SP
	•		•	•	•

**BASE with ROLL-OUT TRAY DIVIDER** L O G I X

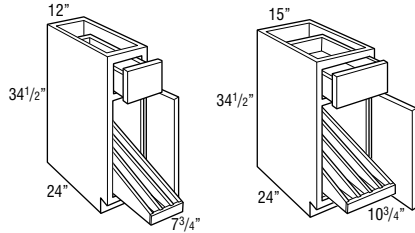

**B12DRO L or R**

**B15DRO L or R**

**Model**

Model	Cubic Feet							
	Tori Oak	Westburke Oak	Tori Hickory Tori Maple	Loren Laminate Tori Cherry Westburke Hickory Westburke Maple Westburke PureStyle™	Calio Oak Gantrell Oak Kesper Oak Reins Oak	Westburke Cherry	Brookway Oak Bryant Hickory Bryant Maple Bryant PureStyle™ Calio Maple Hurley Hickory Hurley Maple Kesper Maple Kesper Oak Reins Maple Reins PureStyle™	
<b>B12DRO L or R</b>	7.8	801	823	869	896	920	922	967
<b>B15DRO L or R</b>	9.4	866	890	941	968	992	996	1043

- Tray divider utilizes Smart Stop undermount guides and bumpers for door protection.
- Dividers are removable.
- 12" - 3 compartments.
- 15" - 4 compartments.

**BASE with TRAY DIVIDER**

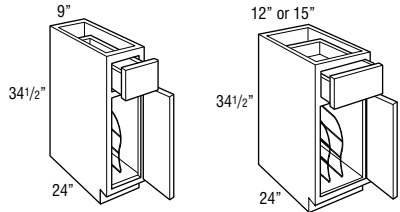

**TD9 L or R**

**TD12 L or R  
TD15 L or R**

<b>TD9 L or R</b>	6.1	457	481	521	542	565	570	601
<b>TD12 L or R</b>	7.8	496	518	564	591	615	617	662
<b>TD15 L or R</b>	9.4	527	551	602	629	653	657	704

- Tray Divider is chrome.
- Tray Divider is also available as an accessory for field installation. See page 295.
- RECTKALL and RECTBKB not available on TD9 L or R.

**BASE FULL HEIGHT with TRAY DIVIDER**

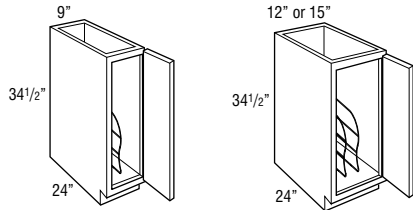

**TD9FH L or R**

**TD12FH L or R  
TD15FH L or R**

<b>TD9FH L or R</b>	6.1	441	460	498	521	543	544	584
<b>TD12FH L or R</b>	7.8	460	480	522	546	564	568	611
<b>TD15FH L or R</b>	9.4	490	511	554	580	603	605	650

- Tray Divider is chrome.
- Tray Divider is also available as an accessory for field installation. See page 295.
- RECTKALL and RECTBKB not available on TD9FH L or R.

Model	Cubic Feet	Cantrell Maple	Bryant Cherry Hurley Cherry Norris Maple Norris PureStyle™	Cairo Cherry Kasper Cherry Reist Cherry	Klewin Oak	Brookway Maple Cantrell Cherry Kersey Hickory Kersey Maple Norris Cherry	Felix Hickory Felix Maple Forte Hickory Forte Maple Forte PureStyle™ Owens Maple Owens PureStyle™	Antico PureStyle™ Brookway Cherry Felix Cherry Forte Cherry Kersey Cherry Klewin Hickory Klewin Maple Owens Cherry	Adair Maple Adair PureStyle™ Keegan Maple	Valero Maple	Adair Cherry Keegan Cherry	Klewin Cherry	Valero Cherry
		8	9	10	11	12	13	14	15	16	17	18	19
B12TDRO L or R	7.8	998	1021	1045	1093	1095	1124	1161	1176	1217	1239	1242	1285
B15TDRO L or R	9.4	1073	1100	1127	1181	1183	1213	1254	1268	1312	1338	1341	1385

Custom Modifications	AUTHL AUTHR	CBO	CCO	CFNTO	CFP	CFRMO	CMAT	CND	DRWTK	FB	FD	FPEB	FTK	MIP	P	RD	RECTKALL RECTKBK	RECTKL RECTKR	RT	SCPDRW	TOTSS	VTK
	•	•	•	•	•	•	•	•	•	•	•	•	•	•	•	•	•	•	•	•	•	•

Construction Upgrades	VPL	Smart Stop Options	INTGH	PG	SP
	•		•	•	

TD9 L or R	6.1	629	651	677	719	722	745	782	790	831	849	854	893
TD12 L or R	7.8	693	716	740	788	790	819	856	871	912	934	937	980
TD15 L or R	9.4	734	761	788	842	844	874	915	929	973	999	1002	1046

Custom Modifications	AUTHL AUTHR	CBO	CCO	CFNTO	CFP	CFRMO	CMAT	CND	DRWTK	FB	FD	FPEB	FTK	MIP	P	RD	RECTKALL RECTKBK	RECTKL RECTKR	RT	SCPDRW	TOTSS	VTK
	•	•	•	•	•	•	•	•	•	•	•	•	•	•	•	•	•	•	•	•	•	•

Construction Upgrades	VPL	Smart Stop Options	INTGH	PG	SP
	•		•	•	

TD9FH L or R	6.1	607	628	649	693	696	719	752	763	799	818	821	857
TD12FH L or R	7.8	634	657	678	726	728	754	787	799	838	857	860	898
TD15FH L or R	9.4	677	700	726	772	775	802	839	854	895	918	922	961

Custom Modifications	AUTHL AUTHR	CBO	CCO	CFNTO	CFP	CFRMO	CMAT	CND	DRWTK	FB	FD	FPEB	FTK	MIP	P	RD	RECTKALL RECTKBK	RECTKL RECTKR	RT	SCPDRW	TOTSS	VTK
	•	•	•	•	•	•	•	•	•	•	•	•	•	•	•	•	•	•	•	•	•	•

Construction Upgrades	VPL	Smart Stop Options	INTGH	PG	SP
	•		•		



**SINK BASE**

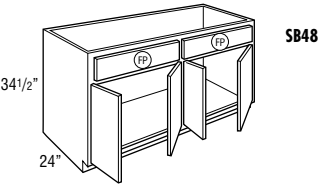
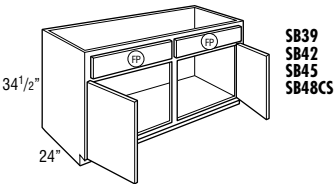
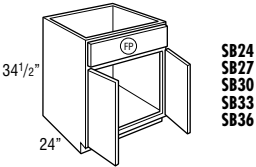
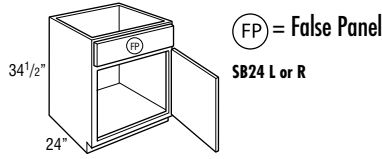

(FP) = False Panel

Model	Cubic Feet	Finish						
		Tori Oak	Westburke Oak	Tori Hickory Tori Maple	Loren Laminate Tori Cherry Westburke Hickory Westburke Maple Westburke PureStyle™	Cairo Oak Gambrell Oak Kesper Oak Reins Oak	Westburke Cherry	Brookway Oak Bryant Hickory Bryant Maple Cairo Maple Hurley Hickory Hurley Maple Kesper Maple Kesper Oak Reins Maple Reins PureStyle™
		1	2	3	4	5	6	7
<b>SB24 L or R</b>	14.4	480	504	557	586	613	615	668
<b>SB24</b>	14.4	551	579	640	672	703	705	766
<b>SB27</b>	16.1	573	601	668	702	733	736	798
<b>SB30</b>	17.7	593	623	690	728	760	764	825
<b>SB33</b>	19.6	617	648	713	751	787	791	856
<b>SB36</b>	21.1	640	673	742	783	819	822	892
<b>SB39</b>	22.7	675	708	782	823	861	866	939
<b>SB42</b>	24.4	704	739	818	860	901	904	981
<b>SB45</b>	24.7	739	776	858	904	948	949	1030
<b>SB48CS</b>	27.7	873	919	1019	1073	1126	1129	1227
<b>SB48</b>	27.7	901	947	1047	1101	1153	1157	1255

- Mini Touch-Up Kit (MTUK) included. MTUK includes small touch-up marker and small fill stick.
- CMAT not available on SB24 L or R, SB24, SB27, SB39, SB42, SB45, SB48CS, and SB48.
- DRWTK not available on SB39, SB42, SB45, SB48CS, and SB48.

**SINK BASE with DRAWERS**

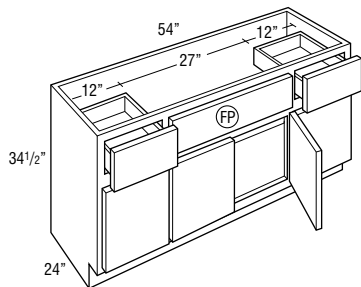

**2SBD54**

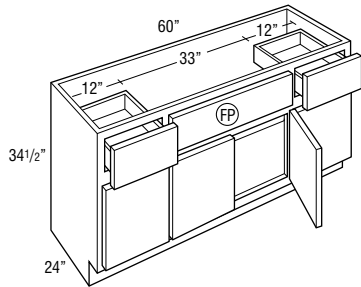

**2SBD60**

Model	Cubic Feet	Finish						
		1	2	3	4	5	6	7
<b>2SBD54</b>	31.0	1202	1261	1395	1469	1536	1542	1674
<b>2SBD60</b>	34.4	1271	1334	1478	1557	1627	1636	1773

- Mini Touch-Up Kit (MTUK) included. MTUK includes small touch-up marker and small fill stick.
- CMAT not available on 2SBD54.

Model	Cubic Feet	Wood Species											
		Cantrell Maple	Bryant Cherry Hurley Cherry Norris Maple Norris PureStyle™	Cairo Cherry Kasper Cherry Reist Cherry	Klewin Oak	Brookway Maple Cantrell Cherry Kersey Hickory Kersey Maple Norris Cherry	Felix Hickory Felix Maple Forte Hickory Forte Maple Forte PureStyle™ Owens Maple Owens PureStyle™	Amico PureStyle™ Brookway Cherry Felix Cherry Forte Cherry Kersey Hickory Klewin Hickory Owens Cherry	Adair Maple Adair PureStyle™ Keegan Maple	Wilero Maple	Adair Cherry Keegan Cherry	Klewin Cherry	Wilero Cherry
<b>SB24 L or R</b>	14.4	701	728	757	812	816	848	889	907	954	981	984	1032
<b>SB24</b>	14.4	803	833	867	932	933	971	1019	1039	1095	1124	1129	1183
<b>SB27</b>	16.1	838	869	904	971	976	1013	1063	1086	1142	1173	1178	1235
<b>SB30</b>	17.7	867	900	935	1008	1009	1051	1101	1124	1182	1214	1218	1278
<b>SB33</b>	19.6	898	932	968	1041	1047	1089	1142	1162	1224	1259	1262	1324
<b>SB36</b>	21.1	934	970	1011	1087	1089	1131	1187	1210	1273	1309	1314	1378
<b>SB39</b>	22.7	985	1021	1062	1142	1147	1190	1250	1275	1342	1379	1384	1453
<b>SB42</b>	24.4	1028	1067	1112	1194	1197	1245	1307	1330	1400	1441	1444	1515
<b>SB45</b>	24.7	1077	1122	1166	1255	1256	1309	1372	1397	1471	1511	1516	1592
<b>SB48CS</b>	27.7	1287	1338	1394	1501	1503	1567	1646	1677	1767	1816	1823	1914
<b>SB48</b>	27.7	1315	1366	1422	1529	1531	1594	1674	1704	1795	1844	1850	1942

Custom Modifications	AUTHL AUTHR	CBO	CCO	CFNTO	CFP	CFRMO	CMAT	CND	DRWTK	FB	FD	FPEB	FTK	MIP	P	RD	RECTKALL RECTKBK	RECTKL RECTKR	RT	SCPDRW	TOTSS	VTK
	•		•	•	STD	•	•	•	•	•		•	•	•	•	•	•	•	•		•	•

Construction Upgrades	VPL	Smart Stop Options	INTGH	PG	SP
	•		•		

<b>2SBD54</b>	31.0	1754	1823	1895	2036	2043	2126	2229	2272	2390	2456	2465	2584
<b>2SBD60</b>	34.4	1859	1933	2009	2159	2163	2251	2362	2408	2534	2604	2611	2742

Custom Modifications	AUTHL AUTHR	CBO	CCO	CFNTO	CFP	CFRMO	CMAT	CND	DRWTK	FB	FD	FPEB	FTK	MIP	P	RD	RECTKALL RECTKBK	RECTKL RECTKR	RT	SCPDRW	TOTSS	VTK
	•	•	•	•	•	•	•	•		•		•	•	•	•	•	•	•				•

Construction Upgrades	VPL	Smart Stop Options	INTGH	PG	SP
	•		•	•	

**SINK BASE with CABMAT™**

**LOGIX**

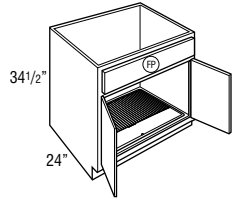

Model	Cubic Feet	Cabinet Material					Cabinet Material	
		Tori Oak	Westburke Oak	Tori Hickory Tori Maple	Loren Laminate Tori Cherry Westburke Hickory Westburke Maple Westburke PureStyle™	Galio Oak Gantrell Oak Kesper Oak Reinsl Oak	Westburke Cherry	Brookway Oak Bryant Hickory Bryant Maple Calo Maple Hurley Hickory Hurley Maple Kesper Maple Kessy Oak Reinsl PureStyle™ Reinsl PureStyle™
		1	2	3	4	5	6	7
<b>SB30CM</b>	17.7	881	911	978	1016	1048	1052	1113
<b>SB33CM</b>	19.6	917	948	1013	1051	1087	1091	1156
<b>SB36CM</b>	21.1	952	985	1054	1095	1131	1134	1204

- Mini Touch-Up Kit (MTUK) included. MTUK includes small touch-up marker and small fill stick.
- CabMat features a gray sloped mat to capture spills.
- CabMat is removable for cleaning.
- 30" wide CabMat has a liquid capacity of 4.2 quarts or 3.9 liters.
- 33" wide CabMat has a liquid capacity of 4.6 quarts or 4.3 liters.
- 36" wide CabMat has a liquid capacity of 5 quarts or 4.7 liters.

**SINK BASE with CADDY**

**LOGIX**

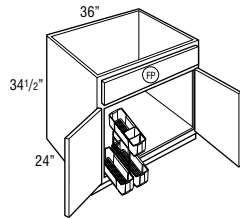

Model	20.9	1104	1137	1206	1247	1283	1286	1356
<b>SB36CDY L or R</b>								

- Mini Touch-Up Kit (MTUK) included. MTUK includes small touch-up marker and small fill stick.
- L or R designates caddy location.
- Caddy is removable and portable.
- Caddy dimensions are: 9 15/16" wide x 18 5/16" tall x 18 5/8" deep.

Model	Cubic Feet	Camtrel Maple	Bryant Cherry Hurley Cherry Norris Maple Norris PureStyle™	Cairo Cherry Kasper Cherry Reist Cherry	Klewin Oak	Brockway Maple Camtrel Cherry Kersey Hickory Kersey Maple Norris Cherry	Felix Hickory Felix Maple Forte Hickory Forte Maple Forte PureStyle™ Owens Maple Owens PureStyle™	Amico PureStyle™ Brockway Cherry Felix Cherry Forte Cherry Kersey Cherry Kersey Hickory Klewin Maple Owens Cherry	Adair Maple Adair PureStyle™ Keegan Maple	Valero Maple	Adair Cherry Keegan Cherry	Klewin Cherry	Valero Cherry
		8	9	10	11	12	13	14	15	16	17	18	19
SB30CM	17.7	1155	1188	1223	1296	1297	1339	1389	1412	1470	1502	1506	1566
SB33CM	19.6	1198	1232	1268	1341	1347	1389	1442	1462	1524	1559	1562	1624
SB36CM	21.1	1246	1282	1323	1399	1401	1443	1499	1522	1585	1621	1626	1690

Custom Modifications	AUTHL AUTHR	CBO	CCO	CFNTO	CFP	CFRMO	CMAT	CND	DRWTK	FB	FD	FPEB	FTK	MIP	P	RD	RECTKALL RECTKBK	RECTKL RECTKR	RT	SCPDRW	TOTSS	VTK
	•	•	•	•	•	•	•	•	•	•	•	•	•	•	•	•	•	•	•	•	•	•

Construction Upgrades	VPL	Smart Stop Options	INTGH	PG	SP
	•		•		

SB36CDY L or R	20.9	1398	1434	1475	1551	1553	1595	1651	1674	1737	1773	1778	1842
----------------	------	------	------	------	------	------	------	------	------	------	------	------	------

Custom Modifications	AUTHL AUTHR	CBO	CCO	CFNTO	CFP	CFRMO	CMAT	CND	DRWTK	FB	FD	FPEB	FTK	MIP	P	RD	RECTKALL RECTKBK	RECTKL RECTKR	RT	SCPDRW	TOTSS	VTK
	•	•	•	•	•	•	•	•	•	•	•	•	•	•	•	•	•	•	•	•	•	•

Construction Upgrades	VPL	Smart Stop Options	INTGH	PG	SP
	•		•		

**SINK BASE with TILT-OUT TRAYS**

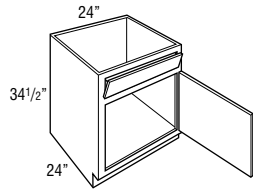

**SB24ST L or R**

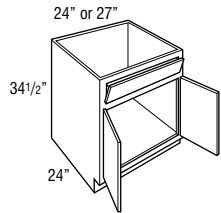

**SB24ST  
SB27ST**

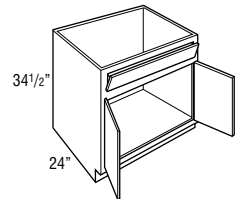

**SB30ST  
SB33ST  
SB36ST**

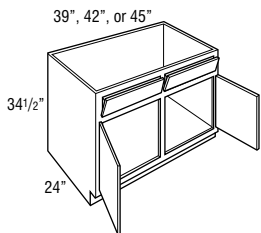

**SB39ST  
SB42ST  
SB45ST**

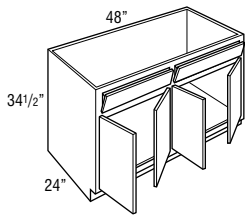

**SB48ST**

**SINK BASE with TILT-OUT TRAYS and CABMAT™**

L O G I X

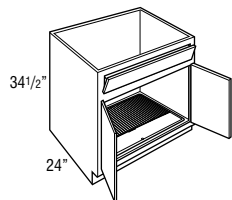

Model	Cubic Feet	Finish						
		Tori Oak	Westburke Oak	Tori Hickory Tori Maple	Loren Laminate Tori Cherry Westburke Hickory Westburke Maple Westburke PureStyle™	Cairo Oak Gantrell Oak Kesper Oak Rensel Oak	Westburke Cherry	Brookway Oak Bryant Hickory Bryant Maple Cairo Maple Hurley Hickory Hurley Maple Kesper Maple Kersey Oak Rensel PureStyle™ Rensel PureStyle™
		1	2	3	4	5	6	7
<b>SB24ST L or R</b>	14.4	630	662	726	762	797	801	859
<b>SB24ST</b>	14.4	630	662	726	762	797	801	859
<b>SB27ST</b>	16.1	640	672	736	772	807	811	870
<b>SB30ST</b>	17.7	651	683	746	782	817	821	880
<b>SB33ST</b>	19.6	674	707	771	807	845	848	910
<b>SB36ST</b>	21.1	704	739	807	846	882	888	951
<b>SB39ST</b>	22.7	738	775	846	886	923	929	996
<b>SB42ST</b>	24.4	792	831	908	949	987	995	1063
<b>SB45ST</b>	25.7	812	851	928	969	1007	1016	1084
<b>SB48ST</b>	27.7	833	872	949	990	1028	1036	1104

- Tilt-out trays are stain resistant, moisture resistant plastic to allow storage of sponges and other cleaning materials.
- Mini Touch-Up Kit (MTUK) included. MTUK includes small touch-up marker and small fill stick.
- Includes two tilt-out trays on 30"-48" wide.
- Tilt-out trays are also available as an accessory for field installation. See page 295.
- CMAT only available on 30", 33", and 36" wide.
- DRWTK not available on 39", 42", 45", and 48" wide.

<b>SB30STCM</b>	17.7	939	971	1034	1070	1105	1109	1168
<b>SB33STCM</b>	19.6	974	1007	1071	1107	1145	1148	1210
<b>SB36STCM</b>	21.1	1016	1051	1119	1158	1194	1200	1263

- Mini Touch-Up Kit (MTUK) included. MTUK includes small touch-up marker and small fill stick.
- CabMat features a gray sloped mat to capture spills.
- CabMat is removable for cleaning.
- 30" wide CabMat has a liquid capacity of 4.2 quarts or 3.9 liters.
- 33" wide CabMat has a liquid capacity of 4.6 quarts or 4.3 liters.
- 36" wide CabMat has a liquid capacity of 5 quarts or 4.7 liters.
- Tilt-out trays are stain resistant, moisture resistant plastic to allow storage of sponges and other cleaning materials.
- Includes two tilt-out trays.
- Tilt-out trays are also available as an accessory for field installation. See page 295.

Model	Cubic Feet	Cantrill Maple	Bryant Cherry Hurley Cherry Norris Maple Norris PureStyle™	Cairo Cherry Kasper Cherry Reist Cherry	Klewin Oak	Brockway Maple Cantrill Cherry Kersey Hickory Kersey Maple Norris Cherry	Falk Hickory Falk Maple Forte Hickory Forte Maple Forte PureStyle™ Owens Maple Owens PureStyle™	Amico PureStyle™ Brockway Cherry Falk Cherry Forte Cherry Kersey Cherry Klewin Hickory Owens Cherry	Adair Maple Adair PureStyle™ Keegan Maple	Valero Maple	Adair Cherry Keegan Cherry	Klewin Cherry	Valero Cherry
		8	9	10	11	12	13	14	15	16	17	18	19
<b>SB24ST L or R</b>	14.4	901	933	971	1038	1045	1080	1136	1163	1224	1246	1252	1313
<b>SB24ST</b>	14.4	901	933	971	1038	1045	1080	1136	1163	1224	1246	1252	1313
<b>SB27ST</b>	16.1	911	944	982	1049	1056	1091	1146	1173	1235	1256	1262	1323
<b>SB30ST</b>	17.7	921	954	992	1059	1066	1101	1157	1183	1245	1266	1273	1333
<b>SB33ST</b>	19.6	950	985	1024	1092	1099	1136	1196	1221	1286	1306	1314	1374
<b>SB36ST</b>	21.1	995	1031	1071	1145	1150	1192	1252	1277	1344	1368	1376	1440
<b>SB39ST</b>	22.7	1042	1080	1124	1198	1205	1249	1311	1339	1409	1433	1443	1509
<b>SB42ST</b>	24.4	1111	1149	1194	1272	1282	1327	1394	1419	1495	1516	1530	1598
<b>SB45ST</b>	25.7	1132	1170	1214	1292	1302	1348	1415	1439	1515	1537	1550	1618
<b>SB48ST</b>	27.7	1152	1190	1235	1313	1323	1368	1435	1460	1536	1557	1571	1639

Custom Modifications	AUTHL AUTHR	CBO	CCO	CFNTO	CFP	CFRMO	CMAT	CND	DRWTK	FB	FD	FPEB	FTK	MIP	P	RD	RECTKALL RECTKBK	RECTKL RECTKR	RT	SCPDRW	TOTSS	VTK
	•		•	•		•	•	•	•	•		•	•	•	•	•	•	•				•

Construction Upgrades	VPL	Smart Stop Options	INTGH	PG	SP
	•		•		

<b>SB30STCM</b>	17.7	1209	1242	1280	1347	1354	1389	1445	1471	1533	1554	1561	1621
<b>SB33STCM</b>	19.6	1250	1285	1324	1392	1399	1436	1496	1521	1586	1606	1614	1674
<b>SB36STCM</b>	21.1	1307	1343	1383	1457	1462	1504	1564	1589	1656	1680	1688	1752

Custom Modifications	AUTHL AUTHR	CBO	CCO	CFNTO	CFP	CFRMO	CMAT	CND	DRWTK	FB	FD	FPEB	FTK	MIP	P	RD	RECTKALL RECTKBK	RECTKL RECTKR	RT	SCPDRW	TOTSS	VTK
	•	•	•	•		•		•	•	•		•	•	•			•	•				•

Construction Upgrades	VPL	Smart Stop Options	INTGH	PG	SP
	•		•		

Model	Cubic Feet							
		Tori Oak	Westburke Oak	Tori Hickory Tori Maple	Loren Laminate Tori Cherry Westburke Hickory Westburke Maple Westburke PureStyle™	Calio Oak Gantrell Oak Kesper Oak Reist Oak	Westburke Cherry	Brookway Oak Bryant Hickory Bryant Maple Calio Maple Hurley Hickory Hurley Maple Kesper Oak Reist Oak Reist PureStyle™
		1	2	3	4	5	6	7

**SINK BASE with TILT-OUT TRAYS and CADDY**

L O G I X

**SB365TCDY L or R**

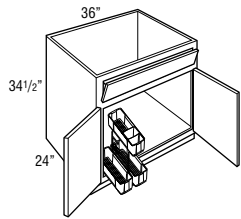

- Mini Touch-Up Kit (MTUK) included. MTUK includes small touch-up marker and small fill stick.
- L or R designates caddy location.
- Caddy is removable and portable.
- Tilt-out trays are stain resistant, moisture resistant plastic to allow storage of sponges and other cleaning materials.
- Includes two tilt-out trays.
- Tilt-out trays are also available as an accessory for field installation. See page 295.
- Caddy dimensions are: 9 15/16" wide x 18 5/16" tall x 18 5/8" deep.

**SINK BASE SUPERCABINET™**

L O G I X

**SB36S**

21.1	1031	1064	1133	1174	1210	1213	1283
------	------	------	------	------	------	------	------

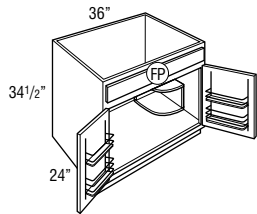

(FP) = False Panel

- Quarter Round Reversible Shelf for left or right applications will be constructed from 3/4" thick laminated furniture board. (Shelf shipped secure, can be positioned in left or right corner.)
- Both doors will have a chrome and wood two-tiered rack.
- Mini Touch-Up Kit (MTUK) included. MTUK includes small touch-up marker and small fill stick.
- Racks on doors are 3 1/4" deep.
- All load bearing surfaces meet KCMA standards of 15 lbs. per square foot.

**SINK BASE SUPERCABINET™ with CABMAT™**

L O G I X

**SB36SCM**

21.1	1343	1376	1445	1486	1522	1525	1595
------	------	------	------	------	------	------	------

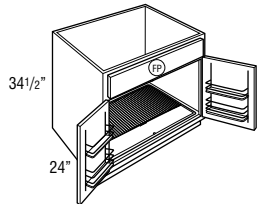

- Mini Touch-Up Kit (MTUK) included. MTUK includes small touch-up marker and small fill stick.
- CabMat features a gray sloped mat to capture spills.
- CabMat is removable for cleaning.
- 36" wide CabMat has a liquid capacity of 5 quarts or 4.7 liters.
- Both doors will have a chrome and wood two-tiered rack.
- Racks on doors are 3 1/4" deep.
- All load bearing surfaces meet KCMA standards of 15 lbs. per square foot.

**SINK BASE SUPERCABINET™ with CADDY**

L O G I X

**SB36SCDY L or R**

20.9	1495	1528	1597	1638	1674	1677	1747
------	------	------	------	------	------	------	------

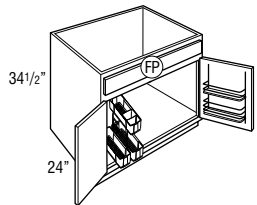

- Mini Touch-Up Kit (MTUK) included. MTUK includes small touch-up marker and small fill stick.
- L or R designates caddy location.
- Caddy is removable and portable.
- Caddy dimensions are: 9 15/16" wide x 18 5/16" tall x 18 5/8" deep.
- Door opposite caddy features a chrome and wood two-tiered rack.
- Door rack width is 13 7/8".
- Door rack depth is 3 1/2".

**SINK BASE SUPERCABINET™ with TILT-OUT TRAYS**

L O G I X

**SB36STS**

21.1	1095	1130	1198	1237	1273	1279	1342
------	------	------	------	------	------	------	------

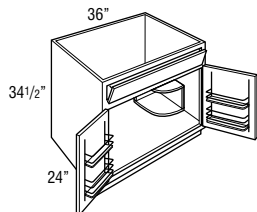

- Quarter Round Reversible Shelf for left or right applications will be constructed from 3/4" thick laminated furniture board. (Shelf shipped secure, can be positioned in left or right corner.)
- Both doors will have a chrome and wood two-tiered rack.
- Mini Touch-Up Kit (MTUK) included. MTUK includes small touch-up marker and small fill stick.
- Racks on doors are 3 1/4" deep.
- Includes two tilt-out trays.
- Tilt-out trays are stain resistant, moisture resistant plastic to allow storage of sponges and other cleaning materials.
- Tilt-out trays are also available as an accessory for field installation. See page 295.
- All load bearing surfaces meet KCMA standards of 15 lbs. per square foot.

Model	Cubic Feet	Canterl Maple	Bryant Cherry Hurley Cherry Norris Maple Norris PureStyle™	Cairo Cherry Kasper Cherry Reist Cherry	Klewin Oak	Brookway Maple Canterl Cherry Kersey Hickory Kersey Maple Norris Cherry	Falk Hickory Falk Maple Forte Hickory Forte Maple Forte PureStyle™ Owens Maple Owens PureStyle™	Antico PureStyle™ Brookway Cherry Falk Cherry Forte Cherry Kersey Cherry Klewin Hickory Klewin Maple Owens Cherry	Adair Maple Adair PureStyle™ Keegan Maple	Wilero Maple	Adair Cherry Keegan Cherry	Klewin Cherry	Wilero Cherry
	8	9	10	11	12	13	14	15	16	17	18	19	
SB36STCDY L or R	20.9	1459	1495	1535	1609	1614	1656	1716	1741	1808	1832	1840	1904

Custom Modifications	AUTHL AUTHR	CBO	CCO	CFNT0	CFP	CFRMO	CMAT	CND	DRWTK	FB	FD	FPEB	FTK	MIP	P	RD	RECTKALL RECTKBK	RECTKL RECTKR	RT	SCPDRW	TOTSS	VTK
	•	•	•	•		•		•	•	•		•	•	•			•	•				•

Construction Upgrades	VPL	Smart Stop Options	INTGH	PG	SP
	•		•		

SB36S	21.1	1325	1361	1402	1478	1480	1522	1578	1601	1664	1700	1705	1769
-------	------	------	------	------	------	------	------	------	------	------	------	------	------

Custom Modifications	AUTHL AUTHR	CBO	CCO	CFNT0	CFP	CFRMO	CMAT	CND	DRWTK	FB	FD	FPEB	FTK	MIP	P	RD	RECTKALL RECTKBK	RECTKL RECTKR	RT	SCPDRW	TOTSS	VTK
	•		•	•	STD	•		•	•	•		•	•	•			•	•			•	•

Construction Upgrades	VPL	Smart Stop Options	INTGH	PG	SP
	•		•		

SB36SCM	21.1	1637	1673	1714	1790	1792	1834	1890	1913	1976	2012	2017	2081
---------	------	------	------	------	------	------	------	------	------	------	------	------	------

Custom Modifications	AUTHL AUTHR	CBO	CCO	CFNT0	CFP	CFRMO	CMAT	CND	DRWTK	FB	FD	FPEB	FTK	MIP	P	RD	RECTKALL RECTKBK	RECTKL RECTKR	RT	SCPDRW	TOTSS	VTK
	•	•	•	•		•		•	•	•		•	•	•			•	•			•	•

Construction Upgrades	VPL	Smart Stop Options	INTGH	PG	SP
	•		•		

SB36SCDY L or R	20.9	1789	1825	1866	1942	1944	1986	2042	2065	2128	2164	2169	2233
-----------------	------	------	------	------	------	------	------	------	------	------	------	------	------

Custom Modifications	AUTHL AUTHR	CBO	CCO	CFNT0	CFP	CFRMO	CMAT	CND	DRWTK	FB	FD	FPEB	FTK	MIP	P	RD	RECTKALL RECTKBK	RECTKL RECTKR	RT	SCPDRW	TOTSS	VTK
	•	•	•	•	STD	•		•	•	•		•	•	•			•	•			•	•

Construction Upgrades	VPL	Smart Stop Options	INTGH	PG	SP
	•		•		

SB36STS	21.1	1386	1422	1462	1536	1541	1583	1643	1668	1735	1759	1767	1831
---------	------	------	------	------	------	------	------	------	------	------	------	------	------

Custom Modifications	AUTHL AUTHR	CBO	CCO	CFNT0	CFP	CFRMO	CMAT	CND	DRWTK	FB	FD	FPEB	FTK	MIP	P	RD	RECTKALL RECTKBK	RECTKL RECTKR	RT	SCPDRW	TOTSS	VTK
	•		•	•		•		•	•	•		•	•	•			•	•				•

Construction Upgrades	VPL	Smart Stop Options	INTGH	PG	SP
	•		•		



**SINK BASE SUPERCABINET™ with TILT-OUT TRAYS and CABMAT™**

LOGIX

**Model**

Cubic Feet	Finish						
	Tori Oak	Westburke Oak	Tori Hickory Tori Maple	Laven Laminate Tori Cherry Westburke Hickory Westburke Maple Westburke PureStyle™	Calvo Oak Gantrell Oak Kesper Oak Reisn Oak	Westburke Cherry	Brookway Oak Bryant Hickory Bryant Maple Calvo Maple Hurley Hickory Hurley Maple Kesper Oak Reisn PureStyle™ Reisn PureStyle™
	1	2	3	4	5	6	7

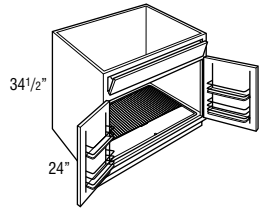

- Mini Touch-Up Kit (MTUK) included. MTUK includes small touch-up marker and small fill stick.
- CabMat features a gray sloped mat to capture spills.
- CabMat is removable for cleaning.
- 36" wide CabMat has a liquid capacity of 5 quarts or 4.7 liters.
- Both doors will have a chrome and wood two-tiered rack.
- Racks on doors are 3 1/4" deep.
- Includes two tilt-out trays.
- Tilt-out trays are stain resistant, moisture resistant plastic to allow storage of sponges and other cleaning materials.
- Tilt-out trays are also available as an accessory for field installation. See page 295.
- All load bearing surfaces meet KCMA standards of 15 lbs. per square foot.

**SINK BASE SUPERCABINET™ with TILT-OUT TRAYS and CADDY**

LOGIX

<b>SB36STSCDY L or R</b>	20.9	1559	1594	1662	1701	1737	1743	1806
--------------------------	------	------	------	------	------	------	------	------

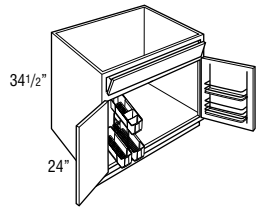

- Mini Touch-Up Kit (MTUK) included. MTUK includes small touch-up marker and small fill stick.
- L or R designates caddy location.
- Caddy is removable and portable.
- Includes two tilt-out trays.
- Tilt-out trays are stain resistant, moisture resistant plastic to allow storage of sponges and other cleaning materials.
- Tilt-out trays are also available as an accessory for field installation. See page 295.
- Caddy dimensions are: 9 15/16" wide x 18 5/16" tall x 18 5/8" deep.
- Door opposite caddy features a chrome and wood two-tiered rack.
- Door rack width is 13 7/8".
- Door rack depth is 3 1/2".

**SINK BASE with DRAWER BELOW**

LOGIX

<b>SB36D</b>	21.1	793	832	921	967	1013	1016	1102
--------------	------	-----	-----	-----	-----	------	------	------

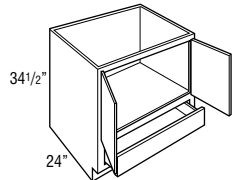

- Drawers are below full cabinet floor.
- Mini Touch-Up Kit (MTUK) included. MTUK includes small touch-up marker and small fill stick.
- Verify that sink, garbage disposal and plumbing fit opening.
- Plumbing going through floor will interfere with drawer operation. 2 3/4" clearance from back of drawer to interior back of cabinet.
- Face frame opening height is 20 1/2".
- Face frame opening height for drawer is 4 1/2".

**SINK BASE with DRAWER BELOW and CABMAT™**

LOGIX

<b>SB36DCM</b>	21.1	1105	1144	1233	1279	1325	1328	1414
----------------	------	------	------	------	------	------	------	------

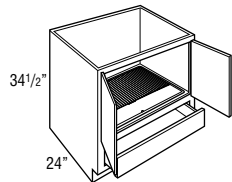

- Drawers are below full cabinet floor.
- Mini Touch-Up Kit (MTUK) included. MTUK includes small touch-up marker and small fill stick.
- Verify that sink, garbage disposal and plumbing fit opening.
- Plumbing going through floor will interfere with drawer operation. 2 3/4" clearance from back of drawer to interior back of cabinet.
- Face frame opening height is 20 1/2".
- Face frame opening height for drawer is 4 1/2".
- CabMat features a gray sloped mat to capture spills.
- CabMat is removable for cleaning.
- 36" wide CabMat has a liquid capacity of 5 quarts or 4.7 liters.

Model	Cubic Feet	8	9	10	11	12	13	14	15	16	17	18	19
		Centrell Maple	Bryant Cherry Hurley Cherry Norris Maple Norris PureStyle™	Cairo Cherry Kasper Cherry Reist Cherry	Klewin Oak	Brookway Maple Centrell Cherry Kersey Hickory Kersey Maple Norris Cherry	Felix Hickory Felix Maple Forte Hickory Forte Maple Forte PureStyle™ Owens Maple Owens PureStyle™	Antico PureStyle™ Brookway Cherry Felix Cherry Forte Cherry Kersey Cherry Klewin Hickory Klewin Maple Owens Cherry	Adair Maple Adair PureStyle™ Keegan Maple	Wilero Maple	Adair Cherry Keegan Cherry	Klewin Cherry	Wilero Cherry
<b>SB36STSCM</b>	21.1	1698	1734	1774	1848	1853	1895	1955	1980	2047	2071	2079	2143

Custom Modifications	AUTHL AUTHR	CBO	CCO	CFNT0	CFP	CFRMO	CMAT	CND	DRWTK	FB	FD	FPEB	FTK	MIP	P	RD	RECTKALL RECTKBK	RECTKL RECTKR	RT	SCPDRW	TOTSS	VTK
	•	•	•	•		•		•	•	•		•	•	•			•	•				•

Construction Upgrades	VPL	Smart Stop Options	INTGH	PG	SP
	•		•		

<b>SB36STSCDY L or R</b>	20.9	1850	1886	1926	2000	2005	2047	2107	2132	2199	2223	2231	2295
--------------------------	------	------	------	------	------	------	------	------	------	------	------	------	------

Custom Modifications	AUTHL AUTHR	CBO	CCO	CFNT0	CFP	CFRMO	CMAT	CND	DRWTK	FB	FD	FPEB	FTK	MIP	P	RD	RECTKALL RECTKBK	RECTKL RECTKR	RT	SCPDRW	TOTSS	VTK
	•	•	•	•		•		•	•	•		•	•	•			•	•				•

Construction Upgrades	VPL	Smart Stop Options	INTGH	PG	SP
	•		•		

<b>SB36D</b>	21.1	1155	1202	1249	1342	1345	1400	1470	1497	1574	1619	1625	1704
--------------	------	------	------	------	------	------	------	------	------	------	------	------	------

Custom Modifications	AUTHL AUTHR	CBO	CCO	CFNT0	CFP	CFRMO	CMAT	CND	DRWTK	FB	FD	FPEB	FTK	MIP	P	RD	RECTKALL RECTKBK	RECTKL RECTKR	RT	SCPDRW	TOTSS	VTK
	•	•	•	•		•	•	•	•	•		•	•	•	•		•	•				•

Construction Upgrades	VPL	Smart Stop Options	INTGH	PG	SP
	•		•	•	

<b>SB36DCM</b>	21.1	1467	1514	1561	1654	1657	1712	1782	1809	1886	1931	1937	2016
----------------	------	------	------	------	------	------	------	------	------	------	------	------	------

Custom Modifications	AUTHL AUTHR	CBO	CCO	CFNT0	CFP	CFRMO	CMAT	CND	DRWTK	FB	FD	FPEB	FTK	MIP	P	RD	RECTKALL RECTKBK	RECTKL RECTKR	RT	SCPDRW	TOTSS	VTK
	•	•	•	•		•		•	•	•		•	•	•			•	•				•

Construction Upgrades	VPL	Smart Stop Options	INTGH	PG	SP
	•		•	•	

**ANGLED CORNER SINK BASE**

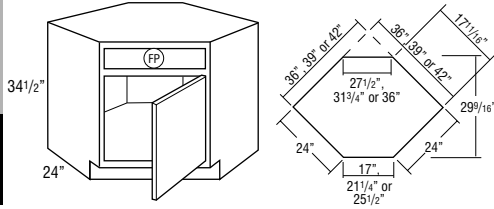

(FP) = False Panel

Max. Sink Widths if cut out is 4" back from face of front frame

Model	Cubic Feet	Cubic Feet					7	
		Tori Oak	Westburke Oak	Tori Hickory Tori Maple	Loren Laminate Tori Cherry Westburke Hickory Westburke Maple Westburke PureStyle™	Calio Oak Gantrell Oak Kesper Oak Rens Oak		Westburke Cherry
<b>ACS36 L or R</b>	25.9	421	443	490	516	540	542	588
<b>ACS39 L or R</b>	33.7	449	473	522	550	573	578	624
<b>ACS42†</b>	38.9	466	487	540	568	594	597	648

- Edges beveled at 45°.
  - Mini Touch-Up Kit (MTUK) included. MTUK includes small touch-up marker and small fill stick.
  - For sufficient dishwasher door clearance and loading/unloading space, a 15" wide base cabinet is recommended for use between a corner sink base and dishwasher.
  - On ACS36, full overlay styles use the same width doors as partial overlay styles (14 1/2" wide) with a partial overlay hinge (38NPOHINGE) to allow for proper door clearance with adjacent cabinets.
- †ACS42 has butt doors.

Wall Width	Frame	Maximum Sink Width	Maximum Sink Depth
36" x 36"	17"	25 3/4"	27 11/32"
39" x 39"	21 1/4"	30"	27 11/32"
42" x 42"	25 1/2"	34 1/4"	27 11/32"

**ANGLED CORNER SINK FRONT without SINK FLOOR**

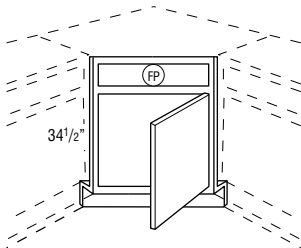

(FP) = False Panel

Max. Sink Widths if cut out is 4" back from face of front frame

<b>ACSF36 L or R</b>	3.3	383	403	445	471	490	494	536
<b>ACSF39 L or R</b>	3.3	404	424	469	493	514	516	560
<b>ACSF42†</b>	3.3	421	443	490	516	540	542	588

- Edges beveled at 45°.
  - Angled corner sink front bottom required for field installation. Order separately. See next item.
  - Toekick and toekick retainer shipped unattached from the face frame.
- †ACSF42 has butt doors.

Wall Width	Frame	Maximum Sink Width	Maximum Sink Depth
36" x 36"	17"	25 3/4"	27 11/32"
39" x 39"	21 1/4"	30"	27 11/32"
42" x 42"	25 1/2"	34 1/4"	27 11/32"

**ANGLED CORNER SINK FRONT BOTTOM**

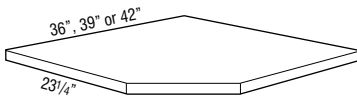

<b>ACSF36</b>	1.0	150	150	150	150	150	150	150
<b>ACSF39</b>	1.0	150	150	150	150	150	150	150
<b>ACSF42</b>	1.0	150	150	150	150	150	150	150

- Designed for use with Angled Corner Sink Front.
- 3/8" thick.

Model	Cubic Feet	Countrell Maple	Bryant Cherry Hurley Cherry Norris Maple Norris PureStyle™	Cairo Cherry Kesper Cherry Reist Cherry	Klewin Oak	Brookway Maple Countrell Cherry Kersey Hickory Kersey Maple Norris Cherry	Felix Hickory Felix Maple Forte Hickory Forte Maple Forte PureStyle™ Owens Maple Owens PureStyle™	Anitico PureStyle™ Brookway Cherry Felix Cherry Forte Cherry Kersey Cherry Klewin Hickory Klewin Maple Owens Cherry	Adair Maple Adair PureStyle™ Keegan Maple	Valero Maple	Adair Cherry Keegan Cherry	Klewin Cherry	Valero Cherry
		8	9	10	11	12	13	14	15	16	17	18	19
ACS36 L or R	25.9	617	641	667	714	719	746	783	798	841	865	868	910
ACS39 L or R	33.7	654	680	707	760	761	792	830	846	889	915	918	962
ACS42	38.9	680	706	735	788	792	822	864	879	925	952	953	1002

Custom Modifications	AUTHL AUTHR	CBO	CCO	CFNTO	CFP	CFRMO	CMAT	CND	DRWTK	FB	FD	FPEB	FTK	MIP	P	RD	RECTKALL RECTKBK	RECTKL RECTKR	RT	SCPDRW	TOTSS	VTK
	•		•	•	STD	•		•		•		•	•	•			•	•				•

Construction Upgrades	VPL	Smart Stop Options	INTGH	PG	SP
	•		•		

ACSF36 L or R	3.3	560	583	608	652	653	681	713	727	764	787	788	828
ACSF39 L or R	3.3	588	612	635	683	685	712	747	762	803	825	827	869
ACSF42	3.3	617	641	667	714	719	746	783	798	841	865	868	910

Custom Modifications	AUTHL AUTHR	CBO	CCO	CFNTO	CFP	CFRMO	CMAT	CND	DRWTK	FB	FD	FPEB	FTK	MIP	P	RD	RECTKALL RECTKBK	RECTKL RECTKR	RT	SCPDRW	TOTSS	VTK
				STD	STD	•		•					•									

Construction Upgrades	VPL	Smart Stop Options	INTGH	PG	SP
			•		

ACSF36	1.0	150	150	150	150	150	150	150	150	150	150	150	150
ACSF39	1.0	150	150	150	150	150	150	150	150	150	150	150	150
ACSF42	1.0	150	150	150	150	150	150	150	150	150	150	150	150

**MODIFICATIONS**  
No modifications available for these products.

**COUNTRY SINK BASE**

30", 33", or 36"

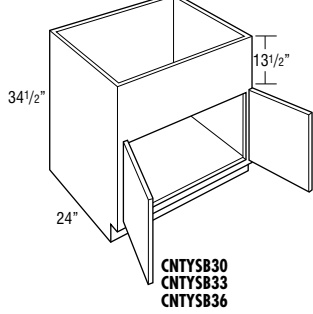

**CNTYSB30  
CNTYSB33  
CNTYSB36**

39", 42", 45", or 48"

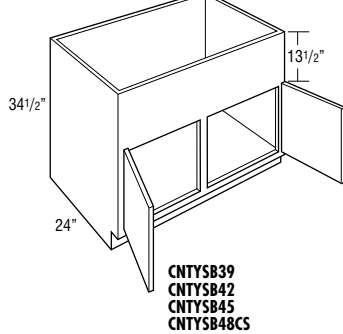

**CNTYSB39  
CNTYSB42  
CNTYSB45  
CNTYSB48CS**

48"

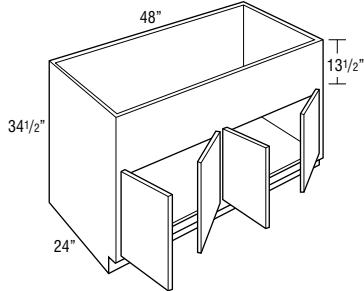

**CNTYSB48**

**COUNTRY SINK BASE with CABMAT™ L O G I X**

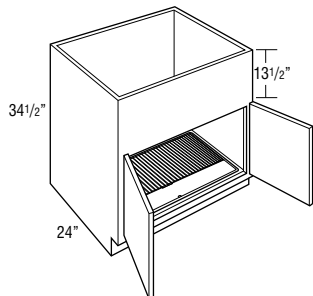

Model	Cubic Feet	Finish						
		Tori Oak	Westburke Oak	Tori Hickory Tori Maple	Loren Laminate Tori Cherry Westburke Hickory Westburke Maple Westburke PureStyle™	Chino Oak Gantrell Oak Kesper Oak Renaist Oak	Westburke Cherry	Brookway Oak Bryant Hickory Bryant Maple Chino Maple Hurley Hickory Hurley Maple Kesper Maple Kessy Oak Renaist PureStyle™
		1	2	3	4	5	6	7
<b>CNTYSB30</b>	17.7	772	812	897	946	987	992	1074
<b>CNTYSB33</b>	19.6	800	841	927	978	1024	1025	1115
<b>CNTYSB36</b>	21.1	832	874	965	1018	1064	1069	1159
<b>CNTYSB39</b>	22.7	878	922	1016	1070	1121	1124	1220
<b>CNTYSB42</b>	24.4	915	960	1063	1121	1173	1177	1273
<b>CNTYSB45</b>	24.7	960	1009	1116	1176	1231	1235	1338
<b>CNTYSB48CS</b>	27.7	1145	1204	1333	1404	1471	1477	1604
<b>CNTYSB48</b>	27.7	1173	1232	1361	1432	1499	1505	1631

- 13 1/2" panel can be trimmed up to 12".
- Mini Touch-Up Kit (MTUK) included. MTUK includes small touch-up marker and small fill stick.
- For apron front sinks requiring a cut-out height of 6 1/2" or less, see Base Drop-in Range Cabinets on page 172.
- Refer to manufacturer's recommendations for additional support required for apron front sinks.
- CMAT and DRWTK not available on CNTYSB39, CNTYSB42, CNTYSB45, CNTYSB48CS and CNTYSB48.

Model	1	2	3	4	5	6	7	
<b>CNTYSB30CM</b>	17.7	1060	1100	1185	1234	1275	1280	1362
<b>CNTYSB33CM</b>	24.7	1100	1141	1227	1278	1324	1325	1415
<b>CNTYSB36CM</b>	27.7	1144	1186	1277	1330	1376	1381	1471

- Mini Touch-Up Kit (MTUK) included. MTUK includes small touch-up marker and small fill stick.
- CabMat features a gray sloped mat to capture spills.
- CabMat is removable for cleaning.
- 30" wide CabMat has a liquid capacity of 4.2 quarts or 3.9 liters.
- 33" wide CabMat has a liquid capacity of 4.6 quarts or 4.3 liters.
- 36" wide CabMat has a liquid capacity of 5 quarts or 4.7 liters.
- 13 1/2" panel can be trimmed to 12".
- For apron front sinks requiring a cut-out height of 6 1/2" or less, see Base Drop-in Range Cabinets on page 172.
- Refer to manufacturer's recommendations for additional support required for apron front sinks.

Model	Cubic Feet	Countertop Maple	Bryant Cherry Hurley Cherry Norris Maple Norris PureStyle™	Cairo Cherry Kasper Cherry Reist Cherry	Klewin Oak	Brockway Maple Countertop Cherry Kersey Hickory Kersey Maple Norris Cherry	Felix Hickory Felix Maple Forte Hickory Forte Maple Forte PureStyle™ Owens Maple Owens PureStyle™	Antico PureStyle™ Brockway Cherry Felix Cherry Forte Cherry Kersey Cherry Klewin Hickory Klewin Maple Owens Cherry	Adair Maple Adair PureStyle™ Keegan Maple	Wilero Maple	Adair Cherry Keegan Cherry	Klewin Cherry	Wilero Cherry
		8	9	10	11	12	13	14	15	16	17	18	19
CNTYSB30	17.7	1127	1171	1216	1310	1312	1365	1432	1460	1537	1579	1584	1663
CNTYSB33	19.6	1170	1212	1261	1354	1361	1415	1484	1510	1591	1635	1640	1720
CNTYSB36	21.1	1215	1262	1312	1411	1414	1472	1544	1574	1658	1703	1708	1793
CNTYSB39	22.7	1282	1327	1380	1482	1489	1548	1625	1658	1745	1795	1799	1887
CNTYSB42	24.4	1334	1388	1442	1552	1555	1619	1699	1731	1821	1872	1878	1971
CNTYSB45	24.7	1401	1458	1515	1631	1633	1702	1786	1816	1913	1967	1973	2071
CNTYSB48CS	27.7	1681	1748	1818	1959	1961	2046	2147	2188	2304	2367	2377	2495
CNTYSB48	27.7	1709	1775	1845	1987	1989	2073	2175	2215	2332	2395	2404	2523

Custom Modifications	AUTHL AUTHR	CBO	CCO	CFNT0	CFP	CFRMO	CMAT	CND	DRWTK	FB	FD	FPEB	FTK	MIP	P	RD	RECTKALL RECTKBK	RECTKL RECTKR	RT	SCPDRW	TOTSS	VTK
	•		•	•		•	•		•	•		•	•	•		•	•	•	•			•

Construction Upgrades	VPL	Smart Stop Options	INTGH	PG	SP
	•		•		

CNTYSB30CM	17.7	1415	1459	1504	1598	1600	1653	1720	1748	1825	1867	1872	1951
CNTYSB33CM	24.7	1470	1512	1561	1654	1661	1715	1784	1810	1891	1935	1940	2020
CNTYSB36CM	27.7	1527	1574	1624	1723	1726	1784	1856	1886	1970	2015	2020	2105

Custom Modifications	AUTHL AUTHR	CBO	CCO	CFNT0	CFP	CFRMO	CMAT	CND	DRWTK	FB	FD	FPEB	FTK	MIP	P	RD	RECTKALL RECTKBK	RECTKL RECTKR	RT	SCPDRW	TOTSS	VTK
	•	•	•	•		•		•	•			•	•	•			•	•				•

Construction Upgrades	VPL	Smart Stop Options	INTGH	PG	SP
	•		•		

**Base Corner Cabinets**

- BCs use the wall space the nomenclature implies and may be pulled up to 3" to accommodate odd dimensions in a kitchen.
- Remember to use 3" filler on adjoining cabinets.
- The adjoining run of cabinets will cover the void.
- BCFW specifies full width blind corner base cabinet.
- The L or R in the cabinet nomenclature indicates the location of the void to ensure clearance; it is not recommended to place BC cabinets next to 27" deep appliances.

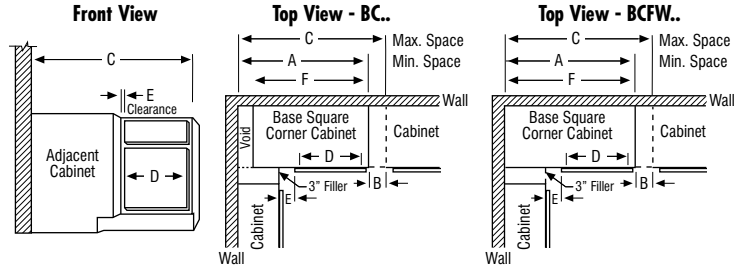

**NOTE:**  
Full overlay styles must be pulled an additional 1 1/2" to ensure proper drawer/pull clearance. 1 1/2" pull is not included in minimum and maximum list.

**BASE CORNER**

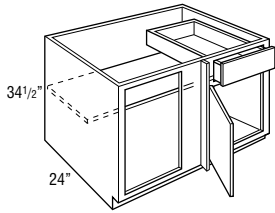

- BC36 - 27" wide
- BC39 - 30" wide
- BC42 - 39" wide
- BC45 - 42" wide
- BC48 - 45" wide

Model	Cubic Feet	Cabinet Style						
		Tori Oak	Westburke Oak	Tori Hickory Tori Maple	Loren Laminates Tori Cherry Westburke Hickory Westburke Maple Westburke PureStyle™	Calio Oak Ginnell Oak Kasper Oak Reins Oak	Westburke Cherry	Brockway Oak Bryant Hickory Bryant Maple Bryant PureStyle™ Calio Maple Flurry Hickory Flurry Maple Kasper Maple Reins Oak Reins Maple Reins PureStyle™
BC36 L or R	16.1	539	565	624	657	633	691	676
BC39 L or R	19.6	579	608	672	708	681	743	728
BC42 L or R	24.4	621	652	721	760	731	797	781
BC45 L or R	24.4	661	694	768	809	778	849	832
BC48 L or R	26.0	704	739	818	858	827	901	884

- Includes one 3" filler, shipped unattached.
- L or R indicates void. L (left) void shown.
- Adjustable 15" deep shelves.

**BASE CORNER with PULL-OUT**

LOGIX

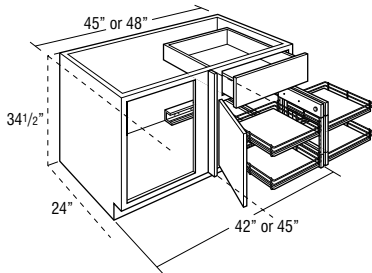

Model	1	2	3	4	5	6	7	
BC45PO L or R	24.4	2709	2742	2816	2857	2826	2897	2880
BC48PO L or R	26.0	2752	2787	2866	2906	2875	2949	2932

- Not recommended for use next to an appliance deeper than standard cabinet depth.
- Cannot be installed next to a wall.
- Pull-out features four adjustable wood shelves with chrome surround. Smart Stop not available.
- Includes one 3" filler, shipped unattached.
- L or R indicates void. L (left) void shown.
- Adjacent cabinet hardware may interfere with adjustable shelf position or pull-out.
- Wire pull-out dimensions are 10 3/4" W x 17 1/4" D x 2 11/16" H.
- For pull-out to open, 10" of adjacent space is required with no obstruction beyond 1 3/4" in front of the cabinet face frame.

**BASE CORNER FULL WIDTH**

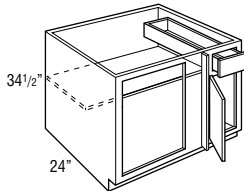

- BCFW36 L or R - 36" wide
- BCFW39 L or R - 39" wide

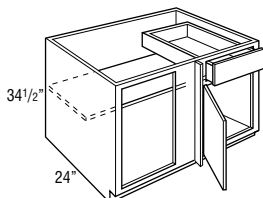

- BCFW42 L or R - 42" wide
- BCFW45 L or R - 45" wide
- BCFW48 L or R - 48" wide

Model	1	2	3	4	5	6	7	
BCFW36 L or R	21.1	770	797	855	888	865	922	908
BCFW39 L or R	22.7	810	839	904	940	912	975	959
BCFW42 L or R	24.4	852	883	952	991	962	1028	1013
BCFW45 L or R	26.0	892	925	999	1040	1009	1080	1063
BCFW48 L or R	27.7	935	970	1050	1090	1058	1132	1115

- Not recommended for use next to an appliance deeper than standard cabinet depth.
- Includes one 3" filler, shipped unattached.
- L or R indicates void. L (left) void shown.
- Adjustable 15" deep shelves.

Model	A		B		C		D		E*		E		F
	Min. Space	Max. Pull*	Max. Space	Cabinet Opening	Full Overlay At Min.	Full Overlay At Max.	Partial Overlay At Min.	Partial Overlay At Max.	Actual Cabinet				
BC36	36"	6"	42"	7 1/2"	1 3/4"	7 3/4"	2 1/2"	8 1/2"	27"				
BC39	39"	4 1/2"	43 1/2"	9"	3 1/4"	7 3/4"	4"	8 1/2"	30"				
BC42	42"	6"	48"	13 1/2"	1 3/4"	7 3/4"	2 1/2"	8 1/2"	39"				
BC45/BC45PO	45"	4 1/2"	49 1/2"	15"	3 1/4"	7 3/4"	4"	8 1/2"	42"				
BC48/BC48PO	48"	3"	51"	16 1/2"	4 1/4"	7 3/4"	5 1/2"	8 1/2"	45"				
BCFW36	36"	5"	41"	7 1/2"	1 3/4"	6 3/4"	2 1/4"	7 1/2"	36"				
BCFW39	39"	3 1/2"	42 1/2"	9"	3 1/4"	6 3/4"	4"	7 1/2"	39"				
BCFW42	42"	9"	51"	13 1/2"	1 3/4"	10 3/4"	2 1/2"	11 1/2"	42"				
BCFW45/BCFW45PO	45"	7 1/2"	52 1/2"	15"	3 1/4"	10 3/4"	4"	11 1/2"	45"				
BCFW48/BCFW48PO	48"	4 1/2"	52 1/2"	18"	3 1/4"	7 3/4"	4"	8 1/2"	48"				

\*Minimum/maximum space between inside edge of door and face of filler/adjoining cabinet. If cabinet is pulled to maximum stated dimension, filler will need to be cleated for proper attachment.

Model	Cubic Feet	Central Maple	Bryant Cherry Haley Cherry Morris Maple Morris PureStyle™	Calio Cherry Kasper Cherry Renss Cherry	Klein Oak	Brookway Maple Central Cherry Kersey Hickory Morris Maple Morris Cherry	Felix Hickory Felix Maple Forte Hickory Forte Maple Forte PureStyle™ Owens Maple Owens PureStyle™	Anico PureStyle™ Brookway Cherry Felix Cherry Forte Cherry Kersey Cherry Klein Hickory Klein Maple Owens Cherry	Adair Maple Adair PureStyle™ Keegan Maple	Valero Maple	Adair Cherry Keegan Cherry	Klein Cherry	Valero Cherry
		8	9	10	11	12	13	14	15	16	17	18	19
BC36 L or R	16.1	711	719	747	768	818	800	841	839	882	922	949	970
BC39 L or R	19.6	766	775	806	824	881	860	904	902	951	992	1019	1044
BC42 L or R	24.4	823	831	865	887	947	925	970	968	1021	1066	1095	1123
BC45 L or R	24.4	876	886	922	946	1007	985	1034	1033	1089	1133	1166	1194
BC48 L or R	26.0	932	943	981	1003	1070	1047	1098	1098	1155	1208	1241	1271

Custom Modifications	AUTHL AUTHR	CBO	CCO	CFNTO	CFP	CFRMO	CMAT	CND	DRWTK	FB	FD	FPEB	FTK	MIP	P	RD	RECTKALL RECTKBK	RECTKL RECTKR	RT	SCPDRW	TOTSS	VTK
	•	•	•	•	•	•	•	•	•	•	•	•	•	•	•	•	•	•				•

Construction Upgrades	VPL	Smart Stop Options	INTGH	PG	SP
	•		•	•	

BC45PO L or R	24.4	2924	2934	2970	2994	3055	3033	3082	3081	3137	3181	3214	3242
BC48PO L or R	26.0	2980	2991	3029	3051	3118	3095	3146	3146	3203	3256	3289	3319

Custom Modifications	AUTHL AUTHR	CBO	CCO	CFNTO	CFP	CFRMO	CMAT	CND	DRWTK	FB	FD	FPEB	FTK	MIP	P	RD	RECTKALL RECTKBK	RECTKL RECTKR	RT	SCPDRW	TOTSS	VTK
	•	•	•	•	•	•	•	•	•	•	•	•	•	•	•	•	•	•				•

Construction Upgrades	VPL	Smart Stop Options	INTGH	PG	SP
	•		•	•	

BCFW36 L or R	21.1	943	950	979	999	1050	1031	1072	1070	1113	1153	1180	1202
BCFW39 L or R	22.7	997	1006	1037	1056	1112	1092	1135	1133	1182	1223	1250	1276

BCFW42 L or R	24.4	1055	1062	1096	1118	1178	1157	1202	1200	1252	1297	1326	1354
BCFW45 L or R	26.0	1107	1117	1153	1177	1239	1216	1265	1264	1320	1364	1397	1425
BCFW48 L or R	27.7	1164	1174	1212	1235	1301	1278	1329	1329	1387	1439	1472	1502

Custom Modifications	AUTHL AUTHR	CBO	CCO	CFNTO	CFP	CFRMO	CMAT	CND	DRWTK	FB	FD	FPEB	FTK	MIP	P	RD	RECTKALL RECTKBK	RECTKL RECTKR	RT	SCPDRW	TOTSS	VTK
	•	•	•	•	•	•	•	•	•	•	•	•	•	•	•	•	•	•				•

Construction Upgrades	VPL	Smart Stop Options	INTGH	PG	SP
	•		•	•	



**BASE CORNER FULL WIDTH with PULL-OUT**

LOGIX

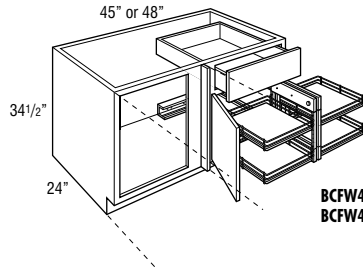

BCFW45PO L or R  
BCFW48PO L or R

Model	Cubic Feet	Material					7	
		Tori Oak	Westburke Oak	Tori Hickory Tori Maple	Loren Laminate Tori Cherry Westburke Hickory Westburke Maple Westburke PureStyle™	Ohio Oak Gantrell Oak Kesper Oak Reist Oak		Westburke Cherry
BCFW45PO L or R	26.0	2940	2973	3047	3088	3057	3128	3111
BCFW48PO L or R	27.7	2983	3018	3098	3138	3106	3180	3163

- Not recommended for use next to an appliance deeper than standard cabinet depth.
- Cannot be installed next to a wall.
- Includes one 3" filler, shipped unattached.
- L or R indicates void. L (left) void shown.
- Pull-out features four adjustable wood shelves with chrome surround. Smart Stop not available.
- Wire pull-out interior dimensions are 10 3/4" W x 17 1/4" D x 2 11/16" H.
- For pull-out to open, 10" of adjacent space is required with no obstruction beyond 1 3/4" in front of the cabinet face frame.
- Adjacent cabinet hardware may interfere with adjustable shelf position on pull-out.

**BASE LAZY SUSAN CORNER with FULL HEIGHT DOOR and LAZY SUSAN (With Center Hinge Door)**

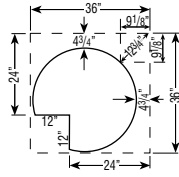
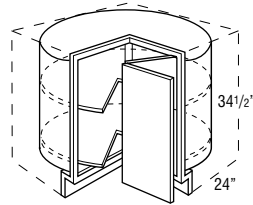

BLS36 L or R	20.0	914	959	1060	1118	1166	1174	1272
--------------	------	-----	-----	------	------	------	------	------

- BLS36 L or R wall width is 36" x 36".
- Cabinet is drum-shaped; adjoining cabinets create sides.
- BLS white plastic shelves are 28" diameter with a chrome pole.
- See Panels & Skins section for BLSBEPWD/LAM if used at end of cabinet run.
- If ordered with VPL, construction and price will not change.
- Drum diameter is 31 1/8" and composed of 1/8" thick hardboard.
- Decorative hardware screws must be countersunk to prevent scratching of adjacent cabinets and face frame of BLS.
- Not recommended for use next to an appliance deeper than standard cabinet depth.

**DIAGONAL BASE with FULL HEIGHT DOOR**

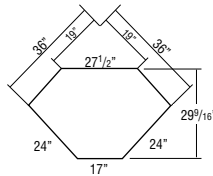
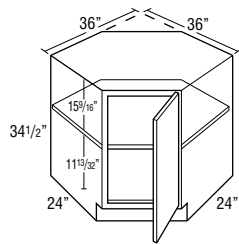

DAB36FS L or R	25.9	564	592	655	690	721	724	786
----------------	------	-----	-----	-----	-----	-----	-----	-----

- One fixed 1/2" thick shelf.
- Full overlay styles use the same width doors as partial overlay styles (14 1/2" wide) with a partial overlay hinge (38NPOHINGE) to allow for proper door clearance with adjacent cabinets.

**DIAGONAL BASE with FULL HEIGHT DOOR & LAZY SUSAN**

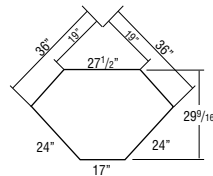
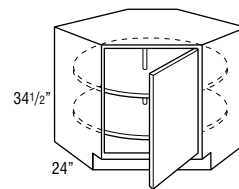

DAB36S L or R	25.9	971	999	1062	1097	1128	1131	1193
---------------	------	-----	-----	------	------	------	------	------

- Features two white 24" diameter round plastic shelves on a chrome pole.
- Full overlay styles use the same width doors as partial overlay styles (14 1/2" wide) with a partial overlay hinge (38NPOHINGE) to allow for proper door clearance with adjacent cabinets.

Model	Cubic Feet	8	9	10	11	12	13	14	15	16	17	18	19
		Countertop Maple	Bryant Cherry Hurley Cherry Norris Maple Norris PureStyle™	Cairo Cherry Kasper Cherry Reist Cherry	Klewin Oak	Brockway Maple Countertop Cherry Kersey Hickory Kersey Maple Norris Cherry	Felix Hickory Felix Maple Forte Hickory Forte Maple Forte PureStyle™ Owens Maple Owens PureStyle™	Amico PureStyle™ Brockway Cherry Felix Cherry Forte Cherry Kersey Hickory Klewin Hickory Klewin Maple Owens Cherry	Adair Maple Adair PureStyle™ Keegan Maple	Valero Maple	Adair Cherry Keegan Cherry	Klewin Cherry	Valero Cherry
BCFW45PO L or R	26.0	3155	3165	3201	3225	3287	3264	3313	3312	3368	3412	3445	3473
BCFW48PO L or R	27.7	3212	3222	3260	3283	3349	3326	3377	3377	3435	3487	3520	3550

Custom Modifications	AUTHL AUTHR	CBO	CCO	CFNTO	CFP	CFRMO	CMAT	CND	DRWTK	FB	FD	FPEB	FTK	MIP	P	RD	RECTKALL RECTKBK	RECTKL RECTKR	RT	SCPDRW	TOTSS	VTK
	•	•	•	•	•	•	•	•		•		•	•	•		•	•	•				•

Construction Upgrades	VPL	Smart Stop Options	INTGH	PG	SP
	•		•	•	

Model	20.0	1332	1386	1440	1548	1552	1615	1695	1726	1816	1868	1874	1967
BLS36 L or R													

Custom Modifications	AUTHL AUTHR	CBO	CCO	CFNTO	CFP	CFRMO	CMAT	CND	DRWTK	FB	FD	FPEB	FTK	MIP	P	RD	RECTKALL RECTKBK	RECTKL RECTKR	RT	SCPDRW	TOTSS	VTK
		•	•																			

Construction Upgrades	VPL	Smart Stop Options	INTGH	PG	SP

Model	25.9	822	854	889	955	959	996	1045	1065	1122	1153	1158	1214
DAB36FS L or R													

Custom Modifications	AUTHL AUTHR	CBO	CCO	CFNTO	CFP	CFRMO	CMAT	CND	DRWTK	FB	FD	FPEB	FTK	MIP	P	RD	RECTKALL RECTKBK	RECTKL RECTKR	RT	SCPDRW	TOTSS	VTK
		•	•	•		•				•		•	•	•			•	•				•

Construction Upgrades	VPL	Smart Stop Options	INTGH	PG	SP
	•		•		

Model	25.9	1229	1261	1296	1362	1366	1403	1452	1472	1529	1560	1565	1621
DAB36S L or R													

Custom Modifications	AUTHL AUTHR	CBO	CCO	CFNTO	CFP	CFRMO	CMAT	CND	DRWTK	FB	FD	FPEB	FTK	MIP	P	RD	RECTKALL RECTKBK	RECTKL RECTKR	RT	SCPDRW	TOTSS	VTK
		•	•	•		•				•		•	•	•			•	•				•

Construction Upgrades	VPL	Smart Stop Options	INTGH	PG	SP
	•		•		

**DIAGONAL BASE with FULL HEIGHT DOOR & SUPER LAZY SUSAN**

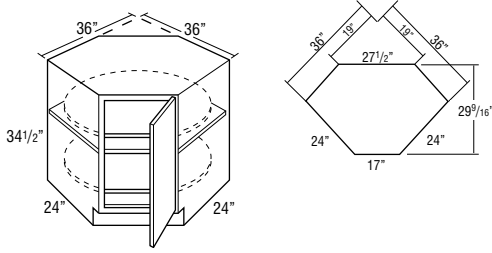

Due to fixed shelf mounting, shelves cannot be retrofitted.

Model	Cubic Feet	Model					Model	
		Tori Oak	Westburke Oak	Tori Hickory Tori Maple	Loren Laminate Tori Cherry Westburke Hickory Westburke Maple Westburke PureStyle™	Calio Oak Gantrell Oak Kesper Oak Reins Oak	Westburke Cherry	Brookway Oak Bryant Hickory Bryant Maple Calio Maple Hurley Hickory Hurley Maple Kesper Maple Kessy Oak Reins Maple Reins PureStyle™
DAB365LS L or R	25.9	1379	1407	1470	1505	1536	1539	1601

- Features two 28" diameter D-shaped plywood revolving shelves with a 1" plywood lip. Lower shelf is mounted to floor. Upper shelf is mounted to fixed shelf. Fixed shelf is 1/2" thick laminated furniture board.
- Full overlay styles use the same width doors as partial overlay styles (14 1/2" wide) with a partial overlay hinge (38NPOHINGE) to allow for proper door clearance with adjacent cabinets.

**BASE EASY REACH**

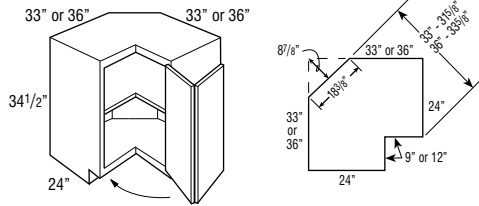

BER33 L or R	24.0	705	740	819	861	902	905	983
BER36 L or R	25.9	705	740	819	861	902	905	983

- BER33 L or R wall width is 33" x 33". BER36 L or R wall width is 36" x 36".
- Decorative hardware screws must be countersunk to prevent scratching of adjacent cabinets and face frame of BER.
- Fixed shelf is 1/2" thick laminated furniture board.
- Cabinet top features I-beam braces with a center support brace.
- Not recommended for use next to an appliance deeper than standard cabinet depth.

**ASYMMETRICAL BASE EASY REACH**

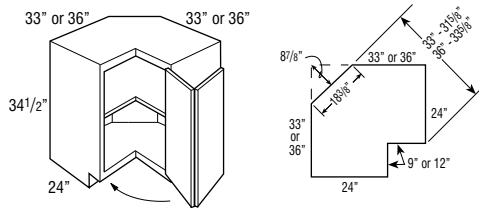

BER3336 L or R	24.5	705	740	819	861	902	905	983
BER3633 L or R	24.5	705	740	819	861	902	905	983

- BER3336 L or R wall width is 33" x 36".
- BER3633 L or R wall width is 36" x 33".
- Legs at the front frames are 9" on 33" and 12" on 36" leg.
- Nomenclature for asymmetrical cabinets reads as follows:  
First set of numbers = left side of cabinet dimensions.  
Second set of numbers = right side of cabinet dimensions.
- Decorative hardware screws must be countersunk to prevent scratching of adjacent cabinets and face frame of BER.
- Fixed shelf is 1/2" thick laminated furniture board.
- Valero doors on 33" side utilize flat center panels.
- Cabinet top features I-beam braces with a center support brace.
- Not recommended for use next to an appliance deeper than standard cabinet depth.

Model	Cubic Feet	8	9	10	11	12	13	14	15	16	17	18	19
		8	9	10	11	12	13	14	15	16	17	18	19
DAB36SLS L or R	25.9	1637	1669	1704	1770	1774	1811	1860	1880	1937	1968	1973	2029

Custom Modifications	AUTHL AUTHR	CBO	CCO	CFNTO	CFP	CFRMO	CMAT	CND	DRWTK	FB	FD	FPEB	FTK	MIP	P	RD	RECTKALL RECTKBK	RECTKL RECTKR	RT	SCPDRW	TOTSS	VTK
		•	•	•		•				•		•	•	•			•	•				•

Construction Upgrades	VPL	Smart Stop Options	INTGH	PG	SP
	•		•		

BER33 L or R	24.0	1030	1068	1113	1196	1201	1247	1309	1331	1401	1442	1448	1518
BER36 L or R	25.9	1030	1068	1113	1196	1201	1247	1309	1331	1401	1442	1448	1518

Custom Modifications	AUTHL AUTHR	CBO	CCO	CFNTO	CFP	CFRMO	CMAT	CND	DRWTK	FB	FD	FPEB	FTK	MIP	P	RD	RECTKALL RECTKBK	RECTKL RECTKR	RT	SCPDRW	TOTSS	VTK
	•	•	•							•		•		•			•	•				•

Construction Upgrades	VPL	Smart Stop Options	INTGH	PG	SP
	•				

BER3336 L or R	24.5	1030	1068	1113	1196	1201	1247	1309	1331	1401	1442	1448	1518
BER3633 L or R	24.5	1030	1068	1113	1196	1201	1247	1309	1331	1401	1442	1448	1518

Custom Modifications	AUTHL AUTHR	CBO	CCO	CFNTO	CFP	CFRMO	CMAT	CND	DRWTK	FB	FD	FPEB	FTK	MIP	P	RD	RECTKALL RECTKBK	RECTKL RECTKR	RT	SCPDRW	TOTSS	VTK
	•	•	•							•		•		•			•	•				•

Construction Upgrades	VPL	Smart Stop Options	INTGH	PG	SP
	•				

**SUPER LAZY SUSAN**

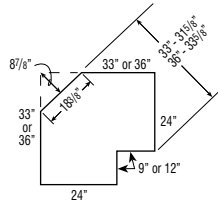
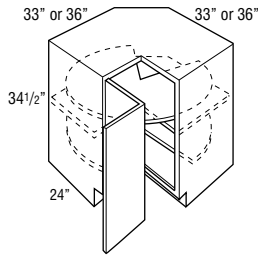

Due to fixed shelf mounting, shelves cannot be retrofitted.

**SOLID WOOD SUPER LAZY SUSAN**

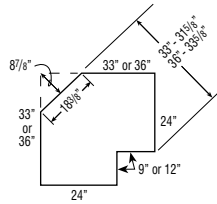
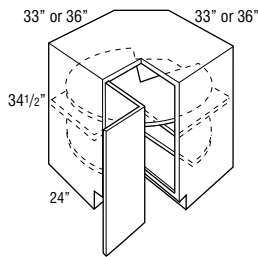

Due to fixed shelf mounting, shelves cannot be retrofitted.

**ASYMMETRICAL SUPER LAZY SUSAN**

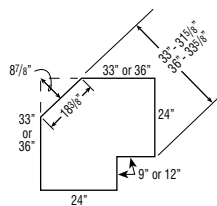
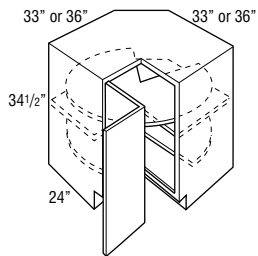

Due to fixed shelf mounting, shelves cannot be retrofitted.

Model	Cubic Feet	Cubic Feet					7	
		Tori Oak	Westburke Oak	Tori Hickory Tori Maple	Loren Laminate Tori Cherry Westburke Hickory Westburke Maple Westburke PureStyle™	Cairo Oak Gambrell Oak Kesper Oak Reins Oak		Westburke Cherry
<b>SLS33 L or R</b>	24.0	1856	1890	1970	2012	2052	2055	2133
<b>SLS36 L or R</b>	30.5	1856	1890	1970	2012	2052	2055	2133

- SLS33 L or R wall width is 33" x 33".
- SLS36 L or R wall width is 36" x 36".
- SLS33 - Susans are 28" diameter.
- SLS36 - Susans are 32" diameter.
- Features two plywood revolving shelves. Lower shelf is mounted to floor. Upper shelf is mounted to fixed shelf. Fixed shelf is 1/2" thick laminated furniture board.
- Decorative hardware screws must be countersunk to prevent scratching adjacent cabinets and face frame of SLS.
- Valero doors on SLS33 utilize flat center panels.
- Cabinet top features I-beam braces with a center support brace.
- Not recommended for use next to an appliance deeper than standard cabinet depth.

Model	Cubic Feet	Cubic Feet					7	
		Tori Oak	Westburke Oak	Tori Hickory Tori Maple	Loren Laminate Tori Cherry Westburke Hickory Westburke Maple Westburke PureStyle™	Cairo Oak Gambrell Oak Kesper Oak Reins Oak		Westburke Cherry
<b>SLSW33 L or R</b>	24.0	2317	2433	2461	2514	2566	2640	2666
<b>SLSW36 L or R</b>	30.5	2317	2433	2461	2514	2566	2640	2666

- SLSW33 L or R wall width is 33" x 33".
- SLSW36 L or R wall width is 36" x 36".
- SLSW33 L or R - Susans are 28" diameter.
- SLSW36 L or R - Susans are 32" diameter.
- Features two hardwood revolving shelves with a 3/16" lip. Lower shelf is mounted to floor. Upper shelf is mounted to fixed shelf. Fixed shelf is 1/2" thick laminated furniture board.
- Decorative hardware screws must be countersunk to prevent scratching adjacent cabinets and face frame of SLS.
- Cabinet top features I-beam braces with a center support brace.
- Not recommended for use next to an appliance deeper than standard cabinet depth.

Model	Cubic Feet	Cubic Feet					7	
		Tori Oak	Westburke Oak	Tori Hickory Tori Maple	Loren Laminate Tori Cherry Westburke Hickory Westburke Maple Westburke PureStyle™	Cairo Oak Gambrell Oak Kesper Oak Reins Oak		Westburke Cherry
<b>SLS3336 L or R</b>	29.1	1856	1890	1970	2012	2052	2055	2133
<b>SLS3633 L or R</b>	29.1	1856	1890	1970	2012	2052	2055	2133

- SLS3336 L or R wall width is 33" x 36".
- SLS3633 L or R wall width is 36" x 33".
- All Asymmetrical Super Susan shelves are 28" diameter.
- Features two plywood revolving shelves. Lower shelf is mounted to floor. Upper shelf is mounted to fixed shelf. Fixed shelf is 1/2" thick laminated furniture board.
- Nomenclature for asymmetrical cabinets reads as follows:  
First set of numbers = left side of cabinet dimensions.  
Second set of numbers = right side of cabinet dimensions.
- Decorative hardware screws must be countersunk to prevent scratching adjacent cabinets and face frame of SLS.
- Valero doors on 33" side utilize flat center panels.
- Cabinet top features I-beam braces with a center support brace.
- Not recommended for use next to an appliance deeper than standard cabinet depth.

Model	Cubic Feet	Countertop Maple	Bryant Cherry Hurley Cherry Norris Maple Norris PureStyle™	Cairo Cherry Kasper Cherry Reist Cherry	Klewin Oak	Brookway Maple Countertop Cherry Kersey Hickory Kersey Maple Norris Cherry	Falk Hickory Falk Maple Forte Hickory Forte Maple Forte PureStyle™ Owens Maple Owens PureStyle™	Antico PureStyle™ Brookway Cherry Falk Cherry Forte Cherry Kersey Hickory Klewin Hickory Klewin Maple Owens Cherry	Adair Maple Adair PureStyle™ Keegan Maple	Valero Maple	Adair Cherry Keegan Cherry	Klewin Cherry	Valero Cherry
		8	9	10	11	12	13	14	15	16	17	18	19
SLS33 L or R	24.0	2180	2218	2264	2346	2351	2397	2459	2482	2551	2593	2599	2669
SLS36 L or R	30.5	2180	2218	2264	2346	2351	2397	2459	2482	2551	2593	2599	2669

Custom Modifications	AUTHL AUTHR	CBO	CCO	CFNTO	CFP	CFRMO	CMAT	CND	DRWTK	FB	FD	FPEB	FTK	MIP	P	RD	RECTKALL RECTKBK	RECTKL RECTKR	RT	SCPDRW	TOTSS	VTK
		•	•							•		•		•			•	•				•

Construction Upgrades	VPL	Smart Stop Options	INTGH	PG	SP
	•				

SLSW33 L or R	24.0	2723	2774	2828	2931	2936	2996	3073	3101	3188	3240	3248	3337
SLSW36 L or R	30.5	2723	2774	2828	2931	2936	2996	3073	3101	3188	3240	3248	3337

Custom Modifications	AUTHL AUTHR	CBO	CCO	CFNTO	CFP	CFRMO	CMAT	CND	DRWTK	FB	FD	FPEB	FTK	MIP	P	RD	RECTKALL RECTKBK	RECTKL RECTKR	RT	SCPDRW	TOTSS	VTK
		•	•							•		•		•			•	•				•

Construction Upgrades	VPL	Smart Stop Options	INTGH	PG	SP
	•				

SLS3336 L or R	29.1	2180	2218	2264	2346	2351	2397	2459	2482	2551	2593	2599	2669
SLS3633 L or R	29.1	2180	2218	2264	2346	2351	2397	2459	2482	2551	2593	2599	2669

Custom Modifications	AUTHL AUTHR	CBO	CCO	CFNTO	CFP	CFRMO	CMAT	CND	DRWTK	FB	FD	FPEB	FTK	MIP	P	RD	RECTKALL RECTKBK	RECTKL RECTKR	RT	SCPDRW	TOTSS	VTK
		•	•							•		•		•			•	•				•

Construction Upgrades	VPL	Smart Stop Options	INTGH	PG	SP
	•				

**ASYMMETRICAL SOLID WOOD SUPER LAZY SUSAN**

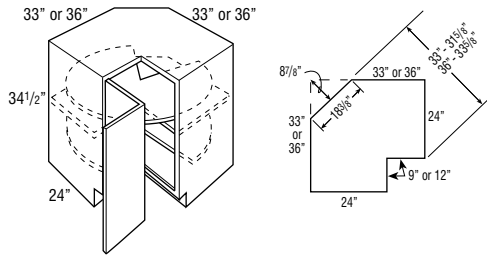

Due to fixed shelf mounting, shelves cannot be retrofitted.

Model	Cubic Feet	Cabinet Material					Cabinet Material	
		Tori Oak	Westburke Oak	Tori Hickory Tori Maple	Loren Laminate Tori Cherry Westburke Hickory Westburke Maple Westburke PureStyle™	Calio Oak Gantrell Oak Kesper Oak Rens Oak	Westburke Cherry	Brookway Oak Bryant Hickory Bryant Maple Calio Maple Hurley Hickory Hurley Maple Kesper Maple Kessy Oak Rens Maple Rens PureStyle™
SLSW3336 L or R	29.1	2317	2433	2461	2514	2566	2640	2666
SLSW3633 L or R	29.1	2317	2433	2461	2514	2566	2640	2666

- SLSW3336 L or R wall width is 33" x 36".
- SLSW3633 L or R wall widths is 36" x 33".
- All Asymmetrical Super Susan shelves are 28" diameter.
- Features two hardwood revolving shelves with a 3/16" lip. Lower shelf is mounted to floor. Upper shelf is mounted to fixed shelf. Fixed shelf is 1/2" thick laminated furniture board.
- Nomenclature for asymmetrical cabinets reads as follows:  
First set of numbers = left side of cabinet dimensions.  
Second set of numbers = right side of cabinet dimensions.
- Decorative hardware screws must be countersunk to prevent scratching adjacent cabinets and face frame of SLS.
- Cabinet top features I-beam braces with a center support brace.
- Not recommended for use next to an appliance deeper than standard cabinet depth.

**BASE TRANSITION CABINET**

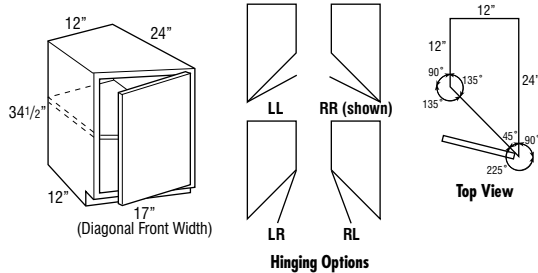

BTC12LL	14.4	463	485	537	566	590	595	645
BTC12RL	14.4	463	485	537	566	590	595	645
BTC12LR	14.4	463	485	537	566	590	595	645
BTC12RR	14.4	463	485	537	566	590	595	645

- One adjustable shelf.
- Cabinets constructed with top.
- Specify door hinging, RR shown.
- Reduced Depth to 18" available.
- RECTALL not available.
- Full overlay styles use the same width doors as partial overlay styles (14 1/2" wide) with a partial overlay hinge (38NPOHNGE) to allow for proper door clearance with adjacent cabinets.

**BASE END CABINET**

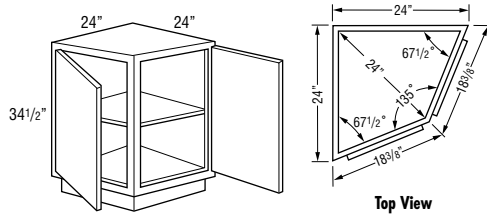

BEC24	14.3	719	756	834	877	916	921	1000
-------	------	-----	-----	-----	-----	-----	-----	------

- Wall width is 24" x 24".
- 24" W x 24" D x 34 1/2" H.
- 24" from outside corner point to frame face.
- Cabinets constructed with top.
- One adjustable shelf.
- Cabinet may be installed against either end of a run.

**TWO DRAWER BASE**

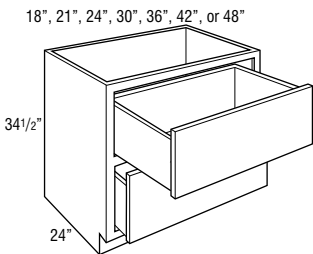

2DB18	11.1	1031	1086	1185	1445	1031	1520	1219
2DB21	12.8	1052	1106	1206	1466	1052	1541	1240
2DB24	14.4	1072	1127	1226	1486	1072	1562	1260
2DB30	17.7	1783	1872	2014	2402	1783	2523	2052
2DB36	21.1	1831	1921	2072	2477	1831	2602	2113
2DB42	23.4	2299	2389	2540	2945	2299	3070	2581
2DB48	26.6	2432	2522	2673	3078	2432	3203	2714

- Exterior drawer box height is 10".
- 2DB42 and 2DB48 depth can be reduced to a minimum of 21".
- DRWTK not available on 2DB42 and 2DB48.
- SCPDRW not available on 2DB18, 2DB21, 2DB24, 2DB42, and 2DB48.
- When SCPDRW is selected, the top drawer will utilize a 6 3/8" high drawer box instead of the current 10" high drawer box, creating a clearance of 6 5/8" for the cooktop.

Model	Cubic Feet	8	9	10	11	12	13	14	15	16	17	18	19
		8	9	10	11	12	13	14	15	16	17	18	19
SLSW3336 L or R	29.1	2723	2774	2828	2931	2936	2996	3073	3101	3188	3240	3248	3337
SLSW3633 L or R	29.1	2723	2774	2828	2931	2936	2996	3073	3101	3188	3240	3248	3337

Custom Modifications	AUTHL AUTHR	CBO	CCO	CFNTO	CFP	CFRMO	CMAT	CND	DRWTK	FB	FD	FPEB	FTK	MIP	P	RD	RECTKALL RECTKBK	RECTKL RECTKR	RT	SCPDRW	TOTSS	VTK
		•	•							•		•		•			•	•				•

Construction Upgrades	VPL	Smart Stop Options	INTGH	PG	SP
	•				

BTC12LL	14.4	675	702	729	782	786	817	856	875	921	946	949	994
BTC12RL	14.4	675	702	729	782	786	817	856	875	921	946	949	994
BTC12LR	14.4	675	702	729	782	786	817	856	875	921	946	949	994
BTC12RR	14.4	675	702	729	782	786	817	856	875	921	946	949	994

Custom Modifications	AUTHL AUTHR	CBO	CCO	CFNTO	CFP	CFRMO	CMAT	CND	DRWTK	FB	FD	FPEB	FTK	MIP	P	RD	RECTKALL RECTKBK	RECTKL RECTKR	RT	SCPDRW	TOTSS	VTK
	•	•	•	•		•				•		•	•	•		•	•	•				•

Construction Upgrades	VPL	Smart Stop Options	INTGH	PG	SP
	•		•		

BEC24	14.3	1047	1090	1131	1216	1221	1269	1331	1357	1428	1469	1473	1545
-------	------	------	------	------	------	------	------	------	------	------	------	------	------

Custom Modifications	AUTHL AUTHR	CBO	CCO	CFNTO	CFP	CFRMO	CMAT	CND	DRWTK	FB	FD	FPEB	FTK	MIP	P	RD	RECTKALL RECTKBK	RECTKL RECTKR	RT	SCPDRW	TOTSS	VTK
		•	•										•	•								•

Construction Upgrades	VPL	Smart Stop Options	INTGH	PG	SP
	•		•		

2DB18	11.1	1115	1367	1425	1219	1440	1257	1323	1382	1382	1544	1488	1544
2DB21	12.8	1136	1388	1445	1240	1461	1278	1344	1402	1402	1565	1508	1565
2DB24	14.4	1157	1408	1466	1260	1481	1298	1364	1423	1423	1585	1529	1585
2DB30	17.7	1900	2277	2366	2057	2397	2116	2219	2307	2307	2550	2465	2550
2DB36	21.1	1954	2348	2443	2119	2471	2180	2285	2377	2377	2634	2543	2634
2DB42	23.4	2422	2816	2911	2587	2939	2648	2753	2845	2845	3102	3011	3102
2DB48	26.6	2555	2949	3044	2720	3072	2781	2886	2978	2978	3235	3144	3235

Custom Modifications	AUTHL AUTHR	CBO	CCO	CFNTO	CFP	CFRMO	CMAT	CND	DRWTK	FB	FD	FPEB	FTK	MIP	P	RD	RECTKALL RECTKBK	RECTKL RECTKR	RT	SCPDRW	TOTSS	VTK
	•	•	•			•			•	•		•	•	•		•	•	•		•		•

Construction Upgrades	VPL	Smart Stop Options	INTGH	PG	SP
	•			STD	



**TWO DRAWER BASE with PEGGED DISH ORGANIZER**

LOGIX

**Model**

Cubic Feet	Model						
	Tori Oak	Westburke Oak	Tori Hickory Tori Maple	Loren Laminate Tori Cherry Westburke Hickory Westburke Maple Westburke PureStyle™	Calio Oak Gantrell Oak Kesper Oak Rensel Oak	Westburke Cherry	Brockway Oak Bryant Hickory Bryant Maple Bryant PureStyle™ Calio Maple Hurley Hickory Hurley Maple Kesper Maple Kesper Oak Rensel Maple Rensel PureStyle™
21.1	2191	2281	2432	2837	2191	2962	2473

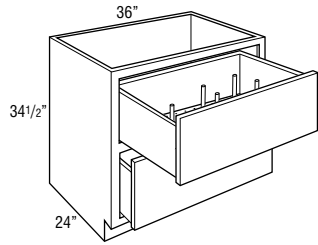

- Includes 8 wooden posts.
- Includes 19/32" thick removable pegged board in top drawer.
- Exterior drawer box height is 10".
- Additional posts available as an accessory. See page 294.
- Posts and pegged board available as accessories for field installation. See page 294.

**TWO DRAWER BASE with ROLL TRAY**

LOGIX

<b>2DB24RT</b>	14.4	1072	1127	1226	1486	1072	1562	1260
<b>2DB30RT</b>	17.7	1783	1872	2014	2402	1783	2523	2052
<b>2DB36RT</b>	21.1	1831	1921	2072	2477	1831	2602	2113

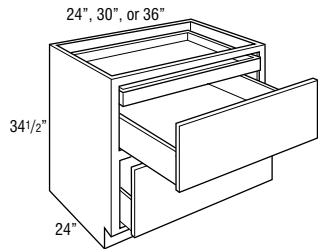

- Includes a roll tray inside top drawer.
- Exterior height for bottom drawer box is 6 3/8".

**TWO DRAWER BASE with ROLL TRAY and PEGGED DISH ORGANIZER**

LOGIX

<b>2DB36RTPDO</b>	21.1	2214	2304	2455	2860	2214	2985	2496
-------------------	------	------	------	------	------	------	------	------

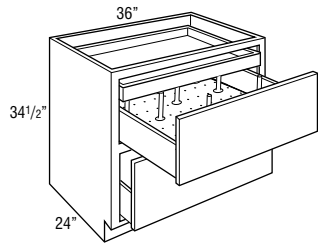

- Includes a roll tray inside top drawer.
- Includes 8 wooden posts.
- Includes 19/32" thick removable pegged board in top drawer.
- Drawer bottoms meet KCMA standards of 15 lbs. per square foot.
- Additional posts available as an accessory. See page 294.
- Posts and pegged board available as accessories for field installation. See page 294.

**TWO DRAWER BASE, DROP-IN RANGE**

<b>2DB36DR</b>	21.1	1977	2077	2239	2676	1977	2811	2282
----------------	------	------	------	------	------	------	------	------

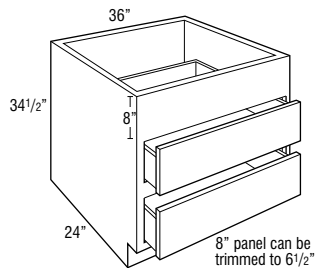

- Exterior height of drawer boxes is 6 3/8".

Model	Cubic Feet	Cantrill Maple	Bryant Cherry Hurley Cherry Norris Maple Norris PureStyle™	Cairo Cherry Kasper Cherry Reist Cherry	Klewin Oak	Brockway Maple Cantrill Cherry Kersey Hickory Kersey Maple Norris Cherry	Felix Hickory Felix Maple Forte Hickory Forte Maple Forte PureStyle™ Owens Maple Owens PureStyle™	Antico PureStyle™ Brockway Cherry Felix Cherry Forte Cherry Kersey Hickory Klewin Hickory Klewin Maple Owens Cherry	Adair Maple Adair PureStyle™ Keegan Maple	Valero Maple	Adair Cherry Keegan Cherry	Klewin Cherry	Valero Cherry
	8	9	10	11	12	13	14	15	16	17	18	19	
<b>2DB36PDO</b>	21.1	2314	2708	2803	2479	2831	2540	2645	2737	2737	2994	2903	2994

Custom Modifications	AUTHL AUTHR	CBO	CCO	CFNTO	CFP	CFRMO	CMAT	CND	DRWTK	FB	FD	FPEB	FTK	MIP	P	RD	RECTKALL RECTKBK	RECTKL RECTKR	RT	SCPDRW	TOTSS	VTK
	•	•	•			•			•	•		•	•	•		•	•	•		•		•

Construction Upgrades	VPL	Smart Stop Options	INTGH	PG	SP
	•			STD	

<b>2DB24RT</b>	14.4	1157	1408	1466	1260	1481	1298	1364	1423	1423	1585	1529	1585
<b>2DB30RT</b>	17.7	1900	2277	2366	2057	2397	2116	2219	2307	2307	2550	2465	2550
<b>2DB36RT</b>	21.1	1954	2348	2443	2119	2471	2180	2285	2377	2377	2634	2543	2634

Custom Modifications	AUTHL AUTHR	CBO	CCO	CFNTO	CFP	CFRMO	CMAT	CND	DRWTK	FB	FD	FPEB	FTK	MIP	P	RD	RECTKALL RECTKBK	RECTKL RECTKR	RT	SCPDRW	TOTSS	VTK
	•	•	•	•		•			•	•		•	•	•		•	•	•				•

Construction Upgrades	VPL	Smart Stop Options	INTGH	PG	SP
	•			STD	STD

<b>2DB36RTPDO</b>	21.1	2337	2731	2826	2502	2854	2563	2668	2760	2760	3017	2926	3017
-------------------	------	------	------	------	------	------	------	------	------	------	------	------	------

Custom Modifications	AUTHL AUTHR	CBO	CCO	CFNTO	CFP	CFRMO	CMAT	CND	DRWTK	FB	FD	FPEB	FTK	MIP	P	RD	RECTKALL RECTKBK	RECTKL RECTKR	RT	SCPDRW	TOTSS	VTK
	•	•	•	•		•			•	•		•	•	•		•	•	•				•

Construction Upgrades	VPL	Smart Stop Options	INTGH	PG	SP
	•			STD	STD

<b>2DB36DR</b>	21.1	2110	2535	2636	2288	2668	2355	2469	2566	2566	2844	2748	2844
----------------	------	------	------	------	------	------	------	------	------	------	------	------	------

Custom Modifications	AUTHL AUTHR	CBO	CCO	CFNTO	CFP	CFRMO	CMAT	CND	DRWTK	FB	FD	FPEB	FTK	MIP	P	RD	RECTKALL RECTKBK	RECTKL RECTKR	RT	SCPDRW	TOTSS	VTK
	•	•	•	•		•			•	•		•	•	•		•	•	•				•

Construction Upgrades	VPL	Smart Stop Options	INTGH	PG	SP
	•			STD	

**THREE DRAWER BASE**

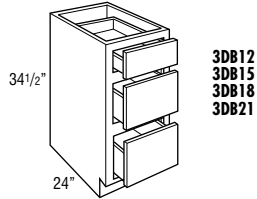

3DB12  
3DB15  
3DB18  
3DB21

24, 27, 30, 33, or 36

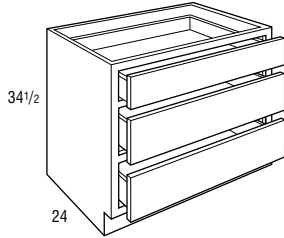

3DB24  
3DB27  
3DB30  
3DB33  
3DB36

Model	Cubic Feet	Cabinet Feet						
		Tori Oak	Westburke Oak	Tori Hickory Tori Maple	Loren Laminate Tori Cherry Westburke Hickory Westburke Maple Westburke PureStyle™	Calio Oak Gantrell Oak Kesper Oak Reins Oak	Westburke Cherry	Brookway Oak Bryant Hickory Bryant Maple Calio Maple Hurley Hickory Hurley Maple Kesper Maple Kessy Oak Reins PureStyle™ Reins PureStyle™
		1	2	3	4	5	6	7
3DB12	7.8	590	620	697	880	590	924	729
3DB15	9.4	634	667	749	946	634	992	783
3DB18	11.1	681	714	805	1016	681	1067	841
3DB21	12.8	731	767	864	1090	731	1144	901
3DB24	14.4	779	819	922	1162	779	1220	963
3DB27	16.1	1028	1077	1189	1472	1028	1545	1234
3DB30	17.7	1271	1334	1460	1780	1271	1870	1503
3DB33	19.6	1314	1380	1510	1843	1314	1936	1555
3DB36	21.1	1354	1423	1559	1905	1354	2000	1606

- Exterior height of bottom 2 drawer boxes is 6 3/8".
- DRWTK not available on 3DB12 and 3DB15.
- PG is an available upgrade on 3DB12-3DB27. PG is standard on 3DB30-3DB36.
- SCPDRW not available on 3DB12, 3DB15, 3DB18, 3DB21, 3DB24, and 3DB27.

**THREE DRAWER BASE with WOOD TIERED CUTLERY DIVIDER DRAWER**

LOGIX

15", 18", 21", or 24"

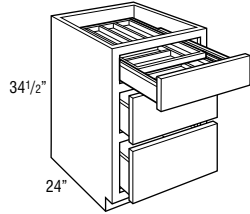

Model	15"	18"	21"	24"	15"	18"	21"	24"
3DB15WTC	9.4	1132	1165	1247	1444	1132	1490	1281
3DB18WTC	11.1	1196	1229	1320	1531	1196	1582	1356
3DB21WTC	12.8	1267	1303	1400	1626	1267	1680	1437
3DB24WTC	14.4	1333	1373	1476	1716	1333	1774	1517

- Includes Wood Tiered Cutlery Divider Drawer in top drawer.
- Exterior height for lower drawer boxes is 6 3/8".
- Exterior WTC drawer box height is 3 3/4", interior height of top tier is 1 5/8", and interior height of bottom tier is 1 3/8".
- Wood Tiered Cutlery Divider Drawer is also available as an accessory. See page 292.
- DRWTK not available on 3DB15WTC.

**THREE DRAWER BASE with DEEP DRAWER**

LOGIX

24", 30", 33", or 36"

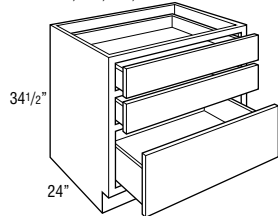

Model	24"	30"	33"	36"	24"	30"	33"	36"
3DBDD24	14.4	1562	1602	1704	1944	1562	2003	1746
3DBDD30	17.7	1815	1879	2005	2325	1815	2415	2048
3DBDD33	17.6	2017	2081	2206	2527	2017	2616	2249
3DBDD36	20.9	2218	2282	2408	2728	2218	2818	2451

- Exterior height of bottom drawer box is 10".
- SCPDRW not available on 3DBDD24.

**FOUR DRAWER BASE**

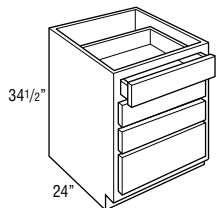

Model	7.8	629	661	746	940	629	987	778
4DB12	7.8	629	661	746	940	629	987	778
4DB15	9.4	680	712	803	1013	680	1064	840
4DB18	11.1	731	767	864	1090	731	1144	901
4DB21	12.8	779	819	922	1162	779	1220	963
4DB24	14.4	837	878	988	1247	837	1310	1032

- DRWTK not available on 4DB12 and 4DB15.

Model	Cubic Feet	Carroll Maple	Bryant Cherry Hurley Cherry Norris Maple Norris PureStyle™	Cairo Cherry Kasper Cherry Reist Cherry	Klewin Oak	Brookway Maple Carroll Cherry Kersey Hickory Kersey Maple Norris Cherry	Falk Hickory Falk Maple Forte Hickory Forte Maple Forte PureStyle™ Owens Maple Owens PureStyle™	Amico PureStyle™ Brookway Cherry Falk Cherry Forte Cherry Kersey Cherry Klewin Hickory Klewin Maple Owens Cherry	Adair Maple Adair PureStyle™ Keegan Maple	Valero Maple	Adair Cherry Keegan Cherry	Klewin Cherry	Valero Cherry
		8	9	10	11	12	13	14	15	16	17	18	19
3DB12	7.8	657	832	866	724	878	757	794	834	834	953	910	953
3DB15	9.4	707	895	930	778	943	812	851	895	895	1022	979	1022
3DB18	11.1	760	960	1000	837	1013	872	915	962	962	1098	1049	1098
3DB21	12.8	815	1031	1071	895	1087	933	980	1031	1031	1178	1126	1178
3DB24	14.4	869	1101	1147	957	1159	998	1048	1101	1101	1259	1203	1259
3DB27	16.1	1124	1395	1452	1231	1469	1276	1338	1401	1401	1581	1518	1581
3DB30	17.7	1378	1687	1754	1502	1776	1554	1630	1702	1702	1905	1833	1905
3DB33	19.6	1425	1746	1814	1554	1837	1606	1686	1759	1759	1973	1898	1973
3DB36	21.1	1471	1804	1875	1605	1900	1660	1742	1816	1816	2040	1960	2040

Custom Modifications	AUTHL AUTHR	CBO	CCO	CFNTO	CFP	CFRMO	CMAT	CND	DRWTK	FB	FD	FPEB	FTK	MIP	P	RD	RECTKALL RECTKBK	RECTKL RECTKR	RT	SCPDRW	TOTSS	VTK
	•	•	•	•	•	•			•	•		•	•	•		•	•	•		•		•

Construction Upgrades	VPL	Smart Stop Options	INTGH	PG	SP
	•			•	

3DB15WTC	9.4	1205	1393	1428	1276	1441	1310	1349	1393	1393	1520	1477	1520
3DB18WTC	11.1	1275	1475	1515	1352	1528	1387	1430	1477	1477	1613	1564	1613
3DB21WTC	12.8	1351	1567	1607	1431	1623	1469	1516	1567	1567	1714	1662	1714
3DB24WTC	14.4	1423	1655	1701	1511	1713	1552	1602	1655	1655	1813	1757	1813

Custom Modifications	AUTHL AUTHR	CBO	CCO	CFNTO	CFP	CFRMO	CMAT	CND	DRWTK	FB	FD	FPEB	FTK	MIP	P	RD	RECTKALL RECTKBK	RECTKL RECTKR	RT	SCPDRW	TOTSS	VTK
	•	•	•	•	•	•			•	•		•	•	•		•	•	•		•		•

Construction Upgrades	VPL	Smart Stop Options	INTGH	PG	SP
	•			STD	

3DBDD24	14.4	1651	1883	1930	1739	1941	1780	1830	1883	1883	2042	1985	2042
3DBDD30	17.7	1922	2232	2299	2047	2321	2099	2175	2247	2247	2450	2378	2450
3DBDD33	17.6	2124	2433	2500	2248	2523	2301	2377	2449	2449	2651	2579	2651
3DBDD36	20.9	2325	2635	2702	2450	2724	2502	2578	2650	2650	2853	2781	2853

Custom Modifications	AUTHL AUTHR	CBO	CCO	CFNTO	CFP	CFRMO	CMAT	CND	DRWTK	FB	FD	FPEB	FTK	MIP	P	RD	RECTKALL RECTKBK	RECTKL RECTKR	RT	SCPDRW	TOTSS	VTK
	•	•	•	•	•	•			•	•		•	•	•		•	•	•		•		•

Construction Upgrades	VPL	Smart Stop Options	INTGH	PG	SP
	•			STD	

4DB12	7.8	705	891	926	774	935	807	847	891	891	1017	975	1017
4DB15	9.4	758	959	998	833	1009	871	914	960	960	1095	1047	1095
4DB18	11.1	815	1031	1071	895	1087	933	980	1031	1031	1178	1126	1178
4DB21	12.8	869	1101	1147	957	1159	998	1048	1101	1101	1259	1203	1259
4DB24	14.4	932	1180	1227	1025	1242	1069	1123	1180	1180	1347	1288	1347

Custom Modifications	AUTHL AUTHR	CBO	CCO	CFNTO	CFP	CFRMO	CMAT	CND	DRWTK	FB	FD	FPEB	FTK	MIP	P	RD	RECTKALL RECTKBK	RECTKL RECTKR	RT	SCPDRW	TOTSS	VTK
	•	•	•	•	•	•			•	•		•	•	•		•	•	•		•		•

Construction Upgrades	VPL	Smart Stop Options	INTGH	PG	SP
				•	

**FOUR DRAWER BASE with CUTLERY INSERT WOOD ORGANIZER**

LOGIX

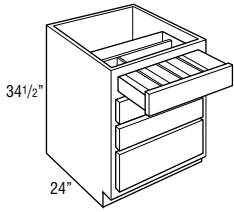

Model	Cubic Feet	Finish						
		Tori Oak	Westburke Oak	Tori Hickory Tori Maple	Loren Laminate Tori Cherry Westburke Hickory Westburke Maple Westburke PureStyle™	Chino Oak Gantrell Oak Kesper Oak Renaist Oak	Westburke Cherry	Brookway Oak Bryant Hickory Bryant Maple Chino Maple Hurley Hickory Hurley Maple Kesper Maple Kesper Oak Renaist PureStyle™ Renaist PureStyle™
<b>4DB15CIW</b>	9.4	866	898	989	1199	866	1250	1026
<b>4DB18CIW</b>	11.1	929	965	1062	1288	929	1342	1099
<b>4DB21CIW</b>	12.8	1036	1076	1179	1419	1036	1477	1220
<b>4DB24CIW</b>	14.4	1113	1154	1264	1523	1113	1586	1308

- Includes Cutlery Insert Wood Organizer.
- Cutlery Insert Wood Organizer is also available as an accessory. See page 291.
- DRWTK not available on 4DB15CIW.

**FOUR DRAWER BASE with WOOD TIERED CUTLERY DIVIDER DRAWER**

LOGIX

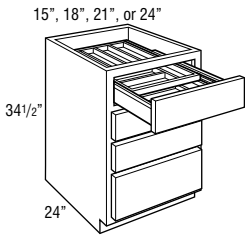

<b>4DB15WTCD</b>	9.4	1178	1210	1301	1511	1178	1562	1338
<b>4DB18WTCD</b>	11.1	1246	1282	1379	1605	1246	1659	1416
<b>4DB21WTCD</b>	12.8	1315	1355	1458	1698	1315	1756	1499
<b>4DB24WTCD</b>	14.4	1391	1432	1542	1801	1391	1864	1586

- Includes Wood Tiered Cutlery Divider Drawer in top drawer.
- Exterior WTCD drawer box height is 3 3/4", interior height of top tier is 1 5/8", and interior height of bottom tier is 1 3/8".
- Wood Tiered Cutlery Divider Drawer is also available as an accessory. See page 292.
- DRWTK not available on 4DB15WTCD.

**BASE WASTEBASKET**

LOGIX

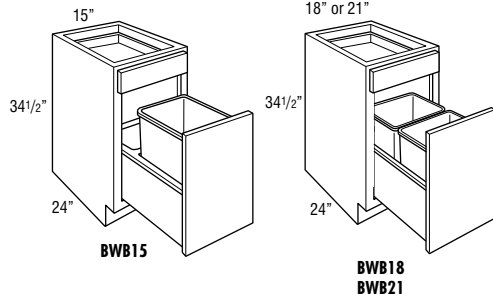

<b>BWB15</b>	9.1	917	941	992	1019	1042	1047	1094
<b>BWB18</b>	11.1	948	971	1022	1053	1080	1081	1136
<b>BWB21</b>	12.8	980	1005	1061	1092	1121	1123	1179

- Pull-out features undermount Smart Stop guides.
- Pull-out height is 10".
- BWB15 includes one 35 quart gray wastebasket and a trash bag storage area.
- BWB18 and BWB21 include two 35 quart gray wastebaskets.
- DRWTK not available on BWB15.

Model	Cubic Feet	Central Maple	Bryant Cherry Hurley Cherry Norris Maple Norris PureStyle™	Cairo Cherry Kasper Cherry Reist Cherry	Klewin Oak	Brookway Maple Central Cherry Kersey Hickory Kersey Maple Norris Cherry	Felix Hickory Felix Maple Forte Hickory Forte Maple Forte PureStyle™ Owens Maple Owens PureStyle™	Antico PureStyle™ Brookway Cherry Felix Cherry Forte Cherry Kersey Hickory Klewin Hickory Klewin Maple Owens Cherry	Adair Maple Adair PureStyle™ Keegan Maple	Wilero Maple	Adair Cherry Keegan Cherry	Klewin Cherry	Wilero Cherry
	8	9	10	11	12	13	14	15	16	17	18	19	
4DB15CIW	9.4	944	1145	1184	1019	1195	1057	1100	1146	1146	1281	1233	1281
4DB18CIW	11.1	1013	1229	1269	1093	1285	1131	1178	1229	1229	1376	1324	1376
4DB21CIW	12.8	1126	1358	1404	1214	1416	1255	1305	1358	1358	1516	1460	1516
4DB24CIW	14.4	1208	1456	1503	1301	1518	1345	1399	1456	1456	1623	1564	1623

Custom Modifications	AUTHL AUTHR	CBO	CCO	CFNT0	CFP	CFRMO	CMAT	CND	DRWTK	FB	FD	FPEB	FTK	MIP	P	RD	RECTKALL RECTKBK	RECTKL RECTKR	RT	SCPDRW	TOTSS	VTK
	•	•	•	•		•			•	•		•	•	•			•	•				•

Construction Upgrades	VPL	Smart Stop Options	INTGH	PG	SP
	•			STD	

4DB15WTC	9.4	1256	1457	1496	1331	1507	1369	1412	1458	1458	1593	1545	1593
4DB18WTC	11.1	1330	1546	1586	1410	1602	1448	1495	1546	1546	1693	1641	1693
4DB21WTC	12.8	1405	1637	1683	1493	1695	1534	1584	1637	1637	1795	1739	1795
4DB24WTC	14.4	1486	1734	1781	1579	1796	1623	1677	1734	1734	1901	1842	1901

Custom Modifications	AUTHL AUTHR	CBO	CCO	CFNT0	CFP	CFRMO	CMAT	CND	DRWTK	FB	FD	FPEB	FTK	MIP	P	RD	RECTKALL RECTKBK	RECTKL RECTKR	RT	SCPDRW	TOTSS	VTK
	•	•	•	•		•			•	•		•	•	•			•	•				•

Construction Upgrades	VPL	Smart Stop Options	INTGH	PG	SP
	•			STD	

BWB15	9.1	1124	1150	1178	1232	1233	1263	1305	1319	1363	1389	1392	1436
BWB18	11.1	1169	1191	1220	1280	1281	1316	1357	1374	1422	1448	1452	1500
BWB21	12.8	1214	1243	1274	1333	1338	1369	1417	1433	1484	1512	1515	1567

Custom Modifications	AUTHL AUTHR	CBO	CCO	CFNT0	CFP	CFRMO	CMAT	CND	DRWTK	FB	FD	FPEB	FTK	MIP	P	RD	RECTKALL RECTKBK	RECTKL RECTKR	RT	SCPDRW	TOTSS	VTK
	•	•	•		•			•	•		•	•	•				•	•				•

Construction Upgrades	VPL	Smart Stop Options	INTGH	PG	SP
	•			•	

**BASE WASTEBASKET FULL HEIGHT**

LOGIX

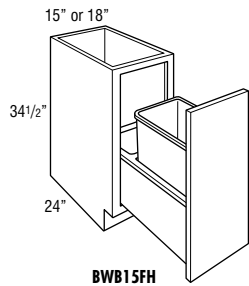

**BWB15FH  
BWB18FH**

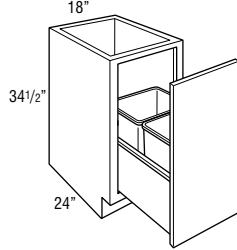

**BWB18FH2**

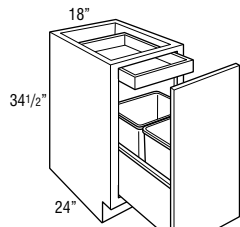

**BWB18FHRT2**

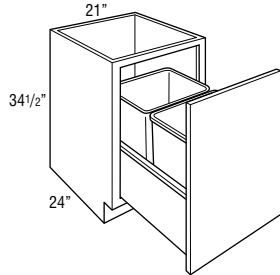

**BWB21FH**

**Model**

Model	Cubic Feet	Finish						
		Tori Oak	Westburke Oak	Tori Hickory Tori Maple	Lozen Laminate Tori Cherry Westburke Hickory Westburke Maple Westburke PureStyle™	Calvo Oak Gantrell Oak Kesper Oak Rensel Oak	Westburke Cherry	Brookway Oak Bryant Hickory Bryant Maple Bryant PureStyle™ Calvo Maple Hurley Hickory Hurley Maple Kesper Maple Kesper Oak Rensel PureStyle™ Rensel PureStyle™
<b>BWB15FH</b>	9.4	880	901	944	969	993	995	1039
<b>BWB18FH</b>	11.1	905	925	972	1000	1025	1027	1076
<b>BWB18FH2</b>	11.1	905	925	972	1000	1025	1027	1076
<b>BWB18FHRT2</b>	11.1	1135	1155	1203	1231	1255	1257	1307
<b>BWB21FH</b>	12.8	933	955	1007	1036	1061	1065	1115

- Pull-out features undermount Smart Stop guides.
- Pull-out height is 10".
- BWB15FH and BWB18FH include one 50 quart gray wastebasket and a trash bag storage area.
- BWB18FH2 includes two 35 quart gray wastebaskets.
- BWB18FHRT2 includes two 35 quart gray wastebaskets and one roll tray.
- BWB21FH includes two 50 quart gray wastebaskets.
- DRWTK not available on BWB15FH.
- PG and SP available only on BWB18FHRT2.

Model	Cubic Feet	Countertop Maple	Bryant Cherry Hurley Cherry Norris Maple Norris PureStyle™	Carlo Cherry Kasper Cherry Reist Cherry	Klewin Oak	Brookway Maple Countertop Cherry Kersey Hickory Kersey Maple Norris Cherry	Falk Hickory Falk Maple Forte Hickory Forte Maple Forte PureStyle™ Owens Maple Owens PureStyle™	Amico PureStyle™ Brookway Cherry Falk Cherry Forte Cherry Kersey Hickory Klewin Hickory Owens Maple	Adair Maple Adair PureStyle™ Keegan Maple	Valero Maple	Adair Cherry Keegan Cherry	Klewin Cherry	Valero Cherry
		8	9	10	11	12	13	14	15	16	17	18	19
<b>BWB15FH</b>	9.4	1067	1090	1115	1162	1165	1191	1228	1244	1285	1308	1312	1351
<b>BWB18FH</b>	11.1	1105	1129	1154	1207	1209	1239	1278	1292	1335	1360	1363	1406
<b>BWB18FH2</b>	11.1	1105	1129	1154	1207	1209	1239	1278	1292	1335	1360	1363	1406
<b>BWB18FHRT2</b>	11.1	1335	1359	1385	1437	1439	1469	1508	1522	1566	1590	1593	1637
<b>BWB21FH</b>	12.8	1147	1174	1203	1256	1259	1290	1331	1347	1393	1420	1423	1470

Custom Modifications	AUTHL AUTHR	CBO	CCO	CFNTO	CFP	CFRMO	CMAT	CND	DRWTK	FB	FD	FPEB	FTK	MIP	P	RD	RECTKALL RECTKBK	RECTKL RECTKR	RT	SCPDRW	TOTSS	VTK
	•	•	•					•	•	•		•	•	•			•	•				•

Construction Upgrades	VPL	Smart Stop Options	INTGH	PG	SP
	•				•



**BASE WINE CUBBY, 24" DEEP**

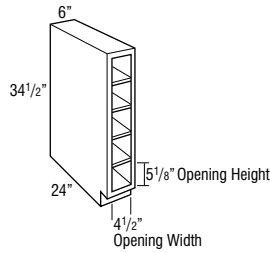

Model	Cubic Feet	Cubic Feet					Cubic Feet	
		Tori Oak	Westburke Oak	Tori Hickory Tori Maple	Loren Laminate Tori Cherry Westburke Hickory Westburke Maple Westburke PureStyle™	Calio Oak Gantrell Oak Kesper Oak Rensil Oak	Westburke Cherry	Brockway Oak Bryant Hickory Bryant Maple Rensil PureStyle™ Calio Maple Hurley Hickory Hurley Maple Kesper Maple Kessy Oak Rensil PureStyle™ Rensil PureStyle™
		1	2	3	4	5	6	7
<b>BWC6</b>	3.7	889	889	889	889	889	889	889

- Vertical application only.
- Matching interior.
- Frameless drilled and doweled construction.
- See BSD6 (Base Spice Cabinets with Drawers).
- Hardwood veneer on 3/4" furniture board core.
- Reduced Depth only available in 3" increments down to 12".

**BASE SPICE DRAWER, 24" DEEP**

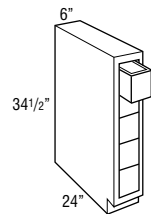

Model	Cubic Feet	1759	1759	1759	1759	1759	1759	1759
<b>BSD6</b>	3.7	1759	1759	1759	1759	1759	1759	1759

- See BWC6 (Base Wine Cubby without Drawers).
- Drawer front is unique to item and compatible with all existing profiles.
- Frameless drilled and doweled construction.
- Hardwood veneer on a 3/4" furniture board core.
- Vertical application only.
- Matching interior.
- Includes five 1/2" hardwood drawers with rabbit joint, 21 13/16" deep.
- Features flush end panels which cannot be skinned.
- Reduced Depth only available in 3" increments down to 12".
- Rensil PureStyle™ drawer fronts will be painted hardwood.

**FLOATING ISLAND BASE**

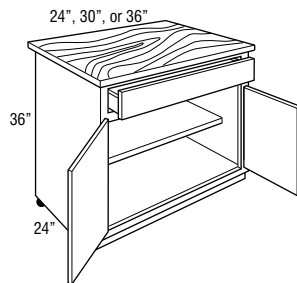

32" high without top and casters.

Model	Cubic Feet	1370	1403	1473	1511	1546	1551	1617
<b>FIG24</b>	15.0	1370	1403	1473	1511	1546	1551	1617
<b>FIG30</b>	18.5	1426	1460	1535	1577	1616	1618	1694
<b>FIG36</b>	21.9	1492	1529	1613	1658	1700	1703	1787

- 1 full width drawer and 1 adjustable 15" shelf.
- 1 1/2" thick solid maple top. Top is treated with FDA approved mineral oil.
- Top overhangs 1" on all sides. For field provided countertops, maximum overhang of 1" on all sides.
- 4 heavy duty locking casters.
- Cabinet sides and back are finished to match cabinet doors.
- Cabinet has butt doors, no center stile.
- Not recommended for use with roll trays.

**BASE PANTRY PULL-OUT**

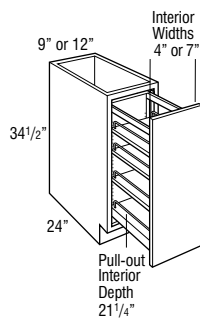

Model	Cubic Feet	1105	1149	1244	1297	1348	1351	1446
<b>BPP9</b>	6.1	1105	1149	1244	1297	1348	1351	1446
<b>BPP12</b>	7.8	1183	1232	1334	1394	1448	1452	1556

- All styles feature a natural finish Smart Stop wood pull-out with adjustable shelves and chrome rail sides. The adjustable rear wall of the pull-out prevents items from falling behind the unit.
- RECTKALL and RECTKBK not available on BPP9.

**BASE UTENSIL PANTRY PULL-OUT**

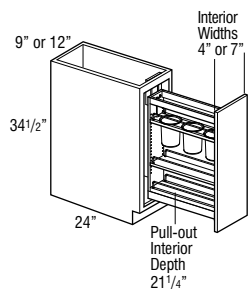

Model	Cubic Feet	1573	1617	1712	1765	1815	1819	1914
<b>BUPP9</b>	5.8	1573	1617	1712	1765	1815	1819	1914
<b>BUPP12</b>	7.5	1651	1699	1802	1862	1916	1919	2024

- All styles feature a natural finish Smart Stop wood pull-out with two adjustable shelves (including canister shelf) and one fixed shelf with chrome rail sides. Top adjustable shelf features three stainless steel canisters for utensils. The adjustable rear wall of the pull-out prevents items from falling behind the unit.
- BUPP9 canisters are 5.85" tall and have an inside diameter of 4.3".
- BUPP12 canisters are 6.7" tall and have an inside diameter of 5".
- RECTKALL and RECTKBK not available on BUPP9.

Model	Cubic Feet	Cabinet Styles											
		8	9	10	11	12	13	14	15	16	17	18	19
<b>BWC6</b>	3.7	889	889	889	889	889	889	889	889	889	889	889	889

Custom Modifications	AUTHL AUTHR	CBO	CCO	CFNT0	CFP	CFRMO	CMAT	CND	DRWTK	FB	FD	FPEB	FTK	MIP	P	RD	RECTKALL RECTKBK	RECTKL RECTKR	RT	SCPDRW	TOTSS	VTK
										STD						•						•

Construction Upgrades	VPL	Smart Stop Options	INTGH	PG	SP

<b>BSD6</b>	3.7	1759	1759	1759	1759	1759	1759	1759	1759	1759	1759	1759	1759
-------------	-----	------	------	------	------	------	------	------	------	------	------	------	------

Custom Modifications	AUTHL AUTHR	CBO	CCO	CFNT0	CFP	CFRMO	CMAT	CND	DRWTK	FB	FD	FPEB	FTK	MIP	P	RD	RECTKALL RECTKBK	RECTKL RECTKR	RT	SCPDRW	TOTSS	VTK
										STD						•						•

Construction Upgrades	VPL	Smart Stop Options	INTGH	PG	SP

<b>FIC24</b>	15.0	1660	1696	1736	1808	1812	1857	1912	1934	1997	2031	2035	2100
<b>FIC30</b>	18.5	1740	1780	1824	1902	1908	1952	2013	2039	2106	2143	2147	2217
<b>FIC36</b>	21.9	1836	1881	1924	2013	2018	2069	2135	2161	2236	2277	2282	2359

Custom Modifications	AUTHL AUTHR	CBO	CCO	CFNT0	CFP	CFRMO	CMAT	CND	DRWTK	FB	FD	FPEB	FTK	MIP	P	RD	RECTKALL RECTKBK	RECTKL RECTKR	RT	SCPDRW	TOTSS	VTK
	•	•	•	•	•	•	•	•		STD	•	•		•								

Construction Upgrades	VPL	Smart Stop Options	INTGH	PG	SP
			•	•	•

<b>BPP9</b>	6.1	1507	1556	1609	1711	1717	1774	1851	1881	1969	2017	2023	2112
<b>BPP12</b>	7.8	1622	1676	1733	1844	1851	1913	1997	2031	2127	2176	2185	2279

Custom Modifications	AUTHL AUTHR	CBO	CCO	CFNT0	CFP	CFRMO	CMAT	CND	DRWTK	FB	FD	FPEB	FTK	MIP	P	RD	RECTKALL RECTKBK	RECTKL RECTKR	RT	SCPDRW	TOTSS	VTK
	•	•	•			•				•		•	•	•	•		•	•				•

Construction Upgrades	VPL	Smart Stop Options	INTGH	PG	SP
	•				

<b>BUPP9</b>	5.8	1975	2024	2077	2178	2185	2242	2319	2349	2436	2485	2491	2579
<b>BUPP12</b>	7.5	2090	2143	2201	2312	2319	2381	2465	2499	2595	2644	2652	2747

Custom Modifications	AUTHL AUTHR	CBO	CCO	CFNT0	CFP	CFRMO	CMAT	CND	DRWTK	FB	FD	FPEB	FTK	MIP	P	RD	RECTKALL RECTKBK	RECTKL RECTKR	RT	SCPDRW	TOTSS	VTK
	•	•	•			•				•		•	•	•	•		•	•				•

Construction Upgrades	VPL	Smart Stop Options	INTGH	PG	SP
	•				

**BASE BOX COLUMN PULL-OUT with OVERLAY** L O G I X

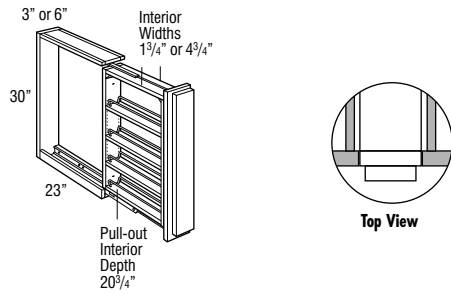

Model	Cubic Feet	Cabinet Feet					7
		Tori Oak	Westburke Oak	Tori Hickory Tori Maple	Loren Laminate Tori Cherry Westburke Hickory Westburke Maple Westburke PureStyle™	Galio Oak Gantrell Oak Kesper Oak Renaist Oak	
<b>BBCPO3OL</b>	1.3	1244	1244	1244	1244	1244	1244
<b>BBCPO6OL</b>	2.5	1460	1460	1460	1460	1460	1460

- Recommended to be installed between two cabinets. Can be installed on the end of a run with the use of an end panel (recommend BEPWD and BEPLAM).
- Can also be installed between a cabinet and a wall or between a cabinet and an end panel.
- Filler is included but unattached.
- Install unit before removing shipping brace and attaching filler.
- Includes profiled full overlay filler.
- Decorative hardware required on base units.
- Modifications not available.
- Toekick not included; must be built up in the field.
- If installed next to an appliance an End Panel must be installed onto the pull-out adjacent to the appliance.
- All styles feature a natural finish Smart Stop wood pull-out with adjustable shelves and chrome rail sides.
- In order to allow proper clearance for opening and closing, allow an additional 1/8" space between adjacent cabinet face frames. The 3" wide pull-outs require 3 1/8" space and the 6" wide pull-outs require 6 1/8" space. Spacers are included with the pull-outs to allow for proper installation.

**BASE DROP-IN RANGE CABINET**

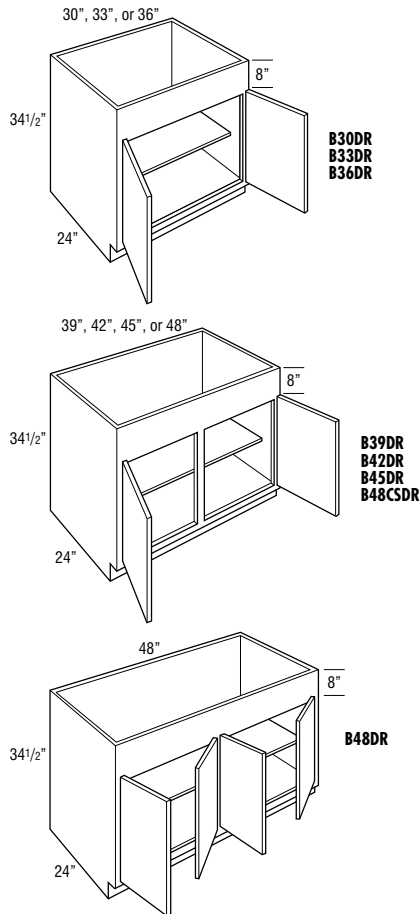

<b>B30DR</b>	17.4	772	812	897	946	987	992	1074
<b>B33DR</b>	19.0	800	841	927	978	1024	1025	1115
<b>B36DR</b>	20.7	832	874	965	1018	1064	1069	1159
<b>B39DR</b>	22.4	878	922	1016	1070	1121	1124	1220
<b>B42DR</b>	24.0	915	960	1063	1121	1173	1177	1273
<b>B45DR</b>	25.7	960	1009	1116	1176	1231	1235	1338
<b>B48CSDR</b>	27.3	1145	1204	1333	1404	1471	1477	1604
<b>B48DR</b>	27.3	1173	1232	1361	1432	1499	1505	1631

- 8" panel can be trimmed up to 6 1/2".
- Adjustable 15" deep shelf.
- Can also be used with apron front sinks, refer to manufacturer's dimension requirements.
- DRWTK not available on B39DR, B42DR, B45DR, B48CSDR, and B48DR.

Model	Cubic Feet	Countertop Maple	Bryant Cherry Hurley Cherry Norris Maple Norris PureStyle™	Cairo Cherry Kasper Cherry Reist Cherry	Klewin Oak	Brookway Maple Countertop Cherry Kersey Hickory Kersey Maple Norris Cherry	Falk Hickory Falk Maple Forte Hickory Forte Maple Forte PureStyle™ Owens Maple Owens PureStyle™	Antico PureStyle™ Brookway Cherry Falk Cherry Forte Cherry Kersey Cherry Klewin Hickory Klewin Maple Owens Cherry	Adair Maple Adair PureStyle™ Keegan Maple	Valero Maple	Adair Cherry Keegan Cherry	Klewin Cherry	Valero Cherry
		8	9	10	11	12	13	14	15	16	17	18	19
BBCPO30L	1.3	1244	1244	1244	1244	1244	1244	1244	1244	1244	1244	1244	1244
BBCPO60L	2.5	1460	1460	1460	1460	1460	1460	1460	1460	1460	1460	1460	1460

MODIFICATIONS
No modifications available for these products.

B30DR	17.4	1127	1171	1216	1310	1312	1365	1432	1460	1537	1579	1584	1663
B33DR	19.0	1170	1212	1261	1354	1361	1415	1484	1510	1591	1635	1640	1720
B36DR	20.7	1215	1262	1312	1411	1414	1472	1544	1574	1658	1703	1708	1793
B39DR	22.4	1282	1327	1380	1482	1489	1548	1625	1658	1745	1795	1799	1887
B42DR	24.0	1334	1388	1442	1552	1555	1619	1699	1731	1821	1872	1878	1971
B45DR	25.7	1401	1458	1515	1631	1633	1702	1786	1816	1913	1967	1973	2071
B48CSDR	27.3	1681	1748	1818	1959	1961	2046	2147	2188	2304	2367	2377	2495
B48DR	27.3	1709	1775	1845	1987	1989	2073	2175	2215	2332	2395	2404	2523

Custom Modifications	AUTHL AUTHR	CBO	CCO	CFNTO	CFP	CFRMO	CMAT	CND	DRWTK	FB	FD	FPEB	FTK	MIP	P	RD	RECTKALL RECTKBK	RECTKL RECTKR	RT	SCPDRW	TOTSS	VTK
	•	•	•	•		•			•	•	•	•	•	•		•	•	•	•			•

Construction Upgrades	VPL	Smart Stop Options	INTGH	PG	SP
	•		•		

**BASE OVEN CABINET**

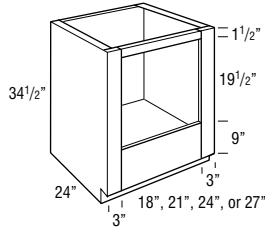

Model	Opening Width	Maximum Width	Opening Height	Maximum Height*
BO24	18"	22 1/2"	19 1/2"	27 1/2"
BO27	21"	25 1/2"	19 1/2"	27 1/2"
BO30	24"	28 1/2"	19 1/2"	27 1/2"
BO33	27"	31 1/2"	19 1/2"	27 1/2"

\*Top frame cross rail can be removed during field installation if cabinet is properly installed between two adjacent cabinets, increasing the maximum height to 28 1/4".

Model	Cubic Feet	Finish						
		Tori Oak	Westburke Oak	Tori Hickory Tori Maple	Loren Laminate Tori Cherry Westburke Hickory Westburke Maple Westburke PureStyle™	Galio Oak Gantrell Oak Kesper Oak Reist Oak	Westburke Cherry	Brookway Oak Bryant Hickory Bryant Maple Bryant PureStyle™ Calo Maple Hurley Hickory Hurley Maple Kesper Maple Kesper Oak Reist PureStyle™ Reist PureStyle™
BO24	14.4	848	848	848	848	848	848	848
BO27	16.1	865	865	865	865	865	865	865
BO30	17.7	880	880	880	880	880	880	880
BO33	19.6	915	915	915	915	915	915	915

- Oven cabinet has laminated interior.
- May not hold cooktop and slide-in oven combination. Refer to cooktop and slide-in oven manufacturer specifications.
- Oven cabinet includes OCINSTALLKIT.

**BASE BUILT-IN MICROWAVE CABINET with DRAWER**

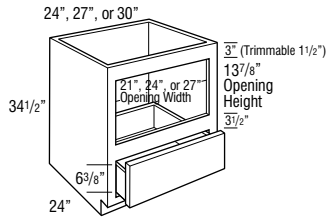

Model	Opening Width	Maximum Width	Opening Height	Maximum Height
BBMWD24	21"	22 1/2"	13 7/8"	16 7/8"
BBMWD27	24"	25 1/2"	13 7/8"	16 7/8"
BBMWD30	27"	28 1/2"	13 7/8"	16 7/8"

BBMWD24	14.4	910	953	1050	1102	1152	1155	1249
BBMWD27	16.1	920	963	1060	1112	1163	1166	1259
BBMWD30	17.7	930	974	1070	1123	1173	1176	1270

- Standard interior.
- For built-in appliance support, OCINSTALLKIT is included in 24" deep cabinets (see page 294 for details), but will not be included when depth is modified.
- The usable cabinet face height between top of drawer front and top of cabinet is 19 1/8" for partial overlay and 19 3/4" for full overlay. Be sure to verify overall appliance height, gap requirements, and cut-out dimensions with cabinet specifications.

**BASE MICROWAVE CABINET with DRAWER**

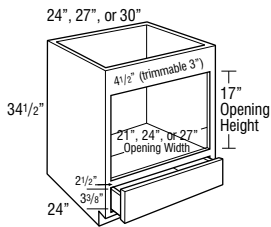

Model	Opening Width	Maximum Width	Opening Height	Maximum Height
BMWWD24	21"	22 1/2"	17"	20"
BMWWD27	24"	25 1/2"	17"	20"
BMWWD30	27"	28 1/2"	17"	20"

BMWWD24	14.4	798	839	927	977	1019	1024	1112
BMWWD27	16.1	837	878	970	1022	1067	1072	1162
BMWWD30	17.7	869	912	1008	1061	1111	1114	1208

- Hardwood veneer on plywood with matching veneer interior.
- Finished interior standard.
- Reinforced plywood floor.
- The usable cabinet face height between top of drawer front and top of cabinet is 23 1/2" for partial overlay and full overlay. Be sure to verify overall appliance height, gap requirements, and cut-out dimensions with cabinet specifications.

Model	Cubic Feet	Countertop Maple	Bryant Cherry Hurley Cherry Norris Maple Norris PureStyle™	Cairo Cherry Kasper Cherry Reist Cherry	Klewin Oak	Brockway Maple Countertop Cherry Kersey Hickory Kersey Maple Norris Cherry	Felix Hickory Felix Maple Forte Hickory Forte Maple Forte PureStyle™ Owens Maple Owens PureStyle™	Antico PureStyle™ Brockway Cherry Felix Cherry Forte Cherry Kersey Cherry Klewin Hickory Klewin Maple Owens Cherry	Adair Maple Adair PureStyle™ Keegan Maple	Valero Maple	Adair Cherry Keegan Cherry	Klewin Cherry	Valero Cherry
		8	9	10	11	12	13	14	15	16	17	18	19
<b>B024</b>	14.4	848	848	848	848	848	848	848	848	848	848	848	848
<b>B027</b>	16.1	865	865	865	865	865	865	865	865	865	865	865	865
<b>B030</b>	17.7	880	880	880	880	880	880	880	880	880	880	880	880
<b>B033</b>	19.6	915	915	915	915	915	915	915	915	915	915	915	915

Custom Modifications	AUTHL AUTHR	CBO	CCO	CFNTO	CFP	CFRMO	CMAT	CND	DRWTK	FB	FD	FPEB	FTK	MIP	P	RD	RECTKALL RECTKBK	RECTKL RECTKR	RT	SCPDRW	TOTSS	VTK
	•					•			•	•		•	•	•		•	•	•				•

Construction Upgrades	VPL	Smart Stop Options	INTGH	PG	SP
	•				

<b>BBMWD24</b>	14.4	1307	1359	1410	1512	1516	1575	1649	1768	1768	1822	1828	1902
<b>BBMWD27</b>	16.1	1317	1369	1421	1522	1527	1585	1659	1778	1778	1832	1838	1912
<b>BBMWD30</b>	17.7	1327	1380	1431	1533	1537	1595	1669	1789	1789	1843	1849	1923

Custom Modifications	AUTHL AUTHR	CBO	CCO	CFNTO	CFP	CFRMO	CMAT	CND	DRWTK	FB	FD	FPEB	FTK	MIP	P	RD	RECTKALL RECTKBK	RECTKL RECTKR	RT	SCPDRW	TOTSS	VTK
	•	•	•	•		•			•	•		•	•	•		•	•	•				•

Construction Upgrades	VPL	Smart Stop Options	INTGH	PG	SP
				STD	

<b>BMWD24</b>	14.4	1163	1210	1260	1353	1357	1412	1481	1589	1589	1638	1643	1709
<b>BMWD27</b>	16.1	1218	1268	1319	1418	1422	1477	1550	1662	1662	1713	1718	1787
<b>BMWD30</b>	17.7	1265	1318	1369	1471	1475	1534	1608	1727	1727	1779	1786	1858

Custom Modifications	AUTHL AUTHR	CBO	CCO	CFNTO	CFP	CFRMO	CMAT	CND	DRWTK	FB	FD	FPEB	FTK	MIP	P	RD	RECTKALL RECTKBK	RECTKL RECTKR	RT	SCPDRW	TOTSS	VTK
	•	•	•	•		•			•	STD		•	•	STD		•	•	•				•

Construction Upgrades	VPL	Smart Stop Options	INTGH	PG	SP
			•		

**BASE MICROWAVE CABINET with DEEP DRAWER**

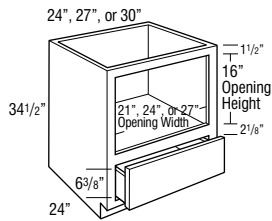

Model	Opening Width	Maximum Width	Opening Height	Maximum Height
BMWD24DD	21"	22 1/2"	16"	16"
BMWD27DD	24"	25 1/2"	16"	16"
BMWD30DD	27"	28 1/2"	16"	16"

Model	Cubic Feet	Tori Oak		Westburke Oak		Tori Hickory / Tori Maple		Loren Laminate / Tori Cherry		Westburke Hickory / Westburke Maple		Westburke PureStyle™		Cairo Oak / Gambrell Oak / Kesper Oak / Reist Oak		Westburke Cherry		Brookway Oak / Bryant Hickory / Bryant Maple / Bryant PureStyle™ / Cairo Maple / Hurley Hickory / Hurley Maple / Kesper Maple / Kessey Oak / Reist PureStyle™ / Reist PureStyle™	
		1	2	3	4	5	6	7											
<b>BMWD24DD</b>	14.4	798	839	927	977	1019	1024	1112											
<b>BMWD27DD</b>	16.1	837	878	970	1022	1067	1072	1162											
<b>BMWD30DD</b>	17.7	930	974	1070	1123	1173	1176	1270											

- Hardwood veneer on plywood with matching veneer interior.
- Finished interior standard.
- Reinforced plywood floor.
- The usable cabinet face height between top of drawer front and top of cabinet is 19 1/8" for partial overlay and 18 3/8" for full overlay. Be sure to verify overall appliance height, gap requirements, and cut-out dimensions with cabinet specifications.

**BASE CORNER PENINSULA**

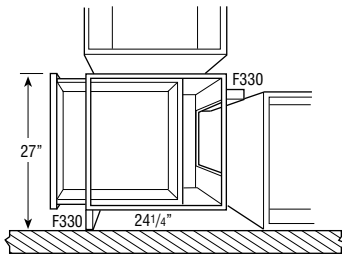

BCP24	14.4	731	767	847	892	930	937	1015
-------	------	-----	-----	-----	-----	-----	-----	------

- Cabinet width is 24".
- Adjustable full depth shelf.
- Includes two 3" fillers, shipped unattached. Fillers are required for drawer and door opening clearance of adjacent cabinets.
- Unfinished toekick on front (B24) and back (BCP) of cabinet.
- Will not accept roll trays.
- Peninsula base cabinets are 1/4" deeper to allow back paneling application on adjacent cabinets in a run with standard 24" deep cabinets.
- RECTKALL not available.

**BASE CORNER PENINSULA with FULL HEIGHT DOOR**

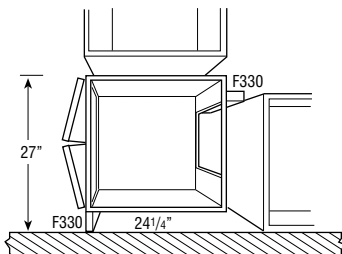

BCP24FH	14.4	1079	1133	1253	1320	1378	1386	1500
---------	------	------	------	------	------	------	------	------

- Cabinet width is 24".
- Adjustable full depth shelf.
- Includes two 3" fillers, shipped unattached. Fillers are required for drawer and door opening clearance of adjacent cabinets.
- Unfinished toekick on front (B24) and back (BCP) of cabinet.
- Will not accept roll trays.
- Peninsula base cabinets are 1/4" deeper to allow back paneling application on adjacent cabinets in a run with standard 24" deep cabinets.
- RECTKALL not available.

Model	Cubic Feet	Countrell Maple	Bryant Cherry Hurley Cherry Norris Maple Norris PureStyle™	Cairo Cherry Kasper Cherry Reist Cherry	Klewin Oak	Brockway Maple Countrell Cherry Kersey Hickory Kersey Maple Norris Cherry	Felix Hickory Felix Maple Forte Hickory Forte Maple Forte PureStyle™ Owens Maple Owens PureStyle™	Anitico PureStyle™ Brockway Cherry Felix Cherry Forte Cherry Kersey Hickory Klewin Hickory Klewin Maple Owens Cherry	Adair Maple Adair PureStyle™ Keegan Maple	Valero Maple	Adair Cherry Keegan Cherry	Klewin Cherry	Valero Cherry
		8	9	10	11	12	13	14	15	16	17	18	19
<b>BMWD24DD</b>	14.4	1163	1210	1260	1353	1357	1412	1481	1589	1589	1638	1643	1709
<b>BMWD27DD</b>	16.1	1218	1268	1319	1418	1422	1477	1550	1662	1662	1713	1718	1787
<b>BMWD30DD</b>	17.7	1327	1380	1431	1533	1537	1595	1669	1789	1789	1843	1849	1923

Custom Modifications	AUTHL AUTHR	CBO	CCO	CFNTO	CFP	CFRMO	CMAT	CND	DRWTK	FB	FD	FPEB	FTK	MIP	P	RD	RECTKALL RECTKBK	RECTKL RECTKR	RT	SCPDRW	TOTSS	VTK	
	•	•	•	•	•	•	•	•	•	•	•	•	•	•	•	•	•	•	•	•	•	•	•

Construction Upgrades	VPL	Smart Stop Options			INTGH	PG	SP
	•				•	•	•

BCP24	14.4	1064	1104	1150	1235	1239	1290	1353	1378	1452	1491	1497	1570
-------	------	------	------	------	------	------	------	------	------	------	------	------	------

Custom Modifications	AUTHL AUTHR	CBO	CCO	CFNTO	CFP	CFRMO	CMAT	CND	DRWTK	FB	FD	FPEB	FTK	MIP	P	RD	RECTKALL RECTKBK	RECTKL RECTKR	RT	SCPDRW	TOTSS	VTK	
	•	•	•	•	•	•	•	•	•	•	•	•	•	•	•	•	•	•	•	•	•	•	•

Construction Upgrades	VPL	Smart Stop Options			INTGH	PG	SP
	•				•	•	•

BCP24FH	14.4	1573	1636	1702	1828	1833	1906	2000	2036	2144	2204	2212	2320
---------	------	------	------	------	------	------	------	------	------	------	------	------	------

Custom Modifications	AUTHL AUTHR	CBO	CCO	CFNTO	CFP	CFRMO	CMAT	CND	DRWTK	FB	FD	FPEB	FTK	MIP	P	RD	RECTKALL RECTKBK	RECTKL RECTKR	RT	SCPDRW	TOTSS	VTK	
	•	•	•	•	•	•	•	•	•	•	•	•	•	•	•	•	•	•	•	•	•	•	•

Construction Upgrades	VPL	Smart Stop Options			INTGH	PG	SP
	•				•		



Cabinet nomenclature with AH represents upper sections with doors that align with 24" or 27" high cabinets.

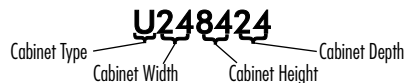

**UTILITY, 84", 87", 90", 93", or 96" TALL, 12" DEEP**

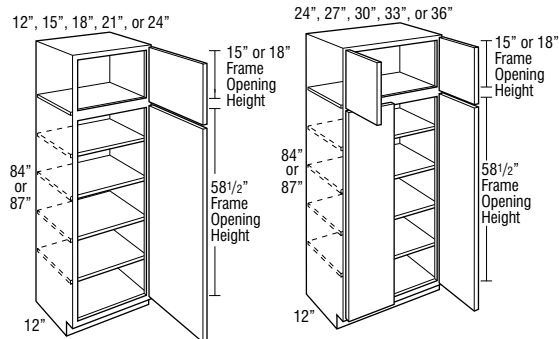

- |                       |                       |                |                |
|-----------------------|-----------------------|----------------|----------------|
| <b>U128412 L or R</b> | <b>U128712 L or R</b> | <b>U248412</b> | <b>U248712</b> |
| <b>U158412 L or R</b> | <b>U158712 L or R</b> | <b>U278412</b> | <b>U278712</b> |
| <b>U188412 L or R</b> | <b>U188712 L or R</b> | <b>U308412</b> | <b>U308712</b> |
| <b>U218412 L or R</b> | <b>U218712 L or R</b> | <b>U338412</b> | <b>U338712</b> |
| <b>U248412 L or R</b> | <b>U248712 L or R</b> | <b>U368412</b> | <b>U368712</b> |

Model	Cabinet Feet	Cabinet Depth						
		1	2	3	4	5	6	7
<b>U128412 L or R</b>	11.0	892	937	1015	1062	1102	1115	1185
<b>U158412 L or R</b>	12.1	928	976	1058	1104	1149	1160	1235
<b>U188412 L or R</b>	14.2	934	982	1063	1113	1155	1168	1240
<b>U218412 L or R</b>	15.8	1061	1114	1208	1263	1315	1326	1412
<b>U248412 L or R</b>	17.8	1185	1244	1353	1417	1473	1486	1583
<b>U248412</b>	17.8	1265	1329	1443	1511	1573	1587	1692
<b>U278412</b>	20.4	1306	1371	1489	1558	1623	1638	1747
<b>U308412</b>	22.0	1345	1412	1535	1606	1674	1687	1800
<b>U338412</b>	24.8	1436	1508	1640	1716	1788	1801	1922
<b>U368412</b>	27.0	1528	1604	1745	1825	1902	1915	2046

- Four full depth adjustable shelves are included but shipped separately.
- Utility cabinets with depths of 12" or less must be installed to wall studs or onto the end of another tall cabinet.
- Depth can be reduced to a minimum of 6". For depths of 6"-8", cabinet will not include toekick/pedestal.
- Tall mitered door styles and PureStyle™ door styles will feature one center panel, other styles will feature two center panels.

<b>U128712 L or R</b>	10.1	917	962	1043	1091	1137	1146	1219
<b>U158712 L or R</b>	12.3	954	1002	1088	1137	1184	1195	1270
<b>U188712 L or R</b>	14.4	1056	1107	1202	1258	1310	1321	1407
<b>U218712 L or R</b>	16.6	1137	1194	1297	1356	1412	1425	1518
<b>U248712 L or R</b>	18.8	1218	1279	1391	1457	1516	1530	1629
<b>U248712</b>	18.8	1300	1365	1486	1554	1619	1632	1740
<b>U278712</b>	20.9	1342	1409	1532	1603	1671	1684	1797
<b>U308712</b>	23.1	1384	1452	1579	1652	1721	1734	1851
<b>U338712</b>	25.2	1477	1551	1687	1765	1839	1852	1979
<b>U368712</b>	27.4	1571	1650	1795	1877	1956	1972	2105

- Four full depth adjustable shelves are included but shipped separately.
- Utility cabinets with depths of 12" or less must be installed to wall studs or onto the end of another tall cabinet.
- Depth can be reduced to a minimum of 6". For depths of 6"-8", cabinet will not include toekick/pedestal.
- Tall mitered door styles and PureStyle™ door styles will feature one center panel, other styles will feature two center panels.

CUSTOM MODIFICATIONS

Mod.	Description	Mod.	Description
AUTHL	Authentic End - Left	FTK	Flush Toekick
AUTHR	Authentic End - Right	MIP	Matching Interior Plywood
CBO	Cabinet Box Only	RD	Reduced Depth
CCO	Cabinet Case Only	RECTKALL	Recessed Island Toekick
CFNTO	Cabinet Front Only	RECTKKBK	Recessed Toekick Back
CFRMO	Cabinet Frame Only	RECTKL	Recessed Toekick Left
CND	Cabinet with No Door, with Drawer	RECTKR	Recessed Toekick Right
DRWTK	Toekick Drawer	RT	Installed Roll Tray
FB	Finished Ends	VTK	Void Toekick
FPEB	Furniture Finished Plywood End Panels		

CONSTRUCTION UPGRADES

Mod.	Description
VPL	All Plywood with Laminate Ends

SMART STOP OPTIONS

Mod.	Description
INTGH	Smart Stop Premium Hinge
PG	Smart Stop Premium Drawer Guide and Dovetail Box
SP	Smart Stop Premium Roll Tray Guide

MODIFICATIONS GRID KEY

- Available
- STD Standard on these cabinets
- L O G I X Logix Organization Cabinet

Model	Cubrt Feet	Camrill Maple	Bryant Cherry Hurley Cherry Morris Maple Morris PureStyle™	Cairo Cherry Kasper Cherry Kens Cherry	Klewin Oak	Brookway Maple Camrill Cherry Kersey Hickory Kersey Maple Morris Cherry	Felix Hickory Felix Maple Forte Hickory Forte Maple Forte PureStyle™ Owens Maple Owens PureStyle™	Anitro PureStyle™ Brookway Cherry Felix Cherry Forte Cherry Kersey Cherry Klewin Hickory Klewin Maple Owens Cherry	Adair Maple Adair PureStyle™ Keegan Maple	Valero Maple	Adair Cherry Keegan Cherry	Klewin Cherry	Valero Cherry
		8	9	10	11	12	13	14	15	16	17	18	19
U128412 L or R	11.0	1237	1278	1330	1422	1428	1473	1545	1568	1650	1683	1696	1772
U158412 L or R	12.1	1289	1332	1387	1479	1486	1536	1610	1632	1718	1752	1767	1844
U188412 L or R	14.2	1294	1338	1393	1485	1495	1541	1618	1639	1725	1759	1773	1852
U218412 L or R	15.8	1473	1527	1587	1693	1702	1759	1844	1870	1969	2008	2023	2114
U248412 L or R	17.8	1652	1713	1779	1901	1910	1974	2072	2100	2211	2256	2274	2378
U248412	17.8	1765	1830	1902	2031	2040	2108	2214	2243	2360	2414	2428	2539
U278412	20.4	1821	1887	1962	2097	2105	2175	2284	2315	2436	2491	2505	2620
U308412	22.0	1877	1945	2022	2160	2169	2244	2355	2386	2511	2567	2583	2702
U338412	24.8	2006	2079	2161	2308	2317	2397	2517	2550	2685	2745	2761	2888
U368412	27.0	2136	2212	2300	2456	2465	2550	2676	2715	2858	2922	2939	3074

U128712 L or R	10.1	1273	1317	1369	1461	1468	1516	1591	1614	1698	1732	1748	1824
U158712 L or R	12.3	1325	1371	1426	1522	1529	1580	1657	1680	1768	1804	1820	1900
U188712 L or R	14.4	1468	1520	1580	1687	1695	1752	1838	1864	1962	2005	2018	2109
U218712 L or R	16.6	1585	1641	1708	1823	1831	1892	1986	2014	2120	2165	2180	2279
U248712 L or R	18.8	1701	1763	1832	1957	1966	2032	2132	2164	2278	2324	2342	2447
U248712	18.8	1818	1882	1958	2091	2099	2171	2279	2311	2432	2486	2502	2615
U278712	20.9	1875	1943	2020	2157	2167	2239	2352	2385	2509	2565	2582	2700
U308712	23.1	1933	2003	2083	2225	2233	2310	2425	2458	2587	2644	2661	2783
U338712	25.2	2065	2139	2226	2377	2388	2469	2592	2628	2765	2826	2846	2976
U368712	27.4	2199	2276	2367	2530	2540	2629	2757	2796	2942	3009	3026	3168

Custom Modifications	AUTHL AUTHR	CBO	CCO	CFNTO	CFRMO	CND	DRWTK	FB	FPEB	FTK	MIP	RD	RECTKALL RECTKKBK	RECTKL RECTKR	RT	VTK
	•	•	•	•	•			•	•	•	•	•		•		•

Construction Upgrades	VPL	Smart Stop Options	INTGH	PG	SP
	•		•		

**UTILITY, 84", 87", 90", 93", or 96" TALL, 12" DEEP (cont'd)**

12", 15", 18", 21", or 24"

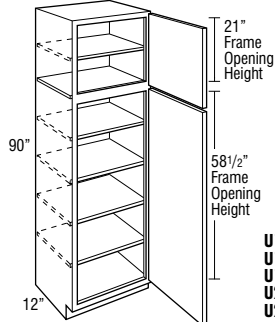

**U129012AH L or R**  
**U159012AH L or R**  
**U189012AH L or R**  
**U219012AH L or R**  
**U249012AH L or R**

24", 27", 30", 33", or 36"

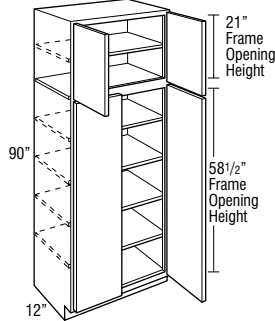

**U249012AH**  
**U279012AH**  
**U309012AH**  
**U339012AH**  
**U369012AH**

Model	Cubic Feet	Finish						
		Tori Oak	Westburke Oak	Tori Hickory Tori Maple	Loren Laminate Tori Cherry Westburke Hickory Westburke Maple Westburke PureStyle™	Calio Oak Cantrell Oak Kesper Oak Renaist Oak	Westburke Cherry	Brookway Oak Bryant Hickory Bryant Maple Bryant PureStyle™ Calio Maple Hurley Hickory Hurley Maple Kesper Maple Kessy Oak Renaist PureStyle™ Renaist PureStyle™
		1	2	3	4	5	6	7
<b>U129012AH L or R</b>	11.0	923	968	1051	1098	1145	1153	1227
<b>U159012AH L or R</b>	12.3	960	1009	1095	1145	1192	1203	1278
<b>U189012AH L or R</b>	14.4	1086	1138	1237	1294	1349	1359	1449
<b>U219012AH L or R</b>	16.9	1155	1213	1320	1380	1437	1449	1545
<b>U249012AH L or R</b>	19.1	1226	1288	1400	1467	1528	1540	1641
<b>U249012AH</b>	19.1	1310	1374	1497	1566	1630	1644	1753
<b>U279012AH</b>	21.9	1351	1419	1543	1614	1682	1695	1809
<b>U309012AH</b>	23.5	1394	1462	1590	1663	1733	1747	1865
<b>U339012AH</b>	26.5	1488	1563	1698	1777	1852	1866	1993
<b>U369012AH</b>	27.4	1581	1661	1807	1890	1970	1986	2120

- AH represents upper section alignment with doors on 24" or 27" high cabinets.
- Five full depth adjustable shelves are included but shipped separately.
- Utility cabinets with depths of 12" or less must be installed to wall studs or onto the end of another tall cabinet.
- Depth can be reduced to a minimum of 6". For depths of 6"-8", cabinet will not include toekick/pedestal.
- Tall mitered door styles and PureStyle™ door styles will feature one center panel, other styles will feature two center panels.

Model	Cubic Feet	Countertop Maple	Bryant Cherry Hurley Cherry Norris Maple Norris PureStyle™	Cairo Cherry Kasper Cherry Reist Cherry	Klewin Oak	Brockway Maple Countertop Cherry Kersey Hickory Kersey Maple Norris Cherry	Felix Hickory Felix Maple Forte Hickory Forte Maple Forte PureStyle™ Owens Maple Owens PureStyle™	Amico PureStyle™ Brockway Cherry Felix Cherry Forte Cherry Kersey Cherry Klewin Hickory Klewin Maple Owens Cherry	Adair Maple Adair PureStyle™ Keegan Maple	Valero Maple	Adair Cherry Keegan Cherry	Klewin Cherry	Valero Cherry
		8	9	10	11	12	13	14	15	16	17	18	19
U129012AH L or R	11.0	1282	1326	1379	1471	1478	1528	1603	1625	1711	1745	1761	1836
U159012AH L or R	12.3	1334	1381	1436	1533	1539	1591	1668	1692	1780	1818	1833	1914
U189012AH L or R	14.4	1511	1566	1627	1737	1746	1804	1894	1920	2022	2066	2079	2174
U219012AH L or R	16.9	1613	1669	1737	1855	1863	1924	2021	2050	2158	2204	2219	2320
U249012AH L or R	19.1	1714	1775	1845	1972	1979	2047	2147	2180	2294	2341	2358	2464
U249012AH	19.1	1831	1896	1973	2105	2114	2187	2296	2327	2450	2503	2521	2635
U279012AH	21.9	1888	1956	2034	2172	2182	2255	2370	2402	2528	2583	2602	2719
U309012AH	23.5	1946	2017	2098	2241	2249	2326	2443	2476	2606	2664	2681	2803
U339012AH	26.5	2081	2155	2242	2394	2406	2487	2610	2647	2786	2847	2866	2998
U369012AH	27.4	2214	2292	2385	2548	2559	2648	2778	2817	2964	3031	3048	3192

Custom Modifications	AUTHL AUTHR	CBO	CCO	CFNT0	CFRMO	CND	DRWTK	FB	FPEB	FTK	MIP	RD	RECTKALL RECTKBK	RECTKL RECTKR	RT	VTK
	•	•	•	•	•			•	•	•	•	•		•		•

Construction Upgrades	VPL	Smart Stop Options			INTGH	PG	SP
	•				•		

**UTILITY, 84", 87", 90", 93", or 96" TALL, 12" DEEP (cont'd)**

12", 15", 18", 21", or 24"

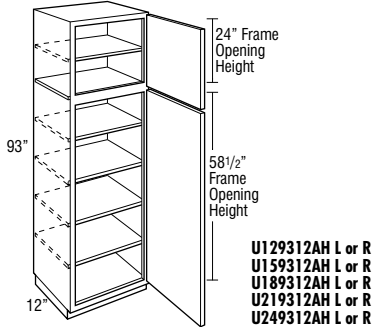

**U129312AH L or R**  
**U159312AH L or R**  
**U189312AH L or R**  
**U219312AH L or R**  
**U249312AH L or R**

24", 27", 30", 33", or 36"

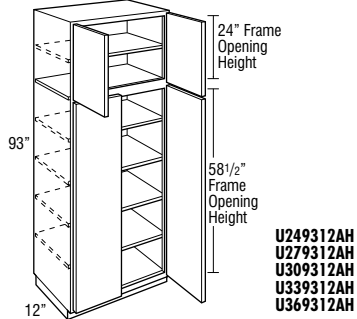

**U249312AH**  
**U279312AH**  
**U309312AH**  
**U339312AH**  
**U369312AH**

12", 15", 18", 21", or 24"

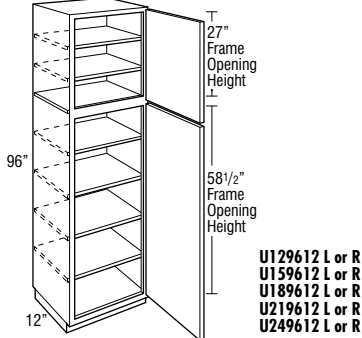

**U129612 L or R**  
**U159612 L or R**  
**U189612 L or R**  
**U219612 L or R**  
**U249612 L or R**

24", 27", 30", 33", or 36"

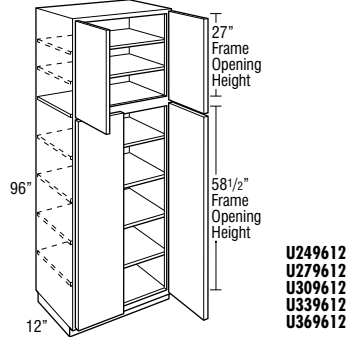

**U249612**  
**U279612**  
**U309612**  
**U339612**  
**U369612**

Model	Cubic Feet	Finish						
		Tori Oak	Westburke Oak	Tori Hickory Tori Maple	Loren Laminate Tori Cherry Westburke Hickory Westburke Maple Westburke PureStyle™	Cairo Oak Cantrell Oak Kesper Oak Renaist Oak	Westburke Cherry	Brookway Oak Bryant Hickory Bryant Maple Bryant PureStyle™ Cairo Maple Hurley Hickory Hurley Maple Kesper Maple Kesper Oak Renaist Maple Renaist PureStyle™
		1	2	3	4	5	6	7
<b>U129312AH L or R</b>	9.2	954	1002	1087	1135	1183	1192	1271
<b>U159312AH L or R</b>	11.3	993	1042	1131	1184	1233	1243	1324
<b>U189312AH L or R</b>	13.4	1122	1178	1282	1339	1396	1406	1501
<b>U219312AH L or R</b>	15.6	1197	1256	1366	1429	1490	1501	1601
<b>U249312AH L or R</b>	17.7	1270	1333	1452	1518	1581	1595	1702
<b>U249312AH</b>	17.7	1357	1425	1548	1622	1690	1703	1818
<b>U279312AH</b>	22.6	1400	1470	1598	1675	1745	1758	1877
<b>U309312AH</b>	21.9	1442	1514	1648	1725	1798	1811	1935
<b>U339312AH</b>	27.4	1540	1617	1760	1842	1919	1936	2064
<b>U369312AH</b>	26.2	1637	1719	1871	1959	2043	2057	2196

- AH represents upper section alignment with doors on 24" or 27" high cabinets.
- Separate pedestal base included but shipped separately on 93" tall.
- Five full depth adjustable shelves are included but shipped separately.
- Utility cabinets with depths of 12" or less must be installed to wall studs or onto the end of another tall cabinet.
- Depth can be reduced to a minimum of 6". For depths of 6"-8", cabinet will not include toekick/pedestal.
- Tall mitered door styles and PureStyle™ door styles will feature one center panel, other styles will feature two center panels.

<b>U129612 L or R</b>	11.9	954	1002	1087	1135	1183	1192	1271
<b>U159612 L or R</b>	13.2	993	1042	1131	1184	1233	1243	1324
<b>U189612 L or R</b>	15.6	1122	1178	1282	1339	1396	1406	1501
<b>U219612 L or R</b>	18.0	1197	1256	1366	1429	1490	1501	1601
<b>U249612 L or R</b>	20.3	1270	1333	1452	1518	1581	1595	1702
<b>U249612</b>	20.3	1357	1425	1548	1622	1690	1703	1818
<b>U279612</b>	23.3	1400	1470	1598	1675	1745	1758	1877
<b>U309612</b>	25.1	1442	1514	1648	1725	1798	1811	1935
<b>U339612</b>	28.2	1540	1617	1760	1842	1919	1936	2064
<b>U369612</b>	29.3	1637	1719	1871	1959	2043	2057	2196

- Separate pedestal base included but shipped separately on 96" tall.
- Six full depth adjustable shelves are included but shipped separately.
- Utility cabinets with depths of 12" or less must be installed to wall studs or onto the end of another tall cabinet.
- Depth can be reduced to a minimum of 6". For depths of 6"-8", cabinet will not include toekick/pedestal.
- Tall mitered door styles and PureStyle™ door styles will feature one center panel, other styles will feature two center panels.

Model	Cubic Feet	Canterell Maple	Bryant Cherry Hurley Cherry Norris Maple Norris PureStyle™	Cairo Cherry Kasper Cherry Reist Cherry	Kevin Oak	Brockway Maple Canterell Cherry Kersey Hickory Kersey Maple Norris Cherry	Felix Hickory Felix Maple Forte Hickory Forte Maple Forte PureStyle™ Owens Maple Owens PureStyle™	Anitico PureStyle™ Brockway Cherry Felix Cherry Forte Cherry Kersey Cherry Kevin Hickory Kevin Maple Owens Cherry	Adair Maple Adair PureStyle™ Keegan Maple	Wilero Maple	Adair Cherry Keegan Cherry	Kevin Cherry	Wilero Cherry
		8	9	10	11	12	13	14	15	16	17	18	19
U129312AH L or R	9.2	1326	1373	1429	1525	1531	1581	1661	1683	1772	1808	1823	1905
U159312AH L or R	11.3	1381	1431	1489	1589	1595	1649	1731	1752	1844	1885	1899	1984
U189312AH L or R	13.4	1568	1623	1687	1803	1809	1873	1966	1991	2097	2142	2158	2254
U219312AH L or R	15.6	1674	1732	1801	1922	1933	1999	2097	2127	2240	2286	2304	2409
U249312AH L or R	17.7	1776	1839	1914	2045	2052	2124	2227	2259	2380	2430	2448	2559
U249312AH	17.7	1899	1967	2046	2185	2194	2270	2381	2417	2543	2598	2616	2734
U279312AH	22.6	1959	2029	2110	2254	2265	2343	2457	2494	2623	2681	2701	2822
U309312AH	21.9	2019	2091	2175	2325	2334	2415	2534	2569	2704	2764	2785	2910
U339312AH	27.4	2157	2236	2325	2483	2494	2580	2707	2746	2889	2954	2975	3111
U369312AH	26.2	2294	2378	2472	2640	2652	2745	2879	2922	3074	3144	3165	3310

U129612 L or R	11.9	1326	1373	1429	1525	1531	1581	1661	1683	1772	1808	1823	1905
U159612 L or R	13.2	1381	1431	1489	1589	1595	1649	1731	1752	1844	1885	1899	1984
U189612 L or R	15.6	1568	1623	1687	1803	1809	1873	1966	1991	2097	2142	2158	2254
U219612 L or R	18.0	1674	1732	1801	1922	1933	1999	2097	2127	2240	2286	2304	2409
U249612 L or R	20.3	1776	1839	1914	2045	2052	2124	2227	2259	2380	2430	2448	2559
U249612	20.3	1899	1967	2046	2185	2194	2270	2381	2417	2543	2598	2616	2734
U279612	23.3	1959	2029	2110	2254	2265	2343	2457	2494	2623	2681	2701	2822
U309612	25.1	2019	2091	2175	2325	2334	2415	2534	2569	2704	2764	2785	2910
U339612	28.2	2157	2236	2325	2483	2494	2580	2707	2746	2889	2954	2975	3111
U369612	29.3	2294	2378	2472	2640	2652	2745	2879	2922	3074	3144	3165	3310

Custom Modifications	AUTHL AUTHR	CBO	CCO	CFNTO	CFRMO	CND	DRWTK	FB	FPEB	FTK	MIP	RD	RECTKALL RECTKBK	RECTKL RECTKR	RT	VTK
	•	•	•	•	•			•	•		•	•		•		

Construction Upgrades	VPL	Smart Stop Options	INTGH	PG	SP
	•		•		

**UTILITY, 84", 87", 90", 93", or 96" TALL, 24" DEEP**

12", 15", 18", 21", or 24"

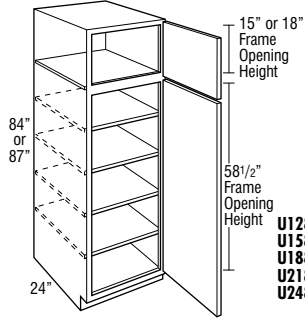

- U128424 L or R
- U158424 L or R
- U188424 L or R
- U218424 L or R
- U248424 L or R
- U128724 L or R
- U158724 L or R
- U188724 L or R
- U218724 L or R
- U248724 L or R

24", 27", 30", 33", or 36"

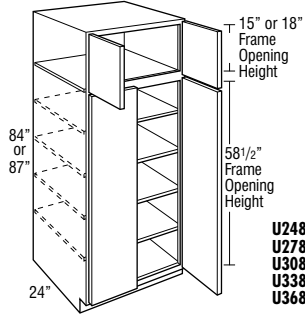

- U248424
- U278424
- U308424
- U338424
- U368424
- U248724
- U278724
- U308724
- U338724
- U368724

12", 15", 18", 21", or 24"

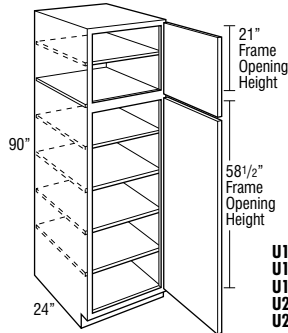

- U129024AH L or R
- U159024AH L or R
- U189024AH L or R
- U219024AH L or R
- U249024AH L or R

24", 27", 30", 33", or 36"

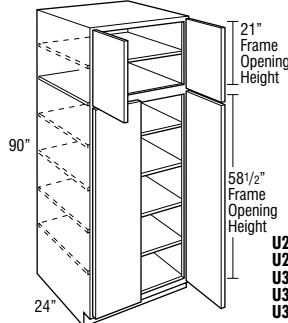

- U249024AH
- U279024AH
- U309024AH
- U339024AH
- U369024AH

Model	Cubic Feet	Cabinet Feet						
		Tori Oak	Westburke Oak	Tori Hickory Tori Maple	Loren Laminare Tori Cherry Westburke Hickory Westburke Maple Westburke PureStyle™	Cairo Oak Cantrell Oak Kesper Oak Rens Oak	Westburke Cherry	Brookway Oak Bryant Hickory Bryant Maple Cairo Maple Hickory Hickory Kesper Maple Kesper Oak Rens Maple Rens PureStyle™
		1	2	3	4	5	6	7
U128424 L or R	16.2	1114	1170	1256	1307	1357	1372	1444
U158424 L or R	22.3	1159	1216	1307	1361	1414	1429	1505
U188424 L or R	26.0	1295	1360	1466	1527	1587	1603	1693
U218424 L or R	29.3	1374	1444	1557	1622	1687	1703	1801
U248424 L or R	33.1	1456	1529	1647	1717	1786	1802	1907
U248424	33.1	1545	1623	1752	1829	1901	1919	2031
U278424	37.4	1592	1672	1805	1884	1959	1977	2093
U308424	40.8	1638	1720	1858	1939	2016	2034	2156
U338424	45.2	1745	1832	1977	2064	2147	2168	2298
U368424	51.2	1851	1943	2098	2191	2280	2301	2439

- Four full depth adjustable shelves are included but shipped separately.
- Depth can be reduced to a minimum of 6". For depths of 6"-8", cabinet will not include toekick/pedestal.
- Tall mitered door styles and PureStyle™ door styles will feature one center panel, other styles will feature two center panels.
- DRWTK not available on U128424 L or R and U158424 L or R.

U128724 L or R	18.8	1141	1198	1287	1341	1392	1407	1485
U158724 L or R	22.8	1188	1247	1342	1395	1449	1465	1547
U188724 L or R	26.8	1329	1395	1504	1570	1631	1649	1740
U218724 L or R	30.8	1412	1482	1598	1667	1734	1751	1851
U248724 L or R	34.8	1494	1568	1693	1764	1835	1851	1960
U248724	34.8	1588	1667	1799	1878	1955	1973	2089
U278724	38.8	1636	1718	1853	1936	2015	2032	2152
U308724	42.9	1682	1766	1908	1992	2072	2092	2214
U338724	46.9	1791	1879	2032	2122	2207	2228	2361
U368724	50.9	1899	1993	2156	2251	2342	2363	2507

- Four full depth adjustable shelves are included but shipped separately.
- Depth can be reduced to a minimum of 6". For depths of 6"-8", cabinet will not include toekick/pedestal.
- Tall mitered door styles and PureStyle™ door styles will feature one center panel, other styles will feature two center panels.
- DRWTK not available on U128724 L or R and U158724 L or R.

U129024AH L or R	17.3	1147	1205	1294	1349	1400	1416	1496
U159024AH L or R	22.6	1196	1255	1350	1403	1459	1474	1557
U189024AH L or R	28.6	1337	1403	1513	1580	1643	1660	1752
U219024AH L or R	31.3	1422	1492	1608	1679	1746	1763	1864
U249024AH L or R	35.5	1503	1578	1704	1775	1847	1864	1974
U249024AH	35.5	1599	1679	1811	1890	1969	1986	2103
U279024AH	40.0	1647	1729	1866	1948	2028	2047	2166
U309024AH	43.7	1693	1777	1920	2006	2087	2106	2229
U339024AH	48.4	1802	1892	2047	2136	2223	2243	2378
U369024AH	50.6	1911	2006	2170	2267	2357	2379	2524

- AH represents upper section alignment with doors on 24" or 27" high cabinets.
- Five full depth adjustable shelves are included but shipped separately.
- Depth can be reduced to a minimum of 6". For depths of 6"-8", cabinet will not include toekick/pedestal.
- Tall mitered door styles and PureStyle™ door styles will feature one center panel, other styles will feature two center panels.
- DRWTK not available on U129024AH L or R and U159024AH L or R.

Model	Cubic Feet	Canterel Maple	Bryant Cherry Hurley Cherry Norris Maple Norris PureStyle™	Cairo Cherry Kesper Cherry Reist Cherry	Klewin Oak	Brockway Maple Canterel Cherry Kersey Hickory Kersey Maple Norris Cherry	Felix Hickory Felix Maple Forte Hickory Forte Maple Forte PureStyle™ Owens Maple Owens PureStyle™	Anitico PureStyle™ Brockway Cherry Felix Cherry Forte Cherry Kersey Cherry Klewin Hickory Klewin Maple Owens Cherry	Adair Maple Adair PureStyle™ Keegan Maple	Wilero Maple	Adair Cherry Keegan Cherry	Klewin Cherry	Wilero Cherry
		8	9	10	11	12	13	14	15	16	17	18	19
U128424 L or R	16.2	1505	1554	1615	1717	1727	1777	1865	1884	1983	2017	2034	2124
U158424 L or R	22.3	1567	1618	1682	1788	1800	1851	1943	1963	2066	2101	2120	2212
U188424 L or R	26.0	1763	1823	1895	2017	2025	2088	2192	2215	2332	2373	2394	2497
U218424 L or R	29.3	1874	1940	2017	2145	2157	2222	2333	2358	2483	2528	2550	2661
U248424 L or R	33.1	1987	2054	2137	2276	2284	2357	2472	2501	2633	2682	2704	2822
U248424	33.1	2117	2189	2276	2423	2435	2512	2636	2666	2806	2860	2885	3010
U278424	37.4	2182	2255	2346	2498	2510	2590	2718	2749	2894	2949	2974	3104
U308424	40.8	2246	2323	2416	2573	2584	2666	2799	2831	2980	3038	3062	3198
U338424	45.2	2395	2476	2577	2745	2757	2844	2985	3020	3180	3241	3267	3413
U368424	51.2	2545	2632	2737	2915	2929	3023	3172	3210	3378	3446	3474	3627

U128724 L or R	18.8	1545	1596	1660	1764	1774	1826	1918	1936	2039	2073	2094	2182
U158724 L or R	22.8	1609	1663	1729	1839	1849	1903	1997	2018	2124	2161	2180	2274
U188724 L or R	26.8	1814	1874	1949	2075	2085	2149	2256	2281	2400	2444	2466	2572
U218724 L or R	30.8	1929	1993	2072	2206	2216	2287	2400	2427	2555	2603	2623	2739
U248724 L or R	34.8	2043	2113	2197	2340	2349	2425	2544	2573	2709	2758	2784	2904
U248724	34.8	2176	2251	2341	2493	2506	2584	2712	2743	2887	2943	2968	3098
U278724	38.8	2243	2319	2414	2570	2584	2664	2795	2829	2978	3036	3061	3194
U308724	42.9	2310	2390	2485	2646	2660	2743	2879	2913	3068	3126	3152	3292
U338724	46.9	2463	2547	2649	2822	2837	2927	3071	3109	3272	3337	3364	3512
U368724	50.9	2614	2705	2813	2997	3013	3109	3263	3303	3478	3546	3574	3732

U129024AH L or R	17.3	1555	1607	1672	1776	1787	1838	1932	1949	2052	2088	2108	2197
U159024AH L or R	22.6	1619	1675	1741	1851	1862	1916	2011	2031	2138	2175	2196	2289
U189024AH L or R	28.6	1827	1886	1962	2089	2100	2164	2273	2298	2418	2461	2484	2591
U219024AH L or R	31.3	1942	2007	2087	2222	2231	2304	2418	2445	2573	2621	2642	2758
U249024AH L or R	35.5	2057	2127	2212	2355	2365	2442	2562	2592	2727	2778	2803	2925
U249024AH	35.5	2192	2267	2357	2510	2524	2603	2730	2762	2907	2964	2988	3120
U279024AH	40.0	2259	2336	2430	2587	2603	2682	2815	2849	3000	3057	3083	3217
U309024AH	43.7	2326	2407	2502	2665	2680	2762	2899	2934	3089	3149	3174	3315
U339024AH	48.4	2480	2565	2668	2841	2858	2947	3092	3130	3295	3361	3388	3536
U369024AH	50.6	2632	2723	2832	3017	3035	3130	3285	3326	3502	3570	3600	3757

Custom Modifications	AUTHL AUTHR	CBO	CCO	CFNTO	CFRMO	CND	DRWTK	FB	FPEB	FTK	MIP	RD	RECTKALL RECTKKBK	RECTKL RECTKR	RT	VTK
	•	•	•	•	•		•	•	•	•	•	•		•	•	•

Construction Upgrades	VPL	Smart Stop Options	INTGH	PG	SP
	•		•		



**UTILITY, 84", 87", 90", 93", or 96" TALL, 24" DEEP (cont'd)**

12", 15", 18", 21", or 24"

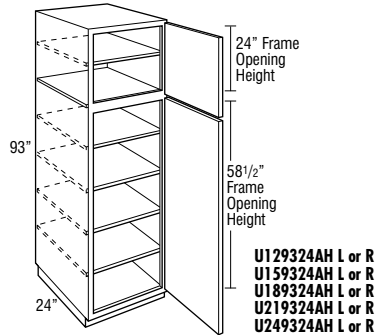

24", 27", 30", 33", or 36"

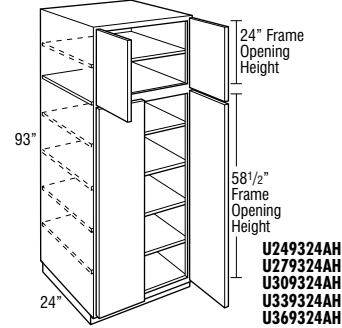

12", 15", 18", 21", or 24"

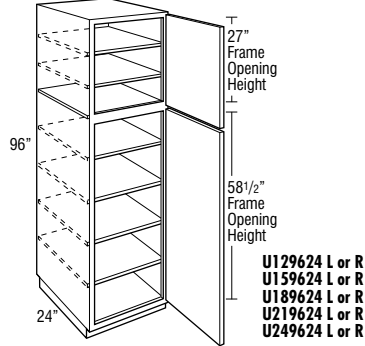

24", 27", 30", 33", or 36"

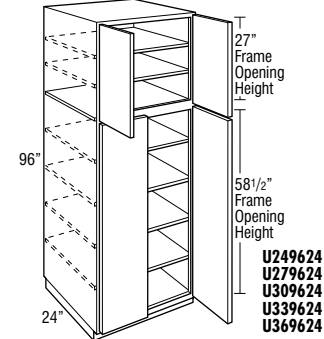

Model	Cubic Feet	Cabinet Feet						
		Tori Oak	Westburke Oak	Tori Hickory Tori Maple	Loren Laminate Tori Cherry Westburke Hickory Westburke Maple Westburke PureStyle™	Cairo Oak Cantrell Oak Kesper Oak Reins Oak	Westburke Cherry	Brookway Oak Bryant Hickory Bryant Maple Bryant PureStyle™ Cairo Maple Hurley Hickory Hurley Maple Kesper Maple Kessy Oak Reins Oak Reins PureStyle™
U129324AH L or R	17.7	1182	1241	1334	1393	1448	1461	1543
U159324AH L or R	21.5	1232	1292	1391	1449	1509	1521	1608
U189324AH L or R	25.8	1384	1453	1566	1633	1696	1716	1813
U219324AH L or R	29.9	1468	1541	1663	1735	1805	1823	1930
U249324AH L or R	34.0	1552	1630	1761	1836	1912	1929	2045
U249324AH	34.0	1651	1734	1874	1955	2034	2053	2178
U279324AH	41.3	1701	1787	1932	2016	2097	2116	2245
U309324AH	44.9	1750	1837	1987	2075	2158	2178	2310
U339324AH	50.0	1863	1956	2116	2210	2300	2321	2463
U369324AH	50.3	1976	2076	2245	2345	2442	2463	2614

- AH represents upper section alignment with doors on 24" or 27" high cabinets.
- Separate pedestal base included but shipped separately on 93" tall.
- Five full depth adjustable shelves are included but shipped separately.
- Depth can be reduced to a minimum of 6". For depths of 6"-8", cabinet will not include toekick/pedestal.
- Tall mitered door styles and PureStyle™ door styles will feature one center panel, other styles will feature two center panels.

U129624 L or R	18.5	1182	1241	1334	1393	1448	1461	1543
U159624 L or R	24.2	1232	1292	1391	1449	1509	1521	1608
U189624 L or R	28.4	1384	1453	1566	1633	1696	1716	1813
U219624 L or R	33.4	1468	1541	1663	1735	1805	1823	1930
U249624 L or R	37.8	1552	1630	1761	1836	1912	1929	2045
U249624	37.8	1651	1734	1874	1955	2034	2053	2178
U279624	42.6	1701	1787	1932	2016	2097	2116	2245
U309624	46.6	1750	1837	1987	2075	2158	2178	2310
U339624	51.6	1863	1956	2116	2210	2300	2321	2463
U369624	54.2	1976	2076	2245	2345	2442	2463	2614

- Separate pedestal base included but shipped separately on 96" tall.
- Six full depth adjustable shelves are included but shipped separately.
- Depth can be reduced to a minimum of 6". For depths of 6"-8", cabinet will not include toekick/pedestal.
- Tall mitered door styles and PureStyle™ door styles will feature one center panel, other styles will feature two center panels.

Model	Cubic Feet	Cantrill Maple	Bryant Cherry Hurley Cherry Norris Maple Norris PureStyle™	Cairo Cherry Kesper Cherry Reist Cherry	Klewin Oak	Brockway Maple Cantrill Cherry Kersey Hickory Kersey Maple Norris Cherry	Felix Hickory Felix Maple Forte Hickory Forte Maple Forte PureStyle™ Owens Maple Owens PureStyle™	Anitico PureStyle™ Brockway Cherry Felix Cherry Forte Cherry Kersey Cherry Klewin Hickory Klewin Maple Owens Cherry	Adair Maple Adair PureStyle™ Keegan Maple	Wilero Maple	Adair Cherry Keegan Cherry	Klewin Cherry	Wilero Cherry
		8	9	10	11	12	13	14	15	16	17	18	19
U129324AH L or R	17.7	1607	1661	1727	1838	1847	1903	1998	2019	2126	2163	2182	2277
U159324AH L or R	21.5	1675	1731	1800	1915	1923	1982	2081	2103	2214	2252	2274	2372
U189324AH L or R	25.8	1889	1954	2032	2162	2174	2242	2351	2379	2503	2550	2573	2685
U219324AH L or R	29.9	2011	2079	2162	2301	2312	2386	2503	2531	2665	2716	2739	2859
U249324AH L or R	34.0	2130	2201	2289	2442	2453	2528	2654	2686	2827	2879	2904	3034
U249324AH	34.0	2271	2348	2443	2601	2613	2695	2830	2865	3014	3074	3099	3235
U279324AH	41.3	2339	2419	2518	2680	2694	2781	2918	2954	3110	3171	3196	3338
U309324AH	44.9	2409	2492	2592	2760	2776	2864	3005	3043	3203	3266	3291	3439
U339324AH	50.0	2568	2655	2762	2945	2959	3055	3205	3244	3417	3485	3511	3669
U369324AH	50.3	2727	2820	2932	3128	3143	3244	3405	3448	3628	3703	3731	3897

U129624 L or R	18.5	1607	1661	1727	1838	1847	1903	1998	2019	2126	2163	2182	2277
U159624 L or R	24.2	1675	1731	1800	1915	1923	1982	2081	2103	2214	2252	2274	2372
U189624 L or R	28.4	1889	1954	2032	2162	2174	2242	2351	2379	2503	2550	2573	2685
U219624 L or R	33.4	2011	2079	2162	2301	2312	2386	2503	2531	2665	2716	2739	2859
U249624 L or R	37.8	2130	2201	2289	2442	2453	2528	2654	2686	2827	2879	2904	3034
U249624	37.8	2271	2348	2443	2601	2613	2695	2830	2865	3014	3074	3099	3235
U279624	42.6	2339	2419	2518	2680	2694	2781	2918	2954	3110	3171	3196	3338
U309624	46.6	2409	2492	2592	2760	2776	2864	3005	3043	3203	3266	3291	3439
U339624	51.6	2568	2655	2762	2945	2959	3055	3205	3244	3417	3485	3511	3669
U369624	54.2	2727	2820	2932	3128	3143	3244	3405	3448	3628	3703	3731	3897

Custom Modifications	AUTHL AUTHR	CBO	CCO	CFNTO	CFRMO	CND	DRWTK	FB	FPEB	FTK	MIP	RD	RECTKALL RECTKBK	RECTKL RECTKR	RT	VTK
	•	•	•	•	•			•	•		•	•		•	•	

Construction Upgrades	VPL	Smart Stop Options	INTGH	PG	SP
	•		•		

**UTILITY with ROLL TRAYS, 84", 87", 90", 93", or 96" TALL, 24" DEEP**

12", 15", 18", 21", or 24"

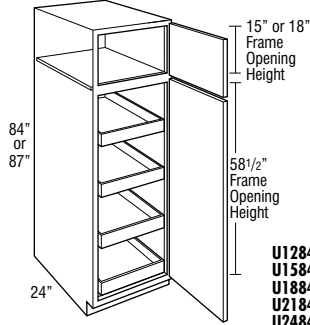

U128424RT L or R U128724RT L or R  
 U158424RT L or R U158724RT L or R  
 U188424RT L or R U188724RT L or R  
 U218424RT L or R U218724RT L or R  
 U248424RT L or R U248724RT L or R

24", 27", 30", 33", or 36"

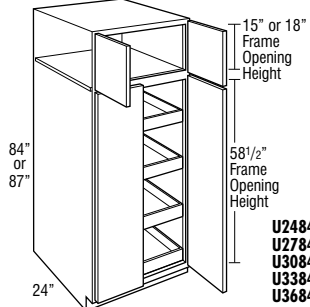

U248424RT U248724RT  
 U278424RT U278724RT  
 U308424RT U308724RT  
 U338424RT U338724RT  
 U368424RT U368724RT

12", 15", 18", 21", or 24"

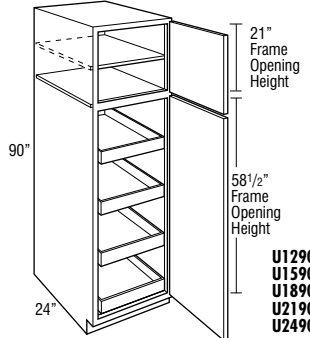

U129024RTAH L or R  
 U159024RTAH L or R  
 U189024RTAH L or R  
 U219024RTAH L or R  
 U249024RTAH L or R

24", 27", 30", 33", or 36"

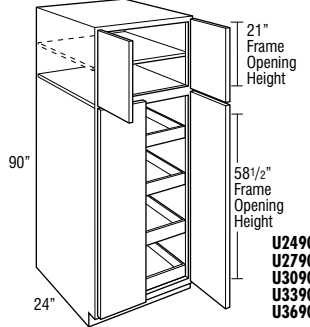

U249024RTAH  
 U279024RTAH  
 U309024RTAH  
 U339024RTAH  
 U369024RTAH

Model	Cubic Feet	Cabinet Feet						
		Tori Oak	Westburne Oak	Tori Hickory Tori Maple	Loren Laminate Tori Cherry Westburne Hickory Westburne Maple Westburne PureStyle™	Cairo Oak Cantrell Oak Kesper Oak Renss Oak	Westburne Cherry	Brookway Oak Bryant Hickory Bryant Maple Cairo Maple Hurley Hickory Hurley Maple Kesper Maple Kessy Oak Renss Maple Renss PureStyle™
		1	2	3	4	5	6	7
U128424RT L or R	16.2	1650	1706	1792	1843	1893	1908	1980
U158424RT L or R	22.3	1695	1752	1843	1897	1950	1965	2041
U188424RT L or R	26.0	1831	1896	2002	2063	2123	2139	2229
U218424RT L or R	29.3	1910	1980	2093	2158	2223	2239	2337
U248424RT L or R	33.1	1992	2065	2183	2253	2322	2338	2443
U248424RT	33.1	2081	2159	2288	2365	2437	2455	2567
U278424RT	37.4	2128	2208	2341	2420	2495	2513	2629
U308424RT	40.8	2174	2256	2394	2475	2552	2570	2692
U338424RT	45.2	2281	2368	2513	2600	2683	2704	2834
U368424RT	51.2	2387	2479	2634	2727	2816	2837	2975

- Four roll trays are included; installed in cabinet.
- Depth can be reduced to a minimum of 18".
- Tall mitered door styles and PureStyle™ door styles will feature one center panel, other styles will feature two center panels.
- DRWTK not available on U128424RT L or R and U158424RT L or R

U128724RT L or R	18.9	1677	1734	1823	1877	1928	1943	2021
U158724RT L or R	22.4	1724	1783	1878	1931	1985	2001	2083
U188724RT L or R	26.5	1865	1931	2040	2106	2167	2185	2276
U218724RT L or R	30.5	1948	2018	2134	2203	2270	2287	2387
U248724RT L or R	34.6	2030	2104	2229	2300	2371	2387	2496
U248724RT	34.6	2124	2203	2335	2414	2491	2509	2625
U278724RT	38.7	2172	2254	2389	2472	2551	2568	2688
U308724RT	42.8	2218	2302	2444	2528	2608	2628	2750
U338724RT	46.8	2327	2415	2568	2658	2743	2764	2897
U368724RT	50.9	2435	2529	2692	2787	2878	2899	3043

- Four roll trays are included; installed in cabinet.
- Depth can be reduced to a minimum of 18".
- Tall mitered door styles and PureStyle™ door styles will feature one center panel, other styles will feature two center panels.
- DRWTK not available on U128724RT L or R and U158724RT L or R

U129024RTAH L or R	17.3	1683	1740	1830	1884	1936	1951	2031
U159024RTAH L or R	22.6	1731	1791	1885	1939	1994	2010	2093
U189024RTAH L or R	28.6	1873	1939	2049	2116	2178	2196	2287
U219024RTAH L or R	31.3	1957	2027	2143	2214	2281	2299	2399
U249024RTAH L or R	35.5	2039	2114	2240	2311	2383	2399	2509
U249024RTAH	35.5	2134	2214	2347	2426	2504	2522	2639
U279024RTAH	40.0	2182	2265	2401	2484	2564	2582	2702
U309024RTAH	43.7	2229	2313	2456	2541	2622	2642	2764
U339024RTAH	48.4	2338	2427	2582	2672	2758	2779	2913
U369024RTAH	50.5	2447	2541	2706	2802	2893	2914	3059

- AH represents upper section alignment with doors on 24" or 27" high cabinets.
- Four roll trays are included; installed in cabinet.
- Depth can be reduced to a minimum of 18".
- Tall mitered door styles and PureStyle™ door styles will feature one center panel, other styles will feature two center panels.
- DRWTK not available on U129024RTAH L or R and U159024RTAH L or R.

Model	Cubic Feet	Canterel Maple	Bryant Cherry Hurley Cherry Norris Maple Norris PureStyle™	Cairo Cherry Kesper Cherry Reist Cherry	Klewin Oak	Brockway Maple Canterel Cherry Kersey Hickory Kersey Maple Norris Cherry	Felix Hickory Felix Maple Forte Hickory Forte Maple Forte PureStyle™ Owens Maple Owens PureStyle™	Amico PureStyle™ Brockway Cherry Felix Cherry Forte Cherry Kersey Cherry Klewin Hickory Klewin Maple Owens Cherry	Adair Maple Adair PureStyle™ Keegan Maple	Wilero Maple	Adair Cherry Keegan Cherry	Klewin Cherry	Wilero Cherry
		8	9	10	11	12	13	14	15	16	17	18	19
U128424RT L or R	16.2	2041	2090	2151	2253	2263	2313	2401	2420	2519	2553	2570	2660
U158424RT L or R	22.3	2103	2154	2218	2324	2336	2387	2479	2499	2602	2637	2656	2748
U188424RT L or R	26.0	2299	2359	2431	2553	2561	2624	2728	2751	2868	2909	2930	3033
U218424RT L or R	29.3	2410	2476	2553	2681	2693	2758	2869	2894	3019	3064	3086	3197
U248424RT L or R	33.1	2523	2590	2673	2812	2820	2893	3008	3037	3169	3218	3240	3358
U248424RT	33.1	2653	2725	2812	2959	2971	3048	3172	3202	3342	3396	3421	3546
U278424RT	37.4	2718	2791	2882	3034	3046	3126	3254	3285	3430	3485	3510	3640
U308424RT	40.8	2782	2859	2952	3109	3120	3202	3335	3367	3516	3574	3598	3734
U338424RT	45.2	2931	3012	3113	3281	3293	3380	3521	3556	3716	3777	3803	3949
U368424RT	51.2	3081	3168	3273	3451	3465	3559	3708	3746	3914	3982	4010	4163

U128724RT L or R	18.9	2081	2132	2196	2300	2310	2362	2454	2472	2575	2609	2630	2718
U158724RT L or R	22.4	2145	2199	2265	2375	2385	2439	2533	2554	2660	2697	2716	2810
U188724RT L or R	26.5	2350	2410	2485	2611	2621	2685	2792	2817	2936	2980	3002	3108
U218724RT L or R	30.5	2465	2529	2608	2742	2752	2823	2936	2963	3091	3139	3159	3275
U248724RT L or R	34.6	2579	2649	2733	2876	2885	2961	3080	3109	3245	3294	3320	3440
U248724RT	34.6	2712	2787	2877	3029	3042	3120	3248	3279	3423	3479	3504	3634
U278724RT	38.7	2779	2855	2950	3106	3120	3200	3331	3365	3514	3572	3597	3730
U308724RT	42.8	2846	2926	3021	3182	3196	3279	3415	3449	3604	3662	3688	3828
U338724RT	46.8	2999	3083	3185	3358	3373	3463	3607	3645	3808	3873	3900	4048
U368724RT	50.9	3150	3241	3349	3533	3549	3645	3799	3839	4014	4082	4110	4268

U129024RTAH L or R	17.3	2091	2142	2207	2312	2322	2374	2467	2485	2587	2623	2644	2732
U159024RTAH L or R	22.6	2155	2210	2277	2387	2397	2452	2546	2567	2674	2711	2731	2825
U189024RTAH L or R	28.6	2362	2422	2498	2624	2636	2700	2808	2833	2953	2997	3019	3126
U219024RTAH L or R	31.3	2477	2542	2622	2757	2766	2839	2953	2980	3109	3157	3178	3294
U249024RTAH L or R	35.5	2593	2663	2748	2891	2901	2977	3097	3127	3263	3313	3339	3460
U249024RTAH	35.5	2727	2802	2893	3046	3059	3138	3266	3298	3443	3499	3524	3656
U279024RTAH	40.0	2794	2871	2966	3123	3138	3218	3350	3384	3535	3593	3619	3752
U309024RTAH	43.7	2862	2942	3038	3200	3216	3298	3435	3470	3625	3684	3710	3851
U339024RTAH	48.4	3015	3100	3203	3377	3393	3483	3628	3666	3830	3896	3924	4072
U369024RTAH	50.5	3167	3259	3368	3553	3570	3666	3821	3861	4038	4106	4136	4293

Custom Modifications	AUTHL AUTHR	CBO	CCO	CFNTO	CFRMO	CND	DRWTK	FB	FPEB	FTK	MIP	RD	RECTKALL RECTKKBK	RECTKL RECTKR	RT	VTK
	•	•	•	•	•		•	•	•	•	•	•		•		•

Construction Upgrades	VPL	Smart Stop Options	INTGH	PG	SP
	•		•		•

**UTILITY with ROLL TRAYS, 84", 87", 90", 93", or 96" TALL, 24" DEEP (cont'd)**

12", 15", 18", 21", or 24"

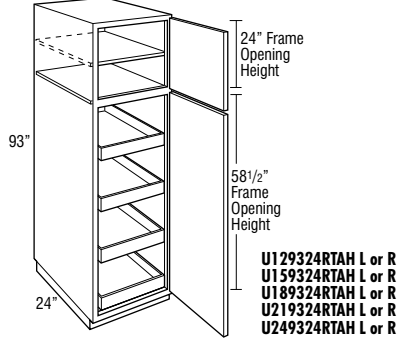

24", 27", 30", 33", or 36"

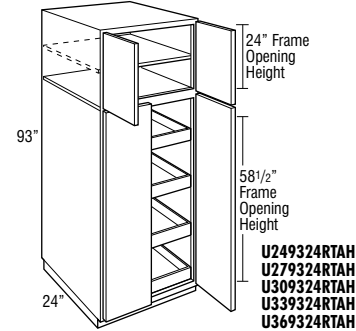

12", 15", 18", 21", or 24"

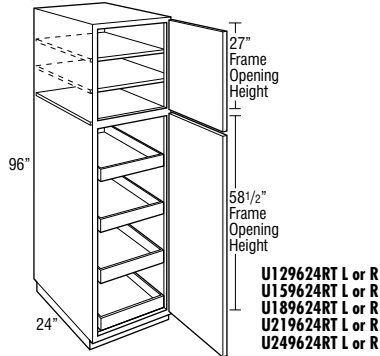

24", 27", 30", 33", or 36"

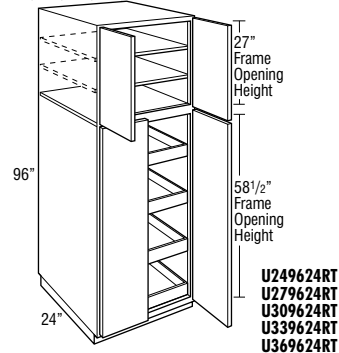

Model	Cubic Feet	Finish						
		Tori Oak	Westburke Oak	Tori Hickory Tori Maple	Loren Laminate Tori Cherry Westburke Hickory Westburke Maple Westburke PureStyle™	Cairo Oak Cantrell Oak Kesper Oak Reins Oak	Westburke Cherry	Brookway Oak Bryant Hickory Bryant Maple Bryant PureStyle™ Cairo Maple Hurley Hickory Hurley Maple Kesper Maple Kesper Oak Reins Oak Reins PureStyle™
		1	2	3	4	5	6	7
U129324RTAH L or R	19.2	1718	1776	1870	1929	1984	1996	2079
U159324RTAH L or R	21.5	1767	1828	1926	1985	2045	2057	2143
U189324RTAH L or R	25.8	1919	1988	2101	2169	2232	2251	2349
U219324RTAH L or R	29.9	2004	2077	2199	2271	2341	2358	2465
U249324RTAH L or R	34.0	2088	2166	2297	2372	2448	2464	2580
U249324RTAH	34.0	2187	2270	2410	2491	2570	2589	2714
U279324RTAH	41.3	2237	2322	2467	2551	2633	2651	2781
U309324RTAH	44.9	2285	2373	2523	2610	2693	2714	2846
U339324RTAH	50.0	2398	2492	2651	2746	2835	2857	2999
U369324RTAH	50.3	2511	2611	2781	2880	2977	2999	3150

- AH represents upper section alignment with doors on 24" or 27" high cabinets.
- Separate pedestal base included but shipped separately on 93" tall.
- Four roll trays are included; installed in cabinet.
- Depth can be reduced to a minimum of 18".
- Tall mitered door styles and PureStyle™ door styles will feature one center panel, other styles will feature two center panels.

U129624RT L or R	18.5	1718	1777	1870	1929	1984	1997	2079
U159624RT L or R	24.2	1768	1828	1927	1985	2045	2057	2144
U189624RT L or R	28.4	1920	1989	2102	2169	2232	2252	2349
U219624RT L or R	33.4	2004	2077	2199	2271	2341	2359	2466
U249624RT L or R	37.8	2088	2166	2297	2372	2448	2465	2581
U249624RT	37.8	2187	2270	2410	2491	2570	2589	2714
U279624RT	42.6	2237	2323	2468	2552	2633	2652	2781
U309624RT	46.6	2286	2373	2523	2611	2694	2714	2846
U339624RT	51.6	2399	2492	2652	2746	2836	2857	2999
U369624RT	54.0	2512	2612	2781	2881	2978	2999	3150

- Separate pedestal base included but shipped separately on 96" tall.
- Four roll trays are included; installed in cabinet.
- Depth can be reduced to a minimum of 18".
- Tall mitered door styles and PureStyle™ door styles will feature one center panel, other styles will feature two center panels.

Model	Cubic Feet	Canterell Maple	Bryant Cherry Hurley Cherry Norris Maple Norris PureStyle™	Cairo Cherry Kasper Cherry Reist Cherry	Klewin Oak	Brockway Maple Canterell Cherry Kersey Hickory Kersey Maple Norris Cherry	Felix Hickory Felix Maple Forte Hickory Forte Maple Forte PureStyle™ Owens Maple Owens PureStyle™	Anitico PureStyle™ Brockway Cherry Felix Cherry Forte Cherry Kersey Hickory Klewin Hickory Owens Cherry	Adair Maple Adair PureStyle™ Keegan Maple	Wilero Maple	Adair Cherry Keegan Cherry	Klewin Cherry	Wilero Cherry
		8	9	10	11	12	13	14	15	16	17	18	19
U129324RTAH L or R	19.2	2142	2197	2263	2374	2383	2438	2534	2555	2661	2699	2718	2813
U159324RTAH L or R	21.5	2210	2267	2336	2451	2459	2518	2616	2639	2750	2788	2810	2907
U189324RTAH L or R	25.8	2425	2490	2568	2697	2710	2778	2887	2914	3039	3086	3109	3221
U219324RTAH L or R	29.9	2546	2614	2697	2836	2848	2922	3039	3067	3200	3252	3274	3394
U249324RTAH L or R	34.0	2666	2737	2825	2977	2988	3063	3190	3222	3363	3415	3440	3569
U249324RTAH	34.0	2806	2884	2978	3136	3149	3231	3366	3401	3550	3609	3635	3771
U279324RTAH	41.3	2874	2954	3053	3216	3230	3316	3454	3490	3645	3707	3732	3874
U309324RTAH	44.9	2944	3027	3127	3296	3311	3400	3540	3578	3739	3802	3826	3974
U339324RTAH	50.0	3104	3191	3298	3481	3494	3591	3741	3780	3953	4021	4046	4205
U369324RTAH	50.3	3263	3355	3467	3664	3678	3780	3940	3984	4163	4238	4266	4433

U129624RT L or R	18.5	2143	2197	2263	2374	2383	2439	2534	2555	2662	2699	2718	2813
U159624RT L or R	24.2	2211	2267	2336	2451	2459	2518	2617	2639	2750	2788	2810	2908
U189624RT L or R	28.4	2425	2490	2568	2698	2710	2778	2887	2915	3039	3086	3109	3221
U219624RT L or R	33.4	2547	2615	2698	2837	2848	2922	3039	3067	3201	3252	3275	3395
U249624RT L or R	37.8	2666	2737	2825	2978	2989	3064	3190	3222	3363	3415	3440	3570
U249624RT	37.8	2807	2884	2979	3137	3149	3231	3366	3401	3550	3610	3635	3771
U279624RT	42.6	2875	2955	3054	3216	3230	3317	3454	3490	3646	3707	3732	3874
U309624RT	46.6	2945	3028	3128	3296	3312	3400	3541	3579	3739	3802	3827	3975
U339624RT	51.6	3104	3191	3298	3481	3495	3591	3741	3780	3953	4021	4047	4205
U369624RT	54.0	3263	3356	3468	3664	3679	3780	3941	3984	4164	4239	4267	4433

Custom Modifications	AUTHL AUTHR	CBO	CCO	CFNTO	CFRMO	CND	DRWTK	FB	FPEB	FTK	MIP	RD	RECTKALL RECTKBK	RECTKL RECTKR	RT	VTK
	•	•	•	•	•			•	•		•	•		•		

Construction Upgrades	VPL	Smart Stop Options	INTGH	PG	SP
	•		•		•

**UTILITY ORGANIZER CABINET, 84", 87", 90", 93", or 96" TALL, 6" DEEP, 24" WIDE**

L O G I X

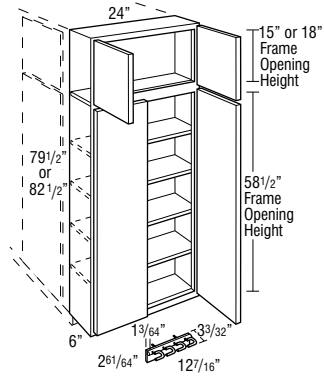

**UOC24846  
UOC24876**

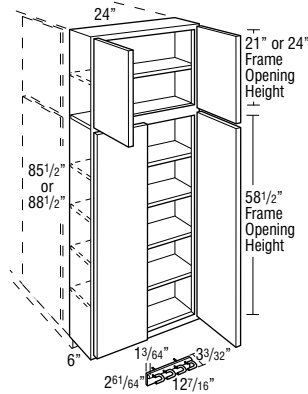

**UOC24906AH  
UOC24936AH**

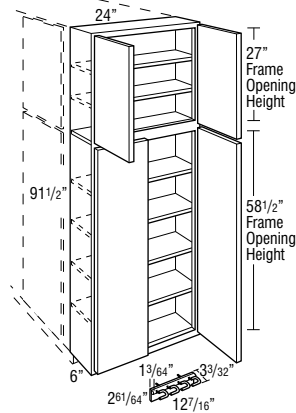

**UOC24966**

Model	Cubic Feet	Cabinet Styles						
		Tori Oak	Westburke Oak	Tori Hickory Tori Maple	Loren Laminate Tori Cherry Westburke Hickory Westburke Maple Westburke PureStyle™	Calio Oak Gantrell Oak Kesper Oak Reist Oak	Westburke Cherry	Brookway Oak Bryant Hickory Bryant Maple Bryant PureStyle™ Calio Maple Hurley Hickory Hurley Maple Kesper Maple Kesper Oak Reist Maple Reist PureStyle™
<b>UOC24846</b>	10.7	1265	1329	1443	1511	1573	1587	1692
<b>UOC24876</b>	11.1	1300	1365	1486	1554	1619	1632	1740

- Includes four adjustable shelves and broom clip shipped separate (not installed).
- 3/4" thick veneered plywood flush ends.
- Designed to be installed onto an adjacent 24" deep Tall cabinet or 24" wide Tall End Panel.
- For proper installation, adjacent cabinet must have FPEB or 1/4" skin applied.
- 6" overlay fillers can be used on the side to add a decorative touch.
- Utility cabinets with depths of 12" or less must be installed to wall studs or onto the end of another tall cabinet.
- Does not include toeboard or pedestal.
- Tall mitered door styles and PureStyle™ door styles will feature one center panel, other styles will feature two center panels.

<b>UOC24906AH</b>	11.5	1310	1374	1497	1566	1630	1644	1753
<b>UOC24936AH</b>	11.9	1357	1425	1548	1622	1690	1703	1818

- AH represents upper section alignment with doors on 24" or 27" high cabinets.
- Includes five adjustable shelves and broom clip shipped separate (not installed).
- 3/4" thick veneered plywood flush ends.
- Designed to be installed onto an adjacent 24" deep Tall cabinet or 24" wide Tall End Panel.
- For proper installation, adjacent cabinet must have FPEB or 1/4" skin applied.
- 6" overlay fillers can be used on the side to add a decorative touch.
- Utility cabinets with depths of 12" or less must be installed to wall studs or onto the end of another tall cabinet.
- Does not include toeboard or pedestal.
- Tall mitered door styles and PureStyle™ door styles will feature one center panel, other styles will feature two center panels.

<b>UOC24966</b>	11.2	1357	1425	1548	1622	1690	1703	1818
-----------------	------	------	------	------	------	------	------	------

- Includes six adjustable shelves and broom clip shipped separate (not installed).
- 3/4" thick veneered plywood flush ends.
- Designed to be installed onto an adjacent 24" deep Tall cabinet or 24" wide Tall End Panel.
- For proper installation, adjacent cabinet must have FPEB or 1/4" skin applied.
- 6" overlay fillers can be used on the side to add a decorative touch.
- Utility cabinets with depths of 12" or less must be installed to wall studs or onto the end of another tall cabinet.
- Does not include toeboard or pedestal.
- Tall mitered door styles and PureStyle™ door styles will feature one center panel, other styles will feature two center panels.

Model	Cubic Feet	Countrell Maple	Bryant Cherry Hurley Cherry Norris Maple Norris PureStyle™	Cairo Cherry Kasper Cherry Reist Cherry	Klewin Oak	Brookway Maple Countrell Cherry Kersey Hickory Kersey Maple Norris Cherry	Felix Hickory Felix Maple Forte Hickory Forte Maple Forte PureStyle™ Owens Maple Owens PureStyle™	Amico PureStyle™ Brookway Cherry Felix Cherry Forte Cherry Kersey Cherry Klewin Hickory Klewin Maple Owens Cherry	Adair Maple Adair PureStyle™ Keegan Maple	Valero Maple	Adair Cherry Keegan Cherry	Klewin Cherry	Valero Cherry
		8	9	10	11	12	13	14	15	16	17	18	19
<b>UOC24846</b>	10.7	1765	1830	1902	2031	2040	2108	2214	2243	2360	2414	2428	2539
<b>UOC24876</b>	11.1	1818	1882	1958	2091	2099	2171	2279	2311	2432	2486	2502	2615

<b>UOC24906AH</b>	11.5	1831	1896	1973	2105	2114	2187	2296	2327	2450	2503	2521	2635
<b>UOC24936AH</b>	11.9	1899	1967	2046	2185	2194	2270	2381	2417	2543	2598	2616	2734

<b>UOC24966</b>	12.2	1899	1967	2046	2185	2194	2270	2381	2417	2543	2598	2616	2734
-----------------	------	------	------	------	------	------	------	------	------	------	------	------	------

Custom Modifications	AUTHL AUTHR	CBO	CCO	CFNT0	CFRMO	CND	DRWTK	FB	FPEB	FTK	MIP	RD	RECTKALL RECTKBK	RECTKL RECTKR	RT	VTK
		•	•	•	•				STD		•					

Construction Upgrades	VPL	Smart Stop Options	INTGH	PG	SP
			•		



**TALL PANTRY PULL-OUT, 84", 87", or 90" TALL, 24" DEEP**

LOGIX

12", 15", or 18"

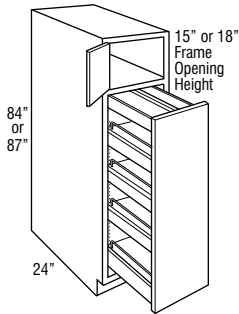

TPP128424 L or R  
TPP158424 L or R  
TPP188424 L or R

TPP128724 L or R  
TPP158724 L or R  
TPP188724 L or R

12", 15", or 18"

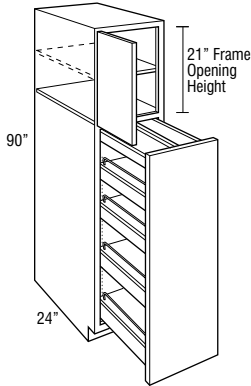

TPP129024AH L or R  
TPP159024AH L or R  
TPP189024AH L or R

Model	Cubic Feet	Finish						
		Tori Oak	Westburke Oak	Tori Hickory Tori Maple	Loren Laminate Tori Cherry Westburke Hickory Westburke Maple Westburke PureStyle™	Caldo Oak Gambrell Oak Kesper Oak Rensel Oak	Westburke Cherry	Brookway Oak Bryant Hickory Bryant Maple Caldo Maple Hurley Hickory Hurley Maple Kesper Maple Kessy Oak Rensel PureStyle™
		1	2	3	4	5	6	7
TPP128424 L or R	17.7	2380	2436	2522	2573	2623	2638	2710
TPP158424 L or R	21.6	2504	2561	2652	2706	2759	2774	2850
TPP188424 L or R	25.6	2640	2705	2811	2872	2932	2948	3038

TPP128724 L or R	18.3	2407	2464	2553	2607	2658	2673	2751
TPP158724 L or R	22.4	2533	2592	2687	2740	2794	2810	2892
TPP188724 L or R	26.5	2674	2740	2849	2915	2976	2994	3085

TPP129024AH L or R	18.9	2413	2470	2560	2614	2666	2681	2761
TPP159024AH L or R	23.2	2540	2600	2694	2748	2803	2819	2902
TPP189024AH L or R	27.4	2682	2748	2858	2925	2987	3005	3096

- AH represents upper section alignment with doors on 24" or 27" high cabinets.
- Three adjustable shelves and one fixed bottom shelf with metallic finish wire rail sides. Natural finish wood pull-out shelves are 20 11/16" deep.
- Pull-out features top/bottom mounted soft-close full extension guides.
- 84" and 87" high do not include shelves in upper section. Upper section 15".
- Tall mitered door styles and PureStyle™ door styles will feature one center panel, other styles will feature two center panels.
- For full access from both sides of unit, do not install against a wall or next to deeper appliances and cabinets.
- Pull-out mechanism not available for order for field installation, only available factory installed.

**TALL PANTRY PULL-OUT, 93" or 96" TALL, 24" DEEP**

LOGIX

12", 15", or 18"

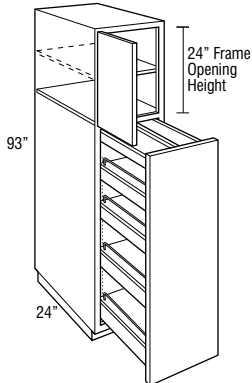

TPP129324AH L or R  
TPP159324AH L or R  
TPP189324AH L or R

12", 15", or 18"

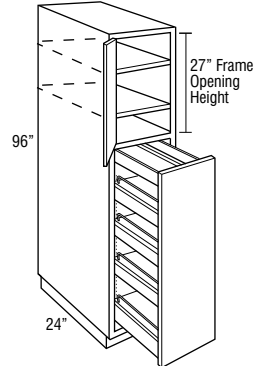

TPP129624 L or R  
TPP159624 L or R  
TPP189624 L or R

TPP129324AH L or R	19.6	2448	2506	2600	2658	2714	2726	2808
TPP159324AH L or R	23.9	2576	2637	2736	2794	2854	2866	2952
TPP189324AH L or R	28.3	2728	2797	2910	2978	3041	3060	3158

TPP129624 L or R	20.2	2448	2507	2600	2659	2714	2727	2809
TPP159624 L or R	24.7	2577	2637	2736	2794	2854	2866	2953
TPP189624 L or R	29.2	2729	2798	2911	2978	3041	3061	3158

- AH represents upper section alignment with doors on 24" or 27" high cabinets.
- Three adjustable shelves and one fixed bottom shelf with metallic finish wire rail sides. Natural finish wood pull-out shelves are 20 11/16" deep.
- Pull-out features top/bottom mounted soft-close full extension guides.
- Separate pedestal base included but shipped separately on 93" and 96" tall. Pedestal is designed to create a Recessed Left or Right Toe Kick application during field installation, or can be centered. Pedestal must be covered with toeboard material.
- Tall mitered door styles and PureStyle™ door styles will feature one center panel, other styles will feature two center panels.
- For full access from both sides of unit, do not install against a wall or next to deeper appliances and cabinets.
- Pull-out mechanism not available for order for field installation, only available factory installed.

Model	Cubic Feet	Cantrill Maple	Bryant Cherry Hurley Cherry Norris Maple Norris PureStyle™	Cairo Cherry Kasper Cherry Reist Cherry	Klewin Oak	Brockway Maple Cantrill Cherry Kersey Hickory Kersey Maple Norris Cherry	Felix Hickory Felix Maple Forte Hickory Forte Maple Forte PureStyle™ Owens Maple Owens PureStyle™	Amico PureStyle™ Brockway Cherry Felix Cherry Forte Cherry Kersey Cherry Klewin Hickory Klewin Maple Owens Cherry	Adair Maple Adair PureStyle™ Keegan Maple	Wilero Maple	Adair Cherry Keegan Cherry	Klewin Cherry	Wilero Cherry
		8	9	10	11	12	13	14	15	16	17	18	19
TPP128424 L or R	17.7	2771	2820	2881	2983	2993	3043	3131	3150	3249	3283	3300	3390
TPP158424 L or R	21.6	2912	2963	3027	3133	3145	3196	3288	3308	3411	3446	3465	3557
TPP188424 L or R	25.6	3108	3168	3240	3362	3370	3433	3537	3560	3677	3718	3739	3842

TPP128724 L or R	18.3	2811	2862	2926	3030	3040	3092	3184	3202	3305	3339	3360	3448
TPP158724 L or R	22.4	2954	3008	3074	3184	3194	3248	3342	3363	3469	3506	3525	3619
TPP188724 L or R	26.5	3159	3219	3294	3420	3430	3494	3601	3626	3745	3789	3811	3917

TPP129024AH L or R	18.9	2821	2872	2937	3042	3052	3104	3197	3215	3317	3353	3374	3462
TPP159024AH L or R	23.2	2964	3019	3086	3196	3206	3261	3355	3376	3483	3520	3540	3634
TPP189024AH L or R	27.4	3171	3231	3307	3434	3445	3509	3618	3642	3762	3806	3828	3935

Custom Modifications	AUTHL AUTHR	CBO	CCO	CFNT0	CFRMO	CND	DRWTK	FB	FPEB	FTK	MIP	RD	RECTKALL RECTKBK	RECTKL RECTKR	RT	VTK
	•	•	•		•			•	•	•	•			•		•

Construction Upgrades	VPL	Smart Stop Options			INTGH	PG	SP
	•				•		

TPP129324AH L or R	19.6	2872	2927	2993	3104	3113	3168	3264	3284	3391	3428	3448	3542
TPP159324AH L or R	23.9	3019	3076	3145	3260	3268	3327	3425	3448	3559	3597	3619	3716
TPP189324AH L or R	28.3	3234	3299	3377	3507	3519	3587	3696	3723	3848	3895	3918	4030

TPP129624 L or R	20.2	2873	2927	2993	3104	3113	3169	3264	3285	3392	3429	3448	3543
TPP159624 L or R	24.7	3020	3076	3145	3260	3268	3327	3426	3448	3559	3597	3619	3717
TPP189624 L or R	29.2	3234	3299	3377	3507	3519	3587	3696	3724	3848	3895	3918	4030

Custom Modifications	AUTHL AUTHR	CBO	CCO	CFNT0	CFRMO	CND	DRWTK	FB	FPEB	FTK	MIP	RD	RECTKALL RECTKBK	RECTKL RECTKR	RT	VTK
	•	•	•		•			•	•	•	•			•		

Construction Upgrades	VPL	Smart Stop Options			INTGH	PG	SP
	•				•		

**SINGLE OVEN CABINET, 84", 87", or 90" TALL, 24" DEEP**

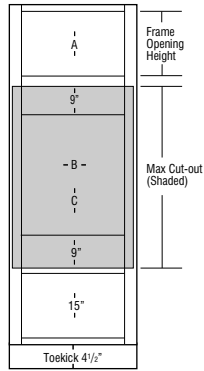
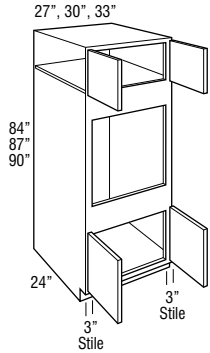

Model	Cubic Feet	Finish						
		Tori Oak	Westburke Oak	Tori Hickory Tori Maple	Loren Laminate Tori Cherry Westburke Hickory Westburke Maple Westburke PureStyle™	Cairo Oak Cantrell Oak Kesper Oak Reins Oak	Westburke Cherry	Brookway Oak Bryant Hickory Bryant Maple Cairo Maple Hurley Hickory Hurley Maple Kesper Maple Kesper Oak Reins Oak Reins PureStyle™
		1	2	3	4	5	6	7
<b>OCS278424</b>	37.9	1225	1286	1423	1498	1567	1572	1706
<b>OCS308424</b>	41.8	1299	1365	1510	1590	1662	1668	1810
<b>OCS338424</b>	45.7	1452	1525	1685	1772	1853	1861	2019
<b>OCS278724</b>	38.7	1338	1403	1552	1633	1710	1715	1863
<b>OCS308724</b>	42.9	1421	1493	1650	1736	1815	1823	1977
<b>OCS338724</b>	46.8	1585	1662	1839	1935	2024	2031	2204
<b>OCS279024AH</b>	38.6	1366	1433	1584	1667	1746	1751	1902
<b>OCS309024AH</b>	42.5	1452	1525	1685	1772	1853	1861	2019
<b>OCS339024AH</b>	46.5	1618	1697	1877	1975	2066	2075	2250

- AH represents upper section alignment with doors on 24" or 27" high cabinets.
- Upper section on 90" tall has one full depth adjustable shelf.
- Oven cavity is standard interior.
- Full overlay styles feature concealed face mount hinges.
- All top and bottom cross rails are 1 1/2" wide.
- All cabinets have 3" stiles on frame.
- Be sure to confirm a heat shield is built into your appliance by the manufacturer or install the heat shield included with your appliance.
- Support shelf for oven not included; for built-in appliance support brackets, use OCINSTALLKIT (included in 24" deep cabinets).
- Depth can be reduced to a minimum of 6". For depths of 6"-8", cabinet will not include toe kick/pedestal.
- Oven cabinets feature an open back in cut-out area designed to improve field appliance installation.
- CBO not available on 84" and 87" tall.

	A Frame Opening Height	B Cut-Out Width		C Cut-Out Height		Door Height (Upper Section)	
		Min.	Max.	Min.	Max.	Partial Overlay	Full Overlay
OCS278424	15"	21"	25 1/2"	28 1/2"	43 1/2"	16"	17 1/2"
OCS308424	15"	24"	28 1/2"	28 1/2"	43 1/2"	16"	17 1/2"
OCS338424	15"	27"	31 1/2"	28 1/2"	43 1/2"	16"	17 1/2"
OCS278724	18"	21"	25 1/2"	28 1/2"	43 1/2"	19"	20 1/2"
OCS308724	18"	24"	28 1/2"	28 1/2"	43 1/2"	19"	20 1/2"
OCS338724	18"	27"	31 1/2"	28 1/2"	43 1/2"	19"	20 1/2"
OCS279024AH	21"	21"	25 1/2"	28 1/2"	43 1/2"	22"	23 1/2"
OCS309024AH	21"	24"	28 1/2"	28 1/2"	43 1/2"	22"	23 1/2"
OCS339024AH	21"	27"	31 1/2"	28 1/2"	43 1/2"	22"	23 1/2"

Maximum cut-out dimension will allow 1/4" reveal for doors and drawer fronts on full overlay and 1" for partial overlay for trim kit face clearance.

Model	Cubic Feet	Cantrill Maple	Bryant Cherry Hurley Cherry Norris Maple Norris PureStyle™	Cairo Cherry Kasper Cherry Reist Cherry	Klewin Oak	Brockway Maple Cantrill Cherry Kersey Hickory Kersey Maple Norris Cherry	Felix Hickory Felix Maple Forte Hickory Forte Maple Forte PureStyle™ Owens Maple Owens PureStyle™	Amico PureStyle™ Brockway Cherry Felix Cherry Forte Cherry Kersey Cherry Klewin Hickory Klewin Maple Owens Cherry	Adair Maple Adair PureStyle™ Keegan Maple	Valero Maple	Adair Cherry Keegan Cherry	Klewin Cherry	Valero Cherry
		8	9	10	11	12	13	14	15	16	17	18	19
OCS278424	37.9	1788	1859	1934	2078	2083	2167	2275	2316	2437	2505	2514	2637
OCS308424	41.8	1899	1973	2051	2204	2211	2299	2413	2457	2585	2659	2667	2799
OCS338424	45.7	2116	2196	2284	2457	2464	2564	2691	2739	2885	2964	2975	3120
OCS278724	38.7	1950	2029	2109	2265	2274	2364	2481	2528	2661	2734	2745	2878
OCS308724	42.9	2072	2152	2238	2407	2414	2510	2636	2682	2825	2903	2913	3056
OCS338724	46.8	2311	2399	2496	2682	2692	2800	2938	2989	3148	3237	3248	3408
OCS279024AH	38.6	1991	2071	2154	2312	2321	2414	2532	2580	2717	2792	2802	2939
OCS309024AH	42.5	2116	2196	2284	2457	2464	2564	2691	2739	2885	2964	2975	3120
OCS339024AH	46.5	2360	2450	2548	2739	2749	2859	3000	3052	3214	3306	3316	3480

Custom Modifications	AUTHL AUTHR	CBO	CCO	CFNTO	CFRMO	CND	DRWTK	FB	FPEB	FTK	MIP	RD	RECTKALL RECTKBK	RECTKL RECTKR	RT	VTK
	•	•	•	•	•		•	•	•	•	•	•		•		•

Construction Upgrades	VPL	Smart Stop Options	INTGH	PG	SP
	•		•		

**SINGLE OVEN CABINET,  
93" or 96" TALL, 24" DEEP**

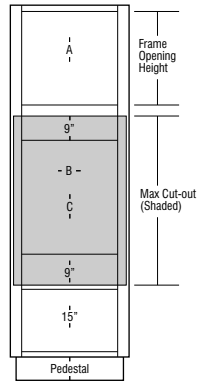
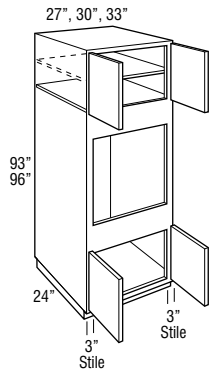

Model	Cubic Feet	Tori Oak		Westburke Oak	Tori Hickory Tori Maple	Loren Laminate Tori Cherry Westburke Hickory Westburke Maple Westburke PureStyle™	Galio Oak Gantrell Oak Kesper Oak Reins Oak	Westburke Cherry	Brockway Oak Bryant Hickory Bryant Maple Calio Maple Hurley Hickory Hurley Maple Kesper Maple Kessy Oak Reins PureStyle™ Reins PureStyle™
		1	2	3	4	5	6	7	
<b>OCS279324AH</b>	38.1	1522	1599	1769	1862	1945	1955	2120	
<b>OCS309324AH</b>	42.2	1618	1697	1877	1975	2066	2075	2250	
<b>OCS339324AH</b>	46.2	1802	1892	2092	2204	2305	2315	2510	

<b>OCS279624</b>	41.2	1522	1599	1769	1862	1945	1955	2120
<b>OCS309624</b>	45.5	1618	1697	1877	1975	2066	2075	2250
<b>OCS339624</b>	49.7	1802	1892	2092	2204	2305	2315	2510

- AH represents upper section alignment with doors on 24" or 27" high cabinets.
- Includes adjustable shelves in upper section:  
93" tall - one shelf  
96" tall - two shelves
- Oven cavity is standard interior.
- Full overlay styles feature concealed face mount hinges.
- All top and bottom cross rails are 1 1/2" wide.
- All cabinets have 3" stiles on frame.
- Be sure to confirm a heat shield is built into your appliance by the manufacturer or install the heat shield included with your appliance.
- Separate pedestal base included but shipped separately on 93" and 96" tall.
- Support shelf for oven not included; for built-in appliance support brackets, use OCINSTALLKIT (included in 24" deep cabinets).
- Depth can be reduced to a minimum of 6". For depths of 6"-8", cabinet will not include toe kick/pedestal.
- Oven cabinets feature an open back in cut-out area designed to improve field appliance installation.

	A Frame Opening Height	B Cut-Out Width		C Cut-Out Height		Door Height (Upper Section)	
		Min.	Max.	Min.	Max.	Partial Overlay	Full Overlay
OCS279324AH	24"	21"	25 1/2"	28 1/2"	43 1/2"	25"	26 1/2"
OCS309324AH	24"	24"	28 1/2"	28 1/2"	43 1/2"	25"	26 1/2"
OCS339324AH	24"	27"	31 1/2"	28 1/2"	43 1/2"	25"	26 1/2"
OCS279624	27"	21"	25 1/2"	28 1/2"	43 1/2"	28"	29 1/2"
OCS309624	27"	24"	28 1/2"	28 1/2"	43 1/2"	28"	29 1/2"
OCS339624	27"	27"	31 1/2"	28 1/2"	43 1/2"	28"	29 1/2"

Maximum cut-out dimension will allow 1/4" reveal for doors and drawer fronts on full overlay and 1" for partial overlay for trim kit face clearance.

Model	Cubic Feet	Countertop	Bryant Cherry Hurley Cherry Norris Maple Norris PureStyle™	Cairo Cherry Kasper Cherry Reist Cherry	Klewin Oak	Brookway Maple Countertop Kersey Hickory Kersey Maple Norris Cherry	Felix Hickory Felix Maple Forte Hickory Forte Maple Forte PureStyle™ Owens Maple Owens PureStyle™	Amico PureStyle™ Brookway Cherry Felix Cherry Forte Cherry Kersey Hickory Klewin Hickory Owens Maple Owens Cherry	Adair Maple Adair PureStyle™ Keegan Maple	Valero Maple	Adair Cherry Keegan Cherry	Klewin Cherry	Valero Cherry
		8	9	10	11	12	13	14	15	16	17	18	19
OCS279324AH	38.1	2223	2309	2400	2580	2590	2691	2826	2877	3031	3116	3126	3280
OCS309324AH	42.2	2360	2450	2548	2739	2749	2859	3000	3052	3214	3306	3316	3480
OCS339324AH	46.2	2632	2733	2843	3057	3065	3186	3345	3407	3587	3687	3700	3882

OCS279624	41.2	2223	2309	2400	2580	2590	2691	2826	2877	3031	3116	3126	3280
OCS309624	45.5	2360	2450	2548	2739	2749	2859	3000	3052	3214	3306	3316	3480
OCS339624	49.7	2632	2733	2843	3057	3065	3186	3345	3407	3587	3687	3700	3882

Custom Modifications	AUTHL AUTHR	CBO	CCO	CFNTO	CFRMO	CND	DRWTK	FB	FPEB	FTK	MIP	RD	RECTKALL RECTKBK	RECTKL RECTKR	RT	VTK
	•	•	•	•	•			•	•		•	•		•		

Construction Upgrades	VPL	Smart Stop Options	INTGH	PG	SP
	•		•		

**SINGLE OVEN CABINET, DEEP DRAWER, 84", 87", or 90" TALL, 24" DEEP**

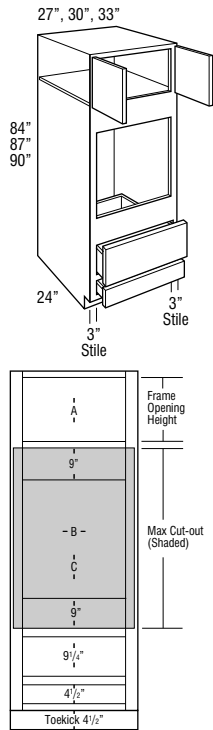

Model	Cubic Feet	Finish						
		Tori Oak	Westburke Oak	Tori Hickory Tori Maple	Loren Laminate Tori Cherry Westburke Hickory Westburke Maple Westburke PureStyle™	Calio Oak Gambrell Oak Kesper Oak Renaist Oak	Westburke Cherry	Brookway Oak Bryant Hickory Bryant Maple Calio Maple Hurley Hickory Hurley Maple Kesper Maple Kessy Oak Renaist Maple Renaist PureStyle™
		1	2	3	4	5	6	7
<b>OCS278424DD</b>	37.4	1673	1733	1870	1945	2014	2019	2154
<b>OCS308424DD</b>	41.3	1833	1899	2044	2124	2196	2202	2344
<b>OCS338424DD</b>	45.2	2100	2173	2334	2421	2502	2509	2668
<b>OCS278724DD</b>	38.7	1786	1850	1999	2081	2157	2162	2310
<b>OCS308724DD</b>	42.9	1954	2026	2183	2270	2349	2356	2510
<b>OCS338724DD</b>	46.8	2234	2311	2488	2583	2673	2680	2853
<b>OCS279024DDAH</b>	40.0	1813	1880	2031	2115	2193	2198	2349
<b>OCS309024DDAH</b>	44.2	1985	2058	2218	2306	2387	2394	2553
<b>OCS339024DDAH</b>	48.4	2267	2346	2526	2623	2715	2723	2899

- AH represents upper section alignment with doors on 24" or 27" high cabinets.
- Upper section on 90" tall has one full depth adjustable shelf.
- Full overlay styles feature concealed face mount hinges.
- All top and bottom cross rails are 1 1/2" wide.
- All cabinets have 3" stiles on frame.
- Be sure to confirm a heat shield is built into your appliance by the manufacturer or install the heat shield included with your appliance. Heat shields are sold separately as an accessory.
- Depth can be reduced to a minimum of 18".
- For built-in appliance support, OCINSTALLKIT is included in 24" deep oven cabinets (see page 294 for details). Oven install kit will not be included when depth is modified.
- Oven cabinets feature an open back in cut-out area designed to improve field appliance installation.

	A Frame Opening Height	B Cut-Out Width		C Cut-Out Height		Door Height (Upper Section)	
		Min.	Max.	Min.	Max.	Partial Overlay	Full Overlay
OCS278424DD	15"	21"	25 1/2"	27 3/4"	42 3/4"	16"	17 1/2"
OCS308424DD	15"	24"	28 1/2"	27 3/4"	42 3/4"	16"	17 1/2"
OCS338424DD	15"	27"	31 1/2"	27 3/4"	42 3/4"	16"	17 1/2"
OCS278724DD	18"	21"	25 1/2"	27 3/4"	42 3/4"	19"	20 1/2"
OCS308724DD	18"	24"	28 1/2"	27 3/4"	42 3/4"	19"	20 1/2"
OCS338724DD	18"	27"	31 1/2"	27 3/4"	42 3/4"	19"	20 1/2"
OCS279024DDAH	21"	21"	25 1/2"	27 3/4"	42 3/4"	22"	23 1/2"
OCS309024DDAH	21"	24"	28 1/2"	27 3/4"	42 3/4"	22"	23 1/2"
OCS339024DDAH	21"	27"	31 1/2"	27 3/4"	42 3/4"	22"	23 1/2"

Maximum cut-out dimension will allow 1/4" reveal for doors and drawer fronts on full overlay and 1" for partial overlay for trim kit face clearance.

Model	Cubic Feet	Cantrill Maple	Bryant Cherry Hurley Cherry Norris Maple Norris PureStyle™	Cairo Cherry Kasper Cherry Reist Cherry	Klewin Oak	Brockway Maple Cantrill Cherry Kersey Hickory Kersey Maple Norris Cherry	Felix Hickory Felix Maple Forte Hickory Forte Maple Forte PureStyle™ Owens Maple Owens PureStyle™	Amico PureStyle™ Brockway Cherry Felix Cherry Forte Cherry Kersey Cherry Klewin Hickory Klewin Maple Owens Cherry	Adair Maple Adair PureStyle™ Keegan Maple	Wilero Maple	Adair Cherry Keegan Cherry	Klewin Cherry	Wilero Cherry
		8	9	10	11	12	13	14	15	16	17	18	19
OCS278424DD	37.4	2235	2306	2381	2525	2530	2614	2722	2763	2885	2952	2962	3084
OCS308424DD	41.3	2432	2506	2584	2738	2745	2832	2946	2990	3119	3193	3200	3333
OCS338424DD	45.2	2764	2844	2933	3106	3113	3213	3340	3387	3533	3612	3624	3769
OCS278724DD	38.7	2397	2476	2557	2712	2721	2812	2928	2975	3109	3182	3192	3326
OCS308724DD	42.9	2606	2685	2771	2940	2947	3044	3169	3216	3358	3437	3447	3590
OCS338724DD	46.8	2960	3048	3145	3331	3341	3449	3587	3638	3796	3886	3897	4056
OCS279024DDAH	40.0	2438	2519	2601	2759	2768	2861	2979	3027	3164	3239	3250	3386
OCS309024DDAH	44.2	2649	2729	2818	2990	2998	3097	3225	3272	3418	3497	3509	3654
OCS339024DDAH	48.4	3009	3098	3197	3387	3398	3508	3648	3701	3862	3955	3965	4128

Custom Modifications	AUTHL AUTHR	CBO	CCO	CFNTO	CFRMO	CND	DRWTK	FB	FPEB	FTK	MIP	RD	RECTKALL RECTKBK	RECTKL RECTKR	RT	VTK
	•	•	•		•	•	•	•	•	•	•	•		•		•

Construction Upgrades	VPL	Smart Stop Options	INTGH	PG	SP
	•		•	STD	



**SINGLE OVEN CABINET, DEEP DRAWER, 93" or 96" TALL, 24" DEEP**

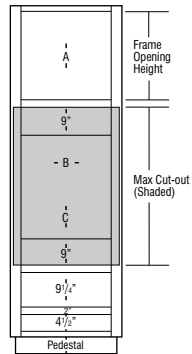
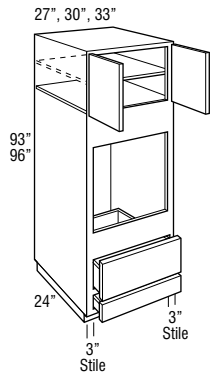

Model	Cubic Feet	Tori Oak	Westburne Oak	Tori Hickory Tori Maple	Loren Laminate Tori Cherry Westburne Hickory Westburne Maple Westburne PureStyle™	Galio Oak Gantrell Oak Kesper Oak Reins Oak	Westburne Cherry	Brockway Oak Bryant Hickory Bryant Maple Cairo Maple Hurley Hickory Hurley Maple Kesper Maple Kesper Oak Reins Maple Reins PureStyle™
		1	2	3	4	5	6	7
OCS279324DDAH	41.3	1970	2046	2216	2309	2392	2402	2567
OCS309324DDAH	45.7	2152	2231	2411	2508	2600	2608	2784
OCS339324DDAH	50.0	2451	2540	2741	2853	2953	2964	3159

OCS279624DD	42.6	1970	2046	2216	2309	2392	2402	2567
OCS309624DD	47.1	2152	2231	2411	2508	2600	2608	2784
OCS339624DD	51.6	2451	2540	2741	2853	2953	2964	3159

- AH represents upper section alignment with doors on 24" or 27" high cabinets.
- Includes adjustable shelves in upper section:  
93" tall - one shelf  
96" tall - two shelves
- Full overlay styles feature concealed face mount hinges.
- All top and bottom cross rails are 1 1/2" wide.
- All cabinets have 3" stiles on frame.
- Be sure to confirm a heat shield is built into your appliance by the manufacturer or install the heat shield included with your appliance. Heat shields are sold separately as an accessory.
- Separate pedestal base included but shipped separately on 93" and 96" tall. Pedestal is designed to create a Recessed Left or Right Toekick application during field installation, or can be centered. Pedestal must be covered with toeboard material.
- Depth can be reduced to a minimum of 18".
- For built-in appliance support, OCINSTALLKIT is included in 24" deep oven cabinets (see page 294 for details). Oven install kit will not be included when depth is modified.
- Oven cabinets feature an open back in cut-out area designed to improve field appliance installation.

	A Frame Opening Height	B Cut-Out Width		C Cut-Out Height		Door Height (Upper Section)	
		Min.	Max.	Min.	Max.	Partial Overlay	Full Overlay
OCS279324DDAH	24"	21"	25 1/2"	27 3/4"	42 3/4"	25"	26 1/2"
OCS309324DDAH	24"	24"	28 1/2"	27 3/4"	42 3/4"	25"	26 1/2"
OCS339324DDAH	24"	27"	31 1/2"	27 3/4"	42 3/4"	25"	26 1/2"
OCS279624DD	27"	21"	25 1/2"	27 3/4"	42 3/4"	28"	29 1/2"
OCS309624DD	27"	24"	28 1/2"	27 3/4"	42 3/4"	28"	29 1/2"
OCS339624DD	27"	27"	31 1/2"	27 3/4"	42 3/4"	28"	29 1/2"

Maximum cut-out dimension will allow 1/4" reveal for doors and drawer fronts on full overlay and 1" for partial overlay for trim kit face clearance.

Model	Cubic Feet	Countertop Maple	Bryant Cherry Hurley Cherry Norris Maple Norris PureStyle™	Cairo Cherry Kasper Cherry Reist Cherry	Klewin Oak	Brockway Maple Countertop Cherry Kersey Hickory Kersey Maple Norris Cherry	Felix Hickory Felix Maple Forte Hickory Forte Maple Forte PureStyle™ Owens Maple Owens PureStyle™	Amico PureStyle™ Brockway Cherry Felix Cherry Forte Cherry Kersey Hickory Klewin Hickory Klewin Maple Owens Cherry	Adair Maple Adair PureStyle™ Keegan Maple	Valero Maple	Adair Cherry Keegan Cherry	Klewin Cherry	Valero Cherry
		8	9	10	11	12	13	14	15	16	17	18	19
OCS279324DDAH	41.3	2670	2756	2848	3027	3037	3138	3273	3325	3478	3563	3573	3728
OCS309324DDAH	45.7	2894	2983	3082	3272	3282	3392	3533	3586	3747	3840	3850	4013
OCS339324DDAH	50.0	3280	3382	3492	3706	3714	3834	3994	4055	4235	4336	4348	4530

OCS279624DD	42.6	2670	2756	2848	3027	3037	3138	3273	3325	3478	3563	3573	3728
OCS309624DD	47.1	2894	2983	3082	3272	3282	3392	3533	3586	3747	3840	3850	4013
OCS339624DD	51.6	3280	3382	3492	3706	3714	3834	3994	4055	4235	4336	4348	4530

Custom Modifications	AUTHL AUTHR	CBO	CCO	CFNTO	CFRMO	CND	DRWTK	FB	FPEB	FTK	MIP	RD	RECTKALL RECTKKBK	RECTKL RECTKR	RT	VTK
	•	•	•		•	•		•	•		•	•		•		

Construction Upgrades	VPL	Smart Stop Options	INTGH	PG	SP
	•		•	STD	

**DOUBLE OVEN CABINET, 84", 87", or 90" TALL, 24" DEEP**

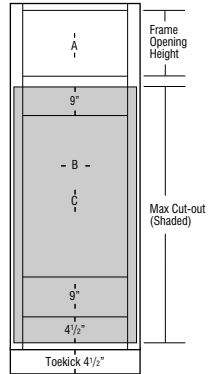
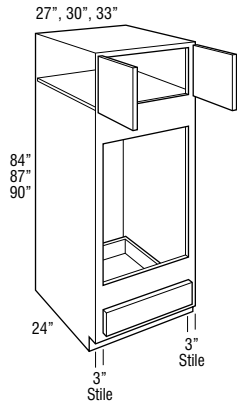

Model	Cubic Feet	Finish						
		Tori Oak	Westburke Oak	Tori Hickory Tori Maple	Loren Laminate Tori Cherry Westburke Hickory Westburke Maple Westburke PureStyle™	Calio Oak Gambrell Oak Kesper Oak Rensel Oak	Westburke Cherry	Brookway Oak Bryant Hickory Bryant Maple Calio Maple Hurley Hickory Hurley Maple Kesper Maple Kessy Oak Rensel PureStyle™
		1	2	3	4	5	6	7
<b>OCD278424</b>	37.9	1189	1250	1385	1456	1522	1529	1660
<b>OCD308424</b>	41.8	1216	1278	1411	1486	1555	1562	1693
<b>OCD338424</b>	45.7	1299	1365	1510	1590	1663	1668	1810
<b>OCD278724</b>	38.7	1281	1346	1488	1565	1637	1643	1785
<b>OCD308724</b>	42.9	1300	1366	1510	1588	1661	1667	1810
<b>OCD338724</b>	46.8	1388	1458	1611	1695	1773	1779	1932
<b>OCD279024AH</b>	38.6	1304	1369	1513	1592	1665	1672	1815
<b>OCD309024AH</b>	42.5	1322	1388	1535	1614	1688	1694	1839
<b>OCD339024AH</b>	46.5	1409	1480	1636	1721	1801	1807	1962

- AH represents upper section alignment with doors on 24" or 27" high cabinets.
- Upper section on 90" tall has one full depth adjustable shelf.
- Oven cavity is standard interior.
- Full overlay styles feature concealed face mount hinges.
- For built-in double oven applications, remove drawer as needed.
- All top and bottom cross rails are 1 1/2" wide.
- All cabinets have 3" stiles on frame.
- Be sure to confirm a heat shield is built into your appliance by the manufacturer or install the heat shield included with your appliance.
- Support shelf for oven not included; for built-in appliance support brackets, use OCINSTALLKIT (included in 24" deep cabinets).
- Depth can be reduced to a minimum of 18".
- Oven cabinets feature an open back in cut-out area designed to improve field appliance installation.

	A Frame Opening Height	B Cut-Out Width		C Cut-Out Height		Door Height (Upper Section)	
		Min.	Max.	Min.	Max.	Partial Overlay	Full Overlay
OCD278424	15"	21"	25 1/2"	39"	60"	16"	17 1/2"
OCD308424	15"	24"	28 1/2"	39"	60"	16"	17 1/2"
OCD338424	15"	27"	31 1/2"	39"	60"	16"	17 1/2"
OCD278724	18"	21"	25 1/2"	39"	60"	19"	20 1/2"
OCD308724	18"	24"	28 1/2"	39"	60"	19"	20 1/2"
OCD338724	18"	27"	31 1/2"	39"	60"	19"	20 1/2"
OCD279024AH	21"	21"	25 1/2"	39"	60"	22"	23 1/2"
OCD309024AH	21"	24"	28 1/2"	39"	60"	22"	23 1/2"
OCD339024AH	21"	27"	31 1/2"	39"	60"	22"	23 1/2"

Maximum cut-out dimension will allow 1/4" reveal for doors and drawer fronts on full overlay and 1" for partial overlay for trim kit face clearance.

Model	Cubic Feet	Cantrill Maple	Bryant Cherry Hurley Cherry Norris Maple Norris PureStyle™	Cairo Cherry Kasper Cherry Reist Cherry	Klewin Oak	Brockway Maple Cantrill Cherry Kersey Hickory Kersey Maple Norris Cherry	Felix Hickory Felix Maple Forte Hickory Forte Maple Forte PureStyle™ Owens Maple Owens PureStyle™	Amico PureStyle™ Brockway Cherry Felix Cherry Forte Cherry Kersey Cherry Klewin Hickory Klewin Maple Owens Cherry	Adair Maple Adair PureStyle™ Keegan Maple	Valero Maple	Adair Cherry Keegan Cherry	Klewin Cherry	Valero Cherry
		8	9	10	11	12	13	14	15	16	17	18	19
OCD278424	37.9	1738	1806	1880	2019	2025	2106	2212	2251	2370	2436	2446	2565
OCD308424	41.8	1774	1843	1917	2060	2068	2152	2255	2299	2419	2486	2493	2617
OCD338424	45.7	1899	1973	2051	2206	2211	2300	2414	2459	2590	2660	2668	2800
OCD278724	38.7	1870	1942	2019	2172	2177	2265	2378	2420	2548	2619	2629	2757
OCD308724	42.9	1899	1973	2051	2205	2211	2298	2413	2457	2587	2659	2668	2799
OCD338724	46.8	2024	2103	2188	2351	2357	2453	2573	2621	2760	2837	2847	2987
OCD279024AH	38.6	1903	1976	2054	2210	2215	2305	2419	2462	2593	2666	2674	2805
OCD309024AH	42.5	1930	2005	2084	2241	2247	2335	2452	2497	2630	2703	2711	2844
OCD339024AH	46.5	2055	2136	2222	2387	2394	2491	2613	2663	2802	2881	2891	3035

Custom Modifications	AUTHL AUTHR	CBO	CCO	CFNTO	CFRMO	CND	DRWTK	FB	FPEB	FTK	MIP	RD	RECTKALL RECTKBK	RECTKL RECTKR	RT	VTK
	•	•	•	•	•	•	•	•	•	•	•	•		•		•

Construction Upgrades	VPL	Smart Stop Options	INTGH	PG	SP
	•		•		

**DOUBLE OVEN CABINET,  
93" or 96" TALL, 24" DEEP**

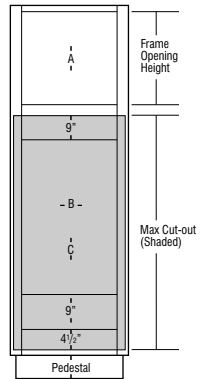
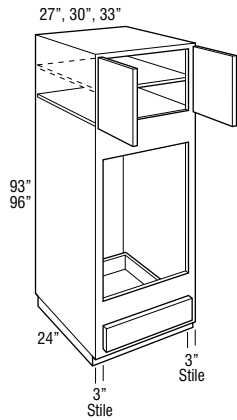

Model	Cubic Feet	Finish						
		Tori Oak	Westburke Oak	Tori Hickory Tori Maple	Loren Laminate Tori Cherry Westburke Hickory Westburke Maple Westburke PureStyle™	Galio Oak Gantrell Oak Kesper Oak Rensil Oak	Westburke Cherry	Brookway Oak Bryant Hickory Bryant Maple Bryant PureStyle™ Calio Maple Hurley Hickory Hurley Maple Kesper Maple Kesper Oak Rensil PureStyle™ Rensil PureStyle™
<b>OCD279324AH</b>	38.1	1412	1482	1640	1726	1806	1813	1969
<b>OCD309324AH</b>	42.2	1428	1500	1659	1745	1824	1832	1987
<b>OCD339324AH</b>	46.2	1515	1592	1761	1853	1940	1945	2112

<b>OCD279624</b>	41.2	1412	1482	1640	1726	1806	1813	1969
<b>OCD309624</b>	45.5	1428	1500	1659	1745	1824	1832	1987
<b>OCD339624</b>	49.7	1515	1592	1761	1853	1940	1945	2112

- AH represents upper section alignment with doors on 24" or 27" high cabinets.
- Includes adjustable shelves in upper section:  
93" tall - one shelf  
96" tall - two shelves
- Oven cavity is standard interior.
- Full overlay styles feature concealed face mount hinges.
- For built-in double oven applications, remove drawer as needed.
- All top and bottom cross rails are 1 1/2" wide.
- All toekick areas are 4 1/2" high.
- All cabinets have 3" stiles on frame.
- Be sure to confirm a heat shield is built into your appliance by the manufacturer or install the heat shield included with your appliance.
- Separate pedestal base included but shipped separately on 93" and 96" tall.
- Support shelf for oven not included; for built-in appliance support brackets, use OCINSTALLKIT (included in 24" deep cabinets).
- Depth can be reduced to a minimum of 18".
- Oven cabinets feature an open back in cut-out area designed to improve field appliance installation.

	A Frame Opening Height	B Cut-Out Width		C Cut-Out Height		Door Height (Upper Section)	
		Min.	Max.	Min.	Max.	Partial Overlay	Full Overlay
OCD279324AH	24"	21"	25 1/2"	39"	60"	25"	26 1/2"
OCD309324AH	24"	24"	28 1/2"	39"	60"	25"	26 1/2"
OCD339324AH	24"	27"	31 1/2"	39"	60"	25"	26 1/2"
OCD279624	27"	21"	25 1/2"	39"	60"	28"	29 1/2"
OCD309624	27"	24"	28 1/2"	39"	60"	28"	29 1/2"
OCD339624	27"	27"	31 1/2"	39"	60"	28"	29 1/2"

Maximum cut-out dimension will allow 1/4" reveal for doors and drawer fronts on full overlay and 1" for partial overlay for trim kit face clearance.

Model	Cubic Feet	Countertop Maple	Bryant Cherry Hurley Cherry Norris Maple Norris PureStyle™	Cairo Cherry Kasper Cherry Reist Cherry	Klewin Oak	Brockway Maple Countertop Cherry Kersey Hickory Kersey Maple Norris Cherry	Felix Hickory Felix Maple Forte Hickory Forte Maple Forte PureStyle™ Owens Maple Owens PureStyle™	Amico PureStyle™ Brockway Cherry Felix Cherry Forte Cherry Kersey Cherry Klewin Hickory Klewin Maple Owens Cherry	Adair Maple Adair PureStyle™ Keegan Maple	Valero Maple	Adair Cherry Keegan Cherry	Klewin Cherry	Valero Cherry
		8	9	10	11	12	13	14	15	16	17	18	19
<b>OCD279324AH</b>	38.1	2060	2140	2226	2392	2400	2496	2620	2667	2808	2891	2899	3041
<b>OCD309324AH</b>	42.2	2082	2163	2249	2419	2426	2523	2649	2699	2840	2921	2929	3073
<b>OCD339324AH</b>	46.2	2215	2300	2391	2570	2578	2681	2813	2867	3016	3100	3113	3264

  

<b>OCD279624</b>	41.2	2060	2140	2226	2392	2400	2496	2620	2667	2808	2891	2899	3041
<b>OCD309624</b>	45.5	2082	2163	2249	2419	2426	2523	2649	2699	2840	2921	2929	3073
<b>OCD339624</b>	49.7	2215	2300	2391	2570	2578	2681	2813	2867	3016	3100	3113	3264

Custom Modifications	AUTHL AUTHR	CBO	CCO	CFNTO	CFRMO	CND	DRWTK	FB	FPEB	FTK	MIP	RD	RECTKALL RECTKBK	RECTKL RECTKR	RT	VTK
	•	•	•	•	•	•		•	•		•	•		•		

Construction Upgrades	VPL	Smart Stop Options	INTGH	PG	SP
	•		•		

**DOUBLE OVEN CABINET, DEEP DRAWER, 84", 87", or 90" TALL, 24" DEEP**

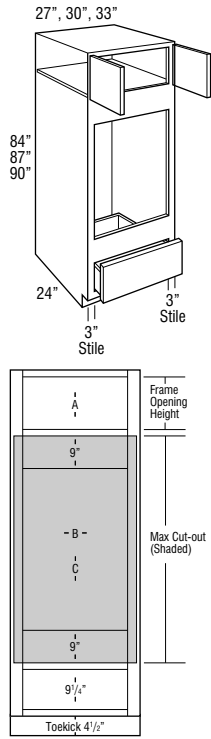

Model	Cubic Feet	Tori Oak	Westburne Oak	Tori Hickory Tori Maple	Loren Laminate Tori Cherry Westburne Hickory Westburne Maple Westburne PureStyle™	Cairo Oak Gambrell Oak Kesper Oak Reins Oak	Westburne Cherry	Brockway Oak Bryant Hickory Bryant Maple Cairo Maple Hurley Hickory Hurley Maple Kesper Maple Kesper Oak Reins Oak Reins PureStyle™
		1	2	3	4	5	6	7
<b>OCD278424DD</b>	37.4	1557	1618	1753	1824	1890	1897	2028
<b>OCD308424DD</b>	41.3	1671	1732	1866	1941	2010	2016	2147
<b>OCD338424DD</b>	45.2	1869	1935	2080	2160	2233	2238	2380
<b>OCD278724DD</b>	38.7	1649	1714	1856	1933	2005	2011	2153
<b>OCD308724DD</b>	42.9	1755	1821	1965	2043	2116	2122	2265
<b>OCD338724DD</b>	46.8	1957	2027	2180	2265	2343	2349	2501
<b>OCD279024DD</b>	40.0	1672	1737	1881	1960	2033	2040	2183
<b>OCD309024DD</b>	44.2	1776	1842	1989	2068	2142	2149	2293
<b>OCD339024DD</b>	48.4	1979	2050	2205	2290	2371	2377	2532

- Full overlay styles feature concealed face mount hinges.
- All top and bottom cross rails are 1 1/2" wide.
- All cabinets have 3" stiles on frame.
- Be sure to confirm a heat shield is built into your appliance by the manufacturer or install the heat shield included with your appliance. Heat shields are sold separately as an accessory.
- Depth can be reduced to a minimum of 18".
- For built-in appliance support, OCINSTALLKIT is included in 24" deep oven cabinets (see page 294 for details). Oven install kit will not be included when depth is modified.
- Oven cabinets feature an open back in cut-out area designed to improve field appliance installation.

	A Frame Opening Height	B Cut-Out Width		C Cut-Out Height		Door Height (Upper Section)	
		Min.	Max.	Min.	Max.	Partial Overlay	Full Overlay
		OCD278424DD	12"	21"	25 1/2"	37 1/4"	52 1/4"
OCD308424DD	12"	24"	28 1/2"	37 1/4"	52 1/4"	13"	14 1/2"
OCD338424DD	12"	27"	31 1/2"	37 1/4"	52 1/4"	13"	14 1/2"
OCD278724DD	15"	21"	25 1/2"	37 1/4"	52 1/4"	16"	17 1/2"
OCD308724DD	15"	24"	28 1/2"	37 1/4"	52 1/4"	16"	17 1/2"
OCD338724DD	15"	27"	31 1/2"	37 1/4"	52 1/4"	16"	17 1/2"
OCD279024DD	18"	21"	25 1/2"	37 1/4"	52 1/4"	19"	20 1/2"
OCD309024DD	18"	24"	28 1/2"	37 1/4"	52 1/4"	19"	20 1/2"
OCD339024DD	18"	27"	31 1/2"	37 1/4"	52 1/4"	19"	20 1/2"

Maximum cut-out dimension will allow 1/4" reveal for doors and drawer fronts on full overlay and 1" for partial overlay for trim kit face clearance.

Model	Cubic Feet	Cantrill Maple	Bryant Cherry Hurley Cherry Norris Maple Norris PureStyle™	Cairo Cherry Kasper Cherry Reist Cherry	Klewin Oak	Brockway Maple Cantrill Cherry Kersey Hickory Kersey Maple Norris Cherry	Felix Hickory Felix Maple Forte Hickory Forte Maple Forte PureStyle™ Owens Maple Owens PureStyle™	Amico PureStyle™ Brockway Cherry Felix Cherry Forte Cherry Kersey Cherry Klewin Hickory Klewin Maple Owens Cherry	Adair Maple Adair PureStyle™ Keegan Maple	Valero Maple	Adair Cherry Keegan Cherry	Klewin Cherry	Valero Cherry
		8	9	10	11	12	13	14	15	16	17	18	19
<b>OCD278424DD</b>	37.4	2106	2174	2248	2387	2393	2474	2580	2619	2738	2804	2814	2933
<b>OCD308424DD</b>	41.3	2229	2298	2372	2514	2523	2606	2710	2753	2873	2940	2947	3072
<b>OCD338424DD</b>	45.2	2468	2542	2620	2776	2781	2869	2983	3028	3159	3230	3237	3370
<b>OCD278724DD</b>	38.7	2238	2310	2387	2540	2545	2633	2746	2788	2916	2987	2997	3125
<b>OCD308724DD</b>	42.9	2353	2427	2505	2659	2666	2752	2867	2911	3042	3114	3122	3254
<b>OCD338724DD</b>	46.8	2594	2673	2757	2921	2927	3022	3143	3191	3330	3407	3416	3557
<b>OCD279024DD</b>	40.0	2271	2344	2422	2578	2583	2673	2787	2830	2961	3034	3042	3173
<b>OCD309024DD</b>	44.2	2384	2459	2538	2695	2702	2789	2906	2951	3084	3157	3165	3299
<b>OCD339024DD</b>	48.4	2624	2706	2791	2957	2964	3060	3183	3232	3372	3451	3460	3604

Custom Modifications	AUTHL AUTHR	CBO	CCO	CFNTO	CFRMO	CND	DRWTK	FB	FPEB	FTK	MIP	RD	RECTKALL RECTKKBK	RECTKL RECTKR	RT	VTK
	•	•	•		•	•	•	•	•	•	•	•		•		•

Construction Upgrades	VPL	Smart Stop Options	INTGH	PG	SP
	•		•	STD	



**DOUBLE OVEN CABINET, DEEP DRAWER, 93" or 96" TALL, 24" DEEP**

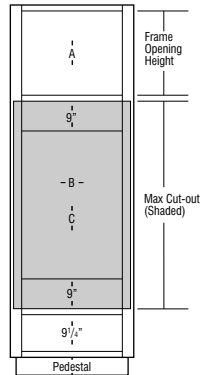
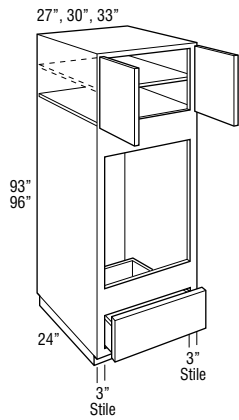

Model	Cubic Feet	Finish						
		Tori Oak	Westburke Oak	Tori Hickory Tori Maple	Loren Laminate Tori Cherry Westburke Hickory Westburke Maple Westburke PureStyle™	Cairo Oak Cantrell Oak Kesper Oak Rensil Oak	Westburke Cherry	Brookway Oak Bryant Hickory Bryant Maple Cairo Maple Hurley Hickory Hurley Maple Kesper Maple Kesper Oak Rensil Maple Rensil PureStyle™
		1	2	3	4	5	6	7
OCD279324DDAH	41.3	1780	1850	2008	2094	2174	2181	2337
OCD309324DDAH	45.7	1882	1954	2114	2199	2278	2286	2442
OCD339324DDAH	50.0	2085	2162	2330	2423	2509	2514	2681
OCD279624DDAH	46.2	1780	1850	2008	2094	2174	2181	2337
OCD309624DDAH	47.1	1882	1954	2114	2199	2278	2286	2442
OCD339624DDAH	51.6	2085	2162	2330	2423	2509	2514	2681

- AH represents upper section alignment with doors on 24" or 27" high cabinets.
- Full overlay styles feature concealed face mount hinges.
- All top and bottom cross rails are 1 1/2" wide.
- All cabinets have 3" stiles on frame.
- Be sure to confirm a heat shield is built into your appliance by the manufacturer or install the heat shield included with your appliance. Heat shields are sold separately as an accessory.
- Separate pedestal base included but shipped separately on 93" and 96" tall. Pedestal is designed to create a Recessed Left or Right Toe-kick application during field installation, or can be centered. Pedestal must be covered with toeboard material.
- One full depth adjustable shelf included, but packaged separately.
- Depth can be reduced to a minimum of 18".
- For built-in appliance support, OCINSTALLKIT is included in 24" deep oven cabinets (see page 294 for details). Oven install kit will not be included when depth is modified.
- Oven cabinets feature an open back in cut-out area designed to improve field appliance installation.

	A Frame Opening Height	B Cut-Out Width		C Cut-Out Height		Door Height (Upper Section)	
		Min.	Max.	Min.	Max.	Partial Overlay	Full Overlay
OCD279324DDAH	21"	21"	25 1/2"	37 1/4"	52 1/4"	22"	23 1/2"
OCD309324DDAH	21"	24"	28 1/2"	37 1/4"	52 1/4"	22"	23 1/2"
OCD339324DDAH	21"	27"	31 1/2"	37 1/4"	52 1/4"	22"	23 1/2"
OCD279624DDAH	24"	21"	25 1/2"	37 1/4"	52 1/4"	25"	26 1/2"
OCD309624DDAH	24"	24"	28 1/2"	37 1/4"	52 1/4"	25"	26 1/2"
OCD339624DDAH	24"	27"	31 1/2"	37 1/4"	52 1/4"	25"	26 1/2"

Maximum cut-out dimension will allow 1/4" reveal for doors and drawer fronts on full overlay and 1" for partial overlay for trim kit face clearance.

Model	Cubic Feet	Countertop Maple	Bryant Cherry Hurley Cherry Norris Maple Norris PureStyle™	Cairo Cherry Kasper Cherry Reist Cherry	Klewin Oak	Brockway Maple Countertop Cherry Kersey Hickory Kersey Maple Norris Cherry	Felix Hickory Felix Maple Forte Hickory Forte Maple Forte PureStyle™ Owens Maple Owens PureStyle™	Amico PureStyle™ Brockway Cherry Felix Cherry Forte Cherry Kersey Cherry Klewin Hickory Klewin Maple Owens Cherry	Adair Maple Adair PureStyle™ Keegan Maple	Valero Maple	Adair Cherry Keegan Cherry	Klewin Cherry	Valero Cherry
		8	9	10	11	12	13	14	15	16	17	18	19
OCD279324DDAH	41.3	2428	2508	2594	2760	2768	2864	2988	3035	3177	3259	3267	3409
OCD309324DDAH	45.7	2536	2617	2704	2873	2880	2977	3104	3153	3295	3375	3383	3527
OCD339324DDAH	50.0	2785	2869	2961	3140	3148	3251	3382	3437	3586	3670	3682	3833
OCD279624DDAH	46.2	2428	2508	2594	2760	2768	2864	2988	3035	3177	3259	3267	3409
OCD309624DDAH	47.1	2536	2617	2704	2873	2880	2977	3104	3153	3295	3375	3383	3527
OCD339624DDAH	51.6	2785	2869	2961	3140	3148	3251	3382	3437	3586	3670	3682	3833

Custom Modifications	AUTHL AUTHR	CBO	CCO	CFNTO	CFRMO	CND	DRWTK	FB	FPEB	FTK	MIP	RD	RECTKALL RECTKBK	RECTKL RECTKR	RT	VTK
	•	•	•		•	•		•	•		•	•		•		

Construction Upgrades	VPL	Smart Stop Options	INTGH	PG	SP
	•		•	STD	

**TALL BUILT-IN MICROWAVE CABINET**

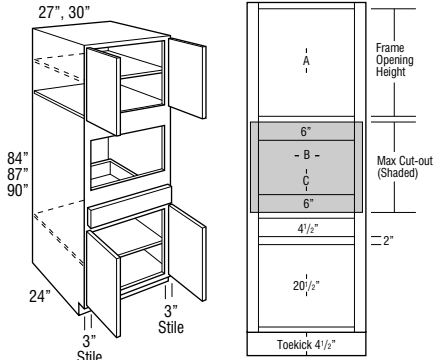

**TBMWB278424AH**  
**TBMWB308424AH**

**TBMWB278724**  
**TBMWB308724**

**TBMWB279024**  
**TBMWB309024**

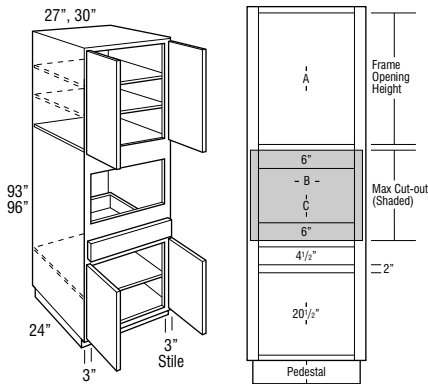

**TBMWB279324**  
**TBMWB309324**

**TBMWB279624**  
**TBMWB309624**

Model	Cubic Feet	Finish						
		Tori Oak	Westburke Oak	Tori Hickory Tori Maple	Loren Laminate Tori Cherry Westburke Hickory Westburke Maple Westburke PureStyle™	Cairo Oak Gambell Oak Kesper Oak Renss Oak	Westburke Cherry	Brookway Oak Bryant Hickory Bryant Maple Cairo Maple Hickory Hickory Kesper Maple Kesper Oak Renss Maple Renss PureStyle™
<b>TBMWB278424AH</b>	37.4	1277	1337	1474	1549	1618	1623	1758
<b>TBMWB308424AH</b>	41.3	1351	1417	1562	1642	1714	1720	1862

<b>TBMWB278724</b>	38.7	1389	1454	1603	1684	1761	1766	1914
<b>TBMWB308724</b>	42.8	1472	1544	1701	1787	1866	1874	2028

<b>TBMWB279024</b>	40.0	1417	1484	1635	1718	1797	1802	1953
<b>TBMWB309024</b>	44.2	1503	1576	1736	1823	1904	1912	2070

<b>TBMWB279324</b>	41.3	1573	1650	1820	1913	1996	2006	2171
<b>TBMWB309324</b>	45.7	1669	1748	1928	2026	2117	2126	2301

<b>TBMWB279624</b>	42.6	1573	1650	1820	1913	1996	2006	2171
<b>TBMWB309624</b>	47.1	1669	1748	1928	2026	2117	2126	2301

- AH represents upper section alignment with doors on 24" or 27" high cabinets.
- Includes adjustable shelves in upper section:  
84" tall - one shelf  
87"-93" tall - two shelves  
96" tall - three shelves
- Uses face mount hinges on full and partial overlay doors (doors and drawer fronts will be sized to full width cabinet, not reduced for wide stiles).
- Base section will utilize a full depth shelf.
- All top and bottom cross rails are 1 1/2" wide.
- All toe-kick areas are 4 1/2" high.
- When CG is specified, face frame will be visible through door if used with a translucent glass design.
- Separate pedestal base included but packaged separately on 93" and 96" tall. Pedestal is designed to create a Recessed Left or Right Toe-kick application during field installation, or can be centered. Pedestal must be covered with toeboard material.
- Includes OCINSTALLKIT for microwave installation.
- DRWTK, FTK, and VTK not available on 93" and 96" tall.

	A Frame Opening Height	B Cut-Out Width		C Cut-Out Height		Door Height (Upper Section)	
		Min.	Max.	Min.	Max.	Partial Overlay	Full Overlay
TBMWB278424AH	24"	21"	25 1/2"	13 1/2"	22 1/2"	25"	27 1/2"
TBMWB308424AH	24"	24"	28 1/2"	13 1/2"	22 1/2"	25"	27 1/2"
TBMWB278724	27"	21"	25 1/2"	13 1/2"	22 1/2"	28"	29 1/2"
TBMWB308724	27"	24"	28 1/2"	13 1/2"	22 1/2"	28"	29 1/2"
TBMWB279024	30"	21"	25 1/2"	13 1/2"	22 1/2"	31"	32 1/2"
TBMWB309024	30"	24"	28 1/2"	13 1/2"	22 1/2"	31"	32 1/2"
TBMWB279324	33"	21"	25 1/2"	13 1/2"	22 1/2"	34"	35 1/2"
TBMWB309324	33"	24"	28 1/2"	13 1/2"	22 1/2"	34"	35 1/2"
TBMWB279624	36"	21"	25 1/2"	13 1/2"	22 1/2"	37"	38 1/2"
TBMWB309624	36"	24"	28 1/2"	13 1/2"	22 1/2"	37"	38 1/2"

Maximum cut-out dimension will allow 1/4" reveal for doors and drawer fronts on full overlay and 1" for partial overlay for trim kit face clearance.

Model	Cubic Feet	Countertop Maple	Bryant Cherry Hurley Cherry Norris Maple Norris PureStyle™	Cairo Cherry Kasper Cherry Reist Cherry	Klewin Oak	Brockway Maple Countertop Cherry Kersey Hickory Kersey Maple Norris Cherry	Felix Hickory Felix Maple Forte Hickory Forte Maple Forte PureStyle™ Owens Maple Owens PureStyle™	Antico PureStyle™ Brockway Cherry Felix Cherry Forte Cherry Kersey Cherry Klewin Hickory Klewin Maple Owens Cherry	Adair Maple Adair PureStyle™ Keegan Maple	Valero Maple	Adair Cherry Keegan Cherry	Klewin Cherry	Valero Cherry
		8	9	10	11	12	13	14	15	16	17	18	19
TBMWB278424AH	37.4	1839	1910	1985	2129	2134	2218	2326	2367	2489	2557	2566	2688
TBMWB308424AH	41.3	1950	2024	2102	2255	2263	2350	2464	2508	2637	2711	2718	2851
TBMWB278724	38.7	2001	2080	2160	2316	2325	2415	2532	2579	2712	2785	2796	2929
TBMWB308724	42.8	2123	2203	2289	2458	2465	2561	2687	2733	2876	2954	2964	3107
TBMWB279024	40.0	2042	2122	2205	2363	2372	2465	2583	2631	2768	2843	2853	2990
TBMWB309024	44.2	2167	2247	2335	2508	2515	2615	2742	2790	2936	3015	3026	3171
TBMWB279324	41.3	2274	2360	2451	2631	2641	2742	2877	2928	3082	3167	3177	3331
TBMWB309324	45.7	2411	2501	2599	2790	2800	2910	3051	3103	3265	3357	3367	3531
TBMWB279624	42.6	2274	2360	2451	2631	2641	2742	2877	2928	3082	3167	3177	3331
TBMWB309624	47.1	2411	2501	2599	2790	2800	2910	3051	3103	3265	3357	3367	3531

Custom Modifications	AUTHL AUTHR	CBO	CCO	CFNT0	CFRMO	CND	DRWTK	FB	FPEB	FTK	MIP	RD	RECTKALL RECTKBK	RECTKL RECTKR	RT	VTK
	•	•	•		•	•	•	•	•	•	•	•		•	•	•

Construction Upgrades	VPL	Decorative Door Options	CG	Smart Stop Options	INTGH	PG	SP
	•		•		•	•	

**OVEN MICROWAVE CABINET,  
84", 87", or 90" TALL, 24" DEEP**

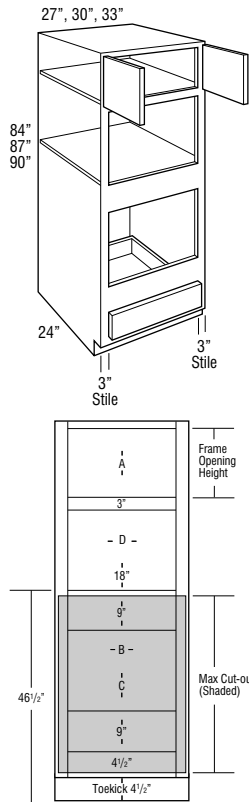

Model	Cubic Feet	Cabinet Material					Door Material	
		Tori Oak	Westburke Oak	Tori Hickory Tori Maple	Loren Laminate Tori Cherry Westburke Hickory Westburke Maple Westburke PureStyle™	Calio Oak Gantrell Oak Kesper Oak Reins Oak	Westburke Cherry	Brookway Oak Bryant Hickory Bryant Maple Calio Maple Hurley Hickory Hurley Maple Kesper Maple Kessy Oak Reins Oak Reins PureStyle™
		1	2	3	4	5	6	7
<b>OMC278424</b>	37.9	1250	1313	1454	1529	1599	1605	1743
<b>OMC308424</b>	41.8	1277	1341	1481	1562	1632	1639	1777
<b>OMC338424</b>	45.7	1365	1432	1585	1668	1747	1752	1902

<b>OMC278724</b>	38.7	1346	1412	1563	1643	1719	1724	1874
<b>OMC308724</b>	42.9	1365	1433	1584	1668	1746	1752	1902
<b>OMC338724</b>	46.8	1458	1530	1691	1779	1861	1869	2027

<b>OMC279024AH</b>	38.6	1369	1437	1590	1672	1749	1754	1907
<b>OMC309024AH</b>	42.5	1388	1457	1610	1695	1773	1780	1933
<b>OMC339024AH</b>	48.5	1480	1554	1718	1807	1889	1898	2059

- AH represents upper section alignment with doors on 24" or 27" high cabinets.
- Upper section on 90" tall has one full depth adjustable shelf.
- Designed for use with separate built-in microwave above, built-in oven below. For built-in double ovens, see pages 204-210.
- Full overlay styles feature concealed face mount hinges.
- All top and bottom cross rails are 1 1/2" wide.
- All toe-kick areas are 4 1/2" high.
- All cabinets have 3" stiles on frame.
- Be sure to confirm a heat shield is built into your appliance by the manufacturer or install the heat shield included with your appliance. Heat shields are sold separately as an accessory.
- Support shelf for oven included; for built-in appliance support brackets, use OCINSTALLKIT (included in 24" deep oven cabinets).
- Depth can be reduced to a minimum of 18".

	A Frame Opening Height	B Cut-Out Width		C Cut-Out Height		D Frame Opening Width	Door Height (Upper Section)	
		Min.	Max.	Min.	Max.		Partial Overlay	Full Overlay
OMC278424	15"	21"	25 1/2"	18"	39"	21"	16"	17 1/2"
OMC308424	15"	24"	28 1/2"	18"	39"	24"	16"	17 1/2"
OMC338424	15"	27"	31 1/2"	18"	39"	27"	16"	17 1/2"
OMC278724	18"	21"	25 1/2"	18"	39"	21"	19"	20 1/2"
OMC308724	18"	24"	28 1/2"	18"	39"	24"	19"	20 1/2"
OMC338724	18"	27"	31 1/2"	18"	39"	27"	19"	20 1/2"
OMC279024AH	21"	21"	25 1/2"	18"	39"	21"	22"	23 1/2"
OMC309024AH	21"	24"	28 1/2"	18"	39"	24"	22"	23 1/2"
OMC339024AH	21"	27"	31 1/2"	18"	39"	27"	22"	23 1/2"

Maximum cut-out dimension will allow 1/4" reveal for doors and drawer fronts on full overlay and 1" for partial overlay for trim kit face clearance.

Model	Cubic Feet	Cantrill Maple	Bryant Cherry Hurley Cherry Norris Maple Norris PureStyle™	Cairo Cherry Kasper Cherry Reist Cherry	Klewin Oak	Brookway Maple Cantrill Cherry Kersey Hickory Kersey Maple Norris Cherry	Felix Hickory Felix Maple Forte Hickory Forte Maple Forte PureStyle™ Owens Maple Owens PureStyle™	Amico PureStyle™ Brookway Cherry Felix Cherry Forte Cherry Kersey Cherry Klewin Hickory Klewin Maple Owens Cherry	Adair Maple Adair PureStyle™ Keegan Maple	Wilero Maple	Adair Cherry Keegan Cherry	Klewin Cherry	Wilero Cherry
		8	9	10	11	12	13	14	15	16	17	18	19
<b>OMC278424</b>	37.9	1827	1898	1974	2120	2128	2212	2323	2363	2489	2559	2567	2692
<b>OMC308424</b>	41.8	1863	1936	2014	2163	2170	2256	2370	2414	2539	2610	2617	2749
<b>OMC338424</b>	45.7	1993	2072	2155	2315	2321	2415	2534	2582	2718	2792	2802	2939
<b>OMC278724</b>	38.7	1965	2040	2121	2280	2286	2379	2496	2540	2676	2752	2760	2896
<b>OMC308724</b>	42.9	1992	2071	2154	2315	2321	2414	2533	2581	2716	2793	2800	2940
<b>OMC338724</b>	46.8	2126	2209	2297	2467	2475	2574	2702	2754	2897	2980	2988	3135
<b>OMC279024AH</b>	38.6	1999	2076	2158	2320	2326	2420	2539	2584	2722	2800	2808	2947
<b>OMC309024AH</b>	42.5	2025	2105	2189	2353	2359	2453	2574	2623	2760	2838	2847	2987
<b>OMC339024AH</b>	48.5	2159	2243	2333	2505	2514	2614	2744	2797	2941	3027	3035	3185

Custom Modifications	AUTHL AUTHR	CBO	CCO	CFNT0	CFRMO	CND	DRWTK	FB	FPEB	FTK	MIP	RD	RECTKALL RECTKBK	RECTKL RECTKR	RT	VTK
	•	•	•	•	•	•	•	•	•	•	•	•		•		•

Construction Upgrades	VPL	Smart Stop Options	INTGH	PG	SP
	•		•	•	

**OVEN MICROWAVE CABINET,  
93" or 96" TALL, 24" DEEP**

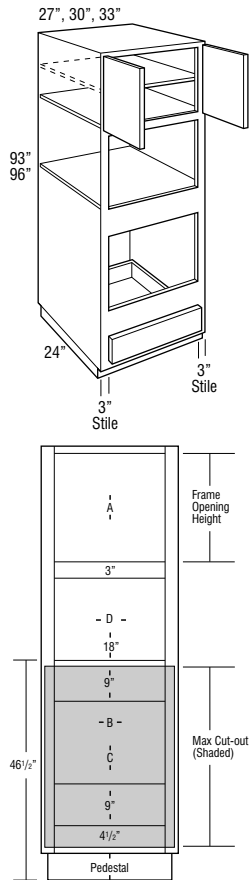

Model	Cubic Feet	Finish						7
		Tori Oak	Westburke Oak	Tori Hickory Tori Maple	Loren Laminate Tori Cherry Westburke Hickory Westburke Maple Westburke PureStyle™	Galio Oak Gantrell Oak Kesper Oak Reins Oak	Westburke Cherry	
<b>OMC279324AH</b>	39.9	1482	1556	1723	1811	1898	1903	2066
<b>OMC309324AH</b>	44.0	1500	1574	1741	1832	1914	1922	2086
<b>OMC339324AH</b>	48.1	1593	1674	1847	1946	2035	2044	2217

<b>OMC279624</b>	41.2	1482	1556	1723	1811	1898	1903	2066
<b>OMC309624</b>	45.5	1500	1574	1741	1832	1914	1922	2086
<b>OMC339624</b>	49.7	1593	1674	1847	1946	2035	2044	2217

- AH represents upper section alignment with doors on 24" or 27" high cabinets.
- Includes adjustable shelves in upper section:  
93" tall - one shelf  
96" tall - two shelves
- Designed for use with separate built-in microwave above, built-in oven below. For built-in double ovens, see pages 204-210.
- Full overlay styles feature concealed face mount hinges.
- All top and bottom cross rails are 1 1/2" wide.
- All toekick areas are 4 1/2" high.
- All cabinets have 3" stiles on frame.
- Be sure to confirm a heat shield is built into your appliance by the manufacturer or install the heat shield included with your appliance. Heat shields are sold separately as an accessory.
- Separate pedestal base included but shipped separately on 93" and 96" tall. Pedestals are the same width as the cabinet box except when specified with FPFB, in which the pedestal will be 1/4" recessed when centered.
- Support shelf for oven included; for built-in appliance support brackets, use OCINSTALLKIT (included in 24" deep oven cabinets).
- Depth can be reduced to a minimum of 18".

	A Frame Opening Height	B Cut-Out Width		C Cut-Out Height		D Frame Opening Width	Door Height (Upper Section)	
		Min.	Max.	Min.	Max.		Partial Overlay	Full Overlay
OMC279324AH	24"	21"	25 1/2"	18"	39"	21"	25"	26 1/2"
OMC309324AH	24"	24"	28 1/2"	18"	39"	24"	25"	26 1/2"
OMC339324AH	24"	27"	31 1/2"	18"	39"	27"	25"	26 1/2"
OMC279624	27"	21"	25 1/2"	18"	39"	21"	28"	29 1/2"
OMC309624	27"	24"	28 1/2"	18"	39"	24"	28"	29 1/2"
OMC339624	27"	27"	31 1/2"	18"	39"	27"	28"	29 1/2"

Maximum cut-out dimension will allow 1/4" reveal for doors and drawer fronts on full overlay and 1" for partial overlay for trim kit face clearance.

Model	Cubic Feet	Cantrill Maple	Bryant Cherry Hurley Cherry Norris Maple Norris PureStyle™	Cairo Cherry Kasper Cherry Reist Cherry	Klewin Oak	Brookway Maple Cantrill Cherry Kersey Hickory Kersey Maple Norris Cherry	Felix Hickory Felix Maple Forte Hickory Forte Maple Forte PureStyle™ Owens Maple Owens PureStyle™	Amico PureStyle™ Brookway Cherry Felix Cherry Forte Cherry Kersey Hickory Klewin Hickory Owens Maple Owens Cherry	Adair Maple Adair PureStyle™ Keegan Maple	Valero Maple	Adair Cherry Keegan Cherry	Klewin Cherry	Valero Cherry
		8	9	10	11	12	13	14	15	16	17	18	19
OMC279324AH	39.9	2163	2248	2338	2512	2522	2622	2751	2801	2949	3035	3043	3194
OMC309324AH	44.0	2187	2273	2361	2539	2548	2650	2782	2833	2982	3065	3075	3228
OMC339324AH	48.1	2326	2415	2511	2700	2706	2814	2954	3010	3168	3256	3267	3427

OMC279624	41.2	2163	2248	2338	2512	2522	2622	2751	2801	2949	3035	3043	3194
OMC309624	45.5	2187	2273	2361	2539	2548	2650	2782	2833	2982	3065	3075	3228
OMC339624	49.7	2326	2415	2511	2700	2706	2814	2954	3010	3168	3256	3267	3427

Custom Modifications	AUTHL AUTHR	CBO	CCO	CFNTO	CFRMO	CND	DRWTK	FB	FPEB	FTK	MIP	RD	RECTKALL RECTKBK	RECTKL RECTKR	RT	VTK
	•	•	•	•	•	•	•	•	•	•	•	•	•	•		

Construction Upgrades	VPL	Smart Stop Options	INTGH	PG	SP
	•		•	•	



**OVEN MICROWAVE CABINET, DEEP DRAWER, 84", 87", or 90" TALL, 24" DEEP**

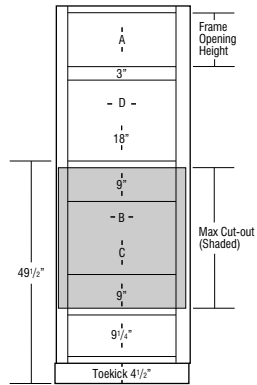
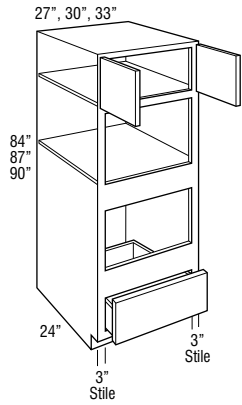

Model	Cubic Feet	Finish						
		Tori Oak	Westburke Oak	Tori Hickory Tori Maple	Loren Laminate Tori Cherry Westburke Hickory Westburke Maple Westburke PureStyle™	Cairo Oak Cantrell Oak Kesper Oak Renaist Oak	Westburke Cherry	Brookway Oak Bryant Hickory Bryant Maple Cairo Maple Hurley Hickory Hurley Maple Kesper Maple Kesper Oak Renaist Maple Renaist PureStyle™
		1	2	3	4	5	6	7
<b>OMC278424DD</b>	37.4	1618	1681	1822	1897	1967	1973	2112
<b>OMC308424DD</b>	41.3	1731	1795	1936	2016	2087	2093	2232
<b>OMC338424DD</b>	45.2	1935	2002	2155	2238	2316	2321	2471

<b>OMC278724DD</b>	38.7	1714	1780	1931	2011	2087	2092	2242
<b>OMC308724DD</b>	42.9	1820	1887	2039	2123	2200	2206	2356
<b>OMC338724DD</b>	46.8	2027	2099	2261	2349	2430	2438	2597

<b>OMC279024DD</b>	40.0	1737	1805	1958	2040	2117	2122	2275
<b>OMC309024DD</b>	44.2	1842	1911	2064	2150	2228	2235	2387
<b>OMC339024DD</b>	48.4	2050	2124	2287	2377	2459	2467	2629

- Designed for use with separate built-in microwave above, built-in oven below. For built-in double ovens, see pages 204-210.
- Full overlay styles feature concealed face mount hinges.
- All top and bottom cross rails are 1 1/2" wide.
- All toekick areas are 4 1/2" high.
- All cabinets have 3" stiles on frame.
- Be sure to confirm a heat shield is built into your appliance by the manufacturer or install the heat shield included with your appliance. Heat shields are sold separately as an accessory.
- Depth can be reduced to a minimum of 12".
- For built-in appliance support, OCINSTALLKIT is included in 24" deep oven cabinets (see page 294 for details). Oven install kit will not be included when depth is modified.

	A Frame Opening Height	B Cut-Out Width		C Cut-Out Height		D Frame Opening Width	Door Height (Upper Section)	
		Min.	Max.	Min.	Max.		Partial Overlay	Full Overlay
OMC278424DD	12"	21"	25 1/2"	16 1/4"	31 1/4"	21"	13"	14 1/2"
OMC308424DD	12"	24"	28 1/2"	16 1/4"	31 1/4"	24"	13"	14 1/2"
OMC338424DD	12"	27"	31 1/2"	16 1/4"	31 1/4"	27"	13"	14 1/2"
OMC278724DD	15"	21"	25 1/2"	16 1/4"	31 1/4"	21"	16"	17 1/2"
OMC308724DD	15"	24"	28 1/2"	16 1/4"	31 1/4"	24"	16"	17 1/2"
OMC338724DD	15"	27"	31 1/2"	16 1/4"	31 1/4"	27"	16"	17 1/2"
OMC279024DD	18"	21"	25 1/2"	16 1/4"	31 1/4"	21"	19"	20 1/2"
OMC309024DD	18"	24"	28 1/2"	16 1/4"	31 1/4"	24"	19"	20 1/2"
OMC339024DD	18"	27"	31 1/2"	16 1/4"	31 1/4"	27"	19"	20 1/2"

Maximum cut-out dimension will allow 1/4" reveal for doors and drawer fronts on full overlay and 1" for partial overlay for trim kit face clearance.

Model	Cubic Feet	Camtrel Maple	Bryant Cherry Hurley Cherry Norris Maple Norris PureStyle™	Cairo Cherry Kasper Cherry Reist Cherry	Klewin Oak	Brockway Maple Camtrel Cherry Kersey Hickory Kersey Maple Norris Cherry	Felix Hickory Felix Maple Forte Hickory Forte Maple Forte PureStyle™ Owens Maple Owens PureStyle™	Amico PureStyle™ Brockway Cherry Felix Cherry Forte Cherry Kersey Cherry Klewin Hickory Klewin Maple Owens Cherry	Adair Maple Adair PureStyle™ Keegan Maple	Valero Maple	Adair Cherry Keegan Cherry	Klewin Cherry	Valero Cherry
		8	9	10	11	12	13	14	15	16	17	18	19
OMC278424DD	37.4	2195	2266	2342	2488	2496	2580	2691	2731	2857	2927	2935	3060
OMC308424DD	41.3	2317	2390	2468	2617	2624	2711	2824	2868	2994	3064	3072	3203
OMC338424DD	45.2	2563	2642	2724	2885	2891	2984	3104	3152	3288	3362	3372	3509
OMC278724DD	38.7	2333	2408	2489	2648	2654	2747	2864	2908	3044	3120	3128	3264
OMC308724DD	42.9	2447	2526	2608	2769	2776	2868	2987	3036	3170	3247	3255	3394
OMC338724DD	46.8	2695	2779	2866	3037	3045	3144	3271	3324	3466	3550	3558	3705
OMC279024DD	40.0	2367	2444	2526	2688	2694	2788	2907	2952	3090	3168	3177	3315
OMC309024DD	44.2	2480	2560	2643	2807	2814	2907	3028	3078	3215	3293	3301	3442
OMC339024DD	48.4	2728	2813	2902	3075	3084	3184	3313	3367	3511	3597	3604	3754

Custom Modifications	AUTHL AUTHR	CBO	CCO	CFNTO	CFRMO	CND	DRWTK	FB	FPEB	FTK	MIP	RD	RECTKALL RECTKBK	RECTKL RECTKR	RT	VTK
	•	•	•		•	•	•	•	•	•	•	•		•		•

Construction Upgrades	VPL	Smart Stop Options	INTGH	PG	SP
	•		•	STD	

**OVEN MICROWAVE CABINET, DEEP DRAWER, 93" or 96" TALL, 24" DEEP**

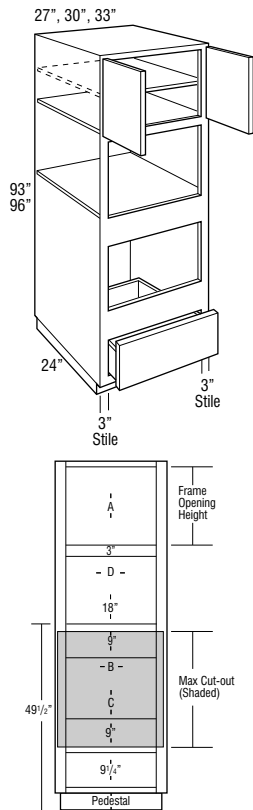

Model	Cubic Feet	Westburke Oak		Tori Hickory Tori Maple	Loren Laminate Tori Cherry Westburke Hickory Westburke Maple Westburke PureStyle™	Galio Oak Gantrell Oak Kesper Oak Rensel Oak	Westburke Cherry	Brookway Oak Bryant Hickory Bryant Maple Bryant PureStyle™ Galio Maple Harley Hickory Harley Maple Kesper Maple Kesper Oak Rensel Maple Rensel PureStyle™	
		1	2	3	4	5	6	7	
OMC279324DDAH	41.3	1850	1924	2091	2179	2266	2271	2434	
OMC309324DDAH	45.7	1954	2028	2196	2286	2369	2377	2540	
OMC339324DDAH	50.0	2163	2243	2417	2516	2605	2613	2787	
OMC279624DDAH	42.6	1850	1924	2091	2179	2266	2271	2434	
OMC309624DDAH	47.1	1954	2028	2196	2286	2369	2377	2540	
OMC339624DDAH	51.6	2163	2243	2417	2516	2605	2613	2787	

- AH represents upper section alignment with doors on 24" or 27" high cabinets.
- Designed for use with separate built-in microwave above, built-in oven below. For built-in double ovens, see pages 204-210.
- Full overlay styles feature concealed face mount hinges.
- All top and bottom cross rails are 1 1/2" wide.
- All toe kick areas are 4 1/2" high.
- All cabinets have 3" stiles on frame.
- Be sure to confirm a heat shield is built into your appliance by the manufacturer or install the heat shield included with your appliance. Heat shields are sold separately as an accessory.
- Separate pedestal base included but shipped separately on 93" and 96" tall. Pedestal is designed to create a Recessed Left or Right Toe Kick application during field installation, or can be centered. Pedestal must be covered with toeboard material.
- One full depth adjustable shelf included, but packaged separately.
- Depth can be reduced to a minimum of 12".
- For built-in appliance support, OCINSTALLKIT is included in 24" deep oven cabinets (see page 294 for details). Oven install kit will not be included when depth is modified.

	A Frame Opening Height	B Cut-Out Width		C Cut-Out Height		D Frame Opening Width	Door Height (Upper Section)	
		Min.	Max.	Min.	Max.		Partial Overlay	Full Overlay
OMC279324DDAH	21"	21"	25 1/2"	16 1/4"	31 1/4"	21"	22"	23 1/2"
OMC309324DDAH	21"	24"	28 1/2"	16 1/4"	31 1/4"	24"	22"	23 1/2"
OMC339324DDAH	21"	27"	31 1/2"	16 1/4"	31 1/4"	27"	22"	23 1/2"
OMC279624DDAH	24"	21"	25 1/2"	16 1/4"	31 1/4"	21"	25"	26 1/2"
OMC309624DDAH	24"	24"	28 1/2"	16 1/4"	31 1/4"	24"	25"	26 1/2"
OMC339624DDAH	24"	27"	31 1/2"	16 1/4"	31 1/4"	27"	25"	26 1/2"

Maximum cut-out dimension will allow 1/4" reveal for doors and drawer fronts on full overlay and 1" for partial overlay for trim kit face clearance.

Model	Cubic Feet	Countertop Maple	Bryant Cherry Hurley Cherry Norris Maple Norris PureStyle™	Cairo Cherry Kasper Cherry Reist Cherry	Klewin Oak	Brockway Maple Countertop Cherry Kersey Hickory Kersey Maple Norris Cherry	Felix Hickory Felix Maple Forte Hickory Forte Maple Forte PureStyle™ Owens Maple Owens PureStyle™	Amico PureStyle™ Brockway Cherry Felix Cherry Forte Cherry Kersey Hickory Klewin Hickory Klewin Maple Owens Cherry	Adair Maple Adair PureStyle™ Keegan Maple	Valero Maple	Adair Cherry Keegan Cherry	Klewin Cherry	Valero Cherry
		8	9	10	11	12	13	14	15	16	17	18	19
OMC279324DDAH	41.3	2531	2616	2706	2880	2890	2990	3119	3169	3317	3403	3411	3562
OMC309324DDAH	45.7	2641	2727	2816	2994	3003	3105	3236	3288	3437	3520	3529	3682
OMC339324DDAH	50.0	2896	2984	3081	3269	3275	3383	3524	3579	3738	3825	3836	3997

OMC279624DDAH	42.6	2531	2616	2706	2880	2890	2990	3119	3169	3317	3403	3411	3562
OMC309624DDAH	47.1	2641	2727	2816	2994	3003	3105	3236	3288	3437	3520	3529	3682
OMC339624DDAH	51.6	2896	2984	3081	3269	3275	3383	3524	3579	3738	3825	3836	3997

Custom Modifications	AUTHL AUTHR	CBO	CCO	CFNTO	CFRMO	CND	DRWTK	FB	FPEB	FTK	MIP	RD	RECTKALL RECTKKBK	RECTKL RECTKR	RT	VTK
	•	•	•		•	•		•	•		•	•		•		

Construction Upgrades	VPL	Smart Stop Options	INTGH	PG	SP
	•		•	STD	

# Diamond®

VIBE™ SERIES

**W1848BCFV**  
 Cabinet Type ← ← Cabinet Width

**NOTE:**  
 All office base cabinets are predrilled for full depth shelves or roll trays.

222

OFFICE & FURNITURE

**WALL BOOKCASE with FURNITURE VALANCE, 48", 51", or 54" HIGH, 12" DEEP**

18", 24", 30", or 36"

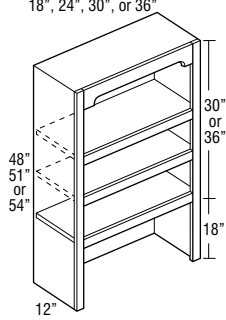

Model	Cubic Feet	Tori Oak	Westburke Oak	Tori Hickory Tori Maple	Levon Laminate Tori Cherry Westburke Hickory Westburke Maple Westburke PureStyle™	Canto Oak Cannel Oak Kasper Oak Rensi Oak	Westburke Cherry	Brockway Oak Bryant Hickory Bryant Maple Bryant PureStyle™ Cato Maple Haley Hickory Haley Maple Kasper Maple Rensi Oak Rensi Maple Rensi PureStyle™
		1	2	3	4	5	6	7
<b>W1848BCFV</b>	8.2	678	678	678	678	678	678	678
<b>W2448BCFV</b>	10.7	824	824	824	824	824	824	824
<b>W3048BCFV</b>	13.2	907	907	907	907	907	907	907
<b>W3648BCFV</b>	15.7	964	964	964	964	964	964	964
<b>W1851BCFV</b>	8.2	722	722	722	722	722	722	722
<b>W2451BCFV</b>	10.8	878	878	878	878	878	878	878
<b>W3051BCFV</b>	13.4	966	966	966	966	966	966	966
<b>W3651BCFV</b>	16.0	1027	1027	1027	1027	1027	1027	1027
<b>W1854BCFV</b>	8.3	733	733	733	733	733	733	733
<b>W2454BCFV</b>	10.9	891	891	891	891	891	891	891
<b>W3054BCFV</b>	13.6	981	981	981	981	981	981	981
<b>W3654BCFV</b>	16.3	1042	1042	1042	1042	1042	1042	1042

- 48", 51", and 54" have two adjustable shelves and one fixed shelf.
- Ends, tops, bottoms, and backs are hardwood veneer plywood.
- Matching interior.
- Face frame has a profiled inside edge.
- Depth can be reduced to a minimum of 9".

CUSTOM MODIFICATIONS			
Mod.	Description	Mod.	Description
AUTHL	Authentic End - Left	FTK	Flush Toekick
AUTHR	Authentic End - Right	ID	Increased Depth
CBO	Cabinet Box Only	MIP	Matching Interior Plywood
CCO	Cabinet Case Only	RD	Reduced Depth
CFNTO	Cabinet Front Only	RECTKALL	Recessed Island Toekick
CFP	Cabinet False Panel	RECTKBK	Recessed Toekick Back
CFRMO	Cabinet Frame Only	RECTKL	Recessed Toekick Left
CND	Cabinet with No Door, with Drawer	RECTKR	Recessed Toekick Right
DRWTK	Toekick Drawer	RT	Installed Roll Tray
FB	Finished Ends	VTK	Void Toekick
FPEB	Furniture Finished Plywood End Panels		

CONSTRUCTION UPGRADES	
Mod.	Description
VPL	All Plywood with Laminate Ends

SMART STOP OPTIONS	
Mod.	Description
INTGH	Smart Stop Premium Hinge
PG	Smart Stop Premium Drawer Guide and Dovetail Box

MODIFICATIONS GRID KEY	
•	Available
STD	Standard on these cabinets

Model	Cubic feet	Central Maple	Bryant Cherry Hurley Cherry Harris Maple Harris PureStyle™	Galto Cherry Kasper Cherry Rensi Cherry	Klewin Oak	Brockway Maple Central Cherry Kersey Hickory Kersey Maple Harris Cherry	Felix Hickory Felix Maple Fore Hickory Fore Maple Fore PureStyle™ Owens Maple Owens PureStyle™	Antico PureStyle™ Brockway Cherry Felix Cherry Fore Cherry Kersey Cherry Klewin Hickory Klewin Maple Owens Cherry	Adair Maple Adair PureStyle™ Kerigan Maple	Valero Maple	Adair Cherry Kerigan Cherry	Klewin Cherry	Valero Cherry
		8	9	10	11	12	13	14	15	16	17	18	19
<b>W1848BCFV</b>	8.2	678	678	678	678	678	678	678	678	678	678	678	678
<b>W2448BCFV</b>	10.7	824	824	824	824	824	824	824	824	824	824	824	824
<b>W3048BCFV</b>	13.2	907	907	907	907	907	907	907	907	907	907	907	907
<b>W3648BCFV</b>	15.7	964	964	964	964	964	964	964	964	964	964	964	964
<b>W1851BCFV</b>	8.2	722	722	722	722	722	722	722	722	722	722	722	722
<b>W2451BCFV</b>	10.8	878	878	878	878	878	878	878	878	878	878	878	878
<b>W3051BCFV</b>	13.4	966	966	966	966	966	966	966	966	966	966	966	966
<b>W3651BCFV</b>	16.0	1027	1027	1027	1027	1027	1027	1027	1027	1027	1027	1027	1027
<b>W1854BCFV</b>	8.3	733	733	733	733	733	733	733	733	733	733	733	733
<b>W2454BCFV</b>	10.9	891	891	891	891	891	891	891	891	891	891	891	891
<b>W3054BCFV</b>	13.6	981	981	981	981	981	981	981	981	981	981	981	981
<b>W3654BCFV</b>	16.3	1042	1042	1042	1042	1042	1042	1042	1042	1042	1042	1042	1042

Custom Modifications	AUTHL AUTHR	CBO	CCO	CFNTO	CFP	CFRMO	CND	DRWTK	FB	FPEB	FTK	ID	MIP	RD	RECTKALL RECTKBK	RECTKL RECTKR	RT	VTK
	•	STD				•			STD	•		•	STD	•				

Construction Upgrades	VPL	Smart Stop Options	INTGH	PG

**WALL BOOKCASE with FURNITURE VALANCE, 57", 60", or 66" HIGH, 12" DEEP**

18", 24", 30", or 36"

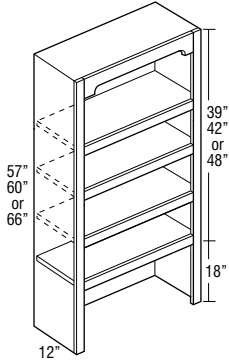

Model	Cubic Feet	Material Options						
		Tori Oak	Westburke Oak	Tori Hickory Tori Maple	Loren Laminate Tori Cherry Westburke Hickory Westburke Maple Westburke PureStyle™	Calio Oak Gantrell Oak Kesper Oak Rensil Oak	Westburke Cherry	Brookway Oak Bryant Hickory Bryant Maple Bryant PureStyle™ Calio Maple Hurley Hickory Hurley Maple Kesper Maple Kesper Oak Rensil PureStyle™ Rensil PureStyle™
		1	2	3	4	5	6	7
<b>W1857BCFV</b>	9.7	813	813	813	813	813	813	813
<b>W2457BCFV</b>	12.9	988	988	988	988	988	988	988
<b>W3057BCFV</b>	15.3	1089	1089	1089	1089	1089	1089	1089
<b>W3657BCFV</b>	18.5	1155	1155	1155	1155	1155	1155	1155
<b>W1860BCFV</b>	8.5	813	813	813	813	813	813	813
<b>W2460BCFV</b>	11.0	988	988	988	988	988	988	988
<b>W3060BCFV</b>	13.9	1089	1089	1089	1089	1089	1089	1089
<b>W3660BCFV</b>	16.8	1155	1155	1155	1155	1155	1155	1155
<b>W1866BCFV</b>	9.5	895	895	895	895	895	895	895
<b>W2466BCFV</b>	12.5	1089	1089	1089	1089	1089	1089	1089
<b>W3066BCFV</b>	15.5	1198	1198	1198	1198	1198	1198	1198
<b>W3666BCFV</b>	18.5	1272	1272	1272	1272	1272	1272	1272

- 57", 60", and 66" have three adjustable shelves and one fixed shelf.
- Ends, tops, bottoms, and backs are hardwood veneer plywood.
- Matching interior.
- Face frame has a profiled inside edge.
- Depth can be reduced to a minimum of 9".
- AUTHL and AUTHR not available on 66" high.

Model	Cubic Feet	Cantrill Maple	Bryant Cherry Hurley Cherry Norris Maple Norris PureStyle™	Cairo Cherry Kasper Cherry Reist Cherry	Klewin Oak	Brockway Maple Cantrill Cherry Kersey Hickory Kersey Maple Norris Cherry	Falk Hickory Falk Maple Forte Hickory Forte Maple Forte PureStyle™ Owens Maple Owens PureStyle™	Amico PureStyle™ Brockway Cherry Falk Cherry Forte Cherry Kersey Cherry Klewin Hickory Klewin Maple Owens Cherry	Adair Maple Adair PureStyle™ Keegan Maple	Valero Maple	Adair Cherry Keegan Cherry	Klewin Cherry	Valero Cherry
		8	9	10	11	12	13	14	15	16	17	18	19
W1857BCFV	9.7	813	813	813	813	813	813	813	813	813	813	813	813
W2457BCFV	12.9	988	988	988	988	988	988	988	988	988	988	988	988
W3057BCFV	15.3	1089	1089	1089	1089	1089	1089	1089	1089	1089	1089	1089	1089
W3657BCFV	18.5	1155	1155	1155	1155	1155	1155	1155	1155	1155	1155	1155	1155
W1860BCFV	8.5	813	813	813	813	813	813	813	813	813	813	813	813
W2460BCFV	11.0	988	988	988	988	988	988	988	988	988	988	988	988
W3060BCFV	13.9	1089	1089	1089	1089	1089	1089	1089	1089	1089	1089	1089	1089
W3660BCFV	16.8	1155	1155	1155	1155	1155	1155	1155	1155	1155	1155	1155	1155
W1866BCFV	9.5	895	895	895	895	895	895	895	895	895	895	895	895
W2466BCFV	12.5	1089	1089	1089	1089	1089	1089	1089	1089	1089	1089	1089	1089
W3066BCFV	15.5	1198	1198	1198	1198	1198	1198	1198	1198	1198	1198	1198	1198
W3666BCFV	18.5	1272	1272	1272	1272	1272	1272	1272	1272	1272	1272	1272	1272

Custom Modifications	AUTHL AUTHR	CBO	CCO	CFNTO	CFP	CFRMO	CND	DRWTK	FB	FPEB	FTK	ID	IMP	RD	RECTKALL RECTKBK	RECTKL RECTKR	RT	VTK
	•	STD				•			STD	•		•	STD	•				

Construction Upgrades	VPL	Smart Stop Options	INTGH	PG



**WALL BOOKCASE with STRAIGHT VALANCE, 48", 51", or 54" HIGH 12" DEEP**

18", 24", 30", or 36"

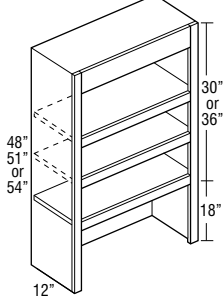

Model	Cubic Feet	Material Options						
		Tori Oak	Westburke Oak	Tori Hickory Tori Maple	Loren Laminate Tori Cherry Westburke Hickory Westburke Maple Westburke PureStyle™	Calio Oak Gantrell Oak Kesper Oak Rens Oak	Westburke Cherry	Brookway Oak Bryant Hickory Bryant Maple Calio Maple Hurley Hickory Hurley Maple Kesper Maple Kessy Oak Rens PureStyle™
		1	2	3	4	5	6	7
<b>W1848BCVV</b>	8.2	678	678	678	678	678	678	678
<b>W2448BCVV</b>	10.7	824	824	824	824	824	824	824
<b>W3048BCVV</b>	13.2	907	907	907	907	907	907	907
<b>W3648BCVV</b>	15.7	964	964	964	964	964	964	964

<b>W1851BCVV</b>	8.2	722	722	722	722	722	722	722
<b>W2451BCVV</b>	10.8	878	878	878	878	878	878	878
<b>W3051BCVV</b>	13.4	966	966	966	966	966	966	966
<b>W3651BCVV</b>	16.0	1027	1027	1027	1027	1027	1027	1027

<b>W1854BCVV</b>	8.3	733	733	733	733	733	733	733
<b>W2454BCVV</b>	10.9	891	891	891	891	891	891	891
<b>W3054BCVV</b>	13.6	981	981	981	981	981	981	981
<b>W3654BCVV</b>	16.3	1042	1042	1042	1042	1042	1042	1042

- 48", 51", and 54" have two adjustable shelves and one fixed shelf.
- Ends, tops, bottoms, and backs are hardwood veneer plywood.
- Matching interior.
- Face frame has a profiled inside edge.
- Depth can be reduced to a minimum of 9".

**WALL BOOKCASE with STRAIGHT VALANCE, 57", 60", or 66" HIGH, 12" DEEP**

18", 24", 30", or 36"

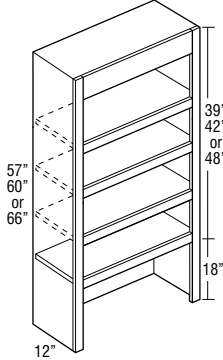

<b>W1857BCVV</b>	9.7	813	813	813	813	813	813	813
<b>W2457BCVV</b>	12.9	988	988	988	988	988	988	988
<b>W3057BCVV</b>	15.3	1089	1089	1089	1089	1089	1089	1089
<b>W3657BCVV</b>	18.5	1155	1155	1155	1155	1155	1155	1155

<b>W1860BCVV</b>	8.5	813	813	813	813	813	813	813
<b>W2460BCVV</b>	11.0	988	988	988	988	988	988	988
<b>W3060BCVV</b>	13.9	1089	1089	1089	1089	1089	1089	1089
<b>W3660BCVV</b>	16.8	1155	1155	1155	1155	1155	1155	1155

<b>W1866BCVV</b>	9.5	895	895	895	895	895	895	895
<b>W2466BCVV</b>	12.5	1089	1089	1089	1089	1089	1089	1089
<b>W3066BCVV</b>	15.5	1198	1198	1198	1198	1198	1198	1198
<b>W3666BCVV</b>	18.5	1272	1272	1272	1272	1272	1272	1272

- 57", 60", and 66" have three adjustable shelves and one fixed shelf.
- Ends, tops, bottoms, and backs are hardwood veneer plywood.
- Matching interior.
- Face frame has a profiled inside edge.
- Depth can be reduced to a minimum of 9".
- AUTHL and AUTHR not available on 66" high.

Model	Cubic Feet	Canthell Maple	Bryant Cherry Hurley Cherry Norris Maple Norris PureStyle™	Cairo Cherry Kesper Cherry Reist Cherry	Klewin Oak	Brookway Maple Canthell Cherry Kersey Hickory Kersey Maple Norris Cherry	Falk Hickory Falk Maple Forte Hickory Forte Maple Forte PureStyle™ Owens Maple Owens PureStyle™	Amico PureStyle™ Brookway Cherry Falk Cherry Forte Cherry Kersey Cherry Klewin Hickory Klewin Maple Owens Cherry	Adair Maple Adair PureStyle™ Keegan Maple	Valero Maple	Adair Cherry Keegan Cherry	Klewin Cherry	Valero Cherry
		8	9	10	11	12	13	14	15	16	17	18	19
W1848BCVV	8.2	678	678	678	678	678	678	678	678	678	678	678	678
W2448BCVV	10.7	824	824	824	824	824	824	824	824	824	824	824	824
W3048BCVV	13.2	907	907	907	907	907	907	907	907	907	907	907	907
W3648BCVV	15.7	964	964	964	964	964	964	964	964	964	964	964	964

W1851BCVV	8.2	722	722	722	722	722	722	722	722	722	722	722	722
W2451BCVV	10.8	878	878	878	878	878	878	878	878	878	878	878	878
W3051BCVV	13.4	966	966	966	966	966	966	966	966	966	966	966	966
W3651BCVV	16.0	1027	1027	1027	1027	1027	1027	1027	1027	1027	1027	1027	1027

W1854BCVV	8.3	733	733	733	733	733	733	733	733	733	733	733	733
W2454BCVV	10.9	891	891	891	891	891	891	891	891	891	891	891	891
W3054BCVV	13.6	981	981	981	981	981	981	981	981	981	981	981	981
W3654BCVV	16.3	1042	1042	1042	1042	1042	1042	1042	1042	1042	1042	1042	1042

Custom Modifications	AUTHL AUTHR	CBO	CCO	CFNTO	CFP	CFRMO	CND	DRWTK	FB	FPEB	FTK	ID	MIP	RD	RECTKALL RECTKBK	RECTKL RECTKR	RT	VTK
	•	STD				•			STD	•		•	STD	•				

Construction Upgrades	VPL	Smart Stop Options	INTGH	PG

W1857BCVV	9.7	813	813	813	813	813	813	813	813	813	813	813	813
W2457BCVV	12.9	988	988	988	988	988	988	988	988	988	988	988	988
W3057BCVV	15.3	1089	1089	1089	1089	1089	1089	1089	1089	1089	1089	1089	1089
W3657BCVV	18.5	1155	1155	1155	1155	1155	1155	1155	1155	1155	1155	1155	1155

W1860BCVV	8.5	813	813	813	813	813	813	813	813	813	813	813	813
W2460BCVV	11.0	988	988	988	988	988	988	988	988	988	988	988	988
W3060BCVV	13.9	1089	1089	1089	1089	1089	1089	1089	1089	1089	1089	1089	1089
W3660BCVV	16.8	1155	1155	1155	1155	1155	1155	1155	1155	1155	1155	1155	1155

W1866BCVV	9.5	895	895	895	895	895	895	895	895	895	895	895	895
W2466BCVV	12.5	1089	1089	1089	1089	1089	1089	1089	1089	1089	1089	1089	1089
W3066BCVV	15.5	1198	1198	1198	1198	1198	1198	1198	1198	1198	1198	1198	1198
W3666BCVV	18.5	1272	1272	1272	1272	1272	1272	1272	1272	1272	1272	1272	1272

Custom Modifications	AUTHL AUTHR	CBO	CCO	CFNTO	CFP	CFRMO	CND	DRWTK	FB	FPEB	FTK	ID	MIP	RD	RECTKALL RECTKBK	RECTKL RECTKR	RT	VTK
	•	STD				•			STD	•		•	STD	•				

Construction Upgrades	VPL	Smart Stop Options	INTGH	PG

**TALL BOOKCASE with FURNITURE  
VALANCE, 84", 87", 90", 93", or 96"  
HIGH, 12" DEEP**

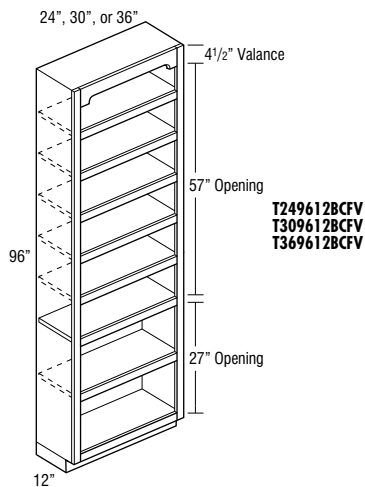
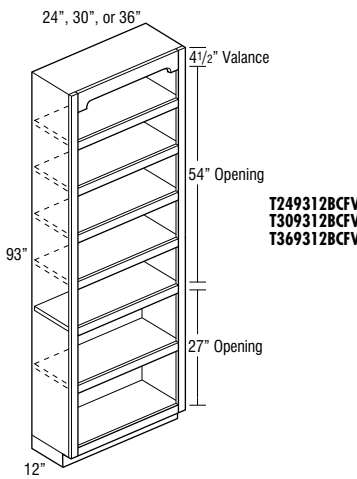
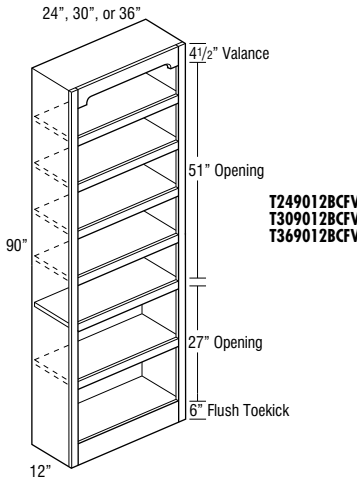
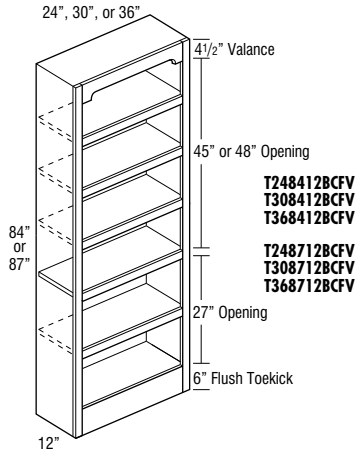

Model	Cubic Feet	Wood Species						
		Tori Oak	Westburke Oak	Tori Hickory Tori Maple	Loren Laminate Tori Cherry Westburke Hickory Westburke Maple Westburke PureStyle™	Cairo Oak Gantrell Oak Kesper Oak Rens Oak	Westburke Cherry	Brookway Oak Bryant Hickory Bryant Maple Cairo Maple Hurley Hickory Hurley Maple Kesper Maple Kessy Oak Rens PureStyle™
		1	2	3	4	5	6	7
T248412BCFV	18.4	1617	1617	1617	1617	1617	1617	1617
T308412BCFV	22.7	1796	1796	1796	1796	1796	1796	1796
T368412BCFV	26.7	1911	1911	1911	1911	1911	1911	1911
T248712BCFV	18.8	1656	1656	1656	1656	1656	1656	1656
T308712BCFV	23.1	1837	1837	1837	1837	1837	1837	1837
T368712BCFV	27.4	1955	1955	1955	1955	1955	1955	1955

- Four adjustable shelves and one fixed shelf.
- Ends, tops, bottoms, and backs are hardwood veneer plywood.
- Matching interior.
- Face frame has a profiled inside edge.
- Depth can be reduced to a minimum of 9".

T249012BCFV	19.1	1665	1665	1665	1665	1665	1665	1665
T309012BCFV	23.5	1847	1847	1847	1847	1847	1847	1847
T369012BCFV	28.0	1967	1967	1967	1967	1967	1967	1967

- Five adjustable shelves and one fixed shelf.
- Ends, tops, bottoms, and backs are hardwood veneer plywood.
- Matching interior.
- Face frame has a profiled inside edge.
- Depth can be reduced to a minimum of 9".

T249312BCFV	20.4	1715	1715	1715	1715	1715	1715	1715
T309312BCFV	25.0	1903	1903	1903	1903	1903	1903	1903
T369312BCFV	29.2	2025	2025	2025	2025	2025	2025	2025

- Five adjustable shelves and one fixed shelf.
- Ends, tops, bottoms, and backs are hardwood veneer plywood.
- Separate pedestal base included but shipped separately on 93" Tall.
- Matching interior.
- Face frame has a profiled inside edge.
- Depth can be reduced to a minimum of 9".

T249612BCFV	20.3	1715	1715	1715	1715	1715	1715	1715
T309612BCFV	25.1	1903	1903	1903	1903	1903	1903	1903
T369612BCFV	29.8	2025	2025	2025	2025	2025	2025	2025

- Six adjustable shelves and one fixed shelf.
- Ends, tops, bottoms, and backs are hardwood veneer plywood.
- Separate pedestal base included but shipped separately on 96" Tall.
- Matching interior.
- Face frame has a profiled inside edge.
- Depth can be reduced to a minimum of 9".
- FTK, RECTKL, and RECTKR not available on 93" and 96" high.

Model	Cubic Feet	Cantrill Maple	Bryant Cherry Hurley Cherry Norris Maple Norris PureStyle™	Cairo Cherry Kasper Cherry Reist Cherry	Klewin Oak	Brockway Maple Cantrill Cherry Kersey Hickory Kersey Maple Norris Cherry	Felix Hickory Felix Maple Forte Hickory Forte Maple Forte PureStyle™ Owens Maple Owens PureStyle™	Amico PureStyle™ Brockway Cherry Felix Cherry Forte Cherry Kersey Cherry Klewin Hickory Klewin Maple Owens Cherry	Adair Maple Adair PureStyle™ Keegan Maple	Wilero Maple	Adair Cherry Keegan Cherry	Klewin Cherry	Wilero Cherry
		8	9	10	11	12	13	14	15	16	17	18	19
T248412BCFV	18.4	1617	1617	1617	1617	1617	1617	1617	1617	1617	1617	1617	1617
T308412BCFV	22.7	1796	1796	1796	1796	1796	1796	1796	1796	1796	1796	1796	1796
T368412BCFV	26.7	1911	1911	1911	1911	1911	1911	1911	1911	1911	1911	1911	1911
T248712BCFV	18.8	1656	1656	1656	1656	1656	1656	1656	1656	1656	1656	1656	1656
T308712BCFV	23.1	1837	1837	1837	1837	1837	1837	1837	1837	1837	1837	1837	1837
T368712BCFV	27.4	1955	1955	1955	1955	1955	1955	1955	1955	1955	1955	1955	1955

T249012BCFV	19.1	1665	1665	1665	1665	1665	1665	1665	1665	1665	1665	1665	1665
T309012BCFV	23.5	1847	1847	1847	1847	1847	1847	1847	1847	1847	1847	1847	1847
T369012BCFV	28.0	1967	1967	1967	1967	1967	1967	1967	1967	1967	1967	1967	1967

T249312BCFV	20.4	1715	1715	1715	1715	1715	1715	1715	1715	1715	1715	1715	1715
T309312BCFV	25.0	1903	1903	1903	1903	1903	1903	1903	1903	1903	1903	1903	1903
T369312BCFV	29.2	2025	2025	2025	2025	2025	2025	2025	2025	2025	2025	2025	2025

T249612BCFV	20.3	1715	1715	1715	1715	1715	1715	1715	1715	1715	1715	1715	1715
T309612BCFV	25.1	1903	1903	1903	1903	1903	1903	1903	1903	1903	1903	1903	1903
T369612BCFV	29.8	2025	2025	2025	2025	2025	2025	2025	2025	2025	2025	2025	2025

Custom Modifications	AUTHL AUTHR	CBO	CCO	CFNTO	CFP	CFRMO	CND	DRWTK	FB	FPEB	FTK	ID	MIP	RD	RECTKALL RECTKBK	RECTKL RECTKR	RT	VTK
		STD				•			STD	•	STD	•	STD	•		•		

Construction Upgrades	VPL	Smart Stop Options	INTGH	PG

**TALL BOOKCASE with STRAIGHT VALANCE, 84", 87", 90", 93", or 96" HIGH, 12" DEEP**

24", 30", or 36"

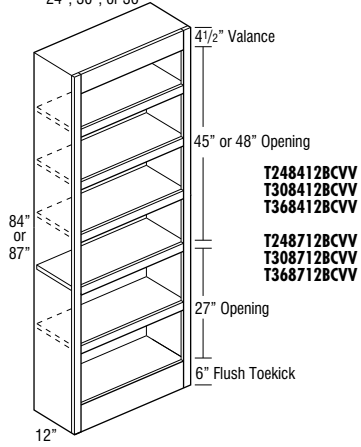

24", 30", or 36"

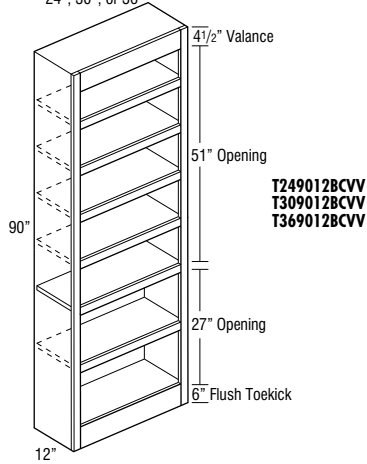

24", 30", or 36"

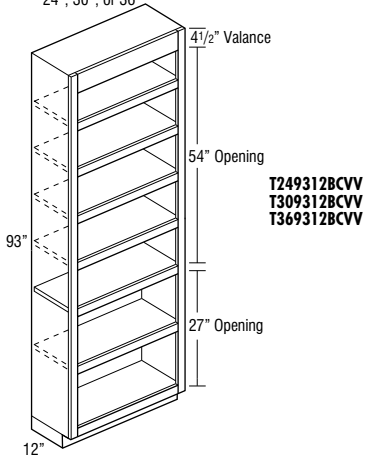

24", 30", or 36"

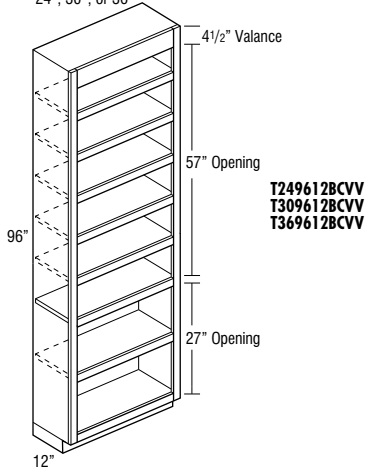

Model	Cubic Feet	Wood Species						
		Tori Oak	Westburke Oak	Tori Hickory Tori Maple	Loren Laminate Tori Cherry Westburke Hickory Westburke Maple Westburke PureStyle™	Cairo Oak Gantrell Oak Kesper Oak Rens Oak	Westburke Cherry	Brookway Oak Bryant Hickory Bryant Maple Cairo Maple Hurley Hickory Hurley Maple Kesper Maple Kessy Oak Rens PureStyle™
		1	2	3	4	5	6	7
<b>T248412BCVV</b>	18.4	1617	1617	1617	1617	1617	1617	1617
<b>T308412BCVV</b>	22.7	1796	1796	1796	1796	1796	1796	1796
<b>T368412BCVV</b>	26.7	1911	1911	1911	1911	1911	1911	1911
<b>T248712BCVV</b>	18.8	1656	1656	1656	1656	1656	1656	1656
<b>T308712BCVV</b>	23.1	1837	1837	1837	1837	1837	1837	1837
<b>T368712BCVV</b>	27.4	1955	1955	1955	1955	1955	1955	1955

- Four adjustable shelves and one fixed shelf.
- Ends, tops, bottoms, and backs are hardwood veneer plywood.
- Matching interior.
- Face frame has a profiled inside edge.
- Depth can be reduced to a minimum of 9".

<b>T249012BCVV</b>	19.1	1665	1665	1665	1665	1665	1665	1665
<b>T309012BCVV</b>	23.5	1847	1847	1847	1847	1847	1847	1847
<b>T369012BCVV</b>	28.0	1967	1967	1967	1967	1967	1967	1967

- Five adjustable shelves and one fixed shelf.
- Ends, tops, bottoms, and backs are hardwood veneer plywood.
- Matching interior.
- Face frame has a profiled inside edge.
- Depth can be reduced to a minimum of 9".

<b>T249312BCVV</b>	20.4	1715	1715	1715	1715	1715	1715	1715
<b>T309312BCVV</b>	25.0	1903	1903	1903	1903	1903	1903	1903
<b>T369312BCVV</b>	29.2	2025	2025	2025	2025	2025	2025	2025

- Five adjustable shelves and one fixed shelf.
- Ends, tops, bottoms, and backs are hardwood veneer plywood.
- Separate pedestal base included but shipped separately on 93" Tall.
- Matching interior.
- Face frame has a profiled inside edge.
- Depth can be reduced to a minimum of 9".

<b>T249612BCVV</b>	19.7	1715	1715	1715	1715	1715	1715	1715
<b>T309612BCVV</b>	24.3	1903	1903	1903	1903	1903	1903	1903
<b>T369612BCVV</b>	28.9	2025	2025	2025	2025	2025	2025	2025

- Six adjustable shelves and one fixed shelf.
- Ends, tops, bottoms, and backs are hardwood veneer plywood.
- Separate pedestal base included but shipped separately on 96" Tall.
- Matching interior.
- Face frame has a profiled inside edge.
- Depth can be reduced to a minimum of 9".
- FTK, RECTKL, and RECTKR not available on 93" and 96" high.

Model	Cubic Feet	Cantrill Maple	Bryant Cherry Hurley Cherry Norris Maple Norris PureStyle™	Cairo Cherry Kasper Cherry Reist Cherry	Klewin Oak	Brockway Maple Cantrill Cherry Kersey Hickory Kersey Maple Norris Cherry	Felix Hickory Felix Maple Forte Hickory Forte Maple Forte PureStyle™ Owens Maple Owens PureStyle™	Amico PureStyle™ Brockway Cherry Felix Cherry Forte Cherry Kersey Cherry Klewin Hickory Klewin Maple Owens Cherry	Adair Maple Adair PureStyle™ Keegan Maple	Wilero Maple	Adair Cherry Keegan Cherry	Klewin Cherry	Wilero Cherry
		8	9	10	11	12	13	14	15	16	17	18	19
T248412BCVV	18.4	1617	1617	1617	1617	1617	1617	1617	1617	1617	1617	1617	1617
T308412BCVV	22.7	1796	1796	1796	1796	1796	1796	1796	1796	1796	1796	1796	1796
T368412BCVV	26.7	1911	1911	1911	1911	1911	1911	1911	1911	1911	1911	1911	1911
T248712BCVV	18.8	1656	1656	1656	1656	1656	1656	1656	1656	1656	1656	1656	1656
T308712BCVV	23.1	1837	1837	1837	1837	1837	1837	1837	1837	1837	1837	1837	1837
T368712BCVV	27.4	1955	1955	1955	1955	1955	1955	1955	1955	1955	1955	1955	1955

T249012BCVV	19.1	1665	1665	1665	1665	1665	1665	1665	1665	1665	1665	1665	1665
T309012BCVV	23.5	1847	1847	1847	1847	1847	1847	1847	1847	1847	1847	1847	1847
T369012BCVV	28.0	1967	1967	1967	1967	1967	1967	1967	1967	1967	1967	1967	1967

T249312BCVV	20.4	1715	1715	1715	1715	1715	1715	1715	1715	1715	1715	1715	1715
T309312BCVV	25.0	1903	1903	1903	1903	1903	1903	1903	1903	1903	1903	1903	1903
T369312BCVV	29.2	2025	2025	2025	2025	2025	2025	2025	2025	2025	2025	2025	2025

T249612BCVV	19.7	1715	1715	1715	1715	1715	1715	1715	1715	1715	1715	1715	1715
T309612BCVV	24.3	1903	1903	1903	1903	1903	1903	1903	1903	1903	1903	1903	1903
T369612BCVV	28.9	2025	2025	2025	2025	2025	2025	2025	2025	2025	2025	2025	2025

Custom Modifications	AUTHL AUTHR	CBO	CCO	CFNTO	CFP	CFRMO	CND	DRWTK	FB	FPEB	FTK	ID	MIP	RD	RECTKALL RECTKBK	RECTKL RECTKR	RT	VTK
		STD				•			STD	•	STD	•	STD	•		•		

Construction Upgrades	VPL	Smart Stop Options	INTGH	PG

**DESK DOOR DRAWER BASE,  
29" HIGH, 21" DEEP**

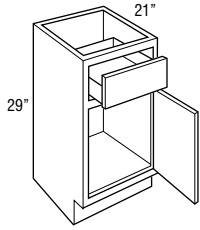

DDO122921 L or R  
DDO152921 L or R  
DDO182921 L or R  
DDO212921 L or R

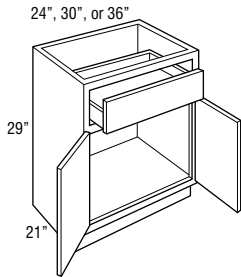

DDO242921  
DDO302921  
DDO362921

**DESK DOOR DRAWER BASE,  
29" HIGH, 24" DEEP**

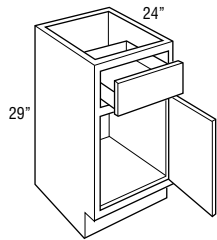

DDO122924 L or R  
DDO152924 L or R  
DDO182924 L or R  
DDO212924 L or R

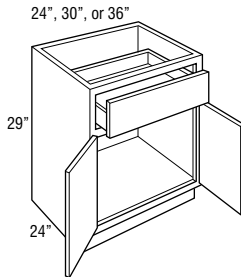

DDO242924  
DDO302924  
DDO362924

**DESK DRAWER BASE, 29" HIGH,  
21" DEEP**

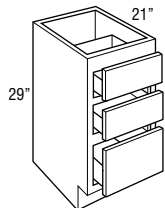

Model	Cubic Feet	Finish						
		Tori Oak	Westburke Oak	Tori Hickory Tori Maple	Loren Laminate Tori Cherry Westburke Hickory Westburke Maple Westburke PureStyle™	Calio Oak Gantrell Oak Kesper Oak Reins Oak	Westburke Cherry	Brookway Oak Bryant Hickory Bryant Maple Calio Maple Hurley Hickory Hurley Maple Kesper Maple Kessy Oak Reins PureStyle™ Reins PureStyle™
		1	2	3	4	5	6	7
DDO122921 L or R	6.4	423	444	491	518	542	543	590
DDO152921 L or R	7.8	449	473	524	551	575	579	626
DDO182921 L or R	9.1	480	504	555	586	613	615	668
DDO212921 L or R	10.5	512	538	593	624	653	655	711
<b>DDO242921</b>	11.9	565	594	653	687	719	722	783
<b>DDO302921</b>	14.9	659	693	765	806	844	847	919
<b>DDO362921</b>	17.9	830	871	962	1013	1059	1064	1153

DDO122924 L or R	7.3	438	460	508	533	557	559	609
DDO152924 L or R	8.8	466	487	540	567	593	596	647
DDO182924 L or R	10.2	493	516	572	602	631	633	687
DDO212924 L or R	11.8	527	554	612	645	673	676	733
<b>DDO242924</b>	13.4	582	611	673	708	740	743	807
<b>DDO302924</b>	14.6	681	714	788	830	868	871	947
<b>DDO362924</b>	17.3	855	898	991	1042	1091	1095	1187

• DRWTK not available on DDO122924 L or R and DDO152924 L or R.

Model	Cubic Feet	Canterell Maple	Bryant Cherry Hurley Cherry Norris Maple Norris PureStyle™	Cairo Cherry Kasper Cherry Reist Cherry	Klewin Oak	Brookway Maple Canterell Cherry Kersey Hickory Kersey Maple Norris Cherry	Felix Hickory Felix Maple Forte Hickory Forte Maple Forte PureStyle™ Owens Maple Owens PureStyle™	Amico PureStyle™ Brookway Cherry Felix Cherry Forte Cherry Kersey Cherry Klewin Hickory Klewin Maple Owens Cherry	Adair Maple Adair PureStyle™ Keegan Maple	Valero Maple	Adair Cherry Keegan Cherry	Klewin Cherry	Valero Cherry
		8	9	10	11	12	13	14	15	16	17	18	19
DDO122921 L or R	6.4	618	643	669	719	719	747	785	800	844	866	869	911
DDO152921 L or R	7.8	656	683	710	764	765	796	837	851	895	921	924	968
DDO182921 L or R	9.1	701	728	757	812	816	848	889	907	954	981	984	1032
DDO212921 L or R	10.5	746	775	806	866	871	902	949	965	1017	1044	1048	1099
DDO242921	11.9	821	852	887	952	956	993	1042	1063	1119	1150	1153	1210
DDO302921	14.9	962	1000	1038	1117	1123	1165	1222	1312	1312	1352	1356	1410
DDO362921	17.9	1209	1255	1305	1401	1408	1462	1536	1648	1648	1698	1703	1772

Custom Modifications	AUTHL AUTHR	CBO	CCO	CFNTO	CFP	CFRMO	CND	DRWTK	FB	FPEB	FTK	ID	MIP	RD	RECTKALL RECTKBK	RECTKL RECTKR	RT	VTK
		•	•	•	•	•	•		•	•	•		•	•	•	•	•	•

Construction Upgrades	VPL	Smart Stop Options	INTGH	PG
	•		•	•

DDO122924 L or R	7.3	637	661	687	740	740	770	809	824	868	892	895	939
DDO152924 L or R	8.8	677	704	732	787	787	820	860	877	923	949	952	998
DDO182924 L or R	10.2	721	748	778	837	841	874	916	934	984	1011	1014	1063
DDO212924 L or R	11.8	769	797	830	892	896	929	977	995	1048	1077	1079	1133
DDO242924	13.4	847	878	912	981	985	1023	1074	1096	1153	1184	1187	1247
DDO302924	14.6	991	1030	1069	1150	1155	1201	1260	1352	1352	1393	1398	1455
DDO362924	17.3	1245	1293	1344	1443	1453	1506	1580	1696	1696	1748	1754	1825

Custom Modifications	AUTHL AUTHR	CBO	CCO	CFNTO	CFP	CFRMO	CND	DRWTK	FB	FPEB	FTK	ID	MIP	RD	RECTKALL RECTKBK	RECTKL RECTKR	RT	VTK
	•	•	•	•	•	•	•	•	•	•	•		•	•	•	•	•	

Construction Upgrades	VPL	Smart Stop Options	INTGH	PG
	•		•	•

DDR122921	6.4	593	750	781	653	793	682	714	752	752	858	821	858
DDR152921	7.8	640	810	842	704	853	735	771	810	810	925	883	925
DDR182921	9.1	686	869	904	756	918	790	827	871	871	993	951	993
DDR212921	10.5	735	928	965	809	980	844	884	929	929	1062	1014	1062
DDR242921	11.9	787	995	1035	866	1048	902	949	995	995	1136	1088	1136

Custom Modifications	AUTHL AUTHR	CBO	CCO	CFNTO	CFP	CFRMO	CND	DRWTK	FB	FPEB	FTK	ID	MIP	RD	RECTKALL RECTKBK	RECTKL RECTKR	RT	VTK
		•	•	•	•	•			•	•	•		•	•	•	•		•

Construction Upgrades	VPL	Smart Stop Options	INTGH	PG
	•			•



**DESK DRAWER BASE, 29" HIGH, 24" DEEP**

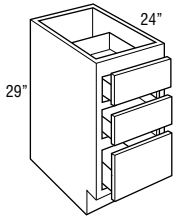

Model	Cubic Feet	Finish						
		Tori Oak	Westburke Oak	Tori Hickory Tori Maple	Loren Laminate Tori Cherry Westburke Hickory Westburke Maple Westburke PureStyle™	Galio Oak Gantrell Oak Kesper Oak Rensel Oak	Westburke Cherry	Brookway Oak Bryant Hickory Bryant Maple Bryant PureStyle™ Calio Maple Hurley Hickory Hurley Maple Kesper Maple Kessy Oak Rensel PureStyle™
		1	2	3	4	5	6	7
<b>DDR122924</b>	7.3	549	575	649	819	549	860	678
<b>DDR152924</b>	8.8	591	621	699	881	591	925	730
<b>DDR182924</b>	10.2	635	668	749	948	635	994	783
<b>DDR212924</b>	11.8	678	711	800	1012	678	1063	838
<b>DDR242924</b>	13.4	727	762	859	1085	727	1136	896

• DRWTK not available on DDR122924 and DDR152924.

**DESK FILE DRAWER BASE, 29" HIGH, 21" or 24" DEEP**

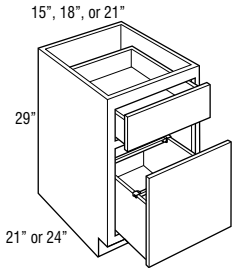

<b>DFD152921</b>	7.8	760	797	856	893	926	938	987
<b>DFD182921</b>	9.1	795	834	897	935	975	983	1037
<b>DFD212921</b>	10.5	841	882	950	992	1031	1041	1099
<b>DFD152924</b>	8.8	782	821	882	920	954	965	1017
<b>DFD182924</b>	10.2	819	860	924	964	1003	1013	1068
<b>DFD212924</b>	11.8	866	909	979	1022	1061	1072	1132

- Door is attached to file drawer.
- Includes Filing System Hardware Kit, which accommodates letter and legal filing.
- AUTHL and AUTHR not available on 21" deep.
- DRWTK not available on DFD152921, DFD182921, DFD212921, and DFD152924.
- Exterior height of file drawer is 10".

**DESK DOUBLE FILE DRAWER BASE, 29" HIGH, 21" or 24" DEEP**

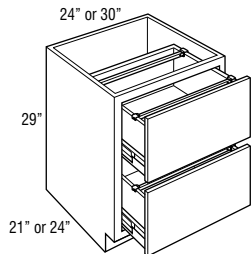

<b>DDFD242921</b>	11.9	984	1034	1113	1160	1205	1217	1288
<b>DDFD302921</b>	14.9	1084	1135	1222	1276	1325	1339	1417
<b>DDFD242924</b>	13.4	1013	1064	1145	1196	1241	1255	1325
<b>DDFD302924</b>	17.9	1116	1172	1260	1314	1365	1380	1459

- Includes Filing System Hardware Kit, which accommodates letter and legal filing.
- Bottom drawer utilizes 125 lb. full extension progressive sidemount guide, does not feature soft close guide.
- Bottom of drawer is not designed to support any weight.
- AUTHL and AUTHR not available on 21" deep.
- DRWTK not available on DDFD242921 and DDFD302921.
- Furniture board braces are utilized for drawer guide supports on end panels.
- Exterior height of drawer box is 9 1/2".

Model	Cubic Feet	Canterell Maple	Bryant Cherry Hurley Cherry Norris Maple Norris PureStyle™	Cairo Cherry Kasper Cherry Reist Cherry	Klewin Oak	Brockway Maple Canterell Cherry Kersey Hickory Kersey Maple Norris Cherry	Felix Hickory Felix Maple Forte Hickory Forte Maple Forte PureStyle™ Owens Maple Owens PureStyle™	Amico PureStyle™ Brockway Cherry Felix Cherry Forte Cherry Kersey Cherry Klewin Hickory Klewin Maple Owens Cherry	Adair Maple Adair PureStyle™ Keegan Maple	Wilero Maple	Adair Cherry Keegan Cherry	Klewin Cherry	Wilero Cherry
		8	9	10	11	12	13	14	15	16	17	18	19
DDR122924	7.3	612	774	805	673	817	703	737	776	776	883	847	883
DDR152924	8.8	658	833	867	724	879	757	794	834	834	953	910	953
DDR182924	10.2	707	895	930	777	946	813	852	897	897	1023	980	1023
DDR212924	11.8	757	956	994	832	1008	868	911	957	957	1094	1044	1094
DDR242924	13.4	811	1025	1066	892	1079	929	977	1028	1028	1172	1121	1172

Custom Modifications	AUTHL AUTHR	CBO	CCO	CFNTO	CFP	CFRMO	CND	DRWTK	FB	FPEB	FTK	ID	MIP	RD	RECTKALL RECTKBK	RECTKL RECTKR	RT	VTK
	•	•	•	•	•	•		•	•	•	•		•	•	•	•		•

Construction Upgrades	VPL	Smart Stop Options	INTGH	PG
	•			•

DFD152921	7.8	1028	1063	1104	1175	1180	1215	1275	1357	1357	1398	1403	1460
DFD182921	9.1	1080	1117	1160	1236	1241	1281	1343	1429	1429	1472	1477	1537
DFD212921	10.5	1146	1185	1234	1311	1319	1358	1426	1518	1518	1565	1570	1633

DFD152924	8.8	1059	1095	1138	1210	1214	1252	1314	1397	1397	1439	1444	1503
DFD182924	10.2	1114	1150	1197	1272	1278	1319	1385	1472	1472	1516	1521	1583
DFD212924	11.8	1180	1221	1270	1351	1358	1399	1469	1565	1565	1612	1617	1682

Custom Modifications	AUTHL AUTHR	CBO	CCO	CFNTO	CFP	CFRMO	CND	DRWTK	FB	FPEB	FTK	ID	MIP	RD	RECTKALL RECTKBK	RECTKL RECTKR	RT	VTK
	•	•	•			•		•	•	•	•		•		•	•		•

Construction Upgrades	VPL	Smart Stop Options	INTGH	PG
	•			STD

DDFD242921	11.9	1339	1388	1442	1534	1542	1589	1666	1776	1776	1830	1836	1910
DDFD302921	14.9	1473	1527	1587	1687	1696	1747	1834	1954	1954	2014	2020	2101

DDFD242924	13.4	1380	1429	1486	1579	1589	1637	1717	1831	1831	1886	1893	1969
DDFD302924	17.9	1516	1571	1635	1737	1748	1800	1888	2012	2012	2072	2080	2163

Custom Modifications	AUTHL AUTHR	CBO	CCO	CFNTO	CFP	CFRMO	CND	DRWTK	FB	FPEB	FTK	ID	MIP	RD	RECTKALL RECTKBK	RECTKL RECTKR	RT	VTK
	•	•	•			•		•	•	•	•		•		•	•		•

Construction Upgrades	VPL	Smart Stop Options	INTGH	PG
	•			

**WOOD TOPS, ONE SIDED, 22 1/2" or 25 1/2" DEEP**

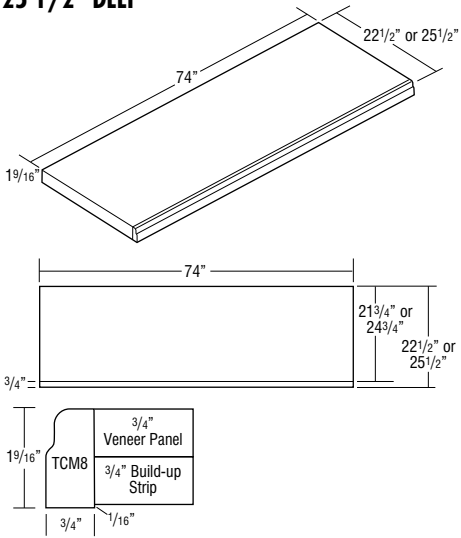

Model	Cubic Feet	Material Options						
		Tori Oak	Westburke Oak	Tori Hickory Tori Maple	Loren Laminare Tori Cherry Westburke Hickory Westburke Maple Westburke PureStyle™	Calio Oak Gantrell Oak Kesper Oak Reins Oak	Westburke Cherry	Brookway Oak Bryant Hickory Bryant Maple Bryant PureStyle™ Calio Maple Hurley Hickory Hurley Maple Kesper Maple Kesper Oak Reins PureStyle™ Reins PureStyle™
1TWT7221	3.8	859	859	859	859	859	859	859
1TWT7224	4.2	975	975	975	975	975	975	975

• 3/4" thick veneer over MDF panels with build-up strips to 1 1/2" thick and Traditional Countertop Moulding (TCM8) on front edge.

**WOOD TOPS, THREE SIDED, 22 1/2" or 25 1/2" DEEP**

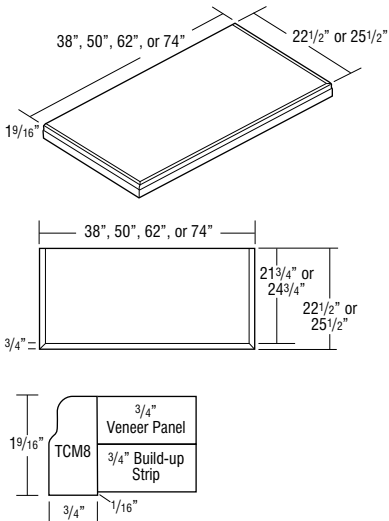

3TWT3621	2.0	491	491	491	491	491	491	491
3TWT4821	2.6	648	648	648	648	648	648	648
3TWT6021	3.2	803	803	803	803	803	803	803
3TWT7221	3.8	957	957	957	957	957	957	957
3TWT3624	2.2	556	556	556	556	556	556	556
3TWT4824	2.9	733	733	733	733	733	733	733
3TWT6024	3.6	909	909	909	909	909	909	909
3TWT7224	4.2	1086	1086	1086	1086	1086	1086	1086

• 3/4" thick veneer over MDF panels with build-up strips to 1 1/2" thick and Traditional Countertop Moulding (TCM8) on front and side edges.

Model	Overall Width	Overall Depth
3TWT3621	38"	22 1/2"
3TWT4821	50"	22 1/2"
3TWT6021	62"	22 1/2"
3TWT7221	74"	22 1/2"

Model	Overall Width	Overall Depth
3TWT3624	38"	25 1/2"
3TWT4824	50"	25 1/2"
3TWT6024	62"	25 1/2"
3TWT7224	74"	25 1/2"

Model	Cubic Feet	Control Maple	Bryant Cherry Hurley Cherry Norris Maple Norris PureStyle™	Cairo Cherry Kasper Cherry Reist Cherry	Klewin Oak	Brockway Maple Control Cherry Kersey Hickory Kersey Maple Norris Cherry	Felix Hickory Felix Maple Forte Hickory Forte Maple Forte PureStyle™ Owens Maple Owens PureStyle™	Antico PureStyle™ Brockway Cherry Felix Cherry Forte Cherry Kersey Hickory Klewin Hickory Klewin Maple Owens Cherry	Adair Maple Adair PureStyle™ Keegan Maple	Valero Maple	Adair Cherry Keegan Cherry	Klewin Cherry	Valero Cherry
		8	9	10	11	12	13	14	15	16	17	18	19
1TWT7221	3.8	859	859	859	859	859	859	859	859	859	859	859	859
1TWT7224	4.2	975	975	975	975	975	975	975	975	975	975	975	975

MODIFICATIONS
No modifications available for these products.

3TWT3621	2.0	491	491	491	491	491	491	491	491	491	491	491	491
3TWT4821	2.6	648	648	648	648	648	648	648	648	648	648	648	648
3TWT6021	3.2	803	803	803	803	803	803	803	803	803	803	803	803
3TWT7221	3.8	957	957	957	957	957	957	957	957	957	957	957	957
3TWT3624	2.2	556	556	556	556	556	556	556	556	556	556	556	556
3TWT4824	2.9	733	733	733	733	733	733	733	733	733	733	733	733
3TWT6024	3.6	909	909	909	909	909	909	909	909	909	909	909	909
3TWT7224	4.2	1086	1086	1086	1086	1086	1086	1086	1086	1086	1086	1086	1086

MODIFICATIONS
No modifications available for these products.

**UNDER COUNTER DRAWER, 4 3/4" HIGH, 21" DEEP**

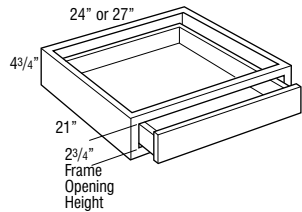

UCD2421  
UCD2721

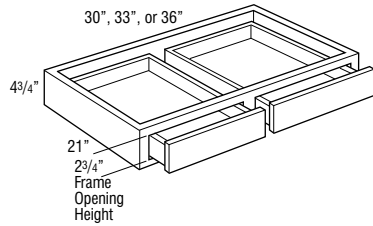

UCD3021  
UCD3321  
UCD3621

**FURNITURE DRAWER, 6 3/4" HIGH, 24" DEEP**

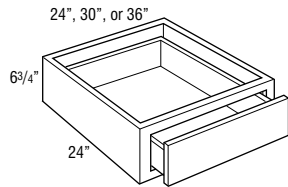

**FURNITURE DRAWER, 12" HIGH, 24" DEEP**

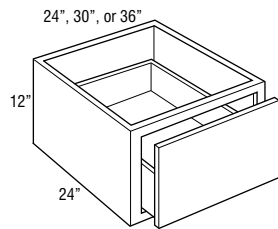

**FURNITURE DRAWER WINDOW BENCH, 18" HIGH, 24" DEEP**

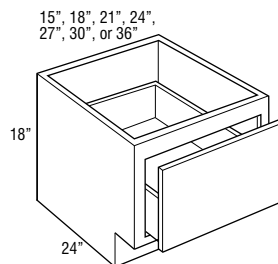

Model	Cubic Feet	Finish						
		Tori Oak	Westburke Oak	Tori Hickory Tori Maple	Loren Laminate Tori Cherry Westburke Hickory Westburke Maple Westburke PureStyle™	Calio Oak Gantrell Oak Kesper Oak Rensl Oak	Westburke Cherry	Brookway Oak Bryant Hickory Bryant Maple Calio Maple Hurley Hickory Hurley Maple Kesper Oak Kesper Maple Rensl PureStyle™ Rensl PureStyle™
		1	2	3	4	5	6	7
UCD2421	2.6	354	371	416	524	354	551	437
UCD2721	2.6	372	390	439	552	372	580	457
UCD3021	2.6	388	407	457	579	388	608	480
UCD3321	2.6	412	432	485	611	412	641	508
UCD3621	2.6	434	455	510	643	434	675	535



- Cabinet is 4 3/4" high. Drawer box within cabinet is 2" high (outside dimension).
- Not trimmable.
- Drawer front is 3/4" slab front.
- The frame to end panel offset is 3/4", which is designed to accommodate the vanity desk leg.
- End panels will feature non-matching laminate exterior.
- Rensi PureStyle™ drawer fronts will be painted hardwood.

FD2406.7524	3.3	398	417	454	553	398	581	469
FD3006.7524	4.1	598	628	676	807	598	848	688
FD3606.7524	4.9	633	664	715	856	633	900	731

- On partial overlay styles, drawer front to face frame is justified to the top to be consistent with current partial overlay reveal. Bottom reveal is 1/4".

FD241224	5.4	523	550	586	696	523	731	597
FD301224	6.6	712	748	804	959	712	1008	820
FD361224	7.9	752	792	852	1021	752	1071	869

- Drawer front to face frame reveal is justified to the bottom to be consistent with both full overlay and partial overlay. Top reveal is 1 1/8" for partial overlay and 3/8" for full overlay.
- Exterior height of drawer box is 6 3/8".

FDWB151824	4.9	701	737	764	873	701	918	763
FDWB181824	5.8	711	747	774	883	711	928	773
FDWB211824	6.7	722	758	784	893	722	939	783
FDWB241824	7.6	732	768	795	904	732	949	794
FDWB271824	8.4	752	788	815	924	752	969	814
FDWB301824	9.3	948	994	1037	1192	948	1253	1041
FDWB361824	11.1	1000	1048	1099	1265	1000	1329	1101

- Drawer front to face frame reveal is justified to the bottom to be consistent with both full overlay and partial overlay. Partial overlay top reveal is 2 5/8" and bottom reveal is 1". Full overlay top reveal is 1 7/8" and bottom reveal is 1/4".
- DRWTK not available on FDWB151824.
- Exterior height of drawer box is 6 3/8".

Model	Cubic Feet	Cantrill Maple	Bryant Cherry Hurley Cherry Norris Maple Norris PureStyle™	Cairo Cherry Kasper Cherry Reist Cherry	Klewin Oak	Brookway Maple Cantrill Cherry Kersey Hickory Kersey Maple Norris Cherry	Felix Hickory Felix Maple Forte Hickory Forte Maple Forte PureStyle™ Owens Maple Owens PureStyle™	Amico PureStyle™ Brookway Cherry Felix Cherry Forte Cherry Kersey Cherry Klewin Hickory Klewin Maple Owens Cherry	Adair Maple Adair PureStyle™ Keegan Maple	Valero Maple	Adair Cherry Keegan Cherry	Klewin Cherry	Valero Cherry
		8	9	10	11	12	13	14	15	16	17	18	19
UCD2421	2.6	393	499	518	420	523	441	463	469	469	523	527	529
UCD2721	2.6	413	524	545	443	551	463	484	487	487	551	555	557
UCD3021	2.6	433	550	571	465	578	483	508	508	508	578	583	586
UCD3321	2.6	457	580	602	490	609	512	538	542	542	609	616	618
UCD3621	2.6	481	611	634	516	641	539	566	570	570	641	648	651

Custom Modifications	AUTHL AUTHR	CBO	CCO	CFNTO	CFP	CFRMO	CND	DRWTK	FB	FPEB	FTK	ID	MIP	RD	RECTKALL RECTKBK	RECTKL RECTKR	RT	VTK
		•	•	•		•			•	•			•	•				

Construction Upgrades	VPL	Smart Stop Options	INTGH	PG
	•			•

FD2406.7524	3.3	430	524	545	468	552	482	506	529	529	591	570	591
FD3006.7524	4.1	638	764	795	691	805	710	745	775	775	856	827	856
FD3606.7524	4.9	676	813	846	733	854	752	792	822	822	911	880	911

Custom Modifications	AUTHL AUTHR	CBO	CCO	CFNTO	CFP	CFRMO	CND	DRWTK	FB	FPEB	FTK	ID	MIP	RD	RECTKALL RECTKBK	RECTKL RECTKR	RT	VTK
		•	•			•			•	•			•	•				

Construction Upgrades	VPL	Smart Stop Options	INTGH	PG
	STD			STD

FD241224	5.4	553	659	686	599	694	614	646	670	670	738	712	738
FD301224	6.6	759	910	947	822	957	846	887	922	922	1019	984	1019
FD361224	7.9	805	966	1005	872	1018	896	943	980	980	1086	1047	1086

Custom Modifications	AUTHL AUTHR	CBO	CCO	CFNTO	CFP	CFRMO	CND	DRWTK	FB	FPEB	FTK	ID	MIP	RD	RECTKALL RECTKBK	RECTKL RECTKR	RT	VTK
		•	•	•		•			•	•			•	•				

Construction Upgrades	VPL	Smart Stop Options	INTGH	PG
	STD			STD

FDWB151824	4.9	719	825	861	772	870	782	821	848	848	912	890	912
FDWB181824	5.8	729	836	872	782	880	793	832	858	858	922	901	922
FDWB211824	6.7	739	846	882	793	890	803	842	869	869	932	911	932
FDWB241824	7.6	749	856	892	803	901	813	852	879	879	943	921	943
FDWB271824	8.4	770	877	913	823	921	834	873	900	900	963	942	963
FDWB301824	9.3	980	1130	1176	1051	1188	1068	1122	1155	1155	1249	1216	1249
FDWB361824	11.1	1037	1201	1248	1113	1262	1131	1187	1226	1226	1326	1292	1326

Custom Modifications	AUTHL AUTHR	CBO	CCO	CFNTO	CFP	CFRMO	CND	DRWTK	FB	FPEB	FTK	ID	MIP	RD	RECTKALL RECTKBK	RECTKL RECTKR	RT	VTK
		•	•	•		•		•	•	•	•		•	•	•	•		•

Construction Upgrades	VPL	Smart Stop Options	INTGH	PG
	STD			STD

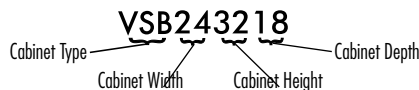

Vanity Cabinets are shipped with an unfinished toekick. Finished toekicks in matching wood veneer or laminate must be ordered separately and field installed.

**NOTE:**

Distance between back of drawer box and back interior of cabinet is 2 3/4".

All vanity cabinets are predrilled for full depth shelves or roll trays.

**VANITY SINK BASE with FALSE PANEL, 32" HIGH, 18" or 21" DEEP**

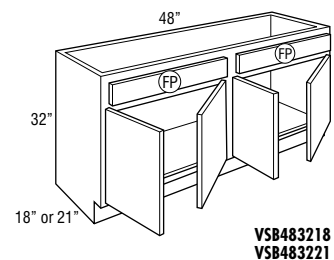
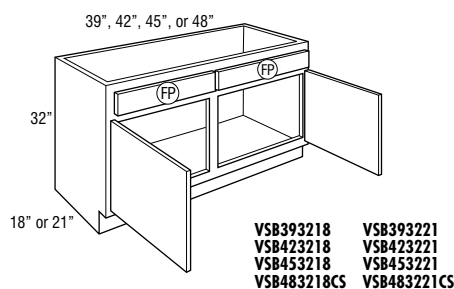
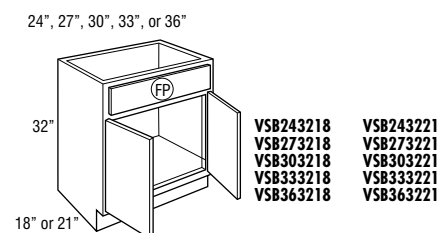
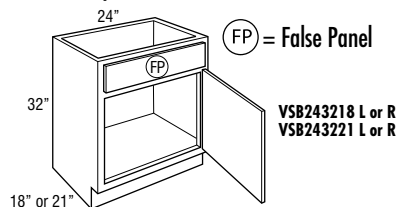

Model	Cubic Feet	Toekicks						
		Tori Oak	Westburke Oak	Tori Hickory Tori Maple	Loren Laminate Tori Cherry Westburke Hickory Westburke Maple Westburke PureStyle™	Callo Oak Ginnell Oak Kasper Oak Reins Oak	Westburke Cherry	Brockway Oak Bryant Hickory Bryant Maple Bryant PureStyle™ Callo Maple Honey Hickory Honey Maple Kasper Maple Reins Oak Reins Maple Reins PureStyle™
VSB243218 L or R	10.4	470	493	546	574	601	602	654
VSB243221 L or R	11.9	470	493	546	574	601	602	654
<b>VSB243218</b>	10.4	499	524	578	609	635	638	688
<b>VSB273218</b>	11.6	510	536	593	623	652	654	710
<b>VSB303218</b>	12.7	527	554	614	647	676	678	736
<b>VSB333218</b>	13.9	551	579	639	674	704	707	766
<b>VSB363218</b>	15.1	573	601	664	702	733	736	797
<b>VSB243221</b>	11.9	499	524	578	609	635	638	688
<b>VSB273221</b>	13.3	510	536	593	623	652	654	710
<b>VSB303221</b>	14.6	527	554	614	647	676	678	736
<b>VSB333221</b>	16.0	551	579	639	674	704	707	766
<b>VSB363221</b>	17.4	573	601	664	702	733	736	797
<b>VSB393218</b>	16.5	597	627	693	731	764	767	831
<b>VSB423218</b>	17.5	621	652	721	760	794	797	865
<b>VSB453218</b>	18.7	653	685	759	797	832	838	908
<b>VSB483218CS</b>	19.9	711	748	831	874	918	920	1002
<b>VSB393221</b>	18.9	597	627	693	731	764	767	831
<b>VSB423221</b>	20.1	621	652	721	760	794	797	865
<b>VSB453221</b>	20.8	653	685	759	797	832	838	908
<b>VSB483221CS</b>	22.9	711	748	831	874	918	920	1002
<b>VSB483218</b>	19.9	739	776	858	902	946	948	1030
<b>VSB483221</b>	22.9	739	776	858	902	946	948	1030

- CMAT not available on VSB393221, VSB423221, VSB453221, VSB483221CS, and 18" deep vanities.
- ID and TOTSS not available on VSB483218CS and VSB483221CS.
- PG available only on VSB483218CS and VSB483221CS.

CUSTOM MODIFICATIONS			
Mod.	Description	Mod.	Description
AUTHL	Authentic End - Left	FTK	Flush Toekick
AUTHR	Authentic End - Right	ID	Increased Depth
CBO	Cabinet Box Only	MIP	Matching Interior Plywood
CCO	Cabinet Case Only	RD	Reduced Depth
CFNTO	Cabinet Front Only	RECTKALL	Recessed Island Toekick
CFP	Cabinet False Panel	RECTKBK	Recessed Toekick Back
CFRMO	Cabinet Frame Only	RECTKL	Recessed Toekick Left
CMAT	CabMat™	RECTKR	Recessed Toekick Right
CND	Cabinet with No Door, with Drawer	RT	Installed Rol Tray
FB	Finished Ends	TOTSS	Tilt-Out Tray, Stainless Steel
FPEB	Furniture Finished Plywood End Panels	VTK	Void Toekick

CONSTRUCTION UPGRADES	
Mod.	Description
VPL	All Plywood with Laminate Ends

SMART STOP OPTIONS	
Mod.	Description
INTGH	Smart Stop Premium Hinge
PG	Smart Stop Premium Drawer Guide and Dovetail Box

MODIFICATIONS GRID KEY	
•	Available
STD	Standard on these cabinets
L O G I X	Logix Organization Cabinet

Model	Cubic Feet	Central Maple	Bryant Cherry Haley Cherry Morris Maple Morris PureStyle™	Calio Cherry Kasper Cherry Reini Cherry	Klewin Oak	Brookway Maple Central Cherry Kersay Hickory Kersay Maple Morris Cherry	Felix Hickory Felix Maple Forte Hickory Forte Maple Forte PureStyle™ Owens Maple Owens PureStyle™	Amico PureStyle™ Brookway Cherry Felix Cherry Forte Cherry Kersay Hickory Klewin Hickory Klewin Maple Owens Cherry	Adair Maple Adair PureStyle™ Keegan Maple	Valero Maple	Adair Cherry Keegan Cherry	Klewin Cherry	Valero Cherry
		8	9	10	11	12	13	14	15	16	17	18	19
<b>VSB243218 L or R</b>	10.4	685	712	741	795	798	830	871	887	933	960	963	1012
<b>VSB243221 L or R</b>	11.9	685	712	741	795	798	830	871	887	933	960	963	1012
<b>VSB243218</b>	10.4	724	752	783	844	845	878	922	940	988	1014	1019	1067
<b>VSB273218</b>	11.6	745	775	806	865	868	900	947	964	1016	1043	1047	1098
<b>VSB303218</b>	12.7	771	803	834	895	898	933	980	1000	1052	1084	1087	1138
<b>VSB333218</b>	13.9	804	834	868	932	934	975	1021	1041	1096	1125	1130	1184
<b>VSB363218</b>	15.1	838	869	904	971	976	1013	1063	1084	1138	1173	1176	1235
<b>VSB243221</b>	11.9	724	752	783	844	845	878	922	940	988	1014	1019	1067
<b>VSB273221</b>	13.3	745	775	806	865	868	900	947	964	1016	1043	1047	1098
<b>VSB303221</b>	14.6	771	803	834	895	898	933	980	1000	1052	1084	1087	1138
<b>VSB333221</b>	16.0	804	834	868	932	934	975	1021	1041	1096	1125	1130	1184
<b>VSB363221</b>	17.4	838	869	904	971	976	1013	1063	1084	1138	1173	1176	1235
<b>VSB393218</b>	16.5	873	906	943	1013	1017	1056	1108	1129	1187	1221	1224	1286
<b>VSB423218</b>	17.5	907	943	981	1053	1058	1098	1153	1174	1236	1269	1273	1336
<b>VSB453218</b>	18.7	952	988	1029	1104	1111	1154	1210	1234	1297	1332	1337	1402
<b>VSB483218CS</b>	19.9	1052	1094	1138	1226	1228	1279	1344	1369	1443	1483	1489	1565
<b>VSB393221</b>	18.9	873	906	943	1013	1017	1056	1108	1129	1187	1221	1224	1286
<b>VSB423221</b>	20.1	907	943	981	1053	1058	1098	1153	1174	1236	1269	1273	1336
<b>VSB453221</b>	20.8	952	988	1029	1104	1111	1154	1210	1234	1297	1332	1337	1402
<b>VSB483221CS</b>	22.9	1052	1094	1138	1226	1228	1279	1344	1369	1443	1483	1489	1565
<b>VSB483218</b>	19.9	1079	1122	1166	1254	1256	1307	1371	1397	1471	1511	1516	1592
<b>VSB483221</b>	22.9	1079	1122	1166	1254	1256	1307	1371	1397	1471	1511	1516	1592

Custom Modifications	AUTHL AUTHR	CBO	CCO	CFNTO	CFP	CFRMO	CMAT	CND	FB	FPEB	FTK	ID	MIP	RD	RECTKALL RECTKBK	RECTKL RECTKR	RT	TOTSS	VTK
	•		•	•	STD	•	•	•	•	•	•	•	•	•	•	•	•	•	•

Construction Upgrades	VPL	Smart Stop Options	INTGH	PG
	•		•	•



**VANITY SINK BASE with FALSE PANEL,  
34 1/2" HIGH, 21" DEEP**

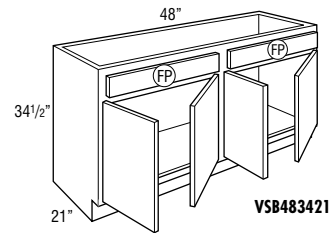
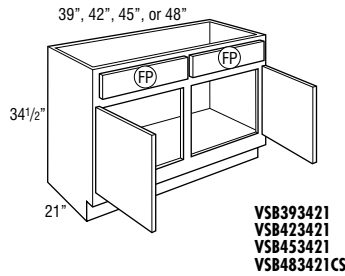
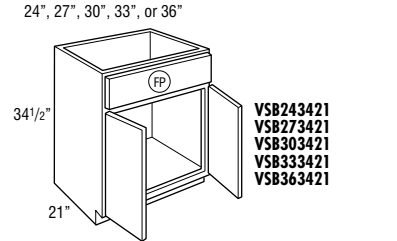
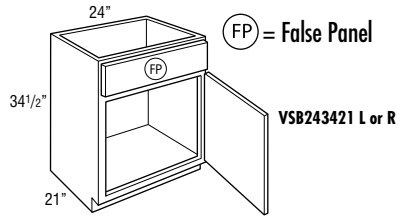

Model	Cubic Feet	Finish						
		Tori Oak	Westburke Oak	Tori Hickory Tori Maple	Loren Laminate Tori Cherry Westburke Hickory Westburke Maple Westburke PureStyle™	Calio Oak Cantrell Oak Kesper Oak Rensl Oak	Westburke Cherry	Brookway Oak Bryant Hickory Bryant Maple Calio Maple Hurley Hickory Hurley Maple Kesper Maple Kessy Oak Rensl PureStyle™
		1	2	3	4	5	6	7
VSB243421 L or R	14.4	555	583	648	681	712	714	771
VSB243421	14.4	570	598	661	694	729	730	792
VSB273421	16.1	573	601	668	702	733	736	798
VSB303421	17.7	593	623	690	728	760	764	825
VSB333421	19.6	617	648	713	751	787	791	856
VSB363421	21.1	640	673	742	783	819	822	892
VSB393421	22.3	672	706	780	822	860	864	937
VSB423421	24.4	704	739	818	860	901	904	981
VSB453421	22.4	739	776	858	904	948	949	1030
VSB483421CS	27.7	799	841	932	985	1031	1036	1126
VSB483421	27.7	827	869	960	1013	1059	1064	1153

- CMAT not available on VSB393421, VSB423421, VSB453421, and VSB483421CS.
- ID and TOTSS not available on VSB483421CS.
- PG available only on VSB483421CS.

**VANITY SINK BASE SUPERCABINET™  
with TILT-OUT TRAYS, 34 1/2" HIGH,  
21" DEEP**

LOGIX

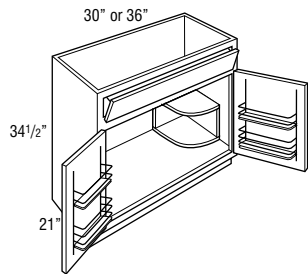

VSSB303421ST	17.7	1206	1236	1304	1341	1372	1376	1439
VSSB363421ST	21.1	1254	1286	1355	1396	1432	1435	1505

- Quarter Round Reversible Shelf for left or right applications will be constructed from 3/4" thick laminated furniture board (shelf shipped secure, can be positioned in left or right corner).
- Bath doors will have chrome & wood two-tiered 3 1/4" deep racks.
- Racks on doors are 3 1/4" deep.
- Includes 2 installed tilt-out trays.
- Tilt-out trays are stain resistant, moisture resistant plastic to allow storage of sponges & other cleaning materials.
- Tilt-out trays are also available as an accessory for field installation. See page 295.
- All load bearing service meet KCMA standards of 15 lbs. per square foot.

Model	Cubic Feet	Canterl Maple	Bryant Cherry Hurley Cherry Norris Maple Norris PureStyle™	Cairo Cherry Kasper Cherry Reist Cherry	Klewin Oak	Brookway Maple Canterl Cherry Kersey Hickory Kersey Maple Norris Cherry	Falk Hickory Falk Maple Forte Hickory Forte Maple Forte PureStyle™ Owens Maple Owens PureStyle™	Antico PureStyle™ Brookway Cherry Falk Cherry Forte Cherry Kersey Cherry Klewin Hickory Klewin Maple Owens Cherry	Adair Maple Adair PureStyle™ Keegan Maple	Valero Maple	Adair Cherry Keegan Cherry	Klewin Cherry	Valero Cherry
		8	9	10	11	12	13	14	15	16	17	18	19
VSB243421 L or R	14.4	813	844	877	944	948	984	1033	1053	1106	1138	1143	1200
VSB243421	14.4	831	864	897	964	967	1005	1057	1076	1132	1163	1170	1225
VSB273421	16.1	838	869	904	971	976	1013	1063	1086	1142	1173	1178	1235
VSB303421	17.7	867	900	935	1008	1009	1051	1101	1124	1182	1214	1218	1278
VSB333421	19.6	898	932	968	1041	1047	1089	1142	1162	1224	1259	1262	1324
VSB363421	21.1	934	970	1011	1087	1089	1131	1187	1210	1273	1309	1314	1378
VSB393421	22.3	982	1019	1062	1140	1143	1188	1247	1271	1336	1375	1380	1446
VSB423421	24.4	1028	1067	1112	1194	1197	1245	1307	1330	1400	1441	1444	1515
VSB453421	22.4	1077	1122	1166	1255	1256	1309	1372	1397	1471	1511	1516	1592
VSB483421CS	27.7	1180	1228	1278	1374	1379	1435	1509	1537	1619	1665	1671	1754
VSB483421	27.7	1208	1256	1306	1402	1406	1463	1537	1565	1647	1693	1698	1782

Custom Modifications	AUTHL AUTHR	CBO	CCO	CFNT0	CFP	CFRMO	CMAT	CND	FB	FPEB	FTK	ID	MIP	RD	RECTKALL RECTKBK	RECTKL RECTKR	RT	TOTSS	VTK
			•	•	STD	•	•	•		•	•	•	•	•	•	•	•	•	•

Construction Upgrades	VPL	Smart Stop Options	INTGH	PG
	•		•	•

VSSB303421ST	17.7	1479	1512	1549	1621	1622	1664	1715	1736	1796	1828	1832	1890
VSSB363421ST	21.1	1548	1584	1623	1699	1701	1745	1801	1824	1886	1921	1926	1991

Custom Modifications	AUTHL AUTHR	CBO	CCO	CFNT0	CFP	CFRMO	CMAT	CND	FB	FPEB	FTK	ID	MIP	RD	RECTKALL RECTKBK	RECTKL RECTKR	RT	TOTSS	VTK
	•	•	•	•		•		•	•	•	•	•	•		•	•			•

Construction Upgrades	VPL	Smart Stop Options	INTGH	PG
	•		•	

**VANITY BASE, SINGLE DOOR with DRAWER, 32" HIGH, 21" DEEP**

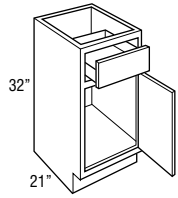

Model	Cubic Feet	Finish						
		Tori Oak	Westburke Oak	Tori Hickory Tori Maple	Loren Laminate Tori Cherry Westburke Hickory Westburke Maple Westburke PureStyle™	Galio Oak Gantrell Oak Kesper Oak Rensel Oak	Westburke Cherry	Brookway Oak Bryant Hickory Bryant Maple Bryant PureStyle™ Calio Maple Hurley Hickory Hurley Maple Kesper Maple Kesper Oak Rensel PureStyle™
		1	2	3	4	5	6	7
VB123221 L or R	6.4	424	445	493	522	544	549	593
VB153221 L or R	7.8	457	481	531	560	585	588	638
VB183221 L or R	9.1	486	511	566	595	623	625	680
VB213221 L or R	10.5	521	546	602	635	662	668	723
VB243221 L or R	11.9	553	581	641	677	708	710	770

**VANITY BASE, SINGLE DOOR with DRAWER, 34 1/2" HIGH, 21" DEEP**

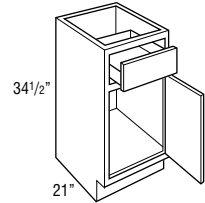

VB123421 L or R	7.8	450	474	525	552	578	580	628
VB153421 L or R	9.4	485	510	565	594	621	624	676
VB183421 L or R	11.1	515	541	599	631	658	663	719
VB213421 L or R	12.8	551	579	639	674	704	707	766
VB243421 L or R	14.4	587	617	681	715	749	751	816

**VANITY BASE, DOUBLE DOOR with DRAWER, 32" HIGH, 21" DEEP**

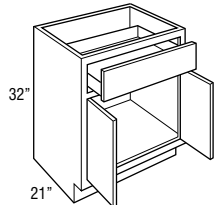

VB243221	11.9	582	611	674	710	742	746	809
----------	------	-----	-----	-----	-----	-----	-----	-----

**VANITY BASE, DOUBLE DOOR with DRAWER, 34 1/2" HIGH, 21" DEEP**

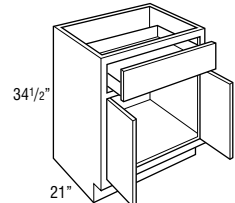

VB243421	14.4	617	648	714	752	787	792	855
----------	------	-----	-----	-----	-----	-----	-----	-----

Model	Cubic Feet	Canthal Maple	Bryant Cherry Hurley Cherry Norris Maple Norris PureStyle™	Cairo Cherry Kasper Cherry Reist Cherry	Klewin Oak	Brookway Maple Canthal Cherry Kersey Hickory Kersey Maple Norris Cherry	Felix Hickory Felix Maple Forte Hickory Forte Maple Forte PureStyle™ Owens Maple Owens PureStyle™	Antico PureStyle™ Brookway Cherry Felix Cherry Forte Cherry Kersey Cherry Klewin Hickory Klewin Maple Owens Cherry	Adair Maple Adair PureStyle™ Keegan Maple	Valero Maple	Adair Cherry Keegan Cherry	Klewin Cherry	Valero Cherry
		8	9	10	11	12	13	14	15	16	17	18	19
VB123221 L or R	6.4	622	647	673	722	724	751	790	806	848	872	875	918
VB153221 L or R	7.8	669	694	722	776	779	811	850	867	912	939	941	987
VB183221 L or R	9.1	711	739	769	825	828	861	906	922	970	996	1001	1049
VB213221 L or R	10.5	758	788	819	880	882	920	964	983	1034	1062	1066	1118
VB243221 L or R	11.9	807	840	874	937	941	978	1025	1044	1099	1130	1133	1189

Custom Modifications	AUTHL AUTHR	CBO	CCO	CFNT0	CFP	CFRMO	CMAT	CND	FB	FPEB	FTK	ID	MIP	RD	RECTKALL RECTKBK	RECTKL RECTKR	RT	TOTSS	VTK
	•	•	•	•	•	•		•	•	•	•	•	•	•	•	•	•		•

Construction Upgrades	VPL	Smart Stop Options	INTGH	PG
	•		•	•

VB123421 L or R	7.8	658	685	712	766	769	799	840	853	898	923	927	971
VB153421 L or R	9.4	708	736	765	822	825	858	901	920	966	994	996	1047
VB183421 L or R	11.1	756	783	815	876	879	915	958	979	1030	1058	1061	1114
VB213421 L or R	12.8	804	834	868	932	934	975	1021	1041	1096	1125	1130	1184
VB243421 L or R	14.4	855	889	925	993	996	1036	1089	1105	1165	1200	1203	1262

Custom Modifications	AUTHL AUTHR	CBO	CCO	CFNT0	CFP	CFRMO	CMAT	CND	FB	FPEB	FTK	ID	MIP	RD	RECTKALL RECTKBK	RECTKL RECTKR	RT	TOTSS	VTK
	•	•	•	•	•	•		•	•	•	•	•	•	•	•	•	•		•

Construction Upgrades	VPL	Smart Stop Options	INTGH	PG
	•		•	•

VB243221	11.9	848	881	918	984	987	1028	1076	1097	1154	1187	1190	1250
----------	------	-----	-----	-----	-----	-----	------	------	------	------	------	------	------

Custom Modifications	AUTHL AUTHR	CBO	CCO	CFNT0	CFP	CFRMO	CMAT	CND	FB	FPEB	FTK	ID	MIP	RD	RECTKALL RECTKBK	RECTKL RECTKR	RT	TOTSS	VTK
	•	•	•	•	•	•		•	•	•	•	•	•	•	•	•	•		•

Construction Upgrades	VPL	Smart Stop Options	INTGH	PG
	•		•	•

VB243421	14.4	898	933	970	1042	1047	1089	1142	1162	1224	1260	1262	1325
----------	------	-----	-----	-----	------	------	------	------	------	------	------	------	------

Custom Modifications	AUTHL AUTHR	CBO	CCO	CFNT0	CFP	CFRMO	CMAT	CND	FB	FPEB	FTK	ID	MIP	RD	RECTKALL RECTKBK	RECTKL RECTKR	RT	TOTSS	VTK
	•	•	•	•	•	•		•	•	•	•	•	•	•	•	•	•		•

Construction Upgrades	VPL	Smart Stop Options	INTGH	PG
	•		•	•

**VANITY DRAWER BASE,  
32" HIGH, 21" DEEP**

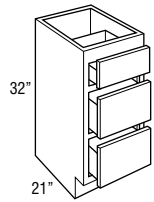

Model	Cubic Feet	Westburke Oak		Tori Hickory Tori Maple	Loren Laminate Tori Cherry Westburke Hickory Westburke Maple Westburke PureStyle™	Caho Oak Gantrell Oak Kesper Oak Renaist Oak		Westburke Cherry	Brookway Oak Bryant Hickory Bryant Maple Bryant PureStyle™ Caho Maple Hurley Hickory Hurley Maple Kesper Maple Kesper Oak Renaist Maple Renaist PureStyle™	
		1	2	3	4	5	6	7		
VDB123221	6.4	531	558	628	794	531	833	657		
VDB153221	7.8	573	601	678	855	573	898	708		
VDB183221	9.1	617	648	729	920	617	965	761		
VDB213221	10.5	657	691	778	982	657	1032	813		
VDB243221	11.9	705	740	834	1051	705	1103	871		

**VANITY DRAWER BASE,  
34 1/2" HIGH, 21" DEEP**

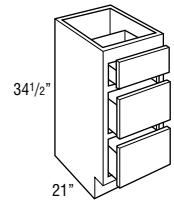

VDB123421	7.8	584	613	690	869	584	912	719
VDB153421	9.4	627	658	741	934	627	982	775
VDB183421	11.1	674	707	796	1004	674	1056	831
VDB213421	12.8	720	757	851	1072	720	1127	889
VDB243421	14.4	771	810	912	1149	771	1207	953

**VANITY PULL-OUT,  
34 1/2" HIGH, 21" DEEP**

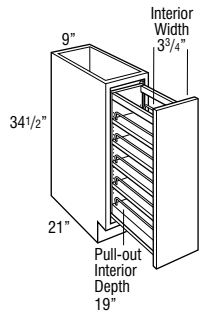

LOGIX

VP93421	4.9	1105	1149	1244	1297	1348	1351	1446
---------	-----	------	------	------	------	------	------	------

- All styles feature a natural finish full extension wood pull-out with adjustable shelves and chrome rail sides.
- Pull-out does not have Smart Stop feature.

Model	Cubic Feet	Countertop	Bryant Cherry Hurley Cherry Norris Maple Norris PureStyle™	Cairo Cherry Kasper Cherry Reist Cherry	Klewin Oak	Brockway Maple Countertop Kersey Hickory Kersey Maple Norris Cherry	Felix Hickory Felix Maple Forte Hickory Forte Maple Forte PureStyle™ Owens Maple Owens PureStyle™	Amico PureStyle™ Brockway Cherry Felix Cherry Forte Cherry Kersey Cherry Klewin Hickory Klewin Maple Owens Cherry	Adair Maple Adair PureStyle™ Keegan Maple	Valero Maple	Adair Cherry Keegan Cherry	Klewin Cherry	Valero Cherry
		8	9	10	11	12	13	14	15	16	17	18	19
VDB123221	6.4	593	750	781	653	793	682	714	752	752	858	821	858
VDB153221	7.8	640	810	842	704	853	735	771	810	810	925	883	925
VDB183221	9.1	686	869	904	756	918	790	827	871	871	993	951	993
VDB213221	10.5	735	928	965	809	980	844	884	929	929	1062	1014	1062
VDB243221	11.9	787	995	1035	866	1048	902	949	995	995	1136	1088	1136

Custom Modifications	AUTHL AUTHR	CBO	CCO	CFNT0	CFP	CFRMO	CMAT	CND	FB	FPEB	FTK	ID	MIP	RD	RECTKALL RECTKBK	RECTKL RECTKR	RT	TOTSS	VTK
	•	•	•	•	•	•			•	•	•	•	•	•	•	•			•

Construction Upgrades	VPL	Smart Stop Options	INTGH	PG
	•			•

VDB123421	7.8	651	823	856	714	867	746	783	823	823	941	898	941
VDB153421	9.4	701	886	922	771	932	805	845	886	886	1014	967	1014
VDB183421	11.1	750	951	988	825	1002	861	906	951	951	1088	1036	1088
VDB213421	12.8	804	1017	1059	886	1070	923	967	1017	1017	1161	1112	1161
VDB243421	14.4	860	1090	1131	947	1147	986	1035	1090	1090	1243	1187	1243

Custom Modifications	AUTHL AUTHR	CBO	CCO	CFNT0	CFP	CFRMO	CMAT	CND	FB	FPEB	FTK	ID	MIP	RD	RECTKALL RECTKBK	RECTKL RECTKR	RT	TOTSS	VTK
	•	•	•	•	•	•			•	•	•	•	•	•	•	•			•

Construction Upgrades	VPL	Smart Stop Options	INTGH	PG
	•			•

VP93421	4.9	1507	1556	1609	1711	1717	1774	1851	1881	1969	2017	2023	2112
---------	-----	------	------	------	------	------	------	------	------	------	------	------	------

Custom Modifications	AUTHL AUTHR	CBO	CCO	CFNT0	CFP	CFRMO	CMAT	CND	FB	FPEB	FTK	ID	MIP	RD	RECTKALL RECTKBK	RECTKL RECTKR	RT	TOTSS	VTK
	•	•	•			•			•	•	•		•			•			•

Construction Upgrades	VPL	Smart Stop Options	INTGH	PG
	•			

**VANITY SINK DRAWER BASE,  
32" HIGH, 21" DEEP**

Model	Cubic Feet	Finish						
		Tori Oak	Westburke Oak	Tori Hickory Tori Maple	Loren Laminate Tori Cherry Westburke Hickory Westburke Maple Westburke PureStyle™	Calio Oak Gantrell Oak Kesper Oak Reinsl Oak	Westburke Cherry	Brookway Oak Bryant Hickory Bryant Maple Calio Maple Hurley Hickory Hurley Maple Kesper Maple Kessy Oak Reinsl PureStyle™ Reinsl PureStyle™
		1	2	3	4	5	6	7
<b>2VSD363221</b>	17.4	732	768	847	893	933	938	1017
<b>2VSD423221</b>	20.1	841	882	977	1028	1074	1077	1171
<b>2VSD453221</b>	21.3	875	918	1015	1067	1116	1119	1217
<b>2VSD483221 CS</b>	22.9	880	925	1025	1078	1131	1134	1236
<b>2VSD483221</b>	22.9	908	953	1053	1106	1159	1162	1263
<b>2VSD543221FP</b>	25.2	977	1024	1132	1190	1247	1252	1359
<b>2VSD57/603221FP</b>	27.6	1034	1087	1201	1262	1322	1325	1440

- AUTHL and AUTHR not available on 2VSD57/603221FP.
- CMAI not available on 2VSD423221, 2VSD453221, and 2VSD483221CS.
- ID and TOTSS not available on 2VSD483221CS.
- RT not available on 2VSD543221FP and 2VSD57/603221FP.

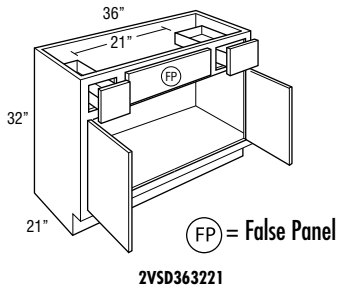

**2VSD363221**

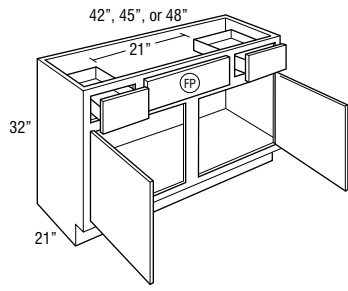

**2VSD423221  
2VSD453221  
2VSD483221CS**

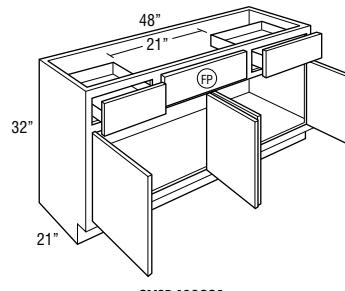

**2VSD483221**

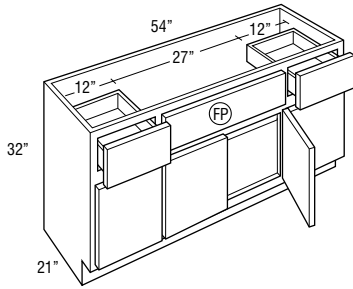

**2VSD543221FP**

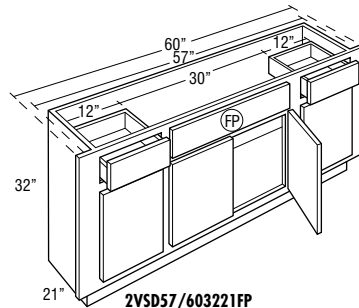

**2VSD57/603221FP**

Model	Cubic Feet	Countertop Maple	Bryant Cherry Hurley Cherry Norris Maple Norris PureStyle™	Cairo Cherry Kasper Cherry Reist Cherry	Klewin Oak	Brockway Maple Countertop Cherry Kersey Hickory Kersey Maple Norris Cherry	Felix Hickory Felix Maple Forte Hickory Forte Maple Forte PureStyle™ Owens Maple Owens PureStyle™	Amico PureStyle™ Brockway Cherry Felix Cherry Forte Cherry Kersey Cherry Klewin Hickory Klewin Maple Owens Cherry	Adair Maple Adair PureStyle™ Keegan Maple	Valero Maple	Adair Cherry Keegan Cherry	Klewin Cherry	Valero Cherry
	8	9	10	11	12	13	14	15	16	17	18	19	
2VSD363221	17.4	1067	1104	1150	1239	1241	1293	1357	1381	1455	1497	1501	1574
2VSD423221	20.1	1226	1273	1325	1425	1428	1485	1559	1587	1669	1717	1725	1807
2VSD453221	21.3	1275	1324	1378	1481	1485	1544	1621	1651	1737	1786	1794	1879
2VSD483221CS	22.9	1295	1347	1402	1510	1514	1575	1654	1687	1777	1827	1834	1923
2VSD483221	22.9	1323	1374	1430	1538	1542	1603	1682	1715	1805	1855	1862	1951
2VSD543221FP	25.2	1424	1478	1538	1652	1659	1723	1808	1842	1940	1993	2002	2100
2VSD57/603221FP	27.6	1509	1568	1631	1752	1755	1828	1917	1954	2057	2114	2120	2225

Custom Modifications	AUTHL AUTHR	CBO	CCO	CFNT0	CFP	CFRMO	CMAT	CND	FB	FPFB	FTK	ID	MIP	RD	RECTKALL RECTKBK	RECTKL RECTKR	RT	TOTSS	VTK
	•	•	•	•	•	•	•	•	•	•	•	•	•	•	•	•	•	•	•

Construction Upgrades	VPL	Smart Stop Options	INTGH	PG
	•		•	•



**VANITY SINK DRAWER BASE,  
34 1/2" HIGH, 21" DEEP**

Model	Cubic Feet	Finish						
		Tori Oak	Westburke Oak	Tori Hickory Tori Maple	Loren Laminate Tori Cherry Westburke Hickory Westburke Maple Westburke PureStyle™	Galio Oak Gantrell Oak Kesper Oak Reinsl Oak	Westburke Cherry	Brockway Oak Bryant Hickory Bryant Maple Bryant PureStyle™ Calio Maple Hurley Hickory Hurley Maple Kesper Maple Kessy Oak Reinsl PureStyle™ Reinsl PureStyle™
		1	2	3	4	5	6	7
<b>2VSD363421</b>	16.5	819	860	951	1001	1047	1049	1142
<b>2VSD423421</b>	19.2	943	989	1093	1149	1203	1207	1311
<b>2VSD453421</b>	22.8	980	1028	1137	1196	1251	1255	1362
<b>2VSD483421 CS</b>	21.9	988	1039	1152	1213	1271	1276	1386
<b>2VSD483421</b>	21.9	1016	1067	1180	1241	1298	1304	1414
<b>2VSD543421FP</b>	24.5	1093	1147	1268	1334	1396	1401	1521
<b>2VSD57/603421FP</b>	27.2	1157	1214	1344	1415	1479	1484	1611

- AUTHL and AUTHR not available on 2VSD57/603421FP.
- CMAI not available on 2VSD423421, 2VSD453421, and 2VSD483421CS.
- ID and TOTSS not available on 2VSD483421CS.
- RT not available on 2VSD543421FP and 2VSD57/603421FP.

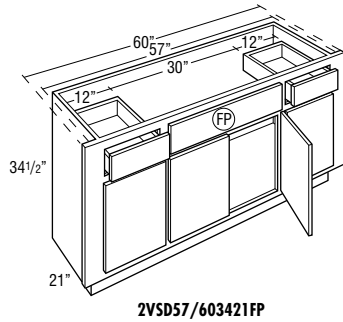
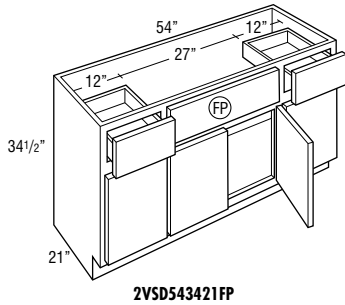
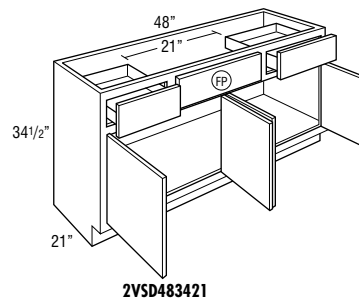
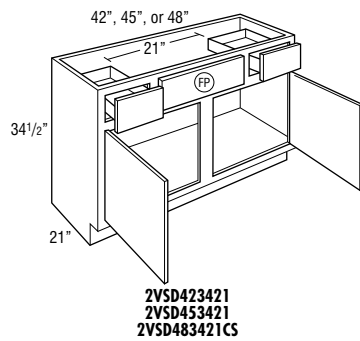
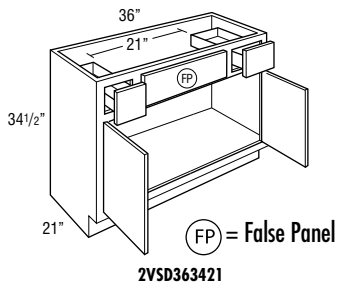

Model	Cubic Feet	Countertop	Bryant Cherry Hurley Cherry Norris Maple Norris PureStyle™	Cairo Cherry Kasper Cherry Reist Cherry	Klewin Oak	Brookway Maple Countertop Kersey Hickory Kersey Maple Norris Cherry	Felix Hickory Felix Maple Forte Hickory Forte Maple Forte PureStyle™ Owens Maple Owens PureStyle™	Amico PureStyle™ Brookway Cherry Felix Cherry Forte Cherry Kersey Cherry Klewin Hickory Klewin Maple Owens Cherry	Adair Maple Adair PureStyle™ Keegan Maple	Valero Maple	Adair Cherry Keegan Cherry	Klewin Cherry	Valero Cherry
		8	9	10	11	12	13	14	15	16	17	18	19
2VSD363421	16.5	1197	1241	1292	1389	1394	1448	1519	1546	1628	1676	1681	1764
2VSD423421	19.2	1373	1428	1485	1595	1601	1663	1746	1779	1873	1922	1932	2024
2VSD453421	22.8	1428	1483	1543	1658	1663	1730	1815	1849	1947	1999	2008	2105
2VSD483421CS	21.9	1455	1511	1573	1692	1698	1769	1857	1890	1992	2049	2055	2159
2VSD483421	21.9	1482	1539	1601	1720	1726	1797	1884	1918	2020	2077	2083	2187
2VSD543421FP	24.5	1595	1656	1721	1851	1857	1933	2027	2064	2172	2234	2242	2351
2VSD57/603421FP	27.2	1690	1755	1828	1962	1967	2047	2147	2189	2304	2366	2375	2492

Custom Modifications	AUTHL AUTHR	CBO	CCO	CFNT0	CFP	CFRMO	CMAT	CND	FB	FPFB	FTK	ID	MIP	RD	RECTKALL RECTKBK	RECTKL RECTKR	RT	TOTSS	VTK
	•	•	•	•	•	•	•	•	•	•	•	•	•	•	•	•	•	•	•

Construction Upgrades	VPL	Smart Stop Options	INTGH	PG
	•		•	•

**VANITY SINK DRAWER BASE with FALSE PANELS, 32" HIGH, 21" DEEP**

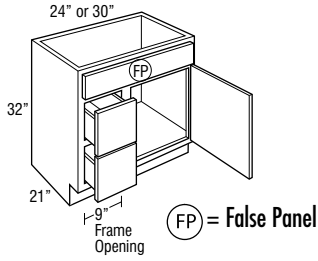

**VSD243221FP DL or DR**  
**VSD303221FP DL or DR**

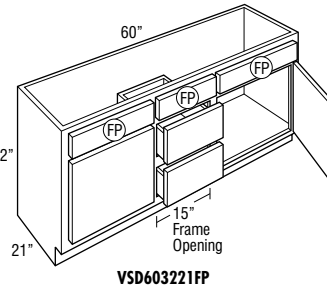
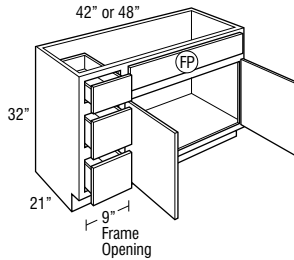
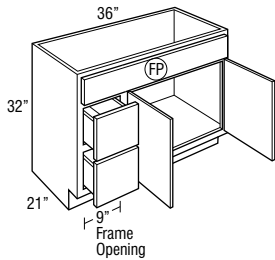

Model	Cubic Feet	Finish						
		Tori Oak	Westburke Oak	Tori Hickory Tori Maple	Loren Laminate Tori Cherry Westburke Hickory Westburke Maple Westburke PureStyle™	Calio Oak Gantrell Oak Kesper Oak Reist Oak	Westburke Cherry	Brookway Oak Bryant Hickory Bryant PureStyle™ Calio Maple Hurley Hickory Hurley Maple Kesper Maple Kessy Oak Reist PureStyle™ Reist PureStyle™
		1	2	3	4	5	6	7
VSD243221FP DL or DR	11.9	690	724	799	841	807	882	861
VSD303221FP DL or DR	14.6	743	781	865	909	875	954	930
VSD363221FP DL or DR	17.4	817	856	949	995	956	1044	1021
VSD423221FP DL or DR	20.1	907	952	1052	1104	1062	1160	1132
VSD483221FP DL or DR	22.9	948	994	1099	1155	1112	1213	1184
<b>VSD603221FP</b>	<b>28.4</b>	<b>1036</b>	<b>1089</b>	<b>1204</b>	<b>1264</b>	<b>1215</b>	<b>1327</b>	<b>1296</b>

- DL or DR indicates drawer location (DL shown).
- CMAT not available on VSD243221FP DL or DR, VSD303221FP DL or DR, and VSD603221FP.

**VANITY SINK DRAWER BASE with FALSE PANEL, 34 1/2" HIGH, 21" DEEP**

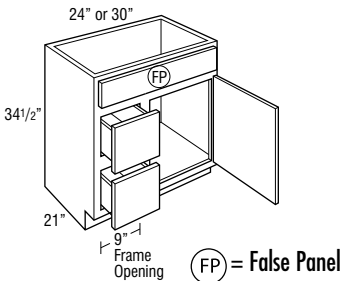

**VSD243421FP DL or DR**  
**VSD303421FP DL or DR**

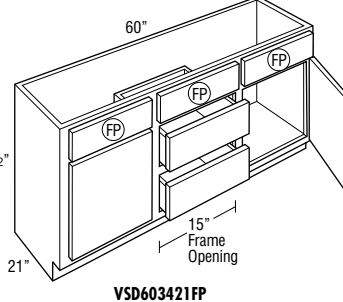
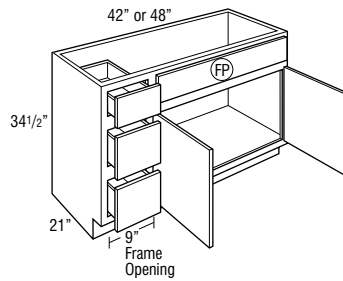
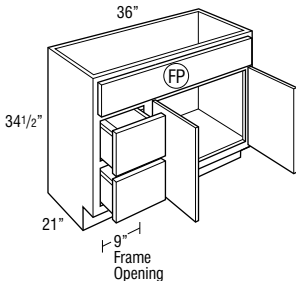

VSD243421FP DL or DR	11.1	771	810	895	943	906	989	964
VSD303421FP DL or DR	13.8	834	876	967	1018	979	1069	1042
VSD363421FP DL or DR	16.5	914	959	1062	1118	1072	1174	1145
VSD423421FP DL or DR	19.2	1014	1065	1179	1240	1189	1302	1269
VSD483421FP DL or DR	21.9	1061	1114	1232	1296	1245	1361	1326
<b>VSD603421FP</b>	<b>27.2</b>	<b>1160</b>	<b>1217</b>	<b>1350</b>	<b>1421</b>	<b>1364</b>	<b>1491</b>	<b>1454</b>

- DL or DR indicates drawer location (DL shown).
- CMAT not available on VSD243421FP DL or DR, VSD303421FP DL or DR, and VSD603421FP.

Model	Cubic Feet	8	9	10	11	12	13	14	15	16	17	18	19
		Cantrill Maple	Bryant Cherry Hurley Cherry Norris Maple Norris PureStyle™	Cairo Cherry Kasper Cherry Reist Cherry	Klewin Oak	Brockway Maple Cantrill Cherry Kersey Hickory Kersey Maple Norris Cherry	Felix Hickory Felix Maple Forte Hickory Forte Maple Forte PureStyle™ Owens Maple Owens PureStyle™	Amico PureStyle™ Brockway Cherry Felix Cherry Forte Cherry Kersey Hickory Klewin Hickory Klewin Maple Owens Cherry	Adair Maple Adair PureStyle™ Keegan Maple	Valero Maple	Adair Cherry Keegan Cherry	Klewin Cherry	Valero Cherry
VSD243221FP DL or DR	11.9	911	919	955	988	1047	1032	1084	1075	1131	1178	1210	1239
VSD303221FP DL or DR	14.6	985	993	1033	1068	1131	1116	1172	1162	1224	1272	1309	1339
VSD363221FP DL or DR	17.4	1079	1090	1131	1173	1239	1221	1283	1275	1342	1396	1433	1469
VSD423221FP DL or DR	20.1	1198	1208	1256	1301	1376	1355	1423	1417	1490	1549	1593	1631
VSD483221FP DL or DR	22.9	1253	1263	1314	1359	1437	1418	1488	1479	1557	1619	1663	1704
<b>VSD603221FP</b>	28.4	1370	1384	1437	1488	1574	1552	1628	1619	1704	1772	1823	1865

Custom Modifications	AUTHL AUTHR	CBO	CCO	CFNT0	CFP	CFRMO	CMAT	CND	FB	FPEB	FTK	ID	MIP	RD	RECTKALL RECTKBK	RECTKL RECTKR	RT	TOTSS	VTK
	•	•	•	•	STD	•	•	•	•	•	•	•	•	•	•	•		•	•

Construction Upgrades	VPL	Smart Stop Options	INTGH	PG
	•		•	•

VSD243421FP DL or DR	11.1	1019	1030	1069	1106	1173	1155	1212	1205	1268	1319	1355	1388
VSD303421FP DL or DR	13.8	1101	1114	1157	1197	1268	1248	1310	1302	1370	1426	1468	1501
VSD363421FP DL or DR	16.5	1208	1220	1269	1312	1388	1368	1436	1427	1502	1564	1607	1646
VSD423421FP DL or DR	19.2	1341	1354	1407	1457	1540	1519	1595	1584	1667	1736	1783	1828
VSD483421FP DL or DR	21.9	1401	1417	1472	1522	1609	1589	1666	1656	1743	1811	1864	1909
<b>VSD603421FP</b>	27.2	1535	1549	1611	1666	1763	1737	1824	1810	1907	1986	2042	2089

Custom Modifications	AUTHL AUTHR	CBO	CCO	CFNT0	CFP	CFRMO	CMAT	CND	FB	FPEB	FTK	ID	MIP	RD	RECTKALL RECTKBK	RECTKL RECTKR	RT	TOTSS	VTK
	•	•	•	•	STD	•	•	•	•	•	•	•	•	•	•	•		•	•

Construction Upgrades	VPL	Smart Stop Options	INTGH	PG
	•		•	•

**VANITY SINK THREE DRAWER BASE,  
32" HIGH, 21" DEEP**

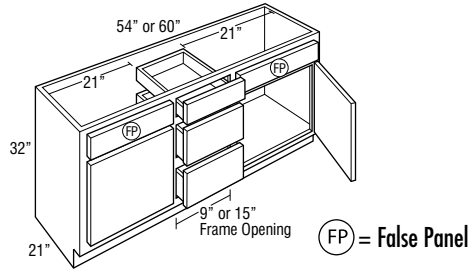

Model	Cubic Feet	Westburke Oak		Tori Hickory Tori Maple	Loren Laminate Tori Cherry Westburke Hickory Westburke Maple Westburke PureStyle™	Chino Oak Gantrell Oak Kesper Oak Renaist Oak		Westburke Cherry	Brookway Oak Bryant Hickory Bryant Maple Chino Maple Hurley Hickory Hurley Maple Kesper Maple Kesper Oak Renaist Maple Renaist PureStyle™
		1	2	3	4	5	6	7	
VS3D543221	25.2	1285	1350	1492	1568	1507	1647	1608	
VS3D603221	27.6	1285	1350	1492	1568	1507	1647	1608	

**VANITY SINK THREE DRAWER BASE,  
34 1/2" HIGH, 21" DEEP**

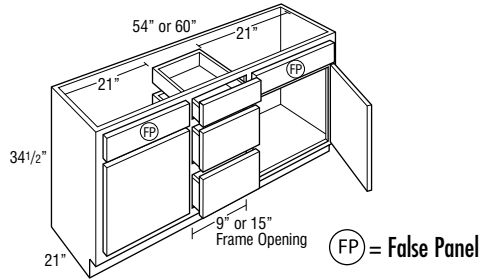

VS3D543421	24.5	1439	1510	1674	1761	1691	1847	1802
VS3D603421	27.2	1439	1510	1674	1761	1691	1847	1802

Model	Cubic Feet	Camtrel Maple	Bryant Cherry Hurley Cherry Norris Maple Norris PureStyle™	Cairo Cherry Kasper Cherry Reist Cherry	Klewin Oak	Brockway Maple Camtrel Cherry Kersey Hickory Kersey Maple Norris Cherry	Falk Hickory Falk Maple Forte Hickory Forte Maple Forte PureStyle™ Owens Maple Owens PureStyle™	Antico PureStyle™ Brockway Cherry Falk Cherry Forte Cherry Kersey Hickory Klewin Hickory Klewin Maple Owens Cherry	Adair Maple Adair PureStyle™ Keegan Maple	Valero Maple	Adair Cherry Keegan Cherry	Klewin Cherry	Valero Cherry
		8	9	10	11	12	13	14	15	16	17	18	19
VS3D543221	25.2	1699	1715	1782	1844	1952	1923	2019	2007	2112	2196	2257	2312
VS3D603221	27.6	1699	1715	1782	1844	1952	1923	2019	2007	2112	2196	2257	2312

Custom Modifications	AUTHL AUTHR	CBO	CCO	CFNT0	CFP	CFRMO	CMAT	CND	FB	FPEB	FTK	ID	MIP	RD	RECTKALL RECTKBK	RECTKL RECTKR	RT	TOTSS	VTK
	•	•	•	•	•	•	•	•	•	•	•	•	•	•	•	•		•	•

Construction Upgrades	VPL	Smart Stop Options	INTGH	PG
	•		•	•

VS3D543421	24.5	1902	1921	1999	2068	2186	2155	2259	2246	2363	2462	2530	2592
VS3D603421	27.2	1902	1921	1999	2068	2186	2155	2259	2246	2363	2462	2530	2592

Custom Modifications	AUTHL AUTHR	CBO	CCO	CFNT0	CFP	CFRMO	CMAT	CND	FB	FPEB	FTK	ID	MIP	RD	RECTKALL RECTKBK	RECTKL RECTKR	RT	TOTSS	VTK
	•	•	•	•	•	•	•	•	•	•	•	•	•	•	•	•		•	•

Construction Upgrades	VPL	Smart Stop Options	INTGH	PG
	•		•	•

**VANITY SINK DRAWER BASE with SIX DRAWERS & FALSE PANEL, 32" HIGH, 21" DEEP**

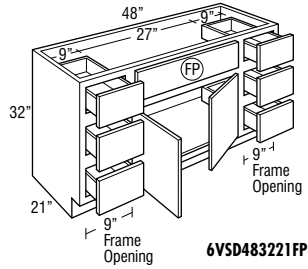

**6VSD483221FP**

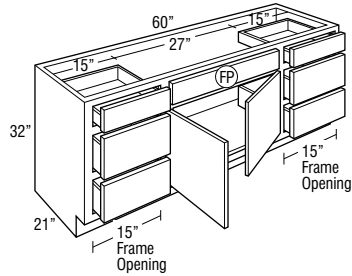

**6VSD603221FP**

**VANITY SINK DRAWER BASE with SIX DRAWERS & FALSE PANEL, 34 1/2" HIGH, 21" DEEP**

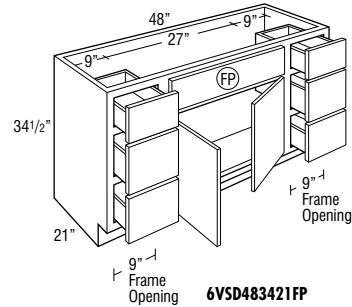

**6VSD483421FP**

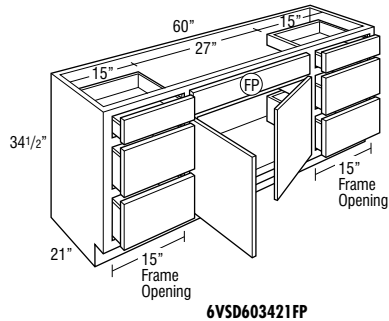

**6VSD603421FP**

Model	Cubic Feet	Tori Oak	Westburke Oak	Tori Hickory Tori Maple	Loren Laminate Tori Cherry Westburke Hickory Westburke Maple Westburke PureStyle™	Calio Oak Gantrell Oak Kesper Oak Rensil Oak	Westburke Cherry	Brookway Oak Bryant Hickory Bryant Maple Calio Maple Hurley Hickory Hurley Maple Kesper Maple Kessy Oak Rensil PureStyle™
		1	2	3	4	5	6	7
<b>6VSD483221FP</b>	22.9	1151	1209	1336	1406	1351	1477	1440
<b>6VSD603221FP</b>	28.4	1366	1433	1584	1667	1603	1751	1709

- 6VSD483221FP drawer stack is 12" wide.
- 6VSD603221FP drawer stack is 18" wide.

<b>6VSD483421FP</b>	21.9	1289	1353	1498	1573	1513	1652	1611
<b>6VSD603421FP</b>	27.2	1531	1607	1774	1868	1796	1962	1914

- 6VSD483421FP drawer stack is 12" wide.
- 6VSD603421FP drawer stack is 18" wide.

Model	Cubic Feet	8	9	10	11	12	13	14	15	16	17	18	19
		Countrell Maple	Bryant Cherry Hurley Cherry Norris Maple Norris PureStyle™	Cairo Cherry Kasper Cherry Reist Cherry	Klewin Oak	Brockway Maple Countrell Cherry Kersey Hickory Kersey Maple Norris Cherry	Felix Hickory Felix Maple Forte Hickory Forte Maple Forte PureStyle™ Owens Maple Owens PureStyle™	Amico PureStyle™ Brockway Cherry Felix Cherry Forte Cherry Kersey Hickory Klewin Hickory Klewin Maple Owens Cherry	Adair Maple Adair PureStyle™ Keegan Maple	Valero Maple	Adair Cherry Keegan Cherry	Klewin Cherry	Valero Cherry
6VSD483221FP	22.9	1522	1537	1598	1652	1749	1723	1808	1799	1892	1969	2023	2072
6VSD603221FP	28.4	1806	1824	1896	1960	2076	2045	2145	2133	2245	2334	2400	2457

Custom Modifications	AUTHL AUTHR	CBO	CCO	CFNT0	CFP	CFRMO	CMAT	CND	FB	FPEB	FTK	ID	MIP	RD	RECTKALL RECTKBK	RECTKL RECTKR	RT	TOTSS	VTK
	•	•	•	•	•	•	•	•	•	•	•	•	•	•	•	•		•	•

Construction Upgrades	VPL	Smart Stop Options	INTGH	PG
	•		•	•

6VSD483421FP	21.9	1705	1720	1789	1851	1957	1933	2027	2015	2120	2206	2267	2321
6VSD603421FP	27.2	2022	2042	2121	2196	2324	2290	2404	2389	2514	2616	2689	2754

Custom Modifications	AUTHL AUTHR	CBO	CCO	CFNT0	CFP	CFRMO	CMAT	CND	FB	FPEB	FTK	ID	MIP	RD	RECTKALL RECTKBK	RECTKL RECTKR	RT	TOTSS	VTK
	•	•	•	•	•	•	•	•	•	•	•	•	•	•	•	•		•	•

Construction Upgrades	VPL	Smart Stop Options	INTGH	PG
	•		•	•



**UNDER COUNTER DRAWER, 4 3/4" HIGH, 21" DEEP**

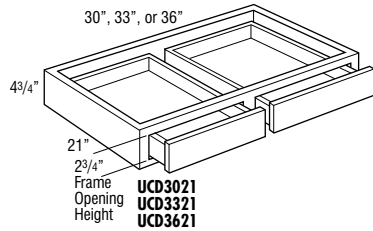
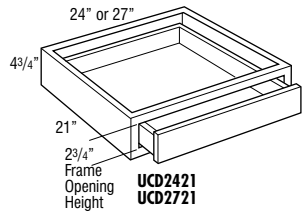

Model	Cubic Feet	Westburke Oak		Tori Hickory Tori Maple	Loren Laminate Tori Cherry Westburke Hickory Westburke Maple Westburke PureStyle™	Coho Oak Gantrell Oak Kesper Oak Reins Oak		Westburke Cherry	Brookway Oak Bryant Hickory Bryant Maple Bryant PureStyle™ Coho Maple Hurley Hickory Hurley Maple Kesper Oak Kesper PureStyle™ Reins PureStyle™	
		1	2	3	4	5	6	7		
UCD2421	2.6	354	371	416	524	354	551	437		
UCD2721	2.6	372	390	439	552	372	580	457		
UCD3021	2.6	388	407	457	579	388	608	480		
UCD3321	2.6	412	432	485	611	412	641	508		
UCD3621	2.6	434	455	510	643	434	675	535		

- Cabinet is 4 3/4" high. Drawer box within cabinet is 2" high.
- Not trimmable.
- Drawer front is 3/4" slab front.
- The frame to end panel offset is 3/4", which is designed to accommodate the vanity desk leg.
- End panels will feature non-matching laminate exterior.
- Rensi PureStyle™ drawer fronts will be painted hardwood.

**LINEN CLOSET**

LOGIX

LC188421 L or R	23.0	1589	1653	1759	1820	1881	1896	1987
-----------------	------	------	------	------	------	------	------	------

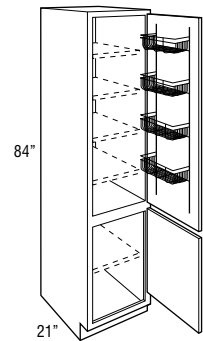

- Upper section features a 5" deep chrome door rack.
- 15" deep adjustable shelves indicated by light dotted lines are included; packaged separately.
- Designed to be used with 34 1/2" high vanities. Bottom door aligns with top of door/drawer front.

**LINEN CLOSET with REMOVABLE HAMPER**

LOGIX

LCRH188421 L or R	23.0	1944	2008	2114	2174	2236	2250	2341
-------------------	------	------	------	------	------	------	------	------

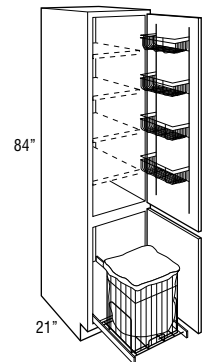

- Hamper size is 14 1/4" high x 14" wide x 18 3/4" deep.
- Upper section features a 5" deep chrome door rack.
- 15" deep adjustable shelves indicated by light dotted lines are included; packaged separately.
- Includes full-extension removable chrome pull-out hamper with removable cloth liner.
- Designed to be used with 34 1/2" high vanities. Bottom door aligns with top of door/drawer front.

Model	Cubic Feet	Camtrel Maple	Bryant Cherry Hurley Cherry Norris Maple Norris PureStyle™	Cairo Cherry Kasper Cherry Reist Cherry	Klewin Oak	Brockway Maple Camtrel Cherry Kersey Hickory Kersey Maple Norris Cherry	Felix Hickory Felix Maple Forte Hickory Forte Maple Forte PureStyle™ Owens Maple Owens PureStyle™	Amico PureStyle™ Brockway Cherry Felix Cherry Forte Cherry Kersey Cherry Klewin Hickory Klewin Maple Owens Cherry	Adair Maple Adair PureStyle™ Keegan Maple	Valero Maple	Adair Cherry Keegan Cherry	Klewin Cherry	Valero Cherry
		8	9	10	11	12	13	14	15	16	17	18	19
UCD2421	2.6	393	499	518	420	523	441	463	469	469	523	527	529
UCD2721	2.6	413	524	545	443	551	463	484	487	487	551	555	557
UCD3021	2.6	433	550	571	465	578	483	508	508	508	578	583	586
UCD3321	2.6	457	580	602	490	609	512	538	542	542	609	616	618
UCD3621	2.6	481	611	634	516	641	539	566	570	570	641	648	651

Custom Modifications	AUTHL AUTHR	CBO	CCO	CFNT0	CFP	CFRMO	CMAT	CND	FB	FPEB	FTK	ID	MIP	RD	RECTKALL RECTKBK	RECTKL RECTKR	RT	TOTSS	VTK
		•	•	•		•						•	•	•					

Construction Upgrades	VPL	Smart Stop Options	INTGH	PG
	•			•

LC188421 L or R	23.0	2057	2116	2189	2310	2319	2382	2486	2509	2626	2666	2688	2791
-----------------	------	------	------	------	------	------	------	------	------	------	------	------	------

Custom Modifications	AUTHL AUTHR	CBO	CCO	CFNT0	CFP	CFRMO	CMAT	CND	FB	FPEB	FTK	ID	MIP	RD	RECTKALL RECTKBK	RECTKL RECTKR	RT	TOTSS	VTK
		•	•	•		•			•	•	•		•		•	•			•

Construction Upgrades	VPL	Smart Stop Options	INTGH	PG
	•		•	

LCRH188421 L or R	23.0	2412	2470	2543	2665	2674	2737	2840	2864	2980	3020	3043	3146
-------------------	------	------	------	------	------	------	------	------	------	------	------	------	------

Custom Modifications	AUTHL AUTHR	CBO	CCO	CFNT0	CFP	CFRMO	CMAT	CND	FB	FPEB	FTK	ID	MIP	RD	RECTKALL RECTKBK	RECTKL RECTKR	RT	TOTSS	VTK
		•	•	•		•			•	•	•		•		•	•			•

Construction Upgrades	VPL	Smart Stop Options	INTGH	PG
	•		•	

**VANITY UTILITY,  
84" TALL, 21" DEEP**

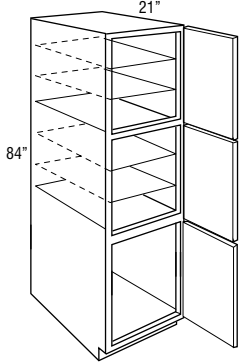

Model	Cubic Feet							
	Tori Oak	Westburke Oak	Tori Hickory Tori Maple	Loren Laminate Tori Cherry Westburke Hickory Westburke Maple Westburke PureStyle™	Calio Oak Gantrell Oak Kesper Oak Reist Oak	Westburke Cherry	Brookway Oak Bryant Hickory Bryant Maple Bryant PureStyle™ Calio Maple Hurley Hickory Hurley Maple Kesper Maple Kessy Oak Reist PureStyle™ Reist PureStyle™	
	1	2	3	4	5	6	7	
<b>VU188421 L or R</b>	23.0	922	967	1069	1125	1178	1181	1283

- Lower door section is drilled to accept adjustable shelf.
- Shelves indicated by light dotted lines are included; packaged separately.
- Shelves indicated by solid lines are fixed.
- Designed to be used with 32" tall vanities. Linen Closet (LC/LCRH) cabinets or kitchen utilities should be used for 34 1/2" vanity applications.

**VANITY WALL TOWEL BAR**

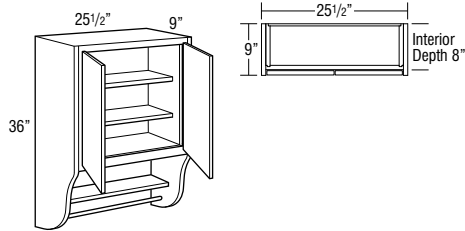

Model	6.8	742	764	809	834	858	860	907
<b>VWTB24</b>								

- Includes 2 adjustable interior shelves, 1 fixed shelf, and towel rack underneath.
- Cabinet has butt doors, no center stile.
- Cabinet features factory applied 3/4" matching veneer over furniture board core end panels. Total cabinet width is 25 1/2".
- Interior cabinet case has plywood end panels.
- When ordered in VPL, back, top, bottom and adjustable shelves are plywood.

**VANITY WALL, 30" HIGH, 6" DEEP**

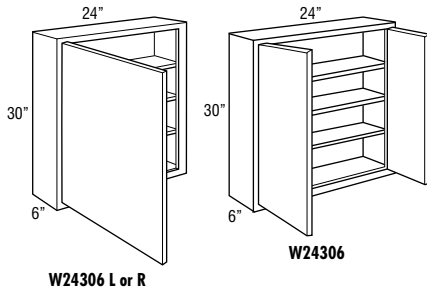

Model	4.0	503	526	578	607	633	634	683
<b>W24306 L or R</b>								

Model	4.0	451	475	526	555	582	583	631
<b>W24306</b>								

- CG and MD available only on W24306 L or R.

**VANITY WALL MIRROR CABINET,  
30" HIGH, 4 9/16" DEEP**

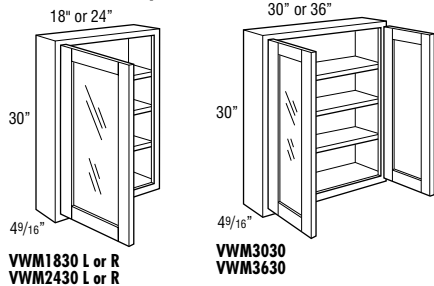

Model	2.7	715	732	772	793	814	814	856
<b>VWM1830 L or R</b>								
<b>VWM2430 L or R</b>	3.5	779	801	848	874	898	900	945

Model	4.3	861	886	942	972	999	1004	1056
<b>VWM3030</b>								
<b>VWM3630</b>	5.1	909	937	996	1031	1062	1064	1124
<b>VWM4230</b>	5.9	968	997	1064	1101	1136	1138	1206

- Standard with CG doors and installed mirror glass.
- Unit intended to be surface mounted. Features standard 1/4" face frame reveal on ends.
- Adjustable shelves.
- Not in available in Loren.

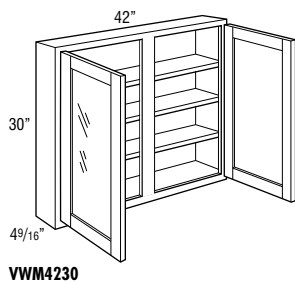

**VWM4230**

Model	Cubic Feet	8	9	10	11	12	13	14	15	16	17	18	19
		Countrell Maple	Bryant Cherry Hurley Cherry Norris PureStyle™ Norris PureStyle™	Cairo Cherry Kesper Cherry Reist Cherry	Klewin Oak	Brockway Maple Countrell Cherry Kersey Hickory Kersey Maple Norris Cherry	Felix Hickory Felix Maple Forte Hickory Forte Maple Forte PureStyle™ Owens Maple Owens PureStyle™	Antico PureStyle™ Brockway Cherry Felix Cherry Forte Cherry Kersey Hickory Kersey Maple Klewin Maple Owens Cherry	Adair Maple Adair PureStyle™ Keegan Maple	Valero Maple	Adair Cherry Keegan Cherry	Klewin Cherry	Valero Cherry
VU188421 L or R	23.0	1344	1397	1454	1562	1565	1628	1709	1740	1832	1883	1889	1982

Custom Modifications	AUTHL AUTHR	CBO	CCO	CFNT0	CFP	CFRMO	CMAT	CND	FB	FPEB	FTK	ID	MIP	RD	RECTKALL RECTKBK	RECTKL RECTKR	RT	TOTSS	VTK
	•	•	•	•		•			•	•	•	•	•	•		•	•		•

Construction Upgrades	VPL	Smart Stop Options	INTGH	PG
	•		•	

VWTB24	6.8	935	958	982	1032	1034	1063	1100	1113	1155	1178	1180	1223
--------	-----	-----	-----	-----	------	------	------	------	------	------	------	------	------

Custom Modifications	AUTHL AUTHR	CBO	CCO	CFNT0	CFP	CFRMO	CMAT	CND	FB	FPEB	FTK	ID	MIP	RD	RECTKALL RECTKBK	RECTKL RECTKR	RT	TOTSS	VTK
		•	•	•		•			STD				•						

Construction Upgrades	VPL	Smart Stop Options	INTGH	PG
			•	

W24306 L or R	4.0	713	739	767	820	822	854	893	910	955	979	981	1029
---------------	-----	-----	-----	-----	-----	-----	-----	-----	-----	-----	-----	-----	------

W24306	4.0	662	688	715	769	771	803	842	858	904	927	929	978
--------	-----	-----	-----	-----	-----	-----	-----	-----	-----	-----	-----	-----	-----

Custom Modifications	AUTHL AUTHR	CBO	CCO	CFNT0	CFP	CFRMO	CMAT	CND	FB	FPEB	FTK	ID	MIP	RD	RECTKALL RECTKBK	RECTKL RECTKR	RT	TOTSS	VTK
		•	•	•		•			•	•			•						

Construction Upgrades	VPL	Decorative Door Options	CG	MD	Smart Stop Options	INTGH	PG
	•		•	•		•	

VWM1830 L or R	2.7	878	899	919	961	964	986	1017	1033	1068	1087	1090	1124
----------------	-----	-----	-----	-----	-----	-----	-----	------	------	------	------	------	------

VWM2430 L or R	3.5	974	997	1021	1070	1073	1101	1138	1154	1197	1218	1220	1265
----------------	-----	-----	-----	------	------	------	------	------	------	------	------	------	------

VWM3030	4.3	1089	1119	1149	1207	1210	1242	1286	1306	1354	1383	1387	1436
---------	-----	------	------	------	------	------	------	------	------	------	------	------	------

VWM3630	5.1	1162	1191	1225	1289	1292	1329	1377	1396	1452	1483	1486	1542
---------	-----	------	------	------	------	------	------	------	------	------	------	------	------

VWM4230	5.9	1247	1281	1317	1390	1393	1433	1486	1508	1568	1601	1607	1668
---------	-----	------	------	------	------	------	------	------	------	------	------	------	------

Custom Modifications	AUTHL AUTHR	CBO	CCO	CFNT0	CFP	CFRMO	CMAT	CND	FB	FPEB	FTK	ID	MIP	RD	RECTKALL RECTKBK	RECTKL RECTKR	RT	TOTSS	VTK
		•	•	•		•			•	•			•						

Construction Upgrades	VPL	Smart Stop Options	INTGH	PG
	•		•	

**VANITY MIRROR**

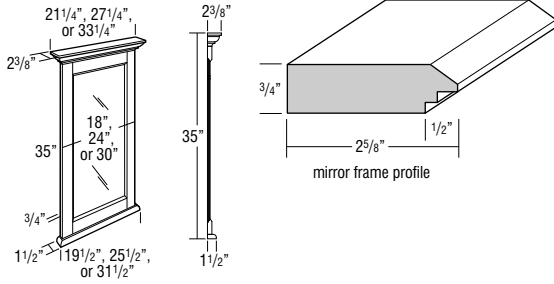

Model	Overall Dimensions Width	Overall Dimensions Height	Mirror - Visible Dimensions Width	Mirror - Visible Dimensions Height
VM2135	21 1/4"	35"	12 15/16"	26 15/16"
VM2735	27 1/4"	35"	18 15/16"	26 15/16"
VM3335	33 1/4"	35"	24 15/16"	26 15/16"

Model	Cubic Feet	Cubic Feet						
		Tori Oak	Westburke Oak	Tori Hickory Tori Maple	Loren Laminate Tori Cherry Westburke Hickory Westburke Maple Westburke PureStyle™	Calio Oak Gantrell Oak Kesper Oak Rens Oak	Westburke Cherry	Brookway Oak Bryant Hickory Bryant Maple Bryant PureStyle™ Calio Maple Hurley Hickory Hurley Maple Kesper Maple Kesper Oak Rens PureStyle™ Rens PureStyle™
		1	2	3	4	5	6	7
VM2135	5.4	N/A	N/A	821	821	N/A	821	821
VM2735	5.4	N/A	N/A	894	894	N/A	894	894
VM3335	5.4	N/A	N/A	971	971	N/A	971	971

- Moulding included on vanity mirrors is not a standard moulding. SWLCRM8 is similar.
- Mirror glass is beveled.
- Includes two installed metal hanging hooks on back.

**SINGLE DOOR MEDICINE CABINET**

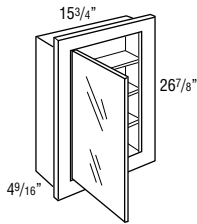

Model	Cabinet Dimensions			Cut-Out Dimensions		
	Width	Height	Depth	Width	Height	Depth
MC16	15 3/4"	26 7/8"	4 9/16"	14 7/16"	25 5/8"	4"

MC16	2.5	454	454	454	454	454	454	454
------	-----	-----	-----	-----	-----	-----	-----	-----

- Unit can be surface mounted or recessed.
- Door of cabinet is glass mirror.
- Matching cabinet doors not available.
- Cabinet has wood frame.
- 1/2" plywood ends, tops, and bottoms.
- Finished exterior.
- Natural Maple laminate interior. White styles have white interior.
- 3/4" laminated plywood shelves.
- Face frame has a profiled inside and outside edge.

**TRI-VIEW MEDICINE CABINET**

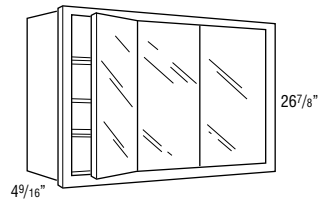

Model	Cabinet Dimensions			Cut-Out Dimensions		
	Width	Height	Depth	Width	Height	Depth
TV30	30"	26 7/8"	4 9/16"	28 11/16"	25 5/8"	4"
TV36	36"	26 7/8"	4 9/16"	34 11/16"	25 5/8"	4"
TV48	48"	26 7/8"	4 9/16"	46 11/16"	25 5/8"	4"

TV30	5.4	1103	1103	1103	1103	1103	1103	1103
TV36	6.5	1204	1204	1204	1204	1204	1204	1204
TV48	8.5	1403	1403	1403	1403	1403	1403	1403

- Cabinet has wood frame.
- Door of cabinet is glass mirror.
- Unit can be surface mounted or recessed.
- 1/2" plywood ends, tops, and bottoms.
- Finished exterior.
- Natural Maple laminate interior. White styles have white interior.
- 3/4" laminated furniture board shelves.
- Face frame has a profiled inside and outside edge.

Model	Cubic Feet	Camtrel Maple	Bryant Cherry Hurley Cherry Norris Maple Norris PureStyle™	Cairo Cherry Kasper Cherry Reist Cherry	Klewin Oak	Brookway Maple Camtrel Cherry Kersey Hickory Kersey Maple Norris Cherry	Felix Hickory Felix Maple Forte Hickory Forte Maple Forte PureStyle™ Owens Maple Owens PureStyle™	Antico PureStyle™ Brookway Cherry Felix Cherry Forte Cherry Kersey Cherry Klewin Hickory Klewin Maple Owens Cherry	Adair Maple Adair PureStyle™ Keegan Maple	Valero Maple	Adair Cherry Keegan Cherry	Klewin Cherry	Valero Cherry
		8	9	10	11	12	13	14	15	16	17	18	19
VM2135	5.4	821	821	821	N/A	821	821	821	821	821	821	821	821
VM2735	5.4	894	894	894	N/A	894	894	894	894	894	894	894	894
VM3335	5.4	971	971	971	N/A	971	971	971	971	971	971	971	971

MODIFICATIONS
No modifications available for these products.

Specie Availability					
Cherry	Hickory	Maple	Oak	Laminate	PureStyle™
•		•		Maple	Maple

MC16	2.5	454	454	454	454	454	454	454	454	454	454	454	454
------	-----	-----	-----	-----	-----	-----	-----	-----	-----	-----	-----	-----	-----

Custom Modifications	AUTHL AUTHR	CBO	CCO	CFNT0	CFP	CFRMO	CMAT	CND	FB	FPEB	FTK	ID	MIP	RD	RECTKALL RECTKBK	RECTKL RECTKR	RT	TOTSS	VTK
		•	•	•		•			STD				•						

Construction Upgrades	VPL	Smart Stop Options	INTGH	PG

TV30	5.4	1103	1103	1103	1103	1103	1103	1103	1103	1103	1103	1103	1103
TV36	6.5	1204	1204	1204	1204	1204	1204	1204	1204	1204	1204	1204	1204
TV48	8.5	1403	1403	1403	1403	1403	1403	1403	1403	1403	1403	1403	1403

Custom Modifications	AUTHL AUTHR	CBO	CCO	CFNT0	CFP	CFRMO	CMAT	CND	FB	FPEB	FTK	ID	MIP	RD	RECTKALL RECTKBK	RECTKL RECTKR	RT	TOTSS	VTK
		•	•			•			STD				•						

Construction Upgrades	VPL	Smart Stop Options	INTGH	PG

**SPECIE AVAILABILITY**

Specie Availability charts list the availability of each product code by specie and any substitutions that are made. Exceptions within a section are noted below the specie availability chart.

For panels with doors and/or fillers attached, specie availability is shown for the panel and filler only.

For Specie Availability, look for this chart throughout.

**Specie Availability**

Cherry	Hickory	Maple	Oak	Laminate	PureStyle™
•	•	•	•	Maple	Maple

**DESCRIPTION MODEL PRICE**

**FILLERS**

**3" WIDE FILLERS**

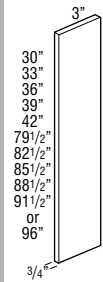

**F3**

<b>F330</b>	58
<b>F333</b>	64
<b>F336</b>	65
<b>F339</b>	68
<b>F342</b>	72
<b>TF384</b>	121
<b>TF387</b>	143
<b>TF390</b>	148
<b>TF393</b>	168
<b>TF396</b>	184
<b>TF396FH</b>	228

- 3/4" thick.
- Finished on front and all edges (backs are not finished).

**Specie Availability**

Cherry	Hickory	Maple	Oak	Laminate	PureStyle™
•	•	•	•	Maple	Maple

**3" WIDE CORNER FILLER**

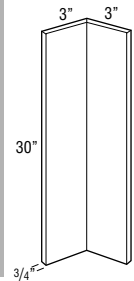

**CF3**

<b>CF330</b>	103
--------------	-----

- 3/4" thick.
- Finished on front and all edges (backs are not finished).

**Specie Availability**

Cherry	Hickory	Maple	Oak	Laminate	PureStyle™
•	•	•	•	Maple	Maple

**6" WIDE FILLERS**

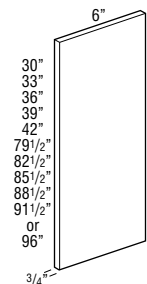

**F6**

<b>F630</b>	88
<b>F633</b>	106
<b>F636</b>	110
<b>F639</b>	119
<b>F642</b>	130
<b>TF684</b>	212
<b>TF687</b>	252
<b>TF690</b>	262
<b>TF693</b>	287
<b>TF696</b>	313
<b>TF696FH</b>	393

- 3/4" thick.
- Finished on front and all edges (backs are not finished).

**Specie Availability**

Cherry	Hickory	Maple	Oak	Laminate	PureStyle™
•	•	•	•	Maple	Maple

**DESCRIPTION**

**MODEL**

**PRICE**

**SPACE FILLERS**



<b>S96X14</b> (1/4" thick)	52
<b>S96X12</b> (1/2" thick)	66

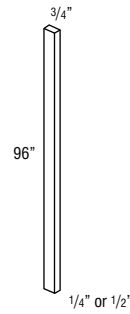

- Designed to fill space between adjacent cabinets; i.e. W1830 butted against side of U188424.
- Finished on front and all edges (backs are not finished).

**Specie Availability**

Cherry	Hickory	Maple	Oak	Laminate	PureStyle™
•	•	•	•	Maple	Maple

**OVERLAY FILLER, 2 1/2" WIDE**

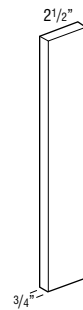

<b>OL312</b>	54
<b>OL315</b>	56
<b>OL318</b>	57
<b>OL321</b>	60
<b>OL324</b>	61
<b>OL327</b>	63
<b>OL330</b>	72
<b>OL333</b>	81
<b>OL336</b>	83
<b>OL339</b>	87
<b>OL342</b>	89
<b>OL384</b>	148
<b>OL387</b>	162
<b>OL390</b>	167
<b>OL393</b>	176
<b>OL396</b>	186
<b>VOL332</b>	63

Model	Partial Overlay Height	Full Overlay Height
OL312	10"	11 1/2"
OL315	13"	14 1/2"
OL318	16"	17 1/2"
OL321	19"	20 1/2"
OL324	21 1/2"	23"
OL327	25 1/2"	27"
OL330	28"	29 1/2"
OL333	31"	32 1/2"
OL336	34"	35 1/2"
OL339	37"	38 1/2"
OL342	40"	41 1/2"
OL384	77 1/2"	79"
OL387	80 1/2"	82"
OL390	83 1/2"	85"
OL393	86 1/2"	88"
OL396	89 1/2"	91"
VOL332	25 1/2"	27"

- 2 1/2" wide overlay fillers can be applied to Wall Message Centers to create custom finished look.
- Overlays in Antico, Bryant, Forte, Kasper, Owens, and Westburke have a shaker profile. Overlays in Norris will have a beaded profile. All other overlays will match the door style outside profile.
- Finished on front and all edges (backs are not finished).
- Norris and Rensi PureStyle™ overlays will be painted hardwood.

**Specie Availability**

Cherry	Hickory	Maple	Oak	Laminate	PureStyle™
•	•	•	•	•	•

**DESCRIPTION MODEL PRICE**

**OVERLAY FILLER, 5 1/2" WIDE**



<b>OL630</b>	102
<b>OL633</b>	129
<b>OL636</b>	135
<b>OL639</b>	142
<b>OL642</b>	148
<b>OL684</b>	248
<b>OL687</b>	281
<b>OL690</b>	289
<b>OL693</b>	299
<b>OL696</b>	306

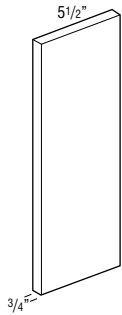

Model	Partial Overlay Height	Full Overlay Height
OL630	28"	29 1/2"
OL633	31"	32 1/2"
OL636	34"	35 1/2"
OL639	37"	38 1/2"
OL642	40"	41 1/2"
OL684	77 1/2"	79"
OL687	80 1/2"	82"
OL690	83 1/2"	85"
OL693	86 1/2"	88"
OL696	89 1/2"	91"

- Overlays in Antico, Bryant, Forte, Kasper, Owens, and Westburke have a shaker profile. Overlays in Norris will have a beaded profile. All other overlays will match the door style outside profile.
- Finished on front and all edges (backs are not finished).
- Norris and Rensi PureStyle™ overlays will be painted hardwood.

**Specie Availability**

Cherry	Hickory	Maple	Oak	Laminate	PureStyle™
•	•	•	•	•	•

**FLUTED/BEADED 3" WIDE REVERSIBLE FILLERS**



<b>FBF330</b> (Reversible) 3" x 30"	152
<b>FBF336</b> (Reversible) 3" x 36"	167
<b>TBF396</b> (Reversible) 3" x 96"	302

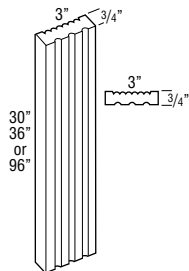

**Specie Availability**

Cherry	Hickory	Maple	Oak	Laminate	PureStyle™
•	•	•	•	Maple	Maple

**FLUTED/BEADED 6" WIDE REVERSIBLE FILLERS**



<b>FBF630</b> (Reversible) 6" x 30"	170
<b>FBF636</b> (Reversible) 6" x 36"	185
<b>TBF696</b> (Reversible) 6" x 96"	335

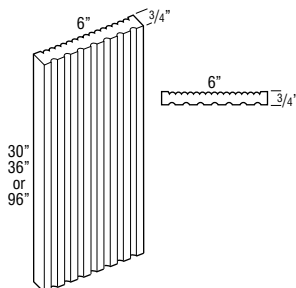

**Specie Availability**

Cherry	Hickory	Maple	Oak	Laminate	PureStyle™
•	•	•	•	Maple	Maple

**DESCRIPTION MODEL PRICE**

**ANGLED FLUTED/PLAIN 3" WIDE REVERSIBLE FILLERS**



<b>BLVDFF30</b> (Reversible) 3" x 30"	191
<b>BLVDFF34.5</b> (Reversible) 3" x 34 1/2"	279
<b>BLVDTF96</b> (Reversible) 3" x 96"	361

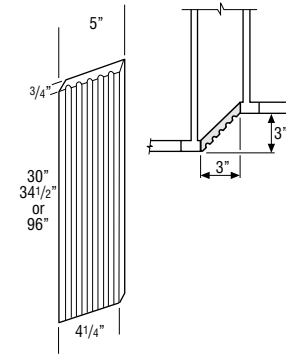

**Specie Availability**

Cherry	Hickory	Maple	Oak	Laminate	PureStyle™
•	•	•	•	Maple	Maple

**BOX COLUMN FILLERS, WALL, 3" WIDE, 15" DEEP**

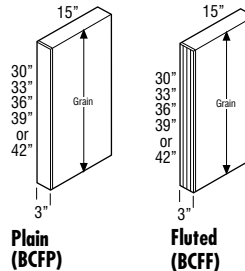

<b>W330BCFP</b>	476
<b>W333BCFP</b>	507
<b>W336BCFP</b>	514
<b>W339BCFP</b>	535
<b>W342BCFP</b>	553
<b>W330BCFF</b>	553
<b>W333BCFF</b>	581
<b>W336BCFF</b>	588
<b>W339BCFF</b>	609
<b>W342BCFF</b>	625

- Available in 1" depth increments from 6" to 27".
- Reversible, may be used on either left or right end.
- Front and both sides finished.
- Enclosed top and bottom.
- 3/8" plywood construction.
- Finished veneer on end panel exterior.

**Custom Modifications**

ID	RD
•	•

**Specie Availability**

Cherry	Hickory	Maple	Oak	Laminate	PureStyle™
•	•	•	•	Maple	Maple



DESCRIPTION	MODEL	PRICE
<b>BOX COLUMN FILLERS, TALL, 3" WIDE, 15" or 27" DEEP</b>	T38415BCFP (15" Deep)	1119
	T38715BCFP (15" Deep)	1130
	T39015BCFP (15" Deep)	1133
	T39315BCFP (15" Deep)	1155
	T39615BCFP (15" Deep)	1155
	T38427BCFP (27" Deep)	1716
	T38727BCFP (27" Deep)	1738
	T39027BCFP (27" Deep)	1743
	T39327BCFP (27" Deep)	1762
	T39627BCFP (27" Deep)	1762
	T38415BCFF (15" Deep)	1214
	T38715BCFF (15" Deep)	1237
T39015BCFF (15" Deep)	1243	
T39315BCFF (15" Deep)	1272	
T39615BCFF (15" Deep)	1272	
T38427BCFF (27" Deep)	1804	
T38727BCFF (27" Deep)	1832	
T39027BCFF (27" Deep)	1839	
T39327BCFF (27" Deep)	1880	
T39627BCFF (27" Deep)	1880	

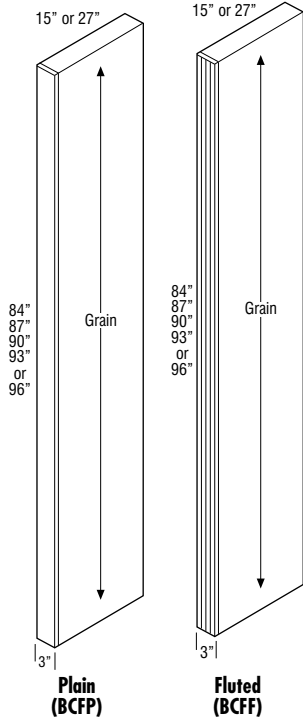

- Available in 1" depth increments from 6" to 27".
- Reversible, may be used on either left or right end.
- Front and both sides finished.
- Enclosed top and bottom.
- 3/8" plywood construction.
- Finished veneer on end panel exterior.

**Custom Modifications**

ID	RD
•*	•

\*ID not available on 27" deep.

**Specie Availability**

Cherry	Hickory	Maple	Oak	Laminate	PureStyle™
•	•	•	•	Maple	Maple

DESCRIPTION	MODEL	PRICE
<b>DECORATIVE APPLIANCE PANELS</b>		

All custom panels can be ordered through 20/20. For manual orders, please fax the order form to customer service.

Due to customized ordering, Decorative Appliance Panels may not be returned.

Custom Panels (DAPNL1/4, DAPNL3/4, and DAPNL3/4APF), square footage requirements are calculated by multiplying the height and width for each panel (square footage = width x height (in inches)/144). Premium finish upcharge will be applied.

**Custom Panels**

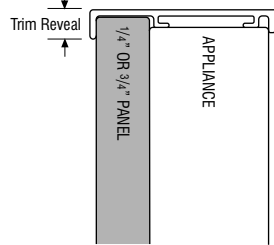

DAPNL1/4	\$40 /sq ft
DAPNL3/4	\$61 /sq ft
DAPNL3/4APF	\$73 /sq ft

- DAPNL1/4 includes 1/4" finished veneer on plywood core panel cut to fit appliance doors.
- DAPNL3/4 kit includes 3/4" furniture board core veneer panel finished on both sides, and all four edges. Panel is cut to fit appliance doors, and mounts to the appliance using trim kits provided by the appliance supplier.
- DAPNL3/4APF kit includes 3/4" plywood veneer panel finished on both sides, and all four edges. Panel is cut to fit appliance doors, and mounts to the appliance using trim kits provided by the appliance supplier.
- Panels mount to the appliance using trim kits provided by the appliance supplier.
- Custom sizes available in 1/16" increments.
- Grain on panels will follow the height dimension (vertical).

	Maximum Width	Minimum Width	Maximum Height	Minimum Height
DAPNL1/4	48"	5"	96"	5"
DAPNL3/4*	48"	5"	48"	5"
DAPNL3/4**	30"	5"	96"	5"

\*If 48" high or less

\*\*If greater than 48" high

**Specie Availability**

Cherry	Hickory	Maple	Oak	Laminate	PureStyle™
•	•	•	•	Maple	Maple

# DECORATIVE APPLIANCE PANEL ORDER FORM

Use one order form per appliance.

## STEP 1: Provide Order Information\*

Account #: \_\_\_\_\_ PO #: \_\_\_\_\_

Date: \_\_\_\_\_ Order #: \_\_\_\_\_

Bill To: \_\_\_\_\_ Ship To: \_\_\_\_\_

## STEP 2: Select Appliance Type\* (circle one per order form)

### Refrigerator/Freezer

<b>Single Door</b> 	<b>Side-by-Side</b> 	<b>Side-by-Side w/Dispenser</b> 	<b>Side-by-Side w/Dispenser &amp; TV</b> 	<b>Top/Bottom</b> 	<b>Top/Bottom w/Drawers</b> 	<b>French Door</b> 	<b>Under Counter</b> 
<b>Single Door w/Grill</b> 	<b>Side-by-Side w/Grill</b> 	<b>Side-by-Side w/Dispenser &amp; Grill</b> 	<b>Side-by-Side w/Dispenser/TV &amp; Grill</b> 	<b>Top/Bottom w/Grill</b> 	<b>French Door w/Dispenser</b> 	<b>Under Counter w/Drawers</b> 	

### Dishwasher/Trash Compactor/ Ice Maker/Wine Cooler

<b>Dishwasher Standard</b> 	<b>Dishwasher Standard</b> 	<b>Trash Compactor/ Ice Maker</b> 
<b>Dishwasher Double Drawer</b> 	<b>Dishwasher Single Drawer</b> 	<b>Wine Cooler</b> 

## STEP 3: Provide Dimensions in Inches for Panels Needed as Listed Above\*

Custom Panels – Dimensions for Custom Size Panel(s)

DAPNL1/4 or DAPNL3/4 or DAPNL3/4APF — Circle Panel

A	_____ in. width	x	_____ in. height	=	_____ square inches	} total square inches
B	_____ in. width	x	_____ in. height	=	_____ square inches	
C	_____ in. width	x	_____ in. height	=	_____ square inches	
D	_____ in. width	x	_____ in. height	=	_____ square inches	
E	_____ in. width	x	_____ in. height	=	_____ square inches	

## STEP 4: Determine Price\* (Refer to Price Book for cost per square foot)

Total square inches from Step 3  ÷ 144 square inches = total square footage x \$  cost per square foot = \$

**Total Cost**

\*\*If premium finish is used, multiply total cost by premium upcharge percentage = \$

## STEP 5: Customer Signature\*

I accept full responsibility for the accuracy of the design above. Signature:

\*ALL FIELDS REQUIRED TO PROCESS ORDER.

**DESCRIPTION MODEL PRICE**  
**PANELS & SKINS**

**END PANEL SKINS, WALL**

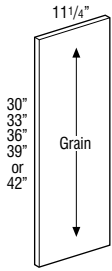

1/4" Finished		
<b>WEPS30WD</b>	83	
<b>WEPS33WD</b>	105	
<b>WEPS36WD</b>	110	
<b>WEPS39WD</b>	109	
<b>WEPS42WD</b>	107	
1/8" Laminate		
<b>WEPS30LAM18</b> ♦	40	
<b>WEPS33LAM18</b> ♦	48	
<b>WEPS36LAM18</b> ♦	50	
<b>WEPS39LAM18</b> ♦	57	
<b>WEPS42LAM18</b> ♦	61	

- Stains: 1/4" thick veneered furniture board.
- Paints: 1/4" thick veneered or solid furniture board
- 1/8" thick laminated furniture board.
- Not compatible with Furniture Ends (FPEB).

**Custom Modifications**

ID	RD
•	•

**Specie Availability**

Cherry	Hickory	Maple	Oak	Laminate	PureStyle™
•	•	•	•	Maple	Maple

♦ Not available in Black or Maritime.

**END PANEL SKINS, BASE**

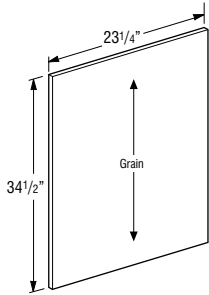

1/4" Finished		
<b>BEPS34.5WD</b>	144	
1/8" Laminate		
<b>BEPS34.5LAM18</b> ♦	70	

- Stains: 1/4" thick veneered furniture board.
- Paints: 1/4" thick veneered or solid furniture board
- 1/8" thick laminated furniture board.

**Custom Modifications**

ID	RD
•	•

**Specie Availability**

Cherry	Hickory	Maple	Oak	Laminate	PureStyle™
•	•	•	•	Maple	Maple

♦ Not available in Black or Maritime.

**DESCRIPTION MODEL PRICE**

**END PANEL SKINS, TALL**

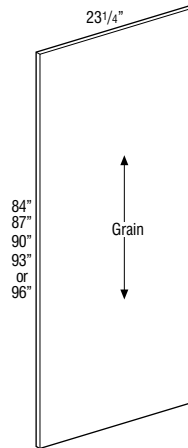
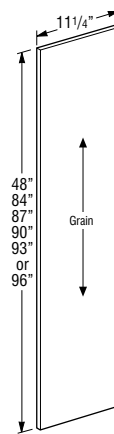

1/4" Finished		
<b>TEPS1248WD</b>	185	
<b>TEPS1284WD</b> †	269	
<b>TEPS1287WD</b> †	269	
<b>TEPS1290WD</b> †	269	
<b>TEPS1293WD</b> †	269	
<b>TEPS1296WD</b> †	269	
1/8" Laminate		
<b>TEPS1248LAM18</b> ♦	95	
<b>TEPS1284LAM18</b> † ♦	117	
<b>TEPS1287LAM18</b> † ♦	117	
<b>TEPS1290LAM18</b> † ♦	117	
<b>TEPS1293LAM18</b> † ♦	117	
<b>TEPS1296LAM18</b> † ♦	117	

1/4" Finished		
<b>TEPS84WD</b> †	317	
<b>TEPS87WD</b> †	379	
<b>TEPS90WD</b> †	395	
<b>TEPS93WD</b> †	410	
<b>TEPS96WD</b> †	410	
1/8" Laminate		
<b>TEPS84LAM18</b> † ♦	168	
<b>TEPS87LAM18</b> † ♦	181	
<b>TEPS90LAM18</b> † ♦	184	
<b>TEPS93LAM18</b> † ♦	207	
<b>TEPS96LAM18</b> † ♦	207	

- Stains: 1/4" thick veneered furniture board.
- Paints: 1/4" thick veneered or solid furniture board
- 1/8" thick laminated furniture board.

†5 day Express Response not available on items greater than 48".

**Custom Modifications**

ID	RD
•	•

**Specie Availability**

Cherry	Hickory	Maple	Oak	Laminate	PureStyle™
•	•	•	•	Maple	Maple

♦ Not available in Black or Maritime.

**DESCRIPTION MODEL PRICE**

**FINISHED BACK SKINS**



1/4" Finished	
<b>BP4830WD</b>	219
<b>BP4834.5WD</b>	253
1/8" Laminate	
<b>BP4830LAM18 ♦</b>	80
<b>BP4834.5LAM18 ♦</b>	87

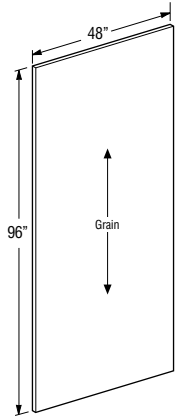
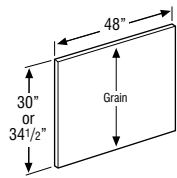

1/4" Finished	
<b>BP4896WD†</b>	533
1/8" Laminate	
<b>BP4896LAM18† ♦</b>	185

- BP\_\_WD in Stains is 1/4" thick veneered furniture board.
- BP\_\_WD in Paints is 1/4" thick veneered or solid furniture board.
- BP\_\_LAM18 is 1/8" thick laminated furniture board.
- For custom sizes refer to DAPNL1/4.

†5 day Express Response not available on items greater than 48".

**Custom Modifications**

ID	RD

**Specie Availability**

Cherry	Hickory	Maple	Oak	Laminate	PureStyle™
•	•	•	•	Maple	Maple

♦ Not available in Black or Maritime.

**CROSS GRAIN VENEER BACK SKIN 1/4" PANELS**

<b>BP9634.5CRSGR</b>	692
<b>BP9648CRSGR</b>	692

- Veneer on MDF core.

**Custom Modifications**

ID	RD

**Specie Availability**

Cherry	Hickory	Maple	Oak	Laminate	PureStyle™
•	•	•	•	Maple	Maple

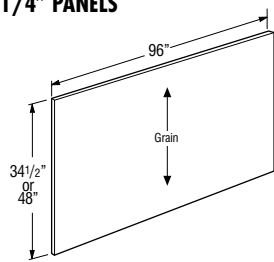

**WOOD V-GROOVED BEADED SKIN 1/4" PANELS**



<b>BP4834.5VG</b>	416
<b>BP4896VG†</b>	955

- Veneer on MDF core.
- V-groove on 3" centers.
- When used as a skin, not compatible with Furniture Ends (FPEB).

†5 day Express Response not available on items greater than 48".

**Custom Modifications**

ID	RD

**Specie Availability**

Cherry	Hickory	Maple	Oak	Laminate	PureStyle™
•	•	•	•	Maple	Maple

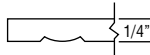
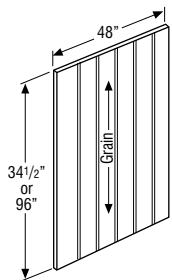

**DESCRIPTION MODEL PRICE**

**END PANELS, WALL**



3/4" Finished	
<b>WEP1230WD</b>	146
3/4" Laminate	
<b>WEP1230LAM* ♦</b>	100

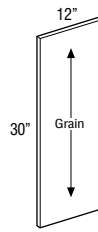

- WEP1230WD in Stains: 3/4" thick veneered furniture board.
- WEP1230WD in Paints: 3/4" thick veneered or solid furniture board.
- WEP1230LAM is 3/4" thick laminated furniture board.
- Panels are finished on two sides and front edge.

\*Loren edgbanding will match door edgbanding selection.

**Custom Modifications**

ID	RD
•	•

**Specie Availability**

Cherry	Hickory	Maple	Oak	Laminate	PureStyle™
•	•	•	•	Maple	Maple

♦ Not available in Black or Maritime.

**END PANELS, BASE**

3/4" Finished	
<b>BEPWD</b>	236
3/4" Laminate	
<b>BEPLAM* ♦</b>	159

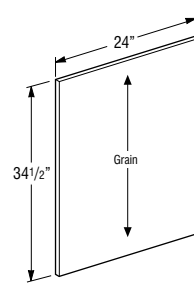

- BEPWD in Stains: 3/4" thick veneered furniture board.
- BEPWD in Paints: 3/4" thick veneered or solid furniture board.
- BEPLAM is 3/4" thick laminated furniture board.
- Panels are finished on two sides and front edge.

\*Loren edgbanding will match door edgbanding selection.

**Custom Modifications**

ID	RD
•	•

**Specie Availability**

Cherry	Hickory	Maple	Oak	Laminate	PureStyle™
•	•	•	•	Maple	Maple

♦ Not available in Black or Maritime.

**END PANELS, LAZY SUSAN**



3/8" Finished	
<b>BLSBEPWD</b>	243
3/8" Laminate	
<b>BLSBEPLAM ♦</b>	164

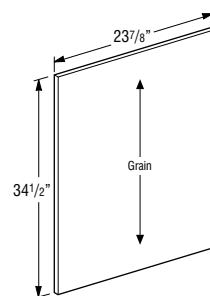

- 3/8" thick veneered or laminated furniture board.
- Panels are finished on one side and front edge.

**Custom Modifications**

ID	RD
•	•

**Specie Availability**

Cherry	Hickory	Maple	Oak	Laminate	PureStyle™
•	•	•	•	Maple	Maple

♦ Not available in Black or Maritime.

**DESCRIPTION**

**MODEL**

**PRICE**

**END PANELS, TALL**

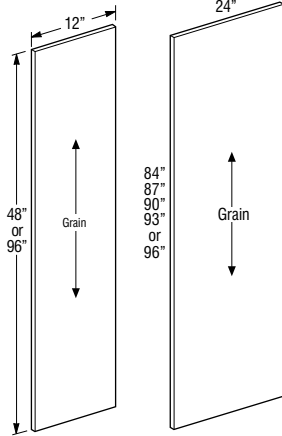

<b>3/4" Finished</b>	
<b>TEP1248WD</b>	263
<b>TEP1296WD†</b>	368
<b>3/4" Laminate</b>	
<b>TEP1248LAM* ♦</b>	144
<b>TEP1296LAM†* ♦</b>	207
<b>3/4" Finished</b>	
<b>TEP2484WD†</b>	514
<b>TEP2487WD†</b>	598
<b>TEP2490WD†</b>	620
<b>TEP2493WD†</b>	720
<b>TEP2496WD†</b>	720
<b>3/4" Laminate</b>	
<b>TEP2484LAM†* ♦</b>	282
<b>TEP2487LAM†* ♦</b>	332
<b>TEP2490LAM†* ♦</b>	344
<b>TEP2493LAM†* ♦</b>	404
<b>TEP2496LAM†* ♦</b>	404

- TEP\_\_WD in Stains: 3/4" thick veneered furniture board.
- TEP\_\_WD in Paints: 3/4" thick veneered or solid furniture board.
- TEP\_\_LAM is 3/4" thick laminated furniture board.
- Panels are finished on two sides and front edge.

†5 day Express Response not available on items greater than 48".

\*Loren edgbanding will match door edgbanding selection.

**Custom Modifications**

ID	RD
•	•

**Specie Availability**

Cherry	Hickory	Maple	Oak	Laminate	PureStyle™
•	•	•	•	Maple	Maple

♦ Not available in Black or Maritime.

**DESCRIPTION**

**MODEL**

**PRICE**

**BASE and TALL PANELS with FILLER ATTACHED**

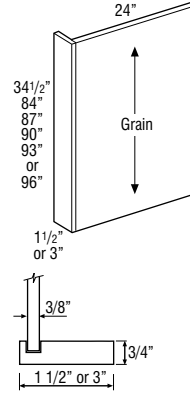

<b>3/8" Finished</b>	
<b>BEPF1.5WD</b>	297
<b>BEPF3WD</b>	323
<b>3/8" Laminate</b>	
<b>BEPF1.5LAM ♦</b>	230
<b>BEPF3LAM ♦</b>	258
<b>3/8" Finished</b>	
<b>TEP2484F1.5WD†</b>	609
<b>TEP2484F3WD†</b>	674
<b>TEP2487F1.5WD†</b>	704
<b>TEP2487F3WD†</b>	783
<b>TEP2490F1.5WD†</b>	728
<b>TEP2490F3WD†</b>	811
<b>TEP2493F1.5WD†</b>	849
<b>TEP2493F3WD†</b>	944
<b>TEP2496F1.5WD†</b>	849
<b>TEP2496F3WD†</b>	944
<b>3/8" Laminate</b>	
<b>TEP2484F1.5LAM† ♦</b>	393
<b>TEP2484F3LAM† ♦</b>	435
<b>TEP2487F1.5LAM† ♦</b>	457
<b>TEP2487F3LAM† ♦</b>	511
<b>TEP2490F1.5LAM† ♦</b>	474
<b>TEP2490F3LAM† ♦</b>	529
<b>TEP2493F1.5LAM† ♦</b>	558
<b>TEP2493F3LAM† ♦</b>	623
<b>TEP2496F1.5LAM† ♦</b>	558
<b>TEP2496F3LAM† ♦</b>	623

- BEPF\_\_WD and TEP\_\_F\_\_WD in Stains: 3/8" thick veneered furniture board.
  - BEPF\_\_WD and TEP\_\_F\_\_WD in Paints: 3/8" thick veneered or solid furniture board.
  - Specify MIP for veneered interior.
  - BEPF\_\_LAM and TEP\_\_F\_\_LAM is 3/8" thick laminated furniture board.
  - All panels have Natural Maple laminate interior
- †5 day Express Response not available on items greater than 48".

**Custom Modifications**

ID	RD
•	•

**Specie Availability**

Cherry	Hickory	Maple	Oak	Laminate	PureStyle™
•	•	•	•	Maple	Maple

♦ Not available in Black or Maritime.

**DESCRIPTION MODEL PRICE**

**BASE and TALL PANELS with FILLER ATTACHED and FURNITURE ENDS**



BEPF1.5FPE	350
BEPF3FPE	382
<hr/>	
TEP2484F1.5FPE†	718
TEP2484F3FPE†	795
TEP2487F1.5FPE†	832
TEP2487F3FPE†	924
TEP2490F1.5FPE†	860
TEP2490F3FPE†	957
TEP2493F1.5FPE†	1004
TEP2493F3FPE†	1115
TEP2496F1.5FPE†	1004
TEP2496F3FPE†	1115

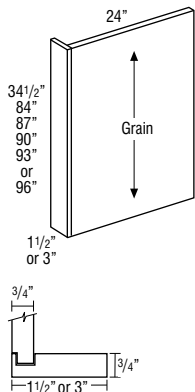

- 3/4" thick veneered plywood.
- †5 day Express Response not available on items greater than 48".

**Custom Modifications**

ID	RD
•	

**Specie Availability**

Cherry	Hickory	Maple	Oak	Laminate	PureStyle™
•	•	•	•	Maple	Maple

**DESCRIPTION MODEL PRICE**

**BASE PANEL with FILLER ATTACHED and AUTHENTIC ENDS, SINGLE DOOR**



BEPF1.5AELSD	854
BEPF1.5AERSD	854
BEPF3AELSD	880
BEPF3AERSD	880

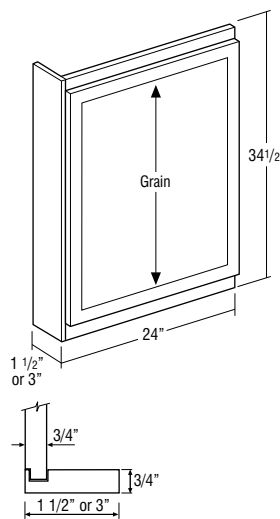

- 3/4" thick veneered plywood with doors attached.
- Panels are finished on two sides and front edge.
- Depth can be reduced in 3" increments down to 9" deep.
- Panel will have veneered exterior and Natural Maple laminated interior standard. For veneered interior, specify MIP.

**Custom Modifications**

FPEB	ID	MIP	RD
STD		•	•

**Specie Availability**

Cherry	Hickory	Maple	Oak	Laminate	PureStyle™
•	•	•	•	Maple	Maple

271

**BASE PANEL with FILLER ATTACHED and AUTHENTIC ENDS**



BEPF1.5AEL	854
BEPF1.5AER	854
BEPF3AEL	880
BEPF3AER	880

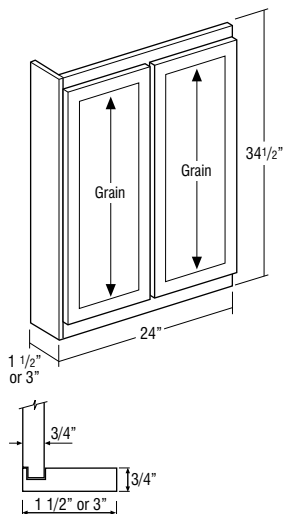

- 3/4" thick veneered plywood with doors attached.
- Panels are finished on two sides and front edge.
- Depth can be increased in 3" increments up to 30" deep.
- Panel will have veneered exterior and Natural Maple laminated interior standard. For veneered interior, specify MIP.

**Custom Modifications**

FPEB	ID	MIP	RD
STD	•	•	

**Specie Availability**

Cherry	Hickory	Maple	Oak	Laminate	PureStyle™
•	•	•	•	Maple	Maple

**TALL PANEL with FILLER ATTACHED and AUTHENTIC ENDS**

TEP2484F1.5AEL	1939
TEP2484F1.5AER	1939
TEP2484F3AEL	2004
TEP2484F3AER	2004
TEP2487F1.5AEL	2034
TEP2487F1.5AER	2034
TEP2487F3AEL	2113
TEP2487F3AER	2113
TEP2490F1.5AHAL	2058
TEP2490F1.5AHAR	2058
TEP2490F3AHAL	2141
TEP2490F3AHAR	2141
TEP2493F1.5AHAL	2179
TEP2493F1.5AHAR	2179
TEP2493F3AHAL	2274
TEP2493F3AHAR	2274
TEP2496F1.5AEL	2179
TEP2496F1.5AER	2179
TEP2496F3AEL	2274
TEP2496F3AER	2274

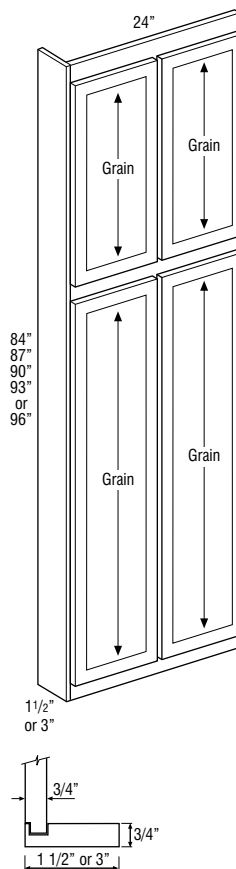

- AH represents upper section alignment with doors on 24" or 27" high cabinets.
- 3/4" thick veneered plywood with doors attached.
- Panels are finished on two sides and front edge.
- Depth can be increased in 3" increments up to 30" deep.
- Panel will have veneered exterior and Natural Maple laminated interior standard. For veneered interior, specify MIP.

**Custom Modifications**

FPEB	ID	MIP	RD
STD	•	•	

**Specie Availability**

Cherry	Hickory	Maple	Oak	Laminate	PureStyle™
•	•	•	•	Maple	Maple

PANELS & SKINS



# NOTES



**DECORATIVE DOOR PANEL KITS, WALL END**

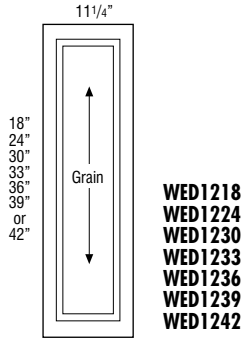

- WED1218
- WED1224
- WED1230
- WED1233
- WED1236
- WED1239
- WED1242

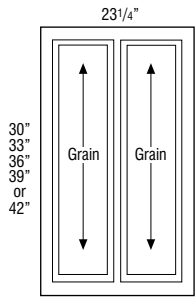

- WED2430
- WED2433
- WED2436
- WED2439
- WED2442

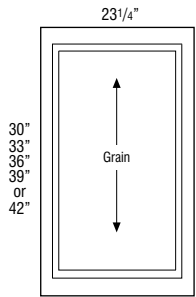

- WED2430SD
- WED2433SD
- WED2436SD
- WED2439SD
- WED2442SD

Model	Cubic Feet	Material						
		Tori Oak	Westburke Oak	Tori Hickory Tori Maple	Loren Laminare Tori Cherry Westburke Hickory Westburke Maple Westburke PureStyle™	Cairo Oak Camille Oak Kesper Oak Renaist Oak	Westburke Cherry	Brookway Oak Bryant Hickory Bryant Maple Cairo Maple Hurley Hickory Hurley Maple Kesper Maple Kersey Oak Renaist PureStyle™
		1	2	3	4	5	6	7
WED1218	1.0	210	220	245	257	269	270	293
WED1224	1.0	233	245	271	284	299	300	323
WED1230	1.0	248	261	287	304	317	320	345
WED1233	1.0	276	290	322	338	353	355	384
WED1236	1.0	283	297	330	346	362	363	394
WED1239	1.0	300	316	350	367	384	387	418
WED1242	1.0	317	332	371	389	406	409	443
WED2430	1.0	373	391	431	453	475	476	516
WED2433	1.0	416	438	486	509	535	536	581
WED2436	1.0	428	449	500	523	549	550	597
WED2439	1.0	456	480	533	558	585	586	638
WED2442	1.0	485	510	565	594	621	624	677
WED2430SD	1.0	336	355	393	412	431	433	470
WED2433SD	1.0	374	394	436	458	478	481	522
WED2436SD	1.0	383	403	446	470	489	493	536
WED2439SD	1.0	407	428	474	499	519	524	567
WED2442SD	1.0	432	453	501	526	550	553	599

- Door panel kits include Wall End Panel Skin and doors with attachment screws for field installation.
- Custom door sizes not available.
- RD available in 3" increments on WED2430SD, WED2433SD, WED2436SD, WED2439SD, and WED2442SD.

**DECORATIVE DOOR PANEL KITS, BASE END**

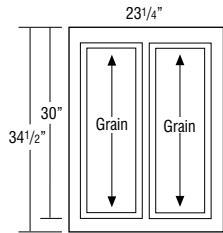

BED

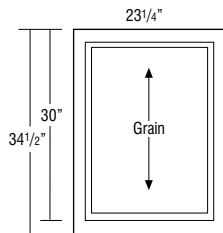

BEDSD

BED	1.0	480	504	556	586	613	615	667
BEDSD	1.0	398	417	457	484	504	509	552

- Door panel kits include Base End Panel Skin and doors with attachment screws for field installation.
- RD available in 3" increments on BEDSD.

Model	Cubic Feet	Cantrill Maple	Bryant Cherry Hurley Cherry Norris Maple Norris PureStyle™	Cairo Cherry Kasper Cherry Reist Cherry	Klewin Oak	Brockway Maple Cantrill Cherry Kersey Hickory Kersey Maple Norris Cherry	Felix Hickory Felix Maple Forte Hickory Forte Maple Forte PureStyle™ Owens Maple Owens PureStyle™	Amico PureStyle™ Brockway Cherry Felix Cherry Forte Cherry Kersey Hickory Klewin Hickory Owens Cherry	Adair Maple Adair PureStyle™ Keegan Maple	Wilero Maple	Adair Cherry Keegan Cherry	Klewin Cherry	Wilero Cherry
		8	9	10	11	12	13	14	15	16	17	18	19
WED1218	1.0	306	318	331	356	356	368	387	398	417	430	430	450
WED1224	1.0	340	354	367	395	396	412	434	441	465	476	477	502
WED1230	1.0	362	376	391	419	420	440	462	469	493	508	510	535
WED1233	1.0	403	419	435	468	469	488	513	522	550	565	566	595
WED1236	1.0	413	431	446	480	481	501	525	536	564	580	581	611
WED1239	1.0	439	455	474	510	511	531	557	568	598	614	617	648
WED1242	1.0	465	482	502	539	541	562	590	600	631	649	652	683

WED2430	1.0	542	560	584	626	629	654	687	702	738	759	761	797
WED2433	1.0	609	632	658	707	709	738	774	788	830	853	856	897
WED2436	1.0	625	650	676	728	729	759	796	810	852	877	880	923
WED2439	1.0	668	693	722	776	777	810	850	865	910	934	940	985
WED2442	1.0	709	738	768	823	825	859	902	920	966	993	998	1045

WED2430SD	1.0	491	510	530	570	572	594	624	637	670	687	690	723
WED2433SD	1.0	547	567	589	635	636	662	695	706	744	767	768	806
WED2436SD	1.0	560	582	603	652	653	680	712	724	763	786	787	827
WED2439SD	1.0	595	619	643	691	693	721	758	770	811	833	837	878
WED2442SD	1.0	628	654	681	731	733	762	799	815	856	881	884	927

**Custom Modifications**

ID	RD
	•

<b>BED</b>	1.0	701	728	757	812	816	847	888	906	953	980	983	1031
------------	-----	-----	-----	-----	-----	-----	-----	-----	-----	-----	-----	-----	------

<b>BEDSD</b>	1.0	579	600	624	672	672	702	736	747	787	810	812	852
--------------	-----	-----	-----	-----	-----	-----	-----	-----	-----	-----	-----	-----	-----

**Custom Modifications**

ID	RD
	•

**DECORATIVE DOOR PANEL KITS,  
TALL END**

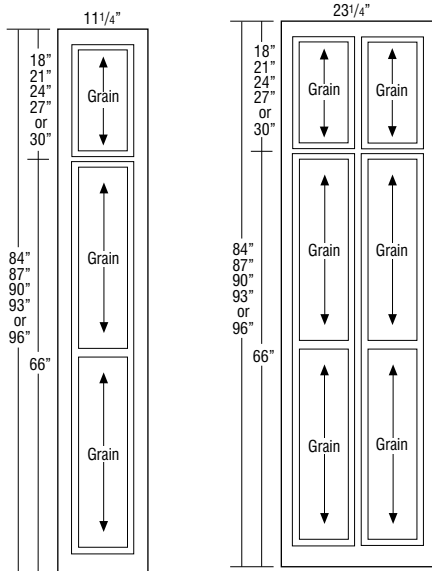

**TED1284  
TED1287  
TED1290AH  
TED1293AH  
TED1296**

**TED2484  
TED2487  
TED2490AH  
TED2493AH  
TED2496**

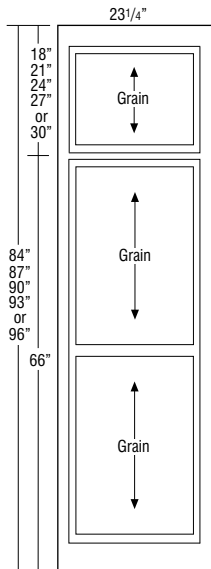

**TED2484SD  
TED2487SD  
TED2490SDAH  
TED2493SDAH  
TED2496SD**

Model	Cubic Feet	Material						
		Tori Oak	Westburke Oak	Tori Hickory Tori Maple	Loren Laminare Tori Cherry Westburke Hickory Westburke Maple Westburke PureStyle™	Calio Oak Gantrell Oak Kesper Oak Rensl Oak	Westburke Cherry	Brookway Oak Bryant Hickory Bryant Maple Bryant PureStyle™ Calio Maple Hurley Hickory Hurley Maple Kesper Maple Kesper Oak Rensl PureStyle™ Rensl PureStyle™
		1	2	3	4	5	6	7
<b>TED1284</b>	1.7	760	798	868	907	944	952	1016
<b>TED1287</b>	2.0	781	820	892	933	970	979	1044
<b>TED1290AH</b>	1.8	786	825	898	940	978	986	1052
<b>TED1293AH</b>	1.9	815	855	929	974	1015	1021	1092
<b>TED1296</b>	1.9	815	855	929	974	1015	1021	1092
<b>TED2484</b>	2.0	1013	1064	1155	1209	1259	1269	1354
<b>TED2487</b>	2.0	1040	1093	1189	1244	1294	1306	1393
<b>TED2490AH</b>	2.0	1048	1100	1198	1253	1304	1315	1402
<b>TED2493AH</b>	2.0	1087	1141	1239	1297	1352	1362	1455
<b>TED2496</b>	2.0	1087	1141	1239	1297	1352	1362	1455
<b>TED2484SD</b>	2.0	950	996	1084	1132	1179	1188	1266
<b>TED2487SD</b>	2.0	976	1025	1114	1165	1214	1223	1305
<b>TED2490SDAH</b>	2.0	982	1032	1122	1173	1222	1232	1314
<b>TED2493SDAH</b>	2.0	1016	1067	1160	1214	1265	1276	1361
<b>TED2496SD</b>	2.0	1016	1067	1160	1214	1265	1276	1361

- AH represents upper section alignment with doors on 24" or 27" high cabinets.
- Door panel kits include Tall End Panel Skin and doors with attachment screws for field installation.
- RD available in 3" increments on TED2484SD, TED2487SD, TED2490SDAH, TED2493SDAH, and TED2496SD.

Model	Cubic Feet	Cantrill Maple	Bryant Cherry Hurley Cherry Norris Maple Norris PureStyle™	Cairo Cherry Kesper Cherry Reist Cherry	Klewin Oak	Brockway Maple Cantrill Cherry Kersey Hickory Kersey Maple Norris Cherry	Felix Hickory Felix Maple Forte Hickory Forte Maple Forte PureStyle™ Owens Maple Owens PureStyle™	Antico PureStyle™ Brockway Cherry Felix Cherry Forte Cherry Kersey Hickory Klewin Hickory Klewin Maple Owens Cherry	Adair Maple Adair PureStyle™ Keegan Maple	Wilero Maple	Adair Cherry Keegan Cherry	Klewin Cherry	Wilero Cherry
		8	9	10	11	12	13	14	15	16	17	18	19
<b>TED1284</b>	1.7	1059	1098	1142	1220	1224	1264	1329	1347	1417	1447	1458	1525
<b>TED1287</b>	2.0	1090	1129	1174	1255	1260	1302	1367	1387	1460	1492	1501	1571
<b>TED1290AH</b>	1.8	1098	1136	1182	1263	1270	1312	1376	1397	1470	1503	1511	1582
<b>TED1293AH</b>	1.9	1140	1180	1227	1311	1316	1361	1428	1449	1526	1558	1570	1641
<b>TED1296</b>	1.9	1140	1180	1227	1311	1316	1361	1428	1449	1526	1558	1570	1641
<b>TED2484</b>	2.0	1411	1463	1522	1625	1632	1687	1771	1796	1888	1930	1944	2031
<b>TED2487</b>	2.0	1453	1505	1566	1673	1681	1736	1823	1849	1946	1989	2002	2093
<b>TED2490AH</b>	2.0	1463	1515	1577	1685	1693	1749	1835	1863	1960	2004	2016	2108
<b>TED2493AH</b>	2.0	1518	1573	1637	1748	1754	1814	1905	1933	2033	2078	2093	2188
<b>TED2496</b>	2.0	1518	1573	1637	1748	1754	1814	1905	1933	2033	2078	2093	2188
<b>TED2484SD</b>	2.0	1322	1369	1425	1521	1528	1579	1659	1680	1769	1805	1818	1901
<b>TED2487SD</b>	2.0	1361	1411	1468	1565	1572	1626	1706	1731	1822	1860	1873	1958
<b>TED2490SDAH</b>	2.0	1370	1422	1478	1576	1583	1638	1718	1743	1835	1873	1886	1973
<b>TED2493SDAH</b>	2.0	1422	1472	1531	1636	1643	1697	1780	1807	1903	1945	1957	2048
<b>TED2496SD</b>	2.0	1422	1472	1531	1636	1643	1697	1780	1807	1903	1945	1957	2048

Custom Modifications

ID	RD
	•

**DESCRIPTION**

**MODEL**

**PRICE**

**VANITY DESK LEGS**



**VDL2129WD**

**227**

**VDL2132WD**

**227**

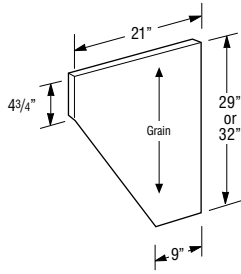

- All panels are finished 2 sides and front edge.
- VDL\_ \_WD in Stains: 3/4" thick veneered furniture board.
- VDL\_ \_WD in Paints: 3/4" thick veneered or solid furniture board.

**Custom Modifications**

ID	RD

**Specie Availability**

Cherry	Hickory	Maple	Oak	Laminate	PureStyle™
•	•	•	•	Maple	Maple

**278**

**PANELS & SKINS**

**DESCRIPTION MODEL PRICE**

**CROWN MOULDING**

**CLASSIC TALL CROWN CLTCROWN8 390**



- One 8" section
- **Cleat shipped unattached can be used for top mount or face frame applications.**

**Specie Availability**

Cherry	Hickory	Maple	Oak	Laminate	PureStyle™
•	•	•	•	Maple	Maple

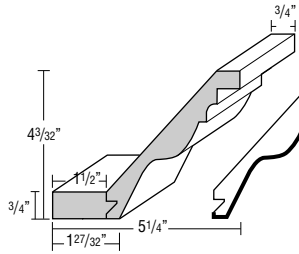

**CORNICE TALL CROWN COTCROWN8 390**



- One 8" section
- **Cleat shipped unattached can be used for top mount or face frame applications.**

**Specie Availability**

Cherry	Hickory	Maple	Oak	Laminate	PureStyle™
•	•	•	•	Maple	Maple

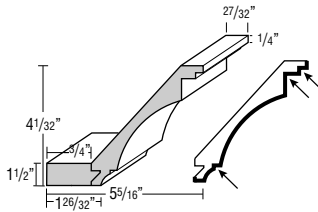

**COVE CROWN COVCROWN8 390**



- One 8" section
- **Cleat shipped unattached can be used for top mount or face frame applications.**

**Specie Availability**

Cherry	Hickory	Maple	Oak	Laminate	PureStyle™
•	•	•	•	Maple	Maple

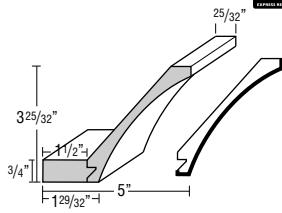

**INSERT CROWN INSCROWN8 429**



- One 8" section.
- **Designed for use with all 2 1/4" insert mouldings.**

**Specie Availability**

Cherry	Hickory	Maple	Oak	Laminate	PureStyle™
•	•	•	•	Maple	Maple

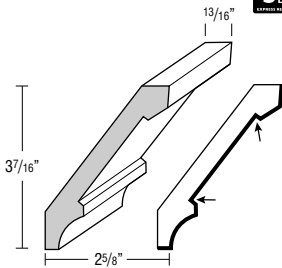

**LARGE STRAIGHT ANGLE CROWN LSCROWN8 299**



- One 8" section.
- **Cleat shipped unattached can be used for top mount or face frame applications.**

**Specie Availability**

Cherry	Hickory	Maple	Oak	Laminate	PureStyle™
•	•	•	•	Maple	Maple

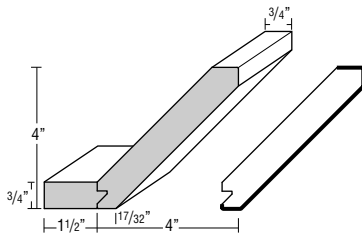

**DESCRIPTION MODEL PRICE**

**MEDIUM STRAIGHT ANGLE CROWN MSACROWN8 269**



- One 8" section.
- **Cleat shipped unattached can be used for top mount or face frame applications.**

**Specie Availability**

Cherry	Hickory	Maple	Oak	Laminate	PureStyle™
•	•	•	•	Maple	Maple

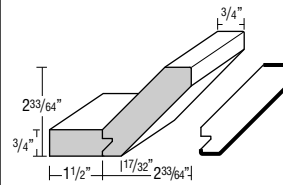

**STRAIGHT ANGLE CROWN SACROWN8 252**



- One 8" section.
- **Cleat shipped unattached can be used for top mount or face frame applications.**

**Specie Availability**

Cherry	Hickory	Maple	Oak	Laminate	PureStyle™
•	•	•	•	Maple	Maple

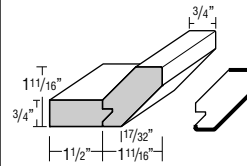

**TALL CROWN MTCROWN8 272**



- One 8" section.

**Specie Availability**

Cherry	Hickory	Maple	Oak	Laminate	PureStyle™
•	•	•	•	Maple	Maple

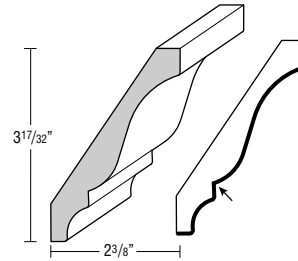

**SHAKER CROWN SHKRCRM8 197**



- Top mount moulding.
- One 8" section.

**Specie Availability**

Cherry	Hickory	Maple	Oak	Laminate	PureStyle™
•	•	•	•	Maple	Maple

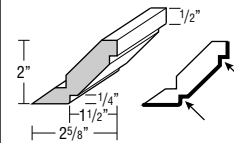

**LARGE SHAKER CROWN LSHAKER8 197**



- One 8" section.

**Specie Availability**

Cherry	Hickory	Maple	Oak	Laminate	PureStyle™
•	•	•	•	Maple	Maple

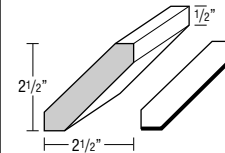

**SMALL COVE CROWN MOULDING SMCOVECROWN8 297**



- One 8" section.

**Specie Availability**

Cherry	Hickory	Maple	Oak	Laminate	PureStyle™
•	•	•	•	Maple	Maple

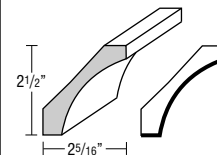

Finished edges indicated by bold lines on side view drawings.  
Glazed edges indicated by arrows on side view drawings.

**DESCRIPTION MODEL PRICE**

**SMALL CROWN**



**SCM8**

133

- Face mounts on Partial Overlay doors. May be face mounted on Full Overlay if used with a cleat.
- One 8' section.
- Moulding can be used as standard or inverted.

**Specie Availability**

Cherry	Hickory	Maple	Oak	Laminate	PureStyle™
•	•	•	•	Maple	Maple

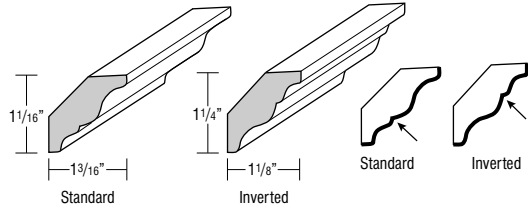

**SOLID WOOD CROWN**



**SWCRM8**

149

- Face mounts on Partial Overlay doors. May be face mounted on Full Overlay if used with a cleat.
- One 8' section.
- Moulding can be used as standard or inverted.

**Specie Availability**

Cherry	Hickory	Maple	Oak	Laminate	PureStyle™
•	•	•	•	Maple	Maple

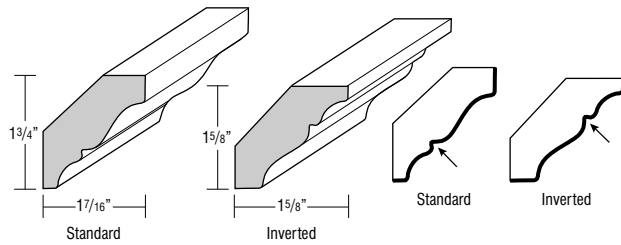

**SOLID WOOD LARGE CROWN**



**SWLCRM8**

254

- Face mounts on Partial Overlay doors. May be face mounted on Full Overlay if used with a cleat.
- One 8' section.
- Moulding can be used as standard or inverted.

**Specie Availability**

Cherry	Hickory	Maple	Oak	Laminate	PureStyle™
•	•	•	•	Maple	Maple

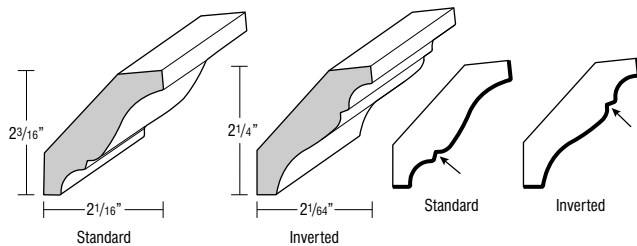

**DESCRIPTION MODEL PRICE**

**SOLID WOOD TALL CROWN**



**SWTCRM8**

272

- Face mounts on Partial Overlay doors. May be face mounted on Full Overlay if used with a cleat.
- One 8' section.
- Moulding can be used as standard or inverted.

**Specie Availability**

Cherry	Hickory	Maple	Oak	Laminate	PureStyle™
•	•	•	•	Maple	Maple

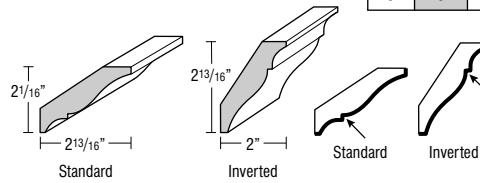

**SOLID WOOD VICTORIAN CROWN**



**SWVCRM8**

284

- Face mounts on Partial Overlay doors. May be face mounted on Full Overlay if used with a cleat.
- Designed for dentil, egg & dart, or rope moulding application.
- One 8' section.

**Specie Availability**

Cherry	Hickory	Maple	Oak	Laminate	PureStyle™
•	•	•	•	Maple	Maple

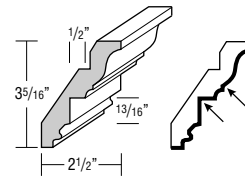

**MOULDING INSERTS**

**NEW DENTIL**



**MDENTIL8**

86

- Designed to face mount on SWVCRM8.
- One 8' section.

**Specie Availability**

Cherry	Hickory	Maple	Oak	Laminate	PureStyle™
•		•	•	Maple	Maple

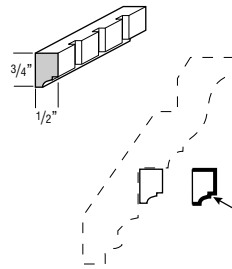

**EGG & DART**



**EGD8**

113

- Designed to face mount on SWVCRM8.
- One 8' section.

**Specie Availability**

Cherry	Hickory	Maple	Oak	Laminate	PureStyle™
		•		Maple	Maple

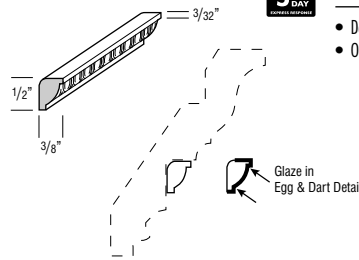

**ROPE**



**RPM8**

113

- Designed to face mount on SWVCRM8.
- One 8' section.

**Specie Availability**

Cherry	Hickory	Maple	Oak	Laminate	PureStyle™
•	•	•	•	Maple	Maple

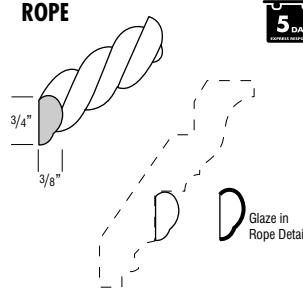

Finished edges indicated by bold lines on side view drawings.  
Glazed edges indicated by arrows on side view drawings.

**DESCRIPTION MODEL PRICE**  
**STARTER MOULDING**

**SOFFIT FILLER MOULDING**



**SFM8**

456

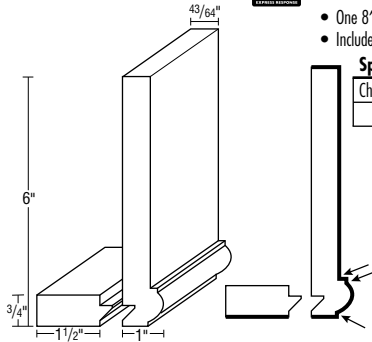

- One 8' section.
- Includes an unattached cleat.

**Specie Availability**

Cherry	Hickory	Maple	Oak	Laminate	PureStyle™
•	•	•	•	Maple	Maple

**STARTER MOULDING**



**STR8**

406

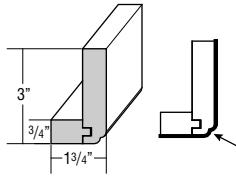

- One 8' section.

**Specie Availability**

Cherry	Hickory	Maple	Oak	Laminate	PureStyle™
•	•	•	•	Maple	Maple

**STARTER MOULDING, SHAKER**



**STR8**

406

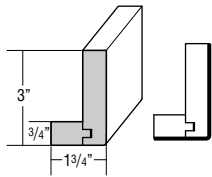

- One 8' section.

**Specie Availability**

Cherry	Hickory	Maple	Oak	Laminate	PureStyle™
•	•	•	•	Maple	Maple

**ACCENT MOULDING**

**ACANTHUS**



**ACAM**

362

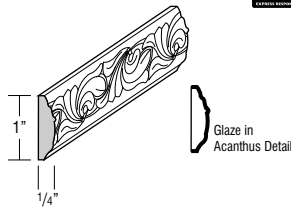

- One 8' section.

**Specie Availability**

Cherry	Hickory	Maple	Oak	Laminate	PureStyle™
•	Beech	•	Beech	Maple	Maple

**BACK PANEL MOULDING**



**BPM8**

125

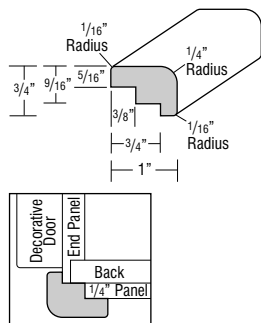

- One 8' section.
- Designed to provide a decorative edge between cabinet and panel-corner seam.

**Specie Availability**

Cherry	Hickory	Maple	Oak	Laminate	PureStyle™
•	•	•	•	Maple	Maple

**DESCRIPTION MODEL PRICE**

**CABINET PANEL EDGE**



**CPE8**

181

- One 8' section.

**Specie Availability**

Cherry	Hickory	Maple	Oak	Laminate	PureStyle™
•	•	•	•	Maple	Maple

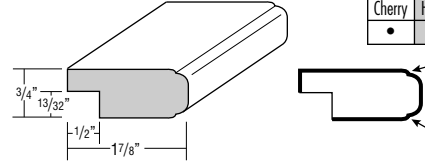

**TRADITIONAL COUNTERTOP EDGE**



**TCM8**

95

- One 8' section.

**Specie Availability**

Cherry	Hickory	Maple	Oak	Laminate	PureStyle™
•	•	•	•	Maple	Maple

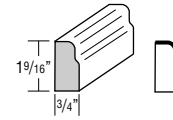

**FLAT SCRIBE**



**SM8**

60

- One 8' section.

**Specie Availability**

Cherry	Hickory	Maple	Oak	Laminate	PureStyle™
•	•	•	•	Maple	Maple

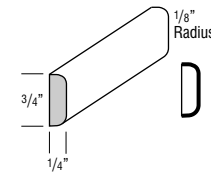

**LIBRARY MOULDING**



**LBRM**

265

- One 8' section.

**Specie Availability**

Cherry	Hickory	Maple	Oak	Laminate	PureStyle™
•	•	•	•	Maple	Maple

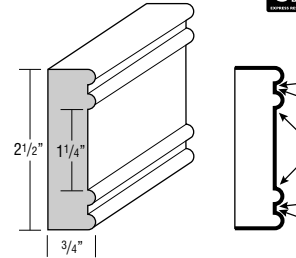

**MIRROR FRAME**



**WMF8**

139

- Pre-grooved.
- One 8' section.

**Specie Availability**

Cherry	Hickory	Maple	Oak	Laminate	PureStyle™
•	•	•	•	Maple	Maple

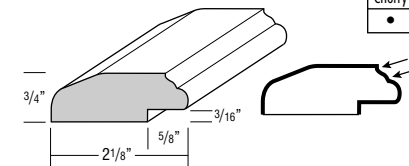

**OGEE EDGE**



**OGEM**

117

- One 8' section.

**Specie Availability**

Cherry	Hickory	Maple	Oak	Laminate	PureStyle™
•	•	•	•	Maple	Maple

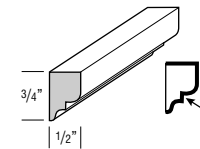

Finished edges indicated by bold lines on side view drawings.  
 Glazed edges indicated by arrows on side view drawings.



**DESCRIPTION** SINGLE BEAD EDGE **MODEL** SBE8 **PRICE** 107

• One 8' section.

**Specie Availability**

Cherry	Hickory	Maple	Oak	Laminate	PureStyle™
•	•	•	•	Maple	Maple

**DESCRIPTION** SMALL SCRIBE **MODEL** SSM8 **PRICE** 46

• One 8' section.

**Specie Availability**

Cherry	Hickory	Maple	Oak	Laminate	PureStyle™
•	•	•	•	Maple	Maple

**DESCRIPTION** SOFFIT TRIM MOULDING **MODEL** TSTM8 **PRICE** 177

• One 8' section.

**Specie Availability**

Cherry	Hickory	Maple	Oak	Laminate	PureStyle™
•	•	•	•	Maple	Maple

**DESCRIPTION** TRIPLE BEAD EDGE **MODEL** TBEM **PRICE** 124

• One 8' section.

**Specie Availability**

Cherry	Hickory	Maple	Oak	Laminate	PureStyle™
•	•	•	•	Maple	Maple

**DESCRIPTION** TRIPLE BEAD PILASTER **MODEL** TBP8 **PRICE** 318

• Finished beaded front and two 4 1/2" sides.

• Can be used vertically between cabinets for an inset look.

• One 8' section.

**Specie Availability**

Cherry	Hickory	Maple	Oak	Laminate	PureStyle™
•	•	•	•	Maple	Maple

**DESCRIPTION** TOE MOULDING **MODEL** BBM8 **PRICE** 266

**BASEBOARD**

• One 8' section.

• BBMB can be used in place of standard toekick to provide a surface for glaze hang-up on premium finishes.

**Specie Availability**

Cherry	Hickory	Maple	Oak	Laminate	PureStyle™
•	•	•	•	Maple	Maple

**DESCRIPTION** BASEBOARD - SHAKER **MODEL** BBMSH8 **PRICE** 266

• One 8' section.

**Specie Availability**

Cherry	Hickory	Maple	Oak	Laminate	PureStyle™
•	•	•	•	Maple	Maple

**DESCRIPTION** TOEBOARDS **MODEL** TB8LAM18 ♦ **PRICE** 40

TB8WD14 **PRICE** 46

TB8LAM38 ♦ **PRICE** 52

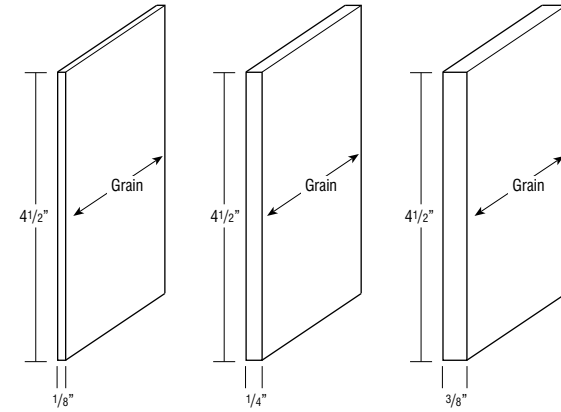

- **TB8LAM18** is 1/8" laminated furniture board (White only).
- **TB8WD14** in Stains: 1/4" thick veneered furniture board.
- **TB8WD14** in Paints: 1/4" thick veneered or solid furniture board.
- **TB8LAM38** is 3/8" Laminated Furniture Board, 1 piece.
- One 8' section.

**Specie Availability**

Cherry	Hickory	Maple	Oak	Laminate	PureStyle™
•	•	•	•	Maple	Maple

♦ Not available in Black or Maritime.

**DESCRIPTION** TOEKICK CAP **MODEL** TKC **PRICE** 31/pair

• All finishes available.

• Sold in pairs.

**Specie Availability**

Cherry	Hickory	Maple	Oak	Laminate	PureStyle™
Maple	Oak	•	•	Maple	Maple

**DESCRIPTION** WINDOW CASING **MODEL** WCT8 **PRICE** 191

**WINDOW CASING - TRADITIONAL**

• One 8' section.

**Specie Availability**

Cherry	Hickory	Maple	Oak	Laminate	PureStyle™
•	•	•	•	Maple	Maple

**DESCRIPTION** LIGHT RAILS **MODEL** CAPM **PRICE** 141

**CAP MOULDING**

• One 8' section.

**Specie Availability**

Cherry	Hickory	Maple	Oak	Laminate	PureStyle™
•	•	•	•	Maple	Maple

Finished edges indicated by bold lines on side view drawings.  
Glazed edges indicated by arrows on side view drawings.

**DESCRIPTION MODEL PRICE**

**LIGHT BAFFLE**



**LB2** (Square)

119

- One 8" section.

**Specie Availability**

Cherry	Hickory	Maple	Oak	Laminate	PureStyle™
•	•	•	•	Maple	Maple

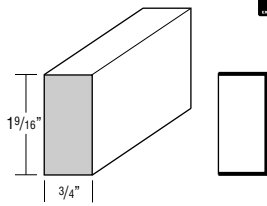

Square Baffle

**SMALL LIGHT RAIL MOULDING**



**SMLR**

439

- One 8" section.

**Specie Availability**

Cherry	Hickory	Maple	Oak	Laminate	PureStyle™
•	•	•	•	Maple	Maple

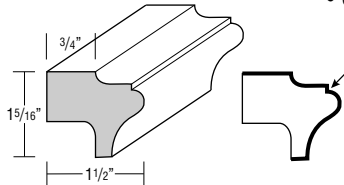

**LIGHT RAIL MOULDING**



**LRM**

502

- One 8" section.

**Specie Availability**

Cherry	Hickory	Maple	Oak	Laminate	PureStyle™
•	•	•	•	Maple	Maple

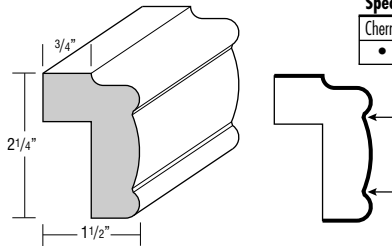

**VALLEY FORGE**



**VFR8**

114

- Must be shimmed at shaded area if used with full overlay styles.
- One 8" section.

**Specie Availability**

Cherry	Hickory	Maple	Oak	Laminate	PureStyle™
•	•	•	•	Maple	Maple

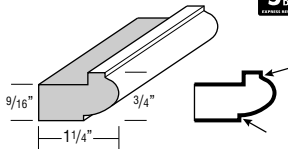

**CORNER MOULDINGS**

**INSIDE CORNER**



**ICM8**

83

- One 8" section.

**Specie Availability**

Cherry	Hickory	Maple	Oak	Laminate	PureStyle™
•	•	•	•	Maple	Maple

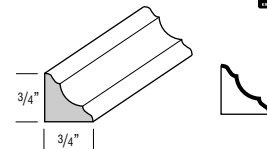

**OUTSIDE CORNER**



**OCM8**

77

- One 8" section.

**Specie Availability**

Cherry	Hickory	Maple	Oak	Laminate	PureStyle™
•	•	•	•	Maple	Maple

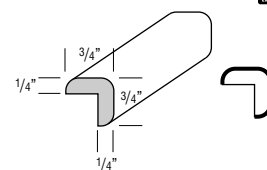

**DESCRIPTION MODEL PRICE**

**OUTSIDE CORNER 135°**



**OC135**

117

- One 8" section.

**Specie Availability**

Cherry	Hickory	Maple	Oak	Laminate	PureStyle™
•	•	•	•	Maple	Maple

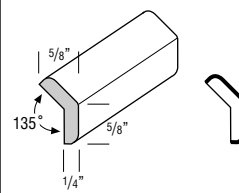

**QUARTER ROUND MOULDING**



**QRM**

76

- One 8" section.

**Specie Availability**

Cherry	Hickory	Maple	Oak	Laminate	PureStyle™
•	•	•	•	Maple	Maple

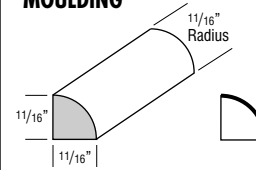

**SHOE - CONVEX INSIDE CORNER**



**SHM8**

70

- One 8" section.

**Specie Availability**

Cherry	Hickory	Maple	Oak	Laminate	PureStyle™
•	•	•	•	Maple	Maple

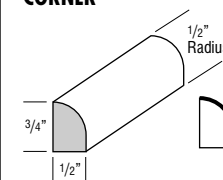

**VALANCES**

**ARCHED VALANCE**



**AV36**

124

**AV48**

148

**AV60**

170

**AV72**

207

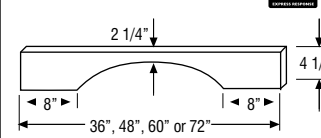

- Side shoulders are 8" wide (6" trimmable each end).
- Bottom edge has 3/16" radius.
- 3/4" thick.

**Specie Availability**

Cherry	Hickory	Maple	Oak	Laminate	PureStyle™
•	•	•	•	Maple	Maple

**FURNITURE VALANCE**



**FV36**

113

**FV48**

137

**FV60**

156

**FV72**

186

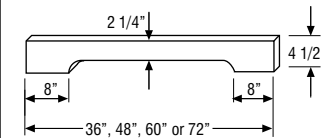

- Side shoulders are 8" wide (6" trimmable each end).
- Bottom edge has 3/16" radius profile on face.
- 3/4" thick.

**Specie Availability**

Cherry	Hickory	Maple	Oak	Laminate	PureStyle™
•	•	•	•	Maple	Maple

**ANGLED FURNITURE TOEKICK VALANCE**



**AVTOE36**

142

**AVTOE48**

172

**AVTOE60**

194

**AVTOE72**

234

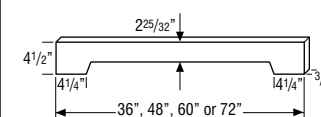

- Each side is trimmable up to 2" per side.

**Specie Availability**

Cherry	Hickory	Maple	Oak	Laminate	PureStyle™
•	•	•	•	Maple	Maple

Finished edges indicated by bold lines on side view drawings.  
Glazed edges indicated by arrows on side view drawings.

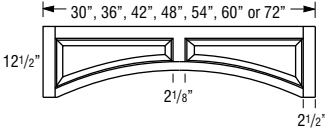
DESCRIPTION	MODEL	PRICE
<b>RAISED PANEL ARCH VALANCE</b> 	<b>RPV30</b>	1124
	<b>RPV36</b>	1181
	<b>RPV42</b>	1238
	<b>RPV48</b>	1380
	<b>RPV54</b>	1526
	<b>RPV60</b>	1669
	<b>RPV72</b>	2017

- Trimable up to 1 3/4" per side.
- Center height 8".
- Raised panel profile is unique to this item and does not match any door style.
- Ends are pocket drilled for installation to adjacent cabinet frames.

**Specie Availability**

Cherry	Hickory	Maple	Oak	Laminate	PureStyle™
•		•	•	Maple	Maple

DESCRIPTION	MODEL	PRICE
<b>STRAIGHT VALANCE</b> 	<b>VV48</b>	122
	<b>VV96</b>	245

- Trimable.
- Profiled bottom edge.
- 3/4" thick.

**Specie Availability**

Cherry	Hickory	Maple	Oak	Laminate	PureStyle™
•	•	•	•	Maple	Maple

**DECORATIVE ORNAMENTS**

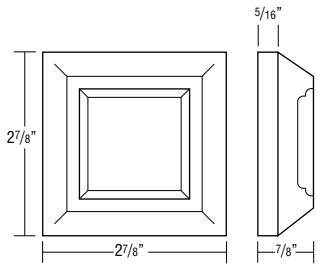
DESCRIPTION	MODEL	PRICE
<b>MISSION ROSETTE</b> 	<b>ROSETTEMIS</b>	313

- Apply with small brad.

**Specie Availability**

Cherry	Hickory	Maple	Oak	Laminate	PureStyle™
•		•	•	Maple	Maple

DESCRIPTION	MODEL	PRICE
<b>CORNER ROSETTE, 3"</b> 	<b>3" Corner Rosette</b>	
	<b>FFRC3X3 (Fluted)</b>	100
	<b>BFRC3X3 (Beaded)</b>	100

**Specie Availability**

Cherry	Hickory	Maple	Oak	Laminate	PureStyle™
•	•	•	•	Maple	Maple

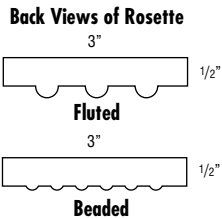

DESCRIPTION	MODEL	PRICE
<b>DECORATIVE SUPPORTS</b>		

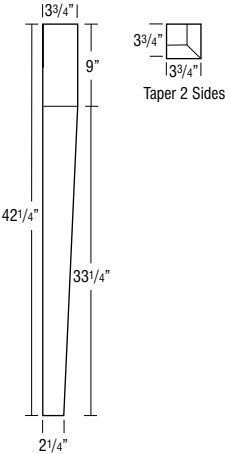
DESCRIPTION	MODEL	PRICE
<b>BAR LEG, 2-SIDED, 42 1/4" HIGH</b> 	<b>2SBARLEG</b>	1089

- Trimable.

**Specie Availability**

Cherry	Hickory	Maple	Oak	Laminate	PureStyle™
•		•	•	Maple	Maple

DESCRIPTION	MODEL	PRICE
<b>BAR LEG, 4-SIDED, 42 1/4" HIGH</b> 	<b>4SBARLEG</b>	1215

- Trimable.

**Specie Availability**

Cherry	Hickory	Maple	Oak	Laminate	PureStyle™
•		•	•	Maple	Maple

DESCRIPTION	MODEL	PRICE
<b>ENGLISH BAR COLUMN, 42 1/4" HIGH</b> 	<b>ENGBARCOLUMN</b>	1231

- Trimable.

**Specie Availability**

Cherry	Hickory	Maple	Oak	Laminate	PureStyle™
•		•	•	Maple	Maple

**DESCRIPTION MODEL PRICE**

**ENGLISH ISLAND COLUMN,  
5" WIDE, 35 1/4" HIGH**



**ENGISLCOLUMN 1384**

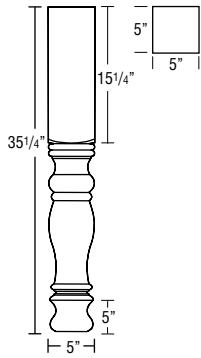

• Trimtable.

**Specie Availability**

Cherry	Hickory	Maple	Oak	Laminate	PureStyle™
•		•	•	Maple	Maple

**DESCRIPTION MODEL PRICE**

**ISLAND LEG, 4-SIDED,  
35 1/4" HIGH**



**4SISLEG 1126**

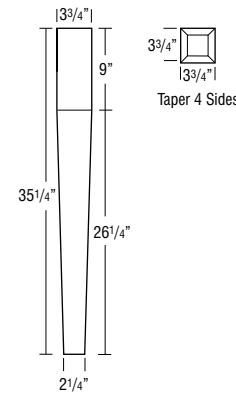

• Trimtable.

**Specie Availability**

Cherry	Hickory	Maple	Oak	Laminate	PureStyle™
•		•	•	Maple	Maple

**SMALL ESTATE LEG,  
2 3/4" WIDE,  
35 1/4" HIGH**



**JESTATELEGS 759**

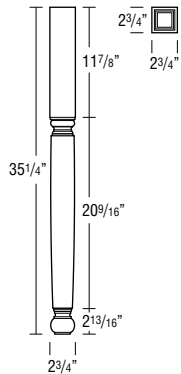

• Trimtable.

**Specie Availability**

Cherry	Hickory	Maple	Oak	Laminate	PureStyle™
		•		Maple	Maple

**METRO BAR COLUMN,  
42 1/4" HIGH**



**METBARCOLUMN 1216**

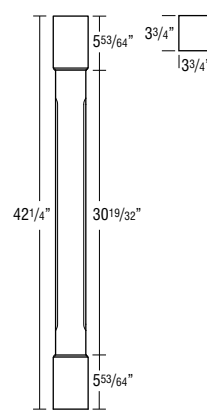

• Trimtable.

**Specie Availability**

Cherry	Hickory	Maple	Oak	Laminate	PureStyle™
•		•	•	Maple	Maple

**ISLAND LEG, 2-SIDED,  
35 1/4" HIGH**



**2SISLEG 849**

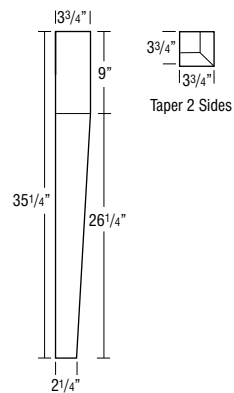

• Trimtable.

**Specie Availability**

Cherry	Hickory	Maple	Oak	Laminate	PureStyle™
•		•	•	Maple	Maple

**METRO ISLAND COLUMN,  
34 5/8" HIGH**



**METISLCOLUMN 1116**

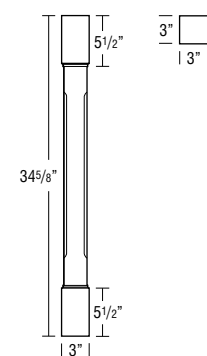

• Trimtable.

• Leg is designed with three pieces joined together.

**Specie Availability**

Cherry	Hickory	Maple	Oak	Laminate	PureStyle™
•		•	•	Maple	Maple

**DESCRIPTION MODEL PRICE**

**MISSION LEG, 34 1/2" HIGH**



**DLEMISSION**

850

• Trimtable.

**Specie Availability**

Cherry	Hickory	Maple	Oak	Laminate	PureStyle™
•		•	•	Maple	Maple

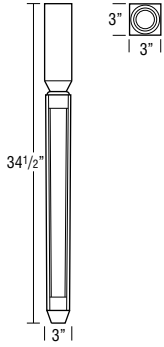

**ISLAND LEG STRAIGHT, 35 1/4" HIGH ISLEGST 522**



• Trimtable.

**Specie Availability**

Cherry	Hickory	Maple	Oak	Laminate	PureStyle™
•		•		Maple	Maple

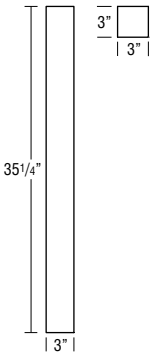

**ISLAND LEG TAPERED, 35 1/4" HIGH ISLEGTPRD 721**



• Trimtable.

**Specie Availability**

Cherry	Hickory	Maple	Oak	Laminate	PureStyle™
		•		Maple	Maple

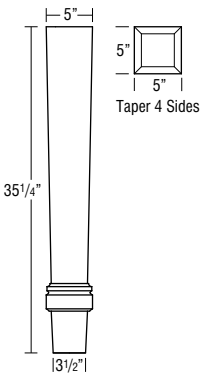

**REED LEG, 34 1/2" HIGH RDLEG 1001**



• Trimtable.

**Specie Availability**

Cherry	Hickory	Maple	Oak	Laminate	PureStyle™
•		•	•	Maple	Maple

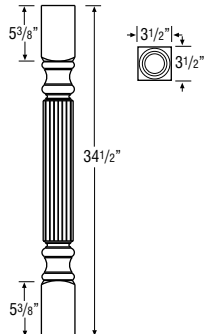

**DESCRIPTION MODEL PRICE**

**SPOOL LEG, 34 1/2" HIGH**



**SPLEG**

1001

• Trimtable.

**Specie Availability**

Cherry	Hickory	Maple	Oak	Laminate	PureStyle™
•		•	•	Maple	Maple

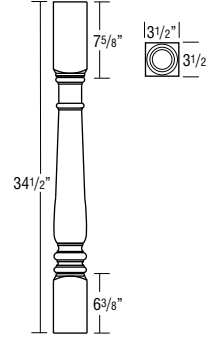

**LARGE SQUARE FOOT, 5" HIGH LGSQFOOT 439**



• Trimtable.

**Specie Availability**

Cherry	Hickory	Maple	Oak	Laminate	PureStyle™
•		•	•	Maple	Maple

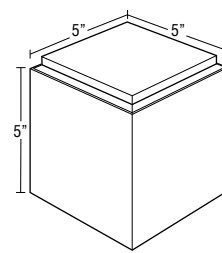

**LILLE FOOT, 4 1/2" HIGH LIFOOT 417**



**Specie Availability**

Cherry	Hickory	Maple	Oak	Laminate	PureStyle™
•		•	•	Maple	Maple

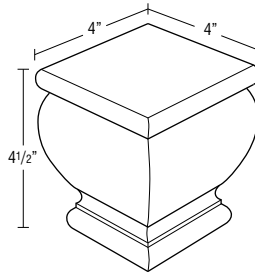

**TAPERED LEG, 6" HIGH TAPLG 265**



• Trimtable.

• Tapered on two sides.

**Specie Availability**

Cherry	Hickory	Maple	Oak	Laminate	PureStyle™
		•		Maple	Maple

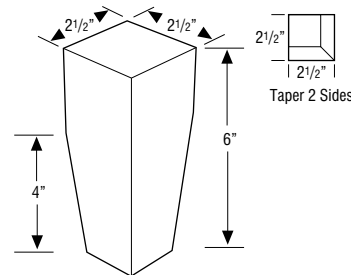

**DESCRIPTION MODEL PRICE**

**TOEKICK TULIP FOOT, 4 5/8" HIGH**



**TKTLFOOT 500**

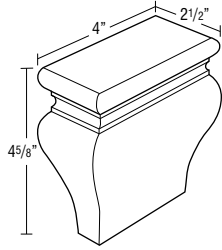

• Trimtable.

**Specie Availability**

Cherry	Hickory	Maple	Oak	Laminate	PureStyle™
•		•	•	Maple	Maple

**TULIP FOOT, 4 5/8" HIGH**



**TLFOOT 465**

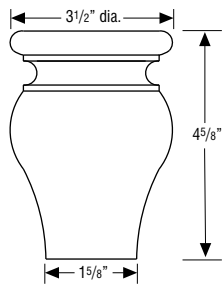

• Trimtable.

**Specie Availability**

Cherry	Hickory	Maple	Oak	Laminate	PureStyle™
•		•	•	Maple	Maple

**2" DECORATIVE SPLIT TURNINGS**



**SPRINGEND (Sold in Pairs) 73 /pair**

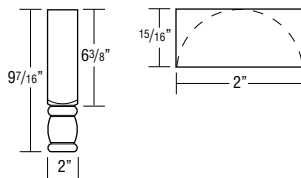

• Ends sold separately from split turnings.

**SPRINGEND**

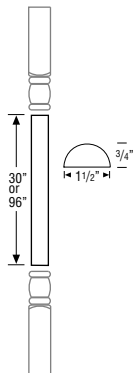

**SPRINGSPPOOL30 (Half Round) 88**

**SPRINGSPPOOL96 (Half Round) 162**

• Ends sold separately from split turnings.

**Specie Availability**

Cherry	Hickory	Maple	Oak	Laminate	PureStyle™
•	•	•	•	Maple	Maple

**SPRINGSPPOOL**

**DESCRIPTION MODEL PRICE**

**DECORATIVE CORBELS & SHELF SUPPORTS**

**NEW 8" BAR CORBEL**



**BARCORBEL8 456**

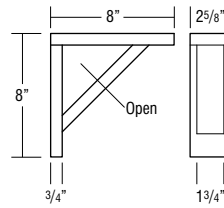

• Not intended for cabinet or freestanding countertop support. For substantial weight support, use a floor mounted support such as a Decorative Leg.

**Specie Availability**

Cherry	Hickory	Maple	Oak	Laminate	PureStyle™
		•		Maple	Maple

**9" SMALL CORBEL**



**SMCORBEL 625**

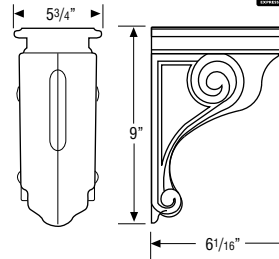

• Not intended for cabinet or freestanding countertop support. For substantial weight support, use a floor mounted support such as a Decorative Leg.

**Specie Availability**

Cherry	Hickory	Maple	Oak	Laminate	PureStyle™
•		•	•	Maple	Maple

**9" ART CORBEL**



**CORBELART9 619**

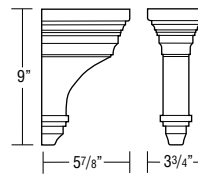

• Not intended for cabinet or freestanding countertop support. For substantial weight support, use a floor mounted support such as a Decorative Leg.

**Specie Availability**

Cherry	Hickory	Maple	Oak	Laminate	PureStyle™
•		•	•	Maple	Maple

**NEW 12" COVE CORBEL**



**COVECORBEL12 691**

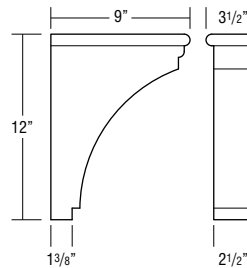

• Not intended for cabinet or freestanding countertop support. For substantial weight support, use a floor mounted support such as a Decorative Leg.

**Specie Availability**

Cherry	Hickory	Maple	Oak	Laminate	PureStyle™
		•		Maple	Maple

**13" LARGE CORBEL**



**LGCORBEL 664**

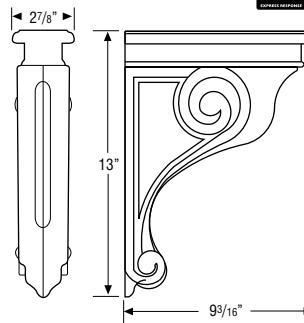

• Not intended for cabinet or freestanding countertop support. For substantial weight support, use a floor mounted support such as a Decorative Leg.

**Specie Availability**

Cherry	Hickory	Maple	Oak	Laminate	PureStyle™
•		•	•	Maple	Maple

**SNACK BAR SUPPORT**



**SBS 191**

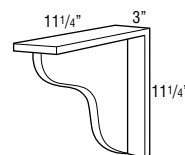

• Not intended for cabinet or freestanding countertop support. For substantial weight support, use a floor mounted support such as a Decorative Leg.

**Specie Availability**

Cherry	Hickory	Maple	Oak	Laminate	PureStyle™
•	•	•	•	Maple	Maple

DESCRIPTION	MODEL	PRICE
<b>LIGHTING</b>		
<ul style="list-style-type: none"> <li>LEDs are a solid state lighting source. LEDs are more efficient, durable, and safer than older light sources.</li> <li>CW = Cool White (Kelvin rating: 5000)</li> <li>WW = Warm White (Kelvin rating: 3200)</li> </ul>		

**LED PUCK LIGHTING, STANDARD**



<b>PUCK18CW</b>	105
<b>PUCK18WW</b>	105

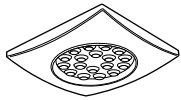

- Contains 18 LED diodes with a life span of 50,000 hours.
- Measures less than 1/4" for low profile surface mounting.
- 65° beam angle.
- Compatible with Dimmable Driver (DIMM241512) and Power Extension Cable (CABL2500).
- Available in: warm or cool white in plastic housing with an aluminum color finish.
- Puck dimension is 2.56" x 2.56" (65mm x 65mm).
- Power usage: 1.25 watts.
- Voltage: 24V Compatibility.

**LED PUCK LIGHTING, HIGH DEFINITION**



<b>PUCK24CW</b>	143
<b>PUCK24WW</b>	143

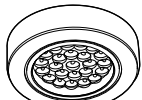

surface mount

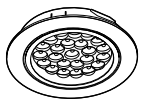

flush mount

- Contains 24 LED diodes with a life span of 50,000 hours.
- Surface or flush mounted (remove ring for flush mounting).
- 50° beam angle.
- Compatible with Dimmable Driver (DIMM241512) and Power Extension Cable (CABL2500).
- Available in: warm or cool white light in aluminum housing.
- Puck diameter is 2.58" (65.5mm) and height is 0.41" (10.5mm).
- Power usage: 1.65 watts.
- Voltage: 24V Compatibility.

**LED FLEXIBLE STRIP**



<b>FLEX12CW</b>	93
<b>FLEX12WW</b>	93
<b>FLEX36CW</b>	330
<b>FLEX36WW</b>	330

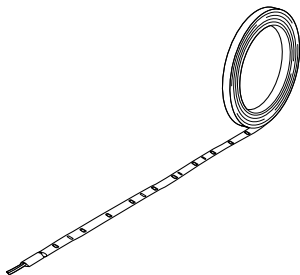

- Linkable and trimmable in increments of either 3" (FLEX12..) or 3 1/4" (FLEX36..), not to exceed a total of 18'.
- Adhesive back.
- Compatible with Dimmable Driver (DIMM121512) and Flex Driver Connection Lead (LEADDFX2500).
- Suggested use: installed over cabinet, under cabinet, in cabinet, and on the toekick.
- Available in: warm or cool white.
- FLEX12.. Dimensions: Length 11.81" (300mm), Width 0.31" (8mm), and Depth 0.1" (2.5mm).
- FLEX36.. Dimensions: Length: 39.37" (1000mm), Width 0.31" (8mm), and Depth 0.1" (2.5mm).
- Power usage: 0.8 watts (FLEX12..) and 2.5 watts (FLEX36..).
- Voltage: 12V Compatibility.

DESCRIPTION	MODEL	PRICE
<b>LED RIGID STRIP</b>		
	<b>RIGID12CW</b>	74
	<b>RIGID12WW</b>	74
	<b>RIGID24CW</b>	108
	<b>RIGID24WW</b>	108



- Linkable.
- Suggested use: straight runs (use link wires for corners).
- Available in 12 or 24 diodes per stick.
- Easy-to-clean, protective shell.
- Compatible with Dimmable Driver (DIMM121512) and Rigid Driver Connection Cable (CABL2500).
- Available in: warm or cool white.
- Includes brackets and screws for easy installation.
- 50,000 hour life span.
- Dimensions (12 Diodes): Length 11.81" (300mm), Width 0.31" (8mm), and Depth 0.24" (6mm).
- Dimensions (24 Diodes): Length 11.22" (285mm), Width 0.31" (8mm), and Depth 0.24" (6mm).
- Power usage: 0.8 watts (RIGID12..) and 1.5 watts (RIGID24..).
- Voltage: 12V Compatibility.

**NEW BATTERY STRIP LIGHT**



<b>BATTLTI</b>	145
----------------	-----

- Battery operated – (4) AAA batteries (not included).
- Motion activated.
- Low power usage (0.3W).
- Plastic aluminum finish.
- Dimensions: Length 11.93" (303mm), Width 0.67" (17mm), and Depth 0.55" (14mm).
- Easy adhesive install.

**STANDARD DRIVERS**

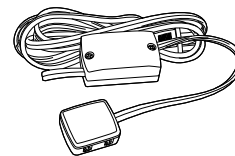

**STAND1264  
STAND2464**

<b>STAND1264</b>	126
<b>STAND2464</b>	126
<b>STAND121512</b>	223
<b>STAND123012</b>	293
<b>STAND243012</b>	293
<b>STAND242012</b>	251

- Product Codes list the driver voltage, watts, and connector ports, such as STAND123012 is 12V, 30W, and 12 connector ports.

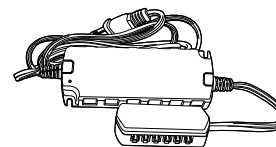

**STAND121512**

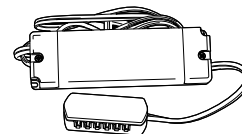

**STAND123012  
STAND243012**

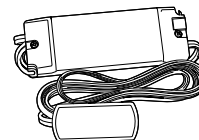

**STAND242012**

	Voltage	Wattage (Max Load)	Connector Ports
STAND1264	12	6	4
STAND2464	24	6	4
STAND121512	12	15	12
STAND123012	12	30	12
STAND243012	24	30	12
STAND242012	24	20	12

**DESCRIPTION MODEL PRICE**

**AC DIMMABLE DRIVERS (DAYBREAK)**



<b>DIMM121512</b>	462
<b>DIMM241512</b>	462

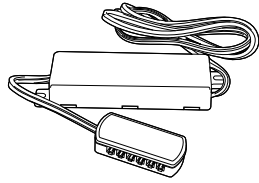

- Available in: 12V and 24V.
- Compatible with most standard wall dimmers.
- Drivers can be hard wired or used with included plug head. Multiple drivers can be used with a single wall dimmer switch and voltages can be mixed.

	Voltage	Wattage (Max Load)	Connector Ports
DIMM121512	12	15	12
DIMM241512	24	15	12

**INFRARED LIGHT SWITCH**



<b>IR1224</b>	114
---------------	-----

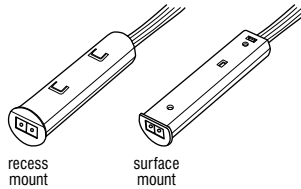

- Compatible with both 12V and 24V products.
- Can be installed inside or under a cabinet or recessed into moulding, turns on and off by passing hand in front of it or when cabinet door is opened or closed.

**LIGHTING ACCESSORIES**

- LEDs are a solid state lighting source. LEDs are more efficient, durable, and safer than older light sources.

**POWER EXTENSION CABLE**



<b>CABL2500</b>	28
-----------------	----

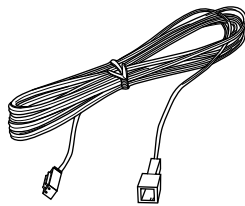

- Provides an additional 98.43" to reach those fixtures which are out of reach with the standard power leads.
- Features a male connector on one end and a female connector on the other.
- Compatible with PUCK18\_\_ and PUCK24\_\_.

**FLEX DRIVER CONNECTION LEAD**



<b>LEADFLX2500</b>	16
--------------------	----

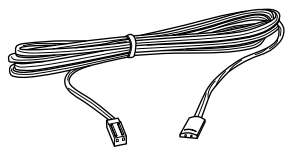

- Required part for each LED flexible strip series, connects the first LED flexible strip in the series to the driver.
- Lead length is 98".
- Compatible with FLEX12\_\_ and FLEX36\_\_.

**FLEX INTER CONNECTIONS**



<b>CONNFLXCRN50</b>	7
---------------------	---

<b>LEADFLXIC500</b>	9
---------------------	---

<b>LEADFLXIC1500</b>	20
----------------------	----

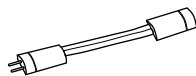

**CONNFLXCRN50**

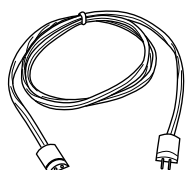

**LEADFLXIC500  
LEADFLXIC1500**

- Used with the LED flexible strips to connect strips together while allowing a gap between sections.
- CONNFLXCRN50 is 1.97" (50mm) and is recommended for the connection of two flexible strips around a corner.
- LEADFLXIC500 is 19.69" (500mm), suggested use is around small obstructions.
- LEADFLXIC1500 is 59" (1500mm), suggested use is around large appliances such as microwaves and refrigerators.
- Compatible with FLEX12\_\_ and FLEX36\_\_.

**DESCRIPTION MODEL PRICE**

**RIGID DRIVER CONNECTION CABLE**



<b>CABLRIGD2500</b>	19
---------------------	----

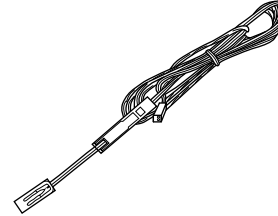

- Required to connect the first LED strip in a series to the driver.
- Cable length is 98".
- Compatible with RIGID12\_\_ and RIGID24\_\_.

**RIGID INTER CONNECTIONS**



<b>CABLRIGCRN30</b>	10
---------------------	----

<b>CABRIGIC300</b>	7
--------------------	---

<b>LEADRIC1500</b>	11
--------------------	----

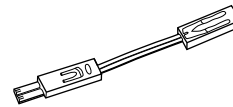

**CABLRIGCRN30**

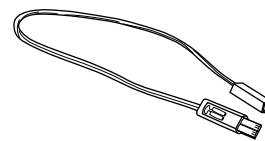

**CABRIGIC300**

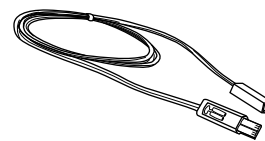

**LEADRIC1500**

- Used with the LED rigid strips to connect strips together while allowing a gap between sections.
- CABLRIGCRN30 is 1.18" (30mm) and is recommended for the connection of two rigid strips around a corner.
- CABRIGIC300 is 11.81" (300mm).
- LEADRIC1500 is 59" (1500mm), suggested use is around large appliances such as microwaves and refrigerators.
- Compatible with RIGID12\_\_ and RIGID24\_\_.

**RIGID STRIP END CAP**



<b>ENDRIG</b>	1
---------------	---

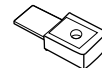

- Used to provide a clean and professional termination of the rigid strip light series.
- Compatible with RIGID12\_\_ and RIGID24\_\_.

**QUATTRO DIMMING RECEIVER**



<b>QDIMREC</b>	468
----------------	-----



- Wireless RF control for an easy, no wire installation.
- Unlimited receiver locations per zone.
- Up to 100' of wireless operation even through obstacles like walls.
- Multiple switches per zone for easy 2, 3, or 4 way control.
- 256 levels of extra smooth dimming.
- Soft start On/Off for gradual dimming.

**QUATTRO WALL CONTROLLER**





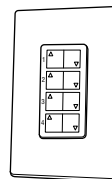

























<b>Q4ZONECON</b>	468
------------------	-----



- Wireless RF control for an easy, no wire installation.
- Unlimited receiver locations per zone with Quattro Dimming Receiver.
- Up to 100' of wireless operation.
- Detachable face for easy handheld remote operation and battery changing.
- Up to 100' of wireless operation even through obstacles like walls.
- Multiple switches per zone for easy 2, 3, or 4 way control.
- Can be ganged (grouped) with wall switches or outlets behind a single cover plate.
- Includes low cost, long life lithium 3V battery for up to 10 years of operation.



DESCRIPTION	MODEL	PRICE
<b>DECORATIVE HARDWARE</b>		
<b>HARDWARE - DECORATIVE PULLS AND KNOBS</b>		
	<b>KNOBH06 - Copper Antique Highlight</b> (1 1/4"W x 1 1/8"L)	10
	<b>KNOBH07 - Copper Antique Highlight</b> (2 1/4"W x 1 1/16"L)	11
	<b>PULLH08 - Copper Antique Highlight - 128mm C/C</b> (15/16"W x 5 1/2"L x 1 1/16"H)	21
	<b>KNOBH10 - Nickel Antique Highlight</b> (1 5/16"W x 3/4"H)	11
	<b>PULLH11 - Nickel Antique Highlight - 96mm C/C</b> (3/8"W x 4 3/4"L x 1 3/8"H)	17
	<b>KNOBH20 - Red Rust Antique</b> (1 1/4"W x 1"H)	6
	<b>KNOBH23 - Ultra Brush Nickel</b> (1 1/4"W x 1"H)	6
	<b>PULLH30 - Ultra Brush Nickel - 128mm C/C</b> (3/16"W x 6 1/2"L x 1 1/8"H)	10
	<b>KNOBH31 - Ultra Brush Nickel</b> (1"W x 3/4"H)	6
	<b>KNOBH32 - Ultra Brush Nickel</b> (1"W x 1/2"H)	9
	<b>PULLH36 - Red Rust Antique - 6" C/C</b> (3/4"W x 7 1/2"L x 1 1/4"H)	53
	<b>KNOBH37 - Red Rust Antique</b> (1.38"W x 1 1/4"H)	33
	<b>PULLH38 - Vibra Black Nickel - 128mm C/C</b> (1 1/4"W x 6 1/8"L x 1 3/8"H)	48
	<b>PULLH39 - Vibra Black Nickel - 96mm C/C</b> (1 1/8"W x 4 3/4"L x 1 1/8"H)	43
	<b>KNOBH40 - Black</b> (1 1/8"W x 1 1/4"L x 1/2"H)	31
	<b>PULLH41 - Black - 5 1/2" C/C</b> (1 1/16"W x 7 1/8"L)	48
	<b>KNOBH46 - Vibra Black Nickel</b> (1"W x 1 1/4"L x 7/8"H)	28
	<b>PULLH50 - Satin Nickel - 5" C/C</b> (5/16"W x 5"L x 1 1/4"H)	46
	<b>PULLH51 - Stainless Steel - 1" C/C</b> (5/16"W x 2"L x 7/16"H)	31
	<b>PULLH52 - Stainless Steel - 7.38" C/C</b> (3/8"W x 8 1/16"L x 7/8"H)	59
	<b>PULLH53 - Satin Nickel - 96mm C/C</b> (5/8"W x 5"L x 1 7/16"H)	43
	<b>KNOBH54 - Black Nickel with Brown Glaze</b> (1 1/4"W x 1 1/8"H)	33
	<b>PULLH55 - Black Nickel with Brown Glaze - 4 1/2" C/C</b> (7/16"W x 5 1/8"L)	43
	<b>PULLH56 - South Haven Antique - 128mm C/C</b> (5 3/8"L)	46
	<b>KNOBH57 - South Haven Antique</b> (1 1/4")	32

DESCRIPTION	MODEL	PRICE
<b>HARDWARE - DECORATIVE PULLS AND KNOBS (cont'd)</b>		
	<b>KNOBH58 - Oil Rubbed Bronze</b> (1 1/4"W x 1"H)	38
	<b>PULLH59 - Oil Rubbed Bronze - 128mm C/C</b> (1 1/4"W x 6 1/8"L x 1/3"H)	53
	<b>PULLH60 - Oil Rubbed Bronze - 96mm C/C</b> (4 7/8"W x 2"L x 7/8"H)	46
	<b>PULLH61 - Black - 96mm C/C</b> (7/16" x 4 15/16"L)	63
	<b>KNOBH62 - Black</b> (2 1/8"W x 2"L x 5/8"H)	27
	<b>PULLH63 - Satin Nickel - 96mm C/C</b> (1/2"W x 4 1/8"L x 1 1/6"H)	37
	<b>PULLH64 - Satin Nickel - 3" C/C</b> (1/2"W x 4 9/16"L x 15/16"H)	33
	<b>KNOBH65 - Stainless Steel</b> (0.088")	31

- Larger pulls may not be compatible with raised profile or 5-piece drawer fronts on face frame openings of 9" wide or less. (See page 45 for 5-Piece Drawer Front Dimensions Chart.)
- Screws included with each hardware piece.

DESCRIPTION	MODEL	PRICE
-------------	-------	-------

**ACCESSORIES**

**BASE PAN STORAGE**

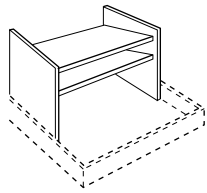

<b>BPS24</b>	570
<b>BPS30</b>	608
<b>BPS36</b>	675

- Roll Tray not included.

Model	Application
BPS24	24" Base
BPS30	30" Base
BPS36	36" Base

**BROOM CLIP**



**BRMCLP**

63

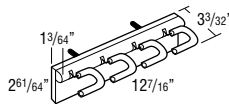

**CABMAT™**



**CABMAT30**

289

**CABMAT33**

300

**CABMAT36**

311

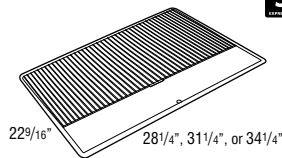

- Designed with a slope to capture spills and is removable for cleaning.
- See CabMat modification for easy size selection by cabinet model.
- Not trimmable. Can also be used in wider cabinets but will create a small void of unprotected area along the end panels.

**L G I X**

Model	Liquid Capacity		Cabinet Size	
	Quarts	Liters	Width	Depth
CABMAT30	4.2	3.9	30"	24"
CABMAT33	4.6	4.3	33"	24"
CABMAT36	5.0	4.7	36"	24"

**CABMAT™ VANITY**



**CABMATV24**

279

**CABMATV30**

289

**CABMATV36**

311

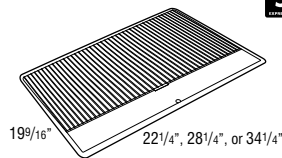

- Designed with a slope to capture spills and is removable for cleaning.
- See CabMat™ modification for easy size selection by cabinet model.
- Not trimmable. Can also be used in wider cabinets but will create a small void of unprotected area along the end panels.

**L G I X**

Model	Liquid Capacity		Cabinet Size	
	Quarts	Liters	Face Frame Opening	Depth
CABMATV24	2.5	2.4	21"-24"	21"
CABMATV30	3.3	3.1	27"-30"	21"
CABMATV36	3.9	3.7	33"	21"

DESCRIPTION	MODEL	PRICE
-------------	-------	-------

**COOKING UTENSIL DIVIDER**



**CUDD24**

271

**CUDD30**

302

**CUDD36**

332

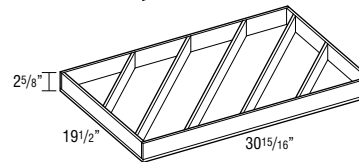
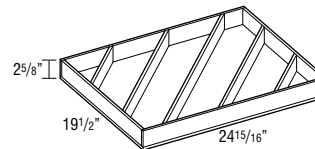
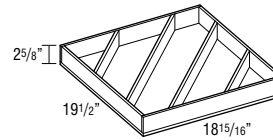

- Pre-assembled natural wood drawer insert (does not fit roll trays).

**L G I X**

**CUTLERY INSERT WOOD ORGANIZER**



**CIW15**

186

**CIW18**

198

**CIW21**

257

**CIW24**

276

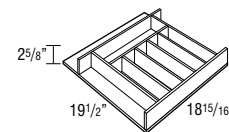
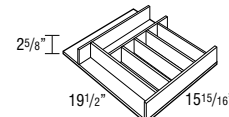
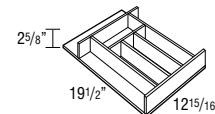
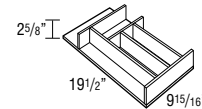

Model	Application
CIW15	15" Base
CIW18	18" Base
CIW21	21" Base
CIW24	24" Base

- Pre-assembled natural wood drawer insert.
- CIW also available installed in B\_CIW, B\_RTCIW, and 4DB\_CIW. See pages 128, 132, and 166.
- Place a cabinet with a CIW next to the dishwasher for convenience.

**L G I X**

**DESCRIPTION MODEL PRICE**

**WOOD TIERED CUTLERY DIVIDER DRAWER, 15", 18", 21", and 24"**



WTCD15	498
WTCD18	515
WTCD21	536
WTCD24	554

Model	Application
WTCD15	15" Base
WTCD18	18" Base
WTCD21	21" Base
WTCD24	24" Base

- Replaces standard drawer. Uses existing cabinet member drawer hardware.
- Requires field installation of drawer front.
- For use with 24" deep cabinets only.
- Exterior WTCD drawer box height is 3 3/4", interior height of top tier is 1 5/8", and interior height of bottom tier is 1 3/8".
- Top divider slides front-to-back.

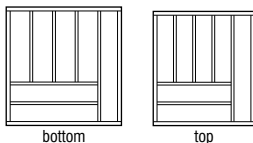
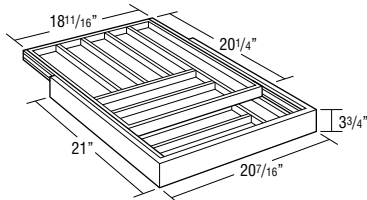
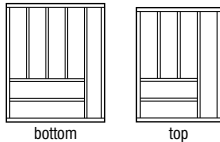
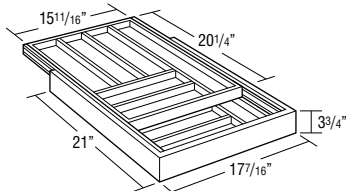
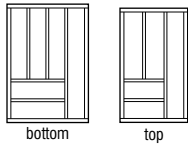
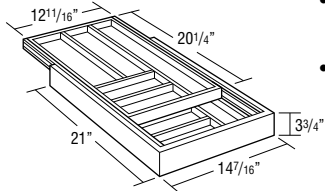
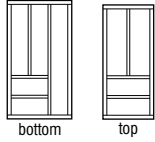
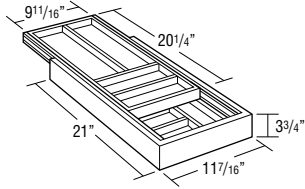

LOGIX

**DESCRIPTION MODEL PRICE**

**EDGEBANDING**



EDGEBAND1OWD	41
EDGEBAND1ONML	41
EDGEBAND1OWHL	41

- Edgebanding will come in a 10' section.
- Finger joints may be visible on unfinished veneer.
- Edgebanding does not come pre-glued.
- EDGEBAND1OWD is unfinished veneer, available in Cherry, Hickory, Maple, and Oak.
- EDGEBAND1ONML is Natural Maple Laminate.
- EDGEBAND1OWHL is White Laminate.

**EXTERIOR SHELF, 12" DEEP**

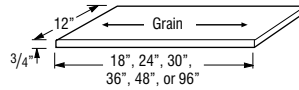

ES1218	161
ES1224	175
ES1230	190
ES1236	205
ES1248	243
ES1296†	353
ES1218APF	214
ES1224APF	227
ES1230APF	243
ES1236APF	257
ES1248APF	291
ES1296APF†	404

- ES1218-ES1296 are 3/4" thick veneered furniture board finished both sides, and front and side edges (back edge is not finished).
  - ES1218APF-ES1296APF are 3/4" thick veneered plywood finished both sides, and front and side edges (back edge is not finished).
- †5 day Express Response not available on items greater than 48".

**Custom Modifications**

ID	RD
•	•

**Specie Availability**

Cherry	Hickory	Maple	Oak	Laminate	PureStyle™
•	•	•	•	Maple	Maple

**DESCRIPTION MODEL PRICE**

**EXTERIOR SHELF, 18" DEEP**

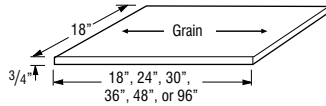

ES1818	184
ES1824	205
ES1830	227
ES1836	249
ES1848	293
ES1896 <sup>†</sup>	469
ES1818APF	235
ES1824APF	257
ES1830APF	279
ES1836APF	301
ES1848APF	345
ES1896APF <sup>†</sup>	521

- ES1818-ES1896 are 3/4" thick veneered furniture board finished both sides, and front and side edges (back edge is not finished).
- ES1818APF-ES1896APF are 3/4" thick veneered plywood finished both sides, and front and side edges (back edge is not finished).

<sup>†</sup>5 day Express Response not available on items greater than 48".

**Custom Modifications**

ID	RD
•	•

**Specie Availability**

Cherry	Hickory	Maple	Oak	Laminate	PureStyle™
•	•	•	•	Maple	Maple

**DESCRIPTION MODEL PRICE**

**EXTERIOR SHELF, 24" DEEP**



ES2418	205
ES2424	234
ES2430	263
ES2436	293
ES2448	353
ES2496 <sup>†</sup>	586
ES2418APF	257
ES2424APF	286
ES2430APF	316
ES2436APF	345
ES2448APF	404
ES2496APF <sup>†</sup>	638

- ES2418-ES2496 are 3/4" thick veneered furniture board finished both sides, and front and side edges (back edge is not finished).
- ES2418APF-ES2496APF are 3/4" thick veneered plywood finished both sides, and front and side edges (back edge is not finished).

<sup>†</sup>5 day Express Response not available on items greater than 48".

**Custom Modifications**

ID	RD
•	•

**Specie Availability**

Cherry	Hickory	Maple	Oak	Laminate	PureStyle™
•	•	•	•	Maple	Maple

**EXTERIOR SHELF, 21" DEEP**

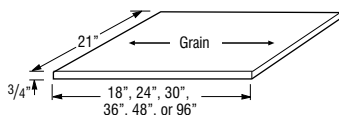

ES2118	194
ES2124	219
ES2130	246
ES2136	271
ES2148	322
ES2196 <sup>†</sup>	527
ES2118APF	246
ES2124APF	271
ES2130APF	298
ES2136APF	323
ES2148APF	374
ES2196APF <sup>†</sup>	580

- ES2118-ES2196 are 3/4" thick veneered furniture board finished both sides, and front and side edges (back edge is not finished).
- ES2118APF-ES2196APF are 3/4" thick veneered plywood finished both sides, and front and side edges (back edge is not finished).

<sup>†</sup>5 day Express Response not available on items greater than 48".

**Custom Modifications**

ID	RD
•	•

**Specie Availability**

Cherry	Hickory	Maple	Oak	Laminate	PureStyle™
•	•	•	•	Maple	Maple

**FULL DEPTH SHELVING To Fit 12" Deep Cabinets**

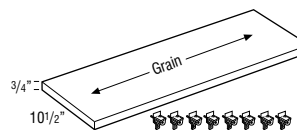

SK912	73
SK1212	73
SK1512	73
SK1812	88
SK2112	88
SK2412	88
SK2712	103
SK3012	103
SK3312	103
SK3612	117
SK3912	117
SK4212	117
SK4812	133

- One shelf, 10 1/2" deep.
- Each kit includes 8 shelf pegs.
- Specify material when ordering.
- Full Depth Shelves will be shipped separate from the cabinet.
- If matching interior is desired, order shelf kit (SK\_\_\_\_) with Matching Interior Plywood (MIP) modification.
- Reduced depth available at 30% upcharge.
- Shelving material specific to construction option. See page 20 for construction details.
- For cabinets ordered with FPEB or MIP, shelf width is 1/4" narrower than standard shelf width and must be specified on SK...order.

**Custom Modifications**

FPEB	ID	MIP	RD
•	•	•	•

**DESCRIPTION MODEL PRICE**

**FULL DEPTH SHELVING**  
To Fit 24" Deep Cabinets

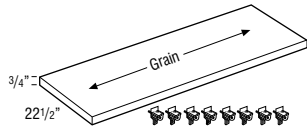

SK924	94
SK1224	94
SK1524	94
SK1824	111
SK2124	111
SK2424	111
SK2724	124
SK3024	124
SK3324	124
SK3624	141
SK3924	141
SK4224	141
SK4824	154

- One shelf, 22 1/2" deep.
- Each kit includes 8 shelf pegs.
- Specify material when ordering.
- Full Depth Shelves will be shipped separate from the cabinet.
- If matching interior is desired, order shelf kit (SK\_\_\_\_) with Matching Interior Plywood (MIP) modification.
- Reduced depth available at 30% upcharge.
- Shelving material specific to construction option. See page 20 for construction details.
- For cabinets ordered with FPEB or MIP, shelf width is 1/4" narrower than standard shelf width and must be specified on SK.. order.

**Custom Modifications**

FPEB	ID	MIP	RD
•	•	•	•

**GLASS SHELF KIT, 12" DEEP**

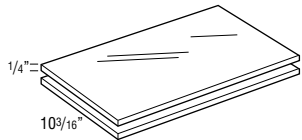

GSK1212	166
GSK1512	170
GSK1812	175
GSK2112	199
GSK2412	210
GSK2712	215
GSK3012	219
GSK3312	231
GSK3612	244

- GSK cannot be trimmed.
- Kit includes two 1/4" tempered shelves.
- Example: GSK1512 = 13 9/32" wide x 10 3/16" deep fits in W1530x12 Deep Cabinet.
- For cabinets ordered with FPEB or MIP, shelf width is 1/4" narrower than standard shelf width and must be specified on GSK.. order.

**Custom Modifications**

FPEB	MIP
•	•

**GLASS SHELF KIT, DIAGONAL**

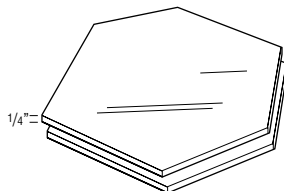

GSKDW24 (Fits DW..2424)	333
GSKDW27 (Fits DW..2727)	333

- GSK cannot be trimmed.
- Kit includes two 1/4" tempered shelves.
- For cabinets ordered with FPEB or MIP, shelf width is 1/4" narrower than standard shelf width and must be specified on GSKDW.. order.

**Custom Modifications**

FPEB	MIP
•	•

**DESCRIPTION MODEL PRICE**

**ANGLED HEAT SHIELDS**

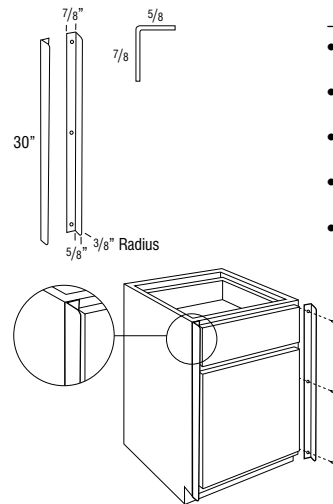

ANGLHEATSHIELD	148
ANGLSHIELDSS	169

- ANGLHEATSHIELD is a pair of 1/16" thick, white powder coated metal shields.
- ANGLSHIELDSS is a pair of 1/16" thick, stainless steel metal shields.
- Heat Shield is used to deflect heat from self-cleaning ovens away from cabinet doors and drawer fronts.
- For use when additional 1/8" cannot be added to the oven manufacturer's recommended space requirement.
- Cabinet door cannot be hinged on the same side as the angled heat shield, not compatible with double door cabinets. Installs on the front of the face frame of each cabinet adjacent to the oven.

**STRAIGHT HEAT SHIELDS**

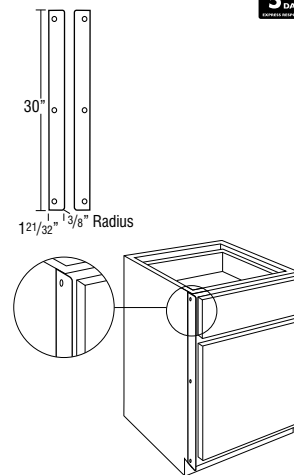

STRTHEATSHIELD	111
STRTHSHIELDSS	132

- STRTHEATSHIELD is a pair of 1/16" thick, white powder coated metal shields.
- STRTHSHIELDSS is a pair of 1/16" thick, stainless steel metal shields.
- Heat Shield is used to deflect heat from self-cleaning ovens away from cabinet doors and drawer fronts.
- For use when additional 1/8" can be added to the oven manufacturer's recommended space requirement.
- Installs on the side of the face frame of each cabinet adjacent to the oven.

**LID ORGANIZERS**

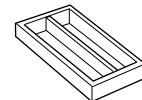

LO	313
----	-----

**OVEN INSTALLATION KIT**

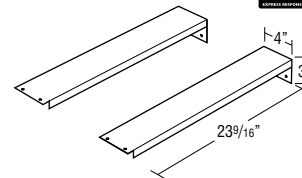

OCINSTALLKIT	62
--------------	----

- Recommended for supporting built-in appliances such as ovens, microwaves, and warming drawers. Refer to appliance manufacturer specifications for installation requirements.
- Weight limit is 400 lbs. per pair.

**PEGGED DISH ORGANIZER**

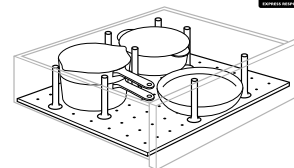

PDO (8 Posts & Board)	383
PDOPOSTS (4 Posts)	98

- For use in 36" wide drawer base cabinets in 6 3/8" or 10" deep drawers, trimmable for cabinets less than 36" wide. Not recommended for use in roll trays.
- Pegged Board is 19/32" thick.
- 29 15/16" x 19 1/2".
- Posts are 6" high.

**DESCRIPTION MODEL PRICE**

**POWER POD**

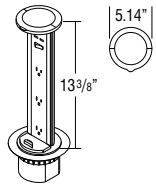

**L O G I X**

<b>PWRPODBK (Black)</b>	<b>635</b>
<b>PWRPODSS (Stainless Steel)</b>	<b>909</b>
<b>PWRPODGM (Gun Metal Black)</b>	<b>909</b>

- Includes: independent power switch, three electrical sockets, and two USB ports (located above power switch).
- 18" of clearance required below surface mount location; and 3 9/16" diameter hole is required in countertop to install.
- This item requires field installation. This accessory cannot be installed above drawers.
- Safe for countertop installation: rated IP54-splash proof from splashing water and water jets per IPX waterproof specifications; and is ETL approved-compliant for electrical and other safety standards to North America safety including: UL, ANSI, CSA, ASTM, and NFPA standards.
- When installed, top lip of strip sits on top of countertop with a pivoting handle. Handle is pulled up to bring bottom of power strip to countertop.
- Cord is 8 ft. long and features a standard 3-prong plug for use in any household outlet. 10 amps.

**SINK BASE CADDY**

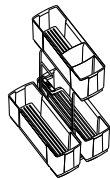

**L O G I X**

<b>SBCADDY</b>	<b>521</b>
----------------	------------

- Caddy is removable and portable.
- Recommended for use in cabinets 18" and wider.
- Caddy dimensions are: 9 15/16" wide x 18 5/16" tall x 18 5/8" deep.
- Caddy fits in cabinets with a minimum: 12" wide x 20 1/2" high frame opening x 21" deep cabinet.

**SLIDING TOWEL RACK**

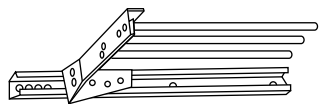

**SPICE RACK PULL DOWN**

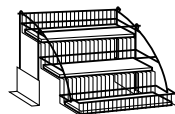

**S**

<b>STR</b>	<b>137</b>
------------	------------

- Metal.
- 5" wide x 17 3/4" long x 1 1/2" high.
- Fits in any sink cabinet.

<b>SPD18</b>	<b>228</b>
--------------	------------

- Spice Rack Pull Down dimensions: 8 15/16" high x 14 13/16" wide x 10 5/16" deep.
- Maximum Weight Capacity: 15 lbs.
- Must be installed on the floor of the cabinet. Cannot be installed on an adjustable shelf.

**TABLET HOLDER**

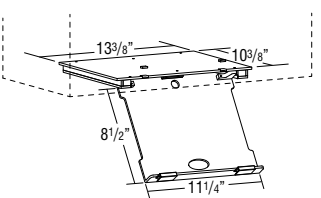

<b>TABLEHLDR</b>	<b>254</b>
------------------	------------

- Mounts under 15" wide cabinet or wider.
- Designed for cabinets 12" deep or deeper.
- Features an acrylic mounting base and pull-down tablet holder tray.
- Tray is movable forward and backward with a slight side to side rotation, and can be utilized at any position.
- Tray has side cut-outs for a charging cord and can be used to store most tablets when closed, depending on overall thickness, width, and height of the tablet.
- Maximum dimensions for tablet: 11 1/4" x 8 1/2" x 1 1/8" thick.
- Tablet Holder has an overall height of 1 17/32" when installed and in closed position (measured from the bottom panel of the cabinet), 0.78" visible from front of cabinet when closed.
- Installation instructions included.

**DESCRIPTION MODEL PRICE**

**TILT-OUT TRAYS, PLASTIC**

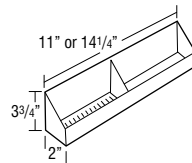

<b>TOT15</b>	<b>101</b>
<b>TOT18</b>	<b>106</b>

- Kit includes two white plastic trays and one pair of tilt-out hinges that attaches to the inside of the false panel.
- One tilt-out tray per false panel on cabinets less than 30" wide and greater than 36" wide, two tilt-out trays attached to one false panel on 30"-36" wide cabinets.
- Clean using a mild soap and water. Avoid scalding water.

Model	Size	Application
TOT15	11" w x 2" d x 3 3/4" h	SB30, SB33
TOT18	14 1/4" w x 2" d x 3 3/4" h	SB36, SB39, SB42, SB24, SB27, SB48

**TILT-OUT TRAYS, STAINLESS STEEL**

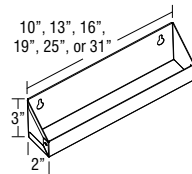

<b>TOTSS10</b>	<b>279</b>
<b>TOTSS13</b>	<b>279</b>
<b>TOTSS16</b>	<b>279</b>
<b>TOTSS19</b>	<b>279</b>
<b>TOTSS25</b>	<b>279</b>
<b>TOTSS31</b>	<b>279</b>

- Attaches to the inside of the false panel.
- One tilt-out tray per false panel.
- Trays are 2" deep and protrude 1 1/16" into cabinet.

Model	Size	Application
TOTSS10	10" w x 2" d x 3" h	ACS36
TOTSS13	13" w x 2" d x 3" h	SB39, ACS39, 2VSD36, 2VSD42, 2VSD48
TOTSS16	16" w x 2" d x 3" h	SB42, VSB42, VSD60FP, VS3D54, VS3D60
TOTSS19	19" w x 2" d x 3" h	SB24, SB27, SB48, ACS42, VSB24, VSB27, VSB48, VSD24FP, 2VSD54FP, 2VSD57/60FP, 6VSD48FP, 6VSD60FP
TOTSS25	25" w x 2" d x 3" h	SB30, SB33, VSB30, VSB33, VSD30FP, VSD42FP
TOTSS31	31" w x 2" d x 3" h	SB36, VSB36, VSD36FP, VSD48FP

**TRAY DIVIDER KIT**

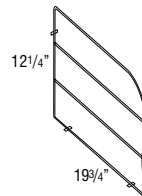

<b>CTDK</b>	<b>59</b>
-------------	-----------

- CTDK: Includes 1 divider, 3 clips, and 3 screws.
- Tray divider is chrome wire.

**WINE GLASS HOLDERS**

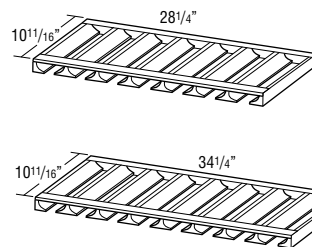

<b>WGH30 (7 slots)</b>	<b>273</b>
<b>WGH36 (8 slots)</b>	<b>333</b>

- Maximum wine glass base is 3 1/4" diameter.
- May be trimmed to fit smaller cabinets.
- Designed for installation under a wall cabinet (between end panels and behind face frame).

Specie Availability				
Cherry	Hickory	Maple	Oak	Laminate
•	•	•	•	•
	Oak		Maple	PureStyle™
	•		•	•

**DESCRIPTION MODEL PRICE**  
**ROLL TRAY KITS**

**ROLL TRAY KIT**

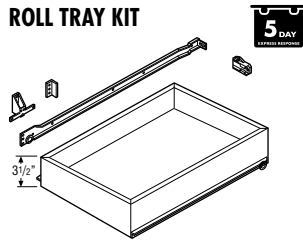

Standard

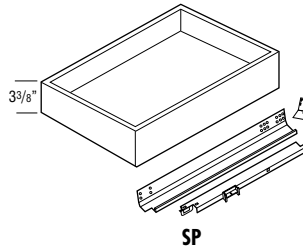

SP

RT15	141
RT18	144
RT21	147
RT24	149
RT27	150
RT30	152
RT33	156
RT36	158
RT15SP	216
RT18SP	219
RT21SP	224
RT24SP	226
RT27SP	227
RT30SP	228
RT33SP	230
RT36SP	234

Width	Application
15"	B15, U15
18"	B18, U18
21"	B21, B42
24"	B24, U24, B48
27"	B27
30"	B30, B30RT, U30
33"	B33, B33RT
36"	B36, B36RT, U36

- RT and RT\_\_SP include roll tray, roll tray brackets, hardware, screws, and installation instructions.
- Exterior dimensions of roll tray are 21" deep x 3 3/8" tall (fits standard 24" deep cabinet).
- Reduced Depth upcharge is applied if roll tray is ordered for a reduced depth cabinet (minimum depth 18").
- RD only available on SP models.

**Custom Modifications**

ID	RD
	•

**DESCRIPTION MODEL PRICE**  
**GUIDE KITS AND PARTS**

**DRAWER GUIDE KITS**  
**DGK\_\_DDFX**

21" or 24"

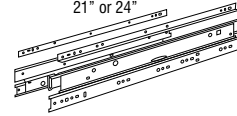

DGK21DDFX	286
DGK24DDFX	286

- Side mount progressive full extension guide utilized on all drawers of DDFD\_\_ cabinets.
- 125 lb. weight capacity per pair.
- Kit includes guide hardware for one drawer box (cabinets, drawer members wood vertical mounting rails and screws).
- Dimension refers to cabinet depth.

**DGKIT\_\_PG**

15", 18", 21", or 24"

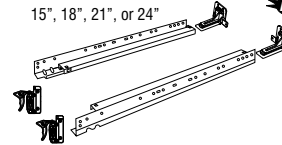

<b>NEW</b> DGKIT15PG	250
<b>NEW</b> DGKIT18PG	250
<b>NEW</b> DGKIT21PG	250
<b>NEW</b> DGKIT24PG	250

- Undermount full extension Smart Stop Premium Guide (PG).
- 90 lb. weight capacity per pair.
- Kit includes guide hardware for one drawer box (cabinets and drawer members, sockets and screws).
- Dimension refers to cabinet depth.

**DGK\_\_SM**

15", 18", 21", or 24"

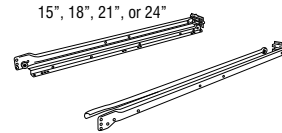

DGK15SM	38
DGK18SM	38
DGK21SM	38
DGK24SM	38

- Kit includes guide hardware for one drawer box (cabinets and drawer members, sockets and screws)
- Dimension refers to cabinet depth.
- SM—Furniture board drawer sidemount guide

**DGK\_\_RT**

15", 18", 21", or 24"

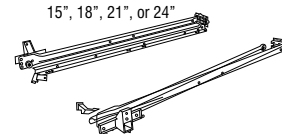

DGK15RT	38
DGK18RT	38
DGK21RT	38
DGK24RT	38

- Side mount guide utilized as standard guides on roll trays.
- 3/4 extension.
- 90 lb. weight capacity per pair.
- Kit includes guide hardware for one drawer box (cabinets and drawer members, sockets and screws).
- Dimension refers to cabinet depth.

**DGKIT\_\_RTSP**

15", 18", 21", or 24"

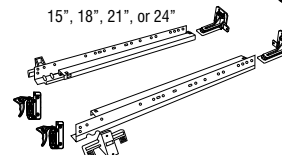

<b>NEW</b> DGKIT15RTSP	250
<b>NEW</b> DGKIT18RTSP	250
<b>NEW</b> DGKIT21RTSP	250
<b>NEW</b> DGKIT24RTSP	250

- Undermount full extension Smart Stop Premium Guide (SP) utilized on roll trays specified with SP upgrade.
- 90 lb. weight capacity per pair.
- Kit includes guide hardware for one drawer box (cabinets and drawer members, sockets and screws).
- Dimension refers to cabinet depth.

DESCRIPTION	MODEL	PRICE
<b>DRAWER GUIDE BACK SOCKETS</b>	 <b>BKSOCKET-PG</b>	47
	<b>BKSOCKET-SP</b>	47
	<b>DGK-BKSCKT-RDSM</b>	47
	<b>DGK-BKSCKT-24SM</b>	47
	<ul style="list-style-type: none"> <li>• BKSOCKET-PG used with Smart Stop drawer guides (12"-24" deep).</li> <li>• BKSOCKET-SP used with Smart Stop roll tray guides.</li> <li>• DGK-BKSCKT-RDSM used with standard sidemount drawer guides (15", 18", 21" deep).</li> <li>• DGK-BKSCKT-24SM used with standard sidemount drawer guides (24" deep).</li> <li>• Sold in pairs.</li> </ul>	

<b>FALSE PANEL CLIP</b>	 <b>FALSEPNLCLIP50</b>	8 /pair
	<b>PFALSEPNLCLIP50</b>	8 /pair
 	<ul style="list-style-type: none"> <li>• Clips come in pairs of two.</li> <li>• Use to secure false front on sink base.</li> </ul>	

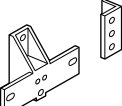
<b>ROLL TRAY PLUG IN BRACKET</b>	 <b>RTBK</b>	48
	<b>RTBKXSXP</b>	48
	<ul style="list-style-type: none"> <li>• For use with roll tray hardware to prevent interference with door hinges. Also included in roll tray hardware kit.</li> <li>• RTBK for use with standard roll trays.</li> <li>• RTBKXSXP for use with premium guide (SP) upgrade.</li> </ul>	

**RTBK**

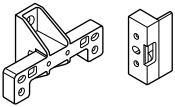

**RTBKXSXP**



## DESCRIPTION

## MODEL

## PRICE

## STAIN, PAINT, &amp; TOUCH-UP TOOLS

## STAIN &amp; PAINT



<b>STAINSTANDARD</b>	108
<b>STAINPREMIUM</b>	262
<b>PAINTQUART</b>	108
<b>PAINTPREMIUM</b>	262
<b>SSC</b>	63
<b>SSCCLEAR</b>	63

- Wiping stains can be sprayed at low pressure.
- STAINSTANDARD, STAINPREMIUM, PAINTQUART, and PAINTPREMIUM sold in quarts.
- SSC are 384 mL aerosol cans available in Paints and PureStyle™ colors and clear.





## TOUCH-UP TOOLS

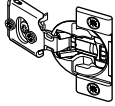
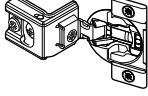
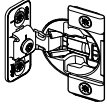
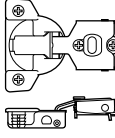
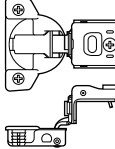

<b>TUK</b>	88
<b>MTUK</b>	44
<b>GLAZEPEN</b>	51

- Touch-Up Kit includes touch up marker and a fill stick.
- Mini Touch-Up Kit includes small touch up marker and a small fill stick.
- GLAZEPEN works on finished doors and does not require a separate top coat.

Finish	Product Code
Barn Wood on Buckskin	STAINPREMIUM
Barn Wood on Cattail	STAINPREMIUM
Barn Wood on Chocolate	STAINPREMIUM
Barn Wood on Cloud	PAINTPREMIUM
Barn Wood on Coconut	PAINTPREMIUM
Barn Wood on Egret	PAINTPREMIUM
Barn Wood on Henna	STAINPREMIUM
Barn Wood on Heron	PAINTPREMIUM
Barn Wood on Limestone	PAINTPREMIUM
Barn Wood on Morel	STAINPREMIUM
Barn Wood on Natural	STAINPREMIUM
Barn Wood on Sahara	STAINPREMIUM
Barn Wood on Thatch	STAINPREMIUM
Barn Wood on Tundra	STAINPREMIUM
Barn Wood on White	PAINTPREMIUM
Black	PAINTQUART
Brown Sugar on Buckskin	STAINPREMIUM
Brown Sugar on Cattail	STAINPREMIUM
Brown Sugar on Chocolate	STAINPREMIUM
Brown Sugar on Cloud	PAINTPREMIUM
Brown Sugar on Coconut	PAINTPREMIUM
Brown Sugar on Egret	PAINTPREMIUM
Brown Sugar on Henna	STAINPREMIUM
Brown Sugar on Heron	PAINTPREMIUM
Brown Sugar on Limestone	PAINTPREMIUM
Brown Sugar on Morel	STAINPREMIUM
Brown Sugar on Natural	STAINPREMIUM
Brown Sugar on Sahara	STAINPREMIUM
Brown Sugar on Thatch	STAINPREMIUM
Brown Sugar on Tundra	STAINPREMIUM
Brown Sugar on White	PAINTPREMIUM
Buckskin	STAINSTANDARD
Cattail	STAINSTANDARD
Chocolate	STAINSTANDARD
Cloud	PAINTQUART
Coconut	PAINTQUART
Egret	PAINTQUART
Henna	STAINSTANDARD
Heron	PAINTQUART
Limestone	PAINTQUART
Maritime	PAINTQUART
Moonstone	PAINTQUART
Morel	STAINSTANDARD
Natural	STAINSTANDARD
Sahara	STAINSTANDARD
Thatch	STAINSTANDARD
Tundra	STAINSTANDARD
White	PAINTQUART

DESCRIPTION	MODEL	PRICE
<b>HINGES</b>		
	<b>38NPOHINGE</b> <b>Partial-overlay Hinge, 6-way Adjustable with integrated Smart Stop</b> <ul style="list-style-type: none"> <li>Sold in pairs.</li> <li>1/2" partial-overlay 107° hinge.</li> <li>For use on full-overlay styles: Wall and Base Transition Cabinets, Diagonal Wall and Base Cabinets, and Angled Corner Sink Bases and Fronts.</li> </ul>	30
	<b>38CFOHINGE</b> <b>Full-overlay Hinge, 6-way Adjustable with integrated Smart Stop</b> <ul style="list-style-type: none"> <li>Sold in pairs.</li> <li>107° full-overlay hinge.</li> <li>For use on all cabinets not specified by other hinges.</li> </ul>	30
	<b>38BFOVHINGE</b> <b>Full-overlay Hinge, 6-way Adjustable with integrated Smart Stop</b> <ul style="list-style-type: none"> <li>Sold in pairs.</li> <li>Full-overlay, face mount 107° hinge.</li> <li>For use on OCD, OCS, OMC, TBMWB, and 30"-42" high WBMW cabinets.</li> </ul>	30
	<b>2925HINGE - 6-way Adjustable, 1/2" Partial-overlay, 107° Hinge</b> <ul style="list-style-type: none"> <li>Sold in pairs.</li> <li>All cabinets not specified by other hinges.</li> </ul>	24
	<b>2933HINGE - 6-way Adjustable, 1 1/4" Full-overlay, 107° Hinge</b> <ul style="list-style-type: none"> <li>Sold in pairs.</li> <li>All cabinets not specified by other hinges.</li> </ul>	24
	<b>1351HINGE - 4-way Adjustable, Full-overlay, Face-mount 107° Hinge</b> <ul style="list-style-type: none"> <li>Sold in pairs.</li> <li>For use on OCD, OCS, OMC, TBMWB, and 30"-42" high WBMW cabinets.</li> </ul>	11
	<b>32049HINGE - 90° Corner Self-Closing Center Hinge</b> <ul style="list-style-type: none"> <li>Sold in pairs.</li> <li>Center Hinge for ER, BLS, SLS, and BER</li> </ul>	80
	<b>942HINGE - 170° Hinge 3/4" Overlay and 90° Corner Full/Partial-overlay Door to Frame</b> <ul style="list-style-type: none"> <li>Sold in pairs.</li> <li>BSC, BLS, SLS, ER, and BER</li> </ul>	67
	<b>7299HINGE - Mirror Hinge</b> <ul style="list-style-type: none"> <li>Sold in pairs.</li> <li>TV and MC cabinets</li> </ul>	12

DESCRIPTION	MODEL	PRICE
-------------	-------	-------

**HINGE ANGLE RESTRICTION CLIP**



**HINGERESCLIP**

12



- For use in applications with cabinets installed at varying depths to prevent the door damage caused by opening into an adjacent cabinet.
- Restricts hinges to 86° opening capability.
- Works only with the 38NPOHINGE and 38CFOHINGE.
- Not recommended for cabinets with roll trays specified in partial-overlay styles.
- Sold in pairs.

**NEW HINGE SHIM**



**HINGESHIM5**

17



- Install between the face frame and hinge to allow additional adjustment of doors. Can be used to reduce gap between butt doors.
- Pack of 5 metal shims.
- Compatible with all hinges except face-mount.

**LIDSTAY**



**LIDSTAY**

227

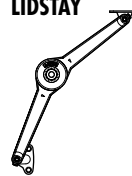

- Sold in pairs.
- Recommended for field installed wall top hinge applications up to 18" high.

**LIDSTAY - HEAVY DUTY**



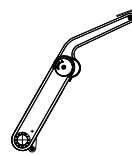

**LIDSTAYHD**

207



- One heavy duty lid stay hinge required per cabinet.
- Recommended for field installed wall top hinge applications of 21" high cabinets.

DESCRIPTION	MODEL	PRICE
<b>PARTS</b>		
<b>DOORS &amp; DRAWER FRONTS</b>	 Door for Any Cabinet 18" High or Less	282 ea.
	Door for Any Cabinet 21" to 30" High	353 ea.
	Door for Any Cabinet 33" or Higher	497 ea.
	No Hinge Route Doors 18" High or Less	282 ea.
	No Hinge Route Doors 21" to 30" High	353 ea.
	No Hinge Route Doors 33" or Higher	497 ea.
	Any Drawer Front	130 ea.
• All applicable modification and premium finish upcharges will apply.		
<b>DRAWERS</b>	 Complete Drawer	208 ea.
	Drawer Box Only	185 ea.
• All applicable modification and premium finish upcharges will apply.		
• Complete Drawer and Drawer Box Only do not include drawer guides. They must be ordered separately.		

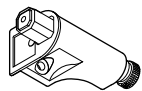
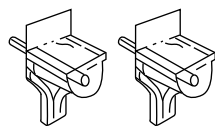
**MISCELLANEOUS PARTS****QCDM****SHELFPEGS**

 BRKOFFSCREW (pkg. 25)	5
INSTALLSCR24 (pkg. 24)	13
INSTALLSCREWS (pkg. 100)	43
TVHDW/WCATCH	129
MC16HDW/WCATCH	67
RETCLIP250BAG	21
RETCLIP259BAG	20
BUMPERPADS (pkg. 25)	7
QCDM	24
SHELFPEGS (pkg. 24)	11

- BRKOFFSCREW is a pack of 25 breakaway screws for use with decorative hardware pulls and knobs.
- INSTALLSCR24 and INSTALLSCREWS are screws for cabinet installation through the cabinet back to the wall studs (includes a pack of 24 or 100).
- TVHDW/WCATCH is one set of the magnetic catch hardware and handle used on mirrors on Tri-View Mirrors (TV.).
- MC16HDW/WCATCH is one set of the magnetic catch hardware, handle, and one pair of hinges used on Single Door Medicine Cabinets (MC16).
- RETCLIP250BAG: 6 retainer clips for use with glass inserts in mullion and cut for glass doors. For use on all styles except PureStyle™ doors.
- RETCLIP259BAG: 6 retainer clips and a variety of rubber feet for use with glass inserts in mullion and cut for glass doors. For use on all PureStyle™ doors only.
- QCDM: Creates a smooth and silent self-closing motion. Each QCDM sold individually and includes all necessary hardware for installation into face frame. Not recommended on bi-fold doors or Base SuperCabinets™.
- SHELFPEGS are 3mm steel pins with clear plastic shoulders.

DESCRIPTION	MODEL	PRICE
<b>SALES SUPPORT TOOLS</b>		
<b>SAMPLE FRAME &amp; DOORS</b>	<b>DOORSAMPLEW</b>	59 net
	<b>DOORSAMPLEB</b>	91 net

- Specify door style and finish.
- Premium finish available with upcharge.
- DOORSAMPLEW features a wall door on a face frame. Overall size is 15"W x 22"H.
- DOORSAMPLEB will have a base door and drawer front on the face frame. Overall size is 15"W x 24 1/2"H.

**DESCRIPTION**

**MODEL**

**PRICE**

**STACK MOULDING KITS**

- Moulding stacks do not ship assembled; field assembly is required. Assembly instructions can be viewed in 20/20 spec pages and will also ship with moulding kits.
- When ordered as a kit, only one finish can be specified. To order with more than one finish, moulding pieces must be ordered separately.
- Moulding stacks include Assembly Instructions. Cleats and finish nails not included.

- How to place a stack moulding in 20/20:
  - Moulding
  - Top Mouldings or Bottom Mouldings
  - Stacked Mouldings
  - Drag and drop desired moulding stack onto wall cabinets

**MOULDING STACK 1**

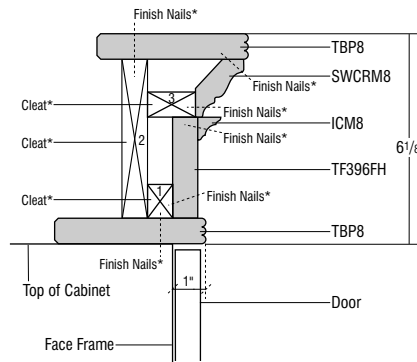
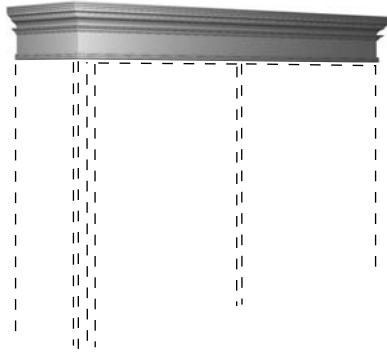

**STKMLD1C**

**1097**

**Specie Availability**

	Cherry	Hickory	Maple	Oak	Laminate	PureStyle™
TBP8	•	•	•	•	Maple	Maple
SWCRM8	•	•	•	•	Maple	Maple
ICM8	•	•	•	•	Maple	Maple
TF396FH	•	•	•	•	Maple	Maple

\*Cleats and finish nails not included.

**301**

**MOULDING STACK 2**

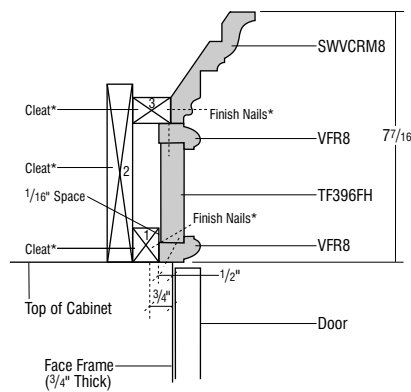
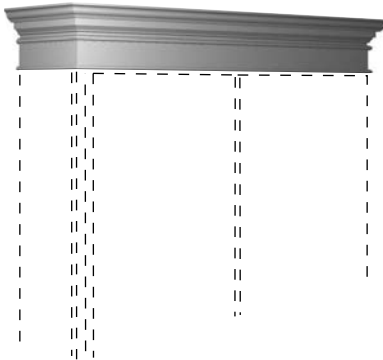

**STKMLD2C**

**741**

**Specie Availability**

	Cherry	Hickory	Maple	Oak	Laminate	PureStyle™
SWVCRM8	•	•	•	•	Maple	Maple
VFR8	•	•	•	•	Maple	Maple
TF396FH	•	•	•	•	Maple	Maple

\*Cleats and finish nails not included.

**MOULDING STACK 3**

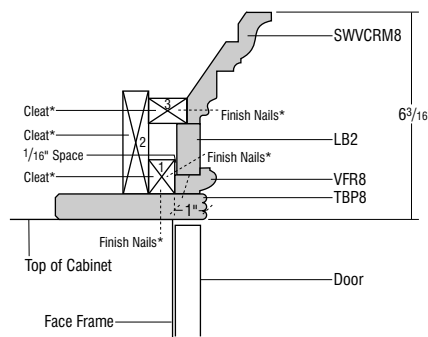
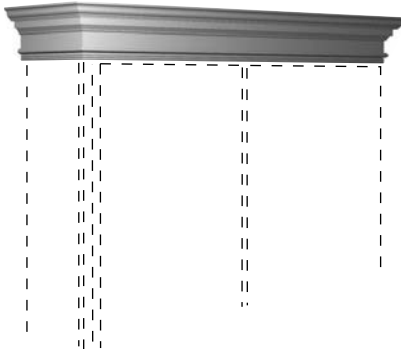

**STKMLD3C**

**837**

**Specie Availability**

	Cherry	Hickory	Maple	Oak	Laminate	PureStyle™
SWVCRM8	•	•	•	•	Maple	Maple
LB2	•	•	•	•	Maple	Maple
VFR8	•	•	•	•	Maple	Maple
TBP8	•	•	•	•	Maple	Maple

\*Cleats and finish nails not included.

**DESCRIPTION**

**MODEL**

**PRICE**

**STACK MOULDING KITS**

- Moulding stacks do not ship assembled; field assembly is required. Assembly instructions can be viewed in 20/20 spec pages and will also ship with moulding kits.
- When ordered as a kit, only one finish can be specified. To order with more than one finish, moulding pieces must be ordered separately.
- Moulding stacks include Assembly Instructions. Cleats and finish nails not included.
- How to place a stack moulding in 20/20:
  - Moulding
  - Top Mouldings or Bottom Mouldings
  - Stacked Mouldings
  - Drag and drop desired moulding stack onto wall cabinets

302

**MOULDING STACK 5**

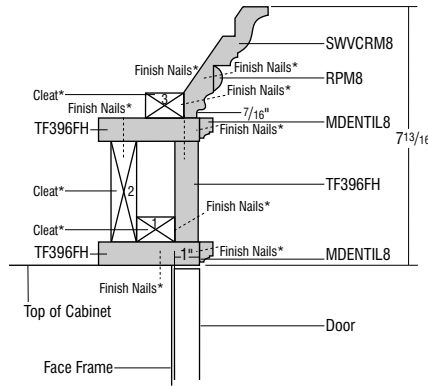
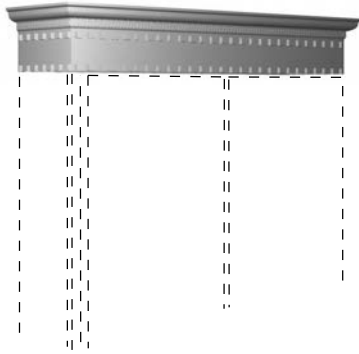

**STKMLD5C**

1254

**Specie Availability**

	Cherry	Hickory	Maple	Oak	Laminate	PureStyle™
SWVCRM8	•	•	•	•	Maple	Maple
RPM8	•	•	•	•	Maple	Maple
MDENTIL8	•	•	•	•	Maple	Maple
TF396FH	•	•	•	•	Maple	Maple

\*Cleats and finish nails not included.

**MOULDING STACK 6**

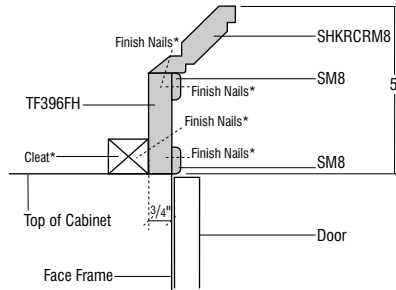
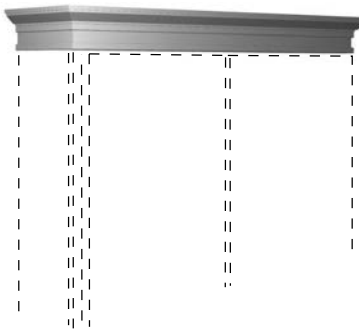

**STKMLD6C**

544

**Specie Availability**

	Cherry	Hickory	Maple	Oak	Laminate	PureStyle™
SHKRCRM8	•	•	•	•	Maple	Maple
SM8	•	•	•	•	Maple	Maple
TF396FH	•	•	•	•	Maple	Maple

\*Cleats and finish nails not included.

**MOULDING STACK 7**

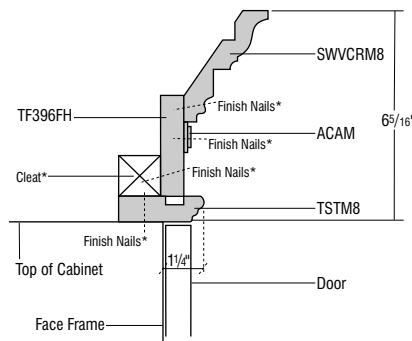
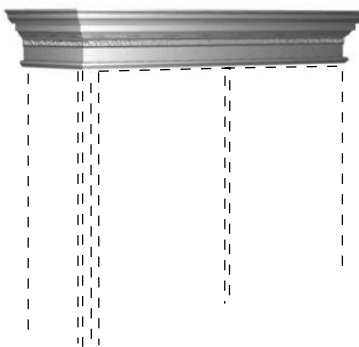

**STKMLD7C**

1052

**Specie Availability**

	Cherry	Hickory	Maple	Oak	Laminate	PureStyle™
SWVCRM8	•	•	•	•	Maple	Maple
ACAM	•	Beech	•	Beech	Maple	Maple
TF396FH	•	•	•	•	Maple	Maple
TSTM8	•	•	•	•	Maple	Maple

\*Cleats and finish nails not included.

**MOULDING STACK 8**

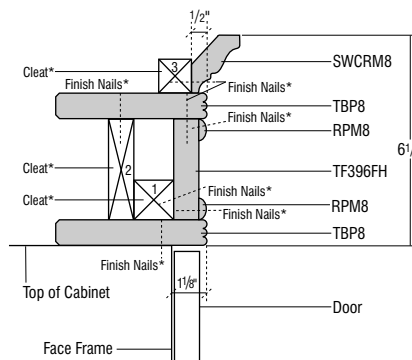
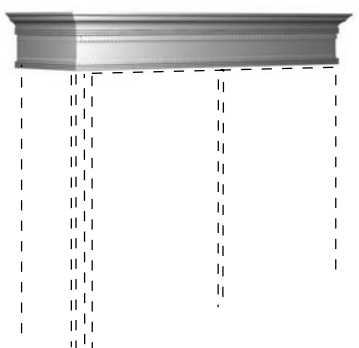

**STKMLD8C**

1240

**Specie Availability**

	Cherry	Hickory	Maple	Oak	Laminate	PureStyle™
SWCRM8	•	•	•	•	Maple	Maple
RPM8	•	•	•	•	Maple	Maple
TBP8	•	•	•	•	Maple	Maple
TF396FH	•	•	•	•	Maple	Maple

\*Cleats and finish nails not included.

STACK MOULDING KITS

**DESCRIPTION**

**MODEL**

**PRICE**

**STACK MOULDING KITS**

- Moulding stacks do not ship assembled; field assembly is required. Assembly instructions can be viewed in 20/20 spec pages and will also ship with moulding kits.
- When ordered as a kit, only one finish can be specified. To order with more than one finish, moulding pieces must be ordered separately.
- Moulding stacks include Assembly Instructions. Cleats and finish nails not included.

- How to place a stack moulding in 20/20:
  - Moulding
  - Top Mouldings or Bottom Mouldings
  - Stacked Mouldings
  - Drag and drop desired moulding stack onto wall cabinets

**MOULDING STACK 10**

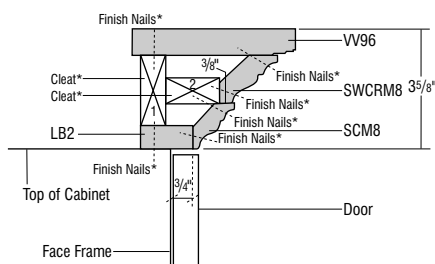
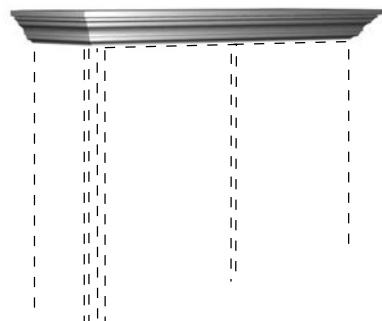

**STKMLD10C**

648

**Specie Availability**

	Cherry	Hickory	Maple	Oak	Laminate	PureStyle™
VV96	•	•	•	•	Maple	Maple
SWCRM8	•	•	•	•	Maple	Maple
SCMB	•	•	•	•	Maple	Maple
LB2	•	•	•	•	Maple	Maple

\*Cleats and finish nails not included.

**303**

**MOULDING STACK 11**

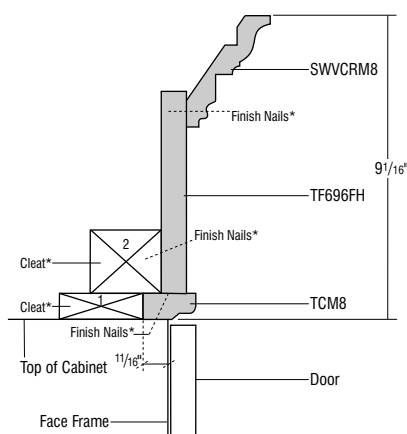
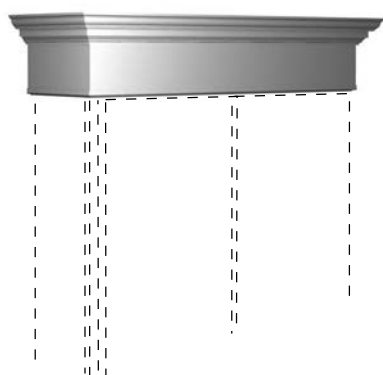

**STKMLD11C**

772

**Specie Availability**

	Cherry	Hickory	Maple	Oak	Laminate	PureStyle™
SWVCRM8	•	•	•	•	Maple	Maple
TF696FH	•	•	•	•	Maple	Maple
TCM8	•	•	•	•	Maple	Maple

\*Cleats and finish nails not included.

**MOULDING STACK 13**

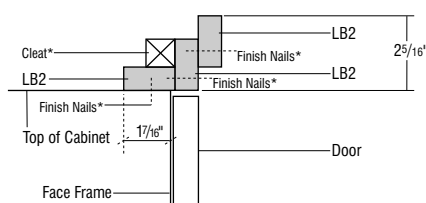
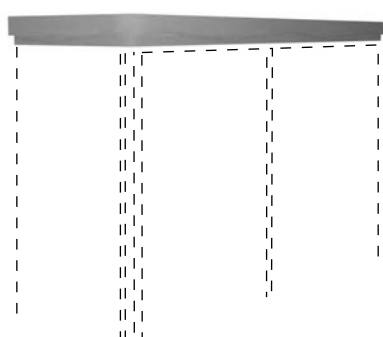

**STKMLD13C**

359

**Specie Availability**

	Cherry	Hickory	Maple	Oak	Laminate	PureStyle™
LB2	•	•	•	•	Maple	Maple

\*Cleats and finish nails not included.

**MOULDING STACK 14**

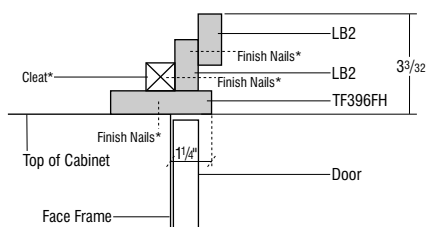
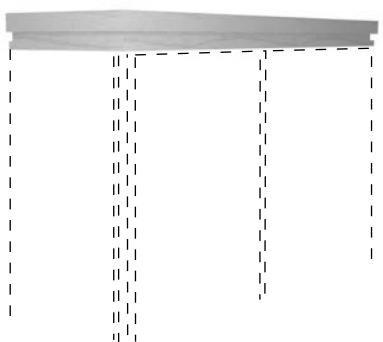

**STKMLD14C**

468

**Specie Availability**

	Cherry	Hickory	Maple	Oak	Laminate	PureStyle™
LB2	•	•	•	•	Maple	Maple
TF396FH	•	•	•	•	Maple	Maple

\*Cleats and finish nails not included.

**DESCRIPTION**

**MODEL**

**PRICE**

**STACK MOULDING KITS**

- Moulding stacks do not ship assembled; field assembly is required. Assembly instructions can be viewed in 20/20 spec pages and will also ship with moulding kits.
- When ordered as a kit, only one finish can be specified. To order with more than one finish, moulding pieces must be ordered separately.
- Moulding stacks include Assembly Instructions. Cleats and finish nails not included.
- How to place a stack moulding in 20/20:
  - Moulding
  - Top Mouldings or Bottom Mouldings
  - Stacked Mouldings
  - Drag and drop desired moulding stack onto wall cabinets

304

**MOULDING STACK 16**

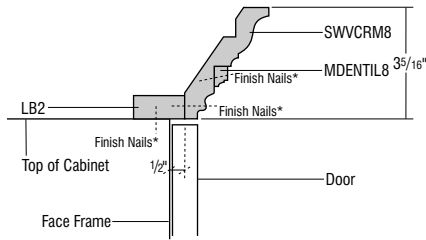
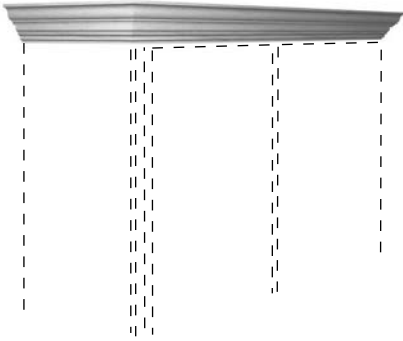

**STKMLD16C**

489

**Specie Availability**

	Cherry	Hickory	Maple	Oak	Laminate	PureStyle™
SWVCRM8	•	•	•	•	Maple	Maple
MDENTIL8	•	•	•	•	Maple	Maple
LB2	•	•	•	•	Maple	Maple

\*Cleats and finish nails not included.

**MOULDING STACK 18**

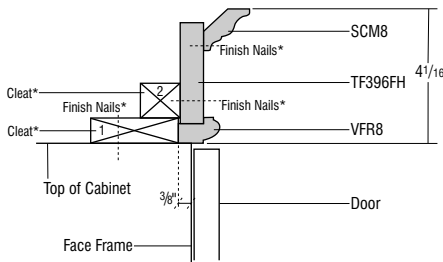
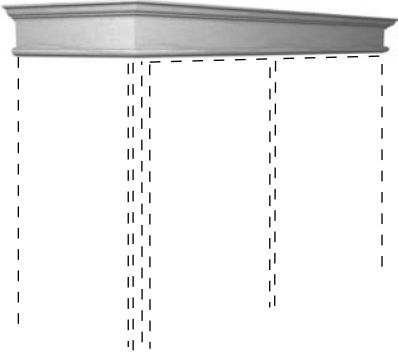

**STKMLD18C**

475

**Specie Availability**

	Cherry	Hickory	Maple	Oak	Laminate	PureStyle™
SCM8	•	•	•	•	Maple	Maple
TF396FH	•	•	•	•	Maple	Maple
VFR8	•	•	•	•	Maple	Maple

\*Cleats and finish nails not included.

**MOULDING STACK 19**

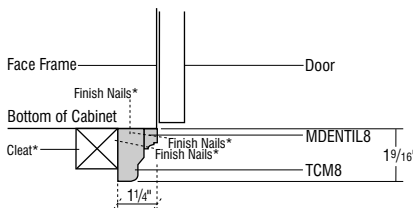
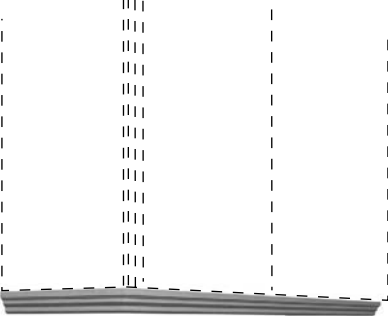

**STKMLD19C**

181

**Specie Availability**

	Cherry	Hickory	Maple	Oak	Laminate	PureStyle™
MDENTIL8	•	•	•	•	Maple	Maple
TCM8	•	•	•	•	Maple	Maple

\*Cleats and finish nails not included.

STACK MOULDING KITS

**DESCRIPTION**

**MODEL**

**PRICE**

**STACK MOULDING KITS**

- Moulding stacks do not ship assembled; field assembly is required. Assembly instructions can be viewed in 20/20 spec pages and will also ship with moulding kits.
- When ordered as a kit, only one finish can be specified. To order with more than one finish, moulding pieces must be ordered separately.
- Moulding stacks include Assembly Instructions. Cleats and finish nails not included.

- How to place a stack moulding in 20/20:
  - Moulding
  - Top Mouldings or Bottom Mouldings
  - Stacked Mouldings
  - Drag and drop desired moulding stack onto wall cabinets

**MOULDING STACK 20**

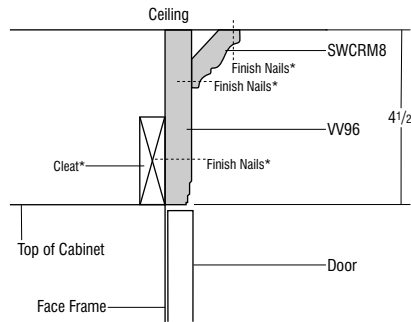
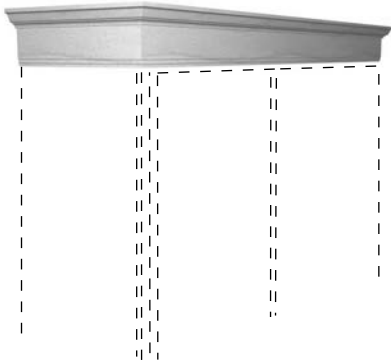

**STKMLD20C**

395

**Specie Availability**

	Cherry	Hickory	Maple	Oak	Laminate	PureStyle™
SWCRM8	•	•	•	•	Maple	Maple
VV96	•	•	•	•	Maple	Maple

\*Cleats and finish nails not included.

**305**

**MOULDING STACK 21**

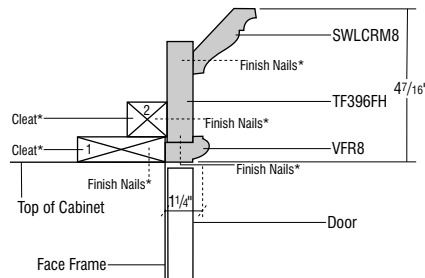
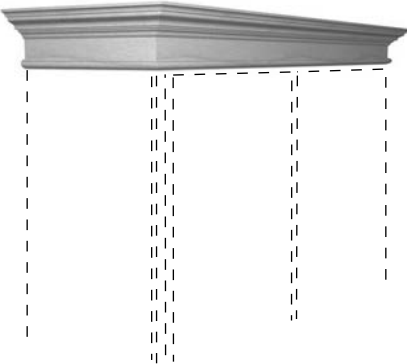

**STKMLD21C**

597

**Specie Availability**

	Cherry	Hickory	Maple	Oak	Laminate	PureStyle™
SWLCRM8	•	•	•	•	Maple	Maple
TF396FH	•	•	•	•	Maple	Maple
VFR8	•	•	•	•	Maple	Maple

\*Cleats and finish nails not included.

**MOULDING STACK 22**

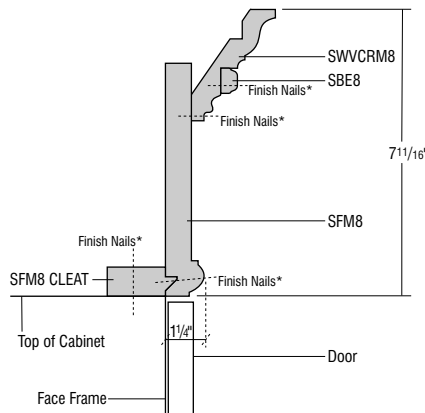
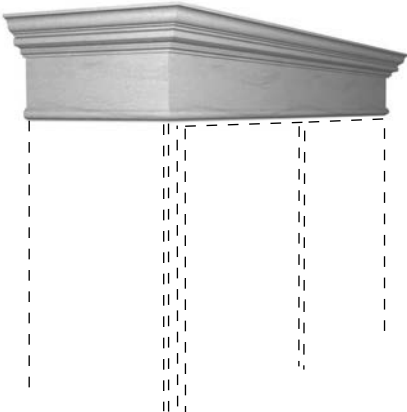

**STKMLD22C**

848

**Specie Availability**

	Cherry	Hickory	Maple	Oak	Laminate	PureStyle™
SWVCRM8	•	•	•	•	Maple	Maple
SBE8	•	•	•	•	Maple	Maple
SFM8	•	•	•	•	Maple	Maple

\*Cleats and finish nails not included.





# Diamond®

## VIBE™ SERIES

Dear Diamond Vibe Customer,

Congratulations on your selection of Diamond Vibe cabinetry in a Paint with Glaze finish. Because of its unique characteristics, this finish is quite different from other cabinetry finishes you may be familiar with. Your satisfaction is important to Diamond Vibe, and we want you to fully understand the characteristics that make painted finishes so distinctive.

It is important to realize that the beauty of wood cabinetry comes from the natural qualities of wood itself. Diamond Vibe utilizes only select solid hardwoods and hardwood veneers. The beauty of these genuine woods lies in the variation of the grain. The textures of those natural grain patterns often remain visible with paint finish and should be accepted as inherent characteristics when selecting painted cabinetry.

Seam lines and hairline cracking at stile, rail and panel joints are a normal characteristic of painted finishes and should not be considered a reason for product replacement. When ordering painted Maple 5-piece styles, the door's center panel will be constructed of MDF material. Over time, there may be a slight color shift in the paint finish due to the continued exposure to natural and artificial light sources. We mention these characteristics because neither Diamond Vibe nor your Diamond Vibe dealer can be responsible for these conditions and variations.



*Example of front joint separation*



*Example of front joint separation*



*Example of end joint separation*

Accordingly, we ask that the following agreement be signed for Paint Finish orders.

---

I have read the foregoing and find the characteristic variations of wood with painted finish are desirable. As such, I agree not to hold Diamond Vibe and/or the Diamond Vibe dealer listed below responsible in the event that these characteristics are later found by me to be less desirable than I had expected.

---

Customer Signature

---

Dealer Signature

---

Customer Name (please print)

---

Dealer Name (please print)

---

Dealer Purchase Order Number

## NOTES

## NOTES

## NOTES

## NOTES

## NOTES

## NOTES

# TERMS AND CONDITIONS

## DIAMOND VIBE CABINETS LIFETIME LIMITED WARRANTY AND GENERAL INFORMATION



Prices and specifications in material, construction and design are subject to change without notice as conditions require, or as improvements are developed.

All orders are subject to credit approval.

To avoid errors, orders should be filled out on Diamond Vibe Cabinet forms.

**All cabinets are manufactured to individual order and cannot be cancelled or changed after manufacturing has begun. Cycle ship orders cannot be changed after the cut-off date.**

Returns will not be accepted without prior written authorization.

Diamond Vibe cabinets carry a Lifetime Limited Warranty. This limited warranty does not cover misuse\*, improper storage, improper installation, labor costs or defects incurred during installation, storage or transportation. We reserve the right to repair or replace any defective material after field inspection by our representative. For complete warranty details, please refer to the Diamond Vibe Warranty Document.

A product count and inspection must be performed before signing the Bill of Lading. Shortage, obvious damage and occurrences of mishandling must be noted on the Bill of Lading before it is signed. Replacement orders must then be made with Diamond Vibe Customer Service. A signed Bill of Lading with no notations will indicate a complete and damage free shipment.

Sales are only to approved, authorized accounts.

Please make reference to the cabinet selection guide for information pertaining to characteristics of wood. This information will tell you the reactions that natural woods might develop under certain conditions after product is finished.



# Diamond®

Make your mark.™

- ◆ EDGE™ SERIES
- ◆ DISTINCTION™ SERIES
- ◆ VIBE™ SERIES

Styles, product availability and construction may vary slightly from those shown in this book due to material availability and/or design evolution. Specifications are subject to change without notice. Customer service is available if your design requires verification of product availability and specifications.

Product photography and illustrations have been reproduced as accurately as printing technologies permit. To ensure highest satisfaction, we strongly recommend you view an actual sample for best color, wood grain and finish representation.

Diamond® is a certified brand in the Kitchen Cabinet Manufacturers Association (KCMA) Environmental Stewardship Program. The program recognizes companies that demonstrate an ongoing commitment to environmental practices and sustainability.

## Diamond® Vibe™ has a Limited Lifetime Warranty.

For terms and conditions, please visit: <https://www.diamondcabinets.com/warranty>

**Front cover image:** LOREN Laminate White and ADAIR PureStyle™ Limestone



KITCHEN CABINET MANUFACTURERS ASSOCIATION  
ENVIRONMENTAL STEWARDSHIP PROGRAM (ESP)  
ALL PRODUCTS MEET THE REQUIREMENTS  
FOR ESP PROGRAM CRITERIA. SEE KCMALR018



Part of the  
MasterBrand®  
Family

[diamondcabinets.com](https://www.diamondcabinets.com)  
#diamondcabinets

© 2018 MasterBrand Cabinets, Inc.

## Customer Service

Hours: Mon - Fri, 7:30 AM - 8:00 PM EST

Phone: (800) 730-0171 Fax: (877) 333-7122

Please reference Service Policies at [www.mbc1touch.com](http://www.mbc1touch.com)

Designer ID #: \_\_\_\_\_

Customer Account #: \_\_\_\_\_

Sales Rep: \_\_\_\_\_