

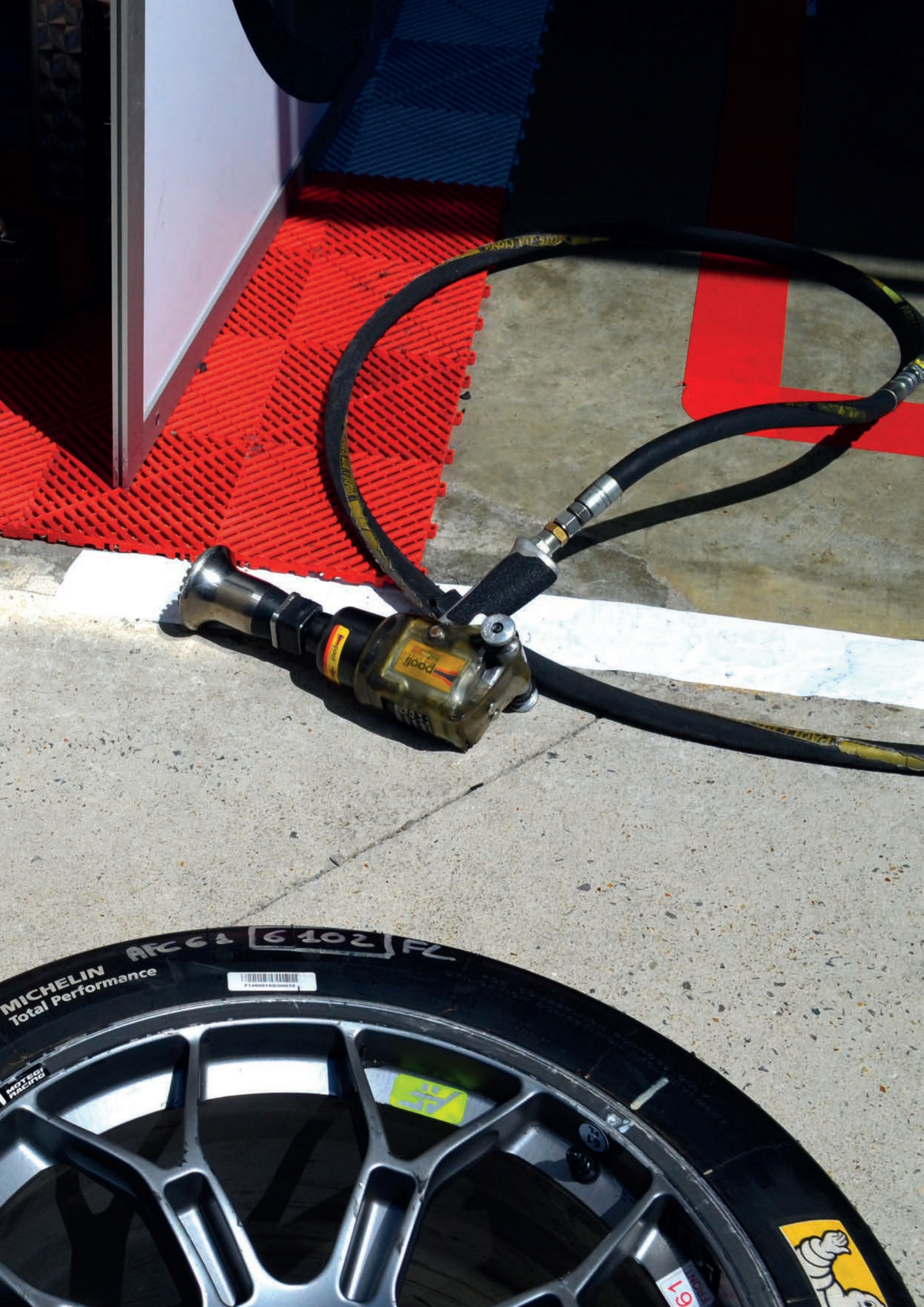

PIT STOP SERIES



MICHELIN  
Total Performance

F148857AG100072

APC 61 6102 FL

MOTOR RACING

PIT STOP

67



RACING



Mechanix  
Mechanix  
Mechanix

RA



paoli  
PIT STOP  
WE SERVED YOUR RACE  
www.pitstoppaoli.com

paoli  
PIT STOP

01

1000



TORQUE AND  
ANGLE SENSOR  
SYSTEM

PAGE 7



WHEEL  
GUNS

PAGE 15



ACCESSORIES

PAGE 33



SUPPORT

PAGE 61



2015



2012



**Torque and Angle Sensor System.** Dino Paoli S.r.l introduces an innovative technology that switches on a LED to signal the completed energy transfer and the correctly tightened wheel nut.

1994



**World champion for speed and power.** In early 90's Dino Paoli S.r.l. supplies all F1 teams and gets into U.S. motorsport, in Formula Indy.

1968



**Origins.** Dino Paoli S.r.l. was born in 1968 and it has specialized in the production of wheel guns used in workshop for commercial vehicle and standard road cars.

2014



**DP 5000 TI MARK II**  
In 2014 DINO PAOLI SRL starts manufacturing new wheel guns by using aerospace materials. Titanium and carbon are now used to produce the futuristic models DP5000-TI-Mark II.

2011



**Formula Nascar.** In 2011 Dino Paoli S.r.l. gets into Formula Nascar with Red Devil™

1975



**On F1 podium.** Thanks to the high quality level and offered service, in 1975 Paoli becomes official supplier to one of the most famous F1 team. This is an important debut that will permit to start a tradition of motorsport.



*Dino Paoli S.r.l. supplies all the teams participating in F1, GP2, DTM, World Series by Renault, IRL, F. Nippon, V8-Supercar, Indy Light and almost all racing teams in Endurance, GT, F.3000, GRAND AM, ALMS.*

*Dino Paoli, the strength of a winning idea embodied in a company working in different sectors: motorsport, automotive, and industry.*

*A craft industry vocation and a long-standing tradition in the production of pneumatic impact wrenches and accessories have led the company to lead the Motorsport sector, making it the ideal partner for several teams, thanks to the high precision and reliability of its products.*

*Wheel guns to suit all the needs of those who believe in speed, making the pit stop a fundamental element in the outcome of a race.*

*Quality, technology, innovation and close collaboration with customers are just some of the features that have made Dino Paoli a successful name in the racing world.*



1997- Mr. Dino Paoli with Mr. Alex Zanardi.

***“Persone, passione, professionalità. Da più di 45 anni Dino Paoli SRL produce tecnologia italiana.”***

*“People, passion, professionalism. For more than 45 years Dino Paoli SRL produces Italian technology.”*



# PRESENCE IN MOTORSPORT CHAMPIONSHIPS

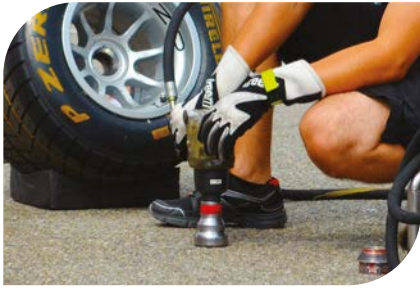

## TEAMS

0% 100%

FORMULA 1



ALMS



GP 2



ENDURANCE



ELMS



SUPER GT



BLANCPAIN



N1 SUPERTAIKYU



24H LE MANS



V8 SUPERCAR



F NIPPON



INDYCAR



GRAND AM



GT



NASCAR







PAOLI  
TSA

# PAOLI TSA

TORQUE AND ANGLE SENSOR SYSTEM

The new torque and angle sensor wheel guns.





## TSA

*State of the art in motorsport pit stop monitoring, the new TSA SYSTEM applies patented high precision non-contact sensing technology to measure the angular rotations of the drive shaft and the torque energy that is transferred at every hammering impact. Intelligent software in the onboard multiprocessor signal processing electronics combines the results of the two measurements: Absolute Torque Energy and Angular Rotations, to determine when the wheel nut sits tight. Additional sensors determine when the tool is active or should go into power save mode. The tool is delivered with a default operation mode which means it can be used straight out of the box. The software however allows the user to make changes to critical operational parameters which can be used to optimize system performance. If used in under controlled conditions, the TSA can help to drastically reduce false tightening incidences. The TSA system can also be mounted on the following Dino Paoli impact wrenches as a TSA UPGRADE: DP2000\*, DP3000\*, DP 4000\* and DP 5000\* Best practice: F1, GP2, IRL, ELMS, WEC.*

## TS LAB

*Using the same fully integrated torque sensor as the TSA system, TS LAB System has been developed as a precise laboratory style measurement tool, whereby analogue torque data can be sampled from the wheel guns several signal output channels. The onboard digital signal processing unit allows the tool to trigger a set of bright LED's, used to inform the operator when a wheel nut has been sufficiently tightened. The delivered software when used together with the TS LAB DATA CENTER is customizable and configurable, and allows a tools performance to be optimized for any application. The TS LAB system can also be mounted on the following Dino Paoli impact wrenches as a TS UPGRADE: DP2000\*, DP3000\*, DP 4000\* and DP 5000\*.*

\* Series



FORMULA 1 / INDY

The technological and mechanical apotheosis both included in one single wheel gun: DP 5000 TI MARK II TSA. The vanguard, the accuracy, the power, all together with a standard Torque and Angle System.

- ERGONOMIC TRIGGER MADE BY STAINLESS
- ANODIZED COVERS BLUE AND RED, ACCORDING TO THE MOTORSPORT TRADITION
- TITANIUM MOTOR
- NEW CARBON PEEK VANES
- MAGNESIUM ALLOY BODY



DP 5000 MARK II TSA LH  
The fast left hand version (blue) loosens nuts tightened clockwise faster.



DP 5000 MARK II TSA RH  
The fast right hand version (red) loosens nuts tightened anticlockwise faster.



Pit Stop Box allowing the connection of 4 wheel guns simultaneously to a Windows PC. Wheel gun pit stop dashboard software for optimizing sensor performance, viewing pit stop results and data logging.

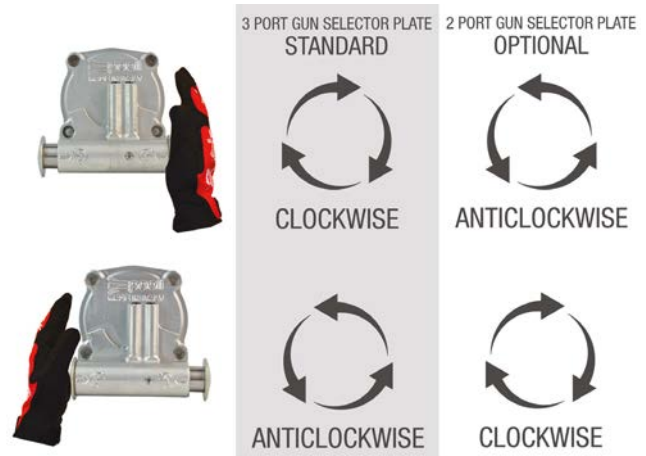

TORQUE AND ANGLE SENSOR

## DP 5000 TI MARK II TSA TECHNICAL DATA

PRODUCT NAME	PRODUCT CODE	VERSION	SQUARE DRIVE		WEIGHT		LENGTH		AIR INLET	SUPPLY HOSE INSIDE DIAMETER	MAX PRESSURE		FREE SPEED RPM	MAX TORQUE		
			inch	mm	kg	lbs	mm	inch			bar	psi		25 bar / 362 psi	Nm	ft-lbs
DP 5000 TI MARK II TSA LH	5000TA.00001	LH	1"	19	4,10	9.0	198	7.79	3/8" BSP	0.51"	13	25	362	14500	3800	2810
DP 5000 TI MARK II TSA RH	5000TA.00002	RH	1"	19	4,10	9.0	198	7.79	3/8" BSP	0.51"	13	25	362	14500	3800	2810

To get the best performance from our wheel guns, we suggest you to use coupling with minimal bore of 10 mm (25/64 inch) and crimped with male 1/2" BSP fittings.



SUGGESTED ACCESSORIES FROM PAGE 33

# DP 4000 MG TSA



FORMULA 1 / GP2 / DTM

Strong, fast and reliable. Fully integrated torque and angle sensors.

- MAGNESIUM ALLOY BODY
- MORE POWER (13.500 RPM)
- NEW CARBON PEEK VANES



DP 4000 MG TSA LH  
The fast left hand version (blue) loosens nuts tightened clockwise faster.



DP 4000 MG TSA RH  
The fast right hand version (red) loosens nuts tightened anticlockwise faster.



Pit Stop Box allowing the connection of 4 wheel guns simultaneously to a Windows PC. Wheel gun pit stop dashboard software for optimizing sensor performance, viewing pit stop results and data logging.

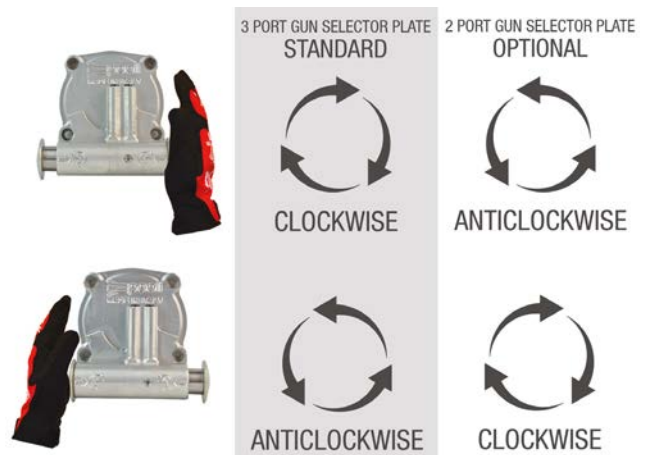

## DP 4000 MG TSA TECHNICAL DATA

PRODUCT NAME	PRODUCT CODE	VERSION	SQUARE DRIVE			WEIGHT			LENGTH		AIR INLET	SUPPLY HOSE INSIDE DIAMETER		MAX PRESSURE		FREE SPEED RPM	MAX TORQUE	
			inch	kg	lbs	mm	inch	inch	inch	mm		bar	psi	20 bar / 290 psi	Nm		ft-lbs	
DP 4000 MG TSA LH	4000TA.00001	LH	1"	4,19	9.2	216	8.50	3/8" BSP	0.51"	13	20	290	13500	3500	2590			
DP 4000 MG TSA RH	4000TA.00002	RH	1"	4,19	9.2	216	8.50	3/8" BSP	0.51"	13	20	290	13500	3500	2590			

To get the best performance from our wheel guns, we suggest you to use coupling with minimal bore of 10 mm (25/64 inch) and crimped with male 1/2" BSP fittings.



SUGGESTED ACCESSORIES FROM PAGE 33

# TSA UPGRADE

## TORQUE SENSOR & ANGLE UPGRADE

DP2000 SERIES, DP3000 SERIES, DP4000 SERIES, DP5000 SERIES

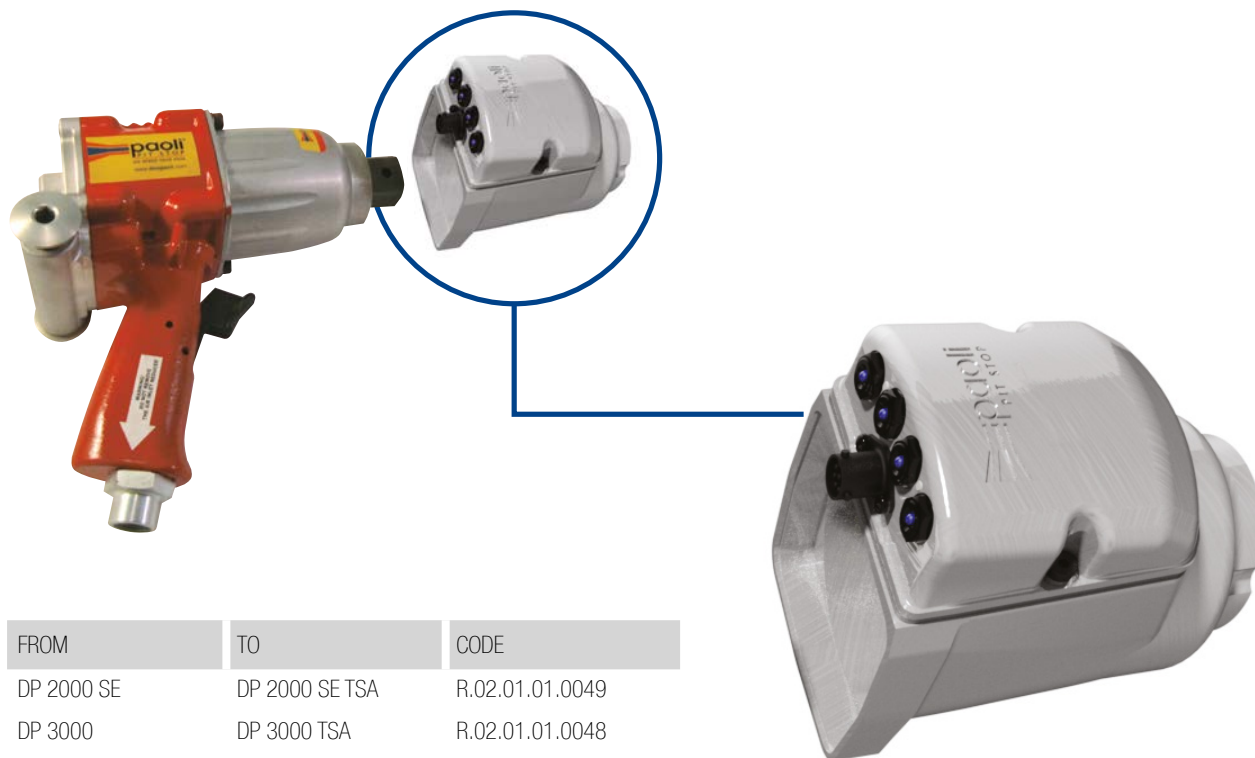

FROM	TO	CODE
DP 2000 SE	DP 2000 SE TSA	R.02.01.01.0049
DP 3000	DP 3000 TSA	R.02.01.01.0048
DP 4000	DP 4000 TSA	R.02.01.01.0047
DP 4000 MG	DP 4000 MG TSA	R.02.01.01.0043
DP 5000 TI	DP 5000 TI TSA	R.02.01.01.0050

*The Torque and Angle Sensor Upgrade is the ideal solution for upgrading from standard Paoli Wheel guns into state of the art Pit Stop monitoring systems.*

*The new TSA UPGRADE uses patented high precision non-contact sensing technology to measure the angular rotations of the drive shaft and the torque energy that is transferred at every hammering impact. Intelligent software in the onboard multiprocessor signal processing electronics combines the results of the two measurements: Absolute Torque Energy and Angular Rotations, to determine when the wheel nut sits tight. Additional sensors determine when the tool is active or should go into power save mode. The tool is delivered with a default operation mode, however the Pit Stop Dashboard software (Windows PC interface) allows the user to make changes to critical operational parameters used to trigger the*

*tools bright LED display, to signal when a wheel-nut tightening process has been completed successfully. If used under controlled conditions, the system can help to dramatically reduce false tightening incidences.*

*The Torque and Angle Sensor Upgrade must be supplemented with the following elements:*

- *The Pit Stop Box used for connecting up to 4 wheel guns to a PC.*
- *The Pit Stop Dashboard used for making changes to all of the critical operational parameters, viewing pit stop results and data logging.*

*Note:*

*When ordering the TSA UPGRADE, your Wheel-guns will be converted, tested and calibrated, in the factory by experienced people at Dino Paoli.*

# PIT STOP BOX



The Pit Stop Box serves as a central system hub for connecting up to 4 wheel gun channels. It is used to power the wheel guns for operation and as an interface to a windows PC via USB. When connected to a PC the user can access to the wheel guns onboard electronic systems with the Pit Stop Dashboard Software.

The pit stop dashboard software can be ordered in two versions:

- Version F1/DTM (for use with 4 wheel guns simultaneously i.e. 1 gun per wheel)
- Version Endurance (for use with only 1 or 2 guns per race car)

## Software Features:

1. Tool Setup and LED trigger calibration: Angle limit and Torque Energy parameters used to trigger the tools onboard LED's can be set for individual race car characteristics.
2. Pit Stop results overview-window allows the comparison of individual wheel change procedures.
3. Numerical and graphic summary of angle, torque and timing of each individual wheel change procedure.
4. Input of file save location, allowing all data acquired during a race or pit stop practice to be saved and reviewed at a later date. For endurance applications where only 1 to 2 wheel guns are used, a wheel change sequence can be predefined for any order of operation.

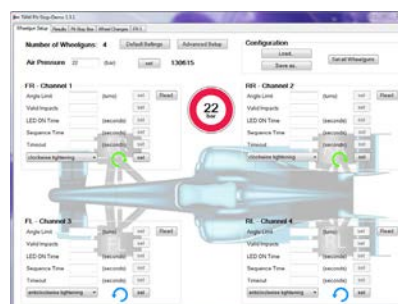

## WHEEL GUN OPERATING CABLES



PRODUCT CODE	LENGTH
B.23.0083	5 m
B.23.0084	10 m
B.23.0085	15 m
B.23.0086	20 m

# DP 4000 MG TS LAB



FORMULA 1 / GP2 / DTM

TS Lab, the ideal R&D device for the development of new wheel nuts / hubs. The torque details will be checked by the dedicated software to get exact and clear measurements

- MAGNESIUM ALLOY BODY
- COMPLETE TORQUE SENSOR INTEGRATION
- REAL TIME TORQUE ENERGY MEASUREMENT



DP 4000 MG TS LAB LH  
The fast left hand version (blue) loosens nuts tightened clockwise faster.



DP 4000 MG TS LAB RH  
The fast right hand version (red) loosens nuts tightened anticlockwise faster.

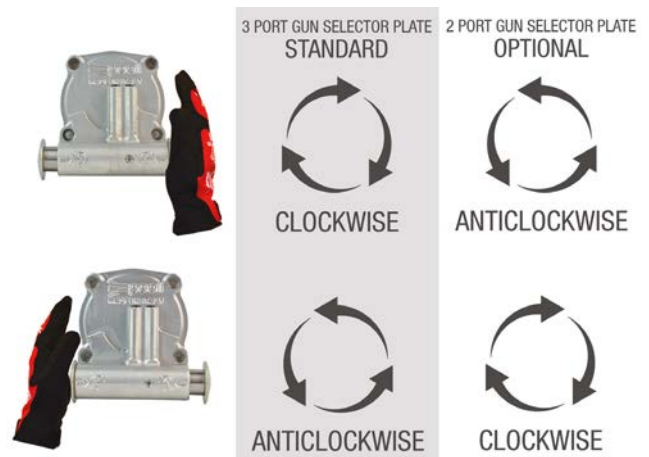

TORQUE AND ANGLE SENSOR

## DP 4000 MG TS LAB TECHNICAL DATA

PRODUCT NAME	PRODUCT CODE	VERSION	SQUARE DRIVE		WEIGHT		LENGTH		AIR INLET	SUPPLY HOSE INSIDE DIAMETER		MAX PRESSURE		FREE SPEED RPM	MAX TORQUE	
			inch	kg	lbs	mm	inch	inch	inch	mm	bar	psi	20 bar / 290 psi	Nm	ft-lbs	
DP 4000 MG TS LH	4000MT.00001	LH	1"	4,27	9.4	216	8.50	3/8" BSP	0.51"	13	20	290	13500	3500	2590	
DP 4000 MG TS RH	4000MT.00002	RH	1"	4,27	9.4	216	8.50	3/8" BSP	0.51"	13	20	290	13500	3500	2590	

To get the best performance from our wheel guns, we suggest you to use coupling with minimal bore of 10 mm (25/64 inch) and crimped with male 1/2" BSP fittings.



SUGGESTED ACCESSORIES FROM PAGE 33

# TS LAB UPGRADE

TORQUE SENSOR LAB UPGRADE  
 DP2000 SERIES, DP3000 SERIES, DP4000 SERIES, DP5000 SERIES

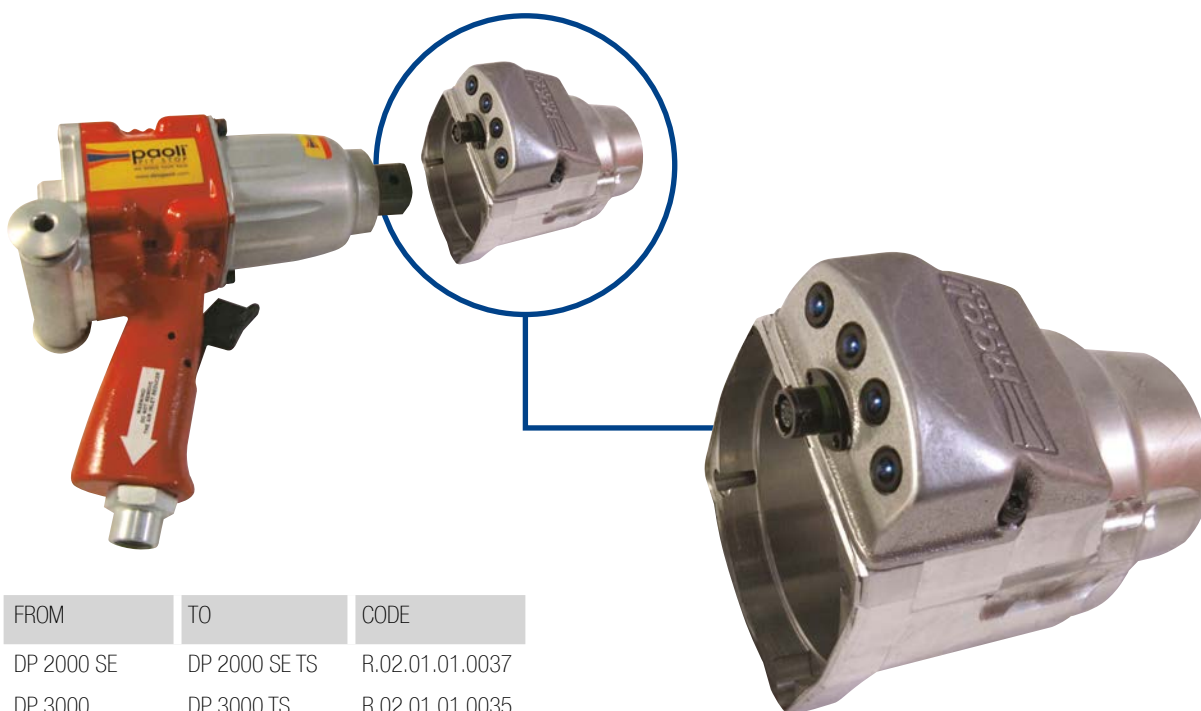

FROM	TO	CODE
DP 2000 SE	DP 2000 SE TS	R.02.01.01.0037
DP 3000	DP 3000 TS	R.02.01.01.0035
DP 4000	DP 4000 TS	R.02.01.01.0034
DP 4000 MG	DP 4000 MG TS	R.02.01.01.0051
DP 5000 TI	DP 5000 TI TS	R.02.01.01.0052

The Upgrade comes with Integrated Torque Sensor and digital signal processor (DSP). When a preprogrammed amount of Torque-Energy has been achieved (during the wheel fastening process) a set of bright LEDs will light-up, informing the tool operator that the target energy transfer has been completed.

This LED trigger point can be set by using the supplementary programming interface kit with included windows based software.

#### Features

- Internal Data Processing
- Real Time Data Monitoring and storage (when using telemetry software)
- User programmable high definition LED trigger set-point

#### Area of Use

Wheel-guns equipped with the Paoli Upgrade are ideal for training and quality monitoring purposes as well as for use in the Pit Lane during a race.

#### Features & Functions

- Easy-to-use Interface to program Wheel Gun Functions
- Allows more accurate setting of LED Trigger Point
- Allows Activation of Teaching Function
- Installable on Windows pc

#### TS LAB DATA CENTER

B.23.0058



#### Features & Functions

- Easy-to-use Interface to program Wheel Gun Functions
- Allows more accurate setting of LED Trigger Point
- Allows Activation of Teaching Function
- installable on Windows pc





PAOLI GUNS

# PAOLI GUNS

WHEEL GUNS

The most used wheel guns in motorsport races





paoli

00911/0

PAOLI

STOP



FORMULA 1 / INDY

Special development: increased performance, perfect ergonomics.

- STANDARD CARBON COVER
- ERGONOMIC TRIGGER MADE BY STAINLESS
- TSA READY
- ANODIZED COVERS BLUE AND RED, ACCORDING TO THE MOTORSPORT TRADITION
- TITANIUM MOTOR
- NEW CARBON PEEK VANES
- MAGNESIUM ALLOY BODY



DP 5000 TI MARK II LH  
The fast left hand version (blue) loosens nuts tightened clockwise faster.



DP 5000 TI MARK II RH  
The fast right hand version (red) loosens nuts tightened anticlockwise faster.



DP 5000 TI MARK II UH  
The special unhanded version (black) loosens at same speed both the nuts tightened clockwise and anticlockwise.

## DP 5000 TI MARK II TECHNICAL DATA

PRODUCT NAME	PRODUCT CODE	VERSION	SQUARE DRIVE			WEIGHT		LENGTH		AIR INLET	SUPPLY HOSE INSIDE DIAMETER		MAX PRESSURE		FREE SPEED RPM	MAX TORQUE	
			inch	kg	lbs	mm	inch	inch	inch		mm	bar	psi	25 bar / 362 psi		Nm	ft-lbs
CARBON COVER																	
DP 5000 TI MARK II LH	5000TI.00004	LH	1"	3,43	7.5	198	7.79	3/8" BSP	0.51"	13	25	362	14500	3800	2810		
DP 5000 TI MARK II RH	5000TI.00005	RH	1"	3,43	7.5	198	7.79	3/8" BSP	0.51"	13	25	362	14500	3800	2810		
DP 5000 TI MARK II UH	5000TI.00006	UH	1"	3,43	7.5	198	7.79	3/8" BSP	0.51"	13	25	362	14000	3500	2590		
AEROSPACE 7075 ALUMINUM COVER																	
DP 5000 TI MARK II LH	5000TI.00001	LH	1"	3,50	7.7	198	7.79	3/8" BSP	0.51"	13	25	362	14500	3800	2810		
DP 5000 TI MARK II RH	5000TI.00002	RH	1"	3,50	7.7	198	7.79	3/8" BSP	0.51"	13	25	362	14500	3800	2810		
DP 5000 TI MARK II UH	5000TI.00003	UH	1"	3,50	7.7	198	7.79	3/8" BSP	0.51"	13	25	362	14000	3500	2590		

To get the best performance from our wheel guns, we suggest you to use coupling with minimal bore of 10 mm (25/64 inch) and crimped with male 1/2" BSP fittings.



SUGGESTED ACCESSORIES FROM PAGE 33

# DP 4000 MG



FORMULA 1 / GP2 / DTM

Strong, fast and reliable.

- MAGNESIUM ALLOY BODY
- LIGHT WEIGHT (JUST 3,64 KG / 8.02 LBS WITH CARBON COVER)
- MORE POWER (13.500 RPM)
- TSA READY
- NEW CARBON PEEK VANES



DP 4000 MG LH  
The fast left hand version (blue) loosens nuts tightened clockwise faster.



DP 4000 MG RH  
The fast right hand version (red) loosens nuts tightened anticlockwise faster.



DP 4000 MG UH  
The special unhand version (black) loosens at same speed both the nuts tightened clockwise and anticlockwise.

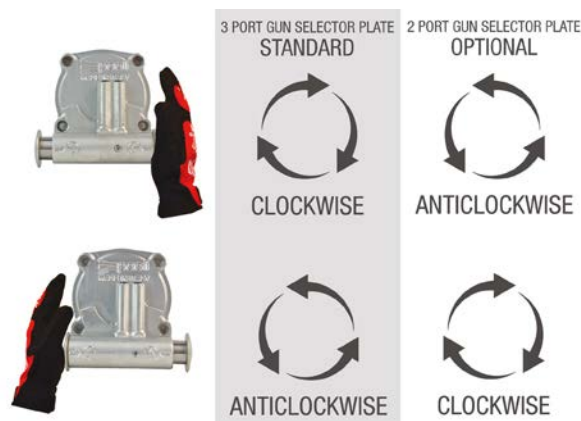

## DP 4000 MG TECHNICAL DATA

PRODUCT NAME	PRODUCT CODE	VERSION	SQUARE DRIVE		WEIGHT		LENGTH		AIR INLET	SUPPLY HOSE INSIDE DIAMETER		MAX PRESSURE		FREE SPEED RPM	MAX TORQUE	
			inch	mm	kg	lbs	mm	inch	inch	inch	mm	bar	psi	20 bar / 290 psi	Nm	ft-lbs
AEROSPACE 7075 ALUMINIUM COVER																
DP 4000 MG LH	4000MG.00001	LH	1"	193	3,71	8.18	193	7.59	3/8" BSP	0.51"	13	20	290	13500	3500	2590
DP 4000 MG RH	4000MG.00002	RH	1"	193	3,71	8.18	193	7.59	3/8" BSP	0.51"	13	20	290	13500	3500	2590
DP 4000 MG UH	4000MG.00003	UH	1"	193	3,71	8.18	193	7.59	3/8" BSP	0.51"	13	20	290	12500	3300	2442
CARBON COVER																
DP 4000 MG LH	4000MG.00024	LH	1"	193	3,64	8.02	193	7.59	3/8" BSP	0.51"	13	20	290	13500	3500	2590
DP 4000 MG RH	4000MG.00025	RH	1"	193	3,64	8.02	193	7.59	3/8" BSP	0.51"	13	20	290	13500	3500	2590
DP 4000 MG UH	4000MG.00026	UH	1"	193	3,64	8.02	193	7.59	3/8" BSP	0.51"	13	20	290	12500	3300	2442

To get the best performance from our wheel guns, we suggest you to use coupling with minimal bore of 10 mm (25/64 inch) and crimped with male 1/2" BSP fittings.



SUGGESTED ACCESSORIES FROM PAGE 33



FORMULA 1 / INDY

Max Pressure! 30 bar / 435 psi

- NEW AEROSPACE ALUMINIUM 7075 FRONT COVER
- OPTIONAL FRONT COVER MADE OF CARBON
- SUPER RESILIENT TRIGGER MADE OF REINFORCED NYLON™
- OPTIONAL TRIGGER MADE OF STAINLESS
- TSA READY
- NEW CARBON PEEK VANES



DP 4000 30BAR LH  
The fast left hand version (blue) loosens nuts tightened clockwise faster.



DP 4000 30BAR RH  
The fast right hand version (red) loosens nuts tightened anticlockwise faster.



DP 4000 30BAR UH  
The special unhand version (black) loosens at same speed both the nuts tightened clockwise and anticlockwise.



## DP 4000 30BAR TECHNICAL DATA

PRODUCT NAME	PRODUCT CODE	VERSION	SQUARE DRIVE		WEIGHT		LENGTH		AIR INLET	SUPPLY HOSE INSIDE DIAMETER	MAX PRESSURE		FREE SPEED RPM	MAX TORQUE		
			inch	mm	kg	lbs	mm	inch			bar	psi		30 bar / 435 psi	Nm	ft-lbs
AEROSPACE 7075 ALUMINIUM COVER																
DP 4000 30BAR LH	400030.00001	LH	1"	193	3,97	8.7	193	7.59	3/8" BSP	0.51"	13	30	435	15500	3800	2810
DP 4000 30BAR RH	400030.00002	RH	1"	193	3,97	8.7	193	7.59	3/8" BSP	0.51"	13	30	435	15500	3800	2810
DP 4000 30BAR UH	400030.00003	UH	1"	193	3,97	8.7	193	7.59	3/8" BSP	0.51"	13	30	435	15000	3500	2590
CARBON COVER																
DP 4000 30BAR LH	400030.00004	LH	1"	193	3,90	8.6	193	7.59	3/8" BSP	0.51"	13	30	435	15500	3800	2810
DP 4000 30BAR RH	400030.00005	RH	1"	193	3,90	8.6	193	7.59	3/8" BSP	0.51"	13	30	435	15500	3800	2810
DP 4000 30BAR UH	400030.00006	UH	1"	193	3,90	8.6	193	7.59	3/8" BSP	0.51"	13	30	435	15000	3500	2590

To get the best performance from our wheel guns, we suggest you to use coupling with minimal bore of 10 mm (25/64 inch) and crimped with male 1/2" BSP fittings.



SUGGESTED ACCESSORIES FROM PAGE 33

paoli®  
PIT STOP  
WE SPEED YOUR RACE

paoli®  
PIT STOP  
WE SPEED YOUR RACE  
www.pacopiltsstop.com

RH



# DP 4000 BIAS



ENDURANCE / ALMS / LE MANS SERIES

Two wheel guns, one body, this is BIAS system!

- FRONT NEEDLE ROLLER BEARINGS
- NEW AEROSPACE ALUMINIUM 7075 FRONT COVER
- EASY TO USE AS THE INSTRUCTIONS ARE ENGRAVED ON THE GUN BACK
- SIMPLY FASTER!

*The BIAS SYSTEM gives you both RH and LH versions inside a single wheel gun. Using the special lever you can change the mode during the pitstop. This model is particularly suitable for those championships in which the use of a single wheel gun is mandatory. The BIAS SYSTEM is capable to give to the operator all the advantages of both the RH and LH modes in a single wheel gun.*

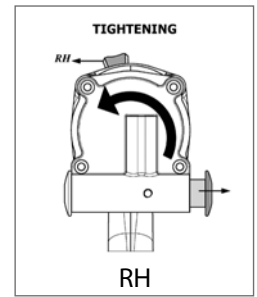
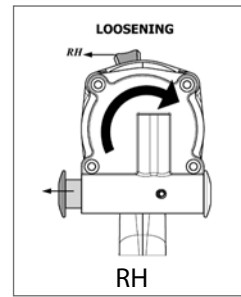
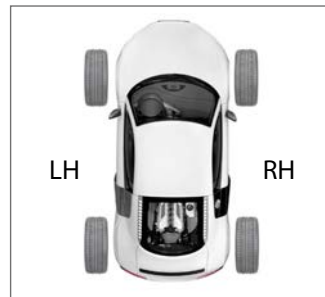
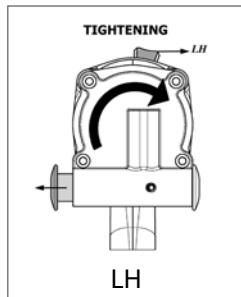
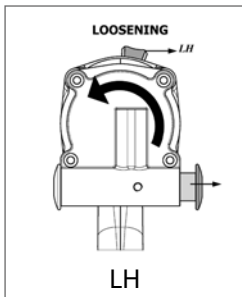

WHEEL GUNS

## DP 4000 BIAS TECHNICAL DATA

PRODUCT NAME	PRODUCT CODE	VERSION	SQUARE DRIVE		WEIGHT		LENGTH		AIR INLET	SUPPLY HOSE INSIDE DIAMETER		MAX PRESSURE		FREE SPEED RPM	MAX TORQUE	
			inch	mm	kg	lbs	mm	inch	inch	inch	mm	bar	psi	20 bar / 290 psi	Nm	ft-lbs
DP 4000 BIAS	4000BS.00001	BIAS	1"	25.4	3,90	8.6	193	7.59	3/8" BSP	0.51"	13	20	290	10500	3000	2250

To get the best performance from our wheel guns, we suggest you to use coupling with minimal bore of 10 mm (25/64 inch) and crimped with male 1/2" BSP fittings.



SUGGESTED ACCESSORIES FROM PAGE 33



V8 SUPERCAR / GT / ENDURANCE

The ultimate solution for V8 touring cars pit stop!

- OPERATING PRESSURE 20 BAR / 290 PSI
- NEW CARBON VANES
- OPTIMIZED AND EFFICIENT EXHAUST (PATENTED SYSTEM)



**SUPERSPORT LH**  
The fast left hand version (blue) loosens nuts tightened clockwise faster.



**SUPERSPORT RH**  
The fast right hand version (red) loosens nuts tightened anticlockwise faster.



## SUPERSPORT TECHNICAL DATA

PRODUCT NAME	PRODUCT CODE	VERSION	SQUARE DRIVE			WEIGHT			LENGTH		AIR INLET	SUPPLY HOSE INSIDE DIAMETER		MAX PRESSURE		FREE SPEED RPM	MAX TORQUE	
			inch	kg	lbs	mm	inch	inch	inch	inch	mm	bar	psi	20 bar / 290 psi	Nm	ft-lbs		
SUPERSPORT 60/40																		
SUPERSPORT LH	SSPORT.00001	LH <span style="color: blue;">■</span>	1"	4,50	9.9	220	8,6	3/8" BSP	0.51"	13	20	290	10500	2800	2065			
SUPERSPORT RH	SSPORT.00002	RH <span style="color: red;">■</span>	1"	4,50	9.9	220	8,6	3/8" BSP	0.51"	13	20	290	10500	2800	2065			
SUPERSPORT 70/30																		
SUPERSPORT LH	SSPORT.00004	LH <span style="color: blue;">■</span>	1"	4,50	9.9	220	8,6	3/8" BSP	0.51"	13	20	290	10500	3000	2212			
SUPERSPORT RH	SSPORT.00005	RH <span style="color: red;">■</span>	1"	4,50	9.9	220	8,6	3/8" BSP	0.51"	13	20	290	10500	2500	1843			



SUGGESTED ACCESSORIES FROM PAGE 33





GRAND AM / GP2

Absolutely the most used wheel gun

- WEIGHT REDUCED THANKS TO NEW AEROSPACE ALUMINIUM 7075
- OPTIONAL CARBON COVER
- NEW CARBON VANES



DP 2000 SE LH  
The fast left hand version (blue) loosens nuts tightened clockwise faster.



DP 2000 SE RH  
The fast right hand version (red) loosens nuts tightened anticlockwise faster.



DP 2000 SE UH  
The special unhanded version (black) loosens at same speed both the nuts tightened clockwise and anticlockwise.



WHEEL GUNS

## DP 2000 SE TECHNICAL DATA

PRODUCT NAME	PRODUCT CODE	VERSION	SQUARE DRIVE		WEIGHT		LENGTH		AIR INLET	SUPPLY HOSE INSIDE DIAMETER		MAX PRESSURE		FREE SPEED RPM	MAX TORQUE	
			inch	kg	lbs	mm	inch	inch	inch	mm	bar	psi	20 bar / 290 psi	Nm	ft-lbs	
AEROSPACE 7075 ALUMINIUM COVER																
DP 2000 SE LH	2000SE.00001	LH	1"	3,90	8.6	186	7.32	3/8" BSP	0.51"	13	20	290	9500	2500	1843	
DP 2000 SE RH	2000SE.00002	RH	1"	3,90	8.6	186	7.32	3/8" BSP	0.51"	13	20	290	9500	2500	1843	
DP 2000 SE UH	2000SE.00003	UH	1"	3,90	8.6	186	7.32	3/8" BSP	0.51"	13	20	290	9000	2200	1622	
CARBON COVER																
DP 2000 SE LH	2000SE.00004	LH	1"	3,83	8.4	186	7.32	3/8" BSP	0.51"	13	20	290	9500	2500	1843	
DP 2000 SE RH	2000SE.00005	RH	1"	3,83	8.4	186	7.32	3/8" BSP	0.51"	13	20	290	9500	2500	1843	
DP 2000 SE UH	2000SE.00006	UH	1"	3,83	8.4	186	7.32	3/8" BSP	0.51"	13	20	290	9000	2200	1622	



SUGGESTED ACCESSORIES FROM PAGE 33



GT / ENDURANCE

Very reliable!

- LIGHT WEIGHT (JUST KG 4,6 / 10 LBS)
- NEW AEROSPACE ALUMINIUM 7075 FRONT COVER.
- NEW CARBON VANES



DP 197 SFE LH  
The fast left hand version (blue) loosens nuts tightened clockwise faster.



DP 197 SFE RH  
The fast right hand version (red) loosens nuts tightened anticlockwise faster.



DP 197 SFE UH  
The special unhanded version (black) loosens at same speed both the nuts tightened clockwise and anticlockwise.



## DP 197 SFE TECHNICAL DATA

PRODUCT NAME	PRODUCT CODE	VERSION	SQUARE DRIVE		WEIGHT		LENGTH		AIR INLET	SUPPLY HOSE INSIDE DIAMETER		MAX PRESSURE		FREE SPEED RPM	MAX TORQUE	
			inch	mm	kg	lbs	mm	inch	inch	inch	mm	bar	psi	20 bar / 290 psi	Nm	ft-lbs
DP 197 SFE LH	197SFE.00001	LH	1"	25.4	4,60	10	200	7.87	3/8" BSP	0.51"	13	20	290	7900	1900	1400
DP 197 SFE RH	197SFE.00002	RH	1"	25.4	4,60	10	200	7.87	3/8" BSP	0.51"	13	20	290	7900	1900	1400
DP 197 SFE UH	197SFE.00003	UH	1"	25.4	4,60	10	200	7.87	3/8" BSP	0.51"	13	20	290	7500	1800	1327



SUGGESTED ACCESSORIES FROM PAGE 33

# DP 176 SFE



PORSCHE / ALMS

The Porsche wheel gun!

- LIGHT WEIGHT (JUST KG 3,95 / 8.7 LBS)
- NEW AEROSPACE ALUMINIUM 7075 FRONT COVER
- INCREASED MAX PRESSURE (20 BAR / 290 PSI)
- NEW CARBON VANES



DP 176 SFE LH

*The fast left hand version (blue) loosens nuts tightened clockwise faster.*



DP 176 SFE RH

*The fast right hand version (red) loosens nuts tightened anticlockwise faster.*



DP 176 SFE UH

*The special unhanded version (black) loosens at same speed both the nuts tightened clockwise and anticlockwise.*



WHEEL GUNS

## DP 176 SFE TECHNICAL DATA

PRODUCT NAME	PRODUCT CODE	VERSION	SQUARE DRIVE		WEIGHT		LENGTH		AIR INLET	SUPPLY HOSE INSIDE DIAMETER		MAX PRESSURE		FREE SPEED RPM	MAX TORQUE	
			inch	mm	kg	lbs	mm	inch	inch	inch	mm	bar	psi	20 bar / 290 psi	Nm	ft-lbs
DP 176 SFE LH	176SFE.00001	LH	3/4"	19	3,95	8.7	185	7.28	3/8" BSP	0.51"	13	20	290	10000	1700	1260
DP 176 SFE RH	176SFE.00002	RH	3/4"	19	3,95	8.7	185	7.28	3/8" BSP	0.51"	13	20	290	10000	1700	1260
DP 176 SFE UH	176SFE.00003	UH	3/4"	19	3,95	8.7	185	7.28	3/8" BSP	0.51"	13	20	290	9500	1600	1180



SUGGESTED ACCESSORIES FROM PAGE 33



**paoli®**  
PIT STOP  
WE SPEED YOUR RACE  
[www.paolipitstop.com](http://www.paolipitstop.com)



GT / ENDURANCE

The new 1" Paoli wheel gun: fast, powerful and reliable

- NEW CARBON VANES
- NEW AEROSPACE ALUMINIUM 7075 FRONT COVER
- INCREASED MAX PRESSURE (20 BAR / 290 PSI)



DP 177 SFE LH  
The fast left hand version (blue) loosens nuts tightened clockwise faster.



DP 177 SFE RH  
The fast right hand version (red) loosens nuts tightened anticlockwise faster.



DP 177 SFE UH  
The special unhandled version (black) loosens at same speed both the nuts tightened clockwise and anticlockwise.



WHEEL GUNS

## DP 177 SFE TECHNICAL DATA

PRODUCT NAME	PRODUCT CODE	VERSION	SQUARE DRIVE		WEIGHT		LENGTH		AIR INLET	SUPPLY HOSE INSIDE DIAMETER		MAX PRESSURE		FREE SPEED RPM	MAX TORQUE	
			inch	mm	kg	lbs	mm	inch	inch	inch	mm	bar	psi	20 bar / 290 psi	Nm	ft-lbs
DP 177 SFE LH	177SFE.00001	LH	1"	25.4	4,20	9.2	193	7.59	3/8" BSP	0.51"	13	20	290	10000	1900	1400
DP 177 SFE RH	177SFE.00002	RH	1"	25.4	4,20	9.2	193	7.59	3/8" BSP	0.51"	13	20	290	10000	1900	1400
DP 177 SFE UH	177SFE.00003	UH	1"	25.4	4,20	9.2	193	7.59	3/8" BSP	0.51"	13	20	290	9500	1800	1327



SUGGESTED ACCESSORIES FROM PAGE 33



PORSCHE / ALMS

Lightweight but very fast and powerful!

- OPERATING PRESSURE 20 BAR / 290 PSI
- NEW CARBON VANES
- OPTIMIZED AND EFFICIENT EXHAUST (PATENTED SYSTEM)
- 90° HANDLE



**BLUE DEVIL LH**  
The fast left hand version (blue) loosens nuts tightened clockwise faster.



**BLUE DEVIL RH**  
The fast right hand version (red) loosens nuts tightened anticlockwise faster.



## BLUE DEVIL TECHNICAL DATA

PRODUCT NAME	PRODUCT CODE	VERSION	SQUARE DRIVE		WEIGHT		LENGTH		AIR INLET	SUPPLY HOSE INSIDE DIAMETER		MAX PRESSURE		FREE SPEED RPM	MAX TORQUE	
			inch	mm	kg	lbs	mm	inch	inch	inch	mm	bar	psi	20 bar / 290 psi	Nm	ft-lbs
BLUE DEVIL 60/40																
BLUE DEVIL LH	BDEVIL.00002	LH	3/4"	188	2,69	5,9	188	7,4	3/8" BSP	0.51"	13	20	290	17000	1200	890
BLUE DEVIL RH	BDEVIL.00004	RH	3/4"	188	2,69	5,9	188	7,4	3/8" BSP	0.51"	13	20	290	17000	1200	890
BLUE DEVIL 70/30																
BLUE DEVIL LH	BDEVIL.00006	LH	3/4"	188	2,69	5,9	188	7,4	3/8" BSP	0.51"	13	20	290	17500	1200	890
BLUE DEVIL RH	BDEVIL.00008	RH	3/4"	188	2,69	5,9	188	7,4	3/8" BSP	0.51"	13	20	290	17500	1200	890



SUGGESTED ACCESSORIES FROM PAGE 33

# DP 36 SF EVO



TOURING

Very fast!

- ADDITIONAL AIR EXHAUSTS TO INCREASE THE SPEED
- NEW CARBON VANES
- DEVELOPED FOR 5 NUTS



DP 36 SF EVO LH  
The fast left hand version (blue) loosens nuts tightened clockwise faster.



DP 36 SF EVO RH  
The fast right hand version (red) loosens nuts tightened anticlockwise faster.



WHEEL GUNS

## DP 36 SF EVO TECHNICAL DATA

PRODUCT NAME	PRODUCT CODE	VERSION	SQUARE DRIVE			WEIGHT			LENGTH		AIR INLET		SUPPLY HOSE INSIDE DIAMETER		MAX PRESSURE		FREE SPEED RPM	MAX TORQUE	
			inch	kg	lbs	mm	inch	inch	inch	inch	mm	bar	psi	14bar / 200psi	Nm	ft-lbs			
DP 36 SF EVO LH	36SFEV.00001	LH	1/2"	2,23	4.9	161	6.3	3/8" BSP	0.39"	10	14	200	14500	850	626				
DP 36 SF EVO RH	36SFEV.00002	RH	1/2"	2,23	4.9	161	6.3	3/8" BSP	0.39"	10	14	200	14500	850	626				
DP 36 SF EVO LH*	36SFEV.00003	LH	1/2"	2,23	4.9	161	6.3	1/4" NPT	0.39"	10	14	200	15000	900	663				

\*US VERSION



SUGGESTED ACCESSORIES FROM PAGE 33



TOURING

Fast and powerful cordless gun for 5 NUTS wheels (TOURING)

Suggested to be used in the garage where it is not possible to get compressed air available and when the tightening torque required is low.

- PROVIDED IN A HARD CASE
- LITHIUM ION BATTERY 18.0v D.C.
- 2 BATTERIES INCLUDED, ONE IN USE AND ONE AS A SPARE



## TORPEDO TECHNICAL DATA

PRODUCT NAME	PRODUCT CODE	VERSION	SQUARE DRIVE	WEIGHT (WITH BATTERY)		LENGTH		WIDTH		HEIGHT		VOLTAGE	MAX TORQUE	
			inch	kg	lbs	mm	inch	mm	inch	mm	inch		volt	Nm
TORPEDO	A.08.0001	CORDLESS	1/2"	3,08	6.8	266	10.4	80	3.1	274	10.7	18.0V d.c.	588	430



SUGGESTED ACCESSORIES FROM PAGE 33





**paoli**  
W P I T  
WE SPEED YOUR  
Sabelt



WHEEL GUN  
DP 36 SF EVO

All technical details  
at page 29



AIR PRESSURE  
REGULATOR  
RGPRSF4

All technical details  
at page 36



HOSE  
H20  
20 BAR/290PSI

All technical details  
at page 39



RED DEVIL  
STREET LEGAL

*Paoli's Motorbikes  
Pit Stop Selection*

## WHEEL GUNS

PRODUCT NAME	PRODUCT CODE	SQUARE DRIVE		WEIGHT		LENGTH		AIR INLET	SUPPLY HOSE INSIDE DIAMETER		MAX PRESSURE		FREE SPEED RPM	MAX TORQUE	
		inch	mm	kg	lbs	mm	inch		inch	mm	bar	psi		20 bar / 290 psi	Nm
DP 36 SF EVO LH	36SFEV.00001	1/2"	161	2,23	4.9	161	6.3	3/8" BSP	0.39"	10	14	200	14500	850	626
RED DEVIL STREET LEGAL	RDEVSL.00001	1/2"	200	2,60	5.7	200	7.8	3/8" BSP	0.39"	10	15	217	12000	1200	888

COVERS	MATERIAL	THICKNESS	PRODUCT CODE
BLUE DEVIL	Transparent Plastic	2 mm	B.18.0019
	Black Rubber	4 mm	B.18.0020
DP 36 SF EVO	Transparent Plastic	2 mm	B.18.0006
	Black Rubber	4 mm	B.18.0004





# ACCESSORIES

AIR SUPPLY SYSTEM  
PIT EQUIPMENT  
OPTIONALS





AIR SUPPLY SYSTEM



COMPRESSORS  
FITTINGS  
page 46

AIR BOTTLES  
page 45

HIGH FLOW  
FILTER  
page 37

HIGH PRESSURE  
OILER  
page 37

HOSES  
pag. 39

AIR BOTTLE  
CONNECTORS  
page 38

AIR PRESSURE  
REGULATORS  
page 36

QUICK RELEASE  
COUPLINGS  
page 42

BRAND NEW



PAOLI WHEEL NUT SOCKETS  
page 55



PAOLI AIR SUPPLY  
page 41

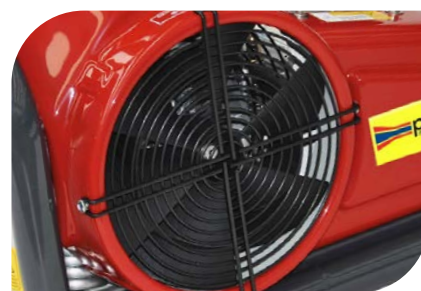

AIR BOTTLE COMPRESSORS  
page 46



GOODRIDGE HOSES  
page 39



PIT STOP HELMET  
page 57



FAST SHUTTLE  
page 53



## AIR PRESSURE REGULATORS



RGPRSF10



RGPRSF9



RGPRSF1 - RGPRSF2



RGPRSF6



RGPRSF4



RGPRSF7



### RGPRSF4

The "Paoli F4" best seller balanced air pressure regulator. Constant air flow at high pressure: it keeps high performances also when the bottle is almost empty. Max air flow superior to any other air pressure regulator!

PRODUCT NAME	PRODUCT CODE	INLET PRESSURE	MAX FLOW (20 BAR/OUT)	GAUGES IN	GAUGES OUT	OVER PRESSURE VALVE SETTING	THREAD OUT	FLOW	AIRJACK	HIGH FLOW FILTER	BALANCED
RGPRSF1	B.40.0001	220 bar	150 Nm <sup>3</sup> /h	0-315 bar	0-100 bar	30	3/8" BSP	medium			
RGPRSF1	B.40.0034	220 bar	150 Nm <sup>3</sup> /h	0-4000 psi	0-1000 psi	30	3/8" BSP	medium			
RGPRSF1	B.40.0040	350 bar	200 Nm <sup>3</sup> /h	0-630 bar	0-60 bar	30	3/8" BSP	medium			
RGPRSF2	B.40.0002	220 bar	150 Nm <sup>3</sup> /h	0-315 bar	0-100 bar	50	3/8" BSP	medium	•		
RGPRSF2	B.40.0035	220 bar	150 Nm <sup>3</sup> /h	0-4000 psi	0-1000 psi	50	3/8" BSP	medium	•		
RGPRSF2	B.40.0041	350 bar	200 Nm <sup>3</sup> /h	0-630 bar	0-100 bar	50	3/8" BSP	medium			
RGPRSF6	B.40.0003	220 bar	75 Nm <sup>3</sup> /h	0-315 bar	0-60 bar	30	3/8" BSP	low			
RGPRSF6	B.40.0031	220 bar	75 Nm <sup>3</sup> /h	0-4000 psi	0-1000 psi	30	3/8" BSP	low			
RGPRSF7	B.40.0004	220 bar	75 Nm <sup>3</sup> /h	0-315 bar	0-100 bar	50	3/8" BSP	low	•		
RGPRSF7	B.40.0032	220 bar	75 Nm <sup>3</sup> /h	0-4000 psi	0-1000 psi	50	3/8" BSP	low	•		
RGPRSF4	B.40.0005	220 bar	400 Nm <sup>3</sup> /h	0-315 bar	0-100 bar	50	3/8" BSP	high	•	•	•
RGPRSF4	B.40.0030	220 bar	400 Nm <sup>3</sup> /h	0-4000 psi	0-1000 psi	50	3/8" BSP	high	•	•	•
RGPRSF4	B.40.0042	350 bar	500 Nm <sup>3</sup> /h	0-630 bar	0-100 bar	50	3/8" BSP	high	•	•	•
RGPRSF9 *	B.40.0006	220 bar	400 Nm <sup>3</sup> /h	0-315 bar	0-60 bar	40	3/8" BSP	high		•	•
RGPRSF9 *	B.40.0033	220 bar	400 Nm <sup>3</sup> /h	0-4000 psi	0-1000 psi	40	3/8" BSP	high		•	•
RGPRSF10 *	B.40.0039	220 bar	800 Nm <sup>3</sup> /h	0-315 bar	0-100 bar	40	3/4" BSP male	high		•	•

\*Piston pilot regulator

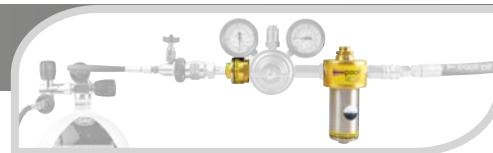

## HIGH FLOW FILTER FOR AIR PRESSURE REGULATORS INLET



B.45.0005

Suitable for pressure regulators for heavy duty application.  
High surface area to grant bigger air flow. Easy maintenance service.

Technical Data:

Thread IN: 1/4" BSP female

Thread OUT: 3/8" BSP male



## HIGH PRESSURE OILER



B.45.0004

More speed and performance, increased reliability on your Paoli gun.

MAX OPERATING PRESSURE	EFFECTIVE BOWL VOLUME	SIZE	MOUNTING POSITION	BOWL MATERIALE
50 bar	200 cm <sup>3</sup>	1/2" BSP	Vertical	AISI 316

The oiler constantly lubricates the air motor and getting the maximum speed and increasing its reliability.

## GAUGES



B.40.0011



B.40.0012



B.40.0016

Glycerin



B.40.0015

Glycerin

CODE	DIAMETER	CONNECTION	RANGE	GLYCERIN	DISPLAY
B.40.0011	63 mm	1/4" BSP	0-63 bar		analogic
B.40.0012	63 mm	1/4" BSP	0-100 bar		analogic
B.40.0013	63 mm	1/4" BSP	0-315 bar		analogic
B.40.0015	63 mm	1/4" BSP	0-100 bar	X	analogic
B.40.0016	63 mm	1/4" BSP	0-315 bar	X	analogic
B.40.0019	79 mm	1/4" BSP	0-100 bar 0-1500 psi		digital
B.40.0020	79 mm	1/4" BSP	0-400 bar 0-5800 psi		digital
B.40.0025	63 mm	1/4" BSP	0-400 psi		analogic
B.40.0026	63 mm	1/4" BSP	0-4000 psi		analogic
B.40.0028	63 mm	1/4" BSP	0-1000 psi		analogic

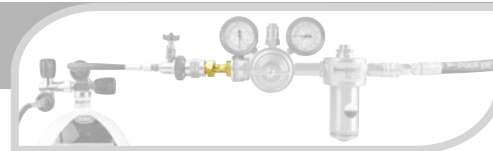

## AIR BOTTLE CONNECTORS



B.01.0002



PRODUCT CODE	WORKING PRESSURE	DESCRIPTION	UNI CODE
B.01.0001	220 bar	COD-BSP	BS341 NR3
B.01.0002	220 bar	COD-D	DIN 477-13
B.01.0003	220 bar	COD-FR-J	ex UNI 4406 02 UNI 11144 NR2
B.01.0004	220 bar	COD-FR-N2	NF E29-650
B.01.0005	220 bar	COD-IT	ex UNI 4410 AIR UNI 11144 NR6
B.01.0006	220 bar	COD-N2	ex UNI 4409 N2 UNI 11144 NR5
B.01.0007	220 bar	COD-US	ex UNI 4412 AR-HE UNI 11144 NR8
B.01.0011	220 bar	COD-J	JAPAN
B.01.0014	220 bar	COD-IN	INDIAN STANDARD 3224 2002
B.01.0013	220 bar	COD-CN	CHINA N2 G5/8"
B.01.0016	220 bar	CGA580	use with RGPRSF1, RGPRSF2, RGPRSF4, RGPRSF9
B.01.0017	220 bar	CGA580	use with RGPRSF6, RGPRSF7

## SPARE GUN AIR SUPPLY DEVICE



B.42.0073

This device allows the operator to get a second spare gun connected to the same air supply. It is needed in case of EMERGENCY (first gun failing) during the pit stop operations.

**WARNING:** you should use just on gun at a time otherwise the air flow drops down very quickly.

Couplings not included

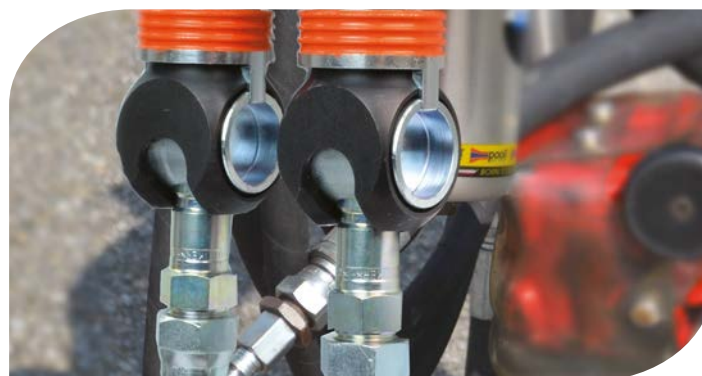

## FIXING NUTS



B.40.0044



B.40.0007

PRODUCT CODE	FOR AIR PRESSURE REGULATORS
B.40.0044	RGPRSF6 - RGPRSF7
B.40.0007	RGPRSF1 - RGPRSF2 - RGPRSF4





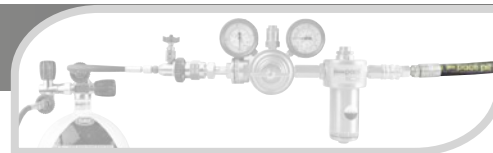

## HOSES



H75

Technical data - bore size: 13 mm, braid od: 23,5 mm, working pressure: 75 bar.

### A - SELECT LENGHT

CODE	LENGHT	CODE	LENGHT
B.41.1001	1 m	B.41.1006	6 m
B.41.1002	2 m	B.41.1007	7 m
B.41.1003	3 m	B.41.1008	8 m
B.41.1004	4 m	B.41.1009	9 m
B.41.1005	5 m	B.41.1010	10 m

### B, C - SELECT COUPLINGS

	ANGLE	1/2"	3/8"	NPT 3/8
Female	0°	B.41.5001	B.41.5002	B.41.5003
	45°	B.41.5004	B.41.5005	
	90°	B.41.5007	B.41.5008	
Male	0°	B.41.5010	B.41.5011	



H20

Technical data - bore size: 10 mm, braid od: 15 mm, working pressure: 20 bar.

### A - SELECT LENGHT

CODE	LENGHT	CODE	LENGHT
B.41.7001	1 m	B.41.7006	6 m
B.41.7002	2 m	B.41.7007	7 m
B.41.7003	3 m	B.41.7008	8 m
B.41.7004	4 m	B.41.7009	9 m
B.41.7005	5 m	B.41.7010	10 m

### B, C - SELECT COUPLINGS

	ANGLE	1/2"	3/8"	NPT 1/4
Female	0°	B.41.8001	B.41.8002	
	45°		B.41.8005	
	90°		B.41.8008	
Male	0°		B.41.8011	B.41.8020
	45°			B.41.8021
	90°			B.41.8022



H75-XR

**GOODRIDGE**

### ANTI-STATIC MATERIAL - PTFE SMOOTHBORE - STAINLESS STEEL BORE - LIGHT WEIGHT

This new kind of hose has got a good flexibility and a good flow rate together with a reduced weight. It is also very durable as the steel braid guarantees an additional protection.

Technical data - bore size: 12.7 mm (0,5"), braid od: 16.5 mm (0,65"), working pressure: 70 bar (1030 psi), burst pres: 280 bar (4120 psi), weight: 0,29 kg/m (0,19 lb/ft), min bend rad: 38 mm (1,496").

LENGHT	CRIMPS	1/2" bsp	3/8" bsp
6 m	0° turning - female	B.20.03.0000	B.20.03.0001
6 m	0° - male	B.20.03.0002	B.20.03.0003
12 m	0° turning - female	B.20.03.0004	B.20.03.0005
12 m	0° - male	B.20.03.0006	B.20.03.0007



#### HOW TO ORDER

##### H75 and H20 HOSES:

- 1 - select the length of the hose (table A)
- 2 - select the fittings at both ends of the hose (table B/C)

##### H75-XR

- 1 - select lenght and fittings (table A)

More items and configuration on demand

## WHIP HOSES



WH3C - B.20.01.0007 Whip Hose w/D3 Turning Connector

WHSC - B.20.01.0002 Whip Hose w/Swivel Fitting

WHTC - B.20.01.0001 Whip Hose w/360° Turning Connector

PRODUCT NAME	PRODUCT CODE	INSIDE DIAMETER	OUTSIDE DIAMETER	LENGTH	CONNECTION SIDE 1	TURNING CONNECTOR	CONNECTION SIDE 2
WHTC	B.20.01.0001	13 mm	23,5 mm	18" (46 cm)	3/8" BSP B.43.0001	type D	B.41.0003 female
WHSC	B.20.01.0002	13 mm	23,5 mm	18" (46 cm)	3/8" BSP B.43.0003	type R	B.41.0003 female
WH3C	B.20.01.0007	13 mm	23,5 mm	18" (46 cm)	3/8" BSP B.43.0003	type D3	B.41.0003 female

## HOSE REELS



B.33.0001

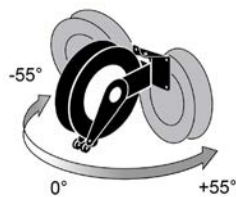

SWIVELLING



CAPACITY	OVERALL DIMENSIONS	WEIGHT	TYPE OF CONNECTION
(50 / 75 bar hose): 15 / 10,3 m	20,5 x 18,1 x 7,3"	61,73 lb	1/2" BSP Female

The hose reels are supplied without hose

## PAOLI AIR SUPPLY

Paoli Pit Stop Series introduces the ideal Air Supply to get the ultimate performances from a Paoli Gun. Our specialists have put together the ideal equipment for the best reliability and the maximum power (during the race and in the garage)



### PAOLI AIR SUPPLY

AIR PRESSURE REGULATOR	B.40.0005
HIGH PRESSURE OILER	B.40.0004
HOSE	H75 Series (B.41.00.XX) crimped with B.41.5010
COUPLINGS FOR REGULATOR	B.42.0058 AND B.42.0070
COUPLINGS FOR PAOLI GUN	B.42.0069 AND B.42.0062
WHEEL GUN CONNECTION	DYNAVARIACOR B.43.0001

## PAOLI AIR SUPPLY PLUS

Air Supply Plus is an upgrade to the Air Supply to get the best on the pit lane. The brand new Goodridge hose and its special couplings guarantee high air flow, safety and light weight also at the highest admissible pressures.

**GOODRIDGE**



### PAOLI AIR SUPPLY PLUS

AIR PRESSURE REGULATOR	B.40.0005
HIGH PRESSURE OILER	B.40.0004
HOSE	H75-XR (6 m B.20.03.0002, 12 m B.20.03.0006)
COUPLINGS FOR REGULATOR	B.42.0058 AND B.42.0070
COUPLINGS FOR PAOLI GUN	B.42.0069 AND B.42.0062
WHEEL GUN CONNECTION	DYNAVARIACOR B.43.0001

To get more information on our special Air Supplies, please contact one of our Paoli Air Supply consultant at: [paolairsystem@paoli.net](mailto:paolairsystem@paoli.net)

QUICK RELEASE COUPLINGS 1/2" (for hose threaded 1/2" bsp)



SECURITY SYSTEM BY OETIKER  
Safety Device. Locking Pressure Series



B.42.0003



B.42.0016



B.42.0004



B.42.0015

PRODUCT CODE	INSIDE DIAMETER	THREAD
■ B.42.0003	11 mm (7/16")	3/8" bsp
■ B.42.0016	11 mm (7/16")	1/2" bsp
■ B.42.0004	11 mm (7/16")	1/2" bsp
■ B.42.0015	11 mm (7/16")	3/8" bsp



STANDARD SERIES  
Standard series for daily use



B.42.0011



B.42.0037



B.42.0047



B.42.0013

PRODUCT CODE	PRODUCT NAME	INSIDE DIAMETER	THREAD
■ B.42.0011	410-1154	10,4 mm (13/32")	3/8" bspt
■ B.42.0037	410-5265	10,4 mm (13/32") ID 60°	1/2" bsp
■ B.42.0047		10,4 mm (13/32") ID 60°	1/2" bsp
■ B.42.0013	410-5154	10,4 mm (13/32")	3/8" bspt



ESAFE SYSTEM - WITH SAFETY OUTLET

The new couplings eSafe by Cejn offer a higher flow, a compact design. They are extremely durable and easy to handle. They also have a function of safety outlet



B.42.0056



B.42.0037



B.42.0054



B.42.0013

PRODUCT CODE	PRODUCT NAME	INSIDE DIAMETER	THREAD
■ B.42.0056	410-2155	10,4 mm (13/32")	3/8" bspt
■ B.42.0037	410-5265	10,4 mm (13/32") ID 60°	1/2" bsp
■ B.42.0054		10,4 mm (13/32") ID 60°	1/2" bsp
■ B.42.0013	410-5154	10,4 mm (13/32")	3/8" bspt



HIGH FLOW SERIES - EXTREME USE

Automatic safety-locking feature. Extremely high flow capacity. One-hand operated



B.42.0058



B.42.0070



B.42.0069



B.42.0062

PRODUCT CODE	PRODUCT NAME	INSIDE DIAMETER	THREAD
■ B.42.0058	442-1154	10,4 mm (13/32")	3/8" bspt
■ B.42.0070	442-5205	10,4 mm (13/32")	1/2" bsp
■ B.42.0069	442-1205	10,4 mm (13/32") ID 60°	1/2" bsp
■ B.42.0062	442-5154	10,4 mm (13/32")	3/8" bspt

■ Air pressure regulator side

■ Wheel gun side

More items on demand

## QUICK RELEASE COUPLINGS 3/8" (for hose threaded 3/8" bsp)



### SECURITY SYSTEM BY OETIKER

Safety Device. Locking Pressure Series



B.42.0001



B.42.0009



B.42.0001



B.42.0008

PRODUCT CODE	INSIDE DIAMETER	THREAD
■ B.42.0001	8 mm (5/16")	3/8" bsp
■ B.42.0009	7,6 mm (19/64") ID 60°	3/8" bsp
■ B.42.0001	8 mm (5/16")	3/8" bsp
■ B.42.0008	7,6 mm (19/64")	3/8" bspt



### STANDARD SERIES

Standard series for daily use



B.42.0005



B.42.0009



B.42.0006



B.42.0008

PRODUCT CODE	PRODUCT NAME	INSIDE DIAMETER	THREAD
■ B.42.0005	320-1154	7,6 mm (19/64")	3/8" bspt
■ B.42.0009	320-5264	7,6 mm (19/64") ID 60°	3/8" bsp
■ B.42.0006	320-1258	7,6 mm (19/64") ID 60°	3/8" bsp
■ B.42.0008	320-5154	7,6 mm (19/64")	3/8" bspt



### ESAFE SYSTEM - WITH SAFETY OUTLET

The new couplings eSafe by Cejn offer a higher flow, a compact design. They are extremely durable and easy to handle. They also have a function of safety outlet



B.42.0050



B.42.0009



B.42.0052



B.42.0008

PRODUCT CODE	PRODUCT NAME	INSIDE DIAMETER	THREAD
■ B.42.0050	320-2154	7,6 mm (19/64")	3/8" bspt
■ B.42.0009	320-5264	7,6 mm (19/64") ID 60°	3/8" bsp
■ B.42.0052	320-2204	7,6 mm (19/64") ID 60°	3/8" bsp
■ B.42.0008	320-5154	7,6 mm (19/64")	3/8" bspt



### HIGH FLOW SERIES - EXTREME USE

Automatic safety-locking feature. Extremely high flow capacity. One-hand operated



B.42.0058



B.42.0062



B.42.0059



B.42.0062

PRODUCT CODE	PRODUCT NAME	INSIDE DIAMETER	THREAD
■ B.42.0058	442-1154	10,4 mm (13/32")	3/8" bspt
■ B.42.0062	442-5154	10,4 mm (13/32")	3/8" bspt
■ B.42.0059		10,4 mm (13/32") ID 60°	3/8" bsp
■ B.42.0062	442-5154	10,4 mm (13/32")	3/8" bspt

■ Air pressure regulator side

■ Wheel gun side

More items on demand

## TURNING CONNECTORS

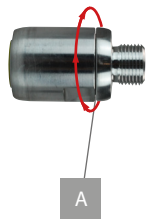

TYPE R

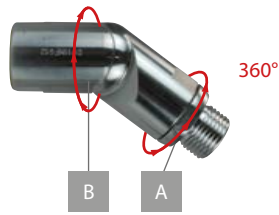

TYPE D

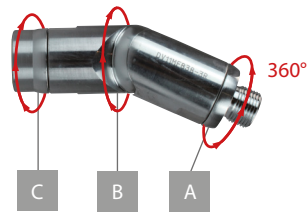

TYPE D3



TYPE	PRODUCT NAME	PRODUCT CODE	MALE/FEMALE	INSIDE DIAMETER	A	B	C
					TURNING	FLEXING HOSE CONNECTOR	TURNING
D	DV11MFG38	B.43.0001	3/8" BSP	11 mm	360°	90°	
D3	DV11MFB38-3R	B.43.0002	3/8" BSP	11 mm	360°	90°	360°
R	RV11MFB38	B.43.0003	3/8" BSP	11 mm	360°	--	
D	DV7MFN14	B.43.0004	1/4" NPT	7 mm	360°	90°	
D	DV11MFG12	B.43.0007	1/2" BSP	11 mm	360°	90°	
D3	DV11MFB12-3R	B.43.0041	1/2" BSP	11 mm	360°	90°	360°
R	RV11MFB12	B.43.0011	1/2" BSP	11 mm	360°	--	--



## AIR BOTTLES



B.22.01.0000  
B.22.01.0002

B.22.01.0003  
B.22.01.0001



C.01.0009

### MOBILE AIR BOTTLE

Ideal to restore the tire pressure.  
Equipped with: pressure gauge, air pressure regulator, hooking system on the belt.

PRODUCT CODE	CAPACITY (LITRES)	PRESSURE (BAR)	CONNECTION	CONNECTION TYPE
B.22.01.0000	15	232	Single	INT - Female / DIN - Male
B.22.01.0003*	15	232	Double	INT - Female / DIN - Male
B.22.01.0002**	18	220	Single	INT - Female / DIN - Male
B.22.01.0001**	18	220	Double	INT - Female / DIN - Male
C.01.0009	1	200		

\*Suggested in order to avoid to dismount the air pressure regulator while recharging the bottle

\*\* Just on demand

## AIR BOTTLES VALVES

This universal connection allows to select from single or double connection.

Universal connection on demand



B.22.04.0003

AIR BOTTLE COMPRESSORS



DPH220



DPH460



DPH380



DPH130

PRODUCT CODE	PRODUCT NAME	ENGINE	CAPACITY	OPERATING PRESSURE	FILLING TIME	NOISE LEVEL	OVERALL DIMENSIONS	DRY WEIGHT	TANK
B.21.0100	DPH130	Single-phase Electric 1,6kW - 2,2HP	130 l/min - 4,6 CFM - 7,8 m3/h	30 bar 435 psi		72 dB	54x60x83 cm 21 1/4x23 5/8x32 11/16 inch	46 kg 102 lb	20 l
B.21.0101	DPH380	Three-phase Electric 5,5kW - 7,5HP	300 l/min - 10,6 CFM - 18 m3/h	300 bar 4350 psi	6' 44" (air bottle 10 l - 0-200 bar)	78 dB	118x54x69 cm 46 1/2x21 1/4x27 5/32 inch	137 kg 302 lb	
B.21.0102	DPH220 * #	Single-phase Electric 2,2kW - 3,0HP	100 l/min - 3,5 CFM - 6 m3/h	300 bar 4350 psi	20' (air bottle 10 l - 0-200 bar)	79 dB	58x41x41 cm 22 7/8x16 9/64x16 9/64 inch	42,5 kg 93,7 lb	
B.21.0103	DPH460 *	Subaru Robin Petrol Engine 4,2kW - 6,0HP	100 l/min - 3,5 CFM - 6 m3/h	300 bar 4350 psi	20' (air bottle 10 l - 0-200 bar)	84 dB	75,5x39x41 cm 29 3/4x15 3/8x16 9/64 inch	42,0 kg 92,6 lb	

\*Standard: final pressure switch with automatic stop. The new Paoli Pit Stop Compressors can deliver both 220 bar and 300 bar air pressure thanks to the 2 different high pressure hoses included.

#Optional: automatic condensated drain (codice B.21.0116)

COMPRESSORS FITTINGS



B.21.0007



B.21.0028



B.21.0065



B.21.0064



B.21.0044

PRODUCT CODE	DESCRIPTION
B.21.0007	DIN 230
B.21.0024	DIN 300
B.21.0044	ITALIAN CONNECTOR
B.21.0066	INT YOKE
B.21.0067	DIN/INT REDUCER
B.21.0014	BC DIN 230
B.21.0028	BC ITALIAN CONNECTOR
B.21.0065	BC INT
B.21.0064	BC DIN 300 USA
B.21.0025	BC DIN 300



STANDARD - B.21.0024



AIR BOTTLE TROLLEYS



C.01.0003 Single



AIR BOTTLE TROLLEY KIT included

- Just one trolley capable to carry the 15 or the 18 litres bottles.
- The trolley has got a support specifically designed for the PAOLI PIT STOP® Regulators RGPRSF1, RGPRSF2, RGPRSF4.
- Two brackets designed to roll and easily carry the supply hose.
- Accessories included: belt and high pressure hose to connect the air bottle to the air pressure regulator.



C.01.0005 Double

PRODUCT CODE	OVERALL DIMENSIONS	WEIGHT (W/O BOTTLE AND REGULATOR)	WEIGHT (WITH BOTTLE AND REGULATOR)
C.01.0003	46 x 39,5 x 116 cm	10,9 kg	32,0 kg
C.01.0005	34,4 x 57,5 x 110,2 cm	5,8 kg	

- Just one trolley capable to carry two 15 or 18 litres bottles.
- Two brackets designed to roll and easily carry the supply hose.

NIPPLE FOR AIR BOTTLE



This is the nipple to adapt the air pressure regulators connectors to be connected to the air bottle through the high pressure hose coming from the high pressure compressor.

B.21.0089 NIPPLES 1/4" BSP FEMALE - 7/16" UNF MALE



FLIGHT CASES



B.48.0001



B.48.0001



B.48.0003



B.48.0002

PRODUCT CODE	DIMENSION	WEIGHT	DESCRIPTION
B.48.0001	99 X 76 X 89 H cm	98,50 kg	for tools, accessories and pit equipment
B.48.0002	73 x 44 x 56 H cm	13,80 kg	for Paoli compressors DPH6
B.48.0003	88 X 54 X 70 H cm	32,50 kg	for Paoli compressors DPH13

Customizations available:

- Overall dimensions
- Drawers configuration
- Logo engraving
- Many finishes of color available (embossed, quartz and smooth)
- Many colors available



## AIRJACK SAFETY PROP



LL-90 - LL-91

	PRODUCT NAME	PRODUCT CODE	HEIGHT	FOR CYLINDER SIZE	FOR AIRJACK
<b>ONE STAGE</b> <i>KRONTEC</i>	LL-90	B.37.04.0001	230 mm	60 mm	LL-21, LL-22, LL-23, LL-24
	LL-90-150	B.37.04.0002	150 mm	60 mm	LL-21-150, LL-22-150, LL-23-150, LL-24-150
	LL-91	B.37.04.0003	230 mm	50 mm	LL-31, LL-32
	LL-91-150	B.37.04.0004	150 mm	50 mm	LL-31-150, LL-32-150
<b>ONE STAGE</b> <i>STÄUBLI</i>	JAC 06.9055	B.37.04.0005	228,5 mm	50 mm	JAC 06.9050, JAC 06.9050/QE
	JAC 06.9066	B.37.04.0006	228,5 mm	60 mm	JAC 06.9060, JAC 06.9060/QE, JAC 06.9060/PO

## CARLIFTER



LL-20 CL

	PRODUCT NAME	PRODUCT CODE	HEIGHT	FOR CYLINDER SIZE	FOR AIRJACK
<b>TWO-STAGE ELEPHANT LEG</b> <i>KRONTEC</i>	LL-20 CL	B.37.04.0007		60 mm	LL-21, LL-22, LL-23, LL-24
	LL-20 CL-PP	B.37.04.0008		60 mm	LL-21-150, LL-22-150, LL-23-150, LL-24-150
	LL-30 CL	B.37.04.0009		50 mm	LL-31, LL-32
	LL-30 CL-PP	B.37.04.0010		50 mm	LL-31-150, LL-32-150
<b>TWO-STAGE ELEPHANT LEG</b> <i>STÄUBLI</i>	JAC 06.9056	B.37.04.0011	434 mm	50 mm	JAC 06.9050, JAC 06.9050/QE
	JAC 06.9065	B.37.04.0012	434 mm	60 mm	JAC 06.9060, JAC 06.9060/QE
	JAC 06.9067	B.37.04.0013	409 mm	60 mm	JAC 06.9060/PO

AIRJACKS

LL-21 / LL-31 "PROFESSIONAL"

PRODUCT NAME	PRODUCT CODE	STROKE	Ø	Ø MOUNTING	THREAD MAX	LIFT CAPABILITY
LL-21	B.37.02.0006	230 mm	60 mm	64 mm	M60x1,5	750kg / 40bar
LL-21-PP	B.37.02.0007	230 mm	60 mm	68 mm	M60x1,5	562kg / 30bar
LL-21-150	B.37.02.0008	150 mm	60 mm	64 mm	M60x1,5	375kg / 20bar
LL-21-SP	On request					
LL-31	B.37.02.0009	230 mm	50 mm	53 mm	M50x1,5	488kg / 40bar
LL-31-150	B.37.02.0010	150 mm	50 mm	53 mm	M50x1,5	366kg / 30bar
LL-31-SP	On request					244kg / 20bar

LL-22 / LL-32 "STANDARD"

PRODUCT NAME	PRODUCT CODE	STROKE	Ø	Ø MOUNTING	THREAD MAX	LIFT CAPABILITY
LL-22	B.37.02.0014	230 mm	60 mm	64 mm	M60x1,5	750kg / 40bar
LL-22-PP	B.37.02.0015	230 mm	60 mm	68 mm	M60x1,5	562kg / 30bar
LL-22-150	B.37.02.0016	150 mm	60 mm	64 mm	M60x1,5	375kg / 20bar
LL-22-SP	On request					
LL-32	B.37.02.0017	230 mm	50 mm	53 mm	M50x1,5	488kg / 40bar
LL-32-150	B.37.02.0018	150 mm	50 mm	53 mm	M50x1,5	366kg / 30bar
LL-32-SP	On request					244kg / 20bar

LL-23 "PROFESSIONAL"

PRODUCT NAME	PRODUCT CODE	STROKE	Ø	Ø MOUNTING	THREAD MAX	LIFT CAPABILITY
LL-23	B.37.02.0011	230 mm	60 mm	64 mm	M60x1,5	750kg / 40bar
LL-23-PP	B.37.02.0012	230 mm	60 mm	68 mm	M60x1,5	562kg / 30bar
LL-23-150	B.37.02.0013	150 mm	60 mm	64 mm	M60x1,5	375kg / 20bar
LL-23-SP	On request					

LL-24 "STANDARD"

PRODUCT NAME	PRODUCT CODE	STROKE	Ø	Ø MOUNTING	THREAD MAX	LIFT CAPABILITY
LL-24	B.37.02.0019	230 mm	60 mm	64 mm	M60x1,5	750kg / 40bar
LL-24-PP	B.37.02.0020	230 mm	60 mm	68 mm	M60x1,5	562kg / 30bar
LL-24-150	B.37.02.0021	150 mm	60 mm	64 mm	M60x1,5	375kg / 20bar
LL-24-SP	On request					

PRODUCT NAME	PRODUCT CODE	STROKE	Ø	Ø MOUNTING	THREAD MAX	LIFT CAPABILITY
JAC 06.9050	B.37.02.0001	236 mm	50 mm	53 mm	M50x1,5	488kg / 40bar
JAC 06.9050/QE	B.37.02.0002	236 mm	50 mm	53 mm	M50x1,5	366kg / 30bar
JAC 06.9060	B.37.02.0003	230 mm	60 mm	64 mm	M60x1,5	244kg / 20bar
JAC 06.9060/PO	B.37.02.0004	230 mm	60 mm	68 mm	M60x1,5	750kg / 40bar
JAC 06.9060/QE	B.37.02.0005	230 mm	60 mm	64 mm	M60x1,5	562kg / 30bar
						375kg / 20bar



**KRONTEC**  
Fitting & Hose Systems



**STÄUBLI**

## AIRLANCE



The KRONTEC “easy-push” system allows a powerless coupling process. The airlance can be used with three connection valves.

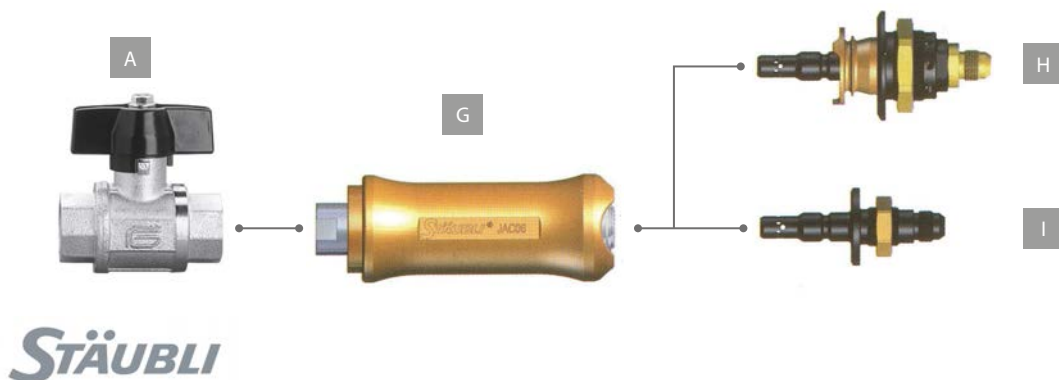

The STÄUBLI system allows a powerless coupling process. The airlance can be used with two connection valves.

	PRODUCT NAME	PRODUCT CODE	THREAD	OPERATING PRESSURE	SIZE
A		B.37.03.0006	3/8" BSP female	100 bar	
B		B.37.06.0007	M16x1,5 male 3/8" BSP male		
C	LL-03	B.37.01.0001	M16 x 1,5 female	0-40 bar	L 230 x D 37 mm
D	LL-13	B.37.03.0002	D-06 9/16-18 UNF	0-40 bar	L 86 mm
E	LL-16	B.37.03.0001	D-06 9/16-18 UNF	0-40 bar	L 81 mm
F	LL-16 plus	B.37.03.0003	D-06 9/16-18 UNF	0-40 bar	L 86 mm
G	JAC 06.1102	B.37.01.0002	3/8" BSP female	15-40 bar	L 130 x D 48 mm
H	JAC 06.5655	B.37.03.0004	D-06	15-40 bar	L 102 mm
I	JAC 06.4655	B.37.03.0005	D-06	15-40 bar	L 83 mm

FRONT & REAR AIR JACK TROLLEYS



B.37.05.02.0001



B.37.05.02.0002



B.37.05.02.0003  
B.37.05.02.0004



B.37.05.02.0005  
B.37.05.02.0006

Pneumatic air jacks to lift racing cars of all types of formula and gt cars / The attachments can be adapted to your model car and championship / Special attachments are available on request if car drawings and pictures are supplied / 4 Light version available

PRODUCT CODE	DESCRIPTION	NOTE
B.37.05.02.0001	Front Air Jack	Usable in most championships except for GP2, GP3, WSR 3.5, Superleague. In any case the championship and/or the car must be known.
B.37.05.02.0002	Rear Air Jack	
B.37.05.02.0003	Front Air Jack	Usable in GP2, GP3, WSR 3.5, Superleague. In any case the championship and/or the car must be known.
B.37.05.02.0004	Rear Air Jack	
B.37.05.02.0005	Front Air Jack	Whitout shovels. If the customer fabricates special shovels for their car.
B.37.05.02.0006	Rear Air Jack	

2-PORT BACK COVER KIT



B.23.0087

Available only for wheel gun DP 4000 MG, DP 4000 MG TSA, DP 4000 TS LAB, DP 4000 BIAS, DP 5000 TI, DP 5000 TI TSA

FAST SHUTTLE



RH - LOOSENING



RH - TIGHTENING

B.23.0106

The Fast Shuttle is an auto reverse shuttle that has got just an ON (loosening) and OFF (tightening) position, being operator friendly as it is able to increase the speed of each operation: in fact the operator has just to push a lever to get the ON (loosening) mode from the OFF (tightening) mode.



CODE	DESCRIPTION	APPLY ON
B.23.0105	LH 3-PORT BLUE	DP 2000-S, DP 4000 MG, DP 5000 TI
B.23.0106	RH 3-PORT RED	DP 2000-S, DP 4000 MG, DP 5000 TI
B.23.0115	LH 2-PORT BLUE	DP 2000-S, DP 4000 MG, DP 5000 TI
B.23.0116	RH 2-PORT RED	DP 2000-S, DP 4000 MG, DP 5000 TI

CARBON COVERS



Screws and washers included

CODE	APPLY ON
B.23.0121	DP 2000 SE, DP 3000, DP 4000, DP 4000 MG
B.23.0109	DP 5000

FAST REVERSE SYSTEM



B.31.0001

Available only for DP2000-S, DP197-SFE and DP176-SFE



B.31.0008

Version with turning cover made of teflon: it absorbs much better the hits.



B.31.0009



B.31.0010

Available only for wheel gun DP 3000, DP 4000 MG, DP 4000 MG TS, BLUE DEVIL, DP 4000 MG-TSA, SUPERSPORT, DP 4000 BIAS.

TRIGGERS

D.01.21.0001 D.01.21.0028



D.01.21.0026  
D.01.21.0027

CODE	MATERIAL	AVAILABLE FOR
D.01.21.0028	Steel	5000TI 5000TI-TSA 4000MG 4000MG-TSA 4000TS-LAB
D.01.21.0027	PA w/ glass fiber	5000TI 5000TI-TSA 4000MG 4000MG-TSA 4000TS-LAB
D.01.21.0001	PA w/ glass fiber [standard]	4000BIAS 5000TI 5000TI-TSA 4000MG 4000MG-TSA 4000TS-LAB
D.01.21.0026	PA w/ carbon fiber	5000TI 5000TI-TSA 4000MG 4000MG-TSA 4000TS-LAB

INSERT ADAPTER



B.29.0001

B.29.0002

Reccomended just for garage use. With this compact insert adapter to a bigger square drive the overall lenght is reduced to an absolute minimum. The insert adapter sticks to the socket by means of a magnet.

CODE	WHEEL GUN	SOCKETS
B.29.0001	3/4"	1"
B.29.0002	1/2"	3/4"

SOCKET RINGS & RETAINERS



WARNING! The socket without the retainer can be dangerous if it gets out during the work!

FOR SQUARE DRIVE	RETAINER	RINGS
1/2"	B.30.01.0011	B.30.02.0001 (18 MM) B.30.02.0002 (24 MM)
3/4"	B.30.01.0010	B.30.02.0003 (38 MM)
1"	B.30.01.0009	B.30.02.0004 (45 MM)





PAOLI WHEEL NUT SOCKETS



SOCKETS WITH FINGERS AND MAGNETS

double version Aerospace Aluminium and Titanium, square drive retaining system w/double safety device (seeger and O'ring). Minimum clearance on the female square drive in order to facilitate the assembly/disassembly. Front OR made of material "no-cut"



B.28.0030 - B.28.0039

CODE	SQUARE DRIVE	MATERIAL	APPLICATION
B.28.0029	1"	titanium	F430
B.28.0038	1"	aluminium	F430
B.28.0030	1"	titanium	F458 GT2
B.28.0039	1"	aluminium	F458 GT2
B.28.0032	1"	titanium	F458 GT3 (14 slots nut)
B.28.0042	1"	aluminium	F458 GT3 (14 slots nut)
B.28.0033	1"	titanium	DALLARA INDYCAR
B.28.0041	1"	aluminium	DALLARA INDYCAR
B.28.0031	1"	titanium	PORSCHE 997 RSR
B.28.0040	1"	aluminium	PORSCHE 997 RSR

POLYGONAL RACE SOCKETS WITH BALLS AND SPRINGS RETAINING SYSTEM

Made of high resistance steel, very light (just 800 grams), square drive retaining system w/double safety device (seeger and O'ring). Minimum clearance on the female square drive in order to facilitate the assembly/disassembly. Balls & Springs nut retaining system.



B.28.0036

CODE	SQUARE DRIVE	MATERIAL	NUT SIZE	APPLICATION
B.28.0034	1"	steel	SW 55 mm	GP3 WSR F3
B.28.0035	3/4"	steel	SW 55 mm	GP3 WSR F3
B.28.0036	1"	steel	SW 65 mm	GP2

HEXAGONAL RACE SOCKETS W/BALLS & SPRINGS RETAINING SYSTEM

The new sockets B.28.0028 are made with high resistance steel, very light (just 780 grams). The new sockets B.28.0037 are made with Aerospace Aluminium. Both sockets have the following characteristics: Minimum clearance on the female square drive in order to facilitate the assembly/disassembly. Combined nut retention system (balls & springs / magnets).



B.28.0028

CODE	SQUARE DRIVE	MATERIAL	NUT SIZE	APPLICATION
B.28.0028	3/4"	steel	SW 36 mm	PORSCHE 996/997 CUP
B.28.0037	1"	aluminium	SW 80 mm	FERRARI 430 CHALLENGE

POLYGONAL SOCKETS W/O RETAINING SYSTEM - These new sockets are designed for use in garage only.



B.28.0016

CODE	SQUARE DRIVE	MATERIAL	NUT SIZE	APPLICATION
B.28.0016	3/4"	steel	SW 36 mm	PORSCHE 996/997 CUP
B.28.0015	1"	steel	SW 80 mm	FERRARI 430 CHALLENGE

METALORE SOCKETS AND WHEEL NUTS



B.28.0002



B.28.0013



B.32.0001 - B.32.0002



B.32.0005 - B.32.0006



B.32.0003 - B.32.0004

PRODUCT CODE	TYPE	VERSION	APPLICATION	DESCRIPTION
B.28.0013	socket	titanium	FERRARI F458 GT2	1" - With fingers
B.28.0002	socket	titanium	FERRARI F430	1" - With fingers
B.28.0006	socket	titanium	PORSCHE 997-RSR	1" - With fingers
B.32.0005	nut	LH - titanium	FERRARI F458 GT2	With fingers
B.32.0006	nut	RH - titanium	FERRARI F458 GT2	With fingers
B.32.0001	nut	LH - titanium	FERRARI F430	With fingers
B.32.0002	nut	RH - titanium	FERRARI F430	With fingers
B.32.0003	nut	LH - titanium	PORSCHE 997-RSR, 911-RSR	With fingers
B.32.0004	nut	RH - titanium	PORSCHE 997-RSR, 911-RSR	With fingers

COVERS



B.18.0003



B.18.0006



B.18.0000



B.18.0014

AVAILABLE TO	MATERIAL	THICKNESS	PRODUCT CODE
DP 5000 TI MARK II TSA (right led box) DP 4000 MG TSA (right led box)	Transparent Plastic	2 mm	B.18.0022
DP 5000 TI MARK II TSA (left led box) DP 4000 MG TSA (left led box)	Transparent Plastic	2 mm	B.18.0026
DP 4000 MG TS LAB (right led box)	Transparent Plastic	2 mm	B.18.0021
DP 4000 MG TS LAB (left led box)	Transparent Plastic	2 mm	B.18.0027
DP 5000 TI (with fast shuttle) DP 4000 MG (with fast shuttle)	Transparent Plastic	2 mm	B.18.0030
DP 5000 TI	Transparent Plastic	2 mm	B.18.0013
DP 4000 MG	Black Rubber	4 mm	B.18.0014
DP 2000 S, SE	Transparent Plastic	2 mm	B.18.0000
	Black Rubber	4 mm	B.18.0005
DP 4000 BIAS	Transparent Plastic	2 mm	B.18.0024
SUPER SPORT	Transparent Plastic	2 mm	B.18.0023
DP 197 SFE	Transparent Plastic	2 mm	B.18.0001
DP 176 SFE DP 177 SFE	Transparent Plastic	2 mm	B.18.0003
BLUE DEVIL	Transparent Plastic	2 mm	B.18.0019
	Black Rubber	4 mm	B.18.0020
DP 36 SF EVO	Transparent Plastic	2 mm	B.18.0006
	Black Rubber	4 mm	B.18.0004

PAOLI PIT STOP HELMETS

MADE IN ITALY

- Shell in HTR (High Thermoplastic Resin)
- Ultra-resistant painting
- INNER LINING removable and washable
- MICROMETRIC BUCKLE
- GOGGLE STRAP HOLDER on the back, to keep the strap of the goggle in place
- DAF VENTILATION system (Direct Air Flux) easy system of regulating the temperature inside the helmet
- NEW MIRROR VISOR ANTI-FOG and ANTI-SCRATCH: equipped with a rubber trim that runs along the visor offering additional comfort and protection to the face of use.



FOR PIT STOP ACTIVITIES ONLY!

B.38.04.01.0004 CHIN GUARDS  
Polyurethane Chin guards to protect from the cold and small bumps. Black.



PRODUCT NAME	PRODUCT CODE	SIZE	COLOR
PIT STOP HELMET	B.38.04.01.0001	MEDIUM / 58	BLACK MATTE HELMET - MIRROR VISOR
PIT STOP HELMET	B.38.04.01.0002	LARGE / 60	BLACK MATTE HELMET - MIRROR VISOR
PIT STOP HELMET	B.38.04.01.0003	X-LARGE / 61	BLACK MATTE HELMET - MIRROR VISOR
CHIN GUARDS	B.38.04.01.0004	ONE SIZE	BLACK

ACCESSORIES

WHEEL GUN BAGS



B.19.0002 RED



B.19.0001 BLUE



B.19.0003 BLACK

Made of technical fabric with polyethylene foam padding. Removable padding. Hand wash with soap and water (not washing machine)

- More colors available
- New design
- Each bag can contain: 1"sq.dr. wheel gun with socket mounted on
- Tags available



**Mechanix**  
TOOL GLOVES  
THE ORIGINAL

**Mechanix**  
TOOL GLOVES  
THE ORIGINAL

**Mechanix**  
TOOL GLOVES  
THE ORIGINAL

GLOVES



FAST FIT®



M-PACT® 2



ORIGINAL® GLOVE



ORIGINAL® VENT

PRODUCT NAME	PRODUCT CODE	SIZE	COLOURS	NOTE
FAST FIT®	B.38.01.01.0001	S	black	Easy On/Off Fit Glove - With improved contours for a better fit, the Fast Fit® Glove is the tool to use for everyday jobs. The glove incorporates a Clarino Synthetic Leather palm, stretch panels between the fingers, two-way stretch Spandex padded back increases protection. A new taller cuff has been added to provide for additional protection and a more secure fit. Performance plus economy. Machine washable.
	B.38.01.01.0002	M		
	B.38.01.01.0003	L		
	B.38.01.01.0004	XL		
M-PACT® 2	B.38.01.01.0025	S	black	Heavy Duty Glove - For super protection and an unbelievable fit, try the M-Pact® 2 Glove. Anatomically designed with advanced features that include tapered stretch side panels that form comfortably between fingers and a molded Neoprene cuff for a seamless fit to your wrist. It also has an integrating impact absorbing molded rubber finger protection and EVA deep ribbed accordion knuckle protection. This glove has it all. Machine washable.
	B.38.01.01.0026	M		
	B.38.01.01.0027	L		
	B.38.01.01.0028	XL		
ORIGINAL® GLOVE	B.38.01.01.0005	S	black	All-Purpose Glove - Designed and manufactured to take on the toughest tasks you can throw at it, the Original® Glove provides a winning combination of versatility and performance. The Clarino Synthetic Leather palm and fingertip extends the life of the glove while the Thermal Plastic Rubber hook and loop cuff closure and two-way stretch Spandex top provides a perfect fit. Machine washable.
	B.38.01.01.0006	M		
	B.38.01.01.0007	L		
	B.38.01.01.0008	XL		
	B.38.01.01.0009	S	red	
	B.38.01.01.0010	M		
	B.38.01.01.0011	L		
	B.38.01.01.0012	XL		
B.38.01.01.0013	S	blue		
B.38.01.01.0014	M			
B.38.01.01.0015	L			
B.38.01.01.0016	XL			
ORIGINAL® VENT	B.38.01.01.0017	S	white	Fully Ventilated Glove - Improved design. Designed for hot or humid conditions, the Original® Vent Glove gives you a single-layer of lightweight air mesh on the top to minimize heat build-up while it's perforated Clarino Synthetic Leather palm and fully ventilated construction keeps the entire hand comfortable and cool. A new taller cuff with an improved rubber closure system gives you the confidence you need when the heat is on. Machine washable.
	B.38.01.01.0018	M		
	B.38.01.01.0019	L		
	B.38.01.01.0020	XL		
	B.38.01.01.0021	S	black	
	B.38.01.01.0022	M		
	B.38.01.01.0023	L		
	B.38.01.01.0024	XL		

LUBRICANTS



B.27.0007



B.27.0004



B.27.0005



B.27.0016

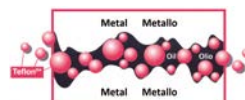

PRODUCT NAME	PRODUCT CODE	QUANTITY	DESCRIPTION
CGRM	B.27.0007	1 kg	Special Grease for PAOLI wheel gun hammer mechanism.
COL1	B.27.0004	1 l	Special Oil for PAOLI wheel gun motors.
COL5	B.27.0005	5 l	Special Oil for PAOLI wheel gun motors.
	B.27.0016	500 ml	Special spray Lubricant for PAOLI wheel gun motors
	B.27.0001	1 l	Oil for compressor pumping unit DPH6, DPH13
	B.27.0003	0,5 l	Oil for compressor pumping unit DPH6, DPH13
	B.27.0002	1 l	Oil for compressor engine unit
	B.27.0017	1 l	Oil for compressor pumping unit DPH220, DPH460
	B.27.0018	1 l	Oil for compressor pumping unit DPH380

GRIP TAPE



T.02.0022



T.02.0023



B.23.0076

PRODUCT CODE	DESCRIPTION
T.02.0023	Handle sticker for DP 5000 TI, DP 4000 MG, DP 2000-S, SUPERSPORT, DP 197 SFE, DP 176 SFE
T.02.0022	Handle sticker for BLUE DEVIL, DP 36 SF EVO
B.23.0076	Grip Tape (10 m x 50 mm)



FOR  
OUR  
PEOPLE  
AND  
SUPPORT

# SUPPORT

SERVICE  
SPARE PARTS  
ENGINEERING



SERVICE



To ensure the reliability, accuracy, power and speed of our product, we recommend a complete overhaul. Our After Sale Service can provide information about after how many cycles (No. 1 cycle = No. 1 LOOSENING + No. 1 TIGHTENING) the service is required. You can also require the repainting of the tool to get it back to the aesthetic (and functional) conditions similar to a new wheel gun. The service Test carries out laboratory testing on individual components subject to greater effort. It is possible also to convert the directionality (for each wheel gun model), transforming it to its different versions (UH, RH, LH).

**S - SERVICE AND REPAIR:**  
the wheel gun is fully overhauled, cleaned, all consumable components replaced and finally tested

**R - SERVICE, REPAIR AND REPAINT:**  
in addition to the service S, the wheel gun is repainted

**T - SERVICE, REPAIR, AND TEST REPAIR:**  
In addition to service R, the wheel gun is subjected to various tests that certify the conformity of the components

**C - SERVICE, REPAIR, REPAINT AND CONVERSION:**  
In addition to service R, the wheel gun is transformed to its different versions (UH, RH, LH).

The table on the following page details all transactions carried out for each type of service.

WHEEL GUNS SERVICE

	S	R	T	C
	SERVICE REPAIR	SERVICE REPAIR REPAINT	TEST	SERVICE REPAIR REPAINT CONVERSION
<b>CHECK</b> Check of the table "Request for Service & Maintenance" that is filled in to the customer.	✓	✓		✓
<b>DISASSEMBLING</b> The wheel gun is completely disassembled.	✓	✓		✓
<b>EXAMINE</b> Check of each part for conformity.	✓	✓		✓
<b>CLEANING</b> Each part is cleaned and taken the grease off.	✓	✓		✓
<b>REPLACEMENT</b> Replacement consumables parts (service kit: vanes, BSPkets, screws, washers, valve seat, etc).	✓	✓		✓
<b>DE-PAINT</b> The alloy parts are de-painted. The clutch cover is re-coated.		✓		✓
<b>RE-ASSEMBLING</b> The wheel gun is re-assembled.	✓	✓		✓
<b>TEST</b> The wheel gun is tested.	✓	✓		✓
<b>RE-PAINTING</b> The wheel gun is prepared for the re-painting and then properly re-painted.		✓		✓
<b>CONVERSION</b> Components replaced to convert in UH, RH, LH.				✓
<b>CERTIFICATE</b> Components are tested and it is certified to comply through analysis in the laboratory.			✓	









## WHEEL GUNS SERVICE CODES

	S	R	T	C
DP 5000 TI	R.01.01.01.0040	R.01.01.01.0041	R.05.01.01.0001	
DP 4000 30BAR	R.01.01.01.0044	R.01.01.01.0045	R.05.01.01.0001	
DP 4000 MG	R.01.01.01.0032	R.01.01.01.0033	R.05.01.01.0001	
SUPERSPORT	R.01.01.01.0030	R.01.01.01.0031	R.05.01.01.0001	
DP 4000 BIAS	R.01.01.01.0042	R.01.01.01.0043	R.05.01.01.0001	
DP 4000	R.01.01.01.0023	R.01.01.01.0024	R.05.01.01.0001	LH → RH R.02.01.01.0038 RH → LH R.02.01.01.0039 UH → RH R.02.01.01.0040 UH → LH R.02.01.01.0041 LH / RH → UH R.02.01.01.0042
DP 3000	R.01.01.01.0019	R.01.01.01.0020	R.05.01.01.0001	
DP 2000 SE DP 2000 S DP 2000	R.01.01.01.0001	R.01.01.01.0002	R.05.01.01.0001	LH → RH R.02.01.01.0009 RH → LH R.02.01.01.0010 UH → RH R.02.01.01.0012 UH → LH R.02.01.01.0011
DP 197 SFE DP 197 SF DP 197 S DP 196 S	R.01.01.01.0009	R.01.01.01.0010	R.05.01.01.0001	LH → RH R.02.01.01.0016 RH → LH R.02.01.01.0017 LH / RH → UH R.02.01.01.0033
DP 176 SFE DP 177 SFE	R.01.01.01.0046	R.01.01.01.0047	R.05.01.01.0001	
DP 176 SF	R.01.01.01.0007	R.01.01.01.0008	R.05.01.01.0001	LH → RH R.02.01.01.0025 RH → LH R.02.01.01.0026
BLUEDEVIL	R.01.01.01.0026	R.01.01.01.0027	R.05.01.01.0001	
DP 36 SF	R.01.01.01.0021	R.01.01.01.0022	R.05.01.01.0001	
DP 36 SF EVO	R.01.01.01.0034	R.01.01.01.0035	R.05.01.01.0001	

NOTE: just if no major parts need to be replaced, otherwise a new estimate of cost will be sent



## AIR PRESSURE REGULATOR SERVICE & REPAIR

Product Name	Gauges	Code
<b>RGPRSF1</b>		
	STANDARD	R.01.03.0001
	GLYCERIN	R.01.03.0008
<b>RGPRSF2</b>		
	STANDARD	R.01.03.0003
	GLYCERIN	R.01.03.0010
<b>RGPRSF4</b>		
	STANDARD	R.01.03.0003
	GLYCERIN	R.01.03.0009

Product Name	Gauges	Code
<b>RGPRSF6</b>		
	STANDARD	R.01.03.0012
<b>RGPRSF7</b>		
	STANDARD	R.01.03.0013
<b>RGPRSF9</b>		
	STANDARD	R.01.03.0014
<b>RGPRSF10</b>		
	STANDARD	R.01.03.0018

## ACCESSORIES SERVICE & REPAIR

Product Name	Code
<b>AIR BOTTLES</b>	
	SERVICE R.01.03.0011
<b>PETROL ENGINE COMPRESSOR</b>	
	SERVICE R.01.03.0005
<b>ELECTRIC COMPRESSOR</b>	
	SERVICE R.01.03.0004

Product Name	Code
<b>HOSES</b>	
	SERVICE R.01.03.0006
<b>COUPLINGS</b>	
	SERVICE R.01.03.0017
<b>COUPLINGS</b>	
	STANDARD R.01.03.0016

## SERVICE KIT



CODE	PRODUCT NAME	AVAILABLE FOR
B.23.0108	KIT5000TI	DP 5000 TI
B.23.0123	KIT400030BAR	DP 4000 30BAR
B.23.0079	KIT4000MG	DP 4000 MG
B.23.0048	KIT4000	DP 4000
B.23.0107	KIT4000BIAS	DP 4000 BIAS
B.23.0001	KIT2000S	DP 2000 S, SE
B.23.0089	KITSUPERSPORT	SUPERSPORT
B.23.0002	KIT197SF	DP 197 SF, SFE
B.23.0119	KIT176SFE	DP 176 SFE, DP 177 SFE
B.23.0054	KITBLUEDEVIL	BLUE DEVIL
B.23.0080	KIT36SFEVO	DP 36 SF EVO
B.23.0104	KIT36SFEVOUS	DP 36 SF EVO US

## WHEEL GUNS SPARE PARTS

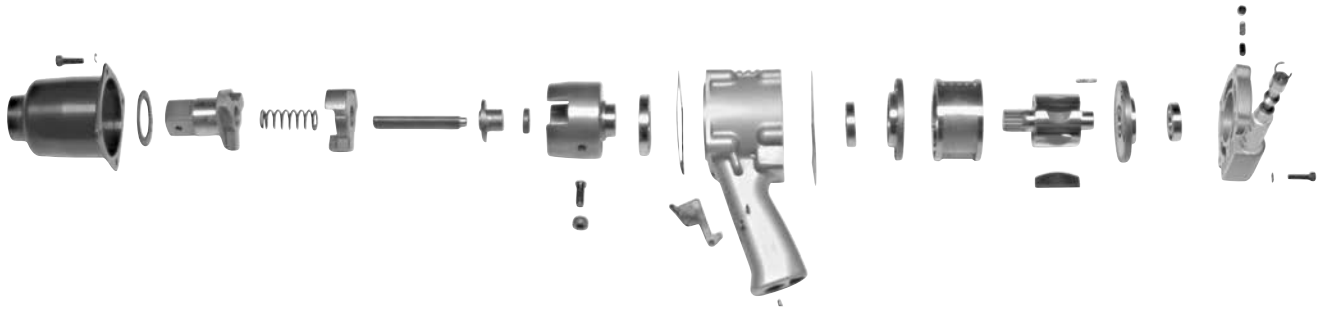

As manufactures of our wheel guns we get available to our customers all the spare parts for maintenance and repair. Contact us for inquiries and quotes or refer to our website:



[www.paoli.net/spareparts](http://www.paoli.net/spareparts)

## ACCESSORIES SERVICE & REPAIR

Across the range of accessories that we sell we provide sales of spare parts. Please contact us for all your needs. We repair and overhaul all our products. Please contact our After Sale Service for information.



[www.paoli.net/support](http://www.paoli.net/support)

## ENGINEERING

Since 1968 we have been building wheel guns, and we would now like to make our professionalism and experience available to our customers to an even greater extent.

We have invested heavily in research and development in order to have procedures and instruments suitable for the study and creation of products most suited to the growing needs of the motor sport industry.

Dino Paoli is, in fact, now able to offer those who request it, an Engineering service which consists in the joint development with the customer of variations of wheel guns components customised according to various needs.

The engineering offer covers several areas: performances, durability, ergonomics, lightness.

To obtain these results we use and work on materials from the aviation and military industry, such as special steels, carbon fibre, aluminium and magnesium alloy, titanium.

The design of the new components is tested using finite element analysis (FEM) and once designed (CAD) these are produced using CAM, which allows us to easily obtain even geometrically complex parts.

We also have a range of suppliers skilled in heat treatments, who are capable of accurately identifying the expected mechanical characteristics.

## CYCLE COUNTER SYSTEM

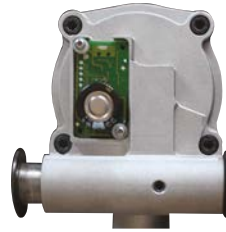

As an example, we show a working project and patented for detection of cycles of each tool, interfaced with windows pc via USB port.

B.23.0070



**Software included**

The cycle-counter is an electrical device which is mounted in the rear cover of the Paoli Pit Stop wheel gun and which is able to detect the following data:

- RPM
- Executed working time (total and partial)
- No. of hits per cycle
- Cycle of work setup to signal scheduled service
- Signal of "scheduled service" by flashing LED
- Memory card to download data (cordless device during the work)
- Electro-magnetic interferences protected
- Self-supplied

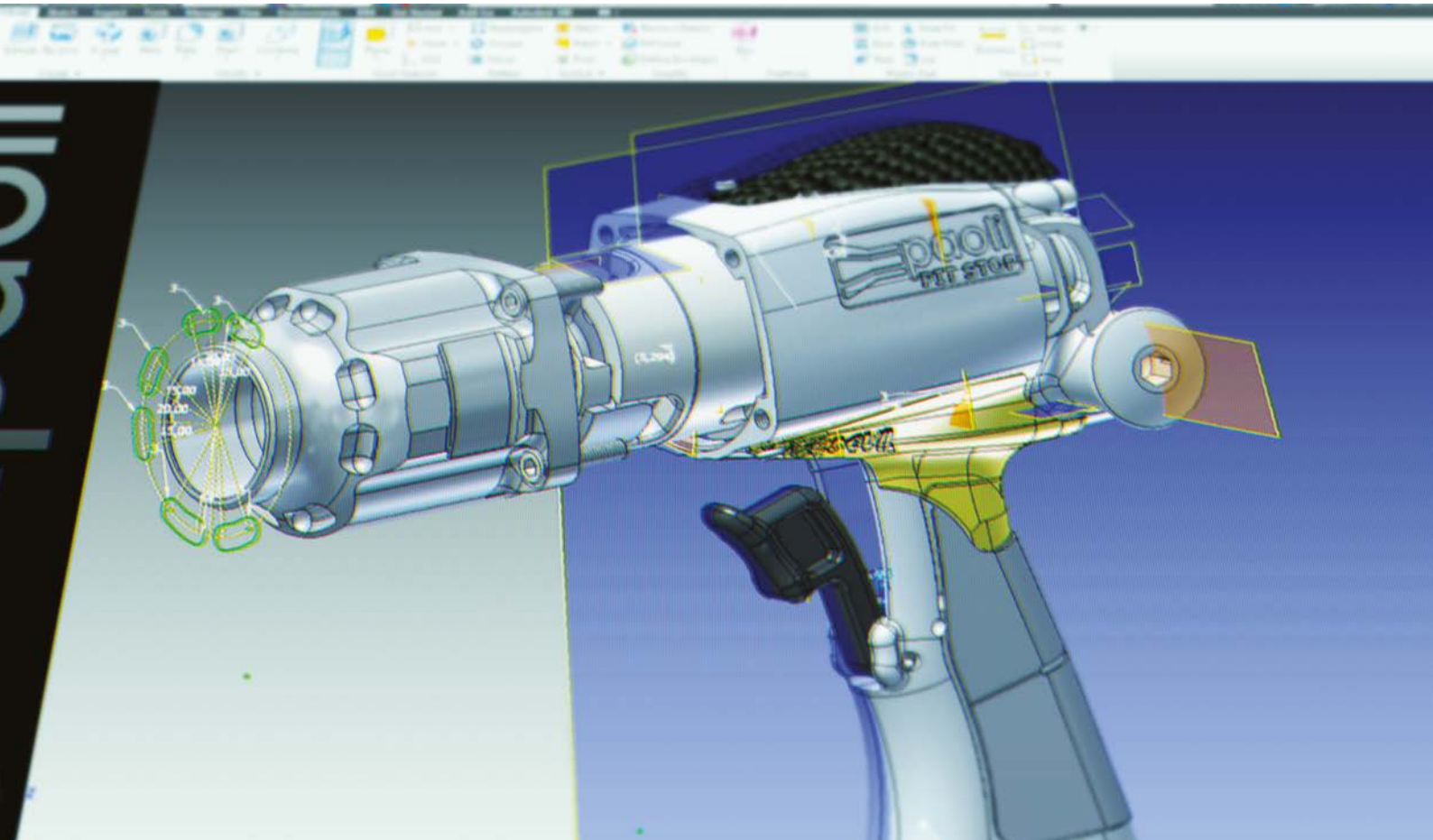



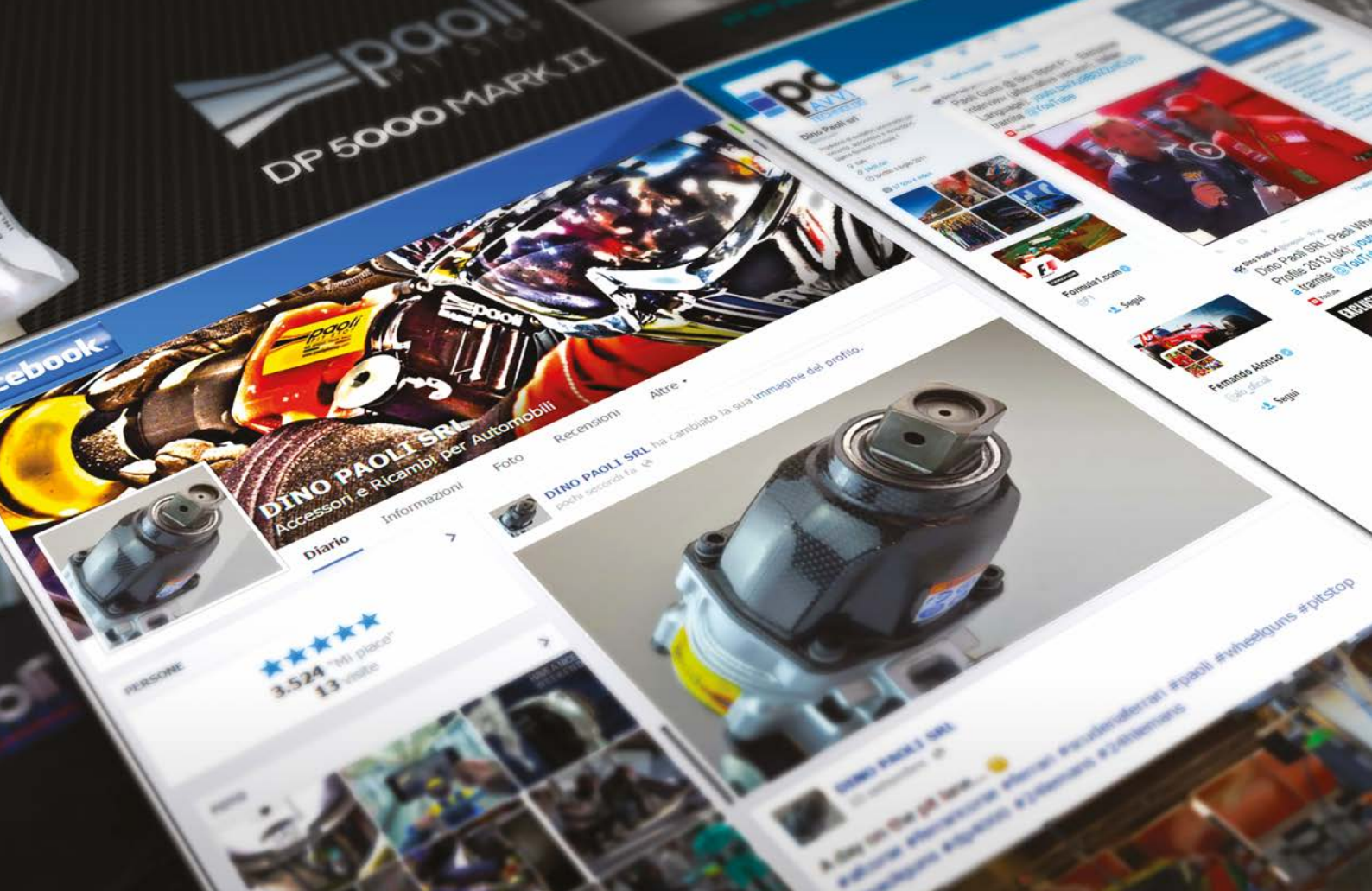

*Follow us!*



paoli.net



facebook.com/  
dinopaoli  
twitter.com/  
dinopaoli  
pinterest.com/  
dinopaoli



MADE IN ITALY

Dino Paoli S.r.l.  
Via G.Dorso, 5 - 42124 - Reggio Emilia - Italy  
Phone: +39.0522.364511 - FAX: +39.0522.304864  
www.paoli.net - sales@paoli.net

JOIN US ON FACEBOOK/DINOPAOLI | WIN PRIZES | GET DISCOUNT | RECEIVE THE LATEST NEWS

WWW.PAOLINETE



Dino Paoli S.r.l.  
Via G. Dorso, 5 - 42124 Reggio Emilia - Italy  
Tel. +39 0522 364511 - Fax +39 0522 304864

[www.paolipitstop.com](http://www.paolipitstop.com) - [sales@paoli.net](mailto:sales@paoli.net)



MADE IN ITALY