

Overview

The HP ProLiant DL380e Gen8 sets the next generation standards of 2U 2-socket rack servers for the industry. With enhanced configuration flexibility, unmatched performance, and leading energy efficient design the DL380e Gen8 offers the perfect solution for the dynamic compute and storage requirements of today's demanding datacenters.

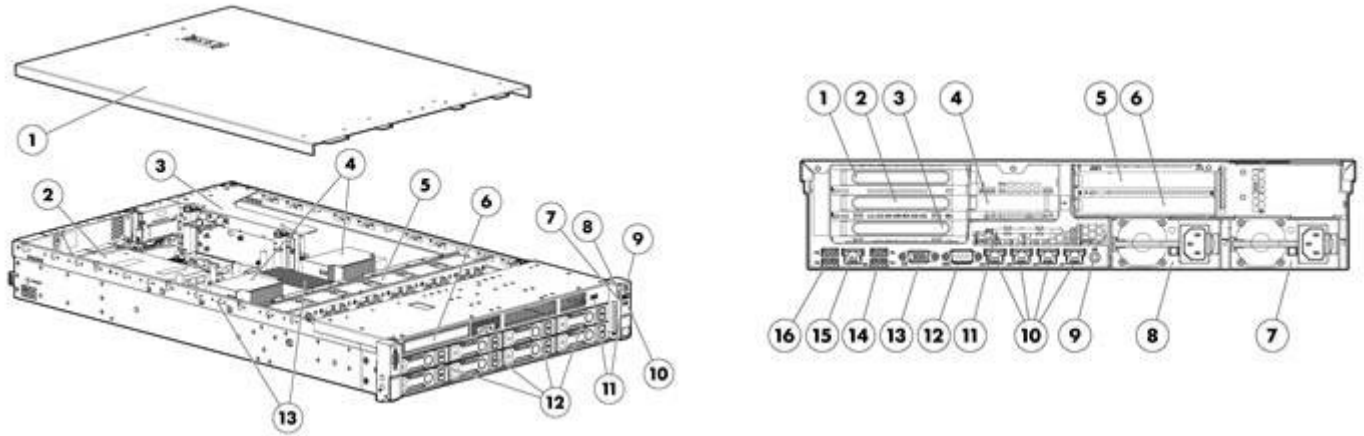

Front View:

1. Quick removal access panel
2. Redundant Hot Plug Power Supplies(upgradeable option)
3. Removable Riser Cage assembly
4. Up to 2 Intel E5-2400 Series Processors
5. Removable Hot Plug Fans modules, (optional, full N+1 redundancy)
6. Optical Disk Drive Bay
7. Health LED
8. Network activity LED
9. Power On /Standby button and system power LED button
10. Unit ID LED
11. USB connectors
12. Hard Drive bays
13. 12 DIMM slots: DDR3 Registered(RDIMM), Load Reduced (LRDIMM) or Unbuffered(UDIMM) memory

Rear View:

1. Riser board without SAS support: Slot1 PCIe3 x8 (4, 1)
Riser board with SAS support: Slot1 PCIe3 x16 (8, 4, 1)
2. Slot2 PCIe3 x16 (8, 4, 1)
3. Only for riser board without SAS support: Slot3 PCIe3 x8 (4, 1)
4. Slot4 PCIe2 x8 (4, 1)
5. Slot5 PCIe3 x16 (16, 8, 4, 1) (optional)
6. Slot6 PCIe3 x16 (8, 4, 1) (optional)
7. Power Supply bay1 (Primary Power Supply)
8. Power Supply bay 2 (Shown populated: optional)
9. Unit ID LED/Button
10. HP Ethernet 1Gb 4-port 366i Adapter (4 x 1GbE)
11. Service tool
12. Serial connector
13. Video connector
14. USB connectors (2)
15. iLO connector
16. USB connectors (2)

Standard Features

NOTE: For the Standard Features shipped in the "Factory Integrated Models", please see the "Configuration Information - Factory Integrated Models" section.

Processor
One of the following
depending on Model

Entry Processors

NOTE: All support up to 1066MHz DDR3 memory speeds.

Intel® Xeon® E5-2407 (2.2GHz/4-core/10MB/6.4GT-s QPI/80W, DDR3-1066, HT)

Intel® Xeon® E5-2403 (1.8GHz/4-core/10MB/6.4GT-s QPI/80W, DDR3-1066, HT)

Base Processors

NOTE: All support up to 1333MHz DDR3 memory speeds.

Intel® Xeon® E5-2440 (2.4GHz/6-core/15MB/7.2GT-s QPI/95W, DDR3-1333, HT, Turbo2-3/3/4/4/5/5)Turbo

Intel® Xeon® E5-2430 (2.2GHz/6-core/15MB/7.2GT-s QPI/95W, DDR3-1333, HT, Turbo2-3/3/4/4/5/5)Turbo

Intel® Xeon® E5-2430L (2.0GHz/6-core/15MB/7.2GT-s QPI/60W, DDR3-1333, HT, Turbo2-3/3/4/4/5/5)Turbo

Intel® Xeon® E5-2420 (1.9GHz/6-core/15MB/7.2GT-s QPI/95W, DDR3-1333, HT, Turbo2-3/3/4/4/5/5)Turbo

Performance Processors

NOTE: All support up to 1600MHz DDR3 memory speeds.

Intel® Xeon® E5-2470 (2.3GHz/8-core/20MB/8GT-s QPI/95W,DDR3-1600, HT, Turbo2-5/5/6/6/7/7/8/8)Turbo+

Intel® Xeon® E5-2450 (2.1GHz/8-core/20MB/8GT-s QPI/95W, DDR3-1600, HT, Turbo2-5/5/6/6/7/7/8/8)Turbo+

Intel® Xeon® E5-2450L (1.8GHz/8-core/20MB/8GT-s QPI/70W, DDR3-1600, HT, Turbo2-2/2/3/3/4/4/5/5)Turbo+

NOTE: HT indicates that the processor model supports Intel® Hyper-Threading Technology.

NOTE: Turbo2 indicates the maximum potential frequency increment when using Intel® Turbo Boost Technology, with 8, 7, 6, 5, 4, 3, 2 and 1 cores active.

NOTE: DDR3 speed is the maximum memory speed of the processor. Actual memory speed may depend on the quantity and type of DIMMs installed.

NOTE: Up to 2 processors supported. Mixing different processor models is not supported.

NOTE: For the Intel® C600 Chipset E5-2400 Series, the letter preceding the model number indicates the Product Line (E3, E5, E7); 2400x v#, 2 = number of CPUs in a Node, 4 is socket/segment designation, 00 = Processor SKU, x = L for low power SKUs and v# (not yet designated) = version number.

Cache Memory
One of the following
depending on Model

20MB (1x20MB) Level 3

NOTE: For Eight-core processors.

15MB (1x15MB) Level 3

NOTE: For Six-core processors.

10MB (1x10MB) Level 3

NOTE: For Quad-core processors.

NOTE: All processor models above list the L3 Cache associated with that particular processor.

Chipset

Intel® C600 Series Chipset

Intel® E5-2400 Processor Family

NOTE: For more information regarding Intel chipsets, please see the following URL:
<http://www.intel.com/products/server/chipsets/>.

Standard Features

Upgradeability	<p>Upgradeable to 2 processors (16 Cores)</p> <p>Up to 12 DIMM slots available</p> <p>NOTE: To take advantage of DIMMs 7-12, a second processor must be installed</p> <p>10 Gigabit networking options via standup card</p> <p>Optional 2 slot riser (x16, x8)</p> <p>NOTE: To take advantage of the additional 2 PCI slot upgrade, a second processor must be installed.</p> <p>Redundant Power Supply</p> <p>Redundant Fan</p> <p>Optical Drive (8SFF/8LFF only)</p>
-----------------------	--

On System Management Processor	<p>HP iLO (Firmware: HP iLO 4)</p> <p>NOTE: For more information, visit: http://www.hp.com/go/ilo</p>
---------------------------------------	---

Memory Protection	<p>Advanced ECC</p> <p>Online Spare</p> <p>Lock-step mode</p>
--------------------------	---

Memory One of the following depending on Model	Type	HP SmartMemory
		DDR3 Load Reduced (LRDIMM), Registered (RDIMM) or Unbuffered (UDIMM)
	DIMM Slots Available	12 (6 DIMM slots per processor, 3 channels per processor, 2 DIMMs per channel)
	Standard (Entry Models - 4GB (1 x 4GB) Registered DIMMs PC3-10600R (1333MHz) SATA)	
	Standard (Entry Models - 4GB (1 x 4GB) Registered DIMMs PC3-10600R (1333MHz) SAS)	
	Standard (Base Models - 8GB (2 x 4GB) Registered DIMMs PC3-10600R (1333MHz) LFF)	
	Standard (Base Models - 8GB (2 x 4GB) Registered DIMMs PC3-10600R (1333MHz) SFF)	
	Standard (High Performance Models)	24GB (6 x 4GB) Registered DIMMs PC3-12800R (1333MHz)
	Standard (Storage Models - LFF)	12GB (3 x 4GB) Registered DIMMs PC3-12800R (1333MHz)
	Standard (Storage Models - SFF)	12GB (3 x 4GB) Registered DIMMs PC3-12800R (1333MHz)
	Maximum Capacity (LRDIMM)	384GB (12 x 32GB LRDIMM @1333MHz)
	Maximum Capacity (RDIMM)	192GB (12 x 16GB RDIMM @1600MHz or 1333MHz)
	Maximum Capacity (UDIMM)	96GB (12 x 8GB UDIMM @1333MHz)
	NOTE: HP memory from previous generation servers are not fully compatible with the HP ProLiant DL380e Gen8 Server.	
	NOTE: To realize the performance memory capabilities listed in this document, HP SmartMemory is required. For additional information, please see the HP SmartMemory QuickSpecs at: http://h18000.www1.hp.com/products/quickspecs/14225_div/14225_div.html	
	NOTE: If only one processor is installed, only half the DIMM slots are available	

Standard Features

NOTE: UDIMM max DIMM population is 12

NOTE: Depending on the memory configuration and processor model, the memory speed may run at 1600MHz, 1333MHz, or 1066MHz. Please see Memory Population Table or the Online Memory Configuration Tool at: www.hp.com/go/ddr3memory-configurator.

Network Controller The HP ProLiant DL380e Gen8 server offers the customer a quad-port NIC standard with the option to upgrade with a variety of networking options.
HP Ethernet 1Gb 4-port 366i Adapter

Expansion Slots

Primary Riser (Standard)	Expansion Slots #	Technology	Bus Width**	Connector Width	Form Factor	Notes
	1	PCIe Gen3.0	X4	X8	Full Length, Full Height Slot	
	2	PCIe Gen3.0	X8	X16	Half Length, Full Height Slot	
	3	PCIe Gen3.0	X8	X8	Half Length, Full Height Slot	
	4	PCIe Gen2.0	X4	X8	Low Profile	
** Indicates the number of physical electrical lanes running to the connector.						
Primary Riser (Riser with SAS)	Expansion Slots #	Technology	Bus Width**	Connector Width	Form Factor	Notes
	1	PCIe Gen3.0	X4	X8	Full Length, Full Height Slot	
	2	PCIe Gen3.0	X8	X16	Half Length, Full Height Slot	
	3	PCIe Gen3.0	NA	NA	NA	Not available for Riser with SAS
	4	PCIe Gen2.0	X4	X8	Low Profile	
** Indicates the number of physical electrical lanes running to the connector.						
Secondary Riser (Optional)	Expansion Slots #	Technology	Bus Width**	Connector Width	Form Factor	Notes
	5	PCIe 3.0	X16	X16	Full length, full height slot	
	6	PCIe 3.0	X8	X16	Half length, full height slot	

**** Indicates the number of physical electrical lanes running to the connector.**

NOTE: When populating slots on secondary riser (p/n 661628-B21), a second processor must be installed.

NOTE: Slot 5 supports up to 225w PCIe cards. An additional Graphic Card Power Adapter Kit is required (663282-B21). See Option Section below for offering.

Standard Features

HP Server ROM

HP ROM (Read Only Memory) is now digitally signed using HP's Corporate Signing Service. This signature is verified before the flash process starts, reducing accidental programming and preventing malicious efforts to corrupt system ROM.

HP ROM provides for essential initialization and validation of hardware components before control is passed to the customer-installed operating system. The ROM also provides the capability of booting from various fixed media (HDD, CD-ROM) and removable media (USB), to continue operation to the operating system.

HP ROM performs very early configuration of the video controller, to allow monitoring of initialization progress via an attached monitor. If configuration or hardware errors are discovered during this early phase of hardware initialization, suitable messages are now displayed on the connected monitor. Additionally, these configuration or hardware errors are logged to the Integrated Management Log (IML) to assist in diagnosis.

HP's ProLiant ROM is used to configure the following:

- Processor and chipset status registers
- System memory, memory map, and memory initialization
- System hardware configuration (Integrated PCI devices and optional PCIe cards).
- Customer-specific BIOS configuration (using the HP ROM-Based Setup Utility (RBSU)).

NOTE: For further information, please refer to HP's RBSU (ROM based setup utility) user guide: www.hp.com/support/rbsu.

Storage Controller

One of the following depending on Model

Entry Model - SATA	HP Dynamic Smart Array B120i Controller NOTE: Provides support for up to 6 SATA drives and data transmission speeds up to 3Gb/s
Entry Model - SAS	HP Dynamic Smart Array B320i/512MB FBWC Controller NOTE: Provides support for up to 8 SAS/SATA drives, data transmission speeds up to 6Gb/s and includes SAS license key.
Base Models - LFF	HP Dynamic Smart Array B320i/512MB FBWC Controller NOTE: Provides support for up to 8 SAS/SATA drives, data transmission speeds up to 6Gb/s and includes SAS license key.
Base Model - SFF	HP Dynamic Smart Array B320i/512MB FBWC Controller NOTE: Provides support for up to 8 SAS/SATA drives, data transmission speeds up to 6Gb/s and includes SAS license key.
High Performance Models	HP Smart Array P420i/1GB FBWC Controller (RAID 0/1/1+0/5/5+0)
Storage Models - LFF	HP Smart Array P420i/1GB FBWC Controller (RAID 0/1/1+0/5/5+0)
Storage Models - SFF	HP Smart Array P420i/2GB FBWC Controller (RAID 0/1/1+0/5/5+0)

Standard Features

Internal Storage Devices One of the following depending on Model	Diskette Drive	None
	Optical Drive	Optional DVD-ROM, DVD-RW NOTE: This option available with all 8SFF or 8LFF drive bay models.
	Hard Drives	None ship standard
	Drive Bays	8 SFF drive bays total with Optical Bay Optional: +8SFF drive bay (total of 16SFF drive bays) NOTE: The Optical Drive bay is not available with +8SFF drive bay optional upgrade. 8 LFF drive bays total with Optical Bay 12 LFF drive bays total without Optical Bay Optional: +2 Rear Drive Bays (LFF or SFF) 25 SFF drive bays total without Optical Bay Optional: +2 Rear Drive Bays (LFF or SFF) NOTE: Drive cage changes are not supported except for adding +8SFF to an existing 8SFF drive cage. NOTE: All Pre-configured Models come populated with some hard drive blanks installed. Should the customer need additional hard drive blanks, they can order more using either P/N 666987-B21: HP SFF Gen8 Hard Drive Blank Kit or P/N 666986-B21: HP LFF Gen8 Hard Drive Blank Kit. These part numbers for single HDD blanks below are also provided should the customer require replacement HDD blanks for their server.

Maximum Internal Storage	Hot Plug SFF SAS	27.0 TB	27 x 1TB (with 25SFF drive cage + Rear 2SFF drive cage)
	Hot Plug SFF SATA	27.0 TB	27 x 1TB (with 25SFF drive cage + Rear 2SFF drive cage)
	Hot Plug LFF SAS	42.0 TB	14 x 3TB (with 12LFF drive cage + Rear 2LFF drive cage)
	Hot Plug LFF SATA	42.0 TB	14 x 3TB (with 12LFF drive cage + Rear 2LFF drive cage)
	Hot Plug SFF SAS SSD	21.6 TB	27 x 800GB (with 25SFF drive cage + Rear 2SFF drive cage)
	Hot Plug SFF SATA SSD	10.8 TB	27 x 400GB (with 25SFF drive cage + Rear 2SFF drive cage)
	Hot Plug LFF SATA SSD	5.6 TB	14 x 400GB (with 12LFF drive cage + Rear 2LFF drive cage)

Interfaces	Serial	1
	Video	2 (1 front, 1 back) not active simultaneously
	LOM Network Ports	4x1GbE ports
	HP iLO Remote Management Network Port	1 Gb Dedicated
	SD slot	1 Internal Secure
	USB 2.0 Ports	Up to 7 total: up to 2 front, 4 back, 1 internal (secure) NOTE: 12LFF and 25SFF drive cage models have 1 front, 4 back and 1 internal USB ports.

Standard Features

Industry Standard Compliance	ACPI 2.0b Compliant PCIe 3.0 Compliant PXE Support WOL Support Microsoft® Logo certifications USB 2.0 Compliant
-------------------------------------	--

Server Power Cords High voltage power cord ships standard with all part numbers.
NOTE: HP ProLiant DL servers no longer ship standard with a 12-foot NEMA 5-15P to C13 power cords (227099-001) that allow connection to 110V US wall outlets in a home or office. ProLiant DL servers are primarily connected to PDU's in data center racks so they now ship standard with only a PDU 6-foot C-14 to C13 power cord (142258-001). If a user wishes to power a ProLiant DL server using a 110V receptacle (NEMA-15), the 12-foot NEMA 5-15 to C13 power cord must be ordered separately. Also available: 110 volt 6-Foot NEMA 5-15p to C13 (AF556A).

Power Specifications To review typical system power ratings use the HP Power Advisor which is available via the online tool located at URL: www.hp.com/go/proliant-energy-efficient or www.hp.com/go/hppoweradvisor.

NOTE: Power Specification and Technical Content for supported power supplies can be found at: http://h18000.www1.hp.com/products/quickspecs/14209_div/14209_div.html

Common Slot Power Supply HP's Common Slot (CS) power supplies allow for commonality of power supplies across a wide range of ProLiant and Integrity servers, as well as HP Storage solutions, and are designed to provide the highest power supply efficiency without degrading system performance. HP CS power supplies are tested by the Electric Power Research Institute (EPRI) and certified through the ECOS 80 Plus power supply program. HP CS power supply options provide efficiency ratings of up to 94% (80 Plus Platinum) and are available in three power output options - 460W, 750W, and 1200W - allowing the customer to "right-size" a power supply for their specific server configuration. All HP Common Slot power sources are UL, CE Mark Compliant, hot-plug and support redundant configurations.

NOTE: Mixing of power supplies in the same server is not supported. All power supplies must be of the same output and efficiency rating. If non-matched power supplies are inserted you will get errors and operation will fail.

HP CS Platinum Plus power supplies are required when enabling HP's Power Discovery Services, a solution that creates an automated, energy-aware network between IT systems and facilities. This allows your company to reclaim millions of dollars in wasted power capacity and downtime costs across data centers. For more information on HP's Power Discovery Services, go to: www.hp.com/go/ipd.

It is highly recommended that you use the HP Power Advisor in defining the "Right-Size" power supply for your needs. HP Power Advisor can be accessed at: www.hp.com/go/hppoweradvisor.

NOTE: The 80 PLUS program is a unique forum that unites electric utilities, the computer industry, and consumers in an effort to bring energy efficient technology solutions to the marketplace. 80 Plus independently tests power supply efficiency and publicly posts the results on www.80Plus.org.

Redundant Power: Optional (1+ 1) power supplies can be purchased through power supply option kits (see Power Supplies for part numbers).

NOTE: Power Specification and Technical Content for supported power supplies can be

Standard Features

found at: http://h18000.www1.hp.com/products/quickspecs/14209_div/14209_div.html

System Fans

One of the following depending on Model

4 Hot-Plug Non-redundant Fans ship standard in 1P Models

- 1P: 4 fans - non-redundancy
- 1P: 5 fans - redundancy

6 Hot-plug Redundant Fans ship standard in 2P Models

- 2P: 5 fans - non-redundancy
- 2P: 6 fans - redundancy

NOTE: Customers may separately purchase redundant fans with the 667855-B21 option kit. Additional fans to support redundancy are also included in -B21 processor option kits when upgrading from one processor to two processor.

Required Cabling

For required cabling information, refer to the HP Web site at: www.hp.com/servers/dl380e-gen8.

Operating Systems and Virtualization Software Support for ProLiant Servers

[Microsoft Windows Server](#)
[Red Hat Enterprise Linux \(RHEL\)](#)
[SUSE Linux Enterprise Server \(SLES\)](#)
[Oracle Solaris](#)
[VMware](#)

NOTE: For more information on HP's Certified and Supported ProLiant Servers for OS and Virtualization Software and latest listing of software drivers available for your server, please visit our Support Matrix at: <http://www.hp.com/go/ossupport> and our driver download page <http://www.hp.com/support/DL380eGen8>

Graphics

Integrated Matrox G200 video standard

- 1280 x 1024 (32 bpp)
 - 1920 x 1200 (16 bpp)
-

Form Factor

One of the following depending on Model

2U Rack form factor

Entry models ship with fixed rails.

All other models ship with sliding rails and cable management system.

8 SFF Drive Bay Version:

3.44 (8.75 cm) Height x 17.54" (44.55 cm) Width x 27.5" (69.85 cm) Length

8 LFF Drive Bay Version:

3.44 (8.75cm) Height x 17.54" (44.55 cm) Width x 29.5" (74.94cm) Length

12 LFF Drive Bay Version:

3.44 (8.75cm) Height x 17.54" (44.55 cm) Width x 29.5" (74.94cm) Length

25 SFF Drive Bay Version:

3.44 (8.75 cm) Height x 17.54" (44.55 cm) Width x 27.5" (69.85 cm) Length

Standard Features

On System Management

HP iLO Management Engine

HP iLO Management Engine is a complete set of embedded management features supporting the complete lifecycle of the server, from initial deployment, through ongoing management, to service alerting and remote support. HP iLO Management Engine comes standard on all HP ProLiant Gen8 Servers. HP iLO Management Engine portfolio includes:

- **HP iLO:** The HP iLO management processor is the core foundation for HP iLO Management Engine. HP iLO for HP ProLiant servers simplify server setup, engage health monitoring, power and thermal control, and promote remote administration for HP ProLiant ML, DL, BL and SL servers. Furthermore with the new HP iLO is the ability to access, deploy, and manage your server anytime from anywhere with your Smartphone device.
- **HP Agentless Management:** With HP iLO Management Engine in every HP ProLiant Gen8 server, the base hardware monitoring and alerting capability is built into the system (running on the HP iLO chipset) and starts working the moment that a power cord and an Ethernet cable is connected to the server.
- **HP Active Health System:** HP Active Health System is an essential component of the HP iLO Management Engine. It provides: Diagnostics tools/scanners wrapped into one; Always on, continuous monitoring for increased stability and shorter downtimes; Rich configuration history; Health and service alerts; Easy export and upload to Service and Support.
- **HP Intelligent Provisioning** (previously known as SmartStart): HP Intelligent Provisioning offers the ability for out-of-the box single-server deployment and configuration without the need for media.

NOTE: For more information, visit: <http://www.hp.com/go/ilo>

HP Insight

management software

HP Service Pack for ProLiant (SPP)

HP Service Pack for ProLiant (SPP) and HP Smart Update Manager (HP SUM) version 5 provide a new, comprehensive approach to firmware and system software maintenance. Together they provide better operating stability and ensure maximum uptime. The SPP will be updated at a predictable cadence, typically coinciding with new HP server hardware launches. By enabling all firmware to be updated online and integrating firmware and system software updates in one operation HP SUM and the SPP offer faster updates of individual servers and dramatically faster updates of entire BladeSystem enclosures. Further improving system uptime and stability is the fact that HP provides 12 months of support on each Service Pack for ProLiant.

The user experience around HP SUM and the SPP has been improved in several ways, starting with the web download. A single web page provides access to a single download containing both the latest version of HP SUM version 5 and the latest SPP. Optional smaller subsets with only specific types of servers or specific operating systems are offered to save on download time. The HP SUM application has been re-written to provide a more straightforward, intuitive user interface that guides the user through the steps of discovery, analyses and update, providing comprehensive information on available updates, criticality and

Standard Features

interdependencies. This information is also available in reports. By providing the option of multiple local or shared repositories which can be easily updated from hp.com, HP SUM provides the tools to optimize stability and consistency throughout the company. While HP SUM and the SPP will recommend the combinations of firmware and system software that HP has found to be the best practice, the application gives customers the flexibility to set their own specific baseline.

The Service Pack for ProLiant has been rigorously tested with specific attention for interaction between firmware, drivers and agents both within the server as well as in interaction with the BladeSystem enclosure components (Onboard Administrator and Virtual Connect). This testing ensures the highest quality as well as providing the input for HP SUM to deploy updates taking into account all interdependencies, when determining the correct updates and order of update deployment.

NOTE: The Service Pack for ProLiant (which includes HP SUM 5) can be downloaded from www.hp.com/go/spp/download. More information can be found: www.hp.com/go/spp and <http://www.hp.com/go/hpsum>

HP Insight management software

HP Service Pack for ProLiant (SPP)

HP Service Pack for ProLiant (SPP) and HP Smart Update Manager (HP SUM) version 5 provide a new, comprehensive approach to firmware and system software maintenance. Together they provide better operating stability and ensure maximum uptime. The SPP will be updated at a predictable cadence, typically coinciding with new HP server hardware launches. By enabling all firmware to be updated online and integrating firmware and system software updates in one operation HP SUM and the SPP offer faster updates of individual servers and dramatically faster updates of entire BladeSystem enclosures. Further improving system uptime and stability is the fact that HP provides 12 months of support on each Service Pack for ProLiant.

The user experience around HP SUM and the SPP has been improved in several ways, starting with the web download. A single web page provides access to a single download containing both the latest version of HP SUM version 5 and the latest SPP. Optional smaller subsets with only specific types of servers or specific operating systems are offered to save on download time. The HP SUM application has been re-written to provide a more straightforward, intuitive user interface that guides the user through the steps of discovery, analyses and update, providing comprehensive information on available updates, criticality and interdependencies. This information is also available in reports. By providing the option of multiple local or shared repositories which can be easily updated from hp.com, HP SUM provides the tools to optimize stability and consistency throughout the company. While HP SUM and the SPP will recommend the combinations of firmware and system software that HP has found to be the best practice, the application gives customers the flexibility to set their own specific baseline.

The Service Pack for ProLiant has been rigorously tested with specific attention for interaction between firmware, drivers and agents both within the server as well as in interaction with the

Standard Features

BladeSystem enclosure components (Onboard Administrator and Virtual Connect). This testing ensures the highest quality as well as providing the input for HP SUM to deploy updates taking into account all interdependencies, when determining the correct updates and order of update deployment.

NOTE: The Service Pack for ProLiant (which includes HP SUM 5) can be downloaded from www.hp.com/go/spp/download. More information can be found: www.hp.com/go/spp and <http://www.hp.com/go/hpsum>

HP Insight

management software

HP Service Pack for ProLiant (SPP)

HP Service Pack for ProLiant (SPP) and HP Smart Update Manager (HP SUM) version 5 provide a new, comprehensive approach to firmware and system software maintenance. Together they provide better operating stability and ensure maximum uptime. The SPP will be updated at a predictable cadence, typically coinciding with new HP server hardware launches. By enabling all firmware to be updated online and integrating firmware and system software updates in one operation HP SUM and the SPP offer faster updates of individual servers and dramatically faster updates of entire BladeSystem enclosures. Further improving system uptime and stability is the fact that HP provides 12 months of support on each Service Pack for ProLiant.

The user experience around HP SUM and the SPP has been improved in several ways, starting with the web download. A single web page provides access to a single download containing both the latest version of HP SUM version 5 and the latest SPP. Optional smaller subsets with only specific types of servers or specific operating systems are offered to save on download time. The HP SUM application has been re-written to provide a more straightforward, intuitive user interface that guides the user through the steps of discovery, analyses and update, providing comprehensive information on available updates, criticality and interdependencies. This information is also available in reports. By providing the option of multiple local or shared repositories which can be easily updated from hp.com, HP SUM provides the tools to optimize stability and consistency throughout the company. While HP SUM and the SPP will recommend the combinations of firmware and system software that HP has found to be the best practice, the application gives customers the flexibility to set their own specific baseline.

The Service Pack for ProLiant has been rigorously tested with specific attention for interaction between firmware, drivers and agents both within the server as well as in interaction with the BladeSystem enclosure components (Onboard Administrator and Virtual Connect). This testing ensures the highest quality as well as providing the input for HP SUM to deploy updates taking into account all interdependencies, when determining the correct updates and order of update deployment.

NOTE: The Service Pack for ProLiant (which includes HP SUM 5) can be downloaded from www.hp.com/go/spp/download. More information can be found: www.hp.com/go/spp and <http://www.hp.com/go/hpsum>

Standard Features

Security	Power-on password
	Serial interface control
	Administrator's password

Warranty

This product is covered by a global limited warranty and supported by HP Services and a worldwide network of HP Authorized Channel Partners resellers. Hardware diagnostic support and repair is available for three years from date of purchase. Support for software and initial setup is available for 90 days from date of purchase. Enhancements to warranty services are available through HP Care Pack services or customized service agreements. Hard drives have either a one year or three year warranty; refer to the specific hard drive QuickSpecs for details.

NOTE: Server Warranty includes 3-Year Parts, 1-Year Labor, 1-Year Onsite support with next business day response. Warranty repairs may be accomplished through the use of Customer Self Repair (CSR) parts. These parts fall into two categories: 1) Mandatory CSR parts are designed for easy replacement. A travel and labor charge will result when customers decline to replace a Mandatory CSR part; 2) Optional CSR parts are also designed for easy replacement but may involve added complexity. Customers may choose to have HP replace Optional CSR parts at no charge. Additional information regarding worldwide limited warranty and technical support is available at: <http://h18004.www1.hp.com/products/servers/platforms/warranty/index.html>

Optional Features

HP Insight management software

HP Insight Control

HP Insight Control, a product option, delivers essential infrastructure management that can help save time and money by making it easy to deploy, migrate, monitor, remote control, and optimize your IT infrastructure through a single, simple management console.

Two versions of Insight Control are available, to serve environments requiring either a Linux-based or a Windows-based central management server: HP Insight Control for Linux, and HP Insight Control. See www.hp.com/go/insightcontrol

HP Insight Control includes one year of 24 x 7 HP Software Technical Support and Update Service ensuring rapid access to HP support staff and proactive delivery of software updates. For more information about this service, please visit: <http://www.hp.com/services/insight>.

HP Matrix Operating Environment

The HP Matrix Operating Environment (Matrix OE) for ProLiant and Integrity servers is an integrated command center that helps you instantly adjust to dynamic business demands. This advanced infrastructure management software lets you reduce the cost of common data center tasks by up to 40 percent while keeping pace with your changing business.

The HP Matrix OE includes the automated provisioning, optimization, and recovery management capabilities for HP CloudSystem Matrix, the ideal platform for private cloud and Infrastructure as a Service (IaaS).

NOTE: For more information, visit: <http://www.hp.com/go/matrixoe>

HP iLO Advanced License for ProLiant Servers

HP iLO management processors for HP ProLiant Gen8 servers virtualizes system controls to help simplify server setup, engage health monitoring and power and thermal control, and promote remote administration. HP iLO functions out-of-the-box without additional software installation and functions regardless of the servers' state of operation. Basic system board management functions, diagnostics, and essential Lights-Out functionality ships standard across all HP ProLiant Gen8 rack, tower and blade servers. The HP iLO can be accessed from any location via a web browser and works hand-in-hand with HP Systems Insight Manager, Insight Control, and Insight Dynamics, helping customers unleash the value of the ProLiant platform and deliver the highest possible quality of IT service to the business.

Advanced functionality, such as graphical remote console, multi-user collaboration, and video record/playback can be activated with the optional HP iLO Advanced or HP iLO Advanced for BladeSystem licenses. The Advanced licensed features offer sophisticated remote administration of servers in dynamic data center and remote locations and can help significantly reduce cost associated with IT-related travel and unplanned downtime.

NOTE: For more information, visit: <http://www.hp.com/go/ilo>

Optional Features

High Performance Clusters	HP Cluster Platforms	HP Cluster Platforms are specifically engineered, factory-integrated large-scale ProLiant clusters optimized for High Performance Computing, with a choice of servers, networks and software. Operating system options include specially priced offerings for Red Hat Enterprise Linux and SUSE Linux Enterprise Server, as well as Microsoft Windows HPC Server. A Cluster Platform Configurator simplifies ordering. http://www.hp.com/go/clusters
	HP HPC Interconnects	High Performance Computing (HPC) interconnect technologies are available for this server as part of the HP Cluster Platform portfolio. These high-speed InfiniBand and Gigabit interconnects are fully supported by HP when integrated within an HP cluster. Flexible, validated solutions can be defined with the help of configuration tools. http://www.hp.com/techservers/clusters/ucp/index.html
	HP Insight Cluster Management Utility	HP Insight Cluster Management Utility (CMU) is an HP-licensed and HP-supported suite of tools that are used for lifecycle management of hyperscale clusters of Linux ProLiant systems. CMU includes software for the centralized provisioning, management and monitoring of nodes. CMU makes the administration of clusters user friendly, efficient, and effective. http://www.hp.com/go/cmu
	HP HPC Linux Value Pack	HP HPC Linux Value Pack (Value Pack) is an HP-licensed and HP-supported option to HP Insight CMU, for the development and deployment of applications on HPC Cluster Platforms. Value Pack includes the Platform LSF workload scheduler and Platform Application Center, as well as the HP-MPI parallelization library. HP HPC Linux Value Pack

HP Insight Online HP Insight Online is a new addition to the HP Support Center for one stop, secure access to product and HP support information personalized to your IT environment. Insight Online can automatically display devices remotely monitored by HP Insight Remote Support. With Insight Online's easy navigation you can efficiently track your IT support contracts and device status from anywhere and at anytime. www.hp.com/go/insightonline

Factory Express Portfolio for Servers and Storage HP Factory Express offers configuration, customization, integration and deployment services for HP servers and storage products. Customers can choose how their factory solutions are built, tested, integrated, shipped and deployed.

Factory Express offers service packages for simple configuration, racking, installation, complex configuration and design services as well as individual factory services, such as image loading, asset tagging, and custom packaging. HP products supported through Factory Express include a wide array of servers and storage: HP Integrity, HP ProLiant, HP ProLiant Server Blades, HP BladeSystem, HP 9000 servers as well as the MSAxxxx, EVA7xxx, EVA, XP, rackable tape libraries and configurable network switches.

For more information on Factory Express services for your specific server model please contact your sales representative or go to: <http://www.hp.com/go/factory-express>.

HP Enterprise Configurator The HP eConfigure-Enterprise Configurator now provides factory default racking for our HP hardware portfolio. This approach is aligned with our strategic direction to meet the needs and expectations of our valued customers. If you require "custom" rack configuration, please contact HP's Customer Business Center or an Authorized Partner for assistance. <http://www.hp.com/products/configurator>.

Service and Support

Service and Support **HP Technology Services for Industry Standard Servers and BladeSystem**

Capitalizing on HP ProLiant server and HP BladeSystem capabilities requires a service partner who understands your increasingly complex business technology environment. That's why it makes sense to team up with the people who know HP infrastructure hardware and software best - the experienced professionals at HP Services.

What HP ProLiant and BladeSystem Services can do for you

HP ProLiant and BladeSystem Services can help you design, deploy, test, integrate, support, and manage IT and infrastructure solutions. This way, HP proposes services solutions that include more than just uplift of base warranty. Foundation Care services deliver scalable support-packages for HP industry-standard servers and software. You can choose the type and level of service that is most suitable for their business needs. New to this portfolio is HP Collaborative Support. If you are running business critical environments, HP offers Proactive Care or Critical Advantage. These services help deliver high levels of application availability through proactive service management and advanced technical response. You can get the support you need by choosing from one of a number of service packaged solutions we have designed to address wider set of customer support needs.

HP Technology Services meets business challenges with services offered in three support recommendations - **Optimized Care, Standard Care, and Basic Care** - available for each product group. Such support solutions enable customers to optimize technology operations, minimize risk and drive better business outcomes with easy-to-buy, easy-to-use scalable support recommendations for servers, storage, networking and software designed to meet your specific needs.

All three service recommendations include support services from the broader portfolio of Foundation Care and Proactive Care services.

Optimized Care

Optimized Care: Supports maintaining servers at optimum performance availability

HP ProLiant Server Hardware Installation

Provides for the basic hardware installation of HP branded servers, storage devices and networking options to assist you in bringing your new hardware into operation in a timely and professional manner <http://h20195.www2.hp.com/V2/GetPDF.aspx/5981-9356EN.pdf>

HP Installation and Startup for Insight Control Software / HP SIM

Provides for the deployment and basic configuration of HP Insight Control or HP SIM (Systems Insight Manager) on HP ProLiant ML and DL series servers or HP BladeSystem servers <http://h20195.www2.hp.com/v2/GetPDF.aspx/4AA0-9972ENW.pdf>

3-Year HP 24x7 4 hour Response, Proactive Care

Helps optimize your systems and delivers high levels of application availability through proactive service management and advanced technical response. A skilled Technical Manager will own your call and end to end until resolved, delivering a single point of contact for you. Helping you to resolve your hardware and software issues and minimizing downtime in your business critical environment.

Additional Services: Factory Express, Education Services, Proactive Select - 30 Credit Package

Service and Support

Standard Care **Standard Care: Service recommendation that maintains high level of server availability**

HP ProLiant Server Hardware Installation

Provides for the basic hardware installation of HP branded servers, storage devices and networking options to assist you in bringing your new hardware into operation in a timely and professional manner <http://h20195.www2.hp.com/V2/GetPDF.aspx/5981-9356EN.pdf>

HP Installation and Startup for Insight Control Software / HP SIM

Provides for the deployment and basic configuration of HP Insight Control or HP SIM (Systems Insight Manager) on HP ProLiant ML and DL series servers or HP BladeSystem servers <http://h20195.www2.hp.com/v2/GetPDF.aspx/4AA0-9972ENW.pdf>

3-Year HP 24x7 4 hour Response, Collaborative Support

Provides problem resolution support across the stack of HW, firmware, and HP and 3rd party SW. In case the issue is with 3rd party SW, HP does known issue resolution. If HP cannot solve the issue, it will contact the third-party vendor and create a problem incident on your behalf.

<http://h20195.www2.hp.com/V2/GetPDF.aspx/4AA3-8232ENW.pdf>

Additional Services: Software support service with 24X7 availability with a 2 hour response, Training courses on Microsoft, Linux (Red Hat and SUSE), VMware, and HP Insight Software, 10 Proactive Select Credit package, Factory Express

<http://www8.hp.com/us/en/business-services/it-services.html?compURI=1078865>

Basic Care

Basic Care: delivers minimum recommended support service level

HP ProLiant Server Hardware Installation

Provides for the basic hardware installation of HP branded servers, storage devices and networking options to assist you in bringing your new hardware into operation in a timely and professional manner <http://h20195.www2.hp.com/V2/GetPDF.aspx/5981-9356EN.pdf>

3-Year HP 24x7 4 hour Response, Hardware Support Onsite Service

Provides you with rapid remote support and if required an HP authorized technical engineer will be on site 24X7 begin hardware maintenance service within 4 hours of the service request being logged

<http://h20195.www2.hp.com/V2/GetPDF.aspx/5982-6547EEE.pdf>

3-Year , HP 24x7 Software Support for Insight Control

Provides remote 3-year software support service that delivers comprehensive software services, including access to HP technical resources and software updates

<http://h20195.www2.hp.com/V2/GetPDF.aspx/5981-6645EEE.pdf>

Additional Services: Factory Express, Education Services, Proactive Select - 10 Credits

Insight Remote Support

Provides 24 X 7 remote monitoring, proactive notifications, and problem resolution. Learn more <http://www.hp.com/go/insightremotesupport>

Service and Support

HP Support Center Personalized online support portal with access to information, tools and experts to support HP business products. Submit support cases online, chat with HP experts, access support resources or collaborate with peers. Learn more <http://www.hp.com/go/hpsc>

HP's Support Center Mobile App* allows you to resolve issues yourself or quickly connect to an agent for live support. Now, you can get access to personalized IT support anywhere, anytime.

HP Insight Remote Support and HP Support Center are available at no additional cost with a HP warranty, HP Care Pack or HP contractual support agreement.

*HP' Support Center Mobile App is subject to local availability

Warranty / Service Coverage

For ProLiant servers and storage systems, the services cover HP-branded hardware options qualified for the server, purchased at the same time or afterward, internal to the enclosure, as well as external monitors up to 22" and tower UPS products; these items will be covered at the same service level and for the same coverage period as the server unless the maximum supported lifetime and/or the maximum usage limitation has been exceeded. Coverage of the UPS battery is not included; standard warranty terms and conditions apply.

The defective media retention service feature option applies only to Disk or eligible SSD/Flash Drives replaced by HP due to malfunction. It does not apply to any exchange of Disk or SSD/Flash Drives that have not failed. SSD/Flash Drives that are specified by HP as consumable parts and/or that have exceeded maximum supported lifetime and/or the maximum usage limit as set forth in the manufacturer's operating manual or the technical data sheet are not eligible for the defective media retention service feature option.

For more information To learn more on HP ProLiant servers and HP BladeSystem servers, please contact your HP sales representative or HP Authorized Channel Partner. Or visit: <http://www.hp.com/services/proliant>

Pre-configured Models

NOTE: For the Standard Features shipped in the "Factory Integrated Models", please see the "Configuration Information - Factory Integrated Models" section.

NOTE: Pre-configured models ship with the configurations below. Options can be selected from the Core or Additional options section of this QuickSpecs.

NOTE: HP does not allow factory integration of options into pre-configured models. Any additional options purchased will be shipped separately.

NOTE: If you desire a custom configuration please see "Configuration Information - Factory Integrated Models" section of this QuickSpecs.

NOTE: All Pre-configured Models come populated with some hard drive blanks installed. Should the customer need additional hard drive blanks, they can order more using either P/N 666987-B21: HP SFF Gen8 Hard Drive Blank Kit or P/N 666986-B21: HP LFF Gen8 Hard Drive Blank Kit.

NOTE: Not all models are available in all regions. Check with your local country HP offices for availability.

Entry Models - SATA

<p>Quad-Core SATA Model HP ProLiant DL380e Gen8 E5-2403 1P 4GB-R Hot Plug 4 LFF 460W PS Entry Server 648255-xx1</p>	<p>Processor(s)</p> <p>Cache Memory</p> <p>Memory</p> <p>Network Controller</p> <p>Storage Controller</p> <p>Hard Drive</p> <p>Internal Storage</p> <p>Optical Drive Bay</p> <p>PCI-Express Slots</p> <p>Power Supply</p> <p>Fans</p> <p>Management</p> <p>Form Factor</p> <p>Warranty</p>	<p>(1) Intel® Xeon® E5-2403 (1.8GHz/4-core/10MB/6.4GT-s QPI/80W, DDR3-1066, HT) Processor</p> <p>10MB (1x10MB) Level 3</p> <p>4GB (1 x 4GB) Registered DIMMs PC3-10600R (1333MHz) NOTE: Memory runs at 1066MHz speed due to processor.</p> <p>HP Ethernet 1Gb 4-port 366i Adapter</p> <p>HP Dynamic Smart Array B120i Controller NOTE: Provides support for up to 6 SATA drives and data transmission speeds up to 3Gb/s Greater than 4 drives requires an additional cable (see p/n 675856-B21)</p> <p>None ship standard; includes 7 LFF hard drive blanks NOTE: This model comes with 7 HDD blanks if no HDD is ordered.</p> <p>8 LFF HDD Bays</p> <p>1; (Optional: DVD-ROM, DVD-RW)</p> <p>4 standard (1-FL/FH, 2-HL/FH, 1-LP)</p> <p>(1) HP 460W CS Gold Hot Plug Power Supply (92% Efficient)</p> <p>4 Hot-Plug Non-redundant Fans NOTE: Customers can upgrade to a redundant fan configuration with the purchase of an option kit (see p/n 667855-B21)</p> <p>HP iLO Management Engine (standard) Optional: HP Insight Control</p> <p>Rack (2U) NOTE: This model has friction rails and does not support in-rack serviceability. NOTE: Includes Rack Mounting Gen8 non-telescoping Friction Rail Kit which does not allow for in rack serviceability. The HP 2U Gen8 Cable Management Arm is not available when using Friction Rails. Caution: HP recommends that a minimum of two people is required for all Rack Server installations. Please refer to your installation instructions for proper tools and number of people to use for any installation.</p> <p>Server Warranty includes 3-Year Parts, 1-Year Labor, 1-Year Onsite support with next business day response.</p>
--	--	--

Pre-configured Models

Entry Models - SAS

Quad-Core SAS Model	Processor(s)	(1) Intel® Xeon® E5-2403 (1.8GHz/4-core/10MB/6.4GT-s QPI/80W, DDR3-1066, HT) Processor
HP ProLiant DL380e		
Gen8 E5-2403 1P	Cache Memory	10MB (1x10MB) Level 3
4GB-R Hot Plug 8 SFF	Memory	4GB (1 x 4GB) Registered DIMMs PC3-10600R (1333MHz) NOTE: Memory runs at 1066MHz speed due to processor.
460W PS Entry Server	Network Controller	HP Ethernet 1Gb 4-port 366i Adapter
648256-xx1	Storage Controller	HP Dynamic Smart Array B320i Controller
	Hard Drive	None ship standard; includes 7 SFF hard drive blanks NOTE: This model comes with 7 HDD blanks if no HDD is ordered.
	Internal Storage	8 SFF HDD Bays
	Optical Drive Bay	1; (Optional: DVD-ROM, DVD-RW)
	PCI-Express Slots	3 standard (1-FL/FH, 1HL/FH, 1-LP)
	Power Supply	(1) HP 460W CS Gold Hot Plug Power Supply (92% Efficient)
	Fans	4 Hot-Plug Non-redundant Fans NOTE: Customers can upgrade to a redundant fan configuration with the purchase of an option kit (see p/n 667855-B21)
	Management	HP iLO Management Engine (standard) Optional: HP Insight Control
	Form Factor	Rack (2U) NOTE: This model has friction rails and does not support in-rack serviceability. NOTE: Includes Rack Mounting Gen8 non-telescoping Friction Rail Kit which does not allow for in rack serviceability. The HP 2U Gen8 Cable Management Arm is not available when using Friction Rails. Caution: HP recommends that a minimum of two people is required for all Rack Server installations. Please refer to your installation instructions for proper tools and number of people to use for any installation.
	Warranty	Server Warranty includes 3-Year Parts, 1-Year Labor, 1-Year Onsite support with next business day response.

Base Models - LFF

HP ProLiant DL380e	Processor(s)	(1) Intel® Xeon® E5-2407 (2.2GHz/4-core/10MB/6.4GT-s QPI/80W, DDR3-1066, HT) Processor
Gen8 E5-2407 1P		
8GB-R Hot Plug 8 LFF	Cache Memory	15MB (1x15MB) Level 3
460W PS Base Server	Memory	8GB (2 x 4GB) Registered DIMMs PC3-10600R (1333MHz) NOTE: Provides support for up to 8 SAS/SATA drives, data transmission speeds up to 6Gb/s and includes SAS license key.
668665-xx1	Network Controller	HP Ethernet 1Gb 4-port 366i Adapter
	Storage Controller	HP Dynamic Smart Array B320i/512MB FBWC Controller
	Hard Drive	None ship standard; includes 7 LFF hard drive blanks NOTE: This model comes with 7 HDD blanks if no HDD is ordered.
	Internal Storage	8 LFF HDD Bays
	Optical Drive Bay	1; (Optional: DVD-ROM, DVD-RW)
	PCI-Express Slots	3 standard (1-FL/FH, 1HL/FH, 1-LP)
	Power Supply	(1) HP 460W CS Gold Hot Plug Power Supply (92% Efficient)
	Fans	4 Hot-Plug Non-redundant Fans NOTE: Customers can upgrade to a redundant fan configuration with the purchase of an option kit (see p/n 667855-B21)

Pre-configured Models

Management	HP iLO Management Engine (standard) Optional: HP Insight Control
Form Factor	Rack (2U) NOTE: Includes Rack Mounting Gen8 telescoping LFF Ball Bearing Rail Kit which does allow for in rack serviceability. Due to the size and weight of the server two people are required to install the server into the rack. To assist in the installation of the server into the rack an optional installation tool is available by contacting your local services representative. Caution: HP recommends that a minimum of two people is required for all Rack Server installations. Please refer to your installation instructions for proper tools and number of people to use for any installation.
Warranty	Server Warranty includes 3-Year Parts, 1-Year Labor, 1-Year Onsite support with next business day response.

Base Models - SFF

HP ProLiant DL380e Gen8 E5-2407 1P 8GB-R Hot Plug 8 SFF 460W PS Base Server 668666-xx1	Processor(s)	(1) Intel® Xeon® E5-2407 (2.2GHz/6-core/15MB/95W, DDR3-1333, HT Turbo2) Processor
	Cache Memory	15MB (1x15MB) Level 3
	Memory	8GB (2 x 4GB) Registered DIMMs PC3-10600R (1333MHz)
	Network Controller	HP Ethernet 1Gb 4-port 366i Adapter
	Storage Controller	HP Dynamic Smart Array B320i/512MB FBWC Controller NOTE: Provides support for up to 8 SAS/SATA drives, data transmission speeds up to 6Gb/s and includes SAS license key.
	Hard Drive	None ship standard; includes 7 SFF hard drive blanks NOTE: This model comes with 7 HDD blanks if no HDD is ordered.
	Internal Storage	8 SFF HDD Bays
	Optical Drive Bay	1; (Optional: DVD-ROM, DVD-RW)
	PCI-Express Slots	3 standard (1-FL/FH, 1HL/FH, 1-LP)
	Power Supply	(1) HP 460W CS Gold Hot Plug Power Supply (92% Efficient)
	Fans	4 Hot-Plug Non-redundant Fans NOTE: Customers can upgrade to a redundant fan configuration with the purchase of an option kit (see p/n 667855-B21)
	Management	HP iLO Management Engine (standard) Optional: HP Insight Control
	Form Factor	Rack (2U) NOTE: Includes Rack Mounting Gen8 telescoping SFF Ball Bearing Rail Kit which does allow for in rack serviceability. Due to the size and weight of the server two people are required to install the server into the rack. To assist in the installation of the server into the rack an optional installation tool is available by contacting your local services representative. Caution: HP recommends that a minimum of two people is required for all Rack Server installations. Please refer to your installation instructions for proper tools and number of people to use for any installation.
	Warranty	Server Warranty includes 3-Year Parts, 1-Year Labor, 1-Year Onsite support with next business day response.

Pre-configured Models

High Performance Models

NOTE: These Models are Energy Star Certified.

<p>HP ProLiant DL380e Gen8 E5-2450 2P 24GB-R P420 Hot Plug 8 SFF 750W PS Perf Svr 668669-xx1</p>	<p>Processor(s) (2) Intel® Xeon® E5-2450 (2.1GHz/8-core/20MB/8GT-s QPI/95W, DDR3-1600, HT, Turbo2- 5/5/6/6/7/7/8/8) Turbo+ Processors</p> <p>Cache Memory 20MB (1x20MB) Level 3</p> <p>Memory 24GB (6 x 4GB) Registered DIMMs PC3-12800R (1333MHz)</p> <p>Network Controller HP Ethernet 1Gb 4-port 366i Adapter</p> <p>Storage Controller HP Smart Array P420i/1GB FBWC Controller (RAID 0/1/1+0/5/5+0)</p> <p>Hard Drive None ship standard; includes 7 SFF hard drive blanks NOTE: This model comes with 7 HDD blanks if no HDD is ordered.</p> <p>Internal Storage 8 SFF HDD Bays</p> <p>Optical Drive Bay 1; (Optional: DVD-ROM, DVD-RW)</p> <p>PCI-Express Slots 4 standard (1-FL/FH, 2-HL/FH, 1-LP)</p> <p>Power Supply (2) HP 750W CS Gold Hot Plug Power Supplies (94% Efficient)</p> <p>Fans 6 Hot-plug Redundant Fans</p> <p>Management HP iLO Management Engine (standard) HP Insight Control Standard</p> <p>Energy Star Meets Energy Star requirements</p> <p>Form Factor Rack (2U) NOTE: Includes Rack Mounting Gen8 telescoping 8SFF Ball Bearing Rail Kit which does allow for in rack serviceability. Due to the size and weight of the server two people are required to install the server into the rack. . To assist in the installation of the server into the rack an optional installation tool is available by contacting your local services representative. Caution: HP recommends that a minimum of two people is required for all Rack Server installations. Please refer to your installation instructions for proper tools and number of people to use for any installation.</p>
<p>Warranty</p>	<p>Server Warranty includes 3-Year Parts, 1-Year Labor, 1-Year Onsite support with next business day response.</p>

Storage Models - LFF

<p>HP ProLiant DL380e Gen8 E5-2420 1P 12GB-R P420 Hot Plug 12 LFF 750W PS Server 668667-xx1</p>	<p>Processor(s) (1) Intel® Xeon® E5-2420 (1.9GHz/6-core/15MB/7.2GT-s QPI/95W, DDR3-1333, HT, Turbo2- 3/3/4/4/5/5) Turbo Processor</p> <p>Cache Memory 15MB (1x15MB) Level 3</p> <p>Memory 12GB (3 x 4GB) Registered DIMMs PC3-12800R (1333MHz)</p> <p>Network Controller HP Ethernet 1Gb 4-port 366i Adapter</p> <p>Storage Controller HP Smart Array P420i/1GB FBWC Controller (RAID 0/1/1+0/5/5+0)</p> <p>Hard Drive None ship standard; includes 11 LFF hard drive blanks NOTE: This model comes with 11 HDD blanks if no HDD is ordered.</p> <p>Internal Storage 12 LFF HDD Bays</p> <p>Optical Drive Bay N/A</p> <p>PCI-Express Slots 4 standard (1-FL/FH, 2-HL/FH, 1-LP)</p> <p>Power Supply (1) HP 750W CS Gold Hot Plug Power Supply (92% Efficient)</p> <p>Fans 4 Hot-Plug Non-redundant Fans</p> <p>Management HP iLO Management Engine (standard) Optional: HP Insight Control</p> <p>Form Factor Rack (2U) NOTE: Includes Rack Mounting Gen8 telescoping LFF Ball Bearing</p>
---	---

Pre-configured Models

Rail Kit which does allow for in rack serviceability. Due to the size and weight of the server two people are required to install the server into the rack. To assist in the installation of the server into the rack an optional installation tool is available by contacting your local services representative. Caution: HP recommends that a minimum of two people is required for all Rack Server installations. Please refer to your installation instructions for proper tools and number of people to use for any installation.

Warranty

Server Warranty includes 3-Year Parts, 1-Year Labor, 1-Year Onsite support with next business day response.

Storage Models - SFF

<p>HP ProLiant DL380e Gen8 E5-2420 1P 12GB-R P420 Hot Plug 25 SFF 750W PS Server 668668-xx1</p>	<p>Processor(s) Cache Memory Memory Network Controller Storage Controller Hard Drive</p> <p>Internal Storage Optical Drive Bay PCI-Express Slots Power Supply Fans Management</p> <p>Form Factor</p>	<p>(1) Intel® Xeon® E5-2420 (1.9GHz/6-core/15MB/7.2GT-s QPI/95W, DDR3-1333, HT, Turbo2- 3/3/4/4/5/5) Turbo Processor</p> <p>15MB (1x15MB) Level 3</p> <p>12GB (3 x 4GB) Registered DIMMs PC3-12800R (1333MHz)</p> <p>HP Ethernet 1Gb 4-port 366i Adapter</p> <p>HP Smart Array P420i/2GB FBWC Controller (RAID 0/1/1+0/5/5+0)</p> <p>None ship standard; includes 24 SFF hard drive blanks NOTE: This model comes with 24 HDD blanks if no HDD is ordered.</p> <p>25 SFF HDD Bays</p> <p>N/A</p> <p>4 standard (1-FL/FH, 2-HL/FH, 1-LP)</p> <p>(1) HP 750W CS Gold Hot Plug Power Supply (92% Efficient)</p> <p>4 Hot-Plug Non-redundant Fans</p> <p>HP iLO Management Engine (standard) Optional: HP Insight Control</p> <p>Rack (2U) NOTE: Includes Rack Mounting Gen8 telescoping SFF Ball Bearing Rail Kit which does allow for in rack serviceability. Due to the size and weight of the server two people are required to install the server into the rack. . To assist in the installation of the server into the rack an optional installation tool is available by contacting your local services representative. Caution: HP recommends that a minimum of two people is required for all Rack Server installations. Please refer to your installation instructions for proper tools and number of people to use for any installation.</p>
	<p>Warranty</p>	<p>Server Warranty includes 3-Year Parts, 1-Year Labor, 1-Year Onsite support with next business day response.</p>

Country Code Key	xx = 00	U.S.
	xx = 20	Brazil
	xx = 29	Japan
	xx = 37	APD
	xx = 42	Europe
	xx = AA	PRC

Configuration Information - Factory Integrated Models

NOTE: This section lists some of the steps required to configure a Factory Integrated Model. To ensure only valid configurations are ordered, HP recommends the use of an HP approved configurator. Contact your local sales representative for information on configurable product offerings and requirements.

NOTE: Factory Integrated Models must start with a CTO Server.

NOTE: FIO indicates that this option is only available as a factory installable option.

NOTE: All Factory Integrated Models will be populated with sufficient hard drive blanks based on the number of initial hard drives ordered with the server.

Step 1: Base Configuration (choose one of the following configurable models)

NOTE: Rail kits and cable management solutions are optional in CTO. See "Step 3: Choose Additional Factory Integratable Options" for details on ordering.

NOTE: The DL380e ships standard with the Dynamic Smart Array B120i controller which provides support for up to 6 SATA drives (greater than 4 drives requires additional cable, p/n 675856-B21) and data transmission speeds up to 3Gb/s. Customers requiring SAS support or greater than 6 drives should select either a Smart Array family controller or the HP Dynamic Smart Array B320i controller (p/n 661387-B21, implemented via riser).

NOTE: Number of HDD blanks in a given chassis is same as number of drive cage bays.

NOTE: Power Supply not included - choose from Options section.

HP Models

HP ProLiant DL380e Gen8 12 LFF Configure-to-order Server

669254-B2

NOTE: This CTO server is designed for customers who are looking for maximum 2U storage performance and density. This model requires two (2) Smart Array P420 controllers if using more than 8 drives.

Factory Integrated Model ships with:

2 x HP Smart Socket Guides for fast processor installation.
 12 DIMM slots for RDIMM, LRDIMM and UDIMM Memory installation
 HP Ethernet 1Gb 4-port 366i Adapter
 HP Dynamic Smart Array B120i Controller with Zero Memory (ZM)
 I/O slots - 4 Slots come standard:

- Slot 1 - FL/FH x4 PCIe 3.0 (x8 connector)
- Slot 2 - HL/FH x8 PCIe 3.0 (x16 connector)
- Slot 3 - HL/FH x8 PCIe 3.0 (x8 connector)
- Slot 4 - Low Profile x4 PCIe 2.0 (x8 connector)
- Additional Slots may be added via selections from the PCI Information and

Options subsection

System Fans - 4 (1 additional fan included with purchase of second processor)

Drive Cage - 12-LFF

USB - 4 Rear, 1 Front, 1 Internal, 1 SD slot

HP iLO Management Engine (standard)

NOTE: New options are available for Rack Rail Kits; these options are no longer standard on-board with this Model Part Number. Please see HP Rack Options below for optional required options.

HP ProLiant DL380e Gen8 12 LFF Configure-to-order Server

669257-B2

NOTE: This CTO server includes an "expander-based" storage backplane. A single Smart Array P420 controller is capable of controlling all 12 LFF drives and optional rear drives.

Factory Integrated Model ships with:

2 x HP Smart Socket Guides for fast processor installation.
 12 DIMM slots for RDIMM, LRDIMM and UDIMM Memory installation
 HP Ethernet 1Gb 4-port 366i Adapter
 HP Dynamic Smart Array B120i Controller with Zero Memory (ZM)
 I/O slots - 4 Slots come standard:

- Slot 1 - FL/FH x4 PCIe 3.0 (x8 connector)
- Slot 2 - HL/FH x8 PCIe 3.0 (x16 connector)
- Slot 3 - HL/FH x8 PCIe 3.0 (x8 connector)

Configuration Information - Factory Integrated Models

- Slot 4 - Low Profile x4 PCIe 2.0 (x8 connector)
- Additional Slots may be added via selections from the PCI Information and

Options subsection

System Fans - 4 (1 additional fan included with purchase of second processor)

Drive Cage - 12-LFF

USB - 4 Rear, 1 Front, 1 Internal, 1 SD slot

HP iLO Management Engine (standard)

NOTE: New options are available for Rack Rail Kits; these options are no longer standard on-board with this Model Part Number. Please see HP Rack Options below for optional required options.

HP ProLiant DL380e Gen8 25 SFF Configure-to-order Server

669256-B2

NOTE: This CTO server includes an "expander-based" storage backplane. A single Smart Array P420 is capable of controlling all 25 SFF drives and optional rear drives.

Factory Integrated Model ships with:

2 x HP Smart Socket Guides for fast processor installation.

12 DIMM slots for RDIMM, LRDIMM and UDIMM Memory installation

HP Ethernet 1Gb 4-port 366i Adapter

HP Dynamic Smart Array B120i Controller with Zero Memory (ZM)

I/O slots - 4 Slots come standard:

- Slot 1 - FL/FH x4 PCIe 3.0 (x8 connector)
- Slot 2 - HL/FH x8 PCIe 3.0 (x16 connector)
- Slot 3 - HL/FH x8 PCIe 3.0 (x8 connector)
- Slot 4 - Low Profile x4 PCIe 2.0 (x8 connector)
- Additional Slots may be added via selections from the PCI Information and

Options subsection

System Fans - 4 (1 additional fans included with purchase of second processor)

Drive Cage - 25-SFF (Optical media drive optional)

USB - 4 Rear, 1 Front, 1 Internal, 1 SD slot

HP iLO Management Engine (standard)

NOTE: New options are available for Rack Rail Kits; these options are no longer standard on-board with this Model Part Number. Please see HP Rack Options below for optional required options.

HP ProLiant DL380e Gen8 8 LFF Configure-to-order Server

669255-B2

NOTE: This CTO server supports 4, 6, and 8LFF drive configurations based on the selection of controller. The HP Dynamic Smart Array B120i is capable of controlling up to 6 SATA drives. Greater than 4 SATA drives require the use of an option cable, p/n 675856-B21). Greater than 6 SATA drives require an HP Dynamic Smart Array B320i or P420 or greater controller.

Factory Integrated Model ships with:

2 x HP Smart Socket Guides for fast processor installation.

12 DIMM slots for RDIMM, LRDIMM and UDIMM Memory installation

HP Ethernet 1Gb 4-port 366i Adapter

HP Dynamic Smart Array B120i Controller with Zero Memory (ZM)

I/O slots - 4 Slots come standard:

- Slot 1 - FL/FH x4 PCIe 3.0 (x8 connector)
- Slot 2 - HL/FH x8 PCIe 3.0 (x16 connector)
- Slot 3 - HL/FH x8 PCIe 3.0 (x8 connector)
- Slot 4 - Low Profile x4 PCIe 2.0 (x8 connector)
- Additional Slots may be added via selections from the PCI Information and

Options subsection

System Fans - 4 (one additional fan included with purchase of second

Configuration Information - Factory Integrated Models

processor)

Drive Cage - 8-LFF (Optical media drive optional)

USB - 4 Rear, 2 Front, 1 Internal, 1 SD slot

HP iLO Management Engine (standard)

NOTE: New options are available for Rack Rail Kits; these options are no longer standard on-board with this Model Part Number. Please see HP Rack Options below for optional required options.

HP ProLiant DL380e Gen8 8 SFF Configure-to-order Server

669253-B2

NOTE: This CTO server supports up to 8SFF drives and is expandable up to 16 SFF drives via the optional 8SFF upgrade kit (p/n 668295-B21).

Factory Integrated Model ships with:

2 x HP Smart Socket Guides for fast processor installation.

12 DIMM slots for RDIMM, LRDIMM and UDIMM Memory installation

HP Ethernet 1Gb 4-port 366i Adapter

HP Dynamic Smart Array B120i Controller with Zero Memory (ZM)

I/O slots - 4 Slots ship standard:

- Slot 1 - FL/FH x4 PCIe 3.0 (x8 connector)
- Slot 2 - HL/FH x8 PCIe 3.0 (x16 connector)
- Slot 3 - HL/FH x8 PCIe 3.0 (x8 connector)
- Slot 4 - Low Profile x4 PCIe 2.0 (x8 connector)
- Additional Slots may be added via selections from the PCI Information and

Options subsection

System Fans - 4 (one additional fan included with purchase of second processor)

Drive Cage - 8-SFF (Optical media drive optional)

USB - 4 Rear, 2 Front, 1 Internal, 1 SD slot

HP iLO Management Engine (standard)

NOTE: New options are available for Rack Rail Kits; these options are no longer standard on-board with this Model Part Number. Please see HP Rack Options below for optional required options.

Step 2: Choose Required Options (only one of the following from each list unless otherwise noted)

HP Processors

NOTE: If two processors are desired, select one xxxxxx-L21 and one xxxxxx-B21

Entry Processors

NOTE: All support up to 1066MHz memory speeds.

HP DL380e Gen8 Intel® Xeon® E5-2407 (2.2GHz/4-core/10MB/80W) FIO Processor Kit

661132-L2

HP DL380e Gen8 Intel® Xeon® E5-2403 (1.8GHz/4-core/10MB/80W) FIO Processor Kit

661134-L2

Base Processors

NOTE: All support up to 1333MHz DDR3 memory speeds.

HP DL380e Gen8 Intel® Xeon® E5-2440 (2.4GHz/6-core/15MB/95W) FIO Processor Kit

661124-L2

HP DL380e Gen8 Intel® Xeon® E5-2430 (2.2GHz/6-core/15MB/95W) FIO Processor Kit

661126-L2

HP DL380e Gen8 Intel® Xeon® E5-2430L (2.0GHz/6-core/15MB/60W) FIO Processor Kit

661138-L2

HP DL380e Gen8 Intel® Xeon® E5-2420 (1.9GHz/6-core/15MB/95W) FIO Processor Kit

661128-L2

Configuration Information - Factory Integrated Models

Performance Processors

NOTE: All support up to 1600MHz DDR3 memory speeds

HP DL380e Gen8 Intel® Xeon® E5-2470 (2.3GHz/8-core/20MB/95W) FIO Processor Kit	661118-L2
HP DL380e Gen8 Intel® Xeon® E5-2450 (2.1GHz/8-core/20MB/95W) FIO Processor Kit	661120-L2
HP DL380e Gen8 Intel® Xeon® E5-2450L (1.8GHz/8-core/20MB/70W) FIO Processor Kit	661136-L2

HP Memory

NOTE: To realize the performance memory capabilities listed in this document, HP SmartMemory is required. For additional information, please see the HP SmartMemory QuickSpecs at:

http://h18000.www1.hp.com/products/quickspecs/14225_div/14225_div.html
(Worldwide)

NOTE: HP memory from previous generation servers are not fully compatible with Smart Memory features in Gen8 Servers.

Registered DIMMs (RDIMMs)

HP 4GB (1x4GB) Single Rank x4 PC3L-10600R (DDR3-1333) Registered CAS-9 Low Voltage Memory Kit	647893-B2
HP 4GB (1x4GB) Single Rank x4 PC3-12800R (DDR3-1600) Registered CAS-11 Memory Kit	647895-B2
HP 8GB (1x8GB) Dual Rank x4 PC3L-10600R (DDR3-1333) Registered CAS-9 Low Voltage Memory Kit	647897-B2
HP 8GB (1x8GB) Single Rank x4 PC3-12800R (DDR3-1600) Registered CAS-11 Memory Kit	647899-B2
HP 8GB (1x8GB) Dual Rank x4 PC3-12800R (DDR3-1600) Registered CAS-11 Memory Kit	690802-B2
HP 16GB (1x16GB) Dual Rank x4 PC3L-10600R (DDR3-1333) Registered CAS-9 Low Voltage Memory Kit	647901-B2
HP 16GB (1x16GB) Dual Rank x4 PC3-12800R (DDR3-1600) Registered CAS-11 Memory Kit	672631-B2

Unbuffered with ECC DIMMs (UDIMMs)

HP 2GB (1x2GB) Single Rank x8 PC3-12800E (DDR3-1600) Unbuffered CAS-11 Memory Kit	669320-B2
HP 2GB (1x2GB) Single Rank x8 PC3L-10600E (DDR3-1333) Unbuffered CAS-9 Low Voltage Memory Kit	647905-B2
HP 4GB (1x4GB) Dual Rank x8 PC3-12800E (DDR3-1600) Unbuffered CAS-11 Memory Kit	669322-B2
HP 4GB (1x4GB) Dual Rank x8 PC3L-10600E (DDR3-1333) Unbuffered CAS-9 Low Voltage Memory Kit	647907-B2
HP 8GB (1x8GB) Dual Rank x8 PC3-12800E (DDR3-1600) Unbuffered CAS-11 Memory Kit	669324-B2
HP 8GB (1x8GB) Dual Rank x8 PC3L-10600E (DDR3-1333) Unbuffered CAS-9 Low Voltage Memory Kit	647909-B2

Load Reduced DIMMs (LRDIMMs)

HP 32GB (1x32GB) Quad Rank x4 PC3L-10600L (DDR3-1333) Load Reduced CAS-9 Low Voltage Memory Kit	647903-B2
---	-----------

NOTE: All DDR3 memory option kits consist of one DIMM per kit. For detailed memory configuration rules and guidelines, please use the Online DDR3 Memory Configuration Tool: www.hp.com/go/ddr3memory-configurator.

NOTE: PC3L is a low voltage memory.

NOTE: Depending on the memory configuration and processor model, 1600MHz and 1333MHz memory may operate at a lower speed. Please see the "Memory" section later in this document and the Online Memory Configuration

Configuration Information - Factory Integrated Models

HP Power Supplies	<p>Tool for details at www.hp.com/go/ddr3memory-configurator.</p> <p>NOTE: Prior to making a power supply selection it is highly recommended that the HP Power Advisor is run to determine the right size power supply for your server configuration. The HP Power Advisor is located at: www.hp.com/go/hppoweradvisor.</p> <p>HP Common Slot Platinum Plus Power Supply Kits</p> <p>NOTE: The following Power Supplies offer up to 94% Efficiency support for Intelligent Power Discovery.</p> <p>HP 460W Common Slot Platinum Plus Hot Plug Power Supply Kit 656362-B2</p> <p>HP 750W Common Slot Platinum Plus Hot Plug Power Supply Kit 656363-B2</p> <p>HP 1200W Common Slot Platinum Plus Hot Plug Power Supply Kit 656364-B2</p> <p>HP Common Slot Gold Power Supplies</p> <p>NOTE: The following Power Supplies offer 92% Efficiency.</p> <p>HP 460W Common Slot Gold Hot Plug Power Supply Kit 503296-B2</p> <p>HP 750W Common Slot Gold Hot Plug Power Supply Kit 512327-B2</p> <p>HP Common Slot -48VDC Power Supplies</p> <p>NOTE: The following Power Supplies offer 92% Efficiency.</p> <p>HP 750W Common Slot -48VDC Hot Plug Power Supply Kit 636673-B2</p> <p>NOTE: The HP 750W Common Slot -48VDC power supply does not ship with a power cable. It has been designed with a terminal block connection allowing for custom design of power cords by the user.</p> <p>NOTE: Option Kits for AC power supplies include the power supply and one PDU IEC cable.</p> <p>NOTE: Power Specification and Technical Content for supported power supplies can be found at: http://h18000.www1.hp.com/products/quickspecs/14209_div/14209_div.html</p>
--------------------------	--

Step 3: Choose Additional Factory Integratable Options (only one of the following from each list unless otherwise noted)

HP Cable Options	HP DL380e Gen8 8 LFF FIO Mini SAS Kit	675160-B2
HP I/O Expansion Options	HP DL380e Gen8 CPU1 with SAS Support FIO Riser Kit	661402-B2
HP Rack Kits	HP 2U Friction Gen8 Rail FIO Kit	663476-B2

Step 4: Choose Additional Options for Factory Integration

NOTE: For additional options, please refer to the "Core Options and Additional Options" section below.

Core Options

NOTE: Some options may not be integrated at the factory. Contact your local sales representative for additional information.

HP Unique Options	HP DL380eGen8 HP Fan Kit	667855-B2
	NOTE: Upgrades a non-redundant server with additional hot-plug fans.	
	HP DL380e Gen8 8SFF HDD CAGE Kit	668295-B2
	NOTE: With upgrade of 8SFF Cage, there is no Optical Drive support and an additional storage controller is required for 1:1 CTO Server.	
	HP DL380e Gen8 CPU1 Riser Kit	661404-B2
	HP DL380e Gen8 x16 PCI-E Riser Kit	661628-B2
	HP Graphic Card Power Adapter Kit	663282-B2

HP Processors

Entry Processors

NOTE: All support up to 1066MHz memory speeds.

HP DL380e Gen8 Intel® Xeon® E5-2407 (2.2GHz/4-core/10MB/80W) Processor Kit 661132-B2

HP DL380e Gen8 Intel® Xeon® E5-2403 (1.8GHz/4-core/10MB/80W) Processor Kit 661134-B2

Base Processors

NOTE: All support up to 1333MHz DDR3 memory speeds.

HP DL380e Gen8 Intel® Xeon® E5-2440 (2.4GHz/6-core/15MB/95W) Processor Kit 661124-B2

HP DL380e Gen8 Intel® Xeon® E5-2430 (2.2GHz/6-core/15MB/95W) Processor Kit 661126-B2

HP DL380e Gen8 Intel® Xeon® E5-2430L (2.0GHz/6-core/15MB/60W) Processor Kit 661138-B2

HP DL380e Gen8 Intel® Xeon® E5-2420 (1.9GHz/6-core/15MB/95W) Processor Kit 661128-B2

Performance Processors

NOTE: All support up to 1600MHz DDR3 memory speeds.

HP DL380e Gen8 Intel® Xeon® E5-2470 (2.3GHz/8-core/20MB/95W) Processor Kit 661118-B2

HP DL380e Gen8 Intel® Xeon® E5-2450 (2.1GHz/8-core/20MB/95W) Processor Kit 661120-B2

HP DL380e Gen8 Intel® Xeon® E5-2450L (1.8GHz/8-core/20MB/70W) Processor Kit 661136-B2

NOTE: Up to 2 processors supported.

NOTE: HT indicates that the processor model supports Intel® /Hyper-Threading Technology

NOTE: Turbo2: Intel® Turbo Boost Technology 2.0 provides more computing power when you need it with performance that adapts to spikes in your workload and delivers more performance upside than then previous generation turbo technology.

NOTE: DDR3 speed is the maximum memory speed of the processor. Actual memory speed may depend on the quantity and type of DIMMs installed.

NOTE: For the Intel® C600 Chipset E5-2400 Series, the letter preceding the model number indicates the Product Line (E3, E5, E7); 2400x v#, 2 = number of CPUs in a Node, 4 is socket/segment designation, 00 = Processor SKU, x = L for low power SKUs and v#(not yet designated) = version number.

Core Options

HP Memory

NOTE: To realize the performance memory capabilities listed in this document, HP SmartMemory is required. For additional information, please see the HP SmartMemory QuickSpecs at:

http://h18000.www1.hp.com/products/quickspecs/14225_div/14225_div.html (Worldwide)

NOTE: HP memory from previous generation servers are not fully compatible with Smart Memory features in Gen8 Servers.

Registered DIMMs (RDIMMs)

HP 4GB (1x4GB) Single Rank x4 PC3L-10600R (DDR3-1333) Registered CAS-9 Low Voltage Memory Kit	647893-B21
HP 4GB (1x4GB) Single Rank x4 PC3-12800R (DDR3-1600) Registered CAS-11 Memory Kit	647895-B21
HP 8GB (1x8GB) Dual Rank x4 PC3L-10600R (DDR3-1333) Registered CAS-9 Low Voltage Memory Kit	647897-B21
HP 8GB (1x8GB) Single Rank x4 PC3-12800R (DDR3-1600) Registered CAS-11 Memory Kit	647899-B21
HP 8GB (1x8GB) Dual Rank x4 PC3-12800R (DDR3-1600) Registered CAS-11 Memory Kit	690802-B21
HP 16GB (1x16GB) Dual Rank x4 PC3L-10600R (DDR3-1333) Registered CAS-9 Low Voltage Memory Kit	647901-B21
HP 16GB (1x16GB) Dual Rank x4 PC3-12800R (DDR3-1600) Registered CAS-11 Memory Kit	672631-B21

Unbuffered with ECC DIMMs (UDIMMs)

HP 2GB (1x2GB) Single Rank x8 PC3-12800E (DDR3-1600) Unbuffered CAS-11 Memory Kit	669320-B21
HP 2GB (1x2GB) Single Rank x8 PC3L-10600E (DDR3-1333) Unbuffered CAS-9 Low Voltage Memory Kit	647905-B21
HP 4GB (1x4GB) Dual Rank x8 PC3-12800E (DDR3-1600) Unbuffered CAS-11 Memory Kit	669322-B21
HP 4GB (1x4GB) Dual Rank x8 PC3L-10600E (DDR3-1333) Unbuffered CAS-9 Low Voltage Memory Kit	647907-B21
HP 8GB (1x8GB) Dual Rank x8 PC3-12800E (DDR3-1600) Unbuffered CAS-11 Memory Kit	669324-B21
HP 8GB (1x8GB) Dual Rank x8 PC3L-10600E (DDR3-1333) Unbuffered CAS-9 Low Voltage Memory Kit	647909-B21

Load Reduced DIMMs (LRDIMMs)

HP 32GB (1x32GB) Quad Rank x4 PC3L-10600L (DDR3-1333) Load Reduced CAS-9 Low Voltage Memory Kit	647903-B21
---	------------

NOTE: All DDR3 memory option kits consist of one DIMM per kit. For detailed memory configuration rules and guidelines, please use the Online DDR3 Memory Configuration Tool: www.hp.com/go/ddr3memory-configurator.

NOTE: PC3L is a low voltage memory.

HP Optical Drives

HP 12.7mm Slim SATA DVD ROM JackBlack Optical Drive	652232-B21
HP 12.7mm Slim SATA DVD RW JackBlack Optical Drive	652235-B21

HP Hard Drives

NOTE: The HP ProLiant DL380e Gen8 Smart Storage solutions are equipped with entirely re-designed Small Form Factor (SFF 2.5 in) and Large Form Factor (LFF 3.5 in) hot plug carriers for HP Qualified Hard Drives and Solid State Drives. These new carriers provide status and activity indicators

Core Options

as well as caution indicators for "Do Not Remove".

NOTE: The components of a storage subsystem (e.g. the drive, the HBA/controller, firmware, and the server backplane) should operate at the same data transfer rate or the system bandwidth will be negotiated down to an acceptable level for all components.

NOTE: Hard drives have either a one year or three year warranty; refer to the specific hard drive QuickSpecs for details.

SAS Hot Plug with SmartDrive SFF (2.5-inch) Enterprise Drives

HP 900GB 6G SAS 10K rpm SFF (2.5-inch) SC Enterprise 3yr Warranty Hard Drive	652589-B21
HP 600GB 6G SAS 10K rpm SFF (2.5-inch) SC Enterprise 3yr Warranty Hard Drive	652583-B21
HP 450GB 6G SAS 10K rpm SFF (2.5-inch) SC Enterprise 3yr Warranty Hard Drive	652572-B21
HP 300GB 6G SAS 10K rpm SFF (2.5-inch) SC Enterprise 3yr Warranty Hard Drive	652564-B21
HP 300GB 6G SAS 15K rpm SFF (2.5-inch) SC Enterprise 3yr Warranty Hard Drive	652611-B21
HP 146GB 6G SAS 15K rpm SFF (2.5-inch) SC Enterprise 3yr Warranty Hard Drive	652605-B21

SAS Hot Plug SmartDrive SFF (2.5-inch) Midline Drives

HP 1TB 6G SAS 7.2K rpm SFF (2.5-inch) SC Midline 1yr Warranty Hard Drive	652749-B21
HP 500GB 6G SAS 7.2K rpm SFF (2.5-inch) SC Midline 1yr Warranty Hard Drive	652745-B21

SAS Hot Plug SmartDrive LFF (3.5-inch) Enterprise Drives

HP 600GB 6G SAS 15K rpm LFF (3.5-inch) SC Enterprise 3yr Warranty Hard Drive	652620-B21
HP 450GB 6G SAS 15K rpm LFF (3.5-inch) SC Enterprise 3yr Warranty Hard Drive	652615-B21

SAS Hot Plug SmartDrive LFF (3.5-inch) Midline Drives

HP 3TB 6G SAS 7.2K rpm LFF (3.5-inch) SC Midline 1yr Warranty Hard Drive	652766-B21
HP 2TB 6G SAS 7.2K rpm LFF (3.5-inch) SC Midline 1yr Warranty Hard Drive	652757-B21
HP 1TB 6G SAS 7.2K rpm LFF (3.5-inch) SC Midline 1yr Warranty Hard Drive	652753-B21

NOTE: Please see the QuickSpecs for Technical Specifications and additional information:

http://h18000.www1.hp.com/products/quickspecs/12244_div/12244_div.html (Worldwide)

6G SATA Hot Plug with SmartDrive SFF (2.5-inch) Midline (MDL) Drives

HP 1TB 6G SATA 7.2K rpm SFF (2.5-inch) SC Midline 1yr Warranty Hard Drive	655710-B21
HP 500GB 6G SATA 7.2K rpm SFF (2.5-inch) SC Midline 1yr Warranty Hard Drive	655708-B21

6G SATA Hot Plug with SmartDrive LFF (3.5-inch) Midline (MDL) Drives

HP 3TB 6G SATA 7.2K rpm LFF (3.5-inch) SC Midline 1yr Warranty Hard Drive	628061-B21
HP 2TB 6G SATA 7.2K rpm LFF (3.5-inch) SC Midline 1yr Warranty Hard Drive	658079-B21

Core Options

HP 1TB 6G SATA 7.2K rpm LFF (3.5-inch) SC Midline 1yr Warranty Hard Drive 657750-B21

HP 500GB 6G SATA 7.2K rpm LFF (3.5-inch) SC Midline 1yr Warranty Hard Drive 658071-B21

NOTE: Please see the QuickSpecs for Technical Specifications and additional information:

http://h18000.www1.hp.com/products/quickspecs/13021_div/13021_div.html (Worldwide)

6G SAS MLC Hot Plug SFF (2.5-inch) Enterprise Mainstream Solid State Drives

HP 800GB 6G SAS MLC SFF (2.5-inch) SC Enterprise Mainstream 3yr Warranty Solid State Drive 653109-B21

HP 400GB 6G SAS MLC SFF (2.5-inch) SC Enterprise Mainstream 3yr Warranty Solid State Drive 653105-B21

HP 200GB 6G SAS MLC SFF (2.5-inch) SC Enterprise Mainstream 3yr Warranty Solid State Drive 658478-B21

6G SAS SLC Hot Plug SFF (2.5-inch) Enterprise Performance Solid State Drives

HP 400GB 6G SAS SLC SFF (2.5-inch) SC Enterprise Performance 3yr Warranty Solid State Drive 653082-B21

HP 200GB 6G SAS SLC SFF (2.5-inch) SC Enterprise Performance 3yr Warranty Solid State Drive 653078-B21

3G SATA MLC Hot Plug SFF (2.5-inch) Enterprise Mainstream Solid State Drives

HP 400GB 3G SATA MLC SFF (2.5-inch) SC Enterprise Mainstream 3yr Warranty Solid State Drive 653120-B21

HP 200GB 3G SATA MLC SFF (2.5-inch) SC Enterprise Mainstream 3yr Warranty Solid State Drive 653118-B21

HP 100GB 3G SATA MLC SFF (2.5-inch) SC Enterprise Mainstream 3yr Warranty Solid State Drive 653112-B21

3G SATA MLC Hot Plug LFF (3.5-inch) Enterprise Mainstream Solid State Drives

HP 400GB 3G SATA MLC LFF (3.5-inch) SC Enterprise Mainstream 3yr Warranty Solid State Drive 653126-B21

HP 200GB 3G SATA MLC LFF (3.5-inch) SC Enterprise Mainstream 3yr Warranty Solid State Drive 653124-B21

HP 100GB 3G SATA MLC LFF (3.5-inch) SC Enterprise Mainstream 3yr Warranty Solid State Drive 653122-B21

NOTE: Please see the QuickSpecs for Technical Specifications and additional information:

http://h18000.www1.hp.com/products/quickspecs/14038_div/14038_div.html (Worldwide)

Hard Drive Kits

NOTE: All Factory Integrated Models will be populated with sufficient hard drive blanks based on the number of initial hard drives ordered with the server.

HP LFF Gen8 Hard Drive Blank Kit 666986-B21

HP SFF Gen8 Hard Drive Blank Kit 666987-B21

HP 2U Gen8 Rear 2LFF Kit 663278-B21

NOTE: Supports 2 hot plug drives in the back of server and the kit includes multiple cable options which allow connections between rear, front backplanes and also between rear backplane, motherboard.

Core Options

HP 2U Gen8 Rear 2SFF Kit	663280-B21
NOTE: Supports 2 hot plug drives in the back of server and the kit includes multiple cable options which allow connections between rear, front backplanes and also between rear backplane, motherboard.	
HP DL380eGen8 8SFF HDD CAGE Kit	668295-B21
NOTE: Provides support for an additional 8 SFF drives. Requires a separate controller. HP recommends the Smart Array P420 controller with 1Gb of FBWC.	
Hard Drive Cables	
HP Gen8 2-port SATA Cable Kit	675856-B21
NOTE: This cable allows the customer to upgrade their B120i-based configuration to support up to 6 LFF SATA drives.	

HP Networking

Gigabit Ethernet adapters

HP NC112T PCI Express Gigabit Server Adapter	503746-B21
HP NC365T 4-port Ethernet Server Adapter	593722-B21
HP Ethernet 1Gb 4-port 331T Adapter	647594-B21
HP Ethernet 1Gb 2-port 332T Adapter	615732-B21
HP Ethernet 1Gb 2-port 361T Adapter	652497-B21

10 Gigabit Ethernet Adapters

NOTE: A minimum of two Gigabytes (2 GB) of server memory is required per each adapter.

NOTE: Direct Attach Cable (DAC) for copper environments or fiber transceivers and cables for fiber-optic environments must be purchased separately.

HP NC523SFP 10Gb 2-port Server Adapter	593717-B21
HP Ethernet 10Gb 2-port 530SFP Adapter	652503-B21
HP NC552SFP 10Gb 2-port Ethernet Server Adapter	614203-B21

NOTE: Please see the QuickSpecs for Technical Specifications and additional information: www.hp.com/go/ProLiantNICs

HP InfiniBand

QLogic InfiniBand 4X QDR PCI-E G2 Dual Port HCA	583211-B21
HP InfiniBand 4X QDR ConnectX-2 PCIe G2 Dual Port HCA	592520-B21
HP InfiniBand FDR/EN 10/40Gb Dual Port 544QSFP Adapter	649281-B21

NOTE: Please see the QuickSpecs for additional information: http://h18000.www1.hp.com/products/quickspecs/13078_div/13078_div.html

HP I/O Expansion Options

HP DL380e Gen8 CPU1 Riser Kit	661404-B21
NOTE: This kit provides three slots that run off of first processor.	
HP DL380e Gen8 x16 PCI-E Riser Kit	661628-B21
NOTE: This kit provides two additional slots that run off of second processor.	

Core Options

HP Power Supplies	<p>NOTE: Prior to making a power supply selection it is highly recommended that the HP Power Advisor is run to determine the right size power supply for your server configuration. The HP Power Advisor is located at: www.hp.com/go/hppoweradvisor.</p> <p>HP Common Slot Platinum Plus Power Supply Kits NOTE: The following Power Supplies offer 94% Efficiency with support for Intelligent Power Discovery.</p> <p>HP 460W Common Slot Platinum Plus Hot Plug Power Supply Kit 656362-B21 HP 750W Common Slot Platinum Plus Hot Plug Power Supply Kit 656363-B21 HP 1200W Common Slot Platinum Plus Hot Plug Power Supply Kit 656364-B21</p> <p>HP Common Slot Gold Power Supplies NOTE: The following Power Supplies offer 92% Efficiency.</p> <p>HP 460W Common Slot Gold Hot Plug Power Supply Kit 503296-B21 HP 750W Common Slot Gold Hot Plug Power Supply Kit 512327-B21</p> <p>HP Common Slot -48VDC Power Supplies NOTE: The following Power Supplies offer 92% Efficiency.</p> <p>HP 750W Common Slot -48VDC Hot Plug Power Supply Kit 636673-B21 NOTE: The HP 750W Common Slot -48VDC power supply does not ship with a power cable. It has been designed with a terminal block connection allowing for custom design of power cords by the user. NOTE: Option Kits contain optional power supply, an IEC power cable and PDU IEC cables. NOTE: Power Specification and Technical Content for supported power supplies can be found at: http://h18000.www1.hp.com/products/quickspecs/14209_div/14209_div.html</p>	
HP Graphic Options	<p>HP Graphic Card Power Adapter Kit 663282-B21 NOTE: The adapter kit is used to provide power to high-wattage cards (example: graphics cards) that require up to 225W of power. NOTE: High wattage cards are supported on the x16 FL/FH slot which is controlled by the second processor. p/n 661628-b21 is required.</p> <p>NVIDIA Quadro 4000 2GB PCI-E Adapter 655933-B21 NOTE: Only the following OS types are supported: 64-bit Only: Red Hat Enterprise Linux 5.x, Red Hat Enterprise Linux 6.x, SUSE Linux Enterprise Server 11 SPx. 64-bit Only: Windows Server 2008 R2 SPx.</p> <p>NVIDIA Quadro 6000 6GB PCI-E Adapter 655935-B21 NOTE: Only the following OS types are supported: 64-bit Only: Red Hat Enterprise Linux 5.x, Red Hat Enterprise Linux 6.x, SUSE Linux Enterprise Server 11 SPx. 64-bit Only: Windows Server 2008 R2 SPx.</p>	
HP Cooling Options	<p>HP DL380eGen8 HP Fan Kit 667855-B21 NOTE: This kit contains a single fan and is used to upgrade non-redundant configurations to redundant configurations.</p>	

Additional Options

NOTE: Some options may not be integrated at the factory. To ensure only valid configurations are ordered, HP recommends the use of an HP approved configurator. Contact your local sales representative for additional information.

HP Insight Software	HP Insight Control	
	HP Insight Control including 1yr 24x7 Technical Support and Updates Electronic License	T9074BAE
	HP Insight Control including 1yr 24x7 Technical Support and Updates Single Server License	452148-B22
	HP Insight Management Media Kit	436222-B21
	NOTE: HP Insight Management Media Kit contains DVDs without licenses. Contains HP Systems Insight Manager, HP Insight Control, HP Matrix Operating Environment, and Virtual Connect Enterprise Manager software. Uses an integrated installer to perform quick and accurate software installation and updates.	
	HP Insight Control Server Deployment	
	HP Insight Control Server Deployment including 1yr 24x7 Support Electronic License	T9082AAE
	HP Insight Control Server Deployment including 1yr 24x7 Support Single Server License	452151-B21
	NOTE: Electronic and Flexible-Quantity licenses can be used to purchase multiple licenses with a single activation key.	
	NOTE: Customer will receive a license entitlement certificate. The license entitlement certificate must be redeemed online or via fax in order to obtain the license activation key(s). Includes one year of 24 x 7 HP Software Technical Support and Update Service.	
	NOTE: Licenses ship without media. The HP Insight Management Media Kit can be ordered separately, or can be downloaded at: http://www.hp.com/go/insightupdates .	
	NOTE: For additional license options please see the Insight Control QuickSpecs at: http://h18000.www1.hp.com/products/quickspecs/12631_div/12631_div.html	
	HP Insight Control for Linux	
	HP Insight Control for Linux including 1yr 24x7 Support Electronic License	TC213AAE
	HP Insight Control for Linux including 1yr 24x7 Support Single Server License	TC209A
	HP Insight Control for Linux Media Kit	TC208A
	NOTE: Media pack DVD contains the ISO image for HP Insight Control for Linux, HP Systems Insight Manager, HP Insight Control power management, HP Insight Control virtual machine management, and an integrated installer. Servers must be acquired separately.	
	NOTE: Licenses ship without media. The Media Kit for Insight Control for Linux can be ordered separately, or can be downloaded at: http://www.hp.com/go/ic-linux (click on Download button).	
	NOTE: Electronic and Flexible-Quantity licenses can be used to purchase multiple licenses with a single set of activation keys.	
	NOTE: For additional License Kits, including electronic licensing options, please see the QuickSpecs at: http://h18000.www1.hp.com/products/quickspecs/13019_div/13019_div.html	

Additional Options

HP iLO Advanced License	HP Integrated Lights-Out (iLO) Advanced for ProLiant Remote Management HP iLO Advanced including 1yr 24x7 Technical Support and Updates Single Server License NOTE: For more information, visit: http://www.hp.com/go/ilo .	512485-B21
--------------------------------	--	------------

High Performance Clusters	HP Cluster Management Utility HP Insight Cluster Management Utility 1yr 24x7 Flexible License QL803B HP Insight Cluster Management Utility 3yr 24x7 Flexible License BD476A NOTE: These part numbers can be used to purchase one certificate for multiple licenses and support with a single activation key. Each license is for one node (server). Customer will receive a printed end user license agreement and license entitlement certificate via physical shipment. The license entitlement certificate must be redeemed online in order to obtain a license key. Customer also will receive a support agreement. HP Insight Cluster Management Utility Media BD477A NOTE: For additional license kits please see the QuickSpecs at: http://h18004.www1.hp.com/products/quickspecs/12612_div/12612_div.html HP HPC Linux Value Pack HP High Performance Computing Linux Value Pack 1 Processor Flexible License TC293B NOTE: This part number can be used to purchase one certificate for multiple licenses with a single activation key. Each license is for one socket (a.k.a. processor). Customer will receive a printed end user license agreement and license entitlement certificate via physical shipment. The license entitlement certificate must be redeemed online in order to obtain a license key. HP High Performance Computing Linux Value Pack Media Kit TC294A NOTE: This part number can be used to purchase media including software and documentation, which will be delivered to the customer. NOTE: For additional license kits please see the QuickSpecs at: http://h18004.www1.hp.com/products/quickspecs/13485_div/13485_div.html
----------------------------------	--

HP I/O Accelerator Options	HP 160GB Single Level Cell PCIe ioDrive for ProLiant Servers 600278-B21 NOTE: A low-profile PCI bracket is included for use in low-profile slots. HP 320GB Multi Level Cell PCIe ioDrive for ProLiant Servers 600279-B21 NOTE: A low-profile PCI bracket is included for use in low-profile slots. HP 320GB Single Level Cell PCIe ioDrive Duo for ProLiant Servers 600281-B21 HP 640GB Multi Level Cell PCIe ioDrive Duo for ProLiant Servers 600282-B21 HP 1.28TB Multi Level Cell PCIe ioDrive Duo for ProLiant Servers 641027-B21 NOTE: Please see the QuickSpecs for Technical Specifications and additional information: http://h18000.www1.hp.com/products/quickspecs/13587_div/13587_div.html (Worldwide)
-----------------------------------	--

Additional Options

HP Security	<p>HP Trusted Platform Module Option 488069-B21</p> <p>NOTE: The TPM (Trusted Platform Module) is a microcontroller chip that can securely store artifacts used to authenticate the server platform. These artifacts can include passwords, certificates and encryption keys. Windows® BitLocker™ Drive Encryption (BitLocker) is a data protection feature available in Windows Server® 2008. BitLocker leverages the enhanced security capabilities of a Trusted Platform Module (TPM) version 1.2. The TPM works with BitLocker to help protect user data and to ensure that a server running Windows Server 2008 has not been tampered with while the system was offline. For more information about TPM, including a white paper, go to: www.hp.com/go/TPM.</p> <p>NOTE: ProLiant OS pre-installed units will come with the partition required for TPM deployment.</p> <p>NOTE: The TPM key is unique to every TPM deployed server and must be retained. Misplacing or losing the key could result in data loss.</p>
	<p>HP 2U Security Bezel Kit 666988-B21</p>

HP Storage Controllers	<p>SAS Controllers</p> <p>Smart Array P222 Controller</p> <p>HP Smart Array P222/512 FBWC 6Gb 1-port Int/1-port Ext SAS Controller 631667-B21</p> <p>Smart Array P420 Controller</p> <p>HP Smart Array P420/1GB FBWC 6Gb 2-ports Int SAS Controller 631670-B21</p> <p>HP Smart Array P420/2GB FBWC 6Gb 2-ports Int SAS Controller 631671-B21</p> <p>Smart Array P421 Controller</p> <p>HP Smart Array P421/1GB FBWC 6Gb 2-ports Ext SAS Controller 631673-B21</p> <p>HP Smart Array P421/2GB FBWC 6Gb 2-ports Ext SAS Controller 631674-B21</p> <p>Smart Array P822 Controller</p> <p>HP Smart Array P822/2GB FBWC 2-ports Int/4-ports Ext SAS Controller 615418-B21</p> <p>Optional Upgrades</p> <p>HP 2GB P-series Smart Array Flash Backed Write Cache 631681-B21</p> <p>HP 512MB B-series 36 inch Dynamic Smart Array Flash Backed Write Cache for ML/DLs 631922-B21</p> <p>NOTE: This kit includes a cable and cache module that is used in conjunction with the B320i controller.</p> <p>HP Smart Array Advanced Pack 2.0 No Media 1 Server 1yr 24x7 Support Software BC377A</p> <p>HP Smart Array Advanced Pack 2.0 No Media Electronic Lic 1yr 24x7 Support Software BC390AAE</p> <p>HP SAS License Key No Media 1 Svr 1yr 24x7 Support for B320i BC393A</p> <p>NOTE: HP Dynamic Smart Array SAS License key for B320i only.</p> <p>HP Smart Array Advanced Pack 2.0 No Media 1 Server 1yr 24x7 Support Software BC377A</p> <p>HP DL380e Gen8 Smart Array Cable Kit 672250-B21</p> <p>NOTE: Please see the QuickSpecs for Technical Specifications and additional information:</p> <p>http://h18000.www1.hp.com/products/quickspecs/14227_div/14227_div.html (Smart Array P222 Controller)</p> <p>http://h18000.www1.hp.com/products/quickspecs/14228_div/14228_div.html (Smart Array P420 Controller)</p> <p>http://h18000.www1.hp.com/products/quickspecs/14229_div/14229_div.html (Smart Array P421 Controller)</p> <p>http://h18000.www1.hp.com/products/quickspecs/14341_div/14341_div.html</p>
-------------------------------	---

Additional Options

(Smart Array P822 Controller)

http://h18000.www1.hp.com/products/quickspecs/13200_div/13200_div.html

(Smart Array Advanced Pack)

Host Bus Adapter

HP H220 Host Bus Adapter

650933-B21

HP H221 Host Bus Adapter

650931-B21

HP H222 Host Bus Adapter

650926-B21

NOTE: Please see the QuickSpecs for Technical Specifications and additional information:

http://h18004.www1.hp.com/products/quickspecs/14336_div/14336_div.html

(HBA 220)

http://h18004.www1.hp.com/products/quickspecs/14222_div/14222_div.html

(HBA 221)

http://h18004.www1.hp.com/products/quickspecs/14337_div/14337_div.html

(HBA 222)

HP Power Cords

NOTE: HP ProLiant servers ships with an IEC-IEC power cord used for rack mounting with Power Distribution Units (PDUs).

HP C13 - SEV 1011 CH 250V 10Amp 1.83m Power Cord

AF565A

HP C13 - DK-2.5A DK 250V 10Amp 1.83m Power Cord

AF566A

HP C13 - CEE-VII EU 250V 10Amp 1.83m Power Cord

AF568A

HP C13 - BS-1363A UK/HK/SG 250V 10Amp 1.83m Power Cord

AF570A

HP C13 - CEI-23-50 IT/CL 250V 10Amp 1.83m Power Cord

AF571A

HP C13 - SABS-164 ZA 250V 10Amp 2.5m Power Cord

AF567A

HP C13 - Nema 6-15P US 250V 15A JP 3.6m Power Cord

A0N33A

HP C13 - Nema 5-15P US/CA 110V 10Amp 1.83m Power Cord

AF556A

HP Cable Options

HP Premier Flex LC/LC Multi-mode OM4 2 fiber 15m Cable

QK735A

HP Premier Flex LC/LC Multi-mode OM4 2 fiber 1m Cable

QK732A

HP Premier Flex LC/LC Multi-mode OM4 2 fiber 2m Cable

QK733A

HP Premier Flex LC/LC Multi-mode OM4 2 fiber 30m Cable

QK736A

HP Premier Flex LC/LC Multi-mode OM4 2 fiber 50m Cable

QK737A

HP Premier Flex LC/LC Multi-mode OM4 5 fiber 1m Cable

QK734A

HP Backup & Recovery Software

HP Data Protector Express

HP Basic Upgrade to Data Protector Express V6 for 1 Server E-LTU

TC333BAE

HP Data Protector Express V6.0 for 10 Server E-LTU

TC332BAE

HP Data Protector Express V6.0 for 1 Server E-LTU

TC330BAE

HP Data Protector Express V6.0 for 3 Server E-LTU

TC331BAE

NOTE: One of these Data Protector Express base products is required. To see available options: <http://www.hp.com/go/dataprotectorexpress>

Additional Options

HP Tape Backup

NOTE: For the complete range of tape drives, autoloaders, libraries and media see: <http://www.hp.com/go/tape>. For hardware and software compatibility of HP tape backup products see: <http://www.hp.com/storage/SPOCK>

HP 1/8 G2 Ultrium 920 SAS Autoloader	AH558A
HP LTO-5 Ultrium 3000 SAS Tape Drive in 1U Rackmount	EJ014A
NOTE: Connection using HP Smart Array P222 Controller (631667-B21) recommended.	
HP MSL2024 1 LTO-5 Ultrium 3000 SAS Tape Library	BL537A
HP MSL2024 Ultrium 920 SAS Tape Library	AH559A
HP 1U USB Rack-Mount Kit	A8007B
HP 1U SAS Rack Mount Kit	AE459B

HP Disk Backup

NOTE: For the complete range of RDX drives and media see: <http://www.hp.com/go/rdx>. For hardware and software compatibility of HP disk backup products see: <http://www.hp.com/storage/SPOCK>.

HP D2D Backup Systems with Backup Data Deduplication

HP D2D2502i Backup System	EJ001C
HP D2D2504i Backup System	EJ002C

HP RDX Removable Disk Backup Systems USB

HP RDX320 Internal Removable Disk Backup System	AJ767A
---	--------

NOTE: For installation into 1U USB Rack-Mount Kit (A8007A). No peripheral bay available for drive installation into the server. 320GB of disk capacity per data cartridge

HP RDX500 Internal Removable Disk Backup System	AJ934A
---	--------

NOTE: For installation into 1U USB Rack-Mount Kit (A8007A). No peripheral bay available for drive installation into the server. 500GB of disk capacity per data cartridge.

HP RDX1000 Internal Removable Disk Backup System	BV847A
--	--------

NOTE: For installation into 1U USB Rack-Mount Kit (A8007A). No peripheral bay available for drive installation into the server. 1 TB of disk capacity per data cartridge.

HP Storage Options

Storage Fibre Channel HBA

NOTE: For the complete listing of Fibre Channel Host Bus Adapters for Windows 2000, Windows Server 2003 and Linux, please see: <http://h18006.www1.hp.com/storage/saninfrastructure/hba.html>

Brocade Fibre Channel HBAs

HP 81B 8Gb 1-port PCIe Fibre Channel Host Bus Adapter	AP769A
HP 82B 8Gb 2-port PCIe Fibre Channel Host Bus Adapter	AP770A

Emulex Fibre Channel HBAs

HP 81E 8Gb 1-port PCIe Fibre Channel Host Bus Adapter	AJ762A
HP 82E 8Gb 2-port PCIe Fibre Channel Host Bus Adapter	AJ763A

QLogic Fibre Channel HBAs

HP 81Q 8Gb 1-port PCIe Fibre Channel Host Bus Adapter	AK344A
HP 82Q 8Gb 2-port PCIe Fibre Channel Host Bus Adapter	AJ764A

Converged Network Adapter

HP CN1100E Dual Port Converged Network Adapter	BK835A
HP CN1000Q Dual Port Converged Network Adapter	BS668A

Additional Options

HP Disk Storage Systems

Disk Enclosures

HP D2000 Disk Enclosures

HP D2600 Disk Enclosure

AJ940A

HP D2700 Disk Enclosure

AJ941A

NOTE: Please see the QuickSpecs for additional options and configuration information at:

http://h18000.www1.hp.com/products/quickspecs/13404_div/13404_div.html

HP Uninterruptible Power Systems

HP Rack-mountable UPS

HP R1500 G3 Uninterruptible Power Supply (UPS)

HP R1.5kVA G3 1U NA Uninterruptible Power System

AF46C

HP R1.5kVA G3 1U JP/TW Uninterruptible Power System

AF47C

HP R1.5kVA G3 1U INTL Uninterruptible Power System

AF471

NOTE: Please see the QuickSpecs for additional information:

http://h18000.www1.hp.com/products/quickspecs/14059_div/14059_div.html
(Worldwide)

HP R/T3000 G2 Uninterruptible Power System (UPS)

HP R/T3000 G2 2U L530 Low Voltage NA/JP Uninterruptible Power System

AF46E

HP R/T3000 G2 2U L620 High Voltage NA/JP Uninterruptible Power System

AF467

HP R/T3000 G2 2U Detachable Cord High Voltage INTL Uninterruptible Power System

AF46E

NOTE: Please see the QuickSpecs for additional information:

http://h18000.www1.hp.com/products/quickspecs/14058_div/14058_div.html
(Worldwide)

NOTE: For additional information on HP Uninterruptible Power Systems please go to: www.hp.com/servers/rackups.

NOTE: For additional information on sizing your server, please reference: <http://www.upssizer.com>.

NOTE: Please see the UPS and PDU cable matrix's on the HP Power Protection and Management page. Under Power Cords, click on the "HP Power Cord Matrix" link. That link will list cable descriptions, requirements, and specifications for UPS and PDU units. Please see the following link:

www.hp.com/products/powercords.

HP Power Distribution Units

Monitored PDUs

HP Monitored Power Distribution Unit: Full Rack Version

HP 17.3kVA 24A Dual Three Phase NA/JP Monitored Power Distribution Unit

AF50C

HP 8.6kVA 24A Single Input Three Phase NA/JP Monitored Power Distribution Unit

AF50A

HP 16.6kVA 40A Dual Input Single Phase NA/JP Monitored Power Distribution Unit

AF50E

HP 8.3kVA 40A Single Input Single Phase NA/JP Monitored Power Distribution Unit

AF50E

HP 22.1kVA 16A Dual Input Three Phase INTL Monitored Power Distribution Unit

AF507

HP 11kVA 16A Single Input Three Phase INTL Monitored Power Distribution Unit

AF50E

HP 14.7kVA 32A Dual Input Single Phase INTL Monitored Power Distribution Unit

AF50C

Additional Options

HP 7.3kVA 32A Single Input Single Phase INTL Monitored Power Distribution Unit AF51C

HP Monitored Power Distribution Unit: Half Rack Version

HP 4.9kVA 24A Single Input Single Phase NA/JP Monitored Power Distribution Unit AF914

HP 7.3kVA 32A Single Input Three Phase INTL Intelligent Modular Power Distribution Unit AF53E

HP 17.3kVA 48A Single Input Three Phase NA/JP Monitored Power Distribution Unit AF91C

HP 7.3kVA 32A Single Input Single Phase INTL Monitored Power Distribution Unit AF91E

HP 22kVA 32A Single Input Three Phase INTL Monitored Power Distribution Unit AF917

NOTE: Please see the QuickSpecs for Technical Specifications and additional information:

http://h18000.www1.hp.com/products/quickspecs/12118_div/12118_div.html

Modular PDUs 1U/0U

NOTE: 1U/0U mounting brackets shipped with the unit (optimized for 10000 G2 and 9000 series racks).

HP 3.6kVA 16A High Voltage INTL Modular Power Distribution Unit 252663-B2

HP 4.9kVA 24A High Voltage NA/JP Modular Power Distribution Unit 252663-D7

HP 8.3kVA 40A High Voltage INTL Modular Power Distribution Unit 252663-B2

HP 8.3kVA 40A High Voltage NA/JP Modular Power Distribution Unit 252663-D7

HP 7.3kVA 32A High Voltage INTL Modular Power Distribution Unit 252663-B3

HP 9.2kVA 40A High Voltage INTL Modular Power Distribution Unit 252663-B3

HP 22kVA 32A Three Phase INTL Core Modular Power Distribution Unit AF51E

NOTE: For additional information on HP Power Distribution Units including accessories please go to: www.hp.com/go/pdu.

NOTE: Please see the UPS and PDU cable matrix's on the HP Power Protection and Management page. Under Power Cords, click on the "HP Power Cord Matrix" link. That link will list cable descriptions, requirements, and specifications for UPS and PDU units. Please see the following link:

www.hp.com/products/powercords.

NOTE: This PDU has a detachable input power cord and allows for adaptability to country specific power requirements.

NOTE: Please see the following QuickSpecs for additional options including shorter jumper cables and country specific power cords:

http://h18000.www1.hp.com/products/quickspecs/11041_div/11041_div.html
(Worldwide)

Additional Options

HP Intelligent Power Distribution Units (iPDU)	iPDU Core Units	
	HP 4.9kVA 24A Single Phase NA/JP Core Intelligent Modular Power Distribution Unit	AF52C
	HP 8.3kVA 40A Single Phase NA/JP Core Intelligent Modular Power Distribution Unit	AF521
	HP 8.6kVA 24A Three Phase NA/JP Core Intelligent Modular Power Distribution Unit	AF522
	HP 14.4kVA 40A Three Phase NA/JP Intelligent Modular Power Distribution Unit	AF533
	HP 17.3kVA 48A Three Phase NA/JP Core Intelligent Modular Power Distribution Unit	AF523
	HP 11.4kVA 16A 415V Three Phase L22-20 NA Core Intelligent Power Distribution Unit	AF90C
	HP 17.3kVA 24A 415V Three Phase L22-30 NA Core Intelligent Power Distribution Unit	AF902
	HP 17.3kVA 24A 415V Three Phase IEC309 NA Core Intelligent Power Distribution Unit	AF901
	HP 7.3kVA 32A Single Phase INTL Core Intelligent Modular Power Distribution Unit	AF52E
	HP 11kVA 16A Three Phase INTL Core Intelligent Modular Power Distribution Unit	AF52E
	HP 22kVA 32A Three Phase INTL Core Intelligent Modular Power Distribution Unit	AF527
	HP 17.3kVA 48A 208V Three Phase 12 Outlet Core NA/JP Intelligent Power Distribution Unit	AF53E
	HP 17.3kVA 24A 415V Three Phase 12 Outlet Core NA/JP Intelligent Power Distribution Unit	AF537
	HP 22kVA 32A 400V Three Phase 12 Outlet Core INTL Intelligent Power Distribution Unit	AF53E
	iPDU Kits with Standard Extension Bars	
	HP 4.9kVA 24A Single Phase NA/JP Intelligent Modular Power Distribution Kit	AF531
	HP 8.6kVA 24A Three Phase NA/JP Intelligent Modular Power Distribution Kit	AF532
	HP 7.3kVA 32A Single Phase INTL Intelligent Modular Power Distribution Kit	AF534
	iPDU Extension Bars	
HP 5xC13 Outlets Power and UID LEDs Pair Standard Extension Bar	AF52E	
NOTE: Please see the QuickSpecs for Technical Specifications and additional information:		
http://h18000.www1.hp.com/products/quickspecs/13650_div/13650_div.html		
(Worldwide)		

Additional Options

HP Rack Series

HP Rack 10000 G2 Series (Carbon/Graphite Metallic)

HP 10642 G2 1200mm deep Shock Rack

AF092

HP 10647 G2 1200mm deep Shock Rack

AF094

NOTE: It is mandatory to use a shock pallet when shipping racks with equipment installed.

NOTE: Please see the QuickSpecs for Technical Specifications and additional information:

http://h18000.www1.hp.com/products/quickspecs/12402_div/12402_div.html
(Worldwide)

NOTE: For additional information regarding Rack Cabinets, please see the following URL: <http://www.hp.com/go/rackandpower>.

NOTE: The increasing power of new high-performance processor technology requires increased cooling efficiency for rack-mounted servers. The 10000 G2 Series Racks provide enhanced airflow for maximum cooling, allowing these racks to be fully loaded with servers using the latest processors.

CAUTION: If a third-party rack is used, observe the following additional requirements to ensure adequate airflow and to prevent damage to the equipment: Front and rear doors: If your 42U server rack includes closing front and rear doors, you must allow 830 square inches (5,350 sq cm) of hole evenly distributed from top to bottom to permit adequate airflow (equivalent to the required 64 percent open area for ventilation). Side: The clearance between the installed rack component and the side panels of the rack must be a minimum of 2.75 inches (7 cm).

CAUTION: Always use blanking panels to fill all remaining empty front panel U-spaces in the rack. This arrangement ensures proper airflow. Using a rack without blanking panels results in improper cooling that can lead to thermal damage.

NOTE: Quick deploy rail system provides tool-free support for racks with square or round mounting holes (including Compaq/HP 7000, 9000, 10000 G2 and HP series), with an adjustment range of 24" - 36". The ambidextrous cable management arm can be mounted on either the left or right side for improved cable management.

NOTE: High Airflow Inserts (High Air Flow Rack Door Insert for the 7142 Rack (single) - PN: 327281-B21; or High Air Flow Rack Door Insert for the 7142 Rack (6-pack) - PN: 327281-B22) are required to support the server in the 7000 series racks. The DL380e Cable Management Arm is not supported on 7000 series racks.

NOTE: Cable management arm must be removed to access hot-plug power supplies when the cable management arm is mounted on the right.

HP Rack Options

HP USB Keyboard and Mouse

HP USB BFR-PVC US Keyboard/Mouse Kit	631341-B21
HP USB BFR with PVC Free UK Keyboard/Mouse Kit	631344-B21
HP USB BFR with PVC Free FR Keyboard/Mouse Kit	631346-B21
HP USB BFR with PVC Free ES Keyboard/Mouse Kit	631348-B21
HP USB BFR with PVC Free DE Keyboard/Mouse Kit	631358-B21
HP USB BFR with PVC Free JP Keyboard/Mouse Kit	631360-B21
HP USB BFR with PVC Free IT Keyboard/Mouse Kit	631362-B21
HP USB BFR with PVC Free CN Keyboard/Mouse Kit	631364-B21
HP USB BFR with PVC Free AE Keyboard/Mouse Kit	638212-B21
HP USB BFR with PVC Free RU Keyboard/Mouse Kit	638214-B21
HP USB BFR with PVC Free AP-Intl Keyboard/Mouse Kit	672097-373
HP USB BFR with PVC Free Intl Keyboard/Mouse Kit	672097-B33

Additional Options

HP USB BFR with PVC Free PT Keyboard/Mouse Kit	672097-133
HP USB BFR with PVC Free TR Keyboard/Mouse Kit	672097-143
HP USB BFR with PVC Free CZ Keyboard/Mouse Kit	672097-223
HP USB BFR with PVC Free FI Keyboard/Mouse Kit	672097-353
HP USB BFR with PVC Free SE Keyboard/Mouse Kit	672097-103
HP USB BFR with PVC Free CH Keyboard/Mouse Kit	672097-113
HP USB BFR with PVC Free KR Keyboard/Mouse Kit	672097-KD3
HP USB BFR with PVC Free IN Keyboard/Mouse Kit	672097-D63

NOTE: Please see the QuickSpecs for Technical Specifications and additional information:

http://h18000.www1.hp.com/products/quickspecs/13972_div/13972_div.html
(Worldwide)

HP Server Console Switches

HP Server Console 0x2x8 Port Analog Switch	AF616A
HP Server Console 0x2x16 Port Analog Switch	AF617A

NOTE: Please see the QuickSpecs for Technical Specifications and additional information:

http://h18000.www1.hp.com/products/quickspecs/11834_div/11834_div.html
(Worldwide)

HP Server Console Switch G2 with Virtual Media & CAC

HP 0x2x16 KVM Server Console Switch G2 with Virtual Media CAC Software	AF618A
HP 0x2x32 KVM Server Console Switch G2 with Virtual Media CAC Software	AF619A

NOTE: Please see the QuickSpecs for Technical Specifications and additional information:

http://h18000.www1.hp.com/products/quickspecs/13475_div/13475_div.html
(Worldwide)

HP IP Console Switch G2 with Virtual Media & CAC

HP 1x1Ex8 KVM IP Console Switch G2 with Virtual Media CAC Software	AF620A
HP 2x1Ex16 KVM IP Console Switch G2 with Virtual Media CAC Software	AF621A
HP 4x1Ex32 KVM IP Console Switch G2 with Virtual Media CAC Software	AF622A

NOTE: Please see the QuickSpecs for Technical Specifications and additional information:

http://h18000.www1.hp.com/products/quickspecs/13474_div/13474_div.html
(Worldwide)

Rail Kits

HP 2U Large Form Factor Ball Bearing Gen8 Rail Kit	663480-B21
--	------------

NOTE: The 2U Ball bearing Rail Kit comes with ambidextrous cable management arm can be mounted on either the left or right side for improved cable management.

HP 2U Small Form Factor Ball Bearing Gen8 Rail Kit	663478-B21
--	------------

NOTE: The 2U Ball bearing Rail Kit comes with ambidextrous cable management arm can be mounted on either the left or right side for improved cable management.

HP Rack Cable Management Velcro Clips	379820-B21
---------------------------------------	------------

Additional Options

HP USB and SD Options	<p>HP 4GB Secure Digital High Capacity Flash Media Kit 580387-B21</p> <p>NOTE: Blank SD media device is supported for use with VMware and Citrix. SD media must be installed in the internal slot of the ProLiant server. Learn more at: http://www.hp.com/go/proliantvirtualization.</p> <p>HP 2GB USB Flash Media Drive Key Kit 608447-B21</p> <p>NOTE: HP qualified blank USB key for use with HP ProLiant servers that support the VMware virtualization environment and other HP value-add software like SmartStart. HP recommends this industry standard USB flash device for use with VMware ESXi. USB device must be installed in the internal slot of the ProLiant server for use with VMware ESXi. Refer to HP VMware Getting Started Guide for installation instructions.</p>
------------------------------	--

HP Care Pack Services	<p>HP Install DL380e Service U6E81E</p> <p>HP Install nonStdHrs DL380e SVC U6E82E</p> <p>HP Startup DL380e Service U6E83E</p> <p>HP Startup nonStd Hrs DL380e Svc U6E84E</p> <p>HP 3y 24h CTR 24x7 DL380e HW Sup U6E85E</p> <p>HP 3y 24h CTR 24x7 wDMR DL380e HW Sup U6E86E</p> <p>HP 3y 4h 13x5 DL380e HW Support U6E27E</p> <p>HP 3y 4h 24x7 DL380e Collab Support U6E31E</p> <p>HP 3y 4h 24x7 DL380e HW Support U6E29E</p> <p>HP 3y 4h 24x7 DL380e ProCare Service U6E33E</p> <p>HP 3y 4h 24x7 w/DMR DL380e Collab Supp U6E32E</p> <p>HP 3y 4h 24x7w/DMR DL380e ProCare SVC U6E34E</p> <p>HP 3y 4h13x5 w/DMR DL380e HW Supp U6E28E</p> <p>HP 3y 4h24x7 w/DMR DL380e HW Supp U6E30E</p> <p>HP 3y 6h CTR 24x7 DL380e Collab Support U6E37E</p> <p>HP 3y 6h CTR 24x7 DL380e HW Supp U6E35E</p> <p>HP 3y 6h CTR 24x7 DL380e ProCare SVC U6E39E</p> <p>HP 3y 6h CTR 24x7 w/DMR DL380e HW Sup U6E36E</p> <p>HP 3y 6hCTR 24x7 w/DMR DL380e Collab Sup U6E38E</p> <p>HP 3y Nbd DL380e Collab Support U6E23E</p> <p>HP 3y Nbd DL380e HW Support U6E21E</p> <p>HP 3y Nbd DL380e ProCare Service U6E25E</p> <p>HP 3y Nbd w/DMR DL380e Collab Support U6E24E</p> <p>HP 3y Nbd w/DMR DL380e HW Support U6E22E</p> <p>HP 3y Nbd w/DMR DL380e ProCare SVC U6E26E</p> <p>HP 3y6hCTR24x7w/DMR DL380e ProCare SVC U6E40E</p> <p>NOTE: For more information, customer/resellers can contact: http://www.hp.com/services/carepack</p>
------------------------------	---

Memory

For detailed memory configuration rules and guidelines, please use the Online DDR3 Memory Configuration Tool: www.hp.com/go/ddr3memory-configurator

Memory Subsystem Architecture

Each Intel® Xeon® E5-2400 family processor socket contains three memory channels that support two DIMMs each for a total of six (6) DIMM per installed processor or a grand total of twelve (12) DIMMs for the server. Up to 32GB capacity DIMMs are supported for 384GB of memory (12 DIMM slots x 32GB per DIMM).

Memory population guidelines

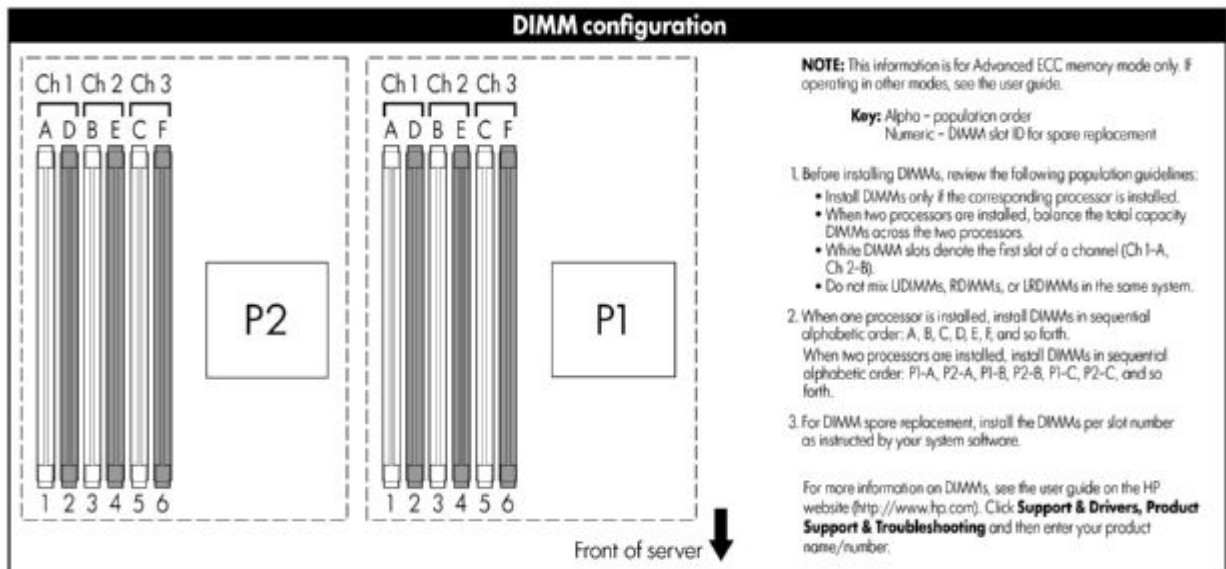

General Memory Population Rules and Guidelines:

- White DIMM slots denote the first slot of a channel. For 1 DPC (DIMM per channel) populate white slots only.
- Install DIMMs only if the corresponding processor is installed.
- If only one processor is installed in a two processor system, only half of the DIMM slots are available.
- To maximize performance, it is recommended to balance the total memory capacity between all installed processors and to load the channels similarly whenever possible.
- Populate DIMMs from heaviest load (quad-rank) to lightest load (single-rank) within a channel. Heaviest load (DIMM with most ranks) within a channel goes furthest from the processor
- RDIMMs operating at either 1.35V or 1.5V may be mixed in any order, but the system will power them at the higher voltage.
- Do not mix RDIMMs, LRDIMMs, and UDIMMs.
- DIMMs of different speeds may be mixed in any order; the server will select a common optimal speed.
- The maximum memory speed is a function of the memory type, memory configuration, and processor model.
- The maximum memory capacity is a function of the memory type and number of installed processors.
- HP memory from previous generation servers is not qualified on the DL380e Gen8 Server. Certain HP SmartMemory features such as memory authentication and enhanced performance may not be supported.
- To realize the performance memory capabilities listed in this document, HP SmartMemory is required. For additional information, please see the HP SmartMemory QuickSpecs at: http://h18000.www1.hp.com/products/quickspecs/14225_div/14225_div.html.
- For memory population rules and additional memory guidelines, please see the DL380e Gen8 user guide at <http://www.hp.com/support>.
- There are three(3) Memory channels per processor; six(6) channels for 2 processors server.
- There are two(2) DIMM slots for each memory channel; twelve(12) total slots for 2 processors server.

Memory

Gen8 Supported Memory Bandwidth and Capacity										
DIMM Type	Registered DIMMS (RDIMMs)						Load Reduced (LRDIMMs)	Unbuffered with ECC DIMMs (UDIMMs)		
DIMM Rank	Single Rank (1R)			Dual Rank (2R)			Quad Rank (4R)	Single Rank (1R)	Dual Rank (2R)	
DIMM Capacity	4GB	4GB	8GB	8GB	16GB	16GB	32GB	2GB	4GB	8GB
DIMM Native Speed (MHz)	1333	1600	1600	1333	1333	1600	1333	1333	1333	1333
Voltage	LV	Std	Std	LV	LV	Std	LV	LV	LV	LV
SLOTS THAT CAN BE POPULATED										
12 slot servers	12	12	12	12	12	12	12	12	12	12
MAXIMUM CAPACITY (GB) ¹										
	48	48	96	96	192	192	384	24	48	96
POPULATED DIMM SPEED (MHz)										
1 DIMM Per Channel	1333	1600	1600	1333	1333	1600	1333 ³	1333	1333	1333
2 DIMM Per Channel	1333	1600	1600	1333	1333	1600	1333 ³	1333 ⁴	1333 ⁴	1333 ⁴

¹ Maximum capacity will vary based on individual server platform qualification schedule
³ LRDIMM enables 2 DIMMs per channel. HP SmartMemory will supports up to 2DPC@1333 at 1.35V. Third party memory may only support 2DPC @1066 at 1.5V.
⁴ For HP SmartMemory, UDIMM is supported at 2DPC@1333 at 1.35V. Third party memory may only support up to 2DPC@1066 at 1.5V.

Memory Speed by Processor Model

Processor Models	Supported Memory Speeds
E5 2470 E5-2450, E5-2450L	1600/1333/1066MHz
E5-2440, E5-2430, E5-2420, E5-2430L	1333/1066MHz
E5-2407, E5-2403	1066MHz

Standard and Maximum Memory Capacity (Pre-configured Models)

Pre Configured Models	Standard Memory	Maximum Memory Plus Optional Memory	Standard Memory Replace with Optional Memory
Intel Xeon E5-2450	24GB (6x 4GB)	120GB (6x 16GB, 6x 4GB)	384GB (12 x 32GB)
Intel Xeon E5-2407	8GB (2x 4GB)	168GB (10x16GB, 2x4GB)	384GB (12 x 32GB)
Intel Xeon E5-2403	4GB (1x 4GB)	180GB (11x16GB, 1x4GB)	384GB (12 x 32GB)

BASIC memory slot & population diagram

Population order; looking from the front of your server CPU#1 is on right side and CPU#2 is on the left. See the population order by alphabetic and numeric progression below.

CPU #1 IS PROCESSOR ON RIGHT - LOOKING FROM FRONT OF SERVER							CPU #1
slot #	Channel 1		Channel 2		Channel 3		
population order	1	2	3	4	5	6	
In Order	A	D	B	E	C	F	
	1	4	2	5	3	6	-

Memory

CPU #2 IS PROCESSOR ON LEFT - LOOKING FROM FRONT OF SERVER							
	Channel 1		Channel 2		Channel 3		CPU #2
slot #	1	2	3	4	5	6	
population order	A	D	B	E	C	F	
In Order	1	4	2	5	3	6	

NOTE: Capacity references are rounded to the common Gigabyte values.

- 1GB = 1024MB
- 2GB = 2048MB
- 4GB = 4096MB
- 8GB = 8192MB
- 16GB = 16384MB
- 32GB = 32768MB

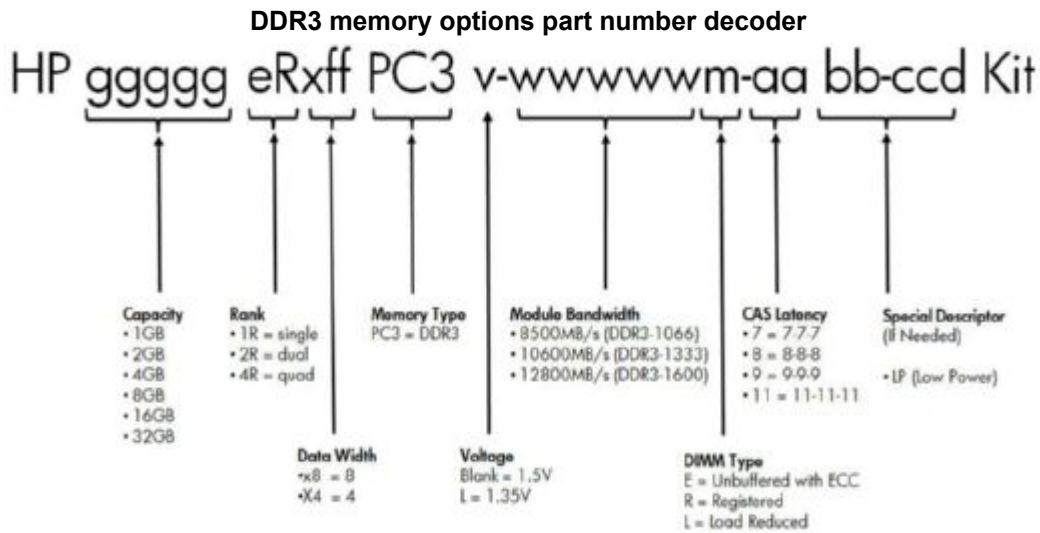

Following are memory options available from HP:

HP Memory

NOTE: To realize the performance memory capabilities listed in this document, HP SmartMemory is required. For additional information, please see the HP SmartMemory QuickSpecs at:

http://h18000.www1.hp.com/products/quickspecs/14225_div/14225_div.html (Worldwide)

NOTE: HP memory from previous generation servers are not fully compatible with the DL360e Gen8 Server.

Registered DIMMs (RDIMMs)

HP 4GB (1x4GB) Single Rank x4 PC3L-10600R (DDR3-1333) Registered CAS-9 Low Voltage Memory Kit	647893-B2
HP 4GB (1x4GB) Single Rank x4 PC3-12800R (DDR3-1600) Registered CAS-11 Memory Kit	647895-B2
HP 8GB (1x8GB) Dual Rank x4 PC3L-10600R (DDR3-1333) Registered CAS-9 Low Voltage Memory Kit	647897-B2
HP 8GB (1x8GB) Single Rank x4 PC3-12800R (DDR3-1600) Registered CAS-11 Memory Kit	647899-B2
HP 8GB (1x8GB) Dual Rank x4 PC3-12800R (DDR3-1600) Registered CAS-11 Memory Kit	690802-B2
HP 16GB (1x16GB) Dual Rank x4 PC3L-10600R (DDR3-1333) Registered CAS-9 Low Voltage Memory Kit	647901-B2
HP 16GB (1x16GB) Dual Rank x4 PC3-12800R (DDR3-1600) Registered CAS-11 Memory Kit	672631-B2

Memory

Unbuffered with ECC DIMMs (UDIMMs)

HP 2GB (1x2GB) Single Rank x8 PC3-12800E (DDR3-1600) Unbuffered CAS-11 Memory Kit	669320-B2
HP 2GB (1x2GB) Single Rank x8 PC3L-10600E (DDR3-1333) Unbuffered CAS-9 Low Voltage Memory Kit	647905-B2
HP 4GB (1x4GB) Dual Rank x8 PC3-12800E (DDR3-1600) Unbuffered CAS-11 Memory Kit	669322-B2
HP 4GB (1x4GB) Dual Rank x8 PC3L-10600E (DDR3-1333) Unbuffered CAS-9 Low Voltage Memory Kit	647907-B2
HP 8GB (1x8GB) Dual Rank x8 PC3-12800E (DDR3-1600) Unbuffered CAS-11 Memory Kit	669324-B2
HP 8GB (1x8GB) Dual Rank x8 PC3L-10600E (DDR3-1333) Unbuffered CAS-9 Low Voltage Memory Kit	647909-B2

Load Reduced DIMMs (LRDIMMs)

HP 32GB (1x32GB) Quad Rank x4 PC3L-10600L (DDR3-1333) Load Reduced CAS-9 Low Voltage Memory Kit	647903-B2
---	-----------

NOTE: All DDR3 memory option kits consist of one DIMM per kit. For detailed memory configuration rules and guidelines, please use the Online DDR3 Memory Configuration Tool: www.hp.com/go/ddr3memory-configurator.

NOTE: PC3L is a low voltage memory.

Storage

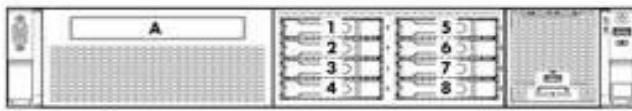

- A Optical Media Bay optional
- 1-8 8 x SFF SATA/SAS/SDD Hot Pluggable Hard Drive Bays

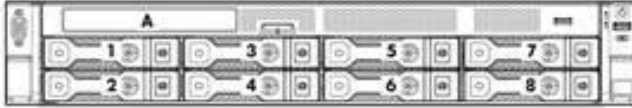

- A Optical Media Bay optional
- 1-8 8 x LFF SATA/SAS/SDD Hot Pluggable Hard Drive Bays

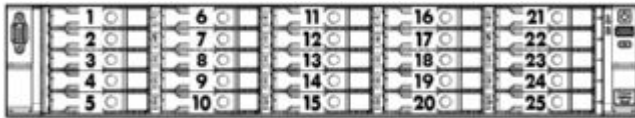

- 1-25 25 x SFF SATA/SAS/SDD Hot Pluggable Hard Drive Bays

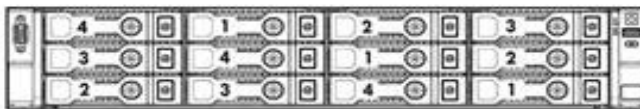

- 1-4, 12 x LFF (1:1) SATA/SAS/SDD Hot Pluggable
- 1-4, Hard drive bays with point to point backplane
- 1-4

Maximum Storage Capacity - (with D2700, SAS/SATA HDD)

Internal (25 SFF Drive Cage)	27TB (27 x 1TB SAS/SATA SFF with 25SFF drive cage + Rear 2SFF drive cage)
Internal (12 LFF Drive Cage)	42TB (14 x 3TB SAS/SATA LFF with 12LFF drive cage + Rear 2LFF drive cage)
External	200TB (200 x 1TB SAS SFF)
Total (25 SFF Drive)	227TB
Total (12 LFF Drive)	242TB

Technical Specifications

System Unit	Dimensions - with bezel (H x W x D)	SFF Drives: 3.44 x 17.54 x 27.5 in (8.75 x 44.55 x 69.85 cm) LFF Drives: 3.44 x 17.54 x 29.5 in (8.75 x 44.55 x 74.94 cm)	
	Weight (approximate)	Maximum (all hard drives: front + rear, full power supply, and processor installed)	71.20 lb (32.30 kg)
		Minimum (one SFF hard drive, single power supply, and processor installed. HDD not installed)	30.80 lb (14.00 kg)
	Input Requirements (per power supply)	Rated Line Voltage	100 to 120 VAC
			200 to 240 VAC
		Rated Input Current	For 1200 W Power Supply: 10 A (at 100 VAC), 4.9 A (at 200 VAC)
			For 750 W Power Supply: 8.9 A (at 100 VAC), 4.3 A (at 200 VAC)
			For 460 W Power Supply: 5.5 A (at 100 VAC), 2.6 A (at 200 VAC)
	Rated Input Frequency	50 to 60 Hz	
	Rated Input Power	For 1200 W Power Supply: 930 W (at 100 VAC), 1348 W (at 200 VAC) For 750 W Power Supply: 857 W (at 100 VAC), 824 W (at 200 VAC) For 460 W Power Supply: 526 W (at 100 VAC), 505 W (at 200 VAC)	
BTU Rating	Maximum	For 1200 W Power Supply: 3530 BTU/hr (at 100 VAC), 4600 BTU/hr (at 200 VAC) For 750 W Power Supply: 2925 BTU/hr (at 100 VAC), 2812 BTU/hr (at 200 VAC) For 460 W Power Supply: 1794 BTU/hr (at 100 VAC), 1725 BTU/hr (at 200 VAC)	
Power Supply Output (per power supply)	Rated Steady-State Power	For 1200 W Power Supply: 800 W (at 100 VAC), 900 W (at 120 VAC), 1200 W (at 200 to 240 VAC) For 750 W Power Supply: 750 W (at 100 to 120 VAC), 750 W (at 200 to 240 VAC) For 460 W Power Supply: 460 W (at 100 to 120 VAC), 460 W (at 200 to 240 VAC)	
		Maximum Peak Power	For 1200 W Power Supply: 800 W (at 100 VAC), 900 W (at 120 VAC), 1200 W (at 200 to 240 VAC)

Technical Specifications

		For 750 W Power Supply: 750 W (at 100 to 120 VAC), 750 W (at 200 to 240 VAC) For 460 W Power Supply: 460 W (at 100 to 120 VAC), 460 W (at 200 to 240 VAC)																	
System Inlet Temperature	Operating	10° to 35°C (50° to 95°F) at sea level with an altitude derating of 1.0°C per every 304.8 m (1.8°F per every 1000 ft) above sea level to a maximum of 3048 m (10,000 ft), no direct sustained sunlight. Maximum rate of change is 10°C/hr (18°F/hr). The upper limit may be limited by the type and number of options installed. System performance may be reduced if operating with a fan fault or above 30°C (86°F).																	
	Non-operating	-30° to 60°C (-22° to 140°F). Maximum rate of change is 20°C/hr (36°F/hr).																	
Relative Humidity (non-condensing)	Operating	10 to 90% relative humidity (Rh), 28°C (82.4°F) maximum wet bulb temperature, non-condensing.																	
	Non-operating	5 to 95% relative humidity (Rh), 38.7°C (101.7°F) maximum wet bulb temperature, non-condensing.																	
Altitude	Operating	3048 m (10,000 ft). This value may be limited by the type and number of options installed. Maximum allowable altitude change rate is 457 m/min (1500 ft/min).																	
	Non-operating	9144 m (30,000 ft). Maximum allowable altitude change rate is 457 m/min (1500 ft/min).																	
Acoustic Noise	Listed are the declared A-Weighted sound power levels (LWAd) and declared average bystander position A-Weighted sound pressure levels (LpAm) when the product is operating in a 23°C ambient environment. Noise emissions were measured in accordance with ISO 7779 (ECMA 74) and declared in accordance with ISO 9296 (ECMA 109). NOTE: The Listed sound levels apply to standard shipping configurations. Additional options may result in increased sound levels																		
		<table border="0"> <thead> <tr> <th>Idle</th> <th>1P Non- Redundant SKU</th> <th>2P Redundant SKU</th> </tr> </thead> <tbody> <tr> <td>LWAd</td> <td>5.8 B</td> <td>5.4 B</td> </tr> <tr> <td>LpAm</td> <td>41 dBA</td> <td>38 dBA</td> </tr> <tr> <th>Operating</th> <th>1P SKU</th> <th>2P SKU</th> </tr> <tr> <td>LWAd</td> <td>5.9 B</td> <td>5.7 B</td> </tr> <tr> <td>LpAm</td> <td>42 dBA</td> <td>41 dBA</td> </tr> </tbody> </table>	Idle	1P Non- Redundant SKU	2P Redundant SKU	LWAd	5.8 B	5.4 B	LpAm	41 dBA	38 dBA	Operating	1P SKU	2P SKU	LWAd	5.9 B	5.7 B	LpAm	42 dBA
Idle	1P Non- Redundant SKU	2P Redundant SKU																	
LWAd	5.8 B	5.4 B																	
LpAm	41 dBA	38 dBA																	
Operating	1P SKU	2P SKU																	
LWAd	5.9 B	5.7 B																	
LpAm	42 dBA	41 dBA																	
Emissions Classification (EMC)	FCC Rating	Class A																	
	Normative Standards	CISPR 22; EN55022; EN55024; FCC CFR 4 Pt 15; ICES-003; CNS14336-1; CNS13438; GB4943; GB9254; EN 61000-3-2; EN 61000-3-3; EN 60950-1; IEC 60950-1																	

Technical Specifications

NOTE: Product conformance to cited product specifications is based on sample (type) testing, evaluation, or assessment. This product or family of products is eligible to bear the appropriate compliance logos and statements.

NOTE: The Listed sound levels apply to standard shipping configurations. Additional options may result in increased sound levels

HP iLO 4 On System Management	Architecture	PCI Express based health and remote management ASIC
	Processor	Embedded ARM processor core operating at 400MHz
	Upgradeability	Firmware upgradeable via Flash ROM
	Video Support	1920 x 1200 (16 bpp) DVR max resolution
	Interfaces	HP iLO Dedicated* Network connection (10/100/1000 Mb/s) on rack, tower and SL systems *Optional Module on some servers HP iLO Shared Network connection (10/100/1000 Mb/s) on rack, tower and SL systems HP iLO network connection to blades (100 Mb/s) to Onboard Administrator (with 10/100/1000 Mb/s uplink) on blade systems
	Memory	16 MB Flash 256 MB DDR 3 with ECC (112 MB after ECC and video)
	Operating System Support	For information on HP's Certified and Supported ProLiant Servers for OS and Virtualization Software and latest listing of software drivers available for your server including how to purchase from HP, please visit our OS Support Site at: http://www.hp.com/go/ossupport
	Client System Support	For information on Client System Support, please visit the HP iLO Feature Comparison Site at: www.hp.com/go/compareilo
	Client Browser Support	Microsoft Internet Explorer 9 NOTE: For customers using Protected Mode, please use the Java based version of Integrated Remote Console. Microsoft Internet Explorer 8 NOTE: For customers using Protected Mode, please use the Java based version of Integrated Remote Console. Microsoft Internet Explorer 7 Firefox Extended Support Release (ESR) 10 (on supported Windows and Linux systems) Firefox 3.6 (on supported Windows and Linux systems)
	Command Line Support	Secure Shell and serial port access Secure Socket Layer Secure Shell version 2
	Security	Advanced Encryption Standard (AES) and Triple Data Encryption Standard (3DES) on browser, CLP and XML scripting interface AES encryption of video RC4 encryption of video
	Directory Support Services	Active Directory v1.0 (Windows 2003)
	Driver Support	HP ProLiant iLO 4 Management Controller Driver Package
	Management protocols supported	SNMP, IPMI 2.0 (system and LAN interface), DMTF Systems Management Architecture for Server Hardware Command Line Protocol (SMASH CLP), HP RIBCL XML

Technical Specifications

HP Dynamic Smart Array B120i Controller	Dimensions	Embedded
	Disk Drive Interface - Transfer rate	3Gb/s SATA (Serial Attached SCSI)
	SATA Connectors	6 internal connectors w/hot plug support
	Server Interface	Intel® C600 Series Chipset integrated SATA controller
	SATA Speed	3Gb/s SATA links
	Cache Memory	optional 40-bit 512MB ECC protected Flash Backed Write Cache (FBWC)
	Logical Drives Supported	Zero Memory, Up to 2 logical volumes (6 physical drives)
	Host Memory Addressing	64-bit, supporting greater than 4GB server memory space
	Hot Plug Support	Yes
	RAID Support	RAID 0 (Striping), RAID 1 (Mirroring)
		RAID 1+0 (Striping & Mirroring)
RAID 5 with optional 512MB FBWC		

NOTE: 512 MB cache is required to enable RAID 5 support

HP Dynamic Smart Array B320i Controller	Dimensions	Embedded
	Disk Drive Interface - Transfer rate	Up to 6Gb/s SAS (Serial Attached SCSI) Up to 6Gb/s SATA (Serial ATA)
	Connectors	2 internal 4X connectors
	Server Interface Speed	x4 PCIe 2.0 provides 4GB/s maximum bandwidth 8 x 6Gb/s SAS links provide 4.8GB/s maximum bandwidth
	Cache Memory	Zero Memory RAID has no cache memory optional 40-bit 512MB ECC protected Flash Backed Write Cache (FBWC)
	Logical Drives Supported	Zero Memory, Up to 2 logical volumes (8 physical drives) Up to 64 logical drives with cache
	Host Memory Addressing	64-bit, supporting greater than 4GB server memory space
	Hot Plug Support	Yes
	RAID Support	RAID 0 (Striping), RAID 1 (Mirroring)
		RAID 1+0 (Striping & Mirroring)
		RAID 5 with optional 512MB FBWC

NOTE: 512 MB cache is required to enable RAID 5 support

Technical Specifications

HP Smart Array P420i Controller	Dimensions	Embedded	
	Disk Drive and Enclosure Interface - transfer rate	6Gb/s SAS (Serial Attached SCSI) 3Gb/s SATA (Serial ATA)	
	SAS Connectors	2 internal 4X connectors	
	Cache Memory Speed	DDR2-800MHz with 40 or 72-bit wide bus	
	Server Interface	x4 PCIe 2.0 provides 2GB/s maximum bandwidth	
	SAS Speed	8 6Gb/s SAS links provide 4.8GB/s maximum bandwidth	
	Cache Memory	Zero Memory RAID has no cache memory 40-bit 256MB ECC protected cache (battery upgrade available) 72-bit 512MB BBWC or 72-bit 512MB and 1G FBWC Zero Memory, Up to 2 logical volumes (8 physical drives)	
	Logical Drives Supported	Up to 64 logical drives with cache	
	Host Memory Addressing	64-bit, supporting greater than 4GB server memory space	
	RAID Support	RAID 6, 6+0 (Advanced Data Guarding) NOTE: RAID 6, 6+0 can be enabled with one of the following combinations: <ul style="list-style-type: none"> • 256 MB cache, Battery kit and Smart Array Advanced Pack License key option upgrades • 512 MB BBWC/FBWC and Smart Array Advanced Pack License key option upgrades • 1G FBWC and Smart Array Advanced Pack License key option upgrades RAID 5, 5+0 (Distributed Data Guarding) NOTE: A minimum of 256 MB cache is required to enable RAID 5, 5+0 support RAID 1+0 (Striping & Mirroring) RAID 0 (Striping), RAID 1 (Mirroring)	
	HP Ethernet 1Gb 4-port 366i Adapter	Network Interface	10Base-T/100Base-TX/1000Base-TX
		Compatibility	EEE 802.3 10Base-T IEEE 802.3ab 1000Base-T IEEE 802.3u 100Base-TX IEEE 1588, IEEE 802.1AS IEEE 802.3az - Energy Efficient Ethernet (EEE)
		Data Transfer Method	PCI Express v 2.0, 5.0 GT/s, two lanes (x2)
	Controller	I350 Powerville	
	Number of Ports	4	
	Network Transfer Rate	10Base-T (Half-Duplex) 10 Mb/s per port, 40 Mb/s combined 10Base-T (Full-Duplex) 20 Mb/s per port, 80 Mb/s combined 100Base-TX (Half-Duplex) 100 Mb/s per port, 400 Mb/s combine 100Base-TX (Full-Duplex) 200 Mb/s per port, 800 Mb/s combined 1000Base-TX (Half and Full-Duplex) 1000Mb/s per port, 4000 Mb/s combined	
	Connector	Two RJ-45	

Technical Specifications

Cable Support

10Base-T

Categories 3, 4 or 5 UTP;
up to 328 ft (100 m)

10/100/1000Base-TX

Category 5 or higher UTP;
up to 328 ft (100 m)**Environment-friendly
Products and
Approach****End-of-life
Management and
Recycling**

Hewlett-Packard offers end-of-life HP product return, trade-in, and recycling programs in many geographic areas. For trade-in information please go to: <http://www.hp.com/go/green>. To recycle your product, please go to: <http://www.hp.com/go/green> or contact your nearest HP sales office. Products returned to HP will be recycled, recovered or disposed of in a responsible manner.

The EU WEEE directive (2002/95/EC) requires manufacturers to provide treatment information for each product type for use by treatment facilities. This information (product disassembly instructions) is posted on the Hewlett Packard web site at: <http://www.hp.com/go/green>. These instructions may be used by recyclers and other WEEE treatment facilities as well as HP OEM customers who integrate and re-sell HP equipment.

© Copyright 2012 Hewlett-Packard Development Company, L.P.

The information contained herein is subject to change without notice.

Microsoft and Windows NT are US registered trademarks of Microsoft Corporation.

Intel, the Intel logo, Xeon and Xeon Inside are trademarks of Intel Corporation in the U.S. and other countries.

The only warranties for HP products and services are set forth in the express warranty statements accompanying such products and services. Nothing herein should be construed as constituting an additional warranty. HP shall not be liable for technical or editorial errors or omissions contained herein.

For hard drives, 1GB = 1 billion bytes. Actual formatted capacity is less.