

PRODUCT CATALOGUE

www.boddingtons-electrical.com



Prospect House, Queenborough Lane
Great Notley, Braintree, CM77 7AG
United Kingdom

T: +44 (0) 1376 567490
F: +44 (0) 1376 567495

E: info@boddingtons-electrical.com
www.boddingtons-electrical.com

Registered in England No 2964089

Distributor:



LIVE WORK Consult AS
Tool Test - Support - Training

952 35 563

post@liveworkconsult.no



PLEASE DON'T BIN ME
Pass me on to a colleague
or recycle me!

PC/01-2013





Boddingtons Electrical has established itself as a leading manufacturer and supplier of insulated tools and electrical safety products.



Disclaimer
Whilst Boddingtons Electrical have made every effort to ensure the accuracy and reliability of the information contained in this catalogue, there may be variations as improvements and/or changes to the products are made from time to time.



The company operates throughout the United Kingdom and exports to many countries worldwide.

Whilst maintaining its traditions and values and providing products of the highest standard it boasts young, innovative design and manufacturing teams with the expertise to provide bespoke solutions.

An essential requirement of the continuing development of the Company's Quality Objectives is the maintenance of a Quality System registered to ISO 9001 status.

Boddingtons Electrical Limited
Prospect House
Queenborough Lane
Great Notley
Braintree CM77 7AG
United Kingdom

T: +44 (0) 1376 567490
F: +44 (0) 1376 567495

E: info@boddingtons-electrical.com
www.boddingtons-electrical.com

Product Catalogue

FULLY INSULATED TOOLS

Pages 2 - 56



1

CABLE PREPARATION TOOLS

Pages 57 - 69



2

MATTING

Pages 70 - 73

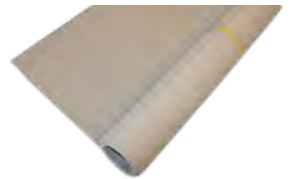

3

INSULATING SHROUDING

Pages 73 - 81



4

PERSONAL PROTECTIVE EQUIPMENT

Pages 82 - 87



5

Cable & Core Cutters with Levered Linkage

(for copper and aluminium cables only)

- ▶ For smooth cutting of copper and aluminium conductors
- ▶ Replaceable cutting blades
- ▶ Razor sharp cutters guarantee a smooth and effortless cut
- ▶ Cutting without crushing the cable, leaving the cable end with very little deformation
- ▶ Blade made of chromium-molybdenum tempered steel
- ▶ Tested to EN/IEC 60900:2004



Part No	Description	Length [mm]	Jaw Opening [mm]	Material Cross Section [mm ²]	Weight [g]	Insulated
253345	Cable and Core Cutter	450	32	120 Copper 300 Aluminium	2040	✓
253845	Spare Blade set for 253345	-	32	-	280	x
253360	Cable and Core Cutter	600	26	150	1965	✓
253370	Cable and Core Cutter	700	33	180	2140	✓
253860	Spare Blade for 253360	-	26	-	325	x
253870	Spare Blade for 253370	-	33	-	455	x
737021	Carrying Case for 253345/ 253360	600	-	-	215	x

Cable & Core Cutter

(for copper and aluminium cables only)

- ▶ Controlled cutting power by means of carefully selected leverage
- ▶ Material high tensile forged steel
- ▶ Cuts aluminium and copper earth cable, plastic and rubber insulated up to 27mm diameter
- ▶ Tested to EN/IEC 60900:2004



Part No	Description	Length [mm]	Jaw Opening [mm]	Material Cross Section [mm ²]	Weight [g]	Insulated
254350	Cable and Core Cutter	500	37	150	1500	✓

Cable Cutters

(for copper and aluminium cables only)

- ▶ Replaceable cutting head
- ▶ Cutting head made of oil-hardened steel
- ▶ The razor sharp blades guarantee a smooth and effortless cut
- ▶ Light metal handles
- ▶ Tested to EN/IEC 60900:2004



Part No	Description	Length [mm]	Jaw Opening [mm]	Material Cross Section [mm ²]	Weight [g]	Insulated
277346	Cable Cutter	460	30	approx. 120	1430	✓
277361	Cable Cutter	600	35	approx. 180	2070	✓
277380	Cable Cutter	800	60	approx. 500	3800	✓
277946	Spare Blade for 277346	-	-	-	640	x
277961	Spare Blade for 277361	-	-	-	660	x
277980	Spare Blade for 277380	-	-	-	1140	x

Ratchet Cable Cutter – Standard Version

- ▶ Single handed operation
- ▶ 100,000 times proven ratchet system
- ▶ Blade is released by a small lever
- ▶ Ideal for areas of restricted access
- ▶ Spare blades and parts available
- ▶ Only for use on copper or aluminium cables



Part No	Description	Length [mm]	Cutting Capacity	Weight [g]	Insulated
252032	Ratchet Cable Cutter – Standard Version	330	ø 32mm / 250mm ²	987	x

Ratchet Cable Cutter – Insulated Version

- ▶ Fully insulated to EN60900 - 1,000V maximum working
- ▶ Single handed operation
- ▶ Blade is released by opening the handles
- ▶ Ideal for areas of restricted access
- ▶ Spare blades and parts available
- ▶ Only for use on copper or aluminium cables
- ▶ Insulating blade cover available



Part No	Description	Length [mm]	Cutting Capacity	Weight [g]	Insulated
252532	Ratchet Cable Cutter – Insulated Version	310	ø 32mm / 250mm ²	1180	✓
252550	Insulating Head Cover	-	-	95	✓

Ratchet Cutters

(for copper and aluminium cables only)

- ▶ Powerful two handed cutter
- ▶ Double ratchet device with cam gearing
- ▶ Wide ranging virtually shatter proof, fixed and moving blade
- ▶ For cutting multi-stranded and fine wire copper and aluminium cables up to 62 or 80mm diameter
- ▶ Suitable for use on thin steel sheathing or steel tape armoured cables (not suitable for hardened steel wire armoured cable)
- ▶ Tested EN/IEC 60900:2004

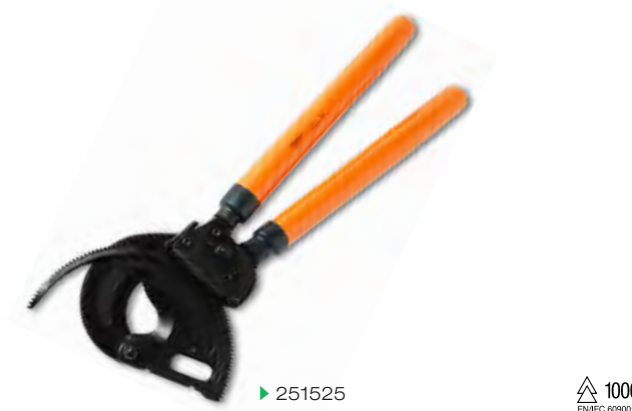

Part No	Description	Length [mm]	Jaw Opening [mm]	Material Cross Section [mm ²]	Weight [g]	Insulated
251522	Ratchet Cutter – Single Handed	420	62	750	2000	✓
251525	Ratchet Cutter – Single Handed	550	80	1000	3150	✓

Rechargeable Cable Cutter

(non-insulated)

- ▶ Suitable for LV and MV cables – up to 4 x 150 mm sq aluminium and 4 x 95mm sq copper
- ▶ For copper and aluminium cables up to maximum of 50mm diameter
- ▶ Cross cutting of blades on ratchet cutter ensures exceptionally clean cut
- ▶ Approx 50 cuts with one battery charge
- ▶ Overload safety cut-out for protection of the tool
- ▶ Kit comprises: 1 x rechargeable cable cutter, 1 x 12 volt rechargeable battery, 1 x battery charger 240V / 50Hz input supply, 1 x tough plastic carrying case



▶ 251550

Part No	Description	L x B x H [mm]	Cutting Capacity ø [mm]	Cutting Force [kN]	Weight [g]	Insulated
251550	Rechargeable Cable Cutter (inc plastic carrying case)	345 x 135 x 105	50	25	2900	✓
251555	Spare Battery	-	-	-	540	x
251556	Spare Blade - moveable	-	-	-	380	x

Steel Wire Cutters

- ▶ Replaceable steel cutting head
- ▶ “Blunt” blades for hardest types of wire
- ▶ Handles made of light metal
- ▶ Tested to EN/IEC 60900:2004



▶ 277446



Part No	Description	Length [mm]	Cu + Al Cable [mm ²]	Steel Wire ø [mm]	Round Steel ø [mm]	Jaw Opening [mm]	Weight [g]	Insulated
277446	Steel Wire Cutter	460	95	10	7	10	1380	✓
277360	Steel Wire Cutter	600	150	14	9	20	2710	✓
277846	Spare Blade for 277446	-	-	-	-	-	475	✓
277860	Spare Blade for 277360	-	-	-	-	-	910	✓

Cable Cutters HV

(for copper and aluminium cables only)

- ▶ Replaceable cutting head
- ▶ Fibre reinforced plastic handles
- ▶ Tested to 50kV, 60 Hz for one minute
- ▶ Cutting blades made of forged special tool steel, heat treated
- ▶ The razor sharp blades guarantee a smooth and effortless cut



▶ ME-150S

Part No	Description	Cutting Capacity [mm ²]	Length [mm]	Weight [g]	Insulated
ME-150S	Cable Cutter HV	150	460	980	✓
ME-150SB	Spare Blade for ME-150S	-	-	650	x
ME-250S	Cable Cutter HV	250	615	1530	✓
ME-250SB	Spare Blade for ME-250S	-	-	700	x

Bolt Cutters

(insulated version)

- ▶ Chrome vanadium blade
- ▶ Tempered steel
- ▶ Adjustable handle position for working in confined spaces
- ▶ Tested to EN/IEC 60900:2004



▶ 275261



Part No	Description	Length [mm]	Cutting Capacity ø [mm] high tensile steel wires	Weight [g]	Insulated
275246	Bolt Cutter	460	7	1500	✓
275261	Bolt Cutter	610	9	2815	✓
275276	Bolt Cutter	760	11	4100	✓
275291	Bolt Cutter	910	13	6300	✓
275295	Bolt Cutter	1070	15	8000	✓
275047	Spare Blade for 275246 & 270245	-	-	1400	x
275062	Spare Blade for 275261 & 270260	-	-	1600	x
275077	Spare Blade for 275276 & 270275	-	-	1800	x
275092	Spare Blade for 275291 & 270290	-	-	1800	x
275107	Spare Blade for 275295 & 270216	-	-	2000	x

Bolt Cutters

(non-insulated)

- ▶ Chrome vanadium blade
- ▶ Tempered steel
- ▶ Adjustable handle position for working in confined spaces



▶ 270275

Part No	Description	Length [mm]	Cutting Capacity ø [mm] high tensile steel wires	Weight [g]	Insulated
270245	Bolt Cutter	450	7	1350	x
270260	Bolt Cutter	600	9	2450	x
270275	Bolt Cutter	750	11	4450	x
270290	Bolt Cutter	900	13	6250	x
270216	Bolt Cutter	1060	15	7950	x

Tree Pruners

- ▶ Blade manufactured from alloy steel with aluminium bottom jaw
- ▶ Jaws hardened and tempered to 35 HRC
- ▶ Blade induction hardened to 50 HRC
- ▶ Tested to EN/IEC 60900:2004



▶ 554650



Part No	Description	Cutting Capacity ø [mm]	Length [mm]	Weight [g]	Insulated
555750	Tree Pruner - Double Pivot Jaw	40	750	2050	✓

Ratchet Cutters

- ▶ Wide range of applications
- ▶ Single handed operation
- ▶ Well proven ratchet drive
- ▶ All steel parts are hardened
- ▶ Quick blade release allows fast backout in any position
- ▶ Can be used in confined areas



Part No	Description	Length [mm]	Width of Head [mm]	Cross Section [mm ²]	Diameter [mm]	Weight [g]	Insulated
251403	Ratchet Cutter	250	150	240	34	1041	x
251404	Ratchet Cutter	320	145	450	52	1000	x
251434	Ratchet Cutter	250	110	300	35	900	x
251442	Ratchet Cutter	250	110	300	42	1000	x
251452	Ratchet Cutter	325	145	500	52	1200	x
251462	Ratchet Cutter	410	160	750	62	2000	x
251463	Ratchet Cutter	410	160	840	62	2200	x
251480	Ratchet Cutter	610	190	1000	80	3000	x

Ratchet Cutter C Type

- ▶ Hand tool with low friction and solid technical drive
- ▶ For daily application
- ▶ Blade with needle bearing
- ▶ Quick blade release allows fast backout in any position
- ▶ Can be used in confined areas



Part No	Description	Length [mm]	Width of Head	Cross Section	Diameter	Weight [g]	Insulated
252401	Ratchet Cutter	245	100mm	185mm ²	25mm	945	x
252402	Ratchet Cutter	330	135mm	450mm ²	52mm	1300	x
252403	Ratchet Cutter	330	135mm	330mm ²	36mm	1400	x
252404	Ratchet Cutter	485	195mm	550mm ²	55mm	3000	x

Universal and Steel Rope Cutter

- ▶ Single handed operation
- ▶ Well proven ratchet drive
- ▶ All steel parts are hardened
- ▶ Quick blade release allows fast backout in any position
- ▶ Wide range of application due to interchangeable cutting blades



Part No	Description	Length [mm]	Width of head [mm]	Cross section [mm ²]	Diameter [mm]	Weight [g]	Insulated
250550	Cable Cutter	230	100	350	50	1100	✓

Spare Blades for Universal and Steel Rope Cutter

Part No 250551 Blade Set B			
Application	Cross Section	Diameter [mm]	Construction
AL / CU	150mm ²	30	
Flexible Steel Cable		10	
Catenary wire	12 / 30		Type 8
ACSR DIN 48 204	11.7		7 / 1.44 mm

Weight: 100g



Part No 250553 Blade Set S			
Application	Cross Section	Diameter [mm]	Construction
AL / CU	350mm ²	50	
Flexible Steel Cable		12	
Catenary wire	240mm ²	50	

Clean cut and little operating force
Weight: 100g

Part No 250552 Blade Set C			
Application	Cross Section	Diameter [mm]	Construction
AL / CU	300mm ²	50	

Cuts big cross sections with little operating force, clean cut, appropriate for most flexible conductors
Does not cut steel
Weight: 100g

Part No 250555 Blade Set S2			
Application	Cross Section	Diameter [mm]	Construction
AL / CU	200mm ²	50	
Flexible Steel Cable		12	
Catenary wire	8	19/1	
ACSR DIN 48 204	24.5	7 / 2.67 mm	
Steel Sheathed Hose	50		
Structural Steel 235JR+AR	10	Solid	
Screws	8	Strength: 8.8	

Slight angular cut, increased operating force
Weight: 100g

Part No 250554 Blade Set S1			
Application	Cross Section	Diameter [mm]	Construction
AL / CU	300mm ²	50	
Flexible Steel Cable		12	
Catenary wire	8		
19/1			
ACSR DIN 48 204	20	7 / 2.1 mm	
Steel Sheathed Hose	50		

Slight angular cut, increased operating force
Colour code: blue
Weight: 100g

Round Cable Cutter

(for copper and aluminium cables only)

- ▶ Specially designed for cutting and stripping cable before the cable lug is applied.
- ▶ Suitable for cutting cables up to 35 mm² of soft, stranded copper and aluminium conductors
- ▶ Single handed operation
- ▶ Specially tempered tool steel
- ▶ Sharp, tempered precision cut blades
- ▶ Tested EN/IEC 60900:2004



Part No	Description	Length [mm]	Jaw Opening [mm]	Material Cross Section [mm ²]	Weight [g]	Insulated
254316	Round Cable Cutter	170	approx. 16	35	187	✓

Cable Cutters

(for copper and aluminium cables only)

- ▶ Specially hardened burnished steel
- ▶ For cutting stranded and multi-fine wire conductors copper and multi fine wired conductors in copper and aluminium cables up to a diameter of 15mm. When 2 cuts are made, up to 18mm diameter cables are possible
- ▶ Tested to EN/IEC 60900:2004



Part No	Description	Length [mm]	Jaw Opening [mm]	Material Cross Section [mm ²]	Weight [g]	Insulated
254315	Cable Cutter	170	approx. 16	35	260	✓

Cable Cutters

(for copper and aluminium cables only)

- ▶ Specially designed for cutting and stripping cable before the cable lug is applied.
- ▶ Single handed operation
- ▶ Specially tempered tool steel
- ▶ Sharp, tempered precision cut blades
- ▶ Tested to EN/IEC 60900:2004



Part No	Description	Length [mm]	Jaw Opening [mm]	Material Cross Section [mm ²]	Weight [g]	Insulated
254321	Cable Cutter	210	approx. 8	50	390	✓

Cable Cutters

(for copper and aluminium cables only)

- ▶ With screwed adjustable joint
- ▶ Manufactured from special tool steel, polished and burnished
- ▶ A clean easy cut based on its new style of cutting geometry
- ▶ For cutting multi-core earth, plastic and rubber cables of aluminium and copper up to a cable diameter of 20mm in one cut
- ▶ Suitable for cutting cable diameters up to 25mm when cutting in two stages
- ▶ Tested to EN/IEC 60900:2004



Part No	Description	Length [mm]	Jaw Opening [mm]	Material Cross Section [mm ²]	Weight [g]	Insulated
254322	Cable Cutter	200	approx. 20	70	350	✓

Cable Cutters

(for copper and aluminium cables only)

- ▶ Specially designed for cutting and stripping cable before the cable lug is applied.
- ▶ Suitable for cutting cables up to 35 mm² of soft, stranded copper and aluminium conductors
- ▶ Single handed operation
- ▶ Specially tempered tool steel
- ▶ Sharp, tempered precision cut blades
- ▶ Tested to EN/IEC 60900:2004



Part No	Description	Length [mm]	Jaw Opening [mm]	Material Cross Section [mm ²]	Weight [g]	Insulated
254323	Cable Cutter	200	approx. 22	50	390	✓

Cable Cutter – Heavy Duty

(for copper and aluminium cables only)

- ▶ Must be positioned with both hands
- ▶ For rough handling and maximum performance
- ▶ Tested to EN/IEC 60900:2004



Part No	Description	Length [mm]	Jaw Opening [mm]	Material Cross Section [mm ²]	Weight [g]	Insulated
254324	Cable Cutter	240	approx. 10	75	545	✓

Cable Cutter – EL type (for copper and aluminium cables only)

- ▶ Heavy duty
- ▶ Single handed use
- ▶ Tested to EN/IEC 60900:2004



Part No	Description	Length [mm]	Material Cross Section [mm ²]	Weight [g]	Insulated
PA1968/10	Cable Cutter	250	25	750	✓

Diagonal Side Cutters

- ▶ For hard and soft wires
- ▶ Inductively tempered blades
- ▶ Cutting power approx. 62 HRC
- ▶ Polished chrome head
- ▶ Tested to EN/IEC 60900:2004



Part No	Description	Length [mm]	Cutting Rates Ø [mm] (soft wire)	Weight [g]	Insulated
236316	Diagonal Side Cutter	160	> 4	245	✓
236318	Diagonal Side Cutter	180	> 4	315	✓
237320	Diagonal Side Cutter Heavy Duty	200	> 4	340	✓
237325	Diagonal Side Cutter Heavy Duty	250	> 4	460	✓

Combination Pliers

- ▶ Blades for hard and soft wire
- ▶ Long cutting edges for thicker cables
- ▶ Inductively tempered blades
- ▶ Cutting power approx. 60 HRC
- ▶ Made of specially tempered tool steel
- ▶ Tested to EN/IEC 60900:2004



Part No	Description	Length [mm]	Cutting Rates Ø [mm] (soft wire)	Weight [g]	Insulated
216316	Combination Pliers	160	10	224	✓
216318	Combination Pliers	180	12	275	✓
216320	Combination Pliers	200	13	310	✓
216323	Combination Pliers	230	14	425	✓
216325	Combination Pliers	250	15	560	✓

Lineman's Pliers

- ▶ Material: Chrome Vanadium
- ▶ Finish: Mirror Chrome
- ▶ Tool Body hardness HRC 45 +/- 3
- ▶ Cutting Edge hardness HRC 62 +/- 2
- ▶ Construction: High leverage design for Increased cutting power
- ▶ Tested to EN/IEC 60900:2004



Part No	Description	Length [mm]	Weight [g]	Insulated
216324	Pliers Lineman's	240	750	✓

Long Nose Pliers

- ▶ Toothed grip
- ▶ Blades for hard and soft wire
- ▶ Inductively tempered blades
- ▶ Cutting power minimum 60 HRC
- ▶ Made of tempered vanadium steel
- ▶ Polished chrome head
- ▶ Tested to EN/IEC 60900:2004



Part No	Description	Length [mm]	Weight [g]	Insulated
225316	Long Nose Pliers	160	176	✓
225320	Long Nose Pliers	200	210	✓

End Wire Stripping Pliers

- ▶ With fine adjustment screw
- ▶ Made of tempered steel
- ▶ Polished chrome head
- ▶ For solid and stranded conductors of up to Ø 5mm
- ▶ Tested to EN/IEC 60900:2004



Part No	Description	Length [mm]	Weight [g]	Insulated
271316	End Wire Stripping Pliers	165	163	✓

Water Pump Pliers

- ▶ Specially hardened toothed grip
- ▶ Strength of teeth approx. 65 HRC
- ▶ Clamping guard prevents injury
- ▶ Optimal leverage
- ▶ 7 Adjustable positions
- ▶ Made of tempered chrome vanadium steel
- ▶ Tested to EN/IEC 60900:2004



Part No	Description	Length [mm]	Weight [g]	Insulated
447240	Water Pump Pliers	250	376	✓

Groove Joint Pliers

- ▶ 6 Adjustable positions
- ▶ Optimal leverage
- ▶ Tested to EN/IEC 60900:2004



Part No	Description	Length [mm]	Weight [g]	Insulated
445300	Groove Joint Pliers	300	700	✓
445410	Groove Joint Pliers	410	1450	✓

Plastic Flat Nose Pliers

- ▶ For meter connections and meter locking
- ▶ Without metal parts
- ▶ Tested to EN/IEC 60900:2004



▶ 630000
1000V
EN/IEC 60900:2004

Part No	Description	Length [mm]	Weight [g]	Insulated
630000	Plastic Flat Nose Pliers	180	85	✓

Plastic Flat Nose Pliers, Round Jaw

- ▶ With rounded jaws
- ▶ Fibreglass reinforced, tough non-brittle plastic
- ▶ For changing cylindrical fuses
- ▶ Jaw openings : Ø 11mm and Ø 18mm
- ▶ Tested to EN/IEC 60900:2004



▶ 217318
1000V
EN/IEC 60900:2004

Part No	Description	Length [mm]	Weight [g]	Insulated
217318	Plastic Flat Nose Pliers, round jaw	180	90	✓

Plastic Flat Nose Pliers, Short Jaw

- ▶ Solid design with excellent twisting and bending strength
- ▶ Fibreglass reinforced, tough non-brittle plastic
- ▶ For holding, bending and twisting of single wires
- ▶ Tested to EN/IEC 60900:2004



▶ 217518
1000V
EN/IEC 60900:2004

Part No	Description	Length [mm]	Weight [g]	Insulated
217518	Plastic Flat Nose Pliers, short jaw	180	100	✓

Plastic Flat Nose Pliers, Long Jaw

- ▶ Fibreglass reinforced, tough non-brittle plastic
- ▶ For fitting and blocking meters
- ▶ For holding and inserting single wires
- ▶ Tested to EN/IEC 60900:2004



▶ 217918
1000V
EN/IEC 60900:2004

Part No	Description	Length [mm]	Weight [g]	Insulated
217918	Plastic Flat Nose Pliers, long jaws	180	98	✓

Insulation Hole Cutter

- ▶ Insulation is pierced at a 4mm diameter and removed
- ▶ Eliminates need of piercing insulation with test probe
- ▶ Gives a safe measuring point
- ▶ Lowers risk regarding misreading and damage to testing device
- ▶ Insulation of tough non-brittle plastic
- ▶ Tested to EN/IEC 60900:2004



▶ 284300
▶ 284200
1000V
EN/IEC 60900:2004

Part No	Description	Length [mm]	Hole Diameter [mm]	Weight [g]	Insulated
284300	Insulation Hole Cutter	200	4	90	✓
284200	Insulation T-Bar Hole Cutter	145	4	150	✓

Cable Knives

(inc. blade cover)

- ▶ Moulded easy grip handle
- ▶ Strong fixed blade
- ▶ Blade of tempered stainless steel
- ▶ Insulation of tough non-brittle plastic
- ▶ Tested to EN/IEC 60900:2004



▶ 281300
▶ 281310
1000V
EN/IEC 60900:2004

Part No	Description	Length [mm]	Length of Blade [mm]	Weight [g]	Insulated
281300	Cable Knife with safety cap	180	50	80	✓
281310	Cable Knife with insulated blade with cap	180	50	80	✓

Cable Knives – Heavy Duty Blade

(inc. blade cover)

- ▶ For stripping cables
- ▶ General stripping applications
- ▶ Easy grip handle



▶ 486501
▶ 104050

Part No	Description	Length [mm]	Length of Blade [mm]	Weight [g]	Insulated
104050	Cable Knife – Heavy Duty Blade	180	50	100	✓
486501	Cable Knife – Straight Blade	185	70	40	x

Cable Knife with Guide Blade

(inc. blade cover)

- ▶ Special blade with horizontal guide blade prevents damage for single cable conductors
- ▶ For slitting and removal of sheath
- ▶ Blade and horizontal guide blade sharpened
- ▶ Blade of tempered stainless steel
- ▶ Insulation of tough non-brittle plastic
- ▶ Tested to EN/IEC 60900:2004



▶ 288700
1000V
EN/IEC 60900:2004

Part No	Description	Length [mm]	Length of Blade [mm]	Weight [g]	Insulated
288700	Cable Knife with Guide Blade	175	47	65	✓

Cable Knife with Replaceable Blade

- ▶ Commercial tapered blade
- ▶ Comfortable handle of impact resistant plastic
- ▶ Collapsible blade safety guard, firmly fixed to handle
- ▶ Blade can be separated from holder
- ▶ Tested to EN/IEC 60900:2004



Part No	Description	Overall Length [mm]	Length of Blade [mm]	Weight [g]	Insulated
281510	Cable Knife with Replaceable steel blade	200	50	70	✓
281512	Blade Holder for 281510/281511	75	-	7	x

Cable Knife with Integrated Blade Safety Guard

- ▶ Straight solid blade with coated back
- ▶ Blade of tempered stainless steel
- ▶ Comfortable handle of impact resistant plastic
- ▶ Collapsible blade safety guard, firmly fixed to handle
- ▶ With replaceable blade
- ▶ Tested to EN/IEC 60900:2004



Part No	Description	Overall Length [mm]	Length of Blade [mm]	Weight [g]	Insulated
281500	Cable Knife with integrated blade safety guard	200	50	70	✓
281501	Spare Blade for 281500	80	50	20	x

Cable Coring Knife with Ceramic Blade

- ▶ With built in blade cover
- ▶ For stripping cables
- ▶ Fully insulated
- ▶ High cutting capacity
- ▶ Minimum production quantity applies
- ▶ Tested to EN/IEC 60900:2004



Part No	Description	Length [mm]	Blade	Weight [g]	Insulated
281550	Cable Coring Knife with Straight Ceramic Blade	185mm	46mm	68	✓

Cable Coring Knife with Curved Blade (inc blade cover)

- ▶ Blade manufactured of tempered stainless steel
- ▶ Curved blade for easy stripping
- ▶ Excellent cutting quality – stays sharp



Part No	Description	Overall Length [mm]	Length of Blade [mm]	Weight [g]	Insulated
104060	Cable Coring Knife with Curved Blade	180	60	175	✓
C99	Cable Coring Knife with Curved Blade	55	70	40	x

Cable Core Stripper

- ▶ Suitable for removal of insulation and sheathing from live armoured cables
- ▶ Exceptionally strong tough polymeric blade
- ▶ Unique handle moulded in softer plastic material to provide a cushion when a hammer is used to initiate a cut in the cable sheath



Part No	Description	Nominal Lift [mm]	Weight [g]	Insulated
120-CS	Cable Core Stripper	90	165	✓

Cable Knife - Heavy Duty

- ▶ Heavy duty fixed blade
- ▶ For cutting cable sheath and splitting lead joints
- ▶ Special shaped blade to ensure clean cut



Part No	Description	Length [mm]	Weight [g]	Depth of Blade [mm]	Insulated
283002	Cable Knife - Heavy Duty	210	183	32	x

Hack / Coring Knives

- ▶ Originally developed for stripping the lead sheath from plic cables
- ▶ Widespread application in the removal of the bedding compound from waveform one cables without damage to the soft aluminium neutral earth wires
- ▶ Special shaped blade to ensure clean cut without damage to the underlying insulation allowing sheath of live cables to be safely removed



Part No	Description	Length [mm]	Weight [g]	Depth of Blade [mm]	Insulated
JTN-4	Plastic Hack Knife	245	113	39	✓
JTN-6	Plastic Coring Knife	196	74	-	✓

Lineman's Knife

- ▶ Non-slip finger grooves
- ▶ Safety locking device
- ▶ Case with whetstone and revolution free joint
- ▶ Well balanced double-edged blade



Part No	Description	Blade Material	Blade Length [mm]	Overall Length [mm]	Weight [g]	Insulated
LE-325	Lineman's Knife with case	Carbon Steel	80	234	130	x

Electrician's Knives

- ▶ Blades manufactured from high carbon steel or stainless steel
- ▶ Durable blades
- ▶ Heavy duty folding knives
- ▶ Corrosion resistant



Part No	Description	Blade Material	Handle Material	Blade Length [mm]	Overall Length [mm]	Weight [g]	Insulated
MEK-50	Electrician's Knife – curved blade	Carbon Steel	Hardwood	50	185	110	x
MEK-60	Electrician's Knife – curved blade	Carbon Steel	Hardwood	60	195	115	x

Electrician's Knives

- ▶ Blades manufactured from high carbon steel or stainless steel
- ▶ Durable blades
- ▶ Heavy duty folding knives
- ▶ Corrosion resistant



Part No	Description	Blade Material	Handle Material	Blade Length [mm]	Overall Length [mm]	Weight [g]	Insulated
MEK-70	Electrician's Knife – straight blade	Carbon Steel	Hardwood	70	205	120	x
MDX-01	Electrician's Knife – straight blade	Stainless Steel	Hardwood	80	195	110	x
MEK-70M	Electrician's Knife – straight blade	Stainless Steel	ABS Plastic	70	205	120	x

Electrician's Scissors with LED warning

- ▶ The permanent built-in red LED warning light is designed to warn the user of any live voltage presence
- ▶ Working temperature – 10/+50°C, rel humidity 20/90%
- ▶ Working range 50 – 1000V AC
- ▶ Requires 2 interchangeable batteries type LR41 1.5V
- ▶ ATTENTION: The integrated electronics do not work on shielded cables



Part No	Description	Length [mm]	Blade Shape	Weight [g]	Insulated
272014	Electrician's Scissors with LED warning	140	Straight	80	x

Electrician's Scissors

- ▶ Two component handles
- ▶ Impact absorbing inserts
- ▶ Ergonomic, light and extra durable
- ▶ High cutting performance



Part No	Description	Length [mm]	Blade Shape	Weight [g]	Insulated
272012	Electrician's Scissors	140	Straight	75	x

Safety Box for Electrician's Scissors

- ▶ Protective, impact resistant, resin case
- ▶ With turning safety clip
- ▶ Suitable for use with Electrician's Scissors



Part No	Description	Length [mm]	Weight [g]	Insulated
272015	Safety box for scissors	12 x 7	10	x

Junior Hacksaw

- ▶ Lightweight
- ▶ Strong compact frame
- ▶ Tested to EN/IEC 60900:2004



Part No	Description	Length of Blade [mm]	Weight [g]	Insulated
701150	Junior Hacksaw 32 tpi blade	150	145	✓
701151	Spare Blade 32 tpi for 701150	150	2	x
701152	Special Wide Blade 18 tpi for 701150	150	8	x
701153	Special Wide Blade 24 tpi for 701150	150	9	x

Hacksaw

- ▶ Lightweight
- ▶ Heavy duty frame
- ▶ Tested to EN/IEC 60900:2004
- ▶ Blade tension and blade Spare can be easily undertaken by using the wing nut device



Part No	Description	Length of Blade [mm]	Overall Length [mm]	Weight [g]	Insulated
701300	Hacksaw 24 tpi blade	300	480	800	✓
701301	Spare Blade 24 tpi for 701300	300	-	10	x
701302	Spare Blade 18 tpi for 701300	300	-	10	x

Bowsaw

- ▶ Specially designed for the Fire & Rescue Service
- ▶ Provides protection for the user in potentially hazardous areas up to 1000V maximum
- ▶ Blade tension and blade Spare can be easily undertaken by using the wing nut device
- ▶ Supplied with a protective plastic blade sleeve
- ▶ Tested to EN/IEC 60900:2004



Part No	Description	Length of Blade [mm]	Overall Length [mm]	Weight [g]	Insulated
701600	Bowsaw	600	780	1720	✓
701601	Spare Blade for 701600	600	-	50	x

Depth Gauge Saw

- ▶ For controlled cutting of cable sheath
- ▶ Standard cutting depth 2mm
- ▶ Other lengths available on request
- ▶ Other depths available on request
- ▶ Tested to EN/IEC 60900:2004



Part No	Description	Length of Blade [mm]	Weight [g]	Insulated
430315	Depth Gauge Saw	150	285	✓
430325	Depth Gauge Saw	250	341	✓

Reversible Ring Ratchet Wrench

- ▶ 31 CrV 3 Steel
- ▶ Double-sided ratchet wrench
- ▶ Tested to EN/IEC 60900:2004
- ▶ Strong torque for heavy duty
- ▶ Also available with insulated head
- ▶ Uninsulated available on request



Part No	Description	Sizes [mm]	Length [mm]	Weight [g]	Insulated
161713	Reversible Ring Ratchet Wrench	10 x 13	235	176	✓
161717	Reversible Ring Ratchet Wrench	13 x 17	280	270	✓
161719	Reversible Ring Ratchet Wrench	17 x 19	320	504	✓
161721	Reversible Ring Ratchet Wrench	17 x 21	320	430	✓
161724	Reversible Ring Ratchet Wrench	19 x 24	320	473	✓
161726	Reversible Ring Ratchet Wrench	21 x 26	340	920	✓
161730	Reversible Ring Ratchet Wrench	24 x 30	420	1212	✓
161732	Reversible Ring Ratchet Wrench	30 x 32	425	1320	✓

Reversible Ring Ratchet Wrench - Insulated Head



Part No	Description	Sizes [mm]	Length [mm]	Weight [g]	Insulated
165713	Reversible Ring Ratchet Wrench	10 x 13	238	182	✓
165717	Reversible Ring Ratchet Wrench	13 x 17	283	281	✓
165719	Reversible Ring Ratchet Wrench	17 x 19	323	515	✓
165721	Reversible Ring Ratchet Wrench	17 x 21	323	442	✓
165724	Reversible Ring Ratchet Wrench	19 x 24	323	480	✓
165726	Reversible Ring Ratchet Wrench	21 x 26	343	932	✓
165730	Reversible Ring Ratchet Wrench	24 x 30	423	1224	✓
165732	Reversible Ring Ratchet Wrench	30 x 32	428	1350	✓

Depth Gauge Saw

- ▶ For cable with sheet steel sheathing
- ▶ Adjustable stopper
- ▶ Replaceable saw-blade
- ▶ Notched saw-blade for soft materials
- ▶ Fine toothed saw-blade for sheet metal
- ▶ Tested to EN/IEC 60900:2004



Part No	Description	Length of Blade [mm]	Weight [g]	Insulated
430302	Universal Saw 24 tpi, fine	120	140	✓
430801	Spare blade 18 tpi, notched for 430302	120	6	x
430805	Spare blade 24 tpi, notched for 430302	120	6	x

Torque Wrench

- ▶ Manufactured of alloyed and hardened steel
- ▶ Socket secured by expanding ball bearing
- ▶ Preset wrenches also available on request
- ▶ Customised socket sets available
- ▶ Suitable for all types of screwdriver heads
- ▶ Adjustment tolerance can be ± of the nominal value
- ▶ Anti-clockwise operation without limitation
- ▶ Tested to EN/IEC 60900:2004



Part No	Description	Adjustable Torque [Nm]	Length [mm]	Weight [g]	Insulated
281212	Torque Wrench ¼" Sq Drive Mini	2 - 10	200	370	✓
281525	Torque Wrench ¼" Sq Drive Mini	5 - 25	200	370	✓
282525	Torque Wrench 3/8" Sq Drive	5 - 25	200	395	✓
307527	Torque Wrench 3/8" Sq Drive	5 - 25	380	937	✓
307550	Torque Wrench 3/8" Sq Drive	5 - 50	370	1118	✓
308280	Torque Wrench ½" Sq Drive	5 - 50	280	900	✓
308201	Torque Wrench ½" Sq Drive	20 - 100	460	1375	✓
308402	Torque Wrench ½" Sq Drive	40 - 220	530	900	✓
308227	Torque Wrench ½" Sq Drive	5 - 25	280	1300	✓
282425	Torque Wrench ½" Sq Drive	5 - 25	200	900	✓
308550	Torque Wrench ½" Sq Drive	5 - 50	370	1100	✓

Reversible Ratchet Lever

- ▶ Manufactured of alloyed and hardened steel
- ▶ Clockwise and anti-clockwise operation
- ▶ Socket locking mechanism - quick release
- ▶ Customised socket sets available
- ▶ Tested to EN/IEC 60900:2004



▶ 131312



Part No	Description	Length [mm]	Height [mm]	Weight [g]	Insulated
131338	Reversible Ratchet Lever 3/8" Sq Drive	200	70	375	✓
131312	Reversible Ratchet Lever 1/2" Sq Drive	260	85	685	✓

Extension Bar

- ▶ Manufactured of alloyed steel
- ▶ Socket secured by expanding ball bearing
- ▶ Suitable for all types of socket
- ▶ Customised socket sets available
- ▶ Tested to EN/IEC 60900:2004



▶ 132312



Part No	Description	Length [mm]	Weight [g]	Insulated
132307	Extension Bar 3/8" Sq Drive	95	100	✓
132312	Extension Bar 3/8" Sq Drive	125	150	✓
132325	Extension Bar 3/8" Sq Drive	250	290	✓
133312	Extension Bar 1/2" Sq Drive	125	244	✓
133325	Extension Bar 1/2" Sq Drive	250	380	✓
133307	Extension Bar 1/2" Sq Drive	75	175	✓

T Bar Lever

- ▶ Manufactured of alloyed steel
- ▶ Socket secured by expanding ball bearing
- ▶ Suitable for all types of socket
- ▶ Customised socket sets available
- ▶ Tested to EN/IEC 60900:2004



▶ 125302



Part No	Description	T Bar Length [mm]	Length [mm]	Weight [g]	Insulated
125402	T Bar Lever 3/8" Sq Drive	150	200	350	✓
125302	T Bar Lever 1/2" Sq Drive	150	200	380	✓
125303	T Bar Lever 1/2" Sq Drive	200	300	540	✓

Socket Set 1/2"

- ▶ Tested to EN/IEC 60900:2004
- ▶ Other customised socket sets available
- ▶ 22 piece set



▶ 131300



Part No	Description	Weight [g]	Insulated
131300	Socket Set 1/2" Sq Drive 6pt 8-24mm Sockets + Case	5200	✓

Socket 3/8" Square Drive for Hexagon Bolts

- ▶ All inserts are manufactured of alloyed and hardened steel
- ▶ Socket secured by expanding ball bearing
- ▶ Customised socket sets available
- ▶ Whitworth and AF" sizes available
- ▶ Tested to EN/IEC 60900:2004
- ▶ Length - Standard 40mm / Long 75mm



6 Point Part No	12 Point Part No	Description	Size [mm]	Weight [g]	Insulated
130206	135206	Socket 3/8" Sq Drive Standard	6	22	✓
130207	135207	Socket 3/8" Sq Drive Standard	7	23	✓
130208	135208	Socket 3/8" Sq Drive Standard	8	25	✓
130209	135209	Socket 3/8" Sq Drive Standard	9	28	✓
130210	135210	Socket 3/8" Sq Drive Standard	10	28	✓
130211	135211	Socket 3/8" Sq Drive Standard	11	28	✓
130212	135212	Socket 3/8" Sq Drive Standard	12	30	✓
130213	135213	Socket 3/8" Sq Drive Standard	13	33	✓
130214	135214	Socket 3/8" Sq Drive Standard	14	34	✓
130215	135215	Socket 3/8" Sq Drive Standard	15	38	✓
130216	135216	Socket 3/8" Sq Drive Standard	16	43	✓
130217	135217	Socket 3/8" Sq Drive Standard	17	48	✓
130218	135218	Socket 3/8" Sq Drive Standard	18	53	✓
130219	135219	Socket 3/8" Sq Drive Standard	19	56	✓
130220	135220	Socket 3/8" Sq Drive Standard	20	70	✓
130221	135221	Socket 3/8" Sq Drive Standard	21	83	✓
130222	135222	Socket 3/8" Sq Drive Standard	22	95	✓
130224	135224	Socket 3/8" Sq Drive Standard	24	112	✓
130308	135308	Socket 3/8" Sq Drive Long	8	50	✓
130309	135309	Socket 3/8" Sq Drive Long	9	55	✓
130310	135310	Socket 3/8" Sq Drive Long	10	63	✓
130311	135311	Socket 3/8" Sq Drive Long	11	67	✓
130312	135312	Socket 3/8" Sq Drive Long	12	70	✓
130313	135313	Socket 3/8" Sq Drive Long	13	77	✓
130314	135314	Socket 3/8" Sq Drive Long	14	85	✓
130315	135315	Socket 3/8" Sq Drive Long	15	100	✓
130316	135316	Socket 3/8" Sq Drive Long	16	113	✓
130317	135317	Socket 3/8" Sq Drive Long	17	122	✓
130318	135318	Socket 3/8" Sq Drive Long	18	130	✓
130319	135319	Socket 3/8" Sq Drive Long	19	144	✓
130320	135320	Socket 3/8" Sq Drive Long	20	150	✓
130321	135321	Socket 3/8" Sq Drive Long	21	160	✓
130322	135322	Socket 3/8" Sq Drive Long	22	185	✓
130323	135323	Socket 3/8" Sq Drive Long	23	210	✓
130324	135324	Socket 3/8" Sq Drive Long	24	250	✓
130327	135327	Socket 3/8" Sq Drive Long	27	315	✓
130330	135330	Socket 3/8" Sq Drive Long	30	360	✓

Socket 1/2" Square Drive for Hexagon Bolts

- ▶ All inserts are manufactured of alloyed and hardened steel
- ▶ Length - Standard 50mm / Long 90mm
- ▶ Socket secured by expanding ball bearing
- ▶ Suitable for all types of socket
- ▶ Customised socket sets available
- ▶ Whitworth and AF" sizes available
- ▶ Tested to EN/IEC 60900:2004



6 Point Part No	12 Point Part No	Description	Size [mm]	Weight [g]	Insulated
130408	135408	Socket 1/2" Sq Drive Standard	8	53	✓
130409	135409	Socket 1/2" Sq Drive Standard	9	53	✓
130410	135410	Socket 1/2" Sq Drive Standard	10	55	✓
130411	135411	Socket 1/2" Sq Drive Standard	11	55	✓
130412	135412	Socket 1/2" Sq Drive Standard	12	57	✓
130413	135413	Socket 1/2" Sq Drive Standard	13	60	✓
130414	135414	Socket 1/2" Sq Drive Standard	14	65	✓
130415	135415	Socket 1/2" Sq Drive Standard	15	70	✓
130416	135416	Socket 1/2" Sq Drive Standard	16	74	✓
130417	135417	Socket 1/2" Sq Drive Standard	17	78	✓
130418	135418	Socket 1/2" Sq Drive Standard	18	82	✓
130419	135419	Socket 1/2" Sq Drive Standard	19	85	✓
130420	135420	Socket 1/2" Sq Drive Standard	20	116	✓
130421	135421	Socket 1/2" Sq Drive Standard	21	127	✓
130422	135422	Socket 1/2" Sq Drive Standard	22	130	✓
130423	135423	Socket 1/2" Sq Drive Standard	23	140	✓
130424	135424	Socket 1/2" Sq Drive Standard	24	148	✓
130425	135425	Socket 1/2" Sq Drive Standard	25	180	✓
130426	135426	Socket 1/2" Sq Drive Standard	26	180	✓
130427	135427	Socket 1/2" Sq Drive Standard	27	210	✓
130430	135430	Socket 1/2" Sq Drive Standard	30	252	✓
130432	135432	Socket 1/2" Sq Drive Standard	32	270	✓
130434	135434	Socket 1/2" Sq Drive Standard	34	300	✓
130508	135508	Socket 1/2" Sq Drive Long	8	102	✓
130509	135509	Socket 1/2" Sq Drive Long	9	105	✓
130510	135510	Socket 1/2" Sq Drive Long	10	118	✓
130511	135511	Socket 1/2" Sq Drive Long	11	120	✓
130512	135512	Socket 1/2" Sq Drive Long	12	123	✓
130513	135513	Socket 1/2" Sq Drive Long	13	127	✓
130514	135514	Socket 1/2" Sq Drive Long	14	134	✓
130515	135515	Socket 1/2" Sq Drive Long	15	140	✓
130516	135516	Socket 1/2" Sq Drive Long	16	150	✓
130517	135517	Socket 1/2" Sq Drive Long	17	170	✓
130518	135518	Socket 1/2" Sq Drive Long	18	188	✓
130519	135519	Socket 1/2" Sq Drive Long	19	204	✓
130520	135520	Socket 1/2" Sq Drive Long	20	210	✓
130521	135521	Socket 1/2" Sq Drive Long	21	216	✓
130522	135522	Socket 1/2" Sq Drive Long	22	226	✓
130523	135523	Socket 1/2" Sq Drive Long	23	241	✓
130524	135524	Socket 1/2" Sq Drive Long	24	270	✓
130525	135525	Socket 1/2" Sq Drive Long	25	276	✓
130526	135526	Socket 1/2" Sq Drive Long	26	300	✓
130527	135527	Socket 1/2" Sq Drive Long	27	337	✓
130530	135530	Socket 1/2" Sq Drive Long	30	390	✓
130532	135532	Socket 1/2" Sq Drive Long	32	423	✓

Allen Key Socket 3/8" & 1/2" Square Drive for Hexagon Socket Head Screws

- ▶ Hexagon sockets are made of alloyed and hardened steel
- ▶ Customised socket sets available
- ▶ Long version available on request
- ▶ Tested to EN/IEC 60900:2004
- ▶ Allen Key Socket for Hexagon Socket Head Screw 3/8" or 1/2" socket – standard length 80mm



Part No	Description	Size [mm]	Weight [g]	Insulated
140304	Allen Key Socket 3/8" Sq Drive - Standard	4.0	50	✓
140305	Allen Key Socket 3/8" Sq Drive - Standard	5.0	56	✓
140306	Allen Key Socket 3/8" Sq Drive - Standard	6.0	60	✓
140308	Allen Key Socket 3/8" Sq Drive - Standard	8.0	78	✓
140310	Allen Key Socket 3/8" Sq Drive - Standard	10.0	103	✓
140311	Allen Key Socket 3/8" Sq Drive - Standard	11.0	114	✓
140312	Allen Key Socket 3/8" Sq Drive - Standard	12.0	124	✓
140313	Allen Key Socket 3/8" Sq Drive - Standard	13.0	135	✓
140314	Allen Key Socket 3/8" Sq Drive - Standard	14.0	118	✓
140504	Allen Key Socket 1/2" Sq Drive - Standard	4.0	65	✓
140505	Allen Key Socket 1/2" Sq Drive - Standard	5.0	70	✓
140506	Allen Key Socket 1/2" Sq Drive - Standard	6.0	74	✓
140507	Allen Key Socket 1/2" Sq Drive - Standard	7.0	79	✓
140508	Allen Key Socket 1/2" Sq Drive - Standard	8.0	87	✓
140509	Allen Key Socket 1/2" Sq Drive - Standard	9.0	90	✓
140510	Allen Key Socket 1/2" Sq Drive - Standard	10.0	108	✓
140512	Allen Key Socket 1/2" Sq Drive - Standard	12.0	126	✓
140514	Allen Key Socket 1/2" Sq Drive - Standard	14.0	158	✓
140517	Allen Key Socket 1/2" Sq Drive - Standard	17.0	170	✓
140519	Allen Key Socket 1/2" Sq Drive - Standard	19.0	185	✓

Miniature BA, Open Ended Spanners



▶ 100960



Part No	Size	Length [mm]	Weight [g]	Insulated
100960	0BA	90	24	✓
100970	2BA	85	17	✓
100980	3BA	80	9	✓
100990	4BA	80	7	✓

Open Ended Spanners – Metric/Whitworth/A/F

- ▶ Made of chrome vanadium steel
- ▶ Long length spanners available on request
- ▶ Torque tested according to DIN899
- ▶ Tested to EN/IEC 60900:2004
- ▶ Spanner sets available on request



Part No	Description	Length [mm]	Size [mm]	Weight [g]	Insulated
151306	Open Ended Spanner - Metric	80	6	20	✓
151307	Open Ended Spanner - Metric	80	7	20	✓
151308	Open Ended Spanner - Metric	95	8	20	✓
151309	Open Ended Spanner - Metric	105	9	24	✓
151310	Open Ended Spanner - Metric	110	10	29	✓
151311	Open Ended Spanner - Metric	115	11	33	✓
151312	Open Ended Spanner - Metric	130	12	44	✓
151313	Open Ended Spanner - Metric	135	13	48	✓
151314	Open Ended Spanner - Metric	140	14	54	✓
151315	Open Ended Spanner - Metric	145	15	58	✓
151316	Open Ended Spanner - Metric	145	16	70	✓
151317	Open Ended Spanner - Metric	155	17	84	✓
151318	Open Ended Spanner - Metric	170	18	100	✓
151319	Open Ended Spanner - Metric	175	19	105	✓
151320	Open Ended Spanner - Metric	200	20	149	✓
151321	Open Ended Spanner - Metric	200	21	159	✓
151322	Open Ended Spanner - Metric	220	22	192	✓
151324	Open Ended Spanner - Metric	240	24	242	✓
151327	Open Ended Spanner - Metric	260	27	322	✓
151330	Open Ended Spanner - Metric	275	30	343	✓
151332	Open Ended Spanner - Metric	305	32	500	✓
151334	Open Ended Spanner - Metric	310	34	500	✓
151336	Open Ended Spanner - Metric	310	36	575	✓

Open Ended Spanners – Whitworth

Part No	Description	Length [mm]	Size ["]	Weight [g]	Insulated
150108	Open Ended Spanner - Whitworth	120	1/8 W	34	✓
150316	Open Ended Spanner - Whitworth	130	3/16 W	44	✓
150104	Open Ended Spanner - Whitworth	140	1/4 W	54	✓
150516	Open Ended Spanner - Whitworth	145	5/16 W	70	✓
150308	Open Ended Spanner - Whitworth	170	3/8 W	100	✓
150716	Open Ended Spanner - Whitworth	200	7/16 W	160	✓
150102	Open Ended Spanner - Whitworth	240	1/2 W	242	✓
150916	Open Ended Spanner - Whitworth	260	9/16 W	322	✓
150508	Open Ended Spanner - Whitworth	275	5/8 W	343	✓
150116	Open Ended Spanner - Whitworth	305	11/16 W	500	✓
150304	Open Ended Spanner - Whitworth	310	3/4 W	500	✓
150708	Open Ended Spanner - Whitworth	320	7/8 W	600	✓
150100	Open Ended Spanner - Whitworth	400	1 W	700	✓

Open Ended Spanners – A/F

Part No	Description	Length [mm]	Size ["]	Weight [g]	Insulated
152104	Open Ended Spanner – A/F	90	1/4 A/F	25	✓
152516	Open Ended Spanner – A/F	100	5/16 A/F	35	✓
152308	Open Ended Spanner – A/F	120	3/8 A/F	40	✓
152716	Open Ended Spanner – A/F	135	7/16 A/F	50	✓
152102	Open Ended Spanner – A/F	140	1/2 A/F	55	✓
152916	Open Ended Spanner – A/F	150	9/16 A/F	65	✓
152508	Open Ended Spanner – A/F	155	5/8 A/F	70	✓
152116	Open Ended Spanner – A/F	175	11/16 A/F	110	✓
152304	Open Ended Spanner – A/F	210	3/4 A/F	160	✓
152708	Open Ended Spanner – A/F	240	7/8 A/F	250	✓
152100	Open Ended Spanner – A/F	260	1 A/F	325	✓
152556	Open Ended Spanner – A/F	320	1 5/16 A/F	500	✓

General Purpose Open Ended Spanners (Handles only insulated)



Part No	Size [mm]	Weight [g]	Insulated	Part No	Size ["]	Weight [g]	Insulated	Part No	Size BSW	Weight [g]	Insulated
155307	7	27	✓	154308	3/8 A/F	69	✓	156316	3/16" whit	48	✓
155308	8	31	✓	154716	7/16 A/F	72	✓	156314	1/4" Whit	70	✓
155310	10	48	✓	154102	1/2 A/F	76	✓	156516	5/16" Whit	85	✓
155311	11	50	✓	154916	9/16 A/F	78	✓	156308	3/8" Whit	125	✓
155312	12	65	✓	154508	5/8 A/F	100	✓	156716	7/16" Whit	190	✓
155313	13	70	✓	154116	11/16 A/F	118	✓	156102	1/2" Whit	235	✓
155314	14	90	✓	154304	3/4 A/F	130	✓	156916	9/16" Whit	270	✓
155315	15	97	✓	154316	13/16 A/F	175	✓	156508	5/8" Whit	300	✓
155316	16	110	✓	154708	7/8 A/F	195	✓	156116	11/16" Whit	320	✓
155317	17	120	✓	154100	1 A/F	240	✓	156304	3/4" Whit	392	✓
155318	18	134	✓	154118	1 1/8 A/F	300	✓	156708	7/8" Whit	520	✓
155319	19	150	✓	154114	1 1/4 A/F	330	✓				
155321	21	185	✓	154156	1 5/16 A/F	360	✓				
155322	22	190	✓	154176	1 7/16 A/F	395	✓				
155323	23	200	✓	154112	1 1/2 A/F	420	✓				
155324	24	210	✓								
155330	30	350	✓								
155332	32	412	✓								
155336	36	507	✓								

Ring Spanners – Metric/Whitworth/Δ /F

- ▶ Made of chrome vanadium steel
- ▶ Conforms to ISO 10104, DIN 838 and UNE 16522
- ▶ Larger sizes available on request
- ▶ Tested to EN/IEC 60900:2004



Part No	Description	Length [mm]	Size [mm]	Weight [g]	Insulated
161306	Ring Spanner - Metric	140	6	41	✓
161307	Ring Spanner - Metric	145	7	50	✓
161308	Ring Spanner - Metric	150	8	62	✓
161309	Ring Spanner - Metric	155	9	68	✓
161310	Ring Spanner - Metric	165	10	84	✓
161311	Ring Spanner - Metric	175	11	90	✓
161312	Ring Spanner - Metric	185	12	106	✓
161313	Ring Spanner - Metric	185	13	113	✓
161314	Ring Spanner - Metric	195	14	135	✓
161315	Ring Spanner - Metric	200	15	160	✓
161316	Ring Spanner - Metric	205	16	175	✓
161317	Ring Spanner - Metric	205	17	205	✓
161318	Ring Spanner - Metric	215	18	227	✓
161319	Ring Spanner - Metric	220	19	296	✓
161320	Ring Spanner - Metric	240	20	300	✓
161321	Ring Spanner - Metric	245	21	305	✓
161322	Ring Spanner - Metric	245	22	308	✓
161324	Ring Spanner - Metric	270	24	422	✓
161327	Ring Spanner - Metric	285	27	455	✓
161330	Ring Spanner - Metric	300	30	561	✓
161332	Ring Spanner - Metric	320	32	646	✓
161334	Ring Spanner - Metric	340	34	1060	✓
161336	Ring Spanner - Metric	340	36	1060	✓

Ring Spanners – Whitworth

Part No	Description	Length [mm]	Size ["]	Weight [g]	Insulated
160108	Ring Spanner – Whitworth	155	1/8	68	✓
160316	Ring Spanner – Whitworth	185	3/16	106	✓
160104	Ring Spanner – Whitworth	195	1/4	135	✓
160516	Ring Spanner – Whitworth	205	5/16	175	✓
160308	Ring Spanner – Whitworth	215	3/8	227	✓
160716	Ring Spanner – Whitworth	245	7/16	305	✓
160102	Ring Spanner – Whitworth	270	1/2	422	✓
160916	Ring Spanner – Whitworth	285	9/16	455	✓
160508	Ring Spanner – Whitworth	295	5/8	540	✓
160116	Ring Spanner – Whitworth	305	11/16	565	✓
160304	Ring Spanner – Whitworth	320	3/4	650	✓
160708	Ring Spanner – Whitworth	360	7/8	1100	✓
160100	Ring Spanner – Whitworth	400	1	1200	✓

Ring Spanners – A/F

Part No	Description	Length [mm]	Size ["]	Weight [g]	Insulated
162104	Ring Spanner – A/F	140	1/4	41	✓
162516	Ring Spanner – A/F	150	5/16	62	✓
162308	Ring Spanner – A/F	165	3/8	84	✓
162716	Ring Spanner – A/F	175	7/16	90	✓
162102	Ring Spanner – A/F	185	1/2	113	✓
162916	Ring Spanner – A/F	195	9/16	135	✓
162508	Ring Spanner – A/F	205	5/8	175	✓
162116	Ring Spanner – A/F	215	11/16	227	✓
162304	Ring Spanner – A/F	220	3/4	296	✓
162708	Ring Spanner – A/F	245	7/8	308	✓
162100	Ring Spanner – A/F	270	1	422	✓

Gear Wrench Spanners – Metric

- ▶ Needs as little as 5° of sweep to move a fastener
- ▶ Surface drive box end virtually eliminates the rounding of fasteners
- ▶ Fully hardened
- ▶ Tested to EN/IEC 60900:2004



Part No	Description	Length [mm]	Size [mm]	Weight [g]	Insulated
161555	Gear Wrench Spanner	115	5.5	20	✓
161506	Gear Wrench Spanner	120	6	25	✓
161507	Gear Wrench Spanner	125	7	28	✓
161508	Gear Wrench Spanner	130	8	30	✓
161509	Gear Wrench Spanner	135	9	35	✓
161510	Gear Wrench Spanner	140	10	40	✓
161511	Gear Wrench Spanner	145	11	50	✓
161512	Gear Wrench Spanner	150	12	60	✓
161513	Gear Wrench Spanner	155	13	80	✓
161514	Gear Wrench Spanner	160	14	90	✓
161515	Gear Wrench Spanner	170	15	105	✓
161516	Gear Wrench Spanner	180	16	125	✓
161517	Gear Wrench Spanner	190	17	145	✓
161518	Gear Wrench Spanner	195	18	170	✓
161519	Gear Wrench Spanner	205	19	180	✓
161521	Gear Wrench Spanner	240	21	280	✓
161522	Gear Wrench Spanner	260	22	320	✓
161524	Gear Wrench Spanner	280	24	450	✓
161525	Gear Wrench Spanner	290	25	465	✓
161527	Gear Wrench Spanner	320	27	500	✓
161530	Gear Wrench Spanner	350	30	530	✓
161532	Gear Wrench Spanner	375	32	550	✓
161534	Gear Wrench Spanner	400	34	575	✓

Fully Insulated Adjustable Spanners

- ▶ Made of chrome vanadium steel
- ▶ Tested to EN/IEC 60900:2004
- ▶ Insulated head and non conductive adjustment button



Part No	Description	Max Jaw Opening [mm]	Length	Metric Hexagon Nut Size	Weight [g]	Insulated
191200	Fully Insulated Adjustable Spanner	29	8" / 200mm	M1 - M18	320	✓
191250	Fully Insulated Adjustable Spanner	33	10" / 250mm	M1 - M22	560	✓
191300	Fully Insulated Adjustable Spanner	38	12" / 300mm	M1 - M24	890	✓

Adjustable Spanners

- ▶ Made of chrome vanadium steel
- ▶ Measurement scale on jaws to size nuts and pipes
- ▶ Cross section of the knurl is tapered to give a smoother and more precise action
- ▶ Tested to EN/IEC 60900:2004



Part No	Description	Max Jaw Opening [mm]	Length	Metric Hexagon Nut Size	Weight [g]	Insulated
192100	Adjustable Spanner	17	4" / 100mm	M1 - M10	70	✓
192150	Adjustable Spanner	24	6" / 150mm	M1 - M16	167	✓
192200	Adjustable Spanner	29	8" / 200mm	M1 - M18	307	✓
192250	Adjustable Spanner	33	10" / 250mm	M1 - M22	521	✓
192300	Adjustable Spanner	38	12" / 300mm	M1 - M24	818	✓
192375	Adjustable Spanner	50	15" / 375mm	M1 - M33	1420	✓
192450	Adjustable Spanner	60	18" / 450mm	M1 - M39	1870	✓

Adjustable Spanners Bahco

- ▶ Made of alloyed and hardened steel
- ▶ Exceeds ISO specifications
- ▶ Withstands high torque loads
- ▶ Tested to EN/IEC 60900:2004
- ▶ Clear measurement scale



Part No	Description	Opening [mm]	Length	Weight [g]	Insulated
151904	Adjustable Spanner - Bahco	0 - 13	4" / 100mm	140	✓
151906	Adjustable Spanner - Bahco	0 - 20	6" / 150mm	162	✓
151908	Adjustable Spanner - Bahco	0 - 27	8" / 200mm	260	✓
151910	Adjustable Spanner - Bahco	0 - 30	10" / 250mm	510	✓
151912	Adjustable Spanner - Bahco	0 - 34	12" / 300mm	870	✓
151915	Adjustable Spanner - Bahco	0 - 44	15" / 375mm	1430	✓
151918	Adjustable Spanner - Bahco	0 - 53	18" / 450mm	1900	✓

Adjustable Spanners with Handstop

- ▶ Made of chrome vanadium steel
- ▶ Measurement scale on jaws to size nuts and pipes
- ▶ Cross section of the knurl is tapered to give a smoother and more precise action
- ▶ Tested to EN/IEC 60900:2004



Part No	Description	Max Jaw Opening [mm]	Length	Metric Hexagon Nut Size	Weight [g]	Insulated
192100H	Adjustable Spanner with handstop	17	4" / 100mm	M1 - M10	150	✓
192150H	Adjustable Spanner with handstop	24	6" / 150mm	M1 - M16	180	✓
192200H	Adjustable Spanner with handstop	29	8" / 200mm	M1 - M18	305	✓
192250H	Adjustable Spanner with handstop	33	10" / 250mm	M1 - M22	582	✓
192300H	Adjustable Spanner with handstop	38	12" / 300mm	M1 - M24	902	✓
192375H	Adjustable Spanner with handstop	50	15" / 375mm	M1 - M33	1490	✓
192450H	Adjustable Spanner with handstop	60	18" / 450mm	M1 - M39	1950	✓

Hammer Head Adjustable

- ▶ Made of chrome vanadium steel
- ▶ Measurement scale on jaws to size nuts and pipes
- ▶ Cross section of the knurl is tapered to give a smoother and more precise action
- ▶ Tested to EN/IEC 60900:2004
- ▶ With hammer head feature
- ▶ Dual purpose tool



Part No	Description	Opening [mm]	Length	Weight [g]	Insulated
193300	Adjustable Spanner	0 - 30	12" / 300mm	875	✓

Hammer

- ▶ Replaceable Inserts
- ▶ Inserts manufactured from nylon
- ▶ Tested to EN/IEC 60900:2004



Part No	Description	Length [mm]	Handle ø [mm]	Insert	Weight [g]	Insulated
410330	Light Hammer	288	26	25	222	✓
410340	Light Hammer	300	26	35	400	✓
410331	Hammer Insert 25mm	-	-	25	34.4	x
410341	Hammer Insert 35mm	-	-	35	67.2	x

Slotted Screwdrivers

- ▶ High torque softgrip screwdrivers for slotted screws
- ▶ Precision hardened Chrome-Vanadium-Molybdenum steel blade
- ▶ Blade insulation directly moulded onto the blade
- ▶ Ergonomic, softgrip multi-component handle
- ▶ Tips and dimensions acc. to DIN 7437, ISO 2380, DIN 5264
- ▶ Tested to EN/IEC 60900:2004



Part No	Description	Tip length [mm]	Tip Width [mm]	Blade Length [mm]	Weight [g]	Insulated
111325	Screwdriver – Slotted	2.5	0.4	75	40	✓
111328	Screwdriver – Slotted	2.8	0.6	75	43	✓
111331	Screwdriver – Slotted	3.0	0.5	100	45	✓
111335	Screwdriver – Slotted	3.5	0.6	100	47	✓
111340	Screwdriver – Slotted	4.0	0.8	100	63	✓
111344	Screwdriver – Slotted	4.5	0.8	125	72	✓
111345	Screwdriver – Slotted	4.5	1.0	125	71	✓
111399	Screwdriver – Slotted	4.5	0.6	175	78	✓
111398	Screwdriver – Slotted	4.5	1.0	175	79	✓
111355	Screwdriver – Slotted	5.5	1.0	125	82	✓
111354	Screwdriver – Slotted	5.5	1.0	150	88	✓
111390	Screwdriver – Slotted	5.5	1.0	175	100	✓
111365	Screwdriver – Slotted	6.5	1.2	150	118	✓
111380	Screwdriver – Slotted	8.0	1.2	175	174	✓
111310	Screwdriver – Slotted	10.0	1.6	200	241	✓

Screwdriver

(for serial terminal connectors)

- ▶ High torque softgrip screwdrivers for terminal screws
- ▶ Precision hardened Chrome-Vanadium-Molybdenum steel blade
- ▶ Blade insulation directly moulded onto the blade
- ▶ Ergonomic, softgrip multi-component handle
- ▶ Tested to EN/IEC 60900:2004



Part No	Description	Point Size [mm]	Blade Length [mm]	Overall Length [mm]	Weight [g]	Insulated
112301	Screwdriver Flat/Poz	0.6 x 4.5	80	175	64	✓
112302	Screwdriver Flat/Poz	0.9 x 6.0	100	210	97	✓

Phillips Screwdrivers

- ▶ High torque softgrip screwdrivers for Phillips screws
- ▶ Precision hardened Chrome-Vanadium-Molybdenum steel blade
- ▶ Blade insulation directly moulded onto the blade
- ▶ Ergonomic, softgrip multi-component handle
- ▶ Tips and dimensions acc. to DIN 7438, ISO 8764-PH
- ▶ Tested to EN/IEC 60900:2004



Part No	Description	Point Size	Blade Length [mm]	Overall Length [mm]	Weight [g]	Insulated
113300	Screwdriver – PH	PH0	60	145	41	✓
113301	Screwdriver – PH	PH1	80	175	64	✓
113302	Screwdriver – PH	PH2	100	210	97	✓
113303	Screwdriver – PH	PH3	150	270	172	✓
113304	Screwdriver – PH	PH4	200	320	241	✓

Pozidrive Screwdrivers

- ▶ High torque softgrip screwdrivers for Pozidrive screws
- ▶ Precision hardened Chrome-Vanadium-Molybdenum steel blade
- ▶ Blade insulation directly moulded onto the blade
- ▶ Ergonomic, softgrip multi-component handle
- ▶ Tips and dimensions acc. to DIN 7438, ISO 8764-PZ
- ▶ Tested to EN/IEC 60900:2004



Part No	Description	Point Size	Blade Length [mm]	Overall Length [mm]	Weight [g]	Insulated
114300	Screwdriver – PZ	PZ0	60	145	41	✓
114301	Screwdriver – PZ	PZ1	80	175	64	✓
114101	Screwdriver – PZ	PZ1	150	250	76	✓
114201	Screwdriver – PZ	PZ1	250	345	91	✓
114302	Screwdriver – PZ	PZ2	100	210	97	✓
114102	Screwdriver – PZ	PZ2	150	260	110	✓
114202	Screwdriver – PZ	PZ2	250	360	136	✓
114303	Screwdriver – PZ	PZ3	150	270	172	✓
114304	Screwdriver – PZ	PZ4	200	320	241	✓

TORX® Screwdrivers

- ▶ High torque softgrip screwdrivers for TORX® screws
- ▶ Precision hardened Chrome-Vanadium-Molybdenum steel blade
- ▶ Blade insulation directly moulded onto the blade
- ▶ Ergonomic, softgrip multi-component handle
- ▶ Tested to EN/IEC 60900:2004



Part No	Description	TORX	Blade Length [mm]	Overall Length [mm]	Weight [g]	Insulated
110905	Screwdriver - TORX	T05	60	148	36	✓
110906	Screwdriver - TORX	T06	60	148	36	✓
110907	Screwdriver - TORX	T07	60	148	36	✓
110908	Screwdriver - TORX	T08	60	148	36	✓
110909	Screwdriver - TORX	T09	60	148	36	✓
110910	Screwdriver - TORX	T10	80	168	37	✓
110915	Screwdriver - TORX	T15	80	178	54	✓
110920	Screwdriver - TORX	T20	100	178	56	✓
110925	Screwdriver - TORX	T25	100	178	63	✓
110927	Screwdriver - TORX	T27	115	178	71	✓
110930	Screwdriver - TORX	T30	115	197	92	✓
110940	Screwdriver - TORX	T40	130	197	110	✓
110945	Screwdriver - TORX	T45	130	209	145	✓

Nut Spinner

- ▶ High torque softgrip screwdrivers for hexagon headed nuts, bolts and screws
- ▶ Precision hardened Chrome-Vanadium-Molybdenum steel blade
- ▶ Blade insulation directly moulded onto the blade
- ▶ Ergonomic, softgrip multi-component handle
- ▶ Tested to EN/IEC 60900:2004



Part No	Description	Point Size [mm]	Blade Length [mm]	Overall Length [mm]	Weight [g]	Insulated
136504	Nut Spinner	4.0	125	223	90	✓
136505	Nut Spinner	5.0	125	223	95	✓
136555	Nut Spinner	5.5	125	223	96	✓
136506	Nut Spinner	6.0	125	223	96	✓
136507	Nut Spinner	7.0	125	234	117	✓
136508	Nut Spinner	8.0	125	234	118	✓
136509	Nut Spinner	9.0	125	234	119	✓
136510	Nut Spinner	10.0	125	234	121	✓
136511	Nut Spinner	11.0	125	246	165	✓
136512	Nut Spinner	12.0	125	246	165	✓
136513	Nut Spinner	13.0	125	246	169	✓
136514	Nut Spinner	14.0	125	246	176	✓

Screwdriver Set

- ▶ High torque softgrip screwdrivers
- ▶ Precision hardened Chrome-Vanadium-Molybdenum steel blade
- ▶ Blade insulation directly moulded onto the blade
- ▶ Ergonomic, softgrip multi-component handle
- ▶ Tested to EN/IEC 60900:2004



Part No	Description	A	B	Contents C	D	E
110700	Screwdriver Set 1	111328	111340	111354	114301	114302
110702	Screwdriver Set 2	111335	111344	111354	114101	114102

Roberston® Square Screwdrivers

- ▶ High torque softgrip screwdrivers for square head screws
- ▶ Precision hardened Chrome-Vanadium-Molybdenum steel blade
- ▶ Blade insulation directly moulded onto the blade
- ▶ Ergonomic, softgrip multi-component handle
- ▶ Tested to EN/IEC 60900:2004



Part No	Description	Size	Blade Length [mm]	Overall Length [mm]	Weight [g]	Insulated
110801	Roberston Square Screwdriver	#1	80	180	64	✓
110802	Roberston Square Screwdriver	#2	100	210	97	✓
110803	Roberston Square Screwdriver	#3	150	265	160	✓

Allen Key Screwdrivers

- ▶ High torque softgrip screwdrivers for hexagon screws
- ▶ Precision hardened Chrome-Vanadium-Molybdenum steel blade
- ▶ Blade insulation directly moulded onto the blade
- ▶ Ergonomic, softgrip multi-component handle
- ▶ Tested to EN/IEC 60900:2004



Part No	Description	Point Size [mm]	Blade Length [mm]	Overall Length [mm]	Weight [g]	Insulated
115303	Screwdriver - Hexagon	3.0	80	170	43	✓
115353	Screwdriver - Hexagon	3.0	150	240	50	✓
115304	Screwdriver - Hexagon	4.0	80	170	63	✓
115354	Screwdriver - Hexagon	4.0	150	240	70	✓
115305	Screwdriver - Hexagon	5.0	80	170	63	✓
115355	Screwdriver - Hexagon	5.0	150	240	82	✓
115306	Screwdriver - Hexagon	6.0	100	170	66	✓
115356	Screwdriver - Hexagon	6.0	150	240	90	✓

Allen Keys – T Bar

- ▶ For use with hex screw heads in cable connectors and cut-outs
- ▶ T Handle offers max torque
- ▶ Tested to EN/IEC 60900:2004



Part No	Description	Size [mm]	Length [mm]	Weight [g]	Insulated
117202	T Bar Allen Key	2	150	83	✓
117203	T Bar Allen Key	3	150	82	✓
117204	T Bar Allen Key	4	150	106	✓
117205	T Bar Allen Key	5	150	148	✓
117206	T Bar Allen Key	6	150	158	✓
117208	T Bar Allen Key	8	150	300	✓
117210	T Bar Allen Key	10	150	345	✓
117223	T Bar Allen Key	3	80	67	✓
117355	T Bar Allen Key	5	320	193	✓
118316	T Bar Allen Key	3/16"	150	174	✓
118532	T Bar Allen Key	5/32"	150	110	✓

Allen Keys – Angled

- ▶ For hex socket screws
- ▶ Metal parts of CV steel with rust proof surface, nickel plated
- ▶ Tested to EN/IEC 60900:2004



Part No	Description	Size [mm]	Length [mm]	Weight [g]	Insulated
116325	Angled Allen Key	2.5	110	28	✓
116303	Angled Allen Key	3	130	31	✓
116304	Angled Allen Key	4	146	34	✓
116305	Angled Allen Key	5	164	36	✓
116306	Angled Allen Key	6	176	46	✓
116308	Angled Allen Key	8	199	80	✓
116310	Angled Allen Key	10	228	125	✓
116312	Angled Allen Key	12	224	340	✓

Cooker Knob Allen Keys

- ▶ For use with hex screw heads in cable connectors and cut outs
- ▶ Tested to EN/IEC 60900:2004



Part No	Description	Size [mm]	Length [mm]	Weight [g]	Insulated
117233	Cooker Knob Allen Key	3	90	12	✓

P Handle Allen Keys

- ▶ High torque softgrip screwdrivers for hexagon socket screws
- ▶ Precision hardened Chrome-Vanadium-Molybdenum steel blade
- ▶ Blade insulation directly moulded onto the blade
- ▶ Ergonomic, softgrip multi-component handle
- ▶ Tested to EN/IEC 60900:2004



Part No	Description	Point Size [mm]	Blade Length [mm]	Overall Length [mm]	Weight [g]	Insulated
117102	P Handle Allen Key	2	100	130	19	✓
117103	P Handle Allen Key	3	100	130	24	✓
117104	P Handle Allen Key	4	145	180	45	✓
117105	P Handle Allen Key	5	145	180	56	✓
117106	P Handle Allen Key	6	195	235	65	✓

P Handle Allen Keys Set

- ▶ High torque softgrip screwdrivers for hexagon socket screws
- ▶ Precision hardened Chrome-Vanadium-Molybdenum steel blade
- ▶ Blade insulation directly moulded onto the blade
- ▶ Ergonomic, softgrip multi-component handle
- ▶ Tested to EN/IEC 60900:2004



Part No	Description	A	B	Contents C	D	E
117100	P Handle Allen Key Set 1	117102	117103	117104	117105	117106
117101	P Handle Allen Key Set 2	117102	117103	117104	117105	-

Connector Holding Tools

- ▶ Tested to EN/IEC 60900:2004
- ▶ For use with SSIPC insulation piercing connector
- ▶ Other sizes available on request



Part No	Description	Opening [mm]	Length [mm]	Weight [g]	Insulated
CHT-SSIPC	Connector Holding Tool SSIPC	37.7 x 46.3	255	520	✓

Connector Holding Tools

- ▶ For use with MSIP insulation piercing connector
- ▶ Tested to EN/IEC 60900:2004
- ▶ Other sizes available on request



Part No	Description	Opening [mm]	Length [mm]	Weight [g]	Insulated
CHT-MSIP	Connector Holding Tool MSIP	59.5 x 28.85	275	460	✓

Connector Holding Tools

- ▶ Double-ended Spanner for use with old and new style BCNE connectors
- ▶ Insulated shroud/cover for BCNE connector, also available [See Page 41]
- ▶ Other sizes available on request
- ▶ Tested to EN/IEC 60900:2004

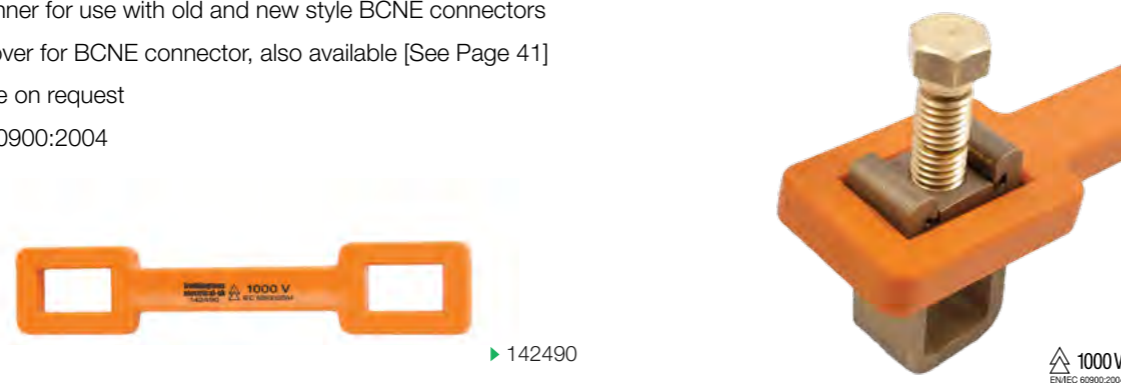

Part No	Description	Opening [mm]	Length [mm]	Weight [g]	Insulated
142490	Connector Holding Tool BCNE	16.5 x 30 - 16.5 x 28.3	175	70	✓
142488	Connector Holding Tool TA	39.5 x 40.7 - 21 x 40	275	120	✓

Connector Holding Tools – Adjustable

- ▶ Designed for use with straight or round connectors
- ▶ For live mechanical cable jointing
- ▶ PVC insulation provides secure gripping of connector
- ▶ Other sizes available on request
- ▶ Nylon insert on handle prevents damage to connector
- ▶ Tested to EN/IEC 60900:2004



Part No	Description	Opening [mm]	Length [mm]	Weight [g]	Insulated
CHT-UST	2 pt CH Tool Standard	10 - 50	280 - 320	800	✓
CHT-UST/T	2 pt CH Tool Standard - T Handle	10 - 50	280 - 320	800	✓
CHT-UST1	2 pt CH Tool Small	5 - 30	180 - 225	350	✓
CHT-UST1/T	2 pt CH Tool Small - T Handle	5 - 30	180 - 225	350	✓

Connector Holding Tools – Fixed

- ▶ For use with branch connectors
- ▶ Tested to EN/IEC 60900:2004
- ▶ Other sizes available on request



Part No	Description	Opening [mm]	Length [mm]	Weight [g]	Insulated
CHT-UBR95	Connector Holding Tool	44.75	250	420	✓
CHTUBR95/2A	Connector Holding Tool	40.75	250	420	✓
CHT-UBR185	Connector Holding Tool	55.75	260	440	✓
CHT-UBR300	Connector Holding Tool	60.75	270	460	✓

Gland Spanner

- ▶ For tightening Aluminium Cable Glands
- ▶ Manufactured from Plastic to prevent damage to the Cable Gland
- ▶ Tested to EN/IEC 60900:2004



Part No	Description	Opening [mm]	Length [mm]	Weight [g]	Insulated
142541	Gland Spanner	57/47mm AF	330	200	✓
142542	Gland Spanner	66/57mm AF	330	200	✓
142543	Gland Spanner	71 /61mm AF	330	200	✓

Link Extractors – Screwdriver Type – Male Thread

- ▶ For removal of cable links in underground cable link boxes
- ▶ Screwdriver type for restricted areas
- ▶ Tested to EN/IEC 60900:2004



Part No	Thread Form	Thread Length [mm]	Blade Size [mm]	Handle Size [mm]	Overall Length [mm]	Weight [g]	Insulated
102350	3/16" Whit	16	150	103 x 25	253	150	✓
102360	1/4" Whit	16	150	103 x 25	253	157	✓
102370	5/16" Whit	16	203	103 x 25	317	273	✓
102380	3/8" Whit	16	203	103 x 25	317	276	✓
102390	M8	16	203	103 x 25	317	273	✓
102400	3/16" Sq End	10	150	103 x 25	253	154	✓
102405	3/16" Sq Acme form thread 3/8" O/D	22	265	114 x 32	385	270	✓

Link Extractors – Screwdriver Type – Female Thread

- ▶ For removal of cable links in underground cable link boxes
- ▶ Screwdriver type for restricted areas
- ▶ Tested to EN/IEC 60900:2004



Part No	Thread Form	Thread Length [mm]	Blade Size [mm]	Handle Size [mm]	Overall Length [mm]	Weight [g]	Insulated
102410	1/4" Whit	16	203	114 x 32	357	277	✓
102420	5/16" Whit	16	203	114 x 32	357	305	✓
102430	3/8" Whit	16	203	114 x 32	357	300	✓
102440	1/2" Whit	16	203	114 x 32	357	300	✓
102450	M8	16	203	114 x 32	357	295	✓
102460	1/2" Whit L Hand	16	203	114 x 32	357	300	✓
102470	1/4" BSF	16	203	114 x 32	357	256	✓
102480	5/16" BSF	16	203	114 x 32	357	311	✓
102490	3/8" BSF	16	203	114 x 32	357	315	✓
102500	1/2" BSF	16	203	114 x 32	357	342	✓

Link Extractors 'T' Bar Type – Male Thread

- ▶ For removal of cable links in underground cable link boxes
- ▶ Screwdriver type for restricted areas
- ▶ Tested to EN/IEC 60900:2004
- ▶ T Handle is ideal for applications where maximum torque is needed



Part No	Thread Form	Thread Length [mm]	T Bar Length [mm]	Overall Length [mm]	Weight [g]	Insulated
102308	4 x 8mm (Ø 3mm x 5mm long pin)	38	90	210	175	✓
102510	1/4" Whit	16	90	140	223	✓
102520	3/8" Whit	16	90	140	170	✓
102530	1/2" Whit	16	90	140	180	✓
102540	M8	16	90	140	180	✓

Link Extractors 'T' Bar Type – Female Thread

- ▶ For removal of cable links in underground link boxes
- ▶ Screwdriver type for restricted areas
- ▶ Tested to EN/IEC 60900:2004
- ▶ T Handle is ideal for applications where maximum torque is needed



Part No	Thread Form	Thread Length [mm]	T Bar Length [mm]	Overall Length [mm]	Weight [g]	Insulated
102545	1/4" Whit	16	90	140	170	✓
102550	3/8" Whit	16	90	140	170	✓
102560	1/2" Whit	16	90	140	180	✓
102570	1/2" BSF	16	90	140	180	✓
102580	1/2" Whit L Hand	16	90	140	220	✓

Box Spanners T Bar

- ▶ Made of cold drawn seamless precision steel tube
- ▶ Tested to EN/IEC 60900:2004
- ▶ Other shaft lengths and sizes available on request



Part No	Description (screw retaining)	Size	T Bar Length [mm]	Overall Length [mm]	Weight [g]	Insulated
102770	Box Spanner T Bar	0BA	110	160	260	✓
102780	Box Spanner T Bar	2BA	90	145	263	✓
102790	Box Spanner T Bar	3BA	90	145	170	✓
102800	Box Spanner T Bar	3/16" Whit	110	160	250	✓
102810	Box Spanner T Bar	1/4" Whit	105	155	225	✓
102860	Box Spanner T Bar	5/8" A/F	160	130	365	✓
102870	Box Spanner T Bar	11/16" A/F	160	130	365	✓
102880	Box Spanner T Bar	3/8" A/F	90	145	170	✓
137408	Box Spanner T Bar	8mm	105	110	290	✓
137410	Box Spanner T Bar	10mm	105	110	310	✓
137411	Box Spanner T Bar	11mm	105	110	330	✓
137412	Box Spanner T Bar	12mm	105	110	350	✓
137413	Box Spanner T Bar	13mm	120	135	360	✓
137414	Box Spanner T Bar	14mm	120	135	440	✓
137416	Box Spanner T Bar	16mm	120	135	450	✓
137417	Box Spanner T Bar	17mm	120	135	450	✓
137418	Box Spanner T Bar	18mm	120	135	470	✓
137419	Box Spanner T Bar	19mm	120	135	510	✓
137420	Box Spanner T Bar	20mm	120	135	510	✓
137422	Box Spanner T Bar	22mm	120	135	520	✓
137424	Box Spanner T Bar	24mm	120	135	540	✓
137427	Box Spanner T Bar	27mm	120	135	620	✓
137430	Box Spanner T Bar	30mm	120	135	605	✓

Push on Shrouds

For uninsulated electric cable ends of all common cross sections and materials

With Gripping Collar

- ▶ Two designs 646xxx (2part moulded) 648xxx (dip coated)
- ▶ Flexible gripping collar, prevents damage to paper insulated cable
- ▶ No deformation of copper wires when applied
- ▶ Holds securely in place
- ▶ Can also be used on cable lugs

Conical / Straight Type

- ▶ Made of strong, resilient insulation material
- ▶ Safely fastened even with irregular cross sections
- ▶ Available with imprint L1, L2, L3

Dimensions not listed here can be supplied in small quantities – price on application

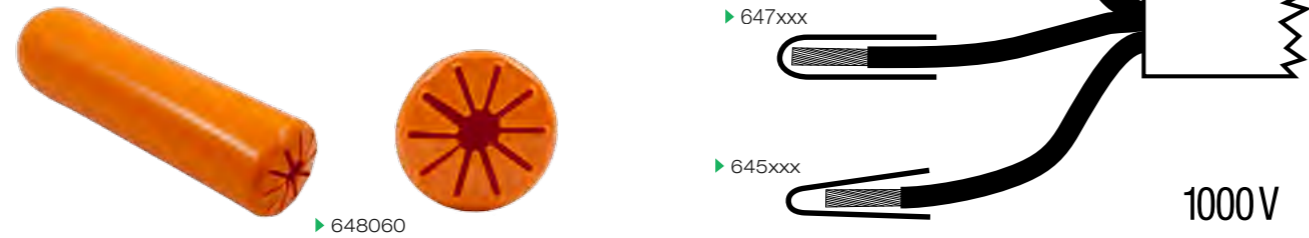

Part No	Description	Length [mm]	Opening ø [mm]	Weight [g]	Insulated
645000	Push On Shroud - conical	30	10	10	✓
645001	Push On Shroud - conical	40	10	15	✓
645002	Push On Shroud - conical	50	10	20	✓
645004	Push On Shroud - conical	60	10	25	✓
645006	Push On Shroud - conical	80	10	30	✓
645010	Push On Shroud - conical	100	10	40	✓
645015	Push On Shroud - conical	80	15	30	✓
645017	Push On Shroud - conical	100	15	35	✓
645018	Push On Shroud - conical	120	15	40	✓
645020	Push On Shroud - conical	100	20	40	✓
645022	Push On Shroud - conical	130	20	45	✓
645025	Push On Shroud - conical	80	25	35	✓
645026	Push On Shroud - conical	100	25	40	✓
645028	Push On Shroud - conical	85	28	40	✓
645030	Push On Shroud - conical	130	30	45	✓
646015	Core End Shroud - gripping collar	100	15	25	✓
646020	Core End Shroud - gripping collar	100	20	33	✓
646025	Core End Shroud - gripping collar	110	25	46	✓
646035	Core End Shroud - gripping collar	130	35	73	✓
647020	Push On Shroud - straight	100	20	55	✓
647030	Push On Shroud - straight	130	30	60	✓
647040	Push On Shroud - straight	150	40	74	✓
648010	Push On Shroud - gripping collar	100	10	45	✓
648020	Push On Shroud - gripping collar	130	20	55	✓
648030	Push On Shroud - gripping collar	150	30	65	✓
648045	Push On Shroud - gripping collar	180	45	80	✓
648060	Push On Shroud - gripping collar	185	60	150	✓

LV Link Shrouds

- ▶ For LV underground cable links
- ▶ Provides insulating barrier
- ▶ Prevents accidental contact with LV links
- ▶ Tested to EN/IEC 60900:2004



Part No	Description	Internal Length [mm]	Internal Width [mm]	Internal Height [mm]	Weight [g]	Insulated
195001	LV Link Shrouds	233	50	50	140	✓
195002	LV Link Shrouds	120	30	42	59	✓
195003	LV Link Shrouds	250	50	42	186	✓
195004	LV Link Shrouds	300	50	50	210	✓

Box Shrouds

- ▶ Used to shroud live blade contacts in cut outs
- ▶ Foam insert to provide secure grip on blade
- ▶ Tested to EN/IEC 60900:2004



Part No	Description	Size [mm]	Height [mm]	Weight [g]	Insulated
194000	Shroud – Box Type with Foam	50 x 70	92	100	✓
194001	Shroud – Box Type Tube & Foam	50 x 50	65	100	✓
194002	Shroud – Box Type with Foam	60 x 60	80	120	✓
194003	Shroud – Box Type with Foam	110 x 80	80	220	✓
194004	Shroud – Box Type with Foam	120 x 93	93	230	✓

Shroud - CNE

- ▶ Insulated shroud/cover for CNE connector
- ▶ Tested to EN/IEC 60900:2004

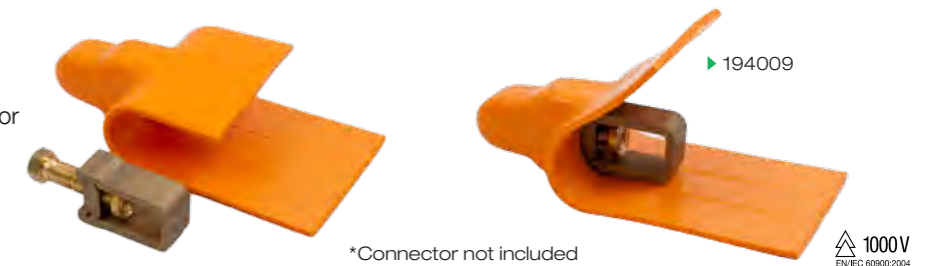

Part No	Description	Size [mm]	Weight [g]	Insulated
194009	Shroud - CNE	120x35x70mm	61	✓

Wedge - Hybrid Neutral

- ▶ For safe cutting of neutral cable
- ▶ Prevents damage to other cores
- ▶ Tested to EN/IEC 60900:2004



Part No	Description	Length [mm]	Weight [g]	Insulated
103075	Wedge - Hybrid Neutral	130	20	✓

Shroud - Universal

- ▶ For Domestic Cut-Outs
- ▶ Tested to EN/IEC 60900:2004

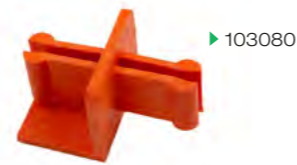

▶ 103080
1000V
EN/IEC 60900:2004

Part No	Description	Shield Area [mm]	Weight [g]	Insulated
103080	Shroud - Universal	32 x 32	10	✓

Shroud - Non-Universal

- ▶ For Domestic Cut-Outs
- ▶ Tested to EN/IEC 60900:2004



▶ 103081
1000V
EN/IEC 60900:2004

Part No	Description	Shield Area [mm]	Weight [g]	Insulated
103081	Shroud - Universal	30 x 25	10	✓

Brushes – Angled or Straight

- ▶ With replaceable head (except 1" straight brush)
- ▶ Handle tested to EN/IEC 60900:2004
- ▶ For cleaning and maintenance
- ▶ Plastic brush available with fixed angled head



▶ 552404

1000V
EN/IEC 60900:2004

Case for Brushes

- ▶ Made of red plastic with press stud
- ▶ Suitable for insulated brushes of up to 400mm

Part No	Description	Length	Weight [mm]	Insulated [g]
552401	Brush 1" angled	400	60	✓
552402	Brush 1 1/2" angled	400	100	✓
552403	Brush 2" angled	410	115	✓
552404	Brush 1" straight	320	80	✓
552405	Brush 1 1/2" straight	410	100	✓
552406	Brush 2" straight	410	130	✓
552431	Brush 1" plastic	400	60	✓
552432	Brush 1 1/2" plastic	400	70	✓
552433	Brush 2" plastic	400	90	✓

Part No	Description	Weight [g]	Insulated
552411	Brush Head 1" angled	10	✓
552412	Brush Head 1 1/2" angled	20	✓
552413	Brush Head 2" angled	25	✓
552415	Brush Head 1 1/2" straight	15	✓
552416	Brush 2" straight	20	✓
552421	Brush Handle 1"	80	✓
552422	Brush Handle 1 1/2"	70	✓
552423	Brush Handle 2"	120	✓
552400	Brush Case (440mm x 70mm)	50	x

Wedges

Wooden Wedge with Groove

- ▶ Manufactured from hardwood
- ▶ Aid for cutting conductors, non slip



▶ 653000

Wooden Wedge without Groove

- ▶ Manufactured from hardwood



▶ 653001

Plastic Wedge, red, without Groove

- ▶ Manufactured from polyamide, reinforced
- ▶ Lightweight



▶ 652002

1000V
EN/IEC 60900:2004

Plastic Wedge, grey, without Groove

- ▶ Manufactured from high strength plastic
- ▶ Very tough



▶ 652001

1000V
EN/IEC 60900:2004

Plastic Wedge, grey, with Groove

- ▶ Manufactured from high strength plastic
- ▶ Aid for cutting conductors, non slip
- ▶ Grey or red



▶ 652005

1000V
EN/IEC 60900:2004

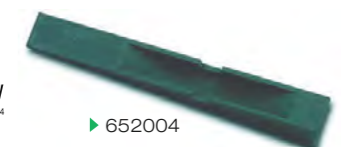

▶ 652004

Wedge, Heavy Duty

- ▶ Manufactured from high strength plastic
- ▶ Suitable for use with large size cable cutter



▶ 652007

1000V
EN/IEC 60900:2004

Plastic Wedge, red

- ▶ Manufactured from polyamide - hard
- ▶ Aid for cutting conductors, non slip
- ▶ Especially for fitting of branch terminals

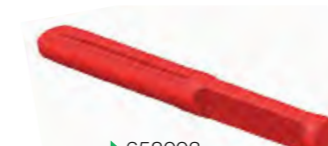

▶ 652003

1000V
EN/IEC 60900:2004

Flanged Chisel

- ▶ For NKBA cable 150 x 25mm
- ▶ Red
- ▶ Non brittle plastic



▶ 654000

1000V
EN/IEC 60900:2004

Part No	Description	Length [mm]	Width [mm]	High	Weight [g]	Insulated
653000	Wooden Wedge with Groove	250	25	30 to 0	54	x
653001	Wooden Wedge without Groove	165	20	37 to 0	45	x
652002	Plastic Wedge, red, without Groove	165	20	30 to 0	43	✓
652001	Plastic Wedge, grey, without Groove	165	20	37 to 0	93	✓
652005	Plastic Wedge, red, with Groove	165	20	37 to 0	90	✓
652007	Plastic Wedge, grey, with Groove	250	30	30 to 0	140	✓
652003	Plastic Wedge, red	170	20	10 to 0	100	✓
654000	Flanged Chisel	140	30 ø	-	63	✓

Core Alignment Tools

- ▶ Used to manipulate bare or insulated cable cores
- ▶ Aligns the cores prior to jointing
- ▶ Produced in nylon



▶ 110-300IC

3 Core

Part No	Description	Cores	Core Size Range	Weight [g]	Insulated
110-95C	Cable Core Twisters	3	70mm ² Bare x 95 mm ² Bare	54	✓
110-X01C	Cable Core Twisters	3	95mm ² Bare x 95 mm ² Ins	63	✓
110-120C	Cable Core Twisters	3	70mm ² Bare x 120 mm ² Bare	63	✓
110-120IC	Cable Core Twisters	3	70mm ² Ins x 120mm ² Ins	50	✓
110-X06C	Cable Core Twisters	3	120mm ² Bare x 120mm ² Ins	48	✓
110-X07C	Cable Core Twisters	3	185mm ² Bare x 185mm ² Ins	183	✓
110-240C	Cable Core Twisters	3	185mm ² Bare x 240mm ² Bare	146	✓
110-300C	Cable Core Twisters	3	185mm ² Bare x 300mm ² Bare	180	✓
110-300IC	Cable Core Twisters	3	185mm ² Ins x 300mm ² Ins	167	✓
110-X08C	Cable Core Twisters	3	300mm ² Bare x 300mm ² Ins	170	✓
110-X09C	Cable Core Twisters	3	70mm ² Bare x 70mm ² Ins	53	✓
110-X10C	Cable Core Twisters	3	95mm ² Bare x 185mm ² Bare	191	✓
110-X11C	Cable Core Twisters	3	95mm ² Ins x 185mm ² Ins	179	✓

4 Core

Part No	Description	Cores	Core Size Range	Weight [g]	Insulated
110-41C	Cable Core Twisters	4	95mm ² Bare x 95mm ² Ins	62	✓
110-42C	Cable Core Twisters	4	185mm ² Ins x 240mm ² Ins	170	✓
110-43C	Cable Core Twisters	4	185mm ² Bare x 240mm ² Bare	183	✓
110-44C	Cable Core Twisters	4	185mm ² Ins x 300mm ² Ins	172	✓
110-X02C	Cable Core Twisters	4	185mm ² Bare x 300mm ² Bare	178	✓
110-X14C	Cable Core Twisters	4	95mm ² Bare x 185mm ² Bare	188	✓
110-X15C	Cable Core Twisters	4	95mm ² Ins x 185mm ² Ins	184	✓

3 & 4 Core

Part No	Description	Cores	Core Size Range	Weight [g]	Insulated
110-X03C	Cable Core Twisters	3 & 4	3C 95mm ² Ins x 4C 95mm ² Ins	61	✓
110-X04C	Cable Core Twisters	3 & 4	3C 185mm ² Ins x 4C 185mm ² Ins	175	✓
110-X05C	Cable Core Twisters	3 & 4	3C 300mm ² Ins x 4C 240mm ² Ins	167	✓
110-X12C	Cable Core Twisters	3 & 4	3C 300mm ² Bare x 4C 300mm ² Bare	170	✓
110-X13C	Cable Core Twisters	3 & 4	3C 300mm ² Ins x 4C 300mm ² Ins	164	✓

Core Alignment Sockets with Square End of 3/8" or 1/2"

- ▶ Insulation of non-brittle plastic
- ▶ Used with the ratchet lever part no. 131338 or 131312
- ▶ Other sizes on request
- ▶ Tested to EN/IEC 60900:2004



▶ 132096 ▶ 132031



Part No	Description	Length [mm]	Cross Section [mm ²]	Weight [g]	Insulated
132095	132096 Core Alignment Socket	75	95 - 150	80	✓
132185	132186 Core Alignment Socket	83	185 - 240	140	✓
132030	132031 Core Alignment Socket	83	300	140	✓

Core Bending Bars

- ▶ For use on sectoral cores
- ▶ For bare and insulated cores
- ▶ Tested to EN/IEC 60900:2004
- ▶ Other Core sizes available



▶ 102990



Part No	Description	Cores	Core Size Range [mm ²]	Weight [g]	Insulated
102940	Core Bending Bar	3	70 Bare	235	✓
102945	Core Bending Bar	3	70 Insulated	276	✓
102950	Core Bending Bar	3	95 Bare	219	✓
102955	Core Bending Bar	3	95 Insulated	235	✓
102960	Core Bending Bar	3	120 Bare	200	✓
102965	Core Bending Bar	3	120 Insulated	225	✓
102970	Core Bending Bar	3	185 Bare	235	✓
102975	Core Bending Bar	3	185 Insulated	235	✓
102980	Core Bending Bar	3	240 Bare	232	✓
102985	Core Bending Bar	3	240 Insulated	244	✓
102990	Core Bending Bar	3	300 Bare	235	✓
102995	Core Bending Bar	3	300 Insulated	235	✓

Knockout Tool

- ▶ Steel shaft and handle
- ▶ Tested to EN/IEC 60900:2004
- ▶ Other sizes available on request



▶ 103101



Part No	Overall Length [mm]	Handle Size [mm]	Weight [g]	Insulated
103101	215	114 x 32	191	✓

Special Wedge

- ▶ Manufactured from Polyamide
- ▶ Suitable for use with a large size cable cutter
- ▶ Aid for cutting conductors, non slip
- ▶ Especially for fitting of branch terminals
- ▶ Tested to EN/IEC 60900:2004

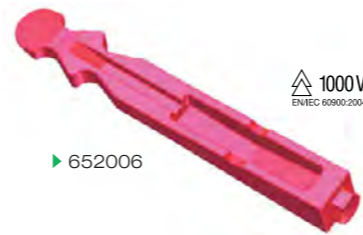

1000V
EN/IEC 60900:2004

Part No	Description	Length [mm]	Width [mm]	High [mm]	Weight [g]	Insulated
652006	Wedge with Groove & Nut	240	30	5 to 30	100	✓
65200601	Wedge with Groove & Hook	270	37	2.5 to 31	125	✓

Wedges – Cable Core Wedge

- ▶ Manufactured from Nylon
- ▶ Without groove



Part No	Description	Length [mm]	Width [mm]	Nominal Lift [mm]	Weight [g]	Insulated
110-1NYC	Cable Core Wedge	150	25	15	42	✓
110-2NYC	Cable Core Wedge	225	25	25	65	✓
110-3NYC	Cable Core Wedge	225	25	38	89	✓
110-4NYC	Cable Core Wedge	150	13	25	32	✓

High Lift Cable Core Guard

- ▶ Used to provide separation between a cable core which is being cut and neighbouring cores
- ▶ Manufactured from nylon



Part No	Description	Nominal Lift [mm]	Weight [g]	Insulated
120-CG1	High Lift Cable Core Guard	23mm	57	✓

Wedges – ABC

- ▶ For use with aerial bundled cables (ABC)
- ▶ Supplied as set of two
- ▶ Includes 1m nylon connecting string



Part No	Description	Nominal Lift [mm]	Weight [g]	Insulated
103010	Wedge ABC – set of two	30	108	✓

Core Separators / Wedges

- ▶ Designed to aid the separation of cores during jointing
- ▶ Smooth surface of material ensures minimal damage to the core insulation
- ▶ Thumb and finger grip assists insertion and removal
- ▶ Design reduces the risk of displacement whilst located between the cable cores



Part No	Description	Length [mm]	Weight [g]	Insulated
JTN-1	Mini Hepwedge Ins Core Separator	130	25	✓
JTN-2	Hepwedge Ins Core Separator	160	52	✓

Core Separator

- ▶ Suitable for three core cables where a conventional wedge cannot be used – for solid aluminium or larger stranded core cables and for cables which have become over-tensioned after laying



Part No	Description	Length [mm]	Weight [g]	Insulated
JTN-3	Maxi Hepwedge Core Separator	262	80	✓

Insulated File

- ▶ Designed to remove the oxide layer from aluminium conductors prior to jointing
- ▶ Multi-coated insulation
- ▶ Other sizes available on request
- ▶ Tested to EN/IEC 60900:2004



1000V
EN/IEC 60900:2004

Part No	Description	Length [mm]	Exposed File Length	Weight [g]	Insulated
101800	Insulated File	190	35mm	85	✓

File Card Brush

- ▶ For cleaning wood and metal files
- ▶ Removes embedded filings far more effectively than an ordinary wire brush
- ▶ The fine scratch wires are webbing mounted and stapled to the wooden stock



Part No	Description	Size [mm]	Weight [g]	Insulated
1037201	File Card Brush	125 x 40	60	x

Tape Measure – Non-Conductive

- ▶ Tape material – non stretchable FRP
- ▶ Case material – ABS resin
- ▶ Proof tested to 20kV
- ▶ 19mm wide



▶ GC-30N

Part No	Description	Size [mm]	Weight [g]	Insulated
GC-30N	Tape Measure – Non Conductive 3m	83 x 73 x 29	150	✓

Diameter Tape

- ▶ 2 metre length
- ▶ 6mm wide
- ▶ Black etched steel blade
- ▶ Grey plastic case



▶ 410002

Part No	Description	Size [mm]	Weight [g]	Insulated
410002	Tape Measure 2m	45mm x 45mm	20	x

Folding Rule – Plastic

- ▶ Manufactured from glass fibre reinforced polyamide
- ▶ Scratch weather and chemical resistant
- ▶ Patented, wear resistant and maintenance free joints
- ▶ 90° lock-in position



▶ 525003 - Open

▶ 525002 - Closed

Part No	Description	Weight [g]	Insulated
525002	Folding Rule – Plastic 1m	90	x
525003	Folding Rule – Plastic 2m	130	x

Dummy Fuse Link

- ▶ Manufactured from non conductive orange plastic
- ▶ Prevents current flow between cut out blades
- ▶ Allows cut out lid to be fitted securely in place



▶ DFL7MM/MK2

▶ DFL7MM

Part No	Description	Weight [g]	Insulated
DFL7MM	Dummy Fuse Link – MC300 Cut Out	20	✓
DFL7MM/MK2	Dummy Fuse Link – MC600 Cut Out	25	✓

Tool Kits / Sets



Jointer's Tool Kit 1

Part No	Description	Weight [kg]
24011/KIT	Jointer's Tool Kit	10

Contents

- ▶ *Tool Box - Professional 26"
- ▶ Allen Key Screwdriver 3mm
- ▶ *Cable Core Wedge 225 x 25 x 38mm
- ▶ Cable Cropper - 250mm
- ▶ Cable Jointer's Coring Knife
- ▶ *Cable Knife - Heavy Duty
- ▶ *Cable Knife Curved Blade
- ▶ *Engineer's File 10" 1/2 Round 2nd Cut
- ▶ *Engineer's File 8" Round 2nd cut
- ▶ Engineer's Pliers 200mm
- ▶ Extension Bar 1/2" Sq Drive 125mm
- ▶ Hack Knife - Plastic 245mm
- ▶ Hacksaw 300mm Blade
- ▶ *Hepwedge Core Sep.160mm
- ▶ Junior Hacksaw 150mm Blade
- ▶ *Maxi Hepwedge Core Sep.262mm
- ▶ *Mini Hepwedge Core Sep.130mm
- ▶ Open Ended Spanner 13mm
- ▶ Open Ended Spanner 17mm
- ▶ Open Ended Spanner 19mm
- ▶ Open Ended Spanner 7/16" W
- ▶ *Ratchet - Reversible 1/2" Sq Drive
- ▶ *Rule - Plastic Measuring 2m Long
- ▶ Safety Clamp Short 45mm jaw
- ▶ Saw - Depth Gauge 120mm blade 24tpi
- ▶ Screwdriver 1.0 x 5.5 x 150mm
- ▶ Screwdriver 1.6 x 10.0 x 200mm
- ▶ Screwdriver PZ Size 2 x 100mm
- ▶ Side Cutters 160mm
- ▶ Socket 6pt 1/2" Drive 13mm
- ▶ Socket 6pt 1/2" Drive 17mm
- ▶ Socket 6pt 1/2" Drive 19mm
- ▶ *Tin Snips - 10"/250mm
- ▶ Water Pump Plier 240mm
- ▶ Wedge - Hybrid Neutral

* Non insulated

Jointer's Tool Kit 2

Part No	Description	Weight [kg]
24011/KIT2	Jointer's Tool Kit 2	9.5

Contents

- ▶ *Tool Box - Professional 26"
- ▶ Allen Key Driver 3mm
- ▶ *Cable Core Wedge 225 x 25 x 38mm
- ▶ Cable Cropper - 250mm
- ▶ Cable Jointer's Coring Knife
- ▶ *Cable Knife - Heavy Duty
- ▶ *Cable Knife Curved Blade
- ▶ *Engineer's File 10" 1/2 Round 2nd Cut
- ▶ *Engineer's File 8" Round 2nd cut
- ▶ Engineer's Pliers 200mm
- ▶ Hack Knife - Plastic 245mm
- ▶ Hacksaw 300mm Blade
- ▶ *Hepwedge Core Sep.160mm
- ▶ *Maxi Hepwedge Core Sep.262mm
- ▶ *Mini Hepwedge Core Sep.130mm
- ▶ Open Ended Spanner 17mm
- ▶ Open Ended Spanner 7/16" W
- ▶ *Ratchet - Reversible 1/2" Sq Drive
- ▶ *Rule - Plastic Measuring 2m Long
- ▶ Safety Clamp Short 45mm jaw
- ▶ Saw - Depth Gauge 120mm blade 24tpi
- ▶ Screwdriver 1.0 x 5.5 x 150mm
- ▶ Screwdriver 1.6 x 10.0 x 200mm
- ▶ Screwdriver PZ Size 2 x 100mm
- ▶ Side Cutters 160mm
- ▶ Socket 6pt 1/2" Drive 13mm
- ▶ Socket 6pt 1/2" Drive 17mm
- ▶ Socket 6pt 1/2" Drive 18mm
- ▶ Socket 6pt 1/2" Drive 19mm
- ▶ *Tin Snips - 10"/250mm
- ▶ Water Pump Plier 240mm
- ▶ Wedge - Hybrid Neutral

* Non insulated

Tool Kits / Sets Cont.



Jointer's Tool Kit 3

Part No	Description	Weight [kg]
24011/KIT3	Jointer's Tool Kit 3	12.5

Contents

- | | | |
|---|---|---|
| <ul style="list-style-type: none"> ▶ *Tool Box - Professional 26" ▶ Allen Key Driver 3mm ▶ Box Spanner T Bar 13mm ▶ *Cable Core Wedge 225 x 25 x 38mm ▶ Cable Cropper 250mm ▶ Cable Jointer's Coring Knife ▶ *Cable Knife - Heavy Duty ▶ *Cable Knife Curved Blade ▶ *Continuity Bond 2 way ▶ *Engineer's File 10" 1/2 Round 2nd Cut ▶ *Engineer's File 8" Round 2nd cut ▶ Engineer's Pliers 200mm ▶ Extension Bar 1/2" Sq Drive | <p>125mm</p> <ul style="list-style-type: none"> ▶ Groove Joint Pliers 300mm ▶ Hack Knife Plastic 245mm ▶ Hacksaw 300mm Blade ▶ *Hepwedge Core Sep.160mm ▶ Junior Hacksaw 150mm Blade ▶ *Maxi Hepwedge Core Sep.262mm ▶ *Mini Hepwedge Core Sep.130mm ▶ Open Ended Spanner 13mm ▶ Open Ended Spanner 17mm ▶ Open Ended Spanner 19mm ▶ Open Ended Spanner 7/16" W ▶ Ratchet - Reversible 1/2" Sq Drive ▶ *Rule - Plastic Measuring 2m Long | <ul style="list-style-type: none"> ▶ Safety Clamp Short 45mm jaw ▶ Saw - Depth Gauge 120mm blade 24tpi ▶ Screwdriver 1.0 x 5.5 x 150mm ▶ Screwdriver 1.6 x 10.0 x 200mm ▶ Screwdriver PZ Size 2 x 100mm ▶ Side Cutters 160mm ▶ Socket 6pt 1/2" Drive 13mm ▶ Socket 6pt 1/2" Drive 17mm ▶ Socket 6pt 1/2" Drive 18mm ▶ Socket 6pt 1/2" Drive 19mm ▶ *Tin Snips - 10"/250mm ▶ Wedge - Hybrid Neutral <p>* Non insulated</p> |
|---|---|---|



Jointer's Tool Kit 4

Part No	Description	Weight [kg]
24011/KIT4	Jointer's Tool Kit 4	12

Contents

- | | | |
|---|---|---|
| <ul style="list-style-type: none"> ▶ *Tool Box - Professional 26" ▶ Allen Key Driver 3mm ▶ *Cable Core Wedge 225 x 25 x 38mm ▶ Cable Cropper 250mm ▶ *Continuity Bond 2 way ▶ *Engineers File 10" 1/2 Round 2nd Cut ▶ *Engineer's File 8" Round 2nd cut ▶ Engineer's Pliers 200mm ▶ Extension Bar 1/2" Sq Drive 125mm ▶ General Purpose Cover 450 x 250mm ▶ Groove Joint Pliers 300mm ▶ Hack Knife 245mm Insulated ▶ Hacksaw 300mm Blade | <ul style="list-style-type: none"> ▶ *Hepwedge Core Sep.160mm ▶ Junior Hacksaw 150mm Blade ▶ *Maxi Hepwedge Core Sep.262mm ▶ *Mini Hepwedge Core Sep.130mm ▶ Nut Spinner 8mm ▶ Open Ended Spanner 13mm ▶ Open Ended Spanner 17mm ▶ Open Ended Spanner 19mm ▶ Open Ended Spanner 7/16" W ▶ Ratchet - Reversible 1/2" Sq Drive ▶ *Rule - Plastic Measuring 2m Long ▶ Safety Clamp Short 45mm jaw ▶ Saw - Depth Gauge 120mm blade 24tpi | <ul style="list-style-type: none"> ▶ Screwdriver 1.0 x 5.5 x 150mm ▶ Screwdriver 1.6 x 10.0 x 200mm ▶ Screwdriver PZ Size 2 x 100mm ▶ Side Cutters 160mm ▶ Socket 6pt 1/2" Drive 13mm ▶ Socket 6pt 1/2" Drive 17mm ▶ Socket 6pt 1/2" Drive 18mm ▶ Socket 6pt 1/2" Drive 19mm ▶ *Tin Snips - 10"/250mm ▶ Wedge - Hybrid Neutral <p>* Non insulated</p> |
|---|---|---|

Tool Kits / Sets Cont.



Jointer's Mate Tool Kit

Part No	Description	Weight [kg]
24011/JMTKIT	Jointer's Mate Tool Kit	8

Contents

- | | | |
|--|--|---|
| <ul style="list-style-type: none"> ▶ *Tool Box - Professional 26" ▶ *ABS Folding Rule 1mtr/39" ▶ *Cabinet Rasp Half Round 10" ▶ *Cable Core Wedge 225 x 25 x 38mm ▶ Cable Cropper 250mm ▶ *Cable Knife - Heavy Duty ▶ *Cable Knife Curved Blade | <ul style="list-style-type: none"> ▶ Hacksaw 300mm Blade ▶ *Hammer - Ball Pein 16oz / 454g ▶ *Hepwedge Core Sep.160mm ▶ Junior Hacksaw 150mm Blade ▶ *Mini Hepwedge Core Sep.130mm ▶ Saw - Depth Gauge 120mm blade 24tpi | <ul style="list-style-type: none"> ▶ Screwdriver 1.0 x 5.5 x 150mm ▶ Screwdriver 1.6 x 10.0 x 200mm ▶ Screwdriver PZ Size 2 x 100mm ▶ Side Cutters 160mm ▶ *Tin Snips - 10"/250mm ▶ Water Pump Plier 240mm <p>* Non insulated</p> |
|--|--|---|



Jointer's General Tool Kit

Part No	Description	Weight kg
912500/KIT	Jointer's General Tool Kit	8

Contents

- | | | |
|---|--|--|
| <ul style="list-style-type: none"> ▶ * Tool Box Cantilever Metal ▶ *ABS Folding Rule 1mtr/39" ▶ *Bench Shears/ Scissors 8" ▶ *Cable Core Former 3C ▶ *Cable Core Spreader 3 Way 95 -100mm² ▶ *Cable Core Wedge 150 x 25 x 15mm ▶ *Cable Core Wedge 225 x 25 x 38mm ▶ Cable Cropper 250mm ▶ Cable Jointer's Coring Knife ▶ *Cable Knife - Heavy Duty ▶ *Cable Knife Curved Blade ▶ Connector Holding Tool 2 Part Adj ▶ *Engineer's File 10" 1/2 Round 2nd Cut ▶ *Engineer's File 10" Bastard Cut 26 tpi ▶ *Engineer's File 10" Second Cut 36 tpi ▶ *Engineer's File 8" Round 2nd Cut ▶ Engineer's Pliers 200mm ▶ Extension Bar 1/2" Sq Drive 125mm ▶ *File Card Brush ▶ *File/Rasp Second Cut Half Round 8" | <ul style="list-style-type: none"> ▶ Flanged Chisel ▶ *Flint Gun ▶ Groove Joint Pliers 300mm ▶ Hacksaw 300mm Blade ▶ *Hammer - Ball Pein 16oz / 454g ▶ Junior Hacksaw 150mm Blade ▶ *Lead Scraper (Triangular) ▶ *Thinline Diameter Tape 2m ▶ Mirror - Jointer's 125 x 100mm ▶ *Oil Bath Saucepan 8" w/basket ▶ *Outside Caliper 6" ▶ *Outside Caliper 8" ▶ *Paraffin Wax Pellets - 1kg Bag ▶ Pliers 160mm Long Nose ▶ *Probe Therm 0-250°C with Case ▶ Reversible Ratchet 1/2" Sq Drive ▶ Saw - Depth Gauge 120mm blade 24tpi ▶ Screwdriver 1.2 x 6.5 x 150mm ▶ Screwdriver 1.2 x 8.0 x 175mm ▶ Screwdriver PZ Size 2 x 100mm | <ul style="list-style-type: none"> ▶ Screwdriver PZ Size 3 x 150mm ▶ Side Cutters 160mm ▶ *Socket 5/16" - 1/4" Sq Drive ▶ Socket 6pt 1/2" Drive 13mm ▶ Socket 6pt 1/2" Drive 14mm ▶ Socket 6pt 1/2" Drive 15mm ▶ Socket 6pt 1/2" Drive 16mm ▶ Socket 6pt 1/2" Drive 17mm ▶ Socket 6pt 1/2" Drive 18mm ▶ Socket 6pt 1/2" Drive 19mm ▶ *Socket 7mm - 1/4" Sq Drive ▶ *Socket 8mm - 1/4" Sq Drive ▶ *Spirit Level 10" ▶ *Bradawl 1 1/4" Blade 3/32" Tip ▶ T Bar Allen Key 3mm x150mm ▶ *Torque Driver ▶ *Wire Brush - 4 Row Stainless Steel ▶ *Multi-Purpose Snips 190mm <p>* Non insulated</p> |
|---|--|--|

Jointer's General Tool Kit 2

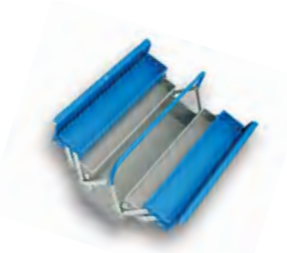

Part No	Description	Weight [kg]
912501/KIT	Jointer's General Tool Kit 2	16

Contents

- ▶ * Tool Box Cantilever Metal
 - ▶ *ABS Folding Rule 1mtr/39"
 - ▶ *Bench Shears/ Scissors 8"
 - ▶ *Cable Core Former
 - ▶ *Cable Core Spreader 3 Way 95-100mm²
 - ▶ *Cable Core Wedge 150 x 25 x 15mm
 - ▶ *Cable Core Wedge 225 x 25 x 38mm
 - ▶ Cable Cropper 250mm
 - ▶ Cable Jointer's Coring Knife
 - ▶ *Cable Knife - Heavy Duty
 - ▶ *Cable Knife Curved Blade
 - ▶ Connector Holding Tool 2 Part Adj
 - ▶ *Engineer's File 10" 1/2 Round 2nd Cut
 - ▶ *Engineer's File 10" Bastard Cut 26 tpi
 - ▶ *Engineer's File 10" Second Cut 36 tpi
 - ▶ *Engineer's File 8" Round 2nd Cut
 - ▶ Engineer's Pliers 200mm
 - ▶ Extension Bar 1/2" Sq Drive 125mm
 - ▶ *File Card Brush
 - ▶ File/Rasp Second Cut Half Round 8"
 - ▶ Flanged Chisel
 - ▶ Groove Joint Pliers 300mm
 - ▶ Hacksaw 300mm Blade
 - ▶ *Hammer - Ball Pein 16oz / 454g
 - ▶ Junior Hacksaw 150mm Blade
 - ▶ *Lead Scraper (Triangular)
 - ▶ *Thinline Diameter Tape 2m
 - ▶ Mirror - Jointer's 125 x 100mm
 - ▶ *Multi-Purpose Snips 190mm
 - ▶ *Outside Caliper 6"
 - ▶ *Outside Caliper 8"
 - ▶ Pliers 160mm Long Nose
 - ▶ *Spare Flints (pk 5) for 217377
 - ▶ Reversible Ratchet 1/2" Sq Drive
 - ▶ Saw - Depth Gauge 120mm blade 24tpi
 - ▶ Screwdriver 1.2 x 6.5 x 150mm
 - ▶ Screwdriver 1.2 x 8.0 x 175mm
 - ▶ Screwdriver PZ Size 2 x 100mm
 - ▶ Screwdriver PZ Size 3 x 150mm
 - ▶ Side Cutters 160mm
 - ▶ *Socket 5/16" - 1/4" Sq Drive
 - ▶ Socket 6pt 1/2" Drive 13mm
 - ▶ Socket 6pt 1/2" Drive 14mm
 - ▶ Socket 6pt 1/2" Drive 15mm
 - ▶ Socket 6pt 1/2" Drive 16mm
 - ▶ Socket 6pt 1/2" Drive 17mm
 - ▶ Socket 6pt 1/2" Drive 18mm
 - ▶ Socket 6pt 1/2" Drive 19mm
 - ▶ *Socket 7mm - 1/4" Sq Drive
 - ▶ *Socket 8mm - 1/4" Sq Drive
 - ▶ *Spark Lighter / Flint Gun
 - ▶ *Spirit Level 10"
 - ▶ *Bradawl 1 1/4" Blade 3/32" Tip
 - ▶ T Bar Allen Key 3mm x150mm
 - ▶ *Torque Driver
 - ▶ *Wire Brush - 4 Row Stainless Steel
- * Non insulated



Linking Tool Kit

Part No	Description	Weight [kg]
24TBHB/KIT	Linking Tool Kit	7.5

Contents

- ▶ Tool Bag 24" Hard Base & Tool Roll - 15 Pocket
 - ▶ Extension Bar 1/2" Sq Drive 125mm
 - ▶ Link Extractor Female 1/4" W
 - ▶ Link Extractor Female 3/8" BSF
 - ▶ Link Extractor Male 1/4" W
 - ▶ Link Extractor Male 3/8" W
 - ▶ Open Ended Spanner 13mm
 - ▶ Open Ended Spanner 17mm
 - ▶ Open Ended Spanner 19mm
 - ▶ Open Ended Spanner 22mm
 - ▶ Open Ended Spanner 24mm
 - ▶ Open Ended Spanner 7/16" W
 - ▶ Reversible Ratchet 1/2" Sq Drive
 - ▶ Safety Clamp 65mm jaw
 - ▶ Screwdriver 1.6 x 10.0 x 200mm
 - ▶ Shroud - Elect Insulating 915x1x1000mm
 - ▶ Socket 6pt 1/2" Drive 13mm
 - ▶ Socket 6pt 1/2" Drive 17mm
 - ▶ Socket 6pt 1/2" Drive 19mm
 - ▶ Water Pump Plier 240mm
- * Non insulated

Lineman's Tool Kit 2



Part No	Description	Weight [kg]
24TBHB/KIT2	Lineman's Tool Kit 2	11.5

Contents

- ▶ *Tool Bag 24" Hard Base
 - ▶ Adjustable 200mm/8" Spanner
 - ▶ Adjustable 300mm/12" Spanner
 - ▶ Allen Key Screwdriver 3mm
 - ▶ Allen Key Screwdriver 7mm
 - ▶ Cable Cropper 250mm
 - ▶ Cable Jointer's Coring Knife
 - ▶ Engineer's Pliers 200mm
 - ▶ Engineer's Pliers 250mm
 - ▶ *Engineer's Pliers 250mm
 - ▶ Extension Bar 1/2" Sq Drive 125mm
 - ▶ Hacksaw 300mm Blade
 - ▶ *Hammer Claw 20oz
 - ▶ Junior Hacksaw 150mm Blade
 - ▶ Podger 13 x 17mm
 - ▶ Podger 17 x 19mm
 - ▶ *Ratchet Cable Cropper
 - ▶ *Reversible Ratchet 1/2" Sq Drive
 - ▶ *Ring Ratchet Podger 13x17mm
 - ▶ *Ring Ratchet Podger 17x19mm
 - ▶ *Saw - Bow 24"
 - ▶ Screwdriver 1.0 x 5.5 x 150mm
 - ▶ Screwdriver 1.2 x 8.0 x 175mm
 - ▶ Screwdriver PZ Size 2 x 100mm
 - ▶ Side Cutters 160mm
 - ▶ Socket 6pt 1/2" Drive 13mm
 - ▶ Socket 6pt 1/2" Drive 17mm
 - ▶ Socket 6pt 1/2" Drive 19mm
 - ▶ *Tape Measure 5m
 - ▶ *Wedge Set ABC
- * Non insulated



Lineman's Tool Kit 3

Part No	Description	Weight [kg]
24TBHB/KIT3	Lineman's Tool Kit 3	11

Contents

- ▶ *Tool Bag 24" Hard Base
 - ▶ *Engineer's Pliers 250mm
 - ▶ *Hammer Claw 20oz
 - ▶ *Ring Ratchet Podger 13 x 17mm
 - ▶ *Ring Ratchet Podger 17 x 19mm
 - ▶ *Saw - Bow 24"
 - ▶ *Tape Measure 5m
 - ▶ *Wedge Set ABC
 - ▶ Adjustable 200mm/8" Spanner
 - ▶ Adjustable 300mm/12" Spanner
 - ▶ Allen Key Screwdriver 3mm
 - ▶ Allen Key Screwdriver 7mm
 - ▶ Cable Cropper 250mm
 - ▶ Cable Jointer's Coring Knife
 - ▶ Engineer's Pliers 200mm
 - ▶ Engineer's Pliers 250mm
 - ▶ Extension Bar 1/2" Sq Drive 125mm
 - ▶ Hacksaw 300mm Blade
 - ▶ Junior Hacksaw 150mm Blade
 - ▶ Podger 13 x 17mm
 - ▶ Podger 17 x 19mm
 - ▶ Reversible Ratchet 1/2" Sq Drive
 - ▶ Screwdriver 1.0 x 5.5 x 150mm
 - ▶ Screwdriver 1.2 x 8.0 x 175mm
 - ▶ Screwdriver PZ Size 2 x 100mm
 - ▶ Side Cutters 160mm
 - ▶ Socket 6pt 1/2" Drive 13mm
 - ▶ Socket 6pt 1/2" Drive 17mm
 - ▶ Socket 6pt 1/2" Drive 19mm
- * Non insulated

Tool Cases

Tool Roll

- ▶ Manufactured from hard wearing polyester
- ▶ Double stitched at stress points
- ▶ 15 pocket compartments



▶ TR15

Part No	Description	Dimensions [mm]	Weight [g]
TR15	Tool Case Folding - Black	675 x 315	400

Tool Case – Folding 14 pocket

- ▶ 14 pocket compartments
- ▶ Manufactured from vinyl
- ▶ Snap fit lock



▶ 10.095.12
*Contents not included

Part No	Description	Dimensions [mm]	Weight [g]
10.095.12	Tool Case Folding - Black	320 x 60 x 250	800

Tool Case – Folding 26 pocket

- ▶ 26 pocket compartments
- ▶ Manufactured from vinyl
- ▶ Snap fit lock



▶ 10.096.12
*Contents not included

Part No	Description	Dimensions [mm]	Weight [g]
10.096.12	Tool Case Folding - Black	380 x 50 x 260	1100

Tool Case – Leather

- ▶ Fold out front compartment
- ▶ Snap fit lock
- ▶ Optional shoulder strap



▶ 10.070.61
*Contents not included

Part No	Description	Dimensions [mm]	Weight [g]
10.070.61	Tool Case – Red Leather	230 x 90 x 290	1700
10.007.21	Shoulder Strap	1300 x 25	175

Tool Case – Leather

- ▶ Fold out front compartment
- ▶ Removable middle partition
- ▶ 47 pocket compartments
- ▶ Document compartment
- ▶ Snap fit lock
- ▶ Optional shoulder strap



▶ 10.074.61
*Contents not included

Part No	Description	Dimensions [mm]	Weight [g]
10.074.61	Tool Case – Red Leather	450 x 150 x 320	3400
10.007.21	Shoulder Strap	1300 x 25	175

Tool Case – Leather

- ▶ Fold out front compartment
- ▶ Removable middle partition
- ▶ Aluminium edge reinforcement
- ▶ 45 pocket compartments
- ▶ Document compartment
- ▶ Snap fit lock
- ▶ Optional shoulder strap



▶ 10.092.61
*Contents not included

Part No	Description	Dimensions [mm]	Weight [g]
10.092.61	Tool Case – Red Leather	470 x 150 x 320	3900
10.007.21	Shoulder Strap	1300 x 25	175

Tool Box – Professional

- ▶ Large capacity
- ▶ Removable tote tray
- ▶ Full length, fold down handle
- ▶ Steel fastening latches
- ▶ Splash proof



▶ 24011
*Contents not included

Part No	Description	Dimensions [mm]	Weight [g]
24011	Tool Box Professional 26"	660 x 275 x 265	3000

Tool Bag – Hard Base

- ▶ Heavy duty polyester with hard plastic base
- ▶ 17 side pockets
- ▶ Heavy duty zip
- ▶ Reinforced with a metal frame for stability and strength



▶ 24TBHB

Part No	Description	Dimensions [mm]	Weight [g]
24TBHB	Tool Bag – Hard Base	610 x 300 x 300	1750

Stripping Tool for Peelable Semi Conductive Screen

- ▶ To strip the non-vulcanized semiconductive layer of MV cables
- ▶ Longitudinal, helical and circular cuts
- ▶ Positioned on the cable like a vice
- ▶ Stop clamp to limit the stripping length
- ▶ Step-by-step depth adjustment
- ▶ Max. rotating diameter 130mm
- ▶ The positioning of the stripper and holding of stop-clamp is assured by the pressure of the stripping
- ▶ The incision depth can be adjusted from 0 to 0.9mm with 0.1mm trips each by turning the corresponding knob
- ▶ The longitudinal and circumferential incision can be performed in one action
- ▶ Application range: 16 - 41mm
- ▶ Insulation thickness: 0 - 2mm
- ▶ Suggested application: Non vulcanized, peelable semiconductive layer



▶ 244410



▶ 244411



▶ 244400



▶ 244412

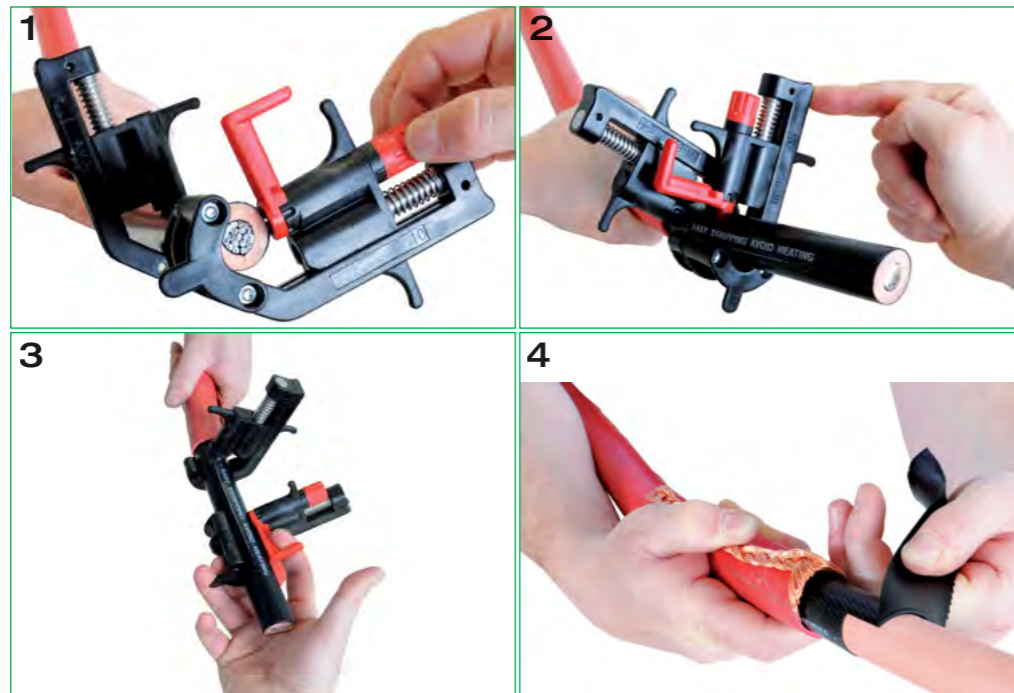

Part No	Description	Weight [g]
244400	Stripping set for peelable semi conductive screen (3 piece)	400
244410	Stripping tool for peelable semi-conductive screen	100
244411	Stop clamp for use with 244410	75
244412	Spare blade for 244410	10
244702	Silicone paste for use with 244410	100

Stripping Tools - Set

- ▶ Designed to strip the outer sheaths, semiconductive layer and to remove the primary insulation.
- ▶ Optimal equipment for for the realisation of the entire stripping procedure of most diverse cable types.
- ▶ Kit contents:
 - 244800 - Cable sheath cutting plier set
 - 244230 - Insulation Removal Tool
 - 244700 - Shaver for bonded semi-conductive screen



▶ 244900

Part No	Description	Weight [g]
244900	Stripping Tools - Set	4000

Shaver – for Bonded Semi Conductive Screen

- ▶ Shaving starts directly at the cable end
- ▶ Cutting depth of blade is adjustable
- ▶ Automatic feed
- ▶ Spring loaded cutting blade to allow for oval shaped cables
- ▶ Adjustable from 16-40mm (244750) or 34-60 mm (244760)



▶ 244750



▶ 244750

Part No	Description	Weight [g]
244750	Shaver for bonded semi-conductive screen Ø 16 to 40mm	1000
244730	Stop Rings set of 10 (244750)	190
244760	Shaver for bonded semi-conductive screen Ø 34 to 60mm	1300
244735	Stop Rings set of 8 (244760)	150
244740	Plastic carry case for p/n 244750/244760	90
244765	Spare blade for 244750/244760	20
244702	Tube Silicone paste for use with 244750/760	100

Cable Sheath & Insulation Removal Tool

- ▶ One tool - two functions
- ▶ Removes outer sheath and also XLPE insulation
- ▶ 2 Types GB-M20 - Ø 15 to 50mm and GB-M30 - Ø 32 to 70mm
- ▶ Both tools give quick, safe and precise cutting



▶ GB-M30



▶ GB-M20

Part No	Description	Weight [g]
GB-M20	Cable sheath cutter & insulation removal tool - cable range Ø 15-50mm	1000
GB-M20/S5	Spare set of plastic rollers (GB-M20)	200
GB-M20/S8	Set of spare blades (5), 10mm cutting depth (GB-M20)	50
GB-M20/S9	Plastic insert to cut VPE Insulation	30
GB-M30	Cable sheath cutter & insulation removal tool - Ø 32-70mm	1200
GB-M30/S5	Spare set of plastic rollers (GB-M30)	200
GB-M30/S8	Set of spare blades (5), 10mm cutting depth (GB-M30)	50
GB-PM20-BOX	Storage Case for GB-M20/M30	860

Insulation Chamfering Tool

- ▶ Designed for chamfered cuts of primary insulation of MV cables (2x 45°)
- ▶ Positioning on the cable with a clamp system
- ▶ Tool fitted with PTFE plates ensuring optimal sliding on the cable without the use of silicone paste
- ▶ Replaceable blade
- ▶ Rotation diameter max. 200mm
- ▶ This tool is not suitable for pencilling
- ▶ Interchangeable blade
- ▶ Application range: Ø 15 - 60mm
- ▶ Suggested application: Any type of primary insulation

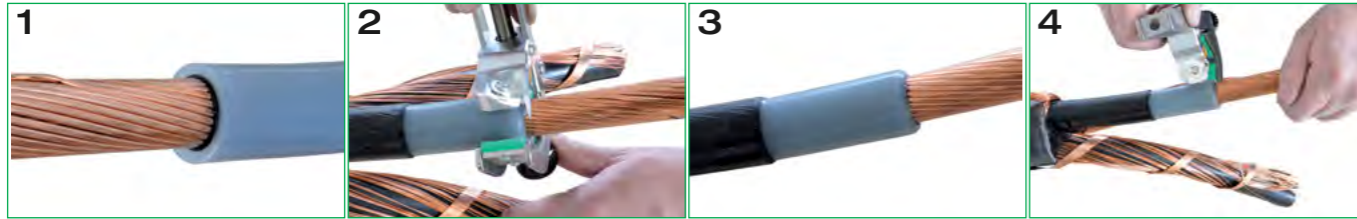

Part No	Description	Weight [g]
244240	Insulating Chamfering tool Ø 15-60mm	390
244242	Spare blade	20

Insulation Chamfering Tool

- ▶ Suitable for round MV cables up to 300mm²
- ▶ For cable diameters from 15 to 40mm
- ▶ Removes the square edge on XLPE insulation to avoid damage to push-on termination joints



Part No	Description	Weight [g]
KG05-3	Chamfering tool Ø 15-40mm	200
KG05-SI	Spare blade	20

Cable Stripper

- ▶ Removes PVC, PE and EPR insulations
- ▶ Suitable for single-core or three core cables
- ▶ Max insulation thickness: 35mm
- ▶ Operating range Ø 80-128mm



Part No	Description	Capacity [mm]	Size [mm]	Weight [g]
244PG6	Cable Stripper	Ø 80-128mm	450x120x240	3600

Shaver - Bonded Screen 40-110mm Ø

- ▶ For peeling the extruded semicon layer of HV cables
- ▶ Working range of the tool is between 40 up to 110mm Ø
- ▶ Smooth surface finish
- ▶ The tool can be set to different cable diameters by adjusting the bearing wheel
- ▶ Cutting depth can be adjusted in steps of 0.1mm
- ▶ Automatic speed can be set by adjusting the speed unit

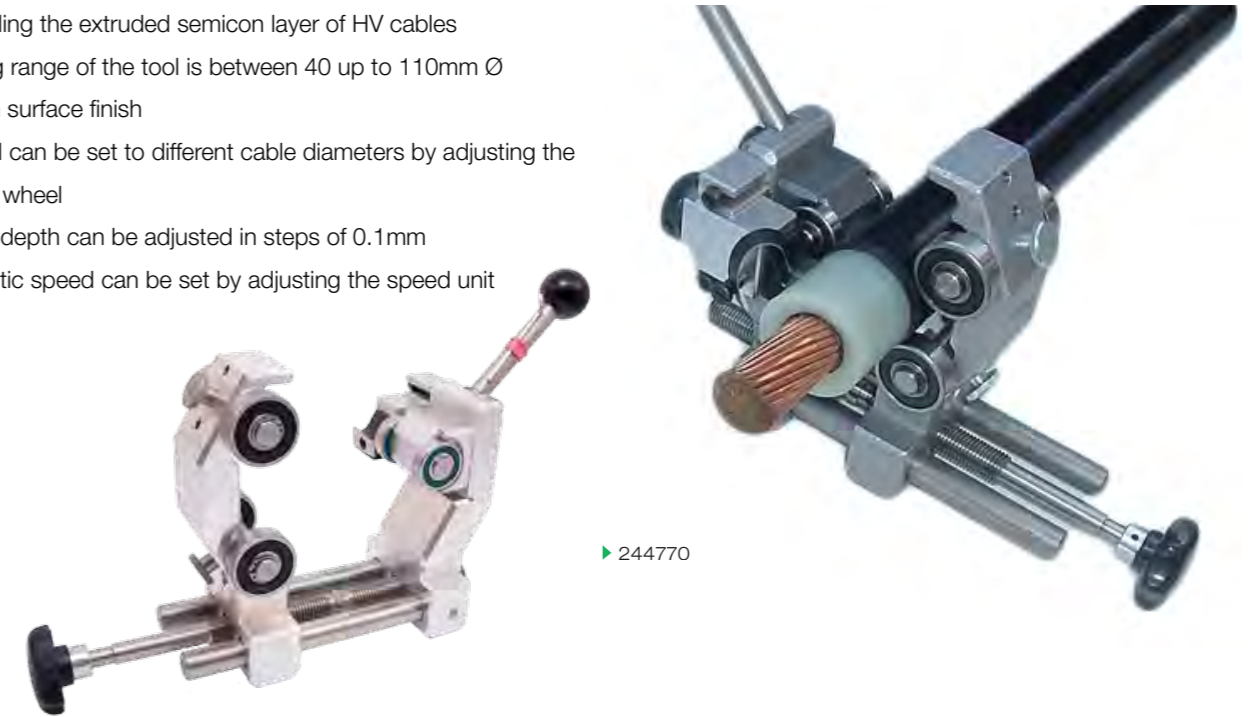

Part No	Description	Weight [g]
244770	Shaver - Bonded Screen 40-110mm Ø	4200
244771	Spare blade	100

Cable Stripper - Outer Sheath & Insulation

- ▶ For cutting and removal of the outer sheath and insulation
- ▶ Two functions in one tool
- ▶ Working range of tool is between 50 up to 130mm Ø
- ▶ Standard length of blade is 22mm - other length available on request
- ▶ Two cutting speeds can be achieved
- ▶ Additional position for circular cutting

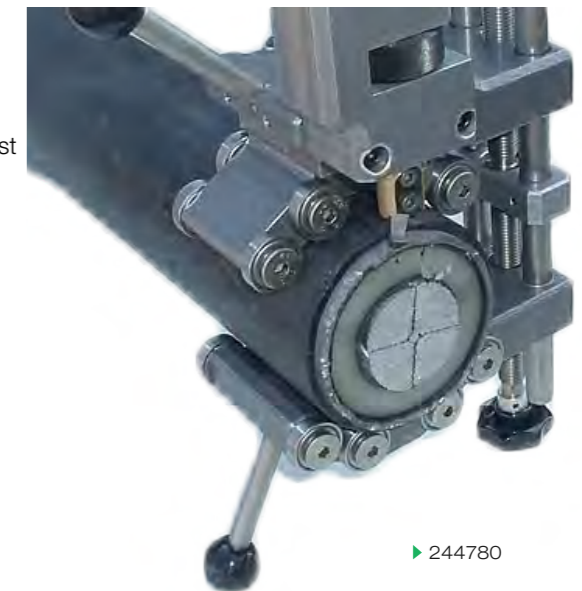

Part No	Description	Weight [g]
244780	Cable Stripper - Outer Sheath & Insulation	5000
244781	Spare blade	100

Consac Sheath Cutting Tool

Designed to cut the aluminium sheath on Consac cable to facilitate jointing and terminating.

- ▶ The tool provides safe and accurate cutting of the sheath without the risk of cutting the live inner conductor
- ▶ Exact cutting depths are achieved when using the different size cutting wheels
- ▶ "T" handle is available to assist the operation of the tool
- ▶ Consac Sheath Punch is available in two sizes - Ø 7 or 10 mm
- ▶ Complete sheath cutting kit in plastic case available on request
- ▶ Insulated Sheath Lifters, two types available - all plastic or coated metal (see picture)
- ▶ Insulating Shrouding kit available - details on request



Part No	Description	Weight [g]
936-MK3	Consac Sheath Cutter MK3 - Ø 23.4 - 32.7mm	1900
936-MK4	Consac Sheath Cutter MK4 - Ø 32.7 - 45.3mm	2000
936-AK	Allen Key for MK3/MK4 Cutter	10
936-TB	T-bar for MK3/MK4 Cutter	160
936-WP	Spare wheel pin for MK3/MK4 Cutter	30
936-PPMK3	Spare set of plastic pads (2) for MK3 Cutter	35
936-PPMK4	Spare set of plastic pads (2) for MK4 Cutter	35
CS90/DB76	Plastic case to hold MK3 sheath cutter and accessories	700
936-HP7	Consac Hole Punch 7mm	700
936-HPI0	Consac Hole Punch 10mm	700
103107	Insulated Consac Sheath Lifter (metal)	350
103108	Insulated Consac Sheath Lifter (all plastic)	50

Cutting Wheels



Part No.	Cutting Depth	Markings	Cable Size	Weight [g]
936-1001	0.90mm	0.9mm	70mm ²	35
936-1002	1.10mm	1.1 mm	70mm ²	35
936-1003	1.60mm	1.6mm	-	35
936-1004	3.00mm	3.0mm	-	35
936-1005	1.70mm	1.7mm 185mm ²	185mm ²	35
936-1008	1.04mm	1.04mm 95mm ²	95mm ²	35
936-1009	1.51mm	1.51mm 185mm ²	185mm ²	35
936-1011	1.40mm	1.4mm 120mm ²	120mm ²	35
936-1012	2.00mm	2.0mm 300mm ²	300mm ²	35

Cable Jointer's Inspection Mirror

A useful aid for inspection of cable joints in confined areas.

- ▶ Mirror manufactured from plastic
- ▶ Rubber moulded casing for easier handling
- ▶ Manufactured from non-conductive materials



Part No	Description	Weight [g]
JM1	Cable jointer's mirror 125 x 100mm	90

Damp Testing Saucepan

A must for all cable jointers when damp testing paper insulation on cables.

- ▶ Small and easily transported
- ▶ Lockable lid to prevent spilling
- ▶ Use with paraffin wax pellets
- ▶ Thermometer fits in lid so that the saucepan lid can remain on when the wax is heating up
- ▶ Supplied with inner basket to remove any waste material in the wax

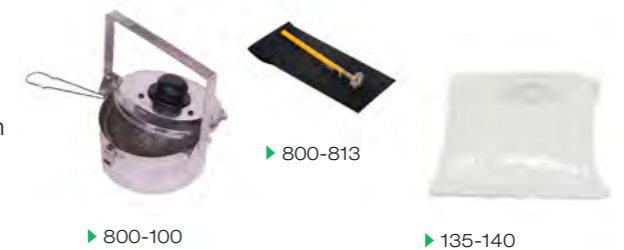

Part No	Description	Weight [g]
800-100	Damp testing saucepan with inner basket and clip on lid	800
135-140	1 kg bag of wax granules to go in saucepan	1000
800-813	Probe thermometer 0-250°C, supplied in plastic wallet	100

Torque Limiting Screwdriver

Mainly used by cable jointers where a specific torque setting is required on cable connectors or jubilee clips.

- ▶ Preset values from 1 to 13.6 Nm
- ▶ 1/4" square drive - male
- ▶ Supplied in plastic wallet
- ▶ Sockets available on request
- ▶ Recalibration service available



Part No	Description	Weight [g]
1015900	Torque limiting driver - preset from 1 to 13.6 Nm (please state required torque setting when ordering)	350
ESM406	Socket 1/4" Drive 6mm	11
ESM407	Socket 1/4" Drive 7mm	11
ESM408	Socket 1/4" Drive 8mm	11
101933	Converter 1/4" hex to 1/4" Sq male	11

HV Switchboard Rubber Matting

- ▶ Tested to IEC61111
- ▶ Standard colour grey
- ▶ Other colours available, minimum production run applies
- ▶ Cut lengths available per metre
- ▶ Flame retardant, oil & acid resistant
- ▶ Upperside Ribbed / Underside Fabric Impression



Part No	Safety Standard	Test Voltage [kV]	Working Voltage [kV]	Width [mm]	Thickness [mm]	Weight [kg]	Standard Roll Length [m]
642102	IEC61111 Class 2	20	17	1000	3.0	40	10
642102R	IEC61111 Class 2	20	17	1000	3.0	100	25
642122	IEC61111 Class 2	20	17	1200	3.0	48	10
642122R	IEC61111 Class 2	20	17	1200	3.0	120	25
642105	IEC61111 Class 4	40	36	1000	4.5	65	10
642105R	IEC61111 Class 4	40	36	1000	4.5	100	15
642125	IEC61111 Class 4	40	36	1200	4.5	78	10
642155	IEC61111 Class 4	40	36	1000	12	180	10

LV & HV Switchboard Rubber Matting

- ▶ Voltages from 450V to 36,000V
- ▶ Including *Low Smoke Flame Retardant option
- ▶ Cut lengths available per metre



Part No	Safety Standard	Test Voltage [kV]	Working Voltage [V]	Width [mm]	Thickness [mm]	Weight per roll [kg]	Standard Roll Length [m]
642300	N/A	11	450	915	6.0	90	11.5
642303	N/A	11	450	1220	6.0	120	11.5
642301	BS921	15	650	915	9.0	145	11.5
642302	BS921	15	650	1220	9.0	195	11.5
20542/LSFR*	ASTM D178 Type 2 Class 1	20	7,500	915	4.5	138	23
20543/LSFR*	ASTM D178 Type 2 Class 2	30	17,000	915	6.0	180	23
20543	ASTM D178 Type 1 Class 2	30	17,000	915	6.0	170	23
20545	ASTM D178 Type 1 Class 4	50	36,000	915	12	330	18

HV Switchboard Rubber Matting

- ▶ Tested to IEC61111
- ▶ Flame Retardant / Oil & Acid Resistant
- ▶ Fabric Finish on both sides
- ▶ Cut lengths available per metre

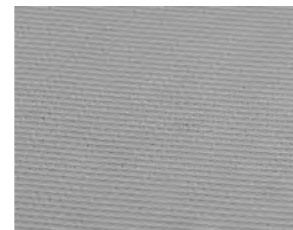

Part No	Safety Standard	Test Voltage [kV]	Working Voltage [kV]	Width [mm]	Thickness [mm]	Weight [kg]	Standard Roll Length [m]
642103	IEC61111 Class 3	30	26.5	1000	3.0	45	10
642123	IEC61111 Class 3	30	26.5	1200	3.0	69	10

HV Switchboard Rubber Matting

- ▶ Tested to IEC61111
- ▶ Standard colour black
- ▶ Flame Retardant / Oil & Acid Resistant
- ▶ Upperside Corrugated / Underside Fabric Impression
- ▶ Cut lengths available per metre

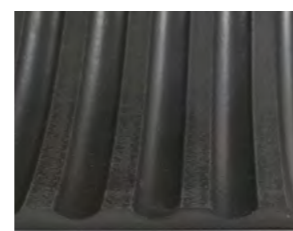

Part No	Safety Standard	Test Voltage [kV]	Working Voltage [kV]	Width [mm]	Thickness [mm]	Weight [kg]	Standard Roll Length [m]
642133	IEC61111 Class 3	30	26.5	1300	5.0	83	10

Cable Tray Matting

- ▶ Basket matting alleviates the problem of cables being damaged when laid directly on the wire basket
- ▶ Available in 1.5mm thickness up to a maximum width of 1000mm
- ▶ Cut lengths available per metre

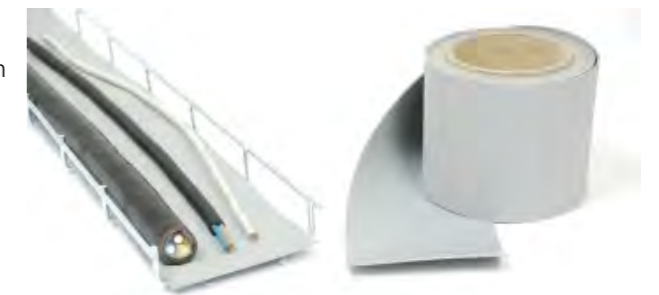

Part No	Description	Size [mm]
600100	Cable Tray Grey	100mm x1.5mm x10m
600150	Cable Tray Grey	150mm x1.5mm x10m
600200	Cable Tray Grey	200mm x1.5mm x10m
600300	Cable Tray Grey	300mm x1.5mm x10m
600450	Cable Tray Grey	450mm x1.5mm x10m
600500	Cable Tray Grey	500mm x1.5mm x10m

Static Dissipative Matting

- ▶ Tough, long lasting and anti-fatigue
- ▶ Designed to protect operatives from static build-up
- ▶ Easy wipe clean surface
- ▶ Grounded via a 10mm male stud fitted to the mat
- ▶ Maximum performance when used with floor mat grounding wire
- ▶ Resistance measurements are $1 \times 10^9 \Omega$ to $1 \times 10^{10} \Omega$



▶ Anti Stat Mat

Kit contents

- ▶ Static dissipative mat
- ▶ Male stud to connect to grounding wire
- ▶ 2m floor mat grounding wire
- ▶ 2 x heel grounders
- ▶ Earth bonding plug



Part No	Description	Size [mm] (9mm thick)	Weight [kg]
642304AS	Static Dissipative Matting	600 x 900	2.0
642304AS/KIT	Static Dissipative Matting Kit - 6 piece	600 x 900	2.5
642307AS	Static Dissipative Matting	900 x 1500	4.0
642307AS/KIT	Static Dissipative Matting Kit - 6 piece	900 x 1500	4.5
642308AS	Static Dissipative Matting	900 x 18.3m	55.0
642308AS/KIT	Static Dissipative Matting Kit - 6 piece	900 x 18.3m	55.5
642306AS	Static Dissipative Matting	900 x per linear metre*	3.0
642306AS/KIT	Static Dissipative Matting Kit - 6 piece	900 x per linear metre*	3.5

* maximum length 18m

Bench Mat Kits

- ▶ Superior three layer static dissipative bench matting in blue or grey
- ▶ Each mat is supplied with a male stud to connect to common point wire
- ▶ Wrist band with 10mm male stud to connect to coil cord
- ▶ Coil cord 10mm male stud and 10mm female stud incorporating 4mm banana socket – length 4.5m
- ▶ Earth bonding plug to connect lead to earth
- ▶ Designed to protect the bench, components and operatives from static electricity



Kit contents

- ▶ Benchmat
- ▶ Male stud to connect to common point wire
- ▶ Wrist band with 10mm male stud to connect to coil cord
- ▶ Coil cord 10mm male stud and 10mm female stud - 1.8m long
- ▶ Common point ground wire 10mm male stud and 10mm female stud inc. 4mm banana socket - 4.5m long
- ▶ Earth bonding plug to connect lead to earth

Part No	Description	Size [mm]	Weight [g]
642404AS	Bench Mat	600 x per linear metre	1500
642404AS/KIT	Bench Mat Kit – 6 piece	600 x per linear metre	2000
642405AS	Bench Mat	900 x per linear metre	2200
642405AS/KIT	Bench Mat Kit – 6 piece	900 x per linear metre	2700
642406AS	Bench Mat	1200 x per linear metre	2900
642406AS/KIT	Bench Mat Kit – 6 piece	1200 x per linear metre	3400
642309WB	Wrist Band – IEC 61340-5-1	-	75
642309HG	Heel Grounder with 1 meg Ω	-	75
642309CC	Coil Cord	1.8m	60
642309CPGW	Common Point Ground Wire	4.5m	120
642309GW	Floor Mat Grounding Wire	2m	90
642309BPUK	UK Earth Bonding Plug	-	80
642309BPEU	European Earth Bonding Plug	-	80

Demarcation Curtain

- ▶ A lightweight, flexible and practical means of panel demarcation, for use by Electrical Engineers whilst working with LV equipment
- ▶ The sheet measures 2,1m in height, 700mm in width and is supplied with red and clear chevrons on the outer edges and green arrows on the inner edges
- ▶ They are also fitted with a magnetic strip which is fixed to the top and bottom of the sheet, making it easy to apply and to remove from panels
- ▶ They can be customised to suit customers specific requirements



▶ 841700

Part No	Description	Size (external) [mm]	Weight [g]
841700	Demarcation Curtain	700 x 2100	1500

Bodtect Overhead Line Shrouding

- ▶ Easily installed on overhead lines whilst offering complete protection
- ▶ Used to protect engineers working with live voltages up to 1000V
- ▶ Conforms to ENTS 43-103 standard
- ▶ Supplied as standard in 3 metre lengths, other lengths available
- ▶ Three separate sizes, 22mm, 32mm and 45mm internal diameter
- ▶ Snapfit Termination Piece secures span of shrouding in place – prevents movement



Part No	Description	Internal ϕ [mm]	Length [mm]	Weight [g]	Insulated
BODTECT22	Bodtect Overhead Line Shrouding 22	22	3000	620	✓
BODTECT32	Bodtect Overhead Line Shrouding 32	32	3000	980	✓
BODTECT45	Bodtect Overhead Line Shrouding 45	45	3000	1360	✓
BODCONNECT22	Bodconnect 22 Snapfit Connector	22	90	20	x
BODCONNECT32	Bodconnect 32 Snapfit Connector	32	130	40	x
BODCONNECT45	Bodconnect 45 Snapfit Connector	45	150	60	x
BODTERM22	Bodterm 22 Snapfit Termination Piece	22	90	25	x
BODTERM32	Bodterm 32 Snapfit Termination Piece	32	130	45	x
BODTERM45	Bodterm 45 Snapfit Termination Piece	45	150	65	x



Line Tap Shrouds

- ▶ To provide protection for overhead line taps
- ▶ Manufactured from UV resistant plastic
- ▶ Protects against salt water damage
- ▶ Available in different colours and sizes minimum order quantities applies



Part No	Description	Size (external) [mm]	Weight [g]
M/261/86	Line Tap Shroud 14mm-Black	42 x 30	10
M/261/87	Line Tap Shroud 16mm-Black	46.5 x 40	12
M/261/88B	Line Tap Shroud 22mm-Black	71 x 41 x 37	25
M/261/88	Line Tap Shroud 22mm-Black Standard Model	101 x 57.6 x 46.1	35
M/261/88C	Line Tap Shroud 22mm-Cream Standard Model	101 x 57.6 x 46.1	35

Stay Wire Protection

- ▶ Spiral cover manufactured from yellow UV resistant plastic
- ▶ Customised lengths and kits available
- ▶ Provides visual identification of staywire



▶ SWP/SGX-16

Part No	Size	Weight [g]
SWP/SGX-16	13mm ID x 20m long	1500
SWP/SGX-20	16mm ID x 20m long	2200
SWP/SGX-32	27mm ID x 20m long	5400

- ▶ Rigid split tube manufactured from yellow UV resistant plastic
- ▶ Customised lengths and kits available
- ▶ Provides visual identification of staywire
- ▶ Each length supplied with three cable ties and pre-drilled holes



▶ SWP-22

Part No	Size	Weight [g]
SWP-22	22mm ID x 1.5m long	350

- ▶ Rigid split tube manufactured from yellow UV resistant plastic
- ▶ Customised lengths available
- ▶ Provides visual identification of staywire
- ▶ Large diameter allows the tube to rotate when in contact with large animals
- ▶ Greatly reduces the risk of damage to staywire/pole



▶ SWP-76

Part No	Size	Weight [g]
SWP-76	76 mm ID x 2m long	900

Rubber Insulating Shrouding

- ▶ Manufactured from 1mm thick orange neoprene with nylon insert for added strength
- ▶ Used to protect engineers working with live voltages up to 1000V
- ▶ Also available 4 types of insulated clamps to hold shrouding in position
- ▶ Used in many applications inc. underground cable jointing, overhead conductors and link box maintenance
- ▶ Approved to ENTS 43-103 specification
- ▶ In line tested to ASTM F-2320
- ▶ Higher working voltages available



Part No	Dimensions [mm] Cuts and Rolls	Weight [g]
599201	120 x 120	17
599202	130 x 230	36
599203	250 x 350	106
599204	600 x 600	436
599205	450 x 600	300
599206	300 x 400	150
599000M	915 x 1000	1200
599002M	915 x 2000	2400
599005M	915 x 5000	6000
599000R	915 x 10,000	12000
599001	915 x 1200	1450

Transparent Insulating Shrouding

- ▶ Used to protect engineers working with live voltages up to 1000V
- ▶ Easily installed
- ▶ Prevents accidental contact with live terminals
- ▶ Also available 3 types of insulated clamps to hold shrouding in position



Part No	Description	Length [m]	Width [mm]	Thickness [mm]	Weight [kg]
641952M	Transparent shrouding	1	1350	0.5	0.80
641952	Transparent shrouding	40	1350	0.5	37

Safety Clamps

- ▶ Available in four sizes
- ▶ Rubber contacts in jaw to protect insulating material
- ▶ Joint with special guide ring
- ▶ Material made of non brittle plastic
- ▶ For use with orange neoprene or transparent shrouding



Part No	Description	Opening [mm]	Length [mm]	Width [mm]	Weight [g]	1000V Insulated
651402	Safety Clamp with Hook	45	165	130	60	✓
651412	Safety Clamp 65mm	65	160	115	70	✓
651409	Safety Clamp, short	45	140	85	52	✓

LV Pocket Shroud Kits

- ▶ Used to protect engineers working with live voltages up to 1000V
- ▶ Easily installed / removed
- ▶ Flexible in cold weather
- ▶ Manufactured from 1mm thick orange neoprene with nylon insert
- ▶ UV resistant with velcro edge fastening
- ▶ Material in line tested to ASTM F-2320
- ▶ Approved to ENTS 43-103 specification
- ▶ Higher working voltages available



Part No	Description	Weight [Kg]
592/KIT	Lineman's Shrouding Kit	7

Part No	Contents	Qty
599-TYPE-1	Reel Insulator Cover 300 x 400mm	5
599-TYPE-2	Conductor Cover 750 x 180mm	10
599-TYPE-3	D-Iron Assembly Cover 650 x 400mm	5
599-TYPE-5	General Purpose Cover 450 x 250mm	5
24TBHB	Tool Bag 24" Hard Base	1

Part No	Description	Weight [Kg]
599/KIT1	Lineman's Shrouding Kit 1	6

Part No	Contents	Qty
599-TYPE-2	Conductor Cover 750 x 180mm	10
599-TYPE-6	General Purpose Cover 700 x 300mm	5
599-TYPE-7	Keyhole Cover 250 x 450mm	5
24TBHB	Tool Bag 24" Hard Base	1

Part No	Description	Weight [Kg]
599/KIT3	Lineman's Shrouding Kit 3	11

Part No	Contents	Qty
599-TYPE-7	Keyhole Cover 250 x 450mm	12
599-TYPE-5	General Purpose Cover 450 x 250mm	12
599-TYPE-9	Conductor/D-Iron Cover 450 x 1250mm	12
599-TYPE-11	Blanket Shroud 600 x 600mm	1
24TBHB	Tool Bag 24" Hard Base	1

LV Pocket Shroud Kits Cont.

Part No	Description	Weight [Kg]
599/KIT4	Lineman's Shrouding Kit 4	11

Part No	Contents	Qty
599-TYPE-2	Conductor Cover 750 x 180mm	4
599-TYPE-3	D-Iron Assembly Cover 650 x 400mm	3
599-TYPE-6	General Purpose Cover 700 x 300mm	6
599-TYPE-9	Conductor/D-Iron Cover 450 x 1250mm	6
599-TYPE-7	Keyhole Cover 250 x 450mm	3
599-TYPE-12	Shroud- Elect Insulating 915x1x2000mm	1
599-TYPE-11	Blanket Shroud 600 x 600mm	1
24TBHB	Tool Bag 24" Hard Base	1

Part No	Description	Weight [Kg]
599/KIT2	Jointer's Shrouding Kit 2	0.48

Part No	Contents	Qty
WALLET-PVC	PVC Wallet – 435 x 335mm	1
5991550	Shroud – 150 x 500mm Velcro	3
5991540	Shroud – 150 x 400mm Velcro	3
5991530	Shroud – 150 x 300mm Velcro	3
5991525	Shroud – 150 x 250mm Velcro	3
5991510	Shroud – 150 x 100mm Velcro	3



► 599/KIT2

LV Pocket Shrouds

- Used to protect engineers working with live voltages up to 1000V
- Easily installed / removed
- Flexible in cold weather
- Manufactured from 1mm thick orange neoprene with nylon insert
- UV resistant with velcro edge fastening
- Material in line tested to ASTM F-2320
- Approved to ENTS 43-103 specification
- Higher working voltages available
- Other sizes available on request



Part No	Description	Size [mm]	Weight [g]	Insulated
599-TYPE-1	Type 1 – Reel Insulator Cover	300 x 400	160	✓
599-TYPE-2	Type 2 – Conductor Cover	750 x 180	180	✓
599-TYPE-3	Type 3 – D-Iron Assembly Cover	400 x 650	340	✓
599-TYPE-4	Type 4 – Conductor Cover 2m x 150mm	2m x 150mm	tba	✓
599-TYPE-5	Type 5 – General Purpose Cover	250 x 450	160	✓
599-TYPE-6	Type 6 – General Purpose Cover	300 x 700	260	✓
599-TYPE-7	Type 7 – Key Hole Cover	250 x 450	160	✓
599-TYPE-8	Type 8 – Conductor Cover	2000 x 100	320	✓
599-TYPE-9	Type 9 – Conductor/D-Iron Cover	1250 x 150/450	360	✓
599-TYPE-10	Type 10 – Conductor Cover	10000 x 100	1540	✓
599-TYPE-11	Type 11 – Blanket Shroud - Small	600 x 600	480	✓
599-TYPE-12	Type 12 – Blanket Shroud – Large	915 x 2000	2300	✓

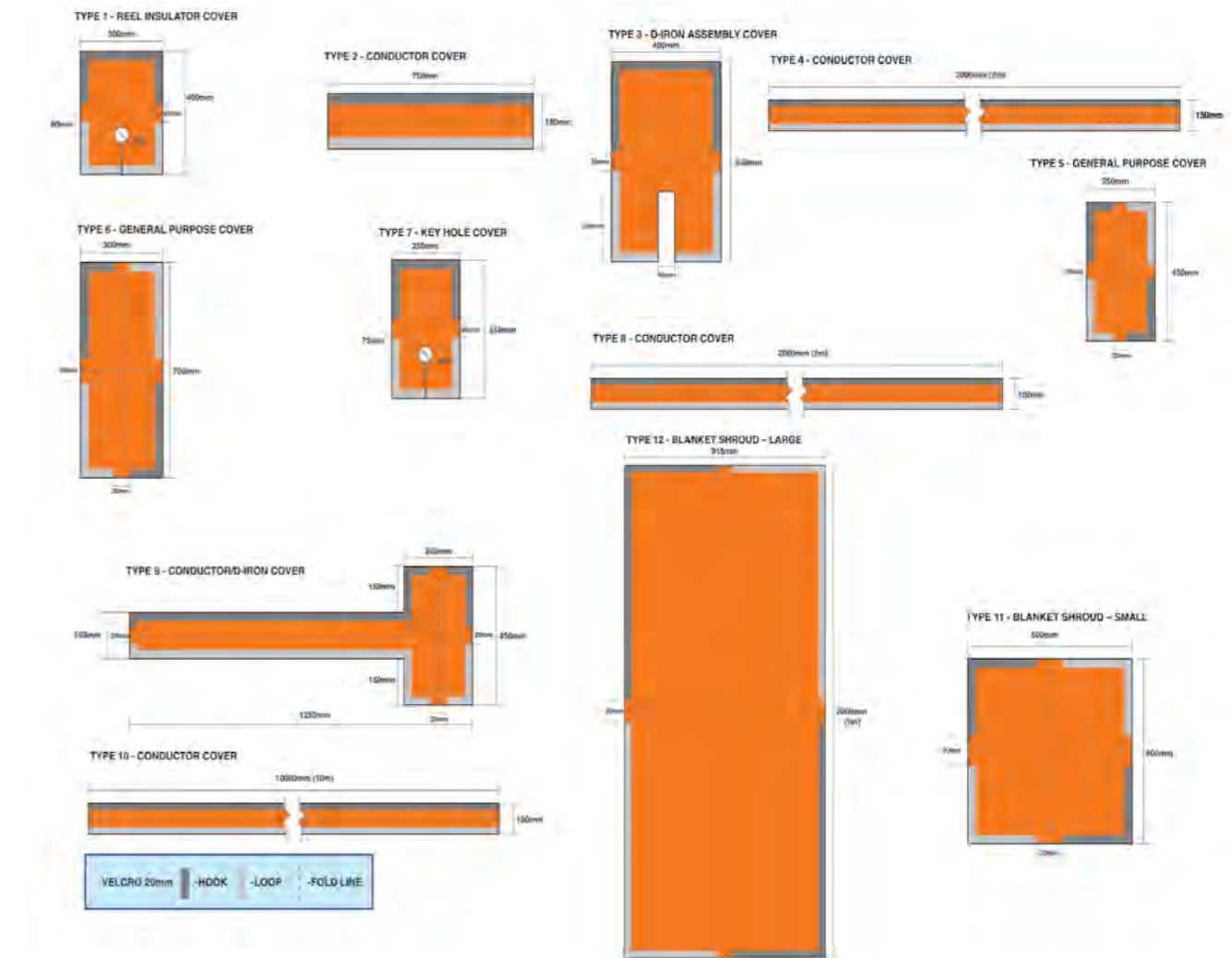

Rubber Insulating Shrouding

- ▶ Tested to IEC61112:2009 – Class 0
- ▶ Manufactured from Orange Elastomer Rubber 1.5mm thick
- ▶ Flame Retardant
- ▶ Oil & Acid Resistant
- ▶ Extremely flexible, even in cold weather
- ▶ Other voltage classes available on request
- ▶ Cut lengths available on request



▶ 601000M

Part No	Dimensions Cuts and Rolls	Weight [kg]
601201	120 x 120	0.022
601202	130 x 230	0.040
601203	250 x 350	0.110
601204	600 x 600	0.440
601205	450 x 600	0.310
601206	300 x 400	0.160
601000R	1000x1.5x10m	20
601000M	1000x1.5x1000mm	2
601200R	1200x1.5x10m	24
601200M	1200x1.5x1000mm	2.4

Jointer's Shrouding Kit

- ▶ Manufactured from Orange Elastomer Rubber 1.5mm thick
- ▶ Tested to IEC61112:2009 – Class 0
- ▶ Used to protect engineers working with live voltages up to 1000V
- ▶ Supplied with PVC wallet



Part No	Description
601-KIT/2	Jointer's Shrouding Kit

Contents

Part No	Description	Size [mm]	Insulated	Weight [g]
601-TYPE-6	Shroud with Velcro	180 x 200	✓	
601-TYPE-7	Shroud with Velcro	100 x 400	✓	
601-TYPE-8	Shroud with Velcro	180 x 460	✓	
601-TYPE-9	Shroud with Velcro	100 x 300	✓	
601-TYPE-10	Shroud with Velcro	270 x 200	✓	
601-TYPE-11	Shroud with Velcro	100 x 200	✓	
601-TYPE-12	Shroud with Velcro	100 x 200	✓	
601-TYPE-13	Shroud	65 x 1000	✓	
601-TYPE-14	Shroud	65 x 1500	✓	
194009	Shroud - CNE	120x35x70	✓	



Jointer's Shrouding Kit

- ▶ Manufactured from Orange Elastomer Rubber 1.5mm thick
- ▶ Tested to IEC61112:2009 – Class 0
- ▶ Used to protect engineers working with live voltages up to 1000V
- ▶ Supplied with PVC wallet



Part No	Description
601-KIT/1	Jointer's Shrouding Kit

Contents

Part No	Description	Size [mm]	Insulated
601-TYPE 1	Paper Insulated Lead Cable Shroud	300 x 300	✓
601-TYPE 2	Neutral Shroud Extension Piece	300 x 170	✓
601-TYPE 3	Neutral Shroud Extension Piece	200 x 170	✓
601-TYPE 4	Large Neutral Cable Shroud	1320 x 170	✓
601-TYPE 5	Small Neutral Cable Shroud	1080 x 170	✓

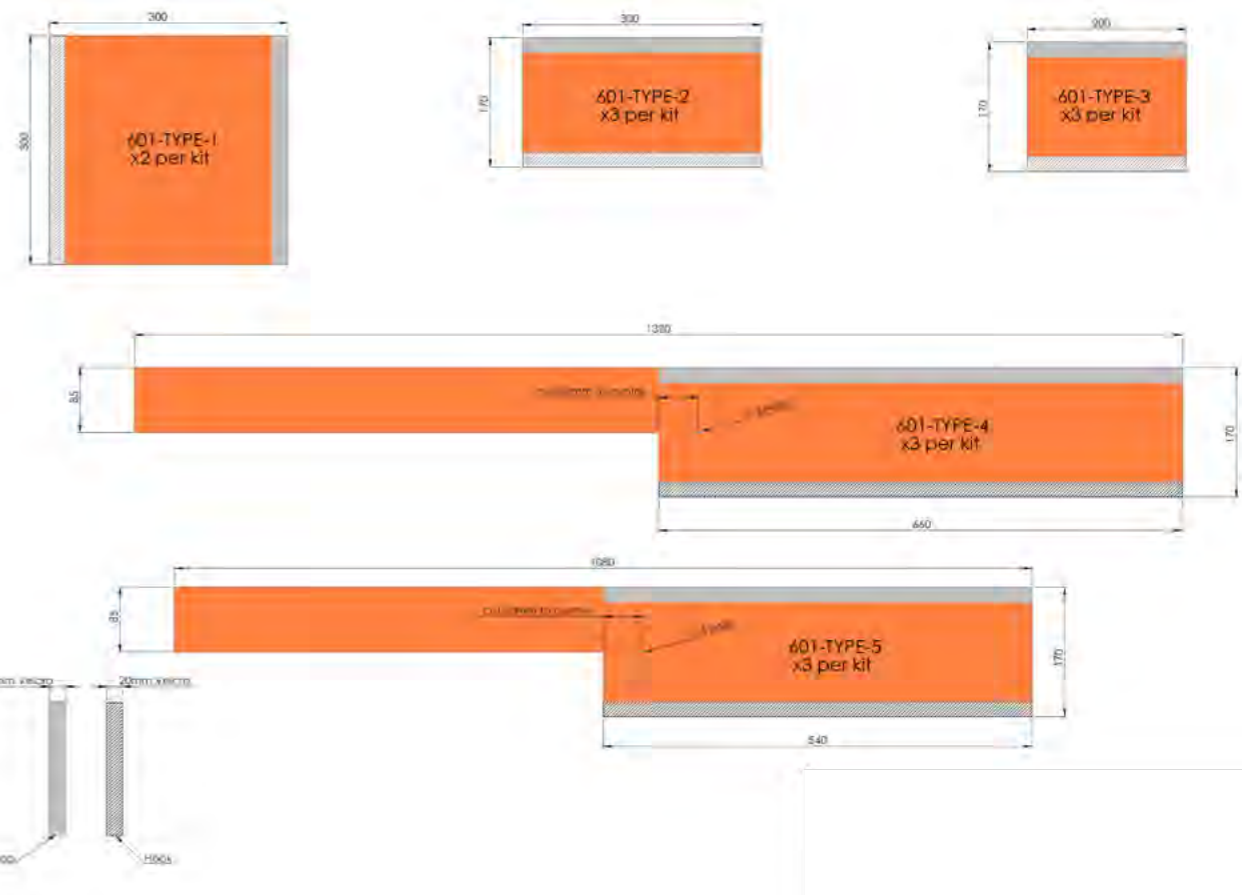

Electrical Safety Gloves

- ▶ Fully insulating gloves each test stamped for working voltages ranging from 500V up to 36,000V – manufactured to EN60903
- ▶ Leather overglove worn over the insulating gloves to protect against mechanical hazards and electrical arcing
- ▶ Cotton undergloves give added comfort in warm and humid conditions
- ▶ The EN60903 and IEC903 standards advise visual inspection by inflation of the glove in order to detect air leaks. This can be carried out by the Pneumatic Glove Tester
- ▶ We can also re-test these gloves to the EN60903 Standard



Part No	Description	Length [mm]	Thickness [mm]	Sizes	Test Voltage [V]	Working Voltage [V]	Class
0583	Insulating Gloves	360	0.5	8,9,10,11	2500	500 max	00
0584	Insulating Gloves	360	1.0	8,9,10,11	5000	1000 max	0
0585	Insulating Gloves	360	1.5	8,9,10,11	10,000	7500 max	1
0586	Insulating Gloves	360	2.3	8,9,10,11	20,000	17,000 max	2
0587	Insulating Gloves	360	2.9	9,10,11	30,000	26,500 max	3
0588	Insulating Gloves	410	3.6	9,10,11	40,000	36,000 max	4
058CGL	Cotton Undergloves -pack of 10	250	N/A	One size	N/A	N/A	N/A
058L	Leather Overgloves	300 - 330	N/A	8,9,10,11,12	N/A	N/A	N/A
058LG	Leather Overgloves	300 - 330	N/A	8,9,10,11	N/A	N/A	N/A

Accessories

Part No	Description	Length [mm]	Thickness mm	Sizes	Test Voltage	Working Voltage	Class
058T	Pneumatic Glove Tester	N/A	N/A	One Size	N/A	N/A	N/A
058B	Glove Storage Bag	390	N/A	One Size	N/A	N/A	N/A
058BX	Glove Storage Box - Clear	370	N/A	One Size	N/A	N/A	N/A
058BXL	Glove Storage Box - Blue	430	N/A	One Size	N/A	N/A	N/A



*Gloves not included

Electrical Safety Gloves - Flex & Grip

- ▶ Fully insulating gloves each test stamped for working voltages ranging from 1000V up to 36,000V – manufactured to EN-60903 & IEC-60903
- ▶ External surface keeps its non-slipping characteristics even in wet conditions
- ▶ Latex used to produce the range give a maximum of suppleness for increased dexterity
- ▶ We can also re-test these gloves to the EN60903 Standard



Part No	Description	Length [mm]	Thickness [mm]	Sizes	Test Voltage [V]	Working Voltage [V]	Class
0574	Insulating Gloves	410	2.1	8,9,10,11	5000	1000 max	0
0575	Insulating Gloves	410	2.6	8,9,10,11	10,000	7500 max	1
0576	Insulating Gloves	410	3.1	8,9,10,11	20,000	17,000 max	2
0577	Insulating Gloves	410	3.1	8,9,10,11	30,000	26,500 max	3
0578	Insulating Gloves	410	3.6	8,9,10,11	40,000	36,000 max	4



Testing gloves to the EN60903 & IEC60903 Standard

Arc Flash Protection

GARMENTS

- ▶ All fabrics, including thread, used in construction of ARC garments are inherently flame retardant
- ▶ Will remain flame retardant regardless of repeated laundering
- ▶ Lightest weight arc flash garments currently on the market
- ▶ Help reduce heat stress
- ▶ Meets or exceeds the requirements of NFPA 70E and ASTM F1506

HOODS

- ▶ Manufactured with ARCX™ energy absorbing polycarbonate plastic
- ▶ Provide superior visible light transmission
- ▶ Specially designed window for each arc level maximizes visible light transmission
- ▶ Scratch resistant coating on the outer surface (for longer product life)
- ▶ Antifog coating on the inner surface (for improved visibility)
- ▶ Meets NFPA 70E, ASTM F2178 and ANSI Z87.1

Specify garment size when ordering – available small to 5XL

Arc 15

- ▶ NFPA 70E Category 2
- ▶ Arc Rating – 15 cal/cm² ATPV
- ▶ Fabric Weight – 8.9 oz/yd²
- ▶ Hood Window VLT – 57%



▶ 663505 Set 2 - Coat, Bib-Overall, Hood with Hard Cap

Part No	Description
663506	Set 1 - Coverall, Hood with Hard Cap
663505	Set 2 - Coat, Bib-Overall, Hood with Hard Cap
663415	Hood
ARC15-CT	Hip Length Coat
ARC15-BIB	Bib-Overalls
ARC15-CVL	Coverall

Arc 25

- ▶ NFPA 70E Category 3
- ▶ Arc Rating – 29 cal/cm² ATPV
- ▶ Fabric Weight – 10 oz/yd²
- ▶ Hood Window VLT – 57%



▶ 663524 Hood



▶ ARC25-BIB



▶ 663523 Coverall

Part No	Description
IFR3A	Set 1 - Coverall, Hood with Hard Cap
IFR3B	Set 2 - Coat, Bib-Overall, Hood with Hard Cap
663524	Hood
ARC25-CT	Hip Length Coat
ARC25-BIB	Bib-Overalls
663523	Coverall

Arc 40

- ▶ NFPA 70E Category 4
- ▶ Arc Rating – 49 cal/cm² ATPV
- ▶ Fabric Weight – 12.1 oz/yd²
- ▶ Hood Window VLT – 52%



▶ Arc 40 Hood



▶ Arc 40 Coat

Part No	Description
IFR4A	Set 1 - Coverall, Hood with Hard Cap
663504	Set 2 - Coat, Bib-Overall, Hood with Hard Cap
ARC40-C	Hood
ARC40-CT	Hip Length Coat
ARC40-BIB	Bib-Overalls
ARC40-CVL	Coverall

Arc 65

- ▶ Category 5 - Arc Rating – 70 cal/cm² ATPV
- ▶ Fabric Weight – 15.5 oz/yd²
- ▶ Hood Window VLT – 42%



▶ ARC65-C Hood



▶ ARC65-CVL



▶ ARC65-CT

Part No	Description
663526	Set 1 - Coverall, Hood with Hard Cap
663521	Set 2 - Coat, Bib-Overall, Hood with Hard Cap
ARC65-C	Hood
ARC65-CT	Hip Length Coat
ARC65-BIB	Bib-Overalls
ARC65-CVL	Coverall

Arc 100

- ▶ Category 6 - Arc Rating – 106 cal/cm² ATPV
- ▶ Fabric Weight – 18.2 oz/yd²
- ▶ Hood Window VLT – 22%



▶ Set 2 - Coat, Bib-Overall, Hood with Hard Cap

Part No	Description
IFR6A	Set 1 - Coverall, Hood with Hard Cap
663522	Set 2 - Coat, Bib-Overall, Hood with Hard Cap
663517	Hood
663515	Hip Length Coat
663516	Bib-Overalls
ARC100-CVL	Coverall

Safety Rescue Hook

- ▶ Used for retrieval of victims of electric shock
- ▶ Two sizes – 1kV + 60kV system voltage
- ▶ Safeguards the life of the first aider
- ▶ The hook station offers safe storage for the hook
- ▶ Should be placed in a prominent and easily accessible position near to the “live” site



▶ 509049



▶ 509048



▶ 509050 (hook not included)

Part No	Description	Dimensions [mm]	Weight [g]
509048	Safety Rescue Hook 1kV	25 Ø x 1000	1000
509049	Safety Rescue Hook 60kV	35 Ø x 1950	2000
509050	Safety Rescue Hook Station 1kV (hook not included)	580 x 450	600
509051	Safety Rescue Hook Station 60kV (hook not included)	580 x 805	1150

Insulating Platform

- ▶ Manufactured from copolymer polypropylene plastic, according to the Standard UNE 204001
- ▶ Rough, non-slip surface
- ▶ Rubber feet gives high adherence to the floor surface
- ▶ Stable, high impact and slip resistance
- ▶ Platform: 525 x 525mm; Surface: 575 x 575mm



▶ 635045

Part No	Description	Height [mm]	Working Voltage [kV]	Weight [kg]
635036	Insulating Platform	200	36	3.48
635045	Insulating Platform	305	45	3.80
635066	Insulating Platform	305	66	3.80

Fibreglass Ladders

- ▶ EN131 Approved
- ▶ Suitable for 1000V working
- ▶ Easy climb tread spacing on steps



▶ 527446

Part No	Description	Safe Working Height [m]	Weight [kg]
527444	4 tread Heavy Duty Fibreglass Steps	2.05	5.41
527446	6 tread Heavy Duty Fibreglass Steps	2.60	7.77
527448	8 tread Heavy Duty Fibreglass Steps	3.13	10.45

Cable Guard

- ▶ Protection of vertical/horizontal cable runs on wooden poles, fences and walls
- ▶ Manufactured from HDPE which provides excellent protection against vandalism and accidental vehicle contact
- ▶ Can also be used to protect other utility supplies on walls i.e. gas, oil, water
- ▶ Supplied with screw fixing holes for easy installation
- ▶ Lightweight and easily transported
- ▶ With UV and flame retardant additives
- ▶ Others colours and sizes available on request



▶ C18765 ▶ C18703 ▶ C18666



Part No	Description	Dimensions	Weight [g]
C18666	Cableguard HDPE Black	ø 19mm x 3.0m	790
C18680	Cableguard HDPE Black	ø 25mm x 3.0m	840
C18703	Cableguard HDPE Black	ø 38mm x 3.0m	1140
C18727	Cableguard HDPE Black	ø 50mm x 3.0m	1420
C18741	Cableguard HDPE Black	ø 64mm x 3.0m	1600
C18765	Cableguard HDPE Black	ø 80mm x 3.0m	2000
C18789	Cableguard PVC Black	ø 100mm x 3.0m	4700
C18790	Cableguard PVC Black	ø 100mm x 3.3 m	5200

Cable and Hose Ramps

- ▶ For the protection of Cables/Hoses from traffic, allowing all types and weights of vehicles to drive over them safely
- ▶ The ramps sit on the road surface slowing down the traffic as they pass over them
- ▶ Different sizes available, to cover varying cable diameters



▶ HR2 Open

▶ HR2 Closed



Part No	Description	Dimensions [mm]	Weight [kg]
HR2	Hose Ramp	970 x 580 x 80	22
HR3	Hose Ramp	855 x 302 x 84	13
HR4	Hose Ramp	830 x 320 x 102	16
HR5	Hose Ramp	1010 x 290 x 135	22
HR6/BL	Hose Ramp Block	600 x 400 x 15	33
HR6/WE	Hose Ramp End	550 x 400 x 150	18

Cable Protect

- ▶ Prevents accidents caused by trailing cables and leads
- ▶ Cable protect can be used indoors and outdoors and on roads to protect temporary traffic light cables, etc.
- ▶ Manufactured in flexible vinyl and tested to BS6458 and BS2782
- ▶ Easily installed – simply unroll and cut to desired length
- ▶ Cables or leads can be pulled through the bore hole, or the cable protect can be slit at the base for easy insertion of cable
- ▶ Cut lengths available upon request

▶ C41881

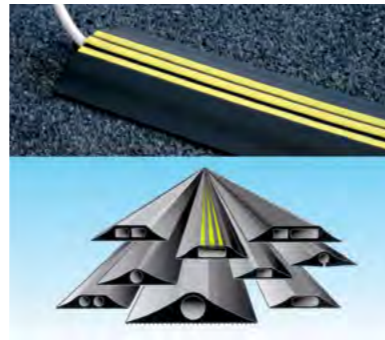

Part No	Description	Hole Size [mm]	Overall Size [mm]	Colour	Application
C41022	Cable Protect Phone	16 x 8	67 x 12 x 9m	Black/Grey	Up to 4 phone leads
C40964	Cable Protect Combi	16 x 10 each	93 x 19 x 9m	Black/Grey	Separating groups of cables
C41084	Cable Protect Multi	30 x 10	80 x 18 x 9m	Black/Grey	Multiple cables
C41086	Cable Protect Multi	30 x 10	80 x 18 x 9m	Clear	Multiple cables
C40988	Cable Protect Speedi	11	75 x 16 x 9m	Black/Grey	Rapid installation
C41046	Cable Protect Double	11 each	81 x 15 x 9m	Black/Grey	Separation of cables and leads
C40940	Cable Protect Large	14	90 x 18 x 9m	Black/Grey	Larger diameter cables & leads Also available "DTp approved"
C41008	Cable Protect Power	26	145 x 34 x 5m	Black only	Power & armoured cables up to ø 1"
C41849	Cable Protect Comnet	32 x 12	110 x 20 x 9m	Black/Grey	Ideal where power & data lead Capacity is unequal
C41881	Cable Protect Hazard	30 x 10	80 x 18 x 9m	Blk/Yellow	Eye catching stripes
C41883	Cable Protect Hazard	30 x 10	80 x 18 x 9m	Wt/Blue	
C41885	Cable Protect Hazard	30 x 10	80 x 18 x 9m	Wt/Red	
C41036	Cable Protect Micro	7.5	62 x 15 x 9m	Black only	Slit base for easy cable insertion Use with small cables
C42106	Cableprotect H/Duty	20	100 x 30 x 9m	Black	Suitable for temporary traffic
C42108	Cableprotect H/Duty	40	165 x 55 x 4m	Black	Suitable for temporary traffic

Cable Protect

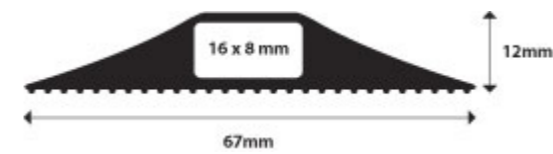

▶ C41022 Cable Protect Phone



▶ C40964 Cable Protect Combi

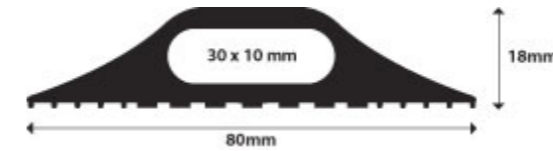

▶ C41084 Cable Protect Multi

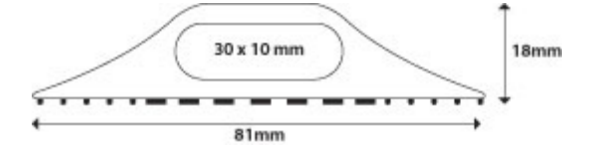

▶ C41086 Cable Protect Multi

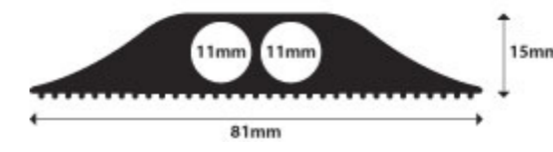

▶ C41046 Cable Protect Double

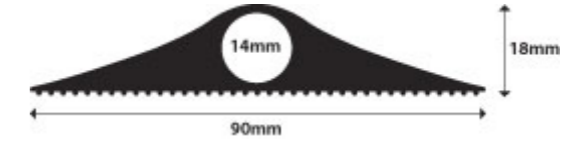

▶ C40940 Cable Protect Large

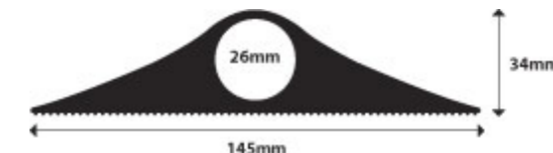

▶ C41008 Cable Protect Power

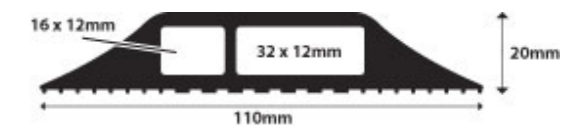

▶ C41849 Cable Protect Comnet

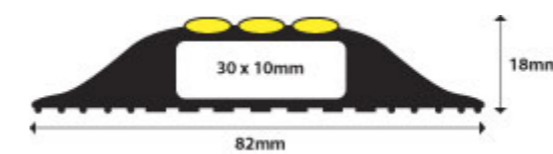

▶ C41881 Cable Protect Hazard
▶ C41883 Cable Protect Hazard
▶ C41885 Cable Protect Hazard



▶ C41036 Cable Protect Micro

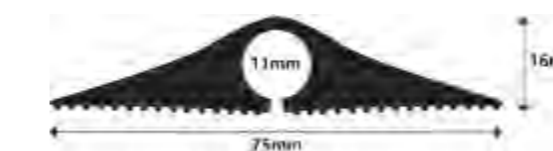

▶ C40988 Cable Protect Speedi

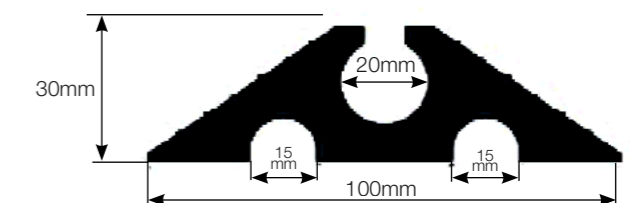

▶ C42106 Cable Heavy Duty

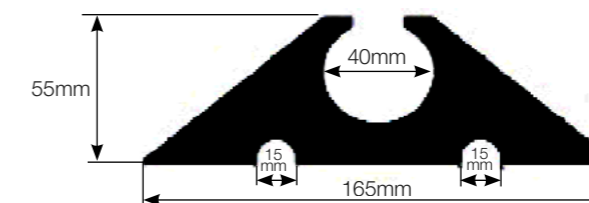

▶ C42108 Cable Heavy Duty

Ball Point Connectors

(for conductors and earth installations)

Ball Point Connectors - threaded bolt

- ▶ Secure connection between fixed point and connection clamp guarantees safety in case of high dynamic and thermal loads during a short circuit
- ▶ The spherical heads of the fixed points are manufactured with a very high quality surface
- ▶ Threaded bolts are dimensioned for high dynamic forces
- ▶ Made of high-tensile copper alloy F65, tin plated
- ▶ Nuts and spring washers manufactured from galvanized steel

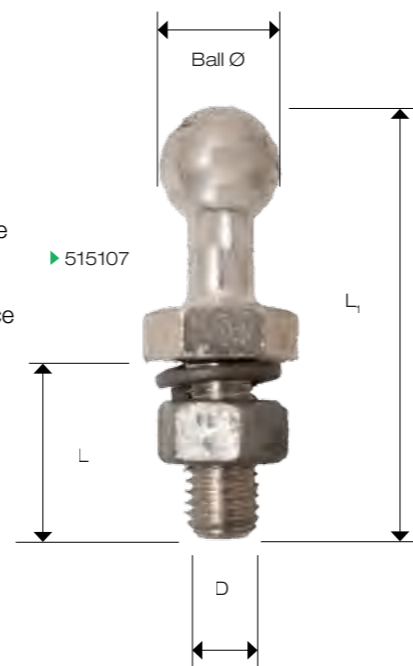

Part No	Description	Dimensions [mm]			Ball Ø [mm]	I _r / t _r [kA / s]	Connection Thread resp. hole Ø [mm]	Weight [g]
		L	L ₁	Key Size SW				
515106	Ball Point Connector (threaded bolt)	25	67	22	20	14 / 0.5	M10	150
515107	Ball Point Connector (threaded bolt)	28	70	22	20	26.5 / 0.5	M12	200
515033	Ball Point Connector (threaded bolt)	36	77	22	20	26.5 / 0.5	M12	200
515032	Ball Point Connector (threaded bolt)	36	88	27	25	33.5 / 0.5	M12	400
515015	Ball Point Connector (threaded bolt)	27	79	27	25	33.5 / 0.5	M16	350
515014	Ball Point Connector (threaded bolt)	47	99	27	25	33.5 / 0.5	M16	400

Ball Point Connectors - straight, female thread

- ▶ Secure connection between fixed point and connection clamp guarantees safety in case of high dynamic and thermal loads during a short circuit
- ▶ The spherical heads of the fixed points are manufactured with a very high quality surface
- ▶ Straight ball point connectors
- ▶ Female Thread, without bolt
- ▶ Made of high-tensile copper alloy F65, tin plated



▶ 515076

Part No	Description	Dimensions [mm]			Ball Ø [mm]	I _r / t _r [kA / s]	Connection Thread resp. hole Ø [mm]	Weight [g]
		L	L ₁	Key Size SW				
515076	Ball Point Connector (straight, with female thread)	18	62	22	20	26.5 / 0.5	M12	200
515075	Ball Point Connector (straight, with female thread)	18	74	27	25	33.5 / 0.5	M12	350
515101	Ball Point Connector (straight, with female thread)	24	77	27	25	33.5 / 0.5	M16	350

Ball Point Connectors Cont.

(for conductors and earth installations)

Angled, female thread

- ▶ Secure connection between fixed point and connection clamp guarantees safety in case of high dynamic and thermal loads during a short circuit
- ▶ The spherical heads of the fixed points are manufactured with a very high quality surface
- ▶ 45° angled ball point connectors
- ▶ Female Thread, without bolt
- ▶ Made of high-tensile copper alloy F65, tin plated

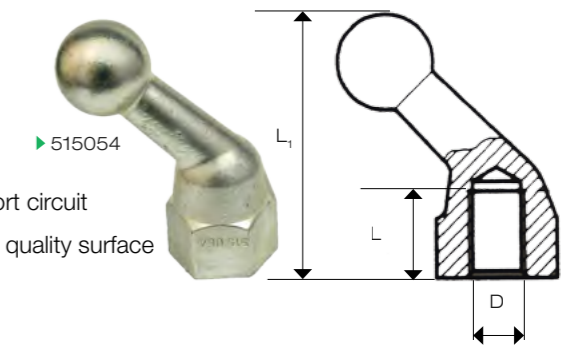

Part No	Description	Dimensions [mm]			Ball Ø [mm]	I _r / t _r [kA / s]	Connection Thread resp. hole Ø [mm]	Weight [g]
		L	L ₁	Key Size SW				
515054	Ball Point Connector (angled at 45°, female thread)	18	56	22	20	26.5 / 0.5	M12	100
515136	Ball Point Connector (angled at 45°, female thread)	24	76	27	25	33.5 / 0.5	M12	200
515055	Ball Point Connector (angled at 45°, female thread)	24	76	27	25	33.5 / 0.5	M16	200

Ball Point Connectors - for round conductors

- ▶ Secure connection between fixed point and connection clamp guarantees safety in case of high dynamic and thermal loads during a short circuit
- ▶ The spherical heads of the fixed points are manufactured with a very high quality surface
- ▶ For round conductors
- ▶ Conductor clamping piece retained by 2 screws
- ▶ Manufactured from copper F20, tin plated
- ▶ Bolts made of stainless steel



Part No	Description	Dimensions [mm]			Ball Ø [mm]	I _r / t _r [kA / s]	Connection Thread resp. hole Ø [mm]	Weight [g]
		L	L ₁	Key Size SW				
515067	Ball Point Connector (for round conductors)	-	58	-	25	33.5 / 0.5	up to 16	250
515068	Ball Point Connector (for round conductors)	-	75	-	25	33.5 / 0.5	16 - 22	350
515069	Ball Point Connector (for round conductors)	-	75	-	25	33.5 / 0.5	22 - 30	350
515077	Ball Point Connector (for round conductors)	-	85	-	25	33.5 / 0.5	30 - 40	450
515086	Ball Point Connector (for round conductors)	-	110	-	25	33.5 / 0.5	50 - 60	700

Ball Point Connectors - for busbar packages

- ▶ Secure connection between fixed point and connection clamp guarantees safety in case of high dynamic and thermal loads during a short circuit
- ▶ The spherical heads of the fixed points are manufactured with a very high quality surface
- ▶ With lug for connection to busbar packages

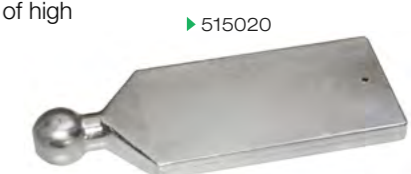

Part No	Description	Dimensions [mm]	Ball Ø [mm]	I _r / t _r [kA / s]	Weight [g]
515020	Ball Point Connector with lug connection	Lug 60 x 10, Length 110	25	33.5 / 0.5	750

Index

PRODUCT INDEX

FULLY INSULATED TOOLS

Allen Keys	34-35	Knockout Tool	45
Box Spanners T Bar	39	Lineman's Knife	15
Brushes – Angled or Straight	42	Link Extractors	38-39
Cable & Core Cutters	2-10	Nut Spinner	32
Cable Core Stripper	15	Pliers	10-12
Cable Coring Knives	14-15	Push on Shrouds/ LV Link/Box Shrouds	40-41
Cable Knives	13-15	Reversible Ratchet Lever	20
Connector Holding Tools	36-37	Reversible Ring Ratchet Wrench - Insulated Head	18
Core Alignment Tools	44	Reversible Ring Ratchet Wrench	18
Core Bending Bars	45	Saw Depth Gauge/Junior/Hacksaw/Bow Saw	17-19
Core Separators	47	Screwdrivers/Screwdriver Set	30-33
Diameter Tape	48	Shrouds – Universal/Non Universal/Push On	40-42
Dummy Fuse Link	48	Shrouds – LV Link/Box/CNE	41
Electrician's Knives	16	Socket Inserts/Sets	21-23
Electrician's Scissors	16-17	Spanners	23-29
Extension Bar	20	T Bar Lever	20
File Card Brush	47	Tape Measure	48
Folding Ruler	48	Tool Cases, Boxes, Bags	54- 56
Gland Spanner	37	Tool Kits / Sets (Jointers/Lineman's/Linking)	49-53
Insulated File	47	Torque Wrench	19
Insulated Hammer	29	Tree Pruners	5
Insulation Hole Cutter	13	Wedges	41,43,46-47

CABLE PREPARATION TOOLS

Cable Joints Inspection Mirror	69	Insulation Removal Set	65
Cable Sheath & Insulation Removal Tool	63	Insulation Removal Tool for ccc(blx) Overhead Cable	59
Cable Sheath Cutter	57	Insulation Removal Tool for MV Cables	59
Cable Sheath Cutting Pliers	60	Insulation Stripper for 11/20kV Cables	64
Cable Stripper	66-67	Preparation kit for 11kV -XLE Insulated Cable	65
Consac Sheath Cutting Tool	68	Shaver for Bonded Semi Cond. Screen 40-110mm Ø	67
Cutting Wheels	68	Shaver for Bonded Semi Conductive Screen	61,63
Damp Testing Saucepan	69	Stripping Pliers	61
Insulation Chamfering Tool	66	Stripping Tool for Peelable Semi Conductive Screen	62

Stripping Tools Set	63	Universal Cable Stripper	58
Torque Limiting Screwdriver	69		

MATTING

Bench Mat Kits	73	LV & HV Switchboard Rubber Matting	70-71
Cable Tray Matting	71	Static Dissipative Matting/Kits	72

INSULATING SHROUDING

Bodtect Overhead Line Shrouding	74	Safety Clamps	76
Demarcation Curtains	73	Shrouds – Universal/Non Universal/Push On	40-42
Line Tap Shrouds	75	Shrouds – LV Link/Box/CNE	41
LV Pocket Shrouds/Jointer's Kits	77-81	Stay Wire Protection	75
Rubber Insulating Shrouding	76	Transparent Insulating Shrouding	76

PERSONAL PROTECTIVE EQUIPMENT

Arc Flash Protection	84-85	Gloves – Electrical Safety – Flex & Grip	83
Boots – Dielectric Overboots	86	Gloves and Accessories – Electrical Safety	82
Boots – Dielectric Safety	86	Goggles / Spectacles	87
Face Shield/ Face Shield – Helmet Mounted	87	Safety Helmet	86

ELECTRICAL SAFETY PRODUCTS

Cable & Hose Ramps	89	Insulating Platform	88
Cable Guard	89	Ladders – Fibreglass	88
Cable Protect	90-91	Safety Rescue Hook	88

TEMPORARY EARTHING AND SHORT CIRCUITING EQUIPMENT

Accessories for Cable Vehicles	102	Earthing Inserts	92
Ball Point Connectors	110-111	Earthing Rods	114-115
Cartridges for Fuse Bases	94-95	Fuse Tongs	115
Conductor Connection Clamps	108	Low Voltage Earthing & Short Circuiting	88-89
Conductor Fixed Points	116-119	Low Voltage Stored Energy Discharge Device	109
Connection Couplings/Cables	102	Multiple Earth Connection	109
Diazed Fuse Links	95	Phase Clamps/Phase Connections	93,101-103
Earth Connection Clamps	98-101,109	Storage System for Earth Leads	109
Earthing and Short Circ. Device For Service Boxes	93,103	Three-Phase Earthing and Short Circuiting Devices	100
Earthing Cable	112	Universal Phase Connection Clamps	101
Earthing Handle	103		

PRODUCT INDEX