

Wire and Cable, Harnessing and Protection Products

Wire and Cable, Harnessing and Protection Products



Tyco Electronics Corporation
300 Constitution Drive
Menlo Park, CA 94025-1164
USA
Tel: (800) 926-2425
(US & Canada)
Tel: +1(650) 361-3860
(All other countries)

Tyco Electronics Corporation
Faraday Road
Dorcan, Swindon
SN3 5HH
Tel: +44 1793 528171

Tyco Electronics Corporation
3816 Noborito, Tama-ku
Kawasaki
Kanagawa 214-8533
Japan
Tel: +81 44 900 5102

Tyco Electronics Corporation
Asia Pacific Headquarters
26 Ang Mo Kio
Industrial Park 2
Singapore 569507
Tel: +65 4866 151

www.tycoelectronics.com

©2002 Tyco Electronics Corporation - July 2002 Printed in the USA - 1654025

Raychem

Raychem

Contents

Application Overview	1
Seal It	1-0
Connect It	1-1
Insulate It	1-2
Protect It	1-3
Wire It	1-4
Hold It	1-5
Join It	1-6
Beautify It	1-7
Reduce It	1-8
Repair It	1-9
Flex It	1-10
All of It	1-11
Electrical Interconnection System Design	2
Harness Design	2-0
Protection of Harness Components	2-4
HarnWare	2-6
Integrated Military Harness Systems for Defense and Allied Industries	2-16
Products	
Tubing	3
Molded Parts	4
Adhesives	5
Adapters	6
Assemblies	7
Electrical Interconnect Products	8
Wire and Cable	9
Application Equipment	10
Supporting Information	11
Equivalents and Conversions	11-0
Temperature Conversion	11-2
Glossary	11-4
Index	11-22

How to use

This catalog has four main sections:

[Application Overview](#)
[Electrical Interconnection System Design](#)
[The Product](#)
[Supporting Information](#)

Application Overview (Section 1) presents general design ideas based on typical uses for Raychem-brand wire and cable, heat-shrinkable tubing and protection products. Application photos depict examples of how customers use our products to enhance the performance and improve the reliability of their specific products in one or more of these generic applications; Seal It, Connect It, Wire It, Insulate It, Protect It, Hold It, Join It, Beautify It, Reduce It, Repair It, Flex It, All of It.

Electrical Identification System Design (Section 2) describes wire harness components and harness protection issues and provides a step-by-step guide to selecting the right Raychem components for a particular wire harnessing system.

Products (Sections 3-10) showcases our product groups. Each section provides:

- An **overview** of the product group.
- A **table of contents** that lets you see at a glance the product families in that product group.
- A **selection guide** to help you determine which product family will satisfy the requirements of your application.
- An explanation of the **part numbering system** for that product group.
- **Information pages** on each product family.

The product information pages provide some or all of the following information (depending on the product family):

- Raychem Fax-on-Demand telephone number to call to order the product literature.
- Fax-on-Demand document ID number(s) and description(s).
- Typical applications for the product family.
- Product features/benefits.
- Abbreviated installation guidelines.
- Specifications and agency approvals.
- Part number selection information (not shown in the illustration on the next page).
- Product data (dimensions, properties, and materials).
- Ordering information.
- Location availability.

Supporting Information (Section 11) provides:

- Equivalents and conversion tables.
- Temperature conversion table.
- Glossary.

How to use

Product Page Guidelines



Market Icons

Use these icons to quickly identify market opportunities at-a-glance. They appear on the product information pages. The icons on each page represent, but are not limited to, the markets that currently exist for that particular product.



Medical



Automotive



Commercial Electronics/Communications



Industrial



Aerospace



Marine



Military



Rail Industries



Space

Tyco Electronics embraces the most valued brand names worldwide

tyco Electronics

Tyco Electronics Corporation—the largest unit of Tyco International Ltd.—was established in September 1999 when Tyco acquired Elcon Products and Raychem Corporation, and integrated them with AMP, acquired earlier the same year. Since then, the company has rapidly grown and strengthened its competencies as an electrical and electronic component supplier, with product offerings in 25 passive and active product segments. In the passives field, Tyco Electronics is now the world's largest supplier.

The company has facilities located around the globe serving customers in the aerospace, automotive, commercial electronics/communications, industrial/energy, marine, medical, military, and rail industries. Tyco Electronics' product portfolio continues to grow, encompassing connector systems and application tooling, active and passive fiber optic devices, complete power systems, wireless components (including ICs, radar sensors, and complete communications systems), GPS and integrated antenna systems, heat-shrink products, circuit protection devices, magnetic components, wire and cable systems, touchscreens, PC boards and backplanes, smart cards, relays, sensors, electronic modules, wire harnessing and labeling products, battery packs, terminal blocks and switches.

A significant result of this continued growth, and a real benefit to customers, is that Tyco Electronics' technology leadership becomes even stronger. The synergies of expertise in materials science, product design, and process engineering, coupled with knowledgeable application engineers, sales representatives, and customer service personnel enables you to make your next generation of products successful.

As a truly global player, Tyco Electronics Corporation has facilities located throughout the world serving customers in a wide range of applications.



Medical



Automotive



Commercial Electronics/
Communications



Industrial



Space



Aerospace



Marine



Military



Rail Industries

About Raychem wire and cable, harnessing, and heat-shrinkable products

Tyco Electronics, for its Raychem products, pioneered the application of radiation crosslinking and the development of heat-shrinkable polymer tubing.

Raychem

The Tyco Electronics Raychem brand of heat-shrinkable polymer products is recognized worldwide. It is backed by a history of proven performance, reliability, innovation and superior quality. Tyco Electronics manufactures the world's largest range of heat-shrinkable tubing – tubing that provides cable protection offering exceptional insulation, mechanical protection, and strain relief. We are the recognized world leader in heat-shrinkable polymer technology.

A broad-based product line of Raychem wire and cable is engineered to meet or exceed the most rigorous technical specifications. Performing from -100° to +260° Celsius, the product line encompasses fire-resistant cable, small-size controlled electrical cables, multi-conductor cable, high-performance radiation crosslinked ETFE airframe wire, low fire hazard wire, high-performance automotive and commercial wire, and NASA-spec and other space-application types. Additionally, a variety of low-cost, easy-to-install components for wire harnesses and cable assemblies are available including splices, adapters, low-profile rectangular connectors, and contacts. These components are approved to widely recognized standards and specifications that include UL, SAE, MIL, Defense, DNV, Lloyds, and ABS.

Tyco Electronics also provides customized harnessing design supported by a pioneering software package, HarnWare, which enables fast, optimum system design with materials and assembly labor estimates.

For over forty-five years customers have recognized the global capabilities of Raychem products. Combining these advanced products with superior technical

support and a global sales/service organization, customers with worldwide operations count on Tyco Electronics to supply the knowledge and products they need to solve specific problems and help them take advantage of opportunity, anywhere it arises. This philosophy has earned Tyco Electronics a reputation for leadership in materials science technologies. Developed from these technologies, Raychem products are sold into many industries including aerospace, automotive, electronics, construction, electrical power, utilities, manufacturing, pipeline, process, rail and mass transit, and telecommunications.



Applications

Seal It

Application Overview

Advanced materials and product design have resulted in a complete line of products offering the most effective sealing available today: adhesive-lined tubing, molded parts, and a variety of solder and crimp connection devices. These easy-to-use products provide superior waterproofing, resistance to hydrocarbons and other chemicals, protection against corrosion and oxidation, and a barrier against dust and dirt.



- Heat-shrinkable, adhesive-lined products—tubings with high shrink ratios, and molded parts—environmentally protect connector-to-cable transitions.
- Waterblocked and anticapillary wire prevent water and most fluids from wicking between the conductor strands. Bundle sealing products block multiconductor cables.
- Adhesive-lined, heat-shrinkable tubing and caps seal and protect electronic components and in-line wire splices from fluids, moisture, and corrosion while also providing strain relief.
- Heat-shrinkable caps lined with an adhesive or encapsulant form a moisture-resistance barrier around stub splices and wire ends.
- Heat-shrinkable, moisture-blocking systems are designed to provide reliable sealing of wire bundles preventing fluid ingress.

Connect It

Application Overview

Raychem electrical interconnect products offer reliable, more cost-effective alternatives to traditional connection methods—such as hand soldering, or crimping and then insulating by taping or overmolding.

With our electrical interconnect products, you start with a precisely engineered, fluxed solder preform inside a transparent, heat-shrinkable sleeve. When the product is heated, the solder preform melts, and the sleeve shrinks to create a connection that is fully insulated and strain-relieved.

This ease of use expands your options even as it enhances the quality of your end product, as in these applications:

- Easy and reliable termination of EMI shields to ground, ensuring effective EMI attenuation. Shield termination products are available for computer, data, and instrumentation cable, communications and video cable, and heavy industrial cable.
- Splicing of one component to another, such as a diode connected to one end of an LED.
- Coaxial terminations to PCBs and terminals.

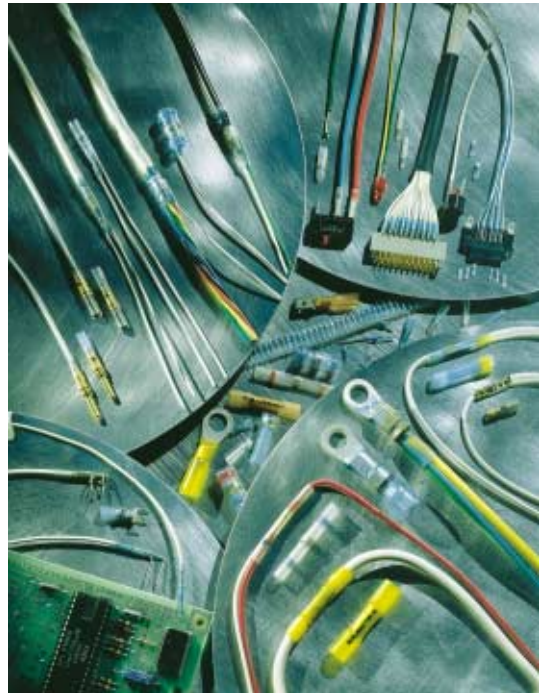

Insulate It

Application Overview

Solving an insulation problem can be easier than you think, especially when you consider the family of Raychem products from Tyco Electronics that can provide superior alternatives to standard methods of insulation such as hand-taping or molding-in-place.



- When heated during installation, our radiation-crosslinked tubings shrink to conform to a variety of shapes, providing dependable insulation.
- Heat-shrinkable end caps insulate wire or cable terminations, providing protection from dust and dirt. End caps with adhesive or encapsulant lining also provide protection from moisture because the lining, when heated, melts and flows to fill surface irregularities of the substrate.
- General-purpose polyolefin tubing is widely used to insulate and strain-relieve wire terminations and connections.
- Delicate electrosurgical instruments can be insulated and protected from abrasion by using one of Raychem's medical-grade, heat-shrinkable tubings specially formulated to meet the requirements of USP Class VI for medical use.
- Components on a PCB, such as capacitors and fuses, can be insulated with a UL VW-1-approved heat-shrinkable tubing to achieve a specific product rating.

Protect It

Application Overview

Designing a brilliant solution is good. Protecting a brilliantly designed solution is even better. A whole family of protection products, made from a wide variety of materials, can provide comprehensive protection: mechanical protection, strain relief, resistance to abrasion and crushing, EMI and noise reduction, fluid resistance, and thermal insulation.

- Tinel-Lock ring braid terminations can be used for applications where shielding is critical. These shape-memory-metal products attach metal braid shields to backshells and provide 360° protection against EMI and EMP.
- Heat-shrinkable tubings provide mechanical protection for hoses and pipes, and also reduce problems caused by wire chafing or cable abrasion.
- Easy-to-install heat-shrinkable tubing and molded parts provide excellent strain relief and electrical insulation for connector-to-cable transitions.
- A heat-shrinkable molded part can relieve the strain on a multiconductor cable to a D-subminiature connector.
- Heat-shrinkable feedthroughs relieve the strain on cables entering junction boxes.
- Highly-flexible, heat-shrinkable fabric tubing provides outstanding abrasion protection for components such as rubber hoses, plastic pipes, and harness wiring bundles, recovering easily even over awkward substrates such as bent hoses.
- Heat-shrinkable MicroFit tubing is used to provide insulation and strain relief for fine-gauge wire (24 to 42 AWG) and fiber optic cables in such end products as medical devices, computers, communications equipment, and commercial electronic products.

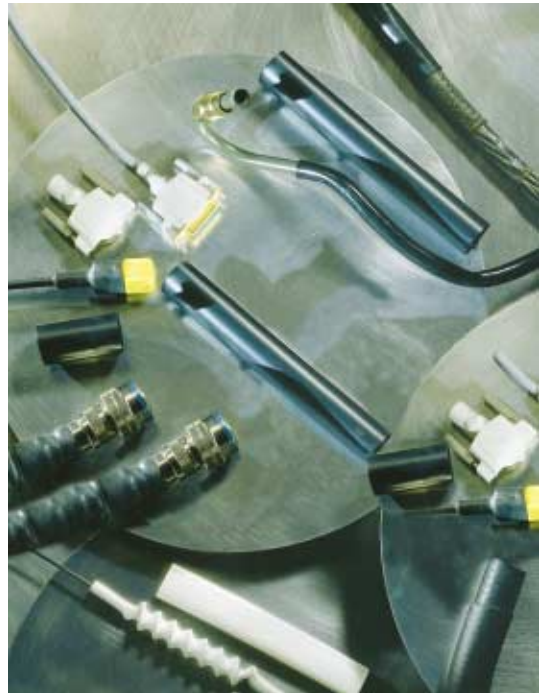

Wire It

Application Overview

Tyco Electronics is a leader in the development of high-performance wire and cable products for demanding applications, including aerospace, industrial equipment, instrumentation, marine, and automotive applications. Precision extrusion capability, materials expertise, and design knowledge provide wire products that are lightweight; smaller than comparable-performance constructions; highly flexible, yet mechanically tough; flame-retardant and resistant to a variety of industrial fluids.



All Raychem products offer outstanding shop-handling characteristics for efficient stripping, wire termination, and bundling. Cable design software is available to create custom multicore cables with unique components, tough but lightweight jacket materials, and optimized shielding. Tyco Electronics can also design complete wiring harnesses for industrial or military applications.

- The FlexLite family of hookup wire provides economical alternatives to fluoropolymers, silicones, and crosslinked polyethylene insulations for applications such as motors, appliances, and lighting, and for applications where thinner walls are needed because of space constraints.
- Raychem high-temperature, dual-wall or single-wall aerospace wire saves space and weight on both military and commercial aircraft and space vehicles.
- Low-fire-hazard primary wires and cable are made from halogen-free, low-smoke materials with a low toxicity index. They offer increased safety, with reduced size and weight, over traditional materials in mass transit and similar applications.

Hold It

Application Overview

To help you arrive at the best way to securely hold and position a component, take a look at the Raychem family of products and consider the many ways that you can use them: to keep components in place, bundle and route wires, create a formed shape for potting, or package components securely before final assembly.

- Thin-wall tubings allow bundling of wires to create very flexible, lightweight harnesses that can withstand harsh environments.
- Fiber and/or copper components can be bundled for a custom multicore cable.
- Cable legs can be held together with a Y-transition molded part.
- Multicore and film-bonded cables hold wires together and also provide EMI protection.
- Tubing can hold a covering (braid or Convolex tubing) onto a substrate.
- Two components (such as a resistor and fuse) can be held together as a package by enclosing them with heat-shrinkable tubing.
- Heat-shrinkable fabric tubing will grip substrates, such as harnesses, tightly to provide secure wire bundles without additional fixing.



Join It

Application Overview

When you have a mechanical connection to make, consider the uniform circumferential recovery force of heat-shrinkable tubing and metals in your designs.



- Join two dissimilar materials, such as a rubber flapper to the end of a nylon tube, or the handle of a medical instrument to the instrument's moving parts.
- Assemble a bellows by covering a spring with heat-shrinkable tubing.
- Use Tinel ring adapters to provide the even circumferential force necessary to attach a metal braid shield to a backshell.
- Clear, adhesive-lined tubing connects water tubes in appliances to provide a rugged and aesthetically appealing joint which is also inspectable.
- Heat-shrinkable tubing is used to join polyester cords to heddles in Jacquard weaving loom harnesses.

Beautify It

Application Overview

Enhancing the appearance of your brilliantly designed solutions couldn't be easier, when you use Raychem products.

- Heat-shrinkable tubing—instead of tape—can create a smooth covering with no loose ends.
- Hot-stamp foils (gold or silver) can attractively showcase a company logo.
- Heat-shrinkable tubing can cover the mechanical attachment of one part to another.
- Tubing can attractively cover a metal railing, such as the type used for crowd control.
- Tubing or molded parts can be color-matched to the original color of fiber, wire insulation, or other components to enhance the appearance of the final product.
- Handles of a variety of tools can be covered with colorful, heat-shrinkable tubing to enhance the appearance of the final product.



Reduce It

Application Overview

With the trend toward miniaturization and higher-density interconnections, products developed for commercial electronics applications must downsize as well.

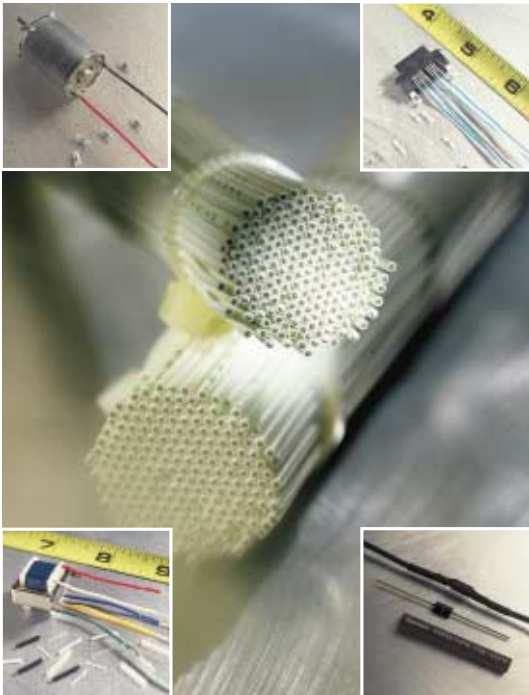

- Versafit V4 tubing—33 percent lighter and smaller than competitive products—is the perfect choice when you need a very-low-profile, thin-wall tubing that installs quickly. In addition to space savings, V4 tubing offers excellent mechanical protection and strain relief for sensitive components.

- The MicroFit family of products can be used to connect and insulate fine-gauge wire (26 to 42 AWG) in such end products as medical devices, computers, and stereo systems. They are easily and quickly installed, thus reducing craft-sensitive labor. MicroFit tubing has a high shrink ratio, up to 3:1, allowing easy installation onto the wire or substrate.

SolderSleeve MicroFit devices feature a one-step controlled solder process for splicing and terminating wires up to 36 AWG—a method that is more reliable and less craft-sensitive than hand-soldering.

- Tyco Electronics can reliably produce primary Raychem wire insulations as thin as 4 mils. Our design software optimizes component placement and shielding to produce small, lightweight custom multicore cables. These cables can offer size and weight reductions that can range from 10 to 40 percent versus comparable-performance constructions of primary wire or cable.

Repair It

Application Overview

Whether for repair or retrofitting, Tyco Electronics offers a whole family of Raychem products that can provide flexible, cost-effective solutions. For example, most failures in electrical wiring harnesses occur within the first six inches of the connector. Raychem products make repairs in this area more reliable, long-lived, and cost-effective.

- High-shrink-ratio tubing can be slipped over the connector without depinning to reinsulate or strain relieve the connector-to-cable transition.
- SolderShield repair splice kits provide the components necessary to splice shielded single-wire or multicore cables.
- Adapters and Uniboot molded parts can be combined to allow reentry to the back of the connector area for pin repair.
- Splash-resistant SCL semirigid heat-shrinkable tubing, with its meltable inner wall, can be stripped off the substrate without leaving a sticky residue, thus providing access to connections requiring reentry.
- Flexible, adhesive-lined tubing can be used to repair damaged wire insulation, providing a moisture seal that is resistant to bending of the wire substrate.

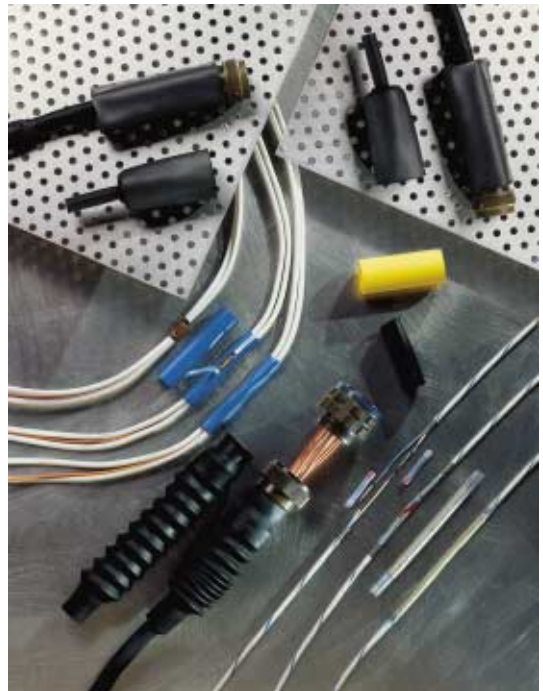

Flex It

Application Overview

In applications where flexibility or flex life are important, Raychem products meet the need—many performing even at low temperatures.



- NT tubing, which is widely used for insulation, strain relief, and abrasion protection on cable harnesses and wire bundles, remains flexible at low temperatures (as low as -70°C) without cracking.
- Hi-Flex heat-shrinkable tubing was developed specifically for sealed cable-jacketing applications where cable flexibility is an important concern. It is also ideal for situations where the cable is subject to motion, such as in industrial machinery, transportation equipment, robotics, and welding.
- For applications where a flexible 90° bend right after the connector is desired, Uniboot molded parts can provide the perfect fit.
- DynaLink wire and cable is designed specifically for applications where flex life is critical: in the robotics industry; in lifts, typing machines, and sewer inspection equipment; and on ships where wire must be capable of unwinding from a large cable reel and then retracting smoothly without strain.

All of It

Application Overview

At Tyco Electronics Corporation, we like the word “multitasking.” So it should come as no surprise that Raychem products are designed to help you integrate several tasks—seal, connect, insulate, protect, wire, hold, join, beautify, reduce, repair, and flex.

In the pages of this catalog, you will find literally hundreds of products designed to provide thousands of solutions—across a wide variety of industries.

Although you will find the catalog features an extensive array of products, keep in mind that, at Tyco Electronics Corporation, we’re always coming up with new ideas and new products—so that we can help you put together the precise solution you need. Also, when you choose any Raychem product, you’re automatically backed by a nationwide network of sales engineers who can provide application and engineering assistance as well as on-site training.



Electrical Interconnection System Design

Table of Contents

Harness Design	2-0
Protection of Harness Components	2-4
HarnWare	2-6
Integrated Military Harness Systems for Defense and Allied Industries	2-16

This section (pages 2-0 through 2-27) attempts to provide assistance with most of the considerations applicable to design of cable and harness assemblies. Caution must be used to ensure that the design is appropriate for a particular application.

Tyco Electronics provides this information as a design aid and assumes no responsibility for and makes no representation regarding the suitability of a design for a specific application.

Electrical Interconnection System Design



Tyco Electronics offers a range of Raychem components for wiring harnesses and cable assemblies in commercial, industrial, automotive, and defense and allied industries. Our components are approved to widely recognized standards (UL, CSA, CE, SAE) and to the military specifications of various governments.

A variety of component material systems can be used to design a rugged, reliable, repairable, shielded, and environmentally sealed harness.

We also offer individual components that can be used independently to meet a specific sealing, insulation, strain relief, protection, identification, or electrical interconnection need.

Harnessing system components include:

- Heat-shrinkable tubing.
- Heat-shrinkable molded shapes.
- Adhesives.
- Adapters.
- Assemblies.
- Electrical interconnect components.
- Wire and cable.
- Solder termination devices.
- Application equipment.

In many cases, properly selected components can raise the performance of a harness to acceptable levels compatible with even very demanding environments where cables are exposed to water, temperature extremes, EMI-radiated fields, or fluids.

Tyco Electronics is the established leader in automotive, aerospace, marine, mass transit, industrial, and military harnessing. Call us for ideas on protecting your harness—whether it's a typical UL wiring system or a harness assembly for demanding environments.

*Tyco Electronics Identification products information available at www.tycoelectronics.com

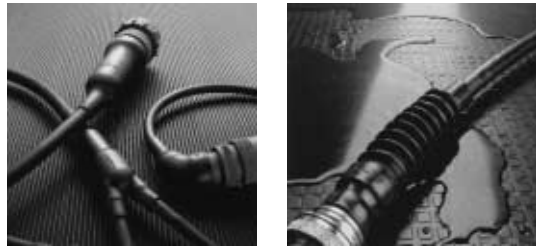

A Raychem molded part provides strain relief on the back end of a connector.

Harness design

Designing wiring harnesses for demanding applications such as defense and aerospace is a complex business:

- Many different parts need to be selected while taking account of various environmental factors and mating part conditions. There can be a large number of alternative design solutions to analyze and the constraints imposed upon harness design are becoming more demanding.
- Weight and space are especially important in missile and aerospace applications. With the additional electrical equipment now in products such as cars, these factors are becoming a bigger issue in these industries.
- Electromagnetic interference (EMI). Harnesses can either radiate interference to, or pick up interference from, nearby equipment. With the increasing use of sensitive electronics in cars, aircraft and military equipment this is a major problem.
- Resistance to environmental hazards including corrosion, high temperature or fire, chemical and nuclear agents. The additional costs of totally sealed wiring harness systems are becoming easier to justify as products and the lives of those who use them, become more dependent upon the fault free operation of electrical systems.
- Repair and maintainability. Electrical and electronic systems in military vehicles and naval vessels now need to be upgraded or modified several times during the life of the main mechanical platform. There are now parts and harness design techniques that make this work easier to accomplish.

Fax-on-demand

US only (800) 260-9099

Outside US (650) 257-2301

Visit our website at www.tycoelectronics.com

This section provides information about the basic components in a harness design, the factors to consider in designing a harness, and the Tyco Electronics HarnWare harness design CAD software. With this information and the selection tables that follow, you will be able to choose from this catalog the right components for an integrated military or high-performance industrial harnessing system.

The checklist on page 2-2 covers some of the factors to consider in the design of a harness.

Harness components

Connectors and wires are the two basic components of a harness that need to be specified. Once they have been chosen, compatible protection, shielding and identification follow.

Connectors

Connectors come in two opposite types: plugs and receptacles. Plugs are commonly referred to as male connectors, receptacles as female connectors. Both contain contacts, usually made of plated copper. The contacts, called pins or sockets, are joined to the conductors and are designed to mate or join with contacts of the opposite type.

The front or joining end of the connector is designed to mate only with a connector having the right configuration. The back end of the connector is where the wires are terminated to the metal contacts.

Connectors for indoor or internal use are generally not designed to resist moisture. Connectors that will be exposed to moisture are generally sealed to meet a specific requirement.

Wires

In this discussion, a wire is defined as an insulated conductor and a cable is defined as two or more wires with or without a common jacket or shield. Conductors are usually made from copper.

A copper conductor can be solid or, when flexibility is important, can consist of smaller strands of copper wire twisted together. The strands can be coated with tin, nickel, or silver to make them easier to terminate or more resistant to corrosion.

Conductors are sized in metric units (mm^2) or by AWG (American Wire Gauge), a holdover from the days when wire was made of steel in steel mills. The AWG refers to the number of passes it takes to draw the wire down to the required size - the larger the AWG, the smaller the wire. Making a 26 AWG wire, for example, requires more passes through reduction dies than are required for a 4 AWG wire.

A 26 AWG stranded wire, however, is made of many smaller wires, such as seven strands of 32 AWG wire (sometimes shown as 7/32 or 7x32).

The choice of insulation for a conductor depends on a number of factors:

- Operating, design, and excursion temperatures of the system.
- Size and weight limitations.
- Mechanical performance desired.
- Flexibility requirements.
- Resistance to various fluids.
- Specialized requirements, such as:
 - low fire hazard or low halogen.
 - low outgassing.

Electrical Interconnection System Design *(cont'd.)*

Harness design checklist

Connectors

- | | |
|--|---|
| <input type="checkbox"/> Sealed or unsealed? | <input type="checkbox"/> Mating frequency? |
| <input type="checkbox"/> Made of plastic or metal? | <input type="checkbox"/> Keyway angle? |
| <input type="checkbox"/> Crimp or solder contacts? | <input type="checkbox"/> Exposed to electrical noise (EMI)? |
| <input type="checkbox"/> Pins or sockets? | |

Geometry

- Dimensions?
- Point to point or branched?
- Configuration of ends - straight, 90°, 45°?

Environment

- | | |
|--|--|
| <input type="checkbox"/> Exposed to sunlight? | <input type="checkbox"/> Exposed to dust? |
| <input type="checkbox"/> Exposed to moisture? | <input type="checkbox"/> Exposed to corrosive fluids? |
| <input type="checkbox"/> Immersed? | <input type="checkbox"/> Exposed to flexing? |
| <input type="checkbox"/> Temperature extremes? | <input type="checkbox"/> Repairable? |
| <input type="checkbox"/> Temperature cycling? | <input type="checkbox"/> Circuit identification? |
| <input type="checkbox"/> Normal operating temperature? | <input type="checkbox"/> Cable identification?* |
| <input type="checkbox"/> Exposed to abrasion? | <input type="checkbox"/> Shielding effectiveness? |
| <input type="checkbox"/> Exposed to mechanical abuse? | <input type="checkbox"/> Magnetic-field-induced signals? |

Circuit

- Voltage?
- Current?
- Signal transmission (impedance, velocity, frequency, etc.)?
- Circuit layout?
- Is circuit integrity critical? What if the circuit fails?

*Tyco Electronics Identification products information available at www.tycoelectronics.com

Fax-on-demand

US only (800) 260-9099

Outside US (650) 257-2301

Visit our website at www.tycoelectronics.com

Protection

Once the connectors and wires have been specified, the method of protection must be considered. Various jacket materials are available to protect the wires and these can be extruded or heat-shrink. Jacket material formulations are compounded to meet a wide range of environmental demands.

Similarly, protection for the wire termination must be considered. In general, the wires will be terminated to connector contacts. Protection products must protect the joints from damage caused by mechanical stress such as flex, torque and tensile load, and corrosion or electrical breakdown from fluid ingress, whilst retaining the ability to be repaired. All these influences and more must be considered when choosing the termination protection method.

Shielding and Shield Termination

Step 3 of the component selection process discussed later in this section gives advice on choosing the appropriate shielding products for the gross shield. Consideration must also be given to the individual cable screen terminations. Can they be pigtailed together with a common termination to a contact or to earth, or should they have individual terminations? If using a solder device, the correct choice is based, not only on size, but also temperature rating or compatibility with the cable braid.

Identification

Circuit identification is important, both in manufacture, where an assembly operator must ensure correct wire to contact termination, and in repair, where a damaged connector may need replacing in difficult circumstances and contact positions have to be easily identified. Individual wire markers help with these two circumstances. Where a cable is severed and access to the ends is prevented, unique identification on the wires, or wire color coding aids repair.

Consideration given to the identification of harness legs is also important. Connectors will normally be chosen with unique keying to prevent incorrect mating but end identification will speed up plugging, particularly for multi-connector harnesses.

It is also good practice to label the harness with its part numbers and other relevant information for traceability purposes.

The Tyco Electronics Identification Products Group offers a variety of products that are compatible to the *HarnWare* design process. For complete information regarding these products visit our website at www.tycoelectronics.com

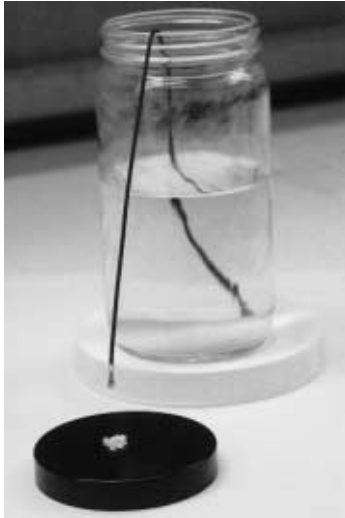

A salt deposit can be seen beneath the end of this 18-AWG, 19-strand wire. The other end of the wire has been immersed in salt water for 24 hours.

Protection of Harness components

Harness components are vulnerable to corrosion, stress, strain, and electromagnetic interference (EMI).

Corrosion

Humidity, moisture, salt, and corrosive fluids can corrode conductors and contacts. What is worse, the corrosion can take place well beyond the point of penetration because of the small tubelike voids—capillaries—between the individual strands of copper that make up the conductor. Called “capillary action,” the penetration of a fluid can “wick” many feet in a relatively short time (see photo left), depending on the specific characteristics of the affected wire. As the copper in the conductor is depleted by corrosion, the conductor can no longer sustain mechanical or electrical loads and the metal will fail. Mechanical failure can thus occur anywhere in the wiring system.

Even before mechanical failure occurs, electrical performance can be adversely affected by the presence of nonconductive by-products from galvanic or aqueous corrosion. Moisture within a connector body may cause an impedance mismatch, increase noise in a signal circuit, or modify the waveform. Even small amounts of corrosion or other contaminants can have a significant impact on contact surfaces and the efficiency with which signals flow through them.

Fax-on-demand

US only (800) 260-9099

Outside US (650) 257-2301

Visit our website at www.tycoelectronics.com

If a chemical solution contacting the electrical connection is itself conductive it can cause a short circuit between conductors. Pure water, not itself a conductor, can also facilitate a short circuit by providing a medium into which conductive salts can dissolve. These salts may be the by-products of corrosion or the result of earlier contamination.

High humidity and temperature cycling in some situations cause condensation, the accumulation of which can also result in a short circuit. Depending on circumstances, the resulting short circuit may be intermittent, significantly complicating the process of identifying the underlying cause.

To prevent corrosion, sealing may have to meet the performance requirements of applicable military specifications or the International Protection (IP) Code.

Stress and strain

Wires that are attached to the connector pins need help to withstand stresses and strain from the cable, which could break the wires from the pins. It is almost always necessary to prevent strain from occurring in a weak spot, such as where the wire is attached to the contact. This is called strain relief and can be provided in a variety of ways, from mechanical devices, such as adapters, to molded boots and heat-shrinkable tubings.

EMI (Electromagnetic Interference)

EMI is similar to the noise heard on an AM radio when the radio is close to high-voltage lines. EMI causes the wire or cable to act like an antenna and pick up electrical signals, which interfere with the signals on the wire and can cause malfunctions in sensitive electronic circuits.

Wiring systems are susceptible to two types of EMI:

- *Radiated emissions* (the electromagnetic energy a wiring system radiates to its surrounding environment), such as the EMI a high-voltage line radiates to its surroundings. (There are regulations on the amount of radiated energy a circuit is allowed to produce.)
- *External radiated emissions* (the electromagnetic energy in the environment), such as the EMI an AM radio picks up from a high-voltage line, causing distortions in the conducted signal. Conducted EMI is noise carried by the cable into the receiving circuit and needs to be filtered.

To reduce susceptibility to radiated emissions from the cable or from external sources, the harness must be grounded, shielded, and/or filtered, depending on the sensitivity of the equipment and the strength and frequency of the EMI.

HarnWare

HarnWare is Tyco Electronics' harness design CAD software. Originally developed for use by our own harness designers it is now offered to our customers so they can benefit from this powerful tool.

From a simple input of geometry, dimensions, connector and wiring details, HarnWare can suggest a design sequence and help with many aspects of wiring harness design including:

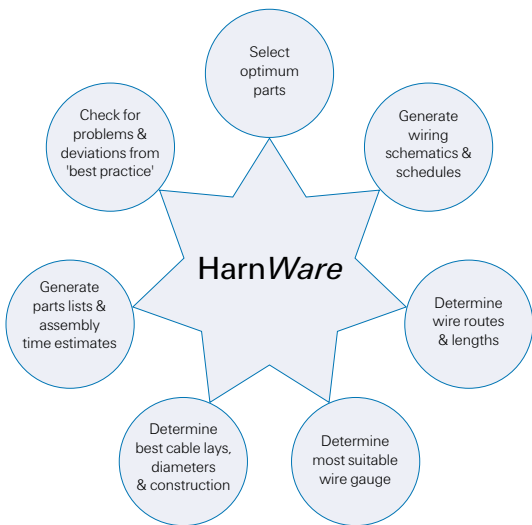

HarnWare is used interactively by harness design engineers. The choices and calculations made by the system can always be modified to suit specific requirements. Design data is saved with each shape in the harness drawing. This data can be reviewed simply by moving the mouse over the parts listed in the Design Wizard. It is, therefore, very easy to incorporate design changes, modify design constraints or analyze alternative design solutions. Moreover a design checker can be used to search for deviations from 'best practice'.

Fax-on-demand

US only (800) 260-9099

Outside US (650) 257-2301

Visit our website at www.tycoelectronics.com

Some HarnWare outputs

The following are some examples of the outputs that HarnWare can generate:

- High quality engineering drawings. Clear and reliable drawings play a crucial role in the success of any design project.
- Point-to-point wiring lists, including calculated wire lengths.
- Fully detailed parts lists. HarnWare automatically generates the parts list table and adds item number balloons into the drawing. Parts lists can also be exported to a spread sheet, database or word processor.
- Assembly time estimates. HarnWare automatically adds the design details into a 'spread sheet' containing standard assembly time synthetics.
- Wiring schematics and schedules.
- Lists of codes of practice describing harness assembly techniques and other issues that are relevant to the parts included in the design.
- Files containing cable marker details can be exported ready for use in marker printing systems such as the Tyco Electronics WinTotal* system. A drawing page showing these cable marker details can also be generated.

A sample set of documents produced by HarnWare is shown at the end of this section.

*Tyco Electronics Identification products information available at www.tycoelectronics.com

Electrical Interconnection System Design (cont'd.)

System building blocks

Some key features of HarnWare are:

- Runs under Microsoft Windows on affordable PC's.
- The user interface is similar to that of commonly used software such as Microsoft Word and Excel.
- Uses the Visio drag and drop drawing system for creating harness drawings more quickly and more easily than with other computer aided design (CAD) systems.

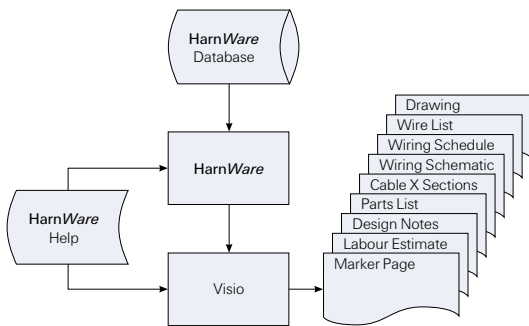

- A growing library of 250 intelligent drawing shapes and a 55,000 record design database which can generate 100,000's of part descriptions for Raychem wiring harness products in their various material and finish permutations.
- Software that traces wire routes through harnesses and automatically creates wiring schematics and calculates wire lengths.
- Analysis options to determine the optimum lay of cables containing mixed diameter wires and to suggest the most appropriate wire gauge for specified current and temperature rise limits.
- Software to help identify the parts most suitable for use within the given design constraints and to fit the mating parts, cables, etc.
- On-line help systems for guidance on using the system and on Raychem wiring harness products.

Designing a harness with HarnWare

Shapes, representing Raychem harnessing products, are dragged and dropped into the harness assembly drawing. The shapes automatically snap and glue together and it takes very little time to produce a high quality drawing (Figure One includes some pages from a sample HarnWare document set). Dimensions and connector references are entered by clicking a shape and typing in the numbers and references.

The HarnWare Design Wizard analyzes the drawing and lists the parts and operations in the suggested design sequence. The wizard also provides quick access to details on each part in the harness and the connections between parts. When the mouse is moved over the parts listed by the wizard, HarnWare outputs such details as part dimensions, materials, finishes, etc.

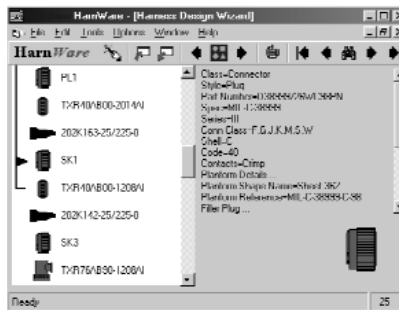

HarnWare indicates the Raychem harness material system that is most suited to the given application, operating temperature range and required defense specifications.

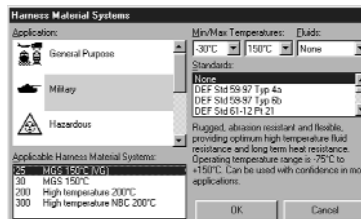

Fax-on-demand

US only (800) 260-9099

Outside US (650) 257-2301

Visit our website at www.tycoelectronics.com

Wire selection

The wire most suited to the particular environment and service conditions is selected using design rules encoded in the HarnWare software and database. If the wire selected is a non-preferred option, alternative types and colours can be identified which may also suit the design requirements and be available on shorter delivery times.

Guidance is also available for choosing the wire gauge most suited to given current loading, ambient temperature, length, number of conductors, etc. For each available wire size HarnWare estimates temperature rises, operating temperatures and voltage drops.

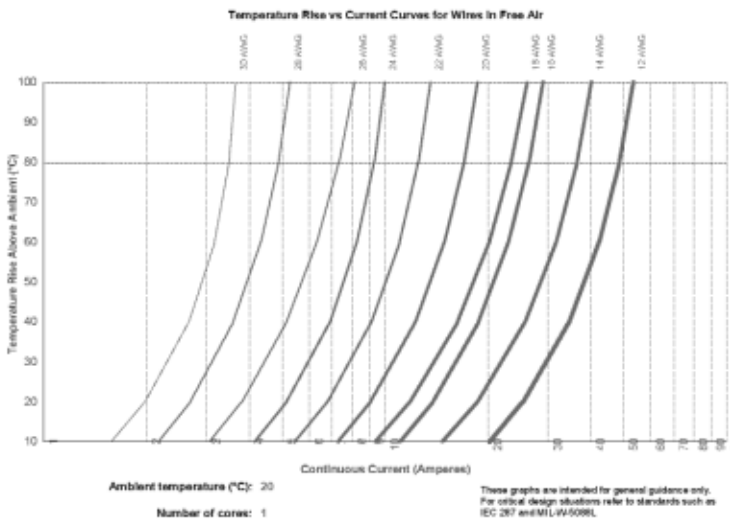
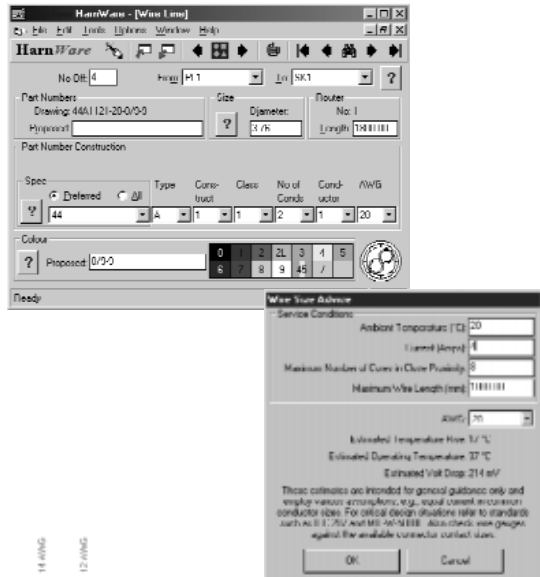

Users should independently evaluate the suitability of the product for their application. Before ordering check with factory for most current data.

Electrical Interconnection System Design *(cont'd.)*

Wire selection *(cont'd.)*

From-To connector references are specified to form a point-to-point wiring list. Wiring schematics can be generated automatically from the information included in the wire list. These schematic diagrams show the pin to pin wiring for all the connectors and wires in a harness design.

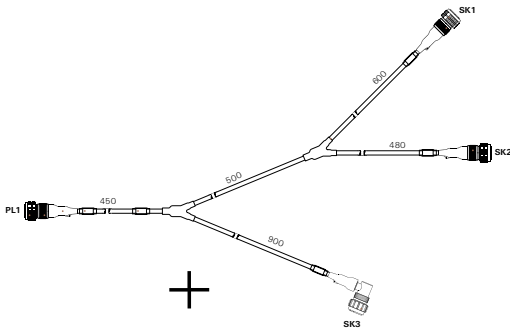

WIRE LIST						
WIRE NO.	ITEM NO.	QTY	FROM	TO	PART NO.	LENGTH
1	2	4	PL1	SK1	44A1121206/8-8	3.76 180000
2	2	5	PL1	SK2	44A1121206/8-8	3.76 166800
3	1	19	PL1	SK3	44A0111209	1.40 198000

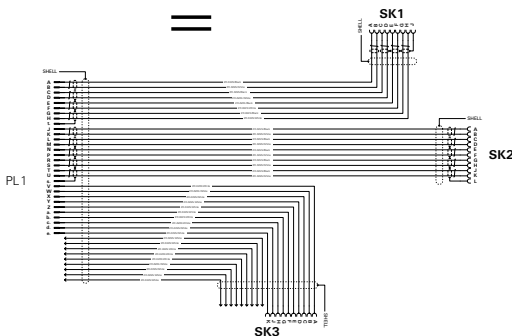

HarnWare automatically:

- Traces the route of each wire in the point-to-point wire list through the harness geometry contained in the drawing.
- Calculates wire lengths by summing the lengths of the harness legs through which each wire is routed. Adjustments are applied based on a variety of design rules relating to the parts through which wires pass.
- Determines the cable sub-assembly structure that would save the maximum amount of labor in assembling the harness.
- Determines the optimum lay of wires in each harness leg and produces a cable cross-section drawing. Alternative lays of cables containing mixed diameter wires are automatically analyzed to identify the smallest diameter and most even construction. In the example below, the listbox contains the quantity of each wire diameter for which HarnWare has automatically developed 29 alternative design solutions. The minimum diameter alternative is shown which is 17.72 mm diameter and uses 2 fillers to achieve a sufficiently round lay.

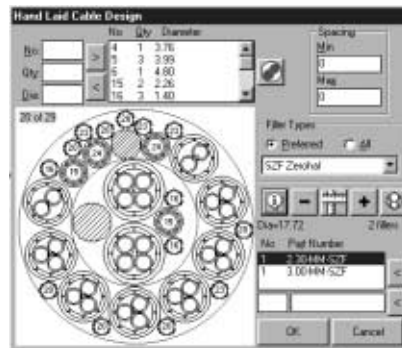

Fax-on-demand

US only (800) 260-9099

Outside US (650) 257-2301

Visit our website at www.tycoelectronics.com

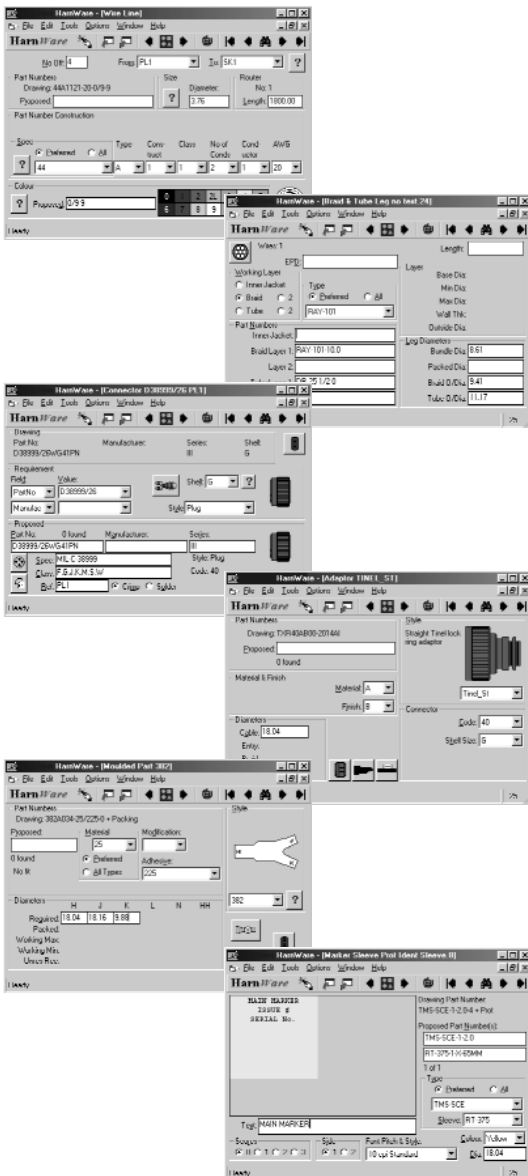

Part selection

All the parts in a harness can be specified. The key steps in selecting parts include:

- Clicking a shape in the harness drawing or the design wizard.
- HarnWare automatically obtains design data and dimensions from the shape and from mating parts in the harness assembly drawing. In the case of a Raychem boot, for example, HarnWare extracts the required style of boot from the shape and the diameters from the mating harness leg and adapter.
- The database is searched for parts suited to the dimensional constraints. The choice is further refined by the service conditions which determine the best materials, finishes and adhesives. When alternative parts are found in the database, HarnWare offers the best option first, which the designer can compare with the other alternatives. The on-line help systems contain details and advice on the various types of parts, materials and finishes and their suitability to different service conditions.

Among the parts that HarnWare helps to select are:

- Adapters
- Braid
- Connectors
- Databus couplers, etc.
- Feedthroughs
- Heat-shrinkable tubing
- Marker sleeves*
- Molded parts
- Solder sleeves
- Wire

*Tyco Electronics Identification products information available at www.tycoelectronics.com

Electrical Interconnection System Design (cont'd.)

PARTS LIST					
ITEM	DESCRIPTION	PART NUMBER	SPEC/REMARKS	QTY	UNIT
1	Wire	4440111-2009	Raychem	30.3	M
2	Wire	4440112-00029-9	Raychem	15.0	M
3	Fiber	2.75MMX2F	Raychem	0.5	M
4	Fiber	3.55MMX2F	Raychem	0.5	M
5	Braid	RAY101-1500	Raychem	1.2	M
6	Braid	RAY101-12.5	Raychem	1.2	M
7	Braid	RAY101-7.5	Raychem	1	M
8	Taking	A1029-43	Raychem	2	PL
9	Taking	DR 26-1/2-0	Raychem	1.8	M
10	Taking	DR 26-1/2-0-20MM	Raychem	1	PL
11	Taking	DR 26-1-0	Raychem	1	M
12	Taking	DR 26-3/4-0	Raychem	0.8	M
13	Taking	RNF100-2/14-0-10MM	Raychem	4	PL
14	Taking	RNF100-1/2-0-20MM	Raychem	3	PL
15	Taking	RNF100-1-0-20MM	Raychem	1	PL
16	Taking	RE-375-2-0-65MM	Raychem	1	PL
17	Taking	RE-375-1-0-65MM	Raychem	3	PL
18	Taking	RE-375-3-0-65MM	Raychem	1	PL
19	Insulation Cap	T04001-0	Raychem	18	PL
20	Adaptor	T090AB00-120BA1	Raychem	1	PL
21	Adaptor	T090AB00-141GA1	Raychem	1	PL
22	Adaptor	T090AB00-0214A1	Raychem	1	PL
23	Adaptor	T090AB00-120BA1	Raychem	1	PL
24	Moulded Part	202K142-25-225-0	Raychem	2	PL
25	Moulded Part	202K183-25-225-0	Raychem	1	PL
26	Moulded Part	202K183-25-225-0	Raychem	1	PL
27	Moulded Part	382A204-25-225-0	Raychem	2	PL
28	Solder Sleeve	B-05-10101	Raychem	1	PL
29	Solder Sleeve	B-05-10201	Raychem	1	PL
30	Solder Sleeve	SI13-335-20189			
31	Marker Sleeve	TMS4RS01-NPT 1/4-02-0			
32	Marker Sleeve	TMS4RS01-NPT 1/4-02-0			
33	Marker Sleeve	TMS4SC11-2-0-04			
34	Marker Sleeve	TMS4SC11-2-0-4			
35	Marker Sleeve	TMS4SC3/4-2-0-4			
36	Connector	D38989/28WC38PL			
37	Connector	D38989/28WD18SA			
38	Connector	D38989/28WD18SA			
39	Connector	D38989/28WD18PL			
40	Fiber Plug	MS27488-20			

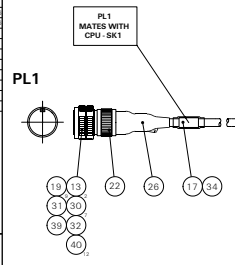

Parts listing

During the parts listing process HarnWare automatically:

- Extracts part details from the drawing
- Generates a sorted and totaled parts list table
- Adds item number balloons to the drawing cross referencing the parts to the parts list table.

HarnWare parts list data can be written to a structured text file ready for use in a variety of other systems including spread sheets, databases or word processors. The parts lists for a number of harnesses can also be combined to form a composite parts list that totalises all the parts for a set of harnesses on a project. Other parts listing options include the ability to:

- Retain existing item numbers when a design is modified.
- Include gaps in the item numbering sequence.
- Convert part numbers to customer numbers or to VG or other industry standard numbers.

Other features

Among the other HarnWare features and options are:

- 3D modelling system for visualising harness designs. HarnWare automatically generates to-scale 3D models which provide virtual prototypes of harnesses designed. The user can see what a harness will look like with lengths, diameters and parts shown to scale thus reducing the potential for errors.
- Lay-up (nail) board designs. Harness lay-up board design can be modelled with pegs automatically positioned along the harness legs. Drawn output can be used on the lay-up board.
- Weight calculation. Most components weights are stored in the HarnWare database and this enables HarnWare to estimate the weight of the harness.

Fax-on-demand

US only (800) 260-9099

Outside US (650) 257-2301

Visit our website at www.tycoelectronics.com

- Labor estimator. Harness drawings can be analyzed and details automatically added to a spread sheet containing assembly time standards. While estimating harness assembly times can never be an exact science, the estimates produced are sufficiently accurate for such purposes as comparing the cost effectiveness of alternative design solutions. A labor estimate is contained in the attached sample HarnWare document set.
- Cable analyzer. This option analyzes the harness topology, wire lengths, etc. in order to suggest where machine, rather than hand, built cable sub-assemblies could result in the maximum cost savings.
- Drawing translator. Drawings can be translated into a number of foreign languages, including French and some Asian languages such as Korean and Japanese. Harnessing phrases, rather than individual words, are translated in order to achieve more meaningful and grammatically correct results.
- Design checker. This analyzes the contents and structure of a harness design against a set of rules. Where potential problems or deviations from 'best practice' are found, HarnWare outputs a warning. The relevant parts in the harness design drawing can be flagged and the warning messages can also be listed in a table for use in design reviews. The warning flags and the messages are all linked to an on-line help system which contains further details on each specific problem.
- Codes of practice. A list can be generated of the codes of practice that are relevant to the parts included in the design. These describe harness assembly techniques and other issues.
- On-line help system. An extensive on-line help system covers system operating procedures and details on many aspects of harness design procedures and Raychem products. The help system is context sensitive and extensively cross-referenced using hyperlinks.

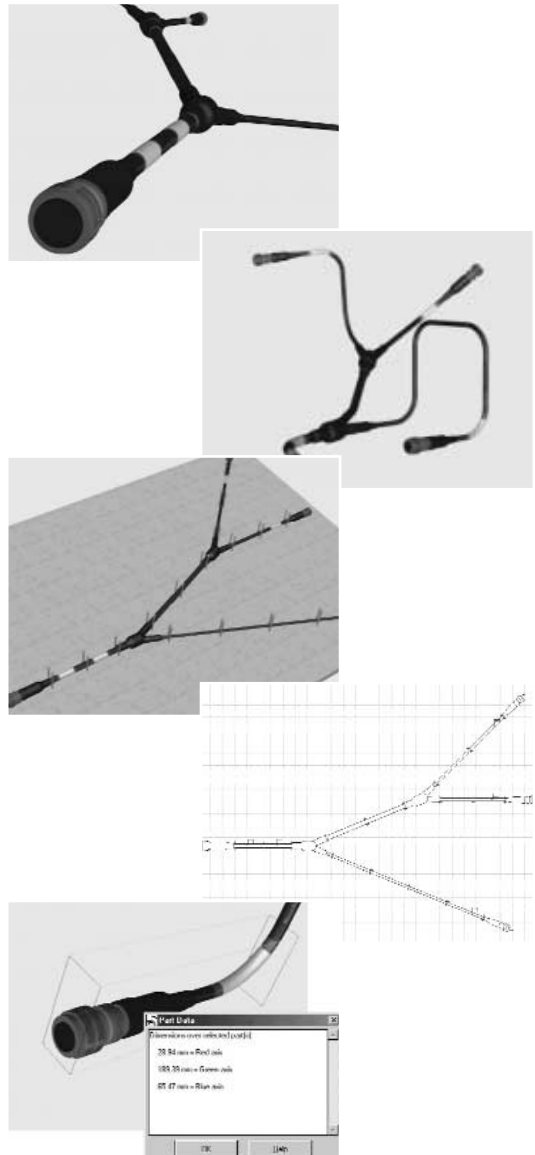

Electrical Interconnection System Design *(cont'd.)*

System integration

HarnWare can be linked to many other computer systems using a variety of interfaces including:

- Parts list data can be exported in structured text files suitable for reading by such systems as spread sheets, databases and word processors.
- Drawings can be imported and exported using industry standard formats such as DXF and IGES.
- Cable marker data can be transferred to marker printing systems such as Tyco Electronics WinTotal* system.
- Wiring connectivity data export for test equipment.

Benefits

The five key benefits of using HarnWare are:

- 1) More detailed and accurate design.
- 2) Up to 20 times faster design and quotation.
- 3) Preferred part selection, to ensure best delivery and price.
- 4) More cost effective design.
- 5) Ensures parts are compatible with the intended service conditions and with mating parts.

Hundreds of users around the world can confirm the benefits of using HarnWare

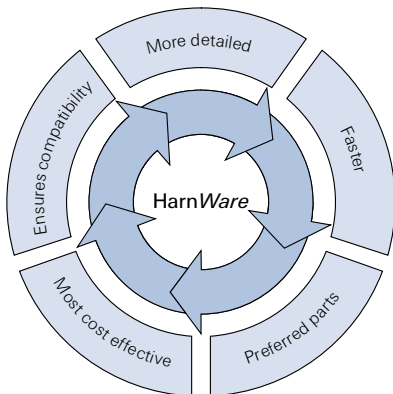

HarnWare Document Set

The following partial set of drawings and associated documents is a simple example of what can be produced using HarnWare.

Detailed Manufacturing Drawing

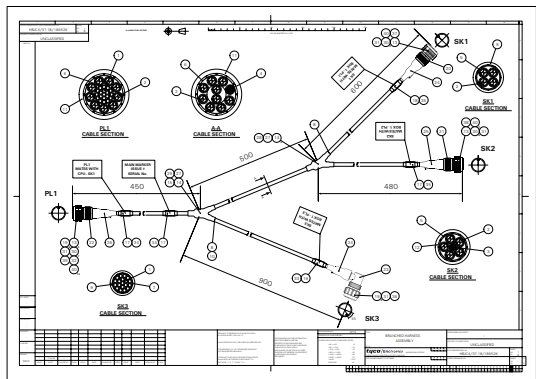

Detailed Wiring Schematic

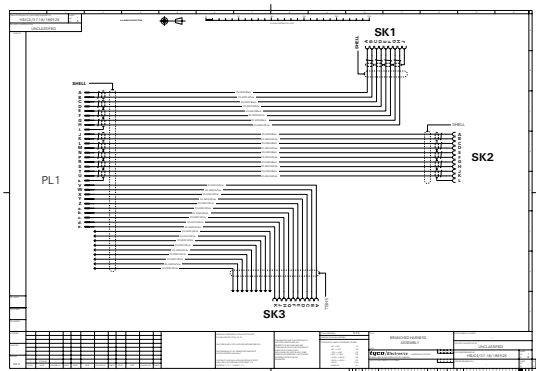

*Tyco Electronics Identification products information available at www.tycoelectronics.com



Assembled military harness



Military harness system components.

Integrated Military Harness systems for Defense and Allied industries

Raychem integrated harness systems have been developed for a wide range of defense and industrial applications. Each system consists of compatible components, including cable jackets, heat-shrinkable components, and adhesives. Performance of these parts is assured because all components are tested separately and as part of an assembled system (see photo top left).

A typical designed harness consists of seven component parts (pictured at left):

1. Primary wire and cable
2. Heat-shrinkable tubing
3. Backshell adapter
4. Molded part
5. Adhesive
6. Cable jacket
7. Marker sleeve*

Additional components for harnessing systems include the following:

- A wide range of special devices, such as SolderSleeve devices for primary wire interconnection.
- A selection of electrical shielding (screening) options, including braids and termination assemblies.
- Multiconductor (multicore) cables.
- Specialty adhesives, sealants, and gels for complete environmental sealing.**

Table 1 on the next page serves as both a summary of Raychem products for specific harnessing systems and a selection table for harnessing system components. An explanation of how to select components for a harness system follows.

*Tyco Electronics Identification products information available at www.tycoelectronics.com

**Tyco Electronics Gel and Sealant product information available at www.tycoelectronics.com

Fax-on-demand

US only (800) 260-9099

Outside US (650) 257-2301

Visit our website at www.tycoelectronics.com**Table 1. Raychem Harnessing systems and their components**

Components	System	System	System	System	System	System
	10	20	25	100	200	300
Wire	44	44	44	99, 100A, 100G	55	55
Tubing	Versafit	NT-FR	DR25	ZHTM	Viton	RT555
Adapter material and plating finish chosen for compatibility with the connectors.						
Molded part	-3, -4, -71	-51	-25	-100	-12	-55/-125
Preinstalled Rayaten molded part	-35		-25S	-100S		
Adhesive	S1017, S1030	S1124, S1048	S1048, S1125	S1030, S1125,	S1125, S1255	S1255-04
Precoated adhesive	/42, /180	/164, /86	/86, /225	/180		
Conductive adhesive			S1184	S1184		
Cable jacket	Thermorad	NT-FR	FDR-25	Zerohal	Viton	RT555
Marker sleeve*	TMS-SCE	TMS-SCE	TMS-SCE	ZH-SCE	HT-SCE	HT-SCE

Selection process

Selecting the components for a harnessing system is a four-step process:

- Step 1:** Select the material system appropriate for the operating conditions and environment to which the harness will be exposed.
- Step 2:** Select the adhesive system appropriate for the material system you select in Step 1.
- Step 3:** Determine the level of EMI shielding required.
- Step 4:** Select the components.

Each step is described on the pages that follow.

A selection table accompanies each step.

You can also use *HarnWare* to design your harness.

Step 1. Select the material system.

Detailed in Table 2 on the next page are the major material systems for use in a wide range of operating conditions and environments.

Choose a material system that:

- Has the physical characteristics your harness requires.
- Will accommodate the operating temperature and the fluids and abuse to which the harness will be exposed.

Fax-on-demand

US only (800) 260-9099

Outside US (650) 257-2301

Visit our website at www.tycoelectronics.com**Table 2. Material system selection**

	System 10	System 20	System 25
Operating temperature	-20°C to 60°C	-55°C to 121°C	-75°C to 150°C*
Physical characteristics	<ul style="list-style-type: none"> Environmentally sealable Lightweight Small diameter Flexible 	<ul style="list-style-type: none"> Environmentally sealed Tough Flexible Low profile 	<ul style="list-style-type: none"> Environmentally sealed Rugged Abrasion-resistant Very flexible
Flammability	<ul style="list-style-type: none"> Flame-retardant Self-extinguishing 	<ul style="list-style-type: none"> Flame-retarded Self-extinguishing 	<ul style="list-style-type: none"> Flame-resistant Self-extinguishing
Fluid resistance	<ul style="list-style-type: none"> Resists common industrial and military cleaning solvents and degreasers. 	<ul style="list-style-type: none"> Resists all common military fuels, oils, and greases 	<ul style="list-style-type: none"> Resists most common military fuels, oils, and greases. up to 70°C.
Typical applications	<ul style="list-style-type: none"> Used in high-performance industrial applications, and in military communication and test equipment. 	<ul style="list-style-type: none"> Specially suited to military vehicles and engine compartments, low profile shapes save space and weight. 	<ul style="list-style-type: none"> Specially suited to military vehicles, aerospace and marine applications, and communication and test equipment.
	System 100	System 200	System 300
Operating temperature	-30°C to 105°C	-55°C to 200°C	-65°C to 200°C
Physical characteristics	<ul style="list-style-type: none"> Environmentally sealed Flexible 	<ul style="list-style-type: none"> Environmentally sealed Very flexible 	<ul style="list-style-type: none"> Environmentally sealed Highly abrasion resistant Low profile
Flammability	<ul style="list-style-type: none"> Low toxicity index (as defined by NES-13) Low smoke emission (as defined by NES-711) Low corrosive gas evolution 	<ul style="list-style-type: none"> Highly flame-retardant 	<ul style="list-style-type: none"> Highly flame-retardant
Fluid resistance	<ul style="list-style-type: none"> Resistant to a range of military fuels, oils, and greases. 	<ul style="list-style-type: none"> Resists long-term immersion in military fuels, oils, and greases at elevated temperatures. 	<ul style="list-style-type: none"> Performs in aggressive fluids at extremely high temperatures Low fluid uptake
Typical applications	<ul style="list-style-type: none"> Specially suitable for confined habitat areas in military and civil applications. Extensively used in surface and submarine vessels and underground railways 	<ul style="list-style-type: none"> Used where there is prolonged exposure to high temperatures. Used where a harness may be permanently immersed in difficult fuels, such as in fuel tanks. 	<ul style="list-style-type: none"> Contamination survivability against NBC threat and decontamination Permanent immersion in aggressive fluids

*Per VG 95343.

Users should independently evaluate the suitability of the product for their application.
Before ordering check with factory for most current data.

Electrical Interconnection System Design *(cont'd.)*

Step 2. Select the adhesive system.

Two types of adhesives are used to bond heat-shrinkable boots and transitions to tubing or wire jacketing:

- Thermosets, which include epoxies and other two-part systems.
- Thermoplastics, which include pre-coated meltable adhesives applied to parts during manufacture and those applied as meltable tapes during assembly.

Table 3 below outlines the differences between thermosets and thermoplastics.

Table 4 shows which adhesive type is appropriate for each harness material system.

Table 3. Comparison of adhesive types

	Thermoset	Thermoplastic
Method of adhesion	Cures through chemical reaction.	Melts, flows, and solidifies.
Application	Two-part types require mixing and application at assembly.	Precoated types require no preparation at assembly.
Cure time	Varies with cure temperature. Oven cure usually desirable.	Not required. Adhesive functional when cooled to room temperature.
Strength	Retains most strength at elevated temperatures.	Loses strength as melt temperature is approached.
Disassembly	Items can be forcibly peeled apart when heated sufficiently.	Items can be separated when heated to temperature of the adhesive.
Repair/reassembly	Requires new adhesive or hot rollback to reenter behind connector without affecting adhesive bonds.	Can be reheated to form new bond if sufficient adhesive remains.

Table 4. Adhesive selection

Material system	Adhesive type	Component adhesive	Precoated adhesive designation	Service temperature
System 10	Thermoplastic	S-1030	/180	80°C
		S-1017	/42	60°C
System 20	Thermoplastic	S-1124	/164	105°C
	Thermoplastic	S-1048	/86	120°C
System 25	Thermoplastic	S-1048	/86	120°C
	Two-part thermoset	S-1125	/225	150°C
System 100	Thermoplastic	S-1030	/180	80°C
		S1048	/86	120°C
	Two-part thermoset	S-1125		150°C
System 200	Two-part thermoset	S-1125		150°C
	Thermoset tape	S-1255-04		200°C
System 300	Thermoset tape	S-1255-04		200°C

Fax-on-demand

US only (800) 260-9099

Outside US (650) 257-2301

Visit our website at www.tycoelectronics.com

Step 3. Determine the level of EMI Shielding required

Tyco Electronics offer several methods and technologies for controlling electromagnetic interference (EMI) and noise in cable harnesses. Developed in response to well-established threats in military and other harsh environments, these technologies can be employed in compatible shielding (screening) systems to achieve the level of shielding required for a harness system. Table 5 on page 2-23 outlines the shielding requirements for various types of threat and levels of interference.

Introduction

This section is intended as a guide for the use of harness designers who are required to achieve a level of EMI control in their design practices. It is not intended that it should be a definitive statement on all aspects of EMI control for harnesses. In case of difficulty contact us for further clarification or consultancy.

For well-designed EMI control of electrical systems it is essential that a detailed knowledge of the system requirements and susceptibility be obtained. The chosen level of shielding will be dependant on the:

- Susceptibility of electrical system.
- Types of components used.
- Physical layout of the system.
- Equipment practices adopted.
- Anticipated EMI threat.

For the most cost effective design of harnesses, which offer a long-term stability in performance, the system should be designed to achieve a balance of component characteristics. Components should only be used if they are qualified to a minimum level of EMI performance and the performance and test method should be applicable to the design technique being used.

For quality assurance purposes minimum EMI characteristics should always be specified and for critical harnesses the complete performance should be measured. The technique to be adopted should always be specified.

Finally the inter-relationship between harnesses and the protection, termination and grounding of equipment boxes is vital for good system performance against EMI. All components form part of the external shield on the system and therefore should be considered in the overall EMI design process.

Subjects covered in this topic are:

- Harness Types - point to point and branched
- Shielding Levels - calculations

Harness types

Harnesses are divided into two types, point-to-point and branched. The advantages and disadvantages of each from an EMI control standpoint are described below. No attempt has been made to analyze their relative merits in mechanical or installation terms.

Point To Point:

The three major components of this type of harness are: connectors, cable, and connector accessories.

Connectors

There are many different types of circular military connectors. However, for a well-shielded harness only those connectors having a guaranteed performance level should be used e.g. Mil-C-26482 Series II and Mil-C-38999 series 1 and 2, and series 3 and 4.

Cable

Cable used in this type of harness is generally machine made. Hand laid cables may also be used but generally the shields incorporated in these harnesses vary in consistency of performance. In the case of machine made cables all shields should be designed for optimum shielding effectiveness at radio frequency.

Connector accessories

Connector accessories, such as Raychem adapters, are available in many styles and therefore their performance varies with construction. For a level of consistency in performance it is essential that, as with connectors, a guarantee in performance level be achieved. Fittings not specified in this way may significantly degrade the overall system performance.

Branched

In addition to those components described above, branched harnesses include transitions. This type of harness is usually made by hand and it is therefore difficult to incorporate accurately made machine fabricated shields. The implications of this are:

Shields

Cable shields may be put on by hand or by feeding through a braiding machine. However, as braid optimisation depends on all the constructional parameters of the braid being accurately specified, unless braid is well constructed the shielding performance can suffer dramatically. Reductions in shield performance of 20-40 dB have been measured on badly made branched harnesses. The alternative method is to use pull on braids. If the cable bundle diameter is known the braid may be designed for optimised performance.

Transitions

Transitions, as with accessories, are very susceptible to performance variability with construction type. For high performance harnesses these components should also have a guaranteed performance. In general the use of techniques such as hand soldering or the use of butted tape wraps are not recommended except where only a low performance of less than 40dB is required.

Shielding levels and component performance

System performance

To specify the overall requirements of a complete electronic system in terms of its EMI characteristics it is necessary to consider the performance of the individual components parts. The harnesses form one of the major entry points for interference and this as such can degrade a complete system performance by a significant amount. In general terms, assuming that a shielded harness system is used, with the available components on the market the overall harness system performance and typical applications may be as below.

- 40 to 50 dB Standard shielded systems for insensitive systems.
- 50 to 60 dB Military standard shielded systems for general applications.
- 60 to 80 dB As above but where full threat EMP & TEMPEST protection is required.
- 80 to 100 dB Severe TEMPEST and very sensitive systems.
- Over 100 dB Exceptional shielding requirements only.

Shield performance is specified in two ways, either as a power relationship in decibels (dB) or as an absolute measurement of the shield performance in terms of the surface transfer impedance. Except for very specific low frequency problems it is general to specify the performance at frequencies in the range 0.1MHz to 100MHz.

Fax-on-demand

US only (800) 260-9099

Outside US (650) 257-2301

Visit our website at www.tycoelectronics.com

Safety margins

As with all designs EMI system design should not be performed to the "limit of performance safety margin should always be incorporated when determining the minimum shielding level appropriate for consistent operation of the system.

The inter-relationship of shielding effectiveness measured in decibels and the surface transfer impedance in ohms presents the designer with a conversion difficulty. External harness circuits vary, as do the coupling characteristics and it is therefore only possible to give an approximate conversion. The normal conversion from decibels to ohms and vice versa is to a reasonable approximation:-

$$\text{Screening Effectiveness (dB)} = 36 - 20 \log_{10} (Z_T \text{ (Ohms)})$$

The constant term is developed from the expressions for the characteristic impedance of the line formed by the harness shield and the ground plane and the internal characteristic impedance of the inside of the harness. The translation from shielding effectiveness to surface transfer impedance is shown below in Table 5 for S.E. from 20 to 105dB.

Connectors

A study of those connector specifications having an EMI test shows that they are generally specified in the frequency band 100MHz to 1GHz. For an assessment at lower frequencies the low frequency performance as dictated by the d.c. resistance of the connector is required. These two parameters enable the EMI characteristic to be made of the complete connector performance. Typical values for standard connectors are 65dB (Mil-C-26482 Series II) and 90dB (Mil-C-38999 Series III) connectors.

Table 5 - Screening effectiveness (SE)/surface transfer impedance (Zt) relationships

S.E. (dB)	Z _T (ohms)	S.E. (dB)	Z _T (ohms)
20	6.309	65	0.0355
25	3.548	70	0.0200
30	1.995	75	0.0112
35	1.122	80	0.0063
40	0.631	85	0.0036
45	0.355	90	0.0020
50	0.200	95	0.0011
55	0.112	100	0.0006
60	0.063	105	0.0004

Cable

In accordance with most common cable specification the shielding performance of a cable is specified at 30MHz. It is also well into the band where inductive leakage is the primary penetration characteristic. For frequencies above or below 30mhz, approximations, as for connectors, must be made. It should be noted that the performance specified at 30MHz in Table 6 for different cable types is the maximum that is allowed using Tyco Electronics' standard Q.C. values. Actual performance may be up to 20dB better.

Connector accessories and transitions

In constructional terms the performance of the connector accessory includes both the resistive terminations to the cable shield and the connector. However, it is most unusual to specify the performance of an accessory and this is a distinct weakness in the design of harnesses. The reason is that the performance is extremely variable as accessories have to fit a variety of different cable sizes and shapes. Where specified at all the relationship between the test method and the coupling mechanism for the EMI must be considered.

Fax-on-demand

US only (800) 260-9099

Outside US (650) 257-2301

Visit our website at www.tycoelectronics.com

Table 6 - Cable performances

Type of Screen	Diameter under screen (mm)	Surface transfer impedance Z_t @ 30 Mhz (maximum)
Single optimised braid	Up to 7.5	100 milli ohms/metre
	7.6 and up	50 milli ohms/metre
Double optimised braid	Up to 7.5	10 milli ohms/metre
	7.6 and up	5 milli ohms/metre
Superscreened (2 braids + 1 wrap)	Up to 7.5	100 micro ohms/metre
	7.6 and up	50 micro ohms/metre

Electrical Interconnection System Design *(cont'd.)*

Complete harness

When considering the complete harness the coupling calculations are relatively simple. In general terms they are the addition of all the individual leakages within the system from connector to connector. The analysis route is therefore as follows:-

1. Convert all decibel values at the desired frequency to surface transfer impedance.
2. Choose components for a 'balanced' system i.e. the components should have approximately the same performance.
3. Add the values determined for surface transfer impedance of the components at the frequency chosen.
4. Reconvert to decibels if necessary.
(Table 5 can be used for this purpose)

As a guide to the shielding performance that can be expected from a harness that is constructed using Raychem components, Table 7 on the next page has been compiled to help in the product selection process.

For branched harnesses it is necessary to determine whether every branch has the same susceptibility requirements or carries the same signals of power. The performance requirement of each branch is then determined and the matrix for the harness established. This is a more complex subject and not discussed here. System improvements may be achieved by changing either the connectors or cable. In general terms changing from a single to a double optimised braid improves the performance of that component by 20-25 dB. A similar advantage is achieved by changing from Mil-C-26482 Series II to Mil-C-38999 Series I connectors. However, the relative significance, as part of the system, of each component must be considered to determine the true weighting effect. For the optimum in system design a balance of component performances should be achieved wherever possible such that each of the components is of similar performance level.

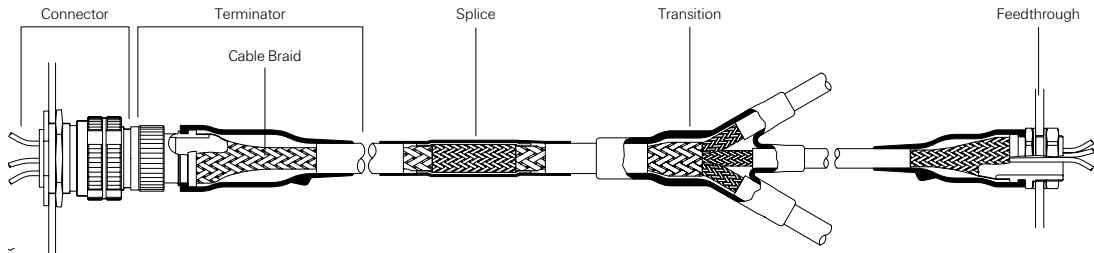

General considerations

Although cables and harnesses are considered to be the most significant in terms of coupling into systems the construction of equipment boxes can play an important part in the overall EMI performance of a system. With the increasing use of high speed digital circuits and the generation of harmonics having high energy content relatively short printed circuit board tracks can radiate or pick up energy as efficiently as cables. If the boxes themselves are not adequately protected these circuits may constitute an EMI threat. There is a further area of significance in the EMI protection of the boxes and this is the connector/box interface. The junction may be considered to be a part of the harness system and any degradation in it may cause an overall harness degradation.

Fax-on-demand

US only (800) 260-9099

Outside US (650) 257-2301

Visit our website at www.tycoelectronics.com

Table 7 - Screen system guide

Harness system components														
Shielding level required	Connector	Adapter Styles		Termination		Cable braid (max. length in m/ft) by cable construction)			SSS	DSS	Transition	Splice	Feed-through	
		Band strap	Braided	Tinel-Lock system	Rayaten assembly	NO	SO	DO						
<60 dB	VG95328 VG95234	■	■	■				<2/6.5	15/49	100/328		Shield tape & Solder-Sleeve device	Solder-Sleeve device solder device	Tinel or solder devices
60 to 80 dB	MILC26482 Series 2 VG96912 Series 1			■				<2/6.5	7/22.9	100/328		Shield tape & Solder-Sleeve device	Solder-Sleeve device	Tinel or Rayaten assembly
>80 dB	MILC38999				■			<0.5/1.6	50/164	65/213	Not recom-	Solder-Sleeve device mended	Solder-Sleeve device	Tinel or Rayaten assembly

NO = Non Optimised, SO = Single Optimised, DO = Double Optimised, SSS = Single Super Shield.

Note:

- The cable lengths are to be used as a guide.
- Outside 30 MHz, the lengths that can be used will vary. For specific harness design outside 30 MHz, please consult Tyco Electronics.
- TinelLock use at shielding levels of 60–80 dB depends on the adapter entry, cable braid size, and design. For further details, contact Tyco Electronics.
- Connectors commonly used but not mentioned in the table may not have a stated shielding performance in their specification. Contact the manufacturer for guidance.
- This guide makes no allowance for the possible effects of resonance. Tyco Electronics should be consulted for advice on compensating for resonance.

Step 4. Select components

Using the previous sections, you can now select all of the components for an integrated harness assembly.

Please refer to the sections on:

Molded Parts	Page 4-0
Wire and Cable	Page 9-0
Adapters	Page 6-0
Assemblies	Page 7-0
Electrical Interconnect Products	Page 8-0
Tubing	Page 3-0

for more detailed component information.

Tubing

Overview

The Tyco Electronics' Raychem brand of tubing was developed when our scientists pioneered the application of radiation crosslinking and the development of heat-shrinkable polymer products. Today Tyco Electronics is recognized worldwide for its expertise in these areas.

The Raychem brand of tubings are made of polyolefins, fluoropolymers, and elastomers enhanced by radiation crosslinking and heat-shrinkability. When heated during installation, our tubings shrink to conform to virtually any shape. They provide dependable insulation, mechanical protection, and strain relief, as well as aesthetic appeal.

Single wall tubings are available in thin-wall, medium-wall, and thick-wall versions. With dual wall tubings, an inner wall – either an encapsulant or an adhesive – melts and flows during installation heating, to protect against environmental damage. Encapsulants protect connections and components from splashes and corrosion. Adhesives go a step further, sealing to plastic, metal, rubber, or other substrates.

You can choose from tubings that are highly flexible or semirigid, designed for operation in high- or low-temperature environments, and halogen-free and flame-retardant to meet a range of industry standards.

Available in many sizes, constructions, lengths, and colors to meet both commercial and military specifications, our tubings can also be customized for special applications.

Installation is fast and easy with handheld heating tools or bench-mounted heaters (see the Application Equipment section). A range of automatic and semi-automatic installation equipment is available for high-volume applications.

tubing Selection Guide

PRODUCT				Polyolefin	Fluoropolymer	Elastomer	Operating temperature (*C/*F)	Min. shrink temperature (*C)	Min. full recovery temperature (*C)	Shrink ratio			
Thin-wall	Single wall	Very flexible	LSTT	•			-40 to 125 (-40 to 257)	65	110	2:1			
			Versafit	•			-55 to 135 (-67 to 275)	70	90	2:1			
			Versafit V	•			-45 to 105 (-49 to 221)	70	90	2:1			
			Versafit V2	•			-45 to 125 (-49 to 257)	70	90	2:1			
			Versafit V4	•			-10 to 125 (14 to 257)	70	90	2:1			
		Flexible	CGPT	•			-40 to 135 (-40 to 275)	80	120	2:1			
			DCPT	•			-55 to 135 (-67 to 275)	80	120	2:1			
			RNF-100	•			-55 to 135 (-67 to 275)	95	121	2:1			
			RNF-150		•		-55 to 150 (-67 to 302)	110	150	2:1			
			RNF-3000	•			-55 to 135 (-67 to 275)	80	120	3:1			
			RP-4800	•			-55 to 135 (-67 to 275)	95	121	4:1			
			RT-375		•		-55 to 150 (-67 to 302)	125	150	2:1			
			TFE and TFE-R		•		-67 to 250 (-89 to 484)		340	1.8:1/ 3.2:1			
			TUGA	•			-55 to 125 (-67 to 257)	85	110	2:1			
			ZH-100	•			-30 to 105 (-22 to 221)	80	120	2:1			
		Semirigid	CRN	•			-55 to 135 (-67 to 275)	110	135	2:1			
			RW175		•		-55 to 175 (-67 to 347)	155	175	2:1			
			RT-3	•			-55 to 135 (-67 to 275)	110	135	2.5:1			
	Dual wall (adhesive-and encapsulant-lined)	Semiflexible	ATUM	•			-55 to 110 (-67 to 230)	80	110	3:1 4:1			
				DWP-125	•			-40 to 110 (-40 to 230)	80	125	3:1		
			HTAT	•			-55 to 125 (-67 to 257)	80	110	4:1			
			Flexible	Rayrim	•			-55 to 80 (-67 to 190)	120	150	N/A		
				RPPM	•			-40 to 85 (-40 to 185)	60	80	4:1		
				TAT-125	•			-55 to 110 (-67 to 230)	95	121	2:1		
			Semirigid	TPEM	•			-55 to 80 (-67 to 190)	120	150	N/A		
				ES1000	•			-40 to 130 (-40 to 266)	110	135	4:1		
				ES2000	•			-40 to 130 (-40 to 266)	110	135	4:1		
				SCL	•			-55 to 110 (-67 to 230)	125	135	3:1		
		SCT	•			-40 to 150 (-40 to 302)	110	135	4:1				
	Medical-grade	Flexible	MT2000	•			-40 to 105 (-40 to 221)	110	140	2.5:1			
				MT3000		•		-55 to 150 (-67 to 302)	110	150	2:1		
			MT5000	•			-70 to 105 (-94 to 221)	90	110	2:1			
			Semirigid	MT1000		•		-55 to 175 (-67 to 347)	155	175	2:1		
Medium-wall	Single wall		DR-25			•	-55 to 150 (-67 to 302)	150	175	2:1			
			NT and NTFR			•	-70 to 121 (-94 to 249)	90	135	1.75:1			
			RT-555			•	-65 to 200 (-85 to 392)	150	220	2:1			
			SFR			•	-75 to 180 (-103 to 356)	135	175	1.75:1			
			SRFR			•	-75 to 200 (-103 to 392)	135	175	1.75:1			
			Viton			•	-40 to 200 (-40 to 392)	100	175	2:1			
			Viton-HW			•	-40 to 200 (-40 to 392)	100	175	2:1			
			ZHTM			•	-30 to 105 (-22 to 221)	80	121	2:1			
			Heavy-wall	Single wall		BSTS	•			-55 to 90 (-67 to 194)	90	121	3:1
						HF	•			-55 to 90 (-67 to 194)	80	121	3:1
HRHF/HRNF/HRSR	•						-55 to 90 (-67 to 194)	80	121	5.6:1			
XFFR	•						-30 to 90 (-67 to 194)	90	121	3:1			
SST	•						-55 to 90 (-67 to 194)	90	121	3:1			
HCTE						•		-55 to 200 (-67 to 392)	N/A	N/A	N/A		
Conduit	Dual wall		ES Caps	•			-40 to 105 (-40 to 221)	100	135	4:1			
			PD Caps	•			-55 to 110 (-67 to 230)	125	135	3:1			
Caps			RayBlock 85	•			-40 to 85 (-40 to 185)	80	110	4:1			
			RayBlock 105	•			-40 to 105 (-40 to 221)	80	110	4:1			
Kits			HFT 5000				-40 to 125 (-40 to 257)	80	110	2:1			
			RF-PET				-50 to 150 (-58 to 302)	N/A	N/A	N/A			
Fiber & Fabric	Single wall	Flexible	RF-PFR				-50 to 150 (-58 to 302)	N/A	N/A	N/A			
			RF-PETM				-50 to 150 (-58 to 302)	N/A	N/A	N/A			
			RF-PETM				-50 to 150 (-58 to 302)	N/A	N/A	N/A			

*For specific Mil-Spec information for each product, refer to individual product pages or the Tubing Specification Cross-Reference Guide on page 3-1

†Clear is not flame-retardant

Size range (inside diameter as supplied)	Colored	Clear	Flame-retardant	UL 224	CSA	VW-1/OFT (UL/CSA)	Mil Spec*	USP Class VI	ABS	DESCRIPTION
1.6 mm to 38.0 mm	•	•								Non-flame-retardant polyolefin
3/64" to 4"	•		•	•	•	•	•			Highly flame-retardant, multi-spec polyolefin
1 mm to 30 mm	•		•	•		•				Highly flame-retardant UL polyolefin
1 mm to 30 mm	•		•	•	•	•	•			Highly flame-retardant polyolefin
3/64" to 1"	•		•	•	•	•	•			Very-thin-wall, highly flame-retardant polyolefin
1 mm to 10 mm	•		•	•	•	•	•			
1.6 mm to 38.0 mm	•	•	•	•	•					General purpose, flame-retardant polyolefin†
3mm to 38mm	•		•	•	•					Green and yellow striped polyolefin
3/64" to 5"	•	•	•	•	•		•			High-performance flexible polyolefin†
3/64" to 1"	•		•	•	•	•	•			High-performance flexible fluoropolymer
1.5 mm to 39 mm	•	•	•	•	•					3:1 shrink ratio general-purpose polyolefin†
3/4" to 4.5"	•		•	•			•			4:1 shrink ratio polyolefin
3/64" to 1"		•	•	•	•	•	•			Clear high-performance flexible fluoropolymer
0.8 mm to 11.9 mm/ 2 mm to 32 mm		•	•				•			High-temperature Teflon
1.2 m to 51 mm	•	•								Brightly colored, tough polyolefin
1/8" to 2"	•									Thin-wall, low-fire-hazard polyolefin
3/64" to 3/4"	•	•	•	•	•		•			Flame-retardant polyolefin†
3/64" to 11/2"	•	•	•	•	•	•	•			High-performance fluoropolymer
.240" to .485"	•		•	•	•					Semirigid polyolefin for terminal insulation
3mm to 40mm	•	•	•				•			3:1 and 4:1 shrink ratio adhesive-lined polyolefin†
4 mm to 52 mm	•		•							
1/8" to 1"	•		•	•	•					3:1 shrink ratio adhesive-lined polyolefin
4 mm to 48 mm	•		•							High-temperature adhesive-lined polyolefin
0.8 mm to 4.5 mm	•									Protective self-adhering edging material
4mm to 16mm	•	•								Dual-wall, moisture-proof polyolefin
1/8" to 1 1/2"	•	•	•	•			•			2:1 adhesive-lined polyolefin†
0.6mm to 4.2mm	•									Protective self-adhering edging material
.225" to .700"		•		•						Clear high-shrink-ratio adhesive-lined polyolefin
.225" to .700"	•		•	•						Flame-retardant adhesive-lined polyolefin
1/8" to 1"	•			•			•			3:1 shrink ratio encapsulant-lined polyolefin
.300" to .700"	•		•							High-temperature adhesive-lined polyolefin
1 mm to 10 mm	•	•						•		Lubricious thin-wall polyolefin
1/16" to 1"	•							•		High-temperature flexible fluoropolymer
1/16" to 1"	•	•						•		Flexible polyolefin
1/16" to 1"	•	•						•		Autoclavable semirigid fluoropolymer
1/8" to 3"	•		•				•			Diesel-resistant elastomer
1/8" to 3"	•		•	NT	NT		•			Very flexible rugged neoprene
1/8" to 2"	•		•	•		•				Fluid- and chemical-resistant fluoropolymer
1/4" to 2"	•		•				•			Very flexible silicone
2.9 mm to 55.0 mm	•			•		•				Very flexible silicone rubber
1/8" to 2"	•		•				•			High-temperature flexible elastomer
1/4" to 2"	•		•				•			Heavy-walled Viton elastomer
3 mm to 40 mm	•		•				•			Low toxicity, flexible polyolefin
.3" to 4.5"	•		•					•		Rugged, general-purpose, thick-wall polyolefin
.4" to 2.7"	•		•					•		Highly flexible, thick-wall polyolefin
.6" to 4"	•		•					•		High-shrink-ratio repair sleeve
.4" to 3"	•		•					•		Halogen-free, flame-retardant polyolefin
.3" to 4.5"	•		•				•	•		Self-sealing, dual-wall polyolefin
.187" to 1.625"	•		•							Modified ETFE, helically convoluted tubing
.225" to .427"	•	•	•	•						High-ratio, adhesive-lined caps
1/8" to 1/2"	•			•						Semirigid encapsulant-lined polyolefin
12mm to 32mm	•		•							Heat-shrinkable water blocking system
12mm to 32mm	•		•							Heat-shrinkable water blocking system
12mm to 80mm	•									Heat-shrinkable, fabric tubing
1/8" to 2"	•									Expandable, braided polyester sleeving
1/8" to 2"	•		•	•		•				Expandable, braided polyester sleeving
3mm to 50mm	•									Expandable, braided polyester sleeving

Users should independently evaluate the suitability of the product for their application.
Before ordering check with factory for most current data.

Tubing

Table of Contents

Tubing Selection Guide			i
Specification Cross-Reference Guide			3-1
Products			
ATUM	High-shrink-ratio, adhesive-lined polyolefin tubing	3-2	RNF-100 Flexible, flame-retardant, general purpose, polyolefin tubing 3-58
BSTS/BSTS-FR	General purpose, heat-shrinkable tubing	3-4	RNF-150 High-performance, flame-resistant, flexible, fluoropolymer tubing 3-60
CGPT	General purpose, flame-retardant, polyolefin tubing	3-6	RNF-3000 Flexible, high-shrink-ratio, flame-retardant, general purpose, polyolefin tubing 3-62
CRN	Semirigid, flame-retardant, polyolefin tubing	3-8	RP-4800 High-shrink-ratio, flame-retardant, polyolefin tubing 3-64
DCPT	Flexible, flame-retardant, dual-color, polyolefin tubing	3-10	RPPM Flexible, dual wall, moisture proof, heat-shrinkable tubing 3-66
DR-25	Heat-shrinkable, flexible, chemical and abrasion resistant tubing	3-12	RT-3 Semirigid, flame-retardant, polyolefin tubing 3-68
DWP-125	Flexible, high-shrink-ratio, adhesive-lined, polyolefin tubing	3-14	RT-375 Clear, flame-resistant, flexible, fluoropolymer tubing 3-70
ES 1000	Clear, high-shrink-ratio, adhesive-lined, semirigid polyolefin tubing	3-16	RT555 Fluid-resistant, chemical resistant, crosslinked fluoropolymer tubing with extended temperature range 3-72
ES2000	Flame-retardant, high-shrink-ratio, adhesive-lined, semirigid polyolefin tubing	3-18	RW-175 High temperature and fluid resistant, extra tough, semirigid, heat-shrinkable tubing 3-74
ES Caps	High-shrink-ratio, adhesive-lined, semirigid polyolefin caps	3-20	SCL Semirigid, encapsulant-lined, polyolefin tubing 3-76
HCTE	Helical convolox tubing with a high crush resistance	3-22	SCT Flame-retardant, adhesive-lined, semirigid polyolefin, heat-shrinkable tubing (extended temperature range) 3-78
HFT5000	Heat-shrinkable, fabric tubing	3-24	SFR Very flexible, flame-retardant, silicone elastomer tubing 3-80
HF	High-flex, heavy-wall, heat-shrinkable tubing	3-26	SRFR Silicone rubber, highly flexible, heat-shrinkable tubing 3-82
HRHF/HRNF/HRSR	High-ratio, heat-shrinkable tubing	3-28	SST/SST-FR Self-sealing, heat-shrinkable tubing 3-84
HTAT	Semiflexible, dual-wall, moisture-resistant, heat-shrinkable tubing	3-30	TAT-125 Adhesive-lined, flexible polyolefin tubing 3-86
LSTT	Low-shrink-temperature, non-flame-retardant heat-shrinkable, polyolefin tubing	3-32	TFE and TFE-R High-temperature, chemically inert, modified Teflon tubing 3-88
MicroFit	Small-diameter, high-shrink-ratio tubing	3-34	TPEM Protective self-adhering edging material 3-90
MT1000	Altera medical-grade, USP Class VI, high-temperature, semirigid, fluoropolymer tubing	3-36	TUGA-GP Brightly colored, shiny, non-flame-retardant, polyolefin tubing 3-92
MT2000	Altera medical-grade, USP Class VI, lubricious, thin-wall, polyolefin tubing	3-38	Versafit Highly, flame-retardant, very flexible, low-shrink-temperature, polyolefin tubing 3-94
MT3000	Altera medical-grade, USP Class VI, high-temperature, flexible, fluoropolymer tubing	3-40	Versafit V Highly flame-retardant, very flexible, low-shrink-temperature, polyolefin tubing 3-96
MT5000	Altera medical-grade, USP Class VI, flexible, polyolefin tubing	3-42	Versafit V2 Highly flame-retardant, very flexible, low-shrink-temperature, polyolefin tubing 3-98
NT/NTFR	Very flexible, rugged neoprene elastomer tubing	3-44	Versafit V4 Very-thin-wall, very flexible, highly flame-retardant, polyolefin tubing 3-100
PD Caps	Semirigid, encapsulant-lined, polyolefin caps	3-46	Viton/Viton-HW/Viton-E/Viton-TV Heat-shrinkable, chemical-resistant, high-temperature tubing 3-102
RayBlock 85	Heat-shrinkable water-blocking system	3-48	XFFR Halogen-free, flame-retardant, heat-shrinkable tubing 3-104
RayBlock 105	Heat-shrinkable water-blocking system	3-50	ZH-100 Flexible, thin-wall, low-fire-hazard tubing 3-106
Rayflex	PET and PFR expandable, braided, polyester sleeving	3-52	ZHTM Heat-shrinkable, flexible tubing with low toxicity for fire safety applications 3-108
Rayflex PETM	Expandable, braided, polyester sleeving	3-54	
Rayrim	Commercial protective, self-adhering, edging material	3-56	

Tubing

Specification Cross-Reference Guide

Product type	UL file	CSA file	AMS-DTL-23053* Sheet	AMS-DTL-23053* Class	MIL-PRF-46846 Type	MIL-PRF-46846 Class	Raychem Specification	Page no.
ATUM	E85381		/4	3			RW-2063 & RK6024	3-2
BSTS							RW-2017	3-4
BSTS-FR			/15	1 & 2**			RW-2017	3-4
CGPT	E35586	LR31929					RW-2059	3-6
CRN Type 1 (colors)	E35586	LR31929†	/6	1			RT-360, Type 1	3-8
CRN Type 2 (clear)			/6	2			RT-360, Type 2	3-8
DCPT	E35586	LR31929					RW-2056	3-10
DR-25			/16				RT-1116	3-12
DWP-125	E35586	LR31929					DWP-125 SCD	3-14
ES1000	E85381						RT-1113	3-16
ES2000	E85381						RT-1112	3-18
ES Caps	E85381						RW-3006	3-20
HCTE							RT-1162	3-22
HF			/15	1**			RW-2023	3-26
HFT 5000							RW-2060	3-24
HRSR							RW-2013	3-28
HRNF							RW-2013	3-28
HRHF							RW-2013	3-28
HTAT							RW-2052	3-30
LSTT							RW-2051	3-32
MicroFit							MicroFit SCD	3-34
MT1000**							MT1000 SCD	3-36
MT2000**							MT2000 SCD	3-38
MT3000							MT3000 SCD	3-40
MT5000**							MT5000 SCD	3-42
NT	E35586	LR31929					RT-510	3-44
NTFR			/1	1 & 2			RW-3012	3-44
PD Caps	E85381						PD Caps SCD	3-46
RayBlock 85							RW-2101	3-48
RayBlock 105							RW-2102	3-50
Rayrim							RK-6182	3-56
RF-PETM								3-54
RF-PET								3-52
RF-PFR								3-52
RNF-100 Type 1 (colors)	E35586	LR31929	/5	1			RT-350, Type 1	3-58
RNF-100 Type 2 (clear)			/5	2			RT-350, Type 2	3-58
RNF-150	E85381 VV-1		/18	2			RT-370	3-60
RNF-3000	E35586	LR31929					RW-2053	3-62
RPPM							RK-6214	3-66
RP-4800	E35586		/5	1††			RT-1122	3-64
RT-3	E35586	LR31929†					RT-360†††	3-68
RT-375	E85381 VV-1	LR31929 VV-1	/18	2			RT-375	3-70
RT-555	E85381						RW-3013	3-72
RW-175	E35586 VV-1	LR31929 OFT	/8				RW-3029	3-74
SCL	E85381		/4	1			RT-1301	3-76
SCT							SCT SCD	3-78
SFR			/10		II	1	RW-3011	3-80
SRFR	E85381 VV-1						RW-2057	3-82
SST	E113638						RW-2011	3-84
SST-FR			/15	1 & 2			RW-2011	3-84
TAT-125 Type 1 (colors)	E85381		/4	2			TAT-125 SCD	3-86
TAT-125 Type 2 (clear)							TAT-125 SCD	3-86
TFE/TFE-R							RW-2054,RW-2055	3-88
TPEM							RK-6029	3-90
TUGA-GP							RW-2201	3-92
Versafit	E35586 VV-1	LR31929 OFT	/5	1 & 3			RW-3009	3-94
Versafit V	E35586 VV-1	LR31929 VV-1					RW-3022	3-96
Versafit V2	E35586 VV-1	LR31929 OFT					RW-3023	3-98
Versafit V4	E35586 VV-1	LR31929 OFT					RW-3010	3-100
Viton			/13				RT-1146	3-102
Viton-HW					III	1	RT-1145	3-102
XFFR							RW 2016	3-104
ZH-100							RW-2013	3-106
ZHTM							RW-2058	3-108

*Formerly MIL-I-23053 and MIL-DTL-23053 **Without adhesive †Black only ††Overexpanded †††With exception to dimensions and longitudinal change.

**Users should independently evaluate the suitability of the product for their application.
Before ordering check with factory for most current data.**



ATUM

High-shrink-ratio, adhesive-lined polyolefin tubing



Applications

Environmentally seals and protects a wide variety of electrical applications, including back end connector sealing, breakouts, and connector-to-cable transitions. High expansion ratio makes it possible to repair most damaged cable jackets without removing connectors.

Operating temperature range

-55°C to 110°C

Features and benefits

- 3:1 and 4:1 shrink ratios allow for connector-to-cable sealing.
- Tubing environmentally seals and protects components and interconnections.
- Medium wall provides increased mechanical protection.
- ATUM adhesive bonds to a wide variety of plastics, rubbers, and metals, including polyethylene, aluminum, steel, and copper.

Installation

Minimum shrink temperature: 80°C

Minimum full recovery temperature: 110°C

Available in:	Americas	Europe	Asia Pacific
	■	■	■

Specifications/approvals			
			
Series	UL**	Military	Raychem
ATUM	600V, 110°C	AMS-DTL-23053/4,* Class 3	RW-2063 - Black RK-6024 - Colors and clear

*Formerly MIL-I-23053/4 and MIL-DTL-23053/4.

**Black only, except sizes 3/1 and 4/1.

Fax-on-demand

US only (800) 260-9099

Outside US (650) 257-2301

Fax ID

2000

2001

Description

Data sheet

RW-2063

Visit our website at www.tycoelectronics.com**Product dimensions (mm/in)**

Size	Inside diameter		Recovered wall thickness**	
	Minimum expanded as supplied	Maximum recovered after heating	Total wall after heating	Adhesive wall after heating (nominal)
3:1				
3/1	3 (0.118)	1 (0.039)	1.00±0.28 (0.039±0.010)	0.50 (0.020)
4.5/1.5	4.5 (0.177)	1.5 (0.059)	1.10±0.25 (0.043±0.011)	0.50 (0.020)
6/2	6 (0.236)	2 (0.079)	1.00±0.28 (0.039±0.010)	0.50 (0.020)
9/3	9 (0.354)	3 (0.118)	1.40±0.28 (0.055±0.010)	0.61 (0.024)
12/4	12 (0.472)	4 (0.157)	1.78±0.38 (0.070±0.015)	0.76 (0.030)
19/6	19 (0.748)	6 (0.236)	2.25±0.55 (0.088±0.020)	0.76 (0.030)
24/8	24 (0.940)	8 (0.315)	2.54±0.55 (0.100±0.020)	1.02 (0.040)
40/13	40 (1.570)	13 (0.512)	2.54±0.55 (0.100±0.020)	1.02 (0.040)
4:1				
4/1	4 (0.157)	1 (0.039)	1.00±0.28 (0.039±0.010)	0.50 (0.020)
8/2	8 (0.315)	2 (0.079)	1.00±0.28 (0.039±0.010)	0.50 (0.020)
12/3	12 (0.472)	3 (0.118)	1.40±0.28 (0.055±0.010)	0.61 (0.024)
16/4	16 (0.630)	4 (0.157)	1.78±0.38 (0.070±0.015)	0.76 (0.030)
24/6	24 (0.945)	6 (0.236)	2.25±0.55 (0.088±0.020)	0.76 (0.030)
32/8	32 (1.260)	8 (0.315)	2.54±0.55 (0.100±0.020)	1.02 (0.040)
52/13	52 (2.050)	13 (0.512)	2.54±0.55 (0.100±0.020)	1.02 (0.040)

**Wall thickness will be less if tubing recovery is restricted during shrinkage.

Ordering information

Color	Standard	Black (-0)
	Nonstandard	Special order colors may be made available on request.
Size selection	Always order the largest size that will shrink snugly over the component to be covered. Special order sizes are available upon request.	
Standard packaging	In 1.2-meter (4-foot) lengths.	
Ordering description***	Specify product name, size and color (for example, ATUM 8/2-0).	

***For supply to MIL, Def Stan and BS add -MS, -DS or -BS to ordering description.

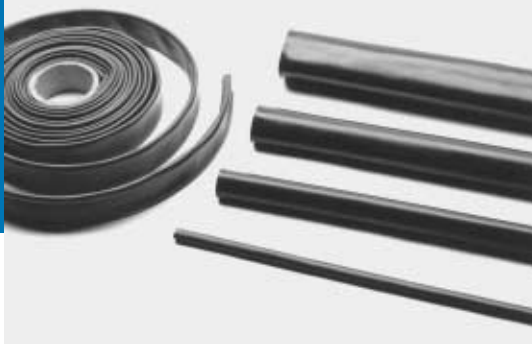

BSTS/BSTS-FR

General purpose, heat-shrinkable tubing



Applications

BSTS heat-shrinkable tubing is made of a rugged polymer that resists moisture, fungus, and weathering. It also has excellent electrical properties. This tubing is useful in applications where insulation, abrasion resistance, and strain relief are important. When used with SFTS tape sealant, it can provide a watertight system in nonpressurized applications.

Operating temperature range

-55°C to 90°C

Features and benefits

- Excellent thick-wall insulation and abrasion protection.
- No adhesive – can be removed easily.
- Expansion ratios as high as 3:1.
- Availability in flame-retardant material with FR callout (see “Ordering information and Part numbering system” on the next page).
- BSTS has the following agency approvals:
 - ABS (American Bureau of Shipping)
 - DNV (Det Norske Veritas)
 - Lloyd’s (Lloyd’s Register of Shipping)

Installation

Minimum shrink temperature: 90°C

Minimum full recovery temperature: 121°C

Available in:	Americas	Europe	Asia Pacific
	■	■	■

Specifications/approvals			
Series	Military	Industry	Raychem
BSTS			
BSTS-FR	AMS-DTL-23053/15*, Class 1 and Class 2**	ASTM D 685, nonburning ASTM D 2863, oxygen index IPCEA S-19-81, cable insulation and jackets	RW-2017

*Formerly MIL-H23053/15 and MIL-DTL-23053/15.

**Except for coatings requirement. Refer to SST-FR when coating is required.

Fax-on-demand

US only (800) 260-9099

Outside US (650) 257-2301

Fax ID

2300

Description

Data sheet

Visit our website at www.tycoelectronics.com**Product dimensions (mm/in)**

Size	Inside diameter		Wall thickness (nominal)	
	Minimum expanded as supplied	Maximum recovered after heating	Expanded as supplied	Recovered after heating****
BSTS-03	7.62 (0.300)	2.54 (0.100)	0.63 (0.025)	1.52 (0.060)
BSTS-04	10.16 (0.400)	3.81 (0.150)	0.63 (0.025)	1.52 (0.060)
BSTS-07M***	19.05 (0.750)	5.59 (0.220)	0.51 (0.020)	1.52 (0.060)
BSTS-07	19.05 (0.750)	5.59 (0.220)	0.76 (0.030)	2.41 (0.010)
BSTS-11M	27.94 (1.100)	9.52 (0.375)	0.76 (0.030)	2.67 (0.110)
BSTS-11	27.94 (1.100)	9.52 (0.375)	1.02 (0.040)	3.05 (0.120)
BSTS-13M	33.02 (1.300)	9.52 (0.375)	0.63 (0.025)	2.67 (0.110)
BSTS-13	33.02 (1.300)	9.52 (0.375)	0.89 (0.035)	3.05 (0.120)
BSTS-15M	38.10 (1.500)	12.70 (0.500)	0.89 (0.035)	3.05 (0.120)
BSTS-15	38.10 (1.500)	12.70 (0.500)	1.27 (0.050)	3.56 (0.140)
BSTS-17M	43.18 (1.700)	12.70 (0.500)	1.02 (0.040)	3.05 (0.120)
BSTS-17	43.18 (1.700)	12.70 (0.500)	1.14 (0.045)	3.56 (0.140)
BSTS-20M	50.80 (2.000)	19.05 (0.750)	1.27 (0.050)	3.05 (0.120)
BSTS-20	50.80 (2.000)	19.05 (0.750)	1.27 (0.050)	3.94 (0.160)
BSTS-27	65.58 (2.700)	22.86 (0.900)	1.27 (0.050)	3.94 (0.160)
BSTS-30	76.20 (3.000)	31.75 (1.250)	1.27 (0.050)	3.94 (0.160)
BSTS-35	88.90 (3.500)	31.75 (1.250)	1.27 (0.050)	3.94 (0.160)
BSTS-40	101.60 (4.000)	44.45 (1.750)	1.27 (0.050)	3.94 (0.160)
BSTS-45	114.30 (4.500)	44.45 (1.750)	1.27 (0.050)	3.94 (0.160)

M = Medium wall tubing. *Wall thickness will be less if tubing recovery is restricted during shrinkage.

Ordering information

Color	Standard	Black (-0)
	Nonstandard	Red (-2), white (-9), clear (-X not flame-retardant)
Size selection	Always order the largest size that will shrink snugly over the component to be covered. Special order sizes are available upon request.	
Standard packaging	1.2-meter (4-foot) or 7.5-meter (25-foot) lengths.	

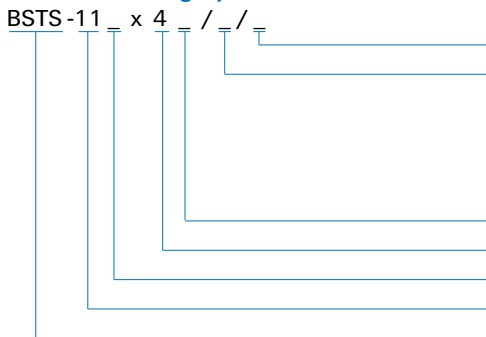
Part numbering system

"NM" - no mark

Color

Black / leave blank (standard)

White / WHT

Red / RED

Clear / CL

"FR" - flame-retardant

Length in feet ((4 and 25 feet standard))

"M" medium wall

Size**Family**

Users should independently evaluate the suitability of the product for their application.
Before ordering check with factory for most current data.



CGPT

General purpose, flame-retardant*, polyolefin tubing



Applications

CGPT is a tough, flexible, general purpose polyolefin tubing with good resistance to common fluids and solvents and a high dielectric strength. Its unique blend of chemical, electrical, and physical properties makes it suitable for a wide range of applications, including electrical insulation, strain relief, cable bundling, color-coding and identification of wires, cables, pipes, and electrical and electronic components, and mechanical protection.

Operating temperature range

-40°C to 135°C

Features and benefits

- 2:1 and 3:1 shrink ratio.
- Very good chemical and solvent resistance.
- Flexible.
- Excellent physical and electrical performance.

Installation

Minimum shrink temperature: 80°C

Minimum full recovery temperature: 120°C

Available in:

Americas

Europe

Asia Pacific



Specifications/approvals

Series	UL	CSA	Raychem
CGPT	E35586 600 V, 125°C	LR3 1929* 600 V, 125°C	RW-2059

*The clear product (-X) is not flame-retardant.

Fax-on-demand

US only (800) 260-9099

Outside US (650) 257-2301

Visit our website at www.tycoelectronics.com**Product dimensions (mm/in)**

Size	Inside diameter		Recovered wall thickness**	
	Minimum expanded as supplied		Maximum recovered after heating	After heating
2:1				
1.2/0.6	1.2 (0.047)		0.6 (0.024)	0.45 ± 0.12 (0.018 ± 0.005)
1.6/0.8	1.6 (0.062)		0.8 (0.031)	0.45 ± 0.12 (0.018 ± 0.005)
2.4/1.2	2.4 (0.093)		1.2 (0.046)	0.50 ± 0.12 (0.019 ± 0.005)
3.2/1.6	3.2 (0.125)		1.6 (0.062)	0.50 ± 0.12 (0.019 ± 0.005)***
4.8/2.4	4.8 (0.187)		2.4 (0.093)	0.50 ± 0.12 (0.019 ± 0.005)***
6.4/3.2	6.4 (0.250)		3.2 (0.125)	0.65 ± 0.15 (0.026 ± 0.006)***
9.5/4.8	9.5 (0.375)		4.8 (0.187)	0.65 ± 0.15 (0.026 ± 0.006)***
12.7/6.4	12.7 (0.500)		6.4 (0.250)	0.65 ± 0.15 (0.026 ± 0.006)***
19/9.5	19.0 (0.748)		9.5 (0.375)	0.75 ± 0.15 (0.029 ± 0.006)***
25.4/12.7	25.4 (1.000)		12.7 (0.500)	0.90 ± 0.20 (0.035 ± 0.008)***
32/16	32 (1.250)		16 (0.629)	0.95 ± 0.20 (0.037 ± 0.008)***
38/19	38.0 (1.496)		19.0 (0.748)	1.00 ± 0.20 (0.039 ± 0.008)***
51/26	51.0 (2.000)		26 (1.00)	1.15 ± 0.25 (0.045 ± 0.010)
76/38	76.0 (2.992)		38.0 (1.496)	1.25 ± 0.25 (0.049 ± 0.010)
102/51	102.0 (4.016)		51.0 (2.008)	1.40 ± 0.30 (0.055 ± 0.012)
3:1				
1.5/0.5	1.5 (0.059)		0.5 (0.020)	0.45 ± 0.12 (0.018 ± 0.005)***
3/1	3.0 (0.118)		1.0 (0.040)	0.55 ± 0.12 (0.022 ± 0.005)***
6/2	6.0 (0.236)		2.0 (0.079)	0.65 ± 0.12 (0.026 ± 0.005)***
9/3	9.0 (0.354)		3.0 (0.118)	0.75 ± 0.15 (0.030 ± 0.006)***
12/4	12.0 (0.472)		4.0 (0.157)	0.75 ± 0.15 (0.030 ± 0.006)***
18/6	18.0 (0.709)		6.0 (0.236)	0.85 ± 0.15 (0.033 ± 0.006)***
24/8	24.0 (0.945)		8.0 (0.315)	1.00 ± 0.20 (0.039 ± 0.008)***
39/13	39.0 (1.540)		13.0 (0.519)	1.15 ± 0.25 (0.045 ± 0.010)

**Wall thickness will be less if tubing recovery is restricted during shrinkage.

Ordering information

Color	Standard	Black (-0), white (-9), red (-2), blue (-6), yellow (-4), green (-5), clear (-X), yellow/green (-45) as indicated above by an ***
Size selection	Always order the largest size that will shrink snugly over the component to be covered. Special order sizes are available upon request.	
Standard packaging****	On spools.	
Ordering description	Specify product name, size and color (for example, CGPT 4.8/2.4-0).	

**** Available in the convenient RaySpool packaging/dispensing system for sizes

2:1 2.4/1.2 up to 25.4/12.7

3:1 3/1 up to 24/8

Users should independently evaluate the suitability of the product for their application.
Before ordering check with factory for most current data.



CRN

*Semirigid, flame-retardant,
polyolefin tubing*



Applications

Ideally suited for wire strain-relief applications such as soldered or crimped connections, wire splices, and terminations. Provides mechanical protection for delicate components. Can be used for component packaging and for rugged marking of cables.

Operating temperature range

-55°C to 135°C

Features and benefits

- 2:1 shrink ratio.
- High abrasion resistance.
- Transfer of flex stress away from typically weak points such as solder and crimp joints, helping ensure a reliable connection.
- Flame-retardance (colors only).
- Outstanding physical and electrical performance.
- Excellent chemical and solvent-resistance properties.

Installation

Minimum shrink temperature: 110°C

Minimum full recovery temperature: 135°C

Available in:



Americas

Europe

Asia Pacific



Specifications/approvals

Series	 UL	 CSA	Military	Raychem
CRN Type 1 (colors)	E35586 600 V, 125°C	LR3 1929 (black only) 600 V, 125°C	AMS-DTL-23053/6*, Class I Def. Stan. 59-97 Type 2C (not red)	RT-360, Type 1 RK-6003
CRN Type 2 (clear)			AMS-DTL-23053/6*, Class 2	RT-360, Type 2

*Formerly MIL-I-23053/6 and MIL-DTL-23053/6.

Fax-on-demand

US only (800) 260-9099

Outside US (650) 257-2301

Fax ID

2020

2021

Description

Data sheet

RT-360

Visit our website at www.tycoelectronics.com**Product dimensions (mm/in)**

Size	Inside diameter		Recovered wall thickness**
	Minimum expanded as supplied	Maximum recovered after heating	After heating
3/64	1.2 (0.046)	0.6 (0.023)	0.51 ± 0.08 (0.020 ± 0.003)
1/16	1.6 (0.063)	0.8 (0.031)	0.51 ± 0.08 (0.020 ± 0.003)
3/32	2.4 (0.093)	1.2 (0.046)	0.51 ± 0.08 (0.020 ± 0.003)
1/8	3.2 (0.125)	1.6 (0.062)	0.51 ± 0.08 (0.020 ± 0.003)
3/16	4.8 (0.187)	2.4 (0.093)	0.64 ± 0.08 (0.025 ± 0.003)
1/4	6.4 (0.250)	3.2 (0.125)	0.64 ± 0.08 (0.025 ± 0.003)
3/8	9.5 (0.375)	4.8 (0.187)	0.76 ± 0.08 (0.030 ± 0.003)
1/2	12.7 (0.500)	6.4 (0.250)	0.76 ± 0.08 (0.030 ± 0.003)
3/4	19.1 (0.750)	9.5 (0.375)	0.89 ± 0.12 (0.035 ± 0.005)

**Wall thickness will be less if tubing recovery is restricted during shrinkage.

Ordering information

Color	Standard	Black (-0)
	Nonstandard	White (-9), red (-2), blue (-6), yellow (-4), green (-5), brown (-1), orange (-3), violet (-7), gray (-8), clear (-X, not flame-retardant)
Size selection	Always order the largest size that will shrink snugly over the component to be covered. Special order sizes are available upon request.	
Standard packaging	In 1.2-meter (4-foot) lengths.	
Ordering description***	Specify product name, size and color (for example, CRN 1/4-0).	

***Europe only. For supply to MIL, Def Stan and BS add -MS, -DS or -BS to ordering description.

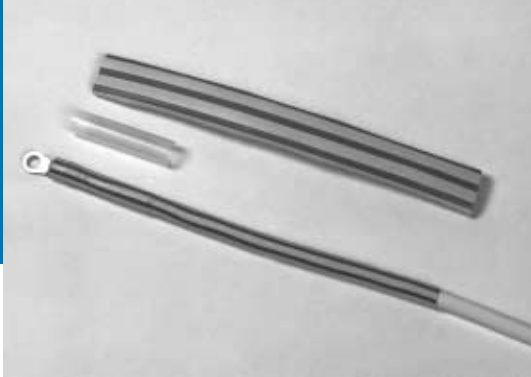

DCPT

Flexible, flame-retardant, dual-color, polyolefin tubing



Applications

Used to identify "ground" on wires and in cables, and to jacket and insulate light-duty harnesses. Easily marked by conventional techniques for additional identification of wire and cable.

Operating temperature range

-55°C to 135°C

Features and benefits

- 2:1 and 3:1 shrink ratio.
- Dual colors (yellow/green) for instant identification.
- Co-extrusion of tubing colors, giving color permanence superior to that of conventional ink marking.
- Flame-retardance.
- Flexibility: able to conform to irregular shapes.
- Excellent physical, chemical, and electrical properties that meet industry standards for highly reliable, general purpose tubing.

Installation

Minimum shrink temperature: 95°C

Minimum full recovery temperature: 120°C

Available in:

Americas

Europe

Asia Pacific



Specifications/approvals

Series	 UL	 CSA	Military	Agency	Raychem
DCPT	E35586 600 V, 125°C	LR31929 600 V, 125°C	Def Stan 59-97 Issue 3 Type 2B VG 95343 Pt 5 Type A	AFS 2270 DIN 29807 VDE 0341 Pt 9005 Type A	RW-2056

Fax-on-demand

US only (800) 260-9099

Outside US (650) 257-2301

Fax ID

2030

Description

Data sheet

Visit our website at www.tycoelectronics.com**Product dimensions (mm/in)**

Size	Inside diameter		Recovered wall thickness*
	Minimum expanded as supplied	Maximum recovered after heating	After heating
2:1			
3/1.5	3 (0.118)	1.5 (0.059)	0.51 ± 0.10 (0.020 ± 0.004)
6/3	6 (0.236)	3.0 (0.118)	0.58 ± 0.10 (0.025 ± 0.004)
8/4	8 (0.315)	4.0 (0.158)	0.64 ± 0.10 (0.025 ± 0.004)
10/5	10 (0.394)	5.0 (0.197)	0.64 ± 0.10 (0.025 ± 0.004)
12/6	12 (0.472)	6.0 (0.236)	0.64 ± 0.10 (0.025 ± 0.004)
19/9	19 (0.748)	9.0 (0.354)	0.76 ± 0.12 (0.030 ± 0.005)
26/13	26 (1.024)	13.0 (0.512)	0.89 ± 0.12 (0.035 ± 0.005)
38/19	38 (1.500)	19.0 (0.748)	1.00 ± 0.12 (0.039 ± 0.005)
51/19	51 (2.000)	19.0 (0.748)	1.02 ± 0.15 (0.040 ± 0.006)
3:1 (Europe only)			
3/1	3.0 (0.118)	1.0 (0.039)	0.55 ± 0.10 (0.022 ± 0.004)
6/2	6.0 (0.236)	2.0 (0.079)	0.65 ± 0.10 (0.026 ± 0.004)
9/3	9.0 (0.354)	3.0 (0.118)	0.75 ± 0.15 (0.030 ± 0.006)
12/4	12.0 (0.472)	4.0 (0.157)	0.75 ± 0.15 (0.030 ± 0.006)
18/6	18.0 (0.709)	6.0 (0.236)	0.85 ± 0.15 (0.033 ± 0.006)
24/8	24.0 (0.945)	8.0 (0.315)	1.00 ± 0.20 (0.039 ± 0.008)

*Wall thickness will be less if tubing recovery is restricted during shrinkage.

Ordering information

Color	Standard	Yellow/green stripe (-45)
Size selection	Always order the largest size that will shrink snugly over the component to be covered. Special order sizes are available upon request.	
Standard packaging	On spools.	
Ordering description**	Specify product name, size and color (for example, DCPT 8/4-45).	

**Europe only. For supply to Def Stan and BS add -DS or -BS to ordering description.



DR-25

Heat-shrinkable, flexible, chemical and abrasion resistant tubing



Applications

Specially formulated for optimum high temperature fluid resistance, and long term heat resistance. Resistant to aviation and diesel fuels, hydraulic fluids and lubricating oils.

Particularly suitable as a jacketing material for military ground vehicle cables and harnesses. It is also ideally suited for the demands of motorsport cable harnesses. When used in conjunction with System 25 heat-shrinkable molded shapes and S1125 high performance adhesive, these products provide a complete cable harness system.

Operating temperature range

-75°C to 150°C (per VG 95343 Part 5 Type D)

Features and benefits

- Flame-retardant.
- System-25 tubing.
- Shrink ratio 2:1.

Installation

Minimum full recovery temperature: 175°C

Available in:	Americas	Europe	Asia Pacific
	■	■	■

Specifications/approvals		
Series	Military	Raychem
DR-25	AMS-DTL-23053/16*	RT-1116
	VG95343 Part 5 Type D	RK 6008/1
	VDE 0341/Pt 9005	
	Def Stan 59-97 Issue 3 Type 6B	
	BS 4G-198 Part 3 10A	

*Formerly MIL-23053/16 and MIL-DTL-23053/16.

Fax-on-demand

US only (800) 260-9099

Outside US (650) 257-2301

Fax ID

2040

2041

Description

Data sheet

RT-1 1 1 16

Visit our website at www.tycoelectronics.com**Product dimensions (mm/in)**

Size	Inside diameter		Recovered wall thickness**
	Minimum expanded as supplied	Maximum recovered after heating	After heating
1/8	3.2 (0.125)	1.6 (0.063)	0.76 ± 0.15 (0.030 ± 0.006)
3/16	4.8 (0.187)	2.4 (0.093)	0.84 ± 0.15 (0.033 ± 0.006)
1/4	6.4 (0.250)	3.2 (0.125)	0.89 ± 0.15 (0.035 ± 0.006)
3/8	9.5 (0.375)	4.8 (0.187)	1.02 ± 0.20 (0.040 ± 0.008)
1/2	12.7 (0.500)	6.4 (0.250)	1.22 ± 0.20 (0.048 ± 0.008)
3/4	19.0 (0.748)	9.5 (0.375)	1.45 ± 0.28 (0.057 ± 0.011)
1	25.4 (1.000)	12.7 (0.500)	1.78 ± 0.28 (0.070 ± 0.011)
1 1/2	38.0 (1.500)	19.0 (0.748)	2.41 ± 0.41 (0.095 ± 0.016)
2	51.0 (2.000)	25.4 (1.000)	2.79 ± 0.41 (0.110 ± 0.016)
3	76.0 (3.000)	38.0 (1.500)	3.18 ± 0.50 (0.125 ± 0.020)

**Wall thickness will be less if tubing recovery is restricted during shrinkage.

Ordering information

Color	Standard	Black (-0)
Size selection	Always order the largest size that will shrink snugly over the component to be covered. Special order sizes are available upon request.	
Standard packaging	On spools.	
Ordering description***	Specify product name, size and color (for example, DR-25-1/8-0)	

***Europe only. For supply to Def Stan and BS add -DS or -BS to ordering description.



DWP-125

Flexible, high-shrink-ratio, adhesive-lined, polyolefin tubing



Applications

Environmentally seals and protects a wide variety of electrical applications, including wire splices, breakouts, and connector-to-cable transitions. Ideal for applications where UL recognized/CSA certified adhesive-lined tubing is required.

Operating temperature range

-40°C to 110°C

Features and benefits

- 3:1 shrink ratio allows for insulation and sealing of irregular shapes.
- Medium wall provides increased mechanical protection while maintaining flexibility when installed.
- Adhesive bonds to a wide variety of plastics, rubber, and metals, including polyethylene, neoprene, and steel.

Installation

Minimum shrink temperature: 80°C

Minimum full recovery temperature: 125°C

Available in:	Americas	Europe	Asia Pacific
	■	■	■

Specifications/approvals			
Series	UL	CSA	Raychem
DWP-125	E35586 600 V, 125°C	LR31929 600 V, 125°C	DWP-125 SCD

Fax-on-demand

US only (800) 260-9099

Outside US (650) 257-2301

Fax ID

2050

2051

Description

Data sheet

SCD

Visit our website at www.tycoelectronics.com**Product dimensions (mm/in)**

Size	Inside diameter		Recovered wall thickness*	
	Minimum expanded as supplied	Maximum recovered after heating	Nominal total wall after heating	Nominal adhesive wall after heating
1/8	3.2 (0.125)	1.0 (0.040)	1.02 (0.040)	0.25 (0.010)
3/16	4.8 (0.187)	1.5 (0.060)	1.40 (0.055)	0.51 (0.020)
1/4	6.4 (0.250)	2.0 (0.080)	1.45 (0.057)	0.56 (0.022)
3/8	9.5 (0.375)	3.0 (0.120)	1.65 (0.065)	0.68 (0.027)
1/2	12.7 (0.500)	4.0 (0.157)	1.78 (0.070)	0.76 (0.030)
3/4	19.1 (0.750)	6.0 (0.230)	2.03 (0.080)	0.76 (0.030)
1	25.4 (1.000)	8.0 (0.320)	2.50 (0.100)	0.76 (0.030)

*Wall thickness will be less if tubing recovery is restricted during shrinkage.

Ordering information

Color	Standard	Black (-0)
	Nonstandard	White (-9), red (-2), blue (-6), yellow (-4), green (-5). Other colors available upon request.
Size selection	Always order the largest size that will shrink snugly over the component to be covered. Special order sizes are available upon request.	
Standard packaging	In 1.2-meter (4-foot) lengths.	
Ordering description	Specify product name, size and color (for example, DWP-125 1/4-0).	

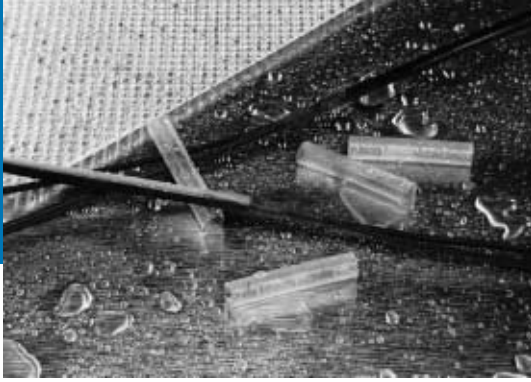

ES1000

Clear, high-shrink-ratio, adhesive-lined, semirigid polyolefin tubing



Applications

Specially designed for environmental sealing and electrical insulation of wire splices, terminations, and components where see-through inspection is required.

Operating temperature range

-40°C to 130°C

Features and benefits

- 4:1 shrink ratio allows a few sizes to cover a wide range of splice and component diameters.
- Mechanically tough tubing provides strain relief and abrasion protection of wire splices, terminals and other components.
- Thick adhesive liner forms an effective barrier against fluids and moisture and performs well at an extended temperature range.

Installation

Minimum shrink temperature: 110°C

Minimum full recovery temperature: 135°C

Available in:

Americas

Europe

Asia Pacific



Specifications/approvals

Series	UL	Raychem
ES1000	E85381 600 V, 125°C	RT-1113

Fax-on-demand

US only (800) 260-9099
 Outside US (650) 257-2301

Fax ID

2550
 2551

Description

Data sheet
 RT-1113

Visit our website at www.tycoelectronics.com

Product dimensions (mm/in)

Part Number	Inside diameter (including core)		Recovered wall thickness*		
	Minimum expanded as supplied	Maximum recovered after heating	Minimum total wall after heating	Minimum jacket wall after heating	Minimum adhesive wall after heating
ES1000-No.1	5.72 (0.225)	1.27 (0.050)	1.20 (0.047)	0.64 (0.025)	0.56 (0.022)
ES1000-No.2	7.44 (0.293)	1.65 (0.065)	1.52 (0.060)	0.76 (0.030)	0.76 (0.030)
ES1000-No.3	10.85 (0.427)	2.41 (0.095)	1.91 (0.075)	0.89 (0.035)	1.02 (0.040)
ES1000-No.4	17.78 (0.700)	4.45 (0.175)	2.41 (0.095)	1.04 (0.041)	1.37 (0.054)

*Wall thickness will be less if tubing recovery is restricted during shrinkage.

Ordering information

Color	Standard	Clear (-X)
Size selection	Always order the largest size that will shrink snugly over the component to be covered.	
Standard packaging	Cut pieces.	
Marking	Tubing will be printed with its numbered size (such as ES-1, ES-2, ES-3, or ES-4).	
Ordering description	Specify product name, numbered size, color, and cut length (for example, ES1000-No. 2-X-50mm).	

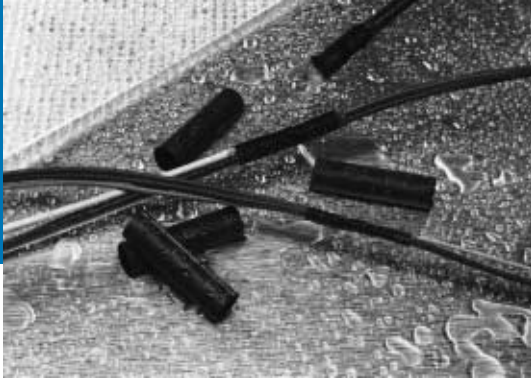

ES2000

Flame-retardant, high-shrink-ratio, adhesive-lined semirigid polyolefin tubing



Applications

Specially designed for environmental sealing and electrical insulation of wire splices, terminations, and components.

Operating temperature range

-40°C to 130°C

Features and benefits

- 4:1 shrink ratio allows a few sizes to cover a wide range of splice and component diameters.
- Flame-retardant and mechanically tough, the tubing provides strain relief and abrasion protection of wire splices, terminals, and other components.
- Thick adhesive liner forms an effective barrier against fluids and moisture and performs well at an extended temperature range.
- UL recognized.

Installation

Minimum shrink temperature: 110°C

Minimum full recovery temperature: 135°C

Available in:

Americas

Europe

Asia Pacific



Specifications/approvals

Series		Raychem
ES2000	E85381 600 V, 125°C	RT-1112

Fax-on-demand

US only (800) 260-9099

Outside US (650) 257-2301

Fax ID

2560

2561

Description

Data sheet

RT-1 1 1 2

Visit our website at www.tycoelectronics.com**Product dimensions (mm/in)**

Part Number	Inside diameter (including core)		Recovered wall thickness*		
	Minimum expanded as supplied	Maximum recovered after heating	Minimum total wall after heating	Minimum jacket wall after heating	Minimum adhesive wall after heating
ES2000-No.1	5.72 (0.225)	1.27 (0.050)	1.20 (0.047)	0.64 (0.025)	0.56 (0.022)
ES2000-No.2	7.44 (0.293)	1.65 (0.065)	1.52 (0.060)	0.76 (0.030)	0.76 (0.030)
ES2000-No.3	10.85 (0.427)	2.41 (0.095)	1.91 (0.075)	0.89 (0.035)	1.02 (0.040)
ES2000-No.4	17.78 (0.700)	4.45 (0.175)	2.41 (0.095)	1.04 (0.041)	1.37 (0.054)

*Wall thickness will be less if tubing recovery is restricted during shrinkage.

Ordering information

Color	Standard	Black (-0)
Size selection	Always order the largest size that will shrink snugly over the component to be covered.	
Standard packaging	Cut pieces.	
Marking	Tubing will be printed with its numbered size (such as ES-1, ES-2, ES-3, or ES-4).	
Ordering description	Specify product name, numbered size, color, and cut length (for example, ES2000-No. 2-0-50mm).	



ES Caps

High-shrink-ratio, adhesive-lined, semirigid polyolefin caps



Applications

Specially designed to provide mechanical and environmental protection of stub splices in electrical harnesses. Clear caps allow see-through inspection; black caps are flame-retardant.

Operating temperature range

-40°C to 105°C

Features and benefits

- 4:1 shrink ratio allows a few sizes to cover a wide range of splice and component diameters.
- Mechanically tough jacket provides strain relief and abrasion protection.
- Thick adhesive liner forms an effective barrier against fluids and moisture and performs well at an extended temperature range.

Installation

Minimum shrink temperature: 100°C

Minimum full recovery temperature: 135°C

Available in:

Americas

Europe

Asia Pacific



Specifications/approvals

Series



UL

Raychem

ES Caps

E85381

RW-3006

600 V, 125°C

Fax-on-demand

US only (800) 260-9099

Outside US (650) 257-2301

Fax ID

2616

2617

Description

Data sheet

RW-3006

Visit our website at www.tycoelectronics.com**Product dimensions (mm/in)**

Part Number	Standard length* as supplied (millimetres)	Inside diameter (including core)		Recovered wall thickness**		
		Minimum expanded as supplied	Maximum recovered after heating	Minimum total wall after heating	Minimum jacket wall after heating	Minimum adhesive wall after heating
ES Cap-No.1	30, 35	5.72 (0.225)	1.27 (0.050)	1.20 (0.047)	0.64 (0.025)	0.56 (0.022)
ES Cap-No.2	30, 35	7.44 (0.293)	1.65 (0.065)	1.52 (0.060)	0.76 (0.030)	0.76 (0.030)
ES Cap-No.3	40, 50	10.85 (0.427)	2.41 (0.095)	1.91 (0.075)	0.89 (0.035)	1.37 (0.054)

*Other cap lengths available upon request.

**Wall thickness will be less if cap recovery is restricted during shrinkage.

Ordering information

Color	Standard	Black (-O), clear (-X)
Size selection	Always order the largest size that will shrink snugly over the component to be covered. Other cap lengths available on request.	
Standard packaging	In pieces.	
Marking	Caps will be marked with the numbered sizes (such as ES-1, ES-2, or ES-3).	
Ordering description	Specify product name, size, color, and length (for example, ES CAP-No. 2-X-35mm).	



HCTE

Helical convoluted tubing with a high crush resistance



Applications

Used as a conduit to provide mechanical protection for electrical wiring systems in applications requiring flexibility, high-temperature performance and good resistance to a variety of fluids. Widely used in the military and commercial aerospace industries. Can be used in conjunction with other Raychem components to form an integrated harnessing system.

Operating temperature range

-55°C to 200°C

Features and benefits

- Highly flame-retardant.
- Highly flexible and fluid resistant.
- Not heat-shrinkable.
- High crush resistance.
- System 300 conduit tubing.

Installation

It is recommended that no more than 70% of the internal area ("fill factor") of the HCTE conduit be occupied by wires in any application.

<i>Available in:</i>	Americas	Europe	Asia Pacific
	■	■	■

<i>Specifications/approvals</i>		
Series	Military	Raychem
HCTE	VG 96936 Part 6	RT-1 162

Fax-on-demand

US only (800) 260-9099
 Outside US (650) 257-2301

Fax ID

2060
 2061

Description

Data sheet
 RT-1 162

Visit our website at www.tycoelectronics.com

Product dimensions (mm/in)

Size	Minimum ID	Maximum OD	Maximum wall thickness
0187	4.6 (0.181)	8.1 (0.320)	0.46 (0.018)
0281	6.9 (0.273)	10.5 (0.414)	0.46 (0.018)
0312	7.7 (0.306)	11.8 (0.450)	0.46 (0.018)
0375	9.2 (0.364)	12.9 (0.510)	0.46 (0.018)
0437	10.8 (0.427)	14.5 (0.571)	0.46 (0.018)
0500	12.3 (0.485)	16.5 (0.650)	0.58 (0.023)
0625	15.4 (0.608)	19.5 (0.770)	0.58 (0.023)
0750	17.9 (0.730)	23.6 (0.930)	0.58 (0.023)
0875	21.8 (0.860)	27.2 (1.073)	0.58 (0.023)
1000	24.7 (0.975)	31.1 (1.226)	0.58 (0.023)
1250	30.7 (1.210)	35.3 (1.539)	0.58 (0.023)
1500	36.5 (1.437)	46.5 (1.832)	0.58 (0.023)
1625	39.6 (1.562)	50.17 (1.975)	0.58 (0.023)
1750	42.67 (1.688)	52.88 (2.082)	0.58 (0.023)
2000	49.20 (1.937)	59.23 (2.332)	0.58 (0.023)

Ordering information

Color	Standard	Black (-0)
Size selection	Always order a conduit size that will ensure that a "fill factor" of 70% is not exceeded.	
Standard packaging	On spools.	
Ordering description	Specify product name, size and color (for example, HCTE-O187-0).	



HFT5000

Heat-shrinkable fabric tubing



Applications

Designed primarily to provide mechanical abrasion protection for components such as rubber hoses, plastic pipes, and harness wiring bundles. Also suitable for other applications, such as noise and rattle suppression.

The woven construction makes HFT5000 extremely flexible and resistant to trapping water, heat and humidity. Provides outstanding abrasion, chafing and cutting protection, even at high temperatures.

Operating temperature range

3000 hours: -40°C to 125°C

1000 hours: -40°C to 150°C

Features and benefits

- Highly flexible woven fabric tubing.
- Polyethylene/polyester construction for excellent abrasion resistance.
- Halogen free.
- Heat-shrinkable, to grip substrates tightly without additional fixing.
- 2:1 shrink ratio for easy installation onto different substrate diameters and sizes.
- Highly flexible woven construction for easy, compliant installation onto awkward substrates such as bent hoses.
- Outstanding abrasion resistance over a wide temperature range.
- Easily cut with standard industrial cutting equipment.
- Resistance to harsh environments.
- Multifilament construction that ensures soft, safe handling.
- Low shrink temperature for safe installation onto heat sensitive substrates.

Installation

Minimum shrink temperature: 80°C

Minimum full recovery temperature: 110°C

Maximum storage temperature: 60°C

Available in:	Americas	Europe	Asia Pacific
	■	■	■

Specifications/approvals	
Series	Raychem
HFT5000	RW-2060

Fax-on-demand

US only (800) 260-9099

Outside US (650) 257-2301

Fax ID

2618

2619

Description

Data sheet

RW-2060

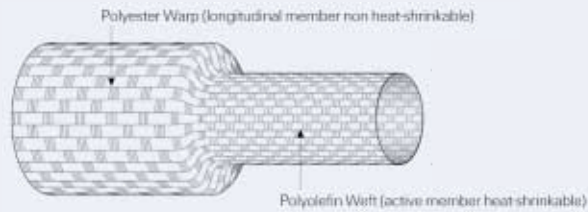
Visit our website at www.tycoelectronics.com**Product dimensions (mm/in)**

Standard sizes	Inside diameter	
	Minimum expanded as supplied	Maximum recovered after heating
12/6	12 (0.47)	6 (0.24)
20/10	20 (0.79)	10 (0.39)
30/15	30 (1.18)	15 (0.59)
40/20	40 (1.57)	20 (0.79)
50/25	50 (1.97)	25 (0.98)
60/30	60 (2.36)	30 (1.18)
70/35	70 (2.76)	35 (1.38)

Non-standard high volume sizes	Inside diameter	
	Minimum expanded as supplied	Maximum recovered after heating
25/12	25 (0.98)	12 (0.47)
34/17	34 (1.34)	17 (0.67)
80/40	80 (3.15)	40 (1.57)

Ordering information

Color	Standard	Black (-0)
Standard packaging	On spools.	
Ordering description	Specify product name, size and color (for example, HFT5000-12/6-0).	

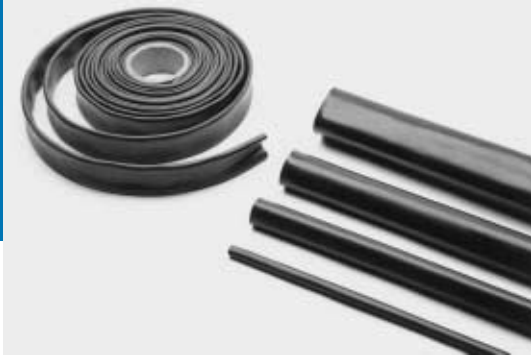

HF

*High-flex, heavy-wall,
heat-shrinkable tubing*



Applications

Developed for cable jacketing applications where cable flexibility is important, high-flex (HF) tubing is ideal for jacketing cables where sharp bends or turns are required. Also ideal for situations where the cable is subject to motion. Such situations are common for industrial machinery, transportation equipment, robotics, welding, and many other cabling applications. To complete the cable jacket seal, the ends may be sealed for further water and corrosion protection by using available tape sealant or adhesive.

Operating temperature range

-55°C to 90°C

Features and benefits

- Offers high flexibility.
- Provides excellent insulation and abrasion-protection, per U.S. Mine Safety and Health Administration (MSHA) regulations.
- Flame-retardant.
- HF has the following agency approvals:
 - ABS (American Bureau of Shipping)
 - DNV (Det Norske Veritas)
 - Lloyd's (Lloyd's Register of Shipping)

Installation

Minimum shrink temperature: 80°C

Minimum full recovery temperature: 121°C

Available in:

Americas

Europe

Asia Pacific

Specifications/approvals

Series	Military	Raychem
HF	AMS-DTL-23053/15* Class 1**	RW-2023

*Formerly MIL-I-23053/15 and MIL-DTL-23053/15.

**Except for coatings requirement.

Fax-on-demand

US only (800) 260-9099

Outside US (650) 257-2301

Fax ID

2280

Description

Data sheet

Visit our website at www.tycoelectronics.com**Product dimensions**

Size	Standard nominal length (m/ft)	Inside diameter (mm/in)		Recovered wall thickness (mm/in)**
		Minimum expanded as supplied	Maximum recovered after heating	Nominal after heating
HF04	1.2, 7.5 (4, 25)	10.16 (0.40)	3.81 (0.150)	1.52 (0.060)
HF07	1.2, 7.5 (4, 25)	19.05 (0.75)	5.59 (0.220)	1.52 (0.060)
HF11	1.2, 7.5 (4, 25)	27.94 (1.10)	9.52 (0.375)	2.67 (0.105)
HF13	1.2, 7.5 (4, 25)	33.02 (1.30)	9.52 (0.375)	2.67 (0.105)
HF15	1.2, 7.5 (4, 25)	38.10 (1.50)	12.70 (0.500)	3.05 (0.120)
HF17	1.2, 7.5 (4, 25)	43.14 (1.70)	12.70 (0.500)	3.05 (0.120)
HF20	1.2, 7.5 (4, 25)	50.80 (2.00)	19.05 (0.750)	3.56 (0.140)
HF27	1.2, 7.5 (4, 25)	68.58 (2.70)	22.86 (0.900)	3.94 (0.155)

**Wall thickness will be less if tubing recovery is restricted during shrinkage.

Ordering information and part numbering system

HF - 17 FR X 4 / _

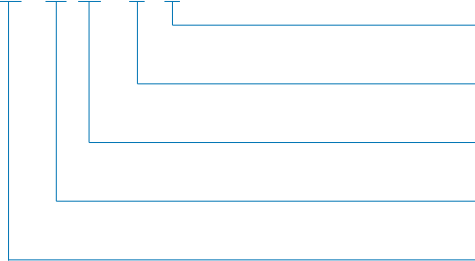

Contact factory for other than standard lengths.
Standard color is black.



HRHF/HRNF/HRSR

High-ratio, heat-shrinkable tubing



Applications

High-ratio (HR) heat-shrinkable tubing, with expansion ratios as high as 5.6 to 1, is designed to accommodate large size differences between cables and cable connectors and backshells, thus simplifying repair of damaged cable. High-ratio tubing is available in semirigid flame-retardant (SR), standard (NF), or high-flex flame-retardant (HF) material and with or without factory-applied sealants and adhesives. The waterproofing sealant provides environmental sealing and is watertight in wet and corrosive locations per USCG CGHQ-3774. The thermoplastic adhesive coating offers excellent strain relief and environmental sealing.

Operating temperature range

-55°C to 90°C

Features and benefits

- Offers toughness and durability.
- Provides excellent insulation and abrasion-protection.
- Is available in flame-retardant material.
- Shrinks to fit (5.6:1).
- FR callouts meet the flame-retardant-material requirements of AMS-DTL-23053/15*.
- HRHF and HRSR have the following agency approvals:
 - ABS (American Bureau of Shipping)
 - DNV (Det Norske Veritas)
 - Lloyd's (Lloyd's Register of Shipping)

Installation

Minimum shrink temperature: 80°C
 Minimum full recovery temperature: 121°C

Available in:	Americas	Europe	Asia Pacific
	■	■	■

Specifications/approvals

Series	Military	Agency	Raychem
HRSR	AMS-DTL-23053/15*	ABS, DNV, Lloyd's	RW-2013
HRHF	AMS-DTL-23053/15*	ABS, DNV, Lloyd's	RW-2013
HRNF			

*Formerly MIL-I-23053/15 and MIL-DTL-23053/15.

Product dimensions (mm/in)

Size†	Inside diameter		Recovered wall thickness††
	Minimum expanded as supplied	Maximum recovered after heating	
HR**060	15.24 (0.60)	3.81 (0.150)	1.52 (0.060)
HR**125	31.75 (1.25)	5.59 (0.220)	1.52 (0.060)
HR**175	44.45 (1.75)	8.00 (0.315)	2.41 (0.095)
HR**200	50.80 (2.00)	9.52 (0.375)	2.67 (0.105)
HR**250	63.50 (2.50)	12.70 (0.500)	3.05 (0.120)
HR**300	76.20 (3.00)	19.05 (0.750)	3.05 (0.120)
HR**400	101.60 (4.00)	22.86 (0.900)	3.56 (0.140)

†For ** substitute HF, NF or SR for material required. Add FR to end of number for flame-retardant material.

††Wall thickness will be less if tubing recovery is restricted during shrinkage.

Fax-on-demand

US only (800) 260-9099
 Outside US (650) 257-2301

Fax ID

2270

Description

Data sheet

Visit our website at www.tycoelectronics.com

Ordering information

Color	Standard	Black (-0)
	Nonstandard	Clear (-X) available on request (not flame-retardant)
Size selection	Always order the largest size that will shrink snugly over the component to be covered. Other sizes are available upon request.	
Standard packaging	10-inch-maximum* lengths.	

*Cutting tolerance is ±1/8 inch.

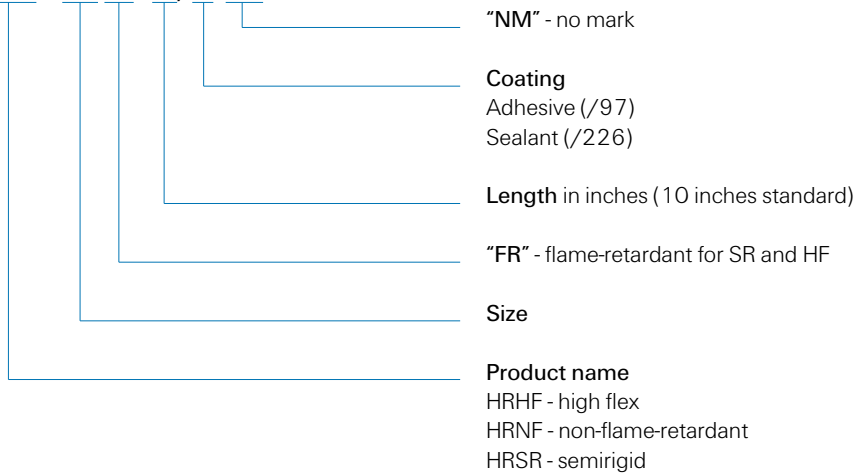
Part numbering system - military approved part numbers**HRHF - 125 FR - 10/97 NM**



HTAT

Semiflexible, dual-wall, moisture-resistant, heat-shrinkable tubing



Applications

Designed to provide environmental sealing for a range of substrates, at elevated temperatures. Manufactured by Tyco Electronics from radiation-crosslinked polyolefins, the inner wall melts when heated and is forced into interstices by the shrinking of the outer wall so that, when cooled, the substrate is encapsulated by a tough, protective moisture barrier. An operating range of -55°C up to 125°C and a high shrink ratio as standard, mean that the tubing offers superior environmental protection to a wide range of irregular shapes with varying dimensions. The jacket is flame-retardant to reduce flame propagation.

Operating temperature range

-55°C to 125°C

Features and benefits

- 4:1 shrink ratio.
- Environmental sealing.
- High-strength bonding.
- Ideal connector sealing covering large diameter differences.

Installation

Minimum shrink temperature: 80°C

Minimum full recovery temperature: 110°C

Available in:

Americas

Europe

Asia Pacific



Specifications/approvals

Series

Raychem

HTAT

RW-2052

Fax-on-demand	Fax ID	Description
US only (800) 260-9099	2620	Data sheet
Outside US (650) 257-2301	2621	RW-2052

Visit our website at www.tycoelectronics.com

Product dimensions (mm/in)

Size	Inside diameter		Recovered wall thickness*	
	Minimum expanded as supplied	Maximum recovered after heating	Total wall after heating	Nominal adhesive wall after heating
4/1	4.0 (0.158)	1.0 (0.039)	1.00 (0.039)	0.40 (0.016)
8/2	8.0 (0.315)	2.0 (0.079)	1.00 (0.039)	0.50 (0.019)
12/3	12.0 (0.472)	3.0 (0.118)	1.40 (0.055)	0.60 (0.024)
16/4	16.0 (0.630)	4.0 (0.158)	1.75 (0.071)	0.75 (0.030)
24/6	24.0 (0.945)	6.0 (0.236)	2.25 (0.089)	0.80 (0.032)
32/8	32.0 (1.260)	8.0 (0.315)	2.50 (0.100)	1.00 (0.039)
48/13	48.0 (1.890)	13.0 (0.512)	2.55 (0.100)	1.00 (0.039)

*Wall thickness will be less if tubing recovery is restricted during shrinkage.

Ordering information

Color	Standard Black (-0)
Size selection	Always order the largest size that will shrink snugly over the component to be covered. Special order sizes are available upon request.
Standard packaging	In 1.2-meter (4-foot) lengths.
Ordering description	Specify product name, size and color (for example, HTAT 8/2-0).



LSTT

Low-shrink-temperature, non-flame-retardant, heat-shrinkable, polyolefin tubing



Applications

LSTT is a highly flexible, low-shrink-temperature, heat-shrinkable tubing. Its low shrink temperature offers exceptionally fast recovery for maximum efficiency in high-volume commercial applications and makes it suitable for use on or near delicate, temperature-sensitive materials, such as PVC jacketed wire and cable. Although not flame-retardant, LSTT meets the automotive flame propagation standard MVSS 302. Typical applications include electrical termination insulation, color-coding, covering of heat-sensitive devices, cosmetic coverings, and mechanical protection.

Features and benefits

- 2:1 shrink ratio.
- Rapid recovery at low temperatures.
- Can be used with temperature-sensitive materials.
- Flexible.
- Not flame-retardant.
- Excellent physical and electrical performance.

Installation

Minimum shrink temperature: 65°C
 Minimum full recovery temperature: 110°C

Operating temperature range

-40°C to 125°C

Available in:	Americas	Europe	Asia Pacific
		■	

Specifications/approvals		
Series	Industry	Raychem
LSTT	MVSS302	RW-205 1

Fax-on-demand

US only (800) 260-9099

Outside US (650) 257-2301

Visit our website at www.tycoelectronics.com**Product dimensions (mm/in)**

Size	Inside diameter		Recovered wall thickness*
	Minimum expanded as supplied	Maximum recovered after heating	After heating
1.6	1.6 (0.063)	0.8 (0.031)	0.50 ± 0.12 (0.018 ± 0.005)
2.4	2.4 (0.093)	1.2 (0.046)	0.55 ± 0.12 (0.022 ± 0.005)
3.2	3.2 (0.125)	1.6 (0.062)	0.55 ± 0.12 (0.022 ± 0.005)
4.8	4.8 (0.187)	2.4 (0.093)	0.55 ± 0.12 (0.022 ± 0.005)
6.4	6.4 (0.250)	3.2 (0.125)	0.65 ± 0.12 (0.026 ± 0.005)
9.5	9.5 (0.375)	4.8 (0.187)	0.65 ± 0.15 (0.026 ± 0.006)
12.7	12.7 (0.500)	6.4 (0.250)	0.65 ± 0.15 (0.026 ± 0.006)
19.0	19.0 (0.748)	9.5 (0.375)	0.80 ± 0.15 (0.032 ± 0.006)
25.4	25.4 (1.000)	12.7 (0.500)	0.95 ± 0.18 (0.037 ± 0.007)
32.0	32.0 (1.260)	16.0 (0.630)	1.05 ± 0.20 (0.041 ± 0.008)
38.0	38.0 (1.496)	19.0 (0.748)	1.05 ± 0.20 (0.041 ± 0.008)
52.0**	52.0 (2.047)	26.0 (1.024)	1.14 ± 0.18 (0.045 ± 0.007)

*Wall thickness will be less if tubing recovery is restricted during shrinkage.

**Available in black only.

Ordering information

Color	Standard	Black (-0), white (-9), red (-2), blue (-6), yellow (-4)
	Nonstandard	Green (-5), grey (-8), clear (X)
Size selection	Always order the largest size that will shrink snugly over the component to be covered. Special order sizes are available upon request.	
Standard packaging***	On spools.	
Ordering description	Specify product name, size and color (for example, LSTT-6.4-0).	

***Available in the convenient RaySpool packaging/dispensing system, for sizes 2.4 up to 25.4



MicroFit

Small-diameter, high-shrink-ratio tubing



Applications

The MicroFit family of small-diameter, high-shrink-ratio tubing is ideal for electrical insulation, mechanical protection, and strain relief in smaller, more compact medical devices and commercial electronics products. Offered in a variety of materials. The RW-175 version of MicroFit tubing is suitable for use in space applications.

Operating temperature range

MT1000: -55°C to 125°C

MT2000: -40°C to 105°C

RW-175: -55°C to 175°C

Features and benefits

- Small diameter.
- High shrink ratio.
- Thin wall.
- Polyolefin and fluoropolymer materials.

Installation

Minimum full recovery temperature:

175°C (MT1000)

140°C (MT2000)

175°C (RW-175)

Available in:	Americas	Europe	Asia Pacific
	■	■	■

Specifications/approvals			
Series	Material	Master File Number	Raychem
Altera MicroFit	USP Class VI (MT1000)	MAF-444 (MT1000)	Altera MicroFit SCD
	USP Class VI (MT2000)	MAF-727 (MT2000)	
RW-175 MicroFit			RW-175 MicroFit SCD

Fax-on-demand

US only (800) 260-9099

Outside US (650) 257-2301

Fax ID

2075

2622

2623

Description

Data sheet

Altera MicroFit SCD

RW-175 MicroFit SCD

Visit our website at www.tycoelectronics.com**Product dimensions (mm/in)**

Size	Inside diameter		Wall thickness	
	Minimum expanded as supplied	Maximum recovered after heating	As supplied (nominal)	Recovered*** (maximum)
MFT*-No. 1-**	0.356 (0.014)	0.178 (0.007)	0.076 (0.003)	0.127 (0.005)
MFT*-No. 2-**	0.610 (0.024)	0.305 (0.012)	0.064 (0.0025)	0.152 (0.006)
MFT*-No. 33-**	1.143 (0.045)	0.432 (0.017)	0.064 (0.0025)	0.118 (0.007)
MFT*-No. 65-**	0.635 (0.025)	0.254 (0.010)	0.127 (0.005)	0.330 (0.013)

*Replace single asterisk with material type: MT1000, MT2000, or RW-175.

**Replace double asterisk with color-code number.

***Wall thickness will be less if tubing recovery is restricted during shrinkage.

Ordering information

Color	MT1000	MT2000	RW-175
Standard	Translucent (-X)	Black (-0), clear (-X)	Translucent (-X)
Nonstandard	Black (-0)	White (-9), red (-2), yellow (-4), blue (-6), orange (-3)	Black (-0)
Size selection	Always order the largest size that will shrink snugly over the component to be covered. Special order sizes are available upon request.		
Standard packaging	On plastic spools****		
Ordering description	Specify product name, material, size and color (for example, MFT-MT2000-No. 1-0).		

****MFT-MT1000 and MFT-MT2000 are double bagged.

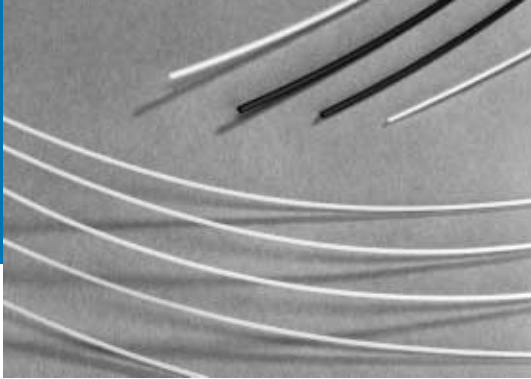

MT1000

Altera medical-grade, USP Class VI, high-temperature, semirigid, fluoropolymer tubing



Applications

Ideal for electrical insulation and strain relief of components that are exposed to high temperatures - either during operation or during sterilization. Thin-wall construction is well suited for applications with clearance constraints.

Operating temperature range

-55°C to 175°C

Features and benefits

- 2:1 shrink ratio.
- Tough, semirigid, very-thin-wall insulation.
- Excellent resistance to a variety of fluids.
- Optional inner adhesive lining in sizes 1/8" and larger (MT1000A).
- USP Class VI material, no heavy metals.
- Double-bagged packaging.
- Compatibility with gamma, ETO, steam, and dry-heat sterilization.

Installation

Minimum shrink temperature: 155°C

Minimum full recovery temperature: 175°C

<i>Available in:</i>	Americas	Europe	Asia Pacific
	■	■	■

<i>Specifications/approvals</i>			
Series	Material	Master File Number	Raychem
MT1000	USP Class VI	MAF-444	MT1000 SCD
MT1000A	USP Class VI	MAF-798	MT1000A SCD

Fax-on-demand

US only (800) 260-9099

Outside US (650) 257-2301

Fax ID

2380

2381

Description

Data sheet

SCD

Visit our website at www.tycoelectronics.com**Product dimensions (mm/in)**

Size	Inside diameter		Recovered wall thickness*
	Minimum expanded as supplied	Maximum recovered after heating	After heating
1/16	1.6 (0.063)	0.8 (0.031)	0.25 ± 0.05 (0.010 ± 0.002)
3/32	2.4 (0.093)	1.2 (0.046)	0.25 ± 0.05 (0.010 ± 0.002)
1/8	3.2 (0.125)	1.6 (0.062)	0.25 ± 0.05 (0.010 ± 0.002)
3/16	4.7 (0.187)	2.4 (0.093)	0.25 ± 0.05 (0.010 ± 0.002)
1/4	6.4 (0.250)	3.2 (0.125)	0.33 ± 0.05 (0.013 ± 0.002)
3/8	9.5 (0.375)	4.7 (0.187)	0.33 ± 0.05 (0.013 ± 0.002)
1/2	12.7 (0.500)	6.4 (0.250)	0.33 ± 0.05 (0.013 ± 0.002)
3/4**	19.1 (0.750)	9.5 (0.375)	0.43 ± 0.08 (0.017 ± 0.003)
1**	25.4 (1.000)	12.7 (0.500)	0.48 ± 0.08 (0.019 ± 0.003)

*Wall thickness will be less if tubing recovery is restricted during shrinkage.

**Nonstandard size; available by special order only.

Ordering information

Color	Standard Nonstandard	Translucent (-X) Black (-O)
Size selection	Always order the largest size that will shrink snugly over the component to be covered. Special order sizes are available upon request.	
Standard packaging	In 1.2-meter (4-foot) lengths, double bagged.	
Ordering description	Specify product name, size and color (for example, MT1000-1/8-X). Specify MT1000A for adhesive-lined constructions (special order).	



MT2000

Altera medical-grade, USP Class VI, lubricious, thin-wall, polyolefin tubing



Applications

Especially suitable for medical application requiring lubricity, flexibility, and excellent electrical insulation performance. A cost-effective alternative to FEP (fluorinated ethylene-propylene) while maintaining performance after gamma sterilization.

Operating temperature range

-40°C to 105°C

Features and benefits

- 2.5:1 shrink ratio.
- Lubricity comparable to FEP.
- Excellent electrical insulation properties.
- Can be manufactured with a very thin wall.
- Optional inner adhesive lining in sizes 3.0 and larger (MT2000A).
- USP Class VI material, no heavy metals.
- Plastic spools and double-bagged packaging.
- Compatibility with gamma and ETO sterilization.

Installation

Minimum shrink temperature: 110°C

Minimum full recovery temperature: 140°C

<i>Available in:</i>	Americas	Europe	Asia Pacific
	■	■	■

<i>Specifications/approvals</i>			
Series	Material	Master File Number	Raychem
MT2000	USP Class VI	MAF-727	MT2000 SCD
MT2000A	USP Class VI	MAF-799	MT2000A SCD

Fax-on-demand

US only (800) 260-9099

Outside US (650) 257-2301

Fax ID

2600

2601

Description

Data sheet

SCD

Visit our website at www.tycoelectronics.com**Product dimensions (mm/in)**

Size (mm)	Inside diameter		Wall thickness	
	Minimum expanded as supplied	Maximum recovered after heating	As supplied (nominal)	Recovered after heating*
1.0	1.0 (0.040)	0.45 (0.018)	0.12 (0.005)	0.25 ± 0.05 (0.010 ± 0.002)
2.0	2.0 (0.080)	0.80 (0.032)	0.12 (0.005)	0.25 ± 0.05 (0.010 ± 0.002)
3.0	3.0 (0.120)	1.20 (0.048)	0.12 (0.005)	0.25 ± 0.05 (0.010 ± 0.002)
6.0	6.0 (0.240)	2.40 (0.096)	0.12 (0.005)	0.25 ± 0.05 (0.010 ± 0.002)
10.0	10.0 (0.400)	4.00 (0.160)	0.12 (0.005)	0.36 ± 0.05 (0.014 ± 0.002)

*Wall thickness will be less if tubing recovery is restricted during shrinkage.

Ordering information

Color	Standard	Black (-0), clear (-X)
	Nonstandard	White (-9), red (-2), blue (-6), yellow (-4), orange (-3)
Size selection	Always order the largest size that will shrink snugly over the component to be covered. Special order sizes are available upon request.	
Standard packaging	On plastic spools, double bagged.	
Ordering description	Specify product name, size and color (for example, MT2000-3.0-0). Specify MT2000A for adhesive-lined constructions (special order).	



MT3000

Altera medical-grade, USP Class VI, high-temperature, flexible, fluoropolymer tubing



Applications

Used for electrical insulation and strain relief of components that are exposed to high temperatures - either during operation or during sterilization. Thin-wall construction is well suited for applications where pliancy coupled with small overall bundle size is desired.

Operating temperature range

-55°C to 150°C

Features and benefits

- 2:1 shrink ratio.
- Tough, flexible, very-thin-wall insulation.
- Excellent resistance to a variety of fluids.
- USP Class VI material, no heavy metals.
- Plastic spools and double-bagged packaging.
- Compatibility with steam (limited cycles), gamma, ETO, and dry-heat sterilization.

Installation

Minimum shrink temperature: 110°C

Minimum full recovery temperature: 150°C

Available in:

Americas

Europe

Asia Pacific



Specifications/approvals

Series	Material	Master File Number	Raychem
MT3000	USP Class VI	MAF-472	MT3000 SCD

Fax-on-demand

US only (800) 260-9099

Outside US (650) 257-2301

Fax ID

2390

2391

Description

Data sheet

SCD

Visit our website at www.tycoelectronics.com**Product dimensions (mm/in)**

Size	Inside diameter		Recovered wall thickness*
	Minimum expanded as supplied	Maximum recovered after heating	After heating
1/16	1.6 (0.063)	0.8 (0.031)	0.25 ± 0.05 (0.010 ± 0.002)
3/32	2.4 (0.093)	1.2 (0.046)	0.25 ± 0.05 (0.010 ± 0.002)
1/8	3.2 (0.125)	1.6 (0.062)	0.25 ± 0.05 (0.010 ± 0.002)
3/16	4.7 (0.187)	2.4 (0.093)	0.25 ± 0.05 (0.010 ± 0.002)
1/4	6.4 (0.250)	3.2 (0.125)	0.30 ± 0.05 (0.012 ± 0.002)
3/8	9.5 (0.375)	4.7 (0.187)	0.30 ± 0.05 (0.012 ± 0.002)
1/2	12.7 (0.500)	6.4 (0.250)	0.30 ± 0.05 (0.012 ± 0.002)
3/4**	19.1 (0.750)	9.5 (0.375)	0.43 ± 0.08 (0.017 ± 0.003)
1**	25.4 (1.000)	12.7 (0.500)	0.48 ± 0.08 (0.019 ± 0.003)

*Wall thickness will be less if tubing recovery is restricted during shrinkage.

**Nonstandard size; available by special order only.

Ordering information

Color	Standard Nonstandard	Black (-0) White (-9)
Size selection	Always order the largest size that will shrink snugly over the component to be covered. Special order sizes are available upon request.	
Standard packaging	On plastic spools, double bagged.	
Ordering description	Specify product name, size and color (for example, MT3000 1/4-0).	



MT5000

Altera medical-grade, USP Class VI, flexible, polyolefin tubing



Applications

Especially suitable for applications requiring excellent electrical insulation performance and resistance to abrasion and harmful solvents such as electrosurgical instruments. Also used for strain relief, color coding, and identification of many medical components and devices.

Operating temperature range

-70°C to 105°C

Features and benefits

- 2:1 shrink ratio.
- Flexibility; variety of colors.
- Excellent electrical insulation properties.
- Inner adhesive-lining optional in sizes 1/8" and larger (MT5000A).
- USP Class VI material, no heavy metals.
- Plastic spools and double-bagged packaging.
- Compatibility with gamma and ETO sterilization.

Installation

Minimum shrink temperature: 90°C

Minimum full recovery temperature: 110°C

Available in:	Americas	Europe	Asia Pacific
	■	■	■

Specifications/approvals			
Series	Material	Master file number	Raychem
MT5000	USP Class VI	MAF-469	MT5000 SCD
MT5000A	USP Class VI	MAF-800	MT5000A SCD

Fax-on-demand

US only (800) 260-9099

Outside US (650) 257-2301

Fax ID

2400

2401

Description

Data sheet

SCD

Visit our website at www.tycoelectronics.com**Product dimensions (mm/in)**

Size	Inside diameter		Recovered wall thickness*
	Minimum expanded as supplied	Maximum recovered after heating	After heating
1/16	1.6 (0.063)	0.8 (0.031)	0.43 ± 0.08 (0.017 ± 0.003)
3/32	2.4 (0.093)	1.2 (0.046)	0.51 ± 0.08 (0.020 ± 0.003)
1/8	3.2 (0.125)	1.6 (0.062)	0.51 ± 0.08 (0.020 ± 0.003)
3/16	4.8 (0.187)	2.4 (0.093)	0.51 ± 0.08 (0.020 ± 0.003)
1/4	6.4 (0.250)	3.2 (0.125)	0.64 ± 0.08 (0.025 ± 0.003)
3/8	9.5 (0.375)	4.8 (0.187)	0.64 ± 0.08 (0.025 ± 0.003)
1/2	12.7 (0.500)	6.4 (0.250)	0.64 ± 0.08 (0.025 ± 0.003)
3/4**	19.1 (0.750)	9.5 (0.375)	0.76 ± 0.08 (0.030 ± 0.003)
1**	25.4 (1.000)	12.7 (0.500)	0.89 ± 0.12 (0.035 ± 0.005)

*Wall thickness will be less if tubing recovery is restricted during shrinkage.

**Nonstandard size; available by special order only.

Ordering information

Color	Standard	Black (-0), clear (-X)
	Nonstandard	White (-9), red (-2), blue (-6), yellow (-4)
Size selection	Always order the largest size that will shrink snugly over the component to be covered. Special order sizes are available upon request.	
Standard packaging	On plastic spools, double bagged.	
Ordering description	Specify product name, size and color (for example, MT5000-1/4-0). Specify MT5000A for adhesive-lined constructions (special order).	



NT/NTR

Very flexible, rugged neoprene elastomer tubing



Applications

Widely used for insulation, strain relief, and abrasion protection on cable harnesses and wire bundles in the military and aerospace industries. Especially suitable for applications requiring exposure to fluids and solvents at elevated temperatures.

Operating temperature range

-70°C to 121°C

Features and benefits

- Remains flexible at low temperatures without cracking.
- Offers outstanding resistance to abrasion and physical abuse while providing the flexibility and strain relief needed for rugged applications.
- Resistant to most fluids and solvents, including aviation and ground-vehicle fuels, lubricating oil, and hydraulic fluids (see Raychem Specification RT-5 1 1, RT-5 10).
- System 30.

Installation

Minimum shrink temperature: 90°C

Minimum full recovery temperature: 135°C

Available in:



Americas

Europe

Asia Pacific



Specifications/approvals

Series	 UL	 CSA	Military	Industry	Raychem
NT	UL E35586 600V, 90°C	CSA LR31929 600V, 90°C (Does not contain neoprene.)			RT-510
NTR			AMS-DTL-23053/1*, Classes 1 & 2 SCX-15112	AMS 3623	RT-511

*Formerly MIL-23053/1 and MIL-DTL-23053/1.

Fax-on-demand	Fax ID	Description
US only (800) 260-9099	2090, 2100	Data sheet
Outside US (650) 257-2301	2091, 2101	RT-510, RT-511

Visit our website at www.tycoelectronics.com

Product dimensions (mm/in)

Size	Inside diameter		Recovered wall thickness**
	Minimum expanded as supplied	Maximum recovered after heating	After heating
1/8	3.2 (0.125)	1.6 (0.061)	0.69 ± 0.20 (0.027 ± 0.008)
3/16	4.8 (0.187)	2.6 (0.100)	0.84 ± 0.25 (0.033 ± 0.010)
1/4	6.4 (0.250)	3.6 (0.143)	0.88 ± 0.25 (0.035 ± 0.010)
3/8	9.5 (0.375)	5.5 (0.214)	1.02 ± 0.25 (0.040 ± 0.010)
1/2	12.7 (0.500)	7.3 (0.286)	1.21 ± 0.38 (0.048 ± 0.015)
5/8	15.9 (0.625)	9.1 (0.357)	1.32 ± 0.38 (0.052 ± 0.015)
3/4	19.1 (0.750)	10.9 (0.428)	1.44 ± 0.38 (0.057 ± 0.015)
7/8	22.2 (0.875)	12.7 (0.500)	1.65 ± 0.38 (0.065 ± 0.015)
1	25.4 (1.000)	14.5 (0.570)	1.77 ± 0.50 (0.070 ± 0.020)
1 1/4	31.8 (1.250)	18.1 (0.714)	2.20 ± 0.50 (0.087 ± 0.020)
1 1/2	38.1 (1.500)	21.8 (0.857)	2.41 ± 0.50 (0.095 ± 0.020)
1 3/4	44.5 (1.750)	25.4 (1.000)	2.71 ± 0.50 (0.107 ± 0.020)
2	50.8 (2.000)	29.0 (1.140)	2.79 ± 0.50 (0.110 ± 0.020)
3	76.2 (3.000)	43.4 (1.710)	3.18 ± 0.50 (0.125 ± 0.020)

**Wall thickness will be less if tubing recovery is restricted during shrinkage.

Ordering information

Color	Standard Black (-0)
Size selection	Always order the largest size that will shrink snugly over the component to be covered. Special order sizes are available upon request.
Standard packaging	On spools.
Ordering description	Specify product name, size and color (for example, NTFR 1/4-0).

Users should independently evaluate the suitability of the product for their application.
Before ordering check with factory for most current data.



PD Caps

Semirigid, encapsulant-lined, polyolefin caps



Applications

PD Caps offer an improved, inexpensive way to encapsulate crimped electrical connections, including those on motor coils. Encapsulant melts and flows to fill surface irregularities of the substrate. These vibration-proof caps are used to insulate and terminate dead-end electrical cables, fixtures, connectors, and other electrical equipment.

Operating temperature range

-55°C to 110°C

Features and benefits

- 3:1 shrink ratio.
- Permanent or temporary way to terminate wires.
- Rapid, simple installation.
- Rugged protection against abrasion, vibration, and flexing.
- PD caps provide a splash-resistant, moisture-resistant covering (but not intended for use where immersion in fluids is required).

Installation

Minimum shrink temperature: 125°C

Minimum full recovery temperature: 135°C

Available in:	Americas	Europe	Asia Pacific
	■	■	■

Specifications/approvals		
Series		Raychem
PD Caps	E85381 600 V, 125°C	PD Caps SCD

Fax-on-demand

US only (800) 260-9099

Outside US (650) 257-2301

Fax ID

2110

2111

Description

Data sheet

SCD

Visit our website at www.tycoelectronics.com**Product dimensions (mm/in)**

Size	Length		Inside diameter		Recovered wall thickness**
	Nominal overall as supplied	Minimum open barrel as supplied*	Minimum expanded as supplied	Maximum recovered after heating	Total wall after heating
1/8	22.0 (0.87)	12.7 (0.50)	3.2 (0.125)	0.58 (0.023)	1.22 ± 0.15 (0.048 ± 0.006)
3/16	25.4 (1.00)	15.2 (0.60)	4.8 (0.187)	1.52 (0.060)	1.57 ± 0.20 (0.062 ± 0.008)
1/4	28.4 (1.12)	15.2 (0.60)	6.4 (0.250)	2.03 (0.080)	1.98 ± 0.20 (0.078 ± 0.008)
3/8	31.8 (1.25)	18.3 (0.72)	9.5 (0.375)	2.29 (0.090)	2.08 ± 0.25 (0.082 ± 0.010)
1/2	38.1 (1.50)	21.6 (0.85)	12.7 (0.500)	2.29 (0.090)	2.54 ± 0.25 (0.100 ± 0.010)

*See glossary for definition of "barrel."

**Wall thickness will be less if recovery is restricted during shrinkage.

Ordering information

Color	Standard	Black (-0)
Size selection	Always order the largest size that will shrink snugly over the component to be covered. Special order sizes are available upon request.	
Standard packaging	In pieces.	
Ordering description	Specify product name, size and color (for example, PD Caps 1/4-0).	



RayBlock 85

Heat-shrinkable water-blocking system



Applications

Designed to provide consistent sealing for cable bundles and the back of connectors. The wires are placed within the channels of a specially formulated hot-melt adhesive profile, then covered by dual-wall, heat-shrinkable tubing with a flame-retardant, radiation-crosslinked outer wall and hot-melt-adhesive inner wall. When the tubing is heated, the hot-melt adhesive melts and the tubing shrinks, forcing the molten adhesive to fill all the voids within the wire bundle and tubing. The result is a solid plug of adhesive molded around each wire in the bundle, creating a moisture-resistant seal.

Features and benefits

- Environmentally seals wire bundles of up to 20 wires.
- Withstands temperature excursions to 105°C.
- Provides excellent strain relief and reduces noise.
- Offers a low-profile installed product only marginally larger than the cable bundle itself.

Installation

Minimum shrink temperature: 80°C

Minimum full recovery temperature: 110°C

Operating temperature range

-40°C to 85°C

Available in:	Americas	Europe	Asia Pacific
	■	■	■

Specifications/approvals	
Series	Raychem
RayBlock 85	RayBlock 85 SCD RW-2101

Fax-on-demand

US only (800) 260-9099

Outside US (650) 257-2301

Fax ID

2062

Description

Data sheet

Visit our website at www.tycoelectronics.com**Product dimensions (mm/in)**

Part number	No. of channels	Profile			Tubing Inside diameter		
		Height	Length	Width	Minimum expanded as supplied	Maximum recovered after heating	Nominal length
RayBlock 85 Kit 0102-A0	2	6.5 (0.256)	2.75 (0.108)	8.50 (0.335)	12.0 (0.472)	3.0 (0.118)	40 (1.57)
RayBlock 85 Kit 0203-A0	3	6.5 (0.256)	2.75 (0.108)	12.25 (0.482)	24.0 (0.945)	6.0 (0.236)	47 (1.85)
RayBlock 85 Kit 0504-A0	4	6.5 (0.256)	2.75 (0.108)	16.0 (0.630)	16.0 (0.630)	4.0 (0.158)	40 (1.57)
RayBlock 85 Kit 0405-A0	5	6.5 (0.256)	2.75 (0.108)	19.75 (0.778)	24.0 (0.945)	6.0 (0.236)	45 (1.77)
RayBlock 85 Kit 0107-A0	7	6.5 (0.256)	2.75 (0.108)	27.25 (1.07)	24.0 (0.945)	6.0 (0.236)	65 (2.56)
RayBlock 85 Kit 0510-A0	10	6.5 (0.256)	2.75 (0.108)	38.50 (1.52)	32.0 (1.26)	8.0 (0.315)	55 (2.17)

Ordering information

Color	Standard	Black (-0)
Size selection	For wire with an outside diameter smaller than 2.8 mm (0.110 inch), use a maximum of two wires per channel. For wire with an outside diameter of 2.8–3.5 mm (0.110 inch to 0.138 inch), use a maximum of one wire per channel. Special order sizes are available upon request.	
Standard packaging	One kit (contains 1000 pcs. of profile and 1000 pcs. of tubing).	



RayBlock 105

Heat-shrinkable water-blocking system



Applications

Designed to provide consistent sealing for cable bundles and the back of connectors. The wires in the bundle are placed within the channels of a specially formulated hot-melt adhesive profile, and then covered by dual-wall, heat-shrinkable tubing with a flame-retardant radiation-crosslinked outer wall and hot-melt-adhesive inner wall. When the tubing is heated, the hot-melt adhesive melts and the tubing shrinks, forcing the molten adhesive to fill all the voids within the wire bundle and tubing. The result is a solid plug of adhesive molded around each wire in the bundle, creating a moisture-resistant seal.

Features and benefits

- Environmentally seals wire bundles of up to 20 wires.
- Withstands temperature excursions to 120°C.
- Provides excellent strain relief and reduces noise.
- Offers a low-profile installed product only marginally larger than the cable bundle itself.

Installation

Minimum shrink temperature: 80°C

Minimum full recovery temperature: 110°C

Operating temperature range

-40°C to 105°C

Available in:	Americas	Europe	Asia Pacific
	■	■	■

Specifications/approvals

Series	Raychem
RayBlock 105	RayBlock 105 SCD RW-2102

Fax-on-demand

US only (800) 260-9099

Outside US (650) 257-2301

Fax ID

2570

Description

Data sheet

Visit our website at www.tycoelectronics.com**Product dimensions (mm/in)**

Part number	No. of channels	Profile			Tubing		
		Height	Length	Width	Inside diameter Minimum expanded as supplied	Maximum recovered after heating	Nominal length
RayBlock 105 Kit 0102-A0	2	6.5 (0.256)	2.75 (0.108)	8.50 (0.335)	12.0 (0.472)	3.0 (0.118)	40 (1.57)
RayBlock 105 Kit 0103-A0	3	6.5 (0.256)	2.75 (0.108)	12.25 (0.482)	16.0 (0.630)	4.0 (0.158)	40 (1.57)
RayBlock 105 Kit 0504-A0	4	6.5 (0.256)	2.75 (0.108)	16.0 (0.630)	16.0 (0.630)	4.0 (0.158)	45 (1.77)
RayBlock 105 Kit 0105-A0	5	6.5 (0.256)	2.75 (0.108)	19.75 (0.778)	24.0 (0.945)	6.0 (0.236)	45 (1.77)
RayBlock 105 Kit 0107-A0	7	6.5 (0.256)	2.75 (0.108)	27.2 (1.07)	24.0 (0.945)	6.0 (0.236)	65 (2.56)
RayBlock 105 Kit 0110-A0	10	6.5 (0.256)	2.75 (0.108)	38.50 (1.52)	32.0 (1.26)	8.0 (0.315)	65 (2.56)

Ordering information

Color	Standard	Black (-0)
Size selection	For wire with an outside diameter smaller than 2.8 mm (0.110 inch), use a maximum of two wires per channel. For wire with an outside diameter of 2.8–3.5 mm (0.110–0.138 inch), use a maximum of one wire per channel. Special order sizes are available upon request.	
Standard packaging	One kit (contains 1000 pcs. of profile and 1000 pcs. of tubing).	



Rayflex

PET and PFR
expandable, braided, polyester sleeving



Applications

Rayflex is perfect for the mechanical protection of wire harnesses, hoses, and all other applications where exceptional flexibility combined with superior abrasion/cut resistance is required. It also serves as an economical means for wire bundling that will not trap heat or moisture; expanding easily to fit over irregular shapes, then contracting to conform and grip. To prevent fraying, these products should be cut to length using a hot knife

Operating temperature range

-50°C to 150°C (220°C for short periods)

Features and benefits

- Excellent abrasion and cut-through resistance.
- Lightweight.
- Flexible (even at low temperatures).
- Fungus-Proof.
- Not affected by most chemicals and solvents; non-hygroscopic.
- PFR meets UL VW-1, FAR25, and is Self-Extinguishing.
- Fiber diameter is 0.01" (0.254mm).

Installation

This product is cold applied.

Available in:	Americas	Europe	Asia Pacific
		■	■

Specifications/approvals			
Series	UL	CSA	Raychem
Rayflex PET			RW-2069
Rayflex PFR	E197586 Rated 125°C	LR31929 Rated 125°C	

Fax-on-demand

US only (800) 260-9099

Outside US (650) 257-2301

Visit our website at www.tycoelectronics.com**Product dimensions (mm/in)**

RAYFLEX PET expandable polyester braid

Size	Nominal Size	Size Range
1/8	3 (0.125)	2.4-6.4 (0.094 - 0.250)
1/4	6 (0.250)	3.2-9.5 (0.125 - 0.375)
3/8	10 (0.375)	4.7-16 (0.188 - 0.630)
1/2	13 (0.500)	6.4-19 (0.250 - 0.750)
3/4	19 (0.750)	13-32 (0.500 - 1.250)
1-1/4	32 (1.250)	19-45 (0.750 - 1.750)
1-3/4	45 (1.750)	32-70 (1.250 - 2.750)
2	51 (2.000)	38-76 (1.500 - 3.000)

RAYFLEX PFR flame-retardant, expandable polyester braid

Size	Nominal Size	Size Range
1/8	3 (0.125)	2.4-6.4 (0.094 - 0.250)
1/4	6 (0.250)	3.2-9.5 (0.125 - 0.375)
3/8	10 (0.375)	4.7-16 (0.188 - 0.630)
1/2	13 (0.500)	6.4-19 (0.250 - 0.750)
3/4	19 (0.750)	13-32 (0.500 - 1.250)
1-1/4	32 (1.250)	19-45 (0.750 - 1.750)
1-3/4	45 (1.750)	32-70 (1.250 - 2.750)
2	51 (2.000)	38-76 (1.500 - 3.000)

Ordering information

Color	Standard	RF-PET: Black (-0) RF-PFR: Black with white X-Cross tracers (-09)
Standard packaging	On spools.	
Ordering description	Specify product name, size and color (for example, RF-PET-1/8-0).	

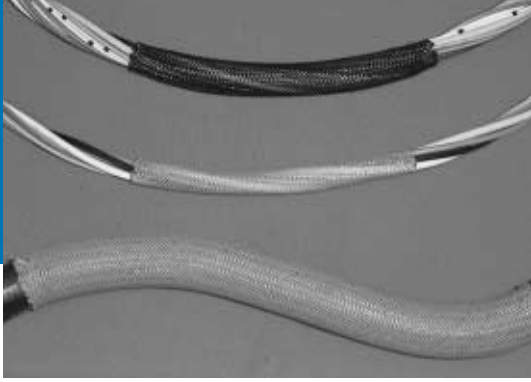

Rayflex PETM

Expandable, braided, polyester sleeving



Applications

Rayflex is suited for the mechanical protection of wire harnesses, hoses, and all other applications where exceptional flexibility combined with superior abrasion/cut resistance is required. It also serves as an economical means for wire bundling that will not trap heat or moisture; expanding easily to fit over irregular shapes, then contracting to conform and grip. To prevent fraying these products should be cut to length using a hot knife.

Operating temperature range

-50°C to 150°C (220°C for short periods)

Features and benefits

- Excellent abrasion and cut-through resistance.
- Lightweight construction with 0.22mm fiber.
- Flexible even at low temperatures.
- Fungus resistant.
- Resistant to most chemicals and solvents; non-hygroscopic.
- Wide range of metric sizes.

Installation

This product is cold applied.

Available in:

Americas

Europe

Asia Pacific



Fax-on-demand

US only (800) 260-9099

Outside US (650) 257-2301

Visit our website at www.tycoelectronics.com**Product dimensions (mm/in)**

Nominal Size	Size Range	
	Minimum	Maximum
3 (0.119)	1 (0.039)	5 (0.197)
4 (0.158)	2 (0.079)	7 (0.276)
5 (0.197)	3 (0.118)	9 (0.354)
6 (0.236)	4 (0.158)	11 (0.433)
8 (0.315)	5 (0.197)	12 (0.472)
10 (0.394)	7 (0.276)	15 (0.591)
12 (0.472)	8 (0.315)	17 (0.669)
15 (0.591)	10 (0.394)	20 (0.787)
20 (0.787)	14 (0.551)	26 (1.024)
25 (0.984)	18 (0.709)	34 (1.339)
30 (1.181)	20 (0.787)	40 (1.575)
40 (1.575)	30 (1.181)	50 (1.969)
50 (1.969)	40 (1.575)	60 (2.362)

Ordering information

Color	Standard	Black (-0), Grey (-8).
Standard packaging	On spools.	
Ordering description	Specify product name, size and color (for example, RF-PETM-03-0).	

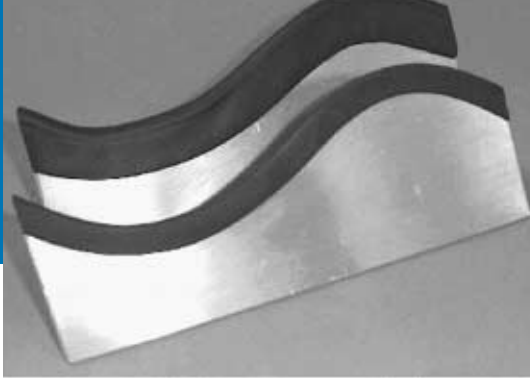

Rayrim

Commercial protective, self-adhering, edging material



Applications

Raychem Rayrim is an extruded strip internally coated with a heat activated adhesive, so that on heating the profile changes from a 'V' to a 'U' section and the adhesive bonds to the substrate profile.

Manufactured from a Raychem radiation cross-linked polyolefin material, the profile offers a clean and rapid means of covering metal, wood and glass edges for all-round protection. The flexible nature of the product allows application to both internal and external radii, as well as straight edges, and the continuous operating temperature of -55°C to +80°C means that the product can give protection under the most testing circumstances.

Operating temperature range

-55°C to +80°C

Features and benefits

- Flexible to allow for protection of curved edges.

Installation

Minimum full recovery temperature: 120°C

Available in:	Americas	Europe	Asia Pacific
	■	■	■

Specifications/approvals	
Series	Raychem
Rayrim	RK-6182

Fax-on-demand

US only (800) 260-9099

Outside US (650) 257-2301

Fax ID

2624

Description

Data sheet

Visit our website at www.tycoelectronics.com**Application range (mm/in)**

Plate	Thickness	Recommended minimum bend radius
SWG		
30-24	0.31-0.56 (0.012-0.022)	10 (0.394)
23-16	0.61-1.63 (0.026-0.064)	15 (0.591)
15-10	1.83-3.25 (0.072-0.128)	20 (0.787)
9-5	3.66-5.38 (0.144-0.212)	25 (0.984)

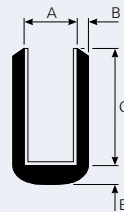
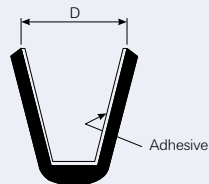
Product dimensions (mm/in)

Size	A (maximum)	B (minimum)	C (minimum)	D (minimum)	E (typical)
Nr. 6	0.6 (0.024)	0.5 (0.020)	3.5 (0.138)	0.8 (0.032)	1.25 (0.049)
Nr. 7	1.0 (0.039)	0.9 (0.035)	4.8 (0.189)	1.6 (0.063)	1.25 (0.049)
Nr. 8	2.0 (0.079)	0.9 (0.035)	6.6 (0.260)	2.5 (0.098)	2.25 (0.089)
Nr. 9	4.2 (0.165)	0.9 (0.035)	13.5 (0.532)	4.5 (0.177)	2.20 (0.087)

Ordering information

Color	Standard	Black (-0)
Size selection	The largest size which will fit on the panel should be ordered.	
Standard packaging	1.2-meter (4-foot) lengths.	
Ordering description	Specify product name and size number (for example, Rayrim Nr.6).	

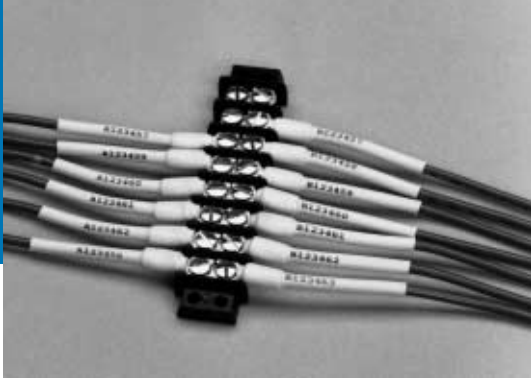

RNF-100

Flexible, flame-retardant, general purpose, polyolefin tubing



Applications

Designed to provide superior mechanical (abrasion, cut-through, and strain relief), thermal, and fluid-resistance performance in demanding environments. Widely used to provide insulation and strain relief of wire terminations and connections. Used for jacketing wire bundles and light-duty harnesses where superior abrasion resistance is a plus. Also used to identify and color-code electrical connections and wire bundles.

Operating temperature range

-55°C to 135°C

Features and benefits

- 2:1 shrink ratio.
- Superior abrasion and solvent resistance when compared with that of many flexible, general purpose polyolefin tubings.
- Excellent physical, chemical, and electrical properties that meet or exceed industrial and military standards for highly reliable, general purpose tubing.
- Flexible; conforms to irregular shapes.
- Flame-retardant (colors only).
- Wide range of sizes and colors.

Installation

Minimum shrink temperature: 95°C

Minimum full recovery temperature: 121°C

Available in:



Americas

Europe

Asia Pacific



Specifications/approvals

Series	 UL	 CSA	Military	Industry	Raychem
RNF-100 Type 1 (colors)	E35586 600 V, 125°C	LR31929 600 V, 125°C	AMS-DTL-23053/5*, Class 1 Def. Stan. 59-97 Type 2B	VDE 0341 Pt 9005 Type A and B	RT-350, Type 1 RK-6001
RNF-100 Type 2 (clear)			AMS-DTL-23053/5*, Class 2 VG 95343 Pt 5 Type B		RT-350, Type 2 RK-6001

*Formerly MIL-I-23053/5 and MIL-DTL-23053/5.

<i>Fax-on-demand</i>	<i>Fax ID</i>	<i>Description</i>
<i>US only (800) 260-9099</i>	2120	Data sheet
<i>Outside US (650) 257-2301</i>	2121	RT-350
	2603	Technical Bulletin

Visit our website at www.tycoelectronics.com

Product dimensions (mm/in)

Size	Inside diameter		Recovered wall thickness**
	Minimum expanded as supplied	Maximum recovered after heating	After heating
3/64	1.2 (0.046)	0.6 (0.023)	0.40 ± 0.08 (0.016 ± 0.003)
1/16	1.6 (0.063)	0.8 (0.031)	0.43 ± 0.08 (0.017 ± 0.003)
3/32	2.4 (0.093)	1.2 (0.046)	0.51 ± 0.08 (0.020 ± 0.003)
1/8	3.2 (0.125)	1.6 (0.062)	0.51 ± 0.08 (0.020 ± 0.003)
3/16	4.8 (0.187)	2.4 (0.093)	0.51 ± 0.08 (0.020 ± 0.003)
1/4	6.4 (0.250)	3.2 (0.125)	0.64 ± 0.08 (0.020 ± 0.003)
3/8	9.5 (0.375)	4.8 (0.187)	0.64 ± 0.08 (0.025 ± 0.003)
1/2	12.7 (0.500)	6.4 (0.250)	0.64 ± 0.08 (0.025 ± 0.003)
3/4	19.1 (0.750)	9.5 (0.375)	0.76 ± 0.08 (0.030 ± 0.003)
1	25.4 (1.000)	12.7 (0.500)	0.89 ± 0.012 (0.035 ± 0.005)
1 1/4	31.8 (1.250)	15.9 (0.625)	1.02 ± 0.15 (0.040 ± 0.006)
1 1/2	38.1 (1.500)	19.1 (0.750)	1.02 ± 0.15 (0.040 ± 0.006)
2	50.8 (2.000)	25.4 (1.000)	1.14 ± 0.16 (0.045 ± 0.007)
3	76.2 (3.000)	38.1 (1.500)	1.27 ± 0.20 (0.050 ± 0.008)
4	101.6 (4.000)	50.8 (2.000)	1.40 ± 0.23 (0.055 ± 0.009)
5	127.0 (5.000)	63.5 (2.500)	1.52 ± 0.23 (0.060 ± 0.009)

**Wall thickness will be less if tubing recovery is restricted during shrinkage.

Ordering information

Color	Standard	Black (-0, BK), white (-9, WH), red (-2, RD), blue (-6, BU), yellow (-4, YO), green (-5, GN), clear (-X, CL)
	Nonstandard	Brown (-1, BN), orange (-3, OR), violet (-7, VT), gray (-8, GY)
Size selection	Always order the largest size that will shrink snugly over the component to be covered. Special order sizes are available upon request.	
Standard packaging	On spools, or in 1.2-meter (4-foot) lengths.	
Ordering description***	Specify product name, size and color (for example, RNF-100 1/4-0 [Europe] or RNF-100 1/4-BK [Americas]).	

***Europe only. For supply to MIL, Def Stan and BS add -MS, -DS or -BS to ordering description.



RNF-150

High-performance, flame-resistant, flexible, fluoropolymer tubing



Applications

Can be used for jacketing and bundling of wires to form light-duty harnesses, especially where a low profile, abrasion resistance, and flexibility are needed. Can also be used to provide insulation and strain relief of electrical connections and wire terminations, identification of wires, and packaging of components.

Operating temperature range

-55°C to 150°C

Features and benefits

- 2:1 shrink ratio.
- Approximately 40 percent thinner walls than most general purpose polyolefin tubings.
- High flame-resistance.
- Excellent physical and electrical properties after exposure to many chemicals and solvents at 50°C (but not recommended for use in direct contact with ketones).
- Recommended maximum temperature for use as a primary insulator: 135°C.

Installation

Minimum shrink temperature: 110°C

Minimum full recovery temperature: 150°C

Available in:	Americas	Europe	Asia Pacific
	■	■	■

Specifications/approvals



Series	UL	Military	Raychem
RNF-150	E85381 VW-1 600 V, 150°C	AMS-DTL-23053/18*, Class 2	RT-370

*Formerly MIL-23053/18 and MIL-DTL-23053/18.

Fax-on-demand

US only (800) 260-9099

Outside US (650) 257-2301

Fax ID

2130

2131

Description

Data sheet

RT-370

Visit our website at www.tycoelectronics.com**Product dimensions (mm/in)**

Size	Inside diameter		Recovered wall thickness**
	Minimum expanded as supplied	Maximum recovered after heating	After heating
3/64	1.2 (0.046)	0.6 (0.023)	0.25 ± 0.05 (0.010 ± 0.002)
1/16	1.6 (0.063)	0.8 (0.031)	0.25 ± 0.05 (0.010 ± 0.002)
3/32	2.4 (0.093)	1.2 (0.046)	0.25 ± 0.05 (0.010 ± 0.002)
1/8	3.2 (0.125)	1.6 (0.062)	0.25 ± 0.05 (0.010 ± 0.002)
3/16	4.8 (0.187)	2.4 (0.093)	0.25 ± 0.05 (0.010 ± 0.002)
1/4	6.4 (0.250)	3.2 (0.125)	0.30 ± 0.08 (0.012 ± 0.003)
3/8	9.5 (0.375)	4.8 (0.187)	0.30 ± 0.08 (0.012 ± 0.003)
1/2	12.7 (0.500)	6.4 (0.250)	0.30 ± 0.08 (0.012 ± 0.003)
3/4	19.1 (0.750)	9.5 (0.375)	0.43 ± 0.08 (0.017 ± 0.003)
1	25.4 (1.000)	12.7 (0.500)	0.48 ± 0.08 (0.019 ± 0.003)

**Wall thickness will be less if tubing recovery is restricted during shrinkage.

Ordering information

Color	Standard Nonstandard	Black (-0) White (-9)
Size selection	Always order the largest size that will shrink snugly over the component to be covered. Special order sizes are available upon request.	
Standard packaging	On spools.	
Ordering description***	Specify product name, size and color (for example, RNF-150 1/4-0).	

***Europe only. For supply to MIL, Def Stan and BS add -MS, -DS or -BS to ordering description.



RNF-3000

Flexible, high-shrink-ratio, flame-retardant, general purpose, polyolefin tubing



Applications

Used for insulation and strain relief of wire terminations and electrical connections. Also ideal for light-duty harnessing, jacketing, and identification of wires, cables, and electrical and electronic components.

Operating temperature range

-55°C to 135°C

Features and benefits



- 3:1 shrink ratio easily accommodates awkward, irregular shapes.
- Few sizes cover a wide range of diameters, allowing reduced inventory.
- Excellent physical, chemical, and electrical properties meet industry standards for highly reliable, general purpose tubing.
- Flame-retardant (colors only).

Installation

Minimum shrink temperature: 80°C

Minimum full recovery temperature: 120°C

Available in:	Americas	Europe	Asia Pacific
	■	■	■

Specifications/approvals					
Series	 UL	 CSA	Military	Industry	Raychem
RNF-3000	E35586 600 V, 125°C	LR31929 600 V, 125°C	Def. Stan. 59-97 Type 2B VG 95343 Pt 5 Type A (color) VG 95343 Pt 5 Type B (clear)	VDE 0341 Pt 9005 Type A and B	RW-2053

Fax-on-demand

US only (800) 260-9099

Outside US (650) 257-2301

Fax ID

2140

2141

Description

Data sheet

RW-2053

Visit our website at www.tycoelectronics.com**Product dimensions (mm/in)**

Size	Inside diameter		Recovered wall thickness*
	Minimum expanded as supplied	Maximum recovered after heating	After heating
1.5/0.5	1.5 (0.060)	0.5 (0.019)	0.45 ± 0.10 (0.018 ± 0.003)
3/1	3 (0.118)	1 (0.039)	0.55 ± 0.10 (0.022 ± 0.003)
4.5/1.5	4.5 (0.177)	1.5 (0.059)	0.55 ± 0.10 (0.022 ± 0.003)
6/2	6 (0.236)	2 (0.079)	0.65 ± 0.10 (0.026 ± 0.003)
9/3	9 (0.354)	3 (0.118)	0.75 ± 0.12 (0.030 ± 0.004)
12/4	12 (0.472)	4 (0.157)	0.75 ± 0.12 (0.030 ± 0.004)
18/6	18 (0.709)	6 (0.236)	0.85 ± 0.12 (0.033 ± 0.004)
24/8	24 (0.944)	8 (0.315)	1.00 ± 0.18 (0.039 ± 0.007)
39/13	39 (1.534)	13 (0.512)	1.15 ± 0.20 (0.045 ± 0.008)

*Wall thickness will be less if tubing recovery is restricted during shrinkage.

Ordering information

Color	Standard**	Black (-0), white (-9), red (-2), blue (-6), yellow (-4), green (-5), clear (-X)
	Nonstandard	Brown (-1), orange (-3), violet (-7), gray (-8)
Size selection	Always order the largest size that will shrink snugly over the component to be covered. Special order sizes are available upon request.	
Standard packaging***	On spools or in 1.2-meter (4-foot) lengths.	
Ordering description****	Specify product name, size and color (for example, RNF-3000 6/2-0).	

**Black is the only standard color in the Americas. All other colors are nonstandard.

***Only spools are standard in the Americas. 1.2 meter (4-foot) lengths are nonstandard.

****Europe only. For supply to MIL, Def Stan and BS add -MS, -DS or -BS to ordering description.



RP-4800

High-shrink-ratio, flame-retardant, polyolefin tubing



Applications

Ideal for repairing harnesses or cables; will pass over a large-diameter connector or transition, and then shrink down onto a smaller-diameter jacket. Can insulate or protect a substrate of varying dimensions. Also provides the abrasion and fluid resistance required in harnessing applications.

Operating temperature range

-55°C to 135°C

Features and benefits

- 4:1 shrink ratio.
- Conforms well to highly variable substrate dimensions.
- Has excellent physical, chemical, and electrical properties that meet or exceed industrial and military standards.
- Shows no significant degradation when exposed to common solvents and chemicals, including aviation fuel and hydraulic fluid.

Installation

Minimum shrink temperature: 95°C

Minimum full recovery temperature: 121°C

Available in:

Americas

Europe

Asia Pacific



Specifications/approvals



Series	UL	Military	Industry	Raychem
RP-4800	E35586 600V, 125°C	AMS-DTL-23053/5*, Class 1 Overexpanded VG 95343 Pt 5 Type A	VDE 0341 Pt 9005 Type A	RT-1122

*Formerly MIL-23053/5 and MIL-DTL-23053/5.

Fax-on-demand

US only (800) 260-9099

Outside US (650) 257-2301

Fax ID

2150

2151

Description

Data sheet

RT-1 122

Visit our website at www.tycoelectronics.com**Product dimensions (mm/in)**

Size	Inside diameter		Recovered wall thickness**
	Minimum expanded as supplied	Maximum recovered after heating	After heating
No. 1	25.4 (1.000)	7.0 (0.275)	1.14 ± 0.18 (0.045 ± 0.007)
No. 2	50.8 (2.000)	14.0 (0.550)	1.14 ± 0.18 (0.045 ± 0.007)
No. 3	76.2 (3.000)	20.6 (0.810)	1.14 ± 0.18 (0.045 ± 0.007)
No. 4	101.6 (4.000)	26.7 (1.050)	1.14 ± 0.18 (0.045 ± 0.007)
No. 5	25.4 (1.000)	11.7 (0.462)	1.14 ± 0.18 (0.045 ± 0.007)
No. 6	60.3 (2.375)	17.3 (0.680)	1.14 ± 0.18 (0.045 ± 0.007)
No. 7	76.2 (3.000)	21.3 (0.840)	1.14 ± 0.18 (0.045 ± 0.007)
No. 8	95.3 (3.750)	23.6 (0.930)	1.14 ± 0.18 (0.045 ± 0.007)
No. 9	114.3 (4.500)	36.8 (1.450)	1.14 ± 0.18 (0.045 ± 0.007)
No. 10	38.1 (1.500)	9.5 (0.375)	1.14 ± 0.18 (0.045 ± 0.007)
No. 11	19.1 (0.750)	4.6 (0.180)	1.14 ± 0.18 (0.045 ± 0.007)

**Wall thickness will be less if tubing recovery is restricted during shrinkage.

Ordering information

Color	Standard	Black (-0)
	Nonstandard	White (-9), red (-2), blue (-6), yellow (-4), green (-5), brown (-1), orange (-3), violet (-7), gray (-8)
Size selection	Always order the largest size that will shrink snugly over the component to be covered. Special order sizes are available upon request.	
Standard packaging	On spools or in 1.2-meter (4-foot) lengths.	
Ordering description***	Specify product name, size and color (for example, RP-4800 No. 1-0).	

***Europe only. For supply to MIL, Def Stan and BS add -MS, -DS or -BS to ordering description.



RPPM

Flexible, dual wall, moisture proof, heat-shrinkable tubing



Applications

RPPM is a flexible, heat-shrinkable, dual wall tubing with an integrally bonded melttable adhesive liner. Available in clear and black, the tough outer jacket with both types offers excellent mechanical strength. RPPM is used for moisture proof encapsulation of a wide variety of components. In particular, it adheres well to PVC. The high shrink ratio allows RPPM to be used with a range of dimensions. Clear RPPM offers excellent clarity for protection of substrates that may need to be inspected during service. Black RPPM has a high gloss finish suitable for cosmetic applications.

Features and benefits

- Environmental sealing.
- Excellent mechanical strength.
- Abrasion resistance.
- 4:1 shrink ratio.

Installation

Minimum shrink temperature: 60°C

Minimum full recovery temperature: 80°C

Operating temperature range

-40°C to 85°C

Available in:

Americas

Europe

Asia Pacific



Specifications/approvals

Series	Raychem
RPPM	RK 6214

<i>Fax-on-demand</i>	<i>Fax ID</i>	<i>Description</i>
<i>US only (800) 260-9099</i>	2625	Data sheet
<i>Outside US (650) 257-2301</i>	2626	RK-6214

Visit our website at www.tycoelectronics.com

Product dimensions (mm/in)

Size	Inside diameter		Recovered wall thickness*	
	Minimum expanded as supplied	Maximum recovered after heating	Total wall after heating (nominal)	Adhesive wall after heating (nominal)
4/1	4.0 (0.158)	1.0 (0.039)	0.8 (0.032)	0.3 (0.012)
8/2	8.0 (0.355)	2.0 (0.079)	0.9 (0.035)	0.3 (0.012)
12/3	12.0 (0.472)	3.0 (0.118)	1.2 (0.047)	0.4 (0.016)
16/4	16.0 (0.630)	4.0 (0.158)	1.5 (0.059)	0.5 (0.020)

*Wall thickness will be less if tubing recovery is restricted during shrinkage.

Ordering information

Color	Standard Black (-O), clear (-X).
Size selection	Always order the largest size that will shrink snugly over the component to be covered. Other lengths and sizes are available subject to special order.
Standard packaging	On spools, in 1.2-meter (4-foot) lengths or cut pieces.
Ordering description	Specify product name, size and color (for example, RPPM-4/1-X).

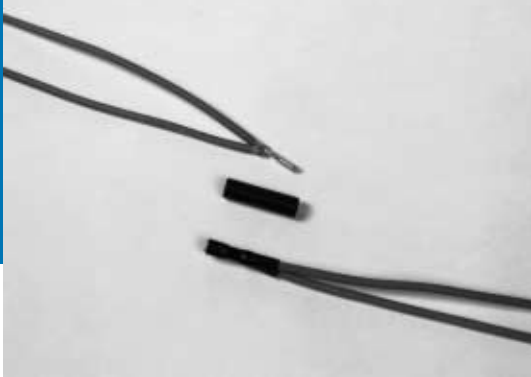

RT-3

Semirigid, flame-retardant, polyolefin tubing



Applications

Suitable for wire strain-relief applications - soldered or crimped connections, wire splices, terminations. Well suited for use with semiautomated production equipment requiring tubing with a tightly controlled expanded diameter. Acts as a tough covering for delicate components; provides mechanical protection.

Operating temperature range

-55°C to 135°C

Features and benefits

- 2.5:1 shrink ratio.
- Tightly controlled expanded diameters.
- High abrasion resistance.
- Semirigidity that transfers flex stress away from typically weak points such as solder and crimp joints, helping to ensure a reliable connection.
- Excellent chemical and solvent resistance.
- Outstanding physical and electrical performance.

Installation

Minimum shrink temperature: 110°C

Minimum full recovery temperature: 135°C

Available in:	Americas	Europe	Asia Pacific
	■		■

Specifications/approvals			
Series	UL	CSA	Raychem
RT-3	E35586 600 V, 125°C	LR3 1929 (black only) 600 V, 125°C	RT-360*

*Except dimensions and longitudinal change.

Fax-on-demand

US only (800) 260-9099

Outside US (650) 257-2301

Fax ID

2160

Description

Data sheet

Visit our website at www.tycoelectronics.com**Product dimensions (mm/in)**

Size	Inside diameter		Recovered wall thickness**
	Minimum expanded as supplied	Maximum recovered after heating	After heating
No. 1	6.1 ± 4 (0.240 ± 0.015)	2.4 (0.095)	0.79 ± 0.08 (0.031 ± 0.003)
No. 2	8.1 ± 4 (0.320 ± 0.015)	3.2 (0.125)	0.79 ± 0.08 (0.031 ± 0.003)
No. 3	9.5 ± 5 (0.375 ± 0.020)	3.8 (0.150)	0.79 ± 0.08 (0.031 ± 0.003)
No. 4	12.3 ± 5 (0.485 ± 0.020)	5.1 (0.200)	0.79 ± 0.08 (0.031 ± 0.003)

**Wall thickness will be less if tubing recovery is restricted during shrinkage.

Ordering information

Color	Standard Black (-0)
Size selection	Always order the largest size that will shrink snugly over the component to be covered. Special order sizes are available upon request.
Standard packaging	In 1-inch cut pieces or in 1.2-meter (4-foot) lengths.
Ordering description	Specify product name, size and color (for example, RT-3 No. 1-0).



RT-375

*Clear, flame-resistant,
flexible, fluoropolymer tubing*



Applications

Protects wire and cable markers subject to extreme abuse, while permitting full inspectability of each item covered. Provides bundling and jacketing of wires and cables, protecting them from mechanical and chemical abuse. Protects electronic components while permitting their identification and inspection.

Operating temperature range

-55°C to 150°C

Features and benefits



- 2:1 shrink ratio.
- Exceptional clarity and clarity stability.
- Toughness, chemical resistance, and high-temperature performance.
- High flame-resistance.
- Approximately 40 percent thinner walls than most general purpose polyolefin tubings.
- Recommended maximum temperature for use as a primary insulator: 135°C.

Installation

Minimum shrink temperature: 125°C

Minimum full recovery temperature: 150°C

Available in:	Americas	Europe	Asia Pacific
	■	■	■

Specifications/approvals				
Series	 UL	 CSA	Military	Raychem
RT-375	E85381 VW-1 600 V, 150°C	LR31929 VW-1 600 V, 150°C	AMS-DTL-23053/18*, Class 2	RT-375

*Formerly MIL-I-23053/18 and MIL-DTL-23053/18.

Fax-on-demand

US only (800) 260-9099

Outside US (650) 257-2301

Fax ID

2170

2171

Description

Data sheet

RT-375

Visit our website at www.tycoelectronics.com**Product dimensions (mm/in)**

Size	Inside diameter		Recovered wall thickness**
	Minimum expanded as supplied	Maximum recovered after heating	After heating
3/64	1.2 (0.046)	0.6 (0.023)	0.25 ± 0.05 (0.010 ± 0.002)
1/16	1.6 (0.063)	0.8 (0.031)	0.25 ± 0.05 (0.010 ± 0.002)
3/32	2.4 (0.093)	1.2 (0.046)	0.25 ± 0.05 (0.010 ± 0.002)
1/8	3.2 (0.125)	1.6 (0.062)	0.25 ± 0.05 (0.010 ± 0.002)
3/16	4.8 (0.187)	2.4 (0.093)	0.25 ± 0.05 (0.010 ± 0.002)
1/4	6.4 (0.250)	3.2 (0.125)	0.30 ± 0.08 (0.012 ± 0.003)
3/8	9.5 (0.375)	4.8 (0.187)	0.30 ± 0.08 (0.012 ± 0.003)
1/2	12.7 (0.500)	6.4 (0.250)	0.30 ± 0.08 (0.012 ± 0.003)
3/4	19.1 (0.750)	9.5 (0.375)	0.43 ± 0.08 (0.012 ± 0.003)
1	25.4 (1.000)	12.7 (0.500)	0.48 ± 0.08 (0.012 ± 0.003)

**Wall thickness will be less if tubing recovery is restricted during shrinkage.

Ordering information

Color	Standard Clear (-X)
Size selection	Always order the largest size that will shrink snugly over the component to be covered. Special order sizes are available upon request.
Standard packaging	On spools.
Ordering description***	Specify product name, size and color (for example, RT-375 1/4-X).

***Europe only. For supply to MIL, Def Stan and BS add -MS, -DS or -BS to ordering description.



RT555

Fluid-resistant, chemical-resistant, crosslinked fluoropolymer tubing with extended temperature range



Applications

Suitable for commercial applications requiring heat resistance (electrical and hydraulic systems near aircraft or automotive engines or in fuel tanks), applications in chemically exposed environments (industrial process equipment in the pulp and paper, steel, and chemical industries), and equipment for handling caustic or dangerous chemicals or inks. Use for insulation and strain relief on appliances (electric ranges, microwave ovens, gas grills, and industrial paint-drying equipment) and for protection of delicate electronic instruments in down-hole applications.

Operating temperature range

-65°C to 200°C

Features and benefits

- Resistance to high temperatures, solvents, corrosive chemicals, and radiation.
- Extreme resistance to hydrocarbons.
- Low outgassing (successfully tested for NASA outgassing requirements).
- Highly flame-retardant.
- 40 percent lighter weight than Viton tubing.
- Meets requirements of RT-700.
- System 300 tubing.

Installation

Minimum shrink temperature: 150°C

Minimum full recovery temperature: 220°C

Available in:

Americas

Europe

Asia Pacific



Specifications/approvals



Series

UL

Military

Raychem

RT555

Listed for 185°C for 100,000-hr continuous use (File E85381)

AR70-75

RT-555

Listed for 200°C for 40,000-hr cumulative intermittent exposure

Fax-on-demand

US only (800) 260-9099

Outside US (650) 257-2301

Fax ID

2580

2581

Description

RT-555

Data sheet

Visit our website at www.tycoelectronics.com**Product dimensions (mm/in)**

Size	Inside diameter		Recovered wall thickness*		
	Minimum expanded as supplied	Maximum recovered after heating	After heating		
			Minimum	Maximum	Nominal
1/8	3.18 (0.125)	1.57 (0.062)	0.25 (0.010)	0.41 (0.016)	0.30 (0.012)
3/16	4.75 (0.187)	2.36 (0.093)	0.28 (0.011)	0.46 (0.018)	0.36 (0.014)
1/4	6.35 (0.250)	3.18 (0.125)	0.33 (0.013)	0.51 (0.020)	0.41 (0.016)
3/8	9.53 (0.375)	4.75 (0.187)	0.41 (0.016)	0.58 (0.023)	0.48 (0.019)
1/2	12.70 (0.500)	6.35 (0.250)	0.41 (0.016)	0.58 (0.023)	0.48 (0.019)
5/8	15.88 (0.625)	7.95 (0.313)	0.48 (0.019)	0.66 (0.026)	0.56 (0.022)
3/4	19.05 (0.750)	9.53 (0.375)	0.61 (0.024)	0.79 (0.031)	0.69 (0.027)
1	25.40 (1.000)	12.70 (0.500)	0.71 (0.028)	0.89 (0.035)	0.79 (0.031)
1 1/4	31.75 (1.250)	15.88 (0.625)	0.76 (0.030)	0.94 (0.037)	0.84 (0.033)
1 1/2	38.10 (1.500)	19.05 (0.750)	0.86 (0.034)	1.04 (0.041)	0.94 (0.037)
2	50.80 (2.000)	25.40 (1.000)	0.94 (0.037)	1.12 (0.044)	1.02 (0.040)

*Wall thickness will be less if tubing recovery is restricted during shrinkage.

Ordering information

Color	Standard	Black (-0)
Size selection	Always order the largest size that will shrink snugly over the component to be covered. Special order sizes are available upon request.	
Standard packaging	On spools.	
Ordering description	Specify product name, size and color (for example, RT555 1/8-0).	



RW-175

High temperature, chemical-resistant, polyvinylidene fluoride tubing



Applications

Especially suitable for applications requiring high-temperature performance, outstanding abrasion resistance and cut-through resistance, or superior chemical and solvent properties. Provides electrical insulation and strain relief of multipin connectors and solder joints. Ideal for applications that require dense packing of components or visual inspection of covered components.

Operating temperature range

-55°C to 175°C

Features and benefits

- 2:1 shrink ratio.
- Tough, semirigid, very-thin-wall insulation.
- High flame-resistance, meeting the requirements of AMS-DTL-23053*, Test C, with UL (VW-1) and CSA (OFT) rating.
- High-temperature performance that meets or exceeds military and industrial standards.
- Protection from most industrial solvents, fuels, and chemicals.
- Recommended maximum temperature for use as a primary insulator: 135°C.

Installation

Minimum shrink temperature: 155°C

Minimum full recovery temperature: 175°C



Available in:

Americas

Europe

Asia Pacific

Specifications/approvals

Series	 UL	 CSA	Military	Industry	Raychem
RW-175	E35586 VW-1 600 V, 150°C	LR31929 OFT 600 V, 150°C	AMS-DTL-23053/8* Def. Stan. 59-97 Type 3 VG 95343 Pt 5 Type F BS 3G 198 Pt4	VDE 0341 Pt 9005	RW-3029/2 RW-3029/1

*Formerly MIL-I-23053 and MIL-DTL-23053/8.

Fax-on-demand

US only (800) 260-9099

Outside US (650) 257-2301

Fax ID

2070

2071

Description

Data sheet

RW-3029/2

Visit our website at www.tycoelectronics.com**Product dimensions (mm/in)**

Size	Inside diameter		Recovered wall thickness**
	Minimum expanded as supplied	Maximum recovered after heating	After heating
3/64	1.2 (0.046)	0.6 (0.023)	0.25 ± 0.05 (0.010 ± 0.002)
1/16	1.6 (0.063)	0.8 (0.031)	0.25 ± 0.05 (0.010 ± 0.002)
3/32	2.4 (0.093)	1.2 (0.046)	0.25 ± 0.05 (0.010 ± 0.002)
1/8	3.2 (0.125)	1.6 (0.062)	0.25 ± 0.05 (0.010 ± 0.002)
3/16	4.8 (0.187)	2.4 (0.093)	0.25 ± 0.05 (0.010 ± 0.002)
1/4	6.4 (0.250)	3.2 (0.125)	0.33 ± 0.05 (0.013 ± 0.002)
3/8	9.5 (0.375)	4.8 (0.187)	0.33 ± 0.05 (0.013 ± 0.002)
1/2	12.7 (0.500)	6.4 (0.250)	0.33 ± 0.05 (0.013 ± 0.002)
3/4	19.1 (0.750)	9.5 (0.375)	0.43 ± 0.08 (0.017 ± 0.003)
1	25.4 (1.000)	12.7 (0.500)	0.48 ± 0.08 (0.019 ± 0.003)
1 1/2	38.1 (1.500)	19.1 (0.750)	0.51 ± 0.08 (0.020 ± 0.003)

**Wall thickness will be less if tubing recovery is restricted during shrinkage.

Ordering information

Color	Standard	Clear (-X)
	Nonstandard	Black (-O)
Size selection	Always order the largest size that will shrink snugly over the component to be covered. Special order sizes are available upon request.	
Standard packaging	In 1.2-meter (4-foot) lengths.	
Ordering description***	Specify product name, size and color (for example, RW-175-3/64-X).	

***Europe only. For supply to MIL, Def Stan and BS add -MS, -DS or -BS to ordering description.



SCL

Semirigid, encapsulant-lined, polyolefin tubing



Applications

Encapsulates components, splices, and terminations where moisture resistance and mechanical protection are required. Encapsulant melts and flows to fill surface irregularities of the substrate. While still hot, the tubing can be blocked to form a wire breakout.

Operating temperature range

-55°C to 110°C

Features and benefits

- 3:1 shrink ratio.
- Splash-resistant, moisture-resistant covering; not intended for use where immersion in fluids is required.
- Rugged protection against abrasion, vibration, and flexing.
- Excellent strain relief and insulation of weak points.

Installation

Minimum shrink temperature: 125°C

Minimum full recovery temperature: 135°C

Available in:	Americas	Europe	Asia Pacific
	■	■	■

Specifications/approvals			
			
Series	UL	Military	Raychem
SCL	E85381 600 V, 125°C	AMS-DTL-23053/4*, Class 1	RT-1301

*Formerly MIL-I-23053/4 and MIL-DTL-23053/4.

Fax-on-demand	Fax ID	Description
US only (800) 260-9099	2180	Data sheet
Outside US (650) 257-2301	2181	RT-1301

Visit our website at www.tycoelectronics.com

Product dimensions (mm/in)

Size	Additional standard color	Inside diameter		Recovered wall thickness**	
		Minimum expanded as supplied	Maximum recovered after heating	Total wall after heating	Meltable wall after heating (nominal)
1/8	Brown	3.2 (0.125)	0.6 (0.023)	0.96 ± 0.15 (0.038 ± 0.006)	0.51 (0.020)
3/16	Gray	4.8 (0.187)	1.5 (0.060)	1.09 ± 0.15 (0.043 ± 0.006)	0.64 (0.025)
1/4	White	6.4 (0.250)	2.0 (0.080)	1.19 ± 0.15 (0.047 ± 0.006)	0.69 (0.027)
3/8	Red	9.5 (0.375)	3.4 (0.135)	1.27 ± 0.18 (0.050 ± 0.007)	0.76 (0.030)
1/2	Blue	12.7 (0.500)	5.0 (0.195)	1.39 ± 0.18 (0.050 ± 0.007)	0.89 (0.035)
3/4	Yellow	19.1 (0.750)	8.0 (0.313)	1.65 ± 0.18 (0.065 ± 0.007)	1.02 (0.040)
1	N/A	25.4 (1.000)	10.2 (0.400)	1.90 ± 0.18 (0.075 ± 0.007)	1.02 (0.040)

**Wall thickness will be less if tubing recovery is restricted during shrinkage.

Ordering information

Color	Standard	Black (-0) for all sizes, plus one additional color per size per Product dimensions table.
Size selection	Always order the largest size that will shrink snugly over the component to be covered. Special order sizes are available upon request.	
Standard packaging	In 1.2-meter (4-foot) lengths.	
Ordering description***	Specify product name, size and color (for example, SCL 1/4-0).	

***Europe only. For supply to MIL, Def Stan and BS add -MS, -DS or -BS to ordering description.



SCT

Flame-retardant, adhesive-lined, semirigid polyolefin tubing (extended temperature range)



Applications

Specially designed to insulate and seal automotive wire splices and components in an under-the-hood automotive environment. Specially formulated to function at an extended temperature range.

Operating temperature range

-40°C to 150°C

Features and benefits

- 4:1 shrink ratio allows a few sizes to cover a wide range of splice and component diameters.
- Flame-retardant and mechanically tough, the tubing provides strain relief and abrasion protection of wire splices, terminals, and other components.
- Thick adhesive liner forms an effective barrier against fluids and moisture and performs well at an extended temperature range.

Installation

Minimum shrink temperature: 110°C

Minimum full recovery temperature: 135°C

Available in:	Americas	Europe	Asia Pacific
	■	■	■

Specifications	
Series	Raychem
SCT	SCT SCD

Fax-on-demand

US only (800) 260-9099

Outside US (650) 257-2301

Fax ID

2627

2628

Description

Data sheet

SCD

Visit our website at www.tycoelectronics.com**Product dimensions (mm/in)**

Size	Inside diameter		Recovered wall thickness*	
	Minimum expanded as supplied	Maximum recovered after heating	Total wall after heating	Melttable wall after heating (nominal)
SCT No. 1	7.6 (0.300)	1.7 (0.065)	1.52 ± 0.30 (0.060 ± 0.012)	0.76 (0.030)
SCT No. 2	9.0 (0.355)	2.3 (0.090)	1.52 ± 0.30 (0.060 ± 0.012)	0.76 (0.030)
SCT No. 3	11.6 (0.455)	2.5 (0.100)	2.29 ± 0.30 (0.090 ± 0.012)	1.40 (0.055)
SCT No. 4	17.8 (0.700)	4.4 (0.175)	2.54 ± 0.30 (0.100 ± 0.012)	1.52 (0.060)

*Wall thickness will be less if tubing recovery is restricted during shrinkage.

Ordering information

Color	Black
Size selection	Always order the largest size that will shrink snugly over the component being covered. Special order sizes are available upon request.
Standard packaging	Cut pieces.
Marking	Tubing will be printed with its numbered size (such as SCT-1, SCT-2, SCT-3, SCT-4).
Ordering description	Specify product name, numbered size, color and cut length (for example, SCT-No.3-0-75mm).



SFR

Very flexible, flame-retardant, silicone elastomer tubing



Applications

Provides cable jacketing, harness protection, and strain relief for electronic components, semiconductor leads, and wire splices. Ideal for applications that require flexibility over a wide range of operating temperatures.

Operating temperature range

-75°C to 180°C

Features and benefits

- Outstanding low-temperature flexibility.
- Resistance to hydraulic fluids, fuel, and lubricating oils.
- Very good ablative characteristics: when exposed to flame, surface turns to insulative char or “ablates.”

Installation

Minimum shrink temperature: 135°C

Minimum full recovery temperature: 175°C

Available in:	Americas	Europe	Asia Pacific
	■	■	■

Specifications/approvals		
Series	Military	Raychem
SFR	AMS-DTL-23053/10* MIL-PRF-46846, Type II, Class 1	RT-1140

*Formerly MIL-I-23053/10 and MIL-DTL-23053/10.

Fax-on-demand

US only (800) 260-9099

Outside US (650) 257-2301

Fax ID

2190

2191

Description

Data sheet

RT-1 140

Visit our website at www.tycoelectronics.com**Product dimensions (mm/in)**

Size	Inside diameter		Recovered wall thickness**
	Minimum expanded as supplied	Maximum recovered after heating	After heating
1/4	6.4 (0.250)	3.6 (0.143)	0.88 ± 0.25 (0.035 ± 0.010)
3/8	9.5 (0.375)	5.4 (0.214)	1.02 ± 0.25 (0.040 ± 0.010)
1/2	12.7 (0.500)	7.3 (0.286)	1.21 ± 0.38 (0.048 ± 0.015)
5/8	15.9 (0.625)	9.1 (0.357)	1.32 ± 0.38 (0.052 ± 0.015)
3/4	19.1 (0.750)	10.9 (0.428)	1.44 ± 0.38 (0.057 ± 0.015)
7/8	22.2 (0.875)	12.7 (0.500)	1.65 ± 0.38 (0.065 ± 0.015)
1	25.4 (1.000)	14.5 (0.570)	1.77 ± 0.51 (0.070 ± 0.020)
1 1/4	31.8 (1.250)	18.1 (0.714)	2.21 ± 0.51 (0.087 ± 0.020)
1 1/2	38.1 (1.500)	21.8 (0.857)	2.41 ± 0.51 (0.095 ± 0.020)
1 3/4	44.5 (1.750)	25.4 (1.000)	2.71 ± 0.51 (0.107 ± 0.020)
2	50.8 (2.000)	29.0 (1.140)	2.79 ± 0.51 (0.110 ± 0.020)

**Wall thickness will be less if tubing recovery is restricted during shrinkage.

Ordering information

Color	Standard	Black (-0)
Size selection	Always order the largest size that will shrink snugly over the component to be covered. Special order sizes are available upon request.	
Standard packaging	On spools.	
Ordering description***	Specify product name, size and color (for example, SFR 1/4-0).	

***Europe only. For supply to MIL, Def Stan and BS add -MS, -DS or -BS to ordering description.



SRFR

Highly flexible, silicone rubber tubing



Applications

Highly flexible and resistant to high and low temperatures. Unlike other silicone materials, SRFR tubing displays outstanding physical strength. The tubing resists extreme heat shocks, and exhibits good thermal insulation.

SRFR tubing is non-burning and has outstanding ablative properties as well as an excellent balance of physical and electrical properties. SRFR tubing is used in medical equipment where its key properties are outstanding flexibility and its ability to withstand exposure to sterilization conditions. Other applications include thyristor power cable insulation, heating element and bus bar insulation, fiber optic bundle sheathing, and rocketry support cable protection.

Features and benefits

- Highly flame-retardant.
- Extremely flexible at high and low temperatures.
- Shrink ratio 1.5:1 minimum except sizes 4/2.9 and 29/20.

Installation

Minimum shrink temperature: 135°C

Minimum full recovery temperature: 175°C

Operating temperature range

-75°C to 200°C

Available in:

Americas

Europe

Asia Pacific



Specifications/approvals



Series

UL

Raychem

SRFR

E85381 VW-1

RW 2057

Fax-on-demand

US only (800) 260-9099

Outside US (650) 257-2301

Visit our website at www.tycoelectronics.com**Product dimensions (mm/in)**

Size	Inside diameter		Recovered wall thickness*
	Minimum expanded as supplied	Maximum recovered after heating	After heating (nominal)
2.9/1.7	2.9 (0.114)	1.7 (0.067)	1.0±0.5 (0.039±0.020)
4/2.9	4.0 (0.158)	2.9 (0.114)	1.0±0.5 (0.039±0.020)
7.8/4.6	7.8 (0.307)	4.6 (0.181)	1.0±0.5 (0.039±0.020)
10/6.5	10.0 (0.394)	6.5 (0.256)	1.5±0.5 (0.059±0.020)
15/9.6	15.0 (0.591)	9.6 (0.378)	1.5±0.5 (0.059±0.020)
21/13	21.0 (0.827)	13.0 (0.512)	2.0±0.75 (0.079±0.030)
29/20	29.0 (1.142)	20.0 (0.787)	2.0±0.75 (0.079±0.030)
41/27	41.0 (1.614)	27.0 (1.063)	3.0±1.0 (0.118±0.039)
51/33	51.0 (2.008)	33.0 (1.299)	3.0±1.0 (0.118±0.039)

**Wall thickness will be less if tubing recovery is restricted during shrinkage.

Ordering information

Color	Standard Gray (-8)
Size selection	The largest size which will recover snugly over the component to be covered should be ordered.
Standard packaging	On spools.
Ordering description	Specify product name, size and color (for example, SRFR-2.9/1.7-8).

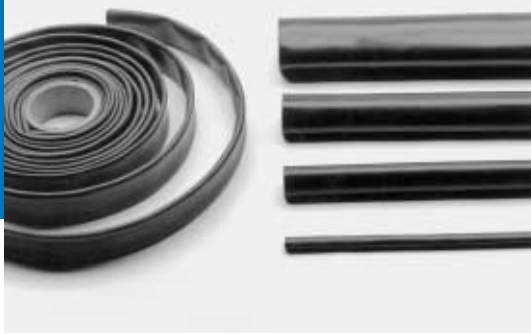

SST/SST-FR

Self-sealing, heat-shrinkable tubing



Applications

SST provides a simple, positive splice-sealing method that offers protection under adverse environmental conditions. Tubing supplied with standard sealant provides water sealing and environmental protection in wet or underground applications. The thermoplastic adhesive not only seals, but also provides mechanical strain relief. The polymer tubing has excellent insulating, abrasion-resisting, and strain-relief properties.

Operating temperature range

-55°C to 90°C

Features and benefits

- Strain relief.
- Thick adhesive liner forms an effective barrier against fluids and moisture.
- Thick-wall insulation and abrasion-protection.
- No need for greases, tape, or epoxy.
- Expansion ratios as high as 3:1.
- Availability in flame-retardant material.
- SST has the following agency approvals:
 - ABS (American Bureau of Shipping)
 - DNV (Det Norske Veritas)
 - Lloyd's (Lloyd's Register of Shipping)

Installation

Minimum shrink temperature: 90°C

Minimum full recovery temperature: 121°C

Available in:	Americas	Europe	Asia Pacific
	■	■	■

Specifications/approvals			
Series	Military	Industry	Raychem
SST			RW 2017
SST-FR	AMS-DTL-23053/15*, Class 1 and Class 2	ASTM D 685, nonburning ASTM D 2863, oxygen index IPCEA S-19-81, cable insulation and jackets IEEE-383 Section 2.5 massive flame vertical tray ABS, DNV, Lloyd's Register	RW 2011

*Formerly MIL-23053/15 and MIL-DTL-23053/15.

Fax-on-demand

US only (800) 260-9099

Outside US (650) 257-2301

Fax ID

2290

Description

Data sheet

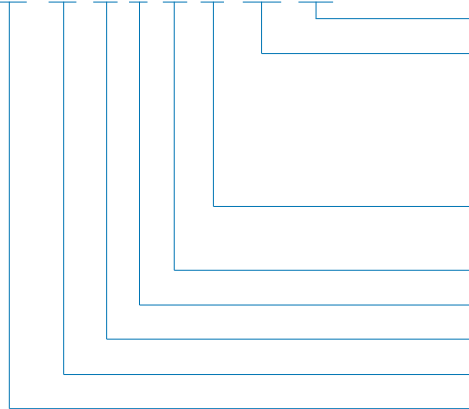
Visit our website at www.tycoelectronics.com**Part numbering system****SST - 48 - 07 M/FR/97/RED/NM**

"NM" - no mark

Color

Black/leave blank (standard)

White/WHT

Red/RED

Clear/CL

Adhesive/sealant

/97 standard with FR /226 standard with NF

"FR" - flame-retardant

"M" - medium wall

Size in inches (48 inch max.)**Length** in inches**Family****Product dimensions (inches)**

Size†	Standard nominal length	Inside diameter		Wall thickness		Recommended cable range for 600-volt cable
		Minimum expanded as supplied	Maximum recovered after heating	Expanded	Nominal wall after heating††	
SST*03	6,30	0.300	0.100	0.025	0.060	#18 through #14 AWG
SST*04	6,30	0.400	0.150	0.025	0.060	#14 through #10 AWG
SST*07M	6,9, 12, 48	0.750	0.220	0.020	0.060	#8 through #1 AWG
SST*07	6,9, 12, 48	0.750	0.220	0.030	0.095	#8 through #1 AWG
SST*-11M	6,9, 12, 48	1.100	0.375	0.030	0.105	#2 through #4/0 AWG
SST*-11	6,9, 12, 48	1.100	0.375	0.040	0.120	#2 through #4/0 AWG
SST*-13M	6,9, 12, 48	1.300	0.375	0.025	0.105	#2 through #4/0 AWG
SST*-13	6,9, 12, 48	1.300	0.375	0.035	0.120	#2 through #4/0 AWG
SST*-15M	6,9, 12, 48	1.500	0.500	0.035	0.120	#2/0 AWG through 500 MCM
SST*-15	6,9, 12, 48	1.500	0.500	0.050	0.140	#2/0 AWG through 500 MCM
SST*-17M	6,9, 12, 48	1.700	0.500	0.030	0.120	#2/0 AWG through 500 MCM
SST*-17	6,9, 12, 48	1.700	0.500	0.045	0.140	#2/0 AWG through 500 MCM
SST*-20M	6,9, 12, 48	2.000	0.750	0.040	0.120	#350 MCM through 1000 MCM
SST*-20	6,9, 12, 48	2.000	0.750	0.050	0.155	#350 MCM through 1000 MCM
SST*-27	12, 18, 24	2.700	0.900	0.050	0.155	#500 MCM through 1250 MCM
SST*-30	12, 18, 24	3.000	1.250	0.050	0.155	#900 MCM through 1500 MCM
SST*-40	12, 18, 24	4.000	1.750	0.050	0.155	#1500 MCM through 2500 MCM
SST*-45	12, 18, 24	4.500	1.750	0.050	0.155	#1500 MCM through 2500 MCM

†In place of asterisk* substitute length of tubing to be ordered. For example, SST*-11, as the third column indicates, comes in 6-, 9-, and 12-inch lengths, so 9-inch SST tubing would be SST 9-11. The suffix M = medium-wall tubing. ††Wall thickness will be less if tubing recovery is restricted during shrinkage.

Ordering information

Color	Standard	Black (-0)
Size selection	Always order the largest size that will shrink snugly over the component to be covered. Special order sizes are available upon request.	
Standard packaging	See Product dimensions table.	
Ordering description	Specify product name, size and color (for example, SST-48-07/FR/RS).	

Users should independently evaluate the suitability of the product for their application.
Before ordering check with factory for most current data.



TAT-125

Adhesive-lined, flexible, polyolefin tubing



Applications

Seals and protects simple in-line splices, bimetallic joints, and components from fluids, moisture, and corrosion. Repairs damaged wire insulation, especially where flexibility is required. Provides one-step electrical insulation and moisture sealing.

Operating temperature range

-55°C to 110°C

Features and benefits

- 2:1 shrink ratio.
- Thin adhesive lining that bonds to outer tubing and surface below, forming a positive environmental seal.
- Flexibility of both tubing and adhesive.
- Moisture seal that is resistant to bending of the substrate.
- Good mechanical strength and cut-through resistance.
- Adhesive that bonds to a wide variety of plastics, rubbers, and metals, including polyethylene, neoprene, lead, and steel.

Installation

Minimum shrink temperature: 95°C
 Minimum full recovery temperature: 121°C

Available in:	Americas	Europe	Asia Pacific
	■		■

Specifications/approvals			
Series		Military	Raychem
TAT-125 Type 1 (colors)	E85381 600 V, 125°C	AMS-DTL-23053/4*, Class 2	TAT-125 SCD
TAT-125 Type 2 (clear)			TAT-125 SCD

*Formerly MIL-I-23053/4 and MIL-DTL-23053/4. Sizes 1/4" through 1 1/2" only.

Fax-on-demand

US only (800) 260-9099

Outside US (650) 257-2301

Fax ID

2200

2201

Description

Data sheet

SCD

Visit our website at www.tycoelectronics.com**Product dimensions (mm/in)**

Size	Inside diameter		Recovered wall thickness**	
	Minimum expanded as supplied	Maximum recovered after heating	Total wall after heating (nominal)	Adhesive wall after heating (nominal)
1/8	3.2 (0.125)	1.6 (0.062)	0.69 (0.027)	0.23 (0.009)
3/16	4.8 (0.187)	2.4 (0.093)	0.71 (0.028)	0.25 (0.010)
1/4	6.4 (0.250)	3.2 (0.125)	0.74 (0.029)	0.13 (0.005)
3/8	9.5 (0.375)	4.8 (0.187)	0.74 (0.029)	0.13 (0.005)
1/2	12.7 (0.500)	6.4 (0.250)	0.76 (0.030)	0.15 (0.006)
3/4	19.1 (0.750)	9.5 (0.375)	0.89 (0.035)	0.15 (0.006)
1	25.4 (1.000)	12.7 (0.500)	1.07 (0.042)	0.20 (0.008)
1 1/2	38.1 (1.500)	19.1 (0.750)	1.19 (0.047)	0.28 (0.011)

**Wall thickness will be less if tubing recovery is restricted during shrinkage.

Ordering information

Color	Standard	Black (-0)
	Nonstandard	White (-9), red (-2), blue (-6), yellow (-4), green (-5), brown (-1), orange (-3), violet (-7), gray (-8), clear (-X, not flame-retardant)
Size selection	Always order the largest size that will shrink snugly over the component to be covered. Special order sizes are available upon request.	
Standard packaging	In 1.2-meter (4-foot) lengths.	
Ordering description	Specify product name, size and color (for example, TAT-125 1/4-0).	



TFE and TFE-R

High-temperature, chemically inert, modified Teflon tubing



Applications

Designed to provide insulation and mechanical protection in severe chemical and thermal environments. Used to cover hydraulic hose and couplings to prevent contamination and corrosion. The high mechanical strength and extremely low coefficient of friction make it ideal for reducing damage to bearing shafts and similar applications.

Features and benefits

- Shrink ratio : 1.8:1 (TFE)
3.2:1 (TFE-R)
- High flame-resistance.
- Excellent chemical resistance.

Installation

Minimum full recovery temperature: 340°C

Operating temperature range

-67°C to 250°C

Available in:	Americas	Europe	Asia Pacific
		■	■

Specifications/approvals		
Series	Military	Raychem
TFE, TFE-R	AMS-DTL-23053/12* Def. Stan. 59-97 Type 5B (TFE) Def. Stan. 59-97 Type 5B (TFE-R)	RW-2055 (TFE) RW-2054 (TFE-R)

*Formerly MIL+23053/12 and MIL-DTL-23053/12.

Fax-on-demand

US only (800) 260-9099

Outside US (650) 257-2301

Visit our website at www.tycoelectronics.com**Product dimensions (inches)**

Size	Inside diameter				Recovered wall thickness**				
	Minimum expanded as supplied		Maximum recovered after heating		After heating (nominal)				
TFE	TFE-R	TFE	TFE-R	TFE	TFE-R	TFE	TFE-R	TFE	TFE-R
30	5/64	0.8	2.0	0.38	0.6	0.23	0.23	0.23	0.23
28	1/8	0.9	3.2	0.46	1.0	0.23	0.25	0.23	0.25
26	1/4	1.1	6.4	0.56	1.6	0.25	0.30	0.25	0.30
24	3/8	1.2	9.5	0.68	2.4	0.25	0.30	0.25	0.30
22	1/2	1.4	12.7	0.81	3.7	0.30	0.38	0.30	0.38
20	5/8	1.5	15.9	0.99	4.5	0.30	0.38	0.30	0.38
18	3/4	1.9	19.0	1.24	5.7	0.30	0.38	0.30	0.38
16	1	2.3	25.4	1.55	7.1	0.30	0.38	0.30	0.38
14	1 1/4	3.0	32.0	1.83	8.8	0.30	0.38	0.30	0.38
12		3.8	-	2.26	-	0.30	-	0.30	-
10		4.8	-	2.84	-	0.30	-	0.30	-
8		6.1	-	3.58	-	0.38	-	0.38	-
6		7.6	-	4.52	-	0.38	-	0.38	-
4		9.4	-	5.69	-	0.38	-	0.38	-
2		10.9	-	7.06	-	0.38	-	0.38	-
0		11.9	-	8.81	-	0.38	-	0.38	-

**Wall thickness will be less if tubing recovery is restricted during shrinkage.

Ordering information

Color	Standard	Clear (-X)
Size selection	Always order the largest size that will shrink snugly over the component to be covered. Special order sizes are available upon request.	
Standard packaging	In 1.2-meter (4-foot) lengths.	
Ordering description***	Specify product name, size and color (for example, TFE-22-X).	

***Europe only. For supply to MIL, Def Stan and BS add -MS, -DS or -BS to ordering description.

TPEM

Protective self-adhering edging material



Applications

TPEM is an extruded V-shaped strip internally coated with a heat activated adhesive, so that on heating the profile changes from a 'V' to a 'U' section to grip the edge and the adhesive bonds to the substrate profile. Manufactured from a Raychem radiation cross-linked polyolefin material, the profile offers a clean and rapid means of covering metal, wood and glass edges for all round protection. The flexible nature of the product allows application to both internal and external radii, as well as straight edges. TPEM has a high bond strength which can give protection under the most testing circumstances.

Operating temperature range

-55°C to 80°C

Features and benefits

- High bond strength.
- Flexibility allows protection of curved edges.
- Clean and rapid installation.

Installation

Minimum full recovery temperature: 120°C

Available in:

Americas

Europe

Asia Pacific

Specifications

Series

Raychem

TPEM

RK-6029

Fax-on-demand

US only (800) 260-9099

Outside US (650) 257-2301

Visit our website at www.tycoelectronics.com**Application range (mm/in)**

Plate	Thickness	Recommended minimum bend radius
SWG		
30-24	0.31-0.56 (0.012-0.022)	10 (0.394)
23-16	0.61-1.63 (0.026-0.064)	15 (0.591)
15-10	1.83-3.25 (0.072-0.128)	20 (0.787)
9-5	3.66-5.38 (0.144-0.212)	25 (0.984)

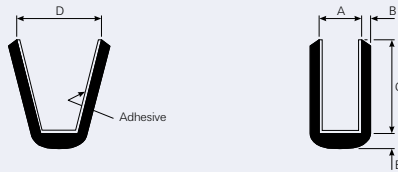
Product dimensions (mm/in)

Size	A (maximum)	B (minimum)	C (minimum)	D (minimum)	E (typical)
Nr. 6	0.6 (0.024)	0.5 (0.020)	3.5 (0.138)	0.8 (0.032)	1.25 (0.049)
Nr. 7	1.0 (0.039)	0.9 (0.035)	4.8 (0.189)	1.6 (0.063)	1.25 (0.049)
Nr. 8	2.0 (0.079)	0.9 (0.035)	6.6 (0.260)	2.5 (0.098)	2.25 (0.089)
Nr. 9	4.2 (0.165)	0.9 (0.035)	13.5 (0.532)	4.5 (0.177)	2.20 (0.087)

Ordering information

Color	Standard	Black (-0)
Size selection	The largest size which will fit over the panel should be ordered.	
Standard packaging	In 1.2-meter (4-foot) lengths.	
Ordering description	Specify product name followed by size (for example, TPEM Nr. 6).	



TUGA-GP

Brightly colored, shiny, non-flame-retardant, polyolefin tubing



Applications

TUGA-GP is a commercial grade tubing for general applications where a flame-retardant product is not needed but where electrical insulation and mechanical performance are important. TUGA-GP makes an attractive covering for many automotive, appliance, and consumer-goods applications. Exceptional transparency of clear version makes it an ideal choice for protecting marked surfaces.

Operating temperature range

-55°C to 125°C

Features and benefits

- 2:1 shrink ratio.
- Can be easily hot-stamped.
- Bright shiny surface; clear version offers exceptional clarity.
- Semiflexible, non-flame-retarded, halogen free.
- Conforms to substrates more uniformly and with less longitudinal change than most PVC-based materials.

Installation

Minimum shrink temperature: 85°C
 Minimum full recovery temperature: 110°C for black
 100°C for all other colors
 and clear.

Available in:

Americas

Europe

Asia Pacific



Specifications/approvals

Series	Raychem
TUGA-GP	RW-2201

Fax-on-demand

US only (800) 260-9099

Outside US (650) 257-2301

Visit our website at www.tycoelectronics.com**Product dimensions (mm/in)**

Size	Inside diameter		Recovered wall thickness*
	Minimum expanded as supplied	Maximum recovered after heating	Maximum after heating
1.2/0.6	1.2 (0.047)	0.6 (0.024)	0.4 (0.016)
1.6/0.8	1.6 (0.062)	0.8 (0.031)	0.4 (0.016)
2.4/1.2	2.4 (0.093)	1.2 (0.047)	0.5 (0.019)
3/1.5	3.0 (0.118)	1.5 (0.059)	0.5 (0.019)
5/2.5	5.0 (0.197)	2.5 (0.098)	0.5 (0.019)
6.4/3.2	6.4 (0.250)	3.2 (0.125)	0.6 (0.024)
8/4	8.0 (0.315)	4.0 (0.157)	0.6 (0.024)
9.5/4.8	9.5 (0.375)	4.8 (0.189)	0.6 (0.024)
11/5.5	11.0 (0.433)	5.5 (0.217)	0.6 (0.024)
12.7/6.4	12.7 (0.500)	6.4 (0.250)	0.6 (0.024)
15/7.5	15.0 (0.591)	7.5 (0.295)	0.8 (0.031)
20/10	20.0 (0.787)	10.0 (0.394)	0.8 (0.031)
25.4/12.7	25.4 (1.000)	12.7 (0.500)	0.9 (0.035)
38/19	38.0 (1.496)	19.0 (0.748)	1.0 (0.039)

*Wall thickness will be less if tubing recovery is restricted during shrinkage.

Ordering information

Color	Standard	Black (-0), white (-9), red (-2)
	Nonstandard	Yellow (-4), clear (-X)
Size selection	Always order the largest size that will shrink snugly over the component to be covered. Special order sizes are available upon request.	
Standard packaging	On spools.	
Ordering description	Specify product name, size and color (for example, TUGA-3/1.5-0/1.5-0).	



Versafit

Highly flame-retardant, very flexible,
low-shrink-temperature, polyolefin tubing



Applications

Cost-effective choice for many commercial and military applications; electrically insulates and protects in-line components, disconnect terminals, and splices. Bundles wires for very flexible light-duty harnesses. Strain-relieves electrical wire connections for commercial applications. Identifies or color-codes wires, cables, terminals, and components.

Operating temperature range

-55°C to 135°C

Features and benefits



- 2:1 shrink ratio.
- Low shrink temperature reduces installation time and the risk of damage to temperature-sensitive components.
- Very flexible; doesn't easily wrinkle when bent.
- Highly flame-retardant.
- Hot stamps extremely well.
- Higher temperature rating, better thermal stability, and higher resistance to physical abuse than noncrosslinked materials.
- Free of polybrominated biphenyls (PBBs) and polybrominated biphenyl oxides and ethers (PBBOs and PBBEs), which are classified as environmentally hazardous substances.

Installation

Minimum shrink temperature: 70°C

Minimum full recovery temperature: 90°C

Available in:	Americas	Europe	Asia Pacific
	■	■	■

Specifications/approvals				
Series	 UL	 CSA	Military	Raychem
Versafit	E35586 VW-1 600 V, 125°C	LR31929 OFT 600 V, 125°C	AMS-DTL-23053/5*, Classes 1 & 3	RW-3009

*Formerly MIL-I-23053/5 and MIL-DTL-23053/5.

Fax-on-demand

US only (800) 260-9099

Outside US (650) 257-2301

Fax ID

2220

2221

2603

Description

Data sheet

RW-3009

Technical Bulletin

Visit our website at www.tycoelectronics.com**Product dimensions (mm/in)**

Size	Inside diameter		Recovered wall thickness**	
	Minimum expanded as supplied	Maximum recovered after heating	After heating	
3/64	1.63 ± 0.2 (0.064 ± 0.008)	0.6 (0.023)	0.40 ± 0.08 (0.016 ± 0.003)	
1/16	1.85 ± 0.2 (0.073 ± 0.007)	0.8 (0.031)	0.43 ± 0.08 (0.017 ± 0.003)	
3/32	2.79 ± 0.2 (0.110 ± 0.007)	1.2 (0.046)	0.51 ± 0.08 (0.020 ± 0.003)	
1/8	3.43 ± 0.2 (0.135 ± 0.007)	1.6 (0.062)	0.51 ± 0.08 (0.020 ± 0.003)	
3/16	5.21 ± 0.3 (0.205 ± 0.010)	2.4 (0.093)	0.51 ± 0.08 (0.020 ± 0.003)	
1/4	7.11 ± 0.3 (0.280 ± 0.010)	3.2 (0.125)	0.64 ± 0.08 (0.025 ± 0.003)	
3/8	10.16 ± 0.4 (0.400 ± 0.015)	4.8 (0.187)	0.64 ± 0.08 (0.025 ± 0.003)	
1/2	13.72 ± 0.4 (0.540 ± 0.015)	6.4 (0.250)	0.64 ± 0.08 (0.025 ± 0.003)	
5/8	16.90 ± 0.4 (0.665 ± 0.015)	8.0 (0.315)	0.76 ± 0.08 (0.030 ± 0.003)	
3/4	20.45 ± 0.4 (0.805 ± 0.015)	9.5 (0.375)	0.76 ± 0.08 (0.030 ± 0.003)	
1	25.53 ± 0.4 (1.055 ± 0.015)	12.7 (0.500)	0.89 ± 0.12 (0.035 ± 0.005)	
1 1/4	33.40 ± 0.7 (1.315 ± 0.025)	15.9 (0.635)	1.02 ± 0.15 (0.040 ± 0.006)	
1 1/2	39.88 ± 0.8 (1.570 ± 0.030)	19.1 (0.750)	1.02 ± 0.15 (0.040 ± 0.006)	
2	52.83 ± 1.0 (2.080 ± 0.040)	25.4 (1.000)	1.14 ± 0.16 (0.045 ± 0.007)	
3	78.49 ± 1.0 (3.090 ± 0.040)	38.1 (1.500)	1.27 ± 0.20 (0.050 ± 0.008)	
4	104.14 ± 1.3 (4.100 ± 0.050)	50.8 (2.000)	1.40 ± 0.23 (0.055 ± 0.009)	

**Wall thickness will be less if tubing recovery is restricted during shrinkage.

Ordering information

Color	Standard	Black (-0), white (-9), red (-2), blue (-6), yellow (-4), green (-5)
	Nonstandard	Brown (-1), orange (-3), violet (-7), gray (-8)
Size selection	Always order the largest size that will shrink snugly over the component to be covered. Special order sizes are available upon request.	
Standard packaging***	On spools.	
Ordering description****	Specify product name, size and color (for example, Versafit 1/4-0).	

***Available in the convenient RaySpool packaging/dispensing system, for sizes 1/16" up to 1".

****Europe only. For supply to MIL, Def Stan and BS add -MS, -DS or -BS to ordering description.



Versafit V

*Highly flame-retardant, very flexible,
low-shrink-temperature, polyolefin tubing*



Applications

Used for electrical insulation and strain relief of commercial wire terminations and electrical connections requiring 105°C performance. Bundles wires for very flexible light-duty harnesses. Identifies or color-codes wires, cables, terminals, and components.

Operating temperature range

-55°C to 105°C

Features and benefits

- 2:1 shrink ratio.
- Low shrink temperature reduces installation time and the risk of damage to temperature-sensitive components.
- Very flexible; doesn't easily wrinkle when bent.
- Hot stamps extremely well.
- Free of polybrominated biphenyls (PBBs) and polybrominated biphenyl oxides and ethers (PBBOs and PBBEs), which are classified as environmentally hazardous substances.
- Higher temperature rating, better thermal stability, and higher resistance to physical abuse than noncrosslinked materials.

Installation

Minimum shrink temperature: 70°C

Minimum full recovery temperature: 90°C

Available in:



Americas

Europe

Asia Pacific



Specifications/approvals

Series	 UL	 CSA	Raychem
Versafit V	E35586 WW-1 600 V, 105°C	LR3 1929 WW-1 600V, 105°C	RW-3022

Fax-on-demand

US only (800) 260-9099

Outside US (650) 257-2301

Visit our website at www.tycoelectronics.com**Product dimensions (mm/in)**

Size	Inside diameter		Wall thickness	
	Minimum expanded as supplied	Maximum recovered after heating	Expanded as supplied (nominal)	Recovered* after heating (minimum)
1.0	1.6±0.2 (0.064±0.008)	0.50 (0.020)	0.20 (0.008)	0.33 (0.013)
1.5	1.6±0.2 (0.064±0.008)	0.75 (0.030)	0.20 (0.008)	0.35 (0.014)
2.0	2.6±0.2 (0.102±0.008)	1.00 (0.039)	0.25 (0.010)	0.43 (0.017)
2.5	3.1±0.2 (0.122±0.008)	1.25 (0.049)	0.25 (0.010)	0.43 (0.017)
3.0	3.6±0.2 (0.142±0.008)	1.50 (0.059)	0.25 (0.010)	0.43 (0.017)
3.5	4.1±0.3 (0.161±0.012)	1.75 (0.069)	0.25 (0.010)	0.43 (0.017)
4.0	4.6±0.3 (0.181±0.012)	2.00 (0.079)	0.25 (0.010)	0.43 (0.017)
5.0	5.6±0.3 (0.221±0.012)	2.50 (0.098)	0.30 (0.012)	0.56 (0.022)
6.0	6.6±0.3 (0.260±0.012)	3.00 (0.118)	0.30 (0.012)	0.56 (0.022)
7.0	7.6±0.3 (0.299±0.012)	3.50 (0.138)	0.30 (0.012)	0.56 (0.022)
8.0	8.6±0.3 (0.339±0.012)	4.00 (0.158)	0.30 (0.012)	0.56 (0.022)
9.0	9.6±0.3 (0.378±0.012)	4.50 (0.177)	0.30 (0.012)	0.56 (0.022)
10.0	10.4±0.3 (0.409±0.012)	5.00 (0.197)	0.30 (0.012)	0.56 (0.022)
11.0	11.4±0.3 (0.449±0.012)	5.50 (0.217)	0.30 (0.012)	0.56 (0.022)
12.0	12.7±0.3 (0.500±0.012)	6.0 (0.236)	0.30 (0.012)	0.56 (0.022)
13.0	13.5±0.3 (0.532±0.012)	6.50 (0.256)	0.35 (0.014)	0.66 (0.026)
14.0	14.4±0.4 (0.567±0.016)	7.0 (0.276)	0.35 (0.014)	0.68 (0.027)
15.0	15.7±0.4 (0.618±0.016)	7.50 (0.295)	0.35 (0.014)	0.68 (0.027)
16.0	16.9±0.4 (0.665±0.016)	8.00 (0.315)	0.35 (0.014)	0.68 (0.027)
18.0	19.0±0.4 (0.748±0.016)	9.00 (0.354)	0.40 (0.016)	0.76 (0.030)
20.0	21.4±0.4 (0.843±0.016)	10.00 (0.394)	0.40 (0.016)	0.76 (0.030)
22.0	23.2±0.4 (0.913±0.016)	11.00 (0.433)	0.45 (0.018)	0.89 (0.035)
25.0	26.8±0.4 (1.055±0.016)	12.50 (0.492)	0.45 (0.018)	0.89 (0.035)
27.0	28.2±0.5 (1.110±0.020)	12.50 (0.492)	0.45 (0.018)	0.89 (0.035)
28.0	30.0±0.5 (1.181±0.020)	14.00 (0.551)	0.45 (0.018)	0.89 (0.035)
30.0	32.1±0.5 (1.264±0.020)	15.00 (0.591)	0.45 (0.018)	0.89 (0.035)

*Wall thickness will be less if tubing recovery is restricted during shrinkage.

Ordering information

Color	Standard Black (-0).
Size selection	Always order the largest size that will shrink snugly over the component to be covered. Special order sizes are available upon request.
Standard packaging	On spools.
Marking	Marked with UL/CSA/-F legends.
Ordering description	Specify product name, size and color (for example, Versafit V-3.0-0).

Users should independently evaluate the suitability of the product for their application.
Before ordering check with factory for most current data.

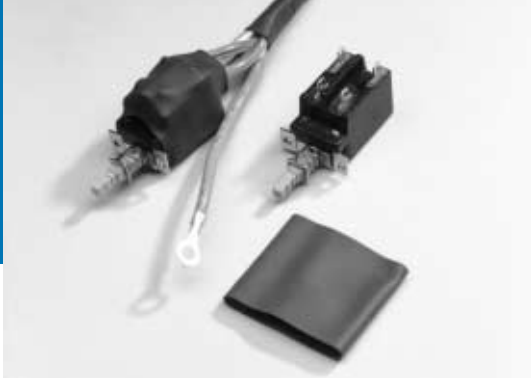

Versafit V2

*Highly flame-retardant, very flexible,
low-shrink-temperature, polyolefin tubing*



Applications

Cost-effective choice for many commercial applications; electrically insulates and protects in-line components, disconnect terminals, and splices. Bundles wires for very flexible light-duty harnesses. Strain-relieves electrical wire connections. Identifies or color-codes wires, cables, terminals, and components.

Operating temperature range

-30°C to 125°C

Features and benefits

- 2:1 shrink ratio.
- Low shrink temperature reduces installation time and the risk of damage to temperature-sensitive components.
- Very flexible; doesn't easily wrinkle when bent.
- Hot stamps extremely well.
- Free of polybrominated biphenyls (PBBs) and polybrominated biphenyl oxides and ethers (PBBOs and PBBEs), which are classified as environmentally hazardous substances.
- Higher temperature rating, better thermal stability, and higher resistance to physical abuse than noncrosslinked materials.

Installation

Minimum shrink temperature: 70°C

Minimum full recovery temperature: 90°C

Available in:

Americas

Europe

Asia Pacific



Specifications/approvals

Series	UL	CSA	Raychem
Versafit V2	E35586 VV-1 600 V, 125°C	LR31929 OFT 600 V, 125°C	RW-3023

Fax-on-demand

US only (800) 260-9099

Outside US (650) 257-2301

Fax ID

2222

2221

Description

Data sheet

RW-3023

Visit our website at www.tycoelectronics.com**Product dimensions (mm/in)**

Size	Inside diameter		Wall thickness	
	Minimum expanded as supplied	Maximum recovered after heating	Expanded as supplied (nominal)	Recovered* after heating (minimum)
1.0	1.6±0.2 (0.064±0.008)	0.50 (0.020)	0.20 (0.008)	0.33 (0.013)
1.5	1.6±0.2 (0.064±0.008)	0.75 (0.030)	0.20 (0.008)	0.35 (0.014)
2.0	2.6±0.2 (0.102±0.008)	1.00 (0.039)	0.25 (0.010)	0.43 (0.017)
2.5	3.1±0.2 (0.122±0.008)	1.25 (0.049)	0.25 (0.010)	0.43 (0.017)
3.0	3.6±0.2 (0.142±0.008)	1.50 (0.059)	0.25 (0.010)	0.43 (0.017)
3.5	4.1±0.3 (0.161±0.012)	1.75 (0.069)	0.25 (0.010)	0.43 (0.017)
4.0	4.6±0.3 (0.181±0.012)	2.00 (0.079)	0.25 (0.010)	0.43 (0.017)
5.0	5.6±0.3 (0.221±0.012)	2.50 (0.098)	0.30 (0.012)	0.56 (0.022)
6.0	6.6±0.3 (0.260±0.012)	3.00 (0.118)	0.30 (0.012)	0.56 (0.022)
7.0	7.6±0.3 (0.299±0.012)	3.50 (0.138)	0.30 (0.012)	0.56 (0.022)
8.0	8.6±0.3 (0.339±0.012)	4.00 (0.158)	0.30 (0.012)	0.56 (0.022)
9.0	9.6±0.3 (0.378±0.012)	4.50 (0.177)	0.30 (0.012)	0.56 (0.022)
10.0	10.4±0.3 (0.409±0.012)	5.00 (0.197)	0.30 (0.012)	0.56 (0.022)
11.0	11.4±0.3 (0.449±0.012)	5.50 (0.217)	0.30 (0.012)	0.56 (0.022)
12.0	12.7±0.3 (0.500±0.012)	6.0 (0.236)	0.30 (0.012)	0.56 (0.022)
13.0	13.5±0.3 (0.532±0.012)	6.50 (0.256)	0.35 (0.014)	0.66 (0.026)
14.0	14.4±0.4 (0.567±0.016)	7.0 (0.276)	0.35 (0.014)	0.68 (0.027)
15.0	15.7±0.4 (0.618±0.016)	7.50 (0.295)	0.35 (0.014)	0.68 (0.027)
16.0	16.9±0.4 (0.665±0.016)	8.00 (0.315)	0.35 (0.014)	0.68 (0.027)
18.0	19.0±0.4 (0.748±0.016)	9.00 (0.354)	0.40 (0.016)	0.76 (0.030)
20.0	21.4±0.4 (0.843±0.016)	10.00 (0.394)	0.40 (0.016)	0.76 (0.030)
22.0	23.2±0.4 (0.913±0.016)	11.00 (0.433)	0.45 (0.018)	0.89 (0.035)
25.0	26.8±0.4 (1.055±0.016)	12.50 (0.492)	0.45 (0.018)	0.89 (0.035)
27.0	28.2±0.5 (1.110±0.020)	12.50 (0.492)	0.45 (0.018)	0.89 (0.035)
28.0	30.0±0.5 (1.181±0.020)	14.00 (0.551)	0.45 (0.018)	0.89 (0.035)
30.0	32.1±0.5 (1.264±0.020)	15.00 (0.591)	0.45 (0.018)	0.89 (0.035)

*Wall thickness will be less if tubing recovery is restricted during shrinkage.

Ordering information

Color	Standard	Black (-0).
	Nonstandard	White (-9), red (-2), blue (-6), yellow (-4), green (-5), orange (-3), violet (-7), brown (-1), gray (-8)
Size selection	Always order the largest size that will shrink snugly over the component to be covered. Special order sizes are available upon request.	
Standard packaging	On spools.	
Marking	Marked with UL/CSA/-F legends.	
Ordering description	Specify product name, size and color (for example, Versafit V2-3.0-0).	

Users should independently evaluate the suitability of the product for their application.
Before ordering check with factory for most current data.



Versafit V4

Very-thin-wall, very flexible, highly flame-retardant, polyolefin tubing



Applications

Typically used where space saving is important. Offers the ability to pack components more closely than is possible with standard tubings. Cost-effective choice for many commercial applications; electrically insulates and protects in-line components, disconnect terminals, and splices. Used for strain relief on high-density connectors.

Operating temperature range

-10°C to 125°C

Features and benefits

- 2:1 shrink ratio.
- Very thin wall provides space savings and rapid shrinking.
- Low shrink temperature further reduces installation time and risk of damage to temperature-sensitive components.
- Very flexible; doesn't easily wrinkle when bent.
- Free of polybrominated biphenyls (PBBs) and polybrominated biphenyl oxides and ethers (PBBOs and PBBEs), which are classified as environmentally hazardous substances.

Installation

Minimum shrink temperature: 70°C

Minimum full recovery temperature: 90°C

Available in:

Americas

Europe

Asia Pacific



Specifications/approvals

	 UL	 CSA	Raychem
Series	UL	CSA	Raychem
Versafit V4	E35586 VW-1 300 V, 125°C	LR31929 OFT 150 V, 125°C	RW-3023

Fax-on-demand

US only (800) 260-9099

Outside US (650) 257-2301

Fax ID

2240

2590

Description

Data sheet

RW-3023

Visit our website at www.tycoelectronics.com**Product dimensions (mm/in)**

Metric size	Inside diameter		Wall thickness	
	Minimum expanded as supplied	Maximum recovered after heating	Expanded as supplied (nominal)	Recovered* after heating (minimum)
1.0/0.5	1.4±0.25 (0.055±0.010)	0.50 (0.020)	0.10 (0.004)	0.25 (0.010)
1.5/0.75	1.9±0.25 (0.075±0.010)	0.75 (0.030)	0.10 (0.004)	0.25 (0.010)
2.0/1.0	2.3±0.25 (0.091±0.010)	1.00 (0.039)	0.10 (0.004)	0.25 (0.010)
2.5/1.25	2.8±0.25 (0.110±0.010)	1.25 (0.049)	0.15 (0.006)	0.25 (0.010)
3.0/1.5	3.3±0.25 (0.130±0.010)	1.50 (0.059)	0.15 (0.006)	0.25 (0.010)
3.5/1.75	3.8±0.25 (0.150±0.010)	1.75 (0.069)	0.15 (0.006)	0.25 (0.010)
4.0/2.0	4.4±0.25 (0.173±0.010)	2.00 (0.079)	0.15 (0.006)	0.25 (0.010)
5.0/2.5	5.5±0.25 (0.217±0.010)	2.50 (0.098)	0.15 (0.006)	0.25 (0.010)
6.0/3.0	6.5±0.40 (0.256±0.016)	3.00 (0.118)	0.15 (0.006)	0.28 (0.011)
7.0/3.5	7.5±0.40 (0.295±0.016)	3.50 (0.138)	0.15 (0.006)	0.28 (0.011)
8.0/4.0	8.5±0.40 (0.335±0.016)	4.00 (0.158)	0.15 (0.006)	0.28 (0.011)
9.0/4.5	9.5±0.40 (0.374±0.016)	4.50 (0.177)	0.15 (0.006)	0.28 (0.011)
10.0/5.0	10.5±0.50 (0.413±0.020)	5.00 (0.197)	0.15 (0.006)	0.28 (0.011)

Inch size	Inside diameter		Recovered wall thickness*
	Minimum expanded as supplied	Maximum recovered after heating	After heating
3/64	1.2 (0.046)	0.6 (0.023)	0.25±0.05 (0.010±0.002)
1/16	1.6 (0.063)	0.8 (0.031)	0.25±0.05 (0.010±0.002)
3/32	2.4 (0.093)	1.2 (0.046)	0.25±0.05 (0.010±0.002)
1/8	3.2 (0.125)	1.6 (0.062)	0.25±0.05 (0.010±0.002)
3/16	4.8 (0.187)	2.4 (0.093)	0.25±0.05 (0.010±0.002)
1/4	6.4 (0.250)	3.2 (0.125)	0.30±0.08 (0.012±0.003)
3/8	9.5 (0.375)	4.8 (0.187)	0.30±0.08 (0.012±0.003)
1/2	12.7 (0.500)	6.4 (0.250)	0.30±0.08 (0.012±0.003)
3/4	19.1 (0.750)	9.5 (0.375)	0.43±0.08 (0.017±0.003)
1	25.4 (1.000)	12.7 (0.500)	0.48±0.08 (0.019±0.003)

*Wall thickness will be less if tubing recovery is restricted during shrinkage.

Ordering information

Color	Standard	Black (-0)
	Nonstandard	Other colors available upon request.
Size selection	Always order the largest size that will shrink snugly over the component to be covered. Special order sizes are available upon request.	
Standard packaging	On spools.	
Marking	Marked with UL/CSA/-F legends (metric sizes) or unmarked (inch sizes).	
Ordering description	Specify product name, size (mm or in) and color (for example, Versafit V4-1.0-0).	

Users should independently evaluate the suitability of the product for their application.
Before ordering check with factory for most current data.



Viton/Viton-HW/ Viton-E/Viton-TW

*Heat-shrinkable, chemical-resistant,
high-temperature tubing*



Applications

Raychem Viton premium heat-shrinkable tubing is fabricated from a crosslinked fluoroelastomer material designed for a wide range of applications. It is available in three configurations. Viton-E is the thickest wall version, Viton-HW has a thinner wall and Viton-TW has the thinnest wall for lighter weight applications. Offering fluid resistance, Viton tubing can be used in applications up to 200°C.

Operating temperature range

Viton, Viton-HW, and Viton-TW: -40°C* to 200°C
Viton-E: -55°C to 200°C

Features and benefits

- High resistance to impact and abrasion.
- Resistance to a wide variety of fuels, lubricants, acids, and solvents at elevated temperatures
- Flexibility at low temperatures without cracking.

Installation

Minimum shrink temperature: 100°C
Minimum full recovery temperature: 175°C

Available in:	Americas	Europe	Asia Pacific
	■	■	■

Specifications/approvals		
Series	Military	Raychem
Viton,	AMS-DTL 23053/13**	RT-1146
Viton-TW		RK-6014/2
Viton-E	Def. Stan. 59-97 Issue 3 Type 4A VG 95343 Part 5 Type E VDE 0341/Pt9005 BS 4G-198 Part 3 12A	RK-6014
Viton-HW	MIL-PRF-46846 Type III, Class I	RT-1145

*Viton-TW is rated for -5°C when tested in accordance with RK-6014/2.

**Formerly MIL-I-23053/13 and MIL-DTL-23053/13.

Fax-on-demand	Fax ID	Description
US only (800) 260-9099	2230, 2420	Data sheet
Outside US (650) 257-2301	223 1, 242 1	RT-1146, RT-1145

Visit our website at www.tycoelectronics.com

Product dimensions (mm/in)

Size	Inside diameter		Recovered wall thickness***		
	Minimum expanded as supplied	Maximum recovered after heating	After heating (nominal)		
			Viton-E	Viton-HW	Viton/Viton-TW
3.2 (1/8)	3.2 (0.125)	1.6 (0.062)	0.76 (0.030)	N/A	0.76 (0.030)
4.8 (3/16)	4.8 (0.188)	2.4 (0.093)	0.84 (0.033)	N/A	0.89 (0.035)
6.4 (1/4)	6.4 (0.250)	3.2 (0.125)	0.89 (0.035)	0.76 (0.030)	0.89 (0.035)
9.5 (3/8)	9.5 (0.375)	4.8 (0.187)	1.02 (0.040)	0.89 (0.035)	0.89 (0.035)
12.7 (1/2)	12.7 (0.500)	6.4 (0.250)	1.22 (0.048)	1.09 (0.043)	0.89 (0.035)
15.9 (5/8)	15.9 (0.625)	7.9 (0.312)	N/A	1.19 (0.047)	1.07 (0.042)
19 (3/4)	19.1 (0.750)	9.5 (0.375)	1.45 (0.057)	1.32 (0.057)	1.07 (0.042)
22 (7/8)	22.2 (0.875)	11.1 (0.437)	N/A	1.53 (0.060)	1.25 (0.049)
25.4 (1)	25.4 (1.000)	12.7 (0.500)	1.78 (0.070)	1.65 (0.065)	1.25 (0.049)
31.8 (1 1/4)	31.8 (1.250)	15.9 (0.625)	N/A	1.78 (0.070)	1.40 (0.055)
38 (1 1/2)	38.1 (1.500)	19.1 (0.750)	2.41 (0.095)	1.91 (0.075)	1.40 (0.055)
51 (2)	50.8 (2.000)	25.4 (1.000)	2.79 (0.110)	2.79 (0.110)	1.65 (0.065)

***Wall thickness will be less if tubing recovery is restricted during shrinkage.

Ordering information

Color	Standard	Black (-0)
Size selection	Always order the largest size that will shrink snugly over the component to be covered. Special order sizes are available upon request.	
Standard packaging	On spools.	
Ordering description****	Specify product name, size and color (for example, Viton 1/4-0).	

****Europe only. For supply to MIL, Def Stan and BS add -MS, -DS or -BS to ordering description.



XFFR

*Halogen-free, flame-retardant,
heat-shrinkable tubing*



Applications

XFFR halogen-free tubing can be used for re-jacketing and repairing halogen-free cables in any enclosed area where a flame-retardant, halogen-free environment is required. These environments include tunnels, buildings, mass transit vehicles, and ships. When installed with SFTS-FR1 tape, the tubing can also be used in applications requiring water sealing and protection from abrasion and corrosion.

Operating temperature range

-55°C to 105°C

Features and benefits

- Emits minimal amounts of toxic or acid gases during combustion.
- Meets performance requirements of MIL-C-24640 and MIL-C-24643 cable jackets.
- Resists moisture, fungus, and weathering.
- Available in expansion ratios as high as 3:1.
- XFFR has the following approvals:
 - ABS (American Bureau of Shipping)
 - DNV (Det Norske Veritas)
 - Lloyd's (Lloyd's Register of Shipping)

Installation

Minimum shrink temperature: 70°C

Minimum full recovery temperature: 121°C

Available in:

Americas

Europe

Asia Pacific

Specifications/approvals

Series	Military	Industry	Raychem
XFFR	MIL-C-24643	NES 713 NES 711	RW-2016

Fax-on-demand

US only (800) 260-9099

Outside US (650) 257-2301

Fax ID

2260

Description

Data sheet

Visit our website at www.tycoelectronics.com**Product dimensions (mm/in)**

Size	Inside diameter		Recovered wall thickness*
	Minimum expanded as supplied	Maximum recovered after heating	After heating (nominal)
XFFR-03	7.62 (0.300)	2.54 (0.100)	1.52 (0.060)
XFFR-04	10.16 (0.400)	3.81 (0.150)	1.52 (0.060)
XFFR-07	19.05 (0.750)	5.59 (0.220)	2.03 (0.080)
XFFR-11	27.94 (1.100)	9.52 (0.375)	2.67 (0.105)
XFFR-15	38.10 (1.500)	12.70 (0.500)	3.05 (0.120)
XFFR-20	50.80 (2.000)	19.05 (0.750)	3.05 (0.120)
XFFR-30	76.20 (3.000)	31.75 (1.250)	3.94 (0.155)

*Wall thickness will be less if tubing recovery is restricted during shrinkage.

Ordering information

Color	Standard	Black (-0)
Size selection	Always order the largest size that will shrink snugly over the component to be covered.	
Standard packaging	1.2-meter (4-foot) or 7.5-meter (25-foot) lengths.	

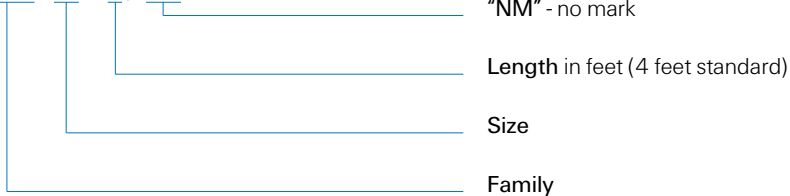
Part numbering system**XFFR - 03 X 4 / NM**

No adhesive.

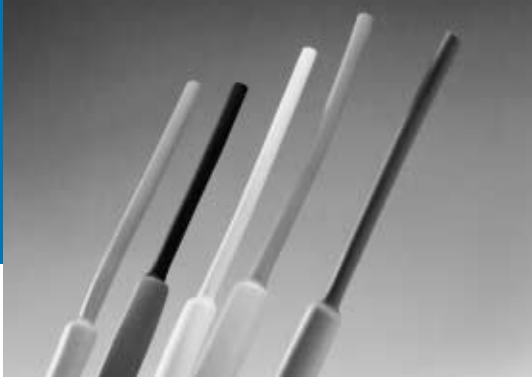

ZH-100

Flexible, thin-wall, low-fire-hazard tubing



Applications

ZH-100 is a flexible, thin-wall, heat-shrinkable tubing designed for low-fire-hazard applications. ZH-100 contains no added halogens, and exhibits excellent fire safety characteristics combined with low evolution of acid gases, while retaining good mechanical and fluid resistance properties.

Operating temperature range

-30°C to 105°C

Features and benefits

- 2:1 shrink ratio.
- Low smoke emissions.
- Flexible, flame-retardant.
- No added halogens.
- Low evolution of acid gases.

Installation

Minimum shrink temperature: 80°C

Minimum full recovery temperature: 120°C

Available in:	Americas	Europe	Asia Pacific
	■	■	■

Specifications/approvals			
Series	Military	Agency	Raychem
ZH-100	Def. Stan. 59-97 Issue 3 Type 8	BR 1326A BS 3G-198 Part 3 Type 15	RW-2013

Fax-on-demand

US only (800) 260-9099

Outside US (650) 257-2301

Visit our website at www.tycoelectronics.com**Product dimensions (mm/in)**

Size	Inside diameter		Recovered wall thickness*
	Minimum expanded as supplied	Maximum recovered after heating	After heating
1/8	3.2 (0.125)	1.6 (0.062)	0.50 ± 0.10 (0.019 ± 0.004)
3/16	4.8 (0.187)	2.4 (0.093)	0.50 ± 0.10 (0.019 ± 0.004)
1/4	6.4 (0.250)	3.2 (0.125)	0.65 ± 0.15 (0.026 ± 0.006)
3/8	9.5 (0.375)	4.8 (0.187)	0.65 ± 0.15 (0.026 ± 0.006)
1/2	12.7 (0.500)	6.4 (0.250)	0.65 ± 0.15 (0.026 ± 0.006)
3/4	19.0 (0.750)	9.5 (0.375)	0.75 ± 0.15 (0.030 ± 0.006)
1	25.4 (1.000)	12.7 (0.500)	0.90 ± 0.15 (0.035 ± 0.006)
1 1/2	38.0 (1.500)	19.0 (0.750)	1.00 ± 0.20 (0.039 ± 0.008)
2	51.0 (2.000)	25.4 (1.000)	1.15 ± 0.25 (0.045 ± 0.010)

*Wall thickness will be less if tubing recovery is restricted during shrinkage.

Ordering information

Color	Standard Nonstandard	Black (-0) White (-9), red (-2), blue (-6), yellow (-4), green (-5)
Size selection	Always order the largest size that will shrink snugly over the component to be covered. Special order sizes are available upon request.	
Standard packaging	On spools.	
Ordering description**	Specify product name, size and color (for example, ZH-100 1/8-0).	

**Europe only. For supply to MIL, Def Stan and BS add -MS, -DS or -BS to ordering description.



ZHTM

Heat-shrinkable, flexible tubing with low toxicity for fire safety applications



Applications

A flexible, thick-wall, heat-shrinkable tubing to be used in conjunction with -100 molded parts and Zerohal cable to form Raychem System 100, this material exhibits excellent fire safety characteristics combined with low smoke emission and low evolution of acid gases while retaining good mechanical and fluid-resistance properties. Used for insulation and protection of cables, harnesses, and electrical and electronic components in enclosed spaces, such as in marine applications, mass transit systems, and offshore installations, to reduce toxicity risks, or where equipment would be irreparably damaged by corrosive products of combustion.

Features and benefits

- 2:1 shrink ratio.
- Low smoke emission.
- System 100 tubing.

Installation

Minimum shrink temperature: 80°C
 Minimum full recovery temperature: 121°C

Operating temperature range

-30°C to 105°C

<i>Available in:</i>	Americas	Europe	Asia Pacific
	■	■	■

<i>Specifications/approvals</i>				
Series	Military	Agency	Industry	Raychem
ZHTM	Def. Stan. 59-97 Issue 3 Type 8	BS 4G-198 Part 3 Type 15 VG 95343 Part 5 Type L VDE 0341/Pt 9005	BR 1326A	RW-2058

Fax-on-demand

US only (800) 260-9099

Outside US (650) 257-2301

Visit our website at www.tycoelectronics.com**Product dimensions (mm/in)**

Size	Inside diameter		Recovered wall thickness*
	Minimum expanded as supplied	Maximum recovered after heating	After heating
3/1.5	3.0 (0.118)	1.5 (0.059)	0.70 ± 0.10 (0.028 ± 0.004)
5/2.5	5.0 (0.197)	2.5 (0.098)	0.75 ± 0.12 (0.030 ± 0.005)
8/4	8.0 (0.315)	4.0 (0.157)	0.80 ± 0.15 (0.031 ± 0.006)
12/6	12.0 (0.472)	6.0 (0.236)	0.90 ± 0.15 (0.035 ± 0.006)
18/9	18.0 (0.709)	9.0 (0.354)	1.00 ± 0.18 (0.039 ± 0.007)
24/12	24.0 (0.945)	12.0 (0.472)	1.10 ± 0.20 (0.043 ± 0.008)
40/20	40.0 (1.575)	20.0 (0.789)	1.30 ± 0.23 (0.051 ± 0.009)
50/30	50.0 (1.969)	30.0 (1.181)	1.50 ± 0.28 (0.059 ± 0.011)

*Wall thickness will be less if tubing recovery is restricted during shrinkage.

Ordering information

Color	Standard	Black (-0)
Size selection	Always order the largest size that will shrink snugly over the component to be covered. Special order sizes are available upon request.	
Standard packaging	On spools.	
Ordering description**	Specify product name, size and color (for example, ZHTM 8/4-0).	

**Europe only. For supply to Def Stan and BS add -DS or -BS to ordering description.

Molded Parts

Overview

Raychem heat-shrinkable molded parts, with adhesive coating, form a watertight seal, protecting cables and equipment from corrosion and mechanical abuse while providing excellent electrical insulating properties. Meeting requirements for most mass-transit, military, and commercial marine applications, Raychem molded parts include:

- Raychem SSC end caps, which provide optimum waterproofing and environmental protection for underwater, underground, or outdoor applications. The end caps are highly resistant to moisture, fungus, and weathering.
- Raychem heat-shrinkable boots and transitions, which replace tapes, mold-in-place epoxies, and grease. These molded parts can be used for cable breakouts, transitions, and terminations. For example, they provide reliable sealing to specific altitudes on standard Navy cable jackets and on lead, steel, aluminum, copper, and most elastomeric insulation materials.

All of these molded parts fit a wide variety of applications. To select the right part for your application, follow these steps:

- Select the necessary shape.
- Match the shape with the appropriate material.
- Select a compatible adhesive, if needed, to provide additional environmental protection. Adhesives come either preinstalled or as separate components (see Section 5).

Also available is an extensive line of adapters (see Section 6) and heat-shrinkable tubings (see Section 3) to further integrate and strengthen harness assemblies.

Whatever your application, Raychem molded parts almost always meets the performance characteristics you require, including operation in low- and high-temperature environments; mechanical strength; resistance to fluids, flame, and mechanical abuse; environmental sealing; and strain relief.

Molded Parts

Table of Contents

Shapes		4-0	Feedthroughs		
Shape selection tables		4-2	207W213 to 256	Two-part feedthrough	4-96
Visual selection guide		4-6	Transitions		
Boot adapter selection tables		4-21	301A011 to 048	T transition	4-98
Material selection table		4-24	301A511 to 514	Slimline T transition	4-99
Materials			322A112 to 158	T transition	4-100
-3	Semirigid modified polyolefin	4-26	342A012 to 058	45° side-breakout transition	4-102
-4	Flexible polyolefin	4-28	362A014 to 114	30° side-breakout transition	4-104
-12	Modified fluoroelastomer	4-30	381A301 to 304	Slimline Y transition	4-105
-25	Fluid-resistant modified elastomer	4-32	382A012 to 046	Y transition	4-106
-25S	Fluid-resistant screened elastomer	4-34	382C312,322&332	Slimline Y transition	4-108
-50	Fluid-resistant modified elastomer	4-36	462A011 to 060	Transition, one to three cables	4-110
-51	Chemical-resistant fluoroelastomer	4-38	462A421 to 424	Slimline transition, one to three cables	4-112
-55	Flexible fluoropolymer	4-40	562A011 to 067	Transition, one to four cables	4-114
-71	Semirigid modified polyolefin	4-42	QFT™	Configurable heat-shrink transition	4-116
-100	Low-fire-hazard material	4-44	SSB, T, F to 8S	Multilegged transitions	4-118
-100S	Low-fire-hazard screened material	4-46	Other		
-125	Flexible fluoropolymer	4-48	202W302 to 342	Heatshrink bobbins	4-120
Molded parts			400W242	Heatshrink positioning ring	4-122
Caps			CES	Heat-shrinkable cable entry seals	4-124
101A011 to 094	End caps	4-50	RayOLOn Kits	Roll-on sealing sleeve	4-130
SSC	Heat-shrinkable end caps	4-52	shrinkHOoP	Cable clamp heat-shrink grommet	4-132
Boots			XL Products	Conversion Table	4-136
202A111 to 196	Straight boot	4-54			
202C611 to 663	Uniboot	4-56			
202D121 to 196	Straight, lipped boot	4-58			
202D211 to 299	Straight, lipped boot	4-60			
202D921 to 963	Straight, lipped boot	4-62			
202F211 to 274	Straight, lipped boot	4-63			
202G211 to 253	Straight, low profile lipped boot	4-64			
202G611 to 653	Uniboot	4-66			
202K121 to 185	Straight, lipped boot	4-68			
214A011 to 052	D-subminiature, straight boot	4-70			
214A311 to 352	D-subminiature, straight boot	4-72			
214P009 to 037	D-subminiature, straight boot with jack screws	4-74			
222A111 to 196	Right-angled boot	4-76			
222D121 to 196	Right-angled, lipped boot	4-78			
222D211 to 299	Right-angled, lipped boot	4-80			
222D921 to 963	Right-angled, lipped boot	4-82			
222F211 to 285	Right-angled, lipped boot	4-84			
222K121 to 185	Right-angled, lipped boot	4-86			
234A011 to 071	D-subminiature, right-angled boot	4-88			
234A111 to 152	D-subminiature, side-entry boot	4-90			
234A611 to 671	D-subminiature, 90° end-entry boot	4-92			
242W042 to 63	45° angled boot	4-94			

Molded Parts

Shapes



Bulbous shapes

Raychem bulbous-shaped molded parts provide rugged mechanical and environmental protection, meet numerous specifications, and have been used successfully in military wire and cable harnesses for more than 30 years.

Most connector strain relief boots come in two versions:

- With an adapter lip molded into the “H” end, which locks into the groove on the backshell adapter (part number is identified with a “D” or “K”).
- Without the adapter lip (the boot may be installed directly on the rear of connector threads 12 mm long or longer). This part number is identified with an “A.”

Many other optional features are available, such as molding ports and drain holes. For other modifications and custom shapes, please contact Tyco Electronics.

Modifications

Certain variations of the standard shapes, such as shorter leg lengths or specific over expansions, are possible. Modifications must be requested prior to your order, for feasibility.

Molding port modifications (-00)

Some specifications call for potting the molded shape with sealant to provide additional protection from moisture. Most of the bulbous boots and transitions can be ordered with molding ports for this purpose.

Drain hole modification (-88)

Some specifications require drain holes in the molded part to provide an exit for condensation. Drain holes must be requested when you place your order.

Specials

Complete design, tooling, and production of custom molded shapes and special adaptations are also possible. Estimates are made upon request.

Fax-on-demand

US only (800) 260-9099

Outside US (650) 257-2301

Visit our website at www.tycoelectronics.com

Heavy-duty cable breakouts

Heavy-duty breakouts provide mechanical strain relief and environmental sealing for power cables where the cable jacket is cut back and conductors broken out.

These boots are used widely in ship building and meet the requirements of the following:

- Lloyd's Register of Shipping
- Det Norske Veritas (DNV)
- American Bureau of Shipping (ABS)
- DOD-STD-2003
- MIL-I-81765/1A



Cable end caps

Heat-shrinkable end caps provide a reliable method of sealing power cables, pipes, conduit, and other cylindrical objects against corrosion and moisture penetration.



Slim-Line shapes





With their low profile, these flexible shapes conform to cables better and create less bulk at transition points and connectors than bulbous shapes.

Raychem molded parts are available in a variety of slim-line shapes, including straight and right-angle boots as well as transitions. A small family of parts can provide a wide variety of expansions (under expansion, over expansion, cutoff). Modifications are easily provided.

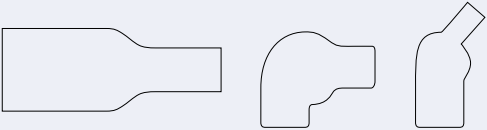
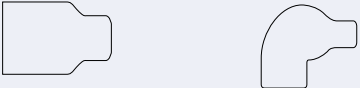

Molded Parts

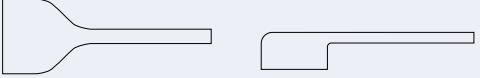
Shape selection tables

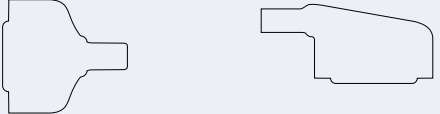
Shape selection: Boots		
Application	Family description	Typical Shapes
Lipped boots for use with a circular adapter	202D121 to 196 222D121 to 196 202K121 to 185 222K121 to 185 242W042 to 063	
Nonlipped boots for use directly on a circular connector	202A111 to 196 222A111 to 196	
Low-profile lipped boots for use with a circular adapter	202D211 to 299 222D211 to 299 202F211 to 274 222F211 to 285 202G211 to 253	
Low-profile lipped boots for use with a circular adapter on an open harness	202D921 to 963 222D921 to 963	
Lipped boots with compressible design for use with a circular adapter	202C611 to 663 202G611 to 653	
Adapter boots for use with D-subminiature connectors	214A011 to 052 234A011 to 071 214A311 to 352 234A111 to 152 234A611 to 671	





Fax-on-demand

US only (800) 260-9099

Outside US (650) 257-2301

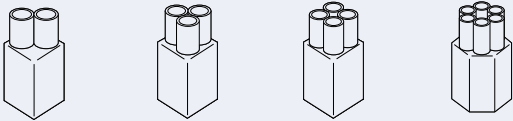
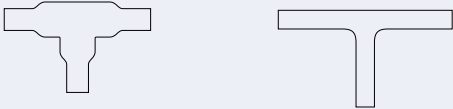

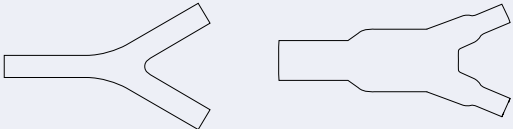
Visit our website at www.tycoelectronics.com

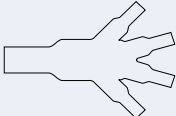
Shape selection: Transitions

Application	Family description	Typical Shapes
Multilegged Transitions	SSB, T, F, 6S	
"T" Transitions	301A011 to 048 301A511 to 514 322A112 to 158	
45° Transitions	342A012 to 058	
30° Transitions	362A014 to 114	
"Y" Transitions	381A301 to 304 382A012 to 046	
3:1 Transitions	462A011 to 060 462A421 to 424	
4:1 Transitions	562A011 to 067	

Molded Parts

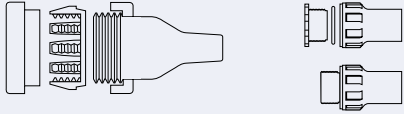
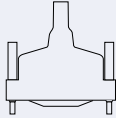
Shape selection tables (cont'd.)

Shape selection: other products		
Application	Family description	Typical Shapes
Feedthroughs	207W213 to 256 CES	
D-subminiatures	214P009 to 037	
End Caps	101A011 to 094	

Fax-on-demand

US only (800) 260-9099

Outside US (650) 257-2301

Visit our website at www.tycoelectronics.com

Molded Parts part numbering system

2 0 2D 1 21 -3 01 / 42 - 0

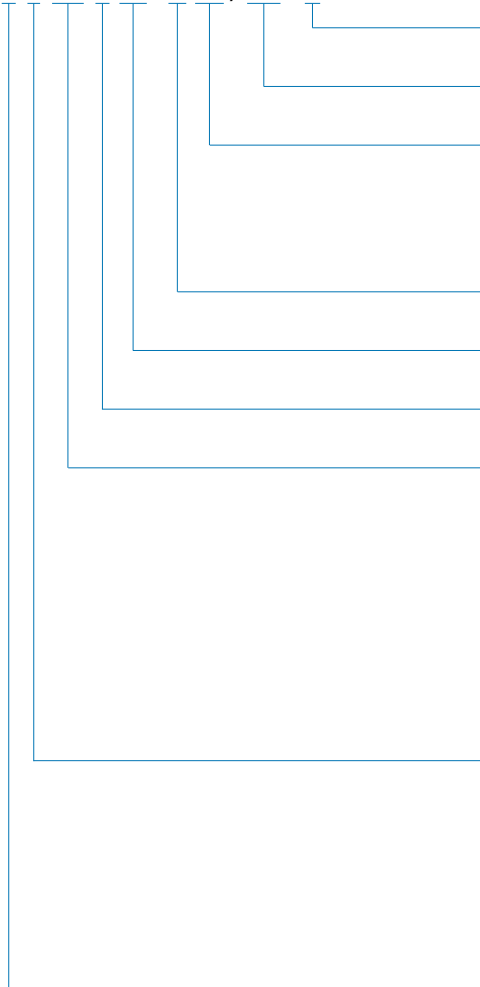

Color (0 = Black). Other colours factory quote

Optional adhesive* coating (precoated in factory)

Modification (available on request)

- Over expansion
- Cutoff
- Molding ports (injection and vent)

Material**

Size of part in family: From 11 (= smallest) to 99 (= largest)

Family number

Type of part:

- A = Nonlipped boots/transitions
- C = Lipped boot
- D = Lipped boot
- F = Lipped boot
- K = Lipped boot
- S = Rayaten
- G = Lipped boot
- W, P = Other shapes

Angle of part:

All openings	One opening
Circular	Noncircular
0 = Straight	0 = Straight
2 = 90°	3 = 90°
4 = 45°	5 = 45°
6 = 30°	7 = 30°

Number of openings in the part

*See Section 5 for details on adhesives.

**See pages 4-24 to 4-25 for details on materials.

Molded Parts

Visual selection guide

Boots: Circular connectors - lipped

Lipped boots for use with an adapter

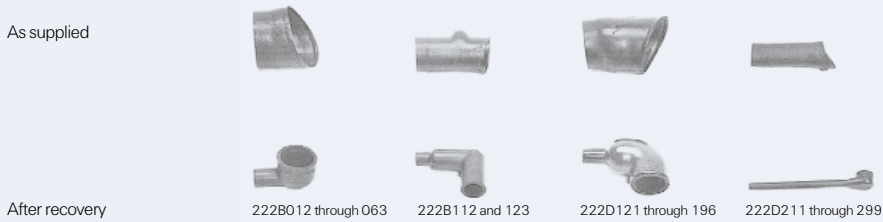
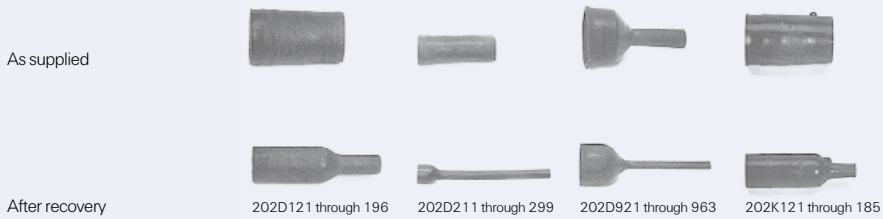

Fax-on-demand

US only (800) 260-9099

Outside US (650) 257-2301

Visit our website at www.tycoelectronics.com

Boots: Circular connectors - nonlipped

Nonlipped boots for direct attachment on connectors

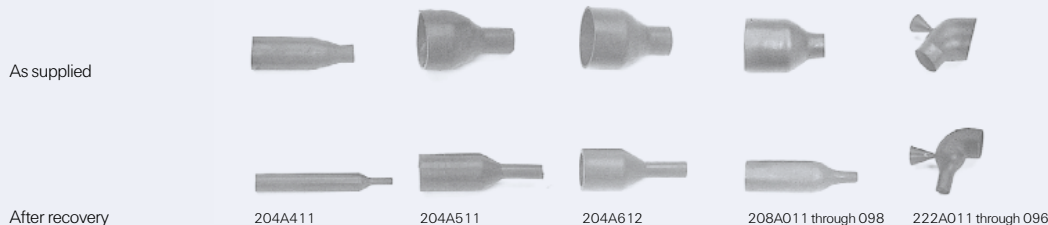
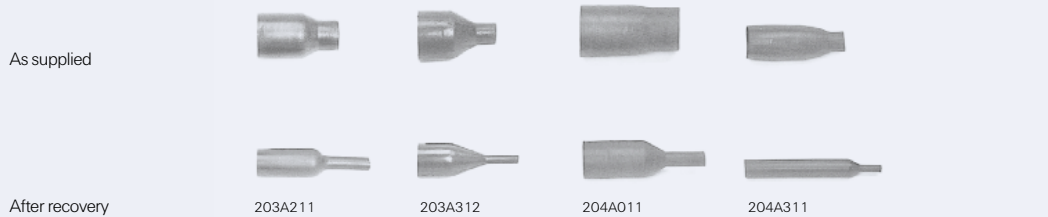
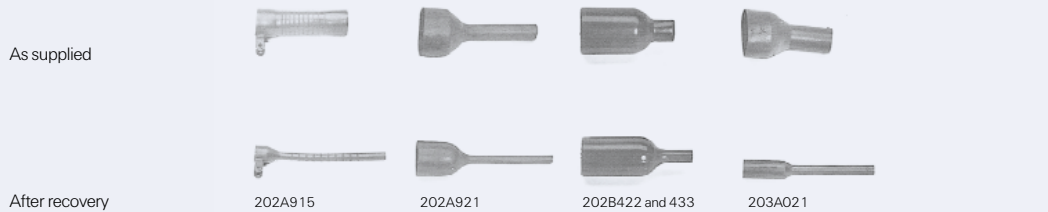
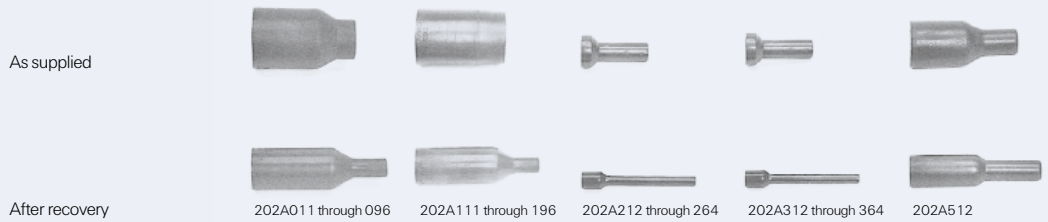

Users should independently evaluate the suitability of the product for their application.
Before ordering check with factory for most current data.

Molded Parts

Visual selection guide (cont'd.)

Boots: Circular connectors - nonlipped (cont'd.)

Nonlipped boots for direct attachment on connectors

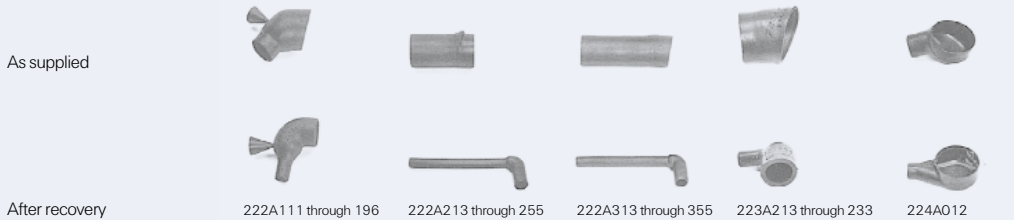

Boots: Circular Connectors—Slim-Line

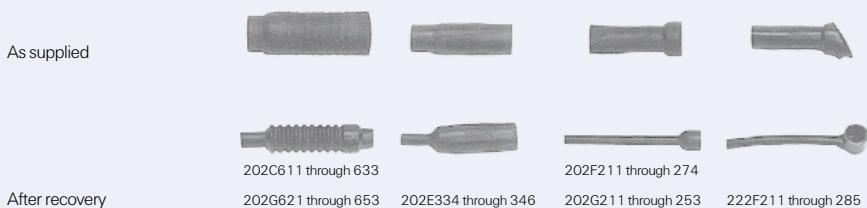

Fax-on-demand

US only (800) 260-9099

Outside US (650) 257-2301

Visit our website at www.tycoelectronics.com

Boots: Rectangular connectors

As supplied					
After recovery					
As supplied					
After recovery					
As supplied					
After recovery					
As supplied					
After recovery					

Users should independently evaluate the suitability of the product for their application.
Before ordering check with factory for most current data.

Molded Parts

Visual selection guide (cont'd.)

Transitions: Bulbous

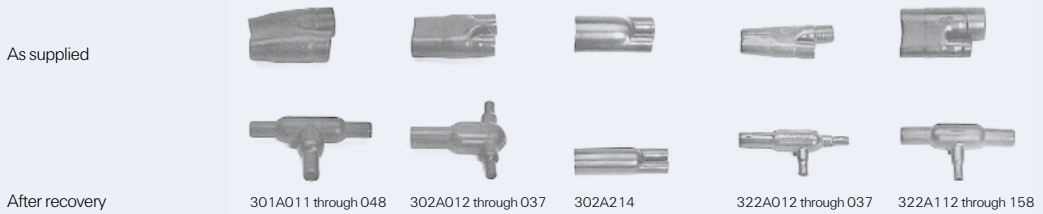

301A011 through 048 302A012 through 037 302A214 322A012 through 037 322A112 through 158

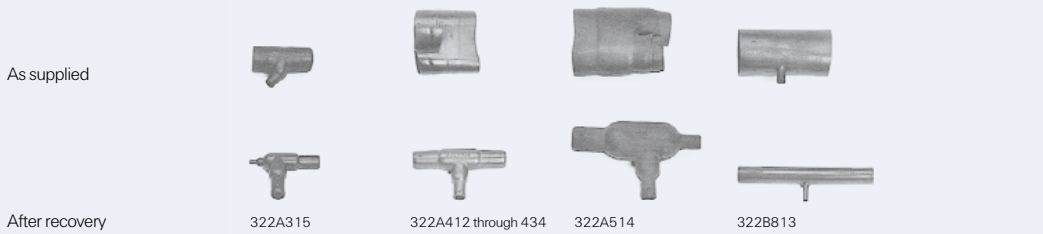

322A315 322A412 through 434 322A514 322B813

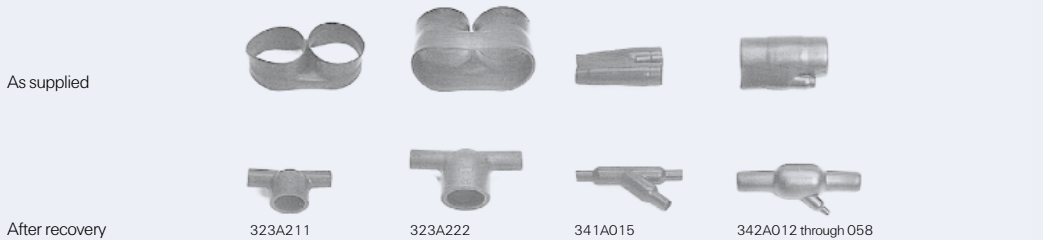

323A211 323A222 341A015 342A012 through 058

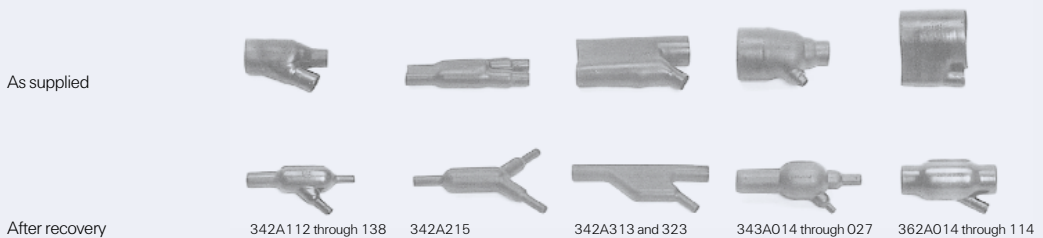

342A112 through 138 342A215 342A313 and 323 343A014 through 027 362A014 through 114

Fax-on-demand

US only (800) 260-9099

Outside US (650) 257-2301

Visit our website at www.tycoelectronics.com

Transitions: Bulbous (cont'd.)

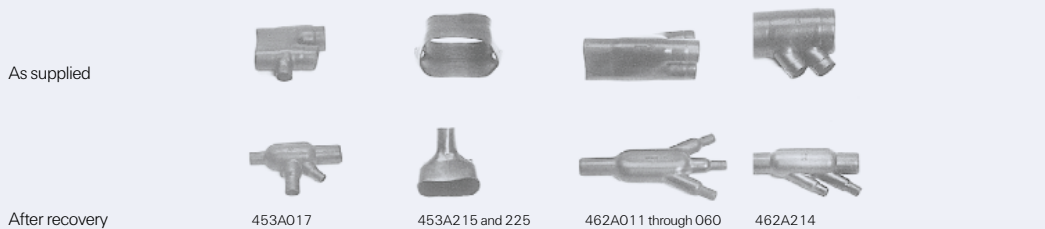
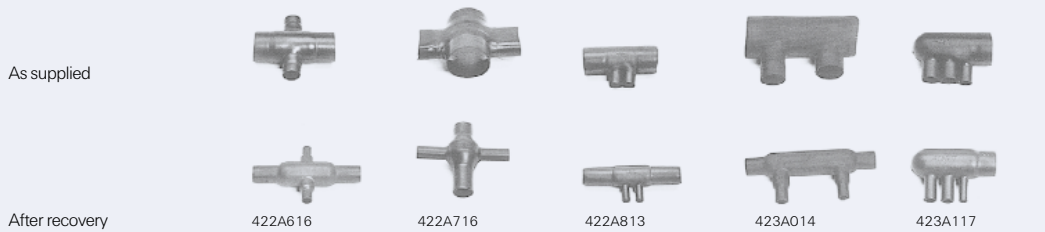
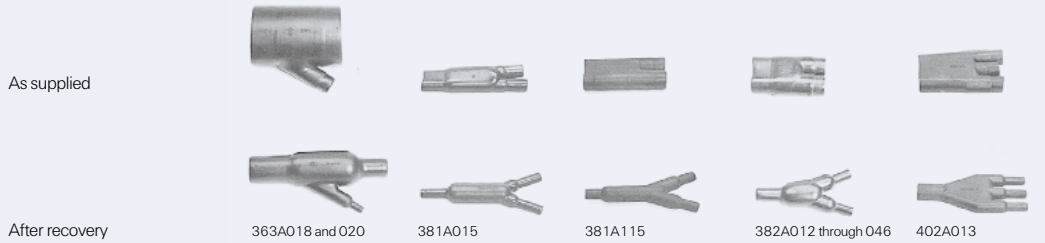

Users should independently evaluate the suitability of the product for their application.
Before ordering check with factory for most current data.

Molded Parts

Visual selection guide (cont'd.)

Transitions: Bulbous (cont'd.)

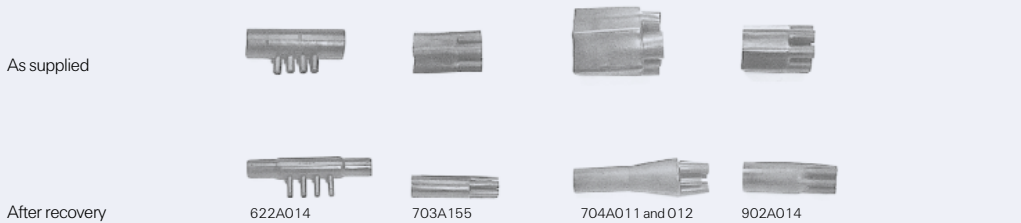
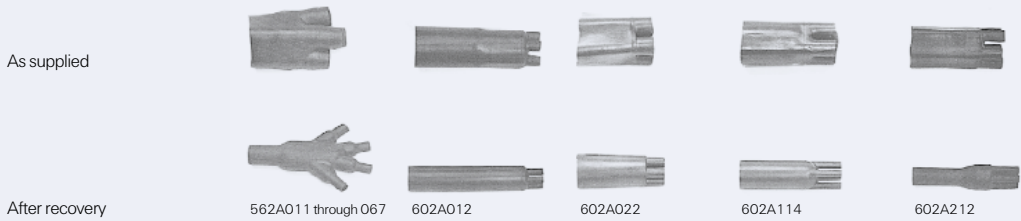
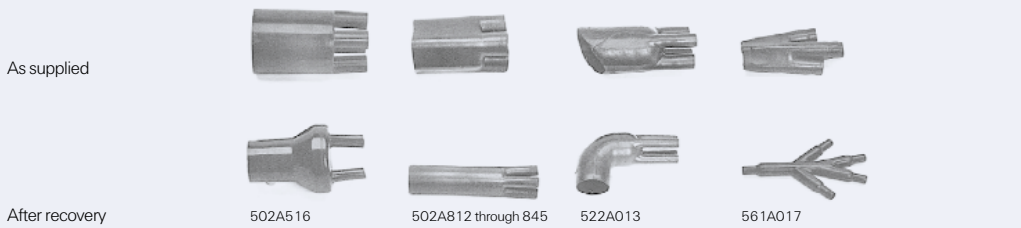

Fax-on-demand

US only (800) 260-9099

Outside US (650) 257-2301

Visit our website at www.tycoelectronics.com

Transitions: Slim-Line

As supplied



After recovery



301A511 through 514

381A301 through 304

462A421 through 424

Molded Parts

Visual selection guide (cont'd.)

Covers

As supplied



After recovery



102A911

102A951

102A961

102A962

102A981

As supplied

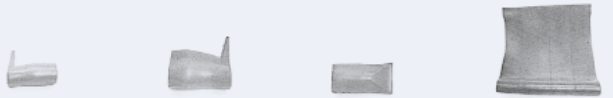

After recovery

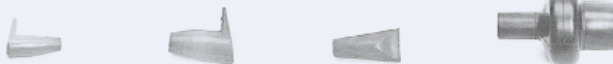

102A992

102A993

102A994

202A817

As supplied



After recovery



220A012 through 023

234A211

234B111 and 122

254A015

301A212

301A222, 301A312

As supplied

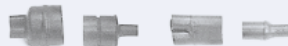

After recovery

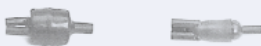

302A734

401A112 and 402A212

Fax-on-demand

US only (800) 260-9099

Outside US (650) 257-2301

Visit our website at www.tycoelectronics.com

Covers (cont'd.)

As supplied



After recovery



As supplied



After recovery

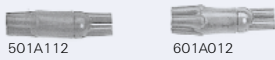

Molded Parts

Visual selection guide (cont'd.)

Sleeves

As supplied



After recovery



200A413 and 200A426 200D944 thru 988

As supplied



After recovery

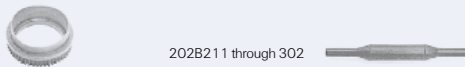

201A711 through 792 (Not heat-shrinkable) 202B811 through 832

Caps

As supplied



After recovery



101A011 thru 094 102A811 through 865

Fax-on-demand

US only (800) 260-9099

Outside US (650) 257-2301

Visit our website at www.tycoelectronics.com

Sleeves

As supplied

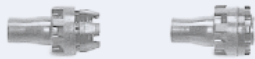

After recovery



207W2 13 through 264
with A-type nut

207W2 13-x-01 through
264-x-01 with B-type nut

Miscellaneous



204A711 and 002A011

Riser and Plug

(Not heat-shrinkable)

Molded Parts

Visual selection guide (cont'd.)

Selected molded parts families

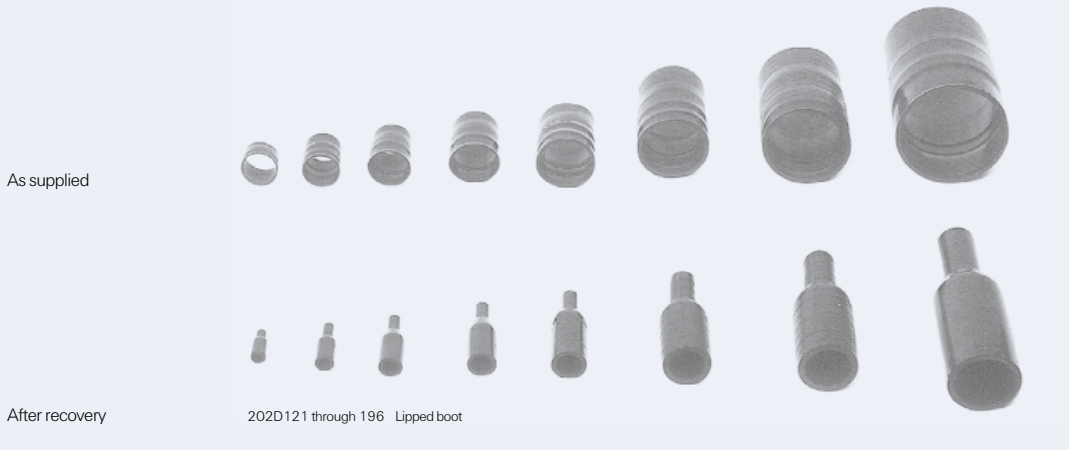
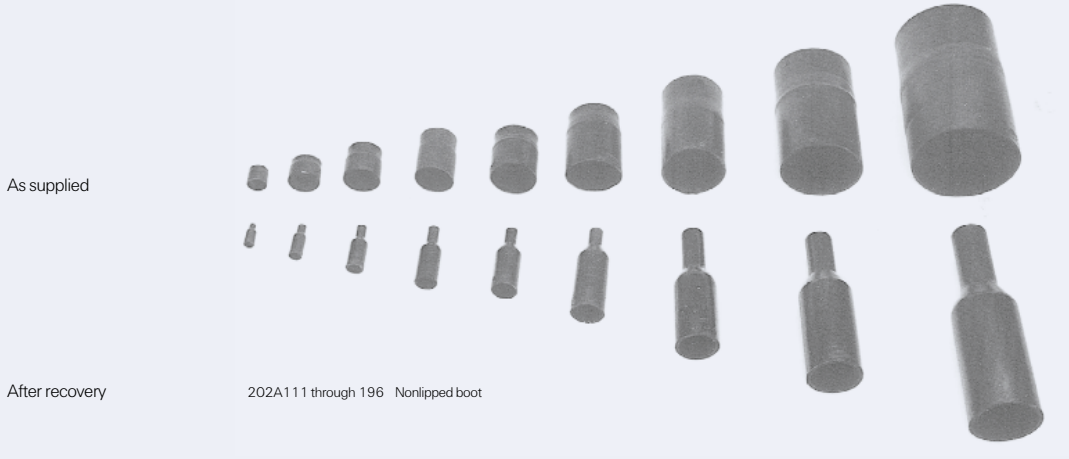

Fax-on-demand

US only (800) 260-9099

Outside US (650) 257-2301

Visit our website at www.tycoelectronics.com

Selected molded parts families (cont'd.)

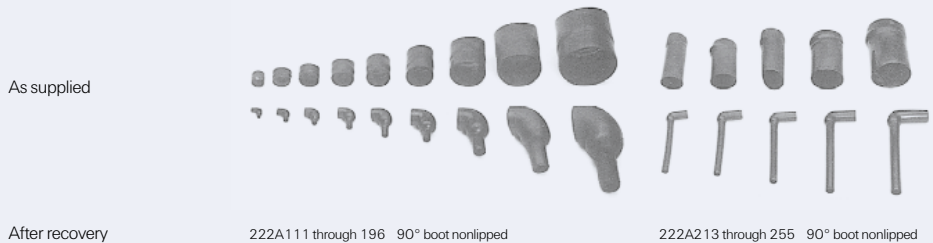
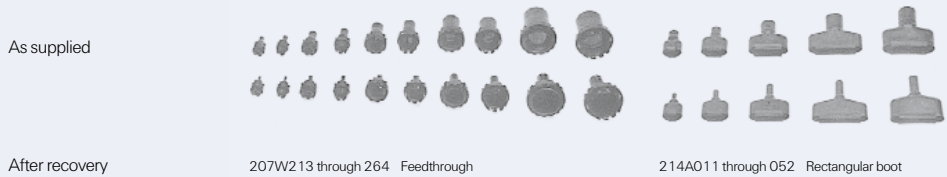

Users should independently evaluate the suitability of the product for their application.
Before ordering check with factory for most current data.

Molded Parts

Visual selection guide (cont'd.)

Selected molded parts families (cont'd.)

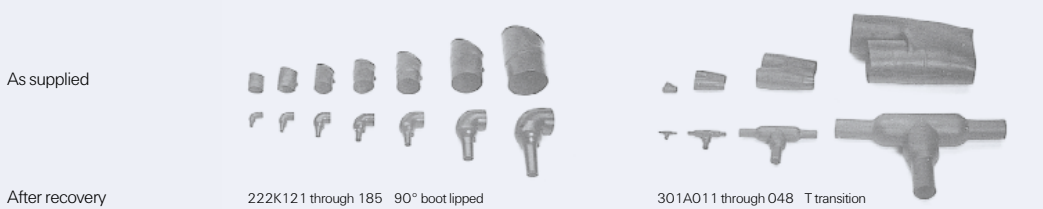
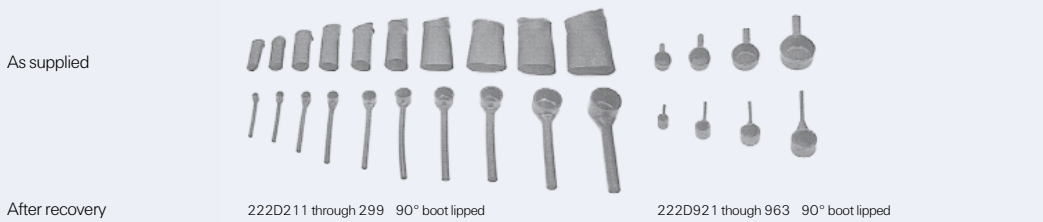

Boot Adapter Selection Tables

Fax-on-demand

US only (800) 260-9099

Outside US (650) 257-2301

Visit our website at www.tycoelectronics.com

Table 1. Boots

Boot type	Material dash number	Part number	Dimensions (Inches)		Fits adapter order number				
			Cable diameter range	Length	Solid	Spin coupling	Entry size Shielded	Tinel-Lock	
Uni-boot	50, 51	202C611	.19-.38	4.75				04	04
		71	202C621	.32-.64	5.25	12	12-14	06-08	04-07
		202C632	.50-1.00	5.75	14-16	16-18	10-14	10-16	
		202C642	.69-1.38	6.25	18-20	20	12-18	12-18	
		202C653	.88-1.74	6.75	22-32	22-32	18-20	16-20	
		202C663	.90-2.19	9.30	24, 28, 31	32, 36			
	55	202G621	.32-.64	5.27	12-14	12-14	06-08	04-07	
		202G632	.50-1.00	5.95	16	16-18	10-14	08-12	
		202G642	.69-1.38	6.19	18-20	20	12-18	12-18	
		202G653	.88-1.74	6.70	22-32	22-32	18-20	16-22	
				16-24, 61	22-28, 61				
Low-profile, straight	50, 51	202F211	.26-.62	4.14	10	08-10	04-07	04-07	
		71	202F221	.30-.76	4.88	12-14	12-14	07-10	05-08
		202F232	.35-.90	5.76	16	16-18	10-14	08-12	
		202F242	.40-1.07	6.78	18-20	20	12-18	12-16	
		202F253	.43-1.18	7.29	22	22	18-20	16-18	
		202F263	.50-1.45	8.41	24-28	24-28	20	18-20	
		202F274	.59-1.69	8.00	24	32			
	55	202G221	.30-.76	4.77	12-14	12-14	07-10	05-08	
		202G232	.35-.90	5.46	16	16-18	10-14	10-12	
		202G242	.40-1.07	6.28	18-20	20	14-18	12-16	
202G253		.43-1.18	7.00	22-28	22-24	16-20	16-18,		
				16-20	20-24				
Low-profile, 90°	50, 51	222F211	.26-.62	4.14	10	08-10	04-07	04-07	
		71	222F221	.30-.82	4.88	12-14	12-14	07-10	05-10
		222F232	.35-.90	5.76	16	16-18	10-14	08-12	
		222F242	.40-1.07	6.78	18-20	20	12-18	12-16	
		222F253	.43-1.18	7.29	22	22	18, 20	16-18	
		222F263	.50-1.45	8.41	24-28	24-28	20	18, 20	
		222F274	.59-1.69	8.84	24	32			
		222F285	.69-2.41	8.95	24-32	32-40			

Users should independently evaluate the suitability of the product for their application.
Before ordering check with factory for most current data.

Boot Adapter Selection Tables *(cont'd.)*

Table 1. Boots *(cont'd.)*

Boot type	Material dash number	Part number	Dimensions (Inches)		Fits adapter order number			
			Cable diameter range	Length	Solid	Spin coupling	Entry size Shielded	Tinel Lock
Low-profile, straight	3,4,25	202D211	.26-62	4.17	08	08-10	08	04-07
		202D221	.30-76	4.77	08-10	08-10	06-07	06-07
		202D232	.35-90	5.46	10-12	10-12	10-12	08-10
		202D242	.40-1.07	6.28	12-14	12-14	12-14	10-12
		202D253	.43-1.18	7.00	16-18	16-18	16-18	14-16
		202D263	.50-1.45	8.00	20-22	20-22	18-20	18-20
		202D274	.59-1.69	8.00	24	28	22-24	22-24
		202D285	.72-2.20	8.00	28	32-34	28	
		202D296	.79-2.35	8.00		40		
Low-profile, 90°	3,4,25	222D211	.26-62	4.14	08	08-10	08	04-07
		222D221	.30-76	4.88	08-10	08-10	06-07	06-08
		222D232	.35-90	5.76	10-12	10-12	10-12	08-10
		222D242	.40-1.07	6.78	12-14	12-14	12-14	10-12
		222D253	.43-1.18	7.29	16-18	16-18	16-18	14-16
		222D263	.50-1.45	8.41	20-22	20-22	18-20	18-20
		222D274	.59-1.69	8.84	24	28	22-24	22-24
		222D285	.72-2.20	8.95	28	32-34	28	
		222D296	.79-2.35	9.19		40		
Bulbous, straight	3,4,25	202D121	.24-75	1.50		08	04-05	04-07
		202D132	.28-92	2.16	08	10	06-07	06-08
		202D142	.30-99	2.63	10	12-14	09-10	07-10
		202D153	.35-1.20	3.15	12-14	16-18	11-14	10-12
		202D163	.41-1.35	4.08	16-18	20-22	15-16	14-16
		202D174	.64-1.77	5.13	20-24	24	18-22	18-22
		202D185	.82-2.10	6.50			24	24
		202D196	1.02-2.75	7.00				
		Bulbous, 90°	3,4,25	222D121	.24-75	0.84		08
222D132	.28-92			1.33	08	10	06-07	05-08
222D142	.30-99			1.44	10	12-14	09-10	08-10
222D152	.35-1.20			1.72	12-14	16-18	11-14	10-14
222D163	.41-1.35			2.11	16-18	20-22	15-16	14-18
222D174	.64-1.77			3.07	20-24	24	18-22	18-22
222D185	.82-2.10			3.84			24	24
222D196	1.02-2.75			4.64				

Fax-on-demand

US only (800) 260-9099

Outside US (650) 257-2301

Visit our website at www.tycoelectronics.com**Table 2. Shims**

Part number	Cable diameter range (inches)	Shim boot or tubing
202C611	.15-.19	Tubing
202C621	.25-.32	Tubing
202C632	.38-.50	Tubing
202C632	.13-.38	202E334
202C632	.57-.69	Tubing
202C642	.39-.57	202E346
202C642	.13-.38	202E344
202C642	.76-.88	Tubing
202C653	.39-.76	202E346
202C653	.13-.38	202E344
202C658	.69-.90	Tubing
202C663	.69-.90	Tubing
202D211/202F211	.20-.26	Tubing
222D211/222F211	.20-.26	Tubing
202D221/202F221	.23-.30	Tubing
222D221/222F221	.23-.30	Tubing
202D221/202F221	.233	Tubing
222D221/222F221	.233	Tubing
202D232/202F232	.27-.35	Tubing
222D232/222F232	.27-.35	Tubing
202D242/202F242	.31-.40	Tubing
222D242/222F242	.13-.31	202E334
202D253/202F253	.33-.43	Tubing
222D253/222F253	.13-.33	202E334
202D263/202F263	.38-.50	Tubing
222D263/222F263	.13-.38	202E334
202D274/202F274	.45-.59	Tubing
222D274/222F274	.39-.45	202E346
222D274/222F274	.13-.38	202E344
222D274/222F274	.53-.69	Tubing
222D285/222F285	.39-.53	202E346
222D285/222F285	.13-.38	202E344
222D1XDU222D1XX		Use tubing as a shim if necessary

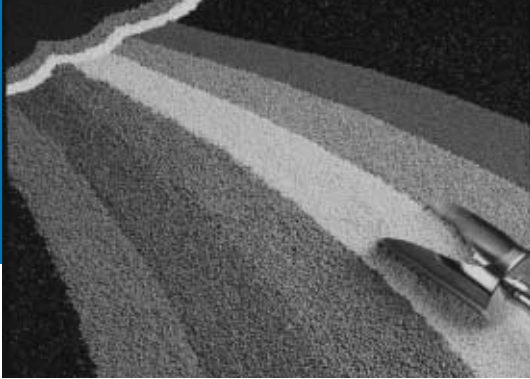

Materials

Material selection table

Applications

Tyco Electronics offers Raychem products in a variety of materials to enable designers and material specifiers to obtain optimum performance.

Material selection table*

Material	Characteristics
-3 Molded Part Material	A general purpose, heat-shrinkable semi rigid and flame retarded polyolefin molding compound with good resistance to fluids and heat. -3 molded parts are ideal for use in applications where toughness combined with resistance to occasional exposure to fluids or heat is required. A wide range of shapes are available in this material. 3 molded parts are recommended for use in System 10.
-3S Molded Part Material	A general purpose, heat-shrinkable flame retarded, polyolefin compound used to make shielded molded parts. -3S molded parts form part of the Rayaten shielding system and are ideal for use in applications where toughness combined with resistance to occasional exposure to fluids or heat is required. -3S molded parts are recommended for use in System 10.
-6 Molded Part Material	Designed for use in applications where extreme flexibility is required. The parts provide excellent strain relief and sealing over a broad temperature range and remain flexible at very low temperatures. The standard colour is black.
-8 Molded Part Material	For use in outer space, where use of low outgassing components is required. The parts provide excellent strain relief at connector cable terminations. Please contact Raychem for available shapes. The standard colour is black.
-12 Molded Part Material	A high temperature, heat-shrinkable, flexible, flame retarded, fluoroelastomeric molding compound with excellent resistance to long term fluid immersion and heat exposure. A wide range of shapes are available in this material. -12 molded parts are recommended for use in System 200.
-25 Molded Part Material	A heat-shrinkable, semi rigid, fluid and temperature resistant, elastomeric molding compound, designed to offer excellent performance in harsh environments. Ideal for use in military vehicles where high temperatures and long term exposure to hot fluids is expected. A wide range of shapes are available in this material. -25 molded parts are recommended for use in System 25.
-25S Molded Part Material	A heat-shrinkable, semi rigid, fluid and temperature resistant, elastomeric compound, used to make shielded molded parts. -25S molded parts form part of the Rayaten shielding system and are ideal for use in military vehicles where high temperatures and long term exposure to hot fluids is expected. -25S molded parts are recommended for use in System 25.
-50 Molded Part Material	A heat-shrinkable, highly flexible, fluid and temperature resistant, VPB molding compound, ideal for use in general purpose and high temperature military applications where exposure to petroleum based solvents is expected. Uniboosts and a wide range of low profile shapes are available in this material. -50 molded parts are recommended for use in System 30 and are compatible with System 25 components.

Fax-on-demand

US only (800) 260-9099

Outside US (650) 257-2301

Visit our website at www.tycoelectronics.com

Material selection table (cont'd.)

Material	Characteristics
-51 Molded Part Material	A heat-shrinkable, rugged, flexible, fluid and temperature resistant, EPB molding compound, ideal for use in general purpose applications where exposure to petroleum based solvents is expected. Uniboosts and a wide range of low profile shapes are available in this material. -51 molded parts are recommended for use in System 20.
55 Molded Part Material	A heat-shrinkable, flexible, flame retarded, fluid and high temperature resistant, modified fluoropolymer molding compound. -55 molded parts are ideal for use in applications where resistance to the effects of N.B.C. agent exposure and decontamination, combined with excellent abrasion resistance is required. A wide range of shapes is available. -55 molded parts are recommended for use in System 300.
-71 Molded Part Material	A heat-shrinkable, flexible, fluid and temperature resistant, polyolefin molding compound, ideal for use in general purpose applications where a good balance of fluid and heat resistance properties is required. Uniboosts and a wide range of low profile shapes are available. -71 molded parts are suitable for use in System 10.
-100 Molded Part Material	A heat-shrinkable, semi flexible, low fire hazard molding compound designed to offer excellent fire safety characteristics combined with low smoke and low acid gas emission -100 also exhibits good mechanical and fluid resistance properties. A wide range of shapes are available in this material. -100 molded parts are recommended for use in System 100.
-100S Molded Part Material	A heat-shrinkable, semi flexible, low fire hazard compound used to make shielded molded parts. 100S molded parts form part of the Rayaten shielding system and are designed to offer excellent fire safety characteristics combined with low smoke and low acid gas emission. -100S also exhibits good mechanical and fluid resistance properties. -100S molded parts are recommended for use in System 100.
-125 Molded Part Material	A heat-shrinkable, flame retarded, fluid and high temperature resistant, modified fluoropolymer molding compound 125 molded parts are ideal for use in applications where resistance to the effects of N.B.C. agent exposure and decontamination, combined with excellent abrasion resistance is required. A range of shapes are available. -125 molded parts are recommended for use in System 300.
-130 Molded Part Material	Non flame-retarded flexible polyolefin.
-146 Molded Part Material	Flame retarded, ultra-high ratio heat-shrinkable material.
-152 Molded Part Material	Flame retarded, high ratio heat-shrinkable material.

*Check with specific part page for applicable materials.

Users should independently evaluate the suitability of the product for their application. Before ordering check with factory for most current data.



-3

Semi-rigid modified polyolefin



Applications

Raychem molded parts in -3 material are designed for use in general harnessing applications where toughness is required and systems are occasionally exposed to fluids or heat. The adhesive-lined parts provide excellent sealing and strain relief at connector-cable terminations and transitions. A wide range of shapes are available in this material. The standard color is black.

Operating temperature range

-55°C to 135°C

Features and benefits

- Heat-shrinkable, semi-rigid flame-retardant molded parts.
- Good resistance to fluids and heat.

Installation

Raychem -3 molded parts will shrink on the application of heat above 125°C.

Recommended installation temperature: 150°C.

Available in:

Americas

Europe

Asia Pacific



Fax-on-demand

US only (800) 260-9099

Outside US (650) 257-2301

Fax ID

4100

Description

RT-301

specification

Visit our website at www.tycoelectronics.com**Specifications/approvals**

UL

Military

Raychem

224, File E85381

MIL-I-81765/1, Type I (U.S.)

RT-301

Def. Stan. 59-97 Issue 3 Type DA (Europe)

RK-6703

BS-G-198-5-DA (Europe)

Product characteristics

		Specification requirements	Test method
Physical	Tensile strength	10.5 MPa (min.)	ISO 37; ASTM D 412
	Ultimate elongation	250% (min.)	ISO 37; ASTM D 412
	2% secant modulus	80–160 MPa	ASTM D 882
	Specific gravity	1.4 (max.)	ISO 1183; ASTM D 792
Thermal	Heat aging for 168 h at 175°C	Ultimate elongation 150% (min.)	ISO 188, ISO 37
	Heat shock for 4 h at 225°C	No dripping, cracking, or flowing	ASTM D 2671
	Low-temperature flex at -55°C	No cracking during mandrel bend	RK-6703, CL 2.7: RT-301 Sec. 4.3.4
	Flammability	Self-extinguishing	RK-6703, CL 2.8: ASTM D 635
Electrical	Electric strength	8 MV/m (min.)	IEC 243
Water absorption		0.5% (max.)	ISO 62
Fluid resistance	Aviation fuel F40	Tensile strength 8.5 MPa (min.)	ISO 1817 and ISO 37
		Ultimate elongation 200% (min.)	after immersion for 24 h at 23°C
	Lubricating oil O-149	Tensile strength 8.5 MPa (min.)	ISO 1817 and ISO 37
		Ultimate elongation 200% (min.)	after immersion for 24 h at 23°C
Phosphate ester hydraulic fluid (DTD 900/4881A)	Tensile strength 8.5 MPa (min.)	ISO 1817 and ISO 37	
	Ultimate elongation 200% (min.)	after immersion for 24 h at 23°C	



-4

Flexible polyolefin



Applications

Raychem molded parts in -4 material are designed for use in general harnessing applications where toughness is required and systems are occasionally exposed to fluids or heat. The adhesive-lined parts provide excellent sealing and strain relief at connector-cable terminations and transitions. A wide range of shapes are available in this material. The standard color is black.

Operating temperature range

-55°C to 135°C

Features and benefits

- Heat-shrinkable, flexible, flame-retardant molded parts.
- Good resistance to fluids and heat.

Installation

Raychem -4 molded parts will shrink on the application of heat above 100°C. Recommended installation temperature: 150°C.

Available in:

Americas



Europe



Asia Pacific



Fax-on-demand

US only (800) 260-9099

Outside US (650) 257-2301

Fax ID

4101

DescriptionRT-1304
specificationVisit our website at www.tycoelectronics.com**Specifications/approvals**

UL

Military

Raychem

224, File E85381

MIL-I-81765/1 (U.S.), Type II (U.S.)

RT-1304

Product characteristics

		Specification requirements	Test method
Physical	Tensile strength	1800 psi (min.)	ASTM D 412
	Ultimate elongation	400% (min.)	ASTM D 412
	Specific gravity	1.3 (max.)	ASTM D 792
Thermal	Heat aging for 168 h at 175°C	Ultimate elongation 300% (min.)	RT 1304 Sec. 4.3.3
	Heat shock for 4 h at 225°C	No dripping, flowing, or cracking	RT 1304 Sec. 4.3.5
	Low-temperature flex at -55°C	No cracking	RT 1304 Sec. 4.3.4
	Flammability (burn time)	Average flame time: 120 s (max.)	ASTM D 635
Electrical	Dielectric strength	350 V/mil (min.)	ASTM D 149
Water absorption		0.3% (max.)	ASTM D 570
Fluid resistance	JP-4 fuel, aviation gasoline, water, hydraulic fluid	Tensile strength 8.5 MPa psi (min.)	RT-1304 Sec. 4.3.3
		Ultimate elongation 200% (min.)	



-12

Modified fluoroelastomer



Applications

Raychem -12 Viton molded parts are designed to be used in conjunction with Viton tubing or multiconductor cable jackets and a suitable adhesive in Raychem's System 200. This system provides excellent resistance to elevated temperatures and continuous fuel immersion. Available in a wide range of configurations, -12 molded parts will operate from -55°C to 200°C. The standard color is black.

Operating temperature range

-55°C to 200°C

Features and benefits

- Heat-shrinkable, flexible, fluid-resistant modified fluoro-elastomer.
- Excellent resistance to long-term fuel immersion.

Installation

Raychem -12 molded parts will shrink on the application of heat above 175°C.
Recommended installation temperature: 220°C.

Available in:

Americas

Europe

Asia Pacific



Fax-on-demand

US only (800) 260-9099

Outside US (650) 257-2301

Fax ID

4104

DescriptionRT-1312
specificationVisit our website at www.tycoelectronics.com**Specifications/approvals**

Military	Raychem
MIL-I-81765/4 (U.S.)	RT-1312
Def. Stan. 59-97 Issue 3 Type DD (Europe)	RK-6712
BS-G-198-5-DD-P (Europe)	

Product characteristics

		Specification requirements	Test method
Physical	Tensile strength	12.4 MPa (min.)	ISO 37
	Ultimate elongation	300% (min.)	ISO 37
	2% secant modulus	70 MPa (max.)	ASTM D 882
	Specific gravity	1.95 (max.)	ISO 1183
Thermal	Heat aging for 168 h at 250°C	Ultimate elongation 250% (min.)	ISO 188, ISO 37
	Heat shock for 4 h at 300°C	No dripping, cracking, or flowing	ASTM D 2671
	Low temperature flex at -55°C	No cracking	ASTM D 2671
	Flammability (burn time)	30 s (max.)	ASTM D 635
Electrical	Electric strength	8 MV/m (min.)	IEC 243
Water absorption		0.5% (max.)	ISO 62
Fluid resistance	Aviation fuel F40	Tensile strength 11 MPa (min.)	ISO 1817
		Ultimate elongation 200% (min.)	after immersion for 24 h at 23 hrs
	Lubricating oil O-149	Tensile strength 11 MPa (min.)	ISO 1817
		Ultimate elongation 200% (min.)	after immersion for 24 h at 93°C
	Hydraulic fluid H515	Tensile strength 11 MPa (min.)	ISO 1817
		Ultimate elongation 200% (min.)	after immersion for 24 h at 93°C



-25

Fluid-resistant modified elastomer



Applications

Raychem heat-shrinkable molded parts in -25 material are designed to be used in conjunction with other System 25 such as DR-25 and S-1125 components, providing a complete cable harness system capability. -25 parts have been specifically formulated and designed to provide optimum high-temperature fluid resistance and long-term heat resistance. This unique balance of properties makes -25 parts particularly suitable for sealing and strain relief at connector-cable terminations and cable-to-cable transitions on military vehicle cables and harnesses. Available in a wide range of configurations, -25 parts will operate from -75°C to 150°C for long periods. The standard color is black.

Operating temperature range

-75°C to 150°C

Features and benefits

- Heat-shrinkable, semi-rigid, chemical- and abrasion-resistant molded shapes.
- Excellent resistance to high-temperature fluids.
- Resistance to long-term exposure at elevated temperatures.

Installation

Raychem -25 molded parts will shrink on the application of heat above 135°C. Recommended installation temperature: 175°C.

Available in:

Americas



Europe



Asia Pacific



Fax-on-demand

US only (800) 260-9099

Outside US (650) 257-2301

Fax ID

4105

DescriptionRT-1325
specificationVisit our website at www.tycoelectronics.com**Specifications/approvals**

Military	Raychem
SC-X-15111 (U.S.)	RT-1325
MIS-34867 (US)	
VG95343 Parts 6, 7, 8 and 9 (Europe)	
Def Stan 59-97, Issue 3, Type DE (Europe)	
BSG-198-5-DE-P	

Product characteristics

		Specification requirements	Test method
Physical	Tensile strength	15 MPa (min.)	ASTM D 412
	Ultimate elongation	350% (min.)	ASTM D 412
	Specific gravity	1.5 (max.)	ASTM D 792
Thermal	Heat aging for 168 h at 150°C	Ultimate elongation 300% (min.)	ASTM D 412
	Heat shock for 4 h at 225°C	No dripping, cracking, or flowing	ASTM D 2671
	Low-temperature flex for 4 h at -70°C	No cracking during mandrel bend	ASTM D 2671
	Flammability (burn time)	120 s (max.)	ASTM D 635
Electrical	Electric strength	8 MV/m	ASTM D 149
Fluid resistance	Aviation fuel JP-4 (MIL-T-5624)	Tensile strength 12 MPa (min.)	ASTM D 412
		Ultimate elongation 300% (min.)	after immersion for 24 h at 25°C
	Hydraulic fluid (MIL-H-6083)	Tensile strength 12 MPa (min.)	ASTM D 412
		Ultimate elongation 300% (min.)	after immersion for 24 h at 25°C
	Diesel fuel (VVF-800 No 2)	Tensile strength 12 MPa (min.)	ASTM D 412
		Ultimate elongation 300% (min.)	after immersion for 24 h at 50°C
Automotive gasoline (MIL-G-3056)	Tensile strength 12 MPa (min.)	ASTM D 412	
	Ultimate elongation 300% (min.)	after immersion for 24 h at 25°C	



-25S

Fluid-resistant screened elastomer



Applications

Rayten screened molded parts in -25S material are designed for use with FDR-25 or DR-25 jacketed screened multiconductor cable and S1 125 adhesive to provide a complete high-performance harness system offering high levels of RFI and EMI protection. This -25 material provides optimum high-temperature fluid-resistance and long-term heat-aging properties. The material is particularly suitable for providing encapsulation, mechanical protection, and strain relief on terminations and cable transitions in harsh environments. The standard color is black. Products made from this material are normally used in an assembly (see pages 7-1 to 7-19).

Operating temperature range

-55 °C to 150 °C

Features and benefits

- Fuel and heat resistance.
- RFI, EMI protection.

Available in:

Americas

Europe

Asia Pacific



Fax-on-demand

US only (800) 260-9099

Outside US (650) 257-2301

Visit our website at www.tycoelectronics.com**Specifications/approvals**

Military	Raychem
VG 95343 Pt. 20, Pt. 22	RK-6719

Product characteristics

		Specification requirements*	Screening effectiveness in dB at		
			3 KHz to 30 MHz (min.)	>30 MHz to 100 MHz (min.)	
Initial values		Tensile strength: 12 MPa (min.) Ultimate elongation: 400% (min.) Metal adhesion: 15 N/cm (min.) Shielding effectiveness	75	70	
Thermal	Heat shock (1/2 h at 200°C)	Tensile strength: 12 MPa (min.) Ultimate elongation: 400% (min.) Shielding effectiveness	75	70	
		Heat aging (168 h at 160°C)	Tensile strength: 12 MPa (min.) Ultimate elongation: 400% (min.) Shielding effectiveness	75	70
	3 thermal cycles of -75°C to 150°C		Tensile strength: 12 MPa (min.) Ultimate elongation: 400% (min.) Shielding effectiveness	75	70
		Chemical	Immersion in the following fluids for 24 h: Lubricating oil (O-156, at 100°C)	Tensile strength: 10 MPa (min.) Ultimate elongation: 300% (min.) Shielding effectiveness	75
Hydraulic fluid H5 15, at 50°C	Tensile strength: 10 MPa (min.) Ultimate elongation: 300% (min.) Shielding effectiveness			75	70
	Aviation fuel JP4 F40, at 23°C			Tensile strength: 10 MPa (min.) Ultimate elongation: 300% (min.) Shielding effectiveness	75
			Diesel fuel F54, at 23°C	Tensile strength: 10 MPa (min.) Ultimate elongation: 300% (min.) Shielding effectiveness	75
1, 1, 1, trichloroethane (1 h, at 23°C)				Tensile strength: 10 MPa (min.) Ultimate elongation: 300% (min.) Shielding effectiveness	75

*Values quoted are for the polymer/metal composite in all cases when terminated using epoxy adhesives. (Refer to Section 5, Adhesives, in this catalog.)



-50

Fluid-resistant modified elastomer



Applications

A high-performance blend of Viton and other polymers, Raychem -50 offers excellent fluid and temperature resistance. It is suitable for use in most areas of military vehicle harnessing. This material is available in the Uniboat range and should be chosen in applications that use System 25 components. The standard color is black.

Operating temperature range

-55°C to 150°C

Features and benefits

- Excellent heat and fluid resistance.
- Low profile.
- Rugged.
- Lightweight.

Installation

Raychem -50 molded parts will shrink on the application of heat above 125°C. Recommended installation temperature is 175°C.

Available in:

Americas

Europe

Asia Pacific



Fax-on-demand

US only (800) 260-9099

Outside US (650) 257-2301

Fax ID

4107

Description

RT-1313

specification

Visit our website at www.tycoelectronics.com**Specifications/approvals**

Military	Raychem
SC-X-15111 (U.S.)	RT-1313

Product characteristics

		Specification requirements	Test method
Physical	Tensile strength	15 MPa (min.)	ASTM D 412
	Ultimate elongation	350% (min.)	ASTM D 412
	Specific gravity	1.5 (max.)	ASTM D 792
Thermal	Heat aging for 168 h at 150°C	Ultimate elongation 300% (min.)	ASTM D 412
	Heat shock for 4 h at 225°C	No dripping, cracking, or flowing	ASTM D 267 1
	Low-temperature flex for 4 h at -70°C	No cracking during mandrel bend	ASTM D 267 1
	Flammability (burn time)	120 s (max.)	ASTM D 635
Electrical	Electric strength	8 MV/m	ASTM D 149
Fluid resistance	Aviation fuel JP-4 (MIL-T-5624)	Tensile strength 12 MPa (min.) Ultimate elongation 300% (min.)	ASTM D 412 after immersion for 24 h at 25°C
	Hydraulic fluid (MIL-H-6083)	Tensile strength 12 MPa (min.) Ultimate elongation 300% (min.)	ASTM D 412 after immersion for 24 h at 25°C
	Diesel fuel (VV-F-800 No 2)	Tensile strength 12 MPa (min.) Ultimate elongation 300% (min.)	ASTM D 412 after immersion for 24 h at 50°C
	Automotive gasoline (MIL-G-3056)	Tensile strength 12 MPa (min.) Ultimate elongation 300% (min.)	ASTM D 412 after immersion for 24 h at 25°C



-51

Chemical-resistant fluoroelastomer



Applications

A high-performance elastomeric blend of polymers, Raychem -51 offers excellent fluid resistance. It is suitable for use in most areas of military vehicle harnessing. This material is available in the Uniboot range and other slimline boots and transitions. The standard color is black.

Operating temperature range

-55°C to 130°C

Features and benefits

- Excellent fuel resistance.
- Low profile.
- Rugged.
- Lightweight.

Installation

Raychem -51 molded parts will shrink on the application of heat above 125°C. Recommended installation temperature is 150°C.

Available in:

Americas

Europe

Asia Pacific



Fax-on-demand

US only (800) 260-9099

Outside US (650) 257-2301

Fax ID

42 12

Description

RT-1321

Visit our website at www.tycoelectronics.com**Specifications/approvals**

Military	Raychem
SC-X-15112 (U.S.)	RT-1321

Product characteristics

		Specification requirements	Test method
Physical	Tensile strength	1500 psi (min.)	ASTM D 412
	Ultimate elongation	300% (min.)	ASTM D 412
	Specific gravity	1.6 (max.)	ASTM D 792
Thermal	Heat aging for 168 h at 121 °C	Tensile strength 1200 psi. (min.)	RT-1321 Sec. 4.3.3
		Elongation 250% (min.)	RT-1321 Sec. 4.3.3
	Heat shock for 4 h at 200 °C	No dripping, flowing, or cracking	RT-1321 Sec. 4.3.5
	Low-temperature flex for 4 h at -55 °C	No cracking	RT-1321 Sec. 4.3.4
	Flammability (burn time)	120 seconds, 1 inch (max.)	ASTM D 635
Electrical	Dielectric strength	200 V/mil (min.)	ASTM D 149
Fluid resistance	Lubricating oil, diesel oil, water for 24 h at 25 °C	Tensile strength 1000 psi (min.)	RT-1321 Sec. 4.3.3 and 4.3.7
		Elongation 225% (min.)	
		Weight increase 10% (max.)	
	Gasoline for 24 h at 25 °C	Tensile strength 800 psi (min.)	RT-1321 Sec. 4.3.3 and 4.3.7
Elongation 225% (min.)			
Weight increase 25% (max.)			
Isopropyl alcohol, cleaning fluid for 24 h at 25 °C	Tensile strength 1400 psi (min.)	RT-1321 Sec. 4.3.3 and 4.3.7	
	Elongation 225% (min.)		
	Weight increase 10% (max.)		
Hydraulic fluid for 24 h at 71 °C	Tensile strength 1000 psi (min.)	RT-1321 Sec. 4.3.3 and 4.3.7	
	Elongation 225% (min.)		
	Weight increase 25% (max.)		



Applications

A heat-shrinkable, flexible, flame retardant, fluid and high temperature resistant, modified fluoropolymer molding compound. -55 molded parts are ideal for use in applications where chemical resistance and abrasion resistance is required. A wide range of shapes is available. -55 molded parts are recommended for use in System 300.

Use the System 300 family of parts in military applications where excellent high temperature performance, coupled with resistance to the effects of N.B.C. agent exposure and decontamination, and good physical and chemical properties are a requirement.

System 300 jacketing is based on a modified fluoropolymer and features a one part epoxy adhesive in tape form.

Operating temperature range

-65°C to 200°C

Features and benefits

- Flame retardant.
- Abrasion and cut through resistance.
- Flexible.
- High temperature resistance.
- High fluid resistance.
- Environmentally sealed.

Installation

This specification covers the requirements for one type of flexible, electrical insulating molded component whose expanded dimensions will reduce to a predetermined size upon the application of heat in excess of 220°C (428°F).

Available in:	Americas	Europe	Asia Pacific
	■	■	■

Specifications/approvals

RT-1330

Product characteristics

Physical			
Tensile Strength	psi (MPa)	3500 minimum (24.1)	Section 4.3.3
Ultimate Elongation	percent	200 minimum	ASTM D 2671
Specific Gravity	—	2.0 maximum	ASTM D 792
Low Temperature Flexibility	—	No cracking	Section 4.3.4
4 hours at -65 ± 2°C (-85 ± 4°F)			
Heat Shock	—	No dripping, flowing or cracking	Section 4.3.5
4 hours at 300°C (572°F)			
Heat Resistance	—	—	Section 4.3.6
336 hours at 250°C (482°F)			
Followed by tests for:			
Tensile Strength	psi (MPa)	2000 minimum (13.8)	Section 4.3.3
Elongation	percent	150 minimum	ASTM D 2671

Fax-on-demand

US only (800) 260-9099

Outside US (650) 257-2301

Visit our website at www.tycoelectronics.com**Product characteristics (cont'd.)****Electrical**

Dielectric Strength	volts/mil	200 minimum	ASTM D 149
Volume Resistivity	ohm-cm	10 ¹¹ minimum	ASTM D 257

Chemical

Corrosive Effect 16 hours at 200 ± 3°C (392 ± 5°F)	—	Noncorrosive	Section 4.3.7 ASTM D 2671 Procedure A
---	---	--------------	---

Flammability

Average Time of Burning	seconds	15 maximum	ASTM D 635
Average Extent of Burning	inches (mm)	0.5 maximum (12.5)	
Fungus Resistance	—	Rating of 1 or less	ASTM G 21
Water Absorption 24 hours at 23 ± 3°C (73 ± 5°F)	percent	0.5 maximum	ASTM D 570

Fluid Resistance

24 hours at 23 ± 3°C (73 ± 5°F) in: Gasoline, Aviation Grade 100 (ASTM D 910)	—	—	Section 4.3.8
---	---	---	---------------

1, 1, 1 Trichloroethane
(MIL-T-81533)

Coolanol 25

Followed by tests for:

Tensile Strength	psi (MPa)	3000 minimum (20.7)	Section 4.3.3
Ultimate Elongation	percent	150 minimum	ASTM D 2671

24 hours at 50 ± 3°C (122 ± 5°F) in:

JP-5 (MIL-T-5624)

Deicing Fluid (MIL-A-8243)

Cleaning Compound

(MIL-C-43616)

5% Salt Solution (O-S-1926)

Fuel Oil, Diesel (VV-F-800, DF-2)

Followed by tests for:

Tensile Strength	psi (MPa)	3000 minimum (20.7)	Section 4.3.3
Ultimate Elongation	percent	150 minimum	ASTM D 2671

24 hours at 75 ± 3°C (167 ± 5°F) in:

Hydraulic Fluid (MIL-H-5606)

Skydrol 500

Lubricating Oil (MIL-L-2104)

Lubricating Oil (MIL-L-7808)

Followed by tests for:

Tensile Strength	psi (MPa)	3000 minimum (20.7)	Section 4.3.3
Ultimate Elongation	percent	150 minimum	ASTM D 2671

Fluid Resistance

5 hours at 23 ± 3°C (73 ± 5°F)	—	—	Section 4.3.8
--------------------------------	---	---	---------------

Tensile Strength
Ultimate Elongation

psi (MPa)	Percent	3500 minimum (24.1)	Section 4.3.3
		150 minimum	ASTM D 2671

Nuclear

Radiation Resistance			Section 4.3.9
----------------------	--	--	---------------

Followed by tests for:

Tensile Strength	psi (MPa)	3500 minimum (24.1)	
Ultimate Elongation	percent	150 minimum	



-71

Semirigid modified polyolefin



Applications

Raychem -71 is a flexible, flame-retardant polyolefin suitable for use in general harnessing applications. The material is very flexible and offers a good balance of fluid and heat resistance. If Uniboot molded parts are required, -71 should be chosen as a replacement for -3. The standard color is black.

Operating temperature range

-55°C to 135°C

Features and benefits

- Flexible.
- Flame-retardant.

Installation

Raychem -71 molded parts will shrink on the application of heat above 100°C. Recommended installation temperature is 150°C.

Available in:

Americas

Europe

Asia Pacific



Fax-on-demand

US only (800) 260-9099

Outside US (650) 257-2301

Fax ID

4108

DescriptionRT-1316
specificationVisit our website at www.tycoelectronics.com**Specifications/approvals**

Military	Raychem
MIL-81765, Type I, Class I (U.S.)	RT-1316

Product characteristics

		Specification requirements	Test method
Physical	Tensile strength	10 MPa (min.)	ASTM D 412
	Ultimate elongation	250% (min.)	ASTM D 412
	Specific gravity	1.40 (max.)	ASTM D 792
Thermal	Heat aging for 168 hr at 175 °C	Ultimate elongation 200% (min.)	ASTM D 412
	Heat shock for 4 h at 250 °C	No dripping, cracking, or flowing	ASTM D 2671
	Low-temperature flex for 4 h at -55 °C	No cracking during mandrel bend	ASTM D 2671
	Flammability (burn time)	90 s (max.)	ASTM D 635
Electrical	Electric strength	8 MV/m	ASTM D 149
Water absorption		0.5% (max.)	ASTM D 570
Fluid resistance	Aviation fuel JP-4 (MIL-T-5624)	Tensile strength 5 MPa (min.) Ultimate elongation 200% (min.)	ASTM D 412 after immersion for 24 h at 25 °C
	Lubricating oil O-149 (MIL-L-7808)	Tensile strength 5 MPa (min.) Ultimate elongation 200% (min.)	ASTM D 412 after immersion for 24 h at 25 °C
	Hydraulic fluid (MIL-H-5606)	Tensile strength 5 MPa (min.)	ASTM D 412 after
		Ultimate elongation 200% (min.)	immersion for 24 h at 25 °C
	Skydrol 500	Tensile strength 5 MPa (min.)	ASTM D 412 after
		Ultimate elongation 200% (min.)	immersion for 24 h at 25 °C



-100

Low-fire-hazard material



Applications

Raychem heat-shrinkable molded parts in -100 material form part of Raychem's System 100. The molded parts are designed for use in conjunction with Raychem's Zerohal cable and tubing for applications where hazard reduction in the event of fire is crucial. The material exhibits excellent fire safety characteristics combined with low-smoke and low-acid-gas emission while retaining good mechanical and fluid-resistant properties. -100 parts with adhesive lining provide location, sealing, and strain relief of cable-connector terminations and cable-cable transitions on harnesses used where there is a need to lower the risk (such as in marine applications, mass transit systems, and offshore installations), or where equipment would be irreparably damaged by the corrosive products of combustion. Available in a wide range of configurations, -100 parts will operate continuously from -30°C to 105°C. The standard color is black.

Operating temperature range

-30°C to 105°C

Features and benefits

- Heat-shrinkable, semiflexible molded shapes for low fire hazard applications.
- Low-smoke index as defined by BS G 198 Part 5.
- Low-toxicity index as defined by NES 713.
- High-temperature index as defined by ISO 4589-3.

Installation

Raychem -100 molded parts will shrink on the application of heat above 120°C. Recommended installation temperature: 150°C.

Available in:

Americas

Europe

Asia Pacific



Fax-on-demand

US only (800) 260-9099

Outside US (650) 257-2301

Fax ID

4109

Description

RT-1323

specification

Visit our website at www.tycoelectronics.com**Specifications/approvals**

Military/NAVSEA	Raychem
5617649 (U.S.)	RT-1323
	RK-6717
Def. Stan 59-97, Issue 3, Type DF (Europe)	
BSG 198 Part 5 Type DF (Europe)	
BR1326 listed Class C	

Product characteristics

		Specification requirements	Test method
Physical	Tensile strength	8 MPa (min.)	ISO 37
	Ultimate elongation	200% (min.)	ISO 37
	2% secant modulus	130 MPa (max.)	ASTM D 882
	Specific gravity	1.5 (max.)	ISO 1183
Thermal	Heat aging for 168 h at 150°C	Ultimate elongation 100% (min.)	ISO 188, ISO 37
	Heat shock for 4 h at 225°C	No dripping, cracking, or flowing	ASTM D 2671
	Low-temperature flex at -30°C	No cracking during mandrel bend	ASTM D 2671
Fire safety properties	Limiting oxygen index	29 min.	ISO 4589-2
	Temperature index	250FC (min.)	ISO 4589-3
	Flammability (burn time)	100 s (max.)	ASTM D 635
	Smoke index	20 (max.)	BSG 198 Part 5
	Toxicity index	5 (max.) per 100 g	NES 713
Electrical	Electric strength	15 MV/m (min.)	IEC 243
Water absorption		0.75% (max.) at 23°C	ISO 62
		3.5% (max.) at 70°C	
Fluid resistance	ISO 1817 Gasoline fuel	Tensile strength 5 MPa (min.)	ISO 1817 and ISO 37 after immersion for 24 h at 23°C
		Ultimate elongation 150% (min.)	
	Lubricating oil O-149	Tensile strength 5 MPa (min.)	ISO 1817 and ISO 37 after immersion for 24 h at 50°C
		Ultimate elongation 150% (min.)	
	Hydraulic fluid H5 15	Tensile strength 5 MPa (min.)	ISO 1817 and ISO 37 after immersion for 24 h at 23°C
		Ultimate elongation 150% (min.)	



-100S

Low-fire-hazard screened material



Applications

-100S is the Zerohal material option in Raychem's Rayaten shield (screen) termination system. This material combines the fire safety properties of -100 with the excellent EMI and RFI screening of Rayaten screened molded parts where there is a need to lower the risk. -100S is suitable for high-performance screen terminations in areas where Raychem Zerohal materials are required. The standard color is black. Products made from these materials are normally used in an assembly (see pages 7-0 to 7-19).

Operating temperature range

-30°C to 105°C

Features and benefits

- Screened Zerohal material.
- Low smoke index as defined by NES 711.
- Low toxicity index as defined by NES 713.
- High temperature index as defined by NES 715.

Available in:

Americas

Europe

Asia Pacific



Fax-on-demand

US only (800) 260-9099

Outside US (650) 257-2301

Visit our website at www.tycoelectronics.com**Specifications/approvals**

Military	Raychem
VG 95343 Pt. 20, Pt. 22	RK-6724

Product characteristics

		Specification requirements*	Screening effectiveness in dB at	
			3 KHz to 30 MHz (min.)	>30 MHz to 100 MHz (min.)
Initial values		Tensile strength: 7 MPa (min.)		
		Metal adhesion: 15 N/cm (min.)		
		Shielding effectiveness	75	70
Thermal	Heat shock (1/2 h at 200°C)	Metal adhesion: 15 N/cm (min.)		
		Shielding effectiveness	75	70
	Heat aging (168 h at 150°C)	Metal adhesion: 15 N/cm (min.)		
		Shielding effectiveness	75	70
Fluids	Immersion in the following fluids for 24 h:			
	Phosphate ester hydraulic fluid DTD900/4881 at 23°C	Tensile strength: 5 MPa (min.)		
		Shielding effectiveness	75	70
	Water at 23°C	Tensile strength: 5 MPa (min.)		
		Shielding effectiveness	75	70
	Lubricating oil O-149 at 50°C	Tensile strength: 5 MPa (min.)		
		Shielding effectiveness	75	70
	Transformer oil S-756 at 50°C	Tensile strength: 5 MPa (min.)		
Shielding effectiveness		75	70	

*Values quoted are for the polymer/metal composite in all cases when terminated using epoxy adhesives. (Refer to Section 5, Adhesives, in this catalog.)



Applications

A heat-shrinkable, flame retardant, fluid and high temperature resistant, modified fluoropolymer molding compound. -125 molded parts are ideal for use in applications where resistance to the effects of N.B.C. agent exposure and decontamination, combined with excellent abrasion resistance is required. A range of shapes is available. -125 molded parts are recommended for use in System 300.

Use the System 300 family of parts in military applications where excellent high temperature performance, coupled with resistance to the effects of N.B.C. agent exposure and decontamination, and good physical and chemical properties are a requirement.

System 300 jacketing is based on a modified fluoropolymer and features a one part epoxy adhesive in tape form.

Operating temperature range

-65°C to 200°C

Features and benefits

- Flame retardant.
- Abrasion and cut through resistance.
- High temperature resistance.
- High fluid resistance.
- Environmentally sealed.

Installation

This specification covers the requirements for one type of electrically insulating molded component whose dimensions will reduce to a predetermined size upon the application of heat in excess of 160°C ± 3°C (320°F ± 5°F).

Available in:	Americas	Europe	Asia Pacific
	■	■	■

Specifications/approvals

RT-1334

Product characteristics

Physical

Elastic Memory	Percent	275 minimum expansion 90 minimum retraction	Section 4.3.2
Tensile Strength	psi (MPa)	4000 minimum (27.5)	Section 4.3.3
Ultimate Elongation	Percent	300 minimum	ASTM D 412
Secant Modulus	psi (MPa)	100,000 maximum (689)	Section 4.3.4 ASTM D 882
Specific Gravity	-	1.85 maximum	ASTM D 792
Low Temperature Flexibility 4 hours at -57 ± 3°C (-70 ± 5°F)	-	No cracking	Section 4.3.5
Heat Shock 4 hours at 300 ± 5°C (572 ± 9°F)	-	No dripping, flowing or cracking	Section 4.3.6
Heat Resistance 168 hours at 250 ± 5°C (482 ± 9°F)	-	-	Section 4.3.7.1
Followed by tests for:			
Tensile Strength	psi (MPa)	3500 minimum (24.1)	Section 4.3.3
Ultimate Elongation	Percent	250 minimum	Section 4.3.3
2000 hours at 150 ± 3°C (302 ± 5°F)	-	-	Section 4.3.7.2
Followed by tests for:			
Tensile Strength	psi (MPa)	3500 minimum (24.1)	Section 4.3.3
Ultimate Elongation	Percent	250 minimum	Section 4.3.3

Fax-on-demand

US only (800) 260-9099

Outside US (650) 257-2301

Visit our website at www.tycoelectronics.com**Product characteristics (cont'd.)**

Electrical			
Dielectric Strength	Volts/mil (<i>kV/mm</i>)	300 minimum (11.9)	ASTM D 149
Volume Resistivity	ohm-cm	10 ¹³ minimum	ASTM D 257
Chemical			
Corrosive Effect 16 hours at 175 ± 3°C (347 ± 5°F)	–	Noncorrosive	Section 4.3.8 ASTM D 2671 Procedure A
Flammability Initial			
Average Time of Burning	Seconds	15 maximum	ASTM D 635
Average Extent of Burning After Fluid Immersion	Inches (<i>mm</i>)	1 maximum (25)	Section 4.3.10
24 hours at 23 ± 3°C (73 ± 5°F) Gasoline, Automotive, Combat MIL-G-3056 Fuel Oil, Diesel VV-F-800 DF-2			
Turbine Fuel, Aviation, JP-4 MIL-T-5624	Seconds Inches (<i>mm</i>)	30 maximum 1 maximum (25)	ASTM D 635
Average Time of Burning Average Extent of burning			
Fungus Resistance	–	Rating of 1 or less	ASTM G 21
Water Absorption 24 hours at 23 ± 3°C (73 ± 5°F)	Percent	0.5 maximum	ASTM D 570
Fluid Resistance 24 hours at 23 ± 3°C (73 ± 5°F) Gasoline, Automotive, Combat MIL-G-3056 24 hours at 50 ± 3°C (122 ± 5°F) Fuel Oil Diesel VV-F-800 DF-2 Turbine Fuel, Aviation, JP-4 MIL-T-5624 Electrolyte 108739 19 5% Salt Solution O-S-1926 Anti-Icing & Defrosting Fluid MIL-A-8243 Lube Oil, Aircraft, Synthetic MIL-L-23699 Lube Oil MIL-L-2 104 Lube Oil, Aircraft, Synthetic MIL-L-7808 24 hours at 100 ± 3°C (212 ± 5°F) Hydraulic Fluid, Synthetic MIL-H-46 170 4 hours at 50 ± 3°C (122 ± 5°F) Cleaning Compound PC-437 5 hours at 23 ± 3°C (73 ± 5°F) Decontaminating Agent, DS-2 MIL-D-50030 Decontaminating Agent STB MIL-D-12468 Followed by tests for:	–	–	Section 4.3.9
Tensile Strength	psi (<i>MPa</i>)	3000 minimum (20.7)	Section 4.3.3
Ultimate Elongation	Percent	250 minimum	Section 4.3.3
Weight Increase	Percent	3 maximum	Section 4.3.9
Adhesive Compatibility	psi (<i>kPa</i>)	100 minimum (689)	Section 4.3.1 1
Lap Shear Strength NSM to S-1264 to DCNS			
Nuclear			
Radiation Resistance followed by tests for:			Section 4.3.12
Tensile Strength	psi (<i>MPa</i>)	4000 (27.6)	Section 4.3.3
Ultimate Elongation	Percent	250	

Users should independently evaluate the suitability of the product for their application.
Before ordering check with factory for most current data.

101A011 to 094

End caps



Applications

Use for protecting cables and pipes or capping unused outlets in transitions. Provides an environmental seal when used with adhesive.

As supplied (a)



After unrestricted recovery (b)

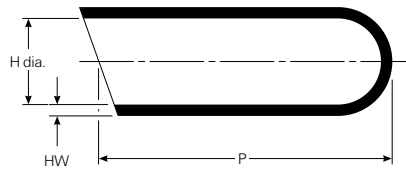

Available in:

Americas

Europe

Asia Pacific



Fax-on-demand

US only (800) 260-9099

Outside US (650) 257-2301

Fax ID

3270

Description

SCD

Visit our website at www.tycoelectronics.com**Materials available**

Material*	Material description	Precoating no.	Adhesive part no.**
-3	Semirigid polyolefin	/42 or /86	S-1017 or S-1048
-4	Flexible polyolefin	/42 or /86	S-1017 or S-1048
-12	Viton	N/A	S-1255-04
-25	Fluid-resistant elastomer	/42 or /86	S-1017 or S-1048 or S-1125
-100	Polyolefin, Zerohal	/180	S-1030

*For more information, please see the appropriate material page in this section.

**For more information, please see Section 5 of this catalog.

Product dimensions (mm/in)

Part number	H		P	HW
	Min. a	Max. b		
101A011	5.1 (.20)	2.0 (.08)	22.9 (.90)	1.02 (.04)
101A021	7.4 (.29)	3.3 (.13)	25.4 (1.0)	1.27 (.05)
101A031	10.2 (.40)	4.8 (.18)	30.5 (1.2)	1.52 (.06)
101A041	15.2 (.60)	6.4 (.25)	40.6 (1.6)	1.78 (.07)
101A052	20.6 (.81)	9.4 (.37)	61.0 (2.4)	2.03 (.08)
101A062	25.4 (1.0)	11.4 (.45)	68.8 (2.7)	2.29 (.09)
101A073	39.4 (1.56)	18.0 (.71)	91.4 (3.6)	2.54 (.10)
101A083	50.8 (2.0)	22.9 (.90)	101.6 (4.0)	2.79 (.11)
101A094	83.8 (3.3)	38.1 (1.5)	114.3 (4.5)	3.05 (.12)

Note: Coating is optional. As supplied dimensions appearing in table are for uncoated parts. When coating is added, entry diameters will be reduced by 1.5 mm (.06") max.



SSC

Heat-shrinkable end caps



Applications

These SSC heat-shrinkable end caps (also sold as SSC end caps) are made from a thermally stabilized, modified polyolefin, which makes them highly resistant to moisture, fungus, and weathering. The end caps also have excellent electrical properties. End caps coated with sealant are available for underwater or underground applications with a pressure differential up to 20 psi between the inside of the cable and the outside environment. End caps may be used over lead, steel, aluminum, copper, polyethylene, polyolefin, EPR, and PVC jacketing materials.

Features and benefits

- Self-sealing for waterproofing (sealant-coated parts only).
- Electrical insulation to 1000 V.
- Abrasion-resistance.
- Mechanical protection
- Easy installation, requiring no special skills.
- Operating temperature range of -40°C to 85°C.
- Minimum shrink temperature of 121°C.

Available in:

Americas



Europe



Asia Pacific



Fax-on-demand

US only (800) 260-9099

Outside US (650) 257-2301

Fax ID

4056

Description

Data sheet

Visit our website at www.tycoelectronics.com**Specifications/approvals**

Type	Raychem	Military/Commercial
SSC-XXX-FR	RWXXXX SSC-XX-FR specification control drawing	MIL-I-81765/1A
SSC-X and SSC-XTV	SSC specification control drawing	PPS-3011/6
S-1017	RT-1050/1	
S-1297	Nemosyne 97/RW-2019	
102LOXX	RW-2024	

Product dimensions (mm/in)

Part number	Inner diameter*		Part length Recovered ± 10 %	Wall thickness (nom.) Recovered ± 20 %
	As supplied (min.)	Recovered (max.)		
SSC-1	10 (.39)	4 (.16)	33.5 (1.32)	2.0 (.08)
SSC-2	20 (.79)	7.5 (.30)	55.3 (2.18)	2.3 (.09)
SSC-3	35 (1.38)	15 (.59)	89.9 (3.54)	3.0 (.12)
SSC-4	55 (2.17)	25 (.98)	143.2 (5.64)	3.3 (.13)
SSC-5	73 (2.87)	32 (1.25)	150.1 (5.91)	3.3 (.13)
SSC-5M1	73 (2.87)	32 (1.25)	79.25 (3.12)	3.3 (.13)
SSC-6	100 (3.94)	45 (1.77)	162.5 (6.40)	4.0 (.16)
SSC-7	120 (4.72)	70 (2.76)	145.0 (5.71)	3.8 (.15)
			± .25	± .010
SSC-075-FR	19.05 (.75)	9.90 (.39)	76.2 (3.00)	2.03 (.08)
SSC-150-FR	38.10 (1.50)	20.06 (.79)	79.50 (3.13)	2.54 (.10)

Note: Coating is optional. As supplied dimensions appearing in table are for uncoated parts. When coating is added, entry diameters will be reduced by 1.5 mm (.06") max.

*Adhesive is optional. As-supplied dimensions appearing in table are for uncoated parts. When adhesive is added, entry diameters will be reduced by 1.5 mm (.06 in) maximum.

Ordering information

Military	
SSC-XTV	Sealing end cap with adhesive S-1017 and valve
SSC-X	Sealing end cap with adhesive S-1017
SSC-XU	End cap, uncoated
SSC-XXX-FR U	End cap, uncoated, round end
SSC-XXX-FR	Sealing end cap with adhesive S-1297, round end

Users should independently evaluate the suitability of the product for their application.
 Before ordering check with factory for most current data.

202A111 to 196

Straight boot



Applications

Use for mechanical protection and connector/cable strain relief. This family of boots has no lip, so that a boot can be installed directly onto the connector accessory thread.

As supplied (a)

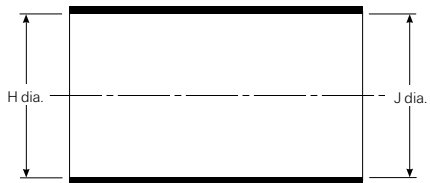

After unrestricted recovery (b)

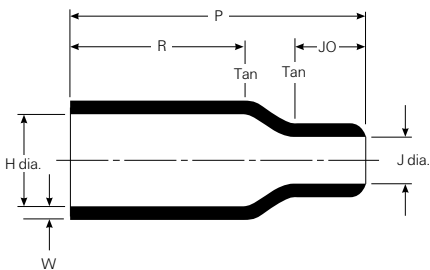

Available in:

Americas

Europe

Asia Pacific



Fax-on-demand

US only (800) 260-9099

Outside US (650) 257-2301

Fax ID

3101

Description

SCD

Visit our website at www.tycoelectronics.com**Materials available**

Material*	Material description	Precoating no.	Adhesive part no.**
-3	Semirigid polyolefin	/42 or /86	S-1017 or S-1048
-4	Flexible polyolefin	/42 or /86	S-1017 or S-1048
-12	Viton	N/A	S-1255-04
-25	Fluid-resistant elastomer	/42 or /86 or /225	S-1017 or S-1048 or S-1125
-100	Polyolefin, Zerohal	/86 or /180	S-1030 or S-1048

*For more information, please see the appropriate material page in this section.

**For more information, please see Section 5 of this catalog.

Product dimensions (mm/in)

Part number	H			J		
	Min.	Min.	Max.	Min.	Min.	Max.
	-3, -4, -25	-12, -100		-3, -4, -25	-12, -100	
	a	a	b	a	a	b
202A111	16.5 (.65)	16.5 (.65)	7.9 (.31)	16.5 (.65)	11.9 (.47)	3.8 (.15)
202A121	24.6 (.97)	22.6 (.89)	9.9 (.39)	24.6 (.97)	17.8 (.70)	5.3 (.21)
202A132	28.4 (1.12)	26.2 (1.03)	14.2 (.56)	28.4 (1.12)	20.3 (.80)	6.6 (.26)
202A142	31.0 (1.22)	31.0 (1.22)	17.8 (.70)	31.0 (1.22)	25.4 (1.00)	7.4 (.29)
202A153	36.1 (1.42)	36.1 (1.42)	21.9 (.86)	36.1 (1.42)	26.2 (1.03)	8.6 (.34)
202A163	42.7 (1.68)	42.7 (1.68)	27.4 (1.08)	42.7 (1.68)	27.2 (1.07)	9.4 (.37)
202A174	51.8 (2.04)	48.3 (1.90)	35.3 (1.39)	51.8 (2.04)	48.3 (1.90)	16.0 (.63)
202A185	66.0 (2.60)	66.0 (2.60)	43.7 (1.72)	66.0 (2.60)	54.1 (2.13)	19.6 (.77)
202A196	86.4 (3.40)	86.4 (3.40)	57.2 (2.25)	86.4 (3.40)	71.4 (2.81)	26.9 (1.06)

Part number	P	R	JO	W
	±10%	±10%	Ref.	±20%
	b	b	b	b
202A111	25.4 (1.00)	14.2 (.56)	5.8 (.23)	1.27 (.05)
202A121	38.1 (1.50)	21.8 (.86)	9.1 (.36)	1.52 (.06)
202A132	51.3 (2.02)	27.9 (1.10)	13.0 (.51)	1.78 (.07)
202A142	66.8 (2.63)	35.6 (1.40)	17.8 (.70)	1.78 (.07)
202A153	73.7 (2.90)	41.4 (1.63)	16.0 (.63)	1.78 (.07)
202A163	99.1 (3.90)	62.7 (2.47)	18.0 (.71)	2.03 (.08)
202A174	130. (5.13)	64.8 (2.55)	41.9 (1.65)	3.30 (.13)
202A185	161.3 (6.35)	90.2 (3.55)	47.8 (1.88)	3.81 (.15)
202A196	212.6 (8.37)	113.0 (4.45)	62.2 (2.45)	4.06 (.16)

Note: Coating is optional. As supplied dimensions appearing in table are for uncoated parts. When coating is added, entry diameters will be reduced by 1.5 mm (.06") max.

Users should independently evaluate the suitability of the product for their application.
Before ordering check with factory for most current data.

202C611 to 663

Uniboot



Applications

Use to provide abrasion protection for connectors. The flexibility of design allows a variety of cable outlet angles. When installed on a spin-coupling adapter, cold reentry to the connector is possible by compressing the molded part. When used with adhesive it provides environmental sealing.

As supplied (a)

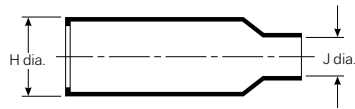

After unrestricted recovery (b)

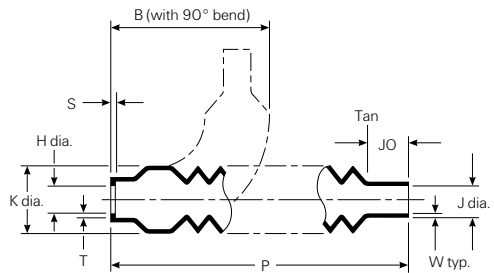

Available in:

Americas

Europe

Asia Pacific



Fax-on-demand

US only (800) 260-9099

Outside US (650) 257-2301

Visit our website at www.tycoelectronics.com**Materials available**

Material*	Material description	Precoating no.	Adhesive part no.**
-50	Viton polymer blend	N/A	S-1125
-51	Elastomer polymer blend	/164	S-1124
-71	Flexible polyolefin	/42 or /86	S-1017 or S-1048

*For more information, please see the appropriate material page in this section.

**For more information, please see Section 5 of this catalog.

Product dimensions (mm/in)

Part number	H			J			K	P
	Min. a-50, -51	a-71	Max. b	Min. a-50, -51	a-71	Max. b	Max. b	±10% b
202C611	14.2 (.56)	17.5 (.69)	6.9 (.27)	11.2 (.44)	14.2 (.56)	4.8 (.19)	21.1 (.83)	120.7 (4.75)
202C621	22.4 (.88)	26.4 (1.04)	11.7 (.46)	17.8 (.70)	26.4 (1.04)	8.1 (.32)	26.7 (1.05)	133.4 (5.25)
202C632	34.0 (1.34)	38.1 (1.50)	17.5 (.69)	26.9 (1.06)	38.1 (1.50)	12.7 (.50)	32.8 (1.29)	146.1 (5.75)
202C642	44.2 (1.74)	47.8 (1.88)	22.4 (.88)	36.6 (1.44)	47.8 (1.88)	17.5 (.69)	37.8 (1.49)	158.8 (6.25)
202C653	21.2 (.838)	54.9 (2.16)	27.9 (1.10)	45.7 (1.80)	54.9 (2.16)	22.4 (.88)	42.9 (1.69)	171.5 (6.75)
202C663	2.25 (.875)	77.2 (3.04)	40.6 (1.60)	57.2 (2.25)	54.6 (2.15)	22.9 (.90)	62.2 (2.45)	236.2 (9.30)

Part number	JO	S	T	W	B
	±10% b	±.03 (.076) b	±.03 (.076) b	Min. b	Nom. b
202C611	17.5 (.69)	1.52 (.06)	1.27 (.05)	0.33 (.013)	62.5 (2.46)
202C621	19. (.78)	1.52 (.06)	1.27 (.05)	0.46 (.018)	67.8 (2.67)
202C632	22.4 (.88)	1.78 (.07)	1.27 (.05)	0.51 (.020)	73.4 (2.89)
202C642	25.4 (1.00)	1.78 (.07)	1.27 (.05)	0.61 (.024)	78.2 (3.08)
202C653	28.4 (1.12)	1.78 (.07)	2.03 (.08)	0.61 (.024)	82.8 (3.26)
202C663	35.1 (1.38)	2.03 (.08)	2.03 (.08)	0.66 (.026)	138.4 (5.45)

Note: Coating is optional. As supplied dimensions appearing in table are for uncoated parts. When coating is added, entry diameters will be reduced by 1.5 mm (.06") max.

202D121 to 196

Straight, lipped boot



Applications

Use in conjunction with Raychem adapters to provide strain relief for harness systems using circular connectors. Boot is compatible with all Raychem grooved adapters of appropriate shell size.

As supplied (a)

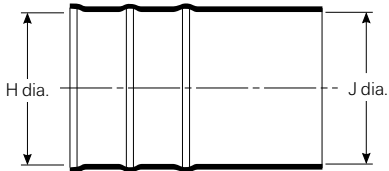

After unrestricted recovery (b)

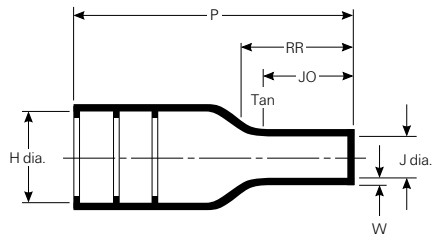

Available in:

Americas

Europe

Asia Pacific

Fax-on-demand

US only (800) 260-9099

Outside US (650) 257-2301

Visit our website at www.tycoelectronics.com**Materials available**

Material*	Material description	Precoating no.	Adhesive part no.**
-3	Semirigid polyolefin	/42 or /86	S-1017 or S-1048
-4	Flexible polyolefin	/42 or /86	S-1017 or S-1048
-12	Viton	N/A	S-1255-04
-25	Fluid-resistant elastomer	/42 or /86 or /225	S-1017 or S-1048 or S-1125
-100	Polyolefin, Zerohal	/180	S-1030

*For more information, please see the appropriate material page in this section.

**For more information, please see Section 5 of this catalog.

Product dimensions (mm/in)

Part Number	H		J		P	JO	W	RR	
	Min.	Max.	Min.	Min.					
	a	b	-3, -4, -25 a	-12, -100 a	Max. b	±10% b	±10% b	±20% b	±10% b
202D121	23.3 (.92)	10.5 (.41)	23.3 (.92)	12.4 (.49)	5.6 (.22)	38.1 (1.50)	10.2 (.40)	1.78 (.07)	
202D132	28.4 (1.12)	14.3 (.56)	28.4 (1.12)	14.7 (.58)	6.6 (.26)	54.9 (2.16)	16.5 (.65)	1.78 (.07)	21.6 (.85)
202D142	31.0 (1.22)	17.8 (.70)	31.0 (1.22)	16.0 (.63)	7.2 (.28)	66.8 (2.63)	17.8 (.70)	2.03 (.08)	24.5 (.96)
202D153	36.0 (1.42)	22.4 (.88)	36.0 (1.42)	18.5 (.73)	8.4 (.33)	80.0 (3.15)	20.8 (.82)	2.03 (.08)	29.7 (1.17)
202D163	42.7 (1.68)	28.2 (1.11)	42.7 (1.68)	22.0 (.87)	9.9 (.39)	103.6 (4.08)	24.6 (.97)	2.29 (.09)	36.7 (1.44)
202D174	51.8 (2.04)	35.1 (1.38)	51.8 (2.04)	35.3 (1.39)	15.8 (.62)	130.3 (5.13)	39.6 (1.56)	3.30 (.13)	53.8 (2.12)
202D185	66.0 (2.60)	44.5 (1.75)	66.0 (2.60)	45.7 (1.80)	20.4 (.80)	165.1 (6.50)	48.3 (1.90)	4.06 (.16)	65.6 (2.59)
202D196	81.7 (3.22)	57.6 (2.27)	81.7 (3.22)	57.1 (2.25)	25.4 (1.00)	177.8 (7.00)	47.8 (1.88)	4.06 (.16)	67.1 (2.64)

Note: Coating is optional. As supplied dimensions appearing in table are for uncoated parts. When coating is added, entry diameters will be reduced by 1.5 mm (.06") max.

202D211 to 299

Straight, lipped boot.



Applications

Use with circular connectors and the appropriate Raychem backshell adapter to provide connector/cable strain relief. Boot is used on open-wire-bundle airborne harnesses, or applications where the long tail replaces cable jacketing removed during termination.

As supplied (a)

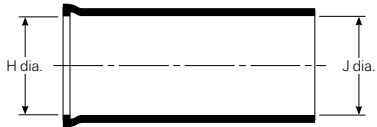

After unrestricted recovery (b)

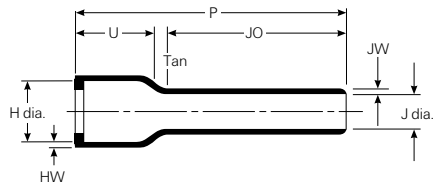

Available in:

Americas

Europe

Asia Pacific

Fax-on-demand	Fax ID	Description
US only (800) 260-9099	3 112	SCD
Outside US (650) 257-2301	3 113	SCD
		-25/225

Visit our website at www.tycoelectronics.com

Materials available

Material*	Material description	Precoating no.	Adhesive part no.**
-3	Semirigid polyolefin	/42 or /86	S-1017 or S-1048
-4	Flexible polyolefin	/42 or /86	S-1017 or S-1048
-12	Viton	N/A	S-1255-04
-25	Fluid-resistant elastomer	/42 or /86 or /225	S-1017 or S-1048 or S-1125
-100	Polyolefin, Zerohal	/180	S-1030

*For more information, please see the appropriate material page in this section.

**For more information, please see Section 5 of this catalog.

Product dimensions (mm/in)

Part number	H		J			P	JO	U	HW	JW
	Min. a	Max. b	Min. -3, -4, -25 a	Min. -12, -100 a	Max. b	±10% b	±10% b	±10% b	±20% b	±20% b
202D211	22.4 (.88)	11.4 (.45)	22.4 (.88)	14.0 (.55)	6.4 (.25)	105.9 (4.17)	86.4 (3.40)	14.2 (.56)	1.52 (.06)	1.14 (.045)
202D221	25.7 (1.01)	15.0 (.59)	25.7 (1.01)	16.0 (.63)	7.4 (.29)	121.2 (4.77)	98.6 (3.88)	15.0 (.59)	1.52 (.06)	1.14 (.045)
202D232	29.5 (1.16)	18.8 (.74)	29.5 (1.16)	18.3 (.72)	8.4 (.33)	138.7 (5.46)	112.8 (4.44)	15.5 (.61)	1.78 (.07)	1.14 (.045)
202D242	34.0 (1.34)	22.9 (.90)	34.0 (1.34)	21.3 (.84)	9.7 (.38)	159.5 (6.28)	130.8 (5.15)	15.7 (.62)	1.78 (.07)	1.14 (.045)
202D253	37.3 (1.47)	29.5 (1.16)	37.3 (1.47)	23.1 (.91)	10.4 (.41)	177.8 (7.00)	142.2 (5.60)	18.0 (.71)	2.0 (.08)	1.14 (.045)
202D263	43.7 (1.72)	34.0 (1.34)	43.7 (1.72)	27.2 (1.07)	12.2 (.48)	203.2 (8.00)	163.1 (6.42)	19.8 (.78)	2.0 (.08)	1.14 (.045)
202D274	50.0 (1.97)	41.2 (1.62)	50.0 (1.97)	31.5 (1.24)	14.2 (.56)	203.2 (8.00)	157.7 (6.21)	20.8 (.82)	2.3 (.09)	1.40 (.055)
202D285	62.7 (2.47)	47.0 (1.85)	62.7 (2.47)	39.1 (1.54)	17.5 (.69)	203.2 (8.00)	153.2 (6.03)	23.4 (.92)	2.5 (.10)	1.40 (.055)
202D296	69.3 (2.73)	59.7 (2.35)	69.3 (2.73)	43.2 (1.70)	19.6 (.77)	203.2 (8.00)	143.3 (5.64)	23.6 (.93)	2.5 (.10)	1.40 (.055)
202D299	81.8 (3.22)	67.1 (2.64)	81.8 (3.22)	51.1 (2.01)	22.9 (.90)	203.2 (8.00)	138.4 (5.45)	31.2 (1.23)	2.5 (.10)	1.40 (.055)

Note: Coating is optional. As supplied dimensions appearing in table are for uncoated parts. When coating is added, entry diameters will be reduced by 1.5 mm (.06") max.

202D921 to 963

Straight, lipped boot

Fax-on-demand

US only (800) 260-9099

Outside US (650) 257-2301

Fax ID Description

3116 SCD

Visit our website at www.tycoelectronics.com



Applications

Use with circular connectors and the appropriate Raychem backshell adapter to provide connector/cable strain relief. Boot is used in applications where only a small number of the available contacts are utilized, thus resulting in a high ratio between the adapter and cable diameters.

As supplied (a)

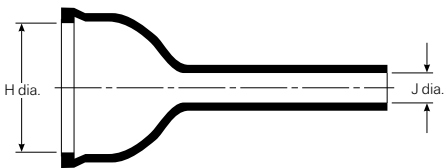

After unrestricted recovery (b)

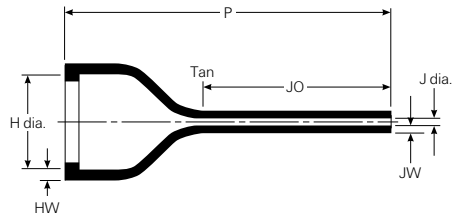

Available in:

Americas

Europe

Asia Pacific

Materials available

Material*	Material description	Precoating no.	Adhesive part no.**
-3	Semirigid polyolefin	/42 or /86	S-1017 or S-1048
-4	Flexible polyolefin	/42 or /86	S-1017 or S-1048
-12	Viton	N/A	S-1255-04
-25	Fluid-resistant elastomer	/42 or /86 or /225	S-1017 or S-1048 or S-1125
-100	Polyolefin, Zerohal	/86 or /180	S-1030 or S-1048

*For more information, please see the appropriate material page in this section.**For more information, please see Section 5 of this catalog.

Product dimensions (mm/in)

Part number	H		J		P	JO	HW	JW	
	Min.	Max.	Min.	Min.					Max.
	a	b	-3, -4, -25 a	-12, -100 a	b	±10% b	±10% b	±20% b	±20% b
202D921	19.3 (.76)	13.0 (.51)	6.3 (.25)	4.5 (.18)	2.1 (.08)	60.2 (2.37)	37.6 (1.48)	1.52 (.06)	1.14 (.045)
202D932	26.1 (1.03)	19.1 (.75)	7.6 (.30)	5.5 (.22)	2.6 (.10)	74.2 (2.92)	45.0 (1.77)	1.78 (.07)	1.14 (.045)
202D953	34.2 (1.35)	26.0 (1.02)	9.6 (.38)	6.6 (.26)	3.1 (.12)	84.3 (3.32)	51.1 (2.01)	1.78 (.07)	1.14 (.045)
202D963	43.6 (1.72)	34.1 (1.34)	11.4 (.45)	7.8 (.31)	3.6 (.14)	99.6 (3.92)	57.7 (2.27)	1.78 (.07)	1.14 (.045)

Note: Coating is optional. As supplied dimensions appearing in table are for uncoated parts. When coating is added, entry diameters will be reduced by 1.5 mm (.06") max.

202F211 to 274

Straight, lipped boot

Fax-on-demand

US only (800) 260-9099

Outside US (650) 257-2301

Fax ID

3121

Description

SCD

Visit our website at www.tycoelectronics.com



Applications

Use in conjunction with Raychem adapters to provide strain relief for harness systems using circular connectors. Boot is compatible with all Raychem grooved adapters of the appropriate shell size.

As supplied (a)

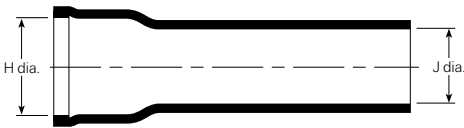

After unrestricted recovery (b)

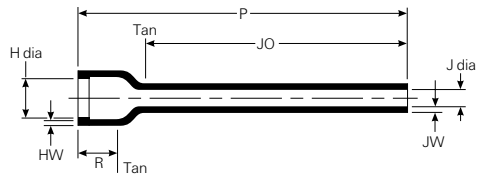

Available in:

Americas

Europe

Asia Pacific

Materials available

Material*	Material description	Precoating no.	Adhesive part no.**
-50	Flexible Viton polymer blend	N/A	S-1125
-51	Flexible elastomer polymer blend	/164	S-1124
-71	Flexible polyolefin	/42 or /86	S-1017 or S-1048

*For more information, please see the appropriate material page in this section. **For more information, please see Section 5 of this catalog.

Product dimensions (mm/in)

Part number	H		J		P	R	JO	HW	JW
	Min.	Max.	Min.	Max.					
202F211	23.9 (.94)	9.9 (.39)	17.3 (.68)	6.6 (.26)	105.9 (4.17)	11.7 (.46)	86.4 (3.40)	1.5 (.06)	1.5 (.06)
202F221	27.2 (1.07)	13.2 (.52)	20.8 (.82)	7.6 (.30)	121.2 (4.77)	12.2 (.48)	98.6 (3.88)	1.5 (.06)	1.5 (.06)
202F232	31.0 (1.22)	18.5 (.73)	24.4 (.96)	8.9 (.35)	138.7 (5.46)	12.2 (.48)	112.8 (4.44)	1.8 (.07)	1.5 (.06)
202F242	35.6 (1.40)	22.1 (.87)	28.7 (1.13)	10.2 (.40)	159.5 (6.28)	12.2 (.48)	130.8 (5.15)	1.8 (.07)	1.5 (.06)
202F253	38.9 (1.53)	28.2 (1.11)	31.5 (1.24)	10.9 (.43)	177.8 (7.00)	14.0 (.55)	142.2 (5.60)	1.8 (.07)	1.5 (.06)
202F263	45.2 (1.78)	32.3 (1.27)	38.4 (1.51)	12.7 (.50)	203.2 (8.00)	15.2 (.60)	163.1 (6.42)	1.8 (.07)	1.5 (.06)
202F274	51.6 (2.03)	41.1 (1.62)	45.5 (1.79)	15.0 (.59)	203.2 (8.00)	15.2 (.60)	157.7 (6.21)	1.8 (.07)	1.8 (.07)

Note: Coating is optional. As supplied dimensions appearing in table are for uncoated parts. When coating is added, entry diameters will be reduced by 1.5 mm (.06") max.

Users should independently evaluate the suitability of the product for their application. Before ordering check with factory for most current data.

202G211 to 253

Straight, low profile lipped boot



Applications

Use in conjunction with Raychem adapters to provide strain relief for harness systems using circular connectors. This range of parts is compatible with all Raychem grooved adapters of appropriate shell or entry size. When used with adhesive it provides environmental sealing.

As supplied (a)

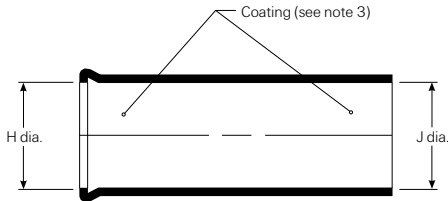

After unrestricted recovery (b)

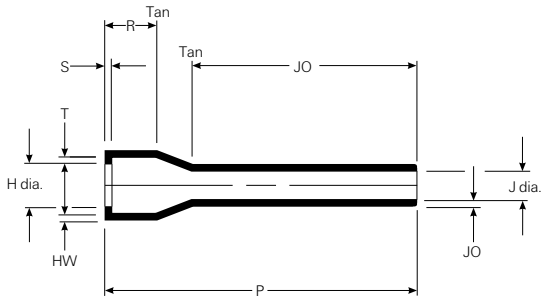

Available in:

Americas

Europe

Asia Pacific



Fax-on-demand

US only (800) 260-9099

Outside US (650) 257-2301

Fax ID

3121

Description

SCD

Visit our website at www.tycoelectronics.com**Materials available**

Material dash no.	Material description	Adhesive
-55	Fluoropolymer	S-1255-04

Product dimensions (mm/in)

Part number	H		J		P	R	S	T	JO	HW	JW
	Min. a	Max. b	Min. a	Max. b	±10% b	±10% b	Ref. b	Ref. b	±10% b	Ref. b	Ref. b
202G211	.94 (23.9)	.39 (9.9)	.94 (23.9)	.29 (7.4)	4.17 (105.9)	.46 (11.7)	.04 (1.0)	.05 (1.3)	3.40 (86.4)	.04 (1.0)	.03 (0.7)
202G221	1.07 (27.2)	.52 (13.2)	1.07 (27.2)	.33 (8.4)	4.77 (121.2)	.48 (12.2)	.04 (1.0)	.05 (1.3)	3.44 (87.4)	.04 (1.0)	.03 (0.7)
202G232	1.22 (31.0)	.73 (18.5)	1.22 (31.0)	.37 (9.4)	5.46 (138.7)	.48 (12.2)	.04 (1.0)	.05 (1.3)	4.11 (104.4)	.04 (1.0)	.03 (0.7)
202G242	1.25 (31.7)	.87 (22.1)	1.25 (31.7)	.42 (10.7)	6.28 (159.5)	.48 (12.2)	.04 (1.0)	.06 (1.5)	4.90 (124.5)	.04 (1.0)	.03 (0.7)
202G253	1.53 (38.9)	1.11 (28.2)	1.53 (38.9)	.47 (11.9)	7.00 (177.8)	.42 (10.6)	.05 (1.3)	.07 (1.8)	5.65 (143.5)	.05 (1.3)	.04 (1.0)

202G611 to 653

Uniboot



Applications

Use to provide abrasion protection for connectors. The flexibility of design allows a variety of cable outlet angles. When installed on a spin-coupling adapter, cold re-entry to the connector is possible by unscrewing the adapter and compressing the molded part. When used with adhesive it provides environmental sealing.

As supplied (a)



After unrestricted recovery (b)

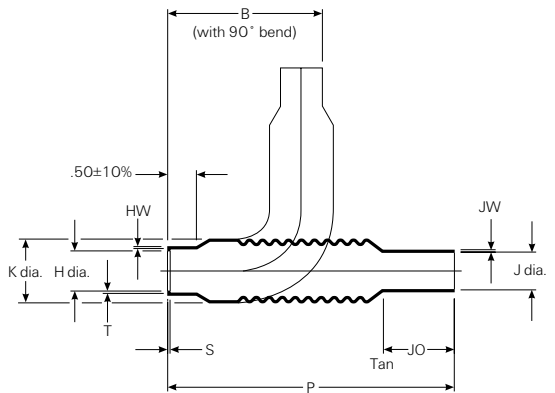

Available in:

Americas

Europe

Asia Pacific



Fax-on-demand

US only (800) 260-9099

Outside US (650) 257-2301

Fax ID

3124

Description

SCD

Visit our website at www.tycoelectronics.com**Materials available**

Material dash no.	Material description	Adhesive
-55	Fluoropolymer	S-1255-04

Product dimensions (mm/in)

Part number	H		J		K	P	JO	HW	JW	S	T	B
	Min. a	Max. b	Min. a	Max. b	Max. b	±10% b	±10% b	Ref. b	Ref. b	Ref. b	Ref. b	Nom. b
202G611	.56 (14.2)	.27 (6.9)	.44 (11.2)	.19 (4.8)	.83 (21.1)	4.75 (120.7)	.69 (17.5)	.04 (1.0)	.03 (0.7)	.04 (1.0)	.05 (1.3)	2.46 (62.5)
202G621	1.05 (26.6)	.46 (11.7)	1.05 (26.6)	.32 (8.1)	1.05 (26.6)	5.27 (133.8)	.78 (19.9)	.04 (1.0)	.03 (0.7)	.04 (1.0)	.05 (1.3)	2.67 (67.8)
202G632	1.30 (33.0)	.69 (17.5)	1.30 (33.0)	.50 (12.7)	1.29 (32.7)	5.95 (151.1)	.88 (22.4)	.04 (1.0)	.03 (0.7)	.04 (1.0)	.05 (1.3)	2.89 (73.4)
202G642	1.40 (35.5)	.88 (22.3)	1.40 (35.5)	.69 (17.5)	1.49 (37.8)	6.19 (157.2)	1.00 (25.4)	.05 (1.3)	.04 (1.0)	.05 (1.3)	.05 (1.3)	3.08 (78.2)
202G653	1.68 (42.6)	1.10 (27.9)	1.68 (42.6)	.88 (22.4)	1.69 (42.9)	6.70 (170.2)	1.12 (28.4)	.05 (1.3)	.04 (1.0)	.05 (1.3)	.06 (1.5)	3.26 (82.8)

202K121 to 185

Straight, lipped boot



Applications

Use in conjunction with Raychem adapters to provide strain relief for harness systems using circular connectors. Boot is compatible with all Raychem grooved adapters of the appropriate shell size.

As supplied (a)

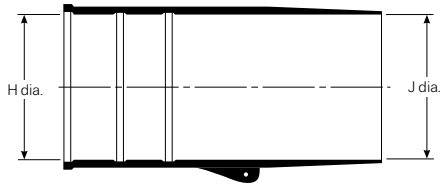

After unrestricted recovery (b)

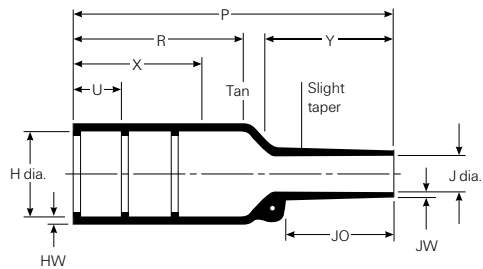

202K121 - 153 = 2 lips

202K163 - 185 = 3 lips

Mod 01 = 1 lip removed

Mod 02 = 2 lips removed

(only available in sizes 163, 174, 185).

Available in:

Americas

Europe

Asia Pacific



Fax-on-demand	Fax ID	Description
US only (800) 260-9099	3125	SCD
Outside US (650) 257-2301	3126	SCD-25/225

Visit our website at www.tycoelectronics.com

Materials available

Material*	Material description	Precoating no.	Adhesive part no.**
-3	Semirigid polyolefin	/42 or /86	S-1017 or S-1048
-4	Flexible polyolefin	/42 or /86	S-1017 or S-1048
-12	Viton	N/A	S-1255-04
-25	Fluid-resistant elastomer	/42 or /86 or /225	S-1017 or S-1048 or S-1125
-100	Polyolefin, Zerohal	/86 or /180	S-1030 or S-1048

*For more information, please see the appropriate material page in this section.

**For more information, please see Section 5 of this catalog.

Product dimensions (mm/in)

Part number	H		J				P		R
	Min.	Max.	Min.	Min.	Min.	Max.	±10%	±10%	
	-3, -4, -12, -25		-3, -4, -25	-12	-100		b	b	
	a	b	a	a	a	b	b	b	
202K121	24.0 (.95)	10.4 (.41)	24.0 (.95)	13.0 (.51)	14.0 (.55)	5.6 (.22)	38.0 (1.50)	21.0 (.83)	
202K132	30.0 (1.18)	14.2 (.56)	30.0 (1.18)	14.0 (.55)	15.0 (.59)	5.9 (.23)	55.0 (2.17)	32.0 (1.26)	
202K142	31.0 (1.22)	18.0 (.71)	31.0 (1.22)	16.0 (.63)	18.0 (.71)	7.1 (.28)	67.0 (2.64)	35.0 (1.38)	
202K153	36.0 (1.42)	22.4 (.88)	36.0 (1.42)	19.0 (.75)	21.0 (.83)	8.4 (.33)	80.0 (3.15)	42.0 (1.65)	
202K163	43.0 (1.69)	28.2 (1.11)	43.0 (1.69)	22.0 (.87)	25.0 (.98)	9.9 (.39)	99.0 (3.90)	61.0 (2.40)	
202K174	60.0 (2.36)	35.1 (1.38)	60.0 (2.36)	35.0 (1.38)	39.0 (1.54)	15.7 (.62)	130.0 (5.12)	72.0 (2.83)	
202K185	66.0 (2.60)	44.5 (1.75)	66.0 (2.60)	38.0 (1.50)	42.0 (1.65)	16.8 (.66)	170.0 (6.69)	90.0 (3.54)	

	U	JO	HW	JW	X	Y
	±10%	±10%	±20%	Min.	±20%	±20%
	b	b	b	b	b	b
202K121	12.0 (.47)	8.5 (.33)	1.6 (.06)	.41 (.016)	24.0 (.94)	13.0 (.51)
202K132	12.0 (.47)	11.5 (.45)	1.8 (.07)	.81 (.032)	24.0 (.94)	18.0 (.71)
202K142	20.0 (.79)	17.0 (.67)	1.8 (.07)	.81 (.032)	32.0 (1.26)	25.0 (.98)
202K153	20.0 (.79)	19.5 (.76)	2.0 (.08)	.81 (.032)	32.0 (1.26)	30.0 (1.18)
202K163	20.0 (.79)	21.0 (.82)	2.2 (.08)	.81 (.032)	52.0 (2.05)	30.0 (1.18)
202K174	20.0 (.79)	39.0 (1.53)	3.3 (.13)	1.02 (.040)	52.0 (2.05)	50.0 (1.97)
202K185	20.0 (.79)	51.5 (2.02)	3.8 (.15)	1.63 (.064)	52.0 (2.05)	70.0 (2.76)

Note: Coating is optional. As supplied dimensions appearing in table are for uncoated parts. When coating is added, entry diameters will be reduced by 1.5 mm (.06") max.

Users should independently evaluate the suitability of the product for their application.
Before ordering check with factory for most current data.

214A011 to 052

D-subminiature, straight boot



Applications

Provides strain relief and mechanical protection on D-subminiature connector terminations.

As supplied (a)

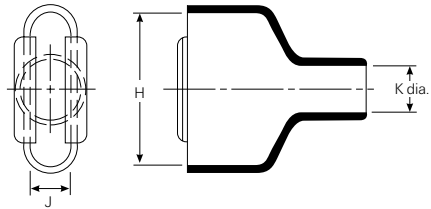

After unrestricted recovery (b)

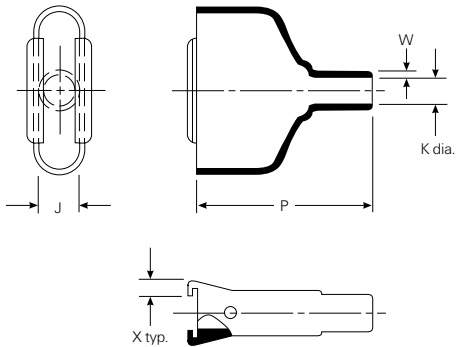

Available in:

Americas

Europe

Asia Pacific



Fax-on-demand

US only (800) 260-9099

Outside US (650) 257-2301

Fax ID

3201

Description

SCD

Visit our website at www.tycoelectronics.com**Materials available**

Material*	Material description	Precoating no.	Adhesive part no.**
-3	Semirigid polyolefin	/42 or /86	S-1017 or S-1048
-4	Flexible polyolefin	/42 or /86	S-1017 or S-1048
-12	Viton	N/A	S-1255-04
-25	Fluid-resistant elastomer	/42 or /86 or /225	S-1017 or S-1048 or S-1125
-100	Polyolefin, Zerohal	/86 or /180	S-1030 or S-1048

*For more information, please see the appropriate material page in this section.

**For more information, please see Section 5 of this catalog.

Product dimensions (mm/in)

Part number	H		J		K	
	±5% a	±5% b	±5% a	±5% b	Min. a	Max. b
214A011	20.3 (.80)	20.3 (.80)	10.7 (.42)	10.7 (.42)	7.9 (.31)	4.1 (.16)
214A021	28.2 (1.11)	28.2 (1.11)	10.7 (.42)	10.7 (.42)	10.2 (.40)	5.3 (.21)
214A032	42.2 (1.66)	42.2 (1.66)	10.7 (.42)	10.7 (.42)	14.0 (.55)	8.1 (.32)
214A042	58.7 (2.31)	58.7 (2.31)	10.7 (.42)	10.7 (.42)	17.3 (.68)	8.6 (.34)
214A052	57.9 (2.28)	57.9 (2.28)	13.7 (.54)	13.7 (.54)	19.1 (.75)	10.7 (.42)

Part number	P	W	X	This boot fits Cannon/ Cinch	Amphenol series 17
	±10% b	±20% b	±20% b		
214A011	33.3 (1.31)	1.0 (.04)	3.0 (.12)	DE-9	XX09X
214A021	38.9 (1.53)	1.0 (.04)	3.0 (.12)	DA-15	XX15X
214A032	45.0 (1.77)	1.0 (.04)	3.0 (.12)	DB-25	XX25X
214A042	53.3 (2.10)	1.0 (.04)	3.0 (.12)	DC-37	XX37X
214A052	61.0 (2.40)	1.0 (.04)	3.0 (.12)	DD-50	XX50X

Note: Coating is optional. As supplied dimensions appearing in table are for uncoated parts. When coating is added, entry diameters will be reduced by 1.5 mm (.06") max.

214A311 to 352

D-subminiature, straight boot



Applications

Provides strain relief and mechanical protection on D-subminiature connector terminations.

As supplied (a)

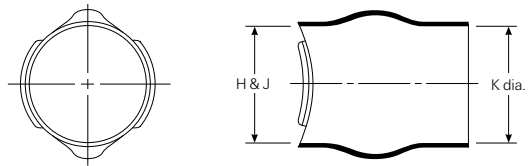

After unrestricted recovery (b)

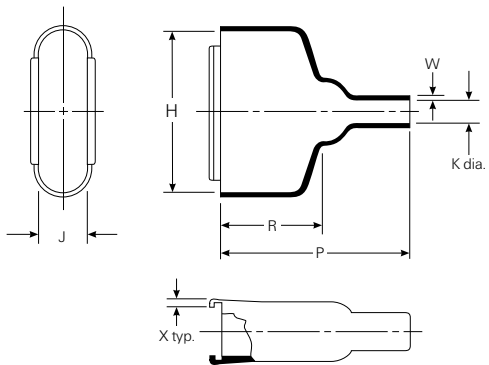

Available in:

Americas

Europe

Asia Pacific



Fax-on-demand

US only (800) 260-9099

Outside US (650) 257-2301

Fax ID

3205

Description

SCD

Visit our website at www.tycoelectronics.com**Materials available**

Material*	Material description	Precoating no.	Adhesive part no.**
-3	Semirigid polyolefin	/42 or /86	S-1017 or S-1048
-4	Flexible polyolefin	/42 or /86	S-1017 or S-1048
-25	Fluid-resistant elastomer	/42 or /86	S-1017 or S-1048 or S-1125

*For more information, please see the appropriate material page in this section.

**For more information, please see Section 5 of this catalog.

Product dimensions (mm/in)

Part number	H		J		K	
	Min. a	±5% b	Min. a	±5% b	Min. a	Max. b
214A311	16.0 (.63)	20.3 (.80)	16.0 (.63)	10.7 (.42)	16.0 (.63)	4.1 (.16)
214A321	19.1 (.75)	28.2 (1.11)	19.1 (.75)	10.7 (.42)	19.1 (.75)	5.3 (.21)
214A332	29.2 (1.15)	42.2 (1.66)	29.2 (1.15)	10.7 (.42)	29.2 (1.15)	8.1 (.32)
214A342	34.3 (1.35)	58.7 (2.31)	34.3 (1.35)	10.7 (.42)	34.3 (1.35)	8.6 (.34)
214A352	37.6 (1.48)	57.9 (2.28)	37.6 (1.48)	13.7 (.54)	37.6 (1.48)	10.7 (.42)
	P	R	W	X	This boot fits	
	±10% b	±10% b	±20% b	±20% b	Cannon/ Cinch	Amphenol series 17
214A311	33.3 (1.31)	19.1 (.75)	1.02 (.04)	3.05 (.12)	DE-9	XX09X
214A321	38.9 (1.53)	22.1 (.87)	1.02 (.04)	3.05 (.12)	DA-15	XX15X
214A332	45.0 (1.77)	25.4 (1.00)	1.02 (.04)	3.05 (.12)	DB-25	XX25X
214A342	53.3 (2.10)	28.4 (1.12)	1.02 (.04)	3.05 (.12)	DC-37	XX37X
214A352	61.0 (2.40)	31.8 (1.25)	1.02 (.04)	3.05 (.12)	DD-50	XX50X

Note: Coating is optional. As supplied dimensions appearing in table are for uncoated parts. When coating is added, entry diameters will be reduced by 1.5 mm (.06") max.

214P009 to 037

D-subminiature, straight boot
with jack screws



Applications

Provides strain relief and mechanical protection on D-subminiature connector terminations.

As supplied (a)

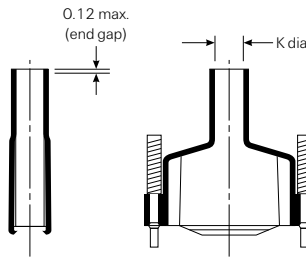

After unrestricted recovery (b)

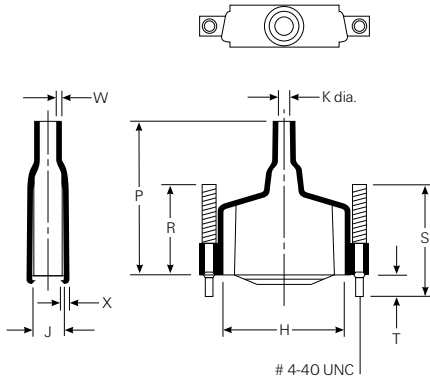

Available in:

Americas

Europe

Asia Pacific



Fax-on-demand

US only (800) 260-9099

Outside US (650) 257-2301

Fax ID

3230

Description

SCD

Visit our website at www.tycoelectronics.com**Materials available**

Material*	Material description
-111-0	Semirigid polyolefin (black)
-111-8	Semirigid polyolefin (gray)

*Contact your Tyco Electronics representative for information on material properties.

Product dimensions (mm/in)

Part number	H	J	K		P	R
	±5% b	±10% b	Min. a	Max. b	±10% b	Ref. b
214P009-XXX	17.3 (.68)	12.0 (.47)	9.0 (.35)	3.8 (.15)	43.0 (1.69)	22.0 (.87)
214P015-XXX	25.2 (.99)	12.0 (.47)	10.5 (.41)	3.8 (.15)	44.0 (1.73)	23.0 (.90)
214P025-XXX	38.4 (1.51)	12.0 (.47)	12.0 (.47)	5.1 (.20)	49.0 (1.87)	25.0 (.98)
214P037-XXX	54.2 (2.13)	12.0 (.47)	12.0 (.47)	5.8 (.22)	55.0 (2.16)	25.0 (.98)

	S	T	X	W	Fits connector size
	Nom. b	Nom. b	±20% b	±20% b	
214P009-XXX	29.0 (1.14)	6.4 (.25)	1.8 (.07)	1.5 (.06)	9 pin
214P015-XXX	29.0 (1.14)	6.4 (.25)	2.03 (.08)	1.5 (.06)	15 pin
214P025-XXX	29.0 (1.14)	6.4 (.25)	2.16 (.085)	1.5 (.06)	25 pin
214P037-XXX	29.0 (1.14)	6.4 (.25)	2.26 (.089)	1.5 (.06)	37 pin

Note: Coating is optional. As supplied dimensions appearing in table are for uncoated parts. When coating is added, entry diameters will be reduced by 1.5 mm (.06") max.

222A111 to 196

Right-angled boot



Applications

Use for mechanical protection and connector-cable strain relief. This family of boots has no lip, so a boot can be installed directly onto the connector accessory thread.

As supplied (a)

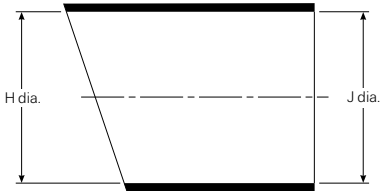

After unrestricted recovery (b)

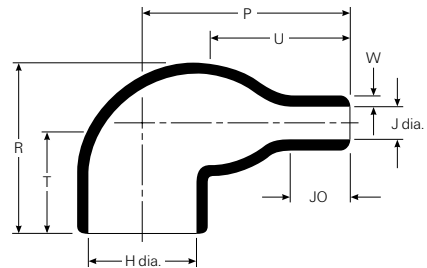

Available in:

Americas

Europe

Asia Pacific



Fax-on-demand

US only (800) 260-9099

Outside US (650) 257-2301

Fax ID

3139

Description

SCD

Visit our website at www.tycoelectronics.com**Materials available**

Material*	Material description	Precoating no.	Adhesive part no.**
-3	Semirigid polyolefin	/42 or /86	S-1017 or S-1048
-4	Flexible polyolefin	/42 or /86	S-1017 or S-1048
-12	Viton	N/A	S-1255-04
-25	Fluid-resistant elastomer	/42 or /86 or /225	S-1017 or S-1048 or S-1125
-100	Polyolefin, Zerohal	/180	S-1030

J end coated only, S1030 tape
supplied in bag for H end

*For more information, please see the appropriate material page in this section.

**For more information, please see Section 5 of this catalog.

Product dimensions (mm/in)

Part Number	H		J			
	Min. a	Max. b	Min. -3, -4, -25 a	Min. -100 a	Min. -12 a	Max. b
222A111	17.8 (.70)	7.9 (.31)	17.8 (.70)	10.9 (.43)	9.9 (.39)	3.8 (.15)
222A121	24.9 (.98)	10.2 (.40)	24.9 (.98)	16.0 (.63)	18.0 (.71)	5.3 (.21)
222A132	30.0 (1.18)	14.2 (.56)	30.0 (1.18)	21.1 (.83)	20.6 (.81)	6.4 (.25)
222A142	32.5 (1.28)	17.3 (.68)	32.5 (1.28)	22.9 (.90)	22.9 (.90)	6.9 (.27)
222A152	36.1 (1.42)	21.8 (.86)	36.1 (1.42)	27.4 (1.08)	26.4 (1.04)	8.4 (.33)
222A163	43.9 (1.73)	27.4 (1.08)	43.9 (1.73)	28.4 (1.12)	27.4 (1.08)	9.4 (.37)
222A174	53.1 (2.09)	33.8 (1.33)	53.1 (2.09)	48.3 (1.90)	46.7 (1.84)	15.0 (.59)
222A185	67.6 (2.66)	44.2 (1.74)	67.6 (2.66)	58.4 (2.30)	54.4 (2.14)	20.3 (.80)
222A196	87.6 (3.45)	55.4 (2.18)	87.6 (3.45)	68.8 (2.71)	63.0 (2.48)	23.4 (.92)

Part Number	P	R	T	U	JO	W
	±10% b	±10% b	±10% b	±10% b	±10% b	±20% b
222A111	17.3 (.68)	20.1 (.79)		11.4 (.45)	4.3 (.17)	1.02 (.04)
222A121	21.3 (.84)	22.6 (.89)		14.7 (.58)	5.8 (.23)	1.27 (.05)
222A132	26.9 (1.06)	26.7 (1.05)	19.1 (.75)	17.8 (.70)	7.1 (.28)	1.52 (.06)
222A142	36.6 (1.44)	30.5 (1.20)	19.1 (.75)	24.9 (.98)	10.2 (.40)	1.78 (.07)
222A152	43.7 (1.72)	35.1 (1.38)	19.1 (.75)	30.0 (1.18)	12.7 (.50)	1.78 (.07)
222A163	53.6 (2.11)	43.9 (1.73)	19.1 (.75)	34.0 (1.34)	17.3 (.68)	2.03 (.08)
222A174	75.7 (2.98)	52.8 (2.08)	25.4 (1.00)	53.3 (2.10)	32.0 (1.26)	3.30 (.13)
222A185	97.5 (3.84)	66.0 (2.60)	25.4 (1.00)	71.1 (2.80)	40.6 (1.60)	3.81 (.15)
222A196	128.0 (5.04)	79.2 (3.12)	25.4 (1.00)	87.6 (3.45)	56.4 (2.22)	4.57 (.18)

Note: Coating is optional. As supplied dimensions appearing in table are for uncoated parts. When coating is added, entry diameters will be reduced by 1.5 mm (.06") max.

Users should independently evaluate the suitability of the product for their application.
Before ordering check with factory for most current data.

222D121 to 196

Right-angled, lipped boot



Applications

Use in conjunction with Raychem adapters to provide strain relief for harness systems using circular connectors. Boot is compatible with all Raychem grooved adapters of the appropriate shell size.

As supplied (a)

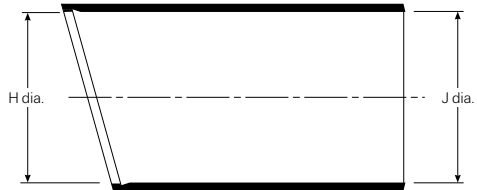

After unrestricted recovery (b)

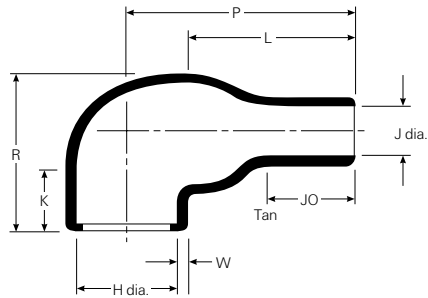

Available in:

Americas

Europe

Asia Pacific



Fax-on-demand

US only (800) 260-9099

Outside US (650) 257-2301

Fax ID

3144

Description

SCD

Visit our website at www.tycoelectronics.com**Materials available**

Material*	Material description	Precoating no.	Adhesive part no.**
-3	Semirigid polyolefin	/42 or /86	S-1017 or S-1048
-4	Flexible polyolefin	/42 or /86	S-1017 or S-1048
-12	Viton	N/A	S-1255-04
-25	Fluid-resistant elastomer	/42 or /86 or /225	S-1017 or S-1048 or S-1125
-100	Polyolefin, Zerohal	/180	S-1030

J end coated only, S1030 tape
supplied in bag for H end

*For more information, please see the appropriate material page in this section.

**For more information, please see Section 5 of this catalog.

Product dimensions (mm/in)

Part number	H		J	J	Min.	Max.	P
	Min.	Max.	Min.	Min.			
	a	a	-3, -4, -25 b	-100 b	-12 b	b	±10% b
222D121	23.4 (.92)	10.4 (.41)	23.4 (.92)	14.0 (.55)	12.4 (.49)	5.6 (.22)	21.3 (.84)
222D132	28.4 (1.12)	14.2 (.56)	28.4 (1.12)	15.0 (.59)	14.7 (.58)	6.6 (.26)	33.8 (1.33)
222D142	31.0 (1.22)	17.8 (.70)	31.0 (1.22)	18.0 (.71)	16.0 (.63)	7.1 (.28)	36.6 (1.44)
222D152	36.0 (1.42)	22.4 (.88)	36.0 (1.42)	21.0 (.83)	18.5 (.73)	8.4 (.33)	43.7 (1.72)
222D163	42.7 (1.68)	28.2 (1.11)	42.7 (1.68)	25.0 (.98)	22.1 (.87)	9.9 (.39)	53.6 (2.11)
222D174	51.8 (2.04)	35.1 (1.38)	51.8 (2.04)	39.0 (1.54)	35.3 (1.39)	15.7 (.62)	78.0 (3.07)
222D185	66.0 (2.60)	44.5 (1.75)	66.0 (2.60)	42.0 (1.65)	45.7 (1.80)	20.3 (.80)	97.5 (3.84)
222D196	81.8 (3.22)	60.5 (2.38)	81.8 (3.22)	57.2 (2.25)	57.2 (2.25)	25.4 (1.00)	117.9 (4.64)

Part number	R	JO	W	K	L
	Ref. b	±10%	±20%	±10% b	±10% b
222D121	22.6 (.89)	5.8 (.23)	1.27 (.05)	15.2 (.60)	14.7 (.58)
222D132	27.2 (1.07)	15.5 (.65)	1.52 (.06)	19.1 (.75)	24.9 (.98)
222D142	31.0 (1.22)	12.7 (.50)	1.78 (.07)	19.1 (.75)	24.9 (.98)
222D152	35.1 (1.38)	14.5 (.57)	1.78 (.07)	19.1 (.75)	30.0 (1.18)
222D163	43.9 (1.73)	17.5 (.69)	2.03 (.08)	19.3 (.76)	33.0 (1.30)
222D174	52.8 (2.08)	33.5 (1.32)	3.30 (.13)	25.4 (1.00)	53.8 (2.12)
222D185	66.0 (2.60)	40.1 (1.58)	3.81 (.15)	25.4 (1.00)	71.1 (2.80)
222D196	83.8 (3.30)	38.1 (1.50)	4.06 (.16)	25.4 (1.00)	80.0 (3.15)

Note: Coating is optional. As supplied dimensions appearing in table are for uncoated parts. When coating is added, entry diameters will be reduced by 1.5 mm (.06") max.

Users should independently evaluate the suitability of the product for their application.
Before ordering check with factory for most current data.

222D211 to 299

Right-angled, lipped boot



Applications

Provides strain relief and mechanical protection between cable and connector. Boot is usually used on open-wire-bundle airborne harnesses, or applications where the long tail replaces cable jacketing removed during termination.

As supplied (a)

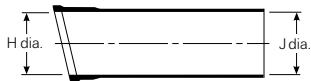

After unrestricted recovery (b)

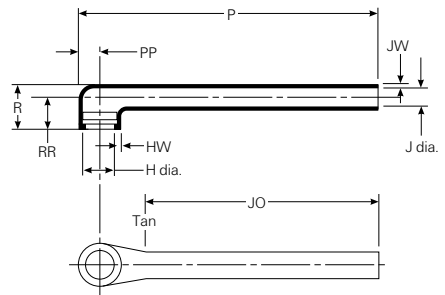

Available in:

Americas

Europe

Asia Pacific



Fax-on-demand

US only (800) 260-9099

Outside US (650) 257-2301

Fax ID

3147

Description

SCD

Visit our website at www.tycoelectronics.com**Materials available**

Material*	Material description	Precoating no.	Adhesive part no.**
-3	Semirigid polyolefin	/42 or /86	S-1017 or S-1048
-4	Flexible polyolefin	/42 or /86	S-1017 or S-1048
-12	Viton	N/A	S-1255-04
-25	Fluid-resistant elastomer	/42 or /86 or /225	S-1017 or S-1048 or S-1125
-100	Polyolefin, Zerohal	/86 or /180	S-1030 or S-1048

J end coated only, S1030 tape
supplied in bag for H end

*For more information, please see the appropriate material page in this section.

**For more information, please see Section 5 of this catalog.

Product dimensions (mm/in)

Part number	H		J			P
	Min.	Max.	Min.	Min.	Max.	±10%
	a	b	-3, -4, -25 a	-12, -100 b	b	b
222D211	22.4 (.88)	11.4 (.45)	22.4 (.88)	14.0 (.55)	6.4 (.25)	105.2 (4.14)
222D221	25.7 (1.01)	15.0 (.59)	25.7 (1.01)	16.0 (.63)	7.4 (.29)	124.0 (4.88)
222D232	29.5 (1.16)	18.8 (.74)	29.5 (1.16)	18.3 (.72)	8.4 (.33)	146.3 (5.76)
222D242	34.0 (1.34)	22.9 (.90)	34.0 (1.34)	21.3 (.84)	9.7 (.38)	172.2 (6.78)
222D253	37.3 (1.47)	29.5 (1.16)	37.3 (1.47)	23.1 (.91)	10.4 (.41)	185.2 (7.29)
222D263	43.7 (1.72)	34.0 (1.34)	43.7 (1.72)	27.2 (1.07)	12.2 (.48)	231.6 (8.41)
222D274	50.0 (1.97)	41.1 (1.62)	50.0 (1.97)	31.5 (1.24)	14.2 (.56)	224.5 (8.84)
222D285	62.7 (2.47)	47.0 (1.85)	62.7 (2.47)	39.1 (1.54)	17.5 (.69)	227.3 (8.95)
222D296	69.3 (2.73)	59.7 (2.35)	69.3 (2.73)	43.2 (1.70)	19.6 (.77)	233.4 (9.19)
222D299	81.8 (3.22)	67.1 (2.64)	81.8 (3.22)	51.1 (2.01)	22.9 (.90)	237.0 (9.33)

	R	JO	PP	RR	HW	JW
	Ref	±10%	±10%	10%		
	b	b	b	b	±20%	±20%
222D211	18.5 (.73)	87.6 (3.45)	6.9 (.27)	12.4 (.49)	1.52 (.06)	1.14 (.045)
222D221	19.8 (.78)	99.1 (3.90)	8.4 (.33)	15.0 (.59)	1.52 (.06)	1.14 (.045)
222D232	20.8 (.82)	114.3 (4.50)	10.4 (.41)	15.5 (.61)	1.78 (.07)	1.14 (.045)
222D242	21.8 (.86)	132.6 (5.22)	12.2 (.48)	15.7 (.62)	1.78 (.07)	1.14 (.045)
222D253	24.4 (.96)	143.8 (5.66)	15.5 (.61)	17.8 (.70)	2.03 (.08)	1.14 (.045)
222D263	27.4 (1.08)	169.2 (6.66)	18.3 (.72)	19.8 (.78)	2.03 (.08)	1.14 (.045)
222D274	29.5 (1.16)	173.2 (6.82)	21.1 (.83)	20.8 (.82)	2.29 (.09)	1.40 (.055)
222D285	33.3 (1.31)	168.1 (6.62)	24.1 (.95)	23.4 (.92)	2.54 (.10)	1.40 (.055)
222D296	35.1 (1.38)	157.2 (6.19)	30.0 (1.18)	23.6 (.93)	2.54 (.10)	1.40 (.055)
222D299	44.5 (1.75)	151.1 (5.95)	33.3 (1.31)	31.2 (1.23)	2.54 (.10)	1.40 (.055)

Note: Coating is optional. As supplied dimensions appearing in table are for uncoated parts. When coating is added, entry diameters will be reduced by 1.5 mm (.06") max.

Users should independently evaluate the suitability of the product for their application.
Before ordering check with factory for most current data.

222D921 to 963

Right-angled, lipped boot



Applications

Provides strain relief and mechanical protection between cable and connector. It is used in applications where only a small number of the available contacts are utilized, resulting in a high ratio between the adapter and cable diameters.

As supplied (a)

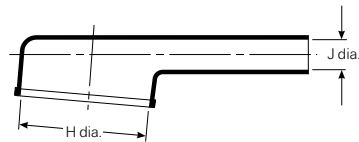

After unrestricted recovery (b)

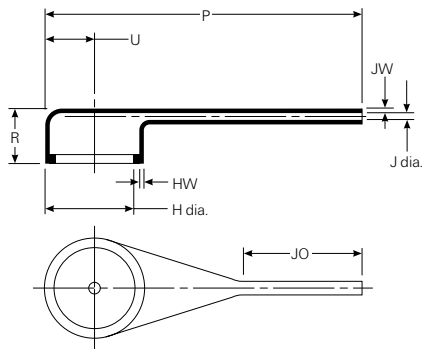

Available in:

Americas

Europe

Asia Pacific



Fax-on-demand

US only (800) 260-9099

Outside US (650) 257-2301

Fax ID

3149

Description

SCD

Visit our website at www.tycoelectronics.com**Materials available**

Material*	Material description	Precoating no.	Adhesive part no.**
-3	Semirigid polyolefin	/42 or /86	S-1017 or S-1048
-4	Flexible polyolefin	/42 or /86	S-1017 or S-1048
-12	Viton	N/A	S-1255-04
-25	Fluid-resistant elastomer	/42 or /86 or /225	S-1017 or S-1048 or S-1125
-100	Polyolefin, Zerohal	/86 or /180	S-1030 or S-1048

J end coated only, S1030 tape
supplied in bag for H end

*For more information, please see the appropriate material page in this section.

**For more information, please see Section 5 of this catalog.

Product dimensions (mm/in)

Part number	H		J			P	R	U	JO	HW	JW
	Min. a	Max. b	Min. a	Min. a	Max. b	±10% b	Ref. b	±10% b	±10% b	±20% b	±20% b
222D921	19.3 (.76)	13.0 (.51)	6.3 (.25)	4.5 (.18)	2.1 (.08)	44.5 (1.75)	16.3 (.64)	5.6 (.22)	21.8 (.86)	1.52 (.06)	1.14 (.045)
222D932	26.1 (1.03)	19.1 (.75)	7.6 (.30)	5.6 (.22)	2.6 (.10)	67.3 (2.65)	18.0 (.71)	8.4 (.33)	29.2 (1.15)	1.78 (.07)	1.14 (.045)
222D953	34.2 (1.35)	26.0 (1.02)	9.6 (.38)	6.6 (.26)	3.0 (.12)	81.3 (3.20)	18.8 (.74)	11.4 (.45)	36.3 (1.39)	1.78 (.07)	1.14 (.045)
222D963	43.6 (1.72)	34.1 (1.34)	11.4 (.45)	7.8 (.31)	3.6 (.14)	115.6(4.55)	21.3 (.84)	15.5 (.61)	47.0 (1.85)	1.78 (.07)	1.14 (.045)

Note: Coating is optional. As supplied dimensions appearing in table are for uncoated parts. When coating is added, entry diameters will be reduced by 1.5 mm (.06") max.

222F211 to 285

Right-angled, lipped boot



Applications

Use in conjunction with Raychem adapters to provide strain relief for harness systems using circular connectors. Boot is compatible with all Raychem grooved adapters of the appropriate shell size.

As supplied (a)

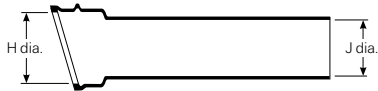

After unrestricted recovery (b)

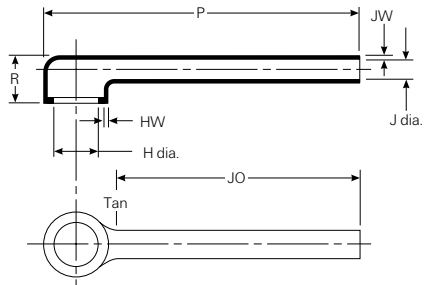

Available in:

Americas

Europe

Asia Pacific

Fax-on-demand

US only (800) 260-9099

Outside US (650) 257-2301

Fax ID

3151

Description

SCD

Visit our website at www.tycoelectronics.com**Materials available**

Material*	Material description	Precoating no.	Adhesive part no.**
-50	Viton polymer blend	N/A	S-1125
-51	Elastomer polymer blend	/164	S-1124
-71	Flexible polyolefin	/42 or /86	S-1017 or S-1048

*For more information, please see the appropriate material page in this section.

**For more information, please see Section 5 of this catalog.

Product dimensions (mm/in)

Part number	H		J		P
	Min. a	Max. b	Min. a	Max. b	±10% b
222F211	23.9 (.94)	9.9 (.39)	17.3 (.68)	6.6 (.26)	105.2 (4.14)
222F221	27.2 (1.07)	13.2 (.52)	20.8 (.82)	7.6 (.30)	124.0 (4.88)
222F232	31.0 (1.22)	18.5 (.73)	24.4 (.96)	8.9 (.35)	146.3 (5.76)
222F242	35.6 (1.40)	22.1 (.87)	28.7 (1.13)	10.2 (.40)	172.2 (6.78)
222F253	38.9 (1.53)	28.2 (1.11)	31.5 (1.24)	10.9 (.43)	185.2 (7.29)
222F263	45.2 (1.78)	32.3 (1.27)	38.4 (1.51)	12.7 (.50)	213.6 (8.41)
222F274	51.6 (2.03)	41.1 (1.62)	44.5 (1.75)	15.0 (.59)	224.5 (8.84)
222F285	62.7 (2.47)	42.9 (1.69)	47.2 (1.86)	17.5 (.69)	227.3 (8.95)

Part number	R	JO	HW	JW
	±10% b	±10% b	+06 to -.03 b	±.03 b
222F211	18.5 (.73)	87.6 (3.45)	1.52 (.06)	1.52 (.06)
222F221	19.8 (.78)	99.1 (3.90)	1.52 (.06)	1.52 (.06)
222F232	20.8 (.82)	114.3 (4.50)	1.78 (.07)	1.52 (.06)
222F242	21.8 (.86)	132.6 (5.22)	1.78 (.07)	1.52 (.06)
222F253	24.4 (.96)	143.8 (5.66)	1.78 (.07)	1.52 (.06)
222F263	27.4 (1.08)	169.2 (6.66)	1.78 (.07)	1.52 (.06)
222F274	29.5 (1.16)	173.2 (6.82)	1.78 (.07)	1.78 (.07)
222F285	33.3 (1.31)	168.1 (6.62)	2.03 (.08)	1.78 (.07)

Note: Coating is optional. As supplied dimensions appearing in table are for uncoated parts. When coating is added, entry diameters will be reduced by 1.5 mm (.06") max.

222K121 to 185

Right-angled, lipped boot



Applications

Use in conjunction with Raychem adapters to provide strain relief for harness systems using circular connectors. Boot is compatible with all Raychem grooved adapters of the appropriate shell size.

As supplied (a)

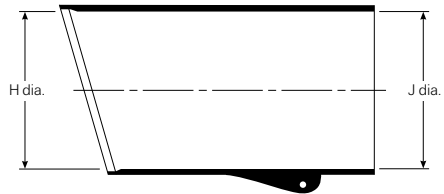

After unrestricted recovery (b)

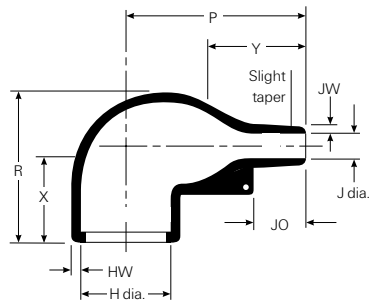

Available in:

Americas

Europe

Asia Pacific



Fax-on-demand

US only (800) 260-9099

Outside US (650) 257-2301

Fax ID

3152 SCD

3153 SCD-25/225

DescriptionVisit our website at www.tycoelectronics.com**Materials available**

Material*	Material description	Precoating no.	Adhesive part no.**
-3	Semirigid polyolefin	/42 or /86	S-1017 or S-1048
-4	Flexible polyolefin	/42 or /86	S-1017 or S-1048
-12	Viton	N/A	S-1255-04
-25	Fluid-resistant elastomer	/42 or /86 or /225	S-1017 or S-1048 or S-1125
-100	Polyolefin, Zerohal	/180	S-1030

J end coated only, S1030 tape
supplied in bag for H end

*For more information, please see the appropriate material page in this section.

**For more information, please see Section 5 of this catalog.

Product dimensions (mm/in)

Part number	H			J			P	R
	Min. -3, -4, -25 a	Min. -100 a	Max. b	Min. -3, -4, -25 a	Min. -100 a	Max. b	±10% b	±10% b
222K121	24.0 (.95)	24.0 (.95)	10.4 (.41)	24.0 (.95)	14.0 (.55)	5.6 (.22)	25.0 (.98)	25.0 (.98)
222K132	30.0 (1.18)	30.0 (1.18)	14.2 (.56)	30.0 (1.18)	15.0 (.59)	5.9 (.23)	32.0 (1.26)	27.0 (1.06)
222K142	31.0 (1.22)	31.0 (1.22)	18.0 (.71)	31.0 (1.22)	18.0 (.71)	7.1 (.28)	39.0 (1.54)	31.0 (1.22)
222K152	36.0 (1.42)	36.0 (1.42)	22.4 (.88)	36.0 (1.42)	21.0 (.83)	8.4 (.33)	46.0 (1.81)	38.0 (1.50)
222K163	43.0 (1.69)	43.0 (1.69)	28.2 (1.11)	43.0 (1.69)	25.0 (.98)	9.9 (.39)	55.0 (2.17)	45.0 (1.77)
222K174	60.0 (2.36)	52.0 (2.05)	35.1 (1.38)	60.0 (2.36)	39.0 (1.54)	15.7 (.62)	80.0 (3.15)	54.0 (2.13)
222K185	66.0 (2.60)	66.0 (2.60)	44.5 (1.75)	66.0 (2.60)	42.0 (1.65)	16.8 (.66)	108.0 (4.25)	68.0 (2.68)

Part number	JO	HW	JW	X	Y
	±10% b	±20% b	±20% b	±20% b	±20% b
222K121	8.5 (.33)	1.3 (.05)	.41 (.016)	18.0 (.71)	16.0 (.63)
222K132	8.5 (.33)	1.5 (.06)	.61 (.024)	18.0 (.71)	20.0 (.79)
222K142	15.0 (.59)	1.8 (.07)	.81 (.032)	18.0 (.71)	20.0 (.79)
222K152	18.0 (.63)	1.8 (.07)	.81 (.032)	25.0 (.98)	25.0 (.98)
222K163	17.5 (.69)	2.0 (.08)	.81 (.032)	25.0 (.98)	30.0 (1.18)
222K174	32.0 (1.26)	3.3 (.13)	1.02 (.040)	25.0 (.98)	45.0 (1.77)
222K185	48.0 (1.89)	3.8 (.15)	1.63 (.064)	35.0 (1.38)	70.0 (2.76)

Note: Coating is optional. As supplied dimensions appearing in table are for uncoated parts. When coating is added, entry diameters will be reduced by 1.5 mm (.06") max.

Users should independently evaluate the suitability of the product for their application.
Before ordering check with factory for most current data.

234A011 to 071

D-subminiature, right-angled boot



Applications

Provides strain relief and mechanical protection on D-subminiature connector terminations.

As supplied (a)

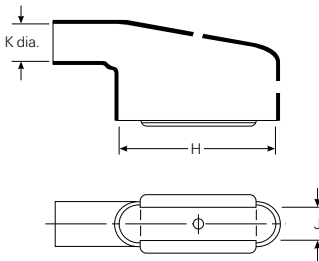

After unrestricted recovery (b)

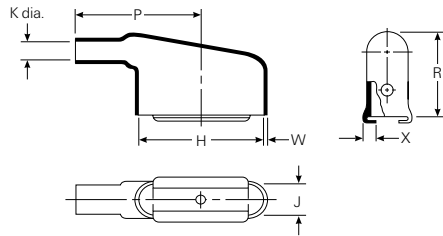

Available in:

Americas

Europe

Asia Pacific



Fax-on-demand

US only (800) 260-9099

Outside US (650) 257-2301

Fax ID

3213

Description

SCD

Visit our website at www.tycoelectronics.com**Materials available**

Material*	Material description	Precoating no.	Adhesive part no.**
-3	Semirigid polyolefin	/42 or /86	S-1017 or S-1048
-4	Flexible polyolefin	/42 or /86	S-1017 or S-1048
-12	Viton	N/A	S-1255-04
-25	Fluid-resistant elastomer	/42 or /86 or /225	S-1017 or S-1048 or S-1125
-100	Polyolefin, Zerohal	/180	S-1030

J end coated only, S1030 tape
supplied in bag for H end

*For more information, please see the appropriate material page in this section.

**For more information, please see Section 5 of this catalog.

Product dimensions (mm/in)

Part number	H		J		K		P	R	W	X	This boot fits Cannon/ Cinch
	±5%	±5%	±5%	±5%	Min.	Max.	±10%	±10%	±20%	±20%	
	a	b	a	b	a	b	b	b	b	b	
234A011	20.3 (.80)	20.3 (.80)	10.7 (.42)	10.7 (.42)	7.9 (.31)	4.1 (.16)	25.9 (1.02)	21.6 (.85)	1.02 (.04)	3.05 (.12)	DE-9
234A021	28.2 (1.11)	28.2 (1.11)	10.7 (.42)	10.7 (.42)	10.2 (.40)	5.3 (.21)	30.7 (1.21)	24.6 (.97)	1.02 (.04)	3.05 (.12)	DA-15
234A032	42.2 (1.66)	42.2 (1.66)	10.7 (.42)	10.7 (.42)	14.0 (.55)	7.4 (.29)	42.9 (1.69)	27.9 (1.10)	1.02 (.04)	3.05 (.12)	DB-25
234A042	58.7 (2.31)	58.7 (2.31)	10.7 (.42)	10.7 (.42)	17.3 (.68)	8.6 (.34)	53.3 (2.10)	30.5 (1.20)	1.02 (.04)	3.05 (.12)	DC-37
234A052	57.9 (2.28)	57.9 (2.28)	13.7 (.54)	13.7 (.54)	19.1 (.75)	10.7 (.42)	55.9 (2.20)	32.3 (1.27)	1.02 (.04)	3.05 (.12)	DD-50
234A061	20.3 (.80)	20.3 (.80)	10.7 (.42)	10.7 (.42)	7.9 (.31)	3.8 (.15)	25.9 (1.02)	18.5 (.73)	1.02 (.04)	3.05 (.12)	DE-9
234A071	28.2 (1.11)	28.2 (1.11)	10.7 (.42)	10.7 (.42)	10.2 (.40)	5.1 (.20)	30.7 (1.21)	19.8 (.78)	1.02 (.04)	3.05 (.12)	DA-15

Note: Coating is optional. As supplied dimensions appearing in table are for uncoated parts. When coating is added, entry diameters will be reduced by 1.5 mm (.06") max.

234A111 to 152

D-subminiature, side-entry boot



Applications

Provides strain relief and mechanical protection on D-subminiature connector terminations.

As supplied (a)

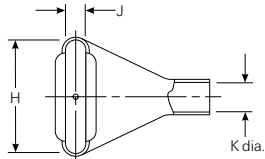

After unrestricted recovery (b)

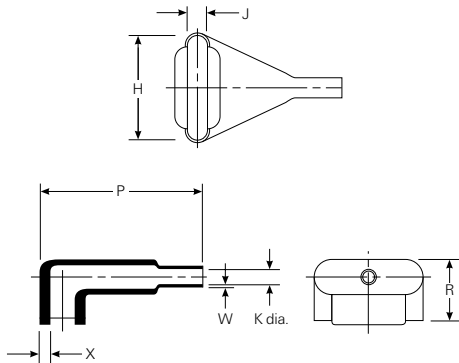

Available in:

Americas

Europe

Asia Pacific



Fax-on-demand

US only (800) 260-9099

Outside US (650) 257-2301

Fax ID

3215

Description

SCD

Visit our website at www.tycoelectronics.com**Materials available**

Material*	Material description	Precoating no.	Adhesive part no.**
-3	Semirigid polyolefin	/42 or /86	S-1017 or S-1048
-4	Flexible polyolefin	/42 or /86	S-1017 or S-1048
-25	Fluid-resistant elastomer	/42 or /86 or /225	S-1017 or S-1048 or S-1125

*For more information, please see the appropriate material page in this section.

**For more information, please see Section 5 of this catalog.

Product dimensions (mm/in)

Part number	H		J		K	
	±5% a	±5% b	±5% a	±5% b	Min. a	Max. b
234A111	20.3 (.80)	20.3 (.80)	10.7 (.42)	10.7 (.42)	7.9 (.31)	4.1 (.16)
234A121	28.2 (1.11)	28.2 (1.11)	10.7 (.42)	10.7 (.42)	10.2 (.40)	5.3 (.21)
234A132	42.2 (1.66)	42.2 (1.66)	10.7 (.42)	10.7 (.42)	14.0 (.55)	6.4 (.25)
234A142	58.7 (2.31)	58.7 (2.31)	10.7 (.42)	10.7 (.42)	17.3 (.68)	7.9 (.31)
234A152	57.9 (2.28)	57.9 (2.28)	13.7 (.54)	13.7 (.54)	19.1 (.75)	9.1 (.36)

Part number	P	R	W	X	This boot fits Cannon/Cinch
	±10% b	±10% b	±20% b	±20% b	
234A111	27.9 (1.10)	18.5 (.73)	1.02 (.04)	3.05 (.12)	DE-9
234A121	35.1 (1.38)	18.8 (.74)	1.02 (.04)	3.05 (.12)	DA-15
234A132	47.5 (1.87)	20.1 (.79)	1.02 (.04)	3.05 (.12)	DB-25
234A142	59.7 (2.35)	20.1 (.79)	1.02 (.04)	3.05 (.12)	DC-37
234A152	63.2 (2.49)	26.4 (1.04)	1.02 (.04)	3.05 (.12)	DD-50

Note: Coating is optional. As supplied dimensions appearing in table are for uncoated parts. When coating is added, entry diameters will be reduced by 1.5 mm (.06") max.

234A611 to 671

D-subminiature, 90° end-entry boot



Applications

Provides strain relief and mechanical protection on D-subminiature connector terminations.

As supplied (a)

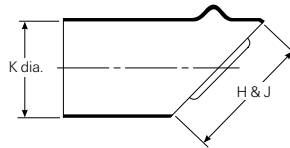

After unrestricted recovery (b)

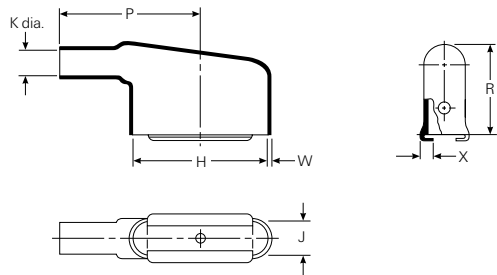

Available in:

Americas

Europe

Asia Pacific

Fax-on-demand

US only (800) 260-9099

Outside US (650) 257-2301

Fax ID

3218

Description

SCD

Visit our website at www.tycoelectronics.com**Materials available**

Material*	Material description	Precoating no.	Adhesive part no.**
-3	Semirigid polyolefin	/42 or /86	S-1017 or S-1048
-4	Flexible polyolefin	/42 or /86	S-1017 or S-1048
-25	Fluid-resistant elastomer	/42 or /86	S-1017 or S-1048 or S-1125

*For more information, please see the appropriate material page in this section.

**For more information, please see Section 5 of this catalog.

Product dimensions (mm/in)

Part number	H		J		K	
	Min. a	±5% b	Min. a	±5% b	Min. a	Max. b
234A611	16.0 (.63)	20.3 (.80)	16.0 (.63)	10.7 (.42)	16.0 (.63)	4.1 (.16)
234A621	19.1 (.75)	28.2 (1.11)	19.1 (.75)	10.7 (.42)	19.1 (.75)	5.3 (.21)
234A632	29.2 (1.15)	42.2 (1.66)	29.2 (1.15)	10.7 (.42)	29.2 (1.15)	7.4 (.29)
234A642	34.3 (1.35)	58.7 (2.31)	34.3 (1.35)	10.7 (.42)	34.3 (1.35)	8.6 (.34)
234A652	37.6 (1.48)	57.9 (2.28)	37.6 (1.48)	13.7 (.54)	37.6 (1.48)	10.7 (.42)
234A661	16.0 (.63)	20.3 (.80)	16.0 (.63)	10.7 (.42)	16.0 (.63)	3.8 (.15)
234A671	19.1 (.75)	28.2 (1.11)	19.1 (.75)	10.7 (.42)	19.1 (.75)	5.1 (.20)

Part number	P	R	W	X	This boot fits Cannon/Cinch
	±10% b	±10% b	±20% b	±20% b	
234A611	25.9 (1.02)	21.6 (.85)	1.02 (.04)	3.05 (.12)	DE-9
234A621	30.7 (1.21)	24.6 (.97)	1.02 (.04)	3.05 (.12)	DA-15
234A632	42.9 (1.69)	27.9 (1.10)	1.02 (.04)	3.05 (.12)	DB-25
234A642	53.3 (2.10)	30.5 (1.20)	1.02 (.04)	3.05 (.12)	DC-37
234A652	55.9 (2.20)	32.3 (1.27)	1.02 (.04)	3.05 (.12)	DD-50
234A661	25.9 (1.02)	18.5 (.73)	1.02 (.04)	3.05 (.12)	DE-9
234A671	30.7 (1.21)	19.8 (.78)	1.02 (.04)	3.05 (.12)	DA-15

Note: Coating is optional. As supplied dimensions appearing in table are for uncoated parts. When coating is added, entry diameters will be reduced by 1.5 mm (.06") max.



242W042 to 63

45° angled boot



Applications

Designed for use in the aggressive environments found adjacent to engines in automotive, aerospace and military applications, heat-shrinkable molded parts provide rugged protection, strain relief and a full 360° environmental seal. The introduction of the 45° option means there is now a choice of three routes to the connector for closer positioning and greater design freedom.

As supplied (a)

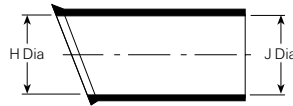

After unrestricted recovery (b)

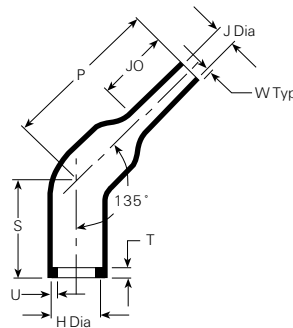

Available in:

Americas

Europe

Asia Pacific



207W213 to 256

Two-part feedthrough



Applications

Use for strain relief and abrasion protection when cables pass through equipment boxes or panels.

As supplied (a)

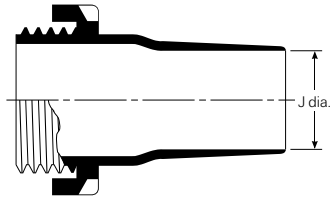

After unrestricted recovery (b)

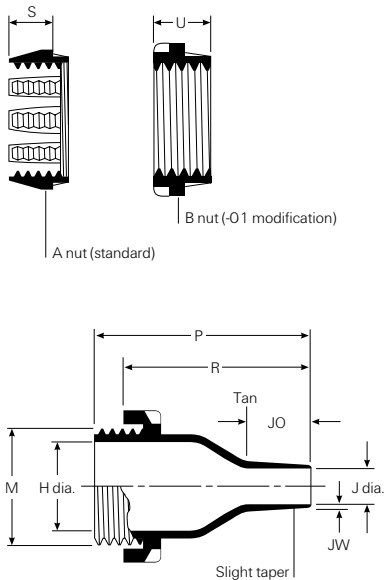

Available in:

Americas

Europe

Asia Pacific

Fax-on-demand

US only (800) 260-9099

Outside US (650) 257-2301

Fax ID

3300

Description

SCD

Visit our website at www.tycoelectronics.com**Materials available**

Material*	Material description	Precoating no.	Adhesive part no.**
-3	Semirigid polyolefin	/42 or /86	S-1017 or S-1048
-4	Flexible polyolefin	/42 or /86	S-1017 or S-1048
-25	Fluid-resistant elastomer	/42 or /86 or /225	S-1017 or S-1048 or S-1125
-100	Polyolefin, Zerohal	/180	S-1030

*For more information, please see the appropriate material page in this section.

**For more information, please see Section 5 of this catalog.

Product dimensions (mm/in)

Part number	H Ref. b	J Min. -3, -4, -12, -25 a		Min. -100 a	Max. b	JO Max. b	M Thread b	P ±10% b
		207W213	11.9 (.47)					
207W223	20.1 (.79)	18.0 (.71)	16.5 (.65)	7.1 (.28)	19.3 (.76)	30.0 (1.18)	71.9 (2.83)	
207W234	30.1 (1.22)	27.9 (1.10)	26.5 (1.04)	11.9 (.47)	26.9 (1.06)	41.9 (1.65)	87.1 (3.43)	
207W245	45.0 (1.77)	41.9 (1.65)	40.5 (1.59)	18.0 (.71)	32.0 (1.26)	55.9 (2.20)	102.1 (4.02)	
207W256	68.1 (2.68)	64.0 (2.52)	64.5 (2.54)	30.0 (1.18)	39.1 (1.54)	80.0 (3.15)	121.9 (4.80)	
	R ±10% b	S ±10% b	U ±10% b	JW ±20% b	Hole Dia. ±.51 (.02)			
207W213	49.0 (1.93)	13.0 (.51)	9.9 (.39)	1.3 (.05)	23.9 (.94)			
207W223	58.9 (2.32)	16.0 (.63)	9.9 (.39)	1.8 (.07)	34.0 (1.34)			
207W234	73.9 (2.91)	18.0 (.71)	9.9 (.39)	2.03 (.08)	47.0 (1.85)			
207W245	88.9 (3.50)	18.0 (.71)	9.9 (.39)	3.05 (.12)	60.5 (2.38)			
207W256	109.0 (4.29)	18.0 (.71)	9.9 (.39)	3.05 (.12)	85.1 (3.35)			

Note: Coating is optional. As supplied dimensions appearing in table are for uncoated parts. When coating is added, entry diameters will be reduced by 1.5 mm (.06") max.

301A011 to 048

T transition

Fax-on-demand

US only (800) 260-9099

Outside US (650) 257-2301

Fax ID Description

3400 SCD

Visit our website at www.tycoelectronics.com



Applications

Provides strain relief and mechanical protection on cable harness assemblies.

As supplied (a)

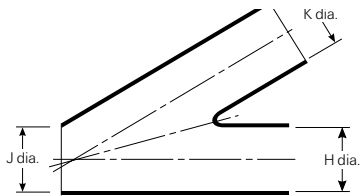

After unrestricted recovery (b)

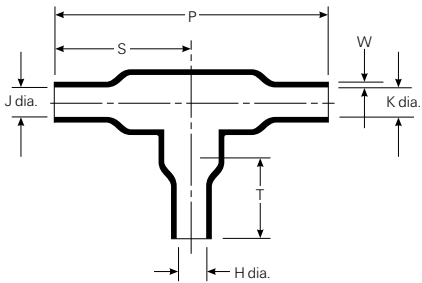

Available in:

Americas

Europe

Asia Pacific

Materials available

Material*	Material description	Precoating no.	Adhesive part no.**
-3	Semirigid polyolefin	/42 or /86	S-1017 or S-1048
-4	Flexible polyolefin	/42 or /86	S-1017 or S-1048
-12	Viton	N/A	S-1255-04
-25	Fluid-resistant elastomer	/42 or /86 or /225	S-1017 or S-1048 or S-1125

*For more information, please see the appropriate material page in this section.

**For more information, please see Section 5 of this catalog.

Product dimensions (mm/in)

Part number	H, J & K		P	S	T	W
	Min. a	Max. b	±10% b	±10% b	±10% b	±30% b
301A011	6.6 (.26)	3.6 (.14)	29.7 (1.17)	15.1 (.59)		1.02 (.04)
301A022	13.2 (.52)	6.9 (.27)	58.7 (2.31)	29.5 (1.16)	17.5 (.69)	1.52 (.06)
301A034	26.9 (1.06)	13.5 (.53)	120.1 (4.73)	60.2 (2.37)	35.6 (1.40)	2.29 (.09)
301A048	55.6 (2.19)	30.2 (1.19)	246.4 (9.70)	123.2 (4.85)	70.9 (2.79)	3.05 (.12)

Note: Coating is optional. As supplied dimensions appearing in table are for uncoated parts. When coating is added, entry diameters will be reduced by 1.5 mm (.06") max.

301A511 to 514

Slimline T transition

Fax-on-demand

US only (800) 260-9099

Outside US (650) 257-2301

Fax ID

3401

Description

SCD

Visit our website at www.tycoelectronics.com



Applications

Provides strain relief and mechanical protection on cable harness assemblies.

As supplied (a)

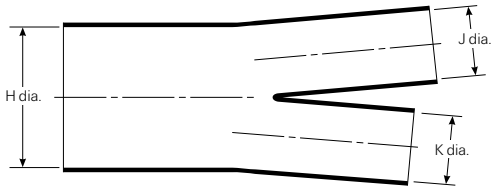

After unrestricted recovery (b)

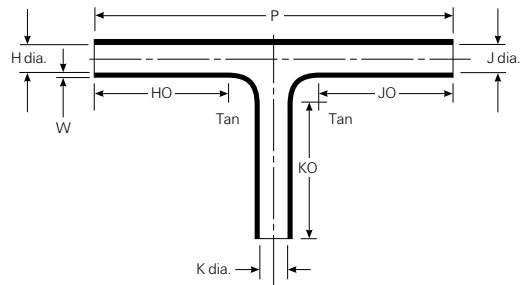

Available in:

Americas

Europe

Asia Pacific

Materials available

Material*	Material description	Precoating no.	Adhesive part no.**
-50	Viton polymer blend	N/A	S-1125
-51	Elastomer polymer blend	/164	S-1124
-71	Flexible polyolefin	/42 or /86	S-1017 or S-1048

*For more information, please see the appropriate material page in this section.

**For more information, please see Section 5 of this catalog.

Product dimensions (mm/in)

Part number	H		J & K		HO, JO, & KO ±10% b	W Nom. b	P Nom. b
	Min. a	Max. b	Min. a	Max. b			
301A511	19.8 (.78)	6.6 (.26)	13.2 (.52)	6.6 (.26)	25.4 (1.00)	1.02 (.04)	80.8 (3.18)
301A512	34.3 (1.35)	11.4 (.45)	22.9 (.90)	11.4 (.45)	41.1 (1.62)	1.27 (.05)	120.4 (4.74)
301A513	60.2 (2.37)	20.1 (.79)	40.1 (1.58)	20.1 (.79)	63.5 (2.50)	1.52 (.06)	175.8 (6.92)
301A514	83.3 (3.28)	33.3 (1.31)	54.9 (2.16)	33.3 (1.31)	88.9 (3.50)	1.78 (.07)	242.3 (9.54)

Note: Coating is optional. As supplied dimensions appearing in table are for uncoated parts. When coating is added, entry diameters will be reduced by 1.5 mm (.06") max.

Users should independently evaluate the suitability of the product for their application.
Before ordering check with factory for most current data.

322A112 to 158

T transition



Applications

Provides strain relief and mechanical protection on cable harness assemblies.

As supplied (a)

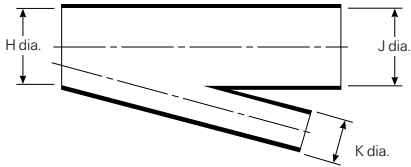

After unrestricted recovery (b)

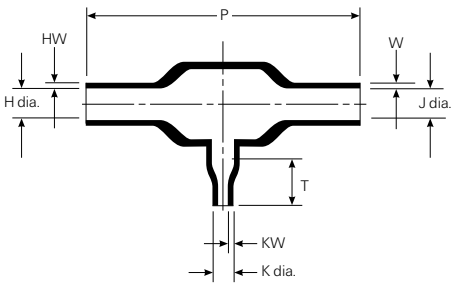

Available in:

Americas

Europe

Asia Pacific

Fax-on-demand

US only (800) 260-9099

Outside US (650) 257-2301

Fax ID

3405

Description

SCD

Visit our website at www.tycoelectronics.com**Materials available**

Material*	Material description	Precoating no.	Adhesive part no.**
-3	Semirigid polyolefin	/42 or /86	S-1017 or S-1048
-4	Flexible polyolefin	/42 or /86	S-1017 or S-1048
-12	Viton	N/A	S-1255-04
-25	Modified elastomer	/42 or /86 or /225	S-1017 or S-1048 or S-1125
-100	Polyolefin, Zerohal	-100-CS1972	S-1030

(S1030 tape supplied in bag)

*For more information, please see the appropriate material page in this section.

**For more information, please see Section 5 of this catalog.

Product dimensions (mm/in)

Part number	H & J		K	
	Min. a	Max. b	Min. a	Max. b
322A112	13.2 (.52)	5.8 (.23)	6.6 (.26)	3.0 (.12)
322A123	26.9 (1.06)	12.4 (.49)	6.6 (.26)	3.0 (.12)
322A134	26.9 (1.06)	12.7 (.50)	13.2 (.52)	5.8 (.23)
322A148	55.6 (2.19)	25.4 (1.00)	13.2 (.52)	5.8 (.23)
322A158	55.6 (2.19)	25.4 (1.00)	26.9 (1.06)	12.4 (.49)

Part number	P	T	HW & W	KW
	±10% b	±10% b	±20% b	±20% b
322A112	52.3 (2.06)		1.52 (.06)	1.02 (.04)
322A123	83.3 (3.28)	10.7 (.42)	2.54 (.10)	1.02 (.04)
322A134	107.7 (4.24)	20.3 (.80)	2.54 (.10)	1.52 (.06)
322A148	180.6 (7.11)	25.4 (1.00)	4.57 (.18)	1.52 (.06)
322A158	222.3 (8.75)	38.1 (1.50)	4.57 (.18)	2.54 (.10)

Note: Coating is optional. As supplied dimensions appearing in table are for uncoated parts. When coating is added, entry diameters will be reduced by 1.5 mm (.06") max.

342A012 to 058

45° side-breakout transition



Applications

Provides strain relief and mechanical protection on cable harness assemblies.

As supplied (a)

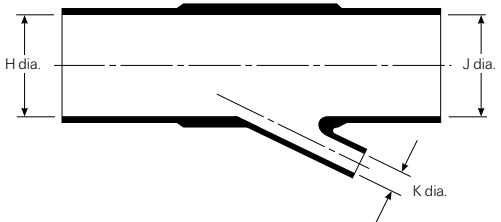

After unrestricted recovery (b)

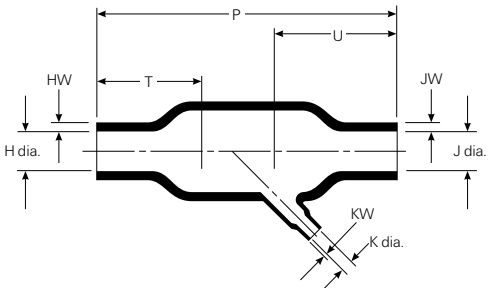

Available in:

Americas

Europe

Asia Pacific



Fax-on-demand

US only (800) 260-9099

Outside US (650) 257-2301

Fax ID

3413

Description

SCD

Visit our website at www.tycoelectronics.com**Materials available**

Material*	Material description	Precoating no.	Adhesive part no.**
-3	Semirigid polyolefin	/42 or /86	S-1017 or S-1048
-4	Flexible polyolefin	/42 or /86	S-1017 or S-1048
-12	Viton	N/A	S-1255-04
-25	Fluid-resistant elastomer	/42 or /86 or /225	S-1017 or S-1048 or S-1125
-100	Polyolefin, Zerohal	-100-CS1972 (S1030 tape supplied in bag)	S-1030

*For more information, please see the appropriate material page in this section.

**For more information, please see Section 5 of this catalog.

Product dimensions (mm/in)

Part number	H & J		K		P
	Min. a	Max. b	Min. a	Max. b	±10% b
342A012	13.2 (.52)	6.9 (.27)	6.6 (.26)	3.6 (.14)	49.3 (1.94)
342A024	26.9 (1.06)	12.7 (.50)	6.6 (.26)	3.6 (.14)	92.5 (3.64)
342A034	26.9 (1.06)	13.7 (.54)	13.2 (.52)	6.1 (.24)	144.8 (5.70)
342A048	55.6 (2.19)	26.9 (1.06)	13.2 (.52)	6.9 (.27)	184.9 (7.28)
342A058	55.6 (2.19)	26.9 (1.06)	26.9 (1.06)	13.7 (.54)	203.5 (8.01)
	T	U	HW & JW	KW	
	±10%	±10%	±20%	±20%	
	b	b	b	b	
342A012	19.6 (.77)	19.6 (.77)	1.52 (.06)	1.02 (.04)	
342A024	31.8 (1.25)	39.6 (1.56)	2.54 (.10)	1.02 (.04)	
342A034	50.8 (2.00)	50.8 (2.00)	2.54 (.10)	1.52 (.06)	
342A048	63.5 (2.50)	63.5 (2.50)	4.57 (.18)	1.52 (.06)	
342A058	66.0 (2.60)	66.0 (2.60)	4.57 (.18)	2.54 (.10)	

Note: Coating is optional. As supplied dimensions appearing in table are for uncoated parts. When coating is added, entry diameters will be reduced by 1.5 mm (.06") max.

362A014 to 114

30° side-breakout transition

Fax-on-demand

US only (800) 260-9099

Outside US (650) 257-2301

Fax ID Description

3417 SCD

Visit our website at www.tycoelectronics.com



Applications

Provides strain relief and mechanical protection on cable harness assemblies.

As supplied (a)

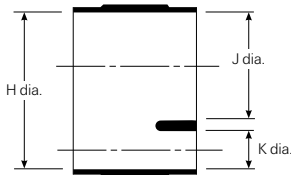

After unrestricted recovery (b)

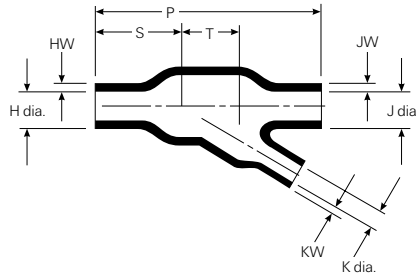

Available in:

Americas

Europe

Asia Pacific

Materials available

Material*	Material description	Precoating no.	Adhesive part no.**
-3	Semirigid polyolefin	/42 or /86	S-1017 or S-1048
-4	Flexible polyolefin	/42 or /86	S-1017 or S-1048
-12	Viton	N/A	S-1255-04
-25	Fluid-resistant elastomer	/42 or /86 or /225	S-1017 or S-1048 or S-1125
-100	Polyolefin, Zerohal	/86 or /180	S-1030 or S-1048

*For more information, please see the appropriate material page in this section.

**For more information, please see Section 5 of this catalog.

Product dimensions (mm/in)

Part number	H & J		K		P	S	T	HW & JW	KW
	Min. a	Max. b	Min. a	Max. b	±10% b	±10% b	±10% b	±20% b	±20% b
362A014	30.5 (1.20)	15.7 (.62)	20.3 (.80)	10.7 (.42)	82.6 (3.25)	31.8 (1.25)	21.1 (.63)	2.54 (.10)	1.78 (.07)
362A024	35.6 (1.40)	18.3 (.72)	15.2 (.60)	8.6 (.34)	63.5 (2.50)	19.1 (.75)	22.4 (.88)	2.54 (.10)	1.52 (.06)
362A114	35.6 (1.40)	18.8 (.74)	10.2 (.40)	5.3 (.21)	61.0 (2.40)	19.1 (.75)	21.3 (.84)	2.79 (.11)	1.52 (.06)

Note: Coating is optional. As supplied dimensions appearing in table are for uncoated parts. When coating is added, entry diameters will be reduced by 1.5 mm (.06") max.

381A301 to 304

Slimline Y transition

Fax-on-demand

US only (800) 260-9099

Outside US (650) 257-2301

Fax ID

3421

Description

SCD

Visit our website at www.tycoelectronics.com



Applications

Provides strain relief and mechanical protection on cable harness assemblies.

As supplied (a)

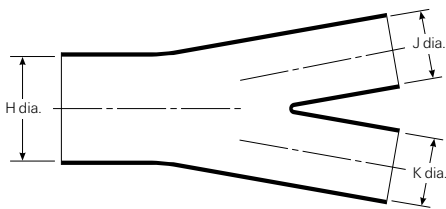

After unrestricted recovery (b)

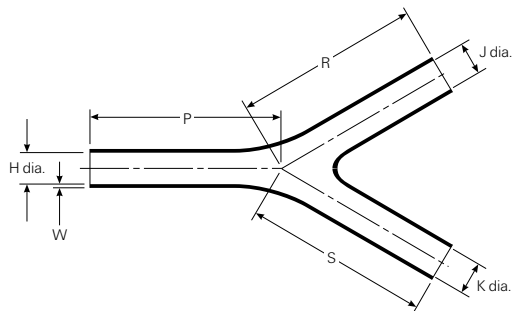

Available in:

Americas

Europe

Asia Pacific

Materials available

Material*	Material description	Precoating no.	Adhesive part no.**
-50	Viton polymer blend	N/A	S-1125
-51	Elastomer polymer blend	/164	S-1124
-71	Flexible polyolefin	/42 or /86	S-1017 or S-1048
-125	Fluoropolymer		S-1255-04

*For more information, please see the appropriate material page in this section.

**For more information, please see Section 5 of this catalog.

Product dimensions (mm/in)

Part number	H		J & K		W	P	R & S
	Min. a	Max. b	Min. a	Max. b	Nom. b	Nom. b	Nom. b
381A301	19.8 (.78)	6.6 (.26)	13.2 (.52)	6.6 (.26)	1.0 (.04)	40.6 (1.60)	40.6 (1.60)
381A302	34.3 (1.35)	11.4 (.45)	22.9 (.90)	11.4 (.45)	1.3 (.05)	63.0 (2.48)	63.0 (2.48)
381A303	60.2 (2.37)	20.1 (.79)	40.1 (1.58)	20.1 (.79)	1.5 (.06)	94.7 (3.73)	94.7 (3.73)
381A304	83.3 (3.28)	33.3 (1.31)	54.9 (2.16)	33.3 (1.31)	1.8 (.07)	133.9 (5.27)	133.9 (5.27)

Note: Coating is optional. As supplied dimensions appearing in table are for uncoated parts. When coating is added, entry diameters will be reduced by 1.5 mm (.06") max.

Users should independently evaluate the suitability of the product for their application. Before ordering check with factory for most current data.

382A012 to 046

Y transition



Applications

Provides strain relief and mechanical protection on cable harness assemblies.

As supplied (a)

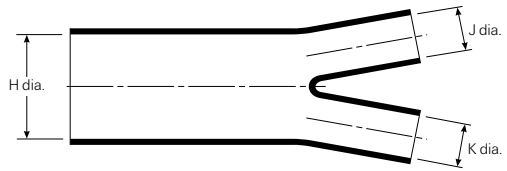

After unrestricted recovery (b)

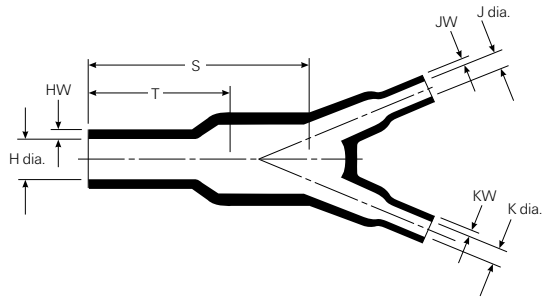

Available in:

Americas

Europe

Asia Pacific



Fax-on-demand

US only (800) 260-9099

Outside US (650) 257-2301

Fax ID

3422

Description

SCD

Visit our website at www.tycoelectronics.com**Materials available**

Material*	Material description	Precoating no.	Adhesive part no.**
-3	Semirigid polyolefin	/42 or /86	S-1017 or S-1048
-4	Flexible polyolefin	/42 or /86	S-1017 or S-1048
-12	Viton	N/A	S-1255-04
-25	Fluid-resistant elastomer	/42 or /86 or /225	S-1017 or S-1048 or S-1125
-100	Polyolefin, Zerohal	-100-CS1972 (S1030 tape supplied in bag)	S-1030

*For more information, please see the appropriate material page in this section.

**For more information, please see Section 5 of this catalog.

Product dimensions (mm/in)

Part number	H		J & K		S	T	HW	JW & KW
	Min. a	Max. b	Min. a	Max. b	±10% b	±10% b	±20% b	±20% b
382A012	13.2 (.52)	6.1 (.24)	6.6 (.26)	3.3 (.13)	23.9 (.94)	15.5 (.61)	1.52 (.06)	1.02 (.04)
382A023	26.9 (1.06)	12.4 (.49)	13.2 (.52)	6.1 (.24)	53.3 (2.10)	33.0 (1.30)	2.54 (.10)	1.52 (.06)
382A034	38.6 (1.52)	18.0 (.71)	26.9 (1.06)	12.4 (.49)	78.7 (3.10)	55.9 (2.20)	3.05 (.12)	2.54 (.10)
382A046	55.6 (2.19)	25.9 (1.02)	26.9 (1.06)	12.7 (.50)	111.8 (4.40)	71.1 (2.80)	4.57 (.18)	2.54 (.10)

Note: Coating is optional. As supplied dimensions appearing in table are for uncoated parts. When coating is added, entry diameters will be reduced by 1.5 mm (.06") max.

382C312, 322 and 332

Slimline Y transition



Applications

Provides strain relief and mechanical protection at two into one Y junctions in cable harness assemblies. When used with adhesive it provides environmental sealing. These parts are based on the 382A3 range. They have the branched outlet(s) reduced in size to accommodate smaller cable diameters without the need for packing or shimming.

As supplied (a)

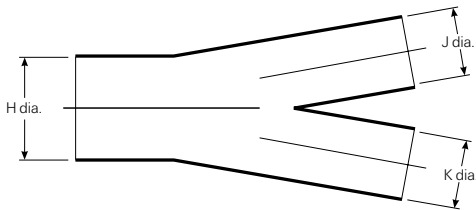

After unrestricted recovery (b)

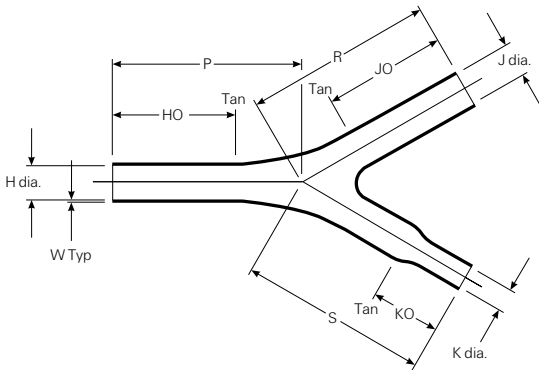

382312

After unrestricted recovery (b)

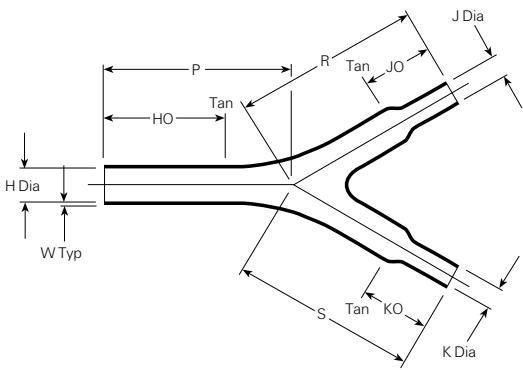

382C322, 382C332

Available in:

Americas

Europe

Asia Pacific



Fax-on-demand

US only (800) 260-9099

Outside US (650) 257-2301

Visit our website at www.tycoelectronics.com**Materials available**

Material dash no.	Material description	Precoating no.	Adhesive part no.
-50	Viton polymer blend	N/A	S-1125
-51	Elastomer polymer blend	/164	S-1124
-71	Flexible polyolefin	/42 or /86	S-1017 or S-1048
-125	Fluoropolymer	N/A	S-1255-04

Product dimensions (mm/in)

Part number	H		J		K		P, R & S	KO	HO & JO	W
	Min.	Max.	Min.	Max.	Min.	Max.	Nom.	±15%	±15%	Nom
	a	b	a	b	a	b	b	b	b	b
382C312	1.20 (30.5)	.45 (11.4)	.90 (22.9)	.45 (11.4)	.60 (15.2)	.30 (7.6)	2.48 (63.0)	.85 (21.6)	1.62 (41.1)	.04 (1.0)

Part number	H		J & K		P, R & S	HO	JO & KO	W
	Min.	Max.	Min.	Max.	Nom.	±15%	±15%	Nom.
	a	b	a	b	b	b	b	b
382C322	.90 (22.9)	.45 (11.4)	.40 (10.2)	.20 (5.1)	2.48 (63.0)	1.62 (41.1)	.85 (21.6)	.04 (1.0)

Part number	H		J & K		P, R & S	HO	JO & KO	W
	Min.	Max.	Min.	Max.	Nom.	±15%	±15%	Nom.
	a	b	a	b	b	b	b	b
382C332	1.00 (25.4)	.45 (11.4)	.60 (15.2)	.30 (7.5)	2.48 (63.0)	1.62 (41.1)	.85 (21.6)	.04 (1.0)

Note: Coating is optional. As supplied dimensions appearing in table are for uncoated parts. When coating is added, entry diameters will be reduced by 1.5 mm (.06") max.

462A011 to 060

Transition, one to three cables



Applications

Provides strain relief and mechanical protection on cable harness assemblies.

As supplied (a)

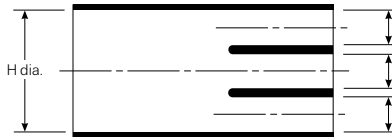

After unrestricted recovery (b)

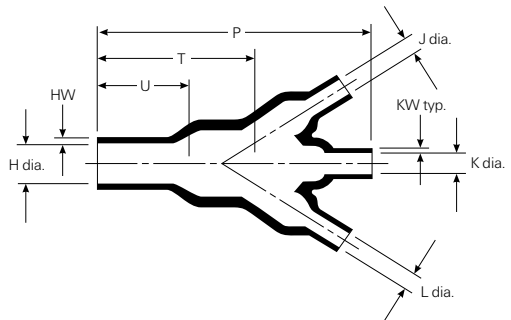

Available in:

Americas

Europe

Asia Pacific



Fax-on-demand

US only (800) 260-9099

Outside US (650) 257-2301

Fax ID

3436

Description

SCD

Visit our website at www.tycoelectronics.com**Materials available**

Material*	Material description	Precoating no.	Adhesive part no.**
-3	Semirigid polyolefin	/42 or /86	S-1017 or S-1048
-4	Flexible polyolefin	/42 or /86	S-1017 or S-1048
-12	Viton	N/A	S-1255-04
-25	Fluid-resistant elastomer	/42 or /86 or /225	S-1017 or S-1048 or S-1125
-100	Polyolefin, Zerohal	-100-CS1972	S-1030

(S1030 tape supplied in bag)

*For more information, please see the appropriate material page in this section.

**For more information, please see Section 5 of this catalog.

Product dimensions (mm/in)

Part number	H		J, K&L		P
	Min. a	Max. b	Min. a	Max. b	±10% b
462A011	13.2 (.52)	6.6 (.26)	6.6 (.26)	3.6 (.14)	46.2 (1.82)
462A023	26.9 (1.06)	13.2 (.52)	13.2 (.52)	6.9 (.27)	93.2 (3.67)
462A034	38.6 (1.52)	18.8 (.74)	19.3 (.76)	9.7 (.38)	135.1 (5.32)
462A046	55.6 (2.19)	25.4 (1.00)	26.9 (1.06)	12.4 (.49)	192.0 (7.56)
462A060	91.4 (3.60)	54.6 (2.15)	45.7 (1.80)	27.4 (1.08)	390.4 (15.37)

	T	U	HW	KW
	±10% b	±10% b	±20% b	±10% b
426A011	30.5 (1.20)	15.7 (.62)	1.52 (.06)	1.02 (.04)
462A023	57.2 (2.25)	33.0 (1.30)	2.54 (.10)	1.52 (.06)
462A034	88.9 (3.50)	45.7 (1.80)	3.05 (.12)	1.78 (.07)
462A046	121.9 (4.80)	71.1 (2.80)	4.57 (.18)	3.05 (.12)
462A060	254.0 (10.00)	127.0 (5.00)	7.11 (.28)	4.57 (.18)

Note: Coating is optional. As supplied dimensions appearing in table are for uncoated parts. When coating is added, entry diameters will be reduced by 1.5 mm (.06") max.

462A421 to 424

Slimline transition, one to three cables



Applications

Provides strain relief and mechanical protection on cable harness assemblies.

As supplied (a)

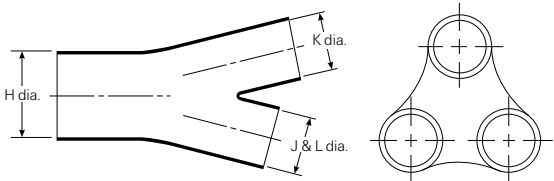

After unrestricted recovery (b)

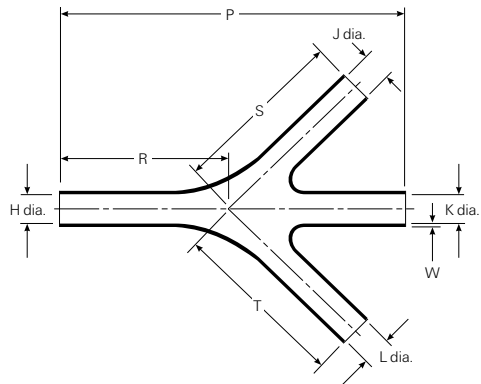

Available in:

Americas

Europe

Asia Pacific



Fax-on-demand

US only (800) 260-9099

Outside US (650) 257-2301

Fax ID

3437

Description

SCD

Visit our website at www.tycoelectronics.com**Materials available**

Material*	Material description	Precoating no.	Adhesive part no.**
-50	Viton polymer blend	N/A	S-1125
-51	Elastomer polymer blend	/164	S-1124
-71	Flexible polyolefin	/42 or /86	S-1017 or S-1048

Product dimensions (mm/in)

Part number	H		J, K & L		W	P	R, S & T
	Min. a	Max. b	Min. a	Max. b	Nom. b	Nom. b	Nom. b
462A421	19.8 (.78)	6.6 (.26)	13.2 (.52)	6.6 (.26)	1.0 (.04)	85.9 (3.38)	42.9 (1.69)
462A422	34.3 (1.35)	11.4 (.45)	20.6 (.81)	11.4 (.45)	1.3 (.05)	135.6 (5.34)	67.8 (2.67)
462A423	60.2 (2.37)	20.1 (.79)	36.1 (1.42)	20.1 (.79)	1.5 (.06)	207.3 (8.16)	103.6 (4.08)

Materials available

Material*	Material description	Precoating no.	Adhesive part no.**
-125	Fluoropolymer		

*For more information, please see the appropriate material page in this section.

**For more information, please see Section 5 of this catalog.

Product dimensions (mm/in)

Part number	H		J, K & L		W	P	R, S & T
	Min. a	Max. b	Min. a	Max. b	Nom. b	Nom. b	Nom. b
462A421	19.8 (.78)	6.6 (.26)	13.2 (.52)	6.6 (.26)	1.0 (.04)	85.9 (3.38)	42.9 (1.69)
462A422	34.3 (1.35)	11.4 (.45)	20.6 (.81)	11.4 (.45)	1.3 (.05)	135.6 (5.34)	67.8 (2.67)
462A423	60.2 (2.37)	20.1 (.79)	36.1 (1.42)	20.1 (.79)	1.5 (.06)	207.3 (8.16)	103.6 (4.08)
462A424	99.8 (3.93)	33.3 (1.31)	54.9 (2.16)	33.3 (1.31)	1.8 (.07)	294.6 (11.60)	147.3 (5.80)

Note: Coating is optional. As supplied dimensions appearing in table are for uncoated parts. When coating is added, entry diameters will be reduced by 1.5 mm (.06") max.

562A011 to 067

Transition, one to four cables



Applications

Provides strain relief and mechanical protection on cable harness assemblies.

As supplied (a)

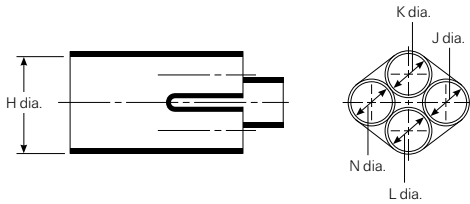

After unrestricted recovery (b)

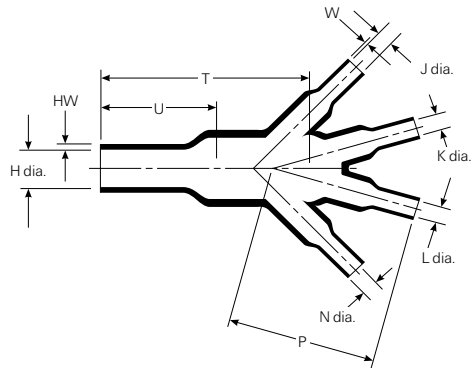

Available in:

Americas

Europe

Asia Pacific



Fax-on-demand

US only (800) 260-9099

Outside US (650) 257-2301

Fax ID

3439

Description

SCD

Visit our website at www.tycoelectronics.com**Materials available**

Material*	Material description	Precoating no.	Adhesive part no.**
-3	Semirigid polyolefin	/42 or /86	S-1017 or S-1048
-4	Flexible polyolefin	/42 or /86	S-1017 or S-1048
-12	Viton	N/A	S-1255-04
-25	Fluid-resistant elastomer	/42 or /86 or /225	S-1017 or S-1048 or S-1125
-100	Polyolefin, Zerohal	-100-CS1972	S-1030

(S1030 tape supplied in bag)

*For more information, please see the appropriate material page in this section.

**For more information, please see Section 5 of this catalog.

Product dimensions (mm/in)

Part number	H		J, K, L & N		P
	Min. a	Max. b	Min. a	Max. b	±10% b
562A011	13.2 (.52)	6.9 (.27)	6.6 (.26)	3.4 (.14)	24.1 (.95)
562A022	19.3 (.76)	9.7 (.38)	9.4 (.37)	5.3 (.21)	35.6 (1.40)
562A032	19.3 (.76)	9.7 (.38)	13.2 (.52)	6.9 (.27)	49.3 (1.94)
562A043	26.9 (1.06)	13.0 (.51)	13.2 (.52)	6.9 (.27)	49.3 (1.94)
562A054	38.6 (1.52)	18.5 (.73)	19.3 (.76)	9.7 (.38)	71.9 (2.83)
562A067	55.6 (2.19)	26.7 (1.05)	26.9 (1.06)	13.0 (.51)	101.6 (4.00)

	T	U	HW	W
	±10% b	±10% b	±20% b	±20% b
562A011	43.9 (1.73)	18.0 (.71)	1.52 (.06)	1.02 (.04)
562A022	43.2 (1.70)	23.1 (.91)	1.78 (.07)	1.02 (.04)
562A032	50.5 (1.99)	25.4 (1.00)	1.78 (.07)	1.52 (.06)
562A043	65.8 (2.59)	33.5 (1.32)	2.54 (.10)	1.52 (.06)
562A054	95.3 (3.75)	46.5 (1.83)	3.05 (.12)	1.78 (.07)
562A067	135.1 (5.32)	65.5 (2.58)	4.57 (.18)	2.54 (.10)

Note: Coating is optional. As supplied dimensions appearing in table are for uncoated parts. When coating is added, entry diameters will be reduced by 1.5 mm (.06") max.



QFT™

Configurable heat-shrink transition



Applications

QFT heat-shrinkable transitions form a watertight seal protecting cable splices from corrosion and mechanical abuse while providing excellent electrical insulating properties. QFT products use special crimps that allow them to be employed as 1:2, 1:3, and even 1:4 transitions. With their high shrink ratio and crimps the configurable QFT product line can accommodate almost all of your transition needs with only 3 product sizes.

Operating temperature range

-20°C to 70°C

Features and benefits

- Configurable heat-shrink transition.
- Low cost commercial polyolefin.
- 60°C shrink temperature.
- High shrink ratio.

Available in:

Americas

Europe

Asia Pacific

Expanded



Recovered

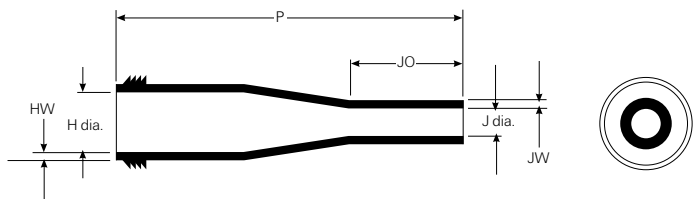

Specifications/approvals

Raychem

RW 2008

Temperature ratings

Operating temperature range	-20°C to 70°C (125°C without sealant)
Minimum recovery temperature	55°C
Maximum storage temperature	40°C

Dimensions table (millimeters)

	H		J		P	JO	HW	JW
	Min.	Max.	Min.	Max.	+/- 10%	+/- 10%	+/- 20%	+/- 20%
QFT1	31.0	9.0	31.0	4.4	60.0	12.0	1.5	1.0
QFT2	43.0	14.0	43.0	7.0	75.0	18.0	1.8	1.0
QFT3	57.0	24.0	57.0	12.0	90.0	25.0	1.8	1.0

Fax-on-demand

US only (800) 260-9099

Outside US (650) 257-2301

Visit our website at www.tycoelectronics.com**Typical QFT performance**

	Property	Performance	Test method
Physical	Tensile strength	10 MPa (1500psi) minimum	ISO 37
	Ultimate elongation	250% minimum	ISO 37
	Longitudinal change	0 to -20% maximum	ISO 1183
	Specific gravity	1.4 maximum	ISO 1183
	Heat aging	Minimum 200% ultimate elongation	ISO 188
	168 hours at 120°C (248°F)	Tensile Strength 10 MPa min.	ISO 37
	Heat shock	No cracking, dripping or flowing	ASTM D 2671
	4 hours at 105°C		
Electrical	Dielectric strength	8MV/m minimum	IEC 243-1
Chemical	Fluid resistance 1	(24 +/- 2h immersion at 23C+/- 2C)	ISO 1817
	Engine Oil	(SAE 20W/50)	
	Hydraulic Fluid		
	Tensile Strength	10 MPa minimum	ISO 37
	Ultimate Elongation	200% minimum	
	Fluid resistance 2	(30 +/- 3m immersion at 23C+/- 2C)	ISO 1817
	Automotive gasoline	(BS 4040)	
	Diesel fuel	(BS 2869)	
	Cleaning fluid	(TL 6850-07)	
	Antifreeze	(Ethylene Glycol/Water 50/50 v/v)	
Engine cleaning fluid	(Gunk)		
	Tensile strength	10 MPa minimum	ISO 37
	Ultimate elongation	200% minimum	

Part numbering system

QFT3 - 130/42 - 0*

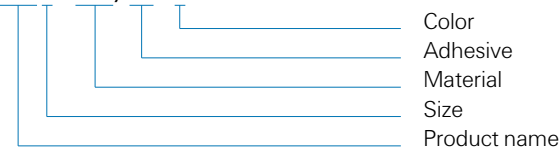

*Available in bulk pack, part number QFT3-130/42-0-B500 (US and UK).

Ordering information

Color	Standard	Black (-0)
	Code	0
Packaging	Standard	10 pieces per bag, 30 clips
	Bulk pack	500 pieces per box and 500 clips per bag (clips ordered separately) - contact factory for details
Crimp tool	QFT-CRIMP-TOOL-MANUAL (069172-000)	

Users should independently evaluate the suitability of the product for their application.
Before ordering check with factory for most current data.



SSB, T, F to 8S

Multilegged transitions



Applications

These flame-retardant heat-shrinkable transitions are especially designed for shipboard applications and meet or exceed all of the U.S. Navy specifications described in MIL-I-8 1765/1A (as of 5/02).

The transitions are made of a rugged, thermally stabilized, modified polyolefin and factory-coated with a thermoplastic adhesive sealant. As a result, they offer excellent water sealing, mechanical abrasion-protection, corrosion-resistance, weatherproofing, and electrical insulation. The transitions replace tapes, epoxies, and grease in applications involving cable breakouts, transitions, and terminations.

Features/Benefits

- Watertight.
- Easy installation, requiring no special skills.
- Compatibility with polyethylene, PVC, lead, steel, aluminum, standard Navy cable jackets, and copper wire and cable.
- Four configurations and twelve sizes (see table).
- Minimum shrink temperature of 121 °C.
- Type approval by:
 - ABS (American Bureau of Shipping)
 - DNV (Det Norske Veritas)
 - Lloyd's (Lloyd's Register of Shipping)

Available in:

Americas

Europe

Asia Pacific



Fax-on-demand

US only (800) 260-9099

Outside US (650) 257-2301

Fax ID

4055

Description

Data sheet

Visit our website at www.tycoelectronics.com**Specifications/approvals**

Commercial	Military
RW-2024	MIL-STD-2003 MIL-I81765/1A

Product dimensions (mm/in)

Description	Number of legs	ID Base		ID legs		Length	
		Min. exp.	Max. rec.	Min. exp.	Min. rec.	Leg	Body
SSB-1202 FR	2	40.64 (1.60)	11.43 (0.45)	13.97 (0.55)	3.81 (0.15)	36.83 (1.45)	62.23 (2.45)
SSB-2002 FR	2	50.8 (2.00)	35.56 (1.40)	19.05 (0.75)	8.89 (0.35)	69.85 (2.75)	88.90 (3.50)
D3-9 FR	2	20.32 (0.80)	9.39 (0.37)	8.38 (0.33)	2.79 (0.11)	17.78 (0.7)	50.8 (2)
D14-30 FR	2	30.48 (1.2)	15.24 (0.6)	12.7 (0.5)	4.32 (0.17)	25.4 (1)	63.5 (2.5)
D50-100 FR	2	48.26 (1.9)	22.86 (0.9)	19.05 (0.75)	7.62 (0.3)	30.48 (1.2)	76.2 (3)
D200-400 FR	2	76.2 (3)	38.1 (1.5)	36.83 (1.45)	12.7 (0.5)	38.1 (1.5)	88.9 (3.5)
T3-9 FR	3	22.86 (0.9)	9.14 (0.36)	8.38 (0.33)	2.29 (0.09)	19.05 (0.75)	50.80 (2.0)
T14-23 FR	3	30.48 (1.2)	17.78 (0.70)	12.70 (0.5)	4.57 (0.18)	25.4 (1)	60.96 (2.40)
T14-50 FR	3	38.1 (1.5)	12.7 (0.5)	16.51 (0.65)	4.06 (0.16)	30.48 (1.2)	76.2 (2.3)
T42-100 FR	3	43.18 (1.7)	22.86 (0.9)	20.32 (0.8)	4.83 (0.19)	30.48 (1.25)	57.15 (2.25)
T150-300 FR	3	60.96 (2.4)	35.56 (1.4)	30.48 (1.25)	12.70 (0.5)	40.6 (1.6)	88.90 (3.50)
T400 FR	3	81.28 (3.2)	50.8 (2)	35.56 (1.4)	17.78 (0.7)	40.6 (1.6)	88.9 (3.5)
T500-600 FR	3	124.46 (4.90)	58.93 (2.32)	50.8 (2)	22.86 (0.9)	50.8 (2)	187.96 (7.40)
F3-9 FR	4	22.86 (0.9)	10.92 (0.43)	7.11 (0.28)	2.79 (0.11)	19.05 (0.75)	50.8 (2)
F-23 FR	4	31.75 (1.25)	20.32 (0.8)	12.7 (0.5)	5.08 (0.2)	27.94 (1.1)	63.50 (2.50)
F42-60 FR	4	44.45 (1.75)	25.4 (1)	20.32 (0.8)	8.13 (0.32)	30.48 (1.25)	63.50 (2.50)
F75-100 FR	4	59.69 (2.35)	25.4 (1)	25.4 (1)	8.89 (0.35)	43.18 (1.7)	165.1 (6.5)
F133-200 FR	4	67.31 (2.65)	35.56 (1.4)	30.48 (1.2)	10.92 (0.43)	38.1 (1.5)	91.44 (3.6)
F150-400 FR	4	133.35 (5.25)	76.2 (3)	34.29 (1.35)	13.97 (0.55)	76.2 (3)	152.4 (6)
6S100-200 FR	6	60.96 (2.4)	36.83 (1.45)	20.32 (0.8)	8.89 (0.35)	69.85 (2.75)	86.36 (3.4)
8S23-75 FR	8	35.56 (1.4)	21.59 (0.85)	10.16 (0.4)	3.3 (0.13)	30.48 (1.25)	50.8 (2)
8S14-50 FR	8	57.15 (2.25)	21.59 (0.85)	14.22 (0.56)	3.3 (0.13)	30.48 (1.25)	50.8 (2)
8S42-100 FR	8	63.50 (2.50)	21.59 (0.85)	22.1 (0.87)	3.3 (0.13)	30.48 (1.25)	50.8 (2)



202W302 to 342

Heatshrink bobbins



Applications

- Fast installation.
- Temperature range of -40°C to 105°C.
- Fits range of diameters.
- Low cost, high volume installation.
- Shrinks onto hose/pipe/ wire harnesses.
- Good mechanical, thermal and chemical properties.
- Good abrasion resistance.
- Excellent location, cushioning and protection of cable or hoses from P clips and wire ties.
- Stays in place when heated.
- Suits most hoses/pipes/wire harnesses.
- No expensive tooling required under body solution.
- Engine area solution.

As supplied (a)

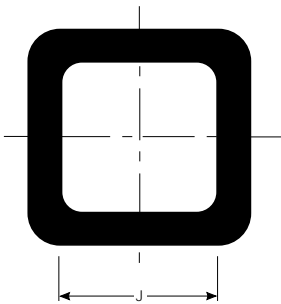

After unrestricted recovery (b)

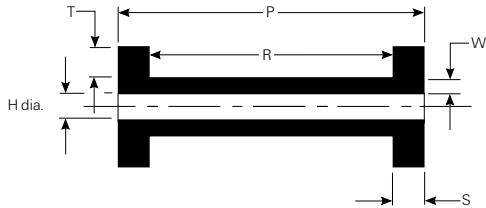

Square expanded = -130 material
 Circular expanded = -12 and -25 material
 -3, -4

Available in:

Americas

Europe

Asia Pacific



Fax-on-demand

US only (800) 260-9099

Outside US (650) 257-2301

Visit our website at www.tycoelectronics.com

Material	Material description	Precoating no.	Adhesive part number
-3	Polyolefin, semi-rigid	/42./86	S-1017, S-1048
-4	Polyolefin, flexible	/42./86	S-1017, S-1048
-12	Viton	N/A	S-1255-04
-25	Fluid resistant elastomer	/86 or /225	S-1017 or S-1048 or S-1125
-130	Flexible polyolefin	/42./86	S-1017

Product dimensions (mm)

Part number	H		J	P	R	S	T	W	Recommended Hose Sizes	
	Min. a	Max. b	Min. a	±10% b	±10% b	±10% b	±10% b	±20% b	Min.	Max.
202W302	29	9.5	29	35	25	5.0	3.0	1.5	11	25
202W312	39	12.7	39	35	25	5.0	3.0	2.0	14	34
202W321	10	3.0	10	29	23	3.0	3.0	1.5	4	8
202W331	19	6.4	19	29	24	2.5	2.0	1.5	8	17
202W342	54	18.0	54	35	25	5.0	3.0	2.0	20	48

Note: Coating is optional. As supplied dimensions appearing in table are for uncoated parts. When coating is added, entry diameters will be reduced by 1.5 mm (.06") max.



400W242

Heatshrink positioning ring



Features and benefits

- Easy to install.
- Close fit to hose/pipe.
- Fits range of diameters due to high expansion.
- Low cost, high volume installation.
- Shrinks onto hose/pipe.
- Minimum distance between substrates.
- Good mechanical, thermal and chemical properties.
- Push on fit to hose/pipe.
- Stays in place when installed.
- No expensive tooling required.
- Positions where needed.
- Keeps hoses/pipes together, optimizing space.
- Under body solution.
- Engine area solution.
- Twinning two hoses/pipes rationalizes part descriptions.
- Hose/pipe can be orientated correctly for ease of fitting to vehicle.

As supplied (a)

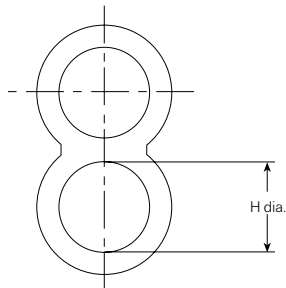

-3, -4, -25, -100

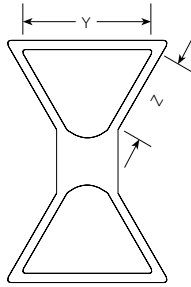

-130

After unrestricted recovery (b)

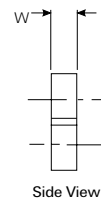
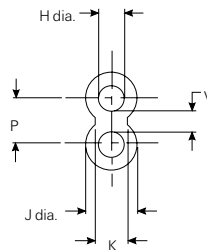

Side View

Available in:

Americas



Europe



Asia Pacific



Fax-on-demand

US only (800) 260-9099

Outside US (650) 257-2301

Visit our website at www.tycoelectronics.com**Product dimensions (mm)**

	H	J	K	P	V	W	Y*	Z*
	Min.	Max.	Max.	± 1.2	± 1.7	± 0.45	± 1	± 2
Part Number	a	b	b	b	b	b	b	a
400W242	28	10.2	19.3	12	17	7.0	10	29

*Applicable for -130 only.

Part numbering system (ordering information)

400W242 -**/**-0

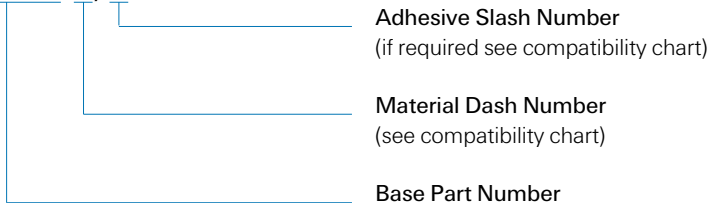
**Compatibility chart**

Material Dash Number	Material Description	Precoating no.	Adhesive part no.
-3	Polyolefin, semi-rigid	/42, /86	S-1017 or S-1048
-4	Polyolefin, flexible	/42, /86	S-1017 or S-1048
-25	Elastomer, fluid resistant	/86, /225	S-1017 or S-1048
-100	Polyolefin, Zerohal	N/A	S-1030
-130	Flexible polyolefin	/42, /86	S-1017

As supplied dimensions are for uncoated parts, when coating is added, entry diameters will reduce by 1.5mm max.



CES

Heat-shrinkable cable entry seals



Applications

Raychem heat-shrinkable cable-entry seals (CESs) provide a watertight, fume-tight seal where cables enter connection boxes, bulkheads, or other enclosures.

CESs are available in two basic types: standard and threaded. The standard CES for thin-wall enclosures consists of a three-part assembly - a rigid plastic nylon nut, an O-ring, and a heat-shrinkable molded area. The CES for threaded-hole applications is a one-part assembly that combines a tapered national pipe thread (NPT) in rigid plastic nylon with a heat-shrinkable molded area.

All CESs are available with the molded area configured with one opening for a single wire or cable entry or with two, three, or four legs of equal size to seal multiple wires or cables at the entry to enclosures and/or bulkheads. To meet sealing requirements, all CESs have factory-applied adhesive that provides the seal to wire and cable jackets. When armored cable is being sealed it may be necessary to use additional sealants, such as G.E. RTV 112 or Dow Corning RTV 732, to form the water seal.

Features and benefits

- Comes in many sizes and configurations.
- Seals multicable openings.
- Meets or exceeds MIL-I-81765/1A.
- Seals per U.S. Coast Guard HQ 3774 in wet, dry, and corrosive locations.

Available in:

Americas

Europe

Asia Pacific



Fax-on-demand

US only (800) 260-9099

Outside US (650) 257-2301

Visit our website at www.tycoelectronics.com**Temperature**

Temperature rating	-55°C to 90°C
Minimum shrink temperature	121°C

Specifications

Type	Raychem	
Molded heat-shrink nose	RT-301	Flame retardant polyolefin
Adhesive	RW-2019	Hot melt adhesive

Dimensions (in inches)

Standard CES

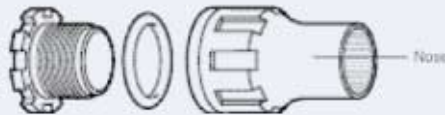

Part number	No. of legs	Overall nom. recommended length	Min. expanded I.D. nose	Max. recovered I.D. nose	Max. I.D. of part	Drill size	Max. O.D. of nut
CES-1	1	2.75	0.50	0.17	0.75	1.00	1.410
CES-2	1	2.75	0.75	0.25	0.75	1.00	1.410
CES-3	1	3.75	1.12	0.50	1.10	1.38	1.902
CES-4	1	4.50	1.60	0.75	1.56	2.00	2.720
CES-4S*	1	4.50	2.00	0.75	2.10	2.36	3.35
CES-5	1	7.00	2.75	1.43	2.90	3.50	4.070

*Part configuration may be different than depicted in figure. Contact Tyco Electronics for specification.

CES (cont'd.)

Heat-shrinkable cable entry seals

Dimensions (in inches)

Multilegged standard CES

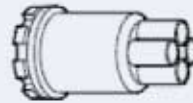
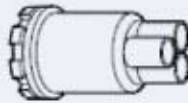
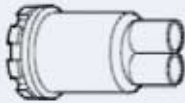

Part number	No. of legs	Overall nom. recommended length	Min. expanded I.D. (each leg)	Max. recovered I.D. (each leg)	Max. I.D. of part	Drill size	Max. O.D. of nut
CES-2-D1A	2	2.75	0.6	0.11	0.75	1.00	1.41
CES-2-T1	3	2.75	0.4	0.11	0.75	1.00	1.41
CES-2-T1B	3	3.5	0.6	0.17	0.75	1.00	1.41
CES-2-F1A	4	2.75	0.4	0.11	0.75	1.00	1.41
CES-2-F1	4	3.5	0.6	0.17	0.75	1.00	1.41
CES-3-D1	2	3.5	0.6	0.17	1.1	1.38	1.90
CES-3-T1	3	3.5	0.6	0.17	1.1	1.38	1.90
CES-3-F1	4	3.5	0.6	0.17	1.1	1.38	1.90
CES-4-D3	2	4	0.9	0.3	1.6	2	2.72
CES-4-T1	3	4	0.9	0.3	1.6	2	2.72
CES-4-F1	4	4	0.9	0.3	1.6	2	2.72
CES-5-T4	3	5	1.25	0.5	2.9	2.5	4.07
CES-5-F4	4	5	1.25	0.5	2.9	2.5	4.07

Threaded CES

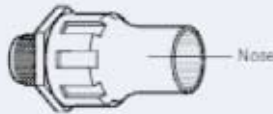

Part number	Overall nom. recommended length	Min. expanded I.D. nose	Max. recovered I.D. nose	Adapter I.D.	National pipe thread size
CES-2-A50	3.30	0.75	0.25	0.50	1/2-14
CES-2-A75	3.30	0.75	0.25	0.75	3/4-14
CES-2-A100	3.30	0.75	0.25	0.75	1-11 1/2
CES-3-A100	4.37	1.12	0.50	1.00	1-11 1/2
CES-3-A150	4.62	1.12	0.50	1.10	1 1/2-11 1/2
CES-4-A-150	5.0	2.00	0.75	1.40	1 1/2-11 1/2
CES-5-A250	6.0	2.75	1.00	2.40	2 1/2-10

Fax-on-demand

US only (800) 260-9099

Outside US (650) 257-2301

Visit our website at www.tycoelectronics.com

Multilegged threaded CES

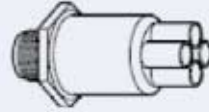
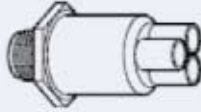
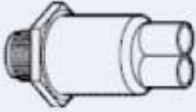

Part number	No. of legs	Overall nom. recommended length	Min. expanded I.D. (each leg)	Max. recovered I.D. (each leg)	Max. I.D. of part	Drill size
CES-2A-T1	3	3.75	0.4	0.11	0.5	1/2-14
CES-2A-F1	4	3.75	0.4	0.11	0.5	1/2-14
CES-2A-D1	2	3.75	0.6	0.11	0.75	3/4-14
CES-2A-T2	3	3.75	0.4	0.11	0.75	3/4-14
CES-2A-F2	4	3.75	0.4	0.11	0.75	3/4-14
CES-3A-D1	2	3.75	0.6	0.17	1	1-11 1/2
CES-2A-T3	3	3.75	0.6	0.17	1	1-11 1/2
CES-3A-F1	4	3.75	0.6	0.17	1	1-11 1/2
CES-3A-D2	2	3.75	0.6	0.17	1.1	1 1/2-11 1/2
CES-3A-T2	3	3.75	0.6	0.17	1.1	1 1/2-11 1/2
CES-3A-F2	4	3.75	0.6	0.17	1.1	1 1/2-11 1/2
CES-4A-D3	2	3.75	0.9	0.3	1.47	1 1/2-11 1/2
CES-4A-T3	3	3.75	0.9	0.3	1.47	1 1/2-11 1/2
CES-4A-F3	4	3.75	0.9	0.3	1.47	1 1/2-11 1/2

Note: Coating is optional. As supplied dimensions appearing in table are for uncoated parts. When coating is added, entry diameters will be reduced by 1.5 mm (.06") max.

Raychem CES (cont'd.)

Heat-shrinkable cable entry seals

Right angle threaded feedthru

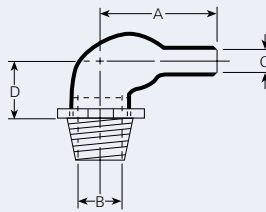

	Min. exp. ID	Max. rec. ID	ID min	D	A	Drill size
CES-2R-A50	0.55	0.28	0.5	1.4	1	0.5
CES-2R-A75	0.75	0.33	0.75	1.7	1.1	0.75
CES-3R-A100	1.1	0.38	1	2.1	1.33	1
CES-3R-A150	1.6	0.62	1.1	3.1	1.56	1.5

Right angle bulkhead feedthru

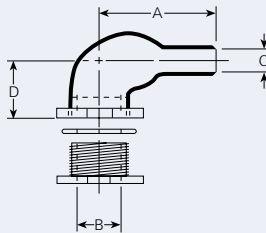

	Min. exp. ID	Max. rec. ID	ID min	Length D	A	Drill size
CES-1R	0.55	0.28	0.5	1.4	1.68	1
CES-2R	0.75	0.33	0.75	1.7	1.77	1
CES-3R	1.1	0.38	1.1	2.1	2.3	1.37
CES-4R	1.6	0.62	1.6	3.1	2.8	2

Fax-on-demand

US only (800) 260-9099

Outside US (650) 257-2301

Visit our website at www.tycoelectronics.com



RayOLOn Kits

Roll-on sealing sleeve



Applications

RayOLOn re-useable roll-on sealing sleeves are a family of products designed to protect connectors, electrical cable splices, and other cylindrical substrates from harsh environmental elements like salt spray and water moisture. RayOLOn sleeves are a part of Raychem's "heatless" sealing products that require no heat guns or torches. This is useful in the areas where the use of motorized heat sources or open flames are prohibited or undesirable.

RayOLOn sealing sleeves provide the sealing of the substrates by simply rolling the sleeve over the area to be protected. If the substrate requires servicing, the sleeve can be rolled off to provide access to the component under the sleeve. After the service is completed, the sleeve

can be rolled on the part again to provide the protection. This operation may be done many times throughout the life of the sleeve providing time and material cost savings.

Operating temperature range

-40°C to 70°C

Features and benefits

- A Raychem heatless sealing solution.
- Re-useable sealing solution.
- Roll-on to seal, roll-off to re-enter.
- Sealing with Raychem GelTek strip.*
- Protection of connectors and splices against corrosion.
- Available in many conveniently packaged kits.

Available in:

Americas

Europe

Asia Pacific



Specifications and approvals

Raychem

RW 3031

Temperature ratings

Continuous operating temperature range	-40°C to 70°C
Short term temperature exposure	-63°C to 90°C
Minimum installation	-25°C

Sleeve dimensions inches (millimeters)

Base part no.	Available kits	Dimensions (reference)		Recommended use range	Connection length
		Diameter	Lengths		
LNCL-11-125	GK	0.51 (13.0)	4.92 (125)	0.22-0.68 (6-17)	3.00 (75)
LNCL-11-205	GK	0.51 (13.0)	8.07 (205)	0.22-0.68 (6-17)	6.00 (150)
LNCL-12-140	GK, CK-N	0.56 (14.2)	5.51 (140)	0.48-0.90 (12-23)	4.00 (100)
LNCL-12-240	GK, CK-N	0.56 (14.2)	9.45 (240)	0.48-0.90 (12-23)	7.00 (175)
LNCL-13-155	GK, TK-8	0.75 (19.0)	6.10 (155)	0.69-1.20 (18-30)	4.00 (100)
LNCL-13-305	GK	0.75 (19.0)	12.00 (305)	0.69-1.20 (18-30)	9.00 (225)
LNCL-14-185	GK, TK-7	1.02 (25.9)	7.28 (185)	0.96-1.50 (25-38)	5.00 (125)
LNCL-14-355	GK	1.02 (25.9)	14.00 (355)	0.96-1.50 (25-38)	10.0 (250)
LNCL-15-185	GK, TK-1, TK-5, TK-6	1.45 (36.8)	7.28 (185)	1.40-2.00 (36-46)	5.00 (125)
LNCL-15-260	GK, SS	1.45 (36.8)	10.2 (260)	1.40-2.00 (36-46)	7.50 (190)
LNCL-15-450	GK, SS	1.45 (36.8)	17.72 (450)	1.40-2.00 (36-46)	12.0 (300)

Refer to Raychem specification control drawing LNCL-XX-125 thru LNCL-XX-450 for more details.

*Tyco Electronics Gel and Sealant product information available at www.tycoelectronics.com

Fax-on-demand

US only (800) 260-9099

Outside US (650) 257-2301

Visit our website at www.tycoelectronics.com

Typical RayOLOn roll-on sealing sleeve properties

	Property	Performance	Test method
Physical/	Tensile strength	8.3 MPa (1200 psi) minimum	ASTMD 2671
	Chemical	Ultimate elongation	100 % minimum
	Density	1.1 g/cm ³ maximum	ASTMD 792
	Water absorption	0.5 % maximum	ASTMD 570
	24 hours at 23° C (73° F)		
	Flammability	40 mm/min maximum	ASTMD 635
Electrical	Dielectric strength	90 kV/cm (225 V/mil) minimum	ASTMD 149
	Volume resistivity	1x10 ¹² Ω-cm	ASTMD 257

Refer to Raychem specification RW3031 for more requirements and performance information.

Notes:

1. The sleeve is not intended to be heated during the installation process.
2. DO NOT CUT LNCL roll-on sealing sleeve.
3. In case of a conflict between this data sheet and RW3031, RW3031 takes precedence.
4. Not recommended for extended exposure to hydrocarbon based fuel or fluids.

Part numbering system

LNCL - XX - XXX - XX - XX

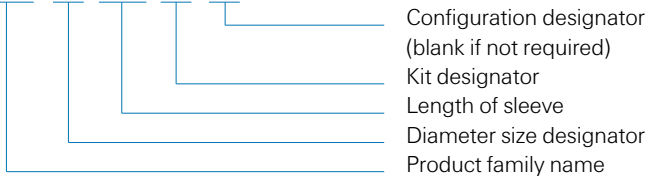

Kits:

GK—General kit:	Roll-on sleeve, gel strip, cable tie, core tube, installation instruction
CK—Connector sealing kit:	Roll-on sleeve, cable tie, connector flange cover, gel strip, installation instruction
TK—Panel boot sealing kit:	Roll-on sleeve, ferrule, gel strip, cable tie, installation instruction
SS—Ship-or-shore kit:	Roll-on sleeve, connection shield, installation instruction

Note: Not all sizes and lengths are available for all kit combinations. Please refer to the table on the previous page.

Users should independently evaluate the suitability of the product for their application.
Before ordering check with factory for most current data.



shrinkHOoP

Cable clamp heat-shrink grommet



Applications

shrinkHOoP grommet (URHR) is an ultra high ratio heat-shrinkable-strain-relief grommet that can be placed over the cable assembly after the connector pinning operation is completed. The ultra-high expansion ratio material conveniently fills the space between the clamp type connector accessory and the cable. (When clamped into position, shrinkHOoP grommet provides strain relief that is more consistent and convenient than many conventional practices – for example, taping, grommet, or tape/grommet combination). The high ratio conformity of shrinkHOoP grommets will match most typical cable configurations from single conductor to the high density multiple conductor arrangements.

With shrinkHOoP grommet, repairs and rework are a snap – simply heat the grommet until soft, slide a NON-METALLIC probe through the center of the wire bundle (enlarging the grommet I.D.). Once cooled, the grommet will remain open allowing wires to be added, removed or reworked. The system can then be checked, the grommet reheated (shrinking it down again), positioned, and clamped in place.

Operating temperature range

-55°C to 135°C

Features and benefits

- Less assembly time.
- Superior strain-relief.
- Fewer errors - less rework.
- Rework made easier.
- No build-up taping or feeding wire through grommet.
- Typical installation in just 10-20 seconds.
- Re-expandable I.D. allows wire addition to a cable bundle.

Available in:

Americas

Europe

Asia Pacific



Fax-on-demand

US only (800) 260-9099

Outside US (650) 257-2301

Visit our website at www.tycoelectronics.com

Specifications/approvals

RW

Dimensions inches (mm)

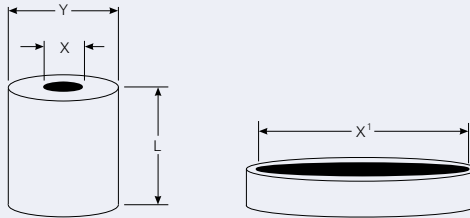

Part Number	I.D.		O.D. (Y) Ref.	Length (L) Ref.	Wt. (gm) Ref.	Notes
	Expanded (X ¹) min.	Recovered (X) max.				
URHR-1	1 (25)	.08 (2.1)	0.25 (6)	0.5 (13)	0.75	a) Recovered length will allow for 0.075" either side of the collar, minimum in most cases.
URHR-2	1.23 (31)	.10 (2.6)	0.375 (10)	0.5 (13)	1	
URHR-3	1.44 (37)	.14 (3.6)	0.5 (13)	0.5 (13)	1.5	
URHR-4	1.85 (47)	0.18 (4.7)	0.562 (14)	0.75 (19)	3.5	
URHR-5	2 (51)	0.20 (5.1)	0.812 (21)	0.75 (19)	5	

Users should independently evaluate the suitability of the product for their application. Before ordering check with factory for most current data.

shrinkHOoP (cont'd.)

Cable clamp heat-shrink grommet

Typical shrinkHOoP grommet performance

	Property	Performance	Test method
Physical	Tensile strength	1500 psi (10.3 Mpa)	ASTM D-412
	Ultimate elongation	250% minimum	ASTM D-412
	Specific gravity	1.4 maximum	ASTM D-792
	Water absorption	0.5 % maximum	ASTM D-570 A
	Flammability	Pass	ASTM D-635
	Corrosion resistance	Pass	ASTM D-2671 A
	Low temperature flex 4 hours at - 67+/-2°F (- 55+/-1 °C)	Pass	ASTM D-2671 C
	Heat resistance 168 hrs at 347+/-2 °F (175+/-1 °C)	200% ultimate elongation, minimum 1200 psi (8.3 Mpa) tensile strength, minimum	ASTM D-2671
	Heat shock 4 hrs at 437+/-5°F (225+/-2°C)	No cracking, dripping or flowing	ASTM D 2671
	Elastic Memory	275% minimum expansion to 4 inch (10 cm) of a fully recovered test specimen, and 93% recovery of expanded specimen after oven conditioning for 1 minute at 302 +/- 4°F (150+/-2 °C)	
Electrical	Dielectric strength	200 v/mil (7880 v/mm) minimum	ASTM D-876
	Volume resistivity	10 ¹⁴ ohm-cm minimum	ASTM D-257
Chemical Fluid Resistance		200% ultimate Elongation, minimum 1200 psi (8.3 Mpa) tensile strength, minimum	ASTM F-146

Fax-on-demand

US only (800) 260-9099

Outside US (650) 257-2301

Visit our website at www.tycoelectronics.com**Selection chart**

Connector series	Connector Size				
	8 (9)	10, 12 (11, 13)	14, 16 (15, 17)	18, 20 (19, 21)	22, 24, 28*
MIL-C-5015					
MS3451, 52, 56, 59	1	2	3	4	5
MS3450	2	3	4	5	•
MIL-C-26500**					
MS24266	1	2	3	4	5
MS24264, 265	2	3	4	5	•
MIL-C-26482					
MS3120, 21, 22, 26	1	2	3	4	5
MS3470, 71, 74, 75, 76	1	2	3	4	5
MS3124, MS3472	2	3	4	5	•
MIL-C-83723 Series I					
M83723/01 & 02, 05 & 06	1	2	3	4	5
07 & 08, 13 & 14, 23 & 24	1	2	3	4	5
M83723/03 & 04	2	3	4	5	•
MIL-C-83723 Series II					
M83723/17 & 18, 23 & 24	1	2	3	4	5
M83723/12 & 20, 21 & 22	2	3	4	5	•
MIL-C-83723 Series III					
M83723/71 & 72 thru 97 & 98	1	2	3	4	5
M83723/66, 67, 68 & 69	2	3	4	5	•
MIL-C-38999 Series I					
MS27469	1	2	3	4	5
MS27466, 68, 96, 27505, 27656	2	3	4	5	•
MIL-C-38999 Series II					
MS27472, 97, 98, 27508, 27513	1	2	3	4	5
MS27473, 84, 27474	2	3	4	5	•
MIL-C-38999 Series III					
38999/26	1	2	3	4	5
38999/20, 24	3	4	5	5	•
Boeing					
BACC45, F, M, N, P, R, S, T	–	2	3	4	5
BACC 63X	–	3	4	5	•
Boeing					
DC39, 31, 34, 35, 50-57	1	2	3	4	5
DC32, 33, 36, 37, 60, 61, 62, 63	2	3	4	5	•

* Consult factory for availability of larger sizes.

** Note: cable support clamp I.D. may effect the size of shrinkHOoP grommet selected.

**Users should independently evaluate the suitability of the product for their application.
Before ordering check with factory for most current data.**

XL Products



Tyco Electronics Corporation has acquired XL Technologies. Use the information in the following table to convert the XL part number into the new Tyco Electronics Raychem product description.

Available in:	Americas	Europe	Asia Pacific
	■	■	■

Ordering information

Description	Convert to	Description	Convert to
XL part number	Description	XL part number	Description
080EK025	SSC-2/239	3A-8117-2B	CES-3A-D1
080EK025-woA	SSC-2/U	3A-8117-3B	CES-2A-T3
137EK050	SSC-3/239	3A-8117-4B	CES-3A-F1
137EK050-woA	SSC-3/U	4-8115-2C	CES-4-D3
1-8117-2A	CES-2A-D1	4-8115-3C	CES-4-T1
1-8117-3A	CES-2A-T1	4-8115-4C	CES-4-F1
1-8117-4A	CES-2A-F1	4-8117-2B	CES-3A-D2
200EK075	SSC-4/239	4-8117-3B	CES-3A-T2
200EK075-woA	SSC-4/U	4-8117-4B	CES-3A-F2
20432242	CES-4/HR-3	4A-8117-2C	CES-4A-D3
2-8115-2A	CES-2-D1A	4A-8117-3C	CES-4A-T3
2-8115-2AOE	CES-2-D1A	4A-8117-4C	CES-4A-F3
2-8115-2B	CES-2-D1	52451-2X12A	91385-2/12
2-8115-3A	CES-2-T1	5-8115-3D	CES-5-T4
2-8115-3B	CES-2-T1B	8114-1	CES-1
2-8115-4A	CES-2-F1A	8114-1-2	CES-1-2
2-8115-4B	CES-2-F1	8114-1-49R	CES-1R
2-8117-2A	CES-2A-D1	8114-2	CES-2
2-8117-2AOE	CES-2A-D1	8114-2-50R	CES-2R
2-8117-3A	CES-2A-T2	8114-2S	CES-2
2-8117-4A	CES-2A-F2	8114-2V	CES-2V
2-8118-3A	CES-2-T1	8114-2VL	CES-2V
2S-8115-2A	CES-2-D1A	8114-3	CES-3
2S-8115-3A	CES-2-T1	8114-3-51R	CES-3R
2S-8115-4A	CES-2-F1A	8114-3L	CES-3L
380EK150	SSC-6/239	8114-3S	CES-3S
380EK150woA	SSC-6/U	8114-4	CES-4
3-8115-2B	CES-3-D1	8114-4-54R	CES-4R
3-8115-3B	CES-3-T1	8114-4N	CES-4
3-8115-4B	CES-3-F1	8114-4S	CES-4S
3-8118-4B	CES-3-F1	8114-4S/C	CES-4S

Fax-on-demand

US only (800) 260-9099

Outside US (650) 257-2301

Visit our website at www.tycoelectronics.com**Ordering information (cont'd.)**

Description XL part number	Convert to Description	Description XL part number	Convert to Description
8114-5	CES-5	91344-5	F133-200 FR
8116-1	CES-2-A50	91344-6	F150-400 FR
8116-1-49R	CES-2R-A50	91346-3	6S100-200 FR
8116-1A	CES-2-A50	91346-30	202A111-3-0
8116-2	CES-2-A75	91346-31	202A111-3/42-0
8116-2-50R	CES-2R-A75	91346-32	202A111-3/86-0
8116-3	CES2-A100	91347-30	202A121-3-0
8116-3-51R	CES-3R-A100	91347-31	202A121-3/42-0
8116-3A	CES-3-A100	91347-32	202A121-3/86-0
8116-4	CES-3-A150	91348-1	8S23-75 FR
8116-4-52R	CES-3R-A150	91348-2	8S14-50 FR
8116-4A	CES-4A-A150	91348-3	8S42-100 FR
8116-5	CES-5-A250	91348-30	202A132-3-0
8118-2	CES-2	91348-31	202A132-3/42-0
91342-1	D3-9 FR	91348-32	202A132-3/86-0
91342-12	D3-30 FR	91349-30	202A142-3-0
91342-2	D14-30 FR	91349-31	202A142-3/42-0
91342-23	D14-100 FR	91349-32	202A142-3/86-0
91342-3X2.5	D50-200 FR	91350-30	202A153-3-0
91342-3	D50-100 FR	91350-31	202A153-3/42-0
91342-34	D50-400 FR	91350-32	202A153-3/86-0
91342-4	D200-400 FR	91351-30	202A163-3-0
91343-1	T3-9 FR	91351-31	202A163-3/42-0
91343-2	T14-23 FR	91351-32	202A163-3/86-0
91343-2A	T14-50 FR	91352-30	202A174-3-0
91343-3	T42-100 FR	91352-31	202A174-3/42-0
91343-4	T150-300 FR	91352-32	202A174-3/86-0
91343-5	T-400 FR	91353-30	202A185-3-0
91343-5678	T3-100 FR	91353-31	202A185-3/42-0
91343-6	T500-600 FR	91353-32	202A185-3/86-0
91343-910	T150-400 FR	91354-30	202A196-3-0
91344-1	F3-9 FR	91354-31	202A196-3/42-0
91344-1213	F3-23 FR	91354-32	202A196-3/86-0
91344-1415	F42-100 FR	913L87-30	202D921-3/0
91344-1617	F75-200 FR	913L87-31	202D921-3/42-0
91344-2	F-23 FR	913L87-32	202D921-3/86-0
91344-3	F42-60 FR	91387-30	202A921-3/0
91344-4	F75-100 FR	91387-31	202A921-3/42-0

Users should independently evaluate the suitability of the product for their application.
Before ordering check with factory for most current data.

XL Products (cont'd.)

High ratio tubing (6:1)

Ordering information (cont'd.)

Description XL part number	Convert to Description	Description XL part number	Convert to Description
913L47-30	202D121-3/-0	913L70-32	202D253-3/86-0
913L47-31	202D121-3/42-0	913L87-30	202D921-3-0
913L47-32	202D121-3/86-0	913L87-31	202D921-3/42-0
913L48-30	202D132-3/-0	913L87-32	202D921-3/86-0
913L48-31	202D132-3/42-0	913R48-30	222A132-3-0
913L48-32	202132-3/-86-0	913R48-31	222A132-3/42-0
913L49-30	202D142-3/-0	913R48-32	222A132-3/86-0
913L49-31	202D142-3/42-0	913R49-30	222A142-3-0
913L49-32	202D142-3/86-0	913R49-31	222A142-3/42-0
913L50-30	202D153-3-0	913R49-32	222A142-3/86-0
913L50-31	202D153-3/42-0	913R50-30	222A152-3-0
913L50-32	202D153-3/86-0	913R50-31	222A152-3/42-0
913L51-30	202D163-3-0	913R50-32	222A152-3/86-0
913L51-31	202D163-3/42-0	913R51-30	222A163-3-0
913L51-32	202D163-3/86-0	913R51-31	222A163-3/42-0
913L52-30	202D174-3-0	913R51-32	222A163-3/86-0
913L52-31	202D174-3/42-0	913R52-30	222A174-3-0
913L52-32	202D174-3/86-0	913R52-31	222A174-3/42-0
913L53-30	202D185-3-0	913R52-32	222A174-3/86-0
913L53-31	202D185-3/42-0	913RL48-30	222D132-3-0
913L53-32	202D185-3/86-0	913RL48-31	222D132-3/42-0
913L54-30	202D196-3-0	913RL48-32	222D132-3/86-0
913L54-31	202D196-3/42-0	913RL49-30	222D142-3-0
913L54-32	202D196-3/86-0	913RL49-31	222D142-3/42-0
913L66-30	202D211-3-0	913RL49-32	222D142-3/86-0
913L66-31	202D211-3/42-0	913RL50-30	222D152-3-0
913L66-32	202D211-3/86-0	913RL50-31	222D152-3/42-0
913L67-30	202D221-3-0	913RL50-32	222D152-3/86-0
913L67-31	202D221-3/42-0	913RL51-30	222D163-3-0
913L67-32	202D221-3/86-0	913RL51-31	222D163-3/42-0
913L68-30	202D232-3-0	913RL51-32	222D163-3/86-0
913L68-31	202D232-3/42-0	913RL52-30	222D174-3-0
913L68-32	202D232-3/86-0	913RL52-31	222D174-3/42-0
913L69-30	202D242-3-0	913RL52-32	222D174-3/86-0
913L69-31	202D242-3/42-0	913Y95-30	381A301-71/-0
913L69-32	202D242-3/86-0	913Y95-31	381A301-71/42-0
913L70-30	202D253-3-0	913Y95-32	371A301-71/86-0
913L70-31	202D253-3/42-0	913Y96-30	381A302-71/-0

Fax-on-demand

US only (800) 260-9099

Outside US (650) 257-2301

Visit our website at www.tycoelectronics.com

Ordering information (cont'd.)

Description	Convert to
XL part number	Description
913Y96-31	381A302-71/42-0
913Y96-32	381A302-71/86-0
HHW-1.3/6A	SST-6-13FR/97-0
HHW-13/6A	SST-6-13FR/97-0
HHW-15/12	SST-12-15FR/97-0
HHW-15/6	SST-6-15FR/97-0
HHW-15/9	SST-9-15FR/97-0
HHW-20/9	SST-9-20FR/97-0
HRSR-1	URHR-1
HRSR-2	URHR-2
HRSR-3	URHR-3
HRSR-4	URHR-4
HRSR-5	URHR-5
XHTA	RHW
XHTU	RHW
XMTA	RPRD

Users should independently evaluate the suitability of the product for their application.
Before ordering check with factory for most current data.

Adhesives

Overview

Tyco Electronics manufactures Raychem adhesives and sealants to accommodate a wide range of applications, materials, and environmental conditions.

Raychem adhesives include both thermosets and thermoplastics.

Thermosets are curable two-part epoxies or crosslinked elastomers.

Thermoplastics are hot-melt adhesives that flow when heated and set when cooled. They reflow when reheated to simplify component repair.

Tyco Electronics also manufactures Raychem products that include a thermoplastic adhesive or a mastic-type sealant for water holdout applications. The sealants adhere to nonoily substrates and can be removed where reentry is necessary.

Adhesives

Table of Contents

Selection Guide	5-0
Adhesive/Sealant Selection Table	5-1
Adhesive/Sealant Product Characteristics Table	5-2
Installation Guide	5-4

Adhesives

Selection guide

To determine the adhesive or sealant most compatible with a Raychem part, you must know the part's product type.

Use the Adhesive/Sealant Selection Table (page 5-1) to determine a Raychem part's product type and the adhesive/sealant compatible with that type.

Use the Adhesive/Sealant Product Characteristics Table (pages 5-2 and 5-3) to be sure the adhesive or sealant has the product characteristics your application requires.

Adhesives

Adhesive/sealant selection table

Fax-on-demand

US only (800) 260-9099

Outside US (650) 257-2301

Visit our website at www.tycoelectronics.com



To use the Selection Table, follow these four steps:

1. Under "Substrate Category," find the product material and product name/part number for the Raychem part.
2. Across the top of the table, find the part's product type and dash number.
3. At the intersection of the substrate category (product material/name/part number) and the product type (by designated dash number) you will find the part number for the most compatible adhesive for the Raychem part.
4. Turn to the Adhesive/Sealant Product Characteristics Table (page 5-2) to verify the characteristics of the adhesive/sealant you selected.

Adhesive/sealant selection table

Substrate Category	Product name examples	Molded part material dash number												
		-3	-4	-6	-8	-12	-25	-50	-51	-55	-71	-100	-125	-130
Polyolefin	RNF-100	S-1006	S-1006								S-1006		S-1006	
	Versafit	S-1009	S-1009								S-1009		S-1009	
	CRN	S-1017	S-1017								S-1017		S-1017	
	BSTS	S-1030	S-1030								S-1030			
	SST	S-1048	S-1048								S-1048			
	HR	S-1298	S-1297								S-1297			
Fluoro-polymer	Kynar	S-1009	S-1009		S-1009	S-1125				S-1009		S-1009		
		S-1048	S-1048							S-1048		S-1048		
		S-1125	S-1125							S-1125		S-1125		
	RT555				S-1255				S-1255			S-1255		
	HCTE				S-1255	S-1125			S-1255					
CONVOLEX				S-1125				S-1125						
Vinyl	PVC	S-1006	S-1006								S-1006			
		S-1009	S-1009								S-1009			
		S-1017	S-1017								S-1017			
Elastomer	DR-25					S-1125	S-1125	S-1125						
	NT	S-1006	S-1006					S-1124		S-1006				
		S-1009	S-1009							S-1009				
		S-1017	S-1017							S-1017				
	NT-FR					S-1125		S-1124						
	SFR													
	SRFR													
	VITON					S-1255				S-1255		S-1255		
Zerohal	XFFR											S-1030		
	ZHTM											S-1030		

*GE RTV 108 used with SFR SRFR and -6 (silicone) molded parts.

Adhesives

Adhesive/sealant product characteristics table

Adhesive/sealant product characteristics table					
Product type	Precoat designation	Type	Operating temperature range	Product designation	Available form/ packaging
Thermosets					
S-1006		Epoxy/polyamide two-part paste	-55°C to 135°C	S-1006 Kit 1 S-1006 Kit 2	Two x 15-gram packs Four x 7.5-gram packs
S-1009		Epoxy/polymercaptan two-part paste	-55°C to 135°C	S-1006 Kit A S-1009 Kit A	Ten 3-gram packs Ten 3-gram packs
S-1255-04		One-part epoxy tape adhesive	-55°C to 200°C	S-1255-04	Tape (3/4" x .020" x 100')
S-1125		Epoxy/polyamide two-part paste	-55°C to 150°C	S-1125 Kit 1 S-1125 Kit 2 S-1125 Kit 3 S-1125 Kit 4 S-1125 Kit 5 S-1125 Kit 8	Five 10-gram packs Two 10-gram packs One 100-gram pack Five 10-gram packs One 10-gram pack Two 50-ml syringes
	/225	Precoated latent-curing epoxy/polyamide	-75°C to 150°C	Precoat only on -25 molded parts	
Thermoplastics					
S-1017	/42	Hot-melt/polyamide	-20°C to 60°C***	S-1017	Tape (1" x .010" x 50')
S-1030	/180	Hot-melt/polyolefin	-80°C to 80°C	S-1030	Tape (3/4" x .010" x 33')
S-1048	/86	Hot-melt, high performance	-55°C to 120°C	S-1048	Tape (1" x .026" x 100')
S-1124	/164	Hot-melt/elastomeric polymer	-55°C to 105°C	S-1124	Tape (3/4" x .018" x 100')
S-1297	/97	Hot-melt/polyamide adhesive	-20°C to 90°C	S-1297	Tape (1" x .010" x 10')
Sealants					
S-1278		Hot-melt grey butyl sealant	-40°C to 90°C	S-1278-01 S-1278-02	Tape (1" x .062" x 25') Tape (3 3/4" x .125" x 10')
S-1305		Hot-melt grey butyl sealant	-40°C to 90°C	S-1305-01	Tape (1" x .062" x 25')

*Shelf life from date of manufacture. **For specific adhesion properties, see product specification sheets.
 Passes cold bend at -40°C per RT-4204. *Only S-1006 Kit A conforms to MIL-A-46864.

Fax-on-demand

US only (800) 260-9099

Outside US (650) 257-2301

Visit our website at www.tycoelectronics.com

Pot life at 23°C	Curing conditions	Shelf life* at or below 25°C	Specifications**	Comments
1 h	96 h at 20°C min. or 1 hr at 120°C	2 years	RT-1006 RK-6612 MIL-A-46864****	General purpose harnessing adhesive. Not used on Viton, silicone or Kynar; 20-minute pot life
20 min	24 h at 20°C min. or 1 hr at 95°C	2 years	RT-1009	General purpose harnessing adhesive. Not used on Viton or silicone; 20-minute pot life
90 min	45 min at 120°C 2 h at 155°C min. or 15 min at 240°C	1 year	RT-1014	One-part epoxy tape used with Viton harness systems. Heat cure required (2 hours at 155°C)
	24 h at 20°C min. or 1 hr at 85°C	18 months	RT-1011 RK-6619 VG-95343	Good fluid-resistant epoxy used with System 25
	Cure during installation of molded parts	1 year 1 year	VG-95343 RK-6630	Precoated epoxy system for System 25
	120°C	Unlimited	RT-1050/1	General purpose harnessing adhesive Standard precoated adhesive for -3 and -4 molded parts
	120°C	Unlimited	RT-1050/6 RK-6017	Good low-temperature flexibility. Available as a preinstalled tape for molded parts
	160°C	Unlimited	RT-1050/3 RK-6626	Requires high temperature to achieve bonding. Highest service temperature for hot melt
	135°C	Unlimited	RT-1050/13	Requires reflowing in an oven at 150°C for 90 minutes. Designed to bond to -51 molded parts.
	120°C	Unlimited	RW-2019	General purpose harnessing adhesive Standard precoated adhesive in Sigmaform molded parts, CES and CSGA cable entry seals, and SST-FR heat-shrinkable tubing
	110°C	Unlimited	RW-2020	General purpose sealant and cable breakout area filler
	110°C	Unlimited	RW-2021	Halogen-free, flame-retardant sealant and cable breakout area filler

Users should independently evaluate the suitability of the product for their application.
Before ordering check with factory for most current data.

Adhesives

Installation guide

Substrate Preparation Procedures

Preparation of the substrate depends on the part to be bonded. Following are two preparation procedures. The first applies to plated metals and adapters; the second applies to polymer molded parts, cable jackets, and tubing materials.

Plated metals and adapters

Thoroughly degrease the surface with a clean cloth or paper wipe dampened with a solvent. The cloth or paper should not be saturated with the solvent. Allow the part to stand for a minute or two to allow complete evaporation of the solvent.

Molded parts, cable jackets, and tubing materials

Carefully and evenly abrade the surface with #320 emery cloth. Wipe contaminants and abraded particles away with a clean cloth or paper wipe dampened with a solvent. The cloth or paper should not be saturated with the solvent. Allow the part to stand for a minute or two to allow complete evaporation of the solvent.

Note:

- Avoid contamination of the prepared surface. If using primer, apply it according to the manufacturer's instructions and allow it to dry.
- Epoxy adhesives may cause skin and eye irritation. Be sure to observe the handling instructions.
- When using hot-melt adhesives on substrates with high heat-sink capacity (such as connector backshells), preheat the substrate until it is hot to touch, then apply the adhesive tape and shrink the molded part in place.

Caution:

The use of cleaning solvent is described in the preparation of various components for adhesive bonding. Please observe the solvent manufacturer's safety recommendations. Several Raychem epoxy adhesives and solvent base primers are also described in some cases. For specific handling precautions, please consult the appropriate Raychem material safety data sheet for the adhesive being used.

Fax-on-demand

US only (800) 260-9099

Outside US (650) 257-2301

Visit our website at www.tycoelectronics.com

Installation Procedures

The three sets of installation instructions that follow are based on the type and/or form of adhesive or sealant to be used.

Select the set of instructions that applies to your application.

Tape adhesives and sealants

Connector boot

1. Degrease the area of the adapter to which the boot will be bonded, using appropriate solvent on a paper tissue or clean cloth. Do not abrade the adapter.
2. Lightly abrade the bonding area of the cable jacket with #320 emery cloth, then wipe off loose particles with a tissue or clean cloth dampened with a solvent.
3. Lightly abrade and wipe 25.4 mm (1 inch) back inside each end of the boot.
4. When using primer, apply a thin, uniform coating to the bonding surface and let it air dry (15–20 minutes).
5. Double-wrap the adhesive tape around the cleaned area of the adapter, placing slight tension on the tape as you wrap. Tack the ends in place with a soldering iron or hot tool.
6. Double-wrap adhesive tape around the cable jacket where the end of the boot is to be located.
7. Position the boot on the adapter and the cable. Apply heat, starting at the connector end.
8. Recover the connector end of the boot onto the adapter and continue heating until the area is fully recovered and the adhesive tape is properly melted.
9. Complete the recovery of the boot, continuing toward the cable end. Heat the cable end of the boot where the adhesive is placed, until the part is fully recovered and the tape has properly melted or flowed. The tape should appear wet, form a bead or fillet between the cable and boot, and show no definition between the layers of tape.
10. Where oven curing is required to complete adhesive bonding, heat the assembled harness in a preheated oven according to the following schedule:
S-1255-02: 2 hours at 155°C
S-1124: 90 minutes at 150°C

Transition

1. Lightly abrade the bonding area of the cable jacket with #320 emery cloth, then wipe off loose particles with a tissue or clean cloth dampened with a solvent.
2. Abrade and wipe the inside of each transition opening.
3. When using primer, apply a thin, uniform coating to the bonding surface and let it air dry (15–20 minutes).
4. Double-wrap the tape around the abraded areas of the cable, placing slight tension on the tape as you wrap. Tack the ends in place with a soldering iron or hot tool.
5. Center the molded part over the transition area. When properly positioned, the part should not fit tightly in the “branched” area of the breakout. A tight fit may cause the part to crease or wrinkle as it recovers. The tape should extend slightly beyond the end of the transition.
6. Apply heat to the center of the transition. Recover one leg of the transition, moving heat from the center of the transition to the adhesive opening of the leg. Repeat the procedure on each leg of the transition.
7. Continue heating each end of the transition until the part is fully recovered and the adhesive tape has properly melted or flowed. The tape should now appear wet, form a bead or fillet between the cable and transition, and show no definition between the layers of tape.
8. Where oven curing is required to complete adhesive bonding, heat the assembled harness in a preheated oven according to the following schedule:
S-1255-02: 2 hours at 155°C
S-1124: 90 minutes at 150°C

Adhesives

Installation guide (cont'd.)

Installation Procedures (cont'd.)

Thermosets

Connector boot

1. Thoroughly mix the two parts according to the instructions provided with the kit.
2. Degrease the area of the adapter to which the boot will be bonded, using appropriate solvent on a paper tissue or clean cloth. Do not abrade the adapter.
3. Lightly abrade the bonding area of the cable jacket with #320 emery cloth, then wipe off loose particles with a tissue or clean cloth.
4. Lightly abrade back 25.4 mm (1 in) inside each end of the boot.
5. Using a spatula, apply the mixed adhesive to the adapter and shrink the adapter to the end of the boot.
6. Apply adhesive to the cable jacket and complete the shrinking process.
7. With a clean cloth, remove excess adhesive from all areas immediately.
8. Follow the curing conditions outlined in this guide.

Transition

1. Thoroughly mix the two parts according to the instructions provided with the kit.
2. Lightly abrade the bonding area of the cable jacket with #320 emery cloth, then wipe off loose particles with a tissue or clean cloth.
3. Abrade and wipe inside each opening of the transition.
4. Using a spatula, apply the mixed adhesive to the cable jacket.
5. Apply heat to the center of the transition. Recover one leg of the transition, moving heat from the center of the transition to the adhesive opening of the leg. Repeat the procedure on each leg.
6. Remove excess adhesive from all areas immediately with a clean cloth.
7. Follow the curing conditions specified for "thermosets" in the "Adhesive/Sealant Product Characteristics Table" on pages 5-2 and 5-3.

Fax-on-demand

US only (800) 260-9099

Outside US (650) 257-2301

Visit our website at www.tycoelectronics.com

Molded parts precoated with thermoplastic adhesive

Connector boot

1. Degrease the area of the adapter to which the boot will be bonded, using appropriate solvent on a paper tissue or clean cloth. Do not abrade the adapter or inside surface of the boot.
2. Lightly abrade the bonding area of the cable jacket with #320 emery cloth, then wipe off loose particles with a tissue or clean cloth dampened with solvent.
3. Position the boot on the adapter and cable. Apply heat starting at the connector end.
4. Recover the connector end of the boot onto the adapter and continue heating until the area is fully recovered and the adhesive is properly melted.
5. Complete the recovery of the boot, continuing toward the cable end of the boot until the part is fully recovered and the adhesive is properly melted. The adhesive should form a bead or fillet between the cable and boot when fully melted.
6. With a clean cloth, remove excess adhesive from all areas immediately.
7. Follow the curing conditions outlined in this guide.

Transition

1. Lightly abrade the bonding area of the cable jacket with #320 emery cloth, then wipe off loose particles with a tissue or clean cloth dampened with solvent.
2. Center the molded part over the transition area.
3. Apply heat to the center of the transition. Recover one leg of the transition, moving heat from the center of the transition to the adhesive opening of the leg. Repeat the procedure on each leg of the transition.
4. Continue heating each end until the part is fully recovered and the adhesive has properly melted. The adhesive should form a bead or fillet between the cable and transition when fully melted.
5. Follow the curing conditions specified for "thermosets" in the "Adhesive/Sealant Product Characteristics Table" on pages 5-2 and 5-3.

Adapters

Overview

For high-performance sealing and strain relief, the perfect mate for a Raychem molded part in a wiring application is a Raychem adapter.

Tyco Electronics offers a variety of Raychem adapters for applications in many industries, including aerospace, marine, and mass transit.

These adapters are:

- Available in many configurations to match applications.
- Easy to install.
- Ideal for high-reliability applications.
- Kitted for customer convenience.

In this section we present Raychem spin-coupling adapters and Tinel-Lock adapters.

The Tinel-Lock adapter utilizes Raychem's Tinel ring to terminate the overall shield to the adapter.

The Tinel ring is a low-profile, high-strength, shape-memory-alloy shield-termination device available in many sizes to accommodate various entry sizes and shield configurations.

Tinel-Lock adapters are ideal for lightweight aerospace applications requiring repeated high-to low-temperature cycles.

Adapters

Table of Contents

Adapter Fundamentals

Definitions	6-0
Types of Adapters	6-2
Adapter Selection Process	6-4

Adapter Selection

Raychem Adapter Code	6-6
Raychem Adapter Family	6-20
Raychem Part Number	6-22
Material and Finish	6-24
Entry Size	6-26
Tinel-Lock	6-32

Adapter Products

Code 18 MIL-C-5015 (MS3100)	
Braided adapters	6-34
Solid adapters	6-36
Spin-coupling adapters	6-38
Tinel-Lock adapters	6-40
Code 21 MIL-C-26482 Series 1	
Braided adapters	6-44
Solid adapters	6-46
Spin-coupling adapters	6-48
Tinel-Lock adapters	6-50
Bandstrap adapters	6-52
Code 32 MIL-C-22992	
Braided adapters	6-54
Spin-coupling adapters	6-56
Tinel-Lock adapters	6-58
Code 40 MIL-C-38999 Series III and IV	
Braided adapters	6-60
Solid adapters	6-62
Spin-coupling adapters	6-64
Tinel-Lock adapters	6-66
Bandstrap adapters	6-68
Code 41 MIL-C-38999 Series I and II	
Braided adapters	6-70
Solid adapters	6-72
Spin-coupling adapters	6-74
Tinel-Lock adapters	6-76
Bandstrap adapters	6-78
Code 47 PAN6433-2	
Bandstrap adapters	6-80
Code 54 MIL-C-5015 (MS3400), MIL-C-26482 Series 2, MIL-C-83723 Series I and III, MIL C-81703 Series III	
Braided adapters	6-82
Solid adapters	6-86
Spin-coupling adapters	6-88
Tinel-Lock adapters	6-90
Bandstrap adapters	6-94
Code 76 BS 9522 F0017 (Pattern 105)	
Spin-coupling adapters	6-96
Tinel-Lock adapters	6-98

Adapter Fundamentals

Definitions

Adapter type

Tyco Electronics offers four Raychem adapter types: solid (sometimes called “fixed”), spin-coupling, braided, and Tinel-Lock. Each is designed to offer a suitable interface between a connector and a heat-shrinkable molded part.

Raychem adapter code

A numerical code is used to identify connectors with similar adapter interfaces. This code is used to determine the adapter family and part number.

Adapter part number

The part number is the sequence of numbers and letters that describes the adapter family (or series), size, material, finish, and modifications. The part numbering system is explained on pages 6-22 and 6-23.

Adapter family

Tyco Electronics offers several families (or series) of Raychem adapter products. Each Raychem adapter part number begins with an alphanumeric prefix denoting the Raychem product family.

Entry size

Entry size is the diameter of the hole through which the cable enters into the adapter. For example, the 08 entry is 12.7 mm (0.5 in). Entry sizes are specified on braided and Tinel-Lock adapters only.

Ring designator

This is a two-letter code that is part of each Tinel-Lock adapter part number. It specifies the size of the Tinel-Lock ring suited to specific types of cable braid.

Shell size

This is the size of a connector as specified by the connector manufacturer. It is normally a two-digit number between 08 and 24, although certain connectors are obtainable in either larger or smaller sizes and some use letter codes.

Order number

This is a two-digit number that specifies the size of the adapter that will mate to the corresponding shell size of a connector. The order number is frequently the same as the connector shell size, but should be checked by reference to the appropriate product page(s) in this catalog or specification control drawings from Fax-on-Demand.

Fax-on-demand

US only (800) 260-9099

Outside US (650) 257-2301

Visit our website at www.tycoelectronics.com

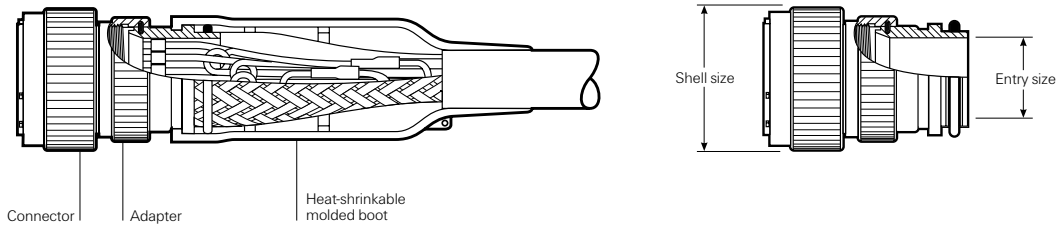

*Users should independently evaluate the suitability of the product for their application.
Before ordering check with factory for most current data.*

Adapter Fundamentals

Types of adapters

Adapter types

Tyco Electronics offers several types of Raychem adapters for unscreened and screened termination systems. The choice is largely dependent upon the screening level required and the braid termination method.

The four principal adapter types are:

- Solid (fixed)
- Spin-coupling
- Braided
- Tinel-Lock

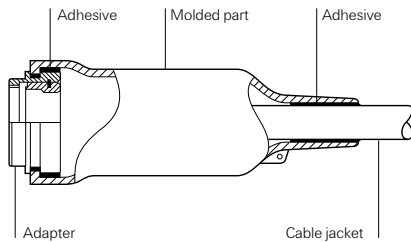

Solid adapters (fixed)

Solid adapters (fixed)

Solid adapters are designed for use where no access is required; for example, when potting is necessary or a lower space profile is needed.

These adapters have a boot groove to accommodate a lipped heat-shrinkable boot. Repair cannot be made without removing the boot.

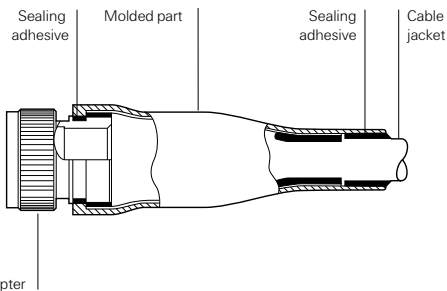

Spin-coupling adapters

Spin-coupling adapters

Spin-coupling adapters are two-part components that have a rotatable coupling nut and a grooved body designed to accommodate lipped-type heat-shrinkable boots.

Spin-couplings with an appropriate molded part are used for environmental protection and strain relief of unscreened cable terminations. Cable repairs can be made without damaging the boot.

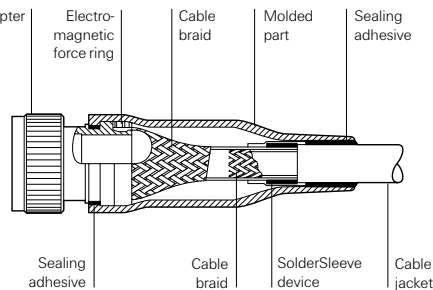

Braided adapters

Braided adapters

These are spin-coupling adapters that have a short length of tubular braided shield attached to the rear of the adapter. The braid is constructed from tinned copper wire and has a handling characteristic that enables it to be pulled down onto a wide range of cable diameters. This allows a standard entry size to be used with most cable sizes.

The shield is terminated to the cable braid using a SolderSleeve device, which provides screen continuity through to the connector. Straight, 45°, and 90° configurations are available.

Fax-on-demand

US only (800) 260-9099

Outside US (650) 257-2301

Visit our website at www.tycoelectronics.com

Tinel-Lock adapters

This termination system consists of a modified spin-coupling adapter with a Tinel-Lock ring. The Tinel-Lock ring is made from a special shape memory metal that shrinks uniformly when heated (see Section 10, Application Equipment).

The Tinel-Lock ring is used to terminate copper cable braid directly onto the rear of the adapter. The adapter entry size and ring designator must be selected to suit the cable diameter and braid type.

The resulting 360° termination withstands severe shock, vibration, temperature cycling, and corrosion. Straight, 45°, and 90° configurations are available.

Roll-back repair with adapters

More than 85 percent of cable repairs are made within 75 mm (3 in) of the connectors—usually because of a broken pin or wire. By reheating the heat-shrinkable boot and unscrewing the adapter coupling nut, the boot can be “rolled back,” providing access to the rear of the connector for repair. This technique is applicable to spin-coupling, shielded, and Tinel-Lock adapters.

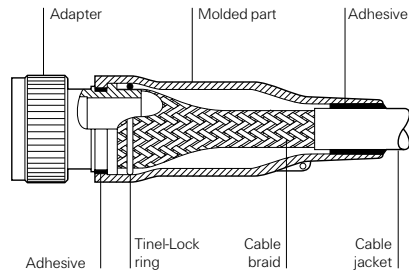

Tinel-Lock adapters

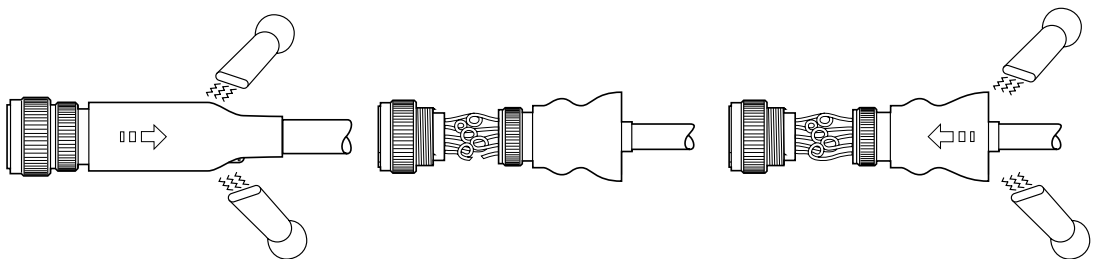

Adapter Fundamentals

Adapter selection process

Step-by-step selection process

Selecting an adapter for your application involves a five-step process:

1. From the connector number, determine:
 - Order number (shell size)
 - Material
 - Plating
2. Decide what adapter type you need for the connector.
3. Determine the Raychem connector code for that adapter type.
(Use Table A, B, or C on pages 6-6 to 6-19).
4. Determine the Raychem adapter family for that connector code.
(Use Table D on pages 6-20 to 6-21).
5. Build the adapter part number.
(See pages 6-22 to 6-23).

The chart on the next page will lead you through these steps.

Fax-on-demand

US only (800) 260-9099

Outside US (650) 257-2301

Visit our website at www.tycoelectronics.com

Adapter selection flowchart

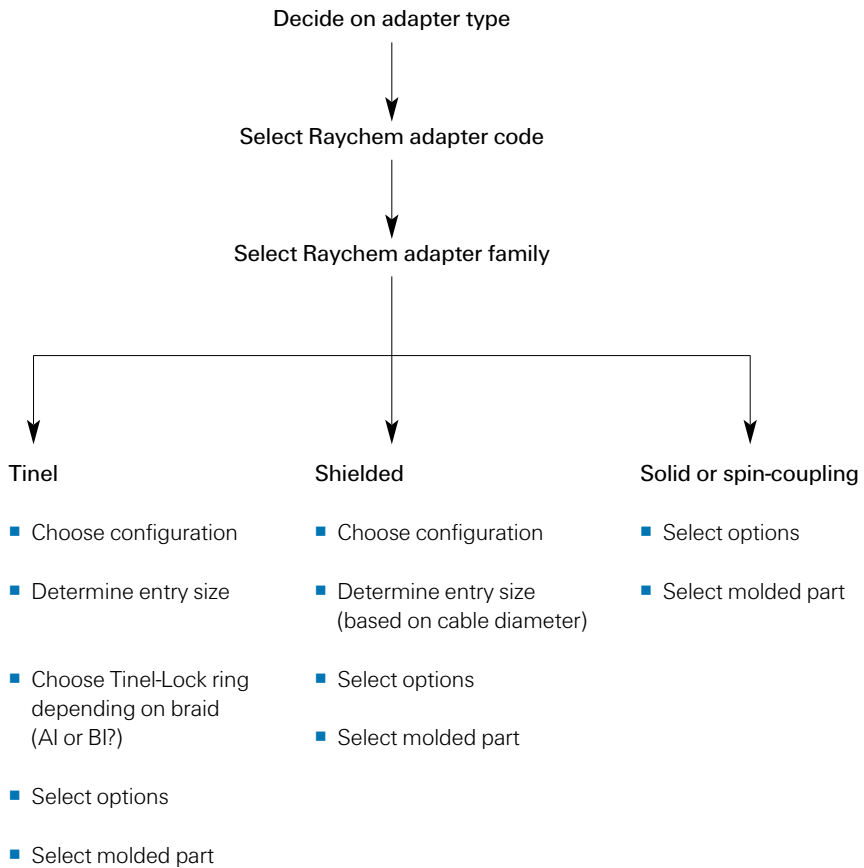

Adapter Selection

Raychem adapter code

Selecting the Raychem connector code

Tables A, B, and C that follow provide Raychem connector codes for typical connectors.

If you know the *military* part number for the connector, you can obtain the Raychem connector code from Table A that begins below.

If you know the *manufacturer's* prefix for the connector, you can obtain the Raychem connector code from Table B that begins on page 6-12.

If you know the *connector specification*, you can obtain the Raychem connector code from Table C on pages 6-18 and 6-19.

Table A. Raychem connector code by military part number

Military part number	Connector specification	Series/Class	Raychem adapter code
D38999/20	MIL-C-38999	Series III: Class C, F, K, W	40
D38999/24	MIL-C-38999	Series III: Class C, F, K, W	40
D38999/26	MIL-C-38999	Series III: Class C, F, K, W	40
D38999/40	MIL-C-38999	Series IV: Class C, F, W	40
D38999/42	MIL-C-38999	Series IV: Class C, F, W	40
D38999/44	MIL-C-38999	Series IV: Class C, F, W	Contact Tyco Electronics.
D38999/46	MIL-C-38999	Series IV: Class F, W	40
D38999/47	MIL-C-38999	Series IV: Class C, W	40
M28840/10	MIL-C-28840	Class D, DS	30
M28840/11	MIL-C-28840	Class D, DS	30
M28840/14	MIL-C-28840	Class D, DS	30
M28840/16	MIL-C-28840	Class D, DS	30
M81511/01	MIL-C-81511	Series 2: Class A, E, F	61
M81511/03	MIL-C-81511	Series 2: Class A, E, F	61
M81511/05	MIL-C-81511	Series 2: Class A, E, F	61
M81511/06	MIL-C-81511	Series 2: Class A, E, F	61
M81511/21	MIL-C-81511	Series 1: Class A, E, F	61
M81511/23	MIL-C-81511	Series 1: Class A, E, F	61
M81511/25	MIL-C-81511	Series 1: Class A, E, F	61
M81511/26	MIL-C-81511	Series 1: Class A, E, F	61
M81511/31	MIL-C-81511	Series 2: Class C, P, T	61

Fax-on-demand

US only (800) 260-9099

Outside US (650) 257-2301

Visit our website at www.tycoelectronics.com**Table A. Raychem connector code by military part number (cont'd.)**

Military part number	Connector specification	Series/Class	Raychem adapter code
M81511/32	MIL-C-81511	Series 2: Class C, P, T	61
M81511/33	MIL-C-81511	Series 2: Class C, P, T	61
M81511/34	MIL-C-81511	Series 2: Class C, P, T	61
M81511/35	MIL-C-81511	Series 1: Class C, P, T	61
M81511/36	MIL-C-81511	Series 1: Class C, P, T	61
M81511/37	MIL-C-81511	Series 1: Class C, P, T	61
M81511/38	MIL-C-81511	Series 1: Class C, P, T	61
M81511/41	MIL-C-81511	Series 3: Class A, E, F	61
M81511/45	MIL-C-81511	Series 3: Class A, E, F	61
M81511/46	MIL-C-81511	Series 3: Class A, E, F	61
M81511/49	MIL-C-81511	Series 3: Class A, E, F	61
M81511/51	MIL-C-81511	Series 4: Class A, E, F	61
M81511/53	MIL-C-81511	Series 4: Class A, E, F	61
M81511/55	MIL-C-81511	Series 4: Class A, E, F	61
M81511/56	MIL-C-81511	Series 4: Class A, E, F	61
M83723/01	MIL-C-83723	Series I: Class A, G, R	54
M83723/02	MIL-C-83723	Series I: Class A, G, R	54
M83723/03	MIL-C-83723	Series I: Class A, G, R	54
M83723/04	MIL-C-83723	Series I: Class A, G, R	54
M83723/05	MIL-C-83723	Series I: Class A, G, R	54
M83723/06	MIL-C-83723	Series I: Class A, G, R	54
M83723/07	MIL-C-83723	Series I: Class A, G, R	54
M83723/08	MIL-C-83723	Series I: Class A, G, R	54
M83723/13	MIL-C-83723	Series I: Class A, G, R	54
M83723/14	MIL-C-83723	Series I: Class A, G, R	54
M83723/17	MIL-C-83723	Series II: Class A, G, R	19
M83723/18	MIL-C-83723	Series II: Class A, G, R	19
M83723/19	MIL-C-83723	Series II: Class A, G, R	19
M83723/20	MIL-C-83723	Series II: Class A, G, R	19
M83723/23	MIL-C-83723	Series II: Class A, G, R	19
M83723/24	MIL-C-83723	Series II: Class A, G, R	19
M83723/36	MIL-C-83723	Series I: Class A, G, R	54
M83723/37	MIL-C-83723	Series I: Class A, G, R	54
M83723/38	MIL-C-83723	Series I: Class A, G, R	54
M83723/39	MIL-C-83723	Series I: Class A, G, R	54
M83723/40	MIL-C-83723	Series I: Class A, G, R	54
M83723/41	MIL-C-83723	Series I: Class A, G, R	54

Users should independently evaluate the suitability of the product for their application.
 Before ordering check with factory for most current data.

Adapter Selection

Raychem adapter code (cont'd.)

Table A. Raychem adapter code by military part number (cont'd.)

Military part number	Connector specification	Series/Class	Raychem adapter code
M83723/42	MIL-C-83723	Series I: Class G, R	54
M83723/43	MIL-C-83723	Series I: Class G, R	54
M83723/48	MIL-C-83723	Series I: Class G, R	54
M83723/49	MIL-C-83723	Series I: Class G, R	54
M83723/52	MIL-C-83723	Series I: Class K	19
M83723/53	MIL-C-83723	Series II: Class K	19
M83723/65	MIL-C-83723	Series III: Class H	54
M83723/66	MIL-C-83723	Series III: Class A, G, R	54
M83723/67	MIL-C-83723	Series III: Class A, G, R	54
M83723/68	MIL-C-83723	Series III: Class A, G, R	54
M83723/69	MIL-C-83723	Series III: Class A, G, R	54
M83723/71	MIL-C-83723	Series III: Class A, G, R	54
M83723/72	MIL-C-83723	Series III: Class A, G, R	54
M83723/73	MIL-C-83723	Series III: Class A, G, R	54
M83723/74	MIL-C-83723	Series III: Class A, G, R	54
M83723/75	MIL-C-83723	Series III: Class A, G, R	54
M83723/76	MIL-C-83723	Series III: Class A, G, R	54
M83723/77	MIL-C-83723	Series III: Class G, R	54
M83723/78	MIL-C-83723	Series III: Class G, R	54
M83723/82	MIL-C-83723	Series III: Class A, G, K, R, S	54
M83723/83	MIL-C-83723	Series III: Class A, G, K, R, S	54
M83723/84	MIL-C-83723	Series III: Class A, G, K, R, S	54
M83723/85	MIL-C-83723	Series III: Class A, G, K, R, S	54
M83723/86	MIL-C-83723	Series III: Class A, G, K, R	54
M83723/87	MIL-C-83723	Series III: Class A, G, K, R	54
M83723/91	MIL-C-83723	Series III: Class G, R, W	54
M83723/92	MIL-C-83723	Series III: Class G, R, W	54
M83723/95	MIL-C-83723	Series III: Class A, G, K, R	54
M83723/96	MIL-C-83723	Series III: Class A, G, K, R	54
M83723/97	MIL-C-83723	Series III: Class S	54
M83723/98	MIL-C-83723	Series III: Class S	54
MS17343	MIL-C-22992	Class C, J, R	32
MS17344	MIL-C-22992	Class C, J, R	32
MS17345	MIL-C-22992	Class C, J, R	32
MS17346	MIL-C-22992	Class C, R	32
MS17347	MIL-C-22992	Class C, J, R	32
MS17348	MIL-C-22992	Class C, R	32

Fax-on-demand

US only (800) 260-9099

Outside US (650) 257-2301

Visit our website at www.tycoelectronics.com**Table A. Raychem adapter code by military part number (cont'd.)**

Military part number	Connector specification	Series/Class	Raychem adapter code
MS24264	MIL-C-26500 (AL)	Class F, G, R Type B&T aluminium shell	51
MS24264	MIL-C-26500 (SST)	Class E Type B&T stainless steel shell	52
MS24265	MIL-C-26500 (AL)	Class F, G, R Type B&T aluminium shell	51
MS24265	MIL-C-26500 (SST)	Class E Type B&T stainless steel shell	52
MS24266	MIL-C-26500 (SST)	Class E Type B&T stainless steel shell	52
MS24266	MIL-C-26500 (AL)	Class F, G, R Type B&T aluminium shell	51
MS27466	MIL-C-38999	Series I: Class E, P, T	41
MS27467	MIL-C-38999	Series I: Class E, P, T	41
MS27468	MIL-C-38999	Series I: Class E, P, T	41
MS27469	MIL-C-38999	Series I: Class Y	Contact Tyco Electronics.
MS27472	MIL-C-38999	Series II: Class T	41
MS27473	MIL-C-38999	Series II: Class E, P, T	41
MS27474	MIL-C-38999	Series II: Class T	41
MS27475	MIL-C-38999	Series II: Class Y	Contact Tyco Electronics.
MS27479	MIL-C-38999	Series II: Class T	41
MS27480	MIL-C-38999	Series II: Class E, T	41
MS27481	MIL-C-38999	Series II: Class T	41
MS27482	MIL-C-38999	Series II: Class Y	Contact Tyco Electronics.
MS27484	MIL-C-38999	Series II: Class E, T	41
MS27497	MIL-C-38999	Series II: Class T	41
MS27515	MIL-C-38999	Series I: Class E	Contact Tyco Electronics.
MS27613	MIL-C-26500 (SST)	Class K Type B&T stainless steel shell	52
MS27614	MIL-C-26500 (SST)	Class K Type B&T stainless steel shell	52
MS27615	MIL-C-26500 (SST)	Class K Type B&T stainless steel shell	52
MS27652	MIL-C-38999	Series I: Class E, T	41
MS27653	MIL-C-38999	Series I: Class E, T	41
MS27654	MIL-C-38999	Series I: Class E, T	Contact Tyco Electronics.
MS27656	MIL-C-38999	Series I: Class E, T	41
MS27661	MIL-C-38999	Series I	41
MS27665	MIL-C-38999	Series I	41
MS3100	MIL-C-5015	Class A, E, F, R less endbell; solder contact	18
MS3101	MIL-C-5015	Class A, E, F, R less endbell; solder contact	18
MS3106	MIL-C-5015	Class A, E, F, R less endbell; solder contact	18
MS3107	MIL-C-5015	Class A, E, F, R less endbell; solder contact	18
MS3108	MIL-C-5015	Solder contact with endbell	15
MS3110	MIL-C-26482	Series 1: Class E, F, J, P	21
MS3111	MIL-C-26482	Series 1: Class E, F, J, P	21

Users should independently evaluate the suitability of the product for their application.
 Before ordering check with factory for most current data.

Adapter Selection

Raychem adapter code (cont'd.)

Table A. Raychem adapter code by military part number (cont'd.)

Military part number	Connector specification	Series/Class	Raychem adapter code
MS3114	MIL-C-26482	Series 1: Class E, F, P	24 ¹
MS3116	MIL-C-26482	Series 1: Class E, F, J, P	21
MS3120	MIL-C-26482	Series 1: Class E, F, J, P	21
MS3121	MIL-C-26482	Series 1: Class E, F, J, P	21
MS3124	MIL-C-26482	Series 1: Class E, F, P	24 ¹
MS3126	MIL-C-26482	Series 1: Class E, F, J, P	21
MS3128	MIL-C-26482	Series 1: Class E, F, J, P	21
MS3130	MIL-C-81703	Series 1: Class E, P, J	71
MS3132	MIL-C-81703	Series 1: Class E	71
MS3134	MIL-C-81703	Series 1: Class E, P, J	71
MS3137	MIL-C-81703	Series 1: Class E, P, J	71
MS3138	MIL-C-81703	Series 1: Class E, P, J	71
MS3140	MIL-C-81703	Series 1: Class E, J	71
MS3144	MIL-C-81703	Series 1: Class E, J	71
MS3147	MIL-C-81703	Series 1: Class E, J	71
MS3148	MIL-C-81703	Series 1: Class E, J	71
MS3400	MIL-C-5015	Class D, L, U, W crimp contact	54
MS3401	MIL-C-5015	Class D, L, U, W crimp contact	54
MS3404	MIL-C-5015	Class D, L, U, W crimp contact	54
MS3406	MIL-C-5015	Class D, L, U, W crimp contact	54
MS3408	MIL-C-5015	Class D, L, U, W crimp contact	54
MS3409	MIL-C-5015	Crimp contact	54
MS3412	MIL-C-5015	Class D, L, U, W crimp contact less endbell	54
MS3424	MIL-C-81703	Series 3: Class E, L	54
MS3445	MIL-C-81703	Series 2: Class E	71
MS3446	MIL-C-81703	Series 3: Class E, L	54
MS3450	MIL-C-5015	Class D, L, U, W crimp contact	54
MS3451	MIL-C-5015	Class D, L, U, W crimp contact	54
MS3454	MIL-C-5015	Class D, L, U, W crimp contact	54
MS3456	MIL-C-5015	Class D, L, U, W crimp contact	54
MS3459	MIL-C-5015	Class L, W crimp contact	54
MS3464	MIL-C-81703	Series 3: Class E, L	54
MS3467	MIL-C-81703	Series 3: Class E, L	54
MS3468	MIL-C-81703	Series 3: Class E, L	54
MS3470	MIL-C-26482	Series 2: Class A, L	54
MS3471	MIL-C-26482	Series 2: Class A, L	54
MS3472	MIL-C-26482	Series 2: Class A, L	54

¹Code 24 connectors have an internal accessory thread.

Fax-on-demand

US only (800) 260-9099

Outside US (650) 257-2301

Visit our website at www.tycoelectronics.com

Table A. Raychem adapter code by military part number (cont'd.)

Military part number	Connector specification	Series/Class	Raychem adapter code
MS3474	MIL-C-26482	Series 2: Class A, L	54
MS3475	MIL-C-26482	Series 2: Class A, L	54
MS3476	MIL-C-26482	Series 2: Class A, L	54
NAS1599	MIL-C-81703	Series 3:	54
NAS1641	MIL-C-81703	Series 3:	54
NAS1642	MIL-C-81703	Series 3:	54
NAS1643	MIL-C-81703	Series 3:	54
NAS1650	MIL-C-81703	Series 3:	54
NAS1651	MIL-C-81703	Series 3:	54
NAS1652	MIL-C-81703	Series 3:	54
NAS1653	MIL-C-81703	Series 3:	54
NAS1692	MIL-C-81703	Series 3:	54
NAS1693	MIL-C-81703	Series 3:	54
NAS1694	MIL-C-81703	Series 3:	54
NAS1699	MIL-C-81703	Series 3:	54
NAS1700	MIL-C-81703	Series 3:	54
NAS1701	MIL-C-81703	Series 3:	54
NAS1702	MIL-C-81703	Series 3:	54

Adapter Selection

Raychem adapter code (cont'd.)

Table B. Raychem adapter code by manufacturer's prefix

Manufacturer's prefix	Manufacturer	Connector specification	Series/Class	Raychem adapter code
10-214	Bendix	MIL-C-5015	MS3100 Class A, E, R	18
10-475	Bendix	40M38277		41
10-720	Bendix	MIL-C-5015	MS3100 Class A, E, R	18
118	Amphenol	MIL-C-26482	Series 2	54
149	Deutsch	MIL-C-81703	Series 1	71
162GB	Amphenol	MIL-C-26482	Series 1	76, 77 ⁴
164GB	Amphenol	BS9522 F0023		Contact Tyco Electronics.
165	Amphenol	None		Contact Tyco Electronics.
172	Amphenol	MIL-C-5015		Contact Tyco Electronics.
179	Amphenol	MIL-C-5015		Contact Tyco Electronics.
182	Amphenol	None		Contact Tyco Electronics.
246	Amphenol	MIL-C-5015	MS3100 Class E, F, R	18
251	Cannon	MIL-C-26482	Series 1	21
2PPN	Plessey	MIL-C-26482	Series 1	21
2PPN-07	Plessey	MIL-C-26482	Series 1	24 ³
2PSN	Plessey	BS9522 F0017	Patt 105	76, 77 ⁴
2PSN-07	Plessey	MIL-C-26482	Series 1	24 ³
348	Amphenol	MIL-C-81511	Series 1 and 2	61
381	Deutsch	40M39569		54
418	Amphenol	MIL-C-38999	Series I and II	41
45/PT	Socapex	MIL-C-26482	Series 1	21
450	Deutsch	MIL-C-26482	Series 1	21
451	Socapex	PRL 54125		21 or 24 ³
460	Deutsch	MIL-C-26482	Series 1	21
48	Amphenol	MIL-C-26500	Alum Class F, G, R	51
486	Amphenol	MIL-C-26482	Series 2	54
518	Amphenol	MIL-C-83723	Series III	54
5MS	FKI2	Def. Stan. 59-35	Patt 121A	75
602	Amphenol	Def. Stan. 59-56	Patt 602	54
602GB	Amphenol	Def. Stan. 59-56	Patt 602	54
62AB-14	Amphenol	MIL-C-26482	Series 1	Contact Tyco Electronics.
62GB	Amphenol	Def. Stan. 59-35	Patt 105	76, 77 ⁴
650	Schaltbau	VG 95329		61
652	Amphenol	LN 29504		54
652	UMD	PRL 54125		21 or 24 ³
674	Schaltbau	VG 95328		Contact Tyco Electronics.
675	Schaltbau	VG 95328		Contact Tyco Electronics.

Fax-on-demand

US only (800) 260-9099

Outside US (650) 257-2301

Visit our website at www.tycoelectronics.com**Table B. Raychem adapter code by manufacturer's prefix (cont'd.)**

Manufacturer's prefix	Manufacturer	Connector specification	Series/Class	Raychem adapter code
679	Schaltbau	VG 95329		61
69	Amphenol	MIL-C-5015	MS3100 Class E, F, R	18
71	Bendix	MIL-C-5015	MS3100 Class A, E, R	18
711	Amphenol	BS9522 F0042		54
801	Amphenol	None		54
837	Deutsch	MIL-C-83723	Series III	54
83723	Souriau	MIL-C-83723	Series III	54
83730	Deutsch	MIL-C-83723	Series III	54
845	Souriau	NFL 54120		Contact Tyco Electronics.
847	Souriau	NFL 54120		Contact Tyco Electronics.
850	Souriau	MIL-C-26482	Series 1	21
851	Souriau	MIL-C-26482	Series 1	21
8520	Souriau	MIL-C-26482	Series 2	54
8525	Souriau	NAS 1599		54
8526	Souriau	PAN 6432-1		54
853	Souriau	MIL-C-83723	Series III	54
857	Souriau	LN 29728		54
89	Souriau	NFL 54140		54
891	Souriau	MIL-C-5015	Class K	Contact Tyco Electronics.
892	Souriau	MIL-C-5015	Class K	Contact Tyco Electronics.
8LT	Souriau	MIL-C-38999	Series I	41
8ST	Souriau	VG 96912	Series 1	47
8T	Souriau	MIL-C-38999	Series II	41
9-815	Deutsch	MIL-C-81511	Series 3 and 4	61
91-483	Bendix	MIL-C-26482	Series 2	54
944	Matrix	MIL-C-5015	MS3400 Class L, U, W	54
951	Deutsch	LN 29500		Contact Tyco Electronics.
97	Amphenol	MIL-C-5015	MS3100 Class A	18
981	Matrix	MIL-C-5015	MS3400	54
A815	Deutsch	MIL-C-81511	Series 3	61
AA70	Deutsch	Not known		71
AB05	AB Elec	Def. Stan. 59-35	Patt 105	76, 77 ⁴
AB06	AB Elec	Def. Stan. 59-35	Patt 105	76, 77 ⁴
ABB	AB Elec	BS9522 F0032		78
ABJ	AB Elec	MIL-C-38999	Series I and II	41
ADS	Deutsch	MIL-C-81703		71
AFD	Deutsch	MIL-C-83723	Series I	54

Users should independently evaluate the suitability of the product for their application.
Before ordering check with factory for most current data.

Adapter Selection

Raychem adapter code (cont'd.)

Table B. Raychem adapter code by manufacturer's prefix (cont'd.)

Manufacturer's prefix	Manufacturer	Connector specification	Series/Class	Raychem adapter code
AFD5	Deutsch	MIL-C-26482	Series 2	54
B815	Deutsch	MIL-C-81511	Series 4	61
BE	Pyle	MIL-C-83723	Series III	54
BG	Bendix	MIL-C-26482	Series I	21
BL	G&H Tech	MIL-C-38999	Series IV	40
BL	TRW	MIL-C-38999	Series IV	40
BT	Burndy	MIL-C-26482	Series 1	21
BT	Pyle	MIL-C-83723	Series III	54
BTK	Deutsch	MIL-C-26482	Series 1	21
BY1	Pyle	MIL-C-83723	Series III	54
C48	TRW	MIL-C-26500	Aluminium	51
CA (Bayonet)	Cannon	VG 95234		78
CA3101	Cannon	MIL-C-5015	MS3100 class E, F, R	18
CA3101	Cannon	MIL-C-5015	MS3100 Class A	18
CA3101KE	Cannon	MIL-C-5015	Class K	Contact Tyco Electronics.
CIR	VEAM	VG 95234		78
CN0930	TRW	MIL-C-83723	Series III	54
CT	Burndy	MIL-C-38999	Series II	41
CT	Plessey	MIL-C-38999	Series II	41
CV-R	Cannon	MIL-C-83723	Series II	19
CV34	Cannon	MIL-C-5015	MS3400 Class L, U, W	54
CVA	Cannon	MIL-C-83723	Series II	19
CWL	Cannon	None		31
CWLD	Cannon	MIL-C-22992	Class C, J, R	32
D817	Deutsch	MIL-C-81703	Series 3	54
DA	Deutsch	None		71
DBAD	Deutsch	MIL-C-81703		Contact Tyco Electronics.
DBAS	Deutsch	MIL-C-81703	Series 3	54
DD	Deutsch	MIL-C-81703	Series 2	71
DFE	Deutsch	MIL-C-26482	Series 2	54
DKM	Deutsch	VG 95328		Contact Tyco Electronics.
DL	Deutsch	MIL-C-83723	Series III	54
DM	Deutsch	MIL-C-81703	Series 1	71
DPX	Cannon			Contact Tyco Electronics.
DS	Deutsch	None		71
DTS	Deutsch	MIL-C-38999	Series III	40
EA	Pyle	None		54

Fax-on-demand

US only (800) 260-9099

Outside US (650) 257-2301

Visit our website at www.tycoelectronics.com**Table B. Raychem adapter code by manufacturer's prefix (cont'd.)**

Manufacturer's prefix	Manufacturer	Connector specification	Series/Class	Raychem adapter code
EB	Pyle	NAS 1599		54
EEG	Pyle	MIL-C-83723	Series I	54
ES	Pyle	None		54
ESC004	Various	MIL-C-5015	Class K	Contact Tyco Electronics.
ET	Pyle	NAS 1599		54
FC	Flight	MIL-C-5015	Rev E only	Contact Tyco Electronics.
FDBA	Deutsch	LN 29504		54
FF	Flight	MIL-C-5015	MS3400 Class D, L, U, W	54
FH	Flight	MIL-C-83723	Series III	54
FPK	Pyle	MIL-C-26500	Class K	52
FP5K	Pyle	MIL-C-26500	Class K	Contact Tyco Electronics.
FYL	Pyle	MIL-C-26500	Class K	52
G	Burndy	None		21
GCE	General	MIL-C-26482	Series 1	21
GTA	Hughes	MIL-C-28840		30
HAN	Deutsch	MIL-C-5015	MS3100 Class E, KE	Contact Tyco Electronics.
HD	SAE	MIL-C-28840		30
HTMAS	Cannon	MIL-C-5015	Class K	Contact Tyco Electronics.
HTMF	Cannon	MIL-C-83723	Series III: Class K	54
HTMS	AB Elec	MVEE 695		75
JT	Amphenol	MIL-C-38999	Series II	41
JT	Bendix/FKI	MIL-C-38999	Series II	41
JT	Socapex	MIL-C-38999	Series II	41
JT-R	FKI	PAN 6433-1		41
JT-R	Teldix	PAN 6433-1		41
KFS	Cannon	MIL-C-28840		30
KJ	Cannon	MIL-C-38999	Series II	41
KJA	Cannon	MIL-C-38999	Series III	40
KJJ	Cannon	MIL-C-38999	Series II	Contact Tyco Electronics.
KJL	Cannon	MIL-C-38999	Series I	Contact Tyco Electronics.
KJL	Cannon	MIL-C-38999	Series I	41
KPSE	Cannon	MIL-C-26482	Series 1	21
KPT	Cannon	MIL-C-26482	Series 1	21
KV-R	Cannon	NAS 1599		54
L	Burndy	MIL-C-26482	Series 1	21
LJT	Bendix	MIL-C-38999	Series I	41
LJT	Socapex	MIL-C-38999	Series I	41

Users should independently evaluate the suitability of the product for their application.
Before ordering check with factory for most current data.

Adapter Selection

Raychem adapter code (cont'd.)

Table B. Raychem adapter code by manufacturer's prefix (cont'd.)

Manufacturer's prefix	Manufacturer	Connector specification	Series/Class	Raychem adapter code
LL3	Deutsch	MIL-C-81511		61
LL5/6	Deutsch	BS9540 F0001	Patt 602	Contact Tyco Electronics.
LMB	Litton-Veam	Def. Stan. 59-35	Patt 121A	75
LPT	Deutsch	MIL-C-26482	Series 1	21
LS	Pyle	None		54
LTT	FKI ²	BS9522 F0029	Patt 616	41
M-T	Burndy	MIL-C-26482	Series 1	21
M723	Matrix	MIL-C-83723	Series II	19
MB1	Matrix	MIL-C-26482	Series 2	54
MB3	Matrix	MIL-C-83723	Series III	54
MB9	Matrix	MIL-C-38999	Series I and II	41
MD	Matrix	MIL-C-26482	Series 2	54
MDR	Deutsch	None		71
MF	Cannon	MIL-C-83723	Series III	54
MK12	Plessey	Def. Stan. 59-35	Patt 603	76, 77 ⁴
MK18	Plessey	Def. Stan. 59-35	Patt 608	79 ⁵
MK38	Plessey	MIL-C-38999	Series I	41
MK25	Plessey	MIL-C-38999	Series II	41
MK7	Plessey	DEF 5325-2	Patt 104	Contact Tyco Electronics.
MK8	Plessey	Def. Stan. 59-35	Patt 105	76, 77 ⁴
ML94	Matrix	MIL-C-38999	Series IV	40
MQ3	Matrix	MIL-C-83723	Series III	54
MT3	Matrix	MIL-C-83723	Series III	54
MT93	Matrix	MIL-C-38999	Series III	40
P5	Plessey	NFL 54 125		76 or 24 ³ , 77 ⁴
PAT104D	AB Elec	Def. Stan. 59-35	Patt 104	Contact Tyco Electronics.
PT	Socapex	MIL-C-26482	Series 1	76, 77 ⁴
PT	Teldix	MIL-C-26482	Series 1	76, 77 ⁴
PT-CE	Bendix	None		22
PT-G	Teldix	VG 95328		Contact Tyco Electronics.
PT-SE	Socapex	MIL-C-26482	Series 1	76, 77 ⁴
PT-SE	Teldix	MIL-C-26482	Series 1	76, 77 ⁴
PT07	Bendix	MIL-C-26482	Series 1	24 ³
PT07SE	FKI ²	MIL-C-26482	Series 1	24 ³
PT33	FKI ²	BS9522 F0017	Patt 105	76, 77 ⁴
PT33SE	FKI ²	BS9522 N0001	Patt 603	76, 77 ⁴
PT44	FKI ²	BS9522 F0017	Patt 105	76, 77 ⁴

Fax-on-demand

US only (800) 260-9099

Outside US (650) 257-2301

Visit our website at www.tycoelectronics.com**Table B. Raychem adapter code by manufacturer's prefix (cont'd.)**

Manufacturer's prefix	Manufacturer	Connector specification	Series/Class	Raychem adapter code
PT44SE	FKI ²	BS9522 N0001	Patt 603	76, 77 ⁴
PT55	FKI ²	BS9522 F0017	Patt 105	76, 77 ⁴
PT55SE	FKI ²	BS9522 N0001	Patt 603	76, 77 ⁴
PT77	FKI ²	BS9522 F0017	Patt 105	76, 77 ⁴
PT77SE	FKI ²	BS9522 N0001	Patt 603	76, 77 ⁴
PTG55	FKI ²	BS9522 F0017	Patt 105	76, 77 ⁴
PTG55SE	FKI ²	BS9522 N0001	Patt 603	76, 77 ⁴
PTS-DR	Bendix	MIL-C-26482	Series 2	54
PV7	Cannon	MIL-C-26482	Series 2	54
PVJ	Cannon	MIL-C-26482	Series 2	54
PVW	Cannon			54
PVX	Cannon	Def. Stan. 59-56	Patt 602	54
QDP	Bendix	None		32
QRP	AB Elec			78
QWL	Bendix	None		31
QWLD	Bendix	MIL-C-22992	Class C, J, R	32
RD1	Raychem	MIS-20065		54
RR	Deutsch	Def. Stan. 59-56	Patt 602	54
RR20	Deutsch	PAN 6432-2		54
RR50	Deutsch	PAN 6432-1		54
RR70	Deutsch	PAN 6432-2		54
RSM	Deutsch	None		71
RTK	Deutsch	None		71
SA	SAE	MIL-C-5015	MS3400	54
SB	Bendix	MIL-C-5015	Class E	18
SB-104	AB Elec	Def. Stan. 59-35	Patt 104	Contact Tyco Electronics.
SB-M4	AB Elec	Def. Stan. 59-35	Patt 104	Contact Tyco Electronics.
SB-MS	AB	BS9522 F0030		75
SC	Bendix	MIL-C-5015	MS3100 Class A	18
SCB	SICEM	VG 95234		Contact Tyco Electronics.
SF	Bendix	MIL-C-5015	MS3100 Class E	18
SG	Bendix	MIL-C-5015	MS3100 Class E	18
SJT	Various	PAN 6433-2		47
SJT07	Various	PAN 6433-2		Contact Tyco Electronics.
SLPT	Deutsch	MIL-C-26482	Series 1	76, 77 ⁴
SM	Bendix	MIL-C-5015	MS3100 Class A, E, R	18
SPT	Bendix	MIL-C-26482	Series 1	76, 77 ⁴

Users should independently evaluate the suitability of the product for their application.
 Before ordering check with factory for most current data.

Adapter Selection

Raychem adapter code (cont'd.)

Table B. Raychem adapter code by manufacturer's prefix (cont'd.)

Manufacturer's prefix	Manufacturer	Connector specification	Series/Class	Raychem adapter code
SPT	Socapex	MIL-C-26482	Series 1	76, 77 ⁴
SPT07	Various	MIL-C-26482	Series 1	24 ³
STK	Deutsch	None		71
STT	FKI ²	BS9522 F0012	Patt 6 15	47
STT07	FKI ²	BS9522 F0012	Patt 6 15	Contact Tyco Electronics.
T3 ¹	Pyle	MIL-C-38999	Series III	40
TRIM TRIO	Burndy	None		Contact Tyco Electronics.
TT	FKI ²	BS9522 N0003	Patt 6 14	41
TV	FKI ² /Bendix	MIL-C-38999	Series III	40
TV-O-R	Bendix	MIL-C-38999	Series III and IV	40
TVP	FKI ² /Bendix	MIL-C-38999	Series III	40
TVPS	FKI ² /Bendix	MIL-C-38999	Series III	Contact Tyco Electronics.
TVS	FKI ² /Bendix	MIL-C-38999	Series III	Contact Tyco Electronics.
Tri-Start	Bendix	MIL-C-38999	Series III and IV	40
VPT	VEAM	MIL-C-26482	Series 1	21
VTT	FKI ²	MIL-C-38999	Series III	40
ZZY/ZZW	Pyle	MIL-C-26500	Class R, G (AL)	51
ZZY/ZZW	Pyle	MIL-C-26500	Class E (SST)	52

¹May be a number or letter depending upon connector style.

²FKI was previously Thorn.

³Code 24 connectors have an internal accessory thread.

⁴Code 77 braided version.

⁵Free connectors only.

Table C. Raychem connector code by connector specification

Connector specification	Series/Class	Raychem adapter code
40M38277		41
40M39569		54
BS9520	G0001	41
BS9520	G0002	41
BS9520	G0003	40
BS9522 F0012	Patt 6 15	47
BS9522 F0014	Patt 104	Contact Tyco Electronics.
BS9522 F0017	Patt 105	76
BS9522 F0020	Patt 608	79 ²
BS9522 F0023		Contact Tyco Electronics.
BS9522 F0029	Patt 6 16	41

Fax-on-demand

US only (800) 260-9099

Outside US (650) 257-2301

Visit our website at www.tycoelectronics.com**Table C. Raychem adapter code by connector specification (cont'd.)**

Connector specification	Series/Class	Raychem adapter code
BS9522 F0030	Patt 12 1A	75
BS9522 F0032	Patt 12 1B	78
BS9522 F0042		54
BS9522 N0001	Patt 603	76
BS9522 N0003	Patt 6 14	41
BS9540 F0001	Patt 602	54
LN 29500		21
LN 29504		54
LN 29728		54
LN 29729		47
MIL-C-22992	Class C, J, R	32
MIL-C-26482	Series 1	21, 24 ¹
MIL-C-26482	Series 2	54
MIL-C-26500	Aluminum, Class F, G, R	51
MIL-C-26500	Stainless steel, Class E, K	52
MIL-C-28840	Class D	30
MIL-C-38999	Series I and II	41
MIL-C-38999	Series III and IV	40
MIL-C-5015	MS3400	54
MIL-C-5015	MS3100	18, 15 (with endbell)
MIL-C-5015	5MS	75
MIL-C-815 1 1	Series 1, 2, 3, and 4	61
MIL-C-81 703	Series 1, 2	71
MIL-C-81 703	Series 3	54
MIL-C-83723	Series II	19
MIL-C-83723	Series I and III	54
MIL-C-85049/59		32
MIL-C-85049/60		54
MIL-C-85049/62		41
MIL-C-85049/69		40
MIS-20065		54
MVEE	5MS	75
NAS 1599		54
NFL 54 120		Contact Tyco Electronics.
NFL 54 140		54
PAN 6432-1		54
PAN 6432-2		54
PAN 6433-1		41
PAN 6433-2		47
PRL 54 125		21, 24 ¹
VG 95234		78
VG 95328		Contact Tyco Electronics.
VG 95329		61
VG 96912	Series 2	41
VG 96912	Series 1	47

¹ Code 24 connectors have an internal accessory thread.² Free connectors only; for other styles contact your Tyco Electronics product representative.

**Users should independently evaluate the suitability of the product for their application.
Before ordering check with factory for most current data.**

Adapter Selection

Raychem adapter family

Selecting the Raychem adapter family

Using Table D on the next page and the Raychem adapter code you selected in Table A, B, or C, select the Raychem adapter family for the adapter type you chose (spin-coupling or Tinel-Lock).

With the alphanumeric prefix for that family you can then build the part number for your Raychem adapter.

Note: Although this catalog presents only Raychem spin-coupling and Tinel-Lock adapters, through the Raychem Fax-on-Demand system you can obtain a specification control drawing for any adapter family shown in Table D.

Fax-on-demand

US only (800) 260-9099

Outside US (650) 257-2301

Visit our website at www.tycoelectronics.com**Table D. Identification of adapter family prefix by Raychem adapter code**

Raychem connector code	Boot adapter		Shielded adapter			Tinel-Lock adapter	Band-strap adapter*
	Solid (fixed)	Spin-coupling	Straight	45°	90°	Straight, 45°, and 90°	
15	210M5	202M5	219M0	219M1	219M2	TXR15	-
18	218M5	218M6	218M7	218M8	218M9	TXR 18	BND 18
19	201M7	201M4	-	-	-	-	-
21	203M6	203M9	206M0	206M1	206M2zx	TXR 21	BND 21
24	208M5	208M6	216M0	216M1	206M5	-	-
30	211M8	211M9	211M5	211M6	211M7	TXR 30	-
32	-	204M3	207M3	212M4	212M5	TXR 32	BND 32
40	209M3	209M4	208M7	208M8	208M9	TXR 40	BND 40
41	202M1	202M2	204M0	204M1	204M2	TXR 41	BND 41
47	202M8	202M7	210M0	210M1	210M2	TXR 47	BND 47
51	207M4	205M5	207M0	207M1	207M2	TXR 51	-
52	208M3	209M6	208M0	208M1	208M2	TXR 52	-
54	201M9	201M1	203M0	203M1	203M2	TXR 54	BND 54
61	202M3	202M4	205M0	205M1	205M2	TXR 61	-
71	203M5	202M9	217M0	217M1	217M2	TXR 71	-
75	228M5	228M7	227M0	227M1	227M2	TXR 75	-
76	225M6	225M5	-	-	-	TXR 76	-
77	228M6	228M8	228M0	228M1	228M2	-	-
78	225M4	225M3	225M0	225M1	225M2	TXR 78	-
79	-	229M3	229M1	229M2	229M0	TXR 79	-
80	215M4	213M5	213M6	213M7	213M8	TXR80	-
81	214M3	214M4	214M5	214M6	214M7	TXR81	-

*Consult your Tyco Electronics product representative for details and other adapter code needs.

Adapter Selection

Raychem part number

Having selected the right adapter type and Raychem adapter family, you can now construct a part number for the adapter.

1. Start with the alphanumeric prefix you selected in Table D. This will be the basis of your part number.
2. Add to the prefix the codes and designators required for your adapter type and application. These may include several or all of the following:
 - Order number
 - Manufacturer's prefix
 - Material
 - Finish
 - Entry size
 - Ring designator
 - Option codes

Using the right codes and designators helps ensure that the adapter you select will meet the application requirements.

To determine which codes and designators you will need, use the Part numbering system on the next page. To select the right codes and designators, turn to the pages that follow.

Fax-on-demand

US only (800) 260-9099

Outside US (650) 257-2301

Visit our website at www.tycoelectronics.com

Part numbering system

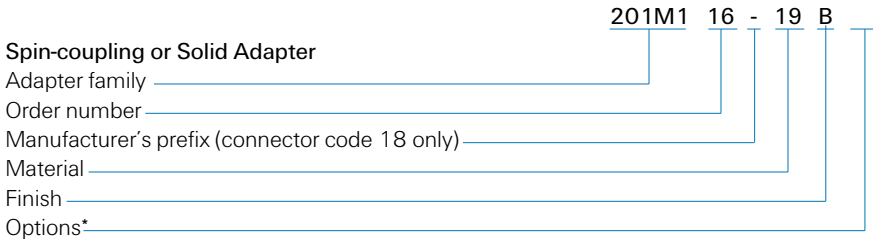

*For full range of options consult your Tyco Electronics product representative.

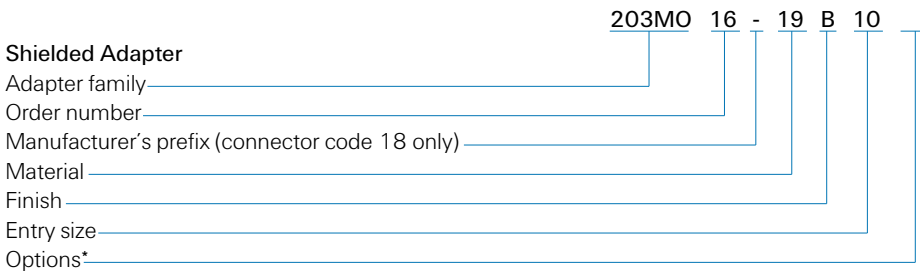

- Standard braid length (6") requires no modification code.
- Nonstandard braid length is stated in inches (12 = 12" length)

*For full range of options consult your Tyco Electronics product representative.

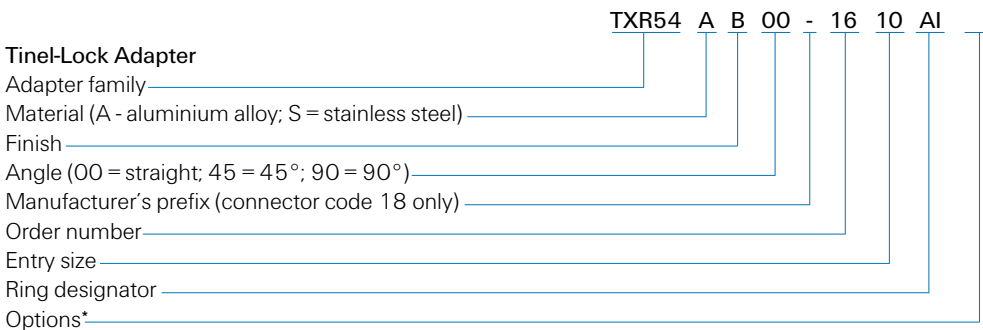

*For full range of options consult your Tyco Electronics product representative.

Users should independently evaluate the suitability of the product for their application. Before ordering check with factory for most current data.

Adapter Selection

Material and finish

Selecting the material and finish

To ensure optimum compatibility, select the adapter material and finish to match those of the connector.

Most circular connectors are manufactured from aluminum with a cadmium finish.

Fax-on-demand

US only (800) 260-9099

Outside US (650) 257-2301

Visit our website at www.tycoelectronics.com**Raychem material codes**

Material* description	Material code		Typical applications
	Solid, spin-coupling, and shielded adapters	Tine-Lock adapters	
Aluminum alloy	19	A	Standard material for normal applications
Stainless steel	62	S	Corrosion-resistant and high-temperature (firewall) applications
Nickel aluminum bronze	01	B	Exposed marine environments

*Other materials available upon request.

Raychem finish codes

Finish* description	Color	Finish code	Typical applications
Cadmium, per QQ-P-416, Type II, Class 3	Olive drab	A	Corrosion-resistant conductive finish
Cadmium, per QQ-P-416, Type II, Class 3 over electroless nickel (500-hour salt-spray-resistant finish)	Olive drab	B	Corrosion resistance for exposed environments
Electroless nickel, per MIL-C-26074, Class 4, Grade B	—	C	High conductivity for optimum screening performance
Anodized, hard, per MIL-A-8625, Type III, Class 2	Black	G	Nonconductive finish for aluminum adapters
Passivated, per QQ-P-35 or MIL-S-5002	—	J	Nonconductive, corrosion-resistant finish for stainless steel adapters
Unplated, shotblast	—	W	Nonreflective finish for nickel aluminum bronze adapters

*Other finishes available upon request.

Adapter Selection

Entry size

Determining the wire bundle size

The entry size of an adapter is based on the size of the wire bundle. If you don't know the size of the wire bundle, measure a prototype or calculate the size.

Calculation of the wire bundle size is based on three values:

- Cable outside diameter (COD)
- Cable jacket thickness
- Jacketed cable diameter

Instructions for calculating these values follow.

COD calculation

To calculate the cable outside diameter, first determine whether the wires in the bundle are of the same size or of different sizes.

COD calculation for wires of the same size

For bundles with wires that are all of the same size, follow these steps:

1. Determine the number of wires in the wire bundle.
2. Find the multiplication factor for that number in Table E below.
3. Find the wire diameter in the Wire and Cable section (Section 9) of this catalog.
4. Multiply the wire diameter (from Step 3) by the multiplication factor (from Step 2) as shown below.

Formula: $D = Fd$

Where: D = Bundle diameter
 F = Multiplication factor
 d = Wire diameter

Example: A bundle of wires containing
27 x 44A0111-22

$F = 6.00$ (the multiplication factor for
27 wires from Table E)
 $d = 1.19$ mm (.049 in)*
 $D = 6 \times 1.19$ mm (6 x .049 in)
 $D = 7.14$ mm (.294 in)

*Diameter of 44A0111-22 wire obtained from the Wire and Cable section (Section 9) of this catalog.

COD calculation for wires of different sizes

To determine the wire bundle diameter when using wires of different sizes, follow these steps:

1. Determine the number of wires in the wire bundle.
2. Find the diameter of the wires in the Wire and Cable section of this catalog.
3. Calculate the cable outside diameter by using this formula:

$$\sqrt{D} = 1.2 \sqrt{N_1d_1^2 + N_2d_2^2 + N_3d_3^2}$$

Where: D = Bundle diameter
 N = Number of wires
 d = Diameter of wires

Example: A bundle of wires containing
3 x 44A0111-221* (1.192-mm dia.)
5 x 44A0111-201* (1.42-mm dia.)
1 x 44A0111-181* (1.65-mm dia.)

$$D = 1.2 \sqrt{3 \times 1.192^2 + 5 \times 1.42^2 + 1 \times 1.65^2}$$
$$D = 1.2 \sqrt{3 \times 1.4 + 5 \times 2.02 + 1 \times 2.7}$$
$$D = 1.2 \sqrt{4.2 + 10.1 + 2.7}$$
$$D = 1.2 \sqrt{17}$$
$$D = 1.2 \times 4.12$$
$$D = 4.95 \text{ mm}$$

*For wire information see the Wire and Cable section (Section 9) of this catalog.

Fax-on-demand

US only (800) 260-9099

Outside US (650) 257-2301

Visit our website at www.tycoelectronics.com

Table E. Multiplication factors for wire bundles with equal size wires

This table provides multiplication factors for wire bundles of 1 to 61 wires.

To determine the approximate diameter of a wire bundle when the wires are all the same size, find the factor for the number of wires in the bundle and multiply the wire diameter by that factor.

Multiplication factors for wire bundles with equal size wires			
Number of wires	Multiplication factor	Number of wires	Multiplication factor
1	1.00	32	6.70
2	1.60	33	6.70
3	2.00	34	7.00
4	2.41	35	7.00
5	2.70	36	7.00
6	3.00	37	7.00
7	3.00	38	7.31
8	3.60	39	7.31
9	4.00	40	7.31
10	4.00	41	7.61
11	4.00	42	7.61
12	4.00	43	7.61
13	4.41	44	7.61
14	4.41	45	8.00
15	4.70	46	8.00
16	4.70	47	8.00
17	5.00	48	8.00
18	5.00	49	8.41
19	5.00	50	8.41
20	5.31	51	8.41
21	5.31	52	8.41
22	5.61	53	8.70
23	5.61	54	8.70
24	5.61	55	8.70
25	6.00	56	8.70
26	6.00	57	9.00
27	6.00	58	9.00
28	6.41	59	9.00
29	6.41	60	9.00
30	6.41	61	9.00
31	6.70		

Users should independently evaluate the suitability of the product for their application.
Before ordering check with factory for most current data.

Adapter Selection

Entry size (cont'd.)

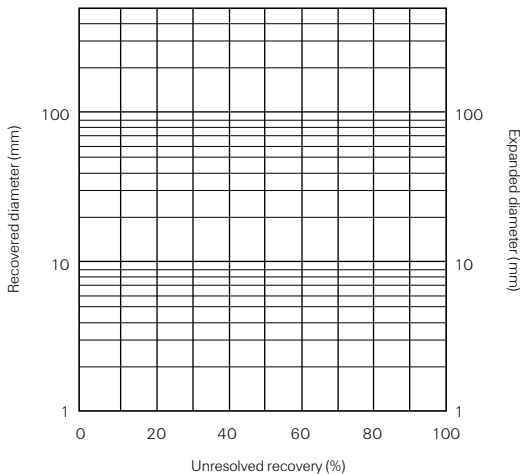

Figure 1.

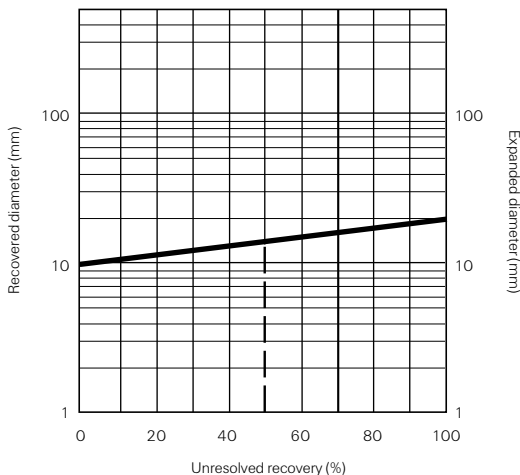

Figure 2.

Cable jacket thickness calculation

To determine the wall thickness of a jacket over a wire bundle:

1. Use the chart in Figure 1 to determine the unresolved recovery of the tubing jacket
2. Use the chart in Figure 3 to determine the wall thickness reduction factor.
3. Calculate the jacket wall thickness by multiplying the fully shrunk wall thickness (as detailed in the Tubing section - Section 3 - of this catalog) by the wall thickness reduction factor.

Step 1. Determine the unresolved recovery of the tubing jacket.

1. Locate the recovered and expanded diameters of the chosen tubing size on the chart in Figure 1.
2. Lay a straight edge between the two values and pencil in a straight line connecting them.
3. Find the wire bundle diameter on the Expanded Diameter scale of the chart in Figure 1.
4. From the wire bundle diameter value, draw a straight horizontal line across the chart.
5. From the intersection of the line from step 3 and the line from step 2, read down vertically to the "Unresolved Recovery" for this combination.

Example (see Figure 2):

Recovered tubing diameter = 10 mm
Expanded tubing diameter = 20 mm
Wire bundle diameter = 13 mm
Unresolved recovery = 50%

Fax-on-demand

US only (800) 260-9099

Outside US (650) 257-2301

Visit our website at www.tycoelectronics.com

Step 2. Find the wall thickness reduction factor.

1. On the Unresolved Recovery scale of the chart in Figure 3 at right, find the unresolved recovery value determined in Step 1.
2. From the unresolved recovery value, draw a straight line across the chart to the curved line.
3. At the point where that line intersects the chart's curved line, read vertically down to the wall thickness reduction factor.

Example shown:

Unresolved recovery = 50%

Reduction factor = 0.68

Step 3. Calculate the jacket wall thickness.

Multiply the fully shrunk wall thickness of the tubing by the reduction factor.

Example:

Fully shrunk wall thickness of tubing = 1.45 mm

Wall thickness reduction factor

(from Figure 3) = 0.68

Jacket wall thickness = 1.4 x 0.68

= 0.99 mm

Note:

If the cable is to be shielded (screened), an addition must be made to the wire bundle diameter for the braid. In the example, 0.8 mm would be added to the wire bundle diameter for a single layer of RAY 101 (36 AWG) braid to make a total wire bundle diameter of 13.8 mm.

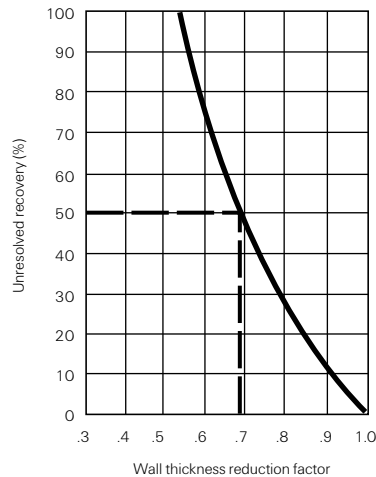

Figure 3.

Adapter Selection

Entry size (cont'd.)

Determining the entry size

Once you have the wire bundle size, you can use the chart in Figure 4 to select the entry size. This chart shows the minimum entry sizes for cables from 3 to 38 mm (.118 to 1.496 in) in diameter. In other words, the white spaces on the chart represent all of the cable outside diameters each entry size will fit.

Follow these steps:

1. Find the cable diameter on the chart.
2. Note the lowest entry size that will fit the cable diameter

Braided adapters

The extreme flexibility of the braid on these adapters accommodates a large range of cable diameters. It is therefore recommended that the standard entry size for any given adapter part number be specified as indicated on the relevant data sheet. Nonstandard entry sizes are available on special order.

Use the selection chart in Figure 4 to ensure that the standard entry size will pass over the jacketed cable diameter.

Tinel-Lock adapters

With Tinel-Lock adapters, the cable braid must be opened up to fit onto the outside diameter of the adapter entry. For optimum performance, select the smallest entry size that will pass over the jacketed cable diameter. Repair of the connector will be easier using the boot and shield rollback if a slightly larger than minimum entry size is used.

The selection chart in Figure 4 shows the minimum entry sizes for cable diameters in the range of 3 mm to 38 mm. This will ensure that the jacketed cable passes through the adapter for easy assembly.

It should be checked to be sure the braid will open sufficiently to fit the entry size selected and to ensure that the braid and boot can be rolled back.

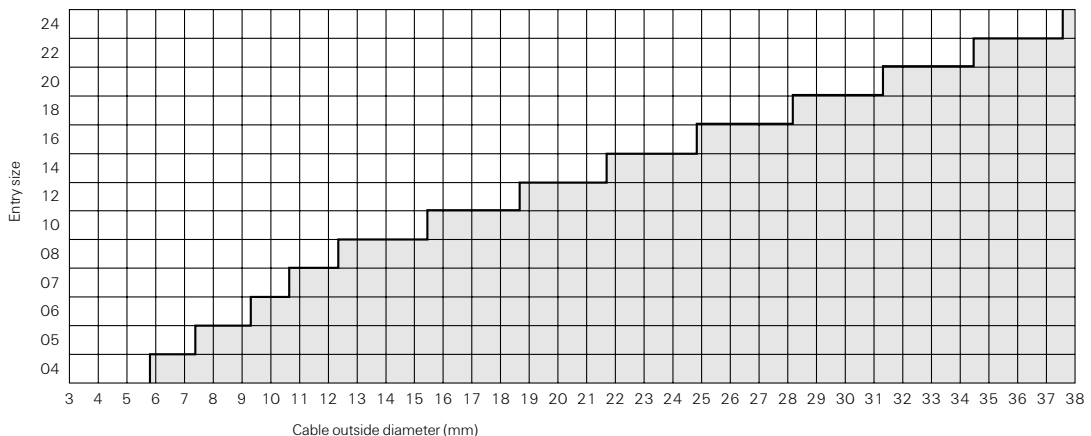

Figure 4. Entry size by cable outside diameter (in millimeters)

Fax-on-demand

US only (800) 260-9099

Outside US (650) 257-2301

Visit our website at www.tycoelectronics.com**Ray 101 Tinned-Copper Braid**

Tyco Electronics manufactures a range of Raychem tubular braided shields (sometimes called “screens”) that are used for shielding hand-built harnesses.

These braids are specially designed to have:

- Good surface transfer impedance
- Large opening ratio
- Good handling characteristics
- Compatibility with Tinel-Lock adapters

Sizes are available to cover wire bundle diameters from 2.5 to 38 mm (.10 to 1.50 in). The table below shows the wire bundle diameter range for each braid size and also shows which adapter entry sizes are compatible with each of these braids and bundle diameters.

The entry sizes do not allow for the additional thickness of the braid and the heat-shrunk cable jacket.

Ray 101 data (mm/in)

Part number	Number of carriers	Number of ends/ carrier	Individual strand size (mm/AWG)	Wire bundle diameter range		Wall thickness (nom.)	Tinel adapter entry size (single-layer brand)
				min.	max.		
RAY 101-3.0	16	10	0.1 (38)	2.5 (.10)	5.0 (.20)	N/A	N/A
RAY 101-4.0	24	7	0.13 (36)	3.5 (.14)	7.5 (.30)	0.4 (.02)	04*
RAY 101-6.0	24	9	0.13 (36)	4.0 (.16)	9.5 (.37)	0.4 (.02)	04, 05, 06*, 07
RAY 101-7.5	24	14	0.13 (36)	6.0 (.24)	14.0 (.55)	0.4 (.02)	05, 06, 07, 10*
RAY 101-10.0	36	12	0.13 (36)	8.0 (.31)	22.0 (.87)	0.4 (.02)	07, 08, 10, 12*
RAY 101-12.5	36	15	0.13 (36)	10.0 (.39)	24.0 (.94)	0.4 (.02)	08, 10, 12, 14, 16*
RAY 101-20.0	48	16	0.13 (36)	16.0 (.63)	38.0 (1.50)	0.4 (.02)	12, 14, 16, 18, 20, 22

*Combination is not preferred; use only if absolutely necessary.

Adapter Selection

Tinel-Lock ring



Tinel-Lock ring and braid

The Tinel-Lock ring designator must be specified according to the type of cable braid used, and is added to the part number after the adapter entry size. There are two types of ring, AI and BI, for each entry size.

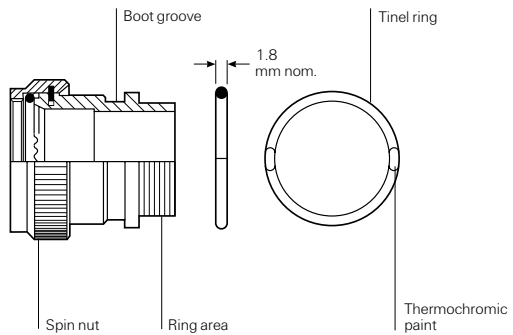

Available in:	Americas	Europe	Asia Pacific
	■	■	■

Braid type	Ring designator A or B = Size of braid I = Insulating layer
Single layer 36 AWG	AI
Single layer 34 AWG	AI
Single layer 32 AWG	BI
Single layer 30 AWG	BI
Double layer 36 AWG	BI
Double layer 34 AWG	BI

Tinel rings are marked with thermochromic paint, which changes color when the correct installation temperature is reached. BI-type rings are identified with a red spot.

Braid type, material, and construction are variable. If in doubt, contact Tyco Electronics for advice.

Table F. Wire gauge (AWG) to diameter cross-reference

Use this table to establish wire gauge if not known.

Wire gauge (AWG)	Diameter	
	mm	(in)
40	0.079	(0.0031)
39	0.089	(0.0035)
38	0.102	(0.0040)
37	0.114	(0.0045)
36	0.127	(0.0050)
35	0.142	(0.0056)
34	0.160	(0.0063)
33	0.180	(0.0071)
32	0.203	(0.0080)
31	0.226	(0.0089)
30	0.254	(0.0100)
29	0.287	(0.0113)
28	0.320	(0.0126)

*Note: It may be necessary to use an 'A' rather than a 'B' ring on entry sizes 04-07 when terminating a multicore cable with double layer machined braid. Braid applied by machine provides less size flexibility than pull-on braid at the smaller entry sizes. If disturbance during assembly causes loss of braid lay, grip of the tin ring may be affected. Evaluation is recommended. Contact Tyco Electronics for more information.

Code 18 MIL-C-5015 (MS3100)

Braided adapters



Manufacturer code	Connector manufacturer
	MS3100/3101/3106
A	Amphenol-Class A
B	Bendix-Class A/E/R
C	Cannon-Class A/E/R
D*	Unknown-Class A/E/R
R	Amphenol-Class R
-	Manufacturer code not required

*Additional pieces supplied when manufacturer is unknown.
All thread sizes for order number apply.

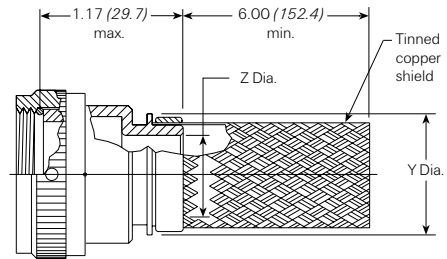

218M7XX-XXXXX

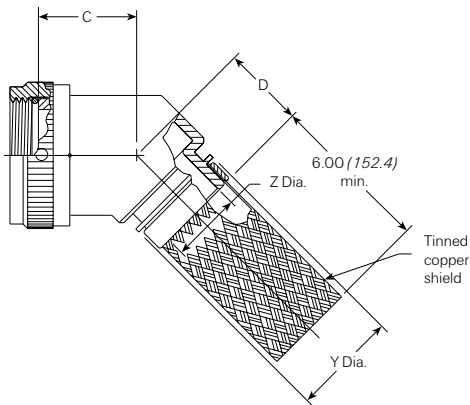

218M8XX-XXXXX

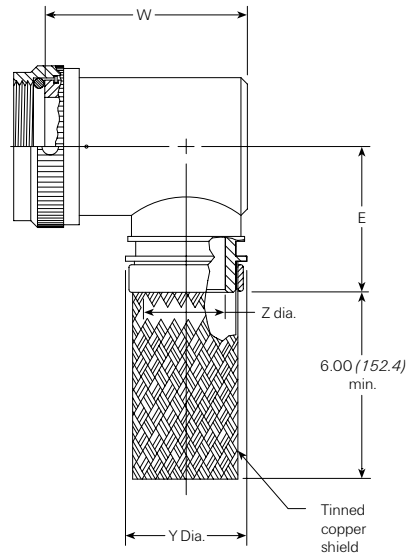

218M9XX-XXXXX

Available in:	Americas	Europe	Asia Pacific
	■	■	■

Fax-on-demand	Fax ID	Description
US only (800) 260-9099	3592	SCD
Outside US (650) 257-2301	3593	SCD
	3594	SCD

Visit our website at www.tycoelectronics.com

Table of dimensions (mm/in)

Order number	Shell size	Manufacturer code	Max. entry size, type 1**	Thread	C max. mm (in)	D max. mm (in)	E max. mm (in)
08	8S	B	04	.375-32 UNEF	20.3 (0.80)	23.4 (0.92)	31.2 (1.23)
08	8S	C	04	.438-28 UNEF	20.3 (0.80)	23.4 (0.92)	31.2 (1.23)
08	8S	A, R	04	.438-27 UNS	20.3 (0.80)	23.4 (0.92)	31.2 (1.23)
08	8S	D	04	See* above.	20.3 (0.80)	23.4 (0.92)	31.2 (1.23)
10	10S	—	06	.500-28 UNEF	21.1 (0.83)	24.1 (0.95)	31.2 (1.23)
11	10SL	C	07	.562-24 UNEF	21.1 (0.83)	24.1 (0.83)	31.2 (1.23)
11	10SL	A, B, R	07	.625-24 UNEF	21.1 (0.83)	24.1 (0.95)	31.2 (1.23)
11	10SL	D	07	See* above.	21.1 (0.83)	24.1 (0.95)	31.2 (1.23)
12	12 & 12S	B, C	08	.625-24 UNEF	21.1 (0.83)	24.1 (0.95)	31.2 (1.23)
12	12 & 12S	A, R	08	.688-24 UNEF	21.8 (0.86)	24.9 (0.98)	33.0 (1.30)
12	12 & 12S	D	08	See* above.	21.8 (0.86)	24.9 (0.98)	33.0 (1.30)
14	14 & 14S	—	10	.750-20 UNEF	21.8 (0.86)	24.9 (0.98)	33.0 (1.30)
16	16 & 16S	—	12	.875-20 UNEF	22.6 (0.89)	25.9 (1.02)	36.1 (1.42)
18	18	—	12	1.000-20 UNEF	23.4 (0.92)	26.7 (1.05)	37.6 (1.48)
20	20	A, B, C	16	1.125-18 UNEF	24.1 (0.95)	27.4 (1.08)	39.4 (1.55)
20	20	R	16	1.125-24 UNS	24.1 (0.95)	27.4 (1.08)	39.4 (1.55)
20	20	D	16	See* above.	24.1 (0.95)	27.4 (1.08)	39.4 (1.55)
22	22	—	18	1.250-18 UNEF	24.9 (0.98)	28.2 (1.11)	40.9 (1.61)
24	24	—	20	1.375-18 UNEF	24.9 (0.98)	28.2 (1.11)	42.4 (1.67)
28	28	—	24	1.625-18 UNEF	27.4 (1.08)	29.7 (1.17)	47.2 (1.86)
32	32	B, C	24	1.875-16 UN	28.2 (1.11)	31.2 (1.23)	48.8 (1.92)
32	32	A, R	24	1.906-18 UN	28.2 (1.11)	31.2 (1.23)	48.8 (1.92)
32	32	D	24	See* above.	28.2 (1.11)	31.2 (1.23)	48.8 (1.92)
36	36	B	24	2.062-16 UNS	31.2 (1.23)	32.3 (1.27)	52.1 (2.05)
36	36	R	24	2.062-20 UNS	31.2 (1.23)	32.3 (1.27)	52.1 (2.05)
36	36	C	24	2.125-16 UN	31.2 (1.23)	32.3 (1.27)	52.1 (2.05)
36	36	A	24	2.125-18 UNS	31.2 (1.23)	32.3 (1.27)	52.1 (2.05)
36	36	D	24	See* above.	31.2 (1.23)	32.3 (1.27)	52.1 (2.05)
40	40	B	24	2.312-16 UNS	32.3 (1.27)	33.0 (1.30)	55.1 (2.17)
40	40	A, C, R	24	2.375-16 UN	32.3 (1.27)	33.0 (1.30)	55.1 (2.17)
40	40	D	24	See* above.	32.3 (1.27)	33.0 (1.30)	55.1 (2.17)
44	44	—	24	2.625-16 UN	34.0 (1.34)	34.5 (1.36)	61.5 (2.42)
48	48	C	24	2.812-18 UNS	34.0 (1.34)	34.5 (1.36)	61.5 (2.42)
48	48	A, R	24	2.875-16 UN	34.0 (1.34)	34.5 (1.36)	61.5 (2.42)
48	48	D	24	See* above.	34.0 (1.34)	34.5 (1.36)	61.5 (2.42)

**For larger than maximum type 1 entry sizes, a two-piece adapter will be supplied. Contact your Tyco Electronics product representative for information.

Entry size dimensions (mm/in)

Entry size	Z dia. +0.25-0.5	Y dia. ±0.38 mm (in)	W max. mm (in)
04	6.35 (0.250)	11.58 (0.456)	31.2 (1.23)
05	7.92 (0.312)	13.08 (0.515)	32.8 (1.29)
06	9.53 (0.375)	14.76 (0.581)	34.3 (1.35)
07	11.13 (0.438)	16.33 (0.643)	36.1 (1.42)
08	12.70 (0.500)	17.91 (0.705)	37.6 (1.48)
10	15.88 (0.625)	21.11 (0.831)	40.6 (1.60)
12	19.05 (0.750)	24.21 (0.953)	43.9 (1.73)
14	22.23 (0.875)	27.46 (1.081)	47.0 (1.85)
16	25.40 (1.000)	30.61 (1.205)	50.8 (2.00)
18	28.58 (1.125)	35.08 (1.381)	54.1 (2.13)
20	31.75 (1.250)	38.25 (1.506)	57.2 (2.25)
22	34.93 (1.375)	41.43 (1.631)	NA
24	38.10 (1.500)	44.60 (1.756)	NA

Users should independently evaluate the suitability of the product for their application.
Before ordering check with factory for most current data.

Code 18 MIL-C-5015 (MS3100)

Solid adapters



Manufacturer code	Connector manufacturer
	MS3100/3101/3106
A	Amphenol-Class A
B	Bendix-Class A/E/R
C	Cannon-Class A/E/R
D*	Unknown-Class A/E/R
R	Amphenol-Class R
-	Manufacturer code not required

*Additional pieces supplied when manufacturer is unknown.
All thread sizes for order number apply.

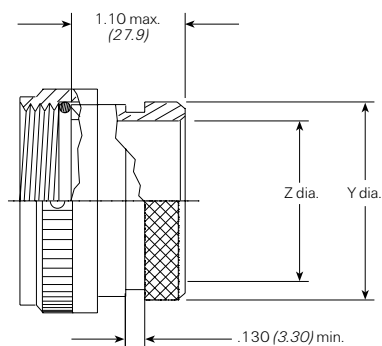

218M5XX-XXX

Available in:	Americas	Europe	Asia Pacific
	■	■	■

Table of dimensions (mm/in)

Order number	Shell size	Manufacturer code	Thread	Y ±0.5	Z min.
08	8S	B	.375-32 UNEF	13.2 (0.52)	6.22 (0.24)
08	8S	C	.438-28 UNEF	13.2 (0.52)	7.80 (0.31)
08	8S	A, R	.438-27 UNS	13.2 (0.52)	7.80 (0.31)
08	8S	D	See * above.	13.2 (0.52)	7.80 (0.31)
10	10S	-	.500-28 UNEF	15.0 (0.59)	9.40 (0.37)
11	10SL	C	.562-24 UNEF	15.0 (0.59)	11.00 (0.43)
11	10SL	A, B, R	.625-24 UNEF	19.3 (0.76)	12.57 (0.49)
11	10SL	D	See * above.	19.3 (0.76)	11.00 (0.43)
12	12 & 12S	B, C	.625-24 UNEF	19.3 (0.76)	12.57 (0.49)
12	12 & 12S	A, R	.688-24 UNEF	19.3 (0.76)	14.15 (0.56)
12	12 & 12S	D	See * above.	19.3 (0.76)	12.57 (0.49)
14	14 & 14S	-	.750-20 UNEF	20.9 (0.82)	15.75 (0.62)
16	16 & 16S	-	.875-20 UNEF	24.1 (0.95)	18.92 (0.74)
18	18	-	1.000-20 UNEF	26.1 (1.03)	20.50 (0.81)
20	20	A, B, C	1.125-18 UNEF	34.0 (1.34)	25.27 (0.99)
20	20	R	1.125-24 UNS	34.0 (1.34)	25.27 (0.99)
20	20	D	See * above.	34.0 (1.34)	25.27 (0.99)
22	22	-	1.250-18 UNEF	36.3 (1.43)	28.45 (1.12)
24	24	-	1.375-18 UNEF	40.5 (1.59)	31.62 (1.24)
28	28	-	1.625-18 UNEF	43.0 (1.69)	34.80 (1.37)
32	32	B, C	1.875-16 UN	48.4 (1.91)	41.15 (1.62)
32	32	A, R	1.906-18 UN	48.4 (1.91)	41.15 (1.62)
32	32	D	See * above.	48.4 (1.91)	41.15 (1.62)
36	36	B	2.062-16 UNS	54.7 (2.15)	47.50 (1.87)
36	36	R	2.062-20 UNS	54.7 (2.15)	47.50 (1.87)
36	36	C	2.125-16 UN	54.7 (2.15)	47.50 (1.87)
36	36	A	2.125-18 UNS	54.7 (2.15)	47.50 (1.87)
36	36	D	See * above.	54.7 (2.15)	47.50 (1.87)

Fax-on-demand

US only (800) 260-9099

Outside US (650) 257-2301

Fax ID

3590

Description

SCD

Visit our website at www.tycoelectronics.com

Table of dimensions (mm/in) (cont'd.)

Order number	Shell size	Manufacturer code	Thread	Y ±0.5	Z min.
40	40	B	2.312-16 UNS	60.6 (2.39)	53.85 (2.12)
40	40	A, C, R	2.375-16 UN	60.6 (2.39)	53.85 (2.12)
40	40	D	See * above.	60.6 (2.39)	53.85 (2.12)
44	44	-	2.625-16 UN	67.1 (2.64)	60.20 (2.37)
48	48	C	2.812-18 UNS	73.5 (2.89)	66.55 (2.62)
48	48	A, R	2.875-16 UN	73.5 (2.89)	66.55 (2.62)
48	48	D	See * above.	73.5 (2.89)	66.55 (2.62)

Molded part selection guide (Solid)

Y diameter mm (in)	Standard K parts			Low-profile D parts		
	Straight part no.	90° part no.	Cable OD (min.) mm (in)	Straight part no.	90° part no.	Cable OD (min.) mm (in)
13.2 (0.52)	202W232		4.3 (0.19)			
13.2 (0.52)	202K121	222K121	5.6 (0.22)	202D211	222D211	6.4 (0.25)
15.0 (0.59)	202K132	222K132	5.9 (0.23)	202D221	222D221	7.4 (0.29)
19.2 (0.76)	202K142	222K142	7.1 (0.28)	202D232	222D232	8.4 (0.33)
20.9 (0.82)	202K142	222K142	7.1 (0.28)	202D232	222D232	8.4 (0.33)
24.1 (0.95)	202K153	222K152	8.4 (0.33)	202D242	222D242	9.7 (0.38)
26.1 (1.03)	202K153	222K152	8.4 (0.33)	202D242	222D242	9.7 (0.38)
34.0 (1.34)	202K163	222K163	9.9 (0.39)	202D253	222D253	10.4 (0.41)
36.2 (1.43)	202K174	222K174	15.7 (0.62)	202D263	222D263	12.2 (0.48)
40.5 (1.59)	202K174	222K174	15.7 (0.62)	202D263	222D263	12.2 (0.48)
43.0 (1.69)	202K174	222K174	15.7 (0.62)	202D263	222D263	12.2 (0.48)
48.4 (1.91)	202K185	222K185	16.8 (0.66)	202D274	222D274	14.3 (0.56)
54.7 (2.15)	202K185	222K185	16.8 (0.66)	202D274	222D274	14.3 (0.56)
60.6 (2.39)	-	-	-	202D285	222D285	17.5 (0.68)
67.1 (2.64)	-	-	-	202D296	222D296	19.6 (0.76)
73.5 (2.89)	-	-	-	202D299	222D299	22.9 (0.89)

Uniboot parts

Y diameter mm (in)	Part no.	Cable OD (min.) mm (in)
13.2 (0.52)	202C611	4.8 (0.19)
15.0 (0.59)	202C621	8.1 (0.32)
19.3 (0.76)	202C621	8.1 (0.32)
20.9 (0.82)	202C632	12.7 (0.50)
24.1 (0.95)	202C632	12.7 (0.50)
26.1 (1.03)	202C642	17.5 (0.69)
34.0 (1.34)	202C653	22.4 (0.88)
36.3 (1.43)	202C653	22.4 (0.88)
40.5 (1.59)	202C653	22.4 (0.88)
43.0 (1.69)	202C663	22.9 (0.90)
48.4 (1.91)	202C663	22.9 (0.90)
54.7 (2.15)	202C663	22.9 (0.90)
60.6 (2.39)	202C663	22.9 (0.90)
67.1 (2.64)	202C663	22.9 (0.90)
73.5 (2.89)	202C663	22.9 (0.90)

Users should independently evaluate the suitability of the product for their application.
Before ordering check with factory for most current data.

Code 18 MIL-C-5015 (MS3100)

Spin-coupling adapters



Manufacturer code	Connector manufacturer MS3100/3101/3106
A	Amphenol-Class A
B	Bendix-Class A/E/R
C	Cannon-Class A/E/R
D*	Unknown-Class A/E/R
R	Amphenol-Class R
-	Manufacturer code not required

*Additional pieces supplied when manufacturer is unknown.
All thread sizes for order number apply.

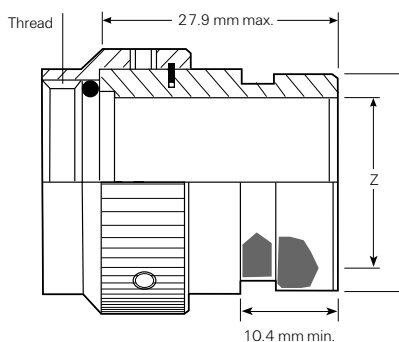

218M6XX-XXX

Available in:	Americas	Europe	Asia Pacific
	■	■	■

Table of dimensions (mm/in)

Order number	Shell size	Manufacturer code	Thread	Y ±0.5	Z min.
08	8S	B	.375-32 UNEF	13.2 (0.52)	6.22 (0.24)
08	8S	C	.438-28 UNEF	13.2 (0.52)	7.80 (0.31)
08	8S	A, R	.438-27 UNS	13.2 (0.52)	7.80 (0.31)
08	8S	D	See * above.	13.2 (0.52)	7.80 (0.31)
10	10S	-	.500-28 UNEF	15.0 (0.59)	9.40 (0.37)
11	10SL	C	.562-24 UNEF	15.0 (0.59)	11.00 (0.43)
11	10SL	A, B, R	.625-24 UNEF	19.3 (0.76)	12.57 (0.49)
11	10SL	D	See * above.	19.3 (0.76)	11.00 (0.43)
12	12 & 12S	B, C	.625-24 UNEF	19.3 (0.76)	12.57 (0.49)
12	12 & 12S	A, R	.688-24 UNEF	19.3 (0.76)	14.15 (0.56)
12	12 & 12S	D	See * above.	19.3 (0.76)	12.57 (0.49)
14	14 & 14S	-	.750-20 UNEF	20.9 (0.82)	15.75 (0.62)
16	16 & 16S	-	.875-20 UNEF	24.1 (0.95)	18.92 (0.74)
18	18	-	1.000-20 UNEF	26.1 (1.03)	20.50 (0.81)
20	20	A, B, C	1.125-18 UNEF	34.0 (1.34)	25.27 (0.99)
20	20	R	1.125-24 UNS	34.0 (1.34)	25.27 (0.99)
20	20	D	See * above.	34.0 (1.34)	25.27 (0.99)
22	22	-	1.250-18 UNEF	36.3 (1.43)	28.45 (1.12)
24	24	-	1.375-18 UNEF	40.5 (1.59)	31.62 (1.24)
28	28	-	1.625-18 UNEF	43.0 (1.69)	34.80 (1.37)
32	32	B, C	1.875-16 UN	48.4 (1.91)	41.15 (1.62)
32	32	A, R	1.906-18 UN	48.4 (1.91)	41.15 (1.62)
32	32	D	See * above.	48.4 (1.91)	41.15 (1.62)
36	36	B	2.062-16 UNS	54.7 (2.15)	47.50 (1.87)
36	36	R	2.062-20 UNS	54.7 (2.15)	47.50 (1.87)
36	36	C	2.125-16 UN	54.7 (2.15)	47.50 (1.87)
36	36	A	2.125-18 UNS	54.7 (2.15)	47.50 (1.87)
36	36	D	See * above.	54.7 (2.15)	47.50 (1.87)

Fax-on-demand

US only (800) 260-9099

Outside US (650) 257-2301

Fax ID

3591

Description

SCD

Visit our website at www.tycoelectronics.com**Table of dimensions (mm/in) (cont'd.)**

Order number	Shell size	Manufacturer code	Thread	Y ±0.5	Z min.
40	40	B	2.312-16 UNS	60.6 (2.39)	53.85 (2.12)
40	40	A, C, R	2.375-16 UN	60.6 (2.39)	53.85 (2.12)
40	40	D	See *above.	60.6 (2.39)	53.85 (2.12)
44	44	-	2.625-16 UN	67.1 (2.64)	60.20 (2.37)
48	48	C	2.812-18 UNS	73.5 (2.89)	66.55 (2.62)
48	48	A, R	2.875-16 UN	73.5 (2.89)	66.55 (2.62)
48	48	D	See *above.	73.5 (2.89)	66.55 (2.62)

Molded part selection guide (Spin-coupling)

Y diameter mm (in)	Standard K parts			Low-profile D parts		
	Straight part no.	90° part no.	Cable OD (min.) mm (in)	Straight part no.	90° part no.	Cable OD (min.) mm (in)
13.2 (0.52)	202W232		4.3 (0.19)			
13.2 (0.52)	202K121	222K121	5.6 (0.22)	202D211	222D211	6.4 (0.25)
15.0 (0.59)	202K132	222K132	5.9 (0.23)	202D221	222D221	7.4 (0.29)
19.2 (0.76)	202K142	222K142	7.1 (0.28)	202D232	222D232	8.4 (0.33)
20.9 (0.82)	202K142	222K142	7.1 (0.28)	202D232	222D232	8.4 (0.33)
24.1 (0.95)	202K153	222K152	8.4 (0.33)	202D242	222D242	9.7 (0.38)
26.1 (1.03)	202K153	222K152	8.4 (0.33)	202D242	222D242	9.7 (0.38)
34.0 (1.34)	202K163	222K163	9.9 (0.33)	202D253	222D253	10.4 (0.41)
36.2 (1.43)	202K174	222K174	15.7 (0.62)	202D263	222D263	12.2 (0.48)
40.5 (1.59)	202K174	222K174	15.7 (0.62)	202D263	222D263	12.2 (0.48)
43.0 (1.69)	202K174	222K174	15.7 (0.62)	202D263	222D263	12.2 (0.48)
48.4 (1.91)	202K185	222K185	16.8 (0.66)	202D274	222D274	14.3 (0.56)
54.7 (2.15)	202K185	222K185	16.8 (0.66)	202D274	222D274	14.3 (0.56)

Uniboot parts

Y diameter mm (in)	Part no.	Cable OD (min.) mm (in)
13.2 (0.52)	202C611	4.8 (0.19)
15.0 (0.59)	202C621	8.1 (0.32)
19.3 (0.76)	202C621	8.1 (0.32)
20.9 (0.82)	202C632	12.7 (0.50)
24.1 (0.95)	202C632	12.7 (0.50)
26.1 (1.03)	202C642	17.5 (0.69)
34.0 (1.34)	202C653	22.4 (0.88)
36.3 (1.43)	202C653	22.4 (0.88)
40.5 (1.59)	202C653	22.4 (0.88)
43.0 (1.69)	202C663	22.9 (0.90)
48.4 (1.91)	202C663	22.9 (0.90)
54.7 (2.15)	202C663	22.9 (0.90)

Users should independently evaluate the suitability of the product for their application.
Before ordering check with factory for most current data.

Code 18 MIL-C-5015 (MS3100)

Tine-Lock adapters



Manufacturer code	Connector manufacturer
	MS3100/3101/3106
A	Amphenol-Class A
B	Bendix-Class A/E/R
C	Cannon-Class A/E/R
D*	Unknown-Class A/E/R
R	Amphenol-Class R
-	Manufacturer code not required

*Additional pieces supplied when manufacturer is unknown.
All thread sizes for order number apply.

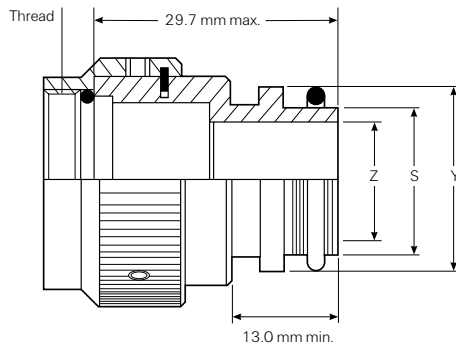

TXR18XX00-XXXXXX

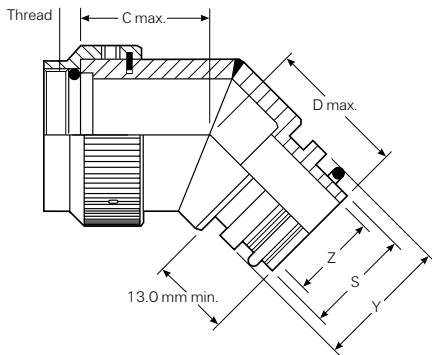

TXR18XX45-XXXXXX

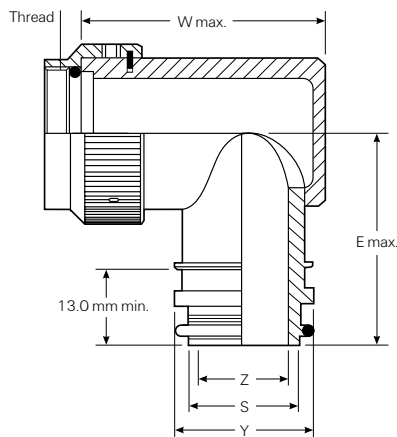

TXR18XX90-XXXXXX

Available in:	Americas	Europe	Asia Pacific
	■	■	■

Table of dimensions (mm/in)

Order number	Shell size	Manufacturer code	Max. entry size, type 1**	Thread	C max. mm (in)	D max. mm (in)	E max. mm (in)
08	8S	B	04	.375-32 UNEF	20.3 (0.80)	23.4 (0.92)	31.2 (1.23)
08	8S	C	04	.438-28 UNEF	20.3 (0.80)	23.4 (0.92)	31.2 (1.23)
08	8S	A, R	04	.438-27 UNS	20.3 (0.80)	23.4 (0.92)	31.2 (1.23)
08	8S	D	04	See * above.	20.3 (0.80)	23.4 (0.92)	31.2 (1.23)
10	10S	-	06	.500-28 UNEF	21.1 (0.83)	24.1 (0.95)	31.2 (1.23)
11	10SL	C	07	.562-24 UNEF	21.1 (0.83)	24.1 (0.83)	31.2 (1.23)
11	10SL	A, B, R	07	.625-24 UNEF	21.1 (0.83)	24.1 (0.95)	31.2 (1.23)
11	10SL	D	07	See * above.	21.1 (0.83)	24.1 (0.95)	31.2 (1.23)
12	12 & 12S	B, C	08	.625-24 UNEF	21.1 (0.83)	24.1 (0.95)	31.2 (1.23)
12	12 & 12S	A, R	08	.688-24 UNEF	21.8 (0.86)	24.9 (0.98)	33.0 (1.30)
12	12 & 12S	D	08	See * above.	21.8 (0.86)	24.9 (0.98)	33.0 (1.30)
14	14 & 14S	-	10	.750-20 UNEF	21.8 (0.86)	24.9 (0.98)	33.0 (1.30)
16	16 & 16S	-	12	.875-20 UNEF	22.6 (0.89)	25.9 (1.02)	36.1 (1.42)
18	18	-	12	1.000-20 UNEF	23.4 (0.92)	26.7 (1.05)	37.6 (1.48)
20	20	A, B, C	16	1.125-18 UNEF	24.1 (0.95)	27.4 (1.08)	39.4 (1.55)
20	20	R	16	1.125-24 UNS	24.1 (0.95)	27.4 (1.08)	39.4 (1.55)
20	20	D	16	See * above.	24.1 (0.95)	27.4 (1.08)	39.4 (1.55)
22	22	-	18	1.250-18 UNEF	24.9 (0.98)	28.2 (1.11)	40.9 (1.61)
24	24	-	20	1.375-18 UNEF	24.9 (0.98)	28.2 (1.11)	42.4 (1.67)
28	28	-	24	1.625-18 UNEF	27.4 (1.08)	29.7 (1.17)	47.2 (1.86)
32	32	B, C	24	1.875-16 UN	28.2 (1.11)	31.2 (1.23)	48.8 (1.92)
32	32	A, R	24	1.906-18 UN	28.2 (1.11)	31.2 (1.23)	48.8 (1.92)
32	32	D	24	See * above.	28.2 (1.11)	31.2 (1.23)	48.8 (1.92)
36	36	B	24	2.062-16 UNS	31.2 (1.23)	32.3 (1.27)	52.1 (2.05)
36	36	R	24	2.062-20 UNS	31.2 (1.23)	32.3 (1.27)	52.1 (2.05)
36	36	C	24	2.125-16 UN	31.2 (1.23)	32.3 (1.27)	52.1 (2.05)
36	36	A	24	2.125-18 UNS	31.2 (1.23)	32.3 (1.27)	52.1 (2.05)
36	36	D	24	See * above.	31.2 (1.23)	32.3 (1.27)	52.1 (2.05)
40	40	B	24	2.312-16 UNS	32.3 (1.27)	33.0 (1.30)	55.1 (2.17)
40	40	A, C, R	24	2.375-16 UN	32.3 (1.27)	33.0 (1.30)	55.1 (2.17)
40	40	D	24	See * above.	32.3 (1.27)	33.0 (1.30)	55.1 (2.17)
44	44	-	24	2.625-16 UN	34.0 (1.34)	34.5 (1.36)	61.5 (2.42)
48	48	C	24	2.812-18 UNS	34.0 (1.34)	34.5 (1.36)	61.5 (2.42)
48	48	A, R	24	2.875-16 UN	34.0 (1.34)	34.5 (1.36)	61.5 (2.42)
48	48	D	24	See * above.	34.0 (1.34)	34.5 (1.36)	61.5 (2.42)

**For larger than maximum type 1 entry sizes, a two-piece adapter will be supplied. Contact your Tyco Electronics product representative for information.

Code 18 MIL-C-5015 (MS3100) (cont'd.)

Tinel-Lock adapters

Entry size dimensions (mm/in)					
Entry size	Z dia. +0.25-0.5 mm (in)	S diameter (min.-max.)		Y dia. ±0.38 mm (in)	W max. mm (in)
		mm	(in)		
04	6.35 (0.25)	9.39-9.56	(0.37-0.38)	13.97 (0.55)	31.50 (1.24)
05	7.92 (0.31)	10.97-11.13	(0.43-0.44)	15.54 (0.61)	34.30 (1.35)
06	9.52 (0.37)	12.57-12.73	(0.49-0.50)	17.14 (0.67)	35.80 (1.41)
07	11.09 (0.44)	14.12-14.31	(0.55-0.56)	18.71 (0.74)	37.30 (1.47)
08	12.70 (0.50)	15.72-15.91	(0.62-0.63)	20.32 (0.80)	39.10 (1.54)
10	15.87 (0.62)	18.84-19.11	(0.74-0.75)	23.49 (0.92)	41.40 (1.63)
12	19.05 (0.75)	22.02-22.28	(0.87-0.88)	26.67 (1.05)	45.50 (1.79)
14	22.23 (0.88)	25.17-25.46	(0.99-1.00)	29.84 (1.17)	48.80 (1.92)
16	25.40 (1.00)	28.34-28.63	(1.12-1.13)	33.02 (1.30)	51.80 (2.04)
18	28.57 (1.12)	31.52-31.81	(1.24-1.25)	36.19 (1.42)	54.90 (2.16)
20	31.75 (1.25)	34.69-34.98	(1.37-1.38)	39.37 (1.55)	58.20 (2.29)
22	34.93 (1.38)	37.79-38.15	(1.49-1.50)	42.55 (1.68)	66.80 (2.63)
24	38.10 (1.50)	40.97-41.33	(1.61-1.63)	45.72 (1.80)	70.10 (2.76)

Fax-on-demand

US only (800) 260-9099

Outside US (650) 257-2301

Fax ID

3711

Description

SCD

Visit our website at www.tycoelectronics.com**Molded part selection guide (Tinel)**

Tinel-Lock entry size	Standard K parts			Low-profile D parts		
	Straight part no.	90° part no.	Cable OD (min.) mm (in)	Straight part no.	90° part no.	Cable OD (min.) mm (in)
04	202K232		3.30 (0.13)			
04	202W232		4.3 (0.19)			
04	202K121	222K121	5.60 (0.22)	202D211	222D211	6.40 (0.25)
05, 06	202K132	222K132	5.90 (0.23)	202D221	222D221	7.40 (0.29)
07, 08	202K142	222K142	7.10 (0.28)	202D232	222D232	8.40 (0.33)
10, 12	202K153	222K152	8.40 (0.33)	202D242	222D242	9.70 (0.38)
14, 16	202K163	222K163	9.90 (0.39)	202D253	222D253	10.50 (0.41)
18, 20, 22	202K174	222K174	15.70 (0.62)	202D263	222D263	12.20 (0.48)
24	202K185	222K185	16.80 (0.66)			
Uniboot parts						
Tinel-Lock entry size	Part no.	Cable OD (min.) mm (in)				
04	202C611	4.8 (0.19)				
05, 06, 07	202C621	8.1 (0.32)				
08, 10, 12	202C632	12.7 (0.50)				
12, 14, 16	202C642	17.5 (0.69)				
16, 18, 20, 22	202C653	22.4 (0.88)				

Code 21 MIL-C-26482 Series 1

Braided adapters

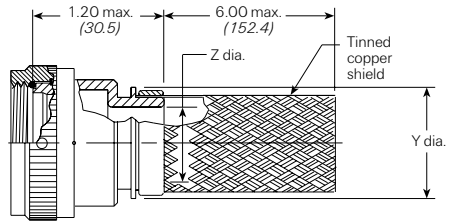

206M0XX-XXXXX

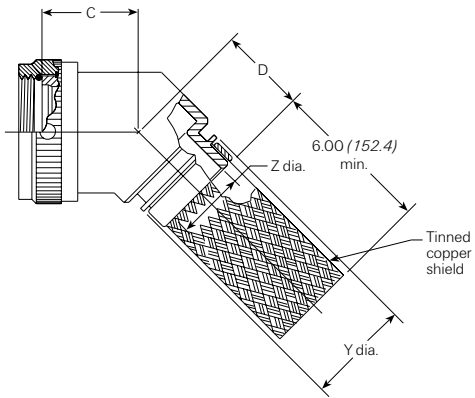

206M1XX-XXXXX

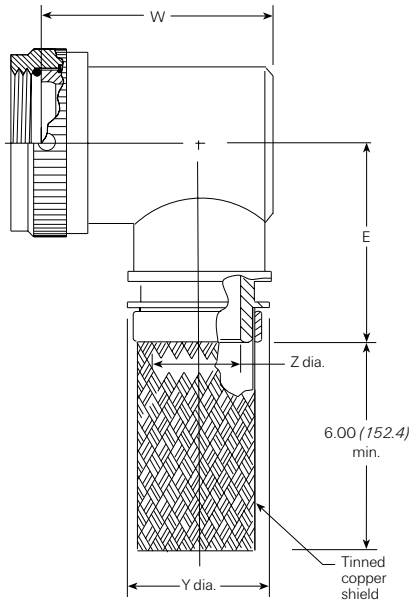

206M2XX-XXXXX

Available in:

Americas

Europe

Asia Pacific



Fax-on-demand

US only (800) 260-9099

Outside US (650) 257-2301

Fax ID

3535 SCD

3536 SCD

3537 SCD

DescriptionVisit our website at www.tycoelectronics.com**Table of dimensions (mm/in)**

Order number	Shell size	Max. entry size, type 1*	Thread	C max. mm (in)	D max. mm (in)	E max. mm (in)
08	8	04	.438-28 UNEF	21.6 (0.85)	23.1 (0.91)	29.0 (1.14)
10	10	06	.562-24 UNEF	22.4 (0.88)	23.9 (0.94)	30.5 (1.20)
12	12	08	.688-24 UNEF	23.1 (0.91)	24.6 (0.97)	32.3 (1.27)
14	14	10	.812-20 UNEF	23.4 (0.92)	24.9 (0.98)	33.5 (1.32)
16	16	12	.938-20 UNEF	24.1 (0.95)	25.7 (1.01)	34.8 (1.37)
18	18	12	1.062-18 UNEF	24.4 (0.96)	25.9 (1.02)	36.3 (1.43)
20	20	14	1.188-18 UNEF	25.1 (0.99)	26.7 (1.05)	38.1 (1.50)
22	22	16	1.312-18 UNEF	25.7 (1.01)	27.4 (1.08)	39.6 (1.56)
24	24	18	1.438-18 UNEF	26.2 (1.03)	27.7 (1.09)	40.9 (1.61)

*For larger than maximum type 1 entry sizes, a two-piece adapter will be supplied. Contact your Tyco Electronics product representative for information.

Entry size dimensions (mm/in)

Entry size	Z +0.25–0.5	Y dia.	W max.
04	6.35 (0.25)	13.97 (0.55)	31.0 (1.22)
05	7.92 (0.31)	15.54 (0.61)	32.8 (1.29)
06	9.52 (0.37)	17.14 (0.67)	34.3 (1.35)
07	11.09 (0.44)	18.71 (0.74)	35.8 (1.41)
08	12.7 (0.50)	20.32 (0.80)	37.3 (1.47)
10	15.87 (0.62)	23.49 (0.92)	40.6 (1.60)
12	19.05 (0.75)	26.67 (1.05)	43.7 (1.72)
14	22.23 (0.88)	29.84 (1.17)	47.0 (1.85)
16	25.4 (1.00)	33.02 (1.30)	50.0 (1.97)
18	28.57 (1.12)	36.19 (1.42)	53.3 (2.10)

Code 21 MIL-C-26482 Series 1

Solid adapters

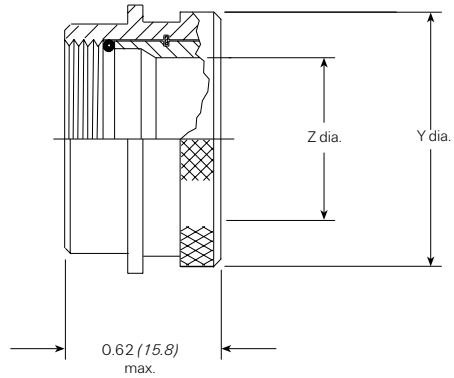

203M6XX-XXX

Available in:

Americas

Europe

Asia Pacific



Table of dimensions (mm/in)

Order number	Shell size	Thread	Y+0.000-0.030 (+0.00)(-0.76) dia.	Z min.
			mm (in)	mm (in)
08	8	.438-28 UNEF	17.88 (0.704)	6.63 (0.26)
10	10	.562-24 UNEF	21.06 (0.829)	9.27 (0.36)
12	12	.688-24 UNEF	24.23 (0.954)	12.98 (0.51)
14	14	.812-20 UNEF	27.41 (1.079)	15.37 (0.61)
16	16	.938-20 UNEF	31.85 (1.254)	18.54 (0.73)
18	18	1.062-18 UNEF	33.03 (1.316)	20.90 (0.82)
20	20	1.188-18 UNEF	36.63 (1.442)	24.10 (0.95)
22	22	1.312-18 UNEF	39.78 (1.566)	27.28 (1.07)
24	24	1.438-18 UNEF	42.98 (1.692)	29.67 (1.17)

Fax-on-demand

US only (800) 260-9099

Outside US (650) 257-2301

Fax ID

3523

Description

SCD

Visit our website at www.tycoelectronics.com**Molded part selection guide (Solid)**

Order no.	Standard K parts			Low-profile D parts		
	Straight part no.	90° part no.	Cable OD (min.) mm (<i>in</i>)	Straight part no.	90° part no.	Cable OD (min.) mm (<i>in</i>)
08	202K132	222K132	5.9 (0.23)	202D221	222D221	7.4 (0.29)
10	202K142	222K142	7.1 (0.28)	202D232	222D232	8.4 (0.33)
12, 14	202K153	222K152	8.4 (0.33)	202D242	222D242	9.7 (0.38)
16, 18	202K163	222K163	9.9 (0.39)	202D253	222D253	10.5 (0.41)
20, 22, 24	202K174	222K174	15.7 (0.62)	202D263	222D263	12.2 (0.48)

Uniboot parts

Order no.	Part no.	Cable OD (min.) mm (<i>in</i>)
08	202C621	8.1 (0.32)
10	202C632	12.7 (0.50)
12, 14	202C642	17.5 (0.69)
16, 18, 20, 22, 24	202C653	22.4 (0.88)

Code 21 MIL-C-26482 Series 1

Spin-coupling adapters

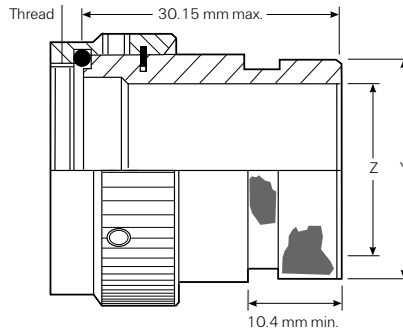

203M9XX-XXX

Available in:

Americas

Europe

Asia Pacific



Table of dimensions (mm/in)

Order number	Shell size	Thread	Y +0.00–0.76 dia. mm (in)	Z min. mm (in)
08	8	.438-28 UNEF	13.54 (0.53)	6.63 (0.26)
10	10	.562-24 UNEF	15.37 (0.61)	9.27 (0.36)
12	12	.688-24 UNEF	19.66 (0.77)	12.98 (0.51)
14	14	.812-20 UNEF	21.29 (0.84)	15.37 (0.61)
16	16	.938-20 UNEF	24.46 (0.96)	18.54 (0.73)
18	18	1.062-18 UNEF	26.47 (1.04)	20.90 (0.82)
20	20	1.188-18 UNEF	30.91 (1.22)	24.10 (0.95)
22	22	1.312-18 UNEF	34.42 (1.36)	27.28 (1.07)
24	24	1.438-18 UNEF	36.65 (1.44)	29.67 (1.17)

Fax-on-demand

US only (800) 260-9099

Outside US (650) 257-2301

Fax ID

3525

Description

SCD

Visit our website at www.tycoelectronics.com**Molded part selection guide (Spin-coupling)**

Order no.	Standard K parts			Low-profile D parts		
	Straight part no.	90° part no.	Cable OD (min.) mm (<i>in</i>)	Straight part no.	90° part no.	Cable OD (min.) mm (<i>in</i>)
08	202W232		4.3 (0.19)			
08	202K121	222K121	5.6 (0.22)	202D211	222D211	6.4 (0.25)
10	202K132	222K132	5.9 (0.23)	202D221	222D221	7.4 (0.29)
12, 14	202K142	222K142	7.1 (0.28)	202D232	222D232	8.4 (0.33)
16, 18	202K153	222K152	8.4 (0.33)	202D242	222D242	9.7 (0.38)
20, 22	202K163	222K163	9.9 (0.39)	202D253	222D253	10.5 (0.41)
24	202K174	222K174	15.7 (0.62)	202D263	222D263	12.2 (0.48)

Uniboot parts

Order no.	Part no.	Cable OD (min.) mm (<i>in</i>)
08	202C611	4.8 (0.19)
10, 12	202C621	8.1 (0.32)
14, 16	202C632	12.7 (0.50)
18, 20	202C642	17.5 (0.69)
22, 24	202C653	22.4 (0.88)

Code 21 MIL-C-26482 Series 1

Tine-Lock adapters

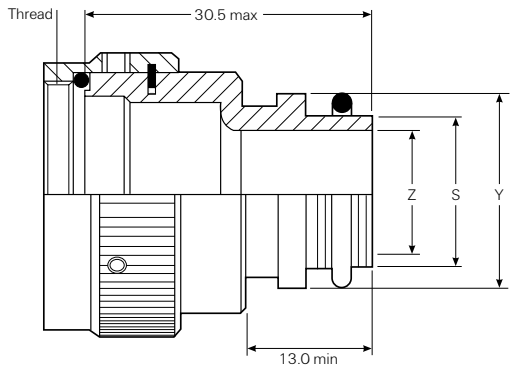

TXR21XX00-XXXX XX

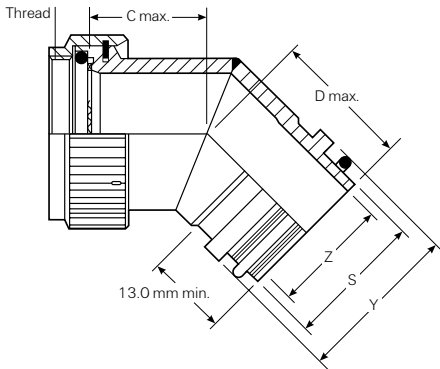

TXR21XX45-XXXXXX

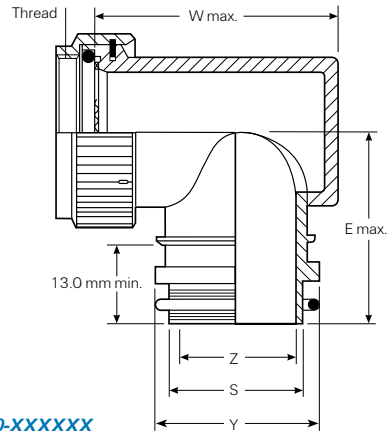

TXR21XX90-XXXXXX

Available in:	Americas	Europe	Asia Pacific
	■	■	■

Fax-on-demand

US only (800) 260-9099

Outside US (650) 257-2301

Fax ID

3712

Description

SCD

Visit our website at www.tycoelectronics.com**Table of dimensions (mm/in)**

Order number	Shell size	Max. entry size, type 1*	Thread	C max. mm (in)	D max. mm (in)	E max. mm (in)
08	8	04	.438-28 UNEF	21.6 (0.85)	23.1 (0.91)	29.0 (1.14)
10	10	06	.562-24 UNEF	22.4 (0.88)	23.9 (0.94)	30.5 (1.20)
12	12	08	.688-24 UNEF	23.1 (0.91)	24.6 (0.97)	32.3 (1.27)
14	14	10	.812-20 UNEF	23.4 (0.92)	24.9 (0.98)	33.5 (1.32)
16	16	12	.938-20 UNEF	24.1 (0.95)	25.7 (1.01)	34.8 (1.37)
18	18	12	1.062-18 UNEF	24.4 (0.96)	25.9 (1.02)	36.3 (1.43)
20	20	14	1.188-18 UNEF	25.1 (0.99)	26.7 (1.05)	38.1 (1.50)
22	22	16	1.312-18 UNEF	25.7 (1.01)	27.4 (1.08)	39.6 (1.56)
24	24	18	1.438-18 UNEF	26.2 (1.03)	27.7 (1.09)	40.9 (1.61)

*For larger than maximum type 1 entry sizes, a two-piece adapter will be supplied. Contact your Tyco Electronics product representative for information.

Entry size dimensions (mm/in)

Entry size	Z +0.25-0.5	S diameter (min.-max.)	Y dia.	W max.
04	6.35 (0.25)	9.39-9.56 (0.37-0.38)	13.97 (0.55)	31.0 (1.22)
05	7.92 (0.31)	10.97-11.13 (0.43-0.44)	15.54 (0.61)	32.8 (1.29)
06	9.52 (0.37)	12.57-12.73 (0.49-0.50)	17.14 (0.67)	34.3 (1.35)
07	11.09 (0.44)	14.12-14.31 (0.55-0.56)	18.71 (0.74)	35.8 (1.41)
08	12.7 (0.50)	15.72-15.91 (0.62-0.63)	20.32 (0.80)	37.3 (1.47)
10	15.87 (0.62)	18.84-19.11 (0.74-0.75)	23.49 (0.92)	40.6 (1.60)
12	19.05 (0.75)	22.02-22.28 (0.87-0.88)	26.67 (1.05)	43.7 (1.72)
14	22.23 (0.88)	25.17-25.46 (0.99-1.00)	29.84 (1.17)	47.0 (1.85)
16	25.4 (1.00)	28.34-28.63 (1.12-1.13)	33.02 (1.30)	50.0 (1.97)
18	28.57 (1.12)	31.52-31.81 (1.24-1.25)	36.19 (1.42)	53.3 (2.10)

Molded part selection guide (Tinel)

Tinel-Lock entry size	Standard K parts			Low-profile D parts		
	Straight part no.	90° part no.	Cable OD (min.) mm (in)	Straight part no.	90° part no.	Cable OD (min.) mm (in)
04	202K232		3.3 (0.1)			
04	202W232		4.3 (0.2)			
04	202K121	222K121	5.6 (0.2)	202D211	222D211	6.4 (0.3)
05, 06	202K132	222K132	5.9 (0.2)	202D221	222D221	7.4 (0.3)
07, 08	202K142	222K142	7.1 (0.3)	202D232	222D232	8.4 (0.3)
10, 12	202K153	222K152	8.4 (0.3)	202D242	222D242	9.7 (0.4)
14, 16	202K163	222K163	9.9 (0.4)	202D253	222D253	10.5 (0.4)
18, 20, 22	202K174	222K174	15.7 (0.6)	202D263	222D263	12.2 (0.5)
24	202K185	222K185	16.8 (0.7)			

Uniboot parts

Tinel-Lock entry size	Part no.	Cable OD (min.) mm (in)
04	202C611	4.8 (0.19)
05, 06, 07	202C621	8.1 (0.32)
08, 10, 12	202C632	12.7 (0.50)
12, 14, 16	202C642	17.5 (0.69)
16, 18, 20, 22	202C653	22.4 (0.88)
24	202C663	22.9 (0.90)

Users should independently evaluate the suitability of the product for their application.

Before ordering check with factory for most current data.

Code 21 MIL-C-26482 Series 1

Bandstrap adapters

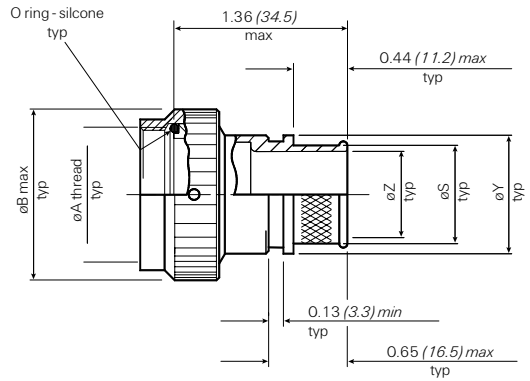

BND21XX00-XXXX

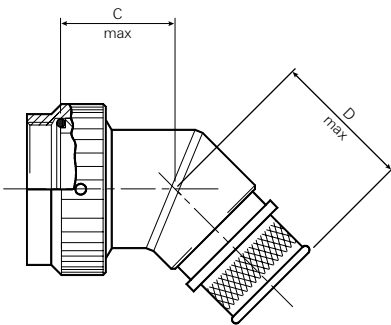

BND21XX45-XXXX

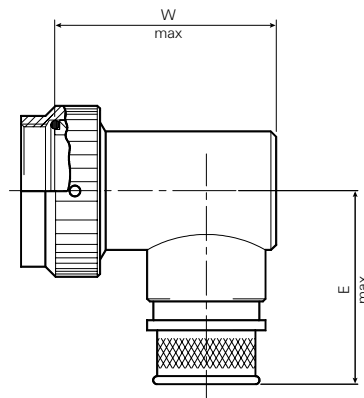

BND21XX90-XXXX

Available in:

Americas

Europe

Asia Pacific



Fax-on-demand

US only (800) 260-9099

Outside US (650) 257-2301

Visit our website at www.tycoelectronics.com**Table of dimensions (mm/in)**

Order number	Shell size	Max. entry size	A Unified thread Class 2B	B max. mm (in)	C max. mm (in)	D max. mm (in)	E max. mm (in)
08	8	04	0.4375-28 UNEF	18.3 (0.72)	21.6 (0.85)	27.2 (1.07)	33.0 (1.30)
10	10	06	0.5625-24 UNEF	21.6 (0.85)	22.4 (0.88)	27.9 (1.10)	34.5 (1.36)
12	12	08	0.6875-24 UNEF	24.9 (0.98)	23.1 (0.91)	28.7 (1.13)	36.3 (1.43)
14	14	10	0.8125-20 UNEF	28.2 (1.11)	23.4 (0.92)	29.0 (1.14)	37.6 (1.48)
16	16	12	0.9375-20 UNEF	31.2 (1.23)	24.1 (0.95)	29.7 (1.17)	38.9 (1.53)
18	18	13	1.0625-18 UNEF	34.5 (1.36)	24.4 (0.96)	30.0 (1.18)	40.4 (1.59)
20	20	15	1.1875-18 UNEF	37.6 (1.48)	25.1 (0.99)	30.7 (1.21)	42.2 (1.66)
22	22	16	1.3125-18 UNEF	40.6 (1.60)	25.7 (1.01)	31.5 (1.24)	43.7 (1.72)
24	24	18	1.4375-18 UNEF	43.2 (1.70)	26.2 (1.03)	31.8 (1.25)	45.0 (1.77)

Entry size dimensions (mm/in)

Entry size	Z +0.25-0.50 (+0.010-0.020)	S diameter mm (in)	Y diameter mm (in)	W max.
03	4.75 (0.188)	7.92 (0.312)	11.10 (0.438)	31.0 (1.22)
04	6.35 (0.250)	9.52 (0.375)	12.70 (0.500)	31.0 (1.22)
05	7.92 (0.312)	11.12 (0.438)	14.30 (0.563)	32.8 (1.29)
06	9.52 (0.375)	12.70 (0.500)	15.88 (0.625)	34.3 (1.35)
07	11.12 (0.438)	14.30 (0.562)	17.50 (0.689)	35.8 (1.41)
08	12.70 (0.500)	15.88 (0.625)	19.05 (0.750)	37.3 (1.47)
09	14.30 (0.562)	17.50 (0.688)	20.65 (0.813)	40.6 (1.60)
10	15.88 (0.625)	19.05 (0.750)	22.23 (0.875)	40.6 (1.60)
11	17.50 (0.688)	20.65 (0.812)	23.80 (0.938)	43.7 (1.72)
12	19.05 (0.750)	22.23 (0.875)	25.40 (1.000)	43.7 (1.72)
13	20.65 (0.812)	23.83 (0.938)	27.00 (1.063)	47.0 (1.85)
14	22.23 (0.875)	25.40 (1.000)	30.16 (1.189)	47.0 (1.85)
15	23.83 (0.938)	27.00 (1.062)	31.75 (1.250)	50.0 (1.97)
16	25.40 (1.000)	28.58 (1.125)	33.34 (1.313)	50.0 (1.97)
18	28.58 (1.125)	31.75 (1.250)	36.51 (1.438)	53.3 (2.10)

Code 32 MIL-C-22992

Braided adapters

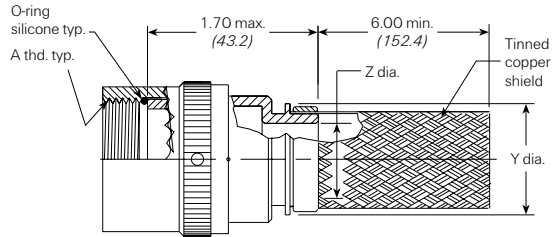

207M3XX-XXXXX

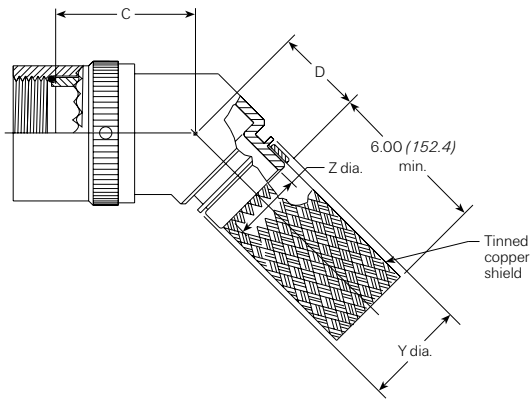

212M4XX-XXXXX

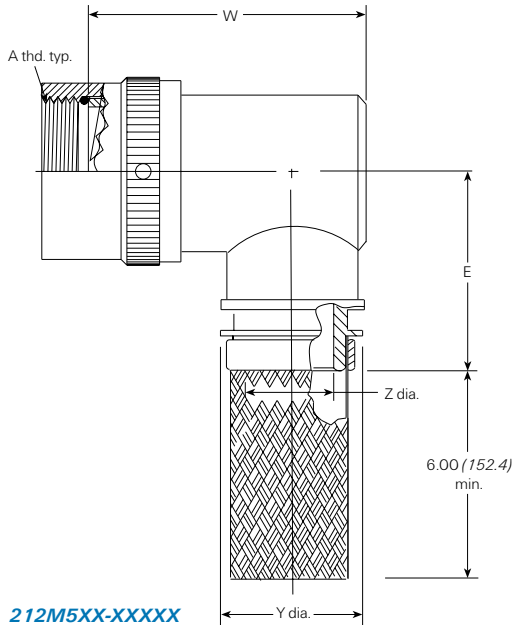

212M5XX-XXXXX

Available in:

Americas

Europe

Asia Pacific



Fax-on-demand	Fax ID	Description
US only (800) 260-9099	3542	SCD
Outside US (650) 257-2301	3573	SCD
	3574	SCD

Visit our website at www.tycoelectronics.com

Table of dimensions (mm/in)

Order number	Shell size	Max. entry size, type 1*	A left hand thd. Class 2B	C max. mm (in)	D max. mm (in)	E max. mm (in)
12	12	08	.750-20 UNEF	29.0 (1.14)	25.4 (1.00)	33.5 (1.32)
14	14	10	.875-20 UNEF	29.7 (1.17)	25.9 (1.02)	35.3 (1.39)
16	16	12	1.000-20 UNEF	30.0 (1.18)	26.2 (1.03)	37.1 (1.46)
18	18	14	1.125-18 UNEF	30.7 (1.21)	26.9 (1.06)	38.6 (1.52)
20	20	16	1.250-18 UNEF	31.2 (1.23)	27.7 (1.09)	40.1 (1.58)
22	22	18	1.375-18 UNEF	32.0 (1.26)	28.2 (1.11)	41.7 (1.64)
24	24	22	1.625-18 UNEF	33.5 (1.32)	30.0 (1.18)	46.5 (1.83)
28	28	24	1.875-16 UN	34.8 (1.37)	31.2 (1.23)	49.8 (1.96)
32	32	28	2.062-16 UNS	36.3 (1.43)	32.5 (1.28)	52.8 (2.08)
36	36	28	2.312-16 UNS	37.6 (1.48)	33.8 (1.33)	56.1 (2.21)
40	40	28	2.625-16 UN	38.9 (1.53)	35.3 (1.39)	58.9 (2.32)

*For larger than maximum type 1 entry sizes, a two-piece adapter will be supplied. Contact your Tyco Electronics product representative for information.

Entry size dimensions (mm/in)

Entry size	Z ±0.20 (±0.51)	Y dia. min.	W max.
03	4.75 (.187)	9.98 (.393)	39.6 (1.56)
04	6.35 (.250)	11.58 (.456)	39.6 (1.56)
05	7.92 (.312)	13.08 (.515)	42.9 (1.69)
06	9.53 (.375)	14.76 (.581)	42.9 (1.69)
07	11.13 (.438)	16.33 (.643)	46.0 (1.81)
08	12.70 (.500)	17.91 (.705)	NA
09	14.27 (.562)	17.91 (.705)	49.3 (1.94)
10	15.88 (.625)	21.11 (.831)	49.3 (1.94)
11	17.48 (.688)	22.68 (.893)	52.3 (2.06)
12	19.05 (.750)	24.21 (.953)	52.3 (2.06)
13	20.62 (.812)	24.21 (.953)	55.6 (2.19)
14	22.23 (.875)	27.46 (1.081)	55.6 (2.19)
15	23.83 (.938)	29.03 (1.143)	59.9 (2.36)
16	25.40 (1.000)	30.61 (1.205)	59.9 (2.36)
18	28.58 (1.125)	35.08 (1.381)	69.6 (2.74)
20	31.75 (1.250)	38.25 (1.506)	72.6 (2.86)
22	34.93 (1.375)	41.43 (1.631)	75.9 (2.99)
24	38.10 (1.500)	44.60 (1.756)	79.0 (3.11)
28	44.45 (1.750)	50.90 (2.004)	85.3 (3.36)

Users should independently evaluate the suitability of the product for their application.
Before ordering check with factory for most current data.

Code 32 MIL-C-22992

Spin-coupling adapters

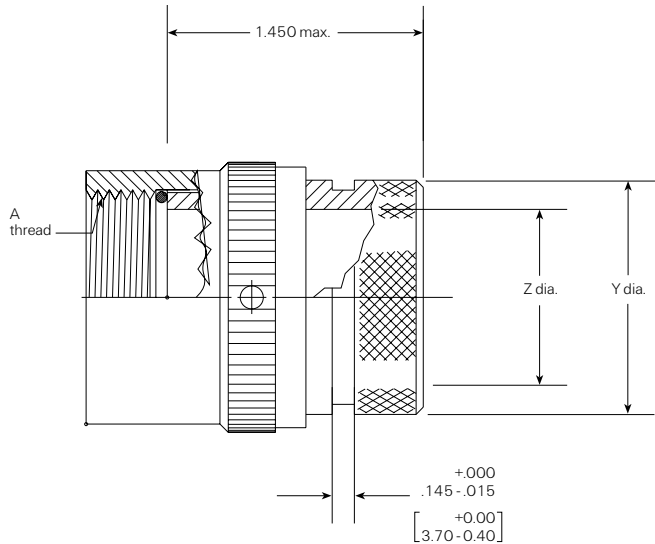

204M3XX-XXX

Available in:	Americas	Europe	Asia Pacific
	■	■	■

Table of dimensions (mm/in)

Base part number	Shell size	A L.H. thread Class 2B	Y ± .020 (±0.51)	Z min.
12	12	.750-20 UNEF	20.24 (.797)	12.47 (.491)
14	14	.875-20 UNEF	23.44 (.923)	14.35 (.565)
16	16	1.000-20 UNEF	26.42 (1.040)	17.53 (.690)
18	18	1.125-18 UNEF	31.17 (1.227)	18.19 (.716)
20	20	1.250-18 UNEF	34.49 (1.358)	21.72 (.855)
22	22	1.375-18 UNEF	37.21 (1.465)	25.02 (.985)
24	24	1.625-18 UNEF	42.82 (1.686)	30.48 (1.200)
28	28	1.875-16 UN	50.06 (1.971)	36.58 (1.440)
32	32	2.062-16 UNS	55.35 (2.179)	40.77 (1.605)
36	36	2.312-16 UNEF	61.01 (2.402)	52.96 (2.085)
40	40	2.625-16 UNS	67.46 (2.656)	57.15 (2.250)
44	44	2.875-16 UNS	70.66 (2.782)	62.46 (2.549)

*For larger than maximum type 1 entry sizes, a two-piece adapter will be supplied. Contact your Tyco Electronics product representative for information.

Fax-on-demand

US only (800) 260-9099

Outside US (650) 257-2301

Fax ID

3529

Description

SCD

Visit our website at www.tycoelectronics.com**Molded part size selection guide (Spin-coupling)**

Order no.	Standard K parts			Low-profile D parts		
	Straight part no.	90° part no.	Cable OD (min.) mm (in)	Straight part no.	90° part no.	Cable OD (min.) mm (in)
12	202K142	222K142	7.1 (0.28)	202D232	222D232	8.4 (0.33)
14, 16	202K153	222K152	8.4 (0.33)	202D242	222D242	9.7 (0.38)
18, 20	202K163	222K163	9.9 (0.39)	202D253	222D253	10.5 (0.41)
22, 24	202K174	222K174	15.7 (0.62)	202D263	222D263	12.2 (0.48)
26, 32, 36	202K185	222K185	16.8 (0.66)			
40, 44	–	–	–	–	–	–

Uniboot parts

Order no.	Part no.	Cable OD (min.) mm (in)
12	202C632	12.7 (0.50)
14, 16	202C642	17.5 (0.69)
18, 20, 22, 24	202C653	22.4 (0.88)
28, 32, 36, 40, 44	–	–

Code 32 MIL-C-22992

Tine-Lock adapters

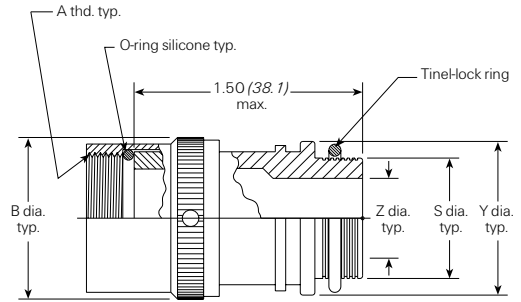

TXR32XX00-XXXXXX

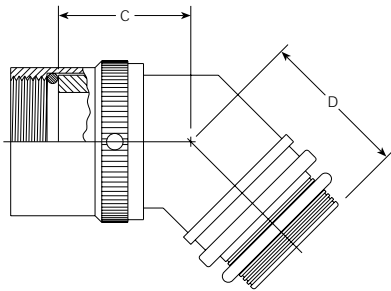

TXR32XX45-XXXXXX

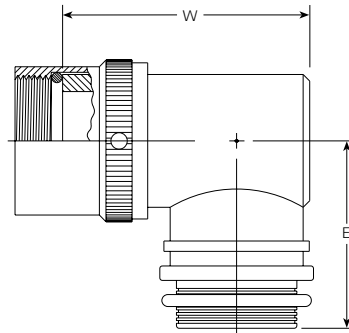

TXR32XX90-XXXXXX

Available in:	Americas	Europe	Asia Pacific
	■	■	■

Fax-on-demand

US only (800) 260-9099

Outside US (650) 257-2301

Fax ID

3716

Description

SCD

Visit our website at www.tycoelectronics.com**Table of dimensions (mm/in)**

Order no.	Shell size	Max. entry size type I	A Left hand thd Class 2B	C max.	D max.	E max.	Z +0.10 -0.20	S dia.	Y ±0.15 (±0.38)	W max.
12	12	08	.750-20 UNEF	29.0 (1.14)	25.4 (1.00)	33.5 (1.32)	19.05 (.750)	22.28 (.877) 22.02 (.867)	26.67 (1.050)	52.3 (2.06)
14	14	10	.875-20 UNEF	29.7 (1.17)	25.9 (1.02)	35.3 (1.39)	22.23 (.875)	25.46 (1.002) 25.17 (.991)	29.84 (1.175)	55.6 (2.19)
16	16	12	1.000-20 UNEF	30.0 (1.18)	26.2 (1.03)	37.1 (1.46)	25.40 (1.000)	28.63 (1.127) 28.34 (1.116)	33.02 (1.300)	59.01 (2.36)
18	18	14	1.125-18 UNEF	30.7 (1.21)	26.9 (1.06)	38.6 (1.52)	28.57 (1.125)	31.81 (1.252) 31.52 (1.241)	36.19 (1.425)	69.6 (2.74)
20	20	16	1.250-18 UNEF	31.2 (1.23)	27.7 (1.09)	40.1 (1.58)	31.75 (1.250)	34.98 (1.377) 34.69 (1.366)	39.37 (1.550)	72.6 (2.86)
22	22	18	1.375-18 UNEF	32.0 (1.26)	28.2 (1.11)	41.7 (1.64)	34.93 (1.375)	38.15 (1.502) 37.79 (1.488)	42.55 (1.675)	75.9 (2.99)
24	24	22	1.625-18 UNEF	33.5 (1.32)	30.0 (1.18)	46.5 (1.83)	38.10 (1.500)	41.33 (1.627) 40.97 (1.613)	45.72 (1.800)	79.0 (3.11)
28	28	24	1.875-16 UN	34.8 (1.37)	31.2 (1.23)	49.8 (1.96)				
32	32	24	2.062-16 UNS	36.3 (1.43)	32.5 (1.28)	52.8 (2.08)				
36	36	24	2.312-16 UNS	37.6 (1.48)	33.8 (1.33)	56.1 (2.21)				
40	40	24	2.625-16 UN	38.9 (1.53)	35.3 (1.39)	58.9 (2.32)				

**For larger than maximum type 1 entry sizes, a two-piece adapter will be supplied. Contact your Tyco Electronics product representative for information.

Code 40 MIL-C-38999 Series III and IV

Braided adapters

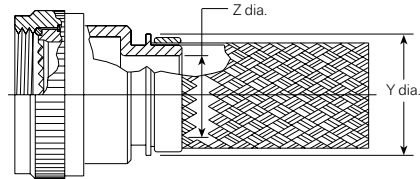

208M7XX-XXXXX

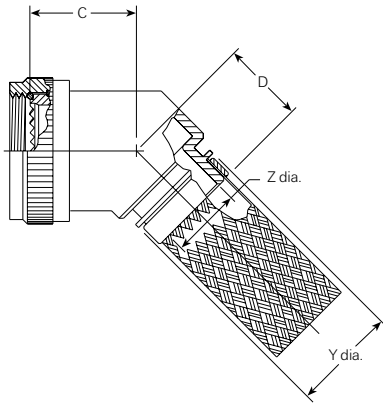

208M8XX-XXXXX

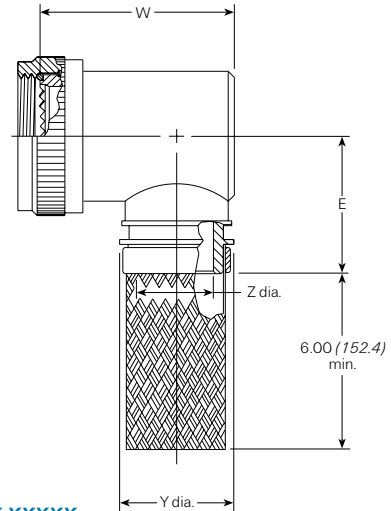

208M9XX-XXXXX

Available in:

Americas

Europe

Asia Pacific



Table of dimensions (mm/in)

Order number	Shell size		Max. entry* size type 1	Thread	C max. mm (in)	D max. mm (in)	E max. mm (in)
	Commercial	Military					
08	9	A	04	M12 x 1.0	20.8 (0.82)	22.6 (0.89)	29.2 (1.15)
10	11	B	07	M15 x 1.0	21.3 (0.84)	23.4 (0.92)	30.7 (1.21)
12	13	C	09	M18 x 1.0	22.1 (0.87)	24.1 (0.95)	32.5 (1.28)
14	15	D	10	M2 x 1.0	22.6 (0.89)	24.1 (0.95)	34.0 (1.34)
16	17	E	12	M25 x 1.0	23.4 (0.92)	24.9 (0.98)	35.6 (1.40)
18	19	F	14	M28 x 1.0	24.1 (0.95)	25.7 (1.01)	37.1 (1.46)
20	21	G	16	M31 x 1.0	24.6 (0.97)	26.4 (1.04)	38.9 (1.53)
22	23	H	18	M34 x 1.0	25.4 (1.00)	27.2 (1.07)	40.4 (1.59)
24	25	J	20	M37 x 1.0	25.9 (1.02)	27.2 (1.07)	42.4 (1.67)

*For larger than maximum type 1 entry sizes, a two-piece adapter will be supplied. Contact your Tyco Electronics product representative for information.

Fax-on-demand

US only (800) 260-9099

Outside US (650) 257-2301

Fax ID

3551 SCD

3552 SCD

3553 SCD

DescriptionVisit our website at www.tycoelectronics.com**Entry size dimensions (mm/in)**

Entry size	Z +0.25-0.5	Y dia.	W max.
04	6.35 (0.25)	13.97 (0.55)	31.2 (1.23)
05	7.92 (0.31)	15.54 (0.61)	32.8 (1.29)
06	9.52 (0.37)	17.14 (0.67)	34.3 (1.35)
07	11.09 (0.44)	18.71 (0.74)	36.1 (1.42)
08	12.7 (0.50)	20.32 (0.80)	37.6 (1.48)
10	15.87 (0.62)	23.49 (0.92)	40.6 (1.60)
12	19.05 (0.75)	26.67 (1.05)	43.9 (1.73)
14	22.23 (0.88)	29.84 (1.17)	47.0 (1.85)
16	25.4 (1.00)	33.02 (1.30)	50.8 (2.00)
18	28.57 (1.12)	36.19 (1.42)	54.1 (2.13)
20	31.75 (1.25)	39.37 (1.55)	57.21 (2.25)

Molded part selection guide (Braided)

Tinel-Lock entry size	Standard K parts			Low-profile D parts		
	Straight part no.	90° part no.	Cable OD (min.) mm (in)	Straight part no.	90° part no.	Cable OD (min.) mm (in)
04	202K232		3.3 (0.1)			
04	202W232		4.3 (0.2)			
04	202K121	222K121	5.6 (0.2)	202D211	222D211	6.4 (0.3)
05, 06	202K132	222K132	5.9 (0.2)	202D221	222D221	7.4 (0.3)
07, 08	202K142	222K142	7.1 (0.3)	202D232	222D232	8.4 (0.3)
10, 12	202K153	222K152	8.4 (0.3)	202D242	222D242	9.7 (0.4)
14, 16	202K163	222K163	9.9 (0.4)	202D253	222D253	10.5 (0.4)
18, 20, 22	202K174	222K174	15.7 (0.6)	202D263	222D263	12.2 (0.5)
24	202K185	222K185	16.8 (0.7)			

Uniboot parts

Tinel-Lock entry size	Part no.	Cable OD (min.) mm (in)
04	202C611	4.8 (0.19)
05, 06, 07	202C621	8.1 (0.32)
08, 10, 12	202C632	12.7 (0.50)
12, 14, 16	202C642	17.5 (0.69)
16, 18, 20, 22	202C653	22.4 (0.88)
24	202C663	22.9 (0.90)

Code 40 MIL-C-38999 Series III and IV

Solid adapters

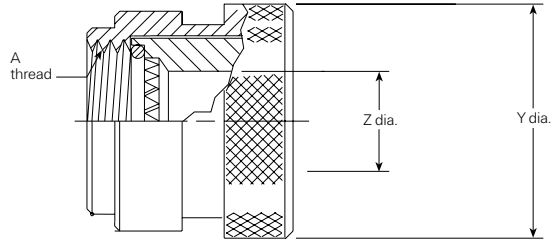

209M3XX-XXX

Available in:

Americas

Europe

Asia Pacific



Table of dimensions (mm/in)

Order number	Shell size Commercial	Military	A Thread	Y +.000 -0.030 (+0.00)(-0.76)	Z dia. min.
08	9	A	M12 x 1.0	18.26 (.719)	6.35 (.250)
10	11	B	M15 x 1.0	21.44 (.844)	9.52 (.375)
12	13	C	M18 x 1.0	24.61 (.969)	12.70 (.500)
14	15	D	M22 x 1.0	30.91 (1.217)	15.88 (.625)
16	17	E	M25 x 1.0	34.40 (1.354)	19.05 (.750)
18	19	F	M28 x 1.0	37.50 (1.476)	20.62 (.812)
20	21	G	M31 x 1.0	38.89 (1.531)	23.80 (.937)
22	23	H	M34 x 1.0	42.06 (1.656)	26.97 (1.062)
24	25	J	M37 x 1.0	45.24 (1.781)	30.18 (1.188)

Fax-on-demand

US only (800) 260-9099

Outside US (650) 257-2301

Fax ID

3554

Description

SCD

Visit our website at www.tycoelectronics.com**Molded part selection guide (Solid)**

Order no.	Standard K parts			Low-profile D parts		
	Straight part no.	90° part no.	Cable OD (min.) mm (<i>in</i>)	Straight part no.	90° part no.	Cable OD (min.) mm (<i>in</i>)
08	202K132	222K132	5.9 (0.23)	202D221	222D221	7.4 (0.29)
10	202K142	222K142	7.1 (0.28)	202D232	222D232	8.4 (0.33)
12, 14	202K153	222K152	8.4 (0.33)	202D242	222D242	9.7 (0.38)
16, 18	202K163	222K163	9.9 (0.39)	202D253	222D253	10.5 (0.41)
20, 22, 24	202K174	222K174	15.7 (0.62)	202D263	222D263	12.2 (0.48)

Uniboot parts

Order no.	Part no.	Cable OD (min.) mm (<i>in</i>)
08	202C621	8.1 (0.32)
10	202C632	12.7 (0.50)
12, 14	202C642	17.5 (0.69)
16, 18, 20, 22	202C653	22.4 (0.88)
24	–	–

Code 40 MIL-C-38999 Series III and IV

Spin-coupling adapters

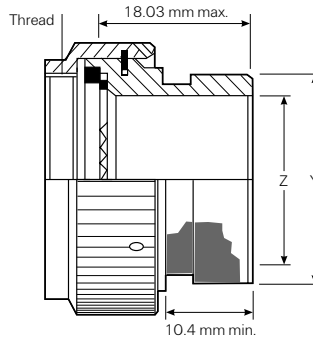

209M4XX-XXX

Available in:

Americas

Europe

Asia Pacific



Table of dimensions (mm/in)

Order number	Shell size		Thread	Y dia. max.		Z dia. max.	
	Commercial	Military		mm	(in)	mm	(in)
08	9	A	M12 x 1.0	13.54	(0.53)	6.35	(0.25)
10	11	B	M15 x 1.0	15.37	(0.61)	9.52	(0.37)
12	13	C	M18 x 1.0	19.66	(0.77)	12.7	(0.50)
14	15	D	M22 x 1.0	21.29	(0.84)	15.75	(0.62)
16	17	E	M25 x 1.0	24.46	(0.96)	18.92	(0.74)
18	19	F	M28 x 1.0	26.47	(1.04)	20.62	(0.81)
20	21	G	M31 x 1.0	30.91	(1.22)	23.8	(0.94)
22	23	H	M34 x 1.0	34.42	(1.36)	26.97	(1.06)
24	25	J	M37 x 1.0	36.65	(1.44)	29.85	(1.18)

Fax-on-demand

US only (800) 260-9099

Outside US (650) 257-2301

Fax ID

3555

Description

SCD

Visit our website at www.tycoelectronics.com**Molded part selection guide (Spin-coupling)**

Order no.	Standard K parts			Low-profile D parts		
	Straight part no.	90° part no.	Cable OD (min.) mm (<i>in</i>)	Straight part no.	90° part no.	Cable OD (min.) mm (<i>in</i>)
03, 08	202W232		4.3 (0.19)			
03, 08	202K121	222K121	5.6 (0.22)	202D211	222D211	6.4 (0.25)
10, 11	202K132	222K132	5.9 (0.23)	202D221	222D221	7.4 (0.29)
12, 14	202K142	222K142	7.1 (0.28)	202D232	222D232	8.4 (0.33)
16, 18	202K153	222K152	8.4 (0.33)	202D242	222D242	9.7 (0.38)
20, 22	202K163	222K163	9.9 (0.39)	202D253	222D253	10.5 (0.41)
24, 28	202K174	222K174	15.7 (0.62)	202D263	222D263	12.2 (0.48)
32, 36	202K185	222K185	16.8 (0.66)			

Uniboot parts

Order no.	Part no.	Cable OD (min.) mm (<i>in</i>)
03, 08	202C611	4.8 (0.19)
10, 11, 12	202C621	8.1 (0.32)
14, 16	202C632	12.7 (0.50)
18, 20	202C642	17.5 (0.69)
22, 24	202C653	22.4 (0.88)

Code 40 MIL-C-38999 Series III and IV

Tinet-Lock adapters

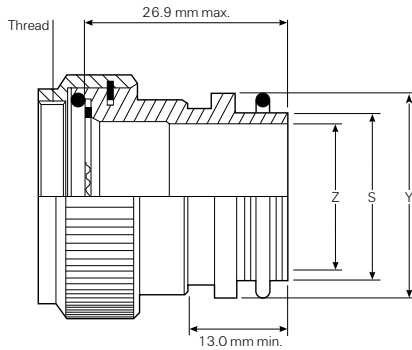

TXR40XX00-XXXXXX

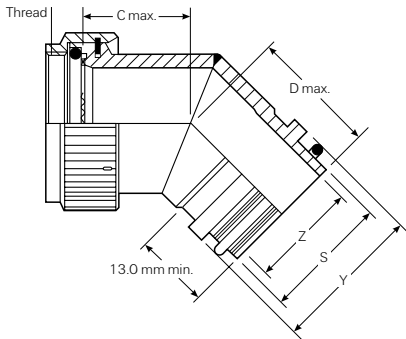

TXR40XX45-XXXXXX

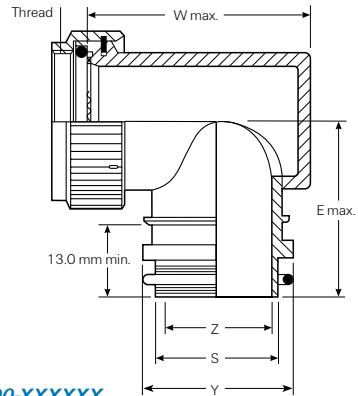

TXR40XX90-XXXXXX

Available in:

Americas

Europe

Asia Pacific

Table of dimensions (mm/in)

Order number	Shell size Commercial	Military	Max. entry* size type 1	Thread	C max. mm (in)	D max. mm (in)	E max. mm (in)
08	9	A	04	M12 x 1.0	20.8 (0.82)	22.6 (0.89)	27.9 (1.10)
10	11	B	07	M15 x 1.0	21.3 (0.84)	23.4 (0.92)	30.5 (1.20)
12	13	C	08	M18 x 1.0	22.1 (0.87)	24.1 (0.95)	32.0 (1.26)
14	15	D	10	M2 x 1.0	22.6 (0.89)	24.1 (0.95)	34.0 (1.34)
16	17	E	12	M25 x 1.0	23.4 (0.92)	24.9 (0.98)	35.6 (1.40)
18	19	F	14	M28 x 1.0	24.1 (0.95)	25.7 (1.01)	36.8 (1.45)
20	21	G	16	M31 x 1.0	24.6 (0.97)	26.4 (1.04)	38.4 (1.51)
22	23	H	18	M34 x 1.0	25.4 (1.00)	27.2 (1.07)	39.9 (1.57)
24	25	J	20	M37 x 1.0	25.9 (1.02)	27.2 (1.07)	42.4 (1.67)

*For larger than maximum type 1 entry sizes, a two-piece adapter will be supplied. Contact your Tyco Electronics product representative for information.

Fax-on-demand

US only (800) 260-9099

Outside US (650) 257-2301

Fax ID

3718

Description

SCD

Visit our website at www.tycoelectronics.com**Entry size dimensions (mm/in)**

Entry size	Z +0.25–0.5	S diameter	Y dia.	W max.
		(min.–max.)	mm (in)	mm (in)
04	6.35 (0.25)	9.39–9.56 (0.37–0.38)	13.97 (0.55)	31.2 (1.23)
05	7.92 (0.31)	10.97–11.13 (0.43–0.44)	15.54 (0.61)	32.8 (1.29)
06	9.52 (0.37)	12.57–12.73 (0.49–0.50)	17.14 (0.67)	34.3 (1.35)
07	11.09 (0.44)	14.12–14.31 (0.55–0.56)	18.71 (0.74)	36.1 (1.42)
08	12.7 (0.50)	15.72–15.91 (0.62–0.63)	20.32 (0.80)	37.6 (1.48)
10	15.87 (0.62)	18.84–19.11 (0.74–0.75)	23.49 (0.92)	40.6 (1.60)
12	19.05 (0.75)	22.02–22.28 (0.87–0.88)	26.67 (1.05)	43.9 (1.73)
14	22.23 (0.88)	25.17–25.46 (0.99–1.00)	29.84 (1.17)	47.0 (1.85)
16	25.4 (1.00)	28.34–28.63 (1.12–1.13)	33.02 (1.30)	50.8 (2.00)
18	28.57 (1.12)	31.52–31.81 (1.24–1.25)	36.19 (1.42)	54.1 (2.13)
20	31.75 (1.25)	34.69–34.98 (1.37–1.38)	39.37 (1.55)	57.21 (2.25)

Molded part selection guide (Tinel)

Tinel-Lock entry size	Standard K parts			Low-profile D parts		
	Straight part no.	90° part no.	Cable OD (min.) mm (in)	Straight part no.	90° part no.	Cable OD (min.) mm (in)
04	202K232		3.3 (0.1)			
04	202W232		4.3 (0.2)			
04	202K121	222K121	5.6 (0.2)	202D211	222D211	6.4 (0.3)
05, 06	202K132	222K132	5.9 (0.2)	202D221	222D221	7.4 (0.3)
07, 08	202K142	222K142	7.1 (0.3)	202D232	222D232	8.4 (0.3)
10, 12	202K153	222K152	8.4 (0.3)	202D242	222D242	9.7 (0.4)
14, 16	202K163	222K163	9.9 (0.4)	202D253	222D253	10.5 (0.4)
18, 20, 22	202K174	222K174	15.7 (0.6)	202D263	222D263	12.2 (0.5)
24	202K185	222K185	16.8 (0.7)			

Uniboot parts

Tinel-Lock entry size	Part no.	Cable OD (min.) mm (in)
04	202C611	4.8 (0.19)
05, 06, 07	202C621	8.1 (0.32)
08, 10, 12	202C632	12.7 (0.50)
12, 14, 16	202C642	17.5 (0.69)
16, 18, 20, 22	202C653	22.4 (0.88)
24	202C663	22.9 (0.90)

Code 40 MIL-C-38999 Series III and IV

Bandstrap adapters

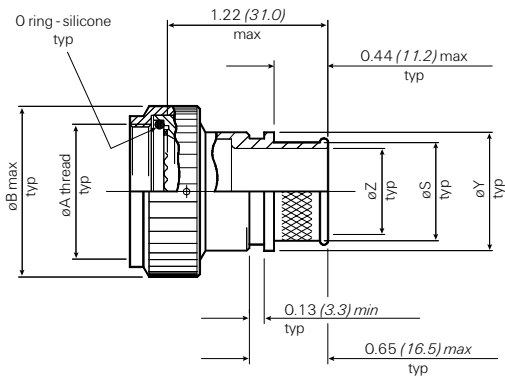

BND40XX00-XXXX

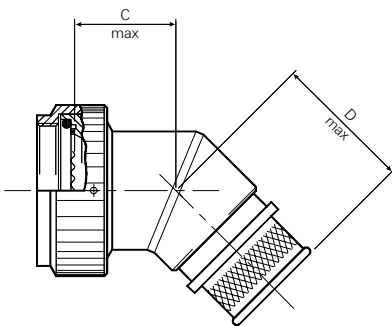

BND40XX45-XXXX

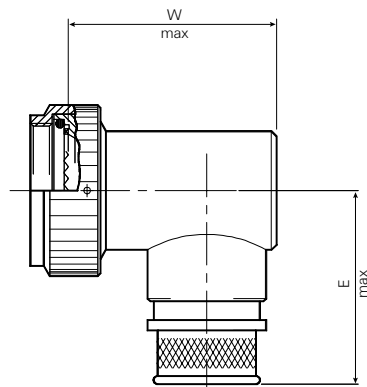

BND40XX90-XXXX

Available in:

Americas

Europe

Asia Pacific



Fax-on-demand

US only (800) 260-9099

Outside US (650) 257-2301

Visit our website at www.tycoelectronics.com**Table of dimensions (mm/in)**

Order number	Shell size COM MIL	Max. entry size	Thread	B max. mm (in)	C max. mm (in)	D max. mm (in)	E max. mm (in)
08	9 A	04	M12 x 1.0	19.1 (0.75)	20.8 (0.82)	26.7 (1.05)	32.0 (1.26)
10	11 B	07	M15 x 1.0	21.6 (0.85)	21.3 (0.84)	27.4 (1.08)	34.5 (1.36)
12	13 C	09	M18 x 1.0	25.4 (1.00)	22.1 (0.87)	28.2 (1.11)	36.1 (1.42)
14	15 D	10	M22 x 1.0	29.2 (1.15)	22.6 (0.89)	28.2 (1.11)	38.1 (1.50)
16	17 E	12	M25 x 1.0	31.8 (1.25)	23.4 (0.92)	29.0 (1.14)	39.6 (1.56)
18	19 F	14	M28 x 1.0	35.6 (1.40)	24.1 (0.95)	29.7 (1.17)	40.9 (1.61)
20	21 G	16	M31 x 1.0	38.1 (1.50)	24.6 (0.97)	30.5 (1.20)	42.4 (1.67)
22	23 H	18	M34 x 1.0	41.9 (1.65)	25.4 (1.00)	31.3 (1.23)	43.9 (1.73)
24	25 J	20	M37 x 1.0	44.5 (1.75)	25.9 (1.02)	31.3 (1.23)	46.5 (1.83)

Entry size dimensions (mm/in)

Entry size	Z +0.25–0.50 (+0.010–0.020)	S diameter mm (in)	Y diameter mm (in)	W max.
03	4.75 (0.188)	7.92 (0.312)	11.10 (0.438)	31.2 (1.23)
04	6.35 (0.250)	9.52 (0.375)	12.70 (0.500)	31.2 (1.23)
05	7.92 (0.312)	11.12 (0.438)	14.30 (0.563)	32.8 (1.29)
06	9.52 (0.375)	12.70 (0.500)	15.88 (0.625)	34.3 (1.35)
07	11.12 (0.438)	14.30 (0.562)	17.50 (0.689)	36.1 (1.42)
08	12.70 (0.500)	15.88 (0.625)	19.05 (0.750)	37.6 (1.48)
09	14.30 (0.562)	17.50 (0.688)	20.65 (0.813)	40.6 (1.60)
10	15.88 (0.625)	19.05 (0.750)	22.23 (0.875)	40.6 (1.60)
11	17.50 (0.688)	20.65 (0.812)	23.80 (0.938)	40.9 (1.73)
12	19.05 (0.750)	22.23 (0.875)	25.40 (1.000)	40.9 (1.73)
13	20.65 (0.812)	23.83 (0.938)	27.00 (1.063)	47.0 (1.85)
14	22.23 (0.875)	25.40 (1.000)	30.16 (1.189)	47.0 (1.85)
15	23.83 (0.938)	27.00 (1.062)	31.75 (1.250)	50.8 (2.00)
16	25.40 (1.000)	28.58 (1.125)	33.34 (1.313)	50.8 (2.00)
18	28.58 (1.125)	31.75 (1.250)	36.51 (1.438)	54.1 (2.13)
20	31.75 (1.250)	34.90 (1.375)	39.69 (1.563)	57.2 (2.25)

Code 41 MIL-C-38999 Series I and II

Braided adapters

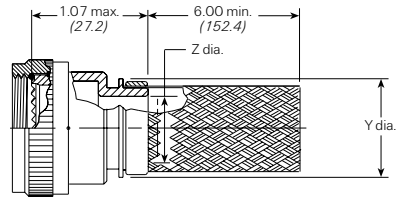

204M0XX-XXXXX

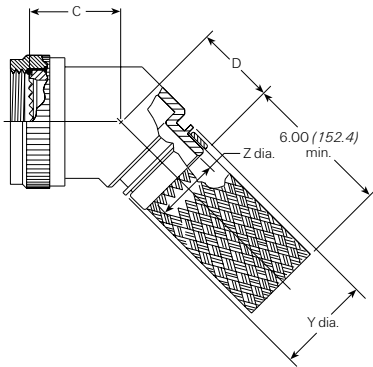

204M1XX-XXXXX

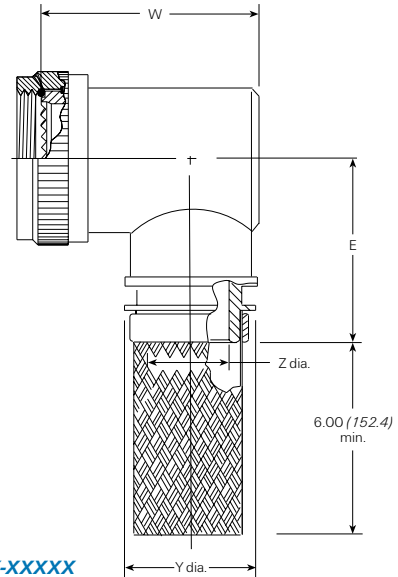

204M2XX-XXXXX

Available in:

Americas

Europe

Asia Pacific

Table of dimensions (mm/in)

Order number	Shell size Series I	Series II	Max. entry* size type 1	A Unified thread class 2B	C max. mm (in)	D max. mm (in)	E max. mm (in)
08	9	8	04	.438-28 UNEF	19.8 (0.78)	23.1 (0.91)	29.2 (1.15)
10	11	10	06	.562-24 UNEF	20.3 (0.80)	23.6 (0.93)	30.7 (1.21)
12	13	12	08	.688-24 UNEF	21.1 (0.83)	24.4 (0.96)	32.5 (1.28)
14	15	14	10	.812-20 UNEF	21.6 (0.85)	24.9 (0.98)	34.0 (1.34)
16	17	16	12	.938-20 UNEF	22.4 (0.88)	25.4 (1.00)	35.6 (1.40)
18	19	18	13	1.062-18 UNEF	22.9 (0.90)	26.2 (1.03)	37.1 (1.46)
20	21	20	15	1.188-18 UNEF	23.6 (0.93)	26.9 (1.06)	38.9 (1.53)
22	23	22	16	1.312-18 UNEF	24.4 (0.96)	27.4 (1.08)	40.4 (1.59)
24	25	24	18	1.438-18 UNEF	24.9 (0.98)	28.2 (1.11)	41.9 (1.65)

*For larger than maximum type 1 entry sizes, a two-piece adapter will be supplied. Contact your Tyco Electronics product representative for information.

Fax-on-demand	Fax ID	Description
US only (800) 260-9099	3526	SCD
Outside US (650) 257-2301	3527	SCD
	3528	SCD

Visit our website at www.tycoelectronics.com

Entry size dimensions (mm/in)

Entry size	Z ±0.020 (±0.51)	Y dia. min.	W max.
03	4.75 (.187)	9.98 (.393)	27.2 (1.07)
04	6.35 (.250)	11.58 (.456)	27.2 (1.07)
05	7.92 (.312)	13.08 (.515)	28.7 (1.13)
06	9.53 (.375)	14.76 (.581)	30.2 (1.19)
07	11.13 (.438)	16.33 (.643)	31.8 (1.25)
08	12.70 (.500)	17.91 (.705)	33.5 (1.32)
09	14.27 (.562)	17.91 (.705)	36.6 (1.44)
10	15.88 (.625)	21.11 (.831)	36.6 (1.44)
11	17.48 (.688)	22.68 (.893)	39.9 (1.57)
12	19.05 (.750)	24.21 (.953)	39.9 (1.57)
13	20.62 (.812)	24.21 (.953)	42.9 (1.69)
14	22.23 (.875)	27.46 (1.081)	42.9 (1.69)
15	23.83 (.938)	29.03 (1.143)	46.2 (1.82)
16	25.40 (1.000)	30.61 (1.205)	46.2 (1.82)
18	28.58 (1.125)	35.08 (1.381)	49.3 (1.94)
20	31.75 (1.250)	38.25 (1.506)	NA
22	34.93 (1.375)	41.43 (1.631)	NA
24	38.10 (1.500)	44.60 (1.756)	NA
28	44.45 (1.750)	50.90 (2.004)	NA

Molded part selection guide (Braided)

Tinel-Lock entry size	Standard K parts			Low-profile D parts		
	Straight part no.	90° part no.	Cable OD (min.) mm (in)	Straight part no.	90° part no.	Cable OD (min.) mm (in)
04	202K232		3.3 (0.1)			
04	202W232		4.3 (0.2)			
04	202K121	222K121	5.6 (0.2)	202D211	222D211	6.4 (0.3)
05, 06	202K132	222K132	5.9 (0.2)	202D221	222D221	7.4 (0.3)
07, 08	202K142	222K142	7.1 (0.3)	202D232	222D232	8.4 (0.3)
10, 12	202K153	222K152	8.4 (0.3)	202D242	222D242	9.7 (0.4)
14, 16	202K163	222K163	9.9 (0.4)	202D253	222D253	10.5 (0.4)
18, 20, 22	202K174	222K174	15.7 (0.6)	202D263	222D263	12.2 (0.5)
24	202K185	222K185	16.8 (0.7)			

Uniboot parts

Tinel-Lock entry size	Part no.	Cable OD (min.) mm (in)
04	202C611	4.8 (0.19)
05, 06, 07	202C621	8.1 (0.32)
08, 10, 12	202C632	12.7 (0.50)
12, 14, 16	202C642	17.5 (0.69)
16, 18, 20, 22	202C653	22.4 (0.88)
24	202C663	22.9 (0.90)

Users should independently evaluate the suitability of the product for their application.
Before ordering check with factory for most current data.

Code 41 MIL-C-38999 Series I and II

Solid adapters

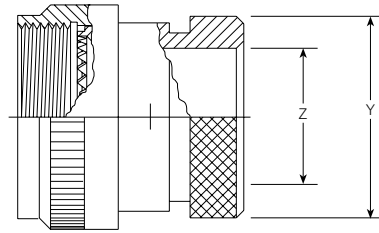

202M1XX-XXX

Available in:

Americas

Europe

Asia Pacific



Table of dimensions (mm/in)

Order number	Shell size		Thread	Y +0.00-0.30 (+0.00)(-0.76) dia.		Z min. mm (in)
	Series I	Series II		mm	(in)	
08	9	8	.438-28 UNEF	18.26	(.719)	6.71 (.264)
10	11	10	.562-24 UNEF	21.44	(.844)	9.96 (.392)
12	13	12	.688-24 UNEF	24.61	(.969)	12.85 (.506)
14	15	14	.812-20 UNEF	27.79	(1.094)	16.03 (.631)
16	17	16	.938-20 UNEF	32.54	(1.281)	19.20 (.756)
18	19	18	1.062-18 UNEF	35.71	(1.406)	21.44 (.844)
20	21	20	1.188-18 UNEF	38.89	(1.531)	24.64 (.970)
22	23	22	1.312-18 UNEF	42.06	(1.656)	27.79 (1.094)
24	25	24	1.438-18 UNEF	45.24	(1.781)	30.71 (1.209)

Fax-on-demand

US only (800) 260-9099

Outside US (650) 257-2301

Fax ID

3509

Description

SCD

Visit our website at www.tycoelectronics.com**Molded part selection guide (Solid)**

Order no.	Standard K parts			Low-profile D parts		
	Straight part no.	90° part no.	Cable OD (min.) mm (<i>in</i>)	Straight part no.	90° part no.	Cable OD (min.) mm (<i>in</i>)
08	202K132	222K132	5.9 (0.23)	202D221	222D221	7.4 (0.29)
10	202K142	222K142	7.1 (0.28)	202D232	222D232	8.4 (0.33)
12, 14	202K153	222K152	8.4 (0.33)	202D242	222D242	9.7 (0.38)
16, 18	202K163	222K163	9.9 (0.39)	202D253	222D253	10.5 (0.41)
20, 22, 24	202K174	222K174	15.7 (0.62)	202D263	222D263	12.2 (0.48)

Uniboot parts

Order no.	Part no.	Cable OD (min.) mm (<i>in</i>)
08	202C621	8.1 (0.32)
10	202C632	12.7 (0.50)
12, 14	202C642	17.5 (0.69)
16, 18, 20, 22	202C653	22.4 (0.88)
24	–	–

Code 41 MIL-C-38999 Series I and II

Spin-coupling adapters

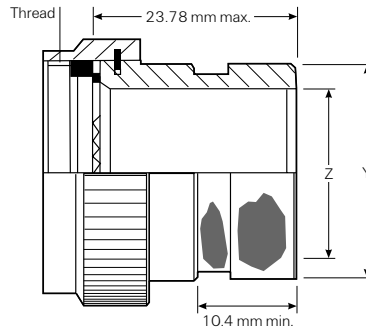

202M2XX-XXX

Available in:

Americas

Europe

Asia Pacific



Table of dimensions (mm/in)

Order number	Shell size		Thread	Y+0.00-0.76 dia.		Z min..	
	Series I	Series II		mm	(in)	mm	(in)
08	9	8	.438-28 UNEF	13.54	(0.53)	6.35	(0.25)
10	11	10	.562-24 UNEF	15.37	(0.61)	9.53	(0.38)
12	13	12	.688-24 UNEF	19.66	(0.77)	12.70	(0.50)
14	15	14	.812-20 UNEF	21.29	(0.84)	15.88	(0.63)
16	17	16	.938-20 UNEF	24.46	(0.96)	19.05	(0.75)
18	19	18	1.062-18 UNEF	26.47	(1.04)	20.62	(0.81)
20	21	20	1.188-18 UNEF	30.91	(1.22)	23.80	(0.94)
22	23	22	1.312-18 UNEF	34.42	(1.36)	26.97	(1.06)
24	25	24	1.438-18 UNEF	36.65	(1.44)	30.18	(1.19)

Fax-on-demand

US only (800) 260-9099

Outside US (650) 257-2301

Fax ID

3510

Description

SCD

Visit our website at www.tycoelectronics.com**Molded part selection guide (Spin-coupling)**

Order no.	Standard K parts			Low-profile D parts		
	Straight part no.	90° part no.	Cable OD (min.) mm (<i>in</i>)	Straight part no.	90° part no.	Cable OD (min.) mm (<i>in</i>)
08	202W232		4.3 (0.19)			
08	202K121	222K121	5.6 (0.22)	202D211	222D211	6.4 (0.25)
10	202K132	222K132	5.9 (0.23)	202D221	222D221	7.4 (0.29)
12, 14	202K142	222K142	7.1 (0.28)	202D232	222D232	8.4 (0.33)
16, 18	202K153	222K152	8.4 (0.33)	202D242	222D242	9.7 (0.38)
20, 22	202K163	222K163	9.9 (0.39)	202D253	222D253	10.5 (0.41)
24, 28	202K174	222K174	15.7 (0.62)	202D263	222D263	12.2 (0.48)

Uniboot parts

Order no.	Part no.	Cable OD (min.) mm (<i>in</i>)
08	202C611	4.8 (0.19)
10, 12	202C621	8.1 (0.32)
14, 16	202C632	12.7 (0.50)
18, 20	202C642	17.5 (0.69)
22, 24	202C653	22.4 (0.88)

Code 41 MIL-C-38999 Series I and II

Tinel-Lock adapters

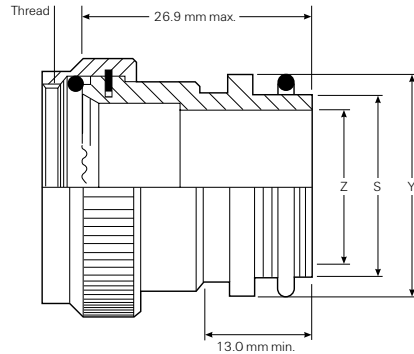

TXR41XX00-XXXXXX

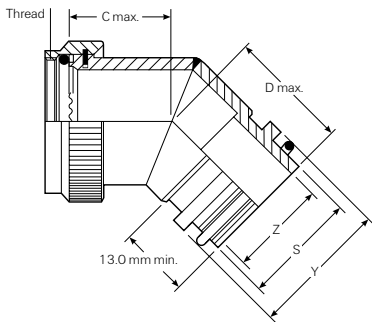

TXR41XX45-XXXXXX

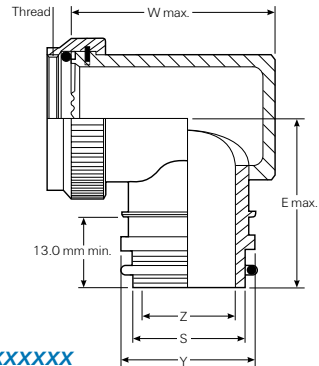

TXR41XX90-XXXXXX

Available in:

Americas

Europe

Asia Pacific



Table of dimensions (mm/in)

Order number	Shell size		Max. entry* size type 1	A Unified thread class 2B	C max. mm (in)	D max. mm (in)	E max. mm (in)
	Series I	Series II					
08	9	8		438-28 UNEF	17.5 (0.69)	23.1 (0.91)	29.2 (1.15)
10	11	10		.562-24 UNEF	18.3 (0.72)	23.6 (0.93)	30.7 (1.21)
12	13	12	08	.688-24 UNEF	18.8 (0.74)	24.4 (0.96)	32.5 (1.28)
14	15	14	10	.812-20 UNEF	19.3 (0.76)	24.9 (0.98)	34.0 (1.34)
16	17	16	12	.938-20 UNEF	20.1 (0.79)	25.4 (1.00)	35.6 (1.40)
18	19	18	13	1.062-18 UNEF	20.6 (0.81)	26.2 (1.03)	37.1 (1.46)
20	21	20	15	1.188-18 UNEF	21.3 (0.84)	26.9 (1.06)	38.9 (1.53)
22	23	22	16	1.312-18 UNEF	22.1 (0.87)	27.4 (1.08)	40.4 (1.59)
24	25	24	18	1.438-18 UNEF	22.6 (0.89)	28.2 (1.11)	41.9 (1.65)

*For larger than maximum type 1 entry sizes, a two-piece adapter will be supplied. Contact your Tyco Electronics product representative for information.

Fax-on-demand

US only (800) 260-9099

Outside US (650) 257-2301

Fax ID

3719

Description

SCD

Visit our website at www.tycoelectronics.com**Entry size dimensions (mm/in)**

Entry size	Z +0.25–0.5	S diameter		Y ±0.38	W max.
		(min.–max.)	(min.–max.)		
04	6.35 (0.25)	9.39–9.56	(0.37–0.38)	13.97 (0.55)	27.2 (1.07)
05	7.92 (0.31)	10.97–11.13	(0.43–0.44)	15.54 (0.61)	28.7 (1.13)
06	9.52 (0.37)	12.57–12.73	(0.49–0.50)	17.14 (0.67)	30.2 (1.19)
07	11.09 (0.44)	14.12–14.31	(0.55–0.56)	18.71 (0.74)	31.8 (1.25)
08	12.7 (0.50)	15.72–15.91	(0.62–0.63)	20.32 (0.80)	33.5 (1.32)
10	15.87 (0.62)	18.84–19.11	(0.74–0.75)	23.49 (0.92)	36.6 (1.44)
12	19.05 (0.75)	22.02–22.28	(0.87–0.88)	26.67 (1.05)	39.9 (1.57)
14	22.23 (0.88)	25.17–25.46	(0.99–1.00)	29.84 (1.17)	42.9 (1.69)
16	25.4 (1.00)	28.34–28.63	(1.12–1.13)	33.02 (1.30)	46.2 (1.82)
18	28.57 (1.12)	31.52–31.81	(1.24–1.25)	36.19 (1.42)	49.3 (1.94)

Molded part selection guide (Tinel)

Tinel-Lock entry size	Standard K parts			Low-profile D parts		
	Straight part no.	90° part no.	Cable OD (min.) mm (in)	Straight part no.	90° part no.	Cable OD (min.) mm (in)
04	202K232		3.3 (0.1)			
04	202W232		4.3 (0.2)			
04	202K121	222K121	5.6 (0.2)	202D211	222D211	6.4 (0.3)
05, 06	202K132	222K132	5.9 (0.2)	202D221	222D221	7.4 (0.3)
07, 08	202K142	222K142	7.1 (0.3)	202D232	222D232	8.4 (0.3)
10, 12	202K153	222K152	8.4 (0.3)	202D242	222D242	9.7 (0.4)
14, 16	202K163	222K163	9.9 (0.4)	202D253	222D253	10.5 (0.4)
18, 20, 22	202K174	222K174	15.7 (0.6)	202D263	222D263	12.2 (0.5)
24	202K185	222K185	16.8 (0.7)			

Uniboot parts

Tinel-Lock entry size	Part no.	Cable OD (min.) mm (in)
04	202C611	4.8 (0.19)
05, 06, 07	202C621	8.1 (0.32)
08, 10, 12	202C632	12.7 (0.50)
12, 14, 16	202C642	17.5 (0.69)
16, 18, 20, 22	202C653	22.4 (0.88)
24	202C663	22.9 (0.90)

Code 41 MIL-C-38999

Series I and II

Bandstrap adapters

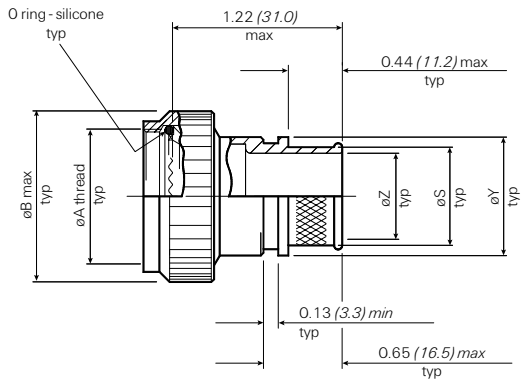

BND41XX00-XXXX

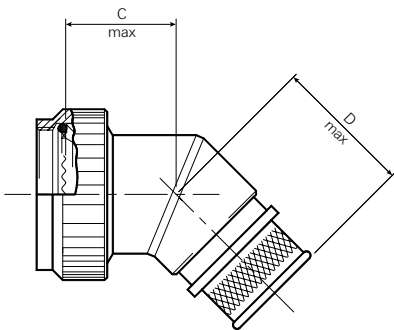

BND41XX45-XXXX

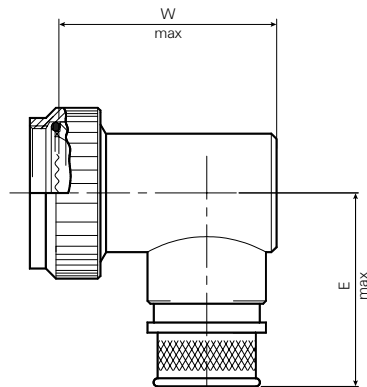

BND41XX90-XXXX

Available in:

Americas

Europe

Asia Pacific



Fax-on-demand

US only (800) 260-9099

Outside US (650) 257-2301

Visit our website at www.tycoelectronics.com**Table of dimensions (mm/in)**

Order number	Shell size		Max. entry size	A Unified thread Class 2B	B max. mm (in)	C max. mm (in)	D max. mm (in)	E max. mm (in)
	I	II						
08	9	08	04	0.4375-28 UNEF	19.1 (0.75)	17.5 (0.69)	27.2 (1.07)	33.3 (1.31)
10	11	10	06	0.5625-24 UNEF	20.8 (0.85)	18.3 (0.72)	27.7 (1.09)	34.8 (1.37)
12	13	12	08	0.6875-24 UNEF	25.4 (1.00)	18.8 (0.74)	28.4 (1.12)	36.6 (1.44)
14	15	14	10	0.8125-20 UNEF	27.2 (1.10)	19.3 (0.76)	29.0 (1.14)	38.1 (1.50)
16	17	16	12	0.9375-20 UNEF	31.8 (1.25)	20.1 (0.79)	29.5 (1.16)	39.6 (1.56)
18	19	18	13	1.0625-18 UNEF	35.6 (1.40)	20.6 (0.81)	30.2 (1.19)	41.1 (1.62)
20	21	20	15	1.1875-18 UNEF	38.1 (1.50)	21.3 (0.84)	31.0 (1.22)	42.9 (1.69)
22	23	22	16	1.3125-18 UNEF	41.9 (1.65)	22.1 (0.87)	31.5 (1.24)	44.5 (1.75)
24	25	24	18	1.4375-18 UNEF	44.5 (1.75)	22.6 (0.89)	32.3 (1.27)	46.0 (1.81)

Entry size dimensions (mm/in)

Entry size	Z +0.25 -0.50 (+0.010 -0.020)	S diameter		Y diameter		W max.
		mm	(in)	mm	(in)	
03	4.75 (0.188)	7.92 (0.312)	11.10 (0.438)	27.2 (1.07)		
04	6.35 (0.250)	9.52 (0.375)	12.70 (0.500)	27.2 (1.07)		
05	7.92 (0.312)	11.12 (0.438)	14.30 (0.563)	28.7 (1.13)		
06	9.52 (0.375)	12.70 (0.500)	15.88 (0.625)	30.2 (1.19)		
07	11.12 (0.438)	14.30 (0.562)	17.50 (0.689)	31.8 (1.25)		
08	12.70 (0.500)	15.88 (0.625)	19.05 (0.750)	33.5 (1.32)		
09	14.30 (0.562)	17.50 (0.688)	20.65 (0.813)	36.6 (1.44)		
10	15.88 (0.625)	19.05 (0.750)	22.23 (0.875)	36.6 (1.44)		
11	17.50 (0.688)	20.65 (0.812)	23.80 (0.938)	39.9 (1.57)		
12	19.05 (0.750)	22.23 (0.875)	25.40 (1.000)	39.9 (1.57)		
13	20.65 (0.812)	23.83 (0.938)	27.00 (1.063)	42.9 (1.69)		
14	22.23 (0.875)	25.40 (1.000)	30.16 (1.189)	42.9 (1.69)		
15	23.83 (0.938)	27.00 (1.062)	31.75 (1.250)	46.2 (1.82)		
16	25.40 (1.000)	28.58 (1.125)	33.34 (1.313)	46.2 (1.82)		
18	28.58 (1.125)	31.75 (1.250)	36.51 (1.438)	49.3 (1.94)		

Code 47 PAN6433-2

Bandstrap adapters

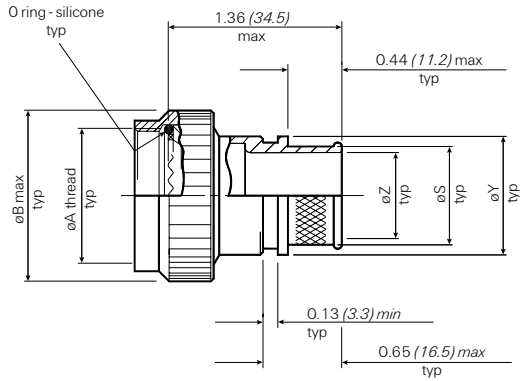

BND47XX00-XXXX

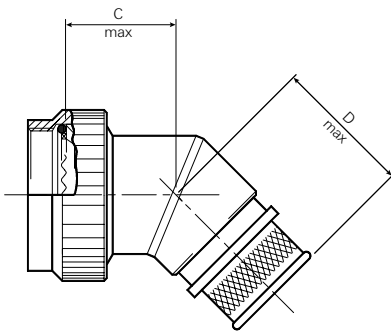

BND47XX45-XXXX

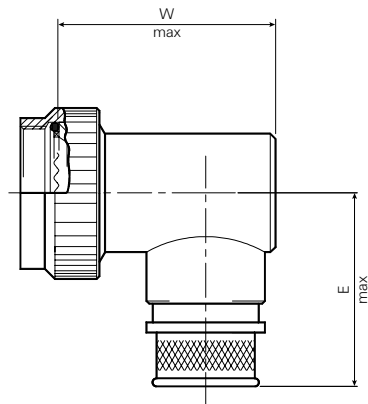

BND47XX90-XXXX

Available in:

Americas

Europe

Asia Pacific



Fax-on-demand

US only (800) 260-9099

Outside US (650) 257-2301

Visit our website at www.tycoelectronics.com**Table of dimensions (mm/in)**

Order number	Shell size	Max. entry size	A Unified thread Class 2B	B max. mm (in)	C max. mm (in)	D max. mm (in)	E max. mm (in)
08	8	04	0.4375-28 UNEF	18.3 (0.72)	17.5 (0.69)	27.2 (1.07)	33.3 (1.31)
10	10	06	0.5625-24 UNEF	21.6 (0.85)	18.3 (0.72)	27.7 (1.09)	34.8 (1.37)
12	12	08	0.6875-24 UNEF	24.6 (0.97)	18.8 (0.74)	28.4 (1.12)	36.6 (1.44)
14	14	10	0.8125-20 UNEF	27.9 (1.10)	19.3 (0.76)	29.0 (1.14)	38.1 (1.50)
16	16	12	0.9375-20 UNEF	31.0 (1.22)	20.1 (0.79)	29.5 (1.16)	39.6 (1.56)
18	18	13	1.0625-18 UNEF	34.3 (1.35)	20.6 (0.81)	30.2 (1.19)	41.1 (1.62)
20	20	15	1.1875-18 UNEF	37.3 (1.47)	21.3 (0.84)	31.0 (1.22)	42.9 (1.69)
22	22	16	1.3125-18 UNEF	40.6 (1.60)	22.1 (0.87)	31.5 (1.24)	44.5 (1.75)
24	24	18	1.4375-18 UNEF	43.7 (1.72)	22.6 (0.89)	32.3 (1.27)	46.0 (1.81)

Entry size dimensions (mm/in)

Entry size	Z +0.25 -0.50 (+0.010 -0.020)	S diameter mm (in)	Y diameter mm (in)	W max.
03	4.75 (0.188)	7.92 (0.312)	11.10 (0.438)	27.2 (1.07)
04	6.35 (0.250)	9.52 (0.375)	12.70 (0.500)	27.2 (1.07)
05	7.92 (0.312)	11.12 (0.438)	14.30 (0.563)	28.7 (1.13)
06	9.52 (0.375)	12.70 (0.500)	15.88 (0.625)	30.2 (1.19)
07	11.12 (0.438)	14.30 (0.562)	17.50 (0.689)	31.8 (1.25)
08	12.70 (0.500)	15.88 (0.625)	19.05 (0.750)	33.5 (1.32)
09	14.30 (0.562)	17.50 (0.688)	20.65 (0.813)	36.6 (1.44)
10	15.88 (0.625)	19.05 (0.750)	22.23 (0.875)	36.6 (1.44)
11	17.50 (0.688)	20.65 (0.812)	23.80 (0.938)	39.9 (1.57)
12	19.05 (0.750)	22.23 (0.875)	25.40 (1.000)	39.9 (1.57)
13	20.65 (0.812)	23.83 (0.938)	27.00 (1.063)	42.9 (1.69)
14	22.23 (0.875)	25.40 (1.000)	30.16 (1.189)	42.9 (1.69)
15	23.83 (0.938)	27.00 (1.062)	31.75 (1.250)	46.2 (1.82)
16	25.40 (1.000)	28.58 (1.125)	33.34 (1.313)	46.2 (1.82)
18	28.58 (1.125)	31.75 (1.250)	36.51 (1.438)	49.3 (1.94)

Code 54

Braided adapters
MIL-C-5015 (MS3400), MIL-C-26482 Series 2,
MIL-C-83723 Series I and III,
MIL-C-81703 Series III

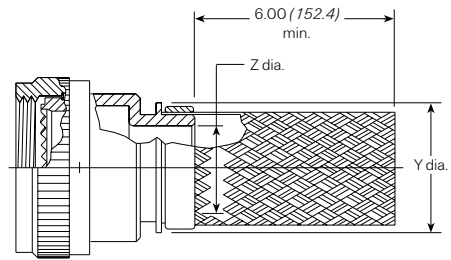

203M0XX-XXXXX

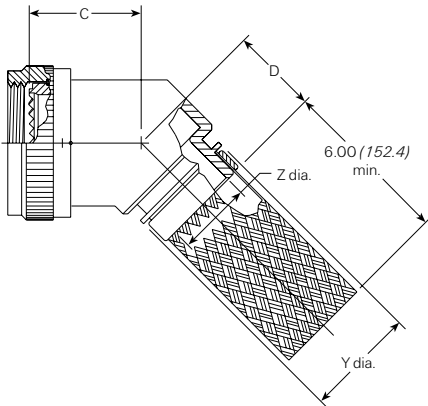

203M1XX-XXXXX

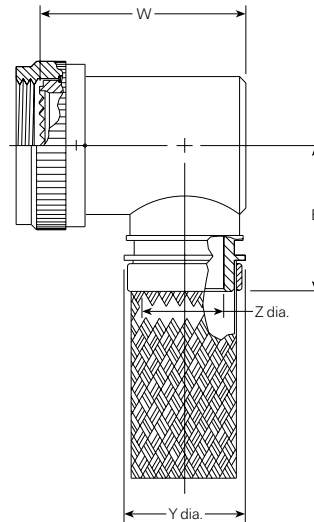

203M2XX-XXXXX

Available in:

Americas

Europe

Asia Pacific



Fax-on-demand	Fax ID	Description
US only (800) 260-9099	3517	SCD
Outside US (650) 257-2301	3518	SCD
	3519	SCD

Visit our website at www.tycoelectronics.com

Table of dimensions (mm/in)

Order number	Shell size		Max. entry size type 1*	Thread	C max.		D max.		E max.	
	MIL-C-81703	MIL-C-5015			mm	(in)	mm	(in)	mm	(in)
03	3		04	.562-24 UNEF	19.10	(0.75)	23.10	(0.91)	28.70	(1.13)
08		8 & 8S	04	.500-20 UNF	19.10	(0.75)	23.10	(0.91)	27.90	(1.10)
10		10, 10S & 10SL	06	.625-24 UNEF	19.60	(0.77)	23.60	(0.93)	29.50	(1.16)
12	7	12 & 12S	08	.750-20 UNEF	20.30	(0.80)	24.10	(0.95)	31.00	(1.22)
14	12	14 & 14S	08	.875-20 UNEF	20.80	(0.82)	24.60	(0.97)	32.50	(1.28)
16	19	16 & 16S	10	1.000-20 UNEF	21.30	(0.84)	25.40	(1.00)	34.30	(1.35)
18	27	18	12	1.062-18 UNEF	21.80	(0.86)	25.70	(1.01)	35.60	(1.40)
20	37	20	14	1.188-18 UNEF	22.40	(0.88)	26.40	(1.04)	37.10	(1.46)
22		22	16	1.312-18 UNEF	23.10	(0.91)	26.90	(1.06)	38.90	(1.53)
24		24	18	1.438-18 UNEF	23.60	(0.93)	27.70	(1.09)	40.40	(1.59)
28		28	22	1.750-18 UNS	24.90	(0.98)	29.20	(1.15)	45.20	(1.78)
32		32	24	2.000-18 UNS	26.20	(1.03)	30.50	(1.20)	48.30	(1.90)
36		36	24	2.250-16 UN	27.40	(1.08)	31.80	(1.25)	51.60	(2.03)
40		40	24	2.500-16 UN	29.00	(1.14)	33.30	(1.31)	54.60	(2.15)
44		44	24	2.750-16 UN	30.20	(1.19)	34.50	(1.36)	57.90	(2.28)
48		48	24	3.000-16 UN	31.50	(1.24)	35.10	(1.38)	61.00	(2.40)
61	61		18	1.500-18 UNEF	23.90	(0.94)	27.90	(1.10)	41.10	(1.62)

*For larger than maximum type 1 entry sizes, a two-piece adapter will be supplied. Contact your Tyco Electronics product representative for information.

Code 54

Braided adapters

MIL-C-50 15 (MS3400), MIL-C-26482 Series 2,

MIL-C-83 723 Series I and III,

MIL-C-8 1 703 Series III (cont'd.)

Entry size dimensions (mm/in)

Entry size	Z +0.25-0.5	S diameter		
		(min.-max.)	Y ±0.38	W max.
04	6.35 (0.25)	9.39-9.56 (0.37-0.38)	13.97 (0.55)	28.4 (1.12)
05	7.92 (0.31)	10.97-11.13 (0.43-0.44)	15.54 (0.61)	30.2 (1.19)
06	9.52 (0.37)	12.57-12.73 (0.49-0.50)	17.14 (0.67)	31.8 (1.25)
07	11.09 (0.44)	14.12-14.31 (0.55-0.56)	18.71 (0.74)	33.3 (1.31)
08	12.7 (0.50)	15.72-15.91 (0.62-0.63)	20.32 (0.80)	35.1 (1.38)
10	15.87 (0.62)	18.84-19.11 (0.74-0.75)	23.49 (0.92)	38.1 (1.50)
12	19.05 (0.75)	22.02-22.28 (0.87-0.88)	26.67 (1.05)	41.1 (1.62)
14	22.23 (0.88)	25.17-25.46 (0.99-1.00)	29.84 (1.17)	44.5 (1.75)
16	25.4 (1.00)	28.34-28.63 (1.12-1.13)	33.02 (1.30)	47.8 (1.88)
18	28.57 (1.12)	31.52-31.81 (1.24-1.25)	36.19 (1.42)	50.8 (2.00)
20	31.75 (1.25)	34.69-34.98 (1.37-1.38)	39.37 (1.55)	53.8 (2.12)
22	34.93 (1.38)	37.79-38.15 (1.49-1.50)	42.55 (1.68)	57.2 (2.25)
24	38.1 (1.50)	40.97-41.33 (1.61-1.63)	45.72 (1.80)	60.5 (2.38)

Fax-on-demand

US only (800) 260-9099

Outside US (650) 257-2301

Fax ID

3517 SCD

3518 SCD

3519 SCD

DescriptionVisit our website at www.tycoelectronics.com**Molded part selection guide (Braided)**

Tinel-Lock entry size	Standard K parts			Low-profile D parts		
	Straight part no.	90° part no.	Cable OD (min.) mm (in)	Straight part no.	90° part no.	Cable OD (min.) mm (in)
04	202K232		3.3 (0.1)			
04	202W232		4.3 (0.2)			
04	202K121	222K121	5.6 (0.2)	202D211	222D211	6.4 (0.3)
05, 06	202K132	222K132	5.9 (0.2)	202D221	222D221	7.4 (0.3)
07, 08	202K142	222K142	7.1 (0.3)	202D232	222D232	8.4 (0.3)
10, 12	202K153	222K152	8.4 (0.3)	202D242	222D242	9.7 (0.4)
14, 16	202K163	222K163	9.9 (0.4)	202D253	222D253	10.5 (0.4)
18, 20, 22	202K174	222K174	15.7 (0.6)	202D263	222D263	12.2 (0.5)
24	202K185	222K185	16.8 (0.7)			
Uniboot parts						
Tinel-Lock entry size	Part no.	Cable OD (min.) mm (in)				
04	202C611	4.8 (0.19)				
05, 06, 07	202C621	8.1 (0.32)				
08, 10, 12	202C632	12.7 (0.50)				
12, 14, 16	202C642	17.5 (0.69)				
16, 18, 20, 22	202C653	22.4 (0.88)				
24	202C663	22.9 (0.90)				

Code 54

Solid adapters
 MIL-C-5015 (MS3400), MIL-C-26482 Series 2,
 MIL-C-83723 Series I and III,
 MIL-C-81703 Series III

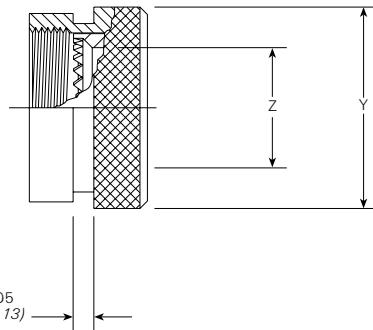

201M9XX-XXX

Available in:	Americas	Europe	Asia Pacific
	■	■	■

Table of dimensions (mm/in)					
Order number	Shell size MIL-C-81703	MIL-C-5015	Thread	Y +0.00-0.51 dia. mm (in)	Z dia. min. mm (in)
03	3		.562-24 UNEF	13.54 (0.53)	6.35 (0.25)
08		8 & 8S	.500-20 UNF	13.54 (0.53)	6.35 (0.25)
10		10, 10S & 10SL	.625-24 UNEF	15.37 (0.61)	9.02 (0.36)
12	7	12 & 12S	.750-20 UNEF	19.66 (0.77)	12.47 (0.49)
14	12	14 & 14S	.875-20 UNEF	21.29 (0.84)	14.35 (0.56)
16	19	16 & 16S	1.000-20 UNEF	24.46 (0.96)	17.53 (0.69)
18	27	18	1.062-18 UNEF	26.47 (1.04)	19.53 (0.77)
20	37	20	1.188-18 UNEF	30.91 (1.22)	22.71 (0.89)
22		22	1.312-18 UNEF	34.42 (1.36)	25.88 (1.02)
24		24	1.438-18 UNEF	36.65 (1.44)	28.80 (1.13)
28		28	1.750-18 UNS	43.41 (1.71)	34.77 (1.37)
32		32	2.000-18 UNS	48.74 (1.92)	41.02 (1.61)
36		36	2.250-16 UN	55.09 (2.17)	46.48 (1.83)
40		40	2.500-16 UN	61.01 (2.40)	51.94 (2.04)
44		44	2.750-16 UN	67.49 (2.66)	58.42 (2.30)
48		48	3.000-16 UN	73.84 (2.91)	64.77 (2.55)
61	61		1.500-18 UNEF	36.65 (1.44)	29.82 (1.17)

Fax-on-demand

US only (800) 260-9099

Outside US (650) 257-2301

Fax ID

3516

Description

SCD

Visit our website at www.tycoelectronics.com**Molded part selection guide (Solid)**

Order no.	Standard K parts			Low-profile D parts		
	Straight part no.	90° part no.	Cable OD (min.) mm (in)	Straight part no.	90° part no.	Cable OD (min.) mm (in)
03	202K132	222K132	5.9 (0.23)	202D221	222D221	7.4 (0.29)
10	202K142	222K142	7.1 (0.28)	202D232	222D232	8.4 (0.33)
12, 14	202K153	222K152	8.4 (0.33)	202D242	222D242	9.7 (0.38)
16, 18, 19, 27	202K163	222K163	9.9 (0.39)	202D253	222D253	10.5 (0.41)
20, 22, 24, 28, 37	202K174	222K174	15.7 (0.62)	202D263	222D263	12.2 (0.48)
28, 32	202K185	222K185	16.8 (0.66)			

Uniboot parts

Order no.	Part no.	Cable OD (min.) mm (in)
08	202C621	8.1 (0.32)
7, 10, 12	202C632	12.7 (0.50)
12, 14	202C642	17.5 (0.69)
16, 18, 19, 20, 22, 24, 27, 37, 61	202C653	22.4 (0.88)

Code 54

Spin-coupling adapters
MIL-C-5015 (MS3400), MIL-C-26482 Series 2,
MIL-C-83723 Series I and III,
MIL-C-81703 Series III

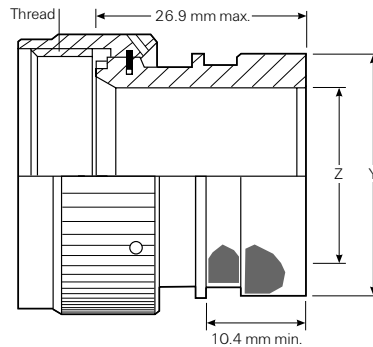

201M1XX-XXX

Available in:	Americas	Europe	Asia Pacific
	■	■	■

Table of dimensions (mm/in)

Order number	Shell size MIL-C-81703	MIL-C-5015	Thread	Y +0.00-0.51 dia. mm (in)	Z dia. min. mm (in)
03	3		.562-24 UNEF	13.54 (0.53)	6.35 (0.25)
08		8 & 8S	.500-20 UNF	13.54 (0.53)	6.35 (0.25)
10		10, 10S & 10SL	.625-24 UNEF	15.37 (0.61)	9.02 (0.36)
12	7	12 & 12S	.750-20 UNEF	19.66 (0.77)	12.47 (0.49)
14	12	14 & 14S	.875-20 UNEF	21.29 (0.84)	14.35 (0.56)
16	19	16 & 16S	1.000-20 UNEF	24.46 (0.96)	17.53 (0.69)
18	27	18	1.062-18 UNEF	26.47 (1.04)	19.53 (0.77)
20	37	20	1.188-18 UNEF	30.91 (1.22)	22.71 (0.89)
22		22	1.312-18 UNEF	34.42 (1.36)	25.88 (1.02)
24		24	1.438-18 UNEF	36.65 (1.44)	28.80 (1.13)
28		28	1.750-18 UNS	43.41 (1.71)	34.77 (1.37)
32		32	2.000-18 UNS	48.74 (1.92)	41.02 (1.61)
36		36	2.250-16 UN	55.09 (2.17)	46.48 (1.83)
40		40	2.500-16 UN	61.01 (2.40)	51.94 (2.04)
44		44	2.750-16 UN	67.49 (2.66)	58.42 (2.30)
48		48	3.000-16 UN	73.84 (2.91)	64.77 (2.55)
61	61		1.500-18 UNEF	36.65 (1.44)	29.82 (1.17)

Fax-on-demand

US only (800) 260-9099

Outside US (650) 257-2301

Fax ID

3504

Description

SCD

Visit our website at www.tycoelectronics.com**Molded part selection guide (Spin-coupling)**

Order no.	Standard K parts			Low-profile D parts		
	Straight part no.	90° part no.	Cable OD (min.) mm (in)	Straight part no.	90° part no.	Cable OD (min.) mm (in)
03, 08	202W232		4.3 (0.19)			
03, 08	202K121	222K121	5.6 (0.22)	202D211	222D211	6.4 (0.25)
10, 11	202K132	222K132	5.9 (0.23)	202D221	222D221	7.4 (0.29)
12, 14	202K142	222K142	7.1 (0.28)	202D232	222D232	8.4 (0.33)
16, 18	202K153	222K152	8.4 (0.33)	202D242	222D242	9.7 (0.38)
20, 22	202K163	222K163	9.9 (0.39)	202D253	222D253	10.5 (0.41)
24, 28, 61	202K174	222K174	15.7 (0.62)	202D263	222D263	12.2 (0.48)
32, 36	202K185	222K185	16.8 (0.66)			

Uniboot parts

Order no.	Part no.	Cable OD (min.) mm (in)
03, 08	202C611	
10, 11, 12	202C621	8.1 (0.32)
14, 16	202C632	12.7 (0.50)
18, 20	202C642	17.5 (0.69)
22, 24, 61	202C653	22.4 (0.88)

Code 54

Tine-Lock adapters
 MIL-C-5015 (MS3400), MIL-C-26482 Series 2,
 MIL-C-83723 Series I and III,
 MIL-C-81703 Series III

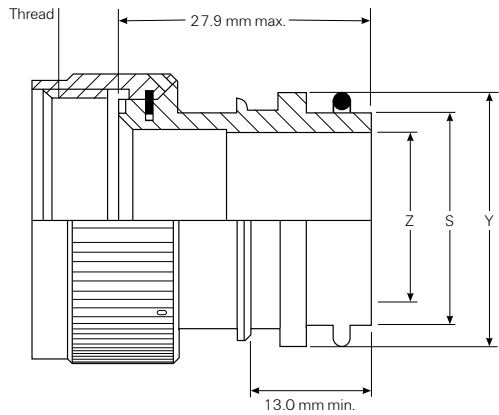

TXR54XX00-XXXXXX

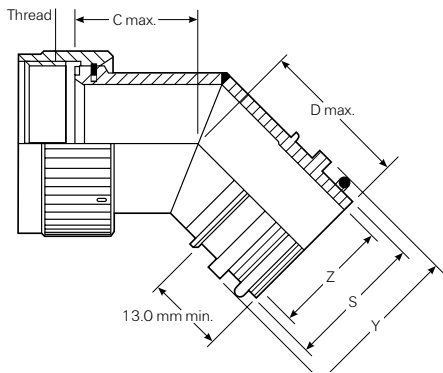

TXR54XX45-XXXXXX

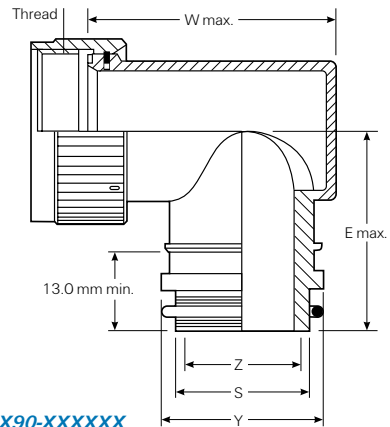

TXR54XX90-XXXXXX

Available in:	Americas	Europe	Asia Pacific
	■	■	■

Fax-on-demand

US only (800) 260-9099

Outside US (650) 257-2301

Fax ID

3723

Description

SCD

Visit our website at www.tycoelectronics.com**Table of dimensions (mm/in)**

Order number	Shell size		Max. entry size type 1*		C max.		D max.		E max.	
	MIL-C-81703	MIL-C-5015		Thread	mm	(in)	mm	(in)	mm	(in)
03	3		04	.562-24 UNEF	19.10	(0.75)	23.10	(0.91)	28.70	(1.13)
08		8 & 8S	04	.500-20 UNF	19.10	(0.75)	23.10	(0.91)	27.90	(1.10)
10		10, 10S & 10SL	06	.625-24 UNEF	19.60	(0.77)	23.60	(0.93)	29.50	(1.16)
12	7	12 & 12S	08	.750-20 UNEF	20.30	(0.80)	24.10	(0.95)	31.00	(1.22)
14	12	14 & 14S	08	.875-20 UNEF	20.80	(0.82)	24.60	(0.97)	32.50	(1.28)
16	19	16 & 16S	10	1.000-20 UNEF	21.30	(0.84)	25.40	(1.00)	34.30	(1.35)
18	27	18	12	1.062-18 UNEF	21.80	(0.86)	25.70	(1.01)	35.60	(1.40)
20	37	20	14	1.188-18 UNEF	22.40	(0.88)	26.40	(1.04)	37.10	(1.46)
22		22	16	1.312-18 UNEF	23.10	(0.91)	26.90	(1.06)	38.90	(1.53)
24		24	18	1.438-18 UNEF	23.60	(0.93)	27.70	(1.09)	40.40	(1.59)
28		28	22	1.750-18 UNS	24.90	(0.98)	29.20	(1.15)	45.20	(1.78)
32		32	24	2.000-18 UNS	26.20	(1.03)	30.50	(1.20)	48.30	(1.90)
36		36	24	2.250-16 UN	27.40	(1.08)	31.80	(1.25)	51.60	(2.03)
40		40	24	2.500-16 UN	29.00	(1.14)	33.30	(1.31)	54.60	(2.15)
44		44	24	2.750-16 UN	30.20	(1.19)	34.50	(1.36)	57.90	(2.28)
48		48	24	3.000-16 UN	31.50	(1.24)	35.10	(1.38)	61.00	(2.40)
61	61		18	1.500-18 UNEF	23.90	(0.94)	27.90	(1.10)	41.10	(1.62)

*For larger than maximum type 1 entry sizes, a two-piece adapter will be supplied. Contact your Tyco Electronics product representative for information.

Entry size dimensions (mm/in)

Entry size	Z +0.25-0.5		S diameter (min.-max.)		Y ±0.38	W max.		
04	6.35	(0.25)	9.39-9.56	(0.37-0.38)	13.97	(0.55)	28.4	(1.12)
05	7.92	(0.31)	10.97-11.13	(0.43-0.44)	15.54	(0.61)	30.2	(1.19)
06	9.52	(0.37)	12.57-12.73	(0.49-0.50)	17.14	(0.67)	31.8	(1.25)
07	11.09	(0.44)	14.12-14.31	(0.55-0.56)	18.71	(0.74)	33.3	(1.31)
08	12.7	(0.50)	15.72-15.91	(0.62-0.63)	20.32	(0.80)	35.1	(1.38)
10	15.87	(0.62)	18.84-19.11	(0.74-0.75)	23.49	(0.92)	38.1	(1.50)
12	19.05	(0.75)	22.02-22.28	(0.87-0.88)	26.67	(1.05)	41.1	(1.62)
14	22.23	(0.88)	25.17-25.46	(0.99-1.00)	29.84	(1.17)	44.5	(1.75)
16	25.4	(1.00)	28.34-28.63	(1.12-1.13)	33.02	(1.30)	47.8	(1.88)
18	28.57	(1.12)	31.52-31.81	(1.24-1.25)	36.19	(1.42)	50.8	(2.00)
20	31.75	(1.25)	34.69-34.98	(1.37-1.38)	39.37	(1.55)	53.8	(2.12)
22	34.93	(1.38)	37.79-38.15	(1.49-1.50)	42.55	(1.68)	57.2	(2.25)
24	38.1	(1.50)	40.97-41.33	(1.61-1.63)	45.72	(1.80)	60.5	(2.38)

Users should independently evaluate the suitability of the product for their application. Before ordering check with factory for most current data.

Code 54

Tinel-Lock adapters

MIL-C-5015 (MS3400), MIL-C-26482 Series 2,

MIL-C-83723 Series I and III,

MIL-C-81703 Series III (cont'd.)



Molded part selection guide (Tinel)

Tinel-Lock entry size	Standard K parts			Low-profile D parts		
	Straight part no.	90° part no.	Cable OD (min.) mm (in)	Straight part no.	90° part no.	Cable OD (min.) mm (in)
04	202K232		3.3 (0.1)			
04	202W232		4.3 (0.2)			
04	202K121	222K121	5.6 (0.2)	202D211	222D211	6.4 (0.3)
05, 06	202K132	222K132	5.9 (0.2)	202D221	222D221	7.4 (0.3)
07, 08	202K142	222K142	7.1 (0.3)	202D232	222D232	8.4 (0.3)
10, 12	202K153	222K152	8.4 (0.3)	202D242	222D242	9.7 (0.4)
14, 16	202K163	222K163	9.9 (0.4)	202D253	222D253	10.5 (0.4)
18, 20, 22	202K174	222K174	15.7 (0.6)	202D263	222D263	12.2 (0.5)
24	202K185	222K185	16.8 (0.7)			

Uniboot parts		
Tinel-Lock entry size	Part no.	Cable OD (min.) mm (in)
04	202C611	4.8 (0.19)
05, 06, 07	202C621	8.1 (0.32)
08, 10, 12	202C632	12.7 (0.50)
12, 14, 16	202C642	17.5 (0.69)
16, 18, 20, 22	202C653	22.4 (0.88)
24	202C663	22.9 (0.90)

<i>Fax-on-demand</i>		<i>Fax ID</i>	<i>Description</i>
<i>US only</i>	<i>(800) 260-9099</i>	<i>3723</i>	<i>SCD</i>
<i>Outside US</i>	<i>(650) 257-2301</i>		

Visit our website at www.tycoelectronics.com

Code 54

Bandstrap adapters
 MIL-C-5015 (MS3400), MIL-C-26482 Series 2,
 MIL-C-83723 Series I and III,
 MIL-C-81703 Series III

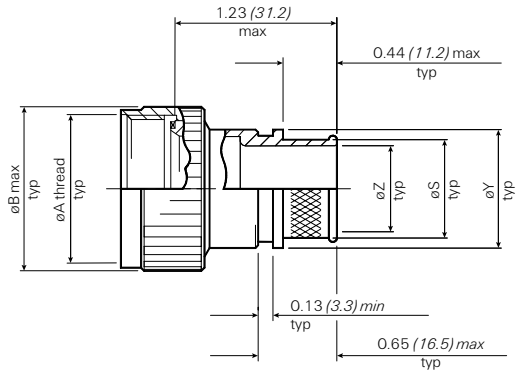

BND54XX00-XXXX

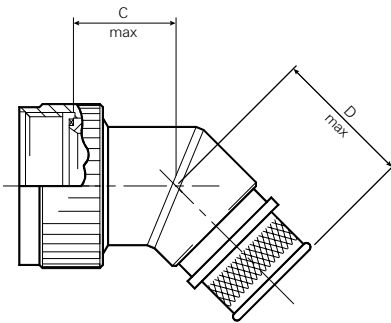

BND54XX45-XXXX

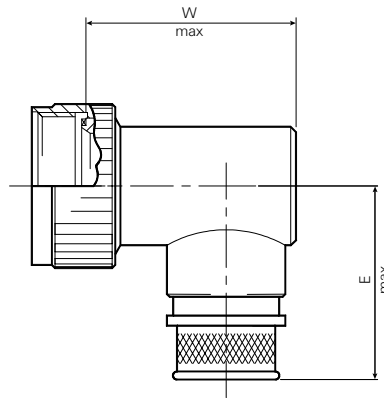

BND54XX90-XXXX

Available in:	Americas	Europe	Asia Pacific
	■	■	■

Fax-on-demand

US only (800) 260-9099

Outside US (650) 257-2301

Visit our website at www.tycoelectronics.com**Table of dimensions (mm/in)**

Order number	Shell size		Max. entry size	A Unified thread Class 2B	B max. mm (in)	C max. mm (in)	D max. mm (in)	E max. mm (in)
	MIL-C 81703	MIL-C 5015						
08	—	8/8S	04	0.5000-20 UNF	15.7 (0.67)	19.0 (0.75)	26.2 (1.03)	31.0 (1.22)
10	—	10/10S/10SL	06	0.6250-24 UNEF	18.5 (0.73)	19.6 (0.77)	26.7 (1.05)	32.5 (1.28)
12	7	12/12S	08	0.7500-20 UNEF	21.8 (0.86)	20.3 (0.80)	27.2 (1.07)	34.3 (1.35)
14	12	14/14S	09	0.8750-20 UNEF	24.9 (0.98)	20.9 (0.82)	27.7 (1.09)	35.6 (1.40)
16	19	16/16S	11	0.9375-20 UNEF	28.2 (1.11)	21.3 (0.84)	28.4 (1.12)	37.1 (1.46)
18	27	18	12	1.0000-20 UNEF	31.0 (1.22)	21.8 (0.86)	28.7 (1.13)	38.9 (1.53)
20	37	20	14	1.1875-18 UNEF	34.3 (1.35)	22.4 (0.88)	29.5 (1.16)	40.4 (1.59)
22	—	22	16	1.3125-18 UNEF	37.3 (1.47)	23.1 (0.91)	30.0 (1.18)	41.9 (1.65)
24	—	24	18	1.4375-18 UNEF	40.5 (1.59)	23.6 (0.93)	30.7 (1.21)	43.4 (1.71)
28	—	28	22	1.7500-18 UNS	50.0 (1.97)	24.9 (0.98)	31.8 (1.25)	48.3 (1.90)
32	—	32	26	2.0000-18 UNS	56.4 (2.22)	26.2 (1.03)	33.3 (1.31)	51.6 (2.03)
36	—	36	28	2.2500-16 UN	62.7 (2.47)	27.4 (1.08)	34.3 (1.35)	54.6 (2.15)
40	—	40	32	2.5000-16 UN	69.1 (2.72)	28.4 (1.12)	35.6 (1.40)	57.7 (2.27)
44	—	44	34	2.7500-16 UN	75.4 (2.97)	29.7 (1.17)	36.8 (1.45)	61.0 (2.40)
48	—	48	34	3.0000-16 UN	81.8 (3.22)	31.0 (1.22)	38.1 (1.50)	64.0 (2.52)
61	61	—	18	1.5000-18 UNEF	41.9 (1.65)	23.9 (0.94)	30.7 (1.21)	44.2 (1.74)

Entry size dimensions (mm/in)

Entry size	øZ +0.25 -0.50 (+0.010 -0.020)		S diameter		Y diameter		W max.
	mm	(in)	mm	(in)	mm	(in)	
03	4.75	(0.188)	7.92	(0.312)	11.10	(0.438)	28.4 (1.12)
04	6.35	(0.250)	9.52	(0.375)	12.70	(0.500)	28.4 (1.12)
05	7.92	(0.312)	11.12	(0.438)	14.30	(0.563)	30.2 (1.19)
06	9.52	(0.375)	12.70	(0.500)	15.88	(0.625)	31.8 (1.25)
07	11.12	(0.438)	14.30	(0.562)	17.50	(0.689)	33.3 (1.31)
08	12.70	(0.500)	15.88	(0.625)	19.05	(0.750)	35.1 (1.38)
09	14.30	(0.562)	17.50	(0.688)	20.65	(0.813)	38.1 (1.50)
10	15.88	(0.625)	19.05	(0.750)	22.23	(0.875)	38.1 (1.50)
11	17.50	(0.688)	20.65	(0.812)	23.80	(0.938)	41.1 (1.62)
12	19.05	(0.750)	22.23	(0.875)	25.40	(1.000)	41.1 (1.62)
13	20.65	(0.812)	23.83	(0.938)	27.00	(1.063)	44.5 (1.75)
14	22.23	(0.875)	25.40	(1.000)	30.16	(1.189)	44.5 (1.75)
15	23.83	(0.938)	27.00	(1.062)	31.75	(1.250)	47.8 (1.88)
16	25.40	(1.000)	28.58	(1.125)	33.34	(1.313)	47.8 (1.88)
18	28.58	(1.125)	31.75	(1.250)	36.51	(1.438)	50.8 (2.00)
20	31.75	(1.250)	34.90	(1.375)	39.69	(1.563)	53.8 (2.12)
22	34.90	(1.375)	38.10	(1.500)	42.86	(1.688)	56.9 (2.24)
24	38.10	(1.500)	41.28	(1.625)	46.83	(1.844)	59.9 (2.36)
26	41.28	(1.625)	44.45	(1.750)	49.61	(1.953)	63.0 (2.48)
28	44.45	(1.750)	47.63	(1.875)	52.78	(2.078)	66.0 (2.60)
30	47.65	(1.875)	50.80	(2.000)	56.36	(2.219)	69.5 (2.74)
32	50.80	(2.000)	54.00	(2.125)	59.53	(2.344)	72.5 (2.85)
34	54.00	(2.125)	57.15	(2.250)	62.71	(2.469)	76.0 (2.99)

Users should independently evaluate the suitability of the product for their application.
 Before ordering check with factory for most current data.

Code 76 BS 9522 F0017 (Pattern 105)

Spin-coupling adapters

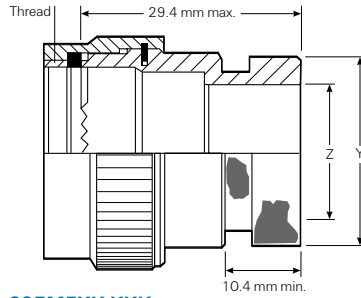

225M5XX-XXX

Available in:

Americas

Europe

Asia Pacific



Fax-on-demand

US only (800) 260-9099

Outside US (650) 257-2301

Fax ID

3603

Description

SCD

Visit our website at www.tycoelectronics.com**Table of dimensions**

Order number	Shell size	Thread	Y max.	Z min.
08	8	.438-28 UNEF	13.54 (0.53)	6.9 (0.27)
10	10	.562-24 UNEF	15.37 (0.61)	9.9 (0.39)
12	12	.688-24 UNEF	19.66 (0.77)	13.4 (0.53)
14	14	.812-20 UNEF	21.29 (0.84)	15.9 (0.63)
16	16	.938-20 UNEF	24.47 (0.96)	18.9 (0.74)
18	18	1.062-18 UNEF	26.47 (1.04)	21.4 (0.84)
20	20	1.188-18 UNEF	30.92 (1.22)	23.9 (0.94)
22	22	1.312-18 UNEF	34.42 (1.36)	27.4 (1.08)
24	24	1.438-18 UNEF	36.4 (1.44)	29.9 (1.18)

Molded part selection guide (Spin-coupling)

Order no.	Standard K parts			Low-profile D parts		
	Straight part no.	90° part no.	Cable OD (min.) mm (in)	Straight part no.	90° part no.	Cable OD (min.) mm (in)
03, 08	202W232		4.3 (0.19)			
03, 08	202K121	222K121	5.6 (0.22)	202D211	222D211	6.4 (0.25)
10, 11	202K132	222K132	5.9 (0.23)	202D221	222D221	7.4 (0.29)
12, 14	202K142	222K142	7.1 (0.28)	202D232	222D232	8.4 (0.33)
16, 18	202K153	222K152	8.4 (0.33)	202D242	222D242	9.7 (0.38)
20, 22	202K163	222K163	9.9 (0.39)	202D253	222D253	10.5 (0.41)
24, 28,	202K174	222K174	15.7 (0.62)	202D263	222D263	12.2 (0.48)
32, 36	202K185	222K185	16.8 (0.66)	202D274	222D274	14.3 (0.56)
Uniboot parts						
Order no.	Part no.	Cable OD (min.) mm (in)				
03, 08	202C611	4.8 (0.19)				
10, 11, 12	202C621	8.1 (0.32)				
14, 16	202C632	12.7 (0.50)				
18, 20	202C642	17.5 (0.69)				
22, 24	202C653	22.4 (0.88)				

Code 76 BS 9522 F00017 (Pattern 105)

Tinel-Lock adapters

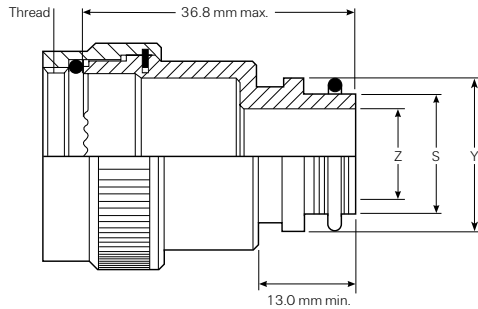

TXR76XX00-XXXXXX

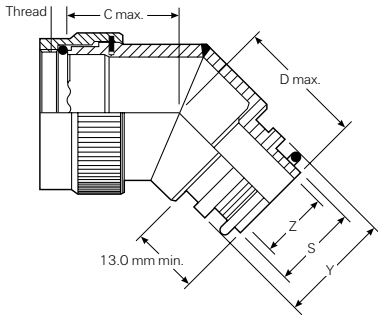

TXR76XX45-XXXXXX

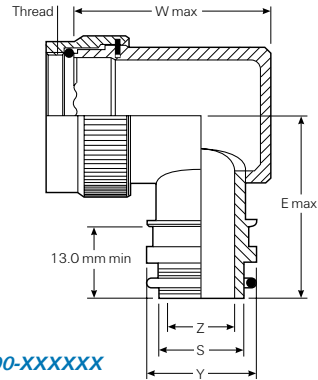

TXR76XX90-XXXXXX

Available in:

Americas

Europe

Asia Pacific



Table of dimensions (mm/in)

Order number	Shell size	Max. entry size type 1*	Thread	C max. mm (in)	D max. mm (in)	E max. mm (in)
08	8	04	.438-28 UNEF	18.0 (.74)	21.3 (.87)	26.7 (1.05)
10	10	07	.562-24 UNEF	18.8 (.76)	22.1 (.90)	28.2 (1.11)
12	12	08	.688-24 UNEF	19.3 (.79)	22.9 (.92)	30.2 (1.19)
14	14	10	.812-20 UNEF	20.1 (.82)	23.4 (.95)	31.8 (1.25)
16	16	12	.938-20 UNEF	20.8 (.84)	24.1 (.97)	33.5 (1.32)
18	18	12	1.062-18 UNEF	21.3 (.87)	24.6 (1.00)	35.1 (1.38)
20	20	16	1.188-18 UNEF	22.1 (.89)	25.4 (1.02)	36.6 (1.44)
22	22	18	1.312-18 UNEF	22.6 (.92)	25.9 (1.05)	38.1 (1.50)
24	24	20	1.438-18 UNEF	23.4 (.97)	26.7 (1.07)	39.4 (1.55)

*For larger than maximum type 1 entry sizes, a two-piece adapter will be supplied. Contact your Tyco Electronics product representative for information.

Fax-on-demand

US only (800) 260-9099

Outside US (650) 257-2301

Fax ID

3728

Description

SCD

Visit our website at www.tycoelectronics.com**Entry size dimensions (mm/in)**

Entry size	Z +0.25-0.5	S diameter		Y dia.	W max.
		(min.-max.)			
04	6.35 (0.25)	9.39-9.56	(0.37-0.38)	13.97 (1.22)	31.0 (0.55)
05	7.92 (0.31)	10.97-11.13	(0.43-0.44)	15.54 (1.29)	32.8 (0.61)
06	9.52 (0.37)	12.57-12.73	(0.49-0.50)	17.14 (1.35)	34.3 (0.67)
07	11.09 (0.44)	14.12-14.31	(0.55-0.56)	18.71 (1.41)	35.8 (0.74)
08	12.7 (0.50)	15.72-15.91	(0.62-0.63)	20.32 (1.47)	37.3 (0.80)
10	15.87 (0.62)	18.84-19.11	(0.74-0.75)	23.49 (1.60)	40.6 (0.92)
12	19.05 (0.75)	22.02-22.28	(0.87-0.88)	26.67 (1.72)	43.7 (1.05)
14	22.23 (0.88)	25.17-25.46	(0.99-1.00)	29.84 (1.85)	47.0 (1.17)
16	25.4 (1.00)	28.34-28.63	(1.12-1.13)	33.02 (1.97)	50.0 (1.30)
18	28.57 (1.12)	31.52-31.81	(1.24-1.25)	36.19 (2.10)	53.3 (1.42)
20	31.75 (1.25)	34.69-34.98	(1.37-1.38)	39.37 (1.55)	53.8 (2.19)

Molded part selection guide (Tinel)

Tinel-Lock entry size	Standard K parts			Low-profile D parts		
	Straight part no.	90° part no.	Cable OD (min.) mm (in)	Straight part no.	90° part no.	Cable OD (min.) mm (in)
04	202K232		3.3 (0.1)			
04	202W232		4.3 (0.2)			
04	202K121	222K121	5.6 (0.2)	202D211	222D211	6.4 (0.3)
05, 06	202K132	222K132	5.9 (0.2)	202D221	222D221	7.4 (0.3)
07, 08	202K142	222K142	7.1 (0.3)	202D232	222D232	8.4 (0.3)
10, 12	202K153	222K152	8.4 (0.3)	202D242	222D242	9.7 (0.4)
14, 16	202K163	222K163	9.9 (0.4)	202D253	222D253	10.5 (0.4)
18, 20, 22	202K174	222K174	15.7 (0.6)	202D263	222D263	12.2 (0.5)
24	202K185	222K185	16.8 (0.7)			

Uniboot parts

Tinel-Lock entry size	Part no.	Cable OD (min.) mm (in)
04	202C611	4.8 (0.19)
05, 06, 07	202C621	8.1 (0.32)
08, 10, 12	202C632	12.7 (0.50)
12, 14, 16	202C642	17.5 (0.69)
16, 18, 20, 22	202C653	22.4 (0.88)
24	202C663	22.9 (0.90)

Assemblies

Overview

Raychem assemblies and kits fit a wide variety of applications.

KTKK assemblies are available with Rayaten screened molded parts, to suit a wide range of connectors. For correct part number referencing please contact Tyco Electronics. Unscreened versions are available as well.

TCFS/R feedthroughs are also available, both with Rayaten screened molded parts or in unscreened versions.

Raychem's KTKK and TCFS/R product families come with the added advantage of preinstalled adhesives, which can drastically reduce the installation time and cost of harness building.

SESK shipboard electrical splice kits can be used to splice multiconductor cables in new ship construction, allowing modular wiring techniques and use of existing wiring when jumbo-sizing commercial ships.

Ship-to-shore kits are used to bring shore power to a ship in dock.

Assemblies

Table of Contents

Assemblies

KTKK Product Family Overview	7-0
KTKK Assemblies Screened	7-2

Feedthroughs

TCFS/R	Cable feedthroughs	7-8
--------	--------------------	-----

Preinstalled Adhesives

S-1030, S-1048, S-1275 (Rayaten)	Preinstalled adhesives	7-12
-------------------------------------	------------------------	------

Kits

SESK	Shipboard electrical splice kits	7-14
Ship or Shore	Breakout kits	7-18

Assemblies

KTKK product family overview

Applications

KTKK cable assemblies are one-part assemblies for screened and unscreened cables. Constructed from Raychem heat-shrinkable screened molded parts and connector adapters, the assembly consists of parts already well proven in harsh military environments.

Installation is simply effected by coupling the adapter to the connector and shrinking the rear of the molded part onto the cable with a hot air gun.

The molded part has a hot-melt adhesive preinstalled to provide a bond between the cable jacket and the molded part.

When used in conjunction with shielded (screened) cables, the assembly provides electrical continuity between the cable shield and the connector with Rayaten molded parts.

Rayaten molded parts are shielded, heat-shrinkable parts providing shielding levels better than 80 dB at 100 MHz.

Available in:

Americas

Europe

Asia Pacific



Fax-on-demand

US only (800) 260-9099

Outside US (650) 257-2301

Visit our website at www.tycoelectronics.com

Assembly Types



Straight assemblies

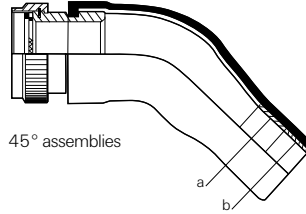

45° assemblies

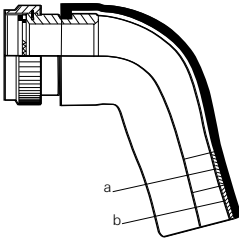

90° assemblies

a = Preinstalled conductive adhesive for use with Rayaten screened molded parts only.

b = Preinstalled environment adhesive for use with screened and unshielded KTKK assemblies (see "Preinstalled adhesives," page 7-12).

Materials available

Material			Specification
-25 fluid-resistant modified elastomer	(see page 4-32)	-25S fluid-resistant modified elastomer, shielded	RK-6719
-100 low-fire-hazard material	(see page 4-44)	-100S low-fire-hazard; shielded	RK-6724

Precoated adhesives

Material	Available coatings (unshielded)	Available coatings (shielded)
-25	S-1048 (/86) high-temperature hot-melt adhesive	
-25S		S-1030 (/180) low-fire-hazard hot-melt adhesive
-100	S-1030 (/180) low-fire-hazard hot-melt adhesive	
-100S		S-1275 conductive adhesive for use with Rayaten molded parts.

KTKK Assemblies Screened



Straight assemblies

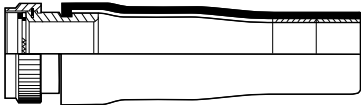

45° assemblies

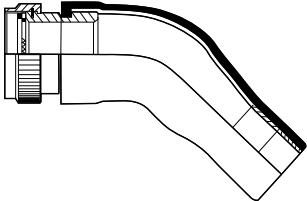

90° assemblies

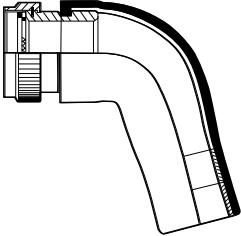

Available in:	Americas	Europe	Asia Pacific
	■	■	■

Fax-on-demand

US only (800) 260-9099

Outside US (650) 257-2301

Visit our website at www.tycoelectronics.com**Pattern 105 connectors or connector code 76****25S fluid resistant elastomer**

Connector shell size	Straight assemblies		45° assemblies		90° assemblies	
	Raychem part no.	Cable O.D. range (mm)	Raychem part no.	Cable O.D. range (mm)	Raychem part no.	Cable O.D. range (mm)
08	KTKK 0520	5.0-8.0	KTKK 0560	5.0-7.0	N/A	N/A
10	KTKK 0521	6.0-13.0	KTKK 0561	6.0-9.0	KTKK 1051	6.0-13.0
12	KTKK 0522	7.2-15.0	KTKK 0562	7.2-11.0	KTKK 1052	7.2-15.0
14	KTKK 0523	7.2-15.0	KTKK 0563	7.2-11.0	KTKK 1053	7.2-15.0
16	KTKK 0524	8.5-19.0	KTKK 0564	8.5-17.0	KTKK 1054	8.5-19.0
18	KTKK 0525	8.5-20.0	KTKK 0565	8.5-17.0	KTKK 1055	8.5-19.0
20	KTKK 0526	10.0-24.0	KTKK 0566	10-21.0	KTKK 1056	10.0-24.0
22	KTKK 0527	10.0-24.0	KTKK 0567	10.0-21.0	KTKK 1057	10.0-24.0
24	KTKK 0528	15.8-33.0	KTKK 0568	15.8-29.0	KTKK 1058	15.8-33.0

100S low fire hazard material

08	KTKK 0465	5.0-7.0	KTKK 0603	5.0-7.0	N/A	N/A
10	KTKK 0466	6.0-9.0	KTKK 0604	6.0-9.0	KTKK 1251	6.0-9.0
12	KTKK 0467	7.2-11.0	KTKK 0605	7.2-11.0	KTKK 1252	7.2-11.0
14	KTKK 0468	7.2-11.0	KTKK 0606	7.2-11.0	KTKK 1253	7.2-11.0
16	KTKK 0469	8.5-17.0	KTKK 0607	8.5-17.0	KTKK 1254	8.5-17.0
18	KTKK 0470	8.5-17.0	KTKK 0608	8.5-17.0	KTKK 1255	8.5-17.0
20	KTKK 0471	10.0-21.0	KTKK 0609	10.0-21.0	KTKK 1256	10.0-21.0
22	KTKK 0472	10.0-21.0	KTKK 0610	10.0-21.0	KTKK 1257	10.0-21.0
24	KTKK 0473	15.8-29.0	KTKK 0611	15.8-29.0	KTKK 1258	15.8-29.0

KTKK Assemblies Screened (cont'd.)

Pattern 602 connectors or connector code 54

25S fluid resistant elastomer

Connector shell size	Straight assemblies		45° assemblies		90° assemblies	
	Raychem part no.	Cable O.D. range (mm)	Raychem part no.	Cable O.D. range (mm)	Raychem part no.	Cable O.D. range (mm)
08	KTKK 0840	5.0-8.0	KTKK 0970	5.0-7.0	N/A	N/A
10	KTKK 0841	6.0-13.0	KTKK 0971	6.0-9.0	KTKK 0851	6.0-13.0
12	KTKK 0842	7.2-15.0	KTKK 0972	7.2-11.0	KTKK 0852	7.2-15.0
14	KTKK 0843	7.2-15.0	KTKK 0973	7.2-11.0	KTKK 0853	7.2-15.0
16	KTKK 0844	8.5-19.0	KTKK 0974	8.5-17.0	KTKK 0854	8.5-19.0
18	KTKK 0845	8.5-19.0	KTKK 0975	8.5-17.0	KTKK 0855	8.5-19.0
20	KTKK 0846	10.0-24.0	KTKK 0976	10-21.0	KTKK 0856	10.0-24.0
22	KTKK 0847	10.0-24.0	KTKK 0977	10.0-21.0	KTKK 0857	10.0-24.0
24	KTKK 0848	15.8-33.0	KTKK 0978	15.8-29.0	KTKK 0858	15.8-33.0

100S low fire hazard material

08	KTKK 0612	5.0-7.0	KTKK 0780	5.0-7.0	N/A	N/A
10	KTKK 0613	6.0-9.0	KTKK 0781	6.0-9.0	KTKK 1241	6.0-9.0
12	KTKK 0614	7.2-11.0	KTKK 0782	7.2-11.0	KTKK 1242	7.2-11.0
14	KTKK 0615	7.2-11.0	KTKK 0783	7.2-11.0	KTKK 1243	7.2-11.0
16	KTKK 0616	8.5-17.0	KTKK 0784	8.5-17.0	KTKK 1244	8.5-17.0
18	KTKK 0617	8.5-17.0	KTKK 0785	8.5-17.0	KTKK 1245	8.5-17.0
20	KTKK 0618	10.0-21.0	KTKK 0786	10.0-21.0	KTKK 1246	10.0-21.0
22	KTKK 0619	10.0-21.0	KTKK 0787	10.0-21.0	KTKK 1247	10.0-21.0
24	KTKK 0620	15.8-29.0	KTKK 0788	15.8-29.0	KTKK 1248	15.8-29.0

Fax-on-demand

US only (800) 260-9099

Outside US (650) 257-2301

Visit our website at www.tycoelectronics.com**Pattern 608 connectors or connector code 79****25S fluid resistant elastomer**

Connector shell size	Straight assemblies		45° assemblies		90° assemblies	
	Raychem part no.	Cable O.D. range (mm)	Raychem part no.	Cable O.D. range (mm)	Raychem part no.	Cable O.D. range (mm)
08	KTKK 0530	5.0-8.0	KTKK 0540	5.0-7.0	N/A	N/A
10	KTKK 0531	6.0-13.0	KTKK 0541	6.0-9.0	KTKK 1261	6.0-13.0
12	KTKK 0532	7.2-15.0	KTKK 0542	7.2-11.0	KTKK 1262	7.2-15.0
14	KTKK 0533	7.2-15.0	KTKK 0543	7.2-11.0	KTKK 1263	7.2-15.0
16	KTKK 0534	8.5-19.0	KTKK 0544	8.5-17.0	KTKK 1264	8.5-19.0
18	KTKK 0535	8.5-19.0	KTKK 0545	8.5-17.0	KTKK 1265	8.5-19.0
20	KTKK 0536	10.0-24.0	KTKK 0546	10.0-21.0	KTKK 1266	10.0-24.0
22	KTKK 0537	10.0-24.0	KTKK 0547	10.0-21.0	KTKK 1267	10.0-24.0
24	KTKK 0538	15.8-33.0	KTKK 0548	15.8-29.0	KTKK 1268	15.8-33.0

100S low fire hazard material

08	KTKK 0444	5.0-7.0	KTKK 0580	5.0-7.0	N/A	N/A
10	KTKK 0445	6.0-9.0	KTKK 0581	6.0-9.0	KTKK 1021	6.0-9.0
12	KTKK 0446	7.2-11.0	KTKK 0582	7.2-11.0	KTKK 1022	7.2-11.0
14	KTKK 0447	7.2-11.0	KTKK 0583	7.2-11.0	KTKK 1023	7.2-11.0
16	KTKK 0448	8.5-17.0	KTKK 0584	8.5-17.0	KTKK 1024	8.5-17.0
18	KTKK 0449	8.5-17.0	KTKK 0585	8.5-17.0	KTKK 1025	8.5-17.0
20	KTKK 0450	10.0-21.0	KTKK 0586	10.0-21.0	KTKK 1026	10.0-21.0
22	KTKK 0451	10.0-21.0	KTKK 0587	10.0-21.0	KTKK 1027	10.0-21.0
24	KTKK 0452	15.8-29.0	KTKK 0588	15.8-29.0	KTKK 1028	15.8-29.0

KTKK Assemblies Screened (cont'd.)

38999 Series III and IV connectors or connector code 40

25S fluid resistant elastomer

Connector shell size	Straight assemblies		45° assemblies		90° assemblies	
	Raychem part no.	Cable O.D. range (mm)	Raychem part no.	Cable O.D. range (mm)	Raychem part no.	Cable O.D. range (mm)
08	KTKK 1110	5.0-8.0	KTKK 1120	5.0-7.0	N/A	N/A
10	KTKK 1111	6.0-13.0	KTKK 1121	6.0-9.0	KTKK 1131	6.0-13.0
12	KTKK 1112	7.2-15.0	KTKK 1122	7.2-11.0	KTKK 1132	7.2-15.0
14	KTKK 1113	7.2-15.0	KTKK 1123	7.2-11.0	KTKK 1133	7.2-15.0
16	KTKK 1114	8.5-19.0	KTKK 1124	8.5-17.0	KTKK 1134	8.5-19.0
18	KTKK 1115	8.5-19.0	KTKK 1125	8.5-17.0	KTKK 1135	8.5-19.0
20	KTKK 1116	10.0-24.0	KTKK 1126	10-21.0	KTKK 1136	10.0-24.0
22	KTKK 1117	10.0-24.0	KTKK 1127	10.0-21.0	KTKK 1137	10.0-24.0
24	KTKK 1118	15.8-33.0	KTKK 1128	15.8-29.0	KTKK 1138	15.8-33.0

100S low fire hazard material

08	KTKK 0670	5.0-7.0	KTKK 0660	5.0-7.0	N/A	N/A
10	KTKK 0671	6.0-9.0	KTKK 0661	6.0-9.0	KTKK 1181	6.0-9.0
12	KTKK 0672	7.2-11.0	KTKK 0662	7.2-11.0	KTKK 1182	7.2-11.0
14	KTKK 0673	7.2-11.0	KTKK 0663	7.2-11.0	KTKK 1183	7.2-11.0
16	KTKK 0674	8.5-17.0	KTKK 0664	8.5-17.0	KTKK 1184	8.5-17.0
18	KTKK 0675	8.5-17.0	KTKK 0665	8.5-17.0	KTKK 1185	8.5-17.0
20	KTKK 0676	10.0-21.0	KTKK 0666	10.0-21.0	KTKK 1186	10.0-21.0
22	KTKK 0677	10.0-21.0	KTKK 0667	10.0-21.0	KTKK 1187	10.0-21.0
24	KTKK 0678	15.8-29.0	KTKK 0668	15.8-29.0	KTKK 1188	15.8-29.0

Fax-on-demand

US only (800) 260-9099

Outside US (650) 257-2301

Visit our website at www.tycoelectronics.com**38999 Series I and II connectors or connector code 41****25S fluid resistant elastomer**

Connector shell size	Straight assemblies		45° assemblies		90° assemblies	
	Raychem part no.	Cable O.D. range (mm)	Raychem part no.	Cable O.D. range (mm)	Raychem part no.	Cable O.D. range (mm)
08	KTKK 0500	5.0-8.0	KTKK 0510	5.0-7.0	N/A	N/A
10	KTKK 0501	6.0-13.0	KTKK 0511	6.0-9.0	KTKK 0831	6.0-13.0
12	KTKK 0502	7.2-15.0	KTKK 0512	7.2-11.0	KTKK 0832	7.2-15.0
14	KTKK 0503	7.2-15.0	KTKK 0513	7.2-11.0	KTKK 0833	7.2-15.0
16	KTKK 0504	8.5-19.0	KTKK 0514	8.5-17.0	KTKK 0834	8.5-19.0
18	KTKK 0505	8.5-19.0	KTKK 0515	8.5-17.0	KTKK 0835	8.5-19.0
20	KTKK 0506	10.0-24.0	KTKK 0516	10-21.0	KTKK 0836	10.0-24.0
22	KTKK 0507	10.0-24.0	KTKK 0517	10.0-21.0	KTKK 0837	10.0-24.0
24	KTKK 0508	15.8-33.0	KTKK 0518	15.8-29.0	KTKK 0838	15.8-33.0

100S low fire hazard material

08	KTKK 0640	5.0-7.0	KTKK 0630	5.0-7.0	N/A	N/A
10	KTKK 0641	6.0-9.0	KTKK 0631	6.0-9.0	KTKK 0721	6.0-9.0
12	KTKK 0642	7.2-11.0	KTKK 0632	7.2-11.0	KTKK 0722	7.2-11.0
14	KTKK 0643	7.2-11.0	KTKK 0633	7.2-11.0	KTKK 0723	7.2-11.0
16	KTKK 0644	8.5-17.0	KTKK 0634	8.5-17.0	KTKK 0724	8.5-17.0
18	KTKK 0645	8.5-17.0	KTKK 0635	8.5-17.0	KTKK 0725	8.5-17.0
20	KTKK 0646	10.0-21.0	KTKK 0636	10.0-21.0	KTKK 0726	10.0-21.0
22	KTKK 0647	10.0-21.0	KTKK 0637	10.0-21.0	KTKK 0727	10.0-21.0
24	KTKK 0648	15.8-29.0	KTKK 0638	15.8-29.0	KTKK 0728	15.8-29.0

TCFS/R

Cable feedthroughs



Applications

Provides environmental sealing and screen continuity to a bulkhead as a cable passes through. The assembly consists of a specifically designed locknut and O-ring seal, onto the rear of which is preinstalled a Raychem heat-shrinkable molded part. Feedthrough installation is simply effected by tightening the locknut on the rear of the bulkhead, which compresses the O-ring and ensures that a small knife-edge provides electrical contact between the assembly and the bulkhead.

When heat is applied to the molded part in the form of hot air, a seal to the cable is formed with hot-melt adhesive. When specified for screened cables, the assembly contains a conductive adhesive, which provides electrical continuity between the screen and the bulkhead via Rayaten molded parts. These molded parts are shielded (screened), heat-shrinkable parts providing shielding levels better than 80 dB at 100 MHz.

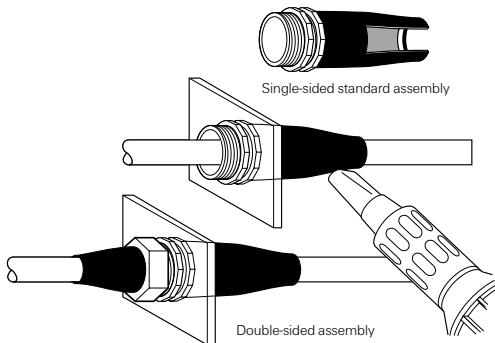

Features and benefits

- Screened or unshielded cables.
- One-piece part.
- Each size covers a wide cable range.
- Light weight.
- Single- or double-sided assembly.

Available in:

Americas

Europe

Asia Pacific

Fax-on-demand

US only (800) 260-9099

Outside US (650) 257-2301

Visit our website at www.tycoelectronics.com

Part numbering system

TCFX* - 12 62C - 0 - 20 - 100 A H

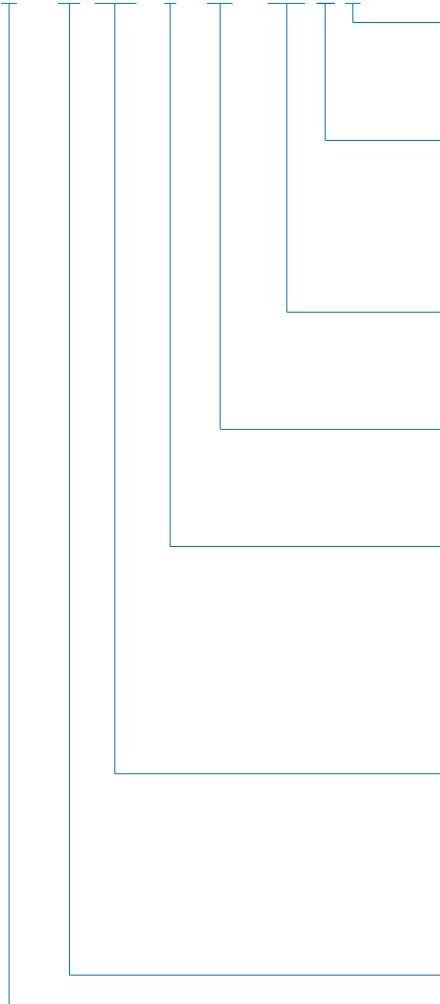

Adhesive system

E = Epoxy (consult factory)

H = S-1030 hot melt

W = S-1048 hot melt

Molded part type

A = Straight unscreened

B = 90° unscreened

C = Straight screened

D = 45° screened

E = 90° screened (16–36 only)

Molded part material

-25 = Semirigid elastomer

-100 = Low fire hazard

Thread length

(may be three digits if more than 95 mm required)

20 mm standard

5 mm increments, minimum 15 mm

Assembly modification code

0 = Standard assembly

1 = Double-sided assembly (only straight unshielded boot available on double nut)

2 = Same as 1 but with potting ports

3 = Locknut

4 = 60° metalwork

5 = Same as 0 but with potting ports

Feedthrough material/finish

01W = Nickel aluminium bronze, shotblast

19B = Aluminium-alloy-plated cadmium, olive drab, over electroless nickel

19C = Aluminium-alloy-plated electroless nickel

19Q = Aluminium-alloy-plated zinc cobalt

62C = Stainless-steel-plated electroless nickel

Feedthrough size

Part description

TCFS uses a full-length molded part

TCFR uses a shortened molded part

(only available on straight assemblies)

*See Molded Parts Materials Section for -25 and -100 information.

TCFS/R (cont'd.)

Cable feedthroughs

Feedthroughs

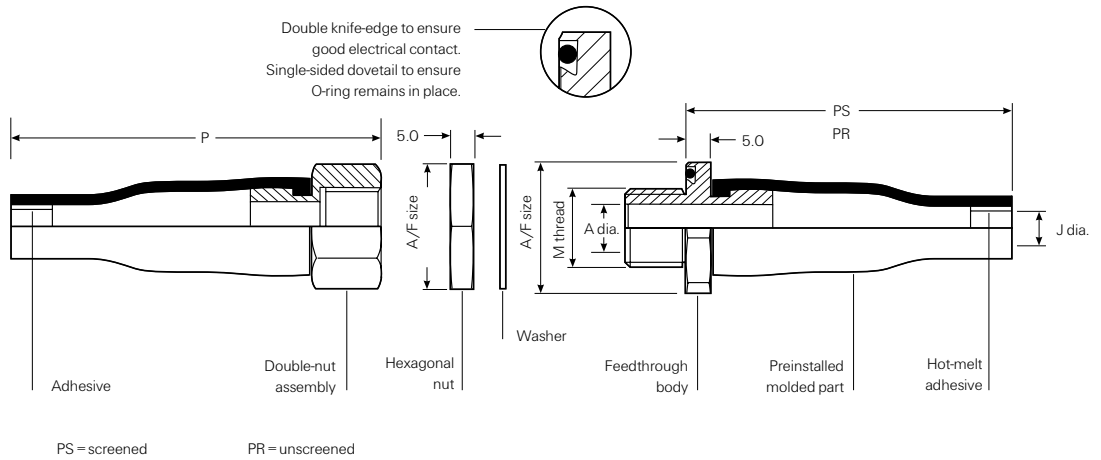

Fax-on-demand

US only (800) 260-9099

Outside US (650) 257-2301

Visit our website at www.tycoelectronics.com**Product dimensions (mm/in)**

Feed-through size	J diameter*										P±10%			
	Unshielded		Shielded a min.			b max.	M thread	A dia. max.	A/F body	A/F nut	unscreened			Hole size
	a min.	b max.	-25S	-100S	P						PS	PR		
TCFS/R-12	11 (.43)	5.6 (.22)	7.5 (.30)	6.5 (.26)	5.0 (.20)	M12x1.5	7.5 (.30)	24 (.95)	17 (.67)	52	50	43	13.0 (.51)	
TCFS/R-16	15 (.59)	5.9 (.23)	12.5 (.49)	8.5 (.33)	6.0 (.24)	M16x1.5	10.2 (.40)	29 (1.14)	22 (.87)	57	65	48	17.0 (.67)	
TCFS/R-20	19 (.75)	7.1 (.28)	14.5 (.57)	10.5 (.41)	7.2 (.28)	M20x1.5	14.0 (.55)	34 (1.34)	27 (1.06)	61	77	52	21.0 (.83)	
TCFS/R-24	23 (.90)	8.4 (.33)	18.5 (.73)	16.5 (.65)	8.5 (.33)	M24x1.5	19.2 (.76)	38 (1.50)	30 (1.18)	74	90	65	25.0 (.98)	
TCFS/R-30	29 (1.14)	9.9 (.39)	23.5 (.93)	20.5 (.81)	10.0 (.39)	M30x1.5	24.2 (.95)	48 (1.89)	36 (1.48)	73	115	64	31.0 (1.22)	
TCFS/R-36	35 (1.38)	15.7 (.62)	32.5 (1.28)	28.5 (1.12)	15.8 (.62)	M36x1.5	30.2 (1.49)	52 (2.05)	41 (1.61)	104	140	95	37.0 (1.46)	
TCFR-48	45 (1.77)	16.8 (.66)	38.5 (1.52)	35.5 (1.40)	N/A	M48x1.5	40.2 (1.58)	67 (2.64)	55 (2.17)	144	110	135	50.0 (1.97)	

*a = Supplied dimension

b = Dimension after free recovery

S-1030, S-1048, S-1275 (Rayaten)

Preinstalled adhesives



Available in:

Americas

Europe

Asia Pacific



Fax-on-demand

US only (800) 260-9099

Outside US (650) 257-2301

Visit our website at www.tycoelectronics.com**Product characteristics****S-1030 Polyolefin Hot-Melt Adhesive**

Precoat designation	/180
Type	Polyolefin hot-melt adhesive
Operating temperature range	-80°C to 80°C
Bonding temperature	120°C
Minimum shelf life at or below 25°C	4 years
Specification	RK-6017, RT-1050/6
Comments	Excellent water blocking and low temperature

S-1048 High-Performance Hot-Melt Adhesive

Precoat designation	/86
Type	High-performance hot-melt adhesive
Operating temperature range	-55°C to 120°C
Bonding temperature	160°C
Minimum shelf life at or below 25°C	4 years
Specification	RK-6626, RT-1050/3
Comments	Good solvent resistance but requires higher temperature to achieve bonding

S-1275 Rayaten Conductive Adhesive* (for KTKK assemblies only)

Type	Electrically conductive polyamide hot-melt adhesives
Operating temperature range	-40°C to 70°C
Bonding temperature	160°C
Minimum shelf life at or below 25°C	2 years
Specification	RK-6637
Comments	Conductive adhesive for use with Rayaten parts

*Not sold separately.



SESK

Shipboard electrical splice kits



Applications

SESK kits provide fast, waterproof repair of single-, two-, three-, four-, and multi-conductor cables. Kits are suitable for both permanent and temporary repairs. The self-sealing heat-shrinkable tubing used in each kit provides a watertight seal for the inner insulation and outer jacket. The flame-retardant tubing material provides electrical and thermal properties similar to those of most Navy standard cables.

Features and benefits

- Waterproofing and corrosionproofing.
- Standard sizes that cover most single-, two-, three-, four-, and multi-conductor cables.
- Excellent electrical-insulation properties and abrasion protection.
- Easy installation.
- Operating temperature range of -55°C to 90°C.
- Approved for new ship construction.

Installation

Minimum shrink temperature: 121°C

Available in:	Americas	Europe	Asia Pacific
	■	■	■

Specifications/approvals				
Series	Military	Industry	Agency	Raychem
SESK	MIL-DTL-23053*	IEEE-383 Massive Flame Vertical Tray Test	Lloyd's Register	
	USCG CGHQ-3774	AST-FR	DNV	
	U.S. Navy drawing 5001027-19	RW-2011	ABS	
Tubing used to replace cable jacket	SST-FR	SST-FR	AST-FR	Sigmaform Nemosyne FR RW-2011

*Formerly MIL-23053/15A.

Fax-on-demand

US only (800) 260-9099

Outside US (650) 257-2301

Fax ID

4060

Description

Data sheet

Visit our website at www.tycoelectronics.com**Product information**

Part number	Cable range (Navy standard)	Approx. AWG equivalent
Single-conductor cable		
SESK S-4	S-4-S-10	#14-#10
SESK S-16	S-16-S-41	#8-#4
SESK S-52	S-52-S-106	#3-#1/0
SESK S-133	S-133-S-250	#2/0-250 mcm
SESK S-300	S-300-S-600	300 mcm-600 mcm
SESK S-650	S-650-S-1000	650 mcm-1000 mcm
Two-conductor cable		
SESK D-3	D-3	#22-#16
SESK D-4	D-4-D-10	#14-#10
SESK D-14	D-14	#9
SESK D-23	D-23-D-41	#7-#4
SESK D-50	D-50-D-168	#3-#3/0
SESK D-200	D-200-D-250	#4/0-250 mcm
SESK D-300	D-300-D-350	300 mcm-350 mcm
SESK D-400	D-400-D-450	400 mcm-450 mcm
Three-conductor cable		
SESK T-3	T-3	#22-#16
SESK T-4	T-4-T-10	#14-#10
SESK T-14	T-14-T-20	#9-#7
SESK T-23	T-23-T-41	#6-#4
SESK T-50	T-50-T-168	#3/0
SESK T-200	T-200-T-250	#4/0-250 mcm
SESK T-300	T-300-T-350	300 mcm-350 mcm
SESK T-400	T-400-T-450	400 mcm-450 mcm
SESK T-500	T-500-T-600	500 mcm-600 mcm

SESK (cont'd.)

Shipboard electrical splice kits

Product information (cont'd.)

Part number	Cable range (Navy standard)	Approx. AWG equivalent
Four-conductor cable		
SESK F-3	F-3	#22-#16
SESK F-4	F-4-F-9	#14-#10
SESK F-23	F-23	#6
SESK F-50	F-50	#3
SESK F-75	F-75-F-100	#1-#1/0
SESK F-150	F-150-F-200	#3/0-#4/0
Multiconductor cable		
SESK M-2	2	#18-#22
SESK M-4	4	#18-#22
SESK M-6	6	#18-#22
SESK M-8	8	#18-#22
SESK M-10	10	#18-#22
SESK M-12	12	#18-#22
SESK M-14	14	#18-#22
SESK M-16	16	#18-#22
SESK M-18	18	#18-#22
SESK M-20	20	#18-#22
SESK M-22	22	#18-#22
SESK M-24	24	#18-#22
SESK M-26	26	#18-#22
SESK M-28	28	#18-#22
SESK M-30	30	#18-#22
SESK M-32	32	#18-#22

Note:

- Multiconductor kits are available for various cable types and AWG ranges, including shielded twisted pairs.
- These kits can be assembled by Tyco Electronics distributors using either SST-FR or AST-FR tubing, and Mil-Spec or Raychem DuraSeal crimps. (Note: SST-FR tubing is approved by the U.S. Navy drawing 500 1027-19. AST-FR is approved by DNV, Lloyd's Register, and ABS.)
- New kits for EPD cables or shielded and jacketed components can be designed. Contact Tyco Electronics for details.

Fax-on-demand

US only (800) 260-9099
Outside US (650) 257-2301

Fax ID

4060

Description

Data sheet

Visit our website at www.tycoelectronics.com

Part numbering system

SESK-300 C TSGU-300

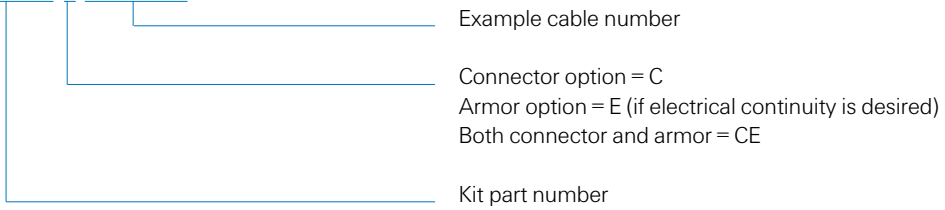



Ship or Shore

Breakout kits



Applications

Waterproof splices for power cables are available in red, white, and black for positive identification of each conductor.

Bolting power cables together and wrapping the splice with tape used to be the accepted method. Now the in-line splice—with thick-wall, self-sealing, heat-shrinkable products—is the accepted system for strain relief, environmental sealing, and phase identification for power cables. Tubing accommodates a large difference between cable diameters. Sigmaform boots can replace tapes, epoxies, and dips.

Features and benefits

- Heat-shrinkable boot replaces potting or molding.
- Flame-retardant tubing has a 3:1 shrink ratio.
- Kit offers resistance to moisture, fungus, and weathering.
- Operating temperature range of -55°C to 90°C .

Installation

Minimum shrink temperature: 121°C

Available in:	Americas	Europe	Asia Pacific
	■	■	■

Specifications/approvals		
Series	Military	Industry
2E171-4	NAVSEA 803-5001027-17	DNV
	MIL-C-24368	Lloyd's
	MIL-DTL-23053/15* and MIL-I-81765/1	ABS

*Formerly MIL-I-23053.

Fax-on-demand

US only (800) 260-9099
Outside US (650) 257-2301

Fax ID

4070

Description

Data sheet

Visit our website at www.tycoelectronics.com

Ordering information

Part number	Model
2E171-4	In-line splice cable sealing kit**

**Each kit contains:

- Cable breakout boot
- Three-phase identification tubings (red, white, and black)
- Three connector tubings
- A #100 grit emery cloth
- Installation instructions

Electrical Interconnect Products

Overview

Raychem dependable, economical wire and cable termination products provide solutions for hundreds of wire and cable interconnect requirements.

All Raychem wire termination products are housed inside transparent heat-shrinkable insulation sleeves, which provide inspectability and can provide various levels of environmental protection. Most Raychem termination products incorporate a fluxed solder preform, which is essential for a highly controlled soldering process. Other products incorporate controlled crimping or a unique process of combining a twist-on coil with controlled soldering to provide high-reliability joints on the widest variety of conductor types and platings.

SolderSleeve technology ensures high-quality electrical and mechanical performance time after time. Premeasured solder and flux create repeatable, reliable terminations, reducing rejects and field failures. When the SolderSleeve device is heated, the tubing shrinks and the solder preform melts to make a fully insulated, strain-relieved, protected solder connection. Heat-shrinkable tubing provides the benefits of insulation, strain relief, and protection for our controlled crimp products. Many Raychem interconnect products have earned UL recognition or Mil-Spec approval.

Raychem interconnect devices combine high-strength materials with innovative design for consistent, long-life performance. And because the insulation sleeve is transparent, operators can easily inspect the connection.

Raychem shrink-to-fit technology even helps reduce inventory, because one device size will fit a wide range of wire gauges, cable diameters, and component shapes.

Raychem interconnect products are designed for many applications, from simple splices to terminators for sophisticated electronic systems, either sealed or unsealed, and for high- or low-temperature environments.

Whether yours is an aerospace, automotive, or mass transit application, or an application for computer and communications electronics, or appliances, you can match your needs with the products described in this catalog. Then make the connection with your Tyco Electronics distributor.

Electrical Interconnect Products

Table of Contents

Typical SolderSleeve Device	8-0	
Typical Installation	8-0	
Product Selection	8-1	
Product Selection Table	8-1	
Product Selection Chart	8-2	
Wire-to-Wire Splicing	8-3	
SolderSleeve wire splices	8-4	
SolderGrip closed end connector splices	8-12	
DuraSeal heat-shrinkable, environmentally sealed, nylon-insulated crimp splices	8-20	
MiniSeal high-performance, immersion-resistant crimp splices	8-22	
Insulated Terminals and Disconnects	8-27	
DuraSeal heat-shrinkable, environmentally sealed, nylon-insulated crimp terminals and disconnects	8-28	
SolderGrip self-fixturing insulated terminals	8-34	
Wire Termination to Pin/Post/Tab	8-41	
SolderSleeve discrete wire terminators	8-42	
Shield Termination	8-47	
SolderSleeve shield terminators	8-48	
Coaxial Cable Termination	8-55	
SolderSleeve coaxial cable terminators	8-56	
SolderSleeve PCB/coaxial cable terminators	8-58	
RF one-step BNC/TNC connectors	8-60	
Cable to Cable Splicing	8-69	
SolderShield shielded and coaxial cable splices	8-70	
Shielded Contacts	8-75	
SolderTacts shielded one-piece solder contacts	8-76	
Data Bus (MIL-STD-1553B) Components	8-85	
Cables	8-86	
In-line microcouplers: one and two stub	8-88	
Ultra lightweight in-line microcouplers 1 - through 8-stub	8-92	
Box couplers	8-94	
Discrete connectors	8-96	
Triaxial size 8 contacts	8-98	
Space-grade data bus components	8-100	
Customer-specified harness assemblies and HarnWare	8-104	
Accessories	8-106	
Other		
Hexashield	High-performance EMC adapters	8-110
MTC Crimp Connectors	High-performance modular rectangular connectors with removable contacts	8-116

Electrical Interconnect Products

Typical SolderSleeve Device/Installation



Typical SolderSleeve Device (illustration of shield terminator concept)

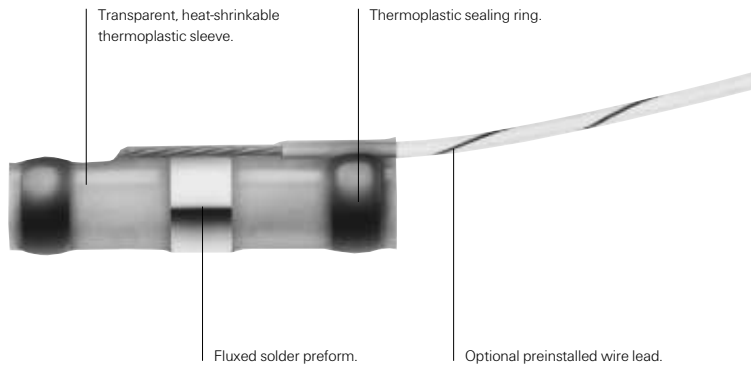

Typical Installation

1. Insert prepared cable

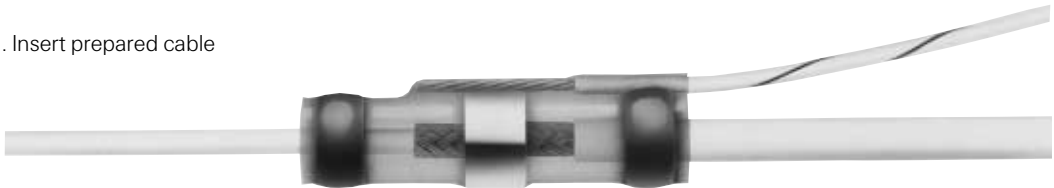

2. Apply heat

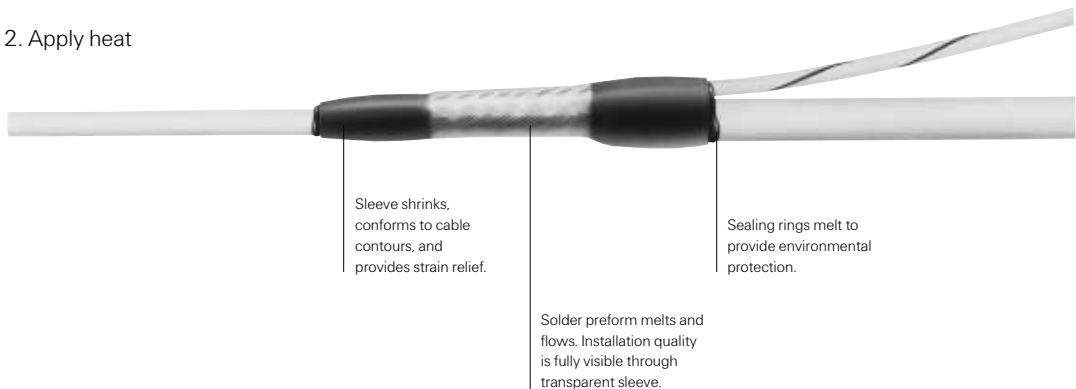

Electrical Interconnect Products

Product Selection

Fax-on-demand

US only (800) 260-9099

Outside US (650) 257-2301

Visit our website at www.tycoelectronics.com



Product selection table

Application type	Max. operating temp.	Connection type	Product description	Series	Page Number
Wire-to-wire splicing	125°C	Solder	SolderSleeve wire splices	CWT-900X	8-4
	150°C	Solder	SolderSleeve wire splices	D-110, D-1744	8-4
	125°C	Coil and solder	SolderGrip closed end connector splices (stub)	SGRP, SGRS	8-12
	125°C	Crimp	DuraSeal crimp splices	D-406	8-20
	150°C	Crimp	MiniSeal crimp splices	D-436 (M81824)	8-22
Terminals and disconnects	125°C	Crimp	DuraSeal crimp terminals and disconnects	B-106	8-28
	150°C	Coil and solder	SolderGrip terminals	SGRT	8-34
Wire termination to pin/post/tab	125°C	Solder	SolderSleeve wire terminators	CWT-15XX	8-42
	150°C	Solder	SolderSleeve wire terminators	D-129, D-141, D-71X	8-42
Shield termination	125°C	Solder	SolderSleeve shield terminators	CWT-X	8-48
	150°C	Solder	SolderSleeve shield terminators	SO1, SO2, M83519, SO63	8-48
	175°C	Solder	SolderSleeve shield terminators	SO96	8-48
Coaxial cable termination	125°C	Solder	SolderSleeve coaxial cable terminators	CWT-4XXX	8-56
	150°C	Solder	SolderSleeve coaxial cable terminators	B-02X, B-04X	8-56
	150°C	Solder	SolderSleeve PCB/coaxial cable terminators	D-607, B-046	8-58
	135°C	Solder	RF one-step BNC/TNC connectors	RBD, RTD	8-60
Cable-to-cable splicing	150°C	Solder/Crimp	SolderShield cable splices	D-150	8-70
Shielded contacts	150°C	Solder	SolderTacts shielded contacts	D-602	8-76
Triax connectors	150°C	Solder	Triax discrete connectors	D-621, DK-621	8-96
MIL-STD-1553	150°C	Solder	Triax discrete connectors	D-621, DK-621	8-96
Data bus connectors	150°C	Solder	Triax discrete connectors	D-621, DK-621	8-96
MIL-STD-1553 In-line couplers	150°C	Solder or connectorized	In-line data bus microcoupler	D-500-04	8-88
MIL-STD-1533	150°C	Connectorized	Data bus box couplers	D-500-025	8-94
Triaxial size 8 contacts	150°C	Solder	Size 8, triaxial MIL-C-38999 contacts	D-602, DK-602	8-98
Data bus cables	150°C	Crimp or solder	MIL-STD-1553 B shielded cable	1061X	8-86
Data bus terminators	150°C	Solder or connectorized	MIL-STD-1553 78° and 3000° terminators	D-621, D-500	8-106
Data bus accessories	150°C	Solder or mechanical	Dust caps, braid terminators, splices	D-600, D-150	8-106

Users should independently evaluate the suitability of the product for their application. Before ordering check with factory for most current data.

Electrical Interconnect Products

Product Selection

Application type	Connection type	Max. operating temp.	Product description	Series	Page number
Wire to wire splicing	Solder	125°C	SolderSleeve wire splices	CWT-900X	8-4
		150°C	SolderSleeve wire splices	D-110, D-1744	8-4
	Crimp	125°C	DuraSeal crimp splices	D-406	8-20
		150°C	MiniSeal crimp splices	D-436 (M81824)	8-22
	Coil and Solder	125°C	SolderGrip closed end connector splices (stub)	SGRP, SGRS	8-12
Terminals and disconnects	Crimp	125°C	DuraSeal crimp terminals and disconnects	B-106	8-28
	Coil and Solder	150°C	SolderGrip terminals	SGRT	8-34
Wire termination to pin/post/tab	Solder	125°C	SolderSleeve wire terminators	CWT-15XX	8-42
		150°C	SolderSleeve wire terminators	D-129, D-141, D-71X	8-42
Shield termination	Solder	125°C	SolderSleeve shield terminators	CWT-X	8-48
		150°C	SolderSleeve shield terminators	S01, S02, M83519, S063	8-48
		175°C	SolderSleeve shield terminators	S096	8-48
Coax cable termination	Solder	125°C	SolderSleeve coaxial cable terminators	CWT-4XXX	8-56
		135°C	RF one-step BNC/TNC connector	RBD, RTD	8-60
		150°C	SolderSleeve coaxial cable terminators	B-02X/04X	8-56
			SolderSleeve PCB/coaxial cable terminators	D-607, B-046	8-58
Cable to cable splicing	Solder/Crimp	150°C	SolderShield cable splices	D-150, B-202	8-70
Shielded contacts	Solder	150°C	SolderTacts shielded contacts	D-602	8-76
MIL-STD-1553B data bus components	Solder	150°C	Data bus couplers, connectors, terminators, accessories	D-500, D-600, D(K)-621	8-85

Wire-to-Wire Splicing

Fax-on-demand

US only (800) 260-9099

Outside US (650) 257-2301

Visit our website at www.tycoelectronics.com



Tyco Electronics offers many products for wire-to-wire splicing: Raychem SolderSleeve splicing devices; SolderGrip splices; and DuraSeal and MiniSeal crimp splices. Like all Raychem interconnect products, the wire-to-wire splicing devices are rugged and reliable, yet easy to install.

Designed for applications with temperatures up to 150°C, products in this section include:

- SolderSleeve splicing devices, which can be used to make sealed or unsealed splices. In a single step, they solder, insulate, encapsulate, and strain-relieve a wide range of wire sizes.
- DuraSeal heat-shrinkable nylon crimp splices are easy to use in factory or repair applications. DuraSeal crimp splices provide watertight sealing and superior protection against corrosion, abrasion, and vibration.
- Small, lightweight, and low-profile MiniSeal high-performance crimp splices, which substantially reduce wire bundle size and weight, are QPL-listed to the MIL-S-81824 specification, and are required by the MIL-W-5088 specification.
- SolderGrip splices, which are closed-end connectors utilizing a spiral copper coil that grips and compresses the conductors and allows a prefluxed solder ring to flow to the center of the splicing area, resulting in a high-reliability, repeatable solder joint.

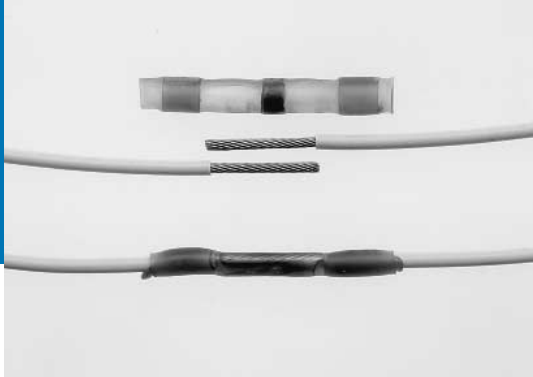

Wire-to-Wire Splicing

SolderSleeve wire splices



Applications

In-line wire splices.

Features and benefits

- Transparent polyvinylidene fluoride or polyolefin sleeve provides encapsulation, inspectability, strain relief, and insulation.
- Prefluxed solder preform provides a controlled soldering process.
- One-piece design makes installation easy and lowers the installed cost.
- With one or two wires per end, the NAS 1744 splices meet 75,000-ft (22,000-m) altitude immersion requirement.
- Thermochromic temperature indicator in the NAS splices facilitates termination and inspection.
- UL and CUL recognized



Available in:

Americas

Europe

Asia Pacific



Fax-on-demand

US only (800) 260-9099

Outside US (650) 257-2301

Fax ID

5000

Description

Data sheet (CWT)

Visit our website at www.tycoelectronics.com**Product options**

Product series	Minimum wire temperature rating	Maximum operating temperature	Intended application environment
CWT	85°C	125°C	Splashproof
D-110	125°C	150°C	Splashproof
D-1744 (NAS 1744)	125°C	150°C	Immersion sealed

Product selection process

From the Product Options table above, select the product series appropriate for your application based on the temperature rating and sealing performance required.

If the application has only one size of wire per side and no more than two wires on either side:

1. Determine wire gauge sizes for both sides of splice.
2. Determine number of wires (one or two wires) for each side of splice.
3. Select part numbers from the appropriate table:
 - For CWT series (low temperature):
Use Table A on page 8-6.
 - For D-110 series (splashproof):
Use Table B on page 8-7.
 - For D-1744 series (immersion sealed):
Use Table C on page 8-9.

If the application has more than one size of wire per side or more than two wires on either side (or if you prefer to work with CMA or mm² sizes):

1. Turn to "CMA/mm² Calculation" on page 8-10 and use the workspace there to calculate the total cross section to be spliced.
2. Use Table E on page 8-11 to select the sleeve recommended for that cross section.

Notes

- While all combinations listed will provide satisfactory solder joints, the degree of strain relief obtained depends on the outer diameter of the wires being joined. Refer to Table E for the recommended size ranges for the sleeves.
- Wires 16 AWG (1.21 mm²) and larger, and wires having more than 19 strands, should be pretinned prior to splicing, to obtain the optimum solder joint quality.
- Part selection for wires 26 AWG (0.15 mm²) and smaller is covered at the end of Table B on page 8-8.

Wire-to-Wire Splicing

SolderSleeve wire splices (cont'd.)

Table A. CWT Series selection

Side A:	Side B: Size and number of conductors										
Size and number of conductors	26 AWG		24 AWG		22 AWG		20 AWG				
	1	2	1	2	1	2	1	2			
26 AWG	1	CWT-9001	CWT-9001	CWT-9001	CWT-9001	CWT-9001	CWT-9002	CWT-9002	CWT-9002	CWT-9002	
	2	CWT-9001	CWT-9001	CWT-9001	CWT-9002	CWT-9001	CWT-9002	CWT-9002	CWT-9002	CWT-9002	
24 AWG	1	CWT-9001	CWT-9001	CWT-9001	CWT-9001	CWT-9001	CWT-9002	CWT-9002	CWT-9002	CWT-9002	
	2	CWT-9001	CWT-9002	CWT-9001	CWT-9002	CWT-9002	CWT-9002	CWT-9002	CWT-9002	CWT-9002	
22 AWG	1	CWT-9001	CWT-9001	CWT-9001	CWT-9002	CWT-9002	CWT-9002	CWT-9002	CWT-9002	CWT-9002	
	2	CWT-9002	CWT-9002	CWT-9002	CWT-9002	CWT-9002	CWT-9002	CWT-9002	CWT-9002	CWT-9003	
20 AWG	1	CWT-9002	CWT-9002	CWT-9002	CWT-9002	CWT-9002	CWT-9002	CWT-9002	CWT-9002	CWT-9003	
	2	CWT-9002	CWT-9002	CWT-9002	CWT-9002	CWT-9002	CWT-9003	CWT-9003	CWT-9003	CWT-9003	
18 AWG	1	CWT-9002	CWT-9002	CWT-9002	CWT-9002	CWT-9002	CWT-9002	CWT-9002	CWT-9002	CWT-9003	
	2	CWT-9003	CWT-9003	CWT-9003	CWT-9003	CWT-9003	CWT-9003	CWT-9003	CWT-9003	CWT-9003	
16 AWG	1	CWT-9002	CWT-9002	CWT-9002	CWT-9002	CWT-9002	CWT-9003	CWT-9003	CWT-9003	CWT-9003	
	2	CWT-9003	CWT-9003	CWT-9003	CWT-9003	CWT-9003	CWT-9003	CWT-9003	CWT-9003	CWT-9003	
14 AWG	1	CWT-9003	CWT-9003	CWT-9003	CWT-9003	CWT-9003	CWT-9003	CWT-9003	CWT-9003	CWT-9003	
	2	CWT-9004	CWT-9004	CWT-9004	CWT-9004	CWT-9004	CWT-9004	CWT-9004	CWT-9004	CWT-9004	
12 AWG	1	CWT-9003	CWT-9003	CWT-9003	CWT-9003	CWT-9003	CWT-9003	CWT-9003	CWT-9003	CWT-9004	
	2	CWT-9005	CWT-9005	CWT-9005	CWT-9005	CWT-9005	CWT-9005	CWT-9005	CWT-9005	CWT-9005	
10 AWG	1	CWT-9005	CWT-9005	CWT-9005	CWT-9005	CWT-9005	CWT-9005	CWT-9005	CWT-9005	CWT-9005	
	18 AWG		16 AWG		14 AWG		12 AWG		10 AWG		
	1		1	2	1	2	1	2		1	
26 AWG	1	CWT-9002	CWT-9003	CWT-9002	CWT-9003	CWT-9003	CWT-9004	CWT-9003	CWT-9005	CWT-9005	CWT-9005
	2	CWT-9002	CWT-9003	CWT-9002	CWT-9003	CWT-9003	CWT-9004	CWT-9003	CWT-9005	CWT-9005	CWT-9005
24 AWG	1	CWT-9002	CWT-9003	CWT-9002	CWT-9003	CWT-9003	CWT-9004	CWT-9003	CWT-9005	CWT-9005	CWT-9005
	2	CWT-9002	CWT-9003	CWT-9002	CWT-9003	CWT-9003	CWT-9004	CWT-9003	CWT-9005	CWT-9005	CWT-9005
22 AWG	1	CWT-9002	CWT-9003	CWT-9002	CWT-9003	CWT-9003	CWT-9004	CWT-9003	CWT-9005	CWT-9005	CWT-9005
	2	CWT-9002	CWT-9003	CWT-9003	CWT-9003	CWT-9003	CWT-9004	CWT-9003	CWT-9005	CWT-9005	CWT-9005
20 AWG	1	CWT-9002	CWT-9003	CWT-9003	CWT-9003	CWT-9003	CWT-9004	CWT-9003	CWT-9005	CWT-9005	CWT-9005
	2	CWT-9003	CWT-9003	CWT-9003	CWT-9003	CWT-9003	CWT-9004	CWT-9004	CWT-9005	CWT-9005	CWT-9005
18 AWG	1	CWT-9003	CWT-9003	CWT-9003	CWT-9003	CWT-9003	CWT-9004	CWT-9004	CWT-9005	CWT-9005	CWT-9005
	2	CWT-9003	CWT-9003	CWT-9003	CWT-9004	CWT-9003	CWT-9004	CWT-9004	CWT-9005	CWT-9005	CWT-9005
16 AWG	1	CWT-9003	CWT-9003	CWT-9003	CWT-9003	CWT-9003	CWT-9004	CWT-9004	CWT-9005	CWT-9005	CWT-9005
	2	CWT-9003	CWT-9004	CWT-9003	CWT-9004	CWT-9004	CWT-9005	CWT-9004	CWT-9005	CWT-9005	CWT-9005
14 AWG	1	CWT-9003	CWT-9003	CWT-9003	CWT-9004	CWT-9003	CWT-9004	CWT-9004	CWT-9005	CWT-9005	CWT-9005
	2	CWT-9004	CWT-9004	CWT-9004	CWT-9005	CWT-9004	CWT-9005	CWT-9005	CWT-9005	CWT-9005	CWT-9005
12 AWG	1	CWT-9004	CWT-9004	CWT-9004	CWT-9004	CWT-9004	CWT-9005	CWT-9004	CWT-9005	CWT-9005	CWT-9005
	2	CWT-9005	CWT-9005	CWT-9005	CWT-9005	CWT-9005	CWT-9005	CWT-9005	CWT-9005	CWT-9005	CWT-9005
10 AWG	1	CWT-9005	CWT-9005	CWT-9005	CWT-9005	CWT-9005	CWT-9005	CWT-9005	CWT-9005	CWT-9005	CWT-9005

Fax-on-demand

US only (800) 260-9099

Outside US (650) 257-2301

Fax ID

600

(D-110+D-1744)

5000 Data sheet (CWT)

Description

Data sheet

(D-110+D-1744)

Data sheet (CWT)

Visit our website at www.tycoelectronics.com**Table B. D-110 Series selection**

Side A:	Side B: Size and number of conductors									
Size and number of conductors	26 AWG		24 AWG		22 AWG		20 AWG			
	1	2	1	2	1	2	1	2		
26 AWG	1	D-110-35	D-110-35	D-110-35	D-110-35	D-110-35	D-110-41	D-110-41	D-110-41	
	2	D-110-35	D-110-35	D-110-35	D-110-41	D-110-35	D-110-41	D-110-41	D-110-41	
24 AWG	1	D-110-35	D-110-35	D-110-35	D-110-35	D-110-35	D-110-41	D-110-41	D-110-41	
	2	D-110-35	D-110-41	D-110-35	D-110-41	D-110-41	D-110-41	D-110-41	D-110-41	
22 AWG	1	D-110-35	D-110-35	D-110-35	D-110-41	D-110-41	D-110-41	D-110-41	D-110-41	
	2	D-110-41	D-110-41	D-110-41	D-110-41	D-110-41	D-110-41	D-110-41	D-110-0181	
20 AWG	1	D-110-41	D-110-41	D-110-41	D-110-41	D-110-41	D-110-41	D-110-41	D-110-0181	
	2	D-110-41	D-110-41	D-110-41	D-110-41	D-110-41	D-110-0181	D-110-0181	D-110-0181	
18 AWG	1	D-110-41	D-110-41	D-110-41	D-110-41	D-110-41	D-110-41	D-110-41	D-110-0181	
	2	D-110-0181	D-110-0181	D-110-0181	D-110-0181	D-110-0181	D-110-0101	D-110-0101	D-110-0101	
16 AWG	1	D-110-41	D-110-41	D-110-41	D-110-41	D-110-41	D-110-0181	D-110-0181	D-110-0181	
	2	D-110-0101	D-110-0101	D-110-0101	D-110-0101	D-110-0181	D-110-0101	D-110-0101	D-110-0101	
14 AWG	1	D-110-0181	D-110-0181	D-110-0181	D-110-0181	D-110-0181	D-110-0101	D-110-0101	D-110-0101	
	2	D-110-0101	D-110-0101	D-110-0101	D-110-0101	D-110-0101	D-110-0090	D-110-0101	D-110-0090	
12 AWG	1	D-110-0101	D-110-0101	D-110-0101	D-110-0101	D-110-0101	D-110-0101	D-110-0101	D-110-0101	
	2	D-110-0090	D-110-0090	D-110-0090	D-110-0090	D-110-0090	D-110-0090	D-110-0090	D-110-0090	
10 AWG	1	D-110-0090	D-110-0090	D-110-0090	D-110-0090	D-110-0090	D-110-0083	D-110-0083	D-110-0083	
	18 AWG		16 AWG		14 AWG		12 AWG		10 AWG	
	1	2	1	2	1	2	1	2	1	
26 AWG	1	D-110-41	D-110-0181	D-110-41	D-110-0101	D-110-0181	D-110-0101	D-110-0101	D-110-0090	D-110-0090
	2	D-110-41	D-110-0181	D-110-41	D-110-0101	D-110-0181	D-110-0101	D-110-0101	D-110-0090	D-110-0090
24 AWG	1	D-110-41	D-110-0181	D-110-41	D-110-0101	D-110-0181	D-110-0101	D-110-0101	D-110-0090	D-110-0090
	2	D-110-41	D-110-0181	D-110-41	D-110-0101	D-110-0181	D-110-0101	D-110-0101	D-110-0090	D-110-0090
22 AWG	1	D-110-41	D-110-0181	D-110-41	D-110-0181	D-110-0181	D-110-0101	D-110-0101	D-110-0090	D-110-0090
	2	D-110-41	D-110-0101	D-110-0181	D-110-0101	D-110-0101	D-110-0090	D-110-0101	D-110-0090	D-110-0090
20 AWG	1	D-110-41	D-110-0101	D-110-0181	D-110-0101	D-110-0101	D-110-0101	D-110-0101	D-110-0090	D-110-0090
	2	D-110-0181	D-110-0101	D-110-0181	D-110-0101	D-110-0101	D-110-0090	D-110-0101	D-110-0090	D-110-0090
18 AWG	1	D-110-0181	D-110-0101	D-110-0181	D-110-0101	D-110-0101	D-110-0090	D-110-0101	D-110-0090	D-110-0090
	2	D-110-0101	D-110-0101	D-110-0101	D-110-0101	D-110-0101	D-110-0090	D-110-0090	D-110-0090	D-110-0083
16 AWG	1	D-110-0181	D-110-0101	D-110-0181	D-110-0101	D-110-0101	D-110-0090	D-110-0101	D-110-0090	D-110-0090
	2	D-110-0101	D-110-0101	D-110-0101	D-110-0090	D-110-0101	D-110-0090	D-110-0090	D-110-0083	D-110-0083
14 AWG	1	D-110-0101	D-110-0101	D-110-0101	D-110-0101	D-110-0101	D-110-0090	D-110-0090	D-110-0090	D-110-0083
	2	D-110-0090	D-110-0090	D-110-0090	D-110-0090	D-110-0090	D-110-0090	D-110-0090	D-110-0083	D-110-0083
12 AWG	1	D-110-0101	D-110-0090	D-110-0101	D-110-0090	D-110-0090	D-110-0090	D-110-0090	D-110-0083	D-110-0083
	2	D-110-0090	D-110-0090	D-110-0090	D-110-0083	D-110-0090	D-110-0083	D-110-0083	D-110-0083	D-110-0083
10 AWG	1	D-110-0083	D-110-0083	D-110-0083	D-110-0083	D-110-0083	D-110-0083	D-110-0083	D-110-0083	D-110-0083

Users should independently evaluate the suitability of the product for their application.
 Before ordering check with factory for most current data.

Wire-to-Wire Splicing

SolderSleeve wire splices (cont'd.)

Table B. (cont'd.) For fine wire splices 26 AWG (0.15 mm²) and smaller (mm/in)

Part number	Inside diameter		
	As supplied*	Fully recovered**	Length***
D-110-0071	0.9 (0.035)	0.6 (0.025)	4.7 (0.185)
D-110-0213	0.9 (0.035)	0.6 (0.025)	4.2 (0.165)
D-110-0214	0.6 (0.025)	0.3 (0.013)	6.3 (0.250)
D-110-0217	1.0 (0.040)	0.6 (0.025)	9.1 (0.360)
D-110-40	0.6 (0.025)	0.5 (0.021)	5.1 (0.200)

Note: Micro SolderSleeve terminations are used for splicing wires smaller than 26 AWG (0.15 mm²).

*Minimum. Wire insulation must be smaller than this.

**Maximum. Wire insulation and combined conductor diameters must be greater than this.

***Nominal. Wire strip length must be approximately one-half of this.

Fax-on-demand

US only (800) 260-9099

Outside US (650) 257-2301

Fax ID

600

(D-110+D-1744)

5000 Data sheet (CWT)

Description

Data sheet

(D-110+D-1744)

Data sheet (CWT)

Visit our website at www.tycoelectronics.com**Table C. D-1744 Series selection**

Side A:	Side B: Size and number of conductors							
Size and number of conductors	26 AWG		24 AWG		22 AWG		20 AWG	
	1	2	1	2	1	2	1	2
26 AWG	1 D-1744-01	D-1744-01	D-1744-01	D-1744-01	D-1744-01	D-1744-01	D-1744-01	D-1744-02
	2 D-1744-01	D-1744-01	D-1744-01	D-1744-01	D-1744-01	D-1744-01	D-1744-02	D-1744-02
24 AWG	1 D-1744-01	D-1744-01	D-1744-01	D-1744-01	D-1744-01	D-1744-01	D-1744-01	D-1744-02
	2 D-1744-01	D-1744-01	D-1744-01	D-1744-01	D-1744-01	D-1744-02	D-1744-02	D-1744-02
22 AWG	1 D-1744-01	D-1744-01	D-1744-01	D-1744-01	D-1744-01	D-1744-02	D-1744-02	D-1744-02
	2 D-1744-01	D-1744-02	D-1744-01	D-1744-02	D-1744-02	D-1744-02	D-1744-02	D-1744-02
20 AWG	1 D-1744-01	D-1744-01	D-1744-01	D-1744-02	D-1744-01	D-1744-02	D-1744-02	D-1744-02
	2 D-1744-02	D-1744-02	D-1744-02	D-1744-02	D-1744-02	D-1744-02	D-1744-02	D-1744-03
18 AWG	1 D-1744-02	D-1744-02	D-1744-02	D-1744-02	D-1744-02	D-1744-02	D-1744-02	D-1744-03
	2 D-1744-03	D-1744-03	D-1744-03	D-1744-03	D-1744-03	D-1744-03	D-1744-03	D-1744-03
16 AWG	1 D-1744-02	D-1744-02	D-1744-02	D-1744-02	D-1744-02	D-1744-02	D-1744-02	D-1744-03
	2 D-1744-03	D-1744-03	D-1744-03	D-1744-03	D-1744-03	D-1744-03	D-1744-03	D-1744-03
14 AWG	1 D-1744-03	D-1744-03	D-1744-03	D-1744-03	D-1744-03	D-1744-03	D-1744-03	D-1744-03
	2 D-1744-03	D-1744-03	D-1744-03	D-1744-03	D-1744-03	D-1744-03	D-1744-03	D-1744-04
12 AWG	1 D-1744-03	D-1744-03	D-1744-03	D-1744-03	D-1744-03	D-1744-03	D-1744-03	D-1744-04
	2 D-1744-04	D-1744-04	D-1744-04		D-1744-04			D-1744-04
	18 AWG		16 AWG		14 AWG		12 AWG	
	1	2	1	2	1	2	1	2
26 AWG	1 D-1744-02	D-1744-03	D-1744-02	D-1744-03	D-1744-03	D-1744-03	D-1744-03	D-1744-04
	2 D-1744-02	D-1744-03	D-1744-02	D-1744-03	D-1744-03	D-1744-03	D-1744-03	D-1744-04
24 AWG	1 D-1744-02	D-1744-03	D-1744-02	D-1744-03	D-1744-03	D-1744-03	D-1744-03	D-1744-04
	2 D-1744-02	D-1744-03	D-1744-02	D-1744-03	D-1744-03	D-1744-03	D-1744-03	D-1744-04
22 AWG	1 D-1744-02	D-1744-03	D-1744-02	D-1744-03	D-1744-03	D-1744-03	D-1744-03	D-1744-04
	2 D-1744-02	D-1744-03	D-1744-02	D-1744-03	D-1744-03	D-1744-03	D-1744-03	D-1744-04
20 AWG	1 D-1744-02	D-1744-03	D-1744-02	D-1744-03	D-1744-03	D-1744-03	D-1744-03	D-1744-04
	2 D-1744-03	D-1744-03	D-1744-03	D-1744-03	D-1744-03	D-1744-04	D-1744-04	D-1744-04
18 AWG	1 D-1744-02	D-1744-03	D-1744-03	D-1744-03	D-1744-03	D-1744-03	D-1744-03	D-1744-03
	2 D-1744-03	D-1744-03	D-1744-03	D-1744-03	D-1744-03	D-1744-04	D-1744-03	D-1744-03
16 AWG	1 D-1744-03	D-1744-03	D-1744-03	D-1744-03	D-1744-03	D-1744-04	D-1744-03	D-1744-03
	2 D-1744-03	D-1744-03	D-1744-03	D-1744-03	D-1744-03	D-1744-04	D-1744-03	D-1744-03
14 AWG	1 D-1744-03	D-1744-03	D-1744-03	D-1744-03	D-1744-03	D-1744-04	D-1744-03	D-1744-03
	2 D-1744-03	D-1744-04	D-1744-04	D-1744-04	D-1744-04			
12 AWG	1 D-1744-03	D-1744-03	D-1744-03	D-1744-04	D-1744-03		D-1744-04	
	2							

Users should independently evaluate the suitability of the product for their application.
 Before ordering check with factory for most current data.

Wire-to-Wire Splicing

SolderSleeve wire splices (cont'd.)

CMA/mm² Calculation

To calculate the total circular mil or mm² area of the conductors to be terminated in a single splice, follow these steps:

1. Choose either CMA or mm² as your unit of measure for selection purposes and continue to use it for all your selection criteria.
2. In the workspace below, list the CMA or mm² for each conductor that will go into the same splice. (To assist you, Table D on this page provides the CMA of typical conductors.)
3. Add together the values listed in the workspace below to obtain the total area.
4. From Table E on the next page, select the part number recommended for the total CMA or mm² you have calculated.
5. Refer to the examples on this page for further clarification.

Wire number	CMA	mm ²	
1	_____	_____	
2	_____	_____	
3	_____	_____	
4	_____	_____	
5	_____	_____	
Total	_____	_____	Part number: _____

CMA/mm² Examples (mm/in)

One-to-One Wire Splice

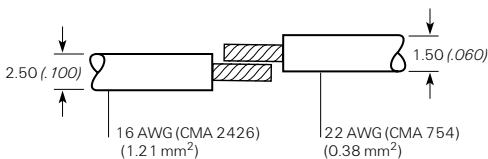

Total CMA = 3180
Total mm² = 1.59

Correct part number selection from Table E (based on CMA/mm² and nominal jacket wire OD) = CWT-9002 or D-110-41 or D-1744-02.

Multiwire Splice

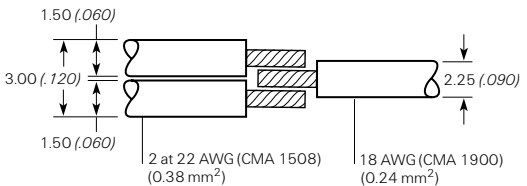

Total CMA = 3408
Total mm² = 1.71

Correct part number selection from Table E (based on CMA/mm² and nominal jacket wire OD) = CWT-9003 or D-110-0181 or D-1744-03.

Table D. CMA of typical AWG conductors

AWG	28	26	24	22	20	18	16	14	12
CMA	177	304	475	754	1216	1900	2426	3831	5874
mm ²	0.09	0.15	0.24	0.38	0.61	0.95	1.21	1.92	2.94

Fax-on-demand

US only (800) 260-9099

Outside US (650) 257-2301

Fax ID

600

(D-110+D-1744)

5000

Description

Data sheet

Data sheet (CWT)

Visit our website at www.tycoelectronics.com**Table E. Multiwire splice selection (mm/in)**

Product series	Wire jacket OD		CMA		mm ²	
	min.	max.	min.	max.	min.	max.
CWT-9001/D-110-35/D-1744-01	.76 (0.03)	1.5 (0.06)	450	1500	0.2	.75
CWT-9002/D-110-41/D-1744-02	1.0 (0.04)	2.8 (0.11)	1250	4000	0.6	2.0
CWT-9003/D-110-0181/D-1744-03	2.0 (0.08)	4.4 (0.17)	3600	5000	1.8	2.5
CWT-9004/D-110-0101/D-1744-04	3.0 (0.12)	5.8 (0.22)	4800	9000	2.4	4.5
CWT-9005/D-110-0090/D-1744-04	4.0 (0.16)	7.0 (0.27)	8500	16200	4.2	8.1
CWT-9005/D-110-0083	4.0 (0.16)	8.6 (0.34)	16200	25000	8.1	12.5

Product characteristics**Material**

Insulation (D-110, D-1744)	Radiation-crosslinked, heat-shrinkable polyvinylidene fluoride	
Insulation (CWT)	Radiation-crosslinked, heat-shrinkable polyolefin	
Solder and flux (D-110, D-1744)	Solder: Sn63 Pb37	Flux: ROL1 per ANSI-J-004 (RMA flux)
Solder and flux (CWT)	Solder: Sn50 Pb32 Cd18	Flux: ROM1 per ASNS-J-004 (RA flux)
Melttable inserts (CWT, D-1744)	Melttable thermoplastic	

Typical performance

Voltage drop	2.0 mV
Tensile strength	Exceeds strength of conductor
Dielectric strength	2.0 kV
Temperature rating (CWT)	-55°C to +125°C
Temperature rating (D-110, D-1744)	-55°C to +150°C
Insulation resistance	1000 megohms

Specifications/approvals

Series	Agency	Raychem
CWT	UL E87681	D-5023
D-110	UL E87681	RT-1404
D-1744	NAS-1744	RT-1404

Installation Requirements

For proper installation of these devices the correct heating tool and reflector attachment must be used. Any one of the following Raychem heating tools is recommended:

- HL 1802E
- IR-1759 MiniRay
- AA-400 Super Heater
- CV-1981

Refer to Raychem installation procedure RPIP 850-00 for detailed instructions and recommended reflector attachments. You will find ordering information for these tools in the Application Equipment section (Section 10) of this catalog.

Users should independently evaluate the suitability of the product for their application.
Before ordering check with factory for most current data.



Wire-to-wire Splicing

SolderGrip closed end connector splices



Applications

SolderGrip heat-shrinkable solder-type closed-end connectors are designed for electrical termination of multiple-wire combinations. They provide a reliable alternative to crimping, welding, or conventional twist-on-style closed-end connectors.

Their unique combination of wire fixturing and controlled-soldering technology provides dependable electrical termination of multiple wire combinations. SolderGrip terminators consist of a heat-shrinkable thermoplastic sleeve containing a spiral-wound copper insert. The insert is fitted with a prefluxed solder band.

This innovation design allows SolderGrip products to reliably terminate as many as 10 wires of different sizes and types in a single device.

The capability of SolderGrip terminators encompasses single or multistranded, bare or tinned copper wires with low- or high-temperature insulation. The termination is environmentally protected and strain relieved.

SolderGrip splice terminators are color-coded for easy identification.

Features and benefits

- Soldered connection.
- Electrical insulation.
- Sealed for immersion (SGRS).
- Excellent strain relief.
- Simple installation.

<i>Available in:</i>	Americas	Europe	Asia Pacific
	■	■	■

<i>Product options</i>		
Product series	Environmental protection	Max. operating temp.
SGRP	Splashproof	125°C
SGRS	Sealed	125°C

Fax-on-demand

US only (800) 260-9099

Outside US (650) 257-2301

Visit our website at www.tycoelectronics.com

Product Selection Process

1. From the Product Options table on the previous page, select the product series appropriate for your application.
2. Determine the wire combination (number of wires and size) of the wire bundle you wish to splice.
3. Use Table C (page 8-16) to select the correct connector for AWG wire combinations.*
For mm² wire combinations use Table A to select a SolderGrip part number.
4. Verify that the wire bundle (with wire insulation) does not exceed the maximum diameter allowed for the connector you selected. Simply check the bundle's diameter against the maximum diameter that Table A (below) lists for that part.
5. Verify that the total amperage to be applied does not exceed the maximum amp rating for the part as specified in Table A.

Example: For connecting a bundle with one 12 AWG wire (1 #12) and two 14 AWG wires (+2 #14), you need an SGRP-4 connector.
For sealed parts, select the SGRS series.

*If the wire combination is not listed in Table C, use the CMA (mm²) method of determining wire bundle size (see "CMA/mm² Calculation" on page 8-14). Using Table B (page 8-15), select the smallest size connector that will fit your total wire CMA (mm²) value.

Table A - Product dimensions and part number descriptions (inches/millimeters)

Insulated closed-end connectors (SGRP series)

Insulated and sealed closed-end connectors (SGRS series)

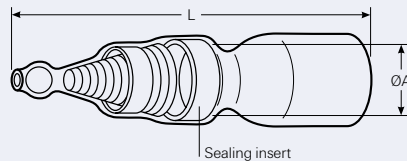
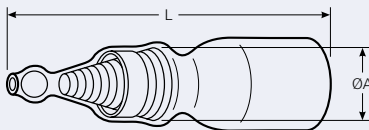

Product dimensions (min.)

Product dimensions (min.)

Part number	Color code	L	ØA	Wire range (min.-max.) CMA/mm ²	Part number	Color code	L	ØA	Wire range (min.-max.) CMA/mm ²
SGRP-1	Green	1.370 (34.8)	.120 (2.9)	1400-4800 (0.7-2.4)	SGRS-1	Green	1.370 (34.8)	0.130 (3.4)	1400-4800 (0.7-2.4)
SGRP-2	Red	1.350 (34.2)	.150 (3.7)	4000-8000 (2.0-4.0)	SGRS-2	Red	1.350 (34.2)	0.190 (4.8)	4000-8000 (2.0-4.0)
SGRP-3	Blue	1.610 (41.0)	.200 (5.1)	7000-16000 (3.5-8.0)	SGRS-3	Blue	1.650 (42.0)	0.290 (7.3)	7000-16000 (3.5-8.0)
SGRP-4	Yellow	1.650 (42.0)	.270 (6.8)	15000-24000 (7.5-12.0)	SGRS-4	Yellow	1.630 (41.5)	0.360 (9.1)	15000-24000 (7.5-12.0)

Users should independently evaluate the suitability of the product for their application.
Before ordering check with factory for most current data.

Wire-to-wire Splicing

SolderGrip closed end connector splices (cont'd.)

CMA/mm² calculation

To calculate the total circular mil or mm² area of the wire bundle to be terminated, follow these steps:

1. Choose either CMA or mm² as your unit of measure for selection purposes and continue to use it for all your selection criteria. (Both measures provide the same results.)
2. In the workspace below, list the CMA or mm² for each conductor in the bundle. (Table B provides the CMA of typical conductors.)
3. Add together the values listed in the workspace below to obtain the total area.
4. Use Table A to select the smallest terminator that will fit the total CMA (mm²).

Wire number	CMA	mm ²	
1	_____	_____	
2	_____	_____	
3	_____	_____	
4	_____	_____	
5	_____	_____	
6	_____	_____	
7	_____	_____	
8	_____	_____	
9	_____	_____	
10	_____	_____	
Total	_____	_____	SolderGrip part number _____

Fax-on-demand

US only (800) 260-9099

Outside US (650) 257-2301

Visit our website at www.tycoelectronics.com

CMA/mm² example

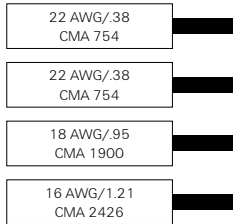

Total CMA = 5834
 Total mm² = 2.92
 Correct part number (based on CMA of 5834
 or mm² of 2.92): SGRP-2 or SGRS-2

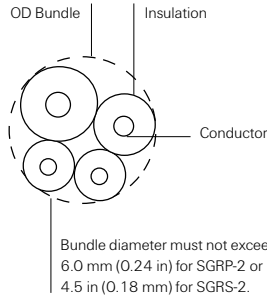

Table B. CMA of typical copper conductors

AWG	30	28	26	24	22	20	18	16	14	12	10	8
CMA	112	177	304	475	754	1216	1900	2426	3831	5874	9354	16983
mm ²	0.05	0.09	0.15	0.24	0.38	0.61	0.95	1.21	1.92	2.94	4.74	8.61

Wire-to-wire Splicing

SolderGrip closed end connector splices (cont'd.)

Table C. SolderGrip wire combinations

Wire combinations	Splash-proof	Sealed	Wire combinations	Splash-proof	Sealed	Wire combinations	Splash-proof	Sealed
1#8+1#12	SGRP-4	SGRS-4	1#14+3#20	SGRP-2	SGRS-2	2#16+1#18+3#20	SGRP-3	SGRS-3
1#8+1#16	SGRP-4	SGRS-4	1#14+4#20	SGRP-3	SGRS-3	2#16+1#18+2#20	SGRP-3	SGRS-3
2#8+2#16	SGRP-4	SGRS-4	1#14+1#18	SGRP-2	SGRS-2	2#16+1#18+1#20	SGRP-2	SGRS-2
1#8+1#14	SGRP-4	SGRS-4	1#14+1#18+1#20	SGRP-2	SGRS-2	2#16+1#18	SGRP-2	SGRS-2
1#8+1#14+1#16	SGRP-4	SGRS-4	1#14+2#18	SGRP-2	SGRS-2	2#16+4#20	SGRP-3	SGRS-3
1#10+1#18	SGRP-3	SGRS-3	1#14+3#18	SGRP-3	SGRS-3	2#16+3#20	SGRP-3	SGRS-3
1#10+2#18	SGRP-3	SGRS-3	1#14+4#18	SGRP-3	SGRS-3	2#16+2#20	SGRP-2	SGRS-2
1#10+3#18	SGRP-3	SGRS-3	1#14+5#18	SGRP-3	SGRS-3	2#16+1#20	SGRP-2	SGRS-2
1#10+1#16	SGRP-3	SGRS-3	1#14+1#16	SGRP-2	SGRS-3	2#16	SGRP-2	SGRS-2
1#10+1#16+1#18	SGRP-3	SGRS-3	1#14+1#16+1#20	SGRP-2	SGRS-2	1#16+5#18	SGRP-3	SGRS-3
1#10+1#16+2#18	SGRP-3	SGRS-3	1#14+1#16+1#18	SGRP-3	SGRS-3	1#16+4#18+1#20	SGRP-3	SGRS-3
1#10+2#16	SGRP-3	SGRS-3	1#14+1#16+2#18	SGRP-3	SGRS-3	1#16+4#18	SGRP-3	SGRS-3
1#10+3#16	SGRP-4	SGRS-4	1#14+1#16+3#18	SGRP-3	SGRS-3	1#16+3#18+2#20	SGRP-3	SGRS-3
1#10+4#16	SGRP-4	SGRS-4	1#14+1#16+4#18	SGRP-3	SGRS-3	1#16+3#18+1#20	SGRP-3	SGRS-3
1#10+5#16	SGRP-4	SGRS-4	1#14+2#16	SGRP-3	SGRS-3	1#16+2#18+3#20	SGRP-3	SGRS-3
1#10+1#14	SGRP-3	SGRS-3	1#14+2#16+1#18	SGRP-3	SGRS-3	1#16+2#18+1#20	SGRP-2	SGRS-2
1#10+1#14+1#18	SGRP-3	SGRS-3	1#14+2#16+2#18	SGRP-3	SGRS-3	1#16+2#18	SGRP-2	SGRS-2
1#10+1#14+1#16	SGRP-3	SGRS-3	1#14+2#16+3#18	SGRP-3	SGRS-3	1#16+1#18+4#20	SGRP-3	SGRS-3
1#10+1#14+2#16	SGRP-3	SGRS-3	1#14+3#16	SGRP-3	SGRS-3	1#16+1#18+3#20	SGRP-2	SGRS-2
1#10+1#14+3#16	SGRP-4	SGRS-4	1#14+3#16+1#18	SGRP-3	SGRS-3	1#16+1#18+2#20	SGRP-2	SGRS-2
1#10+2#14	SGRP-4	SGRS-4	1#14+3#16+2#18	SGRP-3	SGRS-3	1#16+1#18+1#20	SGRP-2	SGRS-2
1#10+3#14	SGRP-4	SGRS-4	1#14+4#16	SGRP-3	SGRS-3	1#16+1#18	SGRP-1	SGRS-1
1#10+1#12	SGRP-3	SGRS-3	1#14+4#16+1#18	SGRP-3	SGRS-3	1#16+4#20	SGRP-2	SGRS-2
1#10+1#12+1#14	SGRP-4	SGRS-4	1#14+5#16	SGRP-3	SGRS-3	1#16+3#20	SGRP-2	SGRS-2
1#10+2#12	SGRP-4	SGRS-4	2#14	SGRP-2	SGRS-2	1#16+1#20+1#22	SGRP-1	SGRS-1
2#10	SGRP-4	SGRS-4	2#14+1#16	SGRP-3	SGRS-3	1#16+1#20	SGRP-1	SGRS-1
2#10+1#16	SGRP-4	SGRS-4	2#14+1#16	SGRP-3	SGRS-3	1#16+3#22	SGRP-1	SGRS-1
1#12+1#18	SGRP-2	SGRS-2	2#14+1#16	SGRP-3	SGRS-3	1#16+2#22	SGRP-1	SGRS-1
1#12+2#18	SGRP-3	SGRS-3	2#14+1#16	SGRP-3	SGRS-3	1#16+1#22	SGRP-1	SGRS-1
1#12+3#18	SGRP-3	SGRS-3	2#14+2#16	SGRP-3	SGRS-3	1#18+1#22	SGRP-1	SGRS-1
1#12+4#18	SGRP-3	SGRS-3	2#14+2#16	SGRP-3	SGRS-3	1#18+2#22	SGRP-1	SGRS-1
1#12+5#18	SGRP-3	SGRS-3	2#14+3#16	SGRP-3	SGRS-3	1#18+3#22	SGRP-1	SGRS-1
1#12+1#16	SGRP-3	SGRS-3	2#14+4#16	SGRP-4	SGRS-4	1#18+1#20	SGRP-1	SGRS-1
1#12+1#16+1#18	SGRP-3	SGRS-3	3#14	SGRP-3	SGRS-3	1#18+1#20+1#22	SGRP-1	SGRS-1
1#12+1#16+2#18	SGRP-3	SGRS-3	3#14+1#16	SGRP-3	SGRS-3	1#18+1#20+2#22	SGRP-1	SGRS-1
1#12+1#16+3#18	SGRP-3	SGRS-3	3#14+2#16	SGRP-4	SGRS-4	1#18+2#20	SGRP-1	SGRS-1
1#12+1#16+4#18	SGRP-4	SGRS-4	3#14+3#16	SGRP-4	SGRS-4	1#18+3#20	SGRP-2	SGRS-2
1#12+2#16	SGRP-3	SGRS-3	4#14	SGRP-3	SGRS-3	1#18+4#20	SGRP-2	SGRS-2

Fax-on-demand

US only (800) 260-9099

Outside US (650) 257-2301

Visit our website at www.tycoelectronics.com

Table C. SolderGrip wire combinations (cont'd.)

Wire combinations	Splash-proof	Sealed	Wire combinations	Splash-proof	Sealed	Wire combinations	Splash-proof	Sealed
1 # 12+2 # 16+1 # 18	SGRP-3	SGRS-3	4 # 14+1 # 16	SGRP-4	SGRS-4	1 # 18+5 # 20	SGRP-2	SGRS-2
1 # 12+2 # 16+2 # 18	SGRP-3	SGRS-3	4 # 14+2 # 16	SGRP-4	SGRS-4	2 # 18	SGRP-1	SGRS-1
1 # 12+3 # 16	SGRP-3	SGRS-3	5 # 14	SGRP-4	SGRS-4	2 # 18+1 # 22	SGRP-1	SGRS-1
1 # 12+4 # 16	SGRP-3	SGRS-3	5 # 14+1 # 16	SGRP-4	SGRS-4	2 # 18+1 # 20	SGRP-2	SGRS-2
1 # 12+5 # 16	SGRP-4	SGRS-4	1 # 16+3 # 18	SGRP-3	SGRS-3	2 # 18+2 # 20	SGRP-2	SGRS-2
1 # 12+1 # 14+1 # 18	SGRP-3	SGRS-3	1 # 16+2 # 18+2 # 20	SGRP-3	SGRS-3	2 # 18+3 # 20	SGRP-2	SGRS-2
1 # 12+1 # 14+2 # 18	SGRP-3	SGRS-3	1 # 16+5 # 20	SGRP-3	SGRS-3	2 # 18+4 # 20	SGRP-3	SGRS-3
1 # 12+1 # 14+3 # 18	SGRP-3	SGRS-3	1 # 16+2 # 20	SGRP-2	SGRS-2	3 # 18	SGRP-2	SGRS-2
1 # 12+1 # 14+1 # 16	SGRP-3	SGRS-3	6 # 16	SGRP-3	SGRS-3	3 # 18+1 # 20	SGRP-2	SGRS-2
1 # 12+1 # 14+2 # 16	SGRP-3	SGRS-3	5 # 16+1 # 18	SGRP-3	SGRS-3	3 # 18+2 # 20	SGRP-3	SGRS-3
1 # 12+1 # 14+3 # 16	SGRP-4	SGRS-4	5 # 16+1 # 20	SGRP-3	SGRS-3	3 # 18+3 # 20	SGRP-3	SGRS-3
1 # 12+1 # 14+4 # 16	SGRP-4	SGRS-4	5 # 16	SGRP-3	SGRS-3	4 # 18	SGRP-2	SGRS-2
1 # 12+2 # 14	SGRP-3	SGRS-3	4 # 16+2 # 18	SGRP-3	SGRS-3	4 # 18+1 # 20	SGRP-3	SGRS-3
1 # 12+2 # 14+1 # 18	SGRP-3	SGRS-3	4 # 16+1 # 18+1 # 20	SGRP-3	SGRS-3	4 # 18+2 # 20	SGRP-3	SGRS-3
1 # 12+2 # 14+1 # 16	SGRP-4	SGRS-4	4 # 16+1 # 18	SGRP-3	SGRS-3	5 # 18	SGRP-3	SGRS-3
1 # 12+2 # 14+2 # 16	SGRP-4	SGRS-4	4 # 16+2 # 20	SGRP-3	SGRS-3	5 # 18+1 # 20	SGRP-3	SGRS-3
1 # 12+2 # 14+3 # 16	SGRP-4	SGRS-4	4 # 16+1 # 20	SGRP-3	SGRS-3	6 # 18	SGRP-3	SGRS-3
1 # 12+3 # 14	SGRP-4	SGRS-4	4 # 16	SGRP-3	SGRS-3	1 # 20+1 # 22	SGRP-1	SGRS-1
1 # 12+3 # 14+1 # 16	SGRP-4	SGRS-4	3 # 16+3 # 18	SGRP-3	SGRS-3	1 # 20+2 # 22	SGRP-1	SGRS-1
1 # 12+4 # 14	SGRP-4	SGRS-4	3 # 16+2 # 18+1 # 20	SGRP-3	SGRS-3	1 # 20+3 # 22	SGRP-1	SGRS-1
2 # 12	SGRP-4	SGRS-4	3 # 16+2 # 18	SGRP-3	SGRS-3	1 # 20+4 # 22	SGRP-1	SGRS-1
2 # 12+1 # 18	SGRP-3	SGRS-3	3 # 16+1 # 18+2 # 20	SGRP-3	SGRS-3	2 # 20	SGRP-1	SGRS-1
2 # 12+1 # 16	SGRP-3	SGRS-3	3 # 16+1 # 18+1 # 20	SGRP-3	SGRS-3	2 # 20+1 # 22	SGRP-1	SGRS-1
2 # 12+1 # 16	SGRP-3	SGRS-3	3 # 16+1 # 18	SGRP-3	SGRS-3	2 # 20+2 # 22	SGRP-1	SGRS-1
2 # 12+2 # 16+1 # 18	SGRP-4	SGRS-4	3 # 16+3 # 20	SGRP-3	SGRS-3	2 # 20+3 # 22	SGRP-1	SGRS-1
2 # 12+3 # 16	SGRP-4	SGRS-4	3 # 16+2 # 20	SGRP-3	SGRS-3	3 # 20	SGRP-1	SGRS-1
2 # 12+1 # 14+1 # 18	SGRP-4	SGRS-4	3 # 16+1 # 20	SGRP-3	SGRS-3	3 # 20+1 # 22	SGRP-1	SGRS-1
2 # 12+1 # 14+1 # 16	SGRP-4	SGRS-4	3 # 16	SGRP-2	SGRS-2	4 # 20	SGRP-2	SGRS-2
3 # 12+1 # 14	SGRP-4	SGRS-4	2 # 16+4 # 18	SGRP-3	SGRS-3	5 # 20	SGRP-2	SGRS-2
2 # 12+2 # 14	SGRP-4	SGRS-4	2 # 16+3 # 18+1 # 20	SGRP-3	SGRS-3	6 # 20	SGRP-2	SGRS-2
3 # 12+1 # 18	SGRP-4	SGRS-4	2 # 16+3 # 18	SGRP-3	SGRS-3	3 # 22	SGRP-1	SGRS-1
3 # 12+1 # 16	SGRP-4	SGRS-4	2 # 16+2 # 18+2 # 20	SGRP-3	SGRS-3	4 # 22	SGRP-1	SGRS-1
1 # 14+1 # 22	SGRP-1	SGRS-1	2 # 16+2 # 18+1 # 20	SGRP-3	SGRS-3	5 # 22	SGRP-1	SGRS-1
1 # 14+1 # 20	SGRP-2	SGRS-2	2 # 16+2 # 18	SGRP-3	SGRS-3	6 # 22	SGRP-1	SGRS-1
1 # 14+2 # 20	SGRP-2	SGRS-2						

Users should independently evaluate the suitability of the product for their application.
Before ordering check with factory for most current data.

Wire-to-wire Splicing

SolderGrip closed end connector splices (cont'd.)

Product characteristics

Material

Insulation	Radiation-crosslinked, transparent heat-shrinkable polyvinylidene fluoride		
Solder preform with flux	Sn 60, Pb 40, ROM 1 flux per ANSI-J-STD-004 (RA flux).		
Sealing insert (SGRS)	Hot melt adhesive		
Spiral wound insert	Copper alloy		

Physical

	Unit	Method of test	Requirement
Dimensions	inches	RB-109	See product dimensions.

Electromechanical

	Unit	Method of test	Typical values
Dielectric withstand voltage	kilovolts	RB-109	2.0
Static heating	degrees	RB-109	Less than 50°C rise

Environmental*

	Unit	Method of test	Requirement
Insulation resistance after water immersion (SGRS only)	megohms	RB-109	100
Contact resistance after exposure	milliohms	RB-109	Less than 6 milliohms

Operating condition

		Value
Temperature rating		-55°C to 125°C
Voltage rating	volts	600

*Immersion resistance sealing is dependent on the wire combinations used. The user should test specific wire combinations. Refer to RB-109 Raychem specification for procedures.

Fax-on-demand

US only (800) 260-9099

Outside US (650) 257-2301

Visit our website at www.tycoelectronics.com

Approvals and reference documents

Agency approvals	UL, CUL E87681
Reference documents	Raychem Specification RB-109 for splices <i>SolderGrip Terminators Selection Guide</i> (H54640), <i>SolderGrip Terminators Installation Procedure</i> (H54636) Specification Control Drawings Splices—Non Sealed (SGRP-X), Splices—Sealed (SGRS-X)

Installation

The SolderGrip product is pushed onto the conductors with a twisting motion. With the product in place, installation can be completed with the proper selection and use of heating tools and reflectors. Either of the following Raychem heating tools is recommended:

- HL 1802E
- CV-1981

Refer to Raychem installation procedure RPIP 820-00 for detailed instructions and recommended reflector attachments.

You will find ordering information for these tools in the Application Equipment section (Section 10) of this catalog.

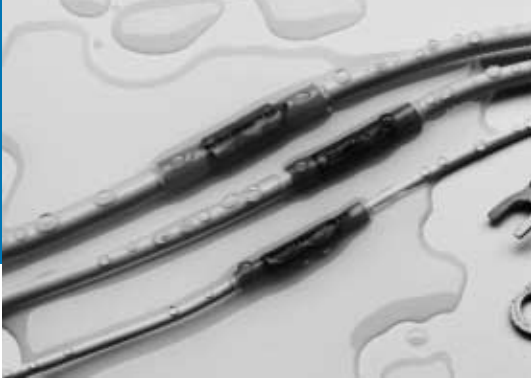

Wire-to-Wire Splicing

DuraSeal heat-shrinkable, environmentally sealed, nylon-insulated crimp splices



Applications

- Automotive/truck wiring repair and maintenance.
- Automotive accessory installations.
- OEM automotive/truck/RV wire harness fabrication.
- Marine electronics.
- Fleet maintenance.
- Commercial wiring (pumps/pools/spas).

Features and benefits

- Protects splices from water, condensation, salt, and corrosion.
- Provides strain relief.
- Protects against vibration in rugged environments.
- Completely insulates and protects electrical connections.
- Has adhesive lining for protection that is more reliable than conventional splices.
- UL, CUL, and Lloyd's listed.



Available in:

Americas

Europe

Asia Pacific



Specifications/approvals

Series	Agency	Raychem
D-406	UL and CUL listed 91J4, File E87681 Lloyd's listed, File 65 247 HH 02-93	RB-107

Product dimensions (inches)

Butt splices

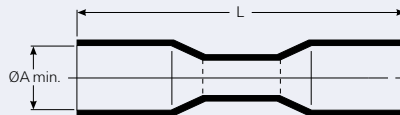

Butt splice dimensions

Wire dimensions

Part number	Butt splice dimensions		Color	Conductor (AWG)	Wire dimensions	
	A min.	L nom.			Insulation O.D. (max.)	Insulation O.D. (min.)
D-406-0001	.145	1.25	Red	22-18	.140	.055
D-406-0002	.180	1.25	Blue	16-14	.175	.080
D-406-0003	.250	1.50	Yellow	12-10	.245	

Fax-on-demand

US only (800) 260-9099

Outside US (650) 257-2301

Fax ID

5100

Description

Data sheet

Visit our website at www.tycoelectronics.com**Product selection process**

1. Determine wire size.
2. Select part number.

Wire size

AWG	mm ²	Part number	Color
22-18	0.38-0.95	D-406-0001	Red
16-14	1.2-2.5	D-406-0002	Blue
12-10	3-6	D-406-0003	Yellow

Product characteristics (typical)

Operating temperature	-55°C to 125°C
Shrink ratio	Approximately 2:1
Physical properties	Cut-through resistance: 31 kg (70 lb) Wire pullout after crimping and recovery: red: 11.3 kg (25 lb); blue: 22.7 kg (50 lb); yellow: 27.2 kg (60 lb) Not flame-retardant No cracking after heat aging for 168 h at 160°C
Chemical properties	Solvent resistance: isopropyl alcohol, trichloroethylene, gasoline, battery acid, diesel fuel, motor oil, antifreeze, brake fluid, 5% salt water
Electrical properties	Dielectric strength: 2500 Vac Insulation resistance: 1000 megohms at 100 Vdc

Installation

1. Select splice of appropriate size. Strip wire 7.5 mm (5/16 in). Insert into crimp barrel.

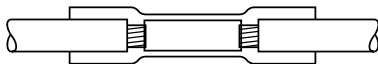

2. Crimp using Raychem AD-1522 crimp tool for preinsulated crimps.

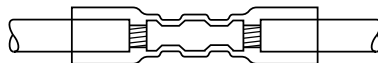

3. Heat crimped splice with heat gun until tubing recovers and adhesive flows.

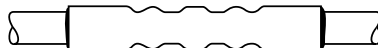
**Installation Requirements**

For proper installation of these devices, the correct crimp tool and a heating tool with a reflector attachment must be used. The Raychem AD-1522 crimp tool and HL 1802E heating tool are recommended.

You will find ordering information for these tools in the Application Equipment section (Section 10) of this catalog.

Refer to Raychem installation procedure RPIP 821-00 for detailed instructions.

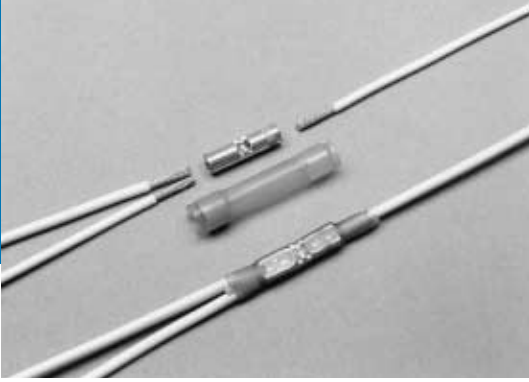

Wire-to-wire Splicing

MiniSeal high-performance, immersion-resistant crimp splices



Applications

MiniSeal wire-to-wire splicing products offer solutions for hundreds of aerospace and defense applications. These environment-resistant splices provide excellent reliability, long term performance, MIL-S-81824/1 qualification, and a low installed cost.

MiniSeal crimp splices consist of a plated copper crimp barrel and a separate, heat-shrinkable, transparent sealing sleeve. They can be used on a combination of wires, from 1:1 to 10:10. MiniSeal splices are one of the smallest, lightest, and most environment-resistant

splices available. They preserve the electrical integrity of the splice by preventing the penetration of liquids and the resulting chemical and galvanic corrosion.

Features and benefits

- Immersion-resistant crimp splices are on QPL for MIL-S-81824.
- Mil-Spec approval.
- Small size.
- Light weight.
- Insulation and strain relief.
- Easy installation.

Available in:

Americas

Europe

Asia Pacific

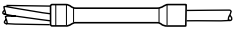

Product Selection Process

1. Determine the type of splice required.
 - Stub (parallel) splice: 
 - Butt (in-line) splice: 
2. Determine which crimp barrel plating is required:
 - Tin plating, recommended for tin or silver-plated wire
 - Nickel plating, recommended for nickel-plated wire, or silver-plated wire in applications above 150°C.
3. Calculate the size of crimp barrel required. Using the CMA/mm² worksheet on the next page, calculate the total cross section to be spliced by adding the circular mil area (CMA) or square millimeters (mm²) of each wire.

Stub splice: Add the CMA or mm² of all wires together.

Butt splice: Calculate each side separately (see example on the worksheet).

Table A below provides the CMA of typical conductors. (Both CMA and mm² give the same results, so choose either CMA or mm² as your unit of measure for selection purposes and continue to use it for all your selection criteria.)
4. Select the color code for the size crimp barrel required. Using Table B (page 8-23), select the crimp barrel—color-coded red, blue, or yellow—for the CMA or mm² you calculated.

Stub splice: Select the barrel that will accommodate the total cross section.

Butt splice: Select the smallest barrel that will accommodate the largest CMA/mm² required. (Refer to the example in the worksheet for a more specific description.) If the CMA/mm² of the smaller side of a butt splice is too small for the size barrel required to fit the larger side, increase the CMA/mm²—either by doubling back one wire (stripping the conductor twice the length you would ordinarily strip it and then folding it back) or by adding a filler wire.

5. Determine the type of sealing sleeve required. Some wire insulations will not fit in the holes of the sealing sleeve inserts, so be sure to compare the internal diameter of each hole with the outer diameter of the wire(s) you intend to insert in that hole. To create a reliable seal, place a maximum of two wires in any hole of the sealing sleeve.
6. Select the part number. Turn to the MiniSeal part number selection tables (Tables C and D, page 8-24) and find the table for the type of splice (stub or butt) required. Using the appropriate table, find the crimp barrel size range and the size and number of wires for your application. Then select the part number for the type of plating required. The color code accompanying that part number should match the color code you arrived at in Table B, confirming that the part number you have selected is correct.

Fax-on-demand

US only (800) 260-9099

Outside US (650) 257-2301

Visit our website at www.tycoelectronics.com

Table A. CMA of typical conductors

Strands	7	19	19	19	19	19	19	19	37
AWG	28	26	24	22	20	18	16	14	12
CMA	177	304	475	754	1216	1900	2426	3831	5874
mm ²	0.09	0.15	0.24	0.38	0.61	0.95	1.21	1.92	2.94

Table B. Crimp barrel color code selection

CMA range	mm ² range	1:1 splice (AWG size)	Color code
304-1510	0.15-0.75	26-20	Red
779-2680	0.39-1.34	20-16	Blue
1900-6755	0.95-3.37	18-12	Yellow

CMA/mm² worksheet

Example:

Application: A butt splice with three AWG 22 wires in one side and one AWG 18 wire in the other side:

The CMA for AWG 22 wire in Table A is 754 (0.38 mm²).

Side one is therefore calculated as follows:

$$CMA = 3 \times 754 = 2262$$

$$(mm^2 = 3 \times 0.38 = 1.14)$$

The other side, where the CMA for AWG 18 is 1900, is calculated as:

$$CMA = 1 \times 1900 = 1900$$

$$(mm^2 = 1 \times 0.95 = 0.95)$$

Using Table B to select the smallest crimp barrel that will easily fit 2262 CMA (0.95 mm²), the blue barrel is the correct choice.

Wire number	CMA	mm ²	
1	_____	_____	
2	_____	_____	
3	_____	_____	
4	_____	_____	
5	_____	_____	
6	_____	_____	
7	_____	_____	
8	_____	_____	
9	_____	_____	
10	_____	_____	
Total	_____	_____	Part number: _____

Users should independently evaluate the suitability of the product for their application. Before ordering check with factory for most current data.

Wire-to-wire Splicing

MiniSeal high-performance, immersion-resistant crimp splices (cont'd.)

Table C. Stub (parallel) splices



















Illustration	Part number		Crimp barrel size range CMA (mm ²) min.-max.	I.D. dimensions (mm/in)			
	Tin plated	Nickel plated		Side 1 Sealing insert	Max. no. of wires	Side 2 Sealing insert	Max. no. of wires
	D-436-0128 Red	D-436-0119 Red	304–1510 (0.15–0.75)	 2.16 (.085)	2	 1.01 (.040)	2
	D-436-58 Blue	D-436-75 Blue	779–2680 (0.39–1.34)	 4.56 (.180)	2	 2.28 (.090)	2
	D-436-59 Yellow	D-436-76 Yellow	1900–6755 (0.95–3.37)	 4.56 (.180)	2	 2.28 (.090)	2
	D-436-60 Blue	D-436-77 Blue	779–2680 (0.39–1.34)	 2.03 (.080)	10 (2 per hole)	 6.35 (.250)	2
	D-436-61 Yellow	D-436-78 Yellow	1900–6755 (0.95–3.37)	 2.03 (.080)	10 (2 per hole)	 6.35 (.250)	2

Table D. Butt (in-line) splices































Illustration	Part number		Crimp barrel size range CMA (mm ²) min.-max.	I.D. dimensions (mm/in)			
	Tin plated	Nickel plated		Side 1 Sealing insert	Max. no. of wires	Side 2 Sealing insert	Max. no. of wires
	D-436-36* Red	D-436-82 Red	304–1510 (0.15–0.75)	 2.16 (.085)	2	 2.16 (.085)	2
	D-436-37* Blue	D-436-83 Blue	779–2680 (0.39–1.34)	 2.79 (.110)	2	 2.79 (.110)	2
	D-436-38* Yellow	D-436-84 Yellow	1900–6755 (0.95–3.37)	 4.32 (.170)	2	 4.32 (.170)	2
	D-436-0110 Red	D-436-85 Red	304–1510 (0.15–0.75)	 2.36 (.093)	6	 4.06 (.160)	2
	D-436-52 Blue	D-436-86 Blue	779–2680 (0.39–1.34)	 2.36 (.093)	6 (2 per hole)	 4.06 (.160)	2
	D-436-53 Yellow	D-436-87 Yellow	1900–6755 (0.95–3.37)	 2.36 (.093)	6 (2 per hole)	 4.06 (.160)	2
	D-436-0115 Red	D-436-88 Red	304–1510 (0.15–0.75)	 2.36 (.093)	6 (2 per hole)	 2.36 (.093)	6 (2 per hole)
	D-436-42 Blue	D-436-89 Blue	779–2680 (0.39–1.34)	 2.36 (.093)	6 (2 per hole)	 2.36 (.093)	6 (2 per hole)
	D-436-43 Yellow	D-436-90 Yellow	1900–6755 (0.95–3.37)	 2.36 (.093)	6 (2 per hole)	 2.36 (.093)	6 (2 per hole)

*Qualified to MIL-S-81824/1.

Fax-on-demand

US only (800) 260-9099

Outside US (650) 257-2301

Visit our website at www.tycoelectronics.com**Product characteristics****Material**

Insulation	Radiation-crosslinked, heat-shrinkable polyvinylidene fluoride
Crimp barrel	Tin- or nickel-plated copper (see Table C)
Melttable inserts	Melttable thermoplastic

Typical performance

Voltage drop	6.9 mV at 4.5 A vs 8.1 mV for an equal length of wire
Tensile strength	Exceeds strength of conductor
Dielectric strength	2.5 kV
Temperature rating	-55°C to 150°C
Insulation resistance	5000 megohms

Specifications/approvals

Series	Military
D-436	MIL-S-81824/1 for D-436-36/37/38

Installation

For proper installation of these devices, the correct crimp tool (Raychem part number AD-1377) and a heating tool and reflector attachment must be used.

Any one of the following Raychem heating tools is recommended:

- HL1802E
- AA-400 Super Heater

Refer to Raychem installation procedure RCPS 200-20 for detailed instructions and recommended reflector attachments.

You will find ordering information for these tools in the Application Equipment section (Section 10) of this catalog.

Insulated Terminals and Disconnects

Fax-on-demand

US only (800) 260-9099

Outside US (650) 257-2301

Visit our website at www.tycoelectronics.com



Raychem insulated electrical terminal products provide repeatable, and rugged examples of terminals available. We start on the front end with terminal sizes and configurations that meet or exceed industry standards in terms of material selection, surface treatment, and electrical performance.

Here the comparison stops. What separates Raychem products from the rest of the industry are the materials and termination techniques used on the back end of the products, which provide unparalleled value. Products include:

- *DuraSeal heat-shrinkable nylon crimp products*, which protect against water, condensation, salt, and corrosion. Their tough, heat-shrinkable nylon tubing resists abrasion and cut-through damage, provides strain relief, and protects against vibration damage. DuraSeal products are simple and quick to install using a crimp tool and a heat source. They accommodate a wide range of wire sizes and are color-coded for easy identification, yet are transparent for visual inspection of the finished splice.
- *SolderGrip heat-shrinkable twist-on products*, which utilize a spiral copper coil that grips and compresses the conductors and allows a prefluxed solder ring to flow to the center of the splicing area, resulting in a highly reliable, repeatable joint. SolderGrip terminals use a durable polyvinylidene fluoride heat-shrinkable tubing that protects the electrical joint and provides insulation and strain relief. The SolderGrip technology is a reliable means of terminating more than two conductors time after time. SolderGrip terminals can terminate a variety of conductor types (solid and stranded) and platings. Terminations on more than eight individual conductors in a single joint have been successfully demonstrated using this product.

DuraSeal product delivers protected electrical joints on industry standard terminals and is suitable for harsh environments.

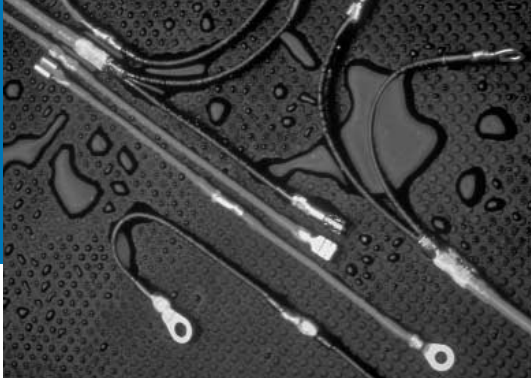

Insulated Terminals and Disconnects

DuraSeal heat-shrinkable environmentally sealed, nylon insulated crimp terminals and disconnects



Applications

DuraSeal products insulate and protect electrical connections from mechanical abuse, wire pull-out, and abrasion while resisting water, salt, and other contaminants.

DuraSeal devices provide a tough, environmentally sealed wire connection. Their crimp barrel or terminal, encased in rugged, heat-shrinkable nylon tubing lined with a special hot-melt adhesive, resists damage from abrasions and cuts.

DuraSeal devices retain flexibility and impact-resistance long after similar products have become brittle.

DuraSeal devices accommodate wire gauge sizes 22 to 10. They are color-coded for easy identification of gauge sizes, yet transparent for inspection of the finished splice.

Features and benefits

- Resistance to moisture and abrasion.
- Strain relief.
- Protection from wire pull-out.
- Easy installation.
- UL and CUL listed.



Available in:

Americas

Europe

Asia Pacific



Approvals and reference documents

Agency approvals	UL listed component, file E87681, terminals except quick connect terminals; file E157833, quick connect terminals
Reference documents	Raychem specifications RB-108, Specification DuraSeal crimp terminals DuraSeal selection guide (H54153) DuraSeal installation guidelines (H54154)

Fax-on-demand

US only (800) 260-9099

Outside US (650) 257-2301

Visit our website at www.tycoelectronics.com

Product characteristics

	Property	Unit	Requirement	Method of test
Physical	Dimensions	Inches	None	See product dimensions
	Tensile strength	Pounds	8 to 40 lbs depending on AWG	UL486C, IEC5 12-8
	Property	Unit	Typical value	Method of test
Electrical	Voltage drop	Millivolts	Less than equal length of wire	MIL-S-81824, IEC5 12-2
	Insulation resistance	Megohms	10 ³ min.	MIL-STD-202 method 302
	Dielectric withstand voltage	Kilovolts	2.5	MIL-STD-202F method 301, IEC5 12-2
	Property	Unit	Requirement	Method of test
Chemical	Diesel fuel		Meet electrical test listed above after conditioning.	ASTM D 3032, ESA-603D
	Brake fluid			
	Antifreeze			
	5% salt water			
Environmental (Fluid resistance)	Humidity		Meet electrical test listed above after conditioning.	MIL-STD-202F method 106, IEC68-2-30
	Immersion			
	Vibration			
	Bending			
	Thermal shock			
	Heat aging (168° @ 85°C)			
Operating conditions	Salt spray			MIL-STD-202F method 101, IEC68-2-11
	Temperature rating		-55°C to +125°C	None
	Minimum shrink temperature		180°C	None
	Voltage rating		600 Volt max	None

Product dimensions (inches)

Fork terminals

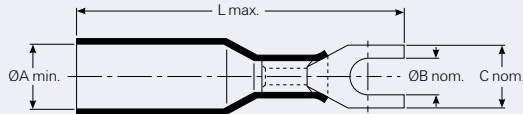

Fork terminal dimensions

Wire dimensions

Part number	Fork terminal dimensions				Color	Wire dimensions		
	A min.	Stud size	C nom.	L max.		Insulation Conductor (AWG)	Insulation O.D. (max.)	O.D. (min.)
B-106-2401	.15	8	.31	1.26	Red	22-18	.150	.055
B-106-2402	.18	8	.31	1.38	Blue	16-14	.175	.080
B-106-2403	.25	8	.31	1.50	Yellow	12-10	.250	.110
B-106-2502	.18	10	.39	1.38	Blue	16-14	.175	.080
B-106-2503	.25	10	.39	1.58	Yellow	12-10	.250	.110

Users should independently evaluate the suitability of the product for their application. Before ordering check with factory for most current data.

Insulated Terminals and Disconnects

DuraSeal heat-shrinkable environmentally sealed, nylon insulated crimp terminals and disconnects (cont'd.)

Product dimensions (inches)

Ring terminals

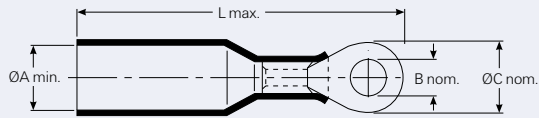

Ring terminal dimensions

Wire dimensions

Part number	Ring terminal dimensions				Color	Conductor (AWG)	Wire dimensions	
	A min.	Stud size	C nom.	L max.			Insulation O.D. (max.)	Insulation O.D. (min.)
B-106-1401	.15	8	.31	1.26	Red	22-18	.150	.055
B-106-1501	.15	10	.39	1.34	Red	22-18	.150	.055
B-106-1601	.15	1/4	.47	1.42	Red	22-18	.150	.055
B-106-1801	.15	5/16	.55	1.54	Red	22-18	.150	.055
B-106-1991	.15	3/8	.70	1.70	Red	22-18	.150	.055
B-106-1402	.18	8	.31	1.30	Blue	16-14	.175	.080
B-106-1502	.18	10	.39	1.38	Blue	16-14	.175	.080
B-106-1602	.18	1/4	.47	1.44	Blue	16-14	.175	.080
B-106-1802	.18	5/16	.55	1.58	Blue	16-14	.175	.080
B-106-1992	.18	3/8	.70	1.73	Blue	16-14	.175	.080
B-106-1403	.25	8	.31	1.50	Yellow	12-10	.250	.110
B-106-1503	.25	10	.39	1.58	Yellow	12-10	.250	.110
B-106-1603	.25	1/4	.47	1.64	Yellow	12-10	.250	.110
B-106-1803	.25	5/16	.55	1.78	Yellow	12-10	.250	.110
B-106-1993	.25	3/8	.70	1.85	Yellow	12-10	.250	.110

Fax-on-demand

US only (800) 260-9099

Outside US (650) 257-2301

Visit our website at www.tycoelectronics.com

Product dimensions (inches)

Push-on terminals

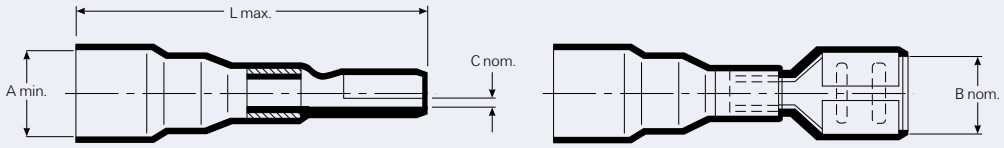

Push-on terminal dimensions

Wire dimensions

Part number	Tab size	A min.	B nom.	C nom.	L max.	Color	Insulation	Insulation	O.D. (min.)
							Conductor (AWG)	O.D. (max.)	
B-106-3631	.250 x .032	.150	.250	.032	1.20	Red	22-18	.150	.055
B-106-3632	.250 x .032	.180	.250	.032	1.26	Blue	16-14	.175	.080
B-106-3633	.250 x .032	.250	.250	.032	1.300	Yellow	12-10	.250	.110
B-106-3281	.110 x .020	.150	.110	.020	.900	Red	22-18	.150	.055
B-106-3481	.187 x .020	.150	.187	.020	1.20	Red	22-18	.150	.055

Tab terminals

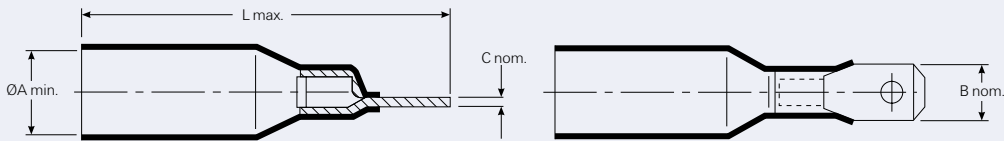

Tab terminal dimensions

Wire dimensions

Part number	Tab size	A min.	B nom.	C nom.	L max.	Color	Insulation	Insulation	O.D. (min.)
							Conductor (AWG)	O.D. (max.)	
B-106-4631	.250 x .032	.150	.250	.032	1.20	Red	22-18	.150	.055
B-106-4632	.250 x .032	.180	.250	.032	1.26	Blue	16-14	.175	.080

Insulated Terminals and Disconnects

DuraSeal heat-shrinkable environmentally sealed, nylon insulated crimp terminals and disconnects (cont'd.)

Product dimensions (inches)

Pin terminals

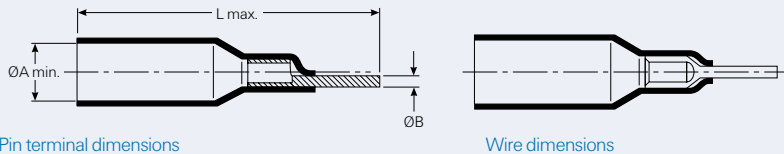

Pin terminal dimensions

Wire dimensions

Part number	A min.	B nom.	L max.	Color	Conductor (AWG)	Insulation O.D. (max.)	Insulation O.D. (min.)
B-106-6201	.150	.080	1.22	Red	22-18	.150	.055

Bullet terminals

Fig. 1

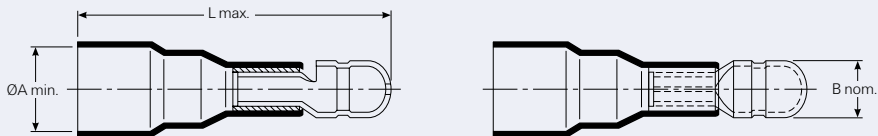
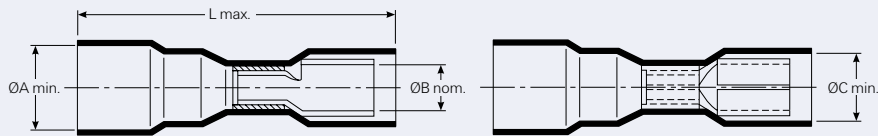

Fig. 2



Bullet terminal dimensions

Wire dimensions

Part number	Fig.	Type	A min.	B nom.	C min.	L max.	Color	Conductor (AWG)	Insulation O.D. (max.)	Insulation O.D. (min.)
B-106-7401	1	M	.150	.150	-	1.32	Red	22-18	.150	.055
B-106-7502	1	M	.180	.200	-	1.36	Blue	16-14	.175	.080
B-106-8401	2	F	.150	.150	.220	1.20	Red	22-18	.150	.055
B-106-8502	2	F	.180	.200	.240	1.28	Blue	16-14	.175	.080

Fax-on-demand

US only (800) 260-9099

Outside US (650) 257-2301

Visit our website at www.tycoelectronics.com

Product characteristics (typical)

Operating temperature	-55°C to 125°C
Shrink ratio	Approximately 2:1
Physical properties	Cut-through resistance: 31.7 kg (70 lb) Wire pullout after crimping and recovery: red: 11.3 kg (25 lb); blue: 22.7 kg (50 lb); yellow: 27.2 kg (60 lb) Not flame-retardant No cracking after heat aging for 168 hr at 160°C
Chemical properties	Solvent resistance: isopropyl alcohol, trichloroethylene, gasoline, battery acid, diesel fuel, motor oil, antifreeze, brake fluid, 5% salt water
Electrical properties	Dielectric strength: 1000 V Insulation resistance: 10 megohms

Specifications/approvals

Series	Agency	Raychem
B-106	UL and CUL 91J4, File E87681 Lloyd's listed, File 65 247 HH 02-93 UL and CUL E157833 (B-106-3XXX/B-106-4XXX)	RB-108

Installation

1. Select appropriate size. For terminal and disconnect terminations, strip wire 6.5 mm (1/4 inch).
2. Crimp using Raychem AD-1522 crimp tool for preinsulated crimps.
3. Heat terminal or disconnect with heat gun until tubing recovers and adhesive flows. Avoid heating ring or fork metallic parts.

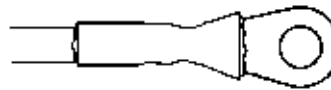
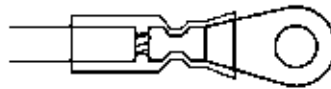
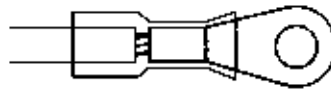

For proper installation of these devices, the correct crimp tool and heating tool with reflector attachment must be used. The Raychem AD-1522 crimp tool and HL1802E heating tool are recommended. You will find ordering information for these tools in the Application Equipment section (Section 10) of this catalog. Refer to Raychem installation procedure RPIP 684-00 for detailed instructions.

Users should independently evaluate the suitability of the product for their application. Before ordering check with factory for most current data.

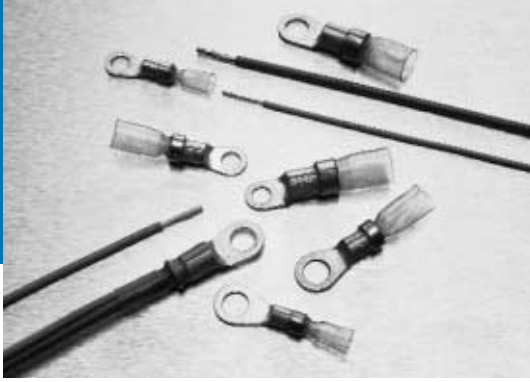

Insulated Terminals and Disconnects

SolderGrip self-fixturing insulated terminals



Applications

Used for terminating multiple wires to terminals.

Features and benefits

- Transparent insulation sleeve provides encapsulation, inspectability, strain relief, and insulation.
- Spiral copper coil grips and compresses the conductors for optimum solder connection.
- Prefluxed solder preform provides a controlled soldering process.
- One-piece design for easy installation.
- Accommodates a wide variety of conductor types, quantities, sizes, and plating types unmatched by any other termination technique.
- UL and CUL recognized.
- Parts meet the performance requirements of MIL-T-7928G.



Available in:	Americas	Europe	Asia Pacific
	■	■	■

Product option	
Product series	Environmental protection
SGRT	Splashproof

Product Selection Process

1. Determine the wire combination (number of wires and size) of the wire bundle you wish to terminate.
2. Use Table C to select the correct terminal for AWG wire combination.* Example: For connecting a bundle with one 12 AWG wire (1 #12) and two 18 AWG wires (+ 2 #18) to a terminal, you need an SGRT-4-XX terminal.
3. Determine the correct stud size.
4. Select the correct part number from Table A for that stud size in the terminal series and size you selected in Step 2. Example: If the stud size is 1/4, select part number SGRT-4-06.
5. Verify that the wire bundle (with wire insulation) does not exceed the maximum diameter allowed for the part you selected. Simply check the bundle's diameter against the maximum diameter that Table A lists for that part.
6. Verify that the total amperage to be applied does not exceed the maximum amp rating for the part as specified in Table A.

* If the wire combination is not listed in Table B, use the CMA (mm²) method of determining wire bundle size (see "CMA/mm² Calculation" on page 8-36). Using Table B, select the smallest size part that will fit your total wire CMA (mm²) value.

Fax-on-demand

US only (800) 260-9099

Outside US (650) 257-2301

Fax ID

5900

Description

Data sheet

Visit our website at www.tycoelectronics.com**Table A. Part number selection (mm/in)**

SolderGrip part number	Stud size	Maximum bundle diameter†	Maximum amp rating	Wire range (min.–max.) CMA/mm ²	Typical length (mm/in)
SGRT-1-02	2 (2)	4.1 (.161)	12.5 A	1400–5000 (0.7–2.5)	38 (1 1/2)
SGRT-2-03	3 (6)	5.0 (.195)	15 A	2400–6000 (1.2–3.0)	38 (1 1/2)
SGRT-2-04	4 (8)		15 A	2400–6000 (1.2–3.0)	38 (1 1/2)
SGRT-2-05	5 (10)		15 A	2400–6000 (1.2–3.0)	38 (1 1/2)
SGRT-2-06	6 (1/4)		15 A	2400–6000 (1.2–3.0)	38 (1 1/2)
SGRT-3-06	6 (1/4)	6.5 (.255)	33 A	5000–13,200 (2.5–6.6)	44.5 (1 3/4)
SGRT-3-08	8 (5/16)		33 A	5000–13,200 (2.5–6.6)	51.0 (2)
SGRT-4-06	6 (1/4)	9.0 (.355)	56 A	12,000–22,400 (6.0–11.2)	44.5 (1 3/4)
SGRT-4-08	8 (5/16)		56 A	12,000–22,400 (6.0–11.2)	51 (2)

†Maximum bundle diameter is measured over wire insulation.

Insulated Terminals and Disconnects

SolderGrip self-fixturing insulated terminals (cont'd.)

CMA/mm² calculation

To calculate the total circular mil or mm² area of the wire bundle to be terminated, follow these steps:

1. Choose either CMA or mm² as your unit of measure for selection purposes and continue to use it for all your selection criteria. (Both measures provide the same results.)
2. In the workspace below, list the CMA or mm² for each conductor in the bundle. (Table B provides the CMA of typical conductors.)
3. Add together the values listed in the workspace below to obtain the total area.
4. Use Table A to select the smallest terminator that will fit the total CMA (mm²).

Wire number	CMA	mm ²	
1	_____	_____	SolderGrip part number
2	_____	_____	
3	_____	_____	
4	_____	_____	
5	_____	_____	
6	_____	_____	
7	_____	_____	
8	_____	_____	
9	_____	_____	
10	_____	_____	
Total	_____	_____	_____

CMA/mm² example

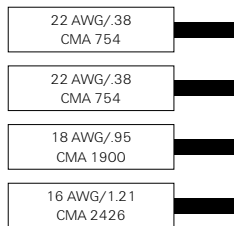

Total CMA = 5834
Total mm² = 2.92
Correct part number (based on CMA of 5834 or mm² of 2.92): SGRT-2-XX if bundle OD is less than 5.0 mm (0.195 in).

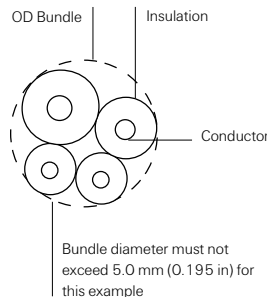

Fax-on-demand

US only (800) 260-9099

Outside US (650) 257-2301

Fax ID

5900

Description

Data sheet

Visit our website at www.tycoelectronics.com

Table B. CMA of typical copper conductors

Strands	7	19	19	19	19	19	19	19	37
AWG	28	26	24	22	20	18	16	14	12
CMA	177	304	475	754	1216	1900	2426	3831	5874
mm ²	0.09	0.15	0.24	0.38	0.61	0.95	1.21	1.92	2.94

Table C. SolderGrip wire combinations (see Table A for terminal size [-XX])

Wire combinations	Part number	Wire combinations	Part number	Wire combinations	Part number
1 # 8	SGRT-4-XX	1 # 12 + 1 # 16 + 4 # 18	SGRT-4-XX	1 # 14 + 4 # 20	SGRT-3-XX
1 # 8 + 1 # 16	SGRT-4-XX	1 # 12 + 2 # 16	SGRT-3-XX	1 # 14 + 1 # 18	SGRT-2-XX
2 # 8 + 2 # 16	SGRT-4-XX	1 # 12 + 2 # 16 + 1 # 18	SGRT-3-XX	1 # 14 + 1 # 18 + 1 # 20	SGRT-3-XX
1 # 8 + 1 # 14	SGRT-4-XX	1 # 12 + 2 # 16 + 2 # 18	SGRT-4-XX	1 # 14 + 2 # 18	SGRT-3-XX
1 # 10	SGRT-3-XX	1 # 12 + 3 # 16	SGRT-4-XX	1 # 14 + 3 # 18	SGRT-3-XX
1 # 10 + 1 to 3 # 18	SGRT-3-XX	1 # 12 + 4 # 16	SGRT-4-XX	1 # 14 + 4 # 18	SGRT-3-XX
1 # 10 + 2 # 18	SGRT-3-XX	1 # 12 + 5 # 16	SGRT-4-XX	1 # 14 + 5 # 18	SGRT-4-XX
1 # 10 + 3 # 18	SGRT-4-XX	1 # 12 + 1 # 14 + 1 # 18	SGRT-3-XX	1 # 14 + 1 # 16	SGRT-3-XX
1 # 10 + 1 # 16	SGRT-3-XX	1 # 12 + 1 # 14 + 2 # 18	SGRT-4-XX	1 # 14 + 1 # 16 + 1 # 20	SGRT-3-XX
1 # 10 + 1 # 16 + 1 # 18	SGRT-4-XX	1 # 12 + 1 # 14 + 3 # 18	SGRT-4-XX	1 # 14 + 1 # 16 + 1 # 18	SGRT-3-XX
1 # 10 + 1 # 16 + 2 # 18	SGRT-4-XX	1 # 12 + 1 # 14 + 1 # 16	SGRT-3-XX	1 # 14 + 1 # 16 + 2 # 18	SGRT-3-XX
1 # 10 + 2 # 16	SGRT-4-XX	1 # 12 + 1 # 14 + 2 # 16	SGRT-4-XX	1 # 14 + 1 # 16 + 3 # 18	SGRT-3-XX
1 # 10 + 3 # 16	SGRT-4-XX	1 # 12 + 1 # 14 + 3 # 16	SGRT-4-XX	1 # 14 + 1 # 16 + 4 # 18	SGRT-4-XX
1 # 10 + 4 # 16	SGRT-4-XX	1 # 12 + 1 # 14 + 4 # 16	SGRT-4-XX	1 # 14 + 2 # 16	SGRT-3-XX
1 # 10 + 5 # 16	SGRT-4-XX	1 # 12 + 2 # 14	SGRT-4-XX	1 # 14 + 2 # 16 + 1 # 18	SGRT-3-XX
1 # 10 + 1 # 14	SGRT-3-XX	1 # 12 + 2 # 14 + 1 # 18	SGRT-4-XX	1 # 14 + 2 # 16 + 2 # 18	SGRT-3-XX
1 # 10 + 1 # 14 + 1 # 18	SGRT-4-XX	1 # 12 + 2 # 14 + 1 # 16	SGRT-4-XX	1 # 14 + 2 # 16 + 3 # 18	SGRT-4-XX
1 # 10 + 1 # 14 + 1 # 16	SGRT-4-XX	1 # 12 + 2 # 14 + 2 # 16	SGRT-4-XX	1 # 14 + 3 # 16	SGRT-3-XX
1 # 10 + 1 # 14 + 2 # 16	SGRT-3-XX	1 # 12 + 2 # 14 + 3 # 16	SGRT-4-XX	1 # 14 + 3 # 16 + 1 # 18	SGRT-3-XX
1 # 10 + 1 # 14 + 3 # 16	SGRT-4-XX	1 # 12 + 3 # 14	SGRT-4-XX	1 # 14 + 3 # 16 + 2 # 18	SGRT-4-XX
1 # 10 + 2 # 14	SGRT-4-XX	1 # 12 + 3 # 14 + 1 # 16	SGRT-4-XX	1 # 14 + 4 # 16	SGRT-4-XX
1 # 10 + 3 # 14	SGRT-4-XX	1 # 12 + 4 # 14	SGRT-4-XX	1 # 14 + 4 # 16 + 1 # 18	SGRT-4-XX
1 # 10 + 1 # 12	SGRT-4-XX	2 # 12 + 1 # 18	SGRT-4-XX	1 # 14 + 5 # 16	SGRT-4-XX
1 # 10 + 1 # 12 + 1 # 14	SGRT-4-XX	2 # 12 + 1 # 16	SGRT-4-XX	2 # 14	SGRT-3-XX
1 # 10 + 2 # 12	SGRT-4-XX	2 # 12 + 2 # 16 + 1 # 18	SGRT-4-XX	2 # 14	SGRT-3-XX
2 # 10	SGRT-4-XX	2 # 12 + 3 # 16	SGRT-4-XX	2 # 14	SGRT-3-XX
2 # 10 + 1 # 16	SGRT-4-XX	2 # 12 + 1 # 14 + 1 # 18	SGRT-4-XX	2 # 14	SGRT-3-XX
1 # 12	SGRT-3-XX	2 # 12 + 1 # 14 + 1 # 16	SGRT-4-XX	2 # 14	SGRT-3-XX
1 # 12 + 1 # 18	SGRT-3-XX	2 # 12 + 2 # 14	SGRT-4-XX	2 # 14 + 1 # 16	SGRT-3-XX
1 # 12 + 2 # 18	SGRT-3-XX	3 # 12 + 1 # 18	SGRT-4-XX	2 # 14 + 1 # 16	SGRT-3-XX
1 # 12 + 3 # 18	SGRT-3-XX	3 # 12 + 1 # 16	SGRT-4-XX	2 # 14 + 1 # 16	SGRT-3-XX
1 # 12 + 4 # 18	SGRT-4-XX	3 # 12 + 1 # 14	SGRT-4-XX	2 # 14 + 1 # 16	SGRT-3-XX
1 # 12 + 5 # 18	SGRT-4-XX	1 # 14	SGRT-2-XX	2 # 14 + 2 # 16	SGRT-3-XX
1 # 12 + 1 # 16	SGRT-3-XX	1 # 14 + 1 # 22	SGRT-2-XX	2 # 14 + 2 # 16	SGRT-3-XX
1 # 12 + 1 # 16 + 1 # 18	SGRT-3-XX	1 # 14 + 1 # 20	SGRT-2-XX	2 # 14 + 3 # 16	SGRT-4-XX
1 # 12 + 1 # 16 + 2 # 18	SGRT-3-XX	1 # 14 + 2 # 20	SGRT-3-XX	2 # 14 + 4 # 16	SGRT-4-XX
1 # 12 + 1 # 16 + 3 # 18	SGRT-4-XX	1 # 14 + 3 # 20	SGRT-3-XX	3 # 14	SGRT-3-XX

Users should independently evaluate the suitability of the product for their application.
Before ordering check with factory for most current data.

Insulated Terminals and Disconnects

SolderGrip self-fixturing insulated terminals (cont'd.)

Table C. SolderGrip wire combinations (see Table A for terminal size [-XX]) (cont'd.)

Wire combinations	Part number	Wire combinations	Part number	Wire combinations	Part number
3 # 14 + 1 # 16	SGRT-4-XX	2 # 16 + 4 # 20	SGRT-3-XX	1 # 18 + 1 # 20 + 2 # 22	SGRT-2-XX
3 # 14 + 2 # 16	SGRT-4-XX	2 # 16 + 1 # 18	SGRT-3-XX	1 # 18 + 2 # 20	SGRT-2-XX
3 # 14 + 3 # 16	SGRT-4-XX	2 # 16 + 1 # 18 + 1 # 20	SGRT-3-XX	1 # 18 + 3 # 20	SGRT-2-XX
4 # 14	SGRT-4-XX	2 # 16 + 1 # 18 + 2 # 20	SGRT-3-XX	1 # 18 + 4 # 20	SGRT-3-XX
4 # 14 + 1 # 16	SGRT-4-XX	2 # 16 + 1 # 18 + 3 # 20	SGRT-3-XX	1 # 18 + 5 # 20	SGRT-3-XX
4 # 14 + 2 # 16	SGRT-4-XX	2 # 16 + 2 # 18	SGRT-3-XX	2 # 18	SGRT-2-XX
5 # 14	SGRT-4-XX	2 # 16 + 2 # 18 + 1 # 20	SGRT-3-XX	2 # 18 + 1 # 22	SGRT-2-XX
5 # 14 + 1 # 16	SGRT-4-XX	2 # 16 + 2 # 18 + 2 # 20	SGRT-3-XX	2 # 18 + 1 # 20	SGRT-2-XX
1 # 16	SGRT-2-XX	2 # 16 + 3 # 18	SGRT-3-XX	2 # 18 + 2 # 20	SGRT-3-XX
1 # 16 + 1 # 22	SGRT-2-XX	2 # 16 + 3 # 18 + 1 # 20	SGRT-3-XX	2 # 18 + 3 # 20	SGRT-3-XX
1 # 16 + 2 # 22	SGRT-2-XX	2 # 16 + 4 # 18	SGRT-3-XX	2 # 18 + 4 # 20	SGRT-3-XX
1 # 16 + 3 # 22	SGRT-2-XX	3 # 16	SGRT-3-XX	3 # 18	SGRT-2-XX
1 # 16 + 1 # 20	SGRT-2-XX	3 # 16 + 1 # 20	SGRT-3-XX	3 # 18 + 1 # 20	SGRT-3-XX
1 # 16 + 1 # 20 + 1 # 22	SGRT-2-XX	3 # 16 + 2 # 20	SGRT-3-XX	3 # 18 + 2 # 20	SGRT-3-XX
1 # 16 + 2 # 20	SGRT-2-XX	3 # 16 + 3 # 20	SGRT-3-XX	3 # 18 + 3 # 20	SGRT-3-XX
1 # 16 + 3 # 20	SGRT-3-XX	3 # 16 + 1 # 18	SGRT-3-XX	4 # 18	SGRT-3-XX
1 # 16 + 4 # 20	SGRT-3-XX	3 # 16 + 1 # 18 + 1 # 20	SGRT-3-XX	4 # 18 + 1 # 20	SGRT-3-XX
1 # 16 + 5 # 20	SGRT-3-XX	3 # 16 + 1 # 18 + 2 # 20	SGRT-3-XX	4 # 18 + 2 # 20	SGRT-3-XX
1 # 16 + 1 # 18	SGRT-2-XX	3 # 16 + 2 # 18	SGRT-3-XX	5 # 18	SGRT-3-XX
1 # 16 + 1 # 18 + 1 # 20	SGRT-2-XX	3 # 16 + 2 # 18 + 1 # 20	SGRT-3-XX	5 # 18 + 1 # 20	SGRT-3-XX
1 # 16 + 1 # 18 + 2 # 20	SGRT-3-XX	3 # 16 + 3 # 18	SGRT-3-XX	6 # 18	SGRT-3-XX
1 # 16 + 1 # 18 + 3 # 20	SGRT-3-XX	4 # 16	SGRT-3-XX	1 # 20 + 2 # 22	SGRT-2-XX
1 # 16 + 1 # 18 + 4 # 20	SGRT-3-XX	4 # 16 + 1 # 20	SGRT-3-XX	1 # 20 + 3 # 22	SGRT-2-XX
1 # 16 + 2 # 18	SGRT-3-XX	4 # 16 + 2 # 20	SGRT-3-XX	1 # 20 + 4 # 22	SGRT-2-XX
1 # 16 + 2 # 18 + 1 # 20	SGRT-3-XX	4 # 16 + 1 # 18	SGRT-3-XX	2 # 20	SGRT-2-XX
1 # 16 + 2 # 18 + 2 # 20	SGRT-3-XX	4 # 16 + 1 # 18 + 1 # 20	SGRT-3-XX	2 # 20 + 1 # 22	SGRT-2-XX
1 # 16 + 2 # 18 + 3 # 20	SGRT-3-XX	4 # 16 + 2 # 18	SGRT-4-XX	2 # 20 + 2 # 22	SGRT-2-XX
1 # 16 + 3 # 18	SGRT-3-XX	5 # 16	SGRT-3-XX	2 # 20 + 3 # 22	SGRT-2-XX
1 # 16 + 3 # 18 + 1 # 20	SGRT-3-XX	5 # 16 + 1 # 20	SGRT-4-XX	3 # 20	SGRT-2-XX
1 # 16 + 3 # 18 + 2 # 20	SGRT-3-XX	5 # 16 + 1 # 18	SGRT-4-XX	3 # 20 + 1 # 22	SGRT-2-XX
1 # 16 + 4 # 18	SGRT-3-XX	6 # 16	SGRT-4-XX	4 # 20	SGRT-2-XX
1 # 16 + 4 # 18 + 1 # 20	SGRT-3-XX	1 # 18 + 1 # 22	SGRT-2-XX	5 # 20	SGRT-3-XX
1 # 16 + 5 # 18	SGRT-3-XX	1 # 18 + 2 # 22	SGRT-2-XX	6 # 20	SGRT-3-XX
2 # 16	SGRT-2-XX	1 # 18 + 3 # 22	SGRT-2-XX	4 # 22	SGRT-2-XX
2 # 16 + 1 # 20	SGRT-3-XX	1 # 18 + 1 # 20	SGRT-2-XX	5 # 22	SGRT-2-XX
2 # 16 + 2 # 20	SGRT-3-XX	1 # 18 + 1 # 20 + 1 # 22	SGRT-2-XX	6 # 22	SGRT-2-XX
2 # 16 + 3 # 20	SGRT-3-XX				

Fax-on-demand

US only (800) 260-9099
 Outside US (650) 257-2301

Fax ID

5900

Description

Data sheet

Visit our website at www.tycoelectronics.com

Product characteristics**Material**

Insulation	Radiation-crosslinked, heat-shrinkable polyvinylidene fluoride (Kynar)
Solder and flux	Sn60 Pb40 with RA flux

Typical performance

Contact resistance	4 mΩ after exposure
Tensile strength	Exceeds strength of individual wires
Temperature rating	-55°C to +125°C
Insulation resistance	100 megohms

Specifications/approvals

Series	Agency	Raychem
SGRT	UL and CUL E87681	RB-120

Installation

The SolderGrip product is pushed onto the conductors with a twisting motion. With the product in place, installation can be completed with the proper selection and use of heating tools and reflectors.

Either of the following Raychem heating tools is recommended:

- HL 1802E
- CV-198 1

Refer to Raychem installation procedure RPIP 820-01 for detailed instructions and recommended reflector attachments.

You will find ordering information for these tools in the Application Equipment section (Section 10) of this catalog.

Wire Termination to Pin/Post/Tab

Fax-on-demand

US only (800) 260-9099

Outside US (650) 257-2301

Visit our website at www.tycoelectronics.com



Raychem SolderSleeve terminators offer easy, one-step solutions for wire connections to pins, posts, and tabs and for mass wire terminations.

Designed for applications with temperatures up to 150°C, the products in this section include SolderSleeve discrete wire terminators, which are heat-shrinkable thermoplastic sleeves containing a precisely engineered fluxed solder preform.

SolderSleeve terminators are also available on carrier tape, spaced precisely to match connector terminal spacing, enabling termination of an entire row of wires at one time.

SolderSleeve wire-to-pin, wire-to-post, and wire-to-tab terminators, like all Raychem termination products, provide reliability and economical installation for greater productivity. They can be supplied either in bulk or on carrier tape.

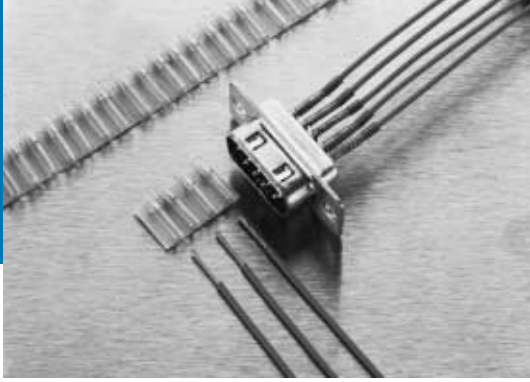

Wire Termination to Pin/Post/Tab

SolderSleeve discrete wire terminators



Applications

Used for terminating wires to component terminals, such as motor tabs, connector pins, and switch terminals.

Features and benefits

- Transparent polyvinylidene fluoride or polyolefin insulation sleeve provides encapsulation, inspectability, strain relief, and insulation.
- Prefluxed solder preform offers a controlled soldering process.
- One-piece design means easy installation and low installed cost.
- Optional tape carrier provides convenience and ease of installation.
- UL and CUL Recognized.



Product selection process

1. Determine the application operating temperature.
2. From the Product Options table on the next page, select the product series appropriate for the application, based on the temperature required.
3. Determine your component connection point type (pin, post, or tab) and dimensions.
4. Determine your wire gauge.
5. Optional: Select tape carrier center-to-center spacing (D-7 1X series only). This should match center spacing of component terminals.
6. Select part number from the appropriate table:
 - For CWT series (applications with low-temperature wires—below 125°C), use Table A.
 - For D-129/141/71X series (applications with wires rated higher than 125°C), use Table B.

Installation

For proper installation of these devices, the correct heating tool and reflector attachment must be used. Either of the following Raychem heating tools are recommended:

- HL1802E
- AA-400 Super Heater

Refer to Raychem installation procedure RCPS 200-12 (for D-129, D-141, D-71X) or RPIP 824-00 (for CWT) for detailed instructions and recommended reflector attachment.

You will find ordering information for these tools in the Application Equipment section (Section 10) of this catalog.

Available in:

Americas

Europe

Asia Pacific



Fax-on-demand

US only (800) 260-9099

Outside US (650) 257-2301

Fax ID

5600

Description



Data sheet

Visit our website at www.tycoelectronics.com**Product options**

Product series	Max. operating temperature	Min. wire temperature rating
CWT	125°C	85°C
D-129, D-141, D-71X	150°C	125°C

Table A. CWT Series (125°C rated) (mm/in)

Connection-point type and size

Terminal dimensions		Wire AWG/mm ²	Part Number
 <p>pin</p>	W = up to 0.63 (.025)	24 (0.24)	CWT-1501
		20 (0.61)	CWT-1502
	W = 0.63 (.025) to 0.89 (.035)	24 (0.24)	CWT-1501
		22 (0.38)	CWT-1502
		20 (0.61)	CWT-1503
 <p>post</p>	W = 0.89 (.035) to 1.14 (.045)	24-22 (0.24-0.38)	CWT-1502
		20-18 (0.61-0.95)	CWT-1503
	W = 1.14 (.045) to 1.52 (.060)	24-22 (0.24-0.38)	CWT-1503
		20-18 (0.61-0.95)	CWT-1504
 <p>tab</p>	W = up to 1.52 (.060)	24-20 (0.24-0.61)	CWT-1501
	W = 1.27 (.050) to 2.28 (.090)	24-18 (0.24-0.95)	CWT-1502
	W = 1.77 (.070) to 2.79 (.110)	24-18 (0.24-0.95)	CWT-1503
	W = 2.54 (.100) to 3.80 (.150)	24-18 (0.24-0.95)	CWT-1504
	W = 2.28 (.090) to 4.70 (.187)	22-16 (0.38-1.21)	CWT-1505

Wire Termination to Pin/Post/Tab

SolderSleeve discrete wire terminators (cont'd.)

Table B. D-129/141/71X Series (up to 150°C rated) (mm/in)

Connection-point type and size

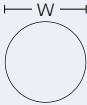
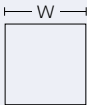
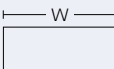
Terminal dimensions	Wire		Tape carrier spacing of sleeves (center-to-center)				
	AWG	mm ²	None	1.27 (0.050)	2.76 (0.100)	3.17 (0.125)	4.0 (0.156)
 pin	W = up to 0.61 (0.024)	30-26 (0.05-0.15)	D-141-30	D-713-03			
		24-22 (0.24-0.38)	D-141-07	D-711-00			
 post	W = 0.63 (0.025) to 0.81 (0.032)	20 (0.61)	D-141-31	D-711-04	D-711-07	D-711-08	
	W = 0.76 (0.030) to 1.27 (0.050)	24-20 (0.24-0.61)	D-141-56				
 tab	W = up to 1.52 (0.060)	24-20 (0.24-0.61)	D-129-05	D-714-01			
	W = 1.27 (0.050) to 2.28 (0.090)	24-20 (0.24-0.61)	D-129-03	D-714-00			
	W = 2.28 (0.090) to 3.55 (0.140)	24-20 (0.24-0.61)	D-129-0043				

For fine wire terminations 0.15 mm² (26 AWG) and smaller* (mm/in)

Part number*	Inside diameter		Fully recovered†	Length††
	As supplied**			
D-110-0062	1.0 (0.040)		0.6 (0.025)	16.0 (0.630)
D-110-0217	1.0 (0.040)		0.6 (0.025)	9.0 (0.360)
D-141-13	0.75 x 1.65 (0.030 X 0.065)		0.75 (0.030)	4.7 (0.185)
D-141-22	0.75 x 1.65 (0.030 X 0.065)		0.75 (0.030)	6.0 (0.240)
D-141-30	0.75 x 1.65 (0.030 X 0.065)		0.75 (0.030)	9.5 (0.375)

Note: Micro SolderSleeve terminators are used for attaching leads smaller than 26 AWG (0.15 mm²) to terminals less than 0.6 mm (0.025 in) wide.

*The D-110 series sleeves are primarily for single wire terminations and do not have a wire stop. The D-141 series will accept either one or two wires; the parts have a built-in wire stop that will locate the wire approximately 0.76 mm (0.03 in) from bottom of terminal.

**Minimum. Wire insulation must be smaller than this. When using the D-141 parts for two-wire terminations, the combined wire insulation diameters must be less than 1.5 mm (0.060 in).

†Maximum. The combination of conductor diameter and terminal width and the wire insulation must be greater than this.

††The terminal length should be at least 1.2 mm (0.05 in) shorter than this. The wire strip length must be adjusted so that, when terminated, the exposed conductor is covered by the sleeve.

Fax-on-demand

US only (800) 260-9099

Outside US (650) 257-2301

Fax ID

5600

Description

Data sheet

Visit our website at www.tycoelectronics.com**Product characteristics****Material**

Insulation (D-129, D-141, D-71X)	Radiation-crosslinked, heat-shrinkable polyvinylidene fluoride	
Insulation (CWT)	Radiation-crosslinked, heat-shrinkable polyolefin	
Solder and flux (D-129, D-141, D-71X)	Solder: Sn63 Pb37	Flux: ROL1 per ANSI-J - 004 (RMA flux)
Solder and flux (CWT)	Solder: Sn50 Pb32 Cd 18	Flux: ROM1 per ANSI-J - 004 (RA flux)

Typical performance

Voltage drop	2.0 mV
Tensile strength	Exceeds strength of conductor
Dielectric strength	2.0 kV
Temperature rating (CWT)	-55°C to 125°C
Temperature rating (D-129, D-141, D-71X)	-55°C to 150°C
Insulation resistance	1000 megohms

Specifications/approvals

Series	Agency	Raychem
CWT	UL and CUL E87681	D-5023
D-129, D-141	UL and CUL E87681	RT-1404

Shield Termination

Fax-on-demand

US only (800) 260-9099

Outside US (650) 257-2301

Visit our website at www.tycoelectronics.com



Raychem SolderSleeve shield grounding terminators provide an environmentally sealed, insulated, and encapsulated solder connection for a variety of applications. SolderSleeve terminators are available in many styles.

Designed for a wide variety of temperature applications ranging from -65°C to 200°C , the products in this section include:

- CWT-X SolderSleeve terminators, designed for low-temperature cables with operating temperatures up to 125°C and suitable for most commercial environments.
- MIL-S-835 19 SolderSleeve terminators, which are immersion resistant and available with or without a preinstalled ground lead.
- SO Series SolderSleeve terminators, which also are immersion resistant and feature the Raychem BiAlloy temperature indication system.

All SolderSleeve products are reliable, versatile, and easy to install, resulting in lower installed costs.

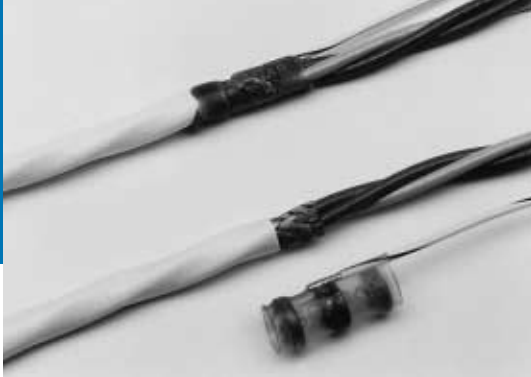

Shield Termination

SolderSleeve shield terminators



Applications

Used for shield-to-ground termination.

Features and benefits

- Transparent insulation sleeve provides encapsulation, inspectability, strain relief, and insulation.
- Prefluxed solder preform provides a controlled soldering process.
- One-piece design offers easy installation and lower installed cost.
- Optional preinstalled ground leads provide convenience and ease of installation.

Product selection process

1. Select product series from the Product Options table below.
2. Determine cable dimensions.
3. Optional: Select preinstalled wire lead type (see Table E on page 8-51 for type descriptions).
4. Select part number (use the selection table indicated for your product series in the Product Options table above).
5. Refer to Table F on page 8-53 for supersession and cross-reference information.

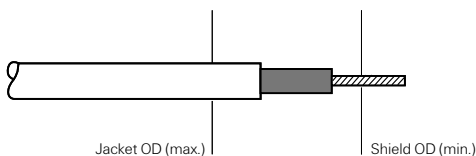

Available in:	Americas	Europe	Asia Pacific
	■	■	■

<i>Product options (refer to Table E on page 8-51 for additional information)</i>							
Product series	System oper. temperature (max.)	Used on cables rated (min.)	Environmental protection	Solder alloy	Flux type	Insulation material	Part no. selection table
CWT	125°C	85°C	Splash resistant	Cd18	RA	Polyolefin	A
SO63*	150°C	125°C	Immersion resistant	Sn63	RMA	Polyvinylidene fluoride	B
SO1/SO2**	150°C	125°C	Immersion resistant	Sn63	RMA	Polyvinylidene fluoride	C
SO96***	175°C	150°C	Immersion resistant	Sn96	RA	Polyvinylidene fluoride	D

*Meets performance requirements of MIL-S-83519 and NAS 1747, supplied with BiAlloy temperature indicator.

**Qualified to MIL-S-83519, supplied with thermochromic temperature indicator.

***Meets performance requirements of MIL-S-83519 and NAS 1747, supplied with thermochromic temperature indicator.

Fax-on-demand

US only (800) 260-9099

Outside US (650) 257-2301

Fax ID

5600

5000

Description

Data sheet

Data sheet (CWT)

Visit our website at www.tycoelectronics.com**Table A. CWT Series (125°C rated) (mm/in)**

The CWT series is suitable for applications using low-temperature wires (typically rated at 85°C to 125°C) with bare copper or tin plating.

Cable OD		Part number	
Jacket OD max.	Shield OD min.	No preinstalled lead	With preinstalled lead (22AWG/0.38 mm ² green)
1.7 (.065)	0.9 (.035)	CWT-3801	-
1.95 (.075)	1.15 (.045)	CWT-3802	-
2.7 (.105)	1.8 (.070)	CWT-3	CWT-3-W122-5
4.5 (.180)	2.3 (.090)	CWT-5	CWT-5-W122-5
6.0 (.235)	3.3 (.130)	CWT-6	CWT-6-W122-5
7.0 (.275)	3.7 (.145)	CWT-7	CWT-7-W122-5
8.7 (.340)	4.2 (.165)	CWT-9	CWT-9-W122-5
10.7 (.420)	7.1 (.280)	CWT-11	CWT-11-W122-5
13.0 (.510)	8.9 (.350)	CWT-13	CWT-13-W122-5

*See Table E on page 8-5 1 for lead description.

Table B. SO63 Series (mm/in)

The SO63 series is immersion resistant, features the Raychem BiAlloy temperature indication system, and meets the performance requirements of MIL-S-83519.

BiAlloy temperature indication system

This system greatly enhances the reliability and repeatability of SO63 series terminators while reducing installed cost. The heat-shrinkable thermoplastic sleeve contains a precisely engineered, fluxed solder band that is visible through the sleeve. The band provides exactly the amount of solder and flux required to terminate the ground lead to the cable shield. Encircling the band is a small temperature indicator ring. This ring melts only when the surfaces to be joined have reached the correct soldering temperature, thus ensuring a properly soldered connection. Process control is built into each sleeve.

Cable OD		Part number					
Jacket OD max.	Shield OD min.	No preinstalled lead	Preinstalled lead option*				
			20 AWG	22 AWG	24 AWG	26 AWG	Braid strap
1.95 (.075)	0.9 (.035)	SO63-1-00	SO63-1-55-20-90	SO63-1-55-22-90	SO63-1-55-24-90	SO63-1-55-26-90	SO63-1-01
2.7 (.105)	1.40 (.055)	SO63-2-00	SO63-2-55-20-90	SO63-2-55-22-90	SO63-2-55-24-90	SO63-2-55-26-90	SO63-2-01
4.3 (.170)	2.15 (.085)	SO63-3-00	SO63-3-55-20-90	SO63-3-55-22-90	SO63-3-55-24-90	SO63-3-55-26-90	SO63-3-01
6.0 (.235)	3.30 (.130)	SO63-4-00	SO63-4-55-20-90	SO63-4-55-22-90	SO63-4-55-24-90	SO63-4-55-26-90	SO63-4-01
7.0 (.275)	4.30 (.170)	SO63-5-00	SO63-5-55-20-90	SO63-5-55-22-90	SO63-5-55-24-90	SO63-5-55-26-90	SO63-5-01

*See Table E on page 8-5 1 for lead description. Color of wire lead is denoted by the last two digits of the part number as follows:
 90 = White with a black stripe 9 = White 0 = Black 6 = Blue (24 AWG only) 5 = Green (20, 22, 24 AWG)

Users should independently evaluate the suitability of the product for their application.
 Before ordering check with factory for most current data.

Shield Termination

SolderSleeve shield terminators (cont'd.)

Table C. S01/S02 M83519 Series (mm/in)

M83519 is the qualified product listed in MIL-S-83519. The series features a thermochromic temperature indicator to assist in termination and inspection. The Raychem part number is permanently marked on the sleeve.

Thermochromic temperature indicator

The M83519 (S01 and S02) series terminators contain a colored thermochromic temperature indicator that exhibits a distinct color change when surfaces have reached wetting temperature. This color change gives both manufacturing and Quality Control an aid in the inspection of the completed termination.

Cable OD		Part number (MIL part number and Raychem part number) by lead option					
Jacket OD max	Shield OD min	No preinstalled lead		Preinstalled lead option*			
		MIL	Raychem	20 AWG		22 AWG	
				MIL	Raychem	MIL	Raychem
1.95 (0.075)	0.9 (.035)	M83519/1-1	S01-01-R	M83519/2-1	S02-01-R	M83519/2-6	S02-06-R
2.7 (0.105)	1.40 (.055)	M83519/1-2	S01-02-R	M83519/2-2	S02-02-R	M83519/2-7	S02-07-R
4.3 (0.170)	2.15 (.085)	M83519/1-3	S01-03-R	M83519/2-3	S02-03-R	M83519/2-8	S02-08-R
6.0 (0.235)	3.30 (.130)	M83519/1-4	S01-04-R	M83519/2-4	S02-04-R	M83519/2-9	S02-09-R
7.0 (0.275)	4.30 (.170)	M83519/1-5	S01-05-R	M83519/2-5	S02-05-R	M83519/2-10	S02-10-R

Jacket OD max	Shield OD min	Preinstalled lead option*			
		24 AWG		26 AWG	
1.95 (0.075)	0.9 (.035)	M83519/2-11	S02-11-R	M83519/2-16	S02-16-R
2.7 (0.105)	1.40 (.055)	M83519/2-12	S02-12-R	M83519/2-17	S02-17-R
4.3 (0.170)	2.15 (.085)	M83519/2-13	S02-13-R	M83519/2-18	S02-18-R
6.0 (0.235)	3.30 (.130)	M83519/2-14	S02-14-R	M83519/2-19	S02-19-R
7.0 (0.275)	4.30 (.170)	M83519/2-15	S02-15-R	M83519/2-20	S02-20-R

*See Table E for lead description.

Fax-on-demand

US only (800) 260-9099
 Outside US (650) 257-2301

Fax ID

5600
 5000

Description

Data sheet
 Data sheet (CWT)

Visit our website at www.tycoelectronics.com

Table D. SO96 Series (175°C rated) (mm/in)

The SO96 series is designed for high-temperature applications with operating temperature requirements up to 200°C. This series features a thermochromic temperature indicator and meets performance requirements of MIL-S-835 19. The solder is Sn96 with RA flux compatible with nickel-plated shields.

Thermochromic temperature indicator

The SO96 series terminators contain a colored thermochromic temperature indicator that exhibits a distinct color change when surfaces have reached wetting temperature. This color change gives both manufacturing and Quality Control an aid in the inspection of the completed termination.

		Part number		
Cable OD		Preinstalled lead option*		
Jacket OD	Shield OD			
max.	min.	No preinstalled lead	22 AWG	Braid strap
1.95 (0.075)	0.9 (.035)	SO96-1-00	SO96-1-55-22-90	SO96-1-01
2.7 (0.105)	1.40 (.055)	SO96-2-00	SO96-2-55-22-90	SO96-2-01
4.3 (0.170)	2.15 (.085)	SO96-3-00	SO96-3-55-22-90	SO96-3-01
6.0 (0.235)	3.30 (.130)	SO96-4-00	SO96-4-55-22-90	SO96-4-01
7.0 (0.275)	4.30 (.170)	SO96-5-00	SO96-5-55-22-90	SO96-5-01

*See Table E for lead description.

Table E. Preinstalled lead description

Series	Lead type	Remarks	Plating	Stranding	Min. length (mm/in)
M835 19, SO63	55A0111	MIL-W-22759/32	Tin	Stranded	150 (6)
SO96	55A0813	MIL-W-22759/41	Nickel	Stranded	150 (6)
SO63, SO96	Braid strap	Uninsulated	Nickel	40 x 38 AWG	150 (6)
CWT	XL polyethylene	UL Listed	Tin	Stranded (W1)	150 (6)

Users should independently evaluate the suitability of the product for their application.
 Before ordering check with factory for most current data.

Shield Termination

SolderSleeve shield terminators (cont'd.)

Product characteristics

Material

Insulation		
SO, M83519	Radiation-crosslinked, heat-shrinkable polyvinylidene fluoride	
CWT	Radiation-crosslinked, heat-shrinkable polyolefin	
Solder and flux		
SO63, M83519	Solder: Sn63 Pb37	Flux: ROL1 per ANSI - J - 004 (RMA Flux)
SO96 series	Solder: Sn96 Ag4	Flux: ROM1 per ANSI - J - 004 (RA Flux)
CWT	Solder: Sn50 Pb32 Cd18	Flux: ROM1 per ANSI - J - 004 (RA Flux)
Ground lead		
CWT series	XL polyethylene	
SO, M83519	MIL-W-22759/32 or /41	

Typical performance

Voltage drop	2.5 mV
Tensile strength	Exceeds strength of ground lead
Dielectric strength	1.0 kV immersed
Temperature rating	
CWT	-55°C to 125°C
SO63/M83519	-55°C to 150°C
SO96 series	-55°C to 175°C
Insulation resistance	1000 megohms

Specifications/approvals

Series	Agency	Raychem
CWT	-	D-5023
SO63*	NAS 1747	RT-1404
M83519**	MIL-S-83519/1&/2	RT-1404
SO96***	NAS 1747	RT-1404

*Meets performance requirements of MIL-S-83519 and NAS 1747, supplied with BiAlloy temperature indicator.

**Qualified to MIL-S-83519, supplied with thermochromic temperature indicator.

***Meets performance requirements of MIL-S-83519 and NAS 1747, supplied with thermochromic temperature indicator.

Installation

For proper installation of these devices, the correct heating tool and reflector attachment must be used. Any one of the following Raychem heating tools is recommended:

- HL1802E
- AA-400 Super Heater
- CV-1981
- MiniRay
- IR-1759

For detailed instructions and recommended reflector attachments, refer to the appropriate Raychem installation procedure:

Series	Procedure
CWT	RPIP 655-00-D
SO63	RCPS 100-70
M83519 (SO1/SO2)	RCPS 100-70
SO96	RCPS 100-70

You will find ordering information for these tools in the Application Equipment section (Section 10) of this catalog.

Fax-on-demand

US only (800) 260-9099

Outside US (650) 257-2301

Fax ID

5600

5000

Description

Data sheet

Data sheet (CWT)

Visit our website at www.tycoelectronics.com**Table F. Inactive NAS part and cross-reference**

Inactive NAS part number	Military part number	Raychem S01/S02* series	Raychem S063** series	D-1XX series	NAS series
1745-1	M83519/1-1	S01-01-R	S063-1-00	D-144-25	
1745-2	M83519/1-2	S01-02-R	S063-2-00	D-100-00	
1745-3	M83519/1-3	S01-03-R	S063-3-00	D-101-00	
1745-17	M83519/1-4	S01-04-R	S063-4-00	D-107-00	
1745-4	M83519/1-5	S01-05-R	S063-5-00	D-103-00	
1745-9					NAS1745-13
1745-10					NAS1745-14
1745-11					NAS1745-15
1745-12					NAS1745-16
1745-13***	M83519/1-1			D-142-83***	
1745-14***	M83519/1-2			D-142-50***	
1745-15***	M83519/1-3			D-142-51***	
1745-23***	M83519/1-4			D-142-56***	
1745-16***	M83519/1-5			D-142-52***	
1746-1	M83519/1-1	S01-01-R	S063-1-00	D-144-25	
1746-2	M83519/1-2	S01-02-R	S063-2-00	D-144-00	
1746-3	M83519/1-3	S01-03-R	S063-3-00	D-144-01	
1746-9	M83519/1-4	S01-04-R	S063-4-00	D-144-46	
1746-4	M83519/1-5	S01-05-R	S063-5-00	D-144-02	
	M83519/2-1	S02-01-R	S063-1-55-20-90		
	M83519/2-2	S02-02-R	S063-2-55-20-90		
	M83519/2-3	S02-03-R	S063-3-55-20-90		
	M83519/2-4	S02-04-R	S063-4-55-20-90		
	M83519/2-5	S02-05-R	S063-5-55-20-90		
	M83519/2-6	S02-06-R	S063-1-55-22-90		
	M83519/2-7	S02-07-R	S063-2-55-22-90		
	M83519/2-8	S02-08-R	S063-3-55-22-90		
	M83519/2-9	S02-09-R	S063-4-55-22-90		
	M83519/2-10	S02-10-R	S063-5-55-22-90		
	M83519/2-11	S02-11-R	S063-1-55-24-90		
	M83519/2-12	S02-12-R	S063-2-55-24-90		
	M83519/2-13	S02-13-R	S063-3-55-24-90		
	M83519/2-14	S02-14-R	S063-4-55-24-90		
	M83519/2-15	S02-15-R	S063-5-55-24-90		
	M83519/2-16	S02-16-R	S063-1-55-26-90		
	M83519/2-17	S02-17-R	S063-2-55-26-90		
	M83519/2-18	S02-18-R	S063-3-55-26-90		
	M83519/2-19	S02-19-R	S063-4-55-26-90		
	M83519/2-20	S02-20-R	S063-5-55-26-90		

*QPL listed to MIL-S-83519. **Meets performance requirements of MIL-S-83519.

***The CWT series is the recommended replacement.

Users should independently evaluate the suitability of the product for their application.

Before ordering check with factory for most current data.

Coaxial Cable Termination

Fax-on-demand

US only (800) 260-9099

Outside US (650) 257-2301

Visit our website at www.tycoelectronics.com



Raychem SolderSleeve coaxial cable terminators allow reliable, easy terminations in a variety of coaxial cable applications, including printed circuit boards (PCBs). The insulating and strain-relieving capabilities of SolderSleeve terminators provide the ideal solution to center-conductor breakage problems.

Designed for applications with temperatures up to 150°C, the products in this section include:

- SolderSleeve coaxial cable terminators, which allow reliable, economical attachment of coaxial cable to connector terminals, printed wiring assemblies, or solderless wrap terminals.
- One-piece SolderSleeve PCB coaxial cable terminators, which permit quick, easy, and cost-effective terminations of coaxial cable to printed circuit boards.
- RF one-step BNC/TNC connectors, which are single-piece assemblies for terminating the center conductor and the braid of a broad range of coaxial cables. They are fully intermateable with MIL-C-39012C connectors and are available in 50-ohm and 75-ohm versions.

With precisely measured solder and flux, SolderSleeve products provide exact process control of terminations. The SolderSleeve method means strong connections with the lowest possible voltage drop. Small, lightweight SolderSleeve terminators are also the ideal solution for high-density packaging problems.



Coaxial Cable Termination

Solder Sleeve coaxial cable terminators



Applications

Used for terminating coaxial cable to component terminals, contacts, printed circuit boards, and solderless wrap terminals.

Features and benefits

- Transparent polyvinylidene fluoride or polyolefin insulation sleeve provides encapsulation, inspectability, strain relief (eliminates center conductor breakage), and insulation.
- Prefluxe solder preform provides a controlled soldering process.

- One-piece design provides easy installation and lower installed cost.
- Preinstalled termination leads provide convenience and ease of installation.

Product selection process

1. Select product series from the product options table below.
2. Select preinstalled lead type from the table below.
3. Determine cable RG number or dimensions.
4. Select part number from Table A (CWT series) or Table B (B-02X/B-04X series) on the next page.

Available in:	Americas	Europe	Asia Pacific
	■	■	■

Product options				
Product series	Max. operating temp.	Use on cables rated (min)	Cable shield plating	Part number selection table
CWT	125°C	85°C	Tin, copper	A
B-02X/B-04X	150°C	125°C	Tin, silver	B

Preinstalled lead descriptions						
Series	Lead type	Plating	Stranding	AWG	Length in mm (in)	Color
CWT	XL polyethelene	Tin	Stranded (W1)	22	150 (6)	White (cntr), green (grnd)
B-021	M81822/13 (solderless wrap)	Silver	Solid-OFHC	24–30	150 (6)	White (cntr), blue (grnd)
B-041	M81822/13 (solderless wrap)	Silver	Solid-OFHC	24–30	150 (6)	White (cntr), blue (grnd)
B-043	M81822/13 (solderless wrap)	Silver	Solid-OFHC	24–30	150 (6)	White (cntr), blue (grnd)
B-020	55A01111 (MIL-W-22759/32)	Tin	Stranded	20–30	150 (6)	White (cntr), blue (grnd)
B-040	55A01111 (MIL-W-22759/32)	Tin	Stranded	20–30	150 (6)	White (cntr), blue (grnd)
B-044	55A01111 (MIL-W-22759/32)	Tin	Stranded	20–30	150 (6)	White (cntr), blue (grnd)

Table A. CWT Series part numbers			
Cable RG number	Dimensions in mm (in)		Part number
	Dielectric OD	Jacket OD	With preinstalled lead (22 AWG/0.38 mm ² green/white)
174	0.8–2.3 (.032–.091)	1.3–2.8 (.051–.110)	CWT-4174-W122-5/9
58, 122	2.0–2.8 (.079–.110)	2.5–4.4 (.100–.173)	CWT-4058-W122-5/9
59	2.8–3.3 (.110–.130)	3.2–6.0 (.125–.235)	CWT-4059-W122-5/9

Fax-on-demand

US only (800) 260-9099

Outside US (650) 257-2301

Fax ID

5600

5000

Description

Data sheet

Data sheet (CWT)

Visit our website at www.tycoelectronics.com**Table B. B-02X/B-04X Series part numbers**

The B-02X/B-04X series uses a one-piece design to terminate coaxial cables rated at 125°C minimum.

- Using Part 1 of this table, select the appropriate coaxial product group (1, 2, or 3) based on your RG cable number, Raychem cable description, or cable dimensions.
- Using Part 2 of this table, select the product part number based on the coaxial product group you selected in Part 1 and the appropriate preinstalled lead type you selected on the previous page.

Part 1: Coaxial product group selection

Typical compatible

part numbers

Dimension range (mm/in)

RG cable number	Raychem cable description	Jacket OD (max.)	Shield OD	Dielectric OD	Conductor OD	One-piece coaxial product group
RG178, RG404	5030A13XX 5028A13XX	3.4 (.134)	1.3–2.3 (.051–.091)	0.5–1.7 (.019–.067)	0.3–0.8 (.011–.032)	Group 1
RG179, RG316	5024A13XX 7530A13XX 7526A13XX 9530A13XX	4.4 (.173)	1.5–2.8 (.060–.110)	1.2–2.5 (.047–.100)	0.3–1.6 (.011–.063)	Group 2
RG180, RG302, RG303	9527A13XX 9528A13XX	6.3 (.248)	2.4–4.6 (.094–.181)	1.4–4.3 (.055–.169)	0.3–2.8 (.011–.110)	Group 3

Part 2: Product part number selection

One-piece coaxial product group	Preinstalled wire type	Preinstalled wire size					
		20 AWG	22 AWG	24 AWG	26 AWG	28 AWG	30 AWG
Group 1	Stranded (M22759)		B-044-22-N	B-044-24-N	B-044-26-N		
	Solid (M81822)			B-043-24-N	B-043-26-N	B-043-28-N	B-043-30-N
Group 2	Stranded (M22759)	B-040-20-N	B-040-22-N	B-040-24-N	B-040-26-N	B-040-28-N	B-040-30-N
	Solid (M81822)			B-041-24-N	B-041-26-N	B-041-28-N	B-041-30-N
Group 3	Stranded (M22759)	B-020-20-N	B-020-22-N	B-020-24-N	B-020-26-N		
	Solid (M81822)				B-021-26-N		

Product characteristics**Material**

Insulation (B-02X/B-04X)	Radiation-crosslinked, heat-shrinkable polyvinylidene fluoride (Kynar)
Insulation (CWT series)	Radiation-crosslinked, heat-shrinkable polyolefin
Solder and flux (B-02X/B-04X)	Solder: Sn63 Pb37 Flux: ROL 1 per ANSI-J-004 (RMA Flux)
Solder and flux (CWT series)	Solder: Sn50 Pb32 Cd 18 Flux: ROM 1 per ANSI-J-004 (RA Flux)

Typical performance

Voltage drop	2.0 mV
Tensile strength	Exceeds strength of conductor
Dielectric strength	2.0 kV
Temperature rating (CWT)	-55°C to 125°C
Temperature rating (B-02X/B-04X)	-55°C to 150°C
Insulation resistance	1000 megohms

Users should independently evaluate the suitability of the product for their application.
Before ordering check with factory for most current data.



Coaxial Cable Termination

Solder Sleeve PCB/coaxial cable terminators



Applications

Used for terminating coaxial cable to printed circuit boards.

Features and benefits

- Provides a completely shielded, low-resistance, matched-impedance termination with very low VSWR (D-607 series only).
- Transparent polyvinylidene fluoride insulation sleeve provides encapsulation, inspectability, strain relief, and insulation.
- Prefluxe solder preform provides a controlled soldering process.
- One-piece design offers easy installation and lower installed cost.
- Preinstalled PCB termination body provides convenience and ease of installation.

Installation

For proper installation of these devices, the correct heating tool and reflector attachment must be used. Any one of the following Raychem heating tools is recommended:

- HL1802E
- AA-400 Super Heater
- IR-1759 MiniRay
- CV-1981

Refer to Raychem installation procedure ES61139 for detailed instructions and recommended reflector attachments.

You will find ordering information for these tools in the Application Equipment section (Section 10) of this catalog.

Product selection process

1. Select product series from the Product Options table below.
2. Determine cable RG number or outside diameter dimensions.
3. Select the appropriate part number from Table A (D-607 series) or Table B (B-046 series).
 - For D-607 (matched impedance) series, determine straight or right-angle entry to PCB and grid pattern, then select the appropriate part number from Table A on the next page.
 - For B-046 (PinPak, or pin to ground) series, determine hole spacing and diameter. Refer to Table B for product selection (see illustration below for cable dimensions).

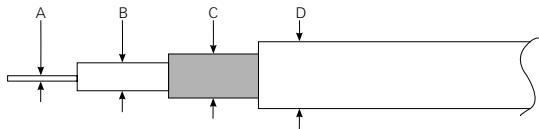

Available in:	Americas	Europe	Asia Pacific
	■	■	■

Product options			
Product series	Typical application performance	Shield method	Part number selection table
D-607	Matched impedance up to 2.3 GHz	Metal body	A
B-046	Effective transmission up to 100 MHz	Pin to ground	B

Fax-on-demand

US only (800) 260-9099

Outside US (650) 257-2301

Fax ID

5600

Description

Data sheet

Visit our website at www.tycoelectronics.com**Specifications/approvals**

Series	Raychem
D-607	RT-1404
B-046	RT-1404

Table A. D-607 Series part numbers

RG cable number	Cable dimensions (mm/in)			Part number		
	Jacket	Shield	Dielectric	Entry to PCB Straight grid 5.08 (.200)	Right angle grid 5.08 (.200)	Straight grid 2.54 (.100)
174, 178, 179,	1.5–3.55	1.1–3.15	0.60–2.25	D-607-09	D-607-10	D-607-40*
316, 404	(.060–.140)	(.045–.125)	(.025–.090)			

Table B. B-046 Series part numbers

RG cable number	Cable dimensions (mm/in)				D max.	Pin diameter	Part number		
	A	B	C	Spacing between pins 2.54 (.100) 5.08 (.200) 6.35 (.250)					
178, 404	0.3–0.8 (.011–.032)	0.5–1.7 (.019–.067)	1.3–2.3 (.050–.091)	3.4 (.134)	0.6 (.023) 0.8 (.031)	B-046-14-N	B-046-10-N	B-046-12-N	
179, 316	0.3–1.6 (.011–.063)	1.2–2.5 (.047–.100)	1.5–2.8 (.060–.110)	4.4 (.173)	0.6 (.023) 0.8 (.031)	B-046-15-N	B-046-66-N	B-046-16-N	
						B-046-68-N	B-046-18-N		

Product characteristics**Material**

Insulation	Radiation-crosslinked, heat-shrinkable polyvinylidene fluoride	
Solder and flux	Solder: Sn63 Pb37	Flux: ROL1 per ANSI - J - 004 (RMA flux)
Termination body/pin	Copper alloy, solder-plated	

Typical performance

Voltage drop	2.0 mV
Tensile strength	Exceeds strength of conductor
Dielectric strength	2.0 kV
Temperature rating	-55°C to 150°C
Insulation resistance	1000 megohms

Electrical performance (typical) D-607 series only

Frequency	VSWR (D-607-09, -40)	VSWR (D-607-10)
350 MHz	1.04 max.	1.04 max.
700 MHz	1.05 max.	1.09 max.
2.3 GHz	1.09 max.	1.12 max.

Users should independently evaluate the suitability of the product for their application.
Before ordering check with factory for most current data.

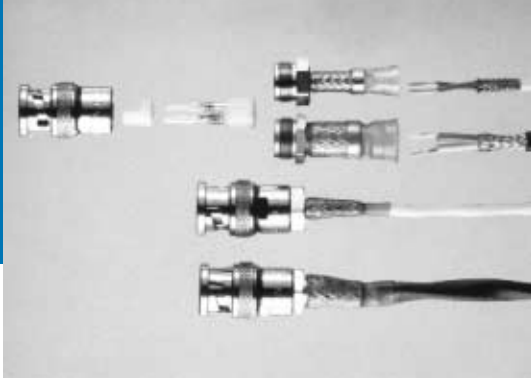

Coaxial Cable Termination

RF one-step BNC/TNC connectors



Applications

RF one-step BNC/TNC connectors are single-piece assemblies for terminating the center conductor and the braid of a broad range of coaxial cables.

The connectors are fully intermateable with MIL-C-39012 connectors and are available in 50-ohm and 75-ohm versions.

Features and benefits

- Easy, quick installation.
- Outstanding cable-retention force.
- Solder-solder connection type (center conductor and braid).
- One-step termination for easy, quick installation and lower installed cost.
- Exceptional cable retention force to withstand high vibration and frequent mates and demates.
- Fully soldered center conductor and braid.
- Excellent built-in strain relief against vibration and excessive handling.
- Long-term reliability.
- Controlled soldering termination.
- Use with standard RG/U cables and Raychem Cheminax cables.
- Three product sizes to accommodate a wide range of cables.
- Meets performance requirements of MIL-C-39012 up to 2.8 GHz.

Available in:	Americas	Europe	Asia Pacific
	■	■	■

Specifications	Installation
Raychem RB-115	For proper installation of these devices, the correct heating tool and reflector attachment must be used. Any one of the following Raychem heating tools is recommended: · Steinel Model HL1802E · CV-1981
	Refer to Raychem installation procedure RPIP 683-00 for detailed instructions.

Coaxial Cable Termination

RF one-step BNC/TNC connectors (cont'd.)

Product characteristics

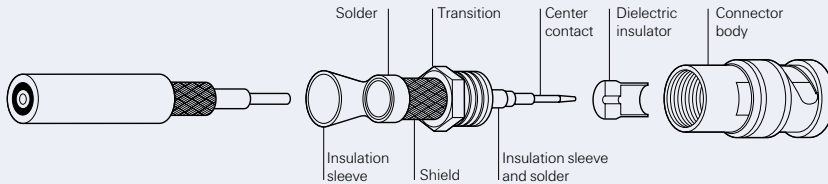

Material

Center contact	Gold-plated beryllium copper (female) Gold-plated brass (male)
Dielectric insulator	PTFE
Transition	Silver-plated brass
Connector body	Nickel-plated brass
Solder and flux	Sn63Pb37, RMA flux
Braided shield	Tin-plated copper wire per ASTM B3
Insulation sleeve	Radiation-crosslinked, heat-shrinkable polyvinylidene fluoride, transparent blue
Strain relief/sealing sleeve	Radiation-crosslinked, heat-shrinkable modified polyolefin with adhesive, black

Typical performance

Dielectric withstand voltage	1500 V
Insulation resistance	5000 megohms
Temperature rating	-55C to 150C
Contact resistance-straight	Inner = 1.5 milliohms, outer = 1.0 milliohm
Contact resistance-right angle	Inner = 2.5 milliohms, outer = 1.5 milliohms
Cable retention force	295N (66 lb) to 822N (196 lb)
Voltage rating	500 V RMS
Connector durability	500 mating cycles minimum

Electrical performance

Nominal impedance	50 and 75 ohms
Frequency range	Up to 2.8 GHz

Part selection process

1. From Product Options and Dimensions on page 8-6 1, select the connector style you need (BNC or TNC, plug or jack, male or female contacts).
2. From the tables that follow, find the appropriate table for the connector style you selected.
3. From the appropriate table, select the connector part number based on the RG cable type or Raychem cable part number.
For cable types not shown use the cable dimensions.

Note: The cable dimensions in each table are keyed to the diagram below.

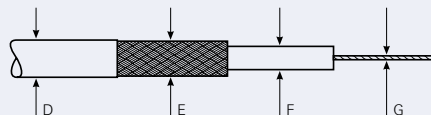

Fax-on-demand

US only (800) 260-9099

Outside US (650) 257-2301

Visit our website at www.tycoelectronics.com**Part number selection - BNC coaxial connectors**

Cable type			Cable dimensions in millimeters (inches)				Part Number
Impedance (ohms)	RG cables	Raychem cables	D (min.-max.)	E (min.-max.)	F (max.)	G (max.)	
BNC straight plugs, male contacts							
50	RG-174, RG-178, RG-188, RG-196, RG-316	5026A1311, 5028A1317, 5030A1317	1.5-5.5 (.060-.217)	0.9-3.0 (.035-.118)	1.55 (.060)	0.65 (.025)	RBD-50-S-00
50	RG-58, RG-141, RG-142, RG-303, RG-400	5019D3318, 5021D1331, 5020A1311	3.5-7.0 (.138-.276)	2.1-5.0 (.083-.197)	3.0 (.118)	1.25 (.050)	RBD-50-M-00
50	RG-165, RG-215, RG-213, RG-225, RG-214	5012F3332, 5012A3311	5.0-12.5 (.197-.500)	4.1-9.5 (.161-.375)	7.3 (.287)	2.45 (.100)	RBD-50-L-00
75	RG-179, RG-187	7530A1317	1.5-5.5 (.060-.217)	0.9-3.0 (.035-.118)	1.55 (.060)	0.65 (.025)	RBD-75-S-00
75		7524A1311, 7528A1317	3.5-7.0 (.138-.276)	2.1-5.0 (.083-.197)	3.7 (.126)	1.25 (.050)	RBD-75-M-00
75	RG-6, RG-11, RG-12, RG-59 RG-144, RG-216		5.0-12.5 (.197-.500)	4.1-9.5 (.161-.375)	7.3 (.287)	2.45 (.100)	RBD-75-L-00
BNC right-angle plugs, male contacts							
50	RG-174, RG-178, RG-188, RG-196, RG-316	5026A1311, 5028A1317, 5030A1317	1.5-5.5 (.060-.217)	0.9-3.0 (.035-.118)	1.55 (.060)	0.65 (.025)	RBD-50-S-01
50	RG-58, RG-141, RG-142, RG-303, RG-400	5019D3318, 5021D1331, 5020A1311	3.5-7.0 (.138-.276)	2.1-5.0 (.083-.197)	3.0 (.118)	1.25 (.050)	RBD-50-M-01
50	RG-165, RG-215, RG-213, RG-225, RG-214	5012F3332, 5012A3311	5.0-12.5 (.197-.500)	4.1-9.5 (.161-.375)	7.3 (.287)	2.45 (.100)	RBD-50-L-01
75	RG-179, RG-187	7530A1317	1.5-5.5 (.060-.217)	0.9-3.0 (.035-.118)	1.55 (.060)	0.65 (.025)	RBD-75-S-01
75		524A1311, 7528A1317	3.5-7.0 (.138-.276)	2.1-5.0 (.083-.197)	3.7 (.146)	1.25 (.050)	RBD-75-M-01
75	RG-6, RG-11, RG-12, RG-59 RG-144, RG-216		5.0-12.5 (.197-.500)	4.1-9.5 (.161-.375)	7.3 (.287)	2.45 (.100)	RBD-75-L-01

Users should independently evaluate the suitability of the product for their application.
Before ordering check with factory for most current data.

Coaxial Cable Termination

RF one-step BNC/TNC connectors (cont'd.)

Part number selection - BNC coaxial connectors

Cable type			Cable dimensions in millimeters (inches)				Part Number
Impedance (ohms)	RG cables	Raychem cables	D (min.-max.)	E (min.-max.)	F (max.)	G (max.)	
BNC straight bulkhead jacks, female contacts							
50	RG-174, RG-178, RG-188, RG-196, RG-316	5026A1311, 5028A1317, 5030A1317	1.5-5.5 (.060-.217)	0.9-3.0 (.035-.118)	1.55 (.060)	0.65 (.025)	RBD-50-S-02
50	RG-58, RG-141, RG-142, RG-303, RG-400	5019D3318, 5021D1331, 5020A1311	3.5-7.0 (.138-.276)	2.1-5.0 (.083-.197)	3.0 (.118)	1.25 (.050)	RBD-50-M-02
50	RG-165, RG-215, RG-213, RG-225, RG-214	5012F3332, 5012A3311	5.0-12.5 (.197-.500)	4.1-9.5 (.161-.375)	7.3 (.287)	2.45 (.100)	RBD-50-L-02
75	RG-179, RG-187	7530A1317	1.5-5. (.060-.217)	5 0.9-3.0 (.035-.118)	1.55 (.060)	0.65 (.025)	RBD-75-S-02
75		75 7524A1311, 7528A1317	3.5-7.0 (.138-.276)	2.1-5.0 (.083-.197)	3.7 (.146)	1.25 (.050)	RBD-75-M-02
75	RG-6, RG-11, RG-12, RG-59 RG-144, RG-216		5.0-12.5 (.197-.500)	4.1-9.5 (.161-.375)	7.3 (.287)	2.45 (.100)	RBD-75-L-02
BNC straight jacks, female contacts							
50	RG-174, RG-178, RG-188, RG-196, RG-316	5026A1311, 5028A1317, 5030A1317	1.5-5.5 (.060-.217)	0.9-3.0 (.035-.118)	1.55 (.060)	0.65 (.025)	RBD-50-S-03
50	RG-58, RG-141, RG-142, RG-303, RG-400	5019D3318, 5021D1331, 5020A1311	3.5-7.0 (.138-.276)	2.1-5.0 (.083-.197)	3.0 (.118)	1.25 (.050)	RBD-50-M-03
50	RG-165, RG-215, RG-213, RG-225, RG-214	5012F3332, 5012A3311	5.0-12.5 (.197-.500)	4.1-9.5 (.161-.375)	7.3 (.287)	2.45 (.100)	RBD-50-L-03
75	RG-179, RG-187	7530A1317	1.5-5.5 (.060-.217)	0.9-3.0 (.035-.118)	1.55 (.060)	0.65 (.025)	RBD-75-S-03
75		75 7524A1311, 7528A1317	3.5-7.0 (.138-.276)	2.1-5.0 (.083-.197)	3.7 (.146)	1.25 (.050)	RBD-75-M-03
75	RG-6, RG-11, RG-12, RG-59 RG-144, RG-216		5.0-12.5 (.197-.500)	4.1-9.5 (.161-.375)	7.3 (.287)	2.45 (.100)	RBD-75-L-03

Fax-on-demand

US only (800) 260-9099

Outside US (650) 257-2301

Visit our website at www.tycoelectronics.com**Part number selection - BNC coaxial connectors (continued)**

Cable type		Cable dimensions in millimeters (inches)				Part Number	
Impedance (ohms)	RG cables	Raychem cables	D (min.-max.)	E (min.-max.)	F (max.)		G (max.)
BNC straight panel jacks, female contacts							
50	RG-174, RG-178, RG-188, RG-196, RG-316	5026A1311, 5028A1317, 5030A1317	1.5-5.5 (.060-.217)	0.9-3.0 (.035-.118)	1.55 (.060)	0.65 (.025)	RBD-50-S-04
50	RG-58, RG-141, RG-142, RG-303, RG-400	5019D3318, 5021D1331, 5020A1311	3.5-7.0 (.138-.276)	2.1-5.0 (.083-.197)	3.0 (.118)	1.25 (.050)	RBD-50-M-04
50	RG-165, RG-215, RG-213, RG-225, RG-214	5012F3332, 5012A3311	5.0-12.5 (.197-.500)	4.1-9.5 (.161-.375)	7.3 (.287)	2.45 (.100)	RBD-50-L-04
75	RG-179, RG-187	7530A1317	1.5-5.5 (.060-.217)	0.9-3.0 (.035-.118)	1.55 (.060)	0.65 (.025)	RBD-75-S-04
75		7524A1311, 7528A1317	3.5-7.0 (.138-.276)	2.1-5.0 (.083-.197)	3.7 (.146)	1.25 (.050)	RBD-75-M-04
75	RG-6, RG-11, RG-12, RG-59 RG-144, RG-216		5.0-12.5 (.197-.500)	4.1-9.5 (.161-.375)	7.3 (.287)	2.45 (.100)	RBD-75-L-04

Part number selection - TNC coaxial connectors

Cable type		Cable dimensions in millimeters (inches)				Part Number	
Impedance (ohms)	RG cables	Raychem cables	D (min.-max.)	E (min.-max.)	F (max.)		G (max.)
TNC straight plugs, male contacts							
50	RG-174, RG-178, RG-188, RG-196, RG-316	5026A1311, 5028A1317, 5030A1317	1.5-5.5 (.060-.217)	0.9-3.0 (.035-.118)	1.55 (.060)	0.65 (.025)	RTD-50-S-00
50	RG-58, RG-141, RG-142, RG-303, RG-400	5019D3318, 5021D1331, 5020A1311	3.5-7.0 (.138-.276)	2.1-5.0 (.083-.197)	3.0 (.118)	1.25 (.050)	RTD-50-M-00
50	RG-165, RG-215, RG-213, RG-225, RG-214	5012F3332, 5012A3311	5.0-12.5 (.197-.500)	4.1-9.5 (.161-.375)	7.3 (.287)	2.45 (.100)	RTD-50-L-00
75	RG-179, RG-187	7530A1317	1.5-5.5 (.060-.217)	0.9-3.0 (.035-.118)	1.55 (.060)	0.65 (.025)	RTD-75-S-00
75		7524A1311, 7528A1317	3.5-7.0 (.138-.276)	2.1-5.0 (.083-.197)	3.7 (.146)	1.25 (.050)	RTD-75-M-00
75	RG-6, RG-11, RG-12, RG-59 RG-144, RG-216		5.0-12.5 (.197-.500)	4.1-9.5 (.161-.375)	7.3 (.287)	2.45 (.100)	RTD-75-L-00

Users should independently evaluate the suitability of the product for their application.
Before ordering check with factory for most current data.

Coaxial Cable Termination

RF one-step BNC/TNC connectors (cont'd.)

Part number selection - TNC coaxial connectors (continued)

Cable type			Cable dimensions in millimeters (inches)				Part Number
Impedance (ohms)		Raychem cables	D (min.-max.)	E (min.-max.)	F (max.)	G (max.)	
TNC right-angle plugs, male contacts							
50	RG-174, RG-178, RG-188, RG-196, RG-316	5026A1311, 5028A1317, 5030A1317	1.5-5.5 (.060-.217)	0.9-3.0 (.035-.118)	1.55 (.060)	0.65 (.025)	RTD-50-S-01
50	RG-58, RG-141, RG-142, RG-303, RG-400	5019D3318, 5021D1331, 5020A1311	3.5-7.0 (.138-.276)	2.1-5.0 (.083-.197)	3.0 (.118)	1.25 (.050)	RTD-50-M-01
50	RG-165, RG-215, RG-213, RG-225, RG-214	5012F3332, 5012A3311	5.0-12.5 (.197-.500)	4.1-9.5 (.161-.375)	7.3 (.287)	2.45 (.100)	RTD-50-L-01
75	RG-179, RG-187	7530A1317	1.5-5.5 (.060-.217)	0.9-3.0 (.035-.118)	1.55 (.060)	0.65 (.025)	RTD-75-S-01
75		7524A1311, 7528A1317	3.5-7.0 (.138-.276)	2.1-5.0 (.083-.197)	3.7 (.146)	1.25 (.050)	RTD-75-M-01
75	RG-6, RG-11, RG-12, RG-59, RG-144, RG-216		5.0-12.5 (.197-.500)	4.1-9.5 (.161-.375)	7.3 (.287)	2.45 (.100)	RTD-75-L-01
TNC straight bulkhead jacks, female contacts							
50	RG-174, RG-178, RG-188, RG-196, RG-316	5026A1311, 5028A1317, 5030A1317	1.5-5.5 (.060-.217)	0.9-3.0 (.035-.118)	1.55 (.060)	0.65 (.025)	RTD-50-S-02
50	RG-58, RG-141, RG-142, RG-303, RG-400	5019D3318, 5021D1331, 5020A1311	3.5-7.0 (.138-.276)	2.1-5.0 (.083-.197)	3.0 (.118)	1.25 (.050)	RTD-50-M-02
50	RG-165, RG-215, RG-213, RG-225, RG-214	5012F3332, 5012A3311	5.0-12.5 (.197-.500)	4.1-9.5 (.161-.375)	7.3 (.287)	2.45 (.100)	RTD-50-L-02
75	RG-179, RG-187	7530A1317	1.5-5.5 (.060-.217)	0.9-3.0 (.035-.118)	1.55 (.060)	0.65 (.025)	RTD-75-S-02
75		7524A1311, 7528A1317	3.5-7.0 (.138-.276)	2.1-5.0 (.083-.197)	3.7 (.146)	1.25 (.050)	RTD-75-M-02
75	RG-6, RG-11, RG-12, RG-59, RG-144, RG-216		5.0-12.5 (.197-.500)	4.1-9.5 (.161-.375)	7.3 (.287)	2.45 (.100)	RTD-75-L-02

Fax-on-demand

US only (800) 260-9099

Outside US (650) 257-2301

Visit our website at www.tycoelectronics.com

Part number selection - TNC coaxial connectors

Cable type			Cable dimensions in millimeters (inches)				Part Number
Impedance (ohms)	RG cables	Raychem cables	D (min.-max.)	E (min.-max.)	F (max.)	G (max.)	
TNC straight jacks, Female contacts							
50	RG-174, RG-178, RG-188, RG-196, RG-316	5026A1311, 5028A1317, 5030A1317	1.5-5.5 (.060-.217)	0.9-3.0 (.035-.118)	1.55 (.060)	0.65 (.025)	RTD-50-S-03
50	RG-58, RG-141, RG-142, RG-303, RG-400	5019D3318, 5021D1331, 5020A1311	3.5-7.0 (.138-.276)	2.1-5.0 (.083-.197)	3.0 (.118)	1.25 (.050)	RTD-50-M-03
50	RG-165, RG-215, RG-213, RG-225, RG-214	5012F3332, 5012A3311	5.0-12.5 (.197-.500)	4.1-9.5 (.161-.375)	7.3 (.287)	2.45 (.100)	RTD-50-L-03
75	RG-179, RG-187	7530A1317	1.5-5.5 (.060-.217)	0.9-3.0 (.035-.118)	1.55 (.060)	0.65 (.025)	RTD-75-S-03
75		7524A1311, 7528A1317	3.5-7.0 (.138-.276)	2.1-5.0 (.083-.197)	3.7 (.146)	1.25 (.050)	RTD-75-M-03
75	RG-6, RG-11, RG-12, RG-59, RG-144, RG-216		5.0-12.5 (.197-.500)	4.1-9.5 (.161-.375)	7.3 (.287)	2.45 (.100)	RTD-75-L-03
TNC straight panel jacks, female contacts							
50	RG-174, RG-178, RG-188, RG-196, RG-316	5026A1311, 5028A1317, 5030A1317	1.5-5.5 (.060-.217)	0.9-3.0 (.035-.118)	1.55 (.060)	0.65 (.025)	RTD-50-S-04
50	RG-58, RG-141, RG-142, RG-303, RG-400	5019D3318, 5021D1331, 5020A1311	3.5-7.0 (.138-.276)	2.1-5.0 (.083-.197)	3.0 (.118)	1.25 (.050)	RTD-50-M-04
50	RG-165, RG-215, RG-213, RG-225, RG-214	5012F3332, 5012A3311	5.0-12.5 (.197-.500)	4.1-9.5 (.161-.375)	7.3 (.287)	2.45 (.100)	RTD-50-L-04
75	RG-179, RG-187	7530A1317	1.5-5.5 (.060-.217)	0.9-3.0 (.035-.118)	1.55 (.060)	0.65 (.025)	RTD-75-S-04
75		7524A1311, 7528A1317	3.5-7.0 (.138-.276)	2.1-5.0 (.083-.197)	3.7 (.146)	1.25 (.050)	RTD-75-M-04
75	RG-6, RG-11, RG-12, RG-59, RG-144, RG-216		5.0-12.5 (.197-.500)	4.1-9.5 (.161-.375)	7.3 (.287)	2.45 (.100)	RTD-75-L-04

Hole pattern for panel-mounted products (mm/in)

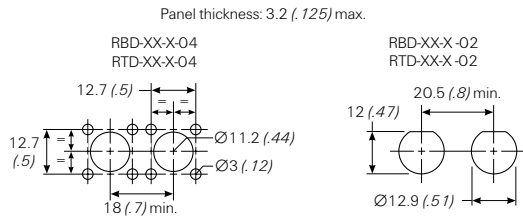

Users should independently evaluate the suitability of the product for their application. Before ordering check with factory for most current data.

Cable-to-Cable Splicing

Fax-on-demand

US only (800) 260-9099

Outside US (650) 257-2301

Visit our website at www.tycoelectronics.com



The question is, how to meet growing performance requirements for shielded cable system fabrication and maintenance while minimizing electromagnetic interference (EMI). The answer is Raychem SolderShield cable splices. SolderShield devices are one-piece products consisting of a flux-coated, solder-impregnated copper shield braid encased in a heat-shrinkable insulation sleeve.

SolderShield cable-to-cable splice kits, designed for single-conductor or multiconductor shielded cables, are ideal for fabrication/repair/rework while restoring the electrical integrity of the cable.

SolderShield devices perform even in demanding environments. They are reliable, versatile, and easy to install.



Cable-to-Cable Splicing

SolderShield shielded and coaxial cable splices



Applications

Used for splicing a wide range of cables, including coaxial and multiconductor cables.

SolderShield devices can be used to repair or splice shielded or coaxial cables. These products consist of a MiniSeal crimp splice plus a flux-coated, solder-impregnated copper shield encased in a heat-shrinkable sealing sleeve, for splicing the shields. SolderShield kits terminate single- or multiple-conductor cables, eliminate EMI problems at the splice, and provide strain relief for the cable.

Features and benefits

- Flux-coated, solder-impregnated copper shield braid encased in a transparent heat-shrinkable insulation sleeve provides a controlled soldering process, encapsulation, inspectability, strain relief, and insulation.
- One-piece design provides easy installation and lower installed cost.
- Circumferential (360°) shielding results in EMI protection and shield continuity equal to or better than the original cable.
- Conductor splices are made using Raychem MiniSeal crimp products, which are recognized by MIL-S-81824 and MIL-W-5088.

Product selection process

For splicing multiconductor cables refer to Table A. For splicing coaxial cables refer to Table B.

Installation

For proper installation of these devices, the correct heating tool and reflector attachment must be used. Any one of the following Raychem heating tools is recommended:

- HL1802E
- IR-1759 MiniRay
- CV-1981

The HT-900B heating tool is designed for use in field applications.

Refer to Raychem installation procedure RCPS 150-02 (D-150 series) and RPIP 699-00 (B-202 series) for detailed instructions and recommended reflector attachment.

You will find ordering information for most of these tools in the Application Equipment section (Section 10) of this catalog.

Available in:

Americas

Europe

Asia Pacific



Specifications/approvals

Series	Military	Raychem
D-150	US: M81824 (conductor splice only) UK: RAF AP 1130-2008-1	RT-1404

Soldershield splice

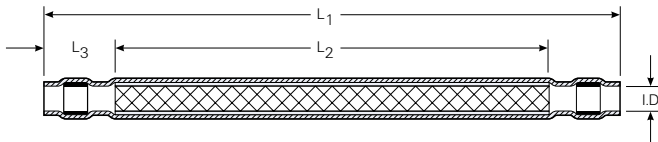

Crimp splice

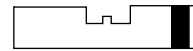

Each SolderShield part consists of a SolderShield splice and one or more conductor splices. Refer to information below for description and numbers of conductor splices.

Table A. Multiconductor cable splices

The SolderShield splice kits listed in this table are for 1:1 cable splices. The kits can be used on cables with tin-, silver-, and nickel-plated copper conductors. All the kits have environmental-sealing capability. The cable temperature rating must be 125°C minimum.

To find the splice kit part number for your application:

1. Determine the number of conductors in the cable to be spliced.
2. Determine the gauge of each conductor or the maximum jacket OD.
3. Determine the conductor plating.
4. Select the appropriate part number from the table below.

SolderShield product dimensions

Part number	Tin plated	Nickel plated	Dimensions (inches/millimeters)			ID min.	Conductor splice		Quantity per kit
			L ₁ max.	L ₂ nom.	L ₃ min.		Size range CMA (mm ²) min.-max.	Color code	
D-150-0168		D-150-0228	3.17 (80.5)	1.97 (50)	.400 (10.2)	.118 (3)	304-1510 (0.15-0.75)	Red	1
D-150-0169		D-150-0229	3.17 (80.5)	1.97 (50)	.400 (10.2)	.157 (4)	779-2680 (0.39-1.34)	Blue	1
D-150-0170		D-150-0230	3.17 (80.5)	1.97 (50)	.400 (10.2)	.197 (5)	1900-6755 (0.95-3.37)	Yellow	1
D-150-0174		D-150-0231	4.17 (10.6)	2.95 (75)	.400 (10.2)	.157 (4)	304-1510 (0.15-0.75)	Red	2
D-150-0175		D-150-0232	4.17 (10.6)	2.95 (75)	.400 (10.2)	.197 (5)	779-2680 (0.39-1.34)	Blue	2
D-150-0176		D-150-0233	4.17 (10.6)	2.95 (75)	.400 (10.2)	.236 (6)	1900-6755 (0.95-3.37)	Yellow	2
D-150-0177		D-150-0234	4.17 (10.6)	2.95 (75)	.400 (10.2)	.356 (9)	304-1510 (0.15-0.75)	Red	4
D-150-0178		D-150-0235	4.17 (10.6)	2.95 (75)	.400 (10.2)	.157 (4)	304-1510 (0.15-0.75)	Red	4
D-150-0179		D-150-0236	4.17 (10.6)	2.95 (75)	.400 (10.2)	.197 (5)	779-2680 (0.39-1.34)	Blue	4
D-150-0180		D-150-0237	4.17 (10.6)	2.95 (75)	.400 (10.2)	.236 (6)	1900-6755 (0.95-3.37)	Yellow	4
D-150-0181		D-150-0238	4.17 (10.6)	2.95 (75)	.400 (10.2)	.353 (9)	1900-6755 (0.95-3.37)	Yellow	4

Users should independently evaluate the suitability of the product for their application. Before ordering check with factory for most current data.

Cable-to-Cable Splicing

SolderShield shielded and coaxial cable splices (cont'd.)

Soldershield splice

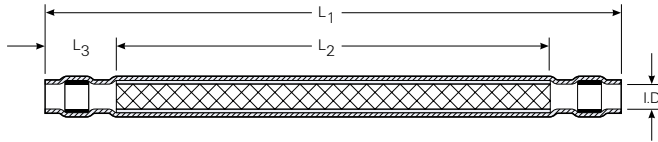

Crimp splice

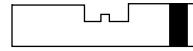

Each SolderShield part consists of a SolderShield splice and one or more conductor splices. Refer to information below for description and numbers of conductor splices.

Table B. Coaxial cable splices

All kits are for one-to-one coaxial cable splices, and all kits have environmental sealing capability. Each kit contains products to splice conductors, build up dielectric, splice the shield, and provide insulation.

RG cable number	Raychem cable description	Conductor splice qty/kit	Part number	SolderShield Dimensions		ID Min
				L ₁ max	L ₂ min	
8A, 9B, 11	5012A3311	1	D-150-0214	3.17	1.97	.472
13, 26, 31	5012E1339			(80.5)	(50)	(12)
115, 144, 149	7518A1311					
165, 213, 214						
216, 235, 391						
393, 397						
178, 196,	5028A1317	1	D-150-0094	3.17	1.97	.118
179, 187, 188,	7528A1317			(80.5)	(50)	(3)
316, 404, M17/138-00001,	5030A1317					
M17/136-00001	7530A1317					
180, 195	5024A1311	1	D-150-0095	3.17	1.97	.157
M17/137-00001	7526A1311			(80.5)	(50)	(4)
M17/139-00001	9527A1318					
	9530E1014					
124, 140, 141	5020A1311	1	D-150-0096	3.17	1.97	.236
159, 302, 303	5022A1311			(80.5)	(50)	(5)
	7522A1311					
	7523D1331					
	7524A1311					
29, 30, 55B	5019D3318	1	B-202-81*	2.2	.90	.275
58, 223	5021D1331			(56)	(23)	(7)
	5022A1311					
59, 62, 71	7523D1331	1	B-202-82*	2.2	.90	.275
	7524A1311			(56)	(23)	(7)
	9524A1311					

*These kits use solder to terminate the center conductors. All other kits use crimp.

Fax-on-demand

US only (800) 260-9099

Outside US (650) 257-2301

Fax ID

5700

Description

Data sheet

Visit our website at www.tycoelectronics.com**Product characteristics****Materials**

Insulation sleeve	Radiation-crosslinked polyvinylidene fluoride
Melttable inserts	Fluorocarbon-based thermoplastic
MiniSeal crimp splice	Base metal: Copper alloy C10200 per ASTM B75 Plating: Tin per MIL-T-10727 or nickel per QQ-N-290
SolderShield shield splice	Base metal: Tin-plated copper wire braid per ASTM B3 Solder and flux coating: Type Sn63 Pb37. Flux: ROM1 per ANSI - J - STD - 004 (RA flux)

Parameter**Test Method****Requirement****Electromechanical performance**

Dielectric strength (shield connection)		No breakdown or arcing at 1000 Vac (RMS)
Dielectric strength (conductor connection)		2.5 kV
Voltage drop	MIL-S-81824	Less than 2.0-millivolt increase
Insulation resistance (shield connection)		1000 megohms minimum at 500 Vdc
Insulation resistance (conductor connection)		5000 megohms
Tensile strength for MiniSeal	MIL-S-81824	Exceed yield strength (pounds) of wire.
Tensile strength for SolderShield	MIL-S-81824	75% of strength (pounds) of unspliced cable
Temperature rating		-55°C to 150°C

Environmental resistance

Salt spray	MIL-STD-202 M101	Meet voltage drop requirement.
Heat aging	750 hours at 150°C	Meet all electromechanical requirements.
Temperature cycling	MIL-STD-202 M107C	Meet all electromechanical requirements.
Altitude immersion	Immersion at 75,000 feet	Meet insulation-resistance requirement.
Corrosion resistance		No evidence of corrosion after testing in accordance with MIL-STD-202, Method 101, Test Condition A

Shielded Contacts

Fax-on-demand

US only (800) 260-9099

Outside US (650) 257-2301

Visit our website at www.tycoelectronics.com



Raychem SolderTacts shielded contacts are designed to provide reliable, one-piece solder terminations for use with circular and rectangular connectors. These controlled soldering contacts help speed installation and reduce installed costs while eliminating the variables associated with hard-to-handle crimped terminations.

With Tyco Electronics' controlled soldering technology, the connections typically exceed the strength of the wire. Transparent insulation and inspection windows permit fully inspectable terminations.

SolderTacts products are available to terminate coaxial cable and twisted wire pairs in both military and commercial applications.



Shielded Contacts

SolderTacts shielded one-piece solder contacts



Applications

One-piece controlled-soldering SolderTacts contacts connectors are designed to terminate coaxial cables, shielded wires, and twisted pairs faster and more reliably than any other method. SolderTacts contacts eliminate the variables associated with hard-to-handle crimping. Their one-step installation accelerates production while reducing handling and installed costs.

Controlled soldering

SolderTacts contacts provide the optimum amount and type of solder and flux in prefluxed solder preforms to control soldering and reduce operator sensitivity. The geometry of the coaxial cable is carried through the connector to eliminate separate pins, help reduce cross talk, and improve shielding effectiveness and signal transmission.

SolderTacts contacts provide simultaneous electrical connection and strain relief. Heat-shrinkable tubing insulations eliminate stress concentration on the wire within the contact. Because the insulation is transparent and inspection windows are provided, terminations are fully inspectable.

Compatibility

The design versatility of SolderTacts contacts makes them exceptionally well suited to military applications, along with commercial aerospace, instrumentation and computers. SolderTacts products are compatible with most standard connector cavities. SolderTacts contacts are intermateable and intermountable with contacts qualified to the indicated specification.

SolderTacts shielded contacts can be terminated with standard Raychem heating tools. Once terminated, they can be installed into connector cavities with standard insertion and extraction tools. They are replaceable without cutting and restripping or shortening the cable.

Features and benefits

- Reliable one-piece solder contacts: through-connector shielding reduces cross-talk, and improves signal transmission.
- One-step installation.
- Solder joints are strong and reliable.
- Terminations are fully inspectable.
- Termination for coax cables, shielded wires, twisted pairs, triaxial cables, for a variety of commercial and military connectors.

Available in:

Americas

Europe

Asia Pacific



Specifications/approvals

Series

Raychem

D-602

D-6002

Fax-on-demand

US only (800) 260-9099

Outside US (650) 257-2301

Visit our website at www.tycoelectronics.com

SolderTacts product construction, MIL-C-26482 Series

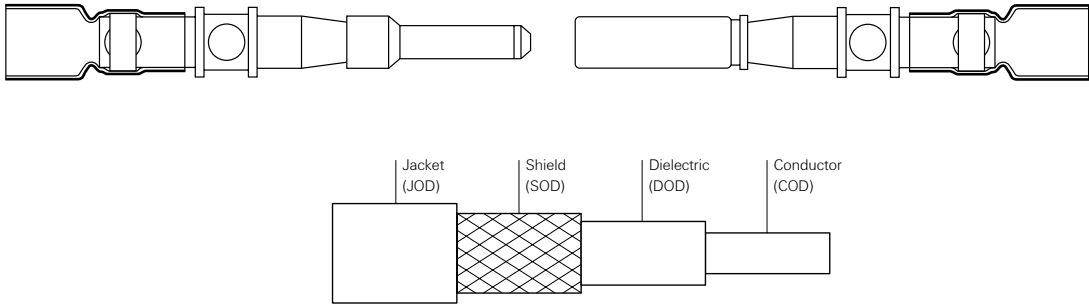

SolderTacts series: MIL-C-26482

Contact military specification	Cable diameter (in inches)				Wire (AWG)	Raychem SolderTacts			
	JOD	SOD	DOD	COD		part number	Size	Polarity	Cable type
MIS-20067/5-001†	.070-.185	.065-.110	.030-.080	.009-.020	24-32	D-602-16	12	S	Coaxial
MIS-20067/6-001†	.070-.185	.065-.110	.030-.080	.009-.020	24-32	D-602-17	12	P	Coaxial
	.060-.130	.066-.089	.036-.069	.012-.026	24-30	D-602-46	16	P	Coaxial
	.060-.130	.066-.084	.036-.069	.012-.026	26-32	D-602-47	16	S	Coaxial
			.030-.049	.011-.031	24-30	D-602-56	16	P	Twinax
		.030-.049	.011-.031	24-30	D-602-57	16	S	Twinax	

†These SolderTact contacts are on qualified parts list for indicated specification.

Tooling selection guide

Part numbers	Engineering standard (termination instructions)	Convection (hot air) heating AT-1319 adapter	Repair wand	IR1004 infrared semiautomatic heater tool set	Contact insertion tool	Contact removal tool
D-602-46/47	ES61137	AT-1319-17	*	*	AD-1525	AD-1526
D-602-56/57	ES61138				(M81969/17-04)	(M81969/19-08)
D-602-16/17	ES61161					

*Could be developed.

Users should independently evaluate the suitability of the product for their application. Before ordering check with factory for most current data.

Shielded Contacts

SolderTacts shielded one-piece solder contacts (cont'd.)

SolderTacts product construction, MIL-C-28748 Series

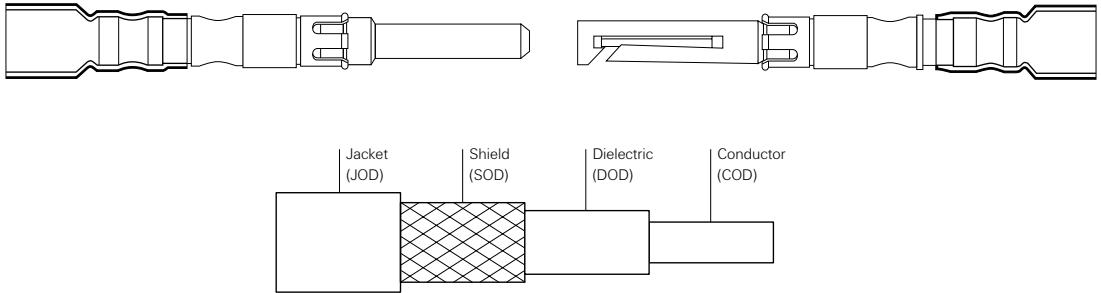

SolderTacts Series: MIL-C-28748 Series

Contact military specification	Cable diameter (in inches)				Wire (AWG)	Raychem SolderTacts			
	JOD	SOD	DOD	COD		part number	Size	Polarity	Cable type
MIS-20067/2-002 ^a	.060-.132	.066-.084	.036-.070	.009-.035	26-32	D-602-44	16	P	Coaxial
MIS-20067/1-001 ^a	.060-.132	.066-.084	.036-.070	.009-.035	26-32	D-602-45	16	S	Coaxial
MIS-20067/4-001 ^a	n/a	n/a	.030-.049	.011-.031	24-30	D-602-54	16	P	Twisted pair
MIS-20067/3-001 ^a	n/a	n/a	.030-.049	.011-.031	24-30	D-602-55	16	S	Twisted pair
M39029/79 ^b	.060-.130	.066-.084	.036-.066	.012-.026	26-32	D-602-72	16	P	Coaxial
M39029/80 ^b	.060-.130	.066-.084	.036-.066	.012-.026	26-32	D-602-73	16	S	Coaxial
M39029/40 ^b	.060-.130	.066-.084	.036-.066	.012-.026	26-32	D-602-76	16	P	Coaxial
M39029/41 ^b	.060-.130	.066-.084	.036-.066	.012-.026	26-32	D-602-77	16	S	Coaxial
			.030-.049	.011-.031	24-30	D-602-0126	16	P	Twisted pair ^c
			.030-.049	.011-.031	24-30	D-602-0127	16	S	Twisted pair ^c
	.060-.132	.066-.084	.036-.070	.009-.018	28-32	D-602-0172	16	P	Coaxial
MIS-20067/2-001,003 ^a	.060-.132	.066-.084	.036-.070	.009-.018	28-32	D-602-0173	16	S	Coaxial
MIS-20067/8-001 ^a			.055-.124	.025-.062	16-20	D-610-09	16	P	Power
MIS-20067/7-001 ^a			.055-.124	.025-.062	16-20	D-610-10	16	S	Power

^a These SolderTacts contacts are on the qualified parts list for indicated specification.

^b These SolderTacts contacts are intermateable and intermountable with contacts qualified to the indicated specification; they replace crimp-style termination.

^c These SolderTacts contacts are designed for twisted-pair cable per MIL-STD-1553B.

Fax-on-demand

US only (800) 260-9099

Outside US (650) 257-2301

Visit our website at www.tycoelectronics.com**Tooling selection guide: MIL-C-28748 Series**

SolderTacts series	Part numbers	Engineering standard (termination instructions)	Convection (hot air) heating AT-1319 adapter	Repair wand	IR1004 infrared semiautomatic heater tool set
748	D-602-44/45	ES61133	AT-1319-14	AD-1480	Tool Set #2
	D-602-0172/0173	ES61240			
	D-602-54/55	ES61132			
	D-602-0126/0127	ES61199			
	D-610-09/10	ES61187	AT-1319-15	AD-1571	Tool Set #10 (AT-1044-12)
	D-602-72/73	ES61135	AT-1319-18	AD-1486	Tool Set #5 (AT-1044-63)
	D-602-76/77	ES61164	AT-1319-20	AD-1554	Tool Set #6 (AT-1044-64)
SolderTacts series	Contact insertion tool	Contact removal tool	Special tools		
748	•	AD-1447	AD-1457A (bushing tool)	AD-1464 (flex tip removal tool)	AD-1496 (twisted pair cut-to- length tool)

*Not applicable.

Shielded Contacts

SolderTacts shielded one-piece solder contacts (cont'd.)

SolderTacts product construction, MIL-C-38999 Series

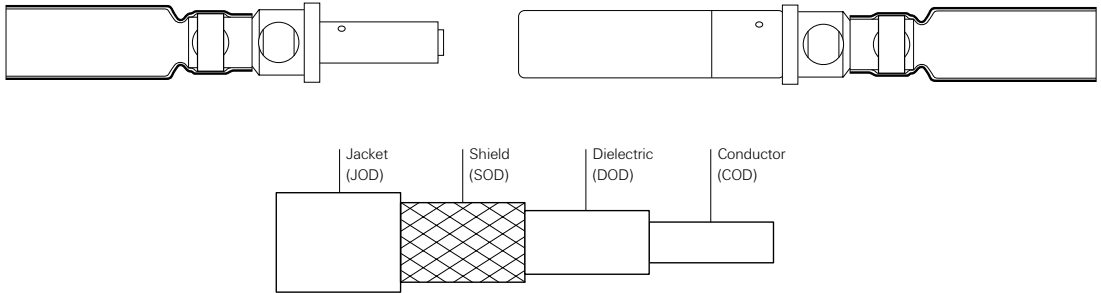

SolderTacts Series: MIL-C-38999, Series I, II, III, IV circular connectors

Contact military specification	United States Air Force drawing no.	Cable diameter (in inches)				Raychem		Size	Polarity	Cable type
		JOD	SOD	DOD	COD	Wire (AWG)	SolderTacts part number			
Series I, III, and IV										
M39029/60		.150-.234	.150-.170	.060-.151	.019-.043	22-24	D-602-0122	8	P	Coaxial
M39029/59		.150-.234	.150-.170	.060-.151	.019-.043	22-24	D-602-0123	8	S	Coaxial
M39029/76	915304-1	.050-.103	.066-.084	.036-.068	.009-.023	26-30	D-602-0140	16	P	Coaxial
M39029/77	915305-1	.050-.103	.066-.084	.036-.068	.009-.023	26-30	D-602-0141	16	S	Coaxial
M39029/76	915304-2	n/a	n/a	.025-.043	.009-.023	26-30	D-602-0142	16	P	Twisted pair
M39029/77	915305-2	n/a	n/a	.025-.043	.009-.023	26-30	D-602-0143	16	S	Twisted pair
M39029/28	915307-1	.058-.122	.066-.094	.044-.080	.019-.035	24-32	D-602-0144	12	P	Coaxial
M39029/75	915308-1	.058-.122	.066-.094	.044-.080	.019-.035	24-32	D-602-0145	12	S	Coaxial
M39029/28	915307-3	n/a	n/a	.029-.057	.019-.035	22-26	D-602-0146	12	P	Twisted pair
M39029/75	915308-3	n/a	n/a	.029-.057	.019-.035	22-26	D-602-0147	12	S	Twisted pair
M39029/28	915307-2	.075-.150	.100-.117	.050-.103	.019-.035	22, 28	D-602-0150	12	P	Coaxial
M39029/75	915308-2	.075-.150	.100-.117	.050-.103	.019-.035	22, 28	D-602-0151	12	S	Coaxial
	8340712-OS-01	.098-.135	.066-.120	.030-.049	.011-.031	24-26	D-602-1108	8	S	Twisted pair ^b
	8340713-OS-01	.098-.135	.066-.120	.030-.049	.011-.031	24-26	D-602-1109	8	P	Twisted pair ^b
		.098-.148	.066-.130	.036-.070	.009-.035	22-26	D-602-1110	8	S	Triaxial
		.098-.148	.066-.130	.036-.070	.009-.035	22-26	D-602-1111	8	P	Triaxial
	8340712-OL-01	.098-.135	.066-.120	.030-.049	.011-.031	24-26	D-602-1112	8	S	Twisted pair ^b
	8340713-OL-01	.098-.135	.066-.120	.030-.049	.011-.031	24-26	D-602-1113	8	P	Twisted pair ^b
M39029/90	8912020-OS-01	.145 max.		.029-.051	.011-.029	24-26	DK-602-0156-N-1	8	P	Twinaxial ^c
M39029/90	8912020-DL-01	.162 max.		.029-.051	.011-.029	24-26	DK-602-0156-N-2	8	P	Twinaxial ^c

Fax-on-demand

US only (800) 260-9099

Outside US (650) 257-2301

Visit our website at www.tycoelectronics.com

SolderTacts Series: MIL-C-38999, Series I, II, III, IV circular connectors (cont'd.)

Contact	United States					Raychem				
military specification	Air Force drawing no.	Cable diameter (in inches)				Wire (AWG)	SolderTacts part number	Size	Polarity	Cable type
		JOD	SOD	DOD	COD					
Series I, III, and IV										
M39029/90	8912020-EL-01	.177 max.		.029-.051	.011-.029	24-26	DK-602-0156-N3	8	P	Twinaxial ^c
M39029/91	8912019-OS-01	.145 max.		.029-.051	.011-.029	24-26	DK-602-0157-N1	8	S	Twinaxial ^c
M39029/91	8912019-DL-01	.162 max.		.029-.051	.011-.029	24-26	DK-602-0157-N2	8	S	Twinaxial ^c
M39029/91	8912019-EL-01	.177 max.		.029-.051	.011-.029	24-26	DK-602-0157-N3	8	S	Twinaxial ^c
M39029/90	8912020-OL-01	.184 max.				20	DK-602-0169-1	8	P	Twinaxial ^c
M39029/91	8912019-OL-01	.184 max. 2				20	DK-602-0170-1	8	S	Twinaxial ^c
Series II										
M39029/76	915304-1	.050-.103	.066-.084	.036-.068	.009-.023	26-30	D-602-0140	16	P	Coaxial
M39029/77	915306-1	.050-.103	.066-.084	.036-.068	.009-.023	26-30	D-602-0171	16	S	Coaxial
M39029/76	915304-2	n/a	n/a	.025-.043	.009-.023	26-30	D-602-0142	16	P	Twisted pair
M39029/77	915306-2			.025-.042	.009-.023	26-30	D-602-0174	16	S	Twisted pair

a These SolderTacts contacts are interchangeable and intermountable with contacts qualified to indicated specification; they replace crimp-style termination.

b These SolderTacts contacts are designed for shielded twisted pair cable per MIL-STD-1553B.

c These SolderTacts contacts are designed for databus contacts per Mil-STD-1553B.

SolderTacts Series: MIL-C-38999 (cont'd.)

Tooling selection guide

SolderTacts series	Part numbers (D-602-)	Engineering standard (termination instructions)	Convection (hot air) heating AT-1319 adapter	Repair wand	IR1004 infrared semiautomatic heater tool set	Contact insertion tool	Contact removal tool*
999 Size 16	0140/0141	ES61226	AT-1319-78	AD-1565	AT-1044-70 (P)	M81969/8-07	M81869/8-08
	0142/0143	ES61224			AT-1044-69 (S)	or	or
	0171	ES61226	AT-1319-27	AD-1572		M81969/14-03	M81969/14-03
	0174	ES61224					
999 Size 12	0144/0145	ES61206	AT-1319-24	AD-1566	AT-1044-72 (P)	M81969/8-09	M81969/8-10
	0146/0147	ES61218			AT-1044-71 (S)	or	or
	0150/0151	ES61223				M81969/14-04	M81969/14-04
999 Size 8	0122/0123	ES61179	AT-1319-22	AD-1568			M81969/14-06
	1108/1109	ES61172	AT-1319-22	AD-1568			or
	1110/1111	ES61172	and	and			Astro ATBX-2277
	1112/1113	ES61184	AT-1319-14	AD-1480			
	0156/0157-X	ES61231					
	0169/0170-X	ES61235					

*Tyco Electronics does not provide this tool. See connector manufacturer.

Users should independently evaluate the suitability of the product for their application. Before ordering check with factory for most current data.

Shielded Contacts

SolderTacts shielded one-piece solder contacts (cont'd.)

SolderTacts product construction, Submin Series

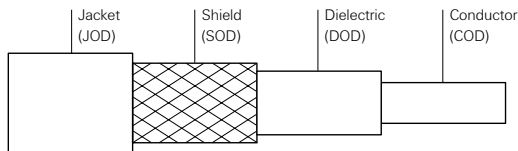
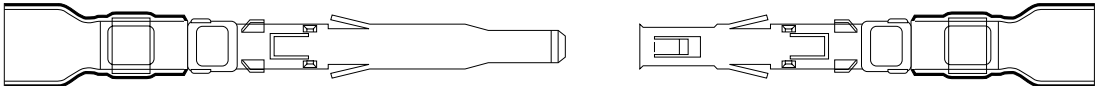

SolderTacts Series: Subminiature*

Raychem Cable diameter (in inches)				Wire				
SolderTacts	Size	Polarity	Cable type	JOD	SOD	DOD	COD	(AWG)
D-602-0278	16	P	Coaxial	.060-.115	.073-.086	.025-.075	.009-.029	24-32
D-602-0279	16	S	Coaxial	.060-.115	.073-.086	.025-.075	.009-.029	24-32
D-602-0288	16	P	Twisted pair			.029-.055	.009-.029	24-32
D-602-0289	16	S	Twisted pair			.029-.055	.009-.029	24-32

* These SolderTacts contacts belong to the Raychem "Subminiature" series of contacts, which are designed for use in commercial connectors.

Tooling selection guide

SolderTacts series	Part numbers (D-602-)	Engineering standard (termination instructions)	Convection (hot air) heating AT-13 19 adapter	Repair AD-1481 wand	IR1004 infrared semiautomatic heater tool set	Contact insertion tool	Contact removal tool	Special tools
Submin	0278/0279 0288/0289	ES61170 ES61169	AT-1319-12	AD-1481	ToolSet #9 (AT-1044-11)	*	AD-1503	AA-400-140 (magnifier)

*Not applicable.

Fax-on-demand

US only (800) 260-9099

Outside US (650) 257-2301

Visit our website at www.tycoelectronics.com**SolderTacts Series: MIL-C-83723**

Contact

military specification*	Cable diameter (in inches)				Wire (AWG)	Raychem				
	JOD	SOD	DOD	COD		SolderTacts	Size	Polarity	Cable type	
M39029/74-400	.094-.140	.077-.098	.052-.081	.011-.029	24-32	D-602-0094	12	P	Coaxial	
M39029/73-397	.094-.140	.077-.098	.052-.081	.011-.029	24-32	D-602-0095	12	S	Coaxial	
M39029/74-401			.029-.057	.011-.029	24-32	D-602-0104	12	P	Twisted pair	
M39029/73-398			.029-.057	.011-.029	24-32	D-602-0105	12	S	Twisted pair	
M39029/74-399	.120-.145	.122-.124	.093-.105	.011-.029	24-32	D-602-0106	12	P	Large coaxial	
M39029/73-396	.120-.145	.112-.124	.093-.105	.011-.029	24-32	D-602-0107	12	S	Large coaxial	

* These SolderTact contacts are on qualified parts list for indicated specification.

Tooling selection guide

Raychem SolderTacts part number	Engineering standard (termination instructions)	Convection (hot air) heating AT-1319 adapter	Repair wand	IR1004 infrared semiautomatic heater tool set	Contact insertion tool	Contact removal tool	Special tools
D-602-0094/0095	ES61128	AT-1319-19	AD-1494	AT-1044-67 (P)	AD-1527	AD-1527	AD-1496
D-602-0106/0107	ES61134	Rev. D	Rev. C	AT-1044-68 (S)	(M81969/14-04)	(M81969/14-04)	(twisted)
D-602-0104/0105	ES61129						

SolderTacts Series: DOD-C-83527

Raychem SolderTacts reference	Size	Polarity	Cable type	Contact military specification
D-602-0185	16	socket	Coaxial	
D-602-0094	12	pin	Coaxial	M39029/74
D-602-0093	12	socket	Coaxial	M39029/73
D-602-0106	12	pin	Coax (large)	M39029/74
D-602-0189	12	socket	Coax (large)	M39029/73

SolderTacts Series: DOD-C-83527 (data bus contacts)*

Raychem SolderTacts reference	Size	Polarity	Cable type	Contact military specification
D-602-0186	8	pin	Twisted pair	M39029/96
D-602-0187	8	socket	Twisted pair	M39029/95
DK-602-0186-2	8	pin	Sh. twisted pair	M39029/96
DK-602-0187-2	8	socket	Sh. twisted pair	M39029/95

* These SolderTact contacts are on designed for shielded twisted pair cable per MIL-STD-1553B.

Users should independently evaluate the suitability of the product for their application.
Before ordering check with factory for most current data.

Shielded Contacts

SolderTacts shielded one-piece solder contacts (cont'd.)

SolderTacts Series: Grommets

Raychem SolderTacts reference	Size	Polarity	Cable type	Contact military specification
D-600-0071				
			For shielded twisted pair	
D-600-0116				
	For size 8 DOD-C-83527 series			
D-600-0125				
	For size 8 MIL-C-38999 series, for twisted pair			

Performance

The performance of SolderTacts contacts is defined by the applicable Raychem specification control drawing (SCD) and Raychem Specification D-6002. Products on qualified product lists meet the requirements of the base specification.

Termination

Termination of SolderTacts contacts is defined in the appropriate Raychem Engineering Standard. To obtain a copy, contact your Tyco Electronics product representative.

Data Bus (MIL-STD-1553B) Components

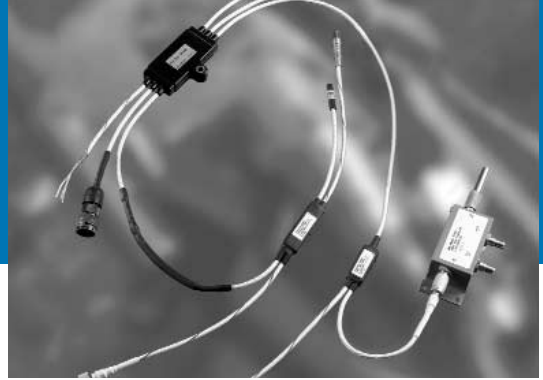

The full line of Raychem data bus products offers a complete system of interconnection hardware for all MIL-STD-1553B multiplexing needs.

Available components include:

- Couplers (micros, boxes, flat packs).
- Data bus cables.
- Triax connectors and contacts with strain relief.
- One-piece triaxial contacts for MIL-C-38999 connectors (size 8 cavity).
- Bus and stub terminators.
- Cable marker sleeves (TMS).
- Lightweight couplers (see page 8-92).
- Space components (see page 8-103).
- Harness design (*HarnWare*).

All Raychem data bus components offer:

- High packaging density and weight savings.
- Design flexibility.
- High performance (to 150°C rating).

Raychem MIL-STD-1553B data bus components are also specified in the Air Force drawings listed in Air Force Drawing 8340707.

Tyco Electronics also supplies complete Raychem data bus networks in accordance with customer harness drawings. Using factory-built harnesses eliminates unnecessary splices and connectors, reducing the cost and increasing the reliability of the networks. Factory-built harnesses are pre-tested and ready for installation.

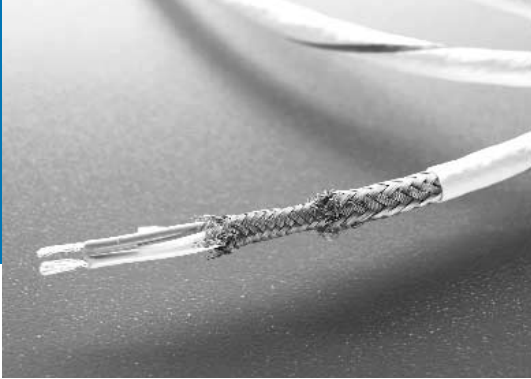

Data Bus (MIL-STD-1553B) Components

Cables



Applications

Tyco Electronics manufactures a line of Raychem SPEC 55 data bus cables that meet or exceed the performance requirements of MIL-STD-1553B. SPEC 55 insulation is a high-temperature, radiation-crosslinked, modified ETFE material that can be used in wire constructions rated up to 200°C.

Features and benefits

- Light weight.
- Highly flexible.
- Flame resistant.
- Chemical resistant to all aircraft fluids.
- Solder iron resistant.
- Defined shielding levels.

Note:

Tyco Electronics will build harnesses with any customer - specified cables and/or connectors.

Fax-on-demand

US only (800) 260-9099

Outside US (650) 257-2301





Fax ID

9040

DescriptionCables and
markers bulletinVisit our website at www.tycoelectronics.com**Specifications/approvals**

Series	Military
SPEC 55 insulation	MIL-W-22759/32-~/35
	MIL-W-22759/41-~/46

Product selection

Cable type		Part number
24 AWG single optimized shield		10612
24 AWG double optimized shield		10613
24 AWG EMP hardened		10614
24 AWG flat shield, unfilled		7724 E 2664



Data Bus (MIL-STD-1553B) Components

In-line microcouplers: one- and two stub



Applications

The low-profile configuration of these couplers enables avionics system designers to plan for optimum coupler locations. Microcouplers are supplied with Raychem SPEC 55 data bus cables, including EMP-hardened versions. They are also available assembled with other components into a complete data bus harness.

Features and benefits

- Environmental sealing.
- No connectors.
- Very small size.
- Light weight (1 stub: 10 g max.; 2 stubs: 15 g max.).
- In-line profile that makes wire bundle mounting possible.
- 360° continuous low-impedance cable-shield terminations.
- Reliable solder termination of all components.
- Potted circuit elements for maximum durability and in-use reliability.
- Ease of installation.
- Altitude immersion resistance.
- Optional eyelet configurations for bulkhead mounting.
- Mean time between failures > 1,000,000 hours.

Available in:

Americas

Europe

Asia Pacific



Specifications/approvals

Series

Military

Raychem

D-500-04

MIL-STD-1553B

D-6020

Fax-on-demand

US only (800) 260-9099

Outside US (650) 257-2301

Fax ID

8070 Microcoupler

bulletin

8080 System bulletin

Visit our website at www.tycoelectronics.com**Product selection**

Single stub

Double stub

D-500-0455-1-YYY-ZZZ



D-500-0455-2-YYY-ZZZ



D-500-0465-1-YYY-ZZZ

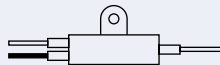

D-500-0465-2-YYY-ZZZ

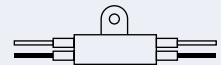

D-500-0456-1-YYY-ZZZ



D-500-0456-2-YYY-ZZZ



D-500-0466-1-YYY-ZZZ

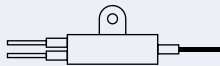

D-500-0466-2-YYY-ZZZ

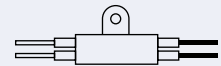

D-500-0457-1-YYY-ZZZ



D-500-0457-2-YYY-ZZZ



D-500-0467-1-YYY-ZZZ

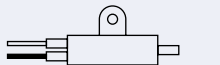

D-500-0467-2-YYY-ZZZ

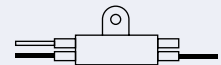

D-500-0458-1-YYY-ZZZ



D-500-0458-2-YYY-ZZZ



D-500-0468-1-YYY-ZZZ

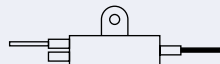

D-500-0468-2-YYY-ZZZ

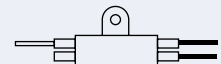

Note:

1. Bus cable

2. Stub cable

Data Bus (MIL-STD-1553B) Components

In-line microcouplers: one- and two-stub (cont'd.)

Microcoupler part numbering system

D-500-04W W-X-YYY-ZZZ

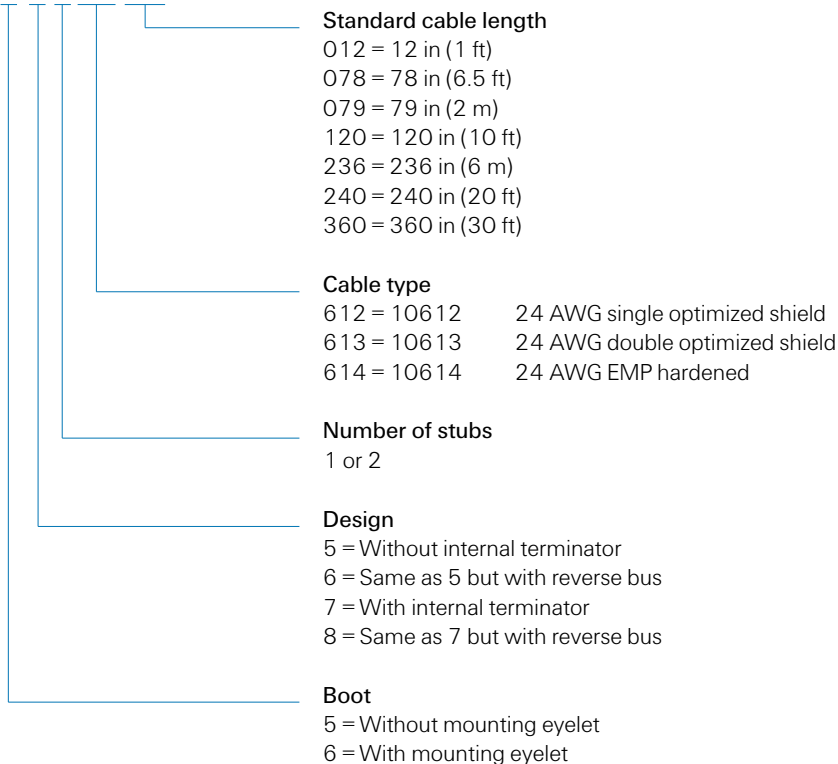

Fax-on-demand

US only (800) 260-9099
Outside US (650) 257-2301

Fax ID

8070
8080

Description

Microcoupler
bulletin
System bulletin

Visit our website at www.tycoelectronics.com

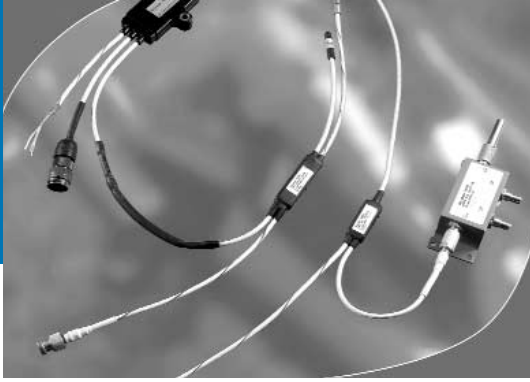

Data Bus (MIL-STD-1553B)

Ultra lightweight in-line microcouplers
1- through 6-stub



Applications

Building on over 20 years of experience and continuous improvement in data bus, including pioneering in-line microcouplers, Tyco Electronics introduces a new family of ultra light weight In-line Raychem Microcouplers, available in 1- through 6-stub configurations.

These couplers offer the same high performance and reliability as Raychem current microcouplers, but their weight is further reduced. They are available in configurations up to 6-stub, and minimize weight there is no option with a mounting eyelet.

Combined with Raychem 24AWG data bus cables, these ultra light couplers allow designers to significantly reduce weight. An unfilled flat braid cable is available for additional weight savings.

They are also available assembled with other customer specified components into a complete factory-built and tested data bus harness.

Features and benefits

- Environmental sealing.
- No connectors.
- Very small size.
- Ultra Light weight (1 stub: 6.5 g max.; 2 stubs: 9.5 g max.).
- In-line profile that makes wire bundle mounting possible.
- 360° continuous low-impedance cable-shield terminations.
- Reliable solder termination of all components.
- Potted circuit elements for maximum durability and in-use reliability.
- Ease of installation.
- Altitude immersion resistance.
- Optional eyelet configurations for bulkhead mounting.
- Mean time between failures > 1,000,000 hours.

Available in:

Americas

Europe

Asia Pacific



Specifications/approvals

Series	Military	Raychem
D-500-L4xx	MIL-STD-1553B	D-6020 (same as current microcouplers)

Lightweight in-line couplers - part numbering system

D-500-L4 5 W -X -YYY -ZZZ

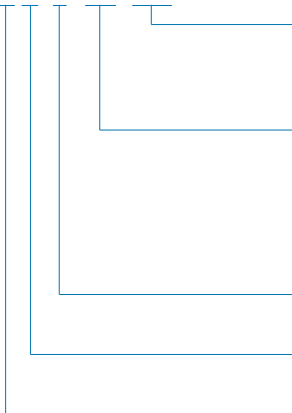

Cable length

012 = 12 in	079 = 79 in	236 = 236 in
078 = 78 in	120 = 120 in	240 = 240 in
		360 = 360 in

Cable type

612 = 10612	(24 AWG single optimized shield)
613 = 10613	(24 AWG double optimized shield)
614 = 10614	(24 AWG EMP hardened)
E26 = 7724E2664	(24 AWG flat shield, unfilled)
Lightest cable	

Number of stubs

1, 2, 3, 4, 5 or 6

Design

5 = Without internal terminator 7 = With internal terminator

Style

5 = Without eyelet

Fax-on-demand

US only (800) 260-9099

Outside US (650) 257-2301













Visit our website at www.tycoelectronics.com

Product selection

D-500-L455-X-YYY-ZZZ

End view
Left side













End view
Right side

	1 stub	
	2 stub	
	3 stub	
	4 stub	
	5 stub	
	6 stub	

D-500-L456-X-YYY-ZZZ

End view
Left side













End view
Right side

	1 stub	
	2 stub	
	3 stub	
	4 stub	
	5 stub	
	6 stub	

D-500-L457-X-YYY-ZZZ

End view
Left side













End view
Right side

	1 stub	
	2 stub	
	3 stub	
	4 stub	
	5 stub	
	6 stub	

D-500-L458-X-YYY-ZZZ

End view
Left side

End view
Right side

	1 stub	
	2 stub	
	3 stub	
	4 stub	
	5 stub	
	6 stub	

Legend
 Bus cable ○
 Stub cable ●

Users should independently evaluate the suitability of the product for their application.
 Before ordering check with factory for most current data.



Data Bus (MIL-STD-1553B) Components

Box couplers



Applications

The multiport capability of these couplers (up to eight stubs) enables avionics system designers to interconnect black boxes with minimum wire runs. Box couplers are supplied with Raychem triaxial threaded or bayonet connectors.

Features and benefits

- Light, robust coupler modules with connector versatility.
- Up to eight stub connectors can be arrayed on the “face” of the box coupler. Bus connectors can also be on the “face” or on the “side” of the box.
- Designed with Raychem D-621 series corrosion-resistant threaded-type or bayonet-type connectors.

Note: Tyco Electronics also designs and manufactures customized Raychem data bus box couplers.

Available in:

Americas

Europe

Asia Pacific



Specifications/approvals

Series	Military	Raychem
D-500-0255	MIL-STD-1553	D-6021

Fax-on-demand

US only (800) 260-9099

Outside US (650) 257-2301

Fax ID

8090

Description

Product bulletin

Visit our website at www.tycoelectronics.com**Product selection**

Coupler type	Part number			
	Threaded	Bayonet A*	Bayonet B*	Bayonet C*
Face - 1 Stub	D-500-0255-511-1	D-500-0255-513-1	D-500-0255-515-1	D-500-0255-517-1
Face - 2 Stub	D-500-0255-521-1	D-500-0255-523-1	D-500-0255-525-1	D-500-0255-527-1
Face - 3 Stub	D-500-0255-531-1	D-500-0255-533-1	D-500-0255-535-1	D-500-0255-537-1
Face - 4 Stub	D-500-0255-541-1	D-500-0255-543-1	D-500-0255-545-1	D-500-0255-547-1
Face - 5 Stub	D-500-0255-551-1	D-500-0255-553-1	D-500-0255-555-1	D-500-0255-557-1
Face - 6 Stub	D-500-0255-561-1	D-500-0255-563-1	D-500-0255-565-1	D-500-0255-567-1
Face - 7 Stub	D-500-0255-571-1	D-500-0255-573-1	D-500-0255-575-1	D-500-0255-577-1
Face - 8 Stub	D-500-0255-581-1	D-500-0255-583-1	D-500-0255-585-1	D-500-0255-587-1
Side - 1 Stub	D-500-0255-512-1	D-500-0255-513-2	D-500-0255-515-2	D-500-0255-517-2
Side - 2 Stub	D-500-0255-522-1	D-500-0255-523-2	D-500-0255-525-2	D-500-0255-527-2
Side - 3 Stub	D-500-0255-532-1	D-500-0255-533-2	D-500-0255-535-2	D-500-0255-537-2
Side - 4 Stub	D-500-0255-542-1	D-500-0255-543-2	D-500-0255-545-2	D-500-0255-547-2
Side - 5 Stub	D-500-0255-552-1	D-500-0255-553-2	D-500-0255-555-2	D-500-0255-557-2
Side - 6 Stub	D-500-0255-562-1	D-500-0255-563-2	D-500-0255-565-2	D-500-0255-567-2
Side - 7 Stub	D-500-0255-572-1	D-500-0255-573-2	D-500-0255-575-2	D-500-0255-577-2
Side - 8 Stub	D-500-0255-582-1	D-500-0255-583-2	D-500-0255-585-2	D-500-0255-587-2

*The bayonet polarization listed is for the bus connector. All stub connectors are Bayonet D polarization. Polarizations are depicted as follows (jack view):

1 = A



2 = B



3 = C



4 = D





Data Bus (MIL-STD-1553B) Components

Discrete connectors



Applications

Designed specifically for MIL-STD-1553B data bus applications, the D-621 connector is intended to be a perfect match for the Raychem airworthy data bus cable. Together they provide durable, reliable, and reworkable interconnection hardware for the MIL-STD-1553B market.

Features and benefits

- Compliance with MIL-STD-1553B hardware requirements.
- Light weight.
- Removable pin or socket contacts.
- Termination with Raychem MIL-STD-1553B data bus cables, including EMP-hardened versions.
- Continuous 360° shield coverage.
- Rugged constructions.
- Termination time of 1 to 2 minutes.
- Inspectable solder terminations.
- Low-skill assembly.
- Reworkable and repairable terminations.
- Strain relief built into the design.
- Low-voltage drop and high reliability because of precisely controlled solder terminations.
- Threaded coupling, with safety wire holes and bayonet coupling styles.
- Low total installed cost.
- 1000-hour salt spray resistance.
- Lower-cost connectors, for benchtop and mock-up.

Available in:

Americas

Europe

Asia Pacific



Specifications/approvals

Series	Military	Raychem
DK-621	MIL-STD-1553B	D-6025

Fax-on-demand

US only (800) 260-9099
Outside US (650) 257-2301

Fax ID

9010

Description

Connectors
bulletin

Visit our website at www.tycoelectronics.com

Connector kit part numbering system

DK-621-04 XX-XX

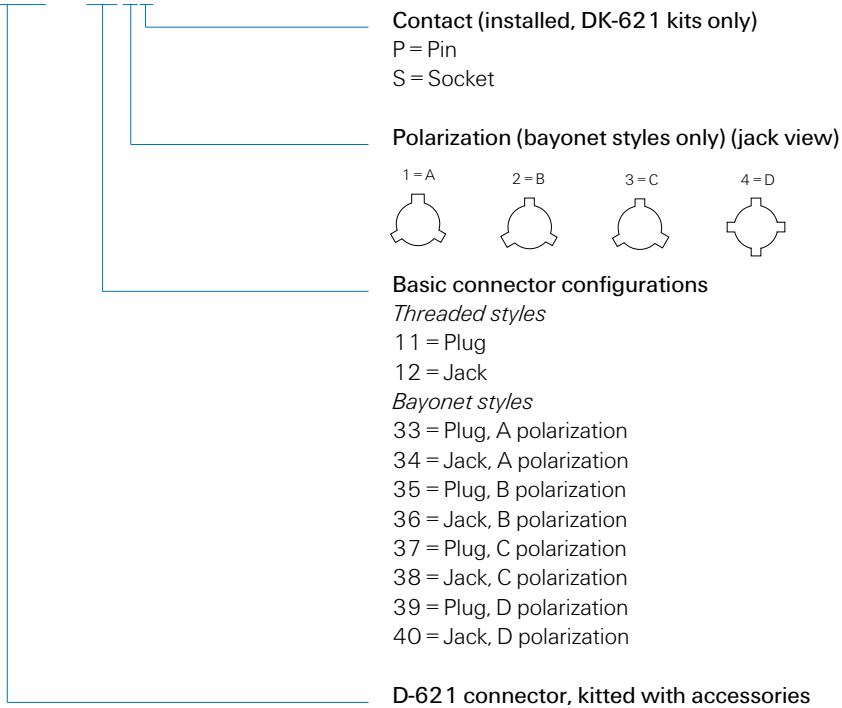

Example:

DK-621-0434-1P = D-621 connector, kitted with accessories, jack bayonet style with A polarization and pin contact.



Data Bus (MIL-STD-1553B) Components

Triaxial size 8 contacts



Applications

Contacts provide full shield coverage with a simple, quick, and reliable termination system. AWG 24 twisted-pair data bus cables are terminated with triaxial SolderTacts contacts, which fit size 8 cavities of MIL-C-38999, Series 1, 3, or 4 connectors.

Raychem size 8 triaxial data bus contacts for MIL-C-38999 connectors have interfaces that comply with MIL-C-39029/90 and /91 to provide ease of termination, and intermateability with more cumbersome crimp contacts.

These contacts provide a fast and convenient method of implementing MIL-STD-1553B connections in MIL-STD-1760 applications.

Features and benefits

- One-step termination.
- Termination time of 1 to 2 minutes.
- No requirements for special termination tools.
- No requirements for special skills.
- Reworkable and repairable terminations.
- Strain relief.
- Continuous 360° shield coverage.
- Triaxial mating face for least susceptibility to damage.
- Rugged construction, because only two parts are being soldered together.
- Inspectable solder terminations.
- Low voltage drop and high reliability due to precisely controlled solder termination.

Available in:

Americas

Europe

Asia Pacific



Fax-on-demand

US only (800) 260-9099

Outside US (650) 257-2301

Fax ID

9020

DescriptionCoaxial contacts
bulletin**Visit our website at www.tycoelectronics.com****Specifications/approvals**

Series	Raychem
Size 8	D-6002

Product selection

Cable type	Pin	Socket
10612	DK-602-0156-N-1	DK-602-0157-N-1
10613	DK-602-0156-N-2	DK-602-0157-N-2
10614	DK-602-0156-N-3	DK-602-0157-N-3

*This product follows Data Bus Discrete Connectors per MIL-Std-1553B.



Data Bus (MIL-STD-1553B) Components

Space-grade data bus components



Applications

Tyco Electronics full line of Raychem data bus products includes space-grade couplers, terminators, triaxial connectors, and SolderShield splices. These space-grade components meet the low outgassing requirements of NASA specification SP-R-0022A and can be used in outer-space applications.

Raychem space-grade components are designed in a variety of configurations and are currently available either as discrete items or as Raychem-assembled harnesses. Using factory-built harnesses eliminates unnecessary splices and connectors, reducing the cost and increasing the reliability of the networks.

Specification control drawings describe the design features and performance characteristics of Raychem space-grade couplers, terminators, connectors, and splices. The space-grade data bus couplers, terminators, and connectors have tin/nickel-plated metallic parts and baked silicone rubber components. For strain relief they include Raychem RT-218 low-outgassing tubing. Unlike parts intended for aircraft applications, these components do not have polymeric environmental covers.

The table on the next page lists Raychem standard space-grade data bus components with their part numbers and descriptions. New components will become available per customer request.

Features and benefits

- Complete line of space-qualified MIL-STD-1553B components.
- Low outgassing levels that meet NASA requirements.
- Light weight.
- Rugged construction.

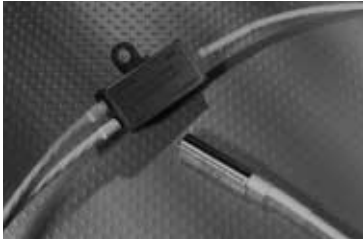

Figure 1. In-line couplers and terminators



Figure 2. Threaded triaxial connectors



Figure 3. Bayonet triaxial connectors



Figure 4. Splice kit

Fax-on-demand

US only (800) 260-9099
 Outside US (650) 257-2301

Fax ID

8065

Description

Data sheet

Visit our website at www.tycoelectronics.com

Available in:

Americas

Europe

Asia Pacific

Specifications/approvals

Series	Raychem
Space-grade databus components	D-6022

Space-grade in-line coupler - part numbering system

D-500-94 W W -X -YYY -ZZZ

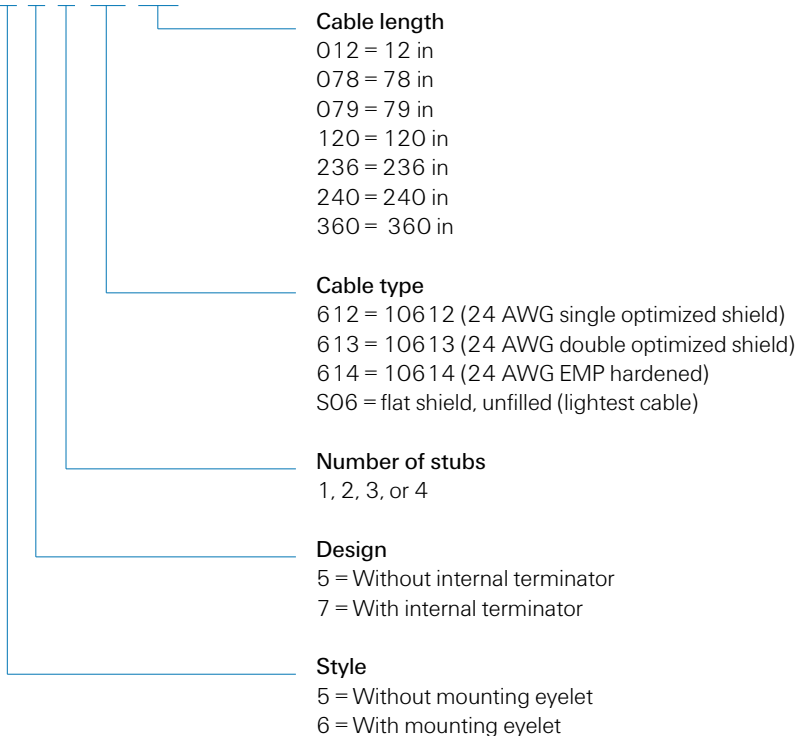

Data Bus (MIL-STD-1553B) Components

Space-grade data bus components (cont'd.)

Space-grade connectors - part numbering system

DK-621 -09 XX -X X

Contact (installed, DK-621 kits only)

P = Pin*

S = Socket*

*May be ordered separately as D-602-0126 (pin)
and D-602-0127 socket

Polarization (bayonet styles only) (jack view)

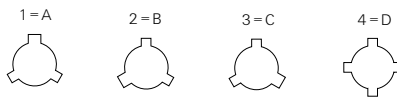

Basic connector configurations

Threaded styles:

11 = Plug

12 = Jack

Bayonet styles:

33 = Plug, A polarization

33 = Jack, A polarization

35 = Plug, B polarization

36 = Jack, B polarization

37 = Plug, C polarization

38 = Jack, C polarization

39 = Plug, D polarization

40 = Jack, D polarization

D-621 connector, kitted with accessories

Fax-on-demand

US only (800) 260-9099
Outside US (650) 257-2301

Fax ID

8065

Description

Data sheet

Visit our website at www.tycoelectronics.com

Space-grade terminators - part numbering system**D-500-9463- ZZZ****Cable type**

612 = 10612 (24 AWG single optimized shield)

613 = 10613 (24 AWG double optimized shield)

614 = 10614 (24 AWG EMP hardened)

S06 = flat shield, unfilled (lightest cable)

Space-grade splice kit = D-150-9708-5

Data Bus (MIL-STD-1553B) Components

*Customer-specified harness assemblies
and HarnWare*



Tyco Electronics supplies complete Raychem data bus networks in accordance with customer harness drawings, with any customer-specified cables and/or connectors. Using factory-built harnesses eliminates unnecessary splices and connectors, reducing the cost and increasing the reliability of the networks. Factory-built harnesses are pre-tested and ready for installation.

HarnWare - harness design software - allows designers to draw a data bus harness in a matter of minutes, while selecting Raychem or others' components; a bill of materials is automatically generated.

Available in:

Americas

Europe

Asia Pacific



Fax-on-demand

US only (800) 260-9099

Outside US (650) 257-2301

Visit our website at www.tycoelectronics.com

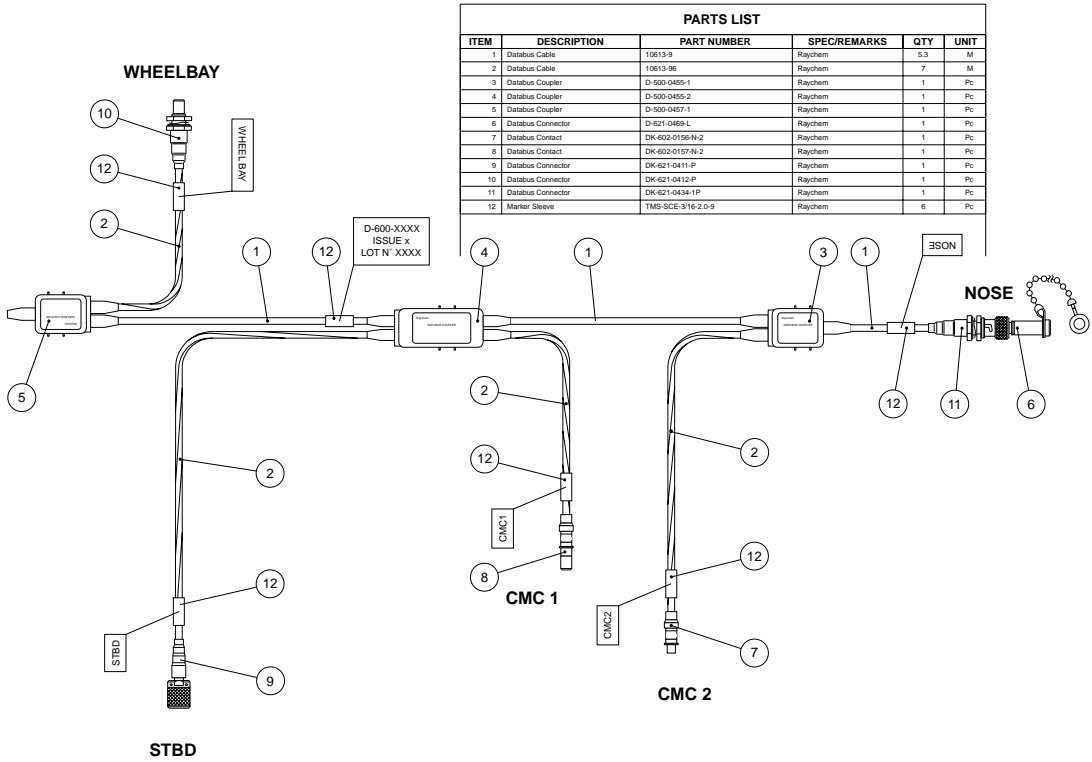

Users should independently evaluate the suitability of the product for their application.
Before ordering check with factory for most current data.



Data Bus (MIL-STD-1553B) Components

Accessories



Applications

Tyco Electronics manufactures all the products needed to build a MIL-STD-1553B data bus network. In addition to the main components (couplers, connectors, contacts, and cables), Tyco Electronics supplies the accessory components that may be necessary to complete a data bus system.

These include:

- Bus and stub terminators (spliced-in and connectorized D-621 series).
- Cable splice kits.
- EMI/environment-resistant connector caps.
- Braid terminators and strain relief tubing (for rework applications).



Features and benefits

- A single source for all harness components.
- Products designed to work together.



Available in:

Americas

Europe

Asia Pacific



Fax-on-demand

US only (800) 260-9099

Outside US (650) 257-2301

Fax ID

9030

Description

Accessories

bulletin

Visit our website at www.tycoelectronics.com**Product selection**

Splice-in



D-621 plug



D-621 jack

Bus and stub terminators**Spliced-in****12-inch cable**

77-ohm 10612 cable	D-500-0463-612
77-ohm 10613 cable	D-500-0463-613
77-ohm 10614 cable	D-500-0463-614
77-ohm 7724E2664 cable	D-500-0463-E26

**D-621 Series—plug****Threaded****Bayonet A****Bayonet B****Bayonet C****Bayonet D**

77-ohm pin contact	D-621-0413	D-621-0453	D-621-0454	D-621-0455	D-621-0456
77-ohm socket contact	D-621-0415	D-621-0469	D-621-0470	D-621-0471	D-621-0472
3000-ohm pin contact	D-621-0417	D-621-0457	D-621-0458	D-621-0459	D-621-0476
3000-ohm socket contact	D-621-0407	D-621-0473	D-621-0474	D-621-0475	D-621-0460

D-621 Series—jack**Threaded****Bayonet A****Bayonet B****Bayonet C****Bayonet D**

77-ohm pin contact	D-621-0418	D-621-0477	D-621-0478	D-621-0479	D-621-0480
77-ohm socket contact	D-621-0406	D-621-0461	D-621-0462	D-621-0463	D-621-0464
3000-ohm pin contact	D-621-0423	D-621-0481	D-621-0482	D-621-0483	D-621-0484
3000-ohm socket contact	D-621-0424	D-621-0465	D-621-0466	D-621-0467	D-621-0468

D-621 Series—L**Lanyard 7"****Connector caps****D-621 Series****Threaded****Bayonet A****Bayonet B****Bayonet C****Bayonet D**

Plug cap for jack connector	D-600-0083	D-600-0068	D-600-0068	D-600-0068	D-600-0065
-----------------------------	------------	------------	------------	------------	------------

Supplied with 7" Lanyard

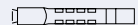
Cable splice kits**Cables****Flexible crimp**

All data bus cables	D-150-0708-5
---------------------	--------------

Data Bus (MIL-STD-1553B) Components

Accessories (cont'd.)

Connector and terminator compatibility					
Panel thickness	Connector	Contact	Terminator reference	Mate with Standard connector	Long reach connector
POLARITY A					
77 Ohm bus terminator	Plug	Pin	D-621-0453(L)	DK-621-0434-1S	DK-621-0550-1S
	Plug	Socket	D-621-0469(L)	DK-621-0434-1P	DK-621-0550-1P
	Jack	Pin	D-621-0477(L)	DK-621-0433-1S	
	Jack	Socket	D-621-0461(L)	DK-621-0433-1P	
3K Ohm stub terminator	Plug	Pin	D-621-0457(L)	D-621-0434-1S	DK-621-0550-1S
	Plug	Socket	D-621-0473(L)	DK-621-0434-1P	DK-621-0550-1P
	Jack	Pin	D-621-0481(L)	DK-621-0433-1S	
	Jack	Socket	D-621-0465(L)	DK-621-0433-1P	
POLARITY B					
77 Ohm bus terminator	Plug	Pin	D-621-0454(L)	DK-621-0436-2S	DK-621-0548-2S
	Plug	Socket	D-621-0470(L)	DK-621-0436-2P	DK-621-0548-2P
	Jack	Pin	D-621-0478(L)	DK-621-0435-2S	
	Jack	Socket	D-621-0462(L)	DK-621-0435-2P	
3K Ohm stub terminator	Plug	Pin	D-621-0458(L)	DK-621-0436-2S	DK-621-0548-2S
	Plug	Socket	D-621-0474(L)	DK-621-0436-2P	DK-621-0548-2P
	Jack	Pin	D-621-0482(L)	DK-621-0435-2S	
	Jack	Socket	D-621-0466(L)	DK-621-0435-2P	
POLARITY C					
77 Ohm bus terminator	Plug	Pin	D-621-0455(L)	DK-621-0438-3S	DK-621-0546-3S
	Plug	Socket	D-621-0471(L)	DK-621-0438-3P	DK-621-0546-3P
	Jack	Pin	D-621-0479(L)	DK-621-0437-3S	
	Jack	Socket	D-621-0463(L)	DK-621-0437-3P	
3K Ohm stub terminator	Plug	Pin	D-621-0459(L)	DK-621-0438-3S	DK-621-0546-3S
	Plug	Socket	D-621-0475(L)	DK-621-0438-3P	DK-621-0546-3P
	Jack	Pin	D-621-0483(L)	DK-621-0437-3S	
	Jack	Socket	D-621-0467(L)	DK-621-0437-3P	
POLARITY D					
77 Ohm bus terminator	Plug	Pin	D-621-0456(L)	DK-621-0440-4S	DK-621-0551-4S
	Plug	Socket	D-621-0472(L)	DK-621-0440-4P	DK-621-0551-4P
	Jack	Pin	D-621-0480(L)	DK-621-0439-4S	
	Jack	Socket	D-621-0464(L)	DK-621-0439-4P	
3K Ohm stub terminator	Plug	Pin	D-621-0460(L)	DK-621-0440-4S	DK-621-0551-4S
	Plug	Socket	D-621-0476(L)	DK-621-0440-4P	DK-621-0551-4P
	Jack	Pin	D-621-0468(L)	DK-621-0439-4S	
	Jack	Socket	D-621-0484(L)	DK-621-0439-4P	
77 Ohm bus terminator	Plug	Pin	D-621-0413(L)	DK-621-0412-S	DK-621-0512-S
	Plug	Socket	D-621-0415(L)	DK-621-0412-P	DK-621-0512-P
	Jack	Pin	D-621-0418(L)	DK-621-0411-S	
	Jack	Socket	D-621-0406(L)	DK-621-0411-P	
3K Ohm stub terminator	Plug	Pin	D-621-0417(L)	DK-621-0412-S	DK-621-0512-S
	Plug	Socket	D-621-0407(L)	DK-621-0412-P	DK-621-0512-P
	Jack	Pin	D-621-0423(L)	DK-621-0411-S	
	Jack	Socket	D-621-0424(L)	DK-621-0411-P	

<i>Fax-on-demand</i>	<i>Fax ID</i>	<i>Description</i>
<i>US only (800) 260-9099</i>	9030	Accessories
<i>Outside US (650) 257-2301</i>		bulletin

Visit our website at www.tycoelectronics.com



HexaShield

High-performance EMC adapters



Applications

Tyco Electronics, a longtime leader in harnessing technology, has written a new chapter in EMC shielding with the introduction of the HexaShield EMC adapter.

Designed to provide EMC protection solutions for both commercial and military applications, HexaShield adapters represent a significant improvement over pigtail termination methods. By providing 360-degree EMC shielding on the termination area of each individual cable, HexaShield adapters provide outstanding shielding effectiveness.

HexaShield adapters are simple to install, easy to maintain, and dependably resistant to mechanical and environmental stresses.

Features and benefits

- Simple installation.
- Easy reentry.
- Simplified maintenance and repair.
- Excellent mechanical and environmental resistance.
- Efficient strain relief.
- Flexibility.
- Versatility.

Principal points and features

- Easy reentry: To insert or remove ferrules from the HexaShield adapter, simply loosen the back nut.
- Superior protection: No degradation of shielding performance.
- Up to four shielded cables accommodated by each ferrule.
- Mechanical and environmental protection equal to backshells complying with MIL-C-85049 Category 3B.
- Strain relief on each individual cable.
- Weight reduction, by possibly eliminating the need for overall shielding.
- Compact size - not exceeding outer diameter of connector.

Simple, one-piece assembly and installation

1. Solder cable or wire shield to a ferrule with a Raychem heat-shrinkable SolderShield terminator.
2. Clip ferrule into one of the grounding star cavities.
3. Secure the back nut of the HexaShield adapter so that the conic ring assembly automatically compresses the ferrules.

Available in:	Americas	Europe	Asia Pacific
	■	■	■

Specifications

Designed to corresponding connector specifications.	Two platings available	Raychem product specifications
	Electroless nickel (MIL-C-26074)	RB-1 10 and RB-1 14
	Olive drab cadmium (QQ-P-4 16 Type II Class 3)	

Installation procedures

Installation procedure for HET-A-02X and HET-A-04X (RPIP-696-00)	Installation procedure for HET-03X (RPIP-696-03)	General procedure for cylindrical connectors, right-angle body (RPIP-696-07)
General procedure for ARINC 600 Size II connectors (RPIP-696-01)	General procedure for cylindrical connectors, straight body (RPIP-696-04)	
General procedure for ARINC 600 Size III connectors (RPIP-696-02)		

Fax-on-demand

US only (800) 260-9099

Outside US (650) 257-2301

Visit our website at www.tycoelectronics.com

Kit descriptions

Hexashield adapters for circular connectors: Straight, 45° and 90° assemblies _

Item	Description
------	-------------

- | | |
|---|---|
| 1 | Straight adapter assembly |
| 2 | Conic ring assembly |
| 3 | Star
Plain (Standard)
Drilled (Option)
Split (Option) _ |
| 4 | Straight adapter assembly - L version
- nominally 0.5" [12.7] longer body |
| 5 | 45° adapter assembly - welded |
| 6 | 45° adapter assembly - cast |
| 7 | 90° adapter assembly - welded |
| 8 | 90° adapter assembly - cast
_ Standard products shown.
Variants available on request.
_ Split star assemblies are shown
on relevant S.C.D's where applicable. |

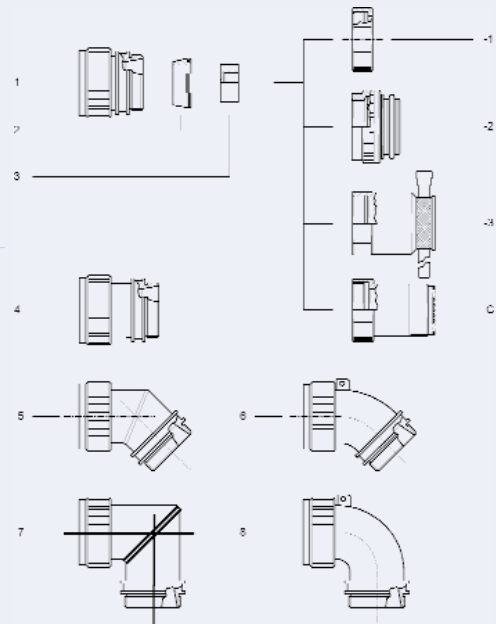

Item	Hexashield Version
------	--------------------

- | | |
|----|--|
| -1 | Back Nut |
| -2 | Tinel adapter assembly
Tinel-Lock ring for single braid |
| -3 | Bandstrap adapter assembly |
| -C | Conduit adapter |

Hexashield adapters for ARINC 404/600 connectors: Sizes 1, 2, 3 and 4 assemblies _

Item	Description
------	-------------

- | | |
|---|---|
| 1 | Left side support |
| 2 | Right side support |
| 3 | Retention bars |
| 4 | Body assemblies
Body
Holding nut
Conic ring assembly
Star _
Back nut |
| 5 | Cavity plug assemblies
Plug
Holding nut |
| 6 | Pan head screws - 4-40 UNC |
| 7 | Spring washers
_ ARINC 600 Size 2 shown
_ Stars are available as plain, drilled or split.
See relevant S.C.D's for further information |

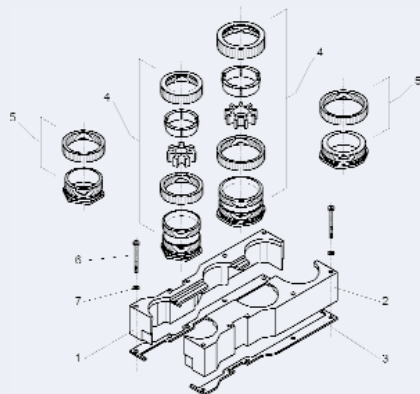

Users should independently evaluate the suitability of the product for their application.
Before ordering check with factory for most current data.

HexaShield (cont'd.)

High-performance EMC adapters

Ordering information

Part numbering for standard products

HexaShield adapter for circular connectors

HEXYYY L -AY -00 S -YY -AY -Y -DS

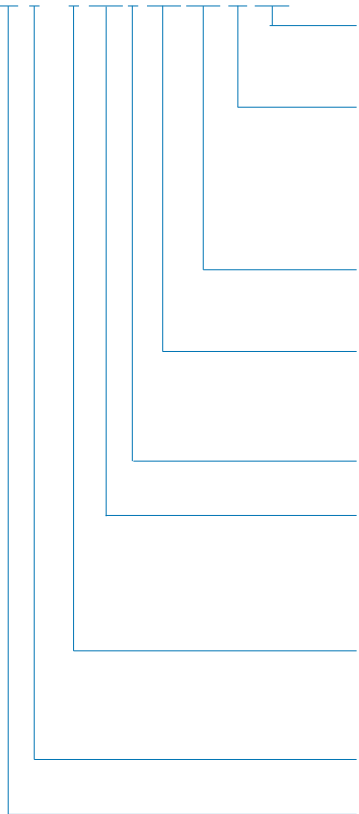

Drilled Star:

*See SCD for Star options (star within a star)

Type of back nut:

- 1 = Standard back nut
- 2 = Clamping nut for tin ring (for overbraid protection)
- 3 = Clamping nut with bandstrap
- C = Clamping nut for conduit applicator

Max. number of ferrules that can be accommodated, from 1 for size 9, to 12 for size 25

Hexashield Size Code:

(09, 11, 13, 15, 17, 19, 21, 23, 25) according to MIL-C-38999 Series 3 and 4 connectors

S = Swept version

Configuration:

- 00 = Straight body
- 45 = 45 degree angle body
- 90 = 90 degree angle body

Type of plating:

- B = Cadmium plated
- C = Electroless nickel

L = Long body

Connector code number:

- 40 = MIL-C-38999 Series 3 and 4
- 41 = MIL-C-38999 Series 1 and 2
- 54 = MIL-C-38723 Series 1 and 3
- MIL-C-25482 Series 2

Fax-on-demand

US only (800) 260-9099

Outside US (650) 257-2301

Visit our website at www.tycoelectronics.com

HexaShield adapter for COLLINS connectors

HEXDB-AC-00-A9-1

00 = Straight body
90 = Right-angle body

HexaShield adapter for ARINC 600 connectors

HEXA6-AY-00-YY-YYY-1

Maximum number of ferrules that can be accommodated:
18 for ARINC size II
36 for ARINC size III

ARINC connector size
02 = ARINC 600 size II
03 = ARINC 600 size III

Type of plating:
B = Cadmium plated
C = Electroless nickel

Part numbering* of ferrule kits

HET-A-02X for small-size cable with SolderShield terminator

HET-A-03X for connection of unshielded cables
ferrules with heat-shrinkable tubing (no shield)

HET-A-04X for large-size cables with SolderShield terminator

Type of plating:
B = Cadmium plated
C = Electroless nickel

HEX07-AX ferrule - solid blank for use when a HET-A is not needed

Type of plating:
B = Cadmium plated
C = Electroless nickel

*Not all part numbers are standard; your local Tyco Electronics representative will assist you in selecting the appropriate standard product

HexaShield (cont'd.)

High-performance EMC adapters

EMC performance

Transfer impedance

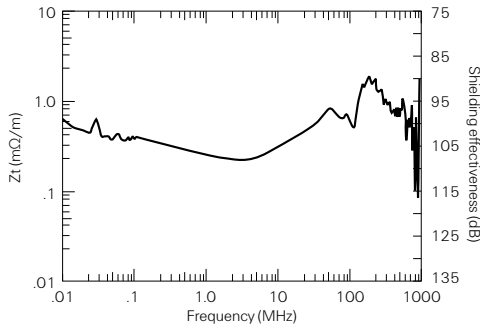

HexaShield size: 23
 Cable: Raychem 5024H8424
 (one cable installed)
 Test method: CEI 96-1

Features

- Outperforms traditional pigtail termination, especially in HIRF performance.
- Withstands 10-kA peak current lightning transients of SAE AE4L-87-3 rev. B.

Protection level

Generalized system performance
 (Actual system performance in any one test method may differ.)

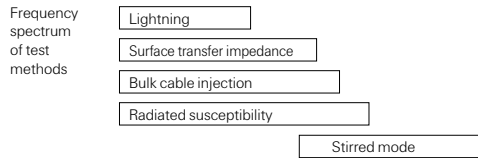
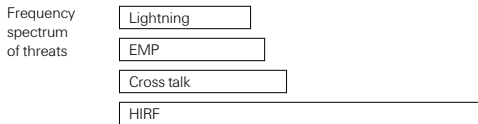
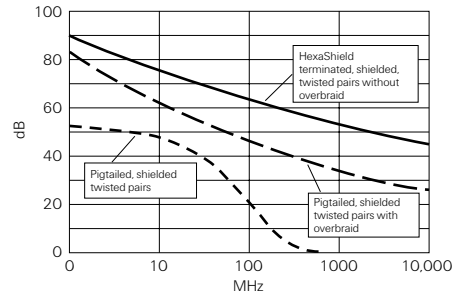

Fax-on-demand

US only (800) 260-9099

Outside US (650) 257-2301

Visit our website at www.tycoelectronics.com

Typical HexaShield applications

Civilian and military aircraft

Avionics

Fighter aircraft

Missiles and launch support systems

Armored and military support vehicles

Navy ships (total shipboard hardening)

Military communications

Engines (FADEC harness hardening)

HexaShield product range

Accommodates the following connector types*:

MIL-C-38999 Series 1, 2, 3, and 4

MIL-C-26482 Series 2

MIL-C-83723 Series 1 and 3

DBAD

ARINC 600

ARINC 404

*Please contact your Tyco Electronics product representative for other connector types and special requests.

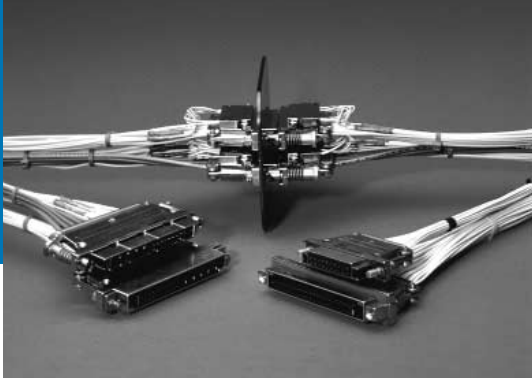

MTC Crimp Connectors

High-performance modular rectangular connectors with removable contacts

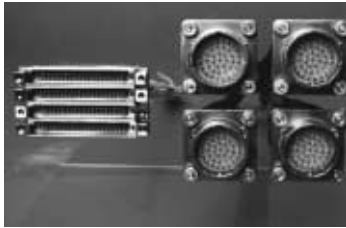

Description

System

The Raychem MTC product line is a complete modular connector system consisting of lightweight, environmentally sealed miniature rectangular connectors (shell housings with removable inserts) and individually removable rear-release contacts.

Components

MTC connectors are now available with quick-disconnect mating hardware, EME shielding accessories, and modular inserts that can accommodate a mix of signal and power crimp contacts and coaxial contacts. The need for special termination tooling has been minimized, while the ease of manufacturing and maintenance has been improved.

Available in:

Americas



Europe



Asia Pacific



Fax-on-demand

US only (800) 260-9099

Outside US (650) 257-2301

Visit our website at www.tycoelectronics.com

Features

Features include:

- Low-profile rectangular design for high packaging density.
- Environmental sealing for aerospace applications.
- Modular components for design versatility and logistics savings.
- Lightweight materials for weight savings.
- Quick-disconnect mating hardware.

Configurations

MTC rectangular connectors using jack screws or quick-disconnect hardware can be stacked or panel-mounted next to each other without any provision for grip space, a feature that can save significant panel area.

MTC connectors are available in 1-inch and 2-inch configurations. Modular removable inserts with size 22 and/or size 16 contact cavities can be combined into the 1-inch and 2-inch MTC housings.

Inserts

MTC inserts are available in 20-cavity and 5-cavity versions. The 20-cavity insert accepts size 20-22 (24 AWG to 20 AWG wire) crimp contacts. The 5-cavity insert accepts size 16–14 crimp contacts. Insertion/extraction of the contacts is rear release.

Note:

Other configurations are available in the MTC family (size 12 contacts; 50 mil spacing for double density; accessories). Please contact Tyco Electronics.

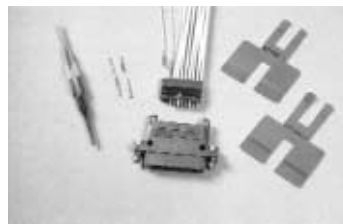

MTC Crimp Connectors (cont'd.)

High-performance modular rectangular connectors with removable contacts

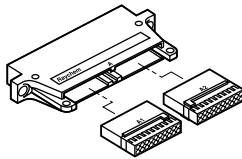

2-inch shell with inserts

20-cavity inserts

MTCP-122-20 inserts are used with MTC100 1-inch and 2-inch shells.

The 1-inch shell takes:

- One MTCP-122-20P (pin contact) or
- One MTCP-122-20S (socket contact)

The 2-inch shell takes:

- One MTCP-122-20P1 and one MTCP-122-20P2 (pin contact) or
- One MTCP-122-20S1 and one MTCP-122-20S2 (socket contact)

2 x 20 cavity inserts (size 20-22)—2-inch shell

Pin insert

- MTCP-122-20P1
- MTCP-122-20P2

Socket insert

- MTCP-122-20S1
- MTCP-122-20S2

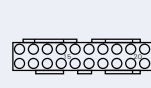
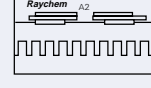
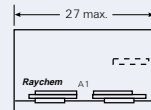
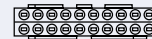
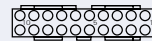
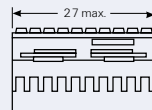

Fax-on-demand

US only (800) 260-9099

Outside US (650) 257-2301

Visit our website at www.tycoelectronics.com

1 x 20 cavity inserts (size 20–22)—1-inch shell

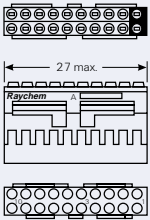
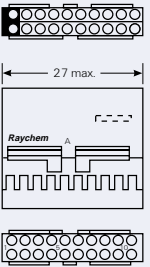
Pin insert	Socket insert
MTCP-122-20P	MTCP-122-20S
	

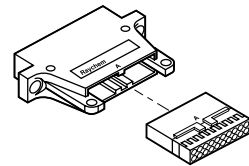



1-inch shell with insert

Contacts for 20-cavity inserts

The contacts for 20-cavity inserts must be ordered separately. They are:

- CTA-0166—pin contact
- CTA-0165—socket contact

Contacts accept 24 AWG to 20 AWG wires.

Pin contact	Socket contact
CTA-0166	CTA-0165
	
Tools	Tools
Positioner for pin contact CE-1605900	Positioner for socket contact CE-1606000
Installation process ES-61413	Installation process ES-61413
Contact removal tool (plastic) CTA-1160	Contact removal tool (plastic) CTA-1160
Extraction tool for MTCP inserts CTA-0161	Extraction tool for MTCP inserts CTA-0161

Users should independently evaluate the suitability of the product for their application. Before ordering check with factory for most current data.

MTC Crimp Connectors (cont'd.)

High-performance modular rectangular connectors with removable contacts

5-cavity inserts (size 16)

MTCP-116-05 inserts are used with MTC100 1-inch and 2-inch shells.

The 1-inch shell takes:

- One MTCP-116-05-P1 (pin contact) or
- One MTCP-116-05-S1 (socket contact)

The 2-inch shell takes:

- One MTCP-116-05P1 and one MTC-116-05P2 (pin contact) or
- One MTCP-116-05-S1 and one MTCP-116-05-S2 (socket contact)

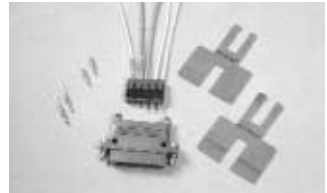

5-cavity inserts (size 16)

Pin insert

MTCP-116-05P1

MTCP-116-05P2

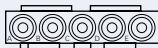
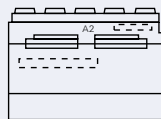
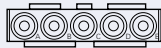
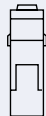
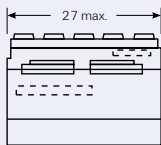
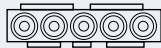

Socket insert

MTCP-116-05S1

MTCP-116-05S2

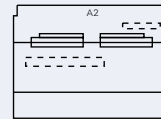
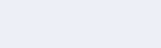
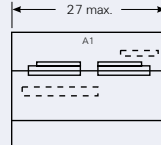
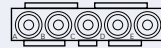

Contacts for 5-cavity inserts

The contacts for 5-cavity inserts must be ordered separately. They include:

- CTA-0079 - pin contact (MS 27493-16) (MIL-C-39029/58 intermateable)
- CTA-0078 - socket contact (MS 27491-16) (MIL-C-39029/57 intermateable)
- D-602-0140 - coaxial pin contact (MIL-C-39029/76 intermateable)
- D-602-0171 - coaxial socket contact (MIL-C-39029/78 intermateable)

Other contacts designed for M38999 Series II connectors can be used.

Pin contact

D-602-0140 (coaxial)

CTA-0079 (power)

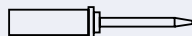

Socket contact

D-602-0171 (coaxial)

CTA-0078 (power)



Fax-on-demand

US only (800) 260-9099

Outside US (650) 257-2301

Visit our website at www.tycoelectronics.com

Hybrids

Hybrid insert combinations of size 22 and size 16 contact cavities are also possible.

2-inch shell—hybrid assembly

Power and signal

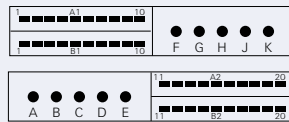

Shells

MTC connector housing shells are available with nickel plating (48-hr salt spray performance) or cadmium over nickel plating (500-hr salt spray performance).

MTC connector housings are offered with quick-disconnect or jack-screw mating hardware. Each connector shell is polarized and has 64 user-defined keying combinations. Lightweight, low-profile EME backshells are also available for increased shielding effectiveness of the connector.

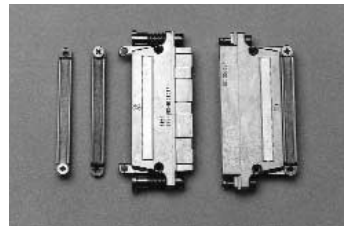

Plug

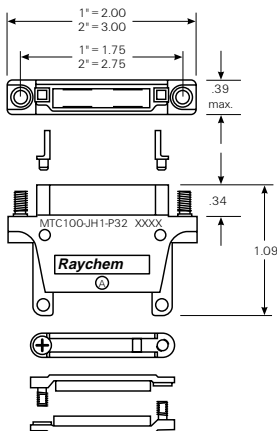

Receptacle

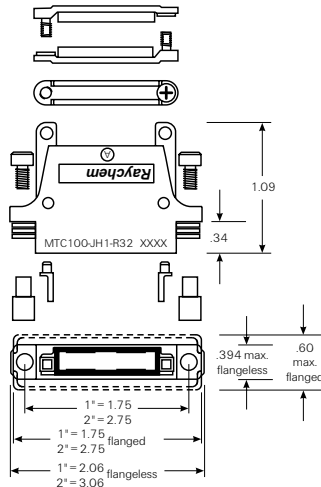

Users should independently evaluate the suitability of the product for their application. Before ordering check with factory for most current data.

MTC Crimp Connectors (cont'd.)

High-performance modular rectangular connectors with removable contacts

MTC shells ordering information

MTC 100X-XHX-XX2

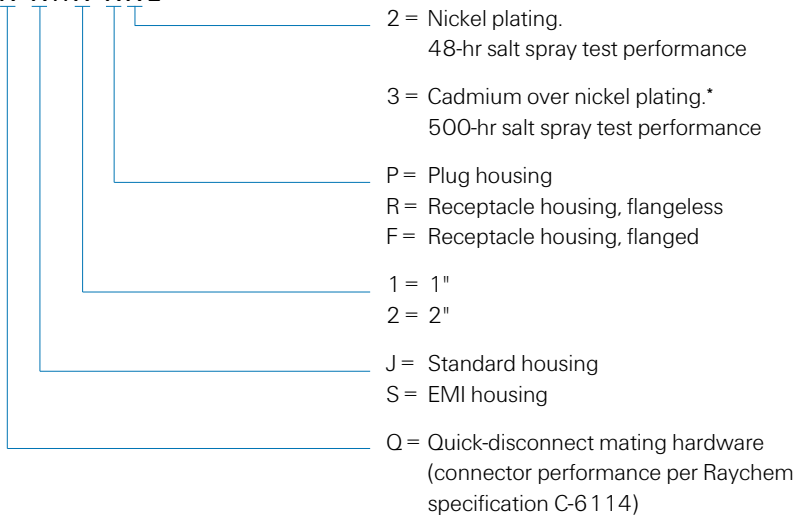

Blank = Jack-screw mating hardware
(connector performance per Raychem specification C-6115)

*Some combinations of shells, mating hardware and EME shielding accessories are not available. Please check with your Tyco Electronics product representative.

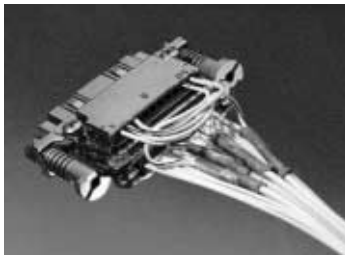

EME shielding accessories for MTC connectors

Grounding block

Allows for cable shield termination grounding on the MTC shell housing via crimp-removable contacts. This grounding scheme allows individual cables to be removed from the connector without cutting a ganged ground connection. Sufficient ground contacts are available to handle shielded twisted-pair cables.

Grounding block

CHA-0301	1-inch grounding block receptacle shell
CHA-0302	2-inch grounding block receptacle shell
CHA-0303	1-inch grounding block plug shell
CHA-0304	2-inch grounding block plug shell

Fax-on-demand

US only (800) 260-9099

Outside US (650) 257-2301

Visit our website at www.tycoelectronics.com

Low-profile EME backshells

Lightweight rectangular EME backshells connect the overall bundle shield to the MTC connector housing. Individual cable shields can also be terminated to the backshell braid by using Raychem SolderSleeve devices.

The backshell is mounted on the MTC housing via the cable clamp screws.

MTC backshell features include a low profile, light weight, and Level II EME performance.

EME backshell adapters

CHA-0275	2-inch adapter (plug or receptacle)
CHA-0276	1-inch adapter (plug or receptacle)

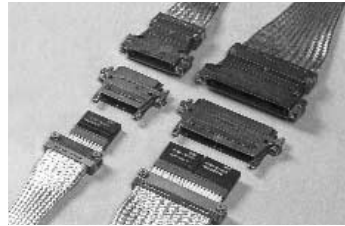

MTC shield-grounding busbars

Raychem MTC shield-grounding busbars allow for simple, cost-effective termination of cable shielding to MTC aluminum housings.

Two-inch shield-grounding busbars terminate up to 20 shielded twisted pairs on a 2-inch MTC connector. The individual shields are terminated to “fingers” on the busbar with Raychem SolderSleeve devices.

The busbar is mounted on the MTC housing via cable clamp screws.

MTC busbar features include a simple termination, cost effectiveness, light weight, and Level I EME performance.

Shield-grounding busbars

CTA-0022	1-inch busbar (with 5 SolderSleeve terminators)
CTA-0023	2-inch busbar (with 10 SolderSleeve terminators)



Wire and Cable

Overview

Tyco Electronics provides wire and cable solutions for challenging environments and demanding applications. The Raychem product range includes high-performance insulated wires, coaxial and data bus cables, power cables, electronics wire, and multicore cables.

- SPEC 44 wire is an economical yet rugged dual-wall insulation system rated at 150°C, with consistently low cost and reliable performance.
- SPEC 55 wire insulation provides high reliability in harsh environments from -65°C to +200°C. Resistant to electrical arc tracking, it combines the easy handling of a flexible wire with excellent resistance to scrapes, abrasion, and cut-through.
- Type 99T dual-wall insulation system is a 105°C rated wire that combines excellent chemical and mechanical resistance with limited fire hazard performance.
- Zerohal 100 wire maintains the benefits of Type 99T while offering a 125°C rated, halogen-free insulation system.
- ElectroLoss Filterline wire reduces the vulnerability of critical circuits to high-frequency electromagnetic interference.
- FlexLite wire and cable products bring Raychem wire and cable technology to the commercial marketplace. They provide performance and durability in a package that addresses the relentless cost/benefit criteria of the industrial and consumer marketplace.
- Cheminax coaxial and data bus cables allow system designers to optimize minimum size and weight with impedance and attenuation characteristics.
- Multiconductor (multicore) cables organize a variety of Raychem wire and cable products in controlled geometries for specific applications. Using a computer-aided design system, Tyco Electronics can quickly design multicore cables to meet your needs. A variety of cable jackets are available to suit most applications.

Raychem wire and cable products can meet your specific application needs. Here are just a few examples:

- Limited-fire-hazard wire and cable for mass transit and marine applications.
- High-performance, high temperature automotive wiring.
- Small, light hookup wires for high-temperature applications in commercial appliances, tools, and devices.
- Very flexible, rugged, thin-wall insulated power cables.
- Low-outgassing space-vehicle wiring.
- Lightweight, shielded wire and cable constructions for aerospace applications.
- Thermocouple extension cables with a range of our high-performance insulations materials.

Contact Tyco Electronics to find out more about wire and cable and our associated interconnection products.

Wire and Cable

Table of Contents

High-Performance Wire and Cable		9-0	Multicore Cables		9-84
Products			Custom-designed Multiconductor (Multi) Cables		9-84
SPEC 44	Wire and cable	9-0	Multiconductor (Multicore) Cables		9-86
SPEC 55	Wire and cable	9-8	Cable Jacket Materials		9-88
Low-Fire-Hazard Wire and Cable		9-18	Properties and Specifications		9-88
Products			Materials		
FR-1000	Halogen-free, fire resistant cable	9-18	FDR 25	Flexible, Diesel resistant	9-90
SeaLite SL 105	Halogen-free, flame retardant cable	9-26	Zerohal	Low fire hazard performance	9-92
Type 99M		9-36	Thermorad HTF/ Fluoroelastomer	High temperature performance	9-96
Zerohal 100A		9-40	Thermorad/Thermorad F	General purpose	9-98
Zerohal 100G		9-44	Raythane, Neoprene, Rayolin, AFR	Other specialized jackets	9-100
Commercial Wire Family		9-48	Electrical Screening	Interference –	
FlexLite Selection Guide		9-48	(shielding)	designing for the threat	9-102
FlexLite/UL Style Cross-Reference		9-48	Computer-Aided Design	Custom design capability	9-104
Products			Power Cables		9-106
FlexLite HM	Hermetic motor lead wire	9-50	Technical Reference Data		9-110
FlexLite DW	Dual-wall primary wire	9-52	Fiber Optic Cables	High performance interconnection fiber optic link	9-112
FlexLite TW	Thin-wall hookup wire and cable	9-54			
FlexLite HT	High-temperature hookup wire	9-56			
FlexLite TX	Ultra-high-temperature hookup wire	9-58			
FLT	Flexible, double insulated, wire for a wide range of industrial applications	9-60			
Controlled Electrical Cables		9-64			
Products					
Thermocouple	Extension cable	9-64			
Electroloss® FilterLine	Lightweight, ruggedized filter line wire and cable filters out high frequency noise	9-68			
Cheminax Cables	Small, lightweight Coaxial, Twin axial, Triaxial cables and High-Speed data network cables. High-performance alternatives to RG and other standard cables	9-74			

SPEC 44

Wire and cable



Applications

SPEC 44 wire has a dual wall construction which combines the outstanding physical and electrical characteristics of radiation crosslinked polyalkene with the excellent mechanical and chemical properties of radiation cross-linked polyvinylidene fluoride (PVDF).

The result is a wire insulation system that offers a 150°C temperature rating, small size, light weight, solder iron resistance, and resistance to most solvents, fuels and lubricants. SPEC 44 wire and cable is highly flame retardant, non-melting, does not cold flow, and though mechanically very tough, is easy to handle and install using conventional tools.

Originally developed for aerospace and military requirements in applications of high density and complex circuitry, SPEC 44 wire and cable now finds wide use throughout industry, in commercial and military electronics, avionics, on satellites, aircraft, helicopters, ships, trains, and offshore platforms where environmental conditions demand consistently reliable performance. In airframe applications SPEC 44 constructions can offer a modern dimensional replacement for PVC/Nylon/Glass braid type wire and cables. SPEC 44 wire is offered in a wide range of sizes in stranded conductors, standard materials available being tin or silver-plated copper and high strength copper alloy. Voltage ratings of 600, 1000 and 2500 volts are available as standard. Shielded and jacketed versions include single and multi-conductor constructions and flat braid shields where further size and weight savings are achieved.

Features and benefits

- Dual wall construction.
- 600, 1000 and 2500 voltage rating.
- Small size, light weight.
- Low smoke and low corrosive gas generation.
- Resistant to most chemicals and electrical arc tracking.

Available in:

Americas

Europe

Asia Pacific

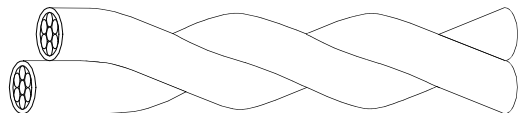
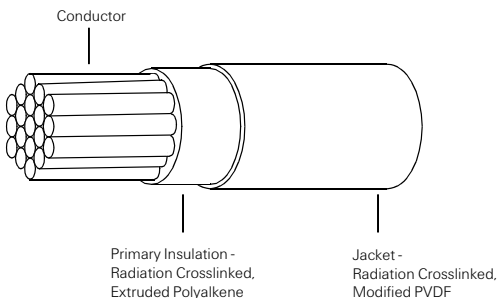

Fax-on-demand

US only (800) 260-9099

Outside US (650) 257-2301

Visit our website at www.tycoelectronics.com

Physical characteristics

Small size

SPEC 44 equipment wire, 600 volt rated has a 0.19 mm (.008 in) nominal wall thickness compared to 0.25 mm (.010 in) and 0.38 mm (.015 in) for equivalent PTFE and PVC wires in MIL-W-16878, MIL-W-22759 or BS G210.

Light weight

Because of the thin wall and low density of the insulation materials considerable weight savings are made over similarly rated PTFE wires, eg:- 44A0111-22AWG equipment wire 4.62 grams/meter max
22AWG PTFE equipment wire, MIL-W-22759 5.54 grams/meter max

General handling

The flexibility of SPEC 44 and the ease with which it takes a 'set' makes it one of the easiest of the 'high performance' wires to install. Stripping is done with conventional die blade strippers.

For details of appropriate tools see separate wire handling guide. The tin-plated conductor usually specified is easily soldered or crimped. The insulation may be hot stamp marked or printed and does not need etching before potting.

Lengths

SPEC 44 is available in long continuous lengths and can be supplied for use on automatic cut and strip wire preparation machines.

Specifications/approvals

MIL-W-81044, NEMA-WC-27500 (Cables)
Def Stan. 61-12 Part 18 Issue 4 - Type 1 pliable (Maintenance Range)
Def Stan. 61-12 Part 26 Issue 3 Type 2, 3, 8 & 9 & METS
VG 95218 Parts 20, 21, 22, 23 and 1000
NATO Stock Numbers (NSN's) exist for most standard constructions
Civil Aviation Authority Accessory Approval E11623
Lloyds Register of Shipping
NASA Preferred Product List
Raychem Specification 44

Typical properties

Temperature rating	-65°C to +150°C
Voltage rating (thin wall)	600 V
Voltage rating (thick wall)	2500 V
Tensile strength and elongation of insulation	30 N/mm ² , 230%
Notch propagation, 0.05mm notch	Pass
Solder iron resistance (370°C, 1 minute)	Pass
Shrinkage, 200°C	<1%
Low temperature bend	-65°C
Voltage withstand (thin wall)	2500 V
Insulation resistance (20°C)	1500 M ohms for 1 km
Resistance: fuels, oils, solvents	Pass



Users should independently evaluate the suitability of the product for their application.
Before ordering check with factory for most current data.

SPEC 44 (cont'd.)

Wire and cable



SPEC 44 wire and cable

Primary wires/twisted pair

				44A011X (600 V)				44A021X (1000 V)			
				primary wire				primary wire			
											
Size	Stranding		CSA (mm ²)	Nom. OD		Max. Weight		Nom. OD		Max. Weight	
	(mm)	#/AWG		(mm)	(in)	(g/m)	lb/kft	(mm)	(in)	(g/m)	lb/kft
30	7/0.10	7/38	0.06	0.68	0.027	1.00	0.71				
28	7/0.13	7/36	0.09	0.76	0.03	1.36	0.96				
26*	19/0.10	19/38	0.15	0.86	0.034	1.98	1.4	1.02	0.04	2.23	1.6
24	19/0.13	19/36	0.25	1.02	0.04	2.97	2	1.17	0.046	3.43	2.4
22	19/0.16	19/34	0.40	1.19	0.047	4.38	3	1.37	0.054	4.92	3.5
20	19/0.20	19/32	0.60	1.40	0.055	6.50	4.5	1.57	0.062	7.30	5.1
18	19/0.25	19/30	1.00	1.65	0.065	9.90	6.8	1.85	0.073	10.90	7.7
16	19/0.29	19/29	1.25	1.83	0.072	12.58	8.6	2.06	0.081	13.88	9.8
14	19/0.36	19/27	2.00	2.26	0.089	19.65	13.2	2.49	0.098	20.90	14.7
12	37/0.32	37/28	3.00	2.74	0.108	30.68	20.2	2.98	0.117	31.34	22.1
10	37/0.40	37/26	5.00	3.28	0.129	46.28	31.1	3.73	0.146	50.4	35.6
8	133/0.29	133/29				5.23		87.6	0.206	5.56	61.8

*For 44A0211-26 the stranding is 7/0.16mm 7/34 AWG

Screened and jacketed cable

				44A111X (600 V)				44A121X (600 V)			
				1 conductor				1 conductor			
											
Size	Stranding		Nom. OD (mm)	Nom. OD		Max. Weight		Nom. OD		Max. Weight	
	(mm)	#/AWG		(mm)	(in)	(g/m)	lb/kft	(mm)	(in)	(g/m)	lb/kft
30	7/0.10	7/38									
28	7/0.13	7/36									
26	19/0.10	19/38	1.57	0.065	5.82	4.6	1.73	0.068	6.51	4.6	
24	19/0.13	19/36	1.83	0.072	8.20	5.8	1.98	0.078	9.18	6.5	
22	19/0.16	19/34	2.00	0.076	10.30	7.2	2.24	0.088	12.35	8.3	
20	19/0.20	19/32	2.26	0.089	14.02	9.9	2.54	0.100	17.40	11.7	
18	19/0.25	19/30	2.62	0.103	19.70	13.9	2.82	0.111	22.61	15.2	
16	19/0.29	19/29	2.79	0.11	23.40	16.5	3.02	0.119	26.63	17.9	
14	19/0.36	19/27	3.22	0.127	32.50	22.9	3.45	0.136	36.15	24.3	
12	37/0.32	37/28	3.70	0.146	45.67	32.1	4.14	0.155	49.55	33.3	





Other sizes are also available in some constructions depending on conductor type and construction required.

Fax-on-demand

US only (800) 260-9099

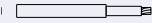
Outside US (650) 257-2301

Visit our website at www.tycoelectronics.com

44A031X (2500 V)				44A081X (600 V)				44A012X (600 V)			
primary wire				airframe wire				twisted pair			
											
Nom. OD		Max. Weight		Nom. OD		Max. Weight		Nom. OD		Max. Weight	
(mm)	(in)	(g/m)	lb/kft	(mm)	(in)	(g/m)	lb/kft	(mm)	(in)	(g/m)	lb/kft
								1.37	0.054	2.12	1.6
								1.52	0.060	2.90	2.1
				1.22	0.048	2.28	2.0	1.73	0.068	4.10	3
1.44	0.057	4.18	3.0	1.37	0.054	3.73	2.6	2.03	0.080	6.08	4.5
1.75	0.069	6.12	4.3	1.57	0.062	5.52	3.8	2.38	0.094	8.91	6.6
1.98	0.078	8.65	6.1	1.78	0.07	7.91	5.4	2.79	0.110	13.30	9.9
2.23	0.088	12.38	8.7	2.03	0.08	11.49	8.0	3.30	0.130	20.21	15
2.46	0.097	15.37	10.9	2.26	0.089	14.32	9.9	3.65	0.144	25.73	19.1
2.92	0.115	23.13	16.2	2.74	0.108	22.08	14.9	4.52	0.178	40.15	29.8
3.32	0.131	34.32	24.2	3.20	0.126	32.23	21.9	5.48	0.216	62.63	46.5
4.09	0.161	54.02	36.5	3.94	0.155	51.80	35.0				
96.20	0.219	5.44	65.0	92.94	0.214		62.8				
44A181X (600 V)				44A112X (600 V)							
1 conductor				2 conductors							
											
Nom. OD		Max. Weight		Nom. OD		Max. Weight					
(mm)	(in)	(g/m)	lb/kft	(mm)	(in)	(g/m)	lb/kft				
				2.23	0.088	8.20	5.8				
				2.38	0.094	9.40	6.6				
				2.59	0.102	12.05	8.1				
2.26	0.089	11.69	7.9	2.99	0.118	16.12	11.3				
2.57	0.101	15.39	10.4	3.35	0.132	21.50	14.5				
2.77	0.109	19.09	12.9	3.76	0.148	27.97	18.8				
3.02	0.119	23.98	16.2	4.32	0.170	38.24	25.7				
3.25	0.128	27.97	18.9	4.67	0.184	44.93	30.2				
3.73	0.147	38.48	26	5.53	0.218	64.28	43.2				
4.19	0.165	52.10	35.2	6.50	0.256	91.51	61.5				

Users should independently evaluate the suitability of the product for their application. Before ordering check with factory for most current data.

SPEC 44 (cont'd.)

Wire and cable

NEMA WC-27500 Cable Part Numbering System

M27500 - AWG XX X X XX

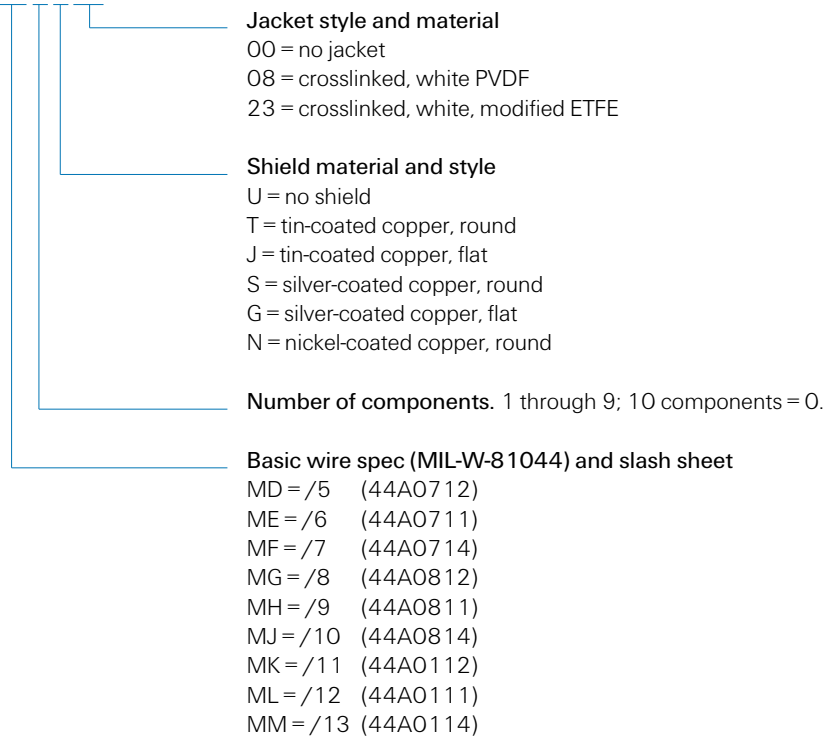

Example:

M27500-22ML3T08 = 44AM1131-22-9/96/93-9

Military part no. _____

Raychem part no. _____

Fax-on-demand

US only (800) 260-9099

Outside US (650) 257-2301

Visit our website at www.tycoelectronics.com

Environmental Performance

Temperature rating

SPEC 44 wire and cable is rated for continuous operation from -65°C to +150°C and for short periods at temperatures as high as 300°C. Heat ageing tests are routinely performed at temperatures of 200°C (168 h) and 300°C (6 h). In addition SPEC 44's insulation will not shrink back under repeated cycling.

Mechanical performance

SPEC 44 wire provides better cut through resistance than some wires with much thicker walls. 600 volt equipment wire 44A0111 (0.19 mm wall) has 40% greater cut through resistance than 600 volt PTFE insulated wire (0.25 mm wall).

Solder iron/overload resistance

The radiation crosslinking of the materials used in SPEC 44 makes them non-melting at high temperature. As a result SPEC 44 wire is resistant to prolonged contact with solder irons and is resistant to current overloads which would melt most thermoplastic insulations.

Chemical resistance

The irradiated dual wall construction of SPEC 44 wire is highly resistant to many acids, alkalis, hydrocarbon solvents, fuels, lubricants, water, and many missile fuels and oxidizers.

Cold flow

Radiation cross-linking of SPEC 44 prevents cold flow of the insulation - a recognized problem of some uncrosslinked materials.

Voltage ratings

Standard available voltage ratings for SPEC 44 wire are 600 volts (0.19 mm wall thickness), 1000 volts (0.28 mm wall) and 2500 volts (0.48 mm wall).

Electrical arc track resistance

SPEC 44 insulation demonstrates a total resistance to arc tracking under both wet and dry conditions at aircraft system voltages.

Low outgassing

For use in space applications, special constructions of SPEC 44 wire are available with low outgassing characteristics, for use in an environment of high vacuum and high temperature.

SPEC 44 (cont'd.)

Wire and cable

Fire hazard performance

Flammability	Federal Aviation Reg FAR-25	Pass
	BS4066 vertical flammability	Pass
	S424 14751 (Swedish chimney)	Pass
	NFC 32070 (2) (French chimney)	Pass
	IEC 332 part 3 (Cable ladder)	Pass
Smoke/Toxicity Index	Smoke Index, Def Stan 61-12 (18)	6 per meter of wire
	Toxicity Index, Def Stan 61-12 (18)	0.8 per meter of wire
	Oxygen Index, NES 714	30% Oxygen
	Temperature Index, NES 715	>300°C

Fax-on-demand

US only (800) 260-9099

Outside US (650) 257-2301

Visit our website at www.tycoelectronics.com

Part numbering system

44 X X X X X- Size- X/X- X

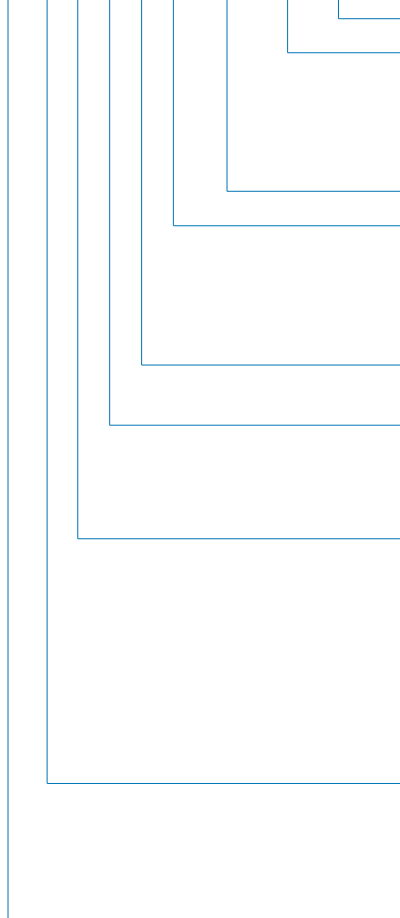

Jacket color (in accordance with MIL-STD-681, white preferred)

Primary wire insulation color

(in accordance with MIL-STD-681)

0=Black 1=Brown 2=Red 2L=Pink 3=Orange 4=Yellow 5=Green
6=Blue 7=Violet 8=Grey 9=White

Additional number after base color indicates stripe

Conductor size

Conductor type

- 1 - Tin-plated copper
- 2 - Silver-plated copper
- 3 - Nickel-plated copper
- 4 - Silver-plated high strength copper alloy (SPHSCA)
- 6 - Nickel-plated high strength copper alloy (NPHSCA)

Number of conductors

1 to 9 0 = 10 conductor

Class of wire

- 1 - 600 V equipment wire
- 2 - 1000 V equipment wire
- 3 - 2500 V equipment wire
- 7 - 600 V nominal weight wire
- 8 - 600 V medium weight wire

Constructions

- 0 - Primary wire and unscreened, unjacketed cables
- 1 - Round braid screened and jacketed†
- 2 - Flat braid screened and jacketed†
- 3 - Round braid, screened, no jacket†
- 4 - Jacketed, no screen
- 5 - Spirally screened and jacketed†
- 7-9 - Special constructions

† Screen material same as conductor material except screen for type 4 conductor is tinned copper.

Type

- I - 135 °C space wire
- A - AWG conductor
- CD - Custom Design
- M - Metric conductor
- B - Radiation crosslinked modified ETFE jacket in place of PVDF
- AM - Designation for M27500 cables
- D - Defense Standard 61-12 Part 2b Issue 3

Basic specification number

Typical ordering example

3 conductors, brown, yellow with green stripe, blue, white jacket. If 600 volt, round braid, 20 AWG tinned conductor, total part number is 44A1131-20-1/45/6-9.

Ordering information

Standard equipment wires (44A0111 12 to 30 AWG) in most common AWGs and colors are kept in stock. In addition, many of the most commonly used single/pair and triple screened cables are also stock items, as are some airframe constructions*. Other constructions and custom designed wire and cable are available on request.

*Europe only.

Users should independently evaluate the suitability of the product for their application. Before ordering check with factory for most current data.

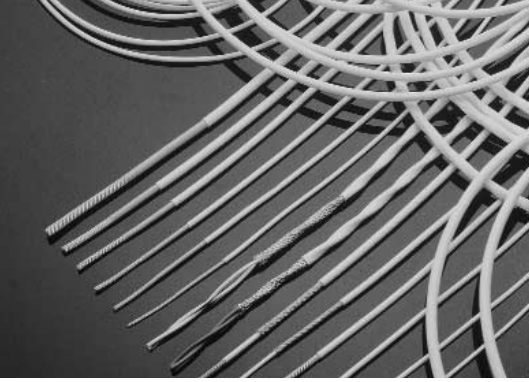

SPEC 55

Wire and cable



Applications

SPEC 55 wire is insulated with modified radiation cross-linked ETFE polymer. It has a temperature rating of -65°C to 200°C continuous using a silver plated copper conductor, and combines the easy handling of a flexible wire with excellent scrape abrasion and cut-through characteristics.

The dual wall airframe construction of SPEC 55 wire is currently used on numerous aircraft programs. It has a choice of two total wall thicknesses, 0.25 mm (55A08XX 10 mil) and 0.2mm (55A02XX 8 mil). Both have a contrasting core color to act as a damage indicator. Chosen for its balance of properties, SPEC 55 wire has outstanding resistance to chemicals and solvents, excellent electrical arc track resistance, and is not susceptible to UV and moisture degradation. Single wall equipment wire constructions are available in 0.10 mm (55/03XX 4 mil) and 0.15 mm (6 mil) wall thicknesses for use inside black boxes where flexibility and solder-iron resistance make it a wire which is very easy to install reliably.

Both single and dual wall insulated wires are available in twisted pairs, triples, etc., and as screened and jacketed cables.

Features and benefits

- Resistant to electrical arc tracking in wet or dry conditions.
- Single or dual wall constructions.
- Small size, ultra light weight.
- Exceptional chemical resistance.
- -65 to 200°C.

Physical characteristics

Size and weight

SPEC 55 wire provides one of the most comprehensive wiring product ranges for aerospace users, with a wide choice of conductor sizes and insulation wall thicknesses. The dual wall airframe wire has an insulation wall thickness of either 0.2mm or 0.25 mm for robustness in unprotected harnesses and has excellent wire to wire abrasion properties.

The single wall equipment wire has a 0.15 mm wall thickness for use inside equipment and protected harnesses. For high density, interconnect wiring, the 450 volt 55M04 1X series of equipment wire has a nominal 0.1 mm wall and provides considerable weight and size savings over other comparable wires.

Handling

The excellent flexibility and handleability makes SPEC 55 the ideal wire to install, both in new aircraft and equipment and for maintenance purposes. The wire is easily stripped with conventional tooling. The insulation is readily marked by hot stamp, ink jet or laser, and can be potted without pre-etching. For full descriptions of the appropriate tools see separate wire handling guide.

SPEC 55PC wire and cable insulation system

This product was originally developed to meet Boeing's material standard BMS 13-48 for the 777 airliner. SPEC 55PC provides lightweight, compact insulation that matches the proven performance of our SPEC 55 wire. Today, 55PC is specified and utilized on the majority of aerospace platforms worldwide.

Tyco Electronics' rigorous, statistical-process-controlled manufacturing has produced Raychem wiring that is rugged and versatile enough for a wide range of commercial and defense aerospace applications, including electronic hook-ups in harsh, open airframe environments.

SPEC 55PC wire and cable systems feature an 8-mil airframe wire that is lighter and smaller than typical 10-mil wire, with little reduction in key mechanical performance features. SPEC 55PC wire offers flame resistance superior to FAA standards and also resists scrape abrasion, notch, propagation, cut-through, and electrical arc tracking.

- Meets Boeing material standard BMS 13-48.
- Exceeds FAR 25 test requirements for flame resistance and smoke density.

Available in:

Americas

Europe

Asia Pacific



Fax-on-demand

US only (800) 260-9099

Outside US (650) 257-2301

Fax ID

6010

6250

2871

Description

Data sheet

RT-Spec 55A

Shop handling procedures

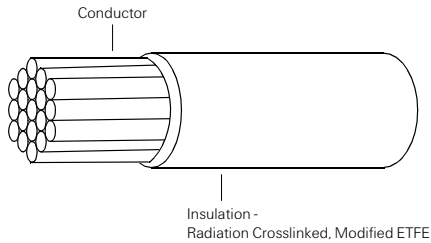
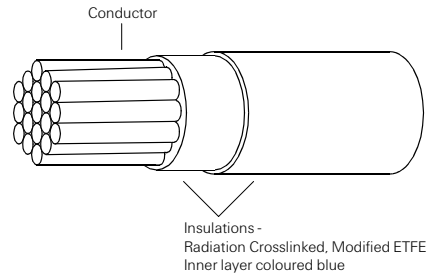
Visit our website at www.tycoelectronics.com**SPEC 55 insulation system - single wall****SPEC 55 insulation system - dual wall****Specifications**

MIL-W-22759/32-35 and /41 to /46 and NEMA-WC-27500 (Cables)

Defense Standard 61-12 Part 33

Part 1001 and Part 1002

VDE 9426, 9427, 9428

British Standard 3G233

Civil Aviation Authority Accessory Approval E11749

Boeing BMS 13-48

Airbus ABS 0820 to 0826

Underwriters Laboratory Style 3467

NASA preferred product list

European Space Agency 3901/012, 3901/020 and 3901/022

Raychem Specification 55

SPEC 55 (cont'd.)

Wire and cable

Typical properties

Temperature rating (Tin plated conductor)	-65 °C to +150 °C
(Silver or nickel plated conductor)	-65 °C to +200 °C
Thermal endurance	200 °C, 10000 h
Scrape abrasion (BS 3G233)	>100 cycles at 150 °C
Flexing endurance (Boeing BSS 7324)	>1000 cycles
Voltage rating	600 V, 450V
Tensile strength + core elongation	(Airframe wire only) 35 N/mm ² , 125%
Tensile strength + total elongation	(All primary wire) 35 N/mm ² , 75%
Notch propagation BS 3G230 0.05 mm notch	Pass
Solder iron resistance (370 °C, 1 minute)	Pass
Solderability - Tin plated copper conductor BS 3G233 conditions	<0.8 secs to wet
Shrinkage	<1%
Long term water resistance	Will not hydrolyze
Permittivity 1 KHz (ASTM D150)	2.7
Dissipation factor (ASTM D150)	0.001
FAR 25	
Afterburn (sec)	⊖
Burn length	31 mm/20 in

Fax-on-demand

US only (800) 260-9099

Outside US (650) 257-2301

Fax ID

6010

6250

2871

Description

Data sheet

RT-Spec 55A

Shop handling procedures

Visit our website at www.tycoelectronics.com**Environmental Performance****Temperature rating**

SPEC 55 wire and cable is rated for continuous operation from -65 °C to +200 °C and for short periods at temperatures as high as 400 °C.

Mechanical performance

Radiation crosslinking of the SPEC 55 insulation significantly improves the following mechanical characteristics; scrape (sharp edges), cross wire abrasion, cut-through resistance and creep resistance.

Solder iron/overload resistance

Radiation crosslinking ensures that the insulation resists melting at high temperatures. As a result SPEC 55 wire is resistant to hot solder irons and current overloads which would melt most thermoplastic insulations.

Chemical resistance

SPEC 55 is unaffected by all commonly used chemicals, eg. fuels, hydraulic fluids, defluxing agents, cleaners, coolants and de-icers. It also shows excellent resistance to weathering (UV, ozone, pollutants, water).

Space wire

SPEC 55 is available in special versions suitable for use in outer space meeting both ESA and NASA requirements for outgassing.

Flammability

Special additives increase the flame retardance of SPEC 55 compared to unirradiated ETFE so that it meets the latest high performance tests, eg. BS 3G230 vertical test FAR 25.

Electrical arc tracking resistance

SPEC 55 insulation demonstrates resistance to arc tracking under both wet and dry conditions at aircraft system voltages.

SPEC 55 wire & cable: standard constructions, nominal sizes, strandings, diameters and weights

Conductor

Primary wire

Twisted pair

Screened & jacketed

Single

Pair

**55PC - extra light weight constructions**

For applications where weight is critical, light weight tight tolerance conductors and insulations are available. These are manufactured using statistical process control methods and achieve weights that are equal or lighter than the equivalent polyimide/PTFE constructions.

SPEC 55 (cont'd.)

Wire and cable

55A - AWG conductor: equipment/interconnect wires & cables

Size	Stranding (mm)	55A011X		55A012X	
		Nom. OD (mm/in)	Max. weight (g per m/lbs per ft)	Nom. OD (mm/in)	Max. weight (g per m/lbs per ft)
30	7/0.102	0.61/0.024	0.98/0.66	1.27/0.048	1.94/1.3
28	7/127	0.68/0.027	1.35/0.91	1.42/0.054	2.68/1.8
26	19/102	0.81/0.032	2.1/1.4	1.67/0.064	4.2/2.8
24	19/127	0.94/0.037	2.98/2.0	1.93/0.074	5.96/4.0
22	19/0.16	1.09/0.043	4.2/2.8	2.23/0.086	8.6/5.8
20	19/0.203	1.27/0.050	6.4/4.3	2.66/0.102	13.26/8.9
18	19/0.25	1.52/0.060	9.7/6.5	3.2/0.122	19.57/13.5
16	19/287	1.73/0.068	12.4/8.3	3.58/0.138	25.8/17.3
14	19/0.36	2.2/0.085	19.4/13.0	4.47/0.172	39.6/26.6
12	37/0.32	2.62/0.103	29.35/19.7	5.38/0.208	60/0/40.3
10	37/0.403	3.25/0.128	47.4/31.8	6.65/0.256	96.7/67.9
8	133/0.287	4.77/0.188	87.6/58.8	9.8/0.376	178.8/12.0

55A - AWG conductor: airframe wires & cables

Size	Stranding (mm)	55A081X		55A082X	
		Nom. OD (mm/in)	Max. weight (g per m/lbs per ft)	Nom. OD (mm/in)	Max. weight (g per m/lbs per ft)
26	19/102	1.01/0.040	2.5/1.7	2.1/0.080	5.1/3.4
24	19/127	1.14/0.045	3.4/2.3	2.33/0.090	6.84/4.6
22	19/0.16	1.27/0.050	4.8/3.2	2.64/0.102	9.98/6.7
20	19/0.203	1.47/0.058	7.0/4.7	3.07/0.118	14.75/9.9
18	19/0.25	1.78/0.070	10.7/7.2	3.63/0.140	21.9/14.7
16	19/287	1.95/0.079	13.4/9.0	4.06/0.156	27.5/18.5
14	37/0.36	2.4/0.094	20.5/13.8	4.9/0.190	42.3/28.4
12	37/0.32	2.82/0.111	30.5/20.5	5.8/0.224	63.0/42.3
10	37/0.403	3.4/0.134	48.3/32.4	7.1/0.272	99.1/66.5

55PC - AWG conductor: statistical process controlled airframe wires & cables

Size	Stranding (mm)	55PC021X		55PC022X	
		Nom. OD (mm/in)	Max. weight (g per m/lbs per ft)	Nom. OD (mm/in)	Max. weight (g per m/lbs per ft)
26	19/102	0.087/0.045	1.8/1.38	-	-
24	19/127	1.00/0.0395	3.2/1.98	2.0/0.079	6.3/0.082
22	19/0.16	1.15/0.0455	4.56/2.90	2.31/0.091	9.12/0.094
20	19/0.203	1.37/0.0540	6.8/4.38	2.74/0.108	13.66/0.111
18	19/0.25	1.61/0.0635	10.3/6.59	3.22/0.127	20.6/0.130
16	19/287	1.8/0.0710	12.96/8.37	3.6/0.142	26.0/0.145
14	19/036	2.18/0.0860	19.86/12.88	4.36/0.172	39.9/0.176
12	37/0.32	2.66/0.1047	30.2/19.73	5.3/0.209	60.8/0.214
10	37/0.403	3.27/0.1290	47.9/31.12	-/0.258	-/0.266

Fax-on-demand

US only (800) 260-9099
 Outside US (650) 257-2301

Fax ID

6010 Data sheet
 6250 RT-Spec 55A
 2871 Shop handling procedures

Visit our website at www.tycoelectronics.com

55A111X		55A112X	
Nom.	Max. weight	Nom.	Max. weight
OD (mm/in)	(g per m/lbs per ft)	OD (mm/in)	(g per m/lbs per ft)
1.51/0.057	5.1/3.4	2.12/0.081	7.74/5.2
1.59/0.060	5.8/3.9	2.27/0.087	8.9/6.0
1.71/0.065	6.85/4.6	2.53/0.097	11.32/7.6
1.84/0.070	8.2/5.5	2.8/0.107	13.86/9.3
1.99/0.076	10.3/6.9	3.07/0.119	17.9/12.0
2.2/0.084	13.4/9.0	3.5/0.135	23.8/16.0
2.45/0.094	17.88/12.0	4.1/0.155	32.6/21.9
2.67/0.102	21.75/14.0	4.43/0.171	39.7/26.7
3.1/0.119	30.4/20.4	5.3/0.205	57.0/38.3
3.55/0.137	42.46/28.5	6.3/0.243	81.2/54.5
4.2/0.161	62.7/42.1	-	-
5.8/0.223	110.5/74.2	-	-
55A181X		55A182X	
1.71/0.073	6.85/5.3	2.63/0.113	11.32/9.6
1.84/0.078	8.2/6.3	2.8/0.123	13.86/11
1.99/0.084	10.3/7.9	3.07/0.135	17.9/13.9
2.2/0.092	13.4/10.0	3.5/0.151	23.8/18.2
2.45/0.103	17.88/13.3	4.1/0.173	32.6/24.5
2.67/0.111	21.75/16.0	4.43/0.189	39.7/28.8
3.1/0.128	30.4/22.2	6.3/0.225	57.0/41.4
3.55/0.145	42.46/30.3	6.3/0.259	81.2/57.4
4.2/0.168	62.7/45.0	-/0.308	-/85.7
55PC121X		55PC122X	
1.52/0.064	6.32/4.4	2.33/0.100	10.75/7.62
1.65/0.069	7.63/5.28	2.89/0.109	13.27/9.34
1.80/0.075	9.55/6.59	2.89/0.122	17.28/12.02
2.00/0.083	12.47/8.62	3.30/0.139	23.00/16.02
2.23/0.093	16.72/11.43	3.78/0.158	31.33/21.57
2.44/0.100	20.05/13.68	4.16/0.174	38.05/26.21
2.79/0.116	28.08/19.28	4.92/0.204	54.25/37.10
3.30/0.135	40.45/27.37	5.92/0.244	78.80/53.91
3.98/0.159	61.16/40.25	7.39/0.297	128.06/83.09

X = 1 - Tin plated copper conductor.

4 - Silver plated high strength copper alloy conductor. (Recommended for size 24 & 26 in airframe applications and mandatory for CAA release.)

Users should independently evaluate the suitability of the product for their application.

Before ordering check with factory for most current data.

SPEC 55 (cont'd.)

Wire and cable

Part numbering system

55 X X X X X- Size- X/X- X

Jacket color (in accordance with MIL-STD-681, white preferred)

Primary wire insulation color

(in accordance with MIL-STD-681)

0=Black 1=Brown 2=Red 2L=Pink 3=Orange 4=Yellow

5=Green 6=Blue 7=Violet 8=Grey 9=White

Additional number after base color indicates stripe

Conductor size

Conductor type

1 - Tin-plated copper 2 - Silver-plated copper

3 - Nickel-plated copper 4 - Silver-plated high strength copper alloy

6 - Nickel-plated high strength copper alloy

Number of conductors

0 = 10 conductors

Class of wire

1 - 600 V equipment wire, light weight

2 - 600 V airframe wire, light weight

4 - 450 V equipment wire (55M Only sizes 20-30)

8 - 600 V airframe wire, normal weight

Constructions

0 - Primary wire and shielded, unjacketed cables

1 - Round braid screened & jacketed cable †

2 - Flat braid screened & jacketed cable †

3 - Round braid, screened cable, no jacket †

4 - Jacketed cable, no screen

5 - Spiral screened and jacketed cable †

8 - Special constructions (part numbers not coded)

9 - Special constructions including light weight

† Screen material same as conductor material except all flat screens and screen for conductor types 4 and 6 shall be tin-plated copper. Other combinations are special. (Refer to Wire and Cable Division).

Type

A - AWG conductor M - Metric conductor

/ - Space wire PC - Process control

D - Defense Standard 6 1-12 Part 2b Issue 3

Basic specification number

Fax-on-demand

US only (800) 260-9099

Outside US (650) 257-2301

Fax ID

6010

6250

2871

Description

Data sheet

RT-Spec 55A

Shop handling procedures

Visit our website at www.tycoelectronics.com**Typical ordering example**

3 conductors, red, yellow, blue, 600 volt equipment wire with overall round braid, 20 AWG tinned conductor and white jacket: total part number is 55A1131-20-2/4/6-9.

Ordering information



A list of stock policy items can be identified by contacting the relevant Product Specialist or Sales Order Office. Stock policy items are recognized by the use of a suffix, such as (300) defining the pack size, typically 55A0111-22-9(300). UK only.

SPEC 55 Part numbering system

Temperature rating	Conductor material	AWG range available	Raychem part no.	MIL-SPEC no.
600-V lightweight single-wall hookup wire, .152 mm (.006 inch) nominal wall				
150°C	Tin-coated copper	12–30	55A0111	M22759/32
200°C	Silver-coated copper	12–28	55A0112	M22759/44
200°C	Nickel-coated copper	12–28	55A0113	M22759/45
200°C	Silver-coated high-strength alloy	20–30	55A0114	M22759/33
200°C	Nickel-coated high-strength alloy	20–28	55A0116	M22759/46
600-V lightweight dual-wall airframe wire, .203 mm (.008 inch) nominal wall				
150°C	Tin-coated copper	6–26	55A0211	
200°C	Silver-coated copper	10–26	55A0212	
200°C	Nickel-coated copper	10–26	55A0213	
200°C	Silver-coated high-strength alloy	18–30	55A0214	
200°C	Nickel-coated high-strength alloy	16–26	55A0216	
600-V dual-wall airframe wire, .254 mm (.010 inch) nominal wall				
150°C	Tin-coated copper	00–24	55A0811	M22759/34
200°C	Silver-coated copper	00–26	55A0812	M22759/43
200°C	Nickel-coated copper	00–26	55A0813	M22759/41
200°C	Silver-coated high-strength alloy	20–26	55A0814	M22759/35
200°C	Nickel-coated high-strength alloy	20–26	55A0816	M22759/42
600-V medium-weight dual-wall airframe wire, .381 mm (.015 inch) nominal wall				
150°C	Tin-coated copper	10–24	55A0711	
200°C	Silver-coated copper	16–24	55A0712	
200°C	Nickel-coated copper	16–24	55A0713	
200°C	Silver-coated high-strength alloy	16–24	55A0714	
200°C	Nickel-coated high-strength alloy	16–26	55A0716	

SPEC 55 (cont'd.)

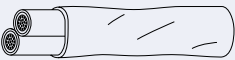
Wire and cable

SPEC 55 cable constructions					
Construction	Number of components	Component conductor ^a	Shield material ^a	Part number Light wt. ^b	Medium wt.
Unshielded, unjacketed		1		55*01X1-AWG-Y	55*08X1-AWG-Y
		2		55*01X2-AWG-Y	55*08X2-AWG-Y
		3		55*01X3-AWG-Y	55*08X3-AWG-Y
		4		55*01X4-AWG-Y	55*08X4-AWG-Y
		6		55*01X6-AWG-Y	55*48X6-AWG-Y
Unshielded, unjacketed		1		55*41X1-AWG-Y	55*48X1-AWG-Y
		2		55*41X2-AWG-Y	55*48X2-AWG-Y
		3		55*41X3-AWG-Y	55*48X3-AWG-Y
		4		55*41X4-AWG-Y	55*48X4-AWG-Y
		6		55*41X6-AWG-Y	55*18X6-AWG-Y
Shielded (round braid), jacketed		1	1	55*11X1-AWG-Y	55*18X1-AWG-Y
		2	2	55*11X2-AWG-Y	55*18X2-AWG-Y
		3	3	55*11X3-AWG-Y	55*18X3-AWG-Y
		4	1	55*11X4-AWG-Y	55*18X4-AWG-Y
		6	3	55*11X6-AWG-Y	55*18X6-AWG-Y
Shielded (flat braid), jacketed		1	1	55*21X1-AWG-Y	55*28X1-AWG-Y
		2	1	55*21X2-AWG-Y	55*28X2-AWG-Y
		3	1	55*21X3-AWG-Y	55*28X3-AWG-Y
		4	1	55*21X4-AWG-Y	55*28X4-AWG-Y
		6	1	55*21X6-AWG-Y	55*28X6-AWG-Y

^aType of conductor or shield material:

- 1 = tin-coated copper
- 2 = silver-coated copper
- 3 = nickel-coated copper
- 4 = silver-coated high-strength copper alloy
- 6 = nickel-coated high-strength copper alloy
- * = A or PC

^bX = no. of wire components

Y = color code

For complete part number, see Part Numbering System on page 9-17.

Fax-on-demand

US only (800) 260-9099

Outside US (650) 257-2301

Fax ID

6010

6250

2871

Description

Data sheet

RT-Spec 55A

Shop handling procedures

Visit our website at www.tycoelectronics.com

NEMA WC-27500 Cable Part Numbering System

M27500 - AWG XX X X XX

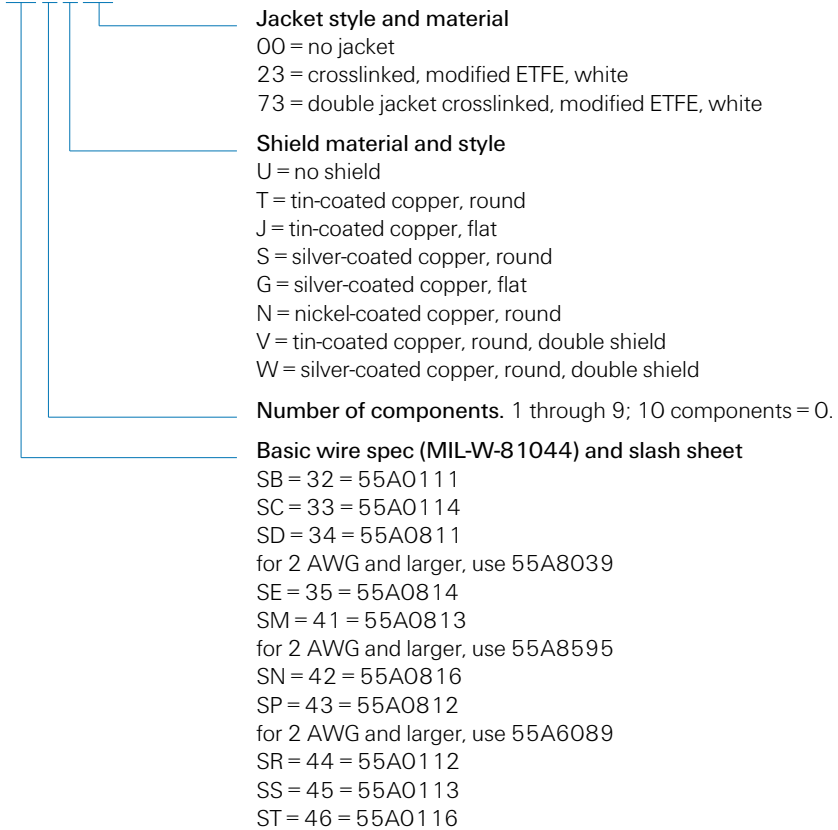

Example:

M275001-20SB3T23 = 55A1131-20-9/96/93-9

Military part no. _____

Raychem part no. _____

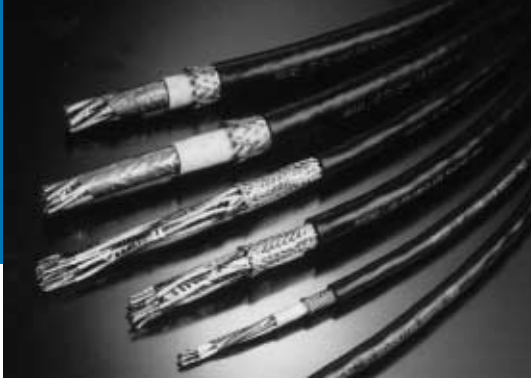

FR-1000

Halogen-free, fire resistant cable range



Applications

Tyco Electronics has developed a new halogen-free, lightweight, small size, fire resistant Raychem cable to exceed the exacting fire resistant requirements of IEC 60331 (ie withstands 950°C for 3 hours as opposed to the 750°C requirement) and meet the flame-retardant requirements of IEC 60332-3 (Cat A), while maintaining significant size and weight savings over conventional materials.

FR-1000 cable consists of Raychem Type 95 primary wire with a Zerohal jacket and can be used throughout the installation, simplifying the selection for designers and electrical engineers. By a combination of our proven expertise in polymer and radiation chemistry, low fire hazard technology and precision extrusion capability, Tyco Electronics has been able to develop a range of Raychem cables featuring reduced size and weight over existing thickwall cables. This offers savings of approximately 30% and optimizes the space available. This results in lower installed costs by downsizing connectors, glanding, cable support structures, and reduced time on installation.

With increasing complexity of electronic systems, sensors, communications and safety equipment, more cables are required to fit into smaller spaces. FR-1000 small size cable can offer distinct advantages over conventional cables. These include:

- Tough and flexible constructions aiding installation through smaller bend radii and extending service life.
- Controlled dimensions simplifying connector and transit selection.
- Resistance to widely used fluids such as diesel fuels, oils, and greases.

Operating temperature range

-30°C to 90°C

Agency recognition

- TBC
- TBC

Features and benefits

- Highly flame retardant.
- Halogen-free.
- Low smoke generation.
- Low toxicity index.
- Low acid gas emission.
- Low water uptake.
- Compatible with Raychem System 100 heat-shrink components, heat-shrink tubing, molded parts and adhesives.

Available in:

Americas

Europe

Asia Pacific



Fax-on-demand

US only (800) 260-9099

Outside US (650) 257-2301

Visit our website at www.tycoelectronics.com

Generic cable construction

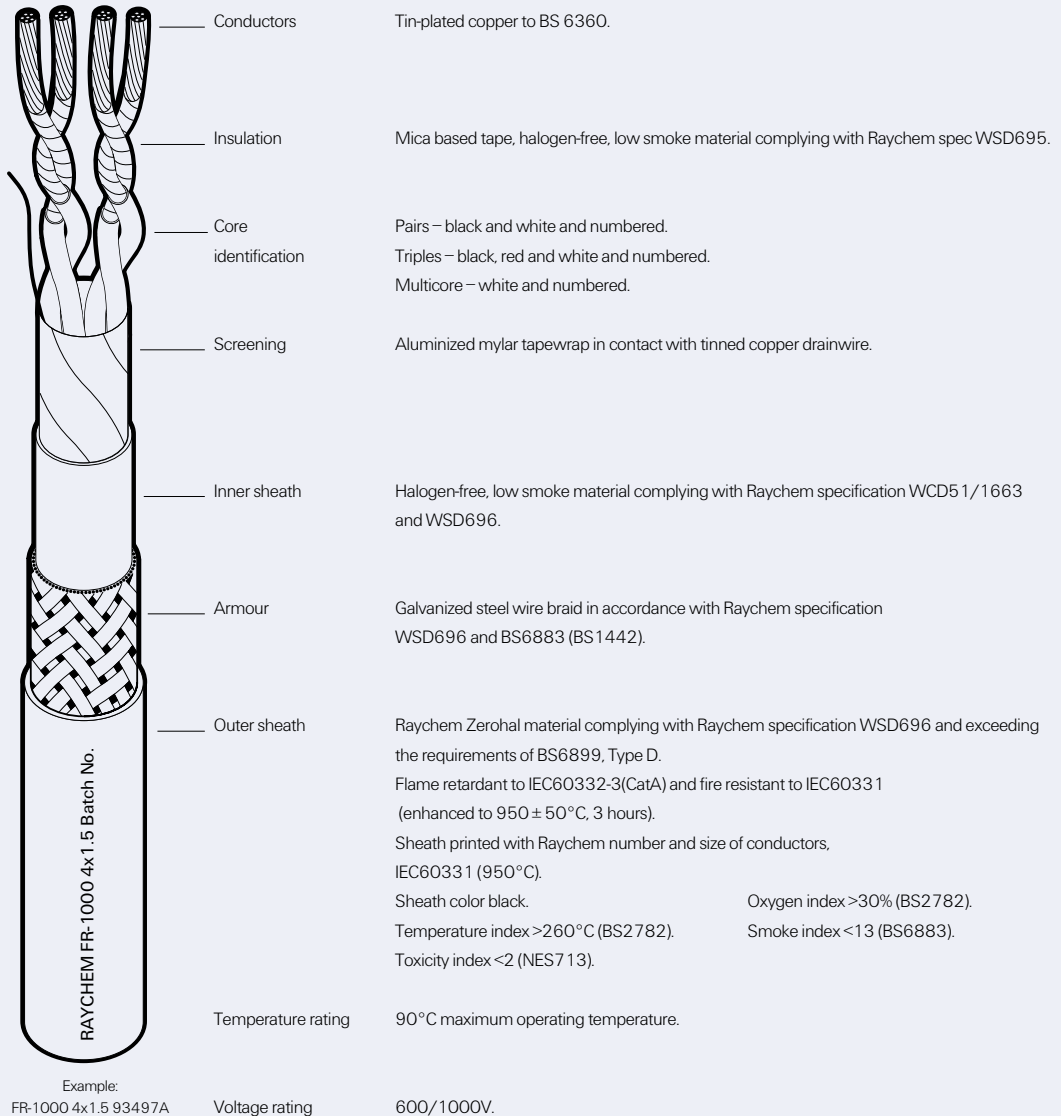

Users should independently evaluate the suitability of the product for their application.
Before ordering check with factory for most current data.

FR-1000 (cont'd.)

Halogen-free, fire resistant cable range

FR-1000 multicore control cables, unscreened, armored, 600/1000V*

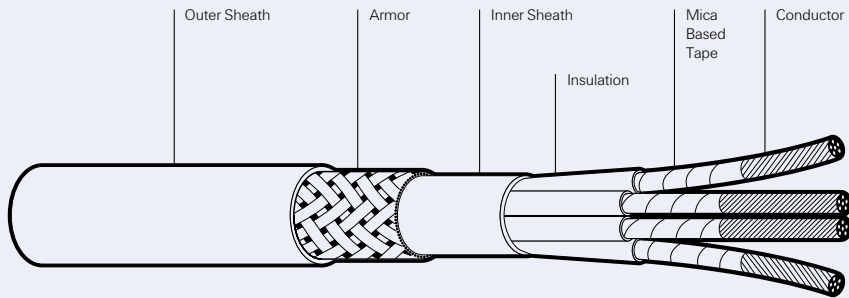

Selection table

Part number	EPD	Construction	Conductor		Diameter		Cable		Nominal weight kg/km	Jacket color
			Stranding	CSA nominal mm ²	Over inner sheath mm	Outer diameter (min.) mm	(max.) mm			
87486A		2x1.5	19/0.32	1.5	6.6	10.2	11.2	178	Black	
87488A		3x1.5	19/0.32	1.5	7.1	10.8	11.6	203	Black	
87490A		4x1.5	19/0.32	1.5	7.7	11.2	12.4	236	Black	
87492A		7x1.5	19/0.32	1.5	9.4	13.0	14.4	328	Black	
87494A		12x1.5	19/0.32	1.5	12.5	16.0	17.6	486	Black	
87496A		19x1.5	19/0.32	1.5	14.7	18.2	20.2	677	Black	
87498A		27x1.5	19/0.32	1.5	17.9	21.3	23.5	906	Black	
87487A		2x2.5	7/0.67	2.5	7.7	11.2	12.4	224	Black	
87489A		3x2.5	7/0.67	2.5	8.2	11.7	12.9	257	Black	
87491A		4x2.5	7/0.67	2.5	9.0	12.6	14.0	312	Black	
87493A		7x2.5	7/0.67	2.5	10.9	14.7	15.7	429	Black	
87495A		12x2.5	7/0.67	2.5	14.6	18.1	20.1	661	Black	
87497A		19x2.5	7/0.67	2.5	17.5	20.9	23.1	936	Black	
87499A		27x2.5	7/0.67	2.5	21.1	25.3	27.3	1321	Black	

*Cables are armored with an overall galvanized steel wire braid armor.

Fax-on-demand

US only (800) 260-9099

Outside US (650) 257-2301

Visit our website at www.tycoelectronics.com

FR-1000 multicore control cables, unscreened, unarmored, 600/1000V

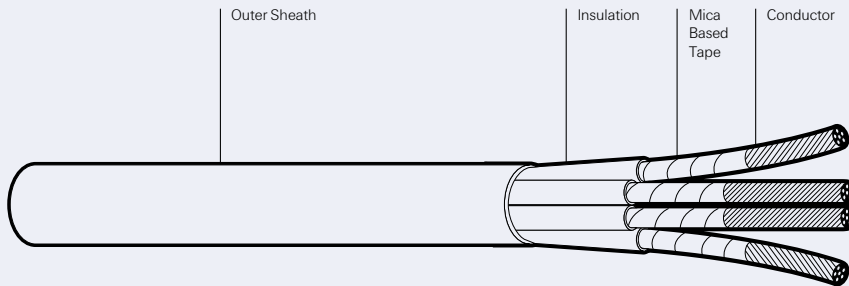

Selection table

Part number	EPD	Construction	Conductor		Cable		Nominal weight kg/km	Jacket color
			Stranding	CSA nominal mm ²	Outer diameter (min.) mm	(max.) mm		
87472A		2x1.5	19/0.32	1.5	7.5	7.9	87	Black
87474A		3x1.5	19/0.32	1.5	7.8	8.6	108	Black
87476A		4x1.5	19/0.32	1.5	8.4	9.2	134	Black
87478A		7x1.5	19/0.32	1.5	10.1	11.1	204	Black
87480A		12x1.5	19/0.32	1.5	13.3	14.3	332	Black
87482A		19x1.5	19/0.32	1.5	15.2	16.8	490	Black
87484A		27x1.5	19/0.32	1.5	18.5	19.9	684	Black
87473A		2x2.5	7/0.67	2.5	8.4	9.2	122	Black
87475A		3x2.5	7/0.67	2.5	8.8	9.8	150	Black
87477A		4x2.5	7/0.67	2.5	9.7	10.7	192	Black
87479A		7x2.5	7/0.67	2.5	11.5	12.7	288	Black
87481A		12x2.5	7/0.67	2.5	15.1	16.7	475	Black
87483A		19x2.5	7/0.67	2.5	17.9	19.7	720	Black
87485A		27x2.5	7/0.67	2.5	21.3	23.5	995	Black

Conductors	Tin plated copper to BS6360
Insulation	Mica based tape, halogen-free, low smoke material complying with Raychem specification WSD695
Core identification	White and numbered
Inner sheath	Halogen-free, low smoke material complying with Raychem specification WCD51/1663 and WSD696
Armor	Galvanized steel wire braid in accordance with Raychem specification WSD696 and BS6883 (BS1442)
Outer sheath	Raychem Zerohal material complying with Raychem specification WSD696 and exceeding the requirements of BS6899, Type D. Flame retardant to IEC60332-3(Cat A) and fire resistant to IEC60331 (enhanced to 950 +/- 50°C, 3 hours) Sheath printed with number and size of conductors, IEC331, Raychem, voltage rating and EPD number Sheath color black Oxygen index >30% (BS2782), Temperature index > 260°C (BS2782), Smoke index <13 (BS6883) Toxicity Index <2 (NES713)
Temperature rating	90°C maximum conductor operating temperature
Voltage rating	600/1000V

Users should independently evaluate the suitability of the product for their application.
Before ordering check with factory for most current data.

FR-1000 (cont'd.)

Halogen-free, fire resistant cable range

FR-1000 multipair control cables, collectively screened and armored 600/1000V*

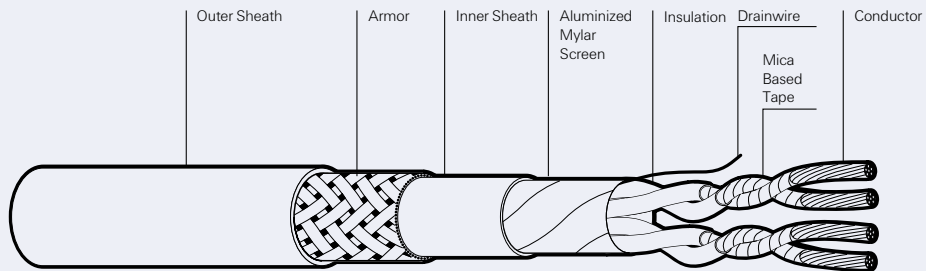

Selection table

Part number	EPD	Construction	Conductor		Diameter (nominal)		Cable			Jacket color
			Stranding	CSA nominal	Over screen	Over inner sheath	Outer diameter (min.)	(max.)	Nominal weight	
			mm ²	mm	mm	mm	mm	mm	kg/km	
93491A		3x2x0.75	19/0.23	0.75	9.7	11.1	14.6	16.2	319	Grey
93492A		7x2x0.75	19/0.23	0.75	13.1	14.6	18.1	20.1	484	Grey
93493A		12x2x0.75	19/0.23	0.75	16.4	18.1	21.5	23.7	685	Grey
93494A		20x2x0.75	19/0.23	0.75	21.2	23.0	26.8	29.6	1090	Grey
87500A		2x1.5	19/0.32	1.5	5.4	6.7	10.7	11.3	192	Black
87501A		2x2x1.5	19/0.32	1.5	7.2	8.6	12.3	13.5	267	Black
87502A		3x2x1.5	19/0.32	1.5	11.2	12.7	16.1	17.9	404	Black
87503A		5x2x1.5	19/0.32	1.5	13.8	15.3	18.8	20.8	541	Black
87504A		7x2x1.5	19/0.32	1.5	15.2	16.9	20.3	22.5	649	Black
87505A		10x2x1.5	19/0.32	1.5	17.5	19.2	22.5	24.9	817	Black
87506A		12x2x1.5	19/0.32	1.5	19.0	20.7	25.2	26.6	999	Black
87507A		20x2x1.5	19/0.32	1.5	24.7	26.5	30.5	33.7	1541	Black
87508A		24x2x1.5	19/0.32	1.5	26.6	28.6	33.6	35.6	1762	Black

*Cables have an overall aluminized mylar screen with drainwire and an overall galvanized steel wire braid armour.

Fax-on-demand

US only (800) 260-9099

Outside US (650) 257-2301

Visit our website at www.tycoelectronics.com

FR-1000 multitrip control cables, collectively screened and armored, 600/1000V*

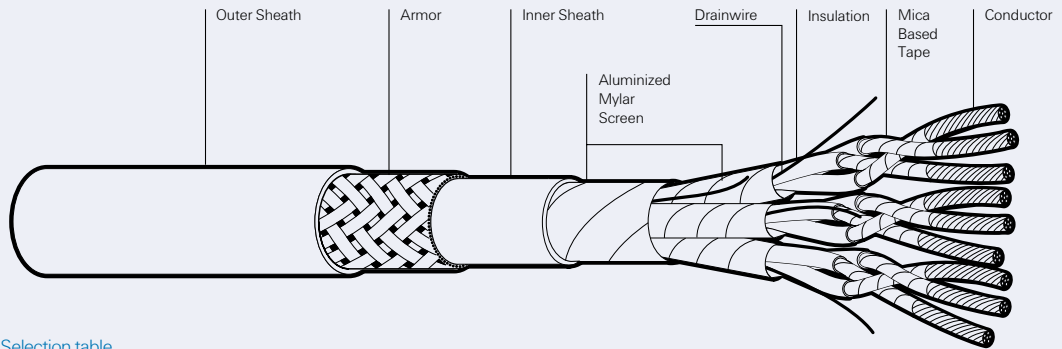

Selection table

Part number	EPD	Construction	Conductor		Diameter (nominal)		Cable		Jacket color	
			Stranding	CSA nominal	Over screen	Over inner sheath	Outer diameter (min)	Outer diameter (max)		Nominal weight
			mm ²	mm	mm	mm	mm	kg/km		
87509A		1x3x1.5	19/0.32	1.5	5.9	7.2	10.7	11.9	216	Black
87510A		3x3x1.5	19/0.32	1.5	12.0	13.5	16.9	18.7	480	Black
87511A		7x3x1.5	19/0.32	1.5	16.2	17.9	21.3	23.5	815	Black
87512A		12x3x1.5	19/0.32	1.5	22.2	24.0	28.1	31.1	1357	Black

*Cables have an overall aluminized mylar screen with drainwire and an overall galvanized steel wire braid armour.

Conductors	Tin plated copper to BS6360
Insulation	Mica based tape, halogen-free, low smoke material complying with Raychem specification WSD695
Core identification	Pairs – black and white and numbered. Triples – black, red and white and numbered
Screening	Aluminized mylar tapewrap in contact with tinned copper drainwire
Inner sheath	Halogen-free, low smoke material complying with Raychem specification WCD51/1663 and WCD696
Armor	Galvanized steel wire braid in accordance with Raychem specification WSD696 and BS6883 (BS1442)
Outer sheath	Raychem Zerohal material complying with Raychem specification WSD696 and exceeding the requirements of BS6899, Type D. Flame retardant to IEC60332-3(Cat A) and fire resistant to IEC60331 (enhanced to 950 +/- 50°C, 3 hours) Sheath printed with number and size of conductors, IEC331, Raychem, voltage rating and EPD number Sheath color black Oxygen index >30% (BS2782), Temperature index > 260°C (BS2782), Smoke index <13 (BS6883) Toxicity Index <2 (NES713)
Temperature rating	90°C maximum conductor operating temperature
Voltage rating	600/1000V

Users should independently evaluate the suitability of the product for their application.
Before ordering check with factory for most current data.

FR-1000 (cont'd.)

Halogen-free, fire resistant cable range

FR-1000 multipair control cables, collectively screened and armored 600/1000V*

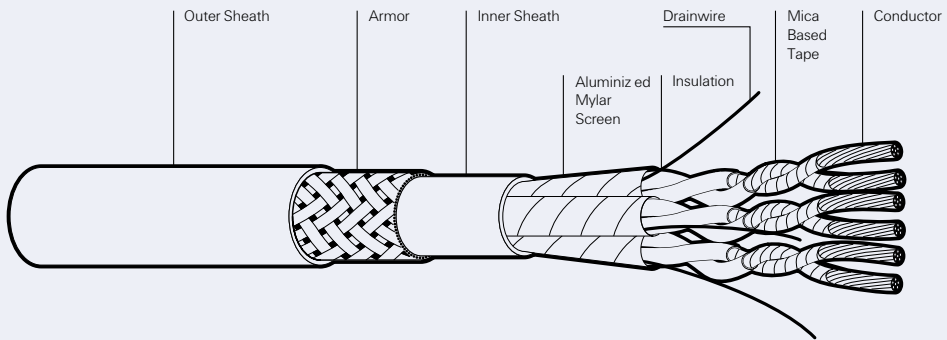

Selection table

Part number	EPD	Construction	Conductor		Diameter (nominal)		Cable		Nominal weight kg/km	Jacket color
			Stranding	CSA nominal	Over screen	Over inner sheath	Outer diameter (min.)	Outer diameter (max.)		
93491A		3x2x0.75	19/0.23	0.75	9.7	11.1	14.6	16.2	319	Grey
93492A		7x2x0.75	19/0.23	0.75	13.1	14.6	18.1	20.1	484	Grey
93493A		12x2x0.75	19/0.23	0.75	16.4	18.1	21.5	23.7	685	Grey
93494A		20x2x0.75	19/0.23	0.75	21.2	23.0	26.8	29.6	1090	Grey
87500A		2x1.5	19/0.32	1.5	5.4	6.7	10.7	11.3	192	Black
87501A		2x2x1.5	19/0.32	1.5	7.2	8.6	12.3	13.5	267	Black
87502A		3x2x1.5	19/0.32	1.5	11.2	12.7	16.1	17.9	404	Black
87503A		5x2x1.5	19/0.32	1.5	13.8	15.3	18.8	20.8	541	Black
87504A		7x2x1.5	19/0.32	1.5	15.2	16.9	20.3	22.5	649	Black
87505A		10x2x1.5	19/0.32	1.5	17.5	19.2	22.5	24.9	817	Black
87506A		12x2x1.5	19/0.32	1.5	19.0	20.7	25.2	26.6	999	Black
87507A		20x2x1.5	19/0.32	1.5	24.7	26.5	30.5	33.7	1541	Black
87508A		24x2x1.5	19/0.32	1.5	26.6	28.6	33.6	35.6	1762	Black

*Cables have an overall aluminized mylar screen with drainwire and an overall galvanized steel wire braid armor.

Fax-on-demand

US only (800) 260-9099

Outside US (650) 257-2301

Visit our website at www.tycoelectronics.com

FR-1000 multitrip control cables, individually screened, armored, 600/1000V*

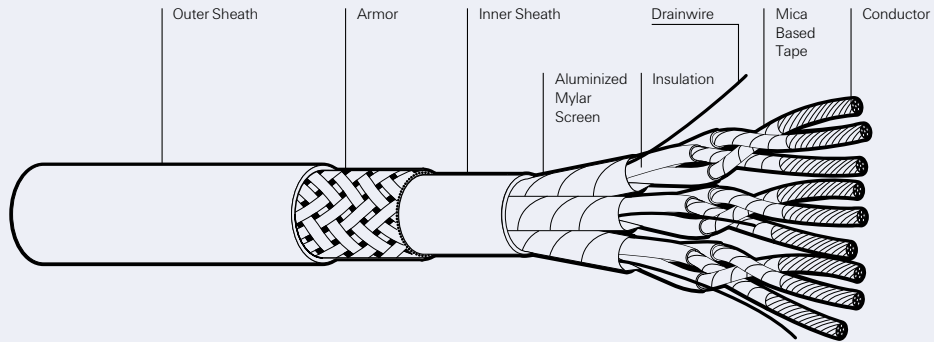

Selection table

Part number	EPD	Construction	Conductor		Diameter (nominal)		Cable	Nominal weight	Jacket color
			Stranding	CSA nominal	Over inner sheath	Outer diameter (min.)			
93500A		3x3x0.75	19/0.23	0.75	12.4	15.9	17.5	407	Grey
93501A		7x3x0.75	19/0.23	0.75	16.8	20.2	22.4	682	Grey
93502A		12x3x0.75	19/0.23	0.75	22.6	26.4	29.2	1111	Grey
93503A		3x1.00	19/0.25	1.0	6.6	10.6	11.6	198	Grey

*Cables have pairs individually screened with aluminized mylar and drainwire and an overall galvanized steel wire braid armor.

Conductors	Tin plated copper to BS6360
Insulation	Mica based tape, halogen-free, low smoke material complying with Raychem specification WSD695
Core identification	Pairs – black and white and numbered. Triples – black, red and white and numbered
Screening	Aluminized mylar tapewrap in contact with tinned copper drainwire
Inner sheath	Halogen-free, low smoke material complying with Raychem specification WCD51/1663 and WSD696
Armor	Galvanized steel wire braid in accordance with Raychem specification WSD696 and BS6883 (BS1442)
Outer sheath	Raychem Zerohal material complying with Raychem specification WSD696 and exceeding the requirements of BS6899, Type D. Flame retardant to IEC60332-3(Cat A) and fire resistant to IEC60331 (enhanced to 950 +/- 50°C, 3 hours) Sheath printed with number and size of conductors, IEC331, Raychem, voltage rating and EPD number Sheath color black Oxygen index >30% (BS2782), Temperature index > 260°C (BS2782), Smoke index <13 (BS6883) Toxicity Index <2 (NES713)
Temperature rating	90°C maximum conductor operating temperature
Voltage rating	600/1000V

Users should independently evaluate the suitability of the product for their application.
Before ordering check with factory for most current data.

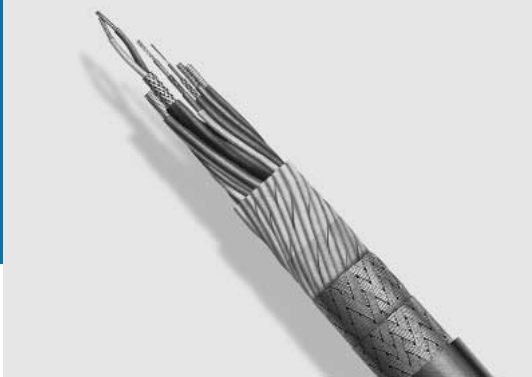

SeaLite SL105

Halogen free, flame-retardant cable range



Applications

Raychem SeaLite SL 105 is a new range of small size, lightweight, low fire hazard cables for the commercial and offshore market place.

The SeaLite SL 105 cable range is the first to be approved to the new Det Norske Veritas Standard for Lightweight Cables Type Approval Program No.6 – 827.11-1.

The SeaLite SL 105 cable range is constructed from flame retardant, halogen-free cores and outer sheath meeting the requirements of SHF2 to IEC 60092-350.

Offering size and weight savings over traditional cables, the SeaLite SL 105 cable range is suitable for use in general power, lighting, communication, control and instrumentation applications.

Agency recognition

- DNV (Det Norske Veritas).
- Lloyds Register of Shipping.
- ABS (American Bureau of Shipping).
- GL (Germanischer Lloyd).
- BV (Bureau Veritas).

Features and benefits

- Reduced size.
- Lightweight.
- Flame retardant to IEC 60332-3 Category A.
- Halogen free.
- Low smoke generation.
- Temperature rating -30°C to +85°C.
- 600V rating.
- Reduced amount of combustible materials.

Available in:

Americas

Europe

Asia Pacific



Fax-on-demand

US only (800) 260-9099

Outside US (650) 257-2301

Visit our website at www.tycoelectronics.com

Generic cable construction

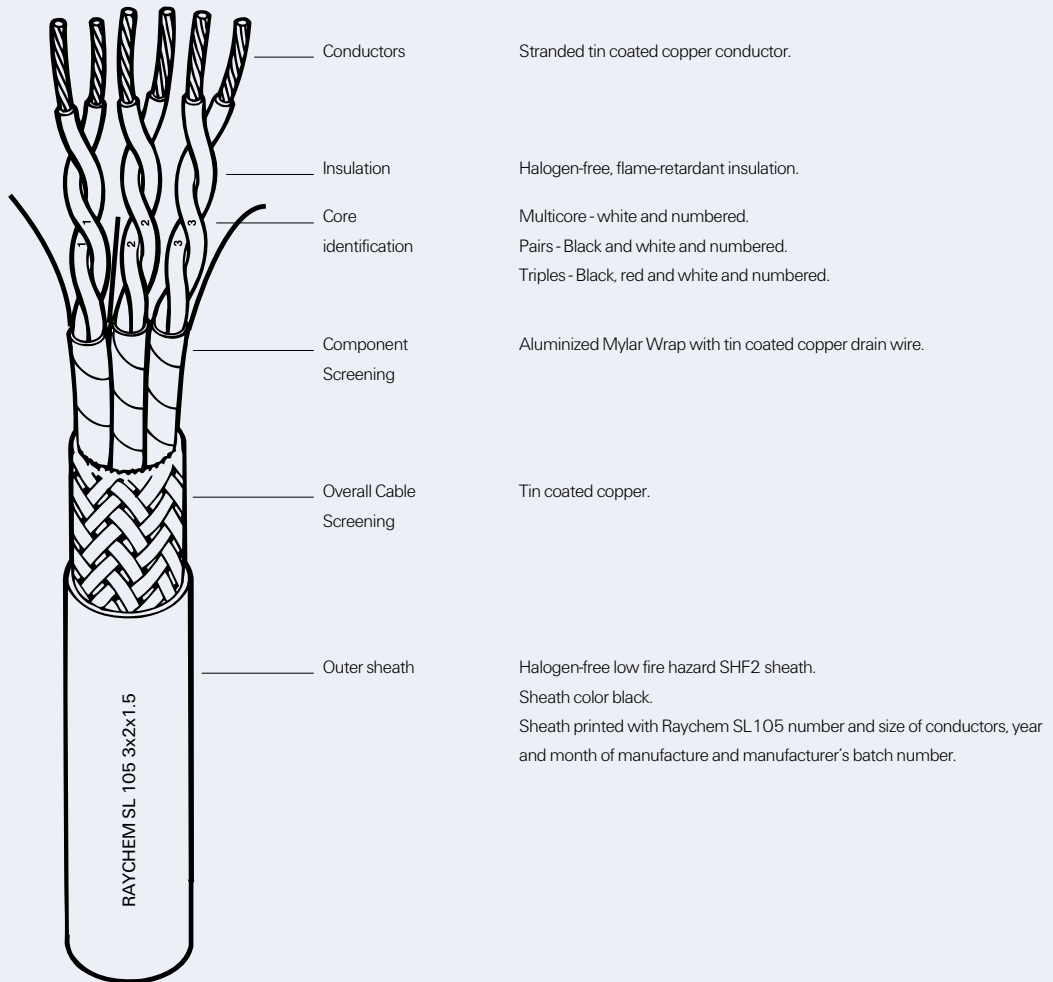

Example:
SL105 3x2x1.5-P10

SeaLite SL105 (cont'd.)

Halogen free, flame-retardant cable range

Specification summary			
Examination or test	Test basis	Requirements	Test on
General properties			
Braid coverage	IEC 60092-350	90% minimum coverage	Cable
Metallic coating of copper conductors	IEC 60092-350 by inspection	Conductor surface will be smooth and uniform. Insulation will not adhere to the conductor.	Conductor
Physical properties			
Tensile strength and ultimate elongation	IEC 60811-1-1	20MPa minimum, 150% minimum (insulation) (speed 50±10 mm/min)	Insulation
Scrape abrasion resistance	NF F 63-808	500 cycles minimum (5N load, 0.45 mm diameter rod, 20°C, 55 cycles/minute)	Core
Dynamic cut through	NF F 63-808	50N minimum (90° 0.13 mm radius blade, 20°C, 100g/s load)	Core
Notch propagation	NF F 63-808	No dielectric breakdown (0.05 mm notch, 6X mandrel, 1.5kV ac for 1 minute)	Core
Mechanical/particular characteristic of sheathing compounds	IEC 60092-350, 12.4 IEC 60092-359 Table II & III	SHF1 or SHF2	Sheath
Thermal properties			
Lifetime	BS 2G 230	>20000h @ 125°C	Core
Accelerated ageing	IEC 60811-1-2	No cracks, no dielectric breakdown (168h @ 180°C, 1.5kV ac for 5 minutes)	Core
Insulation blocking	NF F 63-808	Cores must be easily separated (6h @ 150°C)	Core
Cold bend (Where outer diameter <12.5 mm)	IEC 60811-1-4	No cracks, no dielectric breakdown (-30°C, 10X mandrel, 1.5kV ac for 5 mins for 1m core) (-30°C, 10X mandrel, 3.5kV ac for 5 min. Sample of cable)	Core
Current overload	BS 2G 230	No cracks, no dielectric breakdown (30s @ 250°C, 6X mandrel, wind as in test 11, 1.5kV ac for 5 minutes)	Core

Fax-on-demand

US only (800) 260-9099

Outside US (650) 257-2301

Visit our website at www.tycoelectronics.com**Specification summary (cont'd.)**

Examination or test	Test basis	Requirements	Test on
Electrical properties			
AC and DC voltage tests	IEC 60092-350	No dielectric breakdown	Core
		(2.5kV ac/4.5kV dc for 5 minutes for 1 m of core) (3.5kV ac/5 minutes for each delivery length of cable)	Cable
Insulation – continuity proof test	IEC 60092-350 Clause 9.3b	No dielectric breakdown At least 8kV impulse, 8kV dc or 5.3kV ac	Core
Insulation resistance at 20°C	IEC 60092-350	500M Ω km min. @ 20°C (5m length, quote actual IR)	Core
Insulation resistance at 90°C	IEC 60092-350	1.5M Ω km min @ 90°C (5m length, quote actual IR)	Core
Increase in a.c. capacitance after immersion in water	IEC 60092-350	C14-C1 \leq 0.15C1, C14-C7 \leq 0.05C7 (14 days @ 50°C in tap water)	Core
Environmental properties			
Ozone resistance	IEC 60092-350	No crazing or cracking	Core
	IEC 60811-2-1	(250-300ppm, 25°C, 30h)	
Fluid immersion: 72h @ 70°C – IRM 902, Diesel (F-76), 3.5% salt water	BS 2G 230	No cracking or dielectric breakdown 5% max, swell (6X mandrel, soak in water, 1.5kV ac for 5 minutes)	Core
Fire hazard properties			
Flammability – small scale	IEC 60332-1	Charring confined between 50mm and 540mm from lower edge of top support (Single vertical wire)	Core
Flammability – large scale	IEC 60332-3	Category A, designation F	Cable
Halogen content	IEC 60684-2 cl, 45	Less than 0.5% for each non metallic component	Cable
Toxicity index	IMO FTPC Appendix 3	It of less than 2, report Lc value	Cable
Smoke emission – small scale	ISO 5659-2 Appendix 3	Ds4 150 max. and Dmax 150 max. VOF4 300 max.	Core
Smoke emission – Large scale	IEC 61034-2	70% minimum transmittance	Cable

SeaLite SL105 (cont'd.)

Halogen free, flame-retardant cable range

SeaLite SL105-PI/SeaLite SL105-TI multipair and multitriple individually screened cables

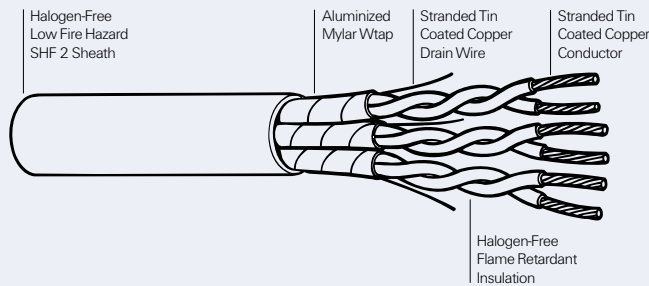

Field of application: Instrumentation and communication control General power and lighting

Voltage class: 0.6/1kV

Temperature class: 85°C

Selection table

Description	Construction	Conductor		Core		Cable			Nominal weight
		Number of strands	Nominal strand diameter	Nominal conductor CSA	Minimum insulation thickness	Nominal outer sheath thickness	Outer diameter (min.)	Outer diameter (max.)	
			mm	mm ²	mm	mm	mm	mm	kg/km
SL105-1x2x0.75-PI	1x2x0.75	19	0.23	0.75	0.18	1.0	4.9	5.5	46
SL105-2x2x0.75-PI	2x2x0.75	19	0.23	0.75	0.18	1.2	8.5	9.3	110
SL105-3x2x0.75-PI	3x2x0.75	19	0.23	0.75	0.18	1.2	8.6	9.6	128
SL105-7x2x0.75-PI	7x2x0.75	19	0.23	0.75	0.18	1.3	11.3	12.5	240
SL105-10x2x0.75-PI	10x2x0.75	19	0.23	0.75	0.18	1.4	13.5	14.9	334
SL105-14x2x0.75-PI	14x2x0.75	19	0.23	0.75	0.18	1.4	14.7	16.3	440
SL105-27x2x0.75-PI	27x2x0.75	19	0.23	0.75	0.18	1.5	19.7	21.7	801
SL105-37x2x0.75-PI	37x2x0.75	19	0.23	0.75	0.18	1.5	22.4	24.8	1066
SL105-3x2x1.0-PI	3x2x1.0	19	0.25	1.0	0.18	1.3	9.4	10.4	158
SL105-7x2x1.0-PI	7x2x1.0	19	0.25	1.0	0.18	1.4	12.4	13.6	300
SL105-12x2x1.0-PI	12x2x1.0	19	0.25	1.0	0.18	1.4	14.8	16.4	474
SL105-1x2x1.5-PI	1x2x1.5	37	0.23	1.5	0.20	1.1	6.1	6.7	73
SL105-2x2x1.5-PI	2x2x1.5	37	0.23	1.5	0.20	1.3	10.6	11.8	176
SL105-3x2x1.5-PI	3x2x1.5	37	0.23	1.5	0.20	1.3	10.8	12.0	208
SL105-7x2x1.5-PI	7x2x1.5	37	0.23	1.5	0.20	1.4	14.3	15.9	399
SL105-10x2x1.5-PI	10x2x1.5	37	0.23	1.5	0.20	1.4	16.8	18.6	547
SL105-14x2x1.5-PI	14x2x1.5	37	0.23	1.5	0.20	1.5	18.7	20.7	741
SL105-27x2x1.5-PI	27x2x1.5	37	0.23	1.5	0.20	1.6	25.1	27.7	1363
SL105-37x2x1.5-PI	37x2x1.5	37	0.23	1.5	0.20	1.8	29.2	32.2	1855
SL105-1x3x0.75-TI	1x3x0.75	19	0.23	0.75	0.18	1.0	5.2	5.8	53
SL105-2x3x0.75-TI	2x3x0.75	19	0.23	0.75	0.18	1.3	9.2	10.2	133
SL105-4x3x0.75-TI	4x3x0.75	19	0.23	0.75	0.18	1.3	10.5	11.7	199
SL105-7x3x0.75-TI	7x3x0.75	19	0.23	0.75	0.18	1.4	12.7	14.1	300
SL105-12x3x0.75-TI	12x3x0.75	19	0.23	0.75	0.18	1.4	16.6	18.4	482

CSA = Cross sectional area

Note: For installation guidelines refer to Tyco Electronics installation guidelines document WT1189

Fax-on-demand

US only (800) 260-9099

Outside US (650) 257-2301

Visit our website at www.tycoelectronics.com

SeaLite SL105-PU multipair unshielded cables

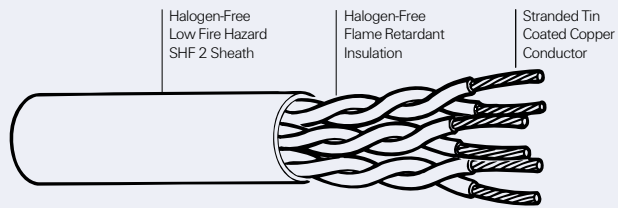

Field of application	Instrumentation and communication control General power and lighting
Voltage class	0.6/1kV
Temperature class	85°C

Selection table

Description	Construction	Conductor		Core		Cable			
		Number of strands	Nominal strand diameter	Nominal conductor CSA	Minimum insulation thickness	Nominal outer sheath thickness	Outer diameter (min.)	Outer diameter (max.)	Nominal weight
			mm	mm ²	mm	mm	mm	mm	kg/km
SL105-1x2x0.75-PU	1x2x0.75	19	0.23	0.75	0.18	1.0	4.8	5.4	40
SL105-2x2x0.75-PU	2x2x0.75	19	0.23	0.75	0.18	1.0	5.4	6.0	58
SL105-3x2x0.75-PU	3x2x0.75	19	0.23	0.75	0.18	1.2	8.1	8.9	101
SL105-4x2x0.75-PU	4x2x0.75	19	0.23	0.75	0.18	1.2	8.6	9.6	123
SL105-7x2x0.75-PU	7x2x0.75	19	0.23	0.75	0.18	1.3	10.4	11.4	184
SL105-10x2x0.75-PU	10x2x0.75	19	0.23	0.75	0.18	1.3	11.6	12.8	244
SL105-14x2x0.75-PU	14x2x0.75	19	0.23	0.75	0.18	1.4	13.5	14.9	331
SL105-19x2x0.75-PU	19x2x0.75	19	0.23	0.75	0.18	1.4	15.3	16.9	430
SL105-24x2x0.75-PU	24x2x0.75	19	0.23	0.75	0.18	1.4	16.8	18.6	527
SL105-37x2x0.75-PU	37x2x0.75	19	0.23	0.75	0.18	1.5	20.4	22.6	786
SL105-7x2x1.0-PU	7x2x1.0	19	0.25	1.0	0.18	1.3	11.1	12.3	214
SL105-10x2x1.0-PU	10x2x1.0	19	0.25	1.0	0.18	1.4	12.6	14.0	293
SL105-4x2x1.5-PU	4x2x1.5	37	0.23	1.5	0.20	1.3	11.0	12.2	210
SL105-7x2x1.5-PU	7x2x1.5	37	0.23	1.5	0.20	1.4	13.2	14.6	315
SL105-10x2x1.5-PU	10x2x1.5	37	0.23	1.5	0.20	1.4	14.9	16.5	424
SL105-14x2x1.5-PU	14x2x1.5	37	0.23	1.5	0.20	1.5	17.3	19.1	578
SL105-19x2x1.5-PU	19x2x1.5	37	0.23	1.5	0.20	1.5	19.7	21.7	758
SL105-24x2x1.5-PU	24x2x1.5	37	0.23	1.5	0.20	1.6	21.9	24.3	947
SL105-37x2x1.5-PU	37x2x1.5	37	0.23	1.5	0.20	1.8	26.9	29.7	1433
SL105-4x2x2.5-PU	4x2x2.5	37	0.29	2.5	0.20	1.4	12.7	14.1	292
SL105-7x2x2.5-PU	7x2x2.5	37	0.29	2.5	0.20	1.4	15.1	16.7	437
SL105-10x2x2.5-PU	10x2x2.5	37	0.29	2.5	0.20	1.5	17.2	19.0	604
SL105-14x2x2.5-PU	14x2x2.5	37	0.29	2.5	0.20	1.5	19.9	21.9	815
SL105-24x2x2.5-PU	24x2x2.5	37	0.29	2.5	0.20	1.7	25.5	28.1	1360
SL105-37x2x2.5-PU	37x2x2.5	37	0.29	2.5	0.20	1.9	31.3	34.5	2061

CSA = Cross sectional area Note: For installation guidelines refer to Tyco Electronics installation guidelines document WT 1189

Users should independently evaluate the suitability of the product for their application. Before ordering check with factory for most current data.

SeaLite SL105 (cont'd.)

Halogen free, flame-retardant cable range

SeaLite SL105-SO multicore overall screened cables

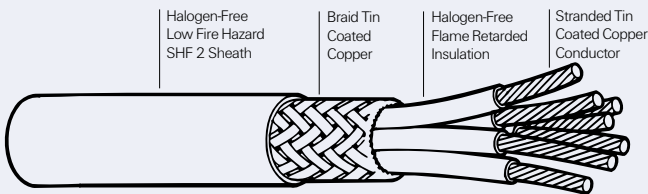

Field of application	Instrumentation and communication control General power and lighting
Voltage class	0.6/1kV
Temperature class	85°C

Selection table

Description	Construction	Conductor		Core		Cable				
		Number of strands	Nominal strand diameter	Nominal conductor CSA	Minimum insulation thickness	Nominal braid wire diameter	Nominal outer sheath thickness	Outer diameter		Nominal weight
		mm		mm ²	mm	mm	mm	(min.)	(max.)	kg/km
SL105-2x1.0-SO	2x1.0	19	0.25	1.0	0.18	0.13	1.0	5.7	6.3	61
SL105-3x1.0-SO	3x1.0	19	0.25	1.0	0.18	0.13	1.1	6.2	6.8	74
SL105-4x1.0-SO	4x1.0	19	0.25	1.0	0.18	0.13	1.1	6.6	7.2	88
SL105-7x1.0-SO	7x1.0	19	0.25	1.0	0.18	0.13	1.2	7.7	8.5	131
SL105-12x1.0-SO	12x1.0	19	0.25	1.0	0.18	0.13	1.3	9.7	10.7	205
SL105-19x1.0-SO	19x1.0	19	0.25	1.0	0.18	0.13	1.3	11.0	12.2	289
SL105-2x1.5-SO	2x1.5	37	0.23	1.5	0.20	0.13	1.1	6.6	7.2	83
SL105-3x1.5-SO	3x1.5	37	0.23	1.5	0.20	0.13	1.2	7.1	7.9	102
SL105-4x1.5-SO	4x1.5	37	0.23	1.5	0.20	0.13	1.2	7.6	8.4	123
SL105-7x1.5-SO	7x1.5	37	0.23	1.5	0.20	0.13	1.2	8.7	9.7	181
SL105-12x1.5-SO	12x1.5	37	0.23	1.5	0.20	0.13	1.3	11.1	12.3	288
SL105-19x1.5-SO	19x1.5	37	0.23	1.5	0.20	0.13	1.4	12.9	14.3	422
SL105-27x1.5-SO	27x1.5	37	0.23	1.5	0.20	0.16	1.4	15.2	16.8	586
SL105-37x1.5-SO	37x1.5	37	0.23	1.5	0.20	0.16	1.4	16.8	18.6	762
SL105-2x2.5-SO	2x2.5	37	0.29	2.5	0.20	0.13	1.2	7.5	8.3	110
SL105-3x2.5-SO	3x2.5	37	0.29	2.5	0.20	0.13	1.2	7.8	8.6	135
SL105-4x2.5-SO	4x2.5	37	0.29	2.5	0.20	0.13	1.2	8.4	9.2	161
SL105-7x2.5-SO	7x2.5	37	0.29	2.5	0.20	0.13	1.3	9.9	10.9	249
SL105-12x2.5-SO	12x2.5	37	0.29	2.5	0.20	0.13	1.4	12.7	14.1	399
SL105-19x2.5-SO	19x2.5	37	0.29	2.5	0.20	0.16	1.4	14.7	16.3	595
SL105-27x2.5-SO	27x2.5	37	0.29	2.5	0.20	0.20	1.5	17.8	19.6	841
SL105-37x2.5-SO	37x2.5	37	0.29	2.5	0.20	0.20	1.5	19.7	21.7	1099

CSA = Cross sectional area

Note: For installation guidelines refer to Tyco Electronics installation guidelines document WT1 189

Fax-on-demand

US only (800) 260-9099

Outside US (650) 257-2301

Visit our website at www.tycoelectronics.com

SeaLite SL105-PO multipair overall screened cables

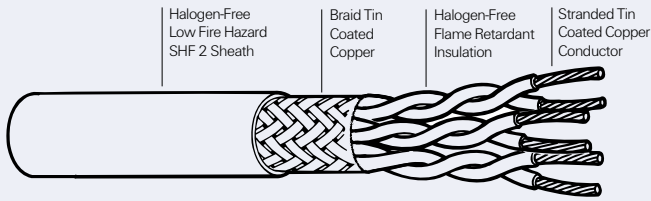

Field of application	Instrumentation and communication control General power and lighting
Voltage class	0.6/1kV
Temperature class	85°C

Selection table

Description	Construction	Conductor		Core		Cable				
		Number of strands	Nominal strand diameter	Nominal conductor CSA	Minimum insulation thickness	Nominal braid wire diameter	Nominal outer sheath thickness	Outer diameter		Nominal weight
		mm		mm ²	mm	mm	mm	mm	mm	kg/km
SL105-2x2x0.75-PO	2x2x0.75	19	0.23	0.75	0.18	0.13	1.1	6.2	6.8	78
SL105-3x2x0.75-PO	3x2x0.75	19	0.23	0.75	0.18	0.13	1.2	8.6	9.6	127
SL105-7x2x0.75-PO	7x2x0.75	19	0.23	0.75	0.18	0.13	1.3	10.9	12.1	219
SL105-14x2x0.75-PO	14x2x0.75	19	0.23	0.75	0.18	0.13	1.4	14.1	15.5	377
SL105-19x2x0.75-PO	19x2x0.75	19	0.23	0.75	0.18	0.16	1.4	16.0	17.6	496
SL105-27x2x0.75-PO	27x2x0.75	19	0.23	0.75	0.18	0.20	1.5	18.7	20.7	694
SL105-37x2x0.75-PO	37x2x0.75	19	0.23	0.75	0.18	0.20	1.6	21.5	23.7	912
SL105-3x2x1.0-PO	3x2x1.0	19	0.25	1.0	0.18	0.13	1.3	9.3	10.3	150
SL105-4x2x1.0-PO	4x2x1.0	19	0.25	1.0	0.18	0.13	1.3	10.1	11.1	179
SL105-5x2x1.0-PO	5x2x1.0	19	0.25	1.0	0.18	0.13	1.3	10.8	12.0	206
SL105-10x2x1.0-PO	10x2x1.0	19	0.25	1.0	0.18	0.13	1.4	13.2	14.6	335
SL105-12x2x1.0-PO	12x2x1.0	19	0.25	1.0	0.18	0.16	1.4	14.2	15.8	399
SL105-20x2x1.0-PO	20x2x1.0	19	0.25	1.0	0.18	0.20	1.5	18.1	19.9	652
SL105-2x2x1.5-PO	2x2x1.5	37	0.23	1.5	0.20	0.13	1.2	7.6	8.4	123
SL105-3x2x1.5-PO	3x2x1.5	37	0.23	1.5	0.20	0.13	1.3	10.7	11.9	202
SL105-4x2x1.5-PO	4x2x1.5	37	0.23	1.5	0.20	0.13	1.3	11.6	12.8	247
SL105-7x2x1.5-PO	7x2x1.5	37	0.23	1.5	0.20	0.13	1.4	13.8	15.2	360
SL105-10x2x1.5-PO	10x2x1.5	37	0.23	1.5	0.20	0.16	1.4	15.6	17.2	488
SL105-12x2x1.5-PO	12x2x1.5	37	0.23	1.5	0.20	0.16	1.4	16.7	18.5	566
SL105-19x2x1.5-PO	19x2x1.5	37	0.23	1.5	0.20	0.20	1.5	20.5	22.7	868
SL105-20x2x1.5-PO	20x2x1.5	37	0.23	1.5	0.20	0.20	1.5	21.2	23.4	933
SL105-27x2x1.5-PO	27x2x1.5	37	0.23	1.5	0.25	0.25	1.7	24.3	26.9	1230
SL105-37x2x1.5-PO	37x2x1.5	37	0.23	1.5	0.20	0.25	1.8	27.9	30.9	1622

CSA = Cross sectional area

Note: For installation guidelines refer to Tyco Electronics installation guidelines document WT1189

Users should independently evaluate the suitability of the product for their application. Before ordering check with factory for most current data.

SeaLite SL105 (cont'd.)

Halogen free, flame-retardant cable range

SeaLite SL105-SU multicore unshielded cables

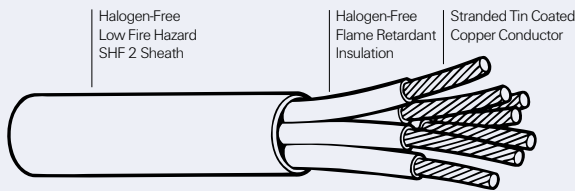

Field of application	Instrumentation and communication control General power and lighting
Voltage class	0.6/1kV
Temperature class	85°C

Selection table

Description	Construction	Conductor		Core		Cable			Nominal weight kg/km
		Number of strands	Nominal strand diameter mm	Nominal conductor CSA mm ²	Minimum insulation thickness mm	Nominal outer sheath thickness mm	Outer diameter (min.) mm	Outer diameter (max.) mm	
SL105-7x0.75-SU	7x0.75	19	0.23	0.75	0.18	1.1	6.5	7.1	91
SL105-12x0.75-SU	12x0.75	19	0.23	0.75	0.18	1.2	8.4	9.2	147
SL105-19x0.75-SU	19x0.75	19	0.23	0.75	0.18	1.3	9.8	10.8	218
SL105-27x0.75-SU	27x0.75	19	0.23	0.75	0.18	1.3	11.4	12.6	297
SL105-2x1.0-SU	2x1.0	19	0.25	1.0	0.18	1.0	5.1	5.7	45
SL105-3x1.0-SU	3x1.0	19	0.25	1.0	0.18	1.0	5.4	6.0	54
SL105-2x1.5-SU	2x1.5	37	0.23	1.5	0.20	1.1	6.0	6.6	64
SL105-3x1.5-SU	3x1.5	37	0.23	1.5	0.20	1.1	6.4	7.0	78
SL105-4x1.5-SU	4x1.5	37	0.23	1.5	0.20	1.1	6.8	7.6	97
SL105-5x1.5-SU	5x1.5	37	0.23	1.5	0.20	1.2	7.6	8.4	122
SL105-7x1.5-SU	7x1.5	37	0.23	1.5	0.20	1.2	8.2	9.0	155
SL105-12x1.5-SU	12x1.5	37	0.23	1.5	0.20	1.3	10.5	11.7	253
SL105-14x1.5-SU	14x1.5	37	0.23	1.5	0.20	1.3	11.0	12.2	288
SL105-19x1.5-SU	19x1.5	37	0.23	1.5	0.20	1.4	12.3	13.7	381
SL105-24x1.5-SU	24x1.5	37	0.23	1.5	0.20	1.4	14.2	15.8	474
SL105-27x1.5-SU	27x1.5	37	0.23	1.5	0.20	1.4	14.5	16.1	523
SL105-37x1.5-SU	37x1.5	37	0.23	1.5	0.20	1.4	16.1	17.9	692
SL105-2x2.5-SU	2x2.5	37	0.29	2.5	0.20	1.1	6.7	7.5	85
SL105-3x2.5-SU	3x2.5	37	0.29	2.5	0.20	1.2	7.2	8.0	112
SL105-4x2.5-SU	4x2.5	37	0.29	2.5	0.20	1.2	7.8	8.6	136
SL105-5x2.5-SU	5x2.5	37	0.29	2.5	0.20	1.2	8.5	9.3	166
SL105-7x2.5-SU	7x2.5	37	0.29	2.5	0.20	1.3	9.3	10.3	218
SL105-12x2.5-SU	12x2.5	37	0.29	2.5	0.20	1.3	12.0	13.2	352
SL105-19x2.5-SU	19x2.5	37	0.29	2.5	0.20	1.4	14.1	15.5	535
SL105-27x2.5-SU	27x2.5	37	0.29	2.5	0.20	1.4	16.7	18.5	739
SL105-37x2.5-SU	37x2.5	37	0.29	2.5	0.20	1.5	18.8	20.8	994

CSA = Cross sectional area

Note: For installation guidelines refer to Tyco Electronics installation guidelines document WT 1189

Fax-on-demand

US only (800) 260-9099

Outside US (650) 257-2301

Visit our website at www.tycoelectronics.com

SeaLite SL105-PIO multipair individually and overall screened cables

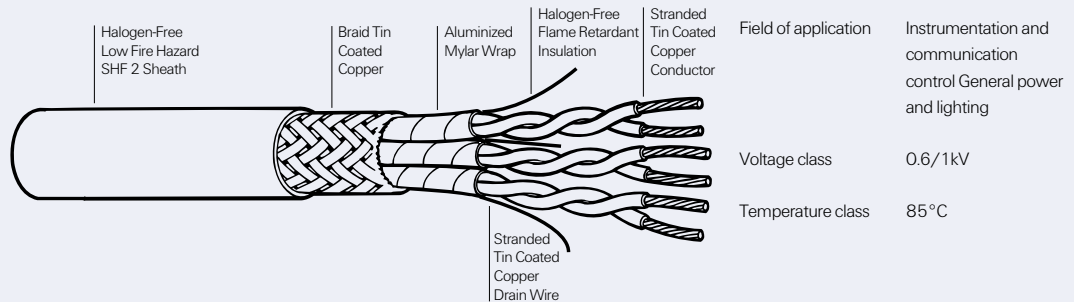

Selection table

Description	Construction	Conductor		Core		Cable				
		Number of strands	Nominal strand diameter	Nominal conductor CSA	Minimum insulation thickness	Outer screen nominal braid wire diameter	Nominal outer sheath thickness	Outer diameter		Nominal weight
		mm		mm ²	mm	mm	mm	mm (min.)	mm (max.)	kg/km
SL105-2x2x0.5-PIO	2x2x0.5	19	0.18	0.5	0.18	0.13	1.2	8.4	9.2	117
SL105-4x2x0.5-PIO	4x2x0.5	19	0.18	0.5	0.18	0.13	1.3	9.3	10.3	163
SL105-7x2x0.5-PIO	7x2x0.5	19	0.18	0.5	0.18	0.13	1.3	10.9	12.1	231
SL105-10x2x0.5-PIO	10x2x0.5	19	0.18	0.5	0.18	0.13	1.4	12.8	14.2	313
SL105-12x2x0.5-PIO	12x2x0.5	19	0.18	0.5	0.18	0.13	1.4	13.1	14.5	355
SL105-19x2x0.5-PIO	19x2x0.5	19	0.18	0.5	0.18	0.16	1.4	15.8	17.4	530
SL105-24x2x0.5-PIO	24x2x0.5	19	0.18	0.5	0.18	0.20	1.5	17.7	19.5	672
SL105-37x2x0.5-PIO	37x2x0.5	19	0.18	0.5	0.18	0.20	1.5	21.0	23.2	966
SL105-1x2x0.75-PIO	1x2x0.75	19	0.23	0.75	0.18	0.13	1.0	5.6	6.2	62
SL105-2x2x0.75-PIO	2x2x0.75	19	0.23	0.75	0.18	0.13	1.3	9.2	10.2	142
SL105-4x2x0.75-PIO	4x2x0.75	19	0.23	0.75	0.18	0.13	1.3	10.2	11.2	195
SL105-7x2x0.75-PIO	7x2x0.75	19	0.23	0.75	0.18	0.13	1.3	11.9	13.1	279
SL105-10x2x0.75-PIO	10x2x0.75	19	0.23	0.75	0.18	0.13	1.4	14.1	15.5	380
SL105-14x2x0.75-PIO	14x2x0.75	19	0.23	0.75	0.18	0.16	1.4	15.4	17.0	504
SL105-19x2x0.75-PIO	19x2x0.75	19	0.23	0.75	0.18	0.20	1.5	17.9	19.7	679
SL105-24x2x0.75-PIO	24x2x0.75	19	0.23	0.75	0.18	0.20	1.5	19.5	21.5	824
SL105-37x2x0.75-PIO	37x2x0.75	19	0.23	0.75	0.18	0.25	1.6	23.7	26.1	1237
SL105-1x2x1.5-PIO	1x2x1.5	37	0.23	1.5	0.20	0.13	1.1	6.7	7.5	94
SL105-2x2x1.5-PIO	2x2x1.5	37	0.23	1.5	0.20	0.13	1.3	11.2	12.4	211
SL105-3x2x1.5-PIO	3x2x1.5	37	0.23	1.5	0.20	0.13	1.3	11.4	12.6	245
SL105-7x2x1.5-PIO	7x2x1.5	37	0.23	1.5	0.20	0.16	1.4	15.0	16.6	460
SL105-12x2x1.5-PIO	12x2x1.5	37	0.23	1.5	0.20	0.20	1.5	18.4	20.4	744
SL105-19x2x1.5-PIO	19x2x1.5	37	0.23	1.5	0.20	0.20	1.6	22.6	25.0	1141
SL105-24x2x1.5-PIO	24x2x1.5	37	0.23	1.5	0.20	0.25	1.6	24.9	27.5	1391

CSA = Cross sectional area

Note: For installation guidelines refer to Tyco Electronics installation guidelines document WT 1189

Users should independently evaluate the suitability of the product for their application. Before ordering check with factory for most current data.



Type 99M



Applications

Type 99M wire has a dual wall construction of radiation cross-linked modified polyester. This combines excellent mechanical performance and chemical resistance with a range of enhanced fire hazard properties. Type 99M wire is designed to meet the stringent low hazard performance now being specified by many authorities, in particular for naval, mass transit and industrial control panel wiring.

During the 1980's there were major changes in the demands of many wire and cable specifications to reduce the risks associated with all aspects of fire hazards. Specifications such as Def Stan 6 1-12 Part 18, have been developed over the last decade demanding improved performance of wires and cables under fire conditions.

This has led to a tightening of the requirements for flammability, smoke generation, corrosive gas generation and hazardous fume emission. Type 99M wire achieves these improvements in performance whilst retaining small size, light weight, flexibility, handleability, resistance to carbon arc tracking and resistance to chemicals and fluids.

Features and benefits

- Low flammability.
- Low smoke generation.
- Low toxicity index.
- Low generation of corrosive gases.
- Small size, lightweight.

Physical characteristics

Handleability

Type 99M wire has been designed to be compatible with modern wiring and harnessing techniques. It is a flexible wire with virtually no springback once set. It is easily stripped with tools such as conventional die-blade strippers.

Small size

Type 99M equipment wire has a nominal 0.2 mm insulation wall thickness which is comparable to other established thin wall wires such as SPEC 44 wire.

Light weight

Type 99M wire is designed to have the same weights as SPEC 44 wire.

Available in:

Americas

Europe

Asia Pacific



Fax-on-demand

US only (800) 260-9099

Outside US (650) 257-2301

Visit our website at www.tycoelectronics.com**Approvals**





Raychem WCD 281

Def Stan 61-12 Part 18 Issue 4 Type 1

Italian Navy STN-SR-01

Lloyds Register

Type 99M wire and cable - nominal sizes, strandings and weights**Primary wires/screened and jacketed cables - 99M**

	99M011X (600 V) primary wire		99M021X (1000 V) primary wire		99M1111 screened & jacketed		99M1121 screened & jacketed		
									
Size	Stranding (mm)	OD (mm)	Weight (g/m)	OD (mm)	Weight (g/m)	OD (mm)	Weight (g/m)	OD (mm)	Weight (g/m)
26	19x0.10	0.88	2.0	1.01	2.2	1.80	7.5	2.91	13.3
24	19x0.12	0.98	3.0	1.17	3.4	1.90	9.2	3.20	16.6
22	19x0.15	1.13	4.4	1.37	4.9	2.05	11.1	3.52	20.5
20	19x0.20	1.40	6.5	1.57	7.3	2.30	14.6	4.02	27.7
18	19x0.25	1.65	9.9	1.85	10.9	2.55	19.3	4.57	37.1
16	19x0.30	1.90	14.15	2.10	14.5	2.95	24.9	5.13	48.5
14	37x0.25	2.25	18.62	2.50	21.8	3.13	30.9	5.72	60.5
12	37x0.32	2.60	25.7	2.97	31.3	3.48	43.4	6.42	86.0

Typical properties

Test	Method	Typical value
Temperature rating	BS G230	125°C
Voltage rating	Raychem	600 V thin wall
Tensile strength/elongation of insulation		30 MPa/250%
Notch propagation (0.05 mm notch)	BS G230	Pass
Shrinkage 200°C	BS G230	<1%
Low temperature bend	BS G230	-55°C
Voltage withstand	BS G230	2.5 kV
Insulation resistance (20°C)	BS G230	1000 M ohms km (min)
Pliability rating	Def Stan 61-12 (18)	82 - Pliable
Fluid resistance	Def Stan 61-12 (18)	
Fuels - aircraft		Pass
Oils - (ASTM No 3)		Pass
Solvents		Pass

Users should independently evaluate the suitability of the product for their application.
Before ordering check with factory for most current data.

Environmental properties

Mechanical performance

The scrape abrasion and cut through resistance of Type 99M wire out performs the well-established performance of SPEC 44 wire throughout its operating temperature range.

Fluid resistance

Type 99M wire demonstrates outstanding resistance to most acids, alkalis, hydrocarbon solvents, fuels, lubricants and water.

Electrical arc tracking

Type 99M wire is resistant to electrical arc tracking under both wet and dry conditions.

Voltage ratings

Standard available voltage ratings for Type 99M wire are 600 V (0.2 mm wall thickness) and 1000 V (0.3 mm wall thickness).

Fire hazard characteristics

Low Toxicity Index

Type 99M wire is designed to meet the low hazardous fume emission levels required in modern specifications. For example, the change in the Toxicity Index requirement from 1.5 to 0.2 between Issue 2 and Issue 3 of Def Stan 61-12 (Part 18), is met by Type 99M wire.

Flammability

Type 99M wire has passed some of the most stringent flammability tests, such as the test in IEC 332 Part 3 (ladder test) and Underwriter's Laboratory for VW1 (individual wire)

Smoke generation

Type 99M wire has been designed to meet stringent smoke tests such as those specified in Def Stan 61-12 (Part 18) and in many mass transit specifications.

Corrosivity

Type 99M wire has a low corrosive gas emission, demonstrated by its low acid gas value and meets the latest requirements of low fire hazard specifications.

Fire hazard properties

Test	Method	Typical value
Flammability	IEC 332 Pt 3	Pass
Toxicity index	Def Stan 61-12 (18)	0.1 per meter of wire
Smoke index	Def Stan 61-12 (18)	8 per meter of wire
Acid gas equivalent	TDE 76/P/76	<1.5%

Fax-on-demand

US only (800) 260-9099

Outside US (650) 257-2301

Visit our website at www.tycoelectronics.com

Part numbering system

99 X X X X X- Size- X/X- X

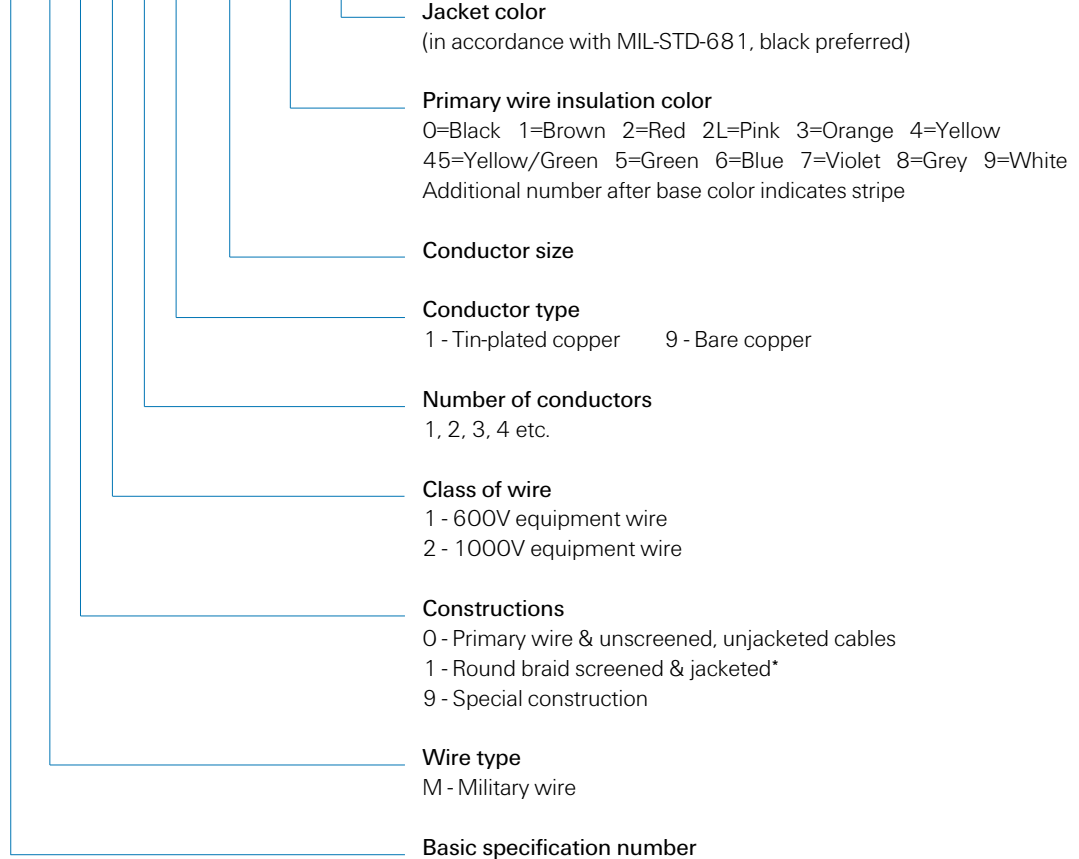

* The cable jackets are Raychem Zerohal and the preferred color is black.

Typical ordering example

Two conductors, transit wire, black, red components, black jacket. Round braid screened, size 20 conductor, 600 volt. Part number is 99M1121-20-0/2-0.



Zerohal 100A



Applications

Raychem's latest generation LFH, thinwall wire has been designed for use primarily in signal, control and light power circuits in subway, regional and high speed trains. It is ideal for applications where space and weight are at a premium; fire safety is important; reliability is imperative; rugged properties to withstand service in an RMT environment are required.

The construction is a dual wall combination of Raychem formulated polymer blends developed to meet the specification requirements while maintaining the desirable features of small size, lightweight, flexibility, non-wrinkling, ease of stripping, compatibility with standard stripping equipment, lack of recoil and mechanical robustness.

Features and benefits

- Halogen free, low smoke.
- Highly flame retardant.
- Flexible, easy to install.
- Small size, lightweight (thin wall construction).

Physical characteristics

Handleability

Zerohal 100A has been designed for minimum recoil during harnessing operations, to be readily handleable by modern wiring and harnessing techniques and to be easily stripped with standard equipment and tools.

Available in:

Americas

Europe

Asia Pacific

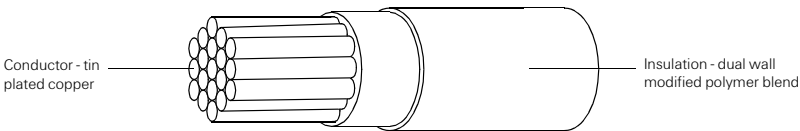

Fax-on-demand

US only (800) 260-9099

Outside US (650) 257-2301

Visit our website at www.tycoelectronics.com**Typical properties**

Test	Method	Typical values																																																				
Physical properties																																																						
Insulation Tensile Strength and Ultimate Elongation	ASTM D3032	Tensile Strength 3500 psi minimum Ultimate Elongation 250% minimum																																																				
Scrape Abrasion Resistance	AAR S 501	1000 cycles minimum (90°, 0.01 inch radial edge blade, 6N load, 20°C)																																																				
Dynamic Cut Through	ASTM D3032	20 lbs. minimum (90°, 0.01 inch radial edge blade, 0.2 inch per min, 20°C)																																																				
Static Cut-through Penetration	AAR S 501	No contact with the conductor (90°, 0.01 inch radial edge blade, 10 min, 9N load, 125°C)																																																				
Thermal Properties																																																						
Temperature Index	ASTM D3032	10,000 hours minimum at 125°C																																																				
Accelerated ageing	ASTM D3032	No cracks, flow or dielectric breakdown. (168hr at 170°C)																																																				
Shrinkage	IEC 81 1-1-3	0.5% maximum at each end. (6hr at 160°C)																																																				
Insulation Blocking	MIL-W-22759E	Cores must be easily separated without damage (24hr at 125°C, 6X mandrel.)																																																				
Electrical Properties																																																						
IR Constant	ASTM D3032	>10000 MΩkft at 20°C >100 MΩkft at 60°C >10 MΩkft at 90°C																																																				
Environmental Properties																																																						
Fluid Immersion	ASTM D3032	<table border="1"> <thead> <tr> <th>Fluid</th> <th>NATO code</th> <th>Temp (°C)</th> <th>Time (hr)</th> </tr> </thead> <tbody> <tr> <td>ASTM No. 1 Oil</td> <td>–</td> <td>100</td> <td>70</td> </tr> <tr> <td>IRM 902 Oil</td> <td>–</td> <td>100</td> <td>70</td> </tr> <tr> <td>IRM 903 Oil</td> <td>–</td> <td>100</td> <td>70</td> </tr> <tr> <td>70/30 iso-octane/toluene</td> <td>–</td> <td>23</td> <td>24</td> </tr> <tr> <td>Engine lubricating oil</td> <td>O-236</td> <td>70</td> <td>24</td> </tr> <tr> <td>Grease</td> <td>G-354</td> <td>70</td> <td>24</td> </tr> <tr> <td>Hydraulic fluid, petroleum base</td> <td>H-515</td> <td>50</td> <td>24</td> </tr> <tr> <td>Silicone damping fluid</td> <td>S-1724</td> <td>70</td> <td>24</td> </tr> <tr> <td>Automotive brake fluid</td> <td>H-542</td> <td>23</td> <td>24</td> </tr> <tr> <td>Fire resistant hydraulic fluid</td> <td>H-544</td> <td>50</td> <td>24</td> </tr> <tr> <td>De-icing fluid</td> <td>S-745</td> <td>23</td> <td>24</td> </tr> <tr> <td>Methyl Ethyl Ketone</td> <td>–</td> <td>23</td> <td>1</td> </tr> </tbody> </table> <p>5% max swell. No dielectric breakdown. (30mm diameter mandrel)</p>	Fluid	NATO code	Temp (°C)	Time (hr)	ASTM No. 1 Oil	–	100	70	IRM 902 Oil	–	100	70	IRM 903 Oil	–	100	70	70/30 iso-octane/toluene	–	23	24	Engine lubricating oil	O-236	70	24	Grease	G-354	70	24	Hydraulic fluid, petroleum base	H-515	50	24	Silicone damping fluid	S-1724	70	24	Automotive brake fluid	H-542	23	24	Fire resistant hydraulic fluid	H-544	50	24	De-icing fluid	S-745	23	24	Methyl Ethyl Ketone	–	23	1
Fluid	NATO code	Temp (°C)	Time (hr)																																																			
ASTM No. 1 Oil	–	100	70																																																			
IRM 902 Oil	–	100	70																																																			
IRM 903 Oil	–	100	70																																																			
70/30 iso-octane/toluene	–	23	24																																																			
Engine lubricating oil	O-236	70	24																																																			
Grease	G-354	70	24																																																			
Hydraulic fluid, petroleum base	H-515	50	24																																																			
Silicone damping fluid	S-1724	70	24																																																			
Automotive brake fluid	H-542	23	24																																																			
Fire resistant hydraulic fluid	H-544	50	24																																																			
De-icing fluid	S-745	23	24																																																			
Methyl Ethyl Ketone	–	23	1																																																			
Fire Hazard Properties																																																						
Flammability - small scale	IEC 332-1	Charring confined between 50mm and 540mm from lower edge of top support. (Single vertical wire, 60 s flame)																																																				
Flammability - large scale	IEC 332-3	2.5m maximum burn length. (Five 3.5m long 37-wire bundles, vertical, 20.5 kW flame)																																																				
Smoke - small scale	ISO 5659-2	Ds1.5 of 100 max., Ds4 of 150 max., Dmax of 150 max., VOF4 of 300 max. (‘NBS’ smoke box with cone heater, 1.8m of wire 50 kW/m ² heat flux with and without a pilot flame)																																																				
Smoke - large scale	IEC 1034	90% minimum transmittance. (3m cube smoke box. Eight 1m long 7-wire bundles, horizontal. Fire source: 1 litre burning alcohol.)																																																				
Toxicity	IMO FTPC	Toxicity index < 1 (Test conditions as in smoke - small scale)																																																				
Halogen Content	IEC 684-2	Less than 0.2% Cl + Br + I. Less than 0.1% F (Wet chemical analysis)																																																				
Copper Mirror Corrosion	ASTM D2671	5% maximum etched area. (0.4g sample, 200°C, 16hr.)																																																				
Acid Gas Detection	IEC 754-2	pH greater than 4.3 10µS/mm maximum (1g sample, tube furnace, T>935°C, gases dissolved in water)																																																				

Users should independently evaluate the suitability of the product for their application.
Before ordering check with factory for most current data.

Environmental properties

Fluid resistance

Zerohal 100A wire demonstrates an outstanding balance of resistance to a wide range of commonly used solvents, fluids and lubricants.

Voltage rating

Zerohal 100A wire is a 600 volt rated wire.

Fire hazard characteristics

Zerohal 100A is a halogen free insulation system and does not contain phosphorus or sulphur. It meets the toxicity, smoke density, halogen content, corrosivity and flammability requirements of major recognized agencies.

Flammability

Zerohal 100A meets the flammability/burning behaviour requirements of major recognized agencies.

Fire hazard properties

Test	Method	Typical value
Flammability - small scale	IEC 332-1	Charring confined between 50mm and 540mm from lower edge of top support. (Single vertical wire, 60 s flame)
Flammability - large scale	IEC 332-3	2.5m maximum burn length. (Five 3.5m long 37-wire bundles, vertical, 20.5 kW flame)
Flammability	IEE383	Pass
Smoke - small scale	ISO 5659-2	Ds 1.5 of 100 max., Ds4 of 150 max., Dmax of 150 max., VOF _s of 300 max. (‘NBS’ smoke box with cone heater, 1.8m of wire 50 kW/m ² heat flux with and without a pilot flame)
Toxicity	IMO FTPC	Toxicity index < 1 (Test conditions as in smoke - small scale)
Halogen Content	IEC 684-2	Less than 0.2% Cl + Br + I. Less than 0.1% F (Wet chemical analysis)
Copper Mirror Corrosion	ASTM D2671	5% maximum etched area. (0.4g sample, 200°C, 16hr.)
Acid Gas Detection	IEC 754-2	pH greater than 4.3 10 μS/mm maximum (1g sample, tube furnace, T > 935°C, gases dissolved in water)

Fax-on-demand

US only (800) 260-9099

Outside US (650) 257-2301

Visit our website at www.tycoelectronics.com

Part numbering system

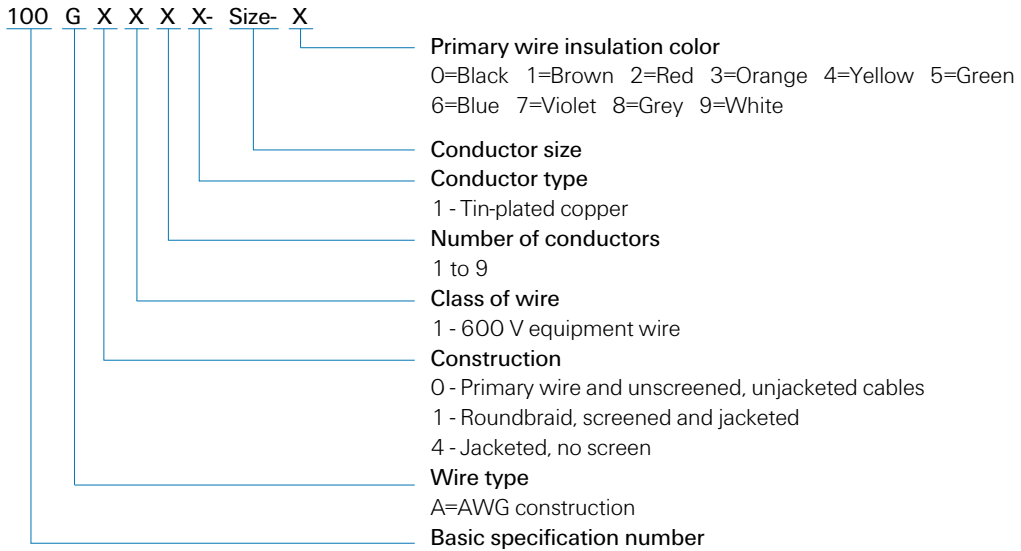

Ordering information

Conductor				Finished wire										
Wire size AWG	Stranding No x AWG dia (mm)	Diameter		Maximum resistance at 20°C		Diameter		Maximum weight		Raychem part number				
		min.	max.	/kft	/km	min.	max.	lbs/kft	kg/km					
		(mm/in)	(mm/in)			(mm/in)	(mm/in)							
24	19x36	0.55	0.022	0.63	0.025	25.7	84.32	1.09	0.043	1.19	0.047	2.41	3.59	100A0111-24*
22	19x34	0.735	0.029	0.79	0.031	15.9	52.2	1.26	0.050	1.33	0.052	3.34	4.98	100A0111-22*
20	19x32	0.94	0.037	1.01	0.040	9.9	32.4	1.46	0.057	1.54	0.061	4.98	7.42	100A0111-20*
18	19x30	1.17	0.046	1.26	0.050	6.2	20.4	1.69	0.067	1.79	0.071	7.31	10.89	100A0111-18*
16	19x29	1.321	0.052	1.37	0.054	4.8	15.8	1.84	0.072	1.94	0.076	9.19	13.70	100A0111-16*
14	19x27	1.65	0.065	1.79	0.070	3.1	10.0	2.27	0.089	2.39	0.094	14.45	21.53	100A0111-14*
12	37x28	2.08	0.082	2.24	0.088	2.0	6.63	2.71	0.107	2.86	0.113	21.03	31.33	100A0111-12*
10	37x26	2.69	0.106	2.83	0.111	1.3	4.13	3.33	0.131	3.51	0.138	33.27	49.58	100A0111-10*

Users should independently evaluate the suitability of the product for their application.
Before ordering check with factory for most current data.



Zerohal 100G



Applications

Raychem Zerohal 100G has been developed to meet the requirements of German Specification VG 952 18-20, Type E primary wire.

The construction is a dual wall combination of Raychem formulated polymer blends developed to meet the specification requirements while maintaining the desirable features of small size, lightweight, flexibility, non-wrinkling, ease of stripping, compatibility with standard stripping equipment, lack of recoil and mechanical robustness.

Features and benefits

- Qualified to VG 952 18-20, Type E.
- Halogen free, low smoke.
- Highly flame retardant.
- Flexible, easy to install.
- Small size, lightweight (thin wall construction).

System

- System 100

Physical characteristics

Handleability

Zerohal 100G has been designed for minimum recoil during harnessing operations, to be readily handleable by modern wiring and harnessing techniques and to be easily stripped with standard equipment and tools.

Available in:

Americas

Europe

Asia Pacific

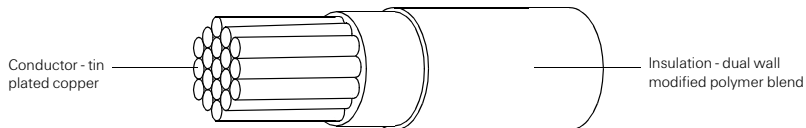

Fax-on-demand

US only (800) 260-9099

Outside US (650) 257-2301

Visit our website at www.tycoelectronics.com**Approvals**

VG 95218-20, Type E (Electrical cables and insulated wires for low frequency

-Part 20: Single core insulated wires.)

Typical properties

Test	Method	Typical value
Max. operating temperature	VG 95218-20, ASTM D 3032	125°C (20,000 h)
Insulation shrinkage (160°C)	DIN VDE 0472 Pt 628, IEC 811-1-3	< 0.5%
Low temperature bend	VG 95218 - Pt 2	-55°C
Pressure test at high temperature	DIN VDE 0472 Pt 609, IEC 811-3-1	125°C, < 30% indentation
Heat ageing (150°C, 6 h)	DIN VDE 0472 Pt 303,	No cracking, no dielectric
(140°C, 120 h)	IEC 811-1-2	breakdown
Voltage rating	VG 95218-20	750/1300 V AC
Abrasion resistance	VG 95218 - Pt 2	Pass
Insulation blocking (125°C)	VG 95218 - Pt 2	Pass
Voltage withstand (23°C, 2.5 kV rms)	DIN VDE 0472 pt 509	Pass
Insulation resistance	DIN VDE 0472 pt 502, IEC 885-1	> 500 M ohms. km (20°C) > 0.5 M ohms. km (90°C)
Chemical resistance		
Grease (G-354)*	VG 95218 - Pt 2, 70°C 24h	< 5% diameter change, no dielectric breakdown
Hydraulic fluid (H-515, H-544)*	VG 95218 - Pt 2, 50°C 24h	< 5% diameter change, no dielectric breakdown
Brake fluid (H-542)*	VG 95218 - Pt 2, 23°C 24h	< 5% diameter change, no dielectric breakdown
De-icing fluid (S-745)*	VG 95218 - Pt 2, 23°C 24h	< 5% diameter change, no dielectric breakdown
MEK	VG 95218 - Pt 2, 23°C 1h	< 5% diameter change, no dielectric breakdown
70/30 ISO-Octane/ Toluene	VG 95218 - Pt 2, 23°C 24h	< 5% diameter change, no dielectric breakdown
Insulation		
Tensile strength	DIN VDE 0472 pt 602, IEC 811-1-1	> 20 MPa
Elongation at break	DIN VDE 0472 pt 602, IEC 811-1-1	> 200%

*NATO code. For further details please consult the German Standard VG 95218-20, Type E.

**Users should independently evaluate the suitability of the product for their application.
Before ordering check with factory for most current data.**

Zerohal 100G (cont'd.)

Environmental properties

Fluid resistance

Zerohal 100G wire demonstrates an outstanding balance of resistance to a wide range of commonly used solvents, fluids and lubricants.

Voltage rating

Zerohal 100G wire is a 750/1300 V AC rated wire.

Fire hazard characteristics

Zerohal 100G is a halogen free insulation system and does not contain phosphorus or sulphur. It meets the toxicity, smoke density, halogen content, corrosivity and flammability requirements of VG 952 18-20, Type E.

Flammability

Zerohal 100G meets the flammability/burning behavior requirements of VG 952 18-20, Type E.

Fire hazard properties

Test	Method	Typical value
Toxicity	NES 713	3.5
Smoke density	IEC 1034 Pt 1 and 2	95% light transmittance
Halogen content	DIN VDE 0472 pt 815	non-detected
Corrosivity of combustion gases	DIN VDE 0472 pt 813, IEC 754-2	5.0 pH, <4 µS/mm conductivity
Flammability	VG 952 18 Pt 2	< 15 sec afterburn < 150 mm burn length

Part numbering system

100 G X X X X- Size- X

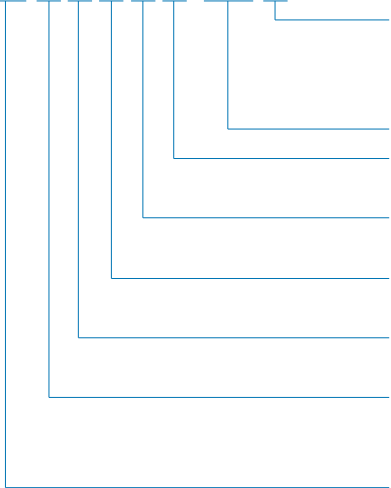

Primary wire insulation color

0=Black 1=Brown 2=Red 2L=Pink 3=Orange 4=Yellow

5=Green 6=Blue 7=Violet 8=Grey 9=White

NB. VG 952 18 T020-EXXX wire only available in colors 0, 1, 4, 5, 6, 9

Conductor size

Conductor type

1 - Tin-plated copper

Number of conductors

1

Class of wire

1 - 750 V equipment wire

Construction

0 - Primary wire

Wire type

G - meeting the performance requirements of German Specification

VG 952 18-20, Type E

Basic specification number

Fax-on-demand

US only (800) 260-9099

Outside US (650) 257-2301

Visit our website at www.tycoelectronics.com**Ordering information**

Conductor		Insulated wire							
Nominal cross sectional area	Stranding No x nom dia (mm)	Diameter (mm)		Maximum resistance at 20°C ohms/km	Diameter (mm)		Maximum weight g/m	VG 95218	Raychem
		min.	max.		min.	max.		part number	part number
0.40	19x0.16	0.74	0.79	50.50	1.28	1.39	5.17	VG 95218 T020-E02*	100G0111-0.40*
0.50	19x0.18	0.82	0.90	40.10	1.37	1.47	6.60	VG 95218 T020-E03*	100G0111-0.50*
0.60	19x0.20	0.95	1.01	31.10	1.47	1.57	7.54	VG 95218 T020-E04*	100G0111-0.60*
0.75	19x0.23	1.04	1.15	26.70	1.59	1.70	8.90	VG 95218 T020-E05*	100G0111-0.75*
1.00	19x0.25	1.17	1.26	20.00	1.69	1.80	10.73	VG 95218 T020-E06*	100G0111-1.00*
1.20	19x0.29	1.32	1.42	15.30	1.88	1.98	13.59	VG 95218 T020-E07*	100G0111-1.20*
1.50	37x0.23	1.46	1.58	13.70	2.03	2.13	15.96	VG 95218 T020-E08*	100G0111-1.50*
2.00	37x0.25	1.68	1.82	10.50	2.31	2.41	20.29	VG 95218 T020-E09*	100G0111-2.00*
2.50	37x0.29	1.85	2.01	8.21	2.48	2.63	25.65	VG 95218 T020-E10*	100G0111-2.50*
3.00	37x0.32	2.12	2.24	6.58	2.70	2.86	31.00	VG 95218 T020-E11*	100G0111-3.00*
4.00	56x0.30	2.41	2.56	4.86	3.01	3.16	43.48	-	100G0111-4.00*

The VG 95218-20, Type E specification defines that the insulation color shall be black, brown, yellow/green, blue or white only.

To ensure full compliance with the specification, order the VG 95218 part number complete with color code.

Raychem Type 100G wire, meeting the performance requirements of VG 95218-20, Type E, is available in other colors (see part numbering system).

To order these colors, order the Raychem 100G part number.

*Color code in accordance with part number system.



FlexLite Commercial Wire Family



Available in:	Americas	Europe	Asia Pacific
	■	■	■

Selection guide

Application	Temperature rating (°C)	Features and benefits	Product name
Hermetic motor lead wire	-20°C to 125°C	<ul style="list-style-type: none"> ■ Very low extractables ■ Excellent shop handling ■ Typically lower in cost than fluoropolymer-insulated wires ■ Light weight, small size 	FlexLite HM
Intermittent-duty motors and heating elements	-45°C to 125°C	<ul style="list-style-type: none"> ■ Insulation that does not melt and flow at high temperatures ■ Excellent chemical resistance ■ WW-1 	FlexLite DW
Electronics, appliance, and motor applications	-55°C to 135°C	<ul style="list-style-type: none"> ■ Small size, light weight ■ No plasticizers or corrosive outgassing 	FlexLite TW
Lighting, motor applications	-55°C to 200°C	<ul style="list-style-type: none"> ■ Insulation does not melt and flow at high temperature ■ WW-1 ■ Excellent shop handling ■ No cold-flow problems 	FlexLite HT
Lighting, appliances, motors	-65°C to 250°C	<ul style="list-style-type: none"> ■ Very high temperature ■ WW-1 ■ Excellent chemical resistance ■ Excellent shop handling 	FlexLite TX

FlexLite/UL style cross-reference

Primary Wire

Product	UL style	Temperature rating	Voltage rating	AWG range	Part description	Nominal wall thickness (mm/mils)
FlexLite HM	10223	125°C	600 volts	10–24	FLHMX031X	0.2 (8)
FlexLite DW	3584	125°C	600 volts	4–28	FLDWX031X	0.2 (8)
FlexLite TW	10208	135°C	600 volts	10–32	FLTWX031X	0.2 (8)
FlexLite HT	3557	200°C	600 volts	6–26	FLHTX031X	0.15 (6)
FlexLite TX	10297	250°C	600 volts	4–28	FLTX031X	0.30 (12)

Note: Additional UL-recognized cable constructions are available. Please contact product management for details.

UL marking and labeling

All FlexLite products are UL labeled and reel marked. UL surface marking is additional. Please contact Tyco Electronics Logistics for further information.

Fax-on-demand

US only (800) 260-9099

Outside US (650) 257-2301

Visit our website at www.tycoelectronics.com

Part numbering system

FL XX X X X X X-XX-X-X

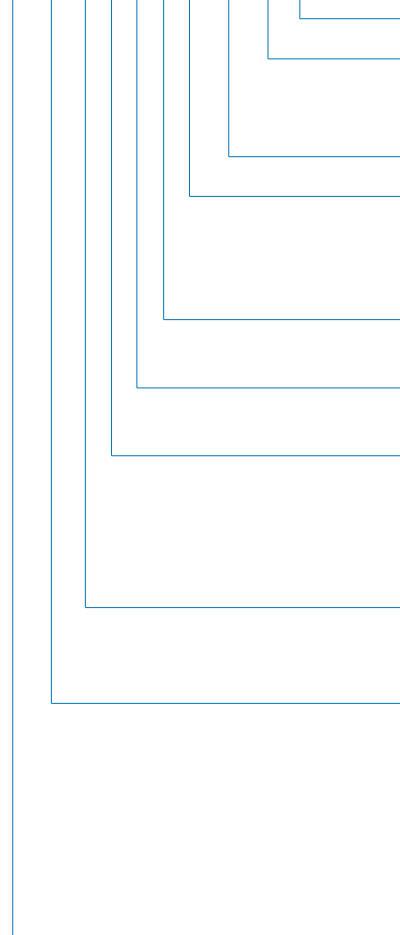

Jacket color-code identification

Primary wire insulation color

0 = Black 1 = Brown 2 = Red 3 = Orange 4 = Yellow
5 = Green 6 = Blue 7 = Violet 8 = Gray 9 = White

Conductor size (AWG) (metric)

Conductor type

1 = Tin-coated copper 2 = Silver-coated copper
3 = Nickel coated copper 4 = Silver-coated high-strength copper alloy
9 = Bare copper 0 = Special

Number of conductors

1 through 10, designator for 10 conductors = 0

Class of wire

1 = 150 volt 2 = 300 volt 3 = 600 volt

Construction

0 = Primary wire, unshielded, unjacketed
1 = Round-braid shielded, jacketed cable
2 = Foil wrap and drain wire 4 = Jacketed cable, no shield
6 = Special constructions

Stranding

A = Solid B = 7 strands C = 19 strands
D = 37 strands K = ASTM B 174, Class K

Product Designator (UL Style)

HT = Raychem WCD-3106 (3557) (200°C)
TW = Raychem WCD-3106 (10208) (135°C)
DW = Raychem WCD-3106 (3584) (125°C)
HM = Raychem WCD-3105 (10223) (125°C)
TX = Raychem WCD-3106 (10297) (250°C)

Basic Specification

FlexLite

Examples:

FLHTCC0311-22-9

200°C, 19-strand, AWG 22, tin-coated copper wire, 600 volt, white

FLTWC1321-AWG-9/0-9

135°C, 19-strand, tin-coated copper, two-component, shielded and jacketed cable, 600 volt, white and black components, white jacket



FlexLite HM

Hermetic motor lead wire



Applications

Designed for hermetic motor applications, Raychem FlexLite HM lead wire offers excellent refrigerant resistance, shop handling, and mechanical performance at lower costs than traditional lead wires for hermetic applications.

FlexLite HM meets the NEMA MW-1000 Refrigerant Extraction Test for R-22 and R-134a, and is UL recognized for use at 125°C and 600 V.

Features and benefits

- UL rated operating temperature -20°C to 125°C
- Very low extractables in refrigerants.
- Excellent shop-handling characteristics offering compatibility with automatic stripping machines.
- Light weight, small size.
- Tough insulation material.
- Gauge sizes from 10-24 AWG.
- Operating temperature to 125°C.

Available in:

Americas

Europe

Asia Pacific

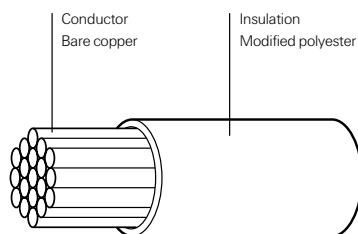

Fax-on-demand

US only (800) 260-9099

Outside US (650) 257-2301

Visit our website at www.tycoelectronics.com**Specifications/approvals**

Series	UL	CUL	CSA	Raychem
HM	Style 10223 Temperature rating 125°C	Recognized	Certified AWMIA/B	WCD-3105

Construction details—dimensions in mm/in

Part number	Conductor		Finished wire			Nominal weight in kg/km (lb/1000 ft)		
	Wire size (AWG) (no. x AWG)	Stranding (target value)	Nominal resistance at 20°C Ω/km (Ω/1000 ft)	Diameter				
				Lower spec. limit	Target value		Upper spec. limit	
FLHMK0319-20*	20	10 x 30	.965 (.0380)	31 (9.45)	1.32 (.052)	1.37 (.054)	1.42 (.056)	6.25 (4.2)
FLHMK0319-18*	18	16 x 30	1.16 (.0455)	23.6 (7.20)	1.52 (.060)	1.58 (.062)	1.63 (.064)	8.93 (6.0)
FLHMK0319-16*	16	26 x 30	1.47 (.0580)	15.1 (4.59)	1.83 (.072)	1.88 (.074)	1.93 (.076)	13.24 (8.9)
FLHMK0319-14*	14	41 x 30	1.85 (.0730)	8.8 (2.68)	2.21 (.087)	2.26 (.089)	2.31 (.091)	20.54 (13.8)
FLHMK0319-12*	12	65 x 30	2.34 (.0920)	5.35 (1.63)	2.74 (.108)	2.79 (.110)	2.84 (.112)	34.39 (23.1)
FLHMK0319-10*	10	104 x 30	2.92 (.115)	3.7 (1.12)	3.38 (.133)	3.43 (.135)	3.48 (.137)	51.21 (34.4)

* Replace asterisk with color code designator:

0 = Black	3 = Orange	7 = Violet
1 = Brown	4 = Yellow	8 = Gray
2 = Red	5 = Green	9 = White

For example: FLHMK0319-18-9 = AWG 18, white



FlexLite DW

Dual-wall primary wire



Applications

FlexLite DW (FLDW) offers a high-performance non melting insulation suitable for a variety of applications, especially those with occasional high-temperature excursions, such as high-power battery-operated devices or intermittent-duty motors or heating elements.

Features and benefits

- UL rated operating temperature to 125°C.
- Non melting insulation material.
- Thin-wall product for size and weight savings.
- Excellent chemical resistance.
- Dual-wall construction for increased mechanical performance.
- Compatibility with automated stripping equipment.
- Variety of colors and constructions.

Available in:	Americas	Europe	Asia Pacific
	■	■	■

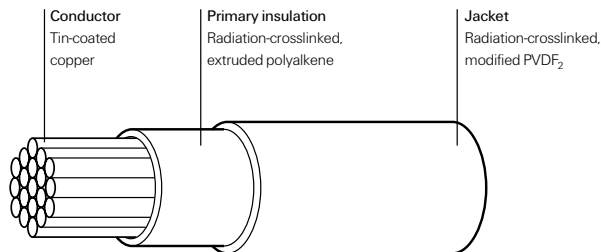

Specifications/approvals				
Series	UL	CUL	CSA	Raychem
DW	Style 3584	Recognized	Certified AWMIA	WCD-3106
	Flammability VW-1			
	Temperature rating 125°C			

Fax-on-demand

US only (800) 260-9099

Outside US (650) 257-2301

Visit our website at www.tycoelectronics.com

Construction details—dimensions in mm/in

Part number	Conductor				Maximum resistance at 20°C Ω/km ($\Omega/1000\text{ft}$)	Finished wire			Nominal weight in kg/km (lb/1000 ft)
	Wire size (AWG) (no. x AWG)	Stranding	Diameter	Diameter		Lower	Target	Upper	
						spec. limit	value	spec. limit	
FLDWC0311-26*	26	19 x 38	.470 (.0185)	135 (41.30)	.965 (.038)	1.02 (.040)	1.07 (.042)	2.38 (1.6)	
FLDWC0311-24*	24	19 x 36	.597 (.0235)	83.3 (25.4)	1.12 (.044)	1.17 (.046)	1.22 (.048)	3.57 (2.4)	
FLDWC0311-22*	22	19 x 34	.749 (.0295)	52.2 (15.9)	1.32 (.052)	1.37 (.054)	1.42 (.056)	5.21 (3.5)	
FLDWC0311-20*	20	19 x 32	.953 (.0375)	32.0 (9.76)	1.52 (.060)	1.57 (.062)	1.63 (.064)	7.59 (5.1)	
FLDWC0311-18*	18	19 x 30	1.18 (.0465)	20.4 (6.22)	1.78 (.070)	1.85 (.073)	1.93 (.076)	11.46 (7.7)	
FLDWC0311-16*	16	19 x 29	1.33 (.0525)	15.8 (4.82)	1.98 (.078)	2.06 (.081)	2.13 (.084)	14.58 (9.8)	
FLDWC0311-14*	14	19 x 27	1.68 (.0660)	10.0 (3.05)	2.39 (.094)	2.49 (.098)	2.59 (.102)	21.88 (14.7)	
FLDWC0311-12*	12	37 x 28	2.16 (.0850)	6.76 (2.02)	2.87 (.113)	2.97 (.117)	3.07 (.121)	32.89 (22.1)	

* Replace asterisk with color code designator:
 0 = Black 3 = Orange 7 = Violet
 1 = Brown 4 = Yellow 8 = Gray
 2 = Red 5 = Green 9 = White
 For example: FLDWC0311-20-9 = AWG 20, white.
 FLDWC0311-1.00-9 = Size 1.00 mm², white.

Construction details

Nominal CSA Part number	Conductor				Maximum resistance at 20°C $\Omega/1000\text{ft}$	Finished wire			Nominal weight in kg/km (lb/1000 ft)
	Wire size (mm ²)	Stranding (no. x dia.)	Diameter (mm/in)			Lower	Target	Upper	
			(min.)	(max.)		spec. limit	value	spec. limit	
FLDWC0311-0.25*	0.25	19 x 0.127	0.55 (.022)	0.63 (.025)	83.6 (25.5)	1.12 (.044)	1.17 (.046)	1.22 (.048)	3.77 (2.53)
FLDWC0311-0.35*	0.35	19 x 0.15	0.72 (.028)	0.77 (.030)	56.1 (17.1)	1.31 (.052)	1.37 (.054)	1.42 (.056)	5.17 (3.46)
FLDWC0311-0.50*	0.50	19 x 0.19	0.86 (.034)	0.88 (.035)	40.1 (12.2)	1.46 (.057)	1.51 (.059)	1.56 (.061)	6.92 (4.64)
FLDWC0311-0.75*	0.75	19 x 0.23	1.05 (.041)	1.08 (.043)	24.7 (7.53)	1.65 (.065)	1.70 (.067)	1.75 (.069)	9.53 (6.39)
FLDWC0311-1.00*	1.00	19 x 0.25	1.17 (.046)	1.26 (.050)	20.0 (6.1)	1.78 (.070)	1.85 (.073)	1.93 (.076)	11.88 (7.96)
FLDWC0311-1.50*	1.50	19 x 0.32	1.46 (.057)	1.51 (.059)	13.7 (4.2)	2.21 (.095)	2.28 (.090)	2.36 (.093)	17.88 (11.98)

* Replace asterisk with color code designator:
 0 = Black 3 = Orange 7 = Violet
 1 = Brown 4 = Yellow 8 = Gray
 2 = Red 5 = Green 9 = White
 For example: FLDWC0311-20-9 = AWG 20, white.
 FLDWC0311-1.00-9 = Size 1.00 mm², white.

Users should independently evaluate the suitability of the product for their application.
 Before ordering check with factory for most current data.



FlexLite TW

Thin-wall hookup wire and cable



Applications

FlexLite TW (FLTW) is commonly used in applications that demand smaller, more rugged components, often in elevated temperatures. Designed to offer reduced size while maintaining superior mechanical performance, FLTW in many cases is a lower-cost solution than expensive fluoropolymer wire.

Features and benefits

- UL rated operating temperature to 135°C.
- Thin-wall product for size and weight savings.
- Tough insulation material.
- Excellent chemical resistance.
- Gauge sizes from 10-32 AWG.
- No plasticizers or corrosive outgassing, which can be detrimental to sensitive electrical and electronic components.

Available in:

Americas

Europe

Asia Pacific

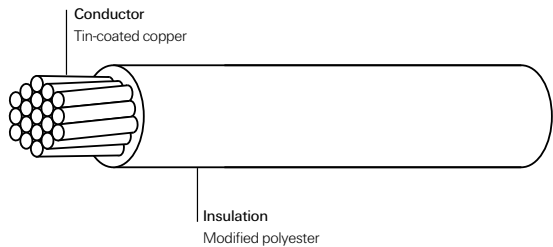

Fax-on-demand

US only (800) 260-9099

Outside US (650) 257-2301

Visit our website at www.tycoelectronics.com**Specifications/approvals**

Series	UL	CUL	CSA	Raychem
TW	Style 10208 Flammability VW1 Temperature range of -55°C to 135°C	Recognized	Certified AWM1A/B	WCD-3106

Construction details—dimensions in mm/in

Part number	Wire size (AWG)	Conductor		Finished wire			Nominal weight in kg/km (lb/1000 ft)	
		Stranding (no. x AWG)	Diameter (target value)	Maximum resistance at 20°C (Ω/1000 ft)	Diameter			
					Lower spec. limit	Target value		Upper spec. limit
FLTWC0311-26*	26	19 x 38	.470 (.0185)	41.30	.813 (.032)	.864 (.034)	.914 (.036)	1.94 (1.3)
FLTWC0311-24*	24	19 x 36	.597 (.0235)	25.4	.965 (.038)	1.02 (.040)	1.07 (.042)	2.83 (1.9)
FLTWC0311-22*	22	19 x 34	.749 (.0295)	15.9	1.43 (.045)	1.19 (.047)	1.25 (.049)	4.17 (2.8)
FLTWC0311-20*	20	19 x 32	.953 (.0375)	9.76	1.35 (.053)	1.40 (.055)	1.45 (.057)	6.25 (4.2)
FLTWC0311-18*	18	19 x 30	1.18 (.0465)	6.22	1.60 (.063)	1.65 (.065)	1.70 (.067)	9.52 (6.4)
FLTWC0311-16*	16	19 x 29	1.33 (.0525)	4.82	1.75 (.069)	1.83 (.072)	1.91 (.075)	12.20 (8.2)
FLTWC0311-14*	14	19 x 27	1.68 (.0660)	3.05	2.16 (.085)	2.26 (.089)	2.36 (.093)	18.90 (12.7)
FLTWD0311-12*	12	37 x 28	2.16 (.0850)	2.06	2.64 (.104)	2.74 (.108)	2.84 (.112)	28.87 (19.4)

* Replace asterisk with color code designator:

0 = Black	3 = Orange	7 = Violet
1 = Brown	4 = Yellow	8 = Gray
2 = Red	5 = Green	9 = White

For example: FLTWC0311-22-9 = AWG 22, white.



FlexLite HT

High-temperature hookup wire



Applications

FlexLite HT (FLHT) is the product of choice for high-temperature applications. It offers shop-handling advantages over silicone/ fiberglass constructions (SF 1/SF2) and is cost-competitive with other fluoropolymer wire. Applications include halogen lights and small high-end appliances where space and temperature are issues.

Features and benefits

- UL rated operating temperature to 200°C.
- Exceptional chemical resistance.
- Thin-wall, for size and weight savings.
- Tough fluoropolymer insulation material.
- Excellent stripping and handling.
- Variety of constructions and colors.
- Crosslinked to minimize cold flow.
- VW-1 flammability rating.
- 600 V rating.

Available in:

Americas

Europe

Asia Pacific

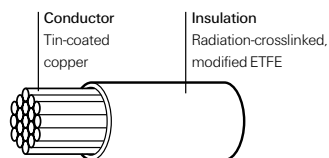

Fax-on-demand

US only (800) 260-9099

Outside US (650) 257-2301

Visit our website at www.tycoelectronics.com**Specifications/approvals**

Series	UL	CUL	CSA	Raychem
HT	Style 3557 Flammability VW-1 Temperature rating 200°C	Recognized	Certified AWMIA/B	WCD-3106

Construction details—dimensions in mm/in

Part number	Wire size (AWG)	Conductor		Finished wire			Nominal weight in kg/km (lb/1000 ft)	
		Stranding (no. x AWG)	Diameter (target value)	Maximum resistance at 20°C (Ω/1000 ft)	Diameter			
					Lower spec. limit	Target value		Upper spec. limit
FLHTC0311-26*	26	19 x 38	.470 (.0185)	41.30	.765 (.0301)	.800 (.0315)	.836 (.0329)	1.89 (1.27)
FLHTC0311-24*	24	19 x 36	.597 (.0235)	25.4	.892 (.0351)	.927 (.0365)	.963 (.0379)	2.76 (1.85)
FLHTC0311-22*	22	19 x 34	.749 (.0295)	15.9	1.04 (.0411)	1.08 (.0425)	1.12 (.0439)	4.08 (2.74)
FLHTC0311-20*	20	19 x 32	.953 (.0375)	9.76	1.25 (.0491)	1.28 (.0505)	1.32 (.0519)	6.21 (4.17)
FLHTC0311-18*	18	19 x 30	1.18 (.0465)	6.22	1.48 (.0583)	1.52 (.0600)	1.57 (.0617)	9.45 (6.34)
FLHTC0311-16*	16	19 x 29	1.33 (.0525)	4.82	1.67 (.0656)	1.71 (.0675)	1.76 (.0694)	12.05 (8.09)
FLHTC0311-14*	14	19 x 27	1.68 (.0660)	3.05	2.03 (.0799)	2.08 (.0820)	2.14 (.0841)	18.60 (12.49)
FLHTD0311-12*	12	37 x 28	2.16 (.0850)	2.06	2.50 (.0984)	2.57 (.1010)	2.63 (.1036)	28.71 (19.29)

Part number	Nominal CSA (mm ²)	Conductor		Finished wire			Nominal weight (kg/km)	
		Stranding No./Dia. (mm)	Diameter (mm) (min.) (max.)	Maximum resistance at 20°C (ohms/km)	Diameter (mm)			
					Lower spec. limit	Target value		Upper spec. limit
FLHTC0311-0.25*	0.25	19/0.127	0.55 0.63	84.3	0.96	1.00	1.03	2.95
FLHTC0311-0.35*	0.35	19/0.15	0.74 0.76	56.1	1.12	1.16	1.19	4.22
FLHTC0311-0.50*	0.50	19/0.19	0.86 0.88	40.1	1.24	1.27	1.31	5.59
FLHTC0311-0.75*	0.75	19/0.23	1.05 1.08	24.7	1.43	1.47	1.51	7.95
FLHTC0311-1.00*	1.00	19/0.25	1.17 1.26	20.0	1.58	1.62	1.66	9.85
FLHTC0311-1.50*	1.50	19/0.32	1.35 1.58	13.7	1.82	1.87	1.92	15.69
FLHTC0311-2.00*	2.00	19/0.36	1.66 1.79	9.7	2.05	2.10	2.16	18.67
FLHTC0311-2.50*	2.50	19/0.41	1.85 2.01	8.2	2.24	2.31	2.38	24.62

* Replace asterisk with color code designator:

0 = Black 1 = Brown 2 = Red 3 = Orange 4 = Yellow 5 = Green 7 = Violet 8 = Gray 9 = White.

For example: FLHTC0311-22-9 = AWG 22, white. FLHTC0311-0.50-9 = Size 0.50mm², white.

Users should independently evaluate the suitability of the product for their application.
Before ordering check with factory for most current data.

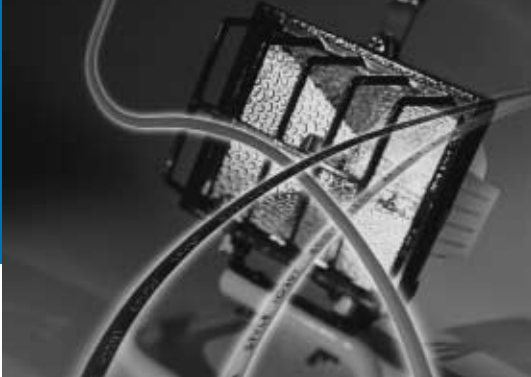

FlexLite TX

Ultrahigh-temperature hookup wire



Applications

FlexLite TX is a UL recognized hookup wire for lighting fixtures, appliance, wiring and industrial applications requiring a 250°C rated wire.

Features and benefits

- UL rated operating temperature -65°C to 250°C.
- UL Style 10297.
- 600 V rating.
- Clear legible wire marking.
- Excellent fluid resistance.
- Excellent handling characteristics.

Available in:

Americas

Europe

Asia Pacific

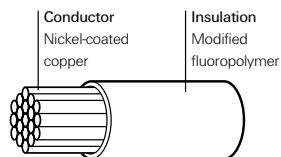

Fax-on-demand

US only (800) 260-9099

Outside US (650) 257-2301

Visit our website at www.tycoelectronics.com**Specifications/approvals**

Series	UL	CUL	CSA	Raychem
TX	Style 10297 Flammability VW-1	Recognized	AWM1A/B	WCD-3106

Construction details—dimensions in mm/in

Part number	Wire size (AWG)	Conductor		Maximum resistance at 20°C (Ω /1000 ft)	Finished wire			Nominal weight in kg/km (lb/1000 ft)
		Stranding (no. x AWG)	Diameter (target value)		Diameter	Lower spec. limit	Target value	
FLTXB0313-28*	28	7 x 36	.368 (.0145)	68.2	.940 (.037)	.991 (.039)	1.04 (.041)	2.19 (1.47)
FLTXC0313-26*	26	19 x 38	.470 (.0185)	39.7	1.04 (.041)	1.09 (.043)	1.14 (.045)	2.95 (1.98)
FLTXC0313-24*	24	19 x 36	.597 (.0235)	25.4	1.17 (.046)	1.22 (.048)	1.27 (.050)	3.97 (2.67)
FLTXC0313-22*	22	19 x 34	.749 (.0295)	15.9	1.30 (.051)	1.37 (.054)	1.45 (.057)	5.45 (3.66)
FLTXC0313-20*	20	19 x 32	.953 (.0375)	9.76	1.50 (.059)	1.57 (.062)	1.65 (.065)	7.84 (5.27)
FLTXC0313-18*	18	19 x 30	1.18 (.0465)	6.22	1.73 (.068)	1.80 (.071)	1.88 (.074)	11.3 (7.59)
FLTXC0313-16*	16	19 x 29	1.33 (.0525)	4.82	1.88 (.074)	1.96 (.077)	2.03 (.080)	13.9 (9.32)
FLTXC0313-14*	14	19 x 27	1.68 (.0660)	3.05	2.18 (.086)	2.29 (.090)	2.39 (.094)	20.6 (13.8)
FLTXD0313-12*	12	37 x 28	2.16 (.0850)	1.97	2.67 (.105)	2.77 (.109)	2.87 (.113)	30.9 (20.8)
FLTXD0313-10*	10	37 x 26	2.72 (.1070)	1.26	3.23 (.124)	3.33 (.131)	3.43 (.135)	48.2 (32.4)

* Replace asterisk with color code designator:

0 = Black 3 = Orange 7 = Violet

1 = Brown 4 = Yellow 8 = Gray

2 = Red 5 = Green 9 = White

For example: FLTXC0313-18-9 = AWG 18, white.



FLT

Flexible, double insulated, high performance wire for a wide range of industrial applications



Applications

FLT dual-wall wire combines flexibility with tough thin wall insulation to enable bundles to be routed through areas in which conventional wires cannot be used. Typical applications include control panels, instruments, lighting equipment, electrical appliances, electric motors, electric pumps, robotics, and the automotive industries.

Features and benefits

- Highly flame retardant/non melting.
- Limited fire hazard.
- 600V rated.
- Excellent fluid resistance.
- Flexible.
- Double insulation (for Class 2 equipment).
- Tough, thin wall.
- Small size, light weight.

Available in:

Americas

Europe

Asia Pacific



Fax-on-demand

US only (800) 260-9099

Outside US (650) 257-2301

Visit our website at www.tycoelectronics.com

Approvals

UL Styles 1385

CSA Class 585 1

IEC 332-1

Standard colors

Color	Black	Brown	Red	Pink	Orange	Yellow
Code	0	1	2	2L	3	4
Color	Green	Blue	Violet	Grey	White	
Code	5	6	7	8	9	

Physical characteristics

Small size

FLT equipment wire 600 volt rated has a 0.20 mm nominal wall thickness compared to 0.25mm and 0.38mm for equivalent PTFE and PVC wires in MIL-W-16878, MIL-W-22759 or BS3G210.

Light weight

Due to the thin wall and low density of the insulation materials, considerable weight savings are made over similarly rated PTFE wires.

For Example: FLT0111 - 0.35 equipment wire 4.38 grams/meter max.

22 AWG PTFE equipment wire MIL-W-22759 5.54 grams/meter max.

General handling

The flexibility of FLT and the ease with which it takes a 'set' makes it one of the easiest of the 'high performance' wires to install. Stripping is done with conventional die blade strippers. For details of appropriate tools see separate wire handling guide. The tin-plated copper conductor usually specified is easily soldered or crimped.

Lengths

FLT is available in long continuous lengths and can be supplied for use on automatic cut and strip preparation machines.

Typical properties

Temperature rated	(Tin-plated conductor) -65 ° C to + 150 ° C
Rated at 125 ° C	In UL style sheet 1385
Voltage rating	600V
No Voltage rating specified	In UL style sheet 1385
Tensile strength + elongation of insulation	30 N/mm ² , 230%
Notch propagation BS 3G230 0.05 mm notch	Pass
Meets BS4066/IEC332-1 Flammability test	Pass
Solder iron resistance (370 ° C, 1 minute)	Pass
Shrinkage @ + 150 ° C	< 1%
Low temperature bend	-65 ° C

Users should independently evaluate the suitability of the product for their application.
Before ordering check with factory for most current data.

FLT (cont'd.)

Flexible, double insulated, high performance wire for a wide range of industrial applications

Environmental performance

Temperature rating

FLT wire is rated for continuous operation from -65° C to + 150°C and for short periods at much higher temperatures.

Mechanical performance

Radiation crosslinking of the FLT insulation significantly improves the following mechanical characteristics; scrape (sharp edges), cut-through resistance and creep resistance.

Solder iron/overload resistance

Radiation crosslinking ensures that the insulation does not melt at high temperature. As a result FLT wire is resistant to hot solder irons and current overloads which would melt most thermoplastic insulations.

Fax-on-demand

US only (800) 260-9099

Outside US (650) 257-2301

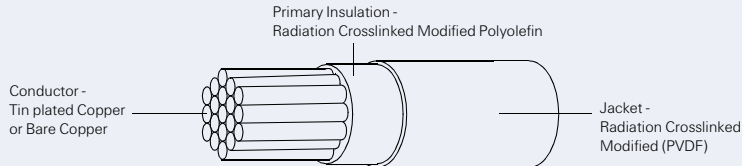
Visit our website at www.tycoelectronics.com**Ordering information****Finished Wire**

Nominal CSA mm ²	Conductor Stranding No/Dia mm	Conductor Diameter (mm)		Maximum Resistance @20°C ohms/km	Diameter (mm)		Nominal weight kg/km	Ordering description
		min.	max.		min.	max.		
0.25	19/0.127	0.55	0.63	83.6	0.91	1.04	2.96	FLT011X-0.25-Y
0.35	19/0.15	0.70	0.80	56.1	1.06	1.21	4.14	FLT011X-0.35-Y
0.50	19/0.19	0.82	0.90	40.1	1.18	1.31	6.63	FLT011X-0.50-Y
0.75	19/0.23	1.05	1.15	24.7	1.41	1.56	8.20	FLT011X-0.75-Y
1.00	19/0.25	1.17	1.26	20.0	1.55	1.70	10.86	FLT011X-1.00-Y
1.50	19/0.32	1.35	1.60	13.7	1.73	2.06	16.47	FLT011X-1.50-Y
2.00	19/0.36	1.66	1.85	9.9	2.12	2.38	20.32	FLT011X-2.00-Y
2.50	19/0.41	1.85	2.05	8.2	2.31	2.61	26.56	FLT011X-2.50-Y

Note: X = Conductor Type 1 = Tin Plated Copper 9 = Bare Copper

Y = Color (see color code on page 9-61)



Thermocouple

Extension cable



Applications

Tyco Electronics manufactures a broad range of Raychem thermocouple extension cables in four thermoelement combinations. Each provides accurate transmission of electromotive force (EMF) from a thermocouple element lead wire of the same conductor material to a thermometer, also known as a pyrometer.

All four types of thermocouple extension cables use 19-strand conductors and are available in twisted pair, jacketed twisted pair, and shielded and jacketed twisted pair configurations. A range of cables is available from 16 AWG to 24 AWG.

Wires and cables are insulated and jacketed with radiation-crosslinked ETFE, which has a continuous operating temperature of -65°C to 200°C . This material, which is fully specified in Raychem SPEC 55, has excellent physical properties and is highly resistant to a wide range of chemicals.

Operating temperature range

-65°C to 200°C

Features and benefits

- 19-strand conductor for flexibility.

Available in:

Americas

Europe

Asia Pacific



Fax-on-demand

US only (800) 260-9099

Outside US (650) 257-2301

Visit our website at www.tycoelectronics.com**Properties**

Initial calibration tolerances for thermocouple extension wires				
Extension cable type	Thermoelement combination	Temperature range	Limit of range	EMF (mv)* (min.–max.)
EX	Chromel-Constantan	0°C to 200°C	±1.7°C	6.18–6.45
JX	Iron-Constantan	0°C to 200°C	±2.2°C	5.15–5.39
KX	Chromel-Alumel	0°C to 200°C	±2.2°C	4.00–4.19
TX	Copper-Constantan	0°C to 100°C	±1.0°C	4.24–4.32

Note: The above is in accordance with ANSI-MC-96.1-1982.

*EMF is measured in millivolts (mv) at 100°C with reference junction at 0°C.

Product dimensions (nominal)**

AWG size	Twisted pair		Twisted, jacketed pair		Twisted, shielded, 38 AWG braid strand, jacketed pair	
	Outside diameter in	Weight in kg/km	Outside diameter in	Weight in kg/km	Outside diameter in	Weight in kg/km
	mm (in)	(lb/1000 ft)	mm (in)	(lb/1000 ft)	mm (in)	(lb/1000 ft)
24	2.29 (.090)	7.3 (4.9)	2.67 (.106)	9.9 (6.7)	3.12 (.123)	16.5 (11.1)
22	2.60 (.102)	9.9 (6.7)	2.99 (.118)	13.0 (8.8)	3.43 (.135)	21.4 (14.4)
20	2.99 (.118)	14.4 (9.7)	3.40 (.134)	18.0 (12.1)	3.83 (.151)	27.8 (18.7)
18	3.56 (.140)	20.9 (14.1)	3.96 (.156)	25.1 (16.9)	4.34 (.173)	37.5 (25.2)
16	3.96 (.156)	26.3 (17.7)	4.37 (.172)	30.9 (20.8)	4.80 (.189)	44.9 (30.2)

**Dimensions for 19-strand-conductor thermocouple. Extension Types EX, JX, KX, and TX.

Thermocouple (cont'd.)

Extension cable

Color-Coding

Thermocouple extension cables are available with the wires color-coded in accordance with four standards: MIL-STD-687, ANSI-MC-96.1, British Standard Code BS 1843, and Japanese JISC-C-1602.

Special cables

Thermocouple extension cables are also available in solid-conductor and seven-strand-conductor configurations. They come in a variety of thermolement combinations, gauges, insulations, and multiple-pair designs, and they are available for outer space applications. Contact Tyco Electronics for details.

<i>Extension cable</i>					
Type EX	Chromel +	Constantan -	Jacket (if present)	Color code Wire	Jacket
ANSI-MC-96.1	Violet	Red	Violet	7/2	7
British Std.-BS 1843	Brown	Blue	Brown	1/6	1
JISC-C-1602	Violet	Red	Violet	7/2	7
Type JX	Iron +	Constantan -	Jacket	Wire	Jacket
MIL-STD-687	Black	Yellow	White	0/4	9
ANSI-MC-96.1	White	Red	Black	9/2	0
British Std.-BS 1843	Yellow	Blue	Black	4/6	0
JISC-C-1602	Red	White	Yellow	2/9	4
Type KX	Chromel +	Alumel -	Jacket	Wire	Jacket
MIL-STD-687	White	Green	White	9/5	9
ANSI-MC-96.1	Yellow	Red	Yellow	4/2	4
British Std.-BS 1843	Brown	Blue	Red	1/6	2
JISC-C-1602	Red	White	Blue	2/9	6
Type TX	Copper +	Constantan -	Jacket	Wire	Jacket
MIL-STD-687	Red	Yellow	White	2/4	9
ANSI-MC-96.1	Blue	Red	Blue	6/2	6
British Std.-BS 1843	White	Blue	Blue	9/6	6
JISC-C-1602	Red	White	Brown	2/9	1

Fax-on-demand

US only (800) 260-9099

Outside US (650) 257-2301

Visit our website at www.tycoelectronics.com**Part Number Selection Table**

The thermocouple cable options outlined in the table on the previous page can be ordered from the table below.

Tyco Electronics will assign a new part number on request for cables falling outside the range shown in the table.

Type	Twisted pair	Twisted, jacketed pair	Shield plating*	Twisted, shielded, jacketed pair
EX	CTC-0077	CTC-0079	T	CTC-0074
			N	55A6169
			S	—
JX	55A8131	CTC-0080	T	CTC-0044
			N	—
			S	—
KX	55A8002	CTC-0012	T	CTC-0018
			N	CTC-0015
			S	CTC-0057
TX	CTC-0078	CTC-0081	T	CTC-0073
			N	—
			S	—

*T = Tin-coated copper.

N = Nickel-coated copper.

S = Silver-coated copper.

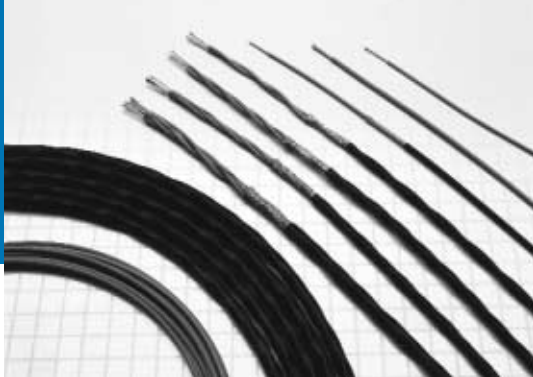

ElectroLoss Filterline

Lightweight, ruggedized filter line wire and cable



Applications

Today's performance needs for military and commercial electronic systems require increasingly sophisticated equipment and greater use of composite structures and enclosures. As electronics become more sensitive, the EMI protection level for electrical equipment is increasing. The Raychem ElectroLoss filter line wire and cable provide a high degree of EMI protection while functioning as conventional electrical wiring.

ElectroLoss products include high-performance wire and cable, which when used as specified, suppress conducted and radiated EMI above 100 MHz.

A reliable alternative to conventional discrete filters and filter-pin connectors, ElectroLoss filter line cables are flexible, lightweight, and compatible with high-density connectors.

The Raychem filter line wire and cable meets the performance requirements of MIL-C-85485, a military specification developed to provide EMI protection for military electrical interconnects.

The absorptive layer in ElectroLoss filter line cable is constructed of a ferrite-loaded high-temperature polymer, which provides high-frequency EMI absorptive characteristics. Achieving maximum attenuation requires concentrating the electromagnetic fields in the absorptive layer - either with a metallic shield on each wire or by an overall metallic shield protecting a bundle of individual component wires.

Radiation-crosslinked, modified conductive EFTE jackets are used over shielded filter line cables to eliminate pathways between adjacent cable shields.

Features and benefits

- Suppresses EMI above 100 MHz.
- Light weight, small size.
- SPEC 55 insulation.
- 600 volt.
- -65°C to 150°C †

Available in:

Americas

Europe

Asia Pacific



55FA0511

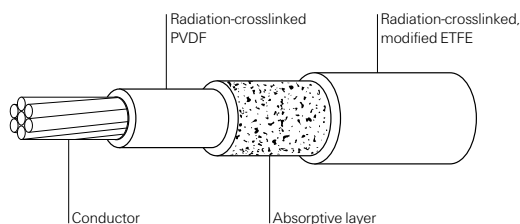

55FB1511

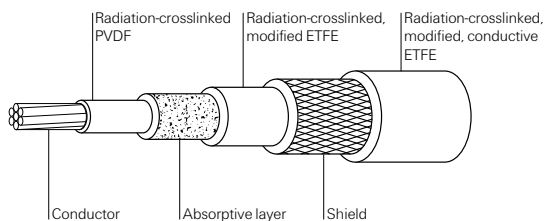

Fax-on-demand

US only (800) 260-9099

Outside US (650) 257-2301

Visit our website at www.tycoelectronics.com

Performance

Effective against conducted EMI ElectroLoss filter line wire and cable systems attenuate high-frequency EMI and allow low frequency signals to pass with minimum loss. When properly installed and used, filter line wire and cables function as low-pass electrical filters, attenuating both conducted and radiated EMI above 100MHz. The performance of ElectroLoss product is best demonstrated by measuring the attenuation (insertion loss) of a length of cable over a broad range of frequencies. Graph 1 depicts typical insertion loss characteristics.

Graph 1 - Typical insertion loss

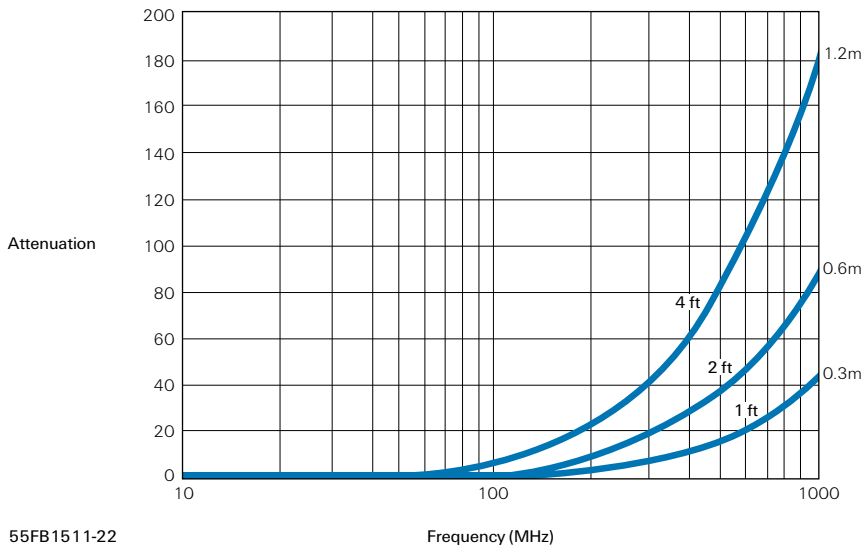

55FB1511-22

Frequency (MHz)

Temperature rating -65°C to +150°C †

Voltage rating 600V r.m.s

† -65°C to 200°C also available

Users should independently evaluate the suitability of the product for their application. Before ordering check with factory for most current data.

ElectroLoss Filterline (cont'd.)

Light weight, ruggedized filter line
wire and cable

Specifications—dimensions in mm/in

Single conductor wire

AWG Size	Conductor stranding (number x AWG)	Maximum outside diameter mm (in)	Maximum weight Kg/Km (lb/1000 ft)	MIL-SPEC part number	Raychem part number
24	19 x 36 silver coated high strength copper alloy	1.19 (.047)	4.46 (3.0)	M85485/10-24A	55FA05114-24*
22	19 x 34 tin coated copper	1.37 (.054)	5.95 (4.0)	M85485/9-22A	55FA05111-22*
20	19 x 32 tin coated copper	1.57 (.062)	8.63 (5.8)	M85485/9-20A	55FA05111-20*
18	19 x 30 tin coated copper	1.85 (.073)	12.95 (8.7)	M85485/9-18A	55FA05111-18*
16	19 x 29 tin coated copper	2.08 (.082)	16.67 (11.2)	M85485/9-16A	55FA05111-16*
14	19 x 27 tin coated copper	2.51 (.099)	23.96 (16.1)	M85485/9-14A	55FA05111-14*
12	37 x 28 tin coated copper	2.95 (.116)	35.71 (24.0)	M85485/9-12A	55FA05111-12*
10	37 x 26 tin coated copper	3.58 (.141)	55.06 (37.0)	M85485/9-10A	55FA05111-10*

Fax-on-demand

US only (800) 260-9099

Outside US (650) 257-2301

Visit our website at www.tycoelectronics.com**Specifications (cont'd.)**

Unshielded, unjacketed 2-5 conductor cables

AWG Size	Number of Conductor	Maximum outside diameter mm (in)	Maximum weight Kg/Km (lb./1000 ft)	MIL-SPEC part number	Raychem part number
24	2	2.39 (.094)	9.08 (6.1)	M85485/11-24M2A	55FA0524-24*
22	2	2.74 (.108)	12.20 (8.2)	M85485/11-22T2A	55FA0521-22*
20	2	3.15 (.124)	17.56 (11.8)	M85485/11-20T2A	55FA0521-20*
18	2	3.71 (.146)	26.34 (17.7)	M85485/11-18T2A	55FA0521-18*
16	2	4.17 (.164)	33.93 (22.8)	M85485/11-16T2A	55FA0521-16*
14	2	5.03 (.198)	48.81 (32.8)	M85485/11-14T2A	55FA0521-14*
24	3	2.59 (.102)	13.69 (9.2)	M85485/11-24M3A	55FA0534-24*
22	3	2.97 (.117)	18.15 (12.2)	M85485/11-22T3A	55FA0531-22*
20	3	3.40 (.134)	26.34 (17.7)	M85485/11-20T3A	55FA0531-20*
18	3	4.01 (.158)	39.58 (26.6)	M85485/11-18T3A	55FA0531-18*
16	3	4.50 (.177)	51.03 (34.3)	M85485/11-16T3A	55FA0531-16*
14	3	5.44 (.214)	73.36 (49.3)	M85485/11-14T3A	55FA0531-14*
24	4	3.28 (.129)	18.15 (12.2)	M85485/11-24M4A	55FA0544-24*
22	4	3.78 (.149)	24.25 (16.3)	M85485/11-22T4A	55FA0541-22*
20	4	4.34 (.171)	35.27 (23.7)	M85485/11-20T4A	55FA0541-20*
18	4	5.11 (.201)	52.82 (35.5)	M85485/11-18T4A	55FA0541-18*
16	4	5.74 (.226)	68.00 (45.7)	M85485/11-16T4A	55FA0541-16*
14	4	6.91 (.272)	97.76 (65.7)	M85485/11-14T4A	55FA0541-14*
24	5	3.58 (.141)	22.77 (15.3)	M85485/11-24M5A	55FA0554-24*
22	5	4.11 (.162)	30.36 (20.4)	M85485/11-22T5A	55FA0551-22*
20	5	4.72 (.186)	44.04 (29.6)	M85485/11-20T5A	55FA0551-20*
18	5	5.56 (.219)	66.07 (44.4)	M85485/11-18T5A	55FA0551-18*
16	5	6.25 (.246)	84.96 (57.1)	M85485/11-16T5A	55FA0551-16*
14	5	7.54 (.297)	122.16 (82.1)	M85485/11-14T5A	55FA0551-14*

* The color of component wire shall be light violet designated by 7L. The designated colors for components in finished cable shall be light violet for component 1 and light violet with stripe designators for remaining component wires as follows:

Component wire	1	2	3	4	5
Color designator	7L	7L6	7L3	7L5	7L2

Users should independently evaluate the suitability of the product for their application.
Before ordering check with factory for most current data.

ElectroLoss Filterline (cont'd.)

Light weight, ruggedized filter line
wire and cable

Specifications (cont'd.)—ElectroLoss FilterLine wire and cable light weight ruggedized constructions

Shielded, jacketed 1-5 conductor cables

AWG size	Number of conductors	Shield size AWG tin coated copper	Maximum outside diameter mm (in)	Maximum weight Kg/Km (lb/1000 ft)	MIL-SPEC part number	Raychem part number
24	1	38	2.13 (.084)	10.86 (7.3)	M85485/12-24U1A	55FB1514-24*
22	1	38	2.31 (.091)	13.09 (8.8)	M85485/12-22T1A	55FB1511-22*
20	1	38	2.51 (.099)	16.67 (11.2)	M85485/12-20T1A	55FB1511-20*
18	1	38	2.79 (.110)	22.17 (14.9)	M85485/12-18T1A	55FB1511-18*
16	1	38	3.02 (.119)	26.78 (18.0)	M85485/12-16T1A	55FB1511-16*
14	1	38	3.45 (.136)	35.86 (24.1)	M85485/12-14T1A	55FB1511-14*
12	1	38	3.89 (.153)	49.40 (33.2)	M85485/12-12T1A	55FB1511-12*
10	1	38	4.55 (.179)	71.57 (48.1)	M85485/12-10T1A	55FB1511-10*
24	2	38	3.33 (.131)	19.34 (13.0)	M85485/12-24U2A	55FB1524-24*
22	2	38	3.68 (.145)	23.81 (16.0)	M85485/12-22T2A	55FB1521-22*
20	2	38	4.09 (.161)	30.50 (20.5)	M85485/12-20T2A	55FB1521-20*
18	2	38	4.65 (.183)	41.37 (27.8)	M85485/12-18T2A	55FB1521-18*
16	2	38	5.11 (.201)	50.59 (34.0)	M85485/12-16T2A	55FB1521-16*
14	2	38	6.02 (.237)	69.49 (46.7)	M85485/12-14T2A	55FB1521-14*
24	3	38	3.53 (.139)	25.30 (17.0)	M85485/12-24U3A	55FB1534-24*
22	3	38	3.91 (.154)	31.10 (20.9)	M85485/12-22T3A	55FB1531-22*
20	3	38	4.34 (.171)	41.07 (27.6)	M85485/12-20T3A	55FB1531-20*
18	3	38	4.95 (.195)	56.54 (38.0)	M85485/12-18T3A	55FB1531-18*
16	3	38	5.44 (.214)	69.94 (47.0)	M85485/12-16T3A	55FB1531-16*
14	3	38	6.43 (.253)	96.87 (65.1)	M85485/12-14T3A	55FB1531-14*
24	4	38	4.19 (.165)	31.69 (21.3)	M85485/12-24U4A	55FB1544-24*
22	4	38	4.67 (.184)	39.58 (26.6)	M85485/12-22T4A	55FB1541-22*
20	4	38	5.23 (.206)	52.68 (35.4)	M85485/12-20T4A	55FB1541-20*
18	4	38	5.99 (.236)	72.91 (49.0)	M85485/12-18T4A	55FB1541-18*
16	4	38	6.68 (.263)	91.36 (61.4)	M85485/12-16T4A	55FB1541-16*
14	4	38	7.85 (.309)	125.59 (84.4)	M85485/12-14T4A	55FB1541-14*
24	5	38	4.52 (.178)	37.80 (25.4)	M85485/12-24U5A	55FB1554-24*
22	5	38	5.05 (.199)	47.32 (31.8)	M85485/12-22T5A	55FB1551-22*
20	5	38	5.66 (.223)	63.39 (42.6)	M85485/12-20T5A	55FB1551-20*
18	5	38	6.55 (.258)	89.43 (60.1)	M85485/12-18T5A	55FB1551-18*
16	5	38	7.24 (.285)	111.00 (74.6)	M85485/12-16T5A	55FB1551-16*
14	5	38	8.53 (.336)	153.26 (103.0)	M85485/12-14T5A	55FB1551-14*

** The jacket for shielded cables are radiation-crosslinked, modified, conductive ETFE and only available in black (0).

Fax-on-demand

US only (800) 260-9099

Outside US (650) 257-2301

Visit our website at www.tycoelectronics.com

Fluid resistance

Fluids	Hydrocarbons
	Fuels and lubricants
	Alcohols
	Cleaning fluids
	Glycols
	Synthetic fuels and lubricants
	Ketones



Cheminax Coaxial Cables

Small, lightweight coaxial cables



Applications

Cheminax controlled electrical cables are used in the aircraft and aerospace industries. They have a wide range of applications in missiles, avionics, radio-frequency and microwave systems, computers, security and surveillance systems, and communications.

Cheminax coaxial cables were designed to solve interconnect problems in electronic systems, such as computers, military equipment, and other areas of high-density packing, where cables are required to perform to more exacting specifications than standard radio-grade (RG) or UL recognized (UR) constructions.

Tyco Electronics' advanced materials technology has allowed the design and development of Raychem Cheminax miniature coaxial cables that offer substantial savings in size and weight while improving mechanical performance and reducing attenuation.

Cables can be designed that are either smaller and lighter than standard RG and UR cables or provide significantly lower attenuation and capacitance with no significant increase in size.

Features and benefits

- Light weight, small size.
- Temperature range of -65°C to 200°C .
- Low capacitance and attenuation.
- High velocity of propagation.
- High flexibility.

Available in:

Americas

Europe

Asia Pacific

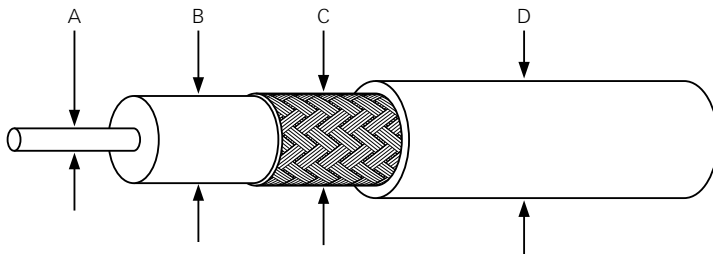

- A Conductor
- B Dielectric
- C Shield
- D Jacket

Fax-on-demand

US only (800) 260-9099

Outside US (650) 257-2301

Fax ID

6110

Description

Data sheet

Visit our website at www.tycoelectronics.com**Specifications/approvals**

Series	UL	Raychem
Cheminax cables	1837, 3258, 3259, and 3264	1200

Product dimensions (nominal)

Typical product part numbers	Impedance (ohms)	Capacitance pF/m (pF/ft)	Attenuation at 400 MHz dB/100m (dB/100 ft)	A Conductor diameter mm (in)	B Dielectric diameter mm (in)	C Shield diameter mm (in)	D Jacket diameter mm (in)	Weight in kg/km (lb/1000ft)
5012E1339	50	98.4 (30.0)	14.8 (4.5)	2.26 (.089)	7.24 (.285)	7.98 (.314)	10.24 (.403)	162.2 (109.0)
5012M1612	50	82.0 (25.0)	16.1 (4.9)	2.26 (.089)	6.07 (.239)	6.60 (.260)	7.06 (.278)	74.5 (50.1)
5024A1311	50	83.7 (25.5)	50.3 (15.3)	0.62 (.025)	1.70 (.067)	2.18 (.085)	2.67 (.104)	11.8 (7.9)
5026D1027	50	88.9 (27.1)	63.7 (19.4)	0.48 (.019)	1.27 (.050)	1.70 (.067)	2.21 (.087)	11.8 (7.9)
5030A1317	50	90.2 (27.5)	97.5 (29.7)	0.30 (.012)	0.79 (.031)	1.12 (.044)	1.57 (.062)	4.5 (3.0)
5030A1424	50	100.4 (30.6)	94.5 (28.8)	0.30 (.012)	0.86 (.034)	1.19 (.047)	1.60 (.063)	5.7 (3.8)
7520A1311	75	56.1 (17.1)	20.0 (6.1)	1.02 (.040)	4.57 (.180)	5.11 (.201)	6.12 (.241)	43.2 (29.0)
7524A1311	75	56.4 (17.2)	31.8 (9.7)	0.62 (.025)	2.82 (.111)	3.25 (.128)	3.86 (.152)	19.2 (12.9)
7528H1424	75	54.5 (16.6)	44.0 (13.4)	0.32 (.013)	1.37 (.054)	1.73 (.068)	2.13 (.084)	8.9 (6.0)
7530A1317	75	60.4 (18.3)	58.8 (17.9)	0.30 (.012)	1.35 (.053)	1.78 (.07)	2.29 (.09)	8.3 (5.6)
7530H1424	75	57.4 (17.5)	58.1 (17.7)	0.30 (.012)	1.30 (.051)	1.73 (.068)	2.03 (.08)	8.5 (5.7)
9522A1311	95	44.3 (13.5)	19.7 (6.0)	0.79 (.031)	5.51 (.217)	6.05 (.238)	7.32 (.288)	55.1 (37.0)
9527J1528	95	44.3 (13.5)	31.8 (9.7)	0.43 (.017)	2.84 (.112)	3.18 (.125)	3.58 (.141)	19.2 (12.9)
9530H1014	95	44.3 (13.5)	44.3 (13.5)	0.30 (.012)	1.83 (.072)	2.26 (.089)	2.62 (.103)	13.1 (8.8)

Note: All values are nominal.

Product characteristics

General	Conductor range	12 AWG to 30 AWG
	Operating temperature range*	-65°C to 200°C
Electrical	Impedance range	50 ohms to 125 ohms
	Dielectric constant	1.65-2.3
	Velocity of propagation	67%-80%

*Temperature rating varies depending on materials used in specific construction.

Users should independently evaluate the suitability of the product for their application.
Before ordering check with factory for most current data.

Cheminax Coaxial Cables *(cont'd.)*

Small, lightweight coaxial cables

Properties (per SCD)

Physical	Typical value of dielectric material					
	Rayfoam L	Rayfoam H	Rayolin F			
Tensile (min.)	6.8 MPa <i>(1000 psi)</i>	4.1 MPa <i>(600 psi)</i>	12.2 MPa <i>(1800 psi)</i>			
Elongation (min.)	50%	50%	200%			
Electrical						
Dielectric withstand (min.)	1000 V	1000 V	1000 V			
Velocity of propagation (nom.)	78%	78%	67%			
Dielectric constant	1.65	1.65	2.2			
Physical	Type value of jacket material					
	Thermorad	SPEC 55	FlexLine	FEP	Zerohal	SPEC 44
Tensile (min.)	13.6 MPa <i>(2000 psi)</i>	34 MPa <i>(5000 psi)</i>	20.4 MPa <i>(3000 psi)</i>	13.6 MPa <i>(2000 psi)</i>	8.2 MPa <i>(1200 psi)</i>	27.2 MPa <i>(4000 psi)</i>
Elongation (min.)	250%	50%	100%	200%	150%	200%
Temperature (max.)	125°C	200°C	200°C	200°C	125°C	150°C
Flammability*	Method C	Method B	Method B	Method B	Method B	Method B
Fluid category*	C	A	A	A	C	

*See Raychem specification WCD-1200 for details.

Fax-on-demand

US only (800) 260-9099

Outside US (650) 257-2301

Fax ID

6110

Description

Data sheet

Visit our website at www.tycoelectronics.com**Cheminax Coaxial Cable Part Numbering System**

50 26 A 1 3 1 4 - 0

Jacket color

- 0 = Black
- 1 = Brown
- 2 = Red
- 3 = Orange
- 4 = Yellow
- 5 = Green
- 6 = Blue
- 7 = Violet
- 8 = Gray
- 9 = White
- 9X = Transparent white

Conductor type

- 1 = Tin-coated copper
- 2 = Silver-coated copper
- 3 = Nickel-coated copper
- 4 = Silver-coated high-strength copper alloy
- 6 = Nickel-coated high strength copper Alloy
- 7 = Tin-coated copper-clad steel
- 8 = Silver-coated copper-clad steel
- 9 = Bare copper
- A = CS95

Dielectric

- 1 = Rayfoam L
- 2 = Rayfoam H
- 3 = Rayolin F
- 4 = FEP (solid)
- 6 = SPEC 55 (modified XL-ETFE)
- 0 = Other

Jacket

- 1 = General purpose PVF2
- 2 = Outerspace PVF2
- 3 = Thermorad
- 4 = FEP
- 5 = Uncrosslinked ETFE
- 6 = SPEC 55
- 7 = FlexLine
- 8 = Zerohal
- 9 = None
- 0 = Other

Construction

- 1 = Single round shield
- 2 = Single flat shield
- 3 = Double round shield
- 4 = 2 shield (other)
- 5 = Triax-round shield
- 6 = Triax - other
- 8 = Composite shield
- 9 = Core only
- 0 = Other

Variation

Letter assigned by Raychem.
(This is not a revision indicator.)

Conductor size (AWG)

Always two digits.

Impedance

Always two digits (if 100 ohms or higher, use last two digits only).

Cheminax

High-performance alternatives to standard cables



Available in:

Americas

Europe

Asia Pacific

Raychem alternatives to RG cables

RG/U	Raychem alternative	Comments
4	5020A3311-0	Small/light
	5018D3311-0	Improved electricals
5	5018D3311-0	Small/light
8	5012E1339-0	Dimensionally similar
11	7518A1311-0	Small/light
29	5020A1311-0	Small/light
31	5012E1339-0	Dimensionally similar
55	5020A3311-0	Small/light
	5018D3311-0	Improved electricals
58	5021D1331-0	Dimensionally similar
	5020A1311-0	Small/light
	5018A1311-0	Improved electricals
59	7523D1331-0	Dimensionally similar
	7524A1311-0	Small/light
	7520A1311-0	Improved electricals
62	9524A1311-0	Small/light
63	2524A1311-0	Small/light
87	5012A3311-0	Small/light
89	5012A3311-0	Small/light
115	5012A3311-0	Small/light
122	5020A1311-0	Improved electricals
124	7524A1311-0	Small/light
133	9524A1311-0	Small/light
140	7524A1311-0	Small/light
141	5020A1311-0	Small/light
142	5019D3318-0	Small/light
	5018D3311-0	Improved electricals
144	7518A1311-0	Small/light
149	7518A1311-0	Small/light

Raychem alternatives to RG cables (cont'd.)

RG/U	Raychem alternative	Comments
159	5020A1311-0	Small/light
174	5026A1311-0	Small/light
	5024A1311-0	Improved electricals
178	5030A1317-0	Small/light
	5028A1317-0	Improved electricals
179	7530A1317-0	Small/light
	7528A1317-0	Improved electricals
180	9530E1014-0	Small/light
	9527A1318-9	Improved electricals
188	5026A1311-0	Small/light
	5024A1311-0	Improved electricals
210	9524A1311-0	Small/light
213	5012E1339-0	Dimensionally similar
214	5012A3311-0	Small/light
223	5019D3318-0	Small/light
	5018D3311-0	Improved electricals
225	5012A3311-0	Small/light
235	5012A3311-0	Small/light
279	7524A1311-0	Dimensionally similar
282	5024A1311-0	Small/light
302	7524A1311-0	Small/light
303	5020A1311-0	Small/light
304	5018A1311-0	Small/light
316	5026A1311-0	Small/light
	5024A1311-0	Improved electricals
393	5012A3311-0	Small/light
400	5020A3311-0	Small/light
	5018D3311-0	Improved electricals
403	5030A5314-0	Small/light

Note: To complement the mechanical and electrical features of Cheminax miniature coax cable, Tyco Electronics offers Raychem Solder Sleeve, SolderTacts, and PinPak termination devices and RF connector devices. Controlled electrical cables and components are available for data bus systems. For further information see the Electrical Interconnect Products section of this catalog.

Fax-on-demand

US only (800) 260-9099

Outside US (650) 257-2301

Visit our website at www.tycoelectronics.com**Raychem alternatives to UR cables**

UR	Raychem alternative	Comments
43	5020A1311-O	Small/light
57	7518A1311-O	Small/light
65	7518A1311-O	Small/light
67	5012E1339-O	Dimensionally similar
70	7524A1311-O	Small/light
72	5020A1311-O	Small/light
76	5020A1311-O	Small/light
84	7524A1311-O	Small/light
90	7522A1311-O	Small/light
95	5026A1311-O	Small/light
96	9524A1311-O	Dimensionally similar
102	5012E1339-O	Dimensionally similar
104	7522A1311-O	Small/light
105	7518A1311-O	Small/light
106	7222A1311-O	Small/light
107	5012E1339-O	Small/light
108	5020A1311-O	Small/light
109	5026A1311-O	Small/light
110	5030A1317-O	Small/light
111	7530A1317-O	Small/light
112	5012A3311-O	Small/light
113	7518A1311-O	Small/light
116	5026A1311-O	Small/light
117	7524A1311-O	Small/light
200	7524A1311-O	Dimensionally similar
201	7522A1311-O	Dimensionally similar
202	7522A1311-O	Dimensionally similar
203	7520A1311-O	Small/light
204	7518A1311-O	Dimensionally similar
205	7518A1311-O	Dimensionally similar
207	7524A1311-O	Small/light
208	7524A1311-O	Small/light
210	7524A1311-O	Small/light
301	5020A1311-O	Small/light
306	7524A1311-O	Small/light

Note: To complement the mechanical and electrical features of Cheminax miniature coax cable, Tyco Electronics offers Raychem Solder Sleeve, SolderTacts, and PinPak termination devices and RF connector devices. Controlled electrical cables and components are available for data bus systems. For further information see the Electrical Interconnect Products section of this catalog.

**Users should independently evaluate the suitability of the product for their application.
Before ordering check with factory for most current data.**

Cheminax Twin Axial Cable

Small, lightweight twin axial cables



Applications

These small, lightweight cables are specially designed for use in MIL-STD-1553 data bus applications. Raychem materials technology allows the design and construction of cables that meet rigorous electrical and environmental performance requirements while minimizing size and weight.

Cheminax twin axial cables provide elegant solutions to an increasing range of data bus and multiplex signal transmission applications.

Features/Benefits

- Light weight, small size.
- Temperature range of -65°C to 200°C .
- Low capacitance.
- High data rates.
- Excellent shop handling.

Available in:

Americas

Europe

Asia Pacific

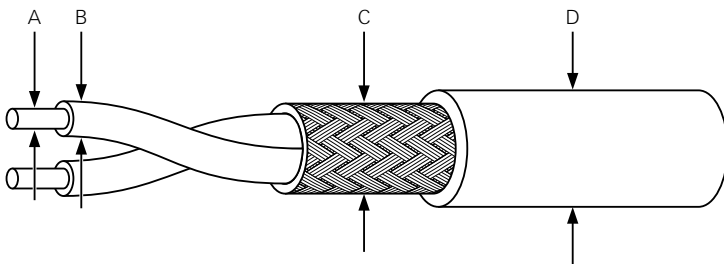

- A Conductor
- B Dielectric
- C Shield
- D Jacket

Fax-on-demand

US only (800) 260-9099

Outside US (650) 257-2301

Visit our website at www.tycoelectronics.com**Specifications/approvals**

Series	UL	Raychem
Cheminax cables	1837, 3258, 3259, and 3264	1200

Product dimensions*

Typical product part numbers	Impedance (ohms)	Capacitance pF/m (pF/ft)	A Conductor diameter mm (in)	B Dielectric diameter mm (in)	C Shield diameter mm (in)	D Jacket diameter mm (in)	Weight in kg/km (lb/1000ft)
5024A1661	50	104.7 (31.9)	.64 (.025)	0.89 (.035)	2.21 (.087)	2.62 (.103)	14.4 (9.7)
5026A1664	50	136.2 (41.5)	.48 (.019)	0.66 (.026)	1.75 (.069)	2.16 (.085)	10.0 (6.7)
7520A1662	75	74.2 (22.6)	1.02 (.040)	2.03 (.080)	4.60 (.181)	5.05 (.199)	42.9 (28.8)
7526J1660	75	88.6 (27.0)	.48 (.019)	0.99 (.039)	2.41 (.095)	2.82 (.111)	14.9 (10.0)
7820D0331	78	67.3 (20.5)	1.02 (.040)	2.11 (.083)	4.75 (.187)	5.72 (.225)	46.9 (31.5)
7824E0422	78	55.1 (16.8)	.64 (.025)	1.19 (.047)	2.82 (.111)	3.33 (.131)	19.6 (13.2)
0022E0311	100	49.2 (15.0)	.79 (.031)	1.98 (.078)	4.39 (.173)	5.16 (.203)	30.5 (20.5)
0024A0024	100	44.3 (13.5)	.64 (.025)	1.30 (.051)	3.02 (.119)	3.63 (.143)	25.1 (16.9)
0026A0024	100	44.0 (13.4)	.48 (.019)	1.14 (.045)	2.72 (.107)	3.23 (.127)	18.7 (12.6)
2524H0524	125	39.4 (12.0)	.64 (.025)	1.83 (.072)	4.09 (.161)	4.50 (.177)	25.3 (17.7)
2526E1114	125	36.1 (11.0)	.48 (.019)	1.40 (.055)	3.33 (.131)	3.73 (.147)	21.7 (14.6)
2530A0314	125	39.4 (12.0)	.30 (.012)	0.86 (.034)	2.16 (.085)	2.67 (.105)	10.6 (7.1)
10595-24	70	91.9 (28.0)	.64 (.025)	1.19 (.047)	2.82 (.111)	3.23 (.127)	17.9 (12.0)
10606-26	75	91.9 (28.0)	.53 (.021)	0.99 (.039)	2.41 (.095)	2.82 (.111)	13.4 (9.0)
10612-24	77	91.9 (28.0)	.64 (.025)	1.22 (.048)	2.90 (.114)	3.30 (.130)	23.7 (15.9)
10613-24	77	91.9 (28.0)	.64 (.025)	1.22 (.048)	3.33 (.131)	3.73 (.147)	39.0 (26.2)
10614-24	77	91.9 (28.0)	.64 (.025)	1.22 (.048)	3.73 (.147)	4.09 (.161)	40.3 (27.1)

*All dimensions are nominal.

Users should independently evaluate the suitability of the product for their application.
Before ordering check with factory for most current data.

Cheminax Twin Axial Cable *(cont'd.)*

Small, lightweight twin axial cables

Product characteristics

General	Conductor range	20 AWG to 30 AWG
	Operating temperature range*	-65°C to 200°C
Electrical	Impedance range	50 ohms to 125 ohms
	Capacitance range	30 pF/ft to 10 pF/ft

*Temperature rating varies depending on materials used in specific construction.

Fax-on-demand

US only (800) 260-9099

Outside US (650) 257-2301

Visit our website at www.tycoelectronics.com**Properties (per SCD)**

Typical value of dielectric material						
Physical	Rayfoam L	Rayfoam H	Rayolin F	FEP (solid)	Radiation-crosslinked XL ETFE	
Tensile (min.)	6.8 MPa (1000 psi)	9.1 MPa (600 psi)	12.2 MPa (1800 psi)	6.8 MPa (1000 psi)	34 MPa (5000 psi)	
Elongation (min.)	50%	50%	200%	150%	50%	
Electrical						
Dielectric withstand (min.)	1000 V	1000 V	1000 V	1000 V	1000 V	
Velocity of propagation (nom.)	78%	78%	67%	69%	61%	
Permittivity (nom.)	1.65	1.65	2.2	2.1	2.7	
Typical value of jacket material						
Physical	Thermorad	SPEC 55	FlexLine	FEP	Zerohal	SPEC 44
Tensile (min.)	13.6 MPa (2000 psi)	34 MPa (5000 psi)	20.4 MPa (3000 psi)	13.6 MPa (2000 psi)	8.2 MPa (1200 psi)	27.2 MPa (4000 psi)
Elongation (min.)	250%	50%	100%	200%	150%	200%
Temperature (max.)	125°C	200°C	200°C	200°C	125°C	150°C
Flammability**	Method C	Method B	Method B	Method B	Method B	Method B
Fluid category**	C	A	A	A	C	B

*See Raychem specification WCD-1200 for details.

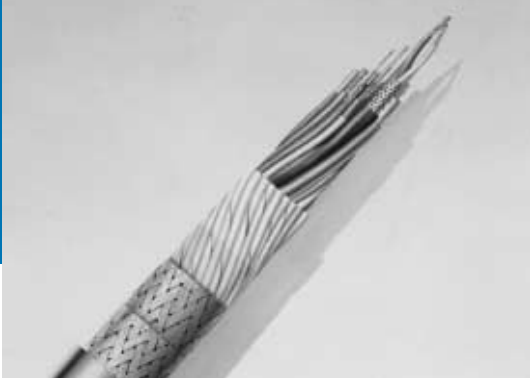

Custom-designed and standard Multiconductor (Multicore) Cables



Applications

Tyco Electronics is the leading manufacturer of Raychem custom-designed, small-size, lightweight, high-performance multiconductor (multicore) cables. Applications are found in the aerospace, commercial marine (Sealite), naval, mass transportation, automotive, offshore, military ground vehicle, ground support, high-performance instrumentation, industrial, and commercial markets. Raychem multiconductor (multicore) cables have been approved to many standards demanding high performance criteria in service use.

Multiconductor (Multicore)

Features and benefits

- Temperature capability: -55°C to 200°C .
- Small size, light weight.
- System compatibility with other Raychem products.
- Complete range of components.
- Specially formulated jacket materials.
- Special shielding (screening) to address EMI/EMC problems.
- Custom designed and purpose built.
- Fast response—design, pricing, and delivery.
- Prototype length facility.
- Raychem Dynalink extended flex-life and increased flexibility.
- Fire-resistant: circuit integrity (IEC331, enhanced 950°C , 3 hours).
- Small-size, lightweight, low-fire-hazard for modern high-speed vessels (Sealite).

Multiconductor (Multicore) cables purpose built and designed using Raychem components and technology

Multiconductor cables are used in widely varying applications and environments. Careful consideration must be given to the selection of components with the right combination of physical, chemical, and electrical properties for specific applications.

Fax-on-demand

US only (800) 260-9099

Outside US (650) 257-2301

Visit our website at www.tycoelectronics.com

Tyco Electronics' leadership in the technologies of polymer blending and subsequent radiation crosslinking has led to the development of a particularly broad range of Raychem cables. High-performance component wires and miniature coaxial cables are combined with unique cable jacket materials to meet the requirements of demanding environments.

Established as one of the leading manufacturers of special purpose Raychem cables, Tyco Electronics has continued to develop both its design and manufacturing expertise.

Development of a sophisticated CAD system has allowed increasingly rapid response to any design request, followed by manufacturing to the highest quality standards.

Planar film-bonded cables

Tyco Electronics can custom-design and build a variety of Raychem component wires and cables onto high-performance carrier films. Components and carriers are matched to ensure temperature and environmental stability.

Available in:	Americas	Europe	Asia Pacific
	■	■	■

Specifications/approvals			
Agency	Industry	Military	Raychem
Underwriters' Laboratories	Lloyd's Register of Shipping	Def. Stan. 61-12 Pt 25	WCD series
BSENISO9001	Det Norske Veritas	VG 952 18 Pts 27 and 28	
MSV 34410-34413, 34435,34436			



Multiconductor (Multicore) Cables



Design flexibility

Components

- SPEC 44 wire and cable
- SPEC 55 wire and cable
- Type 99 wire and cable
- Zerohal 100 wire and cable
- Coaxial cables
- ElectroLoss Filterline cables
- Flexible power cables
- Optical fibers
- Special components

Wraps and braids

- Fabric and film tapes
- Kevlar or steel strength members
- Full range of electrical screens
(including SuperScreens)

Jacket materials

- Zerohal
 - Low smoke, low toxicity index, low corrosive gases
- FDR 25
 - Fluid resistant, flexible, high temperature
- Thermorad
 - General purpose
- Thermorad HTF/
Fluoroelastomer
 - Very high temperature, fluid resistant
- Raythane C
 - Tough and flexible
- Raythane FR
 - Tough, flexible, flame-retardant
- Rayolin
 - Low moisture transmission
- Neoprene
 - Low-temperature flexibility

Fax-on-demand

US only (800) 260-9099

Outside US (650) 257-2301

Visit our website at www.tycoelectronics.com

Cable jacket materials

Properties and specifications

Specifications and approvals (components and jacket materials)

Specifications

UK designation	FDR 25	Zerohal	Fluoro- elastomer	Thermorad	Rayolin	Raythane C	AFR	Neoprene	44 wire	55 wire	100 wire	99 wire	Hytrel
US designation		Zerohal	Thermorad HTF	Thermorad F		Raythane FR		Thermorad NIFR	44 wire	55 wire	100 wire		
Def Stan 61-12 Part 31, NES 518		X											
NES 525		X							X				
Def Stan 61-12 Part 18 type 1 (issue 4) (Maintenance range)									X				
Def Stan 61-12 Part 18 type 1 (issue 4)		X											X
Def Stan 61-12 Part 25		X											X
Def Stan 61-12 Part 26									X				
MSV 34401									X				
MSV 34410, 34411				X					X				
MSV 34412, 34413, 34430 34435, 34436		X							X				
VG 95218 Part 20, 21, 22 and 23									X	X			
VG 95218 Part 24, 25 and 26	X												
VG 95218 Part 27 and 28	X	X							X		X		
VG 95218 Part 1000									X				
VG 95218 Part 1001 and 1002										X			
MIL-C-24640 (PMS 400)		X							X				
MIL-W-81044/MIL-C-27500									X				
MIL-W-22759/MIL-C-27500										X			
AO14000		X											X
NES 517		X			X				X				

Approvals

Lloyds Register of Shipping/DNV		X		X		X			X				X
Bureau Veritas	X	X	X	X		X	X	X	X	X			
UL				X		X (FR)	X		X	X			
CAA									X	X			
BWB	X			X					X	X			
VDE	X			X					X	X			
Det Norskeveritas													
German Isler Lloyds		X										X	
American Bureau of Shipping		X										X	
Lloyds		X										X	
Bureau Veritas		X										X	

Fax-on-demand

US only (800) 260-9099

Outside US (650) 257-2301

Visit our website at www.tycoelectronics.com**Major cable specifications**

Country	Cable specification	Specification description	Approved jacket
UK	Def Stan 61-12 Part 25	Royal Navy/Airforce specification covering limited fire hazard thin-wall insulated electric cables using Def-Stan 61-12 Part 18 approved wire. Signal, control and light power circuits.	Zerohal
Germany	VG 95218 (parts 27 and 28)	Military ground systems specification for signal, control and power cables. Wire to VG 95218 Parts 20-23 and 1000.	FDR-25
Netherlands	MSV 34410, 34411	Royal Netherlands Navy specification. Signal, control and light power cables. Wire to MSV 34401.	Thermorad
	MSV 34412, 34413, 34430, 34435, 34436	Royal Netherlands navy specification. Signal, control and light power cables. Wire to MSV 34401.	Zerohal
USA	MIL-C-24640 (PMS 400)	Navy specification covering limited fire hazard thin-wall insulated electric cables for signal, control and light power circuits. Wire to MIL-W-81044.	Zerohal

Summary of typical cable jacket properties

UK designation	US designation	Property			Chemical resistance			
		Temperature range °C*	Abrasion resistance	Flexibility	Flame resistance	Acid	Alkaline	Hydrocarbon
FDR25		-40 to 150	Fair	Very good	Self-exting	Good	Good	Very good
Zerohal	Zerohal UK & US	-30 to 105	Good	Good	Self-exting	Good	Good	Good
Fluoroelastomer	Thermorad HTF	-20 to 200	Good	Good	Nonburning	Excellent	Excellent	Excellent
Thermorad	Thermorad F	-55 to 125	Good	Good	Self-exting	Good	Good	Good
	Raythane C	-25 to 80	Excellent	Excellent	Self-exting	Fair	Fair	Excellent
Neoprene	Raythane FR	-65 to 90	Excellent	Excellent	Self-exting	Fair	Fair	Excellent
	Thermorad NTFR	-55 to 110	Very good	Excellent	Self-exting	Good	Good	Good
Rayolin		-55 to 95	Very good	Fair	–	Good	Good	Good
AFR		-40 to 105	Excellent	Good	Self-exting	Good	Good	Good
	Thermorad LS	-30 to 105	Good	Good	Self-exting	Good	Good	Good
	Thermorad O	-55 to 125	Good	Good	Self-exting	Good	Good	Good
	Thermorad 300	-65 to 200	Very good	Fair	Self-exting	Excellent	Excellent	Excellent
Polyvinylidene Fluoride	Thermorad K	-65 to 150	Very good	Fair	Self-exting	Excellent	Good	Excellent
Modified ETFE	Thermorad HT	-65 to 200	Very good	Fair	Self-exting	Excellent	Excellent	Excellent
Modified Flexible ETFE	Thermorad FL	-55 to 200	Very good	Good	Self-exting	Excellent	Excellent	Excellent

*Operating temperatures for cables are application dependent. Figures shown are for guidance only. In many cases the limits shown may be extended at both ends of the temperature range. Consult your Tyco Electronics product representative for guidance.

Users should independently evaluate the suitability of the product for their application.
Before ordering check with factory for most current data.

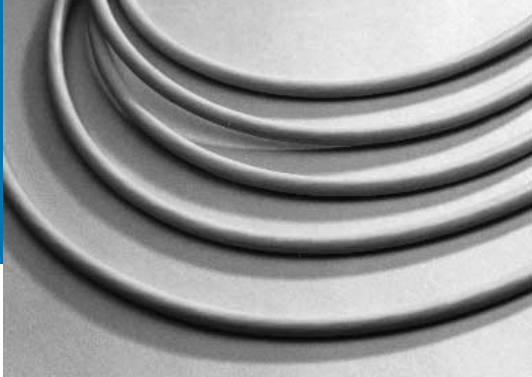

FDR25

*Flexible, diesel resistant
wire and cable jacket material*



Applications

FDR 25 cable jacket was originally developed for the Leopard II main battle tank to provide an exceptional range of properties. Used in compartments exposed to hot diesel fuels and vibration, FDR 25 resists a wide range of aggressive fluids and offers excellent low temperature flexibility. These properties have also led to a widespread use of FDR 25 on other military vehicles and in many applications such as test and communications equipment. FDR 25 is fully compatible with Raychem's high performance harnessing system - System 25.

Operating temperature range

-40°C to 150°C

Features and benefits

- Highly flame retardant.
- Compatible with Raychem System 25 tubing, molded parts and adhesives.
- Qualified to VG and MTV standards.

Available in:

Americas

Europe

Asia Pacific

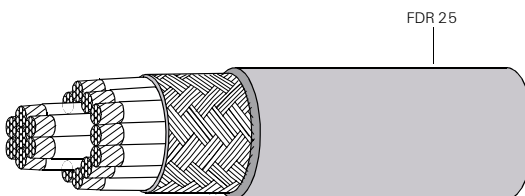

Fax-on-demand

US only (800) 260-9099

Outside US (650) 257-2301

Visit our website at www.tycoelectronics.com**Typical characteristics when tested in accordance with Raychem specification WCD 2002 (UK) and WCD 3304 (US)**

Mechanical	Tensile strength (MPa)	20	
	Elongation (%)	500	
	Tear strength (N/mm)	5	
	Abrasion resistance (1.6 kg load)	40 scrapes min.	
	Cold bend	-40°C	
Thermal ageing	Endurance IEC 216	2500 h 150°C	
	Heat ageing 120h, 175°C	TS 8 MPa (min), Eb 150% (min)	
	Heat shock 4 h at 225°C	No cracks, drips or flowing, 6 mm total shrinkage in 300 mm	
Fluid resistance	24 h immersion	% Retention of properties	
		Tensile strength	Elongation
	Diesel fuels 70°C	70	70
	Hydraulic fluids 50°C	70	70
	Lubricating oils 100°C	70	80
	Cleaning fluids 23°C	90	95
	Deicing fluids 23°C	90	95
Electrical	Insulation resistance 20°C M ohm.km min.	2	
Other	45° flammability	30 s (max) afterburn 100 mm (max) burn length	
	Vertical flammability	Self extinguishing	
	Acid gas	4% HCl equivalent (max.)	



Zerohal

*Low fire hazard performance
wire and cable jacket material*



Applications

Cables rarely initiate fires, but they could be involved in them and can significantly increase the damage caused should they propagate the fire. Until recently the flame retarding of cables was achieved by the use of halogenated flame retardants which are effective fire suppressants, but which unfortunately produce dense smoke and corrosive acid gases when burned. These effects are highly undesirable in a fire, hindering evacuation and fire fighting, endangering life and causing corrosion damage to expensive and vital equipment.

Raychem Zerohal is a halogen-free cable jacket material developed by Tyco Electronics and approved to the most exacting requirements for low fire hazard cables in many countries and, as such, is the most widely accepted material for these applications in the marine, process and mass transport industries. Combined with SPEC 44 wire or Type 99 and 100 wire, this jacket material provides small size, light weight cables (approximately 40% weight saving over conventional materials).

Zerohal combines the good mechanical and electrical features of some conventional cables with good flame retardancy, low smoke generation, low evolution of hazardous and corrosive gases, and good resistance to diesel fuel, lubricating oils and water.

Zerohal jacket material is fully compatible with the low fire hazard harnessing system - System 100.

Features and benefits

- Halogen free.
- Low smoke generation.
- Highly flame retarded.
- Low toxicity index.
- Low corrosive gas emission.
- Temperature rating -30°C to +105°C.

System

- System 100.

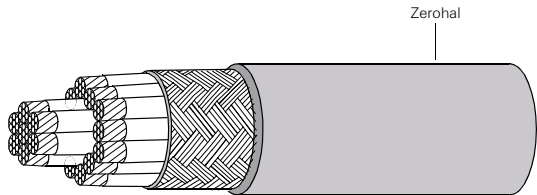

Available in:

Americas

Europe

Asia Pacific



Fax-on-demand

US only (800) 260-9099

Outside US (650) 257-2301

Visit our website at www.tycoelectronics.com**Product characteristics when tested in accordance with Raychem specification WCD 2015 and WC 2001 (Zerohal with Fungicide)**

Mechanical	Tensile strength (MPa)	8	
	Elongation (%)	200	
	Tear strength (N/mm)	5	
	Abrasion resistance (1.6 kg load)	30 scrapes min.	
	Cold bend	-30°C	
Thermal ageing	Heat ageing 120 h 130°C	60% min retention of TS and Eb	
	Heat shock 4 h at 225°C	No cracks, drips or flowing, 6 mm total shrinkage in 300 mm	
Fluid resistance		Retention of properties	
		Tensile strength	Elongation
	Diesel fuels 100°C/24 h	85	75
	IRM 902 24h, 100°C	90	75
	Lubricating oils 50°C/24 h	80	75
	Water uptake (ASTM D570) 70°C/28 days	2% weight uptake (max)	
Electrical	Insulation resistance 20°C	40	
	M ohms km (min)		
Other	45° flammability	Self extinguishing	
	Vertical flammability (Swedish Chimney)	Self extinguishing	
	Acid gas	1.2% HCl equivalent (max)	
	Limiting oxygen index	32%	
	Temperature index	275°C	
	Toxicity index	2.5 per 100 g	
	Smoke index	18	
	Halogen content	None detected	

Zerohal (cont'd.)

*Low fire hazard performance
wire and cable jacket material*

Low fire hazard performance

Flammability

Current thinking on fire hazard defines the term 'Fire Risk'. This description recognizes that the risk in a fire situation is influenced strongly from several factors including, ignitability, heat release, smoke evolution and toxic gas emission together with flammability.

There are several test procedures available used to assess flammability of wires and cables. Still in widespread use is Limiting Oxygen Index (LOI), but it is now generally recognized that because the test is conducted on a single specimen (of cable jacket or wire) in laboratory conditions, the results are, at best, only weakly correlated to actual fire situations. Critical Temperature Index (CTI), is a related test and assesses performance at elevated temperature but nevertheless it is still conducted on a single specimen. More recent evidence and thinking places significantly greater importance on large scale flammability tests, such as IEC 60332-3, in which the sample consists of several bundles of wires. These tests predict more accurately the likely behaviour of cables in actual fire scenarios. Raychem Zerohal cable jackets give very good results in small scale laboratory based tests (e.g. LOI, CTI) and Zerohal cables perform very well in large scale tests (e.g. IEC 60332-3). Overall Zerohal jacketed cables have been shown to exhibit excellent flammability characteristics.

Corrosivity

Under fire conditions, polymers containing halogens, sulphur and phosphorous all form corrosive acid gases or liquids. These acids can then attack items such as printed circuit boards, connectors, control relays and metal structures, including steel reinforcement bars embedded in concrete.

Test methods to evaluate corrosivity involve direct measurement of the amount of acid gas produced during pyrolysis, eg to British Rail Specification TDE 76/P/16 or measurement of pH and electrical conductivities of solutions.

Toxicity Index

The various gases given off by combustion of polymeric materials are toxic to differing degrees.

The Def Stan O2-713, assesses the concentration of each of the possible by-products and, by measuring the amounts of these materials, a Toxicity Index is assigned.

Zerohal jacket material has a typical Toxicity Index of 1.7, compared to a typical value of 6 for CSP and 20 for PVC jacketed cable. The Def Stan 61-12 part 31 specification requirement for a cable jacket is <5.

Smoke

The problems of classifying flammability and corrosive gas generation equally apply to measuring smoke generation. The method accepted by most authorities involves the use of the NBS smoke chamber where optical density of the chamber's atmosphere is constantly measured during pyrolysis.

The 10% visibility line indicates the density of smoke which would cause human disorientation and confusion. The rate of change of smoke density can be summarized to a single numerical value, as in NES 711, to give a smoke index for a material and thus offers simple comparison of materials performance.

Fax-on-demand

US only (800) 260-9099

Outside US (650) 257-2301

Visit our website at www.tycoelectronics.com

Navy applications

37 Component cable comparison

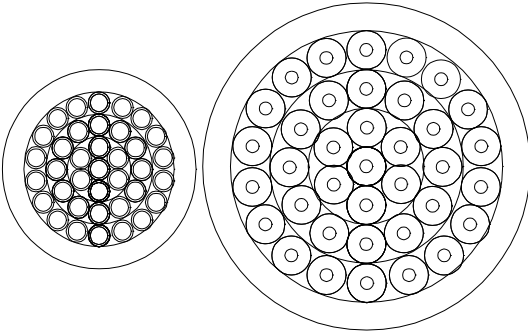

	Raychem cable to Def Stan 6 1-12 Pt25	Cable to DGS 2 12
Diameter	12.5 mm (nom.)	21.3 mm
Weight	328 g/m (nom.)	526 g/m
Conductor	0.60 mm ² (nom.)	0.5 mm ²

Ships are becoming smaller and more sophisticated, with an ever increasing complexity of electronic systems, sensors and weapons. As technology advances shipbuilders are called upon to update and modify existing systems or fit completely new ones. The proliferation of electronic hardware requires more and more communication systems to transfer data from one place to another. To provide all the necessary interconnections, hundreds of multicore cables have to run throughout the ship. These, along with cables for power, lighting and other basic services, create a severe space problem within ducts and hangers.

For the vessel to achieve maximum speed, maneuverability and range, it is vital to keep the "top weight" to a minimum and since most of the equipment is located on the upper decks, system weight must be kept as low as possible.

The diagram shows a lightweight cable compared with a traditional Navy cable having the same cross-sectional area of copper. Both cables have the same number of conductors. A saving in size has been made on the insulation material, but without sacrificing the mechanical or electrical characteristics of the cable. A typical saving in cable tray volume could be as high as 40%. Lightweight cables can also save in excess of twenty tons on a typical frigate and three to five tons on a fast patrol boat.

Raychem lightweight, small size cables are giving reliable service in frigates, corvettes, fast patrol boats, hydrofoils and submarines in many major Navies.

Due to recent improvements in manufacturing, Raychem can now offer an even tighter tolerance of $\pm 2.5\%$ on cable diameter. This is well within the limits imposed by specifications such as Def Stan 6 1-12 part 25, and offers significant benefits to system designers, particularly where cable glanding is involved.

Weight savings within "maxima allowed" by existing specifications are also achievable.

Other applications

The increasing awareness of many areas of industry of the need to minimize fire hazard risk is leading to a rapid growth in the use of Zerohal jacketed cables. Applications include rail and mass transit, offshore platforms and other enclosed areas where a fire would present a significant threat to people or equipment.



Thermorad HTF/ Fluoroelastomer

*High temperature performance
wire and cable jacket material*



Applications

Thermorad HTF/Fluoroelastomer is a material specially formulated for use in applications where exceptional performance is required.

It displays excellent stability during continuous high temperature exposure to adverse chemical environments.

Thermorad HTF/Fluoroelastomer has a continuous operating temperature of up to 200°C, and finds applications in aircraft fuel tanks and on high performance engine cables. Thermorad HTF/ Fluoroelastomer cable jackets are compatible with the Raychem high temperature harnessing systems - System 200.

Features and benefits

- High temperature capability -20°C to +200°C.
- Excellent chemical resistance.
- Flame retardant.
- Continuous aircraft fuel immersion.

System

- System 200

Available in:

Americas

Europe

Asia Pacific

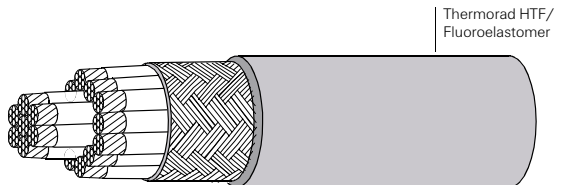

Fax-on-demand

US only (800) 260-9099

Outside US (650) 257-2301

Visit our website at www.tycoelectronics.com**Typical characteristics when tested in accordance with Raychem specification WCD 51/1632**

Mechanical	Tensile strength	12 MPa	
	Elongation	400%	
	Abrasion resistance (1.6 kg load)	40 scrapes min.	
	Cold bend -0°C ± 3°C	No cracking	
Thermal ageing	Heat age	168 h 250°C	
	Heat shock 4 h at 300°C ± 3°C	No cracks, drips or flowing, 6 mm total shrinkage in 300 mm	
Fluid resistance	72 h immersion	% Retention	
		Tensile strength	Elongation
	Diesel oil 100°C	60	60
	ASTM No 2 oil 100°C	60	60
Electrical	Insulation resistance 20°C M ohms. km (min)	10	
Other	45° flammability	30 s (max) afterburn 100 mm (max) burn length	
	Vertical flammability	Self extinguishing	



Thermorad/Thermorad F

General purpose wire and cable jacket material



Applications

Thermorad is a general purpose jacket material which is unaffected by most common chemicals and solvents and is suitable for use during N.B.C. decontamination. Thermorad is highly flame retardant and has an overall balance of physical and chemical properties.

Thermorad cables find widespread use in industrial, commercial and military applications. This includes railways, commercial vehicles, medical equipment, communication equipment and commercial electronics. Thermorad cable jackets are compatible with Raychem polyolefin tubings, molded parts and adhesives.

Features and benefits

- Temperature rating -55°C to $+125^{\circ}\text{C}$.
- Highly flame retardant.
- Resistant to fuels, oils and greases.
- Resistant to NBC decontaminant.
- UL approved.

Available in:

Americas

Europe

Asia Pacific

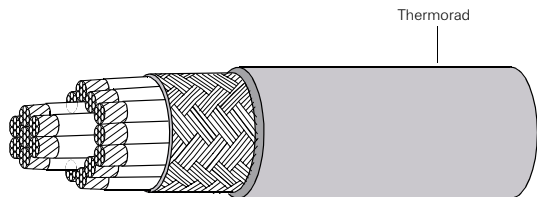

Fax-on-demand

US only (800) 260-9099

Outside US (650) 257-2301

Fax ID

6160

Description

Data sheet

Visit our website at www.tycoelectronics.com**Typical characteristics when tested in accordance with Raychem specification WCD 51/1602 (UK) and WCD 3310 (US)**

Mechanical	Tensile strength	22 MPa	
	Elongation	550%	
	Abrasion resistance (1.6 kg load)	300 scrapes min.	
	Cold bend	-55°C	
Thermal ageing	Heat ageing 120 h, 170°C	60% min. retention of TS and Eb	
	Heat shock 4 hours at 225°C	No cracks, drips or flowing, 6 mm total shrinkage in 300 mm	
Fluid resistance	72 hour immersion, 50°C	% Retention of properties	
		Tensile strength	Elongation
	IRM 902	60	60
	Skydrol	60	60
Electrical	Insulation resistance 20°C	100	
	M ohms km (min)		
Other	45° flammability	30 s (max.) afterburn 75 mm (max.) burn length	
	Acid gas	4% HCl equivalent (max.)	



Raythane, Neoprene, Rayolin, AFR

Specialized wire and cable jacket material



Applications

In addition to the preferred cable jacket materials, Tyco Electronics offers a variety of Raychem cable jackets for specialized applications. For example, specialized materials are available for extreme low temperature flexibility or for enhanced abrasion resistance, or non-cross-linked materials for cable splicing or overmolding.

Features and benefits

Raythane C and Raythane FR

- -25 °C to +80 °C.
- Mechanically tough.
- Can be overmolded.

Rayolin

- -55 °C to +95 °C.
- Excellent long term water immersion.
- Can be overmolded.
- Compatible with Raychem's underwater cable splices.

Neoprene (US designation Thermorad NTFR)

- -55 °C to +90 °C.
- Extreme flexibility.
- Highly flexible at low temperatures.

AFR

- -40 °C to +105 °C.
- Abrasion resistant.
- Fuel resistant.
- Flame retardant.

Available in:

Americas

Europe

Asia Pacific

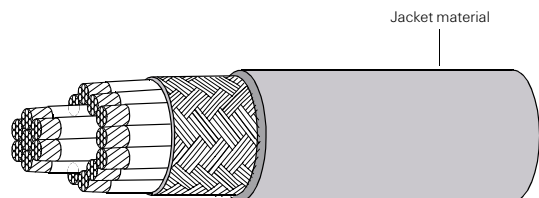

Fax-on-demand

US only (800) 260-9099

Outside US (650) 257-2301

Fax ID

6130

Description

Data sheet

Visit our website at www.tycoelectronics.com**Typical Characteristics when Tested in Accordance with Raychem Specification WCD**

		WCD51/1625	WCD3310	WCD51/147	WCD51/1601	WCD51/1619
		Raythane C	Raythane FR	Neoprene*	Rayolin	AFR
Mechanical	Tensile strength (MPa)	45	45	12	14 12	
	Elongation (%)	400	400	400	250	150
	Abrasion resistance (1.6 kg load)	500 scrapes	500 scrapes	30 scrapes	300 scrapes	200 scrapes
	Cold bend	-25°C	-15°C	-55°C	-55°C	-40°C
Thermal ageing	Endurance (10000 h)	80°C	90°C	90°C	95°C	105°C
Fluid resistance	24 h immersion					
	Diesel fuels 50°C	Excellent	Excellent	Good	-	Good
	Skydrol 50°C	-	-	Excellent	Excellent	Excellent
	IRM 902 100°C	Excellent	Excellent	Good	Good	Good
Electrical	Insulation resistance 20°C	1	1	5	100	100
	M ohms.km (min)					
Other	45° flammability	Pass	Pass	Pass	-	Pass

* In the US use Thermorad NFR to WCD 3314.



Electrical Screening (shielding)

Interference - designing for the threat



Applications

In many applications, screening of cables is important, whether it be to minimize cross-talk within the cable, to prevent interference from external sources, or to eliminate radiation from the cable itself.

The design of cables to provide effective shielding over a broad frequency spectrum is complex, and cables must be tailored to specific electromagnetic environments. From simple aluminized Mylar that provides electrostatic screening, progressively more complex shielding can be designed incorporating plated copper braids and Mu metal wraps.

Optimization

Performance of conventional braiding can be significantly improved by computer optimization. This tightly controlled process can give many times the screening performance of a basic braided screen without weight penalty or increase in optical coverage. Superscreened cables combine Mu metal wraps with optimized braids to provide even further enhanced performance, especially at low frequencies.

Available in:	Americas	Europe	Asia Pacific
	■	■	■

Available screens		
Screen type	Construction	Typical application
Aluminized Mylar		Electrostatic screening
Single Braid		Low level EMI Low sensitivity
Single Optimized Braid		Sensitive lines High EMI
Double Optimized Braid		Highly sensitive lines Severe EMI
Superscreened		EMP/Tempest
Double Superscreened		Severest of applications

Fax-on-demand

US only (800) 260-9099

Outside US (650) 257-2301

Visit our website at www.tycoelectronics.com

Measuring screening efficiency

Surface transfer impedance (Z_t)

To assess the effectiveness of a shield, Tyco Electronics has adopted the line injection method as described in IEC 1196-1 to measure the surface transfer impedance (Z_t) of a cable shield. This relates the open circuit voltage generated on a component wire inside the cable to the current injected on the overall shield. The unit of Z_t is Ohms per meter, thus the voltage coupling is length dependent and long cables exhibit more leakage than similar but shorter length ones. To determine the surface transfer impedance across a range of frequencies, a drive signal is generated by the internal tracking generator of a spectrum analyzer, and amplified. The voltage is induced on the center conductor of the sample which is amplified and returned to the signal generator for measurement. The understanding of leakage mechanisms has enabled Tyco Electronics to design Raychem cables with guaranteed minimum Z_t values for the desired operating environment.

Superscreening

EMP hardened cables

The requirements for nuclear hardened cables present the engineer with a range of problems. The waveform of the EMP is such that the majority of power is dissipated in a frequency band between 1 KHz and 5 MHz, where little protection is given by conventionally screened cables. Tyco Electronics has solved this problem with a range of superscreened cables which give screening performance at these frequencies by incorporating materials which change the inductance of the shield and lower the transfer impedance. Raychem superscreened cables have a sandwich construction of Mu metal tapes between optimized braids. Mu metal is a ferro-magnetic material which has a high permeability over a wide range of field strengths. It is applied to the cable in a way which maintains cable flexibility and minimizes work hardening and any consequent reduction in permeability. Superscreened cables not only give protection against EMP but also other major interference modes. Surface transfer impedance (m. ohms/meter)

Screened cables

Controlling the threat

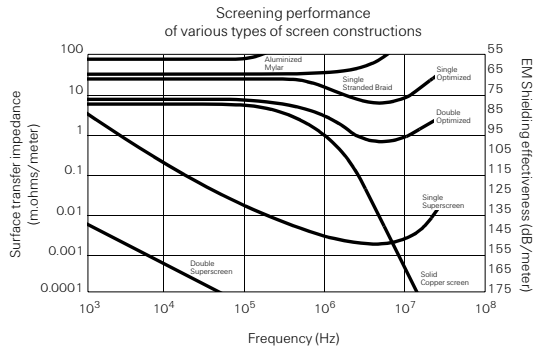

Testing

Tyco Electronics EMC test facilities have the capability for bulk current injection and radiation field testing in addition to surface transfer impedance measurements. The installation is a proven facility in characterising new design parameters.

Design and manufacturing expertise

The problems of shielding cables are complex. However, with the introduction of optimized braids and superscreened cables, Tyco Electronics has the capability to solve the most difficult shielding problems. Shielding of cables without degrading cable flexibility can be provided for coaxial and multiconductor cables for all EMC and EMP conditions. To complement this range of cables, Tyco Electronics manufactures Raychem cable terminations and connector back fittings to give total interconnection system screening performance.



Computer-Aided Design

Custom design capability



Applications

Every year, Tyco Electronics designs and builds several thousand custom, high-performance, multiconductor cables that meet unique product needs.

Design staff can draw on an extensive range of high-performance cable components and jacket materials, while incorporating both color-coding and alphanumeric marking techniques for component identification. These options, combined with a full range of EMI shields (screens), lead to a huge variety of construction possibilities.

Tyco Electronics developed computer-aided design tools to provide a fast response to design requests. The software, used by factory engineers or product specialists in the field, can generate cable design proposals with drawings and quotations in minutes. A design drawing details all the cable data and can be used as the input to harness or cable splice (joint) design. The resulting cable is tailored to customers' exact needs in an efficient design that is superior to the compromise cable selected from a product catalog.

Quality Assurance

Raychem WCD and WSD cable specifications ensure that performance and quality standards are maintained to the highest level. Tyco Electronics manufacturing sites have obtained the highest available quality system approvals, including ISO 9000 and QS9000. Raychem cables are manufactured to meet the requirements of several major specifications.

Available in:

Americas

Europe

Asia Pacific



Fax-on-demand

US only (800) 260-9099

Outside US (650) 257-2301

Visit our website at www.tycoelectronics.com



Power Cables



Applications

Tyco Electronics offers a range of flexible Raychem power cables that are insulated and jacketed using materials that provide improved performance over other materials, such as CSP/EPR, silicone, or PCP/Butyl. Four different types of cable are available:

Type TR is a general purpose, single-wall, 125°C construction normally specified for use inside cabinets in protected areas.

Type ZHI is a halogen-free 105°C cable with good oil resistance. It is particularly suitable for use in offshore, ship, and mass transit applications where low-fire-hazard performance is required. Refer to Raychem specification WCD 2015.

Type FTR is a dual-wall, 125°C, diesel-oil-resistant cable originally developed for tank engine compartment applications. It meets the German BWB VG 952 18 specification. Refer to Raychem specification WCD 2002.

Type AFR is a 105°C, single-extrusion, abrasion-resistant, flame- and fuel-resistant, radiation-crosslinked polyolefin.

Each offers particular advantages for specific applications and each is also available in multiconductor constructions and screened and jacketed versions. Cables offer size and weight savings, good resistance to abrasion and cut-through, and the ability to operate in difficult environments.

Features and benefits

- Choice of jacket materials.
- -55°C to 125°C.
- Size and weight savings.
- Excellent flexibility.
- Resistance to solvents and chemicals.

Available in:

Americas



Europe



Asia Pacific



Fax-on-demand

US only (800) 260-9099

Outside US (650) 257-2301

Visit our website at www.tycoelectronics.com**Specifications/approvals***

Series	Agency	Military	Raychem
TR		Def. Stan. 61-12 Part 31 (jacket material)	WCD 2003, WCD 51/160
ZHI			WCD 2015
FTR		BWB VG 952 18 Types G, H, and K	WCD 2002
AFR	UL style 3496		WCD 2011, WCD 51/160

*See specifications listed for details of performance.

Conductors (tinned soft copper)

Conductor size mm ²	Stranding IEC Class 5		IEC Class 6		Max. resistance at 20°C in Ω/km (Ω/1000 ft) Class 5/6
	no. x mm	Nom. dia. (mm/in)	no. x mm	Nom. dia. (mm/in)	
1.5	30 x 0.25	1.49 (.05)	85 x 0.15	1.53 (.06)	13.20 (4.02)
2.5	50 x 0.25	1.90 (.07)	140 x 0.15	2.40 (.09)	7.82 (2.38)
4.0	56 x 0.30	2.49 (.10)	228 x 0.15	2.90 (.11)	4.85 (1.48)
6.0	84 x 0.30	3.00 (.12)	189 x 0.20	3.60 (.14)	3.23 (0.98)
10.0	80 x 0.40	4.60 (.18)	324 x 0.20	4.55 (.18)	1.88 (0.57)
16.0	126 x 0.40	5.70 (.22)	513 x 0.20	5.50 (.22)	1.19 (0.36)
25.0	196 x 0.40	7.10 (.28)	783 x 0.20	7.30 (.29)	0.78 (0.24)
35.0	276 x 0.40	8.50 (.33)	1107 x 0.20	8.55 (.34)	0.55 (0.17)
50.0	396 x 0.40	10.30 (.41)	702 x 0.30	10.15 (.40)	0.39 (0.12)
70.0	360 x 0.50	12.40 (.49)	999 x 0.30	12.00 (.47)	0.27 (0.08)
95.0	475 x 0.50	14.50 (.57)	1332 x 0.30	14.05 (.55)	0.20 (0.06)
120.0	608 x 0.50	16.00 (.63)	1702 x 0.30	16.30 (.64)	0.15 (0.05)
150.0	777 x 0.50	18.00 (.71)	2109 x 0.30	17.40 (.68)	0.13 (0.04)
185.0	925 x 0.50	20.00 (.79)	2590 x 0.30	20.00 (.79)	0.10 (0.030)
240.0	1221 x 0.50	23.00 (.91)			0.08 (0.024)
300.0	1554 x 0.50	26.00 (1.0)			0.06 (0.018)
400.0	2035 x 0.50	30.00 (1.2)			0.05 (0.015)

Note:

Types TR and FTR use IEC Class 6 conductors.

Types ZHI and AFR use IEC Class 5 conductors.

Users should independently evaluate the suitability of the product for their application.
Before ordering check with factory for most current data.

Power Cables (cont'd.)

Materials performance summary

Material	Tensile strength N/mm ² typical	Abrasion resistance	Cut through	Temperature rating °C 10000 h	Preferred color
TR	20	Excellent	Good	125	Black
ZHI	9	Good	Very Good	105	Black
FTR	18	Good	Good	125	Black
AFR	18	Excellent	Very Good	105	Grey

Note: Where a higher operating temperature is required, Raychem SPEC 55 provides outstanding performance up to 200°C continuous operating temperature. For these or other special applications, please contact Tyco Electronics.

Table 1. Nominal diameters and maximum weights

Cable type						
TR 16				FTR 16		
Conductor size (mm ²)	Part no.	Nom. OD in mm (in)	Max. weight in kg/km (lb/1000 ft)	Part no.	Nom. OD in mm (in)	Max. weight in kg/km (lb/1000 ft)
1.5						
2.5	TR 16 -2.5	3.9 (.15)	34.0 (22.8)			
4.0	-4	4.5 (.17)	51.0 (34.2)	FTR 16 -4	5.6 (.22)	69.0 (46.2)
6.0	-6	5.2 (.20)	73.0 (48.9)	-6	6.3 (.25)	94.0 (63.0)
10.0	-10	6.2 (.24)	117.0 (78.4)	-10	7.5 (.29)	147.0 (98.5)
16.0	-16	7.4 (.29)	182.0 (121.9)	-16	8.8 (.35)	220.0 (147.4)
25.0	-25	9.3 (.37)	274.0 (183.6)	-25	10.7 (.42)	323.0 (216.4)
35.0	-35	10.6 (.42)	383.0 (256.6)	-35	12.1 (.48)	444.0 (297.5)
50.0	-50	12.5 (.49)	542.0 (363.1)	-50	14.0 (.55)	619.0 (414.7)
70.0	-70	14.6 (.57)	765.0 (512.6)	-70	16.2 (.64)	861.0 (576.9)
95.0	-95	17.0 (.67)	1020.0 (683.4)	-95	18.8 (.74)	1148.0 (769.2)
120.0				-120	21.3 (.84)	1484.0 (994.3)
150.0						
185.0						
240.0						
300.0						
400.0						

Fax-on-demand

US only (800) 260-9099

Outside US (650) 257-2301

Visit our website at www.tycoelectronics.com**Table 2. Nominal diameters and maximum weights**

Cable type							
ZHI 15		AFR 35					
Conductor size (mm ²)	Part no. in	Nom. OD mm (in)	Max. weight in kg/km (lb/1000 ft)	Part no.	Nom. OD in mm (in)	Max. weight in kg/km (lb/1000 ft)	
1.5	ZHI 15 -1.5	4.09 (.16)	33.5 (22.4)	AFR 35 -1.5	2.8 (.11)	31.0 (20.8)	
2.5	-2.5	4.69 (.18)	48.8 (32.7)	-2.5	3.9 (.15)	42.0 (28.1)	
4.0	-4	5.49 (.22)	72.1 (48.3)	-4	4.8 (.19)	61.0 (40.9)	
6.0	-6	6.16 (.24)	99.8 (66.9)	-6	6.2 (.24)	92.0 (61.6)	
10.0	-10	8.20 (.32)	159.0 (106.5)	-10	7.0 (.28)	143.0 (95.8)	
16.0	-16	9.30 (.37)	223.0 (149.4)	-16	8.1 (.32)	211.0 (141.1)	
25.0	-25	10.90 (.43)	331.0 (221.8)	-25	10.3 (.41)	333.0 (223.1)	
35.0	-35	12.30 (.48)	448.0 (300.2)	-35	11.7 (.46)	452.0 (302.8)	
50.0	-50	14.70 (.58)	631.0 (422.8)	-50	13.7 (.54)	634.0 (424.8)	
70.0	-70	16.80 (.66)	852.0 (570.8)	-70	16.0 (.63)	885.0 (593.0)	
95.0	-95	19.10 (.75)	1108.0 (742.4)	-95	18.5 (.73)	1165.0 (780.6)	
120.0	-120	21.00 (.83)	1438.0 (963.5)	-120	20.4 (.80)	1480.0 (991.6)	
150.0	-150	23.00 (.91)	1748.0 (1171.2)	-150	22.6 (.89)	1825.0 (1222.8)	
185.0	-185	25.60 (1.01)	2088.0 (1399.0)	-185	24.8 (.98)	2215.0 (1484.1)	
240.0	-240	28.60 (1.13)	2705.0 (1812.4)	-240	27.8 (1.1)	2875.0 (1926.3)	
300.0	-300	32.00 (1.26)	3363.0 (2253.2)	-300	32.0 (1.2)	3645.0 (2442.2)	
400.0	-400	36.40 (1.43)	4396.0 (2945.3)	-400	36.0 (1.4)	4730.0 (3169.1)	

Part numbering system

XXX XX - XX - X

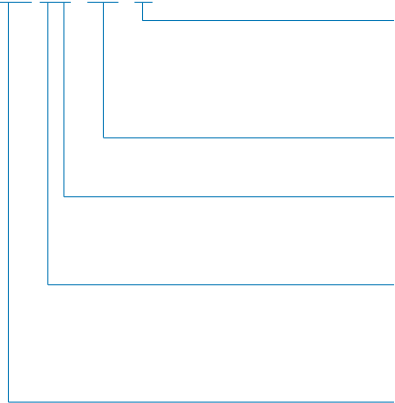
**Standard colors**

0 = Black 8 = Gray

Conductor cross section(1.5 to 400 mm²)**Conductor type**

5 = IEC Class 5 - Flexible 6 = IEC Class 6 - Very flexible

Voltage rating

1 = 600/1000 V

3 = 1900/3300 V

Insulating type

TR

FTR

ZHI

AF



Conductor sizes, strandings, and resistance values



Applications

The conductors used with Raychem wires are concentric in construction and are specifically designed for use with thin-wall insulations. The table on the next page gives nominal values for tin-plated copper, silver-plated copper, and silver-plated high-strength copper alloy (SPHSCA) constructions. Typically, tin-plated copper is suitable for use in applications up to 150°C and silver-plated copper in applications up to 200°C (SPEC 55 wire only).

The current-carrying capacities assume a maximum 60°C increase in temperature of a single wire in free air at 40°C. For details of performance in conditions other than 40°C, call Tyco Electronics Technical Services.

Available in:

Americas

Europe

Asia Pacific



Fax-on-demand

US only (800) 260-9099

Outside US (650) 257-2301

Visit our website at www.tycoelectronics.com**Nominal values of American wire gauge (AWG) and metric conductors**

Size AWG	mm ²	Stranding		Outside diameter (min.-max.)		Max Resistance in Ω/km (Ω/1000 ft)			Current-carrying capacity (amps)
		No./mm	No./AWG	Metric mm	Inches	Tin-copper	Silver-copper	SPHSCA	
30	0.06	7/0.10	7/38	0.28-0.31	0.011-0.012	347 (106)	324 (99)	377 (115)	3.0
28	0.09	7/0.13	7/36	0.36-0.39	0.014-0.015	220 (67)	205 (62)	239 (73)	4.0
26	0.15	19/0.10	19/38	0.46-0.49	0.018-0.019	133 (40)	123 (37)	144 (44)	5.5
24	0.25	19/0.13	19/36	0.55-0.62	0.022-0.024	84 (26)	78 (24)	91 (28)	7.5
22	0.40	19/0.15	19/34	0.70-0.76	0.028-0.030	51 (16)	49 (15)	56 (17)	10.0
20	0.60	19/0.20	19/32	0.92-0.97	0.036-0.038	31 (9)	30 (9)	34 (10)	13.0
18	1.00	19/0.25	19/30	1.18-1.26	0.046-0.050	20 (6)	20 (6)	- -	17.5
16	1.20	19/0.30	19/29	1.34-1.48	0.053-0.058	15 (4)	15 (4)	- -	20.0
14	2.00	37/0.25	37/30	1.65-1.72	0.065-0.068	10 (3)	10 (3)	- -	28.0
12	3.00	37/0.32	37/28	2.12-2.18	0.083-0.086	7 (2)	7 (2)	- -	37.05
10	4.50	37/0.40	37/26	2.69-2.74	0.106-0.108	4 (1)	4 (1)	- -	53.0
8	9.00	133/0.29	133/29	4.01-4.20	0.158-0.165	2 (0.6)	2 (0.6)	- -	78.0
6	13.5	133/0.36	133/27	5.03-5.48 (5.30)	0.198-0.216	1.4 (0.4)	1.4 (0.4)	- -	105.0
4	21.0	133/0.45	133/25	6.35-6.96 (6.62)	0.250-0.274	0.9 (0.3)	0.9 (0.3)	- -	142.0
2	33.0	665/0.25	665/30	8.13-8.64 (8.54)	0.320-0.340	0.6 (0.2)	0.6 (0.2)	- -	196.0
0	51.0	1045/0.25	1045/30	10.00-10.80 (10.87)	0.394-0.425	0.4 (0.1)	0.4 (0.1)	- -	266.0

Note:

Abbreviations:

Cond.	=	Conductor
SPHSCA	=	Silver-plated high-strength copper
Tin-copper	=	Tin-plated copper
Silver-copper	=	Silver-plated copper
N/A	=	Not available

For product details, please refer to relevant specification control drawing.

Current derating factors for wire bundles in free air

No. of wires	2	3	4	7	9	12	15	18	21	24	27	30	37
Derating factor	.825	.73	.66	.54	.49	.43	.39	.36	.33	.31	.29	.28	.26

Users should independently evaluate the suitability of the product for their application.
Before ordering check with factory for most current data.



Fiber Optic Cables

*High performance interconnection
fiber optic link*



Typical applications

- Military communications.
- Military control systems.
- Naval applications.
- Underwater and ROV's.
- Hazardous Environments.

Features and benefits

- Low smoke.
- Low corrosive gas emission.
- Limited fire hazard.
- Halogen free.
- Small size and lightweight.
- Custom design.
- Range of jacket materials.
- Inherent security of transmitted signals.
- Low loss, high performance cables.
- Water-blocking options.
- Meets the requirements of Def Stan 60-1 part 2.

Standard fiber optic cable constructions

The use of increasingly sensitive and more sophisticated equipment in marine and military applications means a corresponding requirement for high performance interconnection links.

Fiber optic links offer high performance and have many advantages over copper systems such as:

- Interference immunity (EMI & RFI).
- High bandwidth (for improved message capacity).
- Small size, lightweight.
- Low loss, durability.
- Security and safety.

However, to ensure the reliability of a fiber system the cable design, materials and interconnection accessories employed are all extremely important.

Tyco Electronics provides a range of single and multi-core Fiber Optic Cables offering innovative solutions to interconnect problems. Tyco Electronics leadership in the field of advanced material technology, coupled with more than 15 years experience of supplying ruggedized cables for marine and military applications, ensures superior performance levels in the harshest of environments.

Available in:

Americas

Europe

Asia Pacific



Fax-on-demand

US only (800) 260-9099

Outside US (650) 257-2301

Visit our website at www.tycoelectronics.com

Simplex fiber optic cable

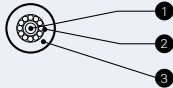

Component	Fiber size	Qty/Diameter
1. Secondary Buffered Fiber	(62.5/125)	1
2. Strength Member		1.5 mm
3. Zerohal Sheath		2.7 ± 0.2 mm

Ruggedized Simplex fiber optic cable

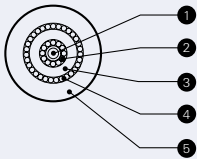

Component	Fiber size	Qty/Diameter
1. Secondary Buffered Fiber	(62.5/125)	1
2. Strength Member		1.5 mm
3. Zerohal Sheath		2.7 mm
4. Strength Member		3.3 mm
5. Zerohal Sheath		5.3 ± 0.2 mm

2 Channel Ruggedized fiber optic cable

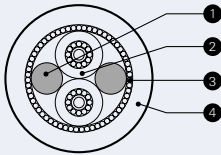

Component	Fiber size	Qty/Diameter
1. Strength Member		2
2. Simplex Cable	(62.5/125)	2
3. Strength Member		6.0 mm
4. Zerohal Sheath		8.2 ± 0.3 mm

4 Channel Ruggedized fiber optic cable

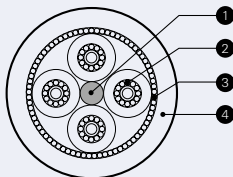

Component	Fiber size	Qty/Diameter
1. Strength Member		1
2. Simplex Cable	(62.5/125)	4 / 6.7 mm
3. Strength Member		7.3 mm
4. Zerohal Sheath		9.5 ± 0.5 mm

8 Channel Ruggedized fiber optic cable

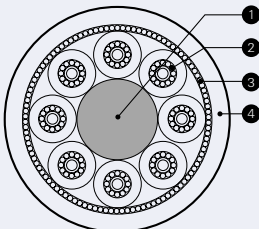

Component	Fiber size	Qty/Diameter
1. Strength Member		1
2. Simplex Cable	(62.5/125)	8 / 9.8 mm
3. Strength Member		10.4 mm
4. Zerohal Sheath		12.5 ± 0.5 mm

Fiber Optic Cables (cont'd.)

High performance interconnection
fiber optic link

Fiber optic equipment cable

The diagram on the right shows a typical equipment cable, which can also be used as a sub-unit or simplex component for the larger multi-core cables, as shown in the diagrams on the previous page.

The fiber used is a high performance tight buffer type comprising an all silica fiber, with multiple coatings designed to provide mechanical and environmental protection, micro-bend resistance, and ease of handling in the field. Most common fiber types are readily available (see table below) and more specialized fibers are available on request.

The equipment cable has a layer of served aramid yarn providing high flexibility and tensile strength, while the outer sheath provides environmental and mechanical protection, along with low smoke emission and chemical resistance.

The materials and types of designs employed have been thoroughly tested to Def Stan 60-1 (see test data on the next page) and Def Stan 6 1-12 Part 31 which demonstrate the suitability of the cables and fibers for use in high performance and critical marine applications.

While offering a standard range of tight buffered multi and single mode fiber optic cables, Tyco Electronics also offers the option of custom design for specific applications. These cables capitalize on the small size of the fiber thereby enabling efficient, ergonomic and reliable interconnection.

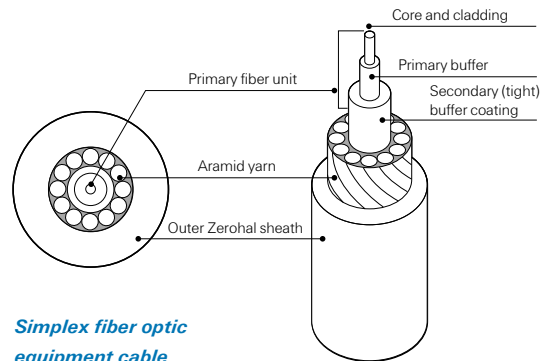

Simplex fiber optic
equipment cable



Typical 2-channel cable

Fiber types and common features

Type	Attenuation	Bandwidth	Dispersion Slope	Numerical Aperture
	dB/km@850/1300/1550nm	MHz-km@850/1300nm	ps/(nm ² -km)	
8/125	-0.4/0.25	n/a	0.093	0.1
50/125	3.5/1.2/-	400/600	n/a	0.20
62.5/125	3.5/1.2/-	160/500	n/a	0.275
100/140	4.5/2.0/-	200/200	n/a	0.29

All fibers supplied with a high performance three layer tight buffer. Cables can be supplied with water-blocking and marking to suit customer requirement, and any combination of the fiber types listed above.

Fax-on-demand

US only (800) 260-9099

Outside US (650) 257-2301

Visit our website at www.tycoelectronics.com

Table of requirements and results from Def Stan 60 – 1 Part 2

Definition	Requirements		Part 2			
Cable tensile strength	<0.5% cable elongation no increase in attenuation at full load and after test compared to pre-test value.	1000N applied at 100N/minute	Pass			
Cable bend	No cracking or deformation of cable sheath. <0.5dB change after test.	20N load, 10 cycles of wind and unwind. 6 wraps.	Pass			
Cold bend	No cracking or deformation of cable sheath. <0.5dB change after test.	20N load, 10 cycles of wind and unwind. 6 wraps. -30°C.	Pass			
Cyclic bend	No cracking or deformation of cable sheath. <0.5dB change after test.	40N, 1000 cycles.	Pass			
Cable impact	No cracking or deformation of cable sheath. <0.5dB change after test.	12.5 mm radius, 1kg hammer, 100 mm height 100 impacts.	Pass			
Cable crush	No cracking or deformation of cable sheath. <0.5dB change after test <20% reduction from original diameter.	2000N/5 min	Pass			
Cable snatch	No cracking or deformation of cable sheath. <0.5dB change after test <20% reduction from original diameter.	1kg, 10 cycles	Pass			
Dynamic cut through	≥ 25N	85°C, 60N/minute, 0.45mm diameter needle blade	Pass			
Tear resistance	5 N/mm		Pass			
Shrinkage	<3mm total	16 hrs at -30°C and 16 hrs at 85°C	Pass			
Scrape abrasion	500 cycles minimum	5N, 85°C, 0.45 mm diameter needle blade	Pass			
Fluids	Volume 25	TS ret 60	Eb ret 60	Diesel F76	28 days @ 20°C	Pass
	swell 15	min % 60	min % 60	OX-30	28 days @ 50°C	Pass
	max % 15	60	60	OX-40 HS200X	28 days @ 50°C	Pass
	10	60	60	OMD-113	28 days @ 50°C	Pass
	50	50	50	OX-28	28 days @ 50°C	Pass
	10	80	80	Deionized water	28 days @ 50°C	Pass
Accelerated ageing	10	80	80	Deionized water + 3.5% NaCl	28 days @ 50°C	Pass
	<20% change in TS/Eb/tear between 14 and 28 days. Eb ≥ 150%	110°C for 14 and 28 days.				Pass
Arrhenius plot	40,000 hours at 85°C	End point measurement: 50% absolute elongation				Pass
Stability	175% max. elongation, 25% max. permanent elongation.	105°C, 0.2N/mm ² stress.				Pass
Pressure	Indentation not to exceed 50%.	85°C for 4 hrs.				Pass
Ozone	No cracks with normal vision.	80 – 100ppm for 120 hrs				Pass
UV light resistance	≤ 80% Eb change, ≤ 20% TS change.	8 hrs UV 55°C, 4 hrs humidity 40°C, (UV-B) 1000 hrs.				Pass
Smoke Index	20 maximum	NES 711				Pass
Toxicity index	5 maximum	NES 713				Pass
Halogen index	No detectable halogens.	Sodium fusion test (Lassaigne)				Pass
Oxygen index	29 minimum	BS 2782 Part 1 Method 14 1D				Pass
Temperature index	250°C minimum	Nes 715				Pass
Flammability	Not to reach within 50 mm of the lower clamp.	BS 4066 Part 1				Pass

Users should independently evaluate the suitability of the product for their application.
Before ordering check with factory for most current data.

Application Equipment

Overview

Raychem application equipment is designed and engineered specifically for installation of Raychem heat-shrinkable products. These tools provide the optimal heating temperatures, performance, and control features for maximum production efficiency.

Application Equipment

Table of Contents

Products

AA-400 Super Heater	Compressed-air heating tool	10-0
AD-1319-9	Holding fixture tool	10-2
AD-1377, AD-1522	Hand-operated crimp tools	10-4
AD-3050-SEAL-TEST-EQUIP	Seal test equipment Splice sealing and connector sealing evaluation - various products	10-6
AD-5000 and RH-396X	Tinel-Lock installation tool Tinel-Lock screened termination products	10-8
AD-5010-Tinel-Bench-230V	Tinel-Lock installation tool Tinel-Lock screened termination products	10-10
CV-1981, CV-1983	Heavy-duty hot-air heating tools	10-12
HL1802E/HL2005E	Steinel general purpose hot-air heating tool	10-14
IR-1891	Shuttle machine - twin workstation heater for multiple installation of short length tubing products	10-16
IR-550 Mark II	Infrared heating tool	10-18
IR-1759 MiniRay	Infrared heating tool	10-20
Model 16B	Belt heater	10-22
Model 19	Conveyor heater for processing Raychem heat-shrinkable tubing and terminating devices	10-24
Model 81CE	Discrete heater	10-26
Model 105	Tunnel oven	10-28
RBK-ILS-Processor MkII	Installation of splice sealing products adjacent to ultrasonic welder	10-30
ThermoGun HG	Hot-air heating tool	10-32



AA-400 Super Heater

Compressed-air heating tool

Applications

Used for installing heat-shrinkable tubing in multiple applications. Excellent for installing SolderSleeve devices (wire-to-pin applications) and SolderTacts contacts.

Features and benefits

- Automatic power cut-off switch to protect heating element if air flow is interrupted.
- Pressure regulator and gauge for adjusting air flow and temperature.
- Indicator light that goes on when power is applied to heating element.
- Very focused heat.
- Wide variety of reflectors available.
- Excellent tool for small items and confined areas.

Available in:

Americas

Europe

Asia Pacific

Specifications

Utility requirements

Electrical	120-V model: 120 Vac, 4 A, 50–60 Hz 240-V model: 240 Vac, 2 A, 50–60 Hz
Air (oil free)	60 psig minimum, 5 cfm

Fax-on-demand

US only (800) 260-9099

Outside US (650) 257-2301

Fax ID

8050

Description

Data sheet

Visit our website at www.tycoelectronics.com**Ordering information**

Model	Voltage	Description	Part number
AA-400 Super Heater with stand, needlepoint tip,	120 Vac	AA-400-32	582602-000
Mini SolderSleeve reflector, and input air filter	240 Vac (CE version)	AA-400-200	281917-000
Accessories and replacement parts	Part number		NSN stock number
SolderSleeve reflector	979646-000	AA-400-94	4940-00-609-4993
Needlepoint tip	979647-000	AA-400-96	4940-00-148-9847
Boot and tubing tip	979691-000	AA-400-101	4940-00-148-9848
Mini SolderSleeve reflector	979663-000	AA-400-102	4940-01-043-7634
Low-flow tip	979672-000	AA-400-103	3439-01-173-8810
Element replacement kit, 120 V	013750-000	AA-400-128	
Element replacement kit, 240 V (CE)	444179-000	AA-400-228	
Stand	979649-000	AA-400-09	
Input air filter	979673-000	AA-400-P-Y-92	



AD-1319-9

Holding fixture tool

Applications

Simplifies and speeds installation of Raychem SolderSleeve terminators or splices and SolderTacts shielded contacts.

Features and benefits

- AD-1319-9 comes with two lateral wire clamps as standard.
- Secures wire or cable, enabling easy installation of products.

Available in:

Americas

Europe

Asia Pacific



Specifications and dimensions

Dimensions	18 cm (7.07 in) W x 15 cm (5.91 in) L
Weight	300 g (.67 lb)

Product range covered

SolderSleeve splices	MiniSeal, CWT-9XXX, D-1744, D-110
Shield terminators	D-100-XX
SolderTacts contacts	D-602-XX

Fax-on-demand

US only (800) 260-9099

Outside US (650) 257-2301

Visit our website at www.tycoelectronics.com

Ordering information

Model	Description	Part number
Holding fixture	AD-1319-9	993850-000
38999 size 8 SolderTacts adapter	AT-1319-22	395241-000
38999 size 16 SolderTacts adapter	AT-1319-78	413186-000
Submin SolderTacts adapter	AT-1319-12	993872-000
748 SolderTacts adapter	AT-1319-14	993877-000
723 SolderTacts adapter	AT-1319-19	993938-000
482 size 16 SolderTacts adapter	AT-1319-17	993917-000

Note: Additional tooling for SolderTacts can be found under SolderTacts contacts.

AD-1377, AD-1522

Hand-operated crimp tools



AD-1377 Crimp Tool

The Raychem AD-1377 crimp tool fits all MiniSeal crimp barrels. It also meets Mil specification M22520/37-01. A calibration verification gauge, AD-1386, is also available for the AD-1377. The gauge meets Mil specification M22520/39-01



AD-1522 Crimp Tool

The Raychem AD-1522 crimp tool crimps all DuraSeal crimp products. It has a preset crimp depth that provides the optimum combination of tensile strength and insulation integrity in the finished splice.

Available in:

Americas

Europe

Asia Pacific



Fax-on-demand

US only (800) 260-9099

Outside US (650) 257-2301

Fax ID

8030

Description

Data sheet

Visit our website at www.tycoelectronics.com**Ordering information**

Model	Description	Part number
AD-1377 MiniSeal crimp tool	AD-1377-CRIMP-TOOL	992008-000
AD-1386 calibration gauge	AD-1386-CALIBRATION-GAUGE	992013-000
AD-1522 DuraSeal crimp tool	AD-1522-1-CRIMPING TOOL	047011-000



AD-3050-SEAL-TEST-EQUIP

*Seal test equipment
Splice sealing and connector sealing
evaluation - various products*

Applications

The AD-3050-SEAL-TEST-EQUIP is a manually operated pneumatic device, intended for use as a convenient 'in-process' sampling technique for checking sealed splices. Different combinations of in-line or stub splices can be pressure tested in any of the combination of fixtures (8 in total). There is also a facility to allow leak testing of various connectors.

Tyco Electronics UK has seen good correlation between results obtained with the AD-3050 and those obtained through water immersion testing. However testing in accordance with the OEM specification is the only guaranteed way of confirming that the OEM spec is being met. The splice products are located in clamps which deliver the test pressure. The product is immersed in water and pressure is delivered down the wire(s) to the sealed area. The test result is determined visually by looking for bubbles in the area of the sealing product.

Use of this equipment is described in Tyco Electronics UK procedure, reference No. PIP/O17/95.

This equipment does not check for poke through i.e. where individual wire strands poke through the installed heat shrinkable sleeve. Poke through is eliminated by ensuring correct welding and subsequent handling conditions.

Features and benefits

- Simple fixture design allows fast sealing test result assisting determination of installation conditions for splice sealing products.
- Connector fixture adapter allows connector sealing verification.
- Strong portable container allows use in various locations.

Available in:

Americas

Europe

Asia Pacific



Fax-on-demand

US only (800) 260-9099

Outside US (650) 257-2301

Visit our website at www.tycoelectronics.com**Technical specification - AD-3050-SEAL-TEST-EQUIP**

Pneumatic Supply	6 bar maximum, filtered supply. 2 bar test pressure maximum. (Test pressure typically 0.5 bar)
Machine Cycle Times for seal testing:	Typically 1 minute.
Total System Noise:	Negligible noise from air test
Dimensions:	550 mm x 350 mm x 215 mm (22" x 14" x 8") (Excludes packing case)
Weight:	4 Kg (8.80 lb) (Excludes packing case) 9.6 Kg (21.20 lb) (Includes packing case)

Ordering information

	Description	Part number
Seal Test Equipment	AD-3050-SEAL-TEST-EQUIP	102119-000

Recommended spares

	Description	Part number
Tool Assembly	AD-3050-SEAL-TEST-EQUIP	102119-000
Set of 8 Seals**	AD-3050-SEAL-8-KIT	299155-000
Clamp assembly including seals	AD-3050-SEAL-CLAMP-ASSY	168927-000
Sealing tape	EPDM foam, 6 mm x 9 mm, with acrylic adhesive backing.	

** - Full set of seals

As the equipment is designed to use readily available pneumatic components, these are listed on the parts list which is included with the equipment



AD-5000



RH-396X

AD-5000 and RH-396X

Tinel-Lock installation tool
Tinel-Lock screened termination products

Applications

The AD-5000-TINEL-ASSY is a manually operated resistance heating tool designed specifically to install Raychem Tinel-Lock ring screened terminations in small batches. Recommended maximum continuous batch is 15, 6 second installations. The standard tool accommodates Tinel Rings from size TR04 to TR24 inclusive.

Various electrode (jaws) types can be used to install other Tinel-Lock ring sizes and types. The operator uses the hand-held tool to install the Tinel-Lock ring in its correct position on screened terminations. The Tinel-Lock ring has two patches of thermochromic paint on the Tinel-Lock ring.

The operator positions the Tinel-Lock ring on the terminations, with at least one of the patches of thermochromic paint visible. The Tinel-Lock ring is then clamped in the jaws to start the installation. Installation is complete when the thermochromic paint turns black.

AD-5000 available in:

Americas

Europe

Asia Pacific



RH-396X available in:

Americas

Europe

Asia Pacific



Fax-on-demand

US only (800) 260-9099

Outside US (650) 257-2301

Visit our website at www.tycoelectronics.com**Technical specification**

Electrical Supply	220V-240V-50Hz
Machine Cycle Times for Tinel-Lock rings used on typical range of harnesses:	5 to 15 Seconds depending on ring size and braid type on the termination.
Mains Fuse	240 V 2 Amp (Type T anti - surge)
Total System Noise	Silent Operation
Dimensions	340 mm x 320 mm x 170 mm
Weight	4.2 Kg.

Product range

	Tinel-Lock Rings
STANDARD ELECTRODES FITTED :	Sizes TR04 to TR24
Conduit Electrodes Fitted	Conduit systems / TR rings on double braid
Square Profile Electrodes Fitted	TC02-TC03 RINGS

Ordering information

	Description	Part number
Tinel installation tool (220V-240V)	AD-5000-TINEL-ASSY	411993-000
Also available in the US and Asia Pacific:		
Resistance heating tool: 915088-01.		
Use with American Beauty Transformer - #105-A12 (110V) or #105-A12-220V (220V) and foot switch #10519		
Tinel installation tool (120 VAC)	RH-3960-1-TINEL-KIT-120V	173643-000
Tinel installation tool (220 VAC)	RH-3965-1-TINEL-KIT-220V	859855-000

Recommended spares -AD-5000

Hand Tool Assembly	AD-5000-TINEL-HAND-TOOL	795257-000
Standard Electrodes (TR04 to TR24 RINGS)	AD-5000-TINEL-STD-ELECT	180245-000
Conduit Electrodes (Conduit systems or TR rings on double braid)	AD-5000-TINEL-COND-ELECT	747235-000
Square Profile Electrodes (TC02-TC03 RINGS)	AD-5000-TINEL-SQ-EXT-ELEC	065583-000

Recommended spares -RH-396X

Hand Tool Assembly	915088-01-TINI-RING-HEATR	170224-000
Foot Switch	IR-500-P-FOOT-SWITCH	993702-000
120 VAC Transformer	TRNSFMR-120V-105-A12-250W	570939-000
220 VAC Transformer	TRNSFMR-220V-105-A12-250W	574557-000

N.B. Electrodes are two per P.C.N.

**Users should independently evaluate the suitability of the product for their application.
Before ordering check with factory for most current data.**



AD-5010-Tinel-Bench-230V

*Tinel-Lock installation tool
Tinel-Lock screened termination products*

Applications

The AD-5010-TINEL-BENCH-230V is a manually operated resistance heating tool designed specifically to install Raychem Tinel-Lock ring screened terminations in large batches, in continuous operation. The tool accommodates Tinel Rings from size TRO4 to TR24 inclusive. Various electrode (jaws) types can be used to install other Tinel-Lock ring sizes and types.

The operator uses the tool to install the Tinel-Lock ring in its correct position on screened terminations. The Tinel-Lock ring has two patches of thermochromic paint to ensure consistent installation.

The operator positions the Tinel-Lock ring on the termination, with at least one of the patches of thermochromic paint visible, and operates the push-button (or footswitch if fitted).

The Tinel-Lock ring is then located in spring - loaded jaws (it is not necessary to clamp the ring manually). The push button or footswitch (if fitted) is then operated to start the cycle, the cable is held in position for the duration of the installation. This is complete when the thermochromic paint turns black. This normally takes between 3 to 12 seconds, depending on ring size, braid type etc. An ammeter on the front panel shows installation current used. A needle file is provided for periodic cleaning of the electrodes.

Available in:

Americas



Europe



Asia Pacific



Fax-on-demand

US only (800) 260-9099

Outside US (650) 257-2301

Visit our website at www.tycoelectronics.com**Technical specification**

Electrical Supply	230 V 50 Hz
Machine Cycle Times for Tinel-Lock rings used on typical range of harnesses:	3 to 12 Seconds depending on ring size and braid type on the termination.
Mains Fuses (2)	240 V 2 Amp (Type T anti - surge)
Total System Noise	Silent Operation
Dimensions	245 mm x 305 mm x 290 mm
Weight	24 Kg

Product range

	Tinel-Lock rings
STANDARD ELECTRODES FITTED :	Sizes TR04 to TR24, conduit systems and TR rings on double braid
Square Profile Electrodes Fitted	TC02-TC03 RINGS

Accessories

	Description	Part number
Footswitch Kit	AD-5010-BENCH-FOOTSW-KIT	072845-000

Recommended spares

	Description	Part number
Standard Electrodes (TR04-TR24 RINGS)	AD-5010-BENCH-STD-ELECT	222899-000
Square Profile Electrodes (TC02-TC03 RINGS)	AD-5010-BENCH-SQ-ELECT	727799-000
Mechanism Assembly (Including electrode set)	AD-5010-BENCH-MECH	924079-000

N.B. Electrodes are two per P.C.N.

Ordering information

	Description	Part number
Tinel installation tool	AD-5000-TINEL-ASSY	411993-000



CV-1981, CV-1983

Heavy-duty hot-air heating tools

Applications

Used for installing dual wall or single wall tubing up to three inches in diameter and for installing SolderSleeve devices. Closed loop version (PID) also available.

Features and benefits

- Robust, double-insulated, heavy-duty unit.
- Highest-wattage unit (1600–2260 watts).
- Integral stand that allows use as bench tool.
- Safe, quiet operation.
- Precisely variable temperature.
- Variety of reflectors available.
- Easy fixturing for dual opposing heating.

Available in:	Americas	Europe	Asia Pacific
	■	■	■

Technical specification

Electrical supply

CV-1981-MK2	120 V and 230 V
CV-1983	120 V and 230 V
CV-1981 PID	120 V and 230 V

Power consumption

CV-1981-MK2	1600 W
CV-1983	2260 W/3060 W
CV-1981 PID	1600 W

Total system noise

CV-1981-MK2	65dB
CV-1983	65dB
CV-1981 PID	>70dB

Length

CV-1981-MK2	340 mm (13")
CV-1983	320 mm (13")
CV-1981 PID	350 mm (13")

Weight

CV-1981-MK2	1.3 kg (2.90 lb)
CV-1983	1.5 kg (3.30 lb)
CV-1981 PID	1.4 kg (3.10 lb)

Air flow

CV-1981-MK2	Max 230 l/min
CV-1983	Max 500 l/min
CV-1981 PID	230 l/min

Product range

All dual wall, single wall and molded part products.

Various devices products.

For other Raychem products discuss with Product Management.

Fax-on-demand

US only (800) 260-9099

Outside US (650) 257-2301

Visit our website at www.tycoelectronics.com**Ordering information**

Equipment	Description	Part number	Voltage	Hz
CV-1981-MK2	CV-1981-120V1600W-CANMK2	A42716-000	120V	50/60 Hz
	CV-1981-120V1600W-UKMK2	E95798-000	120V	50/60 Hz
	CV-1981-230V1600WMMK2	813914-000	230V	50/60 Hz
	CV-1981-230V1600W-SEVMK2	F25836-000	230V	50/60 Hz
	CV-1981-230V1600-UKMK2	340970-000	230V	50/60 Hz
CV-1983	CV-1983-110V-2260W-UK	441753-000	120V	50/60 Hz
	CV-1983-220V-2260W	773898-000	230V	50/60 Hz
	CV-1983-220V-2260W-UK	985426-000	230V	50/60 Hz
	CV-1983-220V-3060W	538361-000	230V	50/60 Hz
	CV-1983-220V-3060W-UK	231866-000	230V	50/60 Hz
CV-1981-PID	CV-1981-120V-1600W-CANPIDF	839218-000	120V	50/60 Hz
	CV-1981-120V-1600W-UKPID	928826-000	120V	50/60 Hz
	CV-1981-230V-1600WPID	958770-000	230V	50/60 Hz
	CV-1981-230V-1600W-SEVPIDF	434366-000	230V	50/60 Hz
	CV-1981-230V-1600W-UKPIDF	385828-000	230V	50/60 Hz
CV-1983 Barrel Adapter	AD-1962	989172-000		

Accessories	Application	Part number
PR-12 reflector	Tubing: 6.3–25.4 mm (0.25"–1")	991973-000
PR-13 reflector	Tubing: Up to 6 mm (0.25")	991963-000
PR-13C reflector	Large SolderSleeve products	991974-000
PR-21 reflector	Tubing: Up to 25.4 mm (1")	991984-000
PR-24 reflector	Tubing/molded parts: 25.4–34.93 mm (1"–1.38")	991964-000
PR-24A reflector	Tubing/molded parts: 34.93–60.33 mm (1.38"–2.38")	991989-000
PR-25 reflector	SolderSleeve products: Up to 7 mm (0.28")	991965-000
PR-25D reflector	SolderSleeve products: 6.3–12.7 mm (0.25"–0.50")	989523-000
PR-26 reflector	Small SolderSleeve products	991967-000
PR-33 reflector	SolderSleeve products: 19.05–25.4 mm (0.75"–1")	997768-000
AD-1962 adapter for larger-barrel CV-1983		989172-000
PR-34 reflector	SolderSleeve products: 12.0–20.0 mm (0.47"–0.79")	989111-000
PR-51	Special narrow reflector for molded part transitions (21.5 x 3.5 mm nozzle)	113069-000

*Note: A42716 supersedes and replaces 538005
340970 supersedes and replaces 923002

Users should independently evaluate the suitability of the product for their application.
Before ordering check with factory for most current data.



HL1802E/HL2005E

Steinel general purpose hot-air heating tool

Applications

Used for installing heat-shrinkable tubings and molded parts, SolderSleeve devices, and SolderTacts contacts.

Features and benefits

- Light weight.
- Easy, quiet operation.
- Precisely variable temperature.
- 1500 watts.
- Reflectors and stand (optional).
- Wide variety of applications.
- CE approved (230 V only).

Available in:

Americas

Europe

Asia Pacific



Specifications

Steinel (120 V) power requirement	120 V, 60 Hz, 12.5 A
Steinel (230 V) power requirement	230 V, 50 Hz, 8.7 A
Rated heater element power	110V - 1500 W/230V-2000W
Weight	850 g (1.9 lb)
Cord length	Approx. 3 m (approx. 8 ft)
Typical temperature output*	49°C to 593°C (120°F to 1100°F)

*The Steinel heating tool is equipped with a variable temperature control. The correct temperature setting of the tool will vary, depending on application characteristics. The recommended procedure is to experiment with scrap materials and start with the lowest temperature range.

Fax-on-demand

US only (800) 260-9099

Outside US (650) 257-2301

Fax ID

8050

Description

Data sheet

Visit our website at www.tycoelectronics.com**Ordering information**

Model /Description	Part number
HL1802E-Kit-120 V**	289759-000
HL2005E-230V-Euro	910424-000
HL2005E-230V-UK	629014-000
HL2005E-Kit-230-Euro**	849224-000

Accessories and replacement parts	Description	Part number
SolderSleeve reflector	HL1802E-074616	832011-000
HL1802E-ADAPT for use with PR reflectors***	HL1802E-ADAPT-PR	444817-000
Tubing reflector	HL1802E-070519	022611-000
Bench stand	HL1802E-BENCH-STD	717083-000
9-mm-diameter reduction nozzle	HL1802E-070618	930321-000

**Complete with SolderSleeve reflector.

***Selection of PR reflectors can be found in CV-1981/CV-1983 section.

Accessories

Clip-on bench stand (P/N 717083-000) for heating tool. Must be ordered separately.



SolderSleeve reflector (P/N 832011-000) for SolderSleeve terminators, SolderTacts contacts, and small-diameter tubing. Comes standard with Steinel heating tool.

Optional tubing reflector (P/N 022611-000) for larger tubing and molded parts. Must be ordered separately.

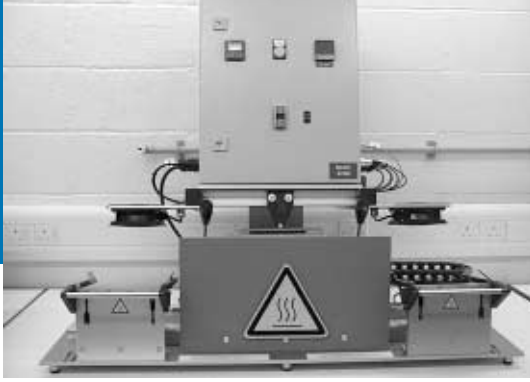

IR-1891

Shuttle machine - twin workstation heater for multiple installation of short length tubing products

Applications

The IR-1891 is suitable for the installation of a range of Raychem heat-shrinkable tubing products onto a variety of small components, e.g. ring terminals, Faston terminals and small connectors etc. The machine is provided with two work stations and a moveable heating head.

Each workstation is provided with supports for tooling fixtures (which must be specified and ordered separately). These support the workpieces and locate the tubing products. The operator loads the workpieces into the fixtures at one of the workstations, ensures that the tubing product is correctly positioned and then slides the heat head into position before initiating the heating cycle. The operator then continues with loading/unloading the other work station whilst the heating cycle is taking place.

The IR-1891-220V-Shuttle-Retrn is provided with closed loop temperature control and in addition the heat head is 'locked' into position by use of an electromagnet during the heating cycle.

Once the other workstation has been loaded and the first installation is complete the heat head is moved into position over the product and the next heating cycle initiated. Heating times vary typically from 3 to 30 seconds depending on the size and type of tubing product. Process rates up to 1200 pieces/hour can be achieved depending on the heating time and the time taken by the operator to load/unload the workpieces. The installation temperature/power can be varied according to product type/size and required cycle times.

The heating elements, which are continuously energized, are of the infra-red medium wave length type and consist of a coiled resistance wire contained in quartz glass tubes. The closed loop temperature control uses similar elements but having integral thermocouple sensors.

Features and benefits

- Automatic cycle start once heater is manually positioned over product, which gives improved process control (recommended for adhesive lined heat-shrinkable tubing e.g. sealing applications).
- Automatic heating head retraction at end of cycle prevents damage to components.
- Multiple product fixture assemblies give increased process rates.
- Cooling fan above each fixture assembly maintains holding fixture at an acceptable temperature.

Available in:

Americas

Europe

Asia Pacific



Fax-on-demand

US only (800) 260-9099

Outside US (650) 257-2301

Visit our website at www.tycoelectronics.com**Technical specification - IR-1891 Shuttle machine**

Electrical Supply	230 V Single Phase
Power Consumption	1600 W
Operating Temperature	650°C max
Process Rate	1200 / hour maximum depending on application and operator
Heating Times	3 to 20 seconds depending on application
System Noise	< 70 dB
Dimensions – 508636-000	L1100 mm x H650 mm x D500 mm (L43" x H25" x D20")
Dimensions – 613148-000 / 167309-000 / 289588-000	L1100 mm x H900 mm x D500mm (L43" x H35" x D20")
Base Plate Dimensions 289588-000 / 167309-000	L1040 mm x D450 mm (L41" x D18")
Base Plate Dimensions 613148-000	L1040 mm x D397 mm (L41" x D16")

Product range

Wide range of Raychem tubing products in particular LSTT, RNF-3000, RNF-100, HTAT, ATUM.

Maximum diameter 20 mm (0.8") and maximum length 60 mm (2")

Ordering information**Description****Part number**

* IR-1891-220V-Shuttle-Retrn

289588-000

* IR-1891-220V-Retrn-Syl

613148-000

Note the descriptions given here DO NOT include the supply of the necessary tooling fixtures. These are designed for each individual application.

Accessories**Description****Part number**

Auto-Return-Kit

IR-1891-Heater-Return-Kit

184947-000

For use on non-preferred IR-1891-220V-shuttle-std serial nos 400 and above

A range of tooling fixtures designed for previous applications are available. Please contact your Tyco Electronics product representative for details.



IR-550 Mark II

Infrared heating tool

Applications

Used for installing small and large Solder Sleeve devices and SolderTacts contacts.

Features and benefits

- Lightweight, portable unit with pedestal base for benchtop operation.
- Foot switch, so both hands can be free to hold parts.
- Commercially available tungsten-halogen lamp.
- Fan-cooled housing.
- Instant on/off heat.
- Viewing window that allows parts to be inspected during installation.
- Quiet, focused IR operation.

Note: For 230V CE-approved version, contact Tyco Electronics Product Management

Available in:

Americas

Europe

Asia Pacific



Specifications

Input power	105–120 V, 50–60 Hz, 4.5 A
Normal lamp life	More than 100 hours of intermittent use
Weight	Approximately 2.5 kg (5.5 lb)
Duty cycle	80%, 90-second max. heating times

Fax-on-demand

US only (800) 260-9099

Outside US (650) 257-2301

Fax ID

8050

Description

Data sheet

Visit our website at www.tycoelectronics.com**Ordering information**

Model	Description	Part number
IR-550 heating tool* (120 V) with RG-2 reflector, viewing window, and foot switch	IR-550-50-MARKIHT-TOOL	994350-000
Accessories and replacement parts		
IR-550 foot switch (included with tool assembly 994350)	IR-550-216	994375-000
RG-6 reflector for large-diameter SolderSleeve terminations; aperture is 25.4 mm (1" wide)	IR-550-19	994590-000
RG-11 reflector; aperture is 12.7 mm (1/2 in) wide	IR-550-41	993695-000
RG-9 reflector; aperture is 9.525 mm (3/8 in) wide	IR-550-39	993693-000
RG-2 reflector, included with 994350; aperture is 19.05 mm (3/4 in) wide	IR-550-24	993770-000
Lamp (120 V)	IR-1000-P-N-13	993020-000
Optical filter	IR-550-237	118902-000
Viewing window (frame not included)	IR-550-238	007510-000

*IR tools are not recommended for use with black wire or cable insulations.



IR-1759 MiniRay

Infrared heating tool

Applications

Used for installing Solder Sleeve devices and SolderTacts contacts.

Features and benefits

- Small, lightweight, fan-cooled unit.
- Small profile for installation where space is restricted.
- Handheld operation.
- Focused heat.
- Quiet, efficient IR operation.
- CE approved.

Available in:	Americas	Europe	Asia Pacific
	■	■	■

Specifications and dimensions

Lamp	Tungsten-halogen Nominal power 250 W, 24 Vac, 50–60 Hz
Fan	12 Vac (supplied through control unit)
Weight	.73 kg (1.6 lb)
Cable length	2 m (6.5 ft)

Electronic control unit

Main supply	110/230 Vac, 50/60 Hz, 1.1 A/5.5A universal
Weight	3.4 kg (7.6 lb)
Dimensions	16.3 x 12.2 x 12.2 cm (6.4 x 4.8 x 4.8 in)

Fax-on-demand

US only (800) 260-9099

Outside US (650) 257-2301

Fax ID

8050

Description

Data sheet

Visit our website at www.tycoelectronics.com**Ordering information**

	Description	Part number
Complete kit consisting of:		
Handtool/Reflector/Control Box (Dual voltage)	IR1759-MK3-AT3130-EDCont	898738-000
Accessories and replacement parts		
Handtool, standard aperture	IR-1759-MK3/A	986899-000
Handtool, large aperture	IR-3104-MK3/A	035343-000
Control Box with time control-230 V	ED-7-001-MK2-230V-50HZ	869233-000
Control Box with time control-110 V	ED-7-002-MK2-110V-60HZ	903553-000
Control Box with manual control-110/230V	ED-7-CONT-230/110V	684886-000
Battery Box	ED-7-Batterybox-230/110V	448969-000
Conversion kit (AE-897) for adapting standard-aperture MiniRay heating tool to wide-aperture MiniRay tool (includes reflector)	AT-313/AE-897	934630
Inner reflector (standard aperture)	AE-424	547918-000
Inner reflector (wide aperture)	AE-153	988285-000
Lamp (250 W, 24 V)	NAE-143-3	988208-000
Filter (standard aperture) US	AES-IR1759-100	431468-000 (US only)
Filter (standard aperture) UK	NAE-144-2	988128-000
Filter (wide aperture)	NAE-144-3	988293-000

*IR tools are not recommended for use with black wire or cable insulations.



Model 16B

Belt heater

Applications

Designed for processing a broad range of heat-shrinkable tubing products up to 19 mm (.75 in) in diameter and 101 mm (4.0 in) long. Suitable for either single-wall or adhesive-lined tubing. Heating-element temperature is adjustable up to 600°C and the belt speed is adjustable to 2.28 m (7.5 ft) per minute. Operator simply positions the heat-shrink tubing over the assembly and feeds it into the process chamber. Heating and cooling take place automatically with the cables or wires securely fixed.

Features and benefits

- Controlled heating for installation of Raychem heat-shrinkable tubing at rates required for mass production.
- Controlled repeatable heating: time and temperature settings can be fixed to maintain repeatable installation parameters.
- Part positioning that is clearly defined and easy to maintain.
- Operation that requires only minimal skill.
- Efficient and economical operation, which greatly reduces labor costs. In most cases the throughput rate is limited only by the rate at which an operator can load parts into the heater.

Available in:

Americas

Europe

Asia Pacific

Fax-on-demand

US only (800) 260-9099

Outside US (650) 257-2301

Fax ID

8020

Description

Data sheet

Visit our website at www.tycoelectronics.com**Specifications and dimensions**

Electrical	Part number 827429-000	Part number 047143-000	Part number 584313-000
Power requirements	120 Vac, 1 \emptyset , 50/60 Hz, 20 A	220 Vac, 1 \emptyset , 50/60 Hz, 15 A, 3-wire	120 Vac, 1 \emptyset , 50/60 Hz, 15 A, 4-wire
Heating elements	875 W (upper and lower)	875 W (upper and lower)	875 W (upper and lower)

Mechanical

Conveyor belt system	Two sets of pinch belts right and left, four belts total
Machine dimensions	48 cm (19") W x 110 cm (43") L x 33 cm (13") H
Shipping dimensions	61 cm (24") W x 111 cm (44") L x 56 cm (42") H
Machine weight without crate	55 kg (120 lb)
Shipping weight with crate	91 kg (200 lb)

Tubing sizes

Inside diameter before recovery	Up to 19 mm (0.75")
Length	Up to 101 mm (4.0")

Optional attachment

Ring terminal kit	Part number 060053-000
-------------------	------------------------



Model 19

Conveyor heater for processing Raychem heat-shrinkable tubing and terminating devices

Applications

The Model 19 conveyor heater is the latest generation of reliable and versatile process heaters for a wide variety of heat-shrinkable products.

Two sets of timing belts grip the individual assemblies and carry them through a closed-loop infrared heating zone, then through a cooling zone, and deposit the completed assemblies in a collection bin.

The processor was designed to meet the requirements of the European Safety Directives and is CE approved, allowing for worldwide use.

The processor is designed to operate on the following line voltages: 210 to 240 Vac, 20 A, 1 Ø, 50/60 Hz.

Options for this processor include:

- Powered or unpowered extension tables to support long or heavy harnesses.
- Kit for processing ring terminals and end terminations.
- Floor stand with wheels.
- Wider heating elements for tubing up to 178 mm (7") long.
- Narrow heating elements for SolderSleeve devices up to 10mm (0.4") diameter and 45 mm (1.8") long or short length tubing less than 50 mm (2").

Features and benefits

- Closed-loop speed and temperature control.
- CE approved for worldwide use.
- Adaptable for different applications.
- Continuous controlled process.

Product features

Controlled heating zone

The Model 19 has two etched-foil heating elements mounted under a quartz face. Consistent heating chamber temperatures are obtained with a closed-loop temperature controller. There is a lockout on the controller to prevent unauthorized changes.

Speed control

Consistent speed is obtained with a closed-loop speed controller. The speed is adjusted using a 3-digit thumbwheel on the front control panel. There is a lockout on the thumbwheel to prevent unauthorized changes.

Minimal skill requirements

There are clearly marked guides for aligning the assembly as well as the tubing or device being processed. The operator only has to center the assembly; the grippers carry it through the heating and cooling zone and deposit it into the unloading bin.

Economical production

The throughput rate is determined by the rate at which an operator can load the processor.

Versatility

The tool description CLTEQ-M19-BELT-HTR part number 714529-000 will handle tubing up to 25 mm (1") diameter and 102 mm (4") long. Tubing up to 178 mm (7") long can be handled with the use of tool description CLTEQ-M19-BELT-HTR-6IN part number 075131-000. The tool description CLTEQ-M19-BELTHEATER-SS part number D43037-000 will handle SolderSleeve devices up to 10 mm (0.4") diameter and 45 mm (1.8") long, or short length tubing (less than 50 mm (2")), where applications require a narrow heat width.

Self-diagnostic circuitry

There are several "self-diagnostic" circuits that alert the operator if any major component fails or if an unsafe processing condition occurs. A light will turn on and a lockout gate will lift in the entry zone, preventing the operator from loading assemblies until the situation has been corrected.

Other features include:

- Emergency stop.
- Automatic cool-down circuit to extend the life of components.
- Lockout on temperature and speed controllers to prevent unauthorized changes.

Fax-on-demand

US only (800) 260-9099

Outside US (650) 257-2301

Visit our website at www.tycoelectronics.com

Available in:

Americas

Europe

Asia Pacific



Specifications and dimensions

Electrical

Power requirements	210–240 Vac, 20 A, 1 Ø, 50/60 Hz
Heating elements	Std = 3160 W/Wide = 3320 W/Narrow = 1760 W

Mechanical

Conveyor belt system	Double-sided timing belts, 0.375" pitch - 9.5 mm
Belt speed	Up to 152 cm/min (5"/min)
Processor dimensions	53 cm (21") W, 135 cm (53") L, 45 cm (18") H
Shipping dimensions	66 cm (26") W, 147 cm (58") L, 58 cm (23") H
Shipping weight with crate	86 kg (190 lb)

Tubing sizes

Tubing diameter (max)	25 mm (1")
Tubing length (max)	102 mm (4") 178 mm (7") wide heating element tool 50 mm (2") narrow heating element tool
Work-piece length (min)	240 mm (9.5")

Version

Part number

Model 19 Standard	714529-000
Model 19 Wide	075131-000
Model 19 Narrow	D43037-000



Model 81CE

Discrete heater

Applications

The Model 81CE is a discrete heater that can process large, complex assemblies or other suitable substrates using a wide variety of heat-shrinkable tubing products up to 25mm (1") in diameter and 127mm (5") in length. It is suitable for use with both single wall and adhesive-lined tubing. Two jaws grip the assembly or substrate, carry it into an infrared heating chamber for a user-selectable predetermined period of time, then return the completed assembly back to the start position for removal.

Features and benefits

- Closed-loop temperature control for a precise and repeatable thermal process.
- Oven dwell time precisely set by a 3-digit thumb wheel digital timer.
- Heat output can be controlled to accommodate a wide variety of applications.
- Operation that requires only minimal skill.
- Contains numerous safety features.
- Meets the requirements of CE, OSHA and the NEC.

Available in:

Americas

Europe

Asia Pacific



NB: Non-preferred tool for Europe - see RBK-PROC-MK2-Processor.

Fax-on-demand

US only (800) 260-9099

Outside US (650) 257-2301

Visit our website at www.tycoelectronics.com**Specifications and dimensions**

Electrical	Part number 07 1965-000	Part number 704393-000
Power requirements	120 VAC, 1Ø, 50/60 Hz, 15 A	220 VAC, 1Ø, 50/60 Hz, 15 A
Heating elements	Two 400 watt infrared stamped foil with infrared heating elements, one top and bottom.	Two 400 watt infrared stamped foil with infrared heating elements, one top and bottom.
Timing system	Eagle digital timer, 1 to 999 seconds	Eagle digital timer, 1 to 999 seconds

Pneumatic

Requirements for jaw traverse	30-40 psi clean shop air	30-40 psi clean shop air
-------------------------------	--------------------------	--------------------------

Dimensions

Control box dimensions		
Length	432 mm (17")	432 mm (17")
Width	216 mm (9")	216 mm (9")
Height	165 mm (7")	165 mm (7")
Control box weight	7.7 kg (17 lb.)	7.7 kg (17 lb.)

Heating chamber dimensions		
Length	380 mm (15")	380 mm (15")
Width	240 mm (10")	240 mm (10")
Height	343 mm (14")	343 mm (14")
Heating chamber weight	18 kg (40 lb.)	18 kg (40 lb.)

Shipping dimensions

Length	610 mm (24")	610 mm (24")
Width	610 mm (24")	610 mm (24")
Height	530 mm (21")	530 mm (21")
Shipping weight	41 kg (90 lb.)	41 kg (90 lb.)

Tubing sizes

Inside diameter before heat	Up to 25.4 mm (1")	Up to 25.4 mm (1")
Length	Up to 127 mm (5")	Up to 127 mm (5")



Model 105

Tunnel oven

Applications

Table conveyor heater that provides a controlled process system suitable for installing a wide variety of heat-shrinkable tubing products up to 76 mm (3") diameter and unlimited in length. Ideally suited for efficient processing of fiber and fabric HFT and both single wall and dual wall tubing. Designed as an integrated modular unit. Assemblies are placed on the entry section of a mesh belt, transported through a heating chamber, across a bank of cooling fans then discharged from the rear of the conveyor.

Features & Benefits

- Closed-loop temperature control for a precise and repeatable thermal process.
- Conveyor speed precisely set by a 3-digit potentiometer.
- Operation that requires only minimal skill.
- Contains numerous safety features.
- Custom length conveyors for longer entry and/or exit sections available.
- Optional accessories to customize the tunnel oven.

Available in:

Americas

Europe

Asia Pacific



Fax-on-demand

US only (800) 260-9099

Outside US (650) 257-2301

Visit our website at www.tycoelectronics.com

Specifications and dimensions (Part number 9550 18-000)

Electrical

Power requirements	208/240 VAC, 1Ø, 50/60 Hz, 15 A
Heating elements	Two 1500 watt infrared stamped foil with black quartz face, one top and bottom
Operating temperature	Ambient to 650°C
Effective heating width	356mm (14")

Dimensions

Control box dimensions

Length	515mm (20")
Width	210mm (8")
Height	178mm (7")

Control box weight 7.7 kg (17 lb)

Heating conveyor dimensions

Length	990mm (39")
Width	685mm (27")
Height	417mm (17")

Heating conveyor weight 68 kg (150 lb)

Shipping Dimensions

Length	1346mm (53")
Width	1168mm (46")
Height	635mm (25")
Shipping weight	146 kg (320 lb)

Tubing sizes

Inside diameter before heat Up to 76.2mm (3")

Length

Perpendicular to belt travel	356mm (14")
Parallel to belt travel	Unlimited



RBK-ILS-Processor MkII

Installation of splice sealing products adjacent to ultrasonic welder

Applications

The RBK-ILS-Processor MkII is a semi-automatic unit designed specifically to install splice sealing products onto ultrasonically welded or crimped splice joints used in automotive harnesses.

The tool can operate in several modes:

- Stand-alone - operator sets time and temperature.
- Sequenced - preset times and temperatures can be sequenced automatically (and can also be randomly selected from sequence stored).
- Automatic - communication with upstream ultrasonic welder can allow time and temperature to be automatically set without operator intervention.

The operator is able to efficiently load both machines and so minimize 'dead time'. Installing Raychem splice sealing products immediately after welding gives reduced installation time and earliest possible mechanical protection for the welded joint. The operator positions the splice sealing product centrally over the splice joint and then locates the assembly into the gripper mechanism.

The wire assembly is automatically ejected, with the splice sealing product installed and the joint area sealed, insulated and strain relieved. In-line or stub-type splices can be installed.

Features and benefits

- Optimized heating element life.
- Installation times, temperatures and product size information storage (individual selection).
- Sequenced installations.
- Operator key lock/password protection levels.
- Automatic heater retraction on mains failure.
- Automatic calibration.
- RS232 interface allows time, temperature and product sizes for the next installation to be transferred from a remote machine (eg an ultrasonic welding tool).
- Machine hours and installation cycle counters.
- Software upgradeable to support special applications.

Available in:

Americas

Europe

Asia Pacific

Fax-on-demand

US only (800) 260-9099

Outside US (650) 257-2301

Visit our website at www.tycoelectronics.com**Technical specification**

Electrical Supply	220V-240V-50Hz
Power Consumption	1.7 Amps (Max)
Operating Temperature	550°C (Max) (500°C recommended)
Machine Cycle Times for splice sealing products used on typical range of automotive splices	6 to 20 seconds depending on wire size and the number or wires used
Total System Noise	<80dB
Dimensions	390mm x 365mm x 225mm (15" x 14" x 9")
Weight	18Kg (40 lb)

Product range

RBK-ILS-125 Products	Sizes 1 to 3A
RBK-ILS-85 Products	Sizes 6/1 to 12/3
For Other Raychem Products (eg RBK-VWS, RBK-ESS...)	Discuss with Product Management

Ordering information

	Description	Part number
Equipment	RBK-Proc-Mk2-Processor	740331-000
Accessories	Stub splice fixture - RBK-ILS-Proc-Stub-Sp-Fix	981721-000
	Air cooled stub splice fixture - RBK-ILS-Proc-Air-Cool-Kit	843800-000
	8 mm ring terminal fixture - RBK-ILS-Proc-Termfix-08mm	049857-000



ThermoGun HG

Hot-air heating tool

Applications

Used for installing molded parts onto adapters or harnesses and installing a broad range of heat-shrinkable products, including boots and tubing up to three inches in diameter.

Features and benefits

- Stand-mounted or handheld, rugged unit for heavy-duty use.
- Built-in stand and turbo-fan-driven blower.
- Adjustable side vents.
- Adjustable temperature.
- 1680 to 2160 watts.
- Large reflector size.
- High heat output for fast installation.

Available in:

Americas

Europe

Asia Pacific



Specifications

Model	Power requirements	Input watts	Temperature range	CFM*	RPM**
HG-501A	120 V, 60 Hz, 14 A	1680	260°C–399°C (500°F–750°F)	23	1700
HG-502A	230 V, 50/60 Hz, 7 A	1680	260°C–399°C (500°F–750°F)	23	1700
HG-75 1A-C	120 V, 60 Hz, 18 A	2160	399°C–538°C (750°F–1000°F)	23	1700
HG-752A	230 V, 50/60 Hz, 9 A	1740	399°C–538°C (750°F–1000°F)	23	1700

*CFM = Cubic feet per minute.

**RPM = Revolutions per minute.

Fax-on-demand

US only (800) 260-9099

Outside US (650) 257-2301

Visit our website at www.tycoelectronics.com

Accessories



A-160-HG reflector (P/N 991017)
for short lengths of tubing up to
19.05 mm (3/4 in) in diameter.
Must be ordered separately.

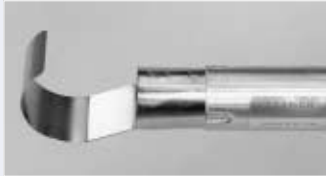

A-170-HG reflector (P/N 991018)
for short lengths of tubing
19.05–50.8 mm (3/4–2 in) in diameter.
Must be ordered separately.



TG-23 reflector (P/N 991026)
for boots up to 44.45 mm (1 3/4 in)
in diameter. Must be ordered separately.

Ordering information

Model***	Housing color	Part number
HG-501A	Red	462047-000
HG-502A	Red	389363-000
HG-751A-C	Red	926935-000
HG-752A	Red	026239-000

Accessories	Tubing application	Part number
A-160-HG standard reflector	Diameters up to 19.05 mm (0.75")	991017-000
A-170-HG large tubing reflector	Diameters of 19.05–50.8 mm (0.75–2")	991018-000
TG-23 small boot reflector	Diameters up to 44.5 mm (1.75")	991026-000
TG-24 large boot reflector		991027-000

***Complete with bench stand.

Supporting Information

Table of Contents

Equivalents and conversions	11-0
Temperature conversion	11-2
Glossary	11-4
Index	11-22

Supporting Information

Equivalents and conversions

<i>Decimal equivalents</i>						
Fraction of inch		Decimal of inch	Decimal millimeters	Fraction of inch	Decimal of inch	Decimal millimeters
	1/64	.0156	0.3969		.5118	13.0000
	1/32	.0313	0.7938		33/64	.5156 13.0969
		.0394	1.0000		17/32	.5313 13.4938
	3/64	.0469	1.1906		35/64	.5469 13.8906
1/16		.0625	1.5875			.5512 14.0000
	5/64	.0781	1.9844	9/16		.5625 14.2875
		.0787	2.0000		37/64	.5781 14.6844
	3/32	.0938	2.3813			.5906 15.0000
	7/64	.1094	2.7781		19/32	.5938 15.0813
		.1181	3.0000		39/64	.6094 15.4781
1/8		.1250	3.1750	5/8		.6250 15.8750
	9/64	.1406	3.5719			.6299 16.0000
	5/32	.1563	3.9688		41/64	.6406 16.2719
		.1575	4.0000		21/32	.6563 16.6688
	11/64	.1719	4.3656			.6693 17.0000
3/16		.1875	4.7625		43/64	.6719 17.0656
		.1969	5.0000	11/16		.6875 17.4625
	13/64	.2031	5.1594		45/64	.7031 17.8594
	7/32	.2188	5.5563			.7087 18.0000
	15/64	.2344	5.9531		23/32	.7188 18.2563
		.2362	6.0000		47/64	.7344 18.6531
1/4		.2500	6.3500			.7480 19.0000
	17/64	.2656	6.7469	3/4		.7500 19.0500
		.2756	7.0000		49/64	.7656 19.4469
	9/32	.2813	7.1438		25/32	.7813 19.8438
	19/64	.2969	7.5406			.7874 20.0000
5/16		.3125	7.9375		51/64	.7969 20.2406
		.3150	8.0000	13/16		.8125 20.6375
	21/64	.3281	8.3344			.8268 21.0000
	11/32	.3438	8.7313		53/64	.8281 21.0344
		.3543	9.0000		27/32	.8438 21.4313
	23/64	.3594	9.1281		55/64	.8594 21.8281
3/8		.3750	9.5250			.8661 22.0000
	25/64	.3906	9.9219	7/8		.8750 22.2500
		.3937	10.0000		57/64	.8906 22.6219
	13/32	.4063	10.3188			.9055 23.0000
	27/64	.4219	10.7156		29/32	.9063 23.0188
		.4331	11.0000		59/64	.9219 23.4156
7/16		.4375	11.1125	15/16		.9375 23.8125
	29/64	.4531	11.5094			.9449 24.0000
	15/32	.4688	11.9063		61/64	.9531 24.2094
		.4724	12.0000		31/32	.9688 24.6063
	31/64	.4844	12.3031			.9843 25.0000
1/2		.5000	12.7000		63/64	.9844 25.0031
				1		1.0000 25.4000

Fax-on-demand

US only (800) 260-9099

Outside US (650) 257-2301

Visit our website at www.tycoelectronics.com**Conversion factors**

Length	Area	Volume	Mass
Inches x 25.40 = Millimeters	Sq. inches x 6.452 = Sq. centimeters	Cu. inches x 16.39 = Cu. centimeters	Ounces x 28.35 = Grams
Millimeters x 0.03937 = Inches	Sq. centimeters x 0.1550 = Sq. inches	Cu. cm. x 0.06102 = Cu. inches	Grams x 0.03527 = Ounces
Feet x 0.3048 = Meters	Sq. feet x 0.0929 = Sq. meters	Cu. feet x 0.02832 = Cu. meters	Pounds x 0.4536 = Kilograms
Meters x 3.281 = Feet	Sq. meters x 10.76 = Sq. feet	Cu. meters x 35.31 = Cu. feet	Kilograms x 2.205 = Pounds
Miles x 1.609 = Kilometers	Sq. miles x 2.59 = Sq. kilometers		Kilograms/km x 0.6214 = Pounds/kft
Kilometers x 0.6214 = Miles	Sq. kilometers x 0.3861 = Sq. miles		Pounds/kft x 1.4881 = Kilograms/km
Ohms/km x 0.3048 = Ohms/kft	Circular mils x 0.7854 = Sq. mil		

Prefixes (SI), values, and symbols

Prefix	Value	Symbol	Prefix	Value	Symbol
Tera	10 ¹²	T	Deci	10 ⁻¹	d
Giga	10 ⁹	G	Centi	10 ⁻²	c
Mega	10 ⁶	M	Milli	10 ⁻³	m
Kilo	10 ³	k	Micro	10 ⁻⁶	μ
Hecto	10 ²	h	Nano	10 ⁻⁹	n
Deca	10 ¹	da	Pico	10 ⁻¹²	p

Supporting Information

Temperature conversion

Temperature conversion formulas

$$^{\circ}\text{C} = (^{\circ}\text{F} - 32) \div 1.8 \quad ^{\circ}\text{F} = (^{\circ}\text{C} \times 1.8) + 32$$

$^{\circ}\text{F}$	$^{\circ}\text{C}$	$^{\circ}\text{F}$	$^{\circ}\text{C}$	$^{\circ}\text{F}$	$^{\circ}\text{C}$	$^{\circ}\text{F}$	$^{\circ}\text{C}$
-103	-75.00	-30	-34.44	25	-3.89	65	18.33
-101.2	-74.00	-28	-33.33	26	-3.33	66	18.89
-99.4	-73.00	-26	-32.22	27	-2.78	67	19.44
-97.6	-72.00	-24	-31.11	28	-2.22	68	20.00
-95.8	-71.00	-22	-30.00	29	-1.67	69	20.56
-94.0	-70.00	-20	-28.89	30	-1.11	70	21.11
-92.2	-69.00	-18	-27.78	31	-0.56	71	21.67
-90.4	-68.00	-16	-26.67	32	0.00	72	22.22
-88.6	-67.00	-14	-25.56	33	0.56	73	22.78
-86.8	-66.00	-12	-24.44	34	1.11	74	23.33
-85.0	-65.00	-10	-23.33	35	1.67	75	23.89
-83.2	-64.00	-8	-22.22	36	2.22	77	25.00
-81.4	-63.00	-6	-21.11	37	2.78	77	25.00
-79.6	-62.00	-4	-20.00	38	3.33	78	25.56
-77.8	-61.00	-2	-18.89	39	3.89	79	26.11
-76.0	-60.00	0	-17.78	40	4.44	80	26.67
-74.2	-59.00	1	-17.22	41	5.00	81	27.22
-72.4	-58.00	2	-16.67	42	5.56	82	27.78
-70.6	-57.00	3	-16.11	43	6.11	83	28.33
-68.8	-56.00	4	-15.56	44	6.67	84	28.89
-67.0	-55.00	5	-15.00	45	7.22	85	29.44
-65.2	-54.00	6	-14.44	46	7.78	86	30.00
-63.4	-53.00	7	-13.89	47	8.33	87	30.56
-61.6	-52.00	8	-13.33	48	8.89	88	31.11
-59.8	-51.00	9	-12.78	49	9.44	89	31.67
-58.0	-50.00	10	-12.22	50	10.00	90	32.22
-56.2	-49.00	11	-11.67	51	10.56	91	32.78
-54.4	-48.00	12	-11.11	52	11.11	92	33.33
-52.6	-47.00	13	-10.56	53	11.67	93	33.89
-50.8	-46.00	14	-10.00	54	12.22	94	34.44
-49.0	-45.00	15	-0.44	55	12.78	95	35.00
-47.2	-44.00	16	-0.89	56	13.33	96	35.56
-45.4	-43.00	17	-1.33	57	13.89	97	36.11
-43.6	-42.00	18	-1.78	58	14.44	98	36.67
-41.8	-41.00	19	-2.22	59	15.00	99	37.22
-40	-40.00	22	-6.11	60	15.56	100	37.78
-38	-38.89	21	-6.11	61	16.11	101	38.33
-36	-37.78	22	-5.56	62	16.67	102	38.88
-34	-36.67	23	-5.00	63	17.22	103	39.44
-32	-35.56	24	-4.44	64	17.78	104	40.00

Fax-on-demand

US only (800) 260-9099

Outside US (650) 257-2301

Visit our website at www.tycoelectronics.com

°F	°C	°F	°C	°F	°C	°F	°C
105	40.55	145	62.78	185	85.00	325	162.78
106	41.11	146	63.33	186	85.55	330	165.56
107	41.66	147	63.88	187	86.11	335	168.33
108	42.22	148	64.44	189	87.22	340	171.11
109	42.77	149	65.00	189	87.22	345	173.89
110	43.33	150	65.56	190	87.78	350	176.67
111	43.88	151	66.11	191	88.33	355	179.44
112	44.44	152	66.66	192	88.88	360	182.22
113	45.00	153	67.22	193	89.44	365	185.00
114	45.55	154	67.77	194	90.00	370	187.78
115	46.11	155	68.33	195	90.55	375	190.55
116	46.66	156	68.88	196	91.11	380	193.33
117	47.22	157	69.44	197	91.66	385	196.11
118	47.77	158	70.00	198	92.22	390	198.89
119	48.33	159	70.55	199	92.77	395	201.67
120	48.89	160	71.11	200	93.33	400	204.44
121	49.44	161	71.66	205	96.11	405	207.22
122	50.00	162	72.22	210	98.89	410	210.00
123	50.55	163	72.77	215	101.67	415	212.78
124	51.11	164	73.33	220	104.44	425	215.56
125	51.67	165	73.89	225	107.22	425	218.33
126	52.22	166	74.44	230	110.00	430	221.11
127	52.77	167	75.00	235	112.78	435	223.89
128	53.33	168	75.55	240	115.56	440	226.67
129	53.88	169	76.11	245	118.33	445	229.44
130	54.44	170	76.67	250	121.11	450	232.22
131	55.00	171	77.22	255	123.89	455	235.00
133	56.11	172	77.77	260	126.67	460	237.78
133	56.11	173	78.33	265	129.44	465	240.55
134	56.66	174	78.88	270	132.22	470	243.33
135	57.22	175	79.44	275	135.00	475	246.11
136	57.77	176	80.00	280	137.78	480	248.89
137	58.33	177	80.55	285	140.55	485	251.67
138	58.88	178	81.11	290	143.33	490	254.44
139	59.44	179	81.66	295	146.11	495	257.22
140	60.00	180	82.22	300	148.89		
141	60.55	181	82.77	305	151.67		
142	61.11	182	83.33	310	154.44		
143	61.66	183	83.88	315	157.22		
144	62.22	184	84.44	320	160.00		

Supporting Information

Glossary

Abrasion-resistance

A measure of the ability of a wire or wire covering to resist damage by mechanical means.

Accelerated Aging

A test in which voltage, temperature, or other test parameters are increased above normal operating values to obtain observable deterioration in a relatively short time. The plotted results give service life within the context of the test.

Adapter

A device usually attached to the rear of connectors that provides for the attachment of harnessing components, such as strain-relief clamps, heat-shrinkable boots, and braid.

Adhesive Liner

Lining that melts and flows inside a sleeve or molded part, filling any voids in between the substrate and the sleeve or molded part. DuraSeal has an adhesive liner.

Adhesive (Hot Melt)

Dual-wall tubing and precoated molded parts whose inner layer melts and flows when heated, fills voids in the areas being covered, and forms a mechanical bond to the substrate. Unlike an encapsulant, an adhesive forms a mechanical bond to the substrate.

Aging

Change in the properties of a material over time and under specific conditions. Generally refers to environmental stimulus such as heat and light.

Altitude Immersion Seal

A seal able to withstand substantial pressure change (for example, from sea level to 75,000 feet).

Amnesia

The tendency over time for a heat-shrinkable elastomeric tubing or molded part to fail to recover completely to its specified recovered size.

See **Shelf Life**.

Ampacity

See **Current-carrying Capacity**.

ASTM

(American Society for Testing and Materials)

A nonprofit industrywide organization that formulates test methods and material specifications, and publishes standards, testing methods, recommended practices, definitions, and other materials.

Attenuation

Power loss resulting in weaker signals in an electrical system as the signals travel along wires. In cables, generally expressed in dB per unit length, usually 100 feet.

AWG (American Wire Gauge)

The recognized method (in the United States) of specifying conductor size. The higher the gauge number, the smaller the conductor size.

Back-mounted

A termination assembly mounted from the inside of a panel or box with its mounting flange inside the equipment.

Band Marking

A continuous circumferential band applied to a wire at regular intervals for identification.

Bare Conductor

A conductor not covered with insulating material.

Barrel

- 1.) Connector barrel: The section of the terminal, splice, or contact that accommodates the stripped conductor.
- 2.) Insulation barrel: The section of the terminal, splice, or contact that accommodates the conductor insulation.
- 3.) Open barrel: The section of a cap that accommodates the conductor.

Fax-on-demand

US only (800) 260-9099

Outside US (650) 257-2301

Visit our website at www.tycoelectronics.com

Batch Number

See **Lot Number**.

Bayonet Coupling

A quick-coupling device for plug and receptacle connectors. Mating is accomplished by rotation of the two parts under pressure.

Beaming

Crosslinking by means of high-energy electrons.

Binder

A spiral wrapping of a thread to hold together the members of a cable.

Blocking

The sticking together of insulated wires; usually caused by heat.

Body

A protective covering of resilient material over any portion of a cable, wire termination, or termination assembly in addition to normal jacketing of insulation, to prevent entry of moisture. Also, a form for holding potting compound.

Bonding Temperature

Temperature above which adhesive melts and flows sufficiently to form an adhesive bond between substrates.

Braid

A woven metallic or fiber layer applied over wire or cable to act as a protective barrier or shielding.

Braid Angle

The angle between the braid strands and the axis of the cable.

Breakdown Voltage

The voltage at which an insulator or dielectric fails to maintain the applied voltage.

Breakout

A region in a harness assembly where a wire or a group of wires is detached to form a separate, terminated branch. Also known as a transition.

Brittle Temperature

The temperature below which a material becomes brittle, often measured by a cold impact test.

Bunch Stranding

A method of twisting individual strands to form a finished stranded conductor. Specifically, a number of strands twisted together in a common direction and with a uniform pitch (or twist) per inch.

Bus

A communal circuit over which data or power is transmitted.

Cable

Two or more wires in a twisted or parallel configuration. Also, a shielded wire.

Cable Clamp

A mechanical clamp attached to the cable side of a termination assembly to support the cable or wire bundle. It provides strain relief and absorbs vibration and shock that would otherwise be transmitted by the cable terminations.

Cable Clamp Adapter

A mechanical adapter that attaches to the rear of a termination assembly to allow the attachment of a cable clamp.

Cable Sealing Clamp

A device consisting of a gland nut designed to seal around the jacket of a cable.

Cabler

A machine that mechanically assembles a group of insulated wires.

Supporting Information

Glossary (cont'd.)

Cabling

The act of twisting together two or more insulated components to form a cable.

Capacitance

The ability of an insulation to store electrical energy. This is a function of the permittivity (dielectric constant) of the insulation. Usually expressed in pico farads/foot for a cable.

Carrier

A group of strands or ends used to form a finished braid.

Characteristic Impedance

The impedance of a transmission line that is independent of length. Also, the ratio of voltage to current at any point along a transmission line on which there are no standing waves.

Chemical Resistance

The ability of an insulation to withstand the presence of materials—such as acids, bases, water, salt water, and fuels—that can deteriorate the insulation, or that, if penetrable to the conductor, can cause dielectric loss of insulating qualities.

Cheminax Cables

Raychem's registered trade name for coaxial cables.

Circuit

The interconnection of a number of electrical elements or parts to accomplish a desired function.

Clocking

The arrangement of connector inserts, jackscrews, polarizing pins, sockets, keys/keyways, or housing configurations to prevent the mismatching or cross-mating of connectors. *See also* **Polarization**.

CMA (Circular Mil Area)

The unit for expressing the cross-sectional area of a conductor. Equal to the diameter of a conductor strand (expressed in mils) squared, times the number of strands.

Coax

See **Coaxial Cable**.

Coaxial Cable

A cable composed of two insulated conductors—such as a conductor and a shield—whose center axis is the same. Usually this term applies only to cable used in electronic signal circuits.

Cold Bend

A test conducted by wrapping tubing or cable around a mandrel or by bending it in an arc while at a low temperature.

Cold Flow

Permanent deformation of polymeric materials (insulation) at ambient temperature due to mechanical force or pressure (not due to heat softening).

Cold Impact

A test performed by subjecting a component to a specified impact during exposure to low temperature. It measures the brittleness of the material.

Cold Joint

A soldered joint made with insufficient heat. (Solder hasn't completely flowed and wet the substrate.)

Color Code

A means of identifying cable components using solid colors or stripes. Also, the scheme that assigns a number from 0 to 9 for each of 10 colors.

Color Stability

The time and temperature ranges within which the color of a material will remain within the specified color limit.

Component

A wire or cable that is combined with other wires or cables to make a multicomponent cable.

Compound

An insulating or jacketing material made by formulating polymeric materials and additives.

Fax-on-demand

US only (800) 260-9099

Outside US (650) 257-2301

Visit our website at www.tycoelectronics.com

Compound Under Strands (CUS)

A problem that occurs when loose stranding, or overheating during extrusion, allows compounds to get under individual strands of conductor.

Concentric Stranding

A method of stranding conductor. Specifically, the final conductor is built up in layers so that the inner diameter of a succeeding layer is always equal to the outer diameter of the underlying layer.

Concentricity

Ratio (expressed as a percentage) of the thinnest to the heaviest wall thickness. Measured on expanded or recovered tubing, or wire insulation, or jacketing.

Conductivity

The capability of a material to carry electrical current, usually expressed as a percentage of copper conductivity (copper being 100%). Specifically, the ratio of the current flow to the potential difference causing the flow. The reciprocal of resistance.

Conductor

The metallic strand or strands used to carry an electric current.

Conductor Resistance

The resistance to flow of the electrical current along a conductor. Expressed in ohms/1000 feet. (Usually referenced to 20°C).

Conduit

A tubular raceway for holding wires or cables.

Configuration

Arrangement of contacts in a multiple-contact connector.

Connector

A device used to physically and electrically connect two or more conductors.

Connector Classes

Categories based on shape, function, and smallest-size contact in a series.

Connector Insert

In connectors with metal shells, the part that holds contacts in proper arrangement while electrically insulating them from each other and from the shell.

Contact

The element in a connector that makes the actual electrical connection. Also the parts of a connector that actually carry the electrical current, and are touched together or separated to control the flow.

Contact Crimp

A contact whose rear portion is a hollow cylinder that accepts the conductor. A crimping tool is applied to swage or form the contact metal firmly against the conductor. Sometimes referred to as a solderless contact.

Contact Resistance

The direct-current resistance of a pair of mated contacts.

Contact Size

The diameter of the engagement end of a pin contact; also related to the current-carrying capacity of a contact.

Continuity

A continuous path for the flow of current in an electrical circuit.

Continuous Operating Temperature

Maximum temperature at which a component will maintain an acceptable lifetime performance, based on accelerated aging prediction.

Continuous Service

Conditions (time, temperature, environment) that describe the lifetime requirements of a component.

Supporting Information

Glossary (cont'd.)

Core

- 1.) In cables, a component or assembly of components over which additional components, such as a shield or a sheath, are applied.
- 2.) Inner wall of dual-wall heat-shrinkable tubing.

Coupling Ring

The portion of a plug that aids in the mating and demating of a plug and receptacle and holds the plug to the receptacle.

Cover, Electrical Connector

An item specifically designed to cover the mating end of a connector for mechanical and/or environmental protection. Also known as a *dust cover*.

Coverage

A calculated percentage that defines the completeness with which a braid or shield covers the surface of the underlying insulated conductor or conductors.

Crimp

Final configuration of a terminal barrel formed by the compression of the terminal barrel and conductor.

Crimping Die

Portion of the crimping tool that shapes the crimp.

Crimping Tool

Mechanism used for crimping.

Crosslinking

The formation of bonds between molecular chains in a polymer by means of chemical catalyzation or electron bombardment. The properties of the resulting thermosetting material are usually improved.

Crosslinking by Irradiation

A method of crosslinking polymers that makes a nonflowing material. This generally improves the properties of the polymer.

Crosstalk

Signal interference between adjacent conductors caused by a transfer of energy.

Crystallinity

The portion of polymer chains that are ordered in a regular (as opposed to amorphous) structure or a crystal lattice. Crystallinity tends to improve mechanical properties and fluid resistance. Crystalline or semicrystalline materials have a well-defined melting point (shrink temperature) at which the structure becomes disordered and the polymer flows.

CSA (Canadian Standards Association)

An agency that has developed standard specifications for products with particular emphasis on safety in the end use.

Curing

See **Thermoset**.

Current

A movement or flow of electrons. Also, the measure of this flow, expressed in amperes.

Current-carrying Capacity

The maximum current an insulated conductor is capable of carrying without exceeding its insulation- and /or jacket-temperature limitations under specified ambient conditions. Also known as ampacity.

Current Rating

The maximum continuous electrical flow of current for which a device is designed to conduct for a specified time at a specified operation temperature. Usually expressed in amperes.

Cutout

The hole, usually round or rectangular, cut into a metal panel in order to mount a connector. The cutout may also include holes for mounting screws or bolts.

Cut-through Resistance

Resistance of solid material to penetration by an object (typically a closely controlled knife edge) under conditions of pressure, temperature, and other elements.

Fax-on-demand

US only (800) 260-9099

Outside US (650) 257-2301

Visit our website at www.tycoelectronics.com

Dielectric

Any insulating material between two conductors that permits electrostatic attraction and repulsion to take place across it. A material having electrical insulating properties.

Dielectric Breakdown

The voltage required to cause an electrical failure or breakthrough of the insulation. Determined by a destructive test. *See also Breakdown Voltage.*

Dielectric Constant (also K)

The ratio of the capacitance between two electrodes with a solid, liquid, or gaseous dielectric, to the capacitance with air between the electrodes. Also called *permittivity* and *specific inductive capacity*. Generally low values are desirable for insulation.

Dielectric Strength

The maximum voltage a dielectric can withstand without rupture. Usually expressed as volts per mil.

Dielectric Withstand Voltage (DWV)

A test voltage for a wire, cable, or insulation.

Direct Current Resistance (DCR)

The resistance offered by any circuit to the flow of direct current.

Direction of Lay

The lateral direction in which the strands or elements of a cable run over the top of the cable as they recede from the observer. Expressed as right-hand or left-hand lay.

Discontinuity

A broken connection, or the loss of a specific connection characteristic. Also, the temporary interruption or variation in current or voltage.

Dissipation Factor

The ratio between the permittivity and the conductivity of a dielectric.

Drain Wire

In a cable, an uninsulated conductor laid over the component, or components, in a foil-shield cable. Used as a ground connection.

Dust Cover

See Cover, Electrical Connector.

EID

See See Expanded ID.

Elastic Memory

The ability of a crosslinked polymer to be deformed to some predetermined shape, hold that shape for a period, and then return to its original shape upon the application of heat.

Elastomer

A material that exhibits very low or zero crystallinity and a high degree of flexibility (rubber is a synonym).

Elongation

The ultimate elongation, or elongation at rupture. Expressed as a percentage of original length.

EMI

Abbreviation for electromagnetic interference.

Encapsulant

Description related to the way dual-wall tubing products and precoated molded parts melt and flow when heated, filling any void in the area being covered. Unlike an adhesive, an encapsulant does not form a mechanical bond to the substrate.

Encapsulation

Covering and sealing.

End

The number of fibers or strands per carrier in braiding operations.

Environmentally Sealed

Description of a system to keep out moisture, dirt, air, or dust that might reduce performance.

Supporting Information

Glossary (cont'd.)

Epoxy

A family of thermosetting resins usually used as adhesives or encapsulants.

ETFE (Ethylenetetrafluoroethylene)

A fluoropolymer used as base resin for SPEC 55 wire and HCTE.

Expanded ID (EID)

The specified minimum (as supplied) internal diameter of tubing.

Expansion Ratio

An expression of how much larger the inside diameter of a tubing is before shrinking. Specifically, the relationship of the minimum (expanded) inside diameter of tubing to the maximum (recovered) inside diameter, expressed as a ratio. *See also* **Shrink Ratio**.

Extraction Tool

A tool used for removing contacts from a connector body.

Extrusion

A process that conveys plastic insulation material, generally via a screw, through forming dies and subsequently cools the insulation material to form a predetermined shape.

Feedthru (feedthrough)

A bushing in a wall or bulkhead with terminations on one or both sides.

Filler

A material used in a cable construction to fill large interstices, thus providing a round construction; can be shaped, round, or in mastic forms. A nonfunctional member used in a cable to provide a more circular cross section.

Flame-resistant

A descriptor applied to a material that is inherently resistant to burning.

Flame Retardant

A descriptor applied to a material that has been made or treated so as to resist burning.

Flat Braid

A braided shield composed of flat strands.

Flat Cable

A cable with each component in a single, flat plane.

Flat Conductor

A conductor having a rectangular cross section, as opposed to a round or square cross section.

Flex Life

A measure of the susceptibility of a conductor or other device to failure due to fatigue from repeated bending.

Fluoropolymer

A polymer that contains atoms of fluorine.

Flux

A liquid or solid that, when heated, exercises a cleaning and protective action upon surfaces. Used to promote or facilitate fusion during soldering or welding.

Front Release Contacts

Connector contacts that are released from the front side of the connector and then removed from the back, wire side of the connector.

Full Recovery Temperature, Minimum

See **Recovery Temperature**.

Gauge

A term used to denote the physical size of a wire. *See also* **AWG**.

Grounding Conductor

A conductor that provides a current return path from an electrical device to ground.

Fax-on-demand

US only (800) 260-9099

Outside US (650) 257-2301

Visit our website at www.tycoelectronics.com

Hardness

A general term that correlates with strength, rigidity, and resistance to abrasion or penetration. Measured on Shore or Rockwell scales. *See also* **Shore**.

Harness

A system providing electrical connection between two or more points.

Heat Aging

A test that subjects components or materials to temperatures above normal operating values to evaluate changes in performance in order to predict service life. *See also* **Accelerated Aging**.

Heat Shock

A test to determine the stability of a material by continuously exposing it to an extremely high temperature for a short period of time. The test was developed both to demonstrate that the material is crosslinked and to observe any problems in dripping, cracking, or flowing.

Heat-Shrinkable Material

A polymeric material capable of being reduced in size when exposed to heat.

Hertz (Hz)

A measure of frequency equal to one cycle per second.

Hookup Wire and Cable

Wiring used to connect various points in electronic assemblies.

Hot-Melt Adhesive

An adhesive that becomes activated by heating. When heated, it melts, flows over the substrate surface, and forms an adhesive bond. Reheating causes the adhesive to remelt.

ID (Internal Diameter)

The inside or internal diameter of a tubing.

Impedance

The total opposition that a circuit offers to the flow of alternating current or any other varying current at a particular frequency. The ohm is the unit of impedance. Admittance is the reciprocal of impedance.

Impulse Test

A high-voltage test designed to locate pinholes in the insulation of a wire or cable by applying a voltage while the wire or cable is being drawn through an electrode.

Insert Cavity (Connector)

A defined hole in the connector insert into which the contacts are inserted.

Insert

Meltable thermoplastic ring placed within a Solder Sleeve device. Aids in encapsulation and sealing.

Insert (Connector)

Part that holds the contacts in their proper arrangement and electrically insulates them from each other and from the shell.

Insert Arrangement (Connector)

The number, spacing, and arrangement of contacts in a termination assembly.

Insertion Tool (Connector)

A tool used to insert removable contacts into a connector.

Inspection Hole

A hole placed at one end of a contact barrel to permit visual inspection, to ensure that the conductor has been inserted to the proper depth in the barrel prior to crimping or soldering.

Insulated Terminal

A solderless terminal with an insulated sleeve over the barrel to prevent a short circuit in certain installations.

Supporting Information

Glossary (cont'd.)

Insulation, Electrical

A nonconductive material usually surrounding or separating two conductive materials. Often called the dielectric in cables designed for high-frequency use.

Insulation, Thermal

A nonconductive material that prevents the passage of heat.

Insulation Resistance

Minimum electrical resistance permitted between any pair of contacts and between conductors and grounding devices of the same connectors in various combinations. An indication of the insulating properties of a material.

Interconnection

The joining of one individual device with another.

Interstice

In a cable construction, the space or void left between or around the cabled components.

Irradiation

In insulations, the exposure of the material to high-energy emissions for the purpose of favorably altering the molecular structure via crosslinking.

Jackscrew

A screw attached to one half of a two-piece, multiple-contact connector and used to draw both halves together and to separate them.

Jacket

- 1.) A material covering over a wire or cable assembly.
- 2.) Outer covering of a dual-wall heat-shrinkable tubing.

Kapton

DuPont's trade name for polyimide film.

Key (Connector)

A short pin or other projection that slides into a mating slot or groove to guide two parts being assembled.

Keying (Connector)

Mechanical arrangement of guide pins and sockets, keying plugs, contacts, bosses, slots, keyways, inserts, or grooves in a connector housing, shell or insert that allows connectors of the same size and type to be lined up; used in situations where there is danger of making a wrong connection.

Keyway

The slot or groove in which a key slides.

kV (Kilovolt)

A unit equal to 1000 volts.

Kynar

Trade name (of Elf Atochem North America) for polyvinylidene fluoride and its copolymers.

Lacing Cord or Twine

Used for lacing and tying cable forms, hookup wires, cable ends, cable bundles, and wire harness assemblies. Available in various materials and impregnants.

Lanyard

A device, attached to certain quick-disconnect connectors, that permits uncoupling and separation of connector halves by a pull on a wire or cable.

Lay

Refers to direction or sometimes the ratio of lay length to core diameter.

Lay Length

A term used in cable manufacturing to denote the distance of advance of one member, or a group of spirally twisted members in one turn, measured axially. The lay of any helical element of a cable or conductor is the axial length of a turn of the helix of that element.

Life Cycle

A test to determine the length of time before failure in a controlled, usually accelerated environment.

Fax-on-demand

US only (800) 260-9099

Outside US (650) 257-2301

Visit our website at www.tycoelectronics.com

Liner

See **Core**.

Longitudinal Change (Shrink Tubing)

The change in length of tubing when recovered. Expressed in the percent of change from the original length.

Loss

Electrical energy that is dissipated as heat.

Loss Factor

The product of the power factor and dielectric constant of an insulating material.

Lot Number

The number that identifies one production run of material. Also known as a *batch number*.

Low-loss Dielectric

An insulating material that has a relatively low dielectric loss, such as polyethylene or Teflon.

Lug

A termination, usually crimped or soldered to a conductor, that allows connection to be made with a retaining screw.

Marking

A printed identification number or symbol applied to the surface of a wire or cable.

Mate (Connections)

To join connector halves in a normal engaging mode.

Megarad

A unit for measuring radiation dosage.

Melt/Flow Index

Measurement of the flow of thermoplastic material under given conditions of temperature and pressure. Expressed as grams per unit of time.

Melting Point

The temperature at which crystallinity disappears when crystalline material is heated.

Mil

A unit equal to one one-thousandth of an inch (.001"); used in measuring the diameter of a conductor or thickness of insulation over a conductor.

MIL-SPEC

Abbreviation for Military Specification, which is a document the U.S. Government issues to define a product that will be used in military end-use applications.

Milking Off

Action that occurs when the inner layer (the encapsulant or adhesive) of the tubing or molded part acts as a lubricant, allowing the tubing to slip off the substrate (because the tubing wants to recover to a smaller diameter).

Minimum Full Recovery Temperature

See **Recovery Temperature**.

MO (Manufacturing Order)

A series of operation-work-order cards identifying materials to be used and the type and quantity of products to be manufactured. An MO is controlled and issued by Production Control to the manufacturing operation.

MOD Code (Material Modification Code)

A code designating a particular stage in the production process. Most MOD codes describe the way the product is packaged.

Supporting Information

Glossary (cont'd.)

MS (Manufacturing Specification)

A set of process instructions used in the manufacturing of tubing products. Customer Logistics, Product Management, or Manufacturing Engineering initiate the MS; Manufacturing Engineering controls it. The product design and quality parameters are provided to Manufacturing Engineering by Product Development and Quality Assurance. Successful trial runs of a new product or design usually precede the initiation of an MS (see **SMO**). A proprietary Raychem document, an MS is not available to customers.

Multiconductor

More than one component within a single-cable complex.

Multiple-Conductor Cable

A combination of two or more components cabled together.

Nick

A small cut or notch in conductor strands or insulation.

Nominal

A descriptor applied to a dimension representing the center of the range of tolerance or a value if no tolerance is applied.

OFT (Optional Flame Test)

Canadian Standards Association's test for flame-retardance. Tubing with an OFT rating is highly flame-retardant.

Ohm

The unit of electrical resistance.

Operating Temperature

The maximum internal temperature at which a system, harness, or connector may operate in continuous service; generally expressed as a time and temperature.

Operating Temperature Range

The range between the maximum and the minimum internal temperature of insulation in a system, harness, or connector in continuous service. The lower limit is determined by low-temperature flex test.

Optional Flame Test

See **OFT**.

Packaging

The process of physically locating, connecting, and protecting devices or components.

Panel

The side or front (usually metal) of a piece of equipment on which connectors are mounted.

Panel-mount

Method of fixing one-half of a connector to a board, panel, or frame. Usually, the female half of the connector is the mounted portion and the male half is the removable portion.

PC (Production Control)

Group responsible for directing and regulating the movement of goods through the entire manufacturing cycle, from the requisitioning of raw materials to the delivery of the finished products.

PCN

See **RPN**.

Peripheral Seal

A seal provided around the periphery of connector inserts to prevent the ingress of fluids or contaminants at the perimeter of mated connectors.

Permittivity

See **Dielectric Constant**.

Pick

The number of crossovers of braiding units per inch of cable.

Fax-on-demand

US only (800) 260-9099

Outside US (650) 257-2301

Visit our website at www.tycoelectronics.com

Pigtail

A short conductor or wire extending from an electrical or electronic device to serve as a jumper or ground connection.

Pin Contact

An electrical terminal, usually in a connector. Normally a smaller termination than a lug.

Plastic Deformation

Change in dimensions under a load that does not recover when the load is removed.

Plasticizer

A softener or lubricant added to a compound to make it easier to process or more flexible in use.

Plating

The overlaying of a thin coating of metal on metallic components to improve conductivity, facilitate soldering, or prevent corrosion.

Plug

The part of a connector that is normally “removable” from the other, permanently mounted part; usually that half of a two-piece connector that contains the pin contacts.

Plug Connector

An electrical connector that is intended to be attached to the free end of a conductor, wire, cable, or bundle, and that couples or mates to a receptacle connector.

Poke Through

A term describing stray wires in a solder joint that poke through the insulation.

Polarization (Connectors)

A mechanical arrangement of inserts or the shell configuration (referred to as clocking in some instances) that prohibits the mating of mismatched plugs and receptacles. *See also* **Clocking**.

Polyamide

A polymer formed by the reaction of a diamine and a diacid. Nylons are commercial polyamides characterized by toughness, solvent resistance, and sharp melting point.

Polymer

A material of high molecular weight formed by the chemical union of monomers.

Polyolefin

A family of polymers (such as polyethylene and polypropylene) made from olefin monomers.

Potting

The permanent sealing of the cable end of a connector with a compound or material that thermosets into an elastomer, to exclude moisture and/or to provide strain relief.

Pre-etching

The act of surface preparation before encapsulating.

Pretinned

Description of an electrical component to which solder has been applied prior to soldering.

Pretinned Solder Cup

Solder cup whose inner surfaces have been precoated with a small amount of solder.

Preform

Usually, the solder ring in a SolderSleeve device.

Primary Insulation

The inner member of a dual-wall wire insulation. The insulation applied directly on the conductor. Also referred to as the core. *See also* **Core**.

Push-back

That property of a braid or shield that allows the braid or shield to be pushed back easily along the cable core.

Supporting Information

Glossary (cont'd.)

PVC (Polyvinyl chloride)

A polymer compound used as wire insulation.

PVDF

Polyvinylidene fluoride.

Quality Assurance

Systematic, planned, and documented activities designed to provide confidence that a product will meet specifications.

Quality Control

Activities that monitor, measure, and control the characteristics of a material, component, or product to documented specifications.

Quick Disconnect

A type of connector shell that permits rapid locking and unlocking of two connector halves.

RA Flux

Rosin-activated flux.

Radiation Crosslinking

The act of crosslinking a material with ionizing radiation. (Most Raychem products are radiation crosslinked, with an electron beam as the form of ionizing radiation.) *See also* **Crosslinking by Irradiation**.

Rated Temperature

The maximum temperature at which a component can operate for extended periods with acceptable changes in its basic properties.

Rated Voltage

The maximum voltage at which an electric component can operate for extended periods without undue degradation.

Rear Release Contacts

Connector contacts designed to be released and removed from the rear (wire side) of the connector. The removal tool engages the contact from the rear and pulls the contact out of the connector contact retainer.

Receptacle

Usually the fixed or stationary half of a two-piece multiple contact connector. Also the connector half usually mounted on a panel and containing socket contacts.

Recover (Heat-shrinkable Components)

Activation of the elastic memory principle (usually with heat) to cause a tubing or molded part to return to its original size.

Recovered ID (RID)

In heat-shrink tubing, the guaranteed maximum internal diameter of tubing after being freely recovered.

Recovery Temperature

The minimum temperature required to fully shrink a product, that is, for the product to recover completely.

Removable Contact

A contact that can be mechanically joined to or removed from an insert. Usually special tools are required to lock the contact in place or remove it for repair or replacement.

Resistance

A measure of the difficulty in moving electrical current through a conductor or insulation when a voltage is applied. It is measured in ohms.

Ribbon Cable

Flat cable with conductors that have been individually insulated together. Its structure is usually characterized by individual colors of insulation for each conductor, although a single color may be used for all conductors.

Fax-on-demand

US only (800) 260-9099

Outside US (650) 257-2301

Visit our website at www.tycoelectronics.com

RID

See **Recovered ID**.

RMA Flux

Rosin-mildly-activated flux.

Rope Lay

A type of conductor lay that uses stranded conductors as components to build a larger conductor.

RPN (Raychem Product Number)

A 10-digit number (such as 123456-4-001) assigned to every standard product and every product manufactured on a special manufacturing order (SMO). The first 6 digits represent the PCN (Product Control Number), followed by a 1-digit MOD Code, and finally a 3-digit suffix. *See also* **MOD Code and SMO**.

RT and RW specifications

Specification that describes standard product properties. Qualification and acceptance inspection criteria are incorporated into RT and RW specifications. RT and RW specifications are issued and controlled by the Specifications Group.

SCD (Specification Control Drawing)

Drawing that defines configuration and material parameters. Issued and controlled by the specifications group. SCDs are frequently used in conjunction with RT Specifications for Thermofit products.

Scoop-proof

A feature that prevents the damage of contacts during misaligned mating.

Sealant

Soft, tacky, pliable material that seals where mechanical strength is not required.

Sealed

Environmentally protected by the thermoplastic inserts or core of encapsulant/adhesive that has melted down around the substrate.

Sealing Plug

A plug that is inserted to fill an unoccupied contact aperture in a termination assembly.

Secant Modulus

A measure of material stiffness; stiffer material has a higher secant modulus. More specifically, the secant modulus is the ratio of stress (nominal) to corresponding strain at any specified point on the stress-strain curve. It is expressed in force per unit area (usually kilograms per square centimeters or pounds per square inch), and reported together with the specified stress or strain.

Service Life

Period of time during which the product is expected to perform satisfactorily.

Service Loop

The extra cable required at a breakout to facilitate maintenance and servicing.

Service Rating

The maximum voltage or current that a termination is designed to carry continuously.

Shelf Life

Generally, the length of time a product or material may be stored without deterioration. Specifically, the length of time during which shrink tubing will retain its expanded ID and return to its recovered ID. Usually not a concern—except for some “amnesic” materials. *See* **Amnesia**.

Supporting Information

Glossary (cont'd.)

Shell (Connector)

The outside case, usually metallic, into which the insert (body) and contacts are assembled. Shells of mating connector halves usually provide for proper alignment and polarization as well as for protection of projecting contacts.

Shield

A conducting layer placed around an insulated conductor or cable to limit the penetration, or escape, of electric or electromagnetic fields, thereby preventing electromagnetic interference. The shield may be formed of metallic braid, metal tape, metal-backed foil, metal tube, or conductive polymer. Usually grounded, the shielding is carried through the connector shell, or through a special internal shell in the case of individual coaxial contacts.

Shielding

See **Shield**.

Shielding Effectiveness (SE)

The reduction in field strength resulting from interposing a metallic barrier between a source and receptor of electromagnetic energy.

Shore

A scale for comparing hardness. Higher Shore values represent harder materials. The hardness of a polymer, for example, is usually represented as Shore A or Shore D, with D being harder.

Shrink Ratio

An expression of how much the inside diameter of shrink tubing will reduce in size when recovered. The inverse of the expansion ratio. See also **Expansion Ratio**.

Shrink Temperature, Minimum

The minimum temperature at which a product begins to recover.

Signal Cable

A cable designed to carry current of less than 12 amperes per conductor.

Skew

Any out-of-squareness of the cut end of a piece of tubing after shrinking.

SMO (Special Manufacturing Order)

An order to evaluate manufacturing and production capability for a new or changed design for a customer and to provide development samples of potential products for customers. SMO products are separate and distinct from standard products. New, potential products are usually run as SMO products for a minimum of three times before being considered for manufacture as a standard product.

Solder

An alloy that melts at relatively low temperatures and is used to join metals with higher melt points.

Solder Contact

A contact or terminal having a cup, hollow cylinder, eyelet, or hook to accept a wire for a conventional soldered termination.

Solder Cup

A tubular end of a terminal into which a wire conductor is inserted prior to being soldered.

Solderability

The property of a metal surface that allows it to be readily wetted by molten solder. See also **Wetting**.

Soldering

A process of joining metallic surfaces with solder without melting the base metal.

SolderSleeve Device

A device of flux-coated solder preform encapsulated in a heat-recoverable plastic sleeve. Upon the application of heat, the flux and solder will melt and flow as the sleeve recovers, forcing the solder around and onto the metallic parts being joined, thus forming an electrically insulated and strain-relieved joint.

Fax-on-demand

US only (800) 260-9099

Outside US (650) 257-2301

Visit our website at www.tycoelectronics.com

Solid Conductor

A conductor composed of one single strand.

Solvent Resistance

The ability of a material to retain physical and electrical properties after being immersed in specific solvents.

SPC

Silver-plated copper.

SPC (Statistical Process Control)

The use of statistical techniques such as control charts to analyze a process or its output so as to take appropriate actions to achieve and maintain a state of control and to improve the capability of the process.

Specific Gravity

The ratio of the density (mass per unit volume) of a material to that of water.

Specific Inductive Capacity

See Dielectric Constant.

Splice

A joint connecting conductors with good mechanical strength and conductivity; a terminal that permanently joins two or more wires.

Strain Relief

The technique for or act of removing or lessening the strain or stress on a joint, splice, or termination. Solder Sleeve devices provide strain relief.

Strain Relief Clamp

See Cable Clamp.

Strand

A single unit of a conductor.

Stranded Conductor

A conductor composed of more than one single strand. The strands in stranded conductors are usually twisted or braided together.

Strip

To remove insulation from a wire or cable.

Stripe

A continuous longitudinal or spiral color strip applied on the surface of a wire, cable, or tubing for identification.

Substrate

The material—such as a wire, post, or tab—over which an interconnection device is used.

Surface Resistance

The ratio of the direct current applied to an insulation system to the current that passes across the surface of the system.

Tape Wrap

A term denoting a spirally or longitudinally applied tape material wrapped around insulated or uninsulated wire and used as a mechanical barrier.

TC

Tinned copper.

Tear Test

A test to determine the tear strength of an insulating material. Usually includes exposure to given thermal conditions or a programmed series of conditions for prescribed periods of time.

Temperature Rating

The maximum temperature at which the insulating material may be used in continuous operation without loss of its basic properties. Usually time dependent.

Tensile Strength

The pull stress (in force per unit area) required to break a given specimen.

Supporting Information

Glossary (cont'd.)

Thermal Rating

The effect of heat or cold applied at such a rate that nonuniform thermal expansion or contraction occurs within a given material or combination of materials. In electrical terminations, the effect can cause inserts and other insulation material to pull away from the metal parts.

Thermal Shock

The effect of high and low temperatures applied at a rapid rate such that nonuniform thermal expansion or contraction occurs within a given material or combination of materials. The result could be stress-cracking or shattering of material.

Thermochromic Indicator

Special compound that changes color when the proper wetting temperature has been reached in the solder joint.

Thermoplastic

A material that softens (melts and flows) when heated and becomes firm when cooled. A type of plastic that can be remelted a number of times without any important change in properties. Nylon, GE's Lexan, and PVC—examples of this type of plastic—are resilient after molding.

Thermoset

A material that hardens or sets when heated and, once set, cannot be resoftened by heating. This application of heat is called "curing."

Thermosetting Plastic

A type of plastic in which an irreversible chemical reaction takes place while the plastic is being molded under heat and pressure.

Thermosetting Adhesive

A curing adhesive that requires heat to promote curing. This type of plastic will not soften when reheated. *See* **Epoxy**.

Tolerance

The total amount by which a quantity is allowed to vary from nominal; thus, the tolerance is half the algebraic difference between the maximum and minimum limits.

Traceability

The ability to trace the history, application, or location of an item and like items or activities by means of recorded identification. The lot number/manufacturing order (MO) number, or SMO number used to identify items or groups of items is traceable back to inspection and procurement records.

Transmission Cable

Two or more transmission lines. If the structure is flat, it is sometimes called flat transmission cable to differentiate it from a round structure such as a jacketed group of coaxial cables. *See also* **Transmission Line**.

Transmission Line

A signal-carrying circuit with controlled electrical characteristics; used to transmit high-frequency or narrow-pulse signals.

Triaxial Cable

A concentrically constructed cable, with a common axis, composed of a center conductor, first shield, and second shield, all insulated from each other.

UL (Underwriters' Laboratories)

A nonprofit independent testing organization that operates a listing service for electrical and electronic materials and equipment.

Ultraviolet Degradation

The degradation caused by long-time exposure of a material to sunlight or other ultraviolet rays.

Fax-on-demand

US only (800) 260-9099

Outside US (650) 257-2301

Visit our website at www.tycoelectronics.com

Velocity of Propagation

The ratio of the speed of a radio frequency wave within a cable or dielectric as compared with the same wave in free space.

Voltage

The term most often used in place of electromotive force, potential, potential difference, or voltage drop to designate the electric pressure that exists between two points and that is capable of producing a current when a closed circuit is connected between the two points.

Voltage Breakdown

The voltage necessary to cause insulation failure.

Voltage Drop

Loss of voltage through a connection or conductor.

Voltage Rating

The voltage that may be continuously applied to wire.

Volume Resistivity

Reciprocal of conductivity; the resistance of a material to the flow of electrical current, usually expressed in ohm-cm.

VSWR (Voltage Standing Wave Ratio)

A measure of the uniformity of impedance along a transmission line, or the quality of the impedance match between a line and the source or load.

VW-1

A rating determined by the Underwriters' Laboratories' (UL) optional Vertical Wire Flame Test—the most difficult flame test for tubing. Tubings with a VW-1 rating are highly flame-retardant.

Wall Thickness

The thickness of the applied insulation or jacket.

Water Absorption Test

A method to determine the water uptake of a material. It is time and temperature dependent.

Water Blocking

The sticking together of insulated wires; usually caused by heat.

Wetting (Solder)

The formation of a relatively uniform, smooth, unbroken, and adherent film of solder to a base metal. Also, the free flow of solder alloy, with proper application of heat and flux, on a metallic surface to produce an adherent bond.

Wicking

The longitudinal flow of a liquid in a wire or cable construction due to capillary action. (This may also apply to solder.)

Wire

A single conductor covered with insulation.

Wire Dress

The orderly arrangement of wires and laced harnesses.

Withstanding Voltage

The test voltage an electrical connector can withstand for one minute without showing evidence of electrical breakdown when the voltage is applied between conductors and grounding devices of the connectors in various combinations.

Supporting Information

Index

Product or Part Number	Page Number	Product or Part Number	Page Number
-3	4-26	301A511 to 514	4-99
-4	4-28	322A112 to 158	4-100
-12	4-30	342A012 to 058	4-102
-25	4-32	362A014 to 114	4-104
-25S	4-34	381A301 to 304	4-105
-50	4-36	382A012 to 046	4-106
-51	4-38	382C312, 322 & 332	4-108
-55	4-40	400W242	4-122
-71	4-42	462A011 to 060	4-110
-100	4-44	462A421 to 424	4-112
-100S	4-46	562A011 to 067	4-114
-125	4-48	7724 E 2664	8-87
101A011 to 094	4-50	10612	8-87
SSC	4-52	10613	8-87
202A111 to 196	4-54	10614	8-87
202C611 to 663	4-56	AA-400 Super Heater	10-0
202D121 to 196	4-58	AD-1319-9	10-2
202D211 to 299	4-60	AD-1377, AD-1522	10-4
202D921 to 963	4-62	AD-3050-SEAL-TEST-EQUIP	10-6
202F211 to 274	4-63	AD-5000 and RH-396X	10-8
202G211 to 253	4-64	AD5010-Tinel-Bench-230V	10-10
202G611 to 653	4-66	Adhesives	5-0–5-7
202K121 to 185	4-68	AFR	9-106
202W302 to 342	4-120	ATUM	3-2
207W213 to 256	4-96	B-02X/04X	8-56–8-57
214A011 to 052	4-70	B-046	8-58–8-59
214A311 to 352	4-72	B-106	8-28
214P009 to 037	4-74	B-202	8-72
222A111 to 196	4-76	BSTS/BSTS-FR	3-4
222D121 to 196	4-78	CES	4-124
222D211 to 299	4-80	CGPT	3-6
222D921 to 963	4-82	Cheminax	9-74
222F211 to 285	4-84	Cheminax coaxial cables	9-74
222K121 to 185	4-86	Cheminax twin axial cable	9-80
234A011 to 071	4-88	Code 18 MIL-C-5015 (MS3100)	6-34
234A111 to 152	4-90	Code 21 MIL-C-26482 Series 1	6-44
234A611 to 671	4-92	Code 32 MIL-C-22992	6-54
242W042 to 63	4-94	Code 40 MIL-C-38999 Series III and IV	6-60
301A011 to 048	4-98	Code 41 MIL-C-38999 Series I and II	6-70

Fax-on-demand

US only (800) 260-9099

Outside US (650) 257-2301

Visit our website at www.tycoelectronics.com

Product or Part Number	Page Number	Product or Part Number	Page Number
Code 47 PAN6433-2	6-80	ES2000 tubing	3-18
Code 54 MIL-C-5015 (MS3400), MIL-C-26482 Series 2, MIL-C-83723 Series I and III, MIL-C-81703 Series III	6-82	ES Caps	3-20
Code 76 BS 9522 F0017 (Pattern 105)	6-96	FDR 25	9-90
CRN	3-8	FLDW (FlexLite DW)	9-52
CV-1981, CV-1983	10-12	FlexLite DW	9-52
CWT-4XXX	8-56—8-57	FlexLite HM	9-50
CWT-15XX	8-42—8-45	FlexLite HT	9-56
CWT-900X	8-5	FlexLite TW	9-54
D-71X	8-43	FlexLite TX	9-58
D-110	8-5	FLHM (FlexLite HM)	9-50
D-129	8-43	FLHT (FlexLite HT)	9-56
D-141	8-43	FLT	9-60
D-150	8-70, 8-107	FLTW (FlexLite TW)	9-54
D-406	8-20	FLTX (FlexLite TX)	9-58
D-500	8-88—8-90	FR-1000 cable	9-18
D-600	8-107	FTR	9-107
D-602	8-76, 8-77	HCTE	3-22
D-607	8-58	Hexashield	8-110
D-621	8-96—8-97, 8-106—8-107	HF	3-26
D-1744	8-5	HL1802E/HL2005E	10-14
Data bus accessories	8-106	HRHF/HRNF/HRSR	3-28
Data bus box couplers	8-94	HTAT	3-30
Data bus cables	8-86	IR-1891	10-16
Data bus customer-specified harness assemblies and <i>HarnWare</i>	8-104	IR-550 Mark II	10-18
Data bus discrete connectors	8-96	KTKK product family overview	7-0
Data bus space-grade components	8-100	KTKK product selection table	7-3
Data bus triaxial size 8 contacts	8-98	LSTT	3-32
Data bus ultra lightweight in-line microcouplers	8-92	M835 19	8-50—8-53
DCPT	3-10	MicroFit	3-34
DR-25	3-12	IR-1759 MiniRay	10-20
DuraSeal crimp terminals and disconnects	8-28	MiniSeal crimp splices	8-22
DuraSeal crimp splices	8-20	Model 16B	10-22
DWP-125	3-14	Model 19	10-24
ElectroLoss Filterline wire	9-68	Model 81CE	10-26
ES1000 tubing	3-16	Model 105	10-28
		MT1000	3-36
		MT2000	3-38
		MT3000	3-40
		MT5000	3-42

Supporting Information

Index (cont'd.)

Product or Part Number	Page Number	Product or Part Number	Page Number
MTC Crimp Connectors	8-116	SCL	3-76
Multiconductor, custom-designed, (multi) cables	9-84	SCT	3-78
Multiconductor (multicore) cables	9-86	Sealite SL105 cable	9-26
NT/NTFR	3-44	SESK (Shipboard Electrical Splice Kits)	7-14
PD Caps	3-46	SFR	3-80
QFT™	4-116	SGRP	8-12—8-19
RayBlock 85	3-48	SGRS	8-12—8-19
RayBlock 105	3-50	SGRT	8-34
Rayflex	3-52	Ship or Shore breakout kits	7-18
Rayflex PETM	3-54	shrinkHOoP	4-132
RayOLOnKits	4-130	SO63	8-48—8-49
Rayrim	3-56	SO96	8-48—8-51
Raythane, Neoprene, Rayolin, AFR	9-100	SolderGrip self-fixturing insulated terminals	8-34
RBD	8-60, 8-62	SolderGrip closed end connector splices	8-12
RBK-ILS-Processor MkII	10-30	SolderShield shielded and coaxial cable splices	8-70
RF one-step BNC/TNC connectors	8-60	SolderSleeve discrete wire terminators	8-42
RNF-100	3-58	SolderSleeve coaxial cable terminators	8-56
RNF-150	3-60	SolderSleeve PCB/coaxial cable terminators	8-58
RNF-3000	3-62	SolderSleeve shield terminators	8-48
RP-4800	3-64	SolderSleeve wire splices	8-4
RPPM	3-66	SolderTacts shielded one-piece solder contacts	8-76
RT-3	3-68	SPEC 44 wire	9-0
RT-375	3-70	SPEC 55 wire	9-8
RT-555	3-72	SRFR	3-82
RTD	8-60, 8-62	SSB, T, F to 8S	4-118
RW-175	3-74	SST/SST-FR	3-84
S-1006	5-2	TAT-125	3-86
S-1009	5-2	TCFS/R cable feedthroughs	7-8
S-1017	5-2	TFE and TFE-R	3-88
S-1030, S-1048, S-1275 (Rayaten)	7-12	Thermocouple	9-64
S-1124	5-2	ThermoGun HG	10-32
S-1125	5-2	Thermorad HTF/Fluoroelastomer	9-96
S-1255	5-2	Thermorad/Thermorad F	9-98
S-1278	5-2	TPEM	3-90
S-1297	5-2	TR	9-106
S-1305	5-2	TUGA-GP	3-92
S01	8-48, 8-53	Type 99M	9-36
S02	8-48, 8-53		

Fax-on-demand

US only (800) 260-9099

Outside US (650) 257-2301

Visit our website at www.tycoelectronics.com

Product or Part Number	Page Number
Versafit	3-94
Versafit V	3-96
Versafit V2	3-98
Versafit V4	3-100
Viton (E, HW, TW)	3-102
XFFR	3-104
XL Products	4-136
Zerohal	9-92
Zerohal 100A	9-40
Zerohal 100G	9-44
ZH-100	3-106
ZHI	9-106
ZHTM	3-108

The following are trademarks of E.I. du Pont de Nemours and Company: Kevlar, Mylar, Neoprene, Teflon, Tefzel, Viton.

The following is a trademark of Elf Atochem North America, Inc.: Kynar.

The following are trademarks of Hoskins Manufacturing Company: Alumel, Chromel.

The following is a trademark of Monsanto Company: Skydrol

The following are trademarks of Rambus Inc.: Direct RDRAM, Direct Rambus, Rambus, RIMM.

The following is a trademark of Exxon Corporation: Coolanol

The following is a trademark of General Electric Corporation: Lexan

The following is a trademark of INCO Alloys International Inc.: Monel

The following are trademarks of Tyco Electronics Corporation: ATUM, Altera, Autosize, BiAlloy, CES, Cheminax, Convolex, dBseal, DR-25, DuraLite, DuraSeal, Dynalink, Electrical Screening, ElectroLoss, FDR 25, Filterline, FlexLine, FlexLite, GelTek, HCTE, HL 1802, HTAT, HarnWare, KTKK, HeatPath, IR-1891, LMx 2000, LMx 3000, LSTT, Maulflex, MicroFit, Mini-Gun, MiniRay, MiniSeal, PinPak, RNF-100, RNF-3000, RPPM, RW-175, Ray 101, Rayaten, RayBlock, Raychem, Rayflex PETM, Rayfoam, RayMark, Rayolin, RayOLON, Rayrim, Raythane, Readyprint, SRFR, SeaLite, Smartring, SolderGrip, SolderPak, SolderShield, SolderSleeve, SolderTacts, SPEC 44, SPEC 55, SPEC 62, System 100, System Six, TPEM, Thermofit, Thermoform, ThermoGun, Thermorad, Tinel, Tinel-Lock, TMS, TMS TOTAL, Type 99, Type 99M, Uniboot, Versafit, VersaThin, Zerohal.

All information, including illustrations, is believed to be reliable. Users, however, should independently evaluate the suitability of each product for their application. Tyco Electronics Corporation makes no warranties as to the accuracy or completeness of the information, and disclaims any liability regarding its use. Tyco Electronics Corporation's only obligations are those in the Standard Terms and Conditions of Sale for these products and in no case will Tyco Electronics Corporation be liable for any incidental, indirect or consequential damages arising from the sale, resale, use, or misuse of the product. Tyco Electronics Corporation Specifications are subject to change without notice. In addition, Tyco Electronics Corporation reserves the right to make changes in materials or processing without notification to the Buyer which do not affect compliance with any applicable specification.