



User's Manual

Code 85184C - Edition 04 - 07/2010

INDEX

1. GENERAL INFORMATION	4
1.1 General information	4
1.2 Copyright	Errore. Il segnalibro non è definito.
1.3 Correct use	Errore. Il segnalibro non è definito.
2. MELT SENSOR AND THE MODELS	Errore. Il segnalibro non è definito.
2.1 Melt Sensor	Errore. Il segnalibro non è definito.
2.2 Models	5
3. TECHNICAL DATA	7
4. WEIGHT AND MECHANICAL DIMENSIONS	24
4.1 Weight	24
4.2 Specific filling liquid	24
4.3 Mechanical dimensions	24
5.1 Instruction and maintenance (Installation hole)	25
5.2 Instruction and maintenance (Sensor installation procedure)	27
5.3 Instruction and maintenance (Mechanical dimensions of transducer / drilling)	28
6. INSTALLATION AND ELECTRICAL CONNECTIONS	29
6.1 General precautions	29
6.2 Transmitters with digital output	29
6.3 Transmitters with amplified analog output	30
6.4 Transducers with non-amplified analog output	33
6.5 Protection for outdoor installations of analog sensors	34
6.6 Standard reference	35
6.7 EMC and RoHS Requisites	36
7. ON-BOARD FUNCTION	37
7.1 Autozero function	37
7.2 Fine-Autozero function	38
7.3 Calibration function	38
7.4 Autospan	39
7.5 Partial reset of the calibration values	39
7.6 Total reset of the calibration values	39
8. AUTOCOMPENSATION FUNCTION	40
8.1 Output signal trend as a function of temperature effect	40
9. MAINTENANCE	41
9.1 Maintenance	41
9.2 Transport, storage and disposal	Errore. Il segnalibro non è definito.
10. SAFETY	Errore. Il segnalibro non è definito.
11. CERTIFICATIONS	44
12. RESOLUTION PROBLEMS	51
13. APPENDIX A: OPERATING PRINCIPLE	52
13.1 Mechanical construction and operation	52
13.2 Strain gauge	52
14. APPENDIX B: IP PROTECTION	54
15. APPENDIX C: GUIDE TO SELECTION OF THE DIAPHRAGM IN CONTACT WITH EXTRUDED POLYMER	55
16. APPENDIX D: ACCURACY CLASS	56
16.1 Calibration curve	56
16.2 Repeatability	56
16.3 Hysteresis	57
16.4 Linearity	57
17. APPENDIX E: HAZARDOUS AREAS	59
17.1 Applications in hazardous areas	59
17.2 European Directive ATEX	60
17.3 North America Factory Mutual	62
18. APPENDIX F: MELT SENSORS WITH CANopen OUTPUT	63

1. GENERAL INFORMATION

1.1 General information

This manual refers to the following products:

M3, ME, MN, MX, MX4, MF, MD, M5, M6, W3, WE, WN, WX, WF, WD, W6, K3, KE, KN, KD and must be kept near the equipment for easy reading and consultation.

It must be read, understood, and strictly follow in order to avoid and prevent accidents and/or malfunctions.

Gefran will not be liable for any injury to people and/or damage to property deriving from disregard of this manual.

1.2 Copyright

Any reproduction of this document, even partial or for internal use, requires Gefran's approval.

1.3 Correct use

Gefran Melt pressure sensors with amplified or non-amplified electrical output are designed and built to measure the pressure and temperature variable of melted plastic at different temperatures according to the filling fluid used.

The correct temperature range is:

- Up to 315°C, for W sensors series
- Up to 400°C, for M sensors series
- Up to 538°C, for K sensors series

If the sensors are used as a safety component in accordance with the Machinery Directive, the equipment builder must take all necessary precautions to ensure that any malfunctions of the Melt pressure sensor do not cause injury to people and/or damage to property.

2. MELT SENSOR AND THE MODELS

2.1 Melt Sensor

Gefran Melt sensors are pressure/temperature transducers and transmitters designed for use in high-temperature environments.

They read media pressure up to a temperature of 538°C, and resist such high temperatures thanks to their special mechanical construction, in which the measurement element is isolated from the Melt.

The constructive principle is based on hydraulic transmission of pressure; mechanical strain is transferred by means of a non-compressible transmission liquid.

The liquid used in these sensors may be mercury (series M), FDA-approved oil (series W) or NaK (series K).

Strain gauge technology translates the physical quantity (pressure) into an electrical signal.

Four different designs are available: rigid rod, flexible sheathing, flexible plus thermocouple, and exposed tip.

Gefran Melt sensors satisfy all installation and field requirements.





The sensors can read an extremely wide range of pressures: from a version with minimum range of 0-17 bar up to a version with a scale of 0-2000 bar.

All models in the catalog can be supplied in two different classes of accuracy: class M, with accuracy of 0.5% FSO, and class H, with accuracy of 0.25% FSO.





mV/V, 4-20mA, 0-10V, 0-5V, and CANopen output signals, and Atex and Factory Mutual versions complete the packet of solutions available for all architectures now utilized for plastics processing machines.

2.2 Models





3.33mV/V OUTPUT

<i>Rigid stem</i> M30 (mercury) W30 (oil) K30 (NaK)	<i>Flexible stem</i> M31 (mercury) W31 (oil) K31 (NaK)	<i>Flexible stem+Thermocouple</i> M32 (mercury) W32 (oil) K32 (NaK)	<i>Exposed tip</i> M33 (mercury) W33 (oil) K33 (NaK)
			





4-20mA CURRENT OUTPUT

<i>Rigid stem</i> ME0 (mercury) WE0 (oil) KE0 (NaK)	<i>Flexible stem</i> ME1 (mercury) WE1 (oil) KE1 (NaK)	<i>Flexible stem+Thermocouple</i> ME2 (mercury) WE2 (oil) KE2 (NaK)	<i>Exposed tip</i> ME3 (mercury) WE3 (oil) KE3 (NaK)
			



0-10V VOLTAGE OUTPUT

<i>Rigid stem</i> MN0 (mercury) WN0 (oil) KN0 (NaK)	<i>Flexible stem</i> MN1 (mercury) WN1 (oil) KN1 (NaK)	<i>Flexible stem+Thermocouple</i> MN2 (mercury) WN2 (oil) KN2 (NaK)	<i>Exposed tip</i> MN3 (mercury) WN3 (oil) KN3 (NaK)
			



DIGITAL OUTPUT CANopen DP404

<i>Rigid stem</i> MD0 (mercury) WD0 (oil) KD0 (NaK)	<i>Flexible stem</i> MD1 (mercury) WD1 (oil) KD1 (NaK)	<i>Flexible stem+Thermocouple</i> MD2 (mercury) WD2 (oil) KD2 (NaK)	<i>Exposed tip</i> MD3 (mercury) WD3 (oil) KD3 (NaK)
			

GUAGE OUTPUT – ANALOG DISPLAY





<i>Rigid stem</i> M50 (mercury)	<i>Flexible stem</i> M51 (mercury)	<i>Flexible stem + Thermocouple</i> M52 (mercury)
		

GAUGE OUTPUT – DIGITAL DISPLAY – RETRANSMISSION 4-20mA

<p><i>Rigid stem</i> M60 (mercury) W60 (oil)</p>	<p><i>Flexible stem</i> M61 (mercury) W61 (oil)</p>	<p><i>Flexible stem + Thermocouple</i> M62 (mercury) W62 (oil)</p>
		





(ATEX Certification)

Intrinsic Safety protection – 4-20mA electrical current output

<p><i>Rigid stem</i> MX0 (mercury) WX0 (oil)</p>	<p><i>Flexible stem</i> MX1 (mercury) WX1 (oil)</p>	<p><i>Flexible stem + Thermocouple</i> MX2 (mercury) WX2 (oil)</p>
		
<p><i>Exposed tip</i> MX3 (mercury) WX3 (oil)</p>	<p><i>Flange stem</i> MX4 (mercury)</p>	
		

(FACTORY MUTUAL Certification)

Explosionproof protection – 4-20mA electrical current output

<p><i>Rigid stem</i> MF0 (mercury) WF0 (oil)</p>	<p><i>Flexible stem</i> MF1 (mercury) WF1 (oil)</p>
	
<p><i>Flexible stem + Thermocouple</i> MF2 (mercury) WF2 (oil)</p>	<p><i>Exposed tip</i> MF3 (mercury) WF3 (oil)</p>
	

3. TECHNICAL DATA

**MELT PRESSURE TRANSDUCERS
M30/M31/M32/M33 series**

Main features

- Pressure range: from 0-35 to 0-2000 bar / from 0-500 to 0-30000 psi
- Accuracy: < ±0.25% FSO (H); < ±0.5% FSO (M)
- Fluid-filled system for temperature stability
- Mercury filling volume: M30 series (30mm³) - M31/M32/M33 series (40mm³)
- 1/2-20UNF, M18x1.5 standard threads, other types available on request
- Standard diaphragm is 15-5PH stainless steel with GTP coating
- 17-7PH corrugated diaphragm with GTP coating for ranges below 100bar (1500psi)

Accuracy (1)	H < ±0.25% FSO (100...2000 bar) M < ±0.5% FSO (35...2000 bar)
Resolution	Infinite
Measurement range	from 0...35 to 0...2000 bar (from 0...500 to 0...30000 psi)
Maximum overpressure	2 x FS 1.5 x FS above 1000bar/1500psi
Measurement principle	Extensimetric
Power supply	6...12Vdc (10Vdc typical)
Strain gauge bridge resistance	350 Ohm (550 Ohm below 100bar/1500psi)
Isolation resistance (at 50Vdc)	> 1000 MOhm
Full Scale Output (FSO) (tolerance ±0.5%FSO)	2.5mV/V (option 2) 3.33 mV/V (option 3)
Zero balance	±0.5%FSO
Calibration signal	80%FSO
Compensated temperature range	0...+100°C / 32...212°F
Maximum temperature range	-30...+120°C / -22...+250°F
Thermal drift in compensated range: Zero/Calibration/Sensibility	< 0.02% FSO/°C < 0.01% FSO/°F
Diaphragm maximum temperature	400°C / 750°F
Zero drift due to change in process temperature	0.02bar/°C 15psi/100°F
Standard material in contact with process medium	Diaphragm: 15-5PH with GTP coating 17-7PH corrugated diaphragm with GTP coating for ranges < 100bar (1500psi) Stem: 17-4PH
Thermocouple (M32 model)	STD: type "J" (isolated junction)
Protection degree (6-pole connector)	IP65
Electrical connections	6-pin connector VPT07RA10-6PT (PT02A-10-6P) 8-pin connector PC02E-12-8P

FSO = Full Scale Output

(1) BFSL method (Best Fit Straight Line): includes combined effects of Non-Linearity, Hysteresis and Repeatability.

According to the European Directive 97/23/CE (PED), for range above 500bar the M3.../M2... series declare the CE mark.

MELT PRESSURE TRANSDUCERS
ME0/ME1/ME2/ME3 series

Main features

- Pressure ranges: from 0-35 to 0-2000 bar / from 0-500 to 0-30000 psi
- Accuracy: < $\pm 0.25\%$ FSO (H); < $\pm 0.5\%$ FSO (M)
- Fluid-filled system for temperature stability
- Mercury filled volume: ME0 series (30mm³) - ME1/ME2/ME3 series (40mm³)
- 1/2-20UNF, M18x1.5 standard threads, other types available on request
- Other diaphragms available on request
- Autozero function on board / external option
- Drift Autocompensation function (SP version)
- Standard diaphragm is 15-5PH stainless steel with GTP coating
- 17-7PH corrugated diaphragm with GTP coating for ranges below 100bar (1500psi)

Accuracy (1)	H < $\pm 0.25\%$ FSO (100...2000 bar) M < $\pm 0.5\%$ FSO (35...2000 bar)
Resolution	Infinite
Measurement range	from 0...35 to 0...2000 bar (from 0...500 to 0...30000 psi)
Maximum overpressure	2 x FS 1.5 x FS above 1000bar/1500psi
Measurement principle	Extensimetric
Power supply	10-30Vdc
Maximum current absorption	32mA
Insulation resistance (at 50Vdc)	> 1000 MOhm
Output signal Full Scale (FSO)	20mA
Zero balance (tolerance $\pm 0.25\%$ FSO)	4mA
Zero signals adjustment (tolerance $\pm 0.25\%$ FSO)	"Autozero" function
Span adjustment within $\pm 5\%$ FSO	See Manual
Maximum allowed load	See diagram
Response time (10...90% FSO)	~1ms
Output noise (RMS 10-400Hz)	< 0.025% FSO
Calibration signal	80% FSO
Output short circuit ingress and reverse polarity protection	YES
Compensated temperature range	0...+85°C
Operating temperature range	-30...+105°C
Storage temperature range	-40...+125°C
Thermal drift in compensated range: Zero/Calibration/Sensibility	< 0.02% FSO/°C
Diaphragm maximum temperature	400°C / 750°F
Zero drift due to change in process temperature (zero)	< 0.02 bar/°C
Zero drift temperature for Autocompensated version (SP) within the temperature range 20°C-400°C inclusive the drift temperature of the housing	< 0.003 bar/°C 100 ≤ p < 500 bar 0.0014% FS/°C p ≥ 500 bar
Standard material in contact with process medium	Diaphragm: 15-5PH with GTP coating 17-7PH corrugated diaphragm with GTP coating for ranges < 100bar (1500psi) Stem: 17-4PH
Thermocouple (ME2 model)	STD: type "J" (isolated junction)
Protection degree (6-pole female connector)	IP65

FSO = Full Scale Output

(1) BFSL method (Best Fit Straight Line): includes combined effects of Non-Linearity, Hysteresis and Repeatability.

**MELT PRESSURE TRANSDUCERS
MN0/MN1/MN2/MN3 series**

Main features

- Pressure ranges: from 0-35 to 0-2000 bar / from 0-500 to 0-30000 psi
- Accuracy: < ±0.25% FSO (H); < ±0.5% FSO (M)
- Fluid-filled system for temperature stability
- Mercury filling volume: MN0 series (30mm³) - MN1/MN2/MN3 series (40mm³)
- 1/2-20UNF, M18x1.5 standard threads, other types available on request
- Other diaphragms available on request
- Autozero function on board / external option
- Drift Autocompensation function (SP version)
- Standard diaphragm is 15-5PH stainless steel with GTP coating
- 17-7PH corrugated diaphragm with GTP coating for ranges below 100bar (1500psi)

Accuracy (1)	H < ±0.25% FSO (100...2000 bar) M < ±0.5% FSO (35...2000 bar)
Resolution	Infinite
Measurement range	from 0...35 to 0...2000 bar (from 0...500 to 0...30000 psi)
Maximum overpressure	2 x FS 1.5 x FS above 1000bar/1500psi
Measurement principle	Extensimetric
Power supply	15...30Vdc (N, C) 10...30Vdc (B, M) -15...+15Vdc (H, L)
Maximum current absorption	25mA
Insulation resistance (at 50Vdc)	> 1000 MOhm
Output signal Full Scale (FSO)	5Vdc (M, H) - 10Vdc (N,L) - 5,1Vdc (B) - 10,1Vdc (C)
Zero balance (tolerance ±0.25% FSO)	0Vdc (M, N, H, L) - 0,1Vdc (B, C)
Zero signals adjustment (tolerance ±0.25% FSO)	"Autozero" function
Span adjustment within ±5% FSO	See Manual
Maximum allowed load	1 mA
Response time (10...90% FSO)	~1ms
Output noise (RMS 10-400Hz)	< 0.025% FSO
Calibration signal	80% FSO
Output short circuit ingress and reverse polarity protection	YES
Compensated temperature range	0...+85°C
Operating temperature range	-30...+105°C
Storage temperature range	-40...+125°C
Thermal drift in compensated range: Zero/Calibration/Sensibility	< 0.02% FSO/°C
Diaphragm maximum temperature	400°C / 750°F
Zero drift due to change in process temperature (zero)	< 0.02 bar/°C
Zero drift temperature for Autocompensated version (SP) within the temperature range 20°C-400°C inclusive the drift temperature of the housing	< 0.003 bar/°C 100 ≤ p < 500 bar 0.0014% FS/°C p ≥ 500 bar
Standard material in contact with process medium	Diaphragm: 15-5PH with GTP coating 17-7PH corrugated diaphragm with GTP coating for ranges < 100bar (1500psi) Stem: 17-4PH
Thermocouple (MN2 model)	STD: type "J" (isolated junction)
Protection degree (6-pole female connector)	IP65

FSO = Full Scale Output

(1) BFSL method (Best Fit Straight Line): includes combined effects of Non-Linearity, Hysteresis and Repeatability.

MELT PRESSURE TRANSMITTERS
MD0/MD1/MD2/MD3 series

Main features

- Pressure ranges: from 0-35 to 0-2000 bar / from 0-500 to 0-30000 psi
- Accuracy: < ±0.25% FSO (H); < ±0.5% FSO (M)
- Hydraulic transmission system to guarantee temperature stability (Hg)
- Quantity of Hg contained for model: series MD0 (30mm³) - MD1/MD2/MD3 (40mm³)
- Standard threading 1/2-20UNF, M18x1.5, other versions on request
- Autozero function on board / external option
- Drift Autocompensation function (SP version)
- Stainless steel 15-5PH diaphragm with GTP coating
- For ranges below 100bar (1500psi): stainless steel 17-7PH corrugated diaphragm with GTP coating

Rated precision, including effects of Linearity, Repeatability and Hysteresis	H < ±0.25% FSO (100...2000 bar) M < ±0.5% FSO (35...2000 bar)
Sampling	16 bit (1)
Pressure ranges	from 0...35 to 0...2000bar (from 0...500 to 0...30000psi)
Maximum applicable pressure	2 x FSO
Measurement principle	Strain gauge
Power supply	12...40Vdc
Typical input	40mA (2)
Insulation resistance (at 50Vdc)	> 1000 MOhm
Signal at rated pressure (FSO)	Depends on FSO
Signal at ambient pressure	0
Calibration of ambient pressure	Insertion o fan offset
Signal protocol	DP404 CANopen, with baud rate selectable from 10K to 1Mbaud (default 500Kbaud)
Response time (10...90% FSO)	20ms
Calibration signal	80% FSO
Protection against overvoltage and reverse polarity of power supply	YES
Compensated temperature range of strain Gauge Housing	0...+76°C (32...170°F)
Maximum temperature range of strain Gauge Housing	-30...+85°C (-22...+185°F)
Thermal drift in compensated range:	
Zero	< 0.02% FSO/°C
Calibration	< 0.01%FSO/°F
Sensitivity	< 0.01%FSO/°F
Max. diaphragm temperature	400°C (750°F)
Influence due to variation of fluid temperature (Zero)	< 0.02 bar/°C (15 psi/100°F)
Standard material in contact with process medium	Diaphragm: 15-5PH with GTP coating 17-7PH corrugated diaphragm with GTP coating for ranges < 100bar (1500psi) Stem: 17-4PH
Thermocouple (MD2 model)	STD: type "J" (isolated coupling)
Protection level	IP65
Electrical connections	M12, DIN EN 50044 5-pin connector

FSO = Full Scale Output (signal at rated pressure)

- (1) Resolution: 0,01bar from 35...500bar, 0,1bar from 700...2000bar
 0,1psi from 5000...350psi, 1psi from 7500...30000psi
- (2) Conditions: Power supply 24Vdc

**MELT PRESSURE TRANSMITTERS FOR APPLICATIONS
IN POTENTIALLY EXPLOSIVE ATMOSPHERES
MX0/MX1/MX2/MX3 series**

Main features

- Pressure ranges: from 0-35 to 0-2000 bar / from 0-500 to 0-30000 psi
- Extensimetric measurement principle with Wheatstone bridge
- Accuracy: < $\pm 0.25\%$ FSO (H); < $\pm 0.5\%$ FSO (M)
- Calibration signal 80% FSO internally generated
- Completely interchangeable with all existing products
- Protection level: IP65 (6-pin connector)
- Standard threading 1/2-20UNF, M18x1.5, other versions on request
- Stainless steel diaphragm 15-5PH with GTP coating
- For ranges below 100bar (1500psi): 17-7PH corrugated stainless steel diaphragm with GTP coating
- Other diaphragm types available on request

Rated precision, including effects of Linearity, Repeatability and Hysteresis	H < $\pm 0.25\%$ FSO (100...2000 bar) M < $\pm 0.5\%$ FSO (35...2000 bar)
Resolution	Infinite
Pressure ranges	from 0...35 to 0...2000bar (from 0...500 to 0...30000psi)
Maximum applicable pressure	2 x FS 1,5 x FS beyond 1000bar/15000psi
Principle of measurement	Strain gauge
Power supply	12...30Vdc
Maximum input	30mA
Isolation resistance (at 50Vdc)	> 1000 MOhm
Signal at rated pressure (FSO)	20mA
Zero balancing	4mA
Calibration:	
Rated pressure	5%FSO
Room pressure	min. 10bar (150psi)
Maximum load	See diagram
Response time (10...90% FSO)	~4ms
Output noise (RMS 10-400Hz)	< 0.05% FSO
Calibration signal	80% FSO
Protection against overvoltages and power supply polarity reverse	YES
Temperature range of strain Gauge Housing	-20...+70°C (-4...+158°F)
Thermal drift compensated range: Zero/Calibration/Sensitivity	< 0.02% FSO/°C (< 0.01% FSO/°F)
Maximum temperature of diaphragm	400°C (750°F)
Influence due to fluid temperature change (Zero)	< 0.02 bar/°C (15 psi/100°F)
Standard material in contact with process medium	Diaphragm: 15-5PH with GTP coating 17-7PH corrugated diaphragm with GTP coating for ranges < 100bar (1500psi) Stem: 17-4PH
Thermocouple (MX2 model)	STD: type "J" (isolated junction)
Protection level (with 6-pin female connector installed)	IP65
Electrical connections	VPT07RA10-6PT (PT02A-10-6P) 6-pin connector PC02E-12-8P 8-pin connector

FSO = Full Scale Output (signal at rated pressure)

**FLANGE STEM MOUNT MELT PRESSURE TRANSMITTERS
FOR APPLICATIONS IN POTENTIALLY EXPLOSIVE
MX4 series**

Main features

- Pressure ranges: from 0-25 to 0-2000 bar / from 0-360 to 0-30000 psi
- Extensimetric measurement principle with Wheatstone bridge
- Accuracy: < $\pm 0.25\%$ FSO (H); < $\pm 0.5\%$ FSO (M)
- Calibration signal 80% FSO internally generated
- Completely interchangeable with all existing products
- Protection level: IP65 (6-pin connector)
- Flange mounting
- Stainless steel diaphragm 15-5PH with GTP coating
- For ranges below 100bar (1500psi): corrugated stainless steel diaphragm with GTP coating
- Other diaphragm types available on request

Rated precision, including effects of Linearity, Repeatability and Hysteresis	H < $\pm 0.25\%$ FSO (100...2000 bar) M < $\pm 0.5\%$ FSO (25...2000 bar)
Resolution	Infinite
Pressure ranges	from 0...25 to 0...2000bar (from 0...360 to 0...30000psi)
Maximum applicable pressure	2 x FS 1,5 x FS beyond 1000bar/15000psi
Principle of measurement	Strain gauge
Power supply	12...30Vdc
Maximum input	30mA
Isolation resistance (at 50Vdc)	> 1000 MOhm
Signal at rated pressure (FSO)	20mA
Zero balancing	4mA
Calibration:	
Rated pressure	5%FSO
Room pressure	min. 10bar (150psi)
Maximum load	See diagram
Response time (10...90% FSO)	~4ms
Output noise (RMS 10-400Hz)	< 0.05% FSO
Calibration signal	80% FSO
Protection against overvoltages and power supply polarity reverse	YES
Temperature range of strain Gauge Housing	-20...+70°C (-4...+158°F)
Thermal drift in compensated range: Zero/Calibration/Sensitivity	< 0.02% FSO/°C (< 0.01% FSO/°F)
Maximum temperature of diaphragm	400°C (750°F)
Influence due to fluid temperature change (Zero)	< 0.02 bar/°C (15 psi/100°F)
Standard material in contact with process medium	Diaphragm: 15-5PH with GTP coating 17-7PH corrugated diaphragm with GTP coating for ranges < 100bar (1500psi) Stem: 17-4PH
Sealing	Copper washer silver plated
Protection level (with 6-pin female connector installed)	IP65
Electrical connections	VPT07RA10-6PT (PT02A-10-6P) 6-pin connector PC02E-12-8P 8-pin connector

FSO = Full Scale Output (signal at rated pressure)

**EXPLOSIONPROOF MELT PRESSURE TRANSMITTER
MF series**

Main features

- Factory Mutual approved Explosionproof for Class I, Division 1, Groups A, B, C, D and Dust-Ignitionproof for Class II, Division 1, Groups E, F, G
- Other approvals: CE, NEMA 4/IP65
- High-level output 2-wire, 4-20mA
- Accuracy: $\pm 0.25\%$ FSO (H); $\pm 0.5\%$ FSO (M)
- Calibration signal 80% FSO internally generated (R-Cal)
- Standard threading 1/2-20UNF, M18x1.5 also available
- Fluid-filled system for temperature stability
- 15-5PH stainless steel diaphragm with Armoloy coating standard
- 17-7PH corrugated diaphragm with TiN (Titanium Nitride) coating for ranges below (1500psi)
- Other diaphragm available on request

Rated precision, including effects of Linearity, Repeatability and Hysteresis	H $\pm 0.25\%$ FSO for ranges 100bar (1500psi) M $\pm 0.5\%$ FSO for ranges 100bar (1500psi)
Resolution	Infinite
Measurement range	from 0...35 to 0...2000bar (from 0...500 to 0...30000psi)
Maximum overpressure	2 x FSO (1000bar [15000psi]) 1,5 x FSO (1000bar [15000psi])
Measurement principle	Strain gauge with Wheatstone bridge
Power supply	12...30Vdc (24Vdc rec.)
Maximum current consumption	20mA
Isolation resistance (at 50Vdc)	> 1000 MOhm
Signal at rated pressure (FSO)	20mA
Zero balance	4mA
Calibration:	
Rated pressure	5%FSO
Room pressure	min. 10bar (150psi)
Response time (10...90% FSO)	~8ms
Output noise (RMS 10-400Hz)	<math>< 0.05\%</math> FSO
Calibration signal	80% FSO
Protection against output short circuit and supply voltage inverted polarity	YES
Protection against output voltage spikes	YES (according to 89/336/EEC)
Strain gauge housing compensated temperature range	from 0°C to 76°C (from 32°F to 170°F)
Housing temperature range	-30...+85°C (-22...+185°F)
Thermal drift in compensated range (*):	
Zero	2.0%/100°C (1.0%/100°F)
Sensitivity	2.0%/100°C (1.0%/100°F)
Maximum diaphragm temperature	400°C (750°F)
Maximum zero drift due to change in process temperature	<math>< 0.02</math> bar/°C (15 psi/100°F)
Material in contact with process medium	
Standard	15-5PH SS (Armoloy coated)
Below 100bar (1500psi)	17-7PH SS corrugated (Titanium Nitride coated)

FSO = Full Scale Output (signal at rated pressure)

(*) For ranges below 70bar (1000psi), zero and sensitivity shift are 6.0%/100°C (3.0%/100°F)

OIL-FILLED MELT PRESSURE TRANSDUCERS
W30/W31/W32/W33 series

Main features

- Pressure ranges: from 0-35 to 0-1000 bar / from 0-500 to 0-15000 psi
- Accuracy: < ±0.25% FSO (H); < ±0.5% FSO (M)
- Fluid-filled system for temperature stability
- Oil filling meets FDA requirements CFR 178.3620 and CFR 172.878
- Oil filling volume: W30 series (30mm³) - W31/W32/W33 series (40mm³)
- 1/2-20UNF, M18x1.5 standard threads, other types available on request
- Standard diaphragm is a 17-7PH stainless steel GTP coating corrugated diaphragm

Accuracy (1)	H < ±0.25% FSO (100...2000 bar) M < ±0.5% FSO (35...2000 bar)
Resolution	Infinite
Measurement range	from 0...35 to 0...1000 bar (from 0...500 to 0...15000 psi)
Maximum overpressure	2 x FS 1.5 x FS above 500bar/7500psi
Measurement principle	Extensimetric
Power supply	6...12Vdc (10Vdc typical)
Strain gauge bridge resistance	350 Ohm (550 Ohm below 100bar/1500psi)
Isolation resistance (at 50Vdc)	> 1000 MOhm
Full Scale Output (tolerance ±0.5%FSO)	2.5mV/V (option 2) 3.33 mV/V (option 3)
Zero balance	±0.5%
Calibration signal	80%FSO
Compensated temperature range	0...+100°C / 32...212°F
Maximum temperature range	-30...+120°C / -22...+250°F
Thermal drift in compensated range: Zero/Calibration/Sensibility	< 0.02% FSO/°C < 0.01% FSO/°F
Diaphragm maximum temperature	315°C / 600°F
Zero drift due to change in process temperature	0.04bar/°C 15psi/100°F
Standard material in contact with process medium	Diaphragm: 17-7PH corrugated diaphragm with GTP coating Stem: 17-4PH
Thermocouple (W32 model)	STD: type "J" (isolated junction)
Protection degree (6-pole connector)	IP65
Electrical connections	6-pin connector VPT07RA10-6PT (PT02A-10-6P) 8-pin connector PC02E-12-8P

FSO = Full Scale Output

(1) BFSL method (Best Fit Straight Line): includes combined effects of Non-Linearity, Hysteresis and Repeatability.

**OIL-FILLED MELT PRESSURE TRANSDUCERS
WE0/WE1/WE2/WE3 series**

Main features

- Pressure ranges: from 0-35 to 0-1000 bar / from 0-500 to 0-15000 psi
- Accuracy: < $\pm 0.25\%$ FSO (H); < $\pm 0.5\%$ FSO (M)
- Fluid-filled system for temperature stability
- Oil filling meets FDA requirements CFR 178.3620 and CFR 172.878
- Oil filling volume: WE0 series (30mm³) - WE1/WE2/WE3 series (40mm³)
- 1/2-20UNF, M18x1.5 standard threads, other types available on request
- Other diaphragms available on request
- Autozero function on board / external option
- Drift Autocompensation function (SP version)
- 17-7PH corrugated diaphragm with GTP coating

Accuracy (1)	H < $\pm 0.25\%$ FSO (100...1000 bar) M < $\pm 0.5\%$ FSO (35...1000 bar)
Resolution	Infinite
Measurement range	from 0...35 to 0...1000 bar (from 0...500 to 0...15000 psi)
Maximum overpressure	2 x FS 1.5 x FS above 500bar/7500psi
Measurement principle	Extensimetric
Power supply	10...30Vdc
Maximum current absorption	32mA
Insulation resistance (at 50Vdc)	> 1000 MOhm
Output signal Full Scale (FSO)	20mA
Zero balance (tolerance $\pm 0.25\%$ FSO)	4mA
Zero signals adjustment (tolerance $\pm 0.25\%$ FSO)	"Autozero" function
Span adjustment within $\pm 5\%$ FSO	See Manual
Maximum allowed load	See diagram
Response time (10...90% FSO)	~1ms
Output noise (RMS 10-400Hz)	< 0.025% FSO
Calibration signal	80% FSO
Output short circuit ingress and reverse polarity protection	YES
Compensated temperature range	0...+85°C
Operating temperature range	-30...+105°C
Storage temperature range	-40...+125°C
Thermal drift in compensated range: Zero/Calibration/Sensibility	< 0.02% FSO/°C
Diaphragm maximum temperature	315°C / 600°F
Zero drift due to change in process temperature (zero)	< 0.04 bar/°C
Zero drift temperature for Autocompensated version (SP) within the temperature range 20°C-315°C inclusive the drift temperature of the housing	< 0.005 bar/°C 100 ≤ p < 500 bar 0.0022% FS/°C p ≥ 500 bar
Standard material in contact with process medium	Diaphragm: 17-7PH corrugated diaphragm with GTP coating Stem: 17-4PH
Thermocouple (WE2 model)	STD: type "J" (isolated junction)
Protection degree (6-pole female connector)	IP65

FSO = Full Scale Output

(1) BFSL method (Best Fit Straight Line): includes combined effects of Non-Linearity, Hysteresis and Repeatability.

OIL-FILLED MELT PRESSURE TRANSDUCERS
WN0/WN1/WN2/WN3 series

Main features

- Pressure ranges: from 0-35 to 0-1000 bar / from 0-500 to 0-15000 psi
- Accuracy: < $\pm 0.25\%$ FSO (H); < $\pm 0.5\%$ FSO (M)
- Fluid-filled system for temperature stability
- Oil filling meets FDA requirements CFR 178.3620 and CFR 172.878
- Oil filling volume: WN0 series (30mm³) - WN1/WN2/WN3 series (40mm³)
- 1/2-20UNF, M18x1.5 standard threads, other types available on request
- Other diaphragms available on request
- Autozero function on board / external option
- Drift Autocompensation function (SP version)
- 17-7PH corrugated diaphragm with GTP coating

Accuracy (1)	H < $\pm 0.25\%$ FSO (100...1000 bar) M < $\pm 0.5\%$ FSO (35...1000 bar)
Resolution	Infinite
Measurement range	from 0...35 to 0...1000 bar (from 0...500 to 0...15000 psi)
Maximum overpressure	2 x FS 1.5 x FS above 500bar/7500psi
Measurement principle	Extensimetric
Power supply	15...30Vdc (N, C) 10...30Vdc (B, M) -15...+15Vdc (H, L)
Maximum current absorption	25mA
Insulation resistance (at 50Vdc)	> 1000 MOhm
Output signal Full Scale (FSO)	5Vdc (M, H) - 10Vdc (N, L) - 5,1Vdc (B) - 10,1Vdc (C)
Zero balance (tolerance $\pm 0.25\%$ FSO)	0Vdc (M, N, H, L) - 0,1Vdc (B, C)
Zero signals adjustment (tolerance $\pm 0.25\%$ FSO)	"Autozero" function
Span adjustment within $\pm 5\%$ FSO	See Manual
Maximum allowed load	1 mA
Response time(10...90% FSO)	~1ms
Output noise (RMS 10-400Hz)	< 0.025% FSO
Calibration signal	80% FSO
Output short circuit ingress and reverse polarity protection	YES
Compensated temperature range	0...+85°C
Operative temperature range	-30...+105°C
Storage temperature range	-40...+125°C
Thermal drift in compensated range: Zero/Calibration/Sensibility	< 0.02% FSO/°C
Diaphragm maximum temperature	315°C / 600°F
Zero drift due to change in process temperature (zero)	< 0.04 bar/°C
Zero drift temperature for Autocompensated version (SP) within the temperature range 20°C-315°C inclusive the drift temperature of the housing	< 0.005 bar/°C 100 ≤ p < 500 bar 0.0022% FS/°C p ≥ 500 bar
Standard material in contact with process medium	Diaphragm: 17-7PH corrugated diaphragm with GTP coating Stem: 17-4PH
Thermocouple (WN2 model)	STD: type "J" (isolated junction)
Protection degree (6-pole female connector)	IP65

FSO = Full Scale Output

(1) BFSL method (Best Fit Straight Line): includes combined effects of Non-Linearity, Hysteresis and Repeatability.

OIL-FILLED MELT PRESSURE TRANSMITTERS
WD0/WD1/WD2/WD3 series

Main features

- Pressure ranges: from 0-35 to 0-1000 bar / from 0-500 to 0-15000 psi
- Accuracy: < ±0.25% FSO (H); < ±0.5% FSO (M)
- Extensimetric measurement principle with Wheatstone bridge
- Hydraulic transmission system to guarantee temperature stability. Filling with certified oil FDA, CFR 178.3620 and CFR 172.878
- Quantity of Oil contained for model: series WD0 (30mm³) - WD1/WD2/WD3 (40mm³)
- Standard threading 1/2-20UNF, M18x1.5, other versions on request
- Autozero function on board / external option
- Drift Autocompensation function (SP version)
- Stainless steel 17-7PH diaphragm with GTP coating

Rated precision, including effects of Linearity, Repeatability and Hysteresis	H < ±0.25% FSO (350...1000 bar) M < ±0.5% FSO (35...1000 bar)
Sampling	16 bit (1)
Pressure ranges	from 0...35 to 0...1000bar (from 0...500 to 0...15000psi)
Maximum applicable pressure	2 x FSO
Measurement principle	Strain gauge
Power supply	12...40Vdc
Typical input	40mA (2)
Insulation resistance (at 50Vdc)	> 1000 MOhm
Signal at rated pressure (FSO)	Depends on FSO
Signal at ambient pressure	0
Calibration of ambient pressure	Insertion of an offset
Signal protocol	DP404 CANopen, with baud rate selectable from 10K to 1Mbaud (default 500Kbaud)
Response time (10...90% FSO)	20ms
Calibration signal	80% FSO
Protection against overvoltage and reverse polarity of power supply	YES
Compensated temperature range of strain Gauge Housing	0...+76°C (32...170°F)
Maximum temperature range of strain Gauge Housing	-30...+85°C (-22...+185°F)
Thermal drift in compensated range:	
Zero Calibration Sensitivity	< 0.02% FSO/°C < 0.01%FSO/°F < 0.01%FSO/°F
Max. diaphragm temperature	315°C (600°F)
influence due to variation of fluid temperature (Zero)	< 0.04 bar/°C (30 psi/100°F)
Standard material in contact with process medium	Diaphragm: 17-7PH corrugated diaphragm with GTP Stem: 17-4PH
Thermocouple (WD2 model)	STD: type "J" (isolated coupling)
Protection level	IP65
Electrical connections	M12, DIN EN 50044 5-pin connector

FSO = Full Scale Output (signal at rated pressure)

- (1) Resolution: 0,01bar from 35...500bar, 0,1bar from 700...1000bar
 0,1psi from 5000...350psi, 1psi from 7500...15000psi
- (2) Conditions: Power supply 24Vdc

**OIL FILLED MELT PRESSURE TRANSMITTERS
FOR HAZARDOUS AREAS
WX0/WX1/WX2/WX3 series**

Main features

- Pressure ranges: from 0-35 to 0-1000 bar / from 0-500 to 0-15000 psi
- Extensimetric measurement principle with Wheatstone bridge
- Accuracy: < $\pm 0.25\%$ FSO (H); < $\pm 0.5\%$ FSO (M)
- Calibration signal 80% FSO internally generated
- Filling with FDA approved oil CFR 178.3620 and CFR 178.878
- Completely interchangeable with all existing products
- Protection level: IP65 (6-pin connector)
- Standard threading 1/2-20UNF, M18x1.5, other versions on request
- Stainless steel 17-7PH diaphragm with GTP coating

Rated precision, including effects of Linearity, Repeatability and Hysteresis	H < $\pm 0.25\%$ FSO (350...1000 bar) M < $\pm 0.5\%$ FSO (35...1000 bar)
Resolution	Infinite
Pressure ranges	from 0...35 to 0...1000bar (from 0...500 to 0...15000psi)
Maximum applicable pressure	2 x FS 1,5 x FS above 500bar/7500psi
Principle of measurement	Strain gauge
Power supply	12...30Vdc
Maximum input	30mA
Isolation resistance (at 50Vdc)	> 1000 MOhm
Signal at rated pressure (FSO)	20mA
Zero balance	4mA
Calibration:	
Rated pressure	5%FSO
Room pressure	min. 10bar (150psi)
Maximum load	See diagram
Response time (10...90% FSO)	~4ms
Output noise (RMS 10-400Hz)	< 0.05% FSO
Calibration signal	80% FSO
Protection against overvoltages and power supply polarity reverse	YES
Protection against pulses injected on output	YES (in compliance with 89/336/EEC)
Temperature range of strain Gauge Housing	-20...+70°C (-4...+158°F)
Thermal drift in compensated range: Zero/Calibration/Sensitivity	< 0.02% FSO/°C (< 0.01% FSO/°F)
Maximum temperature of diaphragm	315°C (600°F)
Influence due to fluid temperature change (Zero)	< 0.04 bar/°C (30 psi/100°F)
Standard material in contact with process medium	Diaphragm: 17-7PH corrugated diaphragm with GTP coating Stem: 17-4PH
Thermocouple (WX2 model)	STD: type "J" (isolated junction)
Protection level (with 6-pin female connector installed)	IP65
Electrical connections	VPT07RA10-6PT (PT02A-10-6P) 6-pin connector PC02E-12-8P 8-pin connector

FSO = Full Scale Output (signal at rated pressure)

**EXPLOSIONPROOF MELT PRESSURE TRANSMITTER (OIL-FILLED)
WF series**

Main features

- Factory Mutual approved Explosionproof for Class I, Division 1, Groups A, B, C, D and Dust-Ignitionproof for Class II, Division 1, Groups E, F, G
- Other approvals: CE, NEMA 4/IP65
- High-level output 2-wires, 4-20mA
- Accuracy: $\pm 0.25\%$ FSO (H); $\pm 0.5\%$ FSO (M)
- Calibration signal 80% FSO internally generated (R-Cal)
- Standard threading 1/2-20UNF, M18x1.5 also available
- Fluid-filled system for temperature stability
- 17-7PH corrugated diaphragm with TiN (Titanium Nitride) coating standard
- Oil-fill is FDA approved. Meets requirements CFR 172.3620 and CFR 172.878

Rated precision, including effects of Linearity, Repeatability and Hysteresis	H $\pm 0.25\%$ FSO for ranges 100bar (1500psi) M $\pm 0.5\%$ FSO for ranges 100bar (1500psi)
Resolution	Infinite
Measurement range	from 0...35 to 0...2000bar (from 0...500 to 0...30000psi)
Maximum overpressure	2 x FSO (1000bar [15000psi]) 1,5 x FSO (1000bar [15000psi])
Measurement principle	Strain gauge with Wheatstone bridge
Power supply	12...30Vdc (24Vdc rec.)
Maximum current consumption	20mA
Isolation resistance (at 50Vdc)	> 1000 MOhm
Full Scale Output (FSO)	20mA
Zero balance	4mA
Calibration:	
Nominal pressure	5%FSO
Room pressure	min. 10bar (150psi)
Response time (10...90% FSO)	~8ms
Output noise (RMS 10-400Hz)	<math>< 0.05\%</math> FSO
Calibration signal	80% FSO
Protection against output signal circuit and suppli voltage inverted polarity	YES
Protection against output voltage spikes	YES (accordino to 89/336/EEC)
Compensated temperature range of strain Gauge Housing	from 0°C to 76°C (from 32°F to 170°F)
Housing temperature range	-30...+85°C (-22...+185°F)
Thermal drift in compensated range (*):	
Zero	2.0%/100°C (1.0%/100°F)
Sensitivity	2.0%/100°C (1.0%/100°F)
Maximum diaphragm temperature	315°C (600°F)
Maximum Zero drift due to ch'ange in process temperature	<math>< 0.02</math> bar/°C (15 psi/100°F)
Material in contact with process medium	17-7PH SS corrugated (Titanium Nitride coated)

FSO = Full Scale Output (signal at rated pressure)

(*) For ranges below 70bar (1000psi), zero and sensitivity shift are 6.0%/100°C (3.0%/100°F)

MELT PRESSURE TRANSDUCERS
K30/K31/K32/K33 series

Main features

- Pressure ranges: from 0-35 to 0-1000 bar / from 0-500 to 0-15000 psi
- Accuracy: < ±0.25% FSO (H); < ±0.5% FSO (M)
- Hydraulic transmission system for pressure signal guarantees stability at working temperature (NaK). Liquid conforming to RoHS Directive. NaK is defined as a safe substance (GRAS)
- Quantity of NaK contained: K30 series (30mm³) [0,00183 in³] - K31/K32/K33 series (40mm³) [0,00244 in³]
- 1/2-20UNF, M18x1.5 standard threads, other types available on request
- Inconel 718 diaphragm with GTP coating for temperatures up to 538°C (1000°F)
- 15-5PH diaphragm with GTP coating for temperatures up to 400°C (750°F)
- Hastelloy C276 diaphragm for temperatures up to 300°C (570°F)
- 17-7PH corrugated diaphragm with GTP coating for ranges below 100bar (1500psi)
- Stem material: 17-4PH

Accuracy (1)	H < ±0.25% FSO (100...1000 bar) M < ±0.5% FSO (35...1000 bar)
Resolution	Infinite
Measurement range	from 0...35 to 0...1000 bar (from 0...500 to 0...15000 psi)
Maximum overpressure	2 x FS 1.5 x FS over 1000bar/15000psi
Measurement principle	Extensimetric
Power supply	6...12Vdc (10Vdc typical)
Bridge resistance	350 Ohm (550 Ohm below 100bar/1500psi)
Insulation resistance (at 50Vdc)	> 1000 MOhm
Output signal Full Scale (FSO) (tolerance ±0.5%FSO)	2.5mV/V (option 2) 3.33 mV/V (option 3)
Zero balance	±5%
Calibration signal	80%FSO
Compensated temperature range	0...+100°C / 32...212°F
Maximum temperature range	-30...+120°C / -22...+250°F
Thermal drift in compensated range: Zero/Calibration/Sensibility	< 0.02% FSO/°C < 0.01% FSO/°F
Diaphragm maximum temperature	538°C / 1000°F
Zero drift due to change in process temperature (zero)	< 3,5 bar/100°C < 28 psi/100°F
Thermocouple (K32 model)	STD: type "J" (isolated junction)
Protection degree (with 6-pole female connector)	IP65
Electrical connections	6-pin connector VPT07RA10-6PT (PT02A-10-6P) 8-pin connector PC02E-12-8P

FSO = Full Scale Output

(1) BFSL method (Best Fit Straight Line): includes combined effects of Non-Linearity, Hysteresis and Repeatability.

MELT PRESSURE TRANSDUCERS
KE0/KE1/KE2/KE3 series

Main features

- Pressure ranges: from 0-35 to 0-1000 bar / from 0-500 to 0-15000 psi
- Accuracy: < ±0.25% FSO (H); < ±0.5% FSO (M)
- Hydraulic transmission system for pressure signal guarantees stability at working temperature (NaK). Liquid conforming to RoHS Directive. NaK is defined as a safe substance (GRAS)
- Quantity of NaK contained: KE0 series (30mm³) [0,00183 in³] - KE1/KE2/KE3 series (40mm³) [0,00244 in³]
- 1/2-20UNF, M18x1.5 standard threads, other types available on request
- Autozero function on board / external option
- Stem drift Autocompensation function (SP version)
- Inconel 718 diaphragm with GTP coating for temperatures up to 538°C (1000°F)
- 15-5PH diaphragm with GTP coating for temperatures up to 400°C (750°F)
- Hastelloy C276 diaphragm for temperatures up to 300°C (570°F)
- 17-7PH corrugated diaphragm with GTP coating for ranges below 100bar (1500psi)
- Stem material: 17-4PH

Accuracy (1)	H < ±0.25% FSO (100...1000 bar) M < ±0.5% FSO (35...1000 bar)
Resolution	Infinite
Measurement range	from 0...35 to 0...1000 bar (from 0...500 to 0...15000 psi)
Maximum overpressure	2 x FS 1.5 x FS over 1000bar/15000psi
Measurement principle	Extensimetric
Power supply	10...30Vdc
Maximum current absorption	32mA
Insulation resistance (at 50Vdc)	> 1000 MOhm
Output signal Full Scale (FSO)	20mA
Zero balance (tolerance ±0.25% FSO)	4mA
Zero signals adjustment (tolerance ±0.25% FSO)	"Autozero" function
Span adjustment within ±5% FSO	See Manual
Maximum allowed load	See diagram
Electronic response time (10...90% FSO)	~1ms
Output noise (RMS 10-400Hz)	< 0.025% FSO
Calibration signal	80% FSO
Output short circuit and reverse polarity protection	YES
Compensated temperature range	0...+85°C
Operative temperature range	-30...+105°C
Storage temperature range	-40...+125°C
Thermal drift in compensated range: Zero/Calibration/Sensibility	< 0.02% FSO/°C
Diaphragm maximum temperature	538°C / 1000°F
Zero drift (zero)	< 3,5 bar/100°C < 28 psi/100°F
Zero drift temperature for Autocompensated version (SP) within the temperature range 20°C-500°C inclusive the drift temperature of the housing	< 0.005 bar/°C 100 ≤ p < 500 bar 0.0022% FS/°C p ≥ 500 bar
Thermocouple (KE2 model)	STD: type "J" (isolated junction)
Protection degree (6-pole female connector)	IP65

FSO = Full Scale Output

(1) BFSL method (Best Fit Straight Line): includes combined effects of Non-Linearity, Hysteresis and Repeatability.

**MELT PRESSURE TRANSDUCERS
KN0/KN1/KN2/KN3 series**

Main features

- Pressure range: from 0-35 to 0-1000 bar / from 0-500 to 0-15000 psi
- Accuracy: < ±0.25% FSO (H); < ±0.5% FSO (M)
- Hydraulic transmission system for pressure signal guarantees stability at working temperature (NaK). Liquid conforming to RoHS Directive. NaK is defined as a safe substance (GRAS)
- Quantity of NaK contained: KN0 series (30mm³) [0,00183 in³] - KN1/KN2/KN3 series (40mm³) [0,00244 in³]
- 1/2-20UNF, M18x1.5 standard threads, other types available on request
- Autozero function on board / external option
- Stem drift Autocompensation function (SP version)
- Inconel 718 diaphragm with GTP coating for temperatures up to 538°C (1000°F)
- 15-5PH diaphragm with GTP coating for temperatures up to 400°C (750°F)
- Hastelloy C276 diaphragm for temperatures up to 300°C (570°F)
- 17-7PH corrugated diaphragm with GTP coating for ranges below 100bar (1500psi)
- Stem material: 17-4PH

Accuracy (1)	H < ±0.25% FSO (100...1000 bar) M < ±0.5% FSO (35...1000 bar)
Resolution	Infinite
Measurement range	from 0...35 to 0...1000 bar (from 0...500 to 0...15000 psi)
Maximum overpressure	2 x FS
Measurement principle	Extensimetric
Power supply	15...30Vdc (N, C) 10...30Vdc (B, M)
Maximum current absorption	25mA
Insulation resistance (at 50Vdc)	> 1000 MOhm
Output signal Full Scale (FSO)	5Vdc (M) - 10Vdc (N) - 5,1Vdc (B) - 10,1Vdc (C)
Zero balance (tolerance ±0.25% FSO)	0Vdc (M, N) - 0,1Vdc (B, C)
Zero signals adjustment (tolerance ±0.25% FSO)	"Autozero" function
Span adjustment within ±5% FSO	See Manual
Maximum allowed load	1 mA
Response time (10...90% FSO)	~1ms
Output noise (RMS 10-400Hz)	< 0.025% FSO
Calibration signal	80% FSO
Output short circuit and reverse polarity protection	YES
Compensated temperature range	0...+85°C
Operative temperature range	-30...+105°C
Storage temperature range	-40...+125°C
Thermal drift in compensated range: Zero/Calibration/Sensibility	< 0.02% FSO/°C
Diaphragm maximum temperature	538°C / 1000°F
Zero drift (zero)	< 3,5 bar/100°C / < 28 psi/100°F
Zero drift temperature for Autocompensated version (SP) within the temperature range 20°C-500°C inclusive the drift temperature of the housing	< 0.005 bar/°C 100 ≤ p < 500 bar 0.0022% FS/°C p ≥ 500 bar
Thermocouple (KN2 model)	STD: type "J" (isolated junction)
Protection degree (6-pole female connector)	IP65

FSO = Full Scale Output

(1) BFSL method (Best Fit Straight Line): includes combined effects of Non-Linearity, Hysteresis and Repeatability.

NaK FILLED MELT PRESSURE TRANSMITTERS
KD0/KD1/KD2/KD3 series

Main features

- Pressure ranges: from 0-35 to 0-700 bar / from 0-500 to 0-10000 psi
- Accuracy: < ±0.25% FSO (H); < ±0.5% FSO (M)
- Hydraulic transmission system to guarantee temperature stability (NaK). Liquid conforming to RoHS directive. NaK is defined as a safe substance (GRAS)
- Quantità of NaK container for model: series KD0 (30mm³) [0,00183 in³] - KD1/KD2/KD3 (40mm³) [0,00244 in³]
- Standard threading 1/2-20UNF, M18x1.5, other versions on request
- Inconel 718 diaphragm with GTP coating for temperatures up to 538°C (1000°F)
- 15-5PH diaphragm with GTP coating for temperatures up to 400°C (750°F)
- Hastelloy C276 diaphragm for temperatures up to 300°C (570°F)
- For ranges below 100bar (1500psi): stainless steel 17-7PH corrugated diaphragm with GTP coating
- Stem material: 17-4PH

Rated precision, including effects of Linearity, Repeatability and Hysteresis	H < ±0.25% FSO (100...1000 bar) M < ±0.5% FSO (35...1000 bar)
Sampling	16 bit (1)
Pressure ranges	from 0...35 to 0...1000bar (from 0...500 to 0...15000psi)
Maximum applicable pressure	2 x FSO
Measurement principle	Strain gauge
Power supply	12...40Vdc
Typical input	40mA (2)
Insulation resistance (at 50Vdc)	> 1000 MOhm
Signal at rated pressure (FSO)	Depends on FSO
Signal at ambient pressure	0
Calibration of ambient pressure	Insertion of an offset
Signal protocol	DP404 CANopen, with baud rate selectable from 10K to 1Mbaud (default 500Kbaud)
Response time (10...90% FSO)	20ms
Calibration signal	80% FSO
Protection against overvoltage and reverse polarità of power supply	YES
Compensated temperature range of strain Gauge Housing	0...+76°C (32...170°F)
Maximum temperature range of strain Gauge Housing	-30...+85°C (-22...+185°F)
Thermal drift in compensated range:	
Zero	< 0.02% FSO/°C
Calibration	< 0.01%FSO/°F
Sensitivity	< 0.01%FSO/°F
Max. diaphragm temperature	538°C (1000°F)
influyente due to variation of fluid temperature (Zero)	< 3.5bar/100°C (< 28psi/100°F)
Thermocouple (KD2 model)	STD: type "J" (isolated junction)
Protection degree	IP65
Electrical connections	M12, DIN EN 50044 5-pin connector

FSO = Full Scale Output (signal at rated pressure)

(1) Resolution: 0,01bar from 35...500bar, 0,1bar from 700...1000bar
 0,1psi from 5000...350psi, 1psi from 7500...15000psi

(2) Conditions: Power supply 24Vdc

4. WEIGHT AND MECHANICAL DIMENSIONS

4.1 Weight

Weight for versions standard to catalogue:

M_0 / W_0 / K_0 series	250 gr.
M_1 / W_1 / K_1 series	350 gr.
M_2 / W_2 / K_2 series	430 gr.
M_3 / W_3 / K_3 series	200 gr.

4.2 Specific filling liquid

MERCURY

- Maximum temperature range 400°C
- Mercury filling volume for M series model:

M30 / ME0 / MN0 / MX0 / MD0 / MF0	30mm ³
M31 / ME1 / MN1 / MX1 / MD1 / MF1	40mm ³
M32 / ME2 / MN2 / MX2 / MD2 / MF2	40mm ³
M33 / ME3 / MN3 / MX3 / MD3 / MF3	40mm ³

OIL

- Oil certified FDA (CFR 178.3620 and CFR 172.878)
- Maximum temperature range 315°C
- Oil filling volume for W series model:

W30 / WE0 / WN0 / WX0 / WD0 / WF0	30mm ³
W31 / WE1 / WN1 / WX1 / WD1 / WF1	40mm ³
W32 / WE2 / WN2 / WX2 / WD2 / WF2	40mm ³
W33 / WE3 / WN3 / WX3 / WD3 / WF3	40mm ³

NaK

- Sodium and potassium alloy (GRAS)
- Maximum temperature range 538°C
- NaK volume for K series model:

K30 / KE0 / KN0 / KD0	30mm ³
K31 / KE1 / KN1 / KD1	40mm ³
K32 / KE2 / KN2 / KD2	40mm ³
K33 / KE3 / KN3 / KD3	40mm ³

4.3 Mechanical dimensions

See the individual product data sheets for mechanical dimensions.

5. INSTALLATION, MOUNTING AND MAINTENANCE

Correct installation of the sensor is essential for good operation and long life.

The Melt sensor's special location and the type of material in which it works demand extreme care when mounting it in the machine.

Following advice for extending the sensors lifetime:

- a) Avoid shocks and abrasions to the in contact diaphragm. Protect the transducer with its cover each time you remove it from its seat.
 - b) The seat must be prepared perfectly and with appropriate tools in order to respect the depth and axiality of the holes and tapping. Pay particular attention to the coaxiality of the holes to the thread, because diaxialities greater than 0.2 mm will break the transducer during assembly. It is essential that hole depth guarantee the absence of chambers or air pockets in which extrusion material may be trapped. To prevent contact with the extrusion screw or with tools used to clean the extrusion chamber, the front diaphragm must not extend from the inner wall of the extruder.
 - c) Before assembling the transducer in machines already in operation, make sure that the housing is clean. Remove any residual with the suitable cleaning device.
 - d) The transducer should be removed only with the machine empty (without pressure) but still hot.
 - e) The transducer should be cleaned with solvents for the material being processed.
- Any mechanical action on the contact diaphragm modifies its operation and could break it.

To make this easier, the product is supplied with full documentation on the dimensions of the installation hole and on procedures to be run before using the sensor.

An accessory drilling kit is also supplied, for exact copying of transducer rod dimensions.

5.1 Instruction and maintenance (Installation hole)

Drilling kit

A drilling kit with shaped tools for drilling, reaming and tapping is available to facilitate correct preparation of the assembly housing.

The assembly housing must be perfect to assure proper transducer function and long life.

Drilling kits are available in the following versions: **KF12, KF18.**

Drilling procedure







- Drill hole ($d4$) up to a distance from the hole equal to the sum of ($a+b+c$) (*tool 3*)
- Drill hole ($d2$) passing with the tip (*tool 1*)
- Create the seal housing at a distance from the hole equal to dimension (a) (*tool 4*)
- With a roughing tap, create threading 1/2-20UNF-2B (recognizable from the greater number of threads beveled at the mouth) (*tool 5*)
- With a finishing tap, go over threading 1/2-20UNF-2B up to a distance from the bottom equal to the sum of ($a+b$) (*tool 6*)
- Ream hole ($d2$) with reamer (*tool 2*).

Check the dimensions of the assembly housing

The dimensions of the assembly housing have to be checked after preparation and before the transducer is installed.

To do this, use closing rod SC12/SC18 as follows:

- 1) Coat the end of the rod with the appropriate ink.
- 2) Lubricate the threaded part to prevent friction.
- 3) Insert the closing rod and screw it fully down.
- 4) Remove the rod and examine it. With the exception of 45° surfaces, the ink should be intact on the entire surface.

DRILLING TOOL KIT			
Version code	KF12	KF18	
Threading type	1/2-20UNF-2B	M18x1,5	
1		∅ 7.6	∅ 9.75
2		∅ 7.95	∅ 10.1
3		∅ 13	∅ 20
4		∅ 11.5 with pilot guide	∅ 16 with pilot guide
5		1/2-20UNF-2B roughing	M18x1,5 roughing
6		1/2-20UNF-2B finishing	M18x1,5 finishing

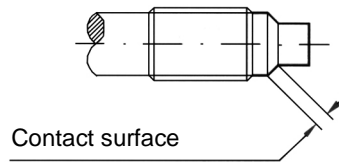
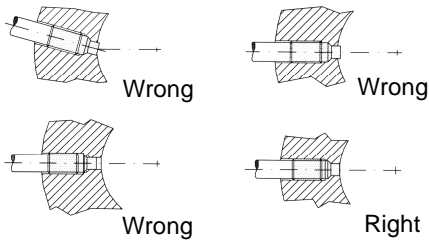

5.2 Instruction and maintenance (Sensor installation procedure)

Installation procedure

- 1) Make sure the assembly drilling procedure was done correctly. If you install the sensor in a previously used hole, make sure the hole is completely clean and free of any plastic residue.
- 2) Remove the protective cap from the sensor point.
- 3) Lubricate the thread with non-grip grease such as Neverseez (Bostik), or C5A (Felpro), or equivalent.
- 4) Insert the sensor securely into the hole, first by hand and then with a wrench, /turn at a time. Recommended torque wrench setting: 50 N-m; maximum: 56.5 N-m.

Calibration procedure

Bring the system to work temperature with the transducer installed and connected to the measurement instrument without any pressure applied.

The measurement chain connected to the transducer is calibrated as follows:

- 1) Reset the indication on the instrument to reset the temperature variation zero shift. In the series with amplified output (transmitter), you can use the Autozero function to run the reset.
 - a) For correct zero resetting of filled transmitters (ME/MN/WE/WN/KE/KN/MX/WX/MD/WD/KD series), run Autozero only after work temperature has been completely reached.
 - b) Zero reset of IMPACT (IE/IN) series transmitters: with the sensor installed and with the extruder at work temperature, wait 1 minute before running Autozero. This delay gives the system time to recognize and compensate all of the signal drifts caused by tightening and temperature. If the transmitter is kept powered, additional Autozero activations can be run immediately; on the other hand, you will have to wait 1 minute each time the system is switched on again.
 - 2) Calibrate the instrument and have it display the calibration value shown on the transducer data plate (80% of full scale).
 - 3) If the instrument does not exactly indicate zero, repeat points 1 and 2.
- In this way, the instrument is calibrated to give the exact indication in the chosen engineering unit.

Removal (fig. 1)

To remove the transducer from its housing and continue the procedure, closing rods with identical mechanical dimensions are available. The closing rods differ by type of threading; applicable pressure is 2000bar for all rods. The closing rod is available in the following versions: **SC12** 1/2-20UNF housing - **SC18** M18x1 housing.

Brackets (fig. 2)

Models with flexible sheathing require precise fastening of the protective housing of the measurement point. We recommend bracket (SF18) for fastening. Remember that the fastening point must be vibration-free (vibrations affect the measurement) and that temperatures must not exceed the maximum temperature for the strain gauge housing (as stated on the technical sheet for the transducer).

Extruder Start up

Bring the system to work temperature with the transducer installed and without any pressure applied. Wait until all the material is at the same temperature to prevent any parts that are still solid from damaging the transducer.

Transducer hole cleaning

Cleaning tool

As mentioned in the notes, the hole must be cleaned before the transducer installation.

The cleaning tool is a hard metal cutting tool specially designed to remove residual working materials.

Recommended procedure (fig. 3)

The procedure must be conducted with the material in fluid state.

- 1) Insert the tool in the housing and screw down the cutting rod (normally a 1/4 turn at a time).
- 2) Turn the pilot cutter clockwise until there is no resistance to cutting.
- 3) Repeat the procedure until the housing is completely clean. For constructive reasons, the maximum torque applicable to the cutter is 5 Nm (1.5 Kgm). If the hole blockage requires higher torque for removal, use the drilling kit and follow the recommended procedure. The cleaning tool is available in the following versions: **CT12** 1/2-20UNF housing - **CT18** M18x1,5 housing.

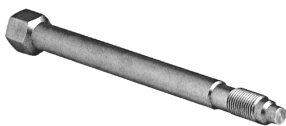

fig. 1

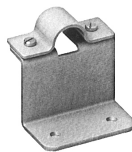

fig. 2

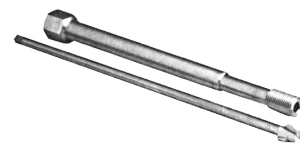
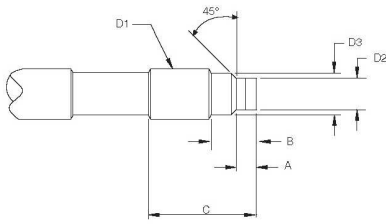
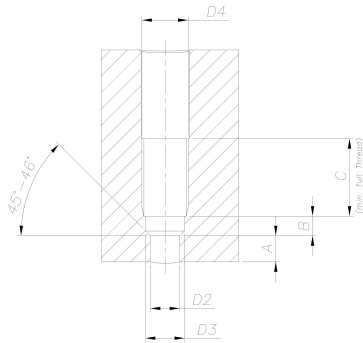

fig. 3

5.3 Instruction and maintenance (Mechanical dimensions of transducer / drilling)



D1	1/2-20UNF	M10x1.0	M14x1.5	M18x1.5
D2	.307/.305" [7.80/7.75mm]	.236/.234" [5.99/5.94mm]	.307/.305" [7.80/7.75mm]	.394/.392" [10.01/9.96mm]
D3	.414/.412" [10.52/10.46mm]	.336/.334" [8.53/8.48mm]	.475/.470" [12.07/11.94mm]	.630/.627" [16.00/15.92mm]
A	.219/.209 " [5.56/5.31mm]	.256/.246 " [6.50/6.25mm]	.236/.226 " [5.99/5.74mm]	.236/.226 " [5.99/5.74mm]
B	.450" [11.43mm]	.430" [10.92mm]	.480" [12.19mm]	.590" [14.98mm]
C	1.07" [27.2mm]	1.06" [26.9mm]	1.28" [32.5mm]	1.34" [34.0mm]



D1	1/2-20UNF	M10x1.0	M14x1.5	M18x1.5
D2	.313 ±0.001" [7.95 ±0.02mm]	.241 ±0.001" [6.12 ±0.02mm]	.319 ±0.001" [8.10 ±0.02mm]	.398 ±0.001" [10.10 ±0.02mm]
D3	.454 ±0.004" [11.53 ±0.1mm]	.344 ±0.004" [8.74 ±0.1mm]	.478 ±0.004" [12.14±0.1mm]	.634 ±0.004" [16.10 ±0.1mm]
D4	.515" [13mm] min.	.515" [13mm] min.	.630" [16mm] min.	.790" [20mm] min.
A	.225" [5.72mm] min.	.263" [6.68mm] min.	.240" [6.10mm] min.	.240" [6.10mm] min.
B	.17" [4.3mm] max.	.11" [2.8mm] max.	.16" [4.0mm] max.	.16" [4.0mm] max.
C	.75" [19mm]	.75" [19mm]	.75" [19mm]	.99" [25mm]

Exposed Capillary

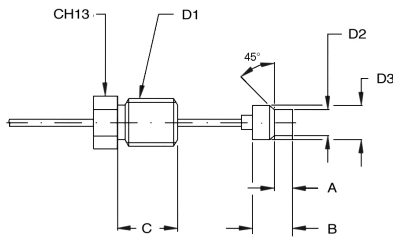

Sensor tip dimensions

D1	1/2-20UNF
D2	.307/.305" [7.80/7.75mm]
D3	.414/.412" [10.52/10.46mm]
A	.125/.120 " [3.18/3.05mm]
B	.318/.312 " [8.08/7.92mm]
C	.81" [20.6mm]

Mounting hole dimensions

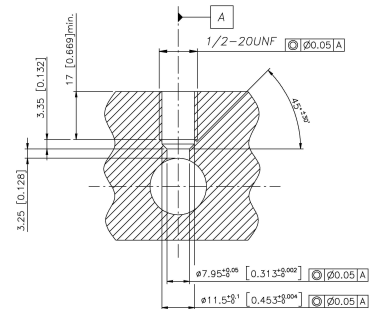

ATTENTION

Incorrect working or shape of the hole can result in properties out of specification, bad behavior or damage to the sensor.

6. INSTALLATION AND ELECTRICAL CONNECTIONS

6.1 General precautions

The system must be used only in accordance with the required protection level. The sensor must be protected against accidental knocks and used in accordance with the instrument's ambient characteristics and performance levels. The sensors must be powered with non-distributed networks and always at lengths of less than 30 mt. In case of outdoor installations, follow the instructions in paragraph 6.5

6.2 Transmitters with digital output

Transducers: MD / WD / KD / I / IJ series

Outputs: CANopen DP404

Installation notes

- The transducer must be grounded (normally through the machine body or equipment it is installed on).
- Use a shielded cable only. The braiding must be connected to the case of the 5-pin connector. On instrument/PLC side, we advise you connect the braiding without power supply (0V GND).
- To prevent interference, separate the power cables from the signal cables.

Standard installation (recommended)

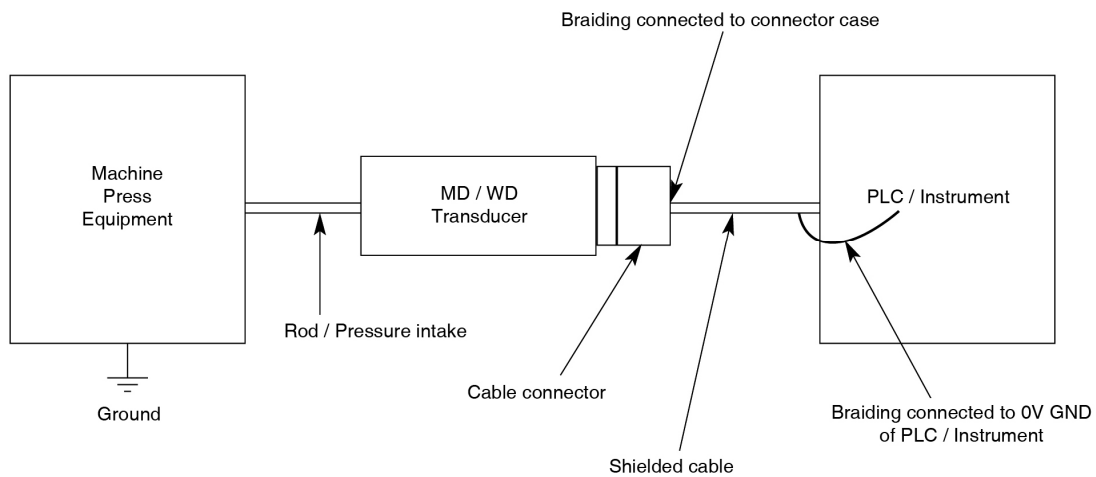

Electrical connections

CAN BUS DP404 digital output

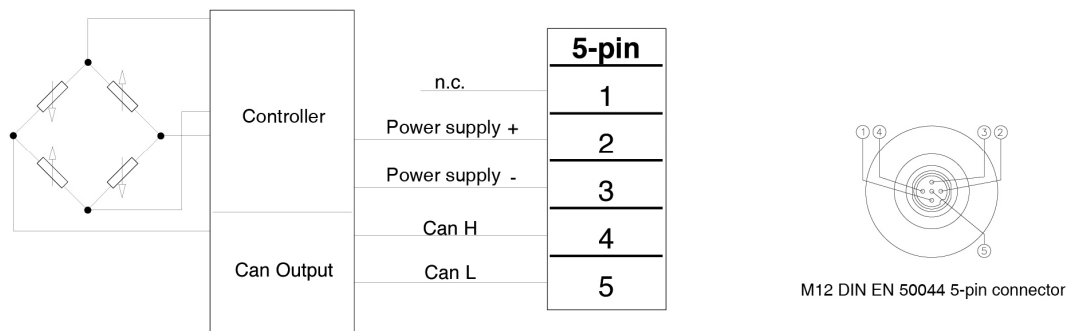

6.3 Transmitters with amplified analog output

Transducers: M / K / W / I series

Outputs: 0...10V, 0...5V, 0,1...10,1V, 1V, 0,1...5V, 1V, 4...20mA, etc...
mV/V

Installation notes

- The transducer must be gronde (normally through the machine body or equipment it is installed on).
- Use a shielded cable only. The braiding must be connected to the connector case. The braiding on instrument / PLC side must be left floating.
- To prevent interference, separate the power cables from the signal cables.

Standard installation (recommended)

M / W / K / I series

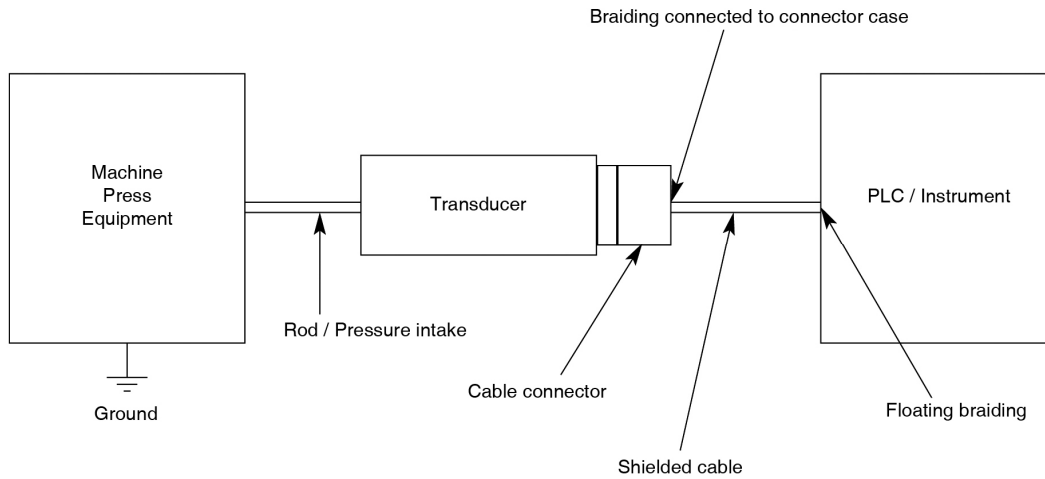

Electrical connections
M / W / K / I series

Current output (4...20mA, 2 wires)

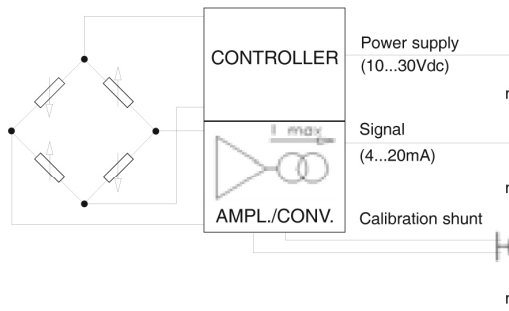

MAGNETIC AUTOZERO

6-pin	8-pin
A	B
C	A
B	D
D	C
E - F	E - F
	G - H

EXTERNAL AUTOZERO

6-pin	8-pin
A	B
C	A
B	D
D	C
E - F	E - F
	G - H

LOAD DIAGRAM
(Current output)

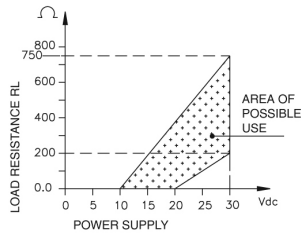

Shield drain wire is tied to connector via cable clamp

Voltage output (M, N, B, C)
Power supply 15..30Vdc

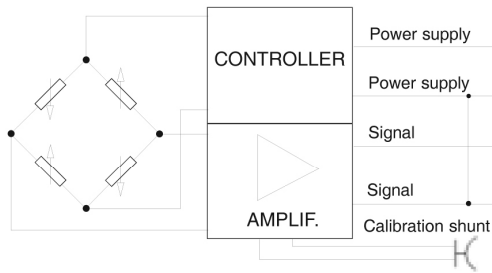

MAGNETIC AUTOZERO

6-pin
C
D
A
B
E - F

EXTERNAL AUTOZERO

6-pin
C
D
A
B
E - F

Shield drain wire is tied to connector via cable clamp

Voltage output (H, L)
Power supply -15..+15Vdc (*)

(*) The Pin B of the connector must be connected to the common of the ± 15Vdc supply

8-pin connector

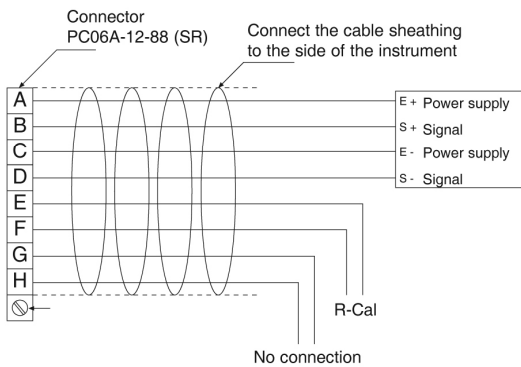

Magnetic Autozero version

- A = Excitation + (white)
- B = Signal + (red)
- C = Excitation - (green)
- D = Signal - (black)
- E = R-Cal (blue)
- F = R-Cal (brown)
- G = no connection
- H = no connection

External Autozero version

- A = Excitation + (white)
- B = Signal + (red)
- C = Excitation - (green)
- D = Signal - (black)
- E = Autozero (blue)
- F = Autozero (brown)
- G = no connection
- H = no connection

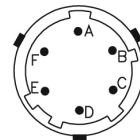

6-pin connector
VPT07RA10-6PT2
(PT02A-10-6P)

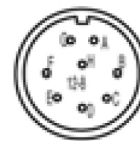

8-pin connector
PC02E-12-8P Bendix

Electrical connections
MF/WF series

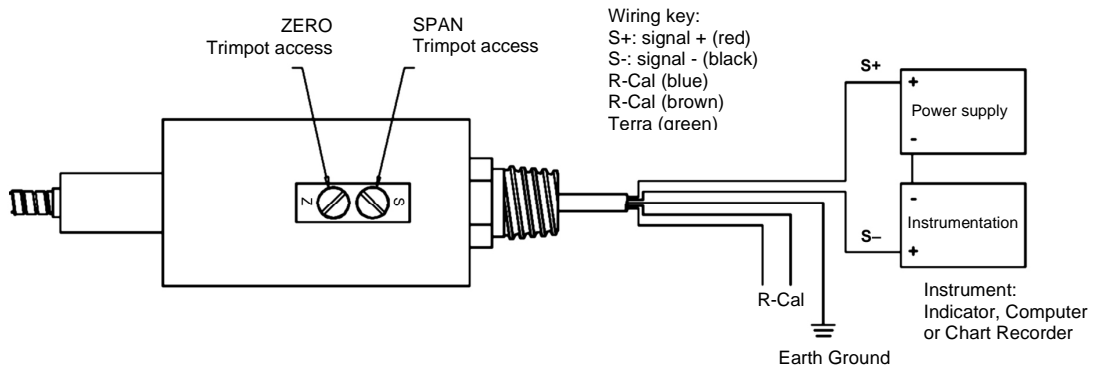

LOAD DIAGRAM

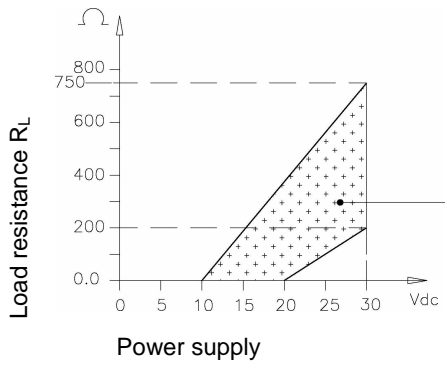

ADJUSTMENTS

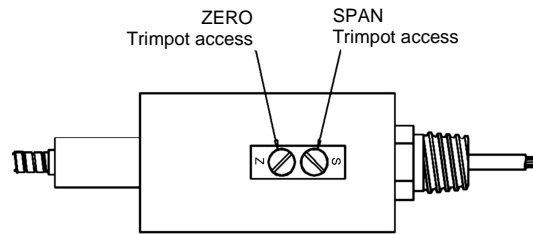

The diagram shows the optimum ratio between the load and supply voltage of the 4-20mA transmitter. For correct usage, choose any combination of load resistance and supply voltage in the shaded area.

Zero and Span adjustment can be made by trimpots inside the transmitter body, accessible after removing the two protection screws.

Span is factory set and should not be adjusted.



WARNING: The trimpot access screws must remain in the transmitter at all times while the device is in a hazardous location. Bring the environment to non-hazardous conditions before removing access screws to adjust zero.



Note

Refer to the specific product safety notes for installations in hazardous areas.

6.4 Transducers with non-amplified analog output

Transducers: M / K / W / I series

Outputs: mV/V

Installation notes

- The transducer must be gronde (normally through the machine body or equipment it is installed on).
- Use a shielded cable only. The braiding on connector side must be left floating. The braiding on instrument / PLC side must be connected to the power supply GND.
- To prevent interference, separate the power cables from the signal cables.

Standard installation (recommended)

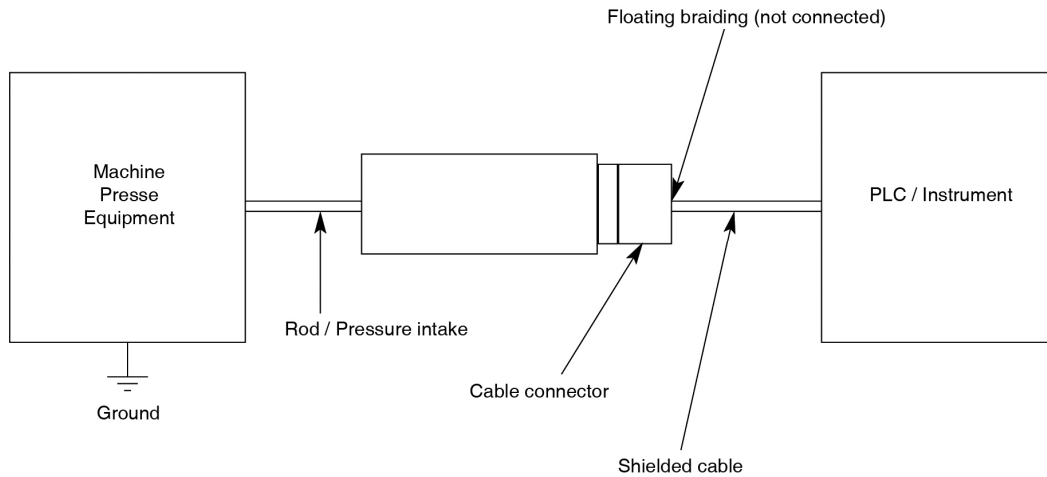

Electrical connections

mV/V output

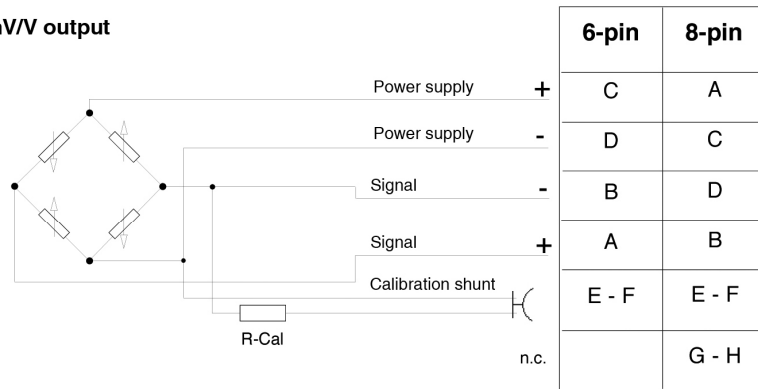

Connect the cable sheathing to the side of the instrument

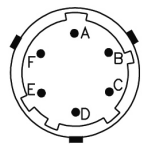

6-pin connector
VPT07RA10-6PT2
(PT02A-10-6P)

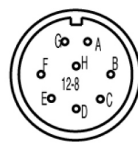

8-pin connector
PC02E-12-8P Bendix

6.5 Protection for outdoor installations of analog sensors

**Pressure / Analog Melt current output
CAL signals if any do not require protection**

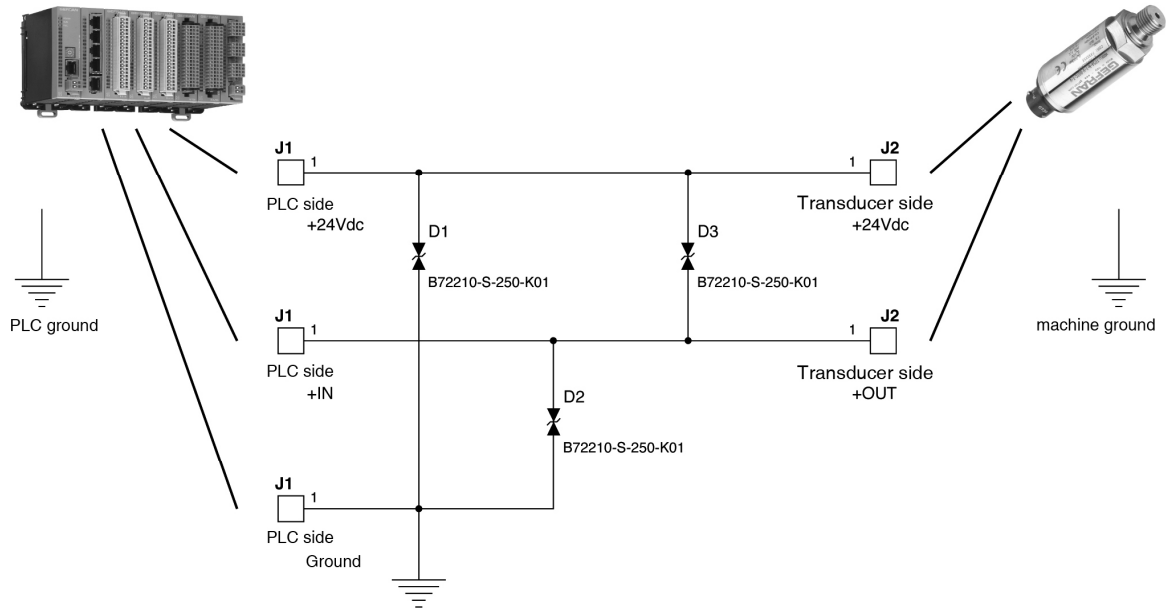

**Pressure / Analog Melt voltage output
CAL signals if any do not require protection**

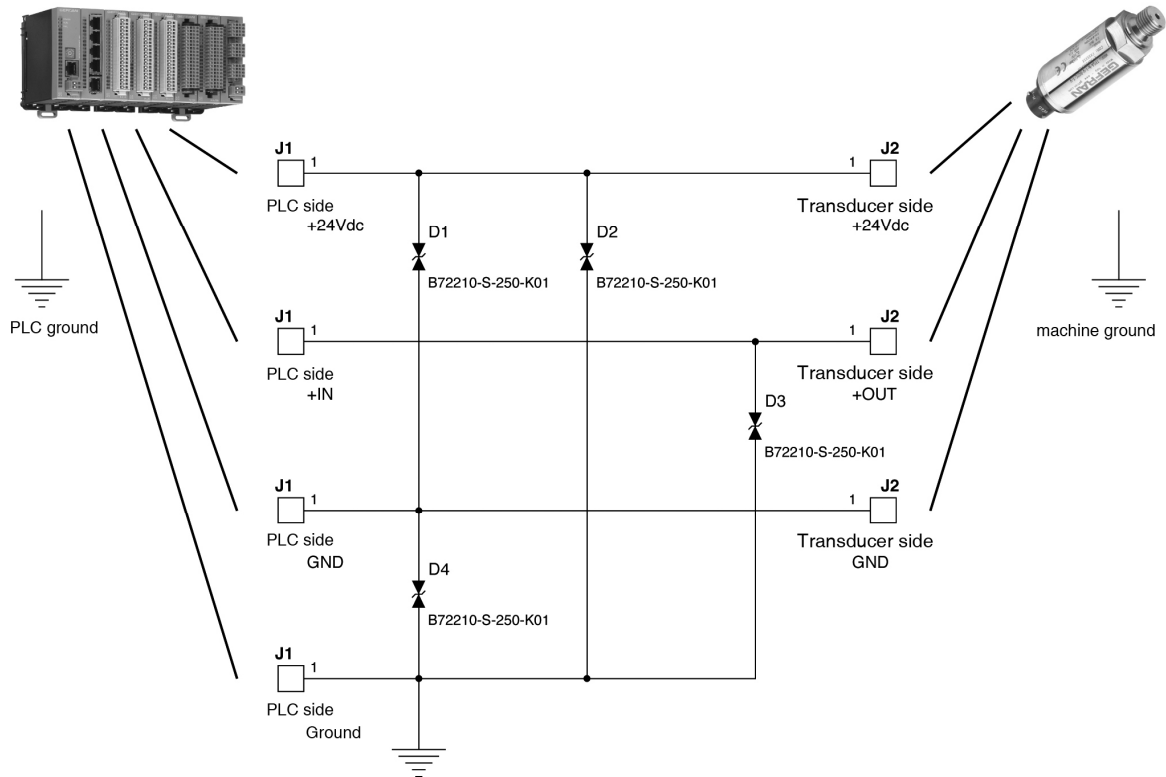

6.6 Standard reference

Gefran products, described in this manual, are compliant to the European Directive 2004/108/CE. They are tested according to the standard EN 61326-1 “Electrical equipment for measurement, control and laboratory use - EMC requirements”, Part 1 “general requirements and EN 61326-2-3 “Electrical equipment for measurement, control and laboratory use - EMC requirements”, Part 2-3: Particular requirements - Test configuration, operational conditions and performance criteria for transducers with integrated or remote signal conditioning.

Electromagnetic Compatibility (EMC) requirements are classified in two types: Emission requirements, Immunity requirements.

Emission requirements

For class B equipment the limits, the measuring methods and the provisions given in CISPR11, EN 61000-3-2 and EN 61000-3-3 apply.

Equipment classification and choice of respective limits shall be determined after taking into account the intended environment and emission requirement in the areas of use.

Immunity requirements

The immunity test requirements are given in table 1. The tests shall be conducted in accordance with the basic standards. The tests shall be carried out one at time.

Table 1 – Immunity test requirements for equipment intended for use in industrial locations

Port	Phenomenon	Basic standard	Test value	Performance criteria requested	Performance criteria applied by Gefran
Enclosure	Electrostatic discharge (ESD)	EN 61000-4-2	4 kV / 8 kV contact/air	B	A
	EM field	EN 61000-4-3	10 V/m (80 MHz to 1 GHz) 3 V/m (1,4 GHz to 2 GHz) 1 V/m (2,0 GHz to 2,7 GHz)	A	A
	Rated power frequency magnetic field	EN 61000-4-8	30 A/m	A	A (@ 400 A/m)
Power supply DC ^{g)}	Burst	EN 61000-4-4	2 kV (5/50 ns, 5 kHz)	B	A
	Surge	EN 61000-4-5	1 kV ^{a)} / 2 kV ^{b)}	B	B
	Conducted RF	EN 61000-4-6	3 V (150 kHz to 80 MHz)	A	A (@ 10V)
I/O signal/control (including functional earth lines)	Burst	EN 61000-4-4	1 kV (5/50 ns, 5 kHz) ^{d)}	B	A
	Surge	EN 61000-4-5	1 kV ^{b), c)}	B	B
	Conducted RF	EN 61000-4-6	3 V (10 kHz to 80 MHz)	A	A (@ 10V)

- a) Line to line
- b) Line to ground
- c) Only in the case of long-distance lines
- d) Only in the case of lines > 3 m
- g) DC connections between parts of equipment/system which are not connected to a d.c. distribution network are treated as I/O signal/control ports

Performance criterion A

During testing, normal performance within the specification limits.

Example

If electronic equipment is require to work with high reliability, the EUT shall operate without any apparent degradation from the manufacturer’s specification.

Performance criterion B

During testing, temporary degradation, or loss of function or performance which is selfrecovering.

Example

During testing, an analogue function value may deviate. After the test, the deviation vanishes.

Performance criterion C

During testing, temporary degradation, or loss of function or performance which requires operator intervention or system reset occurs.

Example

In the case o fan interruption in the mains longer than the specified buffer time, the power suppli unito f the equipment is switched off. The switch-on may be automatic or carried out by the operator.

Copy of the conformity declaration is available dor download on the Gefran web site www.gefran.com.

6.7 EMC and RoHS Requisites

Gefran Melt transducers and transmitters are built in conformity with the following EMC directives:
EMC 2004/108/CE and RoHS 2002/95/CE.

It is important to note that the above results refer to tests run under the working conditions stated in the catalog.
The types of connections used for the power cable sheathing are particularly important.

For transducers with non-amplified output, the cable sheathing must be connected to the instrument side; for transmitters with 4-20mA, 0-10V amplified output, the cable sheathing must be connected to the connector side.

7. ON-BOARD FUNCTION

7.1 Autozero function

AUTOZERO

All signal variations in the absence of pressure can be eliminated by using the Autozero function.

The function is activated by closing a magnetic contact located in the transmitter housing (function cannot be activated when machine is in operation).

The device used for the reset control is a magnet located on the outside of the housing, attached to it by a plastic support.

This system provides total reliability and easy use.

On sensors configured in a dedicated manner, the Autozero function can be activated externally by short-circuiting pins E and F on the connector.

By using the reset control, setting the Zero signal with a trimmer becomes obsolete; the same is true for the Span signal, for which the sensor can be recalibrated via software.

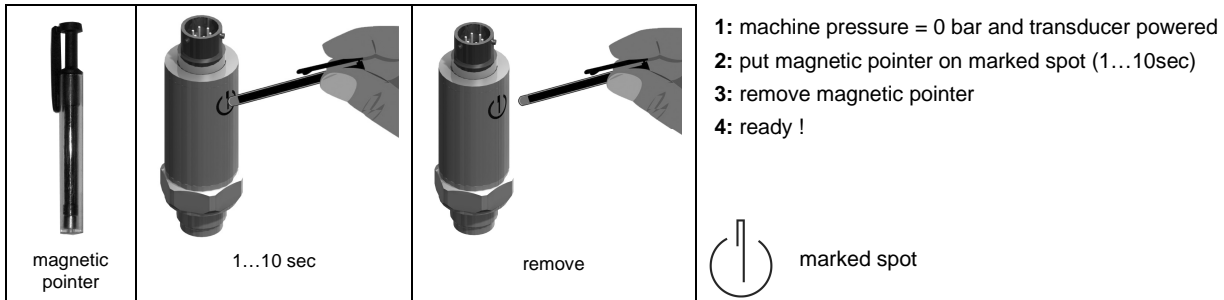

ACTIVATION OF AUTOZERO AFTER THE FIRST INSTALLATION

The Autozero function makes it much easier to run calibrations after the first installation.

With the sensor installed and with the extruder at work temperature, wait 1 minute before running Autozero.

This delay is requie to allow the system temperature to stabilize.

If the transmitter is kept powered, additional Autozero activations can ber un immediately; on the other hand, you will have to wait 1 minute each time the system is switched on again.

AUTOZERO FUNCTION

Application mode	Limits	Result
The Autozero function is activated by: 1) positioning the magnet near the Autozero label on the shell of the sensor. 2) Short-circuiting the pin E-F (external Autozero version). The magnet has to be maintained on the Autozero position for a time within 1 to 10 sec.	The whole Zero unbalancement in comparison to the zero done by the manufacturer, has to be $\pm 10\%$ FS (*).	The Autozero effect will be visible after waiting 2 sec after the start of the function. The precision of the zero value will be defined by the accuracy class of the sensor. The Autozero function doesn't work outside the defined limits.

NOTE:

(*):This value has to be considered typical. Higher limits value will be allowed for different range.

During the Autozero phase, the current output for the ME/WE transmitter series, will increase around 7mA.

That's a short variation only visible during the Autozero phase; it won't have any effects on the final signal.

7.2 Fine-Autozero function

Application mode	Limits	Result
<p>The Fine-Autozero function is activated by:</p> <p>1) positioning the magnet near the Autozero label on the shell of the sensor.</p> <p>2) Short-circuiting the pin E-F (external Autozero version).</p> <p>The magnet has to be maintained on the Autozero position for a time within 10 to 30 sec.</p> <p>After removing the magnet the signal will start changing the value step by step.</p> <p>Stop adjustment: touch the Autozero area with the magnet to stop the signal variation.</p>	<p>The whole Zero unbalancement in comparison to the zero done by the manufacturer, has to be $\pm 10\%FS$ (*)</p>	<p>The output signal will change within a $\pm 100mV$ value ($\pm 0,16mA$ for out 4-20mA) the change decreases in step of 6mV (12uA for 4-20mA output).</p> <p>Ex: 0..-6..-12..//-100..+100..+94..+88..0</p> <p>The signal will be stopped without delay once the Autozero area is touched with the magnet.</p> <p>The Fine-Autozero function doesn't work outside the defined limits.</p>

NOTE:

- (*):this value has to be considered typical. Higher limits value will be allowed for different range
- The step duration time is 1 sec
- During the Autozero phase, the current output for the ME/WE transmitter series, will increase to around 7mA.
- Furthermore between the step variations it will be possible to have short overcurrent up to 7mA.
- That's an immediate variation only visible during the Autozero phase; it won't have any effects on the final signal.

7.3 Calibration function

Application mode	Limits	Result
<p>Start cal: The Calibration function is activated by short-circuiting the pin E - F for a minimum time of 1 sec</p> <p>Stop cal: Release the E - F short-circuit</p>	<p>The whole Zero unbalancement in comparison to the zero done by the manufacturer, has to be $\pm 20\%FS$.</p>	<p>During the Calibration phase the signal will be unbalanced to the 80% FS. The calibration effect is visible 2 sec after short-circuiting E - F.</p> <p>The Calibration function doesn't work outside the defined limits.</p>

NOTE:

- During the Calibration phase, the current output for the transmitter, will increase around 7mA.
- That's an immediate variation only visible during the Calibration phase; it won't have any effects on the final signal.
- Switching off the supply while the calibration function is activated, could be cause of calibration problems; the transmitter can be recalibrated to the initial value by activating the "partial reset function".
- **The Calibration function is not allowed for "external Autozero" version.**

7.4 Autospan

Application mode	Limits	Result
<p>The Autospan function is activated in three steps as explained in the following.</p> <p><u>phase 1) pressure 0 bar:</u> 1^ Autozero Activate the Autozero function</p> <p><u>phase 2) pressure = FS (**):</u> Short-circuit pin E - F. Maintain the E - F short-circuit, after a minimum time of 1 sec., start the "Autozero function"; the magnet has to be maintained in contact for a period of 1 - 10sec. Than release the E - F shortcircuit. Wait a minimum time of 1sec before releasing the E - F short circuit.</p> <p><u>phase 3) pressure 0 bar:</u> 2^ Autozero Activate the Autozero function.</p>	<p>The whole Zero unbalancement in comparison to the zero done by the manufacturer, has to be $\pm 10\%FS$ (*).</p> <p>The whole span unbalancement which can be obtained must be within $\pm 5\%$ of the FS of the transmitter</p>	<p>The transmitter will be calibrated at the new Zero and Span values, within the accuracy class of the sensor (**).</p> <p>The Autozero function doesn't work outside the defined limits.</p>

NOTE:

(*): This value has to be considered typical. Higher limits value will be allowed for different range
 (**): It is possible improve the calibration precision by doing several calibration (Autospan function).
 (**): The FS has to be a pressure within $\pm 5\%FS$

The Autospan function is not allowed for "external Autozero" version.

7.5 Partial reset of the calibration values

Application mode	Limits	Result
<p>The magnet has to be maintained on the Autozero position for a time within 30 to 60 sec.</p>		<p>The Zero of the transmitter will be recalibrated to the factory settings; furthermore an Autozero will be done automatically. The Span calibration will be maintained.</p>

NOTE:

During the partial reset phase, the current output for the transmitter ME/WE series, will increase around 7mA

7.6 Total reset of the calibration values

Application mode	Limits	Result
<p>The magnet has to be maintained on the Autozero position for a time over 60 sec</p>		<p>The Zero and Span of the transmitter will be recalibrated to the factory settings.</p>

NOTE:

During the total reset phase, the current output for the ME/WE transmitter series, will increase around 7mA

8. AUTOCOMPENSATION FUNCTION

Autocompensation of temperature drift

All sensors that use filled technology (i.e., that contain a pressure signal retransmission fluid) share the problem of fluid expansion at working temperature.

A negative consequence of expansion is the generation of pressure inside the sensor.

The transduction element senses this pressure as a pressure variation in the process, so the reading is affected by an error that averages about 2-4bar/100°C.

Thanks to "Autocompensation," both drifts can be reduced until becoming practically negligible.

Fig. 2 shows the degrees of read error achieved, comparing a standard series M sensor to another in the same series but in SP configuration.

The graph shows that for a sensor with pressure range of 200 bar, the maximum read error is 0.003 bar/°C, meaning 1 bar at 300°C, compared to 8 bar for an equivalent 200 bar sensor in standard version.

This result was achieved thanks to a temperature read system that reaches the "important" points of the sensor and constantly monitors every minimum temperature variation on board.

These signals are then transferred to the various stages of conditioning of the electronics until reaching the microprocessor, which performs compensation of the drift errors introduced.

Even the time in which the signal is corrected has been calculated to reduce the effects of temperature transition to a minimum.

This means that the values stated in specifications are always respected for every step of the process.

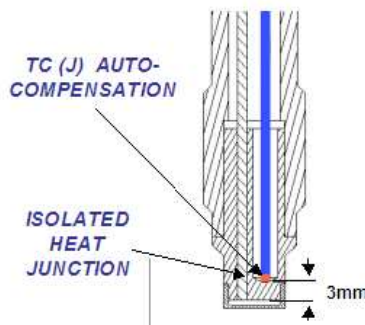

By means of a thermocouple in the signal stem compensated digitally

8.1 Output signal trend as a function of temperature effect

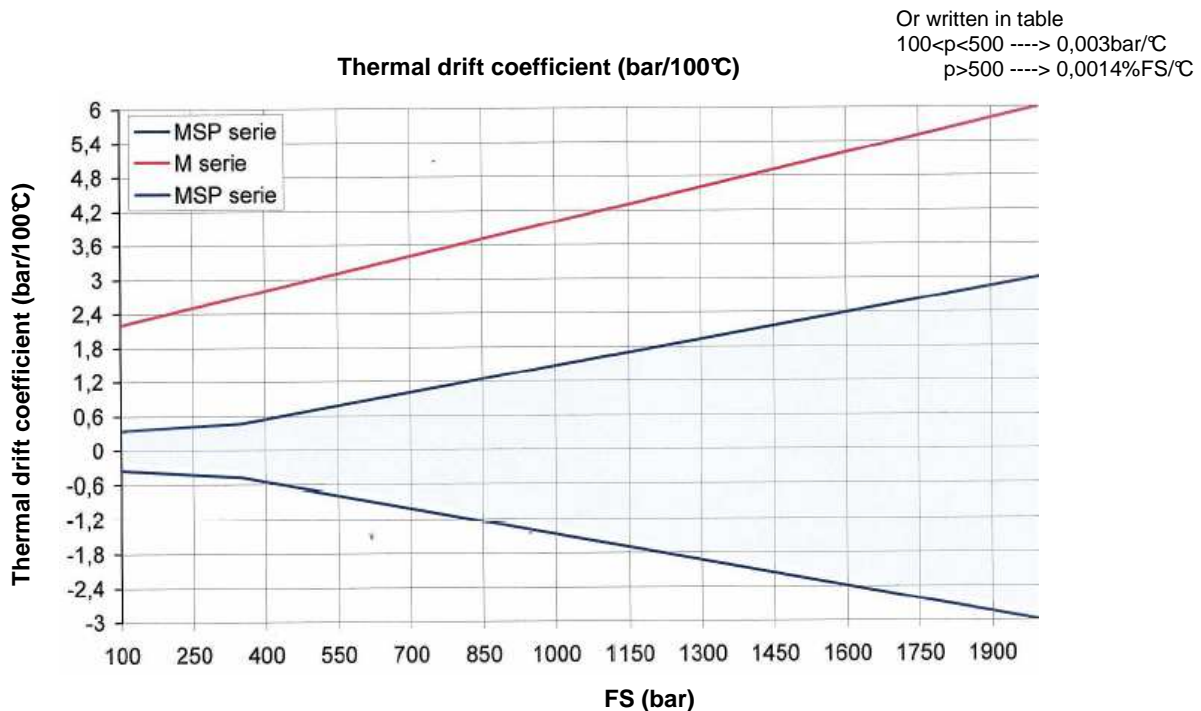

9. MAINTENANCE

9.1 Maintenance

Melt pressure sensors must be installed and electrically connected by trained people, following all applicable recommendations, with zero pressure and voltage, and with the machine switched off.

The sensor must be removed with the plastic in Melt state and the machine in hot conditions.

Always remove the sensor before cleaning the machine, using steel brushes or similar tools.

Always wear protective gloves and always take adequate ESD precautions to prevent electrostatic discharges that could damage the sensor.

Always use the wrench for the hexagonal nut when installing and removing the sensor.

DO NOT force the electronics housing.

Once the sensor is removed, clean it gently with a soft cloth while the material is still malleable.

9.2 Transport, storage and disposal

Melt sensors are made with "Filled" technology and contain a pressure transmission fluid.

Low-compression fluids such as diathermic oil (FDA and USDA approved), NaK (GRAS substance) for food or medical applications, or mercury are used.

Fluid volumes depend on the mechanical structure of the sensor, and leaks can occur only if the contact diaphragm is broken.

Any other type of break will not cause emissions to the environment.

Never transport or store the sensors without the protective cap and without the original packaging.

In particular, as mercury is a hazardous material it must be disposed of in compliance with applicable law.

Gefran accepts its Melt sensors (defective or damaged by use) for disposal.

10. SAFETY

In case of contact or inhalation of the fluid contained in the Melt sensor, follow the instructions on the toxicology sheet for the related substance.

In particular, K series Melt sensors use NaK as filling fluid.

NaK, composed of Sodium and Potassium (22 Na / 78 K), is an eutectic alloy (i.e., a mixture of two or more substances with a lower melting point than that of its single components) with low compressibility and excellent resistance to high temperatures (up to 538°C).

Above all, it is a non-toxic liquid metal that is recognized as GRAS (Generally Regarded As Safe).

This allows K series Melt sensors to work in contact with materials used for foods (wrapping films, beverage containers, etc.) or for pharmaceuticals/cosmetics (drug containers, soaps, etc.).

In addition, it is totally compatible with the European RoHs (Restriction of Hazardous Substances) Directive with regard to electrical and electronic equipment.

If the contact diaphragm breaks due to the application, NaK tends to oxidize or to react with the contact medium (especially in the presence of water or dampness) by an exothermic reaction.

This generates a spark which, due to the scarcity of material contained (from 20 to 40mm³ on the average), can last few seconds (maximum of 5).

Hg TOXICOLOGICAL SHEET

<p>1 Elements identifying substance or preparation and company</p> <ul style="list-style-type: none"> ● Product data ● Molecular formula: Hg ● Structura formula: Hg ● Commercial name: <u>Mercury</u> ● SDS No: CH0349 ● Information supplied by: E.S. & Q. A. 	<p>5 Fire prevention measures</p> <ul style="list-style-type: none"> ● Approved fire extinguishers: CO₂, powder or nebulized water. Extinguish large fires with nebulized water or alcohol-resistant foam. ● Specific risks due to the substances, its combustion products, or released gases: If heated or in case of fire, the product may generate toxic fumes. Fumes contain metal oxides. ● Specific means of protection: Wear an all-service mask in closed rooms.
<p>2 Composition/information on ingredients</p> <ul style="list-style-type: none"> ● Chemical characteristics: <u>CAS number</u> 7439-97-6 mercury ● Identification number/s ● EINECS number: 2311067 ● CEE number: 080-001-00-0 	<p>6 Measures in case of accidental spill</p> <ul style="list-style-type: none"> ● Measures to protect people: In case of vapors/dust/aerosol, use respiratory protections ● Measures to protect environment: In case of infiltration in bodies of water or sewers, notify the competent authorities. Prevent filtration in sewers/surface waters/groundwater. ● Cleaning/absorption methods: Aspirate liquid in suitable container and absorb the rest with porous material (tripoli, acid binder, universal binder, etc.) Dispose of contaminated material in conformity to point 13. Ventilate the area completely.
<p>3 Indication of hazards</p> <ul style="list-style-type: none"> ● Classification of hazard: T Toxic N Hazardous for the environment ● Indications of specific hazards for humans and the environment: R 23 Toxic if inhaled R 33 Danger of cumulative effects R 50/53 Highly toxic for sea life, may cause long-term negative effects on the aquatic environment. 	<p>7 Handling and storage</p> <p>Handling</p> <ul style="list-style-type: none"> ● Instructions for safe handling: Keep containers hermetically sealed. Good ventilation/aspiration in workplaces. Open and handle containers with care. Avoid formation of aerosol. ● Instructions for preventing fires and explosions: Keep all-service mask handy <p>Storage</p> <ul style="list-style-type: none"> ● Requirements for warehouses and containers: Provide floor tank without discharge. ● Instructions for mixed storage: not necessary. ● Additional instructions regarding storage conditions: Keep containers hermetically sealed. ● Storage class: ● Class VbF (ordinance regarding combustible substances): Not applicable.
<p>4 First aid</p> <ul style="list-style-type: none"> ● General instructions: Immediately remove clothing contaminated with product. Remove protective mask only after removing contaminated clothing. In case of irregular breathing or breathing failure, apply artificial respiration. ● Inhalation: Take the victim to a well-ventilated area and administer oxygen. CALL A DOCTOR. If the victim has fainted, try to keep him in a stable position on his side as you move him. ● Contact with skin: Wash immediately with soap and water, rinse thoroughly. ● Contact with eyes: Wash with running water for several minutes, keeping the eyelids wide open. CALL A DOCTOR. ● Ingestion: Call a doctor if victim feels ill. 	<p>8 Exposure control/personal protection</p> <ul style="list-style-type: none"> ● Additional instructions regarding structure of technical systems: No additional data. See point 7 ● Component whose limits must be kept under control in workplaces: Mercury TLV: 0,025 mg/m³ ● Additional instructions: Lists valid on the date of compilation were used as basis ● Means of personal protection: ● General rules for protection and hygiene at the workplace: Keep away from food, drink, and forage. Immediately remove contaminated clothing. Wash hands before taking a break and at end of shift. Store protective gear separately. ● Protective mask: Use the mask in case of brief, slight exposure; for heavier and longer exposure, wear a self-contained breathing apparatus. Use all-service mask only in case of formation of aerosol or mist. ● Protective gloves: Neoprene gloves ● Goggles: Wear goggles while pouring.

Hg TOXICOLOGICAL SHEET

<p>9 Physical and chemical properties</p> <ul style="list-style-type: none"> • Molecular weight: 200,59 g • Form: Liquid • Color: Silver • Odor: None • Unit value/Method: • Change of state • Melting temperature: -38,86°C • Boiling temperature: 356,73°C • Flash point: not applicable • Danger of explosion: product not explosive • Vapor voltage: a 20°C 0,00163 hPa • Density: a 20°C 13,54 g/cm³ • Solubility in/Mixability with water: slightly and/or not mixable • Organic solvents: insoluble 	<p>14 Information on transport</p> <p>Road/rail transport ADR/RID (beyond border)</p> <ul style="list-style-type: none"> • ADR/RID-GGVSE class: 8 corrosive substances • Number/letter: 66c • Kemler number: 80 • ONU number: 2809 • Description of brand: 2809 Mercury <p>Sea transport IMDG</p> <ul style="list-style-type: none"> • IMDG class: 8 • Page: 8191 • ONU number: 2809 • Packing group: III • EMS number: 8-12 • MFAG: - • Exact technical name: Mercury <p>Air transport ICAO-TI and IATA-DGR</p> <ul style="list-style-type: none"> • ICAO/IATA class: 8 • ONU/ID number: 2809 • Packing group: III • Exact technical name: Mercury
<p>10 Stability and reactivity</p> <ul style="list-style-type: none"> • Thermal decomposition/conditions to be avoided: the product does not decompose if correctly used. • Substances to be avoided: acetylene • Hazardous reactions: Reactions with peroxides and other substances forming radicals. Decomposition of hydrogen peroxide. • Hazardous products of decomposition: No hazardous products of decomposition are known 	<p>15 Information on regulations</p> <ul style="list-style-type: none"> • Classification according to CE directives: The product is classified and coded in conformity to CE directives / rules on hazardous products / dir. 67/548 25° updat e / dir. 88/379 4° update • Label code for product hazardness: T Toxic N Hazardous for the environment • Nature of specific risks (R phrases): 23 Toxic if inhaled 33 Danger of cumulative effects 50/53 Highly toxic for aquatic organisms, may cause long-term negative effects on the aquatic environment. • Recommendations of prudence (S phrases): 7 Keep container completely closed 45 In case of accident or malaise, call a doctor immediately (if possible, show him/her the label) 60 This material and its container must be disposed of as hazardous waste 61 Dispose of properly. See the special instructions / data sheet on safety • National regulations: • Classification according to VbF: Not applicable • Class of hazardousness for waters: Hazard for class 3 waters (WGK3) (Classif. on lists): very hazardous Additional regulations, limitations and prohibitive decrees: Maximum concentration in waste water (DPR 319/76 - Merli Law): 0,005 mg/l
<p>11 Toxicological information</p> <ul style="list-style-type: none"> • Acute toxicity: Significant LD/LC50 values for classification: Mercury. For inhalation: LCLo: (30h) 0,03 mg/l (rabbit) • Primary irritability: - on the skin: has no irritating effects. - in the eyes: not particularly irritating. Sensitization: no sensitizing effects are known • Subacute to chronic toxicity: Cumulative effects in case of repeated exposure. 	<p>16 Other information</p> <p>The above data are based on our current knowledge. Nevertheless, they do not represent any guarantee of product characteristics and are not the basis for any legal and/or contractual relationship.</p> <ul style="list-style-type: none"> • Data sheet issued by: E.S. & Q. A. • Contact: Emergency Ph. 0039 2 95231 • Bibliographic references: ECDIN (Environmental Chem. Data and Information Network) IUCLID (International Uniform Chemical Information Database) NIOSH – Registri of Toxic Effects of Chemical Substances Roth – Wassergefährdende Stoffe Verschueren – Handbook of Environmental Data on Organic Chemicals ChemDAT – Safety Data Sheets from E.Merck on CD-ROM Merian – Metals and their compounds in the environment.
<p>12 Ecological information</p> <ul style="list-style-type: none"> • Behavior in ecological context: • Mobility and potential of bioaccumulation: possible biomethylation • Toxic effects on environment: Aquatic toxicity: Mercury LC50 aq.: (Hg++ 96h) 0,06 mg/l (daphnia) • Additional information: Hazard for class 3 waters (WGK German) (Classif. on lists): very hazardous. Do not put in groundwater, rivers, or sewers, even in small doses. Hazard for drinking water even in case of minimum leaks of product in subsoil. Toxic for fish and plankton. 	
<p>13 Information on disposal</p> <ul style="list-style-type: none"> • Product: • Recommendations: Do not dispose of the product together with domestic waste. Do not put in sewers. Recycle if possible; otherwise, contact a company authorized to dispose of industrial waste. • Soiled packing: • Recommendations: Dispose of in conformity to government regulations. Wash with water to be purified and disposed of. 	

11. CERTIFICATIONS

GEFRAN

DICHIARAZIONE DI CONFORMITÀ **CE**
 CONFORMITY DECLARATION **CE**
 DECLARATION DE CONFORMITE **CE**
 KONFORMITÄTSERKLÄRUNG **CE**

In accordo alla guida 22 ISO/IEC e norma ISO/IEC 17050-1, 17050-2 According to guide 22 ISO/IEC and norm ISO/IEC 17050-1, 17050-2 Selon la guide 22 ISO/IEC et la norme ISO/IEC 17050-1, 17050-2 In Übereinstimmung mit der Richtlinie 22 ISO/IEC und der Norm ISO/IEC 17050-1, 17050-2

Il costruttore The manufacturer Le fabricant Der Hersteller	Gefran S.p.a Stabilimento Sensori Via Cave, 11 25050 – Provaglio d’Iseo (BS) – Italy
Indirizzo legale Law address Légal adresse Zugelassenes Adresse	Via Sebina, 74 - 25050 Provaglio d’Iseo - BS - ITALIA

Dichiara sotto la sua esclusiva responsabilità che i prodotti GEFRAN riportanti la marcatura “CE”:
 Declares on his own responsibility that GEFRAN products with the “CE” mark, series:
 Déclare sous sa responsabilité que les produits GEFRAN avec le marquage “CE”:
 Erklärt hiermit, dass die GEFRAN - Produkte mit “CE” - Kennzeichnung:

Melt Pressure Sensors, series
KN, KE, KD, K3, IN, IE, IJ, I3, M5, M6, MFX, W6, WFX,

- sono in accordo con le Direttive Comunitarie (e successive modifiche) e con la relativa legislazione nazionale di recepimento
- are manufactured according with the Community Directives (including the last modifications) and the related National Legislation of conception
- ont été fabriqué selon les Directives Communautaires (y compris les dernières modifications) et avec la relative législation national de conception
- mit den im folgenden genannten Richtlinien übereinstimmen

2004/108/CE (EMC Directive)

- e che sono state applicate le seguenti (parti/articoli di) norme armonizzate (e successive modifiche)
- and that the following (parts/articles of) harmonized standards and regulation have been applied (including the last modifications)
- et que les normes (partes/articles de) harmonisée suivantes ont été appliqués (y compris les dernières modifications)
- die folgenden Normen Anwendung finden

EN 61000-6-2, edition 2005 “Generic immunity standards for industrial environments”
EN 61000-6-4, edition 2007 “Electromagnetic compatibility (EMC). Generic standards. Emission standard for industrial environments”
EN 61326-1, edition 2006 “ Electrical Equipment for measurement, control and laboratory use – EMC requirement

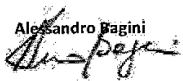
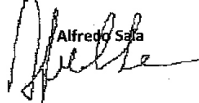
Date: 12.01.2009	Quality Manager Alessandro Pagini 	Chief Executive Officer Alfredo Sala 
-------------------------	---	--

Gefran spa

Via Sebina, 74 25050 Provaglio d’Iseo (BS) Italy	Tel. +39 030 9888.1 Fax +39 030 9839063 www.gefran.com info@gefran.com	Cap. Soc. € 14.400.000 i.v. Reg. Imprese Brescia 03032420170 R.E.A. 313074 BS	N. Mecc. BS 016227 C.F. 03032420170 P.IVA (TVA-VAT-MWS) IT03032420170
--	---	---	--



GEFRAN

DICHIARAZIONE DI CONFORMITÀ CE CE CONFORMITY DECLARATION

In accordo alla guida 22 ISO/IEC e norma ISO 17050-1
According to guide 22 ISO/IEC and standard ISO 17050-1

Il Costruttore:

Gefran S.p.a
Stabilimento Sensori
Via Cave, 11

The manufacturer:

25050 – Provaglio d'Iseo (BS) – Italy

dichiara sotto la sua esclusiva responsabilità che i prodotti:
declare under his own responsibility that the products:

Trasmettitori di pressione di Melt serie
Melt pressure transmitters series

ME - MN - MD - MJ
WN - WD -

ai quali questa dichiarazione si riferisce, sono conformi alle seguenti Direttive:
to which this declaration relates complies with the following Directives:

EMC Directive 2004/108/CE
PED Directive 97/23/CE (*)

(*): solo per trasmettitori con pressioni di fondo scala superiori a 500 bar, con riferimento alla linea guida 1/5
(*): only for transmitters with pressure range above 500 bar, with reference to guideline 1/5

La conformità è stata verificata sulla base dei requisiti delle norme o dei documenti normativi riportati nel seguito (comprese le successive modifiche)

The conformity are under observance of the following standards or standards documents (including the last modifications)

EN 61000-6-3 – EN 61000-6-2

Date:
12.01.2009

Quality Manager
Alessandro Bagini

Chief Executive Officer
Alfredo Sala

Gefran spa

Sede Legale

Via Sebina, 74
25050 Provaglio d'Iseo
(BS)
Italy

Tel. +39 030 9888.1
Fax +39 030 9839063
www.gefran.com
info@gefran.com

Cap. Soc. € 14.400.000 i.v.
Reg. Imprese
03032420170
R.E.A. 313074 BS

N. Mecc. BS 016227
C.F. 03032420170
P.IVA (Tva-VAT-MWS)
IT03032420170

Stabilimento Sensori

Via Cave, 11
25050 Provaglio d'Iseo (BS) - Italy
Tel. +39 030 9291411
Fax +39 030 9823201

GEFRAN

DICHIARAZIONE DI CONFORMITÀ CE CE CONFORMITY DECLARATION

In accordo alla guida 22 ISO/IEC e norma ISO 17050-1
According to guide 22 ISO/IEC and standard ISO 17050-1

Il Costruttore:

Gefran S.p.a
Stabilimento Sensori
Via Cave, 11

The manufacturer:

25050 – Provaglio d'Iseo (BS) – Italy

dichiara sotto la sua esclusiva responsabilità che i prodotti:
declare under his own responsibility that the products:

Trasmettitori di pressione di Melt serie
Melt pressure transmitters series

M2 - M3 - W2 - W3

ai quali questa dichiarazione si riferisce, sono conformi alle seguenti Direttive:
to which this declaration relates complies with the following Directives:

EMC Directive 2004/108/CE
PED Directive 97/23/CE (*)

(*) : solo per trasmettitori con pressioni di fondo scala superiori a 500 bar, con riferimento alla linea guida 1/5
(*) : only for transmitters with pressure range above 500 bar, with reference to guideline 1/5

La conformità è stata verificata sulla base dei requisiti delle norme o dei documenti normativi riportati nel seguito (comprese le successive modifiche)

The conformity are under observance of the following standards or standards documents (including the last modifications)

EN 61000-6-3 – EN 61000-6-2

Date:
12.01.2009

Quality Manager
Alessandro Bagini



Chief Executive Officer
Alfredo Sala

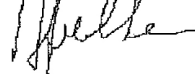

Gefran spa

Sede Legale

Via Sebina, 74
25050 Provaglio d'Iseo
(BS)
Italy

Tel. +39 030 9888.1
Fax +39 030 9839063
www.gefran.com
info@gefran.com

Cap. Soc. € 14.400.000 i.v.
Reg. Imprese
03032420170
R.E.A. 313074 BS

Brescia

N. Mecc. BS 016227
C.F. 03032420170
P.IVA (Tva-VAT-MWS)
IT03032420170

Stabilimento Sensori

Via Cave, 11
25050 Provaglio d'Iseo (BS) - Italy
Tel. +39 030 9291411
Fax +39 030 9823201

GEFRAN

DICHIARAZIONE DI CONFORMITÀ CE
CE CONFORMITY DECLARATION

In accordo alla guida 22 ISO/IEC e norma ISO 17050-1
 According to guide 22 ISO/IEC and standard ISO 17050-1

Il Costruttore: **Gefran S.p.a**
Stabilimento Sensori
Via Cave, 11
 The manufacturer: **25050 – Provaglio d'Iseo (BS) – Italy**

dichiara sotto la sua esclusiva responsabilità che i prodotti:
 declare under his own responsibility that the products:

Trasmettitori di pressione di Melt serie
Melt pressure transmitters series

MX0 - MX1 - MX2 - MX3 - MX4
WX0 - WX1 - WX2 - WX3 - WX4

ai quali questa dichiarazione si riferisce, sono conformi alle seguenti Direttive:
 to which this declaration relates complies with the following Directives:

ATEX Directive 94/9/CE
EMC Directive 2004/108/CE
PED Directive 97/23/CE (*)

(*): solo per trasmettitori con pressioni di fondo scala superiori a 500 bar, con riferimento alla linea guida 1/5
 (*): only for transmitters with pressure range above 500 bar, with referencè to guideline 1/5

La conformità è stata verificata sulla base dei requisiti delle norme o dei documenti normativi riportati nel
 seguito

The conformity are under observance of the following standards or standards documents

EN 60079-0 – EN 60079-11 – EN 60079-26
 EN 61000-6-3 – EN 61000-6-2

Modo di protezione <i>Type of protection</i> II 1 G, Ex ia IIC T4, T5	Temperatura Ambiente <i>Ambient temperature</i> -20°C ÷ +55°C / +70°C
Certificato CE di tipo: <i>EC type certificate:</i> CESI 02 ATEX 107	Organismo Notificato ATEX/Q: <i>Notified body:</i> 0722 CESI

Date:
12.01.2009

Quality Manager
Alessandro Bagini

Chief Executive Officer
Alfredo Saia

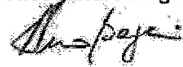
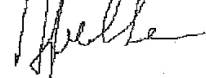
Gefran spa

Sede Legale Via Sebina, 74 25050 Provaglio d'Iseo (BS) Italy	Tel. +39 030 9888.1 Fax +39 030 9839063 www.gefran.com info@gefran.com	Cap. Soc. € 14.400.000 i.v. Reg. Imprese 03032420170 R.E.A. 313074 BS	N. Mecc. BS 016227 C.F. 03032420170 P.IVA (Tva-VAT-MWS) IT03032420170	Stabilimento Sensori Via Cave, 11 25050 Provaglio d'Iseo (BS) - Italy Tel. +39 030 9291411 Fax +39 030 9823201
---	---	--	--	---

GEFRAN

DICHIARAZIONE DI CONFORMITÀ CE

CE CONFORMITY DECLARATION

In accordo alla guida 22 ISO/IEC e norma ISO 17050-1
According to guide 22 ISO/IEC and standard ISO 17050-1

Il Costruttore:

Gefran Spa
Stabilimento Sensori
Via Cave, 11

The manufacturer:

25050 – Provaglio d'Iseo (BS) – Italy

dichiara sotto la sua esclusiva responsabilità che i prodotti:
declare under his own responsibility that the products:

Trasmettitori di pressione di Melt serie
Melt pressure transmitters series

MX0 - MX1 - MX3 - MX4
WX0 - WX1 - WX3 - WX4

ai quali questa dichiarazione si riferisce, sono conformi alle seguenti Direttive:
to which this declaration relates complies with the following Directives:

ATEX Directive 94/9/CE
EMC Directive 2004/108/CE
PED Directive 97/23/CE (*)

(*) : solo per trasmettitori con pressioni di fondo scala superiori a 500 bar, con riferimento alla linea guida 1/5
(*) : only for transmitters with pressure range above 500 bar, with reference to guideline 1/5

La conformità è stata verificata sulla base dei requisiti delle norme o dei documenti normativi riportati nel seguito (comprese le successive modifiche)

The conformity are under observance of the following standards or standards documents (including the last modifications)

EN 60079-0 – EN 60079-15 – EN 61241-0 – EN 61241-1
EN 61000-6-3 – EN 61000-6-2

Marcatura:
Marking:

CE Ex II 3 G D Ex nL IIC T5, Ex tD A22, IP65 T100°C Tamb -20°C ÷ +65°C

Date:
12.01.2009

Quality Manager
Alessandro Bagini

Chief Executive Officer
Alfredo Sala

Gefran spa

Sede Legale

Via Sebina, 74
25050 Provaglio d'Iseo
(BS)
Italy

Tel. +39 030 9888.1
Fax +39 030 9839063
www.gefran.com
info@gefran.com

Cap. Soc. € 14.400.000 i.v.
Reg. Imprese
03032420170
R.E.A. 313074 BS

Brescia
N. Mecc. BS 016227
C.F. 03032420170
P.IVA (Tva-VAT-MWS)
IT03032420170

Stabilimento Sensori

Via Cave, 11
25050 Provaglio d'Iseo (BS) - Italy
Tel. +39 030 9291411
Fax +39 030 9823201

GEFRAN

**DICHIARAZIONE DI CONFORMITÀ CE
CE CONFORMITY DECLARATION**

In accordo alla guida 22 ISO/IEC e norma ISO 17050-1
According to guide 22 ISO/IEC and standard ISO 17050-1

Il Costruttore: **Gefran Spa**
Stabilimento Sensori
Via Cave, 11
The manufacturer: **25050 – Provaglio d'Iseo (BS) – Italy**

dichiara sotto la sua esclusiva responsabilità che i prodotti:
declare under his own responsibility that the products:

**Trasduttori di pressione di Melt serie
Melt pressure transducers series**

M-X - W-X

ai quali questa dichiarazione si riferisce, sono conformi alle seguenti Direttive:
to which this declaration relates complies with the following Directives:

**ATEX Directive 94/9/CE
EMC Directive 2004/108/CE
PED Directive 97/23/CE (*)**

(*): solo per trasduttori con pressioni di fondo scala superiori a 500 bar, con riferimento alla linea guida 1/5

(*): only for transducers with pressure range above 500 bar, with reference to guideline 1/5

La conformità è stata verificata sulla base dei requisiti delle norme o dei documenti normativi riportati nel seguito

The conformity are under observance of the following standards or standards documents

EN 60079-0 – EN 60079-11 – EN 60079-26
EN 61000-6-3 – EN 61000-6-2

Modo di protezione <i>Type of protection</i> II 1 G, Ex ia IIC T6 / T5	Temperatura Ambiente <i>Ambient temperature</i> -20°C + +55°C / -20°C ÷ +70°C
Certificato CE di tipo: <i>EC type certificate</i> CESI 04 ATEX 076	Organismo Notificato ATEX/Q: <i>Notified body</i> 0722 CESI

Date:
12.01.2009

Quality Manager
Alessandro Bagini

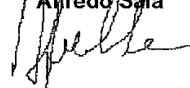
Chief Executive Officer
Alfredo Sala

Gefran spa

Sede Legale
Via Sebina, 74
25050 Provaglio d'Iseo
(BS)
Italy

Tel. +39 030 9888.1
Fax +39 030 9839063
www.gefran.com
info@gefran.com

Cap. Soc. € 14.400.000 i.v.
Reg. Imprese
03032420170
R.E.A. 313074 BS

Brescia
N. Mecc. BS 016227
C.F. 03032420170
P.IVA (Tva-VAT-MWS)
IT03032420170

Stabilimento Sensori
Via Cave, 11
25050 Provaglio d'Iseo (BS) - Italy
Tel. +39 030 9291411
Fax +39 030 9823201

GEFRAN	DICHIARAZIONE DI CONFORMITÀ CONFORMITY DECLARATION
	In accordo alla guida 22 ISO/IEC e norma ISO/IEC 17050-1, 17050-2 According with guide 22 ISO/IEC and norm ISO/IEC 17050-1, 17050-2

Il costruttore

The manufacturer

GEFRAN S.p.A.

Indirizzo legale

Law address

Via Sebina, 74 - 25050 Provaglio d'Iseo – (BRESCIA) - ITALIA -

Sede operativa

Factory address

Via Sebina, 74 - 25050 Provaglio di Iseo – (BS) - ITALIA
Via Cave, 11 – 25050 Provaglio di Iseo (BS) - ITALIA
Via Carducci 24, 21040 Gerenzano (VA) - ITALIA

Dichiara qui di seguito che
Declares hereby that:

All the Gefran products (components for the automation, sensors, drives, motion control)

are compliant with the requirements imposed by the European Directive 2002/95/EC of the European Parliament and of the Council of 27 January 2003 and updated by the European Court of Justice on 1 April 2008, on the restriction of the use of certain hazardous substances in electrical and electronic equipment and specifically that the component does not contain lead, mercury, cadmium, hexavalent chromium, polybrominated biphenyls (PBB), polybrominated diphenyl ethers (PBDE) or deca bromodiphenyl ether other than applications listed in the Annex to the Directive.

Sono conformi ai requisiti definiti dalla Direttiva Europea 2002/95/EC modificata dalla sentenza della corte di giustizia europea del 1 Aprile 2008 riguardante la restrizione all'uso di sostanze dannose nelle apparecchiature elettriche ed elettroniche; in particolare tutti i componenti utilizzati non contengono piombo, mercurio, cadmio, cromo esavalente, PBB, PBDE, DECA-BDE.

Data
Date
15 Sept 2008

Quality Manager
A.Bagini

Chief Executive Officer
A.Sala

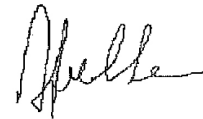
Gefran spa

Via Sebina, 74
25050 Provaglio d'Iseo
(BS)
Italy

Tel. +39 030 9888.1
Fax +39 030 9839063
www.gefran.com
info@gefran.com

Cap. Soc. € 14.400.000 i.v.
Reg. Imprese Brescia
03032420170
R.E.A. 313074 BS

N. Mecc. BS 016227
C.F. 03032420170
P.IVA (TVA-VAT-
MWS)
IT03032420170



D.01.09.2008

12. RESOLUTION PROBLEMS

All Gefran sensors are built in conformity to UNI EN ISO 9001: 2000

In case of malfunction, you can run a series of simple checks to identify the type of fault. If the problem is caused by a sensor malfunction, the sensor **MUST** be returned to Gefran. Only Gefran personnel are permitted to open the sensor. Any repair attempted without Gefran's authorization will cause the warranty expiry.

ELECTROMECHANICAL PROBLEMS		
MALFUNCTION	POSSIBLE CAUSE	POSSIBLE SOLUTION
NO SIGNAL	NO POWER SUPPLY CONNECTION FAILED	CHECK POWER SUPPLY / CONNECTIONS
NO SIGNAL VARIATION	BROKEN DIAPHRAGM PLUG FORMED	CHECK HOUSING AND DIAPHRAGM
EXCESSIVE SIGNAL IMBALANCE	OVERPRESSURE ELECTRONICS MALFUNCTION CALIBRATION ON	CHECK CALIBRATION
SIGNAL VARIATION AT TIGHTENING	INCORRECT INSTALLATION POINT	CHECK INSTALLATION HOLE
NO TEMPERATURE READ (SERIES 2)	BROKEN THERMOCOUPLE BROKEN TC WIRE	CHECK CONTINUITY

13. APPENDIX A: OPERATING PRINCIPLE

13.1 Mechanical construction and operation

Filled-technology Melt sensor

The Melt probe is a pressure sensor that resists high temperatures.

As can be seen on the diagram, the entire structure is built to transfer the pressure of the medium to the transducer part while keeping the transducer as far as possible from the heat source.

The hydraulic circuit built for this purpose consists of a tip with 0.1 mm inner diameter, at the ends of which are welded the contact diaphragm and the strain gauge diaphragm.

The sensor is filled with a liquid with low compression coefficient (mercury or FDA-approved oil for food applications) to transfer strain.

For both versions, the amount of liquid depends on sensor design: the rigid rod contains 30mm³, while flex versions contain 40mm³.

All parts have to be sized in accordance with the strains to which the system is subjected: pressures up to 2000 bar and work temperatures up to 400°C.

The Melt probe must be subjected to a "static" type of strain; "dynamic" applications compromise the product's reliability.

In addition to a guarantee of long life, the sensor is built to guarantee reliable reads in line with the accuracy specifications stated in the technical data for every condition of use described in the instruction manual.

The diaphragm geometries are designed on the basis of volumes and pressures occurring during measurement.

In essence, the pressure that the medium exerts on the contact diaphragm must generate a precise deformation of the measurement diaphragm.

The measurement element (called strain gauge), which translates the physical quantity (pressure) in to an electrical signal, is glued to the measurement diaphragm.

13.2 Strain gauge

Melt pressure sensors with glued strain gauge function

By far the most popular system for measuring the deformation of materials, the strain gauge is used industrially to measure the elongation of metals, especially steel and aluminum.

Its versatility, reliability, and high accuracy in transducing the measured physical quantity makes this is one of the most often used technologies for building pressure sensors.

Thanks to years of experience in building sensors, Gefran offers a wide variety of products using strain gauge technology, including industrial and Melt pressure transducers.

By continuously developing and refining this technology, Gefran creates sensors with unbeatable performance.

Definition of strain gauge

The strain gauge is a device that transduces a physical quantity into an electrical quantity.

The strain gauge is a primary transducer, in that the physical quantity in input is directly transformed into an output quantity.

Secondary transducers include force, acceleration, and pressure sensors, which are based on strain gauge technology, and in which the output quantity is obtained indirectly from the input quantity.

In the second system, the input quantity is converted into an intermediate quantity, and this is converted into the output quantity.

How it's built

In essence, a strain gauge consists of a thin metal wire that is folded and contained in a flexible isolating material according to a special geometry.

The metal wire (measurement element) is in fact made of an extra-thin leaf of metal alloy created by means of chemical incision.

This incision process produces metal grills with dedicated geometries that permit the material to modify its characteristics to the maximum as it changes shape.

The alloys used for the metal leaf are primarily Nickel-Chrome, Platinum-Tungsten, and Karma.

The next step in making a complete strain gauge is gluing the metal leaf onto an isolating support; some versions may have an additional isolating layer over the sensitive element.

These layers, made with polymer-based materials, electrically isolate the sensitive element and make it mechanically compatible to the body on which it will be placed.



Pressure transducer with glued strain gauge function

Taking measurement of strain in pressure transducers as an example, the typical behavior of a glued strain gauge (fig. 3) connected in Wheatstone bridge configuration is analyzed below at rest and at work.

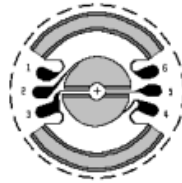

fig. 3

At rest, where the diaphragm is not subject to any strain (fig. 4) the strain gauge is in perfect resistive balance the bridge. Here, the resistance is considered zero, the result only of the natural ohmic difference of the grilles making up the bridge. At work (fig. 5), the strain gauge and, in particular, the center grilles (R1, R3 fig. 2) are strained in traction, while the two outer grilles (R2, R4 Fig. 2) work in compression.

As a result of the strain, the resistive values vary, producing an imbalance of the branches of the bridge. It is easy to see that if a voltage (V+, V-) is applied to the bridge (fig. 2) the voltage signal read in output by points (S+, S-) will vary in proportion to the resistive imbalance of the bridge.

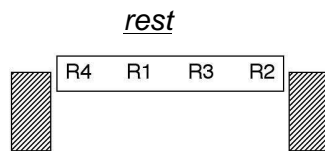

fig. 4

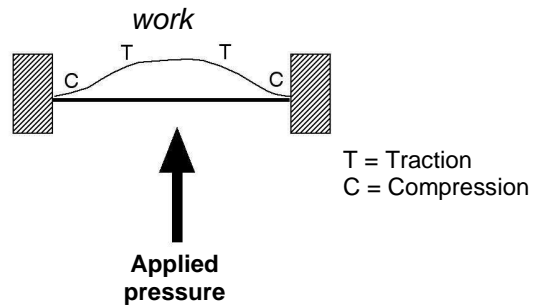

fig. 5

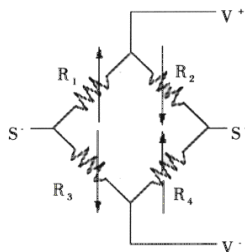

fig. 2

14. APPENDIX B: IP PROTECTION

IP protection indexes indicate the protection level of a device against outside agents.

It consists of two numbers after the prefix IP: the first is the index of protection against solids and dust; the second is the index of protection against liquids.

Three numbers are used in some countries. In this case, the third number is the mechanical index of protection.

Example: the protection index IP45 indicates a protection level of 4 against solids and a protection level of 5 against liquids.

Attention: these indexes are valid under standard ambient conditions.

Gefran Melt transducers and transmitters are built with protection index IP65.

Protection against solid objects

<i>1st number</i>	<i>Description</i>	<i>Definition</i>
0	No protection	No special protection
1	Protection against solid objects larger than 50mm	A part of the body with large surface, such as a hand (protection does not include intentional access). Solid objects with diameter exceeding 50mm.
2	Protection against solid objects larger than 12mm	Finger or similar objects less than 80mm in length. Solid objects with diameter exceeding 12mm.
3	Protection against solid objects larger than 2.5mm	Tools, wires, etc., with diameter or thickness exceeding 2.5mm. Solid objects with diameter exceeding 2.5mm.
4	Protection against solid objects larger than 1.0mm	Wires or strips with thickness exceeding 1.0mm. Solid objects with diameter exceeding 1.0mm
5	Protection against dust	Dust is not completely blocked, but does not enter in amounts sufficient to prevent good operation of the device.
6	High protection against dust	No entry of dust.

Protection against liquids

<i>1st number</i>	<i>Description</i>	<i>Definition</i>
0	No protection	No special protection
1	Protection against drops of water	Vertically dripping water must not have harmful effects
2	Protection against drops of water at angle up to 15°	Vertically dripping water must not have harmful effects when the device is rotated vertically up to 15°
3	Protection against water vapor	Sprays of vapor that fall at an angle up to 60° from vertical must not have harmful effects
4	Protection against sprays of water	Water sprayed on the housing from any direction must not have harmful effects
5	Protection against jets of water	A jet of water pumped from any direction must not have harmful effects
6	Protection against waves	Water from sea waves or a strong jet of water from any direction must not have harmful effects
7	Protection against immersion	Entry of water in an amount sufficient to damage the device must not be possible when the device is immersed in water for a defined length of time under defined pressure conditions
8	Protection against continuous immersion	The device may be immersed in water for an extended length of time under conditions specified by the manufacturer

15. APPENDIX C: GUIDE TO SELECTION OF THE DIAPHRAGM IN CONTACT WITH EXTRUDED POLYMER

SECTOR OF USE	MATERIAL WORKED	TEMPERATURE AND PROCESS PRESSURE	NOTES	SPECIAL VERSION
Heat insulation panels / Plexiglas; plastics for injection	PMMA (high viscosity), plexiglass	190-230°C	Standard diaphragm	000
Hydraulic tubes (drains, sewers, etc...)	PVC-U, UPVC, RPVC (high viscosity)	180-200°C	Standard diaphragm	026-109
Hydraulic tubes for heating, high pressure tubes, tubes for the chimica industry	PP (Polypropilene)	200-230°C	Standard diaphragm	000
Rugs and carpets (moquettes)	PP (Polypropilene)	200-230°C	Standard diaphragm	000
Plastic bags, wrapping films and tapes, low-cost laminates	PE-LD (low density) (o LO-PE)	170-190°C	Standard diaphragm	000
Bags for potato chips, reclosable bags (W/K/I series)	PP (Polypropilene)	200-230°C	Use W series	000
Plastic bottles and other food applications (W/K/I series)	PET		Use W series	000
Nylon films and tapes for packaging; covers with high mechanical strength and resi stance to high temperatures (profiles, corners, etc...)	PA6 (Nylon 6)	210-260°C / P < 500bar	Special diaphragm with excellent resi stance to contact with adhesive materials	123
Films, monofilaments and misc. profiles	PA66 (Nylon 66, Polyamide 66) / PVDF	210-290°C / P > 500bar	Special diaphragm with excellent resi stance to contact with adhesive materials	110
Films for food (roast in a bag) (W/K/I series)	PA66 (Nylon 66, Polyamide 66)	265-290°C	Use W series	123
Packaging for food (DOMOPACK or "cheese paper") (W/K/I series)	PE-HD-High Density (or HD-PE)	180-210°C	Use W series, with standard diaphragm	000
Building industry; mixers for tires	Highly abrasive plastics; extrusion at high flow rate; fiberglass, ceramics, mineral resins, rubber	Up to 400°C 200°C	Special diaphragm with high strength and resi stance to abrasion and rot drift, accuracy and sensitivity	261 - B31
Insulating sheathing for electrical cables	PVC / Corrosive plastics	205-240°C 100-250bar	Special diaphragm, resistant to corrosive materials	109
Finishings (caravans, furniture, home appliances, freezers, formica, etc...)	ABS (Acrylonitrile Butaidene Styrene)		Special diaphragm, resistant to corrosive materials	109
Packing; building	Teflon, PC Polycarbonate-Makrolon, coloring agents; resin additives		Special diaphragm, resistant to corrosive materials	B31
Pharmaceutical use (W/K/I series)	Teflon, PC Polycarbonate-Makrolon, coloring agents; resin additives		K series with special diaphragm or W series with GTP standard	B31
Abrasive applications with moderate temperatures	Processes containing vitreous materials or abrasive resins		Special diaphragm with resi stance to abrasion and rot drift, accuracy and sensitivity	B31
Abrasive applications	Processes containing vitreous materials or abrasive resins		Special diaphragm with resi stance to abrasion and rot drift, accuracy and sensitivity	B31
Recycling of plastic materials	Bulk materials + solid impurities		Special diaphragm with resi stance to abrasion and rot drift, accuracy and sensitivity	B31
Plastics industry FDA approved			W/K/I series with FDA approved coating	B39

16. APPENDIX D: ACCURACY CLASS

16.1 Calibration curve

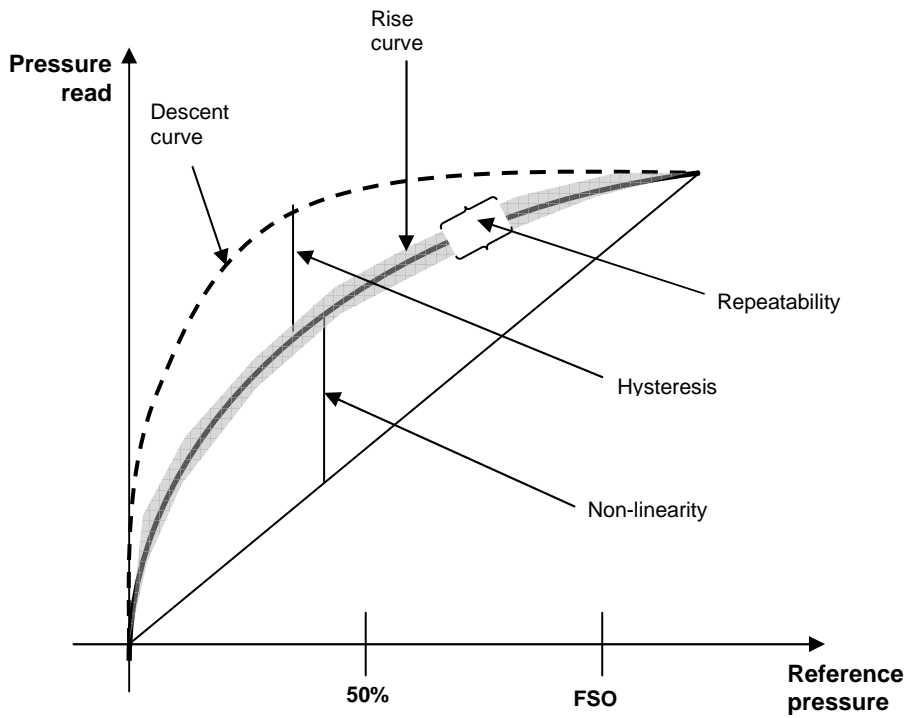

16.2 Repeatability

Repeatability is defined as the ability to reproduce reads in the same direction and under the same conditions when the same pressure is applied consecutively.
 The maximum repeatability error of every Gefran sensor is 0.1% FSO.

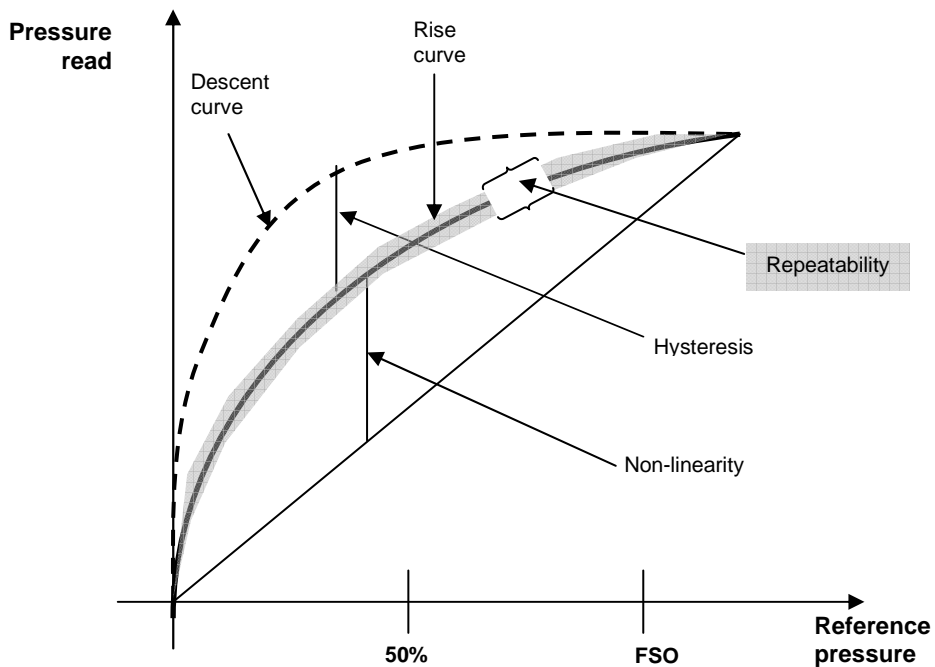

16.3 Hysteresis

The maximum read difference for each reading in a specific range when the value is reached, first in rise and then in descent.

The maximum hysteresis for every Gefran sensor is 0.1% FSO.

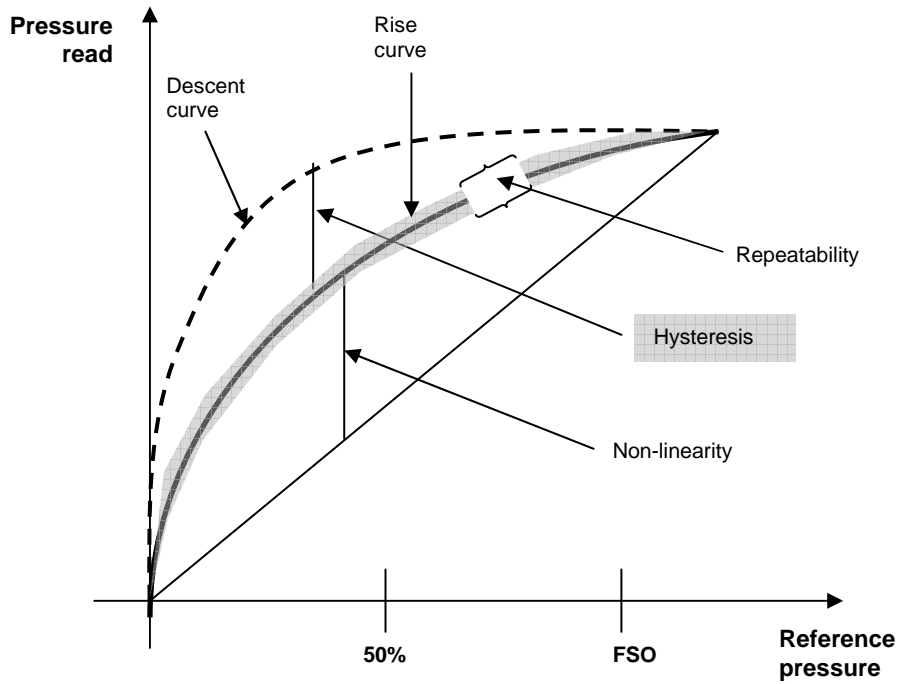

16.4 Linearity

The maximum deviation of the calibration read curve for each calibration value, obtained by comparison to an ideal read curve. Gefran uses the “BSFL” (best straight fit line) method.

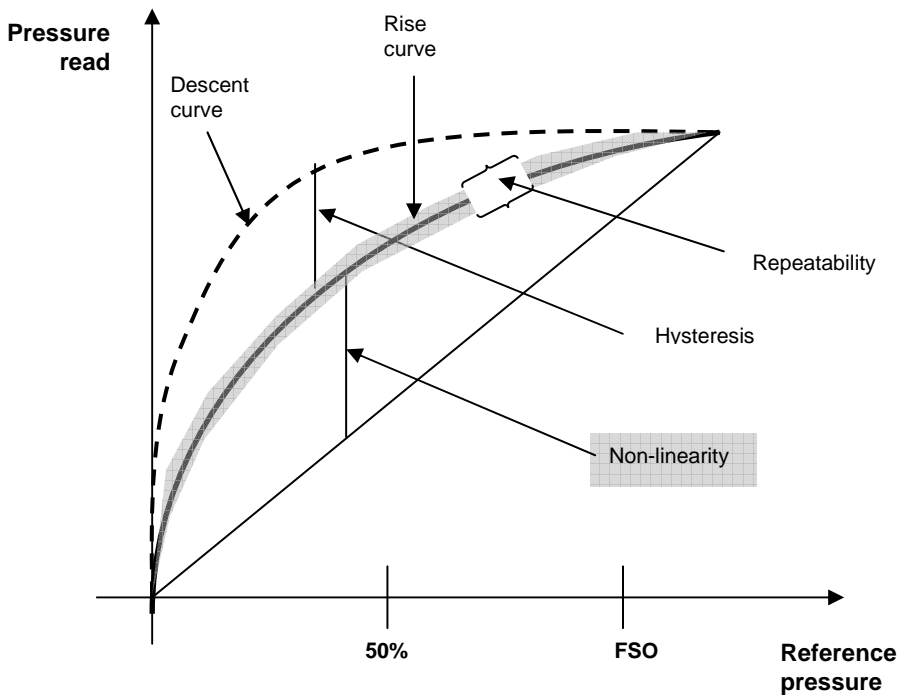

Dependent linearity error (End point)

Dependent linearity error is the deviation between the real characteristic of the transducer and the straight line passing through the two ends; expressed in % of FS.

Independent linearity error (BFSL)

Independent linearity error (BFSL) is the deviation between the real characteristic of the transducer and the straight line of minimum squares. In practice, a straight line is formed that best approximates the real curve.

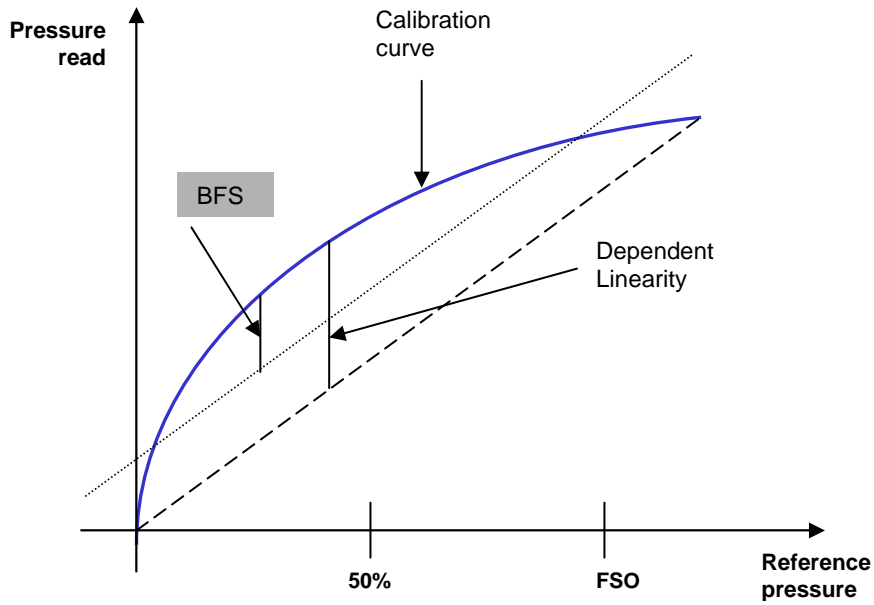

17. APPENDIX E: HAZARDOUS AREAS

17.1 Applications in hazardous areas

“Hazardous Areas” are defined as all areas containing potentially explosive gases, vapors, mists, and/or dust, with the result that the area is identified as having a risk of explosion.

There is a classification of such areas, called zones, used to define the selection criteria for devices that can work inside them.

The Gefran catalog contains a wide selection of industrial pressure sensors and Melt sensors created specifically for use in hazardous areas.

With various possible solutions for solving the “Hazardous Areas” problem, Gefran chose two systems that offer greater guarantees of performance: “Explosionproof” and “Intrinsically safe.”

“Explosionproof” sensors include all Melt sensors in the MF family, which have American Factory Mutual certification.

“Intrinsically safe” include all series of Gefran pressure sensors identified with the letter (X), which conform to the Atex directive.



Plastics refining plant

17.2 European Directive ATEX



The European directive Atex 94/9/CE (**ATEX** , **A**tmospheres **EX**plosibles) regulates protective devices and systems intended for use in hazardous areas, including devices installed outside such areas but designed to protect against risks of explosion.

Inside such areas, only those electric/electronic devices that satisfy a precise safety requisite may be used, i.e., these devices must in no way provoke an explosion.

There are different ways to satisfy such requisite:

PREVENTION, defined with letters (i), intrinsically safe and (e) increased safety

SEGREGATION, identified with letters (p) pressurization, (o) immersion , (m) encapsulation

CONTAINMENT (d), explosionproof.

The two most-used systems are Containment (d) (“explosionproof” devices) and Prevention (ia) (“intrinsically safe” devices).

Explosionproof device Ex d

Explosionproof devices/systems are simply devices inserted in a sturdy metal container with sufficient mechanical strength to contain an internal explosion without releasing flame.

Intrinsically safe devices EX ia

Intrinsically safe devices can work in hazardous areas because they exploit the principle of preventive limitation of energy.

This characteristic guarantees that the component is unable to supply (even in case of malfunction) sufficient energy to cause the area to explode.

Zener barriers

To guarantee absolute safety of the plant, it is always necessary to install so-called “safety barriers” up-line of the sensor. These barriers separate the area at risk from the outside.

In this way, high-energy phenomena that could cause an explosion will not reach the “intrinsically safe” device.

Classification of hazardous areas IEC/CENELEC/EUROPE

There is a classification of hazardous areas, called zones, used to define the selection criteria for devices that can work inside them.

<i>State of flammable material</i>	<i>Continuous presence > 1000 h/year</i>	<i>Discontinuous presence > 10 < 1000 h/year</i>	<i>Anomalous presence < 10 h/year</i>
GAS (G)	ZONE 0	ZONE 1	ZONE 2
DUST (D)	ZONE 20	ZONE 21	ZONE 22

Gas group IEC/CENELEC/EUROPE

An additional subdivision by danger level of potentially explosive gases is made based on the amount of energy needed to ignite them.

Most common explosives gases	CENELEC category	Minimum ignition energy (microJoules)
ACETYLENE	IIC	20
HYDROGEN	IIC	20
ETHYLENE	IIB	60
PROPANE	IIA	180

Temperature class

Each gas is assigned a temperature class based on its ignition temperature. There is no correlation between ignition energy and ignition temperature.

T1	450°C
T2	300°C
T3	200°C
T4	135°C
T5	100°C
T6	85°C

TABLE OF SURFACE TEMPERATURE CLASSES IN RELATION TO GAS IGNITION TEMPERATURE

Room temperature

When defining the temperature class for which the device can work, you have to consider room temperature and the maximum temperature generated by the device. The temperature class is the sum of room temperature and the temperature generated by the device, plus the margin of tolerance (5°C or 10°C) specified by the standard.

(Tamb. + Tdisp.) + 5°C = T(class) T3/T4/T5

(Tamb. + Tdisp.) + 10°C = T(class) T1/T2

How to read ATEX sensor plate data

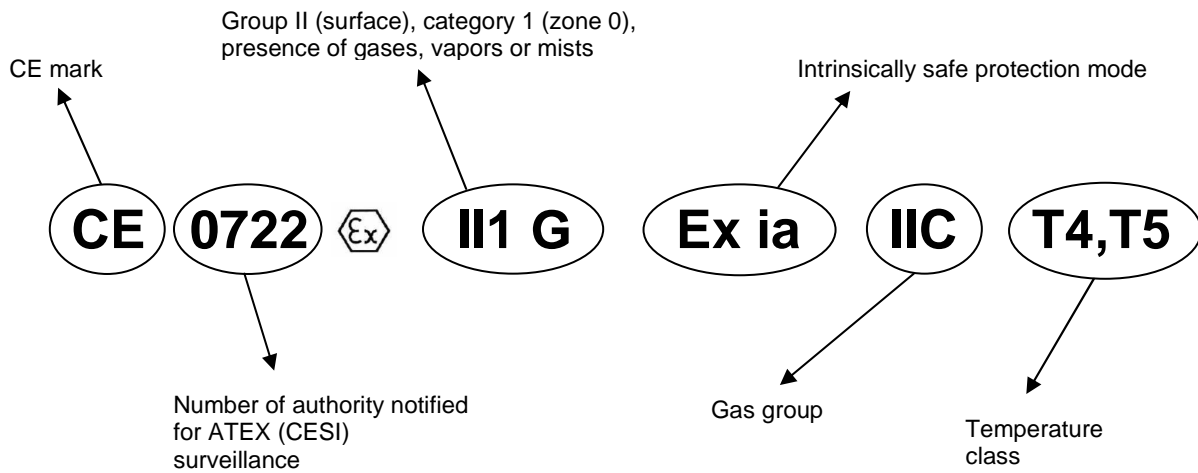

17.3 North America Factory Mutual



The American equivalent of European Atex, Factory Mutual also regulates the use of devices in hazardous areas. It likewise provides various methods to protect against explosion and, as in Europe, the most commonly used are "Intrinsically Safe" and "Explosionproof". Just as for the European IEC/CENELEC/EUROPE, there is an American equivalent called NEC (National Electric Code), which classifies areas, gas/dust groups, and temperature classes in which the devices work.

Classification of areas at risk NEC (National Electric Code)

State of flammable material	<i>Continuous presence > 1000 h/year</i>	<i>Discontinuous presence > 10 < 1000 h/year</i>	<i>Anomalous presence < 10 h/year</i>
NEC 505 GAS	ZONE 0	ZONE 1	ZONE 2
NEC 505 GAS and DUST	DIVISION 1		ZONE 22

Gas group NEC (National Electric Code)

Most common Explosives gases	North America NEC Article 500 CLASS I	Minimum ignition energy (microJoules)
ACETYLENE	A	20
HYDROGEN	B	20
ETHYLENE	C	60
PROPANE	D	180

How to read the plate data on a FACTORY MUTUAL sensor

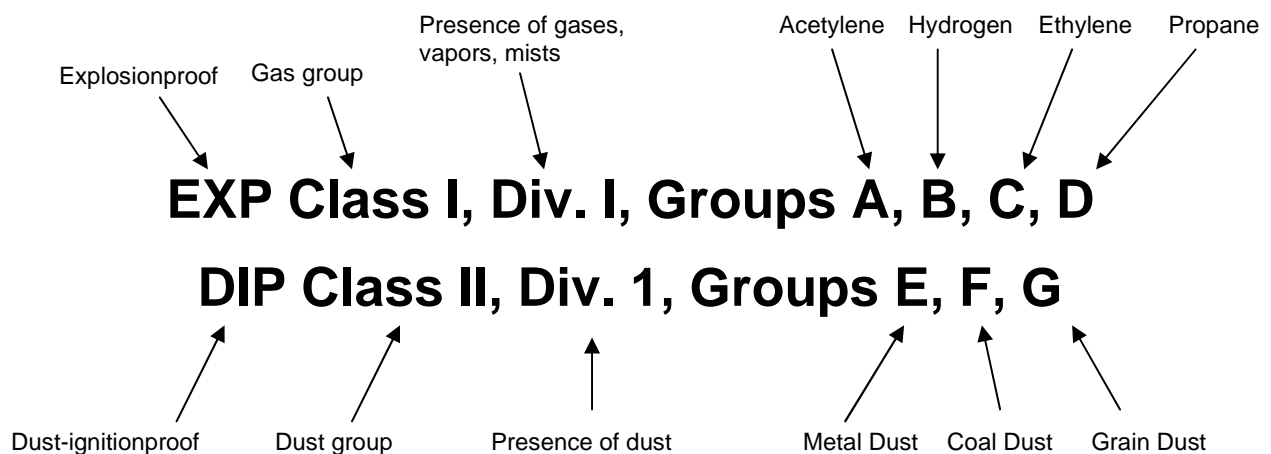

18. APPENDIX F: MELT SENSORS WITH CANopen OUTPUT

In addition to the versions with non-amplified analog output with 2.5 or 3.33 mV/V signal and amplified 4-20mA, 0-10V signal, there are now the series MD and WD, which dialog digitally via DP404 CANOpen protocol.

Among the main technical characteristics is the ability to select the engineering unit for pressure (Bar, Kg/cm², Psi, Kpa), calculation of autozero value to compensate the influence of temperature on the process fluid, generation of a value equal to 80% of full scale for transducer calibration, plus a function for automatic compensation of Zero and Span drift to correct any error generated by a change of temperature in which the device works.

The transducer software lets you set two alarm setpoints to guarantee highly practical management of the extrusion process.

By defining Melt pressure ranges, you achieve extrusion of a product with high, constant quality.

An alternate method with two alarm setpoints is that of working in "threshold" mode, which transmits the signal only within a defined pressure range.

The Melt sensor with digital output has another essential function: recording of the maximum pressure peak reached by the system. In case of system breakdown or malfunction, this lets you check what the actual process conditions were.

With regard to monitoring correct transducer operation, the heart-beat function conducts continuous diagnosis of the device, guaranteeing that the field bus works under predictive diagnostic conditions.

To complete the range of possibilities, both the frequency of data transmission, which can vary from 10Kbaud to 1Mbaud, and the ID node (identification node), can be selected via software or hardware by means of dip-switches.

16-bit signal resolution provides pressure reading at every 0.01bar of variation.

Of course, all the choices provided by the digital output model are added to the standard characteristics of Melt transducers already in the Gefran catalog: various process connections, models with rigid or flexible rod, simultaneous reading of pressure and temperature, range from 35 to 2000 bar, and working temperature up to 400°C.

The digital series also offers a version for mercury-free applications, with WD, KD, IJ-D versions.

GEFRAN spa
Via Sebina, 74
25050 Provaglio d'Iseo (BS) - ITALY
Tel. +39 030 9888.1 - Fax +39 030 9839063
<http://www.gefran.com>
info@gefran.com