



2015 KIT CATALOG

3236 IRVING BOULEVARD

DALLAS, TX 75247

(214) 351-1251

Toll Free (877)-838-7325

Fax (214) 214-351-3949

SALES@HDDISTRIBUTORS.COM

WWW.HDDISTRIBUTORS.COM

TABLE OF CONTENTS

Account Number: _____ Discount %: _____

INTRODUCTION

Introduction.....	ii - iii
Catalog Offerings, Online Ordering and Social Media	iv - v
Freight Information	vi - vii
Ordering information and Terms and Conditions.....	viii - x
Credit Applications / International Ordering Information	xi - xii
Typical Sealing Components and Hydraulic Cylinder Applications	xiii - xv
Product Index by Industry / Seal Kit ID Code Conversion Chart	xvi - xviii

INDUSTRIAL KITS

Index.....	1
Material Used / Glossary of Terms.....	2
Industrial Kits.....	3 - 137

MOBILE KITS

Index.....	139
Mobile Kits.....	140 - 1074

PUMPS, MOTORS AND VALVE KITS

Index.....	1075
Pump, Motor and Valve Kits	1076 - 1122

APPENDIX

Index.....	1123
Technical Information.....	1124 - 1135

H&D DISTRIBUTORS, INC.
3236 Irving Blvd., Dallas, TX 75247
214-351-1251 Fax: 214-351-3949 e-mail: sales@hddistributors.com
CREDIT APPLICATION

Company name:

Physical address:

City: _____ State: _____ Zip: _____

Date business started: _____ SIC Code: _____ Federal Tax ID #: _____

How long at current address?

Type of business - Sole proprietor: Partnership: Corporation: Other: _____

Name of person who will be buying:

Phone: _____ Fax: _____ E-mail: _____

Ship to address:

City: _____ State: _____ Zip: _____

Phone: _____ Fax: _____ E-mail: _____

PO# required on orders? Yes No Order acknowledgements required? Yes No

How should acknowledgements be sent? Fax: _____ E-mail: _____

Do you require orders shipped Freight Collect? Yes No Freight Account #? _____

Preferred shipping method: Will call NDA 2 Day 3 Day Ground

Other (please specify)

A/P Contact - Name: _____ E-mail: _____

Phone: _____ Fax: _____

If this account should not be taxed, please submit a Resale or Exemption Certificate, whichever is applicable.

How should we send your invoice? Mail Fax E-mail Provide the appropriate information below.

Billing address:

City: _____ State: _____ Zip: _____

Email: _____ Fax: _____

BANK REFERENCE

Bank name:

Bank address: _____ Phone: _____

City: _____ State: _____ ZIP: _____

Type of account: _____ Account number: _____

TRADE REFERENCES

Company name: _____ Account # _____

Contact:

Phone: _____ Fax: _____ E-mail: _____

Company name: _____ Account # _____

Contact:

Phone: _____ Fax: _____ E-mail: _____

Company name: _____ Account # _____

Contact:

Phone: _____ Fax: _____ E-mail: _____

AGREEMENT

By submitting this application, you authorize H&D Distributors, Inc. to make inquiries into the banking and business/trade references that you have supplied.

Company name:

Signature: _____ Date: _____

Print Name: _____ Title: _____

HYDRAULIC CYLINDER APPLICATIONS

BACKHOE LOADERS

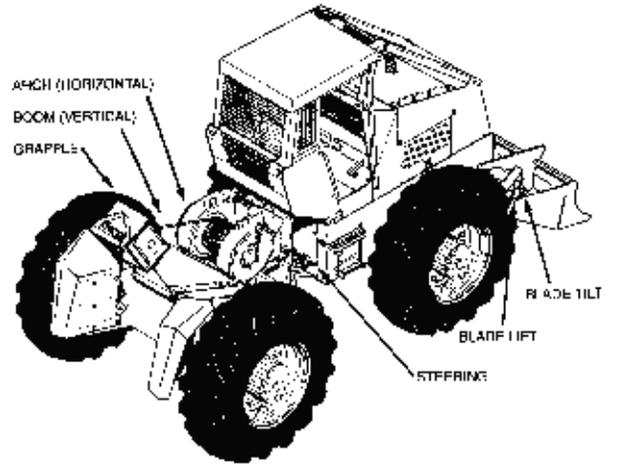
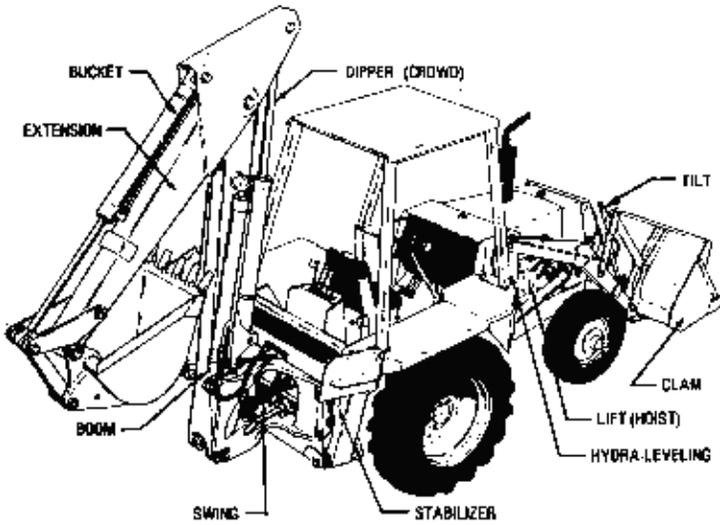

LOG SKIDDERS

CRAWLER DOZERS

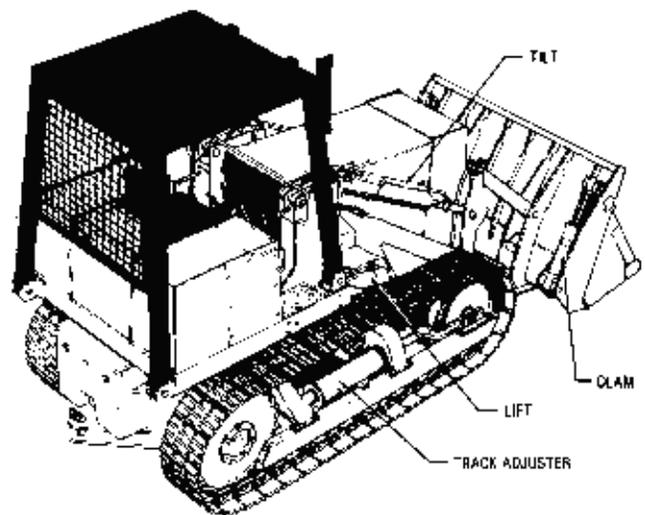
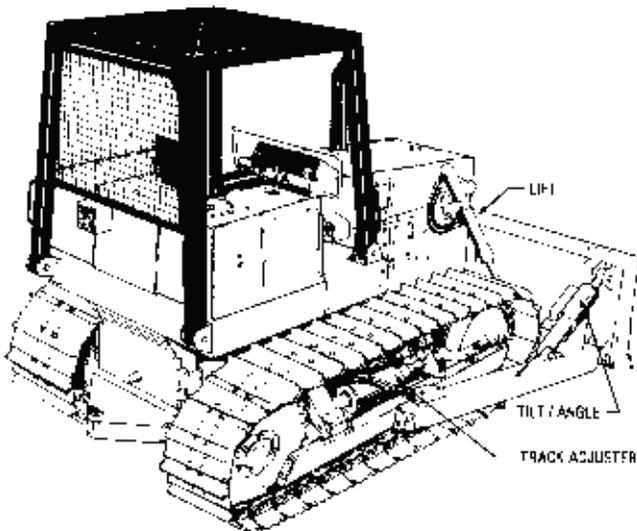

CRAWLER LOADERS

HYDRAULIC CYLINDER APPLICATIONS

EXCAVATORS

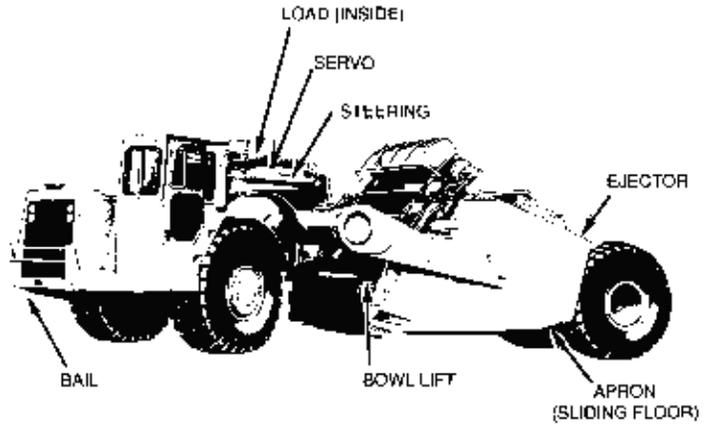
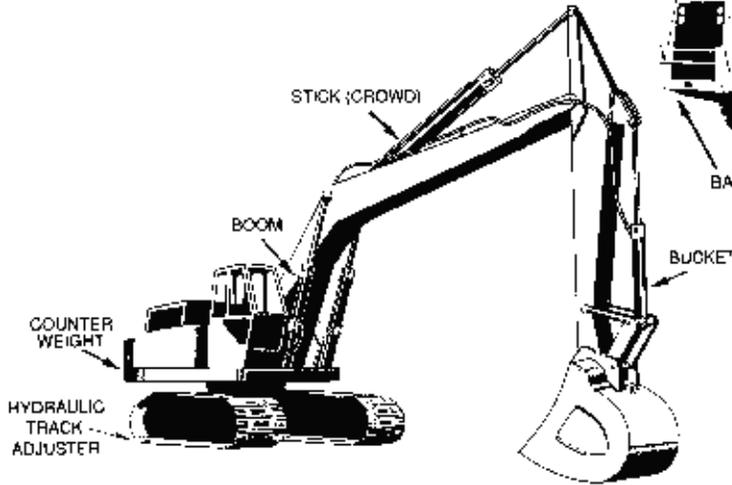

SCRAPERS

MOTOR GRADERS

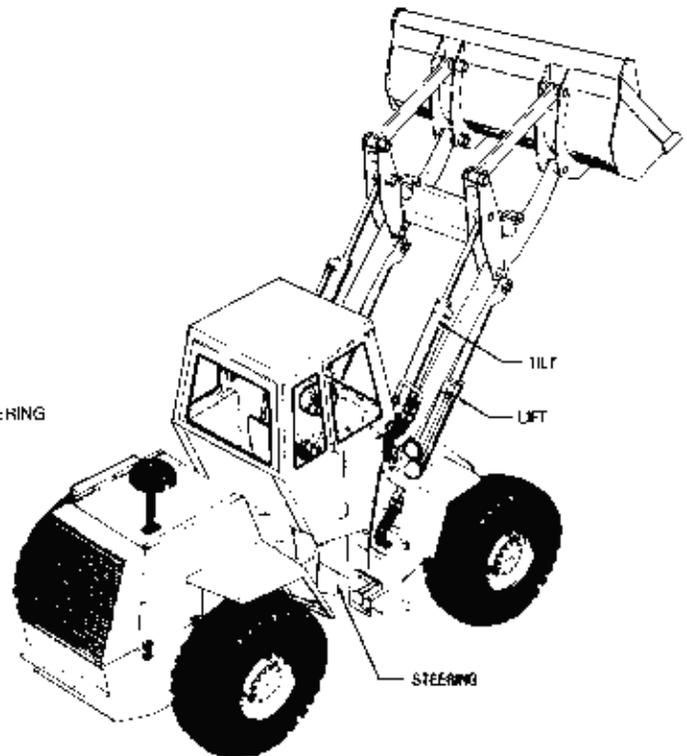
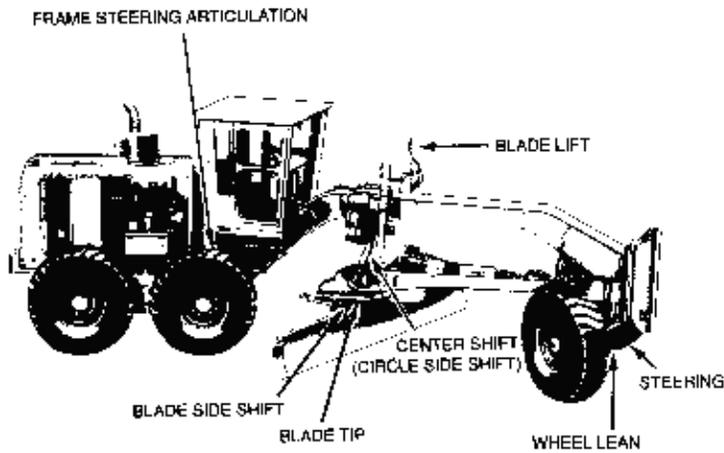

WHEEL LOADERS

PRODUCT INDEX BY INDUSTRY

Repair Kits and Parts

AERIAL PERSONNEL LIFTS	PAGE #
JLG®	687-700
Skyjack	1042
Lucky Loader	992
Mark Hi-Lift	994
Snorkel	1042
Upright	1058

CONSTRUCTION EQUIPMENT	PAGE #
Bobcat®	145-157
Case	163-218
Caterpillar®	219-511
Champion Motor Graders	511
Driltech	533
Dynahoe	533
Euclid Trucks®	535
Fiat-Allis®	536
Fiat-Hitachi	537-540
Ford	541-557
Furukawa	559
Galion - Dresser®	559
Grove Crane	565-568
Hitachi	581-636
Hyundai	652
Ingersoll-Rand	654
International Harvester	655-656
JCB	657-686
John Deere	701-786
Kato	789-790
Kobelco®	791-853
Koehring	854
Komatsu®	855-965
Kubota	966-970
Liebherr	973-987
Link Belt	988
Massey Ferguson	995
Mitsubishi	999-1002
Monarch Road Machinery	1002
Pettibone	1028-1029
Reynolds Scraper®	1040
Samsung®	1040
Takeuchi	1043-1045
TCM	1046-1047
Terex®	1048-1051
Trojan Loader	1058
Volvo	1059-1130
Wabco	1130
Whiteman/Conspray	1131
Yanmar	1133
Yutani	1134-1135

CRANES	PAGE #
Barko	143
Effer Cranes	534
Fassi-Crane	535
FMC	536
Grove Crane	565-568
Hiab	578-580
Hyundai	652
Lorain	992
Lucky Loader	992
P & H Cranes	1029
Prentice®	1030-1038

DUMP BODIES	PAGE #
Fruehauf	559

FORK LIFTS	PAGE #
Allis-Chalmers	140
Baker	141
Cascade	158-162
Champion	511
Clark®	514-515
Crown	527
Gehl®	560-561
Gradall®	562-564
Hyster	651
Kalmar	786-788
Komatsu®	855-965
Lull®	992
Mitsubishi	999-1002
Moffett	1002
Nissan	1017-1018
Pettibone	1028-1029
Raymond	1040
TCM	1046-1047
Towmotor-Caterpillar	510-511
Toyota	1056-1058
White	1131
Yale®	1132-1133

INDUSTRIAL CYLINDERS	PAGE #
Atlas	3-20
Hydroline®	21-50
Miller	51-79
Ortman	80
Parker	81-122
Rexroth	124-125
Royal	126-129
Sheffer	132-134
Tompkins Johnson	135
Vickers® / Eaton	136- 137

PRODUCT INDEX BY INDUSTRY

Repair Kits and Parts

LIFT GATES	PAGE #	PUMP & MOTOR PARTS	PAGE #
Venco.....	1058	Anthony	140-141
Waltco.....	1130	Char-lynn Seal Kits®	512
		Peabody-Galion	1022-1025
		Perfection-Cobey	1026-1027
LOGGING EQUIPMENT	PAGE #	REFUSE EQUIPMENT	PAGE #
Barko	143	Dempster	533
Bell.....	144	Galbreath®	559
Case	163-218	Garwood	559
Caterpillar®	219-511	Heil®	569-577
Eaton-Yale, Timberjack	534	Leach.....	971
ESCO®.....	535	Loadmaster™	991
Franklin	558	McNeilus®	996-997
Husky Brute	637	Pak-Mor	1020-1021
Hydro-Ax.....	650	Peabody-Galion	1022-1025
John Deere	701-786		
Log Hog™	991	TELEHANDLERS	PAGE #
Morbark	1002	Caterpillar®	219-511
Peerless.....	1025	Gehl®	560-561
Prentice®.....	1030-1038	Gradall®	562-564
Ronen.....	1040	JCB.....	657-686
TimberJack	1052-1055	JLG®	687-700
		Pettibone.....	1028-1029
MINING EQUIPMENT	PAGE #	TELESCOPIC CYLINDERS	PAGE #
Caterpillar®	219-511	Anthony	140-141
Euclid Trucks®.....	535	Atlas	141
Hitachi.....	581-636	Commercial®.....	516-525
Komatsu®.....	855-965	Custom Hoists®.....	528-532
Liebherr	973-987	Fontaine®.....	535
Sandvik.....	1041	Glencoe	561
Terex®.....	1048-1051	Heil®.....	569-577
Volvo.....	1059-1130	Hyco	638-650
		Hyva®.....	653
MISCELLANEOUS	PAGE #	Johnson	786
Cameco	157	Marion	993
Chief™ Cylinders.....	513	Peabody-Galion	1022-1025
Cross	526	Perfection-Cobey	1026-1027
Densmore	533	Ward	1131
Edbro Cylinders	534		
Energy	535		
Harsh Mfg®.....	568		
Meyer Products®.....	998		
Pandrol Jackson	1019		
Prince	1039		
Red Lion Tie Rod Cylinders.....	1040		
Skyjack	1042		
Tamrock.....	1042		
Up-Right	1058		

SEAL KIT IDENTIFICATION CODE CONVERSION CHART

WIPERS

I = Insert
P = Press In
N = No Wiper

ROD SEALS

O = O-Ring
OB = O-Ring & B/U
U = U-Seal
UB = U-Seal & Buffer
BB = Tandem Buffers
V = Vee Set
N = None
TR = T Seal
SP = Special
UV = U-Seals &
Vee Sets

PISTON SEALS

1 = None
2 = O-Ring
3 = O-Ring & B/U
4 = 1 U-Seal
5 = 2 U-Seals
6 = 1 Piston Cup
7 = 2 Piston Cups
8 = "SA" Vee Set
9 = "DA" Vee Set
10 = Piston Seal
11 = T Seal
12 = Cast Iron Piston Ring
13 = Special
14 = 4 Piece Capped T-Seal
15 = 5 Piece Piston Seal

ROD X BORE SIZE

EXAMPLE

<u>P</u>	-	<u>U</u>	-	<u>5</u>		<u>2</u>	X	<u>4</u>
Wiper		Rod Seal		Piston Seal		Rod		Bore

NOTE:

These codes were developed as an aid for kit identification. Verification can be made by calling our sales department and comparing the parts to be replaced with those offered in our kit.

Industrial Kits

CONTENTS	PAGE
Materials Used / Glossary of Terms	2
Atlas Cylinder Repair Kits	3 - 20
Hydro-line® Cylinder Repair Kits	21 - 50
Miller Cylinder Repair Kits	51 - 79
Ortman Cylinder Repair Kits	80
Parker Cylinder Repair Kits	81 - 122
Rexroth Cylinder Repair Kits	124 - 125
Royal Cylinder Repair Kits	126 - 129
Sheffer Cylinder Repair Kits	132 - 134
Tompkins-Johnson / TJ Cylinder Repair Kits	135
Vickers® Cylinder Repair Kits	136 - 137

All manufacturer's names, part numbers and descriptions are used for reference purposes only. We do not imply that any part shown is the product of these manufacturers. We also do not imply that the list price shown is exactly that of the manufacturer.

Materials Used

Urethane (URE)

Formulated of copolymers of ether or ester based urethanes, this material is used in a wide application of seals, wipers, back-up rings, cushions, bumpers, and a myriad of other uses. Highly resistant to oil swell, ozone, oxidation and abrasion, it also has excellent cut resistance. Highly resilient, urethanes also have high tensile strength and elongation properties. Urethanes remain an excellent choice in hydraulic systems using petroleum based fluids. Most urethane seals remain flexible and efficient in temperatures ranging from -65° F to +200° F with some able to withstand intermittent temperatures up to +300° F.

Nitrile (NBR) (XNBR)

Two common nitrile copolymer blends are Buna-N (NBR) and Carboxylated Nitrile (XNBR). Possessing very good resistance to petroleum based hydraulic oils, Buna-N also works well with fuels such as diesel or gasoline. XNBR compounds feature improved abrasion resistance and tensile strength. Nitrile seals have a good resistance to compression set, but their flexibility suffers somewhat in the lower temperature range. Seals made from this material have a low resistance to ozone and must be stored carefully in most environments. Working temperatures are -40° to +240°F.

Polytetrafluoroethylene (PTFE)

Most PTFE seals, in order to retain their toughness and flexibility, are fortified with short glass fiber, bronze flashes, carbon, graphite, or a combination of these fillers. Because of a lack of resilience (memory) in PTFE, an energizer is most often employed to obtain the desired fit. Benefits are chemical inertness, high heat resistance, low temperature flexibility, low running friction, and non-adhesive characteristics. Temperatures to +500° F are obtainable but are often reduced by the filler or energizer employed.

Fluorocarbon (FC)

Fluorocarbon combines high temperature resistance with excellent chemical resistance. Excellent for use with alcohol and aromatic fuels and is highly resistant to ultraviolet light and ozone. This material is not recommended for use in low temperatures or in aircraft hydraulic fluids. Temperature range is -20° to +400° F.

Glossary of Terms

Bearing/Wear Rings

Soft metal or plastic rings placed in grooves on the piston or in the head to prevent contact between hard metal surfaces.

Durometer

A generic term referring to the instrument and the scale used to measure the relative hardness of various elastomers. The lower the durometer rating, the softer the material.

Dynamic Seal

A sealing device used between mating surfaces that have relative motion.

Elastomer

A rubber-like material having the capacity for large deformation and rapid, complete recovery from the deforming force.

Gland

A rod bushing containing sealing devices fitted into the rod end cap. A groove or open area machined into the head or piston that houses the sealing device.

Static Seal

A sealing device used between mating surfaces that have no relative motion.

Wiper/Scraper

A device placed in the head of a cylinder for the purpose of excluding foreign matter from the inside of the cylinder.

ATLAS

Kit Type		Page
Series A, L & 2LA	Rod Gland Kits	4 - 5
	Rod Seal Kits	6
	Rod Kits	7
	Piston Kits	8 - 9
	Head Seal Kits	10
Series H	Rod Seal Kits	11
	Piston Seal Kits	12 - 14
	Head Seal Kits	15
Bronze Rod Gland	Air Cylinders	16
Rod Kits	Hydraulic Cylinders	17
Piston Kits	Hydraulic & Pneumatic Cylinders	17
Repair Kits	By Part Number	18 - 20

ATLAS

Series A & L Rod Gland Kits

Series A & L Cylinders Nitrile

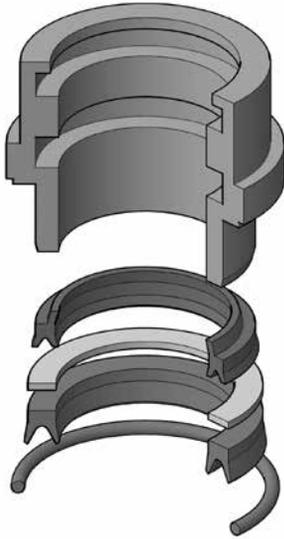

Kit Includes:

- 1 Bronze Gland
- 1 XNBR Wiper
- 1 PTFE Back-Up Ring
- 1 NBR U-Seal
- 1 NBR O-Ring

Series L Cylinders Urethane

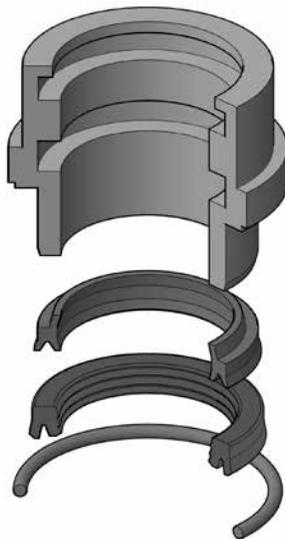

Kit Includes:

- 1 Bronze Gland
- 1 XNBR Wiper
- 1 Multi-lip Urethane U-Seal
- 1 NBR O-Ring

Series A & L Cylinders Fluorocarbon

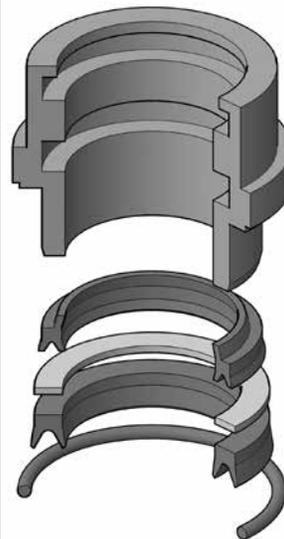

Kit Includes:

- 1 Bronze Gland
- 1 FC Wiper
- 1 PTFE Back-Up Ring
- 1 FC U-Seal
- 1 FC O-Ring

Series A & L Cylinders Bronze

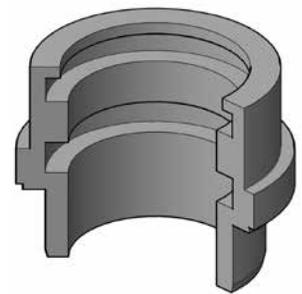

Kit Includes:

- 1 Bronze Gland

Rod Dia.	(NBR) Kit #	List Price	(URE) Kit #	List Price	(FC) Kit #	List Price	(BZ) Kit #	List Price
5/8"	ATL-4A06R000S	\$ 88.70	ATL-EA06R000S	\$ 92.39	ATL-4A06R000V	\$ 117.78	ATL-RGAL-06	\$ 79.28
1"	ATL-4A10R000S	104.38	ATL-EA10R000S	103.33	ATL-4A10R000V	138.41	ATL-RGAL-10	89.04
1-3/8"	ATL-4A13R000S	125.03	ATL-EA13R000S	118.77	ATL-4A13R000V	142.85	ATL-RGAL-13	104.38
1-3/4"	ATL-4A17R000S	147.40	ATL-EA17R000S	140.24	ATL-4A17R000V	169.90	ATL-RGAL-17	121.88
2"	ATL-4A20R000S	172.93	ATL-EA20R000S	172.08	ATL-4A20R000V	198.84	ATL-RGAL-20	147.85
2-1/2"	ATL-4A25R000S	196.70	ATL-EA25R000S	193.38	ATL-4A25R000V	236.62	ATL-RGAL-25	166.94
3"	ATL-4A30R000S	242.95	ATL-EA30R000S	257.53	ATL-4A30R000V	286.49	ATL-RGAL-30	207.75

ATLAS

Series 2LA Rod Gland Kits

Nitrile

Series 2LA Air Cylinders

Fluorocarbon

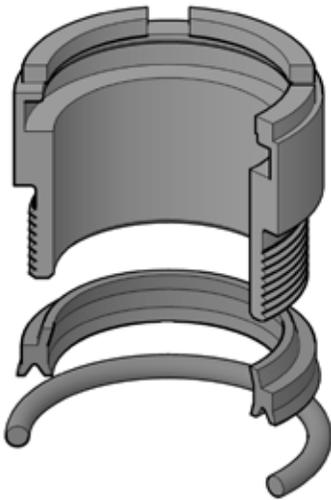

1/2" - 1-3/4"

Kit Includes:

- 1 Bronze gland
- 1 XNBR Wiper/Seal
- 1 NBR O-Ring
- 1 Tube Seal Lubricant

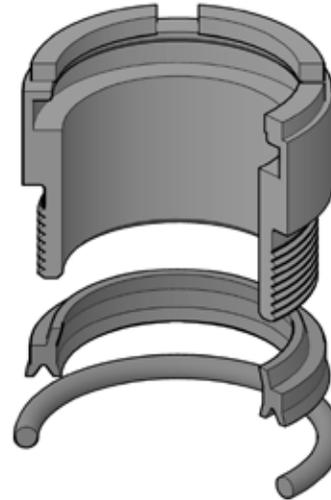

1/2" - 1-3/4"

Kit Includes:

- 1 Bronze gland
- 1 FC Wiper/Seal
- 1 FC O-Ring
- 1 Tube Seal Lubricant

Bore Dia.	(NBR) Kit #	List Price	(FC) Kit #	List Price
1/2"	ATL-RG02MA0051	\$ 40.72	ATL-RG02MA0055	\$ 43.39
5/8"	ATL-RG02MA0061	26.90	ATL-RG02MA0065	42.96
1"	ATL-RG02MA0101	30.82	ATL-RG02MA0105	47.60
1-3/8"	ATL-RG02MA0131	46.03	ATL-RG02MA0135	68.81
1-3/4"	ATL-RG02MA0171	93.67	ATL-RG02MA0175	105.07

ATLAS

ATLAS

Series A & L Rod Seal Kits

Series A Cylinders Nitrile



Kit Includes:

- 1 XNBR Wiper
- 1 PTFE Back-up Ring
- 1 NBR U-Seal
- 1 NBR O-Ring

Series L Cylinders Urethane

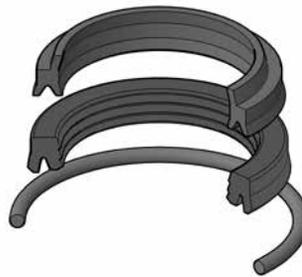

Kit Includes:

- 1 XNBR Wiper
- 1 Multi-lip Urethane U-Seal
- 1 NBR O-Ring

Series A & L Cylinders Fluorocarbon



Kit Includes:

- 1 FC Wiper
- 1 PTFE Back-up Ring
- 1 FC U-Seal
- 1 FC O-Ring

Rod Dia.	(NBR) Kit #	List Price	(URE) Kit #	List Price	(FC) Kit #	List Price
5/8"	ATL-4A06S000S	10.11	ATL-EA06S000S	\$ 8.52	ATL-4A06S000V	\$ 28.08
3/4"	ATL-4A07S000S	13.62	—		ATL-4A07S000V	40.29
1"	ATL-4A10S000S	10.12	ATL-EA10S000S	9.17	ATL-4A10S000V	28.95
1-3/8"	ATL-4A13S000S	10.38	ATL-EA13S000S	9.78	ATL-4A13S000V	30.45
1-3/4"	ATL-4A17S000S	13.07	ATL-EA17S000S	11.44	ATL-4A17S000V	34.13
2"	ATL-4A20S000S	14.60	ATL-EA20S000S	14.75	ATL-4A20S000V	35.54
2-1/2"	ATL-4A25S000S	19.88	ATL-EA25S000S	16.86	ATL-4A25S000V	44.94
3"	ATL-4A30S000S	28.39	ATL-EA30S000S	34.18	ATL-4A30S000V	52.77
3-1/2"	ATL-4A35S000S	31.06	ATL-EA35S000S	49.48	ATL-4A35S000V	65.62
4"	ATL-4A40S000S	33.34	ATL-EA40S000S	55.14	ATL-4A40S000V	100.43
4-1/2"	ATL-4A45S000S	40.72	ATL-EA45S000S	61.32	ATL-4A45S000V	113.25
5"	ATL-4A50S000S	47.47	ATL-EA50S000S	66.52	ATL-4A50S000V	152.32

ATLAS

Series 2LA Rod Kits

Series 2LA Air Cylinders

Nitrile

Fluorocarbon

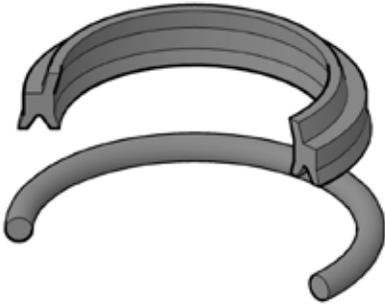

1/2" - 1-3/4"

Kit Includes:

- 1 XNBR Wiper/Seal
- 1 NBR O-Ring
- 1 Tube Seal Lubricant

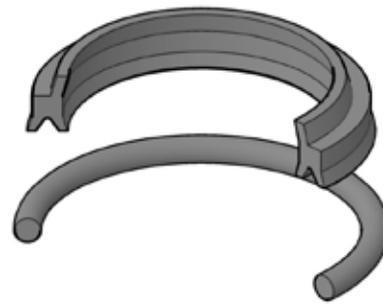

1/2" - 1-3/4"

Kit Includes:

- 1 FC Wiper/Seal
- 1 FC O-Ring
- 1 Tube Seal Lubricant

Rod Dia.	(NBR) Kit #	List Price	(FC) Kit #	List Price
1/2"	ATL-RK02MA0051	\$ 13.14	ATL-RK02MA0055	\$ 19.64
5/8"	ATL-RK02MA0061	13.55	ATL-RK02MA0065	20.18
1"	ATL-RK02MA0101	13.89	ATL-RK02MA0105	20.84
1-3/8"	ATL-RK02MA0131	14.86	ATL-RK02MA0135	26.10
1-3/4"	ATL-RK02MA0171	15.88	ATL-RK02MA0175	32.82

ATLAS

ATLAS

Series A & L Piston Kits

Series A Cylinders Nitrile



Kit Includes:

2 NBR U-Seals
2 HP URE Back-Up Rings
2 NBR O-Ring Head Seals

Series L Cylinders Nitrile



Kit Includes:

2 NBR U-Seals
2 HP URE Back-Up Rings
2 NBR O-Ring Head Seals

Series A & L Cylinders Fluorocarbon



Kit Includes:

2 FC U-Seals
2 HP URE Back-Up Rings
2 FC O-Ring head Seals

Bore Dia.	(NBR) Kit #	List Price	(NBR) Kit #	List Price	(FC) Kit #	List Price
1-1/2"	ATL-4B00S015S	\$ 8.15	ATL-EB00S015S	\$ 8.15	ATL-4B00S015V	\$ 37.42
2"	ATL-4B00S020S	9.71	ATL-EB00S020S	9.71	ATL-4B00S020V	42.78
2-1/2"	ATL-4B00S025S	11.12	ATL-EB00S025S	11.12	ATL-4B00S025V	59.27
3-1/4"	ATL-4B00S032S	13.50	ATL-EB00S032S	13.50	ATL-4B00S032V	63.64
4"	ATL-4B00S040S	17.20	ATL-EB00S040S	17.20	ATL-4B00S040V	75.47
5"	ATL-4B00S050S	20.82	ATL-EB00S050S	20.82	ATL-4B00S050V	93.61
6"	ATL-4B00S060S	27.05	ATL-EB00S060S	27.05	ATL-4B00S060V	128.73
7"	ATL-4B00S070S	75.43	ATL-4B00S070S	75.43	ATL-4B00S070V	232.76
8"	ATL-4B00S080S	85.57	ATL-EB00S080S	85.57	ATL-4B00S080V	280.62
10"	ATL-4B00S100S	121.81	ATL-4B00S100S	121.81	ATL-4B00S100V	388.89
12"	ATL-4B00S120S	164.85	ATL-4B00S120S	164.85	ATL-4B00S120V	603.61
14"	ATL-4B00S140S	255.24	ATL-4B00S140S	255.24	ATL-4B00S140V	889.82

HP URE - High Performance Urethane

ATLAS

Series 2LA Piston Kits

Nitrile

Series 2LA Air Cylinders

Fluorocarbon

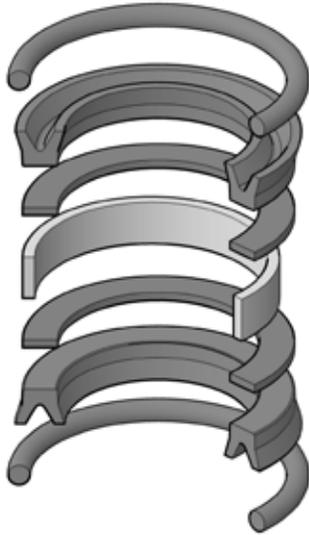

Kit Includes:

2 NBR O-ring Head Seals
2 NBR U-Seals
2 URE Back-up Rings
1 Nylon Wear Ring
1 Tube Seal Lubricant

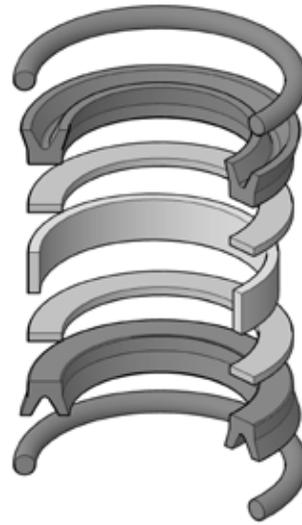

Kit Includes:

2 FC O-ring Head Seals
2 FC U-Seals
2 PTFE Back-up Rings
1 Nylon Wear Ring
1 Tube Seal Lubricant

Bore Dia.	(NBR) Kit #	List Price	(FC) Kit #	List Price
1-1/2"	ATL-PK1502MA01	\$ 24.50	ATL-PK1502MA05	\$ 47.73
2"	ATL-PK2002MA01	24.83	ATL-PK2002MA05	51.11
2-1/2"	ATL-PK2502MA01	26.62	ATL-PK2502MA05	67.84
3-1/4"	ATL-PK3202MA01	32.00	ATL-PK3202MA05	83.86
4"	ATL-PK4002MA01	39.24	ATL-PK4002MA05	95.00
5"	ATL-PK5002MA01	50.78	ATL-PK5002MA05	143.77
6"	ATL-PK6002MA01	67.89	ATL-PK6002MA05	203.63
8"	ATL-PK8002MA01	119.85	ATL-PK8002MA05	340.50

ATLAS

ATLAS

Series A & L Head Seal Kits

Series A & L Head Seal Kits

Nitrile

Fluorocarbon

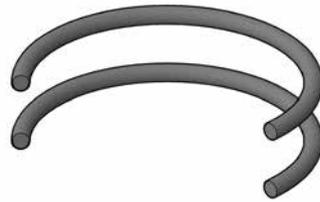
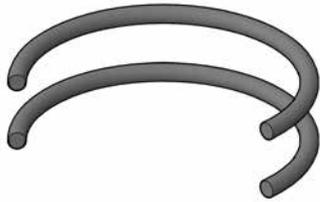

Kit Includes:
2 NBR O-Ring Head Seals

Kit Includes:
2 FC O-Ring Head Seals

Bore Dia.	(NBR) Kit #	List Price	(FC) Kit #	List Price
1-1/2"	ATL-4E00S015S	\$ 4.72	ATL-4E00S015V	\$ 6.79
2"	ATL-4E00S020S	5.01	ATL-4E00S020V	11.54
2-1/2"	ATL-4E00S025S	5.60	ATL-4E00S025V	15.12
3-1/4"	ATL-4E00S032S	5.67	ATL-4E00S032V	17.66
4"	ATL-4E00S040S	5.95	ATL-4E00S040V	22.74
5"	ATL-4E00S050S	6.96	ATL-4E00S050V	32.00
6"	ATL-4E00S060S	8.61	ATL-4E00S060V	33.76
7"	ATL-4E00S070S	8.73	ATL-4E00S070V	47.71
8"	ATL-4E00S080S	10.63	ATL-4E00S080V	47.86
10"	ATL-4E00S100S	12.33	ATL-4E00S100V	53.30
12"	ATL-4E00S120S	14.22	ATL-4E00S120V	64.27
14"	ATL-4E00S140S	71.95	ATL-4E00S140V	129.03

ATLAS

ATLAS

Series H Rod Seal Kits

Nitrile

Series H Rod Seal Kits

Fluorocarbon



Kit Includes:

- 1 URE Wiper (For cyl. mfg. before April 2005)
- 1 XNBR Wiper (For cyl. mfg. April 2005 and after)
- 1 Multi-lip URE U-Seal
- 1 NBR O-Ring

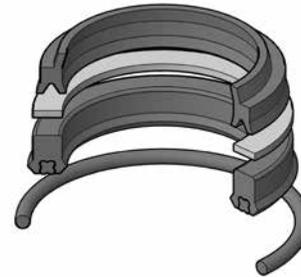

Kit Includes:

- 1 FC Wiper (For cyl. mfg. April 2005 and after*)
- 1 PTFE Back-Up Rings
- 1 FC Loaded FC U-Seals
- 1 FC O-Ring

Rod Dia.	(NBR) Kit #	List Price	(FC) Kit #	List Price
5/8"	ATL-PH06SH000	\$ 9.15	ATL-VH06SH000	\$ 27.95
1"	ATL-PH10SH000	9.88	ATL-VH10SH000	39.44
1-3/8"	ATL-PH13SH000	13.28	ATL-VH13SH000	41.14
1-3/4"	ATL-PH17SH000	13.40	ATL-VH17SH000	48.78
2"	ATL-PH20SH000	18.33	ATL-VH20SH000	55.86
2-1/2"	ATL-PH25SH000	22.86	ATL-VH25SH000	90.29
3"	ATL-PH30SH000	24.26	ATL-VH30SH000	104.04
3-1/2"	ATL-PH35SH000	46.94	ATL-VH35SH000	144.63

* Fluorocarbon Rod Seal Kits for cylinders manufactured before April 2005 use a bronze AN style wiper ring.

ATLAS

Series H (for cylinders manufactured before April 2005) Piston Seal Kits

Series H Piston Seal Kits

Nitrile

Fluorocarbon

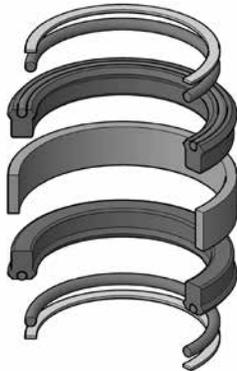

Kit Includes:

- * See notes below
- 2 NBR Loaded URE U-Seals
- 1 Nylon Wear Ring
- 2 NBR O-Ring Head Seals
- 2 PTFE Back-up Rings

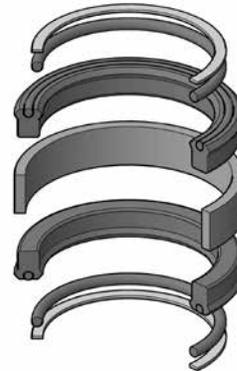

Kit Includes:

- * See notes below
- 2 FC Loaded FC U-Seals
- 1 Nylon Wear Ring
- 2 FC O-Ring Head Seals
- 2 PTFE Back-Up Rings

Bore Dia.	(NBR) Kit #	List Price	(FC) Kit #	List Price
1-1/2"	ATL-1B00S015S	\$ 16.95	ATL-1B00S015V	\$ 51.36
2"	ATL-1B00S020S	19.75	ATL-1B00S020V	57.16
2-1/2"	ATL-1B00S025S	21.08	ATL-1B00S025V	60.67
3-1/4"	ATL-1B00S032S	32.47	ATL-1B00S032V	86.67
4"	ATL-1B00S040S	41.65	ATL-1B00S040V	124.90
5"	ATL-1B00S050S	87.52	ATL-1B00S050V	188.06
6"	ATL-1B00S060S	149.96	ATL-1B00S060V	255.26
7"	ATL-1B00S070S	195.94	ATL-1B00S070V	392.02
8"	ATL-1B00S080S	207.97	ATL-1B00S080V	411.61
10"	ATL-1B00S100S	271.87	ATL-1B00S100V	545.49
12"	ATL-1B00S120S	345.47	ATL-1B00S120V	669.86

* Kit contents are size dependant:
 1-1/2" thru 4" - U-Seals and O-Rings
 5" - U-Seals, O-Rings and Wear Rings
 6" - Same as 5, also includes 2 PTFE U-Seal Back-Up Rings
 7" thru 12" - contain all parts listed

ATLAS

ATLAS

(for cylinders manufactured April 2005 and after) **Series H**
Piston Seal Kits
 (1-1/2" to 6" Bores)

Nitrile



Kit Includes:

2 NBR O-Ring Head Seals
 2 HP URE Back-up Rings
 2 NBR U-Seals

Fluorocarbon



Kit Includes:

2 FC O-Ring Head Seals
 2 PTFE Back-Up Rings
 2 FC U-Seals

Bore Dia.	(NBR) Kit #	List Price	(FC) Kit #	List Price
1-1/2"	ATL-PH00LH015	\$ 13.08	ATL-VH00LH015	\$ 46.02
2"	ATL-PH00LH020	13.83	ATL-VH00LH020	66.30
2-1/2"	ATL-PH00LH025	16.44	ATL-VH00LH025	76.35
3-1/4"	ATL-PH00LH032	30.07	ATL-VH00LH032	88.19
4"	ATL-PH00LH040	35.77	ATL-VH00LH040	201.67
5"	ATL-PH00LH050	52.56	ATL-VH00LH050	302.98
6"	ATL-PH00LH060	78.65	ATL-VH00LH060	356.23

HP URE - High Performance Urethane

ATLAS

Series H (for cylinders manufactured April 2005 and after) Piston Seal Kits (7" & 8" Bores)

ATLAS

Series H Piston Seal Kits

Nitrile

Fluorocarbon

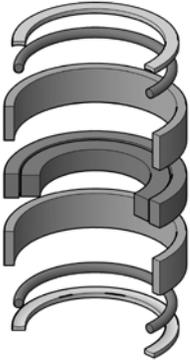
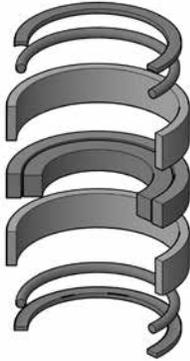

- Kit Includes:**
 2 NBR Back-Up Rings
 2 NBR O-Ring Head Seals
 2 Nylon Wear Rings
 1 Bronze filled PTFE Piston Ring
 w/ 1 NBR Expander

- Kit Includes:**
 2 PTFE Back-Up Rings
 2 FC O-Ring Head Seals
 2 Nylon Wear Rings
 1 Bronze filled PTFE Piston Ring
 w/1 FC Expander

Bore Dia.	(NBR) Kit #	List Price	(FC) Kit #	List Price
7"	ATL-PH00KH070	\$ 316.78	ATL-VH00KH070	\$ 320.44
8"	ATL-PH00KH080	385.03	ATL-VH00KH080	395.37

High load Piston Seal Kits are standard for 7" & 8" Bores

ATLAS

(for cylinders manufactured before April 2005) **Series H
Head Seal Kits**

Nitrile

Series H Head Seal Kits

Fluorocarbon

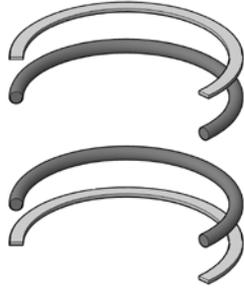

Kit Includes:
2 NBR O-Ring Head Seals
2 PTFE Back-up Rings*



Kit Includes:
2 FC O-Ring Head Seals
2 PTFE Back-up Rings*

Bore Dia.	(NBR) Kit #	List Price	(FC) Kit #	List Price
1-1/2"	ATL-1E00S015S	\$ 4.13	ATL-1E00S015V	\$ 6.14
2"	ATL-1E00S020S	5.30	ATL-1E00S020V	7.31
2-1/2"	ATL-1E00S025S	7.09	ATL-1E00S025V	8.77
3-1/4"	ATL-1E00S032S	13.25	ATL-1E00S032V	17.33
4"	ATL-1E00S040S	16.02	ATL-1E00S040V	18.74
5"	ATL-1E00S050S	19.21	ATL-1E00S050V	29.16
6"	ATL-1E00S060S	30.15	ATL-1E00S060V	31.48
7"	ATL-1E00S070S	63.86	ATL-1E00S070V	74.24
8"	ATL-1E00S080S	67.92	ATL-1E00S080V	86.64
10"	ATL-1E00S100S	123.50	ATL-1E00S100V	139.09
12"	ATL-1E00S120S	140.36	ATL-1E00S120V	160.12

* Back-up Rings in 7", 8", 10" and 12" kits only

ATLAS

Bronze Rod Glands

Series 2LA Air Cylinders

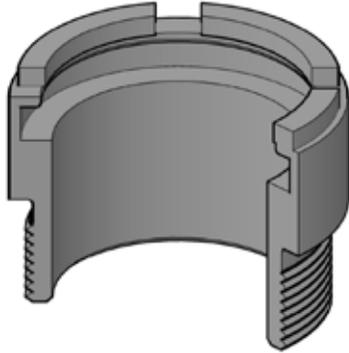

Rod Dia.	Kit #	List Price
1/2"	ATL-RG02MA-05	\$ 36.67
5/8"	ATL-RG02MA-06	27.02
1"	ATL-RG02MA-10	33.82
1-3/8"	ATL-RG02MA-13	48.90
1-3/4"	ATL-RG02MA-17	77.01

ATLAS

ATLAS

Rod Kits

Hydraulic Cylinders

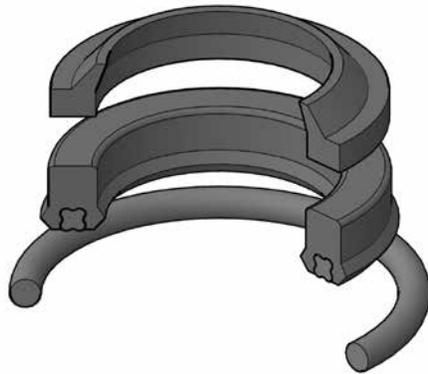

Kit Includes:
 1 URE Wiper
 1 URE Loaded U-seal
 1 NBR O-ring

Rod Dia.	Kit #	List Price
5/8"	ATL-HRK62	\$ 8.77
1"	ATL-HRK100	10.51
1-3/8"	ATL-HRK137	12.19
1-3/8"	ATL-90030340-79	14.22
1-3/8"	ATL-90030370-79	11.66
1-3/4"	ATL-HRK175	13.47
1-3/4"	ATL-90030340-69	12.72
1-3/4"	ATL-90030370-69	12.61
2"	ATL-HRK200	14.44

Piston Kits

Pneumatic Cylinders

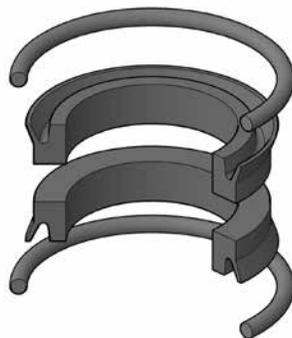

Kit Includes:
 2 URE U-seals
 2 NBR O-rings

Bore Dia.	Kit #	List Price
1-1/2"	—	
2"	ATL-APK20-000	\$ 13.27
2-1/2"	ATL-APK25-000	14.02
3-1/4"	—	
4"	ATL-APK40-000	38.58
5"	ATL-APK50-000	38.90
6"	ATL-APK60-000	45.85
8"	ATL-APK80-000	78.72
10"	ATL-APK100-000	153.27

Hydraulic Cylinders

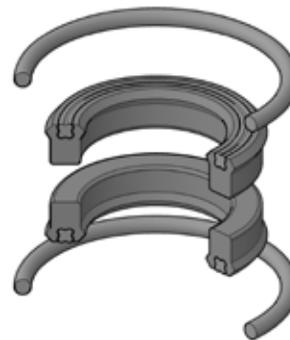

Kit Includes:
 2 URE Loaded U-seals
 2 NBR O-rings

Kit #	List Price
ATL-HPK15-000	\$ 15.55
ATL-HPK20-000	17.43
ATL-HPK25-000	18.92
ATL-HPK35-000	28.35
ATL-HPK40-000	34.19
ATL-HPK50-000	42.48
ATL-HPK60-000	50.78
ATL-HPK80-000	103.32
—	

ATLAS

Kit Number	Code	Rod Size	Bore Size	List Price	Kit Number	Code	Rod Size	Bore Size	List Price
ATL-1B00S015S	N-N-5		1-1/2	\$ 16.95	ATL-4A10R000S	I-U-1	1		\$ 104.38
ATL-1B00S015V	N-N-5		1-1/2	51.36	ATL-4A10R000V	I-U-1	1		138.41
ATL-1B00S020S	N-N-5		2	19.75	ATL-4A10S000S	I-U-1	1		10.12
ATL-1B00S020V	N-N-5		2	57.16	ATL-4A10S000V	I-U-1	1		28.95
ATL-1B00S025S	N-N-5		2-1/2	21.08	ATL-4A13R000S	I-U-1	1-3/8		125.03
ATL-1B00S025V	N-N-5		2-1/2	60.67	ATL-4A13R000V	I-U-1	1-3/8		142.85
ATL-1B00S032S	N-N-5		3-1/4	32.47	ATL-4A13S000S	I-U-1	1-3/8		10.38
ATL-1B00S032V	N-N-5		3-1/4	86.67	ATL-4A13S000V	I-U-1	1-3/8		30.45
ATL-1B00S040S	N-N-5		4	41.65	ATL-4A17R000S	I-U-1	1-3/4		147.40
ATL-1B00S040V	N-N-5		4	124.90	ATL-4A17R000V	I-U-1	1-3/4		169.90
ATL-1B00S050S	N-N-5		5	87.52	ATL-4A17S000S	I-U-1	1-3/4		13.07
ATL-1B00S050V	N-N-5		5	188.06	ATL-4A17S000V	I-U-1	1-3/4		34.13
ATL-1B00S060S	N-N-5		6	149.96	ATL-4A20R000S	I-U-1	2		172.93
ATL-1B00S060V	N-N-5		6	255.26	ATL-4A20R000V	I-U-1	2		198.84
ATL-1B00S070S	N-N-5		7	195.94	ATL-4A20S000S	I-U-1	2		14.60
ATL-1B00S070V	N-N-5		7	392.02	ATL-4A20S000V	I-U-1	2		35.54
ATL-1B00S080S	N-N-5		8	207.97	ATL-4A25R000S	I-U-1	2-1/2		196.70
ATL-1B00S080V	N-N-5		8	411.61	ATL-4A25R000V	I-U-1	2-1/2		236.62
ATL-1B00S100S	N-N-5		10	271.87	ATL-4A25S000S	I-U-1	2-1/2		19.88
ATL-1B00S100V	N-N-5		10	545.49	ATL-4A25S000V	I-U-1	2-1/2		44.94
ATL-1B00S120S	N-N-5		12	345.47	ATL-4A30R000S	I-U-1	3		242.95
ATL-1B00S120V	N-N-5		12	669.86	ATL-4A30R000V	I-U-1	3		286.49
ATL-1E00S015S	Head Seal Kit		1-1/2	4.13	ATL-4A30S000S	I-U-1	3		28.39
ATL-1E00S015V	Head Seal Kit		1-1/2	6.14	ATL-4A30S000V	I-U-1	3		52.77
ATL-1E00S020S	Head Seal Kit		2	5.30	ATL-4A35S000S	I-U-1	3-1/2		31.06
ATL-1E00S020V	Head Seal Kit		2	7.31	ATL-4A35S000V	I-U-1	3-1/2		65.62
ATL-1E00S025S	Head Seal Kit		2-1/2	7.09	ATL-4A40S000S	I-U-1	4		33.34
ATL-1E00S025V	Head Seal Kit		2-1/2	8.77	ATL-4A40S000V	I-U-1	4		100.43
ATL-1E00S032S	Head Seal Kit		3-1/4	13.25	ATL-4A45S000S	I-U-1	4-1/2		40.72
ATL-1E00S032V	Head Seal Kit		3-1/4	17.33	ATL-4A45S000V	I-U-1	4-1/2		113.25
ATL-1E00S040S	Head Seal Kit		4	16.02	ATL-4A50S000S	I-U-1	5		47.47
ATL-1E00S040V	Head Seal Kit		4	18.74	ATL-4A50S000V	I-U-1	5		152.32
ATL-1E00S050S	Head Seal Kit		5	19.21	ATL-4B00S015S	N-N-5		1-1/2	8.15
ATL-1E00S050V	Head Seal Kit		5	29.16	ATL-4B00S015V	N-N-5		1-1/2	37.42
ATL-1E00S060S	Head Seal Kit		6	30.15	ATL-4B00S020S	N-N-5		2	9.71
ATL-1E00S060V	Head Seal Kit		6	31.48	ATL-4B00S020V	N-N-5		2	42.78
ATL-1E00S070S	Head Seal Kit		7	63.86	ATL-4B00S025S	N-N-5		2-1/2	11.12
ATL-1E00S070V	Head Seal Kit		7	74.24	ATL-4B00S025V	N-N-5		2-1/2	59.27
ATL-1E00S080S	Head Seal Kit		8	67.92	ATL-4B00S032S	N-N-5		3-1/4	13.50
ATL-1E00S080V	Head Seal Kit		8	86.64	ATL-4B00S032V	N-N-5		3-1/4	63.64
ATL-1E00S100S	Head Seal Kit		10	123.50	ATL-4B00S040S	N-N-5		4	17.20
ATL-1E00S100V	Head Seal Kit		10	139.09	ATL-4B00S040V	N-N-5		4	75.47
ATL-1E00S120S	Head Seal Kit		12	140.36	ATL-4B00S050S	N-N-5		5	20.82
ATL-1E00S120V	Head Seal Kit		12	160.12	ATL-4B00S050V	N-N-5		5	93.61
ATL-4A06R000S	I-U-1	5/8		88.70	ATL-4B00S060S	N-N-5		6	27.05
ATL-4A06R000V	I-U-1	5/8		117.78	ATL-4B00S060V	N-N-5		6	128.73
ATL-4A06S000S	I-U-1	5/8		10.11	ATL-4B00S070S	N-N-5		7	75.43
ATL-4A06S000V	I-U-1	5/8		28.08	ATL-4B00S070V	N-N-5		7	232.76
ATL-4A07S000S	I-U-1	3/4		13.62	ATL-4B00S080S	N-N-5		8	85.57
ATL-4A07S000V	I-U-1	3/4		40.29	ATL-4B00S080V	N-N-5		8	280.62

ATLAS

Kit Number	Code	Rod Size	Bore Size	List Price	Kit Number	Code	Rod Size	Bore Size	List Price
ATL-4B00S100S	N-N-5		10	\$ 121.81	ATL-EA20S000S	I-U-1	2		\$ 14.75
ATL-4B00S100V	N-N-5		10	388.89	ATL-EA25R000S	I-U-1	2-1/2		193.38
ATL-4B00S120S	N-N-5		12	164.85	ATL-EA25S000S	I-U-1	2-1/2		16.86
ATL-4B00S120V	N-N-5		12	603.61	ATL-EA30R000S	I-U-1	3		257.53
ATL-4B00S140S	N-N-5		14	255.24	ATL-EA30S000S	I-U-1	3		34.18
ATL-4B00S140V	N-N-5		14	889.82	ATL-EA35S000S	I-U-1	3-1/2		49.48
ATL-4E00S015S	Head Seal Kit		1-1/2	4.72	ATL-EA40S000S	I-U-1	4		55.14
ATL-4E00S015V	Head Seal Kit		1-1/2	6.79	ATL-EA45S000S	I-U-1	4-1/2		61.32
ATL-4E00S020S	Head Seal Kit		2	5.01	ATL-EA50S000S	I-U-1	5		66.52
ATL-4E00S020V	Head Seal Kit		2	11.54	ATL-EB00S015S	N-N-5		1-1/2	8.15
ATL-4E00S025S	Head Seal Kit		2-1/2	5.60	ATL-EB00S020S	N-N-5		2	9.71
ATL-4E00S025V	Head Seal Kit		2-1/2	15.12	ATL-EB00S025S	N-N-5		2-1/2	11.12
ATL-4E00S032S	Head Seal Kit		3-1/4	5.67	ATL-EB00S032S	N-N-5		3-1/4	13.50
ATL-4E00S032V	Head Seal Kit		3-1/4	17.66	ATL-EB00S040S	N-N-5		4	17.20
ATL-4E00S040S	Head Seal Kit		4	5.95	ATL-EB00S050S	N-N-5		5	20.82
ATL-4E00S040V	Head Seal Kit		4	22.74	ATL-EB00S060S	N-N-5		6	27.05
ATL-4E00S050S	Head Seal Kit		5	6.96	ATL-4B00S070S	N-N-5		7	75.43
ATL-4E00S050V	Head Seal Kit		5	32.00	ATL-EB00S080S	N-N-5		8	85.57
ATL-4E00S060S	Head Seal Kit		6	8.61	ATL-HPK15-000	N-N-5		1-1/2	15.55
ATL-4E00S060V	Head Seal Kit		6	33.76	ATL-HPK20-000	N-N-5		2	17.43
ATL-4E00S070S	Head Seal Kit		7	8.73	ATL-HPK25-000	N-N-5		2-1/2	18.92
ATL-4E00S070V	Head Seal Kit		7	47.71	ATL-HPK35-000	N-N-5		3-1/4	28.35
ATL-4E00S080S	Head Seal Kit		8	10.63	ATL-HPK40-000	N-N-5		4	34.19
ATL-4E00S080V	Head Seal Kit		8	47.86	ATL-HPK50-000	N-N-5		5	42.48
ATL-4E00S100S	Head Seal Kit		10	12.33	ATL-HPK60-000	N-N-5		6	50.78
ATL-4E00S100V	Head Seal Kit		10	53.30	ATL-HPK80-000	N-N-5		8	103.32
ATL-4E00S120S	Head Seal Kit		12	14.22	ATL-HRK100	I-U-1	1		10.51
ATL-4E00S120V	Head Seal Kit		12	64.27	ATL-HRK137	I-U-1	1-3/8		12.19
ATL-4E00S140S	Head Seal Kit		14	71.95	ATL-HRK175	I-U-1	1-3/4		13.47
ATL-4E00S140V	Head Seal Kit		14	129.03	ATL-HRK200	I-U-1	2		14.44
ATL-90030340-69	I-U-1	1-3/4		12.72	ATL-HRK62	I-U-1	5/8		8.77
ATL-90030340-79	I-U-1	1-3/8		14.22	ATL-PH00KH070	N-N-1		7	316.78
ATL-90030370-69	I-U-1	1-3/4		12.61	ATL-PH00KH080	N-N-1		8	385.03
ATL-90030370-79	I-U-1	1-3/8		11.66	ATL-PH00LH015	N-N-5		1-1/2	13.08
ATL-APK100-000	N-N-5		10	153.27	ATL-PH00LH020	N-N-5		2	13.83
ATL-APK20-000	N-N-5		2	13.27	ATL-PH00LH025	N-N-5		2-1/2	16.44
ATL-APK25-000	N-N-5		2-1/2	14.02	ATL-PH00LH032	N-N-5		3-1/4	30.07
ATL-APK40-000	N-N-5		4	38.58	ATL-PH00LH040	N-N-5		4	35.77
ATL-APK50-000	N-N-5		5	38.90	ATL-PH00LH050	N-N-5		5	52.56
ATL-APK60-000	N-N-5		6	45.85	ATL-PH00LH060	N-N-5		6	78.65
ATL-APK80-000	N-N-5		8	78.72	ATL-PH06SH000	I-U-1	5/8		9.15
ATL-EA06R000S	I-U-1	5/8		92.39	ATL-PH10SH000	I-U-1	1		9.88
ATL-EA06S000S	I-U-1	5/8		8.52	ATL-PH13SH000	I-U-1	1-3/8		13.28
ATL-EA10R000S	I-U-1	1		103.33	ATL-PH17SH000	I-U-1	1-3/4		13.40
ATL-EA10S000S	I-U-1	1		9.17	ATL-PH20SH000	I-U-1	2		18.33
ATL-EA13R000S	I-U-1	1-3/8		118.77	ATL-PH25SH000	I-U-1	2-1/2		22.86
ATL-EA13S000S	I-U-1	1-3/8		9.78	ATL-PH30SH000	I-U-1	3		24.26
ATL-EA17R000S	I-U-1	1-3/4		140.24	ATL-PH35SH000	I-U-1	3-1/2		46.94
ATL-EA17S000S	I-U-1	1-3/4		11.44	ATL-PK1502MA01	N-N-5		1-1/2	24.50
ATL-EA20R000S	I-U-1	2		172.08	ATL-PK1502MA05	N-N-5		1-1/2	47.73

ATLAS

ATLAS

Kit Number	Code	Rod Size	Bore Size	List Price	Kit Number	Code	Rod Size	Bore Size	List Price
ATL-PK2002MA01	N-N-5		2	\$ 24.83	ATL-RG02MA-06	Bronze Rod Gland	5/8		\$ 27.02
ATL-PK2002MA05	N-N-5		2	51.11	ATL-RG02MA-10	Bronze Rod Gland	1		33.82
ATL-PK2502MA01	N-N-5		2-1/2	26.62	ATL-RG02MA-13	Bronze Rod Gland	1-3/8		48.90
ATL-PK2502MA05	N-N-5		2-1/2	67.84	ATL-RG02MA-17	Bronze Rod Gland	1-3/4		77.01
ATL-PK3202MA01	N-N-5		3-1/4	32.00	ATL-RK02MA0051	I-SP-1	1/2		13.14
ATL-PK3202MA05	N-N-5		3-1/4	83.86	ATL-RK02MA0055	I-SP-1	1/2		19.64
ATL-PK4002MA01	N-N-5		4	39.24	ATL-RK02MA0061	I-SP-1	5/8		13.55
ATL-PK4002MA05	N-N-5		4	95.00	ATL-RK02MA0065	I-SP-1	5/8		20.18
ATL-PK5002MA01	N-N-5		5	50.78	ATL-RK02MA0101	I-SP-1	1		13.89
ATL-PK5002MA05	N-N-5		5	143.77	ATL-RK02MA0105	I-SP-1	1		20.84
ATL-PK6002MA01	N-N-5		6	67.89	ATL-RK02MA0131	I-SP-1	1-3/8		14.86
ATL-PK6002MA05	N-N-5		6	203.63	ATL-RK02MA0135	I-SP-1	1-3/8		26.10
ATL-PK8002MA01	N-N-5		8	119.85	ATL-RK02MA0171	I-SP-1	1-3/4		15.88
ATL-PK8002MA05	N-N-5		8	340.50	ATL-RK02MA0175	I-SP-1	1-3/4		32.82
ATL-RGAL-06	Bronze Rod Gland	5/8		79.28	ATL-VH00KH070	N-N-1		7	320.44
ATL-RGAL-10	Bronze Rod Gland	1		89.04	ATL-VH00KH080	N-N-1		8	395.37
ATL-RGAL-13	Bronze Rod Gland	1-3/8		104.38	ATL-VH00LH015	N-N-5	1-1/2		46.02
ATL-RGAL-17	Bronze Rod Gland	1-3/4		121.88	ATL-VH00LH020	N-N-5	2		66.30
ATL-RGAL-20	Bronze Rod Gland	2		147.85	ATL-VH00LH025	N-N-5	2-1/2		76.35
ATL-RGAL-25	Bronze Rod Gland	2-1/2		166.94	ATL-VH00LH032	N-N-5	3-1/4		88.19
ATL-RGAL-30	Bronze Rod Gland	3		207.75	ATL-VH00LH040	N-N-5	4		201.67
ATL-RG02MA0051	I-SP-1	1/2		40.72	ATL-VH00LH050	N-N-5	5		302.98
ATL-RG02MA0055	I-SP-1	1/2		43.39	ATL-VH00LH060	N-N-5	6		356.23
ATL-RG02MA0061	I-SP-1	5/8		26.90	ATL-VH06SH000	I-U-1	5/8		27.95
ATL-RG02MA0065	I-SP-1	5/8		42.96	ATL-VH10SH000	I-U-1	1		39.44
ATL-RG02MA0101	I-SP-1	1		30.82	ATL-VH13SH000	I-U-1	1-3/8		41.14
ATL-RG02MA0105	I-SP-1	1		47.60	ATL-VH17SH000	I-U-1	1-3/4		48.78
ATL-RG02MA0131	I-SP-1	1-3/8		46.03	ATL-VH20SH000	I-U-1	2		55.86
ATL-RG02MA0135	I-SP-1	1-3/8		68.81	ATL-VH25SH000	I-U-1	2-1/2		90.29
ATL-RG02MA0171	I-SP-1	1-3/4		93.67	ATL-VH30SH000	I-U-1	3		104.04
ATL-RG02MA0175	I-SP-1	1-3/4		105.07	ATL-VH35SH000	I-U-1	3-1/2		144.63
ATL-RG02MA-05	Bronze Rod Gland	1/2		36.67					

ATLAS

HYDRO-LINE®

Kit Type		Page
A5 Series	Rod Kits	22
	Piston Kits	23
	Tube End Seals	23
E2 Series	Rod Kits	24
	Piston Kits	24
	Tube End Seals	24
N2 Series	Rod Kits	25
	Piston Kits	26
	Tube End Seals	27
N5 Series	Rod Kits	28 - 29
	Piston Kits	30
	Tube End Seals	30
R2 Series	Rod Kits	31
	Piston Kits	32
	Tube End Seals	33
R5 Series	Rod Kits	34 - 35
	Piston Kits	36
	Tube End Seals	37
Universal Kits	Rod Kits	38
	Gland Kits	39 - 40
	Captive Cushion Adjustment Seal	41
	Piston Kits	42
Repair Kits	By Part Number	43 - 49

HYDRO-LINE®

A5 Series Rod Kits

A5 Cylinders		HA5 Cylinders	
Nitrile	Fluorocarbon	Urethane	Fluorocarbon



- Kit Includes:**
 1 XNBR Wiper
 1 URE Back-up Ring
 1 NBR U-seal
 1 PTFE Back-up Ring
 1 NBR O-ring



- Kit Includes:**
 1 FC Wiper
 1 PTFE Back-up Ring
 1 FC U-seal
 1 PTFE Back-up Ring
 1 FC O-ring

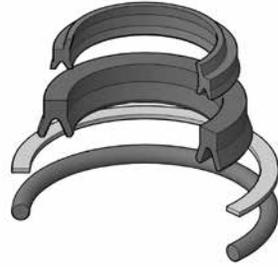

- Kit Includes:**
 1 XNBR Wiper
 1 URE U-seal
 1 PTFE Back-up Ring
 1 NBR O-ring



- Kit Includes:**
 1 FC Wiper
 1 PTFE Back-up Ring
 1 FC Loaded U-seal
 1 PTFE Back-up Ring
 1 FC O-ring

Rod Dia.	(NBR) Kit #	List Price	(FC) Kit #	List Price	(URE) Kit #	List Price	(FC) Kit #	List Price
5/8"	HSKN5-660-05	\$ 9.99	HSKN5-660-05V	\$ 35.85	HSKN5-681-05	\$ 16.82	HSKN5-660-P-05V	\$ 60.31
1"	HSKN5-660-08	10.15	HSKN5-660-08V	37.67	HSKN5-681-08	18.45	HSKN5-660-P-08V	68.47
1-3/8"	HSKN5-660-11	12.73	HSKN5-660-11V	49.23	HSKN5-681-11	20.57	HSKN5-660-P-11V	83.89

HYDRO-LINE®

HYDRO-LINE®

A5 Series Piston Kits

Nitrile

A5 Cylinders

Fluorocarbon

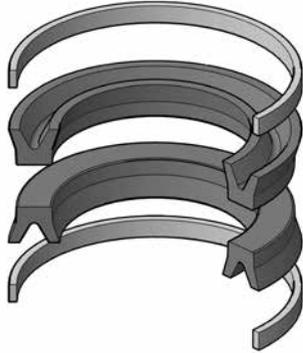

Kit Includes:
2 NBR U-seals
2 PTFE Tube End Seals

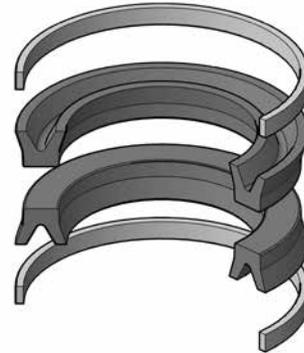

Kit Includes:
2 FC U-seals
2 PTFE Tube End Seals

Bore Dia.	(NBR) Kit #	List Price	(FC) Kit #	List Price
1-1/2"	HSKA5-512-03	\$ 26.28	HSKA5-512-03V	\$ 53.16
2"	HSKA5-512-04	28.00	HSKA5-512-04V	55.08
2-1/2"	HSKA5-512-05	30.16	HSKA5-512-05V	64.96
3-1/4"	HSKA5-512-065	32.53	HSKA5-512-065V	73.25
4"	HSKA5-512-08	37.87	HSKA5-512-08V	79.62
5"	HSKA5-512-10	47.32	HSKA5-512-10V	93.38
6"	HSKA5-512-12	55.72	HSKA5-512-12V	152.80

Tube End Seals

A5 Cylinders PTFE

Bore Dia.	Part #	List Price
1-1/2"	HS-C221-03	\$ 8.67
2"	HS-C221-04	9.44
2-1/2"	HS-C221-05	10.42
3-1/4"	HS-C221-065	11.24
4"	HS-C221-08	12.69
5"	HS-C221-10	17.17
6"	HS-C221-12	22.10



HYDRO-LINE®

E2 Series Rod Kits

E2 Cylinders Nitrile



Rod Dia.	(NBR) Kit #	List Price
5/8"	HSKE2-660-05	\$ 4.43
1"	HSKE2-660-08	4.93
1-3/8"	HSKE2-660-11	5.48

Kit Includes:

- 1 XNBR Wiper
- 1 NBR U-seal
- 1 NBR O-ring

Piston Kits

E2 Cylinders Nitrile

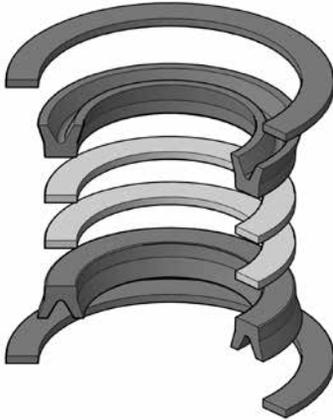

Bore Dia.	(NBR) Kit #	List Price
2"	HSKE2-512-04	\$ 26.66
3-1/4"	HSKE2-512-065	25.63
4"	HSKE2-512-08	44.71

Kit Includes:

- 2 NBR U-seals
- 2 PTFE Back-up Rings (found in 2" & 4" Bore Kits Only)
- 2 Fiber Gaskets

Tube End Seals

E2 Cylinders Fiber

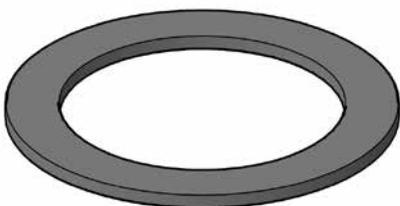

Bore Dia.	Part #	List Price
1-1/2"	HS-E304-03	\$ 2.52
2"	HS-E304-04	2.63
3-1/4"	HS-E304-065	2.94
4"	HS-E304-08	3.32

HYDRO-LINE®

N2 Series Rod Kits

N2 Cylinders

Nitrile

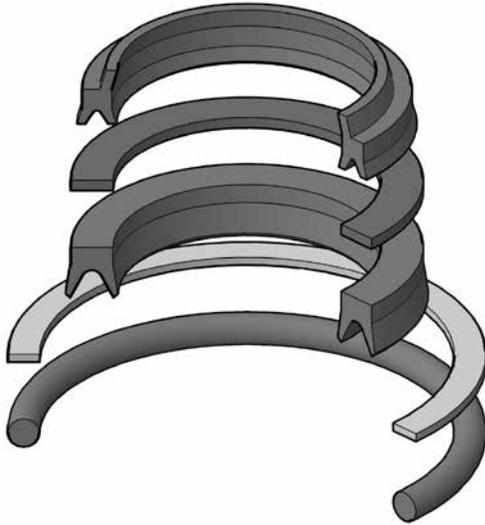

Kit Includes:

- 1 XNBR Wiper
- 1 URE Back-up Ring
- 1 NBR U-seal
- 1 PTFE Back-up Ring
- 1 NBR O-ring

Fluorocarbon

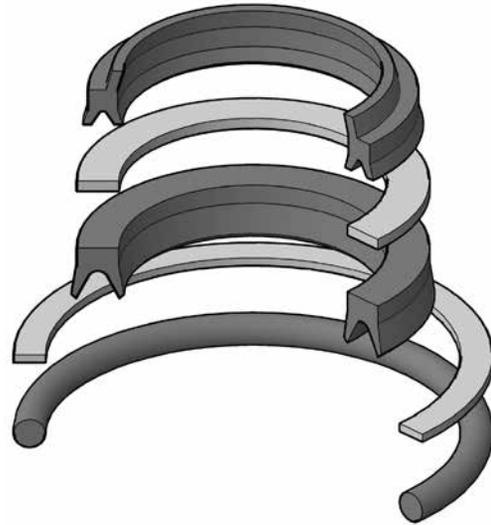

Kit Includes:

- 1 FC Wiper
- 1 PTFE Back-up Ring
- 1 FC U-seal
- 1 PTFE Back-up Ring
- 1 FC O-ring

Rod Dia.	(NBR) Kit #	List Price	(FC) Kit #	List Price
5/8"	HSKN2-661-05	\$ 10.02	HSKN2-661-05V	\$ 37.10
1"	HSKN2-661-08	9.95	HSKN2-661-08V	39.39
1-3/8"	HSKN2-661-11	12.14	HSKN2-661-11V	43.88
1-3/4"	HSKN2-661-14	14.26	HSKN2-661-14V	51.45
2"	HSKN2-661-16	15.79	HSKN2-661-16V	54.33
2-1/2"	HSKN2-661-20	23.69	HSKN2-661-20V	60.63
3"	HSKN5-660-24	20.57	HSKN5-660-24V	80.05
3-1/2"	HSKN5-660-28	22.56	HSKN5-660-28V	93.52
4"	HSKN5-660-32	28.31	HSKN5-660-32V	97.74
4-1/2"	HSKN5-660-36	30.49	HSKN5-660-36V	103.17
5"	HSKN5-660-40	45.14	HSKN5-660-40V	124.02
5-1/2"	HSKN5-660-44	61.54	HSKN5-660-44V	140.06

HYDRO-LINE®

N2 Series Piston Kits

Nitrile

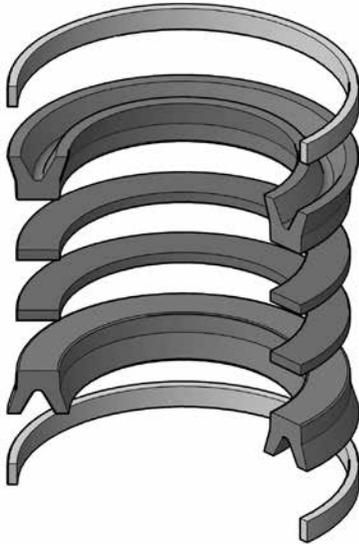

Kit Includes:

- 2 NBR U-seals
- 2 URE Back-up Rings
- 2 PTFE Tube End Seals

N2 Cylinders Fluorocarbon

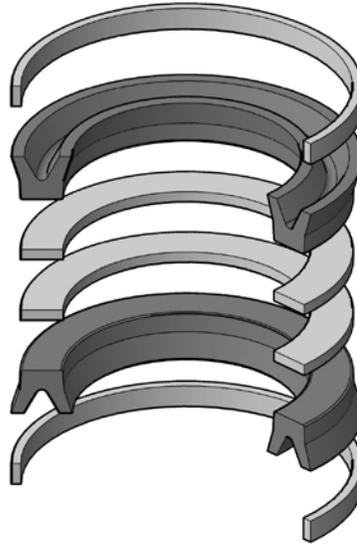

Kit Includes:

- 2 FC U-seals
- 2 PTFE Back-up Rings
- 2 PTFE Tube End Seals

Piston Ring

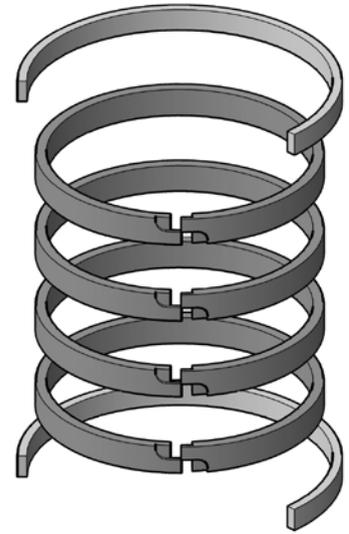

Kit Includes:

- 4 Cast-Iron Piston Rings
- 2 PTFE Tube End Seals

Bore Dia.	(NBR) Kit #	List Price	(FC) Kit #	List Price	(PR) Kit #	List Price
1-1/2"	HSKN2-512-03	\$ 33.54	HSKN2-512-03V	\$ 65.29	HSKN2-511-03	\$ 83.28
2"	HSKN2-512-04	40.65	HSKN2-512-04V	85.72	HSKN2-511-04	94.95
2-1/2"	HSKN2-512-05	43.88	HSKN2-512-05V	91.12	HSKN2-511-05	96.48
3-1/4"	HSKN2-512-065	42.18	HSKN2-512-065V	103.57	HSKN2-511-065	101.84
4"	HSKN2-512-08	50.67	HSKN2-512-08V	122.51	HSKN2-511-08	114.65
5"	HSKN2-512-10	65.10	HSKN2-512-10V	135.67	HSKN2-511-10	139.52
6"	HSKN2-512-12	73.16	HSKN2-512-12V	180.23	HSKN2-511-12	147.35
7"	HSKN2-512-14	111.71	HSKN2-512-14V	265.49	HSKN2-511-14	165.04
8"	HSKN2-512-16	141.47	HSKN2-512-16V	293.28	HSKN2-511-16	202.92
10"	HSKN2-512-20	159.09	HSKN2-512-20V	545.59	HSKN2-511-20	423.78
12"	HSKN2-512-24	250.07	HSKN2-512-24V	808.94	HSKN2-511-24	573.25

HYDRO-LINE®

N2 Series Tube End Seals

N2 Cylinders PTFE

Bore Dia.	Part #	List Price
1-1/2"	HS-C124-03	\$ 10.66
2"	HS-C124-04	12.96
2-1/2"	HS-C124-05	15.00
3-1/4"	HS-C124-065	18.98
4"	HS-C124-08	20.40
5"	HS-C124-10	22.45
6"	HS-C124-12	23.18
7" & UP	HS-C124-STRIP (sold by the foot)	15.60

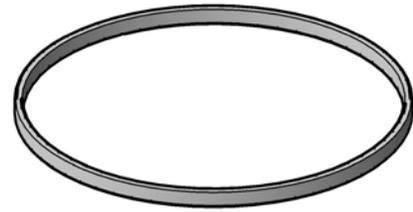

HYDRO-LINE®

N5 Series Rod Kits

N5 & AN5 Cylinders Nitrile

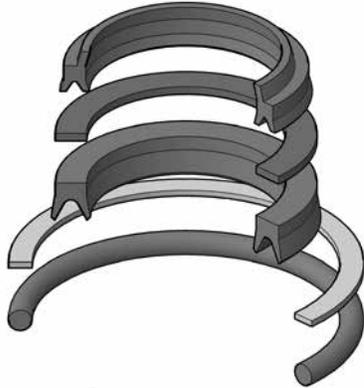

Kit Includes:

- 1 XNBR Wiper
- 1 URE Back-up Ring
- 1 NBR U-seal
- 1 PTFE Back-up Ring
- 1 NBR O-ring

Rod Dia.	(NBR) Kit #	List Price
5/8"	HSKN5-660-05	\$ 9.99
1"	HSKN5-660-08	10.15
1-3/8"	HSKN5-660-11	12.73
1-3/4"	HSKN5-660-14	16.05
2"	HSKN5-660-16	17.98
2-1/2"	HSKN5-660-20	19.78
3"	HSKN5-660-24	20.57
3-1/2"	HSKN5-660-28	22.56
4"	HSKN5-660-32	28.31
4-1/2"	HSKN5-660-36	30.49
5"	HSKN5-660-40	45.14
5-1/2"	HSKN5-660-44	61.54

Rod Kits

N5 Cylinders Fluorocarbon

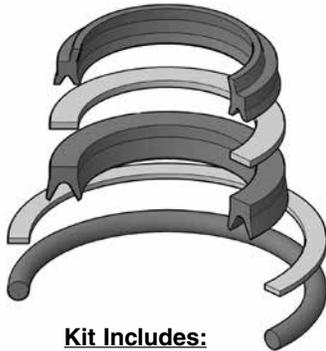

Kit Includes:

- 1 FC Wiper
- 1 PTFE Back-up Ring
- 1 FC U-seal
- 1 PTFE Back-up Ring
- 1 FC O-ring

Rod Dia.	(FC) Kit #	List Price
5/8"	HSKN5-660-05V	\$ 35.85
1"	HSKN5-660-08V	37.67
1-3/8"	HSKN5-660-11V	49.23
1-3/4"	HSKN5-660-14V	51.05
2"	HSKN5-660-16V	54.40
2-1/2"	HSKN5-660-20V	61.39
3"	HSKN5-660-24V	80.05
3-1/2"	HSKN5-660-28V	93.52
4"	HSKN5-660-32V	97.74
4-1/2"	HSKN5-660-36V	103.17
5"	HSKN5-660-40V	124.02
5-1/2"	HSKN5-660-44V	140.06

HYDRO-LINE®

N5 Series Rod Kits

		N5 Cylinders				
Urethane		Urethane		Fluorocarbon		
 <p>Kit Includes: 1 XNBR Wiper 1 URE U-seal 1 PTFE Back-up Ring 1 NBR O-ring</p>		 <p>Kit Includes: 1 XNBR Wiper 1 Urethane Back-up Ring 1 Urethane Loaded U-seal 1 PTFE Back-up Ring 1 NBR O-ring</p>		 <p>Kit Includes: 1 FC Wiper 1 PTFE Back-up Ring 1 FC Loaded U-seal 1 PTFE Back-up Ring 1 FC O-ring</p>		
Rod Dia.	(URE) Kit #	List Price	(URE) Kit #	List Price	(FC) Kit #	List Price
1/2"	—		HSKN5-660-P-04	\$ 14.15	—	
5/8"	HSKN5-681-05	\$ 16.82	—		HSKN5-660-P-05V	\$ 60.31
1"	HSKN5-681-08	18.45	HSKN5-660-P-08	15.72	HSKN5-660-P-08V	68.47
1-3/8"	HSKN5-681-11	20.57	—		HSKN5-660-P-11V	83.89
1-3/4"	HSKN5-681-14	22.00	HSKN5-660-P-14	19.51	HSKN5-660-P-14V	92.44
2"	HSKN5-681-16	28.64	—		HSKN5-660-P-16V	96.27
2-1/2"	HSKN5-681-20	40.33	HSKN5-660-P-20	29.36	HSKN5-660-P-20V	140.38
3"	HSKN5-681-24	43.97	—		HSKN5-660-P-24V	161.68
3-1/2"	HSKN5-681-28	48.16	HSKN5-660-P-28	36.11	HSKN5-660-P-28V	180.52
4"	HSKN5-681-32	56.47	—		HSKN5-660-P-32V	218.02
4-1/2"	HSKN5-681-36	74.19	—		HSKN5-660-P-36V	233.83
5"	HSKN5-681-40	77.71	—		HSKN5-660-P-40V	239.71
5-1/2"	HSKN5-681-44	92.47	—		HSKN5-660-P-44V	245.07

HYDRO-LINE®

N5 Series Piston Kits

HYDRO-LINE®

N5 Cylinders

Nitrile



Kit Includes:

2 NBR U-seals
2 URE Back-up Rings
2 PTFE Tube End Seals

Fluorocarbon

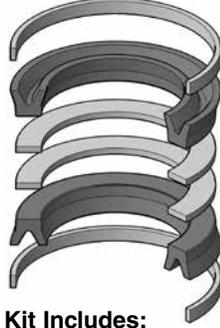

Kit Includes:

2 FC U-seals
2 PTFE Back-up Rings
2 PTFE Tube End Seals

Urethane

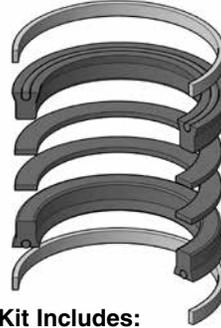

Kit Includes:

2 Urethane U-seals
2 URE Back-up Rings
2 PTFE Tube End Seals

Piston Ring

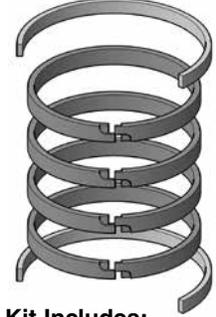

Kit Includes:

4 Cast-Iron Piston Rings
2 PTFE Tube End Seals

Bore Dia.	(NBR) Kit #	List Price	(FC) Kit #	List Price	(URE) Kit #	List Price	(PR) Kit #	List Price
1-1/2"	HSKN5-512-03	\$ 26.07	HSKN5-512-03V	\$ 64.74	—	—	HSKN5-511-03	\$ 82.73
2"	HSKN5-512-04	35.85	HSKN5-512-04V	89.60	—	—	HSKN5-511-04	90.18
2-1/2"	HSKN5-512-05	38.36	HSKN5-512-05V	91.12	HSKN5-512-P-05	\$ 43.68	HSKN5-511-05	90.91
3-1/4"	HSKN5-512-065	42.18	HSKN5-512-065V	95.17	—	—	HSKN5-511-065	93.70
4"	HSKN5-512-08	50.56	HSKN5-512-08V	123.18	—	—	HSKN5-511-08	107.37
5"	HSKN5-512-10	61.65	HSKN5-512-10V	144.64	—	—	HSKN5-511-10	130.70
6"	HSKN5-512-12	64.15	HSKN5-512-12V	171.25	—	—	HSKN5-511-12	147.35
7"	HSKN5-512-14	121.33	HSKN5-512-14V	244.40	—	—	HSKN5-511-14	174.13
8"	HSKN5-512-16	170.20	HSKN5-512-16V	275.19	HSKN5-512-P-16	\$ 218.69	HSKN5-511-16	220.97
10"	HSKN2-512-20	159.09	HSKN2-512-20V	545.59	—	—	HSKN2-511-20	423.78
12"	HSKN2-512-24	250.07	HSKN2-512-24V	808.94	—	—	HSKN2-511-24	573.25

Tube End Seals

N5 Cylinders PTFE

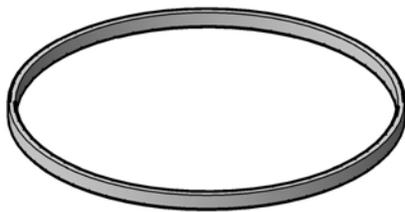

Bore Dia.	Part #	List Price
1-1/2"	HS-C255-03	\$ 11.44
2"	HS-C255-04	13.23
2-1/2"	HS-C255-05	13.96
3-1/4"	HS-C255-065	14.38
4"	HS-C255-08	16.32
5"	HS-C255-10	17.38
6"	HS-C255-12	18.13
7"	HS-C255-14	18.98
8"	HS-C255-16	22.09
10" & UP	HS-C124-STRIP (sold by the foot)	15.60

HYDRO-LINE®

R2 Series Rod Kits

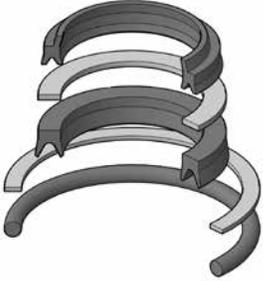
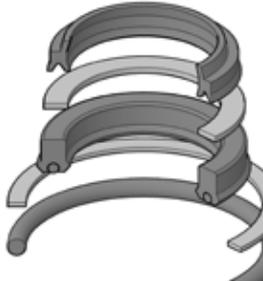
		R2 & LR2 Cylinders							
		Nitrile		Fluorocarbon		Urethane		Fluorocarbon	
									
		Kit Includes: 1 XNBR Wiper 1 URE Back-up Ring 1 NBR U-seal 1 PTFE Back-up Ring 1 NBR O-ring		Kit Includes: 1 FC Wiper 1 PTFE Back-up Ring 1 FC U-seal 1 PTFE Back-up Ring 1 FC O-ring		Kit Includes: 1 XNBR Wiper 1 URE U-seal 1 PTFE Back-up Ring 1 NBR O-ring		Kit Includes: 1 FC Wiper 1 PTFE Back-up Ring 1 FC Loaded U-seal 1 PTFE Back-up Ring 1 FC O-ring	
Rod Dia.	Bore Dia.	(NBR) Kit #	List Price	(FC) Kit #	List Price	(URE) Kit #	List Price	(FC) Kit #	List Price
5/8"	1"	HSKR2-662-05A	\$ 8.78	HSKR2-662-05AV	\$ 37.02	HSKR2-681-05A	\$ 14.69	HSKR2-662-P-05AV	\$ 57.11
5/8"	1.5" & UP	HSKN2-661-05	10.02	HSKN2-661-05V	37.10	—	—	—	—
1"	1.5", 2, 2.5"	HSKR2-662-08	9.57	HSKR2-662-08V	37.78	HSKR2-681-08	18.23	HSKR2-662-P-08V	69.03
1"	3.25" & UP	HSKN2-661-08	9.95	HSKN2-661-08V	39.39	—	—	—	—
1-3/8"	2", 2.5"	HSKR2-662-11	11.66	HSKR2-662-11V	48.68	HSKR2-681-11	18.45	HSKR2-662-P-11V	82.86
1-3/8"	3.25" & UP	HSKN2-661-11	12.14	HSKN2-661-11V	43.88	—	—	—	—
1-3/4"	2.5"	HSKR2-662-14	14.33	HSKR2-662-14V	50.02	HSKR2-681-14	19.27	HSKR2-662-P-14V	89.65
1-3/4"	3.25" & UP	HSKN2-661-14	14.26	HSKN2-661-14V	51.45	—	—	—	—
2"	ALL	HSKN2-661-16	15.79	HSKN2-661-16V	54.33	—	—	—	—
2-1/2"	ALL	HSKN2-661-20	23.69	HSKN2-661-20V	60.63	—	—	—	—
3"	ALL	HSKN5-660-24	20.57	HSKN5-660-24V	80.05	—	—	—	—
3-1/2"	ALL	HSKN5-660-28	22.56	HSKN5-660-28V	93.52	—	—	—	—
4"	ALL	HSKN5-660-32	28.31	HSKN5-660-32V	97.74	—	—	—	—
4-1/2"	ALL	HSKN5-660-36	30.49	HSKN5-660-36V	103.17	—	—	—	—
5"	ALL	HSKN5-660-40	45.14	HSKN5-660-40V	124.02	—	—	—	—
5-1/2"	ALL	HSKN5-660-44	61.54	HSKN5-660-44V	140.06	—	—	—	—

HYDRO-LINE®

R2 Series Piston Kits

Nitrile

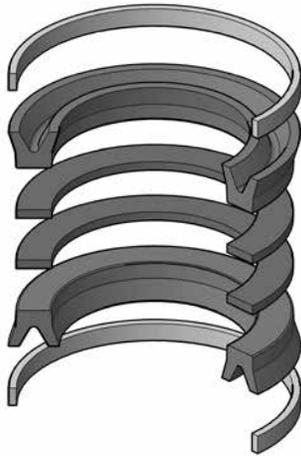

Kit Includes:
2 NBR U-seals
2 URE Back-up Rings
2 PTFE Tube End Seals

R2 & LR2 Cylinders Fluorocarbon

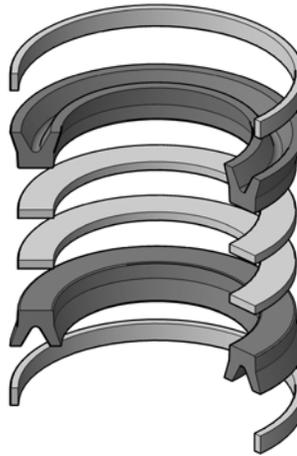

Kit Includes:
2 FC U-seals
2 PTFE Back-up Rings
2 PTFE Tube End Seals

Piston Ring

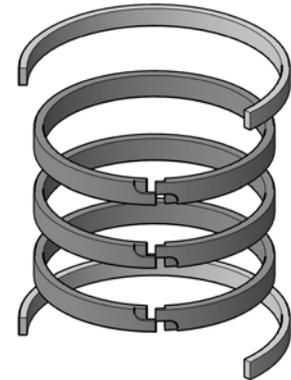

Kit Includes:
3 Cast-Iron Piston Rings
2 PTFE Tube End Seals

Bore Dia.	(NBR) Kit #	List Price	(FC) Kit #	List Price	(PR) Kit #	List Price
1"	HSKR5-512-02	\$ 26.90	HSKR5-512-02V	\$ 57.43	HSKR5-511-02	\$ 89.63
1-1/2"	HSKR5-512-03	28.41	HSKR5-512-03V	60.13	HSKR5-511-03	60.13
2"	HSKR5-512-04	31.09	HSKR5-512-04V	84.83	HSKR5-511-04	61.92
2-1/2"	HSKR5-512-05	33.96	HSKR5-512-05V	86.71	HSKR5-511-05	62.94
3-1/4"	HSKR5-512-065	37.67	HSKR5-512-065V	90.74	HSKR5-511-065	72.86
4"	HSKR5-512-08	44.18	HSKR5-512-08V	116.65	HSKR5-511-08	82.13
5"	HSKR5-512-10	55.95	HSKR5-512-10V	129.93	HSKR5-511-10	106.21
6"	HSKR5-512-12	62.44	HSKR5-512-12V	169.55	HSKR5-511-12	117.71
8"	HSKR5-512-16	162.43	HSKR5-512-16V	321.85	HSKR5-511-16	138.57
10"	HSKR5-512-20	159.09	HSKR5-512-20V	545.59	HSKR5-511-20	394.70
12"	HSKR5-512-24	250.07	HSKR5-512-24V	781.58	HSKR5-511-24	549.14
14"	HSKR5-512-28	359.72	HSKR5-512-28V	852.74	—	—

HYDRO-LINE®

R2 Series Tube End Seals

R2 & LR2 Cylinders PTFE

Bore Dia.	Part #	List Price
1"	HS-C221-02	\$ 8.09
1-1/2"	HS-C221-03	8.67
2"	HS-C221-04	9.44
2-1/2"	HS-C221-05	10.42
3-1/4"	HS-C221-065	11.24
4"	HS-C221-08	12.69
5"	HS-C221-10	17.17
6"	HS-C221-12	22.10
8" & UP	HS-C221-STRIP (sold by the foot)	10.04

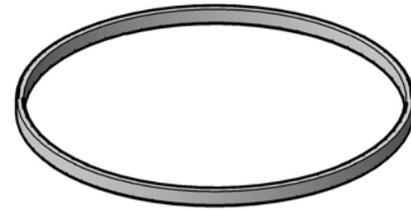

HYDRO-LINE®

R5 Series Rod Kits

R5 & HR5 Cylinders Nitrile

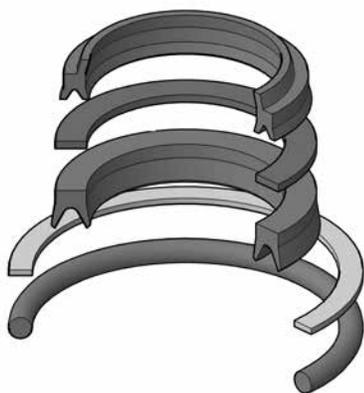

Kit Includes:

- 1 XNBR Wiper
- 1 URE Back-up Ring
- 1 NBR U-seal
- 1 PTFE Back-up Ring
- 1 NBR O-ring

Rod Dia.	Bore Dia.	(NBR) Kit #	List Price
1/2"	1"	HSKN5-660-04	\$ 8.16
5/8"	1"	HSKR2-662-05A	8.78
5/8"	1.5" & UP	HSKN5-660-05	9.99
1"	2" & UP	HSKN5-660-08	10.15
1-3/8"	2.5" & UP	HSKN5-660-11	12.73
1-3/4"	ALL	HSKN5-660-14	16.05
2"	ALL	HSKN5-660-16	17.98
2-1/2"	ALL	HSKN5-660-20	19.78
3"	ALL	HSKN5-660-24	20.57
3-1/2"	ALL	HSKN5-660-28	22.56
4"	ALL	HSKN5-660-32	28.31
4-1/2"	ALL	HSKN5-660-36	30.49
5"	ALL	HSKN5-660-40	45.14
5-1/2"	ALL	HSKN5-660-44	61.54

HYDRO-LINE®

R5 Series Rod Kits

HR5 Cylinders

Fluorocarbon



Kit Includes:

- 1 FC Wiper
- 1 PTFE Back-up Ring
- 1 FC U-seal
- 1 PTFE Back-up Ring
- 1 FC O-ring

Urethane



Kit Includes:

- 1 XNBR Wiper
- 1 URE U-seal
- 1 PTFE Back-up Ring
- 1 NBR O-ring

Urethane



Kit Includes:

- 1 XNBR Wiper
- 1 Urethane Back-up Ring
- 1 Urethane Loaded U-seal
- 1 PTFE Back-up Ring
- 1 NBR O-ring

Fluorocarbon



Kit Includes:

- 1 FC Wiper
- 1 PTFE Back-up Ring
- 1 FC Loaded U-seal
- 1 PTFE Back-up Ring
- 1 FC O-ring

Rod Dia.	Bore Dia.	(FC) Kit #	List Price	(URE) Kit #	List Price	(URE) Kit #	List Price	(FC) Kit #	List Price
1/2"	1"	HSKN5-660-04V	\$ 30.04	—	—	HSKN5-660-P-04	\$ 14.15	HSKN5-660-P-04V	\$ 56.75
5/8"	1"	HSKR2-662-05AV	37.02	HSKN5-681-05A	\$ 14.69	—	—	HSKN5-660-P-05AV	57.12
5/8"	1.5" & UP	HSKN5-660-05V	35.85	HSKN5-681-05	16.82	—	—	HSKN5-660-P-05V	60.31
1"	2" & UP	HSKN5-660-08V	37.67	HSKN5-681-08	18.45	HSKN5-660-P-08	15.72	HSKN5-660-P-08V	68.47
1-3/8"	2.5" & UP	HSKN5-660-11V	49.23	HSKN5-681-11	20.57	—	—	HSKN5-660-P-11V	83.89
1-3/4"	ALL	HSKN5-660-14V	51.05	HSKN5-681-14	22.00	HSKN5-660-P-14	19.51	HSKN5-660-P-14V	92.44
2"	ALL	HSKN5-660-16V	54.40	HSKN5-681-16	28.64	—	—	HSKN5-660-P-16V	96.27
2-1/2"	ALL	HSKN5-660-20V	61.39	HSKN5-681-20	40.33	—	—	HSKN5-660-P-20V	140.38
3"	ALL	HSKN5-660-24V	80.05	HSKN5-681-24	43.97	—	—	HSKN5-660-P-24V	161.68
3-1/2"	ALL	HSKN5-660-28V	93.52	HSKN5-681-28	48.16	HSKN5-660-P-28	36.11	HSKN5-660-P-28V	180.52
4"	ALL	HSKN5-660-32V	97.74	HSKN5-681-32	56.47	—	—	HSKN5-660-P-32V	218.02
4-1/2"	ALL	HSKN5-660-36V	103.17	HSKN5-681-36	74.19	—	—	HSKN5-660-P-36V	233.83
5"	ALL	HSKN5-660-40V	124.02	HSKN5-681-40	77.71	—	—	HSKN5-660-P-40V	239.71
5-1/2"	ALL	HSKN5-660-44V	140.06	HSKN5-681-44	92.47	—	—	HSKN5-660-P-44V	245.07

HYDRO-LINE®

R5 Series Piston Kits

Nitrile

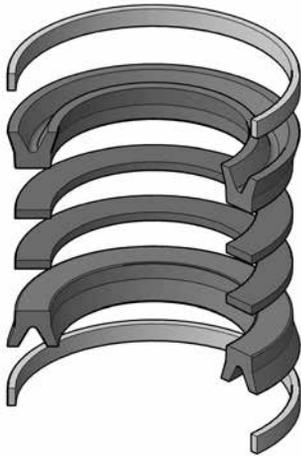

Kit Includes:

2 NBR U-seals
2 URE Back-up Rings
2 PTFE Tube End Seals

R5 Cylinders Fluorocarbon

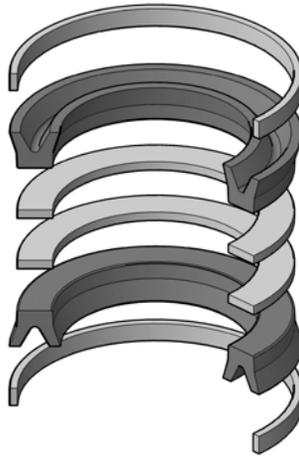

Kit Includes:

2 FC U-seals
2 PTFE Back-up Rings
2 PTFE Tube End Seals

Piston Ring

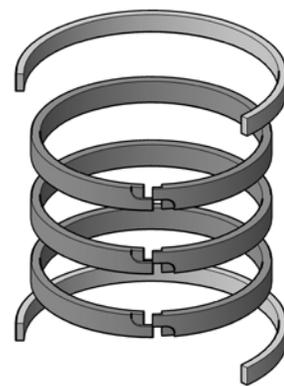

Kit Includes:

3 Cast-Iron Piston Rings
2 PTFE Tube End Seals

Bore Dia.	(NBR) Kit #	List Price	(FC) Kit #	List Price	(PR) Kit #	List Price
1"	HSKR5-512-02	\$ 26.90	HSKR5-512-02V	\$ 57.43	HSKR5-511-02	\$ 89.63
1-1/2"	HSKR5-512-03	28.41	HSKR5-512-03V	60.13	HSKR5-511-03	60.13
2"	HSKR5-512-04	31.09	HSKR5-512-04V	84.83	HSKR5-511-04	61.92
2-1/2"	HSKR5-512-05	33.96	HSKR5-512-05V	86.71	HSKR5-511-05	62.94
3-1/4"	HSKR5-512-065	37.67	HSKR5-512-065V	90.74	HSKR5-511-065	72.86
4"	HSKR5-512-08	44.18	HSKR5-512-08V	116.65	HSKR5-511-08	82.13
5"	HSKR5-512-10	55.95	HSKR5-512-10V	129.93	HSKR5-511-10	106.21
6"	HSKR5-512-12	62.44	HSKR5-512-12V	169.55	HSKR5-511-12	117.71
8"	HSKR5-512-16	162.43	HSKR5-512-16V	321.85	HSKR5-511-16	138.57
10"	HSKR5-512-20	159.09	HSKR5-512-20V	545.59	HSKR5-511-20	394.70
12"	HSKR5-512-24	250.07	HSKR5-512-24V	781.58	HSKR5-511-24	549.14
14"	HSKR5-512-28	359.72	HSKR5-512-28V	852.74	—	—

HYDRO-LINE®

R5 Series Tube End Seals

R5 Cylinders PTFE

Bore Dia.	Part #	List Price
1"	HS-C221-02	\$ 8.09
1-1/2"	HS-C221-03	8.67
2"	HS-C221-04	9.44
2-1/2"	HS-C221-05	10.42
3-1/4"	HS-C221-065	11.24
4"	HS-C221-08	12.69
5"	HS-C221-10	17.17
6"	HS-C221-12	22.10
8" & UP	HS-C221-STRIP (sold by the foot)	10.04

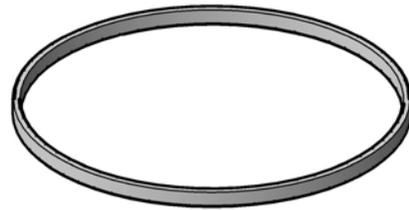

HYDRO-LINE®

UNIVERSAL Rod Kits

A5, N2, N5, R2, & R5 Cylinders (see note)
Nitrile

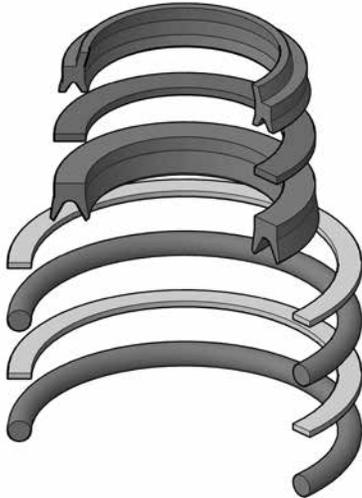

Kit Includes:

- 1 XNBR Wiper
- 1 URE Back-up Ring
- 1 NBR U-seal
- 2 NBR O-rings
- 2 PTFE BU Rings

Fluorocarbon

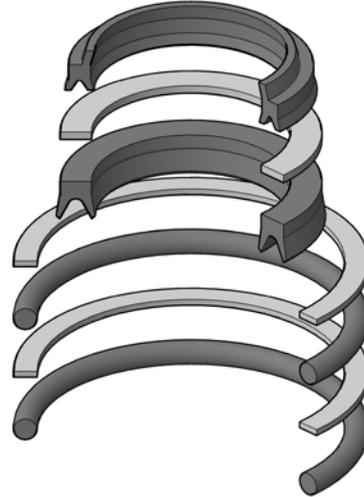

Kit Includes:

- 1 FC Wiper
- 1 PTFE BU Ring
- 1 FC U-seal
- 2 FC O-rings
- 2 PTFE BU Rings

Rod Dia.	(NBR) Kit #	List Price	(FC) Kit #	List Price
5/8"	HSKN25-665-05	\$ 11.58	HSKN25-665-05V	\$ 40.16
1"	HSKN25-665-08	12.05	HSKN25-665-08V	41.78
1-3/8"	HSKN25-665-11	15.38	HSKN25-665-11V	53.05
1-3/4"	HSKN25-665-14	19.42	HSKN25-665-14V	59.56
2"	HSKN25-665-16	21.70	HSKN25-665-16V	63.11
2-1/2"	HSKN25-665-20	25.96	HSKN25-665-20V	71.81

Note: Rod Seal Kits are good for all cylinders except R2/R5 1" Bore X All Rods, 1-1/2" Bore X 1" Rod, and 2" Bore X 1-3/8" Rod.

HYDRO-LINE®

UNIVERSAL Gland Kits

A5, N2, N5, R2, & R5 Cylinders (see note)

Nitrile

Fluorocarbon

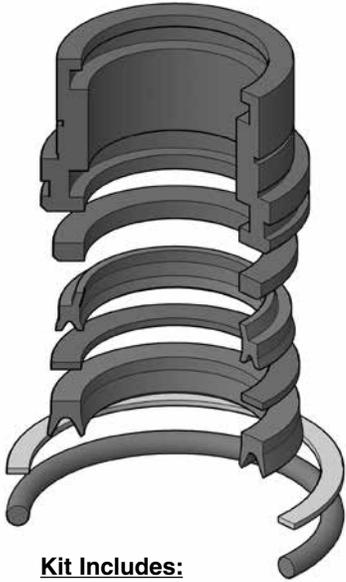

Kit Includes:

- 1 Iron Bushing
- 1 Spacer
- 1 XNBR Wiper
- 1 URE Back-up Ring
- 1 NBR U-seal
- 1 PTFE Back-up ring
- 1 NBR O-ring

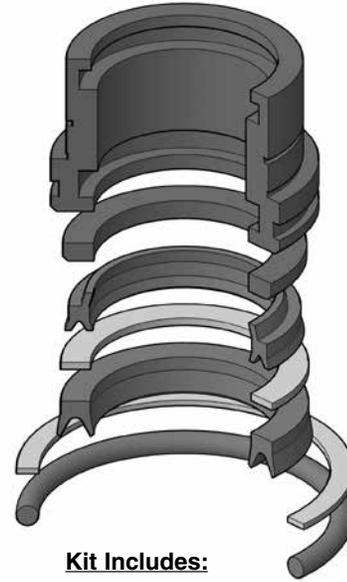

Kit Includes:

- 1 Iron Bushing
- 1 Spacer
- 1 FC Wiper
- 1 PTFE Back-up Ring
- 1 FC U-seal
- 1 PTFE Back-up ring
- 1 FC O-ring

Rod Dia.	(NBR) Kit #	List Price	(FC) Kit #	List Price
5/8"	HN5-665-05	\$ 134.25	HN5-665-05V	\$ 153.02
1"	HN5-665-08	166.65	HN5-665-08V	187.00
1-3/8"	HN5-665-11	178.27	HN5-665-11V	204.43
1-3/4"	HN5-665-14	207.27	HN5-665-14V	232.56
2"	HN5-665-16	215.81	HN5-665-16V	243.28
2-1/2"	HN5-665-20	234.21	HN5-665-20V	261.65
3"	HN5-665-24	352.83	HN5-665-24V	397.62
3-1/2"	HN5-665-28	413.08	HN5-665-28V	449.98
4"	HN5-665-32	457.83	HN5-665-32V	511.77
4-1/2"	HN5-665-36 (2.57" HGT)	648.02	HN5-665-36V (2.57" HGT)	699.61
4-1/2"	HN5-665-36A (1.88" HGT)	648.02	HN5-665-36AV (1.88" HGT)	699.61
5"	HN5-665-40	779.76	HN5-665-40V	846.77
5-1/2"	HN5-665-44	846.15	HN5-665-44V	939.02

**Note: Gland Seal Kits are good for all cylinders with some exceptions.
Call with series, rod & bore size for more information.**

HYDRO-LINE®

UNIVERSAL Gland Kits

A5, N2, N5, R2, & R5 Cylinders (see note)

Iron Bushing

Bronze Bushing

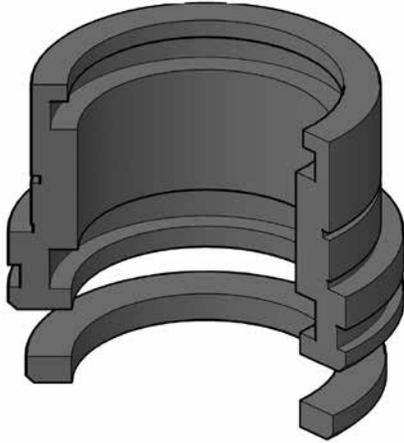

Kit Includes:
1 Iron Bushing
1 Spacer

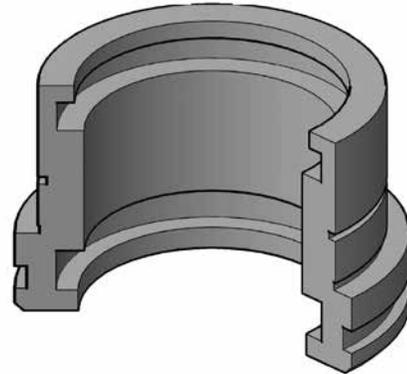

Kit Includes:
1 Bronze Bushing

Rod Dia.	Part #	List Price	Part #	List Price
5/8"	HN5-655-05	\$ 118.76	HN5-B-650-05	\$ 116.13
1"	HN5-655-08	149.49	HN5-B-650-08	124.43
1-3/8"	HN5-655-11	159.26	HN5-B-650-11	146.48
1-3/4"	HN5-655-14	183.67	HN5-B-650-14	169.02
2"	HN5-655-16	191.99	HN5-B-650-16	174.77
2-1/2"	HN5-655-20	206.69	HN5-B-650-20	220.18
3"	HN5-655-24	307.78	HN5-B-650-24	234.56
3-1/2"	HN5-655-28	360.54	HN5-B-650-28	416.24
4"	HN5-655-32	395.70	HN5-B-650-32	447.40
4-1/2"	HN5-655-36 (2.57" HGT)	562.79	HN5-B-650-36 (2.57" HGT)	616.43
4-1/2"	HN5-655-36A (1.88" HGT)	562.79	HN5-B-650-36A (1.88" HGT)	484.98
5"	HN5-655-40	685.88	HN5-B-650-40	677.27
5-1/2"	HN5-655-44	738.66	HN5-B-650-44	707.04

Note: Gland Seal Kits are good for all cylinders with some exceptions.
Call with series, rod & bore size for more information.

HYDRO-LINE®

UNIVERSAL Captive Cushion Adjustment Seal

A, N & R Cylinders

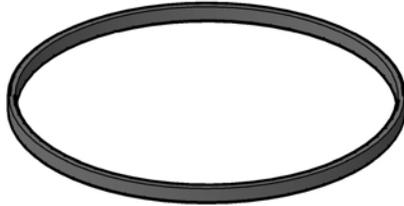

Part #	I.D. X C.S.	List Price
HS-C408-1	.204 X .072	\$ 5.79
HS-C408-1V	.204 X .072	6.97
HS-C408-2	.298 X .072	5.79
HS-C408-2V	.298 X .072	6.97
HS-C408-3	.420 X .072	5.79
HS-C408-3V	.420 X .072	6.97
HS-C408-4	.542 X .072	5.79
HS-C408-4V	.542 X .072	6.97

Used on Captive Cushion Adjustment Valves for precise adjustment under pressure over a broad range of operating conditions. Available in both 90A material - Nitrile and Fluorocarbon.

HYDRO-LINE®

HYDRO-LINE®

UNIVERSAL Piston Kits

Nitrile

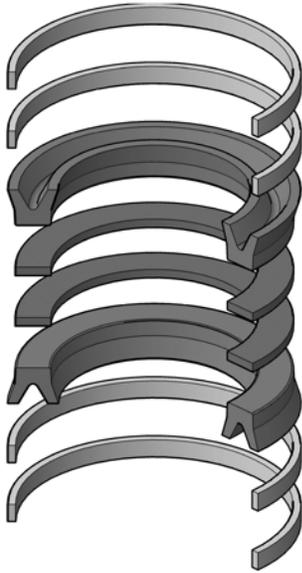

Kit Includes:
 2 NBR U-seals
 2 URE Back-up Rings
 4 PTFE Tube End Seals

N2 & N5 Cylinders Fluorocarbon

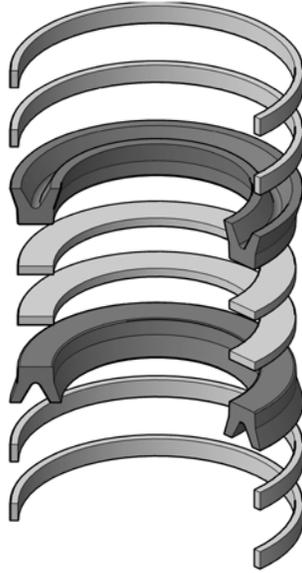

Kit Includes:
 2 FC U-seals
 2 PTFE Back-up Rings
 4 PTFE Tube End Seals

Piston Ring

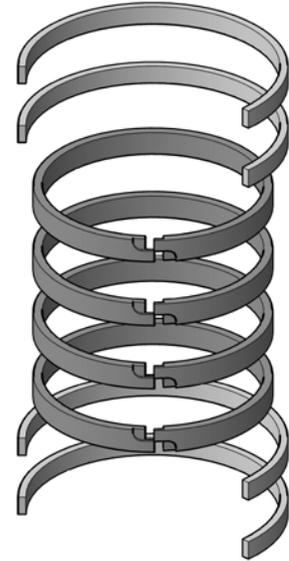

Kit Includes:
 4 Cast Iron Piston Rings
 4 PTFE Tube End Seals

Bore Dia.	(NBR) Kit #	List Price	(FC) Kit #	List Price	(PR) Kit #	List Price
1-1/2"	HSKN25-512-03	\$ 39.42	HSKN25-512-03V	\$ 77.61	HSKN25-511-03	\$ 106.41
2"	HSKN25-512-04	44.23	HSKN25-512-04V	112.74	HSKN25-511-04	119.07
2-1/2"	HSKN25-512-05	46.13	HSKN25-512-05V	121.53	HSKN25-511-05	121.33
3-1/4"	HSKN25-512-065	60.24	HSKN25-512-065V	129.20	HSKN25-511-065	127.48
4"	HSKN25-512-08	70.91	HSKN25-512-08V	159.51	HSKN25-511-08	143.71
5"	HSKN25-512-10	92.89	HSKN25-512-10V	175.64	HSKN25-511-10	170.70
6"	HSKN25-512-12	105.48	HSKN25-512-12V	260.39	HSKN25-511-12	188.65
7"	HSKN25-512-14	124.99	HSKN25-512-14V	312.67	HSKN25-511-14	188.47
8"	HSKN25-512-16	176.59	HSKN25-512-16V	259.10	HSKN25-511-16	229.49

HYDRO-LINE®

HYDRO-LINE®

HYDRO-LINE®

Sales Part Number	Description	Rod Size	Bore Size	List Price
HN5-650-08	HLINE-650			\$ 36.39
HN5-650-11	HLINE-650			41.06
HN5-650-14	HLINE-650			53.33
HN5-650-24	HLINE-650			155.56
HN5-650-S-20	HLINE-650			134.50
HN5-655-05	Bushing w/ spacer	5/8		118.76
HN5-655-08	Bushing w/ spacer	1		149.49
HN5-655-11	Bushing w/ spacer	1-3/8		159.26
HN5-655-14	Bushing w/ spacer	1-3/4		183.67
HN5-655-16	Bushing w/ spacer	2		191.99
HN5-655-20	Bushing w/ spacer	2-1/2		206.69
HN5-655-24	Bushing w/ spacer	3		307.78
HN5-655-28	Bushing w/ spacer	3-1/2		360.54
HN5-655-32	Bushing w/ spacer	4		395.70
HN5-655-36	Bushing w/ spacer	4-1/2 x 2.57ht		562.79
HN5-655-36A	Bushing w/ spacer	4-1/2 x 1.88ht		562.79
HN5-655-40	Bushing w/ spacer	5		685.88
HN5-655-44	Bushing w/ spacer	5-1/2		738.66
HN5-665-05	Rod Gland Kit	5/8		134.25
HN5-665-05V	Rod Gland Kit	5/8		153.02
HN5-665-08	Rod Gland Kit	1		166.65
HN5-665-08V	Rod Gland Kit	1		187.00
HN5-665-11	Rod Gland Kit	1-3/8		178.27
HN5-665-11V	Rod Gland Kit	1-3/8		204.43
HN5-665-14	Rod Gland Kit	1-3/4		207.27
HN5-665-14V	Rod Gland Kit	1-3/4		232.56
HN5-665-16	Rod Gland Kit	2		215.81
HN5-665-16V	Rod Gland Kit	2		243.28
HN5-665-20	Rod Gland Kit	2-1/2		234.21
HN5-665-20V	Rod Gland Kit	2-1/2		261.65
HN5-665-24	Rod Gland Kit	3		352.83
HN5-665-24V	Rod Gland Kit	3		397.62
HN5-665-28	Rod Gland Kit	3-1/2		413.08
HN5-665-28V	Rod Gland Kit	3-1/2		449.98
HN5-665-32	Rod Gland Kit	4		457.83
HN5-665-32V	Rod Gland Kit	4		511.77
HN5-665-36	Rod Gland Kit	4-1/2		648.02
HN5-665-36A	Rod Gland Kit	4-1/2		648.02
HN5-665-36AV	Rod Gland Kit	4-1/2		699.61
HN5-665-36V	Rod Gland Kit	4-1/2		699.61
HN5-665-40	Rod Gland Kit	5		779.76
HN5-665-40V	Rod Gland Kit	5		846.77
HN5-665-44	Rod Gland Kit	5-1/2		846.15
HN5-665-44V	Rod Gland Kit	5-1/2		939.02
HN5-681-08	HLINE-KIT	1		49.53
HN5-681-11	HLINE-KIT	1-3/8		57.25
HN5-681-14	HLINE-KIT	1-3/4		71.70
HN5-681-24	HLINE-KIT	3		201.16
HN5-B-650-05	Gland Kit	5/8		116.13

HYDRO-LINE®

HYDRO-LINE®

Sales Part Number	Description	Rod Size	Bore Size	List Price
HN5-B-650-08	Gland Kit	1		\$ 124.43
HN5-B-650-11	Gland Kit	1-3/8		146.48
HN5-B-650-14	Gland Kit	1-3/4		169.02
HN5-B-650-16	Gland Kit	2		174.77
HN5-B-650-20	Gland Kit	2-1/2		220.18
HN5-B-650-20-NH	HLINE-B-650			109.50
HN5-B-650-24	Gland Kit	3		234.56
HN5-B-650-28	Gland Kit	3-1/2		416.24
HN5-B-650-32	Gland Kit	4		447.40
HN5-B-650-36	Gland Kit	4-1/2		616.43
HN5-B-650-36A	Gland Kit	4-1/2		484.98
HN5-B-650-40	Gland Kit	5		677.27
HN5-B-650-44	Gland Kit	5-1/2		707.04
HN5-B-650-S24	HLINE-B-650			183.83
HN5-B-681-20	HLINE-KIT	2-1/2		138.91
HN5-B-681-28	HLINE-KIT	3-1/2		420.55
HS-C124-03	Tube End Seals		1-1/2	10.66
HS-C124-04	Tube End Seals		2	12.96
HS-C124-05	Tube End Seals		2-1/2	15.00
HS-C124-065	Tube End Seals		3-1/4	18.98
HS-C124-08	Tube End Seals		4	20.40
HS-C124-10	Tube End Seals		5	22.45
HS-C124-12	Tube End Seals		6	23.18
HS-C124-STRIP	Tube End Seals		0.068cs x 0.140w PTFE strip (sold by the foot)	15.60
HS-C221-02	Tube End Seals		1	8.09
HS-C221-03	Tube End Seals		1-1/2	8.67
HS-C221-04	Tube End Seals		2	9.44
HS-C221-05	Tube End Seals		2-1/2	10.42
HS-C221-065	Tube End Seals		3-1/4	11.24
HS-C221-08	Tube End Seals		4	12.69
HS-C221-10	Tube End Seals		5	17.17
HS-C221-12	Tube End Seals		6	22.10
HS-C221-STRIP	Tube End Seals		0.063cs x 0.093w PTFE strip (sold by the foot)	10.04
HS-C255-03	Tube End Seals		1-1/2	11.44
HS-C255-04	Tube End Seals		2	13.23
HS-C255-05	Tube End Seals		2-1/2	13.96
HS-C255-065	Tube End Seals		3-1/4	14.38
HS-C255-08	Tube End Seals		4	16.32
HS-C255-10	Tube End Seals		5	17.38
HS-C255-12	Tube End Seals		6	18.13
HS-C255-14	Tube End Seals		7	18.98
HS-C255-16	Tube End Seals		8	22.09
HS-C408-1	Captive Cushion Adjustment Seal	0.204 ID x 0.072 CS		5.79
HS-C408-1V	Captive Cushion Adjustment Seal	0.204 ID x 0.072 CS		6.97
HS-C408-2	Captive Cushion Adjustment Seal	0.298 ID x 0.072 CS		5.79
HS-C408-2V	Captive Cushion Adjustment Seal	0.298 ID x 0.072 CS		6.97

HYDRO-LINE®

Sales Part Number	Description	Rod Size	Bore Size	List Price
HS-C408-3	Captive Cushion Adjustment Seal	0.420 ID x 0.072 CS		\$ 5.79
HS-C408-3V	Captive Cushion Adjustment Seal	0.420 ID x 0.072 CS		6.97
HS-C408-4	Captive Cushion Adjustment Seal	0.542 ID x 0.072 CS		5.79
HS-C408-4V	Captive Cushion Adjustment Seal	0.542 ID x 0.072 CS		6.97
HS-E304-03	Tube End Seals		1-1/2	2.52
HS-E304-04	Tube End Seals		2	2.63
HS-E304-065	Tube End Seals		3-1/4	2.94
HS-E304-08	Tube End Seals		4	3.32
HSKA5-512-03	Piston Kit		1-1/2	26.28
HSKA5-512-03V	Piston Kit		1-1/2	53.16
HSKA5-512-04	Piston Kit		2	28.00
HSKA5-512-04V	Piston Kit		2	55.08
HSKA5-512-05	Piston Kit		2-1/2	30.16
HSKA5-512-05V	Piston Kit		2-1/2	64.96
HSKA5-512-065	Piston Kit		3-1/4	32.53
HSKA5-512-065V	Piston Kit		3-1/4	73.25
HSKA5-512-08	Piston Kit		4	37.87
HSKA5-512-08V	Piston Kit		4	79.62
HSKA5-512-10	Piston Kit		5	47.32
HSKA5-512-10V	Piston Kit		5	93.38
HSKA5-512-12	Piston Kit		6	55.72
HSKA5-512-12V	Piston Kit		6	152.80
HSKE2-512-04	Piston Kit		2	26.66
HSKE2-512-065	Piston Kit		3-1/4	25.63
HSKE2-512-08	Piston Kit		4	44.71
HSKE2-660-05	Rod Kit	5/8		4.43
HSKE2-660-08	Rod Kit	1		4.93
HSKE2-660-11	Rod Kit	1-3/8		5.48
HSKN2-511-03	Piston Ring Kit		1-1/2	83.28
HSKN2-511-04	Piston Ring Kit		2	94.95
HSKN2-511-05	Piston Ring Kit		2-1/2	96.48
HSKN2-511-065	Piston Ring Kit		3-1/4	101.84
HSKN2-511-08	Piston Ring Kit		4	114.65
HSKN2-511-10	Piston Ring Kit		5	139.52
HSKN2-511-12	Piston Ring Kit		6	147.35
HSKN2-511-14	Piston Ring Kit		7	165.04
HSKN2-511-16	Piston Ring Kit		8	202.92
HSKN2-511-20	Piston Ring Kit		10	423.78
HSKN2-511-24	Piston Ring Kit		12	573.25
HSKN2-512-03	Piston Kit		1-1/2	33.54
HSKN2-512-03V	Piston Kit		1-1/2	65.29
HSKN2-512-04	Piston Kit		2	40.65
HSKN2-512-04V	Piston Kit		2	85.72
HSKN2-512-05	Piston Kit		2-1/2	43.88
HSKN2-512-05V	Piston Kit		2-1/2	91.12
HSKN2-512-065	Piston Kit		3-1/4	42.18
HSKN2-512-065V	Piston Kit		3-1/4	103.57

HYDRO-LINE®

HYDRO-LINE®

HYDRO-LINE®

Sales Part Number	Description	Rod Size	Bore Size	List Price
HSKN2-512-08	Piston Kit		4	\$ 50.67
HSKN2-512-08V	Piston Kit		4	122.51
HSKN2-512-10	Piston Kit		5	65.10
HSKN2-512-10V	Piston Kit		5	135.67
HSKN2-512-12	Piston Kit		6	73.16
HSKN2-512-12V	Piston Kit		6	180.23
HSKN2-512-14	Piston Kit		7	111.71
HSKN2-512-14V	Piston Kit		7	265.49
HSKN2-512-16	Piston Kit		8	141.47
HSKN2-512-16V	Piston Kit		8	293.28
HSKN2-512-20	Piston Kit		10	159.09
HSKN2-512-20V	Piston Kit		10	545.59
HSKN2-512-24	Piston Kit		12	250.07
HSKN2-512-24V	Piston Kit		12	808.94
HSKN25-511-03	Piston Kit		1-1/2	106.41
HSKN25-511-04	Piston Kit		2	119.07
HSKN25-511-05	Piston Kit		2-1/2	121.33
HSKN25-511-065	Piston Kit		3-1/4	127.48
HSKN25-511-08	Piston Kit		4	143.71
HSKN25-511-10	Piston Kit		5	170.70
HSKN25-511-12	Piston Kit		6	188.65
HSKN25-511-14	Piston Kit		7	188.47
HSKN25-511-16	Piston Kit		8	229.49
HSKN25-512-03	Piston Kit		1-1/2	39.42
HSKN25-512-03V	Piston Kit		1-1/2	77.61
HSKN25-512-04	Piston Kit		2	44.23
HSKN25-512-04V	Piston Kit		2	112.74
HSKN25-512-05	Piston Kit		2-1/2	46.13
HSKN25-512-05V	Piston Kit		2-1/2	121.53
HSKN25-512-065	Piston Kit		3-1/4	60.24
HSKN25-512-065V	Piston Kit		3-1/4	129.20
HSKN25-512-08	Piston Kit		4	70.91
HSKN25-512-08V	Piston Kit		4	159.51
HSKN25-512-10	Piston Kit		5	92.89
HSKN25-512-10V	Piston Kit		5	175.64
HSKN25-512-12	Piston Kit		6	105.48
HSKN25-512-12V	Piston Kit		6	260.39
HSKN25-512-14	Piston Kit		7	124.99
HSKN25-512-14V	Piston Kit		7	312.67
HSKN25-512-16	Piston Kit		8	176.59
HSKN25-512-16V	Piston Kit		8	259.10
HSKN25-665-05	Rod Kit	5/8		11.58
HSKN25-665-05V	Rod Kit	5/8		40.16
HSKN25-665-08	Rod Kit	1		12.05
HSKN25-665-08V	Rod Kit	1		41.78
HSKN25-665-11	Rod Kit	1-3/8		15.38
HSKN25-665-11V	Rod Kit	1-3/8		53.05
HSKN25-665-14	Rod Kit	1-3/4		19.42
HSKN25-665-14V	Rod Kit	1-3/4		59.56
HSKN25-665-16	Rod Kit	2		21.70

HYDRO-LINE®

HYDRO-LINE®

Sales Part Number	Description	Rod Size	Bore Size	List Price
HSKN25-665-16V	Rod Kit	2		\$ 63.11
HSKN25-665-20	Rod Kit	2-1/2		25.96
HSKN25-665-20V	Rod Kit	2-1/2		71.81
HSKN2-661-05	Rod Kit	5/8		10.02
HSKN2-661-05V	Rod Kit	5/8		37.10
HSKN2-661-08	Rod Kit	1		9.95
HSKN2-661-08V	Rod Kit	1		39.39
HSKN2-661-11	Rod Kit	1-3/8		12.14
HSKN2-661-11V	Rod Kit	1-3/8		43.88
HSKN2-661-14	Rod Kit	1-3/4		14.26
HSKN2-661-14V	Rod Kit	1-3/4		51.45
HSKN2-661-16	Rod Kit	2		15.79
HSKN2-661-16V	Rod Kit	2		54.33
HSKN2-661-20	Rod Kit	2-1/2		23.69
HSKN2-661-20V	Rod Kit	2-1/2		60.63
HSKN5-511-03	Piston Ring Kit		1-1/2	82.73
HSKN5-511-04	Piston Ring Kit		2	90.18
HSKN5-511-05	Piston Ring Kit		2-1/2	90.91
HSKN5-511-065	Piston Ring Kit		3-1/4	93.70
HSKN5-511-08	Piston Ring Kit		4	107.37
HSKN5-511-10	Piston Ring Kit		5	130.70
HSKN5-511-12	Piston Ring Kit		6	147.35
HSKN5-511-14	Piston Ring Kit		7	174.13
HSKN5-511-16	Piston Ring Kit		8	220.97
HSKN5-512-03	Piston Kit		1-1/2	26.07
HSKN5-512-03V	Piston Kit		1-1/2	64.74
HSKN5-512-04	Piston Kit		2	35.85
HSKN5-512-04V	Piston Kit		2	89.60
HSKN5-512-05	Piston Kit		2-1/2	38.36
HSKN5-512-05V	Piston Kit		2-1/2	91.12
HSKN5-512-065	Piston Kit		3-1/4	42.18
HSKN5-512-065V	Piston Kit		3-1/4	95.17
HSKN5-512-08	Piston Kit		4	50.56
HSKN5-512-08V	Piston Kit		4	123.18
HSKN5-512-10	Piston Kit		5	61.65
HSKN5-512-10V	Piston Kit		5	144.64
HSKN5-512-12	Piston Kit		6	64.15
HSKN5-512-12V	Piston Kit		6	171.25
HSKN5-512-14	Piston Kit		7	121.33
HSKN5-512-14V	Piston Kit		7	244.40
HSKN5-512-16	Piston Kit		8	170.20
HSKN5-512-16V	Piston Kit		8	275.19
HSKN5-512-G-08	HLINE-KIT		4	56.80
HSKN5-512-P-05	Piston Kit		2-1/2	43.68
HSKN5-512-P-16	Piston Kit		8	218.69
HSKN5-517-065	HLINE-KIT		3-1/4	46.93
HSKN5-660-04	Rod Kit	1/2		8.16
HSKN5-660-04V	Rod Kit	1/2		30.04
HSKN5-660-05	Rod Kit	5/8		9.99
HSKN5-660-05V	Rod Kit	5/8		35.85

HYDRO-LINE®

HYDRO-LINE®

Sales Part Number	Description	Rod Size	Bore Size	List Price
HSKN5-660-08	Rod Kit	1		\$ 10.15
HSKN5-660-08V	Rod Kit	1		37.67
HSKN5-660-11	Rod Kit	1-3/8		12.73
HSKN5-660-11V	Rod Kit	1-3/8		49.23
HSKN5-660-14	Rod Kit	1-3/4		16.05
HSKN5-660-14V	Rod Kit	1-3/4		51.05
HSKN5-660-16	Rod Kit	2		17.98
HSKN5-660-16V	Rod Kit	2		54.40
HSKN5-660-20	Rod Kit	2-1/2		19.78
HSKN5-660-20V	Rod Kit	2-1/2		61.39
HSKN5-660-24	Rod Kit	3		20.57
HSKN5-660-24V	Rod Kit	3		80.05
HSKN5-660-28	Rod Kit	3-1/2		22.56
HSKN5-660-28V	Rod Kit	3-1/2		93.52
HSKN5-660-32	Rod Kit	4		28.31
HSKN5-660-32V	Rod Kit	4		97.74
HSKN5-660-36	Rod Kit	4-1/2		30.49
HSKN5-660-36V	Rod Kit	4-1/2		103.17
HSKN5-660-40	Rod Kit	5		45.14
HSKN5-660-40V	Rod Kit	5		124.02
HSKN5-660-44	Rod Kit	5-1/2		61.54
HSKN5-660-44V	Rod Kit	5-1/2		140.06
HSKN5-660-P-04	Rod Kit	1/2	1	14.15
HSKN5-660-P-04V	Rod Kit	1/2	1	56.75
HSKN5-660-P-05AV	Rod Kit	5/8	1	57.12
HSKN5-660-P-05V	Rod Kit	5/8	1.5 & UP	60.31
HSKN5-660-P-08	Rod Kit	1	2 & UP	15.72
HSKN5-660-P-08V	Rod Kit	1	2 & UP	68.47
HSKN5-660-P-11	HLINE-KIT	1-3/8		9.13
HSKN5-660-P-11V	Rod Kit	1-3/8	2.5 & UP	83.89
HSKN5-660-P-14	Rod Kit	1-3/4		19.51
HSKN5-660-P-14V	Rod Kit	1-3/4		92.44
HSKN5-660-P-16V	Rod Kit	2		96.27
HSKN5-660-P-20	Rod Kit	2-1/2		29.36
HSKN5-660-P-20V	Rod Kit	2-1/2		140.38
HSKN5-660-P-24	HLINE-KIT	3		16.27
HSKN5-660-P-24V	Rod Kit	3		161.68
HSKN5-660-P-28	Rod Kit	3-1/2		36.11
HSKN5-660-P-28V	Rod Kit	3-1/2		180.52
HSKN5-660-P-32V	Rod Kit	4		218.02
HSKN5-660-P-36V	Rod Kit	4-1/2		233.83
HSKN5-660-P-40V	Rod Kit	5		239.71
HSKN5-660-P-44V	Rod Kit	5-1/2		245.07
HSKN5-681-05	Rod Kit	5/8		16.82
HSKN5-681-05A	Rod Kit	5/8	1	14.69
HSKN5-681-08	Rod Kit	1		18.45
HSKN5-681-11	Rod Kit	1-3/8		20.57
HSKN5-681-14	Rod Kit	1-3/4		22.00
HSKN5-681-16	Rod Kit	2		28.64
HSKN5-681-20	Rod Kit	2-1/2		40.33

HYDRO-LINE®

HYDRO-LINE®

Sales Part Number	Description	Rod Size	Bore Size	List Price
HSKN5-681-24	Rod Kit	3		\$ 43.97
HSKN5-681-28	Rod Kit	3-1/2		48.16
HSKN5-681-32	Rod Kit	4		56.47
HSKN5-681-36	Rod Kit	4-1/2		74.19
HSKN5-681-40	Rod Kit	5		77.71
HSKN5-681-44	Rod Kit	5-1/2		92.47
HSKN5-681-S-16	HLINE-KIT	2		35.21
HSKN5-681-S-20	HLINE-KIT	2-1/2		37.37
HSKN5-681-S-28	HLINE-KIT	3-1/2		73.11
HSKN5-681-S-36	HLINE-KIT	4-1/2		48.02
HSKN5-B-681-28	HLINE-KIT	3-1/2		29.92
HSKR2-662-05A	Rod Kit	5/8	1	8.78
HSKR2-662-05AV	Rod Kit	5/8	1	37.02
HSKR2-662-08	Rod Kit	1	1.5,2,2.5	9.57
HSKR2-662-08V	Rod Kit	1	1.5,2,2.5	37.78
HSKR2-662-11	Rod Kit	1-3/8	2, 2.5	11.66
HSKR2-662-11V	Rod Kit	1-3/8	2, 2.5	48.68
HSKR2-662-14	Rod Kit	1-3/4	2.5	14.33
HSKR2-662-14V	Rod Kit	1-3/4	2.5	50.02
HSKR2-662-P-05AV	Rod Kit	5/8	1	57.11
HSKR2-662-P-08V	Rod Kit	1	1.5,2,2.5	69.03
HSKR2-662-P-11V	Rod Kit	1-3/8	2, 2.5	82.86
HSKR2-662-P-14V	Rod Kit	1-3/4	2.5	92.79
HSKR2-681-05A	Rod Kit	5/8	1	14.69
HSKR2-681-08	Rod Kit	1	1.5,2,2.5	18.23
HSKR2-681-11	Rod Kit	1-3/8	2, 2.5	18.45
HSKR2-681-14	Rod Kit	1-3/4	2.5	19.27
HSKR5-511-02	Piston Ring Kit		1	89.63
HSKR5-511-03	Piston Ring Kit		1-1/2	60.13
HSKR5-511-04	Piston Ring Kit		2	61.92
HSKR5-511-05	Piston Ring Kit		2-1/2	62.94
HSKR5-511-065	Piston Ring Kit		3-1/4	72.86
HSKR5-511-08	Piston Ring Kit		4	82.13
HSKR5-511-10	Piston Ring Kit		5	106.21
HSKR5-511-12	Piston Ring Kit		6	117.71
HSKR5-511-16	Piston Ring Kit		8	138.57
HSKR5-511-20	Piston Ring Kit		10	394.70
HSKR5-511-24	Piston Ring Kit		12	549.14
HSKR5-512-02	Piston Kit		1	26.90
HSKR5-512-02V	Piston Kit		1	57.43
HSKR5-512-03	Piston Kit		1-1/2	28.41
HSKR5-512-03V	Piston Kit		1-1/2	60.13
HSKR5-512-04	Piston Kit		2	31.09
HSKR5-512-04V	Piston Kit		2	84.83
HSKR5-512-05	Piston Kit		2-1/2	33.96
HSKR5-512-05V	Piston Kit		2-1/2	86.71
HSKR5-512-065	Piston Kit		3-1/4	37.67
HSKR5-512-065V	Piston Kit		3-1/4	90.74
HSKR5-512-08	Piston Kit		4	44.18
HSKR5-512-08V	Piston Kit		4	116.65

HYDRO-LINE®

Sales Part Number	Description	Rod Size	Bore Size	List Price
HSKR5-512-10	Piston Kit		5	\$ 55.95
HSKR5-512-10V	Piston Kit		5	129.93
HSKR5-512-12	Piston Kit		6	62.44
HSKR5-512-12V	Piston Kit		6	169.55
HSKR5-512-16	Piston Kit		8	162.43
HSKR5-512-16V	Piston Kit		8	321.85
HSKR5-512-20	Piston Kit		10	159.09
HSKR5-512-20V	Piston Kit		10	545.59
HSKR5-512-24	Piston Kit		12	250.07
HSKR5-512-24V	Piston Kit		12	781.58
HSKR5-512-28	Piston Kit		14	359.72
HSKR5-512-28V	Piston Kit		14	852.74
HSKX-B-29427-20	HLINE-KIT	2-1/2		17.23
HSKX-B-31300	HLINE-KIT		12.030	296.08
HSKX-B-54030	HLINE-KIT		3	21.39
HSKX-C-53238-36	HLINE-KIT	4-1/2		125.02
HSKX-C-53238-56	HLINE-KIT	7		224.91
HSKX-E-49904	HLINE-KIT	7		260.68

HYDRO-LINE®

MILLER

Kit Type		Page
Rod Kit, Iron Gland	Star Bushing - A, J, & H Cylinders	52
	Pneumatic - A & C Cylinders	53
	Hydraulic - AJ, J, M & H Cylinders	54
	HV Cylinders - Retainer Held - With Retainer & Without Retainer	55
	HV Cylinders-Bolted	56
Star Rod Kits	A, J, & H Cylinders	57
Rod Seal Cage Assembly	Hydraulic	58
Hat Packing	PTFE & Nitrile	59
PTFE Wiper	"U" Style - A, C, J, M, & H Cylinders	60
Iron Gland	Star Bushing Style A, J, & H Cylinders - Retainer Held & Bolted	61
	A, C, J, M, & H Cylinders	62
	HV Cylinders	63
Retainer	A, C, J, M, H & HV Cylinders	64
Caged Assembly Components	Rod Seal Cage, Wave Spring, & Bronze Pressure Ring	64
Piston Kits	A, J, & H Series Cylinders	65
Piston Kits	HV Series Cylinders	66
PTFE Tube Seal Cord	A, C, J, M, & H Cylinders	66
Piston U-seals	All Current Style Cylinders	67
Wear Rings	Air & Hydraulic Service	68
PTFE Tube End Seals	Continuous	69
	Various Kits	69
	Strip PTFE	70
Follower Seals	PTFE	70
Piston Cups	A, AJ, J, JW, H, & HW Cylinders	71
Repair Kits	By Part Number	72 - 79

ORTMAN

Kit Type		Page
Ortman Kits	Various Kits	80

MILLER

Star Bushing Rod Kit, Iron Gland

A, J, & H Cylinders

1998 Style Retainer Held

1998 Style Bolted

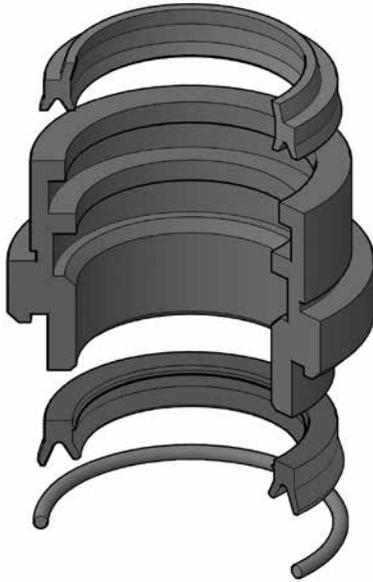

Kit Includes:

- 1 XNBR Wiper
- 1 Retainer Held Star Bushing
- 1 URE Rod Seal
- 1 NBR O-ring

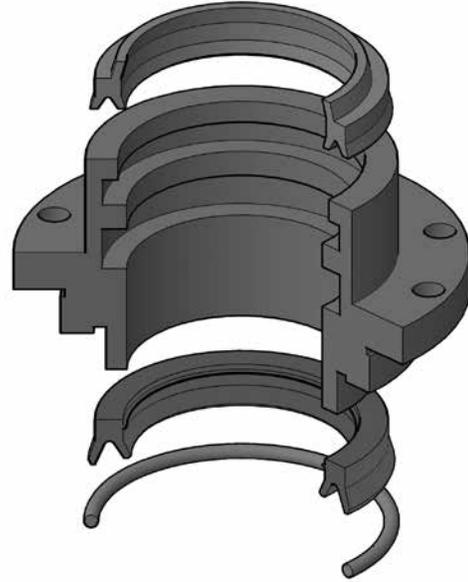

Kit Includes:

- 1 XNBR Wiper
- 1 Bolted Star Bushing
- 1 URE Rod Seal
- 1 NBR O-ring

Rod Dia.	Kit #	List Price	Kit #	List Price
5/8"	MLR-051-KR074-063	\$ 168.94	MLR-051-KR075-063	\$ 226.93
1"	MLR-051-KR074-100	210.21	MLR-051-KR075-100	273.71
1-3/8"	MLR-051-KR074-138	247.82	MLR-051-KR075-138	320.82
1-3/4"	—	—	MLR-051-KR075-175	347.67
2"	—	—	MLR-051-KR075-200	409.52
2-1/2"	—	—	MLR-051-KR075-250	562.27
3"	—	—	MLR-051-KR075-300	720.24
3-1/2"	—	—	MLR-051-KR075-350	966.00
4"	—	—	MLR-051-KR075-400	1038.60
4-1/2"	—	—	MLR-051-KR075-450	1117.80
5"	—	—	MLR-051-KR075-500	1487.78
5-1/2"	—	—	MLR-051-KR075-550	2081.61

Bolted bushings from: 5/8" to 1-3/4" have 4 bolt holes
 2" to 4-1/2" have 8 bolt holes
 5" to 5-1/2" have 12 bolt holes

MILLER

Pneumatic Rod Kit, Iron Gland

A & C Cylinders

Retainer Held

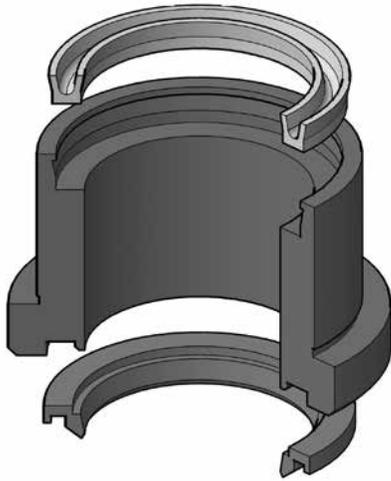

Kit Includes:

- 1 PTFE Wiper
- 1 Retainer Held Iron Gland
- 1 NBR Hat Packing

Bolted

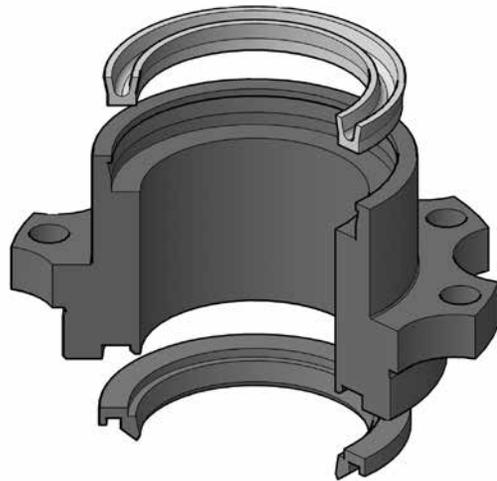

Kit Includes:

- 1 PTFE Wiper
- 1 Bolted Iron Gland
- 1 NBR Hat Packing

Rod Dia.	Kit #	List Price	Kit #	List Price
5/8"	MLR-051-KR010-063	\$ 74.24	MLR-051-KR011-063	\$ 126.09
1"	MLR-051-KR010-100	99.91	MLR-051-KR011-100	145.87
1-3/8"	MLR-051-KR010-138	113.51	MLR-051-KR011-138	157.90
1-3/4"	MLR-051-KR010-175	166.72	MLR-051-KR011-175	248.33
2"	MLR-051-KR010-200	195.01	MLR-051-KR011-200	281.28
2-1/2"	MLR-051-KR010-250	280.60	MLR-051-KR011-250	361.71
3"	MLR-051-KR010-300	366.22	MLR-051-KR011-300	434.10

Bolted bushings from: 5/8" to 1-3/4" have 4 bolt holes
 2" to 4-1/2" have 8 bolt holes
 5" to 5-1/2" have 12 bolt holes

MILLER

Hydraulic Rod Kit, Iron Gland

AJ, J, M, & H Cylinders

Retainer Held

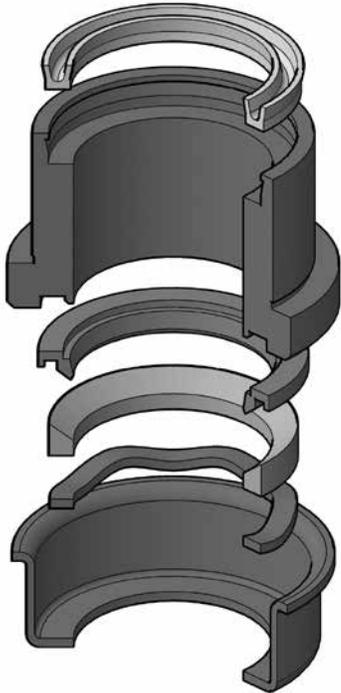

- Kit Includes:**
 1 PTFE Wiper
 1 Retainer Held Iron Gland
 1 PTFE Hat Packing
 1 Bronze Pressure Ring
 1 Wave Spring
 1 Cage

Bolted

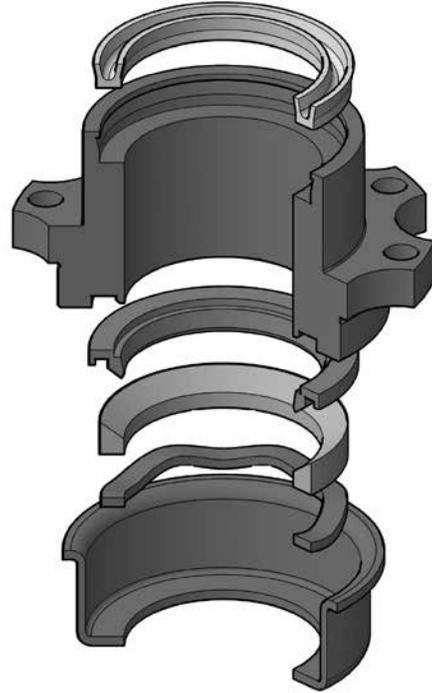

- Kit Includes:**
 1 PTFE Wiper
 1 Bolted Iron Gland
 1 PTFE Hat Packing
 1 Bronze Pressure Ring
 1 Wave Spring
 1 Cage

Rod Dia.	Kit #	List Price	Kit #	List Price
5/8"	MLR-051-KR014-063	\$ 133.01	MLR-051-KR015-063	\$ 164.39
1"	MLR-051-KR014-100	163.93	MLR-051-KR015-100	197.89
1-3/8"	MLR-051-KR014-138	201.52	MLR-051-KR015-138	245.04
1-3/4"	MLR-051-KR014-175	273.01	MLR-051-KR015-175	311.87
2"	MLR-051-KR014-200	329.43	MLR-051-KR015-200	366.63
2-1/2"	MLR-051-KR014-250	405.96	MLR-051-KR015-250	474.06
3"	MLR-051-KR014-300	536.24	MLR-051-KR015-300	592.00

Bolted bushings from: 5/8" to 1-3/4" have 4 bolt holes
 2" to 4-1/2" have 8 bolt holes
 5" to 5-1/2" have 12 bolt holes

MILLER

Rod Kit, Iron Gland

HV Cylinders - Retainer Held

With Retainer

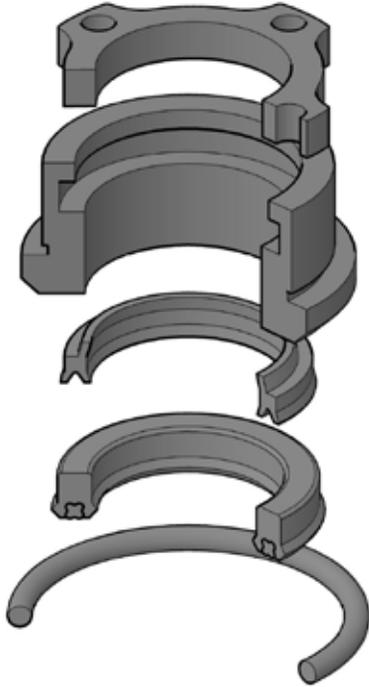

Kit Includes:

- 1 NBR Wiper
- 1 Retainer Held Gland
- 1 Retainer Ring
- 1 URE Rod Seal
- 1 NBR O-ring

Without Retainer

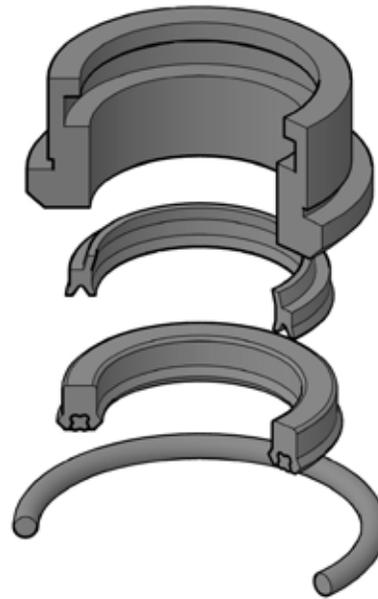

Kit Includes:

- 1 NBR Wiper
- 1 Retainer Held Gland
- 1 URE Rod Seal
- 1 NBR O-ring

Rod Dia.	Kit #	List Price	Kit #	List Price
5/8"	MLR-051-KR065-063	\$ 99.86	MLR-051-KR064-063	\$ 42.63
1"	MLR-051-KR065-100	98.06	MLR-051-KR064-100	50.00
1-3/8"	MLR-051-KR065-138	130.16	MLR-051-KR064-138	62.29

MILLER

Rod Kit, Iron Gland

HV Cylinders-Bolted

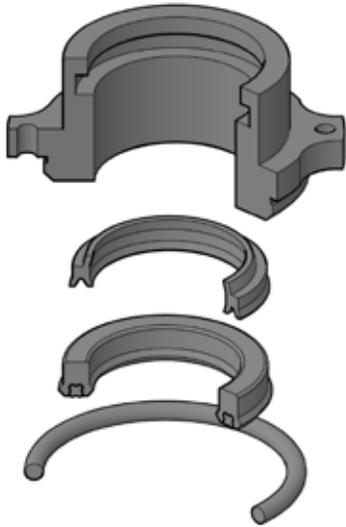

Kit Includes:
 1 NBR Wiper
 1 Bolted Gland
 1 URE Rod Seal
 1 NBR O-ring

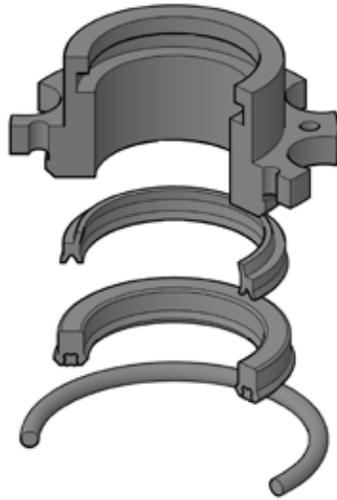

Kit Includes:
 1 NBR Wiper
 1 Bolted Gland
 1 URE Rod Seal
 1 NBR O-ring

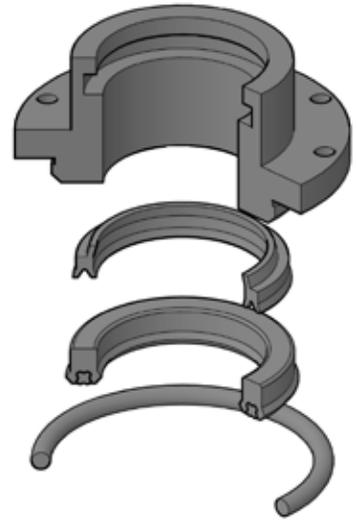

Kit Includes:
 1 NBR Wiper
 1 Bolted Gland
 1 URE Rod Seal
 1 NBR O-ring

Rod Dia.	Kit #	List Price	Kit #	List Price	Kit #	List Price
1-3/4"	MLR-051-KR065-175	\$ 148.83	—	—	—	—
2"	—	—	MLR-051-KR065-200	\$ 159.73	—	—
2-1/2"	—	—	—	—	MLR-051-KR065-250	\$ 186.68
3	—	—	—	—	MLR-051-KR065-300	214.06
3-1/2"	—	—	—	—	MLR-051-KR065-350	244.99

MILLER

MILLER

Star Rod Kits

A, J, & H Cylinders Star Kits

Rod Dia.	Kit #	List Price
5/8"	MLR-051-KR080-063	\$ 20.08
1"	MLR-051-KR080-100	35.47
1-3/8"	MLR-051-KR080-138	47.12
1-3/4"	MLR-051-KR080-175	58.41
2"	MLR-051-KR080-200	65.57
2-1/2"	MLR-051-KR080-250	78.29
3"	MLR-051-KR080-300	141.00
3-1/2"	MLR-051-KR080-350	151.08
4"	MLR-051-KR080-400	169.72
4-1/2"	MLR-051-KR080-450	191.84
5"	MLR-051-KR080-500	205.07
5-1/2"	MLR-051-KR080-550	320.49

Kit Includes:
 1 XNBR Wiper
 1 URE Rod Seal
 1 NBR O-ring



MILLER

MILLER

Hydraulic Rod Seal Cage Assembly

AJ, J, M, & H Cylinders	Boosters & Tandems
-------------------------	--------------------

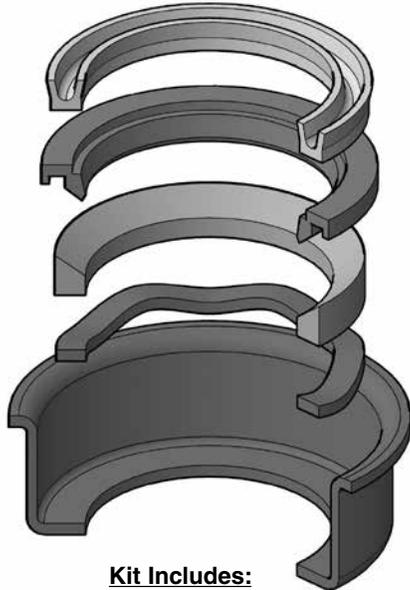

- Kit Includes:**
- 1 PTFE Wiper
 - 1 PTFE Hat Packing
 - 1 Bronze Pressure Ring
 - 1 Wave Spring
 - 1 Cage

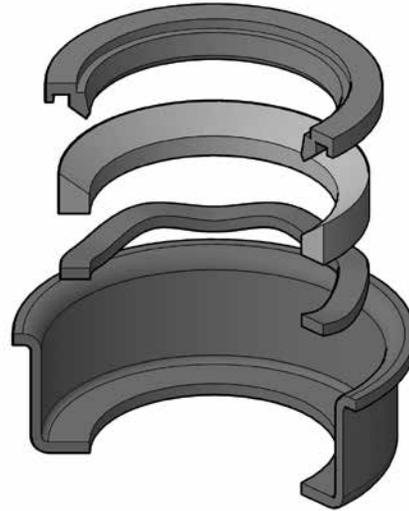

- Kit Includes:**
- 1 PTFE Hat Packing
 - 1 Bronze Pressure Ring
 - 1 Wave Spring
 - 1 Cage
 - No Wiper

Rod Dia.	Kit #	List Price	Kit #	List Price
5/8"	MLR-051-KR012-063	\$ 74.86	MLR-051-KR024-063	\$ 67.88
1"	MLR-051-KR012-100	89.62	MLR-051-KR024-100	81.33
1-3/8"	MLR-051-KR012-138	110.98	MLR-051-KR024-138	100.53
1-3/4"	MLR-051-KR012-175	134.79	MLR-051-KR024-175	122.07
2"	MLR-051-KR012-200	157.38	MLR-051-KR024-200	142.84
2-1/2"	MLR-051-KR012-250	195.93	MLR-051-KR024-250	170.64
3"	MLR-051-KR012-300	262.33	MLR-051-KR024-300	234.08

MILLER

MILLER

Hat Packing

For Hydraulic Service
PTFE

For Air & Water Service
Nitrile



Rod Dia.	Part #	List Price	Part #	List Price
5/8"	MLR-051-RS007-063	\$ 10.30	MLR-051-RS014-063	\$ 11.39
1"	MLR-051-RS007-100	13.24	MLR-051-RS014-100	18.63
1-3/8"	MLR-051-RS007-138	15.59	MLR-051-RS014-138	11.62
1-3/4"	MLR-051-RS007-175	16.42	MLR-051-RS014-175	14.67
2"	MLR-051-RS007-200	16.99	MLR-051-RS014-200	20.40
2-1/2"	MLR-051-RS007-250	21.77	MLR-051-RS014-250	23.83
3"	MLR-051-RS007-300	30.31	MLR-051-RS014-300	26.26
3-1/2"	MLR-051-RS007-350	38.64	MLR-051-RS014-350	37.68
4"	MLR-051-RS007-400	41.58	MLR-051-RS014-400	44.81
4-1/2"	MLR-051-RS007-450	48.41	MLR-051-RS014-450	51.72
5"	MLR-051-RS007-500	52.07	MLR-051-RS014-500	58.74
5-1/2"	MLR-051-RS007-550	61.15	MLR-051-RS014-550	65.66
7"	MLR-051-RS007-700	55.11	—	—
8"	MLR-051-RS007-800	57.70	—	—
9"	MLR-051-RS007-900	57.74	—	—
10"	MLR-051-RS007-1000	112.99	—	—

MILLER

MILLER

PTFE Wiper "U" Style

A, C, J, M, & H Cylinders

Rod Dia.	Part #	List Price
5/8"	MLR-051-WP001-063	\$ 7.43
1"	MLR-051-WP001-100	8.81
1-3/8"	MLR-051-WP001-138	11.12
1-3/4"	MLR-051-WP001-175	13.53
2"	MLR-051-WP001-200	15.42
2-1/2"	MLR-051-WP001-250	26.84
3"	MLR-051-WP001-300	29.96
3-1/2"	MLR-051-WP001-350	33.85
4"	MLR-051-WP001-400	38.45
4-1/2"	MLR-051-WP001-450	50.33
5"	MLR-051-WP001-500	54.22
5-1/2"	MLR-051-WP001-550	55.15
7"	MLR-051-WP001-700	53.90
8"	MLR-051-WP001-800	47.84
9"	MLR-051-WP001-900	60.73
10"	MLR-051-WP001-1000	89.62

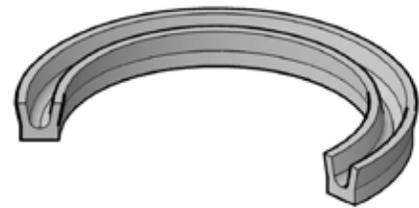

MILLER

MILLER

Iron Gland

Star Bushing Style A, J, & H Cylinders

Retainer Held

Bolted

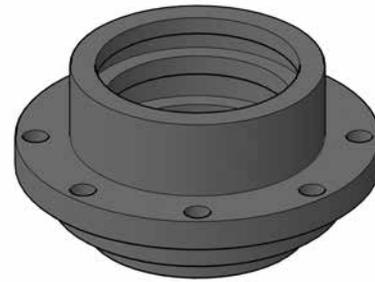

Rod Dia.	Part #	List Price	Part #	List Price
5/8"	MLR-050-BU100-063	\$ 115.74	MLR-050-BU101-063	\$ 141.73
1"	MLR-050-BU100-100	141.65	MLR-050-BU101-100	173.72
1-3/8"	MLR-050-BU100-138	145.31	MLR-050-BU101-138	213.41
1-3/4"	—		MLR-050-BU101-175	214.77
2"	—		MLR-050-BU101-200	265.27
2-1/2"	—		MLR-050-BU101-250	371.55
3"	—		MLR-050-BU101-300	412.54
3-1/2"	—		MLR-050-BU101-350	487.25
4"	—		MLR-050-BU101-400	714.15
4-1/2"	—		MLR-050-BU101-450	772.74
5"	—		MLR-050-BU101-500	878.06
5-1/2"	—		MLR-050-BU101-550	962.24

Bolted bushings from: 5/8" to 1-3/4" have 4 bolt holes
 2" to 4-1/2" have 8 bolt holes
 5" to 5-1/2" have 12 bolt holes

MILLER

Iron Gland

A, C, J, M, & H Cylinders

Retainer Held

Bolted

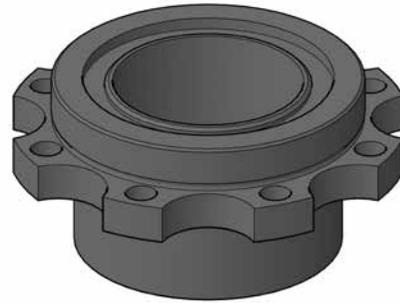

MILLER

Rod Dia.	Part #	List Price	Part #	List Price
5/8"	MLR-050-BU022-063	\$ 61.11	MLR-050-BU024-063	\$ 134.17
1"	MLR-050-BU022-100	76.62	MLR-050-BU024-100	161.62
1-3/8"	MLR-050-BU022-138	92.97	MLR-050-BU024-138	207.95
1-3/4"	MLR-050-BU022-175	133.14	MLR-050-BU024-175	210.31
2"	MLR-050-BU022-200	165.77	MLR-050-BU024-200	236.06
2-1/2"	MLR-050-BU022-250	267.36	MLR-050-BU024-250	272.44
3"	MLR-050-BU022-300	268.97	MLR-050-BU024-300	323.21

Bolted bushings from: 5/8" to 1-3/4" have 4 bolt holes
 2" to 4-1/2" have 8 bolt holes
 5" to 5-1/2" have 12 bolt holes

MILLER

Iron Gland

HV Cylinders

Rod Dia.	Kit #	List Price
5/8"	MLR-RG065-063	\$ 37.72
1"	MLR-RG065-100	43.93
1-3/8"	MLR-RG065-138	54.92

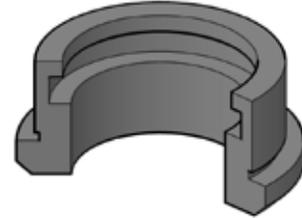

Rod Dia.	Kit #	List Price
1-3/4"	MLR-RG065-175	\$ 141.34

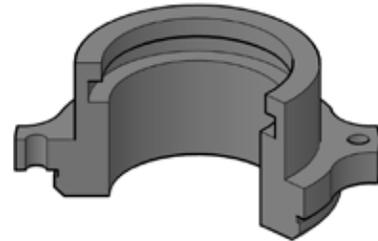

Rod Dia.	Kit #	List Price
2"	MLR-RG065-200	\$ 152.86

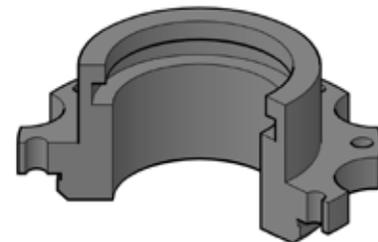

Rod Dia.	Kit #	List Price
2-1/2"	MLR-RG065-250	\$ 178.08
3"	MLR-RG065-300	204.29
3-1/2"	MLR-RG065-350	228.02

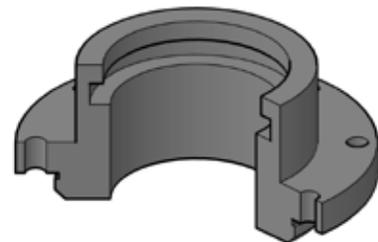

MILLER

Retainer

A, C, J, M, H & HV Cylinders

Rod Dia.	Part #	List Price
5/8"	MLR-050-RT005-063	\$ 38.56
1"	MLR-050-RT005-100	43.01
1-3/8"	MLR-050-RT005-138	54.96



Caged Assembly Components

Rod Seal Cage	Wave Spring	Bronze Pressure Ring
---------------	-------------	----------------------

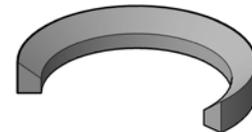
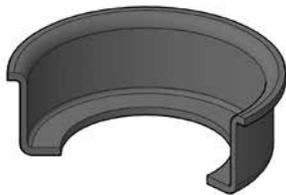

Rod Dia.	Part #	List Price	Part #	List Price	Part #	List Price
5/8"	MLR-051-CG001-063	\$ 25.22	MLR-051-WS004-063	\$ 17.42	MLR-051-PG001-063	\$ 23.82
1"	MLR-051-CG001-100	30.82	MLR-051-WS004-100	17.42	MLR-051-PG001-100	29.75
1-3/8"	MLR-051-CG001-138	32.42	MLR-051-WS004-138	17.42	MLR-051-PG001-138	44.19
1-3/4"	MLR-051-CG001-175	34.24	MLR-051-WS004-175	17.42	MLR-051-PG001-175	60.01
2"	MLR-051-CG001-200	37.55	MLR-051-WS003-200	21.19	MLR-051-PG001-200	70.17
2-1/2"	MLR-051-CG001-250	42.48	MLR-051-WS003-250	22.29	MLR-051-PG001-250	87.46
3"	MLR-051-CG001-300	59.26	MLR-051-WS003-300	26.72	MLR-051-PG001-300	122.48

MILLER

MILLER

Piston Kits

A Series Cylinders

January '82 to Current

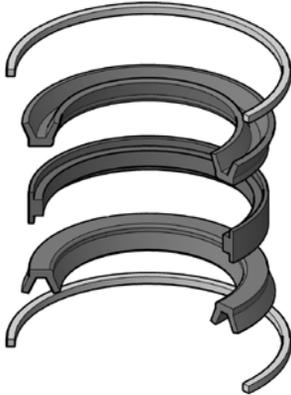

Kit Includes:

2 NBR U-seals
1 Wear Ring
2 PTFE Tube End Seals
(wear ring material and profile varies with size)

J Series Cylinders

January '81 to Current

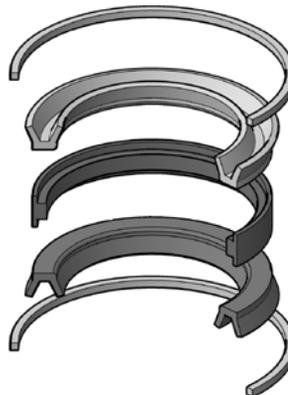

Kit Includes:

2 U-seals (PTFE up to 5",
NBR from 6" to 12")
1 Wear Ring
2 PTFE Tube End Seals
(wear ring and u-seal material and profile varies with size)

H Series Cylinders

January '82 to Current

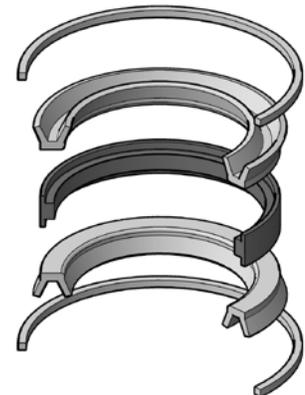

Kit Includes:

2 PTFE U-seals
1 T-Shape Wear Ring
2 PTFE Tube End Seals
(wear ring material varies with size)

Bore Dia.	Kit #	List Price	Kit #	List Price	Kit #	List Price
1-1/2"	MLR-090-KB001-150	\$ 79.24	MLR-091-KB001-150	\$ 91.22	MLR-171-KB001-150	\$ 125.01
2"	MLR-090-KB001-200	101.54	MLR-091-KB001-200	91.74	MLR-171-KB001-200	144.81
2-1/2"	MLR-090-KB001-250	110.14	MLR-091-KB001-250	106.83	MLR-171-KB001-250	174.07
3-1/4"	MLR-090-KB001-325	124.85	MLR-091-KB001-325	140.13	MLR-171-KB001-325	206.98
4"	MLR-090-KB001-400	144.40	MLR-091-KB001-400	154.17	MLR-171-KB001-400	285.78
5"	MLR-090-KB001-500	153.44	MLR-091-KB001-500	216.94	MLR-171-KB001-500	331.97
6"	MLR-090-KB001-600	184.81	MLR-091-KB001-600	231.81	MLR-171-KB001-600	369.45
7"	MLR-090-KB001-700	195.68	MLR-091-KB001-700	238.86	MLR-171-KB001-700	520.67
8"	MLR-090-KB001-800	201.19	MLR-091-KB001-800	257.29	MLR-171-KB001-800	650.03
10"	MLR-090-KB001-1000	225.70	MLR-091-KB001-1000	297.04	MLR-171-KB001-1000	761.68
12"	MLR-090-KB001-1200	258.63	MLR-091-KB001-1200	366.37	MLR-171-KB001-1200	862.16

MILLER

Piston Kits

HV Series Cylinders Urethane

Bore Dia.	(URE) Kit #	List Price
1-1/2"	MLR-181-KB001-150	\$ 55.22
2"	MLR-181-KB001-200	57.57
2-1/2"	MLR-181-KB001-250	60.17
3-1/4"	MLR-181-KB001-325	66.65
4"	MLR-181-KB001-400	71.70
5"	MLR-181-KB001-500	84.89
6"	MLR-181-KB001-600	98.25
7"	MLR-181-KB001-700	99.50
8"	MLR-181-KB001-800	141.92

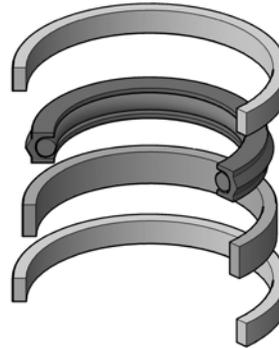

- Kit Includes:**
 1 URE Piston Seal
 1 Wear Ring
 2 PTFE Tube End Seals

MILLER

PTFE Tube Seal Cord

A, C, J, M, & H Cylinders

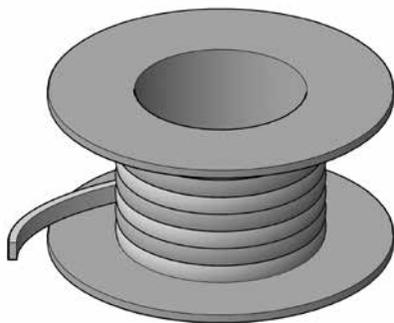

Part #	Radial Wall	Width	List Price
MLR-008-SH001-30	.030	.070	\$ 120.30
Includes: 30' spool of PTFE Head Seal			
MLR-SH1-STRIP	.030	.070	7.95/ft

MILLER

Piston U-seals

All Current Style Cylinders

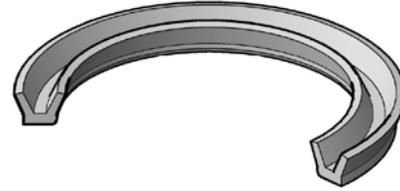
Buna-N
PTFE

Bore Dia.	Part #	List Price	Part #	List Price
1-1/2"	MLR-052-PS025-150	\$ 18.17	MLR-052-PS017-150	\$ 16.94
2"	MLR-052-PS025-200	18.84	MLR-052-PS017-200	17.05
2-1/2"	MLR-052-PS025-250	19.97	MLR-052-PS017-250	20.12
3-1/4"	MLR-052-PS025-325	21.68	MLR-052-PS017-325	26.27
4"	MLR-052-PS025-400	21.50	MLR-052-PS017-400	34.84
5"	MLR-052-PS025-500	25.60	MLR-052-PS017-500	52.25
6"	MLR-052-PS025-600	32.80	MLR-052-PS017-600	59.74
7"	MLR-052-PS025-700	20.51	MLR-052-PS017-700	72.58
8"	MLR-052-PS016-800	25.40	MLR-052-PS017-800	84.55
10"	MLR-052-PS025-1000	75.79	MLR-052-PS017-1000	133.52
12"	MLR-052-PS016-1200	60.22	MLR-052-PS017-1200	179.05
14"	MLR-052-PS025-1400	147.16	MLR-052-PS017-1400	184.12
16"	MLR-052-PS025-1600	299.72	MLR-052-PS017-1600	194.86
18"	—		MLR-052-PS017-1800	235.23

MILLER

MILLER

Wear Rings

Air Service PTFE	Hydraulic Service Acetal	Hydraulic Service Bronze
---------------------	-----------------------------	-----------------------------



Bore Dia.	Part #	List Price	Part #	List Price	Part #	List Price
1-1/2"	MLR-052-WR005-150-25	\$ 29.35	MLR-052-WR009-150-25	\$ 23.47	—	—
2"	MLR-052-WR005-200-25	30.89	MLR-052-WR009-200-25	27.03	—	—
2"	—	—	MLR-052-WR009-200-31	27.45	—	—
2-1/2"	MLR-052-WR005-250-25	32.61	MLR-052-WR009-250-25	33.26	—	—
2-1/2"	—	—	MLR-052-WR009-250-38	35.31	—	—
3-1/4"	MLR-052-WR005-325-25	43.22	MLR-052-WR009-325-25	45.52	—	—
3-1/4"	—	—	MLR-052-WR009-325-50	50.51	—	—
4"	MLR-052-WR005-400-25	53.92	MLR-052-WR009-400-25	52.83	—	—
4"	—	—	MLR-052-WR009-400-63	71.40	—	—
5"	MLR-052-WR005-500-25	67.69	—	—	—	—
5"	—	—	MLR-052-WR009-500-75	141.98	—	—
6"	MLR-052-WR005-600-25	80.93	—	—	—	—
6"	—	—	MLR-052-WR009-600-75	183.90	—	—
7"	MLR-052-WR005-700-38	55.28	—	—	—	—
7"	—	—	—	—	MLR-052-WR008-700-75	\$ 191.99
8"	MLR-052-WR005-800-38	78.32	—	—	—	—
8"	—	—	—	—	MLR-052-WR008-800-125	257.05
10"	MLR-052-WR005-1000-38	82.93	—	—	—	—
10"	—	—	—	—	MLR-052-WR008-1000-125	299.90
12"	MLR-052-WR005-1200-38	104.43	—	—	—	—
12"	—	—	—	—	MLR-052-WR008-1200-125	328.31
16"	MLR-052-WR005-1600-50	162.64	—	—	—	—
18"	MLR-052-WR005-1800-50	168.25	—	—	—	—
20"	MLR-052-WR005-2000-50	195.17	—	—	—	—

MILLER

MILLER

Tube End Seals

Continuous PTFE

A, C, J, M, ER500, & ER3000

H & ER6000

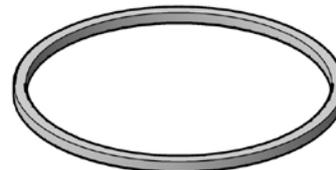
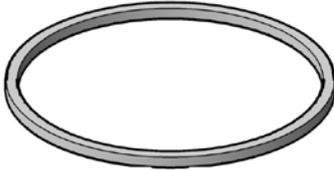

Bore Dia.	Part #	List Price	Part #	List Price
1-1/2"	MLR-090-ES009-150	\$ 9.02	MLR-170-ES010-150	\$ 13.86
2"	MLR-090-ES009-200	16.46	MLR-170-ES010-200	19.62
2-1/2"	MLR-090-ES009-250	16.52	MLR-170-ES010-250	25.46
3-1/4"	MLR-090-ES009-325	16.66	MLR-170-ES010-325	26.54
4"	MLR-090-ES009-400	24.66	MLR-170-ES010-400	31.75
5"	MLR-090-ES009-500	31.05	MLR-170-ES010-500	38.05
6"	MLR-090-ES009-600	38.68	MLR-170-ES010-600	44.03
7"	MLR-090-ES009-700	48.57	MLR-170-ES010-700	49.98
8"	MLR-090-ES009-800	60.45	MLR-170-ES010-800	62.59
10"	MLR-090-ES009-1000	72.10	MLR-170-ES010-1000	72.66
12"	MLR-090-ES009-1200	80.25	MLR-170-ES010-1200	80.97
14"	MLR-090-ES009-1400	79.66	—	—

Various Kits

Kit #	Rod x Bore	List Price
MLR-150-KB001-325	3-1/4	\$ 227.07
MLR-150-KB001-500	5	381.94

Kit Includes:

- 2 Leather Piston Cups
- 2 PTFE Tube End Seals
- 1 PTFE Follower Seal

MILLER

Tube End Seals

Strip PTFE

A, C, J, M, ER500, & ER3000

H & ER6000

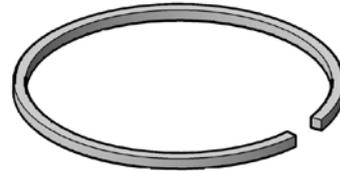
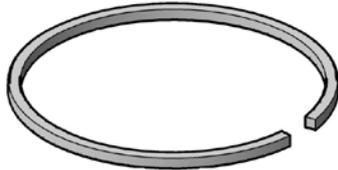

Bore Dia.	Part #	List Price	Strip PTFE	
			Part #	List Price
1-1/2"	MLR-090-ES006-150	\$ 7.83	MLR-170-ES006-150	\$ 7.69
2"	MLR-090-ES006-200	13.65	MLR-170-ES006-200	14.02
2-1/2"	MLR-090-ES006-250	14.36	MLR-170-ES006-250	14.20
3-1/4"	MLR-090-ES006-325	16.61	MLR-170-ES006-325	14.66
4"	MLR-090-ES006-400	20.57	MLR-170-ES006-400	20.89
5"	MLR-090-ES006-500	22.05	MLR-170-ES006-500	21.99
6"	MLR-090-ES006-600	27.23	MLR-170-ES006-600	26.02
7"	MLR-090-ES006-700	26.86	MLR-170-ES006-700	26.86
8"	MLR-090-ES006-800	33.58	MLR-170-ES006-800	33.58
10"	MLR-090-ES006-1000	40.30	MLR-170-ES006-1000	40.30
12"	MLR-090-ES006-1200	47.02	MLR-170-ES006-1200	47.02
14"	MLR-090-ES006-1400	53.74	MLR-170-ES006-1400	53.74
18"	—		MLR-170-ES006-1800	67.18

MILLER

PTFE Follower Seals

J & H Cylinders For 3 Piece Pistons From 1956-1977

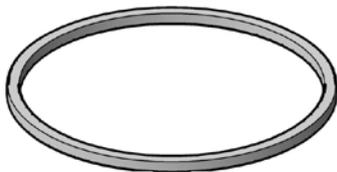

Part #	Bore		I.D.	Radial Wall	Width	List Price
	H	J				
MLR-052-FS001-44	1-1/2	1-1/2, 2, 2-1/2	7/16	0.070	0.070	\$ 9.81
MLR-052-FS001-75	2, 2-1/2	3-1/4, 4, 5	3/4	0.070	0.070	9.37
MLR-052-FS001-100	3-1/4	6, 7, 8	1	0.142	0.142	14.53
MLR-052-FS001-125	4	10	1-1/4	0.142	0.142	16.13
MLR-052-FS001-150	5	12	1-1/2	0.142	0.142	20.40
MLR-052-FS001-188	6	14	1-7/8	0.142	0.142	22.77
MLR-052-FS001-250	8	-	2-1/2	0.142	0.142	23.55

MILLER

Piston Cups

**A, JW, & HW Cylinders
From 1956-1977
Nitrile**

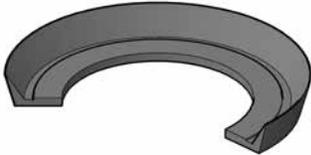

**J & H Cylinders
From 1956-1977
Leather**



**AJ, J, & H Cylinders
From 1956-1977
PTFE**

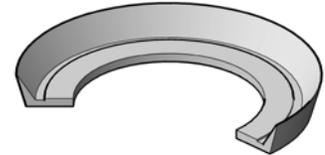

Bore Dia.	Part #	List Price	Part #	List Price	Part #	List Price
1-1/2"	MLR-052-PS001-150	\$ 12.22	MLR-052-PS003-150	\$ 19.59	MLR-052-PS006-150	\$ 23.49
2"	MLR-052-PS001-200	13.07	MLR-052-PS003-200	24.02	MLR-052-PS006-200	32.20
2-1/2"	MLR-052-PS001-250	17.86	MLR-052-PS003-250	32.19	MLR-052-PS006-250	34.95
3-1/4"	MLR-052-PS001-325	27.88	MLR-052-PS003-325	50.55	MLR-052-PS006-325	45.30
4"	MLR-052-PS001-400	32.53	MLR-052-PS003-400	62.24	MLR-052-PS006-400	55.94
5"	MLR-052-PS001-500	42.15	MLR-052-PS003-500	86.58	MLR-052-PS006-500	83.77
6"	MLR-052-PS001-600	47.92	MLR-052-PS003-600	117.36	MLR-052-PS006-600	101.24
7"	—	—	—	—	MLR-052-PS006-700	243.39
8"	MLR-052-PS001-800	54.76	—	—	MLR-052-PS006-800	136.99
10"	MLR-052-PS001-1000	65.42	—	—	MLR-052-PS006-1000	176.73
12"	MLR-052-PS001-1200	199.39	—	—	MLR-052-PS006-1200	235.72

MILLER

MILLER

Sales Part Number	Description	Rod Size	Bore Size	ID	Radial Wall	Width	List Price
MLR-050-BU022-063	Iron Gland	5/8					\$ 61.11
MLR-050-BU022-100	Iron Gland	1					76.62
MLR-050-BU022-138	Iron Gland	1-3/8					92.97
MLR-050-BU022-175	Iron Gland	1-3/4					133.14
MLR-050-BU022-200	Iron Gland	2					165.77
MLR-050-BU022-250	Iron Gland	2-1/2					267.36
MLR-050-BU022-300	Iron Gland	3					268.97
MLR-050-BU024-063	Iron Gland	5/8					134.17
MLR-050-BU024-100	Iron Gland	1					161.62
MLR-050-BU024-138	Iron Gland	1-3/8					207.95
MLR-050-BU024-175	Iron Gland	1-3/4					210.31
MLR-050-BU024-200	Iron Gland	2					236.06
MLR-050-BU024-250	Iron Gland	2-1/2					272.44
MLR-050-BU024-300	Iron Gland	3					323.21
MLR-050-BU100-063	Iron Gland	5/8					115.74
MLR-050-BU100-100	Iron Gland	1					141.65
MLR-050-BU100-138	Iron Gland	1-3/8					145.31
MLR-050-BU101-063	Iron Gland	5/8					141.73
MLR-050-BU101-100	Iron Gland	1					173.72
MLR-050-BU101-138	Iron Gland	1-3/8					213.41
MLR-050-BU101-175	Iron Gland	1-3/4					214.77
MLR-050-BU101-200	Iron Gland	2					265.27
MLR-050-BU101-250	Iron Gland	2-1/2					371.55
MLR-050-BU101-300	Iron Gland	3					412.54
MLR-050-BU101-350	Iron Gland	3-1/2					487.25
MLR-050-BU101-400	Iron Gland	4					714.15
MLR-050-BU101-450	Iron Gland	4-1/2					772.74
MLR-050-BU101-500	Iron Gland	5					878.06
MLR-050-BU101-550	Iron Gland	5-1/2					962.24
MLR-050-RT005-063	Retainer	5/8					38.56
MLR-050-RT005-100	Retainer	1					43.01
MLR-050-RT005-138	Retainer	1-3/8					54.96
MLR-051-CG001-063	Rod Seal Cage	5/8					25.22
MLR-051-CG001-100	Rod Seal Cage	1					30.82
MLR-051-CG001-138	Rod Seal Cage	1-3/8					32.42
MLR-051-CG001-175	Rod Seal Cage	1-3/4					34.24
MLR-051-CG001-200	Rod Seal Cage	2					37.55
MLR-051-CG001-250	Rod Seal Cage	2-1/2					42.48
MLR-051-CG001-300	Rod Seal Cage	3					59.26
MLR-051-KR010-063	Rod Kit - Gland	5/8					74.24
MLR-051-KR010-100	Rod Kit - Gland	1					99.91
MLR-051-KR010-138	Rod Kit - Gland	1-3/8					113.51
MLR-051-KR010-175	Rod Kit - Gland	1-3/4					166.72
MLR-051-KR010-200	Rod Kit - Gland	2					195.01
MLR-051-KR010-250	Rod Kit - Gland	2-1/2					280.60
MLR-051-KR010-300	Rod Kit - Gland	3					366.22
MLR-051-KR011-063	Rod Kit - Gland	5/8					126.09
MLR-051-KR011-100	Rod Kit - Gland	1					145.87
MLR-051-KR011-138	Rod Kit - Gland	1-3/8					157.90
MLR-051-KR011-175	Rod Kit - Gland	1-3/4					248.33

MILLER

Sales Part Number	Description	Rod Size	Bore Size	ID	Radial Wall	Width	List Price
MLR-051-KR011-200	Rod Kit - Gland	2					\$ 281.28
MLR-051-KR011-250	Rod Kit - Gland	2-1/2					361.71
MLR-051-KR011-300	Rod Kit - Gland	3					434.10
MLR-051-KR012-063	Rod Kit - Cage Assembly	5/8					74.86
MLR-051-KR012-100	Rod Kit - Cage Assembly	1					89.62
MLR-051-KR012-138	Rod Kit - Cage Assembly	1-3/8					110.98
MLR-051-KR012-175	Rod Kit - Cage Assembly	1-3/4					134.79
MLR-051-KR012-200	Rod Kit - Cage Assembly	2					157.38
MLR-051-KR012-250	Rod Kit - Cage Assembly	2-1/2					195.93
MLR-051-KR012-300	Rod Kit - Cage Assembly	3					262.33
MLR-051-KR014-063	Rod Kit - Gland	5/8					133.01
MLR-051-KR014-100	Rod Kit - Gland	1					163.93
MLR-051-KR014-138	Rod Kit - Gland	1-3/8					201.52
MLR-051-KR014-175	Rod Kit - Gland	1-3/4					273.01
MLR-051-KR014-200	Rod Kit - Gland	2					329.43
MLR-051-KR014-250	Rod Kit - Gland	2-1/2					405.96
MLR-051-KR014-300	Rod Kit - Gland	3					536.24
MLR-051-KR015-063	Rod Kit - Gland	5/8					164.39
MLR-051-KR015-100	Rod Kit - Gland	1					197.89
MLR-051-KR015-138	Rod Kit - Gland	1-3/8					245.04
MLR-051-KR015-175	Rod Kit - Gland	1-3/4					311.87
MLR-051-KR015-200	Rod Kit - Gland	2					366.63
MLR-051-KR015-250	Rod Kit - Gland	2-1/2					474.06
MLR-051-KR015-300	Rod Kit - Gland	3					592.00
MLR-051-KR024-063	Rod Kit - Cage Assembly	5/8					67.88
MLR-051-KR024-100	Rod Kit - Cage Assembly	1					81.33
MLR-051-KR024-138	Rod Kit - Cage Assembly	1-3/8					100.53
MLR-051-KR024-175	Rod Kit - Cage Assembly	1-3/4					122.07
MLR-051-KR024-200	Rod Kit - Cage Assembly	2					142.84
MLR-051-KR024-250	Rod Kit - Cage Assembly	2-1/2					170.64
MLR-051-KR024-300	Rod Kit - Cage Assembly	3					234.08
MLR-051-KR064-100	Rod Kit - Gland	1					50.00
MLR-051-KR064-138	Rod Kit - Gland	1-3/8					62.29
MLR-051-KR064-063	Rod Kit - Gland	5/8					42.63
MLR-051-KR065-100	Rod Kit - Gland	1					98.06
MLR-051-KR065-138	Rod Kit - Gland	1-3/8					130.16
MLR-051-KR065-175	Rod Kit - Gland	1-3/4					148.83
MLR-051-KR065-200	Rod Kit - Gland	2					159.73
MLR-051-KR065-250	Rod Kit - Gland	2-1/2					186.68
MLR-051-KR065-300	Rod Kit - Gland	3					214.06
MLR-051-KR065-350	Rod Kit - Gland	3-1/2					244.99
MLR-051-KR065-063	Rod Kit - Gland	5/8					99.86
MLR-051-KR074-063	Rod Kit - Gland	5/8					168.94
MLR-051-KR074-100	Rod Kit - Gland	1					210.21
MLR-051-KR074-138	Rod Kit - Gland	1-3/8					247.82
MLR-051-KR075-063	Rod Kit - Gland	5/8					226.93
MLR-051-KR075-100	Rod Kit - Gland	1					273.71
MLR-051-KR075-138	Rod Kit - Gland	1-3/8					320.82
MLR-051-KR075-175	Rod Kit - Gland	1-3/4					347.67
MLR-051-KR075-200	Rod Kit - Gland	2					409.52

MILLER

MILLER

Sales Part Number	Description	Rod Size	Bore Size	ID	Radial Wall	Width	List Price
MLR-051-KR075-250	Rod Kit - Gland	2-1/2					\$ 562.27
MLR-051-KR075-300	Rod Kit - Gland	3					720.24
MLR-051-KR075-350	Rod Kit - Gland	3-1/2					966.00
MLR-051-KR075-400	Rod Kit - Gland	4					1038.60
MLR-051-KR075-450	Rod Kit - Gland	4-1/2					1117.80
MLR-051-KR075-500	Rod Kit - Gland	5					1487.78
MLR-051-KR075-550	Rod Kit - Gland	5-1/2					2081.61
MLR-051-KR080-063	Rod Kit - Seal	5/8					20.08
MLR-051-KR080-100	Rod Kit - Seal	1					35.47
MLR-051-KR080-138	Rod Kit - Seal	1-3/8					47.12
MLR-051-KR080-175	Rod Kit - Seal	1-3/4					58.41
MLR-051-KR080-200	Rod Kit - Seal	2					65.57
MLR-051-KR080-250	Rod Kit - Seal	2-1/2					78.29
MLR-051-KR080-300	Rod Kit - Seal	3					141.00
MLR-051-KR080-350	Rod Kit - Seal	3-1/2					151.08
MLR-051-KR080-400	Rod Kit - Seal	4					169.72
MLR-051-KR080-450	Rod Kit - Seal	4-1/2					191.84
MLR-051-KR080-500	Rod Kit - Seal	5					205.07
MLR-051-KR080-550	Rod Kit - Seal	5-1/2					320.49
MLR-051-PG001-063	Bronze Pressure Ring	5/8					23.82
MLR-051-PG001-100	Bronze Pressure Ring	1					29.75
MLR-051-PG001-138	Bronze Pressure Ring	1-3/8					44.19
MLR-051-PG001-175	Bronze Pressure Ring	1-3/4					60.01
MLR-051-PG001-200	Bronze Pressure Ring	2					70.17
MLR-051-PG001-250	Bronze Pressure Ring	2-1/2					87.46
MLR-051-PG001-300	Bronze Pressure Ring	3					122.48
MLR-051-RS007-063	Hat Packing - PTFE	5/8					10.30
MLR-051-RS007-100	Hat Packing - PTFE	1					13.24
MLR-051-RS007-1000	Hat Packing - PTFE	10					112.99
MLR-051-RS007-138	Hat Packing - PTFE	1-3/8					15.59
MLR-051-RS007-175	Hat Packing - PTFE	1-3/4					16.42
MLR-051-RS007-200	Hat Packing - PTFE	2					16.99
MLR-051-RS007-250	Hat Packing - PTFE	2-1/2					21.77
MLR-051-RS007-300	Hat Packing - PTFE	3					30.31
MLR-051-RS007-350	Hat Packing - PTFE	3-1/2					38.64
MLR-051-RS007-400	Hat Packing - PTFE	4					41.58
MLR-051-RS007-450	Hat Packing - PTFE	4-1/2					48.41
MLR-051-RS007-500	Hat Packing - PTFE	5					52.07
MLR-051-RS007-550	Hat Packing - PTFE	5-1/2					61.15
MLR-051-RS007-700	Hat Packing - PTFE	7					55.11
MLR-051-RS007-800	Hat Packing - PTFE	8					57.70
MLR-051-RS007-900	Hat Packing - PTFE	9					57.74
MLR-051-RS014-063	Hat Packing - Nitrile	5/8					11.39
MLR-051-RS014-100	Hat Packing - Nitrile	1					18.63
MLR-051-RS014-138	Hat Packing - Nitrile	1-3/8					11.62
MLR-051-RS014-175	Hat Packing - Nitrile	1-3/4					14.67
MLR-051-RS014-200	Hat Packing - Nitrile	2					20.40
MLR-051-RS014-250	Hat Packing - Nitrile	2-1/2					23.83
MLR-051-RS014-300	Hat Packing - Nitrile	3					26.26
MLR-051-RS014-350	Hat Packing - Nitrile	3-1/2					37.68

MILLER

MILLER

Sales Part Number	Description	Rod Size	Bore Size	ID	Radial Wall	Width	List Price
MLR-051-RS014-400	Hat Packing - Nitrile	4					\$ 44.81
MLR-051-RS014-450	Hat Packing - Nitrile	4-1/2					51.72
MLR-051-RS014-500	Hat Packing - Nitrile	5					58.74
MLR-051-RS014-550	Hat Packing - Nitrile	5-1/2					65.66
MLR-051-WP001-063	U' Style Wiper - PTFE	5/8					7.43
MLR-051-WP001-100	U' Style Wiper - PTFE	1					8.81
MLR-051-WP001-1000	U' Style Wiper - PTFE	10					89.62
MLR-051-WP001-138	U' Style Wiper - PTFE	1-3/8					11.12
MLR-051-WP001-175	U' Style Wiper - PTFE	1-3/4					13.53
MLR-051-WP001-200	U' Style Wiper - PTFE	2					15.42
MLR-051-WP001-250	U' Style Wiper - PTFE	2-1/2					26.84
MLR-051-WP001-300	U' Style Wiper - PTFE	3					29.96
MLR-051-WP001-350	U' Style Wiper - PTFE	3-1/2					33.85
MLR-051-WP001-400	U' Style Wiper - PTFE	4					38.45
MLR-051-WP001-450	U' Style Wiper - PTFE	4-1/2					50.33
MLR-051-WP001-500	U' Style Wiper - PTFE	5					54.22
MLR-051-WP001-550	U' Style Wiper - PTFE	5-1/2					55.15
MLR-051-WP001-700	U' Style Wiper - PTFE	7					53.90
MLR-051-WP001-800	U' Style Wiper - PTFE	8					47.84
MLR-051-WP001-900	U' Style Wiper - PTFE	9					60.73
MLR-051-WS003-200	Wave Spring	2					21.19
MLR-051-WS003-250	Wave Spring	2-1/2					22.29
MLR-051-WS003-300	Wave Spring	3					26.72
MLR-051-WS004-063	Wave Spring	5/8					17.42
MLR-051-WS004-100	Wave Spring	1					17.42
MLR-051-WS004-138	Wave Spring	1-3/8					17.42
MLR-051-WS004-175	Wave Spring	1-3/4					17.42
MLR-052-FS001-100	Follower Seal			1	0.142	0.142	14.53
MLR-052-FS001-125	Follower Seal			1-1/4	0.142	0.142	16.13
MLR-052-FS001-150	Follower Seal			1-1/2	0.142	0.142	20.40
MLR-052-FS001-188	Follower Seal			1-7/8	0.142	0.142	22.77
MLR-052-FS001-250	Follower Seal			2-1/2	0.142	0.142	23.55
MLR-052-FS001-44	Follower Seal			7/16	0.070	0.070	9.81
MLR-052-FS001-75	Follower Seal			3/4	0.070	0.070	9.37
MLR-052-PS001-1000	Piston Cup - Nitrile		10				65.42
MLR-052-PS001-1200	Piston Cup - Nitrile		12				199.39
MLR-052-PS001-150	Piston Cup - Nitrile		1-1/2				12.22
MLR-052-PS001-200	Piston Cup - Nitrile		2				13.07
MLR-052-PS001-250	Piston Cup - Nitrile		2-1/2				17.86
MLR-052-PS001-325	Piston Cup - Nitrile		3-1/4				27.88
MLR-052-PS001-400	Piston Cup - Nitrile		4				32.53
MLR-052-PS001-500	Piston Cup - Nitrile		5				42.15
MLR-052-PS001-600	Piston Cup - Nitrile		6				47.92
MLR-052-PS001-800	Piston Cup - Nitrile		8				54.76
MLR-052-PS003-150	Piston Cup - Leather		1-1/2				19.59
MLR-052-PS003-200	Piston Cup - Leather		2				24.02
MLR-052-PS003-250	Piston Cup - Leather		2-1/2				32.19
MLR-052-PS003-325	Piston Cup - Leather		3-1/4				50.55
MLR-052-PS003-400	Piston Cup - Leather		4				62.24
MLR-052-PS003-500	Piston Cup - Leather		5				86.58

MILLER

Sales Part Number	Description	Rod Size	Bore Size	ID	Radial Wall	Width	List Price
MLR-052-PS003-600	Piston Cup - Leather		6				\$ 117.36
MLR-052-PS006-1000	Piston Cup - PTFE		10				176.73
MLR-052-PS006-1200	Piston Cup - PTFE		12				235.72
MLR-052-PS006-150	Piston Cup - PTFE		1-1/2				23.49
MLR-052-PS006-200	Piston Cup - PTFE		2				32.20
MLR-052-PS006-250	Piston Cup - PTFE		2-1/2				34.95
MLR-052-PS006-325	Piston Cup - PTFE		3-1/4				45.30
MLR-052-PS006-400	Piston Cup - PTFE		4				55.94
MLR-052-PS006-500	Piston Cup - PTFE		5				83.77
MLR-052-PS006-600	Piston Cup - PTFE		6				101.24
MLR-052-PS006-700	Piston Cup - PTFE		7				243.39
MLR-052-PS006-800	Piston Cup - PTFE		8				136.99
MLR-052-PS016-1200	Piston U-seal - Nitrile		12				60.22
MLR-052-PS016-800	Piston U-seal - Nitrile		8				25.40
MLR-052-PS017-1000	Piston U-seal - PTFE		10				133.52
MLR-052-PS017-1200	Piston U-seal - PTFE		12				179.05
MLR-052-PS017-1400	Piston U-seal - PTFE		14				184.12
MLR-052-PS017-150	Piston U-seal - PTFE		1-1/2				16.94
MLR-052-PS017-1600	Piston U-seal - PTFE		16				194.86
MLR-052-PS017-1800	Piston U-seal - PTFE		18				235.23
MLR-052-PS017-200	Piston U-seal - PTFE		2				17.05
MLR-052-PS017-250	Piston U-seal - PTFE		2-1/2				20.12
MLR-052-PS017-325	Piston U-seal - PTFE		3-1/4				26.27
MLR-052-PS017-400	Piston U-seal - PTFE		4				34.84
MLR-052-PS017-500	Piston U-seal - PTFE		5				52.25
MLR-052-PS017-600	Piston U-seal - PTFE		6				59.74
MLR-052-PS017-700	Piston U-seal - PTFE		7				72.58
MLR-052-PS017-800	Piston U-seal - PTFE		8				84.55
MLR-052-PS025-1000	Piston U-seal - Nitrile		10				75.79
MLR-052-PS025-1400	Piston U-seal - Nitrile		14				147.16
MLR-052-PS025-150	Piston U-seal - Nitrile		1-1/2				18.17
MLR-052-PS025-1600	Piston U-seal - Nitrile		16				299.72
MLR-052-PS025-200	Piston U-seal - Nitrile		2				18.84
MLR-052-PS025-250	Piston U-seal - Nitrile		2-1/2				19.97
MLR-052-PS025-325	Piston U-seal - Nitrile		3-1/4				21.68
MLR-052-PS025-400	Piston U-seal - Nitrile		4				21.50
MLR-052-PS025-500	Piston U-seal - Nitrile		5				25.60
MLR-052-PS025-600	Piston U-seal - Nitrile		6				32.80
MLR-052-PS025-700	Piston U-seal - Nitrile		7				20.51
MLR-052-WR005-1000-38	Wear Ring - PTFE		10				82.93
MLR-052-WR005-1200-38	Wear Ring - PTFE		12				104.43
MLR-052-WR005-150-25	Wear Ring - PTFE		1-1/2				29.35
MLR-052-WR005-1600-50	Wear Ring - PTFE		16				162.64
MLR-052-WR005-1800-50	Wear Ring - PTFE		18				168.25
MLR-052-WR005-2000-50	Wear Ring - PTFE		20				195.17
MLR-052-WR005-200-25	Wear Ring - PTFE		2				30.89
MLR-052-WR005-250-25	Wear Ring - PTFE		2-1/2				32.61
MLR-052-WR005-325-25	Wear Ring - PTFE		3-1/4				43.22
MLR-052-WR005-400-25	Wear Ring - PTFE		4				53.92
MLR-052-WR005-500-25	Wear Ring - PTFE		5				67.69

MILLER

Sales Part Number	Description	Rod Size	Bore Size	ID	Radial Wall	Width	List Price
MLR-052-WR005-600-25	Wear Ring - PTFE		6				\$ 80.93
MLR-052-WR005-700-38	Wear Ring - PTFE		7				55.28
MLR-052-WR005-800-38	Wear Ring - PTFE		8				78.32
MLR-052-WR008-1000-125	Wear Ring - Bronze		10				299.90
MLR-052-WR008-1200-125	Wear Ring - Bronze		12				328.31
MLR-052-WR008-700-75	Wear Ring - Bronze		7				191.99
MLR-052-WR008-800-125	Wear Ring - Bronze		8				257.05
MLR-052-WR009-150-25	Wear Ring - Acetal		1-1/2				23.47
MLR-052-WR009-200-25	Wear Ring - Acetal		2				27.03
MLR-052-WR009-200-31	Wear Ring - Acetal		2				27.45
MLR-052-WR009-250-25	Wear Ring - Acetal		2-1/2				33.26
MLR-052-WR009-250-38	Wear Ring - Acetal		2-1/2				35.31
MLR-052-WR009-325-25	Wear Ring - Acetal		3-1/4				45.52
MLR-052-WR009-325-50	Wear Ring - Acetal		3-1/4				50.51
MLR-052-WR009-400-25	Wear Ring - Acetal		4				52.83
MLR-052-WR009-400-63	Wear Ring - Acetal		4				71.40
MLR-052-WR009-500-75	Wear Ring - Acetal		5				141.98
MLR-052-WR009-600-75	Wear Ring - Acetal		6				183.90
MLR-090-ES006-1000	Tube End Seal		10				40.30
MLR-090-ES006-1200	Tube End Seal		12				47.02
MLR-090-ES006-1400	Tube End Seal		14				53.74
MLR-090-ES006-150	Tube End Seal		1-1/2				7.83
MLR-090-ES006-200	Tube End Seal		2				13.65
MLR-090-ES006-250	Tube End Seal		2-1/2				14.36
MLR-090-ES006-325	Tube End Seal		3-1/4				16.61
MLR-090-ES006-400	Tube End Seal		4				20.57
MLR-090-ES006-500	Tube End Seal		5				22.05
MLR-090-ES006-600	Tube End Seal		6				27.23
MLR-090-ES006-700	Tube End Seal		7				26.86
MLR-090-ES006-800	Tube End Seal		8				33.58
MLR-090-ES009-1000	Tube End Seal		10				72.10
MLR-090-ES009-1200	Tube End Seal		12				80.25
MLR-090-ES009-1400	Tube End Seal		14				79.66
MLR-090-ES009-150	Tube End Seal		1-1/2				9.02
MLR-090-ES009-200	Tube End Seal		2				16.46
MLR-090-ES009-250	Tube End Seal		2-1/2				16.52
MLR-090-ES009-325	Tube End Seal		3-1/4				16.66
MLR-090-ES009-400	Tube End Seal		4				24.66
MLR-090-ES009-500	Tube End Seal		5				31.05
MLR-090-ES009-600	Tube End Seal		6				38.68
MLR-090-ES009-700	Tube End Seal		7				48.57
MLR-090-ES009-800	Tube End Seal		8				60.45
MLR-090-KB001-1000	Piston Kit		10				225.70
MLR-090-KB001-1200	Piston Kit		12				258.63
MLR-090-KB001-150	Piston Kit		1-1/2				79.24
MLR-090-KB001-200	Piston Kit		2				101.54
MLR-090-KB001-250	Piston Kit		2-1/2				110.14
MLR-090-KB001-325	Piston Kit		3-1/4				124.85
MLR-090-KB001-400	Piston Kit		4				144.40
MLR-090-KB001-500	Piston Kit		5				153.44

MILLER

MILLER

Sales Part Number	Description	Rod Size	Bore Size	ID	Radial Wall	Width	List Price
MLR-090-KB001-600	Piston Kit		6				\$ 184.81
MLR-090-KB001-700	Piston Kit		7				195.68
MLR-090-KB001-800	Piston Kit		8				201.19
MLR-091-KB001-1000	Piston Kit		10				297.04
MLR-091-KB001-1200	Piston Kit		12				366.37
MLR-091-KB001-150	Piston Kit		1-1/2				91.22
MLR-091-KB001-200	Piston Kit		2				91.74
MLR-091-KB001-250	Piston Kit		2-1/2				106.83
MLR-091-KB001-325	Piston Kit		3-1/4				140.13
MLR-091-KB001-400	Piston Kit		4				154.17
MLR-091-KB001-500	Piston Kit		5				216.94
MLR-091-KB001-600	Piston Kit		6				231.81
MLR-091-KB001-700	Piston Kit		7				238.86
MLR-091-KB001-800	Piston Kit		8				257.29
MLR-150-KB001-325	Piston Kit		3-1/4				227.07
MLR-150-KB001-500	Piston Kit		5				381.94
MLR-170-ES006-1000	Tube End Seal		10				40.30
MLR-170-ES006-1200	Tube End Seal		12				47.02
MLR-170-ES006-1400	Tube End Seal		14				53.74
MLR-170-ES006-150	Tube End Seal		1-1/2				7.69
MLR-170-ES006-1800	Tube End Seal		18				67.18
MLR-170-ES006-200	Tube End Seal		2				14.02
MLR-170-ES006-250	Tube End Seal		2-1/2				14.20
MLR-170-ES006-325	Tube End Seal		3-1/4				14.66
MLR-170-ES006-400	Tube End Seal		4				20.89
MLR-170-ES006-500	Tube End Seal		5				21.99
MLR-170-ES006-600	Tube End Seal		6				26.02
MLR-170-ES006-700	Tube End Seal		7				26.86
MLR-170-ES006-800	Tube End Seal		8				33.58
MLR-170-ES010-1000	Tube End Seal		10				72.66
MLR-170-ES010-1200	Tube End Seal		12				80.97
MLR-170-ES010-150	Tube End Seal		1-1/2				13.86
MLR-170-ES010-200	Tube End Seal		2				19.62
MLR-170-ES010-250	Tube End Seal		2-1/2				25.46
MLR-170-ES010-325	Tube End Seal		3-1/4				26.54
MLR-170-ES010-400	Tube End Seal		4				31.75
MLR-170-ES010-500	Tube End Seal		5				38.05
MLR-170-ES010-600	Tube End Seal		6				44.03
MLR-170-ES010-700	Tube End Seal		7				49.98
MLR-170-ES010-800	Tube End Seal		8				62.59
MLR-171-KB001-1000	Piston Kit		10				761.68
MLR-171-KB001-1200	Piston Kit		12				862.16
MLR-171-KB001-150	Piston Kit		1-1/2				125.01
MLR-171-KB001-200	Piston Kit		2				144.81
MLR-171-KB001-250	Piston Kit		2-1/2				174.07
MLR-171-KB001-325	Piston Kit		3-1/4				206.98
MLR-171-KB001-400	Piston Kit		4				285.78
MLR-171-KB001-500	Piston Kit		5				331.97
MLR-171-KB001-600	Piston Kit		6				369.45
MLR-171-KB001-700	Piston Kit		7				520.67

MILLER

Sales Part Number	Description	Rod Size	Bore Size	ID	Radial Wall	Width	List Price
MLR-171-KB001-800	Piston Kit		8				\$ 650.03
MLR-181-KB001-150	Piston Kit		1-1/2				55.22
MLR-181-KB001-200	Piston Kit		2				57.57
MLR-181-KB001-250	Piston Kit		2-1/2				60.17
MLR-181-KB001-325	Piston Kit		3-1/4				66.65
MLR-181-KB001-400	Piston Kit		4				71.70
MLR-181-KB001-500	Piston Kit		5				84.89
MLR-181-KB001-600	Piston Kit		6				98.25
MLR-181-KB001-700	Piston Kit		7				99.50
MLR-181-KB001-800	Piston Kit		8				141.92
MLR-RG065-063	Iron Gland		5/8				37.72
MLR-RG065-100	Iron Gland		1				43.93
MLR-RG065-138	Iron Gland		1-3/8				54.92
MLR-RG065-175	Iron Gland		1-3/4				141.34
MLR-RG065-200	Iron Gland		2				152.86
MLR-RG065-250	Iron Gland		2-1/2				178.08
MLR-RG065-300	Iron Gland		3				204.29
MLR-RG065-350	Iron Gland		3-1/2				228.02
MLR-008-SH001-30	0.03cs x 0.07w PTFE strip (30' Spool)						120.30
MLR-SH1-STRIP	0.03cs x 0.07w PTFE strip (sold by the foot)						7.95

MILLER

ORTMAN

Various Kits

Kit #	Code	Rod x Bore	List Price
ORT-RS003540010	I-U-1	5/8 Rod Kit	\$ 15.95
ORT-RS003540020	I-U-1	1 Rod Kit	15.94
ORT-RS003540040	I-U-1	1-3/4 Rod Kit	30.22
ORT-RS003540060	I-U-1	2-1/2 Rod Kit	32.76
ORT-RS003540090	I-U-1	4" Rod Kit	51.96
ORT-TS563511000	N-N-5	3-1/4 Piston Kit	46.99
ORT-TS583511000	N-N-5	4 Piston Kit	35.65
ORT-TS603511000	N-N-5	6 Piston Kit	93.52
ORT-TS777512000	N-N-5	1-1/2 Piston Kit	10.64

Kit Composition Varies

Consult your
Hercules® Sealing Products representative.

PARKER

Kit Type		Page
Rod Gland Kits	A, 2A, 2AN, H, 2H, HD, 3H, VH, L, 2L, 3L, HMI, MA & 2MA Air Cylinders	82 - 88
Rod Kits	A, 2A, 2AN, H, 2H, HD, 3H, VH, L, 2L, 3L, HMI, 2MA Air & 2ML Cylinders	89 - 95
Bronze Rod Glands	A, 2A, 2AN, H, 2H, HD, VH, L, 2L, 3L, MA, HMI, 2MA Air & Hydraulic Cylinders	96 - 97
Gland Wrenches	For Parker Glands	98
Rod & Piston Seal Kits	MA Air Cylinders	99
Piston Kits	HD, HL, 2HL, L, LL, 2LL, & 3LL Hydraulic Cylinders, 1A & 2A Air Cylinders, 2AN, 2MA & 2ML Cylinders, L, 2L, 3L, H, 2H, HD, VH & HMI Cylinders	100 - 107
Piston Ring Kits	H, HD, 2H, L, 2L, & 3L Hydraulic Cylinders	108
Piston Head Seal Kits	2A, 2H, 3L, HD, VH, 2MA, ML & HMI Cylinders	109 - 110
Various Kits		111
Repair Kits	By Part Number	112 - 122

PARKER

Rod Gland Kits

A, 2A, H, 2H, VH, L, 2L, & 3L Cylinders

Nitrile

Fluorocarbon

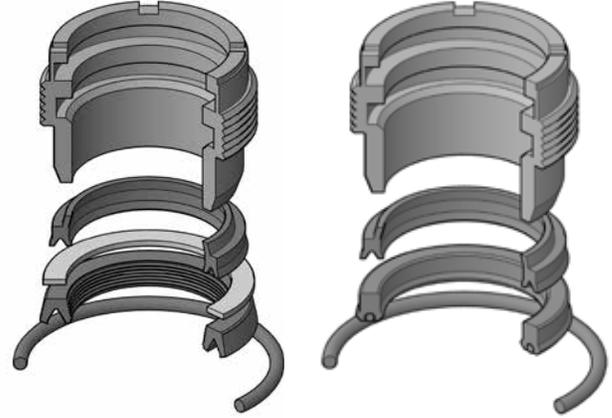
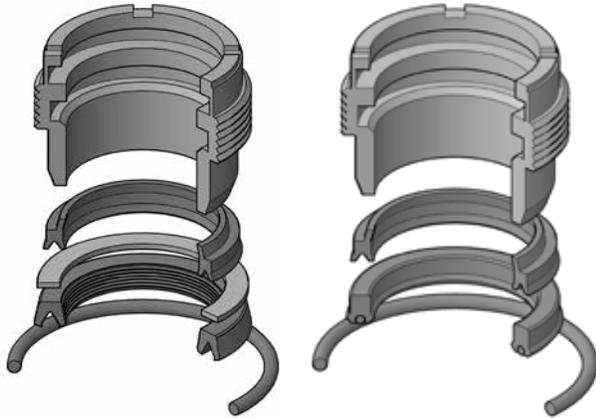

1/2" - 3"

Kit Includes:

- 1 Bronze Gland
- 1 XNBR Wiper
- 1 URE Back-up Ring
- 1 NBR U-seal
- 1 NBR O-ring

3-1/2" - 5-1/2"

Kit Includes:

- 1 Bronze Gland
- 1 XNBR Wiper
- 1 NBR Loaded U-seal
- 1 NBR O-ring

1/2" - 3"

Kit Includes:

- 1 Bronze Gland
- 1 FC Wiper
- 1 PTFE Back-up Ring
- 1 FC U-seal
- 1 FC O-ring

3-1/2" - 5-1/2"

Kit Includes:

- 1 Bronze Gland
- 1 FC Wiper
- 1 FC Loaded U-seal
- 1 FC O-ring

Rod Dia.	Kit #	List Price	Kit #	List Price
1/2"	PKH-RG2AHL0051	\$ 64.99	PKH-RG2AHL0055	\$ 83.53
5/8"	PKH-RG2AHL0061	39.24	PKH-RG2AHL0065	64.03
1"	PKH-RG2AHL0101	48.12	PKH-RG2AHL0105	72.46
1-3/8"	PKH-RG2AHL0131	58.66	PKH-RG2AHL0135	91.03
1-3/4"	PKH-RG2AHL0171	67.94	PKH-RG2AHL0175	99.41
2"	PKH-RG2AHL0201	84.76	PKH-RG2AHL0205	118.32
2-1/2"	PKH-RG2AHL0251	115.64	PKH-RG2AHL0255	153.66
3"	PKH-RG2AHL0301	148.42	PKH-RG2AHL0305	174.68
3-1/2"	PKH-RG2AHL0351	325.37	PKH-RG2AHL0355	352.59
4"	PKH-RG2AHL0401	395.70	PKH-RG2AHL0405	415.46
4-1/2"	PKH-RG2AHL0451	492.33	PKH-RG2AHL0455	496.39
5"	PKH-RG2AHL0501	547.76	PKH-RG2AHL0505	620.05
5-1/2"	PKH-RG2AHL0551	564.93	PKH-RG2AHL0555	676.71

PARKER

PARKER

Rod Gland Kits

HD Cylinders

Urethane



Kit Includes:

- 1 Bronze Gland
- 1 XNBR Wiper
- 1 URE Multi-lip U-seal
- 1 NBR Back-up Ring
- 1 NBR O-ring

Fluorocarbon



Kit Includes:

- 1 Bronze Gland
- 1 FC Wiper
- 1 Multi-lip FC U-seal
- 2 PTFE Back-up Rings
- 1 FC O-ring

Rod Dia.	Kit #	List Price	Kit #	List Price
5/8"	PKH-RG1HDL0061	\$ 55.23	PKH-RG1HDL0065	\$ 66.94
1"	PKH-RG1HDL0101	71.11	PKH-RG1HDL0105	82.44
1-3/8"	PKH-RG1HDL0131	92.34	PKH-RG1HDL0135	111.77
1-3/4"	PKH-RG1HDL0171	109.13	PKH-RG1HDL0175	136.34
2"	PKH-RG1HDL0201	157.01	PKH-RG1HDL0205	184.94
2-1/2"	PKH-RG1HDL0251	210.23	PKH-RG1HDL0255	241.18
3"	PKH-RG1HDL0351	260.60	PKH-RG1HDL0355	296.23

PARKER

Rod Gland Kits

2AN Air Cylinders Nitrile

PARKER

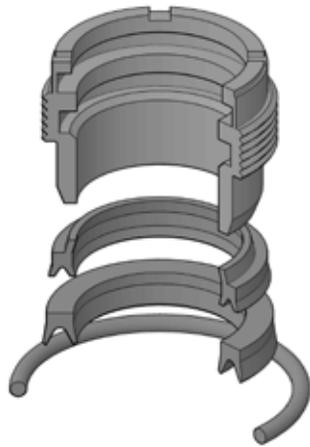

1/2" - 2-1/2"
Kit Includes:
 1 Bronze Gland
 1 XNBR Wiper
 1 NBR U-seal
 1 NBR O-ring

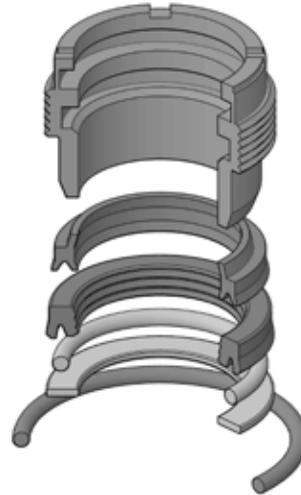

3" - 5-1/2"
Kit Includes:
 1 Bronze Gland
 1 XNBR Wiper
 1 NBR Multi-lip U-seal
 1 Felt Wick
 1 Felt Washer
 1 NBR O-ring

Rod Dia.	Kit #	List Price
1/2"	PKH-RG2AN00051	\$ 42.25
5/8"	PKH-RG2AN00061	43.98
1"	PKH-RG2AN00101	49.42
1-3/8"	PKH-RG2AN00131	52.59
1-3/4"	PKH-RG2AN00171	66.08
2"	PKH-RG2AN00201	80.45
2-1/2"	PKH-RG2AN00251	131.59
3"	PKH-RG2AN00301	199.98
3-1/2"	PKH-RG2AN00351	284.45
4"	PKH-RG2AN00401	381.00
4-1/2"	PKH-RG2AN00451	472.37
5"	PKH-RG2AN00501	563.16
5-1/2"	PKH-RG2AN00551	630.97

PARKER

Rod Gland Kits

H*, 2H*, 3H (7" & 8" Bore), VH, L, 2L, and 3L Cylinders
Urethane

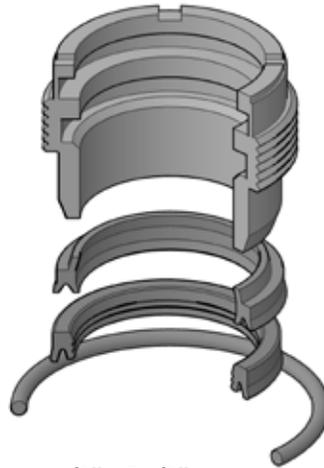

1/2" - 5-1/2"

Kit Includes:

- 1 Bronze Gland
- 1 XNBR Wiper
- 1 Multi-lip Urethane U-seal
- 1 NBR O-ring

Rod Dia.	Kit #	List Price
1/2"	PKH-RG2HLTS051	\$ 95.27
5/8"	PKH-RG2HLTS061	73.06
1"	PKH-RG2HLTS101	82.89
1-3/8"	PKH-RG2HLTS131	96.98
1-3/4"	PKH-RG2HLTS171	104.07
2"	PKH-RG2HLTS201	135.34
2-1/2"	PKH-RG2HLTS251	175.63
3"	PKH-RG2HLTS301	217.71
3-1/2"	PKH-RG2HLTS351	308.05
4"	PKH-RG2HLTS401	402.65
4-1/2"	PKH-RG2HLTS451	437.96
5"	PKH-RG2HLTS501	578.20
5-1/2"	PKH-RG2HLTS551	596.70

* Excludes 10" and 12" Bore for Series H and 2H.

PARKER

Rod Gland Kits

MA Air Cylinders

Nitrile

Fluorocarbon

5/8" Rod Gland profile

1" & 1-3/8" Rod Gland profile

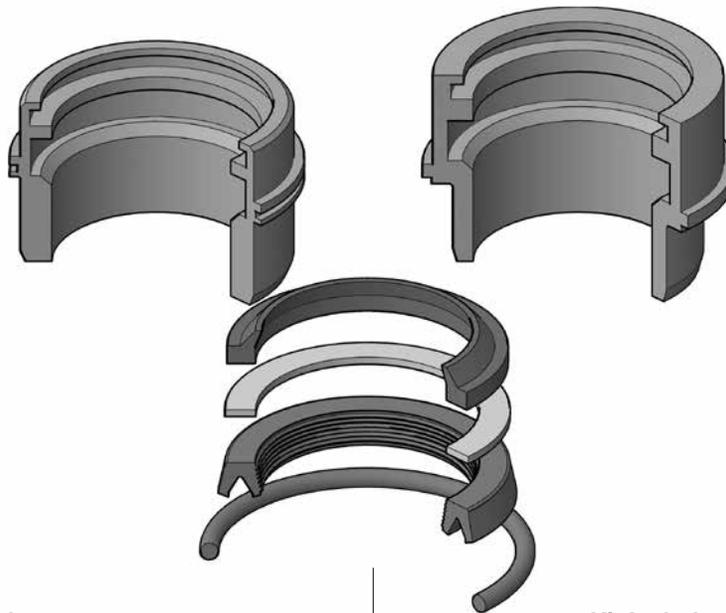

Kit Includes:

- 1 Bronze Gland
- 1 URE Wiper
- 1 PTFE Back-up Ring
- 1 NBR Multi-lip U-seal
- 1 NBR O-ring

Kit Includes:

- 1 Bronze Gland
- 1 FC Wiper
- 1 PTFE Back-up Ring
- 1 FC Multi-lip U-seal
- 1 FC O-ring

Rod Dia.	Kit #	List Price	Kit #	List Price
5/8"	PKH-RGL6948MA1	\$ 48.95	PKH-RGL6948MA5	\$ 55.51
1"	PKH-RGL6949MA1	41.06	PKH-RGL6949MA5	52.93
1-3/8"	PKH-RGL6950MA1	48.87	PKH-RGL6950MA5	65.38

PARKER

PARKER

Rod Gland Kits

2MA Air Cylinders

Nitrile

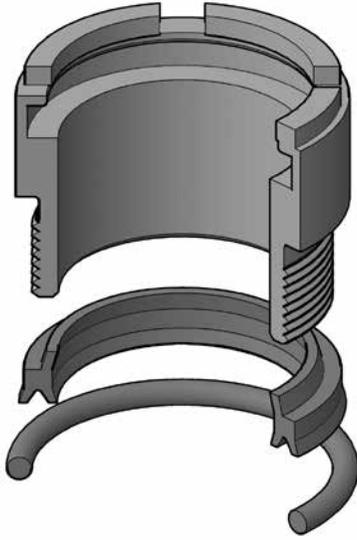

1/2" - 1-3/4"

Kit Includes:

- 1 Bronze Gland
- 1 XNBR Wiper/Seal
- 1 NBR O-ring
- 1 Tube Seal Lubricant

Fluorocarbon

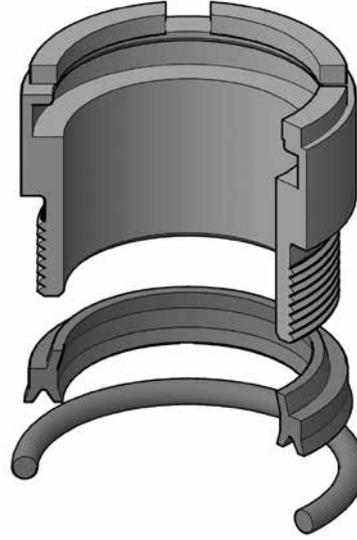

1/2" - 1-3/4"

Kit Includes:

- 1 Bronze Gland
- 1 FC Wiper/Seal
- 1 FC O-ring
- 1 Tube Seal Lubricant

Rod Dia.	Kit #	List Price	Kit #	List Price
1/2"	PKH-RG02MA0051	\$ 40.72	PKH-RG02MA0055	\$ 43.39
5/8"	PKH-RG02MA0061	26.90	PKH-RG02MA0065	42.96
1"	PKH-RG02MA0101	30.82	PKH-RG02MA0105	47.60
1-3/8"	PKH-RG02MA0131	46.03	PKH-RG02MA0135	68.81
1-3/4"	PKH-RG02MA0171	93.67	PKH-RG02MA0175	105.07

PARKER

Rod Gland Kits

HMI Cylinders

Urethane

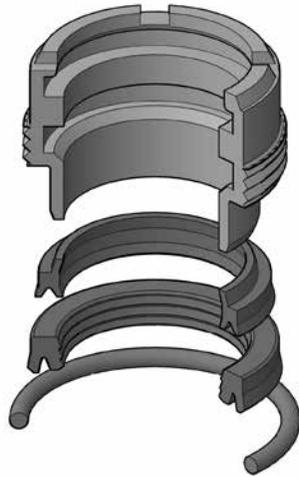

- Kit Includes:**
- 1 Bronze Gland
 - 1 URE Wiper
 - 1 URE Multi-lip U-seal
 - 1 NBR O-ring

Fluorocarbon

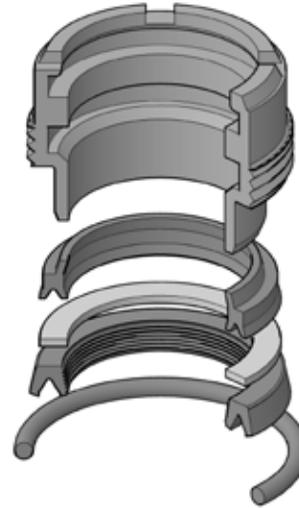

- Kit Includes:**
- 1 Bronze Gland
 - 1 FC Wiper
 - 1 PTFE Back-up Ring
 - 1 FC Multi-lip U-seal
 - 1 FC O-ring

Rod Dia.	Kit #	List Price	Kit #	List Price
12 mm	PKH-RG2HM0121	\$ 61.44	PKH-RG2HM0125	\$ 68.80
14 mm	PKH-RG2HM0141	87.39	PKH-RG2HM0145	94.61
18 mm	PKH-RG2HM0181	85.23	PKH-RG2HM0185	101.06
22 mm	PKH-RG2HM0221	87.98	PKH-RG2HM0225	105.92
28 mm	PKH-RG2HM0281	90.03	PKH-RG2HM0285	117.30
36 mm	PKH-RG2HM0361	86.23	PKH-RG2HM0365	113.88
45 mm	PKH-RG2HM0451	95.53	PKH-RG2HM0455	117.37
56 mm	PKH-RG2HM0561	176.55	PKH-RG2HM0565	218.79
70 mm	PKH-RG2HM0701	259.54	PKH-RG2HM0705	318.11

PARKER

PARKER

Rod Kits

A, 2A, H, 2H, VH, L, 2L, & 3L Cylinders

Nitrile

Fluorocarbon



1/2" - 3"

Kit Includes:

- 1 XNBR Wiper
- 1 URE Back-up Ring
- 1 NBR U-seal
- 1 NBR O-ring



3-1/2" - 5-1/2"

Kit Includes:

- 1 XNBR Wiper
- 1 NBR Loaded U-seal
- 1 NBR O-ring

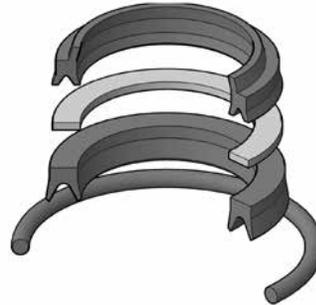

1/2" - 3"

Kit Includes:

- 1 FC Wiper
- 1 PTFE Back-up Ring
- 1 FC U-seal
- 1 FC O-ring



3-1/2" - 5-1/2"

Kit Includes:

- 1 FC Wiper
- 1 FC Loaded U-seal
- 1 FC O-ring

Rod Dia.	Kit #	List Price	Kit #	List Price
1/2"	PKH-RK2AHL0051	\$ 7.53	PKH-RK2AHL0055	\$ 31.29
5/8"	PKH-RK2AHL0061	13.05	PKH-RK2AHL0065	34.39
1"	PKH-RK2AHL0101	9.43	PKH-RK2AHL0105	38.64
1-3/8"	PKH-RK2AHL0131	10.36	PKH-RK2AHL0135	50.04
1-3/4"	PKH-RK2AHL0171	11.99	PKH-RK2AHL0175	52.12
2"	PKH-RK2AHL0201	13.24	PKH-RK2AHL0205	54.32
2-1/2"	PKH-RK2AHL0251	14.86	PKH-RK2AHL0255	59.44
3"	PKH-RK2AHL0301	19.27	PKH-RK2AHL0305	71.74
3-1/2"	PKH-RK2AHL0351	90.18	PKH-RK2AHL0355	148.81
4"	PKH-RK2AHL0401	112.02	PKH-RK2AHL0405	172.43
4-1/2"	PKH-RK2AHL0451	131.35	PKH-RK2AHL0455	215.81
5"	PKH-RK2AHL0501	163.54	PKH-RK2AHL0505	252.16
5-1/2"	PKH-RK2AHL0551	182.61	PKH-RK2AHL0555	361.77

PARKER

Rod Kits

HD Cylinders

Urethane



- Kit Includes:**
- 1 XNBR Wiper
 - 1 Multi-lip Urethane U-seal
 - 1 NBR O-ring
 - 1 NBR Back-up Ring

Fluorocarbon



- Kit Includes:**
- 1 FC Wiper
 - 1 Multi-lip FC U-seal
 - 2 PTFE Back-up Rings
 - 1 FC O-ring

Rod Dia.	Kit #	List Price	Kit #	List Price
5/8"	PKH-RK1HDL0061	\$ 10.49	PKH-RK1HDL0065	\$ 22.20
1"	PKH-RK1HDL0101	12.40	PKH-RK1HDL0105	23.73
1-3/8"	PKH-RK1HDL0131	15.17	PKH-RK1HDL0135	34.60
1-3/4"	PKH-RK1HDL0171	18.68	PKH-RK1HDL0175	38.65
2"	PKH-RK1HDL0201	23.49	PKH-RK1HDL0205	41.07
2-1/2"	PKH-RK1HDL0251	33.18	PKH-RK1HDL0255	64.14
3-1/2"	PKH-RK1HDL0351	43.19	PKH-RK1HDL0355	78.82

PARKER

PARKER

Rod Kits

2AN Air Cylinders Nitrile



1/2" - 2-1/2"

Kit Includes:

- 1 XNBR Wiper
- 1 NBR U-seal
- 1 NBR O-ring

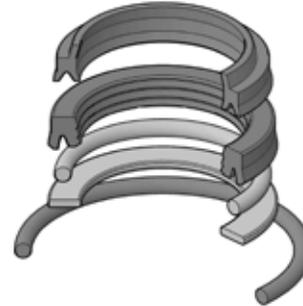

3" - 5-1/2"

Kit Includes:

- 1 XNBR Wiper
- 1 NBR Multi-lip U-seal
- 1 Felt Wick
- 1 Felt Washer
- 1 NBR O-ring

Rod Dia.	Kit #	List Price
1/2"	PKH-RK2AN00051	\$ 18.39
5/8"	PKH-RK2AN00061	19.27
1"	PKH-RK2AN00101	22.14
1-3/8"	PKH-RK2AN00131	24.44
1-3/4"	PKH-RK2AN00171	28.73
2"	PKH-RK2AN00201	33.91
2-1/2"	PKH-RK2AN00251	49.15
3"	PKH-RK2AN00301	81.03
3-1/2"	PKH-RK2AN00351	128.15
4"	PKH-RK2AN00401	155.16
4-1/2"	PKH-RK2AN00451	170.10
5"	PKH-RK2AN00501	186.18
5-1/2"	PKH-RK2AN00551	222.39

PARKER

Rod Kits

H*, 2H*, 3H (7" & 8" Bore), VH, L, 2L, and 3L Cylinders Urethane

Standard seals for Series 2H*, VH, 3L, and 3H (7" and 8" Bore) manufactured after September 30, 1990.
Interchangeable seals for Series H*, 2H*, VH, L, 2L, and 3L manufactured before September 30, 1990.

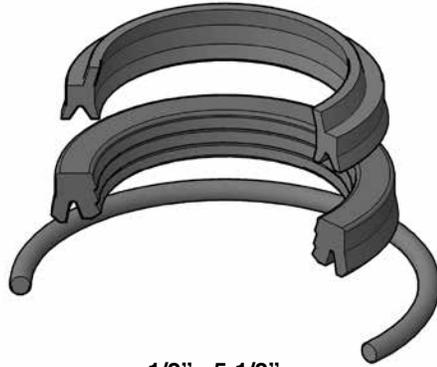

1/2" - 5-1/2"

Kit Includes:

- 1 XNBR Wiper
- 1 Multi-lip Urethane U-seal
- 1 NBR O-ring

Rod Dia.	Kit #	List Price
1/2"	PKH-RK2HLTS051	\$ 22.46
5/8"	PKH-RK2HLTS061	23.01
1"	PKH-RK2HLTS101	27.20
1-3/8"	PKH-RK2HLTS131	32.13
1-3/4"	PKH-RK2HLTS171	37.33
2"	PKH-RK2HLTS201	42.78
2-1/2"	PKH-RK2HLTS251	45.77
3"	PKH-RK2HLTS301	49.75
3-1/2"	PKH-RK2HLTS351	59.61
4"	PKH-RK2HLTS401	66.59
4-1/2"	PKH-RK2HLTS451	72.71
5"	PKH-RK2HLTS501	78.89
5-1/2"	PKH-RK2HLTS551	86.61

* Excludes 10" and 12" Bore for Series H and 2H.

PARKER

Rod Kits

2MA Air Cylinders

Nitrile

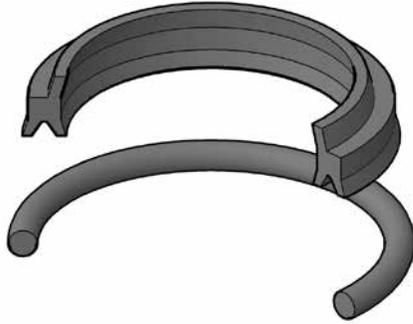

1/2" - 1-3/4"

Kit Includes:

- 1 XNBR Wiper/Seal
- 1 NBR O-ring
- 1 Tube Seal Lubricant

Fluorocarbon

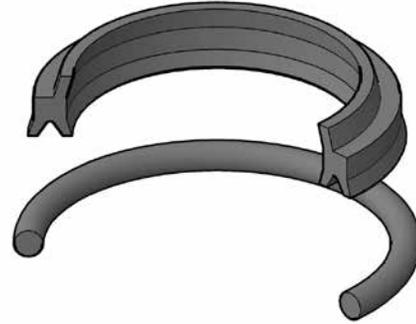

1/2" - 1-3/4"

Kit Includes:

- 1 FC Wiper/Seal
- 1 FC O-ring
- 1 Tube Seal Lubricant

Rod Dia.	Kit #	List Price	Kit #	List Price
1/2"	PKH-RK02MA0051	\$ 13.14	PKH-RK02MA0055	\$ 19.64
5/8"	PKH-RK02MA0061	13.55	PKH-RK02MA0065	20.18
1"	PKH-RK02MA0101	13.89	PKH-RK02MA0105	20.84
1-3/8"	PKH-RK02MA0131	14.86	PKH-RK02MA0135	26.10
1-3/4"	PKH-RK02MA0171	15.88	PKH-RK02MA0175	32.82

PARKER

Rod Kits

2ML Hydraulic Cylinders Urethane



Rod Dia.	Kit #	List Price
5/8"	PKH-RK02ML0061	\$ 17.39
1"	PKH-RK02ML0101	17.97
1-3/8"	PKH-RK02ML0131	20.39
1-3/4"	PKH-RK02ML0171	23.30

1/2" - 5-1/2"

Kit Includes:

- 1 XNBR Wiper / Seal
- 1 Multi-lip Urethane U-seal
- 1 NBR O-ring

PARKER

PARKER

Rod Kits

HMI Cylinders

Urethane



Kit Includes:

- 1 URE Wiper
- 1 URE Multi-lip U-seal
- 1 NBR O-ring

Fluorocarbon

12 - 70mm

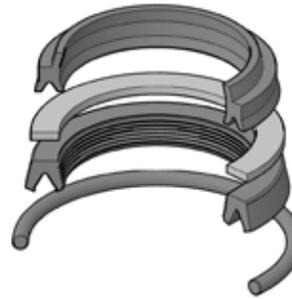

90 - 140mm



Kit Includes:

- 1 FC Wiper
- 1 PTFE Back-up Ring*
- 1 FC Multi-lip U-seal*
- 1 FC O-ring

Rod Dia.	Kit #	List Price	Kit #	List Price
12 mm	PKH-RK2HM0121	\$ 27.90	PKH-RK2HM0125	\$ 35.31
14 mm	PKH-RK2HM0141	28.74	PKH-RK2HM0145	36.00
18 mm	PKH-RK2HM0181	22.25	PKH-RK2HM0185	38.07
22 mm	PKH-RK2HM0221	30.96	PKH-RK2HM0225	39.74
28 mm	PKH-RK2HM0281	13.98	PKH-RK2HM0285	47.75
36 mm	PKH-RK2HM0361	21.26	PKH-RK2HM0365	48.92
45 mm	PKH-RK2HM0451	33.95	PKH-RK2HM0455	55.72
56 mm	PKH-RK2HM0561	36.24	PKH-RK2HM0565	78.50
70 mm	PKH-RK2HM0701	27.82	PKH-RK2HM0705	86.38
90 mm	PKH-RK2HM0901	52.28	PKH-RK2HM0905	281.13
110 mm	PKH-RK2HM1101	67.50	PKH-RK2HM1105	375.75
140 mm	PKH-RK2HM1401	87.61	PKH-RK2HM1405	449.92

* 90, 110, & 140mm Fluorocarbon kits use (1) FC Single Lip Rod U-seal w/ a Bronze/PTFE ID back-up ring

PARKER

Bronze Rod Glands

A, 2A, 2AN, H, 2H, VH, L, 2L, & 3L Air and Hydraulic Cylinders

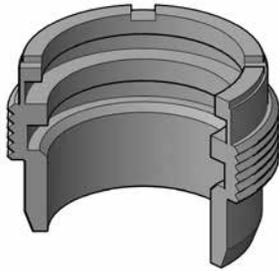

Rod Dia.	Part #	List Price
1/2"	PKH-RG-05	\$ 38.07
5/8"	PKH-RG-06	22.94
1"	PKH-RG-10	26.63
1-3/8"	PKH-RG-13	36.95
1-3/4"	PKH-RG-17	44.94
2"	PKH-RG-20	54.93
2-1/2"	PKH-RG-25	77.50
3"	PKH-RG-30	107.13
3-1/2"	PKH-RG-35	251.32
4"	PKH-RG-40	256.03
4-1/2"	PKH-RG-45	368.19
5"	PKH-RG-50	426.56
5-1/2"	PKH-RG-55	449.86

MA Air Cylinders

5/8" Rod Gland profile

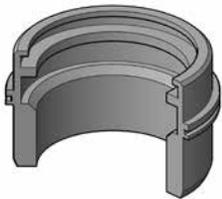

1" & 1-3/8" Rod Gland profile

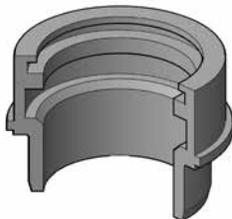

Rod Dia.	Part #	List Price
5/8"	PKH-RGMA-06	\$ 41.26
1"	PKH-RGMA-10	32.64
1-3/8"	PKH-RGMA-13	39.74

2MA Air Cylinders

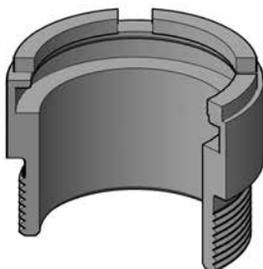

Rod Dia.	Part #	List Price
1/2"	PKH-RG02MA-05	\$ 36.67
5/8"	PKH-RG02MA-06	27.02
1"	PKH-RG02MA-10	33.82
1-3/8"	PKH-RG02MA-13	48.90
1-3/4"	PKH-RG02MA-17	77.01

PARKER

PARKER

Bronze Rod Glands

HMI Hydraulic Cylinders

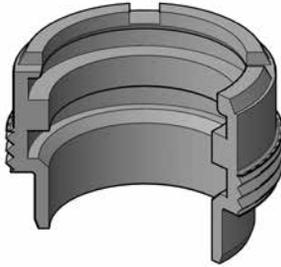

Rod Dia.	Part #	List Price
12 mm	PKH-RGHM-012	\$ 29.01
14 mm	PKH-RGHM-014	50.69
18 mm	PKH-RGHM-018	54.46
22 mm	PKH-RGHM-022	53.24
28 mm	PKH-RGHM-028	57.77
36 mm	PKH-RGHM-036	56.18
45 mm	PKH-RGHM-045	53.27
56 mm	PKH-RGHM-056	121.34
70 mm	PKH-RGHM-070	200.38

HD Hydraulic Cylinders

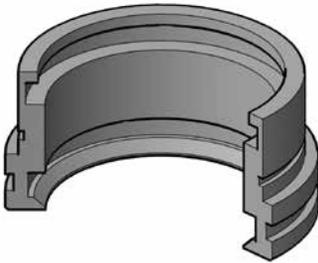

Rod Dia.	Part #	List Price
5/8"	PKH-RGHD-06	\$ 44.73
1"	PKH-RGHD-10	58.71
1-3/8"	PKH-RGHD-13	77.17
1-3/4"	PKH-RGHD-17	97.69
2"	PKH-RGHD-20	143.87
2-1/2"	PKH-RGHD-25	177.04
3-1/2"	PKH-RGHD-35	217.41

PARKER

Gland Wrenches

Parker Gland Wrenches

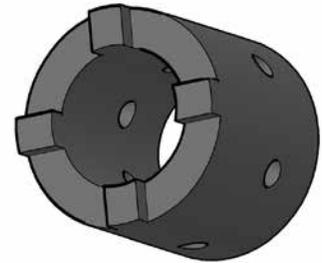
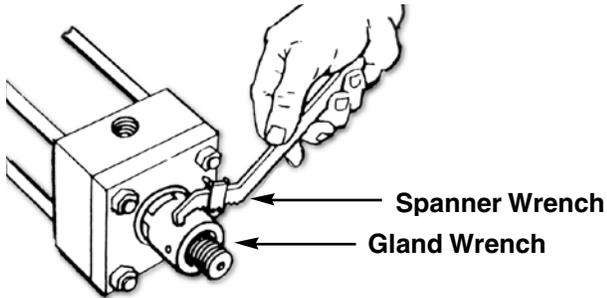

PARKER

Rod Dia.	Kit #	ID X OD X HT	List Price
1/2", 5/8", 12mm & 14mm	PKH-069590	11/16" X 1-1/8" X 1-3/8"	\$ 107.74
18mm	PKH-084765	13/16" X 1-1/4" X 1-7/16"	99.94
1" & 22mm	PKH-069591	1-1/16" X 1-5/8" X 1-1/2"	109.57
28mm	PKH-084766	1-1/4" X 1-11/16" X 1-9/16"	115.53
1-3/8" & 36mm	PKH-069592	1-7/16" X 1-7/8" X 1-5/8"	113.15
1-3/4" & 45mm	PKH-069593	1-13/16" X 2-1/4" X 1-5/8"	114.93
2"	PKH-069594	2-1/16" X 2-1/2" X 2"	129.30
2-1/2" & 56mm	PKH-069595	2-9/16" X 3" X 2-1/8"	143.65
70mm	PKH-069596	2-15/16" X 3-1/2" X 2-3/8"	150.95

PARKER

Rod & Piston Seal Kits

MA Air Cylinders

Nitrile

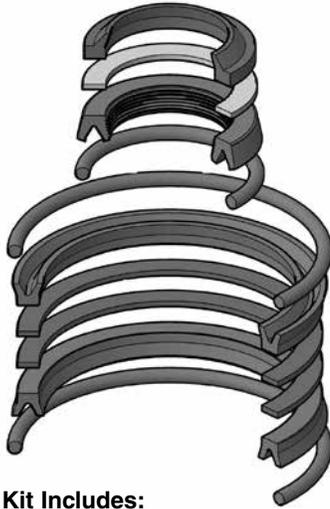

Kit Includes:

- 1 URE Wiper
- 1 PTFE Back-up Ring
- 1 NBR Multi-lip U-seal
- 2 NBR U-seals
- 2 URE Back-up Rings
- 3 NBR O-rings

Fluorocarbon

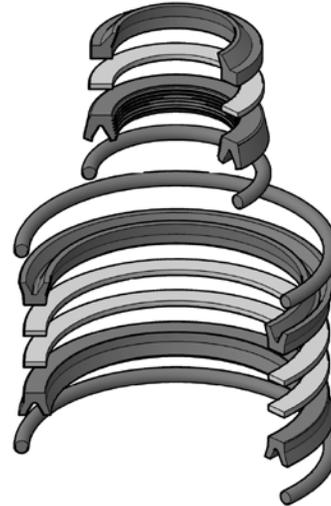

Kit Includes:

- 1 FC Wiper
- 1 FC Multi-lip U-seal
- 2 FC U-seals
- 3 PTFE Back-up Ring
- 3 FC O-rings

Rod Dia.	Bore Dia.	(NBR) Kit #	List Price	(FC) Kit #	List Price
5/8"	1-1/2"	PKH-SKL7000MA1	\$ 21.38	PKH-SKL7000MA5	\$ 60.16
5/8"	2"	PKH-SKL7001MA1	21.57	PKH-SKL7001MA5	62.93
1"	2"	PKH-SKL7002MA1	21.93	PKH-SKL7002MA5	65.71
5/8"	2-1/2"	PKH-SKL7003MA1	28.44	PKH-SKL7003MA5	76.94
1"	2-1/2"	PKH-SKL7004MA1	23.69	PKH-SKL7004MA5	79.72
1"	3-1/4"	PKH-SKL7005MA1	24.61	PKH-SKL7005MA5	84.33
1-3/8"	3-1/4"	PKH-SKL7006MA1	27.88	PKH-SKL7006MA5	96.21
1"	4"	PKH-SKL7007MA1	28.44	PKH-SKL7007MA5	100.02
1-3/8"	4"	PKH-SKL7008MA1	30.68	PKH-SKL7008MA5	111.98
1"	5"	PKH-SKL7009MA1	35.13	PKH-SKL7009MA5	121.92
1-3/8"	5"	PKH-SKL7010MA1	38.42	PKH-SKL7010MA5	133.90
1-3/8"	6"	PKH-SKL7098MA1	41.38	PKH-SKL7098MA5	165.22

PARKER

Piston Kits

HD, HL, 2HL, L, LL, 2LL, & 3LL Hydraulic Cylinders

Nitrile

Fluorocarbon

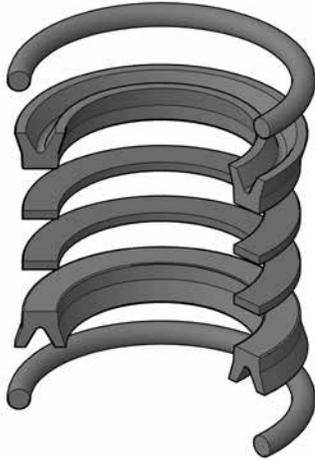

Kit Includes:

2 NBR U-seals
2 NBR O-ring Head Seals
2 URE Back-up Rings

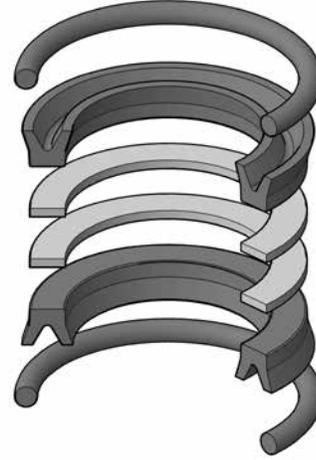

Kit Includes:

2 FC U-seals
2 FC O-ring Head Seals
2 PTFE Back-up Rings

Bore Dia.	(NBR) Kit #	List Price	(FC) Kit #	List Price
1"	PKH-PK102HLL01	\$ 13.77	PKH-PK102HLL05	\$ 48.07
1-1/2"	PKH-PK152HLL01	10.13	PKH-PK152HLL05	49.92
2"	PKH-PK202HLL01	12.91	PKH-PK202HLL05	77.82
2-1/2"	PKH-PK252HLL01	14.98	PKH-PK252HLL05	78.85
3-1/4"	PKH-PK322HLL01	18.57	PKH-PK322HLL05	84.98
4"	PKH-PK402HLL01	24.41	PKH-PK402HLL05	106.12
5"	PKH-PK502HLL01	28.40	PKH-PK502HLL05	126.80
6"	PKH-PK602HLL01	36.92	PKH-PK602HLL05	169.53
7"	PKH-PK702HLL01	98.09	PKH-PK702HLL05	268.77
8"	PKH-PK802HLL01	107.43	PKH-PK802HLL05	367.71
10"	PKH-PK902HLL01	191.55	PKH-PK902HLL05	574.64
12"	PKH-PK922HLL01	259.91	PKH-PK922HLL05	716.95

PARKER

Piston Kits

1A & 2A Air Cylinders

Nitrile

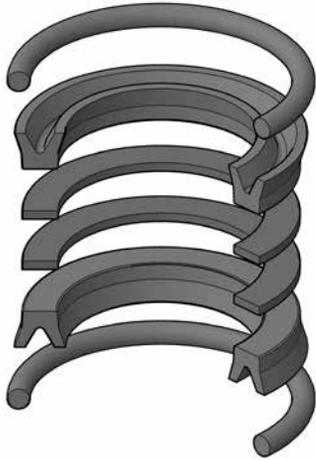

Kit Includes:

- 2 NBR O-ring Head Seals
- 2 NBR U-seals
- 2 URE Back-up Rings

Fluorocarbon

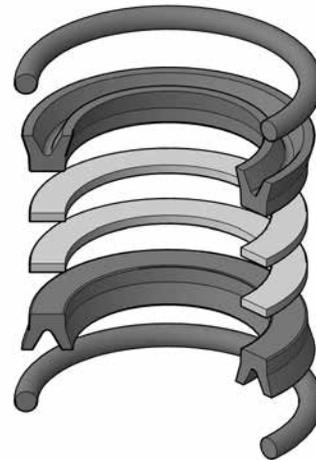

Kit Includes:

- 2 FC O-ring Head Seals
- 2 FC U-seals
- 2 PTFE Back-up Rings

Bore Dia.	(NBR) Kit #	List Price	(FC) Kit #	List Price
1"	PKH-PK1002A001	9.34	PKH-PK1002A005	\$ 35.43
1-1/2"	PKH-PK1502A001	10.97	PKH-PK1502A005	49.92
2"	PKH-PK2002A001	12.91	PKH-PK2002A005	56.97
2-1/2"	PKH-PK2502A001	14.98	PKH-PK2502A005	79.95
3-1/4"	PKH-PK3202A001	18.57	PKH-PK3202A005	93.31
4"	PKH-PK4002A001	24.41	PKH-PK4002A005	100.57
5"	PKH-PK5002A001	28.47	PKH-PK5002A005	127.64
6"	PKH-PK6002A001	36.99	PKH-PK6002A005	169.65
7"	PKH-PK7002A001	92.27	PKH-PK7002A005	268.90
8"	PKH-PK8002A001	107.43	PKH-PK8002A005	367.71
10"	PKH-PK9002A001	159.10	PKH-PK9002A005	466.71
12"	PKH-PK9202A001	216.15	PKH-PK9202A005	716.95
14"	PKH-PK9402A001	334.33	PKH-PK9402A005	1171.36

PARKER

Piston Kits

2AN Cylinders Nitrile



Kit Includes:
2 NBR O-ring Head Seals
2 NBR U-seals

Bore Dia.	Kit #	List Price
1"	PKH-PK1002AN01	\$ 19.17
1-1/2"	PKH-PK1502AN01	21.30
2"	PKH-PK2002AN01	23.80
2-1/2"	PKH-PK2502AN01	29.06
3-1/4"	PKH-PK3202AN01	37.96
4"	PKH-PK4002AN01	46.99
5"	PKH-PK5002AN01	56.39
6"	PKH-PK6002AN01	89.84
7"	PKH-PK7002AN01	97.62
8"	PKH-PK8002AN01	139.45
10"	PKH-PK9002AN01	208.28
12"	PKH-PK9202AN01	381.50

PARKER

Piston Kits

2MA Cylinders

Nitrile

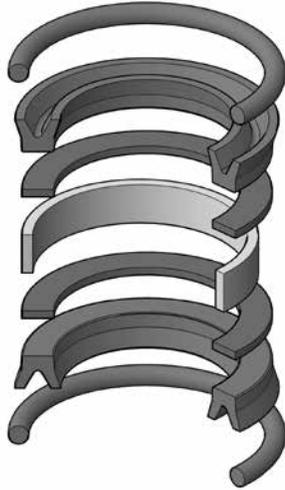

Kit Includes:
 2 NBR O-ring Head Seals
 2 NBR U-seals
 2 URE Back-up Rings
 1 Nylon Wear Ring
 1 Tube Seal Lubricant

Fluorocarbon

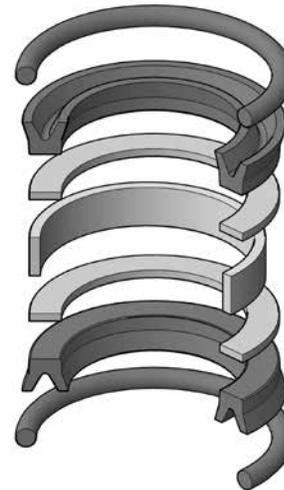

Kit Includes:
 2 FC O-ring Head Seals
 2 FC U-seals
 2 PTFE Back-up Rings
 1 Nylon Wear Ring
 1 Tube Seal Lubricant

Bore Dia.	(NBR) Kit #	List Price	(FC) Kit #	List Price
1-1/2"	PKH-PK1502MA01	\$ 24.50	PKH-PK1502MA05	\$ 47.73
2"	PKH-PK2002MA01	24.83	PKH-PK2002MA05	51.11
2-1/2"	PKH-PK2502MA01	26.62	PKH-PK2502MA05	67.84
3-1/4"	PKH-PK3202MA01	32.00	PKH-PK3202MA05	83.86
4"	PKH-PK4002MA01	39.24	PKH-PK4002MA05	95.00
5"	PKH-PK5002MA01	50.78	PKH-PK5002MA05	143.77
6"	PKH-PK6002MA01	67.89	PKH-PK6002MA05	203.63
8"	PKH-PK8002MA01	119.85	PKH-PK8002MA05	340.50

PARKER

Piston Kits

2ML Cylinders Nitrile

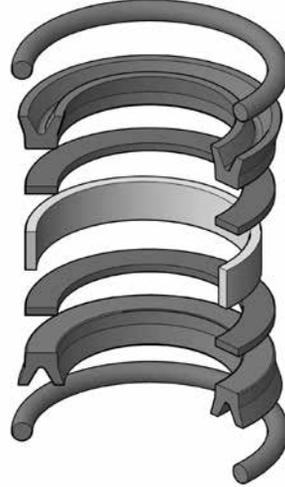

Kit Includes:

- 2 NBR O-ring Head Seals
- 2 NBR U-seals
- 2 URE Back-up Rings
- 1 Nylon Wear Ring

Rod Dia.	Kit #	List Price
1-1/2"	PKH-PK1502ML01	\$ 29.66
2"	PKH-PK2002ML01	22.45
2-1/2"	PKH-PK2502ML01	23.50
3-1/4"	PKH-PK3202ML01	28.00
4"	PKH-PK4002ML01	40.15
5"	PKH-PK5002ML01	66.57
6"	PKH-PK6002ML01	85.16
8"	PKH-PK8002ML01	145.10

PARKER

Piston Kits

HMI Cylinders

Nitrile

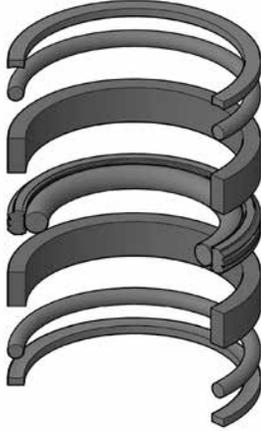

Kit Includes:

2 NBR Back-up Rings*
 2 NBR O-ring Head Seals
 2 Polyacetal Wear Rings
 1 URE Piston Ring
 w/ 1 NBR Expander

Fluorocarbon

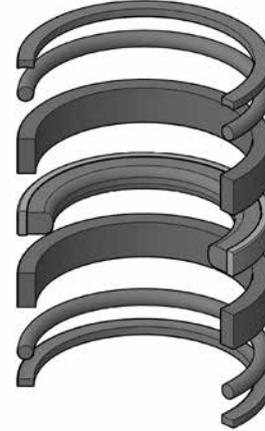

Kit Includes:

2 FC Back-up Rings*
 2 FC O-ring Head Seals
 2 Phenolic Wear Rings
 1 Step-cut Nylon Piston Ring
 w/ 1 FC Expander

Bore Dia.	(NBR) Kit #	List Price	(FC) Kit #	List Price
25 mm	PKH-PN025HM001	\$ 17.53	—	
32 mm	PKH-PN032HM001	20.59	PKH-PN032HM005	\$101.29
40 mm	PKH-PN040HM001	30.23	PKH-PN040HM005	125.15
50 mm	PKH-PN050HM001	32.89	PKH-PN050HM005	131.20
63 mm	PKH-PN063HM001	39.40	PKH-PN063HM005	169.56
80 mm	PKH-PN080HM001	43.34	PKH-PN080HM005	200.21
100 mm	PKH-PN100HM001	57.76	PKH-PN100HM005	205.76
125 mm	PKH-PN125HM001	99.88	PKH-PN125HM005	229.15
160 mm	PKH-PN160HM001	167.33	PKH-PN160HM005	364.74
200 mm	PKH-PN200HM001	176.25	PKH-PN200HM005	421.95

* Back-up Rings used only in 63mm and larger Piston Kits.

PARKER

Piston Kits

Poly Pack kits for L, 2L, 3L, H, 2H, HD, & VH Cylinders

Urethane

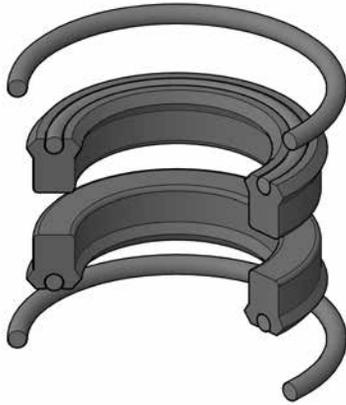

Kit Includes:

2 NBR O-ring Head Seals
2 NBR Loaded Urethane U-seals
2 PTFE Head Seals (1" Bore Only)

Fluorocarbon

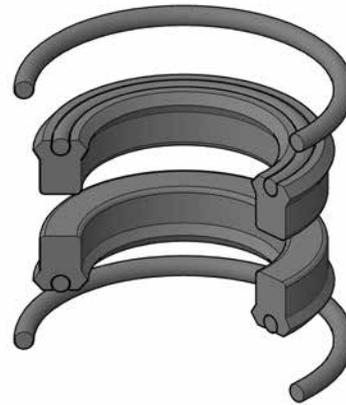

Kit Includes:

2 FC O-ring Head Seals
2 FC Loaded U-seals

Bore Dia.	(NBR) Kit #	List Price	(FC) Kit #	List Price
1"	PKH-PK102HLLP1	\$ 28.11	—	
1-1/2"	PKH-PK152HLLP1	19.40	PKH-PK152HLLP5	\$ 72.46
2"	PKH-PK202HLLP1	21.94	PKH-PK202HLLP5	82.17
2-1/2"	PKH-PK252HLLP1	23.03	PKH-PK252HLLP5	86.90
3-1/4"	PKH-PK322HLLP1	30.87	PKH-PK322HLLP5	160.31
4"	PKH-PK402HLLP1	35.85	PKH-PK402HLLP5	187.99
5"	PKH-PK502HLLP1	58.64	PKH-PK502HLLP5	223.52
6" *	PKH-PK602HLLP1	88.22	PKH-PK602HLLP5	450.55
6" **	PKH-PK602HLLP1-OLD	81.81	PKH-PK602HLLP5-OLD	319.97
8"	PKH-PK802HLLP1	107.64	PKH-PK802HLLP5	420.49

Note: These kits are used in the lipseal type piston for the models shown above.

* These 6" kits are for the current standard piston, Jan. 1992-current. U-seal cross section of .28".

** These 6" kits are for the pre-1992 reworked piston. U-seal cross section of 5/16".

PARKER

Piston Kits

High Load Kits for 2H, VH & HD

Nitrile

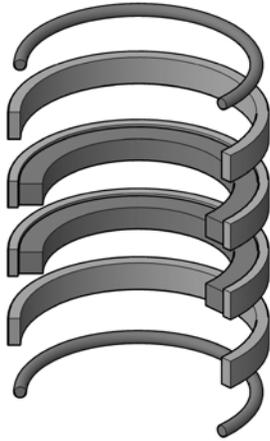

Kit Includes:

2 NBR O-ring Head Seals
 2 Nylon Wear Rings
 2 Bronze filled PTFE Piston Rings
 w/ 2 NBR Expanders

Fluorocarbon

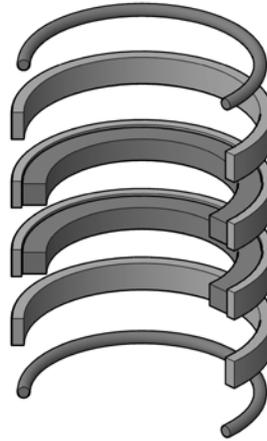

Kit Includes:

2 FC O-ring Head Seals
 2 Nylon Wear Rings
 2 Bronze filled PTFE Piston Rings
 w/ 2 FC Expanders

Bore Dia.	Kit #	List Price	Kit #	List Price
1-1/2"	PKH-PK152HK001	\$ 24.82	PKH-PK152HK005	\$ 43.04
2"	PKH-PK202HK001	32.21	PKH-PK202HK005	48.73
2-1/2"	PKH-PK252HK001	31.06	PKH-PK252HK005	52.38
3-1/4"	PKH-PK322HK001	41.01	PKH-PK322HK005	115.37
4"	PKH-PK402HK001	35.72	PKH-PK402HK005	127.66
5"	PKH-PK502HK001	40.08	PKH-PK502HK005	141.27
6"	PKH-PK602HK001	73.53	PKH-PK602HK005	220.27
7"	PKH-PK702HK001	162.03	PKH-PK702HK005	326.70
8"	PKH-PK802HK001	173.54	PKH-PK802HK005	465.72
10"	PKH-PK902HK001	325.11	PKH-PK902HK005	667.10
12"	PKH-PK922HK001	665.37	PKH-PK922HK005	1143.05

PARKER

Piston Ring Kits

H, HD, 2H, L, 2L, & 3L Hydraulic Cylinders

Nitrile

Fluorocarbon

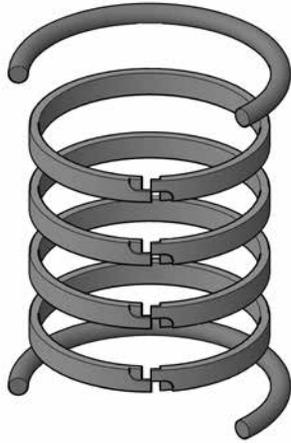

Kit Includes:
 2 NBR O-ring Head Seals
 4 Cast Iron Piston Rings
 2 PTFE Head Seals (1" Bore Only)

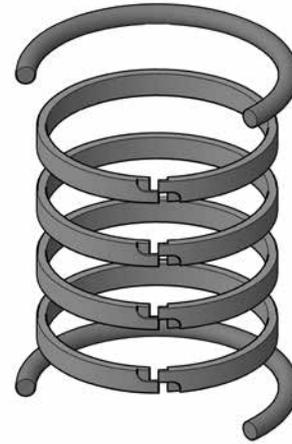

Kit Includes:
 2 FC O-ring Head Seals
 4 Cast Iron Piston Rings
 2 PTFE Head Seals (1" Bore Only)

Bore Dia.	(NBR) Kit #	List Price	(FC) Kit #	List Price
1"	PKH-PR102H0001	\$ 81.33	PKH-PR102H0005	\$ 81.83
1-1/2"	PKH-PR152H0001	45.49	PKH-PR152H0005	52.69
2"	PKH-PR202H0001	48.54	PKH-PR202H0005	54.61
2-1/2"	PKH-PR252H0001	49.08	PKH-PR252H0005	55.38
3-1/4"	PKH-PR322H0001	53.07	PKH-PR322H0005	65.98
4"	PKH-PR402H0001	54.63	PKH-PR402H0005	67.23
5"	PKH-PR502H0001	71.96	PKH-PR502H0005	95.33
6"	PKH-PR602H0001	108.18	PKH-PR602H0005	115.37
7"	PKH-PR702H0001	120.89	PKH-PR702H0005	142.04
8"	PKH-PR802H0001	184.75	PKH-PR802H0005	197.07
10"	PKH-PR902H0001	504.75	PKH-PR902H0005	564.50
12"	PKH-PR922H0001	808.37	PKH-PR922H0005	943.50

PARKER

Piston Head Seal Kits

Nitrile



Kit Includes:
2 NBR O-ring Head Seals

Fluorocarbon



Kit Includes:
2 FC O-ring Head Seals

2A, 2H, 3L, HD, & VH Cylinders

Bore Dia.	(NBR) Kit #	List Price	(FC) Kit #	List Price
1"	PKH-CB102HL001	\$ 6.64	PKH-CB102HL005	\$ 9.33
1-1/2"	PKH-CB152HL001	6.81	PKH-CB152HL005	9.33
2"	PKH-CB202HL001	7.16	PKH-CB202HL005	15.95
2-1/2"	PKH-CB252HL001	7.46	PKH-CB252HL005	19.91
3-1/4"	PKH-CB322HL001	7.89	PKH-CB322HL005	24.20
4"	PKH-CB402HL001	8.24	PKH-CB402HL005	30.28
5"	PKH-CB502HL001	9.49	PKH-CB502HL005	43.71
6"	PKH-CB602HL001	11.30	PKH-CB602HL005	45.71
7"	PKH-CB702HL001	12.18	PKH-CB702HL005	65.58
8"	PKH-CB802HL001	13.82	PKH-CB802HL005	66.74
10"	PKH-CB902HL001	16.84	PKH-CB902HL005	73.89

2MA & ML Cylinders

2MA Cylinders Only

Bore Dia.	(NBR) Kit #	List Price	(FC) Kit #	List Price
1-1/2"	PKH-CB1502MA01	\$ 6.48	PKH-CB1502MA05	\$ 6.71
2"	PKH-CB2002MA01	6.48	PKH-CB2002MA05	11.17
2-1/2"	PKH-CB2502MA01	6.66	PKH-CB2502MA05	11.17
3-1/4"	PKH-CB3202MA01	9.13	PKH-CB3202MA05	14.82
4"	PKH-CB4002MA01	14.32	PKH-CB4002MA05	16.28
5"	PKH-CB5002MA01	18.76	PKH-CB5002MA05	30.05
6"	PKH-CB6002MA01	24.96	PKH-CB6002MA05	48.83
8"	PKH-CB8002MA01	30.50	PKH-CB8002MA05	50.29

PARKER

Piston Head Seal Kits

HMI Hydraulic Cylinders

Nitrile



Kit Includes:
2 NBR Back-up Rings*
2 NBR O-ring Head Seals

Fluorocarbon

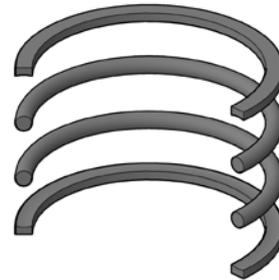

Kit Includes:
2 FC Back-up Rings*
2 FC O-ring Head Seals

Bore Dia.	(NBR) Kit #	List Price	(FC) Kit #	List Price
25 mm	PKH-CB025HM001	\$ 8.25	PKH-CB025HM005	\$ 15.58
32 mm	PKH-CB032HM001	8.51	PKH-CB032HM005	16.01
40 mm	PKH-CB040HM001	8.79	PKH-CB040HM005	16.76
50 mm	PKH-CB050HM001	9.10	PKH-CB050HM005	20.95
63 mm	PKH-CB063HM001	10.90	PKH-CB063HM005	21.21
80 mm	PKH-CB080HM001	11.47	PKH-CB080HM005	21.67
100 mm	PKH-CB100HM001	12.96	PKH-CB100HM005	32.44
125 mm	PKH-CB125HM001	16.86	PKH-CB125HM005	42.50
160 mm	PKH-CB160HM001	22.05	PKH-CB160HM005	73.86
200 mm	PKH-CB200HM001	28.42	PKH-CB200HM005	114.45

* Back-up rings used only in 63mm and larger piston kits.

PARKER

Various Kits

Various Kits

Kit #	Series	Code	Rod x Bore	List Price	
PKH-KT060VP101	VP	I-N-2	1" X 6"	\$ 24.68	Kit Includes: 1 XNBR H Style Wiper 2 NBR O-rings 1 NBR Quad Ring
PKH-KT070VP101	VP	I-N-2	1" X 7"	27.41	
PKH-KT080VP101	VP	I-N-2	1" X 8"	41.73	
PKH-KT100VP101	VP	I-N-2	1" X 10"	51.84	

PARKER

PARKER

Sales Part Number	Description	Rod Size	Bore Size	ID x OD x W	List Price
PKH-069590	Gland Wrench	1/2, 5/8, 12mm, 14mm		11/16 x 1-1/8 x 1-3/8	\$ 107.74
PKH-069591	Gland Wrench	1, 22mm		1-1/16 x 1-5/8 x 1-1/2	109.57
PKH-069592	Gland Wrench	1-3/8, 36mm		1-7/16 x 1-7/8 x 1-5/8	113.15
PKH-069593	Gland Wrench	1-3/4, 45mm		1-13/16 x 2-1/4 x 1-5/8	114.93
PKH-069594	Gland Wrench	2		2-1/16 x 2-1/2 x 2	129.30
PKH-069595	Gland Wrench	2-1/2, 56mm		2-9/16 x 3 x 2-1/8	143.65
PKH-069596	Gland Wrench	70mm		2-15/16 x 3-1/2 x 2-3/8	150.95
PKH-084765	Gland Wrench	18mm		13/16 x 1-1/4 x 1-7/16	99.94
PKH-084766	Gland Wrench	28mm		1-1/4 x 1-11/16 x -1-9/16	115.53
PKH-CB025HM001	Piston Head Seal Kit		25 mm		8.25
PKH-CB025HM005	Piston Head Seal Kit		25 mm		15.58
PKH-CB032HM001	Piston Head Seal Kit		32 mm		8.51
PKH-CB032HM005	Piston Head Seal Kit		32 mm		16.01
PKH-CB040HM001	Piston Head Seal Kit		40 mm		8.79
PKH-CB040HM005	Piston Head Seal Kit		40 mm		16.76
PKH-CB050HM001	Piston Head Seal Kit		50 mm		9.10
PKH-CB050HM005	Piston Head Seal Kit		50 mm		20.95
PKH-CB063HM001	Piston Head Seal Kit		63 mm		10.90
PKH-CB063HM005	Piston Head Seal Kit		63 mm		21.21
PKH-CB080HM001	Piston Head Seal Kit		80 mm		11.47
PKH-CB080HM005	Piston Head Seal Kit		80 mm		21.67
PKH-CB100HM001	Piston Head Seal Kit		100 mm		12.96
PKH-CB100HM005	Piston Head Seal Kit		100 mm		32.44
PKH-CB102HL001	Piston Head Seal Kit		1		6.64
PKH-CB102HL005	Piston Head Seal Kit		1		9.33
PKH-CB125HM001	Piston Head Seal Kit		125 mm		16.86
PKH-CB125HM005	Piston Head Seal Kit		125 mm		42.50
PKH-CB1502MA01	Piston Head Seal Kit		1-1/2		6.48
PKH-CB1502MA05	Piston Head Seal Kit		1-1/2		6.71
PKH-CB152HL001	Piston Head Seal Kit		1-1/2		6.81
PKH-CB152HL005	Piston Head Seal Kit		1-1/2		9.33
PKH-CB160HM001	Piston Head Seal Kit		160 mm		22.05
PKH-CB160HM005	Piston Head Seal Kit		160 mm		73.86
PKH-CB2002MA01	Piston Head Seal Kit		2		6.48
PKH-CB2002MA05	Piston Head Seal Kit		2		11.17
PKH-CB200HM001	Piston Head Seal Kit		200 mm		28.42
PKH-CB200HM005	Piston Head Seal Kit		200 mm		114.45
PKH-CB202HL001	Piston Head Seal Kit		2		7.16
PKH-CB202HL005	Piston Head Seal Kit		2		15.95
PKH-CB2502MA01	Piston Head Seal Kit		2-1/2		6.66
PKH-CB2502MA05	Piston Head Seal Kit		2-1/2		11.17
PKH-CB252HL001	Piston Head Seal Kit		2-1/2		7.46
PKH-CB252HL005	Piston Head Seal Kit		2-1/2		19.91
PKH-CB3202MA01	Piston Head Seal Kit		3-1/4		9.13
PKH-CB3202MA05	Piston Head Seal Kit		3-1/4		14.82
PKH-CB322HL001	Piston Head Seal Kit		3-1/4		7.89
PKH-CB322HL005	Piston Head Seal Kit		3-1/4		24.20
PKH-CB4002MA01	Piston Head Seal Kit		4		14.32
PKH-CB4002MA05	Piston Head Seal Kit		4		16.28
PKH-CB402HL001	Piston Head Seal Kit		4		8.24

PARKER

Sales Part Number	Description	Rod Size	Bore Size	ID x OD x W	List Price
PKH-CB402HL005	Piston Head Seal Kit		4		\$ 30.28
PKH-CB5002MA01	Piston Head Seal Kit		5		18.76
PKH-CB5002MA05	Piston Head Seal Kit		5		30.05
PKH-CB502HL001	Piston Head Seal Kit		5		9.49
PKH-CB502HL005	Piston Head Seal Kit		5		43.71
PKH-CB6002MA01	Piston Head Seal Kit		6		24.96
PKH-CB6002MA05	Piston Head Seal Kit		6		48.83
PKH-CB602HL001	Piston Head Seal Kit		6		11.30
PKH-CB602HL005	Piston Head Seal Kit		6		45.71
PKH-CB702HL001	Piston Head Seal Kit		7		12.18
PKH-CB702HL005	Piston Head Seal Kit		7		65.58
PKH-CB8002MA01	Piston Head Seal Kit		8		30.50
PKH-CB8002MA05	Piston Head Seal Kit		8		50.29
PKH-CB802HL001	Piston Head Seal Kit		8		13.82
PKH-CB802HL005	Piston Head Seal Kit		8		66.74
PKH-CB902HL001	Piston Head Seal Kit		9		16.84
PKH-CB902HL005	Piston Head Seal Kit		9		73.89
PKH-KT060VP101	Rod & Piston Seal Kit	1	6		24.68
PKH-KT070VP101	Rod & Piston Seal Kit	1	7		27.41
PKH-KT080VP101	Rod & Piston Seal Kit	1	8		41.73
PKH-KT100VP101	Rod & Piston Seal Kit	1	10		51.84
PKH-PK1002AN01	Piston Kit		1		19.17
PKH-PK1502AN01	Piston Kit		1-1/2		21.30
PKH-PK2002AN01	Piston Kit		2		23.80
PKH-PK2502AN01	Piston Kit		2-1/2		29.06
PKH-PK3202AN01	Piston Kit		3-1/4		37.96
PKH-PK4002AN01	Piston Kit		4		46.99
PKH-PK5002AN01	Piston Kit		5		56.39
PKH-PK6002AN01	Piston Kit		6		89.84
PKH-PK7002AN01	Piston Kit		7		97.62
PKH-PK8002AN01	Piston Kit		8		139.45
PKH-PK9002AN01	Piston Kit		10		208.28
PKH-PK9202AN01	Piston Kit		12		381.50
PKH-PK1002A001	Piston Kit		1		9.34
PKH-PK1002A005	Piston Kit		1		35.43
PKH-PK102HLL01	Piston Kit		1		13.77
PKH-PK102HLL05	Piston Kit		1		48.07
PKH-PK102HLLP1	Piston Kit		1		28.11
PKH-PK1502A001	Piston Kit		1-1/2		10.97
PKH-PK1502A005	Piston Kit		1-1/2		49.92
PKH-PK1502MA01	Piston Kit		1-1/2		24.50
PKH-PK1502MA05	Piston Kit		1-1/2		47.73
PKH-PK1502ML01	Piston Kit		1-1/2		29.66
PKH-PK152HK001	Piston Kit		1-1/2		24.82
PKH-PK152HK005	Piston Kit		1-1/2		43.04
PKH-PK152HLL01	Piston Kit		1-1/2		10.13
PKH-PK152HLL05	Piston Kit		1-1/2		49.92
PKH-PK152HLLP1	Piston Kit		1-1/2		19.40
PKH-PK152HLLP5	Piston Kit		1-1/2		72.46
PKH-PK2002A001	Piston Kit		2		12.91

PARKER

PARKER

Sales Part Number	Description	Rod Size	Bore Size	ID x OD x W	List Price
PKH-PK2002A005	Piston Kit		2		\$ 56.97
PKH-PK2002MA01	Piston Kit		2		24.83
PKH-PK2002MA05	Piston Kit		2		51.11
PKH-PK2002ML01	Piston Kit		2		22.45
PKH-PK202HK001	Piston Kit		2		32.21
PKH-PK202HK005	Piston Kit		2		48.73
PKH-PK202HLL01	Piston Kit		2		12.91
PKH-PK202HLL05	Piston Kit		2		77.82
PKH-PK202HLLP1	Piston Kit		2		21.94
PKH-PK202HLLP5	Piston Kit		2		82.17
PKH-PK2502A001	Piston Kit		2-1/2		14.98
PKH-PK2502A005	Piston Kit		2-1/2		79.95
PKH-PK2502MA01	Piston Kit		2-1/2		26.62
PKH-PK2502MA05	Piston Kit		2-1/2		67.84
PKH-PK2502ML01	Piston Kit		2-1/2		23.50
PKH-PK252HK001	Piston Kit		2-1/2		31.06
PKH-PK252HK005	Piston Kit		2-1/2		52.38
PKH-PK252HLL01	Piston Kit		2-1/2		14.98
PKH-PK252HLL05	Piston Kit		2-1/2		78.85
PKH-PK252HLLP1	Piston Kit		2-1/2		23.03
PKH-PK252HLLP5	Piston Kit		2-1/2		86.90
PKH-PK3202A001	Piston Kit		3-1/4		18.57
PKH-PK3202A005	Piston Kit		3-1/4		93.31
PKH-PK3202MA01	Piston Kit		3-1/4		32.00
PKH-PK3202MA05	Piston Kit		3-1/4		83.86
PKH-PK3202ML01	Piston Kit		3-1/4		28.00
PKH-PK322HK001	Piston Kit		3-1/4		41.01
PKH-PK322HK005	Piston Kit		3-1/4		115.37
PKH-PK322HLL01	Piston Kit		3-1/4		18.57
PKH-PK322HLL05	Piston Kit		3-1/4		84.98
PKH-PK322HLLP1	Piston Kit		3-1/4		30.87
PKH-PK322HLLP5	Piston Kit		3-1/4		160.31
PKH-PK4002A001	Piston Kit		4		24.41
PKH-PK4002A005	Piston Kit		4		100.57
PKH-PK4002MA01	Piston Kit		4		39.24
PKH-PK4002MA05	Piston Kit		4		95.00
PKH-PK4002ML01	Piston Kit		4		40.15
PKH-PK402HK001	Piston Kit		4		35.72
PKH-PK402HK005	Piston Kit		4		127.66
PKH-PK402HLL01	Piston Kit		4		24.41
PKH-PK402HLL05	Piston Kit		4		106.12
PKH-PK402HLLP1	Piston Kit		4		35.85
PKH-PK402HLLP5	Piston Kit		4		187.99
PKH-PK5002A001	Piston Kit		5		28.47
PKH-PK5002A005	Piston Kit		5		127.64
PKH-PK5002MA01	Piston Kit		5		50.78
PKH-PK5002MA05	Piston Kit		5		143.77
PKH-PK5002ML01	Piston Kit		5		66.57
PKH-PK502HK001	Piston Kit		5		40.08
PKH-PK502HK005	Piston Kit		5		141.27

PARKER

Sales Part Number	Description	Rod Size	Bore Size	ID x OD x W	List Price
PKH-PK502HLL01	Piston Kit		5		\$ 28.40
PKH-PK502HLL05	Piston Kit		5		126.80
PKH-PK502HLLP1	Piston Kit		5		58.64
PKH-PK502HLLP5	Piston Kit		5		223.52
PKH-PK6002A001	Piston Kit		6		36.99
PKH-PK6002A005	Piston Kit		6		169.65
PKH-PK6002MA01	Piston Kit		6		67.89
PKH-PK6002MA05	Piston Kit		6		203.63
PKH-PK6002ML01	Piston Kit		6		85.16
PKH-PK602HK001	Piston Kit		6		73.53
PKH-PK602HK005	Piston Kit		6		220.27
PKH-PK602HLL01	Piston Kit		6		36.92
PKH-PK602HLL05	Piston Kit		6		169.53
PKH-PK602HLLP1	Piston Kit		6		88.22
PKH-PK602HLLP1-OLD	Piston Kit		6		81.81
PKH-PK602HLLP5	Piston Kit		6		450.55
PKH-PK602HLLP5-OLD	Piston Kit		6		319.97
PKH-PK7002A001	Piston Kit		7		92.27
PKH-PK7002A005	Piston Kit		7		268.90
PKH-PK702HK001	Piston Kit		7		162.03
PKH-PK702HK005	Piston Kit		7		326.70
PKH-PK702HLL01	Piston Kit		7		98.09
PKH-PK702HLL05	Piston Kit		7		268.77
PKH-PK8002A001	Piston Kit		8		107.43
PKH-PK8002A005	Piston Kit		8		367.71
PKH-PK8002MA01	Piston Kit		8		119.85
PKH-PK8002MA05	Piston Kit		8		340.50
PKH-PK8002ML01	Piston Kit		8		145.10
PKH-PK802HK001	Piston Kit		8		173.54
PKH-PK802HK005	Piston Kit		8		465.72
PKH-PK802HLL01	Piston Kit		8		107.43
PKH-PK802HLL05	Piston Kit		8		367.71
PKH-PK802HLLP1	Piston Kit		8		107.64
PKH-PK802HLLP5	Piston Kit		8		420.49
PKH-PK9002A001	Piston Kit		10		159.10
PKH-PK9002A005	Piston Kit		10		466.71
PKH-PK902HK001	Piston Kit		10		325.11
PKH-PK902HK005	Piston Kit		10		667.10
PKH-PK902HLL01	Piston Kit		10		191.55
PKH-PK902HLL05	Piston Kit		10		574.64
PKH-PK9202A001	Piston Kit		12		216.15
PKH-PK9202A005	Piston Kit		12		716.95
PKH-PK922HK001	Piston Kit		12		665.37
PKH-PK922HK005	Piston Kit		12		1143.05
PKH-PK922HLL01	Piston Kit		12		259.91
PKH-PK922HLL05	Piston Kit		12		716.95
PKH-PK9402A001	Piston Kit		14		334.33
PKH-PK9402A005	Piston Kit		14		1171.36
PKH-PN025HM001	Piston Kit		25 mm		17.53
PKH-PN025HM005	Piston Kit		25 mm		78.42

PARKER

PARKER

PARKER

Sales Part Number	Description	Rod Size	Bore Size	ID x OD x W	List Price
PKH-PN032HM001	Piston Kit		32 mm		\$ 20.59
PKH-PN032HM005	Piston Kit		32 mm		101.29
PKH-PN040HM001	Piston Kit		40 mm		30.23
PKH-PN040HM005	Piston Kit		40 mm		125.15
PKH-PN050HM001	Piston Kit		50 mm		32.89
PKH-PN050HM005	Piston Kit		50 mm		131.20
PKH-PN063HM001	Piston Kit		63 mm		39.40
PKH-PN063HM005	Piston Kit		63 mm		169.56
PKH-PN080HM001	Piston Kit		80 mm		43.34
PKH-PN080HM005	Piston Kit		80 mm		200.21
PKH-PN100HM001	Piston Kit		100 mm		57.76
PKH-PN100HM005	Piston Kit		100 mm		205.76
PKH-PN125HM001	Piston Kit		125 mm		99.88
PKH-PN125HM005	Piston Kit		125 mm		229.15
PKH-PN160HM001	Piston Kit		160 mm		167.33
PKH-PN160HM005	Piston Kit		160 mm		364.74
PKH-PN200HM001	Piston Kit		200 mm		176.25
PKH-PN200HM005	Piston Kit		200 mm		421.95
PKH-PR102H0001	Piston Ring Kit		1		81.33
PKH-PR102H0005	Piston Ring Kit		1		81.83
PKH-PR152H0001	Piston Ring Kit		1-1/2		45.49
PKH-PR152H0005	Piston Ring Kit		1-1/2		52.69
PKH-PR202H0001	Piston Ring Kit		2		48.54
PKH-PR202H0005	Piston Ring Kit		2		54.61
PKH-PR252H0001	Piston Ring Kit		2-1/2		49.08
PKH-PR252H0005	Piston Ring Kit		2-1/2		55.38
PKH-PR322H0001	Piston Ring Kit		3-1/4		53.07
PKH-PR322H0005	Piston Ring Kit		3-1/4		65.98
PKH-PR402H0001	Piston Ring Kit		4		54.63
PKH-PR402H0005	Piston Ring Kit		4		67.23
PKH-PR502H0001	Piston Ring Kit		5		71.96
PKH-PR502H0005	Piston Ring Kit		5		95.33
PKH-PR602H0001	Piston Ring Kit		6		108.18
PKH-PR602H0005	Piston Ring Kit		6		115.37
PKH-PR702H0001	Piston Ring Kit		7		120.89
PKH-PR702H0005	Piston Ring Kit		7		142.04
PKH-PR802H0001	Piston Ring Kit		8		184.75
PKH-PR802H0005	Piston Ring Kit		8		197.07
PKH-PR902H0001	Piston Ring Kit		10		504.75
PKH-PR902H0005	Piston Ring Kit		10		564.50
PKH-PR922H0001	Piston Ring Kit		12		808.37
PKH-PR922H0005	Piston Ring Kit		12		943.50
PKH-RG02MA0051	Rod Gland Kit	1/2			40.72
PKH-RG02MA0055	Rod Gland Kit	1/2			43.39
PKH-RG02MA0061	Rod Gland Kit	5/8			26.90
PKH-RG02MA0065	Rod Gland Kit	5/8			42.96
PKH-RG02MA0101	Rod Gland Kit	1			30.82
PKH-RG02MA0105	Rod Gland Kit	1			47.60
PKH-RG02MA0131	Rod Gland Kit	1-3/8			46.03
PKH-RG02MA0135	Rod Gland Kit	1-3/8			68.81

PARKER

Sales Part Number	Description	Rod Size	Bore Size	ID x OD x W	List Price
PKH-RG02MA0171	Rod Gland Kit	1-3/4			\$ 93.67
PKH-RG02MA0175	Rod Gland Kit	1-3/4			105.07
PKH-RG02MA-05	Rod Gland	1/2			36.67
PKH-RG02MA-06	Rod Gland	5/8			27.02
PKH-RG02MA-10	Rod Gland	1			33.82
PKH-RG02MA-13	Rod Gland	1-3/8			48.90
PKH-RG02MA-17	Rod Gland	1-3/4			77.01
PKH-RG-05	Rod Gland	1/2			38.07
PKH-RG-06	Rod Gland	5/8			22.94
PKH-RG-10	Rod Gland	1			26.63
PKH-RG-13	Rod Gland	1-3/8			36.95
PKH-RG-17	Rod Gland	1-3/4			44.94
PKH-RG-20	Rod Gland	2			54.93
PKH-RG-25	Rod Gland	2-1/2			77.50
PKH-RG1HDL0061	Rod Gland Kit	5/8			55.23
PKH-RG1HDL0065	Rod Gland Kit	5/8			66.94
PKH-RG1HDL0101	Rod Gland Kit	1			71.11
PKH-RG1HDL0105	Rod Gland Kit	1			82.44
PKH-RG1HDL0131	Rod Gland Kit	1-3/8			92.34
PKH-RG1HDL0135	Rod Gland Kit	1-3/8			111.77
PKH-RG1HDL0171	Rod Gland Kit	1-3/4			109.13
PKH-RG1HDL0175	Rod Gland Kit	1-3/4			136.34
PKH-RG1HDL0201	Rod Gland Kit	2			157.01
PKH-RG1HDL0205	Rod Gland Kit	2			184.94
PKH-RG1HDL0251	Rod Gland Kit	2-1/2			210.23
PKH-RG1HDL0255	Rod Gland Kit	2-1/2			241.18
PKH-RG1HDL0351	Rod Gland Kit	3-1/2			260.60
PKH-RG1HDL0355	Rod Gland Kit	3-1/2			296.23
PKH-RG2AHL0051	Rod Gland Kit	1/2			64.99
PKH-RG2AHL0055	Rod Gland Kit	1/2			83.53
PKH-RG2AHL0061	Rod Gland Kit	5/8			39.24
PKH-RG2AHL0065	Rod Gland Kit	5/8			64.03
PKH-RG2AHL0101	Rod Gland Kit	1			48.12
PKH-RG2AHL0105	Rod Gland Kit	1			72.46
PKH-RG2AHL0131	Rod Gland Kit	1-3/8			58.66
PKH-RG2AHL0135	Rod Gland Kit	1-3/8			91.03
PKH-RG2AHL0171	Rod Gland Kit	1-3/4			67.94
PKH-RG2AHL0175	Rod Gland Kit	1-3/4			99.41
PKH-RG2AHL0201	Rod Gland Kit	2			84.76
PKH-RG2AHL0205	Rod Gland Kit	2			118.32
PKH-RG2AHL0251	Rod Gland Kit	2-1/2			115.64
PKH-RG2AHL0255	Rod Gland Kit	2-1/2			153.66
PKH-RG2AHL0301	Rod Gland Kit	3			148.42
PKH-RG2AHL0305	Rod Gland Kit	3			174.68
PKH-RG2AHL0351	Rod Gland Kit	3-1/2			325.37
PKH-RG2AHL0355	Rod Gland Kit	3-1/2			352.59
PKH-RG2AHL0401	Rod Gland Kit	4			395.70
PKH-RG2AHL0405	Rod Gland Kit	4			415.46
PKH-RG2AHL0451	Rod Gland Kit	4-1/2			492.33
PKH-RG2AHL0455	Rod Gland Kit	4-1/2			496.39

PARKER

PARKER

Sales Part Number	Description	Rod Size	Bore Size	ID x OD x W	List Price
PKH-RG2AHL0501	Rod Gland Kit	5			\$ 547.76
PKH-RG2AHL0505	Rod Gland Kit	5			620.05
PKH-RG2AHL0551	Rod Gland Kit	5-1/2			564.93
PKH-RG2AHL0555	Rod Gland Kit	5-1/2			676.71
PKH-RG2AN00051	Rod Gland Kit	1/2			42.25
PKH-RG2AN00061	Rod Gland Kit	5/8			43.98
PKH-RG2AN00101	Rod Gland Kit	1			49.42
PKH-RG2AN00131	Rod Gland Kit	1-3/8			52.59
PKH-RG2AN00171	Rod Gland Kit	1-3/4			66.08
PKH-RG2AN00201	Rod Gland Kit	2			80.45
PKH-RG2AN00251	Rod Gland Kit	2-1/2			131.59
PKH-RG2AN00301	Rod Gland Kit	3			199.98
PKH-RG2AN00351	Rod Gland Kit	3-1/2			284.45
PKH-RG2AN00401	Rod Gland Kit	4			381.00
PKH-RG2AN00451	Rod Gland Kit	4-1/2			472.37
PKH-RG2AN00501	Rod Gland Kit	5			563.16
PKH-RG2AN00551	Rod Gland Kit	5-1/2			630.97
PKH-RGHD-06	Bronze Rod Gland	5/8			44.73
PKH-RGHD-10	Bronze Rod Gland	1			58.71
PKH-RGHD-13	Bronze Rod Gland	1-3/8			77.17
PKH-RGHD-17	Bronze Rod Gland	1-3/4			97.69
PKH-RGHD-20	Bronze Rod Gland	2			143.87
PKH-RGHD-25	Bronze Rod Gland	2-1/2			177.04
PKH-RGHD-35	Bronze Rod Gland	3-1/2			217.41
PKH-RG2HLTS051	Rod Gland Kit	1/2			95.27
PKH-RG2HLTS061	Rod Gland Kit	5/8			73.06
PKH-RG2HLTS101	Rod Gland Kit	1			82.89
PKH-RG2HLTS131	Rod Gland Kit	1-3/8			96.98
PKH-RG2HLTS171	Rod Gland Kit	1-3/4			104.07
PKH-RG2HLTS201	Rod Gland Kit	2			135.34
PKH-RG2HLTS251	Rod Gland Kit	2-1/2			175.63
PKH-RG2HLTS301	Rod Gland Kit	3			217.71
PKH-RG2HLTS351	Rod Gland Kit	3-1/2			308.05
PKH-RG2HLTS401	Rod Gland Kit	4			402.65
PKH-RG2HLTS451	Rod Gland Kit	4-1/2			437.96
PKH-RG2HLTS501	Rod Gland Kit	5			578.20
PKH-RG2HLTS551	Rod Gland Kit	5-1/2			596.70
PKH-RG2HM0121	Rod Gland Kit	12 mm			61.44
PKH-RG2HM0125	Rod Gland Kit	12 mm			68.80
PKH-RG2HM0141	Rod Gland Kit	14 mm			87.39
PKH-RG2HM0145	Rod Gland Kit	14 mm			94.61
PKH-RG2HM0181	Rod Gland Kit	18 mm			85.23
PKH-RG2HM0185	Rod Gland Kit	18 mm			101.06
PKH-RG2HM0221	Rod Gland Kit	22 mm			87.98
PKH-RG2HM0225	Rod Gland Kit	22 mm			105.92
PKH-RG2HM0281	Rod Gland Kit	28 mm			90.03
PKH-RG2HM0285	Rod Gland Kit	28 mm			117.30
PKH-RG2HM0361	Rod Gland Kit	36 mm			86.23
PKH-RG2HM0365	Rod Gland Kit	36 mm			113.88
PKH-RG2HM0451	Rod Gland Kit	45 mm			95.53

PARKER

Sales Part Number	Description	Rod Size	Bore Size	ID x OD x W	List Price
PKH-RG2HM0455	Rod Gland Kit	45 mm			\$ 117.37
PKH-RG2HM0561	Rod Gland Kit	56 mm			176.55
PKH-RG2HM0565	Rod Gland Kit	56 mm			218.79
PKH-RG2HM0701	Rod Gland Kit	70 mm			259.54
PKH-RG2HM0705	Rod Gland Kit	70 mm			318.11
PKH-RG-30	Rod Gland	3			107.13
PKH-RG-35	Rod Gland	3-1/2			251.32
PKH-RG-40	Rod Gland	4			256.03
PKH-RG-45	Rod Gland	4-1/2			368.19
PKH-RG-50	Rod Gland	5			426.56
PKH-RG-55	Rod Gland	5-1/2			449.86
PKH-RGHM-012	Rod Gland	12 mm			29.01
PKH-RGHM-014	Rod Gland	14 mm			50.69
PKH-RGHM-018	Rod Gland	18 mm			54.46
PKH-RGHM-022	Rod Gland	22 mm			53.24
PKH-RGHM-028	Rod Gland	28 mm			57.77
PKH-RGHM-036	Rod Gland	36 mm			56.18
PKH-RGHM-045	Rod Gland	45 mm			53.27
PKH-RGHM-056	Rod Gland	56 mm			121.34
PKH-RGHM-070	Rod Gland	70 mm			200.38
PKH-RGL6948MA1	Rod Gland Kit	5/8			48.95
PKH-RGL6948MA5	Rod Gland Kit	5/8			55.51
PKH-RGL6949MA1	Rod Gland Kit	1			41.06
PKH-RGL6949MA5	Rod Gland Kit	1			52.93
PKH-RGL6950MA1	Rod Gland Kit	1-3/8			48.87
PKH-RGL6950MA5	Rod Gland Kit	1-3/8			65.38
PKH-RGMA-06	Rod Gland	5/8			41.26
PKH-RGMA-10	Rod Gland	1			32.64
PKH-RGMA-13	Rod Gland	1-3/8			39.74
PKH-RK02MA0051	Rod Kit	1/2			13.14
PKH-RK02MA0055	Rod Kit	1/2			19.64
PKH-RK02MA0061	Rod Kit	5/8			13.55
PKH-RK02MA0065	Rod Kit	5/8			20.18
PKH-RK02MA0101	Rod Kit	1			13.89
PKH-RK02MA0105	Rod Kit	1			20.84
PKH-RK02MA0131	Rod Kit	1-3/8			14.86
PKH-RK02MA0135	Rod Kit	1-3/8			26.10
PKH-RK02MA0171	Rod Kit	1-3/4			15.88
PKH-RK02MA0175	Rod Kit	1-3/4			32.82
PKH-RK02ML0061	Rod Kit	5/8			17.39
PKH-RK02ML0101	Rod Kit	1			17.97
PKH-RK02ML0131	Rod Kit	1-3/8			20.39
PKH-RK02ML0171	Rod Kit	1-3/4			23.30
PKH-RK1HDL0061	Rod Kit	5/8			10.49
PKH-RK1HDL0065	Rod Kit	5/8			22.20
PKH-RK1HDL0101	Rod Kit	1			12.40
PKH-RK1HDL0105	Rod Kit	1			23.73
PKH-RK1HDL0131	Rod Kit	1-3/8			15.17
PKH-RK1HDL0135	Rod Kit	1-3/8			34.60
PKH-RK1HDL0171	Rod Kit	1-3/4			18.68

PARKER

PARKER

Sales Part Number	Description	Rod Size	Bore Size	ID x OD x W	List Price
PKH-RK1HDL0175	Rod Kit	1-3/4			\$ 38.65
PKH-RK1HDL0201	Rod Kit	2			23.49
PKH-RK1HDL0205	Rod Kit	2			41.07
PKH-RK1HDL0251	Rod Kit	2-1/2			33.18
PKH-RK1HDL0255	Rod Kit	2-1/2			64.14
PKH-RK1HDL0351	Rod Kit	3-1/2			43.19
PKH-RK1HDL0355	Rod Kit	3-1/2			78.82
PKH-RK2AHL0051	Rod Kit	1/2			7.53
PKH-RK2AHL0055	Rod Kit	1/2			31.29
PKH-RK2AHL0061	Rod Kit	5/8			13.05
PKH-RK2AHL0065	Rod Kit	5/8			34.39
PKH-RK2AHL0101	Rod Kit	1			9.43
PKH-RK2AHL0105	Rod Kit	1			38.64
PKH-RK2AHL0131	Rod Kit	1-3/8			10.36
PKH-RK2AHL0135	Rod Kit	1-3/8			50.04
PKH-RK2AHL0171	Rod Kit	1-3/4			11.99
PKH-RK2AHL0175	Rod Kit	1-3/4			52.12
PKH-RK2AHL0201	Rod Kit	2			13.24
PKH-RK2AHL0205	Rod Kit	2			54.32
PKH-RK2AHL0251	Rod Kit	2-1/2			14.86
PKH-RK2AHL0255	Rod Kit	2-1/2			59.44
PKH-RK2AHL0301	Rod Kit	3			19.27
PKH-RK2AHL0305	Rod Kit	3			71.74
PKH-RK2AHL0351	Rod Kit	3-1/2			90.18
PKH-RK2AHL0355	Rod Kit	3-1/2			148.81
PKH-RK2AHL0401	Rod Kit	4			112.02
PKH-RK2AHL0405	Rod Kit	4			172.43
PKH-RK2AHL0451	Rod Kit	4-1/2			131.35
PKH-RK2AHL0455	Rod Kit	4-1/2			215.81
PKH-RK2AHL0501	Rod Kit	5			163.54
PKH-RK2AHL0505	Rod Kit	5			252.16
PKH-RK2AHL0551	Rod Kit	5-1/2			182.61
PKH-RK2AHL0555	Rod Kit	5-1/2			361.77
PKH-RK2AN00051	Rod Kit	1/2			18.39
PKH-RK2AN00061	Rod Kit	5/8			19.27
PKH-RK2AN00101	Rod Kit	1			22.14
PKH-RK2AN00131	Rod Kit	1-3/8			24.44
PKH-RK2AN00171	Rod Kit	1-3/4			28.73
PKH-RK2AN00201	Rod Kit	2			33.91
PKH-RK2AN00251	Rod Kit	2-1/2			49.15
PKH-RK2AN00301	Rod Kit	3			81.03
PKH-RK2AN00351	Rod Kit	3-1/2			128.15
PKH-RK2AN00401	Rod Kit	4			155.16
PKH-RK2AN00451	Rod Kit	4-1/2			170.10
PKH-RK2AN00501	Rod Kit	5			186.18
PKH-RK2AN00551	Rod Kit	5-1/2			222.39
PKH-RK2HLTS051	Rod Kit	1/2			22.46
PKH-RK2HLTS061	Rod Kit	5/8			23.01
PKH-RK2HLTS101	Rod Kit	1			27.20
PKH-RK2HLTS131	Rod Kit	1-3/8			32.13

PARKER

Sales Part Number	Description	Rod Size	Bore Size	ID x OD x W	List Price
PKH-RK2HLTS171	Rod Kit	1-3/4			\$ 37.33
PKH-RK2HLTS201	Rod Kit	2			42.78
PKH-RK2HLTS251	Rod Kit	2-1/2			45.77
PKH-RK2HLTS301	Rod Kit	3			49.75
PKH-RK2HLTS351	Rod Kit	3-1/2			59.61
PKH-RK2HLTS401	Rod Kit	4			66.59
PKH-RK2HLTS451	Rod Kit	4-1/2			72.71
PKH-RK2HLTS501	Rod Kit	5			78.89
PKH-RK2HLTS551	Rod Kit	5-1/2			86.61
PKH-RK2HM0121	Rod Kit	12 mm			27.90
PKH-RK2HM0125	Rod Kit	12 mm			35.31
PKH-RK2HM0141	Rod Kit	14 mm			28.74
PKH-RK2HM0145	Rod Kit	14 mm			36.00
PKH-RK2HM0181	Rod Kit	18 mm			22.25
PKH-RK2HM0185	Rod Kit	18 mm			38.07
PKH-RK2HM0221	Rod Kit	22 mm			30.96
PKH-RK2HM0225	Rod Kit	22 mm			39.74
PKH-RK2HM0281	Rod Kit	28 mm			13.98
PKH-RK2HM0285	Rod Kit	28 mm			47.75
PKH-RK2HM0361	Rod Kit	36 mm			21.26
PKH-RK2HM0365	Rod Kit	36 mm			48.92
PKH-RK2HM0451	Rod Kit	45 mm			33.95
PKH-RK2HM0455	Rod Kit	45 mm			55.72
PKH-RK2HM0561	Rod Kit	56 mm			36.24
PKH-RK2HM0565	Rod Kit	56 mm			78.50
PKH-RK2HM0701	Rod Kit	70 mm			27.82
PKH-RK2HM0705	Rod Kit	70 mm			86.38
PKH-RK2HM0901	Rod Kit	90 mm			52.28
PKH-RK2HM0905	Rod Kit	90 mm			281.13
PKH-RK2HM1101	Rod Kit	110 mm			67.50
PKH-RK2HM1105	Rod Kit	110 mm			375.75
PKH-RK2HM1401	Rod Kit	140 mm			87.61
PKH-RK2HM1405	Rod Kit	140 mm			449.92
PKH-SKL7000MA1	Rod & Piston Seal Kit	5/8	1-1/2		21.38
PKH-SKL7000MA5	Rod & Piston Seal Kit	5/8	1-1/2		60.16
PKH-SKL7001MA1	Rod & Piston Seal Kit	5/8	2		21.57
PKH-SKL7001MA5	Rod & Piston Seal Kit	5/8	2		62.93
PKH-SKL7002MA1	Rod & Piston Seal Kit	1	2		21.93
PKH-SKL7002MA5	Rod & Piston Seal Kit	1	2		65.71
PKH-SKL7003MA1	Rod & Piston Seal Kit	5/8	2-1/2		28.44
PKH-SKL7003MA5	Rod & Piston Seal Kit	5/8	2-1/2		76.94
PKH-SKL7004MA1	Rod & Piston Seal Kit	1	2-1/2		23.69
PKH-SKL7004MA5	Rod & Piston Seal Kit	1	2-1/2		79.72
PKH-SKL7005MA1	Rod & Piston Seal Kit	1	3-1/4		24.61
PKH-SKL7005MA5	Rod & Piston Seal Kit	1	3-1/4		84.33
PKH-SKL7006MA1	Rod & Piston Seal Kit	1-3/8	3-1/4		27.88
PKH-SKL7006MA5	Rod & Piston Seal Kit	1-3/8	3-1/4		96.21
PKH-SKL7007MA1	Rod & Piston Seal Kit	1	4		28.44
PKH-SKL7007MA5	Rod & Piston Seal Kit	1	4		100.02
PKH-SKL7008MA1	Rod & Piston Seal Kit	1-3/8	4		30.68

PARKER

PARKER

Sales Part Number	Description	Rod Size	Bore Size	ID x OD x W	List Price
PKH-SKL7008MA5	Rod & Piston Seal Kit	1-3/8	4		\$ 111.98
PKH-SKL7009MA1	Rod & Piston Seal Kit	1	5		35.13
PKH-SKL7009MA5	Rod & Piston Seal Kit	1	5		121.92
PKH-SKL7010MA1	Rod & Piston Seal Kit	1-3/8	5		38.42
PKH-SKL7010MA5	Rod & Piston Seal Kit	1-3/8	5		133.90
PKH-SKL7098MA1	Rod & Piston Seal Kit	1-3/8	6		41.38
PKH-SKL7098MA5	Rod & Piston Seal Kit	1-3/8	6		165.22

PARKER

REXROTH

Kit Type		Page
Gland Kits	CDT4, CGT4	124
Piston Kits	CDT4, CGT4	125

ROYAL

Kit Type		Page
Pneumatic Kits	A Series	126
Pneumatic Kits	M Series	127
Hydraulic Kits	H & S2 Series	128
Repair Kits	By Part Number	129

REXROTH

Gland Kits

CDT4, CGT4* Hydraulic Cylinders Urethane

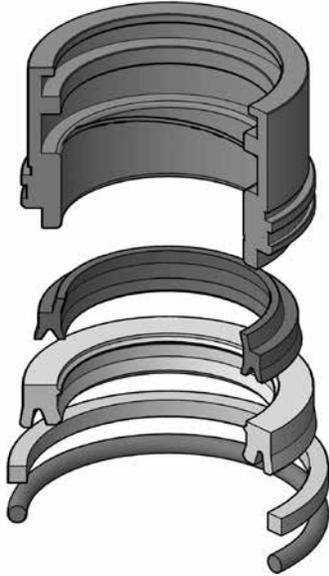

Kit #	Rod Dia.	Bore Dia.	List Price
RRTH-R978006773	5/8"		\$ 102.80
RRTH-R978006774	1"	1-1/2"	110.56
RRTH-R978006775	1"	2" - 2-1/2"	110.46
RRTH-R978006776	1-3/8"	2"	125.52
RRTH-R978006777	1-3/8"	2-1/2" - 3-1/4"	125.51
RRTH-R978006778	1-3/4"		143.71
RRTH-R978006779	2"		169.17
RRTH-R978006780	2-1/2"		192.80

* CGT4 Series Double Rod cylinder may require 2 kits.

Kit Includes:

- 1 Iron Gland
- 1 URE Wiper
- 1 URE U-seal
- 1 PTFE Back-up Ring
- 1 NBR O-ring

REXROTH

Piston Kits

CDT4, CGT4 Hydraulic Cylinders Urethane

Kit #	Bore Dia.	List Price
RRTH-R978006830	1-1/2"	\$ 26.65
RRTH-R978006831	2"	32.27
RRTH-R978006832	2-1/2"	37.84
RRTH-R978006833	3-1/4"	48.88
RRTH-R978006834	4"	63.69
RRTH-R978006835	5"	82.04

Kit Includes:

- 1 Urethane Piston Seal
- 2 Wear Rings
- 2 Tube End Seals
- 2 Back-up Rings

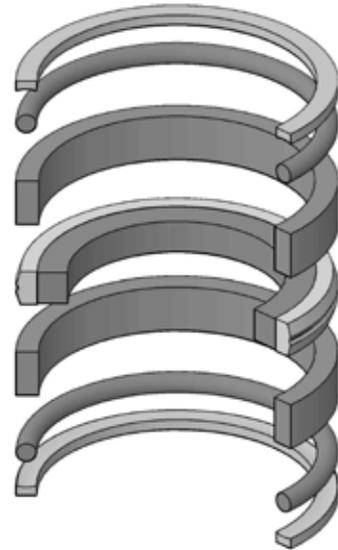

Various Kits

Various Kits

Kit #	Model	Code	Bore	List Price
RRTH-1817005842	RRTH-KIT	N-N-10	63 mm	\$ 88.74

ROYAL

A Series Pneumatic Kits

A Cylinders

Kit Composition Varies
Consult your Hercules® representative.

Kit #	Code	Rod x Bore	List Price
RYL-KA207	N-U-5	3/4" X 2"	\$ 44.67
RYL-KA210	N-U-5	1" X 2"	44.74
RYL-KA310	I-U-5	1" X 3"	53.60
RYL-KA312	I-U-5	1-1/4" X 3"	54.17
RYL-KA412	I-U-5	1-1/4" X 4"	75.24
RYL-KA415	I-U-5	1-1/2" X 4"	75.92
RYL-KA512	I-U-5	1-1/4" X 5"	91.31
RYL-KA515	I-U-5	1-1/2" X 5"	92.00
RYL-KA615	I-U-5	1-1/2" X 6"	115.76
RYL-KA617	I-U-5	1-3/4" X 6"	116.24
RYL-KA1030	I-U-5	3" X 10"	140.80
RYL-KA1230	I-U-5	3" X 12"	147.44
RYL-KA1235	I-U-5	3-1/2" X 12"	150.89
RYL-KA1506	N-U-5	5/8" X 1-1/2"	8.29

ROYAL

M Series Pneumatic Kits

M Cylinders

Kit #	Code	Rod x Bore	List Price
RYL-KM415	N-V-7	1-1/2" X 4"	\$ 41.09
RYL-KM620	N-V-7	2" X 6"	62.85
RYL-KM820	N-V-7	2" X 8"	93.83
RYL-KM825	N-V-7	2-1/2" X 8"	95.87
RYL-KM1025	N-V-7	2-1/2" X 10"	124.80
RYL-KM1030	N-V-7	3" X 10"	132.40
RYL-KM1235	N-V-7	3-1/2" X 12"	191.69

Kit Includes:

- 1 Vee-Set
- 5 NBR O-rings
- 2 NBR Piston Cups

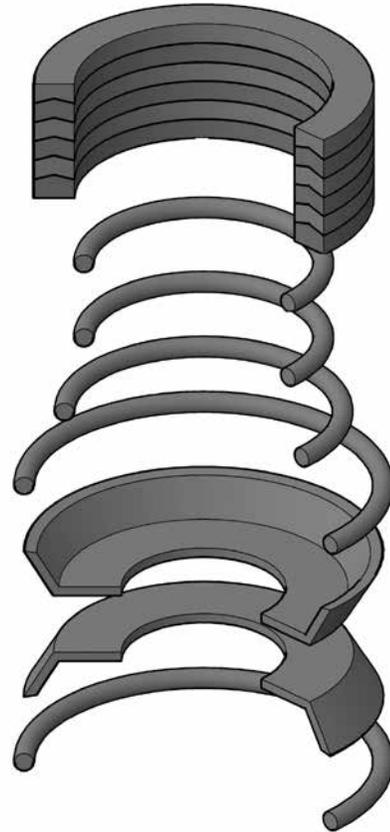

ROYAL

H Series Hydraulic Kits

H Cylinders

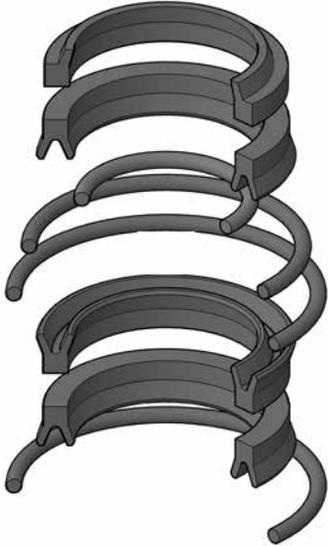

Kit #	Code	Rod x Bore	List Price
RYL-KH1510	I-U-5	1" X 1-1/2"	\$ 49.27
RYL-KH2510	I-U-5	1" X 2-1/2"	64.85
RYL-KH2517	I-U-5	1-3/4" X 2-1/2"	71.31
RYL-KH3217	I-U-5	1-3/4" X 3-1/4"	95.08
RYL-KH3220	I-U-5	2" X 3-1/4"	96.51
RYL-KH4017	I-U-5	1-3/4" X 4"	100.66
RYL-KH4025	I-U-5	2-1/2" X 4"	113.64
RYL-KH5020	I-U-5	2" X 5"	131.14
RYL-KH6025	I-U-5	2-1/2" X 6"	133.28

Kit Includes:

- 1 URE Wiper
- 3 URE U-seals
- 1 NBR O-ring
- 3 URE O-rings

S2 Series Hydraulic Kits

S2 Cylinders

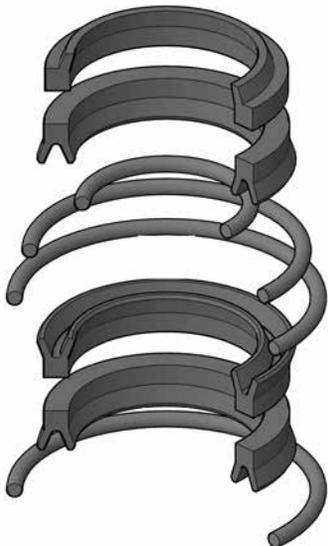

Kit #	Code	Rod x Bore	List Price
RYL-K2K212	I-U-5	1-1/4" X 2"	\$ 39.93
RYL-K2K2510	I-U-5	1" X 2-1/2"	48.70
RYL-K2K2512	I-U-5	1-1/4" X 2-1/2"	47.13
RYL-K2K312	I-U-5	1-1/4" X 3"	56.58

Kit Includes:

- 1 URE Wiper
- 3 URE U-seals
- 4 NBR O-rings

ROYAL

Kit Number	Code	Rod x Bore	List Price
RYL-K2K212	I-U-5	1-1/4 X 2	\$ 39.93
RYL-K2K2510	I-U-5	1 X 2-1/2	48.70
RYL-K2K2512	I-U-5	1-1/4 X 2-1/2	47.13
RYL-K2K312	I-U-5	1-1/4 X 3	56.58
RYL-KA1030	I-U-5	3 X 10	140.80
RYL-KA1230	I-U-5	3 X 12	147.44
RYL-KA1235	I-U-5	3-1/2 X 12	150.89
RYL-KA1506	N-U-5	5/8 X 1-1/2	8.29
RYL-KA207	N-U-5	3/4 X 2	44.67
RYL-KA210	N-U-5	1 X 2	44.74
RYL-KA310	I-U-5	1 X 3	53.60
RYL-KA312	I-U-5	1-1/4 X 3	54.17
RYL-KA412	I-U-5	1-1/4 X 4	75.24
RYL-KA415	I-U-5	1-1/2 X 4	75.92
RYL-KA512	I-U-5	1-1/4 X 5	91.31
RYL-KA515	I-U-5	1-1/2 X 5	92.00
RYL-KA615	I-U-5	1-1/2 X 6	115.76
RYL-KA617	I-U-5	1-3/4 X 6	116.24
RYL-KH1510	I-U-5	1 X 1-1/2	49.27
RYL-KH2510	I-U-5	1 X 2-1/2	64.85
RYL-KH2517	I-U-5	1-3/4 X 2-1/2	71.31
RYL-KH3217	I-U-5	1-3/4 X 3-1/4	95.08
RYL-KH3220	I-U-5	2 X 3-1/4	96.51
RYL-KH4017	I-U-5	1-3/4 X 4	100.66
RYL-KH4025	I-U-5	2-1/2 X 4	113.64
RYL-KH5020	I-U-5	2 X 5	131.14
RYL-KH6025	I-U-5	2-1/2 X 6	133.28
RYL-KM1025	N-V-7	2-1/2 X 10	124.80
RYL-KM1030	N-V-7	3 X 10	132.40
RYL-KM1235	N-V-7	3-1/2 X 12	191.69
RYL-KM415	N-V-7	1-1/2 X 4	41.09
RYL-KM620	N-V-7	2 X 6	62.85
RYL-KM820	N-V-7	2 X 8	93.83
RYL-KM825	N-V-7	2-1/2 X 8	95.87

ROYAL

SHEFFER

Kit Type		Page
Pneumatic Kits	C20 Series	132
	A Series	133
Various Kits		132 - 133
Repair Kits	By Part Number	134

TOMPKINS-JOHNSON / TJ

Kit Type		Page
Tompkins-Johnson / TJ		135

VICKERS® / EATON

Kit Type		Page
Repair Kits	TZ Series	136

VICKERS® / TOMPKINS-JOHNSON

Kit Type		Page
Repair Kits	TE / TF Series	137

SHEFFER

C20 Series

Pneumatic Kits

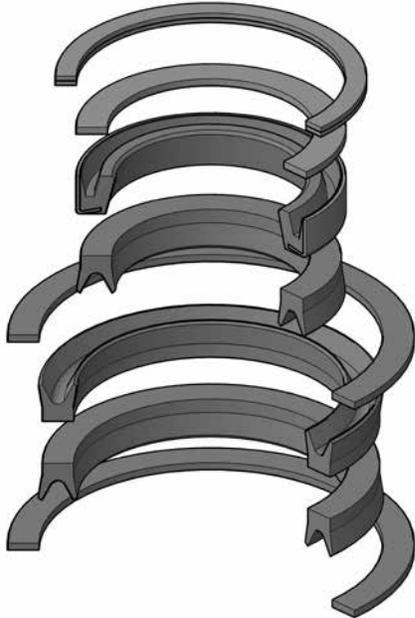

Kit #	Code	Rod x Bore	List Price
SHF-720-00150	P-U-5	1/2" X 1-1/2"	\$ 16.24
SHF-720-00200	P-U-5	1/2" X 2"	17.26
SHF-720-00250	P-U-5	5/8" X 2-1/2"	17.93
SHF-720-00300	P-U-5	3/4" X 3"	18.32
SHF-720-00350	P-U-5	3/4" X 3-1/2"	19.63
SHF-720-00400	P-U-5	1" X 4"	20.39
SHF-720-00500	P-U-5	1" X 5"	23.06
SHF-720-00600	P-U-5	1" X 6"	28.36
SHF-720-00700	P-U-5	1-3/8" X 7"	38.98
SHF-720-00800	P-U-5	1-3/8" X 8"	59.40

Kit Includes:

- 1 Metal-Clad Wiper
- 3 NBR U-seals
- 1 Steel Washer
- 2 Gaskets
- 1 Spiral Retainer Ring

(8" Bore also Includes:
4 NBR O-rings
2 NBR Cushion Seals)

Various Kits

Kit #	Code	Rod x Bore	List Price
SHF-720-01-0300	P-U-5	3/4" X 3"	\$ 23.61
SHF-720-01-0400	P-U-5	1" X 4"	31.70
SHF-720-01-0500	P-U-5	1" X 5"	36.14
SHF-720-01-0800	P-U-5	1-3/8" X 8"	75.93
SHF-726-0267-1000-0175	I-U-5	1-3/4" X 10"	113.69
SHF-760-01-0200-0137	I-U-10	1-3/8" X 2"	91.49
SHF-760-01-0250-0175	I-U-10	1-3/4" X 2-1/2"	33.34
SHF-761-01-0200-0137	I-U-10	1-3/8" x 2"	36.99
SHF-761-01-0250-0175	I-U-10	1-3/4" X 2-1/2"	39.01

Kit Composition Varies

Consult your
Hercules® Sealing Products representative.

SHEFFER

A Series

Pneumatic Kits

Kit #	Code	Rod x Bore	List Price
SHF-726-0167-0200-0062	I-U-5	5/8" X 2"	\$ 14.08
SHF-726-0167-0250-0062	I-U-5	5/8" X 2-1/2"	15.01
SHF-726-0167-0250-0100	I-U-5	1" X 2-1/2"	21.23
SHF-726-0167-0250-0137	I-U-5	1-3/8" X 2-1/2"	23.34
SHF-726-0167-0325-0100	I-U-5	1" X 3-1/4"	21.16
SHF-726-0167-0325-0137	I-U-5	1-3/8" X 3-1/4"	25.50
SHF-726-0167-0325-0175	I-U-5	1-3/4" X 3-1/4"	25.06
SHF-726-0167-0400-0100	I-U-5	1 X 4"	26.46
SHF-726-0167-0400-0137	I-U-5	1-3/8" X 4"	23.20
SHF-726-0167-0400-0175	I-U-5	1-3/4" X 4"	24.97
SHF-726-0167-0500-0100	I-U-5	1 X 5"	37.37
SHF-726-0167-0500-0137	I-U-5	1-3/8" X 5"	26.45
SHF-726-0167-0500-0175	I-U-5	1-3/4" X 5"	27.30
SHF-726-0167-0600-0137	I-U-5	1-3/8" X 6"	40.98
SHF-726-0167-0600-0175	I-U-5	1-3/4" X 6"	43.55
SHF-726-0167-0700-0137	I-U-5	1-3/8" X 7"	44.39
SHF-726-0167-0800-0137	I-U-5	1-3/8" X 8"	50.75
SHF-726-0167-0800-0175	I-U-5	1-3/4" X 8"	59.09
SHF-726-0167-1000-0175	I-U-5	1-3/4" X 10"	88.68

Kit Includes:

- 1 URE Wiper
- 5 NBR U-seals
- 4 NBR O-rings
- 2 Steel Washers
- 2 Spiral Retainer Rings

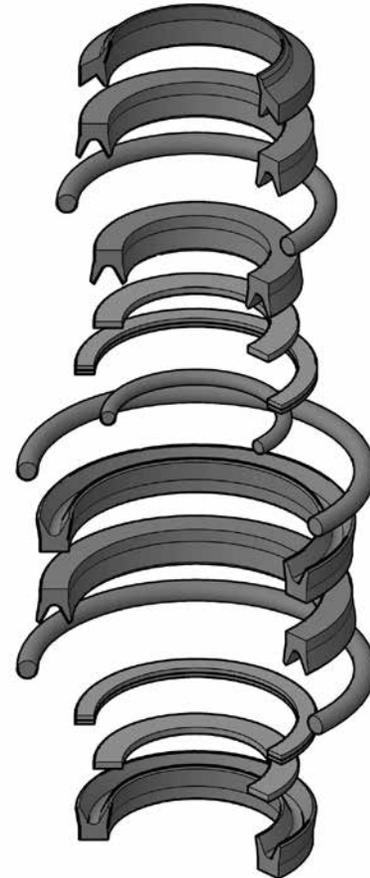

Various Kits

Kit #	Code	Rod x Bore	List Price
SHF-720-01-0600	P-U-4	1" X 6"	\$ 31.48
SHF-726-0107-0200-0100	I-U-5	1" X 2"	13.65
SHF-729-0200-K019	P-U-5	1-1/4" X 2"	30.49
SHF-729-0500-K003	P-U-5	2" X 5" Double Rod	51.52
SHF-757-01-0325-0137	I-U-10	1-3/8" X 3-1/4"	40.86
SHF-759-0100-0325-0137	I-U-5	1-3/8" X 3-1/4"	41.53
SHF-760-0100-0400-0175	I-U-10	1-3/4" X 4"	46.84
SHF-760-22-0600-0250	I-U-1	2-1/2" x 6"	101.36
SHF-761-01-0800-0350	I-U-10	3-1/2" X 8	187.45
SHF-795-S003	I-U-10	1-1/4 X 2-3/4	48.67

Kit Composition Varies

Consult your
Hercules® Sealing Products representative.

SHEFFER

SHEFFER

Kit Number	Code	Rod x Bore	List Price
SHF-100-032	O-Ring	Min Pack 20	\$ 0.29
SHF-100-041	O-Ring	Min Pack 20	0.57
SHF-100-149	O-Ring	Min Pack 20	0.48
SHF-157-0175-0137-031	U-Seal		10.83
SHF-185-301-0325	Piston Seal		6.31
SHF-720-00150	P-U-5	1/2 X 1-1/2	16.24
SHF-720-00200	P-U-5	1/2 X 2	17.26
SHF-720-00250	P-U-5	5/8 X 2-1/2	17.93
SHF-720-00300	P-U-5	3/4 X 3	18.32
SHF-720-00350	P-U-5	3/4 X 3-1/2	19.63
SHF-720-00400	P-U-5	1 X 4	20.39
SHF-720-00500	P-U-5	1 X 5	23.06
SHF-720-00600	P-U-5	1 X 6	28.36
SHF-720-00700	P-U-5	1-3/8 X 7	38.98
SHF-720-00800	P-U-5	1-3/8 X 8	59.40
SHF-720-01-0300	P-U-5	3/4 X 3	23.61
SHF-720-01-0350	P-U-5	3/4 X 3-1/2	24.63
SHF-720-01-0400	P-U-5	1 X 4	31.70
SHF-720-01-0500	P-U-5	1 X 5	36.14
SHF-720-01-0600	P-U-4	1 X 6	31.48
SHF-720-01-0800	P-U-5	1-3/8 X 8	75.93
SHF-726-0107-0200-0100	I-U-5	1 X 2	13.65
SHF-726-0167-0200-0062	I-U-5	5/8 X 2	14.08
SHF-726-0167-0250-0062	I-U-5	5/8 X 2-1/2	15.01
SHF-726-0167-0250-0100	I-U-5	1 X 2-1/2	21.23
SHF-726-0167-0250-0137	I-U-5	1-3/8 X 2-1/2	23.34
SHF-726-0167-0325-0100	I-U-5	1 X 3-1/4	21.16
SHF-726-0167-0325-0137	I-U-5	1-3/8 X 3-1/4	25.50
SHF-726-0167-0325-0175	I-U-5	1-3/4 X 3-1/4	25.06
SHF-726-0167-0400-0100	I-U-5	1 X 4	26.46
SHF-726-0167-0400-0137	I-U-5	1-3/8 X 4	23.20
SHF-726-0167-0400-0175	I-U-5	1-3/4 X 4	24.97
SHF-726-0167-0500-0100	I-U-5	1 X 5	37.37
SHF-726-0167-0500-0137	I-U-5	1-3/8 X 5	26.45
SHF-726-0167-0500-0175	I-U-5	1-3/4 X 5	27.30
SHF-726-0167-0600-0137	I-U-5	1-3/8 X 6	40.98
SHF-726-0167-0600-0175	I-U-5	1-3/4 X 6	43.55
SHF-726-0167-0700-0137	I-U-5	1-3/8 X 7	44.39
SHF-726-0167-0800-0137	I-U-5	1-3/8 X 8	50.75
SHF-726-0167-0800-0175	I-U-5	1-3/4 X 8	59.09
SHF-726-0167-1000-0175	I-U-5	1-3/4 X 10	88.68
SHF-726-0267-1000-0175	I-U-5	1-3/4 X 10	113.69
SHF-729-0200-K019	P-U-5	1-1/4 X 2	30.49
SHF-729-0500-K003	P-U-5	2 X 5 Double Rod	51.52
SHF-757-01-0325-0137	I-U-10	1-3/8 X 3-1/4	40.86
SHF-759-0100-0325-0137	I-U-5	1-3/8 X 3-1/4	41.53
SHF-760-0100-0400-0175	I-U-10	1-3/4 X 4	46.84
SHF-760-01-0200-0137	I-U-10	1-3/8 X 2	91.49
SHF-760-01-0250-0175	I-U-10	1-3/4 X 2-1/2	33.34
SHF-760-22-0600-0250	I-U-1	2-1/2 x 6	101.36
SHF-761-01-0200-0137	I-U-10	1-3/8 X 2	36.99
SHF-761-01-0250-0175	I-U-10	1-3/4 X 2-1/2	39.01
SHF-761-01-0700-0400	I-U-10	4 X 7	77.83
SHF-761-01-0800-0350	I-U-10	3-1/2 X 8	187.45
SHF-795-S003	I-U-10	1-1/4 X 2-3/4	48.67

SHEFFER

TOMPKINS-JOHNSON / TJ

Various Kits

Kit #	Code	Rod x Bore	List Price
TJ-28136862	N-TR-11	1 X 5	\$ 37.58
TJ-6331U-027	N-U-10	1-1/4 X 4	59.82
TJ-6332U-014	N-U-5	1 X 2-1/2	18.87
TJ-6332U-026	N-U-5	1 X 4	24.11
TJ-6332U-028	N-V-5	1-3/8 X 4	22.65
TJ-6332U-030	N-U-5	1-3/4 X 4	27.00
TJ-6332U-035	N-U-5	1 X 5	25.37
TJ-6332U-048	N-V-5	1-3/4 X 6	36.35
TJ-6332U-069	N-V-5	1-3/8 X 8	37.17
TJ-6332U-070	N-V-5	1-3/4 X 8	40.88

Kit Composition Varies

Consult your
Hercules® Sealing Products representative.

VICKERS® / EATON

TZ Series

Urethane Kits For TZ Cylinders

Rod Kits



Kit Includes:

- 1 NBR Wiper
- 1 Urethane Rod Seal
- 1 Wear Strip
- 2 Gland Seals

Piston Kits

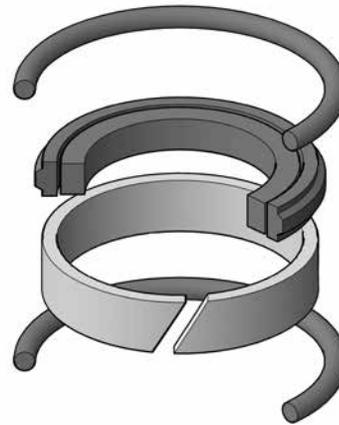

Kit Includes:

- 1 Urethane Piston Seal
- 1 Wear Strip
- 2 Tube End Seals

Rod Dia.	Kit #	List Price	Bore Dia.	Kit #	List Price
5/8"	VI-6533N-TZCC	\$ 22.61	1-1/2"	VI-6633N-TVCE	\$ 18.73
1"	VI-6533N-TZDE	38.54	2"	VI-6633N-TVDG	20.51
1-3/8"	VI-6533N-TZGH	28.59	2-1/2"	VI-6633N-TVEJ	22.42
1-3/4"	VI-6533N-TZHL	30.40	3-1/4"	VI-6633N-TVGL	27.96
2"	VI-6533N-TZKM	34.11	4"	VI-6633N-TVHN	35.86
2-1/2"	VI-6533N-TZLP	39.31	5"	VI-6633N-TVKQ	46.98
3"	VI-6533N-TZMU	48.24	6"	VI-6633N-TZLP	49.71
3-1/2"	VI-6533N-TZNV	49.88	7"	VI-6633N-TZMU	62.14
4"	VI-6533N-TZNW	88.88	8"	VI-6633N-TVNU	56.06
4-1/2"	VI-6533N-TZNY	70.12			
5-1/2"	VI-6533N-TZN1	97.53			
5"	VI-6533N-TZNZ	87.32			

VICKERS® / TOMPKINS-JOHNSON

TE / TF Series

Universal / No Wiper

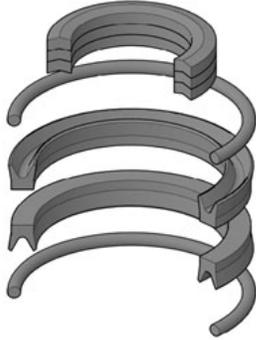

Kit Includes:

- 3 NBR Vee Rings
- 2 NBR Piston Seals
- 2 Tube End Seals

Pneumatic / Urethane Wiper



Kit Includes:

- 1 Urethane Insert Wiper
- 3 NBR Vee Rings
- 2 NBR Piston Seals
- 2 Tube End Seals

Hydraulic / Bronze Wiper

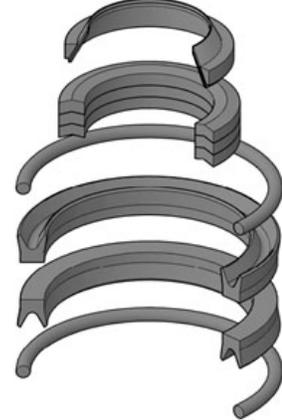

Kit Includes:

- 1 Bronze Insert Wiper
- 3 NBR Vee Rings
- 2 NBR Piston Seals
- 2 Tube End Seals

Rod x Bore	Kit #	List Price	Kit #	List Price	Kit #	List Price
5/8" X 1-1/2"	VI-6332U-004	\$ 12.95	VI-6332U-004-P	\$ 17.08	VI-6332U-004-H	\$ 25.88
5/8" X 2"	VI-6332U-007	13.22	VI-6332U-007-P	17.34	VI-6332U-007-H	26.00
1" X 2"	VI-6332U-009	14.03	VI-6332U-009-P	18.25	VI-6332U-009-H	24.64
1" X 2-1/2"	VI-6332U-014	18.87	VI-6332U-014-P	12.94	VI-6332U-014-H	21.99
1" X 3-1/4"	VI-6332U-020	17.36	VI-6332U-020-P	21.99	VI-6332U-020-H	26.52
1" X 4"	VI-6332U-026	24.11	VI-6332U-026-P	19.92	VI-6332U-026-H	25.48
1" X 1-1/2"	VI-6332U-006	13.72	VI-6332U-006-P	17.85	VI-6332U-006-H	24.45
1" X 5"	VI-6332U-035	25.37	VI-6332U-035-P	24.96	VI-6332U-035-H	38.36
1-3/8" X 2-1/2"	VI-6332U-016	35.87	VI-6332U-016-P	43.59	VI-6332U-016-H	43.21
1-3/8" X 3-1/4"	VI-6332U-022	17.37	VI-6332U-022-P	22.77	VI-6332U-022-H	32.79
1-3/8" X 4"	VI-6332U-028	23.68	VI-6332U-028-P	29.87	VI-6332U-028-H	36.35
1-3/8" X 5"	VI-6332U-037	26.22	VI-6332U-037-P	25.10	VI-6332U-037-H	40.90
1-3/8" X 8"	VI-6332U-069	37.17	VI-6332U-069-P	38.68	VI-6332U-069-H	43.85
1-3/4" X 3-1/4"	VI-6332U-023	21.13	VI-6332U-023-P	27.14	VI-6332U-023-H	41.20
1-3/4" X 4"	VI-6332U-030	25.52	VI-6332U-030-P	32.07	VI-6332U-030-H	43.66
1-3/4" X 5"	VI-6332U-039	28.10	VI-6332U-039-P	34.93	VI-6332U-039-H	46.39
1-3/4" X 6"	VI-6332U-048	36.35	VI-6332U-048-P	38.42	VI-6332U-048-H	43.59
1-3/4" X 8"	VI-6332U-070	40.88	VI-6332U-070-P	43.99	VI-6332U-070-H	49.12
2" X 4"	VI-6332U-031	26.33	VI-6332U-031-P	35.12	VI-6332U-031-H	48.83
2-1/2" X 4"	VI-6332U-033	29.32	VI-6332U-033-P	39.85	VI-6332U-033-H	56.58
2-1/2" X 5"	VI-6332U-042	32.88	VI-6332U-042-P	42.18	VI-6332U-042-H	65.13
3" X 5"	VI-6332U-044	34.95	VI-6332U-044-P	45.86	VI-6332U-044-H	76.76

NOTES

NOTES

Mobile Kits

CONTENTS		PAGE
A - B	Allis Chalmers, Anthony, Atlas, Atlas Copco, Baker, Barko, Bell, Bobcat®, Breaker Tech	140 - 157
C - D	Cameco, Cascade, Case, Caterpillar®, Champion, Char-Lynn®, Chief™, Clark®, Commercial®, Cross, Crown, Custom Hoists®, Dempster, Densmore, Doosan Infracore, Drilteck, Dynahoe	157 - 511
E - F	Eaton - Yale, Edbro, Effer Crane, Energy, Esco®, Euclid®, Fassi-Crane, Fiat-Allis®, FMC, Fontaine®, Fiat-Hitachi, Ford, Franklin, Fruehauf, Furukawa	511 - 535
G - H	Galbreath®, Galion® - Dresser, Garwood, Gehl®, Glencoe, Gradall®, Grove Crane, Harsh®, Heil®, Hiab, Hitachi, Husky Brute, Hyco, Hydro-Ax, Hyster, Hyundai, Hyva®	535 - 621
I - J	Ingersoll-Rand, International Harvester, JCB, JLG®, John Deere, Johnson	622 - 748
K - L	Kalmar, Kato, Kobelco®, Koehring, Komatsu, Kubota®, Leach, Liebherr, Liugong, Link Belt, Load Master™, Log Hog™, Lorain, Lucky Loader, Lull®	748 - 940
M - N	Marion, Mark-Lift, Massey Ferguson, McNeilus®, Meyer®, Mitsubishi, Moffett, Monarch Road, Morbark, New Holland, Nissan, NPK	941 - 967
O - P	Pandrol-Jackson, Pak-Mor, Peabody Galion, Peerless, Perfection-Cobey, Pettibone, P & H Crane, Prentice®, Prince	967 - 987
Q - R	Raymond, Red Lion, Reynolds®, Ronen	988
S - T	Samsung, Sandvik, Skyjack, Snorkel, Steelmaster, Sumitomo, Tamrock, Takeuchi®, TMC, Terex®, Timberjack, Toyota, Trojan	988 - 1006
U - V	Upright, Vanguard, Venco, Volvo	1006 - 1068
W - Z	Wabco, Waltco, Ward, White, Whiteman / Conspray, Yale®, Yanmar, Yutani	1068 - 1073

All manufacturer's names, part numbers and descriptions are used for reference purposes only. We do not imply that any part shown is the product of these manufacturers. We also do not imply that the list price shown is exactly that of the manufacturer.

ALLIS-CHALMERS LIFT TRUCKS

Kit Number	Code (Pg. xviii)	Rod X Bore Size	List Price
AC-4751907	N-V-1	1-1/4 Rod Kit	\$ 88.11
AC-4787570	2 STAGE	1-7/8, 2-1/2	226.53
AC-4787619	9/16" SPOOL	9/16" Spool	10.64
AC-4885085	1 HALF RING	2-1/4 Rod Bearing	3.58
AC-4905170		3/4 Shaft Kit	60.62
AC-4906087	I-U-4	3 X 3-1/2	62.46
AC-4906099	I-U-1	2-1/4 X 2-3/4	97.83
AC-4906100	I-U-1	2-1/4 X 2-3/4	37.98
AC-4906322	I-U-11	1-1/4 X 3	28.20
AC-4906332	I-U-11	1-1/4 X 3	31.13
AC-4906336	I-U-11	1-1/2 X 3-3/4	42.82
AC-4906380	I-U-1	1-3/4 X 2-1/4	23.64
AC-4906390	I-U-1	2-5/8 X 3-1/4	25.93
AC-4906391	I-U-4	3-3/4 X 4-1/4 w/ feed tube	165.61
AC-4906392	I,P-U-1	3-3/4 X 4-1/4	72.64
AC-4906396	I-U-11	1-3/4 X 4-7/8	67.93
AC-4907400		Pump Kit	12.93
AC-4907419	I-U-11	1-1/8 X 2-1/4	28.67
AC-4907474	P-U-1	4 X 4-1/2 w/ feed tube	85.89
AC-4907475	P-U-1	3-1/2 X 4-1/4	60.39
AC-4908297	I-O-3	1 X 2-1/2	16.26
AC-4908540	P-U-1	5 X 5-1/2	99.57
AC-4908541	P-U-1	5 X 5-1/2 w/ feed tube	127.49
AC-4908555	I-O-3	3/4 X 1-1/2	8.42
AC-4908917	I-U-1	3-1/4 X 3-3/4	39.75
AC-4908980	7/8" SPOOL	7/8" Spool	12.13
AC-4909028	I-O-3	1-1/4 X 3-1/2	13.49
AC-4909035	I-O-11	1-1/2 X 2-1/2	52.17
AC-4910116	I-O-11	7/8 X 2	15.39
AC-4910977	9/16" SPOOL	9/16" Spool	8.79
AC-4911398	I-U-4	2 X 3 2 Cylinders	41.21
AC-4912036	I,P-U-1	1, 2-1/4, 3 Stages	107.14
AC-4912039	I-U-11	1-1/8 X 2-1/4	34.18
AC-4912322	I,P-U-1	1, 1-3/4, 2-3/8 Stages	106.91
AC-4912359	P-U-1	3 X 3-1/2	46.30
AC-4913028	P-U-11	7/8 X 2	39.70
AC-4913075	P-U-1	3-3/4 X 4-1/4 w/ feed tube	163.77
AC-4913486	P-U-1	2-1/2 X 3	53.14
AC-4914879	I-U-1	2-3/4 X 3-1/2	35.41
AC-4914917		1-7/8, 2-5/8	97.90
AC-4917136	I-U-10	2-1/4 X 3	62.91
AC-4917655	I-U-4	1-3/4 X 2-1/4	35.18
AC-4918325	I-U-4	1 X 2	35.27
AC-4918585	I-U-1	1-1/2 X 2-1/4	27.21
AC-4932484	I-SP-1	35 mm Rod Kit	13.98
AC-4942582	I-U-1	30 x 55 mm	29.94
AC-4991278	I-OB-3	1-1/8 X 2-1/4	16.93
AC-4992550	N-TR-1	7/8 Rod Only	7.79
AC-4992855	I-V-6	1-1/2 X 3-3/4	86.97
AC-4993273	I-V-6	1-1/4 X 3	76.39
AC-4993661	I-V-6	1-3/4 X 4-7/8	90.36
AC-4998712	I-N-V	3-5/8 X 4-1/4	84.69
AC-78762688	I-U-1	4-1/8 Rod Kit	86.74

ANTHONY TELESCOPIC CYLINDERS

PACKING: Vee packing - no top or bottom adaptors.
 WIPERS: Special wiper strip
 BEARINGS: Top is bronze and serves as top adaptor for vee packing and is machined on top edge o.d. to mate with retainer flange. Bottom is phenolic and serves as bottom adaptor and is machined on bottom o.d. edge to pilot over retainer ring.
 SPECIAL INFO. Unique bearing and packing retaining arrangement on each stage consisting of two external flanges which bolt together to retain top bearing. Internal stop is spiral retaining ring.
 STAGE O.D.'s: 2.475, 3.475, 4.475, 5.475, 6.475

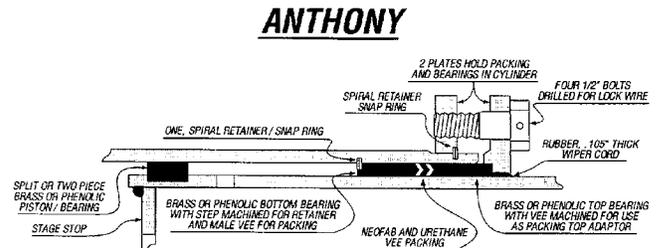

Part Number	Description	List Price
PACKING AND WIPERS		
ANY-S108002W	6-1/2" Vee Set & Wiper	\$ 70.97
ANY-S108003W	5-1/2" Vee Set & Wiper	47.82
ANY-S108004W	4-1/2" Vee Set & Wiper	42.33
ANY-S108005W	3-1/2" Vee Set & Wiper	41.33
ANY-S108006W	2-1/2" Vee Set & Wiper	37.32
BEARINGS		
ANY-S107022	6-1/2" Bottom Bearing	\$ 187.46
ANY-S107023	5-1/2" Bottom Bearing	170.33
ANY-S107024	4-1/2" Bottom Bearing	205.55
ANY-S107025	3-1/2" Bottom Bearing	95.06
INTERNAL RETAINERS		
ANY-S084005	Internal Spiral Retainer for 3" ID	\$ 5.87
ANY-S084017	Internal Spiral Retainer for 4" ID	50.00
ANY-S084018	Internal Spiral Retainer for 5" ID	50.00
ANY-S084019	Internal Spiral Retainer for 6" ID	50.62
ANY-S084020	Internal Spiral Retainer for 7" ID	62.98

ANTHONY TELESCOPIC CYLINDERS

Part Number	Description	List Price
EXTERNAL RETAINERS		
ANY-S084012	External Spiral Retainer for 3-1/2" OD	\$ 11.20
ANY-S084013	External Spiral Retainer for 4-1/2" OD	19.68
ANY-S084021	External Spiral Retainer for 6-1/2" OD	65.10
ANY-S084022	External Spiral Retainer for 5-1/2" OD	62.04
ANY-S084024	External Spiral Retainer for 7-1/2" OD	54.12
ANTHONY REPLACEMENT CYLINDER KIT		
CH-57	Custom #73-81-114, 129, 149	\$ 106.27

ANTHONY PUMP PARTS

Part Number	Description	List Price
ANY-A143031	Bearing	42.07
ANY-A143091	Packing & Nut	104.12

ATLAS TELESCOPIC CYLINDERS

Kit Number	Description	List Price
ATL-15-517	6-1/2" Piston Bearing	\$ 6.41
ATL-15-572	4-1/2" Piston Bearing	4.89
ATL-15-573	5-1/2" Piston Bearing	4.89
ATL-15-614	3-1/2" Piston Bearing	4.57
ATL-15-616	3" Packing, Bearings, Wiper	90.30
ATL-15-617	4" Packing, Bearings, Wiper	98.25
ATL-15-618	5" Packing, Bearings, Wiper	103.95
ATL-15-619	6" Packing, Bearings, Wiper	135.80
ATL-15-620	7" Packing, Bearings, Wiper	201.07
ATL-15-621	8" Packing, Bearings, Wiper	206.17

ATLAS COPCO

Kit Number	Code (Pg. xviii)	Rod X Bore Size	List Price
ATC-5541334300	P-UB-10	3 X 7	\$ 79.27
ATC-5541336900	P-UB-10	2 X 5	51.56
ATC-3218200686	P-UB-14	50 X 125 mm	123.10
ATC-3218200693	P-UB-14	80 X 180 mm	380.01

BAKER LIFT TRUCKS

Kit Number	Code (Pg. xviii)	Rod X Bore Size	List Price
BAK-104840	Multi-Stage	3-1/2, 3-3/8, 4-7/16	\$ 220.64
BAK-105147	I-V-1	4.438 Rod	177.12
BAK-105235	I-V-1	2.950 Rod	67.74
BAK-105652	I-V-5	1-1/4 X 4	86.73
BAK-106390	I-U-5	1-3/4 X 4-1/2	94.50
BAK-106391	I-V-11	1-3/4 X 4	45.51
BAK-106393	I-V-11	1-1/4 X 4	83.11
BAK-106399	I-V-11	1-1/4 X 3	33.19
BAK-106657	I-V-1	3.950 Rod	90.24
BAK-106663	Multi-Stage	2-1/4, 2-3/8, 3-1/4	78.32
BAK-109009	I-U-4	2-1/2 X 3	58.95
BAK-109010	I-V-1	2-1/2 Rod	105.47
BAK-138727	P-U-10	22 X 60 mm	107.96
BAK-3001Y10	I-V-11	1-3/4 X 4	45.24
BAK-3001Y14	Multi-Stage	2-3/8, 3-3/16, 4-15/16	326.64
BAK-3001Y16	I-V-11	1-1/4 X 3	75.69
BAK-3001Y17	I-V-1	3.450 Rod	98.24
BAK-3001Y20	I-V-1	3.950 Rod	91.83
BAK-3001Y22	P-OB-10	3/4 X 2	27.58
BAK-3001Y28	I-V-5	1-1/4 X 3	121.12

BAKER LIFT TRUCKS KIT APPLICATIONS - TILT CYLINDERS

Cylinder Assembly	Repair Kit	Cylinder Assembly	Repair Kit
233HR7774ZC	3001Y10	9025FP	106391
270HR7774ZC	106399	9025FT	3001Y10
9025AT	106399	A9025GK	106393
9025AX	106399	A9025GN	106393
9025BE	3001Y10	9025GN	106393
9025BF	3001Y10	9025HC	106393
9025BL	3001Y10	9025JA	106393
9025BM	106391	9025JJ	106393
9025BN	106391	9025JM	106393
9025CH	106399	9025JS	105652
9025EG	3001Y16	9025JT	105652
9025EP	3001Y16	9025JV	105652
9025EW	3001Y10	9025JW	105652
9025FB	3001Y16	9025JX	3001Y28
9025FF	106391	9025JY	3001Y28
9025FH	3001Y10	9025KA	105652
9025FN	3001Y16	A9025KA	105652

BAKER LIFT TRUCKS**KIT APPLICATIONS - TILT CYLINDERS**

Cylinder Assembly	Repair Kit	Cylinder Assembly	Repair Kit
9025KB	105652	103904-05	105652
9025KC	105652	104183-86	3001Y28
100072-75	3001Y28	104639-40	105652
100472-477	105652	105840-41	105652
100503-508	105652	106058-59	105652
100516-519	105652	108259-60	105652
100742-743	105652	109351-52	105652
100960-963	105652	110872-73	106390
102793-94	3001Y28	113352-53	106390
102961-62	3001Y28		

BAKER LIFT TRUCKS**KIT APPLICATIONS - HOIST CYLINDERS**

Cylinder Assembly	Repair Kit	Cylinder Assembly	Repair Kit
122R7774Z	3001Y14	103583	3001Y20
160R7774XC	3001Y14	103589	3001Y20
230HR7774ZC	3001Y14	103598	3001Y20
270HR7774XC	106399	103635	3001Y20
294U7774XC	106657	103662	105147
295HR7774XC	3001Y17	103775	106663
298U7774XC	3001Y14	103855	106663
9025AD	3001Y14	103894-95	106663
9025AF	3001Y14	104100	104840
9025CN	106657	104131	3001Y14
9025D	106657	104178	105147
9025EH	3001Y17	104244	3001Y14
C9025GB	104840	104278	106663
A9025GC	3001Y20	104349	3001Y20
9025GW	105235	104377	105147
9025HH	3001Y20	104431	104840
9025HX	3001Y20	104438	104840
9025JK	106393	104441	106663
100227-230	105235	104516	105147
102019-20	105235	104529	104840
102064-67	105235	104548	3001Y20
102068-72 & 79	3001Y17	104604	105147
102506-08	105235	104617	105147
102556-559	3001Y17	104705-07	3001Y20
102569-79	106663	104745	104840
102671-79	3001Y14	104794-96	3001Y20
102695-102708	104840	104878	3001Y20
102813-16	3001Y20	104998	104840
102898-900	3001Y20	105104	3001Y20
103102	105147	105163	105147

BAKER LIFT TRUCKS**KIT APPLICATIONS - HOIST CYLINDERS**

Cylinder Assembly	Repair Kit	Cylinder Assembly	Repair Kit
105387-89	109010	111549-562	109010
105727	106663	111843	105235
105730	3001Y14	112006	104840
105842	104840	112037	3001Y20
105845	104840	112061	109009
105855	3001Y20	112111	104840
105933	106663	112213	104840
105962	3001Y20	112419	105235
105970	3001Y20	112562-63	109009
106138	3001Y20	112600	105147
106228	3001Y20	112658	109009
106474-76	109009	112832	105235
106477	109009	112904	104840
106647	104840	112962	109009
106672	106663	113111	105147
106733	104840	113194	109009
107695-96	105147	113228	3001Y20
107794-96	109009	113251	105235
108051	104840	113388	109009
108625	109009	113434	109009
108656	109009	113638	105147
108971-974	105235	114040	109009
109631-641	109009	114141	109009
109788	3001Y20	114283	109009
109823	105147	114392	105147
109879	109010	114889	109009
110095	109009	114954	109009
110506	109010	115237	105147
110648-657	105235	115247	3001Y20
110756	3001Y20	115656	105147
110899	105235	115956	109009
110947-949	109009	116318	109009
111059-61	109009	116740	3001Y20
111124	109010	G7328-3	104840

BARKO

Kit Number	Code (Pg. xviii)	Rod X Bore Size	List Price
BK-65489	6" PISTON KIT		\$ 77.31
BK-65490	I-U-3	2-1/2 X 6	46.23
BK-65500K	P-OB-12	1-3/4 X 5	38.40
BK-65501	P-OB-12	2 X 5	71.80
BK-65512	P-OB-12	1-1/2 X 3-1/2	25.83
BK-65514	P-OB-10, 12	2 X 5	76.32
BK-65515	P-OB-10, 12	2-1/2 X 6	48.29
BK-65523	I-U-5	3 X 7	118.51
BK-65524	I, P-U-5	2-1/2 X 6	111.99
BK-65525	I, P-U-5	2 X 5	96.12
BK-65531	I, P-U-5	2 X 3-1/2	54.02
BK-65532	4-1/2" SWIVEL KIT		82.58
BK-65533	I-P-U-5	2 X 3-1/2	44.91
BK-65536	I-U-5	3 X 6	122.00
BK-65537	I, P-U-5	3 X 6	107.06
BK-65576	3-1/2" SWIVEL KIT		12.93
BK-65578	6" SWIVEL KIT		38.40
BK-65583	I-U-5	4 X 7	129.35
BK-65586	I-U-5	2-1/2 X 5	75.76
BK-65588	5" SWIVEL KIT		54.48
BK-55200013	O-RING KIT		6.96
BK-55200099	1-7/8 SWIVEL KIT		56.78
BK-55200277	I-U-10	2 X 3-1/2	33.68
BK-55200418	I-U-10	2 X 3-1/2	43.57
BK-55200420	I-U-10	2-1/2 X 4-1/2	73.51
BK-55200492	O-RING KIT		4.99
BK-55200499	I-U-14	2 X 4	124.42
BK-55200616	P-UB-14	2-1/2 X 6	206.03
BK-55200617	P-UB-14	3 X 7	206.12
BK-55200636	P-UB-3	3 X 7	73.61
BK-55200637	P-UB-3	2-1/2 X 6	81.56
BK-55200641	P-UB-14	3 X 6	196.42
BK-55200659	P-UB-10	3 X 6	116.99
BK-55200660	P-UB-10	3 X 7	139.12
BK-55200668	P-U-10	2 X 3-1/2	51.86
BK-55200689	P-UB-10	2-1/2 X 6	125.20
BK-55200796	P-UB-10	2-1/2 X 4-1/2	100.67
BK-55200810	P-U-10	2-1/2 X 4-1/2	69.77
BK-55600600	8" SWIVEL KIT		368.94
BK-55600673	O-RING KIT		3.58
BK-55600711	N-U-10	3 X 3-1/2	50.10
BK-55600721	N-U-10	3 X 6	95.69

BARKO

Kit Number	Code (Pg. xviii)	Rod X Bore Size	List Price
BK-55600953	P-UB-14	3-1/2 X 6	\$210.77
BK-55601043	I-UB-14	4 X 7	273.83
BK-56500242	7" SWIVEL KIT		308.74
BK-565002435	3 1/2" SWIVEL KIT		71.84
BK-56500489	N-N-7	6 PISTON KIT	77.31
BK-56500490	I-U-3	2-1/2 X 6	46.23
BK-56500500	P-OB-12	1-3/4 X 5	38.40
BK-56500501	P-OB-12	2 X 5	71.80
BK-56500512	P-OB-12	1-1/2 X 3-1/2	25.83
BK-56500514	P-OB-10,12	2 X 5	76.32
BK-56500515	P-OB-10,12	2-1/2 X 6	48.29
BK-56500523	I-U-5	3 X 7	118.51
BK-56500524	I-U-5	2-1/2 X 6	111.99
BK-56500525	I, P-U-5	2 X 5	96.12
BK-56500531	I, P-U-5	2 X 3-1/2	54.02
BK-56500532	4-1/2" SWIVEL KIT		82.58
BK-56500533	I, P-U-5	2 X 3-1/2	44.91
BK-56500536	I-U-5	3 X 6	122.00
BK-56500537	I, P-U-5	3 X 6	107.06
BK-56500541	N-N-10	6" SWIVEL KIT	124.91
BK-56500576	3-1/2" SWIVEL KIT		12.93
BK-56500578	6" SWIVEL KIT		38.40
BK-56500583	I-U-5	4 X 7	129.35
BK-56500586	I-U-5	2-1/2 X 5	75.76
BK-56500588	5" SWIVEL KIT		66.53

BARKO

Replacement Kits For

BELL

Forestry - Tree Harvesters						
APPLICATION	CYL #	CODE	ROD	BORE	KIT #	List \$
MODEL SUPER T,ULTRA T						
BOOM	230057	P-U-15	50 mm	100 mm	BELL-140575	86.71
GRAB	230058	P-U-15	50 mm	100 mm	BELL-140575	86.71
SAW FEED	230105	P-U-15	1-1/4	63 mm	BELL-140311	56.94
SHEARHEAD ACCUMULATOR	230093	P-U-15	1-1/4	63 mm	BELL-140311	56.94
SHEARHEAD CUT--6"	230134	P-U-10	70 mm	150 mm	BELL-140309	168.20
SHEARHEAD GRAB	230093	P-U-15	1-1/4	63 mm	BELL-140311	56.94
SKIDDING	230106	P-U-15	50 mm	100 mm	BELL-140575	86.71
TILT	230104	P-U-15	1-1/4	63 mm	BELL-140311	56.94

BELL

Kit Number	Code (Pg. xviii)	Rod X Bore Size	List Price
BELL-140138	P-U-13	50 X 100 mm	\$ 86.71
BELL-140309	P-U-10	70 X 150 mm	168.20
BELL-140311	P-U-15	1-1/4 X 63 mm	56.94
BELL-140575	P-U-15	50 X 100 mm	86.71

BELL

Replacement Kits For

BOBCAT®

Backhoe Attachments							
APPLICATION	CYL #	SERIAL #	CODE	ROD	BORE	KIT #	List \$
MODEL 607							
BOOM			I-U-10	1-1/2	3	BCK-6587989	29.38
DIPPER			I-U-10	1-1/2	3	BCK-6587989	29.38
LOCK			I-U-10	1	2	BCK-6589064	36.07
TILT			I-U-10	1-1/2	3	BCK-6587989	29.38
MODEL 709							
BOOM			I-U-10	1-1/2	3-1/4	BCK-6661308	20.71
LOCK			I-U-10	1	2	BCK-6589064	36.07
STABILIZER			I-U-10	1-1/2	3-1/4	BCK-6661308	20.71
TILT			I-U-10	1-1/2	3	BCK-6587989	29.38
MODEL 811							
DIPPER			I-U-10	1-3/4	3-1/2	BCK-6596126	28.10
LOCK			I-U-10	1	2	BCK-6589064	36.07
TILT			I-U-10	1-1/2	3	BCK-6587989	29.38
MODEL 905							
LOCK			I-U-10	1	2	BCK-6589064	36.07
STABILIZER			I-U-10	1	2	BCK-6587790	15.49
TILT			I-U-10	1-1/2	3	BCK-6587989	29.38
MODEL 907							
BUCKET			I-U-10	1-1/2	3	BCK-6587989	29.38
DIPPER			I-U-10	1-1/2	3	BCK-6587989	29.38
LOCK			I-U-10	1	2	BCK-6589064	36.07
STABILIZER			P-OB-3	1	2	BCK-6598343	13.30
TILT			I-U-10	1-1/2	3	BCK-6587989	29.38
MODEL 908A							
LOCK			I-U-10	1	2	BCK-6589064	36.07
STABILIZER			P-OB-3	1	2	BCK-6598343	13.30
TILT			I-U-10	1-1/2	3	BCK-6587989	29.38
MODEL 908B							
LOCK			I-U-10	1	2	BCK-6589064	36.07
STABILIZER			P-OB-3	1	2	BCK-6598343	13.30
TILT			I-U-10	1-1/2	3	BCK-6587989	29.38
MODEL 909							
BOOM			I-U-10	1-1/2	3-1/4	BCK-6661297	16.86
DIPPER			P-OB-3	1	2	BCK-6598343	13.30
LOCK			I-U-10	1	2	BCK-6589064	36.07
TILT			I-U-10	1-1/2	3	BCK-6587989	29.38
MODEL 910							
LOCK			I-U-10	1	2	BCK-6589064	36.07
TILT			I-U-10	1-1/2	3	BCK-6587989	29.38
MODEL 911							
LOCK			I-U-10	1	2	BCK-6589064	36.07
TILT			I-U-10	1-1/2	3	BCK-6587989	29.38
MODEL 913							
DIPPER			I-U-10	1-1/2	3	BCK-6803272	24.98
LOCK			I-U-10	1	2	BCK-6589064	36.07

BOBCAT®

Replacement Kits For

BOBCAT®

Backhoe Attachments							
APPLICATION	CYL #	SERIAL #	CODE	ROD	BORE	KIT #	List \$
MODEL 913							
STABILIZER			I-U-10	1-1/2	3-1/4	BCK-6661298	35.69
			I-U-10	1	2	BCK-6589064	36.07
TILT			I-U-10	1-1/2	3	BCK-6587989	29.38
MODEL 914							
LOCK			I-U-10	1	2	BCK-6589064	36.07
TILT			I-U-10	1-1/2	3	BCK-6587989	29.38
MODEL 914A							
LOCK			I-U-10	1	2	BCK-6589064	36.07
SWING			P-UB-9	2	4	BCK-6519428	53.57
TILT			I-U-10	1-1/2	3	BCK-6587989	29.38
MODEL 914B							
BUCKET			I-U-10	2	3-1/2	BCK-6588059	40.78
LOCK			I-U-10	1	2	BCK-6589064	36.07
TILT			I-U-10	1-1/2	3	BCK-6587989	29.38
Excavators							
APPLICATION	CYL #	SERIAL #	CODE	ROD	BORE	KIT #	List \$
MODEL 220							
ARM			I-U-10	1-3/8	2-3/8	BCK-6661047	21.94
BLADE			I-U-10	1-3/8	2-3/8	BCK-6661047	21.94
BOOM			I-U-10	1-3/8	2-3/8	BCK-6661047	21.94
BUCKET			I-U-10	1-3/8	2-3/8	BCK-6661047	21.94
SWING			I-U-10,12	1-3/8	2-3/8	BCK-6661046	69.12
VALVE-3 SPOOL			VALVE KIT			BCK-6661328	17.51
VALVE-6 SPOOL			O-RING KIT			BCK-6656283	3.93
MODEL 231							
ARM			I-U-10	1-3/4	3	BCK-6804603	34.95
BLADE			I-U-10	1-3/4	3-1/2	BCK-6661052	21.64
BOOM			I-U-10	1-3/4	3-1/4	BCK-6661051	20.62
BUCKET			I-U-10	2	3-1/4	BCK-6810470	41.49
SWING			I-U-10	1-1/2	3	BCK-6661053	21.18
VALVE			O-RING KIT			BCK-6660750	4.03
MODEL 320							
ARM	6810414	224511001 - UP	I-U-10	1-1/2	2-3/8	BCK-6816534	25.82
BLADE	6816479	224511001 - UP	I-U-10	1-3/8	2-3/8	BCK-6809571	25.47
BOOM	6812505	224511001 - UP	I-U-10	1-3/8	2-3/8	BCK-6809571	25.47
BUCKET	6803038	224511001 - UP	I-U-10	1-1/2	2-1/4	BCK-6803325	27.05
SWING	6810486	224511001 - UP	I-U-10	1-1/4	3-1/4	BCK-6808225	22.44
TRACK EXPANSION	6810471	224511001 - UP	I-U-10	1	2	BCK-6589818	25.38
MODEL 320D							
ARM	6810414	223811001 - UP	I-U-10	1-1/2	2-3/8	BCK-6816534	25.82
BLADE	6810615	223811001 - UP	I-U-10	1-3/8	2-3/8	BCK-6803281	34.69
	6816479	223811001 - UP	I-U-10	1-3/8	2-3/8	BCK-6809571	25.47
BUCKET	6803038	223811001 - UP	I-U-10	1-1/2	2-1/4	BCK-6803325	27.05
CLAMP	6810475	223811001 - UP	I-U-10	1	2	BCK-6803474	19.24
SWING	6807167	223811001 - UP	I-U-10	1-1/4	3-1/4	BCK-6801183	22.21
	6810486	223811001 - UP	I-U-10	1-1/4	3-1/4	BCK-6808225	22.44

Replacement Kits For

BOBCAT®

Excavators							
APPLICATION	CYL #	SERIAL #	CODE	ROD	BORE	KIT #	List \$
MODEL 320G							
BLADE	6810615	223911001 - UP	I-U-10	1-3/8	2-3/8	BCK-6803281	34.69
	6816479	223911001 - UP	I-U-10	1-3/8	2-3/8	BCK-6809571	25.47
BUCKET	6803038	223911001 - UP	I-U-10	1-1/2	2-1/4	BCK-6803325	27.05
SWING	6807167	223911001 - UP	I-U-10	1-1/4	3-1/4	BCK-6801183	22.21
	6810486	223911001 - UP	I-U-10	1-1/4	3-1/4	BCK-6808225	22.44
MODEL 322D							
BLADE	6810615	223511001 - UP	I-U-10	1-3/8	2-3/8	BCK-6803281	34.69
	6816479	223511001 - UP	I-U-10	1-3/8	2-3/8	BCK-6809571	25.47
BOOM	6812505	223511001 - UP	I-U-10	1-3/8	2-3/8	BCK-6809571	25.47
BUCKET	6803038	223511001 - UP	I-U-10	1-1/2	2-1/4	BCK-6803325	27.05
SWING	6807167	223511001 - UP	I-U-10	1-1/4	3-1/4	BCK-6801183	22.21
	6810486	223511001 - UP	I-U-10	1-1/4	3-1/4	BCK-6808225	22.44
MODEL 322G							
BLADE	6810615	224011001 - UP	I-U-10	1-3/8	2-3/8	BCK-6803281	34.69
	6816479	224011001 - UP	I-U-10	1-3/8	2-3/8	BCK-6809571	25.47
BUCKET	6803038	224011001 - UP	I-U-10	1-1/2	2-1/4	BCK-6803325	27.05
SWING	6807167	224011001 - UP	I-U-10	1-1/4	3-1/4	BCK-6801183	22.21
	6810486	224011001 - UP	I-U-10	1-1/4	3-1/4	BCK-6808225	22.44
MODEL 323							
BLADE	6816479	562411001 - UP	I-U-10	1-3/8	2-3/8	BCK-6809571	25.47
BOOM	6812505	562411001 - UP	I-U-10	1-3/8	2-3/8	BCK-6809571	25.47
BUCKET	6803038	562411001 - UP	I-U-10	1-1/2	2-1/4	BCK-6803325	27.05
SWING	6810486	562411001 - UP	I-U-10	1-1/4	3-1/4	BCK-6808225	22.44
TRACK EXPANSION	6810471	562411001 - UP	I-U-10	1	2	BCK-6589818	25.38
MODEL 325G							
ARM	6810745	234111001 - UP	I-U-10	1-1/2	3	BCK-6816325	34.58
BLADE	6597371	234111001 - UP	I-U-10	1-1/2	2-3/4	BCK-6589786	24.82
BOOM	6810495	234111001 - UP	I-U-10	1-5/8	3	BCK-6816536	33.30
BUCKET	6808617	234111001 - UP	I-U-10	1-3/8	2-1/2	BCK-6806862	25.18
CLAMP	6817386	234111001 - UP	I-U-10	1-1/2	2-1/4	BCK-6816535	26.70
SWING	6809857	234111001 - UP	I-U-10	1-3/8	2-3/8	BCK-6809571	25.47
MODEL 328G							
ARM	6810745	234211001 - UP	I-U-10	1-1/2	3	BCK-6816325	34.58
BLADE	6597371	234211001 - UP	I-U-10	1-1/2	2-3/4	BCK-6589786	24.82
BOOM	6810495	234211001 - UP	I-U-10	1-5/8	3	BCK-6816536	33.30
BUCKET	6808617	234211001 - UP	I-U-10	1-3/8	2-1/2	BCK-6806862	25.18
CLAMP	6817386	234211001 - UP	I-U-10	1-1/2	2-1/4	BCK-6816535	26.70
SWING	6809857	234211001 - UP	I-U-10	1-3/8	2-3/8	BCK-6809571	25.47
MODEL 329							
ARM	6817188	A2PG1101	I-U-10	1-3/4	3-1/4	BCK-6815085	37.97
BLADE	6597350	A2PG1101	I-U-10	1-3/4	3-1/2	BCK-6803314	28.95
BOOM	7126322	A2PG1101	I-U-10	1-3/4	3-1/4	BCK-6815085	37.97
BUCKET	6812165	A2PG1101	I-U-10	2	3-1/4	BCK-6810470	41.49
CLAMP	6817386	A2PG1101	I-U-10	1-1/2	2-1/4	BCK-6816535	26.70
SWING	6816319	A2PG1101	I-U-10	1-1/2	3	BCK-6816325	34.58

BOBCAT®

Replacement Kits For

BOBCAT®

Excavators							
APPLICATION	CYL #	SERIAL #	CODE	ROD	BORE	KIT #	List \$
MODEL 331							
ARM	6810565	232511001 - UP	I-U-10	1-3/4	3	BCK-6810719	34.87
	6817188	232511001 - UP	I-U-10	1-3/4	3-1/4	BCK-6815085	37.97
BLADE	6597350	232511001 - UP	I-U-10	1-3/4	3-1/2	BCK-6803314	28.95
BOOM	6814980	232513729, 232711597 & 232612761 & Above	I-U-10	1-3/4	3-1/4	BCK-6815085	37.97
CLAMP	6817386	232511001 - UP	I-U-10	1-1/2	2-1/4	BCK-6816535	26.70
EXT ARM	6810433	232511001 - UP	I-U-10	1-1/2	2-1/4	BCK-6816535	26.70
SWING	6814862	232511001 - UP	I-U-10	1-1/2	3	BCK-6816325	34.58
MODEL 331, 331E, 334							
ARM	6810563		I-U-10	1-3/4	3	BCK-6804603	34.95
	6810565		I-U-10	1-3/4	3	BCK-6810719	34.87
	6817188		I-U-10	1-3/4	3-1/4	BCK-7137963	37.97
	7148240		I-U-10	1-3/4	3	BCK-6810719	34.87
	7156131		I-U-10	1-1/2	2-3/4	BCK-7162062	45.70
	7166446		I-U-10	1-1/2	2-3/4	BCK-7162062	45.70
ARM (Extendable)	6805399		I-U-10	1-1/2	2-1/4	BCK-7135557	33.65
	6810433		I-U-10	1-1/2	2-1/4	BCK-7135557	33.65
BLADE	6597350		I-U-10	1-3/4	3-1/2	BCK-7138009	28.95
BOOM	6806214		I-U-10	1-3/4	3-1/4	BCK-7137965	38.63
	6814980		I-U-10	1-3/4	3-1/4	BCK-7137963	37.97
	7148239		I-U-10	1-3/4	3-1/4	BCK-7156581	37.97
	7148522		I-U-10	1-3/4	3	BCK-7162061	46.06
	7156133		I-U-10	1-3/4	3	BCK-7162061	46.06
	7156579		I-U-10	1-3/4	3-1/4	BCK-7162060	37.97
BUCKET	6806102		I-U-10	2	3-1/4	BCK-7137966	36.26
	6812165		I-U-10	2	3-1/4	BCK-7137966	36.26
	7110562		I-U-10	1-3/4	2-3/4	BCK-7137935	28.85
	7147899		I-U-10	2	3-1/4	BCK-7137966	36.26
	7148457		I-U-10	1-3/4	2-3/4	BCK-7137935	28.85
CLAMP	6805607		I-U-10	1-1/2	2-3/4	BCK-6803268	31.52
	6817386		I-U-10	1-1/2	2-1/4	BCK-7135557	33.65
SWING	6806125		I-U-10	1-1/2	3	BCK-7135547	33.40
	6814862		I-U-10	1-1/2	3	BCK-6816325	34.58
	6816319		I-U-10	1-1/2	3	BCK-7135547	33.40
MODEL 337G							
ARM	6818248	234611001 - UP	I-U-10	2-1/4	3-1/2	BCK-6817081	82.72
BLADE	6815923	234611001 - UP	I-U-10	1-3/4	3-1/4	BCK-6816533	38.63
BOOM	6818252	234611001 - UP	I-U-10	2-1/4	4	BCK-6817183	95.74
BUCKET	6818255	234611001 - UP	I-U-10	2	3-1/4	BCK-6810470	41.49
CLAMP	6808069	234611001 - UP	I-U-10	2	2-3/4	BCK-6810717	50.31
SWING	6818258	234611001 - UP	I-U-10	2	3-1/4	BCK-6818161	42.13
MODEL 337WG							
ARM	6818248	235111001 - UP	I-U-10	2-1/4	3-1/2	BCK-6817081	82.72
	6818248	529111001 - UP	I-U-10	2-1/4	3-1/2	BCK-6817081	82.72
	6818248	529511001 - UP	I-U-10	2-1/4	3-1/2	BCK-6817081	82.72
BLADE	6815953	235111001 - UP	I-U-10	1-3/4	3-1/4	BCK-6816533	38.63

BOBCAT®

Replacement Kits For

BOBCAT®

Excavators							
APPLICATION	CYL #	SERIAL #	CODE	ROD	BORE	KIT #	List \$
MODEL 337WG							
BLADE	6815953	529511001 - UP	I-U-10	1-3/4	3-1/4	BCK-6816533	38.63
BOOM	6818252	235111001 - UP	I-U-10	2-1/4	4	BCK-6817183	95.74
	6818252	529111001 - UP	I-U-10	2-1/4	4	BCK-6817183	95.74
	6818252	529511001 - UP	I-U-10	2-1/4	4	BCK-6817183	95.74
BUCKET	6818255	235111001 - UP	I-U-10	2	3-1/4	BCK-6810470	41.49
	6818255	529111001 - UP	I-U-10	2	3-1/4	BCK-6810470	41.49
	6818255	529511001 - UP	I-U-10	2	3-1/4	BCK-6810470	41.49
CLAMP	6808069	235111001 - UP	I-U-10	2	2-3/4	BCK-6810717	50.31
	6808069	529111001 - UP	I-U-10	2	2-3/4	BCK-6810717	50.31
	6808069	529511001 - UP	I-U-10	2	2-3/4	BCK-6810717	50.31
SWING	6818258	235111001 - UP	I-U-10	2	3-1/4	BCK-6818161	42.13
MODEL 341G							
ARM	6818248	234711001 - UP	I-U-10	2-1/4	3-1/2	BCK-6817081	82.72
BLADE	6815953	234711001 - UP	I-U-10	1-3/4	3-1/4	BCK-6816533	38.63
BOOM	6818252	234711001 - UP	I-U-10	2-1/4	4	BCK-6817183	95.74
BUCKET	6818255	234711001 - UP	I-U-10	2	3-1/4	BCK-6810470	41.49
CLAMP	6808069	234711001 - UP	I-U-10	2	2-3/4	BCK-6810717	50.31
MODEL 430							
ANGLE	7134017	563011001 - UP	I-U-10	1-1/2	2-1/2	BCK-7135559	33.41
ARM	7148322		I-U-10	1-3/4	3-1/4	BCK-7156581	37.97
	7156131		I-U-10	1-1/2	2-3/4	BCK-7162062	45.70
	7156578		I-U-10	1-3/4	3-1/4	BCK-7156581	37.97
	7166446		I-U-10	1-1/2	2-3/4	BCK-7162062	45.70
ARM (Extendable)	6805399		I-U-10	1-1/2	2-1/4	BCK-7135557	33.65
	6810433		I-U-10	1-1/2	2-1/4	BCK-7135557	33.65
BLADE	6815009		I-U-10	1-1/2	2-1/2	BCK-7135559	33.41
	7121065		I-U-10	1-1/2	2-1/2	BCK-7135559	33.41
BLADE (Angle)	7134017		I-U-10	1-1/2	3	BCK-7135547	33.40
BOOM	6814980		I-U-10	1-3/4	3-1/4	BCK-7156581	37.97
	7100732		I-U-10	1-3/4	3	BCK-7162061	46.06
	7148239		I-U-10	1-3/4	3-1/4	BCK-7156581	37.97
	7148522		I-U-10	1-3/4	3	BCK-7162061	46.06
	7156133		I-U-10	1-3/4	3	BCK-7162061	46.06
	7156579		I-U-10	1-3/4	3-1/4	BCK-7156581	37.97
BUCKET	6812165		I-U-10	2	3-1/4	BCK-7137966	36.26
	7110562		I-U-10	1-3/4	2-3/4	BCK-7137935	28.85
	7147447		I-U-10	2	3-1/4	BCK-7137966	36.26
	7148457		I-U-10	1-3/4	2-3/4	BCK-7137935	28.85
BUCKET (Extendable Arm)	6806102		I-U-10	2	3-1/4	BCK-7137966	36.26
	7147899		I-U-10	2	3-1/4	BCK-7137966	36.26
CLAMP	6805607		I-U-10	1-1/2	2-1/4	BCK-7135557	33.65
	6817386		I-U-10	1-1/2	2-1/4	BCK-7135557	33.65
EXT ARM	6810433	563011001 - UP	I-U-10	1-1/2	2-1/4	BCK-7135557	33.65
SWING	6816319		I-U-10	1-1/2	3	BCK-7135547	33.40
	7162721		I-U-10	1-1/2	3	BCK-7135547	33.40

BOBCAT®

Replacement Kits For

BOBCAT®

Excavators							
APPLICATION	CYL #	SERIAL #	CODE	ROD	BORE	KIT #	List \$
MODEL 435							
ARM	6816744	563211001 - UP	I-U-10	2	3-1/4	BCK-6817143	50.57
BLADE	6815953	563211001 - UP	I-U-10	1-3/4	3-1/4	BCK-6816533	38.63
BOOM	6814385	563211001 - UP	I-U-10	2	3-3/4	BCK-6815959	104.81
BUCKET	6812517	563211001 - UP	I-U-10	1-3/4	3	BCK-6816352	34.62
CLAMP	6814063	563211001 - UP	I-U-10	1-3/4	2-1/2	BCK-6813752	30.11
SWING	6812633	563211001 - UP	I-U-10	2	3-1/4	BCK-6818161	42.13
MODEL X-225							
ARM	6586724	508312001-UP	I-U-10	1-1/2	2-3/4	BCK-6589796	22.97
BLADE		508312001-UP	I-U-10	1-1/2	2-3/4	BCK-6589796	22.97
	6596045	508312001-UP	I-U-10	1-1/2	2-3/4	BCK-6589786	24.82
BOOM	6586726	508312001-UP	I-U-10	1-1/2	2-3/4	BCK-6589796	22.97
BUCKET	6538977	508312001-UP	I-U-10	1-1/2	2-3/4	BCK-6589796	22.97
SWING	6536372	508312001-UP	I-U-10	1-3/8	2-3/8	BCK-6661047	21.94
MODEL X-320							
ARM			I-U-10	1-1/2	2-3/8	BCK-6816534	25.82
	6588297	511720001-..1115	I-U-10	1-3/8	2-3/8	BCK-6803281	34.69
	6589582	511721116 - UP	I-U-10	1-1/2	2-3/8	BCK-6589807	26.18
	6803040	562313001 - UP	I-U-10	1-1/2	2-3/8	BCK-6589807	26.18
BLADE	6587000	511720001 - UP	I-U-10	1-3/8	2-3/8	BCK-6803281	34.69
	6587000	562313001 - UP	I-U-10	1-3/8	2-3/8	BCK-6803281	34.69
	6802713		I-U-10	1-3/8	2-3/8	BCK-6803281	34.69
BOOM	6587019	511720001-..1115	I-U-10	1-3/8	2-3/8	BCK-6803281	34.69
	6589360	511721116 - UP	I-U-10	1-3/8	2-3/8	BCK-6803281	34.69
	6803045	562313001 - UP	I-U-10	1-3/8	2-3/8	BCK-6803281	34.69
BUCKET			I-U-10	1-1/2	2-1/4	BCK-6803325	27.05
SWING	6587963	511720001 - UP	I-U-10	1-1/4	2-3/8	BCK-6589868	21.84
	6803043	562313001 - UP	I-U-10	1-1/4	3-1/4	BCK-6801183	22.21
MODEL X-325							
ARM	6586724	511820001 - UP	I-U-10	1-1/2	2-3/4	BCK-6589796	22.97
	6595678	514011001-..012999	I-U-10	1-1/2	2-3/4	BCK-6803268	31.52
BLADE	6538976	511820001 - UP	I-U-10	1-1/2	2-3/4	BCK-6589796	22.97
	6596045	511820001 - UP	I-U-10	1-1/2	2-3/4	BCK-6589786	24.82
	6596045	514011001-..012999	I-U-10	1-1/2	2-3/4	BCK-6589786	24.82
BOOM	6586726	511820001 - UP	I-U-10	1-1/2	2-3/4	BCK-6589796	22.97
	6803696	514011001-..012999	I-U-10	1-1/2	2-3/4	BCK-6803268	31.52
BUCKET	6538977	511820001 - UP	I-U-10	1-1/2	2-3/4	BCK-6589796	22.97
	6803693	514011001-..012999	I-U-10	1-1/2	2-3/4	BCK-6803268	31.52
LIFTING CYLINDER	6802235	514011001-..012999	I-U-10	1-1/2	2-3/4	BCK-6803268	31.52
SWING	6536372	511820001 - UP	I-U-10	1-3/8	2-3/8	BCK-6661047	21.94
	6536372	514011001-..012999	I-U-10	1-3/8	2-3/8	BCK-6661047	21.94
MODEL X-331							
ARM			I-U-10	1-3/4	3	BCK-6804603	34.95
	6537325	512920001 - UP	I-U-10	1-3/4	3	BCK-6588079	25.37
BLADE			I-U-10	1-3/4	3-1/2	BCK-6803314	28.95
BOOM			I-U-10	1-3/4	3-1/4	BCK-6816533	38.63
BUCKET			I-U-10	2	3-1/4	BCK-6810470	41.49

BOBCAT®

Replacement Kits For

BOBCAT®

Excavators							
APPLICATION	CYL #	SERIAL #	CODE	ROD	BORE	KIT #	List \$
MODEL X-331							
SWING	6537577	512911001 - UP	I-U-10	1-1/2	3	BCK-6589797	25.60
	6537577	512920001 - UP	I-U-10	1-1/2	3	BCK-6589797	25.60
	6589756		I-U-10	1-1/2	3	BCK-6804604	34.58
Loaders - Skid Steer							
APPLICATION	CYL #	SERIAL #	CODE	ROD	BORE	KIT #	List \$
MODEL 310, 313, 371							
LIFT			I-U-10	1	2	BCK-6587790	15.49
TILT			I-U-10	1	2	BCK-6587790	15.49
MODEL 440							
LIFT			I-U-10	1	2	BCK-6587790	15.49
MODEL 440B							
LIFT			I-U-10	1	2	BCK-6803472	17.57
TILT	6589196	505214001	I-U-10	1-1/4	3	BCK-6803334	27.12
	6592700	505214001	I-U-10	1-1/4	3	BCK-6803334	27.12
MODEL 443							
LIFT			I-U-10	1	2	BCK-6803472	17.57
TILT			I-U-10	1-1/4	3	BCK-6803334	27.12
MODEL 444, 500							
LIFT			I-U-10	1-1/4	2	BCK-6803329	22.31
TILT			I-U-10	1	2	BCK-6803472	17.57
MODEL 450, 453							
LIFT			I-U-10	1	2	BCK-6587790	15.49
MODEL 463							
LIFT	6808340		I-U-10	1-1/4	2	BCK-6804927	29.95
	6812771		I-U-10	1-1/4	2	BCK-6804927	29.95
TILT	6815746		I-U-10	1-1/4	3	BCK-6803334	27.12
	6815798		I-U-10	1-1/4	3	BCK-6803334	27.12
MODEL 520, 530, 533, 540, 542B, 543							
LIFT			I-U-10	1-1/4	2	BCK-6803329	22.31
TILT			I-U-10	1-1/2	3	BCK-6804604	34.58
MODEL 543B							
TILT			I-U-10	1-1/2	3	BCK-6803272	24.98
MODEL 553							
LIFT			I-U-10	1-1/4	2	BCK-6586298	20.23
TILT			I-U-10	1-1/2	3	BCK-6803272	24.98
MODEL 600, 610, 620							
LIFT			I-U-10	1-1/4	2	BCK-6803329	22.31
TILT			I-U-10	1	2	BCK-6803472	17.57
MODEL 630							
LIFT			I-U-10	1-1/4	2	BCK-6803329	22.31
TILT			I-U-10	1-1/2	3-1/4	BCK-6804605	41.77
			I-U-10	1-1/2	3	BCK-6804604	34.58
MODEL 640							
TILT			I-U-10	1-1/2	3-1/4	BCK-6661297	16.86
			I-U-10	1-1/2	3-1/4	BCK-6661308	20.71

BOBCAT®

Replacement Kits For

BOBCAT®

Loaders - Skid Steer							
APPLICATION	CYL #	SERIAL #	CODE	ROD	BORE	KIT #	List \$
MODEL 642							
LIFT	6586671	5014-M-11001	I-U-10	1-1/4	2	BCK-6803329	22.31
TILT w/ Replaceable Tube			I-U-10	1-1/2	3-1/4	BCK-6804605	41.77
			I-U-10	1-1/2	3-1/4	BCK-6661297	16.86
TILT w/ Welded Tube			I-U-10	1-1/2	3-1/4	BCK-6804605	41.77
MODEL 642B							
LIFT			I-U-10	1-1/4	2	BCK-6803329	22.31
TILT			I-U-10	1-1/2	3-1/4	BCK-6804605	41.77
MODEL 643							
LIFT w/ Replaceable Tube	6586671	5015-M-13001	I-U-10	1-1/4	2	BCK-6803329	22.31
TILT w/ Replaceable Tube			I-U-10	1-1/2	3-1/4	BCK-6804605	41.77
			I-U-10	1-1/2	3-1/4	BCK-6661297	16.86
TILT w/ Welded Tube			I-U-10	1-1/2	3-1/4	BCK-6804605	41.77
MODEL 653							
TILT			I-U-10	1-1/2	3-1/4	BCK-6589792	30.22
MODEL 700, 720, 721, 722							
LIFT			I-U-10	1-1/4	2	BCK-6803329	22.31
TILT			I-U-10	1	2	BCK-6803472	17.57
			I-U-10	1	2	BCK-6587790	15.49
MODEL 730, 731, 732							
LIFT			I-U-10	1-1/2	3-1/4	BCK-6804605	41.77
			I-U-10	1-1/4	2	BCK-6803329	22.31
TILT			P-U-10	1-1/2	3-1/4	BCK-6514736	21.56
			I-U-10	1-1/2	3-1/4	BCK-6804605	41.77
MODEL 733							
TILT			P-U-10	1-1/2	3-1/4	BCK-6514736	21.56
MODEL 741, 742, 743							
LIFT			I-U-10	1-1/4	2	BCK-6803329	22.31
LIFT w/ Replaceable Tube			I-U-10	1-1/4	2	BCK-6803329	22.31
TILT			P-U-10	1-1/2	3-1/4	BCK-6514736	21.56
			I-U-10	1-1/2	3-1/4	BCK-6804605	41.77
TILT(CESSNA)			P-U-10	1-1/2	3-1/4	BCK-6514736	21.56
TILT(MELROE)			I-U-10	1-1/2	3-1/4	BCK-6804605	41.77
		<=12999	I-U-10	1-1/2	3-1/4	BCK-6661297	16.86
MODEL 742B							
LIFT	6586671	18001 & Above	I-U-10	1-1/4	2	BCK-6803329	22.31
TILT			I-U-10	1-1/2	3-1/4	BCK-6804605	41.77
MODEL 743B							
LIFT w/ Replaceable Tube	6586671		I-U-10	1-1/4	2	BCK-6803329	22.31
TILT(MELROE)			I-U-10	1-1/2	3-1/4	BCK-6804605	41.77
MODEL 743DS							
LIFT			I-U-10	1-1/4	2	BCK-6803329	22.31
TILT			I-U-10	1-1/2	3-1/4	BCK-6661297	16.86
MODEL 751							
LIFT	6586575	514711001	I-U-10	1-1/4	2	BCK-6803329	22.31
TILT			I-U-10	1-1/2	3-1/4	BCK-6804605	41.77

BOBCAT®

Replacement Kits For

BOBCAT®

Loaders - Skid Steer							
APPLICATION	CYL #	SERIAL #	CODE	ROD	BORE	KIT #	List \$
MODEL 753							
LIFT			I-U-10	1-1/4	2	BCK-6803329	22.31
TILT			I-U-10	1-1/2	3-1/4	BCK-6589792	30.22
			I-U-10	1-1/2	3-1/4	BCK-6804605	41.77
MODEL 763							
LIFT	6589259	512212001 & UP	I-U-10	1-1/2	2-1/4	BCK-6803325	27.05
TILT w/ Rod Eye Grease	6804630	512212001 & UP	I-U-10	1-1/2	3-1/2	BCK-6804606	31.42
MODEL 773							
LIFT	6537254	509635001	I-U-10	1-1/2	2-1/4	BCK-6803325	27.05
TILT			I-U-10	1-1/2	3-1/2	BCK-6804606	31.42
MODEL 825							
LIFT			I-U-10	1-1/2	2-1/4	BCK-6589793	22.84
			I-U-10	1-1/2	2-1/4	BCK-6555117	11.57
TILT			I-U-10	1	2-1/4	BCK-6544447	11.97
TILT w/ Replaceable Tube			I-U-10	1-1/2	3-1/4	BCK-6661297	16.86
MODEL 843							
LIFT			I-U-10	1-1/2	2-1/4	BCK-6589793	22.84
TILT			I-U-10	1-1/2	3-1/4	BCK-6804605	41.77
MODEL 843B							
LIFT	6529692	503760001	I-U-10	1-1/2	2-1/4	BCK-6589793	22.84
TILT			I-U-10	1-1/2	3-1/4	BCK-6804605	41.77
MODEL 853							
LIFT			I-U-10	1-1/2	2-1/4	BCK-6589793	22.84
	6587125	512811001-15999	I-U-10	1-1/2	2-1/4	BCK-6586915	22.90
TILT			I-U-10	1-1/2	3-1/4	BCK-6804605	41.77
MODEL 863							
LIFT	6800973	514411001 & UP	I-U-10	1-3/4	2-1/2	BCK-6803312	29.60
TILT			I-U-10	1-1/2	3-1/2	BCK-6804606	31.42
	6800466	514411001 & UP	I-U-10	1-5/8	3-1/2	BCK-6804615	31.92
MODEL 873							
LIFT	6589198	514111001 & UP	I-U-10	1-1/2	2-3/4	BCK-6804609	41.20
TILT - LH	6597376	514111574-15042	I-U-10	1-1/4	2-1/2	BCK-6595177	22.47
	6597387	514111001-514111573	I-U-10	1-1/4	2-1/2	BCK-6595177	22.47
	6800683	514115043 & UP	I-U-10	1-5/8	2-3/4	BCK-6804616	42.95
TILT - RH	6597377	514111574-15042	I-U-10	1-1/4	2-1/2	BCK-6595177	22.47
	6597388	514111001-514111573	I-U-10	1-1/4	2-1/2	BCK-6595177	22.47
	6800682	514115043 & UP	I-U-10	1-5/8	2-3/4	BCK-6804616	42.95
MODEL 943							
LIFT			I-U-10	1-3/4	3	BCK-6804603	34.95
			I-U-10	1-1/2	3	BCK-6661053	21.18
TILT			I-U-10	1-1/2	3	BCK-6804604	34.58
MODEL 953							
TILT			I-U-10	1-1/2	3	BCK-6803272	24.98
MODEL 970							
LIFT			I-U-10	2	3-1/2	BCK-6588059	40.78
		Prior to 110418	I-V-10	2	3-1/2	BCK-6509053	19.52
TILT			I-U-10	1-1/2	3	BCK-6804604	34.58

BOBCAT®

Replacement Kits For

BOBCAT®

Loaders - Skid Steer							
APPLICATION	CYL #	SERIAL #	CODE	ROD	BORE	KIT #	List \$
MODEL 974, 975							
LIFT			I-U-10	2	3-1/2	BCK-6588059	40.78
TILT			I-U-10	1-1/2	3	BCK-6804604	34.58
MODEL 980							
LIFT			I-U-10	2	3-1/2	BCK-6588059	40.78
TILT			I-U-10	1-1/2	3	BCK-6804604	34.58
MODEL 1213							
LIFT			I-U-10	1-1/2	2-1/4	BCK-6589793	22.84
MODEL A300							
LIFT	6817310		I-U-10	1-5/8	3	BCK-7137939	33.30
	7106456		I-U-10	1-5/8	3	BCK-7137939	33.30
STEERING	6814126		I-U-10	1	2	BCK-7137772	19.24
TILT	6810233		I-U-10	1-1/2	3	BCK-7135547	33.40
MODEL S130							
LIFT	6809201		I-U-10	1-1/4	2	BCK-7137770	29.95
TILT	6804630		I-U-10	1-1/2	3-1/2	BCK-7135555	36.44
MODEL S150, S160							
LIFT	6811994		I-U-10	1-1/2	2-1/4	BCK-7135557	33.65
TILT	6809802		I-U-10	1-3/8	2-3/4	BCK-6806330	30.46
	7117174		I-U-10	1-3/8	2-3/4	BCK-6806330	30.46
MODEL S175, S185							
LIFT	7117667		I-U-10	1-1/2	2-1/2	BCK-7135559	33.41
TILT	7117174		I-U-10	1-3/8	2-3/4	BCK-6806330	30.46
MODEL S205							
LIFT	6811995		I-U-10	1-1/2	2-1/2	BCK-6816537	33.41
	7107895		I-U-10	1-1/2	2-1/2	BCK-6816537	33.41
	7117667		I-U-10	1-1/2	2-1/2	BCK-7135559	33.41
TILT	6809802		I-U-10	1-3/8	2-3/4	BCK-6806330	30.46
	7117174		I-U-10	1-3/8	2-3/4	BCK-6806330	30.46
MODEL S220							
LIFT	6815757		I-U-10	1-3/4	2-1/2	BCK-7137865	23.98
TILT	6810233		I-U-10	1-1/2	3	BCK-7135547	33.40
MODEL S250, S300							
LIFT	6817310		I-U-10	1-5/8	3	BCK-7137939	33.30
	7106456		I-U-10	1-5/8	3	BCK-7137939	33.30
TILT	6810233		I-U-10	1-1/2	3	BCK-7135547	33.40
Loaders - Wheel							
APPLICATION	CYL #	SERIAL #	CODE	ROD	BORE	KIT #	List \$
MODEL 1600							
LIFT			I-U-10	2	3-1/2	BCK-6588059	40.78
MODEL 2400, 2410							
LOADER LIFT			I-U-10	1-3/4	3	BCK-6804603	34.95
LOADER TILT			I-U-10	1-1/2	2-3/4	BCK-6589796	22.97
STEERING			I-U-10	1-1/4	2-3/4	BCK-6661296	14.50

BOBCAT®

BOBCAT® (MELROE)

Kit Number	Code (Pg. xviii)	Rod X Bore Size	List Price
BCK-6504945	P-O-2	1 X 1-7/8	\$ 5.07
BCK-6504959	I-U-10	1-1/4 X 2	11.19
BCK-6504960	I-U-10	1 X 2	10.45
BCK-6504961	P-O-2	1 X 2	5.15
BCK-6505849	P-V-8	1-1/8 X 2	27.09
BCK-6505850	P-V-8	1 X 2	23.81
BCK-6509052	I-U-10	1-1/2 X 3	20.53
BCK-6509053	I-V-10	2 X 3-1/2	19.52
BCK-6509122	I-U-10,12	2 X 4	48.00
BCK-6509123	I-U-10,12	2-1/2 X 4	53.55
BCK-6509124	I-U-10,12	2 X 3-1/2	33.96
BCK-6511216	I-U-10	2-1/2 X 5	32.00
BCK-6511620	# 174 ACCUMULATOR		10.84
BCK-6512049	P-U-10	1-1/4 X 2-1/2	32.87
BCK-6512891	I-U-10	1-1/2 X 3	16.17
BCK-6514736	P-U-10	1-1/2 X 3-1/4	21.56
BCK-6515452	P-OB-3	1-1/2 X 3	11.31
BCK-6515459	P-O-1	2-3/4 ROD	17.17
BCK-6518500	O-RINGS		4.97
BCK-6519428	P-UB-9	2 X 4	53.57
BCK-6529691	I-U-10	1-1/2 X 3-1/4	19.28
BCK-6529991	I-U-10	1-1/2 X 2-3/4	14.55
BCK-6530345	I-U-10	1-1/2 X 3	29.38
BCK-6536322	I-U-10	1-3/4 X 2-3/8	21.94
BCK-6536671	I-U-10	1-3/4 X 2-3/8	21.94
BCK-6537299	I-U-10	2 X 3-1/4	41.97
BCK-6537322	I-U-10	1-1/4 X 2	20.23
BCK-6537361	I-U-10	1-3/4 X 3-1/4	20.62
BCK-6537565	I-U-10	1-3/4 X 3-1/2	21.64
BCK-6537585	I-U-10	1-1/2 X 3	21.18
BCK-6537861	I-U-10	1-3/4 X 3-1/4	20.62
BCK-6538082	I-U-10	1-3/4 X 3	34.95
BCK-6538144	I-U-10	1-1/2 X 3-1/4	25.01
BCK-6544447	I-U-10	1 X 2-1/4	11.97
BCK-6544448	I-U-10	1-1/4 X 2-1/4	10.71
BCK-6548178	I-U-10	2 X 3-1/2	15.28
BCK-6551271	I-U-10	1-1/2 X 3	11.99
BCK-6555117	I-U-10	1-1/2 X 2-1/4	11.57
BCK-6555851	I-U-10	1-1/2 X 3-1/2	17.04

Kit Number	Code (Pg. xviii)	Rod X Bore Size	List Price
BCK-6557718	I-U-10	1-1/2 X 3	\$ 11.24
BCK-6557719	I-U-10	1-1/4 X 2	10.77
BCK-6558847	I-U-10	1-1/2 X 3-1/4	12.81
BCK-6573437	I-OB-3	1-1/2 X 2	1.97
BCK-6586203	I-U-10	1-1/4 X 2-3/4	14.50
BCK-6586298	I-U-10	1-1/4 X 2	20.23
BCK-6586915	I-U-10	1-1/2 X 2-1/4	22.90
BCK-6587790	I-U-10	1 X 2	15.49
BCK-6587974	I-U-10	1-1/2 X 2-1/4	18.56
BCK-6587985	I-U-10	1-1/2 X 2-1/4	31.94
BCK-6587987	I-U-10	1-1/2 X 2-3/4	14.55
BCK-6587989	I-U-10	1-1/2 X 3	29.38
BCK-6587990	I-U-10	1-3/4 X 3	34.95
BCK-6587991	I-U-10	1-3/4 X 3-1/4	27.25
BCK-6588059	I-U-10	2 X 3-1/2	40.78
BCK-6588079	I-U-10	1-3/4 X 3	25.37
BCK-6588083	I-U-10	2 X 3-1/4	41.97
BCK-6589064	I-U-10	1 X 2	36.07
BCK-6589786	I-U-10	1-1/2 X 2-3/4	24.82
BCK-6589792	I-U-10	1-1/2 X 3-1/4	30.22
BCK-6589793	I-U-10	1-1/2 X 2-1/4	22.84
BCK-6589794	I-U-10	1-1/2 X 2-1/4	24.37
BCK-6589796	I-U-10	1-1/2 X 2-3/4	22.97
BCK-6589797	I-U-10	1-1/2 X 3	25.60
BCK-6589798	I-U-10	1-1/2 X 3	28.26
BCK-6589807	I-U-10	1-1/2 X 2-3/8	26.18
BCK-6589818	I-U-10	1 X 2	25.38
BCK-6589868	I-U-10	1-1/4 X 2-3/8	21.84
BCK-6590898	I-U-10	2 X 3	20.18
BCK-6591031	P-U-10	2-1/2 X 5-1/2	42.64
BCK-6591885	I-U-10	1-1/2 X 3-1/4	19.68
BCK-6592010	I-U-10	1-1/2 X 3	16.20
BCK-6592276	I-U-3	1 X 2-1/4	15.69
BCK-6592574	I-U-10	1-1/4 X 3	18.56
BCK-6592780	I-U-10	1-3/4 X 3	18.00
BCK-6593015	I-U-10	1 X 2	36.07
BCK-6593287	I-U-10	2 X 3-3/4	21.96
BCK-6594369	I-U-10	1-1/2 X 3-1/4	35.69
BCK-6595177	I-U-10	1-1/4 X 2-1/2	22.47

BOBCAT®

BOBCAT® (MELROE)

Kit Number	Code (Pg. xviii)	Rod X Bore Size	List Price	Kit Number	Code (Pg. xviii)	Rod X Bore Size	List Price
BCK-6596126	I-U-10	1-3/4 X 3-1/2	\$ 28.10	BCK-6804615	I-U-10	1-5/8 X 3-1/2	\$ 31.92
BCK-6598220	O-RING KIT		4.78	BCK-6804616	I-U-10	1-5/8 X 2-3/4	42.95
BCK-6598343	P-OB-3	1 X 2	13.30	BCK-6804927	I-U-10	1-1/4X2	29.95
BCK-6634687	I-U-5	1-1/4 X 2-1/2	24.92	BCK-6806330	I-U-10	1-3/8 X2-3/4	30.46
BCK-6635405	I-OB-3	1-1/8 X 2-1/2	8.46	BCK-6806862	I-U-10	1-3/8 X 2-1/2	25.18
BCK-6651242	MOTOR SEAL KIT		99.52	BCK-6808225	I-U-10	1-1/4 X 3-1/4	22.44
BCK-6656283	O-RING KIT		3.93	BCK-6808296	I-U-10	1-1/4 X 2-1/2	27.59
BCK-6660750	O-RING KIT		4.03	BCK-6809571	I-U-10	1-3/8 X 2-3/8	25.47
BCK-6661046	I-U-10,12	1-3/8 X 2-3/8	69.12	BCK-6810470	I-U-10	2 X 3-1/4	41.49
BCK-6661047	I-U-10	1-3/8 X 2-3/8	21.94	BCK-6810717	I-U-10	2 X 2-3/4	50.31
BCK-6661051	I-U-10	1-3/4 X 3-1/4	20.62	BCK-6810718	I-U-10	2 X 4	69.40
BCK-6661052	I-U-10	1-3/4 X 3-1/2	21.64	BCK-6810719	I-U-10	1-3/4 X 3	34.87
BCK-6661053	I-U-10	1-1/2 X 3	21.18	BCK-6813752	I-U-10	1-3/4 X 2-1/2	30.11
BCK-6661288	I-U-10	1 X 2	13.17	BCK-6815085	I-U-10	1-3/4 X 3-1/4	37.97
BCK-6661296	I-U-10	1-1/4 X 2-3/4	14.50	BCK-6815959	I-U-10	2 X 3-3/4	104.81
BCK-6661297	I-U-10	1-1/2 X 3-1/4	16.86	BCK-6816325	I-U-10	1-1/2 X 3	34.58
BCK-6661298	I-U-10	1-1/2 X 3-1/4	35.69	BCK-6816325	I-U-10	1-1/2 X 3	34.58
BCK-6661308	I-U-10	1-1/2 X 3-1/4	20.71	BCK-6816352	I-U-10	1-3/4 X 3	34.62
BCK-6661317	I-U-10	1-1/4 X 2-1/4	16.02	BCK-6816533	I-U-10	1-3/4 X 3-1/4	38.63
BCK-6661328	VALVE KIT		17.51	BCK-6816534	I-U-10	1-1/2 X 2-3/8	25.82
BCK-6661329	I-U-10	1-1/4 X 3	18.56	BCK-6816535	I-U-10	1-1/2 X 2-1/4	26.70
BCK-6801183	I-U-10	1-1/4 X 3-1/4	22.21	BCK-6816536	I-U-10	1-5/8 X 3	33.30
BCK-6803268	I-U-10	1-1/2 X 2-3/4	31.52	BCK-6816537	I-U-10	1-1/2 X2-1/2	33.41
BCK-6803272	I-U-10	1-1/2 X 3	24.98	BCK-6817081	I-U-10	2-1/4 X 3-1/2	82.72
BCK-6803274	I-U-10	1-1/2 X 3-1/2	24.61	BCK-6817143	I-U-10	2 X 3-1/4	50.57
BCK-6803281	I-U-10	1-3/8 X 2-3/8	34.69	BCK-6817183	I-U-10	2-1/4 X 4	95.74
BCK-6803312	I-U-10	1-3/4 X 2-1/2	29.60	BCK-6818161	I-U-10	2 X 3-1/4	42.13
BCK-6803313	I-U-10	1-3/4 X 3	33.52	BCK-7135489	I-U-10	1-5/8 X 2-3/4	23.75
BCK-6803314	I-U-10	1-3/4 X 3-1/2	28.95	BCK-7135547	I-U-10	1-1/2 X 3	33.40
BCK-6803325	I-U-10	1-1/2 X 2-1/4	27.05	BCK-7135551	I-U-10	1-1/2 X 3-1/4	33.23
BCK-6803329	I-U-10	1-1/4 X 2	22.31	BCK-7135555	I-U-10	1-1/2 X 3-1/2	36.44
BCK-6803334	I-U-10	1-1/4 X 3	27.12	BCK-7135557	I-U-10	1-1/2 X 2-1/4	33.65
BCK-6803472	I-U-10	1 X 2	17.57	BCK-7135558	I-U-10	1-1/2 X 2-1/4	32.31
BCK-6803474	I-U-10	1 X 2	19.24	BCK-7135559	I-U-10	1-1/2 X 2-1/2	33.41
BCK-6804603	I-U-10	1-3/4 X 3	34.95	BCK-7137770	I-U-10	1-1/4 X 2	29.95
BCK-6804604	I-U-10	1-1/2 X 3	34.58	BCK-7137771	I-U-10	1 X 2	12.80
BCK-6804605	I-U-10	1-1/2 X 3-1/4	41.77	BCK-7137772	I-U-10	1 X 2	19.24
BCK-6804606	I-U-10	1-1/2 X 3-1/2	31.42	BCK-7137865	I-U-10	1-3/4 X 2-1/2	23.98
BCK-6804609	I-U-10	1-1/2 X 2-3/4	41.20	BCK-7137869	I-U-10	1-3/4 X 2-1/2	32.36

BOBCAT® (MELROE)

Kit Number	Code (Pg. xviii)	Rod X Bore Size	List Price
BCK-7137935	I-U-10	1-3/4 X 2-3/4	\$ 28.85
BCK-7137939	I-U-10	1-5/8 X 3	33.30
BCK-7137945	I-U-10	1-3/4 X 3	37.33
BCK-7137963	I-U-10	1-3/4 X 3-1/4	37.97
BCK-7137966	I-U-10	2 X 3-1/4	36.26
BCK-7156581	I-U-10	1-3/4 X 3-1/4	37.97
BCK-7162060	I-U-10	1-3/4 X 3-1/4	37.97
BCK-7162061	I-U-10	1-3/4 X 3	46.06
BCK-7162062	I-U-10	1-1/2 X 2-3/4	45.70
BCK-7199903	I-U-10	1-1/2 X 2-3/4	22.45
BCK-7202518	I-U-10	1-5/8 X 3	33.19
BCK-7225639	I-U-10	1-3/4 X 3	37.33
BCK-749049	I-OB-3	1-1/2 X 2	12.02
BCK-M610	P-O-2	1-1/8 X 1-7/8	4.72

BREAKER TECH

Kit Number	Code (Pg. xviii)	Rod X Bore Size	List Price
BTI-815-0457-ML	I-V-9	2-3/4 X 5	\$ 203.68
BTI-815-0468-ML	I-V-9	3-1/2 X 6	364.28

CAMECO

Kit Number	Cylinder	Code (Pg. xviii)	Rod X Bore Size	List Price
CAM-017-1344693		N-N-14	100mm Piston Kit	\$ 24.49
CAM-017-1344694		P-UB-1	50mm Rod Kit	49.84
CAM-061-0007820		P-U-3	1-1/2 X 3-1/2	16.06
CAM-061-0021481		I-U-4	2-1/2 X 5	217.06
CAM-061-0053967		P-U-1	1-1/4	17.82
CAM-061-0297978		P-U-10	2-1/4 X 3	49.44
CAM-061-05021	001-05007	P-U-5	1-1/4 X 3	78.59
CAM-061-05835		P-U-3	1-1/4 X 2-1/2	14.58
CAM-061-06067	001-06063	P-OB-3	1-1/16 X 2-1/2	11.21
CAM-061-07221		I-V-5	2-1/2 X 7	147.32
CAM-061-08458	001-08459	I-U-5	2-1/2 X 4	84.07
CAM-061-08913		I-U-5	2-1/2 X 5	74.20
CAM-061-09619		P-U-3	2 X 4	29.77
CAM-061-1247081		P-U-1	3 Rod Kit	36.67
CAM-061-1304751		I-U-10	1-1/4 X 2-1/2	19.69
CAM-061-1309627		P-U-10	4 X 7	271.68
CAM-061-1347081		P-U-1	3 Rod Kit	36.67
CAM-061-1362725		I-U-10	1 X 2	13.51
CAM-061-21693		I-U-9	2-1/2 X 4	72.99
CAM-061-21699	001-21359	I-U-9	1-1/4 X 3	91.86
CAM-061-50139		P-V-3	1-1/4 X 3	28.55
CAM-061-53511		P-UB-10	2-1/2 X 4	61.86
CAM-061-53967	001-37224		1-1/4 Rod Kit	32.96
CAM-061-53968		P-U-1	1-1/2 Rod Kit	27.81
CAM-061-53970	001-89599		2-1/2 Rod Kit	36.01
CAM-061-53972	001-89576		3" Piston Kit	36.12
CAM-061-53973	001-89599		4" Piston Kit	36.62
CAM-061-53974		N-N-10	5" Bore	180.30
CAM-062-05672			Valve Kit	3.75
CAM-062-22730			Motor Kit	11.73

BOBCAT® - CAMECO

CASCADE

Kit Number	Code (Pg. xviii)	Rod X Bore Size	List Price
CAS-11.11.73	I-U-15	7/8 X 1-1/2	\$ 25.70
CAS-210090	I-U-4	20 mm X 36 mm	157.23
CAS-210288	I-U-4	20 mm X 36 mm	157.23
CAS-562339	I-U-4,10	1-1/8 X 2-1/4	24.87
CAS-684827	I-U-4	3/4 X 1-1/2	15.02
CAS-552715	I-U-1	2-1/4 X 2-3/4	45.60
CAS-554289	MULTI STAGE	4, 5	156.05
CAS-560349	I-U-4	2" X 75 mm	98.50
CAS-562591	I-U-4	2" X 60 mm	78.73
CAS-564409	I-U-13	25 mm X 63 mm	57.72
CAS-615939	O-RING KIT		6.80
CAS-615940	O-RING KIT		8.96
CAS-628080	I-V-8	1-1/4 X 3	59.98
CAS-630033	I-U-3	1-1/2 X 4-3/4	30.62
CAS-630038	I-U-3	1-1/2 X 4-3/4	28.36
CAS-630445	I-V-8	1-1/4 X 2-1/2	52.64
CAS-631277	P-V-9	2 X 4-3/4	190.33
CAS-638884	MULTI STAGE	2-3/4, 3-3/4	97.59
CAS-639695	I-U-4	3/4 X 1-3/4	48.36
CAS-640371	I-O-4	4 X4-1/2	81.04

Kit Number	Code (Pg. xviii)	Rod X Bore Size	List Price
CAS-641956	MULTI STAGE	4, 5	\$ 133.09
CAS-643280	I-U-4	3 X 3-1/2	50.95
CAS-644690	I-U-5	1-3/4 X 4	94.72
CAS-646305	I-U-3	3-1/2 X 4	62.49
CAS-646339	SWIVEL KIT		6.13
CAS-647626	I-U-4	1 X 2-1/4	24.91
CAS-647892	I-V-8	1-3/4 X 4.520	84.59
CAS-650018	I-U-5	3-1/2 X 7	109.98
CAS-651847	I-N-4	2 X 2-1/2	38.25
CAS-654519	P-V-1	2 X 4-3/4	57.65
CAS-656167	MULTI STAGE	4-1/4, 5-7/16	182.79
CAS-658717	MULTI STAGE	2-3/4, 3-3/4	91.96
CAS-660954	I-U-4	1-5/8 X 3-1/2	54.42
CAS-660955	I-U-4	3 X 4	64.15
CAS-664814	N-U-4	3/4 X 1-3/4	25.94
CAS-667622	MULTI STAGE	2-1/2, 3-1/4, 4-1/2	174.92

45C VIEWMAST II

CAS-T555286	P-U-10	2-1/8 X 3	\$ 76.37
-------------	--------	-----------	----------

REPLACEMENT PARTS FOR CASCADE EQUIPMENT

NOTE: Cascade part numbers are used as a reference only. We do not imply that these kits are original REPLACEMENT PARTS.

BACK-UP RINGS

Part Number	Min. Pkgs.	List Price
CAS-559870	1	\$ 11.14
CAS-563388	10	1.04
CAS-563907	1	2.89
CAS-563977	5	1.86
CAS-564404	1	4.62
CAS-615009	25	0.38
CAS-615012	25	0.39
CAS-615126	10	0.58
CAS-615128	10	0.67
CAS-615130	10	0.81
CAS-615132	10	0.91
CAS-615135	10	1.05
CAS-615140	10	1.44
CAS-615146	5	2.21
CAS-615147	5	1.93
CAS-615150	5	2.23
CAS-615152	5	2.48
CAS-615217	1	4.24
CAS-637565	1	5.49

BACK-UP RINGS

Part Number	Min. Pkgs.	List Price
CAS-638223	1	\$ 7.40
CAS-638224	1	7.40
CAS-638225	1	7.71
CAS-638244	10	0.66
CAS-638245	1	5.42
CAS-638247	1	5.69
CAS-638249	1	5.94
CAS-638250	1	5.28
CAS-638252	1	6.54
CAS-638253	1	6.78
CAS-638256	1	7.59
CAS-638257	1	7.71
CAS-638293	1	6.34
CAS-638295	1	6.78
CAS-638298	1	7.71
CAS-648569	4	3.06
CAS-660952	1	6.78
CAS-669247	5	2.19
CAS-671754	10	0.90

FACE SEALS

Part Number	List Price
CAS-601468	\$ 2.21
CAS-607287	3.75

REPLACEMENT PARTS FOR CASCADE

NOTE: Cascade part numbers are used as a reference only. We do not imply that these kits are original REPLACEMENT PARTS.

O-RINGS

Part Number	Min. Pkgs.	List Price
CAS-1596	50	\$ 0.09
CAS-1912210	20	0.29
CAS-207300	50	0.06
CAS-208761	50	0.09
CAS-208762	50	0.22
CAS-208763	50	0.26
CAS-209063	15	0.80
CAS-209064	15	0.80
CAS-209065	15	0.82
CAS-209066	15	0.88
CAS-212359	50	0.11
CAS-2696	50	0.03
CAS-2697	50	0.03
CAS-2698	50	0.03
CAS-2699	50	0.03
CAS-2700	50	0.06
CAS-2701	50	0.07
CAS-2702	50	0.06
CAS-2703	50	0.07
CAS-2704	50	0.07
CAS-2705	50	0.07
CAS-2706	50	0.07
CAS-2707	50	0.09
CAS-2709	50	0.09
CAS-2712	50	0.12
CAS-2722	20	0.26
CAS-2753	5	2.10
CAS-2785	20	0.54
CAS-2787	20	0.39
CAS-2789	20	0.42
CAS-2792	20	0.53
CAS-2793	20	0.53
CAS-2797	20	0.65
CAS-2799	20	0.69
CAS-2801	20	0.71
CAS-2803	10	0.79
CAS-2804	10	0.85
CAS-2807	10	1.12
CAS-2808	10	1.15
CAS-2809	10	1.18

O-RINGS

Part Number	Min. Pkgs.	List Price
CAS-2811	10	\$ 1.25
CAS-2840	50	0.22
CAS-524737	50	0.07
CAS-543372	10	1.44
CAS-557226	50	0.14
CAS-562127	20	0.63
CAS-564363	20	0.41
CAS-581565	50	0.29
CAS-613376	50	0.10
CAS-617724	50	0.12
CAS-622406	20	0.26
CAS-624737	50	0.07
CAS-624738	50	0.10
CAS-626186	50	0.10
CAS-626189	20	0.22
CAS-628033	20	0.19
CAS-630386	20	0.23
CAS-643330	50	0.06
CAS-643331	50	0.06
CAS-643332	50	0.06
CAS-643333	50	0.06
CAS-643334	50	0.06
CAS-643335	50	0.06
CAS-643336	50	0.06
CAS-643337	50	0.07
CAS-643338	50	0.07
CAS-643339	50	0.09
CAS-643340	50	0.09
CAS-643341	50	0.10
CAS-643342	50	0.10
CAS-643343	50	0.10
CAS-643344	50	0.10
CAS-643345	50	0.12
CAS-643346	50	0.12
CAS-643347	50	0.17
CAS-643348	50	0.19
CAS-643349	50	0.19
CAS-643350	20	0.19
CAS-643351	20	0.20
CAS-643352	20	0.23

O-RINGS

Part Number	Min. Pkgs.	List Price
CAS-643353	20	\$ 0.26
CAS-643354	20	0.29
CAS-643355	20	0.36
CAS-643356	20	0.39
CAS-643357	20	0.39
CAS-643358	20	0.42
CAS-643359	20	0.42
CAS-643360	20	0.47
CAS-643361	20	0.48
CAS-643362	20	0.50
CAS-643363	20	0.57
CAS-643364	20	0.62
CAS-643365	20	0.65
CAS-643366	10	0.77
CAS-643367	10	0.79
CAS-643368	10	0.85
CAS-643369	10	0.94
CAS-643370	10	1.12
CAS-643371	10	1.44
CAS-643373	50	0.09
CAS-643374	50	0.10
CAS-643375	50	0.10
CAS-643376	50	0.10
CAS-643377	50	0.12
CAS-643378	50	0.12
CAS-643379	50	0.12
CAS-643380	50	0.19
CAS-643381	50	0.19
CAS-643382	20	0.20
CAS-643383	20	0.22
CAS-643384	20	0.23
CAS-643385	20	0.23
CAS-643386	20	0.26
CAS-643387	20	0.27
CAS-643388	20	0.27
CAS-643389	20	0.29
CAS-643390	20	0.29
CAS-643391	20	0.29
CAS-643392	20	0.30
CAS-643393	20	0.30

REPLACEMENT PARTS FOR CASCADE EQUIPMENT

NOTE: Cascade part numbers are used as a reference only. We do not imply that these kits are original REPLACEMENT PARTS.

O-RINGS

Part Number	Min. Pkgs.	List Price
CAS-643394	20	\$ 0.36
CAS-643395	20	0.36
CAS-643396	20	0.36
CAS-643397	20	0.42
CAS-643398	20	0.42
CAS-643399	20	0.42
CAS-643400	20	0.47
CAS-643401	20	0.47
CAS-645592	20	0.54
CAS-654926	50	0.19
CAS-655799	50	0.12
CAS-666015	50	0.22
CAS-666183	50	0.22
CAS-666184	50	0.14
CAS-666891	15	0.80
CAS-666892	10	0.88
CAS-666893	15	0.80
CAS-676959	15	0.78
CAS-682862	50	0.07
CAS-684587	50	0.11
CAS-684615	50	0.11
CAS-689937	50	0.11
CAS-689938	50	0.14
CAS-797089	20	0.55

PISTON SEALS

Part Number	Bore Diameter	List Price
CAS-564407	63 mm	\$ 8.37

RETAINER RINGS

Part Number	List Price
CAS-7197	\$ 2.58

U-SEALS

Part Number	Rod Dia.	List Price
CAS-646540	3/4	\$ 4.91
CAS-641835	7/8	5.10
CAS-560502	1	5.30
CAS-662447	1	5.65
CAS-662450	1-3/8	6.44
CAS-662452	1-5/8	6.96
CAS-662454	1-7/8	7.80
CAS-553521	2-1/2	19.62
CAS-662462	3-1/2	15.14
CAS-553954	4-1/2	35.44
CAS-662457	2-1/4	10.11
CAS-553523	3	23.16
CAS-553524	3-1/4	24.26
CAS-662465	4-1/4	19.86
CAS-662467	4-3/4	22.68

REPLACEMENT PARTS FOR CASCADE

NOTE: Cascade part numbers are used as a reference only. We do not imply that these kits are original REPLACEMENT PARTS.

VEE SETS

Part Number	Bore	List Price
CAS-1469	3-1/2	\$ 42.76
CAS-1471	4-1/2	46.31
CAS-1809	1-3/4	18.57
CAS-1861	2-3/4	39.36
CAS-7501	1-3/8	21.38
CAS-7502	2	20.64
CAS-7514	3-3/4	38.83
CAS-7538	4	26.21
CAS-7542	3	22.23
CAS-7554	4-3/4	66.95
CAS-7561	4-1/4	72.84
CAS-7606	2-1/4	16.79
CAS-7608	3-1/2	22.11
CAS-7609	2-1/2	19.95
CAS-7636	4-1/4	41.32
CAS-827	4-1/2	52.80

WEAR RINGS

Part Number	O.D. X Width	List Price
CAS-660761	2-1/4 X 1/2	\$ 4.15
CAS-660769	4 X 1/2	4.65
CAS-660784	4-3/4 X 3/4	5.45
CAS-660786	5-1/4 X 3/4	5.56
CAS-636959	5-3/4 X 3/4	7.15

WIPERS

Part Number	Rod Dia.	List Price
CAS-559961	3/4	\$ 3.25
CAS-636851	7/8	1.20
CAS-636852	1	1.20
CAS-626468	1-1/4	1.30
CAS-636854	1-5/8	2.02
CAS-1916335	2-1/2	5.84
CAS-629608	2-1/2	2.47
CAS-636859	3	3.04
CAS-636860	3-1/4	3.58
CAS-563682	3-1/4	8.46
CAS-636862	4	4.09
CAS-563683	4-1/2	10.90
CAS-626456	4-1/2	4.43
CAS-636864	4-3/4	4.60
CAS-561256	42 mm	20.30

CASCADE

REPLACEMENT SEAL KITS FOR CASE EQUIPMENT*

Replacement Seal Kits By Machine Type

▶ **NEW MODELS**

Table of Contents

Machine Type		Page
Backhoe Loaders	380LL, 430 with Backhoe Models 21, 22, 23, 480, 480B with Backhoe Models 23, 26, 26B, 26S, 480C, 480D, 480D LL, 480E, 480E LL, 480F, 480F LL, 530 with Backhoe Models 31, 32, 32S, 580 Super E, 580 Super K, 580 Super L, 580 Super L Construction King, 580 Super M, 580 Super M SERIES 3, 580 Super M+ SERIES 3, 580 Super N Tier 3 , 580 Super N Tier 4 , 580 with Backhoe Models 33, 33S, 580B with Backhoe Model 35, 580C, 580C Construction King, 580D, 580 Super D, 580F, 580K, 580L, 580M, 580N (Brazil) , 580N Tier 3 , 580N Tier 4 , 590, 590 Super L, 590 Super M, 590 Super M SERIES 3, 590 Super N Tier 3 , 590 Super N Tier 4 , 590SR Super R, 590SR Super R Tier 2, 590SR Super R Tier 3, 680, 680B, 680C, 680CK, 680E, 680G, 680H, 680K, 680L, 780, 780B	164 - 180
Crawler Dozers/Loaders	310E, 310F with Backhoe Model 31, 310G with Backhoe Models 26, 26B, 26S, 32, 33, 350 with Backhoe Models 26, 26B, 26C, 26S, 350B with Backhoe Models 26C, 26D, 420C, 450 with Backhoe Models 26, 26B, 26C, 26S, 32, 33, 35, 450B, 450C, 455B, 455C with Backhoe Models 26D, 35, 475 Cable Layer, 550E, 550G, 550H, 650G, 650K, 750 with Backhoe Models 32, 33S, 34, 750H, 850 with Backhoe Models 34, 35, 36, 850B with Backhoe Model 35, 850C, 855C with Backhoe Models 35A, 35C, 35C WL, 35 WL, 850D with Backhoe Models 35C, 35C WL, 850E, 855E, 850G, 850H, 850K, 1150 with Backhoe Models 32, 34, 36, 1150B, 1150C, 1150D, 1155D, 1150G, 1150H, 1450, 1450B, 1455B	180 - 191
Excavators	880, 880B, 880C, 880D, 880R, 9010B, 9020B, 9030B, 9040B, CX36B, CX130, CX135SR, CX160, CX160B , CX210, CX210B , CX210C , CX240, CX330	191 - 194
Excavators - Compact	CX27B, CX31, CX31B, CX36B, CX50B	194 - 196
Forklifts - Rough Terrain	586G	196
Loaders - Skid Steer	40XT, 60XT, 70XT, 75XT , 85XT , 90XT , 95XT, 1818, 1825, 1835, 1835B, 1835C, 1838, 1840, 1845, 1845S, 1845B, 1845C, SR200 , SR220 , SR250 , SV250 , SV300	196 - 200
Loaders - Wheel	521D, 621, 621B, 621C, 621D, 621E , 621F , 721, 721B, 721C, 721D, 721E , 721F , 821, 821B, 821C, 821E, 921, 921C, W3, W7, W7C, W7E, W8E, W9, W9A, W9B, W9C, W9E, W10, W10B, W10C, W10E, W11, W11B, W14, W14L, W14H, W14B, W18, W20, W20B, W18B, W20C, W24, W24B, W24C, W26B, W26FL, W30, W36	200 - 206
Uni-Loaders	1530B, 1700, 1816B, 1816C, 1818, 1825, 1830, 1835, 1835B, 1840, 1845, 1845B, 1845C, 1845S	206 - 207
Unimogs	MB4/94 with Model 26C Backhoe, P80 Cable Plow, T70	207
Alpha-Numeric Kit Listing		208 - 212
Case Individual Parts		213 - 218

*All manufacturer's names, part numbers and descriptions are used for reference purposes only. We do not imply that any part shown is the product of these manufacturers. We also do not imply that the list price shown is exactly that of the manufacturer.

Replacement Kits For

CASE

Backhoe Loaders									
APPLICATION	CYL #	Piston	SERIAL #	CODE	ROD	BORE	KIT #	List \$	
MODEL 380LL									
LIFT		2pc		P-U-9	1-1/2	2-1/2	JIC-G32294	37.19	
TILT		2pc		P-U-9	1-1/2	2-1/2	JIC-G32294	37.19	
MODEL 430 with Backhoe Models 21, 22, 23									
BACKHOE BOOM				I-U-1	1-3/4		JIC-D42873	21.75	
				I-U-1	1-3/4		JIC-D42872	15.87	
		2pc		N-N-9		3-1/2	JIC-G33237	22.76	
		2pc		N-N-9		3	JIC-G33151	20.56	
BACKHOE BUCKET				I-U-1	2		JIC-D42874	16.92	
		2pc		N-N-9		3	JIC-G33151	20.56	
BACKHOE DIPPER				I-U-1	2		JIC-D42874	16.92	
		2pc		N-N-9		3-1/2	JIC-G33237	22.76	
		2pc		N-N-9		3	JIC-G33151	20.56	
BACKHOE STABILIZER				I-U-1	1-1/4		JIC-D42867	19.79	
		2pc		N-N-9		2-1/2	JIC-G33193	20.06	
BACKHOE SWING				I-U-1	1-1/4		JIC-D42867	19.79	
		2pc		N-N-9		2-1/2	JIC-G33193	20.06	
LOADER LIFT				I-U-1	1-1/2		JIC-D42869	21.34	
		2pc		N-N-9		2-1/2	JIC-G33193	20.06	
LOADER TILT				I-U-1	1-1/2		JIC-D42870	21.19	
		2pc		N-N-9		3	JIC-G33151	20.56	
MODEL 480, 480B with Backhoe Models 23, 26, 26B, 26S									
3-PT HITCH LIFT		2pc		P-UB-9	1-1/2	3	JIC-G105512	53.98	
3-PT HITCH PITCH		1pc		P-UB-10	1-1/4	2-1/2	JIC-G105507	27.28	
		2pc		P-U-9	1-1/4	2-1/2	JIC-G32295	46.74	
3-PT HITCH TILT		2pc		P-U-9	1-1/4	2-1/2	JIC-G32295	46.74	
BACKHOE BOOM		2pc		P-U-9	2-1/4	4	JIC-G34636	62.00	
		2pc		P-UB-9	1-3/4	3-1/2	JIC-G105529	43.24	
				I-U-1	1-3/4		JIC-D42873	21.75	
		2pc		N-N-9		3-1/2	JIC-G33237	22.76	
BACKHOE BUCKET		2pc		P-UB-9	1-3/4	3	JIC-G105524	59.48	
				I-U-1	1-1/2		JIC-D42870	21.19	
				I-U-1	1-3/4		JIC-D42872	15.87	
		2pc		N-N-9		3	JIC-G33151	20.56	
BACKHOE DIPPER		2pc		P-U-9	2	3-1/2	JIC-G32293	41.67	
		2pc		P-UB-9	2	3-1/2	JIC-G105527	54.29	
				I-U-1	2		JIC-D42874	16.92	
		2pc		N-N-9		3-1/2	JIC-G33237	22.76	
BACKHOE DIPPER EXT		2pc		P-UB-9	1-1/2	3	JIC-G105512	53.98	
BACKHOE STABILIZER		2pc		P-U-9	1-3/4	3-1/2	JIC-G105518	46.11	
		2pc		P-UB-9	1-3/4	3-1/2	JIC-G105529	43.24	
		2pc		P-UB-9	1-3/4	3	JIC-G105524	59.48	
				I-U-1	1-1/4		JIC-D42867	19.79	
				I-U-1	1-3/4		JIC-D42872	15.87	
				I-U-1	1-1/2		JIC-D42870	21.19	
		2pc		N-N-9		3	JIC-G33151	20.56	
		2pc		N-N-9		2-1/2	JIC-G33193	20.06	
	BACKHOE SWING		2pc		P-UB-9	1-3/4	4	JIC-G105519	51.50
			2pc		P-U-9	1-1/2	3-1/2	JIC-G34652	40.57
				I-U-1	1-1/2		JIC-D47896	17.09	
				I-U-1	1-1/4		JIC-D42867	19.79	
		2pc		N-N-9		2-1/2	JIC-G33193	20.06	
		2pc		N-N-9		3-1/2	JIC-G33237	22.76	
LOADER LIFT		2pc		P-U-9	1-1/2	2-1/2	JIC-G32294	37.19	
				I-U-1	1-1/2		JIC-D42869	21.34	
		2pc		N-N-9		2-1/2	JIC-G33193	20.06	

CASE

Replacement Kits For

CASE

Backhoe Loaders								
APPLICATION	CYL #	Piston	SERIAL #	CODE	ROD	BORE	KIT #	List \$
MODEL 480, 480B with Backhoe Models 23, 26, 26B, 26S								
LOADER TILT		2pc		P-U-9	1-1/2	2-1/2	JIC-G32294	37.19
		2pc		P-UB-9	1-1/2	3	JIC-G105512	53.98
				I-U-1	1-1/2		JIC-D42870	21.19
		2pc		N-N-9		3	JIC-G33151	20.56
STEERING		1pc	87357171-	I-O-3	3/4	1-1/2	JIC-A44644	10.74
MODEL 480C								
3-PT HITCH LIFT		1pc		P-UB-10	1-1/2	3	JIC-G109452	30.69
		2pc		P-UB-9	1-1/2	3	JIC-G105512	53.98
3-PT HITCH PITCH		1pc		P-UB-10	1-1/4	2-1/2	JIC-G109476	33.05
3-PT HITCH TILT		1pc		P-UB-10	1-1/4	2-1/2	JIC-G109475	34.37
		2pc		P-U-9	1-1/4	2-1/2	JIC-G32295	46.74
BACKHOE BOOM		1pc		P-UB-10	2-1/4	4	JIC-G109505	48.24
		2pc		P-U-9	2-1/4	4	JIC-G34636	62.00
BACKHOE BUCKET		1pc		P-UB-10	1-3/4	3	JIC-1543262C1	42.01
		2pc		P-UB-9	1-3/4	3	JIC-G109462	37.58
BACKHOE DIPPER		2pc		P-UB-9	2	3-1/2	JIC-G109454	36.07
		1pc		P-UB-10	2	3-1/2	JIC-G109453	45.49
BACKHOE DIPPER EXT		1pc		P-UB-10	1-1/2	3	JIC-G109452	30.69
		2pc		P-UB-9	1-1/2	3	JIC-G105512	53.98
BACKHOE STABILIZER		1pc		P-UB-10	1-3/4	3	JIC-1543262C1	42.01
		1pc		P-UB-10	1-3/4	3-1/2	JIC-G109471	44.34
		2pc		P-UB-9	1-3/4	3-1/2	JIC-G109470	39.85
		2pc		P-UB-9	1-3/4	3	JIC-G109462	37.58
BACKHOE SWING				P-U-9	1-1/2	3-1/2	JIC-G34652	40.57
		1pc		P-UB-10	1-1/2	3-1/2	JIC-G109472	41.92
LOADER LIFT		1pc		P-UB-10	1-1/2	2-1/2	JIC-1543253C1	44.57
		2pc		P-UB-9	1-1/2	2-1/2	JIC-G109484	43.21
LOADER TILT		2pc		P-UB-9	1-1/2	2-1/2	JIC-G109484	43.21
		1pc		P-UB-10	1-1/2	2-1/2	JIC-1543253C1	44.57
STEERING		1pc	-8980833	I-O-3	3/4	1-1/2	JIC-A44644	10.74
		1pc	8980834-	I-U-10	3/4	1-1/2	JIC-D148100	23.56
MODEL 480D, 480D LL								
3-PT HITCH LIFT		1pc		P-UB-10	1-1/2	3	JIC-G109452	30.69
3-PT HITCH PITCH		1pc		P-UB-10	1-1/4	2-1/2	JIC-G109476	33.05
3-PT HITCH TILT		1pc		P-UB-10	1-1/4	2-1/2	JIC-G109475	34.37
BACKHOE BUCKET		1pc		P-UB-10	2-1/2	3-1/2	JIC-G109504	44.91
		1pc		P-UB-10	2	3-1/4	JIC-G109465	53.80
BACKHOE DIPPER		1pc		P-UB-10	2	3-1/2	JIC-G109453	45.49
BACKHOE DIPPER EXT		1pc		P-UB-10	1-1/2	3	JIC-G109452	30.69
BACKHOE STABILIZER		1pc		P-UB-10	1-3/4	3-1/2	JIC-G109471	44.34
		1pc		P-UB-10	1-3/4	3	JIC-1543262C1	42.01
BACKHOE SWING		1pc		P-UB-10	1-1/2	3-1/2	JIC-G109472	41.92
LOADER LIFT		1pc		P-UB-10	1-1/2	2-1/2	JIC-1543253C1	44.57
LOADER TILT		1pc		P-UB-10	1-1/2	2-1/2	JIC-1543253C1	44.57
STEERING		1pc	ALL	I-U-10	3/4	1-1/2	JIC-D148100	23.56
MODEL 480E, 480E LL								
3-PT HITCH LIFT		1pc		P-UB-10	1-1/2	3	JIC-G109452	30.69
3-PT HITCH PITCH		1pc		P-UB-10	1-1/4	2-1/2	JIC-G109476	33.05
3-PT HITCH TILT		1pc		P-UB-10	1-1/4	2-1/2	JIC-G109475	34.37
BACKHOE BUCKET		1pc		P-UB-10	2	3-1/4	JIC-G109465	53.80
BACKHOE DIPPER		1pc		P-UB-10	2	3-1/2	JIC-G109453	45.49
BACKHOE DIPPER EXT		1pc		P-UB-10	1-1/2	3	JIC-G109452	30.69
BACKHOE STABILIZER		1pc		P-UB-10	1-3/4	3-1/2	JIC-G109471	44.34
BACKHOE SWING				P-UB-10	1-1/2	3-1/2	JIC-G109472	41.92
LOADER LIFT		1pc		P-UB-10	1-1/2	2-1/2	JIC-1543253C1	44.57

CASE

Replacement Kits For

CASE

Backhoe Loaders								
APPLICATION	CYL #	Piston	SERIAL #	CODE	ROD	BORE	KIT #	List \$
MODEL 480E, 480E LL								
LOADER TILT		1pc		P-UB-10	1-1/2	2-1/2	JIC-1543253C1	44.57
STEERING		1pc	ALL	I-U-10	3/4	1-1/2	JIC-D148100	23.56
MODEL 480F, 480F LL								
3-PT HITCH LIFT	G101188	1pc		P-UB-10	1-1/4	2-1/2	JIC-1543250C1	37.99
	G101189	1pc		P-UB-10	1-1/2	3	JIC-1543252C1	43.70
3-PT HITCH PITCH	1976884C1	1pc		P-UB-10	1-1/4	2-1/2	JIC-1543249C1	47.78
BACKHOE BOOM	G102835	1pc		P-UB-10	1-3/4	4	JIC-1543264C1	52.93
BACKHOE BUCKET	G109342	1pc		P-UB-10	2-1/2	3-1/2	JIC-1543294C1	47.86
BACKHOE STAB. 480F	1340827C1	1pc		P-UB-10	1-3/4	3-1/2	JIC-1543266C1	51.81
BACKHOE SWING	G110395	1pc		P-UB-10	1-1/2	3-1/2	JIC-1543254C1	47.85
BUCKET 480F ONLY	G103503	1pc		P-UB-10	2	3-1/4	JIC-1543268C1	56.74
DIPPER (12ft)	G104844	1pc		P-UB-10	2	3-1/2	JIC-1543274C1	67.94
DIPPER (14ft)	1980159C1	1pc		P-UB-10	2	3-3/4	JIC-1980181C2	69.29
DIPPER EXT. 480F only	G101203	1pc		P-UB-10	1-1/2	3	JIC-1543252C1	43.70
LOADER BUCKET	G101186	1pc		P-UB-10	1-1/2	2-1/2	JIC-1543253C1	44.57
LOADER CLAM	1346189C1	1pc		P-UB-10	1-3/4	3	JIC-1543267C1	50.86
	G101190	1pc		P-UB-10	1-3/4	3	JIC-1543262C1	42.01
LOADER LIFT	1340792C1	1pc		P-UB-10	1-3/4	3	JIC-1543267C1	50.86
MODEL 530 with Backhoe Models 31, 32, 32S								
BACKHOE BOOM		2pc		P-U-9	2	4	JIC-G32616	51.66
				I-U-1	2		JIC-D42876	20.00
		2pc		N-N-9		4	JIC-G33239	24.83
BACKHOE BUCKET		2pc		P-U-9	1-3/4	3-1/2	JIC-G105518	46.11
				I-U-1	1-3/4		JIC-D42873	21.75
		2pc		N-N-9		3-1/2	JIC-G33237	22.76
BACKHOE DIPPER		2pc		P-UB-9	2	4	JIC-G105526	56.82
				I-U-1	2		JIC-D42876	20.00
		2pc		N-N-9		4	JIC-G33239	24.83
BACKHOE STABILIZER		2pc		P-U-9	1-3/4	3-1/2	JIC-G105518	46.11
		2pc		P-UB-9	1-3/4	3-1/2	JIC-G105529	43.24
				I-U-1	1-3/4		JIC-D42873	21.75
		2pc		N-N-9		3-1/2	JIC-G33237	22.76
BACKHOE SWING		2pc		P-U-9	1-3/4	4	JIC-G32617	53.81
				I-U-1	1-3/4		JIC-D42875	16.83
		2pc		N-N-9		4	JIC-G33239	24.83
LOADER HYDRA-LEVELING				I-U-1	1-3/4		JIC-D42872	15.87
		2pc		N-N-9		3	JIC-G33151	20.56
LOADER LIFT				I-U-1	1-1/2		JIC-D42869	21.34
				I-U-1	1-1/2		JIC-D42870	21.19
		2pc		N-N-9		2-1/2	JIC-G33193	20.06
		2pc		N-N-9		3	JIC-G33151	20.56
LOADER TILT				I-U-1	1-1/4		JIC-D42867	19.79
				I-U-1	1-1/2		JIC-D42869	21.34
		2pc		N-N-9		2-1/2	JIC-G33193	20.06
MODEL 580 Super E								
3-PT HITCH LIFT		1pc		P-UB-10	1-1/2	3	JIC-G109452	30.69
3-PT HITCH PITCH		1pc		P-UB-10	1-1/4	2-1/2	JIC-G109476	33.05
3-PT HITCH TILT		1pc		P-UB-10	1-1/4	2-1/2	JIC-G109475	34.37
BACKHOE BOOM		1pc		P-UB-10	1-3/4	3-1/4	JIC-1543265C1	52.05
BACKHOE BUCKET		1pc		P-UB-10	2-1/2	4	JIC-G109424	53.12
		1pc		P-UB-10	2-1/2	3-1/2	JIC-G109504	44.91
BACKHOE DIPPER		1pc		P-UB-10	2	4	JIC-1543273C1	66.53
BACKHOE DIPPER EXT		1pc		P-UB-10	1-1/2	3	JIC-G109452	30.69
BACKHOE STABILIZER		1pc		P-UB-10	2	4	JIC-1543273C1	66.53
BACKHOE SWING		1pc		P-UB-10	2	4	JIC-1543273C1	66.53

Replacement Kits For

CASE

CASE

Backhoe Loaders								
APPLICATION	CYL #	Piston	SERIAL #	CODE	ROD	BORE	KIT #	List \$
MODEL 580 Super E								
LOADER CLAM		1pc		P-UB-10	1-3/4	3	JIC-1543262C1	42.01
LOADER LIFT		1pc		P-UB-10	1-3/4	3	JIC-1543262C1	42.01
LOADER TILT		1pc		P-UB-10	1-1/2	2-1/2	JIC-1543253C1	44.57
STEERING		1pc		I-U-10	3/4	1-1/2	JIC-D148100	23.56
MODEL 580 Super K								
BACKHOE BOOM		1pc		P-UB-10	2-1/4	5	JIC-G110583	138.22
BACKHOE BUCKET		1pc		P-UB-10	2-1/2	3-1/2	JIC-G110046	44.52
BACKHOE DIPPER		1pc		P-UB-10	2-1/2	5	JIC-G110582	53.90
BACKHOE DIPPER EXT		1pc		P-UB-10	1-3/4	3	JIC-G110049	39.82
BACKHOE STABILIZER		1pc		P-UB-10	2	4-1/4	JIC-1543275C1	66.96
BACKHOE SWING		1pc		P-UB-10	1-3/4	3-1/2	JIC-G110621	41.47
LOADER CLAM		1pc		P-UB-10	1-3/4	3	JIC-1543262C1	42.01
LOADER LIFT		1pc		P-UB-10	1-3/4	3-1/2	JIC-G110621	41.47
LOADER TILT		1pc		P-UB-10	1-1/2	3	JIC-G110050	35.14
SIDE SHIFT SWING		1pc		P-UB-10	2-1/4	4-1/2	JIC-1543279C1	58.51
MODEL 580 Super L								
BACKHOE BOOM	144200A1	1pc		P-UB-10	2-1/4	5	JIC-1542919C2	140.47
BACKHOE BUCKET	110290A1	1pc		P-UB-10	2-1/2	3-1/2	JIC-1542923C2	65.68
	235916A1	1pc		P-UB-10	2-1/2	3-1/2	JIC-1542923C2	65.68
BACKHOE DIPPER	126151A1	1pc		P-UB-10	2-1/2	5	JIC-1542915C2	62.09
	183795A1	1pc		P-UB-10	2-1/2	5	JIC-1542915C2	62.09
	183795A2	1pc		P-UB-10	2-1/2	5	JIC-1542915C2	62.09
BACKHOE DIPPER EXT	1340969C2	1pc		P-UB-10	1-3/4	3	JIC-1543267C1	50.86
BACKHOE STABILIZER	143695A1	1pc		P-UB-10	2	4-1/4	JIC-1543275C1	66.96
	143697A1	1pc		P-UB-10	2	4-1/4	JIC-1543275C1	66.96
	199720A1	1pc		P-UB-10	2	4-1/4	JIC-1543275C1	66.96
	199721A1	1pc		P-UB-10	2	4-1/4	JIC-1543275C1	66.96
BACKHOE SWING	139808A1	1pc		P-UB-10	2	4	JIC-122535A1	102.54
LOADER BUCKET	113133A2	1pc		P-UB-10	1-1/2	3	JIC-1543256C1	41.15
LOADER CLAM	1346189C1	1pc		P-UB-10	1-3/4	3	JIC-1543267C1	50.86
	1346190C1	1pc		P-UB-10	1-3/4	3	JIC-1543267C1	50.86
LOADER LIFT	112366A2	1pc		P-UB-10	1-3/4	3-1/4	JIC-1543260C1	52.05
MODEL 580 Super L Construction King								
BACKHOE BOOM	144200A1			P-UB-10	2-1/4	5	JIC-1542919C2	140.47
BACKHOE BUCKET	110290A1			P-UB-10	2-1/2	3-1/2	JIC-1542923C2	65.68
	235916A1			P-UB-10	2-1/2	3-1/2	JIC-1542923C2	65.68
BACKHOE DIPPER	126151A1			P-UB-10	2-1/2	5	JIC-1542915C2	62.09
	183795A1			P-UB-10	2-1/2	5	JIC-1542915C2	62.09
BACKHOE DIPPER EXT	1340969C2			P-UB-10	1-3/4	3	JIC-1543267C1	50.86
BACKHOE SWING	139808A1			P-UB-10	2	4	JIC-122535A1	102.54
	139808A2			P-UB-10	2	4	JIC-122535A1	102.54
LOADER BUCKET	113133A2			P-UB-10	1-1/2	3	JIC-1543256C1	41.15
LOADER CLAM - LH	1346189C1			P-UB-10	1-3/4	3	JIC-1543267C1	50.86
LOADER CLAM - RH	1346190C1			P-UB-10	1-3/4	3	JIC-1543267C1	50.86
LOADER LIFT	112366A2			P-UB-10	1-3/4	3-1/4	JIC-1543260C1	52.05
STABILIZER - LH	143697A1			P-UB-10	2	4-1/4	JIC-1543275C1	66.96
	199721A1			P-UB-10	2	4-1/4	JIC-1543275C1	66.96
STABILIZER - RH	143695A1			P-UB-10	2	4-1/4	JIC-1543275C1	66.96
	199720A1			P-UB-10	2	4-1/4	JIC-1543275C1	66.96
MODEL 580 Super M								
BACKHOE BOOM				P-UB-10	2-1/4	5	JIC-1542919C4	153.29
	310844A1			P-UB-10	2-1/4	5	JIC-1542919C4	153.29
	378031A1			P-UB-10	2-1/4	5	JIC-1542919C4	153.29
	87408036			P-UB-10	2-1/4	5	JIC-1542919C4	153.29
BACKHOE BUCKET	235916A1			P-UB-10	2-1/2	3-1/2	JIC-1542923C2	65.68

Replacement Kits For

CASE

Backhoe Loaders								
APPLICATION	CYL #	Piston	SERIAL #	CODE	ROD	BORE	KIT #	List \$
MODEL 580 Super M								
BACKHOE DIPPER	183795A3			P-UB-10	2-1/2	5	JIC-1542915C2	62.09
BACKHOE EXTENDABLE DIPPER	1340969C2			P-UB-10	1-3/4	3	JIC-1543267C1	50.86
BACKHOE STABILIZER LH	199721A1			P-UB-10	2	4-1/4	JIC-1543275C1	66.96
BACKHOE STABILIZER RH	199720A1			P-UB-10	2	4-1/4	JIC-1543275C1	66.96
BACKHOE SWING	139808A2			P-UB-10	2	4	JIC-122535A1	102.54
LOADER BUCKET	111313A2			P-UB-10	1-1/2	3	JIC-1543256C1	41.15
LOADER CLAM LH	1346190C1			P-UB-10	1-3/4	3	JIC-1543267C1	50.86
LOADER CLAM RH	1346189C1			N-UB-1	1-3/4		JIC-1542875C1	18.28
LOADER LIFT	384240A1			P-UB-10	1-3/4	3-1/4	JIC-1543260C1	52.05
MODEL 580 Super M SERIES 3								
BACKHOE BOOM	87711763		02/08-	P-UB-10,12	2-1/2	5-1/4	JIC-87418297	186.50
BACKHOE BUCKET	235916A1		02/08-	P-UB-10	2-1/2	3-1/2	JIC-1542923C2	65.68
BACKHOE DIPPER	183795A4		02/08-	P-UB-10	2-1/2	5	JIC-1542915C2	62.09
BACKHOE STABILIZER LH	199721A1		02/08-	P-UB-10	2	4-1/4	JIC-84155085	65.99
BACKHOE STABILIZER RH	199720A1		02/08-	P-UB-10	2	4-1/4	JIC-84155085	65.99
BACKHOE SWING	139808A2		02/08-	P-UB-10	2	4	JIC-122535A1	102.54
	188027A2		02/08-	P-UB-10,12	2	3-3/4	JIC-191747A1	98.42
LOADER BUCKET	87609669		02/08-	P-UB-10	1-1/2	3	JIC-1543256C1	41.15
LOADER CLAM LH	87454016		02/08-	P-UB-10	1-3/4	3	JIC-1543267C1	50.86
LOADER CLAM RH	87454017		02/08-	P-UB-10	1-3/4	3	JIC-1543267C1	50.86
LOADER LIFT	384240A1		02/08-	P-UB-10	1-3/4	3-1/4	JIC-1543260C1	52.05
MODEL 580 Super M+ SERIES 3								
BACKHOE BOOM	87711763		02/08-	P-UB-10,12	2-1/2	5-1/4	JIC-87418297	186.50
BACKHOE BUCKET	235916A1		02/08-	P-UB-10	2-1/2	3-1/2	JIC-1542923C2	65.68
BACKHOE DIPPER	183795A4		02/08-	P-UB-10	2-1/2	5	JIC-1542915C2	62.09
BACKHOE EXTENDABLE DIPPER	1340969C2		02/08-	P-UB-10	1-3/4	3	JIC-1543267C1	50.86
BACKHOE STABILIZER LH	177257A1		02/08-	P-UB-10	2-1/4	5	JIC-84154317	67.06
BACKHOE STABILIZER RH	177256A1		02/08-	P-UB-10	2-1/4	5	JIC-84154317	67.06
BACKHOE SWING	139808A2		02/08-	P-UB-10	2	4	JIC-122535A1	102.54
LOADER BUCKET	87609669		02/08-	P-UB-10	1-1/2	3	JIC-1543256C1	41.15
LOADER CLAM LH	87454016		02/08-	P-UB-10	1-3/4	3	JIC-1543267C1	50.86
LOADER CLAM RH	87454017		02/08-	P-UB-10	1-3/4	3	JIC-1543267C1	50.86
LOADER LIFT	384240A1		02/08-	P-UB-10	1-3/4	3-1/4	JIC-1543260C1	52.05
MODEL 580 Super N Tier 3								
BACKHOE BUCKET	84210935			P-UB-12,14	2-1/2	3-1/2	JIC-84259225	83.20
BACKHOE BUCKET (WT)	84210935			P-UB-12,14	2-1/2	3-1/2	JIC-84259225	83.20
BACKHOE STABILIZER LH	84210938			P-UB-14	2-1/4	4-1/2	JIC-84259227	92.93
BACKHOE STABILIZER LH (WT)	84212184			P-UB-14	2-1/2	5-1/4	JIC-84259228	107.56
BACKHOE STABILIZER RH	84210947			P-UB-14	2-1/4	4-1/2	JIC-84259227	92.93
BACKHOE STABILIZER RH (WT)	84210948			P-UB-14	2-1/2	5-1/4	JIC-84259228	107.56
BACKHOE SWING	139808A2			P-UB-10	2	4	JIC-122535A1	102.54
BACKHOE SWING (WT)	139808A2			P-UB-10	2	4	JIC-122535A1	102.54
LOADER 4-IN-1 LH	87454016			P-UB-10	1-3/4	3	JIC-1543267C1	50.86
LOADER 4-IN-1 LH (WT)	87454016			P-UB-10	1-3/4	3	JIC-1543267C1	50.86
LOADER 4-IN-1 RH	87454017			P-UB-10	1-3/4	3	JIC-1543267C1	50.86
LOADER 4-IN-1 RH (WT)	87454017			P-UB-10	1-3/4	3	JIC-1543267C1	50.86
LOADER BUCKET	84210943			P-UB-12,14	1-1/2	3	JIC-84257772	68.25
LOADER BUCKET (WT)	84210943			P-UB-12,14	1-1/2	3	JIC-84257772	68.25
LOADER LIFT	84224057			P-UB-12,14	1-3/4	3-1/4	JIC-84257323	82.65
LOADER LIFT (WT)	84210940			P-UB-12,14	1-7/8	3-1/2	JIC-84258339	91.91
STEERING	84264405			I-U-10	36 mm	63 mm	JIC-84330972	65.79
STEERING (WT)	84264406			I-U-10	40 mm	70 mm	JIC-84331720	114.09

NEW

CASE

Replacement Kits For

NEW

Backhoe Loaders								
APPLICATION	CYL #	Piston	SERIAL #	CODE	ROD	BORE	KIT #	List \$
MODEL 580 Super N Tier 4								
BACKHOE ARM	84421595			P-UB-12,14	2-1/2	3-1/2	JIC-84259225	83.20
BACKHOE ARM (WT)	84421595			P-UB-12,14	2-1/2	3-1/2	JIC-84259225	83.20
BACKHOE STABILIZER	84421605			P-UB-14	2-1/4	4-1/2	JIC-84259227	92.93
BACKHOE STABILIZER (WT)	84421607			P-UB-14	2-1/2	5-1/4	JIC-84259228	107.56
BACKHOE SWING	84428583			P-UB-10	2	4	JIC-122535A1	102.54
BACKHOE SWING (WT)	84428583			P-UB-10	2	4	JIC-122535A1	102.54
BOOM	84421588			P-UB-12,14	2-1/2	5	JIC-84259219	140.00
BOOM (WT)	84421588			P-UB-12,14	2-1/2	5	JIC-84259219	140.00
BUCKET	84421601			P-UB-12,14	1-1/2	3	JIC-84257772	68.25
BUCKET (WT)	84421601			P-UB-12,14	1-1/2	3	JIC-84257772	68.25
CLAM	87455458			P-UB-10	1-3/4	3	JIC-86982377	40.25
CLAM (WT)	87455459			P-UB-10	1-3/4	3	JIC-86982377	40.25
DIPPER	84421591			P-UB-12,14	2-1/2	4-3/4	JIC-84259222	134.08
	84421678			P-UB-10	1-3/4	3	JIC-86982377	40.25
DIPPER (WT)	84421591			P-UB-12,14	2-1/2	4-3/4	JIC-84259222	134.08
	84421678			P-UB-10	1-3/4	3	JIC-86982377	40.25
EXTENDABLE DIPPER	84421678			P-UB-10	1-3/4	3	JIC-86982377	40.25
EXTENDABLE DIPPER (WT)	84421678			P-UB-10	1-3/4	3	JIC-86982377	40.25
LIFT	84421598			P-UB-12,14	1-3/4	3-1/4	JIC-84257323	82.65
LIFT (WT)	84421599			P-UB-12,14	1-7/8	3-1/2	JIC-84258339	91.91
LOADER BUCKET 4-IN-1	87455458			P-UB-10	1-3/4	3	JIC-86982377	40.25
LOADER BUCKET 4-IN-1 (WT)	87455459			P-UB-10	1-3/4	3	JIC-86982377	40.25
STEERING	84264405			I-U-10	36 mm	63 mm	JIC-84330972	65.79
STEERING (WT)	84264405			I-U-10	36 mm	63 mm	JIC-84330972	65.79
STEERING-2WD	401055A1			I-U-10	36 mm	63 mm	JIC-401061A1	65.34
STEERING-4WD (WT)	84264406			I-U-10	40 mm	70 mm	JIC-84331720	114.09
MODEL 580 with Backhoe Models 33, 33S								
3-PT HITCH LIFT		2pc		P-U-9	1-1/2	2-1/2	JIC-G32294	37.19
3-PT HITCH PITCH		1pc		P-UB-10	1-1/4	2-1/2	JIC-G105507	27.28
		2pc		P-U-9	1-1/4	2-1/2	JIC-G32295	46.74
3-PT HITCH TILT		2pc		P-UB-9	1-1/2	3	JIC-G105512	53.98
BACKHOE BOOM		2pc		P-UB-9	2	4	JIC-G105517	56.90
		2pc		P-U-9	2	4	JIC-G32299	53.72
		1pc		P-UB-9	2-1/4	4-1/2	JIC-G105520	91.37
				P-U-1	2-1/4		JIC-D42878	19.31
				I-U-1	2		JIC-D42876	20.00
		2pc		N-N-9		4	JIC-G33239	24.83
		2pc		N-N-9		4-1/2	JIC-DTVS4.5P	53.59
		2pc		P-U-9	2	3-1/2	JIC-G32293	41.67
BACKHOE BUCKET		2pc		P-UB-9	2	3-1/2	JIC-G105527	54.29
				P-U-1	2-1/4		JIC-D42878	19.31
				I-U-1	2		JIC-D42874	16.92
		2pc		I-U-1	1-3/4		JIC-D42873	21.75
		2pc		N-N-9		3-1/2	JIC-G33237	22.76
		2pc		P-U-9	2	4	JIC-G32299	53.72
		2pc		P-UB-9	2	4	JIC-G105517	56.90
				I-U-1	2		JIC-D42876	20.00
BACKHOE DIPPER		2pc		N-N-9		4	JIC-G33239	24.83
		2pc		P-UB-9	1-3/4	3-1/2	JIC-G105529	43.24
		2pc		P-UB-9	1-1/2	3	JIC-G105512	53.98
				I-U-1	1-3/4		JIC-D42873	21.75
BACKHOE DIPPER EXT		2pc		N-N-9		3-1/2	JIC-G33237	22.76
		2pc		P-UB-9	1-3/4	3-1/2	JIC-G105529	43.24
		2pc		P-U-9	1-3/4	3-1/2	JIC-G105518	46.11

CASE

Replacement Kits For

CASE

Backhoe Loaders								
APPLICATION	CYL #	Piston	SERIAL #	CODE	ROD	BORE	KIT #	List \$
MODEL 580 with Backhoe Models 33, 33S								
BACKHOE STABILIZER				I-U-1	1-3/4		JIC-D42873	21.75
		2pc		N-N-9		3-1/2	JIC-G33237	22.76
BACKHOE SWING		2pc		P-UB-9	1-3/4	4	JIC-G105519	51.50
				I-U-1	1-3/4		JIC-D42875	16.83
		2pc		N-N-9		4	JIC-G33239	24.83
LOADER CLAM		2pc		P-UB-9	1-3/4	3	JIC-G105524	59.48
LOADER GRAPPLE		2pc		P-U-9	1-1/2	2-1/2	JIC-G32294	37.19
				I-U-1	1-1/2		JIC-D42869	21.34
		2pc		N-N-9		2-1/2	JIC-G33193	20.06
LOADER HYDRA-LEVELING		2pc		P-UB-9	1-3/4	3	JIC-G105524	59.48
				I-U-1	1-3/4		JIC-D42872	15.87
		2pc		N-N-9		3	JIC-G33151	20.56
LOADER LIFT		2pc		P-UB-9	1-1/2	3	JIC-G105512	53.98
				I-U-1	1-1/2		JIC-D42870	21.19
		2pc		N-N-9		3	JIC-G33151	20.56
LOADER TILT		2pc		P-U-9	1-1/2	2-1/2	JIC-G32294	37.19
				I-U-1	1-1/2		JIC-D42869	21.34
		2pc		N-N-9		2-1/2	JIC-G33193	20.06
MODEL 580B with Backhoe Model 35								
3-PT HITCH LIFT		1pc		P-UB-10	1-1/2	3	JIC-G105548	40.42
		2pc		P-UB-9	1-1/2	3	JIC-G105512	53.98
3-PT HITCH PITCH		2pc		P-U-9	1-1/4	2-1/2	JIC-G32295	46.74
		1pc		P-UB-10	1-1/4	2-1/2	JIC-G105507	27.28
3-PT HITCH TILT		1pc		P-UB-10	1-1/4	2-1/2	JIC-G105551	34.37
		2pc		P-U-9	1-1/4	2-1/2	JIC-G32295	46.74
BACKHOE BOOM		1pc		P-UB-10	1-3/4	3-1/4	JIC-G105547	46.47
		2pc		P-UB-8	1-3/4	3-1/4	JIC-G105528	49.50
BACKHOE BUCKET		2pc		P-UB-9	2	3-1/2	JIC-G105527	54.29
		1pc		P-UB-10	2	3-1/2	JIC-G105546	48.58
BACKHOE DIPPER		1pc		P-UB-10	2	4	JIC-1543273C1	66.53
		2pc		P-UB-9	2	4	JIC-G105517	56.90
BACKHOE DIPPER EXT		1pc		P-UB-10	1-1/2	3	JIC-G105548	40.42
		2pc		P-UB-9	1-1/2	3	JIC-G105512	53.98
BACKHOE STABILIZER		2pc		P-UB-9	1-3/4	3-1/2	JIC-G105529	43.24
		2pc		P-UB-9	2	3-1/2	JIC-G105527	54.29
		1pc		P-UB-10	2	4	JIC-1543273C1	66.53
		2pc		P-UB-9	2	4	JIC-G105517	56.90
BACKHOE SWING		1pc		P-UB-10	2	4	JIC-1543273C1	66.53
		2pc		P-UB-9	2	4	JIC-G105517	56.90
LOADER CLAM		1pc		P-UB-10	1-3/4	3	JIC-G105549	51.43
		2pc		P-UB-9	1-3/4	3	JIC-G105524	59.48
LOADER HYDRA-LEVELING		2pc		P-UB-9	1-3/4	3	JIC-G105524	59.48
		1pc		P-UB-10	1-3/4	3	JIC-G105549	51.43
LOADER LIFT		1pc		P-UB-10	1-1/2	3	JIC-G105548	40.42
		2pc		P-UB-9	1-1/2	3	JIC-G105512	53.98
LOADER TILT		2pc		P-U-9	1-1/2	2-1/2	JIC-G32294	37.19
		1pc		P-UB-10	1-1/2	2-1/2	JIC-G105550	30.33
LOGGING FORK GRAPPLE		1pc		P-UB-10	1-1/2	2-1/2	JIC-G105550	30.33
		2pc		P-U-9	1-1/2	2-1/2	JIC-G32294	37.19
STEERING		1pc		I-O-3	3/4	1-1/2	JIC-A44644	10.74
MODEL 580C								
3-PT HITCH LIFT		1pc		P-UB-10	1-1/2	3	JIC-G109452	30.69
		2pc		P-UB-9	1-1/2	3	JIC-G105512	53.98
3-PT HITCH PITCH		1pc		P-UB-10	1-1/4	2-1/2	JIC-G109476	33.05
3-PT HITCH TILT		2pc		P-U-9	1-1/4	2-1/2	JIC-G32295	46.74

CASE

Replacement Kits For

CASE

Backhoe Loaders								
APPLICATION	CYL #	Piston	SERIAL #	CODE	ROD	BORE	KIT #	List \$
MODEL 580C								
3-PT HITCH TILT		1pc		P-UB-10	1-1/4	2-1/2	JIC-G109475	34.37
BACKHOE BOOM		1pc		P-UB-10	1-3/4	3-1/4	JIC-1543265C1	52.05
		2pc		P-UB-8	1-3/4	3-1/4	JIC-G105528	49.50
BACKHOE BUCKET		1pc		P-UB-10	2	3-1/2	JIC-G109453	45.49
		2pc		P-UB-9	2	3-1/2	JIC-G109454	36.07
BACKHOE DIPPER		2pc		P-UB-9	2	4	JIC-G109421	46.63
		1pc		P-UB-10	2	4	JIC-1543273C1	66.53
BACKHOE DIPPER EXT		1pc		P-UB-10	1-1/2	3	JIC-G109452	30.69
		2pc		P-UB-9	1-1/2	3	JIC-G105512	53.98
BACKHOE STABILIZER		1pc		P-UB-10	2	4	JIC-1543273C1	66.53
		2pc		P-UB-9	2	4	JIC-G109421	46.63
BACKHOE SWING		2pc		P-UB-9	2	4	JIC-G109421	46.63
		1pc		P-UB-10	2	4	JIC-1543273C1	66.53
LOADER CLAM		2pc		P-UB-9	1-3/4	3	JIC-G109462	37.58
		1pc		P-UB-10	1-3/4	3	JIC-1543262C1	42.01
LOADER GRAPPLE		2pc		P-UB-9	1-1/2	2-1/2	JIC-G109484	43.21
		1pc		P-UB-10	1-1/2	2-1/2	JIC-1543253C1	44.57
LOADER LIFT		1pc		P-UB-10	1-3/4	3	JIC-1543262C1	42.01
		2pc		P-UB-9	1-3/4	3	JIC-G109462	37.58
LOADER TILT		2pc		P-UB-9	1-1/2	2-1/2	JIC-G109484	43.21
		1pc		P-UB-10	1-1/2	2-1/2	JIC-1543253C1	44.57
STEERING		1pc	-8983287	I-O-3	3/4	1-1/2	JIC-A44644	10.74
		1pc	8983288-	I-U-10	3/4	1-1/2	JIC-D148100	23.56
MODEL 580C Construction King								
3-PT HITCH LIFT	G101189	1pc		P-UB-10	1-1/2	3	JIC-G105548	40.42
	G33456	2pc		P-UB-9	1-1/2	3	JIC-G105512	53.98
3-PT HITCH PITCH	G33128			P-UB-10	1-1/4	2-1/2	JIC-G105507	27.28
3-PT HITCH TILT	G101188	1pc		P-UB-10	1-1/4	2-1/2	JIC-G105551	34.37
	G33351	2pc		P-U-9	1-1/4	2-1/2	JIC-G32295	46.74
BACKHOE BOOM	G101177	1pc		P-UB-10	1-3/4	3-1/4	JIC-G105547	46.47
	G33881	2pc		P-UB-8	1-3/4	3-1/4	JIC-G105528	49.50
BACKHOE BUCKET	G101176			P-UB-10	2	3-1/2	JIC-G105546	48.58
	G33196	2pc		P-UB-9	2	3-1/2	JIC-G105527	54.29
BACKHOE DIPPER	G101175	1pc		P-UB-10	2	4	JIC-G105545	54.92
	G32079	2pc		P-U-9	2	4	JIC-G34594	55.48
BACKHOE DIPPER EXT	G101183	1pc		P-UB-10	1-1/2	3	JIC-G105548	40.42
	G33142	2pc		P-UB-9	1-1/2	3	JIC-G105512	53.98
BACKHOE STABILIZER LH	G101181	1pc		P-UB-10	2	4	JIC-G105545	54.92
	G34471	2pc		P-U-9	2	4	JIC-G34594	55.48
BACKHOE STABILIZER RH	G101180	1pc		P-UB-10	2	4	JIC-G105545	54.92
	G34470	2pc		P-U-9	2	4	JIC-G34594	55.48
BACKHOE SWING	G101182	1pc		P-UB-10	2	4	JIC-G105545	54.92
	G102525	1pc	5411088-	P-UB-10	2	4	JIC-G105545	54.92
	G34881	2pc		P-U-9	2	4	JIC-G34594	55.48
LOADER BUCKET LH	G33421	2pc		P-U-9	1-1/2	2-1/2	JIC-G32294	37.19
LOADER BUCKET RH	G33420	2pc		P-U-9	1-1/2	2-1/2	JIC-G32294	37.19
LOADER BUCKET TILT LH	G101187	1pc		P-UB-10	1-1/2	2-1/2	JIC-G105550	30.33
LOADER BUCKET TILT RH	G101186	1pc		P-UB-10	1-1/2	2-1/2	JIC-G105550	30.33
LOADER CLAM LH	G101191	1pc		P-UB-10	1-3/4	3	JIC-G105549	51.43
	G33799	2pc		P-UB-9	1-3/4	3	JIC-G105524	59.48
LOADER CLAM RH	G101190	1pc		P-UB-10	1-3/4	3	JIC-G105549	51.43
	G33798	2pc		P-UB-9	1-3/4	3	JIC-G105524	59.48
LOADER GRAPPLE	G101251	1pc		P-UB-10	1-1/2	2-1/2	JIC-G105550	30.33
	G34293	2pc		P-U-9	1-1/2	2-1/2	JIC-G32294	37.19
LOADER LIFT	G101184	1pc		P-UB-10	1-3/4	3	JIC-G105549	51.43

CASE

Replacement Kits For

CASE

Backhoe Loaders								
APPLICATION	CYL #	Piston	SERIAL #	CODE	ROD	BORE	KIT #	List \$
MODEL 580C Construction King								
LOADER LIFT LH	G100414	2pc		P-UB-9	1-3/4	3	JIC-G105524	59.48
LOADER LIFT RH	G100415	2pc		P-UB-9	1-3/4	3	JIC-G105524	59.48
MODEL 580D, 580 Super D								
3-PT HITCH LIFT		1pc		P-UB-10	1-1/2	3	JIC-G109452	30.69
3-PT HITCH PITCH		1pc		P-UB-10	1-1/4	2-1/2	JIC-G109476	33.05
3-PT HITCH TILT		1pc		P-UB-10	1-1/4	2-1/2	JIC-G109475	34.37
BACKHOE BOOM		1pc		P-UB-10	1-3/4	3-1/4	JIC-1543265C1	52.05
BACKHOE BUCKET		1pc		P-UB-10	2	3-1/2	JIC-1543262C1	45.49
		1pc		P-UB-10	2-1/2	3-1/2	JIC-G109504	44.91
BACKHOE DIPPER		1pc		P-UB-10	2-1/2	4	JIC-G109424	53.12
		1pc		P-UB-10	2	4	JIC-1543273C1	66.53
BACKHOE DIPPER EXT		1pc		P-UB-10	1-1/2	3	JIC-G109452	30.69
BACKHOE STABILIZER		1pc		P-UB-10	2	4	JIC-1543273C1	66.53
BACKHOE SWING		1pc		P-UB-10	2	4	JIC-1543273C1	66.53
LOADER CLAM		1pc		P-UB-10	1-3/4	3	JIC-1543262C1	42.01
LOADER LIFT		1pc		P-UB-10	1-3/4	3	JIC-1543262C1	42.01
LOADER TILT		1pc		P-UB-10	1-1/2	2-1/2	JIC-1543253C1	44.57
STEERING		1pc		I-U-10	3/4	1-1/2	JIC-D148100	23.56
MODEL 580F								
BACKHOE BOOM		2pc		P-UB-8	1-3/4	3-1/4	JIC-G105528	49.50
		1pc		P-UB-10	1-3/4	3-1/4	JIC-G105547	46.47
BACKHOE BUCKET		1pc		P-UB-10	2	3-1/2	JIC-G105546	48.58
		2pc		P-UB-9	2	3-1/2	JIC-G105527	54.29
BACKHOE DIPPER		2pc		P-UB-9	2	4	JIC-G105517	56.90
		1pc		P-UB-10	2	4	JIC-1543273C1	66.53
BACKHOE STABILIZER		2pc	-3.775.176	P-UB-9	2	4	JIC-G105517	56.90
		1pc	3.775.177-	P-UB-10	2	4	JIC-1543273C1	66.53
		2pc	-3.785.895	P-UB-9	1-3/4	3	JIC-G105524	59.48
		1pc	3.785.896-	P-UB-10	1-3/4	3	JIC-G105549	51.43
BACKHOE SWING		2pc	-3.775.161	P-UB-9	2	4	JIC-G105517	56.90
		1pc	3.775.162-	P-UB-10	2	4	JIC-1543273C1	66.53
		2pc	-3.785.922	P-U-9	1-3/4	4	JIC-G34626	55.79
		1pc	3.785.923-3.787.235	P-UB-10	1-3/4	4	JIC-G105552	48.42
BOOM EXTENSION		2pc		P-UB-9	1-1/2	3	JIC-G105512	53.98
		1pc		P-UB-10	1-1/2	3	JIC-G105548	40.42
LOADER CLAM		2pc		P-UB-9	1-3/4	3	JIC-G105524	59.48
		1pc		P-UB-10	1-3/4	3	JIC-G105549	51.43
LOADER LIFT		1pc		P-UB-10	2	3-1/4	JIC-G105553	50.94
LOADER TILT		2pc		P-U-9	1-1/2	2-1/2	JIC-G32294	37.19
		1pc		P-UB-10	1-1/2	2-1/2	JIC-G105550	30.33
STEERING		1pc	3.736.937-	I-U-10	3/4	1-1/2	JIC-D148100	23.56
MODEL 580K								
3-PT HITCH LIFT & TILT		1pc		P-UB-10	1-1/4	3	JIC-G110048	31.61
		1pc		P-UB-10	1-1/4	2-3/4	JIC-G110047	42.22
BACKHOE BOOM		1pc		P-UB-10	2-1/4	5	JIC-G110583	138.22
BACKHOE BUCKET		1pc		P-UB-10	2-1/2	3-1/2	JIC-G110046	44.52
BACKHOE DIPPER		1pc		P-UB-10	2-1/2	5	JIC-1542915C2	62.09
BACKHOE DIPPER EXT		1pc		P-UB-10	1-3/4	3	JIC-G110049	39.82
BACKHOE STABILIZER		1pc		P-UB-10	2	4-1/4	JIC-1543275C1	66.96
BACKHOE SWING		1pc		P-UB-10	1-3/4	3-1/4	JIC-G110053	36.53
		1pc		P-UB-10	1-3/4	3-1/2	JIC-G110621	41.47
LOADER CLAM		1pc		P-UB-10	1-3/4	3	JIC-1543262C1	42.01
LOADER LIFT		1pc		P-UB-10	1-3/4	3-1/4	JIC-G110053	36.53
LOADER TILT		1pc		P-UB-10	1-1/2	3	JIC-G110050	35.14
SIDE SHIFT STABILIZER		1pc		P-UB-10	1-3/4	3	JIC-1543262C1	42.01

CASE

Replacement Kits For

CASE

CASE

Backhoe Loaders								
APPLICATION	CYL #	Piston	SERIAL #	CODE	ROD	BORE	KIT #	List \$
MODEL 580K								
SIDE SHIFT SWING		1pc		P-UB-10	2	4	JIC-1543269C1	63.39
STEERING		1pc		P-U-10	1-1/2	2-3/4	JIC-G110045	64.90
MODEL 580L								
3-PT HITCH LIFT	137512A1	1pc		P-UB-10	1-1/2	3	JIC-1543256C1	41.15
	137912A1	1pc		P-U-10	1-1/4	2-1/2	JIC-183286A1	47.39
	196832A1	1pc		P-UB-10	1-1/2	3	JIC-1543256C1	41.15
3-PT HITCH PITCH	138235A1	1pc		P-U-10	1-1/4	2-1/2	JIC-183286A1	47.39
BACKHOE BOOM	182106A1	1pc		P-UB-10,12	2-1/4	4-1/2	JIC-182218A1	92.63
BACKHOE BUCKET	128760A1	1pc		P-UB-10	2-1/4	3-1/4	JIC-131750A2	64.34
BACKHOE DIPPER	175774A1	1pc		P-UB-10,12	2-1/4	4-1/4	JIC-234844A1	96.15
	233114A1	1pc		P-UB-10,12	2-1/4	4-1/4	JIC-234844A1	96.15
BACKHOE DIPPER EXT	1340970C2	1pc		P-UB-10	1-3/4	3	JIC-1543267C1	50.86
BACKHOE STABILIZER	143574A1	1pc		P-UB-10	2	4	JIC-1543269C1	63.39
	143575A1	1pc		P-UB-10	2	4	JIC-1543269C1	63.39
	195503A1	1pc		P-UB-10	2	4	JIC-1543269C1	63.39
	195504A1	1pc		P-UB-10	2	4	JIC-1543269C1	63.39
BACKHOE SWING	139808A1	1pc		P-UB-10	2	4	JIC-122535A1	102.54
	139808A2	1pc		P-UB-10	2	4	JIC-122535A1	102.54
	188027A1	1pc		P-UB-10,12	2	3-3/4	JIC-191747A1	98.42
LOADER BUCKET	175238A1	1pc		P-UB-10	1-1/2	2-3/4	JIC-175251A1	100.57
LOADER CLAM	1346189C1	1pc		P-UB-10	1-3/4	3	JIC-1543267C1	50.86
LOADER LIFT	131417A1	1pc		P-UB-10	1-3/4	3	JIC-1543267C1	50.86
MODEL 580M								
BACKHOE BOOM	189653A2		02/08-	P-UB-10,12	2-1/4	4-1/2	JIC-182218A1	92.63
BACKHOE BUCKET	128760A1		02/08-	P-UB-10	2-1/4	3-1/4	JIC-131750A2	64.34
BACKHOE DIPPER	233114A2		02/08-	P-UB-10,12	2-1/4	4-1/4	JIC-234844A1	96.15
BACKHOE EXTENDABLE DIPPER	1340969C2		02/08-	P-UB-10	1-3/4	3	JIC-1543267C1	50.86
BACKHOE STABILIZER LH	195503A1		02/08-	P-UB-10	2	4	JIC-1543269C1	63.39
BACKHOE STABILIZER RH	195503A1		02/08-	P-UB-10	2	4	JIC-1543269C1	63.39
BACKHOE SWING	188027A2		02/08-	P-UB-10,12	2	3-3/4	JIC-191747A1	98.42
LOADER BUCKET	113133A2			P-UB-10	1-1/2	3	JIC-1543256C1	41.15
	87609669		02/08-	P-UB-10	1-1/2	3	JIC-1543256C1	41.15
LOADER CLAM	1346189C1			P-UB-10	1-3/4	3	JIC-1543267C1	50.86
LOADER CLAM LH	87454016		02/08-	P-UB-10	1-3/4	3	JIC-1543267C1	50.86
LOADER CLAM RH	87454017		02/08-	P-UB-10	1-3/4	3	JIC-1543267C1	50.86
LOADER LIFT	384240A1		02/08-	P-UB-10	1-3/4	3-1/4	JIC-1543260C1	52.05
MODEL 580N (Brazil)								
BACKHOE BUCKET	84421594			P-UB-12,14	2-1/4	3-1/4	JIC-84259224	97.24
BACKHOE EXTENDABLE DIPPER	84421678			P-UB-10	1-3/4	3	JIC-86982377	40.25
BACKHOE STABILIZER LH	84421604			P-UB-14	2-1/4	4-1/4	JIC-84259226	98.05
BACKHOE STABILIZER RH	84421603			P-UB-14	2-1/4	4-1/4	JIC-84259226	98.05
BACKHOE SWING	84426789			P-UB-10,12	2	3-3/4	JIC-191747A1	98.42
LOADER 4-IN-1 LH	87454016			P-UB-10	1-3/4	3	JIC-1543267C1	50.86
LOADER 4-IN-1 RH	87454017			P-UB-10	1-3/4	3	JIC-1543267C1	50.86
LOADER BUCKET	84421600			P-UB-10	1-1/2	3	JIC-1543256C1	41.15
LOADER LIFT	84421597			P-UB-12,14	1-3/4	3-1/4	JIC-84257323	82.65
STEERING	401055A1			I-U-10	36 mm	63 mm	JIC-401061A1	65.34
MODEL 580N Tier 3								
BACKHOE DIPPER	84290402			P-UB-12,14	2-1/4	4-1/4	JIC-84259221	78.67
BACKHOE STABILIZER LH	84210937			P-UB-14	2-1/4	4-1/4	JIC-84259226	98.05
BACKHOE STABILIZER RH	84210946			P-UB-14	2-1/4	4-1/4	JIC-84259226	98.05
BACKHOE SWING	188027A2			P-UB-10,12	2	3-3/4	JIC-191747A1	98.42
LOADER 4-IN-1 LH	87454016			P-UB-10	1-3/4	3	JIC-1543267C1	50.86

NEW

NEW

Replacement Kits For

CASE

Backhoe Loaders								
APPLICATION	CYL #	Piston	SERIAL #	CODE	ROD	BORE	KIT #	List \$
MODEL 580N Tier 3								
LOADER 4-IN-1 RH	87454017			P-UB-10	1-3/4	3	JIC-1543267C1	50.86
LOADER BUCKET	84224079			P-UB-14	1-1/2	3	JIC-84257788	55.50
LOADER LIFT	84210939			P-UB-14	1-3/4	3-1/4	JIC-84257765	58.05
STEERING	84264405			I-U-10	36 mm	63 mm	JIC-84330972	65.79
MODEL 580N Tier 4								
BACKHOE (W/O EXTENDABLE DIPPER)	84421678			P-UB-10	1-3/4	3	JIC-86982377	40.25
BACKHOE STABILIZER LH	84421604			P-UB-14	2-1/4	4-1/4	JIC-84259226	98.05
BACKHOE STABILIZER RH	84421603			P-UB-14	2-1/4	4-1/4	JIC-84259226	98.05
BACKHOE SWING	84426789			P-UB-10,12	2	3-3/4	JIC-84172816	55.19
BOOM	84421585			P-UB-12,14	2-1/4	4-1/2	JIC-84259218	103.42
	84551146			P-UB-12,14	2-1/4	4-1/2	JIC-84259218	103.42
BUCKET	84421594			P-UB-12,14	2-1/4	3-1/4	JIC-84259224	97.24
CLAM LH	87455458			P-UB-10	1-3/4	3	JIC-86982377	40.25
CLAM RH	87455459			P-UB-10	1-3/4	3	JIC-86982377	40.25
DIPPER	47458137			P-UB-12,14	2-1/4	4-1/4	JIC-84259221	78.67
	84421590			P-UB-12,14	2-1/4	4-1/4	JIC-84259221	78.67
EXTENDABLE DIPPER	84421678			P-UB-10	1-3/4	3	JIC-86982377	40.25
LIFT	84421597			P-UB-14	1-3/4	3-1/4	JIC-84257765	58.05
LOADER BUCKET	84421600			P-UB-14	1-1/2	3	JIC-84257788	55.50
LOADER BUCKET 4-IN-1 LH	87455458			P-UB-10	1-3/4	3	JIC-86982377	40.25
LOADER BUCKET 4-IN-1 RH	87455459			P-UB-10	1-3/4	3	JIC-86982377	40.25
STEERING	84264405			I-U-10	36 mm	63 mm	JIC-84330972	65.79
STEERING-2WD	401055A1			I-U-10	36 mm	63 mm	JIC-401061A1	65.34
MODEL 590								
BACKHOE BOOM	1980395C5	1pc		P-UB-10	2-1/2	5-1/2	JIC-1980412C2	200.14
	1980395C6	1pc		P-UB-10	2-1/2	5-1/2	JIC-1980412C2	200.14
BACKHOE BUCKET	1986902C1	1pc		P-UB-10	2-1/2	3-1/2	JIC-1542923C2	65.68
	1986902C2	1pc		P-UB-10	2-1/2	3-1/2	JIC-1542923C2	65.68
BACKHOE DIPPER	1994520C1	1pc		P-UB-10	2-3/4	5-1/2	JIC-1994527C2	182.21
	1994520C2	1pc		P-UB-10	2-3/4	5-1/2	JIC-1994527C2	182.21
BACKHOE DIPPER EXT	1340853C2	1pc		P-UB-10	1-3/4	3	JIC-1543267C1	50.86
BACKHOE STABILIZER	110885A1	1pc		P-UB-10	2-1/4	5	JIC-1543289C2	80.11
	110886A1	1pc		P-UB-10	2-1/4	5	JIC-1543289C2	80.11
	1986810C1	1pc		P-UB-10	2-1/4	5	JIC-1543289C2	80.11
	1986811C1	1pc		P-UB-10	2-1/4	5	JIC-1543289C2	80.11
BACKHOE SWING	1343584C1	1pc		P-UB-10	2	3-3/4	JIC-1980181C2	69.29
	1343584C2	1pc		P-UB-10	2	3-3/4	JIC-1980181C2	69.29
LOADER BUCKET	110306A1	1pc		P-UB-10	1-1/2	3	JIC-1543256C1	41.15
	110309A1	1pc		P-UB-10	1-1/2	3	JIC-1543256C1	41.15
	G108486	1pc		P-UB-10	1-1/2	3	JIC-1543256C1	41.15
	G108487	1pc		P-UB-10	1-1/2	3	JIC-1543256C1	41.15
LOADER CLAM	1346189C1	1pc		P-UB-10	1-3/4	3	JIC-1543267C1	50.86
	1346190C1	1pc		P-UB-10	1-3/4	3	JIC-1543267C1	50.86
LOADER LIFT	110875A1	1pc		P-UB-10	1-3/4	3-1/2	JIC-1543266C1	51.81
	1542743C1	1pc		P-UB-10	1-3/4	3-1/2	JIC-1543266C1	51.81
	1980220C2	1pc		P-UB-10	1-3/4	3-1/2	JIC-1543266C1	51.81
MODEL 590 Super L								
BACKHOE BOOM	175785A1	1pc		P-UB-10	2-1/2	5-1/2	JIC-1980412C2	200.14
BACKHOE BUCKET	1986902C2	1pc		P-UB-10	2-1/2	3-1/2	JIC-1542923C2	65.68
	238435A1	1pc		P-UB-10	2-1/2	3-1/2	JIC-1542923C2	65.68
BACKHOE DIPPER	140965A1	1pc		P-UB-10,12	2-3/4	5-1/2	JIC-179011A1	143.89
BACKHOE DIPPER EXT	1340853C2	1pc		P-UB-10	1-3/4	3	JIC-1543267C1	50.86
BACKHOE STABILIZER	177256A1	1pc		P-UB-10	2-1/4	5	JIC-1543289C2	80.11
	177257A1	1pc		P-UB-10	2-1/4	5	JIC-1543289C2	80.11

CASE

Replacement Kits For

Backhoe Loaders								
APPLICATION	CYL #	Piston	SERIAL #	CODE	ROD	BORE	KIT #	List \$
MODEL 590 Super L								
BACKHOE SWING	139808A1	1pc		P-UB-10	2	4	JIC-122535A1	102.54
LOADER BUCKET	113133A2	1pc		P-UB-10	1-1/2	3	JIC-1543256C1	41.15
LOADER CLAM	1346189C1	1pc		P-UB-10	1-3/4	3	JIC-1543267C1	50.86
	1346190C1	1pc		P-UB-10	1-3/4	3	JIC-1543267C1	50.86
LOADER LIFT	133936A1	1pc		P-UB-10	1-3/4	3-1/2	JIC-1543266C1	51.81
MODEL 590 Super M								
BACKHOE BOOM	175785A1			P-UB-10	2-1/2	5-1/2	JIC-1980412C2	200.14
BACKHOE BUCKET	296434A1			P-UB-10	2-3/4	3-3/4	JIC-297895A1	71.97
BACKHOE DIPPER	140965A1			P-UB-10,12	2-3/4	5-1/2	JIC-179011A1	143.89
BACKHOE EXT. DIPPER	1340853C1			P-UB-10	1-3/4	3	JIC-1543267C1	50.86
BACKHOE SWING	139808A2			P-UB-10	2	4	JIC-122535A1	102.54
LOADER BUCKET	255756A1			P-UB-10	1-3/4	3-1/4	JIC-1543260C1	52.05
LOADER CLAM	1346189C1			P-UB-10	1-3/4	3	JIC-1543267C1	50.86
	1346190C1			P-UB-10	1-3/4	3	JIC-1543267C1	50.86
LOADER LIFT	133936A1			P-UB-10	1-3/4	3-1/2	JIC-1543266C1	51.81
STEERING	1986518C2			P-U-10	1-1/2	2-3/4	JIC-G110045	64.90
MODEL 590 Super M SERIES 3								
BACKHOE BOOM	175785A1		02/08-	I-UB-10	2-1/2	5-1/2	JIC-87367429	143.88
BACKHOE BUCKET	296434A1		02/08-	P-UB-10	2-3/4	3-3/4	JIC-297895A1	71.97
BACKHOE DIPPER	1340853C2		02/08-	P-UB-10	1-3/4	3	JIC-1543267C1	50.86
	140965A1		02/08-	P-UB-10,12	2-3/4	5-1/2	JIC-87367212	123.82
BACKHOE STABILIZER LH	177257A1		02/08-	P-UB-10	2-1/4	5	JIC-84154317	67.06
BACKHOE STABILIZER RH	177256A1		02/08-	P-UB-10	2-1/4	5	JIC-84154317	67.06
BACKHOE SWING	139808A2		02/08-	P-UB-10	2	4	JIC-122535A1	102.54
LOADER BUCKET	255756A1		02/08-	P-UB-10	1-3/4	3-1/4	JIC-1543260C1	52.05
LOADER CLAM LH	87454016		02/08-	P-UB-10	1-3/4	3	JIC-1543267C1	50.86
LOADER CLAM RH	87454017		02/08-	P-UB-10	1-3/4	3	JIC-1543267C1	50.86
LOADER LIFT	133936A1		02/08-	P-UB-10	1-3/4	3-1/2	JIC-1543266C1	51.81
MODEL 590 Super N Tier 3								
BACKHOE BOOM	84210930			P-UB-12,14	2-3/4	5-1/2	JIC-84259220	128.20
BACKHOE BUCKET	84210936			P-UB-12,14	2-1/2	3-1/2	JIC-84259225	83.20
BACKHOE DIPPER	84302994			P-UB-12,14	2-3/4	5-1/4	JIC-84259223	208.48
BACKHOE EXTENDABLE DIPPER	84182292			P-UB-10	1-3/4	3	JIC-86982377	40.25
BACKHOE STABILIZER LH	84212184			P-UB-14	2-1/2	5-1/4	JIC-84259228	107.56
	84212184			Wear Ring		2-5/8	JIC-G102427	11.00
BACKHOE STABILIZER RH	84210948			P-UB-14	2-1/2	5-1/4	JIC-84259228	107.56
	84210948			Wear Ring		2-5/8	JIC-G102427	11.00
BACKHOE SWING	139808A2			P-UB-10	2	4	JIC-122535A1	102.54
LOADER 4-IN-1	87454017			P-UB-10	1-3/4	3	JIC-1543267C1	50.86
LOADER LIFT	84210940			P-UB-12,14	1-7/8	3-1/2	JIC-84258339	91.91
STEERING	401055A1			I-U-10	36 mm	63 mm	JIC-401061A1	65.34
MODEL 590 Super N Tier 4								
BACKHOE (W/O EXTENDABLE DIPPER)	84421679			P-UB-10	1-3/4	3	JIC-86982377	40.25
BACKHOE STABILIZER	84421609			P-UB-14	2-1/2	5-1/4	JIC-84259228	107.56
BACKHOE SWING	84428583			P-UB-10	2	4	JIC-122535A1	102.54
BOOM	84421589			P-UB-12,14	2-3/4	5-1/2	JIC-84259220	128.20
BUCKET	84421596			P-UB-12,14	2-1/2	3-1/2	JIC-84259225	83.20
	84421602			P-UB-12,14	1-3/4	3-1/4	JIC-84257323	82.65
CLAM LH	87455458			P-UB-10	1-3/4	3	JIC-86982377	40.25
CLAM RH	87455459			P-UB-10	1-3/4	3	JIC-86982377	40.25
DIPPER	84420672			P-UB-12,14	2-3/4	5-1/4	JIC-84259223	208.48
EXTENDABLE DIPPER	84421679			P-UB-10	1-3/4	3	JIC-86982377	40.25
LIFT	84421599			P-UB-12,14	1-7/8	3-1/2	JIC-84258339	91.91

CASE

NEW

NEW

Replacement Kits For

CASE

Backhoe Loaders								
APPLICATION	CYL #	Piston	SERIAL #	CODE	ROD	BORE	KIT #	List \$
MODEL 590 Super N Tier 4								
LOADER BUCKET 4-IN-1 LH	87455458			P-UB-10	1-3/4	3	JIC-86982377	40.25
LOADER BUCKET 4-IN-1 RH	87455459			P-UB-10	1-3/4	3	JIC-86982377	40.25
STEERING	84264405			I-U-10	36 mm	63 mm	JIC-84330972	65.79
STEERING-4WD	84264406			I-U-10	40 mm	70 mm	JIC-84331720	114.09
MODEL 590SR Super R								
BACKHOE EXTENSION	87412686		1/04-	P-UB-10	2	2-3/4	JIC-87428866	34.97
BOOM	85820245		1/04-	P-UB-10,12	2-1/2	135 mm	JIC-87428634	195.16
	87412698		1/04-	P-UB-10,12	2-1/2	135 mm	JIC-87428874	160.24
BUCKET	87412691		1/04-	P-UB-10	2-1/2	90 mm	JIC-87428869	62.94
CLAMSHELL	85820005		1/04-	I-U-15	45 mm	80 mm	JIC-85824250	61.97
DIPPER	85820244		1/04-	P-UB-10	63 mm	4-1/2	JIC-85819350	160.88
	87412696		1/04-, After 13 Feb 2008	P-UB-10	2-1/2	4-1/2	JIC-87633295	106.46
LOADER LIFT	87429845		1/04-	P-UB-10	2	3-1/2	JIC-87432407	45.58
LOADER TILT	87429582		1/04-	P-UB-10	1-3/4	3-1/4	JIC-87432412	47.38
STABILIZER (SIDESHIFT)	87412685		1/04-	P-UB-10	2	2-3/4	JIC-87428866	34.97
SWING	87424832		1/04-, -N5GH02283	P-UB-10	2	110 mm	JIC-87445307-NP	64.38
	87450927		1/04-, N5GH002284-	P-UB-10	2	110 mm	JIC-87445307-NP	64.38
MODEL 590SR Super R Tier 2								
BACKHOE	87327257		3/05-	P-UB-10	1-3/4	3	JIC-87342131	39.98
BOOM	87412698		3/05-	P-UB-10,12	2-1/2	135 mm	JIC-87428874	160.24
BUCKET	235916A1		3/05-	P-UB-10	2-1/2	3-1/2	JIC-1542923C2	65.68
CLAMSHELL	87573861		3/05-	I-U-15	45 mm	80 mm	JIC-87573868	61.97
DIPPER	87412696		3/05-, After 13 Feb 2008	P-UB-10	2-1/2	4-1/2	JIC-87633295	106.46
EXTENSION	87412686		3/05-	P-UB-10	2	2-3/4	JIC-87428866	34.97
LOADER LIFT	87429845		3/05-	P-UB-10	2	3-1/2	JIC-87432407	45.58
LOADER TILT	87307299		3/05-	P-UB-10	1-3/4	3-1/4	JIC-87432412	47.38
	87429582		3/05-	P-UB-10	1-3/4	3-1/4	JIC-87432412	47.38
STABILIZER (SIDESHIFT)	87412685		3/05-	P-UB-10	2	2-3/4	JIC-87428866	34.97
	87574187		3/05-	P-UB-10	2	2-3/4	JIC-87428620	38.24
SWING	87450927		3/05-	P-UB-10	2	110 mm	JIC-87428631	73.10
MODEL 590SR Super R Tier 3								
BACKHOE EXTENSION	87327257		2/07-	P-UB-10	1-3/4	3	JIC-87342131	39.98
	87327257		2008-	P-UB-10	1-3/4	3	JIC-87342131	39.98
BOOM	87412698		2/07-	P-UB-10,12	2-1/2	135 mm	JIC-87428874	160.24
	87412698		2008-	P-UB-10,12	2-1/2	135 mm	JIC-87428874	160.24
BUCKET	235916A1		2/07-	P-UB-10	2-1/2	3-1/2	JIC-1542923C2	65.68
	235916A1		2008-	P-UB-10	2-1/2	3-1/2	JIC-1542923C2	65.68
CLAMSHELL	87573861		2/07-	I-U-15	45 mm	80 mm	JIC-87573868	61.97
	87573861		2008-	I-U-15	45 mm	80 mm	JIC-87573868	61.97
DIPPER	87412696		2/07-, After 13 Feb 2008	P-UB-10	2-1/2	4-1/2	JIC-87633295	106.46
	87412696		2008-, After 13 Feb 2008	P-UB-10	2-1/2	4-1/2	JIC-87633295	106.46
LOADER LIFT	87429845		2/07-	P-UB-10	2	3-1/2	JIC-87432407	45.58
	87585103		2008-	P-UB-10	2	3-3/4	JIC-87651309	53.53
LOADER TILT	87307299		2/07-	P-UB-10	1-3/4	3-1/4	JIC-87432412	47.38
	87307299		2008-	P-UB-10	1-3/4	3-1/4	JIC-87432412	47.38
STABILIZER (CENTRE PIVOT)	84209919		2008-	P-UB-14	2-1/4	4	JIC-84209920	83.70
STABILIZER (SIDESHIFT)	87574187		2/07-	P-UB-10	2	2-3/4	JIC-87608671	42.93
	87627940		2008-	P-UB-10	2	3	JIC-87653283	35.16
SWING	87450927		2/07-	P-UB-10	2	110 mm	JIC-87428631	73.10
	87450927		2008-	P-UB-10	2	110 mm	JIC-87428631	73.10

CASE

Replacement Kits For

CASE

Backhoe Loaders								
APPLICATION	CYL #	Piston	SERIAL #	CODE	ROD	BORE	KIT #	List \$
MODEL 680								
3-PT HITCH PITCH		1pc	ALL	P-UB-10	1-1/4	2-1/2	JIC-G110055	51.83
BACKHOE BOOM				P-U-1	2-1/4		JIC-D42878	19.31
		2pc		N-N-9		4-1/2	JIC-DTVS4.5P	53.59
BACKHOE BUCKET				I-U-1	2-1/4		JIC-D42877	15.73
		2pc		N-N-9		4	JIC-G33239	24.83
BACKHOE DIPPER				P-U-1	2-1/4		JIC-D42878	19.31
		2pc		N-N-9		4-1/2	JIC-DTVS4.5P	53.59
BACKHOE STABILIZER				I-U-1	1-3/4		JIC-D42873	21.75
		2pc		N-N-9		3-1/2	JIC-G33237	22.76
BACKHOE SWING				I-U-1	1-3/4		JIC-D42875	16.83
		2pc		N-N-9		4	JIC-G33239	24.83
LOADER TILT				I-U-1	1-3/4		JIC-D42873	21.75
		2pc		N-N-9		3-1/2	JIC-G33237	22.76
MODEL 680B								
BACKHOE BOOM		2pc		P-U-9	2-1/4	5	JIC-G32696	77.87
BACKHOE BUCKET		2pc		P-U-9	2-1/4	4	JIC-G34636	62.00
				I-U-1	2-1/4		JIC-D42877	15.73
		2pc		N-N-9		4	JIC-G33239	24.83
BACKHOE DIPPER		2pc		P-UB-9	2-1/4	4-1/2	JIC-G105520	91.37
				P-U-1	2-1/4		JIC-D42878	19.31
		2pc		N-N-9		4-1/2	JIC-DTVS4.5P	53.59
BACKHOE STABILIZER		2pc		P-U-9	2	4	JIC-G32299	53.72
				I-U-1	2		JIC-D42876	20.00
		2pc		N-N-9		4	JIC-G33239	24.83
BACKHOE SWING		2pc		P-U-9	2	4-1/2	JIC-G32695	78.36
		2pc		P-UB-9	2	4-1/2	JIC-G105525	76.10
		2pc		P-UB-9	1-3/4	3	JIC-G105524	59.48
LOADER HYDRA-LEVELING				I-U-1	1-3/4		JIC-D42872	15.87
		2pc		N-N-9		3	JIC-G33151	20.56
		2pc		P-U-9	2	3-1/2	JIC-G34648	50.20
LOADER LIFT				I-U-1	2		JIC-D42874	16.92
		2pc		N-N-9		3-1/2	JIC-G33237	22.76
		2pc		P-UB-9	1-3/4	3	JIC-G105524	59.48
LOADER TILT				I-U-1	1-3/4		JIC-D42872	15.87
		2pc		N-N-9		3	JIC-G33151	20.56
		2pc		P-UB-9	1-3/4	3	JIC-G105524	59.48
MODEL 680C								
3-PT HITCH PITCH		1pc		P-UB-10	1-1/2	2-1/2	JIC-G105550	30.33
		2pc		P-U-9	1-1/2	2-1/2	JIC-G32294	37.19
3-PT HITCH TILT		2pc		P-U-9	1-1/2	2-1/2	JIC-G32294	37.19
		1pc		P-UB-10	1-1/2	2-1/2	JIC-G105550	30.33
BACKHOE BOOM		2pc		P-U-9	2-1/4	5	JIC-G32696	77.87
BACKHOE BUCKET		1pc		P-UB-10	1-1/4	2-1/2	JIC-G105551	34.37
		2pc		P-U-9	2-1/4	4	JIC-G34636	62.00
BACKHOE DIPPER		2pc		P-UB-9	1-1/2	3	JIC-G105512	53.98
		2pc		P-UB-9	2-1/4	4-1/2	JIC-G105520	91.37
				P-U-1	2-1/4		JIC-D42878	19.31
		2pc		N-N-9		4-1/2	JIC-DTVS4.5P	53.59
BACKHOE DIPPER EXT		2pc		P-UB-9	1-1/2	3	JIC-G105512	53.98
BACKHOE STABILIZER		1pc		P-UB-10	2	4	JIC-1543273C1	66.53
		2pc		P-UB-9	2	4	JIC-G105517	56.90
		2pc		P-U-9	2	4	JIC-G32299	53.72
				I-U-1	2		JIC-D42876	20.00
		2pc		N-N-9		4	JIC-G33239	24.83
BACKHOE SWING		2pc		P-UB-9	2	4-1/2	JIC-G105525	76.10
		2pc		P-U-9	2	4-1/2	JIC-G32695	78.36

CASE

Replacement Kits For

CASE

Backhoe Loaders								
APPLICATION	CYL #	Piston	SERIAL #	CODE	ROD	BORE	KIT #	List \$
MODEL 680C								
LOADER CLAM		1pc		P-UB-10	1-1/2	3	JIC-G105548	40.42
		2pc		P-UB-9	1-1/2	3	JIC-G105512	53.98
LOADER HYDRA-LEVELING		1pc		P-UB-10	1-1/2	3	JIC-G105548	40.42
		2pc		P-UB-9	1-3/4	3	JIC-G105524	59.48
LOADER LIFT		2pc		P-U-9	2	3-1/2	JIC-G34648	50.20
		1pc		P-UB-10	2	3-1/2	JIC-G105546	48.58
		2pc		P-UB-9	2	3-1/2	JIC-G105521	47.35
LOADER TILT		1pc		P-UB-10	1-3/4	3	JIC-G105549	51.43
		2pc		P-UB-9	1-3/4	3	JIC-G105524	59.48
		2pc		P-U-9	1-3/4	3	JIC-G34643	47.52
MODEL 680CK								
BACKHOE BOOM				P-U-1	2-1/4		JIC-D42878	19.31
		2pc		N-N-9		4-1/2	JIC-DTVS4.5P	53.59
BACKHOE BUCKET				I-U-1	2-1/4		JIC-D42877	15.73
		2pc		N-N-9		4	JIC-G33239	24.83
BACKHOE DIPPER				P-U-1	2-1/4		JIC-D42878	19.31
		2pc		N-N-9		4-1/2	JIC-DTVS4.5P	53.59
BACKHOE STABILIZER				I-U-1	2		JIC-D42876	20.00
		2pc		N-N-9		4	JIC-G33239	24.83
BACKHOE SWING				I-U-1	1-3/4		JIC-D42875	16.83
		2pc		N-N-9		4	JIC-G33239	24.83
LOADER HYDRA-LEVELING				I-U-1	1-3/4		JIC-D42872	15.87
		2pc		N-N-9		3	JIC-G33151	20.56
LOADER LIFT				I-U-1	2		JIC-D42874	16.92
		2pc		N-N-9		3-1/2	JIC-G33237	22.76
LOADER TILT				I-U-1	1-3/4		JIC-D42872	15.87
		2pc		N-N-9		3	JIC-G33151	20.56
MODEL 680E								
BACKHOE BOOM		1pc		P-UB-10	2-1/4	4	JIC-G105556	52.53
		2pc		P-U-9	2-1/4	4	JIC-G34827	62.00
BACKHOE BUCKET		2pc		P-U-9	2-1/4	4	JIC-G34636	62.00
		1pc		P-UB-10	2-1/4	4	JIC-G105556	52.53
BACKHOE DIPPER		2pc		P-UB-9	2-1/2	4-1/2	JIC-G105513	94.22
BACKHOE DIPPER EXT		1pc		P-UB-10	1-1/2	3	JIC-G105548	40.42
		2pc		P-UB-9	1-1/2	3	JIC-G105512	53.98
BACKHOE STABILIZER		2pc		P-UB-9	2	4-1/2	JIC-G105525	76.10
BACKHOE SWING		2pc		P-UB-9	2	4	JIC-G105517	56.90
		1pc		P-UB-10	2	4	JIC-1543273C1	66.53
LOADER CLAM		1pc		P-UB-10	1-1/2	3	JIC-G105548	40.42
		2pc		P-UB-9	1-1/2	3	JIC-G105512	53.98
LOADER LIFT		1pc		P-UB-10	2	3-1/2	JIC-G105546	48.58
		2pc		P-UB-9	2	3-1/2	JIC-G105521	47.35
LOADER TILT		1pc		P-UB-10	1-3/4	3	JIC-G105549	51.43
		2pc		P-U-9	1-3/4	3	JIC-G34643	47.52
STEERING		1pc		I-U-10	1-1/4	2-1/8	JIC-A43296	22.53
		1pc		P-U-10	1-1/4	2-1/8	JIC-G101021	23.79
		1pc		P-U-10	1-1/4	2-1/8	JIC-G34819	24.48
MODEL 680G, 680H								
BACKHOE BOOM		1pc		P-UB-10	2-1/4	4	JIC-G105556	52.53
BACKHOE BUCKET		1pc		P-UB-10	2-1/4	4	JIC-G105556	52.53
BACKHOE DIPPER		2pc		P-UB-9	2-1/2	4-1/2	JIC-G105513	94.22
BACKHOE DIPPER EXT		1pc		P-UB-10	1-1/2	3	JIC-G105548	40.42
BACKHOE STABILIZER		2pc		P-UB-9	2	4-1/2	JIC-G105525	76.10
BACKHOE SWING		1pc		P-UB-10	2	4	JIC-1543273C1	66.53
LOADER CLAM		1pc		P-UB-10	1-1/2	3	JIC-G105548	40.42

CASE

Replacement Kits For

CASE

Backhoe Loaders								
APPLICATION	CYL #	Piston	SERIAL #	CODE	ROD	BORE	KIT #	List \$
MODEL 680G, 680H								
LOADER LIFT		1pc		P-UB-10	2	3-1/2	JIC-G105546	48.58
LOADER TILT		1pc		P-UB-10	1-3/4	3	JIC-G105549	51.43
STEERING		1pc		P-U-10	1-1/4	2-1/8	JIC-G34819	24.48
MODEL 680K								
BACKHOE BOOM		1pc		P-UB-10	2-1/4	4	JIC-G109505	48.24
BACKHOE BUCKET		1pc		P-UB-10	2-1/4	4	JIC-G109505	48.24
BACKHOE DIPPER		2pc		P-UB-9	2-1/2	4-1/2	JIC-G109498	86.90
BACKHOE DIPPER EXT		1pc		P-UB-10	1-1/2	3	JIC-G109452	30.69
BACKHOE SWING		1pc		P-UB-10	2	4	JIC-1543273C1	66.53
LOADER CLAM		1pc		P-UB-10	1-1/2	3	JIC-G109452	30.69
LOADER LIFT		1pc		P-UB-10	2	3-1/2	JIC-G109453	45.49
LOADER TILT		1pc		P-UB-10	1-3/4	3	JIC-1543262C1	42.01
STEERING		1pc		P-U-10	1-1/4	2-1/8	JIC-G34819	24.48
MODEL 680L								
BACKHOE BOOM	1343567C1	1pc		P-UB-10	2-1/4	4	JIC-1346478C2	87.31
	G101256	1pc		P-UB-10	2-1/4	4	JIC-1543277C1	58.83
BACKHOE BUCKET	1343602C1	1pc		P-UB-10	2-1/4	4	JIC-1346478C2	87.31
	G103856	1pc		P-UB-10	2-1/4	4	JIC-1543277C1	58.83
BACKHOE DIPPER	1345994C1	1pc		P-UB-10	2-1/2	4-1/2	JIC-1343707C2	69.55
	G101348	2pc		P-UB-9	2-1/2	4-1/2	JIC-1543291C1	88.36
BACKHOE DIPPER EXT	1980375C1	1pc		P-UB-10	1-1/2	3	JIC-1543256C1	41.15
BACKHOE STABILIZER	1986853C1	1pc		P-UB-10	2	4-1/2	JIC-1986856C2	87.91
	G102276	2pc		P-UB-9	2	4-1/2	JIC-1543270C1	96.48
BACKHOE SWING	1978339C1	1pc		P-UB-10	2	4	JIC-1543269C1	63.39
LOADER CLAM	D143217	1pc		I-U-10	2	4	JIC-D143215	31.15
LOADER LIFT	G103073	1pc	-JJG007050523, 526, 540, 547 & UP	P-UB-10	2-1/4	4	JIC-1543277C1	58.83
	G103457	1pc	-JJG0070547, except 423, 526, & 540	P-UB-10	2	3-1/2	JIC-1543274C1	67.94
LOADER TILT	G101220	1pc		P-UB-10	1-3/4	3	JIC-1543262C1	42.01
MODEL 780								
BACKHOE BOOM		2pc		P-UB-9	2-1/2	4-1/2	JIC-G105513	94.22
BACKHOE BUCKET		2pc	-5500549	P-U-9	3	5	JIC-G32668	79.33
		2pc	5500550-	P-UB-9	3	5	JIC-G105531	91.77
BACKHOE DIPPER		2pc		P-UB-9	3	6	JIC-G105516	98.63
BACKHOE DIPPER EXT		2pc		P-U-9	2-1/4	4	JIC-G34636	62.00
		1pc		P-UB-10	2-1/4	4	JIC-G105556	52.53
BACKHOE STABILIZER		2pc		P-UB-9	2-1/2	4-1/2	JIC-G105513	94.22
BACKHOE SWING		2pc		P-UB-9	2-1/4	4-1/2	JIC-G105520	91.37
LOADER CLAM		1pc		P-UB-10	2	4	JIC-1543273C1	66.53
		2pc		P-U-9	2	4	JIC-G32299	53.72
LOADER HYDRA-LEVELING		2pc		P-UB-9	2	4	JIC-G105517	56.90
LOADER LIFT		2pc		P-UB-9	2-1/4	4-1/2	JIC-G105520	91.37
LOADER TILT		2pc		P-U-9	1-3/4	3-1/2	JIC-G32228	41.15
		2pc		P-U-9	1-3/4	3-1/2	JIC-G105508	50.19
MODEL 780B								
BACKHOE BOOM		1pc	ALL	P-UB-10	2-1/2	4-1/2	JIC-G105560	50.48
BACKHOE BUCKET		1pc	ALL	P-UB-10	2-1/2	4-1/2	JIC-G105560	50.48
BACKHOE DIPPER		1pc		P-UB-10	2-3/4	5	JIC-G105562	75.76
BACKHOE DIPPER EXT		1pc		P-UB-10	1-1/2	3	JIC-G105548	40.42
BACKHOE STABILIZER		1pc		P-UB-10	2-1/4	4-1/2	JIC-G105557	67.65
BACKHOE SWING		1pc		P-UB-10	2	4	JIC-1543273C1	66.53
LOADER CLAM		1pc		P-UB-10	2	4	JIC-1543273C1	66.53
LOADER LIFT		1pc		P-UB-10	2-1/4	4	JIC-G105556	52.53
LOADER TILT		1pc		P-UB-10	2	3-1/2	JIC-G105546	48.58

CASE

Replacement Kits For

CASE

Backhoe Loaders								
APPLICATION	CYL #	Piston	SERIAL #	CODE	ROD	BORE	KIT #	List \$
MODEL 780B								
STEERING		1pc		P-U-10	1-1/4	2-1/8	JIC-G34819	24.48
Crawler Dozers/Loaders								
APPLICATION	CYL #	Piston	SERIAL #	CODE	ROD	BORE	KIT #	List \$
MODEL 310E, 310F with Backhoe Model 31								
BACKHOE BOOM		2pc		P-U-9	2	4	JIC-G32616	51.66
				I-U-1	2		JIC-D42876	20.00
		2pc		N-N-9		4	JIC-G33239	24.83
BACKHOE BUCKET		2pc		P-U-9	1-3/4	3-1/2	JIC-G105518	46.11
				I-U-1	1-3/4		JIC-D42873	21.75
		2pc		N-N-9		3-1/2	JIC-G33237	22.76
BACKHOE DIPPER		2pc		P-UB-9	2	4	JIC-G105526	56.82
				I-U-1	2		JIC-D42876	20.00
		2pc		N-N-9		4	JIC-G33239	24.83
BACKHOE STABILIZER				I-U-1	1-3/4		JIC-D42873	21.75
		2pc		N-N-9		3-1/2	JIC-G33237	22.76
BACKHOE SWING		2pc		N-N-9		4	JIC-G33239	24.83
			2019001-3023000	I-U-1	1-3/4		JIC-D42875	16.83
DOZER ANGLING				I-U-1	1-3/4		JIC-D42873	21.75
		2pc		N-N-9		3-1/2	JIC-G33237	22.76
DOZER LIFT				I-U-1	1-1/4		JIC-D42867	19.79
		2pc		N-N-9		2-1/2	JIC-G33193	20.06
DOZER TILT				I-U-1	1-1/4		JIC-D42867	19.79
		2pc		N-N-9		2-1/2	JIC-G33193	20.06
LOADER LIFT				I-U-1	1-3/4		JIC-D42873	21.75
		2pc		N-N-9		3-1/2	JIC-G33237	22.76
LOADER TILT				I-U-1	1-1/4		JIC-D42867	19.79
		2pc		N-N-9		2-1/2	JIC-G33193	20.06
SCARIFIER				I-U-1	1-1/2		JIC-D42870	21.19
		2pc		N-N-9		3	JIC-G33151	20.56
MODEL 310G with Backhoe Models 26, 26B, 26S, 32, 33								
BACKHOE BOOM			3023001.3032323	I-U-1	1-3/4		JIC-D42873	21.75
		2pc	3023001.3032324	N-N-9		3-1/2	JIC-G33237	22.76
		2pc	3023001.3032325	P-UB-9	1-3/4	3-1/2	JIC-G105529	43.24
		2pc	3023001.3032326	P-U-9	2-1/4	4	JIC-G34636	62.00
			3023001.3032327	I-U-1	2		JIC-D42876	20.00
		2pc	3023001.3032328	N-N-9		4	JIC-G33239	24.83
		2pc	3023001.3032329	P-U-9	2	4	JIC-G32299	53.72
		2pc	3023001.3032330	P-UB-9	2	4	JIC-G105517	56.90
			3023001.3032331	P-U-1	2-1/4		JIC-D42878	19.31
		2pc	3023001.3032332	N-N-9		4-1/2	JIC-DTVS4.5P	53.59
		2pc	3023001.3032333	P-UB-9	2-1/4	4-1/2	JIC-G105520	91.37
BACKHOE BUCKET			3023001.3032334	I-U-1	1-3/4		JIC-D42872	15.87
		2pc	3023001.3032335	N-N-9		3-1/2	JIC-G33237	22.76
		2pc	3023001.3032336	P-UB-9	1-3/4	3	JIC-G105524	59.48
			3023001.3032337	I-U-1	1-3/4		JIC-D42873	21.75
		2pc	3023001.3032338	N-N-9		3-1/2	JIC-G33237	22.76
			3023001.3032339	I-U-1	2		JIC-D42874	16.92
		2pc	3023001.3032340	N-N-9		3-1/2	JIC-G33237	22.76
		2pc	3023001.3032341	P-U-9	2	3-1/2	JIC-G32293	41.67
BACKHOE DIPPER		2pc	3023001.3032342	P-UB-9	2	3-1/2	JIC-G105527	54.29
			3023001.3032343	I-U-1	2		JIC-D42874	16.92
		2pc	3023001.3032344	N-N-9		3-1/2	JIC-G33237	22.76
		2pc	3023001.3032345	P-U-9	2	3-1/2	JIC-G32293	41.67
		2pc	3023001.3032346	P-UB-9	2	3-1/2	JIC-G105527	54.29
		3023001.3032347	I-U-1	2		JIC-D42876	20.00	

CASE

CASE

Replacement Kits For

Crawler Dozers/Loaders								
APPLICATION	CYL #	Piston	SERIAL #	CODE	ROD	BORE	KIT #	List \$
MODEL 310G with Backhoe Models 26, 26B, 26S, 32, 33								
BACKHOE DIPPER		2pc	3023001.3032348	N-N-9		4	JIC-G33239	24.83
		2pc	3023001.3032349	P-U-9	2	4	JIC-G32299	53.72
		2pc	3023001.3032350	P-UB-9	2	4	JIC-G105517	56.90
		2pc	3023001.3032351	P-UB-9	1-1/2	3	JIC-G105512	53.98
BACKHOE STABILIZER			3023001.3032308	I-U-1	1-1/2		JIC-D42870	21.19
		2pc	3023001.3032309	N-N-9		3	JIC-G33151	20.56
			3023001.3032310	I-U-1	1-3/4		JIC-D42872	15.87
		2pc	3023001.3032311	N-N-9		3	JIC-G33151	20.56
		2pc	3023001.3032312	P-UB-9	1-3/4	3	JIC-G105524	59.48
			3023001.3032313	I-U-1	1-3/4		JIC-D42873	21.75
		2pc	3023001.3032314	N-N-9		3-1/2	JIC-G33237	22.76
		2pc	3023001.3032315	P-UB-9	1-3/4	3-1/2	JIC-G105529	43.24
		2pc	3023001.3032316	P-U-9	1-3/4	3-1/2	JIC-G105518	46.11
BACKHOE SWING			3023001.3032317	I-U-1	1-1/2		JIC-D47896	17.09
		2pc	3023001.3032318	N-N-9		3-1/2	JIC-G33237	22.76
		2pc	3023001.3032319	P-U-9	1-1/2	3-1/2	JIC-G34652	40.57
		2pc	3023001.3032320	P-UB-9	1-3/4	4	JIC-G105519	51.50
			3023001.3032321	I-U-1	1-3/4		JIC-D42875	16.83
	2pc	3023001.3032322	N-N-9		4	JIC-G33239	24.83	
DOZER ANGLING		2pc	3023001.3032301	P-U-9	1-3/4	3-1/2	JIC-G34622	46.11
			3023001.3032301	I-U-1	1-3/4		JIC-D42873	21.75
		2pc	3023001.3032301	N-N-9		3-1/2	JIC-G33237	22.76
			3023001.3032302	I-U-1	1-1/2		JIC-D42870	21.19
		2pc	3023001.3032303	N-N-9		3	JIC-G33151	20.56
		2pc	3023001.3032304	P-UB-9	1-1/2	3	JIC-G105512	53.98
DOZER LIFT		2pc	3023001.3032301	P-U-9	1-1/4	2-1/2	JIC-G32295	46.74
			3023001.3032301	I-U-1	1-1/4		JIC-D42867	19.79
		2pc	3023001.3032301	N-N-9		2-1/2	JIC-G33193	20.06
DOZER TILT		2pc	3023001.3032301	P-U-9	1-1/4	2-1/2	JIC-G32295	46.74
			3023001.3032301	I-U-1	1-1/4		JIC-D42867	19.79
		2pc	3023001.3032301	N-N-9		2-1/2	JIC-G33193	20.06
EXTENSION			3023001.3032352	I-U-1	1-3/4		JIC-D42873	21.75
		2pc	3023001.3032353	N-N-9		3-1/2	JIC-G33237	22.76
		2pc	3023001.3032354	P-UB-9	1-3/4	3-1/2	JIC-G105529	43.24
LOADER CLAM	G32460	2pc	3023001.3032301	P-UB-9	1-3/4	3	JIC-G105524	59.48
LOADER GRAPPLE		2pc	3023001.3032301	P-U-9	1-1/2	2-1/2	JIC-G32294	37.19
			3023001.3032301	I-U-1	1-1/2		JIC-D42869	21.34
		2pc	3023001.3032301	N-N-9		2-1/2	JIC-G33193	20.06
LOADER HYDRA-LEVELING	D33123	2pc	3023001.3032301	P-U-9	1-1/2	2-1/2	JIC-G32294	37.19
	D33123	2pc	3023001.3032301	I-U-1	1-1/2		JIC-D42869	21.34
	D33123	2pc	3023001.3032301	N-N-9		2-1/2	JIC-G33193	20.06
LOADER LIFT		2pc	3023001.3032301	P-UB-9	1-3/4	3	JIC-G105524	59.48
	D33121, D33122		3023001.3032301	I-U-1	1-3/4		JIC-D42872	15.87
	D33121, D33122	2pc	3023001.3032301	N-N-9		3	JIC-G33151	20.56
LOADER TILT		2pc	3023001.3032301	N-N-9		2-1/2	JIC-G33193	20.06
	D33113, D33114	2pc	3023001.3032301	P-U-9	1-1/2	2-1/2	JIC-G32294	37.19
	D33113, D33114		3023001.3032301	I-U-1	1-1/2		JIC-D42869	21.34
RIPPER			3023001.3032305	I-U-1	1-1/2		JIC-D42870	21.19
		2pc	3023001.3032306	N-N-9		3	JIC-G33151	20.56
		2pc	3023001.3032307	P-UB-9	1-1/2	3	JIC-G105512	53.98
MODEL 350 with Backhoe Models 26, 26B, 26C, 26S								
BACKHOE BOOM		2pc		P-U-9	2-1/4	4	JIC-G34636	62.00

CASE

Replacement Kits For

CASE

Crawler Dozers/Loaders								
APPLICATION	CYL #	Piston	SERIAL #	CODE	ROD	BORE	KIT #	List \$
MODEL 350 with Backhoe Models 26, 26B, 26C, 26S								
BACKHOE BOOM		2pc		P-UB-9	1-3/4	3-1/2	JIC-G105529	43.24
		1pc		P-UB-10	2-1/4	4	JIC-G105556	52.53
				I-U-1	1-3/4		JIC-D42873	21.75
		2pc		N-N-9		3-1/2	JIC-G33237	22.76
BACKHOE BUCKET		1pc		P-UB-10	1-3/4	3	JIC-G105549	51.43
		2pc		P-UB-9	1-3/4	3	JIC-G105524	59.48
				I-U-1	1-3/4		JIC-D42872	15.87
		2pc		N-N-9		3-1/2	JIC-G33237	22.76
BACKHOE DIPPER		1pc		P-UB-10	2	3-1/2	JIC-G105546	48.58
		2pc		P-U-9	2	3-1/2	JIC-G32293	41.67
		2pc		P-UB-9	2	3-1/2	JIC-G105527	54.29
				I-U-1	2		JIC-D42874	16.92
		2pc		N-N-9		3-1/2	JIC-G33237	22.76
BACKHOE DIPPER EXT		1pc		P-UB-10	1-1/2	3	JIC-G105548	40.42
		2pc		P-UB-9	1-1/2	3	JIC-G105512	53.98
BACKHOE STABILIZER		2pc		P-UB-9	1-3/4	3-1/2	JIC-G105529	43.24
		2pc		P-UB-9	1-3/4	3	JIC-G105524	59.48
		2pc		P-U-9	1-3/4	3-1/2	JIC-G105518	46.11
				I-U-1	1-1/2		JIC-D42870	21.19
				I-U-1	1-3/4		JIC-D42872	15.87
		2pc		N-N-9		3	JIC-G33151	20.56
BACKHOE SWING		2pc		P-UB-9	1-3/4	4	JIC-G105519	51.50
		2pc		P-U-9	1-1/2	3-1/2	JIC-G34652	40.57
		1pc		P-UB-10	1-1/2	3-1/2	JIC-G105555	38.03
				I-U-1	1-1/2		JIC-D47896	17.09
		2pc		N-N-9		3-1/2	JIC-G33237	22.76
DOZER ANGLE		2pc		P-U-9	1-3/4	3-1/2	JIC-G105518	46.11
				I-U-1	1-3/4		JIC-D42873	21.75
		2pc		N-N-9		3-1/2	JIC-G33237	22.76
DOZER ANGLE (Angle Tilt Dozer)		1pc		P-UB-10	1-1/2	3	JIC-G105548	40.42
		2pc		P-UB-9	1-1/2	3	JIC-G105512	53.98
				I-U-1	1-1/2		JIC-D42870	21.19
		2pc		N-N-9		3	JIC-G33151	20.56
DOZER LIFT		2pc		P-U-9	1-1/4	2-1/2	JIC-G32295	46.74
		1pc		P-UB-10	1-1/4	2-1/2	JIC-G105551	34.37
				I-U-1	1-1/4		JIC-D42867	19.79
		2pc		N-N-9		2-1/2	JIC-G33193	20.06
DOZER TILT		1pc		P-UB-10	1-1/4	2-1/2	JIC-G105551	34.37
		2pc		P-U-9	1-1/4	2-1/2	JIC-G32295	46.74
				I-U-1	1-1/4		JIC-D42867	19.79
		2pc		N-N-9		2-1/2	JIC-G33193	20.06
LOADER CLAM		2pc		P-UB-9	1-3/4	3	JIC-G105524	59.48
		1pc		P-UB-10	1-3/4	3	JIC-G105549	51.43
LOADER GRAPPLE		2pc		P-U-9	1-1/2	2-1/2	JIC-G32294	37.19
		1pc		P-UB-10	1-1/2	2-1/2	JIC-G105550	30.33
				I-U-1	1-1/2		JIC-D42869	21.34
		2pc		N-N-9		2-1/2	JIC-G33193	20.06
LOADER HYDRA-LEVELING		1pc		P-UB-10	1-1/2	2-1/2	JIC-G105550	30.33
		2pc		P-U-9	1-1/2	2-1/2	JIC-G32294	37.19
				I-U-1	1-1/2		JIC-D42869	21.34
		2pc		N-N-9		2-1/2	JIC-G33193	20.06
LOADER LIFT		2pc		P-UB-9	1-3/4	3	JIC-G105524	59.48
		2pc		P-U-9	1-3/4	3	JIC-G34643	47.52
		1pc		P-UB-10	1-3/4	3	JIC-G105549	51.43

Replacement Kits For

CASE

Crawler Dozers/Loaders								
APPLICATION	CYL #	Piston	SERIAL #	CODE	ROD	BORE	KIT #	List \$
MODEL 350 with Backhoe Models 26, 26B, 26C, 26S								
LOADER LIFT				I-U-1	1-3/4		JIC-D42872	15.87
		2pc		N-N-9		3	JIC-G33151	20.56
LOADER TILT		1pc		P-UB-10	1-1/2	2-1/2	JIC-G105550	30.33
		2pc		P-U-9	1-1/2	2-1/2	JIC-G32294	37.19
				I-U-1	1-1/2		JIC-D42869	21.34
		2pc		N-N-9		2-1/2	JIC-G33193	20.06
RIPPER		2pc		P-UB-9	1-1/2	3	JIC-G105512	53.98
		1pc		P-UB-10	1-1/2	3	JIC-G105548	40.42
				I-U-1	1-1/2		JIC-D42870	21.19
		2pc		N-N-9		3	JIC-G33151	20.56
MODEL 350B with Backhoe Models 26C, 26D								
BACKHOE BOOM		2pc		P-U-9	2-1/4	4	JIC-G34636	62.00
		1pc		P-UB-10	1-3/4	4	JIC-G105552	48.42
		1pc		P-UB-10	2-1/4	4	JIC-G105556	52.53
BACKHOE BUCKET		1pc		P-UB-10	2	3-1/4	JIC-G105553	50.94
		2pc		P-UB-9	1-3/4	3	JIC-G105524	59.48
		1pc		P-UB-10	1-3/4	3	JIC-G105549	51.43
BACKHOE DIPPER		2pc		P-UB-9	2	3-1/2	JIC-G105527	54.29
		1pc		P-UB-10	2	3-1/2	JIC-G105546	48.58
BACKHOE DIPPER EXT		1pc		P-UB-10	1-1/2	3	JIC-G105548	40.42
		2pc		P-UB-9	1-1/2	3	JIC-G105512	53.98
BACKHOE STABILIZER		2pc		P-U-9	1-3/4	3-1/2	JIC-G105518	46.11
		1pc		P-UB-10	1-3/4	3	JIC-G105549	51.43
BACKHOE SWING		1pc		P-UB-10	1-1/2	3-1/2	JIC-G105555	38.03
		2pc		P-U-9	1-1/2	3-1/2	JIC-G34652	40.57
DOZER ANGLE		1pc		P-UB-10	1-1/2	3	JIC-G109452	30.69
DOZER LIFT		1pc		P-UB-10	1-1/4	2-1/2	JIC-G109475	34.37
DOZER TILT		1pc		P-UB-10	1-1/4	2-1/2	JIC-G109475	34.37
LOADER CLAM		1pc		P-UB-10	1-3/4	3	JIC-1543262C1	42.01
LOADER LIFT		1pc		P-UB-10	1-3/4	3	JIC-1543262C1	42.01
LOADER TILT		1pc		P-UB-10	1-1/2	2-1/2	JIC-1543253C1	44.57
RIPPER		1pc		P-UB-10	1-1/2	3	JIC-G109452	30.69
MODEL 420C								
BACKHOE BOOM				I-U-1	2		JIC-D42876	20.00
		2pc		N-N-9		4	JIC-G33239	24.83
BACKHOE BUCKET				I-U-1	1-3/4		JIC-D42873	21.75
		2pc		N-N-9		3-1/2	JIC-G33237	22.76
BACKHOE DIPPER				I-U-1	2		JIC-D42876	20.00
		2pc		N-N-9		4	JIC-G33239	24.83
BACKHOE STABILIZER				I-U-1	1-3/4		JIC-D42873	21.75
		2pc		N-N-9		3-1/2	JIC-G33237	22.76
DOZER ANGLING				I-U-1	1-3/4		JIC-D42873	21.75
		2pc		N-N-9		3-1/2	JIC-G33237	22.76
DOZER LIFT				I-U-1	1-1/4		JIC-D42867	19.79
		2pc		N-N-9		4	JIC-G33239	24.83
DOZER TILT				I-U-1	1-1/4		JIC-D42867	19.79
		2pc		N-N-9		4	JIC-G33239	24.83
LOADER LIFT				I-U-1	1-3/4		JIC-D42873	21.75
		2pc		N-N-9		3-1/2	JIC-G33237	22.76
LOADER TILT				I-U-1	1-1/4		JIC-D42867	19.79
		2pc		N-N-9		4	JIC-G33239	24.83
SCARIFIER				I-U-1	1-1/2		JIC-D42870	21.19
		2pc		N-N-9		4	JIC-G33239	24.83
MODEL 450 with Backhoe Models 26, 26B, 26C, 26S, 32, 33, 35								
BACKHOE BOOM		2pc		P-U-9	2-1/4	4	JIC-G34636	62.00

CASE

Replacement Kits For

CASE

Crawler Dozers/Loaders								
APPLICATION	CYL #	Piston	SERIAL #	CODE	ROD	BORE	KIT #	List \$
MODEL 450 with Backhoe Models 26, 26B, 26C, 26S, 32, 33, 35								
BACKHOE BOOM		2pc		P-UB-8	1-3/4	3-1/4	JIC-G105528	49.50
		2pc		P-U-9	2	4	JIC-G32299	53.72
		1pc		P-UB-10	2-1/4	4	JIC-G105556	52.53
		2pc		P-UB-9	1-3/4	3-1/2	JIC-G105529	43.24
		2pc		P-UB-9	2-1/4	4-1/2	JIC-G105520	91.37
		2pc		P-UB-9	2	4	JIC-G105517	56.90
		1pc		P-UB-10	1-3/4	3-1/4	JIC-G105547	46.47
				P-U-1	2-1/4		JIC-D42878	19.31
				I-U-1	2		JIC-D42876	20.00
				I-U-1	1-3/4		JIC-D42873	21.75
		2pc		N-N-9		4-1/2	JIC-DTVS4.5P	53.59
		2pc		N-N-9		3-1/2	JIC-G33237	22.76
		2pc		N-N-9		4	JIC-G33239	24.83
BACKHOE BUCKET		2pc		P-U-9	2	3-1/2	JIC-G32293	41.67
		2pc		P-UB-9	1-3/4	3	JIC-G105524	59.48
		1pc		P-UB-10	2	3-1/2	JIC-G105546	48.58
		1pc		P-UB-10	1-3/4	3	JIC-G105549	51.43
		2pc		P-UB-9	2	3-1/2	JIC-G105527	54.29
				I-U-1	1-3/4		JIC-D42873	21.75
				I-U-1	2		JIC-D42874	16.92
				I-U-1	1-3/4		JIC-D42872	15.87
		2pc		N-N-9		3-1/2	JIC-G33237	22.76
		1pc		P-UB-10	2	3-1/2	JIC-G105546	48.58
BACKHOE DIPPER		2pc		P-U-9	2	4	JIC-G32299	53.72
		2pc		P-UB-9	2	4	JIC-G105517	56.90
		2pc		P-U-9	2	3-1/2	JIC-G32293	41.67
		2pc		P-UB-9	2	3-1/2	JIC-G105527	54.29
		1pc		P-UB-10	2	4	JIC-1543273C1	66.53
				I-U-1	2		JIC-D42876	20.00
				I-U-1	2		JIC-D42874	16.92
		2pc		N-N-9		3-1/2	JIC-G33237	22.76
		2pc		N-N-9		4	JIC-G33239	24.83
		1pc		P-UB-9	1-3/4	3-1/2	JIC-G105529	43.24
BACKHOE DIPPER EXT		2pc		P-UB-10	1-1/2	3	JIC-G105548	40.42
		2pc		P-UB-9	1-1/2	3	JIC-G105512	53.98
		2pc		I-U-1	1-3/4		JIC-D42873	21.75
		2pc		N-N-9		3-1/2	JIC-G33237	22.76
		1pc		P-UB-10	2	4	JIC-1543273C1	66.53
BACKHOE STABILIZER		2pc		P-UB-9	1-3/4	3-1/2	JIC-G105529	43.24
		2pc		P-UB-9	2	4	JIC-G105517	56.90
		2pc		P-UB-9	1-3/4	3	JIC-G105524	59.48
		2pc		P-U-9	1-3/4	3-1/2	JIC-G105518	46.11
				I-U-1	1-3/4		JIC-D42872	15.87
				I-U-1	1-1/2		JIC-D42870	21.19
				I-U-1	1-3/4		JIC-D42873	21.75
		2pc		N-N-9		3	JIC-G33151	20.56
		2pc		N-N-9		3-1/2	JIC-G33237	22.76
		1pc		P-UB-10	2	4	JIC-1543273C1	66.53
BACKHOE SWING		2pc		P-U-9	1-1/2	3-1/2	JIC-G34652	40.57
		2pc		P-UB-9	2	4	JIC-G105517	56.90
		2pc		P-UB-9	1-3/4	4	JIC-G105519	51.50
		1pc		P-UB-10	1-1/2	3-1/2	JIC-G105555	38.03
				I-U-1	1-3/4		JIC-D42875	16.83
				I-U-1	1-1/2		JIC-D47896	17.09
		2pc		N-N-9		3-1/2	JIC-G33237	22.76

CASE

Replacement Kits For

Crawler Dozers/Loaders								
APPLICATION	CYL #	Piston	SERIAL #	CODE	ROD	BORE	KIT #	List \$
MODEL 450 with Backhoe Models 26, 26B, 26C, 26S, 32, 33, 35								
BACKHOE SWING		2pc		N-N-9		4	JIC-G33239	24.83
DOZER ANGLING (Angle Dozer)		2pc		P-UB-9	1-1/2	2	JIC-G105503	73.41
		2pc		I-U-9	1-1/2	2	JIC-D37361	72.29
DOZER ANGLING (Angle Tilt Dozer)		2pc		P-UB-9	2	4	JIC-G105526	56.82
		1pc		P-UB-10	2	4	JIC-1543273C1	66.53
				I-U-1	2		JIC-D42876	20.00
		2pc		N-N-9		4	JIC-G33239	24.83
DOZER LIFT		2pc		P-U-9	1-1/4	2-1/2	JIC-G32295	46.74
		1pc		P-UB-10	1-1/4	2-1/2	JIC-G105551	34.37
				I-U-1	1-1/4		JIC-D42867	19.79
		2pc		N-N-9		2-1/2	JIC-G33193	20.06
DOZER TILT		2pc		P-U-9	2	3-1/2	JIC-G34648	50.20
		1pc		P-UB-10	2	3-1/2	JIC-G105546	48.58
		2pc		P-UB-9	2	3-1/2	JIC-G105521	47.35
				I-U-1	2		JIC-D42874	16.92
		2pc		N-N-9		3-1/2	JIC-G33237	22.76
LOADER CLAM		2pc		P-UB-9	1-1/2	3	JIC-G105512	53.98
		1pc		P-UB-10	1-1/2	3	JIC-G105548	40.42
				I-U-1	1-1/2		JIC-D42870	21.19
		2pc		N-N-9		3	JIC-G33151	20.56
LOADER HYDRA-LEVELING		1pc		P-UB-10	1-3/4	3	JIC-G105549	51.43
		2pc		P-UB-9	1-3/4	3	JIC-G105524	59.48
				I-U-1	1-3/4		JIC-D42872	15.87
		2pc		N-N-9		3	JIC-G33151	20.56
LOADER LIFT		2pc		P-UB-9	2	3-1/2	JIC-G105521	47.35
		1pc		P-UB-10	2	3-1/2	JIC-G105546	48.58
		2pc		P-U-9	2	3-1/2	JIC-G34648	50.20
				I-U-1	2		JIC-D42874	16.92
		2pc		N-N-9		3-1/2	JIC-G33237	22.76
LOADER TILT		2pc		P-UB-9	1-3/4	3	JIC-G105524	59.48
		2pc		P-U-9	1-3/4	3	JIC-G34643	47.52
		1pc		P-UB-10	1-3/4	3	JIC-G105549	51.43
				I-U-1	1-3/4		JIC-D42872	15.87
		2pc		N-N-9		3	JIC-G33151	20.56
RIPPER		2pc		P-UB-9	1-1/2	3	JIC-G105512	53.98
		1pc		P-UB-10	1-1/2	3	JIC-G105548	40.42
				I-U-1	1-1/2		JIC-D42870	21.19
		2pc		N-N-9		3-1/2	JIC-G33237	22.76
MODEL 450B, 450C, 455B, 455C with Backhoe Models 26D, 35								
BACKHOE BOOM		2pc		P-UB-8	1-3/4	3-1/4	JIC-G105528	49.50
		1pc		P-UB-10	1-3/4	3-1/4	JIC-G105547	46.47
		1pc		P-UB-10	1-3/4	4	JIC-G105552	48.42
BACKHOE BUCKET		1pc		P-UB-10	2	3-1/4	JIC-G105553	50.94
		1pc		P-UB-10	2	3-1/2	JIC-G105546	48.58
		2pc		P-UB-9	2	3-1/2	JIC-G105527	54.29
BACKHOE DIPPER		1pc		P-UB-10	2	4	JIC-1543273C1	66.53
		2pc		P-UB-9	2	4	JIC-G105517	56.90
		1pc		P-UB-10	2	3-1/2	JIC-G105546	48.58
BACKHOE DIPPER EXT		1pc		P-UB-10	1-1/2	3	JIC-G105548	40.42
		2pc		P-UB-9	1-1/2	3	JIC-G105512	53.98
BACKHOE STABILIZER		2pc		P-UB-9	2	4	JIC-G105517	56.90
		1pc		P-UB-10	1-3/4	3	JIC-G105549	51.43
		1pc		P-UB-10	2	4	JIC-1543273C1	66.53

CASE

Replacement Kits For

CASE

Crawler Dozers/Loaders								
APPLICATION	CYL #	Piston	SERIAL #	CODE	ROD	BORE	KIT #	List \$
MODEL 450B, 450C, 455B, 455C with Backhoe Models 26D, 35								
BACKHOE SWING		2pc		P-UB-10	2	4	JIC-1543273C1	66.53
		1pc		P-UB-10	1-1/2	3-1/2	JIC-G105555	38.03
		2pc		P-UB-9	2	4	JIC-G105517	56.90
DOZER ANGLE		1pc		P-UB-10	2	4	JIC-1543273C1	66.53
DOZER LIFT		1pc		P-UB-10	1-1/4	2-1/2	JIC-G105551	34.37
DOZER TILT		1pc		P-UB-10	2	3-1/2	JIC-G105546	48.58
LOADER CLAM		1pc		P-UB-10	1-1/2	3	JIC-G105548	40.42
LOADER HYDRA-LEVELING		1pc		P-UB-10	2	4	JIC-1543273C1	66.53
LOADER LIFT		1pc		P-UB-10	2	3-1/2	JIC-G105546	48.58
LOADER TILT		1pc		P-UB-10	1-1/2	3	JIC-G105548	40.42
RIPPER		1pc		P-UB-10	1-1/2	3	JIC-G105548	40.42
MODEL 475 Cable Layer								
DOZER TILT		1pc		P-UB-10	2	3-1/2	JIC-G105546	48.58
		2pc		P-U-9	2	3-1/2	JIC-G34648	50.20
PLOW LIFT		2pc		P-UB-9	2	4-1/2	JIC-G105525	76.10
PLOW SWING		1pc		P-UB-10	1-1/2	3-1/2	JIC-G105555	38.03
		2pc		P-U-9	1-1/2	3-1/2	JIC-G34646	39.90
REEL & DOZER LIFT		1pc		P-UB-10	1-1/4	2-1/2	JIC-G105551	34.37
		2pc		P-U-9	1-1/4	2-1/2	JIC-G32295	46.74
MODEL 550E								
ANGLE	140146A1			P-UB-10	2	4	JIC-1543273C1	66.53
LIFT	1542565C1			P-UB-10	1-1/2	2-1/2	JIC-1542764C2	53.27
RIPPER	G101230			P-UB-10	1-1/2	3	JIC-1543252C1	43.70
TILT	1542717C1			P-UB-10	1-1/2	3	JIC-1543256C1	41.15
MODEL 550G								
ANGLE	140146A1			P-UB-10	2	4	JIC-1543273C1	66.53
LIFT	1542565C1			P-UB-10	1-1/2	2-1/2	JIC-1542764C2	53.27
RIPPER	G101230			P-UB-10	1-1/2	3	JIC-1543252C1	43.70
TILT	1542717C1			P-UB-10	1-1/2	3	JIC-1543256C1	41.15
MODEL 550H								
ANGLE	307662A1		12/99-	P-UB-10	1-3/4	3	JIC-310478A1	60.89
LIFT	307112A1		12/99-	P-UB-10	1-3/4	3	JIC-1543267C1	50.86
RIPPER	G101230		12/99-	P-UB-10	1-1/2	3	JIC-1543252C1	43.70
TILT	347202A1		12/99-	P-UB-10	1-3/4	3-1/2	JIC-1543266C1	51.81
MODEL 650G								
ANGLE	116969A1			P-UB-10	1-3/4	3-1/2	JIC-1543266C1	51.81
	190595A1			P-UB-10	1-3/4	3-1/2	JIC-1543266C1	51.81
	190595A2			P-UB-10	1-3/4	3-1/2	JIC-250741A1	66.48
LIFT	116211A1			P-UB-10	1-3/4	3-1/2	JIC-1543266C1	51.81
RIPPER	G101214			P-UB-10	1-3/4	3-1/4	JIC-1543265C1	52.05
	G101215			P-UB-10	1-3/4	3-1/4	JIC-1543265C1	52.05
TILT	117511A1			P-UB-10	1-3/4	3-1/2	JIC-1543266C1	51.81
MODEL 650K								
ANGLE	412359A1		11/02-	P-UB-10	1-3/4	3-1/2	JIC-250741A1	66.48
LIFT	417854A1		11/02-	P-UB-10	1-3/4	3-1/2	JIC-1543266C1	51.81
RIPPER LH	86994131		11/02-	N-UB-1	1-3/4		JIC-1542875C1	18.28
RIPPER RH	86994129		11/02-	P-UB-10	1-3/4	3-1/2	JIC-1543266C1	51.81
TILT	412357A1		11/02-	P-UB-10	1-3/4	3-1/2	JIC-1543266C1	51.81
MODEL 750 with Backhoe Models 32, 33S, 34								
BACKHOE BOOM		2pc		P-U-9	2	4	JIC-G32299	53.72
		2pc		P-UB-9	2-1/4	4-1/2	JIC-G105520	91.37
				P-U-1	2-1/4		JIC-D42878	19.31
				I-U-1	2		JIC-D42876	20.00
		2pc		N-N-9		4-1/2	JIC-DTVS4.5P	53.59
		2pc		N-N-9		4	JIC-G33239	24.83

CASE

CASE

Replacement Kits For

Crawler Dozers/Loaders								
APPLICATION	CYL #	Piston	SERIAL #	CODE	ROD	BORE	KIT #	List \$
MODEL 750 with Backhoe Models 32, 33S, 34								
BACKHOE BUCKET		2pc		P-U-9	2	3-1/2	JIC-G32293	41.67
				I-U-1	1-3/4		JIC-D42873	21.75
				I-U-1	2		JIC-D42874	16.92
				I-U-1	2-1/4		JIC-D42877	15.73
		2pc		N-N-9		4	JIC-G33239	24.83
		2pc		N-N-9		3-1/2	JIC-G33237	22.76
BACKHOE DIPPER		2pc		P-U-9	2	4	JIC-G32299	53.72
				P-U-1	2-1/4		JIC-D42878	19.31
				I-U-1	2		JIC-D42876	20.00
		2pc		N-N-9		4	JIC-G33239	24.83
		2pc		N-N-9		4-1/2	JIC-DTVS4.5P	53.59
		2pc		P-UB-9	1-3/4	3-1/2	JIC-G105529	43.24
BACKHOE STABILIZER				I-U-1	1-3/4		JIC-D42873	21.75
		2pc		N-N-9		3-1/2	JIC-G33237	22.76
		2pc		P-UB-9	1-3/4	4	JIC-G105519	51.50
BACKHOE SWING				I-U-1	1-3/4		JIC-D42875	16.83
		2pc		N-N-9		4	JIC-G33239	24.83
		2pc		I-U-9	1-1/2	2-1/2	JIC-D37360	46.20
DOZER ANGLE		2pc		I-U-1	1-3/4		JIC-D42873	21.75
DOZER TILT				N-N-9		3-1/2	JIC-G33237	22.76
		2pc		I-U-1	1-1/2		JIC-D42870	21.19
LOADER LIFT				N-N-9		3	JIC-G33151	20.56
		2pc		I-U-1	2		JIC-D42876	20.00
LOADER TILT				N-N-9		4	JIC-G33239	24.83
		2pc		I-U-1	1-3/4		JIC-D42873	21.75
RIPPER				N-N-9		3-1/2	JIC-G33237	22.76
		2pc		N-N-9		3-1/2	JIC-G33237	22.76
MODEL 750H								
ANGLE	190595A1			P-UB-10	1-3/4	3-1/2	JIC-1543266C1	51.81
	190595A2			P-UB-10	1-3/4	3-1/2	JIC-250741A1	66.48
LIFT	116211A2			P-UB-10	1-3/4	3-1/2	JIC-1543266C1	51.81
RIPPER	G101214			P-UB-10	1-3/4	3-1/4	JIC-1543265C1	52.05
	G101215			P-UB-10	1-3/4	3-1/4	JIC-1543265C1	52.05
TILT	117511A2			P-UB-10	1-3/4	3-1/2	JIC-1543266C1	51.81
MODEL 850 with Backhoe Models 34, 35, 36								
BACKHOE BOOM		2pc		P-UB-8	1-3/4	3-1/4	JIC-G105528	49.50
		1pc		P-UB-10	1-3/4	3-1/4	JIC-G105547	46.47
		2pc		P-U-9	2-1/4	5	JIC-G32696	77.87
				P-U-1	2-1/4		JIC-D42878	19.31
		2pc		N-N-9		4-1/2	JIC-DTVS4.5P	53.59
BACKHOE BUCKET		1pc		P-UB-10	2	3-1/2	JIC-G105546	48.58
		2pc		P-U-9	2-1/4	4	JIC-G34636	62.00
		2pc		P-UB-9	2	3-1/2	JIC-G105527	54.29
				I-U-1	2-1/4		JIC-D42877	15.73
		2pc		N-N-9		4	JIC-G33239	24.83
BACKHOE DIPPER		2pc		P-UB-9	2-1/2	4-1/2	JIC-G105513	94.22
		2pc		P-UB-9	2-1/4	4-1/2	JIC-G105520	91.37
		2pc		P-UB-9	2	4	JIC-G105517	56.90
		1pc		P-UB-10	2	4	JIC-1543273C1	66.53
				P-U-1	2-1/4		JIC-D42878	19.31
		2pc		N-N-9		4-1/2	JIC-DTVS4.5P	53.59
BACKHOE DIPPER EXT		1pc		P-UB-10	1-1/2	3	JIC-G105548	40.42
		2pc		P-UB-9	1-1/2	3	JIC-G105512	53.98
BACKHOE STABILIZER		1pc		P-UB-10	2	4	JIC-1543273C1	66.53
		2pc		P-UB-9	2	4	JIC-G105517	56.90
		2pc		P-U-9	2	4	JIC-G32299	53.72

CASE

Replacement Kits For

CASE

Crawler Dozers/Loaders								
APPLICATION	CYL #	Piston	SERIAL #	CODE	ROD	BORE	KIT #	List \$
MODEL 850 with Backhoe Models 34, 35, 36								
BACKHOE STABILIZER				I-U-1	2		JIC-D42876	20.00
		2pc		N-N-9		4	JIC-G33239	24.83
BACKHOE SWING		2pc		P-U-9	2	4-1/2	JIC-G32695	78.36
		1pc		P-UB-10	2	4	JIC-1543273C1	66.53
		2pc		P-UB-9	2	4-1/2	JIC-G105525	76.10
		2pc		P-UB-9	2	4	JIC-G105517	56.90
				I-U-1	1-3/4		JIC-D42875	16.83
	2pc			N-N-9		4	JIC-G33239	24.83
DOZER ANGLING		2pc		P-UB-9	1-1/2	2-1/2	JIC-G105505	36.57
		2pc		I-U-9	1-1/2	2-1/2	JIC-D37360	46.20
DOZER LIFT		2pc		P-UB-9	1-1/2	3	JIC-G105512	53.98
				I-U-1	1-1/2		JIC-D42870	21.19
	2pc			N-N-9		3	JIC-G33151	20.56
DOZER TILT		2pc		P-U-9	1-3/4	3-1/2	JIC-G105518	46.11
				I-U-1	1-3/4		JIC-D42873	21.75
	2pc			N-N-9		3-1/2	JIC-G33237	22.76
DOZER TILT & PITCH		2pc		P-UB-9	2	3-1/2	JIC-G105521	47.35
LOADER CLAM		2pc		P-U-9	2	4	JIC-G32299	53.72
LOADER HYDRA-LEVELING		2pc		P-U-9	2	4	JIC-G32299	53.72
		2pc		P-UB-9	2	4	JIC-G105517	56.90
				I-U-1	2		JIC-D42876	20.00
	2pc			N-N-9		4	JIC-G33239	24.83
LOADER LIFT				P-UB-9	2-1/4	4-1/2	JIC-G105520	91.37
				P-U-1	2-1/4		JIC-D42878	19.31
	2pc			N-N-9		4-1/2	JIC-DTVS4.5P	53.59
LOADER TILT		2pc		P-U-9	1-3/4	3-1/2	JIC-G105508	50.19
		2pc		P-U-9	1-3/4	3-1/2	JIC-G32228	41.15
				I-U-1	1-3/4		JIC-D42873	21.75
		2pc			N-N-9		3-1/2	JIC-G33237
RIPPER		2pc		P-U-9	1-3/4	4	JIC-G34626	55.79
				I-U-1	1-3/4		JIC-D42875	16.83
		2pc			N-N-9		4	JIC-G33239
MODEL 850B with Backhoe Model 35								
BACKHOE BOOM		1pc		P-UB-10	1-3/4	3-1/4	JIC-G105547	46.47
		2pc		P-UB-8	1-3/4	3-1/4	JIC-G105528	49.50
BACKHOE BUCKET		2pc		P-UB-9	2	3-1/2	JIC-G105527	54.29
		1pc		P-UB-10	2	3-1/2	JIC-G105546	48.58
BACKHOE DIPPER		1pc		P-UB-10	2	4	JIC-1543273C1	66.53
		2pc		P-UB-9	2	4	JIC-G105517	56.90
BACKHOE DIPPER EXT		2pc		P-UB-9	1-1/2	3	JIC-G105512	53.98
		1pc		P-UB-10	1-1/2	3	JIC-G105548	40.42
BACKHOE STABILIZER		1pc		P-UB-10	2	4	JIC-1543273C1	66.53
		2pc		P-UB-9	2	4	JIC-G105517	56.90
BACKHOE SWING		1pc		P-UB-10	2	4	JIC-1543273C1	66.53
		2pc		P-UB-9	2	4	JIC-G105517	56.90
DOZER ANGLE		2pc		P-UB-9	2	4-1/2	JIC-G105525	76.10
DOZER LIFT		1pc		P-UB-10	1-1/2	3	JIC-G105548	40.42
		1pc		P-UB-10	1-3/4	3	JIC-G105549	51.43
DOZER TILT		1pc		P-UB-10	2	4	JIC-1543273C1	66.53
		1pc		P-UB-10	1-3/4	4	JIC-G105552	48.42
LOADER CLAM		1pc		P-UB-10	2	3-1/2	JIC-G105546	48.58
LOADER LIFT		1pc		P-UB-10	2	4	JIC-1543273C1	66.53
LOADER TILT		1pc		P-UB-10	2	3-1/2	JIC-G105546	48.58
RIPPER		1pc		P-UB-10	1-3/4	3-1/4	JIC-G105547	46.47

CASE

Replacement Kits For

Crawler Dozers/Loaders								
APPLICATION	CYL #	Piston	SERIAL #	CODE	ROD	BORE	KIT #	List \$
MODEL 850C, 855C with Backhoe Models 35A, 35C, 35C WL, 35 WL								
BACKHOE BOOM		1pc		P-UB-10	1-3/4	3-1/4	JIC-G105547	46.47
BACKHOE BUCKET		1pc		P-UB-10	2	3-1/2	JIC-G105546	48.58
		1pc		P-UB-10	2-1/2	4	JIC-G109424	53.12
		1pc		P-UB-10	2-1/2	3-1/2	JIC-G109504	44.91
BACKHOE DIPPER		1pc		P-UB-10	2	4	JIC-1543273C1	66.53
BACKHOE DIPPER EXT		1pc		P-UB-10	1-1/2	3	JIC-G105548	40.42
BACKHOE STABILIZER		1pc		P-UB-10	2	4	JIC-1543273C1	66.53
BACKHOE SWING		1pc		P-UB-10	2	4	JIC-1543273C1	66.53
DOZER ANGLE		2pc		P-UB-9	2	4-1/2	JIC-G105525	76.10
DOZER LIFT		1pc		P-UB-10	1-1/2	3	JIC-G105548	40.42
		1pc		P-UB-10	1-3/4	3	JIC-G105549	51.43
DOZER TILT		1pc		P-UB-10	2	4	JIC-1543273C1	66.53
				P-UB-10	1-3/4	4	JIC-G105552	48.42
LOADER CLAM		1pc		P-UB-10	2	3-1/2	JIC-G105546	48.58
LOADER LIFT		1pc		P-UB-10	2	4	JIC-1543273C1	66.53
LOADER TILT		1pc		P-UB-10	2	3-1/2	JIC-G105546	48.58
RIPPER		1pc		P-UB-10	1-3/4	3-1/4	JIC-G105547	46.47
MODEL 850D with Backhoe Models 35C, 35C WL								
BACKHOE BOOM		1pc		P-UB-10	1-3/4	3-1/4	JIC-1543265C1	52.05
BACKHOE BUCKET		1pc		P-UB-10	2-1/2	3-1/2	JIC-G109504	44.91
		1pc		P-UB-10	2-1/2	4	JIC-G109424	53.12
BACKHOE DIPPER		1pc		P-UB-10	2	4	JIC-1543273C1	66.53
BACKHOE DIPPER EXT		1pc		P-UB-10	1-1/2	3	JIC-G109452	30.69
BACKHOE STABILIZER		1pc		P-UB-10	2	4	JIC-1543273C1	66.53
BACKHOE SWING		1pc		P-UB-10	2	4	JIC-1543273C1	66.53
DOZER LIFT		1pc		P-UB-10	1-1/2	3	JIC-G109452	30.69
DOZER TILT		1pc		P-UB-10	2	4	JIC-1543273C1	66.53
LOADER CLAM		1pc		P-UB-10	2	3-1/2	JIC-G109453	45.49
LOADER LIFT		1pc		P-UB-10	2	4	JIC-1543273C1	66.53
LOADER TILT		1pc		P-UB-10	2	3-1/2	JIC-G109453	45.49
RIPPER		1pc		P-UB-10	1-3/4	3-1/4	JIC-1543265C1	52.05
MODEL 850E, 855E								
DOZER ANGLE	1542644C1			P-UB-10	2	4	JIC-1543273C1	66.53
	G103467			P-UB-9	2	4-1/2	JIC-1543270C1	96.48
DOZER LIFT	G101217			P-UB-10	1-1/2	3	JIC-1543252C1	43.70
DOZER TILT	G109485			P-UB-10	2	4	JIC-1543273C1	66.53
LOADER BUCKET	G101210			P-UB-10	2	3-1/2	JIC-1543274C1	67.94
LOADER CLAM	G101211			P-UB-10	2	3-1/2	JIC-1543274C1	67.94
LOADER LIFT L/H	G101213			P-UB-10	2	4	JIC-1543273C1	66.53
LOADER LIFT R/H	G101212			P-UB-10	2	4	JIC-1543273C1	66.53
RIPPER L/H	G101215			P-UB-10	1-3/4	3-1/4	JIC-1543265C1	52.05
RIPPER R/H	G101214			P-UB-10	1-3/4	3-1/4	JIC-1543265C1	52.05
MODEL 850G								
ANGLE	116969A1			P-UB-10	1-3/4	3-1/2	JIC-1543266C1	51.81
	190595A1			P-UB-10	1-3/4	3-1/2	JIC-1543266C1	51.81
LIFT	116211A1			P-UB-10	1-3/4	3-1/2	JIC-1543266C1	51.81
RIPPER L/H	G101215			P-UB-10	1-3/4	3-1/4	JIC-1543265C1	52.05
RIPPER R/H	G101214			P-UB-10	1-3/4	3-1/4	JIC-1543265C1	52.05
TILT	117511A1			P-UB-10	1-3/4	3-1/2	JIC-1543266C1	51.81
MODEL 850H								
ANGLE	190595A2			P-UB-10	1-3/4	3-1/2	JIC-250741A1	66.48
LIFT	116211A2			P-UB-10	1-3/4	3-1/2	JIC-1543266C1	51.81
RIPPER LH	G101215			P-UB-10	1-3/4	3-1/4	JIC-1543265C1	52.05
RIPPER RH	G101214			P-UB-10	1-3/4	3-1/4	JIC-1543265C1	52.05
TILT	117511A2			P-UB-10	1-3/4	3-1/2	JIC-1543266C1	51.81

CASE

Replacement Kits For

CASE

Crawler Dozers/Loaders								
APPLICATION	CYL #	Piston	SERIAL #	CODE	ROD	BORE	KIT #	List \$
MODEL 850K								
ANGLE	412359A1		11/02-	P-UB-10	1-3/4	3-1/2	JIC-250741A1	66.48
LIFT	417854A1		11/02-	P-UB-10	1-3/4	3-1/2	JIC-1543266C1	51.81
RIPPER LH	86994131		11/02-	P-UB-10	1-3/4	3-1/4	JIC-1543265C1	52.05
RIPPER RH	86994129		11/02-	P-UB-10	1-3/4	3-1/4	JIC-1543265C1	52.05
TILT	412357A1		11/02-	P-UB-10	1-3/4	3-1/2	JIC-1543266C1	51.81
MODEL 1150 with Backhoe Models 32, 34, 36								
BACKHOE BOOM		2pc		P-U-9	2-1/4	5	JIC-G32696	77.87
				I-U-1	2		JIC-D42876	20.00
				P-U-1	2-1/4		JIC-D42878	19.31
		2pc		N-N-9		4	JIC-G33239	24.83
		2pc		N-N-9		4-1/2	JIC-DTVS4.5P	53.59
BACKHOE BUCKET		2pc		P-U-9	2-1/4	4	JIC-G34636	62.00
				I-U-1	1-3/4		JIC-D42873	21.75
				I-U-1	2-1/4		JIC-D42877	15.73
		2pc		N-N-9		4	JIC-G33239	24.83
		2pc		N-N-9		3-1/2	JIC-G33237	22.76
BACKHOE DIPPER		2pc		P-UB-9	2-1/4	4-1/2	JIC-G105520	91.37
		2pc		P-UB-9	2-1/2	4-1/2	JIC-G105513	94.22
				I-U-1	2		JIC-D42876	20.00
				P-U-1	2-1/4		JIC-D42878	19.31
		2pc		N-N-9		4	JIC-G33239	24.83
BACKHOE STABILIZER		2pc		N-N-9		4-1/2	JIC-DTVS4.5P	53.59
		2pc		P-UB-9	2	4	JIC-G105517	56.90
		2pc		P-U-9	2	4	JIC-G32299	53.72
				I-U-1	1-3/4		JIC-D42873	21.75
				I-U-1	2		JIC-D42876	20.00
BACKHOE SWING		2pc		N-N-9		3-1/2	JIC-G33237	22.76
		2pc		N-N-9		4	JIC-G33239	24.83
		2pc		P-UB-9	2	4-1/2	JIC-G105525	76.10
		2pc		P-U-9	2	4-1/2	JIC-G32695	78.36
				I-U-1	1-3/4		JIC-D42875	16.83
DOZER LIFT		2pc		N-N-9		4	JIC-G33239	24.83
		2pc		P-U-9	1-3/4	3-1/2	JIC-G105508	50.19
		2pc		P-UB-9	1-3/4	3-1/2	JIC-G105529	43.24
		2pc		P-U-9	1-3/4	3-1/2	JIC-G105518	46.11
				I-U-1	1-3/4		JIC-D42873	21.75
DOZER TILT		2pc		N-N-9		3-1/2	JIC-G33237	22.76
		2pc		P-U-9	1-3/4	3-1/2	JIC-G105518	46.11
				I-U-1	1-3/4		JIC-D42873	21.75
		2pc		N-N-9		3-1/2	JIC-G33237	22.76
		2pc		P-UB-9	2-1/4	4-1/2	JIC-G105520	91.37
LOADER CLAM		2pc		P-U-9	2	4	JIC-G32299	53.72
				I-U-1	2		JIC-D42876	20.00
		2pc		N-N-9		4	JIC-G33239	24.83
		2pc		P-U-9	2-1/2	5-1/2	JIC-G33823	84.83
		2pc		P-UB-9	2-1/4	5	JIC-G32696	77.87
LOADER TILT		2pc		P-UB-9	2	4	JIC-G105526	56.82
		2pc		P-UB-9	2	4	JIC-G105517	56.90
				I-U-1	2		JIC-D42876	20.00
		2pc		N-N-9		4	JIC-G33239	24.83
MODEL 1150B								
DOZER ANGLE		1pc		P-UB-10	1-3/4	3	JIC-G105549	51.43
		2pc		P-UB-9	1-3/4	3	JIC-G105523	51.66
		2pc		P-U-9	1-3/4	3	JIC-G34643	47.52
DOZER TILT		2pc		P-UB-9	2-1/4	4-1/2	JIC-G105520	91.37

CASE

Replacement Kits For

CASE

CASE

Crawler Dozers/Loaders								
APPLICATION	CYL #	Piston	SERIAL #	CODE	ROD	BORE	KIT #	List \$
MODEL 1150B								
DOZER TILT & PITCH		1pc		P-UB-10	2-1/4	4	JIC-G105556	52.53
		2pc		P-U-9	2-1/4	4	JIC-G34636	62.00
FELLER BUNCHER		2pc		P-UB-9	2-1/4	4-1/2	JIC-G105520	91.37
LOADER CLAM		2pc		P-UB-9	2-1/4	4-1/2	JIC-G105520	91.37
LOADER LIFT		2pc		P-UB-9	2-1/4	5	JIC-G105530	95.13
		2pc		P-U-9	2-1/4	5	JIC-G32696	77.87
LOADER TILT		2pc		P-UB-9	2-1/4	4-1/2	JIC-G105520	91.37
RIPPER		2pc		P-UB-9	2	4	JIC-G105526	56.82
		1pc		P-UB-10	2	4	JIC-1543273C1	66.53
MODEL 1150C, 1150D, 1155D								
DOZER ANGLE		1pc		P-UB-10	1-3/4	3	JIC-1543262C1	42.01
DOZER LIFT		1pc		P-UB-10	1-3/4	3-1/2	JIC-G109471	44.34
DOZER TILT		2pc		P-UB-9	2-1/4	4-1/2	JIC-G105520	91.37
DOZER TILT & PITCH		1pc		P-UB-10	2-1/4	4	JIC-G109505	48.24
LOADER CLAM		2pc		P-UB-9	2-1/4	4-1/2	JIC-G105520	91.37
LOADER LIFT		2pc		P-UB-9	2-1/4	5	JIC-G109501	88.01
LOADER TILT		2pc		P-UB-9	2-1/4	4-1/2	JIC-G105520	91.37
RIPPER		1pc		P-UB-10	2	4	JIC-1543273C1	66.53
MODEL 1150G								
ANGLE	G110702			P-UB-10	2-1/2	5	JIC-1542915C2	62.09
LIFT	G109819			P-UB-10	1-3/4	3-1/4	JIC-1543265C1	52.05
RIPPER	G101272			P-UB-10	2	4	JIC-1543273C1	66.53
	G101273			P-UB-10	2	4	JIC-1543273C1	66.53
TILT	G110694			P-UB-10	2-1/2	5	JIC-1542915C2	62.09
MODEL 1150H								
ANGLE	G110702			P-UB-10	2-1/2	5	JIC-1542915C2	62.09
LIFT	G109819			P-UB-10	1-3/4	3-1/4	JIC-1543265C1	52.05
RIPPER LH	G101273			P-UB-10	2	4	JIC-1543273C1	66.53
RIPPER RH	G101272			P-UB-10	2	4	JIC-1543273C1	66.53
TILT	G110694			P-UB-10	2-1/2	5	JIC-1542879C1	64.37
MODEL 1450								
DOZER ANGLE		1pc		P-UB-10	2	4	JIC-1543273C1	66.53
DOZER LIFT		1pc		P-UB-10	2	4	JIC-1543273C1	66.53
		2pc		P-UB-9	2	4	JIC-G105517	56.90
DOZER TILT		2pc		P-UB-9	3	6	JIC-G105516	98.63
DOZER TILT & PITCH		2pc		P-UB-9	2-1/2	5	JIC-G105515	80.19
LOADER CLAM		2pc		P-UB-9	2-1/4	4-1/2	JIC-G105520	91.37
LOADER LIFT		2pc		P-UB-9	2-1/2	5-1/2	JIC-G105514	94.44
LOADER TILT		2pc		P-UB-9	2-1/2	5	JIC-G105515	80.19
RIPPER		1pc		P-UB-10	2	4	JIC-1543273C1	66.53
		2pc		P-UB-9	2	4	JIC-G105526	56.82
MODEL 1450B, 1455B								
DOZER ANGLE		1pc		P-UB-10	2-1/4	4	JIC-G105556	52.53
DOZER LIFT		1pc		P-UB-10	2	4	JIC-1543273C1	66.53
DOZER TILT		2pc		P-UB-9	3	6	JIC-G105516	98.63
DOZER TILT & PITCH		2pc		P-UB-9	2-1/2	5	JIC-G105515	80.19
LOADER CLAM		2pc		P-UB-9	2-1/4	4-1/2	JIC-G105520	91.37
LOADER LIFT		2pc		P-UB-9	2-1/2	5-1/2	JIC-G105514	94.44
LOADER TILT		2pc		P-UB-9	2-1/2	5	JIC-G105515	80.19
RIPPER		1pc		P-UB-10	2	4	JIC-1543273C1	66.53
Excavators								
APPLICATION	CYL #	Piston	SERIAL #	CODE	ROD	BORE	KIT #	List \$
MODEL 880								
ARM		2pc	6200000-6201114	P-UB-9	2-1/2	5-1/2	JIC-G105514	94.44
		2pc	6201115-	P-UB-9	2-3/4	5-1/2	JIC-G105566	152.45

Replacement Kits For

CASE

Excavators								
APPLICATION	CYL #	Piston	SERIAL #	CODE	ROD	BORE	KIT #	List \$
MODEL 880								
BOOM		2pc	6200000-6201114	P-UB-9	2-1/2	5-1/2	JIC-G105514	94.44
		2pc	6201115-	P-UB-9	2-3/4	5-1/2	JIC-G105566	152.45
BUCKET		2pc		P-UB-9	2-1/2	5	JIC-G105515	80.19
EXT BUCKET		2pc		P-UB-9	3	5	JIC-G105531	91.77
EXT DIPPER		2pc		P-U-9	2-1/4	4	JIC-G34636	62.00
		1pc		P-UB-10	2-1/4	4	JIC-G105556	52.53
MODEL 880B, 880C, 880D								
ARM		2pc		P-UB-9	2-3/4	5-1/2	JIC-G105566	152.45
BOOM		2pc		P-UB-9	2-3/4	5-1/2	JIC-G105566	152.45
BUCKET		2pc		P-UB-9	2-1/2	5	JIC-G109499	105.70
MODEL 880R								
ARM		2pc		P-UB-9	2-3/4	5-1/2	JIC-G105566	152.45
BOOM		2pc		P-UB-9	2-3/4	5-1/2	JIC-G105566	152.45
EXT BUCKET		2pc		P-UB-9	3	5	JIC-G105531	91.77
EXT DIPPER		2pc	-5352380	P-U-9	2-1/4	4	JIC-G34636	62.00
		1pc	5352381-	P-UB-10	2-1/4	4	JIC-G105556	52.53
MODEL 9010B								
ARM		1pc		P-UB-10	80 mm	115 mm	JIC-164494A1	289.34
BOOM		1pc		P-UB-10	75 mm	100 mm	JIC-164493A1	180.90
BUCKET		1pc		P-UB-10	70 mm	95 mm	JIC-162976A1	253.10
MODEL 9020B								
ARM		1pc		P-UB-10	90 mm	125 mm	JIC-161913A1	327.95
BOOM		1pc		P-UB-10	80 mm	115 mm	JIC-161912A1	274.59
BUCKET		1pc		P-UB-10	75 mm	105 mm	JIC-161914A1	288.28
MODEL 9030B								
ARM (Long Reach)		1pc		P-UB-10	105 mm	150 mm	JIC-160227A1	387.20
ARM (w/o long reach)		1pc		P-UB-10	100 mm	135 mm	JIC-160579A1	371.83
BOOM (w/ load option)		1pc		P-UB-10	85 mm	125 mm	JIC-164183A1	259.41
BOOM (w/o load option)		1pc		P-UB-10	85 mm	125 mm	JIC-160577A1	262.14
BUCKET (Long Reach)		1pc		P-UB-10	70 mm	95 mm	JIC-162976A1	253.10
BUCKET (w/o long reach)		1pc		P-UB-10	80 mm	120 mm	JIC-160581A1	242.10
MODEL 9040B								
ARM	151155A1			P-UB-10	110 mm	160 mm	JIC-156002A1	478.55
	159453A1			P-UB-10	105 mm	150 mm	JIC-160227A1	387.20
	162816			P-UB-10	105 mm	150 mm	JIC-160227A1	387.20
BOOM	159462A1			P-UB-10	90 mm	130 mm	JIC-LZ00533	300.54
	159463A1			P-UB-10	90 mm	130 mm	JIC-LZ00533	300.54
	162815A1			P-UB-10	90 mm	130 mm	JIC-LZ00533	300.54
BUCKET	159452A1			P-UB-10	90 mm	135 mm	JIC-160229A1	282.60
	160752A1			P-UB-10	70 mm	95 mm	JIC-LZ00522	253.10
MODEL CX36B								
BOOM Cab	PX01V00065F1		PX13-15001-, N6TN61738- NA	P-U-10	45 mm	80 mm	JIC- PX01V00045R300	65.40
BOOM Canopy	PX01V00062F1		PX13-15001-, N6TN61738- NA	P-U-10	45 mm	80 mm	JIC- PX01V00045R300	65.40
MODEL CX130								
ARM	KNV1617			P-UB-10	80 mm	115 mm	JIC-LZ00449	112.49
	KNV1621			P-UB-10	80 mm	115 mm	JIC-LZ00449	112.49
BOOM LH	KNV1616			P-UB-10	70 mm	105 mm	JIC-LZ00448	123.63
	KNV1620			P-UB-10	70 mm	105 mm	JIC-LZ00448	123.63
BOOM RH	KNV1615			P-UB-10	70 mm	105 mm	JIC-LZ00448	123.63
	KNV1619			P-UB-10	70 mm	105 mm	JIC-LZ00448	123.63
BUCKET	KNV1618			P-UB-10	65 mm	95 mm	JIC-LZ00450	80.45
DOZER BLADE LH	168637A1			P-UB-10	70 mm	100 mm	JIC-LQU0245	134.18
DOZER BLADE RH	168636A1			P-UB-10	70 mm	100 mm	JIC-LQU0245	134.18

Replacement Kits For

CASE

CASE

Excavators								
APPLICATION	CYL #	Piston	SERIAL #	CODE	ROD	BORE	KIT #	List \$
MODEL CX135SR								
ARM (w/ Load Hold)	KMV2548		08/02-	P-UB-10	80 mm	115 mm	JIC-LZ00449	112.49
ARM (w/o Load Hold)	KNV1617		08/02-	P-UB-10	80 mm	115 mm	JIC-LZ00449	112.49
BOOM LH (w/ Load Hold)	KMV2547		08/02-	P-UB-10	75 mm	105 mm	JIC-LZ00453	116.84
BOOM LH (w/o Load Hold)	KMV2543		08/02-	P-UB-10	75 mm	105 mm	JIC-LZ00453	116.84
BOOM RH (w/ Load Hold)	KMV2546		08/02-	P-UB-10	75 mm	105 mm	JIC-LZ00453	116.84
BOOM RH (w/o Load Hold)	KMV2542		08/02-	P-UB-10	75 mm	105 mm	JIC-LZ00453	116.84
BUCKET	KMV2545		08/02-	P-UB-10	65 mm	95 mm	JIC-LZ00450	80.45
DOZER BLADE LH (w/ Load Hold)	KMV2554		08/02-	P-UB-10	70 mm	110 mm	JIC-LZ00457	75.93
DOZER BLADE LH (w/o Load Hold)	KMV2368		08/02-	P-UB-10	70 mm	110 mm	JIC-LZ00457	75.93
DOZER BLADE RH (w/ Load Hold)	KMV2553		08/02-	P-UB-10	70 mm	110 mm	JIC-LZ00457	75.93
DOZER BLADE RH (w/o Load Hold)	KMV2367		08/02-	P-UB-10	70 mm	110 mm	JIC-LZ00457	75.93
OFFSET ARM	KMV2551		08/02-	P-UB-10	75 mm	105 mm	JIC-LZ00455	145.17
OFFSET BOOM	KMV2552		08/02-	P-UB-10	65 mm	120 mm	JIC-LZ00456	71.85
MODEL CX160								
ARM (w/o Load Hold)	KLV0308			P-UB-10	90 mm	125 mm	JIC-LZ00452	191.68
ARM(w/ Load Hold)	KLV0353			P-UB-10	90 mm	125 mm	JIC-LZ00452	191.68
BOOM LH (w/ Load Hold)	KLV0352			I-UB-10	80 mm	115 mm	JIC-LZ00451	116.88
BOOM LH (w/o Load Hold)	KLV0306			I-UB-10	80 mm	115 mm	JIC-LZ00451	116.88
BOOM RH (w/ Load Hold)	KLV0351			I-UB-10	80 mm	115 mm	JIC-LZ00451	116.88
BOOM RH (w/o Load Hold)	KLV0307			I-UB-10	80 mm	115 mm	JIC-LZ00451	116.88
BUCKET	KLV0309			P-UB-10	75 mm	105 mm	JIC-LZ00453	116.84
MODEL CX160B								
ARM	KLV11040			P-UB-10	90 mm	125 mm	JIC-LZ011000-D	144.90
BOOM LH	KLV10980			P-UB-10	80 mm	115 mm	JIC-LZ010870	117.53
BOOM RH	KLV10960			P-UB-10	80 mm	115 mm	JIC-LZ010870	117.53
BUCKET	KLV11081			P-UB-10	75 mm	105 mm	JIC-LZ010810	124.14
MODEL CX210								
ARM (w/ Load Hold)	KRV3239			P-UB-10	95 mm	135 mm	JIC-LZ00446	119.75
ARM (w/o Load Hold)	KRV3236			P-UB-10	95 mm	135 mm	JIC-LZ00446	119.75
BOOM (w/ Load Hold)	KRV18920			P-UB-10	85 mm	120 mm	JIC-LZ00445	139.17
BOOM LH	KRV18910			P-UB-10	85 mm	120 mm	JIC-LZ00445	139.17
BOOM RH	KRV18900			P-UB-10	85 mm	120 mm	JIC-LZ00445	139.17
BUCKET	KRV3237			P-UB-10	80 mm	115 mm	JIC-LZ00447	96.08
MODEL CX210B								
ARM	KRV19600			P-UB-10	100 mm	140 mm	JIC-LZ011200	158.73
BOOM LH	KRV19540			P-UB-10	85 mm	120 mm	JIC-LZ010930	122.35
BOOM RH	KRV19520			P-UB-10	85 mm	120 mm	JIC-LZ010930	122.35
BUCKET	KRV19640			P-UB-10	85 mm	120 mm	JIC-LZ010940	117.57
MODEL CX210C								
ARM	KRV19600			P-UB-10	100 mm	140 mm	JIC-LZ011200	158.73
BOOM LH	KRV19540			P-UB-10	85 mm	120 mm	JIC-LZ010930	122.35
BOOM RH	KRV19520			P-UB-10	85 mm	120 mm	JIC-LZ010930	122.35
BUCKET	KNV12541			P-UB-10	65 mm	95 mm	JIC-LZ010710-D	107.27
MODEL CX240								
ARM (w/ Load Hold)	KBV1687			P-UB-10	105 mm	145 mm	JIC-LZ00443	143.51
ARM (w/o Load Hold)	KBV1789			P-UB-10	105 mm	145 mm	JIC-LZ00443	143.51
BOOM (w/ Load Hold)	KBV1686			P-UB-10	90 mm	125 mm	JIC-LZ00442	161.30
BOOM LH (w/o Load Hold)	KBV1788			P-UB-10	90 mm	125 mm	JIC-LZ00442	161.30
BOOM RH (w/o Load Hold)	KBV1787			P-UB-10	90 mm	125 mm	JIC-LZ00442	161.30
BUCKET	KBV1790			P-UB-10	90 mm	130 mm	JIC-LZ00444	155.45
MODEL CX330								
ARM (w/ Load Hold)	KSV1456			P-UB-10	120 mm	170 mm	JIC-LZ00478	359.18

Replacement Kits For

CASE

Excavators								
APPLICATION	CYL #	Piston	SERIAL #	CODE	ROD	BORE	KIT #	List \$
MODEL CX330								
ARM (w/o Load Hold)	KSV1395			P-UB-10	120 mm	170 mm	JIC-LZ00478	359.18
BOOM LH (w/ Load Hold)	KSV1455			P-UB-10	100 mm	145 mm	JIC-LZ00477	309.67
BOOM LH (w/o Load Hold)	KSV1394			P-UB-10	100 mm	145 mm	JIC-LZ00477	309.67
BOOM RH (w/ Load Hold)	KSV1454			P-UB-10	100 mm	145 mm	JIC-LZ00477	309.67
BOOM RH (w/o Load Hold)	KSV1393			P-UB-10	100 mm	145 mm	JIC-LZ00477	309.67
BUCKET	KSV1396			P-UB-10	105 mm	150 mm	JIC-LZ00476	420.84
Excavators - Compact								
APPLICATION	CYL #	Piston	SERIAL #	CODE	ROD	BORE	KIT #	List \$
MODEL CX27B								
BOOM	72282200		06/04-	P-U-10	40 mm	70 mm	JIC-72280471	92.26
	72282211		06/04-	P-U-10	40 mm	70 mm	JIC-72280471	92.26
	72286201		06/04-	P-U-10	40 mm	70 mm	JIC-72280471	92.26
BOOM (CAB)	72286211		N5GN01293 & AFTER 09/05-	P-U-10	40 mm	70 mm	JIC-72280471	92.26
	87601559		N5GN01293 & AFTER 09/05-	P-U-10	40 mm	70 mm	JIC-72280471	92.26
BOOM (CANOPY)	72286201		N5GN01293 & AFTER 09/05-	P-U-10	40 mm	70 mm	JIC-72280471	92.26
	87601559		N5GN01293 & AFTER 09/05-	P-U-10	40 mm	70 mm	JIC-72280471	92.26
BUCKET	72282216		06/04-	P-U-10	35 mm	60 mm	JIC-72282317	94.95
	72286208		06/04-	P-U-10	35 mm	60 mm	JIC-72282317	94.95
	7286208		N5GN01293 & AFTER 09/05-	P-U-10	35 mm	60 mm	JIC-72282317	94.95
	87618923		N5GN01293 & AFTER 09/05-	P-U-10	35 mm	60 mm	JIC-72282317	94.95
DIPPER	72281123		06/04-	P-U-10	40 mm	70 mm	JIC-72282209	92.26
	72286205		06/04-	P-U-10	40 mm	70 mm	JIC-72282209	92.26
	72286205		N5GN01293 & AFTER 09/05-	P-U-10	40 mm	70 mm	JIC-72280471	92.26
	87616282		N5GN01293 & AFTER 09/05-	P-U-10	40 mm	70 mm	JIC-72280471	92.26
DOZER	72281649		06/04-	P-U-10	45 mm	85 mm	JIC-72282324	105.07
	72286196		06/04-	P-U-10	45 mm	85 mm	JIC-72282324	105.07
	72286196		N5GN01293 & AFTER 09/05-	P-U-10	45 mm	85 mm	JIC-72282324	105.07
SWING	72281425		06/04-	P-U-10	45 mm	75 mm	JIC-72280241	64.28
	72285830		N5GN01293 & AFTER 09/05-	P-U-10	45 mm	75 mm	JIC-72280241	64.28
MODEL CX31								
BOOM	47043387		06/04-	P-U-10	45 mm	75 mm	JIC-5001747M91	56.07
BOOM OFFSET	47043386		06/04-	P-U-10	50 mm	80 mm	JIC-5001732M91	77.54
BUCKET	6011206M91		06/04-	P-U-10	35 mm	65 mm	JIC-5001763M91	87.20
DIPPER	6010810M91		06/04-	P-U-10	45 mm	75 mm	JIC-5001747M91	56.07
DOZER	4010814M91		06/04-	P-U-10	55 mm	95 mm	JIC-5001761M91	79.22
MODEL CX31B								
BOOM	72283931		06/04-	P-U-10	45 mm	80 mm	JIC-72280454	65.40
	72283936		06/04-	P-U-10	45 mm	80 mm	JIC-72280454	65.40
	72286375		06/04-	P-U-10	45 mm	80 mm	JIC-72280454	65.40
	72286378		06/04-	P-U-10	45 mm	80 mm	JIC-72280454	65.40
BOOM (CAB)			N5GN00812/AFTER 04/05-	P-U-10	45 mm	80 mm	JIC-72280454	65.40
BOOM (CANOPY)			N5GN00812/AFTER 04/05-	P-U-10	45 mm	80 mm	JIC-PX01V00045R300	65.40
BUCKET			N5GN00812/AFTER 04/05-	P-U-10	40 mm	65 mm	JIC-72280251	71.92
	72285850		06/04-	P-U-10	40 mm	65 mm	JIC-72280251	71.92

CASE

Replacement Kits For

CASE

Excavators - Compact								
APPLICATION	CYL #	Piston	SERIAL #	CODE	ROD	BORE	KIT #	List \$
MODEL CX31B								
DIPPER			N5GN00812/AFTER 04/05-	P-U-10	45 mm	75 mm	JIC-72280241	64.28
	72283933		06/04-	P-U-10	45 mm	75 mm	JIC-72280241	64.28
DOZER			N5GN00812/AFTER 04/05-	P-U-10	50 mm	100 mm	JIC-72280261	69.78
	7228252		06/04-	P-U-10	50 mm	100 mm	JIC-72280261	69.78
	72286391		06/04-	P-U-10	50 mm	100 mm	JIC-72280261	69.78
SWING			N5GN00812/AFTER 04/05-	P-U-10	45 mm	80 mm	JIC-72280268	75.18
	72280262		06/04-	P-U-10	45 mm	80 mm	JIC-72280268	75.18
MODEL CX36B								
BOOM	72283941		06/04-	P-U-10	45 mm	80 mm	JIC-72280454	65.40
	72283945		06/04-	P-U-10	45 mm	80 mm	JIC-72280454	65.40
	72286381		06/04-	P-U-10	45 mm	80 mm	JIC-72280454	65.40
	72286384		06/04-	P-U-10	45 mm	80 mm	JIC-72280454	65.40
BOOM CAB	72286384		N5GN00813 & AFTER 04/05-	P-U-10	45 mm	80 mm	JIC-72280454	65.40
	87639742		N5GN00813 & AFTER 04/05-	P-U-10	45 mm	80 mm	JIC-72280454	65.40
BOOM CANOPY	72286381		N5GN00813 & AFTER 04/05-	P-U-10	45 mm	80 mm	JIC- PX01V00045R300	65.40
	87566885		N5GN00813 & AFTER 04/05-	P-U-10	45 mm	80 mm	JIC- PX01V00045R300	65.40
BUCKET	72284518		06/04-	P-U-10	40 mm	65 mm	JIC-72280251	71.92
	72285850		06/04-	P-U-10	40 mm	65 mm	JIC-72280251	71.92
	72285850		N5GN00813 & AFTER 04/05-	P-U-10	40 mm	65 mm	JIC-72280251	71.92
	87573321		N5GN00813 & AFTER 04/05-	P-U-10	40 mm	65 mm	JIC-72280251	71.92
DIPPER	72283943		06/04-	P-U-10	45 mm	80 mm	JIC-72280268	75.18
	72286389		06/04-	P-U-10	45 mm	80 mm	JIC-72280268	75.18
	72286389		N5GN00813 & AFTER 04/05-	P-U-10	45 mm	80 mm	JIC-72280268	75.18
	87571903		N5GN00813 & AFTER 04/05-	P-U-10	45 mm	80 mm	JIC-72280268	75.18
DOZER	72280252		06/04-	P-U-10	50 mm	100 mm	JIC-72280261	69.78
	72286391		06/04-	P-U-10	50 mm	100 mm	JIC-72280261	69.78
	72286391		N5GN00813 & AFTER 04/05-	P-U-10	50 mm	100 mm	JIC-72280261	69.78
SWING	72280262		06/04-	P-U-10	45 mm	80 mm	JIC-72280268	75.18
	72286392		N5GN00813 & AFTER 04/05-	P-U-10	45 mm	80 mm	JIC-72280268	75.18
MODEL CX50B								
BOOM	72284784		05/04-	P-U-10	45 mm	100 mm	JIC-72284002	73.38
	72284787		05/04-	P-U-10	45 mm	100 mm	JIC-72284002	73.38
	87345193		05/04-	P-U-10	45 mm	100 mm	JIC-72284002	73.38
	87357788		05/04-	P-U-10	45 mm	100 mm	JIC-72284002	73.38
BOOM CAB	87579031		N5GN01157 & AFTER 06/05-	P-U-10	45 mm	100 mm	JIC-72284002	73.38
BOOM CANOPY	87579038		N5GN01157 & AFTER 06/05-	P-U-10	45 mm	100 mm	JIC-72284002	73.38
BUCKET	72284461		05/04-	P-U-10	55 mm	95 mm	JIC-72284000	52.37
	72284461		N5GN01157 & AFTER 06/05-	P-U-10	55 mm	95 mm	JIC-72284000	52.37
DIPPER			N5GN01157 & AFTER 06/05-	P-U-10	50 mm	90 mm	JIC-72283999	104.62
	72284790		05/04-	P-U-10	50 mm	90 mm	JIC-72283999	104.62
	87345185		05/04-	P-U-10	50 mm	90 mm	JIC-72283999	104.62

CASE

Replacement Kits For

CASE

Excavators - Compact								
APPLICATION	CYL #	Piston	SERIAL #	CODE	ROD	BORE	KIT #	List \$
MODEL CX50B								
DOZER			N5GN01157 & AFTER 06/05-	P-U-10	45 mm	75 mm	JIC-72284189	89.11
	72284279		05/04-	P-U-10	45 mm	75 mm	JIC-72284189	89.11
SWING	72283412		N5GN01157 & AFTER 06/05-	P-U-10	50 mm	90 mm	JIC-72284207	85.18
	72283413		05/04-	P-U-10	50 mm	90 mm	JIC-72284207	85.18
Forklifts - Rough Terrain								
APPLICATION	CYL #	Piston	SERIAL #	CODE	ROD	BORE	KIT #	List \$
MODEL 586G								
LIFT	341153A1			P-UB-1	60 mm	2-3/4	JIC-362347A1	65.69
	341187A1			P-UB-1	2	2-1/2	JIC-337742A1	46.81
	348729A1			P-UB-1	2	2-1/2	JIC-337742A1	46.81
	348743A1			P-UB-1	3	3-1/2	JIC-348747A1	63.06
	360622A1			P-UB-1	3	3-1/2	JIC-348747A1	63.06
	360792A1			P-UB-1	2	2-1/2	JIC-337742A1	46.81
SIDESHIFT	327149A1			P-U-10	1-1/4	2-1/2	JIC-79975C2	15.87
STEERING	401055A1	E# 37797		I-U-10	36 mm	63 mm	JIC-401061A1	65.34
	G107720	E# D138		P-U-10	1-1/2	2-3/4	JIC-86991005	34.34
TILT	318877A1			P-UB-10	1-1/2	3	JIC-1543256C1	41.15
Loaders - Skid Steer								
APPLICATION	CYL #	Piston	SERIAL #	CODE	ROD	BORE	KIT #	List \$
MODEL 40XT								
BACKHOE BOOM D100	G100936			P-UB-10	1-1/2	3	JIC-1543252C1	43.70
BACKHOE BOOM D125	305352A1			P-UB-10	1-1/2	3	JIC-1543256C1	41.15
BACKHOE BUCKET D100	G100936			P-UB-10	1-1/2	3	JIC-1543252C1	43.70
BACKHOE BUCKET D125	402216A1			P-UB-10	1-3/4	2-3/4	JIC-433774A1	32.82
BACKHOE DIPPER D100	G100936			P-UB-10	1-1/2	3	JIC-1543252C1	43.70
BACKHOE DIPPER D125	1346411C3			P-UB-10	1-1/2	3	JIC-1543256C1	41.15
BACKHOE SWING D100	384865A1			I,P-U-1	2-3/4		JIC-398166A1	57.82
BACKHOE SWING D125	379623A1			I,P-U-1	2-3/4		JIC-398166A1	57.82
LIFT	87438185			P-UB-11	1-1/2	2-1/4	JIC-86613644	33.43
LOADER BUCKET	447169A1		JAF0374550- NA, JAF0348069- EU	P-U-10	35 mm	65 mm	JIC-86988481	40.74
LOADER LIFT	447170A1		JAF0374550- NA, JAF0348069- EU	P-U-10	40 mm	60 mm	JIC-86988474	35.74
	86614636		-JAF0374549 NA, - JAF0348068 EU	P-UB-11	1-1/2	2-1/4	JIC-86613644	33.43
STABILIZER Fold Down	101643A1			P-U-10	1.375	3	JIC-H673837	79.86
STABILIZER Vertical	H514117			P-OB-3	1	2	JIC-H52704	16.65
MODEL 60XT								
BACKHOE BOOM D100	G100936			P-UB-10	1-1/2	3	JIC-1543252C1	43.70
BACKHOE BOOM D125	305352A1			P-UB-10	1-1/2	3	JIC-1543256C1	41.15
BACKHOE BUCKET D100	G100936			P-UB-10	1-1/2	3	JIC-1543252C1	43.70
BACKHOE BUCKET D125	402216A1			P-UB-10	1-3/4	2-3/4	JIC-433774A1	32.82
BACKHOE DIPPER D100	G100936			P-UB-10	1-1/2	3	JIC-1543252C1	43.70
BACKHOE DIPPER D125	1346411C3			P-UB-10	1-1/2	3	JIC-1543256C1	41.15
BACKHOE SWING D100	384865A1			I,P-U-1	2-3/4		JIC-398166A1	57.82
BACKHOE SWING D125	379623A1			I,P-U-1	2-3/4		JIC-398166A1	57.82
LOADER BUCKET	447171A1		JAF0350357- NA, JAF0350744- EU	P-U-10	35 mm	70 mm	JIC-86988490	52.52
	86614637		-JAF0350356 NA, - JAF0350743 EU	P-UB-11	1-3/8	2-3/4	JIC-86613643	49.14
LOADER LIFT	447173A1		JAF0350357- NA, JAF0350744- EU	P-U-10	40 mm	65 mm	JIC-86988486	32.93
	86614638		-JAF0350356 NA, - JAF0350743 EU	P-UB-11	1-1/2	2-1/2	JIC-86631598	33.62
STABILIZER Fold Down	101643A1			P-U-10	1.375	3	JIC-H673837	79.86

Replacement Kits For

CASE

Loaders - Skid Steer								
APPLICATION	CYL #	Piston	SERIAL #	CODE	ROD	BORE	KIT #	List \$
MODEL 60XT								
STABILIZER Vertical	H514117			P-OB-3	1	2	JIC-H52704	16.65
TILT	87438187			P-UB-11	1-3/8	2-3/4	JIC-86613643	49.14
	87438193			P-U-11	1-1/2	3	JIC-86614269	33.44
MODEL 70XT								
BACKHOE BOOM	305352A1			P-UB-10	1-1/2	3	JIC-1543256C1	41.15
BACKHOE BUCKET	402216A1			P-UB-10	1-3/4	2-3/4	JIC-433774A1	32.82
BACKHOE DIPPER	1346411C3			P-UB-10	1-1/2	3	JIC-1543256C1	41.15
BACKHOE SWING	379623A1			I,P-U-1	2-3/4		JIC-398166A1	57.82
LIFT	87438190			P-UB-11	1-1/2	2-1/2	JIC-86631598	33.62
LOADER BUCKET	447172A1		JAF0371244- NA, JAF0351855- EU	P-U-10	35 mm	75 mm	JIC-86988494	51.04
	86614639		-JAF0371243 NA, - JAF0351854 EU	P-U-11	1-1/2	3	JIC-86614269	33.44
LOADER LIFT	447173A1		JAF0350744- NA, JAF0371244- EU	P-U-10	40 mm	65 mm	JIC-86988486	32.93
	86614638		-JAF0371243 NA, - JAF0351854 EU	P-UB-11	1-1/2	2-1/2	JIC-86631598	33.62
STABILIZER Fold Down	101643A1			P-U-10	1.375	3	JIC-H673837	79.86
STABILIZER Vertical	H514117			P-OB-3	1	2	JIC-H52704	16.65
TILT	87438187			P-UB-11	1-3/8	2-3/4	JIC-86613643	49.14
	87438193			P-U-11	1-1/2	3	JIC-86614269	33.44
MODEL 75XT								
BACKHOE BOOM	1346450C2			P-UB-10	1-1/2	3	JIC-1543256C1	41.15
	305352A1		JAF0318922- NA, JAF0352169- EU	P-UB-10	1-1/2	3	JIC-1543256C1	41.15
BACKHOE BUCKET	1346397C2			P-UB-10	1-1/2	2-3/4	JIC-1346409C2	92.42
	402216A1		JAF0318922- NA, JAF0352169- EU	P-UB-10	1-3/4	2-3/4	JIC-433774A1	32.82
BACKHOE DIPPER	1346411C2			P-UB-10	1-1/2	3	JIC-1543256C1	41.15
	1346411C3			P-UB-10	1-1/2	3	JIC-1543256C1	41.15
	1346411C3		JAF0318922- NA, JAF0352169- EU	P-UB-10	1-1/2	3	JIC-1543256C1	41.15
BACKHOE SWING	379623A1			I,P-U-1	2-3/4		JIC-398166A1	57.82
	H673149			P-OB-1	2-3/4		JIC-H53041	22.61
LOADER BUCKET	259694A3			P-UB-10	1-1/4	2-1/2	JIC-252828A3	25.57
LOADER LIFT	305509A2			P-UB-10	1-1/2	2-1/4	JIC-305517A3	36.56
	336187A1			P-UB-10,12	1-3/4	2-1/2	JIC-198376A2	51.87
STABILIZER (FOLD DOWN)	101643A1			P-U-10	1-3/8	3	JIC-700710260	79.86
STABILIZER (VERTICAL)	H514117			P-OB-3	1	2	JIC-H52704	16.65
MODEL 85XT								
BACKHOE BOOM	1346450C2			P-UB-10	1-1/2	3	JIC-1543256C1	41.15
	305352A1		JAF0352234- NA, JAF0352715- EU	P-UB-10	1-1/2	3	JIC-1543256C1	41.15
BACKHOE BUCKET	1346397C2			P-UB-10	1-1/2	2-3/4	JIC-1346409C2	92.42
	402216A1		JAF0352234- NA, JAF0352715- EU	P-UB-10	1-3/4	2-3/4	JIC-433774A1	32.82
BACKHOE DIPPER	1346411C2			P-UB-10	1-1/2	3	JIC-1543256C1	41.15
	1346411C3		JAF0352234- NA, JAF0352715- EU	P-UB-10	1-1/2	3	JIC-1543256C1	41.15
BACKHOE SWING	379623A1			I,P-U-1	2-3/4		JIC-398166A1	57.82
	H673149			P-OB-1	2-3/4		JIC-H53041	22.61
LOADER BUCKET	258425A3			P-UB-10,12	1-3/8	2-3/4	JIC-275503A2	52.44
	258426A3		JAF0352234- NA, JAF0352715- EU	P-UB-10,12	1-3/8	2-3/4	JIC-275503A2	52.44
LOADER LIFT	189980A3			P-UB-10,12	1-3/4	2-1/2	JIC-198376A2	51.87
	336187A1		JAF0352234- NA, JAF0352715- EU	N-UB-1	1-3/4		JIC-1542875C1	18.28

Replacement Kits For

CASE

NEW

NEW

Loaders - Skid Steer								
APPLICATION	CYL #	Piston	SERIAL #	CODE	ROD	BORE	KIT #	List \$
MODEL 85XT								
STABILIZER (VERTICAL)	H514117			P-OB-3	1	2	JIC-H52704	16.65
MODEL 90XT								
BACKHOE BOOM	1346450C2			P-UB-10	1-1/2	3	JIC-1543256C1	41.15
	305352A1			P-UB-10	1-1/2	3	JIC-1543256C1	41.15
BACKHOE BUCKET	1346397C2			P-UB-10	1-1/2	2-3/4	JIC-1346409C2	92.42
BACKHOE DIPPER	1346411C2			P-UB-10	1-1/2	3	JIC-1543256C1	41.15
	1346411C3			P-UB-10	1-1/2	3	JIC-1543256C1	41.15
BACKHOE SWING	379623A1			I,P-U-1	2-3/4		JIC-398166A1	57.82
	H673149			P-OB-1	2-3/4		JIC-H53041	22.61
LOADER BUCKET	186988A3	DRE, 1-1		P-UB-10	1-3/8	2-1/4	JIC-231921A2	36.43
	327411A1	DRE, 1-1		P-UB-10	1-1/2	2-1/2	JIC-128725A1	29.45
LOADER LIFT	279527A2			P-U-10	1-3/4	2-1/4	JIC-231726A3	38.96
	308258A2			P-U-10	1-3/4	2-1/4	JIC-231726A3	38.96
	308259A1			P-U-10	1-3/4	2-1/4	JIC-231726A3	38.96
STABILIZER (FOLD DOWN)	101643A1			P-U-10	1-3/8	3	JIC-700710260	79.86
STABILIZER (VERTICAL)	H514117			P-OB-3	1	2	JIC-H52704	16.65
TRENCHER BOOM LIFT	221700A1		JAF0320050- NA, JAF0274262- EU	P-U-10	1-3/4	3-1/2	JIC-235933A1	32.22
MODEL 95XT								
BACKHOE BOOM	1346450C2	1pc		P-UB-10	1-1/2	3	JIC-1543256C1	41.15
BACKHOE BUCKET	1346397C2	1pc		P-UB-10	1-1/2	2-3/4	JIC-1346409C2	92.42
BACKHOE DIPPER	1346411C2	1pc		P-UB-10	1-1/2	3	JIC-1543256C1	41.15
BACKHOE SWING	H673149			P-OB-1	2-3/4		JIC-H53041	22.61
LOADER LIFT	139091A3	1pc		P-UB-10,12	1-3/4	2-1/2	JIC-198376A2	51.87
STABILIZER (Fold Down)	101643A1	1pc		P-U-10	1-3/8	3	JIC-700710260	79.86
STABILIZER (Vertical)	H514117	1pc		P-OB-3	1	2	JIC-H52704	16.65
TRENCHER BOOM LIFT	221700A1	1pc		P-U-10	1-3/4	3-1/2	JIC-235933A1	32.22
MODEL 1818								
BUCKET TILT	D136128	1pc		P-U-10	1	2	JIC-N14638	35.14
LOADER BUCKET	104517A1	1pc		P-U-10	1	2	JIC-110510A1	63.26
LOADER LIFT	104516A1	1pc		P-U-10	1-3/8	2	JIC-110507A1	63.26
	D136838	1pc		P-U-10	1-1/4	2	JIC-N14639	43.10
MODEL 1825								
BUCKET TILT	D136128	1pc		P-U-10	1	2	JIC-N14638	35.14
LOADER BUCKET	104517A1	1pc		P-U-10	1	2	JIC-110510A1	63.26
LOADER LIFT	104516A1	1pc		P-U-10	1-3/8	2	JIC-110507A1	63.26
	D136838	1pc		P-U-10	1-1/4	2	JIC-N14639	43.10
MODEL 1835								
GRAPPLE	D61075	1pc		P-U-10	1	2	JIC-D61006	7.98
LOADER BUCKET		1pc		P-UB-10	1-1/4	2-1/2	JIC-G109476	33.05
	G103407	1pc		P-UB-10	1-1/4	2-1/2	JIC-G105507	27.28
LOADER LIFT		1pc		P-UB-10	1-1/2	2-1/2	JIC-G109458	24.25
	G34864	1pc		P-U-10	1-1/4	2-1/8	JIC-G34819	24.48
MODEL 1835B								
GRAPPLE	D61075	1pc		P-U-10	1	2	JIC-D61006	7.98
LOADER BUCKET	G103407	1pc		P-UB-10	1-1/4	2-1/2	JIC-G109476	33.05
LOADER LIFT		1pc		P-UB-10	1-1/2	2-1/2	JIC-G109458	24.25
	G106818	1pc		P-UB-10	1-1/2	2-1/2	JIC-128725A1	29.45
MODEL 1835C								
BUCKET TILT	118110A1	1pc	JAF0130838-	P-U-10	1-1/4	2-1/2	JIC-128728A1	24.92
	G103407	1pc	-JAF0130838	P-U-10	1-1/4	2-1/2	JIC-128728A1	24.92
GRAPPLE	D61075	1pc		P-U-10	1	2	JIC-D61006	7.98
LIFT		1pc		P-U-10	1-1/4	2-1/8	JIC-G34819	24.48
	117824A1	1pc	JAF0130838-	P-UB-10	1-1/2	2-1/2	JIC-128725A1	29.45
	G110666	1pc	-JAF0130838	P-UB-10	1-1/2	2-1/2	JIC-128725A1	29.45

CASE

Replacement Kits For

CASE

CASE

Loaders - Skid Steer								
APPLICATION	CYL #	Piston	SERIAL #	CODE	ROD	BORE	KIT #	List \$
MODEL 1838								
BACKHOE BOOM, DIPPER, & BUCKET	G100936	1pc		P-UB-10	1-1/2	3	JIC-1543252C1	43.70
BACKHOE DIPPER	G109376	1pc		P-UB-10	1-1/2	3	JIC-1543313C1	51.87
BACKHOE SWING	H514125			P-OB-1	2-3/4		JIC-H53041	22.61
GRAPPLE	D61010	1pc		P-U-10	1	2	JIC-D61006	7.98
LOADER BUCKET TILT	118110A1	1pc		P-U-10	1-1/4	2-1/2	JIC-128728A1	24.92
LOADER LIFT	117824A1	1pc		P-UB-10	1-1/2	2-1/2	JIC-128725A1	29.45
STABILIZER (Fold Down)	101643A1	1pc		P-U-10	1-3/8	3	JIC-700710260	79.86
STABILIZER (Vertical)	H514117	1pc		P-OB-3	1	2	JIC-H52704	16.65
MODEL 1840								
BACKHOE BOOM	1346450C2	1pc		P-UB-10	1-1/2	3	JIC-1543256C1	41.15
BACKHOE BUCKET	1346397C2	1pc		P-UB-10	1-1/2	2-3/4	JIC-1346409C2	92.42
BACKHOE DIPPER	1346411C1	1pc		P-UB-10	1-1/2	3	JIC-1543256C1	41.15
BACKHOE SWING	H673149			P-OB-1	2-3/4		JIC-H53041	22.61
GRAPPLE	D61075	1pc		P-U-10	1	2	JIC-D61006	7.98
LOADER BUCKET TILT	118110A1	1pc		P-U-10	1-1/4	2-1/2	JIC-128728A1	24.92
	G103407	1pc		P-U-10	1-1/4	2-1/2	JIC-128728A1	24.92
LOADER LIFT	117824A1	1pc		P-UB-10	1-1/2	2-1/2	JIC-128725A1	29.45
	G110666	1pc		P-UB-10	1-1/2	2-1/2	JIC-128725A1	29.45
STABILIZER (Vertical)	H514117	1pc		P-OB-3	1	2	JIC-H52704	16.65
MODEL 1845, 1845S								
4-IN-1 BUCKET	G33748	1pc		P-UB-10	1-1/2	3	JIC-1543313C1	51.87
BUCKET DUMP	G34926	1pc		P-UB-10	1-1/4	2-1/2	JIC-G105507	27.28
LOADER LIFT - 1845	G37917	1pc		P-UB-10	1-1/2	2-1/2	JIC-128725A1	29.45
LOADER LIFT - 1845S	G100295	1pc		P-UB-10	1-1/2	2-1/2	JIC-128725A1	29.45
SCARIFIER	G33744	1pc		P-UB-10	1-1/2	3	JIC-1543313C1	51.87
MODEL 1845B								
LOADER BUCKET	G34926	1pc		P-UB-10	1-1/4	2-1/2	JIC-G109476	33.05
LOADER CLAM	G33748	1pc		P-UB-10	1-1/2	3	JIC-1543313C1	51.87
LOADER LIFT	G100295	1pc		P-UB-10	1-1/2	2-1/2	JIC-128725A1	29.45
SCARIFIER	G33744	1pc		P-UB-10	1-1/2	3	JIC-1543313C1	51.87
MODEL 1845C								
BACKHOE BOOM	1346450C2	1pc		P-UB-10	1-1/2	3	JIC-1543256C1	41.15
BACKHOE BUCKET	1346397C2	1pc		P-UB-10	1-1/2	2-3/4	JIC-1346409C2	92.42
BACKHOE DIPPER	1346411C1	1pc		P-UB-10	1-1/2	3	JIC-1543256C1	41.15
	G109376	1pc		P-UB-10	1-1/2	3	JIC-1543313C1	51.87
BACKHOE SWING	H673149			P-OB-1	2-3/4		JIC-H53041	22.61
BOOM, DIPPER, & BUCKET	G100936	1pc		P-UB-10	1-1/2	3	JIC-1543252C1	43.70
LOADER BUCKET	G34926	1pc		P-U-10	1-1/4	2-1/2	JIC-128728A1	24.92
LOADER LIFT	117903A1	1pc		P-UB-10	1-1/2	2-1/2	JIC-128725A1	29.45
	129011A1	1pc		P-UB-10	1-1/2	2-1/2	JIC-128725A1	29.45
	G109773	1pc		P-UB-10	1-1/2	2-1/2	JIC-128725A1	29.45
	G109777	1pc		P-UB-10	1-1/2	2-1/2	JIC-128725A1	29.45
STABILIZER	101643A1	1pc		P-U-10	1-3/8	3	JIC-700710260	79.86
	H514117	1pc		P-OB-3	1	2	JIC-H52704	16.65
	H672226	1pc		P-U-10	1-3/8	3	JIC-700710260	79.86
SWING	H514125			P-OB-1	2-3/4		JIC-H53041	22.61
MODEL SR200								
BUCKET	84290567	4/11-		P-UB-10	1-3/8	2-3/4	JIC-84480953	44.19
LIFT	84231611	4/11-		P-UB-10	1-3/4	2-1/2	JIC-87705824	28.43
MODEL SR220								
BUCKET	84290563	4/11-		P-UB-10	1-1/2	3	JIC-84480948	29.00
LIFT	84303684	4/11-		P-UB-10	1-3/4	2-1/2	JIC-87705824	28.43
MODEL SR250								
BUCKET	47364444	R 4A (7/		I-UB-10	1-1/2	3	JIC-47364492	26.12

NEW

NEW

NEW

Replacement Kits For

CASE

Loaders - Skid Steer								
APPLICATION	CYL #	Piston	SERIAL #	CODE	ROD	BORE	KIT #	List \$
MODEL SR250								
BUCKET	84290563	4/11-		P-UB-10	1-1/2	3	JIC-84480948	29.00
LIFT	47364858	R 4A (7/		I-UB-10	1-3/4	2-3/4	JIC-47364907	26.43
	84303684	4/11-		P-UB-10	1-3/4	2-1/2	JIC-87705824	28.43
MODEL SV250								
BUCKET	47364444	R 4A (1/		I-UB-10	1-1/2	3	JIC-47364492	26.12
	84290563	4/11-		P-UB-10	1-1/2	3	JIC-84480948	29.00
LIFT LH	84358576	4/11-		P-UB-10,12	1-3/4	2	JIC-84480921	41.47
	84494545	R 4A (1/		P-UB-10,12	1-3/4	2	JIC-84480921	41.47
LIFT RH	84358575	4/11-		P-UB-10,12	1-3/4	2	JIC-84480921	41.47
	84494544	R 4A (1/		P-UB-10,12	1-3/4	2	JIC-84480921	41.47
MODEL SV300								
BUCKET	47364444	R 4A (7/		I-UB-10	1-1/2	3	JIC-47364492	26.12
	84290563			P-UB-10	1-1/2	3	JIC-84480948	29.00
LIFT	47364858	R 4A (7/		I-UB-10	1-3/4	2-3/4	JIC-47364907	26.43
LIFT LH	84358576	4/11-	NCM445112 NA, NCM458434 EU	P-UB-10,12	1-3/4	2	JIC-84480921	41.47
	84558165	R 4A (7/		P-UB-10,12	2	2-3/4	JIC-84530079	43.31
	84558165	4/11-	NCM445112 NA, NCM458434 EU	P-UB-10,12	2	2-3/4	JIC-84530079	43.31
LIFT RH	84358575	4/11-	NCM445112 NA, NCM458434 EU	P-UB-10,12	1-3/4	2	JIC-84480921	41.47
	84558166	4/11-	NCM445112 NA, NCM458434 EU	P-UB-10,12	2	2-3/4	JIC-84530079	43.31
Loaders - Wheel								
APPLICATION	CYL #	Piston	SERIAL #	CODE	ROD	BORE	KIT #	List \$
MODEL 521D								
LOADER BUCKET	336396A2		-JEE0135500	P-UB-10	2-1/2	4-1/2	JIC-360982A1	68.74
	368885A1		-JEE0135500	P-UB-10	2-1/4	3-3/4	JIC-358013A1	54.01
LOADER BUCKET (XT)	87405381		JEE0135501-	P-UB-10	2-1/4	4-1/8	JIC-381101A1	94.46
	87446958		JEE0135501-	P-UB-10	2-1/4	4	JIC-360979A1	54.67
LOADER BUCKET (Z-BAR)	87366674		JEE0135501-	P-UB-10	2-1/2	4-1/2	JIC-87434291	68.74
	87405363		JEE0135501-	P-UB-10	2-1/2	4-1/2	JIC-360982A1	68.74
LOADER LIFT	337568A1		-JEE0135500	P-UB-10	2-1/4	4	JIC-360979A1	54.67
LOADER LIFT (XR)	87405374		JEE0135501-	P-UB-10	2-1/2	4-1/2	JIC-360982A1	68.74
LOADER LIFT (XT)	87366683		JEE0135501-	P-UB-10	2-1/4	4	JIC-360979A1	54.67
	87405367		JEE0135501-	P-UB-10	2-1/4	4	JIC-360979A1	54.67
LOADER LIFT (Z-BAR)	87405374		JEE0135501-	P-UB-10	2-1/2	4-1/2	JIC-360982A1	68.74
LOADER LIFT (Z-BAR/XT)	87317750		JEE0135501-	P-UB-10	2-1/4	4	JIC-360979A1	54.67
	87366683		JEE0135501-	P-UB-10	2-1/4	4	JIC-360979A1	54.67
MODEL 621								
LOADER CLAM	S300146	1pc	-JAK0021701	I-U-10	2	4	JIC-S300163	23.99
	S301479	1pc	JAK0021701-	I-U-10	2	4	JIC-S301442	36.39
LOADER LIFT	134596C1		JAK0021701-	P-UB-10	3	5	JIC-1543305C1	92.03
	G110354	1pc	JAK0021700-	P-UB-10	3	5	JIC-1543305C1	92.03
	G110355	1pc	-JAK0021700	P-UB-10	3	5	JIC-1543305C1	92.03
LOADER TILT	1343552C2	1pc	JAK0020901-	P-UB-10	3	6	JIC-G110526	93.48
	1980354C1		JAK0020286- JAK0020900	P-UB-10	3	6	JIC-G110526	93.48
	G110312	1pc	-JAK0020286	P-UB-10	3	6	JIC-G110526	93.48
STEERING	1976862C1	1pc	ALL	P-UB-10	1-3/4	3	JIC-G110049	39.82
MODEL 621B								
LOADER CLAM	S301431	1pc		I-U-10	2	4	JIC-S301442	36.39
LOADER LIFT	1343595C1			P-UB-10	3	5	JIC-1543305C1	92.03
	1343596C1	1pc		P-UB-10	3	5	JIC-1543305C1	92.03
LOADER TILT, XT LOADER	112551A1	1pc		P-UB-10	2-1/4	4-1/2	JIC-1543279C1	58.51
LOADER TILT, Z-BAR	1343552C2	1pc		P-UB-10	3	6	JIC-G110526	93.48

Replacement Kits For

CASE

Loaders - Wheel								
APPLICATION	CYL #	Piston	SERIAL #	CODE	ROD	BORE	KIT #	List \$
MODEL 621B								
STEERING	1976862C1	1pc		P-UB-10	1-3/4	3	JIC-1543267C1	50.86
MODEL 621C								
LOADER LIFT	280706A1		ALL	P-UB-10	3	5	JIC-1543305C1	92.03
LOADER TILT	112551A1		ALL	P-UB-10	2-1/4	4-1/2	JIC-1543279C1	58.51
	125872A1		ALL	P-UB-10	3	6	JIC-1543306C1	110.98
	1343552C2		ALL	P-UB-10	3	6	JIC-1543306C1	110.98
STEERING	1976862C1		ALL	P-UB-10	1-3/4	3	JIC-1543267C1	50.86
MODEL 621D								
LOADER BUCKET (XR)	87366695		JEE0135501-	P-UB-10	3	5	JIC-87434293	82.19
	87405382		JEE0135501-	P-UB-10	3	5	JIC-360984A1	82.19
LOADER BUCKET (XT)	87405381		JEE0135501-	P-UB-10	2-1/4	4-1/8	JIC-381101A1	94.46
	87442555		JEE0135501-	P-UB-10	2-1/2	4-1/2	JIC-360982A1	68.74
LOADER BUCKET (Z-BAR)	87366688		JEE0135501-	P-UB-10	3	5	JIC-87434293	82.19
	87405371		JEE0135501-	P-UB-10	3	5	JIC-360984A1	82.19
LOADER LIFT	87318060		JEE0135501-	P-UB-10	2-1/2	4-1/2	JIC-360982A1	68.74
	87366691		JEE0135501-	P-UB-10	2-1/2	4-1/2	JIC-360982A1	68.74
	87405374		JEE0135501-	P-UB-10	2-1/2	4-1/2	JIC-360982A1	68.74
MODEL 621E								
LOADER BUCKET (XR)	87366695			P-UB-10	3	5	JIC-87434293	82.19
LOADER BUCKET (XT)	87442555			P-UB-10	2-1/2	4-1/2	JIC-360982A1	68.74
LOADER BUCKET (Z-BAR)	87366688			P-UB-10	3	5	JIC-87434293	82.19
LOADER LIFT	87577649			P-UB-10	2-1/2	4-3/4	JIC-87598751	69.45
STEERING	87452362			P-UB-10,12	1-3/4	3	JIC-8605261	47.42
MODEL 621F								
LOADER BUCKET (XR/LR)	87577650			P-UB-10	2-1/2	4-3/4	JIC-87598751	69.45
LOADER LIFT (XT/TC)	87577650			P-UB-10	2-1/2	4-3/4	JIC-87598751	69.45
LOADER LIFT (Z-BAR)	87577650			P-UB-10	2-1/2	4-3/4	JIC-87598751	69.45
LOADER TILT (XR/LR)	87366695			P-UB-10	3	5	JIC-87434293	82.19
LOADER TILT (XT/TC)	87442555			P-UB-10	2-1/2	4-1/2	JIC-360982A1	68.74
LOADER TILT (Z-BAR)	87366689			P-UB-10	3	5	JIC-87434293	82.19
STEERING	87452362			P-UB-10,12	1-3/4	3	JIC-8605261	47.42
MODEL 721								
LOADER CLAM	S300146	1pc		I-U-10	2	4	JIC-S300163	23.99
	S301431			I-U-10	2	4	JIC-S301442	36.39
	S301479	1pc		I-U-10	2	4	JIC-S301442	36.39
LOADER LIFT	1343595C1			P-UB-10	3	5	JIC-1543305C1	92.03
	1343596C1			P-UB-10	3	5	JIC-1543305C1	92.03
	G110354	1pc		P-UB-10	3	5	JIC-1543305C1	92.03
	G110355			P-UB-10	3	5	JIC-1543305C1	92.03
LOADER TILT	1345991C1	1pc	JAK0022102- JAK0022217	P-UB-10	3	6-1/2	JIC-1543303C1	154.24
	1980347C4	1pc	JAK002218-	P-UB-10	3	6-1/2	JIC-1543303C1	154.24
STEERING	1976862C1	1pc		P-UB-10	1-3/4	3	JIC-G110049	39.82
MODEL 721B								
LOADER CLAM	S301431	1pc		I-U-10	2	4	JIC-S301442	36.39
LOADER LIFT	1343595C1	1pc		P-UB-10	3	5	JIC-1543305C1	92.03
	1343596C1	1pc		P-UB-10	3	5	JIC-1543305C1	92.03
LOADER TILT, XT LOADER	112551A1	1pc		P-UB-10	2-1/4	4-1/2	JIC-1543279C1	58.51
LOADER TILT, Z-BAR	1980347C4	1pc		P-UB-10	3	6-1/2	JIC-1543303C1	154.24
STEERING	1976862C1	1pc		P-UB-10	1-3/4	3	JIC-1543267C1	50.86
MODEL 721C								
LOADER LIFT	280706A1		ALL	P-UB-10	3	5	JIC-1543305C1	92.03
LOADER TILT	112551A1		ALL	P-UB-10	2-1/4	4-1/2	JIC-1543279C1	58.51
	125873A1		ALL	P-UB-10	3	6-1/2	JIC-1543303C1	154.24
	308986A1		ALL	P-UB-10	3	6-1/2	JIC-1543303C1	154.24
STEERING	1976862C1		ALL	P-UB-10	1-3/4	3	JIC-1543267C1	50.86

NEW

NEW

CASE

Replacement Kits For

CASE

Loaders - Wheel								
APPLICATION	CYL #	Piston	SERIAL #	CODE	ROD	BORE	KIT #	List \$
MODEL 721D								
LOADER BUCKET (XT)	87324809		01/03-	I-UB-10	2-1/4	4-1/2	JIC-87440117	47.45
	87440056		01/03-	I-UB-10	2-1/4	4-1/2	JIC-87440117	47.45
LOADER BUCKET (Z-BAR)	8605291		01/03-	P-UB-10	3	5-3/4	JIC-8605263	87.34
	87441197		01/03-	P-UB-10	3	5-3/4	JIC-87442965	87.34
LOADER LIFT (Z-BAR/XT)	8605290		01/03-	P-UB-10	3	4-3/4	JIC-8605262	100.32
	87318066		01/03-	P-UB-10	3	4-3/4	JIC-8605262	100.32
MODEL 721E								
LOADER BUCKET (XR)	87691131			P-UB-10	3	5-3/4	JIC-87495411	101.37
LOADER BUCKET (XT)	87324809			I-UB-10	2-1/4	4-1/2	JIC-87440117	47.45
LOADER BUCKET (Z-BAR)	87441197			P-UB-10	3	5-3/4	JIC-87442965	87.34
LOADER LIFT	87318066			P-UB-10	3	4-3/4	JIC-8605262	100.32
STEERING	87452362			P-UB-10,12	1-3/4	3	JIC-8605261	47.42
MODEL 721F								
LOADER BUCKET (XR)	87691131			P-UB-10	3	5-3/4	JIC-87495411	101.37
LOADER BUCKET (XT)	87324809			I-UB-10	2-1/4	4-1/2	JIC-87440117	47.45
LOADER BUCKET (Z-BAR)	87441197			P-UB-10	3	5-3/4	JIC-87442965	87.34
LOADER LIFT	87319194			P-UB-10	3	4-3/4	JIC-8605262	100.32
LOADER LIFT (XT)	87319194			I-UB-10	2-1/4	4-1/2	JIC-87440117	47.45
STEERING	87452362			P-UB-10,12	1-3/4	3	JIC-8605261	47.42
MODEL 821								
LOADER CLAM	S301000	1pc		I-U-10	2-1/2	5	JIC-S301013	60.99
LOADER LIFT	1340743C3	1pc		P-UB-10	3	6	JIC-G110526	93.48
	1986601C1	1pc		P-UB-10	3-1/2	6	JIC-1986823C2	153.91
LOADER TILT	1980385C3	1pc		P-UB-10	3-1/2	7	JIC-1543309C1	161.12
STEERING	1986978C1		JAK0024132-	P-UB-10	1-3/4	3-1/2	JIC-G110621	41.47
	1994558C1	1pc	JAK0024132	P-UB-10	1-3/4	3-1/2	JIC-G110621	41.47
MODEL 821B								
LOADER CLAM	S301000	1pc		I-U-10	2-1/2	5	JIC-S301013	60.99
LOADER LIFT	1986601C1	1pc		P-UB-10	3-1/2	6	JIC-1986823C2	153.91
LOADER TILT	1980386C3	1pc		P-UB-10	3-1/2	7	JIC-1543309C1	161.12
STEERING	1986978C1	1pc		P-UB-10	1-3/4	3-1/2	JIC-1543266C1	51.81
MODEL 821C								
LOADER LIFT	1986601C1		ALL	P-UB-10	3-1/2	6	JIC-1986823C2	153.91
LOADER TILT	190385C3		ALL	P-UB-10	3-1/2	7	JIC-1543309C1	161.12
STEERING	229402A1		ALL	P-UB-10	1-3/4	3-1/2	JIC-1543266C1	51.81
MODEL 821E								
LOADER BUCKET (XR)	87696084		8/06-	P-UB-10	3-1/2	6-1/2	JIC-87529743	177.32
LOADER BUCKET (Z-BAR)	87337179		8/06-	P-UB-10	3-1/2	6-1/2	JIC-87529743	177.32
LOADER LIFT	87337177		8/06-	P-UB-10	3	5-1/4	JIC-87530718	108.98
STEERING	87307850		8/06-	P-UB-10,12	1-3/4	3-1/4	JIC-87363451	121.32
MODEL 921								
LOADER LIFT	1986603C1	1pc		P-UB-10	4	7	JIC-1986920C2	177.34
LOADER TILT	1346171C3	1pc		P-UB-10	4	8	JIC-1346357C2	231.31
STEERING	1346169C2	1pc	1346267C1 & 1346268C1	P-UB-10	2	4	JIC-1543269C1	63.39
	1346169C2	1pc	1346269C1 Gland	P-UB-10	2	4	JIC-1543269C1	63.39
MODEL 921C								
LOADER LIFT	1986603C1		ALL	P-UB-10	4	7	JIC-1986920C2	177.34
LOADER TILT	1346171C3		ALL	P-UB-10	4	8	JIC-1346357C2	231.31
STEERING	1346169C4		ALL	P-UB-10	2	4	JIC-1543269C1	63.39
MODEL W3								
BACKHOE BOOM				I-U-1	2		JIC-D42876	20.00
		2pc		N-N-9		4	JIC-G33239	24.83
BACKHOE BUCKET				I-U-1	1-3/4		JIC-D42873	21.75
		2pc		N-N-9		3-1/2	JIC-G33237	22.76
BACKHOE DIPPER				I-U-1	2		JIC-D42876	20.00

Replacement Kits For

CASE

Loaders - Wheel								
APPLICATION	CYL #	Piston	SERIAL #	CODE	ROD	BORE	KIT #	List \$
MODEL W3								
BACKHOE DIPPER		2pc		N-N-9		4	JIC-G33239	24.83
BACKHOE STABILIZER				I-U-1	1-3/4		JIC-D42873	21.75
		2pc		N-N-9		3-1/2	JIC-G33237	22.76
LOADER LIFT				I-U-1	1-1/2		JIC-D42870	21.19
		2pc		N-N-9		3	JIC-G33151	20.56
LOADER TILT				I-U-1	1-1/2		JIC-D42869	21.34
		2pc		N-N-9		2-1/2	JIC-G33193	20.06
MODEL W7, W7C, W7E								
BACKHOE BOOM		2pc		P-U-9	2	4	JIC-G32299	53.72
		2pc		P-UB-9	2-1/4	4-1/2	JIC-G105520	91.37
				I-U-1	2		JIC-D42876	20.00
				P-U-1	2-1/4		JIC-D42878	19.31
		2pc		N-N-9		4-1/2	JIC-DTVS4.5P	53.59
BACKHOE BUCKET		2pc		N-N-9		3	JIC-G33151	20.56
		2pc		P-U-9	2	3-1/2	JIC-G32293	41.67
		2pc		P-U-9	2-1/4	4	JIC-G34636	62.00
				I-U-1	2-1/4		JIC-D42877	15.73
				I-U-1	2		JIC-D42874	16.92
BACKHOE DIPPER		2pc		I-U-1	1-3/4		JIC-D42873	21.75
		2pc		N-N-9		4	JIC-G33239	24.83
		2pc		N-N-9		3-1/2	JIC-G33237	22.76
		2pc		P-U-9	2	4	JIC-G32299	53.72
		2pc		P-UB-9	2-1/4	4-1/2	JIC-G105520	91.37
BACKHOE STABILIZER				P-U-1	2-1/4		JIC-D42878	19.31
				I-U-1	2		JIC-D42876	20.00
		2pc		N-N-9		4	JIC-G33239	24.83
		2pc		N-N-9		4-1/2	JIC-DTVS4.5P	53.59
		2pc		P-U-9	2	4	JIC-G32299	53.72
BACKHOE SWING		2pc		P-U-9	2	4	JIC-G32299	53.72
		2pc		P-UB-9	1-3/4	3-1/2	JIC-G105529	43.24
		2pc		P-U-9	1-3/4	3-1/2	JIC-G105518	46.11
				I-U-1	2		JIC-D42876	20.00
				I-U-1	1-3/4		JIC-D42873	21.75
LOADER LIFT		2pc		N-N-9		4	JIC-G33239	24.83
		2pc		N-N-9		3-1/2	JIC-G33237	22.76
		2pc		P-U-9	2	4	JIC-G105519	51.50
				I-U-1	1-3/4		JIC-D42875	16.83
		2pc		N-N-9		4	JIC-G33239	24.83
LOADER TILT		2pc		P-U-9	2	4	JIC-G32299	53.72
				I-U-1	2		JIC-D42876	20.00
LOADER TILT		2pc		N-N-9		4	JIC-G33239	24.83
LOADER TILT		2pc		P-UB-9	1-1/2	3	JIC-G105512	53.98
MODEL W8E								
LOADER LIFT		2pc		P-U-9	2-1/2	5	JIC-G32184	71.27
LOADER TILT		2pc		P-U-9	1-3/4	3-1/2	JIC-G32228	41.15
MODEL W9, W9A, W9B, W9C, W9E, W10, W10B, W10C, W10E								
BACKHOE BOOM		2pc		P-UB-9	2-1/4	4-1/2	JIC-G105520	91.37
		2pc		P-U-9	2	4	JIC-G32299	53.72
				P-U-1	2-1/4		JIC-D42878	19.31
				I-U-1	2		JIC-D42876	20.00
		2pc		N-N-9		4	JIC-G33239	24.83
BACKHOE BUCKET		2pc		N-N-9		4-1/2	JIC-DTVS4.5P	53.59
		2pc		P-U-9	2	3-1/2	JIC-G32293	41.67
		2pc		P-U-9	2-1/4	4	JIC-G34636	62.00
				I-U-1	1-3/4		JIC-D42873	21.75
				I-U-1	2		JIC-D42874	16.92

CASE

Replacement Kits For

CASE

Loaders - Wheel								
APPLICATION	CYL #	Piston	SERIAL #	CODE	ROD	BORE	KIT #	List \$
MODEL W9, W9A, W9B, W9C, W9E, W10, W10B, W10C, W10E								
BACKHOE BUCKET				I-U-1	2-1/4		JIC-D42877	15.73
		2pc		N-N-9		3-1/2	JIC-G33237	22.76
		2pc		N-N-9		4	JIC-G33239	24.83
BACKHOE DIPPER		2pc		P-U-9	2	4	JIC-G32299	53.72
		2pc		P-UB-9	2-1/4	4-1/2	JIC-G105520	91.37
				P-U-1	2-1/4		JIC-D42878	19.31
				I-U-1	2		JIC-D42876	20.00
		2pc		N-N-9		4	JIC-G33239	24.83
		2pc		N-N-9		4-1/2	JIC-DTVS4.5P	53.59
BACKHOE STABILIZER		2pc		P-UB-9	1-3/4	3-1/2	JIC-G105529	43.24
		2pc		P-U-9	1-3/4	3-1/2	JIC-G105518	46.11
		2pc		P-U-9	2	4	JIC-G32299	53.72
				I-U-1	1-3/4		JIC-D42873	21.75
				I-U-1	2		JIC-D42876	20.00
		2pc		N-N-9		4	JIC-G33239	24.83
BACKHOE SWING		2pc		N-N-9		3-1/2	JIC-G33237	22.76
		2pc		P-UB-9	1-3/4	4	JIC-G105519	51.50
				I-U-1	1-3/4		JIC-D42875	16.83
	2pc		N-N-9		4	JIC-G33239	24.83	
LOADER LIFT		2pc		P-U-9	2-1/2	5	JIC-G32184	71.27
LOADER TILT		2pc		P-U-9	1-3/4	3-1/2	JIC-G32228	41.15
MODEL W11, W11B								
LOADER CLAM		1pc		P-UB-10	1-3/4	3	JIC-1543262C1	42.01
LOADER LIFT		1pc		P-UB-10	2	3-1/2	JIC-G109453	45.49
LOADER TILT		1pc		P-UB-10	1-1/2	2-1/2	JIC-1543253C1	44.57
STEERING		1pc		P-UB-10	1-1/2	3	JIC-G109452	30.69
MODEL W14, W14L, W14H								
BACKHOE BOOM		2pc		P-UB-8	1-3/4	3-1/4	JIC-G105528	49.50
		2pc		P-U-9	2-1/4	4	JIC-G34636	62.00
		1pc		P-UB-10	1-3/4	3-1/4	JIC-1543265C1	52.05
		1pc		P-UB-10	2-1/4	4	JIC-G109505	48.24
BACKHOE BUCKET		2pc		P-UB-9	1-3/4	3	JIC-G109462	37.58
		1pc		P-UB-10	1-3/4	3	JIC-1543262C1	42.01
		2pc		P-UB-9	2	3-1/2	JIC-G109454	36.07
		1pc		P-UB-10	2-1/2	4	JIC-G109424	53.12
		1pc		P-UB-10	2-1/2	3-1/2	JIC-G109504	44.91
		2pc		P-UB-10	1-1/2	3	JIC-G109452	30.69
		1pc		P-UB-10	2	3-1/2	JIC-G109453	45.49
BACKHOE DIPPER		1pc		P-UB-10	2	4	JIC-1543273C1	66.53
		1pc		P-UB-10	2	3-1/2	JIC-G109453	45.49
		2pc		P-UB-9	2	3-1/2	JIC-G109454	36.07
		2pc		P-UB-9	2	4	JIC-G109421	46.63
BACKHOE DIPPER EXT		1pc		P-UB-10	1-1/2	3	JIC-G109452	30.69
		2pc		P-UB-9	1-1/2	3	JIC-G105512	53.98
BACKHOE STABILIZER		1pc		P-UB-10	2	4	JIC-1543273C1	66.53
		1pc		P-UB-10	1-3/4	3-1/2	JIC-G109471	44.34
		2pc		P-UB-9	1-3/4	3-1/2	JIC-G109470	39.85
		2pc		P-UB-9	2	4	JIC-G109421	46.63
BACKHOE SWING		1pc		P-UB-10	1-1/2	3-1/2	JIC-G109472	41.92
		2pc		P-UB-9	2	4	JIC-G109421	46.63
		1pc		P-UB-10	2	4	JIC-1543273C1	66.53
		2pc		P-U-9	1-1/2	3-1/2	JIC-G34652	40.57
LOADER CLAM		2pc		P-UB-9	1-1/2	3	JIC-G105512	53.98
		1pc		P-UB-10	1-1/2	3	JIC-G109452	30.69
LOADER GRAPPLE		1pc		P-UB-10	1-1/2	3	JIC-G109418	30.48

CASE

Replacement Kits For

CASE

CASE

Loaders - Wheel								
APPLICATION	CYL #	Piston	SERIAL #	CODE	ROD	BORE	KIT #	List \$
MODEL W14, W14L, W14H								
LOADER LIFT		2pc		P-UB-9	2-1/4	4-1/2	JIC-G105520	91.37
LOADER TILT		2pc		P-UB-9	1-3/4	3	JIC-G109462	37.58
		1pc		P-UB-10	1-3/4	3	JIC-1543262C1	42.01
STEERING		2pc		P-U-9	1-1/4	2-1/2	JIC-G32295	46.74
		1pc		P-UB-10	1-1/4	2-1/2	JIC-G109475	34.37
MODEL W14B								
LOADER CLAM		1pc		P-UB-10	1-1/2	3	JIC-G109452	30.69
LOADER GRAPPLE		1pc		P-UB-10	1-1/2	3	JIC-G109418	30.48
LOADER LIFT		2pc		P-UB-9	2-1/4	4-1/2	JIC-G105520	91.37
LOADER TILT		1pc		P-UB-10	2	3-1/2	JIC-G109453	45.49
STEERING		1pc		P-UB-10	1-1/4	2-1/2	JIC-G109475	34.37
MODEL W18, W20, W20B								
LOADER CLAM		2pc		P-U-9	2	4	JIC-G32299	53.72
		1pc		P-UB-10	2	4	JIC-1543273C1	66.53
LOADER LIFT		2pc	-9115602	P-U-9	3	5	JIC-G32668	79.33
		2pc	9115603-9123139	P-U-9	3	5	JIC-G109502	90.52
		2pc	9123140-	P-UB-9	2-1/2	5	JIC-G105515	80.19
LOADER TILT		2pc		P-UB-9	2	4	JIC-G109421	46.63
		1pc		P-UB-10	2	4	JIC-1543273C1	66.53
STEERING		1pc		P-UB-10	1-1/2	3	JIC-G109452	30.69
		2pc		P-UB-9	1-1/2	3	JIC-G105512	53.98
MODEL W18B, W20C								
LOADER LIFT		2pc	ALL	P-UB-9	2-1/2	5	JIC-G105515	80.19
LOADER TILT		1pc		P-UB-10	2	4	JIC-1543273C1	66.53
STEERING		1pc		P-UB-10	1-1/2	3	JIC-G109452	30.69
MODEL W24								
LOADER CLAM		2pc		P-U-9	2	4	JIC-G32299	53.72
				I-U-1	2		JIC-D42876	20.00
		2pc		N-N-9		4	JIC-G33239	24.83
LOADER LIFT		2pc		P-U-9	3	5	JIC-G32668	79.33
LOADER TILT		2pc		P-UB-9	2-1/2	4-1/2	JIC-G105513	94.22
STEERING		2pc		N-N-9		3	JIC-G33151	20.56
			-9105108	I-U-1	1-1/2		JIC-D42870	21.19
		2pc	9105109-	P-UB-9	1-1/2	3	JIC-G105512	53.98
MODEL W24B								
LOADER CLAM		1pc		P-UB-10	2	4	JIC-1543273C1	66.53
		2pc		P-U-9	2	4	JIC-G34335	54.84
		2pc		P-U-9	2	4	JIC-G32299	53.72
LOADER LIFT		2pc		P-U-9	3	5	JIC-G34334	97.81
		2pc		P-UB-9	3	5	JIC-G105531	91.77
		2pc		P-U-9	3	5	JIC-G32668	79.33
LOADER TILT		2pc		P-UB-9	2-1/2	4-1/2	JIC-G105513	94.22
STEERING		1pc		P-UB-10	1-1/2	3	JIC-G105548	40.42
		2pc		P-UB-9	1-1/2	3	JIC-G105512	53.98
MODEL W24C								
LOADER CLAM		1pc		P-UB-10	2	4	JIC-1543273C1	66.53
LOADER LIFT		2pc		P-UB-9	3	5	JIC-G105531	91.77
LOADER TILT		2pc		P-UB-9	2-1/2	4-1/2	JIC-G105513	94.22
STEERING		1pc		P-UB-10	1-1/2	3	JIC-G105548	40.42
MODEL W26B, W26FL								
LOADER LIFT		2pc	9107499-	P-UB-9	3	6	JIC-G105516	98.63
LOADER TILT		2pc		P-UB-9	2-1/2	5	JIC-G105515	80.19
		2pc		P-U-9	2-1/2	5	JIC-G32184	71.27
STEERING		2pc		P-U-9	2	3-1/2	JIC-G32293	41.67
		2pc		P-UB-9	2	3-1/2	JIC-G105527	54.29

Replacement Kits For

CASE

Loaders - Wheel								
APPLICATION	CYL #	Piston	SERIAL #	CODE	ROD	BORE	KIT #	List \$
MODEL W26B, W26FL								
STEERING				I-U-1	2		JIC-D42874	16.92
		2pc		N-N-9		3-1/2	JIC-G33237	22.76
MODEL W30								
LOADER CLAM		1pc		P-UB-10	2	4	JIC-1543273C1	66.53
LOADER TILT		2pc		P-UB-9	2-1/4	4-1/2	JIC-G105520	91.37
STEERING		1pc		P-UB-10	1-3/4	3-1/4	JIC-G105547	46.47
MODEL W36								
LOADER LIFT		2pc		P-UB-9	3	6	JIC-G105516	98.63
LOADER TILT		2pc		P-UB-9	2-1/4	4-1/2	JIC-G105520	91.37
STEERING		1pc		P-UB-10	2	4	JIC-1543273C1	66.53
		2pc		P-UB-9	2	4	JIC-G105517	56.90
Uni-Loaders								
APPLICATION	CYL #	Piston	SERIAL #	CODE	ROD	BORE	KIT #	List \$
MODEL 1530B								
BUCKET		1pc		P-UB-10	1-1/2	3	JIC-G105502	39.23
BUCKET CLAM		1pc		P-UB-10	1-1/2	3	JIC-G105502	39.23
GRAPPLE		1pc		P-U-10	1	2	JIC-D61006	7.98
LIFT		1pc	-9818250	P-UB-10	1-1/2	3	JIC-G105502	39.23
		1pc	9818251-	P-UB-10	1-1/2	2-1/2	JIC-G109458	24.25
SCARIFIER		1pc		P-UB-10	1-1/2	3	JIC-G105502	39.23
WOOD TICK		1pc		P-UB-10	1-1/2	3	JIC-G105502	39.23
MODEL 1700								
BUCKET		1pc		P-UB-10	1-1/2	3	JIC-G105502	39.23
BUCKET CLAM		1pc		P-UB-10	1-1/2	3	JIC-G105502	39.23
GRAPPLE		1pc		P-U-10	1	2	JIC-D61006	7.98
LIFT		1pc		P-UB-10	1-1/2	3	JIC-G105502	39.23
SCARIFIER		1pc		P-UB-10	1-1/2	3	JIC-G105502	39.23
WOOD TICK		1pc		P-UB-10	1-1/2	3	JIC-G105502	39.23
MODEL 1816B, 1816C								
BUCKET		1pc		P-U-10	1	2	JIC-D61006	7.98
GRAPPLE		1pc		P-U-10	1	2	JIC-D61006	7.98
LIFT		1pc		P-U-10	1	2	JIC-D61006	7.98
MODEL 1818								
BUCKET TILT	D136128			P-U-10	1	2	JIC-N14638	35.14
LOADER LIFT	D136838			P-U-10	1-1/4	2	JIC-N14639	43.10
MODEL 1825								
BUCKET 4-IN-1	E99740			P-U-10	1	2	JIC-N14638	35.14
BUCKET TILT	D136128			P-U-10	1	2	JIC-N14638	35.14
LOADER LIFT	D136838			P-U-10	1-1/4	2	JIC-N14639	43.10
MODEL 1830								
BUCKET		1pc		P-U-10	1	2-1/2	JIC-G34807	17.06
		1pc		P-U-10	1	2-1/2	JIC-G35378	16.46
		1pc		P-UB-10	1-1/4	2-1/2	JIC-G105507	27.28
GRAPPLE		1pc		P-U-10	1	2	JIC-D61006	7.98
LIFT		1pc		P-U-10	1-1/4	2-1/8	JIC-G34819	24.48
SCARIFIER		1pc		P-UB-10	1-1/2	3	JIC-G105502	39.23
MODEL 1835, 1835B								
BUCKET		1pc		P-UB-10	1-1/4	2-1/2	JIC-G109476	33.05
GRAPPLE		1pc		P-U-10	1	2	JIC-D61006	7.98
LIFT		1pc		P-U-10	1-1/4	2-1/8	JIC-G34819	24.48
		1pc		P-UB-10	1-1/2	2-1/2	JIC-G109458	24.25
MODEL 1840								
BUCKET TILT	118110A1			P-U-10	1-1/4	2-1/2	JIC-128728A1	24.92
	G103407			P-U-10	1-1/4	2-1/2	JIC-128728A1	24.92
GRAPPLE	D61075			P-U-10	1	2	JIC-D61006	7.98
LOADER LIFT	117824A1			P-UB-10	1-1/2	2-1/2	JIC-128725A1	29.45

CASE

Replacement Kits For

CASE

Uni-Loaders								
APPLICATION	CYL #	Piston	SERIAL #	CODE	ROD	BORE	KIT #	List \$
MODEL 1840								
LOADER LIFT	G110666	1pc		P-UB-10	1-1/2	2-1/2	JIC-G109458	24.25
MODEL 1845, 1845B, 1845C, 1845S								
BUCKET		1pc		P-UB-10	1-1/4	2-1/2	JIC-G109476	33.05
CLAM		1pc		P-UB-10	1-1/2	3	JIC-G109418	30.48
LIFT		1pc		P-UB-10	1-1/2	2-1/2	JIC-G109458	24.25
SCARIFIER		1pc		P-UB-10	1-1/2	3	JIC-G109418	30.48
Unimogs								
APPLICATION	CYL #	Piston	SERIAL #	CODE	ROD	BORE	KIT #	List \$
MODEL MB4/94 with Model 26C Backhoe, P80 Cable Plow, T70								
3-PT HITCH LIFT		2pc		P-UB-9	1-1/2	3	JIC-G105512	53.98
		1pc		P-UB-10	1-1/2	3	JIC-G105548	40.42
3-PT HITCH PITCH		1pc		P-UB-10	1-1/4	2-1/2	JIC-G105507	27.28
BACKHOE BOOM		2pc		P-U-9	2-1/4	4	JIC-G34636	62.00
		1pc		P-UB-10	2-1/4	4	JIC-G105556	52.53
BACKHOE BUCKET		1pc		P-UB-10	1-3/4	3	JIC-G105549	51.43
		2pc		P-UB-9	1-3/4	3	JIC-G105524	59.48
BACKHOE DIPPER		1pc		P-UB-10	2	3-1/2	JIC-G105546	48.58
		2pc		P-UB-9	2	3-1/2	JIC-G105527	54.29
BACKHOE DIPPER EXT		1pc		P-UB-10	1-1/2	3	JIC-G105548	40.42
		2pc		P-UB-9	1-1/2	3	JIC-G105512	53.98
BACKHOE STABILIZER		2pc		P-U-9	1-3/4	3-1/2	JIC-G105518	46.11
		2pc		P-UB-9	1-3/4	3	JIC-G105524	59.48
		1pc		P-UB-10	1-3/4	3	JIC-G105549	51.43
BACKHOE SWING		2pc		P-U-9	1-1/2	3-1/2	JIC-G34652	40.57
		1pc		P-UB-10	1-1/2	3-1/2	JIC-G105555	38.03
CABLE PLOW SHIFT		1pc		P-UB-10	1-1/2	2-1/2	JIC-G105550	30.33
FORKLIFT MAST TILT		1pc		P-UB-10	1-1/4	3	JIC-G105510	27.87
LIFT		2pc		P-UB-9	1-3/4	3	JIC-G105524	59.48
TILT		2pc		P-U-9	1-1/2	3-1/2	JIC-G34646	39.90
		1pc		P-UB-10	1-1/2	3	JIC-G105502	39.23

CASE

REPLACEMENT KITS FOR CASE EQUIPMENT

IMPORTANT - PLEASE READ

If a kit part number is unknown, the machine model number, serial number, and cylinder application will help identify the repair kit you need.

Example: Model Number **580C**
 Serial Number **5411021**
 Cylinder Application **Backhoe Swing**

If none of the above information is known, size and description of the parts needed will almost always be sufficient.

Kit Number	Code (Pg. xviii)	Rod X Bore Size	List Price
JIC-110507A1	P-U-10	1-3/8 X 2	\$ 63.26
JIC-110510A1	P-U-10	1 X 2	63.26
JIC-122535A1	P-UB-10	2 X 4	102.54
JIC-128725A1	P-UB-10	1-1/2 X 2-1/2	29.45
JIC-128728A1	P-U-10	1-1/4 X 2-1/2	24.92
JIC-131750A2	P-UB-10	2-1/4 X 3-1/4	64.34
JIC-131790A1	P-UB-10	2-1/4 X 4-1/4	43.67
JIC-1343707C2	P-UB-10	2-1/2 X 4-1/2	69.55
JIC-1346357C2	P-UB-10	4 X 8	231.31
JIC-1346409C2	P-UB-10	1-1/2 X 2-3/4	92.42
JIC-1346478C2	P-UB-10	2-1/4 X 4	87.31
JIC-135352A1	P-UB-10	2 X 3	42.61
JIC-1542764C2	P-UB-10	1-1/2 X 2-1/2	53.27
JIC-1542874C1	N-UB-1	1-1/2	13.24
JIC-1542875C1	N-UB-1	1-3/4	18.28
JIC-1542877C1	N-UB-1	2-1/4	16.84
JIC-1542879C1	P-UB-10	2-1/2 X 5	64.37
JIC-1542881C1	N-UB-1	3	33.10
JIC-1542882C1	N-UB-1	3-1/2	39.83
JIC-1542915C2	P-UB-10	2-1/2 X 5	62.09
JIC-1542919C2	P-UB-10	2-1/4 X 5	140.47
JIC-1542919C4	P-UB-10	2-1/4 X 5	153.29
JIC-1542923C2	P-UB-10	2-1/2 X 3-1/2	65.68
JIC-1542946C1	P-UB-10	1-1/4 X 2-3/4	63.54
JIC-1543249C1	P-UB-10	1-1/4 X 2-1/2	47.78
JIC-1543250C1	P-UB-10	1-1/4 X 2-1/2	37.99
JIC-1543252C1	P-UB-10	1-1/2 X 3	43.70
JIC-1543253C1	P-UB-10	1-1/2 X 2-1/2	44.57
JIC-1543254C1	P-UB-10	1-1/2 X 3-1/2	47.85
JIC-1543256C1	P-UB-10	1-1/2 X 3	41.15
JIC-1543260C1	P-UB-10	1-3/4 X 3-1/4	52.05
JIC-1543261C1	p-ub-10	1-3/4 x 3-1/2	47.86
JIC-1543262C1	P-UB-10	1-3/4 X 3	42.01
JIC-1543263C1	P-UB-9	1-3/4 X 3	61.48
JIC-1543264C1	P-UB-10	1-3/4 X 4	52.93
JIC-1543265C1	P-UB-10	1-3/4 X 3-1/4	52.05
JIC-1543266C1	P-UB-10	1-3/4 X 3-1/2	51.81
JIC-1543267C1	P-UB-10	1-3/4 X 3	50.86

Kit Number	Code (Pg. xviii)	Rod X Bore Size	List Price
JIC-1543268C1	P-UB-10	2 X 3-1/4	\$ 56.74
JIC-1543269C1	P-UB-10	2 X 4	63.39
JIC-1543270C1	P-UB-9	2 X 4-1/2	96.48
JIC-1543271C1	P-UB-9	2 X 4	55.71
JIC-1543273C1	P-UB-10	2 X 4	66.53
JIC-1543274C1	P-UB-10	2 X 3-1/2	67.94
JIC-1543275C1	P-UB-10	2 X 4-1/4	66.96
JIC-1543276C1	P-UB-9	2-1/4 X 4-1/2	99.75
JIC-1543277C1	P-UB-10	2-1/4 X 4	58.83
JIC-1543279C1	P-UB-10	2-1/4 X 4-1/2	58.51
JIC-1543289C2	P-UB-10	2-1/4 X 5	80.11
JIC-1543290C1	P-UB-10	2-1/2 X 4-1/2	50.40
JIC-1543291C1	P-UB-9	2-1/2 X 4-1/2	88.36
JIC-1543294C1	P-UB-10	2-1/2 X 3-1/2	47.86
JIC-1543295C1	P-UB-10	2-1/2 X 4	63.86
JIC-1543299C1	P-UB-8	3 X 6	112.97
JIC-1543303C1	P-UB-10	3 X 6-1/2	154.24
JIC-1543305C1	P-UB-10	3 X 5	92.03
JIC-1543306C1	P-UB-10	3 X 6	110.98
JIC-1543309C1	P-UB-10	3-1/2 X 7	161.12
JIC-1543312C1	P-UB-9	2-1/2 X 5	110.91
JIC-1543313C1	P-UB-10	1-1/2 X 3	51.87
JIC-1543316C1	P-UB-10	1-1/4 X 3	48.96
JIC-1543360C1	P-UB-9	2-1/2 X 5	197.59
JIC-1543378C1	P-UB-9	1-1/2X3	78.42
JIC-1543383C1	P-UB-9	2 X 3-1/2	81.50
JIC-1543385C1	P-UB-10	2-1/4 X 4-1/2	57.45
JIC-156002A1	P-UB-10	110 X 160 mm	478.55
JIC-158846A1	P-UB-10	95 X 140 mm	372.99
JIC-160227A1	P-UB-10	105 X 150 mm	387.20
JIC-160229A1	P-UB-10	90 X 135 mm	282.60
JIC-160577A1	P-UB-10	85 X 125 mm	262.14
JIC-160579A1	P-UB-10	100 X 135 mm	371.83
JIC-160581A1	P-UB-10	80 X 120 mm	242.10
JIC-161912A1	P-UB-10	80 X 115 mm	274.59
JIC-161913A1	P-UB-10	90 X 125 mm	327.95
JIC-161914A1	P-UB-10	75 X 105 mm	288.28
JIC-162976A1	P-UB-10	70 X 95 mm	253.10

CASE

REPLACEMENT KITS FOR CASE EQUIPMENT

Kit Number	Code (Pg. xviii)	Rod X Bore Size	List Price	Kit Number	Code (Pg. xviii)	Rod X Bore Size	List Price
JIC-164183A1	P-UB-10	85 X 125 mm	\$ 259.41	JIC-55355C91	I-OB-10	1 X 2-1/2	\$ 72.25
JIC-164493A1	P-UB-10	75 X 100 mm	180.90	JIC-700710260	P-U-10	1-3/8 X 3	79.86
JIC-164494A1	P-UB-10	80 X 115 mm	289.34	JIC-72280241	P-U-10	45 mm X 75 mm	64.28
JIC-175251A1	P-UB-10	1-1/2 X 2-3/4	100.57	JIC-72280251	P-U-10	40 mm X 65 mm	71.92
JIC-179011A1	P-UB-10,12	2-3/4 X 5-1/2	143.89	JIC-72280261	P-U-10	50 mm X 100 mm	69.78
JIC-182218A1	P-UB-10,12	2-1/4 X 4-1/2	92.63	JIC-72280268	P-U-10	45 mm X 80 mm	75.18
JIC-183286A1	P-U-10	1-1/4 X 2-1/2	47.39	JIC-72280471	P-U-10	40 mm X 70 mm	92.26
JIC-191747A1	P-UB-10,12	2 X 3-3/4	98.42	JIC-72282209	P-U-10	40 mm X 70 mm	92.26
JIC-1980161C1	P-UB-10	2 X 3-1/2	53.74	JIC-72282317	P-U-10	35 mm X 60 mm	94.95
JIC-1980181C2	P-UB-10	2 X 3-3/4	69.29	JIC-72282324	P-U-10	45 mm X 85 mm	105.07
JIC-1980412C2	P-UB-10	2-1/2 X 5-1/2	200.14	JIC-72283999	P-U-10	50 mm X 90 mm	104.62
JIC-198376A2	P-UB-10,12	1-3/4 X 2-1/2	51.87	JIC-72284000	P-U-10	55 mm X 95 mm	52.37
JIC-1986823C2	P-UB-10	3-1/2 X 6	153.91	JIC-72284002	P-U-10	45 mm X 100 mm	73.38
JIC-1986856C2	P-UB-10	2 X 4-1/2	87.91	JIC-72284189	P-U-10	45 mm X 75 mm	89.11
JIC-1986920C2	P-UB-10	4 X 7	177.34	JIC-72284207	P-U-10	50 mm X 90 mm	85.18
JIC-1994527C2	P-UB-10	2-3/4 X 5-1/2	182.21	JIC-79975C2	P-U-10	1-1/4 X 2-1/2	15.87
JIC-201501A1	I-U-10	40 X 70 mm	24.92	JIC-84154317	P-UB-10	2-1/4 X 5	67.06
JIC-231726A3	P-U-10,12	1-3/4 X 2-1/4	38.96	JIC-84155085	P-UB-10	2 X 4-1/4	65.99
JIC-231921A2	P-UB-10	1-3/8 X 2-1/4	36.43	JIC-84172816	P-UB-10,12	2 X 3-3/4	55.19
JIC-234844A1	P-UB-10,12	2-1/4 X 4-1/4	96.15	JIC-84209920	P-UB-14	2-1/4 X 4	83.70
JIC-235933A1	P-U-10	1-3/4 X 3-1/2	32.22	JIC-84257323	P-UB-12,14	1-3/4 X 3-1/4	82.65
JIC-250741A1	P-UB-10	1-3/4 X 3-1/2	66.48	JIC-84257765	P-UB-14	1-3/4 X 3-1/4	58.05
JIC-252828A3	P-UB-10	1-1/4 X 2-1/2	25.57	JIC-84257772	P-UB-12,14	1-1/2 X 3	68.25
JIC-275503A2	P-UB-10,12	1-3/8 X 2-3/4	52.44	JIC-84257788	P-UB-14	1-1/2 X 3	55.50
JIC-279532A1	N-UB-1	1-3/8	25.06	JIC-84258339	P-UB-12,14	1-7/8 X 3-1/2	91.91
JIC-297895A1	P-UB-10	2-3/4 X 3-3/4	71.97	JIC-84259218	P-UB-12,14	2-1/4 X 4-1/2	103.42
JIC-305517A3	P-UB-10,12	1-1/2 X 2-1/4	36.56	JIC-84259219	P-UB-12,14	2-1/2 X 5	140.00
JIC-310478A1	P-UB-10	1-3/4 X 3	60.89	JIC-84259220	P-UB-12,14	2-3/4 X 5-1/2	128.20
JIC-337742A1	P-UB-1	2 X 2-1/2	46.81	JIC-84259221	P-UB-12,14	2-1/4 X 4-1/4	78.67
JIC-348747A1	P-UB-1	3 X 3-1/2	63.06	JIC-84259222	P-UB-12,14	2-1/2 X 4-3/4	134.08
JIC-358013A1	P-UB-10	2-1/4 X 3-3/4	54.01	JIC-84259223	P-UB-12,14	2-3/4 X 5-1/4	208.48
JIC-360979A1	P-UB-10	2-1/4 X 4	54.67	JIC-84259224	P-UB-12,14	2-1/4 X 3-1/4	97.24
JIC-360982A1	P-UB-3	2-1/2 X 4-1/2	68.74	JIC-84259225	P-UB-12,14	2-1/2 X 3-1/2	83.20
JIC-360984A1	P-UB-3	3 X 5	82.19	JIC-84259226	P-UB-14	2-1/4 X 4-1/4	98.05
JIC-362347A1	P-UB-1	60 mm X 2-3/4	65.69	JIC-84259227	P-UB-14	2-1/4 X 4-1/2	92.93
JIC-381101A1	P-UB-10	2-1/4 X 4-1/8	94.46	JIC-84259228	P-UB-14	2-1/2 X 5-1/4	107.56
JIC-398166A1	I,P-U-1	2-3/4	57.82	JIC-84330972	I-U-10	36 mm X 63 mm	65.79
JIC-401061A1	I-U-10	36 mm X 63 mm	65.34	JIC-84331720	I-U-10	40 mm X 70 mm	114.09
JIC-433774A1	P-UB-10	1-3/4 X 2-3/4	32.82	JIC-84365141	P-U-10	50 mm X 90 mm	194.96
JIC-47364492	I-UB-10	1-1/2 X 3	26.12	JIC-84365143	P-U-10	50 mm X 90 mm	194.96
JIC-47364907	I-UB-10	1-3/4 X 2-3/4	26.43	JIC-84480921	P-UB-10,12	1-3/4 X 2-1/2	41.47
JIC-5001732M91	P-U-10	45 mm X 80 mm	77.54	JIC-84480948	P-UB-10	1-1/2 X 3	29.00
JIC-5001747M91	P-U-10	45 mm X 75 mm	56.07	JIC-84480953	P-UB-10	1-3/8 X 2-3/4	44.19
JIC-5001761M91	P-U-10	55 mm X 95 mm	79.22	JIC-84530079	P-UB-10,12	2 X 2-3/4	43.31
JIC-5001763M91	P-U-10	35 mm X 65 mm	87.20	JIC-85819350	P-UB-10	63 mm X 4-1/2	160.88

CASE

REPLACEMENT KITS FOR CASE EQUIPMENT

Kit Number	Code (Pg. xviii)	Rod X Bore Size	List Price	Kit Number	Code (Pg. xviii)	Rod X Bore Size	List Price
JIC-85824250	I-U-15	45 mm X 80 mm	\$ 61.97	JIC-87705824	P-UB-10	1-3/4 X 2-1/2	\$ 28.43
JIC-8605261	P-UB-10,12	1-3/4 X 3	47.42	JIC-907001	P-N-4	2 X 2	26.42
JIC-8605262	P-UB-10	3 X 4-3/4	100.32	JIC-907001	TRACK ADJUSTER		26.42
JIC-8605263	P-UB-10	3 X 5-3/4	87.34	JIC-A43296	I-U-10	1-1/4 X 2-1/8	22.53
JIC-86613643	P-UB-11	1-3/8 X2-3/4	49.14	JIC-A44644	I-O-3	3/4 X 1-1/2	10.74
JIC-86613644	P-UB-11	1-1/2 X 2-1/4	33.43	JIC-A5349616	P-U-10	95 X 125 mm	107.42
JIC-86614269	P-U-11	1-1/2 X 3	33.44	JIC-D143215	I-U-10	2 X 4	31.15
JIC-86631598	P-UB-11	1-1/2 X 2-2/2	33.62	JIC-D148100	I-U-10	3/4 X 1-1/2	23.56
JIC-86982377	P-UB-10	1-3/4 X 3	40.25	JIC-D37360	I-U-9	1-1/2 X 2-1/2	46.20
JIC-86988474	P-U-10	40 mm X 60 mm	35.74	JIC-D37361	I-U-9	1-1/2 X 2	40.76
JIC-86988481	P-U-10	35 mm X 65 mm	40.74	JIC-D42867	I-U-1	1-1/4 ROD	19.79
JIC-86988486	P-U-10	40 mm X 65 mm	32.93	JIC-D42869	I-U-1	1-1/2 ROD	21.34
JIC-86988490	P-U-10	35 mm X 70 mm	52.52	JIC-D42870	I-U-1	1-1/2 ROD	21.19
JIC-86988494	P-U-10	35 mm X 75 mm	51.04	JIC-D42872	I-U-1	1-3/4 ROD	15.87
JIC-86991005	P-U-10	1-1/2 X 2-3/4	34.34	JIC-D42873	I-U-1	1-3/4 ROD	21.75
JIC-87342131	P-UB-10	1-3/4 X 3	39.98	JIC-D42874	I-U-1	2 ROD	16.92
JIC-87363451	P-UB-10,12	1-3/4 X 3-1/4	121.32	JIC-D42875	I-U-1	1-3/4 ROD	16.83
JIC-87367212	P-UB-10,12	2-3/4 X 5-1/2	123.82	JIC-D42876	I-U-1	2 ROD	20.00
JIC-87367429	I-UB-10	2-1/2 X 5-1/2	143.88	JIC-D42877	I-U-1	2-1/4 ROD	15.73
JIC-87418297	P-UB-10,12	2-1/2 X 5-1/4	186.50	JIC-D42878	P-U-1	2-1/4 ROD	19.31
JIC-87428620	P-UB-10	2 X 2-3/4	38.24	JIC-D47651	I-U-1	2 ROD	17.50
JIC-87428631	P-UB-10	2 X 110 mm	73.10	JIC-D47896	I-U-1	1-1/2 ROD	17.09
JIC-87428634	P-UB-10,12	2-1/2 X 135 mm	195.16	JIC-D50279	I-U-9	3 X 5	68.83
JIC-87428866	P-UB-10	2-1/2 X 90 mm	34.97	JIC-D61006	P-U-10	1 X 2	7.98
JIC-87428869	P-UB-10	2 X 2-3/4	62.94	JIC-D83184	I-U-11	3/4 X 1-1/2	17.27
JIC-87428872	I,P-UB-10,12	2-1/2 X 4-1/2	91.01	JIC-G101021	P-U-10	1-1/4 X 2-1/8	23.79
JIC-87428874	P-UB-10,12	2-1/2 X 135 mm	160.24	JIC-G102401	USE JIC-G105545		
JIC-87432407	P-UB-10	2 X 3-1/2	45.58	JIC-G102402	USE JIC-G105546		
JIC-87432412	P-UB-10	1-3/4 X 3-1/4	47.38	JIC-G102403	USE JIC-G105547		
JIC-87434291	P-UB-10	2-1/2 X 4-1/2	68.74	JIC-G102404	USE JIC-G105548		
JIC-87434292	P-UB-10	2-1/4 X 4	54.67	JIC-G102405	USE JIC-G105549		
JIC-87434293	P-UB-10	3 X 5	82.19	JIC-G102406	USE JIC-G105550		
JIC-87440117	I-UB-10	2-1/4 X 4-1/2	47.45	JIC-G102407	USE JIC-G105551		
JIC-87442965	P-UB-10	3 X 6	87.34	JIC-G102408	P-U-10	1-3/4 X 4	46.63
JIC-87445307-NP	P-UB-10	2 X 110 mm	64.38	JIC-G102410	P-U-10	1-3/4 X 3-1/2	43.94
JIC-87495411	P-UB-10	3 X 5-3/4	101.37	JIC-G102411	USE JIC-G105555		
JIC-87529742	P-UB-10	4 X 6-1/2	115.62	JIC-G102412	USE JIC-G105556		
JIC-87529743	P-UB-10	3-1/2 X 6-1/2	177.32	JIC-G105206	P-UB-10	1-1/2 X 2-3/4	69.95
JIC-87530718	P-UB-10	3 X 5-1/4	108.98	JIC-G105502	P-UB-10	1-1/2 X 3	39.23
JIC-87573868	I-U-15	45 mm X 80 mm	61.97	JIC-G105503	P-UB-9	1-1/2 X 2	38.47
JIC-87598751	P-UB-10	2-1/2 X 4-3/4	69.45	JIC-G105505	P-UB-9	1-1/2 X 2-1/2	36.57
JIC-87608671	P-UB-10	2 X 2-3/4	42.93	JIC-G105507	P-UB-10	1-1/4 X 2-1/2	27.28
JIC-87633295	P-UB-10	2-1/2 X 4-1/2	106.46	JIC-G105508	P-U-9	1-3/4 X 3-1/2	50.19
JIC-87651309	P-UB-10	2 X 3-3/4	53.53	JIC-G105510	P-UB-10	1-1/4 X 3	27.87
JIC-87653283	P-UB-10	2 X 3	35.16	JIC-G105512	P-UB-9	1-1/2 X 3	53.98

REPLACEMENT KITS FOR CASE EQUIPMENT

Kit Number	Code (Pg. xviii)	Rod X Bore Size	List Price	Kit Number	Code (Pg. xviii)	Rod X Bore Size	List Price
JIC-G105513	P-UB-9	2-1/2 X 4-1/2	\$ 94.22	JIC-G109460	P-UB-10	1-3/4 X 3	\$ 33.36
JIC-G105514	P-UB-9	2-1/2 X 5-1/2	94.44	JIC-G109462	P-UB-9	1-3/4 X 3	37.58
JIC-G105515	P-UB-9	2-1/2 X 5	80.19	JIC-G109465	P-UB-10	2 X 3-1/4	53.80
JIC-G105516	P-UB-9	3 X 6	98.63	JIC-G109470	P-UB-9	1-3/4 X 3-1/2	39.85
JIC-G105517	P-UB-9	2 X 4	56.90	JIC-G109471	P-UB-10	1-3/4 X 3-1/2	44.34
JIC-G105518	P-U-9	1-3/4 X 3-1/2	46.11	JIC-G109472	P-UB-10	1-1/2 X 3-1/2	41.92
JIC-G105519	P-UB-9	1-3/4 X 4	51.50	JIC-G109475	P-UB-10	1-1/4 X 2-1/2	34.37
JIC-G105520	P-UB-9	2-1/4 X 4-1/2	91.37	JIC-G109476	P-UB-10	1-1/4 X 2-1/2	33.05
JIC-G105521	P-UB-9	2 X 3-1/2	47.35	JIC-G109484	P-UB-9	1-1/2 X 2-1/2	43.21
JIC-G105523	P-UB-9	1-3/4 X 3	51.66	JIC-G109498	P-UB-9	2-1/2 X 4-1/2	86.90
JIC-G105524	P-UB-9	1-3/4 X 3	59.48	JIC-G109499	P-UB-9	2-1/2 X 5	105.70
JIC-G105525	P-UB-9	2 X 4-1/2	76.10	JIC-G109500	P-UB-9	3 X 5-1/2	135.98
JIC-G105526	P-UB-9	2 X 4	56.82	JIC-G109501	P-UB-9	2-1/4 X 5	88.01
JIC-G105527	P-UB-9	2 X 3-1/2	54.29	JIC-G109502	P-U-9	3 X 5	90.52
JIC-G105528	P-UB-8	1-3/4 X 3-1/4	49.50	JIC-G109503	P-U-10	2-1/2 X 4-1/2	50.78
JIC-G105529	P-UB-9	1-3/4 X 3-1/2	43.24	JIC-G109504	P-UB-10	2-1/2 X 3-1/2	44.91
JIC-G105530	P-UB-9	2-1/4 X 5	95.13	JIC-G109505	P-UB-10	2-1/4 X 4	48.24
JIC-G105531	P-UB-9	3 X 5	91.77	JIC-G110045	P-U-10	1-1/2 X 2-3/4	64.90
JIC-G105545	P-UB-10	2 X 4	54.92	JIC-G110046	P-UB-10	2-1/2 X 3-1/2	44.52
JIC-G105546	P-UB-10	2 X 3-1/2	48.58	JIC-G110047	P-UB-10	1-1/4 X 2-3/4	42.22
JIC-G105547	P-UB-10	1-3/4 X 3-1/4	46.47	JIC-G110048	P-UB-10	1-1/4 X 3	31.61
JIC-G105548	P-UB-10	1-1/2 X 3	40.42	JIC-G110049	P-UB-10	1-3/4 X 3	39.82
JIC-G105549	P-UB-10	1-3/4 X 3	51.43	JIC-G110050	P-UB-10	1-1/2 X 3	35.14
JIC-G105550	P-UB-10	1-1/2 X 2-1/2	30.33	JIC-G110053	P-UB-10	1-3/4 X 3-1/4	36.53
JIC-G105551	P-UB-10	1-1/4 X 2-1/2	34.37	JIC-G110055	P-UB-10	1-1/4 X 2-1/2	51.83
JIC-G105552	P-UB-10	1-3/4 X 4	48.42	JIC-G110526	P-UB-10	3 X 6	93.48
JIC-G105553	P-UB-10	2 X 3-1/4	50.94	JIC-G110537	P-UB-10	2 X 4-1/4	55.11
JIC-G105555	P-UB-10	1-1/2 X 3-1/2	38.03	JIC-G110582	P-UB-10	2-1/2 X 5	53.90
JIC-G105556	P-UB-10	2-1/4 X 4	52.53	JIC-G110583	P-UB-10	2-1/4 X 5	138.22
JIC-G105557	P-UB-10	2-1/4 X 4-1/2	67.65	JIC-G110621	P-UB-10	1-3/4 X 3-1/2	41.47
JIC-G105560	P-UB-10	2-1/2 X 4-1/2	50.48	JIC-G32184	P-U-9	2-1/2 X 5	71.27
JIC-G105561	P-UB-10	2-1/2 X 4	46.11	JIC-G32228	P-U-9	1-3/4 X 3-1/2	41.15
JIC-G105562	P-UB-10	2-3/4 X 5	75.76	JIC-G32293	P-U-9	2 X 3-1/2	41.67
JIC-G105563	P-UB-10	2-1/2 X 3-1/2	50.90	JIC-G32294	P-U-9	1-1/2 X 2-1/2	37.19
JIC-G105566	P-UB-9	2-3/4 X 5-1/2	152.45	JIC-G32295	P-U-9	1-1/4 X 2-1/2	46.74
JIC-G109417	P-UB-10	1-3/4 X 3-1/4	46.47	JIC-G32299	P-U-9	2 X 4	53.72
JIC-G109418	P-UB-10	1-1/2 X 3	30.48	JIC-G32616	P-U-9	2 X 4	51.66
JIC-G109421	P-UB-9	2 X 4	46.63	JIC-G32617	P-U-9	1-3/4 X 4	53.81
JIC-G109423	P-UB-10	2 X 4	51.43	JIC-G32668	P-U-9	3 X 5	79.33
JIC-G109424	P-UB-10	2-1/2 X 4	53.12	JIC-G32695	P-U-9	2 X 4-1/2	78.36
JIC-G109452	P-UB-10	1-1/2 X 3	30.69	JIC-G32696	P-U-9	2-1/4 X 5	77.87
JIC-G109453	P-UB-10	2 X 3-1/2	45.49	JIC-G32827	USE JIC-G105505		
JIC-G109454	P-UB-9	2 X 3-1/2	36.07	JIC-G33141	USE JIC-G105507		
JIC-G109456	P-UB-10	1-1/2 X 2-1/2	30.33	JIC-G33823	P-U-9	2-1/2 X 5-1/2	84.83
JIC-G109458	P-UB-10	1-1/2 X 2-1/2	24.25	JIC-G34172	USE JIC-G105507		

CASE

REPLACEMENT KITS FOR CASE EQUIPMENT

Kit Number	Code (Pg. xviii)	Rod X Bore Size	List Price
JIC-G34205	USE JIC-G105510		
JIC-G34277	USE JIC-G109458		
JIC-G34332	USE JIC-G105512		
JIC-G34333	USE JIC-G105513		
JIC-G34334	P-U-9	3 X 5	\$ 97.81
JIC-G34335	P-U-9	2 X 4	54.84
JIC-G34536	USE JIC-G105514		
JIC-G34537	USE JIC-G105515		
JIC-G34569	USE JIC-G105516		
JIC-G34594	P-U-9	2 X 4	55.48
JIC-G34622	P-U-9	1-3/4 X 3-1/2	46.11
JIC-G34624	P-U-9	1-3/4 X 3-1/2	44.34
JIC-G34626	P-U-9	1-3/4 X 4	55.79
JIC-G34628	USE JIC-G105520		
JIC-G34630	USE JIC-G105521		
JIC-G34631	P-U-9	1-3/4 X 3-1/2	44.34
JIC-G34634	USE JIC-G105523		
JIC-G34636	P-U-9	2-1/4 X 4	62.00
JIC-G34642	USE JIC-G105524		
JIC-G34643	P-U-9	1-3/4 X 3	47.52
JIC-G34644	USE JIC-G105525		
JIC-G34646	P-U-9	1-1/2 X 3.5	39.90
JIC-G34647	USE JIC-G105526		
JIC-G34648	P-U-9	2 X 3-1/2	50.20
JIC-G34651	USE JIC-G105527		
JIC-G34652	P-U-9	1-1/2 X 3-1/2	40.57
JIC-G34653	USE JIC-G105528		
JIC-G34655	P-U-9	1-3/4 X 3-1/2	41.67
JIC-G34656	P-U-10	1-1/2 X 3	37.25
JIC-G34752	USE JIC-G105530		
JIC-G34753	USE JIC-G105531		
JIC-G34807	P-U-10	1 X 2-1/2	17.06
JIC-G34819	P-U-10	1-1/4 X 2-1/8	24.48
JIC-G34827	P-U-9	2-1/4 X 4	62.00
JIC-G35374	P-U-10	1 X 3	26.00
JIC-G35378	P-U-10	1 X 2-1/2	16.46
JIC-H52704	P-OB-3	1 X 2	16.65
JIC-H53041	P-OB-1	2-3/4 Rod Kit	22.61
JIC-H673837	P-U-10	1-3/8 X 3	79.86
JIC-LQU0245	P-UB-10	70 mm X 100 mm	134.18
JIC-LZ00361	P-UB-10	85 X 120 mm	137.02
JIC-LZ00440	P-UB-10	115 mm X 170 mm	309.87
JIC-LZ00442	P-UB-10	90 mm X 125 mm	161.30
JIC-LZ00443	P-UB-10	105 mm X 145 mm	143.51
JIC-LZ00444	P-UB-10	90 mm X 130 mm	155.45

Kit Number	Code (Pg. xviii)	Rod X Bore Size	List Price
JIC-LZ00445	P-UB-10	85 mm X 120 mm	\$ 139.17
JIC-LZ00446	P-UB-10	95 mm X 135 mm	119.75
JIC-LZ00447	P-UB-10	80 mm X 115 mm	96.08
JIC-LZ00448	P-UB-10	70 mm X 105 mm	123.63
JIC-LZ00449	P-UB-10	80 mm X 115 mm	112.49
JIC-LZ00450	P-UB-10	65 mm X 95 mm	80.45
JIC-LZ00451	I-UB-10	80 mm X 115 mm	116.88
JIC-LZ00452	P-UB-10	90 mm X 125 mm	191.68
JIC-LZ00453	P-UB-10	75 mm X 105 mm	116.84
JIC-LZ00455	P-UB-10	75 mm X 105 mm	145.17
JIC-LZ00456	P-UB-10	65 mm X 120 mm	71.85
JIC-LZ00457	P-UB-10	70 mm X 110 mm	75.93
JIC-LZ00476	P-UB-10	105 X 150 mm	420.84
JIC-LZ00477	P-UB-10	100 X 145 mm	309.67
JIC-LZ00478	P-UB-10	120 X 170 mm	359.18
JIC-LZ00482	P-UB-10	105 mm X 150 mm	131.16
JIC-LZ00483	P-UB-10	100 mm X 145 mm	116.94
JIC-LZ00484	P-UB-10	120 X 170 mm	359.18
JIC-LZ00522	P-UB-10	70 X 95 mm	253.10
JIC-LZ00533	P-UB-10	90 X 130 mm	300.54
JIC-LZ00539	P-UB-10	75 X 100 mm	172.32
JIC-LZ007630	P-UB-10	85 mm X 120 mm	122.35
JIC-LZ007640	P-UB-10	100 mm X 140 mm	158.73
JIC-LZ007650	P-UB-10	85 mm X 120 mm	117.57
JIC-LZ008100	P-UB-10	80 mm X 115 mm	117.53
JIC-LZ008180	P-UB-10	90 mm X 125 mm	144.90
JIC-LZ008210	P-UB-10	75 mm X 105 mm	124.14
JIC-LZ008750	P-UB-10	65 mm X 95 mm	107.27
JIC-LZ010710-D	P-UB-10	65 mm X 95 mm	107.27
JIC-LZ010810	P-UB-10	75 mm X 105 mm	124.14
JIC-LZ010870	P-UB-10	80 mm X 115 mm	117.53
JIC-LZ010930	P-UB-10	85 mm X 120 mm	122.35
JIC-LZ010940	P-UB-10	85 mm X 120 mm	117.57
JIC-LZ011000-D	P-UB-10	90 mm X 125 mm	144.90
JIC-LZ011200	P-UB-10	100 mm X 140 mm	158.73
JIC-N14638	P-U-10	1 X 2	35.14
JIC-N14639	P-U-10	1-1/4 X 2	43.10
JIC-PX01V00045R300	P-U-10	45 mm X 80 mm	65.40
JIC-S300163	I-U-10	2 X 4	23.99
JIC-S301013	I-U-10	2-1/2 X 5	60.99
JIC-S301442	I-U-10	2 X 4	36.39
JIC-S92713	P-U-9	2-1/2 X 5	77.16
JIC-S92714	P-U-9	2-1/2 X 5-1/2	85.08
JIC-S92724	P-U-9	2-3/4 X 5-1/2	109.35

REPLACEMENT PARTS FOR CASE EQUIPMENT

NOTE: Case part numbers are used as a reference only. We do not imply that these kits are original REPLACEMENT PARTS.

BACK-UP RINGS

Part Number	Min. Pkg.	List Price
JIC-380621A1	1	\$ 3.00
JIC-446178A1	5	2.29
JIC-446179A1	1	3.61
JIC-A35884	13	0.67
JIC-A45035	18	0.48
JIC-A62070	8	0.67
JIC-B92639	3	2.76
JIC-D28497	1	1.97
JIC-D28498	1	3.52
JIC-D28499	1	1.70
JIC-D28500	1	3.80
JIC-D38858	6	1.29
JIC-D39539	1	2.30
JIC-D42453	3	3.26
JIC-G109033	2	4.57
JIC-G109297	10	1.04
JIC-G109298	7	1.18
JIC-G109299	5	1.83
JIC-G109300	4	2.29
JIC-G110421	1	4.57
JIC-G32105	3	3.00
JIC-G32122	6	1.29
JIC-G32126	5	1.50
JIC-G32129	7	1.18
JIC-G32176	5	1.86
JIC-G32284	3	2.60
JIC-G32626	9	0.85
JIC-G32649	2	4.43
JIC-G34260	3	3.78
JIC-H745760	7	1.18
JIC-H754606	6	1.41
JIC-LBU0093	1	15.92
JIC-LE00957	1	14.39
JIC-LE00961	1	18.30
JIC-S92644	3	3.41
JIC-S99881	2	4.34

BUFFER RINGS

Part Number	Rod Diameter	List Price
JIC-1542928C1	2-1/4	\$ 20.97
JIC-1542930C1	2-1/2	22.95
JIC-1542996C1	1-1/2	14.92
JIC-1542998C1	1-3/4	16.94
JIC-1543007C1	2-3/4	24.95
JIC-1543009C1	3	26.95
JIC-1543011C1	3-1/2	30.97
JIC-G107998	2-1/2	7.57
JIC-G109086	2-1/4	9.41
JIC-G109092	1-1/4	4.34
JIC-G109093	1-1/2	14.92
JIC-G109094	1-3/4	6.97
JIC-LE00956	120 mm	63.50

CUSHION SEALS

Part Number	List Price
JIC-LE00746	\$ 23.47
JIC-LE00960	20.77

HEAD SEALS

Part Number	List Price
JIC-84130482	\$ 13.35
JIC-84153643	18.90
JIC-87615483	16.43
JIC-87615484	17.01
JIC-87615486	18.90

REPLACEMENT KITS FOR CASE EQUIPMENT

NOTE: Case part numbers are used as a reference only. We do not imply that these kits are original REPLACEMENT PARTS.

O-RINGS

Part Number	Min. Pkg	List Price
JIC-1340763C1	10	\$ 1.39
JIC-14461280	20	0.65
JIC-14466580	10	1.15
JIC-167266	50	0.21
JIC-218-5002	50	0.16
JIC-218-5004	50	0.22
JIC-218-5009	20	0.38
JIC-22409R1	20	0.53
JIC-235-5234	20	0.59
JIC-237-6004	50	0.22
JIC-237-6006	50	0.22
JIC-237-6008	50	0.25
JIC-237-6010	50	0.26
JIC-237-6012	50	0.32
JIC-237-6016	20	0.42
JIC-237-6020	20	0.53
JIC-237-6024	10	0.77
JIC-238-5014	50	0.06
JIC-238-5115	50	0.09
JIC-238-5116	50	0.09
JIC-238-5210	25	0.27
JIC-238-5214	50	0.17
JIC-238-5224	20	0.54
JIC-238-5226	20	0.39
JIC-238-5228	20	0.42
JIC-238-5230	20	0.50
JIC-238-5231	20	0.53
JIC-238-5232	20	0.53
JIC-238-5233	20	0.56
JIC-238-5234	20	0.59
JIC-238-5238	20	0.69
JIC-238-5245	10	0.98
JIC-238-5246	10	1.12
JIC-238-5247	10	1.15
JIC-238-5250	10	1.25
JIC-238-5252	10	1.29
JIC-238-5258	5	1.76
JIC-238-5360	5	2.28

O-RINGS

Part Number	Min. Pkg	List Price
JIC-238-5437	5	\$ 2.47
JIC-238-6011	50	0.10
JIC-238-6012	50	0.10
JIC-238-6014	50	0.11
JIC-238-6016	50	0.14
JIC-238-6018	50	0.16
JIC-238-6021	50	0.26
JIC-238-6025	50	0.29
JIC-238-6029	20	0.36
JIC-238-6218	19	0.41
JIC-238-6231	12	0.92
JIC-238-7113	15	0.66
JIC-272778	20	0.30
JIC-274296	10	0.85
JIC-281411A1	9	1.48
JIC-307916R1	10	1.01
JIC-343909R1	20	0.53
JIC-343921R1	20	0.66
JIC-343923R1	20	0.80
JIC-369375R1	50	0.16
JIC-446340A1	3	2.78
JIC-510828	10	1.25
JIC-511526	20	0.65
JIC-69122	5	1.51
JIC-70923823	10	1.29
JIC-86509814	20	0.54
JIC-86629633	10	0.98
JIC-86637742	10	1.12
JIC-86977728	50	0.09
JIC-86977781	20	0.53
JIC-87016952	20	0.69
JIC-87016953	20	0.72
JIC-87399718	3	3.02
JIC-87403649	7	1.74
JIC-87530710	3	2.78
JIC-87629041	10	1.38
JIC-9617873	50	0.08
JIC-A14515	20	0.32

O-RINGS

Part Number	Min. Pkg	List Price
JIC-A17526	50	\$ 0.07
JIC-A23316	10	1.15
JIC-A27365	50	0.09
JIC-A27384	10	1.29
JIC-A27410	50	0.07
JIC-A27507	10	0.79
JIC-A27510	10	1.12
JIC-A27994	20	0.65
JIC-A28239	5	1.76
JIC-A28318	20	0.50
JIC-A29456	50	0.19
JIC-A30095	20	0.59
JIC-A30097	50	0.20
JIC-A30915	20	0.22
JIC-A47696	50	0.27
JIC-A55800	5	1.51
JIC-A60212	20	0.29
JIC-A61429	20	0.27
JIC-A7156	20	0.54
JIC-A7982	50	0.17
JIC-D26115	20	0.39
JIC-D26820	20	0.23
JIC-D27878	20	0.29
JIC-D31968	20	0.43
JIC-D36183	10	1.29
JIC-F62075	50	0.10
JIC-G100444	13	1.12
JIC-G100710	13	1.29
JIC-G100713	13	0.98
JIC-G100959	3	3.41
JIC-G10347	10	1.25
JIC-G105104	5	2.63
JIC-G105183	5	1.96
JIC-G15457	20	0.69
JIC-G46889	20	0.62
JIC-H436690	20	0.57
JIC-H743591	10	0.79
JIC-N13688	12	0.92

CASE

REPLACEMENT PARTS FOR CASE EQUIPMENT

NOTE: Case part numbers are used as a reference only. We do not imply that these kits are original REPLACEMENT PARTS.

PISTON SEALS

Part Number	Min. Pkg	List Price
JIC-S6499	20	\$ 0.29
JIC-S6573	50	0.30
JIC-T52486	19	0.47

PISTON SEALS

Part Number	Bore Diameter	List Price
JIC-D60995	2	\$ 5.69
JIC-87715781	2.52	86.87
JIC-87715782	2.77	89.72
JIC-191319A1	2-1/2	14.02
JIC-G100712	2-1/2	22.34
JIC-G102289	2-1/2	10.21
JIC-G33140	2-1/2	9.15
JIC-A61430	2-1/8	10.66
JIC-258546A2	2-3/4	17.59
JIC-G102288	3	26.62
JIC-G32034	3	15.17
JIC-H120188	3	5.25
JIC-364376A1	3	11.33
JIC-87715783	3.02	90.33
JIC-87715786	3.77	98.34
JIC-G100709	3-1/2	10.47
JIC-G102286	3-1/2	22.88

PISTON SEALS

Part Number	Bore Diameter	List Price
JIC-238799A1	3-1/2	\$ 11.33
JIC-G102287	3-1/4	23.65
JIC-192330A1	3-1/4	10.41
JIC-G1340764C1	3-3/4	23.93
JIC-G102285	4	23.65
JIC-87715787	4.02	100.49
JIC-G101994	4-1/2	25.85
JIC-182116A1	4-1/2	71.35
JIC-G110531	4-1/4	26.06
JIC-1986753C1	5	27.91
JIC-140968A1	5-1/2	17.10
JIC-87367210	5-1/2	102.74
JIC-S228607	6-1/2	43.05
JIC-1346359C1	8	48.96
JIC-LEU0096	170 mm	87.84

CASE

REPLACEMENT KITS FOR CASE EQUIPMENT

NOTE: Case part numbers are used as a reference only. We do not imply that these kits are original REPLACEMENT PARTS.

ROD BEARINGS

Part Number	Rod Diameter	List Price
JIC-G34302	1-1/2	5.78
JIC-G34621	1-3/4	5.92
JIC-G34322	2	6.33
JIC-G34307	2-1/2	11.00
JIC-336041A1	2-1/2	11.00
JIC-G34620	2-1/4	12.35
JIC-336039A1	2-1/4	12.35
JIC-S220099	2-3/4	11.80
JIC-G34313	3	13.62

U-SEALS

Part Number	Rod Diameter	List Price
JIC-G34803	1	5.26
JIC-G35372	1	4.75
JIC-D36969	1-1/2	6.21
JIC-G107921	1-1/2	11.91
JIC-1542997C1	1-1/2	11.91
JIC-D36968	1-1/4	5.50
JIC-D60999	1-1/4	5.94
JIC-1542999C1	1-3/4	13.40
JIC-D36970	1-3/4	7.07
JIC-G107922	1-3/4	8.20
JIC-H436694	1-3/8	7.65
JIC-D36971	2	7.75
JIC-G107923	2	15.38
JIC-1542931C1	2-1/2	15.94
JIC-D45571	2-1/2	10.07
JIC-1986572C1	2-1/4	8.92
JIC-D39359	2-1/4	8.92
JIC-1542929C1	2-1/4	16.36
JIC-S220100	2-3/4	10.65
JIC-1543008C1	2-3/4	16.28
JIC-D45572	3	11.16
JIC-G109054	3	16.80
JIC-1543010C1	3	16.80
JIC-A137343	3-1/2	13.12
JIC-S118038	3-1/2	43.18
JIC-1543012C1	3-1/2	18.51
JIC-G109056	4	67.37
JIC-LAU0073	120 mm	55.88

VEE SETS

Part Number	O.D.	List Price
SINGLE ACTING VEE SETS WITH NO CENTER BEARING		
JIC-G33186	3-1/4	\$ 11.99
JIC-D47205	4-1/2	29.41
JIC-D47207	5-1/2	25.82
JIC-SVS5.5P	5-1/2	25.82
JIC-D49321	6	31.05
JIC-SVS6.0P	6	31.05
DOUBLE ACTING VEE SETS WITH CENTER BEARING		
JIC-G33201	2	\$ 19.60
JIC-G33193	2-1/2	20.06
JIC-G33151	3	20.56
JIC-G33237	3-1/2	22.76
JIC-G33239	4	24.83
JIC-DTVS4.5P	4-1/2	53.59
JIC-D36906	5	69.78
JIC-D47206	5	69.78

CASE

REPLACEMENT PARTS FOR CASE EQUIPMENT

NOTE: Case part numbers are used as a reference only. We do not imply that these kits are original REPLACEMENT PARTS.

WEAR RINGS

Part Number	O.D. X Width	List Price
JIC-G102864	1-3/8 X 0.98	\$ 7.97
JIC-G102424	1-5/8 X 0.98	5.78
JIC-G102425	1-7/8 X 0.98	5.92
JIC-G103482	2 X 63/64	31.30
JIC-G100714	2-1/2 X 3/8	4.28
JIC-G34805	2-1/2 X 3/8	4.28
JIC-G101533	2-1/8 X 0.98	6.33
JIC-G101837	2-1/8 X 3/8	4.15
JIC-G34818	2-1/8 X 3/8	4.15
JIC-G105187	2-3/4 X 3/8	4.35
JIC-1346476C1	2-3/8 X 0.975	34.13
JIC-G1346476C1	2-3/8 X 0.98	4.60
JIC-G102426	2-3/8 X 1.48	12.35
JIC-G109908	2-5/8 X 0.98	4.48
JIC-G102427	2-5/8 X 1.48	11.00

WEAR RINGS

Part Number	O.D. X Width	List Price
JIC-252790A1	2-7/8 X 0.978	\$14.07
JIC-G102428	2-7/8 X 1.48	11.80
JIC-H436691	3 X 1/4	4.00
JIC-A17360	3 X 3/4	5.08
JIC-G100449	3 X 3/8	4.42
JIC-G32033	3 X 3/8	4.42
JIC-G100711	3-1/2 X 3/8	4.57
JIC-S109445	3-1/4 X 3/8	4.54
JIC-G102429	3-1/8 X 1.48	13.62
JIC-336042A1	3-1/8 X 1.480	72.10
JIC-G110677	3-3/4 X 1.490	29.46
JIC-S104133	3-3/4 X 1/2	4.65
JIC-362691A1	3-3/4 X 1/2	7.68
JIC-A17341	4 X 1	5.96
JIC-G100448	4 X 3/8	5.80

WEAR RINGS

Part Number	O.D. X Width	List Price
JIC-A63393	4 X 5/8	\$ 5.45
JIC-G101996	4-1/2 X 3/4	5.33
JIC-G110530	4-1/4 X 3/8	5.75
JIC-381100A1	4-1/8 X 1/2	11.88
JIC-446195A1	4-3/4 X 3/4	8.98
JIC-1-9854T1	5 X 0.622	5.45
JIC-G102090	5 X 3/4	5.45
JIC-1980266C1	5-1/2 X 3/4	5.56
JIC-444640A1	5-1/4 X 3/4	5.56
JIC-446196A1	5-3/4 X 3/4	14.83
JIC-S109539	6-1/2 X 1.490	26.58
JIC-S97856	6-1/2 X 1/2	6.41
JIC-LE00897	170 X 9.5 mm	21.63
JIC-LEU0098	170 X 9.7 mm	85.62

REPLACEMENT PARTS FOR CASE EQUIPMENT

NOTE: Case part numbers are used as a reference only. We do not imply that these kits are original REPLACEMENT PARTS.

WIPERS

Part Number	Rod Diameter	List Price
JIC-D60997	1	\$ 2.74
JIC-H746297	1	3.52
JIC-D27706	1-1/2	2.37
JIC-D95142	1-1/2	13.05
JIC-D27705	1-1/4	5.83
JIC-D95141	1-1/4	12.77
JIC-403845R1	1-3/4	14.10
JIC-D27432	1-3/4	5.24
JIC-D95143	1-3/4	14.10
JIC-226847A1	1-3/8	12.92
JIC-H436692	1-3/8	3.17

WIPERS

Part Number	Rod Diameter	List Price
JIC-G103481	1-7/8	14.44
JIC-D27380	2	7.23
JIC-D95144	2	14.63
JIC-403844R1	2	14.63
JIC-D95146	2-1/2	17.72
JIC-D39360	2-1/4	4.34
JIC-D43162	2-1/4	4.34
JIC-D95145	2-1/4	15.66
JIC-G108712	2-1/4	16.37
JIC-193965C91	2-3/4	20.07
JIC-D95147	2-3/4	20.07

WIPERS

Part Number	Rod Diameter	List Price
JIC-H215202	2-3/4	6.56
JIC-D95149	2-3/8	13.42
JIC-D46180	3	5.20
JIC-D95148	3	20.63
JIC-A44651	3/4	1.12
JIC-S92653	3-1/2	27.53
JIC-S97854	3-1/2	27.53
JIC-L104363	3-1/4	19.97
JIC-S108245	4	38.77
JIC-LE00958	120 mm	64.60

REPLACEMENT SEAL KITS FOR CATERPILLAR® EQUIPMENT*

Replacement Seal Kits By Machine Type

Table of Contents

▶ NEW MODELS

Machine Type		Page
Agricultural Tractors	65, 65B, 75, 65C, 65D, 70C, 65E, 69D, 73D, 75C, 75D, 75E, 75G, 85C	220
Attachments	Hydraulic Hammers	220
Backhoe Loaders	416, 416B, 416C, 416D, 416E, 420D, 420E, 420F, 422E, 422F, 424D, 426, 426B, 426C, 428, 428B, 428C, 430D, 430E, 436, 436B, 436C, 438, 438B, 438C, 446, 446B, 446D, 450E	221 - 245
Crawler Dozers	3P, 3S, 4S, 5A, 5S, 6, 6S, 7A, 7S, 7U, 7SU, 8A, 8B, 8D, 8F, 8S, 8U, 9B, 9R, 9S, 9U, D2, D3, D3 LGP, D3B, D3C, D3G, D3K XL & LGP, D4B, D4C, D4D, D4E, D4G, D4H, D4K XL & LGP, D4L, D4T SKH, D5, D5B, D5C, D5E, D5G, D5H, D5K XL & LGP, D5M, D5N, D5T SKH, D6, D6 LGP, D6B, D6C, D6D, D6E, D6G, D6H, D6K LGP, D6K XL, D6M, D6N, D6R, D6T, D7, D7 LGP, D7A, D7B, D7C, D7D, D7E, D7F, D7G, D7H, D7R, D8, D8H, D8K, D8L, D8N, D8R, D8T, D9D, D9G, D9H, D9L, D9N, D9R, D9T, D10, D10N, D10R, D10T, D11N, D11R, D11T	245 - 272
Crawler Loaders	931, 931B, 931C, 933, 933C, 933E, 933F, 933G, 935B, 935C, 939, 939C, 941, 941B, 943, 943B, 951, 951B, 951C, 953, 953B, 953C, 953D, 955, 955C, 955E, 955F, 955H, 955K, 955L, 963, 963B, 963C, 963D, 973, 973C, 977, 977D, 977H, 977K, 977L, 983	272 - 285
Dump Trucks - Articulated	725, 730, 740, D25C, D25D, D30C, D30D, D35C, D35HP, D35HPC, D40D, D250B, D250D, D250E, D300B, D300B AG, D300B CANE H, D350B, D350C, D350D, D350E, D350E, D400, D400D, D400E	285 - 291
Excavators	215, 215B, 215C, 215D, 219, 219D, 225, 225B, 225D, 227, 229, 229D, 231D, 235, 235 FS, 235B, 235C, 235C FS, 235D, 245 FS, 245, 245B, 245B FS, 245D, 302.5, 302.5C, 303 C CR, 303.5, 303.5C CR, 303CR, 304 C CR, 304.5, 304CR, 305 C CR, 305CR, 307, 307B, 307C, 308B, 308C CR, 308D CR, 308D CR SB, 311, 311B, 311C U, 312, 312B, 312BL, 312C, 312CL, 312E, 313B, 314C LCR, 315, 315B, 315B L, 315C, 315C L, 315D L, 315L, 317, 317B, 317BL, 317N, 318B, 318BL, 318C, 318C L, 318C LN, 320, 320B, 320BL, 320C, 320C L, 320C LN, 320C LRR, 320C LU, 320C S, 320C U, 320D, 320D L, 320D LN, 320D LRR, 320D RR, 320L, 320N, 320S, 321B, 321C LCR, 321D LCR, 322, 322B, 322BL, 322C, 322C FM LGP, 322C L, 322C LN, 322L, 322N, 324D L, 325, 325B, 325BL, 325C, 325C L, 325C LN, 325D, 325D L, 325D LN, 325L, 325N, 330, 330B, 330BL, 330C, 330C L, 330C LN, 330D, 330D L, 330D N, 330L, 336D, 336D L, 336D LN, 345B, 345BL, 345C, 345C L, 345D L, 350, 350L, 365, 365B, 375, 375L, E70B, E110, E110B, E120, E120B, E180, EL180, E200B, EL200B, E240, EL240, E240B, EL240B, E300, EL300, E300B, EL300B	291 - 365
Excavators - Front-Shovel	5080, 5110, 5230, 5230B	365
Excavators - Wheel	M315, M316, M318, M320	365 - 366
Forestry - Tree Harvesters	518	366
Integrated Toolcarriers	IT12, IT12B, IT12F, IT14B, IT14C, IT14F, IT14G, IT18, IT18B, IT18F, IT24F, IT28, IT28B, IT28F, IT28G, IT38F, IT38G, IT62G	366 - 372
Landfill Compactors	816, 816B, 816F, 826B, 826C, 826G, 836, 836C	372 - 373
Loaders - Skid Steer	226, 226B, 226B2, 236, 236B, 236B2, 242, 242B, 242B2, 246, 246B, 246C, 252B, 252B2, 262, 262B, 262C, 268B	373 - 383
Loaders - Wheel	902, 904, 906, 908, 910, 910E, 910F, 914, 914G, 916, 918F, 920, 924, 924F, 924G, 924Gz, 924H, 924Hz, 926, 926E, 928F, 928G, 928Hz, 930, 930G, 930H, 930R, 930T, 936, 936E, 936F, 938F, 938G, 938H, 944, 944A, 950, 950B, 950E, 950F, 950G, 950H, 960F, 960G, 962G, 966, 966A, 966B, 966C, 966D, 966E, 966F, 966G, 966H, 966R, 970F, 972G, 972H, 980, 980B, 980C, 980F, 980G, 980H, 980K, 988, 988B, 988F, 988G, 988H, 990, 992, 992B, 992C, 992D, 992G, 992K, 994D, G910, G916, G926, G936, R1300, R1300G, R1600, R1600G, R1700, R1700G	384 - 406
Motor Graders	12, 12E, 12F, 12G, 12H, 12M, 14, 14D, 140, 14E, 14G, 14H, 14M, 16, 16G, 16H, 16M, 24H, 112, 112E, 112F, 120, 120B, 120G, 120H, 130G, 135H, 140B, 140G, 140H, 143H, 160G, 160H, 163H	406 - 422
Off-Highway Trucks	768, 768B, 768C, 769, 769B, 769C, 769D, 770, 771C, 771D, 772, 772B, 772E, 773, 773B, 773D, 773E, 773F, 775, 775B, 775D, 775E, 776, 776B, 776C, 776D, 777, 777B, 777C, 777D, 777F, 783B, 784B, 784C, 785, 785B, 785C, 786, 787B, 789, 789B, 789C, 793, 793B, 793C, 793D	422 - 431
Pipelayers	561B, 561C, 561D, 571A, 571F, 571G, 572C, 572D, 572E, 572F, 572G, 578, 583, 583H, 583K, 583R, 589, 591, 594, 594H, MD7, MD8, MDW8	431 - 432
Scrapers	611, 613, 613B, 613C, 613SC, 615, 615C, 615SC, 621, 621B, 621E, 621F, 621G, 621R, 621S, 621SC, 623, 623B, 623E, 623F, 623G, 623SC, 623SCG, 627, 627B, 627E, 627F, 627G, 627SC, 630, 630B, 630SC, 631, 631B, 631C, 631D, 631E, 631SC, 632, 633, 633B, 633C, 633D, 633SC, 637, 637B, 637D, 637E, 637SC, 639D, 639SC, 641, 641B, 641SC, 650, 650B, 651, 651B, 651C, 651E, 651SC, 657, 657B, 657E, 657SC, 660, 660B, 660SC, 666SC, 666, 666B, J621	432 - 450
Skidders	508, 515, 525, 517, 518, 518C, 520D, 522C, 520C, 525B, 527, 528, 528B, 530B, 535B, 545, FB508, FB518	450 - 452
Soil Compactors	815, 815B, 815F, 815S, 825, 825B, 825C, 825G, 835	452 - 453
Telehandlers	TH62, TH63, TH82, TH83, TH355B, TH360B	453 - 455
Wheel Dozers	814, 814B, 814F, 814S, 824, 824B, 824C, 824S, 834S, 834U, 830M, 834, 834B, 834C	455 - 458
Alpha-Numeric Kit Listing		459 - 480
Caterpillar® Individual Parts		481 - 507

*All manufacturer's names, part numbers and descriptions are used for reference purposes only. We do not imply that any part shown is the product of these manufacturers. We also do not imply that the list price shown is exactly that of the manufacturer.

REPLACEMENT KITS FOR CATERPILLAR® EQUIPMENT

Agricultural Tractors							
APPLICATION	CYL #	Misc-Parts, Instructions, etc.	CODE	ROD	BORE	KIT #	List \$
MODEL 65, 65B, 75							
LIFT							
	9T2230		P-UB-10	2	4	CTC-1328816	96.00
	9T9517		P-UB-10	2	4	CTC-1328816	96.00
MODEL 65C, 65D, 70C							
LIFT							
	9T9517		P-UB-10	2	4	CTC-1328816	96.00
MODEL 65E							
LIFT							
	9T9517		P-UB-10	2	4	CTC-1328816	96.00
MODEL 69D							
STEERING							
	1100532		P-UB-10	2	3	CTC-7X2760	72.94
	9J1287		P-UB-10	2-3/8	3-3/4	CTC-7X2808	83.46
TENSIONER							
	4T4168		I-SP-10	4,6-1/2	5-3/4	CTC-8T4772	325.54
	9J4149		I-SP-10	4,6-1/2	5-3/4	CTC-8T4772	325.54
MODEL 73D							
LIFT							
	1163092		P-UB-3	7	8	CTC-1137478	678.46
STEERING RH							
	7J7686		P-UB-10	2-3/8	4	CTC-8T1389	49.28
TENSIONER							
	1455155		I-SP-10	5,7-1/2	8-1/4	CTC-8T9042	471.07
	9J2017		I-SP-10	5,7-1/2	8-1/4	CTC-8T9042	471.07
	9T3122		I-SP-10	5,7-1/2	8-1/4	CTC-8T9042	471.07
UNSPECIFIED APPLICATION							
	1162837		P-U-3	7	8-1/2	CTC-1417296	282.88
	1U4777		P-UB-3	7	8	CTC-1137478	678.46
	9T6081		P-U-3	7	8-1/2	CTC-1417296	282.88
	9T7204		N-N-10		2	CTC-6E4057	22.14
MODEL 75C							
LIFT							
	9T9517		P-UB-10	2	4	CTC-1328816	96.00
MODEL 75D, 75E, 75G, 85C							
LIFT							
	9T9517		P-UB-10	2	4	CTC-1328816	96.00
Attachments							
APPLICATION	CYL #	Misc-Parts, Instructions, etc.	CODE	ROD	BORE	KIT #	List \$
MODEL Hydraulic Hammers							
63							
	4GL1-121						
			I-U-1	63 mm		CTC-1094745	114.25
H63							
	4GL122-						
			I-U-1	63 mm		CTC-1094745	114.25
H63S							
	4GL122-						
			I-U-1	63 mm		CTC-1094745	114.25
H90C							
	6TZ1-						
			I-U-1	80 mm		CTC-1508828	242.54
H90CS							
	6TZ1-						
			I-U-1	80 mm		CTC-1508828	242.54

REPLACEMENT KITS FOR CATERPILLAR® EQUIPMENT

Backhoe Loaders							
APPLICATION	CYL #	Misc-Parts, Instructions, etc.	CODE	ROD	BORE	KIT #	List \$
MODEL 416							
BACKHOE BOOM							
	4T6878		P-UB-10	1-7/8	3-1/4	CTC-8T3589	83.64
	6E0087		P-UB-10	1-7/8	3-1/4	CTC-3E3297	102.01
	9T5219		P-UB-10	1-7/8	3-1/4	CTC-3E3297	102.01
BACKHOE BUCKET							
	4T5601		P-UB-10	2	3-1/4	CTC-7X2821	145.01
	6E0091		I-UB-10	2-1/2	3-1/2	CTC-3E3299	138.77
	9T2751		P-UB-10	2	3-1/4	CTC-7X2821	145.01
	9T7287		I-UB-10	2-1/2	3-1/2	CTC-3E3299	138.77
	9T7893		P-UB-10	2	3-1/4	CTC-7X2821	145.01
	9T7894		P-UB-10	2	3-1/4	CTC-7X2821	145.01
BACKHOE EXT STICK							
	9T2215		P-UB-10	1-1/2	3	CTC-7X2745	112.40
	9T4809		P-UB-10	1-1/2	3	CTC-7X2737	112.40
	9T7893		P-UB-10	2	3-1/4	CTC-7X2821	145.01
BACKHOE STICK							
	4T6877		P-UB-10	2-1/8	4	CTC-1305923	164.08
	6E0089		P-UB-10	2-1/2	4-1/4	CTC-3E3300	111.23
	9T2215		P-UB-10	1-1/2	3	CTC-7X2737	112.40
	9T5216		P-UB-10	2-1/8	4	CTC-1305923	164.08
	9T7063		P-UB-10	2-1/8	4	CTC-1305923	164.08
	9T7291		P-UB-10	2-1/2	4-1/4	CTC-3E3300	111.23
BACKHOE SWING							
	4T6879		P-UB-10	2-1/8	4	CTC-1305923	164.08
	6E0093		P-UB-10	2-1/8	4	CTC-1305923	164.08
BACKHOE SWING LH							
	4T6879		P-UB-10	2-1/8	4	CTC-8T3593	73.47
BACKHOE SWING RH							
	9T0529		P-UB-10	2-1/8	4	CTC-1305923	164.08
LOADER BUCKET MP							
	9T4006		P-UB-10	1-1/2	3	CTC-7X2737	112.40
LOADER LIFT							
	6E0103		P-UB-10	1-7/8	3-1/4	CTC-3E3297	102.01
	9T0415		P-UB-10	1-7/8	3-1/4	CTC-3E3297	102.01
LOADER TILT							
	6E0105		P-UB-10	1-7/8	3-1/4	CTC-3E3297	102.01
	9T0414		P-UB-10	1-7/8	3-1/4	CTC-8T3589	83.64
	9T4005		P-UB-10	1-7/8	3-1/4	CTC-3E3297	102.01
	9T5370		P-UB-10	1-7/8	3-1/4	CTC-3E3297	102.01
STABILIZER							
	9T7070		P-UB-10	2-1/8	4	CTC-8T3593	73.47
	9T7391		P-UB-10	2-1/8	4	CTC-1305923	164.08
	9T7392		P-UB-10	2-1/8	4	CTC-1305923	164.08
STABILIZER LH							
	4T9911		P-UB-10	2-1/8	4	CTC-1305923	164.08
	6E0097		P-UB-10	2-1/8	4	CTC-1305923	164.08
	9T7070		P-UB-10	2-1/8	4	CTC-1305923	164.08
STABILIZER RH							
	4T6880		P-UB-10	2-1/8	4	CTC-1305923	164.08
	6E0099		P-UB-10	2-1/8	4	CTC-1305923	164.08
	9T7069		P-UB-10	2-1/8	4	CTC-1305923	164.08
STEERING							
	6E5190		P-UB-10	1-7/8	3	CTC-1113301	135.59
	9T1493		P-UB-10	1-7/8	3	CTC-8T3852	199.65

REPLACEMENT KITS FOR CATERPILLAR® EQUIPMENT

Backhoe Loaders							
APPLICATION	CYL #	Misc-Parts, Instructions, etc.	CODE	ROD	BORE	KIT #	List \$
MODEL 416							
UNSPECIFIED APPLICATION							
	1070624		P-UB-10	1-7/8	3-1/4	CTC-3E3297	102.01
	1070625		P-UB-10	1-7/8	3-1/4	CTC-3E3297	102.01
MODEL 416B							
BACKHOE BOOM							
	6E0274		P-UB-10	2-3/8	4-1/2	CTC-3E8877	183.90
BACKHOE BUCKET							
	1268308		I-UB-10	2-1/2	3-1/2	CTC-3E3299	138.77
	6E0275		I-UB-10	2-1/2	3-1/2	CTC-3E3299	138.77
BACKHOE EXT BUCKET							
	6E1964		I-UB-10	2-1/2	3-1/2	CTC-3E3299	138.77
BACKHOE STICK							
	1065694	Rod Bearing width- 1.25"	P-UB-10	2-1/2	4-1/2	CTC-1469860	166.90
	1097020		P-UB-10	2-1/2	4-1/2	CTC-1113300	141.35
	1097021		P-UB-10	2-1/2	4-1/2	CTC-1113300	141.35
	6E0290	Rod Bearing width- 1.25"	P-UB-10	2-1/2	4-1/2	CTC-1469860	166.90
	6E0404		P-UB-10	1-1/2	3	CTC-7X2737	112.40
BACKHOE SWING							
	1166861		P-UB-10	2	4	CTC-1113302	123.12
	6E0288		P-UB-10	2	4	CTC-1113302	123.12
	6E1864		P-UB-10	2	4	CTC-1328816	96.00
LOADER BUCKET MP							
	9T4006		P-UB-10	1-1/2	3	CTC-7X2737	112.40
LOADER LIFT							
	9T0415		P-UB-10	1-7/8	3-1/4	CTC-3E3297	102.01
LOADER TILT							
	6E0105		P-UB-10	1-7/8	3-1/4	CTC-3E3297	102.01
	9T5490		P-UB-10	1-7/8	3-1/4	CTC-3E3297	102.01
STABILIZER							
	1052323		P-UB-10	2-1/8	4	CTC-1305923	164.08
	1052358		P-UB-10	2-1/8	4	CTC-1305923	164.08
	9T2993		P-UB-10	2-1/8	4	CTC-9X2400	123.33
	9T2994		P-UB-10	2-1/8	4	CTC-9X2400	123.33
STABILIZER LH							
	1165354		P-UB-10	2-1/8	4	CTC-8T3593	73.47
	1302364		P-UB-10	2-1/8	4	CTC-1305923	164.08
	6E0097		P-UB-10	2-1/8	4	CTC-1305923	164.08
STABILIZER RH							
	1165353		P-UB-10	2-1/8	4	CTC-1305923	164.08
	1302365		P-UB-10	2-1/8	4	CTC-1305923	164.08
	6E0099		P-UB-10	2-1/8	4	CTC-1305923	164.08
STEERING							
	6E5190		P-UB-10	1-7/8	3	CTC-1113301	135.59
UNSPECIFIED APPLICATION							
	1070624		P-UB-10	1-7/8	3-1/4	CTC-3E3297	102.01
	1070625		P-UB-10	1-7/8	3-1/4	CTC-3E3297	102.01
	1165354		P-UB-10	2-1/8	4	CTC-1305923	164.08
MODEL 416C							
BACKHOE BOOM							
	6E0274		P-UB-10	2-3/8	4-1/2	CTC-3E8877	183.90
	1AR1-UP; 1BR1-UP; 1KR1-UP; 1LR1-UP; 1WR1-8115; 1XR1-415,684-2183; 4ZN1-16043; 5YN1-15147						
	6E0274		P-UB-10	2-3/8	4-1/2	CTC-1945583	84.49
BACKHOE BUCKET							
	1268308		I-UB-10	2-1/2	3-1/2	CTC-3E3299	138.77
	1AR1-UP; 1BR1-UP; 1KR1-UP; 1LR1-UP; 1WR1-UP; 1XR1-2249; 4ZN1-UP; 5YN1-16589						
	1268308		I-UB-10	2-1/2	3-1/2	CTC-1864327	72.09

REPLACEMENT KITS FOR CATERPILLAR® EQUIPMENT

Backhoe Loaders							
APPLICATION	CYL #	Misc-Parts, Instructions, etc.	CODE	ROD	BORE	KIT #	List \$
MODEL 416C							
BACKHOE BUCKET							
1XR2250-UP; 5YN16590-UP							
1668140			I-UB-10	2-3/4	3-3/4	CTC-1361990	179.98
BACKHOE EXT BUCKET							
6E1964			I-UB-10	2-1/2	3-1/2	CTC-3E3299	138.77
1AR1-UP; 1BR1-UP; 1KR1-UP; 1LR1-UP; 1WR1-UP; 1XR1-2249; 4ZN1-UP; 5YN1-16589							
6E1964			I-UB-10	2-1/2	3-1/2	CTC-1864327	72.09
1XR2250-UP; 5YN16590-UP							
1668141			I-UB-10	2-3/4	3-3/4	CTC-1361990	179.98
BACKHOE EXT STICK							
1AR1-UP; 1BR1-UP; 1KR1-UP; 1LR1-UP; 1WR1-8115; 1XR1-UP; 4ZN1-16043; 5YN1-16589							
6E0404			P-UB-10	1-1/2	3	CTC-1856583	47.40
1WR8116-UP; 1XR2184-UP; 4ZN16044-UP; 5YN16590-UP							
1647174			P-UB-10	1-1/2	3	CTC-1856583	47.40
BACKHOE STICK							
1097020			P-UB-10	2-1/2	4-1/2	CTC-1113300	141.35
6E0404			P-UB-10	1-1/2	3	CTC-7X2737	112.40
1AR1-UP; 1BR1-UP; 1KR1-UP; 1LR1-UP; 1WR1-UP; 1XR1-2183; 4ZN1-16043; 5YN1-15147							
1097020			P-UB-10	2-1/2	4-1/2	CTC-1113300	141.35
1WR10495-UP; 1XR2258-UP; 4ZN16044-UP; 5YN16590-UP							
1843709			P-UB-10	2-1/2	4-1/2	CTC-2435805	76.11
1WR8116-UP; 1XR2184-UP; 4ZN16044-UP; 5YN15148-UP							
1692967			P-UB-10	2-1/2	4-1/2	CTC-1864362	75.60
BACKHOE SWING							
1166857			P-UB-10	2	4	CTC-1113302	123.12
1AR1-UP; 1BR1-438; 1BR649-UP; 1KR1-UP; 1LR1-UP; 1WR1-UP; 1XR1-2183; 4ZN1-16043; 5YN1-15147							
1166861			P-UB-10	2	4	CTC-1857686	94.41
1WR8116-UP; 1XR2184-UP; 4ZN16044-UP; 5YN15360-UP							
1699529			P-UB-10	2	4	CTC-1113302	123.12
COUPLER							
1KR1-UP; 1LR1-UP; 1WR1-UP; 1XR1-UP							
9T8823			I-O-3	1	2	CTC-9T0418	85.89
1WR8116-UP							
1783713			I-U-10	1	2	CTC-1809872	122.04
LOADER BUCKET MP							
9T4006			P-UB-10	1-1/2	3	CTC-7X2737	112.40
1AR1-UP; 1BR1-UP; 1KR1-UP; 1LR1-UP; 1WR1-UP; 1XR1-UP; 4ZN16044-UP; 5YN1-15147; 5YN16590-UP							
1851839			P-UB-10	1-1/2	3	CTC-1856583	47.40
1AR1-UP; 1BR1-UP; 1KR1-UP; 1LR1-UP; 1WR1-UP; 1XR1-UP; 4ZN1-UP; 5YN1-UP							
9T4006			P-UB-10	1-1/2	3	CTC-1856583	47.40
1XR2250-UP							
9T4006			P-UB-10	1-1/2	3	CTC-7X2737	112.40
LOADER LIFT							
1AR1-UP; 1BR1-UP; 4ZN1-16043; 5YN1-15147							
6E0103			P-UB-10	1-7/8	3-1/4	CTC-1933088	90.67
9T0415			P-UB-10	1-7/8	3-1/4	CTC-1933088	90.67
1AR1-UP; 1BR1-UP; 4ZN1-UP; 5YN1-UP							
1070624			P-UB-10	1-7/8	3-1/4	CTC-1933088	90.67
1KR1-UP; 1WR1-UP							
1235087			P-UB-10	2	3-1/2	CTC-2281778	80.42
1LR1-UP; 1XR1-UP							
1110888			P-UB-10	2	3-1/2	CTC-1857674	119.55
1235089			P-UB-10	2	3-1/2	CTC-1857674	119.55
LOADER TILT							
6E0105			P-UB-10	1-7/8	3-1/4	CTC-3E3297	102.01

REPLACEMENT KITS FOR CATERPILLAR® EQUIPMENT

Backhoe Loaders							
APPLICATION	CYL #	Misc-Parts, Instructions, etc.	CODE	ROD	BORE	KIT #	List \$
MODEL 416C							
LOADER TILT							
1AR1-UP; 1BR1-648; 4ZN1-16043; 5YN1-3799							
6E0105			P-UB-10	1-7/8	3-1/4	CTC-1933088	90.67
9T5370			P-UB-10	1-7/8	3-1/4	CTC-1933088	90.67
1AR1-UP; 1BR1-UP; 4ZN1-UP; 5YN1-UP							
1070625			P-UB-10	1-7/8	3-1/4	CTC-1933088	90.67
1KR1-UP; 1LR1-UP; 1WR1-UP; 1XR1-UP							
1235091			P-UB-10	2	3	CTC-1857667	87.64
1WR9975-UP; 1XR2250-UP							
1835158			P-UB-10	2	3	CTC-1857667	87.64
STABILIZER							
1AR1-UP; 1BR1-UP; 1KR1-UP; 1LR1-UP; 1WR1-UP; 1XR1-2183; 4ZN1-16043; 5YN1-15147							
1311846			P-UB-10	2-1/8	4	CTC-1935431	90.67
1311847			P-UB-10	2-1/8	4	CTC-1935431	90.67
1WR8116-9103; 1XR2184-2249; 4ZN16044-UP; 5YN15148-16589							
1521806			P-UB-10	2-1/8	4	CTC-1864404	103.09
1WR8116-UP; 1XR2184-2249; 4ZN16044-UP; 5YN15148-16589							
1521796			P-UB-10	2-1/8	4	CTC-1864404	103.09
1WR8442-UP; 1XR2184-UP; 4ZN16044-UP; 5YN15148-UP							
1731926			P-UB-10	2-1/8	4	CTC-1864404	103.09
1731927			P-UB-10	2-1/8	4	CTC-1864404	103.09
STABILIZER LH							
1311846			P-UB-10	2-1/8	4	CTC-1305923	164.08
1521806			P-UB-10	2-1/8	4	CTC-1305923	164.08
STABILIZER RH							
1311847			P-UB-10	2-1/8	4	CTC-1305923	164.08
1521796			P-UB-10	2-1/8	4	CTC-1305923	164.08
STEERING							
1156437			P-UB-10	1-3/4	2-1/2	CTC-1539054	149.34
UNSPECIFIED APPLICATION							
1070624			P-UB-10	1-7/8	3-1/4	CTC-3E3297	102.01
1070625			P-UB-10	1-7/8	3-1/4	CTC-3E3297	102.01
1235087			P-UB-10	2	3-1/2	CTC-7X2783	106.57
1235091			P-UB-10	2	3	CTC-7X2760	72.94
9T8823			I-O-3	1	2	CTC-9T0418	85.89
MODEL 416D							
BACKHOE BOOM							
BFP1-2532; BGJ1-UP; BKG1-537							
6E0274			P-UB-10	2-3/8	4-1/2	CTC-6E0274K	84.49
BFP1-5177							
2063630			P-UB-10	2-3/8	4-3/4	CTC-2350973	103.48
BFP1-UP; BGJ1-UP; BKG1-UP; B2D1-UP							
2063628			P-UB-10	2-3/8	4-1/2	CTC-2063628K	65.96
BFP2533-5177; BGJ1-UP; BKG1-734							
1917753			P-UB-10	2-3/8	4-1/2	CTC-2616885	82.09
BACKHOE BUCKET							
BFP1-5177; BGJ1-522; BKG1-1523							
1804849			I-UB-10	2-1/2	3-1/2	CTC-2235945	68.58
BFP1-5177; BGJ1-522; BKG1-UP							
1804239			I-UB-10	2-1/2	3-1/2	CTC-2235945	68.58
BFP1-UP; BGJ1-UP; BKG1300-UP; B2D1-UP							
2060514			I-UB-10	2-1/2	3-1/2	CTC-2235945	68.58
2060518			I-UB-10	2-1/2	3-1/2	CTC-2235945	68.58
BGJ1050-UP							
1917839			I-UB-10	2-3/4	3-3/4	CTC-1917839K	83.43

REPLACEMENT KITS FOR CATERPILLAR® EQUIPMENT

Backhoe Loaders							
APPLICATION	CYL #	Misc-Parts, Instructions, etc.	CODE	ROD	BORE	KIT #	List \$
MODEL 416D							
BACKHOE EXT STICK							
BFP1-5177; BGJ1-408; BKG1-UP; B2D1-UP							
1647174			P-UB-10	1-1/2	3	CTC-1856583	47.40
BFP5178-UP; BGJ409-UP							
1917725			P-UB-10	1-1/2	3	CTC-1917725K	42.93
BACKHOE STICK							
BFP1-5177; BGJ1-1049; BKG1-777							
1843709			P-UB-10	2-1/2	4-1/2	CTC-2435805	76.11
BFP2533-5177; BGJ1-1049; BKG777-2499							
2060503			P-UB-10	2-1/2	4-1/2	CTC-2297194	57.10
BFP5178-UP; BGJ1-UP; BKG2500-UP; B2D1-UP							
2359829			P-UB-10	2-1/2	4-1/2	CTC-2297194	57.10
LOADER BUCKET MP							
BFP12900-UP							
2265540			I-U-10	1-1/2	3	CTC-2309357	57.37
BFP1-UP; BGJ1-UP; BKG1-UP; CXP940-UP; B2D1-UP							
1851839			P-UB-10	1-1/2	3	CTC-2350354	35.56
LOADER LIFT							
BFP1-2491; BGJ1-UP							
1070624			P-UB-10	1-7/8	3-1/4	CTC-2465926	45.75
BFP12900-UP; BGJ1050-1140							
2300979			P-U-10	1-7/8	3-1/4	CTC-2332628	143.42
BFP1-UP; CXP1-UP; BGJ1-1049; BGJ1141-UP; BKG1-UP; B2D1-UP							
2063549			P-UB-10	1-7/8	3-1/4	CTC-2094979	46.76
BFP2492-5177; BGJ1-522; BKG1-776; CXP1-939							
1917843			P-UB-10	1-7/8	3-1/4	CTC-2094979	46.76
LOADER TILT							
BFP1-2491; BGJ1-522							
1851851			P-UB-10	1-7/8	3-1/4	CTC-1851851K	45.85
BFP1-UP; CXP1-UP; BGJ1-UP; BKG1-UP; B2D1-UP							
2063553			P-UB-10	1-7/8	3-1/4	CTC-2094979	46.76
BFP2492-5177; BGJ1-522; BKG1-1299; CXP1-939							
1924128			P-UB-10	1-7/8	3-1/4	CTC-2094979	46.76
STABILIZER							
B2D267-UP							
2627050			P-UB-10	55 mm	100 mm	CTC-2332623	112.07
BFP13748-UP; BGJ1141-UP; B2D267-UP							
2283499			P-UB-10	55 mm	100 mm	CTC-2332623	112.07
BFP13793-UP; BGJ1141-UP; B2D267-UP							
2283500			P-UB-10	55 mm	100 mm	CTC-2332623	112.07
BFP1-5177; BGJ1-1049; BKG1-776							
1807484			P-UB-10	2-1/8	4	CTC-2857486	84.29
1807485			P-UB-10	2-1/8	4	CTC-2857486	84.29
BFP1-UP; BGJ1-1140; BKG1-UP; B2D1-266							
2060520			P-UB-10	2-1/8	4	CTC-2857486	84.29
2060522			P-UB-10	2-1/8	4	CTC-2857486	84.29
STEERING							
BFP1-12899; BGJ1-1049; BKG1-UP							
1674235			P-UB-10	1-3/4	2-3/4	CTC-2350351	150.09
1674235			P-UB-10	1-3/4	2-3/4	CTC-2350352	104.18
BFP1-9559; BGJ1-1049; CXP1-399							
1787190			I-U-10	36 mm	65 mm	CTC-1787189	228.22
SWING							
BFP1-2461; BGJ1-1049							
1699529			P-UB-10	2	4	CTC-1699529K	75.20

REPLACEMENT KITS FOR CATERPILLAR® EQUIPMENT

Backhoe Loaders							
APPLICATION	CYL #	Misc-Parts, Instructions, etc.	CODE	ROD	BORE	KIT #	List \$
MODEL 416D							
SWING							
BFP13793-UP; BGJ1141-UP; B2D267-UP							
2283506			P-UB-10	50 mm	100 mm	CTC-2332622	64.40
BFP2492-UP; BGJ1-1140; BKG1-UP; B2D1-UP							
1918161			P-UB-10	2	4	CTC-1918161K	48.39
THUMB							
BFP12900-UP							
2754243			I-U-10	50 mm	70 mm	CTC-2764172	48.63
MODEL 416E							
BACKHOE BOOM							
BWC1-UP; CBD1-UP; SHA1-UP							
2107074			P-UB-10	2-1/4	4-1/2	CTC-2959891	65.66
BWC1-UP; SHA1-UP							
2469885			P-UB-10	2-1/4	4-1/2	CTC-2469885K	63.36
BACKHOE BUCKET							
BWC1-UP; CBD1-UP; SHA1-UP							
2107086			I-UB-10	2-3/8	85 mm	CTC-2107086K	72.55
BWC1-UP; SHA1-UP							
2107085			I-UB-10	2-3/8	85 mm	CTC-2107085K	61.54
CBD1-UP							
2107088			I-UB-10	2-1/2	3-1/2	CTC-3387038	34.71
BACKHOE EXT STICK							
BWC1-UP; CBD1-UP; SHA1-UP							
2107098			P-UB-10	1-1/2	3	CTC-2107098K	39.63
BWC1-UP; SHA1-UP							
2107097			P-UB-10	1-1/2	3	CTC-3387156	42.08
BACKHOE STICK							
BWC1-UP; CBD1-UP; SHA1-UP							
2107078			P-UB-10	2-1/4	4-1/4	CTC-3809470	58.20
BWC1-UP; SHA1-UP							
2107077			P-UB-10	2-1/4	4-1/4	CTC-2107077K	60.66
GRAPPLE							
CBD1-UP; SHA1-UP							
2754243			I-U-10	50 mm	70 mm	CTC-2764172	48.63
LOADER BUCKET MP							
BWC1-UP; CBD1-UP; SHA1-UP							
2265540			I-U-10	1-1/2	3	CTC-2309357	57.37
CBD1-UP							
1851839			P-UB-10	1-1/2	3	CTC-2350354	35.56
LOADER LIFT							
BWC1-UP; CBD1-UP; SHA1-UP							
2283508			P-U-10	1-7/8	3-1/4	CTC-2332628	143.42
LOADER TILT							
BWC1-UP; CBD1-UP; SHA1-UP							
2063553			P-UB-10	1-7/8	3-1/4	CTC-2063553K	46.51
STABILIZER							
BWC1-UP; CBD1-5744; SHA1-UP							
2627049			P-UB-10	55 mm	100 mm	CTC-2332623	112.07
2627050			P-UB-10	55 mm	100 mm	CTC-2332623	112.07
SWING							
BWC1-UP; CBD1-5744; SHA1-UP							
2781971			P-UB-10	50 mm	100 mm	CTC-2332622	64.40
MODEL 420D							
BACKHOE BOOM							
1529148			P-UB-10	2-3/8	4-3/4	CTC-2350973	103.48

REPLACEMENT KITS FOR CATERPILLAR® EQUIPMENT

Backhoe Loaders							
APPLICATION	CYL #	Misc-Parts, Instructions, etc.	CODE	ROD	BORE	KIT #	List \$
MODEL 420D							
BACKHOE BOOM							
BKC1-501; BLN1-1832; BMC1-610; FDP1-3137							
1529148			P-UB-10	2-3/8	4-3/4	CTC-2350973	103.48
BKC1-501; BLN1833-4543; BMC1-610; FDP3138-7198							
1917846			P-UB-10	2-3/8	4-3/4	CTC-1917846K	103.99
BKC1-UP; BLN1833-UP; BMC1-UP; FDP7199-UP; MBH1-UP							
2063630			P-UB-10	2-3/8	4-3/4	CTC-2350973	103.48
BACKHOE BUCKET							
1668140			I-UB-10	2-3/4	3-3/4	CTC-2235944	82.00
BKC1-501; BLN1-4543; BMC1-610; FDP1-7198							
1668140			I-UB-10	2-3/4	3-3/4	CTC-2235944	82.00
BKC1-UP; BLN1-UP; BMC1-UP; FDP1-UP							
1917839			I-UB-10	2-3/4	3-3/4	CTC-1917839K	83.43
BKC1-UP; BLN1-UP; BMC1-UP; FDP1-UP; MBH1-UP							
1917835			I-UB-10	2-3/4	3-3/4	CTC-1917835K	83.39
BLN1-4543; FDP1-7198							
1668141			I-UB-10	2-3/4	3-3/4	CTC-1668141K	82.66
BACKHOE EXT BUCKET							
1668141			I-UB-10	2-3/4	3-3/4	CTC-2235944	82.00
BACKHOE EXT STICK							
1647174			P-UB-10	1-1/2	3	CTC-2350354	35.56
BKC1-401; BLN1-4543; BMC1-506; FDP1-7198							
1647174			P-UB-10	1-1/2	3	CTC-1647174K	53.47
BKC402-UP; BLN4544-UP; BMC507-UP; FDP7199-UP							
1917725			P-UB-10	1-1/2	3	CTC-1917725K	42.93
BACKHOE STICK							
1843709			P-UB-10	2-1/2	4-1/2	CTC-2435805	76.11
BKC1-501; BLN1-4543; BMC1-610; FDP1-7198							
1843709			P-UB-10	2-1/2	4-1/2	CTC-2435805	76.11
BKC1-919; BLN1833-10299; BMC1-1059; FDP7199-18399							
2060503			P-UB-10	2-1/2	4-1/2	CTC-2060503K	57.10
BKC502-UP; BLN8014-UP; BMC1-UP; FDP10193-UP; MBH1-UP							
2359829			P-UB-10	2-1/2	4-1/2	CTC-2359829K	57.07
BACKHOE SWING							
1699529			P-UB-10	2	4	CTC-1113302	123.12
COUPLER							
BLN1-UP; MBH1-UP							
1783713			I-U-10	1	2	CTC-1809872	122.04
GRAPPLE							
BLN10300-UP; FDP18400-UP							
2754243			I-U-10	50 mm	70 mm	CTC-2764172	48.63
LOADER BUCKET MP							
1851839			P-UB-10	1-1/2	3	CTC-2350354	35.56
BKC1-UP; BLN1-UP; BMC1-UP; FDP1-UP; MBH1-UP							
1851839			P-UB-10	1-1/2	3	CTC-2350354	35.56
FDP18400-UP; MBH1-UP							
2265540			I-U-10	1-1/2	3	CTC-2309357	57.37
LOADER LIFT							
1807490			P-UB-10	2	85 mm	CTC-2410110	127.72
1832856			P-UB-10	2	85 mm	CTC-2410110	127.72
BKC1-501; FDP1-7198							
1832856			P-UB-10	2	85 mm	CTC-2410110	127.72
BKC1-UP; FDP7199-18399							
1964523			P-UB-10	2	85 mm	CTC-1964523K	143.37
BLN10300-UP; MBH1-UP							
2283505			P-U-10	50 mm	85 mm	CTC-2432276	85.95

REPLACEMENT KITS FOR CATERPILLAR® EQUIPMENT

Backhoe Loaders							
APPLICATION	CYL #	Misc-Parts, Instructions, etc.	CODE	ROD	BORE	KIT #	List \$
MODEL 420D							
LOADER LIFT							
BLN1-4543; BMC1-610							
1807490			P-UB-10	2	85 mm	CTC-1807490K	143.42
BLN1833-4543; BLN4544-10299; BMC1-UP							
1923791			P-UB-10	2	85 mm	CTC-1923791K	142.91
FDP18400-UP							
2300980			P-U-10	50 mm	85 mm	CTC-2432276	85.95
LOADER TILT							
1807482			P-UB-10	2	85 mm	CTC-2410110	127.72
1832848			P-UB-10	2	75 mm	CTC-2410109	94.44
BKC1-501; FDP1-7198							
1807482			P-UB-10	2	85 mm	CTC-1807482K	143.42
BKC1-501; FDP3138-7198							
1924110			P-UB-10	2	85 mm	CTC-1924110K	143.33
BKC1-919; FDP7450-UP							
2007128			P-UB-10	2	4	CTC-2618625	48.43
BKC1-UP; FDP7199-7449							
2063555			P-UB-10	2	85 mm	CTC-2063555K	143.37
BLN1-4543; BMC1-610							
1832848			P-UB-10	2	75 mm	CTC-2410109	94.44
BLN1833-UP; BMC1-UP; MBH1-UP							
1923884			P-UB-10	2	75 mm	CTC-1923884K	70.96
STABILIZER							
BKC1-501; BLN1-4543; BMC1-610; FDP1-7198							
1807484			P-UB-10	2-1/8	4	CTC-2857486	84.29
1807485			P-UB-10	2-1/8	4	CTC-2857486	84.29
BKC1-920; BLN1833-11017; BMC1-1063; FDP7199-20367							
2060520			P-UB-10	2-1/8	4	CTC-2857486	84.29
BKC1-920; BLN1833-11017; BMC1-1063; FDP7199-20477							
2060522			P-UB-10	2-1/8	4	CTC-2857486	84.29
BKC921-UP; BLN11018-UP; BMC1064-UP; FDP20368-UP; MBH1-UP							
2283499			P-UB-10	55 mm	100 mm	CTC-2332623	112.07
BKC921-UP; BLN11018-UP; BMC1064-UP; FDP20478-UP; MBH1-UP							
2283500			P-UB-10	55 mm	100 mm	CTC-2332623	112.07
STEERING							
1674235	ENG 03-UP		P-UB-10	1-3/4	2-3/4	CTC-2350351	150.09
1674235	ENG 00-02		P-UB-10	1-3/4	2-3/4	CTC-2350352	104.18
SWING							
BKC1-501; BLN1-1832; BMC1-610; FDP1-3137							
1699529			P-UB-10	2	4	CTC-1699529K	75.20
BKC1-920; BLN1833-11084; BMC1-1063; FDP3138-20480							
1918161			P-UB-10	2	4	CTC-1918161K	48.39
BKC921-UP; BLN11085-UP; BMC1064-UP; FDP20481-UP; MBH1-UP							
2283506			P-UB-10	50 mm	100 mm	CTC-2332622	64.40
MODEL 420E							
BACKHOE BOOM							
GAN1-UP; HLS1-UP; KMW1-UP; PHC1-UP; PRA1-UP							
2107076			P-UB-10	2-3/8	4-3/4	CTC-2107076K	105.10
HLS1-UP; KMW1-UP; PHC1-UP; PRA1-UP							
2689049			P-UB-10	2-3/8	4-3/4	CTC-2689049K	107.53
BACKHOE BUCKET							
GAN1-UP; HLS1-UP; KMW1-UP; PHC1-UP; PRA1-UP							
2107088			I-UB-10	2-1/2	3-1/2	CTC-3387038	34.71
HLS1-UP; KMW1-UP; PHC1-UP; PRA1-UP							
2107087			I-UB-10	2-1/2	3-1/2	CTC-2107087K	37.50

REPLACEMENT KITS FOR CATERPILLAR® EQUIPMENT

Backhoe Loaders							
APPLICATION	CYL #	Misc-Parts, Instructions, etc.	CODE	ROD	BORE	KIT #	List \$
NEW MODEL 420E							
BACKHOE EXT STICK							
	HLS1-UP; KMW1-UP; PHC1-UP; PRA1-UP						
	2107097		P-UB-10	1-1/2	3	CTC-3387156	42.08
	2107098		P-UB-10	1-1/2	3	CTC-2107098K	39.63
BACKHOE STICK							
	GAN1-UP; HLS1-UP; KMW1-UP; PHC1-UP; PRA1-UP						
	2107082		P-UB-10	65 mm	4-3/4	CTC-3651270	196.61
	HLS1-UP; KMW1-UP; PHC1-UP; PRA1-UP						
	2107081		P-UB-10	65 mm	4-3/4	CTC-3651270	196.61
BACKHOE SWING							
	GAN1-UP; HLS1-UP; KMW1-UP; PHC1-UP; PRA1-UP						
	2781971		P-UB-10	50 mm	100 mm	CTC-2332622	64.40
COUPLER							
	GAN1-UP; KMW1-UP; PHC1-UP						
	1903085		I-U-10	1	2	CTC-1809872	122.04
GRAPPLE							
	HLS1-UP; KMW1-UP						
	2754243		I-U-10	50 mm	70 mm	CTC-2764172	48.63
LOADER BUCKET MP							
	GAN1-UP; HLS1-UP; KMW1-UP; PHC1-UP; PRA1-UP						
	2265540		I-U-10	1-1/2	3	CTC-2309357	57.37
LOADER LIFT							
	GAN1-UP; KMW1-UP; PHC1-UP						
	2283505		P-U-10	50 mm	85 mm	CTC-2432276	85.95
	HLS1-UP; PRA1-UP						
	2283509		P-U-10	50 mm	85 mm	CTC-2432276	85.95
LOADER TILT							
	GAN1-UP; KMW1-UP; PHC1-UP						
	1923884		P-UB-10	2	75 mm	CTC-1923884K	70.96
	HLS1-UP; PRA1-UP						
	2007128		P-UB-10	2	4	CTC-2618625	48.43
STABILIZER							
	GAN1-UP; HLS1-UP; KMW1-UP; PHC1-UP; PRA1-UP						
	2627049		P-UB-10	55 mm	100 mm	CTC-2332623	112.07
	2627050		P-UB-10	55 mm	100 mm	CTC-2332623	112.07
NEW MODEL 420F							
BACKHOE BOOM							
	JWJ1-; LKH1-; LTG1-; SKR1-						
			P-UB-10	2-3/8	4-3/4	CTC-2959893	113.78
BACKHOE BUCKET							
	JWJ1-; LKH1-; LTG1-; SKR1-						
			I-UB-10	2-1/2	3-1/2	CTC-3387038	34.71
BACKHOE EXT STICK							
	JWJ1-; LKH1-; LTG1-; SKR1-						
			P-UB-10	1-1/2	3	CTC-3387156	42.08
BACKHOE STICK							
	JWJ1-; LKH1-; LTG1-; SKR1-						
			P-UB-10	65 mm	4-3/4	CTC-3651270	196.61
COUPLER							
	JWJ1-; LKH1-						
			I-U-10	1	2	CTC-1809872	122.04
LOADER BUCKET MP							
	JWJ1-; LKH1-; LTG1-; SKR1-						
			I-U-10	1-1/2	3	CTC-2309357	57.37

REPLACEMENT KITS FOR CATERPILLAR® EQUIPMENT

Backhoe Loaders							
APPLICATION	CYL #	Misc-Parts, Instructions, etc.	CODE	ROD	BORE	KIT #	List \$
NEW MODEL 422E							
BACKHOE BOOM		DSK1-; HBE1-					
			P-UB-10	2-1/4	4-1/2	CTC-2959891	65.66
BACKHOE BUCKET		DSK1-; HBE1-					
			I-UB-10	2-3/8	85 mm	CTC-3651283	179.49
BACKHOE EXT STICK		DSK1-; HBE1-					
			P-UB-10	1-1/2	3	CTC-3387156	42.08
BACKHOE STABILIZER		DSK1-; HBE1-					
			P-UB-10	1-3/4	2-3/4	CTC-2342595	156.06
BACKHOE STICK		DSK1-; HBE1-					
			P-UB-10	2-1/4	4-1/4	CTC-3809470	58.20
LOADER BUCKET MP		DSK1-; MAW1-					
			I-U-10	1-1/2	3	CTC-2309357	57.37
		HBE1-					
			P-UB-10	1-1/2	3	CTC-2350354	35.56
LOADER LIFT		DSK1-; HBE1-; MAW1-					
				1-7/8	3-1/4	CTC-2342593	65.71
LOADER TILT		DSK1-; HBE1-; MAW1-					
				1-7/8	3-1/4	CTC-2342593	65.71
NEW MODEL 422F							
LOADER BUCKET MP		LRH1-					
			I-U-10	1-1/2	3	CTC-2309357	57.37
NEW MODEL 424D							
BACKHOE BOOM		BGP1-396; BKR1-418					
			P-UB-10	2-3/8	4-1/2	CTC-2418924	78.66
		BGP1-647; BKR1-528					
		1917753	P-UB-10	2-3/8	4-1/2	CTC-2616885	82.09
		BGP397-1612; BKR419-562; CJZ1-; RXA1-					
		2063628		2-3/8	4-1/2	CTC-2350972	184.60
BACKHOE BUCKET		BGP1-1612; BKR1-562; CJZ1-UP; RXA1-UP					
			I-UB-10	2-1/2	3-1/2	CTC-2235945	68.58
BACKHOE EXT STICK		BGP1-396; BKR1-418					
			P-UB-10	1-1/2	3	CTC-2350354	35.56
		BGP397-1612; BKR419-562; CJZ1-; RXA1-					
			P-UB-10	1-1/2	3	CTC-1917725K	42.93
BACKHOE STABILIZER		BGP1-1612; BKR1-562; CJZ1-UP; RXA1-UP					
			P-UB-10	1-3/4	2-3/4	CTC-2342595	156.06
BACKHOE STICK		BGP1-1612; BKR1-562					
		1734015	P-UB-10	2-1/2	4-1/2	CTC-2435805	76.11
		BGP397-1612; BKR419-562; CJZ1-; RXA1-					
		2060509	P-UB-10	2-1/2	4-1/2	CTC-2297194	57.10
		2359831	P-UB-10	2-1/2	4-1/2	CTC-2297194	57.10

REPLACEMENT KITS FOR CATERPILLAR® EQUIPMENT

Backhoe Loaders							
APPLICATION	CYL #	Misc-Parts, Instructions, etc.	CODE	ROD	BORE	KIT #	List \$
MODEL 424D							
BACKHOE SWING							
		BGP1-1612; BKR1-562; CJZ1-277; RXA1-705					
			P-UB-10	2	4	CTC-2409538	76.30
LOADER BUCKET MP							
		BGP1-1612; BKR1-1612; BKR1-562; CJZ1-; RXA1-					
			P-UB-10	1-1/2	3	CTC-2350354	35.56
LOADER LIFT							
		BGP1-396; BKR1-418					
			P-UB-10	1-7/8	3-1/4	CTC-2465926	45.75
		BGP397-1612; BKR419-562; CJZ1-; RXA1-					
				1-7/8	3-1/4	CTC-2342593	65.71
LOADER TILT							
		BGP1-396; BKR1-418					
			P-UB-10	1-7/8	3-1/4	CTC-2465926	45.75
		BGP397-1612; BKR419-562; CJZ1-; RXA1-					
				1-7/8	3-1/4	CTC-2342593	65.71
STEERING							
		BGP1-1612; BKR1-1612					
			I-U-10	36 mm	65 mm	CTC-1787189	228.22
			P-UB-10	1-3/4	2-3/4	CTC-2350351	150.09
MODEL 426							
BACKHOE BACKHOE BOOM							
	4T6969		P-UB-10	2-1/8	3-1/2	CTC-8T3591	108.57
	6E0109		P-UB-10	2	3-1/2	CTC-7X2783	106.57
BACKHOE BOOM							
	9T5222		P-UB-10	2	3-1/2	CTC-7X2822	98.87
BACKHOE BUCKET							
	4T5601		P-UB-10	2	3-1/4	CTC-7X2821	145.01
	6E0091		I-UB-10	2-1/2	3-1/2	CTC-3E3299	138.77
	9T0735		P-UB-10	2	3-1/2	CTC-7X2822	98.87
	9T2751		P-UB-10	2	3-1/4	CTC-7X2821	145.01
	9T7287		I-UB-10	2-1/2	3-1/2	CTC-3E3299	138.77
	9T7894		P-UB-10	2	3-1/4	CTC-7X2821	145.01
BACKHOE EXT STICK							
	9T2215		P-UB-10	1-1/2	3	CTC-7X2737	112.40
	9T2215		P-UB-10	1-1/2	3	CTC-7X2745	112.40
	9T4809		P-UB-10	1-1/2	3	CTC-7X2737	112.40
	9T7893		P-UB-10	2	3-1/4	CTC-7X2821	145.01
BACKHOE STICK							
	4T6968		P-UB-10	2-1/8	4	CTC-1305923	164.08
	6E0111		P-UB-10	2-1/2	4-1/4	CTC-3E3300	111.23
	9T2215		P-UB-10	1-1/2	3	CTC-7X2737	112.40
	9T5220		P-UB-10	2-1/8	4	CTC-1305923	164.08
	9T7066		P-UB-10	2-1/8	4	CTC-1305923	164.08
	9T7289		P-UB-10	2-1/2	4-1/4	CTC-3E3300	111.23
BACKHOE SWING							
	6E0093		P-UB-10	2-1/8	4	CTC-1305923	164.08
BACKHOE SWING LH							
	4T6879		P-UB-10	2-1/8	4	CTC-1305923	164.08
BACKHOE SWING RH							
	9T0529		P-UB-10	2-1/8	4	CTC-1305923	164.08
LOADER BUCKET MP							
	9T4006		P-UB-10	1-1/2	3	CTC-7X2737	112.40
LOADER LIFT							
	6E0103		P-UB-10	1-7/8	3-1/4	CTC-3E3297	102.01
	9T0415		P-UB-10	1-7/8	3-1/4	CTC-3E3297	102.01

REPLACEMENT KITS FOR CATERPILLAR® EQUIPMENT

Backhoe Loaders							
APPLICATION	CYL #	Misc-Parts, Instructions, etc.	CODE	ROD	BORE	KIT #	List \$
MODEL 426							
LOADER TILT							
	6E0113		P-UB-10	2	3-1/2	CTC-7X2783	106.57
	9T0735		P-UB-10	2	3-1/2	CTC-7X2822	98.87
	9T5370		P-UB-10	1-7/8	3-1/4	CTC-8T3589	83.64
	9T5371		P-UB-10	2	3-1/2	CTC-7X2783	106.57
	9T5371		P-UB-10	2	3-1/2	CTC-7X2822	98.87
STABILIZER							
	9T7391		P-UB-10	2-1/8	4	CTC-1305923	164.08
	9T7392		P-UB-10	2-1/8	4	CTC-1305923	164.08
STABILIZER LH							
	4T9911		P-UB-10	2-1/8	4	CTC-1305923	164.08
	6E0097		P-UB-10	2-1/8	4	CTC-1305923	164.08
	9T7070		P-UB-10	2-1/8	4	CTC-1305923	164.08
STABILIZER RH							
	4T6880		P-UB-10	2-1/8	4	CTC-1305923	164.08
	6E0099		P-UB-10	2-1/8	4	CTC-1305923	164.08
	9T7069		P-UB-10	2-1/8	4	CTC-1305923	164.08
STEERING							
	6E5190		P-UB-10	1-7/8	3	CTC-1113301	135.59
	9T1493		P-UB-10	1-7/8	3	CTC-8T3852	199.65
UNSPECIFIED APPLICATION							
	1070624		P-UB-10	1-7/8	3-1/4	CTC-3E3297	102.01
MODEL 426B							
BACKHOE BACKHOE BOOM							
	6E1948		P-UB-10	2-1/2	5	CTC-1361967	200.54
BACKHOE BUCKET							
	1268316		I-UB-10	2-3/4	3-3/4	CTC-9X2020	112.65
	6E1809		I-UB-10	2-3/4	3-3/4	CTC-9X2020	112.65
BACKHOE EXT BUCKET							
	6E3692		I-UB-10	2-3/4	3-3/4	CTC-9X2020	112.65
BACKHOE STICK							
	6E1935		P-UB-10	2-3/4	5	CTC-3E8878	188.48
	6E3662		P-UB-10	1-1/2	3	CTC-7X2737	112.40
BACKHOE SWING							
	1166861		P-UB-10	2	4	CTC-1113302	123.12
	6E0288		P-UB-10	2	4	CTC-1113302	123.12
	6E1864		P-UB-10	2	4	CTC-1328816	96.00
LOADER BUCKET MP							
	9T4006		P-UB-10	1-1/2	3	CTC-7X2737	112.40
LOADER LIFT							
	6E0103		P-UB-10	1-7/8	3-1/4	CTC-3E3297	102.01
	9T0415		P-UB-10	1-7/8	3-1/4	CTC-3E3297	102.01
LOADER TILT							
	1071855		P-UB-10	2	3-1/2	CTC-7X2783	106.57
	6E0113		P-UB-10	2	3-1/2	CTC-7X2783	106.57
STABILIZER							
	1052323		P-UB-10	2-1/8	4	CTC-1305923	164.08
	1052358		P-UB-10	2-1/8	4	CTC-1305923	164.08
STABILIZER LH							
	1165354		P-UB-10	2-1/8	4	CTC-1305923	164.08
	1302364		P-UB-10	2-1/8	4	CTC-1305923	164.08
	6E0098		P-UB-10	2-1/8	4	CTC-1305923	164.08
STABILIZER RH							
	1165353		P-UB-10	2-1/8	4	CTC-1305923	164.08
	1302365		P-UB-10	2-1/8	4	CTC-1305923	164.08
	6E0099		P-UB-10	2-1/8	4	CTC-1305923	164.08

REPLACEMENT KITS FOR CATERPILLAR® EQUIPMENT

Backhoe Loaders							
APPLICATION	CYL #	Misc-Parts, Instructions, etc.	CODE	ROD	BORE	KIT #	List \$
MODEL 426B							
STEERING							
	6E5190		P-UB-10	1-7/8	3	CTC-1113301	135.59
UNSPECIFIED APPLICATION							
	1070624		P-UB-10	1-7/8	3-1/4	CTC-3E3297	102.01
MODEL 426C							
BACKHOE BOOM							
	6E1948		P-UB-10	2-1/2	5	CTC-1361967	200.54
BACKHOE BUCKET							
	1268316		I-UB-10	2-3/4	3-3/4	CTC-9X2020	112.65
BACKHOE EXT BUCKET							
	6E3692		I-UB-10	2-3/4	3-3/4	CTC-9X2020	112.65
BACKHOE STICK							
	1535735		P-UB-10	1-1/2	3	CTC-7X2737	112.40
	6E1935		P-UB-10	2-3/4	5	CTC-3E8878	188.48
	6E3662		P-UB-10	1-1/2	3	CTC-7X2737	112.40
BACKHOE SWING							
	1166861		P-UB-10	2	4	CTC-1113302	123.12
LOADER BUCKET MP							
	9T4006		P-UB-10	1-1/2	3	CTC-7X2737	112.40
LOADER LIFT							
	1108688		P-UB-10	2	3-1/2	CTC-7X2783	106.57
	1216764		P-UB-10	2	3-1/2	CTC-7X2783	106.57
LOADER TILT							
	1071855		P-UB-10	2	3-1/2	CTC-7X2783	106.57
STABILIZER LH							
	1311846		P-UB-10	2-1/8	4	CTC-1305923	164.08
	1521806		P-UB-10	2-1/8	4	CTC-1305923	164.08
STABILIZER RH							
	1311847		P-UB-10	2-1/8	4	CTC-1305923	164.08
	1521796		P-UB-10	2-1/8	4	CTC-1305923	164.08
STEERING							
	1156437		P-UB-10	1-3/4	2-1/2	CTC-1539054	149.34
UNSPECIFIED APPLICATION							
	1235087		P-UB-10	2	3-1/2	CTC-7X2783	106.57
	1235091		P-UB-10	2	3	CTC-7X2760	72.94
	9T8823		I-O-3	1	2	CTC-9T0418	85.89
MODEL 428							
BACKHOE BOOM							
	4T6878		P-UB-10	1-7/8	3-1/4	CTC-8T3589	83.64
	4T6969		P-UB-10	2-1/8	3-1/2	CTC-8T3591	108.57
	6E0087		P-UB-10	1-7/8	3-1/4	CTC-3E3297	102.01
	9T5219		P-UB-10	1-7/8	3-1/4	CTC-3E3297	102.01
	9T5219		P-UB-10	1-7/8	3-1/4	CTC-8T3589	83.64
BACKHOE BUCKET							
	4T5601		P-UB-10	2	3-1/4	CTC-7X2821	145.01
	6E0091		I-UB-10	2-1/2	3-1/2	CTC-3E3299	138.77
	9T2751		P-UB-10	2	3-1/4	CTC-7X2821	145.01
	9T7287		I-UB-10	2-1/2	3-1/2	CTC-3E3299	138.77
	9T7893		P-UB-10	2	3-1/4	CTC-7X2821	145.01
	9T7894		P-UB-10	2	3-1/4	CTC-7X2821	145.01
BACKHOE EXT STICK							
	9T2215		P-UB-10	1-1/2	3	CTC-7X2745	112.40
	9T4809		P-UB-10	1-1/2	3	CTC-7X2737	112.40
	9T7893		P-UB-10	2	3-1/4	CTC-7X2821	145.01

REPLACEMENT KITS FOR CATERPILLAR® EQUIPMENT

Backhoe Loaders							
APPLICATION	CYL #	Misc-Parts, Instructions, etc.	CODE	ROD	BORE	KIT #	List \$
MODEL 428							
BACKHOE STICK							
	4T6877		P-UB-10	2-1/8	4	CTC-8T3593	73.47
	4T6893		P-UB-10	2-1/8	4	CTC-1305923	164.08
	6E0089		P-UB-10	2-1/2	4-1/4	CTC-3E3300	111.23
	9T2214		P-UB-10	1-1/2	3	CTC-7X2737	112.40
	9T2762		P-UB-10	2-1/8	4	CTC-8T3593	73.47
	9T5215		P-UB-10	2-1/8	4	CTC-1305923	164.08
	9T5216		P-UB-10	2-1/8	4	CTC-8T3593	73.47
	9T7063		P-UB-10	2-1/8	4	CTC-1305923	164.08
	9T7291		P-UB-10	2-1/2	4-1/4	CTC-3E3300	111.23
BACKHOE SWING							
	9T0420		P-UB-10	2-1/8	4	CTC-8T3593	73.47
	9T0421		P-UB-10	2-1/8	4	CTC-8T3593	73.47
BACKHOE SWING LH							
	9T0421		P-UB-10	2-1/8	4	CTC-1305923	164.08
BACKHOE SWING RH							
	9T0420		P-UB-10	2-1/8	4	CTC-1305923	164.08
LOADER BUCKET MP							
	9T4006		P-UB-10	1-1/2	3	CTC-7X2737	112.40
LOADER LIFT							
	6E0103		P-UB-10	1-7/8	3-1/4	CTC-3E3297	102.01
	9T0415		P-UB-10	1-7/8	3-1/4	CTC-3E3297	102.01
LOADER TILT							
	6E0113		P-UB-10	2	3-1/2	CTC-7X2783	106.57
	9T0735		P-UB-10	2	3-1/2	CTC-7X2822	98.87
	9T0770		P-UB-10	2	3-1/2	CTC-7X2783	106.57
	9T5370		P-UB-10	1-7/8	3-1/4	CTC-8T3589	83.64
	9T5371		P-UB-10	2	3-1/2	CTC-7X2783	106.57
	9T5371		P-UB-10	2	3-1/2	CTC-7X2822	98.87
STABILIZER							
	6E0119		P-UB-10	1-3/4	2-3/4	CTC-1539053	156.06
	9T0527		P-UB-10	1-3/4	2-3/4	CTC-7X2820	81.89
	9T9709		P-UB-10	1-3/4	2-3/4	CTC-7X2820	81.89
STEERING							
	9T1493		P-UB-10	1-7/8	3	CTC-8T3852	199.65
UNSPECIFIED APPLICATION							
	1070624		P-UB-10	1-7/8	3-1/4	CTC-3E3297	102.01
MODEL 428B							
BACKHOE BOOM							
	6E0274		P-UB-10	2-3/8	4-1/2	CTC-3E8877	183.90
BACKHOE BUCKET							
	1268308		I-UB-10	2-1/2	3-1/2	CTC-3E3299	138.77
	6E0275		I-UB-10	2-1/2	3-1/2	CTC-3E3299	138.77
BACKHOE EXT BUCKET							
	6E1964		I-UB-10	2-1/2	3-1/2	CTC-3E3299	138.77
	6E2421		I-UB-10	2-3/4	3-3/4	CTC-9X2020	112.65
BACKHOE STICK							
	1097021		P-UB-10	2-1/2	4-1/2	CTC-1113300	141.35
	6E0290	Rod Bearing width- 0.98"	P-UB-10	2-1/2	4-1/2	CTC-1113300	141.35
	6E0290	Rod Bearing width- 1.25"	P-UB-10	2-1/2	4-1/2	CTC-1469860	166.90
	6E0404		P-UB-10	1-1/2	3	CTC-7X2737	112.40
BACKHOE SWING							
	1166861		P-UB-10	2	4	CTC-1113302	123.12
	6E0288		P-UB-10	2	4	CTC-1113302	123.12

REPLACEMENT KITS FOR CATERPILLAR® EQUIPMENT

Backhoe Loaders							
APPLICATION	CYL #	Misc-Parts, Instructions, etc.	CODE	ROD	BORE	KIT #	List \$
MODEL 428B							
BACKHOE SWING LH							
	1166858		P-UB-10	2	4	CTC-1113302	123.12
	6E1864		P-UB-10	2	4	CTC-1113302	123.12
LOADER BUCKET MP							
	9T4006		P-UB-10	1-1/2	3	CTC-7X2737	112.40
LOADER LIFT							
	6E0103		P-UB-10	1-7/8	3-1/4	CTC-3E3297	102.01
	9T0415		P-UB-10	1-7/8	3-1/4	CTC-3E3297	102.01
LOADER TILT							
	1071855		P-UB-10	2	3-1/2	CTC-7X2783	106.57
	6E0113		P-UB-10	2	3-1/2	CTC-7X2783	106.57
SIDESHIFT							
	1166858		P-UB-10	2	4	CTC-1113302	123.12
SIDESHIFT RH							
	1166858		P-UB-10	2	4	CTC-1113302	123.12
STABILIZER							
	1266950		P-UB-10	1-3/4	2-3/4	CTC-1539053	156.06
	6E3483		P-UB-10	1-3/4	2-3/4	CTC-1539053	156.06
STEERING							
	6E5190		P-UB-10	1-7/8	3	CTC-1113301	135.59
UNSPECIFIED APPLICATION							
	1070624		P-UB-10	1-7/8	3-1/4	CTC-3E3297	102.01
MODEL 428C							
BACKHOE BOOM							
	6E0274		P-UB-10	2-3/8	4-1/2	CTC-3E8877	183.90
BACKHOE BUCKET							
	1268308		I-UB-10	2-1/2	3-1/2	CTC-3E3299	138.77
	1268312		I-UB-10	2-3/4	3-3/4	CTC-1361990	179.98
	6E0275		I-UB-10	2-1/2	3-1/2	CTC-3E3299	138.77
BACKHOE EXT BUCKET							
	6E1964		I-UB-10	2-1/2	3-1/2	CTC-3E3299	138.77
BACKHOE STICK							
	1097021		P-UB-10	2-1/2	4-1/2	CTC-1113300	141.35
	6E0404		P-UB-10	1-1/2	3	CTC-7X2737	112.40
BACKHOE SWING							
	1166861		P-UB-10	2	4	CTC-1113302	123.12
LOADER BUCKET MP							
	9T4006		P-UB-10	1-1/2	3	CTC-7X2737	112.40
LOADER TILT							
	1071855		P-UB-10	2	3-1/2	CTC-7X2783	106.57
SIDESHIFT							
	1166858		P-UB-10	2	4	CTC-1113302	123.12
SIDESHIFT RH							
	1166858		P-UB-10	2	4	CTC-1113302	123.12
STABILIZER							
	1266950		P-UB-10	1-3/4	2-3/4	CTC-1539053	156.06
STEERING							
	1156437		P-UB-10	1-3/4	2-1/2	CTC-1539054	149.34
UNSPECIFIED APPLICATION							
	1070624		P-UB-10	1-7/8	3-1/4	CTC-3E3297	102.01
	1235087		P-UB-10	2	3-1/2	CTC-7X2783	106.57
	1235091		P-UB-10	2	3	CTC-7X2760	72.94
	9T8823		I-O-3	1	2	CTC-9T0418	85.89

REPLACEMENT KITS FOR CATERPILLAR® EQUIPMENT

Backhoe Loaders							
APPLICATION	CYL #	Misc-Parts, Instructions, etc.	CODE	ROD	BORE	KIT #	List \$
MODEL 430D							
BACKHOE BOOM							
BML1-2280; BNK1-2501							
1832849			P-UB-10	2-3/4	5-3/8	CTC-1832849K	148.51
BML1-UP; BNK2502-UP							
2058655			P-UB-10	2-3/4	5-3/8	CTC-2058655K	148.56
BACKHOE BUCKET							
BML1-2280; BNK1-2501							
1668140			I-UB-10	2-3/4	3-3/4	CTC-2235944	82.00
1668141			I-UB-10	2-3/4	3-3/4	CTC-1668141K	82.66
BML1-UP; BNK1-UP							
1917835			I-UB-10	2-3/4	3-3/4	CTC-2315021	83.43
1917839			I-UB-10	2-3/4	3-3/4	CTC-2315021	83.43
BACKHOE EXT STICK							
BML1-2280; BNK1-2501							
1535735			P-UB-10	1-1/2	3	CTC-2350354	35.56
BML2281-UP; BNK2502-UP							
1917721			P-UB-10	1-1/2	3	CTC-1917721K	42.93
BACKHOE STICK							
BML1-1116; BNK1-2051							
1832850			P-UB-10	65 mm	4-3/4	CTC-1832850K	164.76
BML1-UP; BNK2502-UP							
2058656			P-UB-10	65 mm	4-3/4	CTC-2058656K	168.08
BACKHOE SWING							
BML1-1116; BNK1-1032							
1699529			P-UB-10	2	4	CTC-1699529K	75.20
BML1-5023; BNK1033-6261							
1918161			P-UB-10	2	4	CTC-1918161K	48.39
BML5013-UP; BNK6262-UP							
2283506			P-UB-10	50 mm	100 mm	CTC-2332622	64.40
COUPLER							
BML1-UP							
1783713			I-U-10	1	2	CTC-1809872	122.04
GRAPPLE							
BML4800-UP; BNK5900-UP							
2754243			I-U-10	50 mm	70 mm	CTC-2764172	48.63
LOADER BUCKET MP							
BML1-UP; BNK1-UP							
1851839			P-UB-10	1-1/2	3	CTC-2350354	35.56
BML4800-UP; BNK5900-UP							
2265540			I-U-10	1-1/2	3	CTC-2309357	57.37
LOADER LIFT							
BML1-2280							
1807490			P-UB-10	2	85 mm	CTC-1807490K	143.42
BML1-4799							
1923791			P-UB-10	2	85 mm	CTC-1923791K	142.91
BML4800-UP							
2283505			P-U-10	50 mm	85 mm	CTC-2432276	85.95
BNK1-2501							
1832856			P-UB-10	2	85 mm	CTC-2410110	127.72
BNK2502-5899							
1964523			P-UB-10	2	85 mm	CTC-1964523K	143.37
BNK5900-UP							
2300980			P-U-10	50 mm	85 mm	CTC-2432276	85.95
LOADER TILT							
BML1-2280							
1832848			P-UB-10	2	75 mm	CTC-2410109	94.44

REPLACEMENT KITS FOR CATERPILLAR® EQUIPMENT

Backhoe Loaders							
APPLICATION	CYL #	Misc-Parts, Instructions, etc.	CODE	ROD	BORE	KIT #	List \$
MODEL 430D							
LOADER TILT							
BML1-UP							
1923884			P-UB-10	2	75 mm	CTC-1923884K	70.96
BNK1033-2501							
1924110			P-UB-10	2	85 mm	CTC-1924110K	143.33
BNK1-1032							
1807482			P-UB-10	2	85 mm	CTC-1807482K	143.42
BNK2502-2558							
2063555			P-UB-10	2	85 mm	CTC-2063555K	143.37
BNK2502-UP							
2007128			P-UB-10	2	4	CTC-2618625	48.43
STABILIZER							
BML1-2280; BNK1-2501							
1807484			P-UB-10	2-1/8	4	CTC-2857486	84.29
1807485			P-UB-10	2-1/8	4	CTC-2857486	84.29
BML1-5012; BNK2502-6244							
2060520			P-UB-10	2-1/8	4	CTC-2857486	84.29
BML1-5012; BNK2502-6261							
2060522			P-UB-10	2-1/8	4	CTC-2857486	84.29
BML5013-UP; BNK6245-UP							
2283499			P-UB-10	55 mm	100 mm	CTC-2332623	112.07
BML5013-UP; BNK6262-UP							
2283500			P-UB-10	55 mm	100 mm	CTC-2332623	112.07
MODEL 430E							
BACKHOE BOOM							
DDT1-UP; EAT1-UP; RLN1-UP; SCD1-UP							
2469884			P-UB-10	3	5-1/4	CTC-2959887	121.24
2689051			P-UB-10	3	5-1/4	CTC-2689051K	118.57
BACKHOE BUCKET							
DDT1-UP; EAT1-UP; RLN1-UP; SCD1-UP							
1668140			I-UB-10	2-3/4	3-3/4	CTC-2235944	82.00
2107096			I-UB-10	2-3/4	3-3/4	CTC-2107096K	87.24
BACKHOE EXT STICK							
DDT1-UP; EAT1-UP; RLN1-UP; SCD1-UP							
2107092			P-UB-10	2-1/2	5	CTC-2107092K	75.33
2107097			P-UB-10	1-1/2	3	CTC-3387156	42.08
2107098			P-UB-10	1-1/2	3	CTC-2107098K	39.63
BACKHOE STICK							
DDT1-UP; EAT1-UP; RLN1-UP; SCD1-UP							
2107091			P-UB-10	2-1/2	5	CTC-2107091K	78.07
COUPLER							
DDT1-UP; SCD1-UP							
1903085			I-U-10	1	2	CTC-1809872	122.04
GRAPPLE							
DDT1-UP; EAT1-UP							
2754243			I-U-10	50 mm	70 mm	CTC-2764172	48.63
LOADER BUCKET MP							
DDT1-UP; EAT1-UP; RLN1-UP; SCD1-UP							
2265540			I-U-10	1-1/2	3	CTC-2309357	57.37
LOADER LIFT							
DDT1-UP; SCD1-UP							
2283505			P-U-10	50 mm	85 mm	CTC-2432276	85.95
EAT1-UP; RLN1-UP							
2283509			P-U-10	50 mm	85 mm	CTC-2432276	85.95

REPLACEMENT KITS FOR CATERPILLAR® EQUIPMENT

Backhoe Loaders							
APPLICATION	CYL #	Misc-Parts, Instructions, etc.	CODE	ROD	BORE	KIT #	List \$
MODEL 430E							
LOADER TILT							
DDT1-UP; SCD1-UP							
1923884			P-UB-10	2	75 mm	CTC-1923884K	70.96
EAT1-UP; RLN1-UP							
2007128			P-UB-10	2	4	CTC-2618625	48.43
STABILIZER							
DDT1-UP; EAT1-UP; RLN1-UP; SCD1-UP							
2627049			P-UB-10	55 mm	100 mm	CTC-2332623	112.07
2627050			P-UB-10	55 mm	100 mm	CTC-2332623	112.07
SWING							
DDT1-UP; EAT1-UP; RLN1-UP; SCD1-UP							
2781971			P-UB-10	50 mm	100 mm	CTC-2332622	64.40
MODEL 436							
BACKHOE BOOM							
6E0109			P-UB-10	2	3-1/2	CTC-7X2783	106.57
9T5222			P-UB-10	2	3-1/2	CTC-7X2783	106.57
9T5222			P-UB-10	2	3-1/2	CTC-7X2822	98.87
BACKHOE EXT STICK							
9T4809			P-UB-10	1-1/2	3	CTC-7X2737	112.40
BACKHOE SWING							
4T6879			P-UB-10	2-1/8	4	CTC-1305923	164.08
6E0093			P-UB-10	2-1/8	4	CTC-1305923	164.08
BACKHOE SWING LH							
4T6879			P-UB-10	2-1/8	4	CTC-8T3593	73.47
BACKHOE SWING RH							
9T0529			P-UB-10	2-1/8	4	CTC-1305923	164.08
LOADER BUCKET MP							
9T4006			P-UB-10	1-1/2	3	CTC-7X2737	112.40
LOADER LIFT							
6E0103			P-UB-10	1-7/8	3-1/4	CTC-3E3297	102.01
9T0415			P-UB-10	1-7/8	3-1/4	CTC-3E3297	102.01
LOADER TILT							
6E0113			P-UB-10	2	3-1/2	CTC-7X2783	106.57
9T5371			P-UB-10	2	3-1/2	CTC-7X2783	106.57
9T5371			P-UB-10	2	3-1/2	CTC-7X2822	98.87
STABILIZER							
9T7391			P-UB-10	2-1/8	4	CTC-1305923	164.08
9T7392			P-UB-10	2-1/8	4	CTC-1305923	164.08
STABILIZER LH							
6E0097			P-UB-10	2-1/8	4	CTC-1305923	164.08
9T7070			P-UB-10	2-1/8	4	CTC-1305923	164.08
STABILIZER RH							
6E0099			P-UB-10	2-1/8	4	CTC-1305923	164.08
9T7069			P-UB-10	2-1/8	4	CTC-1305923	164.08
STEERING							
6E5190			P-UB-10	1-7/8	3	CTC-1113301	135.59
9T1493			P-UB-10	1-7/8	3	CTC-8T3852	199.65
UNSPECIFIED APPLICATION							
1070624			P-UB-10	1-7/8	3-1/4	CTC-3E3297	102.01
MODEL 436B							
BACKHOE BOOM							
6E0274			P-UB-10	2-3/8	4-1/2	CTC-3E8877	183.90
6E1948			P-UB-10	2-1/2	5	CTC-1361967	200.54

REPLACEMENT KITS FOR CATERPILLAR® EQUIPMENT

Backhoe Loaders							
APPLICATION	CYL #	Misc-Parts, Instructions, etc.	CODE	ROD	BORE	KIT #	List \$
MODEL 436B							
BACKHOE BUCKET							
	1268316		I-UB-10	2-3/4	3-3/4	CTC-9X2020	112.65
	6E0275		I-UB-10	2-1/2	3-1/2	CTC-3E3299	138.77
	6E1809		I-UB-10	2-3/4	3-3/4	CTC-9X2020	112.65
BACKHOE EXT BUCKET							
	6E3692		I-UB-10	2-3/4	3-3/4	CTC-9X2020	112.65
BACKHOE STICK							
	6E1935		P-UB-10	2-3/4	5	CTC-3E8878	188.48
	6E3662		P-UB-10	1-1/2	3	CTC-7X2737	112.40
BACKHOE SWING							
	1166861		P-UB-10	2	4	CTC-1113302	123.12
	6E0288		P-UB-10	2	4	CTC-1113302	123.12
	6E1864		P-UB-10	2	4	CTC-1328816	96.00
LOADER BUCKET MP							
	9T4006		P-UB-10	1-1/2	3	CTC-7X2737	112.40
LOADER LIFT							
	6E0103		P-UB-10	1-7/8	3-1/4	CTC-3E3297	102.01
	9T0415		P-UB-10	1-7/8	3-1/4	CTC-3E3297	102.01
LOADER TILT							
	1071855		P-UB-10	2	3-1/2	CTC-7X2783	106.57
	6E0113		P-UB-10	2	3-1/2	CTC-7X2783	106.57
STABILIZER							
	1052323		P-UB-10	2-1/8	4	CTC-1305923	164.08
	1052358		P-UB-10	2-1/8	4	CTC-1305923	164.08
	9T2993		P-UB-10	2-1/8	4	CTC-9X2400	123.33
	9T2994		P-UB-10	2-1/8	4	CTC-9X2400	123.33
STABILIZER LH							
	1165354		P-UB-10	2-1/8	4	CTC-1305923	164.08
	1302364		P-UB-10	2-1/8	4	CTC-1305923	164.08
	6E0097		P-UB-10	2-1/8	4	CTC-1305923	164.08
STABILIZER RH							
	1165353		P-UB-10	2-1/8	4	CTC-1305923	164.08
	1302365		P-UB-10	2-1/8	4	CTC-1305923	164.08
	6E0099		P-UB-10	2-1/8	4	CTC-1305923	164.08
	9T7069		P-UB-10	2-1/8	4	CTC-8T3593	73.47
STEERING							
	6E5190		P-UB-10	1-7/8	3	CTC-1113301	135.59
UNSPECIFIED APPLICATION							
	1070624		P-UB-10	1-7/8	3-1/4	CTC-3E3297	102.01
MODEL 436C							
BACKHOE BOOM							
	1118211		P-UB-10	2-5/8	5-1/4	CTC-1361908	183.02
	6E1948		P-UB-10	2-1/2	5	CTC-1361967	200.54
BACKHOE BUCKET							
	1118216		I-UB-10	2-3/4	3-3/4	CTC-9X2020	112.65
	1268316		I-UB-10	2-3/4	3-3/4	CTC-9X2020	112.65
	9T6305		I-UB-10	2-3/4	3-3/4	CTC-9X2020	112.65
BACKHOE EXT BUCKET							
	1144828		I-UB-10	2-3/4	3-3/4	CTC-9X2020	112.65
	6E3692		I-UB-10	2-3/4	3-3/4	CTC-9X2020	112.65
	9T4760		I-UB-10	2-3/4	3-3/4	CTC-9X2020	112.65
BACKHOE EXT STICK							
	6E5383		P-UB-10	1-3/4	3	CTC-7X2825	55.57

REPLACEMENT KITS FOR CATERPILLAR® EQUIPMENT

Backhoe Loaders							
APPLICATION	CYL #	Misc-Parts, Instructions, etc.	CODE	ROD	BORE	KIT #	List \$
MODEL 436C							
BACKHOE STICK							
	1118213		P-UB-10	3	5-1/4	CTC-3E3293	183.95
	1239707		P-UB-10	1-3/4	3	CTC-7X2825	55.57
	1535735		P-UB-10	1-1/2	3	CTC-7X2737	112.40
	6E1936		P-UB-10	2-3/4	5	CTC-3E8878	188.48
	6E3062		P-UB-10	3	5-1/4	CTC-3E3293	183.95
	6E3314		P-UB-10	3	5-1/4	CTC-3E3293	183.95
	6E3662		P-UB-10	1-1/2	3	CTC-7X2737	112.40
	9T8823		I-O-3	1	2	CTC-9T0418	85.89
	9T9186		P-UB-10	3	5-1/4	CTC-3E3293	183.95
BACKHOE SWING							
	1121765		P-UB-10	2	4	CTC-1113302	123.12
	1166861		P-UB-10	2	4	CTC-1113302	123.12
	6E5219		P-UB-10	2	4	CTC-1113302	123.12
BACKHOE SWING LH							
	9T1701		P-UB-10	2-1/8	4	CTC-9X2400	123.33
BACKHOE SWING RH							
	9T1230		P-UB-10	2-1/8	4	CTC-9X2400	123.33
LOADER BUCKET MP							
	9T4006		P-UB-10	1-1/2	3	CTC-7X2737	112.40
LOADER LIFT							
	1108688		P-UB-10	2	3-1/2	CTC-7X2783	106.57
	1117712		P-UB-10	2-1/4	3-3/4	CTC-1361897	164.75
	1216764		P-UB-10	2	3-1/2	CTC-7X2783	106.57
	1257895		P-UB-10	2-1/4	3-3/4	CTC-1361897	164.75
	9T2997		P-UB-10	2	3-3/4	CTC-7X7938	108.26
LOADER TILT							
	1007844		P-UB-10	2	4	CTC-1328816	96.00
	1071855		P-UB-10	2	3-1/2	CTC-7X2783	106.57
	9T2995		P-UB-10	2	4	CTC-1328816	96.00
STABILIZER LH							
	1311846		P-UB-10	2-1/8	4	CTC-1305923	164.08
	1329701		P-UB-10	2-1/8	4	CTC-1305923	164.08
	1521806		P-UB-10	2-1/8	4	CTC-1305923	164.08
	9T2994		P-UB-10	2-1/8	4	CTC-1305923	164.08
STABILIZER RH							
	1311847		P-UB-10	2-1/8	4	CTC-1305923	164.08
	1329700		P-UB-10	2-1/8	4	CTC-1305923	164.08
	1521796		P-UB-10	2-1/8	4	CTC-1305923	164.08
	9T2993		P-UB-10	2-1/8	4	CTC-1305923	164.08
STEERING							
	1156437		P-UB-10	1-3/4	2-1/2	CTC-1539054	149.34
UNSPECIFIED APPLICATION							
	1235087		P-UB-10	2	3-1/2	CTC-7X2783	106.57
	1235091		P-UB-10	2	3	CTC-7X2760	72.94
MODEL 438							
BACKHOE BOOM							
	6E0087		P-UB-10	1-7/8	3-1/4	CTC-3E3297	102.01
	9T5219		P-UB-10	1-7/8	3-1/4	CTC-3E3297	102.01
	9T5219		P-UB-10	1-7/8	3-1/4	CTC-8T3589	83.64
BACKHOE BUCKET							
	4T5601		P-UB-10	2	3-1/4	CTC-7X2821	145.01
	9T2751		P-UB-10	2	3-1/4	CTC-7X2821	145.01
	9T7893		P-UB-10	2	3-1/4	CTC-7X2821	145.01
	9T7894		P-UB-10	2	3-1/4	CTC-7X2821	145.01

REPLACEMENT KITS FOR CATERPILLAR® EQUIPMENT

Backhoe Loaders							
APPLICATION	CYL #	Misc-Parts, Instructions, etc.	CODE	ROD	BORE	KIT #	List \$
MODEL 438							
BACKHOE EXT STICK							
	9T2215		P-UB-10	1-1/2	3	CTC-7X2737	112.40
	9T2215		P-UB-10	1-1/2	3	CTC-7X2745	112.40
	9T4809		P-UB-10	1-1/2	3	CTC-7X2737	112.40
	9T7893		P-UB-10	2	3-1/4	CTC-7X2821	145.01
BACKHOE STICK							
	6E0089		P-UB-10	2-1/2	4-1/4	CTC-3E3300	111.23
	9T2215		P-UB-10	1-1/2	3	CTC-7X2737	112.40
	9T7291		P-UB-10	2-1/2	4-1/4	CTC-3E3300	111.23
BACKHOE SWING							
	9T0420		P-UB-10	2-1/8	4	CTC-8T3593	73.47
	9T0421		P-UB-10	2-1/8	4	CTC-8T3593	73.47
BACKHOE SWING LH							
	9T0421		P-UB-10	2-1/8	4	CTC-1305923	164.08
BACKHOE SWING RH							
	9T0420		P-UB-10	2-1/8	4	CTC-1305923	164.08
LOADER BUCKET MP							
	9T4006		P-UB-10	1-1/2	3	CTC-7X2737	112.40
LOADER LIFT							
	6E0103		P-UB-10	1-7/8	3-1/4	CTC-3E3297	102.01
	9T0415		P-UB-10	1-7/8	3-1/4	CTC-3E3297	102.01
LOADER TILT							
	6E0113		P-UB-10	2	3-1/2	CTC-7X2783	106.57
	9T5371		P-UB-10	2	3-1/2	CTC-7X2783	106.57
	9T5371		P-UB-10	2	3-1/2	CTC-7X2822	98.87
STABILIZER							
	6E0119		P-UB-10	1-3/4	2-3/4	CTC-1539053	156.06
	9T0527		P-UB-10	1-3/4	2-3/4	CTC-7X2820	81.89
	9T9709		P-UB-10	1-3/4	2-3/4	CTC-7X2820	81.89
STEERING							
	9T1493		P-UB-10	1-7/8	3	CTC-8T3852	199.65
UNSPECIFIED APPLICATION							
	1070624		P-UB-10	1-7/8	3-1/4	CTC-3E3297	102.01
MODEL 438B							
BACKHOE BOOM							
	6E0274		P-UB-10	2-3/8	4-1/2	CTC-3E8877	183.90
BACKHOE BUCKET							
	1268308		I-UB-10	2-1/2	3-1/2	CTC-3E3299	138.77
	1268312		I-UB-10	2-3/4	3-3/4	CTC-1361990	179.98
	6E0275		I-UB-10	2-1/2	3-1/2	CTC-3E3299	138.77
	6E3693		I-UB-10	2-3/4	3-3/4	CTC-1361990	179.98
BACKHOE EXT BUCKET							
	6E1964		I-UB-10	2-1/2	3-1/2	CTC-3E3299	138.77
	6E2421		I-UB-10	2-3/4	3-3/4	CTC-9X2020	112.65
BACKHOE STICK							
	1097021		P-UB-10	2-1/2	4-1/2	CTC-1113300	141.35
	6E0290	Rod Bearing width- 0.98"	P-UB-10	2-1/2	4-1/2	CTC-1113300	141.35
	6E0290	Rod Bearing width- 1.25"	P-UB-10	2-1/2	4-1/2	CTC-1469860	166.90
	6E0404		P-UB-10	1-1/2	3	CTC-7X2737	112.40
BACKHOE SWING							
	1166861		P-UB-10	2	4	CTC-1113302	123.12
	6E0288		P-UB-10	2	4	CTC-1113302	123.12
BACKHOE SWING LH							
	6E1864		P-UB-10	2	4	CTC-1113302	123.12
LOADER BUCKET MP							
	9T4006		P-UB-10	1-1/2	3	CTC-7X2737	112.40

REPLACEMENT KITS FOR CATERPILLAR® EQUIPMENT

Backhoe Loaders							
APPLICATION	CYL #	Misc-Parts, Instructions, etc.	CODE	ROD	BORE	KIT #	List \$
MODEL 438B							
LOADER LIFT							
	6E0103		P-UB-10	1-7/8	3-1/4	CTC-3E3297	102.01
	9T0415		P-UB-10	1-7/8	3-1/4	CTC-3E3297	102.01
LOADER TILT							
	1071855		P-UB-10	2	3-1/2	CTC-7X2783	106.57
	6E0113		P-UB-10	2	3-1/2	CTC-7X2783	106.57
SIDESHIFT							
	1166858		P-UB-10	2	4	CTC-1113302	123.12
SIDESHIFT RH							
	1166858		P-UB-10	2	4	CTC-1113302	123.12
STABILIZER							
	1266950		P-UB-10	1-3/4	2-3/4	CTC-1539053	156.06
	6E3483		P-UB-10	1-3/4	2-3/4	CTC-1539053	156.06
UNSPECIFIED APPLICATION							
	1070624		P-UB-10	1-7/8	3-1/4	CTC-3E3297	102.01
MODEL 438C							
BACKHOE BOOM							
	6E0274		P-UB-10	2-3/8	4-1/2	CTC-3E8877	183.90
BACKHOE BUCKET							
	1268312		I-UB-10	2-3/4	3-3/4	CTC-1361990	179.98
	6E3693		I-UB-10	2-3/4	3-3/4	CTC-1361990	179.98
BACKHOE EXT BUCKET							
	6E1964		I-UB-10	2-1/2	3-1/2	CTC-3E3299	138.77
	6E2421		I-UB-10	2-3/4	3-3/4	CTC-9X2020	112.65
BACKHOE STICK							
	1097021		P-UB-10	2-1/2	4-1/2	CTC-1113300	141.35
	6E0404		P-UB-10	1-1/2	3	CTC-7X2737	112.40
BACKHOE SWING							
	1166861		P-UB-10	2	4	CTC-1113302	123.12
LOADER BUCKET MP							
	9T4006		P-UB-10	1-1/2	3	CTC-7X2737	112.40
LOADER TILT							
	1071855		P-UB-10	2	3-1/2	CTC-7X2783	106.57
SIDESHIFT							
	1166858		P-UB-10	2	4	CTC-1113302	123.12
SIDESHIFT RH							
	1166858		P-UB-10	2	4	CTC-1113302	123.12
STABILIZER							
	1266950		P-UB-10	1-3/4	2-3/4	CTC-1539053	156.06
UNSPECIFIED APPLICATION							
	1070624		P-UB-10	1-7/8	3-1/4	CTC-3E3297	102.01
	1235087		P-UB-10	2	3-1/2	CTC-7X2783	106.57
	1235091		P-UB-10	2	3	CTC-7X2760	72.94
	9T8823		I-O-3	1	2	CTC-9T0418	85.89
MODEL 446							
BACKHOE BOOM							
	1118211		P-UB-10	2-5/8	5-1/4	CTC-1361908	183.02
BACKHOE BUCKET							
	9T6305		I-UB-10	2-3/4	3-3/4	CTC-9X2020	112.65
BACKHOE EXT BUCKET							
	1144828		I-UB-10	2-3/4	3-3/4	CTC-9X2020	112.65
BACKHOE EXT STICK							
	6E5383		P-UB-10	1-3/4	3	CTC-7X2825	55.57
	9T2107		P-UB-10	1-3/4	3	CTC-7X2825	55.57

REPLACEMENT KITS FOR CATERPILLAR® EQUIPMENT

Backhoe Loaders							
APPLICATION	CYL #	Misc-Parts, Instructions, etc.	CODE	ROD	BORE	KIT #	List \$
MODEL 446							
BACKHOE STICK							
	1118213		P-UB-10	3	5-1/4	CTC-3E3293	183.95
	6E3062		P-UB-10	3	5-1/4	CTC-3E3293	183.95
	6E3314		P-UB-10	3	5-1/4	CTC-3E3293	183.95
	9T9186		P-UB-10	3	5-1/4	CTC-3E3293	183.95
BACKHOE SWING							
	1121765		P-UB-10	2	4	CTC-1113302	123.12
	6E5219		P-UB-10	2	4	CTC-1113302	123.12
BACKHOE SWING LH							
	9T1701		P-UB-10	2-1/8	4	CTC-9X2400	123.33
BACKHOE SWING RH							
	9T1230		P-UB-10	2-1/8	4	CTC-9X2400	123.33
LOADER LIFT							
	1117712		P-UB-10	2-1/4	3-3/4	CTC-1361897	164.75
	1257895		P-UB-10	2-1/4	3-3/4	CTC-1361897	164.75
	9T2997		P-UB-10	2	3-3/4	CTC-7X7938	108.26
LOADER TILT							
	1007844		P-UB-10	2	4	CTC-1113302	123.12
	1007844		P-UB-10	2	4	CTC-1328816	96.00
	9T2995		P-UB-10	2	4	CTC-1113302	123.12
	9T2995		P-UB-10	2	4	CTC-1328816	96.00
STABILIZER							
	9T2993		P-UB-10	2-1/8	4	CTC-9X2400	123.33
	9T2994		P-UB-10	2-1/8	4	CTC-9X2400	123.33
STABILIZER LH							
	1329701		P-UB-10	2-1/8	4	CTC-1305923	164.08
	9T2994		P-UB-10	2-1/8	4	CTC-1305923	164.08
STABILIZER RH							
	1329700		P-UB-10	2-1/8	4	CTC-1305923	164.08
	9T2993		P-UB-10	2-1/8	4	CTC-1305923	164.08
MODEL 446B							
BACKHOE BOOM							
	1118211		P-UB-10	2-5/8	5-1/4	CTC-1361908	183.02
BACKHOE BUCKET							
	1118217		I-UB-10	2-3/4	3-3/4	CTC-9X2020	112.65
	9T6305		I-UB-10	2-3/4	3-3/4	CTC-9X2020	112.65
BACKHOE EXT BUCKET							
	1144828		I-UB-10	2-3/4	3-3/4	CTC-9X2020	112.65
	9T4760		I-UB-10	2-3/4	3-3/4	CTC-9X2020	112.65
BACKHOE EXT STICK							
	6E5383		P-UB-10	1-3/4	3	CTC-7X2825	55.57
BACKHOE STICK							
	1118213		P-UB-10	3	5-1/4	CTC-3E3293	183.95
	1239707		P-UB-10	1-3/4	3	CTC-7X2825	55.57
	6E3062		P-UB-10	3	5-1/4	CTC-3E3293	183.95
	6E3314		P-UB-10	3	5-1/4	CTC-3E3293	183.95
	9T9186		P-UB-10	3	5-1/4	CTC-3E3293	183.95
BACKHOE SWING							
	1121765		P-UB-10	2	4	CTC-1113302	123.12
	6E5219		P-UB-10	2	4	CTC-1113302	123.12
BACKHOE SWING LH							
	9T1701		P-UB-10	2-1/8	4	CTC-9X2400	123.33
BACKHOE SWING RH							
	9T1230		P-UB-10	2-1/8	4	CTC-9X2400	123.33

REPLACEMENT KITS FOR CATERPILLAR® EQUIPMENT

Backhoe Loaders							
APPLICATION	CYL #	Misc-Parts, Instructions, etc.	CODE	ROD	BORE	KIT #	List \$
MODEL 446B							
LOADER LIFT							
	1117712		P-UB-10	2-1/4	3-3/4	CTC-1361897	164.75
	1257895		P-UB-10	2-1/4	3-3/4	CTC-1361897	164.75
	9T2997		P-UB-10	2	3-3/4	CTC-7X7938	108.26
LOADER TILT							
	1007844		P-UB-10	2	4	CTC-1113302	123.12
	1007844		P-UB-10	2	4	CTC-1328816	96.00
	9T2995		P-UB-10	2	4	CTC-1328816	96.00
SIDESHIFT							
	1121765		P-UB-10	2	4	CTC-1113302	123.12
STABILIZER LH							
	1329701		P-UB-10	2-1/8	4	CTC-1305923	164.08
	9T2994		P-UB-10	2-1/8	4	CTC-1305923	164.08
STABILIZER RH							
	1329700		P-UB-10	2-1/8	4	CTC-1305923	164.08
	9T2993		P-UB-10	2-1/8	4	CTC-1305923	164.08
MODEL 446D							
BACKHOE BOOM							
	DBL1-UP						
	1118211		P-UB-10	2-5/8	5-1/4	CTC-1118211K	110.60
BACKHOE BUCKET							
	DBL1-UP						
	2406029		I-UB-10	2-3/4	3-3/4	CTC-2406029K	76.71
	2406030		I-UB-10	2-3/4	3-3/4	CTC-2406030K	76.71
BACKHOE EXT STICK							
	DBL1-UP						
	2424278		P-UB-10	1-3/4	3	CTC-2342594	40.76
BACKHOE STICK							
	DBL1-UP						
	1118213		P-UB-10	3	5-1/4	CTC-2281776	112.19
BACKHOE SWING							
	DBL1-426						
	1699531		P-UB-10	2	4	CTC-1699531K	71.45
	DBL427-UP						
	2514296		P-UB-10	50 mm	100 mm	CTC-2332622	64.40
LOADER BUCKET MP							
	DBL1-UP						
	2265540		I-U-10	1-1/2	3	CTC-2309357	57.37
	2681322		I-U-10	40 mm	3-1/2	CTC-2711529	25.81
	6Q2195		I,P-U-15	1-1/2	3-1/2	CTC-6Q2203	59.44
LOADER LIFT							
	DBL1-UP						
	1257895		P-UB-10	2-1/4	3-3/4	CTC-1257895K	54.63
LOADER TILT							
	DBL1-UP						
	1007844		P-UB-10	2	4	CTC-1007844K	44.52
STABILIZER							
	DBL1-UP						
	1978079		P-UB-10	2-1/2	4	CTC-1978079K	50.94
	1978083		P-UB-10	2-1/2	4	CTC-1978083K	50.94
STEERING							
	DBL1-UP						
	9T1834		P-UB-10	2-1/8	3-1/4	CTC-9T1834K	227.63
UNSPECIFIED APPLICATION							
	DBL1-UP						
	2429893		P-UB-10	1-3/4	3-1/2	CTC-2401881	74.50

CATERPILLAR®

REPLACEMENT KITS FOR CATERPILLAR® EQUIPMENT

Backhoe Loaders							
APPLICATION	CYL #	Misc-Parts, Instructions, etc.	CODE	ROD	BORE	KIT #	List \$
MODEL 450E							
BACKHOE BOOM							
EBL1-; RBA1-							
	2707285		P-UB-10	70 mm	140 mm	CTC-2707285K	169.40
BACKHOE BUCKET							
EBL1-; RBA1-							
	2707287		P-UB-10	75 mm	100 mm	CTC-3260496	206.22
BACKHOE EXT STICK							
EBL1-; RBA1-							
	2707288		P-UB-10	45 mm	75 mm	CTC-2707288K	136.79
BACKHOE STICK							
EBL1-; RBA1-							
	2707286		P-UB-10	80 mm	140 mm	CTC-2707286K	192.60
BACKHOE SWING							
EBL1-431							
	2868903		P-UB-10	50 mm	100 mm	CTC-2868903K	63.53
EBL432-; LYR1-; RBA1-							
	2974896		P-UB-10	50 mm	100 mm	CTC-2974896K	87.11
LOADER BUCKET MP							
EBL1-; LYR1-							
	2265540		I-U-10	1-1/2	3	CTC-2309357	57.37
LOADER LIFT							
EBL1-; RBA1-							
	1257895		P-UB-10	2-1/4	3-3/4	CTC-1257895K	54.63
LOADER TILT							
EBL1-; RBA1-							
	1007844		P-UB-10	2	4	CTC-2339205	55.18
STABILIZER LH							
EBL1-; RBA1-							
	2707290		P-UB-10	65 mm	115 mm	CTC-3247165	174.37
STABILIZER RH							
EBL1-; RBA1-							
	2707291		P-UB-10	65 mm	115 mm	CTC-3247165	174.37
STEERING							
EBL1-; LYR1-; RBA1-							
	2385285		I-U-10	42 mm	85 mm	CTC-2807013	129.85
THUMB							
EBL1-; LYR1-							
	2754243		I-U-10	50 mm	70 mm	CTC-2764172	48.63
Crawler Dozers							
APPLICATION	CYL #	Misc-Parts, Instructions, etc.	CODE	ROD	BORE	KIT #	List \$
MODEL 3P							
TILT							
	9J8674		P-UB-10	1-1/2	3-1/2	CTC-7X2752	98.74
MODEL 3S							
TILT							
	8J6893		P-UB-10	2	4	CTC-7X2789	105.58
	9J8674		P-UB-10	1-1/2	3-1/2	CTC-7X2752	98.74
MODEL 4S							
DOZER TILT							
	5J1603		P-V-10	2	4-3/4	CTC-7X2677	121.13
MODEL 5A							
LIFT							
	7J8299		P-UB-10	2-1/2	4	CTC-7X2659	162.26
MODEL 5S							
LIFT							
	7J8302		P-UB-10	2-1/2	4	CTC-7X2659	162.26

REPLACEMENT KITS FOR CATERPILLAR® EQUIPMENT

Crawler Dozers							
APPLICATION	CYL #	Misc-Parts, Instructions, etc.	CODE	ROD	BORE	KIT #	List \$
MODEL 5S							
TILT	2J1402		P-UB-10	3	6-1/2	CTC-7X2694	164.42
MODEL 6							
LIFT	7J7974		P-UB-10	1-1/2	4	CTC-7X2738	90.53
RIPPER	2K3663		P-UB-10	2-1/2	7-1/4	CTC-7X2661	187.26
MODEL 6S							
TILT	2J1402		P-UB-10	3	6-1/2	CTC-7X2694	164.42
MODEL 7A							
TILT	5J7929		P-UB-10	2-1/2	6	CTC-7X2692	170.02
MODEL 7S, 7U							
DOZER TILT	3G4533		P-UB-10	3	6-1/2	CTC-1126550	183.43
	3J9694		P-U-10	3-1/2	8-1/4	CTC-7X2720	186.99
	6J9752		P-UB-10	3	6-1/2	CTC-1126550	183.43
	9J8748		P-UB-10	3	6-1/2	CTC-1126550	183.43
MODEL 7SU							
DOZER TILT	3G4533		P-UB-10	3	6-1/2	CTC-1126550	183.43
MODEL 8A							
DOZER LIFT	9J8802		P-UB-10	3-1/2	7-1/2	CTC-7X2722	192.25
MODEL 8B							
PIN PULLER	4J5057		P-V-10	1-1/4	4	CTC-8T1480	85.62
MODEL 8D							
RIPPER PIN PULLER	8J2071		P-UB-10	1-1/2	4	CTC-7X2738	90.53
MODEL 8R							
TILT	7J0192		P-UB-10	3-1/2	8-1/4	CTC-7X2721	301.34
MODEL 8S							
DOZER TILT	2J3894		P-U-10	3-1/2	8-1/4	CTC-7X2720	186.99
	3G5707		P-UB-10	3-1/2	8-1/4	CTC-7X2721	301.34
LIFT LH	5J9378		P-UB-10	2-1/2	5	CTC-7X2675	128.61
LIFT RH	5J9708		P-UB-10	2-1/2	5	CTC-7X2675	128.61
TILT	6J2472		P-UB-10	3-1/2	8-1/4	CTC-7X2728	181.07
	7J0192		P-UB-10	3-1/2	8-1/4	CTC-7X2721	301.34
	8J8682		P-UB-10	3-1/2	8-1/4	CTC-7X2721	301.34
MODEL 8U							
	6J2472		P-UB-10	3-1/2	8-1/4	CTC-7X2728	181.07
DOZER TILT	2J3894		P-U-10	3-1/2	8-1/4	CTC-7X2720	186.99
	3G5707		P-UB-10	3-1/2	8-1/4	CTC-7X2721	301.34
TILT	7J0192		P-UB-10	3-1/2	8-1/4	CTC-7X2721	301.34
	8J8682		P-UB-10	3-1/2	8-1/4	CTC-7X2721	301.34

REPLACEMENT KITS FOR CATERPILLAR® EQUIPMENT

Crawler Dozers							
APPLICATION	CYL #	Misc-Parts, Instructions, etc.	CODE	ROD	BORE	KIT #	List \$
MODEL 9B							
PIN PULLER							
	4J5057		P-V-10	1-1/4	4	CTC-8T1480	85.62
MODEL 9R							
TILT							
	6J1570		P-UB-10	3-1/2	8-1/4	CTC-7X2721	301.34
MODEL 9S, 9U							
DOZER TILT							
	2J6705		P-U-10	3-1/2	8-1/4	CTC-7X2720	186.99
	3G8661		P-UB-10	4	9-1/4	CTC-7X2799	370.31
TILT							
	6J1570		P-UB-10	3-1/2	8-1/4	CTC-7X2721	301.34
MODEL D2							
UNSPECIFIED APPLICATION							
	4H6711		P-V-10	1-1/4	4	CTC-8T1480	85.62
MODEL D3							
ANGLING							
	8J0096		P-UB-10	1-1/2	3-1/2	CTC-7X2752	98.74
	9J8698		P-UB-10	1-1/2	3-1/2	CTC-7X2752	98.74
	9J8761		P-UB-10	1-1/2	3-1/2	CTC-7X2752	98.74
BACKHOE BOOM							
	8J5555		P-UB-10	2-1/4	4-1/2	CTC-7X2748	111.36
BACKHOE BUCKET							
	3G5905		P-UB-10	2-1/4	3-1/2	CTC-7X2818	93.37
	8J5642		P-UB-10	2-1/4	3-1/2	CTC-7X2818	93.37
BACKHOE STABILIZER							
	1U2655		P-UB-10	2	4	CTC-7X2789	105.58
	1U2656		P-UB-10	2	4	CTC-7X2789	105.58
	8J9481		P-UB-10	1-1/2	3-1/2	CTC-7X2752	98.74
BACKHOE STICK							
	8J5448		P-UB-10	2	4	CTC-7X2789	105.58
LIFT							
	7J9223		P-UB-10	1-1/2	3-1/2	CTC-7X2752	98.74
	7J9224		P-UB-10	1-1/2	3-1/2	CTC-7X2752	98.74
	8J6894		P-UB-10	1-1/2	3-1/2	CTC-7X2752	98.74
RIPPER							
	7J9920		P-UB-10	2	4	CTC-1328816	96.00
RIPPER PIN PULLER							
	4H6711		P-V-10	1-1/4	4	CTC-8T1480	85.62
TILT							
	8J0095		P-UB-10	1-1/2	3-1/2	CTC-7X2752	98.74
	8J6893		P-UB-10	2	4	CTC-7X2789	105.58
	9J4042		P-UB-10	1-1/2	3-1/2	CTC-7X2752	98.74
	9J8674		P-UB-10	1-1/2	3-1/2	CTC-7X2752	98.74
TRACK ADJUSTER							
			TRK ADJ			CTC-FIG4405	23.15
MODEL D3 LGP							
LIFT							
	8J6894		P-UB-10	1-1/2	3-1/2	CTC-7X2752	98.74
MODEL D3B							
ANGLING							
	9J8698		P-UB-10	1-1/2	3-1/2	CTC-1327058	107.52
	9J8761		P-UB-10	1-1/2	3-1/2	CTC-7X2752	98.74
BACKHOE BOOM/BUCKET							
	3G5767		P-UB-10	2-1/4	4-1/2	CTC-1326770	155.43
	3G5905		P-UB-10	2-1/4	3-1/2	CTC-1358166	177.50

REPLACEMENT KITS FOR CATERPILLAR® EQUIPMENT

Crawler Dozers							
APPLICATION	CYL #	Misc-Parts, Instructions, etc.	CODE	ROD	BORE	KIT #	List \$
MODEL D3B							
BACKHOE STABILIZER							
	8J6903		P-UB-10	2	4	CTC-7X2789	105.58
	8J6904		P-UB-10	2	4	CTC-7X2789	105.58
	8J9481		P-UB-10	1-1/2	3-1/2	CTC-7X2752	98.74
BACKHOE STICK/BLADE SHIFT							
	3G5771		P-UB-10	2	4	CTC-1328816	96.00
LIFT							
	7J9223		P-UB-10	1-1/2	3-1/2	CTC-1327058	107.52
	8J6894		P-UB-10	1-1/2	3-1/2	CTC-7X2752	98.74
	9T4000		P-UB-10	1-1/2	4	CTC-7X2738	90.53
	9T6652		P-UB-10	1-1/2	3-1/2	CTC-1327058	107.52
RIPPER							
	7J9920		P-UB-10	2	4	CTC-1328816	96.00
STABILIZER							
	3G6792		P-UB-10	1-1/2	3-1/2	CTC-7X2752	98.74
STABILIZER LH							
	1U2656		P-UB-10	2	4	CTC-1328816	96.00
STABILIZER RH							
	1U2655		P-UB-10	2	4	CTC-1328816	96.00
TILT							
	8J0095		P-UB-10	1-1/2	3-1/2	CTC-7X2752	98.74
	8J6893		P-UB-10	2	4	CTC-1328816	96.00
	9J4042		P-UB-10	1-1/2	3-1/2	CTC-7X2752	98.74
	9J8674		P-UB-10	1-1/2	3-1/2	CTC-1327058	107.52
TRACK ADJUSTER							
			TRK ADJ			CTC-FIG4405	23.15
MODEL D3C							
ANGLING							
	1026237		P-UB-10	1-1/2	3-1/2	CTC-1327058	107.52
	1363155		P-UB-10	1-1/2	3-1/2	CTC-1327058	107.52
	1363156		P-UB-10	1-1/2	3-1/2	CTC-1327058	107.52
	1386859		P-UB-10	1-1/2	3	CTC-7X2751	66.28
	1390548		P-UB-10	1-1/2	3	CTC-7X2751	66.28
	9J8698		P-UB-10	1-1/2	3-1/2	CTC-1327058	107.52
BACKHOE BOOM							
	3G5767		P-UB-10	2-1/4	4-1/2	CTC-7X2748	111.36
BACKHOE BUCKET							
	3G5905		P-UB-10	2-1/4	3-1/2	CTC-7X2818	93.37
BACKHOE STABILIZER							
	3G6792		P-UB-10	1-1/2	3-1/2	CTC-7X2752	98.74
BACKHOE STICK							
	3G5771		P-UB-10	2	4	CTC-7X2789	105.58
LIFT							
	1412915		P-UB-10	1-1/2	3-1/2	CTC-1327058	107.52
	7J9223		P-UB-10	1-1/2	3-1/2	CTC-1327058	107.52
	8J6894		P-UB-10	1-1/2	3-1/2	CTC-7X2752	98.74
LIFT RH							
	6E0212		P-UB-10	2	4	CTC-1328816	96.00
RIPPER							
	7J9920		P-UB-10	2	4	CTC-1328816	96.00
TILT							
	1437219		P-UB-10	1-1/2	3-1/2	CTC-1327058	107.52
	8J0095		P-UB-10	1-1/2	3-1/2	CTC-7X2752	98.74
	8J6893		P-UB-10	2	4	CTC-1328816	96.00
	9J4042		P-UB-10	1-1/2	3-1/2	CTC-7X2752	98.74
	9J8674		P-UB-10	1-1/2	3-1/2	CTC-1327058	107.52

REPLACEMENT KITS FOR CATERPILLAR® EQUIPMENT

Crawler Dozers							
APPLICATION	CYL #	Misc-Parts, Instructions, etc.	CODE	ROD	BORE	KIT #	List \$
MODEL D3C							
TRACK ADJUSTER							
			TRK ADJ			CTC-FIG4405	23.15
MODEL D3G							
ANGLING							
BYR1-1323; CFC1-UP; CFF1-UP; JMH1-2051							
2167388			P-UB-10	1-1/2	2-3/4	CTC-2167388K	44.85
BYR1324-UP; JMH2052-UP							
2590459			P-UB-10	1-1/2	2-3/4	CTC-2590459K	44.85
DOZER LIFT							
JMH1-UP; BYR1-UP; CFC1-UP; CFF1-UP							
1833721			P-UB-10	1-1/2	3-1/2	CTC-2465917	72.31
RIPPER-LH							
BYR1-UP; CFC1-UP; CFF1-UP; JMH1-UP							
1920893			P-UB-10	1-1/2	3	CTC-1920893K	50.41
RIPPER-RH							
BYR1-UP; CFC1-UP; CFF1-UP; JMH1-UP							
1920891			P-UB-10	1-1/2	3	CTC-1920891K	50.41
TILT							
JMH1-UP; BYR1-UP; CFC1-UP; CFF1-UP							
1838459			P-UB-10	1-1/2	3-1/2	CTC-1838459K	75.08
MODEL D3K XL & LGP							
ANGLING							
LLL1-UP; FFF1-UP							
2633745			P-UB-10	1-1/2	3	CTC-2633745K	42.16
DOZER LIFT LH							
JTD1-UP; LLL1-UP; FFF1-UP							
2764667			P-UB-10	1-1/2	3-1/2	CTC-2764667K	75.81
DOZER LIFT RH							
JTD1-UP; LLL1-UP; FFF1-UP							
2634068			P-UB-10	1-1/2	3-1/2	CTC-2634068K	75.81
RIPPER LH							
JTD1-UP; LLL1-UP; FFF1-UP							
2624418			P-UB-10	1-1/2	3	CTC-2624418K	42.16
RIPPER RH							
JTD1-UP; LLL1-UP; FFF1-UP							
2624415			P-UB-10	1-1/2	3	CTC-2624415K	42.16
TILT							
JTD1-UP							
3169205			P-UB-10	1-1/2	3	CTC-3169205K	42.16
JTD1-UP; LLL1-UP; FFF1-UP							
2635008			P-UB-10	1-1/2	3-1/2	CTC-2635008K	75.81
MODEL D4B							
ANGLING							
9J8698			P-UB-10	1-1/2	3-1/2	CTC-7X2752	98.74
BACKHOE BOOM/BUCKET							
3G5767			P-UB-10	2-1/4	4-1/2	CTC-1326770	155.43
3G5905			P-UB-10	2-1/4	3-1/2	CTC-1358166	177.50
BACKHOE STICK/BLADE SHIFT							
3G5771			P-UB-10	2	4	CTC-1328816	96.00
LIFT							
7J9223			P-UB-10	1-1/2	3-1/2	CTC-1327058	107.52
9T6652			P-UB-10	1-1/2	3-1/2	CTC-1327058	107.52
RIPPER							
7J9920			P-UB-10	2	4	CTC-1328816	96.00
STABILIZER							
3G6792			P-UB-10	1-1/2	3-1/2	CTC-7X2752	98.74

REPLACEMENT KITS FOR CATERPILLAR® EQUIPMENT

Crawler Dozers							
APPLICATION	CYL #	Misc-Parts, Instructions, etc.	CODE	ROD	BORE	KIT #	List \$
MODEL D4B							
STABILIZER LH							
	1U2656		P-UB-10	2	4	CTC-1328816	96.00
STABILIZER RH							
	1U2655		P-UB-10	2	4	CTC-1328816	96.00
TILT							
	9J8674		P-UB-10	1-1/2	3-1/2	CTC-1327058	107.52
TRACK ADJUSTER							
			TRK ADJ			CTC-FIG4405	23.15
MODEL D4C							
ANGLING							
	1363156		P-UB-10	1-1/2	3-1/2	CTC-1327058	107.52
	1390548		P-UB-10	1-1/2	3	CTC-7X2751	66.28
	9J8698		P-UB-10	1-1/2	3-1/2	CTC-1327058	107.52
LIFT							
	1412915		P-UB-10	1-1/2	3-1/2	CTC-1327058	107.52
	7J9223		P-UB-10	1-1/2	3-1/2	CTC-1327058	107.52
	8J6894		P-UB-10	1-1/2	3-1/2	CTC-7X2752	98.74
RIPPER							
	7J9920		P-UB-10	2	4	CTC-1328816	96.00
TILT							
	1437219		P-UB-10	1-1/2	3-1/2	CTC-1327058	107.52
	9J8674		P-UB-10	1-1/2	3-1/2	CTC-1327058	107.52
TRACK ADJUSTER							
			TRK ADJ			CTC-FIG4400	49.72
			TRK ADJ			CTC-FIG4405	23.15
MODEL D4D							
DOZER							
	4J4890		P-U-10	2	3-1/2	CTC-7X2806	125.58
	4J4891		P-U-10	2	3-1/2	CTC-7X2806	125.58
	4T4575		P-UB-10	2	3-1/2	CTC-7X2769	116.82
	5J1603		P-V-10	2	4-3/4	CTC-7X2677	121.13
DOZER LIFT							
	8J6894		P-UB-10	1-1/2	3-1/2	CTC-7X2752	98.74
RIPPER							
	6J3308		P-UB-10	2-1/2	5-1/2	CTC-8T1374	96.66
	6J3308		P-UB-10	2-1/2	5-1/2	CTC-9X2050	104.21
RIPPER PIN PULLER							
	4H6711		P-V-10	1-1/4	4	CTC-8T1480	85.62
TILT							
	5J1603		P-V-10	2	4-3/4	CTC-7X2677	121.13
TRACK ADJUSTER							
			TRK ADJ			CTC-FIG4400	49.72
MODEL D4E							
DOZER							
	4T4574		P-UB-10	2	3-1/2	CTC-7X2769	116.82
	4T4575		P-UB-10	2	3-1/2	CTC-7X2769	116.82
DOZER TILT							
	5J1603		P-V-10	2	4-3/4	CTC-7X2677	121.13
LIFT							
	3G0892		P-UB-10	1-3/4	3-1/2	CTC-7X2762	103.56
	3G0892		P-UB-10	1-3/4	3-1/2	CTC-7X2784	58.32
	7J8302		P-UB-10	2-1/2	4	CTC-7X2659	162.26
	7J9223		P-UB-10	1-1/2	3-1/2	CTC-7X2752	98.74
	8J6894		P-UB-10	1-1/2	3-1/2	CTC-7X2752	98.74

REPLACEMENT KITS FOR CATERPILLAR® EQUIPMENT

Crawler Dozers							
APPLICATION	CYL #	Misc-Parts, Instructions, etc.	CODE	ROD	BORE	KIT #	List \$
MODEL D4E							
PUMP							
27X							
	9J5083	w/ Felt Ring				CTC-4J9281	20.11
	9J5083	w/ FKM Oil Seal				CTC-9J5116	28.47
27X; 28X; 29X; 36X							
	9J5082	w/ Felt Ring				CTC-4J9281	20.11
	9J5082	w/ FKM Oil Seal				CTC-9J5116	28.47
RIPPER							
	3G5189		P-UB-10	2-1/2	5	CTC-7X2658	180.34
	6J3308		P-UB-10	2-1/2	5-1/2	CTC-8T1374	96.66
	6J3308		P-UB-10	2-1/2	5-1/2	CTC-9X2050	104.21
RIPPER PIN PULLER							
	4H6711		P-V-10	1-1/4	4	CTC-8T1480	85.62
STEERING							
	3G0892		P-UB-10	1-3/4	3-1/2	CTC-7X2762	103.56
	3G0892		P-UB-10	1-3/4	3-1/2	CTC-7X2784	58.32
	4T1574		P-UB-10	2	4	CTC-7X2789	105.58
	6E4892		P-UB-10	1-3/4	3-1/2	CTC-7X2784	58.32
	7J9685		P-UB-10	1-1/2	3-1/2	CTC-7X2812	107.67
TILT							
	5J1603		P-V-10	2	4-3/4	CTC-7X2677	121.13
TRACK ADJUSTER							
			TRK ADJ			CTC-FIG4400	49.72
MODEL D4G							
ANGLING							
CFN1-UP; FDC1-UP; HYD1-UP; TLX1-UP							
	2167388		P-UB-10	1-1/2	2-3/4	CTC-2167388K	44.85
HYD1719-UP; TLX859-UP							
	2590459		P-UB-10	1-1/2	2-3/4	CTC-2590459K	44.85
DOZER LIFT							
CFN1-UP; FDC1-UP; HYD1-UP; TLX1-UP							
	1833721		P-UB-10	1-1/2	3-1/2	CTC-2465917	72.31
RIPPER-LH							
CFN1-UP; FDC1-UP; HYD1-UP; TLX1-UP							
	1920893		P-UB-10	1-1/2	3	CTC-1920893K	50.41
RIPPER-RH							
CFN1-UP; FDC1-UP; HYD1-UP; TLX1-UP							
	1920891		P-UB-10	1-1/2	3	CTC-1920891K	50.41
TILT							
CFN1-UP; FDC1-UP; HYD1-UP; TLX1-UP							
	1838459		P-UB-10	1-1/2	3-1/2	CTC-1838459K	75.08
MODEL D4H							
ANGLING							
	1006174		P-UB-10	1-3/4	3-1/2	CTC-7X2784	58.32
	4T1683		P-UB-10	1-3/4	3-1/2	CTC-7X2784	58.32
	9T9247		P-UB-10	1-3/4	3-1/2	CTC-7X2784	58.32
DOZER LIFT							
	3G9226		P-UB-10	2	4-1/4	CTC-7X2819	108.80
LIFT							
	3G9226		P-UB-10	2	4-1/4	CTC-7X2819	108.80
	4T4783		P-UB-10	2-1/4	3-3/4	CTC-7X2798	78.56
	8J6894		P-UB-10	1-1/2	3-1/2	CTC-7X2752	98.74
RIPPER							
	3G9892		P-UB-10	2	4	CTC-1328816	96.00

REPLACEMENT KITS FOR CATERPILLAR® EQUIPMENT

Crawler Dozers							
APPLICATION	CYL #	Misc-Parts, Instructions, etc.	CODE	ROD	BORE	KIT #	List \$
MODEL D4H							
TILT							
	1U2568		P-UB-10	2	4-1/4	CTC-7X2819	108.80
	4T1063		P-UB-10	2	4-1/4	CTC-1378662	140.09
	8J6893		P-UB-10	2	4	CTC-7X2789	105.58
	9T8760		P-UB-10	2	4-1/4	CTC-1378662	140.09
	9T8760		P-UB-10	2	4-1/4	CTC-7X2766	45.67
	9T9557		P-UB-10	2	4-1/4	CTC-1378662	140.09
MODEL D4K XL & LGP							
ANGLING							
	MMM1-UP; RRR1-UP						
	2633745		P-UB-10	1-1/2	3	CTC-2633745K	42.16
DOZER LIFT LH							
	MMM1-UP; RRR1-UP						
	2764667		P-UB-10	1-1/2	3-1/2	CTC-2764667K	75.81
DOZER LIFT RH							
	MMM1-UP; RRR1-UP						
	2634068		P-UB-10	1-1/2	3-1/2	CTC-2634068K	75.81
RIPPER LH							
	MMM1-UP; RRR1-UP						
	2624418		P-UB-10	1-1/2	3	CTC-2624418K	42.16
RIPPER RH							
	MMM1-UP; RRR1-UP						
	2624415		P-UB-10	1-1/2	3	CTC-2624415K	42.16
TILT							
	MMM1-UP; RRR1-UP						
	2635008		P-UB-10	1-1/2	3-1/2	CTC-2635008K	75.81
MODEL D4L							
DOZER LIFT							
	3G9226		P-UB-10	2	4-1/4	CTC-7X2819	108.80
MODEL D4TSKH							
ANGLING							
	1006174		P-UB-10	1-3/4	3-1/2	CTC-7X2784	58.32
	9T9247		P-UB-10	1-3/4	3-1/2	CTC-7X2784	58.32
LIFT							
	6E0365		P-UB-10	2	4-1/4	CTC-7X2819	108.80
	6E0366		P-UB-10	2-1/2	4-3/4	CTC-1328811	167.09
TILT							
	9T9557		P-UB-10	2	4-1/4	CTC-1378662	140.09
MODEL D5							
DOZER							
	5J8174		P-UB-10	2-1/2	4-1/4	CTC-7X2664	92.53
	5J8176		P-UB-10	2-1/2	4-1/4	CTC-7X2664	92.53
LIFT							
	7J7974		P-UB-10	1-1/2	4	CTC-7X2738	90.53
	7J8299		P-UB-10	2-1/2	4	CTC-1318748	159.35
	7J8302		P-UB-10	2-1/2	4	CTC-1318748	159.35
RIPPER							
	2K3663		P-UB-10	2-1/2	7-1/4	CTC-7X2661	187.26
	8J1779		P-UB-10	2-1/2	7-1/4	CTC-1542502	200.21
TILT							
	2J1402		P-UB-10	3	6-1/2	CTC-1318740	179.37
	2J1402		P-UB-10	3	6-1/2	CTC-7X2694	164.42
TRACK ADJUSTER							
			TRK ADJ			CTC-FIG4400	49.72

REPLACEMENT KITS FOR CATERPILLAR® EQUIPMENT

Crawler Dozers							
APPLICATION	CYL #	Misc-Parts, Instructions, etc.	CODE	ROD	BORE	KIT #	List \$
MODEL D5B							
LIFT							
	7J7974		P-UB-10	1-1/2	4	CTC-7X2738	90.53
	7J8299		P-UB-10	2-1/2	4	CTC-1318748	159.35
	7J8302		P-UB-10	2-1/2	4	CTC-7X2659	162.26
	8J6868		P-UB-10	2-1/2	4	CTC-7X2659	162.26
PUMP							
	27X; 28X; 29X; 36X						
	9J5082	w/ Felt Ring				CTC-4J9281	20.11
	9J5082	w/ FKM Oil Seal				CTC-9J5116	28.47
RIPPER							
	8J1779		P-UB-10	2-1/2	7-1/4	CTC-1542502	200.21
TILT							
	2J1402		P-UB-10	3	6-1/2	CTC-1318733	213.32
	2J1402		P-UB-10	3	6-1/2	CTC-7X2694	164.42
	7J9695		P-UB-10	2-1/2	5-1/2	CTC-9X2050	104.21
TRACK ADJUSTER							
			TRK ADJ			CTC-FIG4400	49.72
MODEL D5C							
ANGLING							
	1363156		P-UB-10	1-1/2	3-1/2	CTC-1327058	107.52
	1390548		P-UB-10	1-1/2	3	CTC-7X2751	66.28
	9J8698		P-UB-10	1-1/2	3-1/2	CTC-1327058	107.52
LIFT							
	1412915		P-UB-10	1-1/2	3-1/2	CTC-1327058	107.52
	7J9223		P-UB-10	1-1/2	3-1/2	CTC-1327058	107.52
RIPPER							
	7J9920		P-UB-10	2	4	CTC-1328816	96.00
TILT							
	1437219		P-UB-10	1-1/2	3-1/2	CTC-1327058	107.52
	9J8674		P-UB-10	1-1/2	3-1/2	CTC-1327058	107.52
MODEL D5E							
LIFT							
	8J6868		P-UB-10	2-1/2	4	CTC-7X2659	162.26
RIPPER							
	8J1779		P-UB-10	2-1/2	7-1/4	CTC-1542502	200.21
TRACK ADJUSTER							
			TRK ADJ			CTC-FIG4400	49.72
MODEL D5G							
ANGLING							
	FDH1141-UP; FDW651-UP; RKG1-2121; WGB1-2700						
	2167388		P-UB-10	1-1/2	2-3/4	CTC-2167388K	44.85
	FDH1-UP; FDW1-UP						
	2011056		P-UB-10	1-1/2	2-3/4	CTC-2011056K	44.85
	RKG2122-UP; WGB2701-UP						
	2590459		P-UB-10	1-1/2	2-3/4	CTC-2590459K	44.85
DOZER LIFT							
	FDH1-UP; FDW1-UP; RKG1-UP; WGB1-UP						
	1833721		P-UB-10	1-1/2	3-1/2	CTC-2465917	72.31
RIPPER-LH							
	FDH1-UP; FDW1-UP; RKG1-UP; WGB1-UP						
	1920893		P-UB-10	1-1/2	3	CTC-1920893K	50.41
RIPPER-RH							
	FDH1-UP; FDW1-UP; RKG1-UP; WGB1-UP						
	1920891		P-UB-10	1-1/2	3	CTC-1920891K	50.41

REPLACEMENT KITS FOR CATERPILLAR® EQUIPMENT

Crawler Dozers							
APPLICATION	CYL #	Misc-Parts, Instructions, etc.	CODE	ROD	BORE	KIT #	List \$
MODEL D5G							
TILT							
	FDH1-UP; FDW1-UP; RKG1-UP; WGB1-UP						
	1838459		P-UB-10	1-1/2	3-1/2	CTC-1838459K	75.08
MODEL D5H							
ANGLING							
	4T1666		P-UB-10	2	4	CTC-7X2789	105.58
	9T9273		P-UB-10	2	4	CTC-1113302	123.12
LIFT							
	1153524		P-UB-10	2-1/4	3-3/4	CTC-1361897	164.75
	1U1839		P-UB-10	2-1/4	3-3/4	CTC-1361897	164.75
	1U2568		P-UB-10	2	4-1/4	CTC-7X2819	108.80
	3G5909		P-UB-10	2	4	CTC-7X2789	105.58
	4T1089		P-UB-10	2-1/4	3-3/4	CTC-1361897	164.75
	4T1659		P-UB-10	2-1/4	4-1/2	CTC-1326770	155.43
	6E5400		P-UB-10	2-1/4	4-1/2	CTC-1354392	145.28
RIPPER							
	3G5909		P-UB-10	2	4	CTC-1328816	96.00
	9T2716		P-UB-10	2-1/2	5	CTC-7X2658	180.34
TILT							
	1U3991		P-UB-10	3	6-1/2	CTC-1126550	183.43
	1U3991		P-UB-10	3	6-1/2	CTC-8T1408	83.58
	4T1625		P-UB-10	2-1/4	4-3/4	CTC-1318778	145.01
	4T2613		P-UB-10	2-1/2	5	CTC-1315118	184.12
	4T2613		P-UB-10	2-1/2	5	CTC-7X2658	180.34
MODEL D5K XL & LGP							
ANGLING							
	WWW1-UP; YYY1-UP						
	2633745		P-UB-10	1-1/2	3	CTC-2633745K	42.16
DOZER LIFT LH							
	JLF1-UP; WWW1-UP; YYY1-UP						
	2764667		P-UB-10	1-1/2	3-1/2	CTC-2764667K	75.81
DOZER LIFT RH							
	JLF1-UP; WWW1-UP; YYY1-UP						
	2634068		P-UB-10	1-1/2	3-1/2	CTC-2634068K	75.81
RIPPER LH							
	JLF1-UP; WWW1-UP; YYY1-UP						
	2624418		P-UB-10	1-1/2	3	CTC-2624418K	42.16
RIPPER RH							
	JLF1-UP; WWW1-UP; YYY1-UP						
	2624415		P-UB-10	1-1/2	3	CTC-2624415K	42.16
TILT							
	JLF1-UP						
	3169205		P-UB-10	1-1/2	3	CTC-3169205K	42.16
	JLF1-UP; WWW1-UP; YYY1-UP						
	2635008		P-UB-10	1-1/2	3-1/2	CTC-2635008K	75.81
MODEL D5M							
ANGLING							
	1061286		P-UB-10	1-3/4	3-1/2	CTC-7X2784	58.32
	1378456		P-UB-10	1-3/4	3-1/2	CTC-7X2784	58.32
	1526482		P-UB-10	1-3/4	3-1/2	CTC-7X2784	58.32
LIFT							
	1059822		P-UB-10	2	4-1/4	CTC-1378662	140.09
	1607610		P-UB-10	2-1/2	4-3/4	CTC-1328811	167.09
	6E0366		P-UB-10	2-1/2	4-3/4	CTC-1328811	167.09
RIPPER							
	3G9892		P-UB-10	2	4	CTC-1328816	96.00

REPLACEMENT KITS FOR CATERPILLAR® EQUIPMENT

Crawler Dozers							
APPLICATION	CYL #	Misc-Parts, Instructions, etc.	CODE	ROD	BORE	KIT #	List \$
MODEL D5N							
ANGLING							
AGG1-UP; AKD1-UP; CFH1-150; CKT1-292							
1526482			P-UB-10	1-3/4	3-1/2	CTC-2401881	74.50
AGG1-UP; AKD1-UP; CFH151-UP; CKT293-UP							
2432058			P-UB-10	1-3/4	3-1/2	CTC-2432058K	77.65
DOZER LIFT							
AGG1-UP; AKD1-UP; CFH1-UP; CKT1-UP							
1677551			P-UB-10	2	4-1/4	CTC-1677551K	51.92
DOZER TILT							
1600045	Includes 0.99" & 1.24" Wear ring		P-UB-10	2-1/2	4-3/4	CTC-1600045K	104.93
1600045	CHG 00-01, 0.99" Wear ring width		P-UB-10	2-1/2	4-3/4	CTC-1864382	98.20
1600045	CHG 06-UP, 1.24" Wear ring width		P-UB-10	2-1/2	4-3/4	CTC-1864399	87.00
RIPPER							
AGG1-UP; AKD1-UP; CFH1-UP; CKT1-UP							
3G9892			P-UB-10	2	4	CTC-2339205	55.18
MODEL D5TSKH							
ANGLING							
9T9273			P-UB-10	2	4	CTC-1113302	123.12
LIFT							
6E0366			P-UB-10	2-1/2	4-3/4	CTC-1328811	167.09
MODEL D6							
RIPPER							
2K3663			P-UB-10	2-1/2	7-1/4	CTC-7X2661	187.26
RIPPER LIFT							
8J1779			P-UB-10	2-1/2	7-1/4	CTC-7X2661	187.26
MODEL D6 LGP							
LIFT							
8J6868			P-UB-10	2-1/2	4	CTC-7X2659	162.26
MODEL D6B							
LIFT							
5J8173			P-UB-10	2-1/2	4-1/4	CTC-7X2664	92.53
PUMP							
27X; 28X; 29X; 36X							
9J5082	w/ Felt Ring					CTC-4J9281	20.11
9J5082	w/ FKM Oil Seal					CTC-9J5116	28.47
RIPPER							
2K3663			P-UB-10	2-1/2	7-1/4	CTC-7X2661	187.26
RIPPER LIFT							
8J1779			P-UB-10	2-1/2	7-1/4	CTC-7X2661	187.26
TILT							
2J1402			P-UB-10	3	6-1/2	CTC-1318733	213.32
2J1402			P-UB-10	3	6-1/2	CTC-7X2694	164.42
TRACK ADJUSTER							
			TRK ADJ			CTC-FIG4400	49.72
MODEL D6C							
BACKHOE STICK/BLADE SHIFT							
8J5448			P-UB-10	2	4	CTC-1328816	96.00
DOZER							
5J8172			P-UB-10	2-1/2	4-1/4	CTC-7X2664	92.53
5J8173			P-UB-10	2-1/2	4-1/4	CTC-7X2664	92.53
DOZER LIFT							
4J4891			P-U-10	2	3-1/2	CTC-7X2806	125.58

REPLACEMENT KITS FOR CATERPILLAR® EQUIPMENT

Crawler Dozers							
APPLICATION	CYL #	Misc-Parts, Instructions, etc.	CODE	ROD	BORE	KIT #	List \$
MODEL D6C							
DOZER TILT							
	1U3495		P-UB-10	2-1/2	6	CTC-7X2674	133.74
	2J1402		P-UB-10	3	6-1/2	CTC-7X2694	164.42
	5J1603		P-V-10	2	4-3/4	CTC-7X2677	121.13
	7J3171		P-UB-10	2-1/2	6	CTC-7X2674	133.74
	7J3172		P-UB-10	2-1/2	6	CTC-7X2674	133.74
LIFT							
	7J7974		P-UB-10	1-1/2	4	CTC-7X2738	90.53
	7J8302		P-UB-10	2-1/2	4	CTC-1318748	159.35
	8J6868		P-UB-10	2-1/2	4	CTC-1318748	159.35
RIPPER							
	2K3663		P-UB-10	2-1/2	7-1/4	CTC-7X2661	187.26
	6J3308		P-UB-10	2-1/2	5-1/2	CTC-8T1374	96.66
	8J1779		P-UB-10	2-1/2	7-1/4	CTC-1542502	200.21
TILT							
	2J1402		P-UB-10	3	6-1/2	CTC-1318733	213.32
TRACK ADJUSTER							
			TRK ADJ			CTC-FIG3400	61.91
MODEL D6D							
BACKHOE STICK/BLADE SHIFT							
	8J5448		P-UB-10	2	4	CTC-1328816	96.00
DOZER TILT							
	1U3495		P-UB-10	2-1/2	6	CTC-7X2674	133.74
	2J1402		P-UB-10	3	6-1/2	CTC-7X2694	164.42
	7J3171		P-UB-10	2-1/2	6	CTC-7X2674	133.74
	7J3172		P-UB-10	2-1/2	6	CTC-7X2674	133.74
DOZER TILT RH							
	7J9695		P-UB-10	2-1/2	5-1/2	CTC-8T1374	96.66
LIFT							
	7J7974		P-UB-10	1-1/2	4	CTC-7X2738	90.53
	7J8302		P-UB-10	2-1/2	4	CTC-1318748	159.35
	8J6868		P-UB-10	2-1/2	4	CTC-1318748	159.35
RIPPER							
	8J1779		P-UB-10	2-1/2	7-1/4	CTC-1542502	200.21
TILT							
	1U3495		P-UB-10	2-1/2	6	CTC-7X2692	170.02
	2J1402		P-UB-10	3	6-1/2	CTC-1318733	213.32
	7J3171		P-UB-10	2-1/2	6	CTC-7X2692	170.02
	7J9695		P-UB-10	2-1/2	5-1/2	CTC-9X2050	104.21
	9T2797		P-UB-10	2-1/2	6	CTC-7X2674	133.74
TILT LH							
	6J0518		P-UB-10	2-1/2	6	CTC-7X2692	170.02
	7J3172		P-UB-10	2-1/2	6	CTC-7X2692	170.02
TILT RH							
	6J0517		P-UB-10	2-1/2	6	CTC-7X2692	170.02
TRACK ADJUSTER							
			TRK ADJ			CTC-FIG3400	61.91
MODEL D6E, D6G							
LIFT							
	8J6868		P-UB-10	2-1/2	4	CTC-1318748	159.35
RIPPER							
	1306135		P-UB-10	2-1/2	7-1/4	CTC-1542502	200.21
	8J1779		P-UB-10	2-1/2	7-1/4	CTC-1542502	200.21

REPLACEMENT KITS FOR CATERPILLAR® EQUIPMENT

Crawler Dozers							
APPLICATION	CYL #	Misc-Parts, Instructions, etc.	CODE	ROD	BORE	KIT #	List \$
MODEL D6E, D6G							
TILT							
	1U3495		P-UB-10	2-1/2	6	CTC-7X2674	133.74
	1U3495		P-UB-10	2-1/2	6	CTC-7X2692	170.02
	9T2797		P-UB-10	2-1/2	6	CTC-7X2674	133.74
UNSPECIFIED APPLICATION							
	2J1402		P-UB-10	3	6-1/2	CTC-1318733	213.32
MODEL D6H							
DOZER							
	1U3989		P-UB-10	2-1/2	3-3/4	CTC-1318700	156.19
	1U3990		P-UB-10	2-1/2	3-3/4	CTC-1318700	156.19
	4Y3807		P-UB-10	2-1/2	3-3/4	CTC-1318700	156.19
	9T8952		P-UB-10	2-1/2	4	CTC-1353223	166.02
	9T8996		P-UB-10	2-1/2	4	CTC-1353223	166.02
DOZER TILT							
	9T6095		P-UB-10	2-1/2	6	CTC-7X2655	117.58
RIPPER							
	9T2716		P-UB-10	2-1/2	5	CTC-7X2658	180.34
TILT							
	1U3991		P-UB-10	3	6-1/2	CTC-1126550	183.43
	1U3991		P-UB-10	3	6-1/2	CTC-7X2694	164.42
	1U3992		P-UB-10	2-1/2	6	CTC-7X2655	117.58
	1U3992		P-UB-10	2-1/2	6	CTC-7X2836	265.91
	3G2798		P-UB-10	2-1/2	5-1/2	CTC-7X2671	153.32
	9T6095		P-UB-10	2-1/2	6	CTC-1315164	210.54
	9T8760		P-UB-10	2	4-1/4	CTC-7X2766	45.67
MODEL D6K LGP							
ANGLING							
	DHA1-UP; FBH1-UP						
	2692728		P-UB-10	45 mm	90 mm	CTC-2692728K	112.17
DOZER LIFT							
	DHA1-UP; FBH1-UP						
	2692730		P-UB-10	60 mm	110 mm	CTC-2692730K	158.08
DOZER TILT							
	DHA1-UP; FBH1-UP						
	2692729		P-UB-10	65 mm	120 mm	CTC-2692729K	135.73
RIPPER							
	4041-UP						
	2270842		P-UB-10	2-1/2	5	CTC-2422542	83.64
	3255723		P-UB-10	2-1/2	5	CTC-3255723K	79.09
MODEL D6K XL							
ANGLING							
	DHA1-UP; FBH1-UP; HMG1-UP						
	2692728		P-UB-10	45 mm	90 mm	CTC-2692728K	112.17
DOZER LIFT							
	DHA1-UP; FBH1-UP; HMG1-UP						
	2692730		P-UB-10	60 mm	110 mm	CTC-2692730K	158.08
DOZER TILT							
	DHA1-UP; FBH1-UP; HMG1-UP						
	2692729		P-UB-10	65 mm	120 mm	CTC-2692729K	135.73
RIPPER							
	4041-UP						
	2270842		P-UB-10	2-1/2	5	CTC-2422542	83.64
	4041-UP; HMG1-UP						
	3255723		P-UB-10	2-1/2	5	CTC-3255723K	79.09

REPLACEMENT KITS FOR CATERPILLAR® EQUIPMENT

Crawler Dozers							
APPLICATION	CYL #	Misc-Parts, Instructions, etc.	CODE	ROD	BORE	KIT #	List \$
MODEL D6M							
ANGLING							
	1103786		P-UB-10	2	4	CTC-1113302	123.12
	1526485		P-UB-10	2	4	CTC-1113302	123.12
LIFT							
	1103269		P-UB-10	2-1/4	4-1/2	CTC-1326770	155.43
	1153524		P-UB-10	2-1/4	3-3/4	CTC-1361897	164.75
RIPPER							
	3G5909		P-UB-10	2	4	CTC-1328816	96.00
	9T2716		P-UB-10	2-1/2	5	CTC-7X2658	180.34
TILT							
	1600054		P-UB-10	2-1/2	5-1/2	CTC-7X2653	168.14
UNSPECIFIED APPLICATION							
	1375107		P-UB-10	2	4	CTC-1113302	123.12
MODEL D6N							
ANGLING							
	AKM1-UP; ALH1-UP; ALR1-UP; ALY1-UP; CBF1-UP; CBJ1-UP; CBL1-UP; CCG1-UP; CCK1-UP; CCS1-UP; DJA1-UP; DJY1-UP						
	2280320		P-UB-10	2	4	CTC-2280320K	73.04
	AKM1-UP; ALY1-UP; CCK1-UP; DJA1-UP; DJY1-UP; GHS1-UP; JAH1-UP; LJR1-UP; MLW1-UP						
	3217048		P-UB-10	2	4	CTC-3217048K	73.16
	ALH1-UP; ALR1-UP						
	1526485		P-UB-10	2	4	CTC-2409538	76.30
DOZER LIFT							
	AKM1-1885; ALY1-2181						
	1922811		P-UB-10	2-1/4	4-1/2	CTC-2417585	76.28
	AKM1-UP; ALH1-UP; ALR1-UP; ALY1-UP; CBJ1-UP; CCK1-UP						
	1U1839		P-UB-10	2-1/4	3-3/4	CTC-1U1839K	58.55
	AKM1-UP; ALH1-UP; ALY1-UP; CBF1-UP; CBJ1-UP; CBL1-UP; CCG1-UP; CCK1-UP; CCS1-UP; DJA1-UP; DJY1-UP; GHS1-UP; JAH1-UP; LJR1-UP; MLW1-UP						
	1103269		P-UB-10	2-1/4	4-1/2	CTC-2417584	77.73
	AKM1-UP; ALH1-UP; CBJ1-UP; CCK1-UP						
	1153524		P-UB-10	2-1/4	3-3/4	CTC-1153524K	58.55
	DJA1-UP; DJY1-UP; GHS1-UP; JAH1-UP; LJR1-UP; MLW1-UP						
	2758416		P-UB-10	2-1/4	3-3/4	CTC-2758416K	58.55
DOZER TILT							
	AKM1-UP; ALH1-UP; ALR1-UP; ALY1-UP; CBF1-UP; CBJ1-UP; CBL1-UP; CCG1-UP; CCK1-UP; CCS1-UP; DJA1-UP; DJY1-UP; JAH1-UP; LJR1-UP						
	1600054		P-UB-10	2-1/2	5-1/2	CTC-2422539	82.78
	AKM1-UP; ALH1-UP; CBF1-UP; CBJ1-UP; CBL1-UP; CCG1-UP; CCK1-UP; CCS1-UP; DJA1-UP; DJY1-UP						
	1153523		P-UB-10	3	6-1/2	CTC-1153523K	123.01
	DJA1-UP; DJY1-UP; GHS1-UP; JAH1-UP; LJR1-UP; MLW1-UP						
	2339134		P-UB-10	3	6-1/2	CTC-2339134K	126.22
	3284267		P-UB-10	2-1/2	5-1/2	CTC-3284267K	82.78
RIPPER LIFT							
	AKM1-UP; ALH1-UP; ALR1-UP; ALY1-UP; CBF1-UP; CBJ1-UP; CBL1-UP; CCG1-UP; CCK1-UP; CCS1-UP						
	9T2716		P-UB-10	2-1/2	5	CTC-2422542	83.64
	AKM1-UP; ALH1-UP; ALR1-UP; ALY1-UP; CBF1-UP; CBL1-UP; CCG1-UP; CCK1-UP; CCS1-UP; DJA1-UP; DJY1-UP; JAH1-UP						
	2270842		P-UB-10	2-1/2	5	CTC-2270842K	78.87
	DJA1-UP; DJY1-UP; GHS1-UP; JAH1-UP; LJR1-UP; MLW1-UP						
	3255723		P-UB-10	2-1/2	5	CTC-3255723K	79.09
MODEL D6R							
DOZER							
	1278931		P-UB-10	2-1/2	4	CTC-1353223	166.02
	1294258		P-UB-10	2-1/2	4	CTC-1353223	166.02
RIPPER							
	9T2716		P-UB-10	2-1/2	5	CTC-7X2658	180.34

CATERPILLAR®

REPLACEMENT KITS FOR CATERPILLAR® EQUIPMENT

Crawler Dozers							
APPLICATION	CYL #	Misc-Parts, Instructions, etc.	CODE	ROD	BORE	KIT #	List \$
MODEL D6R							
TILT							
	1U3991		P-UB-10	3	6-1/2	CTC-1126550	183.43
	1U3991		P-UB-10	3	6-1/2	CTC-8T1408	83.58
	9T6095		P-UB-10	2-1/2	6	CTC-1315164	210.54
	9T6095		P-UB-10	2-1/2	6	CTC-7X2655	117.58
MODEL D6T							
ANGLING							
	DJG1-UP; JWD1-UP; RLW1-UP; WCG1-UP; WFH1-UP; ZEB1-UP						
	2871973		P-UB-10	2-1/4	4	CTC-2871973K	81.23
DOZER ANGLING							
	DJG1-UP; JWD1-UP; RLW1-UP; WCG1-UP; WFH1-UP; ZEB1-UP						
	2278893		P-UB-10	2-1/2	5-1/4	CTC-2278893K	83.43
	GCT1-UP; JHB1-UP; KJL1-UP; LAE1-UP; LAY1-UP; PEZ1-UP; SKL1-UP; SMC1-UP						
	2270841		P-UB-10	2-1/2	6	CTC-2270841K	75.44
DOZER LIFT							
	DJG1-UP; JWD1-UP; RLW1-UP; WFH1-UP; ZEB1-UP						
	2270994		P-UB-10	2-1/2	4	CTC-2270994K	183.56
	GCT1-UP; JHB1-UP; LAE1-UP; LAY1-UP; LBD1-UP; LKJ1-UP; PEZ1-UP; SKL1-UP; SMC1-UP						
	2270844		P-UB-10	2-1/2	4	CTC-2270844K	94.02
	JWD1-UP; RLW1-UP; WCG1-UP; ZEB1-UP						
	2330478		P-UB-10	2-1/2	4	CTC-2330478K	183.56
	KJL1-UP; LAE1-UP; LBD1-UP; LKJ1-UP; PEZ1-UP						
	2270843		P-UB-10	2-1/2	4	CTC-2270843K	94.02
DOZER TILT							
	JHB1-UP; KJL1-UP; LAE1-UP; LAY1-UP; LBD1-UP; LKJ1-UP; PEZ1-UP; SKL1-UP; SMC1-UP						
	2339134		P-UB-10	3	6-1/2	CTC-2339134K	126.22
RIPPER LIFT							
	DJG1-UP; GCT1-UP; JHB1-UP; JWD1-UP; KJL1-UP; LAE1-UP; LAY1-UP; LBD1-UP; LKJ1-UP; PEZ1-UP; RLW1-UP; SKL1-UP; SMC1-UP; WCG1-UP; WFH1-UP; ZEB1-UP						
	2270842		P-UB-10	2-1/2	5	CTC-2270842K	78.87
	3255723		P-UB-10	2-1/2	5	CTC-3255723K	79.09
MODEL D7							
TRACK ADJUSTER							
			TRK ADJ			CTC-FIG3400	61.91
MODEL D7 LGP							
LIFT LH							
	9J4887		P-UB-10	2-1/2	4-3/4	CTC-1014201	138.67
LIFT RH							
	9J4888		P-UB-10	2-1/2	4-3/4	CTC-1014201	138.67
MODEL D7A, D7B, D7C, D7D, D7E							
DOZER LIFT							
	3R6781		P-UB-10	2-1/2	4-3/4	CTC-7X2660	185.90
DOZER LIFT LH							
	1U2133		P-UB-10	2-1/2	4-3/4	CTC-7X2660	185.90
	1U2136		P-UB-10	2-1/2	4-3/4	CTC-7X2660	185.90
DOZER LIFT RH							
	1U2134		P-UB-10	2-1/2	4-3/4	CTC-7X2660	185.90
	1U2135		P-UB-10	2-1/2	4-3/4	CTC-7X2660	185.90
DOZER TILT							
	2J6783		P-U-10	3-1/2	8-1/4	CTC-7X2720	186.99
	3J9694		P-U-10	3-1/2	8-1/4	CTC-7X2720	186.99
	3R6770		P-U-10	3-1/2	8-1/4	CTC-7X2720	186.99
	9J8748		P-UB-10	3	6-1/2	CTC-7X2694	164.42
LIFT							
	3J3271		P-UB-10	2-1/2	6	CTC-7X2679	143.00
	4J6177		P-UB-10	2-1/2	4-3/4	CTC-1014201	138.67
	4J6177		P-UB-10	2-1/2	4-3/4	CTC-7X2660	185.90

REPLACEMENT KITS FOR CATERPILLAR® EQUIPMENT

Crawler Dozers							
APPLICATION	CYL #	Misc-Parts, Instructions, etc.	CODE	ROD	BORE	KIT #	List \$
MODEL D7A, D7B, D7C, D7D, D7E							
RIPPER							
	3J6439		P-UB-10	2-1/2	6	CTC-7X2679	143.00
RIPPER LIFT							
	3R6724	D7E only	P-UB-10	2-1/2	6	CTC-7X2679	143.00
	4T9290		P-UB-10	2-1/2	6	CTC-7X2655	117.58
TILT							
	5J7929		P-UB-10	2-1/2	6	CTC-7X2692	170.02
	6J9752		P-UB-10	3	6-1/2	CTC-1126550	183.43
TRACK ADJUSTER							
		D7C, D7D only	TRK ADJ			CTC-FIG3400	61.91
		D7E only	TRK ADJ			CTC-FIG3404	47.88
MODEL D7F							
DOZER LH							
	1041944		P-UB-10	2-1/2	4-3/4	CTC-1700221	146.61
	1U2136		P-UB-10	2-1/2	4-3/4	CTC-7X2773	184.64
DOZER LIFT							
	3R6781		P-UB-10	2-1/2	4-3/4	CTC-7X2660	185.90
DOZER LIFT LH							
	1U2133		P-UB-10	2-1/2	4-3/4	CTC-7X2660	185.90
	1U2136		P-UB-10	2-1/2	4-3/4	CTC-7X2660	185.90
DOZER LIFT RH							
	1U2134		P-UB-10	2-1/2	4-3/4	CTC-7X2660	185.90
	1U2135		P-UB-10	2-1/2	4-3/4	CTC-7X2660	185.90
DOZER RH							
	1041943		P-UB-10	2-1/2	4-3/4	CTC-1700221	146.61
	1U2135		P-UB-10	2-1/2	4-3/4	CTC-7X2773	184.64
DOZER TILT							
	2J6783		P-U-10	3-1/2	8-1/4	CTC-7X2720	186.99
	3J9694		P-U-10	3-1/2	8-1/4	CTC-7X2720	186.99
	3R6770		P-U-10	3-1/2	8-1/4	CTC-7X2720	186.99
	9J8748		P-UB-10	3	6-1/2	CTC-7X2694	164.42
LIFT							
	3J3271		P-UB-10	2-1/2	6	CTC-7X2679	143.00
	4J6177		P-UB-10	2-1/2	4-3/4	CTC-7X2660	185.90
LIFT LH							
	7J3334		P-UB-10	2-1/2	4-3/4	CTC-7X2773	184.64
LIFT RH							
	7J3333		P-UB-10	2-1/2	4-3/4	CTC-7X2773	184.64
RIPPER							
	3J6439		P-UB-10	2-1/2	6	CTC-7X2679	143.00
RIPPER LIFT							
	3R6724		P-UB-10	2-1/2	6	CTC-7X2679	143.00
	4T9290		P-UB-10	2-1/2	6	CTC-7X2655	117.58
TILT							
	5J7929		P-UB-10	2-1/2	6	CTC-7X2692	170.02
	6J9752		P-UB-10	3	6-1/2	CTC-1126550	183.43
	9J8748		P-UB-10	3	6-1/2	CTC-1126550	183.43
TRACK ADJUSTER							
			TRK ADJ			CTC-FIG3401	57.79
MODEL D7G							
DOZER LH							
	1041944		P-UB-10	2-1/2	4-3/4	CTC-1700221	146.61
	1U2133		P-UB-10	2-1/2	4-3/4	CTC-7X2773	184.64
	1U2136		P-UB-10	2-1/2	4-3/4	CTC-7X2773	184.64
DOZER LIFT							
	3R6781		P-UB-10	2-1/2	4-3/4	CTC-7X2660	185.90

CATERPILLAR®

REPLACEMENT KITS FOR CATERPILLAR® EQUIPMENT

Crawler Dozers							
APPLICATION	CYL #	Misc-Parts, Instructions, etc.	CODE	ROD	BORE	KIT #	List \$
MODEL D7G							
DOZER LIFT LH							
	1U2133		P-UB-10	2-1/2	4-3/4	CTC-7X2660	185.90
	1U2136		P-UB-10	2-1/2	4-3/4	CTC-7X2660	185.90
DOZER LIFT RH							
	1U2134		P-UB-10	2-1/2	4-3/4	CTC-7X2660	185.90
	1U2135		P-UB-10	2-1/2	4-3/4	CTC-7X2660	185.90
DOZER RH							
	1041943		P-UB-10	2-1/2	4-3/4	CTC-1700221	146.61
	1U2134		P-UB-10	2-1/2	4-3/4	CTC-7X2773	184.64
	1U2135		P-UB-10	2-1/2	4-3/4	CTC-7X2773	184.64
DOZER TILT							
	2J6783		P-U-10	3-1/2	8-1/4	CTC-7X2720	186.99
	3J9694		P-U-10	3-1/2	8-1/4	CTC-7X2720	186.99
	3R6770		P-U-10	3-1/2	8-1/4	CTC-7X2720	186.99
	9J8748		P-UB-10	3	6-1/2	CTC-7X2694	164.42
LIFT							
	3J3271		P-UB-10	2-1/2	6	CTC-7X2679	143.00
	3R6781		P-UB-10	2-1/2	4-3/4	CTC-7X2660	185.90
	4J6177		P-UB-10	2-1/2	4-3/4	CTC-1014201	138.67
	4J6177		P-UB-10	2-1/2	4-3/4	CTC-7X2660	185.90
LIFT LH							
	7J3334		P-UB-10	2-1/2	4-3/4	CTC-7X2773	184.64
LIFT RH							
	7J3333		P-UB-10	2-1/2	4-3/4	CTC-7X2773	184.64
	9J4888		P-UB-10	2-1/2	4-3/4	CTC-7X2773	184.64
RIPPER							
	3J6439		P-UB-10	2-1/2	6	CTC-7X2679	143.00
RIPPER LIFT							
	4T9290		P-UB-10	2-1/2	6	CTC-7X2655	117.58
TILT							
	2J1402		P-UB-10	3	6-1/2	CTC-1318733	213.32
	5J7929		P-UB-10	2-1/2	6	CTC-7X2692	170.02
	6J9752		P-UB-10	3	6-1/2	CTC-1126550	183.43
	9J8748		P-UB-10	3	6-1/2	CTC-1126550	183.43
	9J8748		P-UB-10	3	6-1/2	CTC-8T1408	83.58
TILT LH							
	5J7930		P-UB-10	2-1/2	6	CTC-7X2692	170.02
	7J9364		P-UB-10	2-1/2	6	CTC-7X2669	241.94
TRACK ADJUSTER							
			TRK ADJ			CTC-FIG3401	57.79
MODEL D7H							
DOZER							
	1291908		P-UB-10	2-1/2	4	CTC-1353223	166.02
	1U4851		P-UB-10	2-1/2	4	CTC-1353253	163.15
	1U4852		P-UB-10	2-1/2	4	CTC-1353253	163.15
DOZER LIFT							
	1U3989		P-UB-10	2-1/2	3-3/4	CTC-7X2670	94.83
	1U4851		P-UB-10	2-1/2	4	CTC-1318748	159.35
	1U4852		P-UB-10	2-1/2	4	CTC-1318748	159.35
DOZER TILT							
	3G4533		P-UB-10	3	6-1/2	CTC-7X2694	164.42
	9T1370		P-UB-10	3	6-1/2	CTC-7X2694	164.42

REPLACEMENT KITS FOR CATERPILLAR® EQUIPMENT

Crawler Dozers							
APPLICATION	CYL #	Misc-Parts, Instructions, etc.	CODE	ROD	BORE	KIT #	List \$
MODEL D7H							
LIFT							
	1294259		P-UB-10	2-1/2	4	CTC-1353223	166.02
	1U4852		P-UB-10	2-1/2	4	CTC-7X2659	162.26
	4T2098		P-UB-10	2-1/2	4-3/4	CTC-7X2673	184.64
	6E1836		P-UB-10	2-1/2	4	CTC-1353223	166.02
	6E1841		P-UB-10	2-1/2	4	CTC-1353223	166.02
RIPPER							
	4T8639		P-UB-10	2-3/4	5-1/4	CTC-1326121	216.90
	9T0142		P-UB-10	3	7-1/4	CTC-1326184	233.80
TILT							
	1124814		P-UB-10	2-3/4	6	CTC-1352167	217.95
	3G4533		P-UB-10	3	6-1/2	CTC-1126550	183.43
	6J9752		P-UB-10	3	6-1/2	CTC-1126550	183.43
	9T6113		P-UB-10	3	6-1/2	CTC-1126550	183.43
MODEL D7R							
DOZER							
	1291908		P-UB-10	2-1/2	4	CTC-1353223	166.02
	1U4851		P-UB-10	2-1/2	4	CTC-1318748	159.35
	1U4851		P-UB-10	2-1/2	4	CTC-1353253	163.15
	1U4852		P-UB-10	2-1/2	4	CTC-1318748	159.35
	1U4852		P-UB-10	2-1/2	4	CTC-1353253	163.15
LIFT							
	1294259		P-UB-10	2-1/2	4	CTC-1353223	166.02
	6E1836		P-UB-10	2-1/2	4	CTC-1353223	166.02
	6E1841		P-UB-10	2-1/2	4	CTC-1353223	166.02
RIPPER							
	9T0142		P-UB-10	3	7-1/4	CTC-1326184	233.80
TILT							
	1124814		P-UB-10	2-3/4	6	CTC-1352167	217.95
	3G4533		P-UB-10	3	6-1/2	CTC-1126550	183.43
	9T6113		P-UB-10	3	6-1/2	CTC-1126550	183.43
TILT LH							
	1470709		P-UB-10	3	6-1/2	CTC-1126550	183.43
TILT RH							
	1470708		P-UB-10	3	6-1/2	CTC-1126550	183.43
MODEL D8							
DOZER LIFT LH							
	3G8089		P-UB-10	2-3/4	5	CTC-7X2682	161.58
	8J8585		P-U-10	2-3/4	5	CTC-7X2824	123.07
DOZER LIFT RH							
	3G8090		P-UB-10	2-3/4	5	CTC-7X2682	161.58
	8J8584		P-U-10	2-3/4	5	CTC-7X2824	123.07
DOZER TILT							
	2J3894		P-U-10	3-1/2	8-1/4	CTC-7X2720	186.99
LIFT							
	2J2470		P-UB-10	2-1/2	6	CTC-7X2679	143.00
	3J2189		P-UB-10	2-1/2	6	CTC-7X2679	143.00
	5J1243		P-UB-10	2-1/2	6	CTC-7X2679	143.00
	5J2815		P-UB-10	2-1/2	6	CTC-7X2679	143.00
LIFT LH							
	5J9378		P-UB-10	2-1/2	5	CTC-7X2675	128.61
	8J8585		P-U-10	2-3/4	5	CTC-7X2824	123.07
LIFT RH							
	5J9708		P-UB-10	2-1/2	5	CTC-7X2675	128.61
PIN PULLER							
	4J5057		P-V-10	1-1/4	4	CTC-8T1480	85.62

CATERPILLAR®

REPLACEMENT KITS FOR CATERPILLAR® EQUIPMENT

Crawler Dozers							
APPLICATION	CYL #	Misc-Parts, Instructions, etc.	CODE	ROD	BORE	KIT #	List \$
MODEL D8							
RIPPER							
	6J9129		P-UB-10	3	7-1/4	CTC-7X2702	293.82
RIPPER LIFT LH							
	7J3222		P-UB-10	3-1/4	8-1/4	CTC-7X2715	274.21
	7J3222		P-UB-10	3-1/4	8-1/4	CTC-7X2801	252.91
RIPPER LIFT RH							
	7J3221		P-UB-10	3-1/4	8-1/4	CTC-7X2715	274.21
	7J3221		P-UB-10	3-1/4	8-1/4	CTC-7X2801	252.91
RIPPER PIN PULLER							
	7J0508		P-V-10	1-1/4	4	CTC-8T1480	85.62
	8J2071		P-UB-10	1-1/2	4	CTC-7X2738	90.53
TILT							
	6J2472		P-UB-10	3-1/2	8-1/4	CTC-7X2728	181.07
	7J0192		P-UB-10	3-1/2	8-1/4	CTC-7X2721	301.34
	8J8682		P-UB-10	3-1/2	8-1/4	CTC-7X2721	301.34
MODEL D8H							
ANGLING							
	3J2189		P-UB-10	2-1/2	6	CTC-7X2679	143.00
DOZER							
	2J3894		P-U-10	3-1/2	8-1/4	CTC-7X2720	186.99
	5J2815		P-UB-10	2-1/2	6	CTC-7X2679	143.00
LIFT							
	2J2470		P-UB-10	2-1/2	6	CTC-7X2679	143.00
	3J2189		P-UB-10	2-1/2	6	CTC-7X2679	143.00
	5J1243		P-UB-10	2-1/2	6	CTC-7X2679	143.00
LIFT LH							
	5J9378		P-UB-10	2-1/2	5	CTC-7X2675	128.61
LIFT RH							
	5J9708		P-UB-10	2-1/2	5	CTC-7X2675	128.61
PIN PULLER							
	4J5057		P-V-10	1-1/4	4	CTC-8T1480	85.62
	7J0508		P-V-10	1-1/4	4	CTC-8T1480	85.62
	8J2071		P-UB-10	1-1/2	4	CTC-7X2738	90.53
RIPPER							
	6J9129		P-UB-10	3	7-1/4	CTC-7X2702	293.82
	7J3222		P-UB-10	3-1/4	8-1/4	CTC-7X2715	274.21
RIPPER LIFT LH							
	7J3222		P-UB-10	3-1/4	8-1/4	CTC-7X2715	274.21
	7J3222		P-UB-10	3-1/4	8-1/4	CTC-7X2801	252.91
RIPPER LIFT RH							
	7J3221		P-UB-10	3-1/4	8-1/4	CTC-7X2715	274.21
RIPPER PIN PULLER							
	7J0508		P-V-10	1-1/4	4	CTC-8T1480	85.62
RIPPER RH							
	7J3221		P-UB-10	3-1/4	8-1/4	CTC-7X2801	252.91
TILT							
	6J2472		P-UB-10	3-1/2	8-1/4	CTC-7X2728	181.07
	7J0192		P-UB-10	3-1/2	8-1/4	CTC-1371974	264.11
	7J0192		P-UB-10	3-1/2	8-1/4	CTC-7X2721	301.34
TRACK ADJUSTER							
			TRK ADJ			CTC-FIG1401	118.41
MODEL D8K							
DOZER LIFT LH							
	3G8089		P-UB-10	2-3/4	5	CTC-7X2682	161.58
	8J8585		P-U-10	2-3/4	5	CTC-7X2824	123.07

REPLACEMENT KITS FOR CATERPILLAR® EQUIPMENT

Crawler Dozers							
APPLICATION	CYL #	Misc-Parts, Instructions, etc.	CODE	ROD	BORE	KIT #	List \$
MODEL D8K							
DOZER LIFT RH							
	3G8090		P-UB-10	2-3/4	5	CTC-7X2682	161.58
	8J8584		P-U-10	2-3/4	5	CTC-7X2824	123.07
PIN PULLER							
	7J0508		P-V-10	1-1/4	4	CTC-8T1480	85.62
	8J2071		P-UB-10	1-1/2	4	CTC-7X2738	90.53
RIPPER							
	6J9129		P-UB-10	3	7-1/4	CTC-7X2702	293.82
	7J3222		P-UB-10	3-1/4	8-1/4	CTC-7X2715	274.21
RIPPER LIFT LH							
	7J3222		P-UB-10	3-1/4	8-1/4	CTC-7X2715	274.21
	7J3222		P-UB-10	3-1/4	8-1/4	CTC-7X2801	252.91
RIPPER LIFT RH							
	7J3221		P-UB-10	3-1/4	8-1/4	CTC-7X2715	274.21
	7J3221		P-UB-10	3-1/4	8-1/4	CTC-7X2801	252.91
RIPPER PIN PULLER							
	8J2071		P-UB-10	1-1/2	4	CTC-7X2738	90.53
TILT							
	7J0192		P-UB-10	3-1/2	8-1/4	CTC-7X2721	301.34
	8J8682		P-UB-10	3-1/2	8-1/4	CTC-1371974	264.11
MODEL D8L							
DOZER							
	9J8802		P-UB-10	3-1/2	7-1/2	CTC-7X2722	192.25
DOZER LIFT							
	9J8802		P-UB-10	3-1/2	7-1/2	CTC-7X2722	192.25
	9T2860		P-UB-10	3	5-1/4	CTC-7X2756	130.87
DOZER TILT							
	3G5707		P-UB-10	3-1/2	8-1/4	CTC-7X2721	301.34
LIFT							
	3G8537		P-UB-10	3	5-1/4	CTC-1378646	191.13
	3G8537		P-UB-10	3	5-1/4	CTC-7X2756	130.87
	9T2860		P-UB-10	3	5-1/4	CTC-1378646	191.13
	9T2860		P-UB-10	3	5-1/4	CTC-7X2756	130.87
PIN PULLER							
	1U3373		P-UB-10	1-1/2	4	CTC-7X2738	90.53
RIPPER							
	3G6457		P-UB-10	3-1/4	8-1/4	CTC-7X2715	274.21
RIPPER LIFT							
	3G6457		P-UB-10	3-1/4	8-1/4	CTC-7X2715	274.21
RIPPER PIN PULLER							
	1U3373		P-UB-10	1-1/2	4	CTC-7X2738	90.53
RIPPER TILT							
	9T0106		P-UB-10	3	6-1/2	CTC-1126552	239.91
	9T0106		P-UB-10	3	6-1/2	CTC-7X2693	186.80
TILT							
	3G5707		P-UB-10	3-1/2	8-1/4	CTC-1371974	264.11
MODEL D8N							
DOZER							
	6E1102		P-UB-10	3	4-1/2	CTC-1353802	180.47
	6E1175		P-UB-10	3-1/2	7-1/4	CTC-1309483	341.90
	9T0140		P-UB-10	2-3/4	4-1/4	CTC-7X2451	114.76
	9T0141		P-UB-10	3-1/2	7-1/2	CTC-7X2722	192.25
PIN PULLER							
	6E3113		P-UB-10	1-3/4	4	CTC-1316108	112.44
	9T2066		P-UB-10	1-1/2	4	CTC-7X2738	90.53

REPLACEMENT KITS FOR CATERPILLAR® EQUIPMENT

Crawler Dozers							
APPLICATION	CYL #	Misc-Parts, Instructions, etc.	CODE	ROD	BORE	KIT #	List \$
MODEL D8N							
RIPPER							
	9T0142		P-UB-10	3	7-1/4	CTC-1326184	233.80
	9T0143		P-UB-10	3	6-1/2	CTC-1279809	239.57
TILT							
	6E0397		P-UB-10	3	7-1/4	CTC-1326127	215.26
	9T6077		P-UB-10	3	6-1/2	CTC-1126550	183.43
MODEL D8R							
DOZER							
	6E1102		P-UB-10	3	4-1/2	CTC-1353802	180.47
	6E1175		P-UB-10	3-1/2	7-1/4	CTC-1309483	341.90
PIN PULLER							
	6E3113		P-UB-10	1-3/4	4	CTC-1316108	112.44
	9T2066		P-UB-10	1-1/2	4	CTC-7X2738	90.53
RIPPER							
	4Z6313		P-UB-10	3	6-1/2	CTC-1279809	239.57
	9T0142		P-UB-10	3	7-1/4	CTC-1326184	233.80
	9T0143		P-UB-10	3	6-1/2	CTC-1279809	239.57
TILT							
	6E0397		P-UB-10	3	7-1/4	CTC-1326127	215.26
MODEL D8T							
DOZER LIFT							
	J8B1-UP; KPZ1-UP						
	2505861		P-UB-10	3	4-1/2	CTC-2505861K	98.97
DOZER TILT							
	J8B1-UP; KPZ1-UP						
	2407347		P-UB-10	3-1/2	7-1/4	CTC-2407347K	191.90
	2410550		P-UB-10	3-1/2	7-1/4	CTC-2410550K	135.97
	6E0397		P-UB-10	3	7-1/4	CTC-6E0397K	137.85
RIPPER							
	J8B1-UP; KPZ1-UP						
	1553653		P-UB-10	3	7-1/4	CTC-1553653K	186.48
RIPPER PIN PULLER							
	J8B1-UP; KPZ1-UP						
	6E3113		P-UB-10	1-3/4	4	CTC-6E3113K	47.51
RIPPER-LH							
	J8B1-UP; KPZ1-UP						
	1553652		P-UB-10	3	6-1/2	CTC-1553652K	155.83
RIPPER-RH							
	J8B1-UP; KPZ1-UP						
	1650102		P-UB-10	3	6-1/2	CTC-1650102K	168.93
TILT							
	KPZ3627-UP						
	3473272		P-UB-10	3-1/2	7-1/4	CTC-3473272K	161.18
MODEL D9D							
TRACK ADJUSTER							
			TRK ADJ			CTC-FIG0401	107.30
MODEL D9G							
DOZER TILT							
	2J6705		P-U-10	3-1/2	8-1/4	CTC-7X2720	186.99
LIFT LH							
	7J1488		P-UB-10	3-1/4	9-1/4	CTC-7X2707	358.24
LIFT RH							
	7J1487		P-UB-10	3-1/4	9-1/4	CTC-7X2707	358.24

CATERPILLAR®

REPLACEMENT KITS FOR CATERPILLAR® EQUIPMENT

Crawler Dozers							
APPLICATION	CYL #	Misc-Parts, Instructions, etc.	CODE	ROD	BORE	KIT #	List \$
MODEL D9G							
PIN PULLER							
	4J5057		P-V-10	1-1/4	4	CTC-8T1480	85.62
	7J0508		P-V-10	1-1/4	4	CTC-8T1480	85.62
	8J2071		P-UB-10	1-1/2	4	CTC-7X2738	90.53
RIPPER							
	6J7810		P-UB-10	3-1/2	8-1/4	CTC-7X2725	402.70
RIPPER LIFT LH							
	7J1488		P-UB-10	3-1/4	9-1/4	CTC-7X2707	358.24
RIPPER LIFT RH							
	7J1487		P-UB-10	3-1/4	9-1/4	CTC-7X2707	358.24
RIPPER PIN PULLER							
	8J2071		P-UB-10	1-1/2	4	CTC-7X2738	90.53
RIPPER TILT							
	6J7810		P-UB-10	3-1/2	8-1/4	CTC-7X2725	402.70
TILT							
	6J1570		P-UB-10	3-1/2	8-1/4	CTC-1371974	264.11
	6J1570		P-UB-10	3-1/2	8-1/4	CTC-7X2721	301.34
TRACK ADJUSTER							
			TRK ADJ			CTC-FIG0401	107.30
			TRK ADJ			CTC-FIG0402	126.43
MODEL D9H							
DOZER LH							
	3G1174		P-UB-10	3	6-1/4	CTC-7X2697	163.72
	3G1177		P-UB-10	3	6-1/4	CTC-7X2697	163.72
DOZER RH							
	3G1175		P-UB-10	3	6-1/4	CTC-7X2697	163.72
	3G1176		P-UB-10	3	6-1/4	CTC-7X2697	163.72
LIFT LH							
	3G1174		P-UB-10	3	6-1/4	CTC-7X2697	163.72
	3G1177		P-UB-10	3	6-1/4	CTC-7X2697	163.72
	7J1488		P-UB-10	3-1/4	9-1/4	CTC-1895377	249.54
	7J1488		P-UB-10	3-1/4	9-1/4	CTC-7X2707	358.24
LIFT RH							
	3G1175		P-UB-10	3	6-1/4	CTC-7X2697	163.72
	3G1176		P-UB-10	3	6-1/4	CTC-7X2697	163.72
	7J1487		P-UB-10	3-1/4	9-1/4	CTC-1895377	249.54
	7J1487		P-UB-10	3-1/4	9-1/4	CTC-7X2707	358.24
PIN PULLER							
	8J2071		P-UB-10	1-1/2	4	CTC-7X2738	90.53
RIPPER							
	6J7810		P-UB-10	3-1/2	8-1/4	CTC-7X2725	402.70
RIPPER LIFT LH							
	7J1488		P-UB-10	3-1/4	9-1/4	CTC-7X2707	358.24
RIPPER LIFT RH							
	7J1487		P-UB-10	3-1/4	9-1/4	CTC-7X2707	358.24
RIPPER PIN PULLER							
	8J2071		P-UB-10	1-1/2	4	CTC-7X2738	90.53
RIPPER TILT							
	6J7810		P-UB-10	3-1/2	8-1/4	CTC-7X2725	402.70
TILT							
	6J1570		P-UB-10	3-1/2	8-1/4	CTC-1371974	264.11
	6J1570		P-UB-10	3-1/2	8-1/4	CTC-7X2721	301.34
MODEL D9L							
DOZER TILT							
	3G8661		P-UB-10	4	9-1/4	CTC-7X2799	370.31
	4T4248		P-UB-10	4	9-1/4	CTC-7X2799	370.31

CATERPILLAR®

REPLACEMENT KITS FOR CATERPILLAR® EQUIPMENT

Crawler Dozers							
APPLICATION	CYL #	Misc-Parts, Instructions, etc.	CODE	ROD	BORE	KIT #	List \$
MODEL D9L							
LIFT	9J5868		P-UB-10	3-1/4	6	CTC-7X2757	276.98
PIN PULLER	1U3373		P-UB-10	1-1/2	4	CTC-7X2738	90.53
RIPPER LIFT	4T0979		P-UB-10	3-1/4	9-1/4	CTC-7X2707	358.24
RIPPER LIFT LH	4T5111		P-UB-10	3-1/4	9-1/4	CTC-7X2707	358.24
RIPPER LIFT RH	4T5112		P-UB-10	3-1/4	9-1/4	CTC-7X2707	358.24
RIPPER PIN PULLER	1U3373		P-UB-10	1-1/2	4	CTC-7X2738	90.53
RIPPER TILT	4T6970		P-UB-10	3-1/4	8-1/4	CTC-7X2715	274.21
	4T9977		P-UB-10	3-1/4	8-1/4	CTC-7X2715	274.21
MODEL D9N							
DOZER LIFT	9T2860		P-UB-10	3	5-1/4	CTC-7X2756	130.87
DOZER TILT	3G5707		P-UB-10	3-1/2	8-1/4	CTC-7X2721	301.34
LIFT	9T2860		P-UB-10	3	5-1/4	CTC-7X2756	130.87
PIN PULLER	6E3113		P-UB-10	1-3/4	4	CTC-1316108	112.44
	9T2066		P-UB-10	1-1/2	4	CTC-7X2738	90.53
RIPPER	3G6457		P-UB-10	3-1/4	8-1/4	CTC-7X2715	274.21
RIPPER LIFT	3G6457		P-UB-10	3-1/4	8-1/4	CTC-7X2715	274.21
RIPPER PIN PULLER	9T2066		P-UB-10	1-1/2	4	CTC-7X2738	90.53
TILT	3G5707		P-UB-10	3-1/2	8-1/4	CTC-1371974	264.11
	6E4835	1229350 Piston	P-UB-10	3-1/2	8-1/4	CTC-1324905	217.31
	6E4836	1229350 Piston	P-UB-10	3-1/2	8-1/4	CTC-1324905	217.31
MODEL D9R							
DOZER	4Z6172		P-UB-10	3	4-3/4	CTC-1362025	216.42
	6E4433		P-UB-10	3	4-3/4	CTC-1542503	129.53
PIN PULLER	6E3113		P-UB-10	1-3/4	4	CTC-1316108	112.44
RIPPER	1238098		P-UB-10	3-1/4	7-1/4	CTC-1324987	252.11
	1325123		P-UB-10	3-1/4	7-1/4	CTC-1324987	252.11
	9T5813		P-UB-10	3-1/4	7-1/4	CTC-1324987	252.11
RIPPER TILT	1238097		P-UB-10	3	6	CTC-1324937	138.57
	1325149		P-UB-10	3	6	CTC-1324937	138.57
	9T5807		P-UB-10	3	6	CTC-1324937	138.57
TILT	1096778		P-UB-10	3-1/2	8-1/4	CTC-1324905	217.31
TILT LH	1098833		P-UB-10	3-1/2	8-1/4	CTC-1324905	217.31
	6E4835		P-UB-10	3-1/2	8-1/4	CTC-7X2721	301.34

REPLACEMENT KITS FOR CATERPILLAR® EQUIPMENT

Crawler Dozers							
APPLICATION	CYL #	Misc-Parts, Instructions, etc.	CODE	ROD	BORE	KIT #	List \$
MODEL D9R							
TILT RH							
	1098832		P-UB-10	3-1/2	8-1/4	CTC-1324905	217.31
	6E4836		P-UB-10	3-1/2	8-1/4	CTC-7X2721	301.34
MODEL D9T							
DOZER LIFT							
	RJS1-UP						
	2256727		P-UB-10	3	4-3/4	CTC-2256727K	135.79
	RJS1-UP; T9H1-UP; T9J1-UP						
	1658633		P-UB-10	3	4-3/4	CTC-1658633K	134.12
DOZER TILT							
	T9J1-UP						
	4Z6110		P-UB-10	3-1/2	8-1/4	CTC-4Z6110K	181.49
DOZER TILT LH							
	RJS1-UP						
	1098833		P-UB-10	3-1/2	8-1/4	CTC-2456835	190.44
DOZER TILT RH							
	RJS1-UP						
	1098832		P-UB-10	3-1/2	8-1/4	CTC-2456835	190.44
DOZER TILT STABILIZER							
	T9H1-UP; T9J1-UP						
	1096778		P-UB-10	3-1/2	8-1/4	CTC-2456835	190.44
RIPPER							
	CRM1-UP						
	1325123		P-UB-10	3-1/4	7-1/4	CTC-1325123K	172.47
RIPPER - PIN PULLER							
	RJS1-UP						
	6E3113		P-UB-10	1-3/4	4	CTC-2404819	112.44
RIPPER TIP							
	CRM1-UP; MAM1-UP						
	1325149		P-UB-10	3	6	CTC-1325149K	149.75
	RJS1-UP						
	4Z6364	Cold Weather	P-UB-10	3	6	CTC-4Z6364K	129.51
MODEL D10							
DOZER							
	1U2711		P-UB-10	4	10-1/2	CTC-1324932	374.03
	3G5761		P-UB-10	4	10-1/2	CTC-1324932	374.03
DOZER LH							
	4T3211		P-UB-10	4	10-1/2	CTC-1324932	374.03
DOZER LIFT LH							
	4T2727		P-UB-10	4	7	CTC-8T1457	198.80
	9J2959		P-UB-10	4	7	CTC-1326783	268.86
DOZER LIFT RH							
	4T2728		P-UB-10	4	7	CTC-8T1457	198.80
	9J2958		P-UB-10	4	7	CTC-1326783	268.86
DOZER RH							
	4T3210		P-UB-10	4	10-1/2	CTC-1324932	374.03
PIN PULLER							
	1U3373		P-UB-10	1-1/2	4	CTC-7X2738	90.53
	8J2071		P-UB-10	1-1/2	4	CTC-7X2738	90.53
RIPPER							
	3G2220		P-UB-10	3-1/4	8-1/4	CTC-7X2801	252.91
RIPPER PIN PULLER							
	1U3373		P-UB-10	1-1/2	4	CTC-7X2738	90.53
	8J2071		P-UB-10	1-1/2	4	CTC-7X2738	90.53
RIPPER TILT							
	3G2220		P-UB-10	3-1/4	8-1/4	CTC-7X2801	252.91

CATERPILLAR®

REPLACEMENT KITS FOR CATERPILLAR® EQUIPMENT

Crawler Dozers							
APPLICATION	CYL #	Misc-Parts, Instructions, etc.	CODE	ROD	BORE	KIT #	List \$
MODEL D10N							
DOZER							
	9T4279		P-UB-10	4	9-1/4	CTC-1324922	330.41
	9T4280		P-UB-10	4	9-1/4	CTC-1324922	330.41
	9T7341		P-UB-10	4	9-1/4	CTC-1324922	330.41
DOZER LIFT							
	9T2869		P-UB-10	3-1/2	6-1/4	CTC-7X0863	174.96
DOZER TILT							
	9T1180		P-UB-10	4	9-1/4	CTC-7X2799	370.31
	9T4279		P-UB-10	4	9-1/4	CTC-7X2799	370.31
LIFT							
	9T2869		P-UB-10	3-1/2	6-1/4	CTC-1365158	214.08
PIN PULLER							
	6E3113		P-UB-10	1-3/4	4	CTC-1316108	112.44
	9T2066		P-UB-10	1-1/2	4	CTC-7X2738	90.53
RIPPER							
	4T9977		P-UB-10	3-1/4	8-1/4	CTC-7X2715	274.21
RIPPER LH							
	4T5111		P-UB-10	3-1/4	9-1/4	CTC-1469631	252.45
	4T5111		P-UB-10	3-1/4	9-1/4	CTC-7X2707	358.24
RIPPER LIFT LH							
	4T5111		P-UB-10	3-1/4	9-1/4	CTC-7X2707	358.24
RIPPER LIFT RH							
	4T5112		P-UB-10	3-1/4	9-1/4	CTC-7X2707	358.24
RIPPER PIN PULLER							
	9T2066		P-UB-10	1-1/2	4	CTC-7X2738	90.53
RIPPER RH							
	4T5112		P-UB-10	3-1/4	9-1/4	CTC-1469631	252.45
	4T5112		P-UB-10	3-1/4	9-1/4	CTC-7X2707	358.24
RIPPER TILT							
	4T9977		P-UB-10	3-1/4	8-1/4	CTC-7X2715	274.21
TILT LH							
	9J0673		P-UB-10	2-3/4	6	CTC-7X2803	177.39
TILT RH							
	9T9203		P-UB-10	4	9-1/4	CTC-1324922	330.41
TWIN TILT LH							
	9T9204		P-UB-10	4	9-1/4	CTC-7X2799	370.31
TWIN TILT RH							
	9T9203		P-UB-10	4	9-1/4	CTC-7X2799	370.31
MODEL D10R							
DOZER LH							
	9T9204		P-UB-10	4	9-1/4	CTC-1324922	330.41
DOZER RH							
	4T5112		P-UB-10	3-1/4	9-1/4	CTC-1469631	252.45
LIFT							
	9T2869		P-UB-10	3-1/2	6-1/4	CTC-1365158	214.08
PIN PULLER							
	6E3113		P-UB-10	1-3/4	4	CTC-1316108	112.44
RIPPER							
	4T9977		P-UB-10	3-1/4	8-1/4	CTC-7X2715	274.21
RIPPER LH							
	4T5111		P-UB-10	3-1/4	9-1/4	CTC-1469631	252.45
	4T5111		P-UB-10	3-1/4	9-1/4	CTC-7X2707	358.24
RIPPER RH							
	4T5112		P-UB-10	3-1/4	9-1/4	CTC-7X2707	358.24
TILT							
	9T9202		P-UB-10	4	9-1/4	CTC-1324922	330.41

REPLACEMENT KITS FOR CATERPILLAR® EQUIPMENT

Crawler Dozers							
APPLICATION	CYL #	Misc-Parts, Instructions, etc.	CODE	ROD	BORE	KIT #	List \$
MODEL D10T							
DOZER LIFT							
	BHA1-UP; BHF1-UP; BHJ1-UP; BHP1-UP; RJG1-UP						
	9T2869		P-UB-10	3-1/2	6-1/4	CTC-9T2869K	210.79
DOZER LIFT RH							
	RJG1-1900						
	2310865		P-UB-10	3-1/2	6-1/4	CTC-3189220	405.10
	RJG1901-UP						
	3238514		P-UB-10	3-1/2	6-1/4	CTC-3189220	405.10
DOZER TILT							
	BHA1-UP; BHF1-UP; BHJ1-UP; BHP1-UP						
	2320654		P-UB-10	4	9-1/4	CTC-2320654K	298.83
DUAL TILT LH							
	RJG1-UP						
	2320652		P-UB-10	4	9-1/4	CTC-2320652K	288.83
DUAL TILT RH							
	RJG1-UP						
	2320653		P-UB-10	4	9-1/4	CTC-2320653K	288.83
RIPPER - PIN PULLER							
	RJG1-UP						
	6E3113		P-UB-10	1-3/4	4	CTC-2404819	112.44
RIPPER LIFT LH							
	4PP1-UP; BRT1-UP; BEY1-UP						
	1926446		P-UB-10	3-1/2	9-1/4	CTC-1926446K	273.62
RIPPER LIFT RH							
	4PP1-UP; BRT1-UP; BEY1-UP						
	1926445		P-UB-10	3-1/2	9-1/4	CTC-1926445K	273.62
RIPPER TILT							
	4PP1-UP; BRT1-UP; BEY1-UP						
	4T9977		P-UB-10	3-1/4	8-1/4	CTC-4T9977K	161.21
MODEL D11N							
DOZER LIFT LH							
	4T2727		P-UB-10	4	7	CTC-1326783	268.86
	4T2727		P-UB-10	4	7	CTC-8T1457	198.80
DOZER LIFT RH							
	4T2728		P-UB-10	4	7	CTC-1326783	268.86
	4T2728		P-UB-10	4	7	CTC-8T1457	198.80
DOZER TILT							
	1U2711		P-UB-10	4	10-1/2	CTC-1324932	374.03
	9T1180		P-UB-10	4	9-1/4	CTC-7X2799	370.31
	9T4276		P-UB-10	4	9-1/4	CTC-7X2799	370.31
PIN PULLER							
	6E3113		P-UB-10	1-3/4	4	CTC-2404819	112.44
	9T2066		P-UB-10	1-1/2	4	CTC-7X2738	90.53
RIPPER							
	4T7985		P-UB-10	3-1/4	8-1/4	CTC-7X2715	274.21
RIPPER PIN PULLER							
	9T2066		P-UB-10	1-1/2	4	CTC-7X2738	90.53
RIPPER TILT							
	3G2220		P-UB-10	3-1/4	8-1/4	CTC-7X2801	252.91
	3G3220		P-UB-10	3-1/4	8-1/4	CTC-7X2715	274.21
	4T7985		P-UB-10	3-1/4	8-1/4	CTC-7X2715	274.21
TILT							
	9T3715		P-UB-10	4	10-1/2	CTC-1324932	374.03
	9T3716		P-UB-10	4	10-1/2	CTC-1324932	374.03

CATERPILLAR®

REPLACEMENT KITS FOR CATERPILLAR® EQUIPMENT

Crawler Dozers							
APPLICATION	CYL #	Misc-Parts, Instructions, etc.	CODE	ROD	BORE	KIT #	List \$
MODEL D11R							
DOZER							
	1U2711		P-UB-10	4	10-1/2	CTC-1324932	374.03
DOZER LH							
	4T2727		P-UB-10	4	7	CTC-1326783	268.86
	4T2727		P-UB-10	4	7	CTC-8T1457	198.80
DOZER RH							
	4T2728		P-UB-10	4	7	CTC-1326783	268.86
	4T2728		P-UB-10	4	7	CTC-8T1457	198.80
PIN PULLER							
	6E3113		P-UB-10	1-3/4	4	CTC-1316108	112.44
	9T2066		P-UB-10	1-1/2	4	CTC-7X2738	90.53
RIPPER							
	1616615		P-UB-10	3-1/2	10	CTC-2460635	523.95
RIPPER LH							
	1616616		P-UB-10	3-1/2	10	CTC-2460635	523.95
	1617563		P-UB-10	4-1/2	220 mm	CTC-2295546	382.61
RIPPER RH							
	1617562		P-UB-10	4-1/2	220 mm	CTC-2295546	382.61
TILT							
	9T3715		P-UB-10	4	10-1/2	CTC-1324932	374.03
	9T3716		P-UB-10	4	10-1/2	CTC-1324932	374.03
NEW	MODEL D11T						
LIFT							
	AMA1-; GEB1-; JEL1-; 8PP1-; 8RP1-						
	2520471		P-UB-10	4	7	CTC-3189225	250.85
	AMA1-; JEL1-; JNS1-; MDG1-						
	2618004		P-UB-10	4	7	CTC-2618004K	246.96
	BHZ1-; GEB1-; TPB1-						
	2520473		P-UB-10	4	7	CTC-3189225	250.85
RIPPER LIFT							
	AMA1-; GAZ1-; JCJ1-; JEL1-; JJC1-; LJA1-; MJM1-						
	3401877		P-UB-10	3-1/2	10	CTC-2460635	523.95
RIPPER LIFT LH							
	7ZP1-						
	1616616		P-UB-10	3-1/2	10	CTC-2460635	523.95
	GAZ1-; 5MP1-; 7CP1-; 7DP1-; 7PP1-						
	1018614		P-UB-10	3-1/2	10	CTC-2460635	523.95
RIPPER LIFT RH							
	7ZP1-						
	1616615		P-UB-10	3-1/2	10	CTC-2460635	523.95
	GAZ1-; 5MP1-; 7CP1-; 7DP1-; 7PP1-						
	1018581		P-UB-10	3-1/2	10	CTC-2460635	523.95
RIPPER PIN PULLER							
	AMA1-; GEB1-; JEL1-; JNS1-; TPB1-; 7YP1-; 7ZP1-						
	6E3113		P-UB-10	1-3/4	4	CTC-2404819	112.44
RIPPER TILT LH							
	AMA1-; GAZ1-; LJA1-; JJC1-; JCJ1-; JEL1-; MJM1-; 5MP1-; 7CP1-; 7DP1-; 7PP1-						
	1306381		P-UB-10	3-3/4	7-3/4	CTC-1306381K	218.44
RIPPER TILT RH							
	AMA1-; GAZ1-; LJA1-; JJC1-; JCJ1-; JEL1-; MJM1-; 5MP1-; 7CP1-; 7DP1-; 7PP1-						
	1303263		P-UB-10	3-3/4	7-3/4	CTC-1303263K	218.44
TILT							
	GEB1-						
	3082444		P-UB-10	4	10-1/2	CTC-2460649	492.24
	3672255		P-UB-10	4	10-1/2	CTC-3672255K	413.68

REPLACEMENT KITS FOR CATERPILLAR® EQUIPMENT

Crawler Dozers							
APPLICATION	CYL #	Misc-Parts, Instructions, etc.	CODE	ROD	BORE	KIT #	List \$
MODEL D11T							
TILT LH							
7ZP1-							
	1617563		P-UB-10	4-1/2	220 mm	CTC-2295546	382.61
8PP1-; 8RP1-							
	3082462		P-UB-10	4	10-1/2	CTC-2460649	492.24
AMA1-; JEL1-; 8PP1-; 8RP1-							
	3672259		P-UB-10	4	10-1/2	CTC-3672259K	413.68
TILT RH							
7ZP1-							
	1617562		P-UB-10	4-1/2	220 mm	CTC-2295546	382.61
8PP1-; 8RP1-							
	3082464		P-UB-10	4	10-1/2	CTC-2460649	492.24
AMA1-; JEL1-; 8PP1-; 8RP1-							
	3672258		P-UB-10	4	10-1/2	CTC-3672258K	413.68
BHZ1-; JNS1-; MDG1-							
	3082467		P-UB-10	5	10	CTC-3082467K	782.09
Crawler Loaders							
APPLICATION	CYL #	Misc-Parts, Instructions, etc.	CODE	ROD	BORE	KIT #	List \$
MODEL 931							
BACKHOE BOOM							
	3G5767		P-UB-10	2-1/4	4-1/2	CTC-7X2748	111.36
	8J5555		P-UB-10	2-1/4	4-1/2	CTC-7X2748	111.36
BACKHOE BUCKET							
	3G5905		P-UB-10	2-1/4	3-1/2	CTC-7X2818	93.37
	8J5642		P-UB-10	2-1/4	3-1/2	CTC-7X2818	93.37
BACKHOE STABILIZER							
	1U2655		P-UB-10	2	4	CTC-1328816	96.00
	1U2656		P-UB-10	2	4	CTC-1328816	96.00
	3G6792		P-UB-10	1-1/2	3-1/2	CTC-7X2752	98.74
	8J6903		P-UB-10	2	4	CTC-1328816	96.00
	8J6904		P-UB-10	2	4	CTC-1328816	96.00
	8J9481		P-UB-10	1-1/2	3-1/2	CTC-7X2752	98.74
BACKHOE STICK							
	3G5771		P-UB-10	2	4	CTC-1328816	96.00
	8J5448		P-UB-10	2	4	CTC-1328816	96.00
LIFT							
	7J5893		P-UB-10	2	4	CTC-1328816	96.00
	7J5894		P-UB-10	2	4	CTC-1328816	96.00
M.P. BUCKET							
	3G7365		P-UB-10	1-1/2	3-1/2	CTC-7X2752	98.74
	8J5391		P-UB-10	1-1/2	3-1/2	CTC-7X2752	98.74
RIPPER							
	7J9920		P-UB-10	2	4	CTC-1328816	96.00
TILT							
	7J5885		P-UB-10	1-3/4	3	CTC-7X2791	91.70
	9J7905		P-UB-10	1-3/4	3	CTC-7X2791	91.70
MODEL 931B							
BACKHOE BOOM/BUCKET							
	3G5767		P-UB-10	2-1/4	4-1/2	CTC-1326770	155.43
	3G5905		P-UB-10	2-1/4	3-1/2	CTC-1358166	177.50
BACKHOE BUCKET							
	8J5642		P-UB-10	2-1/4	3-1/2	CTC-7X2818	93.37
BACKHOE STABILIZER							
	8J6903		P-UB-10	2	4	CTC-7X2789	105.58
	8J6904		P-UB-10	2	4	CTC-7X2789	105.58
	8J9481		P-UB-10	1-1/2	3-1/2	CTC-7X2752	98.74

REPLACEMENT KITS FOR CATERPILLAR® EQUIPMENT

Crawler Loaders							
APPLICATION	CYL #	Misc-Parts, Instructions, etc.	CODE	ROD	BORE	KIT #	List \$
MODEL 931B							
BACKHOE STICK/BLADE SHIFT							
	3G5771		P-UB-10	2	4	CTC-1328816	96.00
LIFT							
	7J5893		P-UB-10	2	4	CTC-1328816	96.00
	7J5894		P-UB-10	2	4	CTC-1328816	96.00
LIFT LH							
	6E0214		P-UB-10	2	4	CTC-1328816	96.00
	9T6705		P-UB-10	2	4	CTC-1328816	96.00
LIFT RH							
	9T6704		P-UB-10	2	4	CTC-1328816	96.00
M.P. BUCKET							
	3G7365		P-UB-10	1-1/2	3-1/2	CTC-7X2752	98.74
RIPPER							
	7J9920		P-UB-10	2	4	CTC-1328816	96.00
STABILIZER							
	3G6792		P-UB-10	1-1/2	3-1/2	CTC-7X2752	98.74
	8J6903		P-UB-10	2	4	CTC-7X2789	105.58
	8J6904		P-UB-10	2	4	CTC-7X2789	105.58
	8J9481		P-UB-10	1-1/2	3-1/2	CTC-7X2752	98.74
STABILIZER LH							
	1U2656		P-UB-10	2	4	CTC-1328816	96.00
STABILIZER RH							
	1U2655		P-UB-10	2	4	CTC-1328816	96.00
TILT							
	1U3165		P-UB-10	1-3/4	3-1/4	CTC-7X2764	71.17
	4T0963		P-UB-10	1-3/4	3-1/4	CTC-7X2764	71.17
	7J5885		P-UB-10	1-3/4	3	CTC-7X2791	91.70
	9J7905		P-UB-10	1-3/4	3	CTC-7X2791	91.70
MODEL 931C							
BACKHOE BOOM/BUCKET							
	3G5767		P-UB-10	2-1/4	4-1/2	CTC-1326770	155.43
	3G5767		P-UB-10	2-1/4	4-1/2	CTC-7X2748	111.36
	3G5905		P-UB-10	2-1/4	3-1/2	CTC-1358166	177.50
BACKHOE BUCKET							
	8J5642		P-UB-10	2-1/4	3-1/2	CTC-7X2818	93.37
BACKHOE STABILIZER							
	1U2655		P-UB-10	2	4	CTC-7X2789	105.58
	1U2656		P-UB-10	2	4	CTC-7X2789	105.58
	3G6792		P-UB-10	1-1/2	3-1/2	CTC-7X2752	98.74
	8J6903		P-UB-10	2	4	CTC-7X2789	105.58
	8J6904		P-UB-10	2	4	CTC-7X2789	105.58
	8J9481		P-UB-10	1-1/2	3-1/2	CTC-7X2752	98.74
BACKHOE STICK/BLADE SHIFT							
	3G5771		P-UB-10	2	4	CTC-1328816	96.00
BUCKET							
	3G7365		P-UB-10	1-1/2	3-1/2	CTC-7X2752	98.74
LIFT							
	7J5893		P-UB-10	2	4	CTC-1328816	96.00
	7J5894		P-UB-10	2	4	CTC-1328816	96.00
LIFT LH							
	6E0214		P-UB-10	2	4	CTC-1328816	96.00
	9T6705		P-UB-10	2	4	CTC-1328816	96.00
LIFT RH							
	9T6704		P-UB-10	2	4	CTC-1328816	96.00
M.P. BUCKET							
	3G7365		P-UB-10	1-1/2	3-1/2	CTC-7X2752	98.74

REPLACEMENT KITS FOR CATERPILLAR® EQUIPMENT

Crawler Loaders							
APPLICATION	CYL #	Misc-Parts, Instructions, etc.	CODE	ROD	BORE	KIT #	List \$
MODEL 931C							
RIPPER							
	7J9920		P-UB-10	2	4	CTC-1328816	96.00
STABILIZER							
	3G6792		P-UB-10	1-1/2	3-1/2	CTC-7X2752	98.74
STABILIZER LH							
	1U2656		P-UB-10	2	4	CTC-1328816	96.00
STABILIZER RH							
	1U2655		P-UB-10	2	4	CTC-1328816	96.00
TILT							
	4T0963		P-UB-10	1-3/4	3-1/4	CTC-7X2764	71.17
MODEL 933							
BUCKET							
	3G7365		P-UB-10	1-1/2	3-1/2	CTC-7X2752	98.74
LIFT LH							
	1052808		P-UB-10	2	4	CTC-1328816	96.00
LIFT RH							
	1052886		P-UB-10	2	4	CTC-1328816	96.00
	6E0212		P-UB-10	2	4	CTC-1328816	96.00
RIPPER							
	7J9920		P-UB-10	2	4	CTC-1328816	96.00
TILT							
	1012493		P-UB-10	1-3/4	3-1/2	CTC-7X2784	58.32
	1368600		P-UB-10	1-3/4	3-1/2	CTC-7X2784	58.32
MODEL 933C							
BUCKET							
	1494362		P-UB-10	2	4	CTC-1328816	96.00
LIFT RH							
	1412421		P-UB-10	2	4	CTC-1328816	96.00
RIPPER							
	7J9920		P-UB-10	2	4	CTC-1328816	96.00
TILT							
	1214264		P-UB-10	1-3/4	3-1/2	CTC-7X2784	58.32
TRACK ADJUSTER							
			TRK ADJ			CTC-FIG4400	49.72
MODEL 933E, 933F, 933G							
TRACK ADJUSTER							
			TRK ADJ			CTC-FIG4400	49.72
MODEL 935B							
BACKHOE / BOOM BUCKET							
	3G5767		P-UB-10	2-1/4	4-1/2	CTC-1326770	155.43
	3G5905		P-UB-10	2-1/4	3-1/2	CTC-1358166	177.50
BACKHOE BUCKET							
	3G7365		P-UB-10	1-1/2	3-1/2	CTC-7X2752	98.74
BACKHOE STICK/BLADE SHIFT							
	3G5771		P-UB-10	2	4	CTC-1328816	96.00
LIFT							
	7J5893		P-UB-10	2	4	CTC-1328816	96.00
	7J5894		P-UB-10	2	4	CTC-1328816	96.00
LIFT LH							
	6E0214		P-UB-10	2	4	CTC-1328816	96.00
	9T6705		P-UB-10	2	4	CTC-1328816	96.00
LIFT RH							
	9T6704		P-UB-10	2	4	CTC-1328816	96.00
RIPPER							
	7J9920		P-UB-10	2	4	CTC-1328816	96.00

REPLACEMENT KITS FOR CATERPILLAR® EQUIPMENT

Crawler Loaders							
APPLICATION	CYL #	Misc-Parts, Instructions, etc.	CODE	ROD	BORE	KIT #	List \$
MODEL 935B							
STABILIZER							
	3G6792		P-UB-10	1-1/2	3-1/2	CTC-7X2752	98.74
STABILIZER LH							
	1U2656		P-UB-10	2	4	CTC-1328816	96.00
STABILIZER RH							
	1U2655		P-UB-10	2	4	CTC-1328816	96.00
TILT							
	4T0963		P-UB-10	1-3/4	3-1/4	CTC-7X2764	71.17
MODEL 935C							
BACKHOE BOOM/BUCKET							
	3G5767		P-UB-10	2-1/4	4-1/2	CTC-1326770	155.43
	3G5905		P-UB-10	2-1/4	3-1/2	CTC-1358166	177.50
BACKHOE BUCKET							
	3G7365		P-UB-10	1-1/2	3-1/2	CTC-7X2752	98.74
BACKHOE STICK/BLADE SHIFT							
	3G5771		P-UB-10	2	4	CTC-1328816	96.00
LIFT							
	7J5893		P-UB-10	2	4	CTC-1328816	96.00
	7J5894		P-UB-10	2	4	CTC-1328816	96.00
LIFT LH							
	6E0214		P-UB-10	2	4	CTC-1328816	96.00
	9T6705		P-UB-10	2	4	CTC-1328816	96.00
LIFT RH							
	6E0212		P-UB-10	2	4	CTC-1328816	96.00
	9T6704		P-UB-10	2	4	CTC-1328816	96.00
RIPPER							
	7J9920		P-UB-10	2	4	CTC-1328816	96.00
STABILIZER							
	3G6792		P-UB-10	1-1/2	3-1/2	CTC-7X2752	98.74
STABILIZER LH							
	1U2656		P-UB-10	2	4	CTC-1328816	96.00
STABILIZER RH							
	1U2655		P-UB-10	2	4	CTC-1328816	96.00
TILT							
	4T0963		P-UB-10	1-3/4	3-1/4	CTC-7X2764	71.17
MODEL 939							
BUCKET							
	3G7365		P-UB-10	1-1/2	3-1/2	CTC-7X2752	98.74
LIFT LH							
	1052808		P-UB-10	2	4	CTC-1328816	96.00
LIFT RH							
	1052886		P-UB-10	2	4	CTC-1328816	96.00
	6E0212		P-UB-10	2	4	CTC-1328816	96.00
RIPPER							
	7J9920		P-UB-10	2	4	CTC-1328816	96.00
TILT							
	1012518		P-UB-10	2	4	CTC-1328816	96.00
	1363129		P-UB-10	2	4	CTC-1328816	96.00
MODEL 939C							
BUCKET							
	1494362		P-UB-10	2	4	CTC-1328816	96.00
LIFT							
	1412422		P-UB-10	2-1/2	4-1/2	CTC-1113300	141.35
RIPPER							
	7J9920		P-UB-10	2	4	CTC-1328816	96.00

REPLACEMENT KITS FOR CATERPILLAR® EQUIPMENT

Crawler Loaders							
APPLICATION	CYL #	Misc-Parts, Instructions, etc.	CODE	ROD	BORE	KIT #	List \$
MODEL 939C							
TILT							
	1414266		P-UB-10	2	4	CTC-1328816	96.00
MODEL 941							
BUCKET							
	7J6789		P-UB-10	2	4	CTC-7X2789	105.58
	8J5663		P-UB-10	2	4	CTC-7X2789	105.58
BUCKET LH							
	6J2806		P-UB-10	2	4	CTC-7X2789	105.58
BUCKET RH							
	6J2805		P-UB-10	2	4	CTC-7X2789	105.58
LIFT							
	8J6868		P-UB-10	2-1/2	4	CTC-7X2659	162.26
LIFT LH							
	6J3082		P-UB-10	2-1/4	4	CTC-7X2802	94.90
	7J9862		P-UB-10	2-1/4	4	CTC-7X2802	94.90
	9J5726		P-UB-10	2-1/4	4	CTC-7X2802	94.90
LIFT RH							
	6J3081		P-UB-10	2-1/4	4	CTC-7X2802	94.90
	7J9861		P-UB-10	2-1/4	4	CTC-7X2802	94.90
	9J5725		P-UB-10	2-1/4	4	CTC-7X2802	94.90
PUMP							
	16U; 32F; 80H; 86J						
	9J5080	w/ Felt Ring				CTC-4J9281	20.11
	9J5080	w/ FKM Oil Seal				CTC-9J5116	28.47
	80H; 86J						
	7J0583					CTC-9J5111	43.41
RIPPER							
	6J3308		P-UB-10	2-1/2	5-1/2	CTC-8T1374	96.66
	6J3308		P-UB-10	2-1/2	5-1/2	CTC-9X2050	104.21
SIDE DUMP							
	8J5670		P-UB-10	2	4	CTC-7X2755	152.30
	8J5670		P-UB-10	2	4	CTC-7X7937	166.09
TILT							
			P-UB-10	2-3/8	4	CTC-2418925	58.45
TRACK ADJUSTER							
			TRK ADJ			CTC-FIG4400	49.72
MODEL 941B							
BUCKET							
	7J6789		P-UB-10	2	4	CTC-7X2789	105.58
	8J5663		P-UB-10	2	4	CTC-7X2789	105.58
LIFT LH							
	6J3082		P-UB-10	2-1/4	4	CTC-7X2802	94.90
	7J9862		P-UB-10	2-1/4	4	CTC-7X2802	94.90
	9J5726		P-UB-10	2-1/4	4	CTC-7X2802	94.90
LIFT RH							
	6J3081		P-UB-10	2-1/4	4	CTC-7X2802	94.90
	7J9861		P-UB-10	2-1/4	4	CTC-7X2802	94.90
	9J5725		P-UB-10	2-1/4	4	CTC-7X2802	94.90
M.P. BUCKET							
	8J5663		P-UB-10	2	4	CTC-7X2789	105.58
M.P. BUCKET LH							
	6J2806		P-UB-10	2	4	CTC-7X2789	105.58
M.P. BUCKET RH							
	6J2805		P-UB-10	2	4	CTC-7X2789	105.58

CATERPILLAR®

REPLACEMENT KITS FOR CATERPILLAR® EQUIPMENT

Crawler Loaders							
APPLICATION	CYL #	Misc-Parts, Instructions, etc.	CODE	ROD	BORE	KIT #	List \$
MODEL 941B							
PUMP							
	16U; 32F; 80H; 86J						
	9J5080	w/ Felt Ring				CTC-4J9281	20.11
	9J5080	w/ FKM Oil Seal				CTC-9J5116	28.47
	80H; 86J						
	7J0583					CTC-9J5111	43.41
RIPPER							
	6J3308		P-UB-10	2-1/2	5-1/2	CTC-8T1374	96.66
	6J3308		P-UB-10	2-1/2	5-1/2	CTC-9X2050	104.21
SIDE DUMP							
	8J5670		P-UB-10	2	4	CTC-7X2755	152.30
	8J5670		P-UB-10	2	4	CTC-7X7937	166.09
TILT							
			P-UB-10	2-3/8	4	CTC-2418925	58.45
TRACK ADJUSTER							
			TRK ADJ			CTC-FIG4400	49.72
MODEL 943							
BUCKET							
	4T9387		P-UB-10	2	4	CTC-1328816	96.00
	9J4892		P-UB-10	2	4	CTC-7X2789	105.58
BUCKET TILT							
	1U4802		P-UB-10	2-1/2	4-3/4	CTC-7X2660	185.90
LIFT							
	4T1963		P-UB-10	2-1/4	4	CTC-1361171	104.91
	9J0532		P-UB-10	2-1/4	4	CTC-1361171	104.91
M.P. BUCKET							
	9J4892		P-UB-10	2	4	CTC-7X2789	105.58
RIPPER							
	3G1296		P-UB-10	2	4	CTC-1328816	96.00
TILT							
	1U4802		P-UB-10	2-1/2	4-3/4	CTC-7X2660	185.90
	3G4653		P-UB-10	2-1/2	4-3/4	CTC-7X2660	185.90
MODEL 943B							
BUCKET							
	4T9387		P-UB-10	2	4	CTC-1328816	96.00
LIFT							
	9T3623		P-UB-10	2-1/4	4	CTC-1361171	104.91
RIPPER							
	3G1296		P-UB-10	2	4	CTC-1328816	96.00
TILT							
	6E0257		P-UB-10	2-1/2	4-3/4	CTC-1328811	167.09
MODEL 951							
LIFT							
	7J9821		P-UB-10	2-1/4	4-1/4	CTC-7X2750	118.40
	7J9822		P-UB-10	2-1/4	4-1/4	CTC-7X2750	118.40
	9J5728		P-UB-10	2-1/4	4-1/4	CTC-7X2750	118.40
LIFT RH							
	9J5727		P-UB-10	2-1/4	4-1/4	CTC-7X2750	118.40
LOG FORK LH							
	8J5677		P-V-10	2	5	CTC-7X2763	140.20
LOG FORK RH							
	8J5676		P-V-10	2	5	CTC-7X2763	140.20
M.P. BUCKET LH							
	6J2806		P-UB-10	2	4	CTC-7X2789	105.58
M.P. BUCKET RH							
	6J2805		P-UB-10	2	4	CTC-7X2789	105.58

CATERPILLAR®

REPLACEMENT KITS FOR CATERPILLAR® EQUIPMENT

Crawler Loaders							
APPLICATION	CYL #	Misc-Parts, Instructions, etc.	CODE	ROD	BORE	KIT #	List \$
MODEL 951							
RIPPER							
	6J3308		P-UB-10	2-1/2	5-1/2	CTC-8T1374	96.66
TILT							
	4T9387		P-UB-10	2	4	CTC-7X2789	105.58
	5J9815		P-UB-10	2-3/8	4-1/4	CTC-8T1464	55.49
	5J9816		P-UB-10	2-3/8	4-1/4	CTC-8T1464	55.49
	8J5939		P-UB-10	2-3/8	4-1/4	CTC-8T1464	55.49
TILT LH							
	2K3744		P-V-10	2	5	CTC-7X2763	140.20
	3G8083		P-UB-10	2-3/8	4-1/4	CTC-8T1464	55.49
TILT RH							
	2K3743		P-V-10	2	5	CTC-7X2763	140.20
	7J9833		P-UB-10	2-3/8	4-1/4	CTC-8T1464	55.49
TRACK ADJUSTER							
			TRK ADJ			CTC-FIG4400	49.72
MODEL 951B, 951C							
BUCKET							
	7J6789		P-UB-10	2	4	CTC-7X2789	105.58
	8J5663		P-UB-10	2	4	CTC-7X2789	105.58
BUCKET LH							
	6J2806		P-UB-10	2	4	CTC-7X2789	105.58
BUCKET RH							
	6J2805		P-UB-10	2	4	CTC-7X2789	105.58
LIFT LH							
	6J4014		P-UB-10	2-1/4	4-1/4	CTC-7X2750	118.40
	7J9822		P-UB-10	2-1/4	4-1/4	CTC-7X2750	118.40
	9J5728		P-UB-10	2-1/4	4-1/4	CTC-7X2750	118.40
LIFT RH							
	6J4013		P-UB-10	2-1/4	4-1/4	CTC-7X2750	118.40
	7J9821		P-UB-10	2-1/4	4-1/4	CTC-7X2750	118.40
	9J5727		P-UB-10	2-1/4	4-1/4	CTC-7X2750	118.40
PUMP							
	16U; 32F; 80H; 86J						
	9J5080	w/ Felt Ring				CTC-4J9281	20.11
	9J5080	w/ FKM Oil Seal				CTC-9J5116	28.47
	80H; 86J						
	7J0583					CTC-9J5111	43.41
RIPPER							
	6J3308		P-UB-10	2-1/2	5-1/2	CTC-9X2050	104.21
SIDE DUMP							
	8J5670		P-UB-10	2	4	CTC-7X2755	152.30
	8J5670		P-UB-10	2	4	CTC-7X7937	166.09
TILT							
	6J3308		P-UB-10	2-1/2	5-1/2	CTC-8T1374	96.66
	8J5939		P-UB-10	2-3/8	4-1/4	CTC-8T1464	55.49
TILT LH							
	3G8083		P-UB-10	2-3/8	4-1/4	CTC-8T1464	55.49
	5J9815		P-UB-10	2-3/8	4-1/4	CTC-8T1464	55.49
	5J9816		P-UB-10	2-3/8	4-1/4	CTC-8T1464	55.49
	7J9834		P-UB-10	2-3/8	4-1/4	CTC-8T1464	55.49
TILT RH							
	7J9833		P-UB-10	2-3/8	4-1/4	CTC-8T1464	55.49
	8J5939		P-UB-10	2-3/8	4-1/4	CTC-8T1464	55.49
TRACK ADJUSTER							
		951C only	TRK ADJ			CTC-FIG4400	49.72

REPLACEMENT KITS FOR CATERPILLAR® EQUIPMENT

Crawler Loaders							
APPLICATION	CYL #	Misc-Parts, Instructions, etc.	CODE	ROD	BORE	KIT #	List \$
MODEL 953							
BUCKET							
	4T9387		P-UB-10	2	4	CTC-1328816	96.00
	9J4892		P-UB-10	2	4	CTC-7X2789	105.58
LIFT							
	3G0717		P-UB-10	2-1/2	4-3/4	CTC-7X2660	185.90
	3G0717		P-UB-10	2-1/2	4-3/4	CTC-7X2773	184.64
	4T0263		P-UB-10	2-1/2	4-3/4	CTC-1328811	167.09
	4T0263		P-UB-10	2-1/2	4-3/4	CTC-7X2660	185.90
	4T0263		P-UB-10	2-1/2	4-3/4	CTC-7X2673	184.64
	4T2098		P-UB-10	2-1/2	4-3/4	CTC-1328811	167.09
	4T2098		P-UB-10	2-1/2	4-3/4	CTC-7X2660	185.90
	4T2098		P-UB-10	2-1/2	4-3/4	CTC-7X2673	184.64
	9T3625	Rod Bearing width- 0.98"	P-UB-10	2-1/2	4-3/4	CTC-1361131	148.19
RIPPER							
	3G1296		P-UB-10	2	4	CTC-1328816	96.00
SIDE DUMP							
	9T0107		P-UB-10	2	4	CTC-7X2789	105.58
TILT							
	1U0418		P-UB-10	3	5-1/2	CTC-1281673	236.55
	4T1063		P-UB-10	2	4-1/4	CTC-7X2766	45.67
MODEL 953B							
BUCKET							
	4T9387		P-UB-10	2	4	CTC-1328816	96.00
LIFT							
	9T3625	Rod Bearing width- 0.98"	P-UB-10	2-1/2	4-3/4	CTC-1361131	148.19
RIPPER							
	3G1296		P-UB-10	2	4	CTC-1328816	96.00
TILT							
	1U0418		P-UB-10	3	5-1/2	CTC-1281673	236.55
MODEL 953C							
BUCKET							
	4T9387		P-UB-10	2	4	CTC-1328816	96.00
LIFT							
	9T3625	Rod Bearing width- 0.98"	P-UB-10	2-1/2	4-3/4	CTC-1361131	148.19
RIPPER							
	3G1296		P-UB-10	2	4	CTC-1328816	96.00
TILT							
	1U0418		P-UB-10	3	5-1/2	CTC-1281673	236.55
MODEL 953D							
BUCKET MP							
	LBP1-UP						
	2929044		P-UB-10	2	4	CTC-2929044K	71.44
LIFT							
	LBP1-UP						
	2488788		P-UB-10	65 mm	115 mm	CTC-2488788K	157.06
	2526337		P-UB-10	65 mm	115 mm	CTC-2526337K	158.82
RIPPER							
	9JW1-UP						
	2860814		P-UB-10	2	4	CTC-2860814K	71.49
TILT							
	LBP1-UP						
	2696483		P-UB-10	85 mm	140 mm	CTC-2696483K	132.34

REPLACEMENT KITS FOR CATERPILLAR® EQUIPMENT

Crawler Loaders							
APPLICATION	CYL #	Misc-Parts, Instructions, etc.	CODE	ROD	BORE	KIT #	List \$
MODEL 955							
LIFT							
	5J6342		P-UB-10	2-1/2	5-1/2	CTC-9X2050	104.21
	7J1730		P-UB-10	2-1/2	5-1/2	CTC-9X2047	111.99
	7J9640		P-UB-10	2-1/2	5-1/2	CTC-9X2047	111.99
LIFT LH							
	9J2399		P-UB-10	2-1/2	5-1/2	CTC-9X2047	111.99
	9J2399		P-UB-10	2-1/2	5-1/2	CTC-9X2050	104.21
LIFT RH							
	9J2401		P-UB-10	2-1/2	5-1/2	CTC-9X2047	111.99
	9J2401		P-UB-10	2-1/2	5-1/2	CTC-9X2050	104.21
LOG FORK LH							
	8J5677		P-V-10	2	5	CTC-7X2763	140.20
LOG FORK RH							
	8J5676		P-V-10	2	5	CTC-7X2763	140.20
RIPPER							
	5J8190		P-UB-10	2-1/2	5-1/2	CTC-8T1374	96.66
TILT LH							
	2K3744		P-V-10	2	5	CTC-7X2763	140.20
	3G8081		P-UB-10	2-1/2	5	CTC-7X2658	180.34
TILT RH							
	2K3743		P-V-10	2	5	CTC-7X2763	140.20
	7J9637		P-UB-10	2-1/2	5	CTC-1304012	198.05
MODEL 955C							
BUCKET							
	7Y5100		P-UB-10	85 mm	130 mm	CTC-7Y5145	276.61
TRACK ADJUSTER							
			TRK ADJ			CTC-FIG4400	49.72
UNSPECIFIED APPLICATION							
	8J5676		P-V-10	2	5	CTC-7X2763	140.20
MODEL 955E							
BUCKET							
	7Y5100		P-UB-10	85 mm	130 mm	CTC-7Y5145	276.61
LOG FORK LH							
	8J5677		P-V-10	2	5	CTC-7X2763	140.20
LOG FORK RH							
	8J5676		P-V-10	2	5	CTC-7X2763	140.20
TRACK ADJUSTER							
			TRK ADJ			CTC-FIG4400	49.72
MODEL 955F							
TILT LH							
	2K3744		P-V-10	2	5	CTC-7X2763	140.20
TILT RH							
	2K3743		P-V-10	2	5	CTC-7X2763	140.20
TRACK ADJUSTER							
			TRK ADJ			CTC-FIG4400	49.72
MODEL 955H							
LOG FORK LH							
	8J5677		P-V-10	2	5	CTC-7X2763	140.20
LOG FORK RH							
	8J5676		P-V-10	2	5	CTC-7X2763	140.20
RIPPER							
	6J3308		P-UB-10	2-1/2	5-1/2	CTC-8T1374	96.66
	6J3308		P-UB-10	2-1/2	5-1/2	CTC-9X2050	104.21
TILT LH							
	2K3744		P-V-10	2	5	CTC-7X2763	140.20

REPLACEMENT KITS FOR CATERPILLAR® EQUIPMENT

Crawler Loaders							
APPLICATION	CYL #	Misc-Parts, Instructions, etc.	CODE	ROD	BORE	KIT #	List \$
MODEL 955H							
TILT RH	2K3743		P-V-10	2	5	CTC-7X2763	140.20
TRACK ADJUSTER			TRK ADJ			CTC-FIG4400	49.72
MODEL 955K							
BUCKET LH	8J5704		P-V-10	2	4-1/2	CTC-1328783	77.27
BUCKET RH	8J5703		P-V-10	2	4-1/2	CTC-1328783	77.27
CLAMP	8J8498		P-V-10	2	4-1/2	CTC-1328783	77.27
LIFT	5J6342		P-UB-10	2-1/2	5-1/2	CTC-8T1374	96.66
	7J1730		P-UB-10	2-1/2	5-1/2	CTC-9X2047	111.99
	7J9640		P-UB-10	2-1/2	5-1/2	CTC-9X2047	111.99
LIFT LH	9J2399		P-UB-10	2-1/2	5-1/2	CTC-9X2050	104.21
LIFT RH	9J2401		P-UB-10	2-1/2	5-1/2	CTC-9X2050	104.21
RIPPER	5J8190		P-UB-10	2-1/2	5-1/2	CTC-8T1374	96.66
	5J8190		P-UB-10	2-1/2	5-1/2	CTC-9X2050	104.21
TILT	3G8081		P-UB-10	2-1/2	5	CTC-7X2658	180.34
TILT LH	5J6214		P-UB-10	2-1/2	5	CTC-1304012	198.05
	7J9638		P-UB-10	2-1/2	5	CTC-7X2658	180.34
TILT RH	5J6213		P-UB-10	2-1/2	5	CTC-1304012	198.05
	7J9637		P-UB-10	2-1/2	5	CTC-7X2658	180.34
TRACK ADJUSTER			TRK ADJ			CTC-FIG3400	61.91
			TRK ADJ			CTC-FIG4400	49.72
MODEL 955L							
BUCKET LH	8J5704		P-V-10	2	4-1/2	CTC-1328783	77.27
BUCKET RH	8J5703		P-V-10	2	4-1/2	CTC-1328783	77.27
CLAMP	8J8498		P-V-10	2	4-1/2	CTC-1328783	77.27
LIFT	5J6342		P-UB-10	2-1/2	5-1/2	CTC-8T1374	96.66
	7J1730		P-UB-10	2-1/2	5-1/2	CTC-9X2047	111.99
	7J9640		P-UB-10	2-1/2	5-1/2	CTC-9X2047	111.99
LIFT LH	9J2399		P-UB-10	2-1/2	5-1/2	CTC-9X2050	104.21
LIFT RH	9J2401		P-UB-10	2-1/2	5-1/2	CTC-9X2050	104.21
RIPPER	5J8190		P-UB-10	2-1/2	5-1/2	CTC-9X2050	104.21
TILT	3G8081		P-UB-10	2-1/2	5	CTC-7X2658	180.34
TILT LH	5J6214		P-UB-10	2-1/2	5	CTC-1304012	198.05
	7J9638		P-UB-10	2-1/2	5	CTC-7X2658	180.34

REPLACEMENT KITS FOR CATERPILLAR® EQUIPMENT

Crawler Loaders							
APPLICATION	CYL #	Misc-Parts, Instructions, etc.	CODE	ROD	BORE	KIT #	List \$
MODEL 955L							
TILT RH							
	5J6213		P-UB-10	2-1/2	5	CTC-1304012	198.05
	7J9637		P-UB-10	2-1/2	5	CTC-7X2658	180.34
TRACK ADJUSTER							
			TRK ADJ			CTC-FIG3400	61.91
MODEL 963							
CLAMP							
	8J8498		P-V-10	2	4-1/2	CTC-1328783	77.27
DOZER TILT							
	4T1625		P-UB-10	2-1/4	4-3/4	CTC-7X2815	100.09
LIFT							
	4T0263		P-UB-10	2-1/2	4-3/4	CTC-1328811	167.09
	9J8002		P-UB-10	2-3/4	5-1/2	CTC-1327131	207.36
RIPPER							
	9J9881		P-UB-10	2-1/4	4-1/2	CTC-1326770	155.43
RIPPER LIFT							
	8J1779		P-UB-10	2-1/2	7-1/4	CTC-7X2661	187.26
RIPPER RH							
	1U3497		P-UB-10	2-1/4	4-1/2	CTC-1326770	155.43
TILT							
	3G3874		P-UB-10	3-3/4	6-1/2	CTC-7X2731	268.11
	4T1625		P-UB-10	2-1/4	4-3/4	CTC-7X2815	100.09
	9T1403		P-UB-10	3	6	CTC-7X2698	192.84
TRACK ADJUSTER							
			TRK ADJ			CTC-FIG3400	61.91
			TRK ADJ			CTC-FIG3401	57.79
MODEL 963B, 963C							
CLAMP							
	8J8498		P-V-10	2	4-1/2	CTC-1328783	77.27
LIFT							
			P-UB-10	2-3/4	5-1/2	CTC-2601518	127.33
RIPPER							
	1228420		P-UB-10	2-1/4	4-1/2	CTC-1326770	155.43
RIPPER RH							
	1228421		P-UB-10	2-1/4	4-1/2	CTC-1326770	155.43
TILT							
	3G3874		P-UB-10	3-3/4	6-1/2	CTC-7X2731	268.11
MODEL 963D							
BUCKET MP							
	LCS1-UP						
	2929043		P-UB-10	2	4-1/2	CTC-2929043K	63.98
LIFT LH							
	LCS1-UP						
	2469101		P-UB-10	3	5	CTC-2469101K	110.50
LIFT RH							
	LCS1-UP						
	2940509		P-UB-10	3	5	CTC-2940509K	113.06
RIPPER LH							
	8XR1-UP						
	2860813		P-UB-10	2-1/4	4-1/2	CTC-3110662	71.31
RIPPER RH							
	8XR1-UP						
	2860812		P-UB-10	2-1/4	4-1/2	CTC-3110662	71.31
TILT							
	LCS1-UP						
	2940510		P-UB-10	95 mm	150 mm	CTC-2940510K	212.08

CATERPILLAR®

REPLACEMENT KITS FOR CATERPILLAR® EQUIPMENT

Crawler Loaders							
APPLICATION	CYL #	Misc-Parts, Instructions, etc.	CODE	ROD	BORE	KIT #	List \$
MODEL 973							
BUCKET							
	9J1822		P-UB-10	2	5	CTC-7X2788	122.79
LIFT							
	3G0218		P-UB-10	3-1/4	6-1/2	CTC-7X2711	217.02
	4T2098		P-UB-10	2-1/2	4-3/4	CTC-1328811	167.09
RIPPER							
	3G1194		P-UB-10	2-1/2	5	CTC-1315106	174.82
	4T7606		P-UB-10	2-1/2	5	CTC-7X2658	180.34
TILT							
	3G5949		P-UB-10	3-1/4	5-1/2	CTC-7X2712	95.88
	3G6571		P-UB-10	2-1/2	4-3/4	CTC-7X2773	184.64
TRACK ADJUSTER							
			TRK ADJ			CTC-FIG3400	61.91
			TRK ADJ			CTC-FIG3401	57.79
MODEL 973C							
BUCKET							
	9J1822		P-UB-10	2	5	CTC-7X2788	122.79
RIPPER							
	4T7606		P-UB-10	2-1/2	5	CTC-7X2658	180.34
TILT							
	3G5949		P-UB-10	3-1/4	5-1/2	CTC-7X2712	95.88
MODEL 977							
LIFT LH							
	7J9376		P-UB-10	2-3/4	6-1/2	CTC-9X2473	139.28
LIFT RH							
	7J9375		P-UB-10	2-3/4	6-1/2	CTC-9X2473	139.28
LIFT STEEL							
	3G8118		P-V-10	2-3/4	6-1/2	CTC-8T1554	142.59
LOG FORK							
	1K8206		P-V-10	2	5	CTC-7X2763	140.20
	8J5755		P-UB-10	2-1/4	5	CTC-7X2729	168.02
LOG FORK LH							
	8J5677		P-V-10	2	5	CTC-7X2763	140.20
LOG FORK RH							
	8J5676		P-V-10	2	5	CTC-7X2763	140.20
M.P. BUCKET							
	9J1822		P-UB-10	2	5	CTC-7X2788	122.79
	9J1822		P-V-10	2	5	CTC-7X2797	73.39
RIPPER							
	5J7686		P-UB-10	2-1/2	6-1/2	CTC-7X2666	175.79
TILT LH							
	9J0670		P-V-10	2-3/4	6	CTC-8T1553	116.93
	9J0673		P-UB-10	2-3/4	6	CTC-7X2803	177.39
TILT RH							
	9J0671		P-V-10	2-3/4	6	CTC-8T1553	116.93
	9J0672		P-UB-10	2-3/4	6	CTC-7X2803	177.39
TILT STEEL							
	3G8119		P-V-10	2-3/4	6-1/2	CTC-8T1554	142.59
MODEL 977D							
TRACK ADJUSTER							
			TRK ADJ			CTC-FIG3400	61.91
MODEL 977H							
M.P. BUCKET							
	8J5733		P-V-10	2	5	CTC-7X2763	140.20
RIPPER							
	2K3663		P-UB-10	2-1/2	7-1/4	CTC-7X2661	187.26

REPLACEMENT KITS FOR CATERPILLAR® EQUIPMENT

Crawler Loaders							
APPLICATION	CYL #	Misc-Parts, Instructions, etc.	CODE	ROD	BORE	KIT #	List \$
MODEL 977H							
RIPPER LIFT							
	8J1779		P-UB-10	2-1/2	7-1/4	CTC-7X2661	187.26
TRACK ADJUSTER							
			TRK ADJ			CTC-FIG3400	61.91
MODEL 977K							
BUCKET							
	8J5761		P-UB-10	2-1/2	5-1/2	CTC-9X2050	104.21
	9J1822		P-UB-10	2	5	CTC-7X2788	122.79
LIFT LH							
	3G8118		P-V-10	2-3/4	6-1/2	CTC-8T1554	142.59
	7J9376		P-UB-10	2-3/4	6-1/2	CTC-7X2686	124.95
LIFT RH							
	3G8119		P-V-10	2-3/4	6-1/2	CTC-8T1554	142.59
	7J9375		P-UB-10	2-3/4	6-1/2	CTC-7X2686	124.95
LOG FORK							
	8J5755		P-UB-10	2-1/4	5	CTC-7X2729	168.02
PUMP							
	11K; 89P						
	5J5930					CTC-9J5111	43.41
	8J2504					CTC-9J5115	37.59
	11K; 95X						
	9J5073					CTC-9J5115	37.59
RIPPER							
	5J7686		P-UB-10	2-1/2	6-1/2	CTC-7X2666	175.79
SIDE DUMP							
	5J9893		P-UB-10	2-1/2	5	CTC-1315106	174.82
TILT							
	3G8119		P-V-10	2-3/4	6-1/2	CTC-8T1554	142.59
TILT BUCKET LH							
	8J5740		P-UB-10	2	5	CTC-7X2788	122.79
TILT BUCKET RH							
	8J5739		P-UB-10	2	5	CTC-7X2788	122.79
TILT LH							
	9J0670		P-V-10	2-3/4	6	CTC-8T1553	116.93
	9J0673		P-UB-10	2-3/4	6	CTC-7X2803	177.39
TILT RH							
	9J0671		P-V-10	2-3/4	6	CTC-8T1553	116.93
	9J0672		P-UB-10	2-3/4	6	CTC-7X2803	177.39
TRACK ADJUSTER							
			TRK ADJ			CTC-FIG3400	61.91
MODEL 977L							
BUCKET							
	8J5761		P-UB-10	2-1/2	5-1/2	CTC-9X2050	104.21
	9J1822		P-UB-10	2	5	CTC-7X2788	122.79
LIFT LH							
	3G8118		P-V-10	2-3/4	6-1/2	CTC-8T1554	142.59
	7J9376		P-UB-10	2-3/4	6-1/2	CTC-7X2686	124.95
LIFT RH							
	3G8119		P-V-10	2-3/4	6-1/2	CTC-8T1554	142.59
	7J9375		P-UB-10	2-3/4	6-1/2	CTC-7X2686	124.95
LOG FORK							
	8J5755		P-UB-10	2-1/4	5	CTC-7X2729	168.02
PUMP							
	11K; 89P						
	5J5930					CTC-9J5111	43.41
	8J2504					CTC-9J5115	37.59

CATERPILLAR®

REPLACEMENT KITS FOR CATERPILLAR® EQUIPMENT

Crawler Loaders							
APPLICATION	CYL #	Misc-Parts, Instructions, etc.	CODE	ROD	BORE	KIT #	List \$
MODEL 977L							
PUMP							
	11K; 95X						
	9J5073					CTC-9J5115	37.59
RIPPER							
	5J7686		P-UB-10	2-1/2	6-1/2	CTC-7X2666	175.79
SIDE DUMP							
	5J9893		P-UB-10	2-1/2	5	CTC-1315106	174.82
TILT BUCKET LH							
	8J5740		P-UB-10	2	5	CTC-7X2788	122.79
TILT BUCKET RH							
	8J5739		P-UB-10	2	5	CTC-7X2788	122.79
TILT LH							
	9J0670		P-V-10	2-3/4	6	CTC-8T1553	116.93
	9J0673		P-UB-10	2-3/4	6	CTC-7X2803	177.39
TILT RH							
	9J0671		P-V-10	2-3/4	6	CTC-8T1553	116.93
	9J0672		P-UB-10	2-3/4	6	CTC-7X2803	177.39
TRACK ADJUSTER							
			TRK ADJ			CTC-FIG3400	61.91
MODEL 983							
BUCKET CLAMP							
	8J5772		P-UB-10	2-1/2	6	CTC-7X2669	241.94
BUCKET DEMOLITION							
	8J5772		P-UB-10	2-1/2	6	CTC-7X2669	241.94
Dump Trucks - Articulated							
APPLICATION	CYL #	Misc-Parts, Instructions, etc.	CODE	ROD	BORE	KIT #	List \$
MODEL 725							
HOIST							
	AFX1-; B1L1-						
	2414071		P-UB-10	3	4-1/2	CTC-2414071K	117.09
	B1L1-; WWA1-						
	2854031		P-UB-10	3	4-1/2	CTC-2854031K	126.53
STEERING LH							
	AFX1-329						
	1915337		P-UB-10	2	3-1/2	CTC-1857674	119.55
	AFX330-359						
	2095024		P-UB-10	2	3-1/2	CTC-2281778	80.42
	AFX360-418						
	2110604		P-UB-10	2	3-1/2	CTC-2281778	80.42
	AFX419-472						
	2126258		P-UB-10	2	3-1/2	CTC-2281778	80.42
	AFX473-						
	2153024		P-UB-10	2	3-1/2	CTC-2281778	80.42
	AFX473-; B1L1-2127						
	2733267		P-UB-10	2	3-1/2	CTC-2281778	80.42
	B1L2128-2332; WWA1-						
	3316042		P-UB-10	2	3-1/2	CTC-2281778	80.42
	B1L2333-; WWA1-						
	3498518		P-UB-10	2	3-1/2	CTC-2281778	80.42
STEERING RH							
	AFX1-329						
	1915336		P-UB-10	2	3-1/2	CTC-1857674	119.55
	AFX330-359						
	2095023		P-UB-10	2	3-1/2	CTC-2281778	80.42
	AFX360-418						
	2110603		P-UB-10	2	3-1/2	CTC-2281778	80.42

REPLACEMENT KITS FOR CATERPILLAR® EQUIPMENT

Dump Trucks - Articulated							
APPLICATION	CYL #	Misc-Parts, Instructions, etc.	CODE	ROD	BORE	KIT #	List \$
MODEL 725							
STEERING RH							
AFX419-472							
2126257			P-UB-10	2	3-1/2	CTC-2281778	80.42
AFX473-							
2153023			P-UB-10	2	3-1/2	CTC-2281778	80.42
AFX473-; B1L1-2127							
2733266			P-UB-10	2	3-1/2	CTC-2281778	80.42
B1L2128-2332; WWA1-							
3316041			P-UB-10	2	3-1/2	CTC-2281778	80.42
B1L2333-; WWA1-							
3498517			P-UB-10	2	3-1/2	CTC-2281778	80.42
SUSPENSION							
AFX1001-; B1L1-2664; WWA1-							
2004300			P-UB-10	4-1/2	150 mm	CTC-2004300K	239.40
AFX1-1000							
1468928			P-UB-10	4-1/2	150 mm	CTC-1468928K	239.40
SUSPENSION FRONT							
AFX1001-; B1L2665-							
3414122			P-UB-10	4-1/2	150 mm	CTC-3414122K	239.40
TAILGATE							
AFX1-856							
1512611			P-UB-10	2	3	CTC-1857667	87.64
MODEL 730							
HOIST							
AGF1-; B1M1-							
2414062			P-UB-10	3	5	CTC-2414062K	132.49
B1M1-; WWB1-							
2854032			P-UB-10	3	5	CTC-2854032K	148.15
STEERING LH							
AGF1-371							
1915337			P-UB-10	2	3-1/2	CTC-1857674	119.55
AGF372-407							
2095024			P-UB-10	2	3-1/2	CTC-1857674	119.55
AGF408-442							
2110604			P-UB-10	2	3-1/2	CTC-1857674	119.55
AGF443-475							
2126258			P-UB-10	2	3-1/2	CTC-2281778	80.42
AGF476-							
2153024			P-UB-10	2	3-1/2	CTC-2281778	80.42
AGF476-; B1M1-2342; B1W1-349							
2733267			P-UB-10	2	3-1/2	CTC-2281778	80.42
B1M2343-2713; B1W350-366; WWB1-							
3316042			P-UB-10	2	3-1/2	CTC-2281778	80.42
B1M2714-; B1W367-; WWB1-							
3498518			P-UB-10	2	3-1/2	CTC-2281778	80.42
STEERING RH							
AGF1-371							
1915336			P-UB-10	2	3-1/2	CTC-1857674	119.55
AGF372-407							
2095023			P-UB-10	2	3-1/2	CTC-1857674	119.55
AGF408-442							
2110603			P-UB-10	2	3-1/2	CTC-1857674	119.55
AGF443-475							
2126257			P-UB-10	2	3-1/2	CTC-2281778	80.42
AGF476-							
2153023			P-UB-10	2	3-1/2	CTC-2281778	80.42

CATERPILLAR®

REPLACEMENT KITS FOR CATERPILLAR® EQUIPMENT

Dump Trucks - Articulated							
APPLICATION	CYL #	Misc-Parts, Instructions, etc.	CODE	ROD	BORE	KIT #	List \$
MODEL 730							
STEERING RH							
AGF476-; B1M1-2342; B1W1-349							
2733266			P-UB-10	2	3-1/2	CTC-2281778	80.42
B1M2343-2713; B1W350-366; WWB1-							
3316041			P-UB-10	2	3-1/2	CTC-2281778	80.42
B1M2714-; B1W367-; WWB1-							
3498517			P-UB-10	2	3-1/2	CTC-2281778	80.42
SUSPENSION							
AGF1-933							
1468928			P-UB-10	4-1/2	150 mm	CTC-1468928K	239.40
AGF934-; B1M1-; B1W1-; WWB1-							
2004300			P-UB-10	4-1/2	150 mm	CTC-2004300K	239.40
SUSPENSION FRONT							
AGF934-; B1M1-; B1W407-							
3414122			P-UB-10	4-1/2	150 mm	CTC-3414122K	239.40
TAIL GATE							
B1W1-							
2037847	HEAD 1662843		P-U-10	45 mm	75 mm	CTC-2037847K	49.48
TAILGATE							
AGF1-796							
1512611			P-UB-10	2	3	CTC-1857667	87.64
MODEL 740							
HOIST							
AXM1-; B1P1-156							
1416667			P-UB-10	3-1/2	5-1/2	CTC-1416667K	175.56
B1P157-							
2414068			P-UB-10	3-1/2	5-1/2	CTC-2414068K	175.56
B1P157-; WWD1-							
2854034			P-UB-10	3-1/2	5-1/2	CTC-2854034K	207.89
STEERING							
AXM823-; AZZ292-; B1P1-; B1R1-; WWD1-							
2231335			P-UB-10	55 mm	4-1/2	CTC-2179894	126.36
STEERING LH							
AXM1-822; AZZ1-291							
2153026			P-UB-10	55 mm	4-1/2	CTC-2179894	126.36
STEERING RH							
AXM369-822; AZZ264-291							
2153025			P-UB-10	55 mm	4-1/2	CTC-2179894	126.36
SUSPENSION							
AXM1-1182; AZZ1-327							
1468928			P-UB-10	4-1/2	150 mm	CTC-1468928K	239.40
SUSPENSION FRONT							
AXM1183-; AZZ328-; B1P1-; B1R1-; WWD1-							
2282758			P-UB-10	4-1/2	150 mm	CTC-2282758K	239.40
B1P1-; B1R1-							
3414124			P-UB-10	4-1/2	150 mm	CTC-3414124K	239.40
TAILGATE							
AXM1-967							
1512611			P-UB-10	2	3	CTC-1857667	87.64
AZZ1-; B1R1-							
1677329			P-UB-10	2	3	CTC-2384462	46.41
MODEL D25C							
HOIST							
5U7777			I-U-3	3-1/2	5-1/2	CTC-5U7775	333.11
6U6821			I-U-3	3-1/2	5-1/2	CTC-5U7775	333.11

REPLACEMENT KITS FOR CATERPILLAR® EQUIPMENT

Dump Trucks - Articulated							
APPLICATION	CYL #	Misc-Parts, Instructions, etc.	CODE	ROD	BORE	KIT #	List \$
MODEL D25C							
STEERING							
	6U1040		I-U-5	2	4-1/2	CTC-6U9552	230.96
	7U2910		I-U-5	2	4-1/2	CTC-6U9552	230.96
SUSPENSION FRONT							
	6U4161		I-U-10	4	4-1/2	CTC-1045008	288.12
UNSPECIFIED APPLICATION							
	7U9508		I-U-10	4	4-1/2	CTC-1045008	288.12
MODEL D25D							
STEERING							
	1433299		I-UB-10	2	4-1/2	CTC-1857699	222.76
	1453620		P-UB-10	2	4-1/2	CTC-1857700	100.53
	7U2910		I-U-5	2	4-1/2	CTC-6U9552	230.96
SUSPENSION							
	1049660		P-UB-10	3-1/2	4-1/2	CTC-1942756	342.14
SUSPENSION REAR							
	7U9538		I-UB-10	2	4-1/2	CTC-7U9545	319.78
UNSPECIFIED APPLICATION							
	1511179		P-UB-10	3-1/2	4-1/2	CTC-1944399	253.02
	5U7777		I-U-3	3-1/2	5-1/2	CTC-5U7775	333.11
MODEL D30C							
HOIST							
	5U7777		I-U-3	3-1/2	5-1/2	CTC-5U7775	333.11
STEERING							
	6U1040		I-U-5	2	4-1/2	CTC-6U9552	230.96
	7U2910		I-U-5	2	4-1/2	CTC-6U9552	230.96
SUSPENSION FRONT							
	6U4161		I-U-10	4	4-1/2	CTC-1045008	288.12
UNSPECIFIED APPLICATION							
	7U9508		I-U-10	4	4-1/2	CTC-1045008	288.12
MODEL D30D							
STEERING							
	1433299		I-UB-5	2	4-1/2	CTC-1721689	189.29
	1453620		P-UB-10	2	4-1/2	CTC-1721690	50.31
	7U2910		I-U-5	2	4-1/2	CTC-6U9552	230.96
SUSPENSION							
	1049660		P-UB-4	3-1/2	4-1/2	CTC-1417975	165.50
	2U9448		I-U-10	4	4-1/2	CTC-1045008	288.12
SUSPENSION REAR							
	7U9538		I-UB-10	2	4-1/2	CTC-7U9545	319.78
UNSPECIFIED APPLICATION							
	5U7777		I-U-3	3-1/2	5-1/2	CTC-5U7775	333.11
	7U9508		I-U-10	4	4-1/2	CTC-1045008	288.12
MODEL D35C							
HOIST							
	5U7777		I-U-3	3-1/2	5-1/2	CTC-5U7775	333.11
STEERING							
	6U1040		I-U-5	2	4-1/2	CTC-6U9552	230.96
	7U2910		I-U-5	2	4-1/2	CTC-6U9552	230.96
SUSPENSION FRONT							
	6U4161		I-U-10	4	4-1/2	CTC-1045008	288.12
MODEL D35HP							
HOIST							
	5U7777		I-U-3	3-1/2	5-1/2	CTC-5U7775	333.11
STEERING							
	6U1040		I-U-5	2	4-1/2	CTC-6U9552	230.96

REPLACEMENT KITS FOR CATERPILLAR® EQUIPMENT

Dump Trucks - Articulated							
APPLICATION	CYL #	Misc-Parts, Instructions, etc.	CODE	ROD	BORE	KIT #	List \$
MODEL D35HPC							
STEERING							
	7U2910		I-U-5	2	4-1/2	CTC-6U9552	230.96
UNSPECIFIED APPLICATION							
	5U7777		I-U-3	3-1/2	5-1/2	CTC-5U7775	333.11
	6U4161		I-U-10	4	4-1/2	CTC-1045008	288.12
	7U2910		I-U-5	2	4-1/2	CTC-6U9552	230.96
MODEL D40D							
STEERING							
	1453620		P-UB-10	2	4-1/2	CTC-1721690	50.31
	7U2910		I-U-5	2	4-1/2	CTC-6U9552	230.96
SUSPENSION							
	1049660		P-UB-4	3-1/2	4-1/2	CTC-1417975	165.50
SUSPENSION REAR							
	7U9538		I-UB-5	2	4-1/2	CTC-1721689	189.29
MODEL D250B							
HOIST							
	1434850		P-UB-10	3-1/2	5-1/2	CTC-1721691	177.91
	5U7773		I-U-3	3-1/2	5-1/2	CTC-5U7775	333.11
STEERING							
	5U9000		I-U-5	2	4-1/2	CTC-6U9552	230.96
MODEL D250D							
HOIST							
	1478507		P-UB-10	2-3/4	4	CTC-1944397	171.17
	7U6405		I-U-10	2-3/4	4	CTC-7U8075	265.02
SUSPENSION							
	7U7230		P-UB-10	4	4-1/2	CTC-1944396	252.51
UNSPECIFIED APPLICATION							
	1340006		P-UB-10	4	4-1/2	CTC-1944396	252.51
	1512611		P-UB-10	2	3	CTC-1857667	87.64
MODEL D250E							
HOIST							
	1218785		I-U-10	2-3/4	4	CTC-1915027	121.53
	1256187		P-UB-10	3	4	CTC-1315423	220.30
	1478507		P-UB-10	2-3/4	4	CTC-1944397	171.17
STEERING							
	1185432		N-UB-10	2	4	CTC-1857687	148.29
	1466651		N-UB-10	2	4	CTC-1857687	148.29
SUSPENSION							
	1185432		N-UB-10	2	4	CTC-1857687	148.29
UNSPECIFIED APPLICATION							
	1340006		P-UB-10	4	4-1/2	CTC-1944396	252.51
	1447657		P-UB-10	4	4-1/2	CTC-1944396	252.51
	1512611		P-UB-10	2	3	CTC-1857667	87.64
	7U7230		P-UB-10	4	4-1/2	CTC-1944396	252.51
MODEL D300B							
HOIST							
	1434850		P-UB-10	3-1/2	5-1/2	CTC-1721691	177.91
	5U7773		I-U-3	3-1/2	5-1/2	CTC-5U7775	333.11
STEERING							
	5U9000		I-U-5	2	4-1/2	CTC-6U9552	230.96
MODEL D300B AG, D300B CANE H							
STEERING							
	5U9000		I-U-5	2	4-1/2	CTC-6U9552	230.96
MODEL D350B							
HOIST							
	5U7773		I-U-3	3-1/2	5-1/2	CTC-5U7775	333.11

REPLACEMENT KITS FOR CATERPILLAR® EQUIPMENT

Dump Trucks - Articulated							
APPLICATION	CYL #	Misc-Parts, Instructions, etc.	CODE	ROD	BORE	KIT #	List \$
MODEL D350C							
HOIST							
	1434850		P-UB-10	3-1/2	5-1/2	CTC-1721691	177.91
	5U7773		I-U-3	3-1/2	5-1/2	CTC-5U7775	333.11
STEERING							
	6U1040		I-U-5	2	4-1/2	CTC-6U9552	230.96
	7U2910		I-U-5	2	4-1/2	CTC-6U9552	230.96
SUSPENSION							
	6U4161	App requires 2 kits.	I-U-10	4	4-1/2	CTC-1045008	288.12
UNSPECIFIED APPLICATION							
	7U2476		I-U-10	4	4-1/2	CTC-7U2486	334.15
MODEL D350D							
HOIST							
	1434850		P-UB-10	3-1/2	5-1/2	CTC-1721691	177.91
STEERING							
	1433299		I-UB-5	2	4-1/2	CTC-1721689	189.29
	1453620		P-UB-10	2	4-1/2	CTC-1721690	50.31
SUSPENSION							
	1049660		P-UB-4	3-1/2	4-1/2	CTC-1417975	165.50
SUSPENSION REAR							
	7U9538		I-UB-5	2	4-1/2	CTC-1721689	189.29
MODEL D350D, D350E							
STEERING							
	7U2910		I-U-5	2	4-1/2	CTC-6U9552	230.96
SUSPENSION							
	2U8060		I-U-10	4	4-1/2	CTC-1045008	288.12
	7U7198		I-U-10	4	4-1/2	CTC-1045008	288.12
SUSPENSION REAR							
	7U9538		I-UB-10	2	4-1/2	CTC-7U9545	319.78
UNSPECIFIED APPLICATION							
	5U7773		I-U-3	3-1/2	5-1/2	CTC-5U7775	333.11
	7U2476		I-U-10	4	4-1/2	CTC-7U2486	334.15
MODEL D350E							
HOIST							
	1434850		P-UB-10	3-1/2	5-1/2	CTC-1721691	177.91
STEERING							
	1433299		I-UB-5	2	4-1/2	CTC-1721689	189.29
	1453620		P-UB-10	2	4-1/2	CTC-1721690	50.31
SUSPENSION							
	1049660		P-UB-4	3-1/2	4-1/2	CTC-1417975	165.50
SUSPENSION REAR							
	7U9538		I-UB-5	2	4-1/2	CTC-1721689	189.29
MODEL D400							
HOIST							
	1434850		P-UB-10	3-1/2	5-1/2	CTC-1721691	177.91
	5U7773		I-U-3	3-1/2	5-1/2	CTC-5U7775	333.11
STEERING							
	6U1040		I-U-5	2	4-1/2	CTC-6U9552	230.96
	7U2910		I-U-5	2	4-1/2	CTC-6U9552	230.96
MODEL D400D							
STEERING							
	7U2910		I-U-5	2	4-1/2	CTC-6U9552	230.96
SUSPENSION							
	1049660		P-UB-10	3-1/2	4-1/2	CTC-1942756	342.14
	2U8060		I-U-10	4	4-1/2	CTC-1045008	288.12
	7U7198		I-U-10	4	4-1/2	CTC-1045008	288.12
SUSPENSION REAR							
	7U9538		I-UB-10	2	4-1/2	CTC-7U9545	319.78

REPLACEMENT KITS FOR CATERPILLAR® EQUIPMENT

Dump Trucks - Articulated							
APPLICATION	CYL #	Misc-Parts, Instructions, etc.	CODE	ROD	BORE	KIT #	List \$
MODEL D400E							
HOIST							
	1434850		P-UB-10	3-1/2	5-1/2	CTC-1890263	254.49
STEERING							
	1433299		I-UB-10	2	4-1/2	CTC-1857699	222.76
	1453620		P-UB-10	2	4-1/2	CTC-1857700	100.53
	7U2910		I-U-5	2	4-1/2	CTC-6U9552	230.96
SUSPENSION							
	1049660		P-UB-10	3-1/2	4-1/2	CTC-1942756	342.14
	2U8060		I-U-10	4	4-1/2	CTC-1045008	288.12
	7U7198		I-U-10	4	4-1/2	CTC-1045008	288.12
SUSPENSION REAR							
	7U9538		I-UB-10	2	4-1/2	CTC-1857699	222.76
UNSPECIFIED APPLICATION							
	1331584		P-UB-10	4	4-1/2	CTC-1944398	237.58
	1511179		P-UB-10	3-1/2	4-1/2	CTC-1944399	253.02
	1512611		P-UB-10	2	3	CTC-1857667	87.64
	5U7773		I-U-3	3-1/2	5-1/2	CTC-5U7775	333.11
	7U2476		I-U-10	4	4-1/2	CTC-7U2486	334.15
Excavators							
APPLICATION	CYL #	Misc-Parts, Instructions, etc.	CODE	ROD	BORE	KIT #	List \$
MODEL 215							
BOOM							
	8J8613		P-UB-10	2-3/4	4-1/2	CTC-7X2683	189.10
BUCKET							
	8J8612		P-UB-10	2-3/4	4-1/2	CTC-7X2685	169.98
CLAMSHELL							
	9J5832		P-UB-10	3-1/4	6-1/2	CTC-7X2713	138.32
PUMP							
	2XC; 14Z; 57Y; 61Z; 96L						
	4T7025					CTC-3G1707	117.20
STICK							
	8J8611		P-UB-10	3-1/2	5-1/2	CTC-7X2726	165.40
TRACK ADJUSTER							
			TRK ADJ			CTC-FIG3400	61.91
			TRK ADJ			CTC-FIG3404	47.88
MODEL 215B							
BOOM							
	3G2996		P-UB-10	3-1/4	5-1/2	CTC-7X2705	267.03
	8J8613		P-UB-10	2-3/4	4-1/2	CTC-7X2683	189.10
BUCKET							
	8J8612		P-UB-10	2-3/4	4-1/2	CTC-7X2685	169.98
CLAMSHELL							
	9J5832		P-UB-10	3-1/4	6-1/2	CTC-7X2713	138.32
PUMP							
	2XC; 14Z; 57Y; 61Z; 96L						
	4T7025					CTC-3G1707	117.20
STICK							
	8J8611		P-UB-10	3-1/2	5-1/2	CTC-7X2726	165.40
TRACK ADJUSTER							
			TRK ADJ			CTC-FIG3400	61.91
MODEL 215C							
BOOM							
	8J8613		P-UB-10	2-3/4	4-1/2	CTC-7X2683	189.10
BUCKET							
	8J8612		P-UB-10	2-3/4	4-1/2	CTC-7X2685	169.98
	9T6497		P-UB-10	3	4-3/4	CTC-3E8883	160.83

REPLACEMENT KITS FOR CATERPILLAR® EQUIPMENT

Excavators							
APPLICATION	CYL #	Misc-Parts, Instructions, etc.	CODE	ROD	BORE	KIT #	List \$
MODEL 215C							
STICK							
	8J8611		P-UB-10	3-1/2	5-1/2	CTC-7X2726	165.40
TRACK ADJUSTER							
			TRK ADJ			CTC-FIG3400	61.91
			TRK ADJ			CTC-FIG3404	47.88
MODEL 215D							
BOOM							
	8J8613		P-UB-10	2-3/4	4-1/2	CTC-7X2683	189.10
BUCKET							
	9T6497		P-UB-10	3	4-3/4	CTC-3E8883	160.83
STICK							
	9T9280		P-UB-10	3-1/2	5-1/2	CTC-7X2726	165.40
TRACK ADJUSTER							
			TRK ADJ			CTC-FIG3400	61.91
			TRK ADJ			CTC-FIG3404	47.88
MODEL 219							
BOOM							
	8J8613		P-UB-10	2-3/4	4-1/2	CTC-7X2683	189.10
BUCKET							
	8J8612		P-UB-10	2-3/4	4-1/2	CTC-7X2685	169.98
	9T6497		P-UB-10	3	4-3/4	CTC-3E8883	160.83
STICK							
	8J8611		P-UB-10	3-1/2	5-1/2	CTC-7X2726	165.40
TRACK ADJUSTER							
			TRK ADJ			CTC-FIG3400	61.91
			TRK ADJ			CTC-FIG3404	47.88
MODEL 219D							
BUCKET							
	9T6497		P-UB-10	3	4-3/4	CTC-3E8883	160.83
STICK							
	9T9280		P-UB-10	3-1/2	5-1/2	CTC-7X2726	165.40
TRACK ADJUSTER							
			TRK ADJ			CTC-FIG3400	61.91
			TRK ADJ			CTC-FIG3404	47.88
MODEL 225							
BOOM							
	3G2996		P-UB-10	3-1/4	5-1/2	CTC-7X2705	267.03
	3G7384		P-UB-10	3-1/4	5-1/2	CTC-7X2705	267.03
	6E3833		P-UB-10	3-1/4	5-1/2	CTC-7X2705	267.03
	6E3836		P-UB-10	3-1/4	5-1/2	CTC-7X2705	267.03
	8J1698		P-UB-10	3-1/4	5-1/2	CTC-7X2705	267.03
	8J1698		P-UB-10	3-1/4	5-1/2	CTC-7X2823	245.38
BUCKET							
	6E6007		P-UB-10	3-1/4	5-1/2	CTC-7X2705	267.03
	8J2566		P-UB-10	3-1/4	5-1/2	CTC-7X2705	267.03
	8J8612		P-UB-10	2-3/4	4-1/2	CTC-7X2685	169.98
	9J7006		P-UB-10	3-1/4	5-1/2	CTC-1002931	410.29
CLAMSHELL							
	9J5153		P-UB-10	3-1/2	8-1/4	CTC-7X2727	356.38
CONVEYOR SWING							
	9J5153		P-UB-10	3-1/2	8-1/4	CTC-7X2727	356.38
PUMP							
	10W; 51U; 61X; 76U						
	4T7426					CTC-3G1688	202.92

CATERPILLAR®

REPLACEMENT KITS FOR CATERPILLAR® EQUIPMENT

Excavators							
APPLICATION	CYL #	Misc-Parts, Instructions, etc.	CODE	ROD	BORE	KIT #	List \$
MODEL 225							
STICK							
	8J1719		P-UB-10	3-3/4	6	CTC-7X2794	400.05
	9J1755		P-UB-10	3-3/4	6	CTC-1002939	570.42
	9T9744		P-UB-10	3-3/4	6	CTC-3E8888	327.67
MODEL 225B							
BOOM							
	3G2996		P-UB-10	3-1/4	5-1/2	CTC-7X2705	267.03
	6E3833		P-UB-10	3-1/4	5-1/2	CTC-7X2705	267.03
	8J1698		P-UB-10	3-1/4	5-1/2	CTC-7X2705	267.03
	8J1698		P-UB-10	3-1/4	5-1/2	CTC-7X2823	245.38
	9T5230		P-UB-10	3-1/2	6	CTC-3E8889	206.10
	9T5230		P-UB-10	3-1/2	6	CTC-7X7735	260.84
BUCKET							
	6E6007		P-UB-10	3-1/4	5-1/2	CTC-7X2705	267.03
	8J8612		P-UB-10	2-3/4	4-1/2	CTC-7X2685	169.98
	9J7006		P-UB-10	3-1/4	5-1/2	CTC-1002931	410.29
	9J7006		P-UB-10	3-1/4	5-1/2	CTC-1002932	410.80
	9J7006		P-UB-10	3-1/4	5-1/2	CTC-7X2709	167.18
	9T6497		P-UB-10	3	4-3/4	CTC-3E8883	160.83
STICK							
	9J1755		P-UB-10	3-3/4	6	CTC-1002939	570.42
	9J1755		P-UB-10	3-3/4	6	CTC-7X2794	400.05
	9T9744		P-UB-10	3-3/4	6	CTC-3E8888	327.67
TRACK ADJUSTER							
			TRK ADJ			CTC-FIG3400	61.91
MODEL 225D							
BOOM							
	3G2996		P-UB-10	3-1/4	5-1/2	CTC-7X2705	267.03
	9T5230		P-UB-10	3-1/2	6	CTC-7X7735	260.84
	9T9747		P-UB-10	3-1/2	6	CTC-3E8889	206.10
BUCKET							
	6E6007		P-UB-10	3-1/4	5-1/2	CTC-7X2705	267.03
	8J8612		P-UB-10	2-3/4	4-1/2	CTC-7X2685	169.98
	9J7006		P-UB-10	3-1/4	5-1/2	CTC-1002931	410.29
	9J7006		P-UB-10	3-1/4	5-1/2	CTC-1002932	410.80
	9J7006		P-UB-10	3-1/4	5-1/2	CTC-7X2709	167.18
	9T6497		P-UB-10	3	4-3/4	CTC-3E8883	160.83
STICK							
	6E6009		P-UB-10	3-3/4	6	CTC-1002939	570.42
	9J1755		P-UB-10	3-3/4	6	CTC-1002939	570.42
	9J1755		P-UB-10	3-3/4	6	CTC-7X2794	400.05
	9T9744		P-UB-10	3-3/4	6	CTC-1002939	570.42
	9T9744		P-UB-10	3-3/4	6	CTC-3E8888	327.67
TRACK ADJUSTER							
			TRK ADJ			CTC-FIG3400	61.91
MODEL 227							
ARM							
	1U4732		P-UB-10	3-3/4	6	CTC-7X2814	205.52
BOOM							
	3G2996		P-UB-10	3-1/4	5-1/2	CTC-7X2705	267.03
	3G7264		P-UB-10	3-1/4	5-1/2	CTC-7X2705	267.03
	6E3833		P-UB-10	3-1/4	5-1/2	CTC-7X2705	267.03
	8J1698		P-UB-10	3-1/4	5-1/2	CTC-7X2705	267.03
	8J1698		P-UB-10	3-1/4	5-1/2	CTC-7X2823	245.38

REPLACEMENT KITS FOR CATERPILLAR® EQUIPMENT

Excavators							
APPLICATION	CYL #	Misc-Parts, Instructions, etc.	CODE	ROD	BORE	KIT #	List \$
MODEL 227							
BUCKET							
	6E6007		P-UB-10	3-1/4	5-1/2	CTC-7X2705	267.03
	9J7006		P-UB-10	3-1/4	5-1/2	CTC-1002931	410.29
	9J7006		P-UB-10	3-1/4	5-1/2	CTC-1002932	410.80
	9J7006		P-UB-10	3-1/4	5-1/2	CTC-7X2709	167.18
GRAPPLE							
	3G5672		P-UB-10	1-3/4	3	CTC-7X2791	91.70
PUMP							
	10W; 51U; 61X; 76U						
	4T7426					CTC-3G1688	202.92
SHEAR							
	3G2656		P-UB-10	3-1/4	6-1/2	CTC-7X2713	138.32
STICK							
	1U4731		P-UB-10	3-3/4	6	CTC-1002939	570.42
	9J1755		P-UB-10	3-3/4	6	CTC-1002939	570.42
	9J1755		P-UB-10	3-3/4	6	CTC-7X2794	400.05
	9T9744		P-UB-10	3-3/4	6	CTC-3E8888	327.67
TILT							
	3G9241		P-UB-10	2-1/2	4-1/2	CTC-7X2668	176.00
MODEL 229							
ARM							
	1U4732		P-UB-10	3-3/4	6	CTC-7X2814	205.52
BOOM							
	3G2996		P-UB-10	3-1/4	5-1/2	CTC-7X2705	267.03
	3G7264		P-UB-10	3-1/4	5-1/2	CTC-7X2705	267.03
	6E3833		P-UB-10	3-1/4	5-1/2	CTC-7X2705	267.03
	8J1698		P-UB-10	3-1/4	5-1/2	CTC-7X2705	267.03
	8J1698		P-UB-10	3-1/4	5-1/2	CTC-7X2823	245.38
	9T5230		P-UB-10	3-1/2	6	CTC-3E8889	206.10
	9T5230		P-UB-10	3-1/2	6	CTC-7X7735	260.84
BUCKET							
	6E6007		P-UB-10	3-1/4	5-1/2	CTC-7X2705	267.03
	9J7006		P-UB-10	3-1/4	5-1/2	CTC-1002931	410.29
	9J7006		P-UB-10	3-1/4	5-1/2	CTC-1002932	410.80
	9J7006		P-UB-10	3-1/4	5-1/2	CTC-7X2709	167.18
STICK							
	9J1755		P-UB-10	3-3/4	6	CTC-1002939	570.42
	9J1755		P-UB-10	3-3/4	6	CTC-7X2794	400.05
	9T9744		P-UB-10	3-3/4	6	CTC-3E8888	327.67
TRACK ADJUSTER							
			TRK ADJ			CTC-FIG3400	61.91
MODEL 229D							
BOOM							
	9T9371		P-UB-10	4	6	CTC-9X6261	293.92
	9T9371		P-UB-10	4	6	CTC-9X6263	242.17
BUCKET							
	6E6007		P-UB-10	3-1/4	5-1/2	CTC-7X2705	267.03
	9J7006		P-UB-10	3-1/4	5-1/2	CTC-1002931	410.29
	9J7006		P-UB-10	3-1/4	5-1/2	CTC-1002932	410.80
	9J7006		P-UB-10	3-1/4	5-1/2	CTC-7X2709	167.18
STICK							
	6E6009		P-UB-10	3-3/4	6	CTC-1002939	570.42
	9T9744		P-UB-10	3-3/4	6	CTC-1002939	570.42
	9T9744		P-UB-10	3-3/4	6	CTC-3E8888	327.67

REPLACEMENT KITS FOR CATERPILLAR® EQUIPMENT

Excavators							
APPLICATION	CYL #	Misc-Parts, Instructions, etc.	CODE	ROD	BORE	KIT #	List \$
MODEL 231D							
BOOM							
	1052921		P-UB-10	4	6	CTC-9X6261	293.92
	6E3473		P-UB-10	4-1/4	6-1/2	CTC-8T1461	235.53
	8J4589		P-UB-10	4-1/4	6-1/2	CTC-1002934	415.96
	8J4589		P-UB-10	4-1/4	6-1/2	CTC-1002935	423.41
	8J4589		P-UB-10	4-1/4	6-1/2	CTC-8T1461	235.53
	9T9371		P-UB-10	4	6	CTC-9X6261	293.92
	9T9371		P-UB-10	4	6	CTC-9X6263	242.17
BUCKET							
	6E5021		P-UB-10	4	6	CTC-9X6261	293.92
	9T9514		P-UB-10	4	6	CTC-9X6261	293.92
MODEL 235							
BOOM							
	1024210		P-UB-10	4-1/4	6-1/2	CTC-8T1461	235.53
	3G3524		P-UB-10	4-3/4	7-1/4	CTC-8T1545	299.08
	4T1689		P-UB-10	4-1/4	6-1/2	CTC-8T1461	235.53
	4T1921		P-UB-10	4-1/4	6-1/2	CTC-8T1461	235.53
	6C5856		P-UB-10	4-1/4	6-1/2	CTC-8T1461	235.53
	6C5857		P-UB-10	4-1/4	6-1/2	CTC-8T1461	235.53
	8J4589		P-UB-10	4-1/4	6-1/2	CTC-1002934	415.96
	8J4589		P-UB-10	4-1/4	6-1/2	CTC-1002935	423.41
	8J4589		P-UB-10	4-1/4	6-1/2	CTC-8T1461	235.53
	9J2153		P-UB-10	4-1/4	6-1/2	CTC-8T1461	235.53
	9T9995		P-UB-10	4-1/4	6-1/2	CTC-8T1461	235.53
	9T9995		P-UB-10	4-1/4	6-1/2	CTC-9X6379	328.55
BOTTOM DUMP							
	1024216		P-UB-14	4-3/4	6-1/2	CTC-8T1462	252.00
	4T0483		P-UB-10	3	7-1/4	CTC-7X2699	222.83
BUCKET							
	1024216		P-UB-14	4-3/4	6-1/2	CTC-8T1462	252.00
	4T2536		P-UB-14	4-3/4	6-1/2	CTC-8T1462	252.00
	8J8918		P-UB-10	4-3/4	6-1/2	CTC-7X7719	274.97
	9J4100		P-UB-14	4-3/4	6-1/2	CTC-8T1462	252.00
	9J8153		P-UB-10	4-3/4	6	CTC-8T1908	225.44
PIN PULLER							
	1U2813		P-UB-10	2-1/2	4	CTC-7X2665	172.76
PUMP							
	1FD; 3WG; 5AF; 7WC; 8KJ; 32K; 64R; 62X; 81X; 83X						
	4T2507					CTC-8J8652	196.98
SLAVE							
	9J4882		P-UB-10	4	5	CTC-7X2816	261.71
STICK							
	3G5646		P-UB-10	5	7-3/4	CTC-8T1479	395.03
	6E5096		P-UB-10	5	7-3/4	CTC-3E8887	464.82
	8J5603		P-UB-10	5	7-3/4	CTC-8T1479	395.03
	9J1755		P-UB-10	3-3/4	6	CTC-1002939	570.42
	9J7850		P-UB-10	5	7-3/4	CTC-8T1479	395.03
	9T1387		P-UB-10	5	7-3/4	CTC-8T1479	395.03
	9T9354		P-UB-10	5	7-3/4	CTC-3E8887	464.82
	9T9744		P-UB-10	3-3/4	6	CTC-3E8888	327.67

REPLACEMENT KITS FOR CATERPILLAR® EQUIPMENT

Excavators							
APPLICATION	CYL #	Misc-Parts, Instructions, etc.	CODE	ROD	BORE	KIT #	List \$
MODEL 235 FS							
BOOM							
	4T1921		P-UB-10	4-1/4	6-1/2	CTC-8T1461	235.53
	8J4589		P-UB-10	4-1/4	6-1/2	CTC-1002934	415.96
	8J4589		P-UB-10	4-1/4	6-1/2	CTC-1002935	423.41
	8J4589		P-UB-10	4-1/4	6-1/2	CTC-8T1461	235.53
	9J2153		P-UB-10	4-1/4	6-1/2	CTC-8T1461	235.53
BOTTOM DUMP							
	4T0483		P-UB-10	3	7-1/4	CTC-7X2699	222.83
	9J4697		P-UB-10	3	7-1/4	CTC-7X2699	222.83
BUCKET							
	4T2536		P-UB-14	4-3/4	6-1/2	CTC-8T1462	252.00
	9J4100		P-UB-10	4-3/4	6-1/2	CTC-7X7718	260.02
	9J4100		P-UB-10	4-3/4	6-1/2	CTC-7X7719	274.97
	9J4100		P-UB-14	4-3/4	6-1/2	CTC-8T1462	252.00
	9J8153		P-UB-10	4-3/4	6	CTC-8T1908	225.44
SLAVE							
	9J4882		P-UB-10	4	5	CTC-7X2816	261.71
STICK							
	3G5646		P-UB-10	5	7-3/4	CTC-8T1479	395.03
MODEL 235B							
BOOM							
	1024210		P-UB-10	4-1/4	6-1/2	CTC-8T1461	235.53
	4T1689		P-UB-10	4-1/4	6-1/2	CTC-8T1461	235.53
	4T1921		P-UB-10	4-1/4	6-1/2	CTC-8T1461	235.53
	6C5856		P-UB-10	4-1/4	6-1/2	CTC-8T1461	235.53
	6C5857		P-UB-10	4-1/4	6-1/2	CTC-8T1461	235.53
	9T9995		P-UB-10	4-1/4	6-1/2	CTC-8T1461	235.53
	9T9995		P-UB-10	4-1/4	6-1/2	CTC-9X6379	328.55
BOTTOM DUMP							
	4T0483		P-UB-10	3	7-1/4	CTC-7X2699	222.83
BUCKET							
	1024217		P-UB-14	4-3/4	6-1/2	CTC-8T1462	252.00
	4T2536		P-UB-14	4-3/4	6-1/2	CTC-8T1462	252.00
	9J8153		P-UB-10	4-3/4	6	CTC-8T1908	225.44
PUMP							
	1FD; 3WG; 5AF; 7WC; 8KJ; 32K; 64R; 62X; 81X; 83X						
	4T2507					CTC-8J8652	196.98
SLAVE							
	9J4882		P-UB-10	4	5	CTC-7X2816	261.71
STICK							
	3G5646		P-UB-10	5	7-3/4	CTC-8T1479	395.03
	6E5096		P-UB-10	5	7-3/4	CTC-3E8887	464.82
	9T1387		P-UB-10	5	7-3/4	CTC-8T1479	395.03
	9T9354		P-UB-10	5	7-3/4	CTC-3E8887	464.82

CATERPILLAR®

REPLACEMENT KITS FOR CATERPILLAR® EQUIPMENT

Excavators							
APPLICATION	CYL #	Misc-Parts, Instructions, etc.	CODE	ROD	BORE	KIT #	List \$
MODEL 235C							
BOOM							
	1024211		P-UB-10	4-1/4	6-1/2	CTC-8T1461	235.53
	4T1689		P-UB-10	4-1/4	6-1/2	CTC-8T1461	235.53
	4T1921		P-UB-10	4-1/4	6-1/2	CTC-8T1461	235.53
	6C5856		P-UB-10	4-1/4	6-1/2	CTC-8T1461	235.53
	6C5857		P-UB-10	4-1/4	6-1/2	CTC-8T1461	235.53
	6E1643		P-UB-14	4-3/4	7	CTC-8T1567	246.75
	9T6615		P-UB-10	4-3/4	7	CTC-7X7734	448.66
	9T6615		P-UB-14	4-3/4	7	CTC-8T1567	246.75
	9T9360		P-UB-14	4-3/4	7	CTC-8T1567	246.75
	9T9995		P-UB-10	4-1/4	6-1/2	CTC-8T1461	235.53
	9T9995		P-UB-10	4-1/4	6-1/2	CTC-9X6379	328.55
BOTTOM DUMP							
	4T0483		P-UB-10	3	7-1/4	CTC-7X2699	222.83
BUCKET							
	1024216		P-UB-14	4-3/4	6-1/2	CTC-8T1462	252.00
	4T2536		P-UB-14	4-3/4	6-1/2	CTC-8T1462	252.00
	9J8153		P-UB-10	4-3/4	6	CTC-8T1908	225.44
PUMP							
	1FD; 3WG; 5AF; 7WC; 8KJ; 32K; 64R; 62X; 81X; 83X						
	4T2507					CTC-8J8652	196.98
SLAVE							
	9J4882		P-UB-10	4	5	CTC-7X2816	261.71
STICK							
	3G5646		P-UB-10	5	7-3/4	CTC-8T1479	395.03
	6E5096		P-UB-10	5	7-3/4	CTC-3E8887	464.82
	9T1387		P-UB-10	5	7-3/4	CTC-8T1479	395.03
	9T9354		P-UB-10	5	7-3/4	CTC-3E8887	464.82
MODEL 235C FS							
BOOM							
	4T1689		P-UB-10	4-1/4	6-1/2	CTC-8T1461	235.53
	9T6615		P-UB-10	4-3/4	7	CTC-7X7734	448.66
BOTTOM DUMP							
	4T0483		P-UB-10	3	7-1/4	CTC-7X2699	222.83
BUCKET							
	4T2536		P-UB-14	4-3/4	6-1/2	CTC-8T1462	252.00
	9J8153		P-UB-10	4-3/4	6	CTC-8T1908	225.44
MASTER							
	9J4882		P-UB-10	4	5	CTC-7X2816	261.71
STICK							
	9T1387		P-UB-10	5	7-3/4	CTC-8T1479	395.03
MODEL 235D							
BOOM							
	1024210		P-UB-10	4-1/4	6-1/2	CTC-8T1461	235.53
	4T1689		P-UB-10	4-1/4	6-1/2	CTC-8T1461	235.53
	6C5856		P-UB-10	4-1/4	6-1/2	CTC-8T1461	235.53
	6C5857		P-UB-10	4-1/4	6-1/2	CTC-8T1461	235.53
	6E1643		P-UB-14	4-3/4	7	CTC-8T1567	246.75
	9T9995		P-UB-10	4-1/4	6-1/2	CTC-8T1461	235.53
	9T9995		P-UB-10	4-1/4	6-1/2	CTC-9X6379	328.55
BOTTOM DUMP							
	4T0483		P-UB-10	3	7-1/4	CTC-7X2699	222.83
BUCKET							
	1024216		P-UB-14	4-3/4	6-1/2	CTC-8T1462	252.00
	4T2536		P-UB-14	4-3/4	6-1/2	CTC-8T1462	252.00

REPLACEMENT KITS FOR CATERPILLAR® EQUIPMENT

Excavators								
APPLICATION	CYL #	Misc-Parts, Instructions, etc.	CODE	ROD	BORE	KIT #	List \$	
MODEL 235D								
PUMP								
	1FD; 3WG; 5AF; 7WC; 8KJ; 32K; 64R; 62X; 81X; 83X							
	4T2507					CTC-8J8652	196.98	
SLAVE								
	9J4882		P-UB-10	4	5	CTC-7X2816	261.71	
STICK								
	6E5096		P-UB-10	5	7-3/4	CTC-3E8887	464.82	
	9T9354		P-UB-10	5	7-3/4	CTC-3E8887	464.82	
TRACK ADJUSTER								
			TRK ADJ			CTC-FIG0405	112.48	
MODEL 245 FS								
BOOM								
	3G4615		P-UB-10	5	6	CTC-8T1909	349.57	
	9J5379		P-UB-14	4-3/4	7	CTC-8T1567	246.75	
BUCKET								
	1U1646		P-UB-14	4-3/4	7	CTC-8T1565	254.03	
	8J8721		P-UB-14	4-3/4	7	CTC-8T1565	254.03	
STICK								
	3G2778		P-UB-10	5-3/4	8-1/4	CTC-8T1558	688.95	
MODEL 245, 245B								
BOOM								
	1024212		P-UB-14	4-3/4	7	CTC-8T1567	246.75	
	3G3524		P-UB-10	4-3/4	7-1/4	CTC-8T1545	299.08	
	3G4615		P-UB-10	5	6	CTC-8T1909	349.57	
	8J3720		P-UB-14	4-3/4	7	CTC-8T1567	246.75	
	9J5379		P-UB-14	4-3/4	7	CTC-8T1567	246.75	
	9T9358		P-UB-10	4-3/4	7-1/4	CTC-8T1545	299.08	
BOTTOM DUMP								
	1U1659		P-UB-10	3-1/2	7-3/4	CTC-9X2644	239.91	
BUCKET								
	1U1646		P-UB-14	4-3/4	7	CTC-8T1565	254.03	
	1U1646		P-UB-14	4-3/4	7	CTC-8T1567	246.75	
	1U1659		P-UB-10	3-1/2	7-3/4	CTC-9X2644	239.91	
	8J8721		P-UB-10	4-3/4	7	CTC-1371946	378.89	
	8J8721		P-UB-14	4-3/4	7	CTC-8T1565	254.03	
	9J7755		P-UB-10	5-3/4	7	CTC-8C4398	390.63	
	9J9398		P-UB-10	5-3/4	7	CTC-8C4398	390.63	
COUNTERWEIGHT								
	8J6167		P-UB-10	2-1/2	5	CTC-7X2658	180.34	
LIFT								
	8J6167		P-UB-10	2-1/2	5	CTC-1315118	184.12	
	8J6167		P-UB-10	2-1/2	5	CTC-7X2658	180.34	
PUMP								
	6MF; 42X; 82X; 84X; 94L; 95V							
	4T2506					CTC-8J8652	196.98	
STICK								
	1011908		P-UB-10	5-3/4	8-1/4	CTC-3E8880	748.61	
	3G2778		P-UB-10	5-3/4	8-1/4	CTC-3E8880	748.61	
	3G2778		P-UB-10	5-3/4	8-1/4	CTC-8T1558	688.95	
	6E5093		P-UB-10	5-3/4	8-1/4	CTC-3E8880	748.61	
	9T1388		P-UB-10	5-3/4	8-1/4	CTC-3E8880	748.61	
	9T1388		P-UB-10	5-3/4	8-1/4	CTC-8T1558	688.95	
	9T9356		P-UB-10	5-3/4	8-1/4	CTC-3E8880	748.61	
TRACK ADJUSTER								
			TRK ADJ			CTC-FIG0405	112.48	

REPLACEMENT KITS FOR CATERPILLAR® EQUIPMENT

Excavators							
APPLICATION	CYL #	Misc-Parts, Instructions, etc.	CODE	ROD	BORE	KIT #	List \$
MODEL 245B FS							
BOOM							
	3G3524		P-UB-10	4-3/4	7-1/4	CTC-8T1545	299.08
	3G4615		P-UB-10	5	6	CTC-8T1909	349.57
	9J5379		P-UB-14	4-3/4	7	CTC-8T1567	246.75
BUCKET							
	1U1646		P-UB-14	4-3/4	7	CTC-8T1565	254.03
	8J8721		P-UB-14	4-3/4	7	CTC-8T1565	254.03
STICK							
	3G2778		P-UB-10	5-3/4	8-1/4	CTC-8T1558	688.95
MODEL 245D							
BOOM							
	1024212		P-UB-14	4-3/4	7	CTC-8T1567	246.75
	3G3524		P-UB-10	4-3/4	7-1/4	CTC-8T1545	299.08
	8J3720		P-UB-14	4-3/4	7	CTC-8T1567	246.75
	9J5379		P-UB-14	4-3/4	7	CTC-8T1567	246.75
	9T9358		P-UB-10	4-3/4	7-1/4	CTC-8T1545	299.08
BOTTOM DUMP							
	1U1659		P-UB-10	3-1/2	7-3/4	CTC-9X2644	239.91
BUCKET							
	1U1646		P-UB-14	4-3/4	7	CTC-8T1565	254.03
	1U1646		P-UB-14	4-3/4	7	CTC-8T1567	246.75
	8J8721		P-UB-10	4-3/4	7	CTC-1371946	378.89
	9J9398		P-UB-10	5-3/4	7	CTC-8C4398	390.63
LIFT							
	8J6167		P-UB-10	2-1/2	5	CTC-1315118	184.12
	8J6167		P-UB-10	2-1/2	5	CTC-7X2658	180.34
STICK							
	1011908		P-UB-10	5-3/4	8-1/4	CTC-3E8880	748.61
	3G2778		P-UB-10	5-3/4	8-1/4	CTC-3E8880	748.61
	6E5093		P-UB-10	5-3/4	8-1/4	CTC-3E8880	748.61
	9T1388		P-UB-10	5-3/4	8-1/4	CTC-3E8880	748.61
	9T1388		P-UB-10	5-3/4	8-1/4	CTC-8T1558	688.95
	9T9356		P-UB-10	5-3/4	8-1/4	CTC-3E8880	748.61
TRACK ADJUSTER							
			TRK ADJ			CTC-FIG0405	112.48
MODEL 302.5							
BLADE							
	4AZ1-4947						
	1662835		P-U-10	45 mm	75 mm	CTC-1662835K	58.33
	4AZ4948-UP						
	2126335		P-U-10	45 mm	75 mm	CTC-2126335K	58.33
BOOM							
	4AZ1-329						
	1509211		P-U-10	45 mm	75 mm	CTC-1509211K	67.75
	4AZ330-4822						
	1794969		P-U-10	45 mm	75 mm	CTC-1794969K	67.75
	4AZ4823-UP						
	2126337		P-U-10	45 mm	75 mm	CTC-2126337K	62.70
BUCKET							
	4AZ1-4828						
	1513187		P-U-10	35 mm	65 mm	CTC-1513187K	53.79
	4AZ1-UP						
	2269959		P-U-10	35 mm	65 mm	CTC-2269959K	53.33
	4AZ4829-5653						
	2126328		P-U-10	35 mm	65 mm	CTC-2126328K	53.33

REPLACEMENT KITS FOR CATERPILLAR® EQUIPMENT

Excavators							
APPLICATION	CYL #	Misc-Parts, Instructions, etc.	CODE	ROD	BORE	KIT #	List \$
MODEL 302.5							
BUCKET TILT							
4AZ1-UP							
	2443074		P-U-10	30 mm	60 mm	CTC-1608546	53.22
STICK							
4AZ1-4828							
	1512460		P-U-10	40 mm	70 mm	CTC-1512460K	46.37
4AZ1-UP							
	2374079		P-U-10	40 mm	70 mm	CTC-2374079K	45.24
4AZ4829-5653							
	2126329		P-U-10	40 mm	70 mm	CTC-2126329K	45.24
	2373542		P-U-10	40 mm	70 mm	CTC-2373542K	45.24
SWING BOOM							
4AZ1-4822							
	1511266		P-U-10	45 mm	75 mm	CTC-1511266K	58.98
	1724223		P-U-10	45 mm	75 mm	CTC-1724223K	52.05
4AZ4823-UP							
	2126336		P-U-10	45 mm	75 mm	CTC-2126336K	58.33
MODEL 302.5C							
BOOM							
GBB1-UP							
	2126337		P-U-10	45 mm	75 mm	CTC-2126337K	62.70
BUCKET							
GBB1-UP							
	2269959		P-U-10	35 mm	65 mm	CTC-2269959K	53.33
LIFT							
GBB1-UP							
	2309267		P-U-10	45 mm	85 mm	CTC-2309267K	83.09
STICK							
GBB1-UP							
	2374079		P-U-10	40 mm	70 mm	CTC-2374079K	45.24
SWING BOOM							
GBB1-1897							
	2126336		P-U-10	45 mm	75 mm	CTC-2126336K	58.33
GBB1898-UP							
	2935360		P-U-10	45 mm	75 mm	CTC-2935360K	58.35
MODEL 303 C CR							
BLADE ANGLE							
BXT1-UP							
			P-U-10	35 mm	65 mm	CTC-2839122	44.33
BLADE RAISE LOWER							
BXT1-UP							
	2666979		P-U-10	45 mm	80 mm	CTC-2788641	76.04
BOOM							
BXT1-UP							
	2737033		P-U-10	45 mm	80 mm	CTC-2788641	76.04
	2840420		P-U-10	45 mm	80 mm	CTC-2788641	76.04
	2855034		P-U-10	50 mm	85 mm	CTC-2790639	89.47
BUCKET							
BXT1-UP							
	2666973		P-U-10	40 mm	70 mm	CTC-2519845	72.90
	2778672		P-U-10	40 mm	70 mm	CTC-2519845	72.90
STICK							
BXT1-UP							
	2840863		P-U-10	45 mm	80 mm	CTC-2797940	81.14

REPLACEMENT KITS FOR CATERPILLAR® EQUIPMENT

Excavators							
APPLICATION	CYL #	Misc-Parts, Instructions, etc.	CODE	ROD	BORE	KIT #	List \$
MODEL 303 C CR							
TILTABLE BUCKET							
BXT1-UP							
2460192			P-UB-10	1-1/2	3	CTC-2460192K	37.79
2460192			Bushing	1-1/2		CTC-4T6780	9.54
MODEL 303.5							
BLADE							
AFW1-UP; DCH1-UP							
1636935			P-U-10	50 mm	90 mm	CTC-1636935K	122.44
BOOM							
AFW1-UP							
1637006			P-U-10	45 mm	80 mm	CTC-1637006K	109.64
BUCKET							
AFW1-UP; DCH1-UP							
1637008			P-U-10	40 mm	70 mm	CTC-1637008K	148.97
STICK							
AFW1-UP; DCH1-UP							
1636936			P-U-10	45 mm	75 mm	CTC-1636936K	157.91
SWING BOOM							
AFW1-UP; DCH1-UP							
1637007			P-U-10	45 mm	80 mm	CTC-1637007K	109.64
MODEL 303.5C CR							
BLADE ANGLE							
DMY1-UP							
2866384			P-U-10	35 mm	65 mm	CTC-2839122	44.33
BLADE RAISE LOWER							
DMY1-UP							
2666979			P-U-10	45 mm	80 mm	CTC-2788641	76.04
2666979			Link Pin Seal			CTC-1920638	8.83
2666979			Link Pin Seal			CTC-1920638	8.83
BOOM							
DMY1-UP							
2737030			P-U-10	50 mm	85 mm	CTC-2812321	78.55
2843369			P-U-10	50 mm	85 mm	CTC-2812321	78.55
2843369			Link Pin Seal			CTC-1920638	8.83
2843369			Link Pin Seal			CTC-1920638	8.83
BUCKET							
DMY1-UP							
2460192			P-UB-10	1-1/2	3	CTC-2460192K	37.79
2666971			P-U-10	45 mm	75 mm	CTC-2812322	72.31
2666971			Link Pin Seal			CTC-1920638	8.83
2666971			Link Pin Seal			CTC-1920638	8.83
2779900			P-U-10	45 mm	75 mm	CTC-2779900K	72.31
2779900			Link Pin Seal			CTC-1920638	8.83
2779900			Link Pin Seal			CTC-1920638	8.83
STICK							
DMY1-UP							
2840883			P-U-10	50 mm	80 mm	CTC-2812323	78.28
2840883			Link Pin Seal			CTC-1920638	8.83
2840883			Link Pin Seal			CTC-1920638	8.83
SWING BOOM							
DMY1-UP							
2843909			P-U-10	50 mm	85 mm	CTC-2790639	89.47
2843909			Link Pin Seal			CTC-1920638	8.83
2843909			Link Pin Seal			CTC-1920638	8.83

REPLACEMENT KITS FOR CATERPILLAR® EQUIPMENT

Excavators							
APPLICATION	CYL #	Misc-Parts, Instructions, etc.	CODE	ROD	BORE	KIT #	List \$
MODEL 303CR							
BLADE							
DMA1-UP							
	1937859		P-U-10	45 mm	85 mm	CTC-1937859K	76.78
BOOM							
DMA1-UP							
	1987021		P-U-10	50 mm	80 mm	CTC-1987021K	120.20
BUCKET							
DMA1-UP							
	2037172		P-U-10	40 mm	65 mm	CTC-2037172K	47.12
	2190541		P-U-10	40 mm	65 mm	CTC-2190541K	47.12
	2390837		P-U-10	40 mm	65 mm	CTC-2390837K	47.09
STICK							
DMA1-UP							
	1937852		P-U-10	45 mm	75 mm	CTC-1937852K	75.48
	2763879		P-U-10	45 mm	75 mm	CTC-2763879K	75.48
SWING BOOM							
DMA1-UP							
	1937855		P-U-10	45 mm	80 mm	CTC-1937855K	65.49
TILT							
DMA1-UP							
	2460192		P-UB-10	1-1/2	3	CTC-2350354	35.56
MODEL 304 C CR							
BLADE ANGLE							
FPK1-UP							
	2704714		P-U-10	35 mm	65 mm	CTC-2839122	44.33
BLADE RAISE LOWER							
FPK1-UP							
	2937158		P-U-10	55 mm	90 mm	CTC-2937158K	79.64
BOOM							
FPK1-UP							
	2666975		P-U-10	55 mm	90 mm	CTC-2666975K	79.64
	2709475		P-UB-14	55 mm	95 mm	CTC-2773395	100.32
	2828548		P-UB-14	55 mm	95 mm	CTC-2773395	100.32
BUCKET							
FPK1-UP							
	2666969		P-UB-14	45 mm	75 mm	CTC-2774167	144.69
STICK							
FPK1-UP							
	2828550		P-UB-14	50 mm	85 mm	CTC-2774140	84.60
TILTABLE BUCKET							
FPK1-UP							
	2460192		P-UB-10	1-1/2	3	CTC-2460192K	37.79
MODEL 304.5							
BLADE							
ANR1-UP; WAK1-UP							
	1636973		P-U-10	50 mm	100 mm	CTC-1934324	131.82
BOOM							
ANR1-UP; WAK1-UP							
	1636970		P-U-10	50 mm	85 mm	CTC-1934321	139.52
BUCKET							
ANR1-UP; WAK1-UP							
	1636972		P-U-10	45 mm	75 mm	CTC-1934323	75.43
STICK							
ANR1-UP; WAK1-UP							
	1708945		P-U-10	50 mm	80 mm	CTC-1934325	120.17

REPLACEMENT KITS FOR CATERPILLAR® EQUIPMENT

Excavators							
APPLICATION	CYL #	Misc-Parts, Instructions, etc.	CODE	ROD	BORE	KIT #	List \$
MODEL 304.5							
SWING BOOM							
ANR1-UP; WAK1-UP							
	1636971		P-U-10	50 mm	90 mm	CTC-1934322	92.20
MODEL 304CR							
BLADE							
NAD1-UP							
	2153747		P-U-10	55 mm	100 mm	CTC-2167247	139.40
BLADE ANGLE							
NAD1-UP							
	2704714		P-U-10	35 mm	65 mm	CTC-2839122	44.33
BOOM							
NAD1-UP							
	2099617		P-U-10	50 mm	85 mm	CTC-2167644	224.29
	2160991		P-U-10	55 mm	95 mm	CTC-2199066	166.35
BUCKET							
NAD1-UP							
	2180511		P-U-10	45 mm	70 mm	CTC-2168100	196.60
	2397706		P-U-10	45 mm	70 mm	CTC-2168100	196.60
STICK							
NAD1-UP							
	2081152		P-U-10	55 mm	85 mm	CTC-2171643	229.57
MODEL 305 C CR							
BLADE							
HWJ1-834							
	2666977		P-U-10	55 mm	90 mm	CTC-2666977K	79.64
HWJ1-UP							
	2937158		P-U-10	55 mm	90 mm	CTC-2937158K	79.64
BLADE ANGLE							
HWJ1-UP							
	2704714		P-U-10	35 mm	65 mm	CTC-2839122	44.33
BOOM							
HWJ1-UP							
	2666975		P-U-10	55 mm	90 mm	CTC-2666975K	79.64
	2737025		P-U-10	55 mm	100 mm	CTC-2737025K	113.75
	2821535		P-U-10	55 mm	100 mm	CTC-2821535K	113.77
BUCKET							
HWJ1-UP							
	2666967		P-U-10	50 mm	80 mm	CTC-2666967K	103.22
STICK							
HWJ1-UP							
	2821537		P-U-10	55 mm	90 mm	CTC-2821537K	78.59
TILTABLE BUCKET							
HWJ1-UP							
	2460192		P-UB-10	1-1/2	3	CTC-2460192K	37.79
MODEL 305CR							
BLADE							
DGT1-UP; DSA244-UP							
	2153747		P-U-10	55 mm	100 mm	CTC-2167247	139.40
DSA1-243							
	1911962		P-U-10	55 mm	100 mm	CTC-1992402	92.04
BLADE ANGLE							
DGT1-UP							
	2704714		P-U-10	35 mm	65 mm	CTC-2839122	44.33
BOOM							
DGT1-UP; DSA1-UP							
	1911958		P-U-10	55 mm	100 mm	CTC-1989433	90.45

REPLACEMENT KITS FOR CATERPILLAR® EQUIPMENT

Excavators							
APPLICATION	CYL #	Misc-Parts, Instructions, etc.	CODE	ROD	BORE	KIT #	List \$
MODEL 305CR							
BUCKET							
DGT1-UP; DSA1-UP							
	2152232		P-U-10	45 mm	75 mm	CTC-1991149	72.35
STICK							
DGT1-UP; DSA1-UP							
	1911959		P-U-10	55 mm	85 mm	CTC-1990609	85.84
SWING BOOM							
DGT1-UP; DSA1-UP							
	1911961		P-U-10	50 mm	90 mm	CTC-1992097	99.86
MODEL 307							
BLADE LH							
	1076377		P-UB-15	50 mm	90 mm	CTC-0933045	339.41
	1148378		P-UB-15	50 mm	90 mm	CTC-0933045	339.41
BLADE RH							
	1076472		P-UB-15	50 mm	90 mm	CTC-0933045	339.41
	1148377		P-UB-15	50 mm	90 mm	CTC-0933045	339.41
BOOM							
	1038195		P-UB-14	75 mm	110 mm	CTC-1057255	281.63
	1057468		P-UB-14	55 mm	100 mm	CTC-1057480	218.65
	1239937		P-UB-14	55 mm	100 mm	CTC-1057480	218.65
BUCKET							
	1057238		P-UB-14	55 mm	80 mm	CTC-1057253	191.17
OFFSET							
	1057468		P-UB-14	55 mm	100 mm	CTC-1057480	218.65
	1239937		P-UB-14	55 mm	100 mm	CTC-1057480	218.65
STICK							
	1038320		P-UB-14	60 mm	90 mm	CTC-1038333	256.50
	1057437		P-UB-14	60 mm	90 mm	CTC-1038333	256.50
	1251494		P-UB-14	60 mm	90 mm	CTC-1038333	256.50
MODEL 307B							
BLADE							
	1231627		P-UB-10	80 mm	120 mm	CTC-1697835	223.79
	1624835		P-UB-10	80 mm	120 mm	CTC-1697835	223.79
BOOM							
	1336759		P-UB-14	75 mm	110 mm	CTC-1697826	137.75
	1437980		P-UB-14	75 mm	110 mm	CTC-1697826	137.75
	1505901		P-UB-14	55 mm	100 mm	CTC-1697829	147.79
BUCKET							
	1057238		P-UB-14	55 mm	80 mm	CTC-1057253	191.17
	1336765		P-UB-14	55 mm	80 mm	CTC-1697828	155.28
OFFSET							
	1239937		P-UB-14	55 mm	100 mm	CTC-1057480	218.65
STICK							
	1038320		P-UB-14	60 mm	90 mm	CTC-1038333	256.50
	1475903		P-UB-14	60 mm	90 mm	CTC-1697827	213.97
	1505899		P-UB-14	60 mm	90 mm	CTC-1697827	213.97
SWING							
	1437981		P-UB-10	65 mm	100 mm	CTC-1697830	119.01
MODEL 307C							
BLADE							
			P-UB-10	80 mm	120 mm	CTC-1697835	223.79
BCM1-UP; BNE1-UP							
	1799671		P-UB-10	80 mm	120 mm	CTC-1697835	223.79
	1799671		Bushing	80 mm		CTC-1140755	33.98
	2358256		P-UB-10	80 mm	120 mm	CTC-1697835	223.79
	2358256		Bushing	80 mm		CTC-1140755	33.98

REPLACEMENT KITS FOR CATERPILLAR® EQUIPMENT

Excavators							
APPLICATION	CYL #	Misc-Parts, Instructions, etc.	CODE	ROD	BORE	KIT #	List \$
MODEL 307C							
BOOM							
BCM1-UP							
1659273			P-UB-14	75 mm	110 mm	CTC-1697826	137.75
1659273			Bushing	75 mm		CTC-1140750	30.98
1935230			P-UB-14	75 mm	110 mm	CTC-1697826	137.75
1935230			Bushing	75 mm		CTC-1140750	30.98
2357905			P-UB-14	75 mm	110 mm	CTC-1697826	137.75
2357905			Bushing	75 mm		CTC-1140750	30.98
2358249			P-UB-14	75 mm	110 mm	CTC-1697826	137.75
2358249			Bushing	75 mm		CTC-1140750	30.98
2358264			P-UB-14	55 mm	100 mm	CTC-1697829	147.79
2358264			Bushing	55 mm		CTC-1140752	18.35
3044904			P-UB-14	75 mm	110 mm	CTC-1697826	137.75
3044904			Bushing	75 mm		CTC-1140750	30.98
3044909			P-UB-14	75 mm	110 mm	CTC-1697826	137.75
3044909			Bushing	75 mm		CTC-1140750	30.98
BNE1-UP							
2357921			P-UB-14	75 mm	110 mm	CTC-1697826	137.75
2357921			Bushing	75 mm		CTC-1140750	30.98
2557799	VARIABLE ADJUSTABLE BOOM		P-UB-14	55 mm	100 mm	CTC-1697829	147.79
2557799	VARIABLE ADJUSTABLE BOOM		Bushing	55 mm		CTC-1140752	18.35
2557801	VARIABLE ADJUSTABLE BOOM		P-UB-14	75 mm	110 mm	CTC-1697826	137.75
2557801	VARIABLE ADJUSTABLE BOOM		Bushing	75 mm		CTC-1140750	30.98
3044912			P-UB-14	75 mm	110 mm	CTC-1697826	137.75
3044912			Bushing	75 mm		CTC-1140750	30.98
3044913	VARIABLE ADJUSTABLE BOOM		P-UB-14	75 mm	110 mm	CTC-1697826	137.75
3044913	VARIABLE ADJUSTABLE BOOM		Bushing	75 mm		CTC-1140750	30.98
3044915	VARIABLE ADJUSTABLE BOOM		P-UB-14	55 mm	100 mm	CTC-1697829	147.79
3044915	VARIABLE ADJUSTABLE BOOM		Bushing	55 mm		CTC-1140752	18.35
BUCKET							
BCM1-UP; BNE1-UP							
1659279			P-UB-14	55 mm	80 mm	CTC-1697828	155.28
1659279			Bushing	55 mm		CTC-1140752	18.35
3044908			P-UB-14	55 mm	80 mm	CTC-1697828	155.28
3044908			Bushing	55 mm		CTC-1140752	18.35
CAB RISER							
BCM1-UP; BNE1-UP							
2358287			P-UB-14	60 mm	90 mm	CTC-1697827	213.97
2358287			Bushing	60 mm		CTC-1140751	24.20
OFFSET							
BCM1-UP							
1799711			P-UB-14	55 mm	100 mm	CTC-1697829	147.79
1799711			Bushing	55 mm		CTC-1140752	18.35
3044906			P-UB-14	55 mm	100 mm	CTC-1697829	147.79
3044906			Bushing	55 mm		CTC-1140752	18.35
STICK							
BCM1-UP							
1799708			P-UB-14	60 mm	90 mm	CTC-1697827	213.97
1799708			Bushing	60 mm		CTC-1140751	24.20
2042718			P-UB-14	60 mm	90 mm	CTC-2042718K	159.27
2042718			Bushing	60 mm		CTC-1140751	24.20
2358271			P-UB-14	60 mm	90 mm	CTC-1697827	213.97
2358271			Bushing	60 mm		CTC-1140751	24.20
3044907			P-UB-14	60 mm	90 mm	CTC-1697827	213.97
3044907			Bushing	60 mm		CTC-1140751	24.20

REPLACEMENT KITS FOR CATERPILLAR® EQUIPMENT

Excavators							
APPLICATION	CYL #	Misc-Parts, Instructions, etc.	CODE	ROD	BORE	KIT #	List \$
MODEL 307C							
STICK							
BCM1-UP; BNE1-UP							
	1659276		P-UB-14	60 mm	90 mm	CTC-1659276K	123.87
	1659276		Bushing	60 mm		CTC-1140751	24.20
	2357913		P-UB-14	60 mm	90 mm	CTC-1697827	213.97
	2357913		Bushing	60 mm		CTC-1140751	24.20
	3044905		P-UB-14	60 mm	90 mm	CTC-1697827	213.97
	3044905		Bushing	60 mm		CTC-1140751	24.20
	3044910		P-UB-14	60 mm	90 mm	CTC-1697827	213.97
	3044910		Bushing	60 mm		CTC-1140751	24.20
SWING							
BNE1-UP							
	1772556		P-UB-14	75 mm	110 mm	CTC-1697826	137.75
	1772556		Bushing	75 mm		CTC-1140750	30.98
SWING BOOM							
BNE1-463							
	1772474		P-UB-14	60 mm	90 mm	CTC-1697827	213.97
	1772474		Bushing	60 mm		CTC-1140751	24.20
BNE1630-UP							
	3044911		P-UB-14	60 mm	90 mm	CTC-1697827	213.97
	3044911		Bushing	60 mm		CTC-1140751	24.20
BNE464-UP							
	2375468		P-UB-14	60 mm	90 mm	CTC-1697827	213.97
	2375468		Bushing	60 mm		CTC-1140751	24.20
MODEL 308B							
BLADE							
	1231627		P-UB-10	80 mm	120 mm	CTC-1697835	223.79
	1624835		P-UB-10	80 mm	120 mm	CTC-1697835	223.79
BUCKET							
	1057238		P-UB-14	55 mm	80 mm	CTC-1057253	191.17
STICK							
	1038320		P-UB-14	60 mm	90 mm	CTC-1038333	256.50
MODEL 308C CR							
BLADE							
KCX1-UP							
	1799671		P-UB-10	80 mm	120 mm	CTC-1697835	223.79
	1799671		Bushing	80 mm		CTC-1140755	33.98
	2358256		P-UB-10	80 mm	120 mm	CTC-1697835	223.79
	2358256		Bushing	80 mm		CTC-1140755	33.98

CATERPILLAR®

REPLACEMENT KITS FOR CATERPILLAR® EQUIPMENT

Excavators							
APPLICATION	CYL #	Misc-Parts, Instructions, etc.	CODE	ROD	BORE	KIT #	List \$
MODEL 308C CR							
BOOM							
KCX1-UP							
1799645			P-UB-14	75 mm	110 mm	CTC-1697826	137.75
1799645			Bushing	75 mm		CTC-1140750	30.98
1799651			P-UB-10	55 mm	100 mm	CTC-2003242	146.11
1799655			P-UB-10	75 mm	120 mm	CTC-2003239	86.39
1799655			Bushing	75 mm		CTC-1140750	30.98
1799658			P-UB-10	70 mm	100 mm	CTC-2003240	99.67
1799658			Bushing	70 mm		CTC-1140753	29.52
2159893			P-UB-14	75 mm	110 mm	CTC-1697826	137.75
2159893			Bushing	75 mm		CTC-1140750	30.98
2357834			P-UB-10	55 mm	100 mm	CTC-2003242	146.11
2357845			P-UB-10	75 mm	120 mm	CTC-2003239	86.39
2357845			Bushing	75 mm		CTC-1140750	30.98
2357862			P-UB-10	70 mm	100 mm	CTC-2003240	99.67
2357862			Bushing	70 mm		CTC-1140753	29.52
3044900			P-UB-14	75 mm	110 mm	CTC-3044900K	132.48
3044900			Bushing	75 mm		CTC-1140750	30.98
BUCKET							
KCX1-UP							
1659279			P-UB-14	55 mm	80 mm	CTC-1697828	155.28
3044908			P-UB-14	55 mm	80 mm	CTC-1697828	155.28
STICK							
KCX1-UP							
2042718			P-UB-14	60 mm	90 mm	CTC-2042718K	159.27
2042718			Bushing	60 mm		CTC-1140751	24.20
2159896			P-UB-14	60 mm	90 mm	CTC-2159896K	159.27
2159896			Bushing	60 mm		CTC-1140751	24.20
3044910			P-UB-14	60 mm	90 mm	CTC-1697827	213.97
3044910			Bushing	60 mm		CTC-1140751	24.20
MODEL 308D CR							
BLADE							
GBT1-							
3033487			P-UB-10	80 mm	120 mm	CTC-1697835	223.79
BOOM							
GBT1-							
2987702			P-UB-14	70 mm	110 mm	CTC-2987702K	118.91
BUCKET							
GBT1-							
2987704			P-UB-14	55 mm	85 mm	CTC-2987704K	103.99
COUPLER							
GBT1-							
2569777			I-U-14	50 mm	100 mm	CTC-3265235	164.80
3611139			I-U-15	3/4	1-1/4	CTC-3611131	42.93
STICK							
GBT1-							
2987703			P-UB-14	60 mm	95 mm	CTC-2987703K	104.90
THUMB							
GBT1-							
3056716			I-U-10	50 mm	70 mm	CTC-2764172	48.63
3056717			I-U-10	50 mm	70 mm	CTC-2764172	48.63
TRACK ADJUSTER							
GBT1-							
1362462			TRK ADJ			CTC-1362462K	33.94

REPLACEMENT KITS FOR CATERPILLAR® EQUIPMENT

Excavators								
APPLICATION	CYL #	Misc-Parts, Instructions, etc.	CODE	ROD	BORE	KIT #	List \$	
MODEL 308D CR SB								
BLADE								
FYC1-								
	3033487		P-UB-10	80 mm	120 mm	CTC-1697835	223.79	
BOOM								
FYC1-								
	3044915	Variable Adjustable Boom	P-UB-14	55 mm	100 mm	CTC-3747255	147.79	
	3197257		P-UB-14	70 mm	110 mm	CTC-3197257K	118.91	
	3287730		P-UB-14	75 mm	110 mm	CTC-3287730K	118.84	
BUCKET								
FYC1-								
	2987704		P-UB-14	55 mm	85 mm	CTC-2987704K	103.99	
	3044908		P-UB-14	55 mm	80 mm	CTC-1697828	155.28	
COUPLER								
FYC1-								
	2569777		I-U-14	50 mm	100 mm	CTC-3265235	164.80	
	3611139		I-U-15	3/4	1-1/4	CTC-3611131	42.93	
STICK								
FYC1-								
	2987703		P-UB-14	60 mm	95 mm	CTC-2987703K	104.90	
FYC1-1875								
	3044910		P-UB-14	60 mm	90 mm	CTC-1697827	213.97	
	3044910	Bushing		60 mm		CTC-1140751	24.20	
FYC1828-								
	3747244		P-UB-14	60 mm	90 mm	CTC-1697827	213.97	
	3747244	Bushing		60 mm		CTC-1140751	24.20	
SWING BOOM								
FYC1-								
	3145850		P-UB-14	65 mm	110 mm	CTC-3145850K	112.70	
THUMB								
FYC1-								
	3056716		I-U-10	50 mm	70 mm	CTC-2764172	48.63	
	3056717		I-U-10	50 mm	70 mm	CTC-2764172	48.63	
TRACK ADJUSTER								
FYC1-								
	1362462		TRK ADJ			CTC-1362462K	33.94	
MODEL 311								
BOOM								
	1251548		P-UB-10	70 mm	100 mm	CTC-616858	283.80	
	418841		P-UB-10	70 mm	100 mm	CTC-616858	283.80	
BUCKET								
	1251547		P-UB-10	65 mm	100 mm	CTC-418914	211.54	
	1346987		P-UB-10	65 mm	100 mm	CTC-1764935	229.02	
	418840		P-UB-10	65 mm	100 mm	CTC-418914	211.54	
STICK								
	1251549		P-UB-10	75 mm	110 mm	CTC-418913	301.17	
	418842		P-UB-10	75 mm	110 mm	CTC-418913	301.17	
MODEL 311B								
BLADE LH								
	1298009		P-UB-10	80 mm	120 mm	CTC-1697835	223.79	
BLADE RH								
	1298010		P-UB-10	80 mm	120 mm	CTC-1697835	223.79	
BOOM								
	1211395		P-UB-10	70 mm	100 mm	CTC-1211405	282.84	
BUCKET								
	1195447		P-UB-10	65 mm	100 mm	CTC-1195457	222.02	
	1438158		P-UB-10	65 mm	100 mm	CTC-1697839	226.70	

REPLACEMENT KITS FOR CATERPILLAR® EQUIPMENT

Excavators							
APPLICATION	CYL #	Misc-Parts, Instructions, etc.	CODE	ROD	BORE	KIT #	List \$
MODEL 311B							
STICK							
	1211406		P-UB-10	75 mm	110 mm	CTC-1195435	305.78
	1438160		P-UB-10	75 mm	110 mm	CTC-1697837	268.82
MODEL 311C U							
BLADE LH							
	CKE1-UP; PAD1-UP						
	1709809		P-UB-10	80 mm	120 mm	CTC-1709946	359.43
BLADE RH							
	CKE1-UP; PAD1-UP						
	1709810		P-UB-10	80 mm	120 mm	CTC-1709946	359.43
BOOM							
	CKE1-UP; PAD1-UP						
	1709806			70 mm	100 mm	CTC-1709929	321.73
BUCKET							
	CKE1-UP						
	1709809		P-UB-10	65 mm	100 mm	CTC-1709941	134.27
	2959396		P-UB-10	65 mm	100 mm	CTC-1709941	134.27
	CKE1-UP; PAD1-UP						
	2487855		P-UB-10	65 mm	100 mm	CTC-1709941	134.27
	2836118		P-UB-10	65 mm	100 mm	CTC-1709941	134.27
COUPLER							
	CKE1-UP						
	1847487	Quick Coupler	I-U-10	1-3/4	63 mm	CTC-1728486	68.97
	2734147		I-U-10	1-3/4	63 mm	CTC-3265237	68.97
STICK							
	CKE1-UP; PAD1-UP						
	1709807		P-UB-10	75 mm	110 mm	CTC-1709937	161.23
MODEL 312							
BOOM							
	1148519		P-UB-10	75 mm	110 mm	CTC-1148526	248.19
	1251545		P-UB-10	75 mm	110 mm	CTC-418913	301.17
	418838		P-UB-10	75 mm	110 mm	CTC-418913	301.17
BUCKET							
	1195447		P-UB-10	65 mm	100 mm	CTC-1195457	222.02
	1251547		P-UB-10	65 mm	100 mm	CTC-418914	211.54
	1346987		P-UB-10	65 mm	100 mm	CTC-1764935	229.02
	418840		P-UB-10	65 mm	100 mm	CTC-418914	211.54
OFFSET							
	1239906		P-UB-10	70 mm	130 mm	CTC-1697843	304.18
STICK							
	1211406		P-UB-10	75 mm	110 mm	CTC-1195435	305.78
	1239943		P-UB-10	80 mm	120 mm	CTC-1148290	210.02
	1251546		P-UB-10	80 mm	120 mm	CTC-513047	253.42
	1251940		P-UB-10	80 mm	120 mm	CTC-1148290	210.02
	418839		P-UB-10	80 mm	120 mm	CTC-513047	253.42
MODEL 312B, 312BL							
BLADE LH							
	1298009		P-UB-10	80 mm	120 mm	CTC-1697835	223.79
BLADE RH							
	1298010		P-UB-10	80 mm	120 mm	CTC-1697835	223.79
BOOM							
	1195425		P-UB-10	75 mm	110 mm	CTC-1195435	305.78
	1438156		P-UB-10	75 mm	110 mm	CTC-1697837	268.82
BUCKET							
	1195447		P-UB-10	65 mm	100 mm	CTC-1195457	222.02
	1438158		P-UB-10	65 mm	100 mm	CTC-1697839	226.70

REPLACEMENT KITS FOR CATERPILLAR® EQUIPMENT

Excavators							
APPLICATION	CYL #	Misc-Parts, Instructions, etc.	CODE	ROD	BORE	KIT #	List \$
MODEL 312B, 312BL							
STICK							
	1195436		P-UB-10	80 mm	120 mm	CTC-1195446	278.96
	1438157		P-UB-10	80 mm	120 mm	CTC-1697838	280.82
MODEL 312C, 312CL							
BOOM							
			P-UB-10	75 mm	110 mm	CTC-1709937	161.23
			Bushing	75 mm		CTC-1140750	30.98
BUCKET							
			P-UB-10	65 mm	100 mm	CTC-1709941	134.27
			Bushing	65 mm		CTC-1140754	25.67
STICK							
			P-UB-10	80 mm	120 mm	CTC-1709999	199.30
			Bushing	80 mm		CTC-1140755	33.98
MODEL 312E							
BLADE LH							
GAC1-; MJD1-; PZL1-; WEY1-							
	3494109		P-UB-10	80 mm	120 mm	CTC-3494122	179.81
	3494109		Bushing	80 mm		CTC-1140755	33.98
	3852886		P-UB-10	80 mm	120 mm	CTC-3937948	264.26
	3852886		Bushing	80 mm		CTC-3852900	31.26
BLADE RH							
GAC1-; MJD1-; PZL1-; WEY1-							
	3494110		P-UB-10	80 mm	120 mm	CTC-3494122	179.81
	3494110		Bushing	80 mm		CTC-1140755	33.98
	3852887		P-UB-10	80 mm	120 mm	CTC-3937948	264.26
	3852887		Bushing	80 mm		CTC-3852900	31.26
BOOM							
GAC1-; MJD1-; PZL1-; WEY1-							
	3582096		P-UB-10	75 mm	110 mm	CTC-3494119	284.00
	3582096		Bushing	75 mm		CTC-1140750	30.98
	3852828		P-UB-14	75 mm	110 mm	CTC-3937887	221.46
	3852828		Bushing	75 mm		CTC-3937931	27.12
PZL1-; WEY1-							
	1847660	Variable Adjustable Boom	P-U-10	85 mm	140 mm	CTC-3808347	193.15
	1847660	Variable Adjustable Boom	Bushing	85 mm		CTC-1140756	37.06
BUCKET							
GAC1-							
	3746547		P-UB-10	75 mm	110 mm	CTC-3494119	284.00
	3746547		Bushing	75 mm		CTC-1140750	30.98
GAC1-; MJD1-; PZL1-; WEY1-							
	3582108		P-UB-10	70 mm	100 mm	CTC-3494121	192.53
	3582108		Bushing	70 mm		CTC-1140753	29.52
	3687047		P-UB-10	70 mm	100 mm	CTC-3494121	192.53
	3687047		Bushing	70 mm		CTC-1140753	29.52
	3852834		P-UB-14	70 mm	100 mm	CTC-3904227	231.42
	3852834		Bushing	70 mm		CTC-3904158	24.51
COUPLER							
MJD1-; PZL1-; WEY1-							
	3006024		P-U-10,12	1-1/2	2-1/2	CTC-3465584	33.94
PZL1-; WEY1-							
	1690329		I-U-5	40 mm	60 mm	CTC-2027897	42.80

REPLACEMENT KITS FOR CATERPILLAR® EQUIPMENT

Excavators							
APPLICATION	CYL #	Misc-Parts, Instructions, etc.	CODE	ROD	BORE	KIT #	List \$
MODEL 312E							
STICK							
GAC1-; MJD1-; PZL1-; WEY1-							
3582102			P-UB-10	80 mm	120 mm	CTC-3494120	264.08
3582102			Bushing	80 mm		CTC-1140755	33.98
3852831			P-UB-14	80 mm	120 mm	CTC-3937949	230.54
3852831			Bushing	80 mm		CTC-3852900	31.26
TRACK ADJUSTER							
GAC1-; MJD1-; PZL1-; WEY1-							
2979143			TRK ADJ			CTC-2979143K	39.09
MODEL 313B							
BLADE LH							
1298009			P-UB-10	80 mm	120 mm	CTC-1697835	223.79
BLADE RH							
1298010			P-UB-10	80 mm	120 mm	CTC-1697835	223.79
BOOM							
1624758			P-UB-10	75 mm	110 mm	CTC-1697837	268.82
BUCKET							
1346987			P-UB-10	65 mm	100 mm	CTC-1764935	229.02
1438158			P-UB-10	65 mm	100 mm	CTC-1697839	226.70
OFFSET							
1239906			P-UB-10	70 mm	130 mm	CTC-1697843	304.18
STICK							
1195436			P-UB-10	80 mm	120 mm	CTC-1195446	278.96
1211406			P-UB-10	75 mm	110 mm	CTC-1195435	305.78
1438157			P-UB-10	80 mm	120 mm	CTC-1697838	280.82
1438160			P-UB-10	75 mm	110 mm	CTC-1697837	268.82
MODEL 314C LCR							
BLADE LH							
KJA1-UP; PCA1-UP							
1709809			P-UB-10	80 mm	120 mm	CTC-1709946	359.43
1709809			Bushing	80 mm		CTC-1140755	33.98
BLADE RH							
KJA1-UP; PCA1-UP							
1709810			P-UB-10	80 mm	120 mm	CTC-1709946	359.43
1709810			Bushing	80 mm		CTC-1140755	33.98
BOOM							
KJA1-UP; PCA1-UP							
1948228			P-UB-10	75 mm	110 mm	CTC-1709937	161.23
1948228			Bushing	75 mm		CTC-1140750	30.98
1948239			P-UB-10	75 mm	110 mm	CTC-1709937	161.23
1948239			Bushing	75 mm		CTC-1140750	30.98
BUCKET							
KJA1-UP; PCA1-UP							
1709808			P-UB-10	65 mm	100 mm	CTC-1709941	134.27
1709808			Bushing	65 mm		CTC-1140754	25.67
2487855			P-UB-10	65 mm	100 mm	CTC-1709941	134.27
2487855			Bushing	65 mm		CTC-1140754	25.67
2836118			P-UB-10	65 mm	100 mm	CTC-1709941	134.27
2836118			Bushing	65 mm		CTC-1140754	25.67
2959396			P-UB-10	65 mm	100 mm	CTC-1709941	134.27
2959396			Bushing	65 mm		CTC-1140754	25.67
OFFSET							
KJA1-UP; PCA1-UP							
2042765			P-UB-10	75 mm	130 mm	CTC-2003361	204.90
2042765			Bushing	75 mm		CTC-1140750	30.98

REPLACEMENT KITS FOR CATERPILLAR® EQUIPMENT

Excavators							
APPLICATION	CYL #	Misc-Parts, Instructions, etc.	CODE	ROD	BORE	KIT #	List \$
MODEL 314C LCR							
QUICK COUPLER							
KJA1-UP; PCA1-UP							
	1847487		I-U-10	1-3/4	63 mm	CTC-1728486	68.97
	2734147		I-U-10	1-3/4	63 mm	CTC-3265237	68.97
STICK							
KJA1-UP; PCA1-UP							
	1948250		P-UB-10	80 mm	120 mm	CTC-1709999	199.30
	1948250		Bushing	80 mm		CTC-1140755	33.98
	1948312		P-UB-10	80 mm	120 mm	CTC-1709999	199.30
	1948312		Bushing	80 mm		CTC-1140755	33.98
	2512894		P-UB-10	80 mm	120 mm	CTC-1709999	199.30
	2512894		Bushing	80 mm		CTC-1140755	33.98
	3350003		P-UB-10	80 mm	120 mm	CTC-3350007	150.51
	3350003		Bushing	80 mm		CTC-1140755	33.98
MODEL 315							
BOOM							
	1057336		P-UB-10	80 mm	110 mm	CTC-1057359	253.73
	1276046		P-UB-10	80 mm	110 mm	CTC-1057359	253.73
BUCKET							
	1057381		P-UB-10	70 mm	100 mm	CTC-1057397	209.86
	1076640		P-UB-10	80 mm	110 mm	CTC-1057359	253.73
	1276056		P-UB-10	70 mm	100 mm	CTC-1057397	209.86
	1276060		P-UB-10	80 mm	110 mm	CTC-1057359	253.73
STICK							
	1057362		P-UB-10	85 mm	120 mm	CTC-1057379	268.25
	1276051		P-UB-10	85 mm	120 mm	CTC-1057379	268.25
	1624672		P-UB-10	85 mm	120 mm	CTC-1624676	107.62
MODEL 315B							
BOOM							
1SW1-UP; 3AW1-UP; 7RZ1-UP							
	1559251		P-UB-10	80 mm	110 mm	CTC-1659420	143.93
	1559251		Bushing	80 mm		CTC-1140755	33.98
BUCKET							
1SW1-UP; 3AW1-UP; 7RZ1-UP							
	1733490		P-UB-10	70 mm	100 mm	CTC-1799638	101.14
	1733490		Bushing	70 mm		CTC-1140753	29.52
STICK							
1SW1-UP; 3AW1-UP; 7RZ1-UP							
	1559253		P-UB-10	85 mm	120 mm	CTC-1659418	144.69
	1559253		Bushing	85 mm		CTC-1140756	37.06
MODEL 315B L							
BOOM							
1SW1-UP; 3AW1-UP; 5SW1-UP; 7RZ1-UP							
	1559251		P-UB-10	80 mm	110 mm	CTC-1659420	143.93
	1559251		Bushing	80 mm		CTC-1140755	33.98
5SW1-UP							
	1336630		P-UB-10	80 mm	110 mm	CTC-1336646	256.46
	1336630		Bushing	80 mm		CTC-1140755	33.98
	1847660		P-UB-10	85 mm	140 mm	CTC-1847660K	140.22
	1847660		Bushing	85 mm		CTC-1140756	37.06
BUCKET							
1SW1-UP; 3AW1-UP; 7RZ1-UP							
	1733490		P-UB-10	70 mm	100 mm	CTC-1799638	101.14
	1733490		Bushing	70 mm		CTC-1140753	29.52

REPLACEMENT KITS FOR CATERPILLAR® EQUIPMENT

Excavators							
APPLICATION	CYL #	Misc-Parts, Instructions, etc.	CODE	ROD	BORE	KIT #	List \$
MODEL 315B L							
BUCKET							
5SW1-UP							
1336636			P-UB-10	70 mm	100 mm	CTC-1336691	222.64
1336636			Bushing	70 mm		CTC-1140753	29.52
1336639			P-UB-10	80 mm	110 mm	CTC-1336646	256.46
1336639			Bushing	80 mm		CTC-1140755	33.98
1559255			P-UB-10	70 mm	100 mm	CTC-1709827	113.51
1559255			Bushing	70 mm		CTC-1140753	29.52
1588923			P-UB-10	80 mm	110 mm	CTC-1659420	143.93
1588923			Bushing	80 mm		CTC-1140755	33.98
STICK							
1SW1-UP; 3AW1-UP; 5SW1-UP; 7RZ1-UP							
1559253			P-UB-10	85 mm	120 mm	CTC-1659418	144.69
1559253			Bushing	85 mm		CTC-1140756	37.06
5SW1-UP							
1336633			P-UB-10	85 mm	120 mm	CTC-1184131	258.61
1336633			Bushing	85 mm		CTC-1140756	37.06
MODEL 315C							
BOOM							
AKE1-UP; CFB1-UP; CFT1-UP; CJC1-UP							
1733482			P-UB-10	80 mm	110 mm	CTC-1799625	260.56
1733482			Bushing	80 mm		CTC-1140755	33.98
BUCKET							
AKE1-UP; CFB1-UP; CFT1-UP; CJC1-UP							
1733490			P-UB-10	70 mm	100 mm	CTC-1799638	101.14
1733490			Bushing	70 mm		CTC-1140753	29.52
1733493			P-UB-10	80 mm	110 mm	CTC-1799625	260.56
1733493			Bushing	80 mm		CTC-1140755	33.98
2836126			P-UB-10	70 mm	100 mm	CTC-1799638	101.14
2836126			Bushing	70 mm		CTC-1140753	29.52
2836128			P-UB-10	80 mm	110 mm	CTC-1799625	260.56
2836128			Bushing	80 mm		CTC-1140755	33.98
STICK							
AKE1-UP; CFB1-UP; CFT1-UP; CJC1-UP							
1733486			P-UB-10	85 mm	120 mm	CTC-1799634	144.69
1733486			Bushing	85 mm		CTC-1140756	37.06
MODEL 315C L							
BOOM							
AKE1-UP; ANF1-UP; CFB1-UP; CFT1-UP; CJC1-UP							
1733482			P-UB-10	80 mm	110 mm	CTC-1799625	260.56
1733482			Bushing	80 mm		CTC-1140755	33.98
ANF1-UP							
1559251			P-UB-10	80 mm	110 mm	CTC-1659420	143.93
1559251			Bushing	80 mm		CTC-1140755	33.98
1847660			P-UB-10	85 mm	140 mm	CTC-1847660K	140.22
1847660			Bushing	85 mm		CTC-1140756	37.06
BUCKET							
AKE1-UP; ANF1-UP; CFB1-UP; CFT1-UP; CJC1-UP							
1733490			P-UB-10	70 mm	100 mm	CTC-1799638	101.14
1733490			Bushing	70 mm		CTC-1140753	29.52
1733493			P-UB-10	80 mm	110 mm	CTC-1799625	260.56
1733493			Bushing	80 mm		CTC-1140755	33.98
2836126			P-UB-10	70 mm	100 mm	CTC-1799638	101.14
2836126			Bushing	70 mm		CTC-1140753	29.52

REPLACEMENT KITS FOR CATERPILLAR® EQUIPMENT

Excavators							
APPLICATION	CYL #	Misc-Parts, Instructions, etc.	CODE	ROD	BORE	KIT #	List \$
MODEL 315C L							
BUCKET							
AKE1-UP; CFB1-UP; CFT1-UP; CJC1-UP							
2836128			P-UB-10	80 mm	110 mm	CTC-1799625	260.56
2836128			Bushing	80 mm		CTC-1140755	33.98
ANF1-UP							
2836128			P-UB-10	80 mm	110 mm	CTC-1799625	260.56
2836128			Bushing	80 mm		CTC-1140755	33.98
STICK							
AKE1-UP; CFB1-UP; CFT1-UP; CJC1-UP							
1733486			P-UB-10	85 mm	120 mm	CTC-1799634	144.69
1733486			Bushing	85 mm		CTC-1140756	37.06
ANF1-UP							
1559253			P-UB-10	85 mm	120 mm	CTC-1659418	144.69
1559253			Bushing	85 mm		CTC-1140756	37.06
2248528			P-UB-10	85 mm	120 mm	CTC-1659418	144.69
2248528			Bushing	85 mm		CTC-1140756	37.06
MODEL 315D L							
BOOM							
BZN1-UP; CJN1-UP; JGS1-UP; JHA1-UP; KBD1-UP; NCM1-UP							
2590840			P-UB-10	80 mm	110 mm	CTC-2667861	142.07
BZN1-UP; CJN1-UP; JGS1-UP; NCM1-UP; TLE1-UP							
2898093			P-UB-10	80 mm	110 mm	CTC-2667861	142.07
NCM1-UP; TLE1-UP							
1847660	Variable Adj Boom		P-UB-10	85 mm	140 mm	CTC-1847660K	140.22
BUCKET							
BZN1-UP; CJN1-UP; JGS1-UP							
2818979			P-UB-10	70 mm	100 mm	CTC-1799638	101.14
3021734			P-UB-10	80 mm	110 mm	CTC-1799625	260.56
BZN1-UP; CJN1-UP; JGS1-UP; JHA1-UP; KBD1-UP							
3228747			P-UB-10	80 mm	110 mm	CTC-1799625	260.56
BZN1-UP; JGS1-UP; KBD1-UP							
3421892			P-UB-10	80 mm	110 mm	CTC-1799625	260.56
CJN1-UP							
2590916			P-UB-10	80 mm	110 mm	CTC-1799625	260.56
CJN1-UP; JGS1-UP; NCM1-UP; TLE1-UP							
3349944			P-UB-10	80 mm	110 mm	CTC-1799625	260.56
CJN1-UP; KBD1-UP							
2590846			P-UB-10	70 mm	100 mm	CTC-1799638	101.14
CJN1-UP; NCM1-UP							
2898121			P-UB-10	80 mm	110 mm	CTC-1799625	260.56
CJN1-UP; NCM1-UP; TLE1-UP							
2898113			P-UB-10	70 mm	100 mm	CTC-1799638	101.14
COUPLER							
BZN1-UP; CJN1-UP; JGS1-UP; KBD1-UP; NCM1-UP; TLE1-UP							
2569795			I-U-10	50 mm	70 mm	CTC-1728487	56.41
BZN1-UP; JGS1-UP							
3052017			P-U-10,12	1-3/4	3	CTC-3465609	40.43
NCM1-UP; TLE1-UP							
1690329			I-U-5	40 mm	60 mm	CTC-2027897	42.80
STICK							
BZN1-UP; CJN1-UP; JGS1-UP; JHA1-UP; KBD1-UP							
2590843			P-UB-10	85 mm	120 mm	CTC-2667874	127.76
BZN1-UP; CJN1-UP; JGS1-UP; NCM1-UP; TLE1-UP							
3228746			P-UB-10	85 mm	120 mm	CTC-2667874	127.76
CJN1-UP							
2898103			P-UB-10	85 mm	120 mm	CTC-2667874	127.76

REPLACEMENT KITS FOR CATERPILLAR® EQUIPMENT

Excavators							
APPLICATION	CYL #	Misc-Parts, Instructions, etc.	CODE	ROD	BORE	KIT #	List \$
MODEL 315D L							
STICK							
	NCM1-UP						
	2884014		P-UB-10	85 mm	120 mm	CTC-2667874	127.76
MODEL 315L							
BOOM							
	1057336		P-UB-10	80 mm	110 mm	CTC-1057359	253.73
BUCKET							
	1057381		P-UB-10	70 mm	100 mm	CTC-1057397	209.86
	1076640		P-UB-10	80 mm	110 mm	CTC-1057359	253.73
STICK							
	1057362		P-UB-10	85 mm	120 mm	CTC-1057379	268.25
MODEL 317							
BOOM							
	1057336		P-UB-10	80 mm	110 mm	CTC-1057359	253.73
	1276046		P-UB-10	80 mm	110 mm	CTC-1057359	253.73
BUCKET							
	1057381		P-UB-10	70 mm	100 mm	CTC-1057397	209.86
	1076640		P-UB-10	80 mm	110 mm	CTC-1057359	253.73
	1276056		P-UB-10	70 mm	100 mm	CTC-1057397	209.86
	1276060		P-UB-10	80 mm	110 mm	CTC-1057359	253.73
STICK							
	1057362		P-UB-10	85 mm	120 mm	CTC-1057379	268.25
	1276051		P-UB-10	85 mm	120 mm	CTC-1057379	268.25
	1624672		P-UB-10	85 mm	120 mm	CTC-1624676	107.62
MODEL 317B, 317BL							
BOOM							
	1336630	Piston - C 1276047	P-UB-10	80 mm	110 mm	CTC-1336646	256.46
	1336630		Bushing	80 mm		CTC-1140755	33.98
	1559251		P-UB-10	80 mm	110 mm	CTC-1659420	143.93
BUCKET							
	1336636	Piston - C 1336687	P-UB-10	70 mm	100 mm	CTC-1336691	222.64
	1336636		Bushing	70 mm		CTC-1140753	29.52
	1559255		P-UB-10	70 mm	100 mm	CTC-1709827	113.51
	5SW						
	1336639		P-UB-10	80 mm	110 mm	CTC-1336646	256.46
STICK							
	1336633	Piston - C 1276052	P-UB-10	85 mm	120 mm	CTC-1184131	258.61
	1336633		Bushing	85 mm		CTC-1140756	37.06
UNSPECIFIED APPLICATION							
	1588923		P-UB-10	80 mm	110 mm	CTC-1659420	143.93
MODEL 317N							
BOOM							
	1057336		P-UB-10	80 mm	110 mm	CTC-1057359	253.73
BUCKET							
	1057381		P-UB-10	70 mm	100 mm	CTC-1057397	209.86
	1076640		P-UB-10	80 mm	110 mm	CTC-1057359	253.73
STICK							
	1057362		P-UB-10	85 mm	120 mm	CTC-1057379	268.25
MODEL 318B, 318BL							
BOOM							
	1475755		P-UB-10	85 mm	120 mm	CTC-1373763	382.72
BUCKET							
	1183967		P-UB-10	85 mm	120 mm	CTC-1261947	358.23
	1184134		P-UB-10	85 mm	120 mm	CTC-1184131	258.61
	1475763		P-UB-10	80 mm	110 mm	CTC-1659420	143.93
STICK							
	1475760		P-UB-10	95 mm	130 mm	CTC-1659419	234.01

REPLACEMENT KITS FOR CATERPILLAR® EQUIPMENT

Excavators							
APPLICATION	CYL #	Misc-Parts, Instructions, etc.	CODE	ROD	BORE	KIT #	List \$
MODEL 318C							
BOOM							
FAA1-UP; BTG1-UP; DAH1-UP							
1842614			P-UB-10	95 mm	160 mm	CTC-2521191	202.13
1948407			P-UB-10	85 mm	120 mm	CTC-1799634	144.69
BUCKET							
BTG1-UP; DAH1-UP							
2836132			P-UB-10	85 mm	120 mm	CTC-2366368	113.40
BTG475-UP; DAH1136-UP							
2836130			P-UB-10	80 mm	110 mm	CTC-1799625	260.56
FAA1-1135; BTG1-474; DAH1-UP							
1948413			P-UB-10	80 mm	110 mm	CTC-1799625	260.56
FAA1-UP; BTG1-UP; DAH1-UP							
1589061			P-U-10	85 mm	120 mm	CTC-2366389	113.40
COUPLER							
FAA1-UP; BTG1-UP; DAH1-UP							
1690329			I-U-5	40 mm	60 mm	CTC-2027897	42.80
STICK							
FAA1-UP; BTG1-UP; DAH1-UP							
1948410			P-UB-10	95 mm	130 mm	CTC-2159984	112.37
MODEL 318C L							
BOOM							
GPA1-UP; MDY1-UP							
1948416			P-UB-10	85 mm	120 mm	CTC-2478998	168.54
BUCKET							
GPA1-UP; MDY1-UP							
2003220			P-UB-10	80 mm	110 mm	CTC-2478995	151.35
2043689			P-UB-10	85 mm	120 mm	CTC-2479001	153.39
COUPLER							
GPA1-UP; MDY1-UP							
1728402			I-U-10	50 mm	70 mm	CTC-1728487	56.41
STICK							
GPA1-UP; MDY1-UP							
1949418			P-UB-10	95 mm	130 mm	CTC-2590630	173.63
MODEL 318C LN							
BOOM							
GPA1-UP; MDY1-UP							
1948416			P-UB-10	85 mm	120 mm	CTC-2478998	168.54
BUCKET							
GPA1-UP; MDY1-UP							
2003220			P-UB-10	80 mm	110 mm	CTC-2478995	151.35
2043689			P-UB-10	85 mm	120 mm	CTC-2479001	153.39
COUPLER							
GPA1-UP; MDY1-UP							
1728402			I-U-10	50 mm	70 mm	CTC-1728487	56.41
STICK							
GPA1-UP; MDY1-UP							
1949418			P-UB-10	95 mm	130 mm	CTC-2590630	173.63
MODEL 320							
BOOM							
0875491			P-UB-10	85 mm	120 mm	CTC-4I3665	323.97
0875496			P-UB-10	85 mm	120 mm	CTC-0875394	267.83
0875496			P-UB-10	85 mm	120 mm	CTC-1184131	258.61
1069596			P-UB-10	95 mm	160 mm	CTC-6C6091	348.60
BOOM VA							
6C6085			P-UB-10	95 mm	160 mm	CTC-6C6091	348.60

REPLACEMENT KITS FOR CATERPILLAR® EQUIPMENT

Excavators							
APPLICATION	CYL #	Misc-Parts, Instructions, etc.	CODE	ROD	BORE	KIT #	List \$
MODEL 320							
BUCKET							
	0874899		P-UB-10	85 mm	120 mm	CTC-1186023	275.65
	0875633		P-UB-10	85 mm	120 mm	CTC-0875394	267.83
	0875633		P-UB-10	85 mm	120 mm	CTC-1184131	258.61
	1185931		P-UB-10	85 mm	120 mm	CTC-1186023	275.65
	1251547		P-UB-10	65 mm	100 mm	CTC-418914	211.54
	1346987		P-UB-10	65 mm	100 mm	CTC-1764935	229.02
	417652		P-UB-10	65 mm	100 mm	CTC-417664	211.63
	418840		P-UB-10	65 mm	100 mm	CTC-418914	211.54
	717291		P-UB-10	85 mm	130 mm	CTC-7Y5145	276.61
	7Y5100		P-UB-10	85 mm	130 mm	CTC-7Y5145	276.61
STICK							
	0875422		P-UB-10	100 mm	140 mm	CTC-0875387	353.62
	0875493		P-UB-10	100 mm	140 mm	CTC-1270630	352.06
	0876638		P-UB-10	100 mm	140 mm	CTC-0875387	353.62
	7Y4650		P-UB-10	105 mm	150 mm	CTC-1163612	312.32
UNSPECIFIED APPLICATION							
	0874898		P-UB-10	100 mm	140 mm	CTC-1597774	156.42
MODEL 320B, 320BL							
BOOM							
	1183953		P-UB-10	100 mm	140 mm	CTC-1373764	334.02
	1183955		P-UB-10	100 mm	140 mm	CTC-1373764	334.02
	1184023		P-UB-10	85 mm	120 mm	CTC-1373763	382.72
	1184128		P-UB-10	85 mm	120 mm	CTC-1184131	258.61
	1195425		P-UB-10	75 mm	110 mm	CTC-1195435	305.78
	1232081		P-UB-10	105 mm	150 mm	CTC-1373767	433.48
	1336770		P-UB-10	100 mm	140 mm	CTC-1336823	332.37
	1589058		P-UB-10	85 mm	120 mm	CTC-1589092	188.74
	1842614		P-UB-10	95 mm	160 mm	CTC-1884457	227.00
BUCKET							
	1183967		P-UB-10	85 mm	120 mm	CTC-1261947	358.23
	1184134		P-UB-10	85 mm	120 mm	CTC-1184131	258.61
	1195447		P-UB-10	65 mm	100 mm	CTC-1195457	222.02
	1232044		P-UB-10	90 mm	130 mm	CTC-1764914	146.86
	1232084		P-UB-10	90 mm	130 mm	CTC-1373768	455.90
	1251547		P-UB-10	65 mm	100 mm	CTC-418914	211.54
	1346987		P-UB-10	65 mm	100 mm	CTC-1764935	229.02
	1475780		P-UB-10	85 mm	125 mm	CTC-1475781	297.68
	1540756		P-UB-10	90 mm	130 mm	CTC-1540757	464.07
	1589061		P-UB-10	85 mm	120 mm	CTC-1589092	188.74
	1799764		P-UB-10	90 mm	130 mm	CTC-1799772	213.98
	417652		P-UB-10	65 mm	100 mm	CTC-417664	211.63
	418840		P-UB-10	65 mm	100 mm	CTC-418914	211.54
STICK							
	1184000		P-UB-10	105 mm	150 mm	CTC-1680758	361.22
	1232081		P-UB-10	105 mm	150 mm	CTC-1373767	433.48
	1412609		P-UB-10	95 mm	160 mm	CTC-1855574	195.67
	1589059		P-UB-10	100 mm	140 mm	CTC-1589093	126.80
	1589060		P-UB-10	100 mm	140 mm	CTC-1589093	126.80
TILT CAB							
	N/A		P-UB-10	2-1/4	5	CTC-9X6392	165.61

REPLACEMENT KITS FOR CATERPILLAR® EQUIPMENT

Excavators							
APPLICATION	CYL #	Misc-Parts, Instructions, etc.	CODE	ROD	BORE	KIT #	List \$
MODEL 320B, 320BL							
UNSPECIFIED APPLICATION							
	1336771		P-UB-10	105 mm	150 mm	CTC-1373767	433.48
	1336812		P-UB-10	90 mm	130 mm	CTC-1373768	455.90
	1336866		P-UB-10	100 mm	140 mm	CTC-1373661	154.36
	1336867		P-UB-10	100 mm	140 mm	CTC-1373661	154.36
	1540727		P-UB-10	85 mm	120 mm	CTC-1540728	504.80
	1540743		P-UB-10	85 mm	120 mm	CTC-1540744	485.47
	1540772		P-UB-10	90 mm	130 mm	CTC-1540773	463.76
MODEL 320C							
BOOM							
AMC1-UP; ANB1-UP; BBC1-UP; BDC1-UP; BEF1-UP; BER1-UP; BPR1-UP; BRXI-UP							
	1588991		P-UB-10	85 mm	120 mm	CTC-1373763	382.72
	1588991		Bushing	85 mm		CTC-0964402	34.71
AMC1-UP; ANB1-UP; BDC1-UP; BER1-UP; BPR1-UP; BRXI-UP; GNG1-UP; HKT1-UP; MAB1-UP; PAB1-UP; SBN1-UP							
	2043614		P-UB-10	85 mm	120 mm	CTC-2478998	168.54
	2043614		Bushing	85 mm		CTC-0964402	34.71
AMC1-UP; ANB1-UP; GHA1-UP; GNG1-UP; HBC1-UP; HKT1-UP; MAB1-UP; PAB1-UP							
	1850340		P-UB-10	85 mm	120 mm	CTC-2478996	168.54
	1850340		Bushing	85 mm		CTC-0964402	34.71
AMC1-UP; ANB1-UP; MAB1-UP; PAB1-UP							
	2043616		P-UB-10	100 mm	140 mm	CTC-2590633	159.52
	2043616		Bushing	100 mm		CTC-0965625	51.68
	2590702		P-UB-10	100 mm	140 mm	CTC-2590699	159.52
	2590702		Bushing	100 mm		CTC-0965625	51.68
AXK1-UP							
	1842614		P-UB-10	95 mm	160 mm	CTC-2521191	202.13
	1842614		Bushing	95 mm		CTC-6C6093	47.74
AXK1-UP; BBE1-UP; BBL1-UP; BCN1-UP; BDC1-UP; BEA1-UP; BER1-UP; DBG1-UP; GLA1-UP; JTG1-UP							
	1589058		P-UB-10	85 mm	120 mm	CTC-2366368	113.40
	1589058		Bushing	85 mm		CTC-1140756	37.06
BBC1-UP; BCB1-UP; BEF1-UP							
	2043614		P-UB-10	85 mm	120 mm	CTC-2043625	246.55
	2043614		Bushing	85 mm		CTC-0964402	34.71
BBE1-UP; BBL1-UP; BCN1-UP; BEA1-UP; DBG1-UP; GLA1-UP; JTG1-UP							
	1842614		P-UB-10	95 mm	160 mm	CTC-2521191	202.13
	1842614		Bushing	95 mm		CTC-6C6093	47.74
BDC1-UP; BER1-UP							
	1232081		P-UB-10	105 mm	150 mm	CTC-1373767	433.48
	1232081		Bushing	105 mm		CTC-0995572	44.45
BDC1-UP; BER1-UP; RAW1-UP; SBN1-UP							
	2043616		P-UB-10	100 mm	140 mm	CTC-2043626	316.93
	2043616		Bushing	100 mm		CTC-0965625	51.68
MAB1-UP; PAB1-UP							
	2742510		P-UB-10	85 mm	120 mm	CTC-2742511	121.82
	2742510		Bushing	85 mm		CTC-1140756	37.06
RAW1-UP; SBN1-UP							
	1589058		P-UB-10	85 mm	120 mm	CTC-1589092	188.74
	1589058		Bushing	85 mm		CTC-1140756	37.06
BUCKET							
ALF1-UP; BCB1-UP; BDC1-UP; BER1-UP							
	1346987		P-UB-10	65 mm	100 mm	CTC-1764935	229.02
	1346987		Bushing	65 mm		CTC-1140754	25.67

REPLACEMENT KITS FOR CATERPILLAR® EQUIPMENT

Excavators							
APPLICATION	CYL #	Misc-Parts, Instructions, etc.	CODE	ROD	BORE	KIT #	List \$
MODEL 320C							
BUCKET							
AMC1-UP; ANB1-UP							
1588995			P-UB-10	100 mm	140 mm	CTC-1373764	334.02
1588995			Bushing	100 mm		CTC-0965625	51.68
2043618			P-UB-10	85 mm	125 mm	CTC-2479005	155.76
2043618			Bushing	85 mm		CTC-0964402	34.71
2836132			P-UB-10	85 mm	120 mm	CTC-2366368	113.40
2836132			Bushing	85 mm		CTC-1140756	37.06
AMC1-UP; ANB1-UP; AXK1-UP; BBE1-UP; BBL1-UP; BCN1-UP; BEA1-UP; DBG1-UP; GLA1-UP; JTG1-UP							
1589061			P-U-10	85 mm	120 mm	CTC-2366389	113.40
1589061			Bushing	85 mm		CTC-1140756	37.06
AMC1-UP; ANB1-UP; BBC1-UP; BCB1-UP; BEF1-UP; BPR1-UP; BRXI-UP; RAW1-UP; SBN1-UP							
2043617			P-UB-10	85 mm	120 mm	CTC-2043627	144.74
2043617			Bushing	85 mm		CTC-0964402	34.71
AMC1-UP; ANB1-UP; BBC1-UP; BEF1-UP							
1589088			P-UB-10	85 mm	125 mm	CTC-1850223	171.51
1589088			Bushing	85 mm		CTC-0964402	34.71
AMC1-UP; ANB1-UP; BPR1-UP; BRXI-UP; GNG1-UP; HKT1-UP; MAB1-UP; PAB1-UP							
2043689			P-UB-10	85 mm	120 mm	CTC-2479001	153.39
2043689			Bushing	85 mm		CTC-0964402	34.71
AMC1-UP; ANB1-UP; GHA1-UP; GNG1-UP; HBC1-UP; HKT1-UP; MAB1-UP; PAB1-UP							
1799793			P-UB-10	90 mm	130 mm	CTC-2590626	145.21
1799793			Bushing	90 mm		CTC-1052575	33.48
2043696			P-UB-10	85 mm	120 mm	CTC-2479000	153.39
2043696			Bushing	85 mm		CTC-0964402	34.71
AMC1-UP; ANB1-UP; GHA1-UP; HBC1-UP							
1850346			P-UB-10	85 mm	120 mm	CTC-1540744	485.47
1850346			Bushing	85 mm		CTC-0964402	34.71
AMC1-UP; ANB1-UP; MAB1-UP; PAB1-UP							
2096011			P-UB-10	90 mm	130 mm	CTC-2590627	145.21
2096011			Bushing	90 mm		CTC-1052575	33.48
2590694			P-UB-10	85 mm	120 mm	CTC-2590695	168.54
2590694			Bushing	85 mm		CTC-0964402	34.71
2590698			P-UB-10	100 mm	140 mm	CTC-2590699	159.52
2590698			Bushing	100 mm		CTC-0965625	51.68
2590705			P-UB-10	85 mm	120 mm	CTC-2590706	153.39
2590705			Bushing	85 mm		CTC-0964402	34.71
2590732			P-UB-10	90 mm	130 mm	CTC-2590719	146.95
2590732			Bushing	90 mm		CTC-1052575	33.48
AMC1-UP; ANB1-UP; RAW1-UP; SBN1-UP							
1588999			P-UB-10	90 mm	130 mm	CTC-1850196	170.92
1588999			Bushing	90 mm		CTC-1052575	33.48
AXK1-UP							
1799764			P-UB-10	90 mm	130 mm	CTC-2159986	129.44
1799764			Bushing	90 mm		CTC-1140758	42.75
BBC1-UP; BCB1-UP; BEF1-UP							
2043618			P-UB-10	85 mm	125 mm	CTC-2043628	155.76
2043618			Bushing	85 mm		CTC-0964402	34.71
BBE1-UP; BBL1-UP; BCN1-UP; BEA1-UP; DBG1-UP; GLA1-UP; JTG1-UP							
1799764			P-UB-10	90 mm	130 mm	CTC-2159986	129.44
1799764			Bushing	90 mm		CTC-1140758	42.75
2836132			P-UB-10	85 mm	120 mm	CTC-2366368	113.40
2836132			Bushing	85 mm		CTC-1140756	37.06

REPLACEMENT KITS FOR CATERPILLAR® EQUIPMENT

Excavators							
APPLICATION	CYL #	Misc-Parts, Instructions, etc.	CODE	ROD	BORE	KIT #	List \$
MODEL 320C							
BUCKET							
BCB1-UP							
2043689			P-UB-10	85 mm	120 mm	CTC-2043692	153.39
2043689			Bushing	85 mm		CTC-0964402	34.71
2096011			P-UB-10	90 mm	130 mm	CTC-2043630	261.98
2096011			Bushing	90 mm		CTC-1052575	33.48
BDC1-UP; BER1-UP; RAW1-UP; SBN1-UP							
1589061			P-UB-10	85 mm	120 mm	CTC-1589092	188.74
1589061			Bushing	85 mm		CTC-1140756	37.06
1799764			P-UB-10	90 mm	130 mm	CTC-1799772	213.98
1799764			Bushing	90 mm		CTC-1140758	42.75
BPR1-UP; BRXI-UP							
1588997			P-UB-10	85 mm	120 mm	CTC-1261947	358.23
1588997			Bushing	85 mm		CTC-0964402	34.71
MAB1-UP; PAB1-UP							
2742521			P-UB-10	85 mm	120 mm	CTC-2742511	121.82
2742521			Bushing	85 mm		CTC-1140756	37.06
STICK							
AMC1-UP; ANB1-UP; BBC1-UP; BCB1-UP; BEF1-UP; MAB1-UP; PAB1-UP							
2043615			P-UB-10	100 mm	140 mm	CTC-2043626	316.93
2043615			Bushing	100 mm		CTC-0965625	51.68
AMC1-UP; ANB1-UP; BBC1-UP; BEF1-UP; BPR1-UP; BRXI-UP; RAW1-UP; SBN1-UP							
1588993			P-UB-10	100 mm	140 mm	CTC-1373764	334.02
1588993			Bushing	100 mm		CTC-0965625	51.68
AMC1-UP; ANB1-UP; BPR1-UP; BRXI-UP; GNG1-UP; HKT1-UP; MAB1-UP; PAB1-UP							
2144500			P-UB-10	100 mm	140 mm	CTC-2590635	159.52
2144500			Bushing	100 mm		CTC-0965625	51.68
AMC1-UP; ANB1-UP; GHA1-UP; GNG1-UP; HBC1-UP; HKT1-UP; MAB1-UP; PAB1-UP							
1850342			P-UB-10	100 mm	140 mm	CTC-2590631	159.52
1850342			Bushing	100 mm		CTC-0965625	51.68
1850344			P-UB-10	100 mm	140 mm	CTC-2590631	159.52
1850344			Bushing	100 mm		CTC-0965625	51.68
AXK1-UP							
1589059			P-UB-10	100 mm	140 mm	CTC-2159985	126.80
1589059			Bushing	100 mm		CTC-1140757	52.10
AXK1-UP; BBE1-UP; BBL1-UP; BCN1-UP; BEA1-UP; DBG1-UP; GLA1-UP; JTG1-UP							
1589060			P-UB-10	100 mm	140 mm	CTC-2159985	126.80
1589060			Bushing	100 mm		CTC-1140757	52.10
BBC1-UP; BCB1-UP; BEF1-UP							
2144500			P-UB-10	100 mm	140 mm	CTC-2144502	159.52
2144500			Bushing	100 mm		CTC-0965625	51.68
BBE1-UP; BBL1-UP; BCN1-UP; BEA1-UP; DBG1-UP; GLA1-UP; JTG1-UP							
1589059			P-UB-10	100 mm	140 mm	CTC-2095874	262.92
1589059			Bushing	100 mm		CTC-1140757	52.10
BCB1-UP							
1232081			P-UB-10	105 mm	150 mm	CTC-1373767	433.48
1232081			Bushing	105 mm		CTC-0995572	44.45
2043616			P-UB-10	100 mm	140 mm	CTC-2043616	159.52
2043616			Bushing	100 mm		CTC-0965625	51.68
BDC1-UP; BER1-UP; RAW1-UP; SBN1-UP							
1589059			P-UB-10	100 mm	140 mm	CTC-2159985	126.80
1589059			Bushing	100 mm		CTC-1140757	52.10
1589060			P-UB-10	100 mm	140 mm	CTC-2095874	262.92
1589060			Bushing	100 mm		CTC-1140757	52.10

REPLACEMENT KITS FOR CATERPILLAR® EQUIPMENT

Excavators							
APPLICATION	CYL #	Misc-Parts, Instructions, etc.	CODE	ROD	BORE	KIT #	List \$
MODEL 320C							
STICK							
BPR1-UP; BRX1-UP; GNG1-UP; HKT1-UP							
2043615			P-UB-10	100 mm	140 mm	CTC-2590633	159.52
2043615			Bushing	100 mm		CTC-0965625	51.68
MAB1-UP; PAB1-UP							
2742514			P-UB-10	100 mm	140 mm	CTC-2742515	175.30
2742514			Bushing	100 mm		CTC-1140757	52.10
RAW1-UP; SBN1-UP							
2043615			P-UB-10	100 mm	140 mm	CTC-1373764	334.02
2043615			Bushing	100 mm		CTC-0965625	51.68
UNSPECIFIED APPLICATION							
AKH1-UP; ALF1-UP							
1980648			I-U-10	45 mm	60 mm	CTC-1980648K	48.46
MODEL 320C L							
BOOM							
AMC1-UP; ANB1-UP; BBC1-UP; BDC1-UP; BEF1-UP; BER1-UP; BPR1-UP; BRX1-UP							
1588991			P-UB-10	85 mm	120 mm	CTC-1373763	382.72
1588991			Bushing	85 mm		CTC-0964402	34.71
AMC1-UP; ANB1-UP; BDC1-UP; BER1-UP; BPR1-UP; BRX1-UP; EAG1-UP; GNG1-UP; HKT1-UP; MAB1-UP; PAB1-UP; RAW1-UP; SBN1-UP							
2043614			P-UB-10	85 mm	120 mm	CTC-2478998	168.54
2043614			Bushing	85 mm		CTC-0964402	34.71
AMC1-UP; ANB1-UP; GHA1-UP; GNG1-UP; HBC1-UP; HKT1-UP; MAB1-UP; PAB1-UP							
1850340			P-UB-10	85 mm	120 mm	CTC-2478996	168.54
1850340			Bushing	85 mm		CTC-0964402	34.71
AMC1-UP; ANB1-UP; MAB1-UP; PAB1-UP							
2043616			P-UB-10	100 mm	140 mm	CTC-2590633	159.52
2043616			Bushing	100 mm		CTC-0965625	51.68
2590702			P-UB-10	100 mm	140 mm	CTC-2590699	159.52
2590702			Bushing	100 mm		CTC-0965625	51.68
AXK1-UP							
1842614			P-UB-10	95 mm	160 mm	CTC-2521191	202.13
1842614			Bushing	95 mm		CTC-6C6093	47.74
AXK1-UP; BBE1-UP; BBL1-UP; BCN1-UP; BDC1-UP; BEA1-UP; BER1-UP; DBG1-UP; GLA1-UP; JTG1-UP							
1589058			P-UB-10	85 mm	120 mm	CTC-2366368	113.40
1589058			Bushing	85 mm		CTC-1140756	37.06
BBC1-UP; BCB1-UP; BEF1-UP							
2043614			P-UB-10	85 mm	120 mm	CTC-2043625	246.55
2043614			Bushing	85 mm		CTC-0964402	34.71
BBE1-UP; BBL1-UP; BCN1-UP; BEA1-UP; DBG1-UP; GLA1-UP; JTG1-UP							
1842614			P-UB-10	95 mm	160 mm	CTC-2521191	202.13
1842614			Bushing	95 mm		CTC-6C6093	47.74
BDC1-UP; BER1-UP							
1232081			P-UB-10	105 mm	150 mm	CTC-1373767	433.48
1232081			Bushing	105 mm		CTC-0995572	44.45
BDC1-UP; BER1-UP; RAW1-UP; SBN1-UP							
2043616			P-UB-10	100 mm	140 mm	CTC-2043626	316.93
2043616			Bushing	100 mm		CTC-0965625	51.68
MAB1-UP; PAB1-UP							
2742510			P-UB-10	85 mm	120 mm	CTC-2742511	121.82
2742510			Bushing	85 mm		CTC-1140756	37.06
RAW1-UP; SBN1-UP							
1589058			P-UB-10	85 mm	120 mm	CTC-1589092	188.74
1589058			Bushing	85 mm		CTC-1140756	37.06

REPLACEMENT KITS FOR CATERPILLAR® EQUIPMENT

Excavators							
APPLICATION	CYL #	Misc-Parts, Instructions, etc.	CODE	ROD	BORE	KIT #	List \$
MODEL 320C L							
BUCKET							
ALF1-UP; BCB1-UP; BDC1-UP; BER1-UP							
1346987			P-UB-10	65 mm	100 mm	CTC-1764935	229.02
1346987			Bushing	65 mm		CTC-1140754	25.67
AMC1-UP; ANB1-UP							
1588995			P-UB-10	100 mm	140 mm	CTC-1373764	334.02
1588995			Bushing	100 mm		CTC-0965625	51.68
2043618			P-UB-10	85 mm	125 mm	CTC-2479005	155.76
2043618			Bushing	85 mm		CTC-0964402	34.71
2590705			P-UB-10	85 mm	120 mm	CTC-2590706	153.39
2590705			Bushing	85 mm		CTC-0964402	34.71
2836132			P-UB-10	85 mm	120 mm	CTC-2366368	113.40
2836132			Bushing	85 mm		CTC-1140756	37.06
AMC1-UP; ANB1-UP; AXK1-UP; BBE1-UP; BBL1-UP; BCN1-UP; BEA1-UP; DBG1-UP; GLA1-UP; JTG1-UP							
1589061			P-U-10	85 mm	120 mm	CTC-2366389	113.40
1589061			Bushing	85 mm		CTC-1140756	37.06
AMC1-UP; ANB1-UP; BBC1-UP; BEF1-UP							
1589088			P-UB-10	85 mm	125 mm	CTC-1850223	171.51
1589088			Bushing	85 mm		CTC-0964402	34.71
AMC1-UP; ANB1-UP; BCB1-UP; BPR1-UP; BRX1-UP; RAW1-UP; SBN1-UP							
2043617			P-UB-10	85 mm	120 mm	CTC-2043627	144.74
2043617			Bushing	85 mm		CTC-0964402	34.71
AMC1-UP; ANB1-UP; BPR1-UP; BRX1-UP; EAG1-UP; GNG1-UP; HKT1-UP; MAB1-UP; PAB1-UP							
2043689			P-UB-10	85 mm	120 mm	CTC-2479001	153.39
2043689			Bushing	85 mm		CTC-0964402	34.71
AMC1-UP; ANB1-UP; GHA1-UP; GNG1-UP; HBC1-UP; HKT1-UP; MAB1-UP; PAB1-UP							
1799793			P-UB-10	90 mm	130 mm	CTC-2590626	145.21
1799793			Bushing	90 mm		CTC-1052575	33.48
2043696			P-UB-10	85 mm	120 mm	CTC-2479000	153.39
2043696			Bushing	85 mm		CTC-0964402	34.71
AMC1-UP; ANB1-UP; GHA1-UP; HBC1-UP							
1850346			P-UB-10	85 mm	120 mm	CTC-1540744	485.47
1850346			Bushing	85 mm		CTC-0964402	34.71
AMC1-UP; ANB1-UP; MAB1-UP; PAB1-UP							
2096011			P-UB-10	90 mm	130 mm	CTC-2590627	145.21
2096011			Bushing	90 mm		CTC-1052575	33.48
2590694			P-UB-10	85 mm	120 mm	CTC-2590695	168.54
2590694			Bushing	85 mm		CTC-0964402	34.71
2590698			P-UB-10	100 mm	140 mm	CTC-2590699	159.52
2590698			Bushing	100 mm		CTC-0965625	51.68
2590732			P-UB-10	90 mm	130 mm	CTC-2590719	146.95
2590732			Bushing	90 mm		CTC-1052575	33.48
AMC1-UP; ANB1-UP; RAW1-UP; SBN1-UP							
1588999			P-UB-10	90 mm	130 mm	CTC-1850196	170.92
1588999			Bushing	90 mm		CTC-1052575	33.48
AXK1-UP							
1799764			P-UB-10	90 mm	130 mm	CTC-2159986	129.44
1799764			Bushing	90 mm		CTC-1140758	42.75
BBC1-UP; BCB1-UP; BEF1-UP							
2043618			P-UB-10	85 mm	125 mm	CTC-2043628	155.76
2043618			Bushing	85 mm		CTC-0964402	34.71
BBC1-UP; BEF1-UP							
2043617			P-UB-10	85 mm	120 mm	CTC-2043627	144.74
2043617			Bushing	85 mm		CTC-0964402	34.71

REPLACEMENT KITS FOR CATERPILLAR® EQUIPMENT

Excavators							
APPLICATION	CYL #	Misc-Parts, Instructions, etc.	CODE	ROD	BORE	KIT #	List \$
MODEL 320C L							
BUCKET							
BBE1-UP; BBL1-UP; BCN1-UP; BEA1-UP; DBG1-UP; GLA1-UP; JTG1-UP							
1799764			P-UB-10	90 mm	130 mm	CTC-2159986	129.44
1799764			Bushing	90 mm		CTC-1140758	42.75
2836132			P-UB-10	85 mm	120 mm	CTC-2366368	113.40
2836132			Bushing	85 mm		CTC-1140756	37.06
BCB1-UP							
2043689			P-UB-10	85 mm	120 mm	CTC-2043692	153.39
2043689			Bushing	85 mm		CTC-0964402	34.71
2096011			P-UB-10	90 mm	130 mm	CTC-2043630	261.98
2096011			Bushing	90 mm		CTC-1052575	33.48
BDC1-UP; BER1-UP; RAW1-UP; SBN1-UP							
1589061			P-UB-10	85 mm	120 mm	CTC-1589092	188.74
1589061			Bushing	85 mm		CTC-1140756	37.06
1799764			P-UB-10	90 mm	130 mm	CTC-1799772	213.98
1799764			Bushing	90 mm		CTC-1140758	42.75
BPR1-UP; BRXI-UP							
1588997			P-UB-10	85 mm	120 mm	CTC-1261947	358.23
1588997			Bushing	85 mm		CTC-0964402	34.71
MAB1-UP; PAB1-UP							
2590705			P-UB-10	85 mm	120 mm	CTC-2590706	153.39
2590705			Bushing	85 mm		CTC-0964402	34.71
2742521			P-UB-10	85 mm	120 mm	CTC-2742511	121.82
2742521			Bushing	85 mm		CTC-1140756	37.06
STICK							
AMC1-UP; ANB1-UP; BBC1-UP; BCB1-UP; BEF1-UP; MAB1-UP; PAB1-UP							
2043615			P-UB-10	100 mm	140 mm	CTC-2043626	316.93
2043615			Bushing	100 mm		CTC-0965625	51.68
AMC1-UP; ANB1-UP; BBC1-UP; BEF1-UP; BPR1-UP; BRXI-UP; RAW1-UP; SBN1-UP							
1588993			P-UB-10	100 mm	140 mm	CTC-1373764	334.02
1588993			Bushing	100 mm		CTC-0965625	51.68
AMC1-UP; ANB1-UP; BPR1-UP; BRXI-UP; GNG1-UP; HKT1-UP; MAB1-UP; PAB1-UP							
2144500			P-UB-10	100 mm	140 mm	CTC-2590635	159.52
2144500			Bushing	100 mm		CTC-0965625	51.68
AMC1-UP; ANB1-UP; GHA1-UP; GNG1-UP; HBC1-UP; HKT1-UP; MAB1-UP; PAB1-UP							
1850342			P-UB-10	100 mm	140 mm	CTC-2590631	159.52
1850342			Bushing	100 mm		CTC-0965625	51.68
1850344			P-UB-10	100 mm	140 mm	CTC-2590631	159.52
1850344			Bushing	100 mm		CTC-0965625	51.68
AXK1-UP							
1589059			P-UB-10	100 mm	140 mm	CTC-2159985	126.80
1589059			Bushing	100 mm		CTC-1140757	52.10
AXK1-UP; BBE1-UP; BBL1-UP; BCN1-UP; BEA1-UP; DBG1-UP; GLA1-UP; JTG1-UP							
1589060			P-UB-10	100 mm	140 mm	CTC-2159985	126.80
1589060			Bushing	100 mm		CTC-1140757	52.10
BBC1-UP; BCB1-UP; BEF1-UP							
2144500			P-UB-10	100 mm	140 mm	CTC-2144502	159.52
2144500			Bushing	100 mm		CTC-0965625	51.68
BBE1-UP; BBL1-UP; BCN1-UP; BEA1-UP; DBG1-UP; GLA1-UP; JTG1-UP							
1589059			P-UB-10	100 mm	140 mm	CTC-2095874	262.92
1589059			Bushing	100 mm		CTC-1140757	52.10
BCB1-UP							
1232081			P-UB-10	105 mm	150 mm	CTC-1373767	433.48
1232081			Bushing	105 mm		CTC-0995572	44.45
2043616			P-UB-10	100 mm	140 mm	CTC-2043616	159.52
2043616			Bushing	100 mm		CTC-0965625	51.68

REPLACEMENT KITS FOR CATERPILLAR® EQUIPMENT

Excavators							
APPLICATION	CYL #	Misc-Parts, Instructions, etc.	CODE	ROD	BORE	KIT #	List \$
MODEL 320C L							
STICK							
BDC1-UP; BER1-UP; RAW1-UP; SBN1-UP							
1589059			P-UB-10	100 mm	140 mm	CTC-2159985	126.80
1589059			Bushing	100 mm		CTC-1140757	52.10
1589060			P-UB-10	100 mm	140 mm	CTC-2095874	262.92
1589060			Bushing	100 mm		CTC-1140757	52.10
BPR1-UP; BRXI-UP; EAG1-UP; GNG1-UP; HKT1-UP							
2043615			P-UB-10	100 mm	140 mm	CTC-2590633	159.52
2043615			Bushing	100 mm		CTC-0965625	51.68
EAG1-UP							
2144500			P-UB-10	100 mm	140 mm	CTC-2590635	159.52
MAB1-UP; PAB1-UP							
2742514			P-UB-10	100 mm	140 mm	CTC-2742515	175.30
2742514			Bushing	100 mm		CTC-1140757	52.10
RAW1-UP; SBN1-UP							
2043615			P-UB-10	100 mm	140 mm	CTC-1373764	334.02
2043615			Bushing	100 mm		CTC-0965625	51.68
UNSPECIFIED APPLICATION							
AKH1-UP; ALF1-UP							
1980648			I-U-10	45 mm	60 mm	CTC-1980648K	48.46
MODEL 320C LN							
BOOM							
BBE1-UP; BBL1-UP; BCN1-UP; BEA1-UP; DBG1-UP; GLA1-UP; JTG1-UP							
1589058			P-UB-10	85 mm	120 mm	CTC-2366368	113.40
1589058			Bushing	85 mm		CTC-1140756	37.06
1842614			P-UB-10	95 mm	160 mm	CTC-2521191	202.13
1842614			Bushing	95 mm		CTC-6C6093	47.74
BUCKET							
BBE1-UP; BBL1-UP; BCN1-UP; BEA1-UP; DBG1-UP; GLA1-UP; JTG1-UP							
1589061			P-U-10	85 mm	120 mm	CTC-2366389	113.40
1589061			Bushing	85 mm		CTC-1140756	37.06
1799764			P-UB-10	90 mm	130 mm	CTC-2159986	129.44
1799764			Bushing	90 mm		CTC-1140758	42.75
2836132			P-UB-10	85 mm	120 mm	CTC-2366368	113.40
2836132			Bushing	85 mm		CTC-1140756	37.06
STICK							
BBE1-UP; BBL1-UP; BCN1-UP; BEA1-UP; DBG1-UP; GLA1-UP; JTG1-UP							
1589059			P-UB-10	100 mm	140 mm	CTC-2095874	262.92
1589059			Bushing	100 mm		CTC-1140757	52.10
1589060			P-UB-10	100 mm	140 mm	CTC-2159985	126.80
1589060			Bushing	100 mm		CTC-1140757	52.10
MODEL 320C LRR							
BOOM							
GAD1-UP							
1589058			P-UB-10	85 mm	120 mm	CTC-2366368	113.40
1589058			Bushing	85 mm		CTC-1140756	37.06
STICK							
GAD1-UP							
1589059			P-UB-10	100 mm	140 mm	CTC-2159985	126.80
1589059			Bushing	100 mm		CTC-1140757	52.10
MODEL 320C LU							
BOOM							
CLM1-UP; CLZ1-UP							
1588991			P-UB-10	85 mm	120 mm	CTC-1373763	382.72
1588991			Bushing	85 mm		CTC-0964402	34.71

REPLACEMENT KITS FOR CATERPILLAR® EQUIPMENT

Excavators							
APPLICATION	CYL #	Misc-Parts, Instructions, etc.	CODE	ROD	BORE	KIT #	List \$
MODEL 320C LU							
BOOM							
CLM1-UP; CLZ1-UP; MAC1-UP; PAC1-UP							
1850340			P-UB-10	85 mm	120 mm	CTC-2478996	168.54
1850340			Bushing	85 mm		CTC-0964402	34.71
2043614			P-UB-10	85 mm	120 mm	CTC-2478998	168.54
2043614			Bushing	85 mm		CTC-0964402	34.71
MAC1-UP; PAC1-UP							
2742510			P-UB-10	85 mm	120 mm	CTC-2742511	121.82
2742510			Bushing	85 mm		CTC-1140756	37.06
BUCKET							
CLM1-UP; CLZ1-UP							
1850346			P-UB-10	85 mm	120 mm	CTC-1540744	485.47
1850346			Bushing	85 mm		CTC-0964402	34.71
2043617			P-UB-10	85 mm	120 mm	CTC-2043627	144.74
2043617			Bushing	85 mm		CTC-0964402	34.71
2043696			P-UB-10	85 mm	120 mm	CTC-2479000	153.39
2043696			Bushing	85 mm		CTC-0964402	34.71
CLM1-UP; CLZ1-UP; MAC1-UP; PAC1-UP							
2043689			P-UB-10	85 mm	120 mm	CTC-2479001	153.39
2043689			Bushing	85 mm		CTC-0964402	34.71
MAC1-UP; PAC1-UP							
2590694			P-UB-10	85 mm	120 mm	CTC-2590695	168.54
2590694			Bushing	85 mm		CTC-0964402	34.71
2590698			P-UB-10	100 mm	140 mm	CTC-2590699	159.52
2590698			Bushing	100 mm		CTC-0965625	51.68
2590705			P-UB-10	85 mm	120 mm	CTC-2590706	153.39
2590705			Bushing	85 mm		CTC-0964402	34.71
2742521			P-UB-10	85 mm	120 mm	CTC-2742511	121.82
2742521			Bushing	85 mm		CTC-1140756	37.06
STICK							
CLM1-UP; CLZ1-UP							
1588993			P-UB-10	100 mm	140 mm	CTC-1373764	334.02
1588993			Bushing	100 mm		CTC-0965625	51.68
CLM1-UP; CLZ1-UP; MAC1-UP; PAC1-UP							
1850342			P-UB-10	100 mm	140 mm	CTC-2590631	159.52
1850342			Bushing	100 mm		CTC-0965625	51.68
2043615			P-UB-10	100 mm	140 mm	CTC-2590633	159.52
2043615			Bushing	100 mm		CTC-0965625	51.68
MAC1-UP; PAC1-UP							
2742514			P-UB-10	100 mm	140 mm	CTC-2742515	175.30
2742514			Bushing	100 mm		CTC-1140757	52.10
MODEL 320C S							
BOOM							
BBE1-UP; BBL1-UP; BCN1-UP; BEA1-UP; BMZ1-UP; EGL1-UP							
1589058			P-UB-10	85 mm	120 mm	CTC-2366368	113.40
1589058			Bushing	85 mm		CTC-1140756	37.06
BBE1-UP; BBL1-UP; BCN1-UP; BEA1-UP; EGL1-UP							
1842614			P-UB-10	95 mm	160 mm	CTC-2521191	202.13
1842614			Bushing	95 mm		CTC-6C6093	47.74
BMZ1-UP							
1842614			P-UB-10	95 mm	160 mm	CTC-2521191	202.13
1842614			Bushing	95 mm		CTC-6C6093	47.74
BUCKET							
BBE1-UP; BBL1-UP; BCN1-UP; BEA1-UP; BMZ1-UP; EGL1-UP							
1589061			P-U-10	85 mm	120 mm	CTC-2366389	113.40
1589061			Bushing	85 mm		CTC-1140756	37.06

REPLACEMENT KITS FOR CATERPILLAR® EQUIPMENT

Excavators							
APPLICATION	CYL #	Misc-Parts, Instructions, etc.	CODE	ROD	BORE	KIT #	List \$
MODEL 320C S							
BUCKET							
BBE1-UP; BBL1-UP; BCN1-UP; BEA1-UP; EGL1-UP							
1799764			P-UB-10	90 mm	130 mm	CTC-2159986	129.44
1799764			Bushing	90 mm		CTC-1140758	42.75
2836132			P-UB-10	85 mm	120 mm	CTC-2366368	113.40
2836132			Bushing	85 mm		CTC-1140756	37.06
BMZ1-UP							
1799764			P-UB-10	90 mm	130 mm	CTC-2159986	129.44
1799764			Bushing	90 mm		CTC-1140758	42.75
STICK							
BBE1-UP; BBL1-UP; BCN1-UP; BEA1-UP; BMZ1-UP; EGL1-UP							
1589060			P-UB-10	100 mm	140 mm	CTC-2159985	126.80
1589060			Bushing	100 mm		CTC-1140757	52.10
BBE1-UP; BBL1-UP; BCN1-UP; BEA1-UP; EGL1-UP							
1589059			P-UB-10	100 mm	140 mm	CTC-2095874	262.92
1589059			Bushing	100 mm		CTC-1140757	52.10
BMZ1-UP							
1589059			P-UB-10	100 mm	140 mm	CTC-2159985	126.80
1589059			Bushing	100 mm		CTC-1140757	52.10
MODEL 320C U							
BOOM							
CLM1-UP; CLZ1-UP							
1588991			P-UB-10	85 mm	120 mm	CTC-1373763	382.72
1588991			Bushing	85 mm		CTC-0964402	34.71
CLM1-UP; CLZ1-UP; MAC1-UP; PAC1-UP							
1850340			P-UB-10	85 mm	120 mm	CTC-2478996	168.54
1850340			Bushing	85 mm		CTC-0964402	34.71
2043614			P-UB-10	85 mm	120 mm	CTC-2478998	168.54
2043614			Bushing	85 mm		CTC-0964402	34.71
MAC1-UP; PAC1-UP							
2742510			P-UB-10	85 mm	120 mm	CTC-2742511	121.82
2742510			Bushing	85 mm		CTC-1140756	37.06
BUCKET							
CLM1-UP; CLZ1-UP							
1850346			P-UB-10	85 mm	120 mm	CTC-1540744	485.47
1850346			Bushing	85 mm		CTC-0964402	34.71
2043617			P-UB-10	85 mm	120 mm	CTC-2043627	144.74
2043617			Bushing	85 mm		CTC-0964402	34.71
2043696			P-UB-10	85 mm	120 mm	CTC-2479000	153.39
2043696			Bushing	85 mm		CTC-0964402	34.71
CLM1-UP; CLZ1-UP; MAC1-UP; PAC1-UP							
2043689			P-UB-10	85 mm	120 mm	CTC-2479001	153.39
2043689			Bushing	85 mm		CTC-0964402	34.71
MAC1-UP; PAC1-UP							
2590694			P-UB-10	85 mm	120 mm	CTC-2590695	168.54
2590694			Bushing	85 mm		CTC-0964402	34.71
2590698			P-UB-10	100 mm	140 mm	CTC-2590699	159.52
2590698			Bushing	100 mm		CTC-0965625	51.68
2590705			P-UB-10	85 mm	120 mm	CTC-2590706	153.39
2590705			Bushing	85 mm		CTC-0964402	34.71
2742521			P-UB-10	85 mm	120 mm	CTC-2742511	121.82
2742521			Bushing	85 mm		CTC-1140756	37.06
STICK							
CLM1-UP; CLZ1-UP							
1588993			P-UB-10	100 mm	140 mm	CTC-1373764	334.02
1588993			Bushing	100 mm		CTC-0965625	51.68

REPLACEMENT KITS FOR CATERPILLAR® EQUIPMENT

Excavators							
APPLICATION	CYL #	Misc-Parts, Instructions, etc.	CODE	ROD	BORE	KIT #	List \$
MODEL 320C U							
STICK							
CLM1-UP; CLZ1-UP; MAC1-UP; PAC1-UP							
1850342			P-UB-10	100 mm	140 mm	CTC-2590631	159.52
1850342			Bushing	100 mm		CTC-0965625	51.68
2043615			P-UB-10	100 mm	140 mm	CTC-2590633	159.52
2043615			Bushing	100 mm		CTC-0965625	51.68
MAC1-UP; PAC1-UP							
2742514			P-UB-10	100 mm	140 mm	CTC-2742515	175.30
2742514			Bushing	100 mm		CTC-1140757	52.10
MODEL 320D							
BOOM							
A6F1-UP; A8F1-UP; CXY1-UP; DHK1-UP; FAL1-UP; JFZ1-UP; JGZ1-UP; KGF1-UP; MCH1-UP; MDE1-UP; MGG1-UP; PHX1-UP							
2426731			P-UB-10	85 mm	120 mm	CTC-2478868	165.60
2426731			Bushing	85 mm		CTC-0964402	34.71
A6F1-UP; A8F1-UP; CXY1-UP; DHK1-UP; FAL1-UP; KGF1-UP; MCH1-UP; PHX1-UP							
2426751			P-UB-10	100 mm	140 mm	CTC-2478878	203.77
2426751			Bushing	100 mm		CTC-0965625	51.68
BZP1-UP; JGZ1-UP; MDE1-UP							
2426746			P-UB-10	85 mm	120 mm	CTC-2667891	165.60
2426746			Bushing	85 mm		CTC-0964402	34.71
CXY1-UP; DHK1-UP							
2426746			P-UB-10	85 mm	120 mm	CTC-2667891	165.60
2667972			P-UB-10	85 mm	120 mm	CTC-2668011	165.60
2667972			Bushing	85 mm		CTC-0964402	34.71
FAL1-UP; KGF1-UP							
2426746			P-UB-10	85 mm	120 mm	CTC-2667891	165.60
2426746			Bushing	85 mm		CTC-0964402	34.71
GKS1-UP							
2897752			P-UB-10	100 mm	140 mm	CTC-2344566	151.33
2897752			Bushing	100 mm		CTC-0965625	51.68
BUCKET							
A6F1-UP; A8F1-UP; CXY1-UP; DHK1-UP; FAL1-UP; JFZ1-UP; JGZ1-UP; KGF1-UP; MCH1-UP; MDE1-UP; MGG1-UP; PHX1-UP							
2426756			P-UB-10	85 mm	120 mm	CTC-2478888	141.82
2426756			Bushing	85 mm		CTC-0964402	34.71
A6F1-UP; A8F1-UP; CXY1-UP; DHK1-UP; FAL1-UP; KGF1-UP; MCH1-UP; PHX1-UP							
2254591			P-UB-10	95 mm	135 mm	CTC-2344587	138.86
2254591			Bushing	95 mm		CTC-0964430	37.71
BZP1-UP; CXY1-UP; DHK1-UP; FAL1-UP; JGZ1-UP; KGF1-UP; MDE1-UP							
2426759			P-UB-10	85 mm	120 mm	CTC-2667892	141.82
2426759			Bushing	85 mm		CTC-0964402	34.71
CXY1-UP; DHK1-UP							
2667978			P-UB-10	85 mm	120 mm	CTC-2668057	141.82
2667978			Bushing	85 mm		CTC-0964402	34.71
CXY1-UP; DHK1-UP; FAL1-UP; JGZ1-UP; KGF1-UP; MDE1-UP							
2254599			P-UB-10	95 mm	135 mm	CTC-2590656	137.50
2254599			Bushing	95 mm		CTC-0964430	37.71
EBT1-							
2426770			P-UB-10	90 mm	130 mm	CTC-2426770K	140.69
CAB TILT							
GKS1-UP							
2632914			P-UB-10	2-1/4	5	CTC-2417578	65.89
HEEL							
GKS1-UP							
2897756			P-UB-10	90 mm	130 mm	CTC-2590678	134.76
2897756			Bushing	90 mm		CTC-1052575	33.48

REPLACEMENT KITS FOR CATERPILLAR® EQUIPMENT

Excavators							
APPLICATION	CYL #	Misc-Parts, Instructions, etc.	CODE	ROD	BORE	KIT #	List \$
MODEL 320D							
STICK							
A6F1-UP; A8F1-UP; CXY1-UP; DHK1-UP; FAL1-UP; JFZ1-UP; JGZ1-UP; KGF1-UP; MCH1-UP; MDE1-UP; MGG1-UP; PHX1-UP							
2426744			P-UB-10	100 mm	140 mm	CTC-2478974	203.77
2426744			Bushing	100 mm		CTC-0965625	51.68
A6F1-UP; A8F1-UP; CXY1-UP; DHK1-UP; FAL1-UP; KGF1-UP; MCH1-UP; PHX1-UP							
2426734			P-UB-10	100 mm	140 mm	CTC-2478878	203.77
2426734			Bushing	100 mm		CTC-0965625	51.68
BZP1-UP; CXY1-UP; DHK1-UP; FAL1-UP; JGZ1-UP; KGF1-UP; MDE1-UP							
2426748			P-UB-10	100 mm	140 mm	CTC-2590775	203.77
2426748			Bushing	100 mm		CTC-0965625	51.68
CXY1-UP; DHK1-UP							
2667974			P-UB-10	100 mm	140 mm	CTC-2668012	203.77
2667974			Bushing	100 mm		CTC-0965625	51.68
CXY1-UP; DHK1-UP; FAL1-UP; JGZ1-UP; KGF1-UP; MDE1-UP							
2426763			P-UB-10	100 mm	140 mm	CTC-2590775	203.77
2426763			Bushing	100 mm		CTC-0965625	51.68
GKS1-UP							
2897754			P-UB-10	105 mm	150 mm	CTC-2344576	347.56
2897754			Bushing	105 mm		CTC-0995572	44.45
MODEL 320D L							
BOOM							
A6F1-UP; A8F1-UP; A9F1-UP; CXY1-UP; DHK1-UP; FAL1-UP; KGF1-UP; MCH1-UP; PHX1-UP							
2426751			P-UB-10	100 mm	140 mm	CTC-2478878	203.77
2426751			Bushing	100 mm		CTC-0965625	51.68
A6F1-UP; A8F1-UP; CXY1-UP; DHK1-UP; FAL1-UP; JFZ1-UP; JGZ1-UP; KGF1-UP; MCH1-UP; MDE1-UP; MGG1-UP; PHX1-UP							
2426731			P-UB-10	85 mm	120 mm	CTC-2478868	165.60
2426731			Bushing	85 mm		CTC-0964402	34.71
A9F1-UP							
2426731			P-UB-10	85 mm	120 mm	CTC-2478868	165.60
2426731			Bushing	85 mm		CTC-0964402	34.71
CXY1-UP; DHK1-UP							
2426746			P-UB-10	85 mm	120 mm	CTC-2667891	165.60
2667972			P-UB-10	85 mm	120 mm	CTC-2668011	165.60
2667972			Bushing	85 mm		CTC-0964402	34.71
FAL1-UP; KGF1-UP							
2426746			P-UB-10	85 mm	120 mm	CTC-2667891	165.60
2426746			Bushing	85 mm		CTC-0964402	34.71
JGZ1-UP; MDE1-UP							
2426746			P-UB-10	85 mm	120 mm	CTC-2667891	165.60
2426746			Bushing	85 mm		CTC-0964402	34.71
BUCKET							
A6F1-UP; A8F1-UP; A9F1-UP; CXY1-UP; DHK1-UP; FAL1-UP; JFZ1-UP; JGZ1-UP; KGF1-UP; MCH1-UP; MDE1-UP; MGG1-UP; PHX1-UP							
2426756			P-UB-10	85 mm	120 mm	CTC-2478888	141.82
2426756			Bushing	85 mm		CTC-0964402	34.71
A6F1-UP; A8F1-UP; A9F1-UP; CXY1-UP; DHK1-UP; FAL1-UP; KGF1-UP; MCH1-UP; PHX1-UP							
2254591			P-UB-10	95 mm	135 mm	CTC-2344587	138.86
2254591			Bushing	95 mm		CTC-0964430	37.71
CXY1-UP; DHK1-UP							
2667978			P-UB-10	85 mm	120 mm	CTC-2668057	141.82
2667978			Bushing	85 mm		CTC-0964402	34.71
CXY1-UP; DHK1-UP; FAL1-UP; JGZ1-UP; KGF1-UP; MDE1-UP							
2254599			P-UB-10	95 mm	135 mm	CTC-2590656	137.50
2254599			Bushing	95 mm		CTC-0964430	37.71
2426759			P-UB-10	85 mm	120 mm	CTC-2667892	141.82
2426759			Bushing	85 mm		CTC-0964402	34.71

REPLACEMENT KITS FOR CATERPILLAR® EQUIPMENT

Excavators							
APPLICATION	CYL #	Misc-Parts, Instructions, etc.	CODE	ROD	BORE	KIT #	List \$
MODEL 320D L							
STICK							
A6F1-UP; A8F1-UP; A9F1-UP; CXY1-UP; DHK1-UP; FAL1-UP; JFZ1-UP; JGZ1-UP; KGF1-UP; MCH1-UP; MDE1-UP; MGG1-UP; PHX1-UP							
2426744			P-UB-10	100 mm	140 mm	CTC-2478974	203.77
2426744			Bushing	100 mm		CTC-0965625	51.68
A6F1-UP; A8F1-UP; A9F1-UP; CXY1-UP; DHK1-UP; FAL1-UP; KGF1-UP; MCH1-UP; PHX1-UP							
2426734			P-UB-10	100 mm	140 mm	CTC-2478878	203.77
2426734			Bushing	100 mm		CTC-0965625	51.68
CXY1-UP; DHK1-UP							
2667974			P-UB-10	100 mm	140 mm	CTC-2668012	203.77
2667974			Bushing	100 mm		CTC-0965625	51.68
CXY1-UP; DHK1-UP; FAL1-UP; JGZ1-UP; KGF1-UP; MDE1-UP							
2426748			P-UB-10	100 mm	140 mm	CTC-2590775	203.77
2426748			Bushing	100 mm		CTC-0965625	51.68
2426763			P-UB-10	100 mm	140 mm	CTC-2590775	203.77
2426763			Bushing	100 mm		CTC-0965625	51.68
MODEL 320D LN							
BOOM							
WBN1-UP							
2426731			P-UB-10	85 mm	120 mm	CTC-2478868	165.60
2426731			Bushing	85 mm		CTC-0964402	34.71
2426746			P-UB-10	85 mm	120 mm	CTC-2667891	165.60
2426746			Bushing	85 mm		CTC-0964402	34.71
2667972			P-UB-10	85 mm	120 mm	CTC-2668011	165.60
2667972			Bushing	85 mm		CTC-0964402	34.71
BUCKET							
WBN1-UP							
2426756			P-UB-10	85 mm	120 mm	CTC-2478888	141.82
2426756			Bushing	85 mm		CTC-0964402	34.71
2426759			P-UB-10	85 mm	120 mm	CTC-2667892	141.82
2426759			Bushing	85 mm		CTC-0964402	34.71
2667978			P-UB-10	85 mm	120 mm	CTC-2668057	141.82
2667978			Bushing	85 mm		CTC-0964402	34.71
STICK							
WBN1-UP							
2426734			P-UB-10	100 mm	140 mm	CTC-2478878	203.77
2426734			Bushing	100 mm		CTC-0965625	51.68
2426748			P-UB-10	100 mm	140 mm	CTC-2590775	203.77
2426748			Bushing	100 mm		CTC-0965625	51.68
2667974			P-UB-10	100 mm	140 mm	CTC-2668012	203.77
2667974			Bushing	100 mm		CTC-0965625	51.68
MODEL 320D LRR							
BOOM							
EBY1-UP							
2667972			P-UB-10	85 mm	120 mm	CTC-2668011	165.60
2667972			Bushing	85 mm		CTC-0964402	34.71
EBY1-UP; FXK1-UP; GKL1-UP; TAE1-UP; WFD1-UP; XCK1-UP; ZGB1-UP							
2426731			P-UB-10	85 mm	120 mm	CTC-2478868	165.60
2426731			Bushing	85 mm		CTC-0964402	34.71
EBY1-UP; GKL1-UP; TAE1-UP							
2426746			P-UB-10	85 mm	120 mm	CTC-2667891	165.60
2426746			Bushing	85 mm		CTC-0964402	34.71
BUCKET							
EBY1-UP							
2667978			P-UB-10	85 mm	120 mm	CTC-2668057	141.82
2667978			Bushing	85 mm		CTC-0964402	34.71

REPLACEMENT KITS FOR CATERPILLAR® EQUIPMENT

Excavators							
APPLICATION	CYL #	Misc-Parts, Instructions, etc.	CODE	ROD	BORE	KIT #	List \$
MODEL 320D LRR							
BUCKET							
EBY1-UP; FXK1-UP; GKL1-UP; TAE1-UP							
2426759			P-UB-10	85 mm	120 mm	CTC-2667892	141.82
2426759			Bushing	85 mm		CTC-0964402	34.71
EBY1-UP; FXK1-UP; GKL1-UP; TAE1-UP; WFD1-UP; XCK1-UP; ZGB1-UP							
2426756			P-UB-10	85 mm	120 mm	CTC-2478888	141.82
2426756			Bushing	85 mm		CTC-0964402	34.71
STICK							
EBY1-UP							
2667974			P-UB-10	100 mm	140 mm	CTC-2668012	203.77
2667974			Bushing	100 mm		CTC-0965625	51.68
EBY1-UP; FXK1-UP; GKL1-UP; TAE1-UP; WFD1-UP; XCK1-UP							
2426744			P-UB-10	100 mm	140 mm	CTC-2478974	203.77
2426744			Bushing	100 mm		CTC-0965625	51.68
EBY1-UP; FXK1-UP; GKL1-UP; TAE1-UP; WFD1-UP; XCK1-UP; ZGB1-UP							
2426734			P-UB-10	100 mm	140 mm	CTC-2478878	203.77
2426734			Bushing	100 mm		CTC-0965625	51.68
EBY1-UP; GKL1-UP; TAE1-UP							
2426748			P-UB-10	100 mm	140 mm	CTC-2590775	203.77
2426748			Bushing	100 mm		CTC-0965625	51.68
MODEL 320D RR							
BOOM							
EBY1-UP							
2667972			P-UB-10	85 mm	120 mm	CTC-2668011	165.60
2667972			Bushing	85 mm		CTC-0964402	34.71
EBY1-UP; FXK1-UP; GKL1-UP; WFD1-UP; XCK1-UP; YDS1-UP							
2426731			P-UB-10	85 mm	120 mm	CTC-2478868	165.60
2426731			Bushing	85 mm		CTC-0964402	34.71
EBY1-UP; GKL1-UP; YDS1-UP							
2426746			P-UB-10	85 mm	120 mm	CTC-2667891	165.60
2426746			Bushing	85 mm		CTC-0964402	34.71
BUCKET							
EBY1-UP							
2667978			P-UB-10	85 mm	120 mm	CTC-2668057	141.82
2667978			Bushing	85 mm		CTC-0964402	34.71
EBY1-UP; FXK1-UP; GKL1-UP; WFD1-UP; XCK1-UP; YDS1-UP							
2426756			P-UB-10	85 mm	120 mm	CTC-2478888	141.82
2426756			Bushing	85 mm		CTC-0964402	34.71
EBY1-UP; FXK1-UP; GKL1-UP; YDS1-UP							
2426759			P-UB-10	85 mm	120 mm	CTC-2667892	141.82
2426759			Bushing	85 mm		CTC-0964402	34.71
STICK							
EBY1-UP							
2667974			P-UB-10	100 mm	140 mm	CTC-2668012	203.77
2667974			Bushing	100 mm		CTC-0965625	51.68
EBY1-UP; FXK1-UP; GKL1-UP; WFD1-UP; XCK1-UP; YDS1-UP							
2426734			P-UB-10	100 mm	140 mm	CTC-2478878	203.77
2426734			Bushing	100 mm		CTC-0965625	51.68
2426744			P-UB-10	100 mm	140 mm	CTC-2478974	203.77
2426744			Bushing	100 mm		CTC-0965625	51.68
EBY1-UP; GKL1-UP; YDS1-UP							
2426748			P-UB-10	100 mm	140 mm	CTC-2590775	203.77
2426748			Bushing	100 mm		CTC-0965625	51.68
MODEL 320L							
BOOM							
874898			P-UB-10	85 mm	120 mm	CTC-1764934	240.69

REPLACEMENT KITS FOR CATERPILLAR® EQUIPMENT

Excavators							
APPLICATION	CYL #	Misc-Parts, Instructions, etc.	CODE	ROD	BORE	KIT #	List \$
MODEL 320L							
BUCKET							
	1251547		P-UB-10	65 mm	100 mm	CTC-4I8914	211.54
	4I7652		P-UB-10	65 mm	100 mm	CTC-4I7664	211.63
	4I8840		P-UB-10	65 mm	100 mm	CTC-4I8914	211.54
	7I7291		P-UB-10	85 mm	130 mm	CTC-7Y5145	276.61
	7Y5100		P-UB-10	85 mm	130 mm	CTC-7Y5145	276.61
STICK							
	7Y4650		P-UB-10	105 mm	150 mm	CTC-1163612	312.32
	875493		P-UB-10	100 mm	140 mm	CTC-1270630	352.06
MODEL 320N							
BOOM							
	874898		P-UB-10	85 mm	120 mm	CTC-1764934	240.69
BUCKET							
	7Y5100		P-UB-10	85 mm	130 mm	CTC-7Y5145	276.61
STICK							
	875493		P-UB-10	100 mm	140 mm	CTC-1270630	352.06
MODEL 320S							
BOOM							
	0875496		P-UB-10	85 mm	120 mm	CTC-1184131	258.61
	1069596		P-UB-10	95 mm	160 mm	CTC-6C6091	348.60
BOOM VA							
	6C6085		P-UB-10	95 mm	160 mm	CTC-6C6091	348.60
BUCKET							
	0875633		P-UB-10	85 mm	120 mm	CTC-1184131	258.61
	7Y5100		P-UB-10	85 mm	130 mm	CTC-7Y5145	276.61
STICK							
	0875422		P-UB-10	100 mm	140 mm	CTC-0875387	353.62
	0876638		P-UB-10	100 mm	140 mm	CTC-0875387	353.62
MODEL 321B							
BUCKET							
	1232084		P-UB-10	90 mm	130 mm	CTC-1373768	455.90
UNSPECIFIED APPLICATION							
	1183967		P-UB-10	85 mm	120 mm	CTC-1261947	358.23
MODEL 321C LCR							
BLADE LH							
	KCR1-UP; MCF1-UP						
	1913288		P-UB-10	100 mm	140 mm	CTC-1645174	226.42
	1913288		Bushing	100 mm		CTC-0965625	51.68
BLADE RH							
	KCR1-UP; MCF1-UP						
	1913286		P-UB-10	100 mm	140 mm	CTC-1645174	226.42
	1913286		Bushing	100 mm		CTC-0965625	51.68
BOOM							
	KCR1-UP						
	2449116		P-UB-10	85 mm	120 mm	CTC-2478998	168.54
	2449116		Bushing	85 mm		CTC-0964402	34.71
	KCR1-UP; MCF1-UP						
	2160021		P-UB-10	90 mm	125 mm	CTC-2479004	139.73
	2160021		Bushing	90 mm		CTC-1052575	33.48
	MCF1-UP						
	2043614		P-UB-10	85 mm	120 mm	CTC-2043625	246.55
	2043614		Bushing	85 mm		CTC-0964402	34.71
BOOM LH							
	KCR1-UP; MCF1-UP						
	2160018		P-UB-10	90 mm	125 mm	CTC-2479004	139.73
	2160018		Bushing	90 mm		CTC-1052575	33.48

REPLACEMENT KITS FOR CATERPILLAR® EQUIPMENT

Excavators							
APPLICATION	CYL #	Misc-Parts, Instructions, etc.	CODE	ROD	BORE	KIT #	List \$
MODEL 321C LCR							
BUCKET							
KCR1-UP							
2449120			P-UB-10	85 mm	120 mm	CTC-2479001	153.39
2449120			Bushing	85 mm		CTC-0964402	34.71
KCR1-UP; MCF1-UP							
2043689			P-UB-10	85 mm	120 mm	CTC-2479001	153.39
2043689			Bushing	85 mm		CTC-0964402	34.71
STICK							
KCR1-UP							
2424840			P-UB-10	100 mm	140 mm	CTC-2590633	159.52
2424840			Bushing	100 mm		CTC-0965625	51.68
KCR1-UP; MCF1-UP							
2043615			P-UB-10	100 mm	140 mm	CTC-2590633	159.52
2043615			Bushing	100 mm		CTC-0965625	51.68
STICK LH							
MCF1-UP							
2817970			P-UB-10	100 mm	140 mm	CTC-1373764	334.02
2817970			Bushing	100 mm		CTC-0965625	51.68
STICK RH							
MCF1-UP							
2817971			P-UB-10	100 mm	140 mm	CTC-1373764	334.02
2817971			Bushing	100 mm		CTC-0965625	51.68
MODEL 321D LCR							
BLADE LH							
PBD1-UP							
1913288			P-UB-10	100 mm	140 mm	CTC-1645174	226.42
1913288			Bushing	100 mm		CTC-0965625	51.68
BLADE RH							
PBD1-UP							
1913286			P-UB-10	100 mm	140 mm	CTC-1645174	226.42
1913286			Bushing	100 mm		CTC-0965625	51.68
BOOM							
PBD1-UP; TXA1-UP							
2426731			P-UB-10	85 mm	120 mm	CTC-2478868	165.60
2426731			Bushing	85 mm		CTC-0964402	34.71
2795614			P-UB-10	95 mm	160 mm	CTC-2521191	202.13
2795614			Bushing	95 mm		CTC-6C6093	47.74
BOOM LH							
KBZ1-UP; MDT1-UP; MPG1-UP; NAS1-UP; PBD1-UP; TXA1-UP							
2742689			P-UB-10	90 mm	125 mm	CTC-2835988	871.88
2742689			Bushing	90 mm		CTC-1052575	33.48
BOOM RH							
KBZ1-UP; MDT1-UP; MPG1-UP; NAS1-UP; PBD1-UP; TXA1-UP							
2742690			P-UB-10	90 mm	125 mm	CTC-2835988	871.88
2742690			Bushing	90 mm		CTC-1052575	33.48
BUCKET							
KBZ1-UP; MDT1-UP; MPG1-UP; NAS1-UP; PBD1-UP; TXA1-UP							
2426756			P-UB-10	85 mm	120 mm	CTC-2478888	141.82
2426756			Bushing	85 mm		CTC-0964402	34.71
KBZ1-UP; MPG1-UP; TXA1-UP							
3494134			P-UB-10	85 mm	120 mm	CTC-3500967	235.52
3494134			Bushing	85 mm		CTC-0964402	34.71
STICK							
KBZ1-UP; MDT1-UP; MPG1-UP; NAS1-UP; PBD1-UP; TXA1-UP							
2426734			P-UB-10	100 mm	140 mm	CTC-2478878	203.77
2426734			Bushing	100 mm		CTC-0965625	51.68

REPLACEMENT KITS FOR CATERPILLAR® EQUIPMENT

Excavators							
APPLICATION	CYL #	Misc-Parts, Instructions, etc.	CODE	ROD	BORE	KIT #	List \$
MODEL 322							
BOOM							
	1052571		P-UB-10	90 mm	130 mm	CTC-1052585	300.54
	1052588		P-UB-10	100 mm	140 mm	CTC-1270630	352.06
	711345		P-UB-10	90 mm	130 mm	CTC-711360	307.02
BUCKET							
	0875633		P-UB-10	85 mm	120 mm	CTC-0875394	267.83
	0875633		P-UB-10	85 mm	120 mm	CTC-1184131	258.61
	1052597		P-UB-10	85 mm	130 mm	CTC-1052601	448.55
	1185931		P-UB-10	85 mm	120 mm	CTC-1186023	275.65
	418840		P-UB-10	65 mm	100 mm	CTC-418914	211.54
	717291		P-UB-10	85 mm	130 mm	CTC-7Y5145	276.61
	7Y5100		P-UB-10	85 mm	130 mm	CTC-7Y5145	276.61
	7Y5150		P-UB-10	105 mm	150 mm	CTC-1163612	312.32
STICK							
	717341		P-UB-10	100 mm	140 mm	CTC-0875387	353.62
MODEL 322B, 322BL							
BOOM							
	1140636		P-UB-10	100 mm	140 mm	CTC-1184024	336.87
	1184069		P-UB-10	90 mm	130 mm	CTC-1373765	492.64
	1184070		P-UB-10	100 mm	140 mm	CTC-1373764	334.02
	1184166		P-UB-10	90 mm	130 mm	CTC-1184175	305.60
	1336869		P-UB-10	90 mm	130 mm	CTC-1540748	298.17
BUCKET							
	1183921		P-UB-10	105 mm	150 mm	CTC-1163612	312.32
	1183921		P-UB-10	105 mm	150 mm	CTC-1680758	361.22
	1184008		P-UB-10	90 mm	130 mm	CTC-1184175	305.60
	1184134		P-UB-10	85 mm	120 mm	CTC-1184131	258.61
	1232044		P-UB-10	90 mm	130 mm	CTC-1184175	305.60
	1232084		P-UB-10	90 mm	130 mm	CTC-1373768	455.90
	1232091		P-UB-10	90 mm	130 mm	CTC-1261887	442.65
	1251547		P-UB-10	65 mm	100 mm	CTC-418914	211.54
	1336810		P-UB-10	105 mm	150 mm	CTC-1289277	380.82
	1346987		P-UB-10	65 mm	100 mm	CTC-1764935	229.02
	1540756		P-UB-10	90 mm	130 mm	CTC-1540757	464.07
	411726		P-UB-10	110 mm	160 mm	CTC-0876654	332.19
	418840		P-UB-10	65 mm	100 mm	CTC-418914	211.54
STICK							
	1163638		P-UB-10	110 mm	170 mm	CTC-1680759	414.73
	1183953		P-UB-10	100 mm	140 mm	CTC-1373764	334.02
	1184000		P-UB-10	105 mm	150 mm	CTC-1163612	312.32
	1184000		P-UB-10	105 mm	150 mm	CTC-1680758	361.22
	1184176		P-UB-10	100 mm	140 mm	CTC-1184024	336.87
	1336771		P-UB-10	105 mm	150 mm	CTC-1373767	433.48
	7Y4650		P-UB-10	105 mm	150 mm	CTC-7Y4698	347.99
TILT CAB							
	N/A		P-UB-10	2-1/4	5	CTC-9X6392	165.61
UNSPECIFIED APPLICATION							
	1183967		P-UB-10	85 mm	120 mm	CTC-1261947	358.23
	1540743		P-UB-10	85 mm	120 mm	CTC-1540744	485.47
	1540747		P-UB-10	90 mm	130 mm	CTC-1540748	298.17

REPLACEMENT KITS FOR CATERPILLAR® EQUIPMENT

Excavators							
APPLICATION	CYL #	Misc-Parts, Instructions, etc.	CODE	ROD	BORE	KIT #	List \$
MODEL 322C							
BOOM							
BFK1-UP; BGR1-UP							
1772440			P-UB-10	90 mm	130 mm	CTC-2159986	129.44
1772440			Bushing	90 mm		CTC-1140758	42.75
6C9407			P-UB-10	100 mm	170 mm	CTC-2330763	232.61
6C9407			Bushing	100 mm		CTC-1140757	52.10
BKM1-UP; BLP1-UP							
1772440			P-UB-10	90 mm	130 mm	CTC-2159986	129.44
1772440			Bushing	90 mm		CTC-1140758	42.75
1915580			P-UB-10	90 mm	130 mm	CTC-2590625	165.41
1915580			Bushing	90 mm		CTC-1052575	33.48
2043619			P-UB-10	90 mm	130 mm	CTC-2590628	165.41
2043619			Bushing	90 mm		CTC-1052575	33.48
2590711			P-UB-10	90 mm	130 mm	CTC-2590712	167.14
2590711			Bushing	90 mm		CTC-1052575	33.48
2897878			P-UB-10	90 mm	130 mm	CTC-2897878K	165.96
2897878			Bushing	90 mm		CTC-1140758	42.75
BPH1-UP; CAM1-UP; LAR1-UP; MZH1-UP							
1772440			P-UB-10	90 mm	130 mm	CTC-1799772	213.98
1772440			Bushing	90 mm		CTC-1140758	42.75
2044910			P-UB-10	90 mm	130 mm	CTC-2044910K	142.32
2044910			Bushing	90 mm		CTC-1140758	42.75
2044912			P-UB-10	100 mm	140 mm	CTC-2044912K	182.40
2044912			Bushing	100 mm		CTC-1140757	52.10
C3R1-UP; CBY1-UP							
1756855			P-UB-10	100 mm	140 mm	CTC-1756855K	183.88
1756855			Bushing	100 mm		CTC-1140757	52.10
DAA1-UP; FED1-UP							
2742525			P-UB-10	90 mm	130 mm	CTC-2742526	129.23
2742525			Bushing	90 mm		CTC-1140758	42.75
BUCKET							
BFK1-UP; BGR1-UP; BKM1-UP; BLP1-UP							
1772446			P-UB-10	90 mm	130 mm	CTC-2159986	129.44
1772446			Bushing	90 mm		CTC-1140758	42.75
1772465			P-UB-10	105 mm	150 mm	CTC-1915619	167.89
1772465			Bushing	105 mm		CTC-1140760	56.77
2478853			P-UB-10	105 mm	150 mm	CTC-1915619	167.89
2478853			Bushing	105 mm		CTC-1140760	56.77
BKM1-UP							
1346987			P-UB-10	65 mm	100 mm	CTC-1764935	229.02
1346987			Bushing	65 mm		CTC-1140754	25.67
2043689			P-UB-10	85 mm	120 mm	CTC-2479001	153.39
2043689			Bushing	85 mm		CTC-0964402	34.71

REPLACEMENT KITS FOR CATERPILLAR® EQUIPMENT

Excavators							
APPLICATION	CYL #	Misc-Parts, Instructions, etc.	CODE	ROD	BORE	KIT #	List \$
MODEL 322C							
BUCKET							
BKM1-UP; BLP1-UP							
1772453			P-UB-10	90 mm	130 mm	CTC-1261887	442.65
1772453			Bushing	90 mm		CTC-1052575	33.48
1850346			P-UB-10	85 mm	120 mm	CTC-1540744	485.47
1850346			Bushing	85 mm		CTC-0964402	34.71
1915584			P-UB-10	90 mm	130 mm	CTC-2590626	145.21
1915584			Bushing	90 mm		CTC-1052575	33.48
2043621			P-UB-10	90 mm	130 mm	CTC-2590627	145.21
2043621			Bushing	90 mm		CTC-1052575	33.48
2043696			P-UB-10	85 mm	120 mm	CTC-2479000	153.39
2043696			Bushing	85 mm		CTC-0964402	34.71
2590705			P-UB-10	85 mm	120 mm	CTC-2590706	153.39
2590705			Bushing	85 mm		CTC-0964402	34.71
2590718			P-UB-10	90 mm	130 mm	CTC-2590719	146.95
2590718			Bushing	90 mm		CTC-1052575	33.48
2590746			P-UB-10	105 mm	150 mm	CTC-2590743	129.60
2590746			Bushing	105 mm		CTC-1140760	56.77
2897887			P-UB-10	90 mm	130 mm	CTC-2159986	129.44
2897887			Bushing	90 mm		CTC-1140758	42.75
BKM243-UP; BLP180-UP							
2043617			P-UB-10	85 mm	120 mm	CTC-2043627	144.74
2043617			Bushing	85 mm		CTC-0964402	34.71
BPH1-UP; CAM1-UP; LAR1-UP; MZH1-UP							
2044914			P-UB-10	90 mm	130 mm	CTC-2044914K	117.50
2044914			Bushing	90 mm		CTC-1140758	42.75
C3R1-296; CBY1-UP							
1232044			P-UB-10	90 mm	130 mm	CTC-1764914	146.86
1232044			Bushing	90 mm		CTC-1140758	42.75
C3R297-UP							
1799764			P-UB-10	90 mm	130 mm	CTC-1799764K	129.44
1799764			Bushing	90 mm		CTC-1140758	42.75
DAA1-UP; FED1-UP							
2742521			P-UB-10	85 mm	120 mm	CTC-2742511	121.82
2742521			Bushing	85 mm		CTC-1140756	37.06
2742532			P-UB-10	90 mm	130 mm	CTC-2742526	129.23
2742532			Bushing	90 mm		CTC-1140758	42.75
CAB TILT							
BPH1-UP; C3R1001-UP; CAM1-UP; LAR1001-UP; LAR1-UP; MZH1-UP							
1175148			P-UB-10	2-1/4	5	CTC-2417578	65.89
2632914			P-UB-10	2-1/4	5	CTC-2417578	65.89
GRAPPLE							
CBY1-UP							
1504569			P-UB-10	2-1/2	4	CTC-1533724	221.45
STICK							
BFK1-UP; BGR1-UP; BKM1-UP; BLP1-UP							
1772443			P-UB-10	100 mm	140 mm	CTC-2159985	126.80
1772443			Bushing	100 mm		CTC-1140757	52.10
BKM1-UP							
1169123			P-UB-10	105 mm	150 mm	CTC-1997416	213.42
1169123			Bushing	105 mm		CTC-1140760	56.77

REPLACEMENT KITS FOR CATERPILLAR® EQUIPMENT

Excavators							
APPLICATION	CYL #	Misc-Parts, Instructions, etc.	CODE	ROD	BORE	KIT #	List \$
MODEL 322C							
STICK							
BKM1-UP; BLP1-UP							
1915582			P-UB-10	100 mm	140 mm	CTC-2590631	159.52
1915582			Bushing	100 mm		CTC-0965625	51.68
2043620			P-UB-10	100 mm	140 mm	CTC-2590633	159.52
2043620			Bushing	100 mm		CTC-0965625	51.68
2590715			P-UB-10	100 mm	140 mm	CTC-2590699	159.52
2590715			Bushing	100 mm		CTC-0965625	51.68
BPH1-UP; CAM1-UP; LAR1-UP; MZH1-UP							
1772443			P-UB-10	100 mm	140 mm	CTC-1589093	126.80
C3R1-UP; CBY1-UP							
1336771			P-UB-10	105 mm	150 mm	CTC-1373767	433.48
1336771			Bushing	105 mm		CTC-0995572	44.45
1433201			P-UB-10	110 mm	170 mm	CTC-1433201K	248.80
1433201			Bushing	110 mm		CTC-1140761	90.27
CBY1-UP							
1163638			P-UB-10	110 mm	170 mm	CTC-1680759	414.73
1163638			Bushing	110 mm		CTC-1140761	90.27
DAA1-UP; FED1-UP							
2742529			P-UB-10	100 mm	140 mm	CTC-2742515	175.30
2742529			Bushing	100 mm		CTC-1140757	52.10
2897884			P-UB-10	100 mm	140 mm	CTC-2478792	191.79
2897884			Bushing	100 mm		CTC-1140757	52.10
MODEL 322C FM LGP							
BOOM							
BYL1-UP							
1756855			P-UB-10	100 mm	140 mm	CTC-1756855K	183.88
1756855			Bushing	100 mm		CTC-1140757	52.10
1772440			P-UB-10	90 mm	130 mm	CTC-1799772	213.98
1772440			Bushing	90 mm		CTC-1140758	42.75
BUCKET							
BYL1-UP							
1799764			P-UB-10	90 mm	130 mm	CTC-1799764K	129.44
1799764			Bushing	90 mm		CTC-1140758	42.75
CAB TILT							
BYL1001-UP							
2632914		O-ring kit. 2 per application.	O-ring Kit			CTC-1143616	6.35
2632914			P-UB-10	2-1/4	5	CTC-2417578	65.89
BYL1-UP							
1175148		O-ring kit. 2 per application.	O-ring Kit			CTC-1143616	6.35
1175148			P-UB-10	2-1/4	5	CTC-2417578	65.89
STICK							
BYL1-UP							
1336771			P-UB-10	105 mm	150 mm	CTC-1373767	433.48
1336771			Bushing	105 mm		CTC-0995572	44.45
1913118			P-UB-10	110 mm	170 mm	CTC-1913171	248.80
1913118			Bushing	110 mm		CTC-1140761	90.27
MODEL 322C L							
BOOM							
BKJ1-UP							
1772440			P-UB-10	90 mm	130 mm	CTC-1799772	213.98
1772440			Bushing	90 mm		CTC-1140758	42.75
2044910			P-UB-10	90 mm	130 mm	CTC-2044910K	142.32
2044910			Bushing	90 mm		CTC-1140758	42.75
2044912			P-UB-10	100 mm	140 mm	CTC-2044912K	182.40
2044912			Bushing	100 mm		CTC-1140757	52.10

REPLACEMENT KITS FOR CATERPILLAR® EQUIPMENT

Excavators							
APPLICATION	CYL #	Misc-Parts, Instructions, etc.	CODE	ROD	BORE	KIT #	List \$
MODEL 322C L							
BOOM							
BKM1-UP; BLP1-UP							
1772440			P-UB-10	90 mm	130 mm	CTC-2159986	129.44
1772440			Bushing	90 mm		CTC-1140758	42.75
1915580			P-UB-10	90 mm	130 mm	CTC-2590625	165.41
1915580			Bushing	90 mm		CTC-1052575	33.48
2043619			P-UB-10	90 mm	130 mm	CTC-2590628	165.41
2043619			Bushing	90 mm		CTC-1052575	33.48
2590711			P-UB-10	90 mm	130 mm	CTC-2590712	167.14
2590711			Bushing	90 mm		CTC-1052575	33.48
2897878			P-UB-10	90 mm	130 mm	CTC-2897878K	165.96
2897878			Bushing	90 mm		CTC-1140758	42.75
DAA1-UP; FED1-UP							
2742525			P-UB-10	90 mm	130 mm	CTC-2742526	129.23
2742525			Bushing	90 mm		CTC-1140758	42.75
EMR1-UP; MAR1-UP							
1772440			P-UB-10	90 mm	130 mm	CTC-2159986	129.44
1772440			Bushing	90 mm		CTC-1140758	42.75
2113069			P-UB-10	100 mm	170 mm	CTC-2519341	273.82
2113069			Bushing	100 mm		CTC-1140757	52.10
BUCKET							
BKJ1-UP							
1589061			P-U-10	85 mm	120 mm	CTC-2366389	113.40
1589061			Bushing	85 mm		CTC-1140756	37.06
2044914			P-UB-10	90 mm	130 mm	CTC-2044914K	117.50
2044914			Bushing	90 mm		CTC-1140758	42.75
BKJ1-UP; BKM1-UP							
1346987			P-UB-10	65 mm	100 mm	CTC-1764935	229.02
1346987			Bushing	65 mm		CTC-1140754	25.67
BKJ1-UP; BKM1-UP; BLP1-UP; EMR1-UP; MAR1-UP							
1772446			P-UB-10	90 mm	130 mm	CTC-2159986	129.44
1772446			Bushing	90 mm		CTC-1140758	42.75
1772465			P-UB-10	105 mm	150 mm	CTC-1915619	167.89
1772465			Bushing	105 mm		CTC-1140760	56.77
BKM1-UP							
2043689			P-UB-10	85 mm	120 mm	CTC-2479001	153.39
2043689			Bushing	85 mm		CTC-0964402	34.71
BKM1-UP; BLP1-UP							
1772453			P-UB-10	90 mm	130 mm	CTC-1261887	442.65
1772453			Bushing	90 mm		CTC-1052575	33.48
1850346			P-UB-10	85 mm	120 mm	CTC-1540744	485.47
1850346			Bushing	85 mm		CTC-0964402	34.71
1915584			P-UB-10	90 mm	130 mm	CTC-2590626	145.21
1915584			Bushing	90 mm		CTC-1052575	33.48
2043621			P-UB-10	90 mm	130 mm	CTC-2590627	145.21
2043621			Bushing	90 mm		CTC-1052575	33.48
2043696			P-UB-10	85 mm	120 mm	CTC-2479000	153.39
2043696			Bushing	85 mm		CTC-0964402	34.71
2590705			P-UB-10	85 mm	120 mm	CTC-2590706	153.39
2590705			Bushing	85 mm		CTC-0964402	34.71
2590718			P-UB-10	90 mm	130 mm	CTC-2590719	146.95
2590718			Bushing	90 mm		CTC-1052575	33.48
2590746			P-UB-10	105 mm	150 mm	CTC-2590743	129.60
2590746			Bushing	105 mm		CTC-1140760	56.77
2897887			P-UB-10	90 mm	130 mm	CTC-2159986	129.44
2897887			Bushing	90 mm		CTC-1140758	42.75

REPLACEMENT KITS FOR CATERPILLAR® EQUIPMENT

Excavators							
APPLICATION	CYL #	Misc-Parts, Instructions, etc.	CODE	ROD	BORE	KIT #	List \$
MODEL 322C L							
BUCKET							
BKM1-UP; BLP1-UP; EMR1-UP; MAR1-UP							
2478853			P-UB-10	105 mm	150 mm	CTC-1915619	167.89
2478853			Bushing	105 mm		CTC-1140760	56.77
BKM243-UP; BLP180-UP							
2043617			P-UB-10	85 mm	120 mm	CTC-2043627	144.74
2043617			Bushing	85 mm		CTC-0964402	34.71
DAA1-UP; FED1-UP							
2742521			P-UB-10	85 mm	120 mm	CTC-2742511	121.82
2742521			Bushing	85 mm		CTC-1140756	37.06
2742532			P-UB-10	90 mm	130 mm	CTC-2742526	129.23
2742532			Bushing	90 mm		CTC-1140758	42.75
HEK1-UP							
1709808			P-UB-10	65 mm	100 mm	CTC-1709941	134.27
1709808			Bushing	65 mm		CTC-1140754	25.67
STICK							
BKJ1-UP							
1169123			P-UB-10	105 mm	150 mm	CTC-1169123K	194.86
1169123			Bushing	105 mm		CTC-1140760	56.77
1772443			P-UB-10	100 mm	140 mm	CTC-1589093	126.80
BKM1-UP							
1169123			P-UB-10	105 mm	150 mm	CTC-1997416	213.42
1169123			Bushing	105 mm		CTC-1140760	56.77
BKM1-UP; BLP1-UP							
1915582			P-UB-10	100 mm	140 mm	CTC-2590631	159.52
1915582			Bushing	100 mm		CTC-0965625	51.68
2043620			P-UB-10	100 mm	140 mm	CTC-2590633	159.52
2043620			Bushing	100 mm		CTC-0965625	51.68
2590715			P-UB-10	100 mm	140 mm	CTC-2590699	159.52
2590715			Bushing	100 mm		CTC-0965625	51.68
BKM1-UP; BLP1-UP; EMR1-UP; MAR1-UP							
1772443			P-UB-10	100 mm	140 mm	CTC-2159985	126.80
1772443			Bushing	100 mm		CTC-1140757	52.10
DAA1-UP; EMR1-UP; FED1-UP; MAR1-UP							
2897884			P-UB-10	100 mm	140 mm	CTC-2478792	191.79
2897884			Bushing	100 mm		CTC-1140757	52.10
DAA1-UP; FED1-UP							
2742529			P-UB-10	100 mm	140 mm	CTC-2742515	175.30
2742529			Bushing	100 mm		CTC-1140757	52.10
HEK1-UP							
2166607			P-UB-10	105 mm	150 mm	CTC-1915619	167.89
2166607			Bushing	105 mm		CTC-1140760	56.77
MODEL 322C LN							
BOOM							
BFK1-UP; BGR1-UP							
6C9407			P-UB-10	100 mm	170 mm	CTC-2330763	232.61
6C9407			Bushing	100 mm		CTC-1140757	52.10
BFK1-UP; BGR1-UP; EMR1-UP; MAR1-UP							
1772440			P-UB-10	90 mm	130 mm	CTC-2159986	129.44
1772440			Bushing	90 mm		CTC-1140758	42.75
EMR1-UP; MAR1-UP							
2113069			P-UB-10	100 mm	170 mm	CTC-2519341	273.82
2113069			Bushing	100 mm		CTC-1140757	52.10

REPLACEMENT KITS FOR CATERPILLAR® EQUIPMENT

Excavators							
APPLICATION	CYL #	Misc-Parts, Instructions, etc.	CODE	ROD	BORE	KIT #	List \$
MODEL 322C LN							
BUCKET							
BFK1-UP; BGR1-UP; EMR1-UP; MAR1-UP							
1772446			P-UB-10	90 mm	130 mm	CTC-2159986	129.44
1772446			Bushing	90 mm		CTC-1140758	42.75
1772465			P-UB-10	105 mm	150 mm	CTC-1915619	167.89
1772465			Bushing	105 mm		CTC-1140760	56.77
2478853			P-UB-10	105 mm	150 mm	CTC-1915619	167.89
2478853			Bushing	105 mm		CTC-1140760	56.77
STICK							
BFK1-UP; BGR1-UP; EMR1-UP; MAR1-UP							
1772443			P-UB-10	100 mm	140 mm	CTC-2159985	126.80
1772443			Bushing	100 mm		CTC-1140757	52.10
EMR1-UP; MAR1-UP							
2897884			P-UB-10	100 mm	140 mm	CTC-2478792	191.79
2897884			Bushing	100 mm		CTC-1140757	52.10
MODEL 322L							
BOOM							
1052571			P-UB-10	90 mm	130 mm	CTC-1052585	300.54
1052588			P-UB-10	100 mm	140 mm	CTC-1270630	352.06
711345			P-UB-10	90 mm	130 mm	CTC-711360	307.02
BUCKET							
1052597			P-UB-10	85 mm	130 mm	CTC-1052601	448.55
717291			P-UB-10	85 mm	130 mm	CTC-7Y5145	276.61
7Y5100			P-UB-10	85 mm	130 mm	CTC-7Y5145	276.61
7Y5150			P-UB-10	105 mm	150 mm	CTC-1163612	312.32
875633			P-UB-10	85 mm	120 mm	CTC-0875394	267.83
STICK							
717341			P-UB-10	100 mm	140 mm	CTC-0875387	353.62
MODEL 322N							
BOOM							
711345			P-UB-10	90 mm	130 mm	CTC-711360	307.02
BUCKET							
717291			P-UB-10	85 mm	130 mm	CTC-7Y5145	276.61
7Y5100			P-UB-10	85 mm	130 mm	CTC-7Y5145	276.61
7Y5150			P-UB-10	105 mm	150 mm	CTC-1163612	312.32
STICK							
717341			P-UB-10	100 mm	140 mm	CTC-0875387	353.62
MODEL 324D L							
BOOM							
BTK1-UP; JJG1-UP; LAB1-UP; PYT1-UP; SYM1-UP							
2897957			P-UB-10	95 mm	135 mm	CTC-2344488	277.99
2897957			Bushing	95 mm		CTC-1289260	44.36
DFP1-UP; JAT1-UP							
2667981			P-UB-10	95 mm	135 mm	CTC-2668013	177.00
2667981			Bushing	95 mm		CTC-0964430	37.71
2667981			Link Pin Seal	90 mm		CTC-1661495	34.95
2667981			Link Pin Seal	90 mm		CTC-7X4803	34.95
DFP1-UP; JAT1-UP; PYT1-UP							
2426858			P-UB-10	95 mm	135 mm	CTC-2590665	177.00
2426858			Bushing	95 mm		CTC-0964430	37.71
2426858			Link Pin Seal	90 mm		CTC-1661495	34.95
2426858			Link Pin Seal	90 mm		CTC-7X4803	34.95
2426862			P-UB-10	100 mm	140 mm	CTC-2478974	203.77
2426862			Bushing	100 mm		CTC-0965625	51.68

REPLACEMENT KITS FOR CATERPILLAR® EQUIPMENT

Excavators							
APPLICATION	CYL #	Misc-Parts, Instructions, etc.	CODE	ROD	BORE	KIT #	List \$
MODEL 324D L							
BOOM							
DFP1-UP; JAT1-UP; PYT1-UP; TSN1-UP							
2426867			P-UB-10	95 mm	135 mm	CTC-2590774	171.85
2426867			Bushing	95 mm		CTC-0964430	37.71
2426867			Link Pin Seal	90 mm		CTC-1661495	34.95
2426867			Link Pin Seal	90 mm		CTC-7X4803	34.95
JYG1-UP; LAB1-UP; SYM1-UP							
2426849			P-UB-10	95 mm	135 mm	CTC-2344488	277.99
2426849			Bushing	95 mm		CTC-1289260	44.36
BUCKET							
BTK1-UP; JYG1-UP; LAB1-UP; PYT1-UP; SYM1-UP							
2897975			P-UB-10	90 mm	130 mm	CTC-2159986	129.44
2897975			Bushing	90 mm		CTC-1140758	42.75
3154451			P-UB-10	105 mm	150 mm	CTC-1915619	167.89
3154451			Bushing	105 mm		CTC-1140760	56.77
DFP1-UP							
3494134			P-UB-10	85 mm	120 mm	CTC-3500967	235.52
3494134			Bushing	85 mm		CTC-0964402	34.71
DFP1-UP; JAT1-UP							
2667985			P-UB-10	90 mm	130 mm	CTC-2668014	459.33
2667985			Bushing	90 mm		CTC-1052575	33.48
2897699			P-UB-10	70 mm	100 mm	CTC-2836179	201.03
2897699			Bushing	70 mm		CTC-1140753	29.52
DFP1-UP; JAT1-UP; PYT1-UP							
2426756			P-UB-10	85 mm	120 mm	CTC-2478888	141.82
2426756			Bushing	85 mm		CTC-0964402	34.71
2426759			P-UB-10	85 mm	120 mm	CTC-2667892	141.82
2426759			Bushing	85 mm		CTC-0964402	34.71
2426864			P-UB-10	90 mm	130 mm	CTC-2590678	134.76
2426864			Bushing	90 mm		CTC-1052575	33.48
DFP1-UP; JAT1-UP; PYT1-UP; SYM1-UP							
3154442			P-UB-10	105 mm	150 mm	CTC-1915619	167.89
3154442			Bushing	105 mm		CTC-1140760	56.77
DFP1-UP; JAT1-UP; PYT1-UP; TSN1-UP							
2426871			P-UB-10	90 mm	130 mm	CTC-2590776	314.86
2426871			Bushing	90 mm		CTC-1052575	33.48
3154449			P-UB-10	105 mm	150 mm	CTC-2502475	140.84
3154449			Bushing	105 mm		CTC-1140760	56.77
DFP1-UP; JYG1-UP							
2487855			P-UB-10	65 mm	100 mm	CTC-1709941	134.27
2487855			Bushing	65 mm		CTC-1140754	25.67
2836118			P-UB-10	65 mm	100 mm	CTC-1709941	134.27
2836118			Bushing	65 mm		CTC-1140754	25.67
JYG1-UP							
2426767			P-UB-10	85 mm	120 mm	CTC-2478790	113.40
2426767			Bushing	85 mm		CTC-1140756	37.06
JYG1-UP; LAB1-UP; SYM1-UP							
2426855			P-UB-10	90 mm	130 mm	CTC-2426855K	119.61
2426855			Bushing	90 mm		CTC-1140758	42.75
2898012			P-UB-10	105 mm	150 mm	CTC-1915619	167.89
2898012			Bushing	105 mm		CTC-1140760	56.77
JYG1-UP; PYT1-UP							
2897948			P-UB-10	85 mm	120 mm	CTC-2478790	113.40
2897948			Bushing	85 mm		CTC-1140756	37.06

REPLACEMENT KITS FOR CATERPILLAR® EQUIPMENT

Excavators							
APPLICATION	CYL #	Misc-Parts, Instructions, etc.	CODE	ROD	BORE	KIT #	List \$
MODEL 324D L							
BUCKET							
JJG1-UP; SYM1-UP							
2254581			P-UB-10	105 mm	150 mm	CTC-1915619	167.89
2254581			Bushing	105 mm		CTC-1140760	56.77
PYT1-UP							
2898086			P-UB-10	70 mm	100 mm	CTC-2836179	201.03
2898086			Bushing	70 mm		CTC-1140753	29.52
CAB RISER							
DFP1-UP							
2358287			P-UB-14	60 mm	90 mm	CTC-1697827	213.97
2358287			Bushing	60 mm		CTC-1140751	24.20
COUPLER							
BTK1-UP; SYM1-UP							
1690753			P-U-5	40 mm	70 mm	CTC-2191322	35.74
SYM1-UP							
1690329			I-U-5	40 mm	60 mm	CTC-2027897	42.80
FORE BOOM							
SYM1-UP							
2798111			P-UB-10	100 mm	170 mm	CTC-2519341	273.82
2798111			Bushing	100 mm		CTC-1140757	52.10
STICK							
BTK1-UP; JJG270-UP; LAB1-UP; SYM1-UP							
2897967			P-UB-10	100 mm	140 mm	CTC-2478792	191.79
2897967			Bushing	100 mm		CTC-1140757	52.10
DFP1-UP; JAT1-UP							
2667983			P-UB-10	100 mm	140 mm	CTC-2668012	203.77
2667983			Bushing	100 mm		CTC-0965625	51.68
DFP1-UP; JAT1-UP; JJG1-UP; PYT-UP							
2166607			P-UB-10	105 mm	150 mm	CTC-1915619	167.89
2166607			Bushing	105 mm		CTC-1140760	56.77
DFP1-UP; JAT1-UP; PYT1-UP							
2426860			P-UB-10	100 mm	140 mm	CTC-2478878	203.77
2426860			Bushing	100 mm		CTC-0965625	51.68
DFP1-UP; JAT1-UP; PYT1-UP; TSN1-UP							
2426869			P-UB-10	100 mm	140 mm	CTC-2590775	203.77
2426869			Bushing	100 mm		CTC-0965625	51.68
JJG1-UP; LAB1-UP; SYM1-UP							
2426852			P-UB-10	100 mm	140 mm	CTC-2478792	191.79
2426852			Bushing	100 mm		CTC-1140757	52.10
MODEL 325							
BOOM							
7Y4601			P-UB-10	95 mm	130 mm	CTC-7Y5147	309.35
BUCKET							
0875491			P-UB-10	85 mm	120 mm	CTC-4I3665	323.97
0875633			P-UB-10	85 mm	120 mm	CTC-0875394	267.83
0875633			P-UB-10	85 mm	120 mm	CTC-1184131	258.61
1072614			P-UB-10	85 mm	130 mm	CTC-7Y5145	276.61
1346987			P-UB-10	65 mm	100 mm	CTC-1764935	229.02
4I7652			P-UB-10	65 mm	100 mm	CTC-4I7664	211.63
4I8840			P-UB-10	65 mm	100 mm	CTC-4I8914	211.54
7I7291			P-UB-10	85 mm	130 mm	CTC-7Y5145	276.61
7Y5100			P-UB-10	85 mm	130 mm	CTC-7Y5145	276.61
7Y5150			P-UB-10	105 mm	150 mm	CTC-1163612	312.32
STICK							
7Y4650			P-UB-10	105 mm	150 mm	CTC-1163612	312.32
7Y4926			P-UB-10	110 mm	170 mm	CTC-1163649	389.77

REPLACEMENT KITS FOR CATERPILLAR® EQUIPMENT

Excavators							
APPLICATION	CYL #	Misc-Parts, Instructions, etc.	CODE	ROD	BORE	KIT #	List \$
MODEL 325B, 325BL							
BOOM							
	1077040		P-UB-10	100 mm	140 mm	CTC-1373766	320.64
	1140636		P-UB-10	100 mm	140 mm	CTC-1184024	336.87
	1169123		P-UB-10	105 mm	150 mm	CTC-1163612	312.32
	1232081		P-UB-10	105 mm	150 mm	CTC-1373767	433.48
	1540760		P-UB-10	100 mm	140 mm	CTC-1540761	395.63
BUCKET							
	1183921		P-UB-10	105 mm	150 mm	CTC-1163612	312.32
	1183921		P-UB-10	105 mm	150 mm	CTC-1680758	361.22
	1184134		P-UB-10	85 mm	120 mm	CTC-1184131	258.61
	1232044		P-UB-10	90 mm	130 mm	CTC-1184175	305.60
	1232044	325BL Only	P-UB-10	90 mm	130 mm	CTC-1764914	146.86
	1232084		P-UB-10	90 mm	130 mm	CTC-1373768	455.90
	1336810		P-UB-10	105 mm	150 mm	CTC-1289277	380.82
	1497610		P-UB-10	90 mm	130 mm	CTC-1184175	305.60
	1540756		P-UB-10	90 mm	130 mm	CTC-1540757	464.07
	1540772		P-UB-10	90 mm	130 mm	CTC-1540773	463.76
	411726		P-UB-10	110 mm	160 mm	CTC-0876654	332.19
	417652		P-UB-10	65 mm	100 mm	CTC-417664	211.63
	418840		P-UB-10	65 mm	100 mm	CTC-418914	211.54
STICK							
	0875375		P-UB-10	130 mm	180 mm	CTC-0875407	412.06
	1163638		P-UB-10	110 mm	170 mm	CTC-1680759	414.73
	1184000		P-UB-10	105 mm	150 mm	CTC-1163612	312.32
	1184000		P-UB-10	105 mm	150 mm	CTC-1680758	361.22
	1232081		P-UB-10	105 mm	150 mm	CTC-1373767	433.48
	1479427		P-UB-10	105 mm	150 mm	CTC-1680758	361.22
	1540765		P-UB-10	105 mm	150 mm	CTC-1540766	406.18
	7Y4650		P-UB-10	105 mm	150 mm	CTC-7Y4698	347.99
MODEL 325C							
BOOM							
AMH1-UP; BKW1-UP; BMM1-UP; BTD1-UP							
	2096006		P-UB-10	100 mm	140 mm	CTC-2590634	156.55
	2096006		Bushing	100 mm		CTC-0965625	51.68
BKW1-UP; BMM1-UP							
	1799789		P-UB-10	100 mm	140 mm	CTC-1336823	332.37
	1799789		Bushing	100 mm		CTC-0965625	51.68
	1915587		P-UB-10	100 mm	140 mm	CTC-2590632	156.55
	1915587		Bushing	100 mm		CTC-0965625	51.68
	2590724		P-UB-10	100 mm	140 mm	CTC-2590725	156.55
	2590724		Bushing	100 mm		CTC-0965625	51.68
JLC1-UP							
	2033906		P-UB-10	105 mm	150 mm	CTC-1915619	167.89
	2033906		Bushing	105 mm		CTC-1140760	56.77
JLC1-UP; JLD1-UP							
	1799782		P-UB-10	100 mm	140 mm	CTC-2159985	126.80
	1799782		Bushing	100 mm		CTC-1140757	52.10
	1915548		P-UB-10	105 mm	150 mm	CTC-1915619	167.89
	1915548		Bushing	105 mm		CTC-1140760	56.77
	2113069		P-UB-10	100 mm	170 mm	CTC-2519341	273.82
	2113069		Bushing	100 mm		CTC-1140757	52.10
	2502419		P-UB-10	105 mm	150 mm	CTC-2426840	181.64
	2502419		Bushing	105 mm		CTC-1140760	56.77

REPLACEMENT KITS FOR CATERPILLAR® EQUIPMENT

Excavators							
APPLICATION	CYL #	Misc-Parts, Instructions, etc.	CODE	ROD	BORE	KIT #	List \$
MODEL 325C							
BUCKET							
AMH1-UP; BKW1-UP; BMM1-UP; BTD1-UP							
2096011			P-UB-10	90 mm	130 mm	CTC-2590627	145.21
2096011			Bushing	90 mm		CTC-1052575	33.48
AMH1-UP; BTD1-UP; JLC1-UP; JLD1-UP							
1772465			P-UB-10	105 mm	150 mm	CTC-1915619	167.89
1772465			Bushing	105 mm		CTC-1140760	56.77
2478853			P-UB-10	105 mm	150 mm	CTC-1915619	167.89
2478853			Bushing	105 mm		CTC-1140760	56.77
BKW1-UP; BMM1-UP							
1799793			P-UB-10	90 mm	130 mm	CTC-2590626	145.21
1799793			Bushing	90 mm		CTC-1052575	33.48
1948276			P-UB-10	105 mm	150 mm	CTC-2003315	167.89
1948276			Bushing	105 mm		CTC-1140760	56.77
2478854			P-UB-10	105 mm	150 mm	CTC-2502475	140.84
2478854			Bushing	105 mm		CTC-1140760	56.77
2590732			P-UB-10	90 mm	130 mm	CTC-2590719	146.95
2590732			Bushing	90 mm		CTC-1052575	33.48
JLC1-UP							
2201532			P-UB-10	100 mm	140 mm	CTC-2159985	126.80
2201532			Bushing	100 mm		CTC-1140757	52.10
JLC1-UP; JLD1-UP							
1799764			P-UB-10	90 mm	130 mm	CTC-2159986	129.44
1799764			Bushing	90 mm		CTC-1140758	42.75
STICK							
AMH1-UP; BKW1-UP; BMM1-UP; BTD1-UP							
1799791			P-UB-10	105 mm	150 mm	CTC-1799791K	351.86
1799791			Bushing	105 mm		CTC-0995572	44.45
2096008			P-UB-10	105 mm	150 mm	CTC-2590637	356.05
2096008			Bushing	105 mm		CTC-0995572	44.45
BKW1-UP; BMM1-UP							
1915589			P-UB-10	105 mm	150 mm	CTC-2590636	356.05
1915589			Bushing	105 mm		CTC-0995572	44.45
2590728			P-UB-10	105 mm	150 mm	CTC-2590729	356.05
2590728			Bushing	105 mm		CTC-0995572	44.45
JLC1-UP							
2044907			P-UB-10	95 mm	160 mm	CTC-2521191	202.13
2044907			Bushing	95 mm		CTC-6C6093	47.74
JLC1-UP; JLD1-UP							
1799785	Type 1		P-UB-10	105 mm	150 mm	CTC-1915619	167.89
1799785	Type 2		P-UB-10	105 mm	150 mm	CTC-2426840	181.64
1799785	Type 1 and Type 2		Bushing	105 mm		CTC-1140760	56.77
1915551			P-UB-10	115 mm	170 mm	CTC-2316844	328.85
MODEL 325C L							
BOOM							
AMH1-UP; BKW1-UP; BMM1-UP; BTD1-UP							
2096006			P-UB-10	100 mm	140 mm	CTC-2590634	156.55
2096006			Bushing	100 mm		CTC-0965625	51.68
BFE1-UP; CRB1-UP; CSJ1-UP; JLC1-UP; JLD1-UP							
1799782			P-UB-10	100 mm	140 mm	CTC-2159985	126.80
1799782			Bushing	100 mm		CTC-1140757	52.10

REPLACEMENT KITS FOR CATERPILLAR® EQUIPMENT

Excavators							
APPLICATION	CYL #	Misc-Parts, Instructions, etc.	CODE	ROD	BORE	KIT #	List \$
MODEL 325C L							
BOOM							
BKW1-UP; BMM1-UP							
1799789			P-UB-10	100 mm	140 mm	CTC-1336823	332.37
1799789			Bushing	100 mm		CTC-0965625	51.68
1915587			P-UB-10	100 mm	140 mm	CTC-2590632	156.55
1915587			Bushing	100 mm		CTC-0965625	51.68
2590724			P-UB-10	100 mm	140 mm	CTC-2590725	156.55
2590724			Bushing	100 mm		CTC-0965625	51.68
CRB1-UP; CSJ1-UP; JLC1-UP; JLD1-UP							
2113069			P-UB-10	100 mm	170 mm	CTC-2519341	273.82
2113069			Bushing	100 mm		CTC-1140757	52.10
JLC1-UP							
2033906			P-UB-10	105 mm	150 mm	CTC-1915619	167.89
2033906			Bushing	105 mm		CTC-1140760	56.77
JLC1-UP; JLD1-UP							
1915548			P-UB-10	105 mm	150 mm	CTC-1915619	167.89
1915548			Bushing	105 mm		CTC-1140760	56.77
2502419			P-UB-10	105 mm	150 mm	CTC-2426840	181.64
2502419			Bushing	105 mm		CTC-1140760	56.77
BUCKET							
AMH1-UP; BFE1-UP; BTD1-UP; CRB1-UP; CSJ1-UP; JLC1-UP; JLD1-UP							
1772465			P-UB-10	105 mm	150 mm	CTC-1915619	167.89
1772465			Bushing	105 mm		CTC-1140760	56.77
AMH1-UP; BKW1-UP; BMM1-UP; BTD1-UP							
2096011			P-UB-10	90 mm	130 mm	CTC-2590627	145.21
2096011			Bushing	90 mm		CTC-1052575	33.48
AMH1-UP; BTD1-UP; CRB1-UP; CSJ1-UP; JLC1-UP; JLD1-UP							
2478853			P-UB-10	105 mm	150 mm	CTC-1915619	167.89
2478853			Bushing	105 mm		CTC-1140760	56.77
BFE1-UP							
1589061			P-U-10	85 mm	120 mm	CTC-2366389	113.40
1589061			Bushing	85 mm		CTC-1140756	37.06
1799764			P-UB-10	90 mm	130 mm	CTC-1799764K	129.44
1799764			Bushing	90 mm		CTC-1140758	42.75
BKW1-UP; BMM1-UP							
1799793			P-UB-10	90 mm	130 mm	CTC-2590626	145.21
1799793			Bushing	90 mm		CTC-1052575	33.48
1948276			P-UB-10	105 mm	150 mm	CTC-2003315	167.89
1948276			Bushing	105 mm		CTC-1140760	56.77
2478854			P-UB-10	105 mm	150 mm	CTC-2502475	140.84
2478854			Bushing	105 mm		CTC-1140760	56.77
2590732			P-UB-10	90 mm	130 mm	CTC-2590719	146.95
2590732			Bushing	90 mm		CTC-1052575	33.48
CRB1-UP							
1709808			P-UB-10	65 mm	100 mm	CTC-1709941	134.27
1709808			Bushing	65 mm		CTC-1140754	25.67
2959396			P-UB-10	65 mm	100 mm	CTC-1709941	134.27
2959396			Bushing	65 mm		CTC-1140754	25.67
CRB1-UP; CSJ1-UP; JLC1-UP; JLD1-UP							
1799764			P-UB-10	90 mm	130 mm	CTC-2159986	129.44
1799764			Bushing	90 mm		CTC-1140758	42.75
JLC1-UP							
2201532			P-UB-10	100 mm	140 mm	CTC-2159985	126.80
2201532			Bushing	100 mm		CTC-1140757	52.10

REPLACEMENT KITS FOR CATERPILLAR® EQUIPMENT

Excavators							
APPLICATION	CYL #	Misc-Parts, Instructions, etc.	CODE	ROD	BORE	KIT #	List \$
MODEL 325C L							
QUICK COUPLER							
BFE1-UP; CRB1-UP							
1728403			I-U-14	50 mm	100 mm	CTC-2525507	164.80
STICK							
AMH1-UP; BKW1-UP; BMM1-UP; BTD1-UP							
1799791			P-UB-10	105 mm	150 mm	CTC-1799791K	351.86
1799791			Bushing	105 mm		CTC-0995572	44.45
2096008			P-UB-10	105 mm	150 mm	CTC-2590637	356.05
2096008			Bushing	105 mm		CTC-0995572	44.45
BFE1-UP							
1799785			P-UB-10	105 mm	150 mm	CTC-1799785K	181.64
1799785			Bushing	105 mm		CTC-1140760	56.77
BKW1-UP; BMM1-UP							
1915589			P-UB-10	105 mm	150 mm	CTC-2590636	356.05
1915589			Bushing	105 mm		CTC-0995572	44.45
2590728			P-UB-10	105 mm	150 mm	CTC-2590729	356.05
2590728			Bushing	105 mm		CTC-0995572	44.45
CRB1-UP; CSJ1-UP							
2188124			P-UB-10	105 mm	150 mm	CTC-1884219	167.89
2188124			Bushing	105 mm		CTC-1140760	56.77
CRB1-UP; CSJ1-UP; JLC1-UP; JLD1-UP							
1799785	Type 1		P-UB-10	105 mm	150 mm	CTC-1915619	167.89
1799785	Type 2		P-UB-10	105 mm	150 mm	CTC-2426840	181.64
1799785	Type 1 and Type 2		Bushing	105 mm		CTC-1140760	56.77
JLC1-UP							
2044907			P-UB-10	95 mm	160 mm	CTC-2521191	202.13
2044907			Bushing	95 mm		CTC-6C6093	47.74
JLC1-UP; JLD1-UP							
1915551			P-UB-10	115 mm	170 mm	CTC-2316844	328.85
MODEL 325C LN							
BOOM							
CRB1-UP; CSJ1-UP							
1799782			P-UB-10	100 mm	140 mm	CTC-2159985	126.80
1799782			Bushing	100 mm		CTC-1140757	52.10
2113069			P-UB-10	100 mm	170 mm	CTC-2519341	273.82
2113069			Bushing	100 mm		CTC-1140757	52.10
BUCKET							
CRB1-UP							
1709808			P-UB-10	65 mm	100 mm	CTC-1709941	134.27
1709808			Bushing	65 mm		CTC-1140754	25.67
2959396			P-UB-10	65 mm	100 mm	CTC-1709941	134.27
2959396			Bushing	65 mm		CTC-1140754	25.67
CRB1-UP; CSJ1-UP							
1772465			P-UB-10	105 mm	150 mm	CTC-1915619	167.89
1772465			Bushing	105 mm		CTC-1140760	56.77
1799764			P-UB-10	90 mm	130 mm	CTC-2159986	129.44
1799764			Bushing	90 mm		CTC-1140758	42.75
2478853			P-UB-10	105 mm	150 mm	CTC-1915619	167.89
2478853			Bushing	105 mm		CTC-1140760	56.77
QUICK COUPLER							
CRB1-UP							
1728403			I-U-14	50 mm	100 mm	CTC-2525507	164.80

REPLACEMENT KITS FOR CATERPILLAR® EQUIPMENT

Excavators							
APPLICATION	CYL #	Misc-Parts, Instructions, etc.	CODE	ROD	BORE	KIT #	List \$
MODEL 325C LN							
STICK							
CRB1-UP; CSJ1-UP							
1799785	Type 1		P-UB-10	105 mm	150 mm	CTC-1915619	167.89
1799785	Type 2		P-UB-10	105 mm	150 mm	CTC-2426840	181.64
1799785	Type 1 and Type 2		Bushing	105 mm		CTC-1140760	56.77
2188124			P-UB-10	105 mm	150 mm	CTC-1884219	167.89
2188124			Bushing	105 mm		CTC-1140760	56.77
MODEL 325D							
BOOM							
DBH1-UP; KBE1-UP; KDG1-UP; SCR1-UP							
2254584			P-UB-10	100 mm	140 mm	CTC-2344566	151.33
2254584			Bushing	100 mm		CTC-0965625	51.68
KDG1-UP; SCR1-UP							
2254595			P-UB-10	100 mm	140 mm	CTC-2590648	151.33
2254595			Bushing	100 mm		CTC-0965625	51.68
2667988			P-UB-10	100 mm	140 mm	CTC-2668015	144.57
2667988			Bushing	100 mm		CTC-0965625	51.68
BUCKET							
AZP1-UP; DBH1-UP; KBE1-UP; KDG1-UP; SCR1-UP							
2254581			P-UB-10	105 mm	150 mm	CTC-1915619	167.89
2254581			Bushing	105 mm		CTC-1140760	56.77
DBH1-UP; KBE1-UP; KDG1-UP; SCR1-UP							
2254591			P-UB-10	95 mm	135 mm	CTC-2344587	138.86
2254591			Bushing	95 mm		CTC-0964430	37.71
KDG1-UP; SCR1-UP							
2254599			P-UB-10	95 mm	135 mm	CTC-2590656	137.50
2254599			Bushing	95 mm		CTC-0964430	37.71
2254602			P-UB-10	105 mm	150 mm	CTC-2502475	140.84
2254602			Bushing	105 mm		CTC-1140760	56.77
2667992			P-UB-10	95 mm	135 mm	CTC-2668045	138.86
2667992			Bushing	95 mm		CTC-0964430	37.71
2668080			P-UB-10	105 mm	150 mm	CTC-2590743	129.60
2668080			Bushing	105 mm		CTC-1140760	56.77
STICK							
DBH1-UP; KBE1-UP; KDG1-UP; SCR1-UP							
2254588			P-UB-10	105 mm	150 mm	CTC-2344576	347.56
2254588			Bushing	105 mm		CTC-0995572	44.45
2590778			P-UB-10	105 mm	150 mm	CTC-2590779	331.92
2590778			Bushing	105 mm		CTC-0995572	44.45
KDG1-UP; SCR1-UP							
2254597			P-UB-10	105 mm	150 mm	CTC-2590650	347.56
2254597			Bushing	105 mm		CTC-0995572	44.45
2667990			P-UB-10	105 mm	150 mm	CTC-2668016	347.56
2667990			Bushing	105 mm		CTC-0995572	44.45
MODEL 325D L							
BOOM							
A3R1-UP; GBR1-UP; GPB1-UP; JCL1-UP; MCL1-UP; PAL1-UP; PKE1-UP; T2S1-UP							
2254572			P-UB-10	100 mm	140 mm	CTC-2159985	126.80
2254572			Bushing	100 mm		CTC-1140757	52.10
A3R1-UP; GBR1-UP; GPB1-UP; PKE1-UP							
2959400			P-UB-10	100 mm	140 mm	CTC-2478792	191.79
2959400			Bushing	100 mm		CTC-1140757	52.10
DBH1-UP; KBE1-UP; KDG1-UP; SCR1-UP							
2254584			P-UB-10	100 mm	140 mm	CTC-2344566	151.33
2254584			Bushing	100 mm		CTC-0965625	51.68

REPLACEMENT KITS FOR CATERPILLAR® EQUIPMENT

Excavators							
APPLICATION	CYL #	Misc-Parts, Instructions, etc.	CODE	ROD	BORE	KIT #	List \$
MODEL 325D L							
BOOM							
GBR1-UP							
2033906			P-UB-10	105 mm	150 mm	CTC-1915619	167.89
2033906			Bushing	105 mm		CTC-1140760	56.77
2795614			P-UB-10	95 mm	160 mm	CTC-2521191	202.13
2795614			Bushing	95 mm		CTC-6C6093	47.74
GBR1-UP; GPB1-UP; LAL1-UP; MCL1-UP; NAC1-UP; PAL1-UP; PKE1-UP; T2S1-UP							
2959398			P-UB-10	100 mm	140 mm	CTC-2478792	191.79
2959398			Bushing	100 mm		CTC-1140757	52.10
GBR1-UP; GPB1-UP; LAL1-UP; MCL1-UP; PKE1-UP; T2S1-UP							
2798111			P-UB-10	100 mm	170 mm	CTC-2519341	273.82
2798111			Bushing	100 mm		CTC-1140757	52.10
KDG1-UP; SCR1-UP							
2254595			P-UB-10	100 mm	140 mm	CTC-2590648	151.33
2254595			Bushing	100 mm		CTC-0965625	51.68
2667988			P-UB-10	100 mm	140 mm	CTC-2668015	144.57
2667988			Bushing	100 mm		CTC-0965625	51.68
BUCKET							
A3R1-UP							
2487855			P-UB-10	65 mm	100 mm	CTC-1709941	134.27
2487855			Bushing	65 mm		CTC-1140754	25.67
2836118			P-UB-10	65 mm	100 mm	CTC-1709941	134.27
2836118			Bushing	65 mm		CTC-1140754	25.67
A3R1-UP; AZP1-UP; DBH1-UP; GBR1-UP; GPB1-UP; KBE1-UP; KDG1-UP; MCL1-UP; PKE1-UP; SCR1-UP; T2S1-UP							
2254581			P-UB-10	105 mm	150 mm	CTC-1915619	167.89
2254581			Bushing	105 mm		CTC-1140760	56.77
A3R1-UP; GBR1-UP; GPB1-UP; JCL1-UP; MCL1-UP; PAL1-UP; PKE1-UP; T2S1-UP							
2254578			P-UB-10	95 mm	135 mm	CTC-2344488	277.99
2254578			Bushing	95 mm		CTC-1289260	44.36
A3R1-UP; GBR1-UP; GPB1-UP; LAL1-UP; MCL1-UP; NAC1-UP; PAL1-UP; PKE1-UP							
2898004			P-UB-10	95 mm	135 mm	CTC-2344488	277.99
2898004			Bushing	95 mm		CTC-1289260	44.36
A3R1-UP; GBR1-UP; GPB1-UP; LAL1-UP; MCL1-UP; NAC1-UP; PAL1-UP; PKE1-UP; T2S1-UP							
2898012			P-UB-10	105 mm	150 mm	CTC-1915619	167.89
2898012			Bushing	105 mm		CTC-1140760	56.77
DBH1-UP; KBE1-UP; KDG1-UP; SCR1-UP							
2254591			P-UB-10	95 mm	135 mm	CTC-2344587	138.86
2254591			Bushing	95 mm		CTC-0964430	37.71
GBR1-UP							
2201532			P-UB-10	100 mm	140 mm	CTC-2159985	126.80
2201532			Bushing	100 mm		CTC-1140757	52.10
2897948			P-UB-10	85 mm	120 mm	CTC-2478790	113.40
2897948			Bushing	85 mm		CTC-1140756	37.06
GBR1-UP; GPB1-UP; MCL1-UP; PKE1-UP							
2426767			P-UB-10	85 mm	120 mm	CTC-2478790	113.40
2426767			Bushing	85 mm		CTC-1140756	37.06
GPB1-UP							
2959396			P-UB-10	65 mm	100 mm	CTC-1709941	134.27
2959396			Bushing	65 mm		CTC-1140754	25.67
3095975			P-UB-10	65 mm	100 mm	CTC-1709941	134.27
3095975			Bushing	65 mm		CTC-1140754	25.67

REPLACEMENT KITS FOR CATERPILLAR® EQUIPMENT

Excavators							
APPLICATION	CYL #	Misc-Parts, Instructions, etc.	CODE	ROD	BORE	KIT #	List \$
MODEL 325D L							
BUCKET							
KDG1-UP; SCR1-UP							
2254599			P-UB-10	95 mm	135 mm	CTC-2590656	137.50
2254599			Bushing	95 mm		CTC-0964430	37.71
2254602			P-UB-10	105 mm	150 mm	CTC-2502475	140.84
2254602			Bushing	105 mm		CTC-1140760	56.77
2667992			P-UB-10	95 mm	135 mm	CTC-2668045	138.86
2667992			Bushing	95 mm		CTC-0964430	37.71
2668080			P-UB-10	105 mm	150 mm	CTC-2590743	129.60
2668080			Bushing	105 mm		CTC-1140760	56.77
STICK							
A3R1-UP							
2166607			P-UB-10	105 mm	150 mm	CTC-1915619	167.89
2166607			Bushing	105 mm		CTC-1140760	56.77
A3R1-UP; GBR1-UP; GPB1-UP; JCL1-UP; MCL1-UP; PAL1-UP; PKE1-UP; T2S1-UP							
2254575			P-UB-10	105 mm	150 mm	CTC-2426840	181.64
2254575			Bushing	105 mm		CTC-1140760	56.77
A3R1-UP; GBR1-UP; GPB1-UP; LAL1-UP; MCL1-UP; NAC1-UP; PAL1-UP; PKE1-UP; T2S1-UP							
2897994			P-UB-10	105 mm	150 mm	CTC-2426840	181.64
2897994			Bushing	105 mm		CTC-1140760	56.77
DBH1-UP; KBE1-UP; KDG1-UP; SCR1-UP							
2254588			P-UB-10	105 mm	150 mm	CTC-2344576	347.56
2254588			Bushing	105 mm		CTC-0995572	44.45
2590778			P-UB-10	105 mm	150 mm	CTC-2590779	331.92
2590778			Bushing	105 mm		CTC-0995572	44.45
GBR1-UP							
2344601			P-UB-10	115 mm	170 mm	CTC-2316844	328.85
2836188			P-UB-10	115 mm	170 mm	CTC-2316844	328.85
2898031			P-UB-10	115 mm	170 mm	CTC-2316844	328.85
KDG1-UP; SCR1-UP							
2254597			P-UB-10	105 mm	150 mm	CTC-2590650	347.56
2254597			Bushing	105 mm		CTC-0995572	44.45
2667990			P-UB-10	105 mm	150 mm	CTC-2668016	347.56
2667990			Bushing	105 mm		CTC-0995572	44.45
MODEL 325D LN							
BOOM							
GPB1-UP; PKE1-UP							
2254572			P-UB-10	100 mm	140 mm	CTC-2159985	126.80
2254572			Bushing	100 mm		CTC-1140757	52.10
2798111			P-UB-10	100 mm	170 mm	CTC-2519341	273.82
2798111			Bushing	100 mm		CTC-1140757	52.10
2959398			P-UB-10	100 mm	140 mm	CTC-2478792	191.79
2959398			Bushing	100 mm		CTC-1140757	52.10
2959400			P-UB-10	100 mm	140 mm	CTC-2478792	191.79
2959400			Bushing	100 mm		CTC-1140757	52.10
BUCKET							
GPB1-UP							
2959396			P-UB-10	65 mm	100 mm	CTC-1709941	134.27
2959396			Bushing	65 mm		CTC-1140754	25.67
3095975			P-UB-10	65 mm	100 mm	CTC-1709941	134.27
3095975			Bushing	65 mm		CTC-1140754	25.67

REPLACEMENT KITS FOR CATERPILLAR® EQUIPMENT

Excavators							
APPLICATION	CYL #	Misc-Parts, Instructions, etc.	CODE	ROD	BORE	KIT #	List \$
MODEL 325D LN							
BUCKET							
GPB1-UP; PKE1-UP							
2254578			P-UB-10	95 mm	135 mm	CTC-2344488	277.99
2254578			Bushing	95 mm		CTC-1289260	44.36
2254581			P-UB-10	105 mm	150 mm	CTC-1915619	167.89
2254581			Bushing	105 mm		CTC-1140760	56.77
2426767			P-UB-10	85 mm	120 mm	CTC-2478790	113.40
2426767			Bushing	85 mm		CTC-1140756	37.06
2898004			P-UB-10	95 mm	135 mm	CTC-2344488	277.99
2898004			Bushing	95 mm		CTC-1289260	44.36
2898012			P-UB-10	105 mm	150 mm	CTC-1915619	167.89
2898012			Bushing	105 mm		CTC-1140760	56.77
STICK							
GPB1-UP; PKE1-UP							
2254575			P-UB-10	105 mm	150 mm	CTC-2426840	181.64
2254575			Bushing	105 mm		CTC-1140760	56.77
2897994			P-UB-10	105 mm	150 mm	CTC-2426840	181.64
2897994			Bushing	105 mm		CTC-1140760	56.77
MODEL 325L							
BOOM							
7Y4601			P-UB-10	95 mm	130 mm	CTC-7Y5147	309.35
BUCKET							
1251547			P-UB-10	65 mm	100 mm	CTC-4I8914	211.54
4I7652			P-UB-10	65 mm	100 mm	CTC-4I7664	211.63
4I8840			P-UB-10	65 mm	100 mm	CTC-4I8914	211.54
7I7291			P-UB-10	85 mm	130 mm	CTC-7Y5145	276.61
7Y5100			P-UB-10	85 mm	130 mm	CTC-7Y5145	276.61
7Y5150			P-UB-10	105 mm	150 mm	CTC-1163612	312.32
875633			P-UB-10	85 mm	120 mm	CTC-0875394	267.83
STICK							
1169123			P-UB-10	105 mm	150 mm	CTC-1163612	312.32
7Y4650			P-UB-10	105 mm	150 mm	CTC-1163612	312.32
MODEL 325N							
BOOM							
7Y4601			P-UB-10	95 mm	130 mm	CTC-7Y5147	309.35
BUCKET							
7Y5100			P-UB-10	85 mm	130 mm	CTC-7Y5145	276.61
7Y5150			P-UB-10	105 mm	150 mm	CTC-1163612	312.32
875633			P-UB-10	85 mm	120 mm	CTC-0875394	267.83
STICK							
7Y4650			P-UB-10	105 mm	150 mm	CTC-1163612	312.32
MODEL 330							
BOOM							
7Y4906			P-UB-10	105 mm	150 mm	CTC-1163612	312.32
BUCKET							
0875531			P-UB-10	110 mm	160 mm	CTC-0876654	332.19
0875633			P-UB-10	85 mm	120 mm	CTC-0875394	267.83
7Y5100			P-UB-10	85 mm	130 mm	CTC-7Y5145	276.61
7Y5150			P-UB-10	105 mm	150 mm	CTC-1163612	312.32
STICK							
7Y4926			P-UB-10	110 mm	170 mm	CTC-1163649	389.77
MODEL 330B, 330BL							
BOOM							
1163578			P-UB-10	105 mm	150 mm	CTC-1680758	361.22
1336808			P-UB-10	105 mm	150 mm	CTC-1289277	380.82

REPLACEMENT KITS FOR CATERPILLAR® EQUIPMENT

Excavators							
APPLICATION	CYL #	Misc-Parts, Instructions, etc.	CODE	ROD	BORE	KIT #	List \$
MODEL 330B, 330BL							
BUCKET							
	1183921		P-UB-10	105 mm	150 mm	CTC-1680758	361.22
	1183935		P-UB-10	110 mm	160 mm	CTC-1680760	402.31
	1184134		P-UB-10	85 mm	120 mm	CTC-1184131	258.61
	1336810		P-UB-10	105 mm	150 mm	CTC-1289277	380.82
	1336811		P-UB-10	110 mm	160 mm	CTC-1289280	398.82
STICK							
	0875375		P-UB-10	130 mm	180 mm	CTC-0875407	412.06
	1163638		P-UB-10	110 mm	170 mm	CTC-1680759	414.73
	1336809		P-UB-10	110 mm	170 mm	CTC-1289278	411.18
MODEL 330C							
BOOM							
GKX1-UP; JAB1-UP; JCD1-UP; JNK1-UP; KDD1-UP; MCA1-UP							
	1915548		P-UB-10	105 mm	150 mm	CTC-1915619	167.89
	1915548		Bushing	105 mm		CTC-1140760	56.77
GKX1-UP; JAB1-UP; KDD1-UP; MCA1-UP							
	2502473		P-UB-10	105 mm	150 mm	CTC-2502475	140.84
	2502473		Bushing	105 mm		CTC-1140760	56.77
GKX1-UP; MCA1-UP							
	2502419		P-UB-10	105 mm	150 mm	CTC-2426840	181.64
	2502419		Bushing	105 mm		CTC-1140760	56.77
JAB1-UP; KDD1-UP							
	1948270		P-UB-10	105 mm	150 mm	CTC-2003315	167.89
	1948270		Bushing	105 mm		CTC-1140760	56.77
	2502419		P-UB-10	105 mm	150 mm	CTC-2426840	181.64
	2502419		Bushing	105 mm		CTC-1140760	56.77
	2590742		P-UB-10	105 mm	150 mm	CTC-2590743	129.60
	2590742		Bushing	105 mm		CTC-1140760	56.77
JCD1-UP; JNK1-UP							
	2502419		P-UB-10	105 mm	150 mm	CTC-2426840	181.64
	2502419		Bushing	105 mm		CTC-1140760	56.77
BUCKET							
GKX1-UP; JAB1-UP; JCD1-UP; JNK1-UP; KDD1-UP; MCA1-UP							
	1772465		P-UB-10	105 mm	150 mm	CTC-1915619	167.89
	1772465		Bushing	105 mm		CTC-1140760	56.77
	1915554		P-UB-10	110 mm	160 mm	CTC-2159988	206.78
	1915554		Bushing	110 mm		CTC-1140762	84.51
	2478853		P-UB-10	105 mm	150 mm	CTC-1915619	167.89
	2478853		Bushing	105 mm		CTC-1140760	56.77
GKX1-UP; JAB1-UP; KDD1-UP; MCA1-UP							
	2478854		P-UB-10	105 mm	150 mm	CTC-2502475	140.84
	2478854		Bushing	105 mm		CTC-1140760	56.77
JAB1-UP; KDD1-UP							
	1948276		P-UB-10	105 mm	150 mm	CTC-2003315	167.89
	1948276		Bushing	105 mm		CTC-1140760	56.77
	1948279		P-UB-10	110 mm	160 mm	CTC-1948235	244.94
	1948279		Bushing	110 mm		CTC-1140762	84.51
	2590746		P-UB-10	105 mm	150 mm	CTC-2590743	129.60
	2590746		Bushing	105 mm		CTC-1140760	56.77
	2590750		P-UB-10	110 mm	160 mm	CTC-2590751	238.28
	2590750		Bushing	110 mm		CTC-1140762	84.51
JCD1-UP							
	1709808		P-UB-10	65 mm	100 mm	CTC-1709941	134.27
	1709808		Bushing	65 mm		CTC-1140754	25.67
	2959396		P-UB-10	65 mm	100 mm	CTC-1709941	134.27
	2959396		Bushing	65 mm		CTC-1140754	25.67

REPLACEMENT KITS FOR CATERPILLAR® EQUIPMENT

Excavators							
APPLICATION	CYL #	Misc-Parts, Instructions, etc.	CODE	ROD	BORE	KIT #	List \$
MODEL 330C							
BUCKET							
JCD1-UP; JNK1-UP							
1589061			P-U-10	85 mm	120 mm	CTC-2366389	113.40
1589061			Bushing	85 mm		CTC-1140756	37.06
2836132			P-UB-10	85 mm	120 mm	CTC-2366368	113.40
2836132			Bushing	85 mm		CTC-1140756	37.06
STICK							
GKX1-UP; JAB1-UP; KDD1-UP; MCA1-UP							
1915551			P-UB-10	115 mm	170 mm	CTC-2316844	328.85
1948273			P-UB-10	115 mm	170 mm	CTC-2316845	335.75
2897763			P-UB-10	115 mm	170 mm	CTC-2316844	328.85
2897780			P-UB-10	115 mm	170 mm	CTC-2316845	335.75
JAB1-UP; KDD1-UP							
2590767			P-UB-10	115 mm	170 mm	CTC-2590768	334.56
2897784			P-UB-10	115 mm	170 mm	CTC-2590768	334.56
JCD1-UP; JNK1-UP							
1915551			P-UB-10	115 mm	170 mm	CTC-2316844	328.85
UNSPECIFIED APPLICATION							
JCD1-UP; JNK1-UP							
1234121			P-UB-10	2	4	CTC-1234121K	79.24
MODEL 330C L							
BOOM							
CAP1-UP; CGZ1-UP							
2255306			P-UB-10	110 mm	180 mm	CTC-2304001	271.89
2255306			Bushing	110 mm		CTC-1140762	84.51
CAP1-UP; CGZ1-UP; GKX1-UP; JAB1-UP; JCD1-UP; JNK1-UP; KDD1-UP; MCA1-UP; MKM1-UP							
1915548			P-UB-10	105 mm	150 mm	CTC-1915619	167.89
1915548			Bushing	105 mm		CTC-1140760	56.77
CAP1-UP; CGZ1-UP; JCD1-UP; JNK1-UP							
2502419			P-UB-10	105 mm	150 mm	CTC-2426840	181.64
2502419			Bushing	105 mm		CTC-1140760	56.77
CYA1-UP							
1915548			P-UB-10	105 mm	150 mm	CTC-1884219	167.89
1915548			Bushing	105 mm		CTC-1140760	56.77
DKY1-UP							
1915548			P-UB-10	105 mm	150 mm	CTC-1884219	167.89
1915548			Bushing	105 mm		CTC-1140760	56.77
GKX1-UP; JAB1-UP; KDD1-UP; MCA1-UP							
2502473			P-UB-10	105 mm	150 mm	CTC-2502475	140.84
2502473			Bushing	105 mm		CTC-1140760	56.77
GKX1-UP; MCA1-UP; CYA1-UP							
2502419			P-UB-10	105 mm	150 mm	CTC-2426840	181.64
2502419			Bushing	105 mm		CTC-1140760	56.77
JAB1-UP; KDD1-UP							
1948270			P-UB-10	105 mm	150 mm	CTC-2003315	167.89
1948270			Bushing	105 mm		CTC-1140760	56.77
2502419			P-UB-10	105 mm	150 mm	CTC-2426840	181.64
2502419			Bushing	105 mm		CTC-1140760	56.77
2590742			P-UB-10	105 mm	150 mm	CTC-2590743	129.60
2590742			Bushing	105 mm		CTC-1140760	56.77
MKM1-UP							
2162731			P-UB-10	110 mm	160 mm	CTC-2042721	240.35
2162731			Bushing	110 mm		CTC-1140762	84.51

REPLACEMENT KITS FOR CATERPILLAR® EQUIPMENT

Excavators							
APPLICATION	CYL #	Misc-Parts, Instructions, etc.	CODE	ROD	BORE	KIT #	List \$
MODEL 330C L							
BUCKET							
CAP1-UP; CGZ1-UP; DKY1-UP; GKX1-UP; JAB1-UP; JCD1-UP; JNK1-UP; KDD1-UP; MCA1-UP; MKM1-UP							
1772465			P-UB-10	105 mm	150 mm	CTC-1915619	167.89
1772465			Bushing	105 mm		CTC-1140760	56.77
1915554			P-UB-10	110 mm	160 mm	CTC-2159988	206.78
1915554			Bushing	110 mm		CTC-1140762	84.51
CAP1-UP; CGZ1-UP; GKX1-UP; JAB1-UP; JCD1-UP; JNK1-UP; KDD1-UP; MCA1-UP; MKM1-UP							
2478853			P-UB-10	105 mm	150 mm	CTC-1915619	167.89
2478853			Bushing	105 mm		CTC-1140760	56.77
CYA1-UP							
1772465			P-UB-10	105 mm	150 mm	CTC-1884219	167.89
1772465			Bushing	105 mm		CTC-1140760	56.77
1915554			P-UB-10	110 mm	160 mm	CTC-1948396	219.20
1915554			Bushing	110 mm		CTC-1140762	84.51
GKX1-UP; JAB1-UP; KDD1-UP; MCA1-UP							
2478854			P-UB-10	105 mm	150 mm	CTC-2502475	140.84
2478854			Bushing	105 mm		CTC-1140760	56.77
JAB1-UP; KDD1-UP							
1948276			P-UB-10	105 mm	150 mm	CTC-2003315	167.89
1948276			Bushing	105 mm		CTC-1140760	56.77
1948279			P-UB-10	110 mm	160 mm	CTC-1948235	244.94
1948279			Bushing	110 mm		CTC-1140762	84.51
2590746			P-UB-10	105 mm	150 mm	CTC-2590743	129.60
2590746			Bushing	105 mm		CTC-1140760	56.77
2590750			P-UB-10	110 mm	160 mm	CTC-2590751	238.28
2590750			Bushing	110 mm		CTC-1140762	84.51
JCD1-UP							
1709808			P-UB-10	65 mm	100 mm	CTC-1709941	134.27
1709808			Bushing	65 mm		CTC-1140754	25.67
2959396			P-UB-10	65 mm	100 mm	CTC-1709941	134.27
2959396			Bushing	65 mm		CTC-1140754	25.67
JCD1-UP; JNK1-UP							
1589061			P-U-10	85 mm	120 mm	CTC-2366389	113.40
1589061			Bushing	85 mm		CTC-1140756	37.06
2836132			P-UB-10	85 mm	120 mm	CTC-2366368	113.40
2836132			Bushing	85 mm		CTC-1140756	37.06
QUICK COUPLER							
DKY1-UP							
1728403			I-U-14	50 mm	100 mm	CTC-2525507	164.80
STICK							
CAP1-UP; CGZ1-UP; JCD1-UP; JNK1-UP; MKM1-UP							
1915551			P-UB-10	115 mm	170 mm	CTC-2316844	328.85
CYA1-UP							
1915551			P-UB-10	115 mm	170 mm	CTC-1915649	328.85
CYA1-UP; GKX1-UP; JAB1-UP; KDD1-UP; MCA1-UP							
2897763			P-UB-10	115 mm	170 mm	CTC-2316844	328.85
DKY1-UP							
1915551			P-UB-10	115 mm	170 mm	CTC-1915551K	291.48
GKX1-UP; JAB1-UP; KDD1-UP; MCA1-UP							
1915551			P-UB-10	115 mm	170 mm	CTC-2316844	328.85
1948273			P-UB-10	115 mm	170 mm	CTC-2316845	335.75
2897780			P-UB-10	115 mm	170 mm	CTC-2316845	335.75
JAB1-UP; KDD1-UP							
2590767			P-UB-10	115 mm	170 mm	CTC-2590768	334.56
2897784			P-UB-10	115 mm	170 mm	CTC-2590768	334.56

REPLACEMENT KITS FOR CATERPILLAR® EQUIPMENT

Excavators							
APPLICATION	CYL #	Misc-Parts, Instructions, etc.	CODE	ROD	BORE	KIT #	List \$
MODEL 330C L							
STICK							
MKM1-UP							
2141591			P-UB-10	90 mm	130 mm	CTC-2119614	163.47
2141591			Bushing	90 mm		CTC-1140758	42.75
2228776			P-UB-10	100 mm	140 mm	CTC-2159985	126.80
2228776			Bushing	100 mm		CTC-1140757	52.10
UNSPECIFIED APPLICATION							
CAP1-UP; JCD1-UP; JNK1-UP							
1234121			P-UB-10	2	4	CTC-1234121K	79.24
MODEL 330C LN							
BOOM							
CAP1-UP; CGZ1-UP							
1915548			P-UB-10	105 mm	150 mm	CTC-1915619	167.89
1915548			Bushing	105 mm		CTC-1140760	56.77
2255306			P-UB-10	110 mm	180 mm	CTC-2304001	271.89
2255306			Bushing	110 mm		CTC-1140762	84.51
2502419			P-UB-10	105 mm	150 mm	CTC-2426840	181.64
2502419			Bushing	105 mm		CTC-1140760	56.77
BUCKET							
CAP1-UP; CGZ1-UP							
1772465			P-UB-10	105 mm	150 mm	CTC-1915619	167.89
1772465			Bushing	105 mm		CTC-1140760	56.77
1915554			P-UB-10	110 mm	160 mm	CTC-2159988	206.78
1915554			Bushing	110 mm		CTC-1140762	84.51
2478853			P-UB-10	105 mm	150 mm	CTC-1915619	167.89
2478853			Bushing	105 mm		CTC-1140760	56.77
STICK							
CAP1-UP; CGZ1-UP							
1915551			P-UB-10	115 mm	170 mm	CTC-2316844	328.85
UNSPECIFIED APPLICATION							
CAP1-UP							
1234121			P-UB-10	2	4	CTC-1234121K	79.24
MODEL 330D							
BOOM							
EAH1-UP; EDX1-UP; ERN1-UP; FFK1-UP; MEY1-UP; NBD1-UP; THJ1-UP							
2344598			P-UB-10	105 mm	150 mm	CTC-2426840	181.64
2344598			Bushing	105 mm		CTC-1140760	56.77
EAH1-UP; FFK1-UP							
3119517			P-UB-10	105 mm	150 mm	CTC-2426840	181.64
3119517			Bushing	105 mm		CTC-1140760	56.77
3119524			P-UB-10	105 mm	150 mm	CTC-2502475	140.84
3119524			Bushing	105 mm		CTC-1140760	56.77
EAH1-UP; FFK1-UP; MEY1-UP; NBD1-UP							
2344608			P-UB-10	105 mm	150 mm	CTC-2502475	140.84
2344608			Bushing	105 mm		CTC-1140760	56.77
EDX1-UP; MEY1-UP; NBD1-UP							
2668074			P-UB-10	105 mm	150 mm	CTC-2590743	129.60
2668074			Bushing	105 mm		CTC-1140760	56.77
2898021			P-UB-10	105 mm	150 mm	CTC-2426840	181.64
2898021			Bushing	105 mm		CTC-1140760	56.77
MEY1-UP; NBD1-UP							
2898050			P-UB-10	105 mm	150 mm	CTC-2502475	140.84
2898050			Bushing	105 mm		CTC-1140760	56.77

REPLACEMENT KITS FOR CATERPILLAR® EQUIPMENT

Excavators							
APPLICATION	CYL #	Misc-Parts, Instructions, etc.	CODE	ROD	BORE	KIT #	List \$
MODEL 330D							
BUCKET							
EAH1-UP; EDX1-UP; ERN1-UP; FFK1-UP; MEY1-UP; NBD1-UP; THJ1-UP							
2254581			P-UB-10	105 mm	150 mm	CTC-1915619	167.89
2254581			Bushing	105 mm		CTC-1140760	56.77
2344604			P-UB-10	110 mm	160 mm	CTC-2254625	279.23
2344604			Bushing	110 mm		CTC-1140762	84.51
EAH1-UP; FFK1-UP; MEY1-UP; NBD1-UP							
2254602			P-UB-10	105 mm	150 mm	CTC-2502475	140.84
2254602			Bushing	105 mm		CTC-1140760	56.77
2344614			P-UB-10	110 mm	160 mm	CTC-1948235	244.94
2344614			Bushing	110 mm		CTC-1140762	84.51
EDX1-UP; MEY1-UP; NBD1-UP							
2668083			P-UB-10	110 mm	160 mm	CTC-2590751	238.28
2668083			Bushing	110 mm		CTC-1140762	84.51
ERN1-UP; THJ1-UP							
2426767			P-UB-10	85 mm	120 mm	CTC-2478790	113.40
2426767			Bushing	85 mm		CTC-1140756	37.06
2898012			P-UB-10	105 mm	150 mm	CTC-1915619	167.89
2898012			Bushing	105 mm		CTC-1140760	56.77
2898041			P-UB-10	110 mm	160 mm	CTC-2254625	279.23
2898041			Bushing	110 mm		CTC-1140762	84.51
STICK							
EAH1-UP; EDX1-UP; ERN1-UP; FFK1-UP; MEY1-UP; NBD1-UP; THJ1-UP							
2344601			P-UB-10	115 mm	170 mm	CTC-2316844	328.85
2836188			P-UB-10	115 mm	170 mm	CTC-2316844	328.85
EAH1-UP; FFK1-UP; MEY1-UP; NBD1-UP							
2836194			P-UB-10	115 mm	170 mm	CTC-2316845	335.75
EDX1-UP; MEY1-UP; NBD1-UP							
2668077			P-UB-10	115 mm	170 mm	CTC-2590768	334.56
2836195			P-UB-10	115 mm	170 mm	CTC-2590768	334.56
2898031			P-UB-10	115 mm	170 mm	CTC-2316844	328.85
MEY1-UP; NBD1-UP							
2344611			P-UB-10	115 mm	170 mm	CTC-2316845	335.75
2898053			P-UB-10	115 mm	170 mm	CTC-2316845	335.75
MODEL 330D L							
BOOM							
B6H1-UP; EAH1-UP; EDX1-UP; FFK1-UP; GGE1-UP; HAS1-UP; JLP1-UP; MAG1-UP; MEY1-UP; MWP1-UP; NBD1-UP; RAS1-UP; T2Y1-UP							
2344598			P-UB-10	105 mm	150 mm	CTC-2426840	181.64
2344598			Bushing	105 mm		CTC-1140760	56.77
B6H1-UP; EDX1-UP; GGE1-UP; JLP1-UP; LRM1-UP; MEY1-UP; MWP1-UP; NBD1-UP; RAS1-UP; T2Y1-UP							
2898021			P-UB-10	105 mm	150 mm	CTC-2426840	181.64
2898021			Bushing	105 mm		CTC-1140760	56.77
EAH1-UP; FFK1-UP							
3119517			P-UB-10	105 mm	150 mm	CTC-2426840	181.64
3119517			Bushing	105 mm		CTC-1140760	56.77
3119524			P-UB-10	105 mm	150 mm	CTC-2502475	140.84
3119524			Bushing	105 mm		CTC-1140760	56.77
EAH1-UP; FFK1-UP; MEY1-UP; NBD1-UP							
2344608			P-UB-10	105 mm	150 mm	CTC-2502475	140.84
2344608			Bushing	105 mm		CTC-1140760	56.77
EDX1-UP; MEY1-UP; NBD1-UP							
2668074			P-UB-10	105 mm	150 mm	CTC-2590743	129.60
2668074			Bushing	105 mm		CTC-1140760	56.77

REPLACEMENT KITS FOR CATERPILLAR® EQUIPMENT

Excavators							
APPLICATION	CYL #	Misc-Parts, Instructions, etc.	CODE	ROD	BORE	KIT #	List \$
MODEL 330D L							
BOOM							
GGE1-UP; RAS1-UP							
2255306			P-UB-10	110 mm	180 mm	CTC-2304001	271.89
2255306			Bushing	110 mm		CTC-1140762	84.51
MEY1-UP; NBD1-UP							
2898050			P-UB-10	105 mm	150 mm	CTC-2502475	140.84
2898050			Bushing	105 mm		CTC-1140760	56.77
BUCKET							
B6H1-UP; EAH1-UP; EDX1-UP; FFK1-UP; GGE1-UP; HAS1-UP; JLP1-UP; MAG1-UP; MEY1-UP; MWP1-UP; NBD1-UP; RAS1-UP; T2Y1-UP							
2254581			P-UB-10	105 mm	150 mm	CTC-1915619	167.89
2254581			Bushing	105 mm		CTC-1140760	56.77
B6H1-UP; EAH1-UP; EDX1-UP; FFK1-UP; GGE1-UP; JLP1-UP; MEY1-UP; NBD1-UP; RAS1-UP; T2Y1-UP							
2344604			P-UB-10	110 mm	160 mm	CTC-2254625	279.23
2344604			Bushing	110 mm		CTC-1140762	84.51
B6H1-UP; GGE1-UP; HAS1-UP; JLP1-UP; LRM1-UP; MWP1-UP; RAS1-UP; T2Y1-UP							
2898012			P-UB-10	105 mm	150 mm	CTC-1915619	167.89
2898012			Bushing	105 mm		CTC-1140760	56.77
EAH1-UP; FFK1-UP; MEY1-UP; NBD1-UP							
2254602			P-UB-10	105 mm	150 mm	CTC-2502475	140.84
2254602			Bushing	105 mm		CTC-1140760	56.77
2344614			P-UB-10	110 mm	160 mm	CTC-1948235	244.94
2344614			Bushing	110 mm		CTC-1140762	84.51
EDX1-UP; MEY1-UP; NBD1-UP							
2668083			P-UB-10	110 mm	160 mm	CTC-2590751	238.28
2668083			Bushing	110 mm		CTC-1140762	84.51
GGE1-UP; HAS1-UP; LRM1-UP; MWP1-UP; RAS1-UP; T2Y1-UP							
2898041			P-UB-10	110 mm	160 mm	CTC-2254625	279.23
2898041			Bushing	110 mm		CTC-1140762	84.51
MWP1-UP							
2254529			P-UB-10	110 mm	160 mm	CTC-2254625	279.23
2254529			Bushing	110 mm		CTC-1140762	84.51
QUICK COUPLER							
B6H1-UP; JLP1-UP							
1690753			P-U-5	40 mm	70 mm	CTC-2191322	35.74
STICK							
B6H1-UP; EAH1-UP; EDX1-UP; FFK1-UP; GGE1-UP; HAS1-UP; JLP1-UP; MEY1-UP; MWP1-UP; NBD1-UP; RAS1-UP; T2Y1-UP							
2344601			P-UB-10	115 mm	170 mm	CTC-2316844	328.85
B6H1-UP; EDX1-UP; GGE1-UP; MEY1-UP; NBD1-UP; RAS1-UP; T2Y1-UP; JLP1-UP; LRM1-UP							
2898031			P-UB-10	115 mm	170 mm	CTC-2316844	328.85
EAH1-UP; EDX1-UP; FFK1-UP; HAS1-UP; MAG1-UP; MEY1-UP; NBD1-UP; T2Y1-UP							
2836188			P-UB-10	115 mm	170 mm	CTC-2316844	328.85
EAH1-UP; FFK1-UP; MEY1-UP; NBD1-UP							
2836194			P-UB-10	115 mm	170 mm	CTC-2316845	335.75
EDX1-UP; MEY1-UP; NBD1-UP							
2668077			P-UB-10	115 mm	170 mm	CTC-2590768	334.56
2836195			P-UB-10	115 mm	170 mm	CTC-2590768	334.56
MEY1-UP; NBD1-UP							
2344611			P-UB-10	115 mm	170 mm	CTC-2316845	335.75
2898053			P-UB-10	115 mm	170 mm	CTC-2316845	335.75
MWP1-UP							
2898031			P-UB-10	115 mm	170 mm	CTC-2316844	328.85

REPLACEMENT KITS FOR CATERPILLAR® EQUIPMENT

Excavators							
APPLICATION	CYL #	Misc-Parts, Instructions, etc.	CODE	ROD	BORE	KIT #	List \$
MODEL 330D N							
BOOM							
GGE1-UP; RAS1-UP							
2255306			P-UB-10	110 mm	180 mm	CTC-2304001	271.89
2255306			Bushing	110 mm		CTC-1140762	84.51
2344598			P-UB-10	105 mm	150 mm	CTC-2426840	181.64
2344598			Bushing	105 mm		CTC-1140760	56.77
2898021			P-UB-10	105 mm	150 mm	CTC-2426840	181.64
2898021			Bushing	105 mm		CTC-1140760	56.77
BUCKET							
GGE1-UP; RAS1-UP							
2254581			P-UB-10	105 mm	150 mm	CTC-1915619	167.89
2254581			Bushing	105 mm		CTC-1140760	56.77
2344604			P-UB-10	110 mm	160 mm	CTC-2254625	279.23
2344604			Bushing	110 mm		CTC-1140762	84.51
2898012			P-UB-10	105 mm	150 mm	CTC-1915619	167.89
2898012			Bushing	105 mm		CTC-1140760	56.77
2898041			P-UB-10	110 mm	160 mm	CTC-2254625	279.23
2898041			Bushing	110 mm		CTC-1140762	84.51
STICK							
GGE1-UP; RAS1-UP							
2344601			P-UB-10	115 mm	170 mm	CTC-2316844	328.85
2898031			P-UB-10	115 mm	170 mm	CTC-2316844	328.85
MODEL 330L							
BOOM							
7Y4906			P-UB-10	105 mm	150 mm	CTC-1163612	312.32
BUCKET							
1183921			P-UB-10	105 mm	150 mm	CTC-1163612	312.32
1183935			P-UB-10	110 mm	160 mm	CTC-1183946	377.45
4I1726			P-UB-10	110 mm	160 mm	CTC-0876654	332.19
7Y5100			P-UB-10	85 mm	130 mm	CTC-7Y5145	276.61
7Y5150			P-UB-10	105 mm	150 mm	CTC-1163612	312.32
875531			P-UB-10	110 mm	160 mm	CTC-0876654	332.19
STICK							
1163638			P-UB-10	110 mm	170 mm	CTC-1163649	389.77
7Y4926			P-UB-10	110 mm	170 mm	CTC-1163649	389.77
TILT							
1163578			P-UB-10	105 mm	150 mm	CTC-1163612	312.32
MODEL 336D							
BOOM							
JBT1-UP							
3119517			P-UB-10	105 mm	150 mm	CTC-3249485	194.58
JBT1-UP; KKT1-UP; PGW1-UP							
3119524			P-UB-10	105 mm	150 mm	CTC-2502475	140.84
KKT1-UP							
3119531			P-UB-10	105 mm	150 mm	CTC-2502475	140.84
KKT1-UP; PGW1-UP							
3119517			P-UB-10	105 mm	150 mm	CTC-2426840	181.64
3119525			P-UB-10	105 mm	150 mm	CTC-2590743	129.60
3119526			P-UB-10	105 mm	150 mm	CTC-2426840	181.64
MYP1-UP							
2255306	Variable Adj Boom		P-UB-10	110 mm	180 mm	CTC-2304001	271.89
PGW1-UP							
3119531			P-UB-10	105 mm	150 mm	CTC-3764334	194.58

REPLACEMENT KITS FOR CATERPILLAR® EQUIPMENT

Excavators							
APPLICATION	CYL #	Misc-Parts, Instructions, etc.	CODE	ROD	BORE	KIT #	List \$
MODEL 336D							
BUCKET							
JBT1-UP; KKT1-UP; PGW1-UP							
3154442			P-UB-10	105 mm	150 mm	CTC-1915619	167.89
3154442			P-UB-10	105 mm	150 mm	CTC-3764331	162.89
3154449			P-UB-10	105 mm	150 mm	CTC-3764332	162.89
3154463			P-UB-10	110 mm	160 mm	CTC-2254625	279.23
3154471			P-UB-10	110 mm	160 mm	CTC-1948235	244.94
JBT1-UP; PGW1-UP							
3154463			P-UB-10	110 mm	160 mm	CTC-3338750	178.60
KKT1-UP							
2668083			P-UB-10	110 mm	160 mm	CTC-2590751	238.28
2898041			P-UB-10	110 mm	160 mm	CTC-2254625	279.23
KKT1-UP; MYG1-UP; MYP1-UP; PGW1-UP							
3154451			P-UB-10	105 mm	150 mm	CTC-1915619	167.89
KKT1-UP; PGW1-UP							
3154450			P-UB-10	105 mm	150 mm	CTC-2590743	129.60
3154455			P-UB-10	105 mm	150 mm	CTC-2502475	140.84
3154472			P-UB-10	110 mm	160 mm	CTC-2590751	238.28
3154473			P-UB-10	110 mm	160 mm	CTC-2254625	279.23
3154474			P-UB-10	110 mm	160 mm	CTC-1948235	244.94
MYG1-UP; MYP1-UP							
3154473			P-UB-10	110 mm	160 mm	CTC-3338750	178.60
COUPLER							
KKT1-UP; PGW1-UP							
2948011			P-U-10,12	2	3-1/2	CTC-3460643	45.47
MYG1-UP; MYP1-UP							
1690753			P-U-5	40 mm	70 mm	CTC-2191322	35.74
STICK							
JBT1-UP; KKT1-UP; PGW1-UP							
2836188			P-UB-10	115 mm	170 mm	CTC-2316844	328.85
2836194			P-UB-10	115 mm	170 mm	CTC-2316845	335.75
KKT1-UP							
2898031			P-UB-10	115 mm	170 mm	CTC-2316844	328.85
KKT1-UP; PGW1-UP							
2836188			P-UB-10	115 mm	170 mm	CTC-3198295	239.47
2836194			P-UB-10	115 mm	170 mm	CTC-3764333	239.47
2836195			P-UB-10	115 mm	170 mm	CTC-2590768	334.56
2898053			P-UB-10	115 mm	170 mm	CTC-2316845	335.75
MYP1-UP; PGW1-UP							
2898031			P-UB-10	115 mm	170 mm	CTC-3198295	239.47
MODEL 336D L							
BOOM							
DTS1-UP; J2F1-UP; JBF1-UP; JWR1-UP; KDJ1-UP; L5X1-UP; LMG1-UP; MDS1-UP; PPN1-UP; PRF1-UP; PTB1-UP; WET1-UP; W3K1-UP; WRKZ-UP; ZML1-UP							
3119526			P-UB-10	105 mm	150 mm	CTC-2426840	181.64
J2F1-UP; MDS1-UP; W3K1-UP; ZML1-UP							
3585972			P-UB-10	105 mm	150 mm	CTC-3249485	194.58
KDJ1-UP							
2255306	Variable Adj Boom		P-UB-10	110 mm	180 mm	CTC-2304001	271.89
M4T1-UP							
2898021			P-UB-10	105 mm	150 mm	CTC-2426840	181.64
MPL1-UP							
3119517			P-UB-10	105 mm	150 mm	CTC-3249485	194.58
MPL1-UP; PRF1-UP; WRK1-UP							
3119524			P-UB-10	105 mm	150 mm	CTC-2502475	140.84

REPLACEMENT KITS FOR CATERPILLAR® EQUIPMENT

Excavators							
APPLICATION	CYL #	Misc-Parts, Instructions, etc.	CODE	ROD	BORE	KIT #	List \$
MODEL 336D L							
BOOM							
PRF1-UP							
3119531			P-UB-10	105 mm	150 mm	CTC-2502475	140.84
PRF1-UP; WRK1-UP							
3119517			P-UB-10	105 mm	150 mm	CTC-2426840	181.64
3119525			P-UB-10	105 mm	150 mm	CTC-2590743	129.60
WRK1-UP							
3119531			P-UB-10	105 mm	150 mm	CTC-3764334	194.58
BUCKET							
DTS1-UP; J2F1-UP; JBF1-UP; JWR1-UP; KDJ1-UP; LMG1-UP; MDS1-UP; PPN1-UP; PTB1-UP; WET1-UP; W3K1-UP							
3154473			P-UB-10	110 mm	160 mm	CTC-3338750	178.60
DTS1-UP; J2F1-UP; JBF1-UP; JWR1-UP; KDJ1-UP; LMG1-UP; PPN1-UP; PRF1-UP; PTB1-UP; WET1-UP; W3K1-UP; WRK1-UP; ZML1-UP							
3154451			P-UB-10	105 mm	150 mm	CTC-1915619	167.89
DTS1-UP; JBF1-UP; JWR1-UP; LMG1-UP							
2897948			P-UB-10	85 mm	120 mm	CTC-2478790	113.40
J2F1-UP; M4T1-UP							
2898012			P-UB-10	105 mm	150 mm	CTC-1915619	167.89
J2F1-UP; MDS1-UP; W3K1-UP; ZML1-UP							
3579784			P-UB-10	110 mm	160 mm	CTC-3338750	178.60
3588482			P-UB-10	110 mm	160 mm	CTC-3338750	178.60
J2F1-UP; W3K1-UP; ZML1-UP							
3579766			P-UB-10	105 mm	150 mm	CTC-3764331	162.89
M4T1-UP; PRF1-UP							
2898041			P-UB-10	110 mm	160 mm	CTC-2254625	279.23
MPL1-UP; PRF1-UP; WRK1-UP							
3154442			P-UB-10	105 mm	150 mm	CTC-1915619	167.89
3154442			P-UB-10	105 mm	150 mm	CTC-3764331	162.89
3154449			P-UB-10	105 mm	150 mm	CTC-3764332	162.89
3154463			P-UB-10	110 mm	160 mm	CTC-2254625	279.23
3154471			P-UB-10	110 mm	160 mm	CTC-1948235	244.94
MPL1-UP; WRK1-UP							
3154463			P-UB-10	110 mm	160 mm	CTC-3338750	178.60
PRF1-UP							
2668083			P-UB-10	110 mm	160 mm	CTC-2590751	238.28
PRF1-UP; WRK1-UP							
3154450			P-UB-10	105 mm	150 mm	CTC-2590743	129.60
3154455			P-UB-10	105 mm	150 mm	CTC-2502475	140.84
3154472			P-UB-10	110 mm	160 mm	CTC-2590751	238.28
3154473			P-UB-10	110 mm	160 mm	CTC-2254625	279.23
3154474			P-UB-10	110 mm	160 mm	CTC-1948235	244.94
COUPLER							
DTS1-UP; JBF1-UP; KDJ1-UP; LMG1-UP; M4T1-UP; PPN1-UP; WET1-UP							
1690753			P-U-5	40 mm	70 mm	CTC-2191322	35.74
J2F1-UP; W3K1-UP							
3270338			I-U-10	75 mm	100 mm	CTC-3265051	68.94
PRF1-UP; W3K1-UP; WRK1-UP							
2948011			P-U-10,12	2	3-1/2	CTC-3460643	45.47
STICK							
DTS1-UP; JBF1-UP; JWR1-UP; KDJ1-UP; LMG1-UP; PPN1-UP; PTB1-UP; WET1-UP; WRK1-UP							
2898031			P-UB-10	115 mm	170 mm	CTC-3198295	239.47
J2F1-UP; M4T1-UP; MDS1-UP; PRF1-UP; W3K1-UP; ZML1-UP							
2898031			P-UB-10	115 mm	170 mm	CTC-2316844	328.85
J2F1-UP; MDS1-UP; W3K1-UP; ZML1-UP							
3751722			P-UB-10	115 mm	170 mm	CTC-3751733	260.91

REPLACEMENT KITS FOR CATERPILLAR® EQUIPMENT

Excavators							
APPLICATION	CYL #	Misc-Parts, Instructions, etc.	CODE	ROD	BORE	KIT #	List \$
MODEL 336D L							
STICK							
MPL1-UP; PRF1-UP; WRK1-UP							
2836188			P-UB-10	115 mm	170 mm	CTC-2316844	328.85
2836194			P-UB-10	115 mm	170 mm	CTC-2316845	335.75
PRF1-UP; WRK1-UP							
2836188			P-UB-10	115 mm	170 mm	CTC-3198295	239.47
2836194			P-UB-10	115 mm	170 mm	CTC-3764333	239.47
2836195			P-UB-10	115 mm	170 mm	CTC-2590768	334.56
2898053			P-UB-10	115 mm	170 mm	CTC-2316845	335.75
MODEL 336D LN							
BOOM							
MYG1-UP; MYP1-UP							
3119526			P-UB-10	105 mm	150 mm	CTC-2426840	181.64
STICK							
MYG1-UP							
2898031			P-UB-10	115 mm	170 mm	CTC-3198295	239.47
MODEL 345B, 345BL							
BOOM							
1297829			P-UB-10	110 mm	160 mm	CTC-1680760	402.31
1553737			P-UB-10	110 mm	160 mm	CTC-1680760	402.31
BUCKET							
1183935			P-UB-10	110 mm	160 mm	CTC-1680760	402.31
1184134			P-UB-10	85 mm	120 mm	CTC-1184131	258.61
1232044			P-UB-10	90 mm	130 mm	CTC-1184175	305.60
1297835			P-UB-10	110 mm	170 mm	CTC-1680759	414.73
COUNTERWEIGHT							
1231078			P-UB-10	3	4-3/4	CTC-1570288	178.40
MATERIAL HANDLER							
1504125			P-UB-10	110 mm	170 mm	CTC-1680759	414.73
STEERING							
1151371			P-UB-10	2-1/4	4	CTC-1546526	156.02
STICK							
1163638			P-UB-10	110 mm	170 mm	CTC-1680759	414.73
1297832			P-UB-10	130 mm	190 mm	CTC-1261979	304.62
MODEL 345C							
BOOM							
BWY1-UP; ELS1-UP; GCL1-UP; TAJ1-UP; TBA1-UP; WDE1-UP							
2254523			P-UB-10	110 mm	160 mm	CTC-2254625	279.23
2254523			Bushing	110 mm		CTC-1140762	84.51
BWY1-UP; TBA1-UP; WDE1-UP							
2668087			P-UB-10	110 mm	160 mm	CTC-2742460	273.75
2668087			Bushing	110 mm		CTC-1140762	84.51
BUCKET							
BWY1-UP; ELS1-UP; GCL1-UP; TAJ1-UP; TBA1-UP; WDE1-UP							
2254529			P-UB-10	110 mm	160 mm	CTC-2254625	279.23
2254529			Bushing	110 mm		CTC-1140762	84.51
2254532			P-UB-10	110 mm	170 mm	CTC-2344442	247.21
2254532			Bushing	110 mm		CTC-1140761	90.27
BWY1-UP; TBA1-UP; WDE1-UP							
2742456			P-UB-10	110 mm	160 mm	CTC-2742460	273.75
2742456			Bushing	110 mm		CTC-1140762	84.51
2742459			P-UB-10	110 mm	170 mm	CTC-2742462	278.72
2742459			Bushing	110 mm		CTC-1140761	90.27
COUNTERWEIGHT							
BWY1-UP; TAJ1-UP; TBA1-UP; WDE1-UP							
2369769			P-UB-10	3	4-3/4	CTC-2369769K	103.90

REPLACEMENT KITS FOR CATERPILLAR® EQUIPMENT

Excavators							
APPLICATION	CYL #	Misc-Parts, Instructions, etc.	CODE	ROD	BORE	KIT #	List \$
MODEL 345C							
STICK							
BWY1-UP; ELS1-UP; GCL1-UP; TAJ1-UP; TBA1-UP; WDE1-UP							
2254526			P-UB-10	130 mm	190 mm	CTC-2254646	332.87
2254526			Bushing	130 mm		CTC-1140763	86.23
BWY1-UP; TAJ1-UP; TBA1-UP; WDE1-UP							
2426839			P-UB-10	130 mm	190 mm	CTC-2254646	332.87
2426839			Bushing	130 mm		CTC-1140763	86.23
BWY1-UP; TBA1-UP; WDE1-UP							
2742453			P-UB-10	130 mm	190 mm	CTC-2742461	451.00
2742453			Bushing	130 mm		CTC-1140763	86.23
MODEL 345C L							
BOOM							
BWY1-UP; DHP1-UP; ELS1-UP; ESD1-UP; FPC1-UP; GCL1-UP; GJR1-UP; GPH1-UP; LYS1-UP; PJW1-UP; S5M1-UP; TBA1-UP; TDG1-UP; WDE1-UP							
2254523			P-UB-10	110 mm	160 mm	CTC-2254625	279.23
2254523			Bushing	110 mm		CTC-1140762	84.51
BWY1-UP; DHP1-UP; GJR1-UP; TBA1-UP; WDE1-UP							
2668087			P-UB-10	110 mm	160 mm	CTC-2742460	273.75
2668087			Bushing	110 mm		CTC-1140762	84.51
BUCKET							
BWY1-UP; DHP1-UP; ELS1-UP; ESD1-UP; ESD1-UP; FPC1-UP; GCL1-UP; GJR1-UP; GPH1-UP; LYS1-UP; PJW1-UP; PJW1-UP; S5M1-UP; TBA1-UP; TDG1-UP; TDG1-UP; WDE1-UP							
2254529			P-UB-10	110 mm	160 mm	CTC-2254625	279.23
2254529			Bushing	110 mm		CTC-1140762	84.51
BWY1-UP; DHP1-UP; ELS1-UP; ESD1-UP; GCL1-UP; GJR1-UP; GPH1-UP; LYS1-UP; PJW1-UP; S5M1-UP; TBA1-UP; TDG1-UP; WDE1-UP							
2254532			P-UB-10	110 mm	170 mm	CTC-2344442	247.21
2254532			Bushing	110 mm		CTC-1140761	90.27
BWY1-UP; DHP1-UP; GJR1-UP; TBA1-UP; WDE1-UP							
2742456			P-UB-10	110 mm	160 mm	CTC-2742460	273.75
2742456			Bushing	110 mm		CTC-1140762	84.51
2742459			P-UB-10	110 mm	170 mm	CTC-2742462	278.72
2742459			Bushing	110 mm		CTC-1140761	90.27
COUNTERWEIGHT							
BWY1-UP; DHP1-UP; ESD1-UP; FPC1-UP; GJR1-UP; PJW1-UP; TBA1-UP; TDG1-UP; WDE1-UP							
2369769			P-UB-10	3	4-3/4	CTC-2369769K	103.90
STICK							
BWY1-UP; DHP1-UP; ELS1-UP; ESD1-UP; FPC1-UP; GCL1-UP; GJR1-UP; GPH1-UP; LYS1-UP; PJW1-UP; S5M1-UP; TBA1-UP; TDG1-UP; WDE1-UP							
2254526			P-UB-10	130 mm	190 mm	CTC-2254646	332.87
2254526			Bushing	130 mm		CTC-1140763	86.23
BWY1-UP; DHP1-UP; ESD1-UP; GJR1-UP; PJW1-UP; S5M1-UP; TBA1-UP; TDG1-UP; WDE1-UP							
2426839			P-UB-10	130 mm	190 mm	CTC-2254646	332.87
2426839			Bushing	130 mm		CTC-1140763	86.23
BWY1-UP; DHP1-UP; GJR1-UP; TBA1-UP; WDE1-UP							
2742453			P-UB-10	130 mm	190 mm	CTC-2742461	451.00
2742453			Bushing	130 mm		CTC-1140763	86.23
MODEL 345D L							
BOOM							
BYC1-UP; EEH1-UP; GYR1-UP; JKN1-UP; KFH1-UP; LKY1-UP; MLK1-UP; NLM1-UP; PBT1-UP; RAE1-UP; RAJ1-UP; RGD1-UP; RGG1-UP; YEE1-UP							
2254523			P-UB-10	110 mm	160 mm	CTC-3764336	186.68
BYC1-UP; JKN1-UP; PBT1-UP; RAE1-UP							
2668087			P-UB-10	110 mm	160 mm	CTC-2742460	273.75
BUCKET							
BYC1-UP; EEH1-UP; GYR1-UP; JKN1-UP; KFH1-UP; LKY1-UP; MLK1-UP; NLM1-UP; RAE1-UP; PBT1-UP; RAJ1-UP; RGD1-UP; RGG1-UP; YEE1-UP							
2254532			P-UB-10	110 mm	170 mm	CTC-3338675	230.43

REPLACEMENT KITS FOR CATERPILLAR® EQUIPMENT

Excavators							
APPLICATION	CYL #	Misc-Parts, Instructions, etc.	CODE	ROD	BORE	KIT #	List \$
MODEL 345D L							
BUCKET							
BYC1-UP; EEH1-UP; GYR1-UP; JKN1-UP; KFH1-UP; LKY1-UP; NLM1-UP; MLK1-UP; PBT1-UP; RAE1-UP; RAJ1-UP; RGG1-UP; YEE1-UP							
2937678			P-UB-10	110 mm	160 mm	CTC-2254625	279.23
BYC1-UP; GYR1-UP; KFH1-UP; LKY1-UP; NLM1-UP; RGD1-UP; RGG1-UP							
2254529			P-UB-10	110 mm	160 mm	CTC-3338750	178.60
BYC1-UP; JKN1-UP; PBT1-UP; RAE1-UP							
2742456			P-UB-10	110 mm	160 mm	CTC-2742460	273.75
2742459			P-UB-10	110 mm	170 mm	CTC-2742462	278.72
EEH1-UP; JKN1-UP; MLK1-UP; PBT1-UP; RAE1-UP; RAJ1-UP; YEE1-UP							
2254529			P-UB-10	110 mm	160 mm	CTC-2254625	279.23
EEH1-UP; RAJ1-UP; YEE1-UP							
3675217			P-UB-10	110 mm	160 mm	CTC-3338750	178.60
COUNTERWEIGHT							
BYC1-UP; EEH1-UP; JKN1-UP; PBT1-UP; RAE1-UP; RAJ1-UP; YEE1-UP							
2369769			P-UB-10	3	4-3/4	CTC-2369769K	103.90
COUPLER							
EEH1-UP; JKN1-UP; RAJ1-UP; YEE1-UP							
3030703	Quick Coupler		P-U-10,12	3-1/4	5-1/2	CTC-3460644	101.30
EEH1-UP; MLK1-UP; RAJ1-UP; YEE1-UP							
1690753	Lock		P-U-5	40 mm	70 mm	CTC-2191322	35.74
EEH1-UP; RAJ1-UP; YEE1-UP							
2692106			I-U-14	50 mm	100 mm	CTC-2525507	164.80
3242645			I-U-10	50 mm	100 mm	CTC-3265946	72.08
STICK							
BYC1-UP; GYR1-UP; JKN1-UP; KFH1-UP; LKY1-UP; MLK1-UP; NLM1-UP; PBT1-UP; RAE1-UP; RGD1-UP; RGG1-UP; YEE1-UP							
2254526			P-UB-10	130 mm	190 mm	CTC-3319328	341.86
BYC1-UP; JKN1-UP; PBT1-UP; RAE1-UP							
2742453			P-UB-10	130 mm	190 mm	CTC-2742461	451.00
EEH1-UP; RAJ1-UP							
2254526			P-UB-10	130 mm	190 mm	CTC-2254646	332.87
MODEL 350							
BUCKET							
1578989			P-UB-10	110 mm	160 mm	CTC-1560656	275.37
411726			P-UB-10	110 mm	160 mm	CTC-1560656	275.37
413792			P-UB-10	130 mm	180 mm	CTC-1560625	435.94
STICK							
0875375			P-UB-10	130 mm	180 mm	CTC-1560625	435.94
1560674			P-UB-10	130 mm	180 mm	CTC-1560625	435.94
MODEL 350, 350L							
BOOM							
411515			P-UB-10	110 mm	170 mm	CTC-1163649	389.77
411515			P-UB-10	110 mm	170 mm	CTC-1680759	414.73
BUCKET							
411726			P-UB-10	110 mm	160 mm	CTC-0876654	332.19
413792			P-UB-10	130 mm	180 mm	CTC-0875407	412.06
7Y5100			P-UB-10	85 mm	130 mm	CTC-7Y5145	276.61
LIFT							
6E3529			P-UB-10	2-1/2	4	CTC-710968	149.65
STICK							
0875375			P-UB-10	130 mm	180 mm	CTC-0875407	412.06
MODEL 365, 365B							
BUCKET							
1438004			P-UB-10	130 mm	180 mm	CTC-1709830	405.52
1438007			P-UB-10	140 mm	200 mm	CTC-1709829	328.18
COUNTERWEIGHT							
1505913			P-UB-10	90 mm	130 mm	CTC-1184175	305.60

REPLACEMENT KITS FOR CATERPILLAR® EQUIPMENT

Excavators							
APPLICATION	CYL #	Misc-Parts, Instructions, etc.	CODE	ROD	BORE	KIT #	List \$
MODEL 365, 365B							
STICK							
	1438001		P-UB-10	140 mm	200 mm	CTC-1709829	328.18
	1589114		P-UB-10	140 mm	200 mm	CTC-1709829	328.18
MODEL 375							
BOOM							
	6E0018		P-UB-10	140 mm	200 mm	CTC-1560626	675.75
	1JM1-172; 6NK1-; 6RL1-00048; 8WJ1-90; 8XG1-00216; 9WL1-						
	6E0018		P-UB-10	140 mm	200 mm	CTC-2344666	359.42
	1JM173-; 6RL00081-; 8WJ91-; 8XG00313-						
	1140596		P-UB-10	140 mm	200 mm	CTC-1560626	675.75
	6NK1-; 9WL1-						
	1140596		P-UB-10	140 mm	200 mm	CTC-2003495	285.09
	6RL00049-; 8XG00217-						
	1140596		P-UB-10	140 mm	200 mm	CTC-2344666	359.42
BUCKET							
	1578989		P-UB-10	110 mm	160 mm	CTC-1560656	275.37
	411726		P-UB-10	110 mm	160 mm	CTC-1560656	275.37
	1JM1-; 6LR00081-; 6NK1-; 6RL1-; 8WJ1-; 8XG00313-; 9WL1-						
	6E0021		P-UB-10	140 mm	200 mm	CTC-1560626	675.75
	1JM1-; 6LR81-; 6NK1-; 8WJ1-; 8XG00313-; 9WL1-						
	1560694		P-UB-10	140 mm	200 mm	CTC-2003495	285.09
	1JM1-; 6NK1-; 8WJ1-; 9WL1-						
	6E0020		P-UB-10	150 mm	220 mm	CTC-1560627	603.81
	1JM1-; 8WJ1-						
	1560697		P-UB-10	150 mm	220 mm	CTC-1560627	603.81
	6LR00081-; 8XG00313-						
	1560697	TYPE 2	P-UB-10	150 mm	220 mm	CTC-2003496	496.40
	6E0020	TYPE 1	P-UB-10	150 mm	220 mm	CTC-1560627	603.81
	6NK1-; 9WL1-						
	1560697		P-UB-10	150 mm	220 mm	CTC-2003496	496.40
	6RL1-						
	6E0020		P-UB-10	150 mm	220 mm	CTC-1163529	603.81
COUNTERWEIGHT							
	1JM1-111; 6NK1-; 8WJ1-83; 9WL1-						
	6E3529		P-UB-10	2-1/2	4	CTC-710968	149.65
LIFT							
	6E3529		P-UB-10	2-1/2	4	CTC-710968	149.65
STICK							
	1JM1-; 6NK1-; 6RL00081-; 8WJ1-; 8XG00313-; 9WL1-						
	6E0019		P-UB-10	150 mm	220 mm	CTC-1560627	603.81
	1JM1-; 6NK1-; 6RL81-; 8WJ1-; 8XG00313-; 9WL1-						
	1560664		P-UB-10	150 mm	220 mm	CTC-1560627	603.81
	6NK1-; 9WL1-						
	1560679		P-UB-10	150 mm	220 mm	CTC-1560627	603.81
	6RL00106-; 8XG00350-						
	1560665		P-UB-10	150 mm	220 mm	CTC-2003496	496.40
	6RL1-						
	6E0019		P-UB-10	150 mm	220 mm	CTC-1163529	603.81
TRACK ADJUSTER							
	1JM1-; 6NK1-; 6RL1-; 8WJ1-; 8XG1-; 9WL1-						
	7Y0858		TRK ADJ			CTC-7Y0858K	53.89
	6NK1-110; 8XG1-00159						
	7Y0859		TRK ADJ			CTC-7Y0859K	53.89

REPLACEMENT KITS FOR CATERPILLAR® EQUIPMENT

Excavators							
APPLICATION	CYL #	Misc-Parts, Instructions, etc.	CODE	ROD	BORE	KIT #	List \$
MODEL 375L							
BOOM							
	1140596		P-UB-10	140 mm	200 mm	CTC-2344666	359.42
	6E0018		P-UB-10	140 mm	200 mm	CTC-1560626	675.75
BUCKET							
	411726		P-UB-10	110 mm	160 mm	CTC-0876654	332.19
	6E0021		P-UB-10	140 mm	200 mm	CTC-2344666	359.42
LIFT							
	6E3529		P-UB-10	2-1/2	4	CTC-710968	149.65
STICK							
	6E0019		P-UB-10	150 mm	220 mm	CTC-518893	501.04
MODEL E70B							
BLADE							
	5TG1-UP; 6AK1-UP						
	0856321		P-UB-15	50 mm	90 mm	CTC-0933045	339.41
	0856322		P-UB-15	50 mm	90 mm	CTC-0933045	339.41
BOOM							
	5TG1-UP; 6AK1-UP						
	0855096		P-UB-14	75 mm	110 mm	CTC-0995310	281.39
	0856331		P-UB-14	60 mm	90 mm	CTC-0996978	130.01
	0996923		P-UB-14	75 mm	110 mm	CTC-0995310	281.39
	419618		P-UB-14	75 mm	110 mm	CTC-0995310	281.39
	516871		P-UB-14	75 mm	110 mm	CTC-0995310	281.39
BUCKET							
	5TG1-UP; 6AK1-UP						
	0997005		P-UB-14	55 mm	80 mm	CTC-0997004	128.81
STICK							
	5TG1-UP; 6AK1-UP						
	0856337		P-UB-14	60 mm	90 mm	CTC-0996978	130.01
	0996979		P-UB-14	60 mm	90 mm	CTC-0996978	130.01
	1R9847		P-UB-14	60 mm	90 mm	CTC-0996978	130.01
MODEL E110							
BOOM							
	0936151		P-UB-15	70 mm	110 mm	CTC-0938385	236.75
BUCKET							
	0936181		P-UB-15	65 mm	110 mm	CTC-0938390	350.26
STICK							
	0936167		P-UB-15	80 mm	120 mm	CTC-0938388	394.96
MODEL E110B							
BOOM							
	0995402		P-UB-14	70 mm	100 mm	CTC-0995401	240.30
	0995403		P-UB-14	70 mm	100 mm	CTC-0995401	240.30
STICK							
	0855801		P-UB-14	75 mm	110 mm	CTC-0995310	281.39
	0856657		P-UB-14	75 mm	100 mm	CTC-0860174	279.75
	0861937		P-UB-14	75 mm	110 mm	CTC-0995310	281.39
	0995369		P-UB-14	75 mm	110 mm	CTC-0995310	281.39
MODEL E120							
BOOM LH							
	0958487		P-UB-10	75 mm	110 mm	CTC-0967786	365.51
BOOM RH							
	0958486		P-UB-10	75 mm	110 mm	CTC-0967786	365.51
BUCKET							
	0938997		P-UB-10	65 mm	100 mm	CTC-0967625	348.95
STICK							
	0938966		P-UB-10	80 mm	120 mm	CTC-0967799	352.26

REPLACEMENT KITS FOR CATERPILLAR® EQUIPMENT

Excavators							
APPLICATION	CYL #	Misc-Parts, Instructions, etc.	CODE	ROD	BORE	KIT #	List \$
MODEL E120B							
BOOM LH							
	0990662		P-UB-14	75 mm	110 mm	CTC-0995310	281.39
BOOM RH							
	0990663		P-UB-14	75 mm	110 mm	CTC-0995310	281.39
BUCKET							
	0990701		P-UB-14	65 mm	100 mm	CTC-0995312	304.99
STICK							
	7NF01890-03529						
	0861868		P-UB-14	80 mm	120 mm	CTC-0995311	300.29
	7NF03530-UP						
	0855740		P-UB-14	80 mm	120 mm	CTC-0995311	300.29
	7NF1-01889						
	0990682		P-UB-14	80 mm	120 mm	CTC-0995311	300.29
TELESCOPIC STICK							
	0856657		P-UB-14	75 mm	100 mm	CTC-0860174	279.75
MODEL E180, EL180							
BOOM LH							
	0941911		P-UB-10	85 mm	125 mm	CTC-0940691	334.05
BOOM RH							
	0941926		P-UB-10	85 mm	125 mm	CTC-0940691	334.05
BUCKET							
	0941946		P-UB-10	85 mm	125 mm	CTC-0940691	334.05
STICK							
	0941929		P-UB-10	100 mm	140 mm	CTC-0941910	398.72
MODEL E200B, EL200B							
BOOM LH							
	0967907		P-UB-10	85 mm	120 mm	CTC-0964395	402.56
BOOM RH							
	0967908		P-UB-10	85 mm	120 mm	CTC-0964395	402.56
BUCKET							
	0967909		P-UB-10	75 mm	115 mm	CTC-0966457	373.31
BUCKET LONG REACH							
	0993713		P-UB-14	65 mm	100 mm	CTC-0995312	304.99
STICK							
	0967910		P-UB-10	100 mm	140 mm	CTC-1890282	300.23
STICK LONG REACH							
	0993688		P-UB-10	95 mm	130 mm	CTC-0964396	444.14
MODEL E240, EL240							
BOOM LH							
	0941549		P-UB-14	90 mm	140 mm	CTC-0939941	316.83
BOOM RH							
	0941550		P-UB-14	90 mm	140 mm	CTC-0939941	316.83
BUCKET							
	0962391		P-UB-14	90 mm	140 mm	CTC-0939941	316.83
STICK							
	0941406		P-UB-14	100 mm	150 mm	CTC-0942697	264.98
MODEL E240B, EL240B							
BOOM							
	1R8082		P-UB-14	90 mm	140 mm	CTC-0939941	316.83
BOOM LH							
	0996240		P-UB-14	90 mm	140 mm	CTC-0939941	316.83
BOOM RH							
	0996241		P-UB-14	90 mm	140 mm	CTC-0939941	316.83
BUCKET							
	0996233		P-UB-14	90 mm	140 mm	CTC-0939941	316.83
	1R5580		P-UB-14	65 mm	100 mm	CTC-0995312	304.99

REPLACEMENT KITS FOR CATERPILLAR® EQUIPMENT

Excavators							
APPLICATION	CYL #	Misc-Parts, Instructions, etc.	CODE	ROD	BORE	KIT #	List \$
MODEL E240B, EL240B							
STICK							
	0996237		P-UB-14	100 mm	150 mm	CTC-0942697	264.98
MODEL E300, EL300							
BOOM LH							
	0946493		P-UB-14	100 mm	150 mm	CTC-0942697	264.98
BOOM RH							
	0946494		P-UB-14	100 mm	150 mm	CTC-0942697	264.98
BUCKET							
	0962932		P-UB-14	100 mm	150 mm	CTC-0942697	264.98
STICK							
	0962920		P-UB-14	110 mm	160 mm	CTC-0942698	403.40
MODEL E300B, EL300B							
BOOM							
	1R7823		P-UB-10	100 mm	140 mm	CTC-1890282	300.23
BOOM LH							
	0995577		P-UB-10	100 mm	140 mm	CTC-1890282	300.23
BOOM RH							
	0995578		P-UB-10	100 mm	140 mm	CTC-1890282	300.23
Excavators - Front-Shovel							
APPLICATION	CYL #	Misc-Parts, Instructions, etc.	CODE	ROD	BORE	KIT #	List \$
MODEL 5080							
BOOM							
	4I3915		P-UB-10	130 mm	180 mm	CTC-0875407	412.06
STICK							
	6E4272		P-UB-10	150 mm	220 mm	CTC-1560627	603.81
MODEL 5110							
BUCKET							
	6E0020		P-UB-10	150 mm	220 mm	CTC-1560627	603.81
MODEL 5230, 5230B							
BUCKET							
	6E6435		P-UB-10	3-1/2	7-1/4	CTC-1309483	341.90
Excavators - Wheel							
APPLICATION	CYL #	Misc-Parts, Instructions, etc.	CODE	ROD	BORE	KIT #	List \$
MODEL M315							
BOOM							
	1134979		P-UB-10	80 mm	110 mm	CTC-1247009	229.93
	1134989		P-UB-10	80 mm	110 mm	CTC-1247009	229.93
STICK							
	1141872		P-UB-10	80 mm	110 mm	CTC-1247009	229.93
	1586388		P-UB-10	75 mm	110 mm	CTC-1586389	217.04
MODEL M316							
BLADE							
			I-U-10	60 mm	100 mm	CTC-1183135	97.11
BOOM							
			I-U-15	60 mm	110 mm	CTC-1558421	75.98
			P-UB-10	75 mm	140 mm	CTC-2605319	420.26
COUPLER							
			I-U-5	40 mm	60 mm	CTC-2027897	42.80
STABILIZER							
			P-U-10	70 mm	130 mm	CTC-2000920	154.98
STICK							
			P-UB-10	80 mm	120 mm	CTC-2605316	119.46

REPLACEMENT KITS FOR CATERPILLAR® EQUIPMENT

Excavators - Wheel							
APPLICATION	CYL #	Misc-Parts, Instructions, etc.	CODE	ROD	BORE	KIT #	List \$
MODEL M318							
BOOM							
	1112034		I-U-10	60 mm	100 mm	CTC-1183135	97.11
	1124231		P-UB-10	85 mm	120 mm	CTC-1247008	162.73
	1124241		P-UB-10	85 mm	120 mm	CTC-1247008	162.73
	1124243		P-UB-10	85 mm	160 mm	CTC-1247005	208.88
BUCKET							
	1124245		P-UB-10	80 mm	110 mm	CTC-1247007	269.82
MATERIAL HANDLER							
	1415981		P-UB-10	80 mm	110 mm	CTC-1247009	229.93
STICK							
	1124236		P-UB-10	85 mm	120 mm	CTC-1247008	162.73
MODEL M320							
BOOM							
	1279243		P-UB-10	100 mm	170 mm	CTC-1296156	199.63
	1283203		P-UB-10	95 mm	130 mm	CTC-7Y5147	309.35
BUCKET							
	0875633		P-UB-10	85 mm	120 mm	CTC-0875394	267.83
	0875633		P-UB-10	85 mm	120 mm	CTC-1184131	258.61
STICK							
	1279242		P-UB-10	100 mm	140 mm	CTC-0875387	353.62
	1386696		P-UB-10	85 mm	120 mm	CTC-1184131	258.61
Forestry - Tree Harvesters							
APPLICATION	CYL #	Misc-Parts, Instructions, etc.	CODE	ROD	BORE	KIT #	List \$
MODEL 518							
TILT LH							
	9T1777		P-UB-10	2-1/4	4-1/4	CTC-7X2750	118.40
TILT RH							
	9T1772		P-UB-10	2-1/4	4-1/4	CTC-7X2750	118.40
Integrated Toolcarriers							
APPLICATION	CYL #	Misc-Parts, Instructions, etc.	CODE	ROD	BORE	KIT #	List \$
MODEL IT12							
LIFT							
	4T8579		I-U-3	3/4	1-1/2	CTC-1791715	15.63
	4T8580		P-UB-10	2	3-3/4	CTC-7X2787	106.95
M.P. BUCKET							
	8J5391		P-UB-10	1-1/2	3-1/2	CTC-7X2752	98.74
STEERING							
	1U4666		P-UB-10	1-1/2	2-3/4	CTC-7X2736	130.81
	9T5153		P-UB-10	1-1/2	2-3/4	CTC-7X2736	130.81
	9T5729		I-O-3	3/4	1-1/2	CTC-1791749	5.58
TILT							
	4T8581		P-UB-10	1-3/4	3-1/4	CTC-7X2764	71.17
	9T5151		P-UB-10	2	3-1/2	CTC-7X2783	106.57
	9T5489		P-UB-10	1-3/4	3-1/4	CTC-7X2764	71.17
MODEL IT12B							
LIFT							
	6E6398		P-UB-10	2-1/4	3-1/2	CTC-1859503	142.36
	9T5152		P-UB-10	2-1/4	4	CTC-1859527	118.64
PIN PULLER							
	9T5729		I-O-3	3/4	1-1/2	CTC-1791749	5.58

REPLACEMENT KITS FOR CATERPILLAR® EQUIPMENT

Integrated Toolcarriers							
APPLICATION	CYL #	Misc-Parts, Instructions, etc.	CODE	ROD	BORE	KIT #	List \$
MODEL IT12B							
STEERING							
	4T8579		I-U-3	3/4	1-1/2	CTC-1791715	15.63
	9T5729		I-O-3	3/4	1-1/2	CTC-1791749	5.58
	9T7209	Head# 6E4940	P-UB-10	1-1/2	2-3/4	CTC-1361599	110.23
	9T7209	Head# 9T2542	P-UB-10	1-1/2	2-3/4	CTC-7X2736	130.81
	9T7210	Head# 6E4940	P-UB-10	1-1/2	2-3/4	CTC-1361599	110.23
	9T7210	Head# 9T2542	P-UB-10	1-1/2	2-3/4	CTC-7X2736	130.81
STEERING LH							
	6E5900	Head# 1515349	P-UB-10	1-3/4	2-3/4	CTC-1539053	156.06
	6E5900	Head# 6E4941	P-UB-10	1-3/4	2-3/4	CTC-1857024	56.97
	6E5973		P-UB-10	1-1/2	2-3/4	CTC-1361599	110.23
	9T7209	Head# 6E4940	P-UB-10	1-1/2	2-3/4	CTC-1361599	110.23
	9T7209	Head# 9T2542	P-UB-10	1-1/2	2-3/4	CTC-7X2736	130.81
STEERING RH							
	6E5972	Head# 1515349	P-UB-10	1-3/4	2-3/4	CTC-1539053	156.06
	6E5972	Head# 6E4941	P-UB-10	1-3/4	2-3/4	CTC-1857024	56.97
	6E5985		P-UB-10	1-1/2	2-3/4	CTC-1361599	110.23
TILT							
	9T5151		P-UB-10	2	3-1/2	CTC-1857674	119.55
MODEL IT12F							
LIFT							
	6E6398		P-UB-10	2-1/4	3-1/2	CTC-1859503	142.36
	9T5152		P-UB-10	2-1/4	4	CTC-1859527	118.64
STEERING							
	4T8579		I-U-3	3/4	1-1/2	CTC-1791715	15.63
	9T5729		I-O-3	3/4	1-1/2	CTC-1791749	5.58
	9T7209	Head# 6E4940	P-UB-10	1-1/2	2-3/4	CTC-1361599	110.23
	9T7209	Head# 9T2542	P-UB-10	1-1/2	2-3/4	CTC-7X2736	130.81
	9T7210	Head# 6E4940	P-UB-10	1-1/2	2-3/4	CTC-1361599	110.23
	9T7210	Head# 9T2542	P-UB-10	1-1/2	2-3/4	CTC-7X2736	130.81
STEERING LH							
	6E5900	Head# 1515349	P-UB-10	1-3/4	2-3/4	CTC-1539053	156.06
	6E5900	Head# 6E4941	P-UB-10	1-3/4	2-3/4	CTC-1857024	56.97
	6E5973		P-UB-10	1-1/2	2-3/4	CTC-1361599	110.23
STEERING RH							
	6E5972	Head# 1515349	P-UB-10	1-3/4	2-3/4	CTC-1539053	156.06
	6E5972	Head# 6E4941	P-UB-10	1-3/4	2-3/4	CTC-1857024	56.97
	6E5985		P-UB-10	1-1/2	2-3/4	CTC-1361599	110.23
TILT							
	9T5151		P-UB-10	2	3-1/2	CTC-1857674	119.55
MODEL IT14B							
LIFT							
	9T5152		P-UB-10	2-1/4	4	CTC-1859527	118.64
PIN PULLER							
	9T5729		I-O-3	3/4	1-1/2	CTC-1791749	5.58
STEERING							
	4T8579		I-U-3	3/4	1-1/2	CTC-1791715	15.63
	9T5729		I-O-3	3/4	1-1/2	CTC-1791749	5.58
	9T7209	Head# 6E4940	P-UB-10	1-1/2	2-3/4	CTC-1361599	110.23
	9T7209	Head# 9T2542	P-UB-10	1-1/2	2-3/4	CTC-7X2736	130.81
	9T7210	Head# 6E4940	P-UB-10	1-1/2	2-3/4	CTC-1361599	110.23
	9T7210	Head# 9T2542	P-UB-10	1-1/2	2-3/4	CTC-7X2736	130.81
STEERING LH							
	6E5973		P-UB-10	1-1/2	2-3/4	CTC-1361599	110.23
	9T7209	Head# 6E4940	P-UB-10	1-1/2	2-3/4	CTC-1361599	110.23
	9T7209	Head# 9T2542	P-UB-10	1-1/2	2-3/4	CTC-7X2736	130.81

REPLACEMENT KITS FOR CATERPILLAR® EQUIPMENT

Integrated Toolcarriers							
APPLICATION	CYL #	Misc-Parts, Instructions, etc.	CODE	ROD	BORE	KIT #	List \$
MODEL IT14B							
STEERING RH							
	6E5985		P-UB-10	1-1/2	2-3/4	CTC-1361599	110.23
TILT							
	9T5151		P-UB-10	2	3-1/2	CTC-1857674	119.55
MODEL IT14C							
TILT							
	9T5151		P-UB-10	2	3-1/2	CTC-7X2783	106.57
MODEL IT14F							
LIFT							
	6E6398		P-UB-10	2-1/4	3-1/2	CTC-1859503	142.36
STEERING							
	4T8579		I-U-3	3/4	1-1/2	CTC-1791715	15.63
	9T5729		I-O-3	3/4	1-1/2	CTC-1791749	5.58
STEERING LH							
	6E5900	Head# 1515349	P-UB-10	1-3/4	2-3/4	CTC-1539053	156.06
	6E5900	Head# 6E4941	P-UB-10	1-3/4	2-3/4	CTC-1857024	56.97
STEERING RH							
	6E5972	Head# 1515349	P-UB-10	1-3/4	2-3/4	CTC-1539053	156.06
	6E5972	Head# 6E4941	P-UB-10	1-3/4	2-3/4	CTC-1857024	56.97
MODEL IT14G							
FK							
	1491381		P-UB-10	2	3-1/2	CTC-1857674	119.55
LIFT							
	1116244		P-UB-10	2-1/4	3-1/2	CTC-1859503	142.36
	1314401		P-UB-10	2-1/4	3-1/2	CTC-1859503	142.36
	1314402		P-UB-10	2-1/4	3-1/2	CTC-1859503	142.36
STEERING							
	1044187		P-UB-10	1-1/2	2-1/2	CTC-1856601	53.58
	4T8579		I-U-3	3/4	1-1/2	CTC-1791715	15.63
	9T8823		I-O-3	1	2	CTC-9T0418	85.89
MODEL IT18							
LIFT							
	4T5544		I-O-3	1	2	CTC-9T0418	85.89
	4T8648	Head# 3G2956	P-UB-10	2-1/4	4-1/4	CTC-1859507	114.99
	4T8648	Head# 9T7349	P-UB-10	2-1/4	4-1/4	CTC-1859517	138.16
M.P. BUCKET TILT							
	4T4666		P-UB-10	2-1/2	4	CTC-1864338	84.48
PIN COUPLER							
	9T2352		I-O-3	1	2	CTC-9T0418	85.89
PIN PULLER							
	6E5392		I-O-3	1	2	CTC-9T0418	85.89
	6E5393		I-O-3	1	2	CTC-9T0418	85.89
SPECIAL APPLICATION							
	6E0906		I-O-3	1	2	CTC-9T0418	85.89
STEERING							
	1U3322		P-UB-10	1-1/2	3	CTC-1856587	62.87
	4T9981		I-O-3	1	2	CTC-9T0418	85.89
	6E0906		I-O-3	1	2	CTC-9T0418	85.89
	6E5392		I-O-3	1	2	CTC-9T0418	85.89
	9T2352		I-O-3	1	2	CTC-9T0418	85.89
TILT							
	4T4666		P-UB-10	2-1/2	4	CTC-1864338	84.48

CATERPILLAR®

REPLACEMENT KITS FOR CATERPILLAR® EQUIPMENT

Integrated Toolcarriers							
APPLICATION	CYL #	Misc-Parts, Instructions, etc.	CODE	ROD	BORE	KIT #	List \$
MODEL IT18B							
LIFT							
	4T5544		I-O-3	1	2	CTC-9T0418	85.89
	4T9981		I-O-3	1	2	CTC-9T0418	85.89
	6E0906		I-O-3	1	2	CTC-9T0418	85.89
	6E5392		I-O-3	1	2	CTC-9T0418	85.89
	6E5393		I-O-3	1	2	CTC-9T0418	85.89
	9T2352		I-O-3	1	2	CTC-9T0418	85.89
	9T5030	Head# 9T5031	P-UB-10	2-1/2	4-3/4	CTC-1328811	167.09
PIN COUPLER							
	4T9981		I-O-3	1	2	CTC-9T0418	85.89
	6E5392		I-O-3	1	2	CTC-9T0418	85.89
	6E5393		I-O-3	1	2	CTC-9T0418	85.89
	9T2352		I-O-3	1	2	CTC-9T0418	85.89
	9T8485		I-O-3	1	2	CTC-9T0418	85.89
SPECIAL APPLICATION							
	4T5544		I-O-3	1	2	CTC-9T0418	85.89
	6E0906		I-O-3	1	2	CTC-9T0418	85.89
STEERING							
	1U3322		P-UB-10	1-1/2	3	CTC-1856587	62.87
	9T8485		I-O-3	1	2	CTC-9T0418	85.89
TILT							
	9T5267		P-UB-10	2	4	CTC-1857688	72.08
MODEL IT18F							
LIFT							
	1007020	Head# 1206679	P-UB-10	2-1/2	4-3/4	CTC-1361131	148.19
	1007020	Head# 9T3609	P-UB-10	2-1/2	4-3/4	CTC-1864381	160.80
	1341379		P-UB-10	2-1/2	4-3/4	CTC-1361131	148.19
	9T7044		P-UB-10	2-1/2	4-3/4	CTC-1864381	160.80
	9T8823		I-O-3	1	2	CTC-9T0418	85.89
PIN PULLER							
	6E5393		I-O-3	1	2	CTC-9T0418	85.89
STEERING							
	6E1114		I-O-3	1	2	CTC-9T0418	85.89
	9T2637		P-UB-10	1-1/2	2-3/4	CTC-1361599	110.23
TILT							
	1341380		P-UB-10	2	4	CTC-1857688	72.08
	9T7026		P-UB-10	2	4	CTC-1857688	72.08
MODEL IT24F							
LIFT							
	1007020	Head# 1206679	P-UB-10	2-1/2	4-3/4	CTC-1361131	148.19
	1007020	Head# 9T3609	P-UB-10	2-1/2	4-3/4	CTC-1864381	160.80
	1341379		P-UB-10	2-1/2	4-3/4	CTC-1361131	148.19
	1342327		P-UB-10	2-1/4	4	CTC-1546526	156.02
	9T3937		P-UB-10	2-1/4	4	CTC-1546526	156.02
	9T8823		I-O-3	1	2	CTC-9T0418	85.89
STEERING							
	9T2637		P-UB-10	1-1/2	2-3/4	CTC-1361599	110.23

REPLACEMENT KITS FOR CATERPILLAR® EQUIPMENT

Integrated Toolcarriers							
APPLICATION	CYL #	Misc-Parts, Instructions, etc.	CODE	ROD	BORE	KIT #	List \$
MODEL IT24F							
TILT							
	1107845	Head# 1206679	P-UB-10	2-1/2	4-1/2	CTC-1113300	141.35
	1107845	Head# 9T3609	P-UB-10	2-1/2	4-1/2	CTC-1469860	166.90
	1262492		P-UB-10	2	4	CTC-1113302	123.12
	1262492		P-UB-10	2	4	CTC-1857688	72.08
	1341380		P-UB-10	2	4	CTC-1857688	72.08
	1341381		P-UB-10	2	4	CTC-1857688	72.08
	1342671		P-UB-10	2-1/2	4-1/2	CTC-1113300	141.35
	6E1114		I-O-3	1	2	CTC-9T0418	85.89
	6E4651	Head# 1206679	P-UB-10	2-1/2	4-1/2	CTC-1113300	141.35
	6E4651	Head# 9T3609	P-UB-10	2-1/2	4-1/2	CTC-1469860	166.90
	9T7026		P-UB-10	2	4	CTC-1857688	72.08
MODEL IT28							
LIFT							
	3G2991		P-UB-10	2-1/2	4-3/4	CTC-1328811	167.09
PIN PULLER							
	6E5392		I-O-3	1	2	CTC-9T0418	85.89
	6E5393		I-O-3	1	2	CTC-9T0418	85.89
	9T2352		I-O-3	1	2	CTC-9T0418	85.89
SPECIAL APPLICATION							
	4T5544		I-O-3	1	2	CTC-9T0418	85.89
	6E0906		I-O-3	1	2	CTC-9T0418	85.89
STEERING							
	3G3501		P-UB-10	1-1/2	3	CTC-7X2751	66.28
	4T9981		I-O-3	1	2	CTC-9T0418	85.89
	6E0906		I-O-3	1	2	CTC-9T0418	85.89
	6E5392		I-O-3	1	2	CTC-9T0418	85.89
	9T2352		I-O-3	1	2	CTC-9T0418	85.89
TILT							
	4T5544		I-O-3	1	2	CTC-9T0418	85.89
	4T5545	Head# 8J8431	P-UB-10	2-1/2	4-1/4	CTC-1864336	93.80
	4T5545	Head# 9T6548	P-UB-10	2-1/2	4-1/4	CTC-1864373	106.20
TILT MP, BUCKET							
	4T5545	Head# 8J8431	P-UB-10	2-1/2	4-1/4	CTC-1864336	93.80
	4T5545	Head# 9T6548	P-UB-10	2-1/2	4-1/4	CTC-1864373	106.20
MODEL IT28B							
LIFT							
	3G2991		P-UB-10	2-1/2	4-3/4	CTC-1328811	167.09
	4T8648	Head# 3G2956	P-UB-10	2-1/4	4-1/4	CTC-1859507	114.99
	4T8648	Head# 9T7349	P-UB-10	2-1/4	4-1/4	CTC-1859517	138.16
	9T1196		P-UB-10	2-1/2	5-1/2	CTC-7X2672	91.88
PIN COUPLER							
	4T9981		I-O-3	1	2	CTC-9T0418	85.89
	6E5392		I-O-3	1	2	CTC-9T0418	85.89
	9T2352		I-O-3	1	2	CTC-9T0418	85.89
	9T8485		I-O-3	1	2	CTC-9T0418	85.89
SPECIAL APPLICATION							
	4T5544		I-O-3	1	2	CTC-9T0418	85.89
	6E0906		I-O-3	1	2	CTC-9T0418	85.89

REPLACEMENT KITS FOR CATERPILLAR® EQUIPMENT

Integrated Toolcarriers							
APPLICATION	CYL #	Misc-Parts, Instructions, etc.	CODE	ROD	BORE	KIT #	List \$
MODEL IT28B							
STEERING							
	1U3322		P-UB-10	1-1/2	3	CTC-1856587	62.87
	3G3501		P-UB-10	1-1/2	3	CTC-7X2751	66.28
	3G5110		P-UB-10	1-3/4	3-1/2	CTC-7X2762	103.56
	3G5110		P-UB-10	1-3/4	3-1/2	CTC-7X2784	58.32
	4T9981		I-O-3	1	2	CTC-9T0418	85.89
	6E0906		I-O-3	1	2	CTC-9T0418	85.89
	6E5392		I-O-3	1	2	CTC-9T0418	85.89
	6E5393		I-O-3	1	2	CTC-9T0418	85.89
	9T2352		I-O-3	1	2	CTC-9T0418	85.89
	9T8485		I-O-3	1	2	CTC-9T0418	85.89
TILT							
	3G5291		P-UB-10	2-3/4	6-1/2	CTC-7X2686	124.95
	3G6571		P-UB-10	2-1/2	4-3/4	CTC-1328811	167.09
	4T5544		I-O-3	1	2	CTC-9T0418	85.89
	4T5545	Head# 8J8431	P-UB-10	2-1/2	4-1/4	CTC-1864336	93.80
	4T5545	Head# 9T6548	P-UB-10	2-1/2	4-1/4	CTC-1864373	106.20
TILT MP, BUCKET							
	4T5545	Head# 8J8431	P-UB-10	2-1/2	4-1/4	CTC-1864336	93.80
	4T5545	Head# 9T6548	P-UB-10	2-1/2	4-1/4	CTC-1864373	106.20
MODEL IT28F							
LIFT							
	1341384		P-UB-10	2-1/2	4-3/4	CTC-1361131	148.19
	9T6788	Head# 1206679	P-UB-10	2-1/2	4-3/4	CTC-1361131	148.19
	9T6788	Head# 9T3609	P-UB-10	2-1/2	4-3/4	CTC-1864381	160.80
	9T8823		I-O-3	1	2	CTC-9T0418	85.89
PIN PULLER							
	6E5393		I-O-3	1	2	CTC-9T0418	85.89
STEERING							
	6E1114		I-O-3	1	2	CTC-9T0418	85.89
	9T6646		P-UB-10	1-1/2	2-3/4	CTC-1361599	110.23
TILT							
	1341385		P-UB-10	2	4	CTC-1857688	72.08
	9T6929		P-UB-10	2	4	CTC-1857688	72.08
MODEL IT28G							
LIFT							
	1191060		P-UB-10	2-1/2	4-3/4	CTC-1361131	148.19
	6E1114		I-O-3	1	2	CTC-9T0418	85.89
	9T8823		I-O-3	1	2	CTC-9T0418	85.89
STEERING LH							
	1250374		P-UB-10	1-1/2	2-3/4	CTC-1361599	110.23
STEERING RH							
	1250373		P-UB-10	1-1/2	2-3/4	CTC-1856596	47.94
TILT							
	1191852		P-UB-10	2	4	CTC-1857688	72.08
	1273020		P-UB-10	2	4	CTC-1857688	72.08
MODEL IT38F							
LIFT							
	1148131		P-UB-10	3	4-3/4	CTC-1915030	167.68
STEERING							
	1050094		P-UB-10	1-3/4	3	CTC-1857025	54.97
TILT							
	1156963		P-UB-10	2-3/4	4-1/2	CTC-1933117	115.46
MODEL IT38G							
LIFT							
	1148131		P-UB-10	3	4-3/4	CTC-1570288	178.40

REPLACEMENT KITS FOR CATERPILLAR® EQUIPMENT

Integrated Toolcarriers							
APPLICATION	CYL #	Misc-Parts, Instructions, etc.	CODE	ROD	BORE	KIT #	List \$
MODEL IT38G							
LIFT							
	1CW1-UP; 7BS1-UP						
	1148131		P-UB-10	3	4-3/4	CTC-2275349	201.03
STEERING							
	1050094		P-UB-10	1-3/4	3	CTC-7X2825	55.57
	1393312		P-UB-10	1-3/4	3	CTC-7X2825	55.57
TILT							
	1156963		P-UB-10	2-3/4	4-1/2	CTC-1636105	167.16
	1CW1-UP; 7BS1-UP						
	1156963		P-UB-10	2-3/4	4-1/2	CTC-2275348	124.54
MODEL IT62G							
LIFT RH							
	1188296		P-UB-10	3	6	CTC-7X2698	192.84
	1250024		P-UB-10	3	6	CTC-7X2698	192.84
STEERING							
	1188288		P-UB-10	1-3/4	3-1/2	CTC-7X2784	58.32
TILT							
	1349397		P-UB-10	3	5-1/4	CTC-3E3293	183.95
Landfill Compactors							
APPLICATION	CYL #	Misc-Parts, Instructions, etc.	CODE	ROD	BORE	KIT #	List \$
MODEL 816							
LIFT							
	1U2088		P-UB-10	2-1/2	4-3/4	CTC-7X2660	185.90
	4J9233		P-V-10	2	4-1/2	CTC-7X2770	101.37
PUMP							
	15R; 57U; 91P						
	9J5067					CTC-9J5114	27.82
STEERING							
	4T1574		P-UB-10	2	4	CTC-7X2789	105.58
STEERING LH							
	7J9356		P-UB-10	2	4	CTC-7X2755	152.30
STEERING RH							
	7J9355		P-UB-10	2	4	CTC-7X2755	152.30
MODEL 816B							
DOZER							
	1U2088		P-UB-10	2-1/2	4-3/4	CTC-1328811	167.09
DOZER LIFT							
	1U2088		P-UB-10	2-1/2	4-3/4	CTC-7X2660	185.90
STEERING							
	4T1574		P-UB-10	2	4	CTC-1328816	96.00
	6E5024		P-UB-10	2	4	CTC-1113302	123.12
STEERING LH							
	7J9356		P-UB-10	2	4	CTC-7X2755	152.30
MODEL 816F							
DOZER							
	1U2088		P-UB-10	2-1/2	4-3/4	CTC-1328811	167.09
STEERING							
	4T1574		P-UB-10	2	4	CTC-1328816	96.00
	6E5024		P-UB-10	2	4	CTC-1113302	123.12
MODEL 826B							
LIFT							
	7K9401		P-UB-10	2-1/4	5	CTC-7X2729	168.02
	8J2650		P-UB-10	2	4-1/2	CTC-7X2768	91.77
	9J7111		P-UB-10	2-1/2	5-1/2	CTC-7X2653	168.14
STEERING							
	7J9718		P-UB-10	2-1/4	5	CTC-7X2729	168.02

REPLACEMENT KITS FOR CATERPILLAR® EQUIPMENT

Landfill Compactors							
APPLICATION	CYL #	Misc-Parts, Instructions, etc.	CODE	ROD	BORE	KIT #	List \$
MODEL 826B							
STEERING LH							
	9J7087		P-UB-10	2-1/4	5	CTC-7X2729	168.02
STEERING RH							
	9J7086		P-UB-10	2-1/4	5	CTC-7X2729	168.02
MODEL 826C							
LIFT							
	8J2650		P-UB-10	2	4-1/2	CTC-7X2768	91.77
	9J7111		P-UB-10	2-1/2	5-1/2	CTC-7X2653	168.14
STEERING							
	9J7086		P-UB-10	2-1/4	5	CTC-9X6392	165.61
	9J7087		P-UB-10	2-1/4	5	CTC-9X6392	165.61
MODEL 826G							
DOZER							
	1164842		P-UB-10	3	4-3/4	CTC-1570288	178.40
STEERING							
	1175151		P-UB-10	2-1/2	4-1/2	CTC-1113300	141.35
MODEL 836, 836C							
LIFT							
	6J1272		P-V-10	2-1/2	6-1/2	CTC-7X2676	113.26
STEERING							
	9J8165		P-UB-10	2-1/4	5	CTC-9X6392	165.61
Loaders - Skid Steer							
APPLICATION	CYL #	Misc-Parts, Instructions, etc.	CODE	ROD	BORE	KIT #	List \$
MODEL 226							
ANGLE BLADE							
	5FZ1-UP						
	2259521		P-U-10	32 mm	63 mm	CTC-1771958	71.55
BUCKET							
	5FZ1-UP						
	2781969		I-U-10	30 mm	60 mm	CTC-2781970	50.44
	2936264		I-U-10	30 mm	50 mm	CTC-2620941	26.06
BUCKET MP							
	5FZ1-UP						
	1545018		P-U-10	30 mm	60 mm	CTC-1643213	68.69
GRAPPLE							
	5FZ1-11443						
	2781975		I-U-10	30 mm	60 mm	CTC-2781970	50.44
	5FZ1-UP						
	1565512		P-U-10	30 mm	60 mm	CTC-1643213	68.69
	1649295		P-U-10	25 mm	40 mm	CTC-1725285	59.03
LIFT LH							
	5FZ1-UP						
	1428961		I-U-10	35 mm	50 mm	CTC-1428962	51.63
LIFT RH							
	5FZ1-UP						
	1428960		I-U-10	35 mm	50 mm	CTC-1428962	51.63
TILT LH							
	5FZ1-2158						
	1428956		P-U-10	30 mm	65 mm	CTC-1428963	102.44
	5FZ2159-UP						
	1779569		P-U-10	30 mm	65 mm	CTC-1428963	102.44
TILT RH							
	5FZ1-2158						
	1428955		P-U-10	30 mm	65 mm	CTC-1428963	102.44
	5FZ2159-UP						
	1779568		P-U-10	30 mm	65 mm	CTC-1428963	102.44

REPLACEMENT KITS FOR CATERPILLAR® EQUIPMENT

Loaders - Skid Steer							
APPLICATION	CYL #	Misc-Parts, Instructions, etc.	CODE	ROD	BORE	KIT #	List \$
MODEL 226B							
ANGLE BLADE							
MJH1-UP							
	2259521		P-U-10	32 mm	63 mm	CTC-1771958	71.55
	2749930		I-U-10	35 mm	70 mm	CTC-2666140	42.38
BUCKET							
MJH1-10574							
	1545018		P-U-10	30 mm	60 mm	CTC-1643213	68.69
	2781969		I-U-10	30 mm	60 mm	CTC-2781970	50.44
	2936264		I-U-10	30 mm	50 mm	CTC-2620941	26.06
GRAPPLE							
MJH1-10574							
	1565512		P-U-10	30 mm	60 mm	CTC-1643213	68.69
	1649295		P-U-10	25 mm	40 mm	CTC-1725285	59.03
	2781975		I-U-10	30 mm	60 mm	CTC-2781970	50.44
LIFT LH							
MJH1-10574							
	2303683		P-U-10	35 mm	50 mm	CTC-2186826	39.40
LIFT RH							
MJH1-10574							
	2303693		P-U-10	35 mm	50 mm	CTC-2186826	39.40
TILT							
MJH1-UP							
	2749931		I-U-10	35 mm	70 mm	CTC-2666140	42.38
TILT LH							
MJH1-10574							
	2303684		P-U-10	30 mm	65 mm	CTC-2186825	59.17
TILT RH							
MJH1-10574							
	2303694		P-U-10	30 mm	65 mm	CTC-2186825	59.17
MODEL 226B2							
BUCKET							
MJH10575-UP							
	2781969		I-U-10	30 mm	60 mm	CTC-2781970	50.44
	2936264		I-U-10	30 mm	50 mm	CTC-2620941	26.06
GRAPPLE							
MJH10575-UP							
	1649295		P-U-10	25 mm	40 mm	CTC-1725285	59.03
	2781975		I-U-10	30 mm	60 mm	CTC-2781970	50.44
GRAPPLE RH							
MJH10575-UP							
	2550943		I-U-10	25 mm	40 mm	CTC-2863591	21.36
LIFT LH							
MJH10575-15087;15094-15156							
	2303683		P-U-10	35 mm	50 mm	CTC-2186826	39.40
MJH15088-15093;15157-UP							
	2935706		P-U-10	35 mm	50 mm	CTC-3712697	42.65
LIFT RH							
MJH10575-15087;15094-15156							
	2303693		P-U-10	35 mm	50 mm	CTC-2186826	39.40
MJH15088-15093;15157-UP							
	2935705		P-U-10	35 mm	50 mm	CTC-3712697	42.65
TILT LH							
MJH10575-15087;15094-15156							
	2303684		P-U-10	30 mm	65 mm	CTC-2186825	59.17

REPLACEMENT KITS FOR CATERPILLAR® EQUIPMENT

Loaders - Skid Steer							
APPLICATION	CYL #	Misc-Parts, Instructions, etc.	CODE	ROD	BORE	KIT #	List \$
MODEL 226B2							
TILT RH							
MJH10575-15087;15094-15156							
2303694			P-U-10	30 mm	65 mm	CTC-2186825	59.17
MJH15088-15093;15157-UP							
2935707			P-U-10	30 mm	65 mm	CTC-3712718	47.42
MODEL 236							
ANGLE BLADE							
4YZ1-UP							
2259521			P-U-10	32 mm	63 mm	CTC-1771958	71.55
4YZ4000-UP							
2749930			I-U-10	35 mm	70 mm	CTC-2666140	42.38
BUCKET							
4YZ1-UP							
1545018			P-U-10	30 mm	60 mm	CTC-1643213	68.69
2781969			I-U-10	30 mm	60 mm	CTC-2781970	50.44
4YZ4000-UP							
2936264			I-U-10	30 mm	50 mm	CTC-2620941	26.06
GRAPPLE							
4YZ1-UP							
1565512			P-U-10	30 mm	60 mm	CTC-1643213	68.69
1649295			P-U-10	25 mm	40 mm	CTC-1725285	59.03
2781975			I-U-10	30 mm	60 mm	CTC-2781970	50.44
LIFT LH							
4YZ1-UP							
1429196			P-U-10	35 mm	70 mm	CTC-1429192	49.74
1429196			P-U-10	40 mm	60 mm	CTC-1429193	76.16
LIFT RH							
4YZ1-UP							
1429195			P-U-10	35 mm	70 mm	CTC-1429192	49.74
1429195			P-U-10	40 mm	60 mm	CTC-1429193	76.16
TILT							
47Z4000-UP							
2749931			I-U-10	35 mm	70 mm	CTC-2666140	42.38
TILT LH							
4YZ1-UP							
1779566			P-U-10	35 mm	70 mm	CTC-1429192	49.74
TILT RH							
4YZ1-UP							
1779565			P-U-10	35 mm	70 mm	CTC-1429192	49.74
MODEL 236B							
ANGLE BLADE							
HEN1-6749							
2259521			P-U-10	32 mm	63 mm	CTC-1771958	71.55
2749930			I-U-10	35 mm	70 mm	CTC-2666140	42.38
BUCKET							
HEN1-6749							
1545018			P-U-10	30 mm	60 mm	CTC-1643213	68.69
2781969			I-U-10	30 mm	60 mm	CTC-2781970	50.44
2936264			I-U-10	30 mm	50 mm	CTC-2620941	26.06
GRAPPLE							
HEN1-6749							
1565512			P-U-10	30 mm	60 mm	CTC-1643213	68.69
1649295			P-U-10	25 mm	40 mm	CTC-1725285	59.03
2781975			I-U-10	30 mm	60 mm	CTC-2781970	50.44

REPLACEMENT KITS FOR CATERPILLAR® EQUIPMENT

Loaders - Skid Steer							
APPLICATION	CYL #	Misc-Parts, Instructions, etc.	CODE	ROD	BORE	KIT #	List \$
MODEL 236B							
LIFT LH							
HEN1-6749							
	2303685		P-U-10	40 mm	60 mm	CTC-2186823	61.33
LIFT RH							
HEN1-6749							
	2303695		P-U-10	40 mm	60 mm	CTC-2186823	61.33
TILT							
HEN1-6749							
	2749931		I-U-10	35 mm	70 mm	CTC-2666140	42.38
TILT LH							
HEN1-6749							
	2303687		P-U-10	35 mm	70 mm	CTC-2186822	76.42
TILT RH							
HEN1-6749							
	2303697		P-U-10	35 mm	70 mm	CTC-2186822	76.42
MODEL 236B2							
ANGLE BLADE							
HEN6750-UP							
	2259521		P-U-10	32 mm	63 mm	CTC-1771958	71.55
	2749930		I-U-10	35 mm	70 mm	CTC-2666140	42.38
BUCKET							
HEN6750-UP							
	2781969		I-U-10	30 mm	60 mm	CTC-2781970	50.44
	2936264		I-U-10	30 mm	50 mm	CTC-2620941	26.06
GRAPPLE							
HEN6750-UP							
	1649295		P-U-10	25 mm	40 mm	CTC-1725285	59.03
	2550943		I-U-10	25 mm	40 mm	CTC-2863591	21.36
	2781975		I-U-10	30 mm	60 mm	CTC-2781970	50.44
LIFT LH							
HEN6750-9767							
	2303685		P-U-10	40 mm	60 mm	CTC-2186823	61.33
HEN9768-UP							
	2956952		P-U-10	40 mm	60 mm	CTC-3712756	43.36
LIFT RH							
HEN6750-9767							
	2303695		P-U-10	40 mm	60 mm	CTC-2186823	61.33
HEN9768-UP							
	2956951		P-U-10	40 mm	60 mm	CTC-3712756	43.36
TILT							
HEN6750-UP							
	2749931		I-U-10	35 mm	70 mm	CTC-2666140	42.38
TILT LH							
HEN6750-9765							
	2303687		P-U-10	35 mm	70 mm	CTC-2186822	76.42
HEN9766-UP							
	2956954		P-U-10	35 mm	70 mm	CTC-3712760	44.20
TILT RH							
HEN6750-9765							
	2303697		P-U-10	35 mm	70 mm	CTC-2186822	76.42
HEN9766-UP							
	2956953		P-U-10	35 mm	70 mm	CTC-3712760	44.20
MODEL 242							
ANGLE BLADE							
CMB1-UP							
	2259521		P-U-10	32 mm	63 mm	CTC-1771958	71.55

REPLACEMENT KITS FOR CATERPILLAR® EQUIPMENT

Loaders - Skid Steer							
APPLICATION	CYL #	Misc-Parts, Instructions, etc.	CODE	ROD	BORE	KIT #	List \$
MODEL 242							
BUCKET							
CMB1-UP							
	1545018		P-U-10	30 mm	60 mm	CTC-1643213	68.69
	2781969		I-U-10	30 mm	60 mm	CTC-2781970	50.44
	2936264		I-U-10	30 mm	50 mm	CTC-2620941	26.06
GRAPPLE							
CMB1-1646							
	2781975		I-U-10	30 mm	60 mm	CTC-2781970	50.44
CMB1-UP							
	1565512		P-U-10	30 mm	60 mm	CTC-1643213	68.69
	1649295		P-U-10	25 mm	40 mm	CTC-1725285	59.03
LIFT							
CMB1-UP							
	1919641		P-U-10	45 mm	60 mm	CTC-1919605	74.03
TILT LH							
CMB1-UP							
	1779569		P-U-10	30 mm	65 mm	CTC-1428963	102.44
TILT RH							
CMB1-UP							
	1779568		P-U-10	30 mm	65 mm	CTC-1428963	102.44
MODEL 242B							
ANGLE BLADE							
BXM1-4224							
	2259521		P-U-10	32 mm	63 mm	CTC-1771958	71.55
	2749930		I-U-10	35 mm	70 mm	CTC-2666140	42.38
BUCKET							
BXM1-4224							
	1545018		P-U-10	30 mm	60 mm	CTC-1643213	68.69
	2781969		I-U-10	30 mm	60 mm	CTC-2781970	50.44
	2936264		I-U-10	30 mm	50 mm	CTC-2620941	26.06
GRAPPLE							
BXM1-4224							
	1565512		P-U-10	30 mm	60 mm	CTC-1643213	68.69
	1649295		P-U-10	25 mm	40 mm	CTC-1725285	59.03
	2781975		I-U-10	30 mm	60 mm	CTC-2781970	50.44
LIFT							
BXM1-4224							
	2303703		P-U-10	45 mm	60 mm	CTC-2186827	59.44
TILT							
BXM1-4224							
	2749931		I-U-10	35 mm	70 mm	CTC-2666140	42.38
TILT LH							
BXM1-4224							
	2303684		P-U-10	30 mm	65 mm	CTC-2186825	59.17
TILT RH							
BXM1-4224							
	2303694		P-U-10	30 mm	65 mm	CTC-2186825	59.17
MODEL 242B2							
ANGLE BLADE							
BXM4225-UP							
	2259521		P-U-10	32 mm	63 mm	CTC-1771958	71.55
	2749930		I-U-10	35 mm	70 mm	CTC-2666140	42.38
BUCKET							
BXM4225-UP							
	2781969		I-U-10	30 mm	60 mm	CTC-2781970	50.44
	2936264		I-U-10	30 mm	50 mm	CTC-2620941	26.06

REPLACEMENT KITS FOR CATERPILLAR® EQUIPMENT

Loaders - Skid Steer							
APPLICATION	CYL #	Misc-Parts, Instructions, etc.	CODE	ROD	BORE	KIT #	List \$
MODEL 242B2							
GRAPPLE							
BXM4225-UP							
	1649295		P-U-10	25 mm	40 mm	CTC-1725285	59.03
	2781975		I-U-10	30 mm	60 mm	CTC-2781970	50.44
GRAPPLE RH							
BXM4225-UP							
	2550943		I-U-10	25 mm	40 mm	CTC-2863591	21.36
LIFT							
BXM4225-UP							
	2303703		P-U-10	45 mm	60 mm	CTC-2186827	59.44
TILT							
BXM4225-UP							
	2749931		I-U-10	35 mm	70 mm	CTC-2666140	42.38
TILT LH							
BXM4225-UP							
	2303684		P-U-10	30 mm	65 mm	CTC-2186825	59.17
TILT RH							
BXM4225-UP							
	2303694		P-U-10	30 mm	65 mm	CTC-2186825	59.17
MODEL 246							
ANGLE BLADE							
5SZ1-UP							
	2259521		P-U-10	32 mm	63 mm	CTC-1771958	71.55
5SZ4000-UP							
	2749930		I-U-10	35 mm	70 mm	CTC-2666140	42.38
BUCKET							
5SZ1-UP							
	1545018		P-U-10	30 mm	60 mm	CTC-1643213	68.69
	2781969		I-U-10	30 mm	60 mm	CTC-2781970	50.44
5SZ4000-UP							
	2936264		I-U-10	30 mm	50 mm	CTC-2620941	26.06
GRAPPLE							
5SZ1-UP							
	1565512		P-U-10	30 mm	60 mm	CTC-1643213	68.69
	1649295		P-U-10	25 mm	40 mm	CTC-1725285	59.03
	2781975		I-U-10	30 mm	60 mm	CTC-2781970	50.44
LIFT LH							
5SZ1-UP							
	1429196		P-U-10	35 mm	70 mm	CTC-1429192	49.74
	1429196		P-U-10	40 mm	60 mm	CTC-1429193	76.16
LIFT RH							
5SZ1-UP							
	1429195		P-U-10	35 mm	70 mm	CTC-1429192	49.74
	1429195		P-U-10	40 mm	60 mm	CTC-1429193	76.16
TILT							
5SZ4000-UP							
	2749931		I-U-10	35 mm	70 mm	CTC-2666140	42.38
TILT LH							
5SZ1-UP							
	1779566		P-U-10	35 mm	70 mm	CTC-1429192	49.74
TILT RH							
5SZ1-UP							
	1779565		P-U-10	35 mm	70 mm	CTC-1429192	49.74

REPLACEMENT KITS FOR CATERPILLAR® EQUIPMENT

Loaders - Skid Steer							
APPLICATION	CYL #	Misc-Parts, Instructions, etc.	CODE	ROD	BORE	KIT #	List \$
MODEL 246B							
ANGLE BLADE							
	PAT1-UP						
	2259521		P-U-10	32 mm	63 mm	CTC-1771958	71.55
	2749930		I-U-10	35 mm	70 mm	CTC-2666140	42.38
BUCKET							
	PAT1-UP						
	1545018		P-U-10	30 mm	60 mm	CTC-1643213	68.69
	2781969		I-U-10	30 mm	60 mm	CTC-2781970	50.44
	2936264		I-U-10	30 mm	50 mm	CTC-2620941	26.06
GRAPPLE							
	PAT1-UP						
	1565512		P-U-10	30 mm	60 mm	CTC-1643213	68.69
	1649295		P-U-10	25 mm	40 mm	CTC-1725285	59.03
	2781975		I-U-10	30 mm	60 mm	CTC-2781970	50.44
LIFT LH							
	PAT1-UP						
	2303685		P-U-10	40 mm	60 mm	CTC-2186823	61.33
LIFT RH							
	PAT1-UP						
	2303695		P-U-10	40 mm	60 mm	CTC-2186823	61.33
TILT							
	PAT1-UP						
	2749931		I-U-10	35 mm	70 mm	CTC-2666140	42.38
TILT LH							
	PAT1-UP						
	2303687		P-U-10	35 mm	70 mm	CTC-2186822	76.42
TILT RH							
	PAT1-UP						
	2303697		P-U-10	35 mm	70 mm	CTC-2186822	76.42
MODEL 246C							
ANGLE BLADE							
	JAY1-UP						
	2259521		P-U-10	32 mm	63 mm	CTC-1771958	71.55
	2749930		I-U-10	35 mm	70 mm	CTC-2666140	42.38
BUCKET							
	JAY1-UP						
	1545018		P-U-10	30 mm	60 mm	CTC-1643213	68.69
	2781969		I-U-10	30 mm	60 mm	CTC-2781970	50.44
	2936264		I-U-10	30 mm	50 mm	CTC-2620941	26.06
GRAPPLE							
	JAY1-UP						
	1649295		P-U-10	25 mm	40 mm	CTC-1725285	59.03
	2550943		I-U-10	25 mm	40 mm	CTC-2863591	21.36
	2781975		I-U-10	30 mm	60 mm	CTC-2781970	50.44
LIFT							
	JAY1-4094;4096-4202						
	2582512		P-U-10	45 mm	65 mm	CTC-2186824	64.71
	JAY4095;4203-UP						
	2935710		P-U-10	45 mm	65 mm	CTC-3712737	48.44
TILT							
	JAY1-UP						
	2749931		I-U-10	35 mm	70 mm	CTC-2666140	42.38
TILT LH							
	JAY1-4094;4096-4215						
	2582515		P-U-10	35 mm	75 mm	CTC-2583621	47.22

REPLACEMENT KITS FOR CATERPILLAR® EQUIPMENT

Loaders - Skid Steer							
APPLICATION	CYL #	Misc-Parts, Instructions, etc.	CODE	ROD	BORE	KIT #	List \$
MODEL 246C							
TILT LH							
JAY4095;4216-UP							
	2935712		P-U-10	35 mm	75 mm	CTC-3712751	46.94
TILT RH							
JAY1-4094;4096-4215							
	2582514		P-U-10	35 mm	75 mm	CTC-2583621	47.22
JAY4095;4216-UP							
	2935711		P-U-10	35 mm	75 mm	CTC-3712751	46.94
MODEL 252B							
ANGLE BLADE							
SCP1-4599							
	2259521		P-U-10	32 mm	63 mm	CTC-1771958	71.55
	2749930		I-U-10	35 mm	70 mm	CTC-2666140	42.38
BUCKET							
SCP1-4599							
	1545018		P-U-10	30 mm	60 mm	CTC-1643213	68.69
	2781969		I-U-10	30 mm	60 mm	CTC-2781970	50.44
	2936264		I-U-10	30 mm	50 mm	CTC-2620941	26.06
GRAPPLE							
SCP1-4599							
	1565512		P-U-10	30 mm	60 mm	CTC-1643213	68.69
	1649295		P-U-10	25 mm	40 mm	CTC-1725285	59.03
	2781975		I-U-10	30 mm	60 mm	CTC-2781970	50.44
LIFT							
SCP1-4599							
	2303705		P-U-10	45 mm	65 mm	CTC-2186824	64.71
TILT							
SCP1-4599							
	2749931		I-U-10	35 mm	70 mm	CTC-2666140	42.38
TILT LH							
SCP1-4599							
	2303687		P-U-10	35 mm	70 mm	CTC-2186822	76.42
TILT RH							
SCP1-4599							
	2303697		P-U-10	35 mm	70 mm	CTC-2186822	76.42
MODEL 252B2							
ANGLE BLADE							
SCP4600-UP							
	2259521		P-U-10	32 mm	63 mm	CTC-1771958	71.55
	2749930		I-U-10	35 mm	70 mm	CTC-2666140	42.38
BUCKET							
SCP4600-UP							
	2781969		I-U-10	30 mm	60 mm	CTC-2781970	50.44
	2936264		I-U-10	30 mm	50 mm	CTC-2620941	26.06
GRAPPLE							
SCP4600-UP							
	1649295		P-U-10	25 mm	40 mm	CTC-1725285	59.03
	2550943		I-U-10	25 mm	40 mm	CTC-2863591	21.36
	2781975		I-U-10	30 mm	60 mm	CTC-2781970	50.44
LIFT							
SCP4600-UP							
	2303705		P-U-10	45 mm	65 mm	CTC-2186824	64.71
SCP6188-UP							
	2978699		P-U-10	45 mm	65 mm	CTC-3712737	48.44

REPLACEMENT KITS FOR CATERPILLAR® EQUIPMENT

Loaders - Skid Steer							
APPLICATION	CYL #	Misc-Parts, Instructions, etc.	CODE	ROD	BORE	KIT #	List \$
MODEL 252B2							
TILT							
SCP4600-UP							
	2749931		I-U-10	35 mm	70 mm	CTC-2666140	42.38
TILT LH							
SCP4600-6187							
	2303687		P-U-10	35 mm	70 mm	CTC-2186822	76.42
SCP6188-UP							
	2956954		P-U-10	35 mm	70 mm	CTC-3712760	44.20
TILT RH							
SCP4600-6187							
	2303697		P-U-10	35 mm	70 mm	CTC-2186822	76.42
SCP6188-UP							
	2956953		P-U-10	35 mm	70 mm	CTC-3712760	44.20
MODEL 262							
ANGLE BLADE							
CED1-UP							
	2259521		P-U-10	32 mm	63 mm	CTC-1771958	71.55
	2749930		I-U-10	35 mm	70 mm	CTC-2666140	42.38
BUCKET							
CED1-UP							
	1545018		P-U-10	30 mm	60 mm	CTC-1643213	68.69
	2781969		I-U-10	30 mm	60 mm	CTC-2781970	50.44
	2936264		I-U-10	30 mm	50 mm	CTC-2620941	26.06
GRAPPLE							
CED1-UP							
	1565512		P-U-10	30 mm	60 mm	CTC-1643213	68.69
	1649295		P-U-10	25 mm	40 mm	CTC-1725285	59.03
	2781975		I-U-10	30 mm	60 mm	CTC-2781970	50.44
LIFT							
CED1-UP							
	1908041		P-U-10	45 mm	65 mm	CTC-2063805	101.67
TILT							
CED1-UP							
	2749931		I-U-10	35 mm	70 mm	CTC-2666140	42.38
TILT LH							
CED1-UP							
	1779566		P-U-10	35 mm	70 mm	CTC-1429192	49.74
TILT RH							
CED1-UP							
	1779565		P-U-10	35 mm	70 mm	CTC-1429192	49.74
MODEL 262B							
ANGLE BLADE							
PDT1-UP							
	2259521		P-U-10	32 mm	63 mm	CTC-1771958	71.55
	2749930		I-U-10	35 mm	70 mm	CTC-2666140	42.38
BUCKET							
PDT1-UP							
	1545018		P-U-10	30 mm	60 mm	CTC-1643213	68.69
	2781969		I-U-10	30 mm	60 mm	CTC-2781970	50.44
	2936264		I-U-10	30 mm	50 mm	CTC-2620941	26.06
GRAPPLE							
PDT1-UP							
	1565512		P-U-10	30 mm	60 mm	CTC-1643213	68.69
	1649295		P-U-10	25 mm	40 mm	CTC-1725285	59.03
	2781975		I-U-10	30 mm	60 mm	CTC-2781970	50.44

REPLACEMENT KITS FOR CATERPILLAR® EQUIPMENT

Loaders - Skid Steer							
APPLICATION	CYL #	Misc-Parts, Instructions, etc.	CODE	ROD	BORE	KIT #	List \$
MODEL 262B							
LIFT							
PDT1-UP							
	2303705		P-U-10	45 mm	65 mm	CTC-2186824	64.71
TILT							
PDT1-UP							
	2749931		I-U-10	35 mm	70 mm	CTC-2666140	42.38
TILT LH							
PDT1-UP							
	2303687		P-U-10	35 mm	70 mm	CTC-2186822	76.42
TILT RH							
PDT1-UP							
	2303697		P-U-10	35 mm	70 mm	CTC-2186822	76.42
MODEL 262C							
ANGLE BLADE							
MST1-UP							
	225952		P-U-10	32 mm	63 mm	CTC-1771958	71.55
	2749930		I-U-10	35 mm	70 mm	CTC-2666140	42.38
BUCKET							
MST1-UP							
	1545018		P-U-10	30 mm	60 mm	CTC-1643213	68.69
	2781969		I-U-10	30 mm	60 mm	CTC-2781970	50.44
	2936264		I-U-10	30 mm	50 mm	CTC-2620941	26.06
GRAPPLE							
MST1-UP							
	1649295		P-U-10	25 mm	40 mm	CTC-1725285	59.03
	2550943		I-U-10	25 mm	40 mm	CTC-2863591	21.36
	2781975		I-U-10	30 mm	60 mm	CTC-2781970	50.44
LIFT							
MST1-3376							
	2582516		P-U-10	45 mm	65 mm	CTC-2186824	64.71
MST1860-UP							
	2935713		P-U-10	45 mm	65 mm	CTC-3712737	48.44
TILT							
MST1-UP							
	2749931		I-U-10	35 mm	70 mm	CTC-2666140	42.38
TILT LH							
MST1-3357							
	2582515		P-U-10	35 mm	75 mm	CTC-2583621	47.22
MST1860-UP							
	2935712		P-U-10	35 mm	75 mm	CTC-3712751	46.94
TILT RH							
MST1-3357							
	2582514		P-U-10	35 mm	75 mm	CTC-2583621	47.22
MST1860-UP							
	2935711		P-U-10	35 mm	75 mm	CTC-3712751	46.94
MODEL 268B							
ANGLE BLADE							
LBA1-UP							
	2259521		P-U-10	32 mm	63 mm	CTC-1771958	71.55
BUCKET							
LBA1-UP							
	1545018		P-U-10	30 mm	60 mm	CTC-1643213	68.69
	2781969		I-U-10	30 mm	60 mm	CTC-2781970	50.44
	2936264		I-U-10	30 mm	50 mm	CTC-2620941	26.06

REPLACEMENT KITS FOR CATERPILLAR® EQUIPMENT

Loaders - Skid Steer							
APPLICATION	CYL #	Misc-Parts, Instructions, etc.	CODE	ROD	BORE	KIT #	List \$
MODEL 268B							
GRAPPLE							
LBA1-UP							
	1565512		P-U-10	30 mm	60 mm	CTC-1643213	68.69
	1649295		P-U-10	25 mm	40 mm	CTC-1725285	59.03
	2550943		I-U-10	25 mm	40 mm	CTC-2863591	21.36
	2781975		I-U-10	30 mm	60 mm	CTC-2781970	50.44
LIFT							
LBA1-UP							
	2303705		P-U-10	45 mm	65 mm	CTC-2186824	64.71
TILT LH							
LBA1-UP							
	2303687		P-U-10	35 mm	70 mm	CTC-2186822	76.42
TILT RH							
LBA1-UP							
	2303697		P-U-10	35 mm	70 mm	CTC-2186822	76.42
Loaders - Wheel							
APPLICATION	CYL #	Misc-Parts, Instructions, etc.	CODE	ROD	BORE	KIT #	List \$
MODEL 902							
UNSPECIFIED APPLICATION							
	9T4006		P-UB-10	1-1/2	3	CTC-7X2737	112.40
MODEL 904							
LIFT							
	4T8580		P-UB-10	2	3-3/4	CTC-7X2787	106.95
STEERING							
	1U4666		P-UB-10	1-1/2	2-3/4	CTC-7X2749	61.13
TILT							
	4T8581		P-UB-10	1-3/4	3-1/4	CTC-7X2764	71.17
MODEL 906							
BUCKET GRAPPLE							
	1649430		P-UB-10	1-1/4	2-1/2	CTC-1649430K	50.92
LIFT							
	1344485		P-UB-10	55 mm	100 mm	CTC-1344485K	122.11
MULTIPURPOSE BUCKET							
	1349838		P-UB-10	35 mm	70 mm	CTC-1349838K	162.00
	9T4006		P-UB-10	1-1/2	3	CTC-1856583	47.40
SIDE DUMP							
	1250373		P-UB-10	1-1/2	2-3/4	CTC-1856596	47.94
STEERING							
	1349838		P-UB-10	35 mm	70 mm	CTC-1349838K	162.00
STEERING RH							
	1250373		P-UB-10	1-1/2	2-3/4	CTC-1856596	47.94
TILT							
	1350532		P-UB-10	50 mm	85 mm	CTC-1350532K	222.54
MODEL 908							
HIGH DUMP							
	1349848		P-UB-10	35 mm	70 mm	CTC-1349838K	162.00
MULTIPURPOSE BUCKET							
	9T4006		P-UB-10	1-1/2	3	CTC-1856583	47.40
SIDE DUMP							
	1250373		P-UB-10	1-1/2	2-3/4	CTC-1856596	47.94
MODEL 910							
BUCKET							
	8J5391		P-UB-10	1-1/2	3-1/2	CTC-7X2752	98.74
LIFT							
	7J5893		P-UB-10	2	4	CTC-1328816	96.00
	7J5894		P-UB-10	2	4	CTC-1328816	96.00

REPLACEMENT KITS FOR CATERPILLAR® EQUIPMENT

Loaders - Wheel							
APPLICATION	CYL #	Misc-Parts, Instructions, etc.	CODE	ROD	BORE	KIT #	List \$
MODEL 910							
STEERING							
	1U4666		P-UB-10	1-1/2	2-3/4	CTC-7X2736	130.81
	1U4666		P-UB-10	1-1/2	2-3/4	CTC-8T1402	51.29
	8J0070		P-UB-10	1-1/2	2-3/4	CTC-7X2749	61.13
	9T5153		P-UB-10	1-1/2	2-3/4	CTC-7X2736	130.81
	9T7209		P-UB-10	1-1/2	2-3/4	CTC-1361599	110.23
	9T7210		P-UB-10	1-1/2	2-3/4	CTC-1361599	110.23
STEERING LH							
	6E5973		P-UB-10	1-1/2	2-3/4	CTC-1361599	110.23
STEERING RH							
	6E5985		P-UB-10	1-1/2	2-3/4	CTC-1361599	110.23
TILT							
	1U3164		P-UB-10	1-3/4	3-1/4	CTC-7X2764	71.17
	1U3165		P-UB-10	1-3/4	3-1/4	CTC-1328770	124.88
	7J5885		P-UB-10	1-3/4	3	CTC-7X2791	91.70
	9J7905		P-UB-10	1-3/4	3	CTC-7X2791	91.70
TILT EXT'D DUMP							
	1U3164		P-UB-10	1-3/4	3-1/4	CTC-7X2764	71.17
TOOL BAR							
	4H6711		P-V-10	1-1/4	4	CTC-8T1480	85.62
MODEL 910E, 910F							
BUCKET							
	8J5391		P-UB-10	1-1/2	3-1/2	CTC-7X2752	98.74
LIFT							
	6E5969		P-UB-10	2-1/4	4	CTC-1361171	104.91
	9T5745		P-UB-10	2-1/4	4	CTC-1361171	104.91
STEERING							
	9T7209		P-UB-10	1-1/2	2-3/4	CTC-1361599	110.23
	9T7210		P-UB-10	1-1/2	2-3/4	CTC-1361599	110.23
STEERING LH							
	6E5900		P-UB-10	1-3/4	2-3/4	CTC-1539053	156.06
	6E5973		P-UB-10	1-1/2	2-3/4	CTC-1361599	110.23
STEERING RH							
	6E5985		P-UB-10	1-1/2	2-3/4	CTC-1361599	110.23
TILT							
	6E5918		P-UB-10	2-1/4	4	CTC-1361171	104.91
	6E5966	Rod Bearing width- 0.98"	P-UB-10	2-1/2	4-3/4	CTC-1361131	148.19
	9T5778		P-UB-10	2-1/2	4-3/4	CTC-1358695	98.54
MODEL 914							
M.P. BUCKET TILT							
	4T4666		P-UB-10	2-1/2	4	CTC-7X2665	172.76
MODEL 914G							
STEERING							
	9T8823		I-O-3	1	2	CTC-9T0418	85.89
TILT							
	6E5918		P-UB-10	2-1/4	4	CTC-1361171	104.91
MODEL 916							
BUCKET							
	3G7365		P-UB-10	1-1/2	3-1/2	CTC-7X2752	98.74
LIFT							
	4T8648		P-UB-10	2-1/4	4-1/4	CTC-7X2750	118.40
LIFT LH							
	3G6563		P-UB-10	2-1/4	4-1/4	CTC-7X2750	118.40
PIN PULLER							
	6E5393		I-O-3	1	2	CTC-9T0418	85.89

REPLACEMENT KITS FOR CATERPILLAR® EQUIPMENT

Loaders - Wheel							
APPLICATION	CYL #	Misc-Parts, Instructions, etc.	CODE	ROD	BORE	KIT #	List \$
MODEL 916							
STEERING							
	1U3322		P-UB-10	1-1/2	3	CTC-7X2751	66.28
TILT							
	3G6571		P-UB-10	2-1/2	4-3/4	CTC-1328811	167.09
MODEL 918F							
LIFT							
	1342327		P-UB-10	2-1/4	4	CTC-1546526	156.02
	9T3937		P-UB-10	2-1/4	4	CTC-1546526	156.02
PIN PULLER							
	6E5393		I-O-3	1	2	CTC-9T0418	85.89
STEERING							
	9T2637		P-UB-10	1-1/2	2-3/4	CTC-1361599	110.23
TILT							
	1107845		P-UB-10	2-1/2	4-1/2	CTC-1113300	141.35
	1342671		P-UB-10	2-1/2	4-1/2	CTC-1113300	141.35
	6E4651		P-UB-10	2-1/2	4-1/2	CTC-1113300	141.35
MODEL 920							
BUCKET							
	7J6789		P-UB-10	2	4	CTC-7X2789	105.58
	8J5663		P-UB-10	2	4	CTC-7X2789	105.58
BUCKET LH							
	6J2806		P-UB-10	2	4	CTC-7X2789	105.58
BUCKET RH							
	6J2805		P-UB-10	2	4	CTC-7X2789	105.58
LIFT							
	3G5511		P-UB-10	2-1/4	4-1/4	CTC-7X2750	118.40
	3G5512		P-UB-10	2-1/4	4-1/4	CTC-7X2750	118.40
	6J8731		P-UB-10	2-1/4	4-1/4	CTC-7X2750	118.40
	6J8732		P-UB-10	2-1/4	4-1/4	CTC-7X2750	118.40
LIFT LH							
	7J9852		P-UB-10	2-1/4	4-1/4	CTC-7X2750	118.40
LIFT RH							
	7J9851		P-UB-10	2-1/4	4-1/4	CTC-7X2750	118.40
M.P. BUCKET LH							
	6J2806		P-UB-10	2	4	CTC-7X2789	105.58
M.P. BUCKET RH							
	6J2605		P-UB-10	2	4	CTC-7X2789	105.58
PUMP							
	41J; 62K; 75J						
	9J5053					CTC-9J5112	39.78
SIDE DUMP							
	8J5670		P-UB-10	2	4	CTC-7X2755	152.30
	8J5670		P-UB-10	2	4	CTC-7X7937	166.09
STEERING							
	6J5477		P-UB-10	1-1/2	3	CTC-7X2751	66.28
	7J9838		P-UB-10	1-1/2	3	CTC-1372530	64.28
	7J9838		P-UB-10	1-1/2	3	CTC-7X2751	66.28
TILT LH							
	3G5482		P-UB-10	2	4	CTC-1328816	96.00
	7J3052		P-UB-10	2	4	CTC-7X2789	105.58
	7J9676		P-UB-10	2	4	CTC-7X2789	105.58
TILT RH							
	3G5481		P-UB-10	2	4	CTC-1328816	96.00
	7J3051		P-UB-10	2	4	CTC-7X2789	105.58
	7J9675		P-UB-10	2	4	CTC-7X2789	105.58

REPLACEMENT KITS FOR CATERPILLAR® EQUIPMENT

Loaders - Wheel							
APPLICATION	CYL #	Misc-Parts, Instructions, etc.	CODE	ROD	BORE	KIT #	List \$
MODEL 924							
M.P. BUCKET TILT							
	4T5545		P-UB-10	2-1/2	4-1/4	CTC-7X2663	51.12
MODEL 924F							
LIFT							
	1342327		P-UB-10	2-1/4	4	CTC-1546526	156.02
	9T3937		P-UB-10	2-1/4	4	CTC-1546526	156.02
STEERING							
	9T2637		P-UB-10	1-1/2	2-3/4	CTC-1361599	110.23
TILT							
	1107845		P-UB-10	2-1/2	4-1/2	CTC-1113300	141.35
	1342671		P-UB-10	2-1/2	4-1/2	CTC-1113300	141.35
	6E4651		P-UB-10	2-1/2	4-1/2	CTC-1113300	141.35
MODEL 924G							
COUPLER							
3PZ1-UP; 9SW1-UP; AAN1148-UP; DDA1-UP; EEB1-UP; RBB1-UP; WMB1-UP							
	1903085		I-U-10	1	2	CTC-1809872	122.04
9SW1-UP							
	1880563		I-U-10	1	2	CTC-1809872	122.04
9SW-UP; DDA1-UP							
	1783720		I-U-10	1	2	CTC-1809872	122.04
LIFT							
	1417483		P-UB-10	2-1/2	4	CTC-1542501	156.72
	9T8823		I-O-3	1	2	CTC-9T0418	85.89
3DZ1-UP; 6YW1-UP							
	1524187		P-UB-10	2-1/2	4-1/4	CTC-2341951	171.19
3PZ1-UP; 9SW1-UP; AAN1-UP; DDA1-UP; EEB1-UP; RBB1-UP; WMB1-UP							
	1417483		P-UB-10	2-1/2	4	CTC-1417483K	55.83
LOG FORK							
9SW1-UP							
	1491381		P-UB-10	2	3-1/2	CTC-2281778	80.42
MULTIPURPOSE BUCKET							
DDA1-UP; EEB1-UP; WMB1-UP							
	2681322		I-U-10	40 mm	3-1/2	CTC-2711529	25.81
STEERING							
	1426251		P-UB-10	1-1/2	2-3/4	CTC-1361599	110.23
3DZ1-UP; 3PZ1-UP; 6YW1-UP; 9SW1-UP; AAN1-UP; DDA1-UP; EEB1-UP; RBB1-UP; WMB1-UP							
	1426251		P-UB-10	1-1/2	2-3/4	CTC-2339204	64.76
3DZ1-UP; 3PZ1-UP; 6YW1-UP; 9SW1-UP; AAN1-UP; RBB1-UP; WMB1-UP							
	1426251		P-UB-10	1-1/2	2-3/4	CTC-2339204	64.76
TILT							
	1525306		P-UB-10	2-1/2	4-3/4	CTC-1361131	148.19
3DZ1-UP; 6YW1-UP							
	1525306		P-UB-10	2-1/2	4-3/4	CTC-2341948	93.79
3PZ1-UP; 9SW1-UP; AAN1-UP; DDA1-1987; RBB1-1046; WMB1-972							
	1417484		P-UB-10	2-1/2	5-1/4	CTC-1417484K	84.96
6YW1-UP							
	3408871		P-UB-10	2-1/2	4-3/4	CTC-3408871K	100.37
DDA1988-UP; EEB1-UP; RBB1-UP; WMB973-UP							
	2689437		P-UB-10	2-1/2	5-1/4	CTC-2689437K	84.96
RBB1047-UP							
	2689437		P-UB-10	2-1/2	5-1/4	CTC-2689437K	84.96
MODEL 924Gz							
LIFT							
AAB1-UP; DFZ1-UP; RTA1-UP; WGX1-UP							
	1524187		P-UB-10	2-1/2	4-1/4	CTC-2341951	171.19

REPLACEMENT KITS FOR CATERPILLAR® EQUIPMENT

Loaders - Wheel							
APPLICATION	CYL #	Misc-Parts, Instructions, etc.	CODE	ROD	BORE	KIT #	List \$
MODEL 924Gz							
STEERING							
AAB1-UP; DFZ1-UP; RTA1-UP; WGX1-UP							
	1426251		P-UB-10	1-1/2	2-3/4	CTC-2339204	64.76
TILT							
AAB1-UP; DFZ1-UP; RTA1-UP; WGX1-UP							
	1525306		P-UB-10	2-1/2	4-3/4	CTC-2341948	93.79
DFZ1-UP							
	3408871		P-UB-10	2-1/2	4-3/4	CTC-3408871K	100.37
MODEL 924H							
BUCKET							
KLN1-UP							
	1809338		P-UB-10	2	4	CTC-2339205	55.18
BUCKET SIDE DUMP							
KLN1-UP							
	1806336		P-U,UB-10	2	4	CTC-1807208	132.97
COUPLER							
HXC1-UP; JTM1-UP; KLN1-UP; LKW1-UP							
	1903085		I-U-10	1	2	CTC-1809872	122.04
LIFT							
HXC1-UP; JTM1-UP; KLN1-UP; LKW1-UP							
	1417483		P-UB-10	2-1/2	4	CTC-1417483K	55.83
MULTIPURPOSE BUCKET							
HXC1-UP; JTM1-UP; LKW1-UP							
	2681322		I-U-10	40 mm	3-1/2	CTC-2711529	25.81
STEERING							
HXC1-UP; JTM1-UP; KLN1-UP; LKW1-UP							
	1426251		P-UB-10	1-1/2	2-3/4	CTC-2339204	64.76
TILT							
HXC1-UP; JTM1-UP; KLN1-UP; LKW1-UP							
	2689437		P-UB-10	2-1/2	5-1/4	CTC-2689437K	84.96
MODEL 924Hz							
LIFT							
JRL1-UP; JZZ1-UP; PED1-UP; WLB1-UP							
	1524187		P-UB-10	2-1/2	4-1/4	CTC-2341951	171.19
STEERING							
JRL1-UP; JZZ1-UP; PED1-UP; WLB1-UP							
	1426251		P-UB-10	1-1/2	2-3/4	CTC-2339204	64.76
TILT							
JRL1-UP; JZZ1-UP;WLB841-UP							
	3408871		P-UB-10	2-1/2	4-3/4	CTC-3408871K	100.37
PED1-UP; WLB1-UP							
	1525306		P-UB-10	2-1/2	4-3/4	CTC-2341948	93.79
MODEL 926							
BUCKET							
	4T9387		P-UB-10	2	4	CTC-1328816	96.00
LIFT							
	3G2991		P-UB-10	2-1/2	4-3/4	CTC-1328811	167.09
	3G2991		P-UB-10	2-1/2	4-3/4	CTC-7X2660	185.90
PIN PULLER							
	6E5393		I-O-3	1	2	CTC-9T0418	85.89
STEERING							
	3G3501		P-UB-10	1-1/2	3	CTC-7X2751	66.28
TILT							
	3G2798		P-UB-10	2-1/2	5-1/2	CTC-7X2671	153.32
	3G2798		P-UB-10	2-1/2	5-1/2	CTC-9X2047	111.99

REPLACEMENT KITS FOR CATERPILLAR® EQUIPMENT

Loaders - Wheel							
APPLICATION	CYL #	Misc-Parts, Instructions, etc.	CODE	ROD	BORE	KIT #	List \$
MODEL 926E							
BUCKET							
	4T9387		P-UB-10	2	4	CTC-1328816	96.00
LIFT							
	3G2991		P-UB-10	2-1/2	4-3/4	CTC-1328811	167.09
	3G2991		P-UB-10	2-1/2	4-3/4	CTC-7X2660	185.90
STEERING							
	3G3501		P-UB-10	1-1/2	3	CTC-7X2751	66.28
	4T1574		P-UB-10	2	4	CTC-1328816	96.00
TILT							
	3G2798		P-UB-10	2-1/2	5-1/2	CTC-7X2671	153.32
	3G2798		P-UB-10	2-1/2	5-1/2	CTC-9X2047	111.99
	4T1063		P-UB-10	2	4-1/4	CTC-7X2766	45.67
MODEL 928F							
LIFT							
	1341383		P-UB-10	2-1/2	4-1/2	CTC-1113300	141.35
	6E1400		P-UB-10	2-1/2	4-1/2	CTC-1113300	141.35
PIN PULLER							
	6E5393		I-O-3	1	2	CTC-9T0418	85.89
STEERING							
	9T6646		P-UB-10	1-1/2	2-3/4	CTC-1361599	110.23
TILT							
	1341382	Rod Bearing width- 0.98"	P-UB-10	2-1/2	4-3/4	CTC-1361131	148.19
	9T6645	Rod Bearing width- 0.98"	P-UB-10	2-1/2	4-3/4	CTC-1361131	148.19
MODEL 928G							
COUPLER							
	2370946		Chk Vlv Kit			CTC-2138433	12.92
LIFT							
	1191060	Rod Bearing width- 0.98"	P-UB-10	2-1/2	4-3/4	CTC-1864382	98.20
STEERING LH							
	1250374		P-UB-10	1-1/2	2-3/4	CTC-1856596	47.94
STEERING RH							
	1250373		P-UB-10	1-1/2	2-3/4	CTC-1856596	47.94
TILT							
	1188105		P-UB-10	2-1/2	5	CTC-2275347	97.12
MODEL 928Hz							
COUPLER							
	BYD1-UP; CXK1-UP						
	1903085		I-U-10	1	2	CTC-1809872	122.04
	CXK1-UP						
	2370946		Chk Vlv Kit			CTC-2138433	12.92
	2370946		I-U-10	1	2	CTC-2370946K	13.43
	3612508		I-U-10	1	2	CTC-1832091	12.00
	3612508		Chk Vlv Kit			CTC-2138433	12.92
LIFT							
	BYD1-UP; CXK1-UP						
	1191060		P-UB-10	2-1/2	4-3/4	CTC-1864382	98.20
STEERING							
	BYD1-UP; CXK1-UP						
	1250373		P-UB-10	1-1/2	2-3/4	CTC-2339204	64.76
	1250374		P-UB-10	1-1/2	2-3/4	CTC-2339204	64.76
TILT							
	BYD1-UP; CXK1-UP						
	1188105		P-UB-10	2-1/2	5	CTC-2275347	97.12
	CXK867-UP						
	3408752		P-UB-10	2-1/2	5	CTC-3408752K	87.01

REPLACEMENT KITS FOR CATERPILLAR® EQUIPMENT

Loaders - Wheel							
APPLICATION	CYL #	Misc-Parts, Instructions, etc.	CODE	ROD	BORE	KIT #	List \$
MODEL 930							
BUCKET							
	7J6789		P-UB-10	2	4	CTC-7X2789	105.58
	8J5663		P-UB-10	2	4	CTC-7X2789	105.58
BUCKET LH							
	6J2806		P-UB-10	2	4	CTC-7X2789	105.58
BUCKET RH							
	6J2805		P-UB-10	2	4	CTC-7X2789	105.58
LIFT							
	3G5471		P-UB-10	2-1/4	4-1/2	CTC-1326770	155.43
	4T0299		P-UB-10	2-1/4	4-1/2	CTC-7X2748	111.36
LIFT LH							
	7J9872		P-UB-10	2-1/4	4-1/2	CTC-7X2747	193.37
LIFT RH							
	7J9871		P-UB-10	2-1/4	4-1/2	CTC-7X2747	193.37
LOG FORK LH							
	8J5677		P-V-10	2	5	CTC-7X2763	140.20
LOG FORK RH							
	8J5676		P-V-10	2	5	CTC-7X2763	140.20
PUMP							
	41K; 71H; 73U;79J						
	9J5050					CTC-9J5110	36.32
SIDE DUMP							
	8J5670		P-UB-10	2	4	CTC-7X2755	152.30
	8J5670		P-UB-10	2	4	CTC-7X7937	166.09
STEERING							
	7J9838		P-UB-10	1-1/2	3	CTC-1372530	64.28
	7J9838		P-UB-10	1-1/2	3	CTC-7X2751	66.28
TILT LH							
	7J9730		P-UB-10	2	4-1/4	CTC-7X2766	45.67
TILT RH							
	7J9729		P-UB-10	2	4-1/4	CTC-7X2766	45.67
MODEL 930G							
COUPLER							
	TFW1-UP; TWR1-UP						
	1903085		I-U-10	1	2	CTC-1809872	122.04
LIFT							
	TFW1-UP; TWR1-UP						
	2356823		P-UB-10	2-1/2	4-1/2	CTC-2356823K	57.80
MULTIPURPOSE BUCKET							
	TFW1-UP; TWR1-UP						
	2681322		I-U-10	40 mm	3-1/2	CTC-2711529	25.81
TILT							
	TFW1-UP; TWR1-UP						
	2356824		P-UB-10	2-3/4	6	CTC-2356824K	114.58
MODEL 930H							
COUPLER							
	DHC1-UP; FTD1-UP						
	1903085		I-U-10	1	2	CTC-1809872	122.04
LIFT							
	DHC1-UP; FTD1-UP						
	2356823		P-UB-10	2-1/2	4-1/2	CTC-2356823K	57.80
MULTIPURPOSE BUCKET							
	DHC1-UP; FTD1-UP						
	2681322		I-U-10	40 mm	3-1/2	CTC-2711529	25.81

REPLACEMENT KITS FOR CATERPILLAR® EQUIPMENT

Loaders - Wheel							
APPLICATION	CYL #	Misc-Parts, Instructions, etc.	CODE	ROD	BORE	KIT #	List \$
MODEL 930H							
STEERING							
DHC1-UP; FTD1-UP							
	2379271		P-UB-10	1-1/2	2-3/4	CTC-2379271K	45.59
TILT							
DHC1-UP; FTD1-UP							
	2356824		P-UB-10	2-3/4	6	CTC-2356824K	114.58
MODEL 930R, 930T							
ARTICULATION							
	9T2447	930R only	P-UB-10	1-3/4	3	CTC-7X2825	55.57
LIFT LH							
	7J9872		P-UB-10	2-1/4	4-1/2	CTC-7X2747	193.37
LIFT RH							
	7J9871		P-UB-10	2-1/4	4-1/2	CTC-7X2747	193.37
STEERING							
	7J9838		P-UB-10	1-1/2	3	CTC-1372530	64.28
	7J9838		P-UB-10	1-1/2	3	CTC-7X2751	66.28
TILT LH							
	7J9730		P-UB-10	2	4-1/4	CTC-7X2766	45.67
TILT RH							
	7J9729		P-UB-10	2	4-1/4	CTC-7X2766	45.67
MODEL 936							
LIFT							
	3G2991		P-UB-10	2-1/2	4-3/4	CTC-7X2660	185.90
	4T1674		P-UB-10	2-1/2	5-1/2	CTC-7X2672	91.88
	9T1196		P-UB-10	2-1/2	5-1/2	CTC-7X2672	91.88
PIN COUPLER							
	4T9981		I-O-3	1	2	CTC-9T0418	85.89
	6E5392		I-O-3	1	2	CTC-9T0418	85.89
	6E5393		I-O-3	1	2	CTC-9T0418	85.89
	9T8485		I-O-3	1	2	CTC-9T0418	85.89
STEERING							
	3G5110		P-UB-10	1-3/4	3-1/2	CTC-7X2784	58.32
TILT							
	3G5291		P-UB-10	2-3/4	6-1/2	CTC-7X2686	124.95
MODEL 936E							
LIFT							
	3G2991		P-UB-10	2-1/2	4-3/4	CTC-7X2660	185.90
	4T0263		P-UB-10	2-1/2	4-3/4	CTC-7X2660	185.90
	4T0263		P-UB-10	2-1/2	4-3/4	CTC-7X2673	184.64
	4T1674		P-UB-10	2-1/2	5-1/2	CTC-7X2672	91.88
	9T1196		P-UB-10	2-1/2	5-1/2	CTC-7X2672	91.88
M.P. BUCKET							
	4T9387		P-UB-10	2	4	CTC-7X2789	105.58
M.P. BUCKET TILT							
	4T5545		P-UB-10	2-1/2	4-1/4	CTC-7X2663	51.12
PIN COUPLER							
	4T9981		I-O-3	1	2	CTC-9T0418	85.89
	9T2352		I-O-3	1	2	CTC-9T0418	85.89
	9T8485		I-O-3	1	2	CTC-9T0418	85.89
STEERING							
	3G3501		P-UB-10	1-1/2	3	CTC-7X2751	66.28
	3G5110		P-UB-10	1-3/4	3-1/2	CTC-7X2784	58.32
TILT							
	3G5291		P-UB-10	2-3/4	6-1/2	CTC-7X2686	124.95

REPLACEMENT KITS FOR CATERPILLAR® EQUIPMENT

Loaders - Wheel							
APPLICATION	CYL #	Misc-Parts, Instructions, etc.	CODE	ROD	BORE	KIT #	List \$
MODEL 936F							
LIFT							
	9T1196		P-UB-10	2-1/2	5-1/2	CTC-7X2672	91.88
PIN PULLER							
	6E5393		I-O-3	1	2	CTC-9T0418	85.89
STEERING							
	3G5110		P-UB-10	1-3/4	3-1/2	CTC-7X2784	58.32
	6E2035		P-UB-10	1-3/4	3-1/2	CTC-7X2784	58.32
TILT							
	3G5291		P-UB-10	2-3/4	6-1/2	CTC-7X2686	124.95
MODEL 938F							
LIFT							
	1287678		P-UB-10	2-1/2	5	CTC-1361967	200.54
	9T7160	Rod Bearing width- 0.98"	P-UB-10	2-1/2	4-3/4	CTC-1361131	148.19
STEERING							
	1050094		P-UB-10	1-3/4	3	CTC-7X2825	55.57
TILT							
	1377855		P-UB-10	2-3/4	5-1/2	CTC-1358736	219.47
	9T7161		P-UB-10	2-3/4	5-1/2	CTC-1358736	219.47
MODEL 938G							
COUPLER							
	2080828		Chk Vlv Kit			CTC-2138433	12.92
	2370946		Chk Vlv Kit			CTC-2138433	12.92
LIFT							
	1KM1-1123; 2RM1-1123; 7SN1-384						
	9T7160	Head# 1206679	P-UB-10	2-1/2	4-3/4	CTC-1864382	98.20
	9T7160	Head# 9T3609	P-UB-10	2-1/2	4-3/4	CTC-9X2151	85.96
	1KM1124-; 2RM1124-; 7SN385-						
	1287678		P-UB-10	2-1/2	5	CTC-1361967	200.54
STEERING							
	1050094		P-UB-10	1-3/4	3	CTC-7X2825	55.57
	1393312		P-UB-10	1-3/4	3	CTC-7X2825	55.57
TILT							
	4YS1-						
	1377855		P-UB-10	2-3/4	5-1/2	CTC-1358736	219.47
	9T7161		P-UB-10	2-3/4	5-1/2	CTC-1358736	219.47
MODEL 938H							
COUPLER							
	JKM1-UP; MJC1-UP						
	2370946		Chk Vlv Kit			CTC-2138433	12.92
LIFT							
	JKM1-UP; LKM1-UP; MCC1-UP; MJC1-UP						
	2549037		P-UB-10	70 mm	130 mm	CTC-2549037K	385.37
STEERING							
	JKM1-153; LKM1-175						
	1393312		P-UB-10	1-3/4	3	CTC-2275350	34.62
	JKM154-UP; LKM176-UP; MCC1-UP; MJC1-UP						
	3149340		P-UB-10	1-3/4	3	CTC-3260504	71.24
TILT							
	JKM1-905; LKM1-1037; MCC1-UP; MJC1-835						
	3388416		P-UB-10	70 mm	140 mm	CTC-3388416K	361.95
	JKM1-988; LKM1-1037; MJC1-810						
	3171090	High Lift Arrangement	P-UB-10	70 mm	140 mm	CTC-3171090K	361.95
	JKM906-UP; LKM1038-UP; MJC836-UP						
	3461093		P-UB-10	70 mm	140 mm	CTC-3461093K	361.95
	JKM989-UP; LKM1038-UP; MJC811-UP						
	3461094	High Lift Arrangement	P-UB-10	70 mm	140 mm	CTC-3461094K	361.95

REPLACEMENT KITS FOR CATERPILLAR® EQUIPMENT

Loaders - Wheel							
APPLICATION	CYL #	Misc-Parts, Instructions, etc.	CODE	ROD	BORE	KIT #	List \$
MODEL 944, 944A							
LOG FORK LH							
	8J5677		P-V-10	2	5	CTC-7X2763	140.20
LOG FORK RH							
	8J5676		P-V-10	2	5	CTC-7X2763	140.20
MODEL 950							
LIFT							
	7J9690		P-UB-10	2-1/2	5-1/2	CTC-9X2050	104.21
LIFT LH							
	1U1147		P-UB-10	3	6	CTC-7X2698	192.84
LIFT RH							
	1U1148		P-UB-10	3	6	CTC-7X2698	192.84
LOG FORK LH							
	8J5677		P-V-10	2	5	CTC-7X2763	140.20
LOG FORK RH							
	8J5676		P-V-10	2	5	CTC-7X2763	140.20
PUMP							
	31K; 43J; 49U; 73J; 81J						
	9J5070					CTC-9J5114	27.82
SIDE DUMP							
	8J5690		P-V-10	2	5	CTC-7X2763	140.20
STEERING							
	3G0892		P-UB-10	1-3/4	3-1/2	CTC-7X2762	103.56
	3G0892		P-UB-10	1-3/4	3-1/2	CTC-7X2784	58.32
	7J9685		P-UB-10	1-1/2	3-1/2	CTC-7X2812	107.67
TILT							
	3G8786		P-UB-10	3-1/4	7	CTC-7X2704	146.36
	7J9695		P-UB-10	2-1/2	5-1/2	CTC-9X2050	104.21
TILT LH							
	7J9696		P-UB-10	2-1/2	5-1/2	CTC-9X2050	104.21
TILT RH							
	7J9363		P-UB-10	2-1/2	6	CTC-1363121	170.27
TREE HARVESTER DELIMBER							
	8J3829		P-UB-10	2	4	CTC-7X2789	105.58
	9J2481		P-UB-10	1-3/4	3	CTC-7X2791	91.70
MODEL 950B, 950E, 950F							
LIFT							
	4T0263	950B & 950E only	P-UB-10	2-1/2	4-3/4	CTC-1328811	167.09
	4T0263		P-UB-10	2-1/2	4-3/4	CTC-7X2660	185.90
	4T0263		P-UB-10	2-1/2	4-3/4	CTC-7X2673	184.64
	7J9902	950F only	P-UB-10	2	4-1/4	CTC-7X2819	108.80
LIFT LH							
	1U1147		P-UB-10	3	6	CTC-7X2698	192.84
LIFT RH							
	1U1148		P-UB-10	3	6	CTC-7X2698	192.84
STEERING							
	3G0892		P-UB-10	1-3/4	3-1/2	CTC-7X2784	58.32
	6E3889		P-UB-10	1-3/4	3-1/2	CTC-7X2784	58.32
	6E4892		P-UB-10	1-3/4	3-1/2	CTC-7X2784	58.32
	6E5024	950B & 950F only	P-UB-10	2	4	CTC-1113302	123.12
TILT							
	3G8786		P-UB-10	3-1/4	7	CTC-1328518	237.28
MODEL 950G							
COUPLER							
	2080828		Chk Vlv Kit			CTC-2138433	12.92
	2370946		Chk Vlv Kit			CTC-2138433	12.92

REPLACEMENT KITS FOR CATERPILLAR® EQUIPMENT

Loaders - Wheel							
APPLICATION	CYL #	Misc-Parts, Instructions, etc.	CODE	ROD	BORE	KIT #	List \$
MODEL 950G							
LIFT							
	1188296		P-UB-10	3	6	CTC-7X2698	192.84
	1250024		P-UB-10	3	6	CTC-7X2698	192.84
STEERING							
	1188288	Head# 1537182	P-UB-10	1-3/4	3-1/2	CTC-2281795	101.57
	1630324	Head# 1630329	P-UB-10	1-3/4	3-1/2	CTC-2281795	101.57
	4BS1-413; 3JW1-684; 5FW1-784						
	1188288	Head# 9T7890	P-UB-10	1-3/4	3-1/2	CTC-7X2784	58.32
TILT							
	1189001		P-UB-10	3-1/4	7	CTC-7X2710	210.31
	1518206		P-UB-10	3-1/4	8-1/2	CTC-1518206K	361.95
MODEL 950H							
COUPLER							
	2370946		Chk Vlv Kit			CTC-2138433	12.92
LIFT							
	2424271		P-UB-10	3-1/4	5-3/4	CTC-2424271K	262.26
	2424272		P-UB-10	3-1/4	5-3/4	CTC-2424272K	262.26
STEERING							
	1630324		P-UB-10	1-3/4	3-1/2	CTC-2281795	101.57
TILT							
	2424270		P-UB-10	3-1/4	6-1/4	CTC-2424270K	217.41
	2457487		P-UB-10	3-1/2	7-1/2	CTC-2457487K	267.42
	2457491		P-UB-10	3-1/4	6-1/4	CTC-2457491K	217.41
MODEL 960F							
LIFT							
	7J9902		P-UB-10	2	4-1/4	CTC-7X2819	108.80
LIFT LH							
	1U1147		P-UB-10	3	6	CTC-7X2698	192.84
LIFT RH							
	1U1148		P-UB-10	3	6	CTC-7X2698	192.84
STEERING							
	3G0892		P-UB-10	1-3/4	3-1/2	CTC-7X2784	58.32
	6E3889		P-UB-10	1-3/4	3-1/2	CTC-7X2784	58.32
	6E4892		P-UB-10	1-3/4	3-1/2	CTC-7X2784	58.32
TILT							
	3G8786		P-UB-10	3-1/4	7	CTC-1328518	237.28
MODEL 960G, 962G							
LIFT RH							
	1188296		P-UB-10	3	6	CTC-7X2698	192.84
	1250024		P-UB-10	3	6	CTC-7X2698	192.84
STEERING							
	1188288		P-UB-10	1-3/4	3-1/2	CTC-7X2784	58.32
TILT							
	1294447		P-UB-10	3-1/4	7	CTC-7X2710	210.31
MODEL 966							
LIFT							
	9J2434		P-UB-10	2-1/2	6-1/2	CTC-7X2666	175.79
PUMP							
	25U; 30K; 42J; 76J; 78G						
	9J5049					CTC-9J5108	41.54
STEERING							
	6E5024		P-UB-10	2	4	CTC-1113302	123.12
STEERING LH							
	7J9356		P-UB-10	2	4	CTC-7X2755	152.30
TILT							
	3G5497		P-UB-14	3-1/4	8-1/4	CTC-7X2703	243.96

REPLACEMENT KITS FOR CATERPILLAR® EQUIPMENT

Loaders - Wheel							
APPLICATION	CYL #	Misc-Parts, Instructions, etc.	CODE	ROD	BORE	KIT #	List \$
MODEL 966							
TILT LH							
	7J9364		P-UB-10	2-1/2	6	CTC-7X2669	241.94
MODEL 966A							
LOG FORK LH							
	8J5677		P-V-10	2	5	CTC-7X2763	140.20
LOG FORK RH							
	8J5676		P-V-10	2	5	CTC-7X2763	140.20
SIDE DUMP							
	8J5733		P-V-10	2	5	CTC-7X2763	140.20
TILT LH							
	6J6874		P-UB-10	2-1/2	6	CTC-7X2669	241.94
	7J9364		P-UB-10	2-1/2	6	CTC-7X2669	241.94
	7J9364		P-UB-10	2-1/2	6	CTC-8T2066	109.44
TILT RH							
	6J6873		P-UB-10	2-1/2	6	CTC-7X2669	241.94
	7J9363		P-UB-10	2-1/2	6	CTC-7X2669	241.94
	7J9363		P-UB-10	2-1/2	6	CTC-8T2066	109.44
MODEL 966B							
LIFT							
	9J2434		P-UB-10	2-1/2	6-1/2	CTC-7X2666	175.79
LIFT RH							
	4J7859		P-UB-10	2	4	CTC-7X2755	152.30
LOG FORK							
	8J5755		P-UB-10	2-1/4	5	CTC-7X2729	168.02
LOG FORK LH							
	8J5677		P-V-10	2	5	CTC-7X2763	140.20
LOG FORK RH							
	8J5676		P-V-10	2	5	CTC-7X2763	140.20
SIDE DUMP							
	8J5733		P-V-10	2	5	CTC-7X2763	140.20
SPECIAL APPLICATION							
	4J9996		P-UB-10	2-1/2	7-1/4	CTC-7X2661	187.26
STEERING LH							
	7J9356		P-UB-10	2	4	CTC-7X2755	152.30
STEERING RH							
	7J9355		P-UB-10	2	4	CTC-7X2755	152.30
TILT LH							
	6J6874		P-UB-10	2-1/2	6	CTC-7X2669	241.94
	7J9364		P-UB-10	2-1/2	6	CTC-7X2669	241.94
	7J9364		P-UB-10	2-1/2	6	CTC-8T2066	109.44
TILT RH							
	6J6873		P-UB-10	2-1/2	6	CTC-7X2669	241.94
	7J9363		P-UB-10	2-1/2	6	CTC-7X2669	241.94
	7J9363		P-UB-10	2-1/2	6	CTC-8T2066	109.44
MODEL 966C							
BUCKET TILT LH							
	5J2464		P-UB-10	2-1/2	6	CTC-8T2066	109.44
BUCKET TILT RH							
	5J2463		P-UB-10	2-1/2	6	CTC-8T2066	109.44
LIFT							
	3G5471		P-UB-10	2-1/4	4-1/2	CTC-1326770	155.43
	9J2434		P-UB-10	2-1/2	6-1/2	CTC-7X2666	175.79
LOG FORK							
	8J5755		P-UB-10	2-1/4	5	CTC-7X2729	168.02

REPLACEMENT KITS FOR CATERPILLAR® EQUIPMENT

Loaders - Wheel							
APPLICATION	CYL #	Misc-Parts, Instructions, etc.	CODE	ROD	BORE	KIT #	List \$
MODEL 966C							
LOG FORK LH							
	4K0502		P-V-10	2	5	CTC-7X2763	140.20
	8J5677		P-V-10	2	5	CTC-7X2763	140.20
LOG FORK RH							
	8J5676		P-V-10	2	5	CTC-7X2763	140.20
PUMP							
	25U; 30K; 42J; 76J; 78G						
	9J5049					CTC-9J5108	41.54
SIDE DUMP							
	8J5733		P-V-10	2	5	CTC-7X2763	140.20
SPECIAL APPLICATION							
	4J9996		P-UB-10	2-1/2	7-1/4	CTC-7X2661	187.26
STEERING LH							
	7J9356		P-UB-10	2	4	CTC-7X2755	152.30
STEERING RH							
	7J9355		P-UB-10	2	4	CTC-7X2755	152.30
TILT LH							
	6J6874		P-UB-10	2-1/2	6	CTC-7X2669	241.94
	7J9364		P-UB-10	2-1/2	6	CTC-7X2669	241.94
	7J9364		P-UB-10	2-1/2	6	CTC-8T2066	109.44
TILT RH							
	6J6873		P-UB-10	2-1/2	6	CTC-7X2669	241.94
	6J6873		P-UB-10	2-1/2	6	CTC-8T2066	109.44
	6J6875		P-UB-10	2-1/2	6	CTC-8T2066	109.44
	6J6876		P-UB-10	2-1/2	6	CTC-8T2066	109.44
	25U1-2466;30K1-UP;42J1-9229;76J1-UP;78G1-3350						
	7J9363	Head 9J5483; Piston 6J6871	P-UB-10	2-1/2	6	CTC-7X2655	117.58
	9KC1-UP;18B1-UP;25U2467-UP;30K2369-UP;42J9230-UP;76J9656-UP;78G1-UP						
	7J9363	Heads 9T0416,9J5483; Piston 3G6538	P-UB-10	2-1/2	6	CTC-7X2669	241.94
MODEL 966D							
LIFT LH							
	3G5495		P-UB-10	3-1/4	7	CTC-7X2710	210.31
LIFT RH							
	3G5496		P-UB-10	3-1/4	7	CTC-7X2710	210.31
STEERING							
	4T1574		P-UB-10	2	4	CTC-1328816	96.00
	6E4892		P-UB-10	1-3/4	3-1/2	CTC-7X2784	58.32
	6E5024		P-UB-10	2	4	CTC-1113302	123.12
	9J7061		P-UB-10	2	4	CTC-7X2789	105.58
TILT							
	3G5497		P-UB-14	3-1/4	8-1/4	CTC-7X2703	243.96
MODEL 966E, 966F							
LIFT LH							
	3G5495		P-UB-10	3-1/4	7	CTC-7X2710	210.31
LIFT RH							
	3G5496		P-UB-10	3-1/4	7	CTC-7X2710	210.31
STEERING							
	4T1574		P-UB-10	2	4	CTC-1328816	96.00
	6E5024		P-UB-10	2	4	CTC-1113302	123.12
	9J7061	966E only	P-UB-10	2	4	CTC-7X2789	105.58
TILT							
	3G5497		P-UB-14	3-1/4	8-1/4	CTC-7X2703	243.96
MODEL 966G							
LIFT LH							
	1332964		P-UB-10	3-1/4	7	CTC-7X2710	210.31

REPLACEMENT KITS FOR CATERPILLAR® EQUIPMENT

Loaders - Wheel							
APPLICATION	CYL #	Misc-Parts, Instructions, etc.	CODE	ROD	BORE	KIT #	List \$
MODEL 966G							
LIFT RH							
	1332963		P-UB-10	3-1/4	7	CTC-7X2710	210.31
STEERING							
	1331747		P-UB-10	2	3-1/2	CTC-7X2783	106.57
TILT							
	1332962		P-UB-10	3-1/4	9-1/4	CTC-1332962K	296.31
	1449005		P-UB-10	3-1/4	8-1/4	CTC-2281780	244.90
	1713953		P-UB-10	3-1/4	8-1/4	CTC-2281780	244.90
	1882445		P-UB-10	3-1/2	9-1/4	CTC-2282533	325.94
MODEL 966H							
LIFT							
	2424274		P-UB-10	3-1/2	6-1/4	CTC-2959888	213.55
	2424275		P-UB-10	3-1/2	6-1/4	CTC-2959888	213.55
STEERING							
	1331747		P-UB-10	2	3-1/2	CTC-7X2783	106.57
TILT							
	2424273		P-UB-10	3-1/4	170 mm	CTC-2424273K	226.45
	2448777		P-UB-10	3-3/4	7-3/4	CTC-2448777K	261.28
	2457484		P-UB-10	3-1/4	170 mm	CTC-2457484K	226.45
MODEL 966R							
LIFT							
	9J2434		P-UB-10	2-1/2	6-1/2	CTC-7X2666	175.79
STEERING LH							
	7J9356		P-UB-10	2	4	CTC-7X2755	152.30
STEERING RH							
	7J9355		P-UB-10	2	4	CTC-7X2755	152.30
TILT LH							
	7J9364		P-UB-10	2-1/2	6	CTC-1363121	170.27
	7J9364		P-UB-10	2-1/2	6	CTC-7X2669	241.94
	7J9364		P-UB-10	2-1/2	6	CTC-8T2066	109.44
TILT RH							
	7J9363		P-UB-10	2-1/2	6	CTC-1363121	170.27
	7J9363		P-UB-10	2-1/2	6	CTC-7X2669	241.94
	7J9363		P-UB-10	2-1/2	6	CTC-8T2066	109.44
MODEL 970F							
LIFT LH							
	6E5879		P-UB-10	3-1/4	7	CTC-7X2710	210.31
LIFT RH							
	6E5878		P-UB-10	3-1/4	7	CTC-7X2710	210.31
STEERING							
	4T1574		P-UB-10	2	4	CTC-1328816	96.00
	6E5024		P-UB-10	2	4	CTC-1113302	123.12
TILT							
	3G5497		P-UB-14	3-1/4	8-1/4	CTC-7X2703	243.96
MODEL 972G							
LIFT LH							
	1332964	Piston Bearings; 1.49", 1.99"	P-UB-10	3-1/4	7	CTC-7X2710	210.31
	1EW1-UP; 4WW1-UP; 6AW1-UP; 7LS1-UP; 9GW1-500; AAW1-400						
	1332964	Piston Bearing; 1.49"	P-UB-10	3-1/4	7	CTC-2281779	155.45
LIFT RH							
	1332963	Piston Bearings; 1.49", 1.99"	P-UB-10	3-1/4	7	CTC-7X2710	210.31
	1EW1-UP; 4WW1-UP; 6AW1-UP; 7LS1-UP; 9GW1-500; AAW1-400						
	1332963	Piston Bearing; 1.49"	P-UB-10	3-1/4	7	CTC-2281779	155.45
STEERING							
	1331747		P-UB-10	2	3-1/2	CTC-7X2783	106.57

REPLACEMENT KITS FOR CATERPILLAR® EQUIPMENT

Loaders - Wheel							
APPLICATION	CYL #	Misc-Parts, Instructions, etc.	CODE	ROD	BORE	KIT #	List \$
MODEL 972G							
STEERING							
1EW1-UP; 4WW1-UP; 6AW1-UP; 7LS1-UP; 9GW1-319; AAW1-215							
1331747			P-UB-10	2	3-1/2	CTC-7X2783	106.57
1EW1-UP; 6AW1-UP							
1331747			P-UB-1	2		CTC-8C4510	32.91
TILT							
1EW1-UP; 4WW1-341; 6AW1-UP; 7SL1-306; 9GW1-292; AAW1-200							
1332962			P-UB-10	3-1/4	9-1/4	CTC-1332962K	296.31
1EW1-UP; 4WW342-UP; 6AW1-UP; 9GW293-UP; AWW201-UP							
1882445			P-UB-10	3-1/2	9-1/4	CTC-1882445K	255.93
1EW1-UP; 6AW1-UP							
1744715			P-UB-10	3-1/4	9-1/4	CTC-1744715K	209.72
1905955	High Lift Arrangement		P-UB-10	3-1/2	9-1/4	CTC-1905955K	255.93
4WW1-UP; 7SL1-UP							
1533747	Logging Arrangement		P-UB-10	2-1/4	5	CTC-2417578	65.89
2032208	Logging Arrangement		P-UB-10	2-1/4	5	CTC-2417578	65.89
AAW1-196							
1449005			P-UB-10	3-1/4	8-1/4	CTC-1449005K	181.02
MODEL 972H							
BUCKET							
A7D1-UP							
2200525			I-U-15	70 mm	125 mm	CTC-3704117	421.42
COUPLER							
A7D1-UP							
2370946			I-U-10	1	2	CTC-2370946K	13.43
2370946			Chk Vlv Kit			CTC-2138433	12.92
3612507			I-U-10	1	2-1/2	CTC-3156338	18.44
3612507			Chk Vlv Kit			CTC-2138433	12.92
3612508			I-U-10	1	2	CTC-1832091	12.00
3612508			Chk Vlv Kit			CTC-2138433	12.92
LIFT							
A7D1-UP; A7G1-UP; A7J1-UP; GTA1-UP; WLA1-UP							
2424274			P-UB-10	3-1/2	6-1/4	CTC-2959888	213.55
2424275			P-UB-10	3-1/2	6-1/4	CTC-2959888	213.55
STEERING							
A7D1-595; A7G1-1005; A7J1-295; WLA1-UP							
1331747			P-UB-10	2	3-1/2	CTC-7X2783	106.57
A7D596-UP; A7G1006-UP; A7J296-UP; GTA1-UP; WLA1-UP							
3149336			P-UB-10	2	3-1/2	CTC-3260502	144.11
TILT							
A7D1-UP							
2032208	Logging Arrangement		P-UB-10	2-1/4	5	CTC-2417578	65.89
A7D1-UP; A7G1-2157; A7J1-UP; GTA1-UP; WLA1-UP							
2448777	Logging Arrangement		P-UB-10	3-3/4	7-3/4	CTC-3652880	192.42
A7D1-UP; A7G1-UP; A7J1-UP; GTA1-UP							
2457486	High Lift Arrangement		P-UB-10	3-3/4	7-3/4	CTC-3652880	192.42
A7D1-UP; A7G1-UP; GTA1-UP							
3585190	High Lift Arrangement		P-UB-10	3-3/4	7-3/4	CTC-3652880	192.42
A7D1-UP; A7G2158-UP; GTA1-UP; WLA1-UP							
3562220			P-UB-10	3-3/4	7-3/4	CTC-3652880	192.42
MODEL 980							
LIFT							
7J9818	980B only		P-V-10	2-1/2	6-1/2	CTC-7X2678	113.26
7J9818			P-UB-10	3	7-1/4	CTC-7X2699	222.83
LOG FORK							
8J5767			P-UB-10	2-1/4	5	CTC-7X2729	168.02

REPLACEMENT KITS FOR CATERPILLAR® EQUIPMENT

Loaders - Wheel							
APPLICATION	CYL #	Misc-Parts, Instructions, etc.	CODE	ROD	BORE	KIT #	List \$
MODEL 980							
STEERING LH							
	7J9786		P-UB-10	2-1/4	4-1/2	CTC-7X2747	193.37
STEERING RH							
	7J9785		P-UB-10	2-1/4	4-1/2	CTC-7X2747	193.37
TILT LH							
	7J9742		P-UB-10	2-1/2	5-1/2	CTC-9X2050	104.21
TILT RH							
	7J9741		P-UB-10	2-1/2	5-1/2	CTC-9X2050	104.21
MODEL 980B							
LIFT							
	7J9818		P-V-10	2-1/2	6-1/2	CTC-7X2678	113.26
	7J9818		P-UB-10	3	7-1/4	CTC-7X2699	222.83
LOG FORK							
	8J5767		P-UB-10	2-1/4	5	CTC-7X2729	168.02
PUMP							
	11K; 89P						
	5J5930					CTC-9J5111	43.41
	8J2504					CTC-9J5115	37.59
	89P						
	9J5064					CTC-9J5111	43.41
	9J5065					CTC-9J5115	37.59
STEERING LH							
	7J9786		P-UB-10	2-1/4	4-1/2	CTC-7X2747	193.37
STEERING RH							
	7J9785		P-UB-10	2-1/4	4-1/2	CTC-7X2747	193.37
TILT LH							
	7J9742		P-UB-10	2-1/2	5-1/2	CTC-9X2050	104.21
TILT RH							
	7J9741		P-UB-10	2-1/2	5-1/2	CTC-9X2050	104.21
MODEL 980C							
LIFT							
	9J5559		P-UB-10	3-1/2	7-1/2	CTC-7X2730	165.62
	9J8002		P-UB-10	2-3/4	5-1/2	CTC-7X2684	158.94
LIFT-DEEPER DIG							
	1U3527		P-UB-10	3-1/2	7-1/2	CTC-7X2730	165.62
LIFT-HIGH							
	4T6791		P-UB-10	3	6-1/4	CTC-7X2701	116.63
	4T7949		P-UB-10	3	6-1/4	CTC-7X2701	116.63
LOGGER TILT							
	3G5069		P-UB-10	2-3/4	7	CTC-7X2691	151.71
	3G5070		P-UB-10	2-3/4	7	CTC-7X2691	151.71
STEERING							
	6E6653		P-UB-10	2-1/4	4-1/2	CTC-1354392	145.28
STEERING LH							
	9J6536		P-UB-10	2-1/4	4-1/2	CTC-1373529	64.77
STEERING RH							
	9J5869		P-UB-10	2-1/4	4-1/2	CTC-1373529	64.77
TILT							
	1U0418		P-UB-10	3	5-1/2	CTC-7X2813	234.97
	9T2418		P-UB-10	3	6-1/4	CTC-7X2701	116.63
	9T2419		P-UB-10	3	6-1/4	CTC-7X2701	116.63
TILT LH							
	3G1306		P-UB-10	2-3/4	6-1/4	CTC-7X2688	153.14
	3G5070		P-UB-10	2-3/4	7	CTC-1328284	137.75
	4T6791		P-UB-10	3	6-1/4	CTC-7X2701	116.63
	9T2419		P-UB-10	3	6-1/4	CTC-1328491	269.61

REPLACEMENT KITS FOR CATERPILLAR® EQUIPMENT

Loaders - Wheel							
APPLICATION	CYL #	Misc-Parts, Instructions, etc.	CODE	ROD	BORE	KIT #	List \$
MODEL 980C							
TILT RH							
	3G1305		P-UB-10	2-3/4	6-1/4	CTC-7X2688	153.14
	3G5069		P-UB-10	2-3/4	7	CTC-1328284	137.75
	4T7949		P-UB-10	3	6-1/4	CTC-7X2701	116.63
	6E4866		P-UB-10	2-3/4	6-1/4	CTC-7X2688	153.14
	9T2418		P-UB-10	3	6-1/4	CTC-1328491	269.61
MODEL 980F							
LIFT							
	1U3527		P-UB-10	3-1/2	7-1/2	CTC-7X2730	165.62
STEERING							
	6E6653		P-UB-10	2-1/4	4-1/2	CTC-1354392	145.28
STEERING LH							
	9J6536		P-UB-10	2-1/4	4-1/2	CTC-1373529	64.77
STEERING RH							
	9J5869		P-UB-10	2-1/4	4-1/2	CTC-1373529	64.77
TILT LH							
	3G1306		P-UB-10	2-3/4	6-1/4	CTC-7X2688	153.14
	3G5070		P-UB-10	2-3/4	7	CTC-1328284	137.75
	4T6791		P-UB-10	3	6-1/4	CTC-7X2701	116.63
	9T2419		P-UB-10	3	6-1/4	CTC-1328491	269.61
TILT RH							
	3G1305		P-UB-10	2-3/4	6-1/4	CTC-7X2688	153.14
	3G5069		P-UB-10	2-3/4	7	CTC-1328284	137.75
	4T7949		P-UB-10	3	6-1/4	CTC-7X2701	116.63
	6E4866		P-UB-10	2-3/4	6-1/4	CTC-7X2688	153.14
	9T2418		P-UB-10	3	6-1/4	CTC-1328491	269.61
MODEL 980G							
LIFT							
	1118181		P-UB-10	3-1/2	7-3/4	CTC-2281775	165.11
STEERING							
	1151371		P-UB-10	2-1/4	4	CTC-1546526	156.02
TILT							
	1463032		P-UB-10	3	7	CTC-1605796	313.77
TILT LH							
	1125004		P-UB-10	2-3/4	6-1/4	CTC-7X2688	153.14
	1240617		P-UB-10	3	7	CTC-1605796	313.77
	1246227		P-UB-10	3	6-1/4	CTC-1917694	225.05
	1463035		P-UB-10	3	7	CTC-1605796	313.77
TILT RH							
	1125003		P-UB-10	2-3/4	6-1/4	CTC-7X2688	153.14
	1240616		P-UB-10	3	7	CTC-1605796	313.77
	1246228		P-UB-10	3	6-1/4	CTC-1917694	225.05
MODEL 980H							
LIFT							
	1118181		P-UB-10	3-1/2	7-3/4	CTC-2281775	165.11
STEERING							
	1151371		P-UB-10	2-1/4	4	CTC-1546526	156.02
TILT LH							
	1125004		P-UB-10	2-3/4	6-1/4	CTC-7X2688	153.14
	1240617		P-UB-10	3	7	CTC-1605796	313.77
	1246227		P-UB-10	3	6-1/4	CTC-1917694	225.05
TILT RH							
	1125003		P-UB-10	2-3/4	6-1/4	CTC-7X2688	153.14
	1240616		P-UB-10	3	7	CTC-1605796	313.77
	1246228		P-UB-10	3	6-1/4	CTC-1917694	225.05

REPLACEMENT KITS FOR CATERPILLAR® EQUIPMENT

Loaders - Wheel							
APPLICATION	CYL #	Misc-Parts, Instructions, etc.	CODE	ROD	BORE	KIT #	List \$
MODEL 980K							
FORK							
W7K1-							
2032208			P-UB-10	2-1/4	5	CTC-2417578	65.89
LIFT							
GTZ1-; W7K1-							
3349861			P-UB-10	90 mm	180 mm	CTC-3349861K	219.90
TILT							
GTZ1-; W7K1-							
3453897			P-UB-10	100 mm	140 mm	CTC-3453897K	113.76
3519360			P-UB-10	100 mm	140 mm	CTC-3519360K	113.76
W7K1-							
3615042			P-UB-10	100 mm	150 mm	CTC-3615042K	116.71
MODEL 988							
LIFT							
4J7377			P-UB-10	3-1/4	8-1/4	CTC-7X2715	274.21
7J1419			P-V-10	3-1/4	7-1/4	CTC-1354446	214.21
7J9744			P-UB-10	3-1/4	8-1/4	CTC-7X2717	211.36
7J9802			P-V-10	3-1/4	7-1/4	CTC-1354446	214.21
9J4893			P-UB-10	3-1/4	8-1/4	CTC-7X2717	211.36
PUMP							
87A							
7J0592						CTC-9J5111	43.41
STEERING							
6J7590			P-UB-10	2-1/4	5	CTC-7X2729	168.02
7J9718			P-UB-10	2-1/4	5	CTC-7X2729	168.02
7J9984			P-UB-10	2-1/4	5	CTC-7X2729	168.02
TILT							
9J3632			P-UB-10	3-1/4	7-3/4	CTC-7X2706	276.03
TILT LH							
4J5744			P-UB-10	2-1/2	6-1/2	CTC-8T1376	82.33
7J9762			P-UB-10	2-3/4	6-1/2	CTC-7X2689	166.65
TILT RH							
4J5743			P-UB-10	2-1/2	6-1/2	CTC-8T1376	82.33
7J9761			P-UB-10	2-3/4	6-1/2	CTC-7X2689	166.65
UNSPECIFIED APPLICATION							
7K9401			P-UB-10	2-1/4	5	CTC-7X2729	168.02
MODEL 988B							
BUCKET LIFT							
9T8257			P-UB-10	4	8-1/2	CTC-7X2742	223.75
LIFT							
1U4679			P-UB-10	4	8-1/2	CTC-7X2734	313.52
4T7585			P-UB-10	4	8-1/2	CTC-7X2742	223.75
8J5779			P-UB-10	4	8-1/2	CTC-7X2734	313.52
9T8257			P-UB-10	4	8-1/2	CTC-7X2742	223.75
LOGGER TILT							
3G2976			P-UB-10	3-1/2	8-1/2	CTC-7X2719	194.41
STEERING							
5R4547			P-UB-10	2-1/4	5	CTC-9X6392	165.61
9J8165			P-UB-10	2-1/4	5	CTC-9X6392	165.61
TILT							
3G2976			P-UB-10	3-1/2	8-1/2	CTC-7X2719	194.41
4T6792			P-UB-10	3-1/2	7-3/4	CTC-1570284	176.80
9J3632			P-UB-10	3-1/4	7-3/4	CTC-7X2706	276.03
MODEL 988F							
LIFT							
9T8257			P-UB-10	4	8-1/2	CTC-7X2742	223.75

REPLACEMENT KITS FOR CATERPILLAR® EQUIPMENT

Loaders - Wheel							
APPLICATION	CYL #	Misc-Parts, Instructions, etc.	CODE	ROD	BORE	KIT #	List \$
MODEL 988F							
STEERING							
	9J8165		P-UB-10	2-1/4	5	CTC-9X6392	165.61
TILT							
	3G2976		P-UB-10	3-1/2	8-1/2	CTC-7X2719	194.41
	4T6792		P-UB-10	3-1/2	7-3/4	CTC-1570284	176.80
	9J3632		P-UB-10	3-1/4	7-3/4	CTC-7X2706	276.03
MODEL 988G							
LIFT							
	1521644		P-UB-10	4-1/2	220 mm	CTC-2295546	382.61
LIFT LH							
	1686943	Logging Arrangement	P-UB-10	5	9-1/4	CTC-1686943K	349.02
	1738613		P-UB-10	5	220 mm	CTC-1738613K	362.22
LIFT RH							
	1686942	Logging Arrangement	P-UB-10	5	9-1/4	CTC-1686942K	349.02
	1738612		P-UB-10	5	220 mm	CTC-1738612K	362.22
STEERING LH							
	1338173		P-UB-10	2-1/2	4	CTC-1542501	156.72
	2594733		P-UB-10	2-1/2	4	CTC-2295538	172.10
STEERING RH							
	1353288		P-UB-10	2-1/2	4	CTC-1542501	156.72
	2594737		P-UB-10	2-1/2	4	CTC-2295538	172.10
TILT							
	1521644	High Lift Arrangement	P-UB-10	4-1/2	220 mm	CTC-2295546	382.61
	1686944		P-UB-10	4-1/2	9-1/4	CTC-1686944K	394.29
	2311955		P-UB-10	4-1/2	220 mm	CTC-2295546	382.61
NEW	MODEL 988H						
COUPLER							
	BXY1-						
	1949203		I-U-15	30 mm	50 mm	CTC-2341902	22.58
LIFT LH							
	A7A1-						
	1738613		P-UB-10	5	220 mm	CTC-2295549	520.34
	BXY1-						
	1738613		P-UB-10	5	220 mm	CTC-2295549	520.34
LIFT RH							
	A7A1-						
	1738612		P-UB-10	5	220 mm	CTC-2295549	520.34
	BXY1-						
	1738612		P-UB-10	5	220 mm	CTC-2295549	520.34
STEERING							
	A7A1-; BXY1900-						
	2880568		P-UB-10	2-1/2	4	CTC-2295538	172.10
STEERING LH							
	BXY1-1899						
	2594733		P-UB-10	2-1/2	4	CTC-2295538	172.10
STEERING RH							
	BXY1-1899						
	2594737		P-UB-10	2-1/2	4	CTC-2295538	172.10
TILT							
	A7A1-; BXY1-						
	2311955		P-UB-10	4-1/2	220 mm	CTC-2295546	382.61
	BXY1-						
	2716441		P-UB-10	4-1/2	220 mm	CTC-2295546	382.61
NEW	MODEL 990						
STEERING LH							
	6E1244		P-UB-14	3-1/4	5-1/2	CTC-1354539	127.39

REPLACEMENT KITS FOR CATERPILLAR® EQUIPMENT

Loaders - Wheel							
APPLICATION	CYL #	Misc-Parts, Instructions, etc.	CODE	ROD	BORE	KIT #	List \$
MODEL 990							
STEERING RH							
	9T9568		P-UB-14	3-1/4	5-1/2	CTC-1354539	127.39
TILT							
	1459897		P-UB-10	5-3/4	11-1/2	CTC-1354382	467.11
	9T9570		P-UB-10	5-3/4	11-1/2	CTC-1354382	467.11
MODEL 992, 992B							
LIFT							
	7J8969		P-UB-10	6-1/2	10-1/2	CTC-8T1456	440.02
LIFT LH							
	7J8970		P-UB-10	6-1/2	10-1/2	CTC-8T1456	440.02
	8J5978		P-UB-10	6-1/2	10-1/2	CTC-8T1456	440.02
LIFT RH							
	8J5977		P-UB-10	6-1/2	10-1/2	CTC-8T1456	440.02
PUMP							
	25K						
	7J3656					CTC-9J5116	28.47
STEERING							
	7J9800		P-UB-10	2-1/2	5-1/2	CTC-8T1374	96.66
	8J6339		P-UB-10	2-1/2	5-1/2	CTC-7X2653	168.14
	8J6339		P-UB-10	2-1/2	5-1/2	CTC-8T1374	96.66
	9K5707		P-UB-10	2-1/2	5-1/2	CTC-8T1374	96.66
TILT LH							
	8J6338		P-UB-10	3-1/2	8-1/2	CTC-7X2719	194.41
TILT RH							
	8J6337		P-UB-10	3-1/2	8-1/2	CTC-7X2719	194.41
MODEL 992C							
LIFT							
	1U1771		P-UB-10	7	11-1/2	CTC-7X2809	467.64
	9J2994		P-UB-10	7	11-1/2	CTC-7X2809	467.64
LIFT HIGH							
	1U1771		P-UB-10	7	11-1/2	CTC-7X2809	467.64
	9J2994		P-UB-10	7	11-1/2	CTC-7X2809	467.64
PUMP							
	6MF; 42X; 82X; 84X; 94L; 95V						
	4T2506					CTC-8J8652	196.98
STEERING							
	9J5419		P-UB-10	3-1/4	7	CTC-7X2710	210.31
TILT HIGH							
	1U1766		P-UB-10	4	10	CTC-7X2811	284.15
	1U1767		P-UB-10	4	10	CTC-7X2811	284.15
TILT LH							
	3G4599		P-UB-10	4	10	CTC-7X2810	238.90
TILT RH							
	3G4598		P-UB-10	4	10	CTC-7X2810	238.90
MODEL 992D							
LIFT							
	1028731		P-UB-10	7	11-1/2	CTC-7X2809	467.64
	1U1771		P-UB-10	7	11-1/2	CTC-7X2809	467.64
	9J2994		P-UB-10	7	11-1/2	CTC-7X2809	467.64
STEERING							
	9J5419		P-UB-10	3-1/4	7	CTC-7X2710	210.31
TILT LH							
	1026248		P-UB-10	4	10	CTC-7X2810	238.90
	1U1767		P-UB-10	4	10	CTC-7X2811	284.15
	3G4599		P-UB-10	4	10	CTC-7X2810	238.90

REPLACEMENT KITS FOR CATERPILLAR® EQUIPMENT

Loaders - Wheel							
APPLICATION	CYL #	Misc-Parts, Instructions, etc.	CODE	ROD	BORE	KIT #	List \$
MODEL 992D							
TILT RH							
	1026247		P-UB-10	4	10	CTC-7X2810	238.90
	1U1766		P-UB-10	4	10	CTC-7X2811	284.15
	3G4598		P-UB-10	4	10	CTC-7X2810	238.90
MODEL 992G							
LIFT LH							
	7HR1-						
	1128209		P-UB-10	7	11	CTC-1570289	990.36
	7HR1-231						
	1128209		P-UB-10	7	11	CTC-1597532	990.36
	7HR232-99999; ADZ1-; AZX1-833						
	1621523		P-UB-10	7	11	CTC-2297189	1028.76
	AZX834-						
	3153044		P-UB-10	7	11	CTC-2297189	1028.76
LIFT RH							
	7HR1-231						
	1367880		P-UB-10	7	11	CTC-1570289	990.36
	1367880		P-UB-10	7	11	CTC-1597532	990.36
	7HR232-99999; ADZ1-; AZX1-833						
	1621522		P-UB-10	7	11	CTC-2297189	1028.76
	AZX834-						
	3153043		P-UB-10	7	11	CTC-2297189	1028.76
STEERING							
	7HR1-99999; ADZ1-; AZX1-						
	1128208		P-UB-10	3-1/4	5-1/2	CTC-2297191	238.70
TILT							
	7HR1-99999; ADZ1-; AZX1-						
	1677996		P-UB-10	5-1/2	11	CTC-2297190	1589.54
MODEL 992K							
LIFT LH							
	8801-						
	2711717		P-UB-10	7	11	CTC-2297189	1028.76
	H4C1-						
	2711717		P-UB-10	7	11	CTC-2297189	1028.76
	H4C1-; ZMX1-						
	2711717		P-UB-10	7	11	CTC-2297189	1028.76
LIFT RH							
	8801-; ZMX1-						
	2711716		P-UB-10	7	11	CTC-2297189	1028.76
	H4C1-						
	2711716		P-UB-10	7	11	CTC-2297189	1028.76
STEERING							
	8801-; H4C1-; ZMX1-						
	1571352		P-UB-10	3-1/4	5-1/2	CTC-1571352K	161.87
TILT LH							
	8801-; H4C1-; ZMX1-						
	2713572		P-UB-10	6	10-1/2	CTC-2713572K	806.21
MODEL 994D							
LIFT							
	3TZ1-UP						
	1934076		P-UB-10	8	12	CTC-2456821	1196.92
	9T9020		P-UB-10	8	12	CTC-2456821	1196.92
LIFT (HI-LIFT)							
	3TZ1-UP						
	1934075		P-UB-10	8	12	CTC-2456821	1196.92
	9T9023		P-UB-10	8	12	CTC-2456821	1196.92

REPLACEMENT KITS FOR CATERPILLAR® EQUIPMENT

Loaders - Wheel							
APPLICATION	CYL #	Misc-Parts, Instructions, etc.	CODE	ROD	BORE	KIT #	List \$
MODEL 994D							
STEERING LH							
3TZ1-UP							
	6E0529		P-UB-10	4-1/4	7-3/4	CTC-1309763	394.94
	6E0529		P-UB-1	4-1/4		CTC-1309771	276.51
STEERING RH							
3TZ1-UP							
	9T9019		P-UB-10	4-1/4	7-3/4	CTC-2463431	394.94
	9T9019		P-UB-1	4-1/4		CTC-2463432	276.51
TILT LH							
3TZ1-UP							
	1123172	CHG 10-	P-UB-10	5-1/2	10-1/2	CTC-2342590	546.87
	1123172		P-UB-10	5-1/2	10-1/2	CTC-2463437	757.17
TILT LH (HI-LIFT)							
3TZ1-UP							
	1142820		P-UB-10	5-1/2	10-1/2	CTC-2463437	757.17
	2196272	CHG 01-	P-UB-10	5-1/2	10-1/2	CTC-2342590	546.87
	2196272		P-UB-10	5-1/2	10-1/2	CTC-2463437	757.17
TILT RH							
3TZ1-UP							
	1123171	CHG 10, 11-	P-UB-10	5-1/2	10-1/2	CTC-2342590	546.87
	1123171		P-UB-10	5-1/2	10-1/2	CTC-2463437	757.17
TILT RH (HI-LIFT)							
3TZ1-UP							
	1142821		P-UB-10	5-1/2	10-1/2	CTC-2463437	757.17
	2196273	CHG 01-	P-UB-10	5-1/2	10-1/2	CTC-2342590	546.87
	2196273		P-UB-10	5-1/2	10-1/2	CTC-2463437	757.17
MODEL G910							
LIFT							
	7J5893		P-UB-10	2	4	CTC-1328816	96.00
	7J5894		P-UB-10	2	4	CTC-1328816	96.00
STEERING							
	1U4666		P-UB-10	1-1/2	2-3/4	CTC-7X2736	130.81
	1U4666		P-UB-10	1-1/2	2-3/4	CTC-8T1402	51.29
TILT							
	1U3165		P-UB-10	1-3/4	3-1/4	CTC-1328770	124.88
	1U4666		P-UB-10	1-1/2	2-3/4	CTC-7X2749	61.13
	7J5885		P-UB-10	1-3/4	3	CTC-7X2791	91.70
	7J5893		P-UB-10	2	4	CTC-7X2789	105.58
	7J5894		P-UB-10	2	4	CTC-7X2789	105.58
MODEL G916							
LIFT							
	4T8648		P-UB-10	2-1/4	4-1/4	CTC-7X2750	118.40
PIN PULLER							
	6E5393		I-O-3	1	2	CTC-9T0418	85.89
STEERING							
	1U3322		P-UB-10	1-1/2	3	CTC-7X2751	66.28
TILT							
	3G6571		P-UB-10	2-1/2	4-3/4	CTC-1328811	167.09
MODEL G926							
LIFT							
	3G2991		P-UB-10	2-1/2	4-3/4	CTC-1328811	167.09
	3G2991		P-UB-10	2-1/2	4-3/4	CTC-7X2660	185.90
PIN PULLER							
	6E5393		I-O-3	1	2	CTC-9T0418	85.89
STEERING							
	3G3501		P-UB-10	1-1/2	3	CTC-7X2751	66.28

REPLACEMENT KITS FOR CATERPILLAR® EQUIPMENT

Loaders - Wheel							
APPLICATION	CYL #	Misc-Parts, Instructions, etc.	CODE	ROD	BORE	KIT #	List \$
MODEL G926							
TILT							
	3G2798		P-UB-10	2-1/2	5-1/2	CTC-8T3576	93.53
	3G2798		P-UB-10	2-1/2	5-1/2	CTC-9X2047	111.99
MODEL G936							
LIFT							
	4T1674		P-UB-10	2-1/2	5-1/2	CTC-7X2672	91.88
	9T1196		P-UB-10	2-1/2	5-1/2	CTC-7X2672	91.88
PIN PULLER							
	6E5393		I-O-3	1	2	CTC-9T0418	85.89
STEERING							
	3G5110		P-UB-10	1-3/4	3-1/2	CTC-7X2784	58.32
TILT							
	3G5291		P-UB-10	2-3/4	6-1/2	CTC-7X2686	124.95
NEW	MODEL R1300						
EJECTOR							
	6QW1-UP; LJB1-UP; RSL1-UP						
			P-UB-10	2-1/4	4	CTC-2342591	66.77
LIFT							
	6QW1-UP; LJB1-UP; RSL1-UP						
			P-UB-10	3-1/4	7	CTC-2281779	155.45
RAMMER							
	6QW						
			P-UB-10	2-1/2	5	CTC-2430387	215.64
STEERING							
	6QW1-UP; LJB1-UP; RSL1-UP						
			P-UB-10	3	6	CTC-2378313	223.27
TILT							
	6QW1-UP; LJB1-UP; RSL1-UP						
			P-UB-10	4-1/4	8-1/4	CTC-2436225	238.94
NEW	MODEL R1300G						
EJECTOR							
	6QW1-UP; LJB1-UP; RSL1-UP						
			P-UB-10	2-1/4	4	CTC-2342591	66.77
LIFT							
	6QW1-UP; LJB1-UP; RSL1-UP						
			P-UB-10	3-1/4	7	CTC-2281779	155.45
RAMMER							
	6QW						
			P-UB-10	2-1/2	5	CTC-2430387	215.64
STEERING							
	6QW1-UP; LJB1-UP; RSL1-UP						
			P-UB-10	3	6	CTC-2378313	223.27
TILT							
	6QW1-UP; LJB1-UP; RSL1-UP						
			P-UB-10	4-1/4	8-1/4	CTC-2436225	238.94
NEW	MODEL R1600						
EJECTOR							
	9EW1-UP; 9XP1-UP; 9PP1-UP; 9YZ1-UP						
			P-UB-10	2	4-1/2	CTC-2409936	145.66
LIFT							
	9EW830-837						
			P-UB-10	3-1/4	7	CTC-2281779	155.45
	9EW838-UP; 9XP; 9PP; 9YZ						
			P-UB-10	3-1/2	7-1/2	CTC-2456831	222.29
STEERING							
	9EW1-UP; 9XP1-UP; 9PP1-UP; 9YZ1-UP						
			P-UB-10	2	4	CTC-2409538	76.30

REPLACEMENT KITS FOR CATERPILLAR® EQUIPMENT

Loaders - Wheel								
APPLICATION	CYL #	Misc-Parts, Instructions, etc.	CODE	ROD	BORE	KIT #	List \$	
NEW MODEL R1600								
STEERING								
TILT								
9EW1-UP; 9XP1-UP; 9PP1-UP; 9YZ1-UP			P-UB-10	5	9-1/4	ELPH-9EP9170	743.37	
NEW MODEL R1600G								
EJECTOR								
9EW1-UP; 9XP1-UP; 9PP1-UP; 9YZ1-UP			P-UB-10	2	4-1/2	CTC-2409936	145.66	
LIFT								
9EW830-837			P-UB-10	3-1/4	7	CTC-2281779	155.45	
9EW838-UP; 9XP; 9PP; 9YZ			P-UB-10	3-1/2	7-1/2	CTC-2456831	222.29	
STEERING								
9EW1-UP; 9XP1-UP; 9PP1-UP; 9YZ1-UP			P-UB-10	2	4	CTC-2409538	76.30	
TILT								
9EW1-UP; 9XP1-UP; 9PP1-UP; 9YZ1-UP			P-UB-10	5	9-1/4	ELPH-9EP9170	743.37	
NEW MODEL R1700								
LIFT								
4LZ127-178			P-UB-10	4	8-1/2	ELPH-9DE2659	262.71	
4LZ179-187			P-UB-10	4	8-1/2	ELPH-9EL7527	293.06	
4LZ188-UP; 8XZ; SBR			P-UB-10	4	8-1/2	CTC-2460659	270.95	
STEERING								
4LZ1-UP; 8XZ1-UP; SBR1-UP			P-UB-10	2-1/2	5	CTC-1636223	274.69	
TILT								
4LZ127-130			P-UB-10	4	10	ELPH-9DE2994	335.71	
4LZ131-UP; 8XZ; SBR			P-UB-10	5-1/2	10	CTC-1663850	493.77	
NEW MODEL R1700G								
LIFT								
4LZ127-178			P-UB-10	4	8-1/2	ELPH-9DE2659	262.71	
4LZ179-187			P-UB-10	4	8-1/2	ELPH-9EL7527	293.06	
4LZ188-UP; 8XZ; SBR			P-UB-10	4	8-1/2	CTC-2460659	270.95	
STEERING								
4LZ1-UP; 8XZ1-UP; SBR1-UP			P-UB-10	2-1/2	5	CTC-1636223	274.69	
TILT								
4LZ127-130			P-UB-10	4	10	ELPH-9DE2994	335.71	
4LZ131-UP; 8XZ; SBR			P-UB-10	5-1/2	10	CTC-1663850	493.77	
Motor Graders								
APPLICATION	CYL #	Misc-Parts, Instructions, etc.	CODE	ROD	BORE	KIT #	List \$	
MODEL 12								
STEERING								
4J4115			P-UB-10	1-1/2	4	CTC-7X2738	90.53	

CATERPILLAR®

REPLACEMENT KITS FOR CATERPILLAR® EQUIPMENT

Motor Graders							
APPLICATION	CYL #	Misc-Parts, Instructions, etc.	CODE	ROD	BORE	KIT #	List \$
MODEL 12E							
STEERING							
	4J4115		P-UB-10	1-1/2	4	CTC-7X2738	90.53
MODEL 12F							
STEERING							
	4J4115		P-UB-10	1-1/2	4	CTC-7X2738	90.53
MODEL 12G							
ARTICULATION							
	8J0546		P-UB-10	1-3/4	3	CTC-7X2791	91.70
	9T2453		P-UB-10	1-3/4	3	CTC-7X2825	55.57
	9T8784		P-UB-10	1-3/4	3	CTC-7X2825	55.57
BACKHOE STICK/BLADE SHIFT							
	8J0028		P-UB-10	1-3/4	3	CTC-7X2791	91.70
BLADE							
	3G5223		P-UB-10	2	3-1/4	CTC-7X2767	70.29
	8J6380		P-UB-10	2	3-1/4	CTC-7X2767	70.29
	9T2472		P-UB-10	2	3	CTC-7X2753	67.12
	9T2472		P-UB-10	2	3	CTC-7X2760	72.94
BLADE TIP							
	6E1549		P-UB-10	1-1/2	2-3/4	CTC-1361599	110.23
	8J0024		P-UB-10	1-1/2	2-3/4	CTC-7X2749	61.13
	8J0024		P-UB-10	1-1/2	2-3/4	CTC-8T1402	51.29
	9J3466		P-UB-10	1-1/2	2-3/4	CTC-7X2749	61.13
	9T2461		P-UB-10	1-1/2	2-3/4	CTC-1361599	110.23
CENTER SHIFT							
	3G5224		P-UB-10	2	3-1/4	CTC-7X2767	70.29
	9T2549		P-UB-10	2	3	CTC-7X2760	72.94
CONVEYOR SWING							
	3G5224		P-UB-10	2	3-1/4	CTC-7X2767	70.29
	8J6367		P-UB-10	2	3-1/4	CTC-7X2767	70.29
	9T2549		P-UB-10	2	3	CTC-7X2760	72.94
PUMP							
	61M; 72V; 74V						
	8J0498					CTC-3G1708	166.97
RIPPER							
	1137754		P-UB-10	2	4	CTC-1328816	96.00
	8J1658		P-UB-10	2	4	CTC-1328816	96.00
SCARIFIER							
	3G1853		P-UB-10	1-3/4	3	CTC-7X2791	91.70
	8J7321		P-UB-10	1-1/2	3	CTC-7X2751	66.28
	9T2554		P-UB-10	1-3/4	3	CTC-7X2825	55.57
	9T6951		P-UB-10	1-3/4	3	CTC-7X2825	55.57
SIDESHIFT							
	1052094		P-UB-10	1-3/4	3	CTC-7X2825	55.57
	9T2483		P-UB-10	1-3/4	3	CTC-7X2825	55.57
STEERING LH							
	3G8070		P-UB-10	1-1/2	2-1/2	CTC-7X2739	58.51
	8J8820		P-UB-10	1-1/2	2-1/2	CTC-7X2739	58.51
	9T2395		P-UB-10	1-1/2	2-1/4	CTC-7X2826	42.17
STEERING RH							
	3G8069		P-UB-10	1-1/2	2-1/2	CTC-7X2739	58.51
	8J5538		P-UB-10	1-1/2	2-1/2	CTC-7X2739	58.51
	9T2393		P-UB-10	1-1/2	2-1/4	CTC-7X2826	42.17

REPLACEMENT KITS FOR CATERPILLAR® EQUIPMENT

Motor Graders							
APPLICATION	CYL #	Misc-Parts, Instructions, etc.	CODE	ROD	BORE	KIT #	List \$
MODEL 12G							
WHEEL LEAN							
	1219242		P-UB-10	2	3-1/2	CTC-7X2783	106.57
	3G4752		P-UB-10	1-1/2	3-1/2	CTC-7X2752	98.74
	8J5539		P-UB-10	1-1/2	3-1/2	CTC-7X2752	98.74
	9T2520		P-UB-10	1-1/2	3-1/2	CTC-1327058	107.52
MODEL 12H							
ARTICULATION							
	1251-; 2GS1-; 2LR1-; 2WR1-; 4ER1-; 4XM1-; 5ZM1-303; 8MN1-; AMZ1-; CBK1-; XZJ1-						
	9T8784		P-UB-10	1-3/4	3	CTC-3769017	40.40
	2GS1-; 2LR1-; 2WR1-; 4ER1-; 4XM1-; 5ZM1-303; 8MN1-; XZJ1-						
	6E1560		P-UB-10	1-3/4	3	CTC-3769017	40.40
	AMZ1-; CBK1-						
	1376792		P-UB-10	1-7/8	3-1/4	CTC-2465926	45.75
BLADE LIFT							
	1251-; 2GS1-; 2LR291-; 2WR1-; 4ER1-; 4XM766-; 5ZM1-; 8MN1-; AMZ1-; CBK1-						
	1324929		P-UB-10	2	3	CTC-2384462	46.41
BLADE TIP							
	1251-; 2WR566-						
	9T2461		P-UB-10	1-1/2	2-3/4	CTC-2339204	64.76
	1251-; 2WR753-						
	1317191		P-UB-10	1-1/2	2-3/4	CTC-1856596	47.94
	2GS1-388; 2LR1-; 2WR1-; 4ER1-; 4XM1-2005; 5ZM1-297; 8MN1-669						
	6E1549		P-UB-10	1-1/2	2-3/4	CTC-2339204	64.76
	2GS389-; 4ER557-; 4XM2006-; 5ZM298-; 8MN670-; AMZ1-; CBK1-; XZJ1-						
	1317191		P-UB-10	1-1/2	2-3/4	CTC-2339204	64.76
CENTER SHIFT							
	1251-; 2GS1-; 2LR1-; 2WR1-; 4ER1-; 4XM1-; 5ZM1-; 8MN1-; AMZ1-; CBK1-; XZJ1-						
	6E1343		P-UB-10	2	3	CTC-1857667	87.64
CONVEYOR SWING							
	6E1343		P-UB-10	2	3	CTC-7X2760	72.94
LIFT							
	2LR1-290; 2WR1-; 4ER1-; 4XM1-760; 4XM763-765; 8MN1-						
	6E1338		P-UB-10	2	3	CTC-2384462	46.41
	2WR1-						
	3Q8420		P-UB-10	1-3/4	3	CTC-7X2791	91.70
LIFT/TILT							
	1251-; 2WR1-						
	1526485		P-UB-10	2	4	CTC-2409538	76.30
RIPPER							
	1251-; 2LR1-; 2WR1-; 4XM1-; 5ZM1-; AMZ1-						
	1137754		P-UB-10	2	4	CTC-1857688	72.08
	2GS1-; 4ER1-; 8MN1-; CBK1-; XZJ1-						
	1137754		P-UB-10	2	4	CTC-2339205	55.18
SCARIFIER							
	9T2554		P-UB-10	1-3/4	3	CTC-7X2825	55.57
	2GS1-; 2LR1-; 2WR1-; 4ER1-303; 4XM2285-; 5ZM1-; 8MN1-; AMZ1-; CBK1-; XZJ1-						
	1652510		P-UB-10	1-3/4	3	CTC-3769017	40.40
	2LR1-; 4XM1-2284; 5ZM1-						
	9T6951		P-UB-10	1-3/4	3	CTC-7X2825	55.57
SIDESHIFT							
	1251-; 2GS1-; 2LR1-; 2WR1-; 4ER1-; 4XM1-; 5ZM1-; 8MN1-; AMZ1-; CBK1-; XZJ1-						
	1125575		P-UB-10	1-3/4	3	CTC-3769017	40.40
STEERING LH							
	1251-; 2GS448-; 2LR1-; 2WR881-883; 2WR887-; 4ER627-; 4XM1-; 8MN724-; AMZ1-; CBK1-; XZJ1-						
	1309041		P-UB-10	1-1/2	2-1/4	CTC-1856590	31.63

REPLACEMENT KITS FOR CATERPILLAR® EQUIPMENT

Motor Graders							
APPLICATION	CYL #	Misc-Parts, Instructions, etc.	CODE	ROD	BORE	KIT #	List \$
MODEL 12H							
STEERING LH							
2GS1-447; 2LR1-; 2WR1-880; 2WR884-886; 4ER1-626; 4XM1-; 5ZM1-303; 8MN1-723							
	9T2395		P-UB-10	1-1/2	2-1/4	CTC-2465916	55.81
STEERING RH							
1251-; 2GS448-; 2LR1-; 2WR881-883; 2WR887-; 4ER627-; 4XM1-; 8MN724-; AMZ1-; CBK1-; XZJ1-							
	1309042		P-UB-10	1-1/2	2-1/4	CTC-1856590	31.63
2GS1-447; 2LR1-; 2WR1-880; 2WR884-886; 4ER1-626; 4XM1-; 5ZM1-303							
	9T2393		P-UB-10	1-1/2	2-1/4	CTC-2465916	55.81
WHEEL LEAN							
	9T2520		P-UB-10	1-1/2	3-1/2	CTC-1327058	107.52
1251-; 2GS1-; 2LR1-2WR1-; 4ER1-; 4XM1-; 5ZM1-303; 8MN1-; AMZ1-; CBK1-; XZJ1-							
	1219242		P-UB-10	2	3-1/2	CTC-3769011	67.45
MODEL 12M							
ARTICULATION							
B921-; F9B1-; F9M1-; R9P1-; R9S1-							
	2470096		P-UB-10	1-7/8	3-1/4	CTC-2465926	45.75
B9F1-13; B9R1-23							
	2627758		P-UB-10	1-3/4	3	CTC-2275350	34.62
B9F14-; B9R24-							
	3163308		P-UB-10	1-3/4	3	CTC-3769017	40.40
R9B1-							
	3163308		P-UB-10	1-3/4	3	CTC-3233312	40.40
BLADE							
B9F1-; B921-							
	3149338		P-UB-10	1-3/4	3-1/2	CTC-3260503	165.83
BLADE LIFT							
B921-; F9B1-; F9M1-; R9P1-; R9S1-							
	3351974		P-UB-10	2	3	CTC-2384462	46.41
B9F1-; B9R1-; R9B1-							
	2707534		P-UB-10	2	3	CTC-2384462	46.41
BLADE TIP							
B9F1-; B9R1-; B921-; F9B1-; F9M1-; R9B1-; R9P1-; R9S1-							
	1317191		P-UB-10	1-1/2	2-3/4	CTC-2339204	64.76
CENTER SHIFT							
B921-; F9B1-; F9M1-; R9P1-; R9S1-							
	2621907		P-UB-10	2	3	CTC-2384462	46.41
B9F1-; B9R1-; R9B1-							
	2621908		P-UB-10	2	3	CTC-2384462	46.41
LIFT							
B9F1-; B9R1-; R9B1-							
	3351973		P-UB-10	2	3	CTC-2384462	46.41
RIPPER							
B9F1-; B921-							
	1137754		P-UB-10	2	4	CTC-2339205	55.18
B9F1-; B921-; F9B1-; F9M1-R9P1-; R9S1-							
	3262227		P-UB-10	50 mm	110 mm	CTC-4173698	95.87
B9R1-; R9B1-							
	1137754		P-UB-10	2	4	CTC-1857688	72.08
SCARIFIER							
B9F1-; B9R1-; B921-; F9B1-; F9M1-; R9B1-; R9P1-; R9S1-							
	1652510		P-UB-10	1-3/4	3	CTC-3769017	40.40
SIDESHIFT							
B9F1-; B9R1-; B921-; F9B1-; F9M1-; R9B1-; R9P1-; R9S1-							
	2494116		P-UB-10	1-3/4	3	CTC-3769017	40.40

REPLACEMENT KITS FOR CATERPILLAR® EQUIPMENT

Motor Graders							
APPLICATION	CYL #	Misc-Parts, Instructions, etc.	CODE	ROD	BORE	KIT #	List \$
MODEL 12M							
STEERING							
B9F1-; B9R1-; B921-; F9M1-; R9B1-; R9S1-							
	2558715		P-UB-10	2	3	CTC-3076273	38.53
F9B1-; R9P1-							
	2625766		P-UB-10	2	3	CTC-3076273	38.53
WHEEL LEAN							
B9F1-; B9R1-; B921-; F9B1-; F9M1-; R9B1-; R9P1-; R9S1-							
	2495299		P-UB-10	2	3-1/2	CTC-3769011	67.45
WORK TOOL LIFT							
B9F1-; B9R1-; B921-; F9B1-; F9M1-; R9B1-; R9S1-							
	2173501		P-UB-10	1-3/4	3-1/2	CTC-2401881	74.50
MODEL 14							
LIFT							
	3G5227		P-UB-10	2-1/4	3-3/4	CTC-7X2798	78.56
STEERING							
	4J4115		P-UB-10	1-1/2	4	CTC-7X2738	90.53
STEERING LH							
	3G7644		P-UB-10	1-1/2	2-3/4	CTC-7X2749	61.13
STEERING RH							
	3G7643		P-UB-10	1-1/2	2-3/4	CTC-7X2749	61.13
MODEL 14D, 140							
STEERING							
	4J4115		P-UB-10	1-1/2	4	CTC-7X2738	90.53
MODEL 14E							
ARTICULATION							
	8J6269		P-UB-10	2	3-1/2	CTC-7X2792	90.85
	9T2879		P-UB-10	2	3-1/2	CTC-7X2783	106.57
BLADE SHIFT							
	4T0340		P-UB-10	2-1/2	4	CTC-7X2665	172.76
	8J6359		P-UB-10	2-1/4	3-3/4	CTC-7X2798	78.56
BLADE TIP							
	4T0379		P-UB-10	2	4	CTC-7X2789	105.58
	9T3198		P-UB-10	2	4	CTC-7X2782	44.13
CENTER SHIFT							
	3G5228		P-UB-10	2-1/4	3-3/4	CTC-7X2798	78.56
DRAWBAR TIP							
	8J6256		P-UB-10	1-1/2	3	CTC-7X2751	66.28
LIFT							
	3G5227		P-UB-10	2-1/4	3-3/4	CTC-7X2798	78.56
	8J6010		P-UB-10	2-1/4	3-3/4	CTC-7X2798	78.56
LIFT RH							
	6J5843		P-UB-10	2-1/2	5	CTC-7X2675	128.61
LIFT RIPPER							
	3G1762		P-UB-10	2-1/2	5	CTC-7X2658	180.34
	3G5189		P-UB-10	2-1/2	5	CTC-7X2658	180.34
RIPPER							
	5J7686		P-UB-10	2-1/2	6-1/2	CTC-7X2666	175.79
STEERING							
	1U2704		P-UB-10	2	3-1/2	CTC-7X2792	90.85
	4J4115		P-UB-10	1-1/2	4	CTC-7X2738	90.53
	8J5386		P-UB-10	1-1/2	2-3/4	CTC-7X2749	61.13
	9J0541		P-UB-10	1-1/2	2-3/4	CTC-7X2749	61.13
	9T1301		P-UB-10	1-3/4	2-1/2	CTC-7X2827	41.42
	9T1721		P-UB-10	1-3/4	2-1/2	CTC-7X2827	41.42
STEERING LH							
	3G7644		P-UB-10	1-1/2	2-3/4	CTC-7X2749	61.13

REPLACEMENT KITS FOR CATERPILLAR® EQUIPMENT

Motor Graders							
APPLICATION	CYL #	Misc-Parts, Instructions, etc.	CODE	ROD	BORE	KIT #	List \$
MODEL 14E							
STEERING RH							
	3G7643		P-UB-10	1-1/2	2-3/4	CTC-7X2749	61.13
WHEEL LEAN							
	3G4751		P-UB-10	1-1/2	3-1/2	CTC-7X2752	98.74
	8J5385		P-UB-10	1-1/2	3-1/2	CTC-7X2752	98.74
	9T3219		P-UB-10	1-1/2	3-1/2	CTC-1327058	107.52
MODEL 14G							
ARTICULATION							
	1U2704		P-UB-10	2	3-1/2	CTC-7X2792	90.85
	6E2446		P-UB-10	2	3-1/2	CTC-7X2783	106.57
	6E4724		P-UB-10	2	3-1/2	CTC-7X2783	106.57
	9T2879		P-UB-10	2	3-1/2	CTC-7X2783	106.57
BACKHOE STICK/BLADE SHIFT							
	8J6359		P-UB-10	2-1/4	3-3/4	CTC-7X2798	78.56
BLADE							
	8J6010		P-UB-10	2-1/4	3-3/4	CTC-7X2798	78.56
BLADE LIFT							
	3G5227		P-UB-10	2-1/4	3-3/4	CTC-7X2798	78.56
BLADE TIP							
	9T3198		P-UB-10	2	4	CTC-1328816	96.00
	9T8944		P-UB-10	2	4	CTC-1328816	96.00
CENTER SHIFT							
	3G5228		P-UB-10	2-1/4	3-3/4	CTC-7X2798	78.56
CONVEYOR SWING							
	3G5228		P-UB-10	2-1/4	3-3/4	CTC-7X2798	78.56
	8J6250		P-UB-10	2-1/4	3-3/4	CTC-7X2798	78.56
DRAWBAR TIP							
	8J6256		P-UB-10	1-3/4	3	CTC-7X2791	91.70
LIFT RH							
	6J5843		P-UB-10	2-1/2	5	CTC-7X2675	128.61
PUMP							
	93U; 96U						
	4T2767					CTC-3G1689	190.51
RIPPER							
	1135264		P-UB-10	2-1/2	5	CTC-1361967	200.54
	3G1762		P-UB-10	2-1/2	5	CTC-1315106	174.82
	3G5189		P-UB-10	2-1/2	5	CTC-7X2658	180.34
SIDESHIFT							
	4T0340		P-UB-10	2-1/2	4	CTC-7X2665	172.76
	9T3206		P-UB-10	2-1/2	4	CTC-1542501	156.72
STEERING LH							
	3G7644		P-UB-10	1-1/2	2-3/4	CTC-7X2749	61.13
	9J0541		P-UB-10	1-1/2	2-3/4	CTC-7X2749	61.13
	9T1721		P-UB-10	1-3/4	2-1/2	CTC-1539054	149.34
STEERING RH							
	3G7643		P-UB-10	1-1/2	2-3/4	CTC-7X2749	61.13
	8J5386		P-UB-10	1-1/2	2-3/4	CTC-7X2749	61.13
	9T1301		P-UB-10	1-3/4	2-1/2	CTC-1539054	149.34
TIP							
	4T0379		P-UB-10	2	4	CTC-1328816	96.00
WHEEL LEAN							
	1219243		P-UB-10	2	3-1/2	CTC-7X2783	106.57
	3G4751		P-UB-10	1-1/2	3-1/2	CTC-7X2752	98.74
	8J5385		P-UB-10	1-1/2	3-1/2	CTC-7X2752	98.74
	9T3219		P-UB-10	1-1/2	3-1/2	CTC-1327058	107.52

REPLACEMENT KITS FOR CATERPILLAR® EQUIPMENT

Motor Graders							
APPLICATION	CYL #	Misc-Parts, Instructions, etc.	CODE	ROD	BORE	KIT #	List \$
MODEL 14H							
ARTICULATION							
6E2446			P-UB-10	2	3-1/2	CTC-7X2783	106.57
9T2879			P-UB-10	2	3-1/2	CTC-7X2783	106.57
7WJ1-							
6E4724			P-UB-10	2	3-1/2	CTC-3769011	67.45
ASE1-							
1846804			P-UB-10	2	3-1/2	CTC-3769011	67.45
BLADE LIFT							
7WJ1-							
9T2703			P-UB-10	2-1/4	3-1/2	CTC-2350355	166.02
7WJ1-; ASE1-							
1752603			P-UB-10	2-1/4	3-1/2	CTC-2350355	166.02
BLADE TIP							
9T3198			P-UB-10	2	4	CTC-1328816	96.00
7WJ1-; ASE1-							
9T8944			P-UB-10	2	4	CTC-2339205	55.18
CENTER SHIFT							
7WJ1-985							
9T2696			P-UB-10	2-1/4	3-1/2	CTC-9T2696K	60.06
7WJ986-							
1574679			P-UB-10	2-1/4	3-1/2	CTC-2350355	166.02
7WJ986-; ASE1-							
2095773			P-UB-10	2-1/4	3-1/2	CTC-2350355	166.02
RIPPER							
7WJ1-; ASE1-							
1135264	0.98 wide rod bearing		P-UB-10	2-1/2	5	CTC-2275347	97.12
1135264	1.24 wide rod bearing		P-UB-10	2-1/2	5	CTC-2430384	83.92
SIDESHIFT							
7WJ1-; ASE1-							
9T3206	0.98 wide rod bearing		P-UB-10	2-1/2	4	CTC-2341949	57.51
9T3206	1.24 wide rod bearing		P-UB-10	2-1/2	4	CTC-2422548	59.67
STEERING LH							
7WJ1-							
9T1301	Cyl Type 1, Head 6E4941		P-UB-10	1-3/4	2-1/2	CTC-2402484	114.52
9T1301	Cyl Type 2, Head 1515349 or 3831592		P-UB-10	1-3/4	2-1/2	CTC-2405500	59.69
9T1721	Cyl Type 1, Head 6E4941		P-UB-10	1-3/4	2-1/2	CTC-2402484	114.52
9T1721	Cyl Type 2, Head 1515349 or 3831592		P-UB-10	1-3/4	2-1/2	CTC-2405500	59.69
7WJ1-; ASE1-							
1652496			P-UB-10	1-3/4	2-1/2	CTC-2405500	59.69
STEERING RH							
9T1301			P-UB-10	1-3/4	2-1/2	CTC-1539054	149.34
7WJ1-; ASE1-							
1652495			P-UB-10	1-3/4	2-1/2	CTC-2405500	59.69
WHEEL LEAN							
9T3219			P-UB-10	1-1/2	3-1/2	CTC-1327058	107.52
7WJ1-; ASE1-							
1219243			P-UB-10	2	3-1/2	CTC-3769011	67.45
MODEL 14M							
ARTICULATION							
B9J1-1450; R9J1-							
3039598			P-UB-10	55 mm	95 mm	CTC-3176058	114.94
BLADE LIFT							
B9J1-1450; R9J1-250							
2707536			P-UB-10	2-1/4	3-1/2	CTC-2350355	166.02
R9J251-							
3657414			P-UB-10	2-1/4	3-1/2	CTC-2350355	166.02

REPLACEMENT KITS FOR CATERPILLAR® EQUIPMENT

Motor Graders							
APPLICATION	CYL #	Misc-Parts, Instructions, etc.	CODE	ROD	BORE	KIT #	List \$
MODEL 14M							
BLADE TIP							
	B9J1-1450; R9J1-						
	9T8944		P-UB-10	2	4	CTC-2339205	55.18
CENTER SHIFT							
	B9J1-1450; R9J1-						
	2621906		P-UB-10	2-1/4	3-1/2	CTC-2350355	166.02
RIPPER							
	B9J1-1450; R9J1-						
	1135264	0.98 wide rod bearing	P-UB-10	2-1/2	5	CTC-2275347	97.12
	1135264	1.24 wide rod bearing	P-UB-10	2-1/2	5	CTC-2430384	83.92
SIDESHIFT							
	B9J1-1450; R9J1-						
	2575083		P-UB-10	2-1/2	4	CTC-2341949	57.51
STEERING LH							
	B9J1-1450; R9J1-						
	2765682		P-UB-10	2	3	CTC-3655556	35.35
STEERING RH							
	B9J1-1450; R9J1-						
	2765681		P-UB-10	2	3	CTC-3655556	35.35
WHEEL LEAN							
	B9J1-1450; R9J1-						
	2495299		P-UB-10	2	3-1/2	CTC-3769011	67.45
MODEL 16							
BLADE LH							
	6J5844		P-UB-10	2-1/2	5	CTC-7X2675	128.61
BLADE RH							
	6J5843		P-UB-10	2-1/2	5	CTC-7X2675	128.61
LIFT							
	3G5229		P-UB-10	2-1/2	4-1/4	CTC-7X2663	51.12
PUMP							
	49G						
	7J0588					CTC-9J5111	43.41
STEERING							
	5J1931		P-V-10	2	5	CTC-7X2797	73.39
TIP							
	6J9731		P-UB-10	1-1/2	4	CTC-7X2738	90.53
	6J9732		P-UB-10	1-1/2	4	CTC-7X2738	90.53
MODEL 16G							
ARTICULATION							
	1U1649		P-UB-10	2-1/2	4	CTC-7X2665	172.76
	9T3050		P-UB-10	2-1/2	4	CTC-1542501	156.72
BLADE							
	9T3106		P-UB-10	2-1/2	4	CTC-1542501	156.72
BLADE LIFT							
	3G5229		P-UB-10	2-1/2	4-1/4	CTC-7X2663	51.12
	8J5568		P-UB-10	2-1/2	4-1/4	CTC-7X2663	51.12
BLADE TIP							
	6J9731		P-UB-10	1-1/2	4	CTC-7X2738	90.53
	6J9732		P-UB-10	1-1/2	4	CTC-7X2738	90.53
	9T3198		P-UB-10	2	4	CTC-1328816	96.00
	9T8944		P-UB-10	2	4	CTC-1328816	96.00
CENTER SHIFT							
	3G5230		P-UB-10	2-1/2	4-1/4	CTC-7X2663	51.12
CONVEYOR SWING							
	9T3312		P-UB-10	2-1/2	4	CTC-1542501	156.72

REPLACEMENT KITS FOR CATERPILLAR® EQUIPMENT

Motor Graders							
APPLICATION	CYL #	Misc-Parts, Instructions, etc.	CODE	ROD	BORE	KIT #	List \$
MODEL 16G							
DRAWBAR TIP							
	8J3761		P-UB-10	1-3/4	3	CTC-7X2791	91.70
LIFT							
	8J5827		P-UB-10	2-1/2	4-1/4	CTC-7X2663	51.12
LIFT LH							
	6J5844		P-UB-10	2-1/2	5	CTC-7X2675	128.61
LIFT RH							
	6J5843		P-UB-10	2-1/2	5	CTC-7X2675	128.61
PUMP							
93U; 96U							
	4T2767					CTC-3G1689	190.51
RIPPER							
	1135264		P-UB-10	2-1/2	5	CTC-1361967	200.54
	3G1762		P-UB-10	2-1/2	5	CTC-1315106	174.82
	3G5189		P-UB-10	2-1/2	5	CTC-7X2658	180.34
SIDESHIFT							
	4T0340		P-UB-10	2-1/2	4	CTC-7X2665	172.76
	9T3206		P-UB-10	2-1/2	4	CTC-1542501	156.72
STEERING							
	1U2704		P-UB-10	2	3-1/2	CTC-7X2792	90.85
STEERING LH							
	3G7599		P-UB-10	1-3/4	3	CTC-7X2791	91.70
	8J3612		P-UB-10	1-3/4	3	CTC-7X2791	91.70
	9T2854		P-UB-10	1-3/4	2-3/4	CTC-1539053	156.06
STEERING RH							
	3G7600		P-UB-10	1-3/4	3	CTC-7X2791	91.70
	8J8411		P-UB-10	1-3/4	3	CTC-7X2791	91.70
	9T2853		P-UB-10	1-3/4	2-3/4	CTC-1539053	156.06
	9T2853		P-UB-10	1-3/4	2-3/4	CTC-7X2820	81.89
TIP							
	4T0379		P-UB-10	2	4	CTC-1328816	96.00
WHEEL LEAN							
	1219244		P-UB-10	2-1/4	4	CTC-1361171	104.91
	3G4750		P-UB-10	1-3/4	4	CTC-7X2790	96.21
	8J3613		P-UB-10	1-3/4	4	CTC-1316108	112.44
	9T3492		P-UB-10	1-3/4	4	CTC-1316108	112.44
MODEL 16H							
ARTICULATION							
6ZJ1-; ATS1-							
	9T3050	Head 1213397 or 1729981	P-UB-10	2-1/2	4	CTC-2341949	57.51
	9T3050	Head 6E4978	P-UB-10	2-1/2	4	CTC-2422548	59.67
BLADE LIFT							
6ZJ1-; ATS1-							
	9T3106	Head 1213397	P-UB-10	2-1/2	4	CTC-2341949	57.51
	9T3106	Head 6E4978	P-UB-10	2-1/2	4	CTC-2422548	59.67
BLADE TIP							
	9T3198		P-UB-10	2	4	CTC-1328816	96.00
6ZJ1-; ATS1-							
	9T8944		P-UB-10	2	4	CTC-2339205	55.18
CENTER SHIFT							
6ZJ1-; ATS1-							
	9T3312	Head 1213397	P-UB-10	2-1/2	4	CTC-2341949	57.51
	9T3312	Head 6E4978	P-UB-10	2-1/2	4	CTC-2422548	59.67
CONVEYOR SWING							
	9T3312		P-UB-10	2-1/2	4	CTC-1542501	156.72

REPLACEMENT KITS FOR CATERPILLAR® EQUIPMENT

Motor Graders							
APPLICATION	CYL #	Misc-Parts, Instructions, etc.	CODE	ROD	BORE	KIT #	List \$
MODEL 16H							
RIPPER							
6ZJ1-; ATS1-							
	1135264	Head 1213395, 0.98 wide rod bearing	P-UB-10	2-1/2	5	CTC-2275347	97.12
	1135264	1.24 wide rod bearing	P-UB-10	2-1/2	5	CTC-2430384	83.92
SIDESHIFT							
6ZJ1-; ATS1-							
	9T3206	Head 1213397 or 1729981	P-UB-10	2-1/2	4	CTC-2341949	57.51
	9T3206	Head 6E4978	P-UB-10	2-1/2	4	CTC-2422548	59.67
STEERING LH							
6ZJ1-							
	9T2854		P-UB-10	1-3/4	2-3/4	CTC-2342595	156.06
6ZJ1-; ATS1-							
	1652507		P-UB-10	1-3/4	2-3/4	CTC-1857035	116.00
STEERING RH							
6ZJ1-							
	9T2853		P-UB-10	1-3/4	2-3/4	CTC-2342595	156.06
6ZJ1-; ATS1-							
	1652506		P-UB-10	1-3/4	2-3/4	CTC-1857035	116.00
WHEEL LEAN							
	1219244		P-UB-10	2-1/4	4	CTC-1361171	104.91
	9T3492		P-UB-10	1-3/4	4	CTC-1316108	112.44
6ZJ1-; ATS1-							
	1219244		P-UB-10	2-1/4	4	CTC-4252108	93.27
MODEL 16M							
ARTICULATION							
B9H1-722; R9H1-							
	2908074		P-UB-10	2-1/2	4	CTC-2341949	57.51
R9H1-							
	3786610		P-UB-10	2-1/2	4	CTC-2341949	57.51
BLADE LIFT							
B9H1-; R9H1-222							
	2707538		P-UB-10	2-1/2	4	CTC-2341949	57.51
R9H223-							
	3657416		P-UB-10	2-1/2	4	CTC-2341949	57.51
BLADE TIP							
B9H1-; R9H1-							
	9T8944		P-UB-10	2	4	CTC-2339205	55.18
CENTER SHIFT							
B9H1-; R9H1-							
	2621905		P-UB-10	2-1/2	4	CTC-2341949	57.51
RIPPER							
B9H1-; R9H1-							
	1135264	0.98 wide rod bearing	P-UB-10	2-1/2	5	CTC-2275347	97.12
	1135264	1.24 wide rod bearing	P-UB-10	2-1/2	5	CTC-2430384	83.92
SIDESHIFT							
B9H1-; R9H1-							
	2575083		P-UB-10	2-1/2	4	CTC-2341949	57.51
STEERING							
B9H1-; R9H1-							
	2673863		P-UB-10	2	3	CTC-3076273	38.53
WHEEL LEAN							
B9H1-; R9H1-							
	2893054		P-UB-10	2-1/4	4	CTC-4252108	93.27

REPLACEMENT KITS FOR CATERPILLAR® EQUIPMENT

Motor Graders							
APPLICATION	CYL #	Misc-Parts, Instructions, etc.	CODE	ROD	BORE	KIT #	List \$
MODEL 24H							
ARTICULATION							
	1170837		P-UB-10	3	4-3/4	CTC-1570288	178.40
	1433033		P-UB-10	3	5	CTC-1605784	74.98
BLADE							
	1170830		P-UB-10	2-1/4	4	CTC-1361171	104.91
	1170832		P-UB-10	3	5-1/4	CTC-3E3293	183.95
RIPPER							
	1137754		P-UB-10	2	4	CTC-1328816	96.00
STEERING							
	1170833		I-UB-10	2-1/2	3-1/2	CTC-3E3299	138.77
TIP							
	1435988	Rod Bearing width- 0.98"	P-UB-10	2-1/2	4-3/4	CTC-1361131	148.19
WHEEL LEAN							
	1170836	Rod Bearing width- 0.98"	P-UB-10	2-1/2	4-3/4	CTC-1361131	148.19
MODEL 112							
STEERING							
	4J4115		P-UB-10	1-1/2	4	CTC-7X2738	90.53
MODEL 112E							
STEERING							
	4J4115		P-UB-10	1-1/2	4	CTC-7X2738	90.53
MODEL 112F							
STEERING							
	4J4115		P-UB-10	1-1/2	4	CTC-7X2738	90.53
MODEL 120							
STEERING							
	4J4115		P-UB-10	1-1/2	4	CTC-7X2738	90.53
MODEL 120B							
STEERING							
	4J4115		P-UB-10	1-1/2	4	CTC-7X2738	90.53
MODEL 120G							
ARTICULATION							
	8J8590		P-UB-10	1-3/4	3	CTC-7X2791	91.70
	9T2447		P-UB-10	1-3/4	3	CTC-7X2825	55.57
	9T8785		P-UB-10	1-3/4	3	CTC-7X2825	55.57
BACKHOE STICK/BLADE SHIFT							
	8J0028		P-UB-10	1-3/4	3	CTC-7X2791	91.70
	9T2483		P-UB-10	1-3/4	3	CTC-7X2825	55.57
BLADE							
	3G5225		P-UB-10	1-3/4	3	CTC-7X2791	91.70
	8J8589		P-UB-10	1-3/4	3	CTC-7X2791	91.70
	9T2471		P-UB-10	1-3/4	3	CTC-7X2825	55.57
BLADE LIFT							
	3G5225		P-UB-10	1-3/4	3	CTC-7X2791	91.70
BLADE RH							
	6J5843		P-UB-10	2-1/2	5	CTC-7X2675	128.61
BLADE TIP							
	6E1549		P-UB-10	1-1/2	2-3/4	CTC-1361599	110.23
	8J0024		P-UB-10	1-1/2	2-3/4	CTC-7X2749	61.13
	9J3466		P-UB-10	1-1/2	2-3/4	CTC-7X2749	61.13
	9T2461		P-UB-10	1-1/2	2-3/4	CTC-1361599	110.23
CENTER SHIFT							
	3G5226		P-UB-10	1-3/4	3	CTC-7X2791	91.70
	8J6367		P-UB-10	2	3-1/4	CTC-7X2767	70.29
	9T2374		P-UB-10	1-3/4	3	CTC-7X2825	55.57

REPLACEMENT KITS FOR CATERPILLAR® EQUIPMENT

Motor Graders							
APPLICATION	CYL #	Misc-Parts, Instructions, etc.	CODE	ROD	BORE	KIT #	List \$
MODEL 120G							
CONVEYOR SWING							
	3G5226		P-UB-10	1-3/4	3	CTC-7X2791	91.70
	8J8777		P-UB-10	1-3/4	3	CTC-7X2791	91.70
	9T2374		P-UB-10	1-3/4	3	CTC-7X2825	55.57
PUMP							
	87V						
	8J6730					CTC-3G1708	166.97
SCARIFIER							
	3G1853		P-UB-10	1-3/4	3	CTC-7X2791	91.70
	8J7321		P-UB-10	1-1/2	3	CTC-7X2751	66.28
	9T2554		P-UB-10	1-3/4	3	CTC-7X2825	55.57
	9T6951		P-UB-10	1-3/4	3	CTC-7X2825	55.57
SIDESHIFT							
	1052094		P-UB-10	1-3/4	3	CTC-7X2825	55.57
	8J0028		P-UB-10	1-3/4	3	CTC-7X2791	91.70
	9T2483		P-UB-10	1-3/4	3	CTC-7X2825	55.57
STEERING LH							
	3G8070		P-UB-10	1-1/2	2-1/2	CTC-7X2739	58.51
	8J8820		P-UB-10	1-1/2	2-1/2	CTC-7X2739	58.51
	9T2395		P-UB-10	1-1/2	2-1/4	CTC-7X2826	42.17
STEERING RH							
	3G8069		P-UB-10	1-1/2	2-1/2	CTC-7X2739	58.51
	8J5538		P-UB-10	1-1/2	2-1/2	CTC-7X2739	58.51
	9T2393		P-UB-10	1-1/2	2-1/4	CTC-7X2826	42.17
WHEEL LEAN							
	1219242		P-UB-10	2	3-1/2	CTC-7X2783	106.57
	3G4752		P-UB-10	1-1/2	3-1/2	CTC-7X2752	98.74
	8J5539		P-UB-10	1-1/2	3-1/2	CTC-7X2752	98.74
	9T2520		P-UB-10	1-1/2	3-1/2	CTC-1327058	107.52
MODEL 120H							
ARTICULATION							
	6E1554		P-UB-10	1-3/4	3	CTC-7X2825	55.57
	6E4724		P-UB-10	2	3-1/2	CTC-7X2783	106.57
	9T8785		P-UB-10	1-3/4	3	CTC-7X2825	55.57
BLADE							
	1125575		P-UB-10	1-3/4	3	CTC-7X2825	55.57
	1198664		P-UB-10	2	3	CTC-7X2760	72.94
	1324926		P-UB-10	2	3	CTC-7X2760	72.94
BLADE TIP							
	6E1549		P-UB-10	1-1/2	2-3/4	CTC-1361599	110.23
CONVEYOR SWING							
	6E1754		P-UB-10	2	3	CTC-7X2760	72.94
SCARIFIER							
	9T2554		P-UB-10	1-3/4	3	CTC-7X2825	55.57
	9T6951		P-UB-10	1-3/4	3	CTC-7X2825	55.57
STEERING LH							
	9T2395		P-UB-10	1-1/2	2-1/4	CTC-7X2826	42.17
STEERING RH							
	9T2393		P-UB-10	1-1/2	2-1/4	CTC-7X2826	42.17
WHEEL LEAN							
	1219242		P-UB-10	2	3-1/2	CTC-7X2783	106.57
	9T2520		P-UB-10	1-1/2	3-1/2	CTC-1327058	107.52

REPLACEMENT KITS FOR CATERPILLAR® EQUIPMENT

Motor Graders							
APPLICATION	CYL #	Misc-Parts, Instructions, etc.	CODE	ROD	BORE	KIT #	List \$
MODEL 130G							
ARTICULATION							
	8J0546		P-UB-10	1-3/4	3	CTC-7X2791	91.70
	9T2453		P-UB-10	1-3/4	3	CTC-7X2825	55.57
	9T8784		P-UB-10	1-3/4	3	CTC-7X2825	55.57
BACKHOE STICK/BLADE SHIFT							
	8J0028		P-UB-10	1-3/4	3	CTC-7X2791	91.70
	9T2483		P-UB-10	1-3/4	3	CTC-7X2825	55.57
BLADE							
	3G5223		P-UB-10	2	3-1/4	CTC-7X2767	70.29
	8J6380		P-UB-10	2	3-1/4	CTC-7X2767	70.29
	9T2472		P-UB-10	2	3	CTC-7X2760	72.94
BLADE LIFT							
	3G5223		P-UB-10	2	3-1/4	CTC-7X2767	70.29
	9T2471		P-UB-10	1-3/4	3	CTC-7X2825	55.57
	9T2472		P-UB-10	2	3	CTC-7X2753	67.12
BLADE TIP							
	6E1549		P-UB-10	1-1/2	2-3/4	CTC-1361599	110.23
	8J0024		P-UB-10	1-1/2	2-3/4	CTC-7X2749	61.13
	9J3466		P-UB-10	1-1/2	2-3/4	CTC-7X2749	61.13
	9T2461		P-UB-10	1-1/2	2-3/4	CTC-1361599	110.23
CENTER SHIFT							
	3G5224		P-UB-10	2	3-1/4	CTC-7X2767	70.29
	8J6367		P-UB-10	2	3-1/4	CTC-7X2767	70.29
	9T2549		P-UB-10	2	3	CTC-7X2760	72.94
CONVEYOR SWING							
	3G5224		P-UB-10	2	3-1/4	CTC-7X2767	70.29
	8J6367		P-UB-10	2	3-1/4	CTC-7X2767	70.29
	9T2549		P-UB-10	2	3	CTC-7X2760	72.94
LIFT							
	9T2471		P-UB-10	1-3/4	3	CTC-7X2825	55.57
PUMP							
	61M; 72V; 74V						
	8J0498					CTC-3G1708	166.97
RIPPER							
	1137754		P-UB-10	2	4	CTC-1328816	96.00
	8J1658		P-UB-10	2	4	CTC-1328816	96.00
SCARIFIER							
	3G1853		P-UB-10	1-3/4	3	CTC-7X2791	91.70
	8J7321		P-UB-10	1-1/2	3	CTC-7X2751	66.28
	9T2554		P-UB-10	1-3/4	3	CTC-7X2825	55.57
	9T6951		P-UB-10	1-3/4	3	CTC-7X2825	55.57
SIDESHIFT							
	1052094		P-UB-10	1-3/4	3	CTC-7X2825	55.57
	8J0028		P-UB-10	1-3/4	3	CTC-7X2791	91.70
	9T2483		P-UB-10	1-3/4	3	CTC-7X2825	55.57
STEERING LH							
	3G8070		P-UB-10	1-1/2	2-1/2	CTC-7X2739	58.51
	8J8820		P-UB-10	1-1/2	2-1/2	CTC-7X2739	58.51
	9T2395		P-UB-10	1-1/2	2-1/4	CTC-7X2826	42.17
STEERING RH							
	3G8069		P-UB-10	1-1/2	2-1/2	CTC-7X2739	58.51
	8J5538		P-UB-10	1-1/2	2-1/2	CTC-7X2739	58.51
	9T2393		P-UB-10	1-1/2	2-1/4	CTC-7X2826	42.17

REPLACEMENT KITS FOR CATERPILLAR® EQUIPMENT

Motor Graders							
APPLICATION	CYL #	Misc-Parts, Instructions, etc.	CODE	ROD	BORE	KIT #	List \$
MODEL 130G							
WHEEL LEAN							
	1219242		P-UB-10	2	3-1/2	CTC-7X2783	106.57
	3G4752		P-UB-10	1-1/2	3-1/2	CTC-7X2752	98.74
	8J5539		P-UB-10	1-1/2	3-1/2	CTC-7X2752	98.74
	9T2520		P-UB-10	1-1/2	3-1/2	CTC-1327058	107.52
MODEL 135H							
ARTICULATION							
	6E1554		P-UB-10	1-3/4	3	CTC-7X2825	55.57
	6E4724		P-UB-10	2	3-1/2	CTC-7X2783	106.57
	9T8785		P-UB-10	1-3/4	3	CTC-7X2825	55.57
BLADE							
	1324926		P-UB-10	2	3	CTC-7X2760	72.94
BLADE TIP							
	6E1549		P-UB-10	1-1/2	2-3/4	CTC-1361599	110.23
CONVEYOR SWING							
	6E1754		P-UB-10	2	3	CTC-7X2760	72.94
SCARIFIER							
	9T2554		P-UB-10	1-3/4	3	CTC-7X2825	55.57
	9T6951		P-UB-10	1-3/4	3	CTC-7X2825	55.57
SIDESHIFT							
	1125575		P-UB-10	1-3/4	3	CTC-7X2825	55.57
STEERING LH							
	9T2395		P-UB-10	1-1/2	2-1/4	CTC-7X2826	42.17
STEERING RH							
	9T2393		P-UB-10	1-1/2	2-1/4	CTC-7X2826	42.17
WHEEL LEAN							
	1219242		P-UB-10	2	3-1/2	CTC-7X2783	106.57
	9T2520		P-UB-10	1-1/2	3-1/2	CTC-1327058	107.52
MODEL 140B							
RIPPER							
	3G5189		P-UB-10	2-1/2	5	CTC-7X2658	180.34
STEERING							
	4J4115		P-UB-10	1-1/2	4	CTC-7X2738	90.53
MODEL 140G							
ARTICULATION							
	8J0546		P-UB-10	1-3/4	3	CTC-7X2791	91.70
	9T2453		P-UB-10	1-3/4	3	CTC-7X2825	55.57
	9T8784		P-UB-10	1-3/4	3	CTC-7X2825	55.57
BACKHOE STICK/BLADE SHIFT							
	8J0028		P-UB-10	1-3/4	3	CTC-7X2791	91.70
BLADE							
	3G5223		P-UB-10	2	3-1/4	CTC-7X2767	70.29
	8J6380		P-UB-10	2	3-1/4	CTC-7X2767	70.29
	9T2472		P-UB-10	2	3	CTC-7X2760	72.94
BLADE LIFT							
	9T2472		P-UB-10	2	3	CTC-7X2753	67.12
BLADE TIP							
	6E1549		P-UB-10	1-1/2	2-3/4	CTC-1361599	110.23
	8J0024		P-UB-10	1-1/2	2-3/4	CTC-7X2749	61.13
	9J3466		P-UB-10	1-1/2	2-3/4	CTC-7X2749	61.13
	9T2461		P-UB-10	1-1/2	2-3/4	CTC-1361599	110.23
CENTER SHIFT							
	3G5224		P-UB-10	2	3-1/4	CTC-7X2767	70.29
	8J6367		P-UB-10	2	3-1/4	CTC-7X2767	70.29
	9T2549		P-UB-10	2	3	CTC-7X2760	72.94

REPLACEMENT KITS FOR CATERPILLAR® EQUIPMENT

Motor Graders							
APPLICATION	CYL #	Misc-Parts, Instructions, etc.	CODE	ROD	BORE	KIT #	List \$
MODEL 140G							
CONVEYOR SWING							
	3G5224		P-UB-10	2	3-1/4	CTC-7X2767	70.29
	8J6367		P-UB-10	2	3-1/4	CTC-7X2767	70.29
	9T2549		P-UB-10	2	3	CTC-7X2760	72.94
PUMP							
	61M; 72V; 74V						
	8J0498					CTC-3G1708	166.97
RIPPER							
	1137754		P-UB-10	2	4	CTC-1328816	96.00
	8J1658		P-UB-10	2	4	CTC-1328816	96.00
RIPPER LIFT							
	3G5189		P-UB-10	2-1/2	5	CTC-7X2658	180.34
SCARIFIER							
	3G1853		P-UB-10	1-3/4	3	CTC-7X2791	91.70
	8J7321		P-UB-10	1-1/2	3	CTC-7X2751	66.28
	9T2554		P-UB-10	1-3/4	3	CTC-7X2825	55.57
	9T6951		P-UB-10	1-3/4	3	CTC-7X2825	55.57
SIDESHIFT							
	1052094		P-UB-10	1-3/4	3	CTC-7X2825	55.57
	8J0028		P-UB-10	1-3/4	3	CTC-7X2791	91.70
	9T2483		P-UB-10	1-3/4	3	CTC-7X2825	55.57
STEERING LH							
	3G8070		P-UB-10	1-1/2	2-1/2	CTC-7X2739	58.51
	8J8820		P-UB-10	1-1/2	2-1/2	CTC-7X2739	58.51
	9T2395		P-UB-10	1-1/2	2-1/4	CTC-7X2826	42.17
STEERING RH							
	3G8069		P-UB-10	1-1/2	2-1/2	CTC-7X2739	58.51
	8J5538		P-UB-10	1-1/2	2-1/2	CTC-7X2739	58.51
	9T2393		P-UB-10	1-1/2	2-1/4	CTC-7X2826	42.17
WHEEL LEAN							
	1219242		P-UB-10	2	3-1/2	CTC-7X2783	106.57
	3G4752		P-UB-10	1-1/2	3-1/2	CTC-7X2752	98.74
	4J4115		P-UB-10	1-1/2	4	CTC-7X2738	90.53
	8J5539		P-UB-10	1-1/2	3-1/2	CTC-7X2752	98.74
	9T2520		P-UB-10	1-1/2	3-1/2	CTC-1327058	107.52
MODEL 140H, 143H							
ARTICULATION							
	1376790		P-UB-10	1-7/8	3-1/4	CTC-3E3297	102.01
	1376792		P-UB-10	1-7/8	3-1/4	CTC-3E3297	102.01
	6E1560		P-UB-10	1-3/4	3	CTC-7X2825	55.57
	9T8784		P-UB-10	1-3/4	3	CTC-7X2825	55.57
BLADE							
	1324929		P-UB-10	2	3	CTC-7X2760	72.94
BLADE TIP							
	6E1549		P-UB-10	1-1/2	2-3/4	CTC-1361599	110.23
CONVEYOR SWING							
	6E1343		P-UB-10	2	3	CTC-7X2760	72.94
RIPPER							
	1137754		P-UB-10	2	4	CTC-1328816	96.00
SCARIFIER							
	9T2554		P-UB-10	1-3/4	3	CTC-7X2825	55.57
	9T6951		P-UB-10	1-3/4	3	CTC-7X2825	55.57
SIDESHIFT							
	1125575		P-UB-10	1-3/4	3	CTC-7X2825	55.57
STEERING LH							
	9T2395		P-UB-10	1-1/2	2-1/4	CTC-7X2826	42.17

REPLACEMENT KITS FOR CATERPILLAR® EQUIPMENT

Motor Graders							
APPLICATION	CYL #	Misc-Parts, Instructions, etc.	CODE	ROD	BORE	KIT #	List \$
MODEL 140H, 143H							
STEERING RH							
	9T2393		P-UB-10	1-1/2	2-1/4	CTC-7X2826	42.17
WHEEL LEAN							
	1219242		P-UB-10	2	3-1/2	CTC-7X2783	106.57
	9T2520		P-UB-10	1-1/2	3-1/2	CTC-1327058	107.52
MODEL 160G							
ARTICULATION							
	8J0546		P-UB-10	1-3/4	3	CTC-7X2791	91.70
	9T2453		P-UB-10	1-3/4	3	CTC-7X2825	55.57
	9T8784		P-UB-10	1-3/4	3	CTC-7X2825	55.57
BACKHOE STICK/BLADE SHIFT							
	8J0028		P-UB-10	1-3/4	3	CTC-7X2791	91.70
BLADE							
	3G5223		P-UB-10	2	3-1/4	CTC-7X2767	70.29
	8J6380		P-UB-10	2	3-1/4	CTC-7X2767	70.29
	9T2472		P-UB-10	2	3	CTC-7X2753	67.12
	9T2472		P-UB-10	2	3	CTC-7X2760	72.94
BLADE LIFT							
	3G5223		P-UB-10	2	3-1/4	CTC-7X2767	70.29
	9T2472		P-UB-10	2	3	CTC-7X2753	67.12
BLADE TIP							
	6E1549		P-UB-10	1-1/2	2-3/4	CTC-1361599	110.23
	8J0024		P-UB-10	1-1/2	2-3/4	CTC-7X2749	61.13
	9J3466		P-UB-10	1-1/2	2-3/4	CTC-7X2749	61.13
	9T2461		P-UB-10	1-1/2	2-3/4	CTC-1361599	110.23
CENTER SHIFT							
	3G5224		P-UB-10	2	3-1/4	CTC-7X2767	70.29
	9T2549		P-UB-10	2	3	CTC-7X2760	72.94
CONVEYOR SWING							
	3G5224		P-UB-10	2	3-1/4	CTC-7X2767	70.29
	8J6367		P-UB-10	2	3-1/4	CTC-7X2767	70.29
	9T2549		P-UB-10	2	3	CTC-7X2760	72.94
SCARIFIER							
	3G1853		P-UB-10	1-3/4	3	CTC-7X2791	91.70
	9T2554		P-UB-10	1-3/4	3	CTC-7X2825	55.57
	9T6951		P-UB-10	1-3/4	3	CTC-7X2825	55.57
SIDESHIFT							
	1052094		P-UB-10	1-3/4	3	CTC-7X2825	55.57
	8J0028		P-UB-10	1-3/4	3	CTC-7X2791	91.70
	9T2483		P-UB-10	1-3/4	3	CTC-7X2825	55.57
STEERING LH							
	3G8070		P-UB-10	1-1/2	2-1/2	CTC-7X2739	58.51
	8J8820		P-UB-10	1-1/2	2-1/2	CTC-7X2739	58.51
	9T2395		P-UB-10	1-1/2	2-1/4	CTC-7X2826	42.17
STEERING RH							
	3G8069		P-UB-10	1-1/2	2-1/2	CTC-7X2739	58.51
	8J5538		P-UB-10	1-1/2	2-1/2	CTC-7X2739	58.51
	9T2393		P-UB-10	1-1/2	2-1/4	CTC-7X2826	42.17
WHEEL LEAN							
	1219242		P-UB-10	2	3-1/2	CTC-7X2783	106.57
	3G4752		P-UB-10	1-1/2	3-1/2	CTC-7X2752	98.74
	9T2520		P-UB-10	1-1/2	3-1/2	CTC-1327058	107.52

REPLACEMENT KITS FOR CATERPILLAR® EQUIPMENT

Motor Graders							
APPLICATION	CYL #	Misc-Parts, Instructions, etc.	CODE	ROD	BORE	KIT #	List \$
MODEL 160H, 163H							
ARTICULATION							
	1376790		P-UB-10	1-7/8	3-1/4	CTC-3E3297	102.01
	1376792		P-UB-10	1-7/8	3-1/4	CTC-3E3297	102.01
	6E1560		P-UB-10	1-3/4	3	CTC-7X2825	55.57
	9T8784		P-UB-10	1-3/4	3	CTC-7X2825	55.57
BLADE							
	1324929		P-UB-10	2	3	CTC-7X2760	72.94
BLADE TIP							
	6E1549		P-UB-10	1-1/2	2-3/4	CTC-1361599	110.23
CONVEYOR SWING							
	6E1343		P-UB-10	2	3	CTC-7X2760	72.94
RIPPER							
	1137754		P-UB-10	2	4	CTC-1328816	96.00
SCARIFIER							
	9T2554		P-UB-10	1-3/4	3	CTC-7X2825	55.57
	9T6951		P-UB-10	1-3/4	3	CTC-7X2825	55.57
SIDESHIFT							
	1125575		P-UB-10	1-3/4	3	CTC-7X2825	55.57
STEERING LH							
	9T2395		P-UB-10	1-1/2	2-1/4	CTC-7X2826	42.17
STEERING RH							
	9T2393		P-UB-10	1-1/2	2-1/4	CTC-7X2826	42.17
WHEEL LEAN							
	1219242		P-UB-10	2	3-1/2	CTC-7X2783	106.57
	9T2520		P-UB-10	1-1/2	3-1/2	CTC-1327058	107.52
Off-Highway Trucks							
APPLICATION	CYL #	Misc-Parts, Instructions, etc.	CODE	ROD	BORE	KIT #	List \$
MODEL 768							
HOIST							
	4T4168		I-SP-10	4,6-1/2	5-3/4	CTC-8T4772	325.54
STEERING							
	9J1287		P-UB-10	2-3/8	3-3/4	CTC-7X2808	83.46
SUSPENSION REAR							
	5J6572		I-SP-1	7	8-1/2	CTC-5J6572K	235.43
MODEL 768B							
STEERING							
	7J7528		P-UB-10	2-3/8	3-3/4	CTC-7X2808	83.46
	9J1287		P-UB-10	2-3/8	3-3/4	CTC-7X2808	83.46
SUSPENSION FRONT							
	79S1; 02X1-						
			P-UB-3	7	8	CTC-1137475	473.30
SUSPENSION REAR							
			P-U-3	7	8-1/2	CTC-2959886	284.51
	5J6572		I-SP-1	7	8-1/2	CTC-5J6572K	235.43
MODEL 768C							
HOIST							
	9J4149		I-SP-10	4,6-1/2	5-3/4	CTC-8T4772	325.54
STEERING							
			P-UB-10	2-3/8	3-3/4	CTC-2578422	54.73
			P-UB-10	2	3	CTC-2937596	41.44
SUSPENSION							
	1162836		P-U-3	7	8-1/2	CTC-1417296	282.88
SUSPENSION FRONT							
	79S1; 02X1-						
			P-UB-3	7	8	CTC-1137475	473.30

REPLACEMENT KITS FOR CATERPILLAR® EQUIPMENT

Off-Highway Trucks							
APPLICATION	CYL #	Misc-Parts, Instructions, etc.	CODE	ROD	BORE	KIT #	List \$
MODEL 768C							
SUSPENSION REAR							
			P-U-3	7	8-1/2	CTC-2959886	284.51
	5J6572		I-SP-1	7	8-1/2	CTC-5J6572K	235.43
MODEL 769, 769B							
STEERING							
			P-UB-10	2-3/8	3-3/4	CTC-2578422	54.73
	4J4627	Field Replacement Kit	P-UB-10	1-1/2	3-1/2	CTC-7X2812	107.67
99F1031-99F1198							
	6J1203		I-UB-10	2-3/8	3-3/4	CTC-6J1203K	121.67
99F1199-99F4068							
	7J7528		P-UB-10	2-3/8	3-3/4	CTC-7X2808	83.46
99F1-99F1030							
	4J4627		I,P-V-10	1-1/2	3-1/2	CTC-4J4627K	86.57
99F4069-							
	9J1287		P-UB-10	2-3/8	3-3/4	CTC-7X2808	83.46
SUSPENSION							
	7J8286		P-UB-3	7	8	CTC-1137475	473.30
SUSPENSION REAR							
99F1031-; 35W							
	5J6572		I-SP-1	7	8-1/2	CTC-5J6572K	235.43
99F1-99F1030							
	4J8770		I-SP-1	7	8-1/2	CTC-4J8770K	222.44
MODEL 769C							
HOIST							
	4T4168		I-SP-10	4,6-1/2	5-3/4	CTC-8T4772	325.54
	9J4149		I-SP-10	4,6-1/2	5-3/4	CTC-8T4772	325.54
STEERING							
			P-UB-10	2-3/8	3-3/4	CTC-2578422	54.73
			P-UB-10	2	3	CTC-2937596	41.44
SUSPENSION							
	1162836		P-U-3	7	8-1/2	CTC-1417296	282.88
SUSPENSION FRONT							
			P-UB-3	7	8	CTC-2950148	678.46
01X2920-; 3BJ1-; 5TR; 6JR; 5SS; 6YS; 9XS; BCA; BBB							
			P-UB-3	7	8	CTC-1137475	473.30
SUSPENSION REAR							
			P-U-3	7	8-1/2	CTC-2959886	284.51
	5J6572		I-SP-1	7	8-1/2	CTC-5J6572K	235.43
1X1-1X3271							
	3G0688		I-SP-1	7	8-1/2	CTC-5J6572K	235.43
1X3272-							
	3G0688		I-SP-1	7	8-1/2	CTC-3G0688K	235.43
MODEL 769D							
HOIST							
	4T4168		I-SP-10	4,6-1/2	5-3/4	CTC-8T4772	325.54
	9J4149		I-SP-10	4,6-1/2	5-3/4	CTC-8T4772	325.54
STEERING							
			P-UB-10	2	3	CTC-2937596	41.44
	1100532		P-UB-10	2	3	CTC-7X2760	72.94
	9J1287		P-UB-10	2-3/8	3-3/4	CTC-7X2808	83.46
SUSPENSION							
	1162836		P-U-3	7	8-1/2	CTC-1417296	282.88
SUSPENSION FRONT							
01X2920-; 3BJ1-; 5TR; 6JR; 5SS; 6YS; 9XS; BCA; BBB							
			P-UB-3	7	8	CTC-1137475	473.30

REPLACEMENT KITS FOR CATERPILLAR® EQUIPMENT

Off-Highway Trucks								
APPLICATION	CYL #	Misc-Parts, Instructions, etc.	CODE	ROD	BORE	KIT #	List \$	
MODEL 769D								
SUSPENSION REAR								
			P-U-3	7	8-1/2	CTC-2959886	284.51	
UNSPECIFIED APPLICATION								
	1303921		P-UB-3	7	8	CTC-1137475	473.30	
MODEL 770								
STEERING								
			P-UB-10	2	3	CTC-2937596	41.44	
MODEL 771C								
HOIST								
	4T4168		I-SP-10	4,6-1/2	5-3/4	CTC-8T4772	325.54	
	9J4149		I-SP-10	4,6-1/2	5-3/4	CTC-8T4772	325.54	
STEERING								
			P-UB-10	2	3	CTC-2937596	41.44	
	9J1287		P-UB-10	2-3/8	3-3/4	CTC-7X2808	83.46	
SUSPENSION								
	1162836		P-U-3	7	8-1/2	CTC-1417296	282.88	
SUSPENSION FRONT								
			P-UB-3	7	8	CTC-2950148	678.46	
	01X2920-; 3BJ1-; 5TR; 6JR; 5SS; 6YS; 9XS; BCA; BBB							
			P-UB-3	7	8	CTC-1137475	473.30	
SUSPENSION REAR								
			P-U-3	7	8-1/2	CTC-2959886	284.51	
UNSPECIFIED APPLICATION								
	9J5476		P-UB-3	7	8	CTC-1137475	473.30	
MODEL 771D								
HOIST								
	4T4168		I-SP-10	4,6-1/2	5-3/4	CTC-8T4772	325.54	
	9J4149		I-SP-10	4,6-1/2	5-3/4	CTC-8T4772	325.54	
STEERING								
			P-UB-10	2	3	CTC-2937596	41.44	
	1100532		P-UB-10	2	3	CTC-7X2760	72.94	
	9J1287		P-UB-10	2-3/8	3-3/4	CTC-7X2808	83.46	
SUSPENSION								
	1162836		P-U-3	7	8-1/2	CTC-1417296	282.88	
SUSPENSION FRONT								
	01X2920-; 3BJ1-; 5TR; 6JR; 5SS; 6YS; 9XS; BCA; BBB							
			P-UB-3	7	8	CTC-1137475	473.30	
SUSPENSION REAR								
			P-U-3	7	8-1/2	CTC-2959886	284.51	
MODEL 772								
DOOR								
	3G4640		P-UB-10	2-1/2	6	CTC-7X2669	241.94	
	9J8157		P-UB-10	2-1/2	6	CTC-7X2836	265.91	
PUMP								
	11S; 63G; 80S							
	9J5059					CTC-9J5108	41.54	
	9J5060					CTC-9J5109	33.18	
STEERING								
			P-UB-10	2-3/8	4	CTC-2418925	58.45	
			P-UB-10	2	3	CTC-2937596	41.44	
SUSPENSION FRONT								
			P-UB-3	7	8	CTC-2950148	678.46	
	1U4777		P-UB-3	7	8	CTC-1137478	678.46	
	7J3480		P-UB-3	7	8	CTC-1137475	473.30	
	8J2322		P-UB-3	7	8	CTC-1137475	473.30	

REPLACEMENT KITS FOR CATERPILLAR® EQUIPMENT

Off-Highway Trucks							
APPLICATION	CYL #	Misc-Parts, Instructions, etc.	CODE	ROD	BORE	KIT #	List \$
MODEL 772							
SUSPENSION FRONT							
	64W168-						
			P-UB-3	7	8	CTC-1137478	678.46
SUSPENSION REAR							
			P-U-3	7	8-1/2	CTC-2959886	284.51
UNSPECIFIED APPLICATION							
	1163092		P-UB-3	7	8	CTC-1137478	678.46
MODEL 772B							
DOOR							
	3G4640		P-UB-10	2-1/2	6	CTC-7X2669	241.94
	9J8157		P-UB-10	2-1/2	6	CTC-7X2836	265.91
HOIST							
	9J2017		I-SP-10	5,7-1/2	8-1/4	CTC-8T9042	471.07
	9T3122		I-SP-10	5,7-1/2	8-1/4	CTC-8T9042	471.07
STEERING							
			P-UB-10	2-3/8	4	CTC-2418925	58.45
			P-UB-10	2	3	CTC-2937596	41.44
SUSPENSION							
	8J2322		P-UB-3	7	8	CTC-1137475	473.30
SUSPENSION FRONT							
			P-UB-3	7	8	CTC-2950148	678.46
	1U4777		P-UB-3	7	8	CTC-1137478	678.46
	7J3480		P-UB-3	7	8	CTC-1137475	473.30
	64W168-						
			P-UB-3	7	8	CTC-1137478	678.46
SUSPENSION REAR							
			P-U-3	7	8-1/2	CTC-2959886	284.51
UNSPECIFIED APPLICATION							
	1163092		P-UB-3	7	8	CTC-1137478	678.46
MODEL 772E							
SUSPENSION REAR							
			P-U-3	7	8-1/2	CTC-2959886	284.51
MODEL 773							
PUMP							
	11S; 63G; 80S						
	9J5059					CTC-9J5108	41.54
	9J5060					CTC-9J5109	33.18
STEERING							
			P-UB-10	2-3/8	4	CTC-2418925	58.45
SUSPENSION FRONT							
	63G-63G670						
	7J3480		P-UB-3	7	8	CTC-1137475	473.30
	63G671-						
	8J2322		P-UB-3	7	8	CTC-1137475	473.30
	63W1271-; 7XJ1-; 6KR; 7ER; 7CS; 8AS						
			P-UB-3	7	8	CTC-1137478	678.46
SUSPENSION REAR							
	63G; 63W1-63W1724						
	8J9332		I-SP-1	7	8-1/2	CTC-5J6572K	235.43
	63W1725-						
	8J9332		I-SP-1	7	8-1/2	CTC-3G0688K	235.43
MODEL 773B							
DOOR							
	3G4640		P-UB-10	2-1/2	6	CTC-7X2669	241.94

REPLACEMENT KITS FOR CATERPILLAR® EQUIPMENT

Off-Highway Trucks							
APPLICATION	CYL #	Misc-Parts, Instructions, etc.	CODE	ROD	BORE	KIT #	List \$
MODEL 773B							
HOIST							
			I-SP-10	5,7-1/2	6-1/2,8-1/4	CTC-3126388	497.13
	9J2017		I-SP-10	5,7-1/2	8-1/4	CTC-8T9042	471.07
	9T3122		I-SP-10	5,7-1/2	8-1/4	CTC-8T9042	471.07
STEERING RH							
	63G1-; 63W1-						
	7J7686		P-UB-10	2-3/8	4	CTC-8T1389	49.28
SUSPENSION							
	1162837		P-U-3	7	8-1/2	CTC-1417296	282.88
SUSPENSION FRONT							
			P-UB-3	7	8	CTC-2950148	678.46
	63W1271-; 7XJ1-; 6KR; 7ER; 7CS; 8AS						
			P-UB-3	7	8	CTC-1137478	678.46
SUSPENSION REAR							
	9T6082		P-U-3	7	8-1/2	CTC-1417296	282.88
	63G; 63W1-63W1724						
	8J9332		I-SP-1	7	8-1/2	CTC-5J6572K	235.43
	63W1725-						
	8J9332		I-SP-1	7	8-1/2	CTC-3G0688K	235.43
UNSPECIFIED APPLICATION							
	1163092		P-UB-3	7	8	CTC-1137478	678.46
MODEL 773D							
HOIST							
			I-SP-10	5,7-1/2	6-1/2,8-1/4	CTC-3126388	497.13
	1455155		I-SP-10	5,7-1/2	8-1/4	CTC-8T9042	471.07
	9J2017		I-SP-10	5,7-1/2	8-1/4	CTC-8T9042	471.07
STEERING RH							
	7J7686		P-UB-10	2-3/8	4	CTC-8T1389	49.28
SUSPENSION							
	1162837		P-U-3	7	8-1/2	CTC-1417296	282.88
SUSPENSION FRONT							
			P-UB-3	7	8	CTC-2950148	678.46
	1163092		P-UB-3	7	8	CTC-1137478	678.46
	1U4777		P-UB-3	7	8	CTC-1137478	678.46
	63W1271-; 7XJ1-; 6KR; 7ER; 7CS; 8AS						
			P-UB-3	7	8	CTC-1137478	678.46
SUSPENSION REAR							
	9T6082		P-U-3	7	8-1/2	CTC-1417296	282.88
MODEL 773E							
HOIST							
			I-SP-10	5,7-1/2	6-1/2,8-1/4	CTC-3126388	497.13
STEERING							
			P-UB-10	2-1/2	3-1/2	CTC-2949583	72.62
SUSPENSION REAR							
			P-U-3	7	8-1/2	CTC-2976848	294.60
MODEL 773F							
SUSPENSION REAR							
			P-U-3	7	8-1/2	CTC-2976848	294.60
MODEL 775							
HOIST							
	9J2017		I-SP-10	5,7-1/2	8-1/4	CTC-8T9042	471.07
	9T3122		I-SP-10	5,7-1/2	8-1/4	CTC-8T9042	471.07
STEERING RH							
	7J7686		P-UB-10	2-3/8	4	CTC-8T1389	49.28
SUSPENSION							
	1162837		P-U-3	7	8-1/2	CTC-1417296	282.88

REPLACEMENT KITS FOR CATERPILLAR® EQUIPMENT

Off-Highway Trucks							
APPLICATION	CYL #	Misc-Parts, Instructions, etc.	CODE	ROD	BORE	KIT #	List \$
MODEL 775							
SUSPENSION REAR							
	9T6082		P-U-3	7	8-1/2	CTC-1417296	282.88
UNSPECIFIED APPLICATION							
	1163092		P-UB-3	7	8	CTC-1137478	678.46
	1U4777		P-UB-3	7	8	CTC-1137478	678.46
MODEL 775B							
HOIST							
			I-SP-10	5,7-1/2	6-1/2,8-1/4	CTC-3126388	497.13
SUSPENSION							
	1U4777		P-UB-3	7	8	CTC-1137478	678.46
SUSPENSION FRONT							
			P-UB-3	7	8	CTC-2950148	678.46
	63W1271-; 7XJ1-; 6KR; 7ER; 7CS; 8AS						
			P-UB-3	7	8	CTC-1137478	678.46
SUSPENSION REAR							
			P-U-3	7	8-1/2	CTC-2959886	284.51
MODEL 775D							
HOIST							
			I-SP-10	5,7-1/2	6-1/2,8-1/4	CTC-3126388	497.13
	1455155		I-SP-10	5,7-1/2	8-1/4	CTC-8T9042	471.07
	9J2017		I-SP-10	5,7-1/2	8-1/4	CTC-8T9042	471.07
	9T3122		I-SP-10	5,7-1/2	8-1/4	CTC-8T9042	471.07
STEERING RH							
	7J7686		P-UB-10	2-3/8	4	CTC-8T1389	49.28
SUSPENSION							
	1162837		P-U-3	7	8-1/2	CTC-1417296	282.88
SUSPENSION FRONT							
			P-UB-3	7	8	CTC-2950148	678.46
	63W1271-; 7XJ1-; 6KR; 7ER; 7CS; 8AS						
			P-UB-3	7	8	CTC-1137478	678.46
SUSPENSION REAR							
			P-U-3	7	8-1/2	CTC-2959886	284.51
UNSPECIFIED APPLICATION							
	1163092		P-UB-3	7	8	CTC-1137478	678.46
	1U4777		P-UB-3	7	8	CTC-1137478	678.46
	9T6082		P-U-3	7	8-1/2	CTC-1417296	282.88
MODEL 775E							
SUSPENSION FRONT							
			P-UB-3	7	8	CTC-2950148	678.46
	BEC321-471						
			P-U-1	7	8	CTC-2976847	995.33
MODEL 776, 776B							
DOOR							
	3G4640		P-UB-10	2-1/2	6	CTC-7X2669	241.94
STEERING							
			P-UB-10	2-3/8	4	CTC-2418925	58.45
SUSPENSION REAR							
	8J8865		I,P-U-13	9	10-1/2	CTC-1137482	369.52
MODEL 776C, 776D							
STEERING							
	8J9912		P-UB-10	2-3/8	4	CTC-8T1389	49.28
SUSPENSION REAR							
			P-UB-1	9	10-1/2	CTC-2959885	273.04
	8J8865		I,P-U-13	9	10-1/2	CTC-1137482	369.52
MODEL 777							
DOOR							
	3G4640		P-UB-10	2-1/2	6	CTC-7X2669	241.94

REPLACEMENT KITS FOR CATERPILLAR® EQUIPMENT

Off-Highway Trucks							
APPLICATION	CYL #	Misc-Parts, Instructions, etc.	CODE	ROD	BORE	KIT #	List \$
MODEL 777							
HOIST							
	8J8924		I-UB-10	5-1/2	9-1/2	CTC-8T1543	476.39
STEERING							
			P-UB-10	2-3/8	4	CTC-1945600	58.39
			P-UB-10	2-3/8	4	CTC-2418925	58.45
SUSPENSION FRONT							
	4T4756		I,P-U-3	9	10-3/4	CTC-1137463	1950.10
SUSPENSION REAR							
	8J8865		I,P-U-13	9	10-1/2	CTC-1137482	369.52
	84A1284-; 4YC1-						
	8J8865		I-SP-1	9	10-1/2	CTC-9T3972K	493.96
	84A1-84A1283						
	8J8865		I-SP-1	9	10-1/2	CTC-8J8902K	493.96
MODEL 777B							
HOIST							
	8J8924		I-UB-10	5-1/2	9-1/2	CTC-8T1543	476.39
STEERING							
	8J9912		P-UB-10	2-3/8	4	CTC-8T1389	49.28
SUSPENSION FRONT							
	4T4756		I,P-U-3	9	10-3/4	CTC-1137463	1950.10
SUSPENSION REAR							
	8J8865		I,P-U-13	9	10-1/2	CTC-1137482	369.52
	84A1284-; 4YC1-						
	8J8865		I-SP-1	9	10-1/2	CTC-9T3972K	493.96
	84A1-84A1283						
	8J8865		I-SP-1	9	10-1/2	CTC-8J8902K	493.96
MODEL 777C							
HOIST							
	8J8924		I-UB-10	5-1/2	9-1/2	CTC-8T1543	476.39
STEERING							
	8J9912		P-UB-10	2-3/8	4	CTC-8T1389	49.28
SUSPENSION FRONT							
	4T4756		I,P-U-3	9	10-3/4	CTC-1137463	1950.10
SUSPENSION REAR							
			P-UB-1	9	10-1/2	CTC-2959885	273.04
	8J8865		I,P-U-13	9	10-1/2	CTC-1137482	369.52
MODEL 777D							
HOIST							
			I-UB-10	5-1/2	9-1/2	CTC-3170942	400.70
	8J8924		I-UB-10	5-1/2	9-1/2	CTC-8T1543	476.39
STEERING							
	1052440		I-UB-10	2-1/2	3-1/2	CTC-3E3299	138.77
	8J9912		P-UB-10	2-3/8	4	CTC-8T1389	49.28
SUSPENSION FRONT							
	4T4756		I,P-U-3	9	10-3/4	CTC-1137463	1950.10
SUSPENSION REAR							
			P-UB-1	9	10-1/2	CTC-2959885	273.04
	8J8865		I,P-U-13	9	10-1/2	CTC-1137482	369.52
MODEL 777F							
HOIST							
			I-UB-10	5-1/2	7-1/2	CTC-2950145	284.14
STEERING							
			P-UB-10	2-1/2	3-1/2	CTC-2949583	72.62
SUSPENSION FRONT							
			P-UB-1	9	10-3/4	CTC-3087849	1736.32

REPLACEMENT KITS FOR CATERPILLAR® EQUIPMENT

Off-Highway Trucks							
APPLICATION	CYL #	Misc-Parts, Instructions, etc.	CODE	ROD	BORE	KIT #	List \$
MODEL 777F							
SUSPENSION REAR							
			P-U-1	9	10-1/2	CTC-2976849	405.93
MODEL 783B							
HOIST							
		Includes extra parts	I-SP-3,10	7-1/4, 10-1/2	9-1/4, 11-1/2	CTC-0715438	761.92
			I-SP-3,10	7-1/4, 10-1/2	9-1/4, 11-1/2	CTC-8T4939	800.26
STEERING							
			P-UB-10	2-1/2	5	CTC-1304012	198.05
		Serial# 8GB1-316	P-UB-10	2-1/2	5	CTC-7X2658	180.34
SUSPENSION FRONT							
		Insert wiper kit	I-U-3	11	13-1/8	CTC-0711436	1242.85
		Press-in wiper kit	P-U-3	11	13-1/8	CTC-0712436	1328.61
		Combination kit	I,P-U-3	11	13-1/8	CTC-1137476	1660.82
UNSPECIFIED APPLICATION							
	4T5931		I-SP-3,10	7-1/4, 10-1/2	9-1/4, 11-1/2	CTC-8T4939	800.26
MODEL 784B, 784C							
STEERING							
	6E5857		P-UB-10	2-1/2	5	CTC-1304012	198.05
MODEL 785, 785B, 785C							
HOIST							
		Includes extra parts	I-SP-3,10	7-1/4, 10-1/2	9-1/4, 11-1/2	CTC-0715438	761.92
			I-SP-3,10	7-1/4, 10-1/2	9-1/4, 11-1/2	CTC-8T4939	800.26
STEERING							
			P-UB-10	2-1/2	5	CTC-1304012	198.05
			P-UB-10	2-1/2	5	CTC-7X2658	180.34
SUSPENSION FRONT							
		Insert wiper kit	I-U-3	11	13-1/8	CTC-0711436	1242.85
		Press-in wiper kit	P-U-3	11	13-1/8	CTC-0712436	1328.61
		Combination kit	I,P-U-3	11	13-1/8	CTC-1137476	1660.82
UNSPECIFIED APPLICATION							
	4T5931	785C	I-SP-3,10	7-1/4, 10-1/2	9-1/4, 11-1/2	CTC-8T4939	800.26
MODEL 786							
STEERING							
	7J9718		P-UB-10	2-1/4	5	CTC-7X2729	168.02
	7J9984		P-UB-10	2-1/4	5	CTC-7X2729	168.02
TILT LH							
	7J9762		P-UB-10	2-3/4	6-1/2	CTC-7X2689	166.65
TILT RH							
	7J9761		P-UB-10	2-3/4	6-1/2	CTC-7X2689	166.65
MODEL 787B							
STEERING							
	4T6797		P-UB-10	2-3/4	6	CTC-1363337	80.68
SUSPENSION							
	1061801		I,P-U-3	12-1/2	14-1/4	CTC-1137480	939.12
UNSPECIFIED APPLICATION							
	9T2807		I-SP-3,10	7-1/4, 11	9-1/2, 12-1/4	CTC-8C5788	1093.93
MODEL 789, 789B, 789C							
HOIST							
			I-SP-3,10	7-1/4, 11	9-1/2, 12-1/4	CTC-0716439	779.17
		Includes rod wear rings	I-SP-3,10	7-1/4, 11	9-1/2, 12-1/4	CTC-8C5788	1093.93
STEERING							
			P-UB-10	2-3/4	6	CTC-2440953	106.04
SUSPENSION FRONT							
		Insert wiper kit	I-U-3	12-1/2	15-1/8	CTC-0717440	1796.66
		Press-in wiper kit	P-U-3	12-1/2	15-1/8	CTC-0718440	1796.41
		Combination kit	I,P-U-3	12-1/2	15-1/8	CTC-1131073	2020.22

REPLACEMENT KITS FOR CATERPILLAR® EQUIPMENT

Off-Highway Trucks							
APPLICATION	CYL #	Misc-Parts, Instructions, etc.	CODE	ROD	BORE	KIT #	List \$
MODEL 789, 789B, 789C							
SUSPENSION REAR							
		Head# 4T4761	I-U-3	12-1/2	14-1/4	CTC-0719441	756.82
		Head# 1060904, 1061807, 1591977	P-U-3	12-1/2	14-1/4	CTC-0720441	621.89
		Head# 4T4761, 1060904, 1061807, 1591977	I,P-U-3	12-1/2	14-1/4	CTC-1137480	939.12
UNSPECIFIED APPLICATION							
	1061801	789C	I,P-U-3	12-1/2	14-1/4	CTC-1137480	939.12
	4T4844	789B, 789C	I,P-U-3	12-1/2	14-1/4	CTC-1137480	939.12
	9T2807	789C	I-SP-3,10	7-1/4, 11	9-1/2, 12-1/4	CTC-8C5788	1093.93
MODEL 793, 793B							
HOIST							
			I-SP-10, 3	8-3/4, 12-1/2	11, 13-3/4	CTC-1125343	892.77
STEERING							
			P-UB-10	2-3/4	5-1/2	CTC-2601518	127.33
SUSPENSION FRONT							
		Combination kit	I,P-U-3	13-1/2	16-1/8	CTC-1137472	1996.23
		Insert wiper kit	I-U-3	13-1/2	16-1/8	CTC-7751023	1757.76
		Press-in wiper kit	P-U-3	13-1/2	16-1/8	CTC-7761023	1730.51
SUSPENSION REAR							
		Head# 4T4761	I-U-3	12-1/2	14-1/4	CTC-0719441	756.82
		Head# 1060904, 1061807, 1591977	P-U-3	12-1/2	14-1/4	CTC-0720441	621.89
		Head# 1946859; kit includes rod wear ring	P-U-3	12-1/2	14-1/4	CTC-0778441	1702.42
		Head# 4T4761, 1060904, 1061807, 1591977	I,P-U-3	12-1/2	14-1/4	CTC-1137480	939.12
MODEL 793C							
HOIST							
			I-SP-3,10	7-3/4, 11-1/2	10, 12-3/4	CTC-1531282	708.65
STEERING							
			P-UB-10	2-3/4	5-1/2	CTC-2601518	127.33
SUSPENSION FRONT							
		Combination kit	I,P-U-3	13-1/2	16-1/8	CTC-1137472	1996.23
		Insert wiper kit	I-U-3	13-1/2	16-1/8	CTC-7751023	1757.76
		Press-in wiper kit	P-U-3	13-1/2	16-1/8	CTC-7761023	1730.51
SUSPENSION REAR							
		Head# 4T4761	I-U-3	12-1/2	14-1/4	CTC-0719441	756.82
		Head# 1060904, 1061807, 1591977	P-U-3	12-1/2	14-1/4	CTC-0720441	621.89
		Head# 4T4761, 1060904, 1061807, 1591977	I,P-U-3	12-1/2	14-1/4	CTC-1137480	939.12
UNSPECIFIED APPLICATION							
	6E1101		I,P-U-3	12-1/2	14-1/4	CTC-1137480	939.12
MODEL 793D							
HOIST							
		FDB1-UP					
	1212071		I-SP-3,10	7-3/4, 11-1/2	10, 12-3/4	CTC-1531282	708.65
STEERING							
		FDB155-UP					
	9T8912		P-UB-10	2-3/4	5-1/2	CTC-1570287	153.84
		FDB1-UP					
	9T8912		P-UB-10	2-3/4	5-1/2	CTC-1937639	124.31
SUSPENSION FRONT							
		FDB1-UP					
	2848014		P-U-1	13-1/2		CTC-2848014K	2487.49
	2848015		P-U-1	13-1/2		CTC-2848015K	2487.49

REPLACEMENT KITS FOR CATERPILLAR® EQUIPMENT

Off-Highway Trucks							
APPLICATION	CYL #	Misc-Parts, Instructions, etc.	CODE	ROD	BORE	KIT #	List \$
MODEL 793D							
SUSPENSION REAR							
FDB1-UP							
	2848016		P-U-1	12-1/2		CTC-2848016K	1228.27
	2848017		P-U-1	12-1/2		CTC-2848017K	1227.77
Pipelayers							
APPLICATION	CYL #	Misc-Parts, Instructions, etc.	CODE	ROD	BORE	KIT #	List \$
MODEL 561B							
COUNTERWEIGHT LH							
	3G3504		P-UB-10	2	4-1/2	CTC-7X2768	91.77
COUNTERWEIGHT RH							
	3G3505		P-UB-10	2	4-1/2	CTC-7X2768	91.77
MODEL 561C, 561D							
COUNTERWEIGHT LH							
	3G3504		P-UB-10	2	4-1/2	CTC-7X2768	91.77
COUNTERWEIGHT RH							
	3G3505		P-UB-10	2	4-1/2	CTC-7X2768	91.77
TRACK ADJUSTER							
			TRK ADJ			CTC-FIG4400	49.72
MODEL 571A, 571F, 571G							
TRACK ADJUSTER							
			TRK ADJ			CTC-FIG3401	57.79
MODEL 572C, 572D, 572E, 572F							
TRACK ADJUSTER							
			TRK ADJ			CTC-FIG3401	57.79
MODEL 572G							
DOZER LIFT LH							
	1U2136		P-UB-10	2-1/2	4-3/4	CTC-7X2660	185.90
DOZER LIFT RH							
	1U2135		P-UB-10	2-1/2	4-3/4	CTC-7X2660	185.90
PUMP							
38A; 40U; 78V							
	9J5047					CTC-9J5109	33.18
TRACK ADJUSTER							
			TRK ADJ			CTC-FIG3401	57.79
MODEL 578							
COUNTERWEIGHT							
	3G2918		P-V-10	2	4-1/2	CTC-7X2700	73.45
	9T0489		P-V-10	2	4-1/2	CTC-7X2700	73.45
MODEL 583							
COUNTERWEIGHT							
	1M1580		P-V-10	2	4	CTC-7X2800	65.27
PUMP							
38A; 40U; 78V							
	9J5047					CTC-9J5109	33.18
MODEL 583H							
COUNTERWEIGHT							
	1M1580		P-V-10	2	4	CTC-7X2800	65.27
SIDE DUMP							
	8J5670		P-UB-10	2	4	CTC-7X2755	152.30
	8J5670		P-UB-10	2	4	CTC-7X7937	166.09
TRACK ADJUSTER							
			TRK ADJ			CTC-FIG1401	118.41
			TRK ADJ			CTC-FIG1402	132.02
MODEL 583K							
COUNTERWEIGHT							
	1M1580		P-V-10	2	4	CTC-7X2800	65.27

REPLACEMENT KITS FOR CATERPILLAR® EQUIPMENT

Pipelayers							
APPLICATION	CYL #	Misc-Parts, Instructions, etc.	CODE	ROD	BORE	KIT #	List \$
MODEL 583K							
PUMP							
	38A; 40U; 78V						
	9J5047					CTC-9J5109	33.18
SIDE DUMP							
	8J5670		P-UB-10	2	4	CTC-7X2755	152.30
	8J5670		P-UB-10	2	4	CTC-7X7937	166.09
TRACK ADJUSTER							
			TRK ADJ			CTC-FIG1401	118.41
			TRK ADJ			CTC-FIG1402	132.02
MODEL 583R							
COUNTERWEIGHT							
	1333850		P-UB-10	2-1/8	4	CTC-1305923	164.08
MODEL 589							
COUNTERWEIGHT							
	3G2918		P-V-10	2	4-1/2	CTC-7X2700	73.45
MODEL 591							
COUNTERWEIGHT							
	3G9729		P-V-10	2	4-1/2	CTC-7X2700	73.45
MODEL 594, 594H							
LIFT							
	6J0416		P-V-10	2	5	CTC-7X2763	140.20
PUMP							
	62H; 96V						
	9J5046					CTC-9J5109	33.18
TRACK ADJUSTER							
			TRK ADJ			CTC-FIG0401	107.30
			TRK ADJ			CTC-FIG0402	126.43
MODEL MD7, MD8, MDW8							
COUNTERWEIGHT							
	3G3505		P-UB-10	2	4-1/2	CTC-7X2768	91.77
Scrapers							
APPLICATION	CYL #	Misc-Parts, Instructions, etc.	CODE	ROD	BORE	KIT #	List \$
MODEL 611							
BOWL							
	3G5679		P-UB-10	2-1/4	5	CTC-9X6392	165.61
LOAD							
	3G7274		P-UB-10	2-1/4	4-3/4	CTC-1318778	145.01
STEERING							
	6E3566		P-UB-10	2-1/4	4-1/2	CTC-1354392	145.28
MODEL 613							
BOWL LIFT							
	7J6058		P-UB-10	2	4	CTC-7X2755	152.30
EJECTOR							
	1U2012		P-UB-10	2-1/4	3-1/2	CTC-7X2818	93.37
FLOOR							
	7J5528		P-UB-10	2-1/2	5	CTC-7X2675	128.61
PUMP							
	38W; 71M						
	9J5061					CTC-9J5112	39.78
STEERING							
	7J6054		P-UB-10	2	4	CTC-7X2755	152.30
MODEL 613B							
BOWL LIFT							
	7J6058		P-UB-10	2	4	CTC-7X2755	152.30
EJECTOR							
	1U2012		P-UB-10	2-1/4	3-1/2	CTC-7X2818	93.37

REPLACEMENT KITS FOR CATERPILLAR® EQUIPMENT

Scrapers							
APPLICATION	CYL #	Misc-Parts, Instructions, etc.	CODE	ROD	BORE	KIT #	List \$
MODEL 613B							
FLOOR	7J5528		P-UB-10	2-1/2	5	CTC-7X2675	128.61
PUMP	38W; 71M						
	9J5061					CTC-9J5112	39.78
STEERING	1U2291		P-UB-10	2	4	CTC-1328816	96.00
	6E2968		P-UB-10	2	3-1/2	CTC-7X2783	106.57
	7J6054		P-UB-10	2	4	CTC-7X2755	152.30
	9T7900		P-UB-10	2	4	CTC-1328816	96.00
MODEL 613C							
BOWL LIFT	1U3124		P-UB-10	2	4	CTC-7X2789	105.58
EJECTOR	1U2012		P-UB-10	2-1/4	3-1/2	CTC-7X2818	93.37
FLOOR	1U2157		P-UB-10	2-1/2	5	CTC-7X2658	180.34
STEERING	1U2291		P-UB-10	2	4	CTC-7X2789	105.58
MODEL 613SC							
BOWL	1U3124		P-UB-10	2	4	CTC-1328816	96.00
	3G5679		P-UB-10	2-1/4	5	CTC-9X6392	165.61
	7J6058		P-UB-10	2	4	CTC-7X2755	152.30
	9T8252		P-UB-10	2	4	CTC-1328816	96.00
EJECTOR	1U2012		P-UB-10	2-1/4	3-1/2	CTC-1358166	177.50
FLOOR	1U2157		P-UB-10	2-1/2	5	CTC-1315118	184.12
MODEL 615							
BOWL	3G5679		P-UB-10	2-1/4	5	CTC-9X6392	165.61
CUSHION HITCH	3G7274		P-UB-10	2-1/4	4-3/4	CTC-8T2216	81.41
DOOR	3G3883		P-UB-10	2-3/4	5-1/2	CTC-7X2690	103.03
EJECTOR	3G3892		P-UB-10	2-1/2	4-1/4	CTC-7X2663	51.12
LOAD	3G7274		P-UB-10	2-1/4	4-3/4	CTC-1318778	145.01
STEERING	5J1326		P-UB-10	2-1/4	5	CTC-7X2729	168.02
MODEL 615C							
BOWL LIFT	3G5679		P-UB-10	2-1/4	5	CTC-7X2729	168.02
DOOR	3G3883		P-UB-10	2-3/4	5-1/2	CTC-7X2690	103.03
EJECTOR	3G3892		P-UB-10	2-1/2	4-1/4	CTC-7X2663	51.12
LIFT	7J9902		P-UB-10	2	4-1/4	CTC-7X2819	108.80
LOAD	3G7274		P-UB-10	2-1/4	4-3/4	CTC-1318778	145.01

CATERPILLAR®

REPLACEMENT KITS FOR CATERPILLAR® EQUIPMENT

Scrapers								
APPLICATION	CYL #	Misc-Parts, Instructions, etc.	CODE	ROD	BORE	KIT #	List \$	
MODEL 615C								
STEERING								
	5J1326		P-UB-10	2-1/4	5	CTC-7X2729	168.02	
	6E2968		P-UB-10	2	3-1/2	CTC-7X2783	106.57	
	6E3566		P-UB-10	2-1/4	4-1/2	CTC-1354392	145.28	
MODEL 615SC								
BOWL								
	3G5679		P-UB-10	2-1/4	5	CTC-7X2729	168.02	
	3G5679		P-UB-10	2-1/4	5	CTC-9X6392	165.61	
EJECTOR								
	3G3892		P-UB-10	2-1/2	4-1/4	CTC-7X2663	51.12	
STEERING								
	5J1326		P-UB-10	2-1/4	5	CTC-7X2729	168.02	
MODEL 621								
APRON								
	5J0778		P-UB-10	2-3/4	7-1/4	CTC-7X2681	117.57	
BOWL LH								
	5J2450		P-UB-10	2-1/2	6	CTC-7X2662	177.27	
BOWL RH								
	5J2449		P-UB-10	2-1/2	6	CTC-7X2662	177.27	
EJECTOR								
	1U0408		P-UB-10	4	6-1/2	CTC-7X2765	243.96	
	6J9689		P-UB-10	4	6-1/2	CTC-7X2765	243.96	
FLOOR								
	7J5528		P-UB-10	2-1/2	5	CTC-7X2675	128.61	
LOAD								
	8J0204		P-UB-10	2-1/2	5-1/2	CTC-9X2050	104.21	
LOAD CUSHION HITCH								
	8J0204		P-UB-10	2-1/2	5-1/2	CTC-8T1374	96.66	
	9J0537		P-UB-10	2-1/2	6-1/2	CTC-8T1376	82.33	
	9T1803		P-UB-10	2-1/2	5-1/2	CTC-7X2653	168.14	
STEERING								
	5J1326		P-UB-10	2-1/4	5	CTC-7X2729	168.02	
MODEL 621B								
APRON								
	5J0778		P-UB-10	2-3/4	7-1/4	CTC-7X2681	117.57	
BOWL LIFT								
	5J2449		P-UB-10	2-1/2	6	CTC-7X2662	177.27	
	5J2450		P-UB-10	2-1/2	6	CTC-7X2662	177.27	
EJECTOR								
	1U0408		P-UB-10	4	6-1/2	CTC-7X2765	243.96	
	6J9573		P-UB-10	4	6-1/2	CTC-7X2765	243.96	
LOAD								
	8J9446		P-UB-10	2-1/2	5-1/2	CTC-7X2653	168.14	
	8J9446		P-UB-10	2-1/2	5-1/2	CTC-8T1374	96.66	
	8J9446		P-UB-10	2-1/2	5-1/2	CTC-9X2050	104.21	
PUMP								
	DBB; 14S; 15S; 35V; 45P							
	9J5075					CTC-9J5108	41.54	
STEERING								
	3G5192	1.11" wide wear ring, rod bearing incl	P-UB-10	2-1/2	5	CTC-1304012	198.05	
	3G5192	1.55" wide wear ring	P-UB-10	2-1/2	5	CTC-7X2743	116.28	
	5J1326		P-UB-10	2-1/4	5	CTC-7X2729	168.02	
	8J7376		P-UB-10	2-1/2	5	CTC-1315106	174.82	
MODEL 621E								
APRON								
	5J0778		P-UB-10	2-3/4	7-1/4	CTC-7X2681	117.57	

REPLACEMENT KITS FOR CATERPILLAR® EQUIPMENT

Scrapers							
APPLICATION	CYL #	Misc-Parts, Instructions, etc.	CODE	ROD	BORE	KIT #	List \$
MODEL 621E							
BOWL LIFT							
	5J2449		P-UB-10	2-1/2	6	CTC-7X2662	177.27
	5J2450		P-UB-10	2-1/2	6	CTC-7X2662	177.27
EJECTOR							
	1U0408		P-UB-10	4	6-1/2	CTC-7X2765	243.96
	9T4885		P-UB-10	4	6-1/2	CTC-7X2765	243.96
LOAD							
	1083592		P-UB-10	2-1/2	5-1/2	CTC-7X2653	168.14
	9T1803		P-UB-10	2-1/2	5-1/2	CTC-7X2653	168.14
	9T1803		P-UB-10	2-1/2	5-1/2	CTC-8T1374	96.66
STEERING							
	3G5192	1.55" wide wear ring, rod bearing incl	P-UB-10	2-1/2	5	CTC-7X2658	180.34
	4T9364		P-UB-10	2-1/4	5	CTC-7X2729	168.02
	5J1326		P-UB-10	2-1/4	5	CTC-7X2729	168.02
MODEL 621F							
LOAD							
	1083592		P-UB-10	2-1/2	5-1/2	CTC-7X2653	168.14
STEERING							
	3G5192	1.11" wide wear ring, rod bearing incl	P-UB-10	2-1/2	5	CTC-1304012	198.05
	5J1326		P-UB-10	2-1/4	5	CTC-7X2729	168.02
MODEL 621G							
LOAD							
	1083592		P-UB-10	2-1/2	5-1/2	CTC-7X2653	168.14
PUMP							
	DBB; 14S; 15S; 35V; 45P						
	9J5075					CTC-9J5108	41.54
MODEL 621R							
STEERING							
	3G5192	1.11" wide wear ring, rod bearing incl	P-UB-10	2-1/2	5	CTC-1304012	198.05
	3G5192	1.55" wide wear ring	P-UB-10	2-1/2	5	CTC-7X2743	116.28
MODEL 621S							
APRON							
	5J0778		P-UB-10	2-3/4	7-1/4	CTC-7X2681	117.57
	6E3690		P-UB-10	2-3/4	7-1/4	CTC-7X2681	117.57
BOWL LH							
	5J2450		P-UB-10	2-1/2	6	CTC-7X2662	177.27
BOWL RH							
	5J2449		P-UB-10	2-1/2	6	CTC-7X2662	177.27
EJECTOR							
	1U0408		P-UB-10	4	6-1/2	CTC-7X2765	243.96
STEERING							
	3G5192	1.11" wide wear ring, rod bearing incl	P-UB-10	2-1/2	5	CTC-1304012	198.05
MODEL 621SC							
APRON							
	5J0778		P-UB-10	2-3/4	7-1/4	CTC-7X2681	117.57
	6E3690		P-UB-10	2-3/4	7-1/4	CTC-7X2681	117.57
BOWL LH							
	5J2450		P-UB-10	2-1/2	6	CTC-7X2662	177.27
BOWL RH							
	5J2449		P-UB-10	2-1/2	6	CTC-7X2662	177.27
EJECTOR							
	1U0408		P-UB-10	4	6-1/2	CTC-7X2765	243.96
	6J9689		P-UB-10	4	6-1/2	CTC-7X2765	243.96
	9T4885		P-UB-10	4	6-1/2	CTC-7X2765	243.96
LOAD							
	8J0204		P-UB-10	2-1/2	5-1/2	CTC-9X2050	104.21

REPLACEMENT KITS FOR CATERPILLAR® EQUIPMENT

Scrapers							
APPLICATION	CYL #	Misc-Parts, Instructions, etc.	CODE	ROD	BORE	KIT #	List \$
MODEL 621SC							
STEERING							
	3G5192	1.11" wide wear ring, rod bearing incl	P-UB-10	2-1/2	5	CTC-1304012	198.05
	3G5192	1.55" wide wear ring	P-UB-10	2-1/2	5	CTC-7X2743	116.28
	5J1326		P-UB-10	2-1/4	5	CTC-7X2729	168.02
MODEL 623							
EJECTOR							
	8J5478		P-UB-10	2-1/2	5	CTC-1304012	198.05
	8J5478		P-UB-10	2-1/2	5	CTC-7X2658	180.34
FLOOR							
	8J1821		P-UB-10	3	6	CTC-7X2698	192.84
LIFT							
	8J1876		P-UB-10	2-1/2	6	CTC-7X2662	177.27
LOAD							
	8J0204		P-UB-10	2-1/2	5-1/2	CTC-8T1374	96.66
	8J0204		P-UB-10	2-1/2	5-1/2	CTC-9X2050	104.21
	9J0537		P-UB-10	2-1/2	6-1/2	CTC-8T1376	82.33
	9T1803		P-UB-10	2-1/2	5-1/2	CTC-7X2653	168.14
STEERING							
	5J1326		P-UB-10	2-1/4	5	CTC-7X2729	168.02
MODEL 623B							
BOWL LIFT							
	8J1876		P-UB-10	2-1/2	6	CTC-7X2662	177.27
EJECTOR							
	8J5478		P-UB-10	2-1/2	5	CTC-7X2658	180.34
FLOOR							
	8J1821		P-UB-10	3	6	CTC-7X2698	192.84
LOAD							
	8J9446		P-UB-10	2-1/2	5-1/2	CTC-7X2653	168.14
	8J9446		P-UB-10	2-1/2	5-1/2	CTC-8T1374	96.66
PUMP							
	46P						
	9J5074					CTC-9J5114	27.82
	9J5076					CTC-9J5108	41.54
STEERING							
	3G5192	1.11" wide wear ring, rod bearing incl	P-UB-10	2-1/2	5	CTC-1304012	198.05
	3G5192	1.55" wide wear ring, rod bearing incl	P-UB-10	2-1/2	5	CTC-7X2658	180.34
	3G5192	1.55" wide wear ring	P-UB-10	2-1/2	5	CTC-7X2743	116.28
	8J7376		P-UB-10	2-1/2	5	CTC-1315106	174.82
WAGON DOOR							
	3G4640		P-UB-10	2-1/2	6	CTC-7X2669	241.94
MODEL 623E							
BOWL LIFT							
	8J1876		P-UB-10	2-1/2	6	CTC-7X2662	177.27
EJECTOR							
	8J5478		P-UB-10	2-1/2	5	CTC-7X2658	180.34
	9T4886		P-U-10	4-1/2	6	CTC-8C6958	267.96
FLOOR							
	8J1821		P-UB-10	3	6	CTC-7X2698	192.84
LOAD							
	1083592		P-UB-10	2-1/2	5-1/2	CTC-7X2653	168.14
	9T1803		P-UB-10	2-1/2	5-1/2	CTC-7X2653	168.14
	9T1803		P-UB-10	2-1/2	5-1/2	CTC-8T1374	96.66
STEERING							
	3G5192	1.55" wide wear ring, rod bearing incl	P-UB-10	2-1/2	5	CTC-7X2658	180.34

REPLACEMENT KITS FOR CATERPILLAR® EQUIPMENT

Scrapers							
APPLICATION	CYL #	Misc-Parts, Instructions, etc.	CODE	ROD	BORE	KIT #	List \$
MODEL 623F, 623G							
LOAD							
	1083592		P-UB-10	2-1/2	5-1/2	CTC-7X2653	168.14
MODEL 623SC							
EJECTOR							
	8J5478		P-UB-10	2-1/2	5	CTC-1304012	198.05
	8J5478		P-UB-10	2-1/2	5	CTC-7X2658	180.34
FLOOR							
	8J1821		P-UB-10	3	6	CTC-7X2698	192.84
LIFT							
	8J1876		P-UB-10	2-1/2	6	CTC-7X2662	177.27
LOAD							
	8J0204		P-UB-10	2-1/2	5-1/2	CTC-9X2050	104.21
STEERING							
	3G5192	1.11" wide wear ring, rod bearing incl	P-UB-10	2-1/2	5	CTC-1304012	198.05
	3G5192	1.55" wide wear ring	P-UB-10	2-1/2	5	CTC-7X2743	116.28
	5J1326		P-UB-10	2-1/4	5	CTC-7X2729	168.02
MODEL 623SCG							
EJECTOR							
	8J5478		P-UB-10	2-1/2	5	CTC-1304012	198.05
LIFT							
	8J1876		P-UB-10	2-1/2	6	CTC-7X2662	177.27
STEERING							
	3G5192	1.11" wide wear ring, rod bearing incl	P-UB-10	2-1/2	5	CTC-1304012	198.05
MODEL 627							
APRON							
	5J0778		P-UB-10	2-3/4	7-1/4	CTC-7X2681	117.57
BAIL							
	4T5638		P-UB-10	1-3/4	3	CTC-7X2791	91.70
	8J6064		P-U-10	2	3-1/2	CTC-7X2806	125.58
BOWL LH							
	5J2450	Incl. Buffer & Rod Brg - Wear Ring 1.74"	P-UB-10	2-1/2	6	CTC-7X2662	177.27
BOWL LIFT							
	5J2449	Piston # C9J8047 - Wear Ring 1.74"	P-V-10	2-1/2	6	CTC-0514131	126.84
	5J2449	Piston # C5J0968 - Wear Ring 1.31"	P-UB-10	2-1/2	6	CTC-7X2679	143.00
	5J2450	Piston # C9J8047 - Wear Ring 1.74"	P-V-10	2-1/2	6	CTC-0514131	126.84
	5J2450	Piston # C9J8047 - Wear Ring 1.31"	P-UB-10	2-1/2	6	CTC-7X2679	143.00
BOWL RH							
	5J2449	Incl. Buffer & Rod Brg - Wear Ring 1.74"	P-UB-10	2-1/2	6	CTC-7X2662	177.27
EJECTOR							
	1U0408		P-UB-10	4	6-1/2	CTC-7X2765	243.96
LOAD							
	8J0204		P-UB-10	2-1/2	5-1/2	CTC-9X2050	104.21
LOAD CUSHION HITCH							
	8J0204		P-UB-10	2-1/2	5-1/2	CTC-8T1374	96.66
	9J0537		P-UB-10	2-1/2	6-1/2	CTC-8T1376	82.33
	9T1803		P-UB-10	2-1/2	5-1/2	CTC-7X2653	168.14
STEERING							
	5J1326		P-UB-10	2-1/4	5	CTC-7X2729	168.02
MODEL 627B							
APRON							
	5J0778		P-UB-10	2-3/4	7-1/4	CTC-7X2681	117.57
BAIL							
	8J6064		P-U-10	2	3-1/2	CTC-7X2806	125.58
	8J8458		P-UB-10	1-1/2	3-1/2	CTC-7X2752	98.74

REPLACEMENT KITS FOR CATERPILLAR® EQUIPMENT

Scrapers							
APPLICATION	CYL #	Misc-Parts, Instructions, etc.	CODE	ROD	BORE	KIT #	List \$
MODEL 627B							
BOWL LIFT							
5J2449		Piston # C9J8047 - Wear Ring 1.74"	P-V-10	2-1/2	6	CTC-0514131	126.84
5J2449		Incl. Buffer & Rod Brg - Wear Ring 1.74"	P-UB-10	2-1/2	6	CTC-7X2662	177.27
5J2449		Piston # C5J0968 - Wear Ring 1.31"	P-UB-10	2-1/2	6	CTC-7X2679	143.00
5J2450		Piston # C9J8047 - Wear Ring 1.74"	P-V-10	2-1/2	6	CTC-0514131	126.84
5J2450		Incl. Buffer & Rod Brg - Wear Ring 1.74"	P-UB-10	2-1/2	6	CTC-7X2662	177.27
5J2450		Piston # C9J8047 - Wear Ring 1.31"	P-UB-10	2-1/2	6	CTC-7X2679	143.00
EJECTOR							
1U0408			P-UB-10	4	6-1/2	CTC-7X2765	243.96
6J9573			P-UB-10	4	6-1/2	CTC-7X2765	243.96
LOAD							
8J9446			P-UB-10	2-1/2	5-1/2	CTC-7X2653	168.14
8J9446			P-UB-10	2-1/2	5-1/2	CTC-8T1374	96.66
PUMP							
14S; 15S							
9J5135						CTC-9J5108	41.54
DBB; 14S; 15S; 35V; 45P							
9J5075						CTC-9J5108	41.54
STEERING							
3G5192	1.11" wide wear ring, rod bearing incl		P-UB-10	2-1/2	5	CTC-1304012	198.05
3G5192	1.55" wide wear ring, rod bearing incl		P-UB-10	2-1/2	5	CTC-7X2658	180.34
3G5192	1.55" wide wear ring		P-UB-10	2-1/2	5	CTC-7X2743	116.28
5J1326			P-UB-10	2-1/4	5	CTC-7X2729	168.02
8J7376			P-UB-10	2-1/2	5	CTC-1315106	174.82
MODEL 627E							
APRON							
5J0778			P-UB-10	2-3/4	7-1/4	CTC-7X2681	117.57
BAIL							
4T5638			P-UB-10	1-3/4	3	CTC-7X2791	91.70
BOWL LIFT							
5J2449		Wear Ring 1.74"	P-UB-10	2-1/2	6	CTC-7X2662	177.27
5J2450		Wear Ring 1.74"	P-UB-10	2-1/2	6	CTC-7X2662	177.27
EJECTOR							
1U0408			P-UB-10	4	6-1/2	CTC-7X2765	243.96
9T4885			P-UB-10	4	6-1/2	CTC-7X2765	243.96
LOAD							
1083592			P-UB-10	2-1/2	5-1/2	CTC-7X2653	168.14
9T1803			P-UB-10	2-1/2	5-1/2	CTC-7X2653	168.14
9T1803			P-UB-10	2-1/2	5-1/2	CTC-8T1374	96.66
STEERING							
3G5192	1.55" wide wear ring, rod bearing incl		P-UB-10	2-1/2	5	CTC-7X2658	180.34
3G6904			P-UB-10	2-1/2	5	CTC-7X2658	180.34
5J1326			P-UB-10	2-1/4	5	CTC-7X2729	168.02
MODEL 627F							
BAIL							
6E0801			P-UB-10	1-3/4	3	CTC-7X2825	55.57
BOWL LIFT							
5J2449		Wear Ring 1.74"	P-UB-10	2-1/2	6	CTC-7X2662	177.27
5J2450		Wear Ring 1.74"	P-UB-10	2-1/2	6	CTC-7X2662	177.27
LOAD							
1083592			P-UB-10	2-1/2	5-1/2	CTC-7X2653	168.14
MODEL 627G							
BOWL LIFT							
5J2449		Wear Ring 1.74"	P-UB-10	2-1/2	6	CTC-7X2662	177.27
5J2450		Wear Ring 1.74"	P-UB-10	2-1/2	6	CTC-7X2662	177.27

REPLACEMENT KITS FOR CATERPILLAR® EQUIPMENT

Scrapers							
APPLICATION	CYL #	Misc-Parts, Instructions, etc.	CODE	ROD	BORE	KIT #	List \$
MODEL 627SC							
APRON							
	5J0778		P-UB-10	2-3/4	7-1/4	CTC-7X2681	117.57
	6E3690		P-UB-10	2-3/4	7-1/4	CTC-7X2681	117.57
BAIL							
	7J2377		P-U-10	2	3-1/2	CTC-7X2806	125.58
	8J6064		P-U-10	2	3-1/2	CTC-7X2806	125.58
BOWL LH							
	5J2450		P-UB-10	2-1/2	6	CTC-7X2662	177.27
BOWL RH							
	5J2449		P-UB-10	2-1/2	6	CTC-7X2662	177.27
EJECTOR							
	1U0408		P-UB-10	4	6-1/2	CTC-7X2765	243.96
	9T4885		P-UB-10	4	6-1/2	CTC-7X2765	243.96
LOAD							
	8J0204		P-UB-10	2-1/2	5-1/2	CTC-9X2050	104.21
STEERING							
	3G5192	1.11" wide wear ring, rod bearing incl	P-UB-10	2-1/2	5	CTC-1304012	198.05
	3G5192	1.55" wide wear ring, rod bearing incl	P-UB-10	2-1/2	5	CTC-7X2658	180.34
	3G5192	1.55" wide wear ring	P-UB-10	2-1/2	5	CTC-7X2743	116.28
	5J1326		P-UB-10	2-1/4	5	CTC-7X2729	168.02
MODEL 630							
TRACTION CONTROL							
	4D0470		P-V-10	2	5	CTC-7X2763	140.20
	4D5543		P-V-10	2	5	CTC-7X2763	140.20
MODEL 630B							
BOWL							
	6J1983		P-UB-10	3	8-1/4	CTC-7X2695	367.89
EJECTOR							
	6J1419		I-U-10	6	8-1/4	CTC-1180672	677.68
	6J1419		P-V-10	6	8-1/4	CTC-8T1415	306.19
MODEL 630SC							
EJECTOR							
	6J1419		I-U-10	6	8-1/4	CTC-1180672	677.68
MODEL 631							
APRON							
	8J5931		P-UB-10	3	8-1/4	CTC-7X2695	367.89
LIFT RH							
	7J2395		P-UB-10	2-3/4	7-1/4	CTC-7X2687	275.73
LOAD							
	8J9959		P-UB-10	2-1/2	6-1/2	CTC-8T1376	82.33
MODEL 631B							
BOWL LIFT							
	3G9677		P-UB-10	2-3/4	7-1/4	CTC-7X2687	275.73
	7J2395		P-UB-10	2-3/4	7-1/4	CTC-7X2687	275.73
	7J2396		P-UB-10	2-3/4	7-1/4	CTC-7X2687	275.73
EJECTOR							
	6J1419		I-U-10	6	8-1/4	CTC-1180672	677.68
	6J1419		P-V-10	6	8-1/4	CTC-8T1415	306.19
LIFT							
	3G9677		P-UB-10	2-3/4	7-1/4	CTC-7X2687	275.73
LOAD CUSHION HITCH							
	9J0537		P-UB-10	2-1/2	6-1/2	CTC-8T1376	82.33

REPLACEMENT KITS FOR CATERPILLAR® EQUIPMENT

Scrapers							
APPLICATION	CYL #	Misc-Parts, Instructions, etc.	CODE	ROD	BORE	KIT #	List \$
MODEL 631B							
STEERING							
	3J9031		P-UB-10	2-1/2	6-1/2	CTC-8T1376	82.33
	5J1250		P-UB-10	2-1/2	6-1/2	CTC-8T1376	82.33
	5J7806		P-UB-10	2-1/2	6-1/2	CTC-8T1376	82.33
	5J8606		P-UB-10	2-1/2	6-1/2	CTC-1370264	181.70
	8J3544		P-UB-10	2-1/2	6-1/2	CTC-8T1376	82.33
STEERING RH							
	7J1693		P-UB-10	2-1/2	6-1/2	CTC-8T1376	82.33
MODEL 631C							
APRON							
	8J5931		P-UB-10	3	8-1/4	CTC-7X2695	367.89
BOWL LIFT							
	7J2395		P-UB-10	2-3/4	7-1/4	CTC-7X2687	275.73
	7J2396		P-UB-10	2-3/4	7-1/4	CTC-7X2687	275.73
EJECTOR							
	6J1419		I-U-10	6	8-1/4	CTC-1180672	677.68
	6J1419		P-V-10	6	8-1/4	CTC-8T1415	306.19
LIFT LH							
	7J2396		P-UB-10	2-3/4	7-1/4	CTC-7X2687	275.73
LIFT RH							
	7J2395		P-UB-10	2-3/4	7-1/4	CTC-7X2687	275.73
LOAD							
	7J3386		P-UB-10	2-1/2	6	CTC-7X2836	265.91
	9J0537		P-UB-10	2-1/2	6-1/2	CTC-8T1376	82.33
PUMP							
	65M; 66M; 67M; 79P						
	9J5042					CTC-9J5115	37.59
	65M; 67M; 79P						
	9J5052					CTC-9J5111	43.41
STEERING							
	5J7806		P-UB-10	2-1/2	6-1/2	CTC-8T1376	82.33
MODEL 631D							
APRON							
	8J5931		P-UB-10	3	8-1/4	CTC-7X2695	367.89
EJECTOR							
	6J1419		I-U-10	6	8-1/4	CTC-1180672	677.68
	6J1419		P-V-10	6	8-1/4	CTC-8T1415	306.19
	6J5824		P-V-10	6	8-1/4	CTC-8T1415	306.19
LIFT LH							
	9J0409		P-UB-10	2-3/4	7-1/4	CTC-7X2687	275.73
LIFT RH							
	9J0408		P-UB-10	2-3/4	7-1/4	CTC-7X2687	275.73
LOAD							
	8J9959		P-UB-10	2-1/2	6-1/2	CTC-1370264	181.70
	8J9959		P-UB-10	2-1/2	6-1/2	CTC-8T1376	82.33
STEERING							
	3G7607		P-UB-10	2-3/4	6-1/2	CTC-7X2689	166.65
	8J9918		P-UB-10	2-3/4	6-1/2	CTC-7X2689	166.65
MODEL 631E							
APRON							
	8J5931		P-UB-10	3	8-1/4	CTC-7X2695	367.89

REPLACEMENT KITS FOR CATERPILLAR® EQUIPMENT

Scrapers							
APPLICATION	CYL #	Misc-Parts, Instructions, etc.	CODE	ROD	BORE	KIT #	List \$
MODEL 631E							
EJECTOR							
	6E0897		P-UB-10	3	8-1/4	CTC-7X2695	367.89
	6J5824		P-V-10	6	8-1/4	CTC-8T1415	306.19
	9T3595		I-U-10	6	8-1/4	CTC-1180672	677.68
	9T3595		P-V-10	6	8-1/4	CTC-8T1415	306.19
	9T4887		I-U-10	6	8-1/4	CTC-1180672	677.68
	9T4887		P-V-10	6	8-1/4	CTC-8T1415	306.19
LIFT RH							
	9J0408		P-UB-10	2-3/4	7-1/4	CTC-7X2687	275.73
LOAD							
	8J9959		P-UB-10	2-1/2	6-1/2	CTC-1370264	181.70
	8J9959		P-UB-10	2-1/2	6-1/2	CTC-8T1376	82.33
STEERING							
	3G7607		P-UB-10	2-3/4	6-1/2	CTC-7X2689	166.65
	5J7806		P-UB-10	2-1/2	6-1/2	CTC-8T1376	82.33
MODEL 631SC							
APRON							
	8J5931		P-UB-10	3	8-1/4	CTC-7X2695	367.89
EJECTOR							
	6E0897		I-U-10	6	8-1/4	CTC-1180672	677.68
	6E0905		I-U-10	6	8-1/4	CTC-1180672	677.68
	6J1419		I-U-10	6	8-1/4	CTC-1180672	677.68
	6J5824		I-U-10	6	8-1/4	CTC-1180672	677.68
	6J5824		P-V-10	6	8-1/4	CTC-8T1415	306.19
	9T3595		I-U-10	6	8-1/4	CTC-1180672	677.68
	9T4887		I-U-10	6	8-1/4	CTC-1180672	677.68
LIFT LH							
	7J2396		P-UB-10	2-3/4	7-1/4	CTC-7X2687	275.73
	9J0409		P-UB-10	2-3/4	7-1/4	CTC-7X2687	275.73
LIFT RH							
	7J2395		P-UB-10	2-3/4	7-1/4	CTC-7X2687	275.73
	9J0408		P-UB-10	2-3/4	7-1/4	CTC-7X2687	275.73
LOAD							
	7J3386		P-UB-10	2-1/2	6	CTC-7X2836	265.91
STEERING							
	3G7607		P-UB-10	2-3/4	6-1/2	CTC-7X2689	166.65
	3J9031		P-UB-10	2-1/2	6-1/2	CTC-8T1376	82.33
	5J1250		P-UB-10	2-1/2	6-1/2	CTC-8T1376	82.33
	5J7806		P-UB-10	2-1/2	6-1/2	CTC-8T1376	82.33
MODEL 632							
BOWL LIFT							
	6J1983		P-UB-10	3	8-1/4	CTC-7X2695	367.89
EJECTOR							
	6J1419		I-U-10	6	8-1/4	CTC-1180672	677.68
	6J1419		P-V-10	6	8-1/4	CTC-8T1415	306.19
TRACTION CONTROL							
	4D0470		P-V-10	2	5	CTC-7X2763	140.20
	4D5543		P-V-10	2	5	CTC-7X2763	140.20
MODEL 633							
BOWL LIFT							
	3G9677		P-UB-10	2-3/4	7-1/4	CTC-7X2687	275.73
LIFT							
	3G9677		P-UB-10	2-3/4	7-1/4	CTC-7X2687	275.73
LOAD CUSHION HITCH							
	9J0537		P-UB-10	2-1/2	6-1/2	CTC-8T1376	82.33

CATERPILLAR®

REPLACEMENT KITS FOR CATERPILLAR® EQUIPMENT

Scrapers							
APPLICATION	CYL #	Misc-Parts, Instructions, etc.	CODE	ROD	BORE	KIT #	List \$
MODEL 633							
STEERING							
	5J7806		P-UB-10	2-1/2	6-1/2	CTC-1370264	181.70
	5J7806		P-UB-10	2-1/2	6-1/2	CTC-8T1376	82.33
	8J3544		P-UB-10	2-1/2	6-1/2	CTC-8T1376	82.33
STEERING RH							
	7J1693		P-UB-10	2-1/2	6-1/2	CTC-8T1376	82.33
MODEL 633B							
BOWL LIFT							
	3G9677		P-UB-10	2-3/4	7-1/4	CTC-7X2687	275.73
LOAD CUSHION HITCH							
	9J0537		P-UB-10	2-1/2	6-1/2	CTC-8T1376	82.33
STEERING							
	5J7806		P-UB-10	2-1/2	6-1/2	CTC-8T1376	82.33
	6J1516		P-UB-10	2-1/2	6-1/2	CTC-8T1376	82.33
	8J3544		P-UB-10	2-1/2	6-1/2	CTC-8T1376	82.33
STEERING RH							
	7J1693		P-UB-10	2-1/2	6-1/2	CTC-8T1376	82.33
MODEL 633C							
BOWL LIFT							
	3G9677		P-UB-10	2-3/4	7-1/4	CTC-7X2687	275.73
LIFT							
	3G9677		P-UB-10	2-3/4	7-1/4	CTC-7X2687	275.73
LOAD							
	7J3386		P-UB-10	2-1/2	6	CTC-7X2836	265.91
	9J0537		P-UB-10	2-1/2	6-1/2	CTC-1370264	181.70
	9J0537		P-UB-10	2-1/2	6-1/2	CTC-8T1376	82.33
PUMP							
	65M; 66M; 67M; 79P						
	9J5042					CTC-9J5115	37.59
	66M						
	9J5057					CTC-9J5114	27.82
	9J5062					CTC-9J5111	43.41
STEERING							
	5J7806		P-UB-10	2-1/2	6-1/2	CTC-1370264	181.70
	5J7806		P-UB-10	2-1/2	6-1/2	CTC-8T1376	82.33
	6J1516		P-UB-10	2-1/2	6-1/2	CTC-8T1376	82.33
	8J3544		P-UB-10	2-1/2	6-1/2	CTC-1370264	181.70
	8J3544		P-UB-10	2-1/2	6-1/2	CTC-8T1376	82.33
STEERING RH							
	7J1693		P-UB-10	2-1/2	6-1/2	CTC-8T1376	82.33
MODEL 633D							
BOWL LIFT							
	3G9677		P-UB-10	2-3/4	7-1/4	CTC-7X2687	275.73
	7J0243		P-UB-10	2-3/4	7-1/4	CTC-7X2687	275.73
EJECTOR							
	9T3595		I-U-10	6	8-1/4	CTC-1180672	677.68
	9T3595		P-V-10	6	8-1/4	CTC-8T1415	306.19
LOAD							
	1083591		P-UB-10	2-1/2	6-1/2	CTC-1656035	186.78
	8J9959		P-UB-10	2-1/2	6-1/2	CTC-1370264	181.70
	8J9959		P-UB-10	2-1/2	6-1/2	CTC-8T1376	82.33
PUMP							
	25W						
	9J0694					CTC-9J5111	43.41
	4YR; 25W; 58K; 65K; 66K; 67K; 68K						
	9J5044					CTC-9J5108	41.54

REPLACEMENT KITS FOR CATERPILLAR® EQUIPMENT

Scrapers							
APPLICATION	CYL #	Misc-Parts, Instructions, etc.	CODE	ROD	BORE	KIT #	List \$
MODEL 633D							
STEERING							
	3G7607		P-UB-10	2-3/4	6-1/2	CTC-7X2689	166.65
	6J1516		P-UB-10	2-1/2	6-1/2	CTC-8T1376	82.33
	8J9918		P-UB-10	2-3/4	6-1/2	CTC-7X2689	166.65
STEERING RH							
	7J1693		P-UB-10	2-1/2	6-1/2	CTC-8T1376	82.33
MODEL 633SC							
BOWL							
	1313223		P-UB-10	2-3/4	7-1/4	CTC-7X2687	275.73
EJECTOR							
	1U0408		P-UB-10	4	6-1/2	CTC-7X2765	243.96
LIFT							
	3G9677		P-UB-10	2-3/4	7-1/4	CTC-7X2687	275.73
LOAD							
	7J3386		P-UB-10	2-1/2	6	CTC-7X2836	265.91
STEERING							
	5J7806		P-UB-10	2-1/2	6-1/2	CTC-8T1376	82.33
	6J1516		P-UB-10	2-1/2	6-1/2	CTC-8T1376	82.33
	8J3544		P-UB-10	2-1/2	6-1/2	CTC-8T1376	82.33
STEERING RH							
	7J1693		P-UB-10	2-1/2	6-1/2	CTC-8T1376	82.33
MODEL 637							
APRON							
	8J5931		P-UB-10	3	8-1/4	CTC-7X2695	367.89
BAIL							
	4T5638		P-UB-10	1-3/4	3	CTC-7X2791	91.70
	7J2377		P-U-10	2	3-1/2	CTC-7X2806	125.58
	8J6064		P-U-10	2	3-1/2	CTC-7X2806	125.58
BOWL LIFT							
	7J2395		P-UB-10	2-3/4	7-1/4	CTC-7X2687	275.73
	7J2396		P-UB-10	2-3/4	7-1/4	CTC-7X2687	275.73
EJECTOR							
	6J5824		I-U-10	6	8-1/4	CTC-1180672	677.68
	6J5824		P-V-10	6	8-1/4	CTC-8T1415	306.19
LIFT LH							
	7J2396		P-UB-10	2-3/4	7-1/4	CTC-7X2687	275.73
LIFT RH							
	7J2395		P-UB-10	2-3/4	7-1/4	CTC-7X2687	275.73
LOAD							
	7J3386		P-UB-10	2-1/2	6	CTC-7X2836	265.91
	8J9959		P-UB-10	2-1/2	6-1/2	CTC-8T1376	82.33
	9J0537		P-UB-10	2-1/2	6-1/2	CTC-1370264	181.70
	9J0537		P-UB-10	2-1/2	6-1/2	CTC-8T1376	82.33
PUMP							
	65M; 66M; 67M; 79P						
	9J5042					CTC-9J5115	37.59
	65M; 67M; 79P						
	9J5052					CTC-9J5111	43.41
STEERING							
	5J7806		P-UB-10	2-1/2	6-1/2	CTC-1370264	181.70
	5J7806		P-UB-10	2-1/2	6-1/2	CTC-8T1376	82.33
MODEL 637B							
APRON							
	8J5931		P-UB-10	3	8-1/4	CTC-7X2695	367.89

REPLACEMENT KITS FOR CATERPILLAR® EQUIPMENT

Scrapers							
APPLICATION	CYL #	Misc-Parts, Instructions, etc.	CODE	ROD	BORE	KIT #	List \$
MODEL 637B							
BOWL LIFT							
	7J2395		P-UB-10	2-3/4	7-1/4	CTC-7X2687	275.73
	7J2396		P-UB-10	2-3/4	7-1/4	CTC-7X2687	275.73
EJECTOR							
	6J5824		P-V-10	6	8-1/4	CTC-8T1415	306.19
MODEL 637D							
APRON							
	8J5931		P-UB-10	3	8-1/4	CTC-7X2695	367.89
BAIL							
	8J6064		P-U-10	2	3-1/2	CTC-7X2806	125.58
	8J8458		P-UB-10	1-1/2	3-1/2	CTC-7X2752	98.74
EJECTOR							
	6J5824		P-V-10	6	8-1/4	CTC-8T1415	306.19
LIFT LH							
	9J0409		P-UB-10	2-3/4	7-1/4	CTC-7X2687	275.73
LIFT RH							
	9J0408		P-UB-10	2-3/4	7-1/4	CTC-7X2687	275.73
LOAD							
	8J9959		P-UB-10	2-1/2	6-1/2	CTC-1370264	181.70
	8J9959		P-UB-10	2-1/2	6-1/2	CTC-8T1376	82.33
STEERING							
	3G7607		P-UB-10	2-3/4	6-1/2	CTC-7X2689	166.65
	8J9918		P-UB-10	2-3/4	6-1/2	CTC-7X2689	166.65
MODEL 637E							
APRON							
	8J5931		P-UB-10	3	8-1/4	CTC-7X2695	367.89
BAIL							
	4T5638		P-UB-10	1-3/4	3	CTC-7X2791	91.70
EJECTOR							
	6J5824		P-V-10	6	8-1/4	CTC-8T1415	306.19
	9T3595		I-U-10	6	8-1/4	CTC-1180672	677.68
	9T3595		P-V-10	6	8-1/4	CTC-8T1415	306.19
	9T4887		I-U-10	6	8-1/4	CTC-1180672	677.68
	9T4887		P-V-10	6	8-1/4	CTC-8T1415	306.19
LIFT LH							
	9J0409		P-UB-10	2-3/4	7-1/4	CTC-7X2687	275.73
LIFT RH							
	9J0408		P-UB-10	2-3/4	7-1/4	CTC-7X2687	275.73
LOAD							
	8J9959		P-UB-10	2-1/2	6-1/2	CTC-1370264	181.70
	8J9959		P-UB-10	2-1/2	6-1/2	CTC-8T1376	82.33
STEERING							
	3G7607		P-UB-10	2-3/4	6-1/2	CTC-7X2689	166.65
MODEL 637SC							
APRON							
	8J5931		P-UB-10	3	8-1/4	CTC-7X2695	367.89
BAIL							
	7J2377		P-U-10	2	3-1/2	CTC-7X2806	125.58
	8J6064		P-U-10	2	3-1/2	CTC-7X2806	125.58
EJECTOR							
	6E0897		I-U-10	6	8-1/4	CTC-1180672	677.68
	6E0905		I-U-10	6	8-1/4	CTC-1180672	677.68
	6J5824		I-U-10	6	8-1/4	CTC-1180672	677.68
	6J5824		P-V-10	6	8-1/4	CTC-8T1415	306.19
	9T3595		I-U-10	6	8-1/4	CTC-1180672	677.68
	9T4887		I-U-10	6	8-1/4	CTC-1180672	677.68

REPLACEMENT KITS FOR CATERPILLAR® EQUIPMENT

Scrapers							
APPLICATION	CYL #	Misc-Parts, Instructions, etc.	CODE	ROD	BORE	KIT #	List \$
MODEL 637SC							
LIFT LH							
	7J2396		P-UB-10	2-3/4	7-1/4	CTC-7X2687	275.73
	9J0409		P-UB-10	2-3/4	7-1/4	CTC-7X2687	275.73
LIFT RH							
	7J2395		P-UB-10	2-3/4	7-1/4	CTC-7X2687	275.73
	9J0408		P-UB-10	2-3/4	7-1/4	CTC-7X2687	275.73
LOAD							
	7J3386		P-UB-10	2-1/2	6	CTC-7X2836	265.91
STEERING							
	3G7607		P-UB-10	2-3/4	6-1/2	CTC-7X2689	166.65
	5J7806		P-UB-10	2-1/2	6-1/2	CTC-8T1376	82.33
MODEL 639D							
BOWL LIFT							
	3G9677		P-UB-10	2-3/4	7-1/4	CTC-7X2687	275.73
EJECTOR							
	3G2949		P-UB-10	2-1/2	4-1/2	CTC-7X2667	98.87
LOAD							
	8J9959		P-UB-10	2-1/2	6-1/2	CTC-1370264	181.70
	8J9959		P-UB-10	2-1/2	6-1/2	CTC-8T1376	82.33
STEERING							
	3G7607		P-UB-10	2-3/4	6-1/2	CTC-7X2689	166.65
MODEL 639SC							
EJECTOR							
	3G2949		P-UB-10	2-1/2	4-1/2	CTC-7X2667	98.87
LIFT							
	3G9677		P-UB-10	2-3/4	7-1/4	CTC-7X2687	275.73
MODEL 641							
APRON							
	5J8117		P-UB-10	3-1/4	9-1/4	CTC-1328576	332.41
BOWL LIFT LH							
	6J1983		P-UB-10	3	8-1/4	CTC-7X2695	367.89
	7J4364		P-UB-10	3	8-1/4	CTC-7X2695	367.89
BOWL LIFT RH							
	7J4363		P-UB-10	3	8-1/4	CTC-7X2695	367.89
CUSHION HITCH							
	7J4623		P-UB-10	3-1/2	8-1/4	CTC-7X2725	402.70
LOAD							
	5J8623		P-UB-10	3-1/2	8-1/4	CTC-7X2728	181.07
	7J4623		P-UB-10	3-1/2	8-1/4	CTC-7X2725	402.70
STEERING							
	3G9689		P-UB-10	2-3/4	7-1/4	CTC-1372489	190.78
	3G9689	Includes rod bearing	P-UB-10	2-3/4	7-1/4	CTC-7X2687	275.73
MODEL 641B							
APRON							
	5J8117		P-UB-10	3-1/4	9-1/4	CTC-1328576	332.41
BOWL LIFT LH							
	6J1983		P-UB-10	3	8-1/4	CTC-7X2695	367.89
	7J4364		P-UB-10	3	8-1/4	CTC-7X2695	367.89
BOWL LIFT RH							
	7J4363		P-UB-10	3	8-1/4	CTC-7X2695	367.89
CUSHION HITCH							
	7J4623		P-UB-10	3-1/2	8-1/4	CTC-7X2725	402.70
LOAD							
	5J8623		P-UB-10	3-1/2	8-1/4	CTC-7X2728	181.07
	7J4623		P-UB-10	3-1/2	8-1/4	CTC-7X2725	402.70

REPLACEMENT KITS FOR CATERPILLAR® EQUIPMENT

Scrapers							
APPLICATION	CYL #	Misc-Parts, Instructions, etc.	CODE	ROD	BORE	KIT #	List \$
MODEL 641B							
PUMP							
	4YR; 25W; 58K; 65K; 66K; 67K; 68K						
	9J5044					CTC-9J5108	41.54
STEERING							
	3G9689		P-UB-10	2-3/4	7-1/4	CTC-1372489	190.78
	3G9689	Includes rod bearing	P-UB-10	2-3/4	7-1/4	CTC-7X2687	275.73
MODEL 641SC							
BOWL							
	6J1983		P-UB-10	3	8-1/4	CTC-7X2695	367.89
BOWL LH							
	7J4364		P-UB-10	3	8-1/4	CTC-7X2695	367.89
BOWL RH							
	7J4363		P-UB-10	3	8-1/4	CTC-7X2695	367.89
LOAD							
	5J8623		P-UB-10	3-1/2	8-1/4	CTC-7X2728	181.07
	7J4623		P-UB-10	3-1/2	8-1/4	CTC-7X2725	402.70
MODEL 650							
BOWL LIFT LH							
	7J4356		P-UB-10	3-1/4	9-1/4	CTC-7X2716	165.19
	7J4406		P-UB-10	3-1/4	9-1/4	CTC-7X2716	165.19
BOWL LIFT RH							
	7J4355		P-UB-10	3-1/4	9-1/4	CTC-7X2716	165.19
	7J4405		P-UB-10	3-1/4	9-1/4	CTC-7X2716	165.19
SPECIAL APPLICATION							
	4J2064		P-UB-10	2-1/2	6	CTC-7X2679	143.00
	4J9996		P-UB-10	2-1/2	7-1/4	CTC-7X2661	187.26
MODEL 650B							
BOWL LIFT LH							
	7J4356		P-UB-10	3-1/4	9-1/4	CTC-7X2716	165.19
	7J4406		P-UB-10	3-1/4	9-1/4	CTC-7X2716	165.19
BOWL LIFT RH							
	7J4355		P-UB-10	3-1/4	9-1/4	CTC-7X2716	165.19
	7J4405		P-UB-10	3-1/4	9-1/4	CTC-7X2716	165.19
PUMP							
	4YR; 25W; 58K; 65K; 66K; 67K; 68K						
	9J5044					CTC-9J5108	41.54
MODEL 651							
APRON							
	5J8117		P-UB-10	3-1/4	9-1/4	CTC-7X2708	210.93
BOWL LIFT LH							
	7J4398		P-UB-10	3-1/4	9-1/4	CTC-7X2716	165.19
BOWL LIFT RH							
	7J4397		P-UB-10	3-1/4	9-1/4	CTC-7X2716	165.19
CUSHION HITCH							
	7J4623		P-UB-10	3-1/2	8-1/4	CTC-7X2725	402.70
LOAD							
	3G8757		P-UB-10	3-1/2	8-1/4	CTC-7X2724	210.29
	5J8623		P-UB-10	3-1/2	8-1/4	CTC-7X2728	181.07
STEERING							
	3G9689		P-UB-10	2-3/4	7-1/4	CTC-7X2687	275.73
	4T8563		P-UB-10	3-1/4	7-1/4	CTC-7X2718	205.60
MODEL 651B							
APRON							
	5J8117		P-UB-10	3-1/4	9-1/4	CTC-7X2708	210.93
BOWL LIFT LH							
	7J4398		P-UB-10	3-1/4	9-1/4	CTC-7X2716	165.19

REPLACEMENT KITS FOR CATERPILLAR® EQUIPMENT

Scrapers							
APPLICATION	CYL #	Misc-Parts, Instructions, etc.	CODE	ROD	BORE	KIT #	List \$
MODEL 651B							
BOWL LIFT RH	7J4397		P-UB-10	3-1/4	9-1/4	CTC-7X2716	165.19
CUSHION HITCH	7J4623		P-UB-10	3-1/2	8-1/4	CTC-7X2725	402.70
LOAD	5J8623		P-UB-10	3-1/2	8-1/4	CTC-7X2728	181.07
	7J4623		P-UB-10	3-1/2	8-1/4	CTC-7X2725	402.70
PUMP	4YR; 25W; 58K; 65K; 66K; 67K; 68K						
	9J5044					CTC-9J5108	41.54
STEERING	3G9689		P-UB-10	2-3/4	7-1/4	CTC-7X2687	275.73
	5J8149		P-UB-10	2-3/4	7-1/4	CTC-7X2687	275.73
MODEL 651C							
APRON	5J8117		P-UB-10	3-1/4	9-1/4	CTC-7X2708	210.93
STEERING	3G9689		P-UB-10	2-3/4	7-1/4	CTC-7X2687	275.73
	5J8149		P-UB-10	2-3/4	7-1/4	CTC-7X2687	275.73
MODEL 651E							
APRON	3G8621		P-UB-10	3-1/4	9-1/4	CTC-7X2708	210.93
BOWL LIFT	4T5735		P-UB-10	3-1/4	9-1/4	CTC-7X2716	165.19
	4T5736		P-UB-10	3-1/4	9-1/4	CTC-7X2716	165.19
CUSHION HITCH	3G8757		P-UB-10	3-1/2	8-1/4	CTC-7X2724	210.29
LOAD	3G8757		P-UB-10	3-1/2	8-1/4	CTC-7X2724	210.29
PUMP	4YR; 25W; 58K; 65K; 66K; 67K; 68K						
	9J5044					CTC-9J5108	41.54
STEERING	3G5516		P-UB-10	3-1/4	7-1/4	CTC-7X2718	205.60
	3G9689		P-UB-10	2-3/4	7-1/4	CTC-7X2687	275.73
	4T8563		P-UB-10	3-1/4	7-1/4	CTC-7X2718	205.60
MODEL 651SC							
APRON	3G8621		P-UB-10	3-1/4	9-1/4	CTC-7X2708	210.93
BOWL	7J4398		P-UB-10	3-1/4	9-1/4	CTC-7X2716	165.19
BOWL LH	4T5735		P-UB-10	3-1/4	9-1/4	CTC-7X2716	165.19
LOAD	5J8623		P-UB-10	3-1/2	8-1/4	CTC-7X2728	181.07
	7J4623		P-UB-10	3-1/2	8-1/4	CTC-7X2725	402.70
STEERING	4T8563		P-UB-10	3-1/4	7-1/4	CTC-7X2718	205.60
MODEL 657							
APRON	5J8117		P-UB-10	3-1/4	9-1/4	CTC-7X2708	210.93
BAIL	4T5638		P-UB-10	1-3/4	3	CTC-7X2791	91.70
	7J2377		P-U-10	2	3-1/2	CTC-7X2806	125.58
	8J6064		P-U-10	2	3-1/2	CTC-7X2806	125.58
	8J8458		P-UB-10	1-1/2	3-1/2	CTC-7X2752	98.74

REPLACEMENT KITS FOR CATERPILLAR® EQUIPMENT

Scrapers							
APPLICATION	CYL #	Misc-Parts, Instructions, etc.	CODE	ROD	BORE	KIT #	List \$
MODEL 657							
BOWL LIFT LH							
	7J4398		P-UB-10	3-1/4	9-1/4	CTC-7X2716	165.19
BOWL LIFT RH							
	7J4397		P-UB-10	3-1/4	9-1/4	CTC-7X2716	165.19
LOAD							
	3G8757		P-UB-10	3-1/2	8-1/4	CTC-7X2724	210.29
LOAD CUSHION							
	5J8623		P-UB-10	3-1/2	8-1/4	CTC-7X2725	402.70
	5J8623		P-UB-10	3-1/2	8-1/4	CTC-7X2728	181.07
	7J4623		P-UB-10	3-1/2	8-1/4	CTC-7X2725	402.70
STEERING							
	3G5516		P-UB-10	3-1/4	7-1/4	CTC-7X2718	205.60
	3G9689		P-UB-10	2-3/4	7-1/4	CTC-7X2687	275.73
	4T8563		P-UB-10	3-1/4	7-1/4	CTC-7X2718	205.60
	5J8149		P-UB-10	2-3/4	7-1/4	CTC-7X2687	275.73
MODEL 657B							
APRON							
	5J4354		P-UB-10	3-1/4	9-1/4	CTC-7X2708	210.93
	5J8117		P-UB-10	3-1/4	9-1/4	CTC-7X2708	210.93
BAIL							
	7J2377		P-U-10	2	3-1/2	CTC-7X2806	125.58
	8J6064		P-U-10	2	3-1/2	CTC-7X2806	125.58
	8J8458		P-UB-10	1-1/2	3-1/2	CTC-7X2752	98.74
BOWL LIFT LH							
	7J4398		P-UB-10	3-1/4	9-1/4	CTC-7X2716	165.19
BOWL LIFT RH							
	7J4397		P-UB-10	3-1/4	9-1/4	CTC-7X2716	165.19
LOAD							
	5J8623		P-UB-10	3-1/2	8-1/4	CTC-7X2728	181.07
	7J4623		P-UB-10	3-1/2	8-1/4	CTC-7X2725	402.70
LOAD CUSHION							
	5J8623		P-UB-10	3-1/2	8-1/4	CTC-7X2725	402.70
	7J4623		P-UB-10	3-1/2	8-1/4	CTC-7X2725	402.70
PUMP							
	4YR; 25W; 58K; 65K; 66K; 67K; 68K						
	9J5044					CTC-9J5108	41.54
STEERING							
	3G9689		P-UB-10	2-3/4	7-1/4	CTC-7X2687	275.73
	5J8149		P-UB-10	2-3/4	7-1/4	CTC-7X2687	275.73
MODEL 657E							
APRON							
	3G8621		P-UB-10	3-1/4	9-1/4	CTC-7X2708	210.93
BAIL							
	4T5638		P-UB-10	1-3/4	3	CTC-7X2791	91.70
	8J8458		P-UB-10	1-1/2	3-1/2	CTC-7X2752	98.74
BOWL LIFT							
	4T5735		P-UB-10	3-1/4	9-1/4	CTC-7X2716	165.19
	4T5736		P-UB-10	3-1/4	9-1/4	CTC-7X2716	165.19
CUSHION HITCH							
	3G8757		P-UB-10	3-1/2	8-1/4	CTC-7X2724	210.29
EJECTOR							
	9T4886		P-U-10	4-1/2	6	CTC-8C6958	267.96
	9T4887		I-U-10	6	8-1/4	CTC-1180672	677.68
	9T4887		P-V-10	6	8-1/4	CTC-8T1415	306.19
LOAD							
	3G8757		P-UB-10	3-1/2	8-1/4	CTC-7X2724	210.29

REPLACEMENT KITS FOR CATERPILLAR® EQUIPMENT

Scrapers							
APPLICATION	CYL #	Misc-Parts, Instructions, etc.	CODE	ROD	BORE	KIT #	List \$
MODEL 657E							
STEERING							
	3G5516		P-UB-10	3-1/4	7-1/4	CTC-7X2718	205.60
	4T8563		P-UB-10	3-1/4	7-1/4	CTC-7X2718	205.60
MODEL 657SC							
APRON							
	3G8621		P-UB-10	3-1/4	9-1/4	CTC-7X2708	210.93
	5J8117		P-UB-10	3-1/4	9-1/4	CTC-7X2708	210.93
BAIL							
	7J2377		P-U-10	2	3-1/2	CTC-7X2806	125.58
	8J6062		P-U-10	2	3-1/2	CTC-7X2806	125.58
	8J8457		P-UB-10	1-1/2	3-1/2	CTC-7X2752	98.74
BOWL							
	7J4398		P-UB-10	3-1/4	9-1/4	CTC-7X2716	165.19
BOWL LH							
	4T5735		P-UB-10	3-1/4	9-1/4	CTC-7X2716	165.19
BOWL RH							
	7J4397		P-UB-10	3-1/4	9-1/4	CTC-7X2716	165.19
LOAD							
	5J8623		P-UB-10	3-1/2	8-1/4	CTC-7X2728	181.07
	7J4623		P-UB-10	3-1/2	8-1/4	CTC-7X2725	402.70
STEERING							
	4T8563		P-UB-10	3-1/4	7-1/4	CTC-7X2718	205.60
MODEL 660							
BOWL LIFT LH							
	7J4356		P-UB-10	3-1/4	9-1/4	CTC-1328608	250.20
BOWL LIFT RH							
	7J4355		P-UB-10	3-1/4	9-1/4	CTC-1328608	250.20
SPECIAL APPLICATION							
	4J2064		P-UB-10	2-1/2	6	CTC-7X2679	143.00
MODEL 660B							
BOWL LIFT LH							
	7J4356		P-UB-10	3-1/4	9-1/4	CTC-1328608	250.20
	7J4406		P-UB-10	3-1/4	9-1/4	CTC-7X2716	165.19
BOWL LIFT RH							
	7J4355		P-UB-10	3-1/4	9-1/4	CTC-1328608	250.20
	7J4405		P-UB-10	3-1/4	9-1/4	CTC-7X2716	165.19
PUMP							
	4YR; 25W; 58K; 65K; 66K; 67K; 68K						
	9J5044					CTC-9J5108	41.54
SPECIAL APPLICATION							
	4J2064		P-UB-10	2-1/2	6	CTC-7X2679	143.00
MODEL 660SC, 666SC							
BOWL LH							
	7J4356		P-UB-10	3-1/4	9-1/4	CTC-7X2716	165.19
MODEL 666							
BOWL LIFT LH							
	7J4356		P-UB-10	3-1/4	9-1/4	CTC-1328608	250.20
	7J4406		P-UB-10	3-1/4	9-1/4	CTC-7X2716	165.19
BOWL LIFT RH							
	7J4355		P-UB-10	3-1/4	9-1/4	CTC-1328608	250.20
	7J4405		P-UB-10	3-1/4	9-1/4	CTC-7X2716	165.19
SPECIAL APPLICATION							
	4J2064		P-UB-10	2-1/2	6	CTC-7X2679	143.00
	4J9996		P-UB-10	2-1/2	7-1/4	CTC-7X2661	187.26
MODEL 666B							
BOWL LIFT LH							
	7J4356		P-UB-10	3-1/4	9-1/4	CTC-1328608	250.20

REPLACEMENT KITS FOR CATERPILLAR® EQUIPMENT

Scrapers							
APPLICATION	CYL #	Misc-Parts, Instructions, etc.	CODE	ROD	BORE	KIT #	List \$
MODEL 666B							
BOWL LIFT RH							
	7J4355		P-UB-10	3-1/4	9-1/4	CTC-1328608	250.20
PUMP							
	4YR; 25W; 58K; 65K; 66K; 67K; 68K						
	9J5044					CTC-9J5108	41.54
MODEL J621							
FLOOR							
	7J5528		P-UB-10	2-1/2	5	CTC-7X2675	128.61
Skidders							
APPLICATION	CYL #	Misc-Parts, Instructions, etc.	CODE	ROD	BORE	KIT #	List \$
MODEL 508							
BOOM							
	4T0863		P-UB-10	1-3/4	3-1/2	CTC-7X2784	58.32
GRAPPLE							
	4T0859		P-UB-10	2-1/4	4-1/2	CTC-7X2748	111.36
	9T5924		P-UB-10	2-1/4	4	CTC-7X2744	57.25
LIFT LH							
	4T9394		P-UB-10	1-1/2	3	CTC-7X2751	66.28
LIFT RH							
	4T0862		P-UB-10	1-1/2	3	CTC-7X2751	66.28
STEERING LH							
	4T0861		P-UB-10	1-1/2	3-1/4	CTC-7X2741	75.03
STEERING RH							
	4T0860		P-UB-10	1-1/2	3-1/4	CTC-7X2741	75.03
TONG							
	4T0859		P-UB-10	2-1/4	4-1/2	CTC-1326770	155.43
MODEL 515, 525							
LIFT							
	1117951		P-UB-10	2	4	CTC-1113302	123.12
	1397547		P-UB-10	2	4	CTC-1113302	123.12
MODEL 517							
ANGLING							
	1006174		P-UB-10	1-3/4	3-1/2	CTC-7X2784	58.32
LIFT							
	6E0365		P-UB-10	2	4-1/4	CTC-7X2819	108.80
TILT							
	9T9557		P-UB-10	2	4-1/4	CTC-1378662	140.09
MODEL 518							
LIFT							
	7J8925		P-UB-10	2	4	CTC-1328816	96.00
	9T1773		P-UB-10	2-1/2	5	CTC-1315118	184.12
PUMP							
	55U						
	9J5072					CTC-9J5116	28.47
STEERING LH							
	7J3350		P-UB-10	1-3/4	3	CTC-7X2825	55.57
STEERING RH							
	7J3349		P-UB-10	1-3/4	3	CTC-7X2825	55.57
TILT LH							
	9T1777		P-UB-10	2-1/4	4-1/4	CTC-7X2750	118.40
TILT RH							
	9T1772		P-UB-10	2-1/4	4-1/4	CTC-7X2750	118.40
MODEL 518C, 520D, 522C							
LIFT							
	1117951		P-UB-10	2	4	CTC-1113302	123.12
	1397547		P-UB-10	2	4	CTC-1113302	123.12
	7J8925	518C & 522C only	P-UB-10	2	4	CTC-1328816	96.00

REPLACEMENT KITS FOR CATERPILLAR® EQUIPMENT

Skidders							
APPLICATION	CYL #	Misc-Parts, Instructions, etc.	CODE	ROD	BORE	KIT #	List \$
MODEL 518C, 520D, 522C							
STEERING LH							
	7J3350		P-UB-10	1-3/4	3	CTC-7X2825	55.57
STEERING RH							
	7J3349		P-UB-10	1-3/4	3	CTC-7X2825	55.57
MODEL 520C							
LIFT							
	7J8925		P-UB-10	2	4	CTC-7X2789	105.58
STEERING RH							
	7J3349		P-UB-10	1-3/4	3	CTC-7X2791	91.70
MODEL 525B							
LIFT							
	1600492		P-UB-10	2-1/4	4	CTC-1546526	156.02
MODEL 527							
LIFT							
	1418640		P-UB-10	2-1/4	3-3/4	CTC-1361897	164.75
	1607610		P-UB-10	2-1/2	4-3/4	CTC-1328811	167.09
	6E0366		P-UB-10	2-1/2	4-3/4	CTC-1328811	167.09
MODEL 528							
DOZER LIFT							
	7J9902		P-UB-10	2	4-1/4	CTC-7X2819	108.80
PUMP							
	51S; 78W						
	9J5071					CTC-9J5112	39.78
STEERING LH							
	7J9234		P-UB-10	1-1/2	3-1/2	CTC-7X2752	98.74
	9J5856		P-UB-10	1-3/4	3-3/4	CTC-1329361	44.82
STEERING RH							
	7J9233		P-UB-10	1-1/2	3-1/2	CTC-7X2752	98.74
	9J5854		P-UB-10	1-3/4	3-3/4	CTC-1329361	44.82
MODEL 528B							
DOZER							
	7J9902		P-UB-10	2	4-1/4	CTC-7X2819	108.80
STEERING LH							
	9J5856		P-UB-10	1-3/4	3-3/4	CTC-1329361	44.82
STEERING RH							
	9J5854		P-UB-10	1-3/4	3-3/4	CTC-1329361	44.82
MODEL 530B							
DOZER							
	7J9902		P-UB-10	2	4-1/4	CTC-7X2819	108.80
LIFT							
	7J9902		P-UB-10	2	4-1/4	CTC-7X2819	108.80
STEERING							
	9J5854		P-UB-10	1-3/4	3-3/4	CTC-1329361	44.82
	9J5856		P-UB-10	1-3/4	3-3/4	CTC-1329361	44.82
MODEL 535B, 545							
LIFT							
	1600492		P-UB-10	2-1/4	4	CTC-1546526	156.02
MODEL FB508							
GRAPPLE							
	4T0860		P-UB-10	1-1/2	3-1/4	CTC-7X2741	75.03
	4T0861		P-UB-10	1-1/2	3-1/4	CTC-7X2741	75.03
	9T5924		P-UB-10	1-1/2	3-1/4	CTC-7X2741	75.03
MODEL FB518							
LIFT							
	9T1773		P-UB-10	2-1/2	5	CTC-7X2658	180.34

REPLACEMENT KITS FOR CATERPILLAR® EQUIPMENT

Skidders							
APPLICATION	CYL #	Misc-Parts, Instructions, etc.	CODE	ROD	BORE	KIT #	List \$
MODEL FB518							
STEERING							
	7J3349		P-UB-10	1-3/4	3	CTC-7X2791	91.70
	7J3350		P-UB-10	1-3/4	3	CTC-7X2791	91.70
TILT LH							
	9T1777		P-UB-10	2-1/4	4-1/4	CTC-7X2750	118.40
TILT RH							
	9T1772		P-UB-10	2-1/4	4-1/4	CTC-7X2750	118.40
Soil Compactors							
APPLICATION	CYL #	Misc-Parts, Instructions, etc.	CODE	ROD	BORE	KIT #	List \$
MODEL 815							
LIFT							
	3G0881		P-UB-10	2	4	CTC-7X2789	105.58
	8J6809		P-UB-10	2	4	CTC-7X2755	152.30
	8J8756		P-UB-10	2	4	CTC-7X2789	105.58
LIFT RH							
	4J7859		P-UB-10	2	4	CTC-7X2755	152.30
PUMP							
	15R; 57U; 91P						
	9J5067					CTC-9J5114	27.82
STEERING							
	4T1574		P-UB-10	2	4	CTC-1328816	96.00
	4T1574		P-UB-10	2	4	CTC-7X2789	105.58
	7J6054		P-UB-10	2	4	CTC-7X2755	152.30
STEERING LH							
	7J9356		P-UB-10	2	4	CTC-7X2755	152.30
STEERING RH							
	7J9355		P-UB-10	2	4	CTC-7X2755	152.30
TILT							
	1U1988		P-UB-10	2	4	CTC-7X2755	152.30
MODEL 815B							
LIFT							
	3G0881		P-UB-10	2	4	CTC-1328816	96.00
	8J6809		P-UB-10	2	4	CTC-7X2755	152.30
STEERING							
	4T1574		P-UB-10	2	4	CTC-1328816	96.00
	6E5024		P-UB-10	2	4	CTC-1113302	123.12
TILT							
	1U1988		P-UB-10	2	4	CTC-7X2755	152.30
MODEL 815F							
LIFT							
	3G0881		P-UB-10	2	4	CTC-1328816	96.00
STEERING							
	4T1574		P-UB-10	2	4	CTC-1328816	96.00
	6E5024		P-UB-10	2	4	CTC-1113302	123.12
MODEL 815S							
TILT							
	1U1988		P-UB-10	2	4	CTC-7X2755	152.30
MODEL 825							
LIFT							
	8J2650		P-UB-10	2	4-1/2	CTC-7X2768	91.77
	9J7934		P-UB-10	2	4-1/2	CTC-7X2768	91.77
STEERING LH							
	9J7087		P-UB-10	2-1/4	5	CTC-7X2729	168.02
STEERING RH							
	9J7086		P-UB-10	2-1/4	5	CTC-7X2729	168.02

REPLACEMENT KITS FOR CATERPILLAR® EQUIPMENT

Soil Compactors							
APPLICATION	CYL #	Misc-Parts, Instructions, etc.	CODE	ROD	BORE	KIT #	List \$
MODEL 825							
TILT							
	9J7951		P-UB-10	2	4-1/2	CTC-7X2768	91.77
MODEL 825B							
LIFT							
	4J9233		P-V-10	2	4-1/2	CTC-7X2770	101.37
	7J9818		P-UB-10	3	7-1/4	CTC-7X2699	222.83
	8J2650		P-UB-10	2	4-1/2	CTC-7X2768	91.77
	9J7934		P-UB-10	2	4-1/2	CTC-7X2768	91.77
STEERING							
	6J7590		P-UB-10	2-1/4	5	CTC-7X2729	168.02
	7J9718		P-UB-10	2-1/4	5	CTC-7X2729	168.02
	7K9401		P-UB-10	2-1/4	5	CTC-7X2729	168.02
STEERING LH							
	9J7087		P-UB-10	2-1/4	5	CTC-7X2729	168.02
STEERING RH							
	9J7086		P-UB-10	2-1/4	5	CTC-7X2729	168.02
TILT							
	9J7951		P-UB-10	2	4-1/2	CTC-7X2768	91.77
MODEL 825C							
LIFT							
	7J9818		P-UB-10	3	7-1/4	CTC-7X2699	222.83
	8J2650		P-UB-10	2	4-1/2	CTC-7X2768	91.77
	9J7934		P-UB-10	2	4-1/2	CTC-7X2768	91.77
STEERING LH							
	9J7087		P-UB-10	2-1/4	5	CTC-9X6392	165.61
STEERING RH							
	9J7086		P-UB-10	2-1/4	5	CTC-9X6392	165.61
TILT							
	9J7951		P-UB-10	2	4-1/2	CTC-7X2768	91.77
MODEL 825G							
LIFT							
	1199226		P-UB-10	2-1/4	3-3/4	CTC-1361897	164.75
	1447349		P-UB-10	2-1/4	3-3/4	CTC-1361897	164.75
	1493236		P-UB-10	2-1/4	3-3/4	CTC-1361897	164.75
STEERING							
	1175151		P-UB-10	2-1/2	4-1/2	CTC-1113300	141.35
TILT							
	1198863		P-UB-10	2	3-3/4	CTC-7X7938	108.26
MODEL 835							
LIFT							
	4J9233		P-V-10	2	4-1/2	CTC-7X2770	101.37
STEERING							
	7J9984		P-UB-10	2-1/4	5	CTC-7X2729	168.02
Telehandlers							
APPLICATION	CYL #	Misc-Parts, Instructions, etc.	CODE	ROD	BORE	KIT #	List \$
MODEL TH62, TH63, TH82, TH83							
MULTIPURPOSE BUCKET							
	9T4006		P-UB-10	1-1/2	3	CTC-1856583	47.40
UNSPECIFIED APPLICATION							
	9T4006		P-UB-10	1-1/2	3	CTC-7X2737	112.40
MODEL TH355B							
AXLE LOCK							
	SLE1-2050055		P-U-10	2	100 mm	CTC-2050055K	78.74
BOOM							
	SLE1-4499-2028910		P-U-10	4	5-1/4	CTC-2028910K	144.23

NEW

REPLACEMENT KITS FOR CATERPILLAR® EQUIPMENT

Telehandlers							
APPLICATION	CYL #	Misc-Parts, Instructions, etc.	CODE	ROD	BORE	KIT #	List \$
MODEL TH355B							
BOOM							
SLE1-4499; JRK1-							
2251846			P-U-10	4	5-1/4	CTC-2251846K	144.23
SLE4500-							
2533933			P-U-10	4	5-1/4	CTC-2533933K	144.23
2533964			P-U-10	4	5-1/4	CTC-2533964K	144.23
BUCKET MULTIPURPOSE							
SLE1-; JRK1-							
9T4006			P-UB-10	1-1/2	3	CTC-1856583	47.40
CARRIAGE - Side Shift							
SLE1-; JRK1-							
2245091			P-UB-10	1-1/2	3	CTC-2245091K	34.69
COUPLER							
SLE1-							
2364442			P-U-10	25 mm	50 mm	CTC-2392956	34.89
FORK							
SLE1-; JRK1-							
2799336			P-U-10	75 mm	125 mm	CTC-2799336K	150.09
FRAME LEVELING							
SLE4500-; JRK1-							
2047813			P-U-10	2	100 mm	CTC-2047813K	78.74
STABILIZER							
SLE1-							
2598723			P-U-10	55 mm	115 mm	CTC-2598723K	117.41
SLE1-; JRK1-							
2072068			P-U-10	55 mm	125 mm	CTC-2072068K	154.40
STEERING							
SLE1-; JRK1-							
2167483			I-U-10	38 mm	85 mm	CTC-2172886	139.79
TAIL GATE							
SLE1-							
2037847	HEAD 2037855		P-U-10	45 mm	75 mm	CTC-2037847K2	55.89
SLE1-; JRK1-							
2037847	HEAD 1662843		P-U-10	45 mm	75 mm	CTC-2037847K	49.48
TELESCOPING							
SLE1-1231							
2319220			P-U-10	70 mm	100 mm	CTC-2331014	83.13
SLE1232-							
2413160			P-U-10	70 mm	100 mm	CTC-2331014	83.13
TILT							
SLE1-; JRK1-							
2037756			P-U-10	75 mm	125 mm	CTC-2037756K	150.09
MODEL TH360B							
AXLE LOCK							
SLE1-							
2050055			P-U-10	2	100 mm	CTC-2050055K	78.74
BOOM							
SLE1-4499							
2028910			P-U-10	4	5-1/4	CTC-2028910K	144.23
SLE1-4499; JRK1-							
2251846			P-U-10	4	5-1/4	CTC-2251846K	144.23
SLE4500-							
2533933			P-U-10	4	5-1/4	CTC-2533933K	144.23
2533964			P-U-10	4	5-1/4	CTC-2533964K	144.23

REPLACEMENT KITS FOR CATERPILLAR® EQUIPMENT

NEW

Telehandlers							
APPLICATION	CYL #	Misc-Parts, Instructions, etc.	CODE	ROD	BORE	KIT #	List \$
MODEL TH360B							
BUCKET MULTIPURPOSE							
SLE1-; JRK1-							
	9T4006		P-UB-10	1-1/2	3	CTC-1856583	47.40
CARRIAGE - Side Shift							
SLE1-; JRK1-							
	2245091		P-UB-10	1-1/2	3	CTC-2245091K	34.69
COUPLER							
SLE1-							
	2364442		P-U-10	25 mm	50 mm	CTC-2392956	34.89
FORK							
SLE1-; JRK1-							
	2799336		P-U-10	75 mm	125 mm	CTC-2799336K	150.09
FRAME LEVELING							
SLE4500-; JRK1-							
	2047813		P-U-10	2	100 mm	CTC-2047813K	78.74
STABILIZER							
SLE1-							
	2598723		P-U-10	55 mm	115 mm	CTC-2598723K	117.41
SLE1-; JRK1-							
	2072068		P-U-10	55 mm	125 mm	CTC-2072068K	154.40
STEERING							
SLE1-; JRK1-							
	2167483		I-U-10	38 mm	85 mm	CTC-2172886	139.79
TAIL GATE							
SLE1-							
	2037847	HEAD 2037855	P-U-10	45 mm	75 mm	CTC-2037847K2	55.89
SLE1-; JRK1-							
	2037847	HEAD 1662843	P-U-10	45 mm	75 mm	CTC-2037847K	49.48
TELESCOPING							
SLE1-1231							
	2319220		P-U-10	70 mm	100 mm	CTC-2331014	83.13
SLE1232-							
	2413160		P-U-10	70 mm	100 mm	CTC-2331014	83.13
TILT							
SLE1-; JRK1-							
	2037756		P-U-10	75 mm	125 mm	CTC-2037756K	150.09
Wheel Dozers							
APPLICATION	CYL #	Misc-Parts, Instructions, etc.	CODE	ROD	BORE	KIT #	List \$
MODEL 814							
BLADE TIP							
	1U4744		P-UB-10	2	4	CTC-7X2755	152.30
DOZER							
	7J7028		P-UB-10	2-1/2	4-3/4	CTC-7X2773	184.64
DOZER LIFT							
	7J7028		P-UB-10	2-1/2	4-3/4	CTC-7X2660	185.90
LIFT							
	1U2088		P-UB-10	2-1/2	4-3/4	CTC-7X2660	185.90
LIFT RH							
	4J7859		P-UB-10	2	4	CTC-7X2755	152.30
PUMP							
14R; 90P							
	9J5068					CTC-9J5114	27.82
STEERING							
	4T1574		P-UB-10	2	4	CTC-1328816	96.00
STEERING LH							
	7J9356		P-UB-10	2	4	CTC-7X2755	152.30

CATERPILLAR®

REPLACEMENT KITS FOR CATERPILLAR® EQUIPMENT

Wheel Dozers							
APPLICATION	CYL #	Misc-Parts, Instructions, etc.	CODE	ROD	BORE	KIT #	List \$
MODEL 814							
STEERING RH							
	7J9355		P-UB-10	2	4	CTC-7X2755	152.30
TILT							
	7J7295		P-UB-10	2	4-1/2	CTC-7X2768	91.77
MODEL 814B							
BLADE TIP							
	1U4744		P-UB-10	2	4	CTC-7X2755	152.30
DOZER							
	1U2088		P-UB-10	2-1/2	4-3/4	CTC-1328811	167.09
DOZER LIFT							
	1U2088		P-UB-10	2-1/2	4-3/4	CTC-7X2660	185.90
	7J7028		P-UB-10	2-1/2	4-3/4	CTC-7X2660	185.90
STEERING							
	4T1574		P-UB-10	2	4	CTC-1328816	96.00
	6E5024		P-UB-10	2	4	CTC-1113302	123.12
TILT							
	7J7295		P-UB-10	2	4-1/2	CTC-7X2768	91.77
MODEL 814F							
DOZER							
	1U2088		P-UB-10	2-1/2	4-3/4	CTC-1328811	167.09
STEERING							
	4T1574		P-UB-10	2	4	CTC-1328816	96.00
	6E5024		P-UB-10	2	4	CTC-1113302	123.12
MODEL 814S							
BLADE TIP							
	1U4744		P-UB-10	2	4	CTC-7X2755	152.30
TILT							
	7J7295		P-UB-10	2	4-1/2	CTC-7X2768	91.77
MODEL 824							
BLADE TIP							
	4J5632		P-V-10	2-1/2	6-1/2	CTC-7X2678	113.26
	4J6006	App requires 2 kits.	P-UB-10	2-1/2	6	CTC-7X2656	166.88
	4J6006	App requires 2 kits.	P-UB-10	2-1/2	6	CTC-7X2692	170.02
BLADE TIP LH							
	4J4498		P-UB-10	2-1/2	6	CTC-7X2656	166.88
LIFT							
	3J9307		P-V-10	2-1/2	6-1/2	CTC-7X2676	113.26
	4J6005		P-V-10	2-1/2	6-1/2	CTC-7X2676	113.26
	4J7621		P-V-10	2-1/2	6-1/2	CTC-7X2676	113.26
	4J9233		P-V-10	2	4-1/2	CTC-7X2770	101.37
	6J1269		P-V-10	2-1/2	6-1/2	CTC-7X2676	113.26
	6J1272		P-V-10	2-1/2	6-1/2	CTC-7X2676	113.26
	6J1273		P-V-10	2-1/2	6-1/2	CTC-7X2676	113.26
	9J7111		P-UB-10	2-1/2	5-1/2	CTC-7X2653	168.14
PUMP							
	29G; 36H; 43E						
	3J6536					CTC-9J5115	37.59
STEERING							
	7J9984		P-UB-10	2-1/4	5	CTC-7X2729	168.02
STEERING LH							
	9J7087		P-UB-10	2-1/4	5	CTC-7X2729	168.02
STEERING RH							
	9J7086		P-UB-10	2-1/4	5	CTC-7X2729	168.02
TILT RH							
	4J4497		P-V-10	2-1/2	6-1/2	CTC-7X2678	113.26

REPLACEMENT KITS FOR CATERPILLAR® EQUIPMENT

Wheel Dozers							
APPLICATION	CYL #	Misc-Parts, Instructions, etc.	CODE	ROD	BORE	KIT #	List \$
MODEL 824B							
BLADE							
	7K9401		P-UB-10	2-1/4	5	CTC-7X2729	168.02
BLADE LH							
	4J4498		P-UB-10	2-1/2	6	CTC-7X2656	166.88
BLADE TIP							
	4J6006	App requires 2 kits.	P-UB-10	2-1/2	6	CTC-7X2656	166.88
BLADE TIP LH							
	4J4498		P-UB-10	2-1/2	6	CTC-7X2656	166.88
LIFT							
	3J9307		P-V-10	2-1/2	6-1/2	CTC-7X2676	113.26
	4J6005		P-V-10	2-1/2	6-1/2	CTC-7X2676	113.26
	4J7621		P-V-10	2-1/2	6-1/2	CTC-7X2676	113.26
	4J9233		P-V-10	2	4-1/2	CTC-7X2770	101.37
	6J1269		P-V-10	2-1/2	6-1/2	CTC-7X2676	113.26
	6J1272		P-V-10	2-1/2	6-1/2	CTC-7X2676	113.26
	6J1273		P-V-10	2-1/2	6-1/2	CTC-7X2676	113.26
	9J7111		P-UB-10	2-1/2	5-1/2	CTC-7X2653	168.14
PUMP							
	29G; 36H; 43E						
	3J6536					CTC-9J5115	37.59
STEERING							
	6J7590		P-UB-10	2-1/4	5	CTC-7X2729	168.02
	7J9718		P-UB-10	2-1/4	5	CTC-7X2729	168.02
	7J9984		P-UB-10	2-1/4	5	CTC-7X2729	168.02
STEERING LH							
	9J7087		P-UB-10	2-1/4	5	CTC-7X2729	168.02
STEERING RH							
	9J7086		P-UB-10	2-1/4	5	CTC-7X2729	168.02
TILT RH							
	4J4497		P-V-10	2-1/2	6-1/2	CTC-7X2678	113.26
MODEL 824C							
BLADE LH							
	4J4498		P-UB-10	2-1/2	6	CTC-7X2656	166.88
BLADE RH							
	4J4497		P-V-10	2-1/2	6-1/2	CTC-7X2678	113.26
BLADE TIP							
	4J4497		P-V-10	2-1/2	6-1/2	CTC-7X2678	113.26
	4J5632		P-V-10	2-1/2	6-1/2	CTC-7X2678	113.26
	4J6006	App requires 2 kits.	P-UB-10	2-1/2	6	CTC-7X2656	166.88
BLADE TIP LH							
	4J4498		P-UB-10	2-1/2	6	CTC-7X2656	166.88
LIFT							
	4J6005		P-V-10	2-1/2	6-1/2	CTC-7X2676	113.26
	6J1269		P-V-10	2-1/2	6-1/2	CTC-7X2676	113.26
	6J1272		P-V-10	2-1/2	6-1/2	CTC-7X2676	113.26
	6J1273		P-V-10	2-1/2	6-1/2	CTC-7X2676	113.26
	9J7111		P-UB-10	2-1/2	5-1/2	CTC-7X2653	168.14
LIFT LH							
	4J4498		P-UB-10	2-1/2	6	CTC-7X2656	166.88
STEERING LH							
	9J7087		P-UB-10	2-1/4	5	CTC-9X6392	165.61
STEERING RH							
	9J7086		P-UB-10	2-1/4	5	CTC-9X6392	165.61
MODEL 824S, 834S, 834U							
LIFT LH							
	4J4498		P-UB-10	2-1/2	6	CTC-7X2656	166.88

REPLACEMENT KITS FOR CATERPILLAR® EQUIPMENT

Wheel Dozers							
APPLICATION	CYL #	Misc-Parts, Instructions, etc.	CODE	ROD	BORE	KIT #	List \$
MODEL 824S, 834S, 834U							
TILT RH							
	4J4497		P-V-10	2-1/2	6-1/2	CTC-7X2678	113.26
MODEL 830M							
DOZER LIFT							
	3R4109		P-UB-10	2-1/2	4-3/4	CTC-7X2660	185.90
LIFT							
	3J6439		P-UB-10	2-1/2	6	CTC-7X2679	143.00
RIPPER LIFT							
	3R6724		P-UB-10	2-1/2	6	CTC-7X2679	143.00
STEERING							
	5R0062		P-UB-10	2-1/4	5	CTC-7X2729	168.02
	7J9984		P-UB-10	2-1/4	5	CTC-7X2729	168.02
MODEL 834							
BLADE LH							
	4J4498		P-UB-10	2-1/2	6	CTC-7X2656	166.88
BLADE TIP							
	4J5632		P-V-10	2-1/2	6-1/2	CTC-7X2678	113.26
	4J6006	App requires 2 kits.	P-UB-10	2-1/2	6	CTC-7X2656	166.88
LIFT							
	4J6005		P-V-10	2-1/2	6-1/2	CTC-7X2676	113.26
	4J7621		P-V-10	2-1/2	6-1/2	CTC-7X2676	113.26
	4J9233		P-V-10	2	4-1/2	CTC-7X2770	101.37
	6J1269		P-V-10	2-1/2	6-1/2	CTC-7X2676	113.26
	6J1272		P-V-10	2-1/2	6-1/2	CTC-7X2676	113.26
PUMP							
	29G; 36H; 43E						
	3J6536					CTC-9J5115	37.59
STEERING							
	7J9984		P-UB-10	2-1/4	5	CTC-7X2729	168.02
	9J8165		P-UB-10	2-1/4	5	CTC-9X6392	165.61
TILT RH							
	4J4497		P-V-10	2-1/2	6-1/2	CTC-7X2678	113.26
MODEL 834B							
BLADE LH							
	4J4498		P-UB-10	2-1/2	6	CTC-7X2656	166.88
BLADE TIP							
	4J5632		P-V-10	2-1/2	6-1/2	CTC-7X2678	113.26
LIFT							
	4J7621		P-V-10	2-1/2	6-1/2	CTC-7X2676	113.26
	6J1272		P-V-10	2-1/2	6-1/2	CTC-7X2676	113.26
LIFT LH							
	4J4498		P-UB-10	2-1/2	6	CTC-7X2656	166.88
STEERING							
	9J8165		P-UB-10	2-1/4	5	CTC-9X6392	165.61
TILT RH							
	4J4497		P-V-10	2-1/2	6-1/2	CTC-7X2678	113.26
TIP							
	4J6006	App requires 2 kits.	P-UB-10	2-1/2	6	CTC-7X2656	166.88
MODEL 834C							
BLADE TIP							
	4J5632		P-V-10	2-1/2	6-1/2	CTC-7X2678	113.26
	4J6006	App requires 2 kits.	P-UB-10	2-1/2	6	CTC-7X2656	166.88

REPLACEMENT KITS FOR CATERPILLAR® EQUIPMENT

IMPORTANT – PLEASE READ

If a kit part number is unknown, the machine model number, serial number, and cylinder application will help identify the repair kit you need.

Example: Model Number **D5**
Serial Number **63J806**
Cylinder Application **Dozer Lift**

If none of the above information is known, size and description of the parts needed will almost always be sufficient.

NOTE: CATERPILLAR® kit numbers are used as a reference only. We do not imply that these kits are original REPLACEMENT KITS.

Kit Number	Code (Pg. xviii)	Rod X Bore Size	List Price	Kit Number	Code (Pg. xviii)	Rod X Bore Size	List Price
CTC-1362462K	TRACK ADJUSTER KIT		\$ 33.94	CTC-0938390	P-UB-15	65 mm X 110 mm	\$ 350.26
CTC-2979143K	TRACK ADJUSTER KIT		39.09	CTC-0939941	P-UB-14	90 mm X 140 mm	316.83
CTC-417338K	TRACK ADJUSTER KIT		29.79	CTC-0940691	P-UB-10	85 mm X 125 mm	334.05
CTC-7Y0858K	TRACK ADJUSTER KIT		53.89	CTC-0941910	P-UB-10	100 mm X 140 mm	398.72
CTC-7Y0859K	TRACK ADJUSTER KIT		53.89	CTC-0942697	P-UB-14	100 mm X 150 mm	264.98
CTC-FIG0401	TRACK ADJUSTER KIT		107.3	CTC-0942698	P-UB-14	110 mm X 160 mm	403.40
CTC-FIG0402	TRACK ADJUSTER KIT		126.43	CTC-0964395	P-UB-10	85 mm X 120 mm	402.56
CTC-FIG0405	TRACK ADJUSTER KIT		112.48	CTC-0964396	P-UB-10	95 mm X 130 mm	444.14
CTC-FIG1401	TRACK ADJUSTER KIT		118.41	CTC-0966457	P-UB-10	75 mm X 115 mm	373.31
CTC-FIG1402	TRACK ADJUSTER KIT		132.02	CTC-0967625	P-UB-10	65 x 100 mm	348.95
CTC-FIG1405	TRACK ADJUSTER KIT		69.13	CTC-0967786	P-UB-10	75 x 110 mm	365.51
CTC-FIG3400	TRACK ADJUSTER KIT		61.91	CTC-0967799	P-UB-10	80 mm X 120 mm	352.26
CTC-FIG3401	TRACK ADJUSTER KIT		57.79	CTC-0974392	P-UB-10	3 X 7-1/4	90.49
CTC-FIG3404	TRACK ADJUSTER KIT		47.88	CTC-0976094	P-UB-10	3 X 6-1/4	130.69
CTC-FIG4400	TRACK ADJUSTER KIT		49.72	CTC-0995310	P-UB-14	75 mm X 110 mm	281.39
CTC-FIG4405	TRACK ADJUSTER KIT		23.15	CTC-0995311	P-UB-14	80 mm X 120 mm	300.29
CTC-0399196	O-RINGS		3.28	CTC-0995312	P-UB-14	65 mm X 100 mm	304.99
CTC-0514131	P-V-10	2-1/2 X 6	126.84	CTC-0995401	P-UB-14	70 X 100 mm	240.30
CTC-0543309	I-UB-10	2-1/4 X 3-1/2	51.58	CTC-0996978	P-UB-14	60 X 90 mm	130.01
CTC-0555211	I-U-10	3-1/2,5-1/2,6-1/2 X 5,6,7	320.69	CTC-0997004	P-UB-14	55 X 80 mm	128.81
CTC-0711436	I-U-3	11 X 13-1/8	1242.85	CTC-1002931	P-UB-10	3-1/4 X 5-1/2	410.29
CTC-0712436	P-U-3	11 X 13-1/8	1328.61	CTC-1002932	P-UB-10	3-1/4 X 5-1/2	410.80
CTC-0715438	I-SP-3,10	7-1/4,10-1/2 X 9-1/4, 11-1/2	761.92	CTC-1002934	P-UB-10	4-1/4 X 6-1/2	415.96
CTC-0716439	I-SP-3,10	7-1/4,11	779.17	CTC-1002935	P-UB-10	4-1/4 X 6-1/2	423.41
CTC-0717440	I-U-3	12-1/2 X 15-1/8	1796.66	CTC-1002939	P-UB-10	3-3/4 X 6	570.42
CTC-0718440	P-U-3	12-1/2 X 15-1/8	1796.41	CTC-1007844K	P-UB-10	2 X 4	44.52
CTC-0719441	I-U-3	12-1/2 X 14-1/4	756.82	CTC-1007844K	P-UB-10	2 X 4	44.52
CTC-0720441	P-U-3	12-1/2 X 14-1/4	621.89	CTC-1014201	P-UB-10	2-1/2 X 4-3/4	138.67
CTC-0728446	P-UB-1	9 X 10-3/4	1446.96	CTC-1014867	P-V-10	3 X 6-1/4	159.58
CTC-0778441	P-U-3	12-1/2 X 14-1/4	1702.42	CTC-1014874	P-UB-10	2-3/4 X 6-1/2	121.88
CTC-0860174	P-UB-14	75 x 100 mm	279.75	CTC-1016061	I-U-10	30 X 63 mm	130.39
CTC-0875387	P-UB-10	100 X 140 mm	353.62	CTC-1017554	P-UB-10	5-1/2 X 10-1/2	369.24
CTC-0875394	P-UB-10	85 X 120 mm	267.83	CTC-1038333	P-UB-14	60 X 90 mm	256.50
CTC-0875407	P-UB-10	130 X 180 mm	412.06	CTC-1040763	P-U-1	70 mm Rod Kit	51.79
CTC-0876654	P-UB-10	110 X 160 mm	332.19	CTC-1041023	P-U-1	75 mm Rod Kit	48.93
CTC-0901523	MULTI STAGE	2.50, 3.25, 4.00	131.32	CTC-1045008	I-U-10	4 X 4-1/2	288.12
CTC-0904400	N-U-1	1-1/2	45.26	CTC-1052585	P-UB-10	90 X 130 mm	300.54
CTC-0911700	I-U-1	75 mm	45.09	CTC-1052601	P-UB-10	85 X 130 mm	448.55
CTC-0912786	I-V-1	5,9	497.99	CTC-1057253	P-UB-14	55 X 80 mm	191.17
CTC-0919842	P-U-14	45 X 90 mm	82.66	CTC-1057255	P-UB-14	75 X 110 mm	281.63
CTC-0933045	P-UB-15	50 mm X 90mm	339.41	CTC-1057359	P-UB-10	80 X 100 mm	253.73
CTC-0938385	P-UB-15	70 mm X 110 mm	236.75	CTC-1057379	P-UB-10	85 X 120 mm	268.25
CTC-0938388	P-UB-15	80 mm X 120 mm	394.96	CTC-1057397	P-UB-10	70 X 100 mm	209.86

REPLACEMENT KITS FOR CATERPILLAR® EQUIPMENT

NOTE: CATERPILLAR® kit numbers are used as a reference only. We do not imply that these kits are original REPLACEMENT KITS.

Kit Number	Code (Pg. xviii)	Rod X Bore Size	List Price	Kit Number	Code (Pg. xviii)	Rod X Bore Size	List Price
CTC-1057480	P-UB-14	55 X 100 mm	\$ 218.65	CTC-1239920	P-UB-10	70 X 130 mm	\$ 250.50
CTC-1082148	O-RINGS		10.29	CTC-1247005	P-UB-10	85 X 160 mm	208.88
CTC-1094745	I-U-1	63 mm	114.25	CTC-1247006	P-UB-10	70 mm X 130 mm	225.16
CTC-1113203	O-RING KIT		10.85	CTC-1247007	P-UB-10	80 X 110 mm	269.82
CTC-1113300	P-UB-10	2-1/2 X 4-1/2	141.35	CTC-1247008	P-UB-10	85 X 120 mm	162.73
CTC-1113301	P-UB-10	1-7/8 X 3	135.59	CTC-1247009	P-UB-10	80 X 110 mm	229.93
CTC-1113302	P-UB-10	2 X 4	123.12	CTC-1247010	P-UB-10	75 mm X 140 mm	254.67
CTC-1113725	P-UB-10	3-1/4 X 5-1/2	158.41	CTC-1257895K	P-UB-10	2-1/4 X 3-3/4	54.63
CTC-1118211K	P-UB-10	2-5/8 X 5-1/4	110.60	CTC-1257895K	P-UB-10	2-1/4 X 3-3/4	54.63
CTC-1118211K	P-UB-10	2-5/8 X 5-1/4	110.60	CTC-1259700	P-U-10	70 mm X 110 mm	181.15
CTC-1125343	I-SP-3,10	8-3/4, 12-1/2 X 11, 13-3/4	892.77	CTC-1261887	P-UB-10	90 X 130 mm	442.65
CTC-1126550	P-UB-10	3 X 6-1/2	183.43	CTC-1261937	P-UB-10	85 X 120 mm	140.36
CTC-1126552	P-UB-10	3 X 6-1/2	239.91	CTC-1261947	P-UB-10	85 X 120 mm	358.23
CTC-1131073	I,P-U-3	12-1/2 X 15-1/8	2020.22	CTC-1261979	P-UB-10	130 X 190 mm	304.62
CTC-1132693	I-U-3	1-1/4 X 2-1/2	17.29	CTC-1270630	P-UB-10	100 X 140 mm	352.06
CTC-1137463	I,P-U-3	9 X 10-3/4	1950.10	CTC-1270631	P-UB-10	100 X 140 mm	354.44
CTC-1137472	I,P-U-3	13-1/2 X 16-1/8	1996.23	CTC-1270795	P-UB-10	2-1/2 X 5	122.66
CTC-1137475	P-UB-3	7 X 8	473.30	CTC-1279809	P-UB-10	3 X 6-1/2	239.57
CTC-1137476	I,P-U-3	11 X 13-1/8	1660.82	CTC-1281187	P-UB-10	3-1/4 X 7	275.38
CTC-1137478	P-UB-3	7 X 8	678.46	CTC-1281673	P-UB-10	3 x 5-1/2	236.55
CTC-1137480	I,P-U-3	12-1/2 X 14-1/4	939.12	CTC-1289277	P-UB-10	105 X 150 mm	380.82
CTC-1137482	I,P-U-13	9 X 10-1/2	369.52	CTC-1289278	P-UB-10	110 X 170 mm	411.18
CTC-1143616	O-RING KIT		6.35	CTC-1289280	P-UB-10	110 X 160 mm	398.82
CTC-1148131K	P-UB-10	3 X 4-3/4	201.03	CTC-1296156	P-UB-10	100 X 170 mm	199.63
CTC-1148290	P-UB-10	80 X 120 mm	210.02	CTC-1303263K	P-UB-10	3-3/4 X 7-3/4	218.44
CTC-1148526	P-UB-10	75 X 110 mm	248.19	CTC-1304012	P-UB-10	2-1/2 X 5	198.05
CTC-1153523K	P-UB-10	3 X 6-1/2	123.01	CTC-1305923	P-UB-10	2-1/8 X 4	164.08
CTC-1153524K	P-UB-10	2-1/4 X 3-3/4	58.55	CTC-1306381K	P-UB-10	3-3/4 X 7-3/4	218.44
CTC-1156963K	P-UB-10	2-3/4 X 4-1/2	124.54	CTC-1309466	P-UB-10	3 X 6	243.56
CTC-1163529	P-UB-10	150 X 220 mm	603.81	CTC-1309483	P-UB-10	3-1/2 x 7-1/4	341.90
CTC-1163612	P-UB-10	105 X 150 mm	312.32	CTC-1309702	P-UB-10	6 X 7-1/2	367.85
CTC-1163649	P-UB-10	110 X 170 mm	389.77	CTC-1309712	P-UB-10	6 X 7-1/2	399.19
CTC-1169123K	P-UB-10	105 X 150 mm	194.86	CTC-1309758	P-UB-10	7 X 10	420.22
CTC-1180672	I-U-10	6 X 8-1/4	677.68	CTC-1309763	P-UB-10	4-1/4 X 7-3/4	394.94
CTC-1183135	I-U-10	60 X 100 mm	97.11	CTC-1309771	P-UB-1	4-1/4	276.51
CTC-1183135	I-U-10	60 mm X 100 mm	97.11	CTC-1315083	P-UB-10	3-1/2 X 6-1/4	139.30
CTC-1183946	P-UB-10	110 X 160 mm	377.45	CTC-1315088	P-UB-10	2-1/4 X 4-1/4	163.15
CTC-1184024	P-UB-10	100 X 140 mm	336.87	CTC-1315106	P-UB-10	2-1/2 X 5	174.82
CTC-1184131	P-UB-10	85 X 120 mm	258.61	CTC-1315118	P-UB-10	2-1/2 X 5	184.12
CTC-1184175	P-UB-10	90 X 130 mm	305.60	CTC-1315164	P-UB-10	2-1/2 X 6	210.54
CTC-1186023	P-UB-10	85 X 120 mm	275.65	CTC-1315420	I-U-10	2-3/4 X 4	163.62
CTC-1194418	P-UB-10	3-1/2 X 10	332.47	CTC-1315421	I-UB-10	2 X 4	150.13
CTC-1195435	P-UB-10	75 X 110 mm	305.78	CTC-1315423	P-UB-10	3 X 4	220.30
CTC-1195446	P-UB-10	80 X 120 mm	278.96	CTC-1315424	P-UB-10	3-1/2 X 4-1/2	221.10
CTC-1195457	P-UB-10	65 X 100 mm	222.02	CTC-1316102	P-UB-10	3-1/2 X 8-1/4	271.58
CTC-1211405	P-UB-10	70 X 100 mm	282.84	CTC-1316108	P-UB-10	1-3/4 X 4	112.44
CTC-1211526	P-UB-10	90 mm X 160 mm	254.89	CTC-1316109	P-UB-10	3 X 4-3/4	116.51
CTC-1211577	O-RING KIT		131.88	CTC-1316117	P-UB-10	3-1/2 X 6-1/4	254.12
CTC-1231768	P-UB-10	75 X 120 mm	299.35	CTC-1316122	P-UB-5	3-1/2 X 4-1/2	249.18
CTC-1231771	P-UB-10	70 X 100 mm	267.82	CTC-1318700	P-UB-10	2-1/2 X 3-3/4	156.19
CTC-1234121K	P-UB-10	2 X 4	79.24	CTC-1318733	P-UB-10	3 X 6-1/2	213.32

REPLACEMENT KITS FOR CATERPILLAR® EQUIPMENT

NOTE: CATERPILLAR® kit numbers are used as a reference only. We do not imply that these kits are original REPLACEMENT KITS.

Kit Number	Code (Pg. xviii)	Rod X Bore Size	List Price	Kit Number	Code (Pg. xviii)	Rod X Bore Size	List Price
CTC-1318740	P-UB-10	3 X 6-1/2	\$ 179.37	CTC-1334802	P-UB-10	3-1/4 X 7	\$ 256.40
CTC-1318748	P-UB-10	2-1/2 X 4	159.35	CTC-1336646	P-UB-10	80 X 110 mm	256.46
CTC-1318778	P-UB-10	2-1/4 x 4-3/4	145.01	CTC-1336691	P-UB-10	70 X 100 mm	222.64
CTC-1321417	P-UB-10	2-1/4 X 3-3/4	142.53	CTC-1336823	P-UB-10	100 X 140 mm	332.37
CTC-1324905	P-UB-10	3-1/2 X 8-1/4	217.31	CTC-1344485K	P-UB-10	55 X 100 mm	122.11
CTC-1324919	P-UB-10	3-1/2 X 10	328.07	CTC-1347123	P-UB-10	85 mm X 125 mm	594.01
CTC-1324922	P-UB-10	4 X 9-1/4	330.41	CTC-1347127	P-UB-10	90 X 130 mm	422.39
CTC-1324932	P-UB-10	4 x 10-1/2	374.03	CTC-1347128	P-UB-10	100 mm X 140 mm	322.19
CTC-1324937	P-UB-10	3 X 6	138.57	CTC-1349838K	P-UB-10	35 X 70 mm	162.00
CTC-1324987	P-UB-10	3-1/4 X 7-1/4	252.11	CTC-1350532K	P-UB-10	50 X 85 mm	222.54
CTC-1324993	P-UB-10	3-1/4 X 7-3/4	264.19	CTC-1352167	P-UB-10	2-3/4 x 6	217.95
CTC-1324997	P-UB-10	3-3/4 X 7-3/4	249.52	CTC-1353223	P-UB-10	2-1/2 X 4	166.02
CTC-1325123K	P-UB-10	3-1/4 X 7-1/4	172.47	CTC-1353253	P-UB-10	2-1/2 X 4	163.15
CTC-1325123K	P-UB-10	3-1/4 X 7-1/4	172.47	CTC-1353802	P-UB-10	3 x 4-1/2	180.47
CTC-1325149K	P-UB-10	3 X 6	149.75	CTC-1353829	P-UB-10	3 X 4-1/2	210.45
CTC-1325149K	P-UB-10	3 X 6	149.75	CTC-1354382	P-UB-10	5-3/4 X 11-1/2	467.11
CTC-1326121	P-UB-10	2-3/4 x 5-1/4	216.90	CTC-1354392	P-UB-10	2-1/4 x 4-1/2	145.28
CTC-1326127	P-UB-10	3 X 7-1/4	215.26	CTC-1354402	P-UB-10	3-1/4 X 8-1/4	258.13
CTC-1326130	P-UB-10	3-1/2 X 7-1/4	249.61	CTC-1354446	P-V-10	3-1/4 X 7-1/4	214.21
CTC-1326148	P-UB-10	2-3/4 X 4-1/4	177.53	CTC-1354539	P-UB-14	3-1/4 X 5-1/2	127.39
CTC-1326170	P-UB-10	2-3/4 X 4-1/4	177.23	CTC-1358143	P-UB-10	3 X 5-1/2	194.76
CTC-1326180	P-UB-10	3 X 7-1/4	220.15	CTC-1358153	P-UB-10	3 X 5-1/2	195.43
CTC-1326184	P-UB-10	3 X 7-1/4	233.80	CTC-1358166	P-UB-10	2-1/4 X 3-1/2	177.50
CTC-1326770	P-UB-10	2-1/4 X 4-1/2	155.43	CTC-1358695	P-UB-10	2-1/2 X 4-3/4	98.54
CTC-1326783	P-UB-10	4 X 7	268.86	CTC-1358736	P-UB-10	2-3/4 X 5-1/2	219.47
CTC-1326806	P-UB-10	4 X 7	366.84	CTC-1361131	P-UB-10	2-1/2 x 4-3/4	148.19
CTC-1327058	P-UB-10	1-1/2 X 3-1/2	107.52	CTC-1361171	P-UB-10	2-1/4 X 4	104.91
CTC-1327114	P-UB-10	2-1/2 X 4-1/4	162.03	CTC-1361599	P-UB-10	1-1/2 X 2-3/4	110.23
CTC-1327123	P-UB-10	2-1/2 X 5-1/2	185.51	CTC-1361897	P-UB-10	2-1/4 X 3-3/4	164.75
CTC-1327129	P-UB-10	2-3/4 X 5-1/2	186.63	CTC-1361908	P-UB-10	2-5/8 X 5-1/4	183.02
CTC-1327131	P-UB-10	2-3/4 X 5-1/2	207.36	CTC-1361967	P-UB-10	2-1/2 X 5	200.54
CTC-1328088	P-UB-10	2-3/4 X 6-1/2	213.84	CTC-1361990	I-UB-10	2-3/4 X 3-3/4	179.98
CTC-1328111	P-UB-10	2-3/4 X 5-1/2	187.84	CTC-1362025	P-UB-10	3 X 4-3/4	216.42
CTC-1328284	P-UB-10	2-3/4 X 7	137.75	CTC-1362049	P-UB-10	110 mm X 170 mm	266.27
CTC-1328491	P-UB-10	3 X 6-1/4	269.61	CTC-1362721	P-UB-10	3-1/2 X 7-1/2	198.11
CTC-1328518	P-UB-10	3-1/4 X 7	237.28	CTC-1363084	P-UB-10	3 x 6	146.05
CTC-1328576	P-UB-10	3-1/4 X 9-1/4	332.41	CTC-1363121	P-UB-10	2-1/2 X 6	170.27
CTC-1328608	P-UB-10	3-1/4 X 9-1/4	250.20	CTC-1363337	P-UB-10	2-3/4 X 6	80.68
CTC-1328620	P-UB-10	3-1/4 X 7-1/4	229.08	CTC-1363741	P-UB-3	3 X 6-1/2	162.97
CTC-1328633	P-UB-10	1-1/2 X 3-1/4	113.48	CTC-1365158	P-UB-10	3-1/2 X 6-1/4	214.08
CTC-1328770	P-UB-10	1-3/4 X 3-1/4	124.88	CTC-1368341	P-UB-10	2-1/2 X 6-1/2	168.68
CTC-1328783	P-V-10	2 X 4-1/2	77.27	CTC-1368797	P-UB-10	3-1/4 X 6-1/2	229.24
CTC-1328811	P-UB-10	2-1/2 X 4-3/4	167.09	CTC-1368823	P-UB-10	3-3/4 X 6-1/2	176.96
CTC-1328816	P-UB-10	2 X 4	96.00	CTC-1368865	P-UB-10	4 X 6-1/2	366.03
CTC-1328849	P-UB-10	1-3/4 X 3	117.21	CTC-1370264	P-UB-10	2-1/2 X 6-1/2	181.70
CTC-1329361	P-UB-10	1-3/4 X 3-3/4	44.82	CTC-1370315	P-UB-10	2-3/4 X 7-1/4	241.46
CTC-1331747K	P-UB-10	2 X 3-1/2	82.19	CTC-1371384	P-UB-10	3-1/4 X 9-1/4	238.50
CTC-1332274	P-UB-10	4 X 10	326.58	CTC-1371394	P-UB-10	3-1/4 X 9-1/4	207.90
CTC-1332962K	P-UB-10	3-1/4 X 9-1/4	296.31	CTC-1371762	P-UB-10	4 X 9-1/4	288.75
CTC-1333614	P-UB-10	4 X 7	314.53	CTC-1371774	P-UB-10	4-3/4 X 7-1/4	372.48
CTC-1334759	P-UB-10	3-1/4 X 7	171.12	CTC-1371946	P-UB-10	4-3/4 X 7	378.89

CATERPILLAR®

REPLACEMENT KITS FOR CATERPILLAR® EQUIPMENT

NOTE: CATERPILLAR® kit numbers are used as a reference only. We do not imply that these kits are original REPLACEMENT KITS.

Kit Number	Code (Pg. xviii)	Rod X Bore Size	List Price	Kit Number	Code (Pg. xviii)	Rod X Bore Size	List Price
CTC-1371955	P-UB-10	4-3/4 X 6-1/2	\$ 323.47	CTC-1475839	P-UB-10	85 X 120 mm	\$ 292.54
CTC-1371974	P-UB-10	3-1/2 X 8-1/4	264.11	CTC-1475875	P-UB-10	95 mm X 130 mm	273.04
CTC-1372489	P-UB-10	2-3/4 X 7-1/4	190.78	CTC-1505833	P-UB-10	95 mm X 130 mm	501.44
CTC-1372530	P-UB-10	1-1/2 X 3	64.28	CTC-1505850	P-UB-10	80 mm X 110 mm	121.10
CTC-1372533	P-UB-10	1-1/2 X 3	95.16	CTC-1508828	I-U-1	80 mm	242.54
CTC-1373496	P-U-10	2-1/2 X 5	124.46	CTC-1509211K	P-U-10	45 X 75 mm	67.75
CTC-1373529	P-UB-10	2-1/4 X 4-1/2	64.77	CTC-1511266K	P-U-10	45 X 75 mm	58.98
CTC-1373602	P-UB-10	2-1/4 X 4-1/2	160.30	CTC-1512460K	P-U-10	40 X 70 mm	46.37
CTC-1373661	P-UB-10	100 X 140 mm	154.36	CTC-1513187K	P-U-10	35 X 65 mm	53.79
CTC-1373763	P-UB-10	85 X 120 mm	382.72	CTC-1518206K	P-UB-10	3-1/4 X 8-1/2	361.95
CTC-1373764	P-UB-10	100 X 140 mm	334.02	CTC-1526482K	P-UB-10	1-3/4 X 3-1/2	74.50
CTC-1373765	P-UB-10	90 X 130 mm	492.64	CTC-1526485K	P-UB-10	2 X 4	76.30
CTC-1373766	P-UB-10	100 X 140 mm	320.64	CTC-1529148K	P-UB-10	2-3/8 X 4-3/4	103.48
CTC-1373767	P-UB-10	105 X 150 mm	433.48	CTC-1531282	I-SP-3,10	7-3/4, 11-1/2 X 10, 12-3/4	708.65
CTC-1373768	P-UB-10	90 X 130 mm	455.90	CTC-1533724	P-UB-10	2-1/2 X 4	221.45
CTC-1378527	P-UB-10	2 X 4-1/4	100.79	CTC-1534973	P-UB-10	3-1/2 X 8-1/2	293.69
CTC-1378646	P-UB-10	3 X 5-1/4	191.13	CTC-1539053	P-UB-10	1-3/4 X 2-3/4	156.06
CTC-1378662	P-UB-10	2 X 4-1/4	140.09	CTC-1539054	P-UB-10	1-3/4 X 2-1/2	149.34
CTC-1379011	P-UB-10	55 X 100 mm	260.02	CTC-1540728	P-UB-10	85 X 120 mm	504.80
CTC-1379403	P-UB-10	105 X 150 mm	375.71	CTC-1540735	P-UB-10	100 X 140 mm	384.06
CTC-1416667K	P-UB-10	3-1/2 X 5-1/2	175.56	CTC-1540744	P-UB-10	85 X 120 mm	485.47
CTC-1417296	P-U-3	7 X 8-1/2	282.88	CTC-1540748	P-UB-10	90 x 130 mm	298.17
CTC-1417483K	P-UB-10	2-1/2 X 4	55.83	CTC-1540757	P-UB-10	90 X 130mm	464.07
CTC-1417484K	P-UB-10	2-1/2 X 5-1/4	84.96	CTC-1540761	P-UB-10	100 X 140 mm	395.63
CTC-1417975	P-UB-4	3-1/2 X 4-1/2	165.50	CTC-1540766	P-UB-10	105 X 150 mm	406.18
CTC-1425422	P-UB-10	75 mm X 110 mm	285.65	CTC-1540773	P-UB-10	90 X 130mm	463.76
CTC-1425425	P-UB-10	80 mm X 120 mm	292.09	CTC-1542501	P-UB-10	2-1/2 X 4	156.72
CTC-1425428	P-UB-10	65 X 100 mm	293.84	CTC-1542502	P-UB-10	2-1/2 X 7-1/4	200.21
CTC-1428962	I-U-10	35 X 50 mm	51.63	CTC-1542503	P-UB-10	3 X 4-3/4	129.53
CTC-1428962	I-U-10	35 mm X 50 mm	51.63	CTC-1542505	P-UB-10	6 X 7-1/2	461.07
CTC-1428963	P-U-10	30 mm X 65 mm	102.44	CTC-1546525	P-UB-10	2-1/4 X 4-3/4	158.87
CTC-1428963	P-UB-10	30 X 65 mm	102.44	CTC-1546526	P-UB-10	2-1/4 X 4	156.02
CTC-1429192	P-U-10	35 mm X 70 mm	49.74	CTC-1553652K	P-UB-10	3 X 6-1/2	155.83
CTC-1429193	P-U-10	40 mm X 60 mm	76.16	CTC-1553653K	P-UB-10	3 X 7-1/4	186.48
CTC-1432918	P-UB-10	3 X 5-1/4	192.32	CTC-1558421	I-U-15	60 mm X 110 mm	75.98
CTC-1433201K	P-UB-10	100 X 170 mm	248.80	CTC-1560625	P-UB-10	130 X 180 mm	435.94
CTC-1437982	P-UB-14	75 X 110 mm	347.18	CTC-1560626	P-UB-10	140 x 200 mm	675.75
CTC-1437983	P-UB-14	60 X 90 mm	285.88	CTC-1560627	P-UB-10	150 X 220 mm	603.81
CTC-1438139	P-UB-10	130 mm X 180 mm	399.62	CTC-1560656	P-UB-10	110 mm X 160 mm	275.37
CTC-1438152	P-UB-10	70 X 100 mm	262.95	CTC-1563798	P-UB-10	2-1/2 X 4-3/4	160.71
CTC-1438153	P-UB-10	65X100 mm	273.71	CTC-1565208	P-UB-10	1-1/2 X 2-1/2	104.59
CTC-1438154	P-UB-10	75 mm X 110 mm	254.34	CTC-1570246	P-UB-10	2 X 3-1/2	136.66
CTC-1438155	P-UB-10	80 mm X 120 mm	243.77	CTC-1570284	P-UB-10	3-1/2 x 7-3/4	333.76
CTC-1449005K	P-UB-10	3-1/4 X 8-1/4	181.02	CTC-1570286	P-UB-10	2-1/2 X 5-1/2	176.82
CTC-1456902	O-RING KIT		5.39	CTC-1570287	P-UB-10	2-3/4 X 5-1/2	153.84
CTC-1468928K	P-UB-10	4-1/2 X 150 mm	239.40	CTC-1570288	P-UB-10	3 X 4-3/4	178.40
CTC-1469624	P-UB-10	3-1/4 X 9-1/4	249.17	CTC-1570289	P-UB-10	7 X 11	990.36
CTC-1469631	P-UB-10	3-1/4 X 9-1/4	252.45	CTC-1570290	P-UB-10	2 X 4	139.85
CTC-1469860	P-UB-10	2-1/2 X 4-1/2	166.90	CTC-1571352K	P-UB-10	3-1/4 X 5-1/2	161.87
CTC-1475740	P-UB-10	140 mm X 200 mm	332.87	CTC-1582872	P-UB-10	3 X 5	241.65
CTC-1475781	P-UB-10	85 x 125 mm	297.68	CTC-1586389	P-UB-10	75 X 110 mm	217.04

CATERPILLAR®

REPLACEMENT KITS FOR CATERPILLAR® EQUIPMENT

NOTE: CATERPILLAR® kit numbers are used as a reference only. We do not imply that these kits are original REPLACEMENT KITS.

Kit Number	Code (Pg. xviii)	Rod X Bore Size	List Price	Kit Number	Code (Pg. xviii)	Rod X Bore Size	List Price
CTC-1588925	P-UB-10	70 X 100 mm	\$ 234.36	CTC-1686944K	P-UB-10	4-1/2 X 9-1/4	\$ 394.29
CTC-1588926	P-UB-10	80 X 110 mm	259.34	CTC-1697826	P-UB-14	75 X 110 mm	137.75
CTC-1589092	P-UB-10	85 X 120 mm	188.74	CTC-1697827	P-UB-14	60 mm X 90 mm	213.97
CTC-1589093	P-UB-10	100 X 140 mm	126.80	CTC-1697828	P-UB-14	55 X 80 mm	155.28
CTC-1597532	P-UB-10	7 X 11	990.36	CTC-1697829	P-UB-14	55 X 100 mm	147.79
CTC-1597773	P-UB-10	85 X 120 mm	546.71	CTC-1697830	P-UB-10	65 mm X 100 mm	119.01
CTC-1597774	P-UB-10	100 X 140 mm	156.42	CTC-1697831	P-UB-10	75 X 120 mm	372.42
CTC-1597775	P-UB-10	85 X 120 mm	183.90	CTC-1697832	P-UB-10	70 X 100 mm	313.73
CTC-1597776	P-UB-10	90 X 130 mm	540.94	CTC-1697834	P-UB-10	55 X 100 mm	251.56
CTC-1597778	P-UB-10	85 X 130 mm	501.17	CTC-1697835	P-UB-10	80 X 120 mm	223.79
CTC-1600045K	P-UB-10	2-1/2 X 4-3/4	104.93	CTC-1697836	P-UB-10	70 X 100	297.57
CTC-1600054K	P-UB-10	2-1/2 X 5-1/2	82.78	CTC-1697837	P-UB-10	75 x 110 mm	268.82
CTC-1605784	P-UB-10	3 X 5	74.98	CTC-1697838	P-UB-10	80 x 120 mm	280.82
CTC-1605785	P-UB-10	3-1/4 X 6-1/2	185.17	CTC-1697839	P-UB-10	65 x 100 mm	226.70
CTC-1605795	P-UB-10	2-1/2 X 5-1/4	182.59	CTC-1697840	P-UB-10	75 mm X 110 mm	116.95
CTC-1605796	P-UB-10	3 x 7	313.77	CTC-1697841	P-UB-10	80 mm X 120 mm	297.89
CTC-1608546	P-U-10	30 X 60 mm	53.22	CTC-1697842	P-UB-10	65 X 100 mm	311.10
CTC-1609874	O-RINGS		46.70	CTC-1697843	P-UB-10	70 X 130 mm	304.18
CTC-1624675	P-UB-10	80 X 110 mm	305.86	CTC-1697844	P-UB-10	75 mm X 110 mm	248.01
CTC-1624676	P-UB-10	85 mm X 120 mm	107.62	CTC-1697845	P-UB-14	55 X 80 mm	127.97
CTC-1624677	P-UB-10	70 mm X 100 mm	241.34	CTC-1697895	P-UB-14	60 X 90 mm	212.83
CTC-1636105	P-UB-10	2-3/4 X 4-1/2	167.16	CTC-1699529K	P-UB-10	2 X 4	75.20
CTC-1636223	P-UB-10	2-1/2 X 5	274.69	CTC-1699531K	P-UB-10	2 X 4	71.45
CTC-1636935K	P-U-10	50 X 90 mm	122.44	CTC-1700221	P-UB-10	2-1/2 X 4-3/4	146.61
CTC-1636936K	P-U-10	45 X 75 mm	157.91	CTC-1709827	P-UB-10	70 X 100 mm	113.51
CTC-1637006K	P-U-10	45 X 80 mm	109.64	CTC-1709829	P-UB-10	140 mm X 200 mm	328.18
CTC-1637007K	P-U-10	45 X 80 mm	109.64	CTC-1709830	P-UB-10	130 mm X 180 mm	405.52
CTC-1637008K	P-U-10	40 X 70 mm	148.97	CTC-1709929	P-UB-10	70 X 100 mm	321.73
CTC-1643213	P-U-10	30 mm X 60 mm	68.69	CTC-1709937	P-UB-10	75 X 110 mm	161.23
CTC-1645174	P-UB-10	100 X 140 mm	226.42	CTC-1709941	P-UB-10	65 X 100 mm	134.27
CTC-1647174K	P-UB-10	1-1/2 X 3	53.47	CTC-1709946	P-UB-10	80 X 120 mm	359.43
CTC-1649430K	P-UB-10	1-1/4 X 2-1/2	50.92	CTC-1709999	P-UB-10	80 X 120 mm	199.30
CTC-1650102K	P-UB-10	3 X 6-1/2	168.93	CTC-1721685	P-UB-10	2 X 3	140.68
CTC-1654342	P-UB-14	50 mm X 90 mm	118.30	CTC-1721687	P-UB-4	4 X 4-1/2	153.44
CTC-1656035	P-UB-10	2-1/2 X 6-1/2	186.78	CTC-1721688	P-UB-10	2-3/4 X 4	164.39
CTC-1658633K	P-UB-10	3 X 4-3/4	134.12	CTC-1721689	I-UB-5	2 X 4-1/2	189.29
CTC-1659276K	P-UB-14	60 X 90 mm	123.87	CTC-1721690	P-UB-10	2 X 4-1/2	50.31
CTC-1659416	P-UB-10	130 X 190 mm	305.20	CTC-1721691	P-UB-10	3-1/2 X 5-1/2	177.91
CTC-1659418	P-UB-10	85 X 120 mm	144.69	CTC-1721692	P-UB-10	4 X 4-1/2	189.06
CTC-1659419	P-UB-10	95 mm X 130 mm	234.01	CTC-1721693	P-UB-10	3-1/2 X 4-1/2	191.33
CTC-1659420	P-UB-10	80 X 110 mm	143.93	CTC-1724223K	P-U-10	45 X 75 mm	52.05
CTC-1662835K	P-U-10	45 X 75 mm	58.33	CTC-1725285	P-U-10	25 mm X 40 mm	59.03
CTC-1663850	P-UB-10	5-1/2 X 10	493.77	CTC-1728486	I-U-10	1-3/4 X 63 mm	68.97
CTC-1668140K	I-UB-10	2-3/4 X 3-3/4	82.66	CTC-1728487	I-U-10	50 mm X 70 mm	56.41
CTC-1668141K	I-UB-10	2-3/4 X 3-3/4	82.66	CTC-1728500	P-UB-10	105 X 180 mm	376.11
CTC-1677551K	P-UB-10	2 X 4-1/4	51.92	CTC-1738612K	P-UB-10	5 X 220 mm	362.22
CTC-1680758	P-UB-10	105 X 150 mm	361.22	CTC-1738613K	P-UB-10	5 X 220 mm	362.22
CTC-1680759	P-UB-10	110 X 170 mm	414.73	CTC-1744715K	P-UB-10	3-1/4 X 9-1/4	209.72
CTC-1680760	P-UB-10	110 X 160 mm	402.31	CTC-1749425	P-UB-10	3-1/2 X 6-1/4	244.90
CTC-1686942K	P-UB-10	5 X 9-1/4	349.02	CTC-1756855K	P-UB-10	100 X 140 mm	183.88
CTC-1686943K	P-UB-10	5 X 9-1/4	349.02	CTC-1764912	P-UB-10	85 X 120 mm	273.66

CATERPILLAR®

REPLACEMENT KITS FOR CATERPILLAR® EQUIPMENT

NOTE: CATERPILLAR® kit numbers are used as a reference only. We do not imply that these kits are original REPLACEMENT KITS.

Kit Number	Code (Pg. xviii)	Rod X Bore Size	List Price	Kit Number	Code (Pg. xviii)	Rod X Bore Size	List Price
CTC-1764913	P-UB-10	100 X 140 mm	\$ 344.38	CTC-1856596	P-UB-10	1-1/2 X 2-3/4	\$ 47.94
CTC-1764914	P-UB-10	90 X 130 mm	146.86	CTC-1856598	P-UB-10	1-1/2 X 3	29.36
CTC-1764934	P-UB-10	85 X 120 mm	240.69	CTC-1856601	P-UB-10	1-1/2 X 2-1/2	53.58
CTC-1764935	P-UB-10	65 X 100 mm	229.02	CTC-1857018	P-UB-10	1-3/4 X 3-1/2	61.94
CTC-1764999	P-UB-10	95 X 130 mm	248.73	CTC-1857019	P-UB-10	1-3/4 X 3-1/4	33.21
CTC-1771958	P-U-10	32 mm X 63 mm	71.55	CTC-1857020	P-UB-10	1-3/4 X 3-1/2	71.09
CTC-1787189	I-U-10	36 X 65 mm	228.22	CTC-1857021	P-UB-10	1-3/4 X 4	30.72
CTC-1787189NLN	I-U-10	36 mm X 65 mm	122.57	CTC-1857022	P-UB-10	1-3/4 X 3	29.19
CTC-1788382	P-UB-10	100 X 170 mm	385.11	CTC-1857023	P-UB-10	1-3/4 X 3-3/4	32.94
CTC-1791715	I-U-3	3/4 X 1-1/2	15.63	CTC-1857024	P-UB-10	1-3/4 X 2-3/4	56.97
CTC-1791749	I-O-3	3/4 X 1-1/2	5.58	CTC-1857025	P-UB-10	1-3/4 X 3	54.97
CTC-1794969K	P-U-10	45 X 75 mm	67.75	CTC-1857026	P-UB-10	1-3/4 X 2-1/2	107.18
CTC-1799625	P-UB-10	80 X 110 mm	260.56	CTC-1857027	P-UB-10	1-3/4 X 2-3/4	30.11
CTC-1799634	P-UB-10	85 X 120 mm	144.69	CTC-1857029	P-UB-10	1-3/4 X 4	138.40
CTC-1799638	P-UB-10	70 X 100 mm	101.14	CTC-1857030	P-UB-10	1-3/4 X 3-1/4	105.48
CTC-1799764K	P-UB-10	90 X 130 mm	129.44	CTC-1857033	P-UB-10	1-3/4 X 3-3/4	134.14
CTC-1799772	P-U-10	90 X 130 mm	213.98	CTC-1857035	P-UB-10	1-3/4 X 2-3/4	116.00
CTC-1799785K	P-UB-10	105 X 150 mm	181.64	CTC-1857036	P-UB-10	1-3/4 X 2-1/2	149.34
CTC-1799791K	P-UB-10	105 X 150 mm	351.86	CTC-1857037	P-UB-10	1-3/4 X 3	107.98
CTC-1800062	P-UB-10	2-1/8 X 4	162.78	CTC-1857662	P-UB-10	2-3/4 X 4-1/2	178.25
CTC-1807208	P-U,UB-10	2 X 4	132.97	CTC-1857663	P-UB-10	3-1/4 X 5-1/2	282.15
CTC-1807482K	P-UB-10	2 X 85 mm	143.42	CTC-1857664	P-UB-10	3-1/4 X 5-1/2	199.15
CTC-1807484K	P-UB-10	2-1/8 X 4	103.51	CTC-1857666	P-UB-10	2 X 4	53.53
CTC-1807485K	P-UB-10	2-1/8 X 4	103.51	CTC-1857667	P-UB-10	2 X 3	87.64
CTC-1807490K	P-UB-10	2 X 85 mm	143.42	CTC-1857668	P-V-10	2 X 5	157.27
CTC-1809872	I-U-10	1 X 2	122.04	CTC-1857669	P-UB-10	2 X 4-1/4	50.03
CTC-1832091	I-U-10	1 X 2	12.00	CTC-1857670	P-UB-10	2 X 3-1/4	42.71
CTC-1832848K	P-UB-10	2 X 75 mm	95.85	CTC-1857671	P-UB-10	2 X 4-1/2	47.52
CTC-1832849K	P-UB-10	2-3/4 X 5-3/8	148.51	CTC-1857672	P-UB-10	2 X 3-1/2	73.03
CTC-1832850K	P-UB-10	65 mm X 4-3/4	164.76	CTC-1857674	P-UB-10	2 X 3-1/2	119.55
CTC-1832856K	P-UB-10	2 X 85 mm	143.42	CTC-1857675	P-UB-10	2 X 3-3/4	124.90
CTC-1833721K	P-UB-10	1-1/2 X 3-1/2	72.31	CTC-1857676	P-UB-10	2 X 5	61.50
CTC-1838459K	P-UB-10	1-1/2 X 3-1/2	75.08	CTC-1857677	P-UB-10	2 X 4	40.21
CTC-1843709K	P-UB-10	2-1/2 X 4-1/2	76.11	CTC-1857678	P-UB-10	2 X 3-1/2	73.29
CTC-1847660K	P-UB-10	85 X 140 mm	140.22	CTC-1857680	P-V-10	2 X 4	58.23
CTC-1850196	P-UB-10	90 X 130 mm	170.92	CTC-1857681	P-U-10	2 X 3-1/2	111.46
CTC-1850223	P-UB-10	85 X 125 mm	171.51	CTC-1857682	P-UB-10	2 X 4-1/4	62.58
CTC-1851839K	P-UB-10	1-1/2 X 3	42.18	CTC-1857683	P-UB-10	2 X 3-1/4	45.75
CTC-1851851K	P-UB-10	1-7/8 X 3-1/4	45.85	CTC-1857684	P-UB-10	2 X 3-3/4	45.49
CTC-1855574	P-UB-10	95 X 160	195.67	CTC-1857685	P-UB-10	3-1/4 X 5-1/2	304.73
CTC-1856582	P-UB-10	1-1/2 X 2-3/4	115.36	CTC-1857686	P-UB-10	2 X 4	94.41
CTC-1856583	P-UB-10	1-1/2 X 3	47.40	CTC-1857687	N-UB-10	2 X 4	148.29
CTC-1856584	P-UB-10	1-1/2 X 4	46.02	CTC-1857688	P-UB-10	2 X 4	72.08
CTC-1856585	P-UB-10	1-1/2 X 2-1/2	31.77	CTC-1857689	P-UB-10	2 X 4-1/2	141.30
CTC-1856586	P-UB-10	1-1/2 X 2-3/4	35.55	CTC-1857694	P-UB-10	2 X 4-1/4	112.75
CTC-1856587	P-UB-10	1-1/2 X 3	62.87	CTC-1857696	P-UB-10	2 X 4-1/4	46.45
CTC-1856588	P-UB-10	1-1/2 X 3-1/2	66.97	CTC-1857698	P-UB-10	2 X 4	56.49
CTC-1856589	P-UB-10	1-1/2 X 3-1/2	65.17	CTC-1857699	I-UB-10	2 X 4-1/2	222.76
CTC-1856590	P-UB-10	1-1/2 X 2-1/4	31.63	CTC-1857700	P-UB-10	2 X 4-1/2	100.53
CTC-1856591	P-UB-10	1-1/2 X 3-1/2	135.62	CTC-1859502	P-UB-10	2-1/4 X 5	61.68
CTC-1856593	P-UB-10	1-1/2 X 3-1/4	41.97	CTC-1859503	P-UB-10	2-1/4 X 3-1/2	142.36

CATERPILLAR®

REPLACEMENT KITS FOR CATERPILLAR® EQUIPMENT

NOTE: CATERPILLAR® kit numbers are used as a reference only. We do not imply that these kits are original REPLACEMENT KITS.

Kit Number	Code (Pg. xviii)	Rod X Bore Size	List Price	Kit Number	Code (Pg. xviii)	Rod X Bore Size	List Price
CTC-1859504	P-UB-10	2-3/4 X 4-1/2	\$ 56.74	CTC-1864378	P-UB-10	2-1/2 X 4-3/4	\$ 91.93
CTC-1859505	P-UB-10	2-1/4 X 4-1/2	45.55	CTC-1864379	P-UB-10	2-1/2 X 4	141.12
CTC-1859507	P-UB-10	2-1/4 X 4-1/4	114.99	CTC-1864380	P-UB-10	2-1/2 X 4	173.61
CTC-1859508	P-UB-10	2-1/4 X 4	113.29	CTC-1864381	P-UB-10	2-1/2 X 4-3/4	160.80
CTC-1859509	P-UB-10	2-1/4 X 3-3/4	114.41	CTC-1864382	P-UB-10	2-1/2 X 4-3/4	98.20
CTC-1859510	P-UB-10	2-1/4 X 4	117.99	CTC-1864383	P-UB-10	2-1/2 X 5	151.49
CTC-1859511	P-UB-10	2-1/4 X 4-3/4	126.85	CTC-1864386	P-UB-10	2-1/2 X 6-1/2	80.87
CTC-1859512	P-UB-10	2-1/4 X 3-1/2	115.91	CTC-1864388	P-UB-10	2-1/2 X 6-1/2	178.91
CTC-1859517	P-UB-10	2-1/4 X 4-1/4	138.16	CTC-1864389	P-U-10	2-1/2 X 5	122.46
CTC-1859519	P-UB-10	2-1/4 X 4-3/4	150.03	CTC-1864391	P-UB-10	2-1/2 X 4-1/2	82.78
CTC-1859523	P-UB-10	2-1/4 X 4-1/2	54.70	CTC-1864392	P-UB-10	2-1/2 X 4	184.61
CTC-1859525	P-UB-10	2-1/4 X 4-1/2	142.03	CTC-1864393	P-UB-10	2-1/2 X 7-1/4	190.26
CTC-1859526	P-UB-10	2-1/4 X 3-1/2	181.10	CTC-1864394	P-UB-10	2-1/2 X 4-3/4	180.04
CTC-1859527	P-UB-10	2-1/4 X 4	118.64	CTC-1864396	P-UB-10	2-1/2 X 5-1/2	207.52
CTC-1859528	P-UB-10	2-1/4 X 3-3/4	137.42	CTC-1864397	P-UB-10	2-1/2 X 5-1/4	198.53
CTC-1859530	P-UB-10	2-1/4 X 4-1/2	145.21	CTC-1864398	P-UB-10	2-1/2 X 6-1/2	208.48
CTC-1859532	P-UB-10	2-1/4 X 4-1/2	177.29	CTC-1864399	P-UB-10	2-1/2 X 4-3/4	87.00
CTC-1859534	P-UB-10	2-1/4 X 4-3/4	177.40	CTC-1864401	P-UB-10	4-3/4 X 6-1/2	369.20
CTC-1859535	P-UB-10	2-1/4 X 4	92.86	CTC-1864404	P-UB-10	2-1/8 X 4	103.09
CTC-1864327	I-UB-10	2-1/2 X 3-1/2	72.09	CTC-1864405	P-UB-10	2-3/8 X 4-1/4	142.65
CTC-1864328	P-UB-10	2-1/2 X 4-1/4	112.75	CTC-1864406	P-UB-10	2-1/8 X 3-1/2	156.94
CTC-1864329	P-UB-10	2-1/2 X 5-1/2	205.60	CTC-1869285	P-UB-10	5-1/2 X 10-1/2	451.72
CTC-1864330	P-UB-10	2-1/2 X 6	249.48	CTC-1882445K	P-UB-10	3-1/2 X 9-1/4	255.93
CTC-1864331	P-UB-10	2-1/2 X 6-1/2	250.56	CTC-1884219	P-UB-10	105 X 150 mm	167.89
CTC-1864332	P-UB-10	2-1/2 X 5	75.71	CTC-1884457	P-UB-10	95 X 160 mm	227.00
CTC-1864333	P-UB-10	2-1/2 X 4	62.71	CTC-1890263	P-UB-10	3-1/2 X 5-1/2	254.49
CTC-1864334	P-UB-10	2-1/2 X 7-1/4	139.38	CTC-1890264	P-UB-10	3-1/4 X 8-1/4	144.03
CTC-1864335	P-UB-10	2-1/2 X 6	244.68	CTC-1890267	P-UB-10	3-1/2 X 8-1/4	273.58
CTC-1864336	P-UB-10	2-1/2 X 4-1/4	93.80	CTC-1890268	P-U-10	2-3/4 X 5	79.46
CTC-1864337	P-UB-10	2-1/2 X 4-1/4	51.75	CTC-1890269	P-UB-10	3 X 6-1/2	186.14
CTC-1864338	P-UB-10	2-1/2 X 4	84.48	CTC-1890271	P-UB-10	2-3/8 X 3-3/4	54.72
CTC-1864339	P-UB-10	2-1/2 X 6-1/2	206.30	CTC-1890272	P-UB-10	4-3/4 X 6	368.00
CTC-1864340	P-UB-10	2-1/2 X 6	107.74	CTC-1890273	P-UB-10	3 X 4	216.71
CTC-1864341	P-UB-10	2-1/2 X 3-3/4	56.59	CTC-1890274	P-UB-10	2-5/8 X 5-1/4	354.38
CTC-1864342	P-UB-10	2-1/2 X 5-1/2	168.23	CTC-1890281	P-UB-10	100 X 140 mm	416.79
CTC-1864349	P-U-10	2-1/2 X 6	104.42	CTC-1890282	P-UB-10	100 x 140 mm	300.23
CTC-1864350	P-UB-10	2-1/2 X 4-3/4	123.33	CTC-1895369	P-UB-10	3-1/4 X 7	207.39
CTC-1864351	P-UB-10	2-1/2 X 6	139.28	CTC-1895370	P-UB-10	3-1/4 X 7	237.60
CTC-1864356	P-UB-10	2-1/2 X 5-1/2	184.75	CTC-1895371	P-UB-10	3-1/4 X 7	274.03
CTC-1864357	P-UB-10	2-1/2 X 6-1/2	97.11	CTC-1895373	P-UB-10	3-1/4 X 8-1/4	174.29
CTC-1864358	P-U-10	2-1/2 X 5-1/2	56.60	CTC-1895374	P-UB-10	3-1/4 X 7	111.91
CTC-1864359	P-UB-10	2-1/2 X 4-3/4	138.62	CTC-1895375	P-UB-10	3-1/4 X 7	154.11
CTC-1864362	P-UB-10	2-1/2 X 4-1/2	75.60	CTC-1895377	P-UB-10	3-1/4 x 9-1/4	249.54
CTC-1864363	P-UB-10	2-1/2 X 5	83.92	CTC-1895378	P-UB-10	3-1/4 X 9-1/4	238.06
CTC-1864365	P-UB-10	2-1/2 X 5	72.94	CTC-1895379	P-UB-10	3-1/4 X 9-1/4	254.74
CTC-1864366	P-UB-10	2-1/2 X 5	189.68	CTC-1895381	P-UB-10	3-1/4 X 5-1/2	149.37
CTC-1864368	P-UB-10	2-1/2 X 6	77.72	CTC-1895382	P-UB-10	3-1/4 X 5-1/2	301.64
CTC-1864369	P-UB-10	2-1/2 X 3-3/4	137.09	CTC-1895383	P-UB-10	3-1/4 X 8-1/4	287.59
CTC-1864371	P-UB-10	2-1/2 X 4	133.35	CTC-1895384	P-UB-10	3-1/4 X 7-3/4	187.12
CTC-1864373	P-UB-10	2-1/2 X 4-1/4	106.20	CTC-1895386	P-UB-10	3-1/4 X 7-1/4	273.58
CTC-1864375	P-UB-10	2-1/2 X 5-1/2	196.53	CTC-1895387	P-UB-10	3-1/4 X 6-1/2	217.62

CATERPILLAR®

REPLACEMENT KITS FOR CATERPILLAR® EQUIPMENT

NOTE: CATERPILLAR® kit numbers are used as a reference only. We do not imply that these kits are original REPLACEMENT KITS.

Kit Number	Code (Pg. xviii)	Rod X Bore Size	List Price	Kit Number	Code (Pg. xviii)	Rod X Bore Size	List Price
CTC-1905431	P-UB-10	3-1/4 X 8-1/4	\$ 215.35	CTC-1920742	P-UB-10	3 X 4-3/4	\$ 380.65
CTC-1905432	P-UB-10	3-1/4 X 9-1/4	358.59	CTC-1920743	P-UB-10	3 X 5-1/4	343.63
CTC-1905434	P-UB-10	3-1/4 X 9-1/4	260.39	CTC-1920891K	P-UB-10	1-1/2 X 3	50.41
CTC-1905955K	P-UB-10	3-1/2 X 9-1/4	255.93	CTC-1920893K	P-UB-10	1-1/2 X 3	50.41
CTC-1908141	P-UB-10	2-1/2 X 4-1/2	188.54	CTC-1921409	P-UB-10	3 X 7-1/4	173.00
CTC-1912319	P-UB-10	3-1/4 X 5-1/2	199.04	CTC-1921411	P-UB-10	3 X 4-1/2	384.63
CTC-1912321	P-UB-10	3 X 5-1/2	203.91	CTC-1922811K	P-UB-10	2-1/4 X 4-1/2	76.28
CTC-1912322	P-UB-10	3 X 5-1/2	124.25	CTC-1923003	P-UB-10	3 X 8-1/4	318.20
CTC-1912430	P-U-10	3 X 6-1/2	134.64	CTC-1923004	P-UB-10	3-1/4 X 6	218.35
CTC-1912432	P-UB-10	3 X 6-1/2	109.28	CTC-1923006	P-UB-10	3 X 5-1/4	204.10
CTC-1912433	P-UB-10	3 X 7-1/4	231.85	CTC-1923007	P-UB-10	3 X 4-3/4	184.15
CTC-1912434	P-UB-10	3 X 7-1/4	138.24	CTC-1923008	P-UB-10	3 X 4-3/4	160.54
CTC-1913170	P-UB-10	110 X 170 mm	496.72	CTC-1923009	P-UB-10	2-3/4 X 6-1/4	251.70
CTC-1913171	P-UB-10	110 X 170	248.80	CTC-1923010	P-UB-10	3 X 5-1/4	138.21
CTC-1913564	P-UB-10	3 X 6-1/2	101.82	CTC-1923791K	P-UB-10	2 X 85 mm	142.91
CTC-1913565	P-UB-10	3 X 6-1/2	125.90	CTC-1923884K	P-UB-10	2 X 75 mm	70.96
CTC-1915027	I-U-10	2-3/4 X 4	121.53	CTC-1924110K	P-UB-10	2 X 85 mm	143.33
CTC-1915028	P-UB-10	3 X 4-3/4	116.51	CTC-1926445K	P-UB-10	3-1/2 X 9-1/4	273.62
CTC-1915029	P-UB-10	3 X 4-3/4	380.65	CTC-1926446K	P-UB-10	3-1/2 X 9-1/4	273.62
CTC-1915030	P-UB-10	3 X 4-3/4	167.68	CTC-1932344	P-UB-10	3-1/2 X 6	276.87
CTC-1915031	P-UB-10	3 X 6	138.57	CTC-1932345	P-UB-10	3 X 5-1/4	162.74
CTC-1915551K	P-UB-10	115 X 170	291.48	CTC-1932346	P-UB-10	3-1/2 X 6	316.13
CTC-1915619	P-UB-10	105 X 150 mm	167.89	CTC-1932347	P-UB-10	3 X 5	190.91
CTC-1915649	P-UB-10	115 X 170	328.85	CTC-1932348	P-UB-10	3 X 7	266.95
CTC-1916508	P-UB-10	3 X 7-1/4	162.81	CTC-1933088	P-UB-10	1-7/8 X 3-1/4	90.67
CTC-1916511	P-UB-10	3 X 7-1/4	178.85	CTC-1933089	P-UB-10	2-3/4 X 5	133.54
CTC-1917692	P-UB-10	3 X 6-1/4	172.50	CTC-1933090	P-UB-10	2-3/4 X 6-1/2	202.43
CTC-1917693	P-UB-10	3-1/4 X 9-1/4	328.73	CTC-1933091	P-UB-10	2-3/4 X 7-1/4	163.17
CTC-1917694	P-UB-10	3 X 6-1/4	225.05	CTC-1933092	P-UB-10	2-3/4 X 6-1/2	85.28
CTC-1917696	P-UB-10	3-1/4 X 9-1/4	371.88	CTC-1933093	P-UB-10	2-3/4 X 5-1/2	169.10
CTC-1917721K	P-UB-10	1-1/2 X 3	42.93	CTC-1933094	P-UB-10	2-3/4 X 7	259.36
CTC-1917725K	P-UB-10	1-1/2 X 3	42.93	CTC-1933096	P-UB-10	3-1/2 X 7-1/2	287.65
CTC-1917753K	P-UB-10	2-3/8 X 4-1/2	84.96	CTC-1933097	P-UB-10	2-3/4 X 6-1/2	99.72
CTC-1917835K	I-UB-10	2-3/4 X 3-3/4	83.39	CTC-1933098	P-UB-10	4 X 10	238.90
CTC-1917839K	I-UB-10	2-3/4 X 3-3/4	83.43	CTC-1933099	P-UB-10	4 X 10	346.26
CTC-1917846K	P-UB-10	2-3/8 X 4-3/4	103.99	CTC-1933102	P-UB-10	4 X 9-1/4	326.09
CTC-1918161K	P-UB-10	2 X 4	48.39	CTC-1933103	P-UB-10	4 X 10-1/2	396.32
CTC-1919203	P-UB-10	3 X 6-1/4	160.98	CTC-1933104	P-UB-10	2-3/4 X 6-1/2	235.59
CTC-1919204	P-UB-10	3 X 6	168.49	CTC-1933106	P-UB-10	2-3/4 X 5-1/2	223.09
CTC-1919205	P-UB-10	3-1/4 X 8-1/4	166.75	CTC-1933108	P-UB-10	2-3/4 X 7	278.88
CTC-1919206	P-UB-10	3-1/4 X 6-1/2	206.64	CTC-1933112	P-UB-10	4 X 9-1/4	243.05
CTC-1919207	P-UB-10	3-1/4 X 9-1/4	252.08	CTC-1933114	P-UB-10	2-3/4 X 7-1/4	238.97
CTC-1919208	P-UB-10	4 X 6-1/2	474.94	CTC-1933115	P-UB-10	3-1/2 X 8-1/2	369.13
CTC-1919209	P-UB-10	3-1/4 X 9-1/4	279.88	CTC-1933116	P-UB-10	3-1/2 X 7-3/4	156.74
CTC-1919212	P-UB-10	3 X 6	177.89	CTC-1933117	P-UB-10	2-3/4 X 4-1/2	115.46
CTC-1919214	P-UB-10	3-1/4 X 6-1/2	247.41	CTC-1934321	P-U-10	50 X 85 mm	139.52
CTC-1919216	P-UB-10	4 X 6-1/2	442.69	CTC-1934322	P-U-10	50 X 90 mm	92.20
CTC-1919605	P-U-10	45 mm X 60 mm	74.03	CTC-1934323	P-U-10	45 X 75 mm	75.43
CTC-1920738	P-UB-10	3-1/4 X 5-1/2	189.76	CTC-1934324	P-U-10	50 X 100 mm	131.82
CTC-1920739	P-UB-10	3-1/4 X 7-1/4	171.97	CTC-1934325	P-U-10	50 X 80 mm	120.17
CTC-1920740	P-UB-10	3-1/4 X 7-1/4	229.08	CTC-1935427	P-UB-10	2-3/4 X 6	97.29

CATERPILLAR®

REPLACEMENT KITS FOR CATERPILLAR® EQUIPMENT

NOTE: CATERPILLAR® kit numbers are used as a reference only. We do not imply that these kits are original REPLACEMENT KITS.

Kit Number	Code (Pg. xviii)	Rod X Bore Size	List Price	Kit Number	Code (Pg. xviii)	Rod X Bore Size	List Price
CTC-1935428	P-UB-10	2-3/4 X 7-1/4	\$ 184.76	CTC-1945593	P-V-10	1-1/4 X 4	\$ 133.49
CTC-1935429	P-UB-10	4 X 7	317.86	CTC-1945594	P-UB-10	4-3/4 X 7-1/4	410.85
CTC-1935431	P-UB-10	2-1/8 X 4	90.67	CTC-1945596	P-UB-10	3-3/4 X 7-3/4	232.48
CTC-1935433	P-UB-10	3-1/2 X 8-1/4	217.31	CTC-1945600	P-UB-10	2-3/8 X 4	58.39
CTC-1935434	P-UB-10	4 X 7	334.71	CTC-1945603	I-UB-10	2-3/4 X 3-3/4	90.51
CTC-1935435	P-UB-10	4 X 7	356.82	CTC-1945604	P-UB-10	2-1/8 X 4	168.12
CTC-1935437	P-UB-10	4 X 7	339.17	CTC-1945605	P-UB-10	4-1/4 X 6-1/2	340.10
CTC-1935438	P-UB-10	2-3/4 X 6	69.99	CTC-1945606	P-UB-10	4-1/4 X 7-3/4	263.86
CTC-1935440	P-UB-10	2-3/4 X 7-1/4	260.25	CTC-1945608	P-UB-10	4 X 8-1/2	290.88
CTC-1937619	P-UB-10	2-3/4 X 5	179.21	CTC-1945610	P-UB-10	4-3/4 X 7-1/4	395.19
CTC-1937620	P-UB-10	2-3/4 X 4-1/4	89.08	CTC-1945611	P-UB-10	4-3/4 X 7	369.11
CTC-1937621	P-UB-10	2-3/4 X 5-1/2	145.50	CTC-1945612	P-UB-10	4-3/4 X 6-1/2	363.26
CTC-1937622	P-UB-10	3-1/2 X 7-1/2	156.91	CTC-1945614	I-UB-10	2-1/2 X 3-1/2	192.63
CTC-1937623	P-UB-10	2-3/4 X 6	153.68	CTC-1948235	P-UB-10	110 X 160	244.94
CTC-1937624	P-UB-10	2-3/4 X 6-1/2	163.84	CTC-1948363	P-UB-10	100 X 140 mm	416.50
CTC-1937625	P-UB-10	4 X 6	215.07	CTC-1948366	P-UB-10	105 X 150 mm	388.02
CTC-1937626	P-UB-10	1-7/8 X 3	208.65	CTC-1948396	P-UB-10	110 X 160	219.20
CTC-1937628	P-UB-10	3-1/2 X 8-1/4	327.10	CTC-1964523K	P-UB-10	2 X 85 mm	143.37
CTC-1937629	P-UB-10	2-3/4 X 4-1/4	153.98	CTC-1978079K	P-UB-10	2-1/2 X 4	50.94
CTC-1937630	P-UB-10	2-3/4 X 5-1/2	205.65	CTC-1978083K	P-UB-10	2-1/2 X 4	50.94
CTC-1937631	P-UB-10	2-3/4 X 5-1/2	220.76	CTC-1980648K	I-U-10	45 X 60	48.46
CTC-1937633	P-UB-10	3-1/2 X 7-1/2	248.01	CTC-1987021K	P-U-10	50 X 80 mm	120.20
CTC-1937635	P-UB-10	3-1/2 X 6-1/4	248.48	CTC-1989433	P-U-10	55 X 100 mm	90.45
CTC-1937637	P-UB-10	3-1/2 X 8-1/4	288.05	CTC-1990609	P-U-10	55 X 85 mm	85.84
CTC-1937639	P-UB-10	2-3/4 X 5-1/2	124.31	CTC-1991149	P-U-10	45 X 75 mm	72.35
CTC-1937640	P-UB-10	3-1/2 X 6-1/4	216.65	CTC-1992097	P-U-10	50 X 90 mm	99.86
CTC-1937852K	P-U-10	45 X 75 mm	75.48	CTC-1992402	P-U-10	55 X 100 mm	92.04
CTC-1937855K	P-U-10	45 X 80 mm	65.49	CTC-1997416	P-UB-10	105 X 150 mm	213.42
CTC-1937859K	P-U-10	45 X 85 mm	76.78	CTC-1997417	P-UB-10	110 X 170	230.95
CTC-1939260	P-UB-10	4 X 8-1/2	358.32	CTC-1U1839K	P-UB-10	2-1/4 X 3-3/4	58.55
CTC-1939261	P-UB-10	356-3/4 X 6	247.43	CTC-2000920	P-U-10	70 mm X 130 mm	154.98
CTC-1939263	P-UB-10	3-3/4 X 6	264.54	CTC-2003239	P-UB-10	75 X 120 mm	86.39
CTC-1939264	P-UB-10	3-1/2 X 7-1/4	180.22	CTC-2003240	P-UB-10	70 X 100 mm	99.67
CTC-1939265	P-UB-10	3-1/2 X 4-1/2	283.81	CTC-2003242	P-UB-10	55 X 100 mm	146.11
CTC-1939266	P-UB-10	3-1/2 X 10	351.96	CTC-2003315	P-UB-10	105 X 150 mm	167.89
CTC-1939267	P-UB-10	2-3/4 X 6	173.57	CTC-2003361	P-UB-10	75 X 130 mm	204.90
CTC-1939269	P-UB-10	2-3/4 X 5-1/2	126.47	CTC-2003495	P-UB-10	140 mm X 200 mm	285.09
CTC-1939270	I-UB-10	2-3/4 X 3-3/4	105.38	CTC-2003496	P-UB-10	150 mm X 220 mm	496.40
CTC-1942756	P-UB-10	3-1/2 X 4-1/2	342.14	CTC-2003497	P-UB-10	150 X 220 mm	501.04
CTC-1944389	P-UB-10	3-3/4 X 6-1/2	198.86	CTC-2003498	P-UB-10	130 X 190	323.83
CTC-1944393	P-UB-10	3-3/4 X 6-1/2	199.03	CTC-2003499	P-UB-10	130 X 180	314.11
CTC-1944395	P-UB-10	7 X 11	990.36	CTC-2003572	P-UB-10	110 mm X 160 mm	242.11
CTC-1944396	P-UB-10	4 X 4-1/2	252.51	CTC-2003621	P-UB-10	130 X 190 mm	590.82
CTC-1944397	P-UB-10	2-3/4 X 4	171.17	CTC-2004300K	P-UB-10	4-1/2 X 150 mm	239.40
CTC-1944398	P-UB-10	4 X 4-1/2	237.58	CTC-2007128K	P-UB-10	2 X 4	48.43
CTC-1944399	P-UB-10	3-1/2 X 4-1/2	253.02	CTC-2011056K	P-UB-10	1-1/2 X 2-3/4	44.85
CTC-1945583	P-UB-10	2-3/8 X 4-1/2	84.49	CTC-2014838	P-UB-10	3 X 4-3/4	345.96
CTC-1945586	P-UB-10	3-1/2 X 10-1/2	375.98	CTC-2022263	P-UB-10	100 X 140 mm	452.95
CTC-1945587	P-UB-10	3-1/2 X 8-1/4	196.41	CTC-2022264	P-UB-10	105 X 150 mm	504.50
CTC-1945588	P-UB-10	7 X 11	879.54	CTC-2027897	I-U-5	40 mm X 60 mm	42.80
CTC-1945591	P-UB-10	4-1/4 X 6-1/2	558.73	CTC-2028910K	P-U-10	4 X 5-1/4	144.23

CATERPILLAR®

REPLACEMENT KITS FOR CATERPILLAR® EQUIPMENT

NOTE: CATERPILLAR® kit numbers are used as a reference only. We do not imply that these kits are original REPLACEMENT KITS.

Kit Number	Code (Pg. xviii)	Rod X Bore Size	List Price	Kit Number	Code (Pg. xviii)	Rod X Bore Size	List Price
CTC-2037172K	P-U-10	40 X 65 mm	\$ 47.12	CTC-2107086K	I-UB-10	2-3/8 X 85 mm	\$ 72.55
CTC-2037756K	P-U-10	75 mm X 125 mm	150.09	CTC-2107087K	I-UB-10	2-1/2 X 3-1/2	37.50
CTC-2037847K	P-U-10	45 mm X 75 mm	49.48	CTC-2107088K	I-UB-10	2-1/2 X 3-1/2	34.71
CTC-2037847K2	P-U-10	45 mm X 75 mm	55.89	CTC-2107091K	P-UB-10	2-1/2 X 5	78.07
CTC-2041129	P-UB-10	1-3/4 X 3-1/2	156.24	CTC-2107092K	P-UB-10	2-1/2 X 5	75.33
CTC-2042718K	P-UB-14	60 X 90 mm	159.27	CTC-2107096K	I-UB-10	2-3/4 X 3-3/4	87.24
CTC-2042721	P-UB-10	110 X 160	240.35	CTC-2107097K	P-UB-10	1-1/2 X 3	42.08
CTC-2043398	P-UB-10	2-1/2 X 4-1/2	204.45	CTC-2107098K	P-UB-10	1-1/2 X 3	39.63
CTC-2043616	P-UB-10	100 X 140	159.52	CTC-2110620	P-UB-10	2-1/2 X 5-1/4	195.37
CTC-2043625	P-UB-10	85 X 120 mm	246.55	CTC-2115306	P-UB-10	140 mm X 200 mm	471.05
CTC-2043626	P-UB-10	100 X 140 mm	316.93	CTC-2118740	P-UB-10	85 mm X 130 mm	311.69
CTC-2043627	P-UB-10	85 X 120	144.74	CTC-2118742	P-UB-10	2-1/2 X 4	174.63
CTC-2043628	P-UB-10	85 X 125	155.76	CTC-2119614	P-UB-10	90 X 130	163.47
CTC-2043629	P-UB-10	90 X 130 mm	280.88	CTC-2126328K	P-U-10	35 X 65 mm	53.33
CTC-2043630	P-UB-10	90 X 130 mm	261.98	CTC-2126329K	P-U-10	40 X 70 mm	45.24
CTC-2043692	P-UB-10	85 X 120	153.39	CTC-2126335K	P-U-10	45 X 75 mm	58.33
CTC-2044910K	P-UB-10	90 X 130	142.32	CTC-2126336K	P-U-10	45 X 75 mm	58.33
CTC-2044912K	P-UB-10	100 X 140	182.40	CTC-2126337K	P-U-10	45 X 75 mm	62.70
CTC-2044914K	P-UB-10	90 X 130	117.50	CTC-2138433	I-U-10	2-1/2 X 5	12.92
CTC-2047813K	P-U-10	2 X 100 mm	78.74	CTC-2144502	P-UB-10	100 X 140	159.52
CTC-2050055K	P-U-10	2 X 100 mm	78.74	CTC-2146321	P-UB-10	100 X 140 mm	466.79
CTC-2058655K	P-UB-10	2-3/4 X 5-3/8	148.56	CTC-2147581	P-UB-10	100 X 140 mm	454.04
CTC-2058656K	P-UB-10	65 mm X 4-3/4	168.08	CTC-2149170	P-UB-10	3-1/4 X 8-1/4	175.62
CTC-2058668	P-UB-10	3 X 7-1/4	253.37	CTC-2152436	P-UB-10	4-3/4 X 7	402.33
CTC-2060503K	P-UB-10	2-1/2 X 4-1/2	57.10	CTC-2159896K	P-UB-14	60 X 90 mm	159.27
CTC-2060520K	P-UB-10	2-1/8 X 4	103.51	CTC-2159984	P-UB-10	95 mm X 130 mm	112.37
CTC-2060522K	P-UB-10	2-1/8 X 4	103.51	CTC-2159985	P-UB-10	100 X 140 mm	126.80
CTC-2062857	P-UB-10	3-1/4 X 5-1/2	440.54	CTC-2159986	P-UB-10	90 X 130	129.44
CTC-2063553K	P-UB-10	1-7/8 X 3-1/4	46.51	CTC-2159988	P-UB-10	110 X 160	206.78
CTC-2063555K	P-UB-10	2 X 85 mm	143.37	CTC-2159989	P-UB-10	110 X 160 mm	263.61
CTC-2063628K	P-UB-10	2-3/8 X 4-1/2	65.96	CTC-2159990	P-UB-10	110 X 170	229.07
CTC-2063805	P-U-10	45 mm X 65 mm	101.67	CTC-2159995	P-UB-10	140 X 200	392.54
CTC-2072068K	P-U-10	55 mm X 125 mm	154.40	CTC-2159996	P-UB-10	130 mm X 180 mm	296.04
CTC-2089504	P-UB-10	105 X 150 mm	133.95	CTC-2167247	P-U-10	55 X 100 mm	139.40
CTC-2089506	P-UB-10	140 X 200 mm	593.24	CTC-2167388K	P-UB-10	1-1/2 X 2-3/4	44.85
CTC-2089508	P-UB-10	100 X 140 mm	421.87	CTC-2167644	P-U-10	50 X 85 mm	224.29
CTC-2089509	P-UB-10	90 X 130 mm	404.27	CTC-2168100	P-U-10	45 X 70 mm	196.60
CTC-2092101	P-UB-10	3 X 5-1/2	199.35	CTC-2171007	P-UB-10	105 mm X 180 mm	343.57
CTC-2094979	P-UB-10	1-7/8 X 3-1/4	46.76	CTC-2171643	P-U-10	55 X 85 mm	229.57
CTC-2095873	P-UB-10	90 X 130 mm	401.23	CTC-2172886	I-U-10	38 mm X 85 mm	139.79
CTC-2095874	P-UB-10	100 X 140 mm	262.92	CTC-2179894	P-UB-10	55 mm X 4-1/2	126.36
CTC-2095959	P-UB-10	95 mm X 130 mm	516.26	CTC-2186822	P-U-10	35 mm X 70 mm	76.42
CTC-2101427	P-UB-10	90 X 160 mm	422.57	CTC-2186823	P-U-10	40 mm X 60 mm	61.33
CTC-2106150	P-UB-10	105 X 150 mm	502.37	CTC-2186824	P-U-10	45 mm X 65 mm	64.71
CTC-2106151	P-UB-10	105 X 150 mm	504.50	CTC-2186825	P-U-10	30 mm X 65 mm	59.17
CTC-2107076K	P-UB-10	2-3/8 X 4-3/4	105.10	CTC-2186826	P-U-10	35 mm X 50 mm	39.40
CTC-2107077K	P-UB-10	2-1/4 X 4-1/4	60.66	CTC-2186827	P-U-10	45 mm X 60 mm	59.44
CTC-2107078K	P-UB-10	2-1/4 X 4-1/4	58.20	CTC-2190541K	P-U-10	40 X 65 mm	47.12
CTC-2107081K	P-UB-10	65 mm X 4-3/4	198.74	CTC-2191322	P-U-5	40 mm X 70 mm	35.74
CTC-2107082K	P-UB-10	65 mm X 4-3/4	196.61	CTC-2199066	P-U-10	55 X 95 mm	166.35
CTC-2107085K	I-UB-10	2-3/8 X 85 mm	61.54	CTC-2222376	P-UB-10	65 mm X 100 mm	158.32

CATERPILLAR®

REPLACEMENT KITS FOR CATERPILLAR® EQUIPMENT

NOTE: CATERPILLAR® kit numbers are used as a reference only. We do not imply that these kits are original REPLACEMENT KITS.

Kit Number	Code (Pg. xviii)	Rod X Bore Size	List Price	Kit Number	Code (Pg. xviii)	Rod X Bore Size	List Price
CTC-2235944	I-UB-10	2-3/4 X 3-3/4	\$ 82.00	CTC-2304001	P-UB-10	110 X 180	\$ 271.89
CTC-2235945	I-UB-10	2-1/2 X 3-1/2	68.58	CTC-2309267K	P-U-10	45 X 85 mm	83.09
CTC-2245091K	P-UB-10	1-1/2 X 3	34.69	CTC-2309357	I-U-10	1-1/2 X 3	57.37
CTC-2251846K	P-U-10	4 X 5-1/4	144.23	CTC-2310898	P-UB-10	2-1/2 X 4-1/2	78.05
CTC-2254625	P-UB-10	110 X 160	279.23	CTC-2315021	I-UB-10	2-3/4 X 3-3/4	83.43
CTC-2254646	P-UB-10	130 X 190	332.87	CTC-2316844	P-UB-10	115 X 170	328.85
CTC-2256727K	P-UB-10	3 X 4-3/4	135.79	CTC-2316845	P-UB-10	115 X 170	335.75
CTC-2269959K	P-U-10	35 X 65 mm	53.33	CTC-2320652K	P-UB-10	4 X 9-1/4	288.83
CTC-2270841K	P-UB-10	2-1/2 X 6	75.44	CTC-2320653K	P-UB-10	4 X 9-1/4	288.83
CTC-2270842K	P-UB-10	2-1/2 X 5	78.87	CTC-2320654K	P-UB-10	4 X 9-1/4	298.83
CTC-2270843K	P-UB-10	2-1/2 X 4	94.02	CTC-2330478K	P-UB-10	2-1/2 X 4	183.56
CTC-2270844K	P-UB-10	2-1/2 X 4	94.02	CTC-2330761	P-UB-10	95 X 130 mm	472.75
CTC-2270994K	P-UB-10	2-1/2 X 4	183.56	CTC-2330763	P-UB-10	100 X 170	232.61
CTC-2275347	P-UB-10	2-1/2 X 5	97.12	CTC-2330764	P-UB-10	95 X 160 mm	209.96
CTC-2275348	P-UB-10	2-3/4 X 4-1/2	124.54	CTC-2331014	P-U-10	70 mm X 100 mm	83.13
CTC-2275349	P-UB-10	3 X 4-3/4	201.03	CTC-2332622	P-UB-10	50 mm X 100 mm	64.40
CTC-2275350	P-UB-10	1-3/4 X 3	34.62	CTC-2332623	P-UB-10	55 mm X 100 mm	112.07
CTC-2278893K	P-UB-10	2-1/2 X 5-1/4	83.43	CTC-2332628	P-U-10	1-7/8 X 3-1/4	143.42
CTC-2280320K	P-UB-10	2 X 4	73.04	CTC-2339134K	P-UB-10	3 X 6-1/2	126.22
CTC-2280806	P-UB-10	3 X 7	301.03	CTC-2339204	P-UB-10	1-1/2 X 2-3/4	64.76
CTC-2280807	P-UB-10	3 X 6-1/4	275.55	CTC-2339205	P-UB-10	2 X 4	55.18
CTC-2280808	P-UB-10	2-3/4 X 6-1/4	251.70	CTC-2341902	I-U-15	30 mm X 50 mm	22.58
CTC-2280809	P-UB-10	2-3/4 X 5-1/2	126.47	CTC-2341948	P-UB-10	2-1/2 X 4-3/4	93.79
CTC-2281775	P-UB-10	3-1/2 X 7-3/4	165.11	CTC-2341949	P-UB-10	2-1/2 X 4	57.51
CTC-2281776	P-UB-10	3 X 5-1/4	112.19	CTC-2341950	P-UB-10	2-1/2 X 5-1/4	223.98
CTC-2281778	P-UB-10	2 X 3-1/2	80.42	CTC-2341951	P-UB-10	2-1/2 X 4-1/4	171.19
CTC-2281779	P-UB-10	3-1/4 X 7	155.45	CTC-2342590	P-UB-10	5-1/2 X 10-1/2	546.87
CTC-2281780	P-UB-10	3-1/4 X 8-1/4	244.90	CTC-2342591	P-UB-10	2-1/4 X 4	66.77
CTC-2281792	P-UB-10	3-1/4 X 7	148.07	CTC-2342592	P-UB-10	1-1/2 X 2-1/2	128.24
CTC-2281793	P-UB-10	3 X 6	149.90	CTC-2342593	P-UB-10	1-7/8 X 3-1/4	65.71
CTC-2281795	P-UB-10	1-3/4 X 3-1/2	101.57	CTC-2342594	P-UB-10	1-3/4 X 3	40.76
CTC-2282533	P-UB-10	3-1/2 X 9-1/4	325.94	CTC-2342595	P-UB-10	1-3/4 X 2-3/4	156.06
CTC-2282758K	P-UB-10	4-1/2 X 150 mm	239.40	CTC-2344442	P-UB-10	110 X 170	247.21
CTC-2285271	P-UB-10	2-1/2 X 4-3/4	83.13	CTC-2344488	P-UB-10	95 X 135	277.99
CTC-2285272	P-UB-10	2-1/2 X 4-3/4	91.93	CTC-2344566	P-UB-10	100 X 140	151.33
CTC-2285273	P-UB-10	2-1/2 X 5-1/2	86.19	CTC-2344576	P-UB-10	105 X 150	347.56
CTC-2285274	P-UB-10	2-3/4 X 5-1/2	224.34	CTC-2344587	P-UB-10	95 X 135	138.86
CTC-2285275	P-UB-10	2-3/4 X 5-1/2	191.75	CTC-2344666	P-UB-10	140 mm X 200 mm	447.10
CTC-2292626	P-UB-10	2-1/2 X 4	101.83	CTC-2344667	P-UB-10	150 X 220 mm	723.06
CTC-2292758	P-UB-10	3 X 4-1/2	87.95	CTC-2344673	P-UB-10	130 mm X 180 mm	304.43
CTC-2292968	P-UB-10	3 X 4-3/4	414.46	CTC-2344674	P-UB-10	110 X 160 mm	228.46
CTC-2293635	P-UB-10	3-1/2 X 6-1/4	304.12	CTC-2350351	P-UB-10	1-3/4 X 2-3/4	150.09
CTC-2293636	P-UB-10	3-1/2 X 6-1/4	329.65	CTC-2350352	P-UB-10	1-3/4 X 2-3/4	104.18
CTC-2295507	P-UB-10	4 X 7	250.85	CTC-2350353	P-UB-10	1-3/4 X 3	163.31
CTC-2295538	P-UB-10	2-1/2 X 4	172.10	CTC-2350354	P-UB-10	1-1/2 X 3	35.56
CTC-2295546	P-UB-10	4-1/2 X 220 mm	382.61	CTC-2350355	P-UB-10	2-1/4 X 3-1/2	166.02
CTC-2295549	P-UB-10	5" X 220 mm	520.34	CTC-2350969	P-UB-10	2-1/4 X 3-3/4	175.62
CTC-2297173	P-UB-10	3-1/4 X 8-1/2	318.50	CTC-2350970	P-UB-10	2-5/8 X 5-1/4	334.19
CTC-2297189	P-UB-10	7 X 11	1028.76	CTC-2350972	P-UB-10	2-3/8 X 4-1/2	184.60
CTC-2297191	P-UB-10	3-1/4 X 5-1/2	238.70	CTC-2350973	P-UB-10	2-3/8 X 4-3/4	159.14
CTC-2297194	P-UB-10	2-1/2 X 4-1/2	57.10	CTC-2350974	P-UB-10	3-1/2 X 7	304.51

REPLACEMENT KITS FOR CATERPILLAR® EQUIPMENT

NOTE: CATERPILLAR® kit numbers are used as a reference only. We do not imply that these kits are original REPLACEMENT KITS.

Kit Number	Code (Pg. xviii)	Rod X Bore Size	List Price	Kit Number	Code (Pg. xviii)	Rod X Bore Size	List Price
CTC-2355802	P-UB-10	2-3/4 X 6-1/2	\$ 75.17	CTC-2409938	P-UB-10	2 X 4-1/4	\$ 125.90
CTC-2355804	P-UB-10	2-3/4 X 6-1/2	206.86	CTC-2409939	P-UB-10	2 X 4-1/4	145.78
CTC-2356823K	P-UB-10	2-1/2 X 4-1/2	57.80	CTC-2409941	P-UB-10	2 X 4	160.96
CTC-2356824K	P-UB-10	2-3/4 X 6	114.58	CTC-2409942	P-UB-10	2 X 4-1/2	167.28
CTC-2359829K	P-UB-10	2-1/2 X 4-1/2	57.07	CTC-2410108	P-U-10	2 X 4-3/4	163.16
CTC-2366368	P-UB-10	85 X 120	113.40	CTC-2410109	P-UB-10	2in x 75mm	94.44
CTC-2366389	P-U-10	85 X 120	113.40	CTC-2410110	P-UB-10	2in x 85mm	127.72
CTC-2369769K	P-UB-10	3 X 4-3/4	103.90	CTC-2410550K	P-UB-10	3-1/2 X 7-1/4	135.97
CTC-2370946K	I-U-10	1 X 2	13.43	CTC-2410895	P-UB-10	2-1/4 X 5	63.31
CTC-2373542K	P-U-10	40 X 70 mm	45.24	CTC-2410896	P-UB-10	2-1/4 X 4-1/2	78.30
CTC-2374079K	P-U-10	40 X 70 mm	45.24	CTC-2410897	P-UB-10	2-1/4 X 4-1/2	47.80
CTC-2375448	P-UB-10	4" X 230 mm	416.99	CTC-2410898	P-UB-10	2-1/4 X 4-1/4	58.64
CTC-2378277	P-UB-10	2 X 4	53.43	CTC-2410899	P-UB-10	2-1/4 X 4	143.88
CTC-2378313	P-UB-10	3 X 6	223.27	CTC-2410900	P-UB-2	2-1/4 X 3-3/4	42.28
CTC-2379271K	P-UB-10	1-1/2 X 2-3/4	45.59	CTC-2410901	P-UB-10	2-1/4 X 4	57.41
CTC-2384462	P-UB-10	2 X 3	46.41	CTC-2410902	P-UB-10	2-1/4 X 4-3/4	79.94
CTC-2384487	P-V-10	2 X 5	58.22	CTC-2410903	P-UB-10	2-1/4 X 3-1/2	80.09
CTC-2384501	P-UB-10	2 X 4-1/4	44.05	CTC-2414062K	P-UB-10	3 X 5	132.49
CTC-2386661	P-UB-10	2 X 3-1/4	43.55	CTC-2414068K	P-UB-10	3-1/2 X 5-1/2	175.56
CTC-2386718	P-UB-10	2 X 4-1/2	42.84	CTC-2414071K	P-UB-10	3 X 4-1/2	117.09
CTC-2386859	P-UB-10	2 X 3-1/2	70.49	CTC-2417578	P-UB-10	2-1/4 X 5	65.89
CTC-2386882	P-U-10	2 X 4-1/2	157.15	CTC-2417579	P-UB-10	2-1/4 X 4-1/4	180.58
CTC-2390837K	P-U-10	40 X 65 mm	47.09	CTC-2417580	P-UB-10	2-1/4 X 4-3/4	172.18
CTC-2392956	P-U-10	25 mm X 50 mm	34.89	CTC-2417584	P-UB-10	2-1/4 X 4-1/2	77.73
CTC-2401661	P-UB-10	1-3/4 X 3-1/2	82.15	CTC-2417585	P-UB-10	2-1/4 X 4-1/2	76.28
CTC-2401671	P-UB-10	1-3/4 X 3-1/4	38.78	CTC-2418916	P-UB-10	2-1/4 X 3-1/2	198.13
CTC-2401881	P-UB-10	1-3/4 X 3-1/2	74.50	CTC-2418917	P-UB-10	2-1/4 X 4-1/2	181.35
CTC-2401905	P-UB-10	1-3/4 X 4	107.11	CTC-2418919	P-UB-10	2-1/4 X 4-1/2	186.67
CTC-2402016	P-UB-10	1-3/4 X 3	42.98	CTC-2418920	P-U-10	2-1/4 X 4-3/4	167.36
CTC-2402481	P-UB-10	1-3/4 X 3-3/4	46.82	CTC-2418921	P-UB-10	2-1/4 X 4	76.64
CTC-2402482	P-UB-10	1-3/4 X 2-3/4	42.53	CTC-2418924	P-UB-10	2-3/4 X 4-1/2	78.66
CTC-2402484	P-UB-10	1-3/4 X 2-1/2	114.52	CTC-2418925	P-UB-10	2-3/8 X 4	58.45
CTC-2404713	P-UB-10	1-3/4 X 2-3/4	103.25	CTC-2419297	P-UB-10	2-1/4 X 4	159.76
CTC-2404819	P-UB-10	1-3/4 X 4	112.44	CTC-2422538	P-UB-10	2-1/2 X 4-1/4	59.06
CTC-2405500	P-UB-10	1-3/4 X 2-1/2	59.69	CTC-2422539	P-UB-10	2-1/2 X 5-1/2	82.78
CTC-2405524	P-UB-10	1-3/4 X 3	125.45	CTC-2422540	P-UB-10	2-1/2 X 6	96.81
CTC-2406029K	I-UB-10	2-3/4 X 3-3/4	76.71	CTC-2422541	P-UB-10	2-1/2 X 6-1/2	281.64
CTC-2406030K	I-UB-10	2-3/4 X 3-3/4	76.71	CTC-2422542	P-UB-10	2-1/2 X 5	83.64
CTC-2406869	P-UB-10	2 X 3-3/4	130.69	CTC-2422543	P-UB-10	2-1/1 X 4	62.37
CTC-2406883	P-UB-10	2 X 5	180.63	CTC-2422544	P-UB-10	2-1/2 X 7-1/4	83.91
CTC-2406899	P-UB-10	2 X 4	55.18	CTC-2422545	P-UB-10	2-1/2 X 6	245.43
CTC-2407308	P-UB-10	2 X 3-1/2	73.29	CTC-2422546	P-UB-10	2-1/2 X 4-1/4	64.31
CTC-2407347K	P-UB-10	3-1/2 X 7-1/4	191.90	CTC-2422547	P-UB-10	2-1/2 X 4-1/4	59.23
CTC-2408479	P-U-10	2 X 5	167.91	CTC-2422548	P-UB-10	2-1/2 X 4	59.67
CTC-2408513	P-V-10	2 X 4	170.13	CTC-2422549	P-UB-10	2-1/2 X 6-1/2	91.60
CTC-2408515	P-U-10	2 X 3-1/2	111.46	CTC-2422550	P-UB-10	2-1/2 X 6	112.17
CTC-2408523	P-UB-10	2 X 4-1/4	59.63	CTC-2422551	P-UB-10	2-1/2 X 3-3/4	56.59
CTC-2408525	P-UB-10	2 X 3-1/4	47.81	CTC-2422552	P-U-10	2-1/2 X 6	181.58
CTC-2409518	P-UB-10	2 X 3-3/4	162.48	CTC-2422553	P-U-10	2-1/2 X 5	84.89
CTC-2409538	P-UB-10	2 X 4	76.30	CTC-2422554	P-U-10	2-1/2 X 6-1/2	191.02
CTC-2409936	P-UB-10	2 X 4-1/2	145.66	CTC-2422555	P-U-10	2-1/2 X 6-1/2	190.53

CATERPILLAR®

REPLACEMENT KITS FOR CATERPILLAR® EQUIPMENT

NOTE: CATERPILLAR® kit numbers are used as a reference only. We do not imply that these kits are original REPLACEMENT KITS.

Kit Number	Code (Pg. xviii)	Rod X Bore Size	List Price	Kit Number	Code (Pg. xviii)	Rod X Bore Size	List Price
CTC-2422556	P-U-10	2-1/2 X 6	\$ 94.11	CTC-2440959	P-UB-10	2-3/4 X 4-1/4	\$ 103.52
CTC-2422557	P-U-10	2-1/2 X 6	89.62	CTC-2440960	P-UB-10	2-3/4 X 5-1/2	186.56
CTC-2422558	P-UB-10	2-1/2 X 6	69.61	CTC-2440961	P-UB-10	2-3/4 X 6	76.32
CTC-2424270K	P-UB-10	3-1/4 X 6-1/4	217.41	CTC-2440962	P-UB-10	2-3/4 X 6-1/2	212.23
CTC-2424271K	P-UB-10	3-1/4 X 5-3/4	262.26	CTC-2440964	P-UB-10	2-3/4 X 4-1/4	82.50
CTC-2424272K	P-UB-10	3-1/4 X 5-3/4	262.26	CTC-2440965	P-UB-10	2-3/4 X 5-1/2	223.16
CTC-2424273K	P-UB-10	3-1/4 X 170 mm	226.45	CTC-2440966	P-UB-10	2-3/4 X 5-1/2	239.51
CTC-2426770K	P-UB-10	90 mm X 130 mm	140.69	CTC-2440969	P-UB-10	2-3/4 X 6	208.90
CTC-2426840	P-UB-10	105 X 150	181.64	CTC-2440971	P-UB-10	2-3/4 X 4	189.23
CTC-2426855K	P-UB-10	90 X 130 mm	119.61	CTC-2440972	P-UB-10	2-3/4 X 5	197.27
CTC-2430381	P-UB-10	2-1/2 X 5-1/2	76.98	CTC-2440973	P-UB-10	2-3/4 X 6	230.95
CTC-2430382	P-UB-10	2-1/2 X 6-1/2	113.35	CTC-2440975	P-UB-10	3 X 6-1/2	239.29
CTC-2430383	P-UB-10	2-1/2 X 5-1/2	65.27	CTC-2440976	P-UB-10	3 X 4	78.67
CTC-2430384	P-UB-10	2-1/2 X 5	83.92	CTC-2440978	P-UB-10	3 X 5-1/2	281.74
CTC-2430386	P-UB-10	2-1/2 X 5	72.94	CTC-2440979	P-UB-10	3 X 5-1/2	103.98
CTC-2430387	P-UB-10	2-1/2 X 5	215.64	CTC-2440980	P-UB-10	3 X 6-1/2	158.55
CTC-2430389	P-UB-10	2-1/2 X 3-3/4	157.85	CTC-2442044	P-UB-10	3 X 6-1/2	109.28
CTC-2430391	P-UB-10	2-1/2 X 4	69.71	CTC-2442046	P-UB-10	3 X 7-1/4	156.84
CTC-2430393	P-UB-10	2-1/2 X 4-1/4	193.69	CTC-2442047	P-UB-10	3 X 7-1/4	262.08
CTC-2430395	P-UB-10	2-1/2 X 5-1/2	219.13	CTC-2442049	P-UB-10	3 X 6-1/2	108.79
CTC-2430397	P-UB-10	2-1/2 X 4	117.40	CTC-2442050	P-UB-10	3 X 6-1/2	126.02
CTC-2430398	P-UB-10	2-1/2 X 4-3/4	185.17	CTC-2442053	P-UB-10	3 X 6	334.61
CTC-2432058K	P-UB-10	1-3/4 X 3-1/2	77.65	CTC-2442054	P-UB-10	3 X 4-3/4	337.71
CTC-2432276	P-U-10	50 mm X 85 mm	85.95	CTC-2442055	P-UB-10	3 X 6	124.93
CTC-2435796	P-UB-10	2-1/2 X 6-1/2	79.27	CTC-2442056	P-UB-10	3 X 7-1/4	129.64
CTC-2435797	P-UB-10	2-1/2 X 6-1/2	213.66	CTC-2442059	P-UB-10	3 X 7-1/4	241.28
CTC-2435798	P-UB-10	2-1/2 X 4-1/2	78.29	CTC-2442060	P-UB-10	3-1/4 X 6	142.96
CTC-2435799	P-UB-10	2-1/2 X 7-1/4	205.12	CTC-2442061	P-UB-10	3 X 6-1/4	164.12
CTC-2435800	P-UB-10	2-1/2 X 4-3/4	183.13	CTC-2442064	P-UB-10	3 X 6	72.88
CTC-2435801	P-UB-10	2-1/2 X 5-1/2	215.84	CTC-2442067	P-UB-10	3 X 7-1/4	138.57
CTC-2435802	P-UB-10	2-1/2 X 5-1/4	224.58	CTC-2442069	P-UB-10	3 X 8-1/4	333.86
CTC-2435803	P-UB-10	2-1/2 X 6-1/2	228.02	CTC-2442070	P-UB-10	3 X 4-3/4	184.15
CTC-2435804	P-UB-10	2-1/2 X 4-3/4	179.79	CTC-2442071	P-UB-10	3 X 4-3/4	245.27
CTC-2435805	P-UB-10	2-1/2 X 4-1/2	117.42	CTC-2442072	P-UB-10	3 X 5-1/4	344.59
CTC-2435806	P-UB-10	2-1/2 X 4-1/2	185.69	CTC-2442073	P-UB-10	3 X 5-1/4	107.37
CTC-2435808	P-UB-10	2-3/4 X 4-1/2	150.76	CTC-2442074	P-UB-10	3 X 5	89.70
CTC-2435809	P-U-10	2-3/4 X 5	75.18	CTC-2442075	P-UB-10	3 X 4-3/4	357.76
CTC-2435810	P-UB-10	2-3/4 X 5-1/4	128.64	CTC-2442076	P-UB-10	3 X 7-1/4	230.90
CTC-2435811	P-UB-10	2-3/4 X 5	63.90	CTC-2442077	P-UB-10	3 X 5-1/2	227.32
CTC-2435812	P-UB-10	2-3/4 X 6-1/2	138.37	CTC-2442079	P-UB-10	3-1/4 X 5-1/2	133.96
CTC-2435814	P-UB-10	2-3/4 X 7-1/4	248.81	CTC-2442080	P-UB-10	3-1/4 X 5-1/2	129.49
CTC-2435815	P-UB-10	2-3/4 X 7	233.75	CTC-2445647	P-UB-10	3-3/4 X 6	247.43
CTC-2435816	P-UB-10	2-3/4 X 6-1/2	95.82	CTC-2448777K	P-UB-10	3-3/4 X 7-3/4	261.28
CTC-2435818	P-UB-10	2-3/4 X 7	288.98	CTC-2450579	P-UB-10	3-1/4 X 5-1/2	361.66
CTC-2435820	P-UB-10	2-3/4 X 7-1/4	230.96	CTC-2450580	P-UB-10	3-1/4 X 8-1/4	280.66
CTC-2436225	P-UB-10	4-1/4 X 8-1/4	238.94	CTC-2450581	P-UB-10	3-1/4 X 7	252.74
CTC-2440953	P-UB-10	2-3/4 X 6	106.04	CTC-2450582	P-UB-10	3-1/4 X 7	286.89
CTC-2440954	P-UB-10	2-3/4 X 7-1/4	156.93	CTC-2450584	P-UB-10	3-1/4 X 8-1/4	174.29
CTC-2440955	P-UB-10	2-3/4 X 6	69.99	CTC-2450585	P-UB-10	3-1/4 X 7	111.91
CTC-2440957	P-UB-10	2-3/4 X 7-1/4	294.02	CTC-2450586	P-UB-10	3-1/4 X 7	259.64
CTC-2440958	P-UB-10	2-3/4 X 5	123.26	CTC-2450588	P-UB-10	3-1/4 X 9-1/4	279.00

REPLACEMENT KITS FOR CATERPILLAR® EQUIPMENT

NOTE: CATERPILLAR® kit numbers are used as a reference only. We do not imply that these kits are original REPLACEMENT KITS.

Kit Number	Code (Pg. xviii)	Rod X Bore Size	List Price	Kit Number	Code (Pg. xviii)	Rod X Bore Size	List Price
CTC-2450589	P-UB-10	3-1/4 X 9-1/4	\$ 238.06	CTC-2460637	P-UB-10	3-1/2 X 10-1/2	\$ 435.86
CTC-2450590	P-UB-10	3-1/4 X 9-1/4	363.00	CTC-2460638	P-UB-10	3-1/2 X 8-1/4	126.50
CTC-2450592	P-UB-10	3-1/4 X 5-1/2	151.02	CTC-2460639	P-UB-10	3-1/2 X 7-1/4	313.38
CTC-2450593	P-UB-10	3-1/4 X 8-1/4	299.73	CTC-2460641	P-UB-10	4 X 6-1/2	529.69
CTC-2450594	P-UB-10	3-1/4 X 7-3/4	187.12	CTC-2460643	P-UB-10	4 X 6-1/2	476.92
CTC-2450596	P-UB-10	3-1/4 X 7-1/4	185.00	CTC-2460644	P-UB-10	4 X 10	396.49
CTC-2450597	P-UB-10	3-1/4 X 6-1/2	231.17	CTC-2460645	P-UB-10	4 X 10	455.16
CTC-2450599	P-UB-10	3-1/4 X 8-1/4	141.02	CTC-2460648	P-UB-10	4 X 9-1/4	326.09
CTC-2450600	P-UB-10	3-1/4 X 9-1/4	258.36	CTC-2460649	P-UB-10	4 X 10-1/2	492.24
CTC-2450601	P-UB-10	3-1/4 X 5-1/2	361.66	CTC-2460652	P-UB-10	4 X 9-1/4	243.05
CTC-2450602	P-UB-10	3-1/4 X 9-1/4	366.26	CTC-2460653	P-UB-10	4 X 7	343.08
CTC-2450603	P-UB-10	3-1/4 X 9-1/4	383.66	CTC-2460655	P-UB-10	4 X 7	391.16
CTC-2450605	P-UB-10	3-1/4 X 8-1/4	229.08	CTC-2460657	P-UB-10	4 X 7	347.78
CTC-2450606	P-UB-10	3-1/4 X 6-1/2	265.41	CTC-2460658	P-UB-10	4 X 6	351.67
CTC-2450607	P-UB-10	3-1/4 X 9-1/4	281.13	CTC-2460659	P-UB-10	4 X 8-1/2	270.95
CTC-2450609	P-UB-10	3-1/4 X 9-1/4	291.36	CTC-2463425	P-UB-4	4 X 4-1/2	218.02
CTC-2450611	P-UB-10	3-1/4 X 6-1/2	257.65	CTC-2463426	P-UB-10	4 X 4-1/2	263.59
CTC-2450612	P-UB-10	3-1/4 X 5-1/2	245.34	CTC-2463427	P-UB-10	4 X 8-1/2	178.75
CTC-2450613	P-UB-10	3-1/4 X 7-1/4	234.87	CTC-2463430	P-UB-10	4-1/4 X 6-1/2	415.58
CTC-2450614	P-UB-10	3-1/4 X 7-1/4	229.08	CTC-2463431	P-UB-10	4-1/4 X 7-3/4	394.94
CTC-2450617	P-UB-10	3-1/4 X 6	188.04	CTC-2463432	P-UB-1	4-1/4	276.51
CTC-2450620	P-UB-10	3-1/4 X 6-1/4	297.55	CTC-2463434	P-UB-10	5 X 7-3/4	654.71
CTC-2456815	P-V-10	1-1/4 X 4	33.05	CTC-2463437	P-UB-10	5-1/2 X 10-1/2	757.17
CTC-2456816	P-UB-10	65 mm X 4-3/4	164.76	CTC-2463439	P-UB-10	5-3/4 X 7	248.34
CTC-2456821	P-UB-10	8 X 12	1196.92	CTC-2463440	P-UB-10	5-3/4 X 8-1/4	643.22
CTC-2456824	P-UB-10	3-1/2 X 5-1/2	175.80	CTC-2463442	P-UB-10	6 X 8-1/4	717.75
CTC-2456825	P-UB-10	3-1/2 X 5-1/2	288.94	CTC-2463445	P-UB-10	6 X 7-1/2	665.91
CTC-2456826	P-U-10	3-1/2 X 8-1/4	290.92	CTC-2463448	P-UB-10	7 X 10	714.14
CTC-2456827	P-UB-10	3-1/2 X 8-1/4	354.42	CTC-2463450	P-UB-10	7 X 11	990.36
CTC-2456828	P-UB-10	3-1/2 X 6	333.89	CTC-2465907	P-UB-10	7 X 11-1/2	930.75
CTC-2456829	P-UB-10	3-1/2 X 6	170.61	CTC-2465909	P-UB-10	1-1/2 X 2-3/4	75.20
CTC-2456831	P-UB-10	3-1/2 X 7-1/2	222.29	CTC-2465910	P-UB-10	1-1/2 X 4	46.02
CTC-2456832	P-UB-10	3-1/2 X 8-1/2	363.12	CTC-2465911	P-UB-10	1-1/2 X 2-1/2	55.02
CTC-2456833	P-UB-10	3-1/2 X 8-1/4	322.95	CTC-2465912	P-UB-10	1-1/2 X 2-3/4	55.88
CTC-2456834	P-UB-10	3-1/2 X 7-1/2	156.85	CTC-2465913	P-UB-10	1-1/2 X 3	63.09
CTC-2456835	P-UB-10	3-1/2 X 8-1/4	190.44	CTC-2465914	P-UB-10	1-1/2 X 3-1/2	80.30
CTC-2456836	P-UB-10	3-1/2 X 7-1/2	271.34	CTC-2465915	P-UB-10	1-1/2 X 3-1/2	82.53
CTC-2456837	P-UB-10	3-1/2 X 8-1/4	173.67	CTC-2465916	P-UB-10	1-1/2 X 2-1/4	55.81
CTC-2456839	P-UB-10	3-1/2 X 7-1/4	180.22	CTC-2465917	P-UB-10	1-1/2 X 3-1/2	72.31
CTC-2456840	P-UB-10	3-1/2 X 4-1/2	319.89	CTC-2465919	P-UB-10	1-1/2 X 3-1/4	140.85
CTC-2457484K	P-UB-10	3-1/4 X 170 mm	226.45	CTC-2465922	P-UB-10	1-1/2 X 3	47.08
CTC-2457487K	P-UB-10	3-1/2 X 7-1/2	267.42	CTC-2465923	P-UB-10	1-1/2 X 3	118.01
CTC-2457491K	P-UB-10	3-1/4 X 6-1/4	217.41	CTC-2465925	P-UB-10	1-7/8 X 3	120.09
CTC-2459835	P-UB-10	2-3/8, 3-3/4, 6	380.30	CTC-2465926	P-UB-10	1-7/8 X 3-1/4	65.89
CTC-2459838	P-UB-10	3-3/4 X 6-1/2	324.76	CTC-2465927	P-UB-10	1-7/8 X 3	113.42
CTC-2459839	P-UB-10	3-3/4 X 6-1/2	229.98	CTC-2465928	P-UB-10	2-1/8 X 4	197.11
CTC-2459840	P-UB-10	3-3/4 X 7-3/4	345.76	CTC-2465929	P-UB-10	2-1/8 X 4	44.74
CTC-2459842	P-UB-10	100 mm X 140 mm	165.59	CTC-2465931	P-UB-10	2-1/8 X 4	170.81
CTC-2460192K	P-UB-10	1-1/2 X 3	37.79	CTC-2465937	P-UB-10	85 mm X 130 mm	132.69
CTC-2460635	P-UB-10	3-1/2 X 10	523.95	CTC-2465938	P-UB-10	85 mm X 120 mm	190.56
CTC-2460636	P-UB-10	3-1/2 X 4-1/2	272.47	CTC-2465940	P-UB-10	90 X 130 mm	327.95

CATERPILLAR®

REPLACEMENT KITS FOR CATERPILLAR® EQUIPMENT

NOTE: CATERPILLAR® kit numbers are used as a reference only. We do not imply that these kits are original REPLACEMENT KITS.

Kit Number	Code (Pg. xviii)	Rod X Bore Size	List Price	Kit Number	Code (Pg. xviii)	Rod X Bore Size	List Price
CTC-2469101K	P-UB-10	3 X 5	\$ 110.50	CTC-2526337K	P-UB-10	65 mm X 115 mm	\$ 158.82
CTC-2469885K	P-UB-10	2-1/4 X 4-1/2	63.36	CTC-2533933K	P-U-10	4 X 5-1/4	144.23
CTC-2470257	P-UB-10	90 X 130 mm	409.83	CTC-2533964K	P-U-10	4 X 5-1/4	144.23
CTC-2478790	P-UB-10	85 X 120	113.40	CTC-2535204	P-UB-10	2-3/8 X 4-1/4	53.87
CTC-2478792	P-UB-10	100 X 140	191.79	CTC-2549037K	P-UB-10	70 X 130 mm	385.37
CTC-2478868	P-UB-10	85 X 120	165.60	CTC-2567093	P-UB-10	100 X 170 mm	433.14
CTC-2478878	P-UB-10	100 X 140	203.77	CTC-2578422	P-UB-10	2-3/8 X 3-3/4	54.73
CTC-2478888	P-UB-10	85 X 120	141.82	CTC-2580313	P-UB-10	85 X 130	150.71
CTC-2478974	P-UB-10	100 X 140	203.77	CTC-2580500	P-UB-10	85 X 120	150.60
CTC-2478995	P-UB-10	80 mm X 110 mm	151.35	CTC-2580501	P-UB-10	85 mm X 120 mm	158.84
CTC-2478996	P-UB-10	85 X 120	168.54	CTC-2580503	P-UB-10	85 mm X 160 mm	342.14
CTC-2478998	P-UB-10	85 X 120	168.54	CTC-2580504	P-UB-10	85 mm X 160 mm	234.48
CTC-2479000	P-UB-10	85 X 120	153.39	CTC-2583621	P-U-10	35 mm X 75 mm	47.22
CTC-2479001	P-UB-10	85 X 120	153.39	CTC-2590459K	P-UB-10	1-1/2 X 2-3/4	44.85
CTC-2479004	P-UB-10	90 X 125 mm	139.73	CTC-2590625	P-UB-10	90 X 130	165.41
CTC-2479005	P-UB-10	85 X 125	155.76	CTC-2590626	P-UB-10	90 X 130	145.21
CTC-2481162	P-UB-10	100 X 140 mm	186.88	CTC-2590627	P-UB-10	90 X 130	145.21
CTC-2481163	P-UB-10	100 X 140 mm	423.62	CTC-2590628	P-UB-10	90 X 130	165.41
CTC-2481165	P-UB-10	100 X 140	167.40	CTC-2590630	P-UB-10	95 mm X 130 mm	173.63
CTC-2481166	P-UB-10	100 mm X 140 mm	212.49	CTC-2590631	P-UB-10	100 X 140	159.52
CTC-2481167	P-UB-10	100 X 140 mm	389.63	CTC-2590632	P-UB-10	100 X 140	156.55
CTC-2481168	P-UB-10	105 mm X 150 mm	200.24	CTC-2590633	P-UB-10	100 X 140	159.52
CTC-2481169	P-UB-10	105 X 150 mm	413.62	CTC-2590634	P-UB-10	100 X 140	156.55
CTC-2481172	P-UB-10	110 X 160 mm	415.84	CTC-2590635	P-UB-10	100 X 140	159.52
CTC-2481175	P-UB-10	4-3/4 X 6-1/2	485.55	CTC-2590636	P-UB-10	105 X 150	356.05
CTC-2481176	P-UB-10	4-3/4 X 6	396.07	CTC-2590637	P-UB-10	105 X 150	356.05
CTC-2481178	P-UB-10	4-3/4 X 7-1/4	453.69	CTC-2590648	P-UB-10	100 X 140	151.33
CTC-2481181	P-UB-10	4-3/4 X 7-1/4	473.81	CTC-2590650	P-UB-10	105 X 150	347.56
CTC-2481182	P-UB-10	4-3/4 X 7	446.86	CTC-2590656	P-UB-10	95 X 135	137.50
CTC-2481183	P-UB-10	4-3/4 X 6-1/2	444.72	CTC-2590665	P-UB-10	95 X 135 mm	177.00
CTC-2481185	P-UB-10	4-3/4 X 7	492.63	CTC-2590678	P-UB-10	90 X 130	134.76
CTC-2481186	P-UB-10	140 X 200 mm	687.82	CTC-2590695	P-UB-10	85 X 120	168.54
CTC-2481187	P-UB-10	140 mm X 200 mm	503.49	CTC-2590699	P-UB-10	100 X 140	159.52
CTC-2481188	P-UB-10	6-1/2 X 10-1/2	579.04	CTC-2590706	P-UB-10	85 X 120	153.39
CTC-2481197	P-UB-10	5-1/4 X 7-3/4	499.78	CTC-2590712	P-UB-10	90 X 130	167.14
CTC-2481198	P-UB-10	5-1/2 X 10-1/2	884.49	CTC-2590719	P-UB-10	90 X 130	146.95
CTC-2488788K	P-UB-10	65 mm X 115 mm	157.06	CTC-2590725	P-UB-10	100 X 140	156.55
CTC-2495105	P-UB-10	3 X 4-1/2	397.03	CTC-2590729	P-UB-10	105 X 150	356.05
CTC-2502475	P-UB-10	105 X 150	140.84	CTC-2590743	P-UB-10	105 X 150	129.60
CTC-2502485	P-UB-10	100 X 140	170.54	CTC-2590751	P-UB-10	110 X 160	238.28
CTC-2502486	P-UB-10	90 mm X 130 mm	203.99	CTC-2590768	P-UB-10	115 X 170	334.56
CTC-2502487	P-UB-10	85 X 120 mm	146.21	CTC-2590774	P-UB-10	95 X 135 mm	171.85
CTC-2505861K	P-UB-10	3 X 4-1/2	98.97	CTC-2590775	P-UB-10	100 X 140	203.77
CTC-2519341	P-UB-10	100 X 170	273.82	CTC-2590776	P-UB-10	90 X 130 mm	314.86
CTC-2519845	P-U-10	40 mm X 70 mm	72.90	CTC-2590779	P-UB-10	105 X 150	331.92
CTC-2521191	P-UB-10	95 X 160	202.13	CTC-2594733K	P-UB-10	2-1/2 X 4	88.15
CTC-2522423	P-UB-10	130 X 180 mm	509.21	CTC-2594737K	P-UB-10	2-1/2 X 4	88.15
CTC-2522425	P-UB-10	130 X 190 mm	538.16	CTC-2598723K	P-U-10	55 mm X 115 mm	117.41
CTC-2525105	P-UB-10	3-1/4 X 5	215.86	CTC-2600273	P-UB-10	2 X 85 mm	99.11
CTC-2525507	I-U-14	50 mm X 100 mm	164.80	CTC-2601518	P-UB-10	2-3/4 X 5-1/2	127.33
CTC-2526101	P-UB-10	90 X 160 mm	372.72	CTC-2605316	P-UB-10	80 mm X 120 mm	119.46

REPLACEMENT KITS FOR CATERPILLAR® EQUIPMENT

NOTE: CATERPILLAR® kit numbers are used as a reference only. We do not imply that these kits are original REPLACEMENT KITS.

Kit Number	Code (Pg. xviii)	Rod X Bore Size	List Price	Kit Number	Code (Pg. xviii)	Rod X Bore Size	List Price
CTC-2605317	P-UB-10	80 X 110	\$ 221.12	CTC-2737025K	P-U-10	55 X 100	\$ 113.75
CTC-2605318	P-UB-10	75 mm X 110 mm	284.87	CTC-2742460	P-UB-10	110 X 160	273.75
CTC-2605319	P-UB-10	75 X 140 mm	420.26	CTC-2742461	P-UB-10	130 X 190	451.00
CTC-2605322	P-UB-10	75 mm X 110 mm	316.33	CTC-2742462	P-UB-10	110 X 170	278.72
CTC-2610582	P-UB-10	3-1/2 X 9-1/4	379.91	CTC-2742511	P-UB-10	85 X 120	121.82
CTC-2611073	P-UB-10	3-1/4 X 5-1/2	279.55	CTC-2742515	P-UB-10	100 X 140	175.30
CTC-2616885	P-UB-10	2-3/8 X 4-1/2	82.09	CTC-2742526	P-UB-10	90 mm X 130 mm	129.23
CTC-2617175	P-UB-10	2 X 75 mm	82.86	CTC-2742649	P-UB-10	95 mm X 130 mm	521.03
CTC-2618001	P-UB-10	2-3/4 X 6	144.45	CTC-2748318	P-UB-10	70 X 130 mm	355.19
CTC-2618004K	P-UB-10	4 X 7	246.96	CTC-2758416K	P-UB-10	2-1/4 X 3-3/4	58.55
CTC-2618566	P-UB-10	2 X 4	74.51	CTC-2763879K	P-U-10	45 X 75 mm	75.48
CTC-2618625	P-UB-10	2 X 4	177.06	CTC-2764172	I-U-10	50 mm X 70 mm	48.63
CTC-2620941	I-U-10	30 mm X 50 mm	26.06	CTC-2764667K	P-UB-10	1-1/2 X 3-1/2	75.81
CTC-2624415K	P-UB-10	1-1/2 X 3	42.16	CTC-2773395	P-UB-14	55 X 95	100.32
CTC-2624418K	P-UB-10	1-1/2 X 3	42.16	CTC-2774140	P-UB-14	50 X 85	84.60
CTC-2633745K	P-UB-10	1-1/2 X 3	42.16	CTC-2774167	P-UB-14	45 X 75	144.69
CTC-2634068K	P-UB-10	1-1/2 X 3-1/2	75.81	CTC-2779900K	P-U-10	45 X 75 mm	72.31
CTC-2635008K	P-UB-10	1-1/2 X 3-1/2	75.81	CTC-2781970	I-U-10	30 mm X 60 mm	50.44
CTC-2645751	P-UB-10	110 mm X 170 mm	347.63	CTC-2788641	P-U-10	45 X 80	76.04
CTC-2666140	I-U-10	35 mm X 70 mm	42.38	CTC-2790639	P-U-10	50 X 85	89.47
CTC-2666967K	P-U-10	50 X 80	103.22	CTC-2797940	P-U-10	45 X 80	81.14
CTC-2666975K	P-U-10	55 X 90	79.64	CTC-2799336K	P-U-10	75 mm X 125 mm	150.09
CTC-2666977K	P-U-10	55 X 90	79.64	CTC-2807013	I-U-10	42 mm X 85 mm	129.85
CTC-2667806	P-UB-10	85 mm X 120 mm	362.86	CTC-2812321	P-U-10	50 X 85 mm	78.55
CTC-2667812	P-UB-10	95 mm X 130 mm	471.92	CTC-2812322	P-U-10	45 X 75 mm	72.31
CTC-2667861	P-UB-10	80 mm X 110 mm	142.07	CTC-2812323	P-U-10	50 X 80 mm	78.28
CTC-2667874	P-UB-10	85 mm X 120 mm	127.76	CTC-2821535K	P-U-10	55 X 100	113.77
CTC-2667891	P-UB-10	85 X 120	165.60	CTC-2821537K	P-U-10	55 X 90	78.59
CTC-2667892	P-UB-10	85 X 120	141.82	CTC-2833454	P-UB-10	1-1/2 X 2-3/4	140.00
CTC-2668011	P-UB-10	85 X 120	165.60	CTC-2835988	P-UB-10	90 X 125 mm	871.88
CTC-2668012	P-UB-10	100 X 140	203.77	CTC-2836179	P-UB-10	70 X 100 mm	201.03
CTC-2668013	P-UB-10	95 X 135 mm	177.00	CTC-2839122	P-U-10	35 X 65	44.33
CTC-2668014	P-UB-10	90 X 130 mm	459.33	CTC-2845360	P-UB-10	2-1/4 X 3-3/4	171.90
CTC-2668015	P-UB-10	100 X 140	144.57	CTC-2848014K	P-U-1	13-1/2	2487.49
CTC-2668016	P-UB-10	105 X 150	347.56	CTC-2848015K	P-U-1	13-1/2	2487.49
CTC-2668045	P-UB-10	95 X 135	138.86	CTC-2848016K	P-U-1	12-1/2	1228.27
CTC-2668057	P-UB-10	85 X 120	141.82	CTC-2848017K	P-U-1	12-1/2	1227.77
CTC-2689049K	P-UB-10	2-3/8 X 4-3/4	107.53	CTC-2854031K	P-UB-10	3 X 4-1/2	126.53
CTC-2689051K	P-UB-10	3 X 5-1/4	118.57	CTC-2854032K	P-UB-10	3 X 5	148.15
CTC-2689437K	P-UB-10	2-1/2 X 5-1/4	84.96	CTC-2854034K	P-UB-10	3-1/2 X 5-1/2	207.89
CTC-2692728K	P-UB-10	45 mm X 90 mm	112.17	CTC-2857486	P-UB-10	2-1/8 X 4	84.29
CTC-2692729K	P-UB-10	65 mm X 120 mm	135.73	CTC-2860113	P-UB-10	70 mm X 100 mm	117.32
CTC-2692730K	P-UB-10	60 mm X 110 mm	158.08	CTC-2860114	P-UB-14	65 mm X 90 mm	207.01
CTC-2696483K	P-UB-10	85 mm X 140 mm	132.34	CTC-2860814K	P-UB-10	2 X 4	71.49
CTC-2701537	O-RING KIT		93.72	CTC-2861075	P-UB-10	2-3/4 X 6	113.48
CTC-2701539	O-RING KIT		43.27	CTC-2863591	I-U-10	25 mm X 40 mm	21.36
CTC-2707285K	P-UB-10	70 mm X 140 mm	169.40	CTC-2868903K	P-UB-10	50 mm X 100 mm	63.53
CTC-2707286K	P-UB-10	80 mm X 140 mm	192.60	CTC-2871973K	P-UB-10	2-1/4 X 4	81.23
CTC-2707288K	P-UB-10	45 mm X 75 mm	136.79	CTC-2897716	P-UB-10	80 mm X 120 mm	435.30
CTC-2711529	I-U-10	40 mm X 3-1/2	25.81	CTC-2897733	P-UB-10	75 mm X 110 mm	420.32
CTC-2713572K	P-UB-10	6 X 10-1/2	806.21	CTC-2897878K	P-UB-10	90 X 130	165.96

CATERPILLAR®

REPLACEMENT KITS FOR CATERPILLAR® EQUIPMENT

NOTE: CATERPILLAR® kit numbers are used as a reference only. We do not imply that these kits are original REPLACEMENT KITS.

Kit Number	Code (Pg. xviii)	Rod X Bore Size	List Price	Kit Number	Code (Pg. xviii)	Rod X Bore Size	List Price
CTC-2929043K	P-UB-10	2 X 4-1/2	\$ 63.98	CTC-3171090K	P-UB-10	70 X 140 mm	\$ 361.95
CTC-2929044K	P-UB-10	2 X 4	71.44	CTC-3176058	P-UB-10	55 mm X 95 mm	114.94
CTC-2935360K	P-U-10	45 X 75 mm	58.35	CTC-3189220	P-UB-10	3-1/2 X 6-1/4	405.10
CTC-2937158K	P-U-10	55 X 90	79.64	CTC-3189225	P-UB-10	4 X 7	426.84
CTC-2937596	P-UB-10	2 X 3	41.44	CTC-3192248	P-UB-10	3-1/2 X 6-1/4	346.17
CTC-2940509K	P-UB-10	3 X 5	113.06	CTC-3193556	P-UB-10	3 X 4-1/2	250.78
CTC-2940510K	P-UB-10	95 mm X 150 mm	212.08	CTC-3193558	P-UB-10	3 X 4-3/4	124.71
CTC-2949583	P-UB-10	2-1/2 X 3-1/2	72.62	CTC-3197257K	P-UB-14	70 mm X 110 mm	118.91
CTC-2950145	I-UB-10	5-1/2 X 7-1/2	284.14	CTC-3198295	P-UB-10	115 mm X 170 mm	239.47
CTC-2950147	P-U-3	7 X 8-1/2	285.56	CTC-3206346	P-UB-10	65 mm X 100 mm	158.32
CTC-2950148	P-UB-3	7 X 8	678.46	CTC-3217048K	P-UB-10	2 X 4	73.16
CTC-2950148AV	P-SP-3	7 X 8	618.04	CTC-3233312	P-UB-10	1-3/4 X 3	40.40
CTC-2959885	P-UB-1	9 X 10-1/2	273.04	CTC-3234199	P-UB-10	2-3/4 X 5-1/2	190.59
CTC-2959886	P-U-3	7 X 8-1/2	284.51	CTC-3247165	P-UB-10	65 mm X 115 mm	174.37
CTC-2959887	P-UB-10	3 X 5-1/4	121.24	CTC-3249485	P-UB-10	105 mm X 150 mm	194.58
CTC-2959888	P-UB-10	3-1/2 X 6-1/4	213.55	CTC-3255723K	P-UB-10	2-1/2 X 5	79.09
CTC-2959890	P-UB-10	3 X 6	233.02	CTC-3260496	P-UB-10	75 mm X 100 mm	206.22
CTC-2959891	P-UB-10	2-1/4 X 4-1/2	65.66	CTC-3260501	P-UB-10	2 X 4-1/2	112.37
CTC-2959892	P-UB-10	3-1/2 X 5-1/2	155.80	CTC-3260502	P-UB-10	2 X 3-1/2	144.11
CTC-2959893	P-UB-10	2-3/8 X 4-3/4	113.78	CTC-3260503	P-UB-10	1-3/4 X 3-1/2	165.83
CTC-2959894	P-UB-10	110 mm X 170 mm	426.42	CTC-3260504	P-UB-10	1-3/4 X 3	71.24
CTC-2959895	P-UB-10	130 X 180	309.51	CTC-3265051	I-U-10	75 mm X 100 mm	68.94
CTC-2974896K	P-UB-10	50 mm X 100 mm	87.11	CTC-3265235	I-U-14	50 mm X 100 mm	164.80
CTC-2976845	P-UB-10	70 mm X 130 mm	338.93	CTC-3265237	I-U-10	1-3/4 X 63 mm	68.97
CTC-2976847	P-U-1	7 X 8	995.33	CTC-3265946	I-U-10	50 mm X 100 mm	72.08
CTC-2976848	P-U-3	7 X 8-1/2	294.60	CTC-3281867	I-U-14	50 mm X 100 mm	164.80
CTC-2976849	P-U-1	9 X 10-1/2	405.93	CTC-3284267K	P-UB-10	2-1/2 X 5-1/2	82.78
CTC-2976852	P-UB-1	9 X 10-3/4	1736.32	CTC-3287730K	P-UB-14	75 mm X 110 mm	118.84
CTC-2987702K	P-UB-14	70 mm X 110 mm	118.91	CTC-3319328	P-UB-10	130 mm X 190 mm	341.86
CTC-2987703K	P-UB-14	60 mm X 95 mm	104.90	CTC-3322569	I-UB-10	2-1/2 X 3-1/2	223.54
CTC-2987704K	P-UB-14	55 mm X 85 mm	103.99	CTC-3338675	P-UB-10	110 mm X 170 mm	230.43
CTC-2R0037	O-RINGS		16.09	CTC-3338750	P-UB-10	110 mm X 160 mm	178.60
CTC-2S3477	P-V-10	3 X 9-1/4	196.86	CTC-3349861K	P-UB-10	90 mm X 180 mm	219.90
CTC-2U0937	I-U-3	3-1/2 X 4-1/2	177.13	CTC-3350007	P-UB-10	80 X 120 mm	150.51
CTC-2Y4534	O-RINGS		34.79	CTC-3367341	P-UB-1	12-1/2	2956.55
CTC-2Y5154	O-RINGS		185.00	CTC-3367351	P-UB-10	2-1/2 X 5-1/2	207.78
CTC-2Y6216	O-RINGS		9.20	CTC-3367352	P-UB-10	2-1/2 X 5-1/2	164.88
CTC-3044900K	P-UB-14	75 X 110 mm	132.48	CTC-3367358	P-UB-10	3 X 5-1/2	216.49
CTC-3050795	O-RING KIT		8.49	CTC-3367359	P-UB-10	3 X 5-1/2	227.10
CTC-3076273	P-UB-10	2 X 3	38.53	CTC-3385840	P-UB-1	12-1/2	2476.72
CTC-3082467K	P-UB-10	5 X 10	782.09	CTC-3387038	I-UB-10	2-1/2 X 3-1/2	34.71
CTC-3087830	P-UB-10	110 X 160 mm	420.10	CTC-3387156	P-UB-10	1-1/2 X 3	42.08
CTC-3087849	P-UB-1	9 X 10-3/4	1736.32	CTC-3388416K	P-UB-10	70 X 140 mm	361.95
CTC-3105478	P-UB-10	1-3/4 X 3-1/2	187.98	CTC-3408752K	P-UB-10	2-1/2 X 5	87.01
CTC-3110662	P-UB-10	2-1/4 X 4-1/2	71.31	CTC-3408871K	P-UB-10	2-1/2 X 4-3/4	100.37
CTC-3126388	I-SP-10	5,7-1/2X 6-1/2, 8-1/4	497.13	CTC-3414122K	P-UB-10	4-1/2 X 150 mm	239.40
CTC-3133829	P-UB-10	3-1/4" X 170 mm	351.90	CTC-3414124K	P-UB-10	4-1/2 X 150 mm	239.40
CTC-3145850K	P-UB-14	65 mm X 110 mm	112.70	CTC-3453897K	P-UB-10	100 mm X 140 mm	113.76
CTC-3156338	I-U-10	1 X 2-1/2	18.44	CTC-3460643	P-U-10,12	2 X 3-1/2	45.47
CTC-3169205K	P-UB-10	1-1/2 X 3	42.16	CTC-3460644	P-U-10,12	3-1/4 X 5-1/2	101.30
CTC-3170942	I-UB-10	5-1/2 X 9-1/2	400.70	CTC-3461093K	P-UB-10	70 X 140 mm	361.95

CATERPILLAR®

REPLACEMENT KITS FOR CATERPILLAR® EQUIPMENT

NOTE: CATERPILLAR® kit numbers are used as a reference only. We do not imply that these kits are original REPLACEMENT KITS.

Kit Number	Code (Pg. xviii)	Rod X Bore Size	List Price	Kit Number	Code (Pg. xviii)	Rod X Bore Size	List Price
CTC-3461094K	P-UB-10	70 X 140 mm	361.95	CTC-3E3298	P-UB-10	2-1/8 X 4	\$ 44.25
CTC-3465584	P-U-10,12	1-1/2 X 2-1/2	33.94	CTC-3E3299	I-UB-10	2-1/2 X 3-1/2	138.77
CTC-3465609	P-U-10,12	1-3/4 X 3	40.43	CTC-3E3300	P-UB-10	2-1/2 X 4-1/4	111.23
CTC-3473272K	P-UB-10	3-1/2 X 7-1/4	161.18	CTC-3E3301	P-UB-10	4-3/4 X 7	212.16
CTC-3494119	P-UB-10	75 mm X 110 mm	284.00	CTC-3E3302	P-UB-10	2-1/2 X 5	68.66
CTC-3494120	P-UB-10	80 mm X 120 mm	264.08	CTC-3E3303	P-UB-10	4 X 6-1/2	280.37
CTC-3494121	P-UB-10	70 mm X 100 mm	192.53	CTC-3E3313	P-UB-10	3 X 5-1/4	72.49
CTC-3494122	P-UB-10	80 mm X 120 mm	179.81	CTC-3E3314	I-UB-10	2-3/4 X 3-3/4	177.81
CTC-3500962	P-UB-10	85 mm X 120 mm	370.18	CTC-3E8877	P-UB-10	2-3/8 X 4-1/2	183.90
CTC-3500967	P-UB-10	85 X 120 mm	235.52	CTC-3E8878	P-UB-10	2-3/4 X 5	188.48
CTC-3500970	P-UB-10	100 mm X 140 mm	375.97	CTC-3E8880	P-UB-10	5-3/4 X 8-1/4	748.61
CTC-3507157	I-SP-3,10	7-3/4,11-1/2 X	708.65	CTC-3E8881	P-UB-10	4-3/4 X 7-1/4	299.08
CTC-3519360K	P-UB-10	100 mm X 140 mm	113.76	CTC-3E8883	P-UB-10	3 X 4-3/4	160.83
CTC-3611131	I-U-15	3/4 X 1-1/4	42.93	CTC-3E8884	P-UB-10	2 X 4	104.59
CTC-3615042K	P-UB-10	100 mm X 150 mm	116.71	CTC-3E8887	P-UB-10	5 X 7-3/4	464.82
CTC-3651270	P-UB-10	65 mm X 4-3/4	196.61	CTC-3E8888	P-UB-10	3-3/4 X 6	327.67
CTC-3651283	I-UB-10	2-3/8 X 85 mm	179.49	CTC-3E8889	P-UB-10	3-1/2 X 6	206.10
CTC-3652880	P-UB-10	3-3/4 X 7-3/4	192.42	CTC-3G06888K	I-SP-1	7 X 8-1/2	235.43
CTC-3652932	P-UB-10	2-1/2 X 4	123.70	CTC-3G8700	O-rings		7.49
CTC-3655556	P-UB-10	2 X 3	35.35	CTC-3G9892K	P-UB-10	2 X 4	55.18
CTC-3672255K	P-UB-10	4 X 10-1/2	413.68	CTC-4173698	P-UB-10	50 mm X 110 mm	95.87
CTC-3672258K	P-UB-10	4 X 10-1/2	413.68	CTC-4252108	P-UB-10	2-1/4 X 4	93.27
CTC-3672259K	P-UB-10	4 X 10-1/2	413.68	CTC-4C4782	NITRILE O-RING KIT		270.64
CTC-3704117	I-U-15	70 mm X 125 mm	421.42	CTC-4C4784	D-RING KIT		160.18
CTC-3712697	P-U-10	35 mm X 50 mm	42.65	CTC-4C4788	O-RING KIT		93.72
CTC-3712718	P-U-10	30 mm X 65 mm	47.42	CTC-4C8253	SILICONE O-RING KIT		431.48
CTC-3712737	P-U-10	45 mm X 65 mm	48.44	CTC-4D4229	PUMP KIT		18.17
CTC-3712751	P-U-10	35 mm X 75 mm	46.94	CTC-4D9559	PUMP KIT		13.97
CTC-3712756	P-U-10	40 mm X 60 mm	43.36	CTC-4I3861	P-UB-10	70 mm X 150 mm	241.89
CTC-3712760	P-U-10	35 mm X 70 mm	44.20	CTC-4J9279	PUMP KIT		16.82
CTC-3747255	P-UB-14	55 mm X 100 mm	147.79	CTC-4J9286	PUMP KIT		22.94
CTC-3751733	P-UB-10	115 mm X 170 mm	260.91	CTC-4J9291	PUMP KIT		48.47
CTC-3764331	P-UB-10	105 mm X 150 mm	162.89	CTC-4T9977K	P-UB-10	3-1/4 X 8-1/4	161.21
CTC-3764332	P-UB-10	105 mm X 150 mm	162.89	CTC-4Z6110K	P-UB-10	3-1/2 X 8-1/4	181.49
CTC-3764333	P-UB-10	115 mm X 170 mm	239.47	CTC-4Z6364K	P-UB-10	3 X 6	129.51
CTC-3764334	P-UB-10	105 mm X 150 mm	194.58	CTC-5I8892	P-UB-10	140 mm X 200 mm	396.57
CTC-3764336	P-UB-10	110 mm X 160 mm	186.68	CTC-5J0102	PUMP KIT		39.28
CTC-3769011	P-UB-10	2 X 3-1/2	67.45	CTC-5P8433	D-RING KIT		160.18
CTC-3769016	P-UB-10	1-3/4 X 3-1/2	106.90	CTC-5R4759	P-UB-10	1-3/4 X 3	81.60
CTC-3769017	P-UB-10	1-3/4 X 3	40.40	CTC-5R4760	P-UB-10	1-1/2 X 3-1/2	50.34
CTC-3808347	P-UB-10	85 mm X 140 mm	193.15	CTC-5R4761	P-UB-10	2 X 3-1/4	81.56
CTC-3809470	P-UB-10	2-1/4 X 4-1/4	58.20	CTC-5R4762	P-UB-10	2 X 3-1/4	56.37
CTC-3904227	P-UB-14	70 mm X 100 mm	231.42	CTC-5R4764	P-UB-10	1-1/2 X 2-1/2	31.77
CTC-3937887	P-UB-14	75 mm X 110 mm	221.46	CTC-5R4765	P-UB-10	1-1/2 X 2-1/2	31.77
CTC-3937948	P-UB-10	80 mm X 120 mm	264.26	CTC-5R4766	O-RINGS		7.82
CTC-3937949	P-UB-14	80 mm X 120 mm	230.54	CTC-5U5412	I-U-5	3-1/2 X 5-1/2	70.83
CTC-3E3291	P-UB-10	1-3/4 X 2-3/4	36.96	CTC-5U5413	I-U-5	3-1/2 X 4-1/2	280.30
CTC-3E3292	P-UB-10	4 X 6	230.82	CTC-5U6157	I-U-1	2	10.20
CTC-3E3293	P-UB-10	3 X 5-1/4	183.95	CTC-6C6156	P-UB-10	100 X 170 mm	378.08
CTC-3E3294	P-UB-10	2 X 5	58.07	CTC-6E0274K	P-UB-10	2-3/8 X 4-1/2	84.49
CTC-3E3297	P-UB-10	1-7/8 X 3-1/4	102.01	CTC-6E0397K	P-UB-10	3 X 7-1/4	137.85

CATERPILLAR®

REPLACEMENT KITS FOR CATERPILLAR® EQUIPMENT

NOTE: CATERPILLAR® kit numbers are used as a reference only. We do not imply that these kits are original REPLACEMENT KITS.

Kit Number	Code (Pg. xviii)	Rod X Bore Size	List Price	Kit Number	Code (Pg. xviii)	Rod X Bore Size	List Price
CTC-6E3113K	P-UB-10	1-3/4 X 4	\$ 47.51	CTC-7X2713	P-UB-14	3-1/4 X 6-1/2	\$ 138.32
CTC-6I6858	P-UB-10	70 X 100 mm	283.80	CTC-7X2714	P-UB-14	3-1/4 X 5-1/2	167.18
CTC-6Q2203	I,P-U-15	1-1/2	59.44	CTC-7X2715	P-UB-10	3-1/4 X 8-1/4	274.21
CTC-6U4788	I-U-5	3-1/2 X 5-1/2	257.63	CTC-7X2716	P-UB-10	3-1/4 X 9-1/4	165.19
CTC-7S2720	I-V-10	3-1/4 X 9-1/4	262.43	CTC-7X2717	P-UB-14	3-1/4 X 8-1/4	211.36
CTC-7S2721	N-V-10	3-1/4 X 9-1/4	168.28	CTC-7X2718	P-UB-10	3-1/4 X 7-1/4	205.60
CTC-7S2727	P-V-10	2-1/4 X 5	114.03	CTC-7X2719	P-UB-10	3-1/2 X 8-1/2	194.41
CTC-7U2662	I-U-5	3-1/2 X 4-1/2	329.50	CTC-7X2720	P-U-10	3-1/2 X 8-1/4	186.99
CTC-7U6672	I-U-4	3-1/2 X 4	150.49	CTC-7X2721	P-UB-10	3-1/2 X 8-1/4	301.34
CTC-7U7625	I-UB-10	1-3/4 X 3-1/2	143.42	CTC-7X2722	P-UB-10	3-1/2 X 7-1/2	192.25
CTC-7U8058	I-U-10	2-3/4 X 4-1/2	286.04	CTC-7X2723	P-UB-10	3-1/2 X 10-1/2	259.95
CTC-7U8423	I-UB-10	2 X 4	160.31	CTC-7X2724	P-UB-14	3-1/2 X 8-1/4	210.29
CTC-7U9275	P-UB-4	4 X 4-1/2	326.61	CTC-7X2725	P-UB-10	3-1/2 X 8-1/4	402.70
CTC-7X2486	P-UB-10	3-1/4 X 8-1/4	125.66	CTC-7X2725X	P-UB-10	3-1/2 X 8-1/4	118.68
CTC-7X2487	P-UB-10	2 X 4	32.61	CTC-7X2726	P-UB-14	3-1/2 X 5-1/2	165.40
CTC-7X2654	PI-UB-10	2-1/2 X 4	123.18	CTC-7X2727	P-UB-14	3-1/2 X 8-1/4	356.38
CTC-7X2657	P-UB-10	2-1/2 X 6-1/2	137.76	CTC-7X2728	P-UB-10	3-1/2 X 8-1/4	181.07
CTC-7X2680	P-UB-10	2-3/4 X 6	141.81	CTC-7X2729	P-UB-10	2-1/4 X 5	168.02
CTC-7X2681	P-UB-10	2-3/4 X 7-1/4	117.57	CTC-7X2730	P-UB-14	3-1/2 X 7-1/2	165.62
CTC-7X2682	P-UB-10	2-3/4 X 5	161.58	CTC-7X2731	P-UB-10	3-3/4 X 6-1/2	268.11
CTC-7X2683	P-UB-14	2-3/4 X 4-1/2	189.10	CTC-7X2734	P-UB-10	4 X 8-1/2	313.52
CTC-7X2684	P-UB-10	2-3/4 X 5-1/2	158.94	CTC-7X2736	P-UB-10	1-1/2 X 2-3/4	130.81
CTC-7X2685	P-UB-14	2-3/4 X 4-1/2	169.98	CTC-7X2737	P-UB-10	1-1/2 X 3	112.40
CTC-7X2686	P-UB-14	2-3/4 X 6-1/2	124.95	CTC-7X2738	P-UB-10	1-1/2 X 4	90.53
CTC-7X2687	P-UB-10	2-3/4 X 7-1/4	275.73	CTC-7X2739	P-UB-10	1-1/2 X 2-1/2	58.51
CTC-7X2688	P-UB-14	2-3/4 X 6-1/4	153.14	CTC-7X2740	P-UB-10	2-1/4 X 3-1/2	77.66
CTC-7X2689	P-UB-10	2-3/4 X 6-1/2	166.65	CTC-7X2741	P-UB-10	1-1/2 X 3-1/4	75.03
CTC-7X2690	P-UB-10	2-3/4 X 5-1/2	103.03	CTC-7X2742	P-UB-14	4 X 8-1/2	223.75
CTC-7X2691	P-UB-14	2-3/4 X 7	151.71	CTC-7X2743	P-UB-10	2-1/2 X 5	116.28
CTC-7X2692	P-UB-10	2-1/2 X 6	170.02	CTC-7X2744	P-UB-10	2-1/4 X 4	57.25
CTC-7X2693	P-UB-10	3 X 6-1/2	186.80	CTC-7X2744	P-UB-10	2-1/4 X 4	57.25
CTC-7X2694	P-UB-10	3 X 6-1/2	164.42	CTC-7X2745	P-UB-10	1-1/2 X 3	112.40
CTC-7X2695	P-UB-10	3 X 8-1/4	367.89	CTC-7X2746	P-UB-10	1-1/2 X 3-1/2	63.31
CTC-7X2696	P-UB-10	3 X 6-1/2	90.41	CTC-7X2747	P-UB-10	2-1/4 X 4-1/2	193.37
CTC-7X2697	P-UB-10	3 X 6-1/4	163.72	CTC-7X2748	P-UB-10	2-1/4 X 4-1/2	111.36
CTC-7X2698	P-UB-10	3 X 6	192.84	CTC-7X2749	P-UB-10	1-1/2 X 2-3/4	61.13
CTC-7X2699	P-UB-14	3 X 7-1/4	222.83	CTC-7X2750	P-UB-10	2-1/4 X 4-1/4	118.40
CTC-7X2700	P-V-10	2 X 4-1/2	73.45	CTC-7X2751	P-UB-10	1-1/2 X 3	66.28
CTC-7X2701	P-UB-14	3 X 6-1/4	116.63	CTC-7X2752	P-UB-10	1-1/2 X 3-1/2	98.74
CTC-7X2702	P-UB-10	3 X 7-1/4	293.82	CTC-7X2753	P-UB-10	2 X 3	67.12
CTC-7X2703	P-UB-14	3-1/4 X 8-1/4	243.96	CTC-7X2755	P-UB-10	2 X 4	152.30
CTC-7X2704	P-UB-10	3-1/4 X 7	146.36	CTC-7X2755A	P-UB-10	2 X 4	97.86
CTC-7X2705	P-UB-10	3-1/4 X 5-1/2	267.03	CTC-7X2756	P-UB-10	3 X 5-1/4	130.87
CTC-7X2706	P-UB-10	3-1/4 X 7-3/4	276.03	CTC-7X2757	P-UB-10	3-1/4 X 6	276.98
CTC-7X2707	P-UB-10	3-1/4 X 9-1/4	358.24	CTC-7X2760	P-UB-10	2 X 3	72.94
CTC-7X2707A	P-UB-10	3-1/4 X 9-1/4	288.03	CTC-7X2761	P-UB-10	1-3/4 X 4	58.04
CTC-7X2708	P-UB-10	3-1/4 X 9-1/4	210.93	CTC-7X2762	P-UB-10	1-3/4 X 3-1/2	103.56
CTC-7X2709	P-UB-14	3-1/4 X 5-1/2	167.18	CTC-7X2763	P-V-10	2 X 5	140.20
CTC-7X2710	P-UB-10	3-1/4 X 7	210.31	CTC-7X2764	P-UB-10	1-3/4 X 3-1/4	71.17
CTC-7X2711	P-UB-10	3-1/4 X 6-1/2	217.02	CTC-7X2765	P-UB-14	4 X 6-1/2	243.96
CTC-7X2712	P-UB-10	3-1/4 X 5-1/2	95.88	CTC-7X2766	P-UB-10	2 X 4-1/4	45.67

CATERPILLAR®

REPLACEMENT KITS FOR CATERPILLAR® EQUIPMENT

NOTE: CATERPILLAR® kit numbers are used as a reference only. We do not imply that these kits are original REPLACEMENT KITS.

Kit Number	Code (Pg. xviii)	Rod X Bore Size	List Price	Kit Number	Code (Pg. xviii)	Rod X Bore Size	List Price
CTC-7X2767	P-UB-10	2 X 3-1/4	\$ 70.29	CTC-7X2836	P-UB-14	2-1/2 X 6	\$ 265.91
CTC-7X2768	P-UB-10	2 X 4-1/2	91.77	CTC-7X2882	P-UB-10	1-3/4 X 3-1/2	67.46
CTC-7X2769	P-UB-10	2 X 3-1/2	116.82	CTC-7X7718	P-UB-10	4-3/4 X 6-1/2	260.02
CTC-7X2770	P-V-10	2 X 4-1/2	101.37	CTC-7X7719	P-UB-10	4-3/4 X 6-1/2	274.97
CTC-7X2773	P-UB-10	2-1/2 X 4-3/4	184.64	CTC-7X7734	P-UB-10	4-3/4 X 7	448.66
CTC-7X2782	P-UB-10	2 X 4	44.13	CTC-7X7735	P-UB-10	3-1/2 X 6	260.84
CTC-7X2783	P-UB-10	2 X 3-1/2	106.57	CTC-7X7937	P-UB-10	2 X 4	166.09
CTC-7X2784	P-UB-10	1-3/4 X 3-1/2	58.32	CTC-7X7938	P-UB-10	2 X 3-3/4	108.26
CTC-7X2785	P-UB-10	2 X 4	84.61	CTC-7X7947	P-UB-10	2 X 4	64.86
CTC-7X2787	P-UB-10	2 X 3-3/4	106.95	CTC-7X7956	P-UB-10	1-3/4 X 3	31.48
CTC-7X2788	P-UB-10	2 X 5	122.79	CTC-7Y4698	P-UB-10	105 X 150 mm	347.99
CTC-7X2789	P-UB-10	2 X 4	105.58	CTC-7Y4970	P-UB-10	110 X 170 mm	389.77
CTC-7X2790	P-UB-10	1-3/4 X 4	96.21	CTC-7Y5145	P-UB-10	85 X 130 mm	276.61
CTC-7X2791	P-UB-10	1-3/4 X 3	91.70	CTC-7Y5147	P-UB-10	95 X 130 mm	309.35
CTC-7X2792	P-UB-10	2 X 3-1/2	90.85	CTC-8C3316	P-UB-10	1-1/2 X 3-1/2	54.96
CTC-7X2793	P-UB-10	4 X 10-1/2	305.16	CTC-8C3317	P-UB-10	1-1/2 X 2-3/4	51.29
CTC-7X2794	P-UB-10	3-3/4 X 6	400.05	CTC-8C3318	P-UB-10	1-3/4 X 2-3/4	31.23
CTC-7X2795	P-UB-10	2-1/4 X 4	109.26	CTC-8C3319	P-UB-10	1-3/4 X 4	50.56
CTC-7X2796	P-V-10	2-3/4 X 9-1/4	125.75	CTC-8C3408	P-UB-10	2 X 3-1/2	61.59
CTC-7X2797	P-V-10	2 X 5	73.39	CTC-8C4029	P-UB-10	1-1/2 X 3	36.33
CTC-7X2798	P-UB-10	2-1/4 X 3-3/4	78.56	CTC-8C4030	P-UB-10	3-1/4 X 6-1/2	368.64
CTC-7X2799	P-UB-10	4 X 9-1/4	370.31	CTC-8C4031	P-UB-10	3-1/4 X 5-1/2	365.40
CTC-7X2800	P-V-10	2 X 4	65.27	CTC-8C4398	P-UB-10	5-3/4 x 7	390.63
CTC-7X2801	P-UB-10	3-1/4 X 8-1/4	252.91	CTC-8C4510	P-UB-1	2	32.91
CTC-7X2802	P-UB-10	2-1/4 X 4	94.90	CTC-8C5768	P-UB-10	2-1/2 X 6	102.67
CTC-7X2803	P-UB-10	2-3/4 X 6	177.39	CTC-8C5788	I-SP-3,10	7-1/4, 11 X 9-1/2, 12-1/4	1093.93
CTC-7X2804	P-UB-14	2-3/4 X 6-1/2	222.00	CTC-8C6707	P-UB-10	3 X 6-1/2	148.86
CTC-7X2805	P-UB-10	2 X 4-1/2	65.89	CTC-8C6896	P-UB-10	2-1/2 X 4-3/4	94.22
CTC-7X2806	P-U-10	2 X 3-1/2	125.58	CTC-8C6958	P-U-10	4-1/2 X 6	267.96
CTC-7X2807	P-UB-10	1-3/4 X 3-3/4	38.33	CTC-8C8731	P-U-10	5-3/4 X 8-1/4	409.47
CTC-7X2808	P-UB-10	2-3/8 X 3-3/4	83.46	CTC-8C9353	P-UB-10	2 X 4	61.22
CTC-7X2809	P-UB-10	7 X 11-1/2	467.64	CTC-8C9438	P-UB-10	2 X 4-1/2	77.30
CTC-7X2810	P-UB-10	4 X 10	238.90	CTC-8J2004	O-RINGS		10.31
CTC-7X2811	P-UB-14	4 X 10	284.15	CTC-8J2005	O-RINGS		11.18
CTC-7X2812	P-UB-10	1-1/2 X 3-1/2	107.67	CTC-8J8487	PUMP KIT		48.75
CTC-7X2813	P-UB-10	3 X 5-1/2	234.97	CTC-8J8902K	I-SP-1	9 X 10-1/2	493.96
CTC-7X2814	P-UB-14	3-3/4 X 6	205.52	CTC-8T1370	P-UB-10	2 X 4	57.53
CTC-7X2815	P-UB-10	2-1/4 X 4-3/4	100.09	CTC-8T1371	P-UB-10	1-3/4 X 4	51.82
CTC-7X2816	P-UB-10	4 X 5	261.71	CTC-8T1372	P-UB-10	1-1/2 X 3-1/2	47.67
CTC-7X2817	P-UB-10	4 X 10	295.35	CTC-8T1373	P-UB-10	1-3/4 X 3	44.38
CTC-7X2818	P-UB-10	2-1/4 X 3-1/2	93.37	CTC-8T1374	P-UB-10	2-1/2 X 5-1/2	96.66
CTC-7X2819	P-UB-10	2 X 4-1/4	108.80	CTC-8T1375	P-UB-10	2-1/2 X 5	69.65
CTC-7X2820	P-UB-10	1-3/4 X 2-3/4	81.89	CTC-8T1376	P-UB-10	2-1/2 X 6-1/2	82.33
CTC-7X2821	P-UB-10	2 X 3-1/4	145.01	CTC-8T1378	P-UB-10	2-1/2 X 4	70.29
CTC-7X2822	P-UB-10	2 X 3-1/2	98.87	CTC-8T1379	P-UB-10	3-1/4 X 8-1/4	130.54
CTC-7X2823	P-UB-10	3-1/4 X 5-1/2	245.38	CTC-8T1380	P-UB-10	2 X 3-1/2	54.68
CTC-7X2824	P-U-10	2-3/4 X 5	123.07	CTC-8T1381	P-UB-10	2-1/2 X 4-3/4	80.18
CTC-7X2825	P-UB-10	1-3/4 X 3	55.57	CTC-8T1382	P-UB-10	1-1/2 X 4	38.63
CTC-7X2826	P-UB-10	1-1/2 X 2-1/4	42.17	CTC-8T1383	P-UB-10	2-3/4 X 6-1/2	86.45
CTC-7X2827	P-UB-10	1-3/4 X 2-1/2	41.42	CTC-8T1384	P-UB-10	4 x 8-1/2	323.30
CTC-7X2828	P-UB-10	1-3/4 X 2-3/4	57.56	CTC-8T1385	P-UB-10	2-1/4 X 5	98.30

CATERPILLAR®

REPLACEMENT KITS FOR CATERPILLAR® EQUIPMENT

NOTE: CATERPILLAR® kit numbers are used as a reference only. We do not imply that these kits are original REPLACEMENT KITS.

Kit Number	Code (Pg. xviii)	Rod X Bore Size	List Price	Kit Number	Code (Pg. xviii)	Rod X Bore Size	List Price
CTC-8T1386	P-UB-10	2 X 4	\$ 89.05	CTC-8T1464	P-UB-10	2-3/8 X 4-1/4	\$ 55.49
CTC-8T1388	P-UB-10	1-3/4 X 3-1/2	50.64	CTC-8T1466	P-UB-10	2-1/2 X 4	67.75
CTC-8T1389	P-UB-10	2-3/8 X 4	49.28	CTC-8T1467	P-UB-10	3-1/2 X 8-1/4	150.21
CTC-8T1390	P-V-10	2 X 5	83.71	CTC-8T1468	P-UB-10	3-1/2 X 8-1/4	129.11
CTC-8T1391	P-UB-10	3-1/4 X 6	95.88	CTC-8T1470	P-UB-10	2-3/4 X 4-1/2	96.11
CTC-8T1392	P-UB-10	1-3/4 X 3-1/4	57.77	CTC-8T1472	P-UB-10	2-1/2 X 6-1/2	84.32
CTC-8T1393	P-UB-10	3-1/2 X 8-1/2	150.34	CTC-8T1473	P-UB-10	2-1/4 X 3-3/4	44.35
CTC-8T1394	P-UB-10	3-1/4 X 7	94.80	CTC-8T1474	P-UB-10	4 X 9-1/4	412.20
CTC-8T1395	P-UB-10	2-1/4 X 4-1/2	66.48	CTC-8T1477	P-UB-14	3-1/2 X 8-1/4	209.38
CTC-8T1396	P-UB-10	2-1/4 X 4-1/2	58.07	CTC-8T1478	P-UB-10	3-1/4 X 7	202.92
CTC-8T1397	P-UB-10	1-1/2 X 2-1/2	47.90	CTC-8T1479	P-UB-10	5 X 7-3/4	395.03
CTC-8T1398	P-UB-14	3-1/4 X 5-1/2	214.60	CTC-8T1480	P-V-10	1-1/4 X 4	85.62
CTC-8T1399	P-UB-10	3-1/4 X 7-3/4	127.12	CTC-8T1481	P-V-10	2 X 4	70.16
CTC-8T1400	P-UB-10	3 X 6-1/2	83.58	CTC-8T1484	P-UB-10	2-1/4 X 4	64.88
CTC-8T1401	P-V-10	3-1/2 X 8-1/4	162.26	CTC-8T1488	P-V-10	2-1/2 X 6	107.37
CTC-8T1402	P-UB-10	1-1/2 X 2-3/4	51.29	CTC-8T1489	P-UB-10	3 X 6	132.40
CTC-8T1403	P-V-10	2-1/2 X 6	121.17	CTC-8T1494	P-UB-10	2-3/4 X 5-1/2	83.51
CTC-8T1404	P-UB-10	2-3/4 X 7-1/4	114.11	CTC-8T1525	P-UB-10	2-3/4 X 5-1/2	100.65
CTC-8T1405	P-UB-10	3 X 8-1/4	153.42	CTC-8T1526	P-UB-10	2-3/4 X 6	78.82
CTC-8T1406	P-V-10	2-1/2 X 5	74.00	CTC-8T1527	P-UB-10	2-3/4 X 5	76.57
CTC-8T1408	P-UB-10	3 X 6-1/2	83.58	CTC-8T1528	P-UB-10	2-3/4 X 6-1/2	84.37
CTC-8T1409	P-UB-10	4 X 6-1/2	176.09	CTC-8T1529	P-UB-10	2-3/4 X 7	118.19
CTC-8T1410	P-UB-10	3-1/2 X 8-1/4	152.34	CTC-8T1530	P-UB-10	2-3/4 X 6-1/4	129.20
CTC-8T1411	P-UB-10	3-1/4 X 9-1/4	174.97	CTC-8T1531	P-UB-10	2 X 4-1/2	55.69
CTC-8T1412	P-UB-10	2 X 4-1/4	45.67	CTC-8T1532	P-V-10	2 X 3-1/2	65.64
CTC-8T1413	P-UB-10	2-1/4 X 4-1/4	68.68	CTC-8T1534	P-UB-10	2-1/2 X 4-1/2	66.93
CTC-8T1414	P-UB-10	2 X 3-1/4	51.41	CTC-8T1541	P-UB-10	1-3/4 X 3-3/4	47.20
CTC-8T1415	P-V-10	6 X 8-1/4	306.19	CTC-8T1542	P-UB-10	2-3/8 X 3-3/4	62.64
CTC-8T1416	P-UB-10	2-1/2 X 7-1/4	94.22	CTC-8T1543	I-UB-10	5-1/2 X 9-1/2	476.39
CTC-8T1417	P-UB-10	2-3/4 X 7-1/4	117.57	CTC-8T1544	P-UB-10	7 X 11-1/2	278.42
CTC-8T1418	P-V-10	2-1/2 X 6	126.84	CTC-8T1545	P-UB-14	4-3/4 X 7-1/4	299.08
CTC-8T1419	P-UB-10	2 X 4-1/2	58.89	CTC-8T1546	P-UB-10	4 X 10	234.54
CTC-8T1420	P-UB-10	2 X 3-1/2	56.82	CTC-8T1548	P-UB-10	1-1/2 X 3-1/2	49.64
CTC-8T1421	P-V-10	2 X 4-3/4	86.28	CTC-8T1549	P-UB-14	3 X 5-1/2	185.99
CTC-8T1422	P-V-10	2-1/2 X 6	121.17	CTC-8T1551	P-UB-14	3 X 7-1/4	186.76
CTC-8T1423	P-UB-10	3-1/2 X 7-1/2	127.48	CTC-8T1553	P-V-10	2-3/4 X 6	116.93
CTC-8T1426	P-V-10	3-1/4 X 5-1/2	209.64	CTC-8T1554	P-V-14	2-3/4 X 6-1/2	142.59
CTC-8T1427	P-V-10	3-1/4 X 6-1/2	230.27	CTC-8T1555	P-UB-14	3-1/4 X 6-1/2	183.67
CTC-8T1428	P-UB-10	3 X 5-1/4	130.87	CTC-8T1558	P-UB-10	5-3/4 X 8-1/4	688.95
CTC-8T1429	P-UB-10	2-1/2 X 4-1/4	51.12	CTC-8T1559	P-UB-10	3-1/2 X 8-1/4	116.25
CTC-8T1430	P-UB-10	3-1/4 X 9-1/4	152.06	CTC-8T1563	P-UB-10	3-1/4 X 5-1/2	102.37
CTC-8T1432	P-UB-10	4 X 10-1/2	180.78	CTC-8T1565	P-UB-14	4-3/4 X 7	254.03
CTC-8T1435	P-UB-10	1-1/2 X 3	45.26	CTC-8T1566	P-UB-14	3-1/4 X 6-1/2	183.74
CTC-8T1438	P-UB-10	2-1/2 X 4-1/4	64.94	CTC-8T1567	P-UB-14	4-3/4 X 7	246.75
CTC-8T1439	P-UB-10	2-1/4 X 4	65.91	CTC-8T1772	P-UB-10	2-1/2 X 4-1/2	84.21
CTC-8T1448	P-UB-10	3-1/2 X 10-1/2	164.6	CTC-8T1906	P-UB-10	3 X 6	95.36
CTC-8T1451	P-UB-10	3 X 6-1/4	96.99	CTC-8T1908	P-UB-14	4-3/4 X 6	225.44
CTC-8T1456	P-UB-14	6-1/2 X 10-1/2	440.02	CTC-8T1909	P-UB-10	5 X 6	349.57
CTC-8T1457	P-UB-10	4 X 7	198.80	CTC-8T2066	P-UB-10	2-1/2 X 6	109.44
CTC-8T1461	P-UB-10	4-1/4 X 6-1/2	235.53	CTC-8T2166	P-UB-10	3-1/4 X 8-1/4	137.12
CTC-8T1462	P-UB-14	4-3/4 X 6-1/2	252.00	CTC-8T2216	P-UB-10	2-1/4 X 4-3/4	81.41

CATERPILLAR®

REPLACEMENT KITS FOR CATERPILLAR® EQUIPMENT

NOTE: CATERPILLAR® kit numbers are used as a reference only. We do not imply that these kits are original REPLACEMENT KITS.

Kit Number	Code (Pg. xviii)	Rod X Bore Size	List Price	Kit Number	Code (Pg. xviii)	Rod X Bore Size	List Price
CTC-8T2289	P-UB-10	4 X 5	\$ 113.62	CTC-9X2151	P-UB-10	2-1/2 X 4-3/4	\$ 85.96
CTC-8T2332	P-UB-10	3 X 6-1/4	107.28	CTC-9X2153	P-UB-10	1-1/2 X 2-3/4	54.94
CTC-8T2583	P-UB-14	3-1/2 X 8-1/2	198.15	CTC-9X2400	P-UB-10	2-1/8 X 4	123.33
CTC-8T3015	P-UB-10	2-1/2 X 3-3/4	60.93	CTC-9X2473	P-UB-10	2-3/4 X 6-1/2	139.28
CTC-8T3565	P-UB-10	4 X 10	401.51	CTC-9X2515	P-UB-10	2-1/4 X 4	57.25
CTC-8T3574	P-UB-10	2-1/4 X 3-1/2	52.15	CTC-9X2638	P-UB-10	1-3/4 X 2-3/4	36.96
CTC-8T3575	P-UB-10	2 X 4-1/4	46.85	CTC-9X2641	P-UB-10	2-1/4 X 4	57.25
CTC-8T3576	P-UB-10	2-1/2 X 5-1/2	93.53	CTC-9X2644	P-UB-10	3-1/2 X 7-3/4	239.91
CTC-8T3577	P-UB-10	2-1/2 X 5-1/2	71.63	CTC-9X2645	P-UB-10	3-1/2 X 7-3/4	117.54
CTC-8T3589	P-UB-10	1-7/8 X 3-1/4	83.64	CTC-9X6027	P-SP-10	2-1/2 X 5-1/2	117.47
CTC-8T3590	P-UB-10	2 X 3-1/4	77.96	CTC-9X6254	P-UB-10	4-1/4 X 6-1/2	250.48
CTC-8T3591	P-UB-10	2-1/8 X 3-1/2	108.57	CTC-9X6255	P-UB-10	4-1/4 X 6-1/2	253.29
CTC-8T3592	P-UB-10	2 X 3-1/2	66.03	CTC-9X6261	P-UB-10	4 X 6	293.92
CTC-8T3593	P-UB-10	2-1/8 X 4	73.47	CTC-9X6263	P-UB-10	4 X 6	242.17
CTC-8T3648	P-UB-10	3-1/4 X 9-1/4	152.06	CTC-9X6379	P-UB-10	4-1/4 X 6-1/2	328.55
CTC-8T3649	P-UB-10	3-1/2 X 7-1/2	130.55	CTC-9X6392	P-UB-10	2-1/4 X 5	165.61
CTC-8T3739	P-UB-10	3-1/4 X 8-1/4	142.41	CTC-9X6393	P-UB-10	3-3/4 X 6	282.86
CTC-8T3740	P-UB-10	3 X 7-1/4	123.33	CTC-9X6398	P-V-10	3-1/4 X 6-1/2	226.37
CTC-8T3741	P-UB-10	2-3/4 X 6-1/2	94.08	CTC-C75300011	P-UB-13	70 X 110 mm	253.63
CTC-8T3852	P-UB-10	1-7/8 X 3	199.65	CTC-C75300021	P-UB-13	80 X 120 mm	242.55
CTC-8T4770	P-UB-10	3-1/4 X 7-1/4	99.08	CTC-C75300031	P-UB-13	65 X 110 mm	267.74
CTC-8T4772	I-SP-10	4, 6-1/2 X 5-3/4	325.54	CTC-C95300623	P-UB-10	80 X 120 mm	286.76
CTC-8T4891	P-UB-10	2-1/2 X 4-3/4	79.93	CTC-C95300731	P-UB-10	65 X 100 mm	196.84
CTC-8T4892	P-UB-10	1-1/2 X 3-1/2	53.28	CTC-C95301729	P-UB-10	75 X 110 mm	201.51
CTC-8T4939	I-SP-3,10	7-1/4, 10-1/2 X 9-1/4, 11-1/2	800.26	CTC-E25300061	P-UB-14	90 X 140 mm	439.01
CTC-8T4940	P-V-10	2-3/4 X 5	88.99	CTC-E35300040	P-UB-10	85 X 125 mm	334.05
CTC-8T9042	I-SP-10	5,7-1/2 X 8-1/4	471.07	CTC-E75300010	P-UB-10	100 X 140 mm	398.72
CTC-9J3886	O-RINGS		2.24	CTC-E85300011	P-UB-10	85 X 120 mm	402.56
CTC-9J5106	PUMP KIT		37.05	CTC-E85300021	P-UB-10	95 X 130 mm	444.14
CTC-9J5118	PUMP KIT		30.45	CTC-E85300031	P-UB-10	75 X 115 mm	373.31
CTC-9J5119	PUMP KIT		30.93	CTC-F15300011	P-UB-14	100 X 150 mm	486.20
CTC-9J6488	O-RINGS		9.80	CTC-F15300021	P-UB-14	110 X 160 mm	403.40
CTC-9M5603	P-V-10	2-3/4 X 9-1/4	169.83	ELPH-1DE3187	P-UB-14	4 X 230 mm	385.14
CTC-9M5604	P-U-10	2-1/2 X 7-1/4	117.55	ELPH-9DE1800	P-UB-10	3 X 6	190.51
CTC-9M5605	P-V-10	2-3/4 X 8-1/4	154.58	ELPH-9DE1809	P-UB-10	2-1/2 X 5	164.08
CTC-9S3135	SPLIT FLANGE O-RING KIT		41.59	ELPH-9DE1817	P-UB-10	3-1/4 X 7-3/4	244.98
CTC-9T0418	I-O-3	1 X 2	85.89	ELPH-9DE2659	P-UB-10	4 X 8-1/2	262.71
CTC-9T1834K	P-UB-10	2-1/8 X 3-1/4	227.63	ELPH-9DE2994	P-UB-10	4 X 10	335.71
CTC-9T2696K	P-UB-10	2-1/4 X 3-1/2	60.06	ELPH-9EL1171	P-UB-10	5-1/2 X 10	518.58
CTC-9T2716K	P-UB-10	2-1/2 X 5	83.64	ELPH-9EL7527	P-UB-10	4 X 8-1/2	293.06
CTC-9T2869K	P-UB-10	3-1/2 X 6-1/4	210.79	ELPH-9EL8333	P-UB-10	5-1/2 X 10-1/2	580.46
CTC-9T3972K	I-SP-1	9 X 10-1/2	493.96	ELPH-9EP9170	P-UB-10	5 X 9-1/4	743.37
CTC-9T7125	P-SP-1	1" Rod Kit	16.60	ELPH-9EQ0379	P-UB-10	3 X 6	223.27
CTC-9T8912K	P-UB-10	2-3/4 X 5-1/2	153.84	ELPH-9EQ0380	P-UB-10	4-1/4 X 8-1/4	238.94
CTC-9X2020	I-UB-10	2-3/4 X 3-3/4	112.65				
CTC-9X2031	P-UB-10	2-1/8 X 3-1/4	225.99				
CTC-9X2047	P-UB-10	2-1/2 X 5-1/2	111.99				
CTC-9X2050	P-UB-10	2-1/2 X 5-1/2	104.21				
CTC-9X2063	P-UB-10	4-3/4 X 7	217.59				
CTC-9X2150	P-UB-10	1-1/2 X 2-3/4	59.16				

CATERPILLAR®

REPLACEMENT PARTS FOR CATERPILLAR® EQUIPMENT

NOTE: CATERPILLAR® kit numbers are used as a reference only. We do not imply that these kits are original REPLACEMENT KITS.

1 PIECE BUFFER RINGS

Part Number	Rod Dia.	List Price
CTC-5P4673	7/8	\$ 4.15
CTC-9J3497	1-1/4	4.40
CTC-6J9733	1-1/2	5.48
CTC-6J9178	1-3/4	4.70
CTC-4T6778	1-7/8	12.76
CTC-9X3566	1-7/8	15.79
CTC-6J6917	2	4.39
CTC-4T6127	2-1/8	5.92
CTC-4T6127N	2-1/8	6.64
CTC-9X3568	2-1/8	19.61
CTC-5J3616	2-1/4	6.64
CTC-6J6916	2-3/8	5.93
CTC-5J3620	2-1/2	5.54
CTC-1U4020	2-5/8	10.60
CTC-6J6553	2-3/4	6.51
CTC-6J6915	3	7.53
CTC-6J7167	3-1/4	7.13
CTC-6J6736	3-1/2	8.36
CTC-8J6070	3-3/4	9.45
CTC-8J4627	4	13.70
CTC-7J8943	4-1/4	9.63
CTC-3G5055	4-3/8	8.95
CTC-7J9257	4-3/4	12.57
CTC-8J4509	5	13.02
CTC-9J5468	5-3/4	21.39
CTC-6J8631	6-1/2	16.79
CTC-9J2495	7	22.17
CTC-0959791	50 mm	9.90
CTC-A04600811	65 mm	\$ 12.11
CTC-A04600813	80 mm	14.56
CTC-7Y4630	95 mm	52.69

2 PIECE BUFFER RINGS

Part Number	Rod Dia.	List Price
CTC-8C9122	1-1/2	\$ 14.69
CTC-1672190	1-3/4	4.29
CTC-8C9123	1-3/4	15.66
CTC-1672195	2	3.49
CTC-8C9124	2	17.14
CTC-8C9125	2-1/4	22.08
CTC-8C9138	2-3/8	24.59
CTC-8C3839	2-1/2	20.44
CTC-1672206	2-5/8	23.69
CTC-9T9363	2-5/8	23.69
CTC-1672207	2-3/4	7.21
CTC-8C3841	2-3/4	26.06
CTC-8C9126	3	17.31
CTC-8C9121	3-1/4	25.96
CTC-1672211	3-1/2	8.17
CTC-2017748	3-1/2	31.38
CTC-8C9127	3-1/2	31.38
CTC-8C9128	3-3/4	33.27
CTC-1672216	4	10.91
CTC-8C9129	4	35.09
CTC-6E0425	4-1/4	56.08
CTC-1672220	4-1/2	60.71
CTC-2951317	4-1/2	60.71
CTC-3358964	4-1/2	60.71
CTC-3G8507	4-1/2	60.71
CTC-8C9144	4-1/2	50.92
CTC-9X7261	4-3/4	75.56
CTC-9X3581	5	78.49
CTC-9X7267	5-1/4	62.35
CTC-9X3575	5-3/4	102.81
CTC-8C9130	7	65.32
CTC-1095258	35.4 mm	11.71
CTC-2774162	45 mm	49.87
CTC-1410706	50 mm	18.46
CTC-2774131	50 mm	18.46
CTC-0996997	55 mm	18.57
CTC-1572237	55 mm	24.14
CTC-2773384	55 mm	18.57
CTC-0931481	60 mm	26.37

2 PIECE BUFFER RINGS

Part Number	Rod Dia.	List Price
CTC-1336784	60 mm	\$ 26.37
CTC-0931482	65 mm	31.36
CTC-1262149	65 mm	31.36
CTC-A04601014	65 mm	31.36
CTC-0931483	70 mm	34.23
CTC-1262150	70 mm	34.23
CTC-1672235	70 mm	45.07
CTC-1709841	70 mm	34.23
CTC-1709842	75 mm	36.39
CTC-A04601015	70 mm	34.23
CTC-0963469	75 mm	36.39
CTC-1262151	75 mm	36.39
CTC-A04601016	75 mm	36.39
CTC-0931484	80 mm	38.54
CTC-1262152	80 mm	38.54
CTC-1709843	80 mm	38.54
CTC-A04601017	80 mm	38.54
CTC-7Y5118	85 mm	41.35
CTC-1231943	85 mm	41.35
CTC-1540732	85 mm	41.35
CTC-1709844	85 mm	41.35
CTC-2043622	85 mm	41.35
CTC-2742494	85 mm	41.35
CTC-0961585	90 mm	49.91
CTC-1540752	90 mm	49.91
CTC-1672212	90 mm	49.91
CTC-1709845	90 mm	49.91
CTC-2043624	90 mm	49.91
CTC-2742495	90 mm	49.91
CTC-1672213	95 mm	52.69
CTC-1709846	95 mm	52.69
CTC-2095957	95 mm	52.69
CTC-2590652	95 mm	52.69
CTC-0962663	100 mm	54.21
CTC-1231983	100 mm	54.21
CTC-1540739	100 mm	54.21
CTC-1672215	100 mm	54.21
CTC-1709847	100 mm	54.21
CTC-2043623	100 mm	54.21

CATERPILLAR®

REPLACEMENT PARTS FOR CATERPILLAR® EQUIPMENT

NOTE: CATERPILLAR® kit numbers are used as a reference only. We do not imply that these kits are original REPLACEMENT KITS.

2 PIECE BUFFER RINGS

Part Number	Rod Dia.	List Price
CTC-2742496	100 mm	\$ 54.21
CTC-1231942	105 mm	56.18
CTC-1540770	105 mm	56.18
CTC-1672217	105 mm	56.18
CTC-2096009	105 mm	56.18
CTC-2667956	105 mm	56.18
CTC-1289266	110 mm	58.49
CTC-2667957	110 mm	58.49
CTC-7Y4943	110 mm	58.49
CTC-A04601018	110 mm	58.49
CTC-1915645	115 mm	32.26
CTC-2590773	115 mm	32.26
CTC-1704827	125 mm	53.72
CTC-0965169	130 mm	98.56
CTC-1709850	130 mm	98.56
CTC-2667958	130 mm	98.56
CTC-1672226	140 mm	160.49
CTC-1709851	140 mm	160.49
CTC-8C9189	140 mm	160.49
CTC-1672229	150 mm	105.20
CTC-1709853	150 mm	105.20

3 PIECE BUFFER RINGS

Part Number	Rod Dia.	List Price
CTC-2332616	50 mm	\$ 7.78
CTC-2332615	55 mm	7.78
CTC-1505840	80 mm	66.49
CTC-0861023	85 mm	70.18
CTC-1672210	85 mm	70.18
CTC-4I3611	85 mm	70.18
CTC-1052576	90 mm	73.86
CTC-1076257	100 mm	84.89
CTC-0556510010	100 mm	36.84
CTC-4I3626	100 mm	84.89
CTC-1140704	105 mm	88.58

DYR STYLE BUFFER RINGS

Part Number	Rod Dia.	List Price
CTC-1672186	1-1/2	\$ 2.76
CTC-1672191	1-3/4	19.69
CTC-3081884	1-3/4	19.69
CTC-1672192	1-7/8	6.64
CTC-3081876	2	68.89
CTC-2892935	2	3.49
CTC-1672201	2-1/2	5.27
CTC-1672204	2-1/2	59.89
CTC-2892937	2-1/2	5.27
CTC-1672200	2-1/4	4.67
CTC-1506744	2-1/8	29.55
CTC-1672197	2-1/8	29.55
CTC-1672198	2-1/8	5.44
CTC-1485674	2-3/4	24.95
CTC-1672202	2-3/8	6.14
CTC-1529022	3	26.95
CTC-1672208	3	8.53
CTC-3124248	3	26.95
CTC-3119316	3-1/2	30.97
CTC-1672209	3-1/4	7.75
CTC-3465193	3-1/4	7.75
CTC-1672214	3-3/4	9.26
CTC-3465192	3-3/4	9.26
CTC-3119319	4	44.20
CTC-1672218	4-1/4	214.01
CTC-1672221	4-3/4	192.64
CTC-1672725	5-1/2	75.58
CTC-1672239	8	114.52
CTC-1465150	40 mm	9.06
CTC-1672242	45 mm	39.28
CTC-1672183	50 mm	28.12
CTC-1336785	55 mm	18.57
CTC-1709838	55 mm	18.57
CTC-1672199	55 mm	18.57
CTC-3295789	55 mm	18.57
CTC-1672185	60 mm	49.73
CTC-1709839	60 mm	26.37
CTC-1460739	65 mm	31.36

DYR STYLE BUFFER RINGS

Part Number	Rod Dia.	List Price
CTC-1709840	65 mm	\$ 31.36
CTC-3494116	70 mm	62.56
CTC-4161298	70 mm	62.56
CTC-1672184	75 mm	91.94
CTC-3494115	75 mm	67.21
CTC-4161276	75 mm	67.21
CTC-1672243	80 mm	94.25
CTC-2095960	80 mm	38.54
CTC-3555814	80 mm	70.61
CTC-4161287	80 mm	70.61
CTC-3500952	85 mm	41.35
CTC-1232048	90 mm	49.91
CTC-1505885	95 mm	52.69
CTC-3246438	105 mm	56.18
CTC-3338687	110 mm	58.49
CTC-1232031	110 mm	58.49
CTC-3249484	115 mm	32.26
CTC-3338672	130 mm	98.56
CTC-1262108	130 mm	98.56
CTC-1475769	140 mm	160.49

CATERPILLAR®

REPLACEMENT PARTS FOR CATERPILLAR® EQUIPMENT

NOTE: CATERPILLAR® kit numbers are used as a reference only. We do not imply that these kits are original REPLACEMENT KITS.

2 PIECE PISTON SEALS

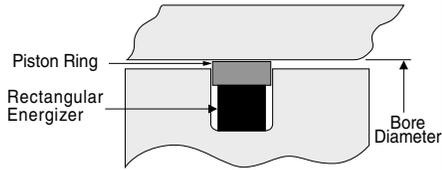

Part Number	Bore Dia.	List Price
CTC-5J7004	2	10.5
CTC-5J7004A	2	10.50
CTC-1U3998	2-1/4	13.72
CTC-1U3998A	2-1/4	13.72
CTC-8J6213	2-1/2	12.50
CTC-8J6213A	2-1/2	12.50
CTC-5J7010	2-3/4	19.09
CTC-5J7010A	2-3/4	19.09
CTC-6J1972	3	14.06
CTC-6J1972A	3	14.06
CTC-2443839	3-1/4	90.73
CTC-6J0793	3-1/4	19.95
CTC-6J0793A	3-1/4	19.95
CTC-5J7013	3-1/2	14.86
CTC-5J7013A	3-1/2	14.86
CTC-5J8011	3-3/4	25.39
CTC-5J8011A	3-3/4	25.39
CTC-5J5402	4	19.75
CTC-5J5402A	4	19.75
CTC-5J7854	4-1/4	21.33
CTC-5J7854A	4-1/4	21.33
CTC-5J4986	4-1/2	24.65
CTC-5J4986A	4-1/2	24.65
CTC-5J4987	4-3/4	26.94
CTC-5J4987A	4-3/4	26.94
CTC-5J5020	5	29.19
CTC-5J5020A	5	29.19
CTC-5J7234	5-1/4	32.60
CTC-5J7234A	5-1/4	34.80
CTC-5J4988	5-1/2	28.53
CTC-5J4988A	5-1/2	34.48
CTC-9J4981	5-3/4	40.05
CTC-5J4989	6	32.98
CTC-5J4989A	6	32.98

2 PIECE PISTON SEALS

Part Number	Bore Dia.	List Price
CTC-5J4990	6-1/4	33.7
CTC-5J4990A	6-1/4	28.89
CTC-5J4991	6-1/2	37.85
CTC-5J4991A	6-1/2	37.85
CTC-5J4997	7	41.03
CTC-5J4997A	7	41.03
CTC-5J4993	7-1/4	45.77
CTC-5J4993A	7-1/4	45.77
CTC-9J7117	7-1/2	72.22
CTC-9J7117A	7-1/2	72.22
CTC-5J7016	7-3/4	99.76
CTC-5J7016A	7-3/4	99.76
CTC-5J5559	8-1/4	39.54
CTC-5J5559A	8-1/4	39.54
CTC-6J9385	8-1/2	47.95
CTC-6J9385A	8-1/2	51.75
CTC-5J7019	9-1/4	58.21
CTC-5J7019A	9-1/4	50.53
CTC-1214179	10	176.42
CTC-1674004	50 mm	11.20
CTC-1449485	60 mm	14.04
CTC-1980659	60 mm	12.93
CTC-2047228	65 mm	21.35
CTC-1403750	65 mm	34.32
CTC-1617144	65 mm	18.52
CTC-1404273	70 mm	35.86
CTC-1617145	70 mm	16.87
CTC-1754721	70 mm	35.86
CTC-1617146	75 mm	17.08
CTC-1920684	75 mm	35.35
CTC-1930784	75 mm	22.92
CTC-1991141	75 mm	35.35
CTC-1200890	75 mm	22.92
CTC-2107029	75 mm	35.35
CTC-1463923	80 mm	36.54
CTC-1931394	80 mm	39.51
CTC-1931770	85 mm	29.05
CTC-1463968	85 mm	37.58
CTC-1617149	85 mm	32.85

2 PIECE PISTON SEALS

Part Number	Bore Dia.	List Price
CTC-1934313	85 mm	32.66
CTC-2107026	85 mm	37.58
CTC-2332584	85 mm	32.85
CTC-1463994	90 mm	39.69
CTC-1708800	90 mm	39.69
CTC-1445287	90 mm	33.63
CTC-1931368	90 mm	46.14
CTC-1522464	95 mm	44.21
CTC-1708781	100 mm	37.06
CTC-2057956	100 mm	37.06
CTC-1407649	100 mm	35.17
CTC-0963893	110 mm	54.44
CTC-1460743	115 mm	41.37
CTC-0967803	120 mm	55.74
CTC-1864955	125 mm	59.98
CTC-0961564	125 mm	55.74
CTC-0861345	130 mm	57.68
CTC-2344583	135 mm	65.14
CTC-0961570	140 mm	65.86
CTC-8C9193	150 mm	105.20
CTC-1704826	220 mm	371.65

2 PIECE STEP-CUT PISTON SEALS

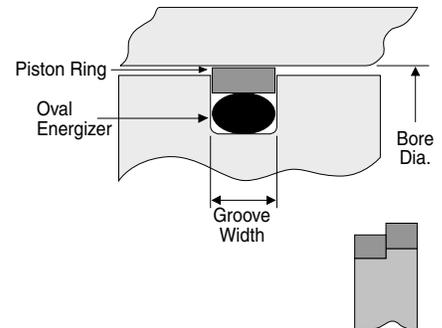

Part Number	Bore Dia.	Groove Width	List Price
CTC-1665295	2-3/4	0.19	\$ 33.85
CTC-4T8054	3-1/2	0.19	25.46
CTC-2613644	3-3/4		29.28

CATERPILLAR®

REPLACEMENT PARTS FOR CATERPILLAR® EQUIPMENT

NOTE: CATERPILLAR® kit numbers are used as a reference only. We do not imply that these kits are original REPLACEMENT KITS.

2 PIECE STEP-CUT PISTON SEALS

Part Number	Bore Dia.	Groove Width	List Price
CTC-8C9160	4	0.25	\$ 32.86
CTC-9X7269	4-1/2	0.25	48.14
CTC-4T8588	4 3/4		84.24
CTC-9X7264	5	0.38	45.72
CTC-1546744	5-3/8		50.56
CTC-8T0763	5-1/4	0.38	36.89
CTC-6E0465	5-1/2	0.38	49.64
CTC-4T5173	5-1/2	0.63	39.32
CTC-4T4144	6	0.63	42.69
CTC-8T1788	6 1/4		57.05
CTC-4T8695	6-1/2	0.63	38.15
CTC-8T1789	7	0.63	41.90
CTC-8T1792	7-3/4	0.63	47.31
CTC-9T0119	8-1/2	0.63	57.09
CTC-8T1793	8-1/4	0.63	60.34
CTC-8T1794	10	0.69	90.01
CTC-8T1795	10-1/4	.069	108.43
CTC-8T1796	10-1/2	0.69	97.93
CTC-8T1797	11-1/2	0.69	115.32
CTC-1921453	12-1/2		173.34
CTC-1846970	75 mm		60.12
CTC-1841687	85 mm		32.90
CTC-2332585	100 mm		37.07
CTC-9X7298	100 mm	7.24 mm	63.85
CTC-9X7301	110 mm	7.24 mm	73.06
CTC-9X3589	115 mm	7.24 mm	40.69
CTC-9X3592	120 mm	7.24 mm	70.08
CTC-9X3595	130 mm	7.24 mm	66.30
CTC-2371934	135 mm	7.24 mm	104.15
CTC-9X3598	140 mm	9.63 mm	75.22
CTC-9X3601	150 mm	9.63 mm	64.04
CTC-9X3604	160 mm	9.63 mm	64.15
CTC-9X3607	170 mm	9.63 mm	74.31
CTC-9X3610	180 mm	9.63 mm	74.32
CTC-1251286	190 mm		61.36

3 PIECE PISTON SEALS

Part Number	Rod Dia.	List Price
CTC-0556510010	100 mm	\$ 36.84

5 PIECE PISTON SEALS

Part Number	Bore Dia.	List Price
CTC-0931488	90 mm	\$ 112.54
CTC-5W6382	110 mm	26.58
CTC-A04601216	120 mm	144.65
CTC-8Q5983	140 mm	44.64
CTC-1843474	150 mm	38.39

CAPPED PISTON T-SEALS

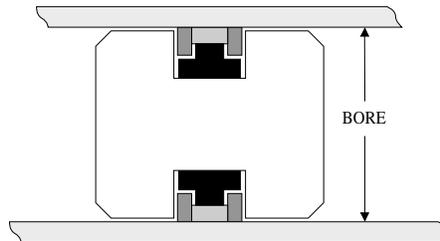

Part Number	Bore Dia.	List Price
CTC-8J3747	4-1/2	\$ 105.37
CTC-9J7868	5	128.75
CTC-8J8767	5-1/2	144.47
CTC-9J1242	6	150.95
CTC-9J5558	6-1/4	154.18
CTC-8J8703	6-1/2	170.11
CTC-8J3749	7	\$ 175.40
CTC-8J4510	7-1/4	181.10
CTC-9J5567	7-1/2	183.65
CTC-8J5644	7-3/4	191.33
CTC-8J4390	8-1/4	204.11
CTC-3G4762	8-1/2	214.10
CTC-9J3406	10	253.99
CTC-3G4765	10-1/2	274.32
CTC-9J2987	11-1/2	312.24
CTC-2508729	75 mm	48.66
CTC-0996998	80 mm	50.46
CTC-1231669	85 mm	62.70
CTC-2639886	85 mm	62.70
CTC-0996973	90 mm	57.35
CTC-2773389	95 mm	62.70

CAPPED PISTON T-SEALS

Part Number	Bore Dia.	List Price
CTC-3049305	95 mm	\$ 62.70
CTC-5I5928	100 mm	61.94
CTC-0996922	110 mm	65.35
CTC-4161280	110 mm	70.65
CTC-A04601713	110 mm	70.65
CTC-4161291	120 mm	73.63
CTC-A04601719	160 mm	123.77

NON CATERPILLAR® PISTON SEALS

Part Number	Bore Dia.	List Price
CTC-3E4244	1	\$ 4.58
CTC-3E4245	1-1/8	6.11
CTC-3E4246	1-1/4	5.05
CTC-3E4247	1-1/2	5.26
CTC-3E4248	1-5/8	5.35
CTC-3E4249	1-3/4	5.48
CTC-3E4250	2	5.69
CTC-3E4251	2-1/4	5.91
CTC-3E4252	2-1/2	5.98
CTC-3E4253	2-3/4	6.04
CTC-3E4254	3	6.21
CTC-3E4255	3-1/4	6.31
CTC-3E4256	3-1/2	6.49

CATERPILLAR®

REPLACEMENT PARTS FOR CATERPILLAR® EQUIPMENT

NOTE: CATERPILLAR® kit numbers are used as a reference only. We do not imply that these kits are original REPLACEMENT KITS.

BACK-UP RINGS

Part Number	Min. Pkgs.	List Price
CTC-0300167	10	\$ 2.03
CTC-0306121	25	0.34
CTC-0306141	5	2.93
CTC-0875391	1	16.19
CTC-0875397	1	64.81
CTC-0875436	1	12.58
CTC-0875510	1	12.08
CTC-0875550	1	14.41
CTC-0931512	1	6.13
CTC-0931513	1	8.19
CTC-0931514	1	12.31
CTC-0931515	1	13.59
CTC-0931518	1	22.99
CTC-0931519	1	25.81
CTC-0951783	1	2.46
CTC-0951786	1	2.46
CTC-0951789	1	2.46
CTC-0951796	1	7.10
CTC-0961054	1	48.16
CTC-0961055	1	9.56
CTC-0961566	1	12.08
CTC-0961568	1	11.54
CTC-0961588	1	11.54
CTC-0962665	1	13.43
CTC-0963467	1	24.03
CTC-0963964	1	12.08
CTC-0964276	1	2.81
CTC-0990172	1	5.59
CTC-0990173	1	3.53
CTC-0990660	1	10.01
CTC-0990681	1	10.98
CTC-0990699	1	16.50
CTC-0993204	1	11.54
CTC-0995399	1	11.35
CTC-0996974	1	8.40
CTC-0996999	1	36.48
CTC-0997000	1	11.18
CTC-0997030	1	2.46
CTC-1011983	1	2.54
CTC-1035754	5	2.93

BACK-UP RINGS

Part Number	Min. Pkgs.	List Price
CTC-1052578	1	\$ 11.54
CTC-1052579	1	12.23
CTC-1052583	1	12.59
CTC-1057360	1	11.85
CTC-1057375	1	12.08
CTC-1057393	1	9.75
CTC-1076255	1	13.43
CTC-1076258	1	22.38
CTC-1076262	1	14.88
CTC-1079308	1	10.31
CTC-1140706	1	14.56
CTC-1140711	1	16.01
CTC-1211372	1	13.43
CTC-1214160	1	10.38
CTC-1220440	1	12.51
CTC-1238614	1	15.10
CTC-1259695	1	17.71
CTC-1261978	1	17.46
CTC-1336716	1	11.59
CTC-1336914	1	11.54
CTC-1373660	1	56.14
CTC-1400233	3	3.41
CTC-1407652	1	12.58
CTC-1475771	1	45.71
CTC-1505827	1	59.26
CTC-1505842	1	11.85
CTC-1505844	1	10.30
CTC-1522461	1	11.35
CTC-1540731	1	11.54
CTC-1540738	1	13.43
CTC-1540751	1	11.54
CTC-1540763	1	13.43
CTC-1540769	1	37.81
CTC-1559193	1	41.00
CTC-1576961	1	33.33
CTC-1577244	1	58.73
CTC-1577245	1	58.34
CTC-1583026	1	6.26
CTC-1583027	1	21.53
CTC-1583031	1	4.65

BACK-UP RINGS

Part Number	Min. Pkgs.	List Price
CTC-1583032	1	\$ 72.53
CTC-1607550	1	0.85
CTC-1627209	1	4.28
CTC-1627210	1	34.31
CTC-1663002	1	12.59
CTC-1682271	5	1.86
CTC-1704746	1	26.22
CTC-1704748	1	47.15
CTC-1704749	1	24.85
CTC-1754726	1	6.07
CTC-1843478	1	2.37
CTC-1850347	1	2.46
CTC-1850348	1	2.94
CTC-1890215	2	6.17
CTC-1915647	1	38.07
CTC-1920624	1	10.45
CTC-1920676	1	8.20
CTC-1921160	1	11.14
CTC-1921169	1	18.81
CTC-1922048	1	18.75
CTC-1922056	1	57.02
CTC-1922057	1	127.54
CTC-1922093	1	2.35
CTC-1930788	1	28.51
CTC-1930791	1	11.88
CTC-1931373	1	31.51
CTC-1931396	1	12.31
CTC-1931806	1	16.50
CTC-1934315	1	12.59
CTC-1948355	1	13.43
CTC-1948365	1	13.43
CTC-1980661	1	28.51
CTC-1982640	1	15.92
CTC-1982643	1	13.66
CTC-1982644	1	10.31
CTC-1989418	1	2.75
CTC-1K7095	4	2.29
CTC-1K7098	5	1.86
CTC-1S0668	6	1.29
CTC-1S0669	5	1.50

CATERPILLAR®

REPLACEMENT PARTS FOR CATERPILLAR® EQUIPMENT

NOTE: CATERPILLAR® kit numbers are used as a reference only. We do not imply that these kits are original REPLACEMENT KITS.

BACK-UP RINGS

Part Number	Min. Pkgs.	List Price
CTC-1S0670	8	\$ 0.98
CTC-1U1101	2	6.85
CTC-1U1626	1	6.00
CTC-1U1738	2	4.57
CTC-1U1770	2	5.13
CTC-1U3173	2	4.95
CTC-1U3307	2	5.13
CTC-2020970	1	37.39
CTC-2034021	1	31.51
CTC-2034037	1	28.51
CTC-2047232	1	20.28
CTC-2047235	1	5.64
CTC-2057951	1	11.35
CTC-2151942	3	2.20
CTC-2159864	1	49.12
CTC-2168095	1	9.56
CTC-2199051	1	12.08
CTC-2213541	4	2.83
CTC-2332599	10	1.29
CTC-2344487	1	12.35
CTC-2344581	1	12.40
CTC-2344584	1	13.72
CTC-2376124	1	11.02
CTC-2377078	1	6.07
CTC-2378378	1	11.18
CTC-2443838	6	1.26
CTC-2448826	5	1.80
CTC-2462899	1	27.16
CTC-2508718	1	8.20
CTC-2590654	1	11.54
CTC-2593174	1	4.39
CTC-2639883	1	11.18
CTC-2725643	1	36.48
CTC-2725680	1	31.51
CTC-2773386	1	11.35
CTC-2774933	1	11.35
CTC-2788633	1	11.02
CTC-2803114	1	11.35
CTC-2J0744	2	6.74
CTC-2J3961	3	2.60

BACK-UP RINGS

Part Number	Min. Pkgs.	List Price
CTC-2J4066	5	\$ 1.50
CTC-2J7767	3	3.00
CTC-2K2940	2	4.92
CTC-2K2961	3	3.41
CTC-2K3258	2	4.08
CTC-2K4096	3	2.76
CTC-2K4473	2	4.43
CTC-2K6830	5	1.86
CTC-2K8256	2	4.32
CTC-2Y8973	6	1.49
CTC-3292586	1	0.62
CTC-3292587	1	0.78
CTC-3292588	1	0.85
CTC-3292589	1	1.10
CTC-3292591	1	0.98
CTC-3C3239	10	1.04
CTC-3E6783	1	5.63
CTC-3E6795	1	20.21
CTC-3G3747	2	5.01
CTC-3J2688	1	7.37
CTC-3J8466	1	7.21
CTC-3J9742	2	5.50
CTC-3K7219	9	0.90
CTC-3K7863	9	0.85
CTC-3K8692	9	0.90
CTC-3K8699	10	0.94
CTC-3P1204	8	0.98
CTC-3P1205	8	0.90
CTC-3P1206	5	1.73
CTC-3P1207	7	1.18
CTC-4161275	1	39.34
CTC-4161278	5	1.83
CTC-4161286	1	33.48
CTC-4161289	3	2.57
CTC-4161297	1	22.31
CTC-4161300	5	1.83
CTC-4I3615	1	11.43
CTC-4I3627	1	13.26
CTC-4I3631	1	14.88
CTC-4I6330	1	18.25

BACK-UP RINGS

Part Number	Min. Pkgs.	List Price
CTC-4I6442	1	\$ 20.07
CTC-4J1151	1	7.57
CTC-4J6557	2	6.85
CTC-4J9218	2	4.83
CTC-4J9219	5	1.49
CTC-4J9220	5	1.86
CTC-4J9221	4	2.52
CTC-4J9223	2	4.43
CTC-4J9224	6	1.29
CTC-4J9225	7	1.18
CTC-4K4759	9	0.85
CTC-4T3107	2	5.15
CTC-4T5072	4	2.83
CTC-4T5929	1	18.64
CTC-5I6063	1	12.59
CTC-5J0604	2	3.91
CTC-5J0605	10	1.04
CTC-5J3934	5	1.80
CTC-5J6444	2	6.01
CTC-5J7865	5	1.86
CTC-5K7865	5	1.86
CTC-5P0909	3	3.41
CTC-5P0910	4	2.37
CTC-5P0911	6	1.42
CTC-5P2134	8	1.04
CTC-5P2199	10	0.94
CTC-5P3235	2	5.15
CTC-5P7857	9	0.85
CTC-5P7858	9	0.85
CTC-5P8208	10	0.94
CTC-5P8921	4	2.52
CTC-5P9685	8	0.94
CTC-5P9686	8	1.04
CTC-5P9687	8	1.04
CTC-5U6910	1	5.72
CTC-6E0358	25	0.43
CTC-6J1021	10	1.04
CTC-6J1381	6	1.29
CTC-6J2418	8	1.04
CTC-6J2420	7	1.18

CATERPILLAR®

REPLACEMENT PARTS FOR CATERPILLAR® EQUIPMENT

NOTE: CATERPILLAR® kit numbers are used as a reference only. We do not imply that these kits are original REPLACEMENT KITS.

BACK-UP RINGS

Part Number	Min. Pkgs.	List Price
CTC-6J5731	7	\$ 1.18
CTC-6U3042	3	3.48
CTC-6U4789	1	3.47
CTC-6U5640	3	2.23
CTC-6V1555	7	1.18
CTC-6V1556	8	0.98
CTC-6V1557	10	0.94
CTC-6V1558	7	1.18
CTC-6V1941	8	0.90
CTC-6V3299	8	1.04
CTC-6V3300	8	1.04
CTC-6V3580	1	9.17
CTC-6V3838	9	0.85
CTC-6V3956	9	0.85
CTC-6V5658	1	4.04
CTC-6V6923	6	2.09
CTC-7J4823	1	6.74
CTC-7J6287	10	1.04
CTC-7J6288	8	0.94
CTC-7J8955	2	4.57
CTC-7U2449	25	0.35
CTC-7X4757	2	5.13
CTC-7X4776	25	0.35
CTC-7X4807	2	4.08
CTC-7Y4217	1	2.46
CTC-7Y4628	1	59.26
CTC-7Y4633	1	11.82
CTC-7Y4669	1	57.76
CTC-7Y4673	1	13.66
CTC-7Y4941	1	13.43
CTC-7Y4945	1	15.92
CTC-7Y5116	1	56.26
CTC-8C9188	1	45.71
CTC-8C9192	1	49.12
CTC-8I1735	1	4.50
CTC-8J0548	2	4.57
CTC-8J1666	2	4.57
CTC-8J1689	3	3.22
CTC-8J1717	2	3.87
CTC-8J2574	6	1.29

BACK-UP RINGS

Part Number	Min. Pkgs.	List Price
CTC-8J3752	4	\$ 2.27
CTC-8J4385	2	4.57
CTC-8J8880	1	7.67
CTC-8Q5979	1	3.22
CTC-8T8434	1	3.78
CTC-9J0240	9	0.85
CTC-9J0705	10	0.80
CTC-9J0707	5	2.54
CTC-9J7861	3	2.68
CTC-9T8761	5	2.54
CTC-9X4596	1	7.67
CTC-9X4615	1	8.10
CTC-9X7273	2	4.57
CTC-9X7278	4	2.52
CTC-9X7279	3	2.68
CTC-A04700312	1	10.01
CTC-A04700313	1	10.98
CTC-A04700414	1	41.43
CTC-A04700415	1	9.56
CTC-A04700416	1	9.56
CTC-A04700417	1	33.48
CTC-A04700712	1	10.01

CUSHION SEALS

Part Number	List Price
CTC-0855864	\$ 17.49
CTC-0861089	28.15
CTC-0875389	33.29
CTC-0995359	28.82
CTC-0998282	25.89
CTC-0998297	44.74
CTC-1038341	29.68
CTC-1052581	23.55
CTC-1057265	23.78
CTC-1076260	44.74
CTC-1076266	23.27
CTC-1163519	36.96

CUSHION SEALS

Part Number	List Price
CTC-1211997	\$ 4.72
CTC-1261870	27.89
CTC-1261876	20.63
CTC-1261879	24.88
CTC-1261935	30.18
CTC-1505830	31.34
CTC-1559187	7.18
CTC-1859050	30.75
CTC-1859051	28.82
CTC-1859084	4.72
CTC-1913128	27.54
CTC-1915706	32.25
CTC-1931369	5.75
CTC-2003620	33.29
CTC-2144501	20.63
CTC-2163418	10.93
CTC-2316805	94.39
CTC-2316843	32.25
CTC-2426833	27.47
CTC-2445323	31.34
CTC-2478789	21.34
CTC-2478791	26.91
CTC-2478829	21.58
CTC-2667859	17.53
CTC-2725637	21.42
CTC-2789128	7.20
CTC-2835971	5.24
CTC-2835972	15.87
CTC-2897921	27.74
CTC-3145910	4.72
CTC-4161281	5.06
CTC-4161293	2.70
CTC-4161294	2.41
CTC-518516	28.64
CTC-616784	28.15
CTC-616785	32.44
CTC-616786	27.63
CTC-616787	26.91
CTC-616790	30.51

CATERPILLAR®

REPLACEMENT PARTS FOR CATERPILLAR® EQUIPMENT

NOTE: CATERPILLAR® kit numbers are used as a reference only. We do not imply that these kits are original REPLACEMENT KITS.

CUSHION SEALS

Part Number	List Price
CTC-6I6791	\$ 30.84
CTC-6I6921	30.75
CTC-6I6922	28.82
CTC-6I6970	23.27
CTC-7I1352	27.89
CTC-7Y4665	28.64
CTC-D35310900	30.25

D-RINGS

Part Number	I.D.	List Price
CTC-1P3700	19 mm	\$ 1.39
CTC-1P3702	25.4 mm	1.56
CTC-1P3703	31.9 mm	1.86
CTC-1P3704	38.2 mm	2.01
CTC-1P3705	44.7 mm	2.16
CTC-1P3706	51.1 mm	2.31
CTC-1P3707	54.2 mm	2.36
CTC-1P3708	57.4 mm	2.50
CTC-1P3709	63.9 mm	2.62

DUST SEALS

Part Number	Rod Dia.	List Price
CTC-1920638	40 mm	\$ 8.83
CTC-0931430	45 mm	5.12
CTC-2725645	50 mm	5.81
CTC-2725665	45 mm	5.12
CTC-2773392	50 mm	5.81
CTC-2774134	45 mm	5.12

HEAD SEALS

Part Number	List Price
CTC-8C9016	\$ 71.50
CTC-1095260	2.93

OVERSIZED HEAD SEALS

Part Number	Bore Dia.	List Price
CTC-8C4889	2-1/2	\$ 9.20
CTC-8C4890	2-3/4	9.25
CTC-8T8367	3	9.32
CTC-8C4891	3-1/4	9.38
CTC-8T8367	3-3/4	9.32
CTC-8T8373	4-3/4	13.69
CTC-8T8374	5	41.13
CTC-8T8376	5-1/2	53.24
CTC-8T8377	6	52.77
CTC-8T8379	6-1/2	54.33
CTC-8T8380	7	56.03
CTC-8T8381	7-1/4	26.97
CTC-8C0553	7-1/2	13.05
CTC-8C4892	7-3/4	35.30
CTC-8T8382	8-1/4	23.01
CTC-8C4893	8-1/2	64.48
CTC-8C4896	10-1/4	18.97
CTC-8C4897	10-1/2	22.59
CTC-8C4898	11-1/2	30.82

OIL SEALS

Part Number	List Price
CTC-1J2150	\$ 23.81
CTC-4F4584	5.72
CTC-4N1584	7.63

O-RINGS

Part Number	Min. Pkgs.	List Price
CTC-0032770	1	\$ 4.16
CTC-0038137	50	0.12
CTC-0041963	20	0.36
CTC-0041964	20	0.47
CTC-0058592	50	0.26
CTC-0058593	20	0.30
CTC-0068350	1	4.96
CTC-0068352	10	0.79
CTC-0082103	50	0.27
CTC-0092061	3	2.44
CTC-0304605	50	0.10
CTC-0304606	10	1.01
CTC-0314392	5	2.40
CTC-0329714	20	0.57
CTC-0329882	20	0.29
CTC-0335853	10	1.08
CTC-0335879	1	0.41
CTC-0336027	10	1.83
CTC-0336031	2	4.41
CTC-0336032	15	0.66
CTC-0336033	20	0.41
CTC-0336034	10	0.95
CTC-0336038	3	3.05
CTC-0336039	15	0.78
CTC-0336041	10	1.49
CTC-0336042	10	1.15
CTC-0336044	15	0.53
CTC-0350273	2	5.27
CTC-0546849	5	7.26
CTC-0617538	30	0.36
CTC-0617539	5	1.22
CTC-0617540	3	2.33
CTC-0618341	3	3.44
CTC-0618561	2	3.63
CTC-0618639	15	0.66
CTC-0619455	3	2.95
CTC-0619456	2	3.50
CTC-0619457	2	4.05
CTC-0619458	5	1.74

REPLACEMENT PARTS FOR CATERPILLAR® EQUIPMENT

NOTE: CATERPILLAR® part numbers are used as a reference only. We do not imply that these kits are original REPLACEMENT PARTS.

O-RINGS

Part Number	Min. Pkgs.	List Price
CTC-0619729	1	\$ 4.21
CTC-0689002	5	1.64
CTC-0773241	50	0.12
CTC-0775843	20	0.42
CTC-0777539	10	0.87
CTC-0815391	5	2.38
CTC-0857537	50	0.14
CTC-0857538	50	0.30
CTC-0857539	50	0.27
CTC-0857540	20	0.49
CTC-0858219	1	4.16
CTC-0903093	3	3.21
CTC-0922304	25	0.36
CTC-0931344	1	14.91
CTC-0949672	20	0.67
CTC-0951508	100	0.09
CTC-0951509	100	0.09
CTC-0951510	100	0.09
CTC-0951511	100	0.11
CTC-0951512	100	0.11
CTC-0951513	100	0.11
CTC-0951514	100	0.11
CTC-0951515	100	0.09
CTC-0951516	100	0.55
CTC-0951517	100	0.11
CTC-0951518	100	0.77
CTC-0951519	100	0.11
CTC-0951521	100	0.96
CTC-0951522	100	0.12
CTC-0951524	100	0.13
CTC-0951525	25	1.17
CTC-0951526	25	1.24
CTC-0951527	25	0.36
CTC-0951528	25	0.46
CTC-0951530	20	0.48
CTC-0951531	20	0.48
CTC-0951532	20	0.49
CTC-0951533	20	0.49
CTC-0951534	20	0.60
CTC-0951536	20	2.38

O-RINGS

Part Number	Min. Pkgs.	List Price
CTC-0951537	20	\$ 0.64
CTC-0951538	20	0.64
CTC-0951539	20	2.79
CTC-0951540	20	2.79
CTC-0951541	20	0.67
CTC-0951543	10	0.88
CTC-0951544	10	0.88
CTC-0951545	10	0.90
CTC-0951546	5	2.36
CTC-0951547	10	0.93
CTC-0951549	2	3.38
CTC-0951550	2	4.31
CTC-0951551	2	4.32
CTC-0951552	2	4.62
CTC-0951553	2	4.72
CTC-0951554	2	4.90
CTC-0951555	2	5.00
CTC-0951556	2	5.18
CTC-0951557	2	5.28
CTC-0951558	2	6.86
CTC-0951559	2	6.91
CTC-0951560	2	6.98
CTC-0951561	2	7.22
CTC-0951562	2	7.27
CTC-0951563	2	7.49
CTC-0951564	2	7.62
CTC-0951565	1	14.39
CTC-0951566	1	14.76
CTC-0951567	1	16.56
CTC-0951568	1	28.37
CTC-0951569	1	29.85
CTC-0951571	100	0.08
CTC-0951572	100	0.11
CTC-0951573	100	0.11
CTC-0951574	50	0.23
CTC-0951575	50	0.25
CTC-0951576	50	0.25
CTC-0951577	25	0.40
CTC-0951578	50	0.26
CTC-0951579	25	0.41

O-RINGS

Part Number	Min. Pkgs.	List Price
CTC-0951580	25	\$ 0.41
CTC-0951581	20	0.55
CTC-0951583	20	0.56
CTC-0951584	20	0.56
CTC-0951585	20	0.57
CTC-0951587	20	0.75
CTC-0951589	20	0.46
CTC-0951590	20	0.77
CTC-0951591	20	0.56
CTC-0951592	20	0.72
CTC-0951593	20	0.72
CTC-0951594	10	0.94
CTC-0951595	10	0.94
CTC-0951597	10	1.20
CTC-0951598	10	1.24
CTC-0951599	10	1.26
CTC-0951600	10	1.32
CTC-0951601	10	1.32
CTC-0951602	10	1.34
CTC-0951603	10	1.41
CTC-0951604	10	1.43
CTC-0951605	10	1.45
CTC-0951606	10	1.50
CTC-0951608	5	1.62
CTC-0951609	5	1.65
CTC-0951610	5	2.10
CTC-0951611	5	2.16
CTC-0951612	5	2.38
CTC-0951613	5	2.17
CTC-0951615	5	2.48
CTC-0951616	5	2.54
CTC-0951617	5	2.55
CTC-0951618	2	3.37
CTC-0951621	2	4.28
CTC-0951623	2	4.78
CTC-0951624	2	4.89
CTC-0951625	2	5.00
CTC-0951626	2	5.18
CTC-0951627	2	5.28
CTC-0951628	2	6.88

CATERPILLAR®

REPLACEMENT PARTS FOR CATERPILLAR® EQUIPMENT

NOTE: CATERPILLAR® part numbers are used as a reference only. We do not imply that these kits are original REPLACEMENT PARTS.

O-RINGS

Part Number	Min. Pkgs.	List Price
CTC-0951629	2	\$ 6.94
CTC-0951630	2	7.03
CTC-0951631	2	7.11
CTC-0951632	2	7.16
CTC-0951633	2	7.32
CTC-0951634	2	7.46
CTC-0951635	2	9.07
CTC-0951636	1	16.47
CTC-0951637	1	18.45
CTC-0951639	1	20.54
CTC-0951640	1	21.40
CTC-0951641	1	21.95
CTC-0951642	1	41.92
CTC-0951657	25	0.36
CTC-0951658	20	0.48
CTC-0951659	20	0.63
CTC-0951662	10	3.20
CTC-0951663	10	1.01
CTC-0951671	5	7.43
CTC-0951673	5	2.09
CTC-0951674	5	8.93
CTC-0951675	5	2.71
CTC-0951676	5	2.83
CTC-0951678	5	9.68
CTC-0951679	2	10.74
CTC-0951680	2	11.10
CTC-0951681	2	3.49
CTC-0951682	2	5.68
CTC-0951683	2	5.72
CTC-0951684	2	5.89
CTC-0951685	2	14.89
CTC-0951686	2	8.10
CTC-0951687	2	8.17
CTC-0951688	2	8.26
CTC-0951689	2	9.64
CTC-0951690	2	9.81
CTC-0951691	2	10.01
CTC-0951692	1	10.16
CTC-0951693	1	11.70
CTC-0951694	1	13.67

O-RINGS

Part Number	Min. Pkgs.	List Price
CTC-0951695	1	\$ 14.54
CTC-0951696	25	0.40
CTC-0951698	20	0.54
CTC-0951700	20	0.66
CTC-0951704	10	1.53
CTC-0951705	10	1.59
CTC-0951706	5	1.83
CTC-0951707	5	1.82
CTC-0951708	5	1.84
CTC-0951709	5	7.09
CTC-0951710	5	1.78
CTC-0951711	5	2.30
CTC-0951712	5	2.32
CTC-0951713	5	7.43
CTC-0951714	5	2.59
CTC-0951715	5	2.65
CTC-0951716	5	8.93
CTC-0951717	5	2.73
CTC-0951718	5	2.96
CTC-0951719	5	9.68
CTC-0951720	5	3.03
CTC-0951721	2	10.74
CTC-0951722	2	6.34
CTC-0951723	2	3.64
CTC-0951724	2	7.77
CTC-0951725	2	9.25
CTC-0951726	2	9.65
CTC-0951727	1	11.69
CTC-0951728	1	11.79
CTC-0951729	1	12.00
CTC-0951730	1	13.39
CTC-0951731	1	13.69
CTC-0951732	1	17.83
CTC-0951733	1	21.15
CTC-0951734	1	25.13
CTC-0951735	1	26.04
CTC-0951736	1	30.03
CTC-0951737	1	32.27
CTC-0951738	1	34.18
CTC-0951739	1	42.17

O-RINGS

Part Number	Min. Pkgs.	List Price
CTC-0951750	50	\$ 0.11
CTC-0951751	50	0.14
CTC-0951753	20	0.73
CTC-0958859	2	6.75
CTC-0960034	25	0.34
CTC-0960035	1	22.25
CTC-0960037	1	64.67
CTC-0960071	2	7.11
CTC-0960121	5	2.40
CTC-0963021	50	0.10
CTC-0963044	50	0.30
CTC-0963944	1	12.77
CTC-0964921	2	5.75
CTC-0965382	2	7.16
CTC-0965572	10	1.42
CTC-0966100	20	0.33
CTC-0967041	2	6.74
CTC-0975203	50	0.07
CTC-0975204	50	0.12
CTC-0975205	50	0.12
CTC-0990187	20	0.29
CTC-0994780	10	1.11
CTC-0994846	1	27.17
CTC-0998232	50	0.27
CTC-1020889	1	6.92
CTC-1038254	10	0.87
CTC-1038255	5	1.84
CTC-1044948	5	2.43
CTC-1059843	50	0.10
CTC-1073114	1	19.09
CTC-1073117	10	1.30
CTC-1074057	20	0.47
CTC-1076259	5	3.20
CTC-1077642	20	0.54
CTC-1085803	10	1.01
CTC-1085806	2	5.61
CTC-1092332	1	6.99
CTC-1092333	14	0.80
CTC-1093203	15	1.08
CTC-1093205	3	2.44

REPLACEMENT PARTS FOR CATERPILLAR® EQUIPMENT

NOTE: CATERPILLAR® part numbers are used as a reference only. We do not imply that these kits are original REPLACEMENT PARTS.

O-RINGS

Part Number	Min. Pkgs.	List Price
CTC-1093206	10	\$ 1.10
CTC-1094791	5	2.59
CTC-1094792	20	0.72
CTC-1095694	1	0.82
CTC-1095698	10	1.58
CTC-1095700	5	2.12
CTC-1095702	1	8.87
CTC-1095704	5	2.84
CTC-1097411	1	27.86
CTC-1097412	20	0.47
CTC-1099685	10	1.00
CTC-1104742	1	1.49
CTC-1117052	5	2.97
CTC-1120033	100	0.06
CTC-1120034	100	0.11
CTC-1123102	15	0.66
CTC-1123540	2	3.46
CTC-1126920	1	10.41
CTC-1132073	1	23.30
CTC-1135304	1	6.29
CTC-1136303	50	0.11
CTC-1137820	20	0.83
CTC-1137822	10	1.59
CTC-1149275	5	1.64
CTC-1163682	10	1.28
CTC-1171266	10	1.27
CTC-1171495	20	0.67
CTC-1177273	20	0.47
CTC-1177282	5	3.05
CTC-1178801	1	6.77
CTC-1178803	5	1.55
CTC-1182720	5	1.90
CTC-1183122	5	1.76
CTC-1183125	5	3.76
CTC-1183128	5	2.53
CTC-1183131	10	1.42
CTC-1185068	50	0.20
CTC-1197843	20	0.68
CTC-1197844	20	0.94
CTC-1197845	5	3.44

O-RINGS

Part Number	Min. Pkgs.	List Price
CTC-1199443	8	\$ 0.90
CTC-1217687	20	0.63
CTC-1218094	5	1.80
CTC-1218112	100	0.11
CTC-1218117	10	0.80
CTC-1228352	50	0.14
CTC-1229250	1	1.32
CTC-1229251	5	2.40
CTC-1232341	100	0.09
CTC-1232342	100	0.24
CTC-1232343	10	0.99
CTC-1241858	2	3.50
CTC-1241859	2	5.60
CTC-1249346	50	0.25
CTC-1251372	10	0.99
CTC-1254194	1	4.69
CTC-1259701	5	1.79
CTC-1259794	1	8.02
CTC-1264002	1	8.01
CTC-1264003	1	5.57
CTC-1266514	3	3.22
CTC-1266515	3	3.22
CTC-1266516	1	3.24
CTC-1291609	3	3.26
CTC-1300229	1	9.11
CTC-1313715	20	0.80
CTC-1313716	5	2.57
CTC-1313718	2	6.03
CTC-1323056	2	6.91
CTC-1324240	5	1.68
CTC-1334771	50	0.31
CTC-1345691	2	3.45
CTC-1352652	15	0.79
CTC-1356950	1	30.55
CTC-1357935	5	1.88
CTC-1362942	1	14.45
CTC-1367226	20	0.48
CTC-1367227	8	1.46
CTC-1374350	1	58.66

O-RINGS

Part Number	Min. Pkgs.	List Price
CTC-1376667	10	\$ 1.10
CTC-1378101	1	0.88
CTC-1400226	1	9.20
CTC-1400240	1	4.69
CTC-1407663	2	9.13
CTC-1410749	2	4.03
CTC-1411774	5	3.54
CTC-1434637	5	3.86
CTC-1447338	2	2.38
CTC-1490231	10	1.04
CTC-1522939	10	1.83
CTC-1531157	2	5.16
CTC-1534906	10	1.15
CTC-1534907	15	0.78
CTC-1548741	1	20.40
CTC-1565198	1	19.93
CTC-1572238	20	0.55
CTC-1598802	1	57.73
CTC-1600526	20	0.69
CTC-1614102	1	3.27
CTC-1616149	50	0.11
CTC-1618068	1	10.65
CTC-1618069	1	11.34
CTC-1629997	1	3.05
CTC-1654852	1	27.43
CTC-1654854	3	1.74
CTC-1658066	5	1.90
CTC-1659448	10	1.30
CTC-1697442	1	6.77
CTC-1704821	1	8.45
CTC-1704823	1	13.77
CTC-1704824	1	27.14
CTC-1704825	1	8.59
CTC-1705715	2	6.07
CTC-1705941	1	21.21
CTC-1707098	1	6.14
CTC-1707106	1	16.87
CTC-1738277	5	1.50
CTC-1753135	15	0.66
CTC-1755077	1	12.46

CATERPILLAR®

REPLACEMENT PARTS FOR CATERPILLAR® EQUIPMENT

NOTE: CATERPILLAR® part numbers are used as a reference only. We do not imply that these kits are original REPLACEMENT PARTS.

O-RINGS

Part Number	Min. Pkgs.	List Price
CTC-1757894	20	\$ 0.47
CTC-1757895	20	0.53
CTC-1757896	20	0.59
CTC-1757897	20	0.62
CTC-1757898	20	0.69
CTC-1757900	20	0.72
CTC-1757901	1	2.78
CTC-1757902	10	0.98
CTC-1757903	5	2.29
CTC-1757904	10	1.25
CTC-1757905	10	1.29
CTC-1761378	1	9.17
CTC-1776911	1	35.36
CTC-1799013	10	1.60
CTC-1802391	1	9.51
CTC-1808424	6	0.94
CTC-1808722	50	0.34
CTC-1871979	15	1.04
CTC-1878567	10	1.12
CTC-1882199	1	1.94
CTC-1903010	5	3.05
CTC-1903011	5	2.17
CTC-1931736	1	10.83
CTC-1949584	2	3.63
CTC-1H0474	10	1.06
CTC-1H1023	50	0.06
CTC-1H5728	20	0.50
CTC-1H6227	10	0.79
CTC-1H7339	20	0.59
CTC-1H8128	20	0.71
CTC-1H8171	50	0.12
CTC-1H8278	5	2.63
CTC-1H8720	20	0.47
CTC-1H9696	20	0.54
CTC-1J2176	5	2.68
CTC-1J2859	10	1.29
CTC-1J2890	1	4.06
CTC-1J9671	50	0.22
CTC-1M0556	5	3.63
CTC-1M1077	50	0.12

O-RINGS

Part Number	Min. Pkgs.	List Price
CTC-1M3548	5	\$ 3.26
CTC-1M9015	1	4.06
CTC-1R5318	20	0.41
CTC-1S7408	10	1.29
CTC-1S8947	50	0.09
CTC-1T0132	1	3.27
CTC-1U3174	1	3.59
CTC-2074849	10	0.82
CTC-2167244	1	0.10
CTC-2287093	1	1.90
CTC-2287094	1	2.10
CTC-2287095	1	3.47
CTC-2332597	10	1.04
CTC-2332601	10	1.30
CTC-2332603	5	1.82
CTC-2434572	1	8.52
CTC-2487172	1	7.29
CTC-2639891	50	0.11
CTC-2667959	2	7.32
CTC-2667960	2	9.13
CTC-2667961	2	9.65
CTC-2667962	1	13.39
CTC-2667966	5	2.73
CTC-2667967	5	3.01
CTC-2667968	2	3.55
CTC-2667969	2	3.64
CTC-2668026	5	3.03
CTC-2742500	5	2.73
CTC-2742501	2	7.16
CTC-2742502	1	6.05
CTC-2A3676	5	3.87
CTC-2D0598	20	0.27
CTC-2D1692	1	2.94
CTC-2D6533	1	4.24
CTC-2D8009	5	1.57
CTC-2D8363	1	13.08
CTC-2D8364	1	9.81
CTC-2D9572	1	3.27
CTC-2H2665	20	0.71
CTC-2H3927	20	0.32

O-RINGS

Part Number	Min. Pkgs.	List Price
CTC-2H3928	10	\$ 0.88
CTC-2H3931	20	0.65
CTC-2H3932	50	0.19
CTC-2H3933	20	0.72
CTC-2H3934	20	0.72
CTC-2H3935	10	1.38
CTC-2H4145	20	0.69
CTC-2H6124	5	2.74
CTC-2H6184	20	0.62
CTC-2H6338	20	0.65
CTC-2H6340	1	5.10
CTC-2H9247	10	1.29
CTC-2J8163	10	1.15
CTC-2K2939	5	2.16
CTC-2K4472	5	1.96
CTC-2K8198	50	0.19
CTC-2K8257	5	1.69
CTC-2M0340	1	3.00
CTC-2M1309	1	5.69
CTC-2M3340	1	7.85
CTC-2M4453	50	0.09
CTC-2M9780	50	0.26
CTC-2N3350	3	3.22
CTC-2N5749	5	1.55
CTC-2P1692	5	1.29
CTC-2R0039	10	1.22
CTC-2S4078	20	0.53
CTC-2S8439	5	1.57
CTC-2T2691	20	0.79
CTC-2T2692	15	0.66
CTC-2T2695	5	2.30
CTC-2U5338	100	0.11
CTC-2U5339	10	1.26
CTC-2U5341	5	1.79
CTC-2U5343	5	2.09
CTC-2U5354	1	12.83
CTC-2U5355	1	14.45
CTC-2Y2271	50	0.10
CTC-2Y2272	50	0.10
CTC-2Y2347	50	0.29

CATERPILLAR®

REPLACEMENT PARTS FOR CATERPILLAR® EQUIPMENT

NOTE: CATERPILLAR® part numbers are used as a reference only. We do not imply that these kits are original REPLACEMENT ARTS.

O-RINGS

Part Number	Min. Pkgs.	List Price
CTC-3162516	5	\$ 2.68
CTC-3162517	5	2.82
CTC-3202510	1	51.98
CTC-328970	15	0.51
CTC-3A9280	10	3.20
CTC-3B8453	50	0.22
CTC-3C5546	10	1.38
CTC-3D2824	50	0.32
CTC-3D2895	3	2.86
CTC-3D2898	20	0.29
CTC-3D2992	50	0.12
CTC-3D4004	5	1.49
CTC-3D4245	50	0.10
CTC-3D7805	20	0.36
CTC-3D8241	1	13.09
CTC-3E4296	10	0.97
CTC-3E4297	1	10.74
CTC-3E4298	50	0.22
CTC-3E4299	20	0.63
CTC-3E6703	10	1.86
CTC-3E6704	1	2.68
CTC-3E6705	2	3.65
CTC-3E6708	20	0.55
CTC-3E6710	1	4.98
CTC-3E6714	10	6.45
CTC-3E6720	1	2.47
CTC-3E6723	10	1.60
CTC-3E6725	5	2.03
CTC-3E6730	20	0.92
CTC-3E6732	10	1.19
CTC-3E6734	1	3.68
CTC-3E6735	10	1.41
CTC-3E6736	5	2.38
CTC-3E6744	1	5.16
CTC-3E6747	5	1.36
CTC-3E6749	5	1.47
CTC-3E6751	1	24.85
CTC-3E6760	50	0.10
CTC-3E6761	25	0.33
CTC-3E6766	2	3.83

O-RINGS

Part Number	Min. Pkgs.	List Price
CTC-3E6771	20	\$ 0.50
CTC-3E6773	2	6.18
CTC-3E6785	1	7.29
CTC-3E6788	5	1.74
CTC-3E6790	4	1.79
CTC-3E6794	1	4.06
CTC-3E6799	2	6.43
CTC-3F1547	5	2.74
CTC-3F5792	10	1.29
CTC-3G1209	50	0.10
CTC-3H0107	50	0.12
CTC-3H0442	50	0.03
CTC-3H1461	20	0.22
CTC-3H2652	20	0.59
CTC-3H3385	50	0.09
CTC-3H4970	50	0.19
CTC-3J0634	5	2.41
CTC-3J1907	50	0.22
CTC-3J7354	50	0.22
CTC-3J9015	20	0.23
CTC-3K0360	50	0.25
CTC-3K0715	10	0.85
CTC-3K4025	20	0.48
CTC-3P0439	20	0.88
CTC-3P0648	2	3.72
CTC-3P0649	1	6.99
CTC-3P0650	1	6.29
CTC-3P0651	1	7.89
CTC-3P0653	1	9.11
CTC-3P0654	1	12.17
CTC-3P0655	1	9.77
CTC-3P0656	1	8.62
CTC-3P0657	1	8.23
CTC-3P0658	1	41.37
CTC-3P1155	5	1.55
CTC-3S1223	5	2.16
CTC-3S6538	20	0.32
CTC-3S9233	50	0.12
CTC-3T7528	100	0.09
CTC-4161277	10	1.50

O-RINGS

Part Number	Min. Pkgs.	List Price
CTC-4161288	10	\$ 1.86
CTC-4D1577	1	7.52
CTC-4D2297	50	0.07
CTC-4D3107	20	0.23
CTC-4D4503	1	5.55
CTC-4D4508	1	6.22
CTC-4D6548	1	1.42
CTC-4D6695	1	5.23
CTC-4F4097	20	0.65
CTC-4F5607	20	0.29
CTC-4F7387	10	1.29
CTC-4F7388	1	3.86
CTC-4F7389	20	0.32
CTC-4F7390	20	0.56
CTC-4F7391	50	0.20
CTC-4F7507	5	2.13
CTC-4F7952	20	0.26
CTC-4F8824	20	0.42
CTC-4F8946	50	\$ 0.19
CTC-4F9029	50	0.20
CTC-4F9653	20	0.47
CTC-4H6520	5	2.36
CTC-4H6730	1	11.44
CTC-4H9105	10	0.98
CTC-4J0519	20	0.41
CTC-4J0520	20	0.43
CTC-4J0521	20	0.47
CTC-4J0522	20	0.53
CTC-4J0523	20	0.64
CTC-4J0524	20	0.66
CTC-4J0525	20	0.68
CTC-4J0526	20	0.77
CTC-4J0527	20	0.80
CTC-4J0528	20	0.83
CTC-4J0537	20	0.80
CTC-4J1253	1	7.85
CTC-4J4577	50	0.10
CTC-4J5140	50	0.27
CTC-4J5267	50	0.30
CTC-4J5268	50	0.14

CATERPILLAR®



REPLACEMENT PARTS FOR CATERPILLAR® EQUIPMENT

NOTE: CATERPILLAR® part numbers are used as a reference only. We do not imply that these kits are original REPLACEMENT PARTS.

O-RINGS

Part Number	Min. Pkgs.	List Price
CTC-4J5351	50	\$ 0.14
CTC-4J5477	50	0.10
CTC-4J5573	20	0.61
CTC-4J5733	50	0.16
CTC-4J7533	50	0.16
CTC-4J8996	50	0.29
CTC-4J8997	50	0.34
CTC-4J8998	20	0.47
CTC-4K1388	20	0.38
CTC-4K2039	50	0.06
CTC-4K4986	50	0.27
CTC-4K6804	1	3.00
CTC-4L7711	20	0.27
CTC-4L9564	10	0.98
CTC-4M0189	10	0.85
CTC-4M0661	1	5.89
CTC-4M0737	1	7.73
CTC-4N1230	1	3.39
CTC-4S5879	1	6.42
CTC-4T4128	1	7.85
CTC-4W0435	5	1.79
CTC-4W2754	1	3.21
CTC-4W4616	1	1.79
CTC-5D1071	1	7.85
CTC-5D1597	10	1.74
CTC-5D5957	1	6.99
CTC-5D5959	1	29.31
CTC-5D6428	1	13.38
CTC-5D6539	50	0.19
CTC-5D6543	20	0.19
CTC-5E8767	5	1.39
CTC-5E8768	5	1.64
CTC-5E8769	3	3.74
CTC-5E8770	2	3.46
CTC-5E9816	15	0.80
CTC-5F0149	10	1.15
CTC-5F1678	50	0.17
CTC-5F3092	10	0.85
CTC-5F3106	10	1.25
CTC-5F3144	10	1.18

O-RINGS

Part Number	Min. Pkgs.	List Price
CTC-5F3999	10	\$ 1.25
CTC-5F6222	1	3.39
CTC-5F7054	50	0.10
CTC-5F8000	20	0.39
CTC-5F9144	50	0.06
CTC-5F9657	20	0.23
CTC-5H2767	50	0.12
CTC-5H2824	5	3.71
CTC-5H3252	5	1.64
CTC-5H4909	1	3.27
CTC-5H5672	10	1.44
CTC-5H6005	50	0.07
CTC-5H6733	5	2.13
CTC-5H6734	10	1.12
CTC-5H7370	20	0.29
CTC-5H8038	50	0.22
CTC-5H8624	10	1.18
CTC-5H8848	20	0.53
CTC-5H9524	5	2.10
CTC-5I8417	1	4.99
CTC-5I8426	1	4.08
CTC-5I8623	1	4.62
CTC-5J2383	1	5.30
CTC-5J2974	50	0.14
CTC-5J3886	5	1.44
CTC-5K0216	20	0.50
CTC-5K0227	20	0.47
CTC-5K1787	5	2.74
CTC-5K5221	20	0.30
CTC-5K5959	20	0.50
CTC-5K6526	20	0.36
CTC-5K9090	50	0.26
CTC-5L2727	20	0.32
CTC-5L4758	50	0.07
CTC-5L4759	50	0.10
CTC-5L5032	5	2.63
CTC-5M2057	20	0.20
CTC-5M5860	20	0.29
CTC-5M6200	1	9.16
CTC-5M6509	20	0.47

O-RINGS

Part Number	Min. Pkgs.	List Price
CTC-5M7142	5	\$ 2.74
CTC-5M7423	20	0.29
CTC-5P0840	8	0.92
CTC-5P0908	20	0.48
CTC-5P1480	2	4.94
CTC-5P1979	5	1.96
CTC-5P2235	1	4.06
CTC-5P2236	1	9.39
CTC-5P2545	1	3.92
CTC-5P2568	20	0.27
CTC-5P2569	10	1.12
CTC-5P2931	20	0.62
CTC-5P3108	50	0.22
CTC-5P3620	5	2.28
CTC-5P3863	20	0.62
CTC-5P3864	5	1.76
CTC-5P3881	20	0.65
CTC-5P3944	50	0.12
CTC-5P4268	3	2.12
CTC-5P4326	5	1.51
CTC-5P4342	1	4.91
CTC-5P4889	2	4.94
CTC-5P4892	2	3.86
CTC-5P4933	50	0.11
CTC-5P5397	5	2.02
CTC-5P5598	7	0.99
CTC-5P5600	15	0.81
CTC-5P5601	10	0.90
CTC-5P5756	3	2.44
CTC-5P5757	2	2.65
CTC-5P5846	1	5.02
CTC-5P5874	50	0.11
CTC-5P6300	50	0.22
CTC-5P6302	10	1.41
CTC-5P6718	5	1.12
CTC-5P7530	10	1.22
CTC-5P7593	1	4.49
CTC-5P7701	4	3.22
CTC-5P7818	1	12.91
CTC-5P8065	5	1.47

UNITED STATES
PHONE 1-800-777-5617
FAX 1-800-759-6391

US SALES OFFICE HOURS
8 AM TO 5:30 PM EASTERN TIME
WWW.HDDISPRIBUSORS.COM
www.HerculesUS.com

WORLDWIDE
PHONE 1-727-796-1300
FAX 1-727-797-8849

REPLACEMENT PARTS FOR CATERPILLAR® EQUIPMENT

NOTE: CATERPILLAR® part numbers are used as a reference only. We do not imply that these kits are original REPLACEMENT PARTS.

O-RINGS			O-RINGS			O-RINGS		
Part Number	Min. Pkgs.	List Price	Part Number	Min. Pkgs.	List Price	Part Number	Min. Pkgs.	List Price
CTC-5P8066	1	\$ 2.00	CTC-6H5672	50	\$ 0.23	CTC-6V3907	1	\$ 14.54
CTC-5P8068	2	4.74	CTC-6H9691	50	0.03	CTC-6V3908	1	13.90
CTC-5P8118	4	1.65	CTC-6I1064	8	0.94	CTC-6V3922	50	0.16
CTC-5P8210	3	1.88	CTC-6J1038	50	0.26	CTC-6V3955	3	3.07
CTC-5P8211	3	3.31	CTC-6J2245	10	0.77	CTC-6V3967	1	63.05
CTC-5P8215	20	0.23	CTC-6J2419	20	0.22	CTC-6V3968	1	30.55
CTC-5P8286	1	9.11	CTC-6J2680	10	1.02	CTC-6V4297	1	26.90
CTC-5P8428	1	12.48	CTC-6J5541	5	3.29	CTC-6V4314	1	17.28
CTC-5P8429	1	35.86	CTC-6K6307	10	0.77	CTC-6V4315	1	13.15
CTC-5P8861	1	29.26	CTC-6K9149	5	3.93	CTC-6V4366	15	0.83
CTC-5P8862	1	28.12	CTC-6M5062	50	0.06	CTC-6V4367	5	1.43
CTC-5P8872	1	15.41	CTC-6R0365	10	1.29	CTC-6V4430	2	3.51
CTC-5P8883	3	1.74	CTC-6V0357	50	0.36	CTC-6V4480	2	3.51
CTC-5P8940	1	16.50	CTC-6V0894	50	0.17	CTC-6V4589	8	1.46
CTC-5P8942	1	0.38	CTC-6V0895	20	0.36	CTC-6V5049	14	0.80
CTC-5P9040	4	1.96	CTC-6V0913	50	0.14	CTC-6V5050	5	2.37
CTC-5P9186	1	0.86	CTC-6V0973	1	12.48	CTC-6V5051	1	10.32
CTC-5P9217	1	7.85	CTC-6V1175	1	7.85	CTC-6V5052	1	14.54
CTC-5P9658	10	1.01	CTC-6V1195	1	9.86	CTC-6V5053	1	7.41
CTC-5P9757	15	0.48	CTC-6V1196	2	5.38	CTC-6V5054	1	20.18
CTC-5P9890	2	3.46	CTC-6V1197	1	6.52	CTC-6V5055	1	25.71
CTC-5P9939	20	0.39	CTC-6V1320	2	4.08	CTC-6V5057	1	54.92
CTC-5S0982	5	3.98	CTC-6V1653	3	3.63	CTC-6V5060	1	70.44
CTC-5S3676	1	3.27	CTC-6V1902	1	13.21	CTC-6V5095	1	33.72
CTC-5S6760	1	23.32	CTC-6V1934	1	6.88	CTC-6V5101	1	14.60
CTC-5S9134	1	13.60	CTC-6V3251	15	0.88	CTC-6V5102	1	30.76
CTC-5W9413	10	1.24	CTC-6V3263	1	10.00	CTC-6V5103	1	23.83
CTC-6D7128	12	0.69	CTC-6V3319	1	11.89	CTC-6V5134	2	3.76
CTC-6D7146	2	4.77	CTC-6V3348	3	3.29	CTC-6V5142	15	0.80
CTC-6D7889	2	2.56	CTC-6V3349	1	34.42	CTC-6V5143	5	1.65
CTC-6D9157	5	2.16	CTC-6V3551	1	12.04	CTC-6V5167	1	25.95
CTC-6F0671	5	3.39	CTC-6V3684	1	21.45	CTC-6V5266	3	2.19
CTC-6F0711	20	0.29	CTC-6V3685	40	0.36	CTC-6V5375	1	39.55
CTC-6F4718	5	1.96	CTC-6V3830	1	4.41	CTC-6V5393	20	0.34
CTC-6F4855	50	0.07	CTC-6V3831	1	6.84	CTC-6V5553	1	11.69
CTC-6F5559	50	0.07	CTC-6V3832	2	2.31	CTC-6V5556	50	0.26
CTC-6F6673	50	0.20	CTC-6V3833	1	10.87	CTC-6V5586	50	0.10
CTC-6F8146	20	0.65	CTC-6V3834	5	4.19	CTC-6V5656	1	11.61
CTC-6H3977	20	0.56	CTC-6V3835	1	20.92	CTC-6V5657	5	2.28
CTC-6H4162	1	4.59	CTC-6V3865	3	2.76	CTC-6V5722	50	0.10

CATERPILLAR®



REPLACEMENT PARTS FOR CATERPILLAR® EQUIPMENT

NOTE: CATERPILLAR® part numbers are used as a reference only. We do not imply that these kits are original REPLACEMENT ARTS.

O-RINGS

Part Number	Min. Pkgs.	List Price
CTC-6V5758	10	\$ 0.88
CTC-6V5759	8	0.90
CTC-6V5862	1	7.85
CTC-6V6228	10	1.12
CTC-6V6339	50	3.03
CTC-6V6353	1	6.59
CTC-6V6580	50	0.22
CTC-6V6638	1	65.45
CTC-6V6707	10	1.22
CTC-6V6755	5	1.55
CTC-6V6756	3	3.31
CTC-6V7350	1	5.84
CTC-6V7351	1	9.70
CTC-6V7610	5	1.83
CTC-6V7658	1	1.83
CTC-6V7681	1	12.10
CTC-6V7701	1	42.15
CTC-6V8001	2	5.60
CTC-6V8002	2	5.84
CTC-6V8218	50	0.30
CTC-6V8260	1	8.23
CTC-6V8350	15	0.94
CTC-6V8397	50	0.10
CTC-6V8398	50	0.11
CTC-6V8399	50	0.16
CTC-6V8400	50	0.29
CTC-6V8467	5	2.06
CTC-6V8676	3	1.96
CTC-6V8958	2	7.77
CTC-6V8978	50	0.29
CTC-6V9746	50	0.16
CTC-7D1195	5	3.42
CTC-7D7111	1	14.97
CTC-7D9014	5	3.82
CTC-7E4846	50	0.27
CTC-7E4847	20	0.34
CTC-7F2122	10	0.79
CTC-7F8267	20	0.32
CTC-7F8268	20	0.39
CTC-7H2444	10	0.88

O-RINGS

Part Number	Min. Pkgs.	List Price
CTC-7H9959	5	\$ 3.11
CTC-7J0204	50	0.16
CTC-7J2036	20	0.42
CTC-7J6285	10	1.20
CTC-7J8956	5	2.36
CTC-7J9108	50	0.14
CTC-7L4090	10	1.29
CTC-7L4774	5	1.41
CTC-7L9061	10	0.81
CTC-7M5873	5	1.49
CTC-7M8485	20	0.42
CTC-7R8872	20	0.53
CTC-7S4001	10	1.02
CTC-7S8554	1	5.89
CTC-7S8561	1	8.18
CTC-7U3263	2	9.81
CTC-7U7852	1	26.04
CTC-7X1547	1	15.85
CTC-7X1550	50	0.34
CTC-7X4744	10	1.29
CTC-7X4745	3	2.12
CTC-7X4782	10	1.15
CTC-7X4805	10	0.90
CTC-7X4810	1	36.69
CTC-7X5494	10	0.79
CTC-7X8592	5	1.65
CTC-7X9372	10	0.77
CTC-7Y4277	1	5.71
CTC-7Y4294	1	6.45
CTC-7Y5219	50	0.14
CTC-7Y5269	20	0.68
CTC-7Y5280	100	0.08
CTC-8B4967	50	0.23
CTC-8B7216	50	0.06
CTC-8C0563	20	0.70
CTC-8C0624	5	1.55
CTC-8C3057	5	2.32
CTC-8C3058	5	5.78
CTC-8C3059	2	14.47
CTC-8C3077	2	6.15

O-RINGS

Part Number	Min. Pkgs.	List Price
CTC-8C3079	3	\$ 2.10
CTC-8C3080	20	0.30
CTC-8C3081	20	0.47
CTC-8C3085	50	0.10
CTC-8C3086	50	0.14
CTC-8C3087	50	0.16
CTC-8C3088	50	0.26
CTC-8C3089	2	3.83
CTC-8C3093	15	0.88
CTC-8C3095	9	0.36
CTC-8C3097	20	0.55
CTC-8C3098	50	0.10
CTC-8C3101	5	2.68
CTC-8C3102	5	2.68
CTC-8C3103	1	15.80
CTC-8C3107	1	5.51
CTC-8C3131	20	0.54
CTC-8C3828	1	62.62
CTC-8C5179	1	4.59
CTC-8C5197	2	3.16
CTC-8C5230	1	5.16
CTC-8C5237	1	1.12
CTC-8F4469	5	1.84
CTC-8F4994	50	0.23
CTC-8F5900	1	3.27
CTC-8F6230	1	3.27
CTC-8F6498	1	5.10
CTC-8F6711	20	0.42
CTC-8F7219	50	0.03
CTC-8F8230	1	3.27
CTC-8F8733	5	1.76
CTC-8F8861	1	4.91
CTC-8F8882	20	0.53
CTC-8F9206	50	0.07
CTC-8F9516	5	1.51
CTC-8F9538	50	0.03
CTC-8F9960	1	8.11
CTC-8H0273	5	2.47
CTC-8H2046	10	1.06
CTC-8H7521	20	0.69

UNITED STATES

PHONE 1-800-777-5617
FAX 1-800-759-6391

US SALES OFFICE HOURS

WWW.HERCULESSEALINGPRODUCTS.COM
www.HerculesUS.com

WORLDWIDE

PHONE 1-727-796-1300
FAX 1-727-797-8849

REPLACEMENT PARTS FOR CATERPILLAR® EQUIPMENT

NOTE: CATERPILLAR® part numbers are used as a reference only. We do not imply that these kits are original REPLACEMENT PARTS.

O-RINGS			O-RINGS			O-RINGS		
Part Number	Min. Pkgs.	List Price	Part Number	Min. Pkgs.	List Price	Part Number	Min. Pkgs.	List Price
CTC-8H8257	1	\$ 5.55	CTC-8T6444	5	\$ 2.41	CTC-9X7357	10	\$ 1.83
CTC-8I1736	5	2.28	CTC-8T6447	50	0.09	CTC-9X7358	5	3.14
CTC-8I4427	50	0.07	CTC-8T6716	5	2.17	CTC-9X7371	1	8.71
CTC-8J1665	5	2.52	CTC-8T6717	3	3.50	CTC-9X7375	5	1.96
CTC-8J1688	5	1.76	CTC-8T7568	5	2.74	CTC-9X7377	10	0.95
CTC-8J2413	50	0.22	CTC-8T9522	5	1.52	CTC-9X7380	30	0.07
CTC-8J4351	3	2.72	CTC-8T9527	1	7.41	CTC-9X7383	15	0.13
CTC-8J4386	1	5.53	CTC-8T9529	15	0.88	CTC-9X7422	1	6.77
CTC-8J8343	50	0.12	CTC-8U1958	2	11.10	CTC-9X7430	10	2.57
CTC-8J8725	2	3.63	CTC-8U4125	1	2.69	CTC-9X7432	1	1.74
CTC-8J8879	1	3.59	CTC-8U5927	2	4.15	CTC-9X7440	5	2.67
CTC-8L2746	1	0.48	CTC-8U5942	1	0.59	CTC-9X7454	50	0.16
CTC-8L2777	15	0.57	CTC-8U6013	100	0.11	CTC-9X7458	5	2.13
CTC-8L2779	1	0.38	CTC-8U7381	50	0.26	CTC-9X7557	2	6.07
CTC-8L9241	1	4.12	CTC-9C3493	1	5.71	CTC-9X7562	1	19.45
CTC-8M8997	50	0.09	CTC-9F1399	5	2.10	CTC-9X7566	5	2.28
CTC-8P6357	1	16.98	CTC-9F4446	10	\$ 0.88	CTC-9X7676	15	\$ 0.48
CTC-8S5011	2	\$ 2.74	CTC-9F7283	10	1.29	CTC-9X7680	15	0.73
CTC-8S5953	20	0.68	CTC-9H4557	50	0.23	CTC-9X7681	15	0.80
CTC-8T0116	100	0.11	CTC-9J5686	20	0.85	CTC-9X7683	1	2.28
CTC-8T0135	20	0.36	CTC-9J6491	50	0.14	CTC-9X7684	20	0.26
CTC-8T0315	20	0.36	CTC-9M2092	10	1.18	CTC-9X7688	0	59.52
CTC-8T0568	3	2.63	CTC-9M3786	5	2.02	CTC-9X7692	50	0.28
CTC-8T0678	1	3.92	CTC-9M5024	5	2.74	CTC-9X7712	3	3.27
CTC-8T2148	20	2.09	CTC-9M5892	1	11.44	CTC-9X7715	2	6.29
CTC-8T2360	3	3.03	CTC-9M5894	1	3.05	CTC-9X7725	5	2.21
CTC-8T2361	3	3.07	CTC-9N1756	1	0.36	CTC-9X7734	8	0.81
CTC-8T3013	1	18.95	CTC-9R2496	5	1.79	CTC-9X7745	50	0.25
CTC-8T3338	5	6.32	CTC-9S3888	5	1.64	CTC-Z440101000	2	5.28
CTC-8T4202	20	0.67	CTC-9S8307	20	0.77	CTC-Z440101100	2	6.86
CTC-8T4811	1	7.85	CTC-9T4057	50	0.22	CTC-Z440201000	2	6.62
CTC-8T4827	50	0.30	CTC-9W3340	25	0.42	CTC-Z440201400	2	7.32
CTC-8T4894	5	9.68	CTC-9X3979	10	1.29	CTC-Z441001000	1	2.06
CTC-8T4945	1	0.93	CTC-9X4576	1	9.90	CTC-Z441001100	5	8.93
CTC-8T5039	5	2.98	CTC-9X4611	10	1.45	CTC-Z441100950	1	2.38
CTC-8T5049	10	1.67	CTC-9X4617	10	1.07	CTC-Z441101050	5	2.65
CTC-8T5376	5	1.78	CTC-9X4626	10	0.87	CTC-Z441101150	5	2.73
CTC-8T5452	10	1.29	CTC-9X7286	1	10.48	CTC-Z441101600	2	9.65
CTC-8T6346	5	2.49	CTC-9X7287	1	7.74			
CTC-8T6404	5	1.96	CTC-9X7295	1	13.21			

CATERPILLAR®



REPLACEMENT PARTS FOR CATERPILLAR® EQUIPMENT

NOTE: CATERPILLAR® part numbers are used as a reference only. We do not imply that these kits are original REPLACEMENT ARTS.

SILICONE O-RINGS

Part Number	Min. Pkgs.	List Price
CTC-1M6036	2	\$ 6.87
CTC-1S0004	5	3.48
CTC-1S2174	5	2.98
CTC-1S7462	6	1.05
CTC-1S9799	6	1.81
CTC-2M2561	3	5.65
CTC-2P3538	5	4.59
CTC-2S2251	5	5.97
CTC-3S4489	5	1.38
CTC-5H7153	4	3.53
CTC-5H8853	20	0.40
CTC-5M3038	5	3.85
CTC-5P4932	11	1.26
CTC-5P6436	11	0.62
CTC-5P6620	20	0.60
CTC-6F0249	4	1.49
CTC-6L1648	4	3.81
CTC-6L1649	3	4.91
CTC-6L1650	3	4.10
CTC-6L1651	3	6.42
CTC-6L9284	3	4.74
CTC-7X4800	20	0.59
CTC-8M1112	6	1.22
CTC-8M4389	5	1.07
CTC-8M4390	3	4.10
CTC-8M4395	3	3.13
CTC-8M4431	4	1.09
CTC-8M4432	5	2.12
CTC-8M4435	5	1.59
CTC-8M4436	3	3.76
CTC-8M4437	10	0.89
CTC-8M4438	5	0.93
CTC-8M4443	3	3.38
CTC-8M4445	5	1.78
CTC-8M4446	5	1.88
CTC-8M4447	6	0.88
CTC-8M4448	5	1.07
CTC-8M4986	10	3.09
CTC-8M4987	10	2.68
CTC-8M4988	5	2.10
CTC-8M4989	2	4.64
CTC-8M4990	3	3.09

SILICONE O-RINGS

Part Number	Min. Pkgs.	List Price
CTC-8M4991	3	\$ 4.85
CTC-8M4992	3	3.71
CTC-8M5010	3	3.92
CTC-8M5127	12	0.57
CTC-8M5248	5	2.32
CTC-8M5249	5	2.85
CTC-8M5251	12	0.77
CTC-8M5252	3	4.73
CTC-8M5253	8	0.66
CTC-8M5254	5	2.47
CTC-8M5260	8	0.64
CTC-8M5661	3	3.53
CTC-8M8157	5	0.83
CTC-8M8281	5	1.27
CTC-8M8282	6	1.04
CTC-8M8283	3	1.18
CTC-8M8515	5	1.86
CTC-9H6067	5	3.76
CTC-9M4218	2	5.35
CTC-9M4849	5	3.97
CTC-9M7002	3	5.51
CTC-9M7539	3	3.67
CTC-9M9647	3	5.76

RECTANGULAR ROD SEALS

Part Number	Rod Dia.	Desc.	List Price
CTC-8C9139	2-1/2	Seal	\$ 22.17
CTC-5J1731	7	Seal	18.76
CTC-5J5150	7	Back-up Ring	13.88
CTC-8T3539	7	Seal	13.88
CTC-8T3540	7	Back-up Ring	21.50
CTC-6J7693	9	Seal	27.24
CTC-8T3541	9	Seal	13.88
CTC-8T3542	9	Back-up Ring	25.46
CTC-9J4753	9	Back-up Ring	13.88

RETAINER RINGS

Part Number	List Price
CTC-0950930	\$ 2.66
CTC-1H8397	4.22
CTC-1L4775	3.58
CTC-2D0830	9.20
CTC-7M2275	11.49
CTC-7Y0976	6.99
CTC-7Y5119	17.77
CTC-8H8024	7.76
CTC-9H5604	7.82
CTC-9H7668	1.50

ROD BUSHINGS

Part Number	Rod Dia.	List Price
CTC-1934637	3-1/2	\$ 94.94
CTC-8T7692	7	320.40
CTC-1U4626	11	858.98
CTC-1890593	1-1/4	7.97
CTC-1140752	55 mm	18.35
CTC-1140751	60 mm	24.20
CTC-1140754	65 mm	25.67
CTC-1460742	65 mm	13.03
CTC-1140753	70 mm	29.52
CTC-3904158	70 mm	24.51
CTC-1140750	75 mm	30.98
CTC-1148836	75 mm	34.02
CTC-3937931	75 mm	27.12
CTC-1140755	80 mm	33.98
CTC-1505839	80 mm	31.26
CTC-3852900	80 mm	31.26
CTC-0931824	85 mm	37.06
CTC-0964402	85 mm	34.71
CTC-1140756	85 mm	37.06
CTC-1052575	90 mm	33.48
CTC-1140758	90 mm	42.75
CTC-0964430	95 mm	37.71
CTC-1289260	95 mm	44.36
CTC-6C6093	95 mm	47.74
CTC-7Y4625	95 mm	44.36
CTC-0931826	100 mm	52.10
CTC-0965625	100 mm	51.68
CTC-1140757	100 mm	52.10

UNITED STATES
PHONE 1-800-777-5617
FAX 1-800-759-6391

US SALES OFFICE HOURS
8 AM TO 5:30 PM EASTERN TIME
WWW.HDDISDISTRIBUTORS.COM
www.HerculesUS.com

WORLDWIDE
PHONE 1-727-796-1300
FAX 1-727-797-8849

REPLACEMENT PARTS FOR CATERPILLAR® EQUIPMENT

NOTE: CATERPILLAR® part numbers are used as a reference only. We do not imply that these kits are original REPLACEMENT PARTS.

ROD BUSHINGS

Part Number	Rod Dia.	List Price
CTC-0995572	105 mm	\$ 44.45
CTC-1140760	105 mm	56.77
CTC-1140761	110 mm	90.27
CTC-1140762	110 mm	84.51
CTC-1140763	130 mm	86.23
CTC-1140763	130 mm	86.23
CTC-1289261	140 mm	108.18
CTC-1289262	150 mm	109.04

ROD VEE SETS

Part Number	Rod Dia.	List Price
CTC-1J0132	1-1/4	\$ 8.75
CTC-1K7110	1-1/4	8.75
CTC-3D1123	1-1/2	14.60
CTC-2K0248	1-3/4	19.75
CTC-1K7112	2	17.41
CTC-3F9609	2	38.42
CTC-2K4434	2-1/4	19.92
CTC-1K7114	2-1/2	26.50
CTC-4F8420	2-1/2	36.23
CTC-4J5830	2-1/2	23.17
CTC-5F3498	2-3/4	38.63
CTC-2J1408	3	30.58
CTC-2K1516	3	46.21
CTC-4J6897	3-1/4	36.49
CTC-1J2148	3-1/2	61.35
CTC-8M3912	3-1/2	19.61
CTC-2K0050	4	61.31
CTC-2K1335	4-1/2	52.37
CTC-3J7768	7-1/4	138.03

SHIMS

Part Number	List Price
CTC-0964441	\$ 13.46
CTC-0964477	12.55
CTC-0965741	11.00
CTC-1076265	11.00

SWIVEL SEALS

Part Number	List Price
CTC-1597782	\$ 37.68

U-SEALS

Part Number	Rod Dia.	List Price
CTC-7J0375	5/8	\$ 7.10
CTC-6J1878	3/4	7.36
CTC-0352380	7/8	7.64
CTC-6J1889	1	4.75
CTC-1890217	1-1/4	8.77
CTC-4T0959	1-1/4	9.39
CTC-5J8125	1-1/4	9.39
CTC-2S5867	1-1/2	17.71
CTC-5J8150	1-1/2	10.80
CTC-9J4038	1-1/2	16.79
CTC-4T0488	1-5/8	11.91
CTC-1672300	1-3/4	9.14
CTC-3518628	1 3/4	9.14
CTC-5J8175	1-3/4	12.35
CTC-8J5816	1-3/4	12.35
CTC-3081883	1-3/4	20.08
CTC-1672302	1-7/8	8.79
CTC-2332609	1-7/8	8.79
CTC-4S9006	1-7/8	25.75
CTC-4T6898	1-7/8	26.07
CTC-1672304	2	12.27
CTC-2892946	2	9.32
CTC-3G3259	2	22.13
CTC-3G3260	2	15.38
CTC-5J8200	2	15.38
CTC-5U3644	2	9.01
CTC-9J1318	2	22.13
CTC-3081873	2	14.65
CTC-3568331	2	9.32
CTC-1672305	2-1/8	22.48
CTC-3P1344	2-1/8	16.17
CTC-4T6126	2-1/8	22.48
CTC-1672307	2-1/4	16.36
CTC-3623819	2-1/4	16.36
CTC-5J8225	2-1/4	16.36
CTC-7J4820	2-1/4	24.91
CTC-0917173	2-3/8	17.98
CTC-3G2911	2-3/8	48.25

U-SEALS

Part Number	Rod Dia.	List Price
CTC-5J8238	2-3/8	\$ 15.58
CTC-9J1322	2-3/8	15.58
CTC-1672314	2-1/2	17.59
CTC-2892948	2-1/2	16.02
CTC-3G3752	2-1/2	44.34
CTC-3G3809	2-1/2	44.34
CTC-4S9007	2-1/2	34.24
CTC-5J0964	2-1/2	15.94
CTC-7J4824	2-1/2	44.34
CTC-9X7257	2-1/2	44.34
CTC-1672438	2-1/2	90.14
CTC-1672315	2-5/8	16.28
CTC-3G4718	2-5/8	16.28
CTC-1672317	2-3/4	16.02
CTC-5J8275	2-3/4	16.28
CTC-9J2944	2-3/4	29.88
CTC-1P4879	3	39.17
CTC-5J8300	3	16.80
CTC-3124245	3	16.17
CTC-1672320	3-1/4	17.71
CTC-4153212	3-1/4	17.71
CTC-5J8325	3-1/4	17.71
CTC-7J2145	3-1/4	34.59
CTC-3G5051	3-3/8	17.71
CTC-5P1140	3-3/8	13.05
CTC-1049658	3-1/2	18.51
CTC-1672324	3-1/2	21.84
CTC-1P4880	3-1/2	23.88
CTC-5J8350	3-1/2	18.51
CTC-7J2150	3-1/2	37.26
CTC-3119317	3-1/2	18.61
CTC-1672328	3-3/4	21.72
CTC-1672331	3-3/4	28.44
CTC-3465200	3-3/4	21.72
CTC-5J8375	3-3/4	21.72
CTC-2U9113	4	23.76
CTC-5J8400	4	28.44
CTC-7U6945	4	23.76
CTC-3119320	4	42.32
CTC-1672333	4-1/4	27.85
CTC-6J1425	4-1/4	28.82
CTC-9J1336	4-1/4	28.82
CTC-0917170	4-3/8	59.15
CTC-1672336	4-1/2	32.79
CTC-6J1450	4-1/2	32.79

CATERPILLAR®

REPLACEMENT PARTS FOR CATERPILLAR® EQUIPMENT

NOTE: CATERPILLAR® part numbers are used as a reference only. We do not imply that these kits are original REPLACEMENT ARTS.

U-SEALS

Part Number	Rod Dia.	List Price
CTC-9J1340	4-1/2	\$ 32.79
CTC-2951316	4-1/2	32.79
CTC-3413191	4-1/2	32.79
CTC-6J1475	4-3/4	37.95
CTC-9J1344	4-3/4	37.95
CTC-4T5664	4-7/8	34.98
CTC-2U5379	5	23.86
CTC-3G5056	5	28.18
CTC-5P1139	5	28.18
CTC-6K2430	5	53.11
CTC-8J4524	5	58.08
CTC-9J1684	5	28.18
CTC-1672339	5	58.08
CTC-4T5699	5-1/4	36.86
CTC-1672344	5 1/2	48.41
CTC-6J1550	5-1/2	44.90
CTC-9J1692	5-1/2	44.90
CTC-3G2286	5-3/4	69.32
CTC-9J5467	5-3/4	61.48
CTC-9J5470	5-3/4	61.48
CTC-4T9901	6	59.08
CTC-8J4394	6-1/4	54.08
CTC-6J1650	6-1/2	70.5
CTC-8J1880	6-1/2	70.50
CTC-8J4387	6-1/2	84.56
CTC-1672352	7	76.84
CTC-3G2649	7	64.79
CTC-6J1700	7	64.79
CTC-1672354	8	405.32
CTC-9X7389	11	163.35
CTC-9X7388	12-1/2	174.42
CTC-0940876	10 mm	10.69
CTC-3Q7691	22 mm	5.49
CTC-1449481	30 mm	10.60
CTC-2991379	35 mm	12.08
CTC-2032344	35 mm	11.94
CTC-1402377	35 mm	10.20
CTC-2047231	40 mm	12.53
CTC-2126073	40 mm	15.83
CTC-6R8715	40 mm	17.28
CTC-1449493	40 mm	15.91
CTC-1921159	40 mm	23.46
CTC-1991136	45 mm	12.10
CTC-2035383	45 mm	16.65
CTC-2986947	45 mm	15.75

U-SEALS

Part Number	Rod Dia.	List Price
CTC-1463916	45 mm	\$ 12.10
CTC-1672297	45 mm	7.67
CTC-1980660	45 mm	13.97
CTC-1438914	45 mm	12.51
CTC-1920623	45 mm	19.56
CTC-2774161	45 mm	44.93
CTC-1461103	50 mm	17.05
CTC-1708823	50 mm	17.05
CTC-1921168	50 mm	36.48
CTC-1931372	50 mm	16.76
CTC-2034020	50 mm	16.76
CTC-2167638	50 mm	20.16
CTC-1463957	50 mm	17.05
CTC-2332610	50 mm	12.80
CTC-2725679	50 mm	16.76
CTC-2774130	50 mm	37.74
CTC-0959790	50 mm	16.76
CTC-1672303	50 mm	11.27
CTC-1708773	55 mm	17.20
CTC-2125097	55 mm	19.27
CTC-2167238	55 mm	17.20
CTC-2332611	55 mm	57.40
CTC-2725642	55 mm	20.92
CTC-0996996	55 mm	20.92
CTC-1672306	55 mm	35.88
CTC-2773383	55 mm	42.75
CTC-1183120	60 mm	19.36
CTC-0931475	60 mm	16.87
CTC-1672301	60 mm	18.55
CTC-1095256	63 mm	28.12
CTC-1095259	63 mm	23.56
CTC-0931476	65 mm	19.42
CTC-1709856	65 mm	26.19
CTC-1915683	65 mm	24.64
CTC-1460740	65 mm	24.64
CTC-1182716	70 mm	23.05
CTC-3494118	70 mm	43.70
CTC-0931477	70 mm	19.27
CTC-1709857	70 mm	36.54
CTC-8Q5877	70 mm	17.50
CTC-A04600915	70 mm	19.27
CTC-1672299	70 mm	32.81
CTC-4161296	70 mm	31.45
CTC-0963468	75 mm	23.45
CTC-8Q6011	75 mm	26.40

U-SEALS

Part Number	Rod Dia.	List Price
CTC-A04600918	75 mm	\$ 23.45
CTC-1709858	75 mm	21.25
CTC-1672318	75 mm	14.32
CTC-3494117	75 mm	38.64
CTC-4161274	75 mm	39.39
CTC-0931479	80 mm	20.43
CTC-0994156	80 mm	25.66
CTC-1709859	80 mm	31.89
CTC-A04600917	80 mm	25.66
CTC-1572236	80 mm	15.96
CTC-1672343	80 mm	14.05
CTC-3555816	80 mm	31.97
CTC-4161285	80 mm	51.46
CTC-7Q8581	80 mm	38.67
CTC-0961567	85 mm	27.86
CTC-1540730	85 mm	29.65
CTC-1672322	85 mm	29.65
CTC-1709860	85 mm	23.42
CTC-2742497	85 mm	35.20
CTC-7Y5117	85 mm	27.96
CTC-1373656	85 mm	29.65
CTC-3500957	85 mm	29.65
CTC-0961587	90 mm	42.03
CTC-1052577	90 mm	29.33
CTC-1540750	90 mm	29.33
CTC-1672325	90 mm	22.19
CTC-2160003	90 mm	29.65
CTC-2742498	90 mm	28.55
CTC-1336913	90 mm	29.33
CTC-1505826	95 mm	23.68
CTC-1672326	95 mm	24.07
CTC-2160004	95 mm	8.36
CTC-2590653	95 mm	31.03
CTC-7Y4629	95 mm	31.03
CTC-1672327	95 mm	43.92
CTC-0962664	100 mm	23.72
CTC-1076256	100 mm	33.93
CTC-1211371	100 mm	27.49
CTC-1373659	100 mm	27.49
CTC-1540737	100 mm	27.49
CTC-1672329	100 mm	36.70
CTC-1672330	100 mm	27.49
CTC-2160005	100 mm	23.72
CTC-2742499	100 mm	24.75
CTC-8U6849	100 mm	27.49

CATERPILLAR®

REPLACEMENT PARTS FOR CATERPILLAR® EQUIPMENT

NOTE: CATERPILLAR® part numbers are used as a reference only. We do not imply that these kits are original REPLACEMENT PARTS.

U-SEALS

Part Number	Rod Dia.	List Price
CTC-1540762	100 mm	\$ 33.93
CTC-3500960	100 mm	23.72
CTC-1948354	105 mm	38.07
CTC-1948364	105 mm	38.07
CTC-2590733	105 mm	48.61
CTC-7Y4670	105 mm	38.84
CTC-0955600	105 mm	42.16
CTC-1289269	105 mm	38.84
CTC-1540768	105 mm	42.16
CTC-3246439	105 mm	48.61
CTC-1289270	110 mm	43.89
CTC-1672338	110 mm	50.20
CTC-2590734	110 mm	59.46
CTC-3338688	110 mm	74.65
CTC-7Y4942	110 mm	43.89
CTC-3033491	110 mm	98.38
CTC-3249486	115 mm	73.15
CTC-1915646	115 mm	73.15
CTC-2042848	115 mm	73.15
CTC-2095876	115 mm	73.56
CTC-2590735	115 mm	78.36
CTC-3338673	130 mm	180.66
CTC-2160008	130 mm	29.08
CTC-2590736	130 mm	180.66
CTC-2160009	140 mm	35.90
CTC-1475770	140 mm	35.90
CTC-1948370	150 mm	87.57
CTC-2160011	150 mm	16.78

NON-CATERPILLAR® U-SEALS

Part Number	Rod Dia.	List Price
CTC-3E4175	1-1/8	\$ 5.92
CTC-3E4284	1-1/8	6.60
CTC-3E4180	1-1/4	5.61
CTC-3E4181	1-1/4	6.07
CTC-3E4193	1-1/4	6.62
CTC-3E4182	1-3/8	6.44
CTC-3E4194	1-3/8	6.84
CTC-3E4283	1-3/8	6.42
CTC-3E4183	1-1/2	6.53
CTC-3E4195	1-1/2	7.53
CTC-3E4215	1-1/2	9.13

NON-CATERPILLAR® U-SEALS

Part Number	Rod Dia.	List Price
CTC-3E4184	1-5/8	\$ 6.96
CTC-3E4201	1-5/8	7.28
CTC-3E4185	1-3/4	7.37
CTC-3E4216	1-3/4	10.14
CTC-3E4287	1-3/4	8.23
CTC-3E4186	2	8.22
CTC-3E4196	2	9.01
CTC-3E4217	2	10.84
CTC-3E4227	2	15.33
CTC-3E4187	2-1/4	9.18
CTC-3E4197	2-1/4	10.11
CTC-3E4218	2-1/4	12.84
CTC-3E4228	2-1/4	17.08
CTC-3E4188	2-3/8	9.96
CTC-3E4204	2-3/8	9.94
CTC-3E4189	2-1/2	9.89
CTC-3E4198	2-1/2	11.13
CTC-3E4219	2-1/2	12.96
CTC-3E4229	2-1/2	17.98
CTC-3E4285	2-1/2	12.92
CTC-3E4199	2-3/4	12.14
CTC-3E4220	2-3/4	14.08
CTC-3E4230	2-3/4	20.52
CTC-3E4190	3	11.96
CTC-3E4200	3	13.12
CTC-3E4221	3	15.22
CTC-3E4231	3	21.36
CTC-3E4222	3-3/8	16.91
CTC-3E4286	3-3/8	16.87
CTC-3E4191	3-1/2	14.26
CTC-3E4202	3-1/2	15.14
CTC-3E4223	3-1/2	18.41
CTC-3E4232	3-1/2	24.28
CTC-3E4192	3-3/4	16.67
CTC-3E4203	3-3/4	16.02
CTC-3E4224	3-3/4	19.59
CTC-3E4225	4	19.98
CTC-3E4233	4	27.41
CTC-3E4205	4-1/4	20.87
CTC-3E4206	4-1/2	20.62
CTC-3E4234	4-1/2	30.12
CTC-3E4207	4-3/4	22.64
CTC-3E4208	5	23.86
CTC-3E4226	5	27.25
CTC-3E4235	5	33.00

NON-CATERPILLAR® U-SEALS

Part Number	Rod Dia.	List Price
CTC-3E4209	5-1/4	\$ 27.14
CTC-3E4210	5-1/2	27.05
CTC-3E4236	5-1/2	35.73
CTC-3E4211	6	28.28
CTC-3E4237	6	38.22
CTC-3E4212	6-1/2	32.05
CTC-3E4238	6-1/2	40.52
CTC-3E4213	7	34.71
CTC-3E4239	7	43.24
CTC-3E4240	7-1/2	50.67
CTC-3E4214	8	42.00

WEAR RINGS

Part Number	O.D. X Width	List Price
CTC-5J9073	1-1/2 X 0.485	\$ 6.79
CTC-8C9120	1-5/8 X 13/16	11.17
CTC-4T6780	1-5/8 X .98	9.54
CTC-8T5443	1-5/8 X 1-1/4	20.07
CTC-4T6907	1-7/8 X .98	23.46
CTC-8T6441	2 X 1/4	21.00
CTC-5J7942	2 X 1/2	4.85
CTC-8T6442	2 X .72	23.81
CTC-4T6779	2 X .98	31.30
CTC-4T5613	2-1/8 X 1	6.33
CTC-8T7030	2-1/8 X 1-1/4	29.97
CTC-8T6682	2-1/4 X .36	49.73
CTC-8T6681	2-1/4 X .72	49.00
CTC-7H2423	2-1/4 X 7/8	7.81
CTC-4T6128	2-1/4 X .98	27.43
CTC-8T4958	2-3/8 X 1	35.32
CTC-8T8204	2-3/8 X 1-3/16	31.57
CTC-8J6212	2-1/2 X 3/4	9.18
CTC-9X7260	2-1/2 X 1.246	17.25
CTC-009004097	2.51 X 3.11	39.05
CTC-8T0785	2-5/8 X .98	34.27
CTC-8T5668	2-5/8 X 1-1/4	39.28
CTC-8T8394	2-5/8 X 1-11/16	50.16
CTC-8T8365	2.7 X 2.28	75.28
CTC-8J0112	2-3/4 X 15/16	13.09
CTC-8T7372	2-3/4 X .97	14.22
CTC-8C9200	2-7/8 X 1	42.50

REPLACEMENT PARTS FOR CATERPILLAR® EQUIPMENT

NOTE: CATERPILLAR® kit numbers are used as a reference only. We do not imply that these kits are original REPLACEMENT KITS.

WEAR RINGS

Part Number	O.D. X Width	List Price
CTC-8C9114	2-7/8 X 1	\$ 42.50
CTC-6C2385	2-7/8 X 1-1/4	35.67
CTC-8T7849	2-7/8 X 1.57	49.66
CTC-8T7020	2-7/8 X 1-13/16	32.30
CTC-8T6743	2.95 X 1.96	63.22
CTC-2233353	3 X 3/4	5.08
CTC-6U0381	3 X 3/4	5.08
CTC-6J5733	3 X .99	16.40
CTC-8T6443	3 X 1	15.26
CTC-4T7283	3 X 1.24	22.99
CTC-8C9161	3-1/8 X .97	15.12
CTC-9T0094	3-1/8 X 1.24	70.68
CTC-8T1714	3-1/8 X 1-9/16	78.35
CTC-8T7584	3-1/8 X 1-5/8	40.00
CTC-8C9153	3.20 X 1.17	53.61
CTC-8J2577	3-1/4 X 3/4	17.94
CTC-8J6371	3-1/4 X 1.11	17.72
CTC-8T6683	3-1/4 X 1-1/8	57.92
CTC-8T0777	3-3/8 X 1.74	71.23
CTC-2233502	3-3/8 X 3/4	5.08
CTC-8T4813	3.45 X 1-5/8	51.89
CTC-8T6745	3.45 X 1.96	58.72
CTC-8T6744	3.45 X 2.74	84.83
CTC-7J6916	3-1/2 X 5/8	5.08
CTC-2233356	3-1/2 X 3/4	5.10
CTC-7U7647	3-1/2 X 3/4	5.10
CTC-6H5496	3-1/2 X 7/8	10.53
CTC-5J3326	3-1/2 X 1-1/8	31.84
CTC-7J9885	3-1/2 X 1-1/8	14.16
CTC-4J3236	3-1/2 X 1-1/2	15.79
CTC-8C5245	3-5/8 X 1.05	48.04
CTC-8T3329	3-5/8 X 1.88	57.67
CTC-8C3829	3.7 X 1.76	94.94
CTC-1324907	3.7 X 1.88	85.24
CTC-8T6746	3.7 X 2.36	66.55
CTC-2233357	3-3/4 X 3/4	13.18
CTC-1194761	3-3/4 X 1	15.33
CTC-8J6245	3-3/4 X 1	15.33
CTC-5J8019	3-3/4 X 1.24	15.59
CTC-6J3075	3-3/4 X 1.99	42.01
CTC-8T7848	3-7/8 X 1.57	78.85
CTC-8T3330	3.95 X 2-7/16	97.42
CTC-5J7154	4 X 5/8	15.26
CTC-8H0214	4 X 7/8	10.74

WEAR RINGS

Part Number	O.D. X Width	List Price
CTC-6J2797	4 X .99	\$ 20.53
CTC-6U3246	4 X 1	5.96
CTC-1M1571	4 x 1-1/4	23.88
CTC-3G4723	4-1/8 X .42	18.36
CTC-8T7538	4.2 X 1.56	80.73
CTC-8T6747	4.2 X 2.55	67.98
CTC-2259524	4-1/4 X 3/4	9.30
CTC-1194760	4-1/4 X 1	13.27
CTC-6J7264	4-1/4 X 1	26.64
CTC-6J4003	4-1/4 X 1-1/4	14.59
CTC-5J8157	4-1/4 X 1.49	19.46
CTC-4T4753	4-1/4 X 1.88	31.24
CTC-7J3300	4.258 X 2.49	54.53
CTC-8T6748	4.45 X 2-3/8	75.97
CTC-2264162	4-1/2 X 3/4	14.00
CTC-2233360	4-3/4 X 3/4	16.99
CTC-5U3531	4-1/2 X 3/4	5.33
CTC-6H6270	4-1/2 X 7/8	12.60
CTC-4J4605	4-1/2 X 15/16	16.24
CTC-1460744	4-1/2 X 1	\$ 15.49
CTC-4J3745	4-1/2 X 1	15.49
CTC-6U4154	4-1/2 X 1	7.30
CTC-4J2630	4-1/2 X 1-1/2	22.86
CTC-4J2620	4-1/2 X 1-1/2	22.43
CTC-6J4175	4-1/2 X 1.86	37.10
CTC-4T8758	4-1/2 X 1.86	37.10
CTC-0901301	4-1/2 X 2.362	61.80
CTC-4T9248	4-3/4 X 1-1/4	21.80
CTC-4J3342	4-3/4 X 1-1/4	21.80
CTC-5J3326	4-3/4 X 1-1/4	31.84
CTC-1317184	4-3/4 X 1.64	39.94
CTC-3J7663	4-3/4 X 1.99	102.70
CTC-9J9792	4-3/4 X 3-1/2	63.84
CTC-4T6929	4-3/4 X 3-1/2	63.84
CTC-8T7850	4.950 X 1.96	56.78
CTC-2263860	5 X 3/4	20.69
CTC-7J1627	5 X 0.85	21.12
CTC-4J4630	5 X 1-1/8	18.18
CTC-8M4226	5 X 1.24	39.54
CTC-4J3420	5 X 1.55	19.19
CTC-4T4752	5 X 1-3/4	23.20
CTC-8T3331	5.2 X 2-1/2	94.94
CTC-7J8878	5-1/4 X 3/16	9.36
CTC-9J7978	5-1/4 X 3/4	25.65

WEAR RINGS

Part Number	O.D. X Width	List Price
CTC-2D0714	5-1/4 X 1.02	\$ 41.99
CTC-4J3887	5-1/4 X 1.307	14.41
CTC-9J7978	5-1/4 X 1.49	25.65
CTC-9J3054	5-1/4 X 3.61	81.83
CTC-4T5718	5.45 X 2.49	91.54
CTC-1546747	5-3/8 X 1	15.51
CTC-5U4278	5-1/2 X 3/4	5.56
CTC-4J4606	5-1/2 X 1-1/4	20.57
CTC-3J9026	5-1/2 X 1-3/8	40.21
CTC-7J3303	5-1/2 X 1.61	51.15
CTC-9J7191	5-1/2 X 1.74	63.11
CTC-1898686	5-1/2 X 1-3/4	63.11
CTC-7J1731	5-1/2 X 1-3/4	27.55
CTC-4J3518	5-1/2 X 1.99	56.43
CTC-8C9112	5-1/2 X 1.99	56.43
CTC-8J1690	5-1/2 X 2.24	66.25
CTC-1724019	5-3/4 X 1.61	82.34
CTC-9J4164	5-3/4 X 1.62	82.34
CTC-6J3074	5-3/4 X 1.99	64.38
CTC-8J9917	5-3/4 X 2.36	88.17
CTC-8T7851	5.95 X 1.96	87.26
CTC-8T3332	5.95 X 3.61	143.72
CTC-7J8877	6 X 3/16	41.65
CTC-3G6537	6 X 1.07	35.99
CTC-5J0014	6 X 1-1/4	28.53
CTC-1J0708	6 X 1-5/16	30.49
CTC-9J5860	6 X 1-1/2	27.73
CTC-7J5326	6 X 1-3/4	51.45
CTC-4T6930	6 X 2.74	145.94
CTC-8J1746	6 X 2.74	145.94
CTC-8J1764	6 X 2.74	145.94
CTC-8J1714	6 X 2.86	110.00
CTC-5J3326	6-1/4 X 1.49	31.84
CTC-9J5550	6-1/4 X 1-3/4	53.16
CTC-4T9319	6-1/4 X 2.74	147.60
CTC-5J0058	6-1/2 X 1-1/4	29.21
CTC-7J8880	6-1/2 X 1/4	29.48
CTC-4J7532	6-1/2 X 1	22.23
CTC-3J9027	6-1/2 X 1.37	26.44
CTC-9T0096	6-1/2 X 1-1/2	26.58
CTC-3J9703	6-1/2 X 1-1/2	26.58
CTC-9J9806	6-1/2 X 1.74	52.91
CTC-7J1938	6-1/2 X 2	44.86
CTC-9J3055	6-1/2 X 2.74	147.60

CATERPILLAR®

REPLACEMENT PARTS FOR CATERPILLAR® EQUIPMENT

NOTE: CATERPILLAR® part numbers are used as a reference only. We do not imply that these kits are original REPLACEMENT PARTS.

WEAR RINGS

Part Number	O.D. X Width	List Price
CTC-7J9232	6-1/2 X 2.86	\$ 72.88
CTC-9J0811	6-1/2 X 3.485	142.27
CTC-7J8881	6-1/2 X 3.49	189.51
CTC-1915604	6-3/4 X 0.99	61.08
CTC-8M4228	7 X 1.485	23.66
CTC-3G5098	7 X 1.74	53.06
CTC-9J0711	7 X 1.99	55.17
CTC-3G3470	7 X 2.365	132.23
CTC-8J1662	7 X 3-1/8	54.67
CTC-8T6749	7.2 X 3.14	128.52
CTC-1J2674	7-1/4 X 1-3/8	58.20
CTC-3J7848	7-1/4 X 2	57.23
CTC-1U1734	7-1/4 X 3-1/16	159.70
CTC-8T7693	7-1/4 X 7.1	273.02
CTC-4J7663	7-1/4 X 7.10	273.02
CTC-8T1127	7-3/8 X 1.61	107.12
CTC-1U2218	7-1/2 X 1-1/2	45.80
CTC-8J9936	7-1/2 X 2.36	84.78
CTC-9J5562	7-1/2 X 2-1/2	80.98
CTC-4T4811	7-1/2 X 2.95	215.01
CTC-7J8886	7-3/4 X 1/4	12.03
CTC-5J5037	7-3/4 X 1.61	113.02
CTC-9J5037	7-3/4 X 1.61	113.02
CTC-9J3624	7-3/4 X 1.99	61.53
CTC-7J9247	7-3/4 X 3-1/2	139.58
CTC-4T6932	7-3/4 X 4.49	255.14
CTC-3G4625	7-3/4 X 4.49	255.14
CTC-1214703	8 X 2.93	104.21
CTC-4J9047	8 X 5	130.89
CTC-8T7695	8 X 5	130.89
CTC-6E0245	8.200 X 2.950	150.11
CTC-7J8887	8-1/4 X 1/4	26.77
CTC-2J0745	8-1/4 X 1-1/4	30.24
CTC-4J7376	8-1/4 X 1-1/2	40.94
CTC-3J8683	8-1/4 X 1-3/4	52.61
CTC-3G9882	8-1/4 X 1.99	131.33
CTC-8J8375	8-1/4 X 2-1/8	81.51
CTC-3J7632	8-1/4 X 2-1/4	87.15
CTC-7J3301	8-1/4 X 2.49	133.96
CTC-8J8826	8-1/4 X 2.74	108.05
CTC-9J8102	8-1/4 X 2.74	181.15
CTC-8T7694	8-1/2 X 3	134.52
CTC-4T9320	8-1/4 X 3-1/2	187.48
CTC-9J3056	8-1/4 X 4.11	92.22

WEAR RINGS

Part Number	O.D. X Width	List Price
CTC-7J8064	8-1/2 X 2.36	\$ 117.88
CTC-9M1604	8-1/2 X 3	134.52
CTC-6E0248	9 X 2.946	84.47
CTC-1J5281	9-1/4 X 1-3/4	35.18
CTC-4T5949	9-1/4 X 1.96	80.42
CTC-7J2087	9-1/4 X 2-1/4	134.08
CTC-8C3846	9-3/8 X 9	1,446.29
CTC-4T6097	9-1/2 X 1.93	183.22
CTC-1214175	10 X 1.9	87.03
CTC-1178865	10 X 1-1/2	36.20
CTC-8C3843	10 X 2.74	137.29
CTC-9J3369	10 X 3-1/4	106.45
CTC-7J8890	10-1/4 X 0.243	28.19
CTC-2299443	10-1/2 X 2.382	124.82
CTC-9J1159	10 1/2 X 2.74	180.63
CTC-8J8900	10-1/2 X 3-3/4	106.87
CTC-8J5980	10-1/2 X 4	152.72
CTC-8T6637	10-3/4 X 6-1/2	1,578.05
CTC-6E0249	11 X 1.923	93.55
CTC-1080124	11 X 3.235	229.83
CTC-8T1129	11-3/8 X 2.61	130.14
CTC-9J2991	11-1/2 X 3-7/8	117.32
CTC-4T6096	12-1/4 X 4	284.10
CTC-1U2694	12-1/2 X 4	206.13
CTC-6E0308	12-1/2 X 1.460	124.47
CTC-1530119	12-3/4 X 4	235.16
CTC-8T1130	12-7/8 X 2.86	387.08
CTC-1944420	12-7/8 X 4.03	716.36
CTC-4T4827	12-7/8 X 12.18	890.58
CTC-1U4627	13-1/8 X 7.85	756.09
CTC-9X7439	13-7/8 X 2.36	158.76
CTC-9X3563	13-7/8 X 10	642.07
CTC-6E0247	13-3/4 X 4	259.43
CTC-4T4129	14-1/4 X 3.99	270.87
CTC-4T4825	15-1/8 X 7.71	669.07
CTC-9X3564	16-1/8 X 7.69	632.42
CTC-1449482	33 X 14.2 mm	7.00
CTC-1473779	38 X 14.2 mm	7.13
CTC-1449494	43 X 14.2 mm	6.00
CTC-1509403	48 X 14.2 mm	7.43
CTC-1438916	48 X 25 mm	10.92
CTC-1794354	50 X 15 mm	9.83
CTC-1410709	53 X 24.5 mm	15.10
CTC-0908007	55 X 7.9 mm	18.95

WEAR RINGS

Part Number	O.D. X Width	List Price
CTC-1449486	60 X 14.8 mm	\$ 8.08
CTC-1980663	60 X 18 mm	5.95
CTC-1183121	60 X 9.5 mm	7.57
CTC-1890589	63 X 20 mm	11.21
CTC-1400176	63 X 24.8 mm	25.84
CTC-2047227	65 X 10 mm	6.90
CTC-1449491	65 X 14.8 mm	8.33
CTC-2377904	65 X 6 mm	9.54
CTC-1404272	70 X 11.8 mm	73.28
CTC-1754720	70 X 12 mm	73.28
CTC-1512566	70 X 14.8 mm	8.33
CTC-2377088	70 X 6 mm	10.34
CTC-1057252	71.3 X 5.9 mm	34.32
CTC-2508733	75 X 10 mm	11.15
CTC-1920683	75 X 11.8 mm	98.46
CTC-1509402	75 X 14.8 mm	8.53
CTC-1438918	75 X 29.8 mm	20.48
CTC-1991142	75 X 6 mm	24.13
CTC-2812315	75 X 6 mm	24.13
CTC-1930783	75 X 9.8 mm	2.56
CTC-1865147	78 X 25 mm	19.84
CTC-1931393	80 X 10 mm	3.53
CTC-1463922	80 X 11.8 mm	113.59
CTC-0997002	80 X 30 mm	14.56
CTC-0997003	80 X 6 mm	63.29
CTC-2376136	80 X 6 mm	11.92
CTC-1052630	81.3 X 5.9 mm	36.31
CTC-1865148	83 X 25 mm	20.01
CTC-2639887	85 X 12.5 mm	7.89
CTC-1463967	85 X 14.8 mm	128.79
CTC-1512565	85 X 15 mm	17.94
CTC-1231667	85 X 29.8 mm	7.55
CTC-1379009	85 X 6 mm	49.80
CTC-2781986	85 X 6 mm	28.75
CTC-1990601	85 X 6 mm	28.75
CTC-1934312	85 X 9.8 mm	2.93
CTC-2659683	88 X 25 mm	25.84
CTC-0861044	90 X 10 mm	56.36
CTC-1931367	90 X 10 mm	13.47
CTC-1463993	90 X 14.8 mm	128.45
CTC-0996976	90 X 3 mm	21.88
CTC-0996977	90 X 6 mm	36.31
CTC-1057388	91.3 X 5.9 mm	9.90
CTC-1865397	93 X 24.9 mm	36.78

CATERPILLAR®

REPLACEMENT PARTS FOR CATERPILLAR® EQUIPMENT

NOTE: CATERPILLAR® kit numbers are used as a reference only. We do not imply that these kits are original REPLACEMENT KITS.

WEAR RINGS

Part Number	O.D. X Width	List Price
CTC-2773390	95 X 12.5 mm	\$ 5.86
CTC-1522463	95 X 14.8 mm	55.31
CTC-2613637	95 X 25.4 mm	23.92
CTC-3049304	95 X 29.8 mm	9.49
CTC-3049303	95 X 6 mm	37.81
CTC-1931769	100 X 10 mm	5.44
CTC-2332589	100 X 12.5 mm	13.92
CTC-1183127	100 X 14.8 mm	15.90
CTC-2057955	100 X 14.8 mm	140.78
CTC-1438024	100 X 22.4 mm	26.73
CTC-2332588	100 X 25 mm	18.04
CTC-0931605	100 X 30 mm	10.70
CTC-1195456	100 X 30 mm	16.10
CTC-0931628	100 X 5.9 mm	72.59
CTC-1438033	100 X 5.9 mm	18.60
CTC-1438025	100 X 6 mm	33.01
CTC-1989424	100 X 6.2 mm	15.37
CTC-4161303	100 X 7.9 mm	22.78
CTC-2835953	100 X 9 mm	6.41
CTC-4161301	100 X 9.5 mm	12.98
CTC-1079306	105 x 15 mm	43.65
CTC-2835927	110 X 11 mm	28.92
CTC-1438030	110 X 22.4 mm	27.37
CTC-0931603	110 X 30 mm	27.81
CTC-1195434	110 X 30 mm	23.79
CTC-A04901911	110 X 30 mm	27.81
CTC-1057354	110 X 35 mm	24.71
CTC-1336678	110 X 35 mm	24.71
CTC-0931629	110 X 5.9 mm	79.26
CTC-1438031	110 X 5.9 mm	16.16
CTC-1438034	110 X 5.9 mm	19.82
CTC-1505846	110 X 5.9 mm	79.26
CTC-1600033	110 X 5.9 mm	79.26
CTC-1052629	110 X 5.9 mm	79.26
CTC-1505845	110 X 7.9 mm	10.89
CTC-2478994	110 X 7.9 mm	12.67
CTC-4161282	110 X 7.9 mm	9.80
CTC-4161279	110 X 9.5 mm	13.60
CTC-2835940	120 X 11 mm	29.32
CTC-1589063	120 X 15.5 mm	20.53
CTC-1438028	120 X 22.4 mm	29.99
CTC-1475837	120 X 27.35 mm	38.27
CTC-0931604	120 X 30 mm	29.51
CTC-1195445	120 X 30 mm	24.73

WEAR RINGS

Part Number	O.D. X Width	List Price
CTC-0875505	120 X 35 mm	\$ 47.35
CTC-1184130	120 X 35 mm	47.35
CTC-1438027	120 X 5.9 mm	17.29
CTC-1438035	120 X 5.9 mm	20.52
CTC-0931630	120 X 6 mm	36.19
CTC-0964406	120 X 7.9 mm	11.73
CTC-1261936	120 X 7.9 mm	11.73
CTC-1663003	120 X 7.9 mm	12.10
CTC-2478865	120 X 7.9 mm	11.73
CTC-0860255	120 X 8 mm	47.08
CTC-4161292	120 X 8 mm	47.08
CTC-4161290	120 X 9.5 mm	14.83
CTC-1865137	125 X 27.8 mm	27.19
CTC-0961565	125 X 8 mm	49.06
CTC-1357939	130 X 14.8 mm	20.52
CTC-1704829	130 X 15 mm	48.92
CTC-1799771	130 X 18.1 mm	36.26
CTC-1475852	130 X 30 mm	37.47
CTC-1184019	130 X 40 mm	58.30
CTC-7Y4636	130 X 40 mm	58.30
CTC-1261871	130 X 7.9 mm	13.04
CTC-1475853	130 X 7.9 mm	19.30
CTC-1505884	130 X 7.9 mm	22.61
CTC-2479006	130 X 7.9 mm	13.04
CTC-419392	130 X 7.9 mm	13.04
CTC-0861346	130 X 8 mm	49.93
CTC-7Y4632	130 X 8 mm	49.93
CTC-2344483	135 X 18.1 mm	18.21
CTC-2344485	135 X 7.75 mm	37.33
CTC-2344585	135 X 7.9 mm	14.40
CTC-2344586	135 X 8 mm	50.87
CTC-1645168	140 X 19.5 mm	90.72
CTC-1589065	140 X 20.35 mm	51.49
CTC-1183995	140 X 45 mm	63.18
CTC-0961571	140 X 8 mm	51.51
CTC-0961800	140 X 8 mm	51.51
CTC-1076264	140 X 8 mm	51.51
CTC-1076263	140 X 9.5 mm	23.49
CTC-1211555	140 X 9.5 mm	23.49
CTC-1261877	140 X 9.5 mm	23.49
CTC-2478874	140 X 9.5 mm	23.49
CTC-413632	140 X 9.5 mm	23.49
CTC-1873464	150 X 20 mm	27.81
CTC-1163589	150 X 45 mm	66.90

WEAR RINGS

Part Number	O.D. X Width	List Price
CTC-7Y4697	150 X 45 mm	\$ 66.90
CTC-1884218	150 X 7.8 mm	17.80
CTC-0961581	150 X 7.9 mm	105.58
CTC-1140713	150 X 8 mm	56.88
CTC-1140712	150 X 9.5 mm	15.01
CTC-1948357	150 X 9.5 mm	15.01
CTC-2344574	150 X 9.5 mm	15.01
CTC-1850230	160 X 20.5 mm	38.80
CTC-1183944	160 X 45 mm	70.27
CTC-0963201	160 X 8.9 mm	140.23
CTC-1850231	160 X 8.9 mm	11.37
CTC-1057262	170 X 50 mm	97.65
CTC-1915605	170 X 9.2 mm	9.70
CTC-1438138	180 X 28 mm	53.20
CTC-1052653	180 X 55 mm	110.51
CTC-0965167	180 X 8.9 mm	133.15
CTC-1475787	180 X 8.9 mm	17.25
CTC-2042845	190 X 28.5 mm	55.33
CTC-1261974	190 X 55 mm	88.00
CTC-1261976	190 X 8.9 mm	89.04
CTC-2042846	190 X 9.2 mm	13.84
CTC-1475738	200 X 28 mm	48.44
CTC-9X3570	200 X 59.8 mm	80.77
CTC-0857248	200 X 8.9 mm	186.01
CTC-1475776	200 X 9 mm	21.86
CTC-1704828	220 X 15 mm	73.38
CTC-6E0496	220 X 59.8 mm	80.77
CTC-4I6443	220 X 8.9 mm	196.78

WIPERS

Part Number	Rod Dia.	List Price
CTC-5M6708	0.6	\$ 3.31
CTC-2287467	5/8	7.09
CTC-5J2274	5/8	2.74
CTC-6J2274	5/8	2.74
CTC-6J1879	3/4	2.74
CTC-0352379	7/8	4.77
CTC-1K9060	7/8	3.05
CTC-3E4124	1	4.87
CTC-6J1890	1	2.74
CTC-7K1864	1	9.87
CTC-3E4138	1-1/8	2.74

CATERPILLAR®

REPLACEMENT PARTS FOR CATERPILLAR® EQUIPMENT

NOTE: CATERPILLAR® part numbers are used as a reference only. We do not imply that these kits are original REPLACEMENT PARTS.

WIPERS

Part Number	Rod Dia.	List Price
CTC-0303232	1-1/4	5.41
CTC-1890218	1-1/4	12.77
CTC-3E4125	1-1/4	5.41
CTC-3E4139	1-1/4	2.99
CTC-3E4160	1-1/4	12.77
CTC-4J8982	1-1/4	14.78
CTC-3E4140	1-3/8	3.19
CTC-3E4159	1-3/8	12.92
CTC-1672450	1-1/2	27.54
CTC-2268202	1-1/2	27.54
CTC-3E4161	1-1/2	13.05
CTC-4J8979	1-1/2	13.61
CTC-5J6795	1-1/2	3.50
CTC-8C9131	1-1/2	27.54
CTC-3E4103	1-1/2	1.93
CTC-3E4126	1-1/2	6.22
CTC-3E4141	1-1/2	3.50
CTC-4T0486	1-5/8	13.80
CTC-3E4163	1-5/8	3.73
CTC-3E4104	1-5/8	2.02
CTC-3081880	1-3/4	28.05
CTC-7U7648	1-3/4	3.92
CTC-1506739	1-3/4	28.05
CTC-2313539	1-3/4	28.05
CTC-3E4105	1-3/4	2.02
CTC-3E4162	1-3/4	14.10
CTC-4J8980	1-3/4	14.35
CTC-7J6932	1-3/4	14.10
CTC-7K9202	1-3/4	14.10
CTC-8C9132	1-3/4	28.05
CTC-9D6582	1-3/4	14.10
CTC-1672452	1-3/4	28.05
CTC-3E4127	1-3/4	6.61
CTC-3E4142	1-3/4	3.92
CTC-3E4150	1-3/4	4.63
CTC-1672455	1-7/8	28.52
CTC-2271143	1-7/8	28.52
CTC-3G4721	1-7/8	4.06
CTC-3P1347	1-7/8	14.44
CTC-4T6777	1-7/8	15.38
CTC-1672457	2	29.40
CTC-2299382	2	29.40
CTC-2332606	2	29.40
CTC-3081845	2	29.40
CTC-1K6981	2	18.47
CTC-3E4106	2	2.06

WIPERS

Part Number	Rod Dia.	List Price
CTC-3E4128	2	7.55
CTC-3E4143	2	4.11
CTC-3E4151	2	5.27
CTC-3E4164	2	14.63
CTC-4T0415	2	4.11
CTC-5P0093	2	5.49
CTC-5U3693	2	4.11
CTC-7K9203	2	16.25
CTC-8C9133	2	29.40
CTC-8J6416	2	14.63
CTC-9D6583	2	16.25
CTC-1506745	2-1/8	30.03
CTC-1672458	2-1/8	30.03
CTC-2271145	2-1/8	30.03
CTC-2332607	2-1/8	30.03
CTC-4T6125	2-1/8	10.69
CTC-3P1345	2-3/16	19.19
CTC-0346124	2-1/4	15.66
CTC-1672459	2-1/4	30.64
CTC-2313538	2-1/4	30.64
CTC-3E4107	2-1/4	2.19
CTC-4J3515	2-1/4	16.37
CTC-6J0217	2-1/4	4.34
CTC-7K9204	2-1/4	15.66
CTC-8C9134	2-1/4	30.64
CTC-3E4129	2-1/4	7.94
CTC-3E4144	2-1/4	4.34
CTC-3E4152	2-1/4	5.55
CTC-3E4165	2-1/4	15.66
CTC-1672461	2-3/8	31.81
CTC-2313540	2-3/8	31.81
CTC-3E4167	2-3/8	4.34
CTC-3P1461	2-3/8	13.42
CTC-5J8016	2-3/8	4.56
CTC-6J3892	2-3/8	13.53
CTC-8T1308	2-3/8	13.42
CTC-9J1319	2-3/8	13.53
CTC-1672463	2-1/2	33.00
CTC-2253281	2-1/2	33.00
CTC-2271148	2-1/2	22.61
CTC-7J8273	2-1/2	18.02
CTC-1K6982	2-1/2	18.02
CTC-3E4130	2-1/2	8.36
CTC-3E4153	2-1/2	5.84
CTC-5J8156	2-1/2	4.86
CTC-7K9205	2-1/2	17.72

WIPERS

Part Number	Rod Dia.	List Price
CTC-8C3840	2-1/2	33.00
CTC-9D6585	2-1/2	17.72
CTC-3E4108	2-1/2	2.47
CTC-3E4145	2-1/2	4.34
CTC-3E4166	2-1/2	17.72
CTC-1672464	2-5/8	22.23
CTC-2271146	2-5/8	22.23
CTC-3E4131	2-5/8	8.90
CTC-3G4719	2-5/8	4.86
CTC-7K9207	2-5/8	18.02
CTC-9D6586	2-5/8	18.02
CTC-9X3569	2-5/8	23.40
CTC-1491488	2-3/4	34.95
CTC-2253283	2-3/4	34.95
CTC-1J3540	2-3/4	21.86
CTC-3E4168	2-3/4	20.07
CTC-5J7036	2-3/4	5.00
CTC-7K9208	2-3/4	20.07
CTC-7J8274	2-3/4	21.86
CTC-7U4137	2-3/4	5.00
CTC-8C3842	2-3/4	34.95
CTC-9D6588	2-3/4	20.07
CTC-1672467	2-3/4	34.95
CTC-3E4109	2-3/4	2.61
CTC-3E4132	2-3/4	9.56
CTC-3E4169	2-3/4	5.00
CTC-1672469	3	36.11
CTC-2253284	3	36.11
CTC-2J1411	3	23.95
CTC-3E4110	3	3.04
CTC-3E4133	3	10.74
CTC-3E4146	3	5.23
CTC-3E4154	3	7.47
CTC-3E4170	3	20.63
CTC-5J7030	3	5.20
CTC-5P4061	3	17.50
CTC-7K9209	3	20.63
CTC-8C5218	3	36.11
CTC-8J0249	3	23.95
CTC-9D6589	3	20.63
CTC-2313542	3	36.11
CTC-3124247	3	36.11
CTC-3G5050	3-1/8	18.38
CTC-5P4196	3-1/8	18.38
CTC-5P4976	3-1/8	18.38
CTC-1672471	3-1/4	37.14

CATERPILLAR®

REPLACEMENT PARTS FOR CATERPILLAR® EQUIPMENT

NOTE: CATERPILLAR® kit numbers are used as a reference only. We do not imply that these kits are original REPLACEMENT KITS.

WIPERS

Part Number	Rod Dia.	List Price
CTC-7J7732	3-1/4	24.46
CTC-2253285	3-1/4	37.14
CTC-3E4173	3-1/4	19.97
CTC-5J7034	3-1/4	5.78
CTC-6J4169	3-1/4	24.46
CTC-7K9211	3-1/4	20.07
CTC-8T8389	3-1/4	37.14
CTC-3E4171	3-3/8	5.95
CTC-3G5052	3-3/8	15.95
CTC-5P1177	3-3/8	15.95
CTC-3E4111	3-3/8	3.62
CTC-3119318	3-1/2	38.06
CTC-1433672	3-1/2	38.06
CTC-1672474	3-1/2	38.06
CTC-2253286	3-1/2	38.06
CTC-3E4147	3-1/2	5.95
CTC-3E4176	3-1/2	27.53
CTC-4J8981	3-1/2	38.06
CTC-5J7032	3-1/2	5.95
CTC-7K9212	3-1/2	27.53
CTC-7K9213	3-1/2	23.11
CTC-8C5219	3-1/2	38.06
CTC-8C5219	3-1/2	38.06
CTC-9D6591	3-1/2	20.07
CTC-3E4112	3-1/2	3.67
CTC-3E4134	3-1/2	12.73
CTC-3E4155	3-1/2	8.87
CTC-5U3529	3-1/2	5.95
CTC-3465196	3-3/4	38.73
CTC-2271149	3-3/4	38.73
CTC-3E4113	3-3/4	3.88
CTC-3E4172	3-3/4	6.90
CTC-4T5540	3-3/4	6.90
CTC-5P5322	3-3/4	33.13
CTC-7K9214	3-3/4	33.13
CTC-8C9135	3-3/4	38.73
CTC-8J6069	3-3/4	24.42
CTC-9J1325	3-3/4	24.42
CTC-1389739	4	7.75
CTC-1672482	4	39.00
CTC-2253287	4	39.00
CTC-3E4114	4	4.09
CTC-3E4135	4	16.60
CTC-3E4148	4	7.75
CTC-3E4156	4	9.80
CTC-3E4177	4	38.77

WIPERS

Part Number	Rod Dia.	List Price
CTC-5J2221	4	7.75
CTC-5P0067	4	39.85
CTC-7J5673	4	31.33
CTC-7K9216	4	38.77
CTC-7K9217	4	39.85
CTC-8C5220	4	39.00
CTC-3119321	4	39.00
CTC-2253288	4-1/4	48.80
CTC-3E4115	4-1/4	4.31
CTC-4T1637	4-1/4	8.01
CTC-5P3193	4-1/4	31.99
CTC-7J8942	4-1/4	40.18
CTC-3G5053	4-3/8	47.59
CTC-5P1176	4-3/8	47.59
CTC-2253289	4-1/2	55.11
CTC-2951315	4-1/2	55.11
CTC-3358966	4-1/2	55.11
CTC-3E4116	4-1/2	4.43
CTC-3E4136	4-1/2	19.35
CTC-3E4178	4-1/2	53.73
CTC-3G8505	4-1/2	8.68
CTC-3J4458	4-1/2	53.73
CTC-7K9218	4-1/2	32.18
CTC-3E4157	4-1/2	10.90
CTC-3E4117	4-3/4	4.60
CTC-7J9256	4-3/4	43.82
CTC-7K9219	4-3/4	42.78
CTC-0903016	5	46.43
CTC-3E4118	5	5.43
CTC-3E4137	5	21.65
CTC-3E4149	5	12.12
CTC-3E4158	5	12.89
CTC-7K9220	5	42.78
CTC-8J4520	5	58.17
CTC-9J2547	5	12.12
CTC-9X3582	5	65.69
CTC-3469383	5	65.69
CTC-4T5663	5-1/4	14.97
CTC-3E4119	5-1/4	5.51
CTC-1525063	5-1/2	41.30
CTC-9X3573	5-1/2	41.30
CTC-6J3073	5-1/2	52.86
CTC-9J5469	5-3/4	38.13
CTC-3E4120	5-3/4	6.60
CTC-1U2708	6	17.82
CTC-3E4121	6	6.91

WIPERS

Part Number	Rod Dia.	List Price
CTC-3J7622	6	79.12
CTC-2253294	6	33.08
CTC-3E4122	6-1/2	7.30
CTC-5P2322	6-1/2	77.73
CTC-5P2672	6-1/2	25.76
CTC-6J0542	6-1/2	66.67
CTC-7J2806	6-1/2	61.13
CTC-8J1877	6-1/2	61.13
CTC-3J4460	6-3/4	59.44
CTC-8C9146	6-3/4	77.73
CTC-3E4123	6-3/4	7.43
CTC-2J4779	7	138.61
CTC-5J2682	7	61.47
CTC-8C9136	7	81.15
CTC-9X7333	7	138.61
CTC-9X7366	7	61.47
CTC-3469382	7	81.15
CTC-4T4802	7-1/4	21.82
CTC-7J3320	7-1/2	74.53
CTC-1214172	7-3/4	23.49
CTC-2253299	8	141.29
CTC-8J9934	8-1/2	63.41
CTC-2892957	9	181.20
CTC-6J7694	9	28.94
CTC-9X7354	9	181.20
CTC-1U4625	11	40.32
CTC-9X7353	11	112.26
CTC-9X7368	11	40.32
CTC-4T4130	12-1/2	93.45
CTC-9X7352	12-1/2	117.24
CTC-9X7369	12-1/2	93.45
CTC-9X7350	13-1/2	120.35
CTC-9X7370	13-1/2	197.84
CTC-1449480	30 mm	21.38
CTC-1402392	35 mm	21.92
CTC-1404934	35 mm	17.88
CTC-1921161	40 mm	21.56
CTC-2047233	40 mm	13.27
CTC-1449492	40 mm	22.35
CTC-1754734	40 mm	21.86
CTC-6R8716	40 mm	4.33
CTC-1920625	45 mm	23.50
CTC-1930789	45 mm	9.39
CTC-1991137	45 mm	23.72
CTC-2034038	45 mm	9.39
CTC-1410713	45 mm	22.89

CATERPILLAR®

REPLACEMENT PARTS FOR CATERPILLAR® EQUIPMENT

NOTE: CATERPILLAR® part numbers are used as a reference only. We do not imply that these kits are original REPLACEMENT PARTS.

WIPERS

Part Number	Rod Dia.	List Price
CTC-1461086	45 mm	\$ 23.72
CTC-1980662	45 mm	4.75
CTC-2330617	45 mm	10.11
CTC-2508702	45 mm	23.72
CTC-0993929	50 mm	36.56
CTC-1465884	50 mm	24.03
CTC-1708824	50 mm	24.03
CTC-1921171	50 mm	24.68
CTC-1931374	50 mm	36.56
CTC-2034022	50 mm	36.56
CTC-0957101	50 mm	23.63
CTC-1163393	50 mm	36.56
CTC-1463958	50 mm	24.03
CTC-2330619	50 mm	10.78
CTC-2725681	50 mm	36.56
CTC-2774129	50 mm	24.03
CTC-1708774	55 mm	28.61
CTC-3295791	55 mm	12.73
CTC-3743664	55 mm	28.61
CTC-0996995	55 mm	27.00
CTC-1163392	55 mm	27.00
CTC-1659280	55 mm	28.61
CTC-2330625	55 mm	11.64
CTC-2725644	55 mm	11.06
CTC-2773381	55 mm	28.61
CTC-0961884	60 mm	13.89
CTC-0931433	60 mm	8.14
CTC-0931435	60 mm	29.26
CTC-1163391	60 mm	29.26
CTC-1183119	60 mm	3.82
CTC-1659281	60 mm	31.01
CTC-2330618	60 mm	19.46
CTC-1095257	63 mm	14.86
CTC-3743666	65 mm	32.87
CTC-0957102	65 mm	12.74
CTC-1163390	65 mm	31.03
CTC-1460741	65 mm	25.82
CTC-1659282	65 mm	32.87
CTC-1948332	65 mm	32.87
CTC-A04501417	65 mm	31.03
CTC-2258698	70 mm	26.39
CTC-3743667	70 mm	35.28
CTC-4161295	70 mm	35.28
CTC-0931434	70 mm	10.29
CTC-0931436	70 mm	33.30
CTC-0931439	70 mm	13.36

WIPERS

Part Number	Rod Dia.	List Price
CTC-1163389	70 mm	\$ 33.30
CTC-1659283	70 mm	35.28
CTC-1982952	70 mm	35.28
CTC-2782324	70 mm	163.88
CTC-8Q5891	70 mm	26.39
CTC-A04501418	70 mm	33.30
CTC-3743668	75 mm	37.92
CTC-0965119	75 mm	14.17
CTC-1163388	75 mm	35.80
CTC-1659284	75 mm	37.92
CTC-4161273	75 mm	37.92
CTC-A04501419	75 mm	35.80
CTC-0931440	80 mm	14.53
CTC-0931379	80 mm	16.29
CTC-0990121	80 mm	42.22
CTC-1163387	80 mm	42.22
CTC-1505841	80 mm	44.73
CTC-1659285	80 mm	44.73
CTC-2330637	80 mm	23.91
CTC-4161284	80 mm	44.73
CTC-A04501420	80 mm	42.22
CTC-0940707	85 mm	50.77
CTC-1140644	85 mm	47.92
CTC-1211611	85 mm	50.77
CTC-1540729	85 mm	50.77
CTC-1659286	85 mm	50.77
CTC-2330622	85 mm	29.96
CTC-7Y5115	85 mm	47.92
CTC-2829598	90 mm	26.67
CTC-0931441	90 mm	51.80
CTC-1163386	90 mm	51.80
CTC-1261885	90 mm	54.89
CTC-1540749	90 mm	54.89
CTC-1659287	90 mm	54.89
CTC-1661495	90 mm	34.95
CTC-1672473	90 mm	54.89
CTC-1793046	90 mm	51.80
CTC-7X4803	90 mm	34.95
CTC-1140645	95 mm	35.07
CTC-1359054	95 mm	28.52
CTC-1505828	95 mm	28.52
CTC-1659288	95 mm	28.52
CTC-2330624	95 mm	33.46
CTC-2590655	95 mm	28.52
CTC-7Y4626	95 mm	35.07
CTC-0931437	100 mm	54.39

WIPERS

Part Number	Rod Dia.	List Price
CTC-0944057	100 mm	\$ 57.63
CTC-0960059	100 mm	54.39
CTC-1076254	100 mm	54.39
CTC-1140646	100 mm	54.39
CTC-1336904	100 mm	57.63
CTC-1540736	100 mm	57.63
CTC-1659289	100 mm	57.63
CTC-1672480	100 mm	57.63
CTC-9X4597	100 mm	43.27
CTC-7Y4667	105 mm	20.90
CTC-1140647	105 mm	52.56
CTC-1336813	105 mm	55.68
CTC-1336909	105 mm	55.68
CTC-1540767	105 mm	55.68
CTC-1659290	105 mm	55.68
CTC-1672483	105 mm	55.68
CTC-1119957	110 mm	55.72
CTC-1336814	110 mm	59.03
CTC-1659291	110 mm	59.03
CTC-3033489	110 mm	55.55
CTC-7Y4940	110 mm	55.72
CTC-A04903618	110 mm	55.72
CTC-1915648	115 mm	25.70
CTC-2095877	115 mm	25.70
CTC-1659292	125 mm	33.65
CTC-1704830	125 mm	42.12
CTC-0965536	130 mm	33.63
CTC-1119958	130 mm	66.72
CTC-1362443	130 mm	66.72
CTC-1659293	130 mm	70.69
CTC-1672494	140 mm	72.43
CTC-1076615	140 mm	68.36
CTC-1659294	140 mm	72.43
CTC-1672496	150 mm	75.95
CTC-1076616	150 mm	71.68
CTC-1659296	150 mm	75.95
CTC-7Y0975	150 mm	71.68

CATERPILLAR®

REPLACEMENT PARTS FOR CATERPILLAR® EQUIPMENT

NOTE: CATERPILLAR® part numbers are used as a reference only. We do not imply that these kits are original REPLACEMENT PARTS.

“NYLON INSERT” LOCKING NUTS

Manufactured from the finest quality steel to offer superior strength, Hercules® Sealing Products locking nuts with nylon inserts are specifically designed and manufactured to exact dimensions. The high temperature locking inserts are designed to withstand the high temperatures associated with close tolerance performance applications.

Part Number	Thread Size & Pitch	Height	Flats	List Price
CTC-2J0564	2 - 12	1-5/8	3-1/8	\$ 60.85
CTC-2J3247	1-3/4 - 12	1-7/16	2-3/4	57.00
CTC-2J3950	1-1/2 - 12	1-5/16	2-3/8	39.19
CTC-2J6384	1-1/4 - 12	1-1/8	2	34.92
CTC-2J7686	2-1/2 - 12	2-3/16	4	280.94
CTC-3J6899	2-1/4 - 12	2-13/16	3-1/2	177.41
CTC-3J9449	2-1/2 - 12	2-5/8	4	262.58
CTC-3J9545	2 - 12	2-7/16	3-1/8	163.29
CTC-4J6888	2-3/4 - 12	2-1/4	4	165.98
CTC-4J8734	2-3/4 - 12	3-1/8	4	317.35
CTC-5J3488	2-1/4 - 12	1-15/16	3-1/2	129.57
CTC-5J5731	1-3/4 - 12	1-7/16	2-1/2	46.80
CTC-7J9250	3-1/4 - 12	3-1/8	4-1/2	339.36
CTC-9X6018	4 - 12	3.73	5.62	712.30
CTC-1438149	M48 × 2	50 mm	75 mm	151.72
CTC-1438150	M56 × 2	56 mm	85 mm	159.44
CTC-1336686	M56 × 2	57 mm	80 mm	174.34
CTC-1475835	M64 × 2	63 mm	95 mm	214.32
CTC-7Y4622	M72 × 2	70 mm	105 mm	396.59
CTC-7Y4695	M80 × 2	76 mm	115 mm	379.34
CTC-1232060	M80 × 2	64 mm	115 mm	268.94
CTC-1232112	M90 × 2	76 mm	130 mm	476.02
CTC-7Y4956	M90 × 2	84 mm	130 mm	454.24
CTC-0875385	M95 × 2	88 mm	135 mm	565.72
CTC-1261971	M100 × 2	89 mm	146 mm	1085.51
CTC-1163513	M105 × 2	97 mm	150 mm	976.76
CTC-1163516	M120 × 2	108 mm	170 mm	1080.48

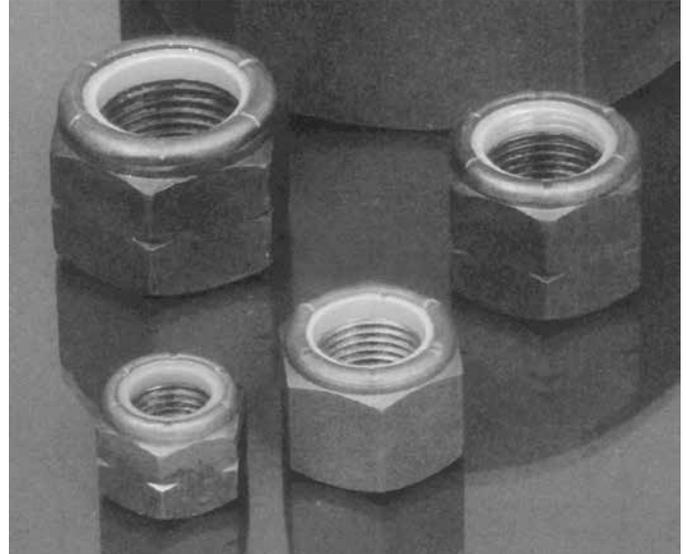

CATERPILLAR®

REPLACEMENT KITS FOR CATERPILLAR® EQUIPMENT

NOTE: CATERPILLAR® part numbers are used as a reference only. We do not imply that these kits are original REPLACEMENT PARTS.

CAT D-RING KIT

This handy kit, in an unbreakable box, contains the 9 most popular sized D-Rings used on CATERPILLAR® equipment.

Part Number: CTC-4C4784

List Price: \$ 160.18



CAT SILICONE O-RING KIT

This handy kit, in an unbreakable box, contains 149 silicone o-rings in the 32 most popular sizes used on CATERPILLAR® equipment.

Part Number: CTC-4C8253

List Price: \$ 431.48



CAT NITRILE O-RING KIT

This handy kit, in an unbreakable box, contains 570 nitrile o-rings in the 32 most popular sizes used on CATERPILLAR® equipment.

Part Number: CTC-4C4782

List Price: \$ 270.64



CAT KIT FACE KIT

This handy kit contains a total of 120 90 Durometer O-Rings in 8 different sizes.

Part Number: CTC-4C5859

List Price: \$ 79.74



CAT FLANGE KIT

This handy kit contains the 6 most popular sized flange seals O-Rings used on CATERPILLAR® equipment.

Part Number: CTC-2701545

List Price: \$ 41.59



REPLACEMENT KITS FOR CATERPILLAR® TOWMOTOR LIFT TRUCKS

NOTE: If you can locate the cylinder group number, it can aid in identifying the proper kit.

Kit Number	Code (Pg. xviii)	Rode X Bore Size	List Price	Kit Number	Code (Pg. xviii)	Rode X Bore Size	List Price
TM-1033947	I-U-10	40 X 90 mm	\$ 71.54	TM-396848	P-UB-11	1-1/4 X 3	\$ 41.58
TM-1040763	P-U-1	70 mm	56.22	TM-396849	I-V-8	2 X 5.025	65.84
TM-1040900	I-U-10	37 X 71 mm	38.55	TM-659060	O-RINGS		7.01
TM-1040948	P-U-1	35 mm	28.60	TM-690003	I-U-5	2 X 5	101.03
TM-1041095	P-U-1	40 x 50 mm	95.04	TM-691389	I-OB-3	1-1/2 X 2-1/2	21.78
TM-1042519	P-U-1	85 X 100 mm	66.58	TM-693683	O-RINGS		8.37
TM-1042609	P-U-4	45 X 55 mm	71.22	TM-694526	I-UB-5	2 X 5	96.81
TM-1146727	P-U-14	50 X 110 mm	103.83	TM-694527	I-UB-5	2-1/2 X 6	107.05
TM-206398	RETAINER RING		0.88	TM-694528	I-U-4,10	2 X 4-1/2	65.71
TM-324908	I-V-8	2 X 4.525	62.49	TM-695522	I-UB-5	1-1/4 X 3-1/2	69.52
TM-375427	I-U-11	1 X 2-1/2	16.97	TM-695523	I-UB-5	1-1/2 X 4	82.99
TM-376968	I-U-1	2-1/2 Rod	33.21	TM-901523	I-U-1	2-1/2, 3-1/4, 4 Stages	151.91
TM-388594-6	P-UB-10	1-1/2 X 3-1/2	40.49	TM-905761	P-U-1	3-1/8, 4-3/8 Stages	197.80
TM-396743	I-P-N-8	3 X 4.025	89.66	TM-905771	P-U-1	2-3/8, 4-3/8 Stages	160.20
TM-396744	I,P-U-8	2-1/2 X 3.525	40.22	TM-905961	VALVE KIT		11.28
TM-396746	I,P-U-1	2-1/4, 3-1/4, 4-1/8 Stages	138.07	TM-905962	VALVE KIT		5.29
TM-396747	P-U-8	3 X 3.525	55.26	TM-906496	I-U-10	3 X 4	53.99
TM-396748	I-U-8	3 X 4.025	51.04	TM-911700	I-U-1	75 mm Rod Kit	45.09
TM-396749	P-U-1	3-1/8, 4-3/8, 5 Stages	234.68	TM-911701	I-U-1	50 mm Rod Kit	47.95
TM-396750	P-U-1	2-3/16 X 2-1/2	47.27	TM-911725	I-O-10	25 X 50 mm	47.75
TM-396751	P-U-8	3-3/4 X 5.025	84.98	TM-911726	I-U-10	35 X 80 mm	57.83
TM-396752	I-U-8	2-5/8 X 3.025	60.97	TM-911956	P-U-1	1-5/8 Rod Kit	23.05
TM-396754	I-U-8	2-1/2 X 3.025	40.04	TM-912067	P-UB-10	1-1/4 X 3	31.06
TM-396755	I-U-8	3 X 3.525	48.58	TM-912711	P-U-1	2-3/8 Rod Kit	35.82
TM-396756	I-P-1-8	3 X 4.025	73.94	TM-912748	P-U-1	2-3/8 Rod Kit	35.92
TM-396757	P-U-1	2-3/8, 4-3/8, 5-3/4 Stages	218.99	TM-914206	P-UB-10	2 X 4-1/2	65.41
TM-396758	I-P-U-1	1-7/8, 2-3/4, 3-5/8 Stages	119.70	TM-914634	I-U-1	3-3/4" Rod	39.50
TM-396759	I-V-1	2.700, 3.450, 5.700 Stgs.	150.08	TM-914635	I-U-10	2 X 2-1/2	68.42
TM-396760	I-V-1	2.200, 2.950, 4.700 Stgs.	116.72	TM-914636	N-U-10	4 X 4-1/2	102.64
TM-396761	I,P-N-8	3 X 5.025	102.08	TM-917170	U-SEAL	4-3/8	33.05
TM-396801	P-U-1	3-3/8, 4-3/8, 5 Stages	260.14	TM-917174	U-SEAL	2-1/4	8.92
TM-396842	P-UB-10	1-1/2 X 3-1/2	39.17	TM-917175	U-SEAL	3-1/4	12.35
TM-396843	P-U-11	1-1/2 X 3-1/2	29.84	TM-917177	U-SEAL	2-3/4	10.65
TM-396844	P-UB-11	1-1/2 X 3-1/2	31.28	TM-918024	P-U-4	150 X 180 mm	368.79
TM-396845	I-U-11	1-1/4 X 3	23.30	TM-919851	P-U-15	120 X 180 mm	653.21
TM-396846	P-UB-10	2 X 4-1/2	88.09	TM-920666	I-U-1	50 mm Rod Kit	39.23
TM-396847	I-V-8	2 X 4.525	57.33	TM-923282	I-U-10	2 X 2-1/2	108.41

CATERPILLAR®

REPLACEMENT PARTS FOR CATERPILLAR® TOWMOTOR LIFT TRUCKS

Part Number	Type	I.D.	O.D.	Hgt.	List Price
TM-5461	Vee Set	1-1/4	1-3/4		\$ 10.85
TM-41248	Vee Set	2.200	2.700	1	19.53
TM-41250	Vee Set	2.950	3.450	1	22.26
TM-41252	Vee Set	4.700	5.290	1	36.40
TM-41340	Vee Set	4.025	5.025	1.3	43.98
TM-67841	Vee Set	2.700	3.450		25.44
TM-67842	Vee Set	3.450	4.250	1.5	46.00

Part Number	Type	I.D.	O.D.	Hgt.	List Price
TM-67843	Vee Set	5.700	6.450		\$ 50.20
TM-303231	Wiper	1	1-3/8	3/16	2.97
TM-303233	Wiper	2			3.44
TM-303260	Vee Set	2.275	3.025	1.2	20.03
TM-371212	Modular Back-up Ring	5	5-3/4	.226	33.75
TM-903016	Wiper	5	5-3/4	3/8	46.43

CHAMPION MOTOR GRADER

Kit Number	Code (Pg. xviii)	Rode X Bore Size	List Price
CHMP-26408	I-U-5	1-3/8 X 3	\$ 47.55
CHMP-26409	I-U-5	2 X 4	68.58
CHMP-26410	I-U-5	2 X 5	92.75

CHAR-LYNN® SEAL KITS*

CHAR-LYNN® Model Identification

XXX - XXX - XXX
 Product - Product - Engineering
 Line Identification Change Code

Kit Number	Series	Description	Model Number	List Price
CHR-6405	10,000 Note: The -002 and -003 bearingless motors use 4 seals while the -004 motor uses 3 seals. Note: This kit is not applicable to 10,000 series two speed motors.	Motor Seal Kit	119-XXXX-002;-003;-004 120-XXXX-002;-003;-004 121-XXXX-002;-003;-004	\$ 109.79
CHR-6406	10,000 Note: Applicable to 10,000 series two speed motors.	Shaft Seal Kit	119-XXXX-001;-002;-003;-004 120-XXXX-002;-003;-004	118.19
CHR-60023	H	Buna N Seal Kit	101-XXXX-007	81.67
	A	Buna N Seal Kit	130-XXXX-001	
CHR-60026	S	Buna N Seal Kit	103-XXXX-007	84.20
CHR-60036	H	Buna N Seal Kit	101-XXXX-005	64.00
CHR-60042	S	Buna N Seal Kit	103-XXXX-006	84.65
CHR-60533	S	Buna N Seal Kit	103-XXXX-008	78.59
CHR-60539	S	Buna N Seal Kit	103-XXXX-009;-010	99.52
CHR-60540	A	Buna N Seal Kit	130-XXXX-002;-003	96.70
	H	Buna N Seal Kit	101-XXXX-008;-009	
CHR-61104	6000	Shaft Seal Kit	112-XXXX-002;-003;-004 113-XXXX-002;-003;-004	164.85
CHR-61105	6000	Rear Motor Kit	112-XXXX-002;-003;-004 113-XXXX-002;-003;-004	60.32
CHR-61234	4000	Rear Motor Kit	109-XXXX-004; 110-XXXX-004	56.01
CHR-61236	4000	Shaft Seal Kit	109-XXXX-004; 110-XXXX-004	88.32
CHR-61237	6000	Shaft Seal Kit	112-XXXX-005; 113-XXXX-005	89.38
CHR-61238	6000	Rear Motor Kit	112-XXXX-005; 113-XXXX-005	80.42
CHR-61252	2000 Note: Not for 106- Bearingless motors.	Buna N Seal Kit	104-XXXX-003;-004;-005 105-XXXX-003;-004;-005	127.15
CHR-61258	2000	Buna N Seal Kit	104-XXXX-006; 105-XXXX-006	127.67
CHR-61259	2000 Note: Does not fit 106-XXXX-003;-004;-005 motors	Buna N Seal Kit	106-XXXX-006	61.96
CHR-64417	Steering unit with external shaft			49.34
CHR-64418	Steering unit with internal spline			84.92

*Original OEM Char-Lynn Kits

CHIEF™ CYLINDERS

Kit Number	Code (Pg. xviii)	Rod X Bore Size	List Price	Kit Number	Code (Pg. xviii)	Rod X Bore Size	List Price
CTR-203-001	P-OB-3	1-1/8" x 2"	\$ 8.94	CTR-781-036	I-U-1	4" Rod Kit	\$ 43.65
CTR-203-002	P-OB-3	1-1/8" x 2-1/2"	9.37	CTR-781-038	I-U-1	5" Rod Kit	66.28
CTR-203-004	P-OB-3	1-1/4" x 3-1/2"	10.66	CTR-781-039	I-U-1	1-1/8" Rod Kit	11.41
CTR-203-005	P-OB-3	1-1/2" x 3-1/2"	11.01	CTR-781-042	I-U-1	2-3/4" Rod Kit	27.14
CTR-203-006	P-OB-3	1-1/4" x 4"	10.49	CTR-781-043	I-U-1	1" Rod Kit	10.42
CTR-203-011	P-OB-3	1-1/4" x 2-3/8"	8.68	CTR-781-044	I-U-1	1-1/8" Rod Kit	11.77
CTR-203-029	P-OB-3	1-1/2" x 3"	10.42	CTR-781-049	I-U-1	2" Rod Kit	20.70
CTR-203-150	P-U-10	1" x 1-1/2"	13.63	CTR-781-100	N-N-10	2" Piston Kit	7.74
CTR-203-151	P-U-10	1-1/4" x 2"	18.90	CTR-781-101	N-N-10	2-1/2" Piston Kit	8.00
CTR-203-152	P-U-10	1-3/8" x 2-1/2"	20.10	CTR-781-102	N-N-10	3" Piston Kit	13.05
CTR-203-153	P-U-10	1-1/2" x 3"	20.65	CTR-781-103	N-N-10	3-1/2" Piston Kit	13.29
CTR-781-007	I-U-1	1-1/2" Rod Kit	16.67	CTR-781-104	N-N-10	4" Piston Kit	14.21
CTR-781-009	I-U-1	2" Rod Kit	20.39	CTR-781-105	N-N-10	4-1/2" Piston Kit	16.75
CTR-781-013	I-U-1	1-3/4" Rod Kit	14.66	CTR-781-107	N-N-10	5-1/2" Piston Kit	18.57
CTR-781-014	I-U-1	2" Rod Kit	24.06	CTR-781-108	N-N-10	6" Piston Kit	24.49
CTR-781-015	I-U-1	2-1/4" Rod Kit	24.85	CTR-781-201	N-N-10	7" Piston Kit	34.13
CTR-781-020	I-U-1	2" Rod Kit	23.35	CTR-781-203	N-N-10	9" Piston Kit	74.27
CTR-781-021	I-U-1	2-1/2" Rod Kit	28.06	CTR-781-204	N-N-10	10" Piston Kit	109.92
CTR-781-022	I-U-1	2-3/4" Rod Kit	28.31	CTR-781-206	N-N-10	12" Piston Kit	181.86
CTR-781-028	I-U-1	3" Rod Kit	30.76	CTR-781-303	I-U-1	4" Rod Kit	31.73
CTR-781-029	I-U-1	3 1/2" Rod Kit	34.55	CTR-781-305	I-U-1	2-1/4" Rod Kit	17.71
CTR-781-030	I-U-1	4" Rod Kit	38.75	CTR-781-310	I-U-1	1-1/4" Rod Kit	10.85
CTR-781-034	I-U-1	4" Rod Kit	41.38	CTR-781-312	I-U-1	1-3/4" Rod Kit	14.06
CTR-781-035	I-U-1	3-1/2" Rod Kit	42.46	CTR-781-313	I-U-1	2" Rod Kit	15.95

CLARK® LIFT TRUCKS

NOTE: A CLARK® deck number can positively identify the kit needed for lift cylinders. Looking at the upright (lift mechanism) from the driver's seat, the deck number is stamped on the right outer channel.

SAMPLE: MO141, HO351, FO168, etc.

ALSO NOTE: Kits with an "E" suffix contain original equipment u-seals. Kits without "E" suffix contain Hercules® Sealing Products designed seals.

Kit Number	Code (Pg. xviii)	Rod X Bore Size	List Price	Kit Number	Code (Pg. xviii)	Rod X Bore Size	List Price
CLK-1795529	I-U-5	1-1/2 X 4	\$ 62.46	CLK-1811179	I-V-5	1-1/2 X 4	\$ 84.66
CLK-1810820	O-RINGS		10.92	CLK-1811180	I-V-5	1-1/4 X 4	77.61
CLK-1811046	I-U-10	1-1/4 X 3	26.16	CLK-1811184	I-V-5	1-1/4 X 3	84.47
CLK-1811107	I-N-4	2 X 2-1/4	27.11	CLK-1811200	I-V-4	2 X 6	153.19
CLK-1811108	I-N-4	2-1/4 X 2-1/2	20.97	CLK-1811200-E	I-V-4	2 X 6	287.45
CLK-1811120		1-3/4, 3-1/8 VID, 3-7/8, 5-1/4 UID	151.72	CLK-1811204	I-V-1	1-1/4 ROD	83.99
CLK-1811120-E		1-3/4, 3-1/8 VID, 3-7/8, 5-1/4 UID	246.22	CLK-1811206	I-V-5	3/4 X 1-5/8	38.68
CLK-1811122		2-1/8 VID, 3-7/8, 4-3/4, 6-1/2 UID	203.70	CLK-1811207	I-V-5	1 X 2	56.13
CLK-1811122-E		2-1/8 VID, 3-7/8, 4-3/4, 6-1/2 UID	283.55	CLK-1811209	I-V-5	1 X 2-1/4	63.29
CLK-1811123-E		3-1/4, 4-1/4 VID'S, 6-1/2 UID'S	298.96	CLK-1811210	I-V-5	1-1/4 X 2-3/4	78.38
CLK-1811124		2-1/8, 3-1/8 VID'S	88.12	CLK-1811212	I-V-5	1-1/4 X 3-1/4	81.62
CLK-1811125		2-1/8, 3-1/8, 4-1/2 VID'S	200.52	CLK-1811217	I-V-5	1-3/4 X 4-1/2	61.99
CLK-1811126		2-3/4, 3-3/4, 5-3/4 VID'S	212.37	CLK-1811218	I-V-5	2 X 6	335.13
CLK-1811127		2-3/4, 3-3/4, 5-3/4 VID'S	217.28	CLK-1811231	N-N-5	2.26" Piston Kit	42.12
CLK-1811129	I-N-4	2-1/2 X 4	43.97	CLK-1811244	I-U-10	1-1/8 X 2-1/4	27.27
CLK-1811130		1-3/4, 2-5/8, 3-3/4 VID'S	126.86	CLK-1811275	I-V-5	1-1/2 X 4	64.04
CLK-1811131		1-3/4, 3-1/8 VID, 3-7/8, 5-1/4 UID	162.55	CLK-1811309	I-U-10	1 X 3	14.59
CLK-1811131-E		1-3/4, 3-1/8 VID, 3-7/8, 5-1/4 UID	221.81	CLK-1811314		1-3/4 VID, 3-1/8, 3-7/8, 5-1/4 UID	134.51
CLK-1811132		1-3/4, 2-5/8 VID, 3-3/8, 4-1/2 UID	115.65	CLK-1811314-E		1-3/4 VID, 3-1/8, 3-7/8, 5-1/4 UID	192.28
CLK-1811132-E		1-3/4, 2-5/8 VID, 3-3/8, 4-1/2 UID	180.46	CLK-1811315		1-3/4 VID, 3-1/8, 3-7/8, 5-1/4 UID	153.26
CLK-1811133		1-3/4, 2-5/8 VID'S	60.12	CLK-1811315-E		1-3/4 VID, 3-1/8, 3-7/8, 5-1/4 UID	195.09
CLK-1811142		1-3/4, 2-5/8, 3-3/4 VID'S	206.97	CLK-1811327		2-1/8 VID, 3-7/8, 4-3/4, 6-1/2 UID	179.70
CLK-1811148		2-1/8 VID, 3-7/8, 4-3/4, 6-1/2 UID	213.64	CLK-1811327-E		2-1/8 VID, 3-7/8, 4-3/4, 6-1/2 UID	283.23
CLK-1811148-E		2-1/8 VID, 3-7/8, 4-3/4, 6-1/2 UID	284.51	CLK-1811369	P-U-4	60 mm X 73 mm	67.68
CLK-1811149	I-U-4	3-1/2 X 4-3/4	97.99	CLK-1811376	I-U-10	40 mm X 4"	50.67
CLK-1811154	I-U-1	2-1/2 X 3-1/4	28.39	CLK-1811392	P-U-10	1-3/4 X 3	65.93
CLK-1811155	I-N-4	2-1/2 X 3	26.80	CLK-1811393	I-U-10	40 mm X 4"	56.07
CLK-1811157	I-U-5	5 X 7	180.76	CLK-1811415	P-U-4	60 X 78 mm	72.12
CLK-1811158	I-U-5	4-1/2 X 6	139.47	CLK-1811537	P-U-1	60 mm	70.55
CLK-1811158-E	I-U-5	4-1/2 X 6	169.36	CLK-1811538	I-U-4	40 X 56 mm	59.90
CLK-1811159		1-3/4, 3-1/8 VID, 3-7/8, 5-1/4 UID	153.46	CLK-1811542	I-U-10	1-3/8 X 3	32.78
CLK-1811159-E		1-3/4, 3-1/8 VID, 3-7/8, 5-1/4 UID	222.71	CLK-1811544	I-U-10	1 X 2	56.87
CLK-1811160		1-3/4, 2-5/8 VID, 3-3/8, 4-1/2 UID	114.82	CLK-1811569	P-U-10	2 X 3-3/8	49.71
CLK-1811160-E		1-3/4, 2-5/8 VID, 3-3/8, 4-1/2 UID	180.46	CLK-1811582	I-U-10	1-1/4 X 3-1/2	30.25
CLK-1811161		1-3/4, 3-1/8 VID, 3-7/8, 5-1/4 UID	154.64	CLK-1811691	P-U-1	2 X 2.450	34.53
CLK-1811161-E		1-3/4, 3-1/8 VID, 3-7/8, 5-1/4 UID	215.57	CLK-1811697	I-U-10	1-1/4 X 3-1/2	31.82
CLK-1811162		2-1/8, 3-1/8, 4-1/2 UID'S	164.49	CLK-1811719	I-U-10	40 mm X 3-1/2	36.15
CLK-1811163		2-1/8, 3-1/8, 4-1/2 VID'S	202.91	CLK-1811759	I-U-10	1-1/4 X 3	31.27
CLK-1811164		1-3/4, 2-5/8, 3-3/8, 4-5/8 UID'S	102.55	CLK-1811785	I-U-10	40 mm x 3-1/2	42.29
CLK-1811164-E		1-3/4, 2-5/8, 3-3/8, 4-5/8 UID'S	200.57	CLK-1811799	I-U-10	2 X 3-3/8	80.07

CLARK® LIFT TRUCKS

Kit Number	Code (Pg. xviii)	Rod X Bore Size	List Price
CLK-1811820	I-U-10	2 X 3	\$ 31.78
CLK-1811828	I-U-10	2 X 3	28.09
CLK-1811852	I-U-1	3 X 3-1/2	62.40
CLK-1811855	P-U-1	60 mm X 72 mm	43.50
CLK-1811972	I-U-10	1-1/4 X 3	39.75
CLK-1813014	P-U-1	2 X 2-1/2	42.84
CLK-1813015	I-U-1	2-5/8 Rod Kit	69.79
CLK-1813016	I-U-1	3 X 3-1/2	55.30
CLK-1813017	P-U-1	60mm X 72 mm	43.50
CLK-1813023	I-U-1	40 mm X 2-3/16"	41.85
CLK-1813024	I-U-1	40 mm Rod Kit	20.89
CLK-1813032	I-U-10	50 mm X 3-3/8"	66.78
CLK-1813055	I-U-10	50 mm X 3-1/8"	72.39
CLK-1813075	I-U-10	40 mm X 3-1/2"	41.36
CLK-1813076	I-U-10	40 mm X 4"	44.19
CLK-1813082	I-U-10	50 X 86 mm	61.13
CLK-1813084	I-U-1	50 mm Rod Kit	24.00
CLK-1813176	I-U-4	60 X 73 mm	75.15
CLK-1818816	P-U-10	3/4 X 1-3/4	26.80
CLK-1818864	P-U-10	3/4 X 2	19.89
CLK-1821328	I-U-10	7/8 X 2	13.96
CLK-1830350	I-N-4	2 X 2-1/4	29.30
CLK-1830352	I-N-4	3-1/4 X 4	44.33
CLK-1830358	I-N-4	2-1/2 X 3-1/4	52.34
CLK-1830360	I-N-4	2-1/2 X 3	29.84
CLK-1830361	I-N-4	2-1/4 X 2-1/2	33.71
CLK-1830649	I-U-10	3/4 X 2-3/4	32.48
CLK-1831042	N-V-1	1-1/4" Rod Kit	9.68

Kit Number	Code (Pg. xviii)	Rod X Bore Size	List Price
CLK-1831074	I-U-10	1-3/4 X 4-1/2	\$ 43.11
CLK-1831075	I-V-1	3-1/4 Rod Kit	42.99
CLK-1831076	I-U-10	1-1/8 X 2-1/2	27.11
CLK-1991085	P-TR-10	2 X 4	40.76
CLK-2367420	I-U-1	2-1/4 X 3-1/4	103.33
CLK-3009626	P-U-10	25 mm X 50 mm	68.62
CLK-3986876	MOTOR KIT		28.88
CLK-841270	P-U-10	2 X 3-3/4	35.22
CLK-886547	P-TR-12	1 X 2	48.43
CLK-896505	MOTOR KIT		7.20
CLK-905074	MOTOR KIT		15.92
CLK-907984	VALVE KIT		18.01
CLK-908985	VALVE KIT		17.20
CLK-912339	P-U-1	2-1/2 X 3	38.62
CLK-914698	I-U-4	1 X 2-1/2	27.32
CLK-914703	I-O-4	1-1/4 X 3	18.26
CLK-917282	O-RING KIT		7.90
CLK-917713	N-N-10	2" Piston Kit	22.11
CLK-918886	I-U-10	2 X 3-3/8	39.00
CLK-921115A	VALVE KIT		10.47
CLK-990076	VALVE KIT		4.41
CLK-990208	SWIVEL KIT		7.05
CLK-990209	SWIVEL KIT		10.54
CLK-992511	O-RING KIT		7.22
CLK-994287	VALVE KIT		12.46
CLK-995815	SWIVEL KIT		10.54
CLK-999820	P-U-10	3/4 X 1-3/4	34.71

CLARK®

FOR CLARK®-MICHIGAN CONSTRUCTION EQUIPMENT
SEE OUR LISTING OF KITS UNDER THE VOLVO SECTION IN THIS CATALOG.

U-SEALS

Part Number	Rod Dia.	List Price
CLK-2377669	48 mm	\$ 20.92
CLK-2791698	50 mm	14.96
CLK-2793753	40 mm	14.02
CLK-328300	1	7.98

PISTON U-SEALS

Part Number	Bore Dia.	List Price
CLK-1650143	2.266	\$ 15.60

O-RINGS

Part Number	Min Pkg Qty	List Price
CLK-1301093	20	\$ 0.50
CLK-2825250	1	6.29

BACK-UP RINGS

Part Number	Min Pkg Qty	List Price
CLK-994384	2	\$ 2.46

WIPERS

Part Number	Rod Dia.	List Price
CLK-1657085	1-1/4	\$ 2.99

VEE SETS

Part Number	Rod Dia.	List Price
CLK-1665683	1-1/4	\$ 22.36

COMMERCIAL® HYDRAULICS

- PACKING:** Vee packing with nylon top and bottom adaptors.
5/16" cross section.
- WIPERS:** .190 shoulder thickness on wipers.
- BEARINGS:** One above packing - may be either bronze or nylon.
- PISTON:** Welded to stage. Single action uses single nylon wear ring. Double action uses 3 cast iron piston rings and 2 nylon wear rings.
- STAGE O.D.'s:** 2.750; 3.750; 4.750; 5.750; 6.750; 7.905; 9.375
- SPECIAL INFO.:** Threaded internal stop ring. Uses wave spring under vee packing.
- IDENTIFICATION:** Cylinder number stamped on metal tag on cylinder body.
Ex: SD85MC-15-220 double acting
S85DC-40-190 single acting

COMMERCIAL

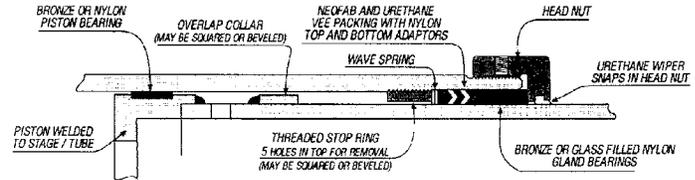

CYLINDER REBUILD KITS SINGLE ACTING DUMP BODY CYLINDERS

Kit includes: Wiper Rings, Packing Assemblies, Bearing Rings, Piston Bearings, Wave Springs, Set Screws & Nylon Balls

Part Number	Cyl. Model Number	List Price
CM-375-1804-017	S53	\$ 170.58
CM-375-1804-020	S62	156.03
CM-375-1804-018	S63	212.50
CM-375-1804-021	S64	256.39
CM-375-1804-019	S73	268.60
CM-375-1804-022	S74	350.62
CM-375-1804-023	S84	405.06
CM-375-1804-024	S85	479.58
CM-375-1804-025	S95	694.54

CYLINDER REPACK KITS SINGLE ACTING DUMP BODY CYLINDERS

Kit includes: Wiper Rings, Packing Assemblies

Part Number	Cyl. Model Number	List Price
CM-391-1804-020	S53	\$ 73.63
CM-375-1804-026	S62	89.02
CM-391-1804-109	S63	93.21
CM-391-1804-237	S64	112.17
CM-375-1804-002	S73	125.14
CM-375-1804-003	S74	149.36
CM-391-1804-054	S84	238.43
CM-391-1804-060	S85	209.04
CM-375-1804-004	S95	389.67

Part Number	Description	List Price
PACKING & WIPERS (INCLUDES SHIMS)		
CM-3VSW	2-3/4" Vee Set & Wiper	\$ 25.54
CM-4VSW	3-3/4" Vee Set & Wiper	26.80
CM-5VSW	4-3/4" Vee Set & Wiper	33.49
CM-6VSW	5-3/4" Vee Set & Wiper	42.67
CM-7VSW	6-3/4" Vee Set & Wiper	61.98
CM-8VSW	7.905" Vee Set & Wiper	65.92
CM-9.37VSW	9-3/8" Vee Set & Wiper	136.10

Part Number	Description	List Price
GLAND BEARINGS		
CM-275NB	2-3/4" Gland Bearing	\$ 17.60
CM-375NB	3-3/4" Gland Bearing	17.63
CM-475NB	4-3/4" Gland Bearing	27.03
CM-575NB	5-3/4" Gland Bearing	31.09
CM-675NB	6-3/4" Gland Bearing	32.64
CM-790NB	7.905" Gland Bearing	49.21
CM-937NB	9-3/8" Gland Bearing	106.96
GLAND BEARINGS KITS		
CM-NYB35	2-3/4" - 4-3/4" Gland Bearings	\$ 57.62
CM-NYB46	3-3/4" - 5-3/4" Gland Bearings	70.10
CM-NYB47	3-3/4" - 6-3/4" Gland Bearings	101.09
CM-NYB48	3-3/4" - 7.905" Gland Bearings	147.77
CM-NYB49	3-3/4" - 9-3/8" Gland Bearings	318.40
CM-NYB57	4-3/4" - 6-3/4" Gland Bearings	84.80
CM-NYB58	4-3/4" - 7.905" Gland Bearings	131.99
PISTON BEARINGS		
CM-391-2684-123	2-3/4" Piston Bearing	\$ 4.43
CM-391-2684-069	3-3/4" Piston Bearing	6.60
CM-391-2684-070	4-3/4" Piston Bearing	6.68
CM-391-2684-071	5-3/4" Piston Bearing	7.55
CM-391-2684-072	6-3/4" Piston Bearing	8.65
CM-391-2684-098	9-3/8" Piston Bearing	20.74
NYLON PISTON BEARINGS		
CM-U3023-32	2-3/4" Piston Bearing	\$ 4.43
CM-U3023-42	3-3/4" Piston Bearing	6.60
CM-U3023-52	4-3/4" Piston Bearing	6.68
CM-U3023-62	5-3/4" Piston Bearing	7.55
CM-U3023-72	6-3/4" Piston Bearing	8.65
CM-U3023-84	7.905" Piston Bearing	10.24
CM-U3023-98	9-3/8" Piston Bearing	20.74
CM-X29-1	Bleeder Valve	5.36
BRONZE PISTON BEARINGS		
CM-375-9023-038	4-3/4" Bronze Piston Bearings	\$ 79.74
CM-U3023-52B	4-3/4" Bronze Piston Bearings	79.74
CM-375-9023-039	5-3/4" Bronze Piston Bearings	89.32
CM-U3023-62B	5-3/4" Bronze Piston Bearings	89.32

COMMERCIAL® HYDRAULICS

Part Number	Description	List Price
BRONZE PISTON BEARINGS		
CM-375-9023-040	6-3/4" Bronze Piston Bearings	\$ 93.16
CM-U3023-72B	6-3/4" Bronze Piston Bearings	93.16
CM-375-9023-041	7.905" Bronze Piston Bearings	108.95
CM-U3023-84B	7.905" Bronze Piston Bearings	108.95
CM-375-9023-042	9-3/8"-stage Bronze Piston Bearings	275.77
CM-U3023-98B	9-3/8" Bronze Piston Bearings	275.77
PISTON RINGS (Double Acting)		
CM-X78-4-25	3-3/4" Piston Ring	\$ 12.02
CM-X78-5-25	4-3/4" Piston Ring	15.82
CM-X78-6-25	5-3/4" Piston Ring	18.67
CM-X78-7-25	6-3/4" Piston Ring	27.66
CM-X78-8-437	7.905" Piston Ring	38.41
CM-X78-9-88	9-3/8" Piston Ring	80.99
KITS		
CM-35	2-3/4" - 4-3/4" Vee Sets & Wipers	\$ 73.63
CM-36	2-3/4" - 5-3/4" Vee Sets & Wipers	112.17
CM-38	2-3/4" - 7.905" Vee Sets & Wipers	228.08
CM-46	3-3/4" - 5-3/4" Vee Sets & Wipers	93.21
CM-47	3-3/4"-6-3/4" Vee Sets & Wipers	149.36
CM-48	3-3/4"-7.905" Vee Sets & Wipers	209.04
CM-49	3-3/4"-9-3/8" Vee Sets & Wipers	428.73
CM-56	4-3/4 - 5-3/4" Vee Sets & Wipers	89.02
CM-57	4-3/4"-6-3/4" Vee Sets & Wipers	125.14
CM-58	4-3/4"-7.905" Vee Sets & Wipers	238.43
CM-59	5"-9" Vee Sets & Wipers	389.67
CM-69	5-3/4"-9-3/8" Vee Sets & Wipers	304.30
CM-NPB35	2-3/4"-4-3/4" Piston Bearings	21.65
CM-NPB36	2-3/4"-5-3/4" Piston Bearings	61.31
CM-NPB46	3-3/4"-5-3/4" Piston Bearing	50.98
CM-NPB47	3-3/4"-6-3/4" Piston Bearings	36.09
CM-NPB48	3-3/4"-7.905" Piston Bearings	97.02
CM-NPB57	4-3/4"-6-3/4" Piston Bearings	27.99
CM-NPB58	4-3/4"-7.905" Piston Bearings	80.84
CM-NYB35	2-3/4"-4-3/4" Gland Bearings	57.62
CM-NYB36	2-3/4"-5-3/4" Gland Bearings	86.72
CM-NYB47	3-3/4"-6-3/4" Gland Bearings	101.09
CM-NYB48	3-3/4"-7.905" Gland Bearings	147.77
CM-NYB57	4-3/4"-6-3/4" Gland Bearings	84.80
CM-NYB58	4-3/4"-7.905" Gland Bearings	131.99
CM-NYB69	5-3/4"-9-3/8" Gland Bearings	157.72
CM-PR48	3-3/4"-7.905" Piston Rings	370.67
CM-PR58	4-3/4"-7.905" Piston Rings	324.18
CM-375-1805-062	2-3/4,3-3/4,4-3/4	339.48
THREADED STOPS		
CM-F3020	3-3/4" Threaded Stop Ring	\$ 236.69
CM-F4020	2-3/4" Threaded Stop Ring	99.32
CM-F5020	5-3/4" Threaded Stop Ring	108.95
CM-F6020	4-3/4" Threaded Stop Ring	114.69

Part Number	Description	List Price
THREADED STOPS		
CM-F7020	6-3/4" Threaded Stop Ring	\$ 126.22
CM-F9020	9-3/8" Threaded Stop Ring	619.00
CM-G8020	7.905" Threaded Stop Ring	156.39
HEAD NUTS (MEASURED AT WIPER I.D.)		
CM-MA3011-37	3-3/4" Bronze Internal Head Nut	\$ 130.40
CM-MA3011-47	4-3/4" Bronze Internal Head Nut	155.41
CM-MA3011-57	5-3/4" Bronze Internal Head Nut	305.57
CM-MA3011-67	6-3/4" Bronze Internal Head Nut	335.68
CM-MA3011-79	7.905" Bronze Internal Head Nut	378.69
CM-MA3011-93	9-3/8" Bronze Internal Head Nut	565.39
CM-391-1470-162	2-3/4" Steel External Head Nut	87.42
CM-YA3011-27	2-3/4" Steel External Head Nut	87.42
CM-391-1470-163	3-3/4" Steel External Head Nut	113.38
CM-YA3011-37	3-3/4" Steel External Head Nut	113.38
CM-391-1470-164	4-3/4" Steel External Head Nut	116.85
CM-YA3011-47	4-3/4" Steel External Head Nut	116.85
CM-391-1470-165	5-3/4" Steel External Head Nut	143.78
CM-YA3011-57	5-3/4" Steel External Head Nut	143.78
CM-391-1470-166	6-3/4" Steel External Head Nut	186.60
CM-YA3011-67	6-3/4" Steel External Head Nut	186.60
CM-YA3011-79	7.905" Steel External Head Nut	265.27
CM-YA3011-93	9-3/8" Steel External Head Nut	547.05
VALVE SERVICE KITS		
CM-391-1803-030	Valve Series A20 Service Kit	\$ 6.73
CM-391-1803-201	Valve Series A35 Service Kit	32.95
WAVE SPRINGS		
CM-P1327-27	2-3/4" Wave Spring	\$ 18.00
CM-391-3581-320	2-3/4" Wave Spring	18.00
CM-375-9327-003	3-1/8" Wave Spring	14.42
CM-P1327-37	3-3/4" Wave Spring	12.18
CM-391-3581-300	3-3/4" Wave Spring	12.18
CM-391-3581-300	3-3/4" Wave Spring	12.18
CM-375-9327-008	4-1/8" Wave Spring	10.96
CM-P1327-47	4-3/4" Wave Spring	14.43
CM-391-3581-301	4-3/4" Wave Spring	14.43
CM-P1327-57	5-3/4" Wave Spring	14.55
CM-391-3581-302	5-3/4" Wave Spring	14.55
CM-P1327-67	6-3/4" Wave Spring	39.56
CM-391-3581-303	6-3/4" Wave Spring	39.56
CM-P1327-79	7.905" Wave Spring	57.21
CM-P1327-93	9-3/8" Wave Spring	91.54
CM-391-3581-310	9-3/8" Wave Spring	91.54
MISCELLANEOUS		
CM-391-1281-005	Grease Fitting 1/8 NPT	\$ 1.05
CM-375-2686-010	Lock Wire	12.67
CM-391-1431-121	Set Screw	0.96
CM-391-1431-141	Set Screw	1.19
CM-391-0284-004	Nylon Slug	1.46

REPLACEMENT PARTS FOR COMMERCIAL® EQUIPMENT

NOTE: Commercial part numbers are used as a reference only. We do not imply that these kits are original REPLACEMENT PARTS.

BACK-UP RINGS

Part Number	Min. Pkgs.	List Price
CM-11218	10	\$ 0.90
CM-11224	10	0.98
CM-11228	10	1.04
CM-11232	10	1.18
CM-11236	10	1.29
CM-11252	1	3.41
CM-11322	10	0.90
CM-11326	10	1.04
CM-11330	10	1.04
CM-11334	10	1.09
CM-11336	10	1.18
CM-11338	10	1.26
CM-11339	10	1.33
CM-11342	5	1.54
CM-11343	5	1.73
CM-11346	5	2.27
CM-11347	5	2.37
CM-11350	5	2.68
CM-11351	1	3.00
CM-11354	1	3.22
CM-11355	1	3.41
CM-11358	1	3.87
CM-11359	1	4.08
CM-11364	1	4.57
CM-11368	1	4.57
CM-11425	3	2.68
CM-11429	1	3.48
CM-11433	1	3.89
CM-11439	1	4.54
CM-11443	1	6.36
CM-11448	1	11.53
CM-11450	1	12.51
CM-375-2681-031	1	4.95
CM-375-2681-041	10	1.29
CM-375-2681-042	5	3.23
CM-375-2681-049	1	3.89
CM-375-2681-050	5	2.73
CM-375-2681-056	1	5.05
CM-375-2681-063	5	1.70
CM-391-2681-016	25	0.34

BACK-UP RINGS

Part Number	Min. Pkgs.	List Price
CM-391-2681-040	1	\$ 4.93
CM-391-2681-041	10	1.29
CM-391-2681-064	1	3.50
CM-391-2681-068	1	4.46
CM-391-2681-070	1	4.50
CM-391-2681-074	1	5.92
CM-391-2681-075	1	\$ 5.97
CM-391-2681-081	1	7.17
CM-391-2681-090	1	7.69
CM-391-2681-261	1	4.52
CM-391-2681-303	10	0.48
CM-391-2681-320	10	0.55
CM-391-2681-326	10	0.73
CM-391-2681-330	5	1.80
CM-391-2681-331	5	2.31
CM-391-2681-354	5	2.23
CM-391-2681-389	1	7.21
CM-391-2681-409	25	0.43
CM-391-2681-410	25	0.47
CM-391-2681-413	5	1.69
CM-391-2681-419	1	4.52
CM-391-2681-420	5	2.21
CM-391-2681-436	10	0.96
CM-391-2681-450	10	1.49
CM-391-2681-551	1	7.23
CM-391-2681-572	5	2.06
CM-391-2681-574	25	0.41
CM-391-2681-576	5	1.93
CM-391-2681-578	10	1.49
CM-391-2681-639	25	0.48
CM-391-2691-001	10	0.62
CM-391-2691-002	10	0.67
CM-391-2691-008	10	0.99
CM-391-2691-016	10	1.49
CM-391-2691-028	5	2.79
CM-391-2691-034	1	3.71
CM-391-2691-040	1	4.93
CM-391-2691-043	1	6.01
CM-391-2881-450	10	1.49

BUFFER RINGS

Part Number	Rod Dia.	List Price
CM-260015	1-1/8	\$ 16.25
CM-375-9006-333	1-3/4	23.46
CM-26004	2	24.68
CM-375-9006-344	2	26.56
CM-26010	2-5/8	33.22
CM-375-9006-345	3	40.33
CM-26036	4	56.68
CM-375-9006-513	5	75.46
CM-375-9006-516	5	74.95
CM-375-9006-480	7	82.37

O-RINGS

Part Number	Min. Pkgs.	List Price
CM-10016	50	\$ 0.07
CM-10022	50	0.10
CM-10113	50	0.07
CM-10116	50	0.09
CM-10120	50	0.10
CM-10128	20	0.23
CM-10129	20	0.23
CM-10153	20	0.65
CM-10218	50	0.20
CM-10222	20	0.26
CM-10224	20	0.54
CM-10228	20	0.42
CM-10230	20	0.50
CM-10232	20	0.53
CM-10232U	2	11.95
CM-10236	20	0.65
CM-10242	10	0.79
CM-10246	10	1.12
CM-10252	10	1.29
CM-10254	5	1.51
CM-10322	20	0.29
CM-10326	20	0.32
CM-10330	20	0.56
CM-10334	20	0.72
CM-10336	10	0.85

REPLACEMENT PARTS FOR COMMERCIAL® EQUIPMENT

NOTE: Commercial part numbers are used as a reference only. We do not imply that these kits are original REPLACEMENT PARTS.

O-RINGS			O-RINGS			O-RINGS		
Part Number	Min. Pkgs.	List Price	Part Number	Min. Pkgs.	List Price	Part Number	Min. Pkgs.	List Price
CM-10338	10	\$ 0.88	CM-391-2881-001	30	\$ 0.36	CM-391-2881-043	2	\$ 5.38
CM-10339	10	0.98	CM-391-2881-002	30	0.36	CM-391-2881-044	2	5.60
CM-10342	10	1.15	CM-391-2881-003	20	0.41	CM-391-2881-046	1	6.99
CM-10343	10	1.18	CM-391-2881-004	20	0.41	CM-391-2881-048	1	7.86
CM-10346	10	1.29	CM-391-2881-005	20	0.48	CM-391-2881-049	1	8.23
CM-10347	10	1.29	CM-391-2881-006	15	0.53	CM-391-2881-050	1	8.71
CM-10350	5	1.51	CM-391-2881-007	15	0.57	CM-391-2881-051	1	9.70
CM-10351	5	1.51	CM-391-2881-008	15	0.66	CM-391-2881-052	1	10.65
CM-10354	5	1.76	CM-391-2881-009	15	0.66	CM-391-2881-053	1	11.89
CM-10355	5	1.96	CM-391-2881-010	15	0.66	CM-391-2881-054	1	13.21
CM-10358	5	2.16	CM-391-2881-012	10	0.77	CM-391-2881-055	1	14.54
CM-10359	5	2.16	CM-391-2881-013	10	0.81	CM-391-2881-056	1	19.93
CM-10364	5	2.63	CM-391-2881-014	10	0.86	CM-391-2881-095	50	0.34
CM-10368	5	2.74	CM-391-2881-015	10	0.88	CM-391-2881-096	50	0.20
CM-10425	5	1.64	CM-391-2881-016	5	1.36	CM-391-2881-100	20	0.26
CM-10429	5	1.84	CM-391-2881-017	5	1.65	CM-391-2881-102	50	0.19
CM-10433	5	2.13	CM-391-2881-018	5	1.74	CM-391-2881-113	20	0.69
CM-10439	5	2.74	CM-391-2881-019	4	1.88	CM-391-2881-114	10	0.79
CM-10443	1	3.39	CM-391-2881-020	3	1.88	CM-391-2881-117	10	1.29
CM-10448	1	4.06	CM-391-2881-021	4	2.14	CM-391-2881-124	20	0.32
CM-10450	1	4.91	CM-391-2881-022	2	2.97	CM-391-2881-140	50	0.20
CM-30337	10	1.29	CM-391-2881-023	5	1.22	CM-391-2881-142	20	0.54
CM-30345	7	1.48	CM-391-2881-024	5	1.29	CM-391-2881-146	10	1.25
CM-30349	6	1.74	CM-391-2881-025	5	1.43	CM-391-2881-153	5	1.64
CM-30427	3	2.78	CM-391-2881-027	10	0.90	CM-391-2881-154	10	1.12
CM-30431	3	2.78	CM-391-2881-028	4	1.65	CM-391-2881-165	5	2.16
CM-30434	3	2.83	CM-391-2881-029	5	1.74	CM-391-2881-167	10	0.85
CM-375-2881-025	1	4.21	CM-391-2881-030	3	1.74	CM-391-2881-172	20	0.23
CM-375-2881-033	5	3.84	CM-391-2881-031	3	1.88	CM-391-2881-187	1	3.73
CM-375-2881-038	10	1.29	CM-391-2881-032	3	2.00	CM-391-2881-189	1	4.06
CM-375-2881-039	5	3.06	CM-391-2881-033	3	2.12	CM-391-2881-197	50	0.25
CM-375-2881-043	1	3.05	CM-391-2881-034	3	2.33	CM-391-2881-215	50	0.19
CM-375-2881-044	5	2.67	CM-391-2881-035	3	2.46	CM-391-2881-230	5	2.10
CM-375-2881-047	1	4.34	CM-391-2881-036	3	2.72	CM-391-2881-232	20	0.72
CM-375-2881-048	5	1.29	CM-391-2881-037	3	2.95	CM-391-2881-237	20	0.72
CM-375-2881-051	5	1.76	CM-391-2881-038	3	3.31	CM-391-2881-263	1	14.54
CM-375-2881-052	5	2.02	CM-391-2881-039	3	3.64	CM-391-2881-280	5	2.63
CM-375-2881-056	1	4.59	CM-391-2881-040	2	3.86	CM-391-2881-321	50	0.10
CM-375-2884-002	5	1.66	CM-391-2881-041	2	4.05	CM-391-2881-322	50	0.10
CM-391-2811-371	10	2.00	CM-391-2881-042	2	4.41	CM-391-2881-323	50	0.10

REPLACEMENT PARTS FOR COMMERCIAL® EQUIPMENT

NOTE: Commercial part numbers are used as a reference only. We do not imply that these kits are original REPLACEMENT PARTS.

O-RINGS

Part Number	Min. Pkgs.	List Price
CM-391-2881-324	50	\$ 0.10
CM-391-2881-325	50	0.10
CM-391-2881-326	50	0.10
CM-391-2881-327	50	0.11
CM-391-2881-328	50	0.11
CM-391-2881-329	50	0.14
CM-391-2881-330	50	0.14
CM-391-2881-331	50	0.14
CM-391-2881-332	50	0.14
CM-391-2881-333	50	0.16
CM-391-2881-334	50	0.27
CM-391-2881-335	50	0.27
CM-391-2881-336	50	0.29
CM-391-2881-337	50	0.30
CM-391-2881-338	50	0.30
CM-391-2881-339	50	0.34
CM-391-2881-340	50	0.34
CM-391-2881-342	20	0.41
CM-391-2881-343	20	0.43
CM-391-2881-344	20	0.47
CM-391-2881-345	20	0.47
CM-391-2881-346	20	0.53
CM-391-2881-347	20	0.68
CM-391-2881-348	20	0.68
CM-391-2881-349	20	0.72
CM-391-2881-350	20	0.77
CM-391-2881-351	20	0.92
CM-391-2881-352	20	0.98
CM-391-2881-353	10	1.02
CM-391-2881-356	10	1.27
CM-391-2881-357	10	1.39
CM-391-2881-358	10	1.45
CM-391-2881-359	10	1.50
CM-391-2881-360	10	1.65
CM-391-2881-361	10	1.74
CM-391-2881-362	50	0.11
CM-391-2881-363	50	0.11
CM-391-2881-364	5	3.28
CM-391-2881-365	1	4.02
CM-391-2881-366	1	6.45

O-RINGS

Part Number	Min. Pkgs.	List Price
CM-391-2881-367	1	\$ 7.38
CM-391-2881-368	10	1.45
CM-391-2881-369	10	1.50
CM-391-2881-370	5	2.03
CM-391-2881-372	5	3.13
CM-391-2881-373	5	3.86
CM-391-2881-374	1	4.92
CM-391-2881-379	1	4.96
CM-391-2881-380	1	5.41
CM-391-2881-381	1	5.71
CM-391-2881-382	1	6.08
CM-391-2881-383	1	6.32
CM-391-2881-384	1	8.37
CM-391-2881-386	1	15.24
CM-391-2881-387	1	15.77
CM-391-2881-394	3	3.24
CM-391-2881-406	1	7.07
CM-391-2881-407	5	2.32
CM-391-2881-410	1	14.82
CM-391-2881-411	10	1.88
CM-391-2881-425	1	9.11
CM-391-2881-443	50	0.22
CM-391-2881-451	20	0.77
CM-391-2881-452	1	11.69
CM-391-2881-454	50	0.10
CM-391-2881-474	1	19.22
CM-391-2881-475	1	21.45
CM-391-2881-476	20	0.68
CM-391-2881-480	20	0.38
CM-391-2881-481	10	0.95
CM-391-2881-486	5	1.44
CM-391-2881-487	2	2.74
CM-391-2881-498	20	0.41
CM-391-2881-499	20	0.50
CM-391-2881-601	2	4.94
CM-391-2881-602	2	6.03
CM-391-2881-603	10	0.88
CM-391-2881-610	5	1.47
CM-391-2881-612	3	1.96
CM-391-2881-620	2	3.46

O-RINGS

Part Number	Min. Pkgs.	List Price
CM-391-2881-632	50	\$ 0.22
CM-391-2881-634	50	0.12
CM-391-2881-649	10	0.98
CM-391-2881-699	2	4.63
CM-391-2881-700	1	7.74
CM-391-2881-701	1	31.50
CM-391-2881-702	1	41.37
CM-391-2881-705	5	3.44
CM-391-2881-708	2	3.50
CM-391-2881-714	1	21.09
CM-391-2881-715	1	25.95
CM-391-2881-716	1	13.60
CM-391-2881-719	40	0.36
CM-391-2881-726	1	7.18
CM-391-2881-728	10	1.02
CM-391-2881-731	1	4.62
CM-391-2881-732	10	1.41
CM-391-2881-733	1	7.25
CM-391-2881-734	1	8.01
CM-391-2881-735	20	0.64
CM-391-2881-760	5	2.40
CM-391-2881-761	10	1.19
CM-391-2881-762	1	4.59
CM-391-2881-763	20	0.83
CM-391-2881-764	5	2.14
CM-391-2881-765	20	0.68
CM-391-2881-766	10	1.98
CM-391-2881-772	10	1.04
CM-391-2881-777	10	1.22
CM-391-2881-783	20	0.77
CM-391-2881-785	50	0.26
CM-391-2881-792	50	0.14
CM-391-2881-793	50	0.11
CM-391-2881-795	50	0.26
CM-391-2881-796	50	0.26
CM-391-2881-822	50	0.09
CM-391-2881-839	50	0.12
CM-391-2882-230	10	1.79
CM-391-2882-236	50	0.12
CM-391-2882-328	20	0.65

REPLACEMENT PARTS FOR COMMERCIAL® EQUIPMENT

NOTE: Commercial part numbers are used as a reference only. We do not imply that these kits are original REPLACEMENT PARTS.

O-RINGS

Part Number	Min. Pkgs.	List Price
CM-391-2884-003	12	\$ 0.77
CM-391-2884-029	3	3.53

PISTON RINGS

Part Number	Bore Dia.	List Price
CM-31150	1-1/2	\$ 7.05
CM-31201	2	10.66
CM-31202	2	10.32
CM-31203	2	12.88
CM-31251	2	10.01
CM-31252	2-1/2	10.01
CM-31302	3	10.41
CM-31303	3	10.80
CM-31304	3	10.87
CM-31321	3-1/4	10.41
CM-31322	3-1/4	10.41
CM-31323	3-1/4	10.54
CM-375-9078-024	3.49	10.94
CM-31351	3-1/2	10.94
CM-31352	3-1/2	10.94
CM-31353	3-1/2	10.94
CM-391-2681-637	3-1/2	10.94
CM-31375	3-3/4	11.27
CM-31403	3.99	11.37
CM-31402	4	10.95
CM-31404	4	11.37
CM-375-9078-025	4	10.95
CM-31423	4-1/4	12.02
CM-31452	4-1/2	12.02
CM-31453	4-1/2	12.41
CM-31454	4-1/2	12.27
CM-375-9078-026	4-1/2	12.02
CM-391-2681-636	4-1/2	12.41
CM-31475	4-3/4	12.30
CM-31502	5	12.66
CM-31503	5	12.66
CM-31504	5	19.52
CM-31512	5-1/8	18.30
CM-391-2683-019	5.26	15.82
CM-31552	5-1/2	17.10
CM-31553	5-1/2	17.10
CM-31554	5-1/2	17.10

PISTON RINGS

Part Number	Bore Dia.	List Price
CM-375-9078-016	5-1/2	\$ 17.10
CM-375-9078-027	5-1/2	17.10
CM-31575	5-3/4	24.85
CM-31603	6	17.28
CM-31604	6	17.28
CM-31624	6-1/4	27.09
CM-391-2683-024	6.26	18.67
CM-31653	6-1/2	19.78
CM-31654	6-1/2	19.78
CM-31703	7	22.78
CM-31704	7	31.16
CM-391-2683-029	7.26	27.66
CM-31705	7-1/2	34.24
CM-31803	8	34.65
CM-391-2683-034	8.42	38.41
CM-391-2683-042	9.88	80.99
CM-391-2683-037	10-1/2	158.20

PISTON SEALS

Part Number	Bore Dia.	List Price
CM-29112	1-1/8	\$ 6.11
CM-29128	1-1/4	5.05
CM-29137	1-3/8	8.52
CM-29138	1-3/8	6.84
CM-29150	1-1/2	5.26
CM-29176	1-3/4	7.94
CM-29200	2	5.69
CM-29201	2	8.86
CM-29202	2	8.86
CM-29225	2-1/4	5.91
CM-29226	2-1/4	9.42
CM-29227	2-1/4	9.92
CM-29250	2-1/2	5.98
CM-29251	2-1/2	9.86
CM-29252	2-1/2	10.00
CM-29252755	2-1/2	6.87
CM-375-9006-200	2-1/2	37.48
CM-29275	2-3/4	6.04
CM-29276	2-3/4	11.77
CM-29277	2-3/4	12.04
CM-375-9006-416	2.999	17.39
CM-29300	3	6.21

PISTON SEALS

Part Number	Bore Dia.	List Price
CM-29301	3	\$ 15.17
CM-29302	3	12.91
CM-29302755	3	8.69
CM-29303	3	15.86
CM-375-9006-329	3	15.86
CM-391-2683-061	3	15.86
CM-391-2881-748	3	10.04
CM-29324	3-1/4	18.85
CM-29325	3-1/4	6.31
CM-29326	3-1/4	15.99
CM-29327	3-1/4	\$ 15.32
CM-29327755	3-1/4	10.31
CM-29328	3-1/4	18.85
CM-29350	3-1/2	6.49
CM-29351	3-1/2	16.47
CM-29352	3-1/2	16.89
CM-29352755	3-1/2	10.47
CM-375-9006-245	3-1/2	20.77
CM-375-9006-334	3-1/2	98.12
CM-375-9006-417	3-1/2	14.11
CM-375-9006-458	3-1/2	17.42
CM-29375	3-3/4	7.04
CM-29376	3-3/4	16.56
CM-29377	3-3/4	19.19
CM-375-9006-172	3-3/4	23.58
CM-391-2882-329	3-3/4	14.46
CM-29400	4	7.16
CM-29401	4	16.92
CM-29402	4	21.33
CM-29402755	4	10.85
CM-29402CT	4	102.96
CM-29403	4	16.75
CM-29404	4	26.21
CM-375-9006-022	4	26.21
CM-375-9006-331	4	26.21
CM-375-9006-419	4	16.75
CM-391-2683-071	4	66.51
CM-29425	4-1/4	7.30
CM-29427	4-1/4	24.63
CM-391-2683-050	4-1/4	30.28
CM-391-2683-079	4-1/4	30.28
CM-375-9006-046	4.265	68.08
CM-29450	4-1/2	7.99
CM-29451	4-1/2	17.09
CM-29452	4-1/2	25.85
CM-29452755	4-1/2	11.28

REPLACEMENT PARTS FOR COMMERCIAL® EQUIPMENT

NOTE: Commercial part numbers are used as a reference only. We do not imply that these kits are original REPLACEMENT PARTS.

PISTON SEALS

Part Number	Bore Dia.	List Price
CM-391-2683-055	4-1/2	\$ 31.79
CM-375-9006-256	4.627	54.25
CM-29475	4-3/4	12.43
CM-29476	4-3/4	20.83
CM-29477	4-3/4	26.65
CM-29500	5	8.92
CM-29501	5	21.19
CM-29502	5	27.91
CM-29502755	5	13.41
CM-29503	5	\$ 34.31
CM-375-9006-495	5	127.60
CM-391-2683-062	5	34.31
CM-375-9006-350	5.001	27.12
CM-375-9006-418	5.001	27.12
CM-29526	5-1/4	22.64
CM-29527	5-1/4	32.88
CM-29529	5-1/4	9.55
CM-391-2683-046	5-1/4	40.42
CM-29550	5-1/2	9.82
CM-29551	5-1/2	24.01
CM-29552	5-1/2	36.77
CM-29552755	5-1/2	18.87
CM-375-9006-211	5-1/2	85.15
CM-29575	5-3/4	10.44
CM-29576	5-3/4	29.38
CM-29577	5-3/4	39.71
CM-29600	6	10.96
CM-29601	6	33.34
CM-29602	6	42.63
CM-29602755	6	19.72
CM-29602CT	6	144.93
CM-391-2683-063	6	52.42
CM-29625	6-1/4	43.05
CM-29650	6-1/2	13.92
CM-29652	6-1/2	43.05
CM-375-9006-264	6-1/2	52.91
CM-29700	7	14.29
CM-29702	7	43.82
CM-29702755	7	20.64
CM-391-2683-080	7	53.87
CM-391-2683-044	7-1/4	53.94
CM-29752	7-1/2	43.94
CM-29800	8	14.53
CM-29802	8	48.96
CM-29802755	8	21.71
CM-391-2683-056	8	61.66

PISTON SEALS

Part Number	Bore Dia.	List Price
CM-29850	8-1/2	\$ 55.38
CM-29851	8-1/2	41.08
CM-375-9006-402	8-1/2	72.39
CM-29902	9	65.50
CM-29902755	9	50.63
CM-391-2683-048	9	83.26
CM-391-2683-057	9-1/2	105.15
CM-29010	10	72.90
CM-29010755	10	59.79
CM-29015	10-1/2	155.51
CM-391-2683-064	11	204.23
CM-375-9006-193	12	211.83

RETAINER RINGS

Part Number	List Price
CM-375-2685-002	\$ 8.25
CM-375-2686-009	5.87

ROD SEALS

Part Number	Rod Dia.	List Price
CM-391-2881-483	3/4	\$ 6.85
CM-391-2881-745	7/8	7.79
CM-391-2881-739	1	6.85
CM-391-2881-617	1-1/4	7.00
CM-22082-621	1-1/2	18.39
CM-391-2881-736	1-1/2	7.79
CM-391-2881-740	1-3/4	7.21
CM-22005-621	2	22.13
CM-391-2881-679	2	8.03
CM-22009-621	2-1/2	27.26
CM-391-2881-706	2-1/2	9.97
CM-391-2881-743	2-3/4	11.36
CM-22031-621	3	32.37
CM-391-2881-742	3	12.20
CM-391-2881-758	3	12.20
CM-391-2881-737	3-3/4	17.19
CM-391-2881-698	3-7/8	17.74
CM-22098-621	4	41.75
CM-375-9006-388	4	67.37
CM-391-2881-738	4	18.85

ROD SEALS

Part Number	Rod Dia.	List Price
CM-391-2881-741	4-1/4	\$ 20.52
CM-391-2881-744	5-1/4	37.58

U-SEALS

Part Number	Rod Dia.	List Price
CM-220004	3/4	\$ 4.57
CM-220005	3/4	4.90
CM-22001	3/4	5.30
CM-22016	7/8	5.08
CM-22017	7/8	5.07
CM-22202	7/8	5.62
CM-22002	1	5.65
CM-22066	1	5.65
CM-22074	1	5.29
CM-22224	1	5.65
CM-23011	1	4.75
CM-23086	1	4.79
CM-23223	1	5.26
CM-23224	1	4.79
CM-22010	1-1/8	8.06
CM-22014	1-1/8	4.75
CM-22020	1-1/8	5.90
CM-22220	1-1/8	5.51
CM-23226	1-1/8	8.38
CM-22003	1-1/4	5.61
CM-22216	1-1/4	6.60
CM-22217	1-1/4	6.28
CM-23096	1-1/4	5.50
CM-23097	1-1/4	5.31
CM-23098	1-1/4	5.09
CM-23228	1-1/4	5.50
CM-23229	1-1/4	5.48
CM-375-9006-028	1-1/4	5.94
CM-391-1982-903	1-1/4	6.60
CM-22021	1-3/8	6.42
CM-22022	1-3/8	7.59
CM-22045	1-3/8	6.83
CM-23231	1-3/8	5.81
CM-23406	1-3/8	7.19
CM-22059	1-1/2	6.20
CM-22065	1-1/2	6.51
CM-22082	1-1/2	7.50
CM-22221	1-1/2	5.75
CM-22227	1-1/2	7.50

REPLACEMENT PARTS FOR COMMERCIAL® EQUIPMENT

NOTE: Commercial part numbers are used as a reference only. We do not imply that these kits are original REPLACEMENT PARTS.

U-SEALS

Part Number	Rod Dia.	List Price
CM-23105	1-1/2	\$ 6.39
CM-23106	1-1/2	6.37
CM-23233	1-1/2	6.21
CM-23234	1-1/2	6.21
CM-391-1982-905	1-1/2	7.50
CM-22056	1.062	4.67
CM-22006	1-5/8	6.14
CM-22083	1-5/8	8.17
CM-22205	1-5/8	7.28
CM-22230	1-5/8	8.17
CM-23109	1-5/8	6.48
CM-22004	1-3/4	10.12
CM-22042	1-3/4	8.20
CM-22204	1-3/4	7.37
CM-22231	1-3/4	7.37
CM-23112	1-3/4	6.70
CM-23114	1-3/4	6.58
CM-23141	1-3/4	7.99
CM-23238	1-3/4	7.07
CM-23239	1-3/4	9.28
CM-23414	1-3/4	7.99
CM-375-9006-087	1-3/4	7.37
CM-391-1982-900	1-3/4	8.20
CM-22102	1-7/8	10.56
CM-22005	2	8.98
CM-22049	2	8.20
CM-22073	2	6.51
CM-22076	2	8.19
CM-22203	2	6.51
CM-23118	2	7.52
CM-23119	2	7.00
CM-23246	2	7.93
CM-23247	2	7.75
CM-23248	2	7.37
CM-23249	2	7.13
CM-23920	2	7.75
CM-375-9006-411	2	15.84
CM-391-1982-899	2	8.98
CM-22222	2-1/8	6.73
CM-22007	2-1/4	7.18
CM-22064	2-1/4	10.08
CM-22078	2-1/4	12.13
CM-23253	2-1/4	8.92
CM-23427	2-1/4	10.99
CM-391-1982-890	2-1/4	10.08
CM-23432	2-3/8	10.67
CM-375-9006-174	2-3/8	9.94

U-SEALS

Part Number	Rod Dia.	List Price
CM-22009	2-1/2	\$ 11.10
CM-22025	2-1/2	9.92
CM-22026	2-1/2	17.94
CM-22050	2-1/2	9.86
CM-22060	2-1/2	7.39
CM-22061	2-1/2	11.10
CM-22079	2-1/2	9.86
CM-22207	2-1/2	12.92
CM-23134	2-1/2	8.69
CM-23259	2-1/2	10.07
CM-23260	2-1/2	9.88
CM-23433	2-1/2	11.39
CM-23576	2-1/2	14.06
CM-375-9006-173	2-1/2	9.86
CM-375-9006-432	2-1/2	11.13
CM-391-1982-891	2-1/2	12.92
CM-22028	2-5/8	7.39
CM-22029	2-5/8	11.57
CM-23136	2-5/8	9.10
CM-23578	2-5/8	15.92
CM-22030	2-3/4	10.73
CM-22100	2-3/4	12.12
CM-22101	2-3/4	10.73
CM-23264	2-3/4	10.65
CM-23581	2-3/4	16.35
CM-375-9006-088	2-3/4	10.73
CM-391-1982-902	2-3/4	14.03
CM-22215	2-7/8	15.14
CM-375-9006-154	2-7/8	11.50
CM-22011	3	15.18
CM-22031	3	13.09
CM-22032	3	11.57
CM-22044	3	22.30
CM-22047	3	21.30
CM-23268	3	11.16
CM-23269	3	10.78
CM-23446	3	19.61
CM-23586	3	18.03
CM-375-9006-092	3	11.92
CM-375-9006-108	3	21.30
CM-375-9006-238	3	13.09
CM-375-9006-343	3	21.24
CM-375-9006-430	3	28.37
CM-391-1982-909	3	15.18
CM-23149	3-1/8	10.34
CM-22068	3-1/4	14.10
CM-22081	3-1/4	14.10

U-SEALS

Part Number	Rod Dia.	List Price
CM-22210	3-1/4	\$ 14.71
CM-23273	3-1/4	12.35
CM-23274	3-1/4	11.50
CM-23593	3-1/4	18.32
CM-375-9006-431	3-1/4	12.35
CM-391-1982-892	3-1/4	17.05
CM-22012	3-1/2	24.23
CM-22051	3-1/2	24.23
CM-22072	3-1/2	18.41
CM-22085	3-1/2	15.11
CM-22096	3-1/2	13.88
CM-23279	3-1/2	13.12
CM-391-1982-120	3-1/2	18.41
CM-391-1982-910	3-1/2	14.23
CM-22018	3-5/8	10.73
CM-22069	3-5/8	26.19
CM-22089	3-5/8	25.10
CM-22095	3-5/8	26.19
CM-22041	3-3/4	20.38
CM-22228	3-3/4	19.59
CM-23286	3-3/4	13.62
CM-23604	3-3/4	24.85
CM-375-9006-319	3-3/4	25.76
CM-375-9006-349	3-3/4	25.76
CM-391-1982-894	3-3/4	20.38
CM-375-9006-043	3-7/8	20.38
CM-22034	4	19.93
CM-22053	4	12.82
CM-22055	4	17.39
CM-22098	4	17.39
CM-23291	4	13.90
CM-23292	4	14.77
CM-23293	4	14.44
CM-23294	4	18.72
CM-375-9006-019	4	17.39
CM-375-9006-054	4	27.34
CM-391-1982-904	4	19.93
CM-22035	4-1/4	20.81
CM-22048	4-1/4	20.81
CM-22209	4-1/4	28.63
CM-22219	4-1/4	20.96
CM-23616	4-1/4	25.20
CM-23617	4-1/4	23.98
CM-23618	4-1/4	25.20
CM-375-9006-257	4-1/4	13.27
CM-391-1982-893	4-1/4	20.96
CM-22036	4-1/2	30.07

REPLACEMENT PARTS FOR COMMERCIAL® EQUIPMENT

NOTE: Commercial part numbers are used as a reference only. We do not imply that these kits are original REPLACEMENT PARTS.

U-SEALS

Part Number	Rod Dia.	List Price
CM-22088	4-1/2	\$ 20.62
CM-22214	4-1/2	22.71
CM-23304	4-1/2	17.23
CM-23306	4-1/2	17.23
CM-23621	4-1/2	34.45
CM-375-9006-096	4-1/2	22.71
CM-375-9006-145	4-1/2	20.62
CM-375-9006-403	4-1/2	48.54
CM-375-9006-407	4-1/2	30.12
CM-22058	4-5/8	21.93
CM-375-9006-182	4-5/8	24.38
CM-22052	4-3/4	22.64
CM-22218	4-3/4	25.30
CM-23630	4-3/4	26.22
CM-375-9006-246	4-3/4	17.52
CM-375-9006-280	4-3/4	31.42
CM-391-1982-895	4-3/4	25.30
CM-22037	5	23.86
CM-22087	5	38.73
CM-22094	5	27.25
CM-22290	5	27.25
CM-23318	5	34.62
CM-23320	5	34.62
CM-23670	5	39.07
CM-375-9006-434	5	33.00
CM-375-9006-457	5	28.81
CM-391-1982-908	5	27.25
CM-23638	5-1/4	28.43
CM-23639	5-1/4	29.36
CM-23640	5-1/4	29.83
CM-23493	5-3/8	26.88
CM-23494	5-3/8	26.22
CM-23495	5-3/8	24.35
CM-22038	5-1/2	27.85
CM-22039	5-1/2	27.05
CM-22040	5-1/2	35.64
CM-23330	5-1/2	29.88
CM-23331	5-1/2	29.88
CM-23645	5-1/2	30.45
CM-375-9006-316	5-1/2	27.05
CM-375-9006-450	5-1/2	35.64
CM-22091	5-3/4	30.32
CM-23658	5-3/4	30.36
CM-375-9006-281	5-3/4	38.57
CM-391-1982-896	5-3/4	33.03
CM-22054	6	28.28
CM-22070	6	38.13

U-SEALS

Part Number	Rod Dia.	List Price
CM-375-9006-025	6	\$ 28.28
CM-22225	6-1/4	39.08
CM-23659	6-1/4	32.42
CM-23660	6-1/4	35.12
CM-22062	6-1/2	36.63
CM-22092	6-1/2	40.43
CM-375-9006-020	6-1/2	32.05
CM-375-9006-455	6-1/2	51.88
CM-375-9006-197	6-3/4	33.41
CM-375-9006-098	7	34.71
CM-375-9006-479	7	244.93
CM-22097	7-1/2	61.94
CM-375-9006-024	8	42.00
CM-375-9006-021	8-1/2	44.98
CM-22063	9	68.49
CM-375-9006-097	9-1/4	74.13

VEE SETS

Part Number	Rod Dia.	List Price
CM-21039	1-1/2	\$ 12.49

WEAR RINGS

Part Number	O.D. X Width	List Price
CM-25000	1-1/4 X 3/8	\$ 3.89
CM-25125	1-1/4 X 1/2	4.73
CM-25122	1-1/2 X 3/8	3.89
CM-25124	1-1/2 X 1/2	3.89
CM-375-9023-071	1-1/2 X 1/2	3.89
CM-391-2684-148	1-1/2 X 1/2	3.89
CM-25040	1-1/2 X 5/8	3.89
CM-375-9003-246	1-1/2 X 5/8	3.89
CM-25009	1-3/4 X 3/8	3.94
CM-25010	1-3/4 X 1/2	3.84
CM-391-2684-149	1-3/4 X 1/2	3.84
CM-25009	1-3/4 X 3/8	3.94
CM-25149	2 X 1/4	3.34
CM-25001	2 X 3/8	3.94
CM-25011	2 X 1/2	4.15
CM-375-9023-092	2 X 1/2	4.15

WEAR RINGS

Part Number	O.D. X Width	List Price
CM-391-2684-150	2 X 1/2	\$ 4.15
CM-25558	2 X 3/4	4.41
CM-25002	2-1/4 X 3/8	4.15
CM-25012	2-1/4 X 1/2	4.15
CM-375-9003-238	2-1/4 X 1/2	7.38
CM-391-2684-151	2-1/4 X 1/2	4.15
CM-25147	2-1/4 X 5/8	4.35
CM-25050	2-1/4 X 3/4	4.28
CM-375-9003-202	2-1/4 X 3/4	7.68
CM-391-2684-101	2-1/4 X 3/4	4.28
CM-25013	2-3/8 X 1/2	4.28
CM-25003	2-1/2 X 3/8	4.28
CM-25014	2-1/2 X 1/2	4.31
CM-375-9023-072	2-1/2 X 1/2	4.31
CM-391-2684-152	2-1/2 X 1/2	7.15
CM-2505025	2-1/2 X 3/4	5.13
CM-25072	2-3/4 X 1	20.96
CM-375-9023-142	2-3/4 X 1	23.23
CM-25015	2-3/4 X 1/2	4.35
CM-375-9023-052	2-3/4 X 1/2	4.35
CM-375-9023-070	2-3/4 X 1/2	4.35
CM-375-9003-027	2-3/4 X 2	18.97
CM-25004	2-3/4 X 3/8	4.35
CM-250655	2-7/8 X 1	5.65
CM-25116	3 X 1	4.93
CM-25144	3 X 1/4	4.00
CM-25016	3 X 1/2	11.03
CM-250505	3 X 3/4	5.08
CM-25115	3 X 3/4	5.08
CM-391-2684-097	3 X 3/4	5.08
CM-25006	3-1/4 X 3/8	4.54
CM-25017	3-1/4 X 1/2	4.54
CM-375-9023-031	3-1/4 X 1/2	4.54
CM-391-2684-124	3-1/4 X 1/2	4.54
CM-391-2684-133	3-1/4 X 1/2	4.54
CM-25051	3-1/4 X 3/4	5.08
CM-391-2684-077	3-1/4 X 3/4	5.08
CM-25834	3-1/4 X 1	5.45
CM-375-9003-071	3-1/4 X 1	9.65
CM-375-9003-059	3-1/4 X 2	25.98
CM-375-9023-128	3-1/4 X 2-1/8	25.57
CM-25119	3-1/2 X 3/8	4.57
CM-25018	3-1/2 X 1/2	4.57

REPLACEMENT PARTS FOR COMMERCIAL® EQUIPMENT

NOTE: Commercial part numbers are used as a reference only. We do not imply that these kits are original REPLACEMENT PARTS.

WEAR RINGS

Part Number	O.D. X Width	List Price
CM-375-9023-036	3-1/2 X 1/2	\$ 4.57
CM-375-9023-089	3-1/2 X 1/2	4.57
CM-25035	3-1/2 X 5/8	5.08
CM-25052	3-1/2 X 3/4	5.10
CM-375-9023-116	3-1/2 X 3/4	17.79
CM-391-2681-635	3-1/2 X 3/4	17.79
CM-391-2684-092	3-1/2 X 3/4	5.10
CM-25071	3-1/2 X 1	5.53
CM-25145	3-3/4 X 3/8	5.80
CM-25019	3-3/4 X 1/2	4.65
CM-375-9023-147	3-3/4 X 1/2	12.45
CM-391-2684-163	3-3/4 X 3/4	5.34
CM-375-9023-135	3-3/4 X 1.240	15.59
CM-25007	4 X 3/8	5.80
CM-25020	4 X 1/2	4.65
CM-391-2684-004	4 X 1/2	4.65
CM-391-2684-153	4 X 1/2	4.65
CM-25036	4 X 5/8	5.45
CM-25053	4 X 3/4	5.10
CM-391-2684-080	4 X 3/4	5.10
CM-25065	4 X 1	5.96
CM-375-9023-088	4 X 1	5.96
CM-375-9023-149	4 X 1	29.50
CM-25021	4-1/4 X 1/2	4.78
CM-375-9003-257	4-1/4 X 1/2	4.78
CM-375-9023-021	4-1/4 X 1/2	4.78
CM-25037	4-1/4 X 5/8	5.45
CM-25135	4-1/4 X 3/4	5.65
CM-391-2684-118	4-1/4 X 3/4	5.65
CM-375-9023-027	4-1/4 X 7/8	24.88
CM-375-3023-031	4-1/4 X 1	7.30
CM-375-9003-036	4-1/4 X 1-1/4	13.00
CM-25066	4-1/2 X 1	7.30
CM-25022	4-1/2 X 1/2	4.89
CM-375-9023-032	4-1/2 X 1/2	4.89
CM-25038	4-1/2 X 5/8	5.45
CM-25054	4-1/2 X 3/4	5.33
CM-25121	4-3/4 X 1/2	4.89
CM-375-9023-033	4-3/4 X 1/2	4.89
CM-25123	4-3/4 X 1	7.36
CM-375-9003-216	4-3/4 X 1-1/4	13.60
CM-25847	4-3/4 X 2	36.21
CM-25023	5 X 1/2	4.89

WEAR RINGS

Part Number	O.D. X Width	List Price
CM-375-9023-034	5 X 1/2	\$ 4.89
CM-391-2684-142	5 X 1/2	4.89
CM-25055	5 X 3/4	5.45
CM-391-2684-121	5 X 3/4	5.45
CM-25039	5 X 0.622	5.45
CM-25067	5 X 1	7.36
CM-25118	5-1/4 X 1/2	4.89
CM-391-2684-125	5-1/4 X 1/2	4.89
CM-25143	5-1/4 X 5/8	5.45
CM-391-2684-082	5-1/4 X 3/4	5.56
CM-375-9023-141	5-1/4 X 1-1/4	14.65
CM-375-9023-134	5-1/4 X 2	39.54
CM-25554	5-1/2 X 1	7.44
CM-25024	5-1/2 X 1/2	4.89
CM-391-2684-145	5-1/2 X 1/2	4.89
CM-25056	5-1/2 X 3/4	5.56
CM-375-9023-090	5-1/2 X 3/4	5.56
CM-391-2684-155	5-1/2 X 3/4	5.56
CM-25025	5-3/4 X 1/2	5.58
CM-25041	5-3/4 X 5/8	5.95
CM-375-9003-252	5-3/4 X 1-1/2	27.44
CM-375-9023-140	5-3/4 X 1-1/2	27.44

WIPERS

Part Number	Rod Dia.	List Price
CM-14075	3/4	\$ 3.16
CM-391-3881-116	3/4	1.12
CM-12100	1	2.74
CM-391-3881-105	1	1.20
CM-12112	1-1/8	2.74
CM-12125	1-1/4	2.99
CM-391-3881-101	1-1/4	1.30
CM-375-3026-017	1-3/8	3.17
CM-12150	1-1/2	3.50
CM-14151	1-1/2	13.39
CM-391-3881-102	1-1/2	13.05
CM-391-3881-106	1-1/2	1.93
CM-12175	1-3/4	3.92
CM-13019	1-3/4	2.02
CM-375-9026-081	1-3/4	3.92
CM-391-3881-095	1-3/4	2.02
CM-391-3881-104	1-3/4	14.10

WIPERS

Part Number	Rod Dia.	List Price
CM-12200	2	\$ 4.11
CM-375-9026-083	2	4.11
CM-375-9026-112	2	7.55
CM-391-3881-071	2	2.06
CM-12225	2-1/4	4.34
CM-391-3881-053	2-1/4	2.19
CM-391-3881-107	2-3/8	2.26
CM-12250	2-1/2	4.34
CM-375-9026-082	2-1/2	4.86
CM-391-3881-055	2-1/2	2.47
CM-391-3881-103	2-1/2	17.72
CM-12262	2-5/8	4.69
CM-12275	2-3/4	5.00
CM-375-9026-047	2-3/4	20.07
CM-391-3881-108	2-3/4	2.61
CM-12300	3	5.23
CM-375-9026-121	3	7.47
CM-375-9026-132	3	3.04
CM-391-3881-054	3-1/4	3.58
CM-12350	3-1/2	5.95
CM-391-3881-096	3-1/2	3.67
CM-391-3881-112	3-7/8	3.97
CM-12400	4	7.75
CM-375-9026-017	4	38.77
CM-375-9026-044	4	7.75
CM-375-9026-131	4	4.09
CM-391-3881-099	4	4.09
CM-391-3881-110	4-1/8	4.20
CM-375-9026-079	4-1/4	31.99
CM-391-3881-056	4-1/4	4.31
CM-12450	4-1/2	8.68
CM-12453-520	4-1/2	11.99
CM-375-9026-098	4-1/2	8.68
CM-375-9026-106	4-1/2	4.43
CM-375-9026-066	4-3/4	42.78
CM-375-9026-128	4-3/4	43.82
CM-12500	5	12.12
CM-375-9026-130	5	11.77
CM-391-3881-114	5	5.43
CM-375-9026-006	5-1/2	15.06
CM-391-3881-115	6	6.91
CM-391-3881-111	6-1/4	7.15
CM-391-3881-109	6-1/2	7.30
CM-391-3881-121	6-1/2	61.13
CM-375-9026-120	7	21.16
CM-375-9026-097	8-1/4	25.46

CROSS

Kit Number	Code (Pg. xviii)	Rod X Bore Size	List Price	Kit Number	Code (Pg. xviii)	Rod X Bore Size	List Price
CR-1C 1480	P-U-5	1-1/16 X 2	\$ 28.57	CR-1C 4750	P-OB-3	1 X 2	\$ 11.35
CR-1C 4147	P-OB-3	1-1/8 X 3	12.90	CR-1C 4759	P-OB-3	1-1/4 X 2-1/2	11.69
CR-1C 4244	P-OB-3	1-1/16 X 2	16.24	CR-1C 4765	P-OB-3	1-1/4 X 3	11.79
CR-1C 4429	P-OB-3	1-1/4 X 3-1/2	14.60	CR-1C 4785	P-OB-3	1-1/2 X 4	16.05
CR-1C 4430	P-OB-3	1-1/4 X 4	15.29	CR-1C 4786-A	P-OB-3	2 X 4	13.83
CR-1C 4433	P-OB-3	1-1/16 X 2-1/2	16.91	CR-1C 4796	P-OB-3	2-1/2 X 5	21.49
CR-1C 4629	P-OB-3	1-1/4 X 3	11.11	CR-1C 9964	P-U-5	2 X 4	56.46
CR-1C 4630	P-OB-3	1-1/2 X 3	11.35	CR-2C 1955	P-U-5	1-1/2 X 4	56.18
CR-1C 4631	P-OB-3	1-1/2 X 3-1/2	14.98	CR-2C 2842	P-OB-3	1-1/4 X 3	16.78
CR-1C 4637	P-OB-3	1-1/2 X 4	21.49	CR-2C 5395	P-U-5	3-1/2 X 6	91.97
CR-1C 4638	P-OB-3	2 X 4	15.09	CR-3C 2597	P-U-5	1-1/2 X 3	35.59
CR-1C 4642	P-OB-3	3/4 X 1-1/2	18.98	CR-3C 7684	P-OB-3	1-3/4 X 4	23.68

CROWN LIFT TRUCKS

Kit Number	Code (Pg. xviii)	Rod X Bore Size	List Price
CRN-087484		O-RING	\$ 4.35
CRN-088719		O-RING	3.89
CRN-089178	I-U-13	1-3/4 X 3-1/2	52.87
CRN-093217		O-RING	4.17
CRN-101296	I-U-1	2-1/2" Rod Kit	22.46
CRN-101301	I-U-1	2 ROD KIT	26.58
CRN-101302	I-U-1	1-7/8 X 2-1/2	70.11
CRN-101305	I-U-1	1-5/8 X Rod Kit	102.90
CRN-101309	I-U-1	1-7/8" ROD KIT	73.56
CRN-101310	I-U-1	2-1/2" ROD KIT	29.90
CRN-101313	I-U-1	1-3/8" Rod Kit	27.00
CRN-101314	I-U-1	2-1/8" ROD KIT	20.86
CRN-101316	I-U-1	2-3/8" ROD KIT	48.70
CRN-101323	I-V-1	1-7/8" Rod Kit	71.42
CRN-101326	I-U-1	2-3/8" Rod Kit	33.07
CRN-101329	I-U-1	1-7/8, 2-5/8 Stages	82.28
CRN-101331	I-U-1	1-3/4, 2-3/8 Stages	65.99
CRN-101332	I-U-1	1-3/4 X 2-1/2	22.01
CRN-101334	I-U-1	1-7/8, 2-5/8 Rod kit	83.00
CRN-101335	I-U-1	1-5/8, 2-1/4 Stages	71.53
CRN-101336	I-U-1	1-5/8, 2-1/4 Stages	74.02
CRN-101339	I-U-1	2" Rod Kit	81.83
CRN-101340	I-U-1	1-7/8 ROD KIT	22.47
CRN-101341	I-U-5	1-1/4 X 2-3/8	54.96
CRN-101342	I-U-3	1-1/2 X 3	72.57
CRN-101343	I-U-5	3/4 X 2	64.09
CRN-101346	I-U-5	3/4 X 1-3/4	45.81
CRN-101347	I-U-5	3/4 X 2-1/8	63.15
CRN-101376	I-U-5	1-1/4 X 3	87.53

Kit Number	Code (Pg. xviii)	Rod X Bore Size	List Price
CRN-101377	I-U-5	1 x 1-3/4	\$ 47.23
CRN-102659		VALVE KIT	5.11
CRN-105476004		O-RING	7.66
CRN-105476-6		O-RING	2.56
CRN-107366	I-O-1	1/2" Valve Kit	18.63
CRN-111573	I-U-1	3" ROD KIT	36.99
CRN-111574	I-U-1	2" ROD KIT	23.72
CRN-111790-001		O-RING	2.56
CRN-111790-12		O-RING	2.56
CRN-111790-2		O-RING	5.11
CRN-111790-3		O-RING	3.22
CRN-111790-4		O-RING	3.22
CRN-111790-9		O-RING	3.03
CRN-112022	I-U-4	7/8 X 2	22.94
CRN-112704		8, 9/16" Spools Rod Kit	19.83
CRN-113744	I-U-13	2-1/2 X 3-1/4	59.43
CRN-113745	I-U-13	3/4 x 1-3/4	29.48
CRN-115604	I-U-4	7/8 X 2	36.57
CRN-116360	N-O-1	O-RING	5.66
CRN-116820	I-U-1	2" rod kit	16.39
CRN-42249	I-U-1	56 X 80 mm	39.80
CRN-43023-1		VALVE KIT	32.72
CRN-78685		VALVE KIT	15.21
CRN-79017		VALVE KIT	4.69
CRN-87317	N-O-1	O-RING	4.17
CRN-89704	I-U-13	1-3/4 x 2-3/4	74.03
CRN-90880	I-U-5	3/4 X 1-3/4	47.59
CRN-94580	I-O-1	5/8" Rod kit	5.56

CROWN

CUSTOM HOISTS® 700 SERIES

PACKING:	Vee packing with nylon top and bottom adapters.
WIPERS:	An improved dual-lip snap in wiper to minimize contamination entry.
Bearing:	Top mineral filled nylon bearing.
Retainer Ring:	Heavy duty for improved strength.
Plunger Stop:	Beveled plunger stop for plunger center.
Piston Wear Ring:	Wear ring with increased cross-section for added strength.
Stage O.D.'S:	3-3/16", 4-1/8", 5-1/16" & 6"
Identification:	Part number and serial number stamped in body near base of cylinder. Ex. 63-702-120

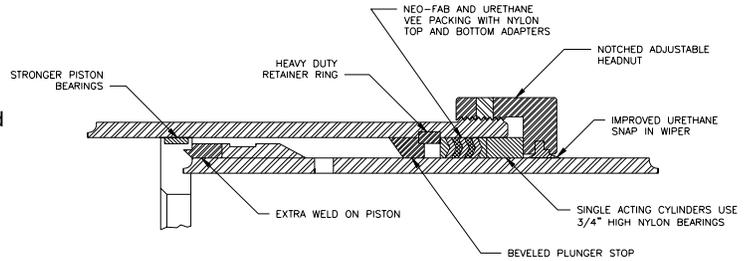

Part Number	Description	List Price
SEAL KITS		
CH-SK-53-700	3 - 5" Seal Kit	\$ 113.58
CH-SK-63-700	4 - 6" Seal Kit	129.98
CH-SK-64-700	3 - 6" Seal Kit	160.28
CH-SK-74-700	4 - 7" Seal Kit	234.52
MINOR PACKING KITS		
CH-MPK-53-700	3 - 5" Minor Packing Kit	\$ 199.26
CH-MPK-63-700	4 - 6" Minor Packing Kit	217.75
CH-MPK-64-700	3 - 6" Minor Packing Kit	274.47
CH-MPK-74-700	4 - 7" Minor Packing Kit	414.47
MAJOR PACKING KITS		
CH-MRK-53-700	3 - 5" Major Repair Kit	\$ 622.44
CH-MRK-63-700	4 - 6" Major Repair Kit	670.68
CH-MRK-64-700	3 - 6" Major Repair Kit	837.80
CH-MRK-74-700	4 - 7" Major Repair Kit	1004.56
NYLON TOP BEARINGS		
CH-1BU11-3-3/16	3-3/16" Nylon Top Bearing	\$ 19.82
CH-1BU11-4-1/8	4-1/8" Nylon Top Bearing	20.44
CH-1BU11-5-1/16	5-1/16" Nylon Top Bearing	20.56
CH-1BU11-6	6" Nylon Top Bearing	16.37
CH-1BU11-7	7" Nylon Top Bearing	17.82
PACKINGS		
CH-700-3-3/16VS	3-3/16" Vee Set	\$ 23.98
CH-700-4-1/8VS	4-1/8" Vee Set	27.85
CH-700-5-1/16VS	5-1/16" Vee Set	34.57
CH-700-6VS	6" Vee Set	27.12
CH-PK-1-7	7" Vee Set	33.80

Part Number	Description	List Price
WIPERS		
CH-1WR1-3-3/16	3-3/16" Wiper	\$ 8.19
CH-1WR1-4-1/8	4-1/8" Wiper	10.64
CH-1WR1-5-1/16	5-1/16" Wiper	13.13
CH-1WR1-6	6" Wiper	11.02
CH-1WR1-7	7" Wiper	13.63
RETAINER RINGS		
CH-2RR58-368	3-11/16" Retainer Ring	\$ 46.64
CH-2RR58-462	4-5/8" Retainer Ring	46.64
CH-2RR58-550	5-1/2" Retainer Ring	48.96
CH-2RR58-650	6-1/2" Retainer Ring	46.40
CH-2RR58-750	7" Retainer Ring	56.64
PLUNGER STOP		
CH-2PS44-3-3/16	3-3/16" Plunger Stop	\$ 65.36
CH-2PS44-4-1/8	4-1/8" Plunger Stop	66.97
CH-2PS44-5-1/16	5-1/16" Plunger Stop	70.43
CH-2PS44-6	6" Plunger Stop	70.84
CH-2PS36-7	7" Plunger Stop	81.77
PISTON WEAR RINGS		
CH-2WG3-3-3/16	3-3/16" Piston Wear Ring	\$ 4.98
CH-2WG3-4-1/8	4-1/8" Piston Wear Ring	6.26
CH-2WG3-5-1/16	5-1/16" Piston Wear Ring	7.37
CH-2WG3-6	6" Piston Wear Ring	8.90
CH-2WG1-7	7" Piston Wear Ring	7.58
WAVE SPRING		
CH-1WA11-7	7" Wave Spring	\$ 35.42
BUSHING		
CH-1BU195-7	7" Bushing	\$ 22.47

CUSTOM HOISTS® 400 SERIES

PACKING:	Vee packing with nylon top and bottom adapters.
WIPERS:	An improved dual-lip snap in wiper to minimize contamination entry.
WAVE SPRING:	To apply a continuous force on the packing.
BEARINGS:	Top and bottom mineral filled nylon bearing.
RETAINER RING:	Heavy duty for improved strength.
PLUNGER STOP:	Beveled plunger stop for plunger centering.
PISTON WEAR RING:	Wear ring with increased cross-section for added strength.
STAGE O.D.'S:	3, 4, 5, 6, 7, 8, 8-1/4, 9-1/8, 9-3/4
IDENTIFICATION:	Part number and serial number stamped in body near oil port near base of cylinder. Example: 85-402-250 single acting.

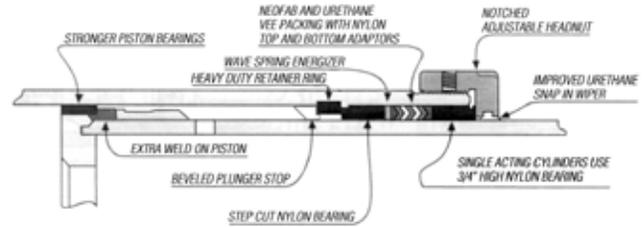

Part Number	Description	List Price
SEAL KITS		
CH-SK-53-400	3 - 5" Seal Kit	\$ 148.20
CH-SK-63-400	4 - 6" Seal Kit	178.34
CH-SK-64-400	3 - 6" Seal Kit	222.87
CH-SK-73-400	5 - 7" Seal Kit	233.85
CH-SK-74-400	4 - 7" Seal Kit	279.12
CH-SK-8-1/4 5-400	4 - 8-1/4" Seal Kit	483.41
CH-SK-84-400	5 - 8" Seal Kit	349.80
CH-SK-85-400	4 - 8" Seal Kit	395.50
CH-SK-95-400	5 - 9-1/8" Seal Kit	548.18
MINOR PACKING KITS		
CH-MPK-53-400	3 - 5" Minor Packing Kit	\$ 243.65
CH-MPK-63-400	4 - 6" Minor Packing Kit	279.32
CH-MPK-64-400	3 - 6" Minor Packing Kit	354.44
CH-MPK-73-400	5 - 7" Minor Packing Kit	343.65
CH-MPK-74-400	4 - 7" Minor Packing Kit	419.95
CH-MPK-8-1/4 5-400	4 - 8-1/4" Minor Packing Kit	748.19
CH-MPK-84-400	5 - 8" Minor Packing Kit	539.37
CH-MPK-85-400	4 - 8" Minor Packing Kit	581.15
CH-MPK-95-400	5 - 9" Minor Packing Kit	1138.08
MAJOR REPAIR KITS		
CH-MRK-53-400	3 - 5" Major Repair Kit	\$ 730.31
CH-MRK-63-400	4 - 6" Major Repair Kit	766.28
CH-MRK-64-400	3 - 6" Major Repair Kit	1003.04
CH-MRK-73-400	5 - 7" Major Repair Kit	826.03
CH-MRK-74-400	4 - 7" Major Repair Kit	1069.08
CH-MRK-8-1/4 5-400	4 - 8-1/4" Major Repair Kit	2091.23
CH-MRK-84-400	5 - 8" Major Repair Kit	1209.59
CH-MRK-85-400	4 - 8" Major Repair Kit	1453.16
CH-MRK-95-400	5 - 9" Major Repair Kit	2282.37
PACKING & WIPERS		
CH-400-3VSW	3" Vee Set & Wiper	\$ 20.47
CH-400-4VSW	4" Vee Set & Wiper	29.07
CH-400-5VSW	5" Vee Set & Wiper	35.02
CH-400-6VSW	6" Vee Set & Wiper	43.42
CH-400-7VSW	7" Vee Set & Wiper	51.82
CH-400-8.25VSW	8-1/4" Vee Set & Wiper	144.39
CH-400-8VSW	8" Vee Set & Wiper	63.21
CH-400-9.12VSW	9-1/8" Vee Set & Wiper	179.64
NYLON BOTTOM BEARINGS		
CH-1BU195-3	3" Nylon Bottom Bearing	\$ 16.48
CH-1BU195-4	4" Nylon Bottom Bearing	16.92
CH-1BU195-5	5" Nylon Bottom Bearing	18.42
CH-1BU195-6	6" Nylon Bottom Bearing	19.82
CH-1BU195-7	7" Nylon Bottom Bearing	22.47
CH-1BU195-8	8" Nylon Bottom Bearing	26.34
CH-1BU195-825	8-1/4" Nylon Bottom Bearing	61.51
CH-1BU195-91	9-1/8" Nylon Bottom Bearing	40.15
NYLON TOP BEARINGS		
CH-1BU11-3	3" Nylon Top Bearing	\$ 13.14
CH-1BU11-4	4" Nylon Top Bearing	13.14

Part Number	Description	List Price
NYLON TOP BEARINGS		
CH-1BU11-5	5" Nylon Top Bearing	\$ 13.85
CH-1BU11-6	6" Nylon Top Bearing	16.37
CH-1BU11-7	7" Nylon Top Bearing	17.82
CH-1BU11-8	8" Nylon Top Bearing	21.59
CH-1BU11-82	8-1/4" Nylon Top Bearing	40.90
CH-1BU11-91	9-1/8" Nylon Top Bearing	73.05
RETAINER RINGS		
CH-2RR58-350	3-1/2" Retainer Ring	\$ 52.76
CH-2RR58-450	4-1/2" Retainer Ring	51.56
CH-2RR58-550	5-1/2" Retainer Ring	48.96
CH-2RR58-650	6-1/2" Retainer Ring	46.40
CH-2RR58-750	7-1/2" Retainer Ring	56.64
CH-2RR58-850	8-1/2" Retainer Ring	73.44
CH-2RR58-9	9" Retainer Ring	216.54
CH-2RR58-975	9-3/4" Retainer Ring	155.81
WAVE SPRINGS		
CH-1WA11-3	3" Wave Spring	\$ 15.38
CH-1WA11-4	4" Wave Spring	16.66
CH-1WA11-5	5" Wave Spring	18.50
CH-1WA11-6	6" Wave Spring	21.83
CH-1WA11-7	7" Wave Spring	35.42
CH-1WA11-8	8" Wave Spring	38.05
CH-1WA11-825	8-1/4" Wave Spring	40.18
CH-1WA11-91	9-1/8" Wave Spring	42.96
PLUNGER STOPS		
CH-2PS36-3	3" Plunger Stop	\$ 75.96
CH-2PS36-4	4" Plunger Stop	77.41
CH-2PS36-5	5" Plunger Stop	77.64
CH-2PS36-6	6" Plunger Stop	80.31
CH-2PS36-7	7" Plunger Stop	81.77
CH-2PS36-8	8" Plunger Stop	101.88
CH-2PS36-825	8-1/4" Plunger Stop	120.81
CH-2PS36-91	9-1/8" Plunger Stop	200.45
PISTON WEAR RINGS		
CH-2WG1-3	3" Piston Wear Ring	\$ 5.13
CH-2WG1-4	4" Piston Wear Ring	10.37
CH-2WG1-5	5" Piston Wear Ring	5.62
CH-2WG1-8	8" Piston Wear Ring	13.70
CH-2WG1-6	6" Piston Wear Ring	6.34
CH-2WG1-7	7" Piston Wear Ring	7.58
CH-2WG1-91	9-1/8" Piston Wear Ring	22.48
WIPERS		
CH-1WR1-3	3" WIPER	\$ 6.50
CH-1WR1-4	4" WIPER	7.77
CH-1WR1-5	5" WIPER	9.36
CH-1WR1-6	6" WIPER	11.02
CH-1WR1-7	7" WIPER	13.63
CH-1WR1-8	8" WIPER	16.10
CH-1WR1-825	8-1/4" WIPER	22.87
CH-1WR1-91	9.12" WIPER	33.12

CUSTOM HOISTS® TELESCOPICS

- PACKING:** Vee packing with nylon top and bottom adaptors.
4" thru 8" all 1/4" c.s.
- WIPERS:** Snap in.
- BEARINGS:** One bronze or mineral filled nylon bearing above the packing.
- PISTON:** Steel pistons welded to stage. Replaceable "T" shaped nylon wear rings. Double action use 2 cast iron piston rings in separate grooves.
- STAGE O.D.'s:** 3, 4, 5, 6, 7, 8, 8-1/4, 9-1/8, 9-3/4
- SPECIAL INFO.:** Uses 2 spiral retainer rings with metal spacer in between.
- IDENTIFICATION:** Part number and serial number stamped in body near oil port near base of cylinder.
Example: 85-2-220 single acting;
DAT73-4-128 double acting

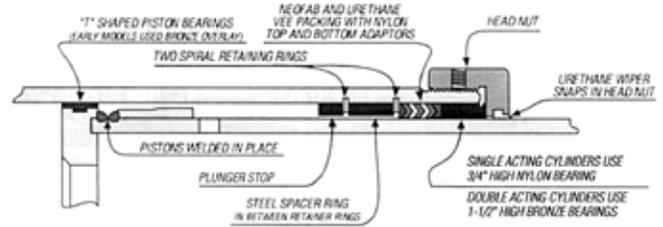

Part Number	Description	List Price
PACKING & WIPERS		
CH-3VSW	3" Vee Set & Wiper	\$ 18.80
CH-4VSW	4" Vee Set & Wiper	20.89
CH-5VSW	5" Vee Set & Wiper	24.05
CH-6VSW	6" Vee Set & Wiper	29.31
CH-7VSW	7" Vee Set & Wiper	34.23
CH-8.25VSW	8-1/4" Vee Set & Wiper	88.14
CH-8VSW	8" Vee Set & Wiper	38.54
CH-9.12VSW	9-1/8" Vee Set & Wiper	127.35
CH-9.75VSW	9-3/4" Vee Set & Wiper	190.54
NYLON TOP BEARINGS		
CH-1BU11-3	3" Nylon Top Bearing	\$ 13.14
CH-1BU11-4	4" Nylon Top Bearing	13.14
CH-1BU11-5	5" Nylon Top Bearing	13.85
CH-1BU11-6	6" Nylon Top Bearing	16.37
CH-1BU11-7	7" Nylon Top Bearing	17.82
CH-1BU11-8	8" Nylon Top Bearing	21.59
CH-1BU11-82	8-1/4" Nylon Top Bearing	40.90
CH-1BU11-91	9-1/8" Nylon Top Bearing	73.05
CH-1BU1291/8	9-1/8" Nylon Top Bearing 1-1/2" Tall	91.95
BRONZE TOP BEARINGS		
CH-1BU3-3	3" X 3-1/2" X 1-1/2" Bronze Top Bearing	\$133.69
CH-1BU3-4	4" X 4-1/2" X 1-1/2" Bronze Top Bearing	97.75
CH-1BU3-5	5" X 5-1/2" X 1-1/2" Bronze Top Bearing	104.12
CH-1BU3-587	5-7/8" X 6-3/8" X 1-1/2" Bronze Top Bearing	177.39
CH-1BU3-6	6" X 6-1/2" X 1-1/2" Bronze Top Bearing	115.38
CH-1BU3-7	7" X 7-1/2" X 1-1/2" Bronze Top Bearing	132.65
CH-1BU3-8	8" X 8-1/2" X 1-1/2" Bronze Top Bearing	151.81
CH-1BU3-825	8-1/4" X 9" X 1-1/2" Bronze Top Bearing	227.20
SPIRAL RETAINER RINGS		
CH-1RR1-35	3-1/2" Bore Spiral Retainer Ring	\$ 4.30
CH-1RR1-45	4-1/2" Bore Spiral Retainer Ring	10.23
CH-1RR1-55	5-1/2" Bore Spiral Retainer Ring	10.46
CH-1RR1-637	6-3/8" Bore Spiral Retainer Ring	72.27
CH-1RR1-65	6-1/2" Bore Spiral Retainer Ring	8.10
CH-1RR1-75	7-1/2" Bore Spiral Retainer Ring	10.73
CH-1RR1-85	8-1/2" Bore Spiral Retainer Ring	13.30
CH-1RR1-9	9" Bore Spiral Retainer Ring	74.72
CH-1RR1-97	9-3/4" Bore Spiral Retainer Ring	85.10
CH-1RR1-105	10-1/2" Bore Spiral Retainer Ring	111.92

Part Number	Description	List Price
SPACER RINGS		
CH-2SP1-3	3" Spacer	\$ 27.14
CH-2SP1-4	4" Spacer	49.37
CH-2SP1-5	5" Spacer	47.27
CH-2SP1-6	6" Spacer	53.05
CH-2SP1-7	7" Spacer	66.02
CH-2SP1-8	8" Spacer	82.22
CH-2SP1-8.25	8-1/4" Spacer	368.25
T-SHAPED PISTON WEAR RINGS		
CH-2GR6-3	3" Piston Wear Ring	\$ 7.87
CH-2GR6-4	4" Piston Wear Ring	8.48
CH-2GR6-5	5" Piston Wear Ring	10.83
CH-2GR6-6	6" Piston Wear Ring	13.41
CH-2GR6-7	7" Piston Wear Ring	14.59
CH-2GR6-8	8" Piston Wear Ring	24.07
CH-2GR6-825	8-1/4" Piston Wear Ring	34.39
CH-2GR6-91	9-1/8" Piston Wear Ring	34.39
CH-2GR6-975	9-3/4" Piston Wear Ring	36.11
PISTON WEAR RINGS		
CH-2WG1-3	3" Piston Wear Ring	\$ 5.13
CH-2WG1-4	4" Piston Wear Ring	10.37
CH-2WG1-5	5" Piston Wear Ring	5.62
CH-2WG1-8	8" Piston Wear Ring	13.70
CH-2WG1-6	6" Piston Wear Ring	6.34
CH-2WG1-7	7" Piston Wear Ring	7.58
CH-2WG1-91	9-1/8" Piston Wear Ring	22.48
PISTON RINGS (DOUBLE ACTING)		
CH-2PR3-35	3-1/2" Piston Ring	\$ 10.94
CH-2PR3-45	4-1/2" Piston Ring	14.65
CH-2PR3-55	5-1/2" Piston Ring	18.82
CH-2PR3-637	6-3/8" Piston Ring	133.19
CH-2PR3-65	6-1/2" Piston Ring	30.47
CH-2PR3-75	7-1/2" Piston Ring	28.61
CH-2PR3-85	8-1/2" Piston Ring	38.55
CH-2PR3-97	9-3/4" Piston Ring	79.33
CH-2PR3-105	10-1/2" Piston Ring	140.06

CUSTOM HOISTS®

CUSTOM HOISTS® TELESCOPICS

Part Number	Description	List Price
KITS		
CH-35	3" - 5" Vee Set & Wiper	\$ 68.43
CH-46	4" - 6" Vee Set & Wiper	66.22
CH-47	4" - 7" Vee Set & Wiper	126.95
CH-48	4" - 8" Vee Set & Wiper	134.79
CH-48-1/4	4" - 8 - 1/4" Vee Set & Wiper	233.97
CH-49	4" - 9 - 1/8" Vee Set & Wiper	328.38
CH-57	Custom #73-81-114, 129, 149	106.27
CH-57	5" - 7" Vee Set & Wiper	106.27
CH-58	5" - 8" Vee Set & Wiper	153.12
CH-59	5" - 9-1/8" Vee Set & Wiper	307.74
CH-NPB35	3" - 5" Nylon Piston Wear Ring Kit	31.32
CH-NPB36	3" - 6" Nylon Piston Wear Ring Kit	46.79
CH-NPB46	4" - 6" Nylon Piston Wear Ring Kit	37.72
CH-NPB47	4" - 7" Nylon Piston Wear Ring Kit	54.54
CH-NPB48	4" - 8" Nylon Piston Wear Ring Kit	82.28
CH-NPB48-1/4	4" - 8-1/4" Nylon Piston Wear Ring Kit	94.19
CH-NPB49	4" - 9-1/8" Nylon Piston Wear Ring	121.92
CH-NPB57	5" - 7" Piston Wear Ring Kit	44.76
CH-NPB58	5" - 8" Piston Wear Ring Kit	72.46
CH-NPB59	5" - 9-1/8" Piston Wear Ring Kit	112.14
CH-NYB35-DA	2 ea. 3" - 5" Nylon Top Bearings	77.49
CH-NYB35-SA	1 ea. 3" - 5" Nylon Top Bearings	38.75
CH-NYB36-DA	2 ea. 3" - 6" Nylon Top Bearings	109.14
CH-NYB36-SA	1 ea. 3" - 6" Nylon Top Bearings	54.58
CH-NYB46-DA	2 ea. 4" - 6" Nylon Top Bearings	83.68
CH-NYB46-SA	1 ea. 4" - 6" Nylon Top Bearings	41.85
CH-NYB47-DA	2 ea. 4" - 7" Nylon Top Bearings	118.54
CH-NYB47-SA	1 ea. 4" - 7" Nylon Top Bearings	59.03
CH-NYB48-1/4	1 ea. 4" - 8-1/4" Nylon Top Bearings	98.84
CH-NYB48-DA	2 ea. 4" - 8" Nylon Top Bearings	159.68
CH-NYB48-SA	1 ea. 4" - 8" Nylon Top Bearings	79.83
CH-NYB49-DA	2 ea. 4" - 8" Nylon Top Bearing & 1 ea. 9-1/8" Nylon Top Bearings	279.84
CH-NYB57-DA	2 ea. 5" - 7" Nylon Top Bearings	92.66
CH-NYB57-SA	1 ea. 5" - 7" Nylon Top Bearings	46.33
CH-NYB58-DA	2 ea. 5" - 8" Nylon Top Bearings	134.27
CH-NYB58-SA	1 ea. 5" - 8" Nylon Top Bearings	67.13
CH-NYB59-DA	2 ea. 5" - 9-1/8" Nylon Top Bearings	264.59
CH-NYB59-SA	1 ea. 5" - 9" Nylon Top Bearings	133.35
CH-PR35	2 ea. 3-1/2" - 5-1/2" Piston Rings	119.29
CH-PR36	2 ea. 3-1/2" - 6-1/2" Piston Rings	198.61
CH-PR46	2 ea. 4-1/2" - 6-1/2" Piston Rings	166.37
CH-PR47	2 ea. 4-1/2" - 7-1/2" Piston Rings	240.75
CH-PR48	2 ea. 4-1/2" - 8-1/2" Piston Rings	340.96
CH-PR49	2 ea. 4-1/2" - 9-3/4" Piston Rings	547.29
CH-PR57	2 ea. 5-1/2" - 7-1/2" Piston Rings	202.62
CH-PR58	2 ea. 5-1/2" - 8-1/2" Piston Rings	302.83
CH-PR59	2 ea. 5-1/2" - 9-3/4" Piston Rings	509.18
CH-PS1-3	3" Plunger Stop	35.01
CH-PS1-4	4" Plunger Stop	78.52
CH-PS1-5	5" Plunger Stop	83.87

Part Number	Description	List Price
KITS		
CH-PS1-587	5-7/8" Plunger Stop	\$ 99.79
CH-PS1-6	6" Plunger Stop	80.02
CH-PS1-7	7" Plunger Stop	59.30
CH-PS1-8	8" Plunger Stop	66.34
CH-PS1-82	8-1/4" Plunger Stop	187.88
CH-PS1-91	9-1/8" Plunger Stop	108.09
CH-PS1-975	9-3/4" Plunger Stop	102.71
CH-SR35	2 ea. 3-1/2" - 5-1/2" Spiral Retainer	61.38
CH-SR36	2 ea. 3-1/2" - 6-1/2" Spiral Retainer	81.62
CH-SR46	2 ea. 4-1/2" - 6-1/2" Spiral Retainer	74.10
CH-SR47	2 ea. 4-1/2" - 7-1/2" Spiral Retainer	101.68
CH-SR48	2 ea. 4-1/2" - 8-1/2" Spiral Retainer	135.94
CH-SR48-1/4	2 ea. 4-1/2" - 9" Spiral Retainer	391.13
CH-SR49	2 ea. 4-1/2" - 9-3/4" Spiral Retainer	351.94
CH-SR57	2 ea. 5-1/2" - 7-1/2" Spiral Retainer	75.37
CH-SR58	2 ea. 5-1/2" - 8-1/2" Spiral Retainer	109.63
CH-SR59	2 ea. 5-1/2" - 9-3/4" Spiral Retainer	325.64
HEAD NUTS (Measured at thread - have 12th/in)		
CH-2HN-4	4" Head Nut	\$ 75.90
CH-2HN-5	5" Head Nut	78.06
CH-2HN-6	6" Head Nut	103.27
CH-2HN-7	7" Head Nut	107.67
CH-2HN-8	8" Head Nut	129.55
CH-2HN-82	8-1/4" Head Nut	341.29
CH-2HN-9	9" Head Nut	283.27
CH-3HN1-11.25	11-1/4" Head Nut (over 9-3/4" Stage)	727.17
CH-3HN1-11.25	11-1/4" Head Nut (over 9-3/4" Stage)	727.17
MISCELLANEOUS PARTS		
CH-ABVA-1	Automatic Bleeder	\$ 47.58
CH-MBVA-1	Manual Bleeder valve	5.36
CH-MBVA-3	OEM Style Manual Bleeder Valve	29.87
CH-SL-2-1	Nylon Slug	0.66
CH-SS-3-1	Set Screw	1.29
MAJOR REPAIR KITS (SINGLE ACTING)		
Kits include: Packing, wipers, nylon bushings, snap rings, piston bearing, set screws and nylon slugs.		
CH-MRK-63	4" - 6"	\$ 241.98
CH-MRK-74	4" - 7"	232.85
CH-MRK-84	5" - 8"	391.93
CH-MRK-85	4" - 8"	472.46
CH-MRK-95	5" - 9-1/8"	900.63
MAJOR REPAIR KITS (DOUBLE ACTING)		
CH-DAT-MRK-53	3" - 5"	\$ 702.13
CH-DAT-MRK-63	4" - 6"	766.32
CH-DAT-MRK-64	3" - 6"	911.14
CH-DAT-MRK-74	4" - 7"	1033.62
CH-DAT-MRK-84	5" - 8"	1130.65
CH-DAT-MRK-85	4" - 8"	1377.85
CH-DAT-MRK-96	4" - 9-1/8"	2288.85

CUSTOM HOISTS® PISTON-ROD CYLINDERS

CUSTOM HOISTS®

Kit Number	Cylinder Number	Code (Pg. xviii)	RodX-Bore Size	List Price	Kit Number	Cylinder Number	Code (Pg. xviii)	RodX-Bore Size	List Price
CH-SK-3-23		I-U-10	2 X 3	\$ 26.63	CH-SK-6-23	DA6-92-46,62,68	I-V-12	4-1/2 X 6	\$ 128.69
CH-SK-3-24		I-U-10	1-3/4 X 3	19.01	CH-SK-6-26	DA6-73-34	I-V-5	2-1/2 X 6	76.91
CH-SK-4-4	DA4-77-14	I-V-5	1-3/4 X 4	47.83	CH-SK-6-29	DA6-158-42	I-U-5	2-3/4 X 6	98.30
CH-SK-4-5	DA4-107-24	I-U-5	2-1/2 X 4	56.53	CH-SK-6-30	DA6-49-78	I-U-12	4 X 6	117.49
CH-SK-4-6	DA4-104-48	I-U-5	2 X 4	58.00	CH-SK-6-31	DA6-40-108	I-U-12	4-1/2 X 6	150.31
CH-SK-4-13	DA4-126-28	I-U-5	2-3/4 X 4	56.24	CH-SK-6-33		I-U-1	4" Rod Kit	27.10
CH-SK-4-19	SA4-11-25	I-V-1	4" Rod Kit	34.84	CH-SK-6-34	DA6-100-63	I-V-10	4 X 6	104.20
CH-SK-4-21	DA4-142-21-1/2	I-V-10	2-1/2 X 4	45.31	CH-SK-6-42	DA6-188-60, DA6-188-52-/12, DA6-194-72	I-V-5	4 X 6	80.59
CH-SK-4-23	DA4-171-27-3/4	I-V-10,12	2-3/4 X 4	50.89	CH-SK-6-44	DA6-203-42	I-V-5	2-3/4 X 6	100.31
CH-SK-4-49		I-V-10	2-3/4 X 4	37.06	CH-SK-6-54	DA6-9-60-1/2, DA6-9-70-1/2	I-V-10	4 X 6	126.09
CH-SK-4-53		I-UB-10,12	2 X 4	53.28	CH-SK-6-6	DA6-47-47	P-V-5	4 X 6	84.02
CH-SK-4-1/2-6	DA4-1/2-21	I-U-11	2 X 4-1/2	85.18	CH-SK-6-8	DA6-68-79	I-U-5	4 X 6	83.50
CH-SK-4-1/2-8	DA4-1/2-41-48-5/8	P-U-12	2 X 4-1/2	126.14	CH-SK-6-84		I-U-10	5 X 6	62.91
CH-SK-4-1/2-15	DA4-1/2-44-21	I-V-5	3 X 4-1/2	65.57	CH-SK-7-1	DA7-5	I-U-12	5-1/2 X 7	203.83
CH-SK-4-1/2-26		P-UB-10,12	2 X 4-1/2	72.57	CH-SK-7-16	DA7-4-23	I-V-5	3 X 7	94.61
CH-SK-4-1/2-29		I-V-10,12	2 X 4-1/2	92.94	CH-SK-7-17	DA7-78-79	I-V-5	4 X 7	98.79
CH-SK-5-1	DA5-67-14	I-U-5	2 X 5	55.90	CH-SK-7-18	DA-7-29	I-U-10	5-1/2 X 7	151.27
CH-SK-5-12	DA5-144-36	I-V-11,12	2-1/2 X 5	123.36	CH-SK-7-20	DA7-36-78,	I-U-12	4-1/2 X 7	140.52
CH-SK-5-13	DA5-47-27	I-V-5	3 X 5	94.32	CH-SK-7-34		I-V-4,12	2-1/2 X 7	143.70
CH-SK-5-21	DA5-130-16	I-V-5	2-1/2 X 5	87.66	CH-SK-7-35	DA7-121,78,83 or 55	I-U-10	4-1/2 X 7	130.59
CH-SK-5-28	DA5-41-19,20,23	I-V-5	3 X 5	89.10	CH-SK-7-43		I-U-4	2 X 7	59.52
CH-SK-5-35	DA5-4-26	I-V-9	2-1/2 X 5	73.97	CH-SK-7-5	DA7-36-115	I-U-12	4-1/2 X 7	153.64
CH-SK-5-1/2-25		I-V-10,12	2-1/2 X 5-1/2	72.94	CH-SK-7-9	DA7-63	I-U-10	4-1/2 X 7	153.25
CH-SK-6-1	DA6-60, DA6-88, DA6-90	I-V-1	4-1/2 X 6	41.96	CH-SK-8-1		I-V-4	3 X 8	117.43
CH-SK-6-11	DA6-39-78	I-V-5	4-1/2 X 6	170.12	CH-SK-8-21	DA8-16-25	I-V-12	2-1/2 X 8	133.21
CH-SK-6-15		I-V-5	3-1/2 X 6	104.26	CH-SK-8-3		I-U-5	3 X 8	129.73
CH-SK-6-2	DA6-39-78, DA- 87-67	I-U-12	4-1/2 X 6	123.65	CH-SK-9-2	DA9-19-19	I-V-5	3-1/2 X 9	235.58
CH-SK-6-22	DA6-140	I-V-5	4 x 6	84.98	CH-SK-42-60	42-60-43 or CH-475 3"-4" Vee Set & Wiper Telescopic			41.51

**Stocked in Our
US Facility**

DEMPSTER REFUSE TRUCKS

Kit Number	Cylinder Number	Code (Pg. xviii)	RodXBore Size	List Price
DD-350U	BB7053	P-U-5	2 X 3-1/2	\$ 48.96
DD-401U	BB6579, 6581, 6583, 7999, 8004, 8010	P-U-5	2 X 4	46.94
DD-501U	BB6451	P-U-5	2-1/2 X 5	55.44
DD-520U	BB8000	P-U-5	2 X 5	56.15
DD-5470K	CB5470	I-V-1	3 X 3-1/2	25.43
DD-5937K	BB5937	I-V-9	2 X 5	130.50
DD-5938K	BB5938	I-V-9	3 X 5	144.22
DD-6888K	BB6888, BB8281	P-N-1	2-1/2 X 3-1/2	33.49
DD-6996K	BB6996, BB8010	P-U-5	3 X 5	62.32
DD-6997K	BB6997	P-U-5	2 X 5	57.40
DD-8112K	BB8112	P-U-5	2-1/2 X 6	90.25
DD-8133K	BB8133	P-V-5	2-1/2 X 6	92.97
DD-8134K	BB8134	P-V-5	3 X 5	69.46
DD-8169K	BB8169	P-V-5	2 X 4	53.02
DD-8185K		P-V-5	2 X 5	57.92
DD-8206K		P-V-5	3 X 6	87.53
DD-8235K		P-U-5	3 X 5	74.83
DD-HA 2557	AB12308	N-OB-3	1-1/8 X 2-1/2	7.99
DD-HA 2561	AB12225	P-OB-3	1-1/8 X 2-1/2	19.02
DD-HA 2629	PI100-20	I-OB-3	1-1/2 X 3	15.53
DD-HA 2630	PI100-21	I-U-5	1-1/2 X 3-1/2	32.23
DD-HA 2632		I-U-4,12	4 X 4-1/2	65.96
DD-HA 2633		I-U-1	3" ROD	15.31
DD-HA 2634	PI100-94, CB10006	I-OB-3	1-1/2 X 2-1/2	13.89
DD-HA 2895	AB13978	I-OB-3	1-1/2 X 2-1/2	16.13
DD-HA 3300	BB8379-1, BB8748-1, BB8281-1	I-V-5	2 X 4	49.40
DD-HA 3301	BB6888, BB8281-1	I-N-4	2-1/2 X 3-1/2	17.94
DD-HA 3302	BB8133-1	I-V-5	2-1/2 X 6	80.16
DD-HA 3303	BB8374-1, BB8185-1	I-V-5	2 X 5	64.31
DD-HA 3304	BB8134-1	I-V-5	3 X 5	68.65
DD-HA 3527	AB19461, AB19462CH.	I-V-9	3 X 6	90.68
DD-HA 3541	AB19775TH	I-V-5,12	2 X 5	77.80
DD-HA 3542	AB19774TH	I-V-5,12	2 X 4	68.83
DD-HA 3557	AB19602TH	I-N-4	2-1/2 X 3-1/2	24.49
DD-HA 3558	AB19601TH	I-V-5	3 X 5	68.84
DD-HA 3559	AB19600TH	I-V-5	2-1/2 X 6	101.52
DD-HA 3562	AB19869TH	I-V-5	2 X 4	55.20
DD-HA 3563	AB19890TH	I-V-5	2 X 5	64.28
DD-HA 3775		I-U-5	1-3/4 X 4	45.02
DD-HA 3799		I-U-13	2-1/2 X 3-1/2	35.36
DD-HA 3809		I-U-10,12	2 X 4	75.68

Kit Number	Cylinder Number	Code (Pg. xviii)	RodXBore Size	List Price
DD-HA 3868		I-U-10,12	2-1/2 X 4-1/2	\$103.11
DD-HA 3869		I-U-4	1-1/4 X 2	19.98
DD-HA 4166		I-U-10,12	2-1/2 X 5	78.86
DD-HA 4263		I-U-1	3-1/2 X 4	38.10
DD-HA 4264		I-U-10	3 X 5	46.85
DD-HA 4265		I-U-10	2-1/2 X 6	53.61
DD-HA 4387		I-U-10	2-1/2 X 4	92.43
DD-HA 4444		I-U-10	2" X 4"	66.76
DD-HYO 49	O-Ring Kit for 6 Stage Hyco 4"-9"			20.71
DD-PK00107	DB07208, AB26635	P-V-5	2-1/2 X 6	76.48

DENSMORE

Kit Number	Code (Pg. xviii)	Rod X Bore Size	List Price
DN501220767A	I-U-3	1-1/4 X 5	\$ 40.29
DN6012272438	I-U-3	1-1/4 X 6	52.39
DN6014304312	I-U-3	1-1/2 X 6	40.72
DN6020304312	I-U-3	2 X 6	49.42
DN7014273372	I-U-3	1-1/2 X 7	63.59
DN7020303312	I-U-3	2 X 7	60.63

DRILTECH

Kit Number	Code (Pg. xviii)	Rod X Bore Size	List Price
DT-1027-088	I-V-9	2-1/2 X 5	\$ 122.05
DT-1029-085	I-V-9	3 X 4-1/2	148.16
DT-12471-058	I-V-9	3-3/4 X 5	308.41
DT-1974-065	I-V-9	3 X 5	198.11
DT-3130-077	I-V-9	3 X 5	126.74

DYNAHOE

Kit Number	Code (Pg. xviii)	Rod X Bore Size	List Price
DH-116613	P-U-10	3 X 6	\$ 78.72
DH-116840	P-U-10	2-1/2 X 4	51.40

DOOSAN INFRACORE

KITS			
Kit Number	Code (Pg. xviii)	Rod X Bore Size	List Price
DI-401107-00936	I-U-10	35 X 50 mm	\$ 48.52
DI-401107-00384A	P-UB-10	60 X 110 mm	69.81
DI-401107-00432	N-N-4	70 mm	40.61
DI-401107-00920	P-U-1	70 mm	23.13
DI-401107-00389A	P-UB-10	70 X 120 mm	159.93
DI-401107-00490	P-UB-10	75 X 140 mm	110.17
DI-2440-9339KT	P-UB-14	80 X 120 mm	143.95
DI-401107-00294A	P-UB-14	80 X 120 mm	118.51
DI-401107-00921	P-U-1	85 mm	37.31
DI-2440-9234KT	P-UB-14	85 X 120 mm	147.21
DI-440-00355AKT	P-UB-14	85 X 120 mm	146.04
DI-401107-00269A	P-UB-14	85 X 120 mm	103.85
DI-401107-00277A	P-UB-14	85 X 120 mm	123.80
DI-2440-9236KT	P-UB-14	95 X 135 mm	149.07
DI-401107-00197A	P-UB-14	95 X 135 mm	128.83
DI-401107-00274A	P-UB-10	95 X 140 mm	149.15
DI-401107-00911	P-U-1	100 mm	42.58
DI-401107-00201A	P-UB-14	100 X 140 mm	134.41
DI-401107-00203A	P-UB-10	105 X 150 mm	154.04
BUFFER RINGS			
Part Number		Rod Dia.	List Price
DI-E5500260		80 mm	\$ 38.54
DI-E5500280		85 mm	41.35
DI-E5500310		95 mm	52.69
PISTON SEALS			
Part Number		Bore Dia.	List Price
DI-E5130260		120 mm	\$ 73.63
DI-E5130310		135 mm	94.12
U-SEALS			
Part Number		Rod Dia.	List Price
DI-E5300340		80 mm	\$ 25.66
DI-E5303140		85 mm	28.84
DI-E6303260		95 mm	31.30
WIPERS			
Part Number		Rod Dia.	List Price
DI-E6020260		80 mm	\$ 44.73
DI-E6020280		85 mm	50.77
DI-E6020310		95 mm	28.52

EATON-YALE, TIMBERJACK

Kit Number	Code (Pg. xviii)	Rod X Bore Size	List Price
EY-2106793	P-U-10	1-1/2 X 3	\$ 44.77
EY-6955800	I-U-10	2 X 3-1/2	55.62
EY-6955804	I-U-10	2-1/4 X 5	87.18
EY-6955805	I-U-10	2-1/2 X 5-1/2	89.83

EDBRO

Kit Number	Bore	Lip Hgt.	Thick-ness	Hole Size	List Price
9200-062ED	2	7/8	7/32	5/8	\$ 14.17
9262-087ED	2-5/8	7/8	7/32	7/8	26.08
9325-100ED	3-1/4	7/8	7/32	1	28.11
9387-112ED	3-7/8	7/8	7/32	1-1/8	32.14
9475-125ED	4-3/4	7/8	7/32	1-1/4	38.67
9575-150ED	5-3/4	7/8	7/32	1-1/2	45.88

EFFER CRANES

Kit Number	Code (Pg. xviii)	Rod X Bore Size	List Price
EF-2160990	I-U-15	100 X 140 mm	\$ 93.03
EF-2166980	I-U-15	35 X 50 mm	48.40
EF-2261990	I-U-15	130 X 220 mm	163.12
EF-2565990	I-U-15	70 X 90 mm	59.74
EF-2663990	I-U-15	65, 125, X 95, 150 mm	149.54
EF-2761990	I-U-15	110 X 150 mm	125.05
EF-3461990	I-U-15	90 X 130 mm	92.49
EF-3760990	I-U-15	120 X 170 mm	116.70
EF-3761990	I-U-15	90 X 130 mm	92.49
EF-3764990	N-N-15	130 mm PISTON	84.70
EF-3861990	I-U-15	65 X 100 mm	68.29
EF-4464990	N-N-15	130 mm PISTON	146.93
EF-4469990	I-U-15	35, 75, 120 X 55, 90, 135 mm	187.94
EF-8086500	N-N-15	95, 150 PISTONS	150.87
EF-8087300	N-N-15	130 mm PISTON	43.86

ENERGY

Kit Number	Code (Pg. xviii)	Rod X Bore Size	List Price
EN-12621X	I-U-3	2 X 4	\$ 45.55
EN-A2430	P-OB-3	1-1/8 X 2	9.22
EN-A2859	P-U-3	1-1/4 X 3	16.78
EN-A7564	P-U-3	1-1/2 X 4	24.17

ESCO®

Kit Number	Code (Pg. xviii)	Rod X Bore Size	List Price
ES-402965	O-Rings		\$ 4.99
ES-402968	O-Rings/Back-Ups		9.69
ES-402970	O-Rings/Back-Ups		4.65
ES-4046426	I-U-5,10	2-1/2 X 5	116.83
ES-4049054	TRW Motor Kit		80.91
ES-4050756	I-U-10	2-1/4 X 4	40.00
ES-4095570	I-U-10	2-1/4 X 4	40.00
ES-420885	I-U-5	1-1/2 X 3-1/2	25.99
ES-421446	I, P-U-5	2 X 4	31.84
ES-421461	I, P-U-5	2 X 5	83.42
ES-421479	P-U-5	2 X 6	91.45
ES-422204	I, P-U-5	2 X 3-1/2	54.99
ES-434043	I-U-10	2-1/2 X 5	38.40
ES-434837	I-U-4	2-1/2 X 4	45.27
ES-435261	I-U-5	1-1/2 X 3-1/2 Boom Cyl.	47.82
ES-435398	I-U-10	2 X 4	30.18
ES-435430	I-U-10	2 X 4	36.06
ES-435686	I-U-5,10	2-1/2 X 5	116.88
ES-435942	I-U-10	2-1/4 X 4	38.28

EUCLID® TRUCKS

Kit Number	Code (Pg. xviii)	Description	List Price
EUC-12977806		Multi-Stage Kit 4, 6.5, 8.5	\$ 554.35
EUC-4046574		Multi-Stage Kit 6.25, 7, 8.25, 9, 10.5, 11	1037.15
EUC-603323		Multi-Stage Kit 4, 6, 8	467.03
EUC-E12590794	P-U-10	2 X 4	57.09
EUC-E12631739	I-UB-11	6 X 8	1192.00
EUC-E12631740	I-UB-11	5 X 8	905.60
EUC-R22HOIST		Multi-Stage Kit 4, 6.5, 8.5	265.96
EUC-R50HOIST		Multi-Stage Kit 3, 6, 8	194.35

FASSI-CRANE

Kit Number	Code (Pg. xviii)	Rod X Bore Size	List Price
FAS-GSC-21	I-U-1	25 mm Rod Kit	\$ 24.65
FAS-GSC-23	N-N-15	110 mm Piston Kit	129.73
FAS-GSC-33		160 mm Bore	40.50
FAS-GSC-35	N-N-15	80 mm Piston Kit	33.72
FAS-GSC-36	N-N-15	95 mm Piston Kit	47.82
FAS-GSC-56	I-U-15	80 X 95 mm	65.51
FAS-GSC-57	I-U-15	70 X 80 mm	38.68
FAS-GSC-62	I-U-15	80 X 95 mm	60.57
FAS-GSC-125	I-U-15	95 X 140 mm	158.00
FAS-GSC-138	I-U-15	50 X 75 mm	69.84
FAS-GSC-140	I-U-1	30 mm Rod Kit	29.25
FAS-GSC-152		O-Ring Kit	8.35
FAS-GSC-156	I-U-15	60, 95 mm Stages	201.16
FAS-GSC-157	I-U-15	95 X 100 mm	150.64
FAS-GSC-158	I-U-15	60 X 90 mm	162.93
FAS-GSC-161	I-U-15	35 X 60 mm	37.16
FAS-GSC-162	I-U-15	35, 70 mm Stages	108.46
FAS-GSC-202	N-N-15	130 mm Rod Kit	81.68
FAS-GSC-203	I-U-15	100 X 170 mm	92.24
FAS-GSC-217	N-N-15	150 mm Piston Kit	95.69
FAS-GSC-228	I-U-15	55 X 95 mm	50.45
FAS-GSC-245	I-U-15	55 X 85 mm	59.49
FAS-GSC-277	I-U-15	45 X 70 mm	58.31
FAS-GSC-279	I-U-15	55 X 85 mm	64.75
FAS-GSC-288	I-U-15	120 x 190 mm	149.90

FONTAINE®

Kit Number	Description	List Price
FNT-38	3" - 8" Vee Sets & Wipers	\$ 233.73
FNT-3VSW	3" Vee Set & Wiper	25.69
FNT-46	4" - 6" Vee Sets & Wipers	104.17
FNT-48	4" - 8" Vee Sets & Wipers	208.01
FNT-4VSW	4" Vee Set & Wiper	22.24
FNT-58	5" - 8" Vee Sets & Wipers	179.01
FNT-5VSW	5" Vee Set & Wiper	27.14
FNT-6VSW	6" Vee Set & Wiper	30.55
FNT-7VSW	7" Vee Set & Wiper	35.56
FNT-8VSW	8" Vee Set & Wiper	44.14

FMC

Kit Number	Code (Pg. xviii)	Rod X Bore Size	List Price
FMC-232-7178-090	N-U,V-3	5/8 X 1-1/2	\$ 28.60
FMC-238-0858-090	P-V-7	2-1/2 X 5	93.69
FMC-238-4389-090	I-U-10	2-1/2 X 5	34.40
FMC-238-4529-090	P-V-7	1-1/2 X 4	91.85
FMC-239-4563-091	O-RING KIT		4.40
FMC-239-8317-090	I-V-5	1 X 2	42.26
FMC-360-4-0006	I-V-1	4-1/2 X 5	55.09
FMC-3X0094	P-U-10	1-1/2 X 3	26.02
FMC-507065	I-U-10	1-1/4 X 3	26.34
FMC-514-0246-090	I-U-4	2-1/2 X 5	46.63
FMC-514-0247-090	I-U-5	2-1/2 X 5	54.41
FMC-514-0844-090	I-U-1	2-1/2 X 3-1/2	37.55
FMC-514-0856-090	I-V-1	4-1/2 ROD KIT	28.71
FMC-514-1536-090	I-U-4	1-1/2 X 3-1/2	45.19
FMC-515-4130-090	I-V-5	2-1/2 X 5	70.02
FMC-515-6322-090	I-V-1	4-1/2 ROD KIT	49.12
FMC-515-8903-090	I-U-10	1-1/8 X 2-1/2	28.51
FMC-517-2118	P-U-5	1-1/4 X 3	50.45
FMC-517-2880	P-OB-3	1-1/4 X 3	12.75
FMC-519-9547-090	N-N-5	8" PISTON KIT	118.70
FMC-519-9548-090	P-U-10	3-1/2 X 6	54.41
FMC-519-9887-090	I-U-11	1-1/4 X 3	36.19
FMC-620-0104-090	I-U-11	3/4 X 1-1/2	17.57
FMC-620-0188-090	I-U-4	3 X 5	86.00
FMC-620-0190-090	I-U-4	2 X 3-1/2	44.74
FMC-620-0236-090	I-U-5	2 X 3-1/2	53.51
FMC-620-0307-090	I-U-11	1/2 X 1	23.57
FMC-620-0736-090	I-U-11	1-1/4 X 2	16.86
FMC-620-1545-090	I-U-5	3 X 4	112.87
FMC-620-1571-090	I-U-1	2-1/2 X 3	19.27
FMC-621-3234-090	I-U-1	2-1/2	16.18
FMC-621-5638-090	I-U-10	3/4 X 1-1/2	108.82
FMC-621-5639-090	I-U-10	3/4 X 1-1/2	15.08
FMC-621-5641-090	I-U-1	2-1/2 ROD KIT	59.64
FMC-621-5644-090	I-U-10	3 X 5	81.58
FMC-621-5645-090	I-U-10	2 X 3-1/2	66.22
FMC-621-5646-090	I-U-10	2 X 3-1/2	66.22
FMC-621-5658	O-RING KIT		4.99
FMC-624-0850-090	I-U-1	2-1/2 X 85 mm	15.97

FIAT-ALLIS®

Kit Number	Code (Pg. xviii)	Rod X Bore Size	List Price
FA-790458-11-1	P-U-13	70 X 125mm	\$ 213.28
BACK-UP RINGS			
Part Number	Min. Pkgs.		List Price
FA-79076127	1		\$ 5.92
FA-8292276	1		5.92
FA-8298072	1		20.72
O-RINGS			
Part Number	Min. Pkgs.		List Price
FA-8292274	5		\$ 2.74
PISTON SEALS			
Part Number	Bore Dia.	List Price	
FA-8292275	180 mm	\$ 77.35	
U-SEALS			
Part Number	Rod Dia.	List Price	
FA-79031333	90 mm	\$ 26.10	
RETAINER RINGS			
Part Number	List Price		
FA-70925993	\$ 1.86		
FA-70925994	3.49		
FA-70925995	3.49		
FA-70925996	3.58		
FA-70926385	4.47		
FA-70926776	0.76		
FA-70926800	0.76		
FA-70927575	1.08		
FA-70927690	0.76		
FA-70927691	0.80		
FA-70927692	1.18		
FA-70927693	0.88		
FA-70927695	1.62		
FA-70927696	1.62		
FA-70927700	1.99		
FA-70927701	3.26		
FA-70927702	3.49		
FA-70927704	3.85		
FA-70928826	1.08		
FA-70935974	3.05		

Replacement Kits For

FIAT-HITACHI

Excavators						
APPLICATION	CODE	ROD	BORE	MISC	KIT #	List \$
MODEL FH120, FH130-1, FH130-2						
ARM	P-UB-1	80 mm			FH-71400106	73.77
	N-N-14		115 mm		FH-71400116	114.06
	Bushing	80 mm			FH-71400109	33.98
BOOM	I-UB-1	75 mm			FH-71400089	66.73
	N-N-14		105 mm		FH-71400092	153.56
	Bushing	75 mm			FH-71400087	32.70
BUCKET	P-UB-1	65 mm			FH-71400056	65.07
	N-N-14		95 mm		FH-71400069	77.53
	Bushing	65 mm			FH-71400058	26.24
MODEL FH130-3						
ARM	P-UB-1	80 mm			FH-71445694	101.29
	N-N-14		115 mm		FH-71445785	128.55
	Bushing	80 mm			FH-71447625	30.95
BOOM	I-UB-1	75 mm			FH-71445759	56.37
	N-N-10		105 mm		FH-71445781	118.23
	Bushing	75 mm			FH-71447626	32.70
BUCKET	P-UB-1	65 mm			FH-71445753	49.51
	N-N-10		95 mm		FH-71445777	65.77
	Bushing	65 mm			FH-71447627	26.89
MODEL FH150-1, FH150-1W, FH150-2						
ARM	P-UB-1	85 mm			FH-71400199	83.76
	N-N-14		120 mm		FH-71400231	155.63
	Bushing	85 mm			FH-71400202	37.06
BOOM	P-UB-1	80 mm			FH-71400106	73.77
	N-N-14		115 mm		FH-71400116	114.06
	Bushing	80 mm			FH-71400109	33.98
BUCKET	P-UB-1	80 mm			FH-71400106	73.77
	N-N-14		115 mm		FH-71400116	114.06
	Bushing	80 mm			FH-71400109	33.98
MODEL FH150-3						
ARM	P-UB-1	85 mm			FH-71445728	91.64
	N-N-14		120 mm		FH-71445708	146.78
	Bushing	85 mm			FH-71447620	18.28
BOOM	P-UB-1	80 mm			FH-71445694	101.29
	N-N-14		115 mm		FH-71445785	128.55
	Bushing	80 mm			FH-71447625	30.95
BUCKET	P-UB-1	80 mm			FH-71445694	101.29
	N-N-14		115 mm		FH-71445785	128.55
	Bushing	80 mm			FH-71447625	30.95
MODEL FH200-1, FH200-2						
ARM	P-UB-1	95 mm			FH-71400186	88.26
	N-N-14		135 mm		FH-71400161	148.98
	Bushing	95 mm			FH-71400189	44.36
BOOM	P-UB-1	85 mm			FH-71400199	83.76
	Bushing	85 mm			FH-71400202	37.06
BUCKET	P-UB-1	80 mm			FH-71400106	73.77

Replacement Kits For

FIAT-HITACHI

Excavators						
APPLICATION	CODE	ROD	BORE	MISC	KIT #	List \$
MODEL FH200-1, FH200-2						
BUCKET	N-N-14		120 mm		FH-71400231	155.63
	Bushing	80 mm			FH-71400109	33.98
MODEL FH200-3						
ARM	P-UB-1	95 mm			FH-71445615	117.81
	N-N-14		135 mm		FH-71445801	187.82
	Bushing	95 mm			FH-71447621	37.71
BOOM	P-UB-1	85 mm			FH-71445728	91.64
	N-N-14		120 mm		FH-71445708	146.78
	Bushing	85 mm			FH-71447620	18.28
BUCKET	P-UB-1	80 mm			FH-71445694	101.29
	N-N-14		120 mm		FH-71445708	146.78
	Bushing	80 mm			FH-71447625	30.95
MODEL FH220-1, FH220-2						
ARM	P-UB-1	100 mm			FH-71400133	94.05
	N-N-14		145 mm		FH-71400137	208.27
	Bushing	100 mm			FH-71400125	59.52
BOOM	P-UB-1	90 mm			FH-71400152	92.05
	N-N-14		135 mm		FH-71400161	148.98
	Bushing	90 mm			FH-71400155	42.75
BUCKET	P-UB-1	90 mm			FH-71400152	92.05
	N-N-14		135 mm		FH-71400161	148.98
	Bushing	90 mm			FH-71400155	42.75
MODEL FH220-3						
ARM	P-UB-1	100 mm			FH-71445765	121.86
	N-N-14		145 mm		FH-71445811	242.46
	Bushing	100 mm			FH-71447902	51.17
BOOM	P-UB-1	90 mm			FH-71445647	105.64
	N-N-14		135 mm		FH-71445801	187.82
	Bushing	90 mm			FH-71447622	33.15
BUCKET	P-UB-1	90 mm			FH-71445647	105.64
	N-N-14		135 mm		FH-71445801	187.82
	Bushing	90 mm			FH-71447622	33.15
MODEL FH300-1, FH300-2						
ARM	P-UB-1	110 mm			FH-71400275	115.09
	N-N-14		165 mm		FH-71400282	220.18
	Bushing	110 mm			FH-71400278	84.51
BOOM	P-UB-1	100 mm			FH-71400133	94.05
	N-N-14		145 mm		FH-71400137	208.27
	Bushing	100 mm			FH-71400125	59.52
BUCKET	P-UB-1	95 mm			FH-71400186	88.26
	N-N-14		145 mm		FH-71400137	208.27
	Bushing	95 mm			FH-71400189	44.36

REPLACEMENT KITS FOR FIAT-HITACHI

NOTE: Fiat-Hitachi part numbers are used as a reference only. We do not imply that these kit are original REPLACEMENT PARTS.

Kit Number	Rod Diameter	Bore Diameter	List Price	Kit Number	Rod Diameter	Bore Diameter	List Price
FH-71400056			\$ 65.07	FH-71418534	90 mm		\$ 54.55
FH-71400058	65 mm		26.24	FH-71418539		145 mm	3.67
FH-71400066			1.53	FH-71418542		145 mm	106.58
FH-71400069			77.53	FH-71445615	95 mm		117.81
FH-71400087	75 mm		32.70	FH-71445647	90 mm		105.64
FH-71400089	75 mm		66.73	FH-71445694	80 mm		101.29
FH-71400090			2.03	FH-71445708		120 mm	146.78
FH-71400092		105 mm	153.56	FH-71445728	85 mm		91.64
FH-71400106	80 mm		73.77	FH-71445742		125 mm	66.61
FH-71400116		115 mm	114.06	FH-71445753	65 mm		49.51
FH-71400133	100 mm		94.05	FH-71445759	75 mm		56.37
FH-71400137		145 mm	208.27	FH-71445765	100 mm		121.86
FH-71400152	90 mm		92.05	FH-71445777		95 mm	65.77
FH-71400161		135 mm	148.98	FH-71445781		105 mm	118.23
FH-71400186	95 mm		88.26	FH-71445785		115 mm	128.55
FH-71400199	85 mm		83.76	FH-71445801		135 mm	187.82
FH-71400231		120 mm	155.63	FH-71445811		145 mm	242.46
FH-71400275	110 mm		115.09	FH-71445827			8.20
FH-71400282		165 mm	220.18	FH-71445830			10.89
FH-71400375	95 mm		38.95	FH-71452214		170 mm	6.35
FH-71408744	70 mm		49.81	FH-71465022	100 mm		56.53
FH-71408756		105 mm	88.30	FH-71466446		115 mm	95.41
FH-71408778	80 mm		51.89	FH-71470391	105 mm		72.17
FH-71408806	65 mm		44.37	FH-71470396	115 mm		87.81
FH-71408811		95 mm	76.87	FH-71470402		150 mm	125.79
FH-71418431	95 mm		57.17	FH-71470405		170 mm	140.16
FH-71418444		130 mm	76.86	FH-71470408		150 mm	4.19
FH-71418514		110 mm	78.08				

REPLACEMENT PARTS FOR FIAT-HITACHI

NOTE: Fiat-Hitachi part numbers are used as a reference only. We do not imply that these kit are original REPLACEMENT PARTS.

O-RINGS

Part Number	Min. Pkgs.	List Price
FH-14472980	10	\$ 1.24
FH-14473180	10	1.24
FH-14473280	10	1.38
FH-14474480	5	1.57
FH-14474780	5	1.76
FH-14475380	5	2.20

ROD BUSHINGS

Part Number	Rod Diameter	List Price
FH-71400109	80 mm	\$ 33.98
FH-71400125	100 mm	59.52
FH-71400155	90 mm	42.75
FH-71400189	95 mm	44.36
FH-71400202	85 mm	37.06
FH-71400278	110 mm	84.51
FH-71447620	85 mm	34.71
FH-71447621	95 mm	37.71
FH-71447622	90 mm	33.15
FH-71447625	80 mm	30.95
FH-71447626	75 mm	32.70
FH-71447627	65 mm	26.89
FH-71447902	100 mm	51.17

REPLACEMENT SEAL KITS FOR FORD EQUIPMENT*

Replacement Seal Kits By Machine Type

Table of Contents

Machine Type		Page
Backhoe Loaders	340, 540, 340A, 540A, 340B, 540B, 445, 445A, 445C, 445D, 450, 455, 455C, 455D, 545, 545A, 545C, 545D, 550, 555, 555A, 555A-XL, 555B, 555C, 555D, 555E, 575D, 575E, 650, 655, 655A, 655C, 655D, 655E, 675D, 675E, 730, 740, 750, 753, 755, 755A, 755B, 5500-5550, 6500, 7500, A62, A64, A66	518 - 531
Tractors	2600, 3600, 4600, 4600-SU, 3400, 3500, 3550, 4400, 4500, 5600, 6600, 7600	531
Alpha-Numeric Kit Listing		532
Ford Individual Parts		533

*All manufacturer's names, part numbers and descriptions are used for reference purposes only. We do not imply that any part shown is the product of these manufacturers. We also do not imply that the list price shown is exactly that of the manufacturer.

Replacement Kits For

FORD

Backhoe Loaders								
APPLICATION	CYL #	Piston Type	SERIAL #	CODE	ROD	BORE	KIT #	List \$
MODEL 340, 540								
BACKHOE BUCKET	D8NN-B576-FB	2pc	78/9-81	P-UV-9	63 mm	90 mm	FD-251032	220.13
	D8NN-B576-FB	1pc	78/9-81	P-UV-10	63 mm	90 mm	FD-251321	143.05
BACKHOE CROWD	D8NN-B578-AA	2pc	78/9-81	P-V-9	50 mm	100 mm	FD-251035	316.47
	D8NN-B578-AA	1pc	78/9-81	P-SP-10	50 mm	100 mm	FD-251316	196.78
	D8NN-B578-CC	2pc	78/9-81	P-UV-9	63 mm	115 mm	FD-251036	188.31
	D8NN-B578-CC	1pc	78/9-81	P-UV-10	63 mm	115 mm	FD-251319	118.20
BACKHOE LIFT	D8NN-B577-BB	2pc	78/9-81	P-UV-9	56 mm	115 mm	FD-251034	205.42
	D8NN-B577-BB	1pc	78/9-81	P-UV-10	56 mm	115 mm	FD-251318	151.92
	D8NN-B577-CB	2pc	78/9-81	P-V-9	50 mm	100 mm	FD-251035	316.47
	D8NN-B577-CB	1pc	78/9-81	P-SP-10	50 mm	100 mm	FD-251316	196.78
BACKHOE STABILIZER	D8NN-B580-AA	2pc to 1pc	78/9-81	P-SP-10	50 mm	100 mm	FD-251339	163.62
	D8NN-B580-AA	2pc	78/9-81	P-UV-8	50 mm	100 mm	FD-251038	132.01
BACKHOE SWING	D8NN-B579-BE		78/9-81	P-UV-9	56 mm	110 mm	FD-251037	214.70
LOADER BUCKET	D8NN-L903-FC		3-81/9-81	P-U-10	35 mm	60 mm	FD-251369	42.05
LOADER LIFT	D8NN-L905-FD		3-81/9-81	P-SP-10	40 mm	60 mm	FD-251370	47.25
MODEL 340A, 540A								
BACKHOE BUCKET	D8NN-B576-EC	1pc	84/5-85	P-UV-10	63 mm	90 mm	FD-251321	143.05
	D8NN-B576-FB	1pc	10-81/5-85	P-UV-10	63 mm	90 mm	FD-251321	143.05
BACKHOE CROWD	D8NN-B578-AA	1pc	10-81/5-85	P-SP-10	50 mm	100 mm	FD-251316	196.78
	D8NN-B578-AB	1pc	82/5-85	P-SP-10	50 mm	100 mm	FD-251316	196.78
	D8NN-B578-CC	1pc	10-81/5-85	P-UV-10	63 mm	115 mm	FD-251319	118.20
BACKHOE LIFT	D8NN-B577-BB	1pc	10-81/5-85	P-UV-10	56 mm	115 mm	FD-251318	151.92
	D8NN-B577-CB	1pc	10-81/5-85	P-SP-10	50 mm	100 mm	FD-251316	196.78
BACKHOE STABILIZER	D8NN-B580-AA	2pc to 1pc	10-81/1-83	P-SP-10	50 mm	100 mm	FD-251339	163.62
	D8NN-B580-AA	2pc	10-81/1-83	P-UV-8	50 mm	100 mm	FD-251038	132.01
	D8NN-B580-AD	1pc	2-83/5-85	P-UV-10	56 mm	100 mm	FD-251315	98.48
BACKHOE SWING	D8NN-B579-BE		10-81/8-82	P-UV-9	56 mm	110 mm	FD-251037	214.70
	E0NN-B579-BB		9-82/5-85	P-UV-10	50 mm	110 mm	FD-251303	106.49
LOADER BUCKET	D8NN-L903-FC		10-81/5-85	P-U-10	35 mm	60 mm	FD-251369	42.05
LOADER LIFT	D8NN-L905-FD		10-81/5-85	P-SP-10	40 mm	60 mm	FD-251370	47.25
MODEL 340B, 540B								
BACKHOE BUCKET	D8NN-B576-EC	1pc	6-85/11-88	P-UV-10	63 mm	90 mm	FD-251321	143.05
	D8NN-B576-FB	1pc	6-85/11-88	P-UV-10	63 mm	90 mm	FD-251321	143.05
BACKHOE CROWD	D8NN-B578-AA	1pc	6-85/11-88	P-SP-10	50 mm	100 mm	FD-251316	196.78
	D8NN-B578-AB	1pc	6-85/11-88	P-SP-10	50 mm	100 mm	FD-251316	196.78
	D8NN-B578-CC	1pc	6-85/11-88	P-UV-10	63 mm	115 mm	FD-251319	118.20
BACKHOE LIFT	D8NN-B577-BB	1pc	6-85/11-88	P-UV-10	56 mm	115 mm	FD-251318	151.92
	D8NN-B577-CB	1pc	6-85/11-88	P-SP-10	50 mm	100 mm	FD-251316	196.78
BACKHOE STABILIZER	D8NN-B580-AD	1pc	6-85/6-87	P-UV-10	56 mm	100 mm	FD-251315	98.48
	E4NN-B580-AA	1pc	7-87/11-88	P-UV-10	56 mm	100 mm	FD-251315	98.48
BACKHOE SWING	E0NN-B579-BB		6-85/11-88	P-UV-10	50 mm	110 mm	FD-251303	106.49
LOADER BUCKET	D8NN-L903-FC		6-85/11-88	P-U-10	35 mm	60 mm	FD-251369	42.05
LOADER LIFT	D8NN-L905-FD		6-85/11-88	P-SP-10	40 mm	60 mm	FD-251370	47.25
MODEL 445								
BACKHOE BUCKET	D8NN-B576-EC	1pc	84/5-85	P-UV-10	63 mm	90 mm	FD-251321	143.05
	D8NN-B576-FB	2pc	78/11-81	P-UV-9	63 mm	90 mm	FD-251032	220.13

FORD

Replacement Kits For

FORD

Backhoe Loaders								
APPLICATION	CYL #	Piston Type	SERIAL #	CODE	ROD	BORE	KIT #	List \$
MODEL 445								
BACKHOE BUCKET	D8NN-B576-FB	1pc	78/5-85	P-UV-10	63 mm	90 mm	FD-251321	143.05
BACKHOE CROWD	D8NN-B578-AA	2pc	78/11-81	P-V-9	50 mm	100 mm	FD-251035	316.47
	D8NN-B578-AA	1pc	78/5-85	P-SP-10	50 mm	100 mm	FD-251316	196.78
	D8NN-B578-AB	1pc	82/5-85	P-SP-10	50 mm	100 mm	FD-251316	196.78
	D8NN-B578-CC	2pc	78/11-81	P-UV-9	63 mm	115 mm	FD-251036	188.31
	D8NN-B578-CC	1pc	78/5-85	P-UV-10	63 mm	115 mm	FD-251319	118.20
BACKHOE LIFT	D8NN-B577-BB	2pc	78/11-81	P-UV-9	56 mm	115 mm	FD-251034	205.42
	D8NN-B577-BB	1pc	78/5-85	P-UV-10	56 mm	115 mm	FD-251318	151.92
	D8NN-B577-CB	2pc	78/11-81	P-V-9	50 mm	100 mm	FD-251035	316.47
	D8NN-B577-CB	1pc	78/5-85	P-SP-10	50 mm	100 mm	FD-251316	196.78
BACKHOE STABILIZER	D8NN-B580-AA	2pc	78/1-83	P-UV-8	50 mm	100 mm	FD-251038	132.01
	D8NN-B580-AA	2pc to 1pc	78/1-83	P-SP-10	50 mm	100 mm	FD-251339	163.62
	D8NN-B580-AD	1pc	2-83/5-85	P-UV-10	56 mm	100 mm	FD-251315	98.48
BACKHOE SWING	D8NN-B579-BE		78/8-82	P-UV-9	56 mm	110 mm	FD-251037	214.70
	E0NN-B579-BB		9-82/5-85	P-UV-10	50 mm	110 mm	FD-251303	106.49
LOADER BUCKET	D8NN-L903-AF		78/5-85	P-SP-10	40 mm	70 mm	FD-251072	36.57
	D8NN-L903-DD		78/5-85	P-SP-10	40 mm	70 mm	FD-251072	36.57
LOADER LIFT	D8NN-L905-DG		78/5-85	P-SP-10	50 mm	70 mm	FD-251162	41.50
MODEL 445A								
BACKHOE BUCKET	D8NN-B576-EC	1pc	6-85/12-86	P-UV-10	63 mm	90 mm	FD-251321	143.05
	D8NN-B576-FB	1pc	6-85/12-86	P-UV-10	63 mm	90 mm	FD-251321	143.05
BACKHOE CROWD	D8NN-B578-AA	1pc	6-85/12-86	P-SP-10	50 mm	100 mm	FD-251316	196.78
	D8NN-B578-AB	1pc	6-85/12-86	P-SP-10	50 mm	100 mm	FD-251316	196.78
	D8NN-B578-CC	1pc	6-85/12-86	P-UV-10	63 mm	115 mm	FD-251319	118.20
BACKHOE LIFT	D8NN-B577-BB	1pc	6-85/12-86	P-UV-10	56 mm	115 mm	FD-251318	151.92
	D8NN-B577-CB	1pc	6-85/12-86	P-SP-10	50 mm	100 mm	FD-251316	196.78
BACKHOE STABILIZER	D8NN-B580-AD	1pc	6-85/12-86	P-UV-10	56 mm	100 mm	FD-251315	98.48
BACKHOE SWING	E0NN-B579-BB		6-85/12-86	P-UV-10	50 mm	110 mm	FD-251303	106.49
LOADER BUCKET	D8NN-L903-AF		6-85/12-86	P-SP-10	40 mm	70 mm	FD-251072	36.57
	D8NN-L903-DD		6-85/12-86	P-SP-10	40 mm	70 mm	FD-251072	36.57
LOADER LIFT	D8NN-L905-DG		6-85/12-86	P-SP-10	50 mm	70 mm	FD-251162	41.50
MODEL 445C								
LOADER BUCKET	F1NN-L903-BA		3-89/6-91, 7-91/-	P-UB-10	40 mm	70 mm	FD-FP419	68.59
LOADER LIFT	F1NN-L905-BB		3-89/6-91, 7-91/11-91	P-UB-10	50 mm	70 mm	FD-FP459	65.17
MODEL 445D								
LOADER BUCKET	F1NN-L903-BA		7-91/	P-UB-10	40 mm	70 mm	FD-FP419	68.59
LOADER LIFT	F1NN-L905-BB		7-91/11-92, 12-92/-	P-UB-10	50 mm	70 mm	FD-FP459	65.17
MODEL 450								
BACKHOE BUCKET	D8NN-B576-EC	1pc	87/11-88	P-UV-10	63 mm	90 mm	FD-251321	143.05
	D8NN-B576-FB	1pc	87/11-88	P-UV-10	63 mm	90 mm	FD-251321	143.05
BACKHOE CROWD	D8NN-B578-AA	1pc	87/11-88	P-SP-10	50 mm	100 mm	FD-251316	196.78
	D8NN-B578-AB	1pc	87/11-88	P-SP-10	50 mm	100 mm	FD-251316	196.78
	D8NN-B578-CC	1pc	87/11-88	P-UV-10	63 mm	115 mm	FD-251319	118.20
BACKHOE LIFT	D8NN-B577-BB	1pc	87/11-88	P-UV-10	56 mm	115 mm	FD-251318	151.92

Replacement Kits For

FORD

Backhoe Loaders								
APPLICATION	CYL #	Piston Type	SERIAL #	CODE	ROD	BORE	KIT #	List \$
MODEL 450								
BACKHOE LIFT	D8NN-B577-CB	1pc	87/11-88	P-SP-10	50 mm	100 mm	FD-251316	196.78
BACKHOE STABILIZER	D8NN-B580-AD	1pc	1-87/6-87	P-UV-10	56 mm	100 mm	FD-251315	98.48
	E4NN-B580-AA	1pc	7-87/11-88	P-UV-10	56 mm	100 mm	FD-251315	98.48
BACKHOE SWING	E0NN-B579-BB		87/11-88	P-UV-10	50 mm	110 mm	FD-251303	106.49
LOADER BUCKET	D8NN-L903-DD		87/11-88	P-SP-10	40 mm	70 mm	FD-251072	36.57
LOADER LIFT	D8NN-L905-DG		87/11-88	P-SP-10	50 mm	70 mm	FD-251162	41.50
MODEL 455								
BACKHOE BUCKET	D8NN-B576-EC		7-87/11-88	P-UV-10	63 mm	90 mm	FD-251321	143.05
	D8NN-B576-FB		7-87/11-88	P-UV-10	63 mm	90 mm	FD-251321	143.05
BACKHOE CROWD	D8NN-B578-AB		7/87-11-88	P-SP-10	50 mm	100 mm	FD-251316	196.78
	E6NN-B578-AA		7/87-11-88	P-SP-10	50 mm	100 mm	FD-251316	196.78
BACKHOE EXTENDABLE DIPSTICK	E4NN-C492-AA		7-87/11-88	P-V-10	50 mm	80 mm	FD-251317	145.08
BACKHOE LIFT	E6NN-B577-AA		7-87/11-88	P-SP-10	50 mm	100 mm	FD-251316	196.78
	E9NN-B577-AA		7-87/11-88	P-SP-10	50 mm	100 mm	FD-251316	196.78
BACKHOE STABILIZER	E4NN-B580-AA		7-87/11-88	P-UV-10	56 mm	100 mm	FD-251315	98.48
BACKHOE SWING	E6NN-B579-AA		7-87/11-88	P-UV-10	50 mm	110 mm	FD-251303	106.49
LOADER BUCKET LH	E0NN-L904-AA		7-87/11-88	P-U-10	1-1/2	3	FD-251363	29.62
LOADER BUCKET RH	E0NN-L903-AA		7-87/11-88	P-U-10	1-1/2	3	FD-251363	29.62
LOADER LIFT	E4NN-L905-AA		7-87/11-88	P-U-10	2	3	FD-251362	28.59
MODEL 455C								
BACKHOE BUCKET	E7NN-B576-AB		12-88/8-92	P-U-10	63 mm	90 mm	FD-FP456	78.97
BACKHOE CROWD	E7NN-B578-BC		12-88/12-91	P-UB-10	63 mm	115 mm	FD-FP455	104.77
	F1NN-B578-BA		1-92/8-92	P-UB-10	63 mm	115 mm	FD-FP455	104.77
BACKHOE EXTENDABLE DIPSTICK	E7NN-C492-AB		12-88/8-92	P-UB-10	50 mm	80 mm	FD-FP457	58.38
BACKHOE LIFT	E7NN-B577-CC		12-88/12-91	P-UB-10	56 mm	115 mm	FD-FP454	154.37
	F1NN-B577-AA		1-92/8-92	P-UB-10	56 mm	115 mm	FD-FP454	154.37
BACKHOE STABILIZER	E7NN-B580-AE		12-88/4-92	P-UB-10	56 mm	100 mm	FD-FP458	113.10
	F1NN-B580-AA		5-92/8-92	P-UB-10	56 mm	100 mm	FD-FP458	113.10
BACKHOE SWING	E7NN-B579-AC		12-88/8-92	P-UB-10	50 mm	110 mm	FD-FP460	114.76
LOADER BUCKET	E7NN-L903-BA		12-88/6-91	P-UB-10	40 mm	80 mm	FD-85804740	63.57
	F1NN-L903-CA		7-91/8-92	P-UB-10	40 mm	80 mm	FD-85804740	63.57
LOADER LIFT	E7NN-L905-AC		12-88/8-92	P-UB-10	50 mm	80 mm	FD-FP417	66.52
MODEL 455D								
BACKHOE BUCKET	E7NN-B576-AB		9-92/	P-U-10	63 mm	90 mm	FD-FP456	78.97
BACKHOE CROWD	F1NN-B578-BA		9-92/	P-UB-10	63 mm	115 mm	FD-FP455	104.77
BACKHOE EXTENDABLE DIPSTICK	E7NN-C492-AB		9-92/8-93	P-UB-10	50 mm	80 mm	FD-FP457	58.38
	E7NN-C492-AD		9-93/	P-UB-10	50 mm	80 mm	FD-FP457	58.38
BACKHOE LIFT	F1NN-B577-AA		9-92/	P-UB-10	56 mm	115 mm	FD-FP454	154.37
BACKHOE STABILIZER	F1NN-B580-AA		9-92/8-93	P-UB-10	56 mm	100 mm	FD-FP458	113.10
	F2NN-B580-AA		9-93/	P-UB-10	56 mm	100 mm	FD-FP458	113.10
BACKHOE SWING	E7NN-B579-AC		9-92/8-93	P-UB-10	50 mm	110 mm	FD-FP460	114.76
	E7NN-B579-AD		9-93/	P-UB-10	50 mm	110 mm	FD-FP460	114.76
LOADER BUCKET	F1NN-L903-CA		9-92/	P-UB-10	40 mm	80 mm	FD-85804740	63.57

Replacement Kits For

FORD

Backhoe Loaders								
APPLICATION	CYL #	Piston Type	SERIAL #	CODE	ROD	BORE	KIT #	List \$
MODEL 455D								
LOADER LIFT	E7NN-L905-AC		9-92/	P-UB-10	50 mm	80 mm	FD-FP417	66.52
MODEL 545								
BACKHOE BUCKET	D8NN-B576-EC	1pc	84/5-85	P-UV-10	63 mm	90 mm	FD-251321	143.05
	D8NN-B576-FB	2pc	78/11-81	P-UV-9	63 mm	90 mm	FD-251032	220.13
	D8NN-B576-FB	1pc	78/5-85	P-UV-10	63 mm	90 mm	FD-251321	143.05
BACKHOE CROWD	D8NN-B578-AA	2pc	78/11-81	P-V-9	50 mm	100 mm	FD-251035	316.47
	D8NN-B578-AA	1pc	78/5-85	P-SP-10	50 mm	100 mm	FD-251316	196.78
	D8NN-B578-AB	1pc	82/5-85	P-SP-10	50 mm	100 mm	FD-251316	196.78
	D8NN-B578-CC	2pc	78/11-81	P-UV-9	63 mm	115 mm	FD-251036	188.31
	D8NN-B578-CC	1pc	78/5-85	P-UV-10	63 mm	115 mm	FD-251319	118.20
BACKHOE LIFT	D8NN-B577-BB	2pc	78/11-81	P-UV-9	56 mm	115 mm	FD-251034	205.42
	D8NN-B577-BB	1pc	78/5-85	P-UV-10	56 mm	115 mm	FD-251318	151.92
	D8NN-B577-CB	2pc	78/11-81	P-V-9	50 mm	100 mm	FD-251035	316.47
	D8NN-B577-CB	1pc	78/5-85	P-SP-10	50 mm	100 mm	FD-251316	196.78
BACKHOE STABILIZER	D8NN-B580-AA	2pc	78/1-83	P-UV-8	50 mm	100 mm	FD-251038	132.01
	D8NN-B580-AA	2pc to 1pc	78/1-83	P-SP-10	50 mm	100 mm	FD-251339	163.62
	D8NN-B580-AD	1pc	2-83/5-85	P-UV-10	56 mm	100 mm	FD-251315	98.48
BACKHOE SWING	D8NN-B579-BE		78/8-82	P-UV-9	56 mm	110 mm	FD-251037	214.70
	E0NN-B579-BB		9-82/5-85	P-UV-10	50 mm	110 mm	FD-251303	106.49
LOADER BUCKET	D8NN-L903-AF		78/5-85	P-SP-10	40 mm	70 mm	FD-251072	36.57
	D8NN-L903-CE		78/5-85	P-U-10	40 mm	80 mm	FD-251073	52.75
	D8NN-L903-DD		78/5-85	P-SP-10	40 mm	70 mm	FD-251072	36.57
LOADER LIFT	D8NN-L905-CE		78/5-85	P-SP-10	50 mm	80 mm	FD-251074	43.49
	D8NN-L905-DG		78/5-85	P-SP-10	50 mm	70 mm	FD-251162	41.50
MODEL 545A								
BACKHOE BUCKET	D8NN-B576-EC	1pc	6-85/11-88	P-UV-10	63 mm	90 mm	FD-251321	143.05
	D8NN-B576-FB	1pc	6-85/11-88	P-UV-10	63 mm	90 mm	FD-251321	143.05
BACKHOE CROWD	D8NN-B578-AA	1pc	6-85/11-88	P-SP-10	50 mm	100 mm	FD-251316	196.78
	D8NN-B578-AB	1pc	6-85/11-88	P-SP-10	50 mm	100 mm	FD-251316	196.78
	D8NN-B578-CC	1pc	6-85/11-88	P-UV-10	63 mm	115 mm	FD-251319	118.20
BACKHOE LIFT	D8NN-B577-BB	1pc	6-85/11-88	P-UV-10	56 mm	115 mm	FD-251318	151.92
	D8NN-B577-CB	1pc	6-85/11-88	P-SP-10	50 mm	100 mm	FD-251316	196.78
BACKHOE STABILIZER	D8NN-B580-AD	1pc	6-85/6-87	P-UV-10	56 mm	100 mm	FD-251315	98.48
	E4NN-B580-AA	1pc	7-87/11-88	P-UV-10	56 mm	100 mm	FD-251315	98.48
BACKHOE SWING	E0NN-B579-BB		6-85/11-88	P-UV-10	50 mm	110 mm	FD-251303	106.49
LOADER BUCKET	D8NN-L903-AF		6-85/11-88	P-SP-10	40 mm	70 mm	FD-251072	36.57
	D8NN-L903-CE		6-85/11-88	P-U-10	40 mm	80 mm	FD-251073	52.75
	D8NN-L903-DD		6-85/11-88	P-SP-10	40 mm	70 mm	FD-251072	36.57
LOADER LIFT	D8NN-L905-CE		6-85/11-88	P-SP-10	50 mm	80 mm	FD-251074	43.49
	D8NN-L905-DG		6-85/11-88	P-SP-10	50 mm	70 mm	FD-251162	41.50
MODEL 545C								
LOADER BUCKET	E7NN-L903-BA		3-89/6-91	P-UB-10	40 mm	80 mm	FD-85804740	63.57
	F1NN-L903-CA		7-91/	P-UB-10	40 mm	80 mm	FD-85804740	63.57
LOADER LIFT	E7NN-L905-DA		3-89/6-91	P-UB-10	50 mm	80 mm	FD-FP417	66.52
	F1NN-L905-AB		7-91/11-92	P-UB-10	50 mm	80 mm	FD-FP417	66.52

FORD

Replacement Kits For

FORD

Backhoe Loaders								
APPLICATION	CYL #	Piston Type	SERIAL #	CODE	ROD	BORE	KIT #	List \$
MODEL 545D								
LOADER BUCKET	F1NN-L903-CA		7-91/	P-UB-10	40 mm	80 mm	FD-85804740	63.57
LOADER LIFT	F1NN-L905-AB		7-91/11-92, 12-92/	P-UB-10	50 mm	80 mm	FD-FP417	66.52
MODEL 550								
BACKHOE BUCKET	D5NN-B576-B		75/83		2-1/2	3.52	FD-309949	81.25
BACKHOE CROWD	D5NN-B578-C		75/83	P-V-9	2-1/4	4-1/2	FD-309948	88.65
	D7NN-B578-C		75/83	P-V-9	2	4	FD-309946	111.06
BACKHOE LIFT HEAVY DUTY	D7NN-B577-F		77/78	P-V-9	2-1/2	5	FD-309962	111.67
BACKHOE LIFT-CENTER PIVOT	D7NN-B577-B		75/83	P-V-9	2	4-1/2	FD-309947	91.55
	D7NN-B577-C		75/83	P-V-9	2	4	FD-309946	111.06
BACKHOE LIFT-SIDESHIFT	D7NN-B577-B		4-78/83	P-V-9	2	4-1/2	FD-309947	91.55
	D7NN-B577-D		75/3-78	P-V-9	2	4	FD-309946	111.06
BACKHOE STABILIZER-CENTERPIVOT	D7NN-B580-C		75/78	P-V-8	1-3/4	4	FD-309940	69.34
BACKHOE STABILIZER-SIDESHIFT	D8NN-B580-CA		75/83	P-V-8	1-1/2	3	FD-309974F	92.73
BACKHOE SWING-CENTER PIVOT	D7NN-B579-D		75/83	P-V-8	1-3/4	4-1/2	FD-309939	74.68
	D7NN-B579-E		75/83	P-V-8	1-3/4	4	FD-309940	69.34
LOADER BUCKET LH	D5NN-L904-A		75/83	P-U-8	1-1/2	3	FD-309985F	70.61
LOADER BUCKET RH	D5NN-L903-C		75/83	P-U-8	1-1/2	3	FD-309985F	70.61
LOADER LIFT	E3NN-L905-AA		75/83	P-U-8	2	3	FD-309984F	71.13
MODEL 555								
ARM		1pc		P-UV-10	63 mm	115 mm	FD-251319	118.20
		2pc		P-UV-9	63 mm	115 mm	FD-251036	188.31
BACKHOE BUCKET	D8NN-B576-EC	1pc	10-78/10-88	P-UV-10	63 mm	90 mm	FD-251321	143.05
	D8NN-B576-EC	2pc	10-78/11-81	P-UV-9	63 mm	90 mm	FD-251032	220.13
BACKHOE CROWD	D8NN-B578-BB	1pc	10-78/10-88	P-UV-10	63 mm	115 mm	FD-251319	118.20
	D8NN-B578-BB	2pc	10-78/11-81	P-UV-9	63 mm	115 mm	FD-251036	188.31
	D8NN-B578-CC	1pc	10-78/10-88	P-UV-10	63 mm	115 mm	FD-251319	118.20
	D8NN-B578-CC	2pc	10-78/11-81	P-UV-9	63 mm	115 mm	FD-251036	188.31
BACKHOE EXTENDABLE DIPSTICK	D8NN-C492-BB	1pc	10-78/7-87	P-V-10	50 mm	80 mm	FD-251317	145.08
BACKHOE LIFT	D8NN-B577-AB	1pc	10-78/10-88	P-UV-10	63 mm	125 mm	FD-251320	109.22
	D8NN-B577-AB	2pc	10-78/81	P-UV-9	63 mm	125 mm	FD-251033	211.64
	D8NN-B577-BB	1pc	10-78/10-88	P-UV-10	56 mm	115 mm	FD-251318	151.92
	D8NN-B577-BB	2pc	10-78/81	P-UV-9	56 mm	115 mm	FD-251034	205.42
BACKHOE STABILIZER-CENTERPIVOT	D8NN-B580-AA	1pc	10-78/1-83	P-SP-10	50 mm	100 mm	FD-251339	163.62
	D8NN-B580-AA	2pc	10-78/1-83	P-UV-8	50 mm	100 mm	FD-251038	132.01
	D8NN-B580-AD	1pc	2-83/6-87	P-UV-10	56 mm	100 mm	FD-251315	98.48
	E4NN-B580-AA	1pc	7-87/10-88	P-UV-10	56 mm	100 mm	FD-251315	98.48
BACKHOE STABILIZER-SIDESHIFT	E0NN-B580-AA		84/10-88	P-U-10	45 mm	70 mm	FD-251361	95.43
BACKHOE SWING	D8NN-B579-BE		10-78/8-82	P-UV-9	56 mm	110 mm	FD-251037	214.70

Replacement Kits For

FORD

Backhoe Loaders								
APPLICATION	CYL #	Piston Type	SERIAL #	CODE	ROD	BORE	KIT #	List \$
MODEL 555								
BACKHOE SWING-CENTER PIVOT	E6NN-B579-AA		9-82/10-88	P-UV-10	50 mm	110 mm	FD-251303	106.49
BACKHOE SWING-SIDESHIFT	E1NN-B579-AB		84/10-88	P-UV-10	50 mm	110 mm	FD-251303	106.49
LOADER BUCKET LH	D5NN-L904-A		10-78/83	P-U-8	1-1/2	3	FD-309985F	70.61
	E0NN-L904-AA		84/10-88	P-U-10	1-1/2	3	FD-251363	29.62
LOADER BUCKET RH	D5NN-L903-C		10-78/83	P-U-8	1-1/2	3	FD-309985F	70.61
	E0NN-L903-AA		84/10-88	P-U-10	1-1/2	3	FD-251363	29.62
LOADER LIFT	E3NN-L905-AA		10-78/83	P-U-8	2	3	FD-309984F	71.13
	E4NN-L905-AA		84/10-88	P-U-10	2	3	FD-251362	28.59
MODEL 555A								
BACKHOE BUCKET	D8NN-B576-EC	1pc	84/5-85	P-UV-10	63 mm	90 mm	FD-251321	143.05
BACKHOE CROWD	D8NN-B578-BB	1pc	84/5-85	P-UV-10	63 mm	115 mm	FD-251319	118.20
	D8NN-B578-CC	1pc	84/5-85	P-UV-10	63 mm	115 mm	FD-251319	118.20
BACKHOE EXTENDABLE DIPSTICK	D8NN-C492-BB	1pc	84/5-85	P-V-10	50 mm	80 mm	FD-251317	145.08
BACKHOE LIFT	D8NN-B577-AB	1pc	84/5-85	P-UV-10	63 mm	125 mm	FD-251320	109.22
	D8NN-B577-BB	1pc	84/5-85	P-UV-10	56 mm	115 mm	FD-251318	151.92
BACKHOE STABILIZER-CENTERPIVOT	D8NN-B580-AD	1pc	84/5-85	P-UV-10	56 mm	100 mm	FD-251315	98.48
BACKHOE STABILIZER-SIDESHIFT	E0NN-B580-AA		84/5-85	P-U-10	45 mm	70 mm	FD-251361	95.43
BACKHOE SWING-CENTER PIVOT	E6NN-B579-AA		84/5-85	P-UV-10	50 mm	110 mm	FD-251303	106.49
BACKHOE SWING-SIDESHIFT	E1NN-B579-AB		84/5-85	P-UV-10	50 mm	110 mm	FD-251303	106.49
LOADER BUCKET LH	E0NN-L904-AA		84/5-85	P-U-10	1-1/2	3	FD-251363	29.62
LOADER BUCKET RH	E0NN-L903-AA		84/5-85	P-U-10	1-1/2	3	FD-251363	29.62
LOADER LIFT	E4NN-L905-AA		84/5-85	P-U-10	2	3	FD-251362	28.59
MODEL 555A-XL								
BACKHOE BUCKET	D8NN-B576-EC			P-UV-10	63 mm	90 mm	FD-251321	143.05
BACKHOE CROWD	D8NN-B578-BB			P-UV-10	63 mm	115 mm	FD-251319	118.20
	D8NN-B578-CC			P-UV-10	63 mm	115 mm	FD-251319	118.20
BACKHOE EXTENDABLE DIPSTICK	D8NN-C492-BB			P-V-10	50 mm	80 mm	FD-251317	145.08
BACKHOE LIFT	D8NN-B577-AB			P-UV-10	63 mm	125 mm	FD-251320	109.22
	D8NN-B577-BB			P-UV-10	56 mm	115 mm	FD-251318	151.92
BACKHOE STABILIZER-CENTERPIVOT	D8NN-B580-AD			P-UV-10	56 mm	100 mm	FD-251315	98.48
BACKHOE STABILIZER-SIDESHIFT	E0NN-B580-AA			P-U-10	45 mm	70 mm	FD-251361	95.43
BACKHOE SWING-CENTER PIVOT	E6NN-B579-AA			P-UV-10	50 mm	110 mm	FD-251303	106.49
BACKHOE SWING-SIDESHIFT	E1NN-B579-AB			P-UV-10	50 mm	110 mm	FD-251303	106.49
LOADER BUCKET LH	E0NN-L904-AA			P-U-10	1-1/2	3	FD-251363	29.62
LOADER BUCKET RH	E0NN-L903-AA			P-U-10	1-1/2	3	FD-251363	29.62
LOADER LIFT	E4NN-L905-AA			P-U-10	2	3	FD-251362	28.59

FORD

Replacement Kits For

FORD

Backhoe Loaders								
APPLICATION	CYL #	Piston Type	SERIAL #	CODE	ROD	BORE	KIT #	List \$
MODEL 555B								
BACKHOE BUCKET	D8NN-B576-EC	1pc	6-85/10-88	P-UV-10	63 mm	90 mm	FD-251321	143.05
BACKHOE CROWD	D8NN-B578-BB	1pc	6-85/10-88	P-UV-10	63 mm	115 mm	FD-251319	118.20
	D8NN-B578-CC	1pc	6-85/10-88	P-UV-10	63 mm	115 mm	FD-251319	118.20
BACKHOE LIFT	D8NN-B577-AB	1pc	6-85/10-88	P-UV-10	63 mm	125 mm	FD-251320	109.22
	D8NN-B577-BB	1pc	6-85/10-88	P-UV-10	56 mm	115 mm	FD-251318	151.92
BACKHOE STABILIZER-CENTERPIVOT	D8NN-B580-AD	1pc	6-85/6-87	P-UV-10	56 mm	100 mm	FD-251315	98.48
	E4NN-B580-AA	1pc	7-87/10-88	P-UV-10	56 mm	100 mm	FD-251315	98.48
BACKHOE STABILIZER-SIDESHIFT	E0NN-B580-AA		6-85/10-88	P-U-10	45 mm	70 mm	FD-251361	95.43
BACKHOE SWING-CENTER PIVOT	E6NN-B579-AA		6-85/10-88	P-UV-10	50 mm	110 mm	FD-251303	106.49
BACKHOE SWING-SIDESHIFT	E1NN-B579-AB		6-85/10-88	P-UV-10	50 mm	110 mm	FD-251303	106.49
LOADER BUCKET LH	E0NN-L904-AA		6-85/10-88	P-U-10	1-1/2	3	FD-251363	29.62
LOADER BUCKET RH	E0NN-L903-AA		6-85/10-88	P-U-10	1-1/2	3	FD-251363	29.62
LOADER LIFT	E4NN-L905-AA		6-85/10-88	P-U-10	2	3	FD-251362	28.59
MODEL 555C								
BACKHOE BUCKET	E7NN-B576-AB		11-88/8-92	P-U-10	63 mm	90 mm	FD-FP456	78.97
BACKHOE CROWD	F1NN-B578-AA		11-88/8-92	P-UB-10	63 mm	115 mm	FD-FP455	104.77
BACKHOE EXTENDABLE DIPSTICK	E7NN-C492-AB		11-88/8-92	P-UB-10	50 mm	80 mm	FD-FP457	58.38
BACKHOE LIFT W/HED	E7NN-B577-AE		11-88/12-91	P-UB-10	63 mm	125 mm	FD-85804741	149.83
BACKHOE LIFT W/O HED	E7NN-B577-BE		11-88/12-91	P-UB-10	56 mm	115 mm	FD-FP454	154.37
BACKHOE STABILIZER-CENTERPIVOT	F2NN-B580-AA		11-88/8-92	P-UB-10	56 mm	100 mm	FD-FP458	113.10
BACKHOE STABILIZER-SIDESHIFT	E7NN-B580-BA		11-88/8-92	P-UB-10	50 mm	70 mm	FD-FP459	65.17
BACKHOE SWING - CENTER PIVOT	E7NN-B579-BA		11-88/8-92	P-UB-10	50 mm	110 mm	FD-FP460	114.76
BACKHOE SWING - SIDE SHIFT	E7NN-B579-BA		11-88/8-92	P-UB-10	50 mm	110 mm	FD-FP460	114.76
LOADER BUCKET LH	F1NN-L904-AA		11-88/8-92	P-UB-10	40 mm	80 mm	FD-85804740	63.57
LOADER BUCKET RH	F1NN-L903-AA		11-88/8-92	P-UB-10	40 mm	80 mm	FD-85804740	63.57
LOADER BUCKET-MULTIPURPOSE	E7NN-A136-AA		11-88/5-92	P-UB-10	40 mm	70 mm	FD-FP419	68.59
LOADER LIFT	E7NN-L905-BB		11-88/8-92	P-UB-10	50 mm	80 mm	FD-FP417	66.52
MODEL 555D								
BACKHOE BUCKET	E7NN-B576-AB		9-92/	P-U-10	63 mm	90 mm	FD-FP456	78.97
BACKHOE CROWD	F1NN-B578-AA		9-92/	P-UB-10	63 mm	115 mm	FD-FP455	104.77
BACKHOE EXTENDABLE DIPSTICK	E7NN-C492-AB		9-92/8-93	P-UB-10	50 mm	80 mm	FD-FP457	58.38
	E7NN-C492-AD		9-93/	P-UB-10	50 mm	80 mm	FD-FP457	58.38
BACKHOE LIFT W/HED	F1NN-B577-CA		9-92/	P-UB-10	63 mm	125 mm	FD-85804741	149.83
BACKHOE LIFT W/O HED	F1NN-B577-BA		9-92/	P-UB-10	56 mm	115 mm	FD-FP454	154.37
BACKHOE STABILIZER-CENTERPIVOT	F2NN-B580-AA		9-92/	P-UB-10	56 mm	100 mm	FD-FP458	113.10

FORD

Replacement Kits For

FORD

Backhoe Loaders								
APPLICATION	CYL #	Piston Type	SERIAL #	CODE	ROD	BORE	KIT #	List \$
MODEL 555D								
BACKHOE STABILIZER- SIDESHIFT	E7NN-B580-BA		9-92/8-93	P-UB-10	50 mm	70 mm	FD-FP459	65.17
	E7NN-B580-BB		9-93/	P-UB-10	50 mm	70 mm	FD-FP459	65.17
BACKHOE SWING - CENTER PIVOT	E7NN-B579-AB		9-92/8-93	P-UB-10	50 mm	110 mm	FD-FP460	114.76
	E7NN-B579-AD		9-93/	P-UB-10	50 mm	110 mm	FD-FP460	114.76
BACKHOE SWING - SIDE SHIFT	E7NN-B579-BA		9-92/8-93	P-UB-10	50 mm	110 mm	FD-FP460	114.76
	E7NN-B579-BC		9-93/	P-UB-10	50 mm	110 mm	FD-FP460	114.76
LOADER BUCKET LH	F1NN-L904-AA		9-92/	P-UB-10	40 mm	80 mm	FD-85804740	63.57
LOADER BUCKET RH	F1NN-L903-AA		9-92/	P-UB-10	40 mm	80 mm	FD-85804740	63.57
LOADER BUCKET- MULTIPURPOSE	F1NN-A136-AA		9-92/	P-UB-10	40 mm	70 mm	FD-FP419	68.59
LOADER LIFT	E7NN-L905-BC		4-93/	P-UB-10	50 mm	80 mm	FD-FP417	66.52
POWER STEERING	F1NN-3A540- AA		5-92/	I-U-10	40 mm	2-3/4	FD-FINN3A539AA	41.21
MODEL 555E								
BACKHOE BOOM LIFT	85800400			P-UB-10	63 mm	125 mm	FD-85804741	149.83
BACKHOE BUCKET	83962129			P-U-10	63 mm	90 mm	FD-85804743	124.10
BACKHOE CROWD	81873434			P-UB-10	63 mm	115 mm	FD-85804742	164.85
BACKHOE H.E.D.	85800800			P-UB-10	50 mm	70 mm	FD-85802569	65.11
BACKHOE STABILIZER	85800600			P-UB-10	56 mm	100 mm	FD-83971999	113.10
BACKHOE SWING	85800300			P-UB-10	50 mm	110 mm	FD-85802570	73.96
LOADER BUCKET	85800500			P-UB-10	40 mm	80 mm	FD-85804740	63.57
LOADER LIFT	85800100			P-UB-10	50 mm	90 mm	FD-85802567	64.05
MODEL 575D								
BACKHOE BUCKET	E7NN-B576-AB		9-92/	P-U-10	63 mm	90 mm	FD-FP456	78.97
BACKHOE CROWD	F1NN-B578-AA		9-92/	P-UB-10	63 mm	115 mm	FD-FP455	104.77
BACKHOE EXTENDABLE DIPSTICK	E7NN-C492-AD		9-93/	P-UB-10	50 mm	80 mm	FD-FP457	58.38
BACKHOE STABILIZER- CENTERPIVOT	F2NN-B580-AA		9-92/	P-UB-10	56 mm	100 mm	FD-FP458	113.10
BACKHOE STABILIZER- SIDESHIFT	E7NN-B580-BA		9-92/8-93	P-UB-10	50 mm	70 mm	FD-FP459	65.17
	E7NN-B580-BB		9-93/	P-UB-10	50 mm	70 mm	FD-FP459	65.17
BACKHOE SWING - CENTER PIVOT	E7NN-B579-AD		9-93/	P-UB-10	50 mm	110 mm	FD-FP460	114.76
	E7NN-B579-BA		9-92/8-93	P-UB-10	50 mm	110 mm	FD-FP460	114.76
BACKHOE SWING - SIDE SHIFT	E7NN-B579-BA		9-92/8-93	P-UB-10	50 mm	110 mm	FD-FP460	114.76
	E7NN-B579-BC		9-93/	P-UB-10	50 mm	110 mm	FD-FP460	114.76
LOADER BUCKET LH	F1NN-L904-AA		9-92/	P-UB-10	40 mm	80 mm	FD-85804740	63.57
LOADER BUCKET RH	F1NN-L903-AA		9-92/	P-UB-10	40 mm	80 mm	FD-85804740	63.57
LOADER BUCKET- MULTIPURPOSE	F1NN-A136-AA		9-92/	P-UB-10	40 mm	70 mm	FD-FP419	68.59
LOADER LIFT	E7NN-L905-BC		4-93/	P-UB-10	50 mm	80 mm	FD-FP417	66.52
MODEL 575E								
BACKHOE BOOM LIFT	85800400			P-UB-10	63 mm	125 mm	FD-85804741	149.83
BACKHOE BUCKET	83962129			P-U-10	63 mm	90 mm	FD-85804743	124.10

FORD

Replacement Kits For

FORD

Backhoe Loaders

APPLICATION	CYL #	Piston Type	SERIAL #	CODE	ROD	BORE	KIT #	List \$
MODEL 575E								
BACKHOE CROWD	81873434			P-UB-10	63 mm	115 mm	FD-85804742	164.85
BACKHOE H.E.D.	85800800			P-UB-10	50 mm	70 mm	FD-85802569	65.11
BACKHOE STABILIZER	85800600			P-UB-10	56 mm	100 mm	FD-83971999	113.10
BACKHOE SWING	85800300			P-UB-10	50 mm	110 mm	FD-85802570	73.96
LOADER BUCKET	85800500			P-UB-10	40 mm	80 mm	FD-85804740	63.57
LOADER LIFT	85800100			P-UB-10	50 mm	90 mm	FD-85802567	64.05
MODEL 650								
BACKHOE BUCKET	D5NN-B576-B		11-75/77		2-1/2	3.52	FD-309949	81.25
BACKHOE CROWD	D7NN-B578-B		11-75/77	P-V-9	2-1/4	4-1/2	FD-309948	88.65
BACKHOE LIFT	D7NN-B577-F		11-75/77	P-V-9	2-1/2	5	FD-309962	111.67
BACKHOE STABILIZER	D7NN-B580-C		11-75/77	P-V-8	1-3/4	4	FD-309940	69.34
BACKHOE SWING	D7NN-B579-D		11-75/77	P-V-8	1-3/4	4-1/2	FD-309939	74.68
LOADER BUCKET	D7NN-L903-A		11-75/77	P-V-9	2-1/4	4	FD-309951	98.39
LOADER HYDRO BUCKET	7708113		11-75/77	P-U-13	2	3	FD-7708145	49.26
LOADER LIFT	D7NN-L905-F		11-75/77	P-V-9	2-1/4	4	FD-309951	98.39
MODEL 655								
BACKHOE BUCKET		2pc			2-1/2	3.52	FD-309949	81.25
	D8NN-B576-EC	1pc	7-85/10-88	P-UV-10	63 mm	90 mm	FD-251321	143.05
BACKHOE CROWD		2pc		P-V-9	2-1/4	4-1/2	FD-309948	88.65
	D8NN-B578-BB	1pc	7-85/10-88	P-UV-10	63 mm	115 mm	FD-251319	118.20
	D8NN-B578-CC	1pc	7-85/10-88	P-UV-10	63 mm	115 mm	FD-251319	118.20
BACKHOE EXTENDABLE DIPSTICK	D8NN-C492-BB	1pc	7-85/7-87	P-V-10	50 mm	80 mm	FD-251317	145.08
BACKHOE LIFT		2pc		P-V-9	2	4-1/2	FD-309947	91.55
	D8NN-B577-AB	1pc	7-85/10-88	P-UV-10	63 mm	125 mm	FD-251320	109.22
	D8NN-B577-BB	1pc	7-85/10-88	P-UV-10	56 mm	115 mm	FD-251318	151.92
BACKHOE STABILIZER		2pc		P-V-8	1-3/4	4	FD-309940	69.34
BACKHOE STABILIZER-CENTERPIVOT	D8NN-B580-AD	1pc	7-85/6-87	P-UV-10	56 mm	100 mm	FD-251315	98.48
	E4NN-B580-AA	1pc	7-87/10-88	P-UV-10	56 mm	100 mm	FD-251315	98.48
BACKHOE STABILIZER-SIDESHIFT	E0NN-B580-AA		7-85/10-88	P-U-10	45 mm	70 mm	FD-251361	95.43
BACKHOE SWING		2pc		P-V-8	1-3/4	4-1/2	FD-309939	74.68
BACKHOE SWING-CENTER PIVOT	E6NN-B579-AA		7-85/10-88	P-UV-10	50 mm	110 mm	FD-251303	106.49
BACKHOE SWING-SIDESHIFT	E1NN-B579-AB		7-85/10-88	P-UV-10	50 mm	110 mm	FD-251303	106.49
LOADER BUCKET LH	E0NN-L904-AA		7-85/10-88	P-U-10	1-1/2	3	FD-251363	29.62
LOADER BUCKET RH	E0NN-L903-AA		7-85/10-88	P-U-10	1-1/2	3	FD-251363	29.62
LOADER LIFT	E4NN-L905-AA		7-85/10-88	P-U-10	2	3	FD-251362	28.59
MODEL 655A								
BACKHOE BUCKET	D8NN-B576-EC	1pc	6-85/10-88	P-UV-10	63 mm	90 mm	FD-251321	143.05
BACKHOE CROWD	D8NN-B578-BB	1pc	6-85/10-88	P-UV-10	63 mm	115 mm	FD-251319	118.20
	D8NN-B578-CC	1pc	6-85/10-88	P-UV-10	63 mm	115 mm	FD-251319	118.20
BACKHOE EXTENDABLE DIPSTICK	D8NN-C492-BB	1pc	6-85/7-87	P-V-10	50 mm	80 mm	FD-251317	145.08
BACKHOE LIFT	D8NN-B577-AB	1pc	6-85/10-88	P-UV-10	63 mm	125 mm	FD-251320	109.22

FORD

Replacement Kits For

FORD

Backhoe Loaders								
APPLICATION	CYL #	Piston Type	SERIAL #	CODE	ROD	BORE	KIT #	List \$
MODEL 655A								
BACKHOE LIFT	D8NN-B577-BB	1pc	6-85/10-88	P-UV-10	56 mm	115 mm	FD-251318	151.92
BACKHOE STABILIZER-CENTERPIVOT	D8NN-B580-AD	1pc	6-85/6-87	P-UV-10	56 mm	100 mm	FD-251315	98.48
	E4NN-B580-AA	1pc	7-87/10-88	P-UV-10	56 mm	100 mm	FD-251315	98.48
BACKHOE STABILIZER-SIDESHIFT	E0NN-B580-AA		6-85/10-88	P-U-10	45 mm	70 mm	FD-251361	95.43
BACKHOE SWING-CENTER PIVOT	E6NN-B579-AA		6-85/10-88	P-UV-10	50 mm	110 mm	FD-251303	106.49
BACKHOE SWING-SIDESHIFT	E1NN-B579-AB		6-85/10-88	P-UV-10	50 mm	110 mm	FD-251303	106.49
LOADER BUCKET LH	E0NN-L904-AA		6-85/10-88	P-U-10	1-1/2	3	FD-251363	29.62
LOADER BUCKET RH	E0NN-L903-AA		6-85/10-88	P-U-10	1-1/2	3	FD-251363	29.62
LOADER LIFT	E4NN-L905-AA		6-85/10-88	P-U-10	2	3	FD-251362	28.59
MODEL 655C								
BACKHOE BUCKET	E7NN-B576-AB		11-88/8-92	P-U-10	63 mm	90 mm	FD-FP456	78.97
BACKHOE CROWD	F1NN-B578-AA		11-88/8-92	P-UB-10	63 mm	115 mm	FD-FP455	104.77
BACKHOE EXTENDABLE DIPSTICK	E7NN-C492-BD		11-88/8-92	P-UB-10	50 mm	80 mm	FD-FP457	58.38
BACKHOE LIFT	E7NN-B577-AE		11-88/12-91	P-UB-10	63 mm	125 mm	FD-85804741	149.83
BACKHOE STABILIZER-CENTERPIVOT	F2NN-B580-AA		11-88/8-92	P-UB-10	56 mm	100 mm	FD-FP458	113.10
BACKHOE STABILIZER-SIDESHIFT	E7NN-B580-BA		11-88/8-92	P-UB-10	50 mm	70 mm	FD-FP459	65.17
BACKHOE SWING - CENTER PIVOT	E7NN-B579-BA		11-88/8-92	P-UB-10	50 mm	110 mm	FD-FP460	114.76
BACKHOE SWING - SIDE SHIFT	E7NN-B579-BA		11-88/8-92	P-UB-10	50 mm	110 mm	FD-FP460	114.76
LOADER BUCKET LH	F1NN-L904-AA		11-88/8-92	P-UB-10	40 mm	80 mm	FD-85804740	63.57
LOADER BUCKET RH	F1NN-L903-AA		11-88/8-92	P-UB-10	40 mm	80 mm	FD-85804740	63.57
LOADER BUCKET-MULTIPURPOSE	E7NN-A136-AA		11-88/5-92	P-UB-10	40 mm	70 mm	FD-FP419	68.59
LOADER LIFT	E7NN-L905-BB		11-88/8-92	P-UB-10	50 mm	80 mm	FD-FP417	66.52
MODEL 655D								
BACKHOE BUCKET	E7NN-B576-AB		9-92/	P-U-10	63 mm	90 mm	FD-FP456	78.97
BACKHOE CROWD	F1NN-B578-AA		9-92/	P-UB-10	63 mm	115 mm	FD-FP455	104.77
BACKHOE EXTENDABLE DIPSTICK	E7NN-C492-BD		9-92/	P-UB-10	50 mm	80 mm	FD-FP457	58.38
BACKHOE LIFT	F1NN-B577-CA		9-92/	P-UB-10	63 mm	125 mm	FD-85804741	149.83
BACKHOE STABILIZER-CENTERPIVOT	F2NN-B580-AA		9-92/	P-UB-10	56 mm	100 mm	FD-FP458	113.10
BACKHOE STABILIZER-SIDESHIFT	E7NN-B580-BA		9-92/8-93	P-UB-10	50 mm	70 mm	FD-FP459	65.17
	E7NN-B580-BB		9-93/	P-UB-10	50 mm	70 mm	FD-FP459	65.17
BACKHOE SWING - CENTER PIVOT	E7NN-B579-AD		9-93/	P-UB-10	50 mm	110 mm	FD-FP460	114.76
	E7NN-B579-BA		9-92/8-93	P-UB-10	50 mm	110 mm	FD-FP460	114.76
BACKHOE SWING - SIDE SHIFT	E7NN-B579-BA		9-92/8-93	P-UB-10	50 mm	110 mm	FD-FP460	114.76
	E7NN-B579-BC		9-93/	P-UB-10	50 mm	110 mm	FD-FP460	114.76
LOADER BUCKET LH	F1NN-L904-AA		9-92/	P-UB-10	40 mm	80 mm	FD-85804740	63.57

FORD

Replacement Kits For

FORD

Backhoe Loaders								
APPLICATION	CYL #	Piston Type	SERIAL #	CODE	ROD	BORE	KIT #	List \$
MODEL 655D								
LOADER BUCKET RH	F1NN-L903-AA		9-92/	P-UB-10	40 mm	80 mm	FD-85804740	63.57
LOADER BUCKET-MULTIPURPOSE	F1NN-A136-AA		9-92/	P-UB-10	40 mm	70 mm	FD-FP419	68.59
LOADER LIFT	E7NN-L905-BC		4-93/	P-UB-10	50 mm	80 mm	FD-FP417	66.52
MODEL 655E								
BACKHOE BOOM LIFT	85800200			P-UB-10	63 mm	5-1/8	FD-85802568	212.13
BACKHOE BUCKET	83962129			P-U-10	63 mm	90 mm	FD-85804743	124.10
BACKHOE CROWD	81873434			P-UB-10	63 mm	115 mm	FD-85804742	164.85
BACKHOE H.E.D.	85800700			P-UB-10	50 mm	70 mm	FD-85802569	65.11
BACKHOE STABILIZER	85800600			P-UB-10	56 mm	100 mm	FD-83971999	113.10
BACKHOE SWING	85800300			P-UB-10	50 mm	110 mm	FD-85802570	73.96
LOADER BUCKET	85800500			P-UB-10	40 mm	80 mm	FD-85804740	63.57
LOADER LIFT	85800100			P-UB-10	50 mm	90 mm	FD-85802567	64.05
MODEL 675D								
BACKHOE BUCKET	E7NN-B576-AB		9-92/	P-U-10	63 mm	90 mm	FD-FP456	78.97
BACKHOE CROWD	F1NN-B578-AA		9-92/	P-UB-10	63 mm	115 mm	FD-FP455	104.77
BACKHOE EXTENDABLE DIPSTICK	E7NN-C492-BD		9-92/	P-UB-10	50 mm	80 mm	FD-FP457	58.38
BACKHOE STABILIZER-CENTERPIVOT	F2NN-B580-AA		9-92/	P-UB-10	56 mm	100 mm	FD-FP458	113.10
BACKHOE STABILIZER-SIDESHIFT	E7NN-B580-BA		9-92/8-93	P-UB-10	50 mm	70 mm	FD-FP459	65.17
	E7NN-B580-BB		9-93/	P-UB-10	50 mm	70 mm	FD-FP459	65.17
BACKHOE SWING - CENTER PIVOT	E7NN-B579-AD		9-93/	P-UB-10	50 mm	110 mm	FD-FP460	114.76
	E7NN-B579-BA		9-92/8-93	P-UB-10	50 mm	110 mm	FD-FP460	114.76
BACKHOE SWING - SIDE SHIFT	E7NN-B579-BA		9-92/8-93	P-UB-10	50 mm	110 mm	FD-FP460	114.76
	E7NN-B579-BC		9-93/	P-UB-10	50 mm	110 mm	FD-FP460	114.76
LOADER BUCKET LH	F1NN-L904-AA		9-92/	P-UB-10	40 mm	80 mm	FD-85804740	63.57
LOADER BUCKET RH	F1NN-L903-AA		9-92/	P-UB-10	40 mm	80 mm	FD-85804740	63.57
LOADER BUCKET-MULTIPURPOSE	F1NN-A136-AA		9-92/	P-UB-10	40 mm	70 mm	FD-FP419	68.59
LOADER LIFT	E7NN-L905-BC		4-93/	P-UB-10	50 mm	80 mm	FD-FP417	66.52
MODEL 675E								
BACKHOE BOOM LIFT	85800200			P-UB-10	63 mm	5-1/8	FD-85802568	212.13
BACKHOE BUCKET	83962129			P-U-10	63 mm	90 mm	FD-85804743	124.10
BACKHOE CROWD	81873434			P-UB-10	63 mm	115 mm	FD-85804742	164.85
BACKHOE H.E.D.	85800700			P-UB-10	50 mm	70 mm	FD-85802569	65.11
BACKHOE STABILIZER	85800600			P-UB-10	56 mm	100 mm	FD-83971999	113.10
BACKHOE SWING	85800300			P-UB-10	50 mm	110 mm	FD-85802570	73.96
LOADER BUCKET	85800500			P-UB-10	40 mm	80 mm	FD-85804740	63.57
LOADER LIFT	85800100			P-UB-10	50 mm	90 mm	FD-85802567	64.05
MODEL 730								
LOADER BUCKET				P-V-8	1-1/4	2	FD-309957	28.72
LOADER LIFT				P-V-8	1-1/2	2	FD-309956	42.11
MODEL 740								
LOADER BUCKET				P-V-8	1-1/2	3	FD-309959	52.60

FORD

Replacement Kits For

FORD

Backhoe Loaders								
APPLICATION	CYL #	Piston Type	SERIAL #	CODE	ROD	BORE	KIT #	List \$
MODEL 740								
LOADER LIFT				P-V-8	2	3	FD-309960	57.44
MODEL 750								
BACKHOE BUCKET	D5NN-B576-C		11-75/78	P-V-9	2-1/2	4	FD-309970	101.41
BACKHOE CROWD	D7NN-B578-A		11-75/78	P-V-9	2-1/2	5	FD-309962	111.67
BACKHOE LIFT	D7NN-B577-A		11-75/78	P-V-9	2-1/2	5-1/2	FD-309963	118.80
BACKHOE STABILIZER	D7NN-B580-A		11-75/78	P-V-8	2	4-1/2	FD-309941	84.41
BACKHOE SWING	D5NN-B579-D		11-75/78	P-V-9	1-3/4	3-1/2	FD-309950	95.50
LOADER BUCKET	D7NN-L903-A		11-75/78	P-V-9	2-1/4	4	FD-309951	98.39
LOADER HYDRO BUCKET	7708113		11-75/78	P-U-13	2	3	FD-7708145	49.26
LOADER LIFT	D7NN-L905-A		11-75/78	P-V-9	2-1/4	3-3/4	FD-309969	95.50
MODEL 753								
BACKHOE BUCKET					2-1/2	3.52	FD-309949	81.25
BACKHOE CROWD				P-V-9	2	4	FD-309946	111.06
BACKHOE LIFT				P-V-9	2	4	FD-309946	111.06
BACKHOE STABILIZER				P-V-8	1-3/4	4	FD-309940	69.34
BACKHOE SWING				P-V-8	1-3/4	4	FD-309940	69.34
MODEL 755								
BACKHOE BUCKET		2pc			2-1/2	3.52	FD-309949	81.25
	D5NN-B576-C		78/83	P-V-9	2-1/2	4	FD-309970	101.41
BACKHOE CROWD		2pc		P-V-9	2-1/4	4-1/2	FD-309948	88.65
	D7NN-B578-A		78/5-79	P-V-9	2-1/2	5	FD-309962	111.67
	E8NN-B578-AA		6-79/83	P-UV-9	63 mm	125 mm	FD-251160	216.26
BACKHOE LIFT		2pc		P-V-9	2	4-1/2	FD-309947	91.55
	D7NN-B577-A		78/5-79	P-V-9	2-1/2	5-1/2	FD-309963	118.80
	D9NN-B577-AA		6-79/83	P-UV-9	63 mm	150 mm	FD-251159	224.74
BACKHOE STABILIZER		2pc		P-V-8	1-3/4	4	FD-309940	69.34
	D7NN-B580-A		78/83	P-V-8	2	4-1/2	FD-309941	84.41
BACKHOE SWING		2pc		P-V-8	1-3/4	4-1/2	FD-309939	74.68
	D5NN-B579-D		78/83	P-V-9	1-3/4	3-1/2	FD-309950	95.50
LOADER BUCKET	D7NN-L903-A		78/83	P-V-9	2-1/4	4	FD-309951	98.39
LOADER HYDRO BUCKET	7708113		78/83	P-U-13	2	3	FD-7708145	49.26
LOADER LIFT	D7NN-L905-A		78/83	P-V-9	2-1/4	3-3/4	FD-309969	95.50
MODEL 755A								
BACKHOE BUCKET	D5NN-B576-C		84/5-86	P-V-9	2-1/2	4	FD-309970	101.41
	E5NN-B576-AA		6-86/12-86	P-UV-10	56 mm	100 mm	FD-251315	98.48
BACKHOE CROWD	E8NN-B578-AA		84/86	P-UV-9	63 mm	125 mm	FD-251160	216.26
BACKHOE LIFT	D9NN-B577-AA		84/86	P-UV-9	63 mm	150 mm	FD-251159	224.74
BACKHOE STABILIZER	D7NN-B580-A		84/86	P-V-8	2	4-1/2	FD-309941	84.41
BACKHOE SWING	D5NN-B579-D		83/5-86	P-V-9	1-3/4	3-1/2	FD-309950	95.50
	E6NN-B579-AA		6-86/12-86	P-UV-10	50 mm	110 mm	FD-251303	106.49
LOADER BUCKET	D7NN-L903-A		84/5-86	P-V-9	2-1/4	4	FD-309951	98.39
	E5NN-L903-AA		6-86/12-86	P-UV-10	56 mm	100 mm	FD-251315	98.48
LOADER HYDRO BUCKET	7708113		84/86	P-U-13	2	3	FD-7708145	49.26

FORD

Replacement Kits For

FORD

Backhoe Loaders								
APPLICATION	CYL #	Piston Type	SERIAL #	CODE	ROD	BORE	KIT #	List \$
MODEL 755A								
LOADER LIFT	D7NN-L905-A		84/5-86	P-V-9	2-1/4	3-3/4	FD-309969	95.50
	E5NN-L905-AA		6-86/12-86	P-UV-10	56 mm	100 mm	FD-251315	98.48
MODEL 755B								
BACKHOE BUCKET	E5NN-B576-AA		87/10-88	P-UV-10	56 mm	100 mm	FD-251315	98.48
	E8NN-B576-AA		11-88	P-UB-10	56 mm	100 mm	FD-FP398	88.33
BACKHOE CROWD	E8NN-B578-AA		11-88/	P-UB-9	63 mm	125 mm	FD-FP528	202.90
	E8NN-B578-AA		87/10-88	P-UV-9	63 mm	125 mm	FD-251160	216.26
BACKHOE EXTENDABLE DIPSTICK	E6NN-C492-AA		5-87/2-89	P-V-10	50 mm	80 mm	FD-251317	145.08
	E7NN-C492-BD		3-89/	P-UB-10	50 mm	80 mm	FD-FP457	58.38
BACKHOE LIFT	D9NN-B577-AA		87/	P-UV-9	63 mm	150 mm	FD-251159	224.74
BACKHOE STABILIZER	D7NN-B580-A		87/10-88	P-V-8	2	4-1/2	FD-309941	84.41
	E8NN-B580-AA		11-88/	P-UB-10	56 mm	115 mm	FD-FP410	84.31
BACKHOE SWING	E6NN-B579-AA		87/10-88	P-UV-10	50 mm	110 mm	FD-251303	106.49
	E7NN-B579-AB		11-88/	P-UB-10	50 mm	110 mm	FD-FP460	114.76
LOADER BUCKET	E5NN-L903-AA		87/10-88	P-UV-10	56 mm	100 mm	FD-251315	98.48
	E8NN-L903-AA		11-88/	P-UB-10	56 mm	100 mm	FD-FP398	88.33
LOADER HYDRO BUCKET	7708113		87/	P-U-13	2	3	FD-7708145	49.26
LOADER LIFT	E5NN-L905-AA		87/10-88	P-UV-10	56 mm	100 mm	FD-251315	98.48
	E8NN-L905-AA		11-88/	P-UB-10	56 mm	100 mm	FD-FP398	88.33
MODEL 5500-5550								
BACKHOE ARM				P-V-9	2-1/2	5	FD-309962	111.67
BACKHOE BUCKET					2-1/2	3.52	FD-309949	81.25
BACKHOE LIFT				P-V-9	2-1/2	5-1/2	FD-309963	118.80
BACKHOE STABILIZER				P-V-8	2	4-1/2	FD-309941	84.41
BACKHOE SWING				P-V-9	1-3/4	3-1/2	FD-309950	95.50
LOADER BUCKET				P-V-9	2-1/2	4	FD-309970	101.41
LOADER LIFT				P-V-9	2-1/4	4	FD-309951	98.39
MODEL 6500								
BACKHOE BUCKET	D5NN-B576-B		73/10-75		2-1/2	3.52	FD-309949	81.25
BACKHOE CROWD	D7NN-B578-B		73/10-75	P-V-9	2-1/4	4-1/2	FD-309948	88.65
BACKHOE LIFT	D7NN-B577-F		73/10-75	P-V-9	2-1/2	5	FD-309962	111.67
BACKHOE STABILIZER	D7NN-B580-C		73/10-75	P-V-8	1-3/4	4	FD-309940	69.34
BACKHOE SWING	D7NN-B579-D		73/10-75	P-V-8	1-3/4	4-1/2	FD-309939	74.68
LOADER BUCKET	D7NN-L903-A		73/10-75	P-V-9	2-1/4	4	FD-309951	98.39
LOADER HYDRO BUCKET	7708113		73/10-75	P-U-13	2	3	FD-7708145	49.26
LOADER LIFT	D7NN-L905-F		73/10-75	P-V-9	2-1/4	4	FD-309951	98.39
MODEL 7500								
BACKHOE BUCKET	D5NN-B576-C		73/10-75	P-V-9	2-1/2	4	FD-309970	101.41
BACKHOE CROWD	D7NN-B578-A		73/10-75	P-V-9	2-1/2	5	FD-309962	111.67
BACKHOE LIFT	D7NN-B577-A		73/10-75	P-V-9	2-1/2	5-1/2	FD-309963	118.80
BACKHOE STABILIZER	D7NN-B580-A		73/10-75	P-V-8	2	4-1/2	FD-309941	84.41
BACKHOE SWING	D5NN-B579-D		73/10-75	P-V-9	1-3/4	3-1/2	FD-309950	95.50
LOADER BUCKET	D7NN-L903-A		73/10-75	P-V-9	2-1/4	4	FD-309951	98.39

FORD

Replacement Kits For

Backhoe Loaders								
APPLICATION	CYL #	Piston Type	SERIAL #	CODE	ROD	BORE	KIT #	List \$
MODEL 7500								
LOADER HYDRO BUCKET	7708113		73/10-75	P-U-13	2	3	FD-7708145	49.26
LOADER LIFT	D7NN-L905-A		73/10-75	P-V-9	2-1/4	3-3/4	FD-309969	95.50
MODEL A62								
LOADER BUCKET				P-V-9	2-1/2	5-1/2	FD-309977	130.89
LOADER LIFT				P-V-9	2	4-1/2	FD-309980	101.05
MODEL A64								
LOADER BUCKET				P-V-9	3	6	FD-309978	139.12
LOADER LIFT				P-V-9	2-1/2	5.025	FD-309981	114.21
MODEL A66								
LOADER BUCKET				P-V-9	3	6-1/2	FD-309979	153.38
LOADER LIFT				P-V-9	2-1/2	5-1/2	FD-309963	118.80
Tractors								
APPLICATION	CYL #	Piston Type	SERIAL #	CODE	ROD	BORE	KIT #	List \$
MODEL								
	7102266			N-OB-1	1-1/4		FD-7102289	10.13
	CED2NNC846C			P-OB-10	1-1/4	3	FD-CE41300922	47.01
	CED2NNC846D			P-OB-10	7/8	2	FD-CE41200904	20.73
	D2NN-C846-A			I-U-3	1-3/8	3	FD-DHPNC846A	22.61
	D2NN-C846-B			I-TR-3	1-3/8	3-1/2	FD-DHPNC846D	21.82
	D2NN-C846-C			I-TR-3	1-3/8	3	FD-DHPNC846C	22.30
	D2NN-C846-D			I-TR-3	1	2	FD-DHPNC846B	16.24
	D8NN-C846-AA			I-U-3	1-3/8	3-1/2	FD-PRNPMCKS916	22.90
	MPP20TB08			I-TR-3	1	2	FD-DHPNC846B	16.24
	MPP30TB08			I-TR-3	1-3/8	3	FD-DHPNC846C	22.30
	MPP35TB08			I-TR-3	1-3/8	3-1/2	FD-DHPNC846D	21.82
MODEL 2600, 3600, 4600, 4600-SU								
ACCESSORY	D2NN-C846-B		75/81	I-TR-3	1-3/8	3-1/2	FD-DHPNC846D	21.82
	D2NN-C846-C		75/81	I-TR-3	1-3/8	3	FD-DHPNC846C	22.30
	D2NN-C846-D		75/81	I-TR-3	1	2	FD-DHPNC846B	16.24
MODEL 3400, 3500, 3550, 4400, 4500								
ACCESSORY	7102266		65/74	N-OB-1	1-1/4		FD-7102289	10.13
	D2NN-C846-B		65/74	I-TR-3	1-3/8	3-1/2	FD-DHPNC846D	21.82
	D2NN-C846-C		65/74	I-TR-3	1-3/8	3	FD-DHPNC846C	22.30
	D2NN-C846-D		65/74	I-TR-3	1	2	FD-DHPNC846B	16.24
MODEL 5600								
ACCESSORY	D2NN-C846-A		75/81	I-U-3	1-3/8	3	FD-DHPNC846A	22.61
	D8NN-C846-AA		75/81	I-U-3	1-3/8	3-1/2	FD-PRNPMCKS916	22.90
MODEL 6600, 7600								
ACCESSORY	D2NN-C846-A		75/81	I-U-3	1-3/8	3	FD-DHPNC846A	22.61
	D2NN-C846-B		75/81	I-TR-3	1-3/8	3-1/2	FD-DHPNC846D	21.82
	D2NN-C846-C		75/81	I-TR-3	1-3/8	3	FD-DHPNC846C	22.30
	D2NN-C846-D		75/81	I-TR-3	1	2	FD-DHPNC846B	16.24
	D8NN-C846-AA		75/81	I-U-3	1-3/8	3-1/2	FD-PRNPMCKS916	22.90

FORD

REPLACEMENT KITS FOR FORD EQUIPMENT

FORD

Kit Number	Code (Pg. xviii)	Pist.	Rod X Bore Size	List Price
FD-251032	P-UV-9	2 pc.	63 X 90 mm	\$ 220.13
FD-251033	P-UV-9	2 pc.	63 X 125 mm	211.64
FD-251034	P-UV-9	2 pc.	56 X 115 mm	205.42
FD-251035	P-V-9	2 pc.	50 X 100 mm	316.47
FD-251036	P-UV-9	2 pc.	63 X 115 mm	188.31
FD-251037	P-UV-9	2 pc.	56 X 110 mm	214.70
FD-251038	P-UV-8	2 pc.	50 X 100 mm	132.01
FD-251072	P-UV-8	1 pc.	40 X 70 mm	36.57
FD-251073	P-U-10	1 pc.	40 X 80 mm	52.75
FD-251074	P-U-10	1 pc.	50 X 80 mm	43.49
FD-251074B	P-U-10	1 pc.	50 X 80 mm	66.52
FD-251159	P-UV-9	2 pc.	63 X 150 mm	224.74
FD-251160	P-UV-9	2 pc.	63 X 125 mm	216.26
FD-251162	P-U-10	1 pc.	50 X 70 mm	41.50
FD-251303	P-UV-10	1 pc.	50 X 110 mm	142.22
FD-251315	P-UV-10	1 pc.	56 X 100 mm	98.48
FD-251316	P-UV-10	1 pc.	50 X 100 mm	196.78
FD-251317	P-V-10	1 pc.	50 X 80 mm	145.08
FD-251318	P-UV-10	1 pc.	56 X 115 mm	151.92
FD-251319	P-UV-10	1 pc.	63 X 115 mm	152.91
FD-251320	P-UV-10	1 pc.	63 X 125 mm	157.01
FD-251321	P-UV-10	1 pc.	63 X 90 mm	143.05
FD-251339	P-UV-10	2 pc.	50 X 100 mm	163.62
FD-251361	P-U-10	1 pc.	45 X 70 mm	95.43
FD-251362	P-U-10	1 pc.	2 X 3	28.59
FD-251363	P-U-10	1 pc.	1-1/2 X 3	29.62
FD-251369	P-U-10	1 pc.	35 X 60 mm	42.05
FD-251370	P-U-10	1 pc.	40 X 60 mm	47.25
FD-309938	P-V-8	2 pc.	1-3/4 x 3-1/2	83.38
FD-309939	P-V-8	2 pc.	1-3/4 X 4-1/2	77.45
FD-309940	P-V-8	2 pc.	1-3/4 X 4	71.91
FD-309941	P-V-8	2 pc.	2 X 4-1/2	84.41
FD-309945	P-V-9	2 pc.	1-3/4 X 3-1/2	92.90
FD-309946	P-V-9	2 pc.	2 X 4	111.06
FD-309947	P-V-9	2 pc.	2 X 4-1/2	91.55
FD-309948	P-V-9	2 pc.	2-1/4 X 4-1/2	104.19
FD-309949	P-V-9	2 pc.	2-1/2 X 3-1/2	95.50
FD-309950	P-V-9	2 pc.	1-3/4 X 3-1/2	95.50
FD-309951	P-V-9	2 pc.	2-1/4 X 4	98.39
FD-309956	P-V-8	2 pc.	1-1/2 X 2	42.11
FD-309957	P-V-8	2 pc.	1-1/4 X 2	28.72
FD-309959	P-V-8	2 pc.	1-1/2 X 3	52.60

Kit Number	Code (Pg. xviii)	Pist.	Rod X Bore Size	List Price
FD-309960	P-V-8	2 pc.	2 X 3	\$ 57.44
FD-309962	P-V-9	2 pc.	2-1/2 X 5	111.67
FD-309963	P-V-9	2 pc.	2-1/2 X 5-1/2	118.80
FD-309969	P-V-9	2 pc.	2-1/4 X 3-3/4	95.50
FD-309970	P-V-9	2 pc.	2-1/2 X 4	101.41
FD-309974F	P-V-8	2 pc.	1-1/2 X 3	92.73
FD-309977	P-V-9	2 pc.	2-1/2 X 5-1/2	130.89
FD-309978	P-V-9	2 pc.	3 X 6	139.12
FD-309979	P-V-9	2 pc.	3 X 6-1/2	153.38
FD-309980	P-V-9	2 pc.	2 X 4-1/2	101.05
FD-309981	P-V-9	2 pc.	2-1/2 X 5.025	114.21
FD-309984	P-U-8	2 pc.	2 X 3.025	47.66
FD-309984F	P-U-8	2 pc.	2 X 3	71.13
FD-309985	P-U-8	2 pc.	1-1/2 X 3.025	45.88
FD-309985F	P-U-8	2 pc.	1-1/2 X 3	70.61
FD-7708145	P-U-13	1 pc.	2 X 3	49.26
FD-83971999	P-UB-10	1 pc.	56 X 100 mm	113.10
FD-85802567	P-UB-10	1 pc.	50 X 90 mm	64.05
FD-85802568	P-UB-10	1 pc.	63 mm X 5.125	212.13
FD-85802569	P-UB-10	1 pc.	50 X 70 mm	65.11
FD-85802570	I-UB-10	1 pc.	50 X 110 mm	73.96
FD-85804740	P-UB-10	1 pc.	40 X 80 mm	63.57
FD-85804741	P-UB-10	1 pc.	63 X 125 mm	149.83
FD-85804742	P-UB-10	1 pc.	63 X 115 mm	164.85
FD-85804743	P-U-10	1 pc.	63 X 90 mm	124.10
FD-FINN3A539AA	I-U-10	1 pc.	40 mm X 2-3/4	41.21
FD-FP398	P-UB-10	1 pc.	56 X 100 mm	88.33
FD-FP410	P-UB-10	1 pc.	56 X 115 mm	84.31
FD-FP417	P-UB-10	1 pc.	50 X 80 mm	66.52
FD-FP419	P-UB-10	1 pc.	40 X 70 mm	68.59
FD-FP454	P-UB-10	1 pc.	56 x 115 mm	154.37
FD-FP455	P-UB-10	1 pc.	63 x 115 mm	104.77
FD-FP456	P-U-10	1 pc.	63 x 90 mm	78.97
FD-FP457	P-UB-10	1 pc.	50 X 80 mm	58.38
FD-FP458	P-UB-10	1 pc.	56 X 100 mm	113.10
FD-FP459	P-UB-10	1 pc.	50 X 70 mm	65.17
FD-FP460	P-UB-10	1 pc.	50 x 110 mm	114.76
FD-FP528	P-UB-9	1 pc.	63 X 125 mm	202.90

FORD TRACTORS

Kit Number	Code (Pg. xviii)	Rod X Bore Size	List Price
FD-7102289	N-OB-1	1-1/4 ROD	\$ 10.13
FD-CE41200904	P-OB-10	7/8 X 2	20.73
FD-CE41300922	P-OB-10	1-1/4 X 3	47.01
FD-DHPNC846B	I-TR-3	1 X 2	16.24
FD-DHPNC846C	I-TR-3	1-3/8 X 3	22.30

FORD VEE SETS

Part Number	I.D.	O.D.	H.	List Price
FVS12504S079	1-1/4	1-3/4	.079	\$ 8.76
FVS15004S128	1-1/2	2	1.265	11.50
FVS15004U087	1-1/2	2	7/8	16.20
FVS22504U087	2-1/4	2-3/4	7/8	17.57
FVS25004U087	2-1/2	3	7/8	17.27
FVS25004X100	2-1/2	3	1	20.86
FVS30206S118	2.275	3.025	1-3/16	25.17
FVS35206S102	2.775	3.525	1.015	25.89
FVS37706D102	3.025	3.775	1.015	27.31
FVS40206D102	3.275	4.025	1.015	41.44
FVS45206D102	3.775	4.525	1.015	42.88
FVS45206S102	3.775	4.525	1.015	40.54
FVS50206D102	4.275	5.025	1.015	38.12
FVS55206D102	4.775	5.525	1.015	41.70
FVS60206D102	5-1/4	6	1.015	50.60
FVS65206D102	5-3/4	6-1/2	1.015	61.12

REPLACEMENT PARTS FOR FORD

NOTE: Ford part numbers are used as a reference only. We do not imply that these kits are original REPLACEMENT PARTS.

O-RINGS

Part Number	Min Pkg Qty	List Price
FD-83911408	5	\$ 2.28
FD-83937337	10	1.39
FD-83963231	10	1.41
FD-87031S91	50	0.07
FD-87032S92	50	0.07
FD-87033S91	50	0.07
FD-87034S92	50	0.07
FD-87036S92	50	0.09
FD-87037S92	50	0.09
FD-87039S91	50	0.10
FD-87043S92	50	0.12
FD-NCA38368	50	0.09

BACK-UP RINGS

Part Number	Min Pkg Qty	List Price
FD-7701432	10	\$ 1.19
FD-83912407	10	0.99
FD-83963261	2	14.47
FD-83963264	2	10.83

ROD BUSHINGS

Part Number	Rod Dia.	List Price
FD-83963215	56 mm	\$ 12.11

WIPERS

Part Number	Rod Dia.	List Price
FD-83910527	56 mm	\$ 20.14
FD-83910528	63 mm	23.40
FD-83912409	40 mm	21.35

BUFFER RINGS

Part Number	Rod Dia.	List Price
FD-83962601	40 mm	\$ 8.96
FD-83963211	56 mm	10.12

U-SEALS

Part Number	Rod Dia.	List Price
FD-83962600	40 mm	\$ 14.02
FD-83986700	56 mm	20.09

FRANKLIN

Kit Number	Code (Pg. xviii)	Rod X Bore Size	List Price	Kit Number	Code (Pg. xviii)	Rod X Bore Size	List Price
FR-1023070	I-U-10	2-1/2 X 5	\$ 49.37	FR-1504160	P-V-7	2-1/2 X 4	\$ 66.16
FR-1025526	I-U-10	2-1/2 X 5	47.37	FR-1504353	I-V-12	2 X 4	103.63
FR-1026526	I-U-10	2-1/2 X 5	46.06	FR-1504669	P-V-10,12	2-1/2 X 4	82.55
FR-1028996	I-U-10	1-3/4 X 3-1/2	42.24	FR-1504704	P-V-10, 12	1-3/8 X 3	70.45
FR-1028997	I-U-10	3 X 6	61.27	FR-1504986	I-U-5	2-1/2 X 5	96.69
FR-1500278	2" Self-Aligning Bushing		70.63	FR-1505499	I-U-10	2-1/2 X 5	106.68
FR-1500328A	P-V-1	1-3/8 ROD	26.55	FR-1505720	I-U-10	2-1/2 X 4	35.87
FR-1500328B	P-V-12	1-3/8 X 3	71.32	FR-1505721	I-U-10	2-1/2 X 4	48.50
FR-1500341	P-V-7	1-3/8 X 3	55.32	FR-1505724	I-U-10	1-1/2 X 3	37.29
FR-1500525A	3" PISTON SEAL		6.21	FR-1505725	I-U-10	4 X 5	58.22
FR-1500527A	7" PISTON SEAL		14.29	FR-1505727	I-U-10	1-3/4 X 3-1/2	41.83
FR-1500568A	P-V-1	1-1/2 ROD	29.74	FR-1505761	P-U-10	1-3/4 X 3-1/2	46.77
FR-1500568B	P-V-12	1-1/2 X 3-1/2	63.84	FR-1506186	I-U-10	2 X 4	37.19
FR-1500893	P-V-10,12	2-1/2 X 4	71.91	FR-1507263	I-U-5	4 X 7	80.73
FR-1500893A	P-V-10	2-1/2 X 4	39.15	FR-1507265	I-U-5	2 X 3	25.54
FR-1500893B	P-V-10,12	2-1/2 X 4	60.49	FR-1507266	I-U-5	2 X 3-1/2	27.60
FR-1500900A	P-V-10	1-1/2 X 3-1/2	40.74	FR-1507280	I-U-5	3 X 6	93.62
FR-1500900B	P-V-10,12	1-1/2 X 3-1/2	63.90	FR-1507281	I-U-5	3 X 7	82.54
FR-1500921	3" Piston Kit		13.32	FR-1507282	I-U-5	3 X 6	70.58
FR-1501279	P-V-5	2 X 4-1/2	67.92	FR-1507283	I-U-5	1-1/2 X 3-1/2	26.64
FR-1503650	P-V-12	2 X 3-1/2	69.62	FR-1507284	I-U-5	1-1/2 X 3	24.34
FR-1504074	I-U-5	2-1/2 X 5	60.14	FR-H22/32/42	I-U-4	1-3/8 X 3-1/4	26.56

REPLACEMENT PARTS FOR FRANKLIN

NOTE: Franklin part numbers are used as a reference only. We do not imply that these kits are original REPLACEMENT PARTS.

PISTON SEALS

Part Number	Rod Dia.	List Price
FR-1505510	4	\$ 27.30

FRUEHAUF BOTTOM DUMP AIR CYLINDERS

Kit Number	Code (Pg. xviii)	Rod X Bore Size	List Price
FRU-D10252	I-V-5	1-5/8 X 7	\$ 85.87
FRU-D1052	I-V-5	1-5/8 X 6	81.46
FRU-HLA96845	I-V, U-5	1-5/8 X 6	84.90
FRU-HLA96855	I-V,U-5	1-5/8 X 7	89.73
FRU-HMD	I-U-11	1-1/2 X 3	28.07

FURUKAWA

Kit Number	Code (Pg. xviii)	Rod X Bore Size	List Price
FUR-341541-99110	P-U-5	40 X 80	\$ 149.42
FUR-341831-99110	P-U-5	65 X 140	144.41
FUR-341831-99120	I-U-5	55 X 110	122.10

GALBREATH® ROLL-OFF

Kit Number	Code (Pg. xviii)	Rod X Bore Size	List Price
GLB-1110	I-U-12	4-1/2 X 6	\$ 152.16
GLB-1905		NB1669-1	11.53
GLB-2473	I-U-12	3 X 7	122.26
GLB-2481		X73-37-17	7.93
GLB-3135	I-U-1	3 Rod Kit	30.57

GALION®-DRESSER®

Kit Number	Description	List Price
GD-D48664	5-1/2" Double Acting Vee Set	\$ 24.85
GD-D50182	3-1/2" Double Acting Vee Set	61.62
GD-D63806	11-1/4" X 12 Vee Set	196.73

GARWOOD

Kit Number	Code (Pg. xviii)	Rod X Bore Size	List Price
GW-2044692K	I-V-5	2 X 7	\$ 71.15
GW-2061839K	I-V-5	1-3/4 X 4	56.26
GW-2061841K	I-V-1	3-1/8, 4-1/2, 5-3/4 Stgs	138.81
GW-2064753K	I-V-1	4, 5, 6 Stages	98.07
GW-2064754K	I-V-1	5, 6, 7 Stages	117.98
GW-2064755K	I-V-1	4, 5, 6, 7 Stages	144.11
GW-2069544K	I-TR-1	2-1/2, 3-1/4 Stages	31.56
GW-2072369	I-U-5	2-1/2 X 5	72.42
GW-2073610K	N-U-4	3-1/2 X 4	45.79
GW-2074132K	I-U-5	3-1/2 X 5	60.03
GW-2074235K	N-N-4	3" Bore	24.56
GW-2074467K	I-U-5	2-1/2 X 5	54.98
GW-2079197K	I-U-5	3-1/2 X 5	64.12

Replacement Kits For

GEHL®

Forklifts							
APPLICATION	CYL #	SERIAL #	CODE	ROD	BORE	KIT #	List \$
MODEL 552, 553							
ATTACHMENT ROTATE	L63594		I-U-10	1	2-1/2	GEHL-L99170	37.14
ATTACHMENT SLAVE	L63014		I-U-11	1-3/4	3-1/2	GEHL-L98527	38.43
ATTACHMENT TILT	L63013		I-U-11	2	4	GEHL-L98548	60.19
BOOM EXTEND	L63012		I-U-11	2-1/2	3-1/2	GEHL-L98558	74.06
BOOM LIFT	L63199		I-U-11	2-1/2	4-1/2	GEHL-L98521	68.04
FORK SHIFT	L66920		I-U-10	1-1/4	2	GEHL-L99958	77.84
FRAME LEVEL	L63015		I-U-11	1-3/4	4	GEHL-L98506	45.12
STEER	L98444		I-U-10	45 mm	90 mm	GEHL-L98565	114.74
MODEL 663							
BOOM EXTEND	L64333		I-U-10	3	4	GEHL-L99386	81.01
BOOM LIFT	L64014		I-U-10	3	4	GEHL-L99331	115.97
CARRIER SLAVE	L61869		I-U-10	1-3/4	3-1/2	GEHL-L99332	60.92
CARRIER TILT	L61868		I-U-10	2	4	GEHL-L99385	90.12
FRAME SWAY	L64054	Prior-4319	I-U-10	3	4	GEHL-L97674	67.91
	L64085	4320-4356	P-U-5	1-3/4	4	GEHL-L97903	64.98
	L64818	4357-UP	I-U-10	1-3/4	4	GEHL-L99382	75.80
ROTATE CARRIAGE	L61317		I-U-10	1-3/8	3	GEHL-L97769	45.18
STEER	L97649-L97976		I-U-10	1-1/8	2-1/4	GEHL-L97978	36.09
MODEL 883							
ATTACHMENT TILT	L49988A	7001-7004	I-U-10	2-1/2	5	GEHL-L97716	97.31
	L64086	7005-7444	P-U-10	2-1/2	5	GEHL-L97922	78.60
BOOM EXTEND	L64385	7001-7004	I-U-10	3-1/2	4-1/2	GEHL-L97713	78.36
	L66770	7446-UP	I-U-10	3-1/2	4-1/2	GEHL-L99376	94.04
BOOM LIFT	L64083	7005-7445	I-U-10	3-1/2	4-1/2	GEHL-L97908	52.47
	L64401	7001-7004	I-U-10	3-1/2	4-1/2	GEHL-L97711	65.33
BOOM SLAVE	L64087	7001-7004	I-U-10	2-1/4	4-1/2	GEHL-L97917	54.66
	L64087	7005-7171	I-U-10	2-1/4	4-1/2	GEHL-L97715	61.09
	L66032	7172-7444	I-U-10	2-1/4	4-1/2	GEHL-L97917	54.66
	L66666	7445-UP	I-U-11	2-1/4	5	GEHL-L99330	92.77
FORK SHIFT	L66920		I-U-10	1-1/4	2	GEHL-L99958	77.84
FRAME LEVEL	L64085	7005-7445	P-U-5	1-3/4	4	GEHL-L97903	64.98
	L64818	7001-7004, 7446-UP	I-U-10	1-3/4	4	GEHL-L99382	75.80
MAST LIFT	L66537		I-U-10	2	3	GEHL-L98848	37.26
OUTRIGGER	L64968	Prior-7386	I-U-10	2-1/2	4	GEHL-L97938	42.96
	L66642	7387-UP	I-U-11	2-1/2	4	GEHL-L99059	58.00
ROTATE CARRIAGE	L61317		I-U-10	1-3/8	3	GEHL-L97769	45.18
STEER	L97649		I-U-10	1-1/8	2-1/4	GEHL-L97978	36.09
	L99428		I-U-10	1-1/8	3	GEHL-L99430	45.68
SWING CARRIAGE	L63970	2781-UP	I-U-10	1-1/4	2-1/2	GEHL-L99944	36.46
	L65659	Prior-2780	I-U-10	1-3/8	3	GEHL-L97955	57.79

GEHL®

GEHL®

Kit Number	Code (Pg. xviii)	Rod X Bore Size	List Price
GEHL-L97617	I-U-10	2 X 4	\$ 44.18
GEHL-L97674	I-U-10	3 X 4	67.91
GEHL-L97711	I-U-10	3-1/2 X 4-1/2	65.33
GEHL-L97713	I-U-10	3-1/2 X 4-1/2	78.36
GEHL-L97715	I-U-10	2-1/4 X 4-1/2	61.09
GEHL-L97716	I-U-10	2-1/2 X 5	97.31
GEHL-L97769	I-U-10	1-3/8 X 3	45.18
GEHL-L97903	P-U-5	1-3/4 X 4	64.98
GEHL-L97908	I-U-10	3-1/2 X 4-1/2	52.47
GEHL-L97917	I-U-10	2-1/4 X 4-1/2	54.66
GEHL-L97922	P-U-10	2-1/2 X 5	78.60
GEHL-L97938	I-U-10	2-1/2 X 4	42.96
GEHL-L97955	I-U-10	1-3/8 X 3	57.79
GEHL-L97978	I-U-10	1-1/8 X 2-1/4	36.09
GEHL-L98506	I-U-11	1-3/4 X 4	45.12
GEHL-L98521	I-U-11	2-1/2 X 4-1/2	68.04
GEHL-L98527	I-U-11	1-3/4 X 3-1/2	38.43
GEHL-L98548	I-U-11	2 X 4	60.19
GEHL-L98558	I-U-11	2-1/2 X 3-1/2	74.06
GEHL-L98565	I-U-10	45 X 90 mm	114.74
GEHL-L98848	I-U-10	2 X 3	37.26
GEHL-L99059	I-U-11	2-1/2 X 4	58.00
GEHL-L99170	I-U-10	1 X 2-1/2	37.14
GEHL-L99330	I-U-11	2-1/4 X 5	92.77
GEHL-L99331	I-U-10	3 X 4	115.97

GEHL®

Kit Number	Code (Pg. xviii)	Rod X Bore Size	List Price
GEHL-L99332	I-U-10	1-3/4 X 3-1/2	\$ 60.92
GEHL-L99376	I-U-10	3-1/2 X 4-1/2	94.04
GEHL-L99382	I-U-10	1-3/4 X 4	75.80
GEHL-L99385	I-U-10	2 X 4	90.12
GEHL-L99386	I-U-10	3 X 4	81.01
GEHL-L99430	I-U-10	1-1/8 X 3	45.68
GEHL-L99944	I-U-10	1-1/4 X 2-1/2	36.46
GEHL-L99958	I-U-10	1-1/4 X 2	77.84

GLENCOE

Kit Number	Code (Pg. xviii)	Rod X Bore Size	List Price
GLC-TH200B-K	I-TR-1	2-1/2, 2-7/8, 3-3/8 Stages	\$ 54.57
GLC-TH80	I-TR-1	2-3/8, 2-7/8 Stages	32.79
GLC-UA80568	I-TR-1	2-7/8, 3-3/8 Stages	43.10
GLC-UA80569	I-TR-1	2-3/8, 2-7/8, 3-3/8 Stages	59.16
GLC-UA80570	I-TR-1	2-3/8, 2-7/8, 3-3/8, 3-7/8 Stgs	88.37
GLC-UA80589	I-TR-1	2-7/8, 3-3/8, 3-7/8 Stages	68.02

Replacement Kits For

GRADALL®

Forklifts - Rough Terrain							
APPLICATION	CYL #	SERIAL #	CODE	ROD	BORE	KIT #	List \$
MODEL 532C-6							
COMPENSATING	9112-3049	0188002-UP	I-U-10	3-1/8	6-1/4	GRD-91124049	61.79
CROWD	9112-3009	0188002-UP	P-U-10	2-1/2	3-1/2	GRD-91124044	39.36
	9112-5024	0188153-UP	P-U-14	2-1/2	3-1/2	GRD-91123080	138.69
LIFT(IOWA)	9112-3111	0288587, 0288692	P-UB-10	3	5-1/2	GRD-91124071	106.51
	9112-3111	0288695-0288715	P-UB-10	3	5-1/2	GRD-91124071	106.51
	9112-3111	0288940H-0388020H	P-UB-10	3	5-1/2	GRD-91124071	106.51
LIFT(SEITZ)	9112-3010	0188002-0288586	P-U-10	3	5-1/2	GRD-91124036	86.09
	9112-3010	0288588-0288691	P-U-10	3	5-1/2	GRD-91124036	86.09
	9112-3010	0288693, 0288694	P-U-10	3	5-1/2	GRD-91124036	86.09
	9112-3010	0288716-0288939	P-U-10	3	5-1/2	GRD-91124036	86.09
STEERING(IOWA)	9108-3467	0288587, 0288692	P-UB-10	1-1/4	2-1/2	GRD-91084305	59.14
	9108-3467	0288695-0288715	P-UB-10	1-1/4	2-1/2	GRD-91084305	59.14
	9108-3467	0288940H-0388020H	P-UB-10	1-1/4	2-1/2	GRD-91084305	59.14
STEERING(SEITZ)	9108-3281	0188002-0288586	P-U-10	1-1/4	2-1/2	GRD-91084183	28.02
	9108-3281	0288588-0288691	P-U-10	1-1/4	2-1/2	GRD-91084183	28.02
	9108-3281	0288693, 0288694	P-U-10	1-1/4	2-1/2	GRD-91084183	28.02
	9108-3281	0288716-0288939	P-U-10	1-1/4	2-1/2	GRD-91084183	28.02
SWAY(IOWA)	9108-3471	0288587, 0288692	P-UB-10	2	3-1/2	GRD-91084308	94.68
	9108-3471	0288695-0288715	P-UB-10	2	3-1/2	GRD-91084308	94.68
	9108-3471	0288940H-0388020H	P-UB-10	2	3-1/2	GRD-91084308	94.68
SWAY(SEITZ)	9108-3286	0188002-0288586	P-U-10	2	3-1/2	GRD-91084189	30.94
	9108-3286	0288588-0288691	P-U-10	2	3-1/2	GRD-91084189	30.94
	9108-3286	0288693, 0288694	P-U-10	2	3-1/2	GRD-91084189	30.94
	9108-3286	0288716-0288939	P-U-10	2	3-1/2	GRD-91084189	30.94
TILT	9112-3067	0188002-UP	P-U-10	2-1/2	5	GRD-91034278	45.05
MODEL 534B-6							
COMPENSATING	9103-3288	0144293H-UP	P-U-10	2-1/2	5	GRD-91034150	53.36
CROWD	9080-1293	8344001L-UP	I-U-10	2-1/2	4	GRD-90208023	54.23
CROWD(IOWA)	9103-3290	0144293H-UP	P-U-10	2-1/2	4	GRD-91034223	48.44
LIFT	9080-1333	8344001L-UP	I-U-10	2-1/2	5	GRD-90207953	42.72
LIFT(IOWA)	9103-3286	0144293H-UP	P-U-10	2-1/2	5	GRD-91034140	53.78
STEERING	9045-3034	For Service	P-UB-10	1-1/2	3	GRD-91144006	82.09
STEERING(IOWA)	9103-3291	0144293H-UP	P-U-10	1-1/2	3	GRD-91034145	37.44
STEERING(JARP)	9080-1313	8344001L-UP	I-U-10	1-1/2	3	GRD-90202551	20.89
SWAY	9080-1270	8344001L-8644030G	I-U-10	2	4	GRD-90201553	33.89
	9104-3139	8644031G-UP	I-U-10	2	4	GRD-91044205	27.33
SWAY(IOWA)	9104-3205	0144293H-UP	P-U-10	2	4	GRD-91044275	45.16
TILT	9080-1292	8344001L-8344011L	I-U-10	2	4	GRD-90201553	33.89
	9080-1357	8344012L-8744136G	I-U-10	2-1/2	4	GRD-91034049	36.42
TILT COMP	9080-1291	8344001L-8344011L	I-U-10	2	4	GRD-90201553	33.89
	9080-1356	8344012L-8744136G	I-U-10	2-1/2	4	GRD-91034049	36.42
TILT COMP(JARP)	9080-1328	8744142G-UP	I-U-10	2-1/2	5	GRD-90207954	38.66
TILT(IOWA)	9103-3287	0144293H-UP	P-U-10	2-1/2	5	GRD-91034150	53.36
TILT(JARP)	9080-1327	8744142G-UP	I-U-10	2-1/2	5	GRD-90207954	38.66
MODEL 534B-8							
COMPENSATING	9103-3288	0144293H-UP	P-U-10	2-1/2	5	GRD-91034150	53.36

GRADALL®

Replacement Kits For

GRADALL®

Forklifts - Rough Terrain							
APPLICATION	CYL #	SERIAL #	CODE	ROD	BORE	KIT #	List \$
MODEL 534B-8							
CROWD	9080-1293	8344001L-UP	I-U-10	2-1/2	4	GRD-90208023	54.23
CROWD(IOWA)	9103-3290	0144293H-UP	P-U-10	2-1/2	4	GRD-91034223	48.44
LIFT	9080-1180	8344001L-UP	I-U-10	2-1/2	4-1/2	GRD-90207956	36.60
LIFT(IOWA)	9103-3286	0144293H-UP	P-U-10	2-1/2	5	GRD-91034140	53.78
STEERING	9045-3034	For Service	P-UB-10	1-1/2	3	GRD-91144006	82.09
STEERING(IOWA)	9103-3291	0144293H-UP	P-U-10	1-1/2	3	GRD-91034145	37.44
STEERING(JARP)	9080-1313	8344001L-UP	I-U-10	1-1/2	3	GRD-90202551	20.89
SWAY	9080-1270	8344001L-8644030G	I-U-10	2	4	GRD-90201553	33.89
	9104-3139	8644031G-UP	I-U-10	2	4	GRD-91044205	27.33
SWAY(IOWA)	9104-3205	0144293H-UP	P-U-10	2	4	GRD-91044275	45.16
TILT COMP(JARP)	9080-1328	8344001L-UP	I-U-10	2-1/2	5	GRD-90207954	38.66
TILT(IOWA)	9103-3287	0144293H-UP	P-U-10	2-1/2	5	GRD-91034150	53.36
TILT(JARP)	9080-1327	8344001L-UP	I-U-10	2-1/2	5	GRD-90207954	38.66
MODEL 534B-9							
COMPENSATING	9104-3304	0144860S-UP	P-U-10	2-1/2	5	GRD-91034278	45.05
CROWD	9103-3368	0144860S-UP	P-U-10	2-1/2	4	GRD-91034290	40.28
LIFT	9103-3371	0144860S-UP	P-U-10	2-1/2	5	GRD-91034278	45.05
STEERING	9103-3478	0244089S-UP	P-U-10	1-1/2	3	GRD-91034301	38.73
	9104-3316	0144860S-UP	P-U-10	1-1/2	3	GRD-91034301	38.73
SWAY	9103-3367	0144860S-UP	P-U-10	2	4	GRD-91034297	35.44
TILT	9103-3369	0144860S-UP	P-U-10	2-1/2	5	GRD-91034278	45.05
MODEL 534C-6							
COMPENSATING(IOWA)	9108-3470	0288587, 0288692	P-UB-10	2-1/2	5	GRD-91034339	87.16
	9108-3470	0288695-0288715	P-UB-10	2-1/2	5	GRD-91034339	87.16
	9108-3470	0288940H-0388020H	P-UB-10	2-1/2	5	GRD-91034339	87.16
COMPENSATING(SEITZ)	9108-3285	0188002-0288586	P-U-10	2-1/2	5	GRD-91084169	40.06
	9108-3285	0288588-0288691	P-U-10	2-1/2	5	GRD-91084169	40.06
	9108-3285	0288693, 0288694	P-U-10	2-1/2	5	GRD-91084169	40.06
	9108-3285	0288716-0288939	P-U-10	2-1/2	5	GRD-91084169	40.06
CROWD	9112-3009	0188002-UP	P-U-10	2-1/2	3-1/2	GRD-91124044	39.36
	9112-5024	0188153-UP	P-U-14	2-1/2	3-1/2	GRD-91123080	138.69
LIFT(IOWA)	9112-3111	0288587, 0288692	P-UB-10	3	5-1/2	GRD-91124071	106.51
	9112-3111	0288695-0288715	P-UB-10	3	5-1/2	GRD-91124071	106.51
	9112-3111	0288940H-0388020H	P-UB-10	3	5-1/2	GRD-91124071	106.51
LIFT(SEITZ)	9112-3010	0188002-0288586	P-U-10	3	5-1/2	GRD-91124036	86.09
	9112-3010	0288588-0288691	P-U-10	3	5-1/2	GRD-91124036	86.09
	9112-3010	0288693, 0288694	P-U-10	3	5-1/2	GRD-91124036	86.09
	9112-3010	0288716-0288939	P-U-10	3	5-1/2	GRD-91124036	86.09
STEERING(IOWA)	9108-3467	0288587, 0288692	P-UB-10	1-1/4	2-1/2	GRD-91084305	59.14
	9108-3467	0288695-0288715	P-UB-10	1-1/4	2-1/2	GRD-91084305	59.14
	9108-3467	0288940H-0388020H	P-UB-10	1-1/4	2-1/2	GRD-91084305	59.14
STEERING(SEITZ)	9108-3281	0188002-0288586	P-U-10	1-1/4	2-1/2	GRD-91084183	28.02
	9108-3281	0288588-0288691	P-U-10	1-1/4	2-1/2	GRD-91084183	28.02
	9108-3281	0288693, 0288694	P-U-10	1-1/4	2-1/2	GRD-91084183	28.02
	9108-3281	0288716-0288939	P-U-10	1-1/4	2-1/2	GRD-91084183	28.02
SWAY(IOWA)	9108-3471	0288587, 0288692	P-UB-10	2	3-1/2	GRD-91084308	94.68

GRADALL®

Replacement Kits For

GRADALL®**Forklifts - Rough Terrain**

APPLICATION	CYL #	SERIAL #	CODE	ROD	BORE	KIT #	List \$
MODEL 534C-6							
SWAY(IOWA)	9108-3471	0288695-0288715	P-UB-10	2	3-1/2	GRD-91084308	94.68
	9108-3471	0288940H-0388020H	P-UB-10	2	3-1/2	GRD-91084308	94.68
SWAY(SEITZ)	9108-3286	0188002-0288586	P-U-10	2	3-1/2	GRD-91084189	30.94
	9108-3286	0288588-0288691	P-U-10	2	3-1/2	GRD-91084189	30.94
	9108-3286	0288693, 0288694	P-U-10	2	3-1/2	GRD-91084189	30.94
	9108-3286	0288716-0288939	P-U-10	2	3-1/2	GRD-91084189	30.94
TILT(IOWA)	9108-3472	0288587, 0288692	P-UB-10	2	4	GRD-91034337	62.88
	9108-3472	0288695-0288715	P-UB-10	2	4	GRD-91034337	62.88
	9108-3472	0288940H-0388020H	P-UB-10	2	4	GRD-91034337	62.88
TILT(SEITZ)	9108-3379	0188002-0288586	P-U-10	2	4	GRD-91034297	35.44
	9108-3379	0288588-0288691	P-U-10	2	4	GRD-91034297	35.44
	9108-3379	0288693, 0288694	P-U-10	2	4	GRD-91034297	35.44
	9108-3379	0288716-0288939	P-U-10	2	4	GRD-91034297	35.44

GRADALL®

Kit Number	Code (Pg. xviii)	Rod X Bore Size	List Price
GRD-8692-5036	P-U-10	3-1/4 X 5	\$ 279.24
GRD-90201553	I-U-10	2X4	33.89
GRD-90202551	I-U-10	1-1/2X3	20.89
GRD-90207953	I-U-10	2-1/2X5	42.72
GRD-90207954	I-U-10	2-1/2X5	38.66
GRD-90207956	I-U-10	2-1/2X4-1/2	36.60
GRD-90208023	I-U-10	2-1/2X4	54.23
GRD-91034049	I-U-10	2-1/2X4	36.42
GRD-91034140	P-U-10	2-1/2X5	53.78
GRD-91034145	P-U-10	1-1/2X3	37.44
GRD-91034150	P-U-10	2-1/2X5	53.36
GRD-91034223	P-U-10	2-1/2X4	48.44
GRD-91034278	P-U-10	2-1/2X5	45.05
GRD-91034290	P-U-10	2-1/2X4	40.28
GRD-91034297	P-U-10	2X4	35.44
GRD-91034301	P-U-10	1-1/2X3	38.73
GRD-91034337	P-UB-10	2X4	62.88
GRD-91034339	P-UB-10	2-1/2X5	87.16
GRD-91044205	I-U-10	2X4	27.33
GRD-91044275	P-U-10	2X4	45.16

Kit Number	Code (Pg. xviii)	Rod X Bore Size	List Price
GRD-91044335	I-U-11, 12	2-1/2 X 5	\$ 107.84
GRD-91084169	P-U-10	2-1/2X5	40.06
GRD-91084183	P-U-10	1-1/4X2-1/2	28.02
GRD-91084189	P-U-10	2X3-1/2	30.94
GRD-91084305	P-UB-10	1-1/4X2-1/2	59.14
GRD-91084308	P-UB-10	2X3-1/2	94.68
GRD-91123080	P-U-14	2-1/2X3-1/2	138.69
GRD-91124036	P-U-10	3X5-1/2	86.09
GRD-91124044	P-U-10	2-1/2X3-1/2	39.36
GRD-91124049	I-U-10	3-1/8X6-1/4	61.79
GRD-91124071	P-UB-10	3X5-1/2	106.51
GRD-91144006	P-UB-10	1-1/2X3	82.09

Replacement Kits For

GROVE CRANE

Cranes - Rough Terrain						
APPLICATION	CODE	ROD	BORE	MISC	KIT #	List \$
MODEL RT58B, RT58C, RT58D						
BOOM LIFT	I-U-11	3-5/8	8-1/4		GC9752100164	278.80
BOOM TELE	I-U-11	4-1/2	6-1/2		GC9752100232	165.24
EXTENSION	I-U-11	3-5/8	7		GC9752100329	234.00
STABILIZER	I-U-11	3-5/8	7		GC9752100329	234.00
SWIVEL	SWIVEL		7-1/2		GC9752100358	96.07
MODEL RT60S						
BOOM LIFT	I-U-10	3-1/2	8-1/4		GC9752100027	57.13
BOOM TELE	I-U-11	3	4		GC9752100114	57.55
	I-U-11	3-5/8	5		GC9752100076	129.18
EXTENSION	I-U-11	1-3/4	3		GC9752100072	64.69
STABILIZER	I-U-11	3-5/8	5		GC9752100076	129.18
SWIVEL	SWIVEL		3-3/4		GC9752100303	44.59
	SWIVEL		8-1/4		GC9752100302	294.86
MODEL RT515, RT518, RT525, RT527						
BOOM LIFT	I-U-11	3-5/8	9		GC9752100199	295.52
BOOM TELE	I-U-11	5	6-1/2		GC9752100238	190.25
EXTENSION	I-U-11	1-3/4	3		GC9752100072	64.69
STABILIZER	I-U-11	4	5-1/2		GC9752100240	217.74
SWIVEL	SWIVEL		5-1/2		GC9752100312	84.81
	SWIVEL		8-1/2		GC9752100311	190.77
Cranes - Truck Mounted						
APPLICATION	CODE	ROD	BORE	MISC	KIT #	List \$
MODEL TM150, TM155						
BOOM LIFT	I-U-10	3-5/8	8-1/4		GC9752100074	145.77
	I-U-10	3-1/2	8-1/4		GC9752100027	57.13
BOOM TELE	I-U-11	2-5/8	4		GC9752100035	52.77
	I-U-11	3-5/8	5		GC9752100034	69.95
EXTENSION	I-U-11	1-3/4	3		GC9752100072	64.69
	I-U-10	1-3/4	3		GC9752100019	32.28
STABILIZER	I-U-10	3-5/8	5		GC9752100008	59.81
MODEL TM180						
BOOM LIFT	I-U-10	3-1/2	8-1/4		GC9752100027	57.13
BOOM TELE	I-U-11	2-5/8	4		GC9752100075	85.96
	I-U-11	3-5/8	5		GC9752100076	129.18
	I-U-11	3	4		GC9752100114	57.55
EXTENSION	I-U-11	1-3/4	3		GC9752100072	64.69
STABILIZER	I-U-11	3-5/8	5		GC9752100076	129.18
MODEL TM250						
BOOM LIFT	I-U-10	6	11		GC9752100029	224.28
BOOM TELE	I-U-11	5-1/2	7		GC9752100193	180.19
EXTENSION	I-U-11	1-3/4	3		GC9752100072	64.69
JACK	I-U-11	3-5/8	5		GC9752100229	188.91
STABILIZER	I-U-11	3-5/8	5		GC9752100229	188.91
SWIVEL	SWIVEL		8-1/2		GC9752100306	131.09
	SWIVEL		8-1/2		GC9752100314	313.96

GROVE CRANE

Replacement Kits For

GROVE CRANE

Cranes - Truck Mounted						
APPLICATION	CODE	ROD	BORE	MISC	KIT #	List \$
MODEL TM300						
BOOM LIFT	I-U-10	6-1/2	8-1/4		GC9752100146	268.94
BOOM TELE	I-U-11	4-1/2	5-1/2		GC9752100157	147.05
EXTENSION	I-U-11	1-3/4	3		GC9752100072	64.69
JACK	I-U-11	3-5/8	5		GC9752100229	188.91
STABILIZER	I-U-11	4-3/4	6		GC9752100162	149.25
SWIVEL	SWIVEL		8-1/2		GC9752100314	313.96
MODEL TM400						
BOOM LIFT	I-U-10	6-1/2	12-1/2		GC9752100039	228.67
BOOM TELE	I-U-11	4-1/2	6		GC9752100077	105.36
	I-U-11	3-5/8	5		GC9752100076	129.18
EXTENSION	I-U-11	1-3/4	3		GC9752100072	64.69
STABILIZER	I-U-10	4-1/2	7-1/2		GC9576100048	54.60
MODEL TM475						
BOOM TELE	I-U-11	4-1/2	5-1/2		GC9752100202	216.88
EXTENSION	I-U-11	1-3/4	3		GC9752100072	64.69
JACK	I-U-11	3-5/8	5		GC9752100229	188.91
STABILIZER	I-U-11	4-3/4	6		GC9752100162	149.25
SWIVEL	SWIVEL		8-1/2		GC9752100314	313.96
MODEL TM750E						
BOOM TELE	I-U-11	5	6		GC9752100293	255.31
EXTENSION	I-U-11	1-3/4	3		GC9752100369	66.37
JACK	I-U-11	3-5/8	5		GC9752100364	159.88
STABILIZER	I-U-11	4-3/4	6		GC9752100163	140.90
SWIVEL	SWIVEL		5-1/2		GC9752100300	34.39
MODEL TM800						
EXTENSION	I-U-11	5-1/2	6-1/2		GC9752100090	166.17
MODEL TM870E						
BOOM LIFT	I-U-11	7	10		GC9752100286	435.08
EXTENSION	I-U-11	1-3/4	3		GC9752100072	64.69
JACK	I-U-11	4-3/4	6		GC9752100163	140.90
STABILIZER	I-U-11	4-3/4	6		GC9752100163	140.90
SWIVEL	SWIVEL		5-1/2		GC9752100300	34.39
MODEL TMS250EB						
BOOM LIFT	I-U-10	6	11		GC9752100029	224.28
BOOM TELE	I-U-11	5-1/2	7		GC9752100193	180.19
EXTENSION	I-U-10	1-1/2	2-1/2		GC9752100363	48.19
JACK	I-U-11	3-5/8	5		GC9752100364	159.88
STABILIZER	I-U-11	4	5-1/2		GC9752100387	201.09
SWIVEL	SWIVEL		8-1/2		GC9752100538	371.96
	SWIVEL		8-1/2		GC9752100306	131.09
MODEL TMS275						
BOOM LIFT	I-U-10	6	11		GC9752100029	224.28
BOOM TELE	I-U-11	3-5/8	5		GC9752100076	129.18
EXTENSION	I-U-10	1-3/4	3		GC9752100009	32.09
STABILIZER	I-U-10	3-1/2	5-7/8		GC9372100153	75.79

GROVE CRANE

REPLACEMENT KITS FOR GROVE CRANE

Kit Number	Code (Pg. xviii)	Rod X Bore Size	List Price	Kit Number	Code (Pg. xviii)	Rod X Bore Size	List Price
GC360006321	I-OB-4	2-1/2 X 4-1/2	\$ 38.86	GC9752100146	I-U-10	6-1/2 X 8-1/4	\$ 268.94
GC6576000014	I-U-10	2-5/8 X 4	41.90	GC9752100150	I-U-11	6 X 7	223.78
GC9372100153	I-U-10	3-1/2 X 5-7/8	75.79	GC9752100152	I-U-10	7 X 11	334.35
GC9372100165	I-U-10	6 X 11	152.96	GC9752100157	I-U-11	4-1/2 X 5-1/2	147.05
GC9372101365	I-U-4	2-1/2 X 4-1/2	40.69	GC9752100160		O-RING KIT	7.10
GC9576000014	I-U-10	2-5/8 X 4	38.05	GC9752100161		O-RING KIT	6.57
GC9576100048	I-U-10	4-1/2 X 7-1/2	54.60	GC9752100162	I-U-11	4-3/4 X 6	149.25
GC9752100002	I-U-10	2-5/8 X 5	50.33	GC9752100163	I-U-11	4-3/4 X 6	140.90
GC9752100003	I-U-10	1-1/4 X 3	19.92	GC9752100164	I-U-11	3-5/8 X 8-1/4	278.80
GC9752100004	I-U-10	2-5/8 X 7	71.43	GC9752100167	I-U-11	6 X 7	192.53
GC9752100008	I-U-10	3-5/8 X 5	59.81	GC9752100168	I-U-11	5-1/2 X 7	238.31
GC9752100009	I-U-10	1-3/4 X 3	32.09	GC9752100173	I-U-11	5-1/2 X 6-1/2	272.74
GC9752100019	I-U-10	1-3/4 X 3	32.28	GC9752100180	I-U-11	6 X 8-1/4	254.52
GC9752100027	I-U-10	3-1/2 X 8-1/4	57.13	GC9752100181	I-U-11	7 X 8-1/4	427.46
GC9752100029	I-U-10	6 X 11	224.28	GC9752100182		VALVE KIT	10.19
GC9752100032	I-U-10	2-5/8 X 4	44.35	GC9752100184	I-U-13	7 X 11	419.42
GC9752100034	I-U-11	3-5/8 X 5	69.95	GC9752100184U	I-U-10	7 X 11 UNIV. KIT	583.49
GC9752100035	I-U-11	2-5/8 X 4	52.77	GC9752100186	I-U-11	6 X 10	407.41
GC9752100039	I-U-10	6-1/2 X 12-1/2	228.67	GC9752100187	I-U-11	3-5/8 X 6	159.20
GC9752100072	I-U-11	1-3/4 X 3	64.69	GC9752100189	I-U-11	4-1/2 X 6	146.57
GC9752100074	I-U-10	3-5/8 X 8-1/4	145.77	GC9752100192	I-U-11	6 X 10	529.49
GC9752100075	I-U-11	2-5/8 X 4	85.96	GC9752100193	I-U-11	5-1/2 X 7	180.19
GC9752100076	I-U-11	3-5/8 X 5	129.18	GC9752100198	I-U-11	7 X 11	553.58
GC9752100077	I-U-11	4-1/2 X 6	105.36	GC9752100199	I-U-11	3-5/8 X 9	295.52
GC9752100079	I-U-11	2-5/8 X 5	110.28	GC9752100202	I-U-11	4-1/2 X 5-1/2	216.88
GC9752100081	I-U-11	3-5/8 X 7	139.04	GC9752100229	I-U-11	3-5/8 X 5	188.91
GC9752100082	I-U-11	2-5/8 X 7	132.71	GC9752100232	I-U-11	4-1/2 X 6-1/2	165.24
GC9752100083	I-U-11	3-5/8 X 6	136.78	GC9752100234	I-U-11	4-1/2 X 6	175.83
GC9752100085	I-U-11	2 X 4	70.19	GC9752100235	I-U-11	2-5/8 X 5	109.06
GC9752100090	I-U-11	5-1/2 X 6-1/2	166.17	GC9752100236	I-U-11	3-5/8 X 8-1/4	248.26
GC9752100111	I-U-11	4-3/4 X 6	154.82	GC9752100238	I-U-11	5 X 6-1/2	190.25
GC9752100112	I-U-11	5-1/2 X 7	184.09	GC9752100239	I-U-11	4 X 5-1/2	191.58
GC9752100114	I-U-11	3 X 4	57.55	GC9752100240	I-U-11	4 X 5-1/2	217.74
GC9752100115		EXTENSION LINE KIT	53.89	GC9752100241	I-U-11	3-5/8 X 5	158.02
GC9752100116		O-RING KIT	6.89	GC9752100242	I-U-11	2-5/8 X 5	160.28
GC9752100117		O-RING KIT	41.34	GC9752100243	I-U-11	5-1/2 X 7	313.56
GC9752100119		TUBE EXTENSION KIT	54.29	GC9752100267		O-RING KIT	4.80
GC9752100121		O-RING KIT	8.58	GC9752100286	I-U-11	7 X 10	435.08
GC9752100123	N-U-4	5/8 X 1-7/8	17.19	GC9752100290	I-U-11	6 X 9	395.27
GC9752100127	I-U-11	6 X 10	320.54	GC9752100293	I-U-11	5 X 6	255.31
GC9752100137	I-U-10	6 X 10	332.98	GC9752100298		7-1/2" SWIVEL KIT	158.05
GC9752100138	I-U-13	7 X 11	529.26	GC9752100299		6" SWIVEL KIT	84.15

REPLACEMENT KITS FOR GROVE CRANE

Kit Number	Code (Pg. xviii)	Rod X Bore Size	List Price
GC9752100300		5-1/2" SWIVEL KIT	\$ 34.39
GC9752100301		8-1/2" SWIVEL KIT	271.68
GC9752100302		8-1/4" SWIVEL KIT	294.86
GC9752100303		3-3/4" SWIVEL KIT	44.59
GC9752100306		8-1/2" SWIVEL KIT	131.09
GC9752100307		8-1/2" SWIVEL KIT	226.78
GC9752100311		8-1/2" SWIVEL KIT	190.77
GC9752100312		5-1/2" SWIVEL KIT	84.81
GC9752100314		8-1/2" SWIVEL KIT	313.96
GC9752100324	I-U-10	1-3/4 X 3	78.14
GC9752100328		VALVE KIT	10.81
GC9752100329	I-U-11	3-5/8 X 7	234.00
GC9752100345	I-U-11	4-1/2 X 5-1/2	169.20
GC9752100358		7-1/2" SWIVEL KIT	96.07
GC9752100361		7" SWIVEL KIT	132.86
GC9752100363	I-U-10	1-1/2 X 2-1/2	48.19
GC9752100364	I-U-11	3-5/8 X 5	159.88
GC9752100369	I-U-11	1-3/4 X 3	66.37
GC9752100377	I-U-11	3 X 4-1/2	107.68

Kit Number	Code (Pg. xviii)	Rod X Bore Size	List Price
GC9752100385		5-1/2" SWIVEL KIT	\$ 85.79
GC9752100387	I-U-11	4 X 5-1/2	201.09
GC9752100391		Valve Kit	7.20
GC9752100445	I-U-11	6 X 9	402.05
GC9752100461	I-U-11	3-5/8 X 5	204.62
GC9752100463	I-UB-11	7 X 9	500.55
GC9752100466		EXTENSION LINE KIT	56.16
GC9752100467	I-U-11	3-5/8 X 7	254.75
GC9752100468	I-U-11	3-5/8 X 5	199.55
GC9752100470	I-UB-11	5 X 8-1/4	325.76
GC9752100475	I-U-11	7 X 9	432.91
GC9752100477	I-U-11	3 X 5-1/2	143.12
GC9752100491	I-U-11	3-5/8 X 8-1/4	245.50
GC9752100498		EXTENSION LINE KIT	42.10
GC9752100532	I-UB-9	5 X 6	593.01
GC9752100538		8-1/2" SWIVEL KIT	371.96
GC9752100563		5-1/2" SWIVEL KIT	85.79
GC9752101126		8-1/2" SWIVEL KIT	513.68

REPLACEMENT PARTS FOR GROVE CRANE

NOTE: Grove Crane part numbers are used as a reference only. We do not imply that these kits are original REPLACEMENT PARTS.

FACE SEALS

Part Number	List Price
GC-9372100033	\$ 13.23

WEAR RINGS

Part Number	OD X W	List Price
GC-7753000190	6-1/2 X 1/2	\$ 6.41
GC-9372100733	11 X 1/2	61.62

MODULAR BEARINGS

Part Number	ID	List Price
GC-9372100572	7	\$ 62.76

HARSH® MFG.

Kit Number	Code (Pg. xviii)	Rod X Bore Size	List Price
HM-A9113	I-OB-1	1-3/4 X 2-3/4	\$ 8.65
HM-A9112	I-OB-1	1-7/8 X 2-1/4	3.36
HM-A9114	I-OB-1	2-7/8" ROD	10.76
HM-A9115	I-OB-1	3-3/8" ROD	10.46
HM-A9116	I-OB-1	3-7/8" ROD	12.93

Replacement Kits For

HEIL®

Refuse - Front Loaders								
APPLICATION	CYL #	SERIAL #	CODE	ROD	BORE	Miscellaneous	KIT #	List \$
MODEL Half Pak III Full Eject								
ARM	1-6813		N-N-14		115 mm		HL-1-6370-002	79.09
	1-6813		P-UB-1	63 mm			HL-1-6370-001	93.82
EJECTOR	1-6076		I,P-UB-12	3,4,5	STAGES		HL-K272-4872	659.69
EJECTOR CYL	1-4911		I-V-12	3,4,5	STAGES		HL-K272-3588	510.62
FORK	1-4868		I-V-10	2	4		HL-K272-3582	53.07
	1-6671		N-N-10		100 mm		HL-1-6669-002	50.15
	1-6671		P-UB-1	50 mm			HL-1-6369-001	148.14
	1-6777		N-N-10		100 mm		HL-1-6669-002	50.15
	1-6777		P-UB-1	50 mm			HL-1-6777-001	127.75
	1-6778		N-N-10		100 mm		HL-1-6669-002	50.15
	1-6778		P-UB-1	50 mm			HL-1-6777-001	127.75
LIFT ARM	1-5150	3105106-	P-UB-14	2-1/2	4-1/2		HL-K272-3605	142.31
PACKER/EJECTOR	1-4911	SEPT 1998 - 3105162	I-V-12	3,4,5	STAGES		HL-K272-3588	510.62
	1-6076	3105300-	I,P-UB-12	3,4,5	STAGES		HL-K272-4872	659.69
	1-6525		P-UB-1	100 mm			HL-1-6525-010	214.04
	1-6525		N-N-14		140 mm		HL-1-6525-011	139.73
	1-6597		I,P-UB-12	3,4,5	STAGES		HL-K272-4872	659.69
	1-6598		I,P-UB-12	3,4,5	STAGES		HL-K272-4872	659.69
	1-6627		I,P-UB-12	3,4,5	STAGES		HL-K272-4872	659.69
SERVICE HOIST	1-6414		P-U-10	1-3/4	4		HL-1-3735-021	82.42
TAILGATE RAISE	1-6833		I,P-UB-1	45 mm			HL-1-6521-001	86.01
Refuse - Rear Loaders								
APPLICATION	CYL #	SERIAL #	CODE	ROD	BORE	Miscellaneous	KIT #	List \$
MODEL Formula 4000 & 4000 MK IV								
BLADE	1-4108	4F-1014878 -	I-V-10, 12	2-1/2	4		HL-K272-0956	74.06
CONTAINER ARM	1-4283	4F-1014878 -	I-V-10	1-1/2	3		HL-K272-0966	36.24
EJECTOR	1-4050		I-V-12	2,3,4,5	STAGES	18, 20 yds, Narrow Units	HL-K272-0933	157.65
	1-4053		I-V-12	2,3,4,5	STAGES	16, 18 yds, Narrow Units	HL-K272-0933	157.65
	1-4054		I-V-12	2,3,4,5	STAGES	25 yd, Narrow Units	HL-K272-0933	157.65
	1-6222		I-U-12	3,4,5	STAGES	11, 13 yds	HL-K272-4885	420.66
	1-6223		I-U-12	3,4,5	STAGES	11, 13 yds, Narrow Units	HL-K272-4885	420.66
	1-6224, 1-6225, 1-6226	4F-1014878 -	I-U-12	3,4,5,6	STAGES		HL-K272-4884	639.97
GRAB-BAR	1-5069	4F-1014878 -	I-U-10	1-1/2	2-1/2		HL-K272-0958	36.53
GRAB-BAR MECHANISM	1-4105	4F-1014878 -	I-U-10	1-1/2	2-1/2		HL-K272-0958	36.53
REEVING	1-6061		I-UB-10	4	5-1/2		HL-K272-0989	76.76
	1-6189	4F-1014878 -	I-UB-10	4	5-1/2		HL-K272-0989	76.76
SLIDE	1-4110	4F-1014878 -	I-V-10, 12	2	4-1/2		HL-K272-0957	106.80
TAILGATE RAISE	1-4070	4F-1014878 -	I-V-1	2-1/2	3		HL-K272-0937	28.37

HEIL®

Replacement Kits For

HEIL®

Refuse - Rear Loaders								
APPLICATION	CYL #	SERIAL #	CODE	ROD	BORE	Miscellaneous	KIT #	List \$
MODEL Formula 5000 - January 2006 and AFTER								
CONTAINER ARM MECHANISM	1-4283		I-V-10	1-1/2	3		HL-K272-0966	36.24
EJECTOR	1-6421		I-V-12	3,4,5,6,7	STAGES		HL-K272-8484	791.00
	1-6426		I-V-12	3,4,5,6	STAGES		HL-K272-4880	371.84
	1-6427		I-V-12	3,4,5,6	STAGES		HL-K272-4880	371.84
INSIDE LOWER PANEL	1-6611		I,P-UB-14	3-1/2	5-1/2		HL-1-6611-004	190.73
OUTSIDE UPPER PANEL	1-6610		I-UB-14	2-1/2	5-1/2		HL-1-6610-007	125.19
REEVING	1-6061		I-UB-10	4	5-1/2		HL-K272-0989	76.76
ROLL BAR MECHANISM	1-4105		I-U-10	1-1/2	2-1/2		HL-K272-0958	36.53
ROLL-BAR FLIPPER	1-5069		I-U-10	1-1/2	2-1/2		HL-K272-0958	36.53
TAILGATE RAISE	1-4880		I-V-1	3-1/2	4		HL-K272-0938	35.60
MODEL Formula 5000 & 5000 MK V								
CONTAINER ARM MECHANISM	1-4105, 1-4264		I-U-10	1-1/2	2-1/2		HL-K272-0958	36.53
CONTAINER DUMP	1-4283		I-V-10	1-1/2	3		HL-K272-0966	36.24
EJECTOR	1-4261, 1-4266, 1-4267		I-V-12	4,5,6	STAGES		HL-K272-0976	306.44
	1-4261, 63132-DA		I-V-12	4,5,6	STAGES	25 yd	HL-K272-0976	306.44
	1-4266, 63108-DA		I-V-12	4,5,6	STAGES	20 yd	HL-K272-0976	306.44
	1-4343	3722-	I-U-1	4,5,6,7	STAGES	32 yd	HL-K272-2774	431.86
	1-4821	2740 - 3721	I-V-12	4,5,6,7	STAGES	32 yd	HL-K272-3991	443.78
INSIDE LOWER PANEL	1-4347, 1-4887	2740 - 6845	I-V-10, 12	3-1/2	5-1/2		HL-K272-2776	76.42
	1-4887	2740 - 6845	I-V-10, 12	3-1/2	5-1/2		HL-K272-2776	76.42
	1-5111	6846-	P-UB-14	3-1/2	5-1/2		HL-K272-3609	218.39
OUTSIDE UPPER PANEL	1-4824, 1-4884	2740 - 6845	I-V-10	2-1/2	5		HL-K272-2778	70.24
	1-5110	6846-	P-UB-14	2-1/2	5		HL-K272-3608	144.69
PACKER BLADE	1-4884		I-V-10	2-1/2	5	Outside Cylinder	HL-K272-2778	70.24
	1-4887		I-V-10, 12	3-1/2	5-1/2	Inside Cylinder	HL-K272-2776	76.42
REEVING	1-4309	5002740 - 5008724	I-UB-10	4	5-1/2		HL-K272-0989	76.76
	1-6160	5008725-	I-UB-10	4	5-1/2		HL-K272-0989	76.76
	1-6160	5008725-	I-UB-4	1-1/8	3		HL-1-6160-100	69.17
TAILGATE RAISE	1-4348	2740 - 4236	I-V-1	3-1/2	4		HL-K272-0938	35.60
	1-4880	4237-	I-V-1	3-1/2	4		HL-K272-0938	35.60

HEIL®

Replacement Kits For

HEIL®

Refuse - Side Loaders								
APPLICATION	CYL #	SERIAL #	CODE	ROD	BORE	Miscellaneous	KIT #	List \$
MODEL CP Python - Rapid Rail								
BODY RAISE	1-6445		I-U-4	3-1/4	4		HL-K272-8491	189.60
GRAB	1-6667		N-N-14		80 mm		HL-1-6767-003	84.66
LIFT/REACH	1-6666		N-N-14		80 mm		HL-1-6767-003	84.66
PACKER	1-6406		P-UB-14	1-1/2	5		HL-1-6406-100	165.79
TAILGATE RAISE	1-6754		I-U-10	1-1/2	3		HL-1-6754-001	67.01
MODEL Formula 7000								
BODY HOIST	1-4807	405 & up	I-V-5,12	1-1/2	3-1/2		HL-K272-3084	126.05
	1-4807	405-	I-V-1	3-1/4, 4	STAGES		HL-K272-3083	40.93
	1-6191	405-	I-U-4	3-1/4, 4	STAGES		HL-K272-4893	184.11
GRABBER	1-4297	405-	I-V-5,12	1-1/2	3-1/2		HL-272-2767	91.54
	1-4327	405-	I-V-12	1-1/2	3		HL-K272-0981	73.55
	1-4843	405-	I-V-12	1-1/2	3		HL-K272-0981	73.55
LIFT	1-4338	405-	I-V-12	1-1/2	3		HL-K272-0981	73.55
PACKER	1-4298	1 - 447	I-UB-10	4	5-1/2		HL-K272-0989	76.76
	1-4878	448-	I-UB-10	4	5-1/2		HL-K272-0989	76.76
REACH	1-4276	405-	I-V-12	1-1/2	3		HL-K272-0981	73.55
SIDE			I-V-10	3-1/2	5		HL-K272-0969	67.62
TAILGATE	1-4305	405-	I-V-10	1-1/2	3		HL-K272-0966	36.24
MODEL Rapid Rail Auto-Side Loader 01/2000 -								
ARM	1-6407		P-UB-14	2	3		HL-1-6404-100	118.16
BODY RAISE	1-6445		I-U-4	3-1/4	4		HL-K272-8491	189.60
DUMP	1-6407		P-UB-14	1-1/8	3		HL-1-6402-100	121.24
GRABBER CYL	1-6416		P-UB-14	1-1/8	3		HL-1-6402-100	121.24
IN-OUT	1-6403		I-UB-14	1-1/8	1-3/4		HL-1-6403-100	124.42
PACKER	1-6406		P-UB-14	1-1/2	5		HL-1-6406-100	165.79
TAILGATE RAISE	1-6405		P-UB-10	1-1/8	3	Units built Jan/2000 and after	HL-1-6405-100	65.10
	1-6754		I-U-10	1-1/2	3	Units built July/2003 and after	HL-1-6754-001	67.01
MODEL Rapid Rail Auto-Side Loader 10/94 - 6/98								
ARM	1-6404		P-UB-14	2	3		HL-1-6404-100	118.16
BODY RAISE	1-4807	-1837	I-V-1	3-1/4, 4	STAGES		HL-K272-3083	40.93
	1-6191	1838-	I-U-4	3-1/4, 4	STAGES	2 Stage	HL-K272-4893	184.11
DUMP	1-6160		I-UB-4	1-1/8	3		HL-1-6160-100	69.17
DUMP & GRAB	1-6407		P-UB-14	1-1/8	3		HL-1-6402-100	121.24
GRIP	1-6330	-0329	I-UB-4	1-1/8	2-1/2		HL-K272-6627	67.69
	1-6331	0330-	I-UB-4	1-1/8	3		HL-1-6160-100	69.17
IN-OUT	1-6162		I-UB-14	1-1/8	1-3/4		HL-1-6194-100	95.02
	1-6403		I-UB-14	1-1/8	1-3/4		HL-1-6403-100	124.42
LIFT	1-6161		I-UB-4	2	3		HL-1-6161-100	86.74
PACKER	1-6164		I-UB-4	1-1/2	5		HL-1-6164-100	68.84
	1-6406		P-UB-14	1-1/2	5		HL-1-6406-100	165.79
TAILGATE	1-6405		P-UB-10	1-1/8	3		HL-1-6405-100	65.10
TAILGATE RAISE	1-6163		I-UB-4	1-1/8	3		HL-1-6160-100	69.17

HEIL®

HEIL® REPAIR KIT

Kit Number	Cylinder Number	Description	Code	Rod	Bore	List \$
HL-001-6554-025			P-UB-10	1-1/2	3	63.26
HL-1-3690-09	1-3690, 1-3691		I-V-10	4	6	57.19
HL-1-3692-07	1-3692, 1-3695, 1-3717, 1-3719		I-U-10	1-1/2	2-1/2	13.23
HL-1-3693-09	1-3693		I-V-10	2-1/2	5	37.62
HL-1-3706-05	1-3705, 1-3706		I-V-10	4	6	77.49
HL-1-4098K	1-4098		I-V-10	2-1/2	7-1/2	71.95
HL-1-4181-16	1-4181		I-U-5	4	4-1/2	62.66
HL-1-5098K	1-5098		P-UB-14	2-1/2	4-1/2	136.60
HL-1-5110-10	1-5110		P-UB-14	2-1/2	5	144.69
HL-1-6070K	1-6070		P-UB-14,12	1-1/2	3	120.71
HL-1-6085-1K	1-6085		P-UB-12,14	1-1/2	3	166.85
HL-1-6160-100	1-6160, 1-6163, 1-6331		I-UB-4	1-1/8	3	69.17
HL-1-6161-100	1-6161		I-UB-4	2	3	86.74
HL-1-6164-100	1-6164		I-UB-4	1-1/2	5	68.84
HL-1-6194-100	1-6162		I-UB-14	1-1/8	1-3/4	95.02
HL-1-6402-100	1-6407		P-UB-14	1-1/8	3	121.24
HL-1-6403-100	1-6403		I-UB-14	1-1/8	1-3/4	124.42
HL-1-6404-100	1-6404		P-UB-14	2	3	118.16
HL-1-6405-100	1-6405		P-UB-10	1-1/8	3	65.10
HL-1-6406-100	1-6406		P-UB-14	1-1/2	5	165.79
HL-1-6754-001			I-U-10	1-1/2	3	67.01
HL-272-2767	001-4297		I-V-5,12	1-1/2	3-1/2	91.54
HL-6403-34	A1D3705,A1D3706		I-V-10	4	6	79.11
HL-A1C2819K	A1D2819		P-V-12	4-1/2	6-1/2	247.94
HL-A1D1275-2K	A1D1275-2K		I-V-1	3-1/2		51.51
HL-A1D1276K	A1D1276		I-V-1	2,3-1/2	STAGES	82.01
HL-A1D1285K	A1D1285		I-V-1	2-3/8		24.52
HL-A1D1868K		HH30 Reeving Cylinder	I-V-12	3-1/2	5	171.94
HL-A1D2105K	A1D2105		N-V-12	1-1/2	3	39.63
HL-A1D2801K	A1D2801		I-V-1	3-1/2		28.85
HL-A1D2844K	A1D2844		P-V-12	2-3/4	5-1/2	82.83
HL-A1D2847-1	A1D2847		I-V-1	3-1/2		37.03
HL-A1D2928K	A1D2928		I-V-12	2	4-1/2	44.10
HL-A1D3503K	A1D3503		I-V-1	3-1/2		28.15
HL-A1D3523K	A1D3523		I-V-1	2,3-1/2	STAGES	50.79
HL-A1D3541-14		Load Lugger	I-U-10	4	4-1/2	47.78
HL-A1D3672K	A1D3672K		I-V-10, 12	2-1/4	3-1/2	46.22
HL-A1D3809K	3809		I-U-10	2	4-1/2	58.63
HL-A1D3856K	A1D3856		I-U-1	2-1/4	3-1/2	28.56
HL-A1D3874K	A1D3874		I-V-1	3-1/2		23.10
HL-A1D3917	A1D3917		I-V-10	3-1/2	5	72.03
HL-K22-3132	A1D3606		I-U-10,12	1-1/2	3	25.95
HL-K252-9310	AIE2125		I-V-12	4-3/4, 6-1/4	STAGES	315.25
HL-K252-9312	AIE2108		I,P-V12	6-1/4, 8-5/8	STAGES	439.94
HL-K272-0659	A1D3873		I-V-12	2, 3-1/2	STAGES	80.42
HL-K272-0660	A1D3923		I-V-10	3-1/2	5	91.85
HL-K272-0661	A1D3924		I-V-10	3-1/2	5-1/2	86.54
HL-K272-0662	AID3605, 1-3623		I-U-1	2-1/2	3	29.43
HL-K272-0663	A1D3513		I-V-1	1-1/2		25.44

HEIL® REPAIR KIT

Kit Number	Cylinder Number	Description	Code	Rod	Bore	List \$
HL-K272-0664	A1D3921		I-U-10	2	4-1/2	54.57
HL-K272-0665	A1D39021-4017		I-U-10	2-1/4	3-1/2	49.70
HL-K272-0666	4 STAGE EJECTOR		I-V-12	2,3,4,5	STAGES	165.60
HL-K272-0667	A1D3904		I-U-10	2-3/4	5-1/2	87.11
HL-K272-0668	A1D3903		I-U-10	3-1/2	5	80.81
HL-K272-0669	A1D3802		I-U-1	3-1/2	4	31.88
HL-K272-0672	A001-3807		I-U-10	2-1/4	5-1/2	61.97
HL-K272-0673	A001-3531		I-U-10	1-1/2	3	44.15
HL-K272-0674	A001-3525		I-U-10	2	4	47.60
HL-K272-0676	A1D3835		I-V-12	2,3,4	STAGES	124.74
HL-K272-0677				2,3,4	BEARING	148.38
HL-K272-0933	1-4050, 1-4053, 1-4054		I-V-12	2,3,4,5	STAGES	157.65
HL-K272-0934	1-4052		I-V-12	2,3,4	STAGES	115.14
HL-K272-0937	1-4820, 1-4070		I-V-1	2-1/2	3	28.37
HL-K272-0938	1-4272, 1-4348, 1-4880		I-V-1	3-1/2	4	35.60
HL-K272-0939		Tailgate Cylinder	I-V-12	2-1/2	3	47.22
HL-K272-0941	1-4081		I-U-10, 12	2-3/4	5-1/2	127.43
HL-K272-0944	A1D4100		I-V-10	2-1/4	3-1/2	37.05
HL-K272-0945	A1D4101		I-V-10	2	4-1/2	44.72
HL-K272-0946	A1D4092		I-N-4	1-3/4	3	19.38
HL-K272-0948	A1D4093, 1-4340		I-V-10, 12	2-1/2	5	131.08
HL-K272-0949	A1D4094		I-V-10, 12	3	5	133.65
HL-K272-0950	1-4097		I-V-10, 12	3	4-1/2	88.54
HL-K272-0951			I-V-10	2-1/2	7-1/2	73.39
HL-K272-0953	A1D4103		I-V-10	3-1/2	5	97.71
HL-K272-0954	A1D4104		I-V-10	3-1/2	5-1/2	54.96
HL-K272-0955	A1D4106		I-V-10, 12	2, 3-1/2	STAGES	129.35
HL-K272-0956	A1D4108		I-V-10, 12	2-1/2	4	74.06
HL-K272-0956A	A1D4108		I-V-10	2-1/2	4	74.06
HL-K272-0957	A1D4110		I-V-10, 12	2	4-1/2	106.80
HL-K272-0957A	A1D4110		I-V-10	2	4-1/2	106.80
HL-K272-0958	1-4339, 1-4105, 1-4264		I-U-10	1-1/2	2-1/2	36.53
HL-K272-0959	1-4341, 1-4864		I-V-10	2	4	50.95
HL-K272-0962	A001-4114		I-V-12	1-1/2	3	60.36
HL-K272-0963	1-4265		I-V-10, 12	2-1/4	5-1/2	159.97
HL-K272-0966			I-V-10	1-1/2	3	36.24
HL-K272-0966	1-4305, 1-4283, 1-4870		I-V-10	1-1/2	3	36.24
HL-K272-0969			I-V-10	3-1/2	5	67.62
HL-K272-0974			I-U-10	2	4	52.25
HL-K272-0976	A001-4261		I-V-12	4,5,6	STAGES	306.44
HL-K272-0980			N-N-12		4	32.09
HL-K272-0981	1-4883, 1-4276, 1-4338, 1-4327		I-V-12	1-1/2	3	73.55
HL-K272-0983			I-U-5	4	4-1/2	101.40
HL-K272-0989	1-4309, 1-4298, 1-4878, 1-6160, 1-6189		I-UB-10	4	5-1/2	76.76
HL-K272-0994	1-4328, 1-4330		I-V-10	4	6	56.06
HL-K272-1024	1-4139, 1-4140, 1-4854, 1-4137, 1-4138		I-V-1	3-1/8,4,5	STAGES	81.54
HL-K272-1026	1-4141, 1-4142, 1-4143, 1-4144		I-V-1	4,5,6	STAGES	103.16
HL-K272-1027	1-4143, 1-4144, 1-4141, 1-4142		I-V-1	4,5,6	STAGES	146.11

HEIL® REPAIR KIT

Kit Number	Cylinder Number	Description	Code	Rod	Bore	List \$
HL-K272-2771	1-4344		I-V-10, 12	2	5	115.49
HL-K272-2774	001-4343		I-U-1	4,5,6,7	STAGES	431.86
HL-K272-2775	1-4345		I-V-10, 12	2	4	75.43
HL-K272-2776	001-4887		I-V-10, 12	3-1/2	5-1/2	76.42
HL-K272-2778			I-V-10	2-1/2	5	70.24
HL-K272-2880	1-4467		I-U-1	4, 5	STAGES	129.94
HL-K272-2924		Valve Kit				10.06
HL-K272-3083	001-4807		I-V-1	3-1/4, 4	STAGES	40.93
HL-K272-3334	1-4149		I-V-10	3-1/2	5	78.43
HL-K272-3572	1-4849		I-V-12	3-1/2	4	71.10
HL-K272-3581	1-4882		I-V-10	4	5-1/2	65.39
HL-K272-3582	1-4903, 1-6126, 1-4868, 1-4902		I-V-10	2	4	53.07
HL-K272-3583	1-4869		I-V-10	3-1/2	5	89.17
HL-K272-3584	1-4871		I-V-10, 12	2-1/2	4-1/2	71.96
HL-K272-3586	1-4876		I-U-5	1-1/2	2-1/8	30.57
HL-K272-3588	1-4911		I-V-12	3,4,5	STAGES	510.62
HL-K272-3594	1-5088		P-UB-10	1-3/4	3	58.46
HL-K272-3595	1-5082		P-UB-12,14	2	4	176.26
HL-K272-3600	1-5112, 1-5147		I,P-V,UB-1	3,4,5	STAGES	676.81
HL-K272-3605	1-5150		P-UB-14	2-1/2	4-1/2	142.31
HL-K272-3607	1-5146		P-UB-14	4	5-1/2	204.57
HL-K272-3608	001-5110		P-UB-14	2-1/2	5	144.69
HL-K272-3609	001-5111		P-UB-14	3-1/2	5-1/2	218.39
HL-K272-3991	1-4270		I-V-12	4,5,6,7	STAGES	443.78
HL-K272-3991			I-V-12	4,5,6,7	STAGES	443.78
HL-K272-4285			I-V-1	4,5,6	STAGES	175.16
HL-K272-4456			I-U-10	2	6	81.13
HL-K272-4872	1-6076, MRK-CYL 50009-53-189		I,P-UB-12	3,4,5	STAGES	659.69
HL-K272-4884	1-6224, 1-6225, 1-6226		I-U-12	3,4,5,6	STAGES	639.97
HL-K272-4885			I-U-12	3,4,5	STAGES	420.66
HL-K272-4893	1-6191		I-U-4	3-1/4, 4	STAGES	184.11
HL-K272-4932	A1E4159		I-U-1	3-1/8,4,5	STAGES	179.23
HL-K272-4933	1-4140, 1-4137, 1-4138, 1-4139, A1D-4437		I-V-1	3-1/8,4,5	STAGES	145.04
HL-K272-4938			I-U-1	4,5,6	STAGES	214.36
HL-K272-4939		Wipers, U-seals, Gland, & Piston Bearings		4,5,6	STAGES	238.97
HL-K272-6627	1-6330		I-UB-4	1-1/8	2-1/2	67.69
HL-K272-8491	001-6445		I-U-4	3-1/4	4	189.60

HERCULES® REPLACEMENT CYLINDERS FOR HEIL® HPT SERIES DUMP BODIES

Hercules® Part Number	Original Part Number	Changed To	Changed To	Changed To	Current Part Number
HPT53100	A1D1972	A1D3140	A1D3887	A1E3983	A1-4137
HPT53110	A1D1766	A1D3141	A1D3888	A1E3984	A1-4138
HPT53120	A1D1973	A1D3058	A1D3889	A1E3985	A1-4139
HPT53130	A1D1974	A1D3139	A1D3890	A1E3986	A1-4140
HPT63120	A1D2043	A1D3177	A1D3891	A1E3998	A1-4141
HPT63130	A1D2044	A1D3178	A1D3892	A1E3999	A1-4142
HPT63140	A1D2298	A1D3179	A1D3893	A1E4000	A1-4143
HPT63160	A1D2624	A1D3180	A1D3180	A1E3180	A1-4144

**STOCKED IN OUR
US FACILITY**

HEIL® REPLACEMENT PARTS FOR DOUBLE ACTING AND SINGLE ACTING TELESCOPIC CYLINDERS

NOTE: The following parts and kits are for the old style Heil telescopic cylinders with vee packing and spiral retainer rings.

- PACKING:** Vee packing with no adaptors.
WIPERS: Some cylinders used bronze wipers trapped between the gland collar and the top bearing. Some cylinders used "AN" wipers which snap into a groove in the gland collar.
BEARINGS: Cast iron that serve as top and bottom adaptors for vee packing.
STAGE O.D.s: 3-1/8 (3/16" C.S), 4, 5, 6, (1/4" C.S.)
SPECIAL INFO.: Uses one spiral type retainer ring per stage as internal stop. Gland collars have 2 "ears" cast 180° apart.
IDENTIFICATION: Metal tag attached to cylinder body with model/part number. Example: AID3140

HEIL "OLD STYLE" HPT SERIES

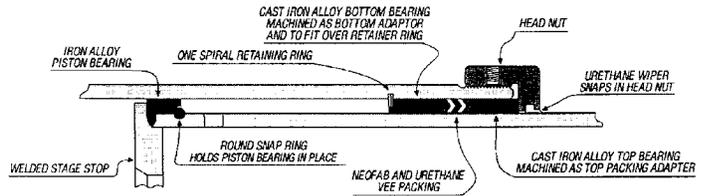

Part Number	Description	List Price
HL26B2090-2A	2" VEE SET & WIPER	\$ 13.61
HL26B2090-3A	3" VEE SET & WIPER	14.91
HL26B2266-1A	3-1/8" VEE SET & WIPER	25.11
HL26B2260-1A	4" VEE SET & WIPER	27.29
HL26B2260-2A	5" VEE SET & WIPER	47.98
HL26B2260-3A	6" VEE SET & WIPER	52.39
HL26A2083-1	2" SPIRAL RETAINER	4.97
HL26A2083-2	3" SPIRAL RETAINER	9.19
HL26A2240-1	3-1/8" SPIRAL RETAINER	17.05
HL26A2083-3	4" SPIRAL RETAINER	10.23
HL26A2083-4	5" SPIRAL RETAINER	9.30
HL26A2406-1	6" SPIRAL RETAINER	24.79
HL26A2080	2" PISTON RING	10.39
HL26A2081	3" PISTON RING	10.94
HL-1-4881-012	3-1/2" PISTON RING	46.96
HL26A2082	4" PISTON RING	12.41
HL-1-4881-013	4-1/2" PISTON RING	26.20
HL26B2221	5" PISTON RING	17.10
HL-26A4142	4" PISTON SEAL	30.59
HL-26-4149	4-1/2" PISTON SEAL	28.62
HL-26A4149	4-1/2" PISTON SEAL	28.62
HL-26A4151	5" PISTON SEAL	43.81
HL-26-4141	5-1/2" PISTON SEAL	45.19

Part Number	Description	List Price
HL-24	2" - 4" VEE SETS W/ WIPERS	\$ 55.39
HL-25	2" - 5" VEE SETS W/ WIPERS	92.89
HL-35	3-1/8" - 5" VEE SETS W/ WIPERS	89.41
HL-46	4" - 6" VEE SETS W/ WIPERS	116.51

The following kits contain packing, wiper, top & bottom bearings & spiral snap ring.

Kit Number	Stage O.D.	List Price
HL-2PBTK	2"	\$ 60.08
HL-3PBTK	3"	64.99
HL-3.12PBTK	3-1/8"	64.37
HL-4PBTK	4"	77.18
HL-5PBTK	5"	103.37
HL-6PBTK	6"	122.00
HL-24PBTK	2" - 4"	211.47
HL-35PBTK	3-1/8" - 5"	229.72
HL-46PBTK	4" - 6"	288.79

HEIL® REPLACEMENT PARTS

Part Number	Description	List Price
HL-26-4200-43	BACK-UP RINGS - MIN. QTY 3	\$ 3.34
HL-26-2608-43	O-RINGS - MIN. QTY 3	2.68
HL-26-2083-003	RETAINER RING	10.23

Part Number	Description	List Price
HL-26-3980-12	4" U-SEAL	\$ 17.39
HL-26-3979-08	Wiper - ODxW - 5-1/2 X 1/2	4.89
HL-26-3977-13	4" Wiper	7.75

HEIL® REPLACEMENT PARTS FOR SINGLE ACTING DUMP TRUCK CYLINDERS

NOTE: The following parts and kits are for the new style Heil telescopic dump cylinders with welded stop rings and the base held in with snap rings.

HEIL "NEW STYLE" HPT SERIES

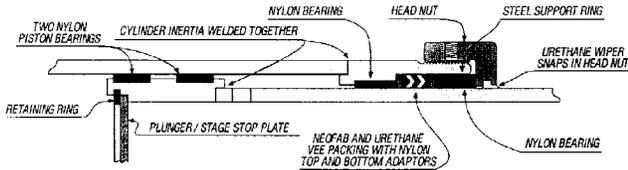

PACKING: Vee packing with nylon top and bottom adaptors.
WIPERS: AN Style
BEARINGS: Split 1/8" thick nylon wear rings.
STAGE O.D.'s: 3-1/8, 4, 5, 6
SPECIAL INFO.: Has welded stop in gland. Cylinder disassembles by removing large Tru-Arc type snap ring which retains the cylinder base and bottom of each stage.
IDENTIFICATION: Metal tag attached to cylinder body with model/part number.
 Example: AIE3938

Part Number	Description	List Price
HL26-4157-3	5" ID UPPER WEAR RING	\$ 5.45
HL26-4157-4	6" ID UPPER WEAR RING	5.99
HL26-4176-4	6-1/2" OD LOWER WEAR RING	6.41
HL26-4394-1	3-1/8" ID UPPER WEAR RING	6.52
HL26-4394-2	4" ID UPPER WEAR RING	5.45
HL26-4395-1	3-1/2" OD LOWER WEAR RING	6.45
HL26-4395-2	4-1/2" OD LOWER WEAR RING	5.33
HL26-4395-3	5-1/2" OD LOWER WEAR RING	5.56
HL-26-4395-4	6-1/2" OD LOWER WEAR RING	6.41
HL-K272-1024	3-1/8" - 5" PACKING, WIPERS, O-RING	81.54
HL-K272-1026	4" - 6" PACKING, WIPERS, O-RING	103.16
HL-K272-1027	4" - 6" PACKING, WIPERS, WEAR RINGS	146.11

HEIL "NEW STYLE" HPT SERIES

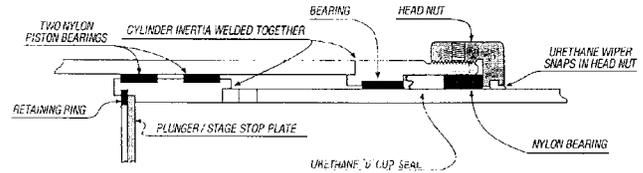

PACKING: Urethane U-Seals
WIPERS: AN Style
BEARINGS: Nylon bearings above and below U-Seal
STAGE O.D.'s: 3-1/8, 4, 5, 6
SPECIAL INFO.: Welded stop in gland. Tru-Arc type snap ring which retains the cylinder base and bottom of each stage.
IDENTIFICATION: Metal tag attached to cylinder body with model/part number.
 Example: AIE4159

Part Number	Description	List Price
HL-K272-3588	3, 4, 5" stages - vee-set, wipers, gland bearing, quattro rings, nylon slug, set screw	\$ 510.62
HL-K272-4932	3-1/8, 4, 5" stages - U-seals, wipers, gland bearing, quattro rings, nylon slug, set screw	179.23
HL-K272-4938	4, 5, 6" stages - U-seals, wipers, gland bearings, quattro ring, nylon slug, set screw	214.36
HL-K272-4939	4, 5, 6" stages - U-seals, wipers, bearings, quattro ring, nylon slug, set screw	238.97

HEIL® SPECIAL HEIL TELESCOPIC VEE SETS

Part Number	Size	List Price
HL26A2038	2-1/2 X 2-7/8	\$ 8.14
HL26A2039	3-1/4 X 3-5/8	9.68
HL26A2215	1-3/4 X 2-1/8	11.05
HL26B2191-2	6-1/4 X 6-3/4	81.34
HL26B2202-1H	2 X 3 W/WIPER	35.41

Part Number	Size	List Price
HL26B2203-1H	3-1/2 X 5 W/WIPER	\$ 63.04
HL26B2482-1	8-5/8 X 9-5/16	143.17
HL26B2484-1	6-1/4 X 7-5/16	131.38
HL30004X182	3 X 3-1/2 X 1.825	65.09
HL40004X184	4 X 4-1/2 X 1.845	81.74

Replacement Kits For

HIAB

Cranes								
APPLICATION	CYL #	SERIAL #	CODE	ROD	BORE	Miscellaneous	KIT #	List \$
MODEL 045								
1ST EXTENSION			P-U-15	40 mm	55 mm		HIAB-542121	56.89
2ND & 3RD EXT.			P-U-15	30 mm	50 mm		HIAB-542130	50.11
INNER BOOM			P-U-15	50 mm	90 mm		HIAB-542105	61.70
LONG OUTRIGGER			P-U-15	50 mm	70 mm		HIAB-542156	72.76
OUTER BOOM			P-U-15	50 mm	90 mm		HIAB-542113	62.18
SWING			N-N-5	N/A	100 mm		HIAB-542148	100.89
MODEL 070								
BOOM EXT			P-U-13	33 mm	60 mm		HIAB-330-0897	34.35
	AW		P-U-15	35, 80 mm	60, 70, 92 mm		HIAB-330-0731	165.40
INNER BOOM			P-U-13	90 mm	125 mm		HIAB-330-0871	161.46
OUTER BOOM			P-U-13	70 mm	100 mm		HIAB-330-0889	97.47
MODEL 071								
BOOM EXT	3400441		P-U-15	35, 80 mm	60, 70, 92 mm		HIAB-330-0731	165.40
	3478378		I-U-15	50 mm	80 mm		HIAB-330-1044	49.70
	3501515		I-U-15	50 mm	80 mm		HIAB-330-1044	49.70
	3509052		P-U-15	35, 80 mm	60, 70, 92 mm		HIAB-330-0731	165.40
INNER BOOM	3554589		P-U-13	90 mm	125 mm		HIAB-330-0871	161.46
OUTER BOOM	3300889		P-U-13	70 mm	100 mm		HIAB-330-0889	97.47
OUTRIGGER	3502414		P-U-15	70 mm	90 mm		HIAB-330-1028	54.02
MODEL 100								
BOOM EXT	A		P-SP-15	45 mm	70 mm		HIAB-330-0714	52.00
INNER BOOM			I-SP-15	80 mm	125 mm		HIAB-330-0692	88.15
MODEL 120								
BOOM EXT			P-U-15	45 mm	63 mm		HIAB-330-1311	42.58
			P-U-15	40 mm	63 mm	Updated Version	HIAB-330-1320	47.70
OUTER BOOM			P-U-15	90 mm	125 mm		HIAB-330-1303	116.03
MODEL 140								
BOOM EXT			I-U-15	50 mm	80 mm		HIAB-330-1044	49.70
	AW		P-U-13,15	40, 90 mm	70, 105 mm		HIAB-330-0668	167.50
	AWV		I-U-15	33 mm	60 mm		HIAB-330-1001	31.52
INNER BOOM			I-U-13	80 mm	140 mm		HIAB-330-1036	133.39
OUTER BOOM			I-U-13	80 mm	140 mm		HIAB-330-1036	133.39
MODEL 175								
BOOM EXT	3608603		P-U-15	40 mm	63 mm		HIAB-330-1613	54.25
	3616819		P-U-15	45 mm	70 mm		HIAB-330-1583	62.24
	3622100		P-U-15	45 mm	70 mm		HIAB-330-1583	62.24
	3625681		P-U-15	40 mm	63 mm		HIAB-330-1613	54.25
EXTENSION	3583872		P-U-15	25 mm	40 mm		HIAB-330-1052	79.35
INNER BOOM	3625745		P-U-15	100 mm	160 mm		HIAB-330-1443	153.27
OUTER BOOM	3561330		P-U-15	100 mm	140 mm		HIAB-330-1290	95.31
OUTRIGGER	3531031		P-U-15	70 mm	90 mm		HIAB-330-1028	54.02
	3592774		P-U-15	70 mm	90 mm		HIAB-330-1028	54.02
	3594769		P-U-15	70 mm	90 mm		HIAB-330-1028	54.02

Replacement Kits For

HIAB

Cranes								
APPLICATION	CYL #	SERIAL #	CODE	ROD	BORE	Miscellaneous	KIT #	List \$
MODEL 650								
BOOM EXT	3088031		I-U-15	33 mm	60 mm		HIAB-330-1001	31.52
	AW		P-U-15	32, 85 mm	65, 100 mm		HIAB-330-0633	122.97
	AW		P-U-15	35, 80 mm	60, 70, 92 mm	Model 650/1	HIAB-330-0731	165.40
D. BOOM EXT	3080005		P-U-15	35, 80 mm	60, 70, 92 mm		HIAB-330-0731	165.40
	3199622		P-U-15	32, 85 mm	65, 100 mm		HIAB-330-0633	122.97
	3402746		P-U-15	32, 85 mm	65, 100 mm		HIAB-330-0633	122.97
	3411176		P-U-15	32, 85 mm	65, 100 mm		HIAB-330-0633	122.97
	3419258		P-U-15	35, 80 mm	60, 70, 92 mm		HIAB-330-0731	165.40
	6216765		P-U-15	32, 85 mm	65, 100 mm		HIAB-330-0633	122.97
D.A. INNER BOOM	3051919		I-U-15	100 mm	140 mm		HIAB-330-0501	100.20
	3091919		I-U-15	100 mm	140 mm		HIAB-330-0501	100.20
	3099199	90001-->	I-U-13	100 mm	140 mm		HIAB-330-0749	97.97
INNER BOOM		90001-->	I-U-13	100 mm	140 mm		HIAB-330-0749	97.97
	3155528	-->65450	I-U-1	140 mm	160 mm		HIAB-330-0218	83.95
MODEL 985								
1ST EXTENSION			P-SP-15	45 mm	70 mm		HIAB-330-0714	52.00
2ND EXTENSION			P-U-15	35, 80 mm	60, 70, 92 mm		HIAB-330-0731	165.40
3RD EXTENSION			I-U-15	33 mm	60 mm		HIAB-330-0595	43.36
AH EXTENSION			P-SP-15	45 mm	70 mm		HIAB-330-0714	52.00
INNER BOOM			I-SP-15	80 mm	125 mm		HIAB-330-0692	88.15
OUTER BOOM			I-SP-15	80 mm	125 mm		HIAB-330-0692	88.15
MODEL 1165								
INNER BOOM			I-SP-15	80 mm	140 mm		HIAB-622-1688	101.36
OUTER BOOM			I-SP-15	80 mm	140 mm		HIAB-622-1688	101.36
MODEL 1165/1								
BOOM EXT	A		I-U-15	50 mm	80 mm		HIAB-330-1044	49.70
	AW	TO 1977	P-U-13,15	40, 90 mm	70, 105 mm		HIAB-330-0668	167.50
INNER BOOM			I-U-13	80 mm	140 mm		HIAB-330-1036	133.39
OUTER BOOM			I-U-13	80 mm	140 mm		HIAB-330-1036	133.39
MODEL 1165/2								
BOOM EXT	3407110		P-U-13,15	40, 90 mm	70, 105 mm		HIAB-330-0668	167.50
	3430405		I-U-15	33 mm	60 mm		HIAB-330-1001	31.52
	6215645		I-U-15	50 mm	80 mm		HIAB-330-1044	49.70
INNER BOOM	3445038		I-SP-15	80 mm	140 mm		HIAB-622-1688	101.36
OUTER BOOM	3445852		I-SP-15	80 mm	140 mm		HIAB-622-1688	101.36
MODEL 1770								
BOOM EXT	A		I-U-15	50 mm	80 mm		HIAB-330-1044	49.70
	AW		P-U-13,15	40, 90 mm	70, 105 mm		HIAB-330-0668	167.50
INNER BOOM			P-U-13	80 mm	125 mm		HIAB-872-8330	83.71
OUTER BOOM			P-U-13	100 mm	180 mm		HIAB-872-8348	139.08
OUTRIGGER			P-U-15	90 mm	110 mm	13 Ton Leg	HIAB-330-0773	87.11
MODEL 2640								
INNER BOOM			P-U-13	100 mm	140 mm		HIAB-872-8038	93.74
OUTER BOOM			P-U-13	100 mm	140 mm		HIAB-872-8038	93.74

REPLACEMENT KITS FOR HIAB

Kit Number	Code (Pg. xviii)	Rod X Bore Size	List Price
HIAB-121039	P-U-15	63 x 110 mm	\$ 72.88
HIAB-330-0218	I-U-1	140 X 160 mm	83.95
HIAB-330-0315	N-N-5	100 mm Piston Kit	97.08
HIAB-330-0498	N-N-5	105 MM Piston Kit	107.41
HIAB-330-0501	I-U-15	100 X 140 mm	100.20
HIAB-330-0528	N-N-5	105 mm Piston Kit	109.80
HIAB-330-0595	I-U-15	33 X 60 mm	43.36
HIAB-330-0625	P-O-1	78 mm Rod Kit	36.93
HIAB-330-0633	P-U-15	32, 85 X 65, 100 mm	122.97
HIAB-330-0668	P-U-13, 15	40 , 90 mm Stages	167.50
HIAB-330-0692	I-U-15	80 X 125 mm	88.15
HIAB-330-0714	P-SP-15	45 X 70 mm	52.00
HIAB-330-0731	P-U-15	35, 80 mm Stages	165.40
HIAB-330-0749	I-U-15	100 X 140 mm	97.97
HIAB-330-0773	P-U-15	90 X 110 mm	87.11
HIAB-330-0871	P-U-15	90 X 125 mm	161.46
HIAB-330-0889	P-U-15	70 X 100 mm	97.47
HIAB-330-0897	P-U-15	33 X 60 mm	34.35
HIAB-330-0951	P-U-15	100 X 180 mm	119.66
HIAB-330-1001	I-U-15	33 X 60 mm	31.52
HIAB-330-1028	P-U-15	70 X 90 mm	54.02
HIAB-330-1036	I-U-15	80 X 140 mm	133.39
HIAB-330-1044	I-U-15	50 X 80 mm	49.70
HIAB-330-1052	P-U-15	25 X 40 mm	79.35
HIAB-330-1061	P-U-15	70 X 125 mm	78.84
HIAB-330-1231	P-U-15	90 X 160 mm	109.82
HIAB-330-1249	P-U-15	40 x 70 mm	53.41
HIAB-330-1290	P-U-15	100 X 140 mm	95.31
HIAB-330-1303	P-U-15	90 X 125 mm	116.03
HIAB-330-1311	P-U-15	45 X 63 mm	42.58

Kit Number	Code (Pg. xviii)	Rod X Bore Size	List Price
HIAB-330-1320	P-U-15	40 X 63 mm	\$ 47.70
HIAB-330-1443	P-U-15	100 X 160 mm	153.27
HIAB-330-1583	P-U-15	45 X 70 mm	62.24
HIAB-330-1613	P-U-15	40 X 63 mm	54.25
HIAB-542105	P-U-15	50 X 90 mm	61.70
HIAB-542113	P-U-15	50 X 90 mm	62.18
HIAB-542121	P-U-15	40 X 55 mm	56.89
HIAB-542130	P-U-15	30 X 50 mm	50.11
HIAB-542148	N-N-5	100 mm Piston Kit	100.89
HIAB-542156	P-U-15	50 X 70 mm	72.76
HIAB-607-2267	I-O-15	74 X 85 mm	44.38
HIAB-622-1599	I-U-15	63 X 125 mm	69.72
HIAB-622-1661	I-SP-15	63 X 140 mm	92.57
HIAB-622-1670	I-SP-15	70 X 140 mm	104.62
HIAB-622-1688	I-SP-15	80 X 140 mm	101.36
HIAB-622-2170	I-U-15	32, 90 mm Stages	191.24
HIAB-711-4659	P-U-15	50 x 110 mm	97.97
HIAB-711-4660	I-U-15	30 x 50 mm	35.51
HIAB-711-5366	I,P-U-15	80 X 140 mm	109.66
HIAB-711-5834	I-U-15	30 X 70 mm	47.71
HIAB-712-4173	I,P-U-15	100 x 180 mm	284.98
HIAB-712-4174	I-U-15	50 x 90 mm	111.59
HIAB-825-2050	P-U-15	45 X 80 mm	55.35
HIAB-872-8038	P-U-15	100 X 140 mm	93.74
HIAB-872-8046	P-U-15	100 X 140 mm	121.89
HIAB-872-8330	P-U-15	80 X 125 mm	83.71
HIAB-872-8348	P-U-15	100 X 180 mm	139.08
HIAB-872-8356	I-SP-15	50 X 80 mm	52.67
HIAB-995-0621	N-N-4	100 mm Piston Kit	48.31
HIAB-995-9122	N-N-5	105 mm Piston Kit	52.56

HIAB

REPLACEMENT SEAL KITS FOR HITACHI EQUIPMENT*

Replacement Seal Kits By Machine Type

Table of Contents

▶ **NEW MODELS**

Machine Type

Page

Excavators	EX100, EX100-5 , EX100-5LC , EX120, EX120-2, EX120-5, EX120K-3, EX130H-5, EX150, EX150LC-5, EX160LC-5, EX200, EX200LC, EX200-2, EX200LC-2, EX200-3, EX200LC-3, EX200H-3, EX200LCH-3, EX200-5, EX200LC-5, EX210H-5, EX210LCH-5, EX220, EX220-2, EX220-3, EX220LC-3, EX220-5, EX220LC-5, EX230-5, EX230LC-5, EX230H-5, EX230LCH-5, EX270, EX270LC, EX270-5, EX270LC-5, EX280H-5, EX280LCH-5, EX300, EX300LC, EX300-3, EX300LC-3, EX300H-3, EX300LCH-3, EX300-5, EX330-5, EX350-5, EX370-5 (H,HD,K,&LC), EX400, EX400LC, EX400H, EX400LCH, EX400-3, EX400LC-3, EX400H-3, EX400LCH-3, EX400-3C, EX400LC-3C, EX450H-3C, EX450LCH-3C, EX400-5, EX400LC-5, EX450LC-5, EX450LCH-5, EX700, EX700H, EX1000, EX1800, EX3500, UH083, UH083LC, UH107, UH122, UH122LC, UH123, UH172, UH181, UH501, ZX35U-3 , ZX35U-3F , ZX38U-3 , ZX38U-3F , ZX120, ZX120E, ZX130H, ZX130K, ZX130LCN, ZX120-3 , ZX130-3 , ZX130K-3 , ZX130LCN-3 , ZX135US-3, ZX135US-5 , ZX135USK-3, ZX160LC, ZX160LC-3, ZX160LC-5 , ZX200, ZX200LC, ZX210, ZX210LC, ZX210LCH, ZX210K, ZX210LCK, ZX210N, ZX240, ZX200-3, ZX210LC-3, ZX210LC-5 , ZX225US-3, ZX225USLC-3, ZX225USLC-5 , ZX230, ZX230LC, ZX240-3, ZX240LC-3, ZX240H, ZX240LCH, ZX240K, ZX240LCK, ZX250, ZX250LC, ZX250LCN, ZX250LC-3, ZX250LCN-3, ZX250H-3, ZX250LCH-3, ZX250K-3, ZX250LCK, ZX250LC-3, ZX250LCN-3, ZX250H-3, ZX250LCH-3, ZX250K-3, ZX250LCK-3, ZX270, ZX270LC, ZX280LC, ZX280LCN, ZX270-3, ZX330, ZX330LC, ZX350LC, ZX350LCH, ZX350H, ZX350K, ZX350LCK, ZX370, ZX370MTH, ZX330-3, ZX330LC-3, ZX350LC-3, ZX350LCN-3, ZX350H-3, ZX350LCH-3, ZX350K-3, ZX350LCK-3, ZX350LC-5N, ZX360LC-3, ZX450, ZX450LC, ZX450H, ZX450LCH, ZX460LCH, ZX480MT, ZX480MTH, ZX450-3, ZX450LC-3, ZX470H-3, ZX470LCH-3, ZX470LC-5B, ZX500LC-3, ZX520LCH-3, ZX800, ZX850H, ZX870H-3	582 - 621
Excavators - Compact	EX50U, EX50UNA, EX50UR, EX55UR, EX55UR-3, UH07-3, UH07-5, UH07-7, UH009, UH010, UH012, UH016, UH035, UH045, UH061, ZX35U-2, ZX50U, ZX50U-2, ZX50U-3, ZX50U-3F, ZX50U-3U, ZX60, ZX70, ZX70LC, ZX80, ZX80LCK, ZX80SB, ZX80SBLC	621 - 625
Loaders - Wheel	LX100	625
Off-Highway Trucks	EH1600	625
Alpha-Numeric Kit Listing		626 - 629
Hitachi Individual Parts		630 - 636

HITACHI

*All manufacturer's names, part numbers and descriptions are used for reference purposes only. We do not imply that any part shown is the product of these manufacturers. We also do not imply that the list price shown is exactly that of the manufacturer.

HITACHI

Replacement Kits For

Excavators								
APPLICATION	CYL #	SERIAL #	CODE	ROD	BORE	Misc	KIT #	List \$
MODEL EX100								
ARM			P-UB-10	75 mm	105 mm		HIT-4206343	141.03
BOOM			P-UB-10	70 mm	95 mm		HIT-4206340	143.69
BUCKET			P-UB-10	65 mm	95 mm		HIT-4206345	126.79
MODEL EX100-5								
ARM	4187908	02001-	P-UB-10	75 mm	105 mm		HIT-4206343	141.03
	4187908	02001-	P-UB-10	75 mm	105 mm		HIT-4206343-EX	426.97
	4187908	02001-	Bushing	75 mm			HIT-0310504	27.12
	4187908	02001-	Wear Ring		105 mm		HIT-0310509	34.46
	4187908	02001-	Wear Ring		105 mm		HIT-0310510	95.77
BOOM LH	4187907	02001-	P-UB-10	70 mm	95 mm		HIT-4206340	143.69
	4187907	02001-	P-UB-10	70 mm	95 mm		HIT-4206340-EX	192.16
	4187907	02001-	Bushing	70 mm			HIT-0310304	24.51
	4187907	02001-	Wear Ring		95 mm		HIT-0310610	37.81
	4187907	02001-	Wear Ring		95 mm		HIT-0310609	10.66
BOOM RH	4187906	02001-	P-UB-10	70 mm	95 mm		HIT-4206340	143.69
	4187906	02001-	P-UB-10	70 mm	95 mm		HIT-4206340-EX	192.16
	4187906	02001-	Bushing	70 mm			HIT-0310304	24.51
	4187906	02001-	Wear Ring		95 mm		HIT-0310610	37.81
	4187906	02001-	Wear Ring		95 mm		HIT-0310609	10.66
BUCKET	4187909	02001-	P-UB-10	65 mm	95 mm		HIT-4206345	126.79
	4187909	02001-	P-UB-10	65 mm	95 mm		HIT-4206345-EX	175.26
	4187909	02001-	Bushing	65 mm			HIT-0310604	21.71
	4187909	02001-	Wear Ring		95 mm		HIT-0310610	37.81
	4187909	02001-	Wear Ring		95 mm		HIT-0310609	10.66
MODEL EX100-5LC								
ARM	4187908	02001-	P-UB-10	75 mm	105 mm		HIT-4206343	141.03
	4187908	02001-	P-UB-10	75 mm	105 mm		HIT-4206343-EX	426.97
	4187908	02001-	Bushing	75 mm			HIT-0310504	27.12
	4187908	02001-	Wear Ring		105 mm		HIT-0310510	95.77
	4187908	02001-	Wear Ring		105 mm		HIT-0310509	34.46
BOOM LH	4187907	02001-	P-UB-10	70 mm	95 mm		HIT-4206340	143.69
	4187907	02001-	P-UB-10	70 mm	95 mm		HIT-4206340-EX	192.16
	4187907	02001-	Bushing	70 mm			HIT-0310304	24.51
	4187907	02001-	Wear Ring		95 mm		HIT-0310610	37.81
	4187907	02001-	Wear Ring		95 mm		HIT-0310609	10.66
BOOM RH	4187906	02001-	P-UB-10	70 mm	95 mm		HIT-4206340	143.69
	4187906	02001-	P-UB-10	70 mm	95 mm		HIT-4206340-EX	192.16
	4187906	02001-	Bushing	70 mm			HIT-0310304	24.51
	4187906	02001-	Wear Ring		95 mm		HIT-0310609	10.66
	4187906	02001-	Wear Ring		95 mm		HIT-0310610	37.81
BUCKET	4187909	02001-	P-UB-10	65 mm	95 mm		HIT-4206345	126.79
	4187909	02001-	P-UB-10	65 mm	95 mm		HIT-4206345-EX	175.26
	4187909	02001-	Bushing	65 mm			HIT-0310604	21.71
	4187909	02001-	Wear Ring		95 mm		HIT-0310609	10.66
	4187909	02001-	Wear Ring		95 mm		HIT-0310610	37.81
MODEL EX120								
ARM			P-UB-10	80 mm	115 mm		HIT-4206344	150.81
BOOM			P-UB-10	75 mm	105 mm		HIT-4206343	141.03
BUCKET			P-UB-10	65 mm	95 mm		HIT-4206345	126.79
MODEL EX120-2								
ARM			P-UB-10	80 mm	110 mm		HIT-4286463	169.60
BOOM			P-UB-10	70 mm	105 mm		HIT-4286459	126.58
BUCKET			P-UB-10	65 mm	95 mm		HIT-4286739	139.92
MODEL EX120-5								
ARM	4317313	030001-	P-UB-10	80 mm	110 mm		HIT-4364913	121.34

Hercules Sealing Products and original equipment Hitachi kits may not include the necessary wear rings for your cylinder rebuild.
Kits with an -EX suffix will include these wear rings.

Please ask your sales representative for a cross-reference if no -EX kit or complementary parts are listed.

HITACHI

Replacement Kits For

Excavators								
APPLICATION	CYL #	SERIAL #	CODE	ROD	BORE	Misc	KIT #	List \$
MODEL EX120-5								
ARM	4317313	030001-	P-UB-10	80 mm	110 mm		HIT-4364913-EX	194.02
	4317313	030001-	Wear Ring		110 mm		HIT-0667008	10.89
	4317313	030001-	Wear Ring		110 mm		HIT-0298907	79.26
	4371393	030001-	P-UB-10	75 mm	105 mm	Offset Boom	HIT-4379261	105.86
	4371393	030001-	P-UB-10	75 mm	105 mm		HIT-4379261-EX	179.28
	4371393	030001-	Wear Ring		105 mm	Offset Boom	HIT-0666808	34.46
	4371393	030001-	Wear Ring		120 mm	Offset Boom	HIT-0998904	47.08
BLADE LH	4361273	030001-	P-UB-10	70 mm	100 mm		HIT-4388027	333.03
	4397513	030001-	P-UB-10	70 mm	100 mm		HIT-4388027	333.03
BLADE RH	4359928	030001-	P-UB-10	70 mm	100 mm		HIT-4388027	333.03
BOOM LH	4317312	030001-	P-UB-10	70 mm	105 mm		HIT-4364912	101.28
	4317312	030001-	P-UB-10	70 mm	105 mm		HIT-4364912-EX	174.70
	4317312	030001-	Wear Ring		105 mm		HIT-0310510	95.77
	4317312	030001-	Wear Ring		105 mm		HIT-0666808	34.46
	4372542	030001-	P-UB-10	70 mm	95 mm	Offset Boom	HIT-4379260	96.34
	4372542	030001-	P-UB-10	70 mm	95 mm		HIT-4379260-EX	166.87
	4372542	030001-	Wear Ring		95 mm	Offset Boom	HIT-0310610	37.81
	4372542	030001-	Wear Ring		95 mm	Offset Boom	HIT-0667108	14.84
BOOM RH	4317311	030001-	P-UB-10	70 mm	105 mm		HIT-4364912	101.28
	4317311	030001-	P-UB-10	70 mm	105 mm		HIT-4364912-EX	174.70
	4317311	030001-	Wear Ring		105 mm		HIT-0666808	34.46
	4317311	030001-	Wear Ring		105 mm		HIT-0310510	95.77
	4372544	030001-	P-UB-10	70 mm	95 mm	Offset Boom	HIT-4379260	96.34
	4372544	030001-	P-UB-10	70 mm	95 mm		HIT-4379260-EX	166.87
	4372544	030001-	Wear Ring		95 mm	Offset Boom	HIT-0310610	37.81
	4372544	030001-	Wear Ring		95 mm	Offset Boom	HIT-0667108	14.84
BUCKET	4316457	030001-	P-UB-10	65 mm	95 mm		HIT-4364914	305.35
MODEL EX120K-3								
ARM	4257644	28201-	P-UB-10	80 mm	110 mm		HIT-4320993	115.19
	4257644	28201-	P-UB-10	80 mm	110 mm		HIT-4320993-EX	305.08
	4257644	28201-	Wear Ring		110 mm		HIT-0298907	79.26
	4257644	28201-	Wear Ring		110 mm		HIT-0409009	42.72
BOOM LH	4257643	28201-	P-UB-10	70 mm	105 mm		HIT-4320990	155.88
BOOM RH	4257642	28201-	P-UB-10	70 mm	105 mm		HIT-4320990	155.88
BUCKET	4269538	28201-	P-UB-10	65 mm	95 mm		HIT-4320994	305.35
MODEL EX130H-5								
ARM	4317313	030001-	P-UB-10	80 mm	110 mm		HIT-4364913	121.34
	4317313	030001-	P-UB-10	80 mm	110 mm		HIT-4364913-EX	194.02
	4317313	030001-	Wear Ring		110 mm		HIT-0298907	79.26
	4317313	030001-	Wear Ring		110 mm		HIT-0667008	10.89
	4371393	030001-	P-UB-10	75 mm	105 mm	Offset Boom	HIT-4379261	105.86
	4371393	030001-	P-UB-10	75 mm	105 mm		HIT-4379261-EX	179.28
	4371393	030001-	Wear Ring		105 mm	Offset Boom	HIT-0666808	34.46
	4371393	030001-	Wear Ring		120 mm	Offset Boom	HIT-0998904	47.08
BLADE LH	4361273	030001-	P-UB-10	70 mm	100 mm		HIT-4388027	333.03
	4397513	030001-	P-UB-10	70 mm	100 mm		HIT-4388027	333.03
BLADE RH	4359928	030001-	P-UB-10	70 mm	100 mm		HIT-4388027	333.03
BOOM LH	4317312	030001-	P-UB-10	70 mm	105 mm		HIT-4364912	101.28
	4317312	030001-	P-UB-10	70 mm	105 mm		HIT-4364912-EX	174.70
	4317312	030001-	Wear Ring		105 mm		HIT-0666808	34.46
	4317312	030001-	Wear Ring		105 mm		HIT-0310510	95.77
	4372542	030001-	P-UB-10	70 mm	95 mm	Offset Boom	HIT-4379260	96.34
	4372542	030001-	P-UB-10	70 mm	95 mm		HIT-4379260-EX	166.87
	4372542	030001-	Wear Ring		95 mm	Offset Boom	HIT-0310610	37.81
4372542	030001-	Wear Ring		95 mm	Offset Boom	HIT-0667108	14.84	

Hercules Sealing Products and original equipment Hitachi kits may not include the necessary wear rings for your cylinder rebuild. Kits with an -EX suffix will include these wear rings.

Please ask your sales representative for a cross-reference if no -EX kit or complementary parts are listed.

Replacement Kits For

HITACHI

Excavators								
APPLICATION	CYL #	SERIAL #	CODE	ROD	BORE	Misc	KIT #	List \$
MODEL EX130H-5								
BOOM RH	4317311	030001-	P-UB-10	70 mm	105 mm		HIT-4364912	101.28
	4317311	030001-	P-UB-10	70 mm	105 mm		HIT-4364912-EX	174.70
	4317311	030001-	Wear Ring		105 mm		HIT-0310510	95.77
	4317311	030001-	Wear Ring		105 mm		HIT-0666808	34.46
	4372544	030001-	P-UB-10	70 mm	95 mm	Offset Boom	HIT-4379260	96.34
	4372544	030001-	P-UB-10	70 mm	95 mm		HIT-4379260-EX	166.87
	4372544	030001-	Wear Ring		95 mm	Offset Boom	HIT-0667108	14.84
	4372544	030001-	Wear Ring		95 mm	Offset Boom	HIT-0310610	37.81
BUCKET	4316457	030001-	P-UB-10	65 mm	95 mm		HIT-4364914	305.35
MODEL EX150								
ARM	4193532	01001-	P-UB-10	85 mm	120 mm		HIT-4216264P	234.03
BOOM LH	4193533	01001-	P-UB-10	80 mm	115 mm		HIT-4369893P	189.14
BOOM RH	4193531	01001-	P-UB-10	80 mm	115 mm		HIT-4369893P	189.14
BUCKET	4193534	01001-	P-UB-10	80 mm	115 mm		HIT-4369893P	189.14
MODEL EX150LC-5, EX160LC-5								
ARM	4370784	1002-	P-UB-10	85 mm	115 mm		HIT-4389720	239.98
	4370784	1002-	Bushing	85 mm			HIT-4272960	34.71
	4370784	1002-	Wear Ring		115 mm		HIT-0310908	40.55
	4370784	1002-	Wear Ring		115 mm		HIT-0686405	10.89
BOOM LH	4370783	1002-	P-UB-10	80 mm	110 mm		HIT-4389719	211.60
	4370783	1002-	Bushing	80 mm			HIT-0309304	31.26
	4370783	1002-	Wear Ring		110 mm		HIT-0298907	79.26
	4370783	1002-	Wear Ring		110 mm		HIT-0667008	10.89
BOOM RH	4370782	1002-	P-UB-10	80 mm	110 mm		HIT-4389719	211.60
	4370782	1002-	Bushing	80 mm			HIT-0309304	31.26
	4370782	1002-	Wear Ring		110 mm		HIT-0298907	79.26
	4370782	1002-	Wear Ring		110 mm		HIT-0667008	10.89
BUCKET	4370785	1002-	P-UB-10	75 mm	105 mm		HIT-4389721	155.96
	4370785	1002-	Bushing	75 mm			HIT-0310504	27.12
	4370785	1002-	Wear Ring		105 mm		HIT-0310510	95.77
	4370785	1002-	Wear Ring		105 mm		HIT-0666808	34.46
MODEL EX200, EX200LC								
ARM	4180278	30001-	P-UB-10	95 mm	135 mm		HIT-4206019	271.75
BOOM LH	4180277	30001-	P-UB-10	85 mm	125 mm		HIT-4206018	184.00
	4223826	30001-	P-UB-10	85 mm	125 mm		HIT-4206018	184.00
BOOM RH	4180276	30001-	P-UB-10	85 mm	125 mm		HIT-4206018	184.00
	4223825	30001-	P-UB-10	85 mm	125 mm		HIT-4206018	184.00
BUCKET	4180279	30001-	P-UB-10	80 mm	120 mm		HIT-4206020	204.64
CLAMSHELL	2024987	30001-	P-UB-10	85 mm	135 mm		HIT-4214722	191.06
MODEL EX200-2, EX200LC-2								
ARM	4250226	60001-	P-UB-10	95 mm	130 mm		HIT-4286780	209.11
	4250226	60001-	Bushing	95 mm			HIT-0309204	37.71
	4250226	60001-	Wear Ring		130 mm		HIT-0409912	16.36
	4250226	60001-	Wear Ring		130 mm		HIT-0254309	49.93
BOOM LH	4250224	60001-	P-UB-10	85 mm	120 mm		HIT-4286774	202.10
	4250224	60001-	Bushing	85 mm			HIT-4272960	34.71
	4250224	60001-	Wear Ring		120 mm		HIT-0309309	13.29
	4250224	60001-	Wear Ring		120 mm		HIT-0261308	47.08
BOOM RH	4250223	60001-	P-UB-10	85 mm	120 mm		HIT-4286774	202.10
	4250223	60001-	Bushing	85 mm			HIT-4272960	34.71
	4250223	60001-	Wear Ring		120 mm		HIT-0261308	47.08
	4250223	60001-	Wear Ring		120 mm		HIT-0309309	13.29
BUCKET	4250225	60001-	P-UB-10	75 mm	110 mm		HIT-4286784	152.67
	4250225	60001-	Bushing	75 mm			HIT-0310504	27.12
	4250225	60001-	Wear Ring		110 mm		HIT-0298907	79.26

Hercules Sealing Products and original equipment Hitachi kits may not include the necessary wear rings for your cylinder rebuild.
Kits with an -EX suffix will include these wear rings.

Please ask your sales representative for a cross-reference if no -EX kit or complementary parts are listed.

Replacement Kits For

HITACHI

HITACHI

Excavators									
APPLICATION	CYL #	SERIAL #	CODE	ROD	BORE	Misc	KIT #	List \$	
MODEL EX200-2, EX200LC-2									
BUCKET	4250225	60001-	Wear Ring		110 mm		HIT-0410005	12.67	
	4287889	60001-	Bushing	65 mm		River	HIT-0310604	21.71	
	4287889	60001-	Wear Ring		95 mm	River	HIT-0310609	10.66	
	4287889	60001-	Wear Ring		95 mm	River	HIT-0310610	37.81	
	4287889	60001-D91/12	P-UB-10	65 mm	95 mm	River	HIT-4286739	139.92	
CLAMSHELL	4288743	60001-	P-UB-10	85 mm	125 mm		HIT-4369902	313.26	
	4288743	60001-	Bushing	85 mm			HIT-4272960	34.71	
	4288743	60001-	Wear Ring		125 mm		HIT-0223713	49.06	
	4288743	60001-	Wear Ring		125 mm		HIT-0309009	13.92	
ROLLING	4305528	65612-	P-UB-10	95 mm	150 mm		HIT-4320954	197.96	
	4305528	65612-	Bushing	95 mm			HIT-0309204	37.71	
	4305528	65612-	Wear Ring		150 mm		HIT-0237220	56.88	
	4305528	65612-	Wear Ring		150 mm		HIT-0387305	18.08	
MODEL EX200-3, EX200LC-3, EX200H-3, EX200LCH-3									
ARM	4314778	78001-	Bushing	95 mm			HIT-0309204	37.71	
	4314778	78001-	Wear Ring		130 mm		HIT-0254309	49.93	
	4314778	78001-	Wear Ring		130 mm		HIT-0409912	16.36	
	4314778	D95/06-	P-UB-10	95 mm	130 mm		HIT-4369914	250.83	
BOOM LH	4250224	78001-	P-UB-10	85 mm	120 mm		HIT-4369901	196.06	
	4250224	78001-	Bushing	85 mm			HIT-4272960	34.71	
	4250224	78001-	Wear Ring		120 mm		HIT-0261308	47.08	
	4250224	78001-	Wear Ring		120 mm		HIT-0309309	13.29	
BOOM RH	4250224	D95/06-	P-UB-10	85 mm	120 mm		HIT-4369901	196.06	
	4250223	78001-	Bushing	85 mm			HIT-4272960	34.71	
	4250223	78001-	Wear Ring		120 mm		HIT-0309309	13.29	
	4250223	78001-	Wear Ring		120 mm		HIT-0261308	47.08	
BUCKET	4250223	D95/06-	P-UB-10	85 mm	120 mm		HIT-4369901	196.06	
	4250225	78001-	Bushing	75 mm			HIT-0310504	27.12	
	4250225	78001-	Wear Ring		110 mm		HIT-0410005	12.67	
	4250225	78001-	Wear Ring		110 mm		HIT-0298907	79.26	
BUCKET	4250225	D95/06-	P-UB-10	75 mm	110 mm		HIT-4369890	176.38	
	4287889	78001-	Bushing	65 mm		River	HIT-0310604	21.71	
	4287889	78001-	Wear Ring		95 mm	River	HIT-0310610	37.81	
	4287889	78001-	Wear Ring		95 mm	River	HIT-0310609	10.66	
	4287889	D95/06-	P-UB-10	65 mm	95 mm	River	HIT-4369766	114.28	
	CLAMSHELL	4288743	78001-	Bushing	85 mm			HIT-4272960	34.71
		4288743	78001-	Wear Ring		125 mm		HIT-0223713	49.06
		4288743	78001-	Wear Ring		125 mm		HIT-0309009	13.92
		4288743	78001-D95/05	P-UB-10	85 mm	125 mm		HIT-4369902	313.26
	4288743	D95/06-	P-UB-10	85 mm	125 mm		HIT-4369902	313.26	
MODEL EX200-5, EX200LC-5, EX210H-5, EX210LCH-5									
ARM	4316930	050001-	P-UB-10	95 mm	130 mm		HIT-4364916	258.35	
	4316930	050001-	P-UB-10	95 mm	130 mm		HIT-4364916-EX	349.15	
	4316930	050001-	Bushing	95 mm			HIT-0309204	37.71	
	4316930	050001-	Wear Ring		130 mm		HIT-0254309	49.93	
	4316930	050001-	Wear Ring		130 mm		HIT-0667409	13.04	
	4372914	050001-	P-UB-10	95 mm	130 mm		HIT-4364916	258.35	
	4372914	050001-	P-UB-10	95 mm	130 mm		HIT-4364916-EX	349.15	
	4372914	050001-	Bushing	95 mm			HIT-0309204	37.71	
	4372914	050001-	Wear Ring		130 mm		HIT-0254309	49.93	
	4372914	050001-	Wear Ring		130 mm		HIT-0667409	13.04	
BOOM LH	4317394	050001-	P-UB-10	85 mm	120 mm		HIT-4364915	204.72	
	4317394	050001-	P-UB-10	85 mm	120 mm		HIT-4364915-EX	289.01	
	4317394	050001-	Bushing	85 mm			HIT-4272960	34.71	
	4317394	050001-	Wear Ring		120 mm		HIT-0261308	47.08	

Hercules Sealing Products and original equipment Hitachi kits may not include the necessary wear rings for your cylinder rebuild.
Kits with an -EX suffix will include these wear rings.

Please ask your sales representative for a cross-reference if no -EX kit or complementary parts are listed.

Replacement Kits For

HITACHI

Excavators									
APPLICATION	CYL #	SERIAL #	CODE	ROD	BORE	Misc	KIT #	List \$	
MODEL EX200-5, EX200LC-5, EX210H-5, EX210LCH-5									
BOOM LH	4317394	050001-	Wear Ring		120 mm		HIT-0667206	11.73	
	4372913	050001-	P-UB-10	85 mm	120 mm		HIT-4364915	204.72	
	4372913	050001-	P-UB-10	85 mm	120 mm		HIT-4364915-EX	289.01	
	4372913	050001-	Bushing	85 mm			HIT-4272960	34.71	
	4372913	050001-	Wear Ring		120 mm		HIT-0261308	47.08	
	4372913	050001-	Wear Ring		120 mm		HIT-0667206	11.73	
BOOM RH	4317393	050001-	P-UB-10	85 mm	120 mm		HIT-4364915	204.72	
	4317393	050001-	P-UB-10	85 mm	120 mm		HIT-4364915-EX	289.01	
	4317393	050001-	Bushing	85 mm			HIT-4272960	34.71	
	4317393	050001-	Wear Ring		120 mm		HIT-0261308	47.08	
	4317393	050001-	Wear Ring		120 mm		HIT-0667206	11.73	
	4372912	050001-	P-UB-10	85 mm	120 mm		HIT-4364915	204.72	
	4372912	050001-	P-UB-10	85 mm	120 mm		HIT-4364915-EX	289.01	
	4372912	050001-	Bushing	85 mm			HIT-4272960	34.71	
	4372912	050001-	Wear Ring		120 mm		HIT-0261308	47.08	
	4372912	050001-	Wear Ring		120 mm		HIT-0667206	11.73	
	BUCKET	4318327	050001-	P-UB-10	75 mm	110 mm		HIT-4369890	176.38
		4318327	050001-	P-UB-10	75 mm	110 mm		HIT-4369890-EX	298.77
4318327		050001-	Bushing	75 mm			HIT-0310504	27.12	
4318327		050001-	Wear Ring		110 mm		HIT-0298907	79.26	
4318327		050001-	Wear Ring		110 mm		HIT-0410005	12.67	
4371061		050001-	P-UB-10	65 mm	95 mm	River	HIT-4369766	114.28	
4371061		050001-	P-UB-10	65 mm	95 mm	River	HIT-4369766-EX	181.53	
4371061		050001-	Bushing	65 mm		River	HIT-0310604	21.71	
4371061		050001-	Wear Ring		95 mm	River	HIT-0310609	10.66	
4371061		050001-	Wear Ring		95 mm	River	HIT-0310610	37.81	
4372915		050001-	P-UB-10	75 mm	110 mm		HIT-4369890	176.38	
4372915		050001-	P-UB-10	75 mm	110 mm		HIT-4369890-EX	298.77	
4372915		050001-	Bushing	75 mm			HIT-0310504	27.12	
4372915		050001-	Wear Ring		110 mm		HIT-0410005	12.67	
4372915		050001-	Wear Ring		110 mm		HIT-0298907	79.26	
CLAMSHELL		4288743	050001-	P-UB-10	85 mm	125 mm		HIT-4369902	313.26
		4288743	050001-	Bushing	85 mm			HIT-4272960	34.71
	4288743	050001-	Wear Ring		125 mm		HIT-0309009	13.92	
	4288743	050001-	Wear Ring		125 mm		HIT-0223713	49.06	
MODEL EX220									
ARM			P-UB-14	100 mm	145 mm		HIT-4203831	229.52	
BOOM			P-UB-10	90 mm	135 mm		HIT-4203830	211.60	
BUCKET			P-UB-10	90 mm	135 mm		HIT-4203830	211.60	
MODEL EX220-2									
ARM			P-UB-10	100 mm	135 mm		HIT-9103843	246.02	
BOOM			P-UB-10	90 mm	125 mm		HIT-9103842	187.80	
BUCKET			P-UB-10	85 mm	125 mm		HIT-9103844	189.43	
MODEL EX220-3, EX220LC-3									
ARM	9101317	10001-	P-UB-10	100 mm	135 mm		HIT-9103843	246.02	
	9101317	10001-	Bushing	100 mm			HIT-4272963	52.10	
	9101317	10001-	Wear Ring		135 mm		HIT-4252191	20.40	
	9101317	10001-	Wear Ring		135 mm		HIT-4185246	59.59	
BOOM LH	9101316	10001-	P-UB-10	90 mm	125 mm		HIT-9103842	187.80	
	9101316	10001-	Bushing	90 mm			HIT-4272961	33.48	
	9101316	10001-	Wear Ring		125 mm		HIT-4168234	125.42	
	9101316	10001-	Wear Ring		125 mm		HIT-4253562	14.83	
BOOM RH	9101315	10001-	P-UB-10	90 mm	125 mm		HIT-9103842	187.80	
	9101315	10001-	Bushing	90 mm			HIT-4272961	33.48	
	9101315	10001-	Wear Ring		125 mm		HIT-4168234	125.42	

Hercules Sealing Products and original equipment Hitachi kits may not include the necessary wear rings for your cylinder rebuild.
Kits with an -EX suffix will include these wear rings.

Please ask your sales representative for a cross-reference if no -EX kit or complementary parts are listed.

HITACHI

Replacement Kits For

Excavators								
APPLICATION	CYL #	SERIAL #	CODE	ROD	BORE	Misc	KIT #	List \$
MODEL EX220-3, EX220LC-3								
BOOM RH	9101315	10001-	Wear Ring		125 mm		HIT-4253562	14.83
BUCKET	9101318	10001-	P-UB-10	85 mm	125 mm		HIT-9103844	189.43
	9101318	10001-	Bushing	85 mm			HIT-4272960	34.71
	9101318	10001-	Wear Ring		125 mm		HIT-4168234	125.42
	9101318	10001-	Wear Ring		125 mm		HIT-4253562	14.83
MODEL EX220-5, EX220LC-5, EX230LC-5, EX230H-5, EX230LCH-5								
ARM	4380500	1001-	P-UB-10	105 mm	145 mm	River	HIT-4369943	272.83
	4380500	1001-	Bushing	105 mm		River	HIT-0373405	44.45
	4380500	1001-	Wear Ring		145 mm	River	HIT-0492209	17.94
	4380500	1001-	Wear Ring		145 mm	River	HIT-0373413	81.03
	9101317	1001-	P-UB-14	100 mm	135 mm		HIT-9178284	191.54
	9101317	1001-	Bushing	100 mm			HIT-4272963	52.10
	9101317	1001-	Wear Ring		135 mm		HIT-4185246	59.59
	9101317	1001-	Wear Ring		135 mm		HIT-4252191	20.40
	9147233	1001-	Bushing	100 mm			HIT-4272963	52.10
	9147233	1001-	Wear Ring		135 mm		HIT-4185246	59.59
	9147233	1001-	Wear Ring		135 mm		HIT-4252191	20.40
	9147233	D96/12-	P-UB-14	100 mm	135 mm		HIT-9178284	191.54
	BOOM LH	9101316	1001-	P-UB-14	90 mm	125 mm		HIT-9178283
9101316		1001-	Bushing	90 mm			HIT-4272961	33.48
9101316		1001-	Wear Ring		125 mm		HIT-4168234	125.42
9101316		1001-	Wear Ring		125 mm		HIT-4253562	14.83
9147232		1001-	Bushing	90 mm			HIT-4272961	33.48
9147232		1001-	Wear Ring		125 mm		HIT-4168234	125.42
9147232		1001-	Wear Ring		125 mm		HIT-4253562	14.83
9147232		D96/12-	P-UB-14	90 mm	125 mm		HIT-9178283	143.64
BOOM RH	9101315	1001-	P-UB-14	90 mm	125 mm		HIT-9178283	143.64
	9101315	1001-	Bushing	90 mm			HIT-4272961	33.48
	9101315	1001-	Wear Ring		125 mm		HIT-4168234	125.42
	9101315	1001-	Wear Ring		125 mm		HIT-4253562	14.83
	9147231	1001-	P-UB-14	90 mm	125 mm		HIT-9178283	143.64
	9147231	1001-	Bushing	90 mm			HIT-4272961	33.48
	9147231	1001-	Wear Ring		125 mm		HIT-4253562	14.83
BUCKET	9147231	1001-	Wear Ring		125 mm		HIT-4168234	125.42
	4371061	1001-	P-UB-10	65 mm	95 mm	River	HIT-4369766	114.28
	4371061	1001-	Bushing	65 mm		River	HIT-0310604	21.71
	4371061	1001-	Wear Ring		95 mm	River	HIT-0310609	10.66
	4371061	1001-	Wear Ring		95 mm	River	HIT-0310610	37.81
	9101318	1001-	P-UB-14	85 mm	125 mm		HIT-9178294	150.37
	9101318	1001-	Bushing	85 mm			HIT-4272960	34.71
	9101318	1001-	Wear Ring		125 mm		HIT-4168234	125.42
	9101318	1001-	Wear Ring		125 mm		HIT-4253562	14.83
	9147234	1001-	Bushing	85 mm			HIT-4272960	34.71
	9147234	1001-	Wear Ring		125 mm		HIT-4253562	14.83
	9147234	1001-	Wear Ring		125 mm		HIT-4168234	125.42
9147234	D96/12-	P-UB-14	85 mm	125 mm		HIT-9178294	150.37	
MODEL EX270, EX270LC								
ARM	9076106	50001-	P-UB-14	105 mm	150 mm		HIT-9078844	337.89
BOOM	ALL	50001-	P-UB-14	95 mm	145 mm		HIT-9078843	225.76
BUCKET	ALL	50001-	P-UB-14	95 mm	145 mm		HIT-9078843	225.76
MODEL EX270-5, EX270LC-5, EX280H-5, EX280LCH-5								
ARM	9147237	10001-	P-UB-14	100 mm	145 mm		HIT-9180579	204.29
	9147237	10001-	Bushing	100 mm			HIT-4272963	52.10
	9147237	10001-	Wear Ring		145 mm		HIT-4194621	19.00
	9147237	10001-	Wear Ring		145 mm		HIT-4185247	65.19

Hercules Sealing Products and original equipment Hitachi kits may not include the necessary wear rings for your cylinder rebuild.
Kits with an -EX suffix will include these wear rings.

Please ask your sales representative for a cross-reference if no -EX kit or complementary parts are listed.

Replacement Kits For

HITACHI

Excavators								
APPLICATION	CYL #	SERIAL #	CODE	ROD	BORE	Misc	KIT #	List \$
MODEL EX270-5, EX270LC-5, EX280H-5, EX280LCH-5								
BOOM LH	9147236	10001-	P-UB-14	95 mm	135 mm		HIT-9180587	180.01
	9147236	10001-	Bushing	95 mm			HIT-4272962	37.71
	9147236	10001-	Wear Ring		135 mm		HIT-4185246	59.59
	9147236	10001-	Wear Ring		135 mm		HIT-4252191	20.40
BOOM RH	9147235	10001-	P-UB-14	95 mm	135 mm		HIT-9180587	180.01
	9147235	10001-	Bushing	95 mm			HIT-4272962	37.71
	9147235	10001-	Wear Ring		135 mm		HIT-4185246	59.59
	9147235	10001-	Wear Ring		135 mm		HIT-4252191	20.40
BUCKET	9147238	10001-	P-UB-14	90 mm	135 mm		HIT-9180580	164.31
	9147238	10001-	Bushing	90 mm			HIT-4272961	33.48
	9147238	10001-	Wear Ring		135 mm		HIT-4185246	59.59
	9147238	10001-	Wear Ring		135 mm		HIT-4252191	20.40
MODEL EX300, EX300LC								
ARM			P-UB-14	110 mm	165 mm		HIT-9078846	331.61
BOOM			P-UB-14	100 mm	145 mm		HIT-9078845	229.52
BUCKET			P-UB-14	95 mm	145 mm		HIT-9078843	225.76
MODEL EX300-3, EX300LC-3, EX300H-3, EX300LCH-3								
ARM	9122617		P-UB-14	110 mm	165 mm		HIT-9123264	184.74
	9122617	7001-	Bushing	110 mm			HIT-4284534	84.51
	9122617	7001-	Wear Ring		165 mm		HIT-4194624	138.11
	9122617	7001-	Wear Ring		165 mm		HIT-4194623	27.81
BOOM LH	9122616	7001-	P-UB-14	100 mm	145 mm		HIT-9078845	229.52
	9122616	7001-	Bushing	100 mm			HIT-4272963	52.10
	9122616	7001-	Wear Ring		145 mm		HIT-4185249	17.54
	9122616	7001-	Wear Ring		145 mm		HIT-4185247	65.19
BOOM RH	9122615	7001-	P-UB-14	100 mm	145 mm		HIT-9078845	229.52
	9122615	7001-	Bushing	100 mm			HIT-4272963	52.10
	9122615	7001-	Wear Ring		145 mm		HIT-4185249	17.54
	9122615	7001-	Wear Ring		145 mm		HIT-4185247	65.19
BUCKET	4326775	7001-	P-UB-10	65 mm	100 mm	River	HIT-4369767	120.06
	4326775	7001-	Bushing	65 mm		River	HIT-0310604	21.71
	4326775	7001-	Wear Ring		100 mm	River	HIT-0254908	72.59
	4326775	7001-	Wear Ring		100 mm	River	HIT-0326005	11.88
	9122618	7001-	Bushing	95 mm			HIT-4284535	44.36
	9122618	7001-	Wear Ring		145 mm		HIT-4185247	65.19
	9122618	7001-	Wear Ring		145 mm		HIT-4185249	17.54
	9122618	7001-HL803556	P-UB-14	95 mm	145 mm		HIT-9123265	146.70
9122618	HL803557-	P-UB-14	95 mm	145 mm		HIT-9175564	165.86	
MODEL EX300-5, EX330-5, EX350-5, EX370-5 (H,HD,K,&LC)								
ARM	9164990	20001-	P-UB-14	115 mm	170 mm		HIT-9180582	244.22
	9164990	20001-	Bushing	115 mm			HIT-4370337	66.38
	9164990	20001-	Wear Ring		170 mm		HIT-4370064	36.15
	9164990	20001-	Wear Ring		170 mm		HIT-4370063	85.62
BOOM LH	9164872	20001-	P-UB-14	105 mm	150 mm		HIT-9180581	279.79
	9164872	20001-	Bushing	105 mm			HIT-4383093	46.86
	9164872	20001-	Wear Ring		150 mm		HIT-4171490	68.31
	9164872	20001-	Wear Ring		150 mm		HIT-4194622	18.88
BOOM RH	9164874	20001-	P-UB-14	105 mm	150 mm		HIT-9180581	279.79
	9164874	20001-	Bushing	105 mm			HIT-4383093	46.86
	9164874	20001-	Wear Ring		150 mm		HIT-4194622	18.88
	9164874	20001-	Wear Ring		150 mm		HIT-4171490	68.31
BUCKET	9164997	20001-	P-UB-14	95 mm	145 mm		HIT-9175564	165.86
	9164997	20001-	Bushing	95 mm			HIT-4284535	44.36
	9164997	20001-	Wear Ring		145 mm		HIT-4185249	17.54
	9164997	20001-	Wear Ring		145 mm		HIT-4185247	65.19

Hercules Sealing Products and original equipment Hitachi kits may not include the necessary wear rings for your cylinder rebuild. Kits with an -EX suffix will include these wear rings.

Please ask your sales representative for a cross-reference if no -EX kit or complementary parts are listed.

HITACHI

Replacement Kits For

Excavators								
APPLICATION	CYL #	SERIAL #	CODE	ROD	BORE	Misc	KIT #	List \$
MODEL EX400, EX400LC, EX400H, EX400LCH								
ARM	4206480	02001-	P-UB-10	130 mm	190 mm		HIT-4236058	349.66
BOOM LH	4206479	02001-	P-UB-10	115 mm	170 mm		HIT-4236057	323.03
BOOM RH	4206478	02001-	P-UB-10	115 mm	170 mm		HIT-4236057	323.03
BUCKET	4206481	02001-	P-UB-10	115 mm	170 mm		HIT-4236057	323.03
MODEL EX400-3, EX400LC-3, EX400H-3, EX400LCH-3								
ARM	4219778	5001-	P-UB-10	115 mm	170 mm	Load Shovel	HIT-4236057	323.03
	4219778	5001-	Bushing	115 mm		Load Shovel	HIT-0352704	50.20
	4219778	5001-	Bushing	115 mm		Load Shovel	HIT-0352708	17.76
	4219778	5001-	Wear Ring		170 mm	Load Shovel	HIT-0352712	20.09
	4219778	5001-	Wear Ring		170 mm	Load Shovel	HIT-0259307	85.62
	4310243	5001-	P-UB-10	130 mm	190 mm		HIT-4438679	314.64
	4310243	5001-	Bushing	130 mm			HIT-0353004	71.19
	4310243	5001-	Bushing	130 mm			HIT-0417605	48.77
	4310243	5001-	Wear Ring		190 mm		HIT-0420307	38.95
	4310243	5001-	Wear Ring		190 mm		HIT-0242512	89.04
BOOM LH	4249749	5162, 5164	P-UB-10	115 mm	170 mm	Load Shovel	HIT-4236057	323.03
	4249749	5162, 5164	Bushing	115 mm		Load Shovel	HIT-0352708	17.76
	4249749	5162, 5164	Bushing	115 mm		Load Shovel	HIT-0352704	50.20
	4249749	5162, 5164	Wear Ring		170 mm	Load Shovel	HIT-0259307	85.62
	4249749	5162, 5164	Wear Ring		170 mm	Load Shovel	HIT-0352712	20.09
	4310242	5001-	P-UB-10	115 mm	170 mm		HIT-4438672	372.00
	4310242	5001-	Bushing	115 mm			HIT-0460004	42.70
	4310242	5001-	Bushing	115 mm			HIT-0352704	50.20
	4310242	5001-	Wear Ring		170 mm		HIT-0420109	21.63
	4310242	5001-	Wear Ring		170 mm		HIT-0259307	85.62
	4350424	5001-	P-UB-10	115 mm	170 mm	Load Shovel	HIT-4438672	372.00
	4350424	5001-	Bushing	115 mm		Load Shovel	HIT-0460004	42.70
	4350424	5001-	Bushing	115 mm		Load Shovel	HIT-0352704	50.20
	4350424	5001-	Wear Ring		170 mm	Load Shovel	HIT-0420109	21.63
	4350424	5001-	Wear Ring		170 mm	Load Shovel	HIT-0259307	85.62
	BOOM RH	4249748	5162, 5164	P-UB-10	115 mm	170 mm	Load Shovel	HIT-4236057
4249748		5162, 5164	Bushing	115 mm		Load Shovel	HIT-0352704	50.20
4249748		5162, 5164	Bushing	115 mm		Load Shovel	HIT-0352708	17.76
4249748		5162, 5164	Wear Ring		170 mm	Load Shovel	HIT-0259307	85.62
4249748		5162, 5164	Wear Ring		170 mm	Load Shovel	HIT-0352712	20.09
4310241		5001-	P-UB-10	115 mm	170 mm		HIT-4438672	372.00
4310241		5001-	Bushing	115 mm			HIT-0352704	50.20
4310241		5001-	Bushing	115 mm			HIT-0460004	42.70
4310241		5001-	Wear Ring		170 mm		HIT-0420109	21.63
4310241		5001-	Wear Ring		170 mm		HIT-0259307	85.62
4350423		5001-	P-UB-10	115 mm	170 mm	Load Shovel	HIT-4438672	372.00
4350423		5001-	Bushing	115 mm		Load Shovel	HIT-0460004	42.70
4350423		5001-	Bushing	115 mm		Load Shovel	HIT-0352704	50.20
4350423		5001-	Wear Ring		170 mm	Load Shovel	HIT-0259307	85.62
4350423		5001-	Wear Ring		170 mm	Load Shovel	HIT-0420109	21.63
BUCKET		4310244	5001-	P-UB-10	115 mm	170 mm		HIT-4438672
	4310244	5001-	Bushing	115 mm			HIT-0460004	42.70
	4310244	5001-	Bushing	115 mm			HIT-0352704	50.20
	4310244	5001-	Wear Ring		170 mm		HIT-0259307	85.62
	4310244	5001-	Wear Ring		170 mm		HIT-0420109	21.63
	4390024	ALL	P-UB-10	120 mm	170 mm		HIT-4438681	232.96
	4390024	ALL	Bushing	120 mm			HIT-0450506	48.63
	4390024	ALL	Bushing	120 mm			HIT-0450508	58.73
	4390024	ALL	Wear Ring		170 mm		HIT-0420109	21.63
	4390024	ALL	Wear Ring		170 mm		HIT-0259307	85.62

Hercules Sealing Products and original equipment Hitachi kits may not include the necessary wear rings for your cylinder rebuild. Kits with an -EX suffix will include these wear rings.

Please ask your sales representative for a cross-reference if no -EX kit or complementary parts are listed.

Replacement Kits For

HITACHI

Excavators								
APPLICATION	CYL #	SERIAL #	CODE	ROD	BORE	Misc	KIT #	List \$
MODEL EX400-3, EX400LC-3, EX400H-3, EX400LCH-3								
BUCKET	9138785	5001-	P-UB-14	95 mm	145 mm	Long Arm	HIT-9123265	146.70
	9138785	5001-	Bushing	95 mm		Long Arm	HIT-4284535	44.36
	9138785	5001-	Wear Ring		145 mm	Long Arm	HIT-4185249	17.54
	9138785	5001-	Wear Ring		145 mm	Long Arm	HIT-4185247	65.19
BUCKET LH	4219781	5001-	P-UB-10	115 mm	150 mm	Load Shovel	HIT-4255532	242.90
	4219781	5001-	Bushing	115 mm		Load Shovel	HIT-0352708	17.76
	4219781	5001-	Bushing	115 mm		Load Shovel	HIT-0352704	50.20
	4219781	5001-	Wear Ring		150 mm	Load Shovel	HIT-0237220	56.88
BUCKET RH	4219781	5001-	Wear Ring		150 mm	Load Shovel	HIT-0387305	18.08
	4219780	5001-	P-UB-10	115 mm	150 mm	Load Shovel	HIT-4255532	242.90
	4219780	5001-	Bushing	115 mm		Load Shovel	HIT-0352708	17.76
	4219780	5001-	Bushing	115 mm		Load Shovel	HIT-0352704	50.20
DUMP	4219780	5001-	Wear Ring		150 mm	Load Shovel	HIT-0237220	56.88
	4219780	5001-	Wear Ring		150 mm	Load Shovel	HIT-0387305	18.08
	4219782	5001-	P-UB-10	65 mm	100 mm	Load Shovel	HIT-4255533	100.81
	4219782	5001-	Bushing	65 mm		Load Shovel	HIT-0387503	24.45
LEVEL	4219782	5001-	Bushing	65 mm		Load Shovel	HIT-0310604	21.71
	4219782	5001-	Wear Ring		100 mm	Load Shovel	HIT-0254908	72.59
	4219782	5001-	Wear Ring		100 mm	Load Shovel	HIT-0326005	11.88
	4219779	5001-	P-UB-10	115 mm	170 mm	Load Shovel	HIT-4236057	323.03
LOADING SHOVEL	4219779	5001-	Bushing	115 mm		Load Shovel	HIT-0352704	50.20
	4219779	5001-	Bushing	115 mm		Load Shovel	HIT-0352708	17.76
	4219779	5001-	Wear Ring		170 mm	Load Shovel	HIT-0259307	85.62
	4219779	5001-	Wear Ring		170 mm	Load Shovel	HIT-0352712	20.09
LOADING SHOVEL	4344048	5001-	P-U-10	65 mm	130 mm		HIT-4363078	133.70
	4344048	5001-	Bushing	65 mm			HIT-0657704	22.57
	4344048	5001-	Wear Ring		130 mm		HIT-0657706	101.01
MODEL EX400-3C, EX400LC-3C, EX450H-3C, EX450LCH-3C								
ARM	4310243	6001-	P-UB-10	130 mm	190 mm		HIT-4438679	314.64
	4310243	6001-	Bushing	130 mm			HIT-0417605	48.77
	4310243	6001-	Bushing	130 mm			HIT-0353004	71.19
	4310243	6001-	Wear Ring		190 mm		HIT-0242512	89.04
	4310243	6001-	Wear Ring		190 mm		HIT-0420307	38.95
BOOM LH	4310242	6001-	P-UB-10	115 mm	170 mm		HIT-4438672	372.00
	4310242	6001-	Bushing	115 mm			HIT-0352704	50.20
	4310242	6001-	Bushing	115 mm			HIT-0460004	42.70
	4310242	6001-	Wear Ring		170 mm		HIT-0259307	85.62
BOOM RH	4310242	6001-	Wear Ring		170 mm		HIT-0420109	21.63
	4310241	6001-	P-UB-10	115 mm	170 mm		HIT-4438672	372.00
	4310241	6001-	Bushing	115 mm			HIT-0352704	50.20
	4310241	6001-	Bushing	115 mm			HIT-0460004	42.70
BUCKET	4310241	6001-	Wear Ring		170 mm		HIT-0259307	85.62
	4310241	6001-	Wear Ring		170 mm		HIT-0420109	21.63
	4310244	6001-	P-UB-10	115 mm	170 mm		HIT-4438672	372.00
	4310244	6001-	Bushing	115 mm			HIT-0352704	50.20
LOADING SHOVEL	4310244	6001-	Bushing	115 mm			HIT-0460004	42.70
	4310244	6001-	Wear Ring		170 mm		HIT-0259307	85.62
	4310244	6001-	Wear Ring		170 mm		HIT-0420109	21.63
	9138785	6001-	P-UB-14	95 mm	145 mm	Long Arm	HIT-9123265	146.70
	9138785	6001-	Bushing	95 mm		Long Arm	HIT-4284535	44.36
	9138785	6001-	Wear Ring		145 mm	Long Arm	HIT-4185247	65.19
LOADING SHOVEL	9138785	6001-	Wear Ring		145 mm	Long Arm	HIT-4185249	17.54
	4344048	6001-	P-U-10	65 mm	130 mm		HIT-4363078	133.70
	4344048	6001-	Bushing	65 mm			HIT-0657704	22.57
	4344048	6001-	Wear Ring		130 mm		HIT-0657706	101.01

Hercules Sealing Products and original equipment Hitachi kits may not include the necessary wear rings for your cylinder rebuild.
Kits with an -EX suffix will include these wear rings.

Please ask your sales representative for a cross-reference if no -EX kit or complementary parts are listed.

Replacement Kits For

HITACHI

HITACHI

Excavators								
APPLICATION	CYL #	SERIAL #	CODE	ROD	BORE	Misc	KIT #	List \$
MODEL EX400-5, EX400LC-5, EX450LC-5, EX450LCH-5								
ARM	4310243	7001-	P-UB-10	130 mm	190 mm		HIT-4438679	314.64
	4310243	7001-	Bushing	130 mm			HIT-0417605	48.77
	4310243	7001-	Bushing	130 mm			HIT-0353004	71.19
	4310243	7001-	Wear Ring		190 mm		HIT-0242512	89.04
	4310243	7001-	Wear Ring		190 mm		HIT-0420307	38.95
BOOM LH	4310242	7001-	P-UB-10	115 mm	170 mm		HIT-4438672	372.00
	4310242	7001-	Bushing	115 mm			HIT-0352704	50.20
	4310242	7001-	Bushing	115 mm			HIT-0460004	42.70
	4310242	7001-	Wear Ring		170 mm		HIT-0259307	85.62
	4310242	7001-	Wear Ring		170 mm		HIT-0420109	21.63
BOOM RH	4310241	7001-	P-UB-10	115 mm	170 mm		HIT-4438672	372.00
	4310241	7001-	Bushing	115 mm			HIT-0352704	50.20
	4310241	7001-	Bushing	115 mm			HIT-0460004	42.70
	4310241	7001-	Wear Ring		170 mm		HIT-0259307	85.62
	4310241	7001-	Wear Ring		170 mm		HIT-0420109	21.63
BUCKET	4310244		P-UB-10	115 mm	170 mm		HIT-4438672	372.00
	4310244		Bushing	115 mm			HIT-0352704	50.20
	4310244		Bushing	115 mm			HIT-0460004	42.70
	4310244		Wear Ring		170 mm		HIT-0259307	85.62
	4310244		Wear Ring		170 mm		HIT-0420109	21.63
	4390024		P-UB-10	120 mm	170 mm		HIT-4438681	232.96
	4390024		Bushing	120 mm			HIT-0450506	48.63
	4390024		Bushing	120 mm			HIT-0450508	58.73
	4390024		Wear Ring		170 mm		HIT-0259307	85.62
	4390024		Wear Ring		170 mm		HIT-0420109	21.63
	9138785	7001-	P-UB-14	95 mm	145 mm	Long Arm	HIT-9123265	146.70
	9138785	7001-	Bushing	95 mm		Long Arm	HIT-4284535	44.36
	9138785	7001-	Wear Ring		145 mm	Long Arm	HIT-4185247	65.19
	9138785	7001-	Wear Ring		145 mm	Long Arm	HIT-4185249	17.54
	LOADING SHOVEL	4344048	7001-	P-U-10	65 mm	130 mm		HIT-4363078
4344048		7001-	Bushing	65 mm			HIT-0657704	22.57
4344048		7001-	Wear Ring		130 mm		HIT-0657706	101.01
MODEL EX700, EX700H								
ARM	4218518	01003-	P-UB-10	150 mm	215 mm		HIT-4254042	420.28
	4253060	6/89-	P-UB-10	150 mm	215 mm		HIT-4266596	420.28
BOOM	4218516	01003-	P-UB-10	140 mm	200 mm		HIT-4254041	366.37
	4218517	01003-	P-UB-10	140 mm	200 mm		HIT-4254041	366.37
BUCKET	4251780	01003-	P-UB-10	130 mm	190 mm		HIT-4256119	346.08
	4253061	6/89-	P-UB-10	150 mm	215 mm		HIT-4266596	420.28
MODEL EX1000								
ARM	4157138	101-	P-U-10	150 mm	225 mm		HIT-4163898	354.61
	4157138	101-	P-UB-10	150 mm	225 mm		HIT-4171991	653.18
BOOM	4157139	101-	P-UB-10	160 mm	240 mm		HIT-4171990	756.40
	4157139	101-	P-U-10	160 mm	240 mm		HIT-4163899	408.80
BUCKET	4174020	101-	P-UB-10	160 mm	240 mm		HIT-4171990	756.40
	4193517	101-	P-UB-10	160 mm	240 mm		HIT-4171990	756.40
DUMP	4157143	101-	P-UB-10	80 mm	140 mm		HIT-4171993	321.46
	4157143	101-	P-U-10	80 mm	140 mm		HIT-4163901	173.65
LEVEL	4157142	101-	P-UB-10	160 mm	240 mm		HIT-4171990	756.40
	4157142	101-	P-U-10	160 mm	240 mm		HIT-4163899	408.80
TILT	4157140	101-	P-U-10	140 mm	190 mm		HIT-4163900	288.34
	4157140	101-	P-UB-10	140 mm	190 mm		HIT-4171992	447.87
MODEL EX1800								
DUMP	4248484		P-UB-10	110 mm	190 mm		HIT-4221872	516.94

Hercules Sealing Products and original equipment Hitachi kits may not include the necessary wear rings for your cylinder rebuild.
Kits with an -EX suffix will include these wear rings.

Please ask your sales representative for a cross-reference if no -EX kit or complementary parts are listed.

Replacement Kits For

HITACHI

Excavators								
APPLICATION	CYL #	SERIAL #	CODE	ROD	BORE	Misc	KIT #	List \$
MODEL EX3500								
DUMP			P-UB-10	130 mm	225 mm		HIT-4210676	746.68
MODEL UH083, UH083LC								
ARM	4132364	20001-20010	P-UB-5	100 mm	140 mm		HIT-4153205	267.02
	4132364	20051-	P-UB-5	100 mm	140 mm		HIT-4153205	267.02
	4153281	20011-20050	P-UB-10	100 mm	140 mm		HIT-4153211	251.99
BOOM LH	4128103	20001-20010	P-UB-5	85 mm	125 mm		HIT-4153203	317.13
	4153280	20011-20050	P-UB-10	90 mm	130 mm		HIT-4153209	172.00
	4153312	20051-	P-UB-5	85 mm	125 mm		HIT-4153203	317.13
BOOM RH	4128102	20001-20010	P-UB-5	85 mm	125 mm		HIT-4153203	317.13
	4153279	20011-20050	P-UB-10	90 mm	130 mm		HIT-4153209	172.00
	4153311	20051-	P-UB-5	85 mm	125 mm		HIT-4153203	317.13
BUCKET	4128105	20001-20010	P-UB-5	80 mm	125 mm		HIT-4153207	238.90
	4128105	20051-	P-UB-5	80 mm	125 mm		HIT-4153207	238.90
	4153282	20011-20050	P-UB-10	80 mm	125 mm		HIT-4153213	223.05
MODEL UH107								
ARM			P-UB-5	105 mm	150 mm		HIT-4096959	368.41
BOOM			P-UB-5	95 mm	150 mm		HIT-4096957	233.25
BUCKET			P-UB-5	95 mm	150 mm		HIT-4096960	231.96
MODEL UH122, UH122LC								
ARM	3011918	125	P-UB-5	105 mm	150 mm		HIT-4096958	326.05
	3015873	351-605	P-UB-5	105 mm	150 mm		HIT-4096959	368.41
	3019398	835-	P-UB-5	105 mm	150 mm		HIT-4122040	384.76
	3020009	606-834	P-UB-5	105 mm	150 mm		HIT-4117746	369.98
BOOM LH	3010528	125-605	P-UB-5	95 mm	150 mm		HIT-4096957	233.25
	3020012	606-835	P-UB-5	95 mm	150 mm		HIT-4117745	277.99
	3020973	836-	P-UB-5	95 mm	150 mm		HIT-4122039	295.46
BOOM RH	3010527	125-605	P-UB-5	95 mm	150 mm		HIT-4096957	233.25
	3020011	606-835	P-UB-5	95 mm	150 mm		HIT-4117745	277.99
	3020972	836-	P-UB-5	95 mm	150 mm		HIT-4122039	295.46
BUCKET	3010530	125-	P-UB-5	95 mm	150 mm		HIT-4096960	231.96
MODEL UH123								
ARM	4170628	3001-	P-UB-10	105 mm	150 mm		HIT-4163569	206.76
BOOM LH	4170627	3001-	P-UB-10	95 mm	150 mm		HIT-4179470	255.66
BOOM RH	4173626	3001-	P-UB-10	95 mm	150 mm		HIT-4179470	255.66
BUCKET	4170629	3001-	P-UB-10	95 mm	150 mm		HIT-4163573	255.24
MODEL UH172								
ARM	3015411	601-	P-UB-5	120 mm	190 mm		HIT-4101392	514.11
BOOM LH	3014038		P-UB-5	110 mm	170 mm		HIT-4094852	489.04
BOOM RH	3013801		P-UB-5	110 mm	170 mm		HIT-4094852	489.04
BUCKET	3014042	001-	P-UB-5	110 mm	170 mm		HIT-4094852	489.04
MODEL UH181								
ARM	3022991	005-009;053-069	P-UB-5	110 mm	170 mm		HIT-4153235	499.01
	3027628	001-165	P-UB-5	120 mm	190 mm		HIT-4162027	564.90
	3031888	166-	P-UB-10	120 mm	190 mm		HIT-4176980	337.27
	4167618	001-004;010-052	P-UB-10	110 mm	170 mm		HIT-4167722	306.41
	4167618	070-	P-UB-10	110 mm	170 mm		HIT-4167722	306.41
BOOM LH	3026175		P-UB-5	110 mm	170 mm		HIT-4162026	529.62
	4167617		P-UB-10	110 mm	170 mm		HIT-4167721	312.33
BOOM RH	3026114		P-UB-5	110 mm	170 mm		HIT-4162026	529.62
	4167616		P-UB-10	110 mm	170 mm		HIT-4167721	312.33
BUCKET	3026115	001-145	P-UB-5	110 mm	170 mm		HIT-4162028	528.67
	3027022	001-	P-UB-5	95 mm	150 mm		HIT-4150681	343.27
	3031889	146-	P-UB-10	110 mm	170 mm		HIT-4167721	312.33
DUMP	3024187	001-	P-UB-5	55 mm	100 mm		HIT-4144635	288.05
LEVEL	3025213	001-	P-UB-5	110 mm	170 mm		HIT-4153237	454.72

Hercules Sealing Products and original equipment Hitachi kits may not include the necessary wear rings for your cylinder rebuild.
Kits with an -EX suffix will include these wear rings.

Please ask your sales representative for a cross-reference if no -EX kit or complementary parts are listed.

HITACHI

Replacement Kits For

Excavators								
APPLICATION	CYL #	SERIAL #	CODE	ROD	BORE	Misc	KIT #	List \$
MODEL UH181								
TILT	3022992	005-009;053-069	P-UB-5	110 mm	150 mm		HIT-4153236	348.99
	4167620	001-004;010-052;070-	P-UB-10	110 mm	140 mm		HIT-4167724	302.70
MODEL UH501								
ARM	4157138	002-	P-U-10	150 mm	225 mm		HIT-4163898	354.61
BOOM	4157139	002-	P-U-10	160 mm	240 mm		HIT-4163899	408.80
DUMP	4157143	002-	P-U-10	80 mm	140 mm		HIT-4163901	173.65
LEVEL	4157142	002-	P-U-10	160 mm	240 mm		HIT-4163899	408.80
TILT LH	4157141	002-	P-U-10	140 mm	190 mm		HIT-4163900	288.34
TILT RH	4157140	002-	P-U-10	140 mm	190 mm		HIT-4163900	288.34
MODEL ZX35U-3								
ARM	4699449	020001-	P-U-10	45 mm	75 mm		HIT-4704455	62.42
	4699449	020001-	Bushing	45 mm			HIT-0891518	11.07
ARM (ML)	4702249	020001-	P-U-10	45 mm	75 mm		HIT-4704455	62.42
	4702249	020001-	Bushing	45 mm			HIT-0891518	11.07
BLADE	4617784	020001-	P-U-14	45 mm	95 mm		HIT-4622066	140.44
	4617784	020001-	Bushing	45 mm			HIT-0920515	12.81
BOOM (CAB ML)	4627539	020001-	P-U-10	50 mm	85 mm		HIT-4634033	104.57
	4627539	020001-	Bushing	50 mm			HIT-0948703	12.96
BOOM (CAB)	4690142	020001-	P-U-10	50 mm	85 mm		HIT-4634033	104.57
	4690142	020001-	Bushing	50 mm			HIT-0948703	12.96
BOOM (CANOPY ML)	4627538	020001-	P-U-10	50 mm	85 mm		HIT-4634033	104.57
	4627538	020001-	Bushing	50 mm			HIT-0948703	12.96
BOOM (CANOPY)	4690141	020001-	P-U-10	50 mm	85 mm		HIT-4634033	104.57
	4690141	020001-	Bushing	50 mm			HIT-0948703	12.96
BUCKET	4640335	020001-	P-U-10	40 mm	65 mm		HIT-4614058	123.26
	4640335	020001-	Bushing	40 mm			HIT-0892005	9.33
	4648844	020001-	P-U-10	40 mm	65 mm		HIT-4614058	123.26
	4648844	020001-	Bushing	40 mm			HIT-0892005	9.33
SWING	4608470	020001-	P-U-10	45 mm	85 mm		HIT-4614059	124.10
	4608470	020001-	Bushing	45 mm			HIT-0891605	11.07
MODEL ZX35U-3F								
ARM	4699449	020001-	P-U-10	45 mm	75 mm		HIT-4704455	62.42
	4699449	020001-	Bushing	45 mm			HIT-0891518	11.07
ARM (ML)	4702249	020001-	P-U-10	45 mm	75 mm		HIT-4704455	62.42
	4702249	020001-	Bushing	45 mm			HIT-0891518	11.07
BLADE	4617784	020001-	P-U-14	45 mm	95 mm		HIT-4622066	140.44
	4617784	020001-	Bushing	45 mm			HIT-0920515	12.81
BOOM (CAB ML)	4627539	020001-	P-U-10	50 mm	85 mm		HIT-4634033	104.57
	4627539	020001-	Bushing	50 mm			HIT-0948703	12.96
BOOM (CAB)	4690142	020001-	P-U-10	50 mm	85 mm		HIT-4634033	104.57
	4690142	020001-	Bushing	50 mm			HIT-0948703	12.96
BOOM (CANOPY ML)	4627538	020001-	P-U-10	50 mm	85 mm		HIT-4634033	104.57
	4627538	020001-	Bushing	50 mm			HIT-0948703	12.96
BOOM (CANOPY)	4690141	020001-	P-U-10	50 mm	85 mm		HIT-4634033	104.57
	4690141	020001-	Bushing	50 mm			HIT-0948703	12.96
BUCKET	4640335	020001-	P-U-10	40 mm	65 mm		HIT-4614058	123.26
	4640335	020001-	Bushing	40 mm			HIT-0892005	9.33
	4648844	020001-	P-U-10	40 mm	65 mm		HIT-4614058	123.26
	4648844	020001-	Bushing	40 mm			HIT-0892005	9.33
SWING	4608470	020001-	P-U-10	45 mm	85 mm		HIT-4614059	124.10
	4608470	020001-	Bushing	45 mm			HIT-0891605	11.07
MODEL ZX38U-3								
ARM	4699449	020001-	P-U-10	45 mm	75 mm		HIT-4704455	62.42
	4699449	020001-	Bushing	45 mm			HIT-0891518	11.07

Hercules Sealing Products and original equipment Hitachi kits may not include the necessary wear rings for your cylinder rebuild. Kits with an -EX suffix will include these wear rings.

Please ask your sales representative for a cross-reference if no -EX kit or complementary parts are listed.

Replacement Kits For

HITACHI

Excavators								
APPLICATION	CYL #	SERIAL #	CODE	ROD	BORE	Misc	KIT #	List \$
MODEL ZX38U-3								
ARM (ML)	4702249	020001-	P-U-10	45 mm	75 mm		HIT-4704455	62.42
	4702249	020001-	Bushing	45 mm			HIT-0891518	11.07
BLADE	4617784	020001-	P-U-14	45 mm	95 mm		HIT-4622066	140.44
	4617784	020001-	Bushing	45 mm			HIT-0920515	12.81
BOOM (CAB ML)	4627539	020001-	P-U-10	50 mm	85 mm		HIT-4634033	104.57
	4627539	020001-	Bushing	50 mm			HIT-0948703	12.96
BOOM (CAB)	4690142	020001-	P-U-10	50 mm	85 mm		HIT-4634033	104.57
	4690142	020001-	Bushing	50 mm			HIT-0948703	12.96
BOOM (CANOPY ML)	4627538	020001-	P-U-10	50 mm	85 mm		HIT-4634033	104.57
	4627538	020001-	Bushing	50 mm			HIT-0948703	12.96
BOOM (CANOPY)	4690141	020001-	P-U-10	50 mm	85 mm		HIT-4634033	104.57
	4690141	020001-	Bushing	50 mm			HIT-0948703	12.96
BUCKET	4640335	020001-	P-U-10	40 mm	65 mm		HIT-4614058	123.26
	4640335	020001-	Bushing	40 mm			HIT-0892005	9.33
	4648844	020001-	P-U-10	40 mm	65 mm		HIT-4614058	123.26
	4648844	020001-	Bushing	40 mm			HIT-0892005	9.33
SWING	4608470	020001-	P-U-10	45 mm	85 mm		HIT-4614059	124.10
	4608470	020001-	Bushing	45 mm			HIT-0891605	11.07
MODEL ZX38U-3F								
ARM	4699449	020001-	P-U-10	45 mm	75 mm		HIT-4704455	62.42
	4699449	020001-	Bushing	45 mm			HIT-0891518	11.07
ARM (ML)	4702249	020001-	P-U-10	45 mm	75 mm		HIT-4704455	62.42
	4702249	020001-	Bushing	45 mm			HIT-0891518	11.07
BLADE	4617784	020001-	P-U-14	45 mm	95 mm		HIT-4622066	140.44
	4617784	020001-	Bushing	45 mm			HIT-0920515	12.81
BOOM (CAB ML)	4627539	020001-	P-U-10	50 mm	85 mm		HIT-4634033	104.57
	4627539	020001-	Bushing	50 mm			HIT-0948703	12.96
BOOM (CAB)	4690142	020001-	P-U-10	50 mm	85 mm		HIT-4634033	104.57
	4690142	020001-	Bushing	50 mm			HIT-0948703	12.96
BOOM (CANOPY ML)	4627538	020001-	P-U-10	50 mm	85 mm		HIT-4634033	104.57
	4627538	020001-	Bushing	50 mm			HIT-0948703	12.96
BOOM (CANOPY)	4690141	020001-	P-U-10	50 mm	85 mm		HIT-4634033	104.57
	4690141	020001-	Bushing	50 mm			HIT-0948703	12.96
BUCKET	4640335	020001-	P-U-10	40 mm	65 mm		HIT-4614058	123.26
	4640335	020001-	Bushing	40 mm			HIT-0892005	9.33
	4648844	020001-	P-U-10	40 mm	65 mm		HIT-4614058	123.26
	4648844	020001-	Bushing	40 mm			HIT-0892005	9.33
SWING	4608470	020001-	P-U-10	45 mm	85 mm		HIT-4614059	124.10
	4608470	020001-	Bushing	45 mm			HIT-0891605	11.07
MODEL ZX120, ZX120E, ZX130H, ZX130K, ZX130LCN								
ARM	4423852	060001-	P-UB-10	80 mm	115 mm	Mono Boom	HIT-4448396	201.08
	4423852	060001-	P-UB-10	80 mm	115 mm	Mono Boom	HIT-4448396-EX	275.43
	4423852	060001-	Bushing	80 mm		Mono Boom	HIT-0309304	31.26
	4423852	060001-	Wear Ring		115 mm	Mono Boom	HIT-0686405	10.89
	4423852	060001-	Wear Ring		115 mm	Mono Boom	HIT-0310908	40.55
	4438210	060001-	P-UB-10	80 mm	115 mm	Mono Boom	HIT-4448396	201.08
	4438210	060001-	P-UB-10	80 mm	115 mm	Mono Boom	HIT-4448396-EX	275.43
	4438210	060001-	Bushing	80 mm		Mono Boom	HIT-0309304	31.26
	4438210	060001-	Wear Ring		115 mm	Mono Boom	HIT-0686405	10.89
	4438210	060001-	Wear Ring		115 mm	Mono Boom	HIT-0310908	40.55
	4608256	060001-	P-UB-10	80 mm	115 mm	2P-Boom	HIT-4448396	201.08
	4608256	060001-	P-UB-10	80 mm	115 mm	2P-Boom	HIT-4448396-EX	275.43
	4608256	060001-	Bushing	80 mm		2P-Boom	HIT-0309304	31.26
	4608256	060001-	Wear Ring		115 mm	2P-Boom	HIT-0686405	10.89
	4608256	060001-	Wear Ring		115 mm	2P-Boom	HIT-0310908	40.55

Hercules Sealing Products and original equipment Hitachi kits may not include the necessary wear rings for your cylinder rebuild.
Kits with an -EX suffix will include these wear rings.

Please ask your sales representative for a cross-reference if no -EX kit or complementary parts are listed.

HITACHI

Replacement Kits For

Excavators								
APPLICATION	CYL #	SERIAL #	CODE	ROD	BORE	Misc	KIT #	List \$
MODEL ZX120, ZX120E, ZX130H, ZX130K, ZX130LCN								
ARM	4612138	060001-	P-UB-10	80 mm	115 mm	2P-Boom	HIT-4448396	201.08
	4612138	060001-	P-UB-10	80 mm	115 mm	2P-Boom	HIT-4448396-EX	275.43
	4612138	060001-	Bushing	80 mm		2P-Boom	HIT-0309304	31.26
	4612138	060001-	Wear Ring		115 mm	2P-Boom	HIT-0310908	40.55
	4612138	060001-	Wear Ring		115 mm	2P-Boom	HIT-0686405	10.89
BLADE LH	4432509	060001-	P-UB-10	70 mm	100 mm		HIT-4388027	333.03
BLADE RH	4432510	060001-	P-UB-10	70 mm	100 mm		HIT-4388027	333.03
BOOM LH	4428437	060001-	P-UB-10	70 mm	105 mm		HIT-4448395	166.66
	4428437	060001-	P-UB-10	70 mm	105 mm		HIT-4448395-EX	361.69
	4428437	060001-	Bushing	70 mm			HIT-0310304	24.51
	4428437	060001-	Wear Ring		105 mm		HIT-0310510	95.77
	4428437	060001-	Wear Ring		105 mm		HIT-0666808	34.46
	4438211	060001-	P-UB-10	70 mm	105 mm		HIT-4448395	166.66
	4438211	060001-	P-UB-10	70 mm	105 mm		HIT-4448395-EX	361.69
	4438211	060001-	Bushing	70 mm			HIT-0310304	24.51
	4438211	060001-	Wear Ring		105 mm		HIT-0666808	34.46
BOOM RH	4428436	060001-	P-UB-10	70 mm	105 mm		HIT-4448395	166.66
	4428436	060001-	P-UB-10	70 mm	105 mm		HIT-4448395-EX	361.69
	4428436	060001-	Bushing	70 mm			HIT-0310304	24.51
	4428436	060001-	Wear Ring		105 mm		HIT-0310510	95.77
	4428436	060001-	Wear Ring		105 mm		HIT-0666808	34.46
	4438212	060001-	P-UB-10	70 mm	105 mm		HIT-4448395	166.66
	4438212	060001-	P-UB-10	70 mm	105 mm		HIT-4448395-EX	361.69
	4438212	060001-	Bushing	70 mm			HIT-0310304	24.51
	4438212	060001-	Wear Ring		105 mm		HIT-0666808	34.46
BUCKET	4423853	060001-	P-UB-10	70 mm	100 mm		HIT-4448397	160.32
	4423853	060001-	P-UB-10	70 mm	100 mm		HIT-4448397-EX	282.31
	4423853	060001-	Bushing	70 mm			HIT-0310304	24.51
	4423853	060001-	Wear Ring		100 mm		HIT-0686707	15.37
	4423853	060001-	Wear Ring		100 mm		HIT-0254908	72.59
MODEL ZX120-3								
ARM	4678948	080001-	P-UB-10	80 mm	115 mm	MONO BOOM	HIT-4669905	111.63
	4678948	080001-	P-UB-10	80 mm	115 mm	MONO BOOM	HIT-4669905-EX	155.42
	4678948	080001-	Bushing	80 mm		MONO BOOM	HIT-0309304	31.26
	4678948	080001-	Wear Ring		115 mm	MONO BOOM	HIT-0310908	40.55
	4678948	080001-	Wear Ring		115 mm	MONO BOOM	HIT-1102304	10.89
	4682187	080001-	P-UB-10	80 mm	115 mm	2P-BOOM	HIT-4669905	111.63
	4682187	080001-	P-UB-10	80 mm	115 mm	2P-BOOM	HIT-4669905-EX	155.42
	4682187	080001-	Bushing	80 mm		2P-BOOM	HIT-0309304	31.26
	4682187	080001-	Wear Ring		115 mm	2P-BOOM	HIT-1102304	10.89
	4682187	080001-	Wear Ring		115 mm	2P-BOOM	HIT-0310908	40.55
	4682535	080001-	P-UB-10	80 mm	115 mm	MONO BOOM	HIT-4669905	111.63
	4682535	080001-	P-UB-10	80 mm	115 mm	MONO BOOM	HIT-4669905-EX	155.42
	4682535	080001-	Bushing	80 mm		MONO BOOM	HIT-0309304	31.26
	4682535	080001-	Wear Ring		115 mm	MONO BOOM	HIT-0310908	40.55
	4682535	080001-	Wear Ring		115 mm	MONO BOOM	HIT-1102304	10.89
	4682536	080001-	P-UB-10	80 mm	115 mm	2P-BOOM	HIT-4669905	111.63
	4682536	080001-	P-UB-10	80 mm	115 mm	2P-BOOM	HIT-4669905-EX	155.42
	4682536	080001-	Bushing	80 mm		2P-BOOM	HIT-0309304	31.26
	4682536	080001-	Wear Ring		115 mm	2P-BOOM	HIT-0310908	40.55
	4682536	080001-	Wear Ring		115 mm	2P-BOOM	HIT-1102304	10.89
	BLADE LH	4432509	080001-	P-UB-10	70 mm	100 mm		HIT-4388027
4432509		080001-	Bushing	70 mm			HIT-0643402	10.24

Hercules Sealing Products and original equipment Hitachi kits may not include the necessary wear rings for your cylinder rebuild.
Kits with an -EX suffix will include these wear rings.

Please ask your sales representative for a cross-reference if no -EX kit or complementary parts are listed.

Replacement Kits For

HITACHI

Excavators

APPLICATION	CYL #	SERIAL #	CODE	ROD	BORE	Misc	KIT #	List \$
MODEL ZX120-3								
BLADE RH	4432510	080001-	P-UB-10	70 mm	100 mm		HIT-4388027	333.03
	4432510	080001-	Bushing	70 mm			HIT-0643402	10.24
BOOM LH	4642007	080001-	P-UB-10	70 mm	105 mm		HIT-4662895	166.66
	4642007	080001-	P-UB-10	70 mm	105 mm		HIT-4662895-EX	361.69
	4642007	080001-	Bushing	70 mm			HIT-0310304	24.51
	4642007	080001-	Wear Ring		105 mm		HIT-0310510	95.77
	4642007	080001-	Wear Ring		105 mm		HIT-0907801	11.26
	4682801	080001-	P-UB-10	70 mm	105 mm		HIT-4662895	166.66
	4682801	080001-	P-UB-10	70 mm	105 mm		HIT-4662895-EX	361.69
	4682801	080001-	Bushing	70 mm			HIT-0310304	24.51
	4682801	080001-	Wear Ring		105 mm		HIT-0907801	11.26
	4682801	080001-	Wear Ring		105 mm		HIT-0310510	95.77
	4689663	080001-	P-UB-10	70 mm	105 mm	ML CRANE	HIT-4662895	166.66
	4689663	080001-	P-UB-10	70 mm	105 mm	ML CRANE	HIT-4662895-EX	361.69
	4689663	080001-	Bushing	70 mm		ML CRANE	HIT-0310304	24.51
	4689663	080001-	Wear Ring		105 mm	ML CRANE	HIT-0310510	95.77
	4689663	080001-	Wear Ring		105 mm	ML CRANE	HIT-0907801	11.26
BOOM RH	4642006	080001-	P-UB-10	70 mm	105 mm		HIT-4662895	166.66
	4642006	080001-	P-UB-10	70 mm	105 mm		HIT-4662895-EX	361.69
	4642006	080001-	Bushing	70 mm			HIT-0310304	24.51
	4642006	080001-	Wear Ring		105 mm		HIT-0907801	11.26
	4642006	080001-	Wear Ring		105 mm		HIT-0310510	95.77
	4682800	080001-	P-UB-10	70 mm	105 mm		HIT-4662895	166.66
	4682800	080001-	P-UB-10	70 mm	105 mm		HIT-4662895-EX	361.69
	4682800	080001-	Bushing	70 mm			HIT-0310304	24.51
	4682800	080001-	Wear Ring		105 mm		HIT-0310510	95.77
	4682800	080001-	Wear Ring		105 mm		HIT-0907801	11.26
BUCKET	4646526	080001-	P-UB-10	70 mm	100 mm		HIT-4663496	92.26
	4646526	080001-	P-UB-10	70 mm	100 mm		HIT-4663496-EX	175.80
	4646526	080001-	Bushing	70 mm			HIT-0310304	24.51
	4646526	080001-	Wear Ring		100 mm		HIT-0254908	72.59
	4646526	080001-	Wear Ring		100 mm		HIT-1137704	11.88
POSITIONING	4682188	080001-	P-UB-10	95 mm	140 mm		HIT-4649053	181.93
	4682188	080001-	P-UB-10	95 mm	140 mm		HIT-4649053-EX	280.04
	4682188	080001-	Bushing	95 mm			HIT-0309204	37.71
	4682188	080001-	Wear Ring		140 mm		HIT-0224108	51.51
	4682188	080001-	Wear Ring		140 mm		HIT-0960302	17.94
	4682537	080001-	P-UB-10	95 mm	140 mm		HIT-4649053	181.93
	4682537	080001-	P-UB-10	95 mm	140 mm		HIT-4649053-EX	280.04
	4682537	080001-	Bushing	95 mm			HIT-0309204	37.71
	4682537	080001-	Wear Ring		140 mm		HIT-0224108	51.51
4682537	080001-	Wear Ring		140 mm		HIT-0960302	17.94	
MODEL ZX130-3								
ARM	4678948	080001-	P-UB-10	80 mm	115 mm	MONO BOOM	HIT-4669905	111.63
	4678948	080001-	P-UB-10	80 mm	115 mm	MONO BOOM	HIT-4669905-EX	155.42
	4678948	080001-	Bushing	80 mm		MONO BOOM	HIT-0309304	31.26
	4678948	080001-	Wear Ring		115 mm	MONO BOOM	HIT-1102304	10.89
	4678948	080001-	Wear Ring		115 mm	MONO BOOM	HIT-0310908	40.55
	4682187	080001-	P-UB-10	80 mm	115 mm	2P-BOOM	HIT-4669905	111.63
	4682187	080001-	P-UB-10	80 mm	115 mm	2P-BOOM	HIT-4669905-EX	155.42
	4682187	080001-	Bushing	80 mm		2P-BOOM	HIT-0309304	31.26
	4682187	080001-	Wear Ring		115 mm	2P-BOOM	HIT-0310908	40.55
	4682187	080001-	Wear Ring		115 mm	2P-BOOM	HIT-1102304	10.89
	4682535	080001-	P-UB-10	80 mm	115 mm	MONO BOOM	HIT-4669905	111.63
	4682535	080001-	P-UB-10	80 mm	115 mm	MONO BOOM	HIT-4669905-EX	155.42

Hercules Sealing Products and original equipment Hitachi kits may not include the necessary wear rings for your cylinder rebuild.
Kits with an -EX suffix will include these wear rings.

Please ask your sales representative for a cross-reference if no -EX kit or complementary parts are listed.

Replacement Kits For

HITACHI

Excavators								
APPLICATION	CYL #	SERIAL #	CODE	ROD	BORE	Misc	KIT #	List \$
MODEL ZX130-3								
ARM	4682535	080001-	Bushing	80 mm		MONO BOOM	HIT-0309304	31.26
	4682535	080001-	Wear Ring		115 mm	MONO BOOM	HIT-0310908	40.55
	4682535	080001-	Wear Ring		115 mm	MONO BOOM	HIT-1102304	10.89
	4682536	080001-	P-UB-10	80 mm	115 mm	2P-BOOM	HIT-4669905	111.63
	4682536	080001-	P-UB-10	80 mm	115 mm	2P-BOOM	HIT-4669905-EX	155.42
	4682536	080001-	Bushing	80 mm		2P-BOOM	HIT-0309304	31.26
	4682536	080001-	Wear Ring		115 mm	2P-BOOM	HIT-1102304	10.89
	4682536	080001-	Wear Ring		115 mm	2P-BOOM	HIT-0310908	40.55
BLADE LH	4432509	080001-	P-UB-10	70 mm	100 mm		HIT-4388027	333.03
	4432509	080001-	Bushing	70 mm			HIT-0643402	10.24
BLADE RH	4432510	080001-	P-UB-10	70 mm	100 mm		HIT-4388027	333.03
	4432510	080001-	Bushing	70 mm			HIT-0643402	10.24
BOOM LH	4642007	080001-	P-UB-10	70 mm	105 mm		HIT-4662895	166.66
	4642007	080001-	P-UB-10	70 mm	105 mm		HIT-4662895-EX	361.69
	4642007	080001-	Bushing	70 mm			HIT-0310304	24.51
	4642007	080001-	Wear Ring		105 mm		HIT-0907801	11.26
	4642007	080001-	Wear Ring		105 mm		HIT-0310510	95.77
	4682801	080001-	P-UB-10	70 mm	105 mm		HIT-4662895	166.66
	4682801	080001-	P-UB-10	70 mm	105 mm		HIT-4662895-EX	361.69
	4682801	080001-	Bushing	70 mm			HIT-0310304	24.51
	4682801	080001-	Wear Ring		105 mm		HIT-0310510	95.77
	4682801	080001-	Wear Ring		105 mm		HIT-0907801	11.26
	4689663	080001-	P-UB-10	70 mm	105 mm	ML CRANE	HIT-4662895	166.66
	4689663	080001-	P-UB-10	70 mm	105 mm	ML CRANE	HIT-4662895-EX	361.69
	4689663	080001-	Bushing	70 mm		ML CRANE	HIT-0310304	24.51
	4689663	080001-	Wear Ring		105 mm	ML CRANE	HIT-0310510	95.77
	4689663	080001-	Wear Ring		105 mm	ML CRANE	HIT-0907801	11.26
BOOM RH	4642006	080001-	P-UB-10	70 mm	105 mm		HIT-4662895	166.66
	4642006	080001-	P-UB-10	70 mm	105 mm		HIT-4662895-EX	361.69
	4642006	080001-	Bushing	70 mm			HIT-0310304	24.51
	4642006	080001-	Wear Ring		105 mm		HIT-0907801	11.26
	4642006	080001-	Wear Ring		105 mm		HIT-0310510	95.77
	4682800	080001-	P-UB-10	70 mm	105 mm		HIT-4662895	166.66
	4682800	080001-	P-UB-10	70 mm	105 mm		HIT-4662895-EX	361.69
	4682800	080001-	Bushing	70 mm			HIT-0310304	24.51
	4682800	080001-	Wear Ring		105 mm		HIT-0310510	95.77
	4682800	080001-	Wear Ring		105 mm		HIT-0907801	11.26
BUCKET	4646526	080001-	P-UB-10	70 mm	100 mm		HIT-4663496	92.26
	4646526	080001-	P-UB-10	70 mm	100 mm		HIT-4663496-EX	175.80
	4646526	080001-	Bushing	70 mm			HIT-0310304	24.51
	4646526	080001-	Wear Ring		100 mm		HIT-1137704	11.88
	4646526	080001-	Wear Ring		100 mm		HIT-0254908	72.59
POSITIONING	4682188	080001-	P-UB-10	95 mm	140 mm		HIT-4649053	181.93
	4682188	080001-	P-UB-10	95 mm	140 mm		HIT-4649053-EX	280.04
	4682188	080001-	Bushing	95 mm			HIT-0309204	37.71
	4682188	080001-	Wear Ring		140 mm		HIT-0224108	51.51
	4682188	080001-	Wear Ring		140 mm		HIT-0960302	17.94
	4682537	080001-	P-UB-10	95 mm	140 mm		HIT-4649053	181.93
	4682537	080001-	P-UB-10	95 mm	140 mm		HIT-4649053-EX	280.04
	4682537	080001-	Bushing	95 mm			HIT-0309204	37.71
	4682537	080001-	Wear Ring		140 mm		HIT-0224108	51.51
	4682537	080001-	Wear Ring		140 mm		HIT-0960302	17.94
	MODEL ZX130K-3							
ARM	4678948	080001-	P-UB-10	80 mm	115 mm	MONO BOOM	HIT-4669905	111.63
	4678948	080001-	P-UB-10	80 mm	115 mm	MONO BOOM	HIT-4669905-EX	155.42

Hercules Sealing Products and original equipment Hitachi kits may not include the necessary wear rings for your cylinder rebuild.
Kits with an -EX suffix will include these wear rings.

Please ask your sales representative for a cross-reference if no -EX kit or complementary parts are listed.

Replacement Kits For

HITACHI

Excavators

NEW

APPLICATION	CYL #	SERIAL #	CODE	ROD	BORE	Misc	KIT #	List \$
MODEL ZX130K-3								
ARM	4678948	080001-	Bushing	80 mm		MONO BOOM	HIT-0309304	31.26
	4678948	080001-	Wear Ring		115 mm	MONO BOOM	HIT-1102304	10.89
	4678948	080001-	Wear Ring		115 mm	MONO BOOM	HIT-0310908	40.55
	4682187	080001-	P-UB-10	80 mm	115 mm	2P-BOOM	HIT-4669905	111.63
	4682187	080001-	P-UB-10	80 mm	115 mm	2P-BOOM	HIT-4669905-EX	155.42
	4682187	080001-	Bushing	80 mm		2P-BOOM	HIT-0309304	31.26
	4682187	080001-	Wear Ring		115 mm	2P-BOOM	HIT-0310908	40.55
	4682187	080001-	Wear Ring		115 mm	2P-BOOM	HIT-1102304	10.89
	4682535	080001-	P-UB-10	80 mm	115 mm	MONO BOOM	HIT-4669905	111.63
	4682535	080001-	P-UB-10	80 mm	115 mm	MONO BOOM	HIT-4669905-EX	155.42
	4682535	080001-	Bushing	80 mm		MONO BOOM	HIT-0309304	31.26
	4682535	080001-	Wear Ring		115 mm	MONO BOOM	HIT-0310908	40.55
	4682535	080001-	Wear Ring		115 mm	MONO BOOM	HIT-1102304	10.89
	4682536	080001-	P-UB-10	80 mm	115 mm	2P-BOOM	HIT-4669905	111.63
	4682536	080001-	P-UB-10	80 mm	115 mm	2P-BOOM	HIT-4669905-EX	155.42
	BLADE LH	4432509	080001-	P-UB-10	70 mm	100 mm		HIT-4388027
4432509		080001-	Bushing	70 mm			HIT-0643402	10.24
BLADE RH	4432510	080001-	P-UB-10	70 mm	100 mm		HIT-4388027	333.03
	4432510	080001-	Bushing	70 mm			HIT-0643402	10.24
BOOM LH	4642007	080001-	P-UB-10	70 mm	105 mm		HIT-4662895	166.66
	4642007	080001-	P-UB-10	70 mm	105 mm		HIT-4662895-EX	361.69
	4642007	080001-	Bushing	70 mm			HIT-0310304	24.51
	4642007	080001-	Wear Ring		105 mm		HIT-0310510	95.77
	4642007	080001-	Wear Ring		105 mm		HIT-0907801	11.26
	4682801	080001-	P-UB-10	70 mm	105 mm		HIT-4662895	166.66
	4682801	080001-	P-UB-10	70 mm	105 mm		HIT-4662895-EX	361.69
	4682801	080001-	Bushing	70 mm			HIT-0310304	24.51
	4682801	080001-	Wear Ring		105 mm		HIT-0310510	95.77
	4682801	080001-	Wear Ring		105 mm		HIT-0907801	11.26
	4689663	080001-	P-UB-10	70 mm	105 mm	ML CRANE	HIT-4662895	166.66
	4689663	080001-	P-UB-10	70 mm	105 mm	ML CRANE	HIT-4662895-EX	361.69
	4689663	080001-	Bushing	70 mm		ML CRANE	HIT-0310304	24.51
	4689663	080001-	Wear Ring		105 mm	ML CRANE	HIT-0310510	95.77
	4689663	080001-	Wear Ring		105 mm	ML CRANE	HIT-0907801	11.26
	BOOM RH	4642006	080001-	P-UB-10	70 mm	105 mm		HIT-4662895
4642006		080001-	P-UB-10	70 mm	105 mm		HIT-4662895-EX	361.69
4642006		080001-	Bushing	70 mm			HIT-0310304	24.51
4642006		080001-	Wear Ring		105 mm		HIT-0310510	95.77
4642006		080001-	Wear Ring		105 mm		HIT-0907801	11.26
4682800		080001-	P-UB-10	70 mm	105 mm		HIT-4662895	166.66
4682800		080001-	P-UB-10	70 mm	105 mm		HIT-4662895-EX	361.69
4682800		080001-	Bushing	70 mm			HIT-0310304	24.51
4682800		080001-	Wear Ring		105 mm		HIT-0310510	95.77
4682800		080001-	Wear Ring		105 mm		HIT-0907801	11.26
BUCKET	4646526	080001-	P-UB-10	70 mm	100 mm		HIT-4663496	92.26
	4646526	080001-	P-UB-10	70 mm	100 mm		HIT-4663496-EX	175.80
	4646526	080001-	Bushing	70 mm			HIT-0310304	24.51
	4646526	080001-	Wear Ring		100 mm		HIT-0254908	72.59
	4646526	080001-	Wear Ring		100 mm		HIT-1137704	11.88
POSITIONING	4682188	080001-	P-UB-10	95 mm	140 mm		HIT-4649053	181.93
	4682188	080001-	P-UB-10	95 mm	140 mm		HIT-4649053-EX	280.04
	4682188	080001-	Bushing	95 mm			HIT-0309204	37.71

Hercules Sealing Products and original equipment Hitachi kits may not include the necessary wear rings for your cylinder rebuild.
Kits with an -EX suffix will include these wear rings.

Please ask your sales representative for a cross-reference if no -EX kit or complementary parts are listed.

HITACHI

Replacement Kits For

Excavators								
APPLICATION	CYL #	SERIAL #	CODE	ROD	BORE	Misc	KIT #	List \$
MODEL ZX130K-3								
POSITIONING	4682188	080001-	Wear Ring		140 mm		HIT-0224108	51.51
	4682188	080001-	Wear Ring		140 mm		HIT-0960302	17.94
	4682537	080001-	P-UB-10	95 mm	140 mm		HIT-4649053	181.93
	4682537	080001-	P-UB-10	95 mm	140 mm		HIT-4649053-EX	280.04
	4682537	080001-	Bushing	95 mm			HIT-0309204	37.71
	4682537	080001-	Wear Ring		140 mm		HIT-0224108	51.51
	4682537	080001-	Wear Ring		140 mm		HIT-0960302	17.94
MODEL ZX130LCN-3								
ARM	4678948	080001-	P-UB-10	80 mm	115 mm	MONO BOOM	HIT-4669905	111.63
	4678948	080001-	P-UB-10	80 mm	115 mm	MONO BOOM	HIT-4669905-EX	155.42
	4678948	080001-	Bushing	80 mm		MONO BOOM	HIT-0309304	31.26
	4678948	080001-	Wear Ring		115 mm	MONO BOOM	HIT-0310908	40.55
	4678948	080001-	Wear Ring		115 mm	MONO BOOM	HIT-1102304	10.89
	4682187	080001-	P-UB-10	80 mm	115 mm	2P-BOOM	HIT-4669905	111.63
	4682187	080001-	P-UB-10	80 mm	115 mm	2P-BOOM	HIT-4669905-EX	155.42
	4682187	080001-	Bushing	80 mm		2P-BOOM	HIT-0309304	31.26
	4682187	080001-	Wear Ring		115 mm	2P-BOOM	HIT-0310908	40.55
	4682187	080001-	Wear Ring		115 mm	2P-BOOM	HIT-1102304	10.89
	4682535	080001-	P-UB-10	80 mm	115 mm	MONO BOOM	HIT-4669905	111.63
	4682535	080001-	P-UB-10	80 mm	115 mm	MONO BOOM	HIT-4669905-EX	155.42
	4682535	080001-	Bushing	80 mm		MONO BOOM	HIT-0309304	31.26
	4682535	080001-	Wear Ring		115 mm	MONO BOOM	HIT-0310908	40.55
	4682535	080001-	Wear Ring		115 mm	MONO BOOM	HIT-1102304	10.89
	4682536	080001-	P-UB-10	80 mm	115 mm	2P-BOOM	HIT-4669905	111.63
	4682536	080001-	P-UB-10	80 mm	115 mm	2P-BOOM	HIT-4669905-EX	155.42
	4682536	080001-	Bushing	80 mm		2P-BOOM	HIT-0309304	31.26
	4682536	080001-	Wear Ring		115 mm	2P-BOOM	HIT-0310908	40.55
	4682536	080001-	Wear Ring		115 mm	2P-BOOM	HIT-1102304	10.89
BLADE LH	4432509	080001-	P-UB-10	70 mm	100 mm		HIT-4388027	333.03
	4432509	080001-	Bushing	70 mm			HIT-0643402	10.24
BLADE RH	4432510	080001-	P-UB-10	70 mm	100 mm		HIT-4388027	333.03
	4432510	080001-	Bushing	70 mm			HIT-0643402	10.24
BOOM LH	4642007	080001-	P-UB-10	70 mm	105 mm		HIT-4662895	166.66
	4642007	080001-	P-UB-10	70 mm	105 mm		HIT-4662895-EX	361.69
	4642007	080001-	Bushing	70 mm			HIT-0310304	24.51
	4642007	080001-	Wear Ring		105 mm		HIT-0310510	95.77
	4642007	080001-	Wear Ring		105 mm		HIT-0907801	11.26
	4682801	080001-	P-UB-10	70 mm	105 mm		HIT-4662895	166.66
	4682801	080001-	P-UB-10	70 mm	105 mm		HIT-4662895-EX	361.69
	4682801	080001-	Bushing	70 mm			HIT-0310304	24.51
	4682801	080001-	Wear Ring		105 mm		HIT-0310510	95.77
	4682801	080001-	Wear Ring		105 mm		HIT-0907801	11.26
	4689663	080001-	P-UB-10	70 mm	105 mm	ML CRANE	HIT-4662895	166.66
	4689663	080001-	P-UB-10	70 mm	105 mm	ML CRANE	HIT-4662895-EX	361.69
	4689663	080001-	Bushing	70 mm		ML CRANE	HIT-0310304	24.51
	4689663	080001-	Wear Ring		105 mm	ML CRANE	HIT-0310510	95.77
4689663	080001-	Wear Ring		105 mm	ML CRANE	HIT-0907801	11.26	
BOOM RH	4642006	080001-	P-UB-10	70 mm	105 mm		HIT-4662895	166.66
	4642006	080001-	P-UB-10	70 mm	105 mm		HIT-4662895-EX	361.69
	4642006	080001-	Bushing	70 mm			HIT-0310304	24.51
	4642006	080001-	Wear Ring		105 mm		HIT-0310510	95.77
	4642006	080001-	Wear Ring		105 mm		HIT-0907801	11.26
	4682800	080001-	P-UB-10	70 mm	105 mm		HIT-4662895	166.66
	4682800	080001-	P-UB-10	70 mm	105 mm		HIT-4662895-EX	361.69
	4682800	080001-	Bushing	70 mm			HIT-0310304	24.51

Hercules Sealing Products and original equipment Hitachi kits may not include the necessary wear rings for your cylinder rebuild.
Kits with an -EX suffix will include these wear rings.

Please ask your sales representative for a cross-reference if no -EX kit or complementary parts are listed.

Replacement Kits For

HITACHI

NEW

Excavators								
APPLICATION	CYL #	SERIAL #	CODE	ROD	BORE	Misc	KIT #	List \$
MODEL ZX130LCN-3								
BOOM RH	4682800	080001-	Wear Ring		105 mm		HIT-0310510	95.77
	4682800	080001-	Wear Ring		105 mm		HIT-0907801	11.26
BUCKET	4646526	080001-	P-UB-10	70 mm	100 mm		HIT-4663496	92.26
	4646526	080001-	P-UB-10	70 mm	100 mm		HIT-4663496-EX	175.80
	4646526	080001-	Bushing	70 mm			HIT-0310304	24.51
	4646526	080001-	Wear Ring		100 mm		HIT-0254908	72.59
	4646526	080001-	Wear Ring		100 mm		HIT-1137704	11.88
POSITIONING	4682188	080001-	P-UB-10	95 mm	140 mm		HIT-4649053	181.93
	4682188	080001-	P-UB-10	95 mm	140 mm		HIT-4649053-EX	280.04
	4682188	080001-	Bushing	95 mm			HIT-0309204	37.71
	4682188	080001-	Wear Ring		140 mm		HIT-0960302	17.94
	4682188	080001-	Wear Ring		140 mm		HIT-0224108	51.51
	4682537	080001-	P-UB-10	95 mm	140 mm		HIT-4649053	181.93
	4682537	080001-	P-UB-10	95 mm	140 mm		HIT-4649053-EX	280.04
	4682537	080001-	Bushing	95 mm			HIT-0309204	37.71
	4682537	080001-	Wear Ring		140 mm		HIT-0224108	51.51
4682537	080001-	Wear Ring		140 mm		HIT-0960302	17.94	
MODEL ZX135US-3								
ARM	4678948	080001-	P-UB-10	80 mm	115 mm		HIT-4669905	111.63
	4678948	080001-	P-UB-10	80 mm	115 mm		HIT-4669905-EX	155.42
	4678948	080001-	Wear Ring		115 mm		HIT-1102304	10.89
	4682535	080001-	P-UB-10	80 mm	115 mm	With Hose Rupture Valve	HIT-4669905	111.63
	4682535	080001-	P-UB-10	80 mm	115 mm	With Hose Rupture Valve	HIT-4669905-EX	155.42
	4682535	080001-	Wear Ring		115 mm	With Hose Rupture Valve	HIT-1102304	10.89
	4683743	080001-	Wear Ring		115 mm		HIT-1102304	10.89
	4683743	080001-	Wear Ring		115 mm		HIT-0310908	40.55
	4683811	080001-	Wear Ring		115 mm		HIT-0310908	40.55
	4683811	080001-	Wear Ring		115 mm		HIT-1102304	10.89
BLADE RH	4432509	080001-	P-UB-10	70 mm	100 mm		HIT-4388027	333.03
	4432510	080001-	P-UB-10	70 mm	100 mm		HIT-4388027	333.03
BOOM LH	4647563	080001-	P-UB-10	70 mm	105 mm		HIT-4662895	166.66
	4647563	080001-	P-UB-10	70 mm	105 mm		HIT-4662895-EX	361.69
	4647563	080001-	Wear Ring		105 mm		HIT-0310510	95.77
	4647563	080001-	Wear Ring		105 mm		HIT-0907801	11.26
	4683742	080001-	P-UB-10	70 mm	105 mm		HIT-4662895	166.66
	4683742	080001-	P-UB-10	70 mm	105 mm		HIT-4662895-EX	361.69
	4683742	080001-	Wear Ring		105 mm		HIT-0907801	11.26
	4683742	080001-	Wear Ring		105 mm		HIT-0310510	95.77
	4683744	080001-	P-UB-10	70 mm	105 mm		HIT-4662895	166.66
	4683744	080001-	P-UB-10	70 mm	105 mm		HIT-4662895-EX	361.69
	4683744	080001-	Wear Ring		105 mm		HIT-0310510	95.77
	4683744	080001-	Wear Ring		105 mm		HIT-0907801	11.26
	4683791	080001-	P-UB-10	70 mm	105 mm		HIT-4662895	166.66
	4683791	080001-	P-UB-10	70 mm	105 mm		HIT-4662895-EX	361.69
	4683791	080001-	Wear Ring		105 mm		HIT-0310510	95.77
	4683791	080001-	Wear Ring		105 mm		HIT-0907801	11.26
	4689665	080001-	P-UB-10	70 mm	105 mm		HIT-4662895	166.66
4689665	080001-	P-UB-10	70 mm	105 mm		HIT-4662895-EX	361.69	
4689665	080001-	Wear Ring		105 mm		HIT-0310510	95.77	
4689665	080001-	Wear Ring		105 mm		HIT-0907801	11.26	
BOOM RH	4647564	080001-	P-UB-10	70 mm	105 mm		HIT-4662895	166.66
	4647564	080001-	P-UB-10	70 mm	105 mm		HIT-4662895-EX	361.69
	4647564	080001-	Wear Ring		105 mm		HIT-0310510	95.77

Hercules Sealing Products and original equipment Hitachi kits may not include the necessary wear rings for your cylinder rebuild.
Kits with an -EX suffix will include these wear rings.

Please ask your sales representative for a cross-reference if no -EX kit or complementary parts are listed.

HITACHI

Replacement Kits For

Excavators								
APPLICATION	CYL #	SERIAL #	CODE	ROD	BORE	Misc	KIT #	List \$
MODEL ZX135US-3								
BOOM RH	4647564	080001-	Wear Ring		105 mm		HIT-0907801	11.26
	4683741	080001-	P-UB-10	70 mm	105 mm		HIT-4662895	166.66
	4683741	080001-	P-UB-10	70 mm	105 mm		HIT-4662895-EX	361.69
	4683741	080001-	Wear Ring		105 mm		HIT-0907801	11.26
	4683741	080001-	Wear Ring		105 mm		HIT-0310510	95.77
	4683745	080001-	P-UB-10	70 mm	105 mm		HIT-4662895	166.66
	4683745	080001-	P-UB-10	70 mm	105 mm		HIT-4662895-EX	361.69
	4683745	080001-	Wear Ring		105 mm		HIT-0310510	95.77
	4683745	080001-	Wear Ring		105 mm		HIT-0907801	11.26
	4683792	080001-	P-UB-10	70 mm	105 mm		HIT-4662895	166.66
	4683792	080001-	P-UB-10	70 mm	105 mm		HIT-4662895-EX	361.69
	4683792	080001-	Wear Ring		105 mm		HIT-0310510	95.77
	4683792	080001-	Wear Ring		105 mm		HIT-0907801	11.26
BUCKET	4646526	080001-	P-UB-10	70 mm	100 mm		HIT-4663496	92.26
	4646526	080001-	P-UB-10	70 mm	100 mm		HIT-4663496-EX	175.80
	4646526	080001-	Wear Ring		100 mm		HIT-1137704	11.88
	4646526	080001-	Wear Ring		100 mm		HIT-0254908	72.59
	4683746	080001-	P-UB-10	65 mm	95 mm	Offset Boom	HIT-4662894	79.97
	4683746	080001-	P-UB-10	65 mm	95 mm	Offset Boom	HIT-4662894-EX	150.49
	4683746	080001-	Wear Ring		95 mm	Offset Boom	HIT-0310610	37.81
	4683746	080001-	Wear Ring		95 mm	Offset Boom	HIT-1183502	14.84
MODEL ZX135US-5								
ARM	9323697	100001-	P-UB-10	70 mm	100 mm		HIT-FYA00012900	177.73
BLADE LH	9187647	100001-	P-UB-10	70 mm	100 mm		HIT-4388027	333.03
	9187647	100001-	Bushing	70 mm			HIT-0643402	10.24
BLADE RH	9187648	100001-	P-UB-10	70 mm	100 mm		HIT-4388027	333.03
	9187648	100001-	Bushing	70 mm			HIT-0643402	10.24
BOOM LH	9323700	100001-	P-UB-10	70 mm	105 mm		HIT-FYA00012899	194.26
	9323700	100001-	Bushing	70 mm			HIT-FXB00002262	10.24
BOOM RH	9323699	100001-	P-UB-10	70 mm	105 mm		HIT-FYA00012899	194.26
	9323699	100001-	Bushing	70 mm			HIT-FXB00002262	10.24
BUCKET	9323698	100001-	P-UB-10	80 mm	115 mm		HIT-FYA00012901	226.08
MODEL ZX135USK-3								
ARM	4678948	080001-	P-UB-10	80 mm	115 mm		HIT-4669905	111.63
	4678948	080001-	P-UB-10	80 mm	115 mm		HIT-4669905-EX	155.42
	4678948	080001-	Wear Ring		115 mm		HIT-1102304	10.89
	4682535	080001-	P-UB-10	80 mm	115 mm	With Hose Rupture Valve	HIT-4669905	111.63
	4682535	080001-	P-UB-10	80 mm	115 mm	With Hose Rupture Valve	HIT-4669905-EX	155.42
	4682535	080001-	Wear Ring		115 mm	With Hose Rupture Valve	HIT-1102304	10.89
	4683743	080001-	Wear Ring		115 mm		HIT-1102304	10.89
	4683743	080001-	Wear Ring		115 mm		HIT-0310908	40.55
	4683811	080001-	Wear Ring		115 mm		HIT-1102304	10.89
	4683811	080001-	Wear Ring		115 mm		HIT-0310908	40.55
	BLADE RH	4432509	080001-	P-UB-10	70 mm	100 mm		HIT-4388027
4432510		080001-	P-UB-10	70 mm	100 mm		HIT-4388027	333.03
BOOM LH	4647563	080001-	P-UB-10	70 mm	105 mm		HIT-4662895	166.66
	4647563	080001-	P-UB-10	70 mm	105 mm		HIT-4662895-EX	361.69
	4647563	080001-	Wear Ring		105 mm		HIT-0907801	11.26
	4647563	080001-	Wear Ring		105 mm		HIT-0310510	95.77
	4683742	080001-	P-UB-10	70 mm	105 mm		HIT-4662895	166.66
	4683742	080001-	P-UB-10	70 mm	105 mm		HIT-4662895-EX	361.69
	4683742	080001-	Wear Ring		105 mm		HIT-0310510	95.77
	4683742	080001-	Wear Ring		105 mm		HIT-0907801	11.26

Hercules Sealing Products and original equipment Hitachi kits may not include the necessary wear rings for your cylinder rebuild. Kits with an -EX suffix will include these wear rings.

Please ask your sales representative for a cross-reference if no -EX kit or complementary parts are listed.

Replacement Kits For

HITACHI

Excavators									
APPLICATION	CYL #	SERIAL #	CODE	ROD	BORE	Misc	KIT #	List \$	
MODEL ZX135USK-3									
BOOM LH	4683744	080001-	P-UB-10	70 mm	105 mm		HIT-4662895	166.66	
	4683744	080001-	P-UB-10	70 mm	105 mm		HIT-4662895-EX	361.69	
	4683744	080001-	Wear Ring		105 mm		HIT-0907801	11.26	
	4683744	080001-	Wear Ring		105 mm		HIT-0310510	95.77	
	4683791	080001-	P-UB-10	70 mm	105 mm		HIT-4662895	166.66	
	4683791	080001-	P-UB-10	70 mm	105 mm		HIT-4662895-EX	361.69	
	4683791	080001-	Wear Ring		105 mm		HIT-0907801	11.26	
	4683791	080001-	Wear Ring		105 mm		HIT-0310510	95.77	
	4689665	080001-	P-UB-10	70 mm	105 mm		HIT-4662895	166.66	
	4689665	080001-	P-UB-10	70 mm	105 mm		HIT-4662895-EX	361.69	
	4689665	080001-	Wear Ring		105 mm		HIT-0907801	11.26	
	4689665	080001-	Wear Ring		105 mm		HIT-0310510	95.77	
	BOOM RH	4647564	080001-	P-UB-10	70 mm	105 mm		HIT-4662895	166.66
		4647564	080001-	P-UB-10	70 mm	105 mm		HIT-4662895-EX	361.69
		4647564	080001-	Wear Ring		105 mm		HIT-0310510	95.77
		4647564	080001-	Wear Ring		105 mm		HIT-0907801	11.26
4683741		080001-	P-UB-10	70 mm	105 mm		HIT-4662895	166.66	
4683741		080001-	P-UB-10	70 mm	105 mm		HIT-4662895-EX	361.69	
4683741		080001-	Wear Ring		105 mm		HIT-0907801	11.26	
4683741		080001-	Wear Ring		105 mm		HIT-0310510	95.77	
4683745		080001-	P-UB-10	70 mm	105 mm		HIT-4662895	166.66	
4683745		080001-	P-UB-10	70 mm	105 mm		HIT-4662895-EX	361.69	
4683745		080001-	Wear Ring		105 mm		HIT-0310510	95.77	
4683745		080001-	Wear Ring		105 mm		HIT-0907801	11.26	
4683792		080001-	P-UB-10	70 mm	105 mm		HIT-4662895	166.66	
4683792		080001-	P-UB-10	70 mm	105 mm		HIT-4662895-EX	361.69	
4683792		080001-	Wear Ring		105 mm		HIT-0310510	95.77	
BUCKET		4646526	080001-	P-UB-10	70 mm	100 mm		HIT-4663496	92.26
	4646526	080001-	P-UB-10	70 mm	100 mm		HIT-4663496-EX	175.80	
	4646526	080001-	Wear Ring		100 mm		HIT-1137704	11.88	
	4646526	080001-	Wear Ring		100 mm		HIT-0254908	72.59	
	4683746	080001-	P-UB-10	65 mm	95 mm	Offset Boom	HIT-4662894	79.97	
	4683746	080001-	P-UB-10	65 mm	95 mm	Offset Boom	HIT-4662894-EX	150.49	
	4683746	080001-	Wear Ring		95 mm	Offset Boom	HIT-0310610	37.81	
	4683746	080001-	Wear Ring		95 mm	Offset Boom	HIT-1183502	14.84	
MODEL ZX160LC									
ARM	4448533	005001-	P-UB-10	90 mm	120 mm	Mono Boom	HIT-4467380	237.87	
	4448533	005001-	Bushing	90 mm		Mono Boom	HIT-0325904	33.48	
	4448533	005001-	Wear Ring		120 mm	Mono Boom	HIT-0261308	47.08	
	4448533	005001-	Wear Ring		120 mm	Mono Boom	HIT-0667206	11.73	
	4458882	005001-	P-UB-10	90 mm	120 mm	Mono Boom	HIT-4467380	237.87	
	4458882	005001-	Bushing	90 mm		Mono Boom	HIT-0325904	33.48	
	4458882	005001-	Wear Ring		120 mm	Mono Boom	HIT-0667206	11.73	
	4458882	005001-	Wear Ring		120 mm	Mono Boom	HIT-0261308	47.08	
	4474565	005001-	P-UB-10	90 mm	120 mm	2P-Boom	HIT-4467380	237.87	
	4474565	005001-	Bushing	90 mm		2P-Boom	HIT-0325904	33.48	
	4474565	005001-	Wear Ring		120 mm	2P-Boom	HIT-0667206	11.73	
	4474565	005001-	Wear Ring		120 mm	2P-Boom	HIT-0261308	47.08	
	4485923	005001-	P-UB-10	90 mm	120 mm	2P-Boom	HIT-4467380	237.87	
	4485923	005001-	Bushing	90 mm		2P-Boom	HIT-0325904	33.48	
	4485923	005001-	Wear Ring		120 mm	2P-Boom	HIT-0667206	11.73	
	4485923	005001-	Wear Ring		120 mm	2P-Boom	HIT-0261308	47.08	
BOOM LH	4448532	005001-	P-UB-10	80 mm	110 mm		HIT-4467379	219.60	
	4448532	005001-	Bushing	80 mm			HIT-0309304	31.26	

Hercules Sealing Products and original equipment Hitachi kits may not include the necessary wear rings for your cylinder rebuild. Kits with an -EX suffix will include these wear rings.

Please ask your sales representative for a cross-reference if no -EX kit or complementary parts are listed.

HITACHI

Replacement Kits For

Excavators								
APPLICATION	CYL #	SERIAL #	CODE	ROD	BORE	Misc	KIT #	List \$
MODEL ZX160LC								
BOOM LH	4448532	005001-	Wear Ring		110 mm		HIT-0298907	79.26
	4448532	005001-	Wear Ring		110 mm		HIT-0667008	10.89
	4458884	005001-	P-UB-10	80 mm	110 mm	Mono Boom	HIT-4467379	219.60
	4458884	005001-	Bushing	80 mm		Mono Boom	HIT-0309304	31.26
	4458884	005001-	Wear Ring		110 mm	Mono Boom	HIT-0298907	79.26
	4458884	005001-	Wear Ring		110 mm	Mono Boom	HIT-0667008	10.89
	4607550	005001-	P-UB-10	80 mm	110 mm	2P-Boom	HIT-4467379	219.60
	4607550	005001-	Bushing	80 mm		2P-Boom	HIT-0309304	31.26
	4607550	005001-	Wear Ring		110 mm	2P-Boom	HIT-0667008	10.89
	4607550	005001-	Wear Ring		110 mm	2P-Boom	HIT-0298907	79.26
BOOM RH	4448531	005001-	P-UB-10	80 mm	110 mm		HIT-4467379	219.60
	4448531	005001-	Bushing	80 mm			HIT-0309304	31.26
	4448531	005001-	Wear Ring		110 mm		HIT-0298907	79.26
	4448531	005001-	Wear Ring		110 mm		HIT-0667008	10.89
	4458883	005001-	P-UB-10	80 mm	110 mm	Mono Boom	HIT-4467379	219.60
	4458883	005001-	Bushing	80 mm		Mono Boom	HIT-0309304	31.26
	4458883	005001-	Wear Ring		110 mm	Mono Boom	HIT-0667008	10.89
	4458883	005001-	Wear Ring		110 mm	Mono Boom	HIT-0298907	79.26
	4607549	005001-	P-UB-10	80 mm	110 mm	2P-Boom	HIT-4467379	219.60
	4607549	005001-	Bushing	80 mm		2P-Boom	HIT-0309304	31.26
BUCKET	4607549	005001-	Wear Ring		110 mm	2P-Boom	HIT-0298907	79.26
	4448534	005001-	P-UB-10	75 mm	105 mm		HIT-4467381	163.74
	4448534	005001-	Bushing	75 mm			HIT-0310504	27.12
4448534	005001-	Wear Ring		105 mm		HIT-0310510	95.77	
MODEL ZX160LC-3								
ARM	4645315	010001-	P-UB-10	90 mm	120 mm		HIT-4662888	237.87
	4645315	010001-	P-UB-10	90 mm	120 mm		HIT-4662888-EX	282.93
	4645315	010001-	Wear Ring		120 mm		HIT-0998904	47.08
	4645315	010001-	Wear Ring		120 mm		HIT-0261308	47.08
	4653229	010001-	P-UB-10	90 mm	120 mm	2P-Boom	HIT-4662888	237.87
	4653229	010001-	P-UB-10	90 mm	120 mm	2P-Boom	HIT-4662888-EX	282.93
	4653229	010001-	Wear Ring		120 mm	2P-Boom	HIT-0998904	47.08
	4653229	010001-	Wear Ring		120 mm	2P-Boom	HIT-0261308	47.08
	4661832	010001-	P-UB-10	90 mm	120 mm	With Hose Rupture Valve	HIT-4662888	237.87
	4661832	010001-	P-UB-10	90 mm	120 mm	With Hose Rupture Valve	HIT-4662888-EX	282.93
	4661832	010001-	Wear Ring		120 mm	With Hose Rupture Valve	HIT-0261308	47.08
	4661832	010001-	Wear Ring		120 mm	With Hose Rupture Valve	HIT-0998904	47.08
	4663379	010001-	P-UB-10	90 mm	120 mm	2P-Boom w/ Hose Rupture Valve	HIT-4662888	237.87
	4663379	010001-	P-UB-10	90 mm	120 mm	2P-Boom w/ Hose Rupture Valve	HIT-4662888-EX	282.93
	4663379	010001-	Wear Ring		120 mm	2P-Boom w/ Hose Rupture Valve	HIT-0261308	47.08
	4663379	010001-	Wear Ring		120 mm	2P-Boom w/ Hose Rupture Valve	HIT-0998904	47.08
BOOM LH	4645314	010001-		80 mm	110 mm		HIT-4662891	201.87
	4645314	010001-		80 mm	110 mm		HIT-4662891-EX	264.19
	4645314	010001-	Wear Ring		110 mm		HIT-0298907	79.26
	4645314	010001-	Wear Ring		110 mm		HIT-1119106	10.89

Hercules Sealing Products and original equipment Hitachi kits may not include the necessary wear rings for your cylinder rebuild. Kits with an -EX suffix will include these wear rings.

Please ask your sales representative for a cross-reference if no -EX kit or complementary parts are listed.

Replacement Kits For

HITACHI

Excavators								
APPLICATION	CYL #	SERIAL #	CODE	ROD	BORE	Misc	KIT #	List \$
MODEL ZX160LC-3								
BOOM LH	4661831	010001-		80 mm	110 mm		HIT-4662891	201.87
	4661831	010001-		80 mm	110 mm		HIT-4662891-EX	264.19
	4661831	010001-	Wear Ring		110 mm		HIT-1119106	10.89
	4661831	010001-	Wear Ring		110 mm		HIT-0298907	79.26
BOOM RH	4645310	010001-		80 mm	110 mm		HIT-4662891	201.87
	4645310	010001-		80 mm	110 mm		HIT-4662891-EX	264.19
	4645310	010001-	Wear Ring		110 mm		HIT-0298907	79.26
	4645310	010001-	Wear Ring		110 mm		HIT-1119106	10.89
	4661830	010001-		80 mm	110 mm		HIT-4662891	201.87
	4661830	010001-		80 mm	110 mm		HIT-4662891-EX	264.19
	4661830	010001-	Wear Ring		110 mm		HIT-1119106	10.89
	4661830	010001-	Wear Ring		110 mm		HIT-0298907	79.26
BUCKET	4645316	010001-	P-UB-10	75 mm	105 mm		HIT-4663493	163.74
POSITIONING	4659610	010001-	P-UB-10	95 mm	140 mm		HIT-4649053	181.93
	4661833	010001-	P-UB-10	95 mm	140 mm		HIT-4649053	181.93
MODEL ZX160LC-5								
ARM	9257020H	-230046		90 mm	120 mm		HIT-4657449	237.87
	9257020H	-230046		90 mm	120 mm		HIT-4657449-EX	282.93
	9257020H	-230046	Bushing	90 mm			HIT-AT264321	33.48
	9257020H	-230046	Wear Ring		120 mm		HIT-H227906	13.29
	9257020H	-230046	Wear Ring		120 mm		HIT-AT264356	28.15
	9323703	230047-	P-UB-10	90 mm	120 mm		HIT-FYA00012903	342.41
	9323703	230047-	Bushing	90 mm			HIT-FXB00002051	36.70
BOOM LH	9257019H	-230045		80 mm	110 mm		HIT-4662891	201.87
	9257019H	-230045		80 mm	110 mm		HIT-4662891-EX	264.19
	9257019H	-230045	Bushing	80 mm			HIT-AT264314	31.26
	9257019H	-230045	Wear Ring		110 mm		HIT-1119106	10.89
	9257019H	-230045	Wear Ring		110 mm		HIT-4S00156	79.26
	9323702	230046-	P-UB-10	80 mm	110 mm		HIT-FYA00012902	261.83
	9323702	230046-	Bushing	80 mm			HIT-FXB00002113	31.26
BOOM RH	9257018H	-230045		80 mm	110 mm		HIT-4662891	201.87
	9257018H	-230045		80 mm	110 mm		HIT-4662891-EX	264.19
	9257018H	-230045	Bushing	80 mm			HIT-AT264314	31.26
	9257018H	-230045	Wear Ring		110 mm		HIT-1119106	10.89
	9257018H	-230045	Wear Ring		110 mm		HIT-4S00156	79.26
	9323701	230046-	P-UB-10	80 mm	110 mm		HIT-FYA00012902	261.83
	9323701	230046-	Bushing	80 mm			HIT-FXB00002113	31.26
BUCKET	9257021H	-230056	P-UB-10	75 mm	105 mm		HIT-4663493	163.74
	9257021H	-230056		75 mm	105 mm		HIT-4663493-EX	204.67
	9257021H	-230056	Bushing	75 mm			HIT-TH109311	27.12
	9257021H	-230056	Wear Ring		105 mm		HIT-AT264388	23.12
	9257021H	-230056	Wear Ring		105 mm		HIT-0907801	11.26
	9323704	230057-	P-UB-10	75 mm	105 mm		HIT-FYA00012904	249.33
	9323704	230057-	Bushing	75 mm			HIT-FXB00002087	27.12
MODEL ZX200, ZX200LC, ZX210, ZX210LC, ZX210LCH, ZX210K, ZX210LCK, ZX210N, ZX240								
ARM	4316930	100001-	P-UB-10	95 mm	130 mm	River Maint	HIT-4364916	258.35
	4316930	100001-	P-UB-10	95 mm	130 mm	River Maint	HIT-4364916-EX	349.15
	4316930	100001-	Bushing	95 mm		River Maint	HIT-0309204	37.71
	4316930	100001-	Wear Ring		130 mm	River Maint	HIT-0667409	13.04
	4316930	100001-	Wear Ring		130 mm	River Maint	HIT-0254309	49.93
	4385638	100001-103568	P-UB-10	95 mm	135 mm	Mono Boom	HIT-4448399	221.89
	4385638	100001-103568	P-UB-10	95 mm	135 mm	Mono Boom	HIT-4448399-EX	315.31
	4385638	100001-103568	Bushing	95 mm		Mono Boom	HIT-0309204	37.71
	4385638	100001-103568	Wear Ring		135 mm	Mono Boom	HIT-0789110	14.40
	4385638	100001-103568	Wear Ring		135 mm	Mono Boom	HIT-0309212	50.87

Hercules Sealing Products and original equipment Hitachi kits may not include the necessary wear rings for your cylinder rebuild.
Kits with an -EX suffix will include these wear rings.

Please ask your sales representative for a cross-reference if no -EX kit or complementary parts are listed.

Replacement Kits For

HITACHI

HITACHI

Excavators									
APPLICATION	CYL #	SERIAL #	CODE	ROD	BORE	Misc	KIT #	List \$	
MODEL	ZX200, ZX200LC, ZX210, ZX210LC, ZX210LCH, ZX210K, ZX210LCK, ZX210N, ZX240								
ARM	4438207	100001-	P-UB-10	95 mm	135 mm				
	4438207	100001-	P-UB-10	95 mm	135 mm	Mono Boom	HIT-4448399	221.89	
	4438207	100001-	Bushing	95 mm		Mono Boom	HIT-4448399-EX	315.31	
	4438207	100001-	Bushing	95 mm		Mono Boom	HIT-0309204	37.71	
	4438207	100001-	Wear Ring		135 mm	Mono Boom	HIT-0309212	50.87	
	4438207	100001-	Wear Ring		135 mm	Mono Boom	HIT-0789110	14.40	
	4470801	103569-	P-UB-10	100 mm	135 mm				
	4470801	103569-	P-UB-10	100 mm	135 mm				
	4470801	103569-	Bushing	100 mm					
	4470801	103569-	Bushing	100 mm					
	4470801	103569-	Wear Ring		135 mm				
	4470801	103569-	Wear Ring		135 mm				
	4470801	103569-	Wear Ring		135 mm				
	4474568	100001-	P-UB-10	95 mm	135 mm	2P-Boom	HIT-4448399	221.89	
	4474568	100001-	P-UB-10	95 mm	135 mm	2P-Boom	HIT-4448399-EX	315.31	
	4474568	100001-	Bushing	95 mm		2P-Boom	HIT-0309204	37.71	
	4474568	100001-	Bushing	95 mm		2P-Boom	HIT-0309204	37.71	
	4474568	100001-	Wear Ring		135 mm	2P-Boom	HIT-0789110	14.40	
	4474568	100001-	Wear Ring		135 mm	2P-Boom	HIT-0789110	14.40	
	4474568	100001-	Wear Ring		135 mm	2P-Boom	HIT-0309212	50.87	
4485921	100001-	P-UB-10	95 mm	135 mm	2P-Boom	HIT-4448399	221.89		
4485921	100001-	P-UB-10	95 mm	135 mm	2P-Boom	HIT-4448399-EX	315.31		
4485921	100001-	Bushing	95 mm		2P-Boom	HIT-0309204	37.71		
4485921	100001-	Bushing	95 mm		2P-Boom	HIT-0309204	37.71		
4485921	100001-	Wear Ring		135 mm	2P-Boom	HIT-0309212	50.87		
4485921	100001-	Wear Ring		135 mm	2P-Boom	HIT-0789110	14.40		
BOOM LH	4410247	100001-	P-UB-10	85 mm	120 mm				
	4410247	100001-	P-UB-10	85 mm	120 mm				
	4410247	100001-	Bushing	85 mm					
	4410247	100001-	Bushing	85 mm					
	4410247	100001-	Wear Ring		120 mm				
	4410247	100001-	Wear Ring		120 mm				
	4410247	100001-	Wear Ring		120 mm				
	4438208	100001-	P-UB-10	85 mm	120 mm	Mono Boom	HIT-4448398	176.23	
	4438208	100001-	P-UB-10	85 mm	120 mm	Mono Boom	HIT-4448398-EX	271.98	
	4438208	100001-	Bushing	85 mm		Mono Boom	HIT-0309004	34.71	
	4438208	100001-	Bushing	85 mm		Mono Boom	HIT-0309004	34.71	
	4438208	100001-	Wear Ring		120 mm	Mono Boom	HIT-0667206	11.73	
	4438208	100001-	Wear Ring		120 mm	Mono Boom	HIT-0667206	11.73	
	4438208	100001-	Wear Ring		120 mm	Mono Boom	HIT-0261308	47.08	
	4438208	100001-	Wear Ring		120 mm	Mono Boom	HIT-0261308	47.08	
	4607535	100001-	P-UB-10	85 mm	120 mm	2P-Boom	HIT-4448398	176.23	
	4607535	100001-	P-UB-10	85 mm	120 mm	2P-Boom	HIT-4448398-EX	271.98	
4607535	100001-	Bushing	85 mm		2P-Boom	HIT-0309004	34.71		
4607535	100001-	Bushing	85 mm		2P-Boom	HIT-0309004	34.71		
4607535	100001-	Wear Ring		120 mm	2P-Boom	HIT-0261308	47.08		
4607535	100001-	Wear Ring		120 mm	2P-Boom	HIT-0261308	47.08		
4607535	100001-	Wear Ring		120 mm	2P-Boom	HIT-0667206	11.73		
BOOM RH	4410244	100001-	P-UB-10	85 mm	120 mm				
	4410244	100001-	P-UB-10	85 mm	120 mm				
	4410244	100001-	Bushing	85 mm					
	4410244	100001-	Bushing	85 mm					
	4410244	100001-	Wear Ring		120 mm				
	4410244	100001-	Wear Ring		120 mm				
	4410244	100001-	Wear Ring		120 mm				
	4438209	100001-	P-UB-10	85 mm	120 mm	Mono Boom	HIT-4448398	176.23	
	4438209	100001-	P-UB-10	85 mm	120 mm	Mono Boom	HIT-4448398-EX	271.98	
	4438209	100001-	Bushing	85 mm		Mono Boom	HIT-0309004	34.71	
	4438209	100001-	Bushing	85 mm		Mono Boom	HIT-0309004	34.71	
	4438209	100001-	Wear Ring		120 mm	Mono Boom	HIT-0667206	11.73	
	4438209	100001-	Wear Ring		120 mm	Mono Boom	HIT-0667206	11.73	
	4438209	100001-	Wear Ring		120 mm	Mono Boom	HIT-0261308	47.08	
	4438209	100001-	Wear Ring		120 mm	Mono Boom	HIT-0261308	47.08	
4607534	100001-	P-UB-10	85 mm	120 mm	2P-Boom	HIT-4448398	176.23		
4607534	100001-	P-UB-10	85 mm	120 mm	2P-Boom	HIT-4448398-EX	271.98		
4607534	100001-	Bushing	85 mm		2P-Boom	HIT-0309004	34.71		
4607534	100001-	Bushing	85 mm		2P-Boom	HIT-0309004	34.71		
4607534	100001-	Wear Ring		120 mm	2P-Boom	HIT-0667206	11.73		
4607534	100001-	Wear Ring		120 mm	2P-Boom	HIT-0667206	11.73		
4607534	100001-	Wear Ring		120 mm	2P-Boom	HIT-0261308	47.08		
4607534	100001-	Wear Ring		120 mm	2P-Boom	HIT-0261308	47.08		
BUCKET	4371061	100001-	P-UB-10	65 mm	95 mm	River Maint	HIT-4364914	305.35	
	4385637	100001-	P-UB-10	80 mm	115 mm				
	4385637	100001-	P-UB-10	80 mm	115 mm				
	4385637	100001-	Bushing	80 mm					
	4385637	100001-	Bushing	80 mm					
4385637	100001-	Wear Ring		115 mm					
4385637	100001-	Wear Ring		115 mm					

Hercules Sealing Products and original equipment Hitachi kits may not include the necessary wear rings for your cylinder rebuild. Kits with an -EX suffix will include these wear rings.

Please ask your sales representative for a cross-reference if no -EX kit or complementary parts are listed.

Replacement Kits For

HITACHI

Excavators								
APPLICATION	CYL #	SERIAL #	CODE	ROD	BORE	Misc	KIT #	List \$
MODEL ZX200, ZX200LC, ZX210, ZX210LC, ZX210LCH, ZX210K, ZX210LCK, ZX210N, ZX240								
BUCKET	4385637	100001-	Wear Ring		115 mm		HIT-0310908	40.55
MODEL ZX200-3								
ARM	4613950	00100001-	P-UB-10	95 mm	135 mm		HIT-4654422	221.89
	4613950	00100001-	P-UB-10	95 mm	135 mm		HIT-4654422-EX	315.31
	4613950	00100001-	Bushing	95 mm			HIT-0309204	37.71
	4613950	00100001-	Wear Ring		135 mm		HIT-0309212	50.87
	4613950	00100001-	Wear Ring		135 mm		HIT-0962104	14.40
BOOM LH	4664872	00100001-	P-UB-10	85 mm	120 mm		HIT-4661485	176.23
	4664872	00100001-	P-UB-10	85 mm	120 mm		HIT-4661485-EX	292.84
	4664872	00100001-	Bushing	85 mm			HIT-0309004	34.71
	4664872	00100001-	Wear Ring		120 mm		HIT-0261308	47.08
	4664872	00100001-	Wear Ring		120 mm		HIT-0998904	47.08
BOOM RH	4664871	00100001-	P-UB-10	85 mm	120 mm		HIT-4661485	176.23
	4664871	00100001-	P-UB-10	85 mm	120 mm		HIT-4661485-EX	292.84
	4664871	00100001-	Bushing	85 mm			HIT-0309004	34.71
	4664871	00100001-	Wear Ring		120 mm		HIT-0998904	47.08
	4664871	00100001-	Wear Ring		120 mm		HIT-0261308	47.08
BUCKET	4629154	00100001-	P-UB-10	80 mm	115 mm		HIT-1102306	102.20
MODEL ZX210LC-3								
ARM	4613950	00100001-	P-UB-10	95 mm	135 mm		HIT-4654422	221.89
	4613950	00100001-	P-UB-10	95 mm	135 mm		HIT-4654422-EX	315.31
	4613950	00100001-	Bushing	95 mm			HIT-0309204	37.71
	4613950	00100001-	Wear Ring		135 mm		HIT-0309212	50.87
	4613950	00100001-	Wear Ring		135 mm		HIT-0962104	14.40
BOOM LH	4664872	00100001-	P-UB-10	85 mm	120 mm		HIT-4661485	176.23
	4664872	00100001-	P-UB-10	85 mm	120 mm		HIT-4661485-EX	292.84
	4664872	00100001-	Bushing	85 mm			HIT-0309004	34.71
	4664872	00100001-	Wear Ring		120 mm		HIT-0261308	47.08
	4664872	00100001-	Wear Ring		120 mm		HIT-0998904	47.08
BOOM RH	4664871	00100001-	P-UB-10	85 mm	120 mm		HIT-4661485	176.23
	4664871	00100001-	P-UB-10	85 mm	120 mm		HIT-4661485-EX	292.84
	4664871	00100001-	Bushing	85 mm			HIT-0309004	34.71
	4664871	00100001-	Wear Ring		120 mm		HIT-0998904	47.08
	4664871	00100001-	Wear Ring		120 mm		HIT-0261308	47.08
BUCKET	4629154	00100001-	P-UB-10	80 mm	115 mm		HIT-1102306	102.20
MODEL ZX210LC-5								
ARM	9234748H		P-UB-10	95 mm	135 mm		HIT-AH225135	342.13
	9234748H		Bushing	95 mm			HIT-T108050	37.71
BOOM LH	9286529H		P-UB-10	85 mm	120 mm		HIT-AH225136	198.05
	9286529H		Bushing	85 mm			HIT-T108019	34.71
BOOM RH	9286528H		P-UB-10	85 mm	120 mm		HIT-AH225136	198.05
	9286528H		Bushing	85 mm			HIT-T108019	34.71
BUCKET	9248307H		P-UB-10	80 mm	115 mm		HIT-AH225137	102.20
	9248307H		Bushing	80 mm			HIT-T108041	31.26
MODEL ZX225US-3								
ARM	4613950	200001-	P-UB-10	95 mm	135 mm		HIT-4654422	221.89
	4613950	200001-	P-UB-10	95 mm	135 mm		HIT-4654422-EX	315.31
	4613950	200001-	Wear Ring		135 mm		HIT-0962104	14.40
	4613950	200001-	Wear Ring		135 mm		HIT-0309212	50.87
	4646744	200001-	P-UB-10	95 mm	135 mm		HIT-4654422	221.89
	4646744	200001-	P-UB-10	95 mm	135 mm		HIT-4654422-EX	315.31
	4646744	200001-	Wear Ring		135 mm		HIT-0962104	14.40
BOOM LH	4646744	200001-	Wear Ring		135 mm		HIT-0309212	50.87
	4632437	200001-	P-UB-10	85 mm	120 mm		HIT-4654421	198.05

Hercules Sealing Products and original equipment Hitachi kits may not include the necessary wear rings for your cylinder rebuild.
Kits with an -EX suffix will include these wear rings.

Please ask your sales representative for a cross-reference if no -EX kit or complementary parts are listed.

Replacement Kits For

HITACHI

Excavators								
APPLICATION	CYL #	SERIAL #	CODE	ROD	BORE	Misc	KIT #	List \$
MODEL ZX225US-3								
BOOM LH	4648672	200001-	P-UB-10	85 mm	120 mm	With Hose Rupture Valve	HIT-4654421	198.05
	4654085	200001-	P-UB-10	85 mm	120 mm	With Hose Rupture Valve (ML)	HIT-4654421	198.05
BOOM RH	4632512	200001-	P-UB-10	85 mm	120 mm		HIT-4654421	198.05
	4648656	200001-	P-UB-10	85 mm	120 mm	With Hose Rupture Valve	HIT-4654421	198.05
BUCKET	4629154	200001-	P-UB-10	80 mm	115 mm		HIT-1102306	102.20
MODEL ZX225USLC-3								
ARM	4613950	200001-	P-UB-10	95 mm	135 mm		HIT-4654422	221.89
	4613950	200001-	P-UB-10	95 mm	135 mm		HIT-4654422-EX	315.31
	4613950	200001-	Wear Ring		135 mm		HIT-0309212	50.87
	4613950	200001-	Wear Ring		135 mm		HIT-0962104	14.40
	4646744	200001-	P-UB-10	95 mm	135 mm		HIT-4654422	221.89
	4646744	200001-	P-UB-10	95 mm	135 mm		HIT-4654422-EX	315.31
	4646744	200001-	Wear Ring		135 mm		HIT-0962104	14.40
	4646744	200001-	Wear Ring		135 mm		HIT-0309212	50.87
BOOM LH	4632437	200001-	P-UB-10	85 mm	120 mm		HIT-4654421	198.05
	4648672	200001-	P-UB-10	85 mm	120 mm	With Hose Rupture Valve	HIT-4654421	198.05
	4654085	200001-	P-UB-10	85 mm	120 mm	With Hose Rupture Valve (ML)	HIT-4654421	198.05
BOOM RH	4632512	200001-	P-UB-10	85 mm	120 mm		HIT-4654421	198.05
	4648656	200001-	P-UB-10	85 mm	120 mm	With Hose Rupture Valve	HIT-4654421	198.05
BUCKET	4629154	200001-	P-UB-10	80 mm	115 mm		HIT-1102306	102.20
MODEL ZX225USLC-5								
ARM	9169805	100001-	P-UB-10	95 mm	135 mm		HIT-AH225135	342.13
BOOM LH	9196649	100001-	P-UB-10	85 mm	120 mm		HIT-AH225136	198.05
BOOM RH	9196650	100001-	P-UB-10	85 mm	120 mm		HIT-AH225136	198.05
BUCKET	9169806	100001-	P-UB-10	80 mm	115 mm		HIT-AH173451	310.18
MODEL ZX230, ZX230LC								
ARM	4613898	D04/05-	P-UB-10	105 mm	140 mm	Mono Boom	HIT-4631062	226.75
	4613898	D04/05-	P-UB-10	105 mm	140 mm	Mono Boom	HIT-4631062-EX	347.58
	4613898	D04/05-	Bushing	105 mm		Mono Boom	HIT-0373405	44.45
	4613898	D04/05-	Wear Ring		140 mm	Mono Boom	HIT-0224108	51.51
	4613898	D04/05-	Wear Ring		140 mm	Mono Boom	HIT-0937408	17.94
	4630579	D04/08-	P-UB-10	105 mm	140 mm	2P-Boom	HIT-4631062	226.75
	4630579	D04/08-	P-UB-10	105 mm	140 mm	2P-Boom	HIT-4631062-EX	347.58
	4630579	D04/08-	Bushing	105 mm		2P-Boom	HIT-0373405	44.45
	4630579	D04/08-	Wear Ring		140 mm	2P-Boom	HIT-0224108	51.51
	4630579	D04/08-	Wear Ring		140 mm	2P-Boom	HIT-0960302	17.94
	9187392	010001-D04/04	P-UB-14	105 mm	140 mm	Mono Boom	HIT-4485613	155.44
	9187392	010001-D04/04	P-UB-14	105 mm	140 mm	Mono Boom	HIT-4485613-EX	267.81
	9187392	010001-D04/04	Bushing	105 mm		Mono Boom	HIT-4432450	44.45
	9187392	010001-D04/04	Wear Ring		140 mm	Mono Boom	HIT-4414671	18.90
	9187392	010001-D04/04	Wear Ring		140 mm	Mono Boom	HIT-4168233	61.56
	9232344	010001-D04/07	P-UB-14	105 mm	140 mm	2P-Boom	HIT-9207059	155.44
	9232344	010001-D04/07	P-UB-14	105 mm	140 mm	2P-Boom	HIT-9207059-EX	267.81
	9232344	010001-D04/07	Bushing	105 mm		2P-Boom	HIT-4432450	44.45
	9232344	010001-D04/07	Wear Ring		140 mm	2P-Boom	HIT-4414671	18.90
	9232344	010001-D04/07	Wear Ring		140 mm	2P-Boom	HIT-4168233	61.56
	BOOM LH	4613893	D03/08-	P-UB-10	90 mm	125 mm		HIT-4624394
4613893		D03/08-	P-UB-10	90 mm	125 mm		HIT-4624394-EX	294.71
4613893		D03/08-	Bushing	90 mm			HIT-0325904	33.48



Hercules Sealing Products and original equipment Hitachi kits may not include the necessary wear rings for your cylinder rebuild. Kits with an -EX suffix will include these wear rings.

Please ask your sales representative for a cross-reference if no -EX kit or complementary parts are listed.

Replacement Kits For

HITACHI

Excavators								
APPLICATION	CYL #	SERIAL #	CODE	ROD	BORE	Misc	KIT #	List \$
MODEL ZX230, ZX230LC								
BOOM LH	4613893	D03/08-	Wear Ring		125 mm		HIT-0223713	49.06
	4613893	D03/08-	Wear Ring		125 mm		HIT-0926604	13.92
	9187391	010001-D03/07	P-UB-14	90 mm	125 mm		HIT-4485612	108.45
	9187391	010001-D03/07	P-UB-14	90 mm	125 mm		HIT-4485612-EX	275.78
	9187391	010001-D03/07	Bushing	90 mm			HIT-4272961	33.48
	9187391	010001-D03/07	Wear Ring		125 mm		HIT-4253562	14.83
	9187391	010001-D03/07	Piston Ring		125 mm		HIT-4431271	28.45
BOOM RH	4613892	D03/08-	P-UB-10	90 mm	125 mm		HIT-4624394	188.44
	4613892	D03/08-	P-UB-10	90 mm	125 mm		HIT-4624394-EX	294.71
	4613892	D03/08-	Bushing	90 mm			HIT-0325904	33.48
	4613892	D03/08-	Wear Ring		125 mm		HIT-0223713	49.06
	4613892	D03/08-	Wear Ring		125 mm		HIT-0926604	13.92
	9187390	010001-D03/07	P-UB-14	90 mm	125 mm		HIT-4485612	108.45
	9187390	010001-D03/07	P-UB-14	90 mm	125 mm		HIT-4485612-EX	275.78
	9187390	010001-D03/07	Bushing	90 mm			HIT-4272961	33.48
	9187390	010001-D03/07	Wear Ring		125 mm		HIT-4253562	14.83
9187390	010001-D03/07	Piston Ring		125 mm		HIT-4431271	28.45	
BUCKET	4613899	D03/11-	P-UB-10	90 mm	130 mm		HIT-4627361	79.35
	4613899	D03/11-	P-UB-10	90 mm	130 mm		HIT-4627361-EX	172.49
	4613899	D03/11-	Bushing	90 mm			HIT-0325904	33.48
	4613899	D03/11-	Wear Ring		130 mm		HIT-0254309	49.93
	4613899	D03/11-	Wear Ring		130 mm		HIT-0932805	16.36
	9187393	010001-D03/10	P-UB-14	90 mm	130 mm		HIT-4485614	122.18
	9187393	010001-D03/10	P-UB-14	90 mm	130 mm		HIT-4485614-EX	252.62
	9187393	010001-D03/10	Bushing	90 mm			HIT-4272961	33.48
	9187393	010001-D03/10	Wear Ring		130 mm		HIT-4431329	26.31
	9187393	010001-D03/10	Piston Ring		130 mm		HIT-4431272	58.26
MODEL ZX240-3, ZX240LC-3								
ARM	4618364	020001-	P-UB-10	100 mm	140 mm		HIT-4649050	252.00
	4618364	020001-	P-UB-10	100 mm	140 mm		HIT-4649050-EX	350.11
	4618364	020001-	Bushing	100 mm			HIT-0836104	51.68
	4618364	020001-	Wear Ring		140 mm		HIT-0960302	17.94
	4618364	020001-	Wear Ring		140 mm		HIT-0224108	51.51
BOOM LH	4628627	020001-	P-UB-10	90 mm	125 mm		HIT-4650419	188.44
	4628627	020001-	P-UB-10	90 mm	125 mm		HIT-4650419-EX	294.71
	4628627	020001-	Bushing	90 mm			HIT-0325904	33.48
	4628627	020001-	Wear Ring		125 mm		HIT-0926604	13.92
	4628627	020001-	Wear Ring		125 mm		HIT-0223713	49.06
BOOM RH	4628626	020001-	P-UB-10	90 mm	125 mm		HIT-4650419	188.44
	4628626	020001-	P-UB-10	90 mm	125 mm		HIT-4650419-EX	294.71
	4628626	020001-	Bushing	90 mm			HIT-0325904	33.48
	4628626	020001-	Wear Ring		125 mm		HIT-0223713	49.06
	4628626	020001-	Wear Ring		125 mm		HIT-0926604	13.92
BUCKET	4628634	020001-	P-UB-10	90 mm	130 mm		HIT-4650433	156.98
	4628634	020001-	P-UB-10	90 mm	130 mm		HIT-4650433-EX	250.12
	4628634	020001-	Bushing	90 mm			HIT-0325904	33.48
	4628634	020001-	Wear Ring		130 mm		HIT-0254309	49.93
	4628634	020001-	Wear Ring		130 mm		HIT-0974906	16.36
MODEL ZX240H, ZX240LCH, ZX240K, ZX240LCK								
ARM	4613898	D04/05-	P-UB-10	105 mm	140 mm	Mono Boom	HIT-4631062	226.75
	4613898	D04/05-	P-UB-10	105 mm	140 mm	Mono Boom	HIT-4631062-EX	347.58
	4613898	D04/05-	Bushing	105 mm		Mono Boom	HIT-0373405	44.45
	4613898	D04/05-	Wear Ring		140 mm	Mono Boom	HIT-0937408	17.94
	4613898	D04/05-	Wear Ring		140 mm	Mono Boom	HIT-0224108	51.51
	4630579	D04/08-	P-UB-10	105 mm	140 mm	2P-Boom	HIT-4631062	226.75

Hercules Sealing Products and original equipment Hitachi kits may not include the necessary wear rings for your cylinder rebuild. Kits with an -EX suffix will include these wear rings.

Please ask your sales representative for a cross-reference if no -EX kit or complementary parts are listed.

Replacement Kits For

HITACHI

HITACHI

Excavators								
APPLICATION	CYL #	SERIAL #	CODE	ROD	BORE	Misc	KIT #	List \$
MODEL ZX240H, ZX240LCH, ZX240K, ZX240LCK								
ARM	4630579	D04/08-	P-UB-10	105 mm	140 mm	2P-Boom	HIT-4631062-EX	347.58
	4630579	D04/08-	Bushing	105 mm		2P-Boom	HIT-0373405	44.45
	4630579	D04/08-	Wear Ring		140 mm	2P-Boom	HIT-0960302	17.94
	4630579	D04/08-	Wear Ring		140 mm	2P-Boom	HIT-0224108	51.51
	9187392	010001-D04/04	P-UB-14	105 mm	140 mm	Mono Boom	HIT-4485613	155.44
	9187392	010001-D04/04	P-UB-14	105 mm	140 mm	Mono Boom	HIT-4485613-EX	267.81
	9187392	010001-D04/04	Bushing	105 mm		Mono Boom	HIT-4432450	44.45
	9187392	010001-D04/04	Wear Ring		140 mm	Mono Boom	HIT-4168233	61.56
	9187392	010001-D04/04	Wear Ring		140 mm	Mono Boom	HIT-4414671	18.90
	9232344	010001-D04/07	P-UB-14	105 mm	140 mm	2P-Boom	HIT-9207059	155.44
	9232344	010001-D04/07	P-UB-14	105 mm	140 mm	2P-Boom	HIT-9207059-EX	267.81
	9232344	010001-D04/07	Bushing	105 mm		2P-Boom	HIT-4432450	44.45
	9232344	010001-D04/07	Wear Ring		140 mm	2P-Boom	HIT-4168233	61.56
	9232344	010001-D04/07	Wear Ring		140 mm	2P-Boom	HIT-4414671	18.90
BOOM LH	4613893	D03/08-	P-UB-10	90 mm	125 mm		HIT-4624394	188.44
	4613893	D03/08-	P-UB-10	90 mm	125 mm		HIT-4624394-EX	294.71
	4613893	D03/08-	Bushing	90 mm			HIT-0325904	33.48
	4613893	D03/08-	Wear Ring		125 mm		HIT-0223713	49.06
	4613893	D03/08-	Wear Ring		125 mm		HIT-0926604	13.92
	9187391	010001-D03/07	P-UB-14	90 mm	125 mm		HIT-4485612	108.45
	9187391	010001-D03/07	P-UB-14	90 mm	125 mm		HIT-4485612-EX	275.78
	9187391	010001-D03/07	Bushing	90 mm			HIT-4272961	33.48
	9187391	010001-D03/07	Wear Ring		125 mm		HIT-4253562	14.83
	9187391	010001-D03/07	Piston Ring		125 mm		HIT-4431271	28.45
BOOM RH	4613892	D03/08-	P-UB-10	90 mm	125 mm		HIT-4624394	188.44
	4613892	D03/08-	P-UB-10	90 mm	125 mm		HIT-4624394-EX	294.71
	4613892	D03/08-	Bushing	90 mm			HIT-0325904	33.48
	4613892	D03/08-	Wear Ring		125 mm		HIT-0223713	49.06
	4613892	D03/08-	Wear Ring		125 mm		HIT-0926604	13.92
	9187390	010001-D03/07	P-UB-14	90 mm	125 mm		HIT-4485612	108.45
	9187390	010001-D03/07	P-UB-14	90 mm	125 mm		HIT-4485612-EX	275.78
	9187390	010001-D03/07	Bushing	90 mm			HIT-4272961	33.48
	9187390	010001-D03/07	Wear Ring		125 mm		HIT-4253562	14.83
	9187390	010001-D03/07	Piston Ring		125 mm		HIT-4431271	28.45
BUCKET	4613899	D03/11-	P-UB-10	90 mm	130 mm		HIT-4627361	79.35
	4613899	D03/11-	P-UB-10	90 mm	130 mm		HIT-4627361-EX	172.49
	4613899	D03/11-	Bushing	90 mm			HIT-0325904	33.48
	4613899	D03/11-	Wear Ring		130 mm		HIT-0932805	16.36
	4613899	D03/11-	Wear Ring		130 mm		HIT-0254309	49.93
	9187393	010001-D03/10	P-UB-14	90 mm	130 mm		HIT-4485614	122.18
	9187393	010001-D03/10	P-UB-14	90 mm	130 mm		HIT-4485614-EX	252.62
	9187393	010001-D03/10	Bushing	90 mm			HIT-4272961	33.48
	9187393	010001-D03/10	Wear Ring		130 mm		HIT-4431329	26.31
	9187393	010001-D03/10	Piston Ring		130 mm		HIT-4431272	58.26
MODEL ZX250, ZX250LC, ZX250LCN								
ARM	4613898	D04/05-	P-UB-10	105 mm	140 mm	Mono Boom	HIT-4631062	226.75
	4613898	D04/05-	P-UB-10	105 mm	140 mm	Mono Boom	HIT-4631062-EX	347.58
	4613898	D04/05-	Bushing	105 mm		Mono Boom	HIT-0373405	44.45
	4613898	D04/05-	Wear Ring		140 mm	Mono Boom	HIT-0224108	51.51
	4613898	D04/05-	Wear Ring		140 mm	Mono Boom	HIT-0937408	17.94
	4630579	D04/08-	P-UB-10	105 mm	140 mm	2P-Boom	HIT-4631062	226.75
	4630579	D04/08-	P-UB-10	105 mm	140 mm	2P-Boom	HIT-4631062-EX	347.58
	4630579	D04/08-	Bushing	105 mm		2P-Boom	HIT-0373405	44.45
	4630579	D04/08-	Wear Ring		140 mm	2P-Boom	HIT-0224108	51.51
	4630579	D04/08-	Wear Ring		140 mm	2P-Boom	HIT-0960302	17.94

Hercules Sealing Products and original equipment Hitachi kits may not include the necessary wear rings for your cylinder rebuild. Kits with an -EX suffix will include these wear rings.

Please ask your sales representative for a cross-reference if no -EX kit or complementary parts are listed.

Replacement Kits For

HITACHI

Excavators								
APPLICATION	CYL #	SERIAL #	CODE	ROD	BORE	Misc	KIT #	List \$
MODEL ZX250, ZX250LC, ZX250LCN								
ARM	9187390	010001-D03/07	P-UB-14	90 mm	125 mm		HIT-4485612	108.45
	9187390	010001-D03/07	P-UB-14	90 mm	125 mm		HIT-4485612-EX	275.78
	9187390	010001-D03/07	Bushing	90 mm			HIT-4272961	33.48
	9187390	010001-D03/07	Wear Ring		125 mm		HIT-4253562	14.83
	9187390	010001-D03/07	Piston Ring		125 mm		HIT-4431271	28.45
	9187392	010001-D04/04	P-UB-14	105 mm	140 mm	Mono Boom	HIT-4485613	155.44
	9187392	010001-D04/04	P-UB-14	105 mm	140 mm	Mono Boom	HIT-4485613-EX	267.81
	9187392	010001-D04/04	Bushing	105 mm		Mono Boom	HIT-4432450	44.45
	9187392	010001-D04/04	Wear Ring		140 mm	Mono Boom	HIT-4414671	18.90
	9187392	010001-D04/04	Wear Ring		140 mm	Mono Boom	HIT-4168233	61.56
	9232344	010001-D04/07	P-UB-14	105 mm	140 mm	2P-Boom	HIT-9207059	155.44
	9232344	010001-D04/07	P-UB-14	105 mm	140 mm	2P-Boom	HIT-9207059-EX	267.81
	9232344	010001-D04/07	Bushing	105 mm		2P-Boom	HIT-4432450	44.45
	9232344	010001-D04/07	Wear Ring		140 mm	2P-Boom	HIT-4414671	18.90
	9232344	010001-D04/07	Wear Ring		140 mm	2P-Boom	HIT-4168233	61.56
BOOM LH	4613893	D03/08-	P-UB-10	90 mm	125 mm		HIT-4624394	188.44
	4613893	D03/08-	P-UB-10	90 mm	125 mm		HIT-4624394-EX	294.71
	4613893	D03/08-	Bushing	90 mm			HIT-0325904	33.48
	4613893	D03/08-	Wear Ring		125 mm		HIT-0223713	49.06
	4613893	D03/08-	Wear Ring		125 mm		HIT-0926604	13.92
	9187391	010001-D03/07	P-UB-14	90 mm	125 mm		HIT-4485612	108.45
	9187391	010001-D03/07	P-UB-14	90 mm	125 mm		HIT-4485612-EX	275.78
	9187391	010001-D03/07	Bushing	90 mm			HIT-4272961	33.48
	9187391	010001-D03/07	Wear Ring		125 mm		HIT-4253562	14.83
	9187391	010001-D03/07	Piston Ring		125 mm		HIT-4431271	28.45
BOOM RH	4613892	D03/08-	P-UB-10	90 mm	125 mm		HIT-4624394	188.44
	4613892	D03/08-	P-UB-10	90 mm	125 mm		HIT-4624394-EX	294.71
	4613892	D03/08-	Bushing	90 mm			HIT-0325904	33.48
	4613892	D03/08-	Wear Ring		125 mm		HIT-0223713	49.06
	4613892	D03/08-	Wear Ring		125 mm		HIT-0926604	13.92
BUCKET	4613899	D03/11-	P-UB-10	90 mm	130 mm		HIT-4627361	79.35
	4613899	D03/11-	P-UB-10	90 mm	130 mm		HIT-4627361-EX	172.49
	4613899	D03/11-	Bushing	90 mm			HIT-0325904	33.48
	4613899	D03/11-	Wear Ring		130 mm		HIT-0932805	16.36
	4613899	D03/11-	Wear Ring		130 mm		HIT-0254309	49.93
	9187393	010001-D03/10	P-UB-14	90 mm	130 mm		HIT-4485614	122.18
	9187393	010001-D03/10	P-UB-14	90 mm	130 mm		HIT-4485614-EX	252.62
	9187393	010001-D03/10	Bushing	90 mm			HIT-4272961	33.48
	9187393	010001-D03/10	Wear Ring		130 mm		HIT-4431329	26.31
	9187393	010001-D03/10	Piston Ring		130 mm		HIT-4431272	58.26
MODEL ZX250LC-3, ZX250LCN-3, ZX250H-3, ZX250LCH-3, ZX250K-3, ZX250LCK-3								
BUCKET	4628634	020001-	P-UB-10	90 mm	130 mm		HIT-4650433	156.98
	4628634	020001-	P-UB-10	90 mm	130 mm		HIT-4650433-EX	250.12
	4628634	020001-	Bushing	90 mm			HIT-0325904	33.48
	4628634	020001-	Wear Ring		130 mm		HIT-0974906	16.36
	4628634	020001-	Wear Ring		130 mm		HIT-0254309	49.93
MODEL ZX250LC-3, ZX250LCN-3, ZX250H-3, ZX250LCH-3, ZX250K-3, ZX250LCK-3								
ARM	4618364	020001-	P-UB-10	100 mm	140 mm		HIT-4649050	252.00
	4618364	020001-	P-UB-10	100 mm	140 mm		HIT-4649050-EX	350.11
	4618364	020001-	Bushing	100 mm			HIT-0836104	51.68
	4618364	020001-	Wear Ring		140 mm		HIT-0224108	51.51
	4618364	020001-	Wear Ring		140 mm		HIT-0960302	17.94
BOOM LH	4628627	020001-	P-UB-10	90 mm	125 mm		HIT-4650419	188.44
	4628627	020001-	P-UB-10	90 mm	125 mm		HIT-4650419-EX	294.71
	4628627	020001-	Bushing	90 mm			HIT-0325904	33.48

Hercules Sealing Products and original equipment Hitachi kits may not include the necessary wear rings for your cylinder rebuild.
Kits with an -EX suffix will include these wear rings.

Please ask your sales representative for a cross-reference if no -EX kit or complementary parts are listed.

Replacement Kits For

HITACHI

Excavators									
APPLICATION	CYL #	SERIAL #	CODE	ROD	BORE	Misc	KIT #	List \$	
MODEL ZX250LC-3, ZX250LCN-3, ZX250H-3, ZX250LCH-3, ZX250K-3, ZX250LCK-3									
BOOM LH	4628627	020001-	Wear Ring		125 mm		HIT-0926604	13.92	
	4628627	020001-	Wear Ring		125 mm		HIT-0223713	49.06	
BOOM RH	4628626	020001-	P-UB-10	90 mm	125 mm		HIT-4650419	188.44	
	4628626	020001-	P-UB-10	90 mm	125 mm		HIT-4650419-EX	294.71	
	4628626	020001-	Bushing	90 mm			HIT-0325904	33.48	
	4628626	020001-	Wear Ring		125 mm		HIT-0223713	49.06	
	4628626	020001-	Wear Ring		125 mm		HIT-0926604	13.92	
	MODEL ZX270, ZX270LC, ZX280LC, ZX280LCN								
ARM	4628581	D04/08-, D05/01-	P-UB-10	100 mm	145 mm	Mono Boom	HIT-4639938	238.14	
	4628581	D04/08-, D05/01-	Bushing	100 mm		Mono Boom	HIT-0836104	51.68	
	4628581	D04/08-, D05/01-	Wear Ring		145 mm	Mono Boom	HIT-0962008	17.94	
	4628581	D04/08-, D05/01-	Wear Ring		145 mm	Mono Boom	HIT-0373413	81.03	
	9186598	020001-D04/07, 020001-D04/12	P-UB-14	100 mm	145 mm	Mono Boom	HIT-9180579	204.29	
	9186598	020001-D04/07, 020001-D04/12	P-UB-14	100 mm	145 mm	Mono Boom	HIT-9180579-EX	321.35	
	9186598	020001-D04/07, 020001-D04/12	Bushing	100 mm		Mono Boom	HIT-4272963	52.10	
	9186598	020001-D04/07, 020001-D04/12	Wear Ring		145 mm	Mono Boom	HIT-4185247	65.19	
	9186598	020001-D04/07, 020001-D04/12	Wear Ring		145 mm	Mono Boom	HIT-4194621	19.00	
	9232345	020001-D04/07, 020001-D04/12	P-UB-14	100 mm	145 mm	2P-Boom	HIT-9180579	204.29	
	9232345	020001-D04/07, 020001-D04/12	P-UB-14	100 mm	145 mm	2P-Boom	HIT-9180579-EX	321.35	
	9232345	020001-D04/07, 020001-D04/12	Bushing	100 mm		2P-Boom	HIT-4272963	52.10	
	9232345	020001-D04/07, 020001-D04/12	Wear Ring		145 mm	2P-Boom	HIT-4185247	65.19	
	9232345	020001-D04/07, 020001-D04/12	Wear Ring		145 mm	2P-Boom	HIT-4194621	19.00	
	BOOM LH	4628583	D04/08-, D05/01-	P-UB-10	95 mm	135 mm		HIT-4639936	246.95
		4628583	D04/08-, D05/01-	P-UB-10	95 mm	135 mm		HIT-4639936-EX	340.35
4628583		D04/08-, D05/01-	Wear Ring		135 mm		HIT-0962104	14.40	
9186597		020001-D04/07, 020001-D04/12	P-UB-14	95 mm	135 mm		HIT-4485615	145.27	
9186597		020001-D04/07, 020001-D04/12	P-UB-14	95 mm	135 mm		HIT-4485615-EX	258.11	
9186597		020001-D04/07, 020001-D04/12	Bushing	95 mm			HIT-4272962	37.71	
9186597		020001-D04/07, 020001-D04/12	Wear Ring		135 mm		HIT-4252191	20.40	
9186597		020001-D04/07, 020001-D04/12	Wear Ring		135 mm		HIT-4185246	59.59	
9186598		D04/08-, D05/01-	P-UB-10	95 mm	135 mm		HIT-4639936	246.95	
BOOM RH	4628582	D04/08-, D05/01-	P-UB-10	95 mm	135 mm		HIT-4639936	246.95	
	4628582	D04/08-, D05/01-	P-UB-10	95 mm	135 mm		HIT-4639936-EX	340.35	
	4628582	D04/08-, D05/01-	Bushing	95 mm			HIT-0309204	37.71	
	4628582	D04/08-, D05/01-	Wear Ring		135 mm		HIT-0962104	14.40	
	4628582	D04/08-, D05/01-	Wear Ring		135 mm		HIT-0309212	50.87	
	9186596	020001-D04/07, 020001-D04/12	P-UB-14	95 mm	135 mm		HIT-4485615	145.27	
	9186596	020001-D04/07, 020001-D04/12	P-UB-14	95 mm	135 mm		HIT-4485615-EX	258.11	
	9186596	020001-D04/07, 020001-D04/12	Bushing	95 mm			HIT-4272962	37.71	
	9186596	020001-D04/07, 020001-D04/12	Wear Ring		135 mm		HIT-4185246	59.59	
	9186598	D04/08-, D05/01-	P-UB-10	95 mm	135 mm		HIT-4639936	246.95	

Hercules Sealing Products and original equipment Hitachi kits may not include the necessary wear rings for your cylinder rebuild.
Kits with an -EX suffix will include these wear rings.

Please ask your sales representative for a cross-reference if no -EX kit or complementary parts are listed.

Replacement Kits For

HITACHI

Excavators									
APPLICATION	CYL #	SERIAL #	CODE	ROD	BORE	Misc	KIT #	List \$	
MODEL ZX270, ZX270LC, ZX280LC, ZX280LCN									
BOOM RH	9186596	020001-D04/07, 020001-D04/12	Wear Ring		135 mm		HIT-4252191	20.40	
BUCKET	4628580	D04/08-, D05/01-	P-UB-10	90 mm	135 mm		HIT-4639939	284.62	
	4628580	D04/08-, D05/01-	P-UB-10	90 mm	135 mm		HIT-4639939-EX	319.37	
	4628580	D04/08-, D05/01-	Bushing	90 mm			HIT-0325904	33.48	
	4628580	D04/08-, D05/01-	Wear Ring		135 mm		HIT-0309212	50.87	
	4628580	D04/08-, D05/01-	Wear Ring		135 mm		HIT-0962104	14.40	
	9186599	020001-D04/07, 020001-D04/12	P-UB-14	90 mm	135 mm		HIT-9180580	164.31	
	9186599	020001-D04/07, 020001-D04/12	P-UB-14	90 mm	135 mm		HIT-9180580-EX	277.12	
	9186599	020001-D04/07, 020001-D04/12	Bushing	90 mm			HIT-4272961	33.48	
	9186599	020001-D04/07, 020001-D04/12	Wear Ring		135 mm		HIT-4252191	20.40	
9186599	020001-D04/07, 020001-D04/12	Wear Ring		135 mm		HIT-4185246	59.59		
MODEL ZX270-3									
ARM	4628630	00100001-	P-UB-14	105 mm	150 mm		HIT-4649752	227.63	
BOOM LH	4628631	00100001-	P-UB-14	95 mm	135 mm		HIT-4649745	162.63	
BOOM RH	4628632	00100001-	P-UB-14	95 mm	135 mm		HIT-4649745	162.63	
BUCKET	4628628	00100001-	P-UB-14	90 mm	135 mm		HIT-4649751	165.93	
MODEL ZX330, ZX330LC, ZX350LC, ZX350LCH, ZX350H, ZX350K, ZX350LCK, ZX370, ZX370MTH									
ARM	4611472	D04/08-	P-UB-14	115 mm	170 mm	Mono Boom	HIT-4640118	391.59	
	4611472	D04/08-	Piston Ring		170 mm	Mono Boom	HIT-0961424	53.13	
	9186602	030001-D04/07	P-UB-14	115 mm	170 mm	Mono Boom	HIT-9180582	244.22	
	9186602	030001-D04/07	P-UB-14	115 mm	170 mm	Mono Boom	HIT-9180582-EX	419.40	
	9186602	030001-D04/07	Bushing	115 mm		Mono Boom	HIT-4370337	66.38	
	9186602	030001-D04/07	Wear Ring		170 mm	Mono Boom	HIT-4370063	85.62	
	9186602	030001-D04/07	Wear Ring		170 mm	Mono Boom	HIT-4370064	36.15	
	9232346	030001-	P-UB-14	115 mm	170 mm	2P-Boom	HIT-9180582	244.22	
	9232346	030001-	P-UB-14	115 mm	170 mm	2P-Boom	HIT-9180582-EX	419.40	
	9232346	030001-	Bushing	115 mm		2P-Boom	HIT-4370337	66.38	
	9232346	030001-	Wear Ring		170 mm	2P-Boom	HIT-4370063	85.62	
	BOOM LH	4611474	D04/08-	P-UB-14	105 mm	150 mm		HIT-4640107	514.81
		9186601	030001-D04/07	P-UB-14	105 mm	150 mm		HIT-9180581	279.79
9186601		030001-D04/07	P-UB-14	105 mm	150 mm		HIT-9180581-EX	404.29	
9186601		030001-D04/07	Bushing	105 mm			HIT-4383093	46.86	
9186601		030001-D04/07	Wear Ring		150 mm		HIT-4194622	18.88	
9186601		030001-D04/07	Wear Ring		150 mm		HIT-4171490	68.31	
BOOM RH	4611473	D04/08-	P-UB-14	105 mm	150 mm		HIT-4640107	514.81	
	9186600	030001-D04/07	P-UB-14	105 mm	150 mm		HIT-9180581	279.79	
	9186600	030001-D04/07	P-UB-14	105 mm	150 mm		HIT-9180581-EX	404.29	
	9186600	030001-D04/07	Bushing	105 mm			HIT-4383093	46.86	
	9186600	030001-D04/07	Wear Ring		150 mm		HIT-4194622	18.88	
	9186600	030001-D04/07	Wear Ring		150 mm		HIT-4171490	68.31	
BUCKET	4611475	D04/08-	P-UB-14	95 mm	145 mm		HIT-4640108	450.03	
	9186603	030001-D04/07	P-UB-14	95 mm	145 mm		HIT-9175564	165.86	
	9186603	030001-D04/07	P-UB-14	95 mm	145 mm		HIT-9175564-EX	283.66	
	9186603	030001-D04/07	Bushing	95 mm			HIT-4284535	44.36	
	9186603	030001-D04/07	Wear Ring		145 mm		HIT-4185249	17.54	
	9186603	030001-D04/07	Wear Ring		145 mm		HIT-4185247	65.19	
MODEL ZX330-3, ZX330LC-3									
ARM	4628635	050001-	P-UB-10	115 mm	170 mm		HIT-4649051	210.51	
	4628635	050001-	P-UB-10	115 mm	170 mm		HIT-4649051-EX	357.91	
	4628635	050001-	Bushing	115 mm			HIT-0352704	50.20	

Hercules Sealing Products and original equipment Hitachi kits may not include the necessary wear rings for your cylinder rebuild.
Kits with an -EX suffix will include these wear rings.

Please ask your sales representative for a cross-reference if no -EX kit or complementary parts are listed.

Replacement Kits For

HITACHI

HITACHI

Excavators								
APPLICATION	CYL #	SERIAL #	CODE	ROD	BORE	Misc	KIT #	List \$
MODEL ZX330-3, ZX330LC-3								
ARM	4628635	050001-	Wear Ring		170 mm		HIT-0975411	21.63
	4628635	050001-	Wear Ring		170 mm		HIT-0259307	85.62
	4639441	050001-	P-UB-10	115 mm	170 mm		HIT-4649051	210.51
	4639441	050001-	P-UB-10	115 mm	170 mm		HIT-4649051-EX	357.91
	4639441	050001-	Bushing	115 mm			HIT-0352704	50.20
	4639441	050001-	Wear Ring		170 mm		HIT-0975411	21.63
	4639441	050001-	Wear Ring		170 mm		HIT-0259307	85.62
	4644677	050001-	P-UB-10	115 mm	170 mm		HIT-4649051	210.51
	4644677	050001-	P-UB-10	115 mm	170 mm		HIT-4649051-EX	357.91
	4644677	050001-	Bushing	115 mm			HIT-0352704	50.20
	4644677	050001-	Wear Ring		170 mm		HIT-0975411	21.63
	4644677	050001-	Wear Ring		170 mm		HIT-0259307	85.62
	4646776	050001-	P-UB-10	115 mm	170 mm		HIT-4649051	210.51
	4646776	050001-	P-UB-10	115 mm	170 mm		HIT-4649051-EX	357.91
	4646776	050001-	Bushing	115 mm			HIT-0352704	50.20
	4646776	050001-	Wear Ring		170 mm		HIT-0975411	21.63
4646776	050001-	Wear Ring		170 mm		HIT-0259307	85.62	
BOOM LH	4628637	050001-	P-UB-10	100 mm	145 mm		HIT-4649049	204.28
	4628637	050001-	P-UB-10	100 mm	145 mm		HIT-4649049-EX	338.93
	4628637	050001-	Bushing	100 mm			HIT-0836104	51.68
	4628637	050001-	Wear Ring		145 mm		HIT-0373413	81.03
	4628637	050001-	Wear Ring		145 mm		HIT-0962008	17.94
	4638831	050001-	P-UB-10	100 mm	145 mm		HIT-4649049	204.28
	4638831	050001-	P-UB-10	100 mm	145 mm		HIT-4649049-EX	338.93
	4638831	050001-	Bushing	100 mm			HIT-0836104	51.68
	4638831	050001-	Wear Ring		145 mm		HIT-0962008	17.94
	4638831	050001-	Wear Ring		145 mm		HIT-0373413	81.03
BOOM RH	4628636	050001-	P-UB-10	100 mm	145 mm		HIT-4649049	204.28
	4628636	050001-	P-UB-10	100 mm	145 mm		HIT-4649049-EX	338.93
	4628636	050001-	Bushing	100 mm			HIT-0836104	51.68
	4628636	050001-	Wear Ring		145 mm		HIT-0962008	17.94
	4628636	050001-	Wear Ring		145 mm		HIT-0373413	81.03
	4644670	050001-	P-UB-10	100 mm	145 mm		HIT-4649049	204.28
	4644670	050001-	P-UB-10	100 mm	145 mm		HIT-4649049-EX	338.93
	4644670	050001-	Bushing	100 mm			HIT-0836104	51.68
	4644670	050001-	Wear Ring		145 mm		HIT-0962008	17.94
4644670	050001-	Wear Ring		145 mm		HIT-0373413	81.03	
BUCKET	4643260	050001-	P-UB-10	95 mm	140 mm		HIT-4649053	181.93
	4643260	050001-	P-UB-10	95 mm	140 mm		HIT-4649053-EX	280.04
	4643260	050001-	Bushing	95 mm			HIT-0309204	37.71
	4643260	050001-	Wear Ring		140 mm		HIT-0960302	17.94
	4643260	050001-	Wear Ring		140 mm		HIT-0224108	51.51
MODEL ZX350LC-3, ZX350LCN-3, ZX350H-3, ZX350LCH-3, ZX350K-3, ZX350LCK-3								
ARM	4628635	050001-	P-UB-10	115 mm	170 mm		HIT-4649051	210.51
	4628635	050001-	P-UB-10	115 mm	170 mm		HIT-4649051-EX	357.91
	4628635	050001-	Bushing	115 mm			HIT-0352704	50.20
	4628635	050001-	Wear Ring		170 mm		HIT-0975411	21.63
	4628635	050001-	Wear Ring		170 mm		HIT-0259307	85.62
	4639441	050001-	P-UB-10	115 mm	170 mm		HIT-4649051	210.51
	4639441	050001-	P-UB-10	115 mm	170 mm		HIT-4649051-EX	357.91
	4639441	050001-	Bushing	115 mm			HIT-0352704	50.20
	4639441	050001-	Wear Ring		170 mm		HIT-0259307	85.62
	4639441	050001-	Wear Ring		170 mm		HIT-0975411	21.63
	4644677	050001-	P-UB-10	115 mm	170 mm		HIT-4649051	210.51
	4644677	050001-	P-UB-10	115 mm	170 mm		HIT-4649051-EX	357.91

Hercules Sealing Products and original equipment Hitachi kits may not include the necessary wear rings for your cylinder rebuild.
Kits with an -EX suffix will include these wear rings.

Please ask your sales representative for a cross-reference if no -EX kit or complementary parts are listed.

Replacement Kits For

HITACHI

Excavators								
APPLICATION	CYL #	SERIAL #	CODE	ROD	BORE	Misc	KIT #	List \$
MODEL ZX350LC-3, ZX350LCN-3, ZX350LH-3, ZX350LCH-3, ZX350K-3, ZX350LCK-3								
ARM	4644677	050001-	Bushing	115 mm			HIT-0352704	50.20
	4644677	050001-	Wear Ring		170 mm		HIT-0259307	85.62
	4644677	050001-	Wear Ring		170 mm		HIT-0975411	21.63
	4646776	050001-	P-UB-10	115 mm	170 mm		HIT-4649051	210.51
	4646776	050001-	P-UB-10	115 mm	170 mm		HIT-4649051-EX	357.91
	4646776	050001-	Bushing	115 mm			HIT-0352704	50.20
	4646776	050001-	Wear Ring		170 mm		HIT-0975411	21.63
	4646776	050001-	Wear Ring		170 mm		HIT-0259307	85.62
BOOM LH	4628637	050001-	P-UB-10	100 mm	145 mm		HIT-4649049	204.28
	4628637	050001-	P-UB-10	100 mm	145 mm		HIT-4649049-EX	338.93
	4628637	050001-	Bushing	100 mm			HIT-0836104	51.68
	4628637	050001-	Wear Ring		145 mm		HIT-0962008	17.94
	4628637	050001-	Wear Ring		145 mm		HIT-0373413	81.03
	4638831	050001-	P-UB-10	100 mm	145 mm		HIT-4649049	204.28
	4638831	050001-	P-UB-10	100 mm	145 mm		HIT-4649049-EX	338.93
	4638831	050001-	Bushing	100 mm			HIT-0836104	51.68
	4638831	050001-	Wear Ring		145 mm		HIT-0373413	81.03
	4638831	050001-	Wear Ring		145 mm		HIT-0962008	17.94
BOOM RH	4628636	050001-	P-UB-10	100 mm	145 mm		HIT-4649049	204.28
	4628636	050001-	P-UB-10	100 mm	145 mm		HIT-4649049-EX	338.93
	4628636	050001-	Bushing	100 mm			HIT-0836104	51.68
	4628636	050001-	Wear Ring		145 mm		HIT-0962008	17.94
	4628636	050001-	Wear Ring		145 mm		HIT-0373413	81.03
	4644670	050001-	P-UB-10	100 mm	145 mm		HIT-4649049	204.28
	4644670	050001-	P-UB-10	100 mm	145 mm		HIT-4649049-EX	338.93
	4644670	050001-	Bushing	100 mm			HIT-0836104	51.68
	4644670	050001-	Wear Ring		145 mm		HIT-0962008	17.94
	4644670	050001-	Wear Ring		145 mm		HIT-0373413	81.03
BUCKET	4643260	050001-	P-UB-10	95 mm	140 mm		HIT-4649053	181.93
	4643260	050001-	P-UB-10	95 mm	140 mm		HIT-4649053-EX	280.04
	4643260	050001-	Bushing	95 mm			HIT-0309204	37.71
	4643260	050001-	Wear Ring		140 mm		HIT-0224108	51.51
	4643260	050001-	Wear Ring		140 mm		HIT-0960302	17.94
MODEL ZX350LC-5N								
ARM			P-UB-14	115 mm	170 mm		HIT-4640118	391.59
	9303616H		P-UB-10	115 mm	170 mm		HIT-4S00930	222.48
	9303616H			115 mm	170 mm		HIT-4S00930-EX	354.35
	9303616H		Wear Ring		170 mm		HIT-AT264248	85.62
	9303616H		Wear Ring		170 mm		HIT-4S00858	21.63
BOOM LH	9246664		P-UB-10	100 mm	145 mm		HIT-4S00783	204.28
	9246664		P-UB-10	100 mm	145 mm		HIT-4S00783-EX	338.93
BOOM RH	9246663		P-UB-10	100 mm	145 mm		HIT-4S00783	204.28
	9246663		P-UB-10	100 mm	145 mm		HIT-4S00783-EX	338.93
	9246663		Wear Ring		145 mm		HIT-4S00803	17.94
	9246663		Wear Ring		145 mm		HIT-4S00804	81.03
BUCKET			P-UB-10	75 mm	105 mm		HIT-AH155040	461.55
	4379259		P-UB-10	65 mm	95 mm		HIT-AT196469	305.35
	9255452H		P-UB-10	95 mm	140 mm		HIT-FYA00001398	122.49
	9255452H		P-UB-10	95 mm	140 mm		HIT-FYA00001398-EX	227.74
	9255452H		Wear Ring		140 mm		HIT-4S00705	17.94
	9255452H		Wear Ring		140 mm		HIT-TH102797	51.51
THUMB	AT383284		I-UB-14	3	5		HIT-AT383285	200.29
MODEL ZX360LC-3								
ARM	4628635	00100001-	P-UB-10	115 mm	170 mm		HIT-4649051	210.51

Hercules Sealing Products and original equipment Hitachi kits may not include the necessary wear rings for your cylinder rebuild.
Kits with an -EX suffix will include these wear rings.

Please ask your sales representative for a cross-reference if no -EX kit or complementary parts are listed.

Replacement Kits For

HITACHI

Excavators								
APPLICATION	CYL #	SERIAL #	CODE	ROD	BORE	Misc	KIT #	List \$
MODEL ZX360LC-3								
ARM	4628635	00100001-	P-UB-10	115 mm	170 mm		HIT-4649051-EX	357.91
	4628635	00100001-	Bushing	115 mm			HIT-0352704	50.20
	4628635	00100001-	Wear Ring		170 mm		HIT-0975411	21.63
	4628635	00100001-	Wear Ring		170 mm		HIT-0259307	85.62
BOOM LH	4628637	00100001-	P-UB-10	100 mm	145 mm		HIT-4649049	204.28
	4628637	00100001-	P-UB-10	100 mm	145 mm		HIT-4649049-EX	338.93
	4628637	00100001-	Bushing	100 mm			HIT-0836104	51.68
	4628637	00100001-	Wear Ring		145 mm		HIT-0962008	17.94
	4628637	00100001-	Wear Ring		145 mm		HIT-0373413	81.03
BOOM RH	4628636	00100001-	P-UB-10	100 mm	145 mm		HIT-4649049	204.28
	4628636	00100001-	P-UB-10	100 mm	145 mm		HIT-4649049-EX	338.93
	4628636	00100001-	Bushing	100 mm			HIT-0836104	51.68
	4628636	00100001-	Wear Ring		145 mm		HIT-0373413	81.03
	4628636	00100001-	Wear Ring		145 mm		HIT-0962008	17.94
BUCKET	4643260	00100001-	P-UB-10	95 mm	140 mm		HIT-4649053	181.93
	4643260	00100001-	P-UB-10	95 mm	140 mm		HIT-4649053-EX	280.04
	4643260	00100001-	Bushing	95 mm			HIT-0309204	37.71
	4643260	00100001-	Wear Ring		140 mm		HIT-0224108	51.51
	4643260	00100001-	Wear Ring		140 mm		HIT-0960302	17.94
MODEL ZX450, ZX450LC, ZX450H, ZX450LCH, ZX460LCH, ZX480MT, ZX480MTH								
BACKHOE ARM	4310243	010001-	P-UB-10	130 mm	190 mm		HIT-4438679	314.64
	4310243	010001-	Bushing	130 mm			HIT-0353004	71.19
	4310243	010001-	Wear Ring		190 mm		HIT-0420307	38.95
	4310243	010001-	Wear Ring		190 mm		HIT-0242512	89.04
	4310243	050001-	P-UB-10	130 mm	190 mm		HIT-4438679	314.64
BACKHOE BOOM LH	4310242	010001-D03-/07	P-UB-10	115 mm	170 mm		HIT-4438672	372.00
	4310242	010607-010612, 010621-010626, 010638-	P-UB-10	115 mm	170 mm		HIT-4438672	372.00
	4310242	010607-010612, 010621-010626, 010638-	Bushing	115 mm			HIT-0352704	50.20
	4310242	010607-010612, 010621-010626, 010638-	Wear Ring		170 mm		HIT-0420109	21.63
	4310242	010607-010612, 010621-010626, 010638-	Wear Ring		170 mm		HIT-0259307	85.62
	4310242	050002-	P-UB-10	115 mm	170 mm		HIT-4438672	372.00
	9174340	010001-010606, 010613-010620, 010627-010637	P-UB-14	115 mm	170 mm		HIT-9180582	244.22
	9174340	010001-010606, 010613-010620, 010627-010637	Bushing	115 mm			HIT-4370337	66.38
	9174340	010001-010606, 010613-010620, 010627-010637	Wear Ring		170 mm		HIT-4370064	36.15
	9174340	010001-010606, 010613-010620, 010627-010637	Wear Ring		170 mm		HIT-4370063	85.62
	9174340	010001-D03-/07	P-UB-14	115 mm	170 mm		HIT-9180582	244.22
	9174340	050001	P-UB-14	115 mm	170 mm		HIT-9180582	244.22
	BACKHOE BOOM RH	4310241	010607-010612, 010621-010626, 010638-	P-UB-10	115 mm	170 mm		HIT-4438672
4310241		010607-010612, 010621-010626, 010638-	Bushing	115 mm			HIT-0352704	50.20

Hercules Sealing Products and original equipment Hitachi kits may not include the necessary wear rings for your cylinder rebuild.
Kits with an -EX suffix will include these wear rings.

Please ask your sales representative for a cross-reference if no -EX kit or complementary parts are listed.

Replacement Kits For

HITACHI

Excavators								
APPLICATION	CYL #	SERIAL #	CODE	ROD	BORE	Misc	KIT #	List \$
MODEL ZX450, ZX450LC, ZX450H, ZX450LCH, ZX460LCH, ZX480MT, ZX480MTH								
BACKHOE BOOM RH	4310241	010607-010612, 010621-010626, 010638-	Wear Ring		170 mm		HIT-0420109	21.63
	4310241	010607-010612, 010621-010626, 010638-	Wear Ring		170 mm		HIT-0259307	85.62
	4310241	050002-	P-UB-10	115 mm	170 mm		HIT-4438672	372.00
	4310241	D03/08-	P-UB-10	115 mm	170 mm		HIT-4438672	372.00
	9174339	010001-010606, 010613-010620, 010627-010637	P-UB-14	115 mm	170 mm		HIT-9180582	244.22
	9174339	010001-010606, 010613-010620, 010627-010637	Bushing	115 mm			HIT-4370337	66.38
	9174339	010001-010606, 010613-010620, 010627-010637	Wear Ring		170 mm		HIT-4370064	36.15
	9174339	010001-010606, 010613-010620, 010627-010637	Wear Ring		170 mm		HIT-4370063	85.62
	9174339	010001-D03/07	P-UB-14	115 mm	170 mm		HIT-9180582	244.22
	9174339	050001	P-UB-14	115 mm	170 mm		HIT-9180582	244.22
	9209136	010001-	P-UB-14	115 mm	170 mm	Long Arm	HIT-9180582	244.22
	BACKHOE BUCKET	4390024	010001-	P-UB-10	120 mm	170 mm		HIT-4438681
4390024		010001-	Bushing	120 mm			HIT-0450506	48.63
4390024		010001-	Wear Ring		170 mm		HIT-0420109	21.63
4390024		010001-	Wear Ring		170 mm		HIT-0259307	85.62
4390024		050001-	P-UB-10	120 mm	170 mm		HIT-4438681	232.96
9138785		010001-	P-UB-14	95 mm	145 mm	Long Arm	HIT-9123265	146.70
9138785		010001-	Bushing	95 mm		Long Arm	HIT-4284535	44.36
9138785		010001-	Wear Ring		145 mm	Long Arm	HIT-4185247	65.19
9138785		010001-	Wear Ring		145 mm	Long Arm	HIT-4185249	17.54
LOADER ARM	4219778	010001-	P-UB-10	115 mm	170 mm		HIT-4255531	256.74
	4219778	010001-	P-UB-10	115 mm	170 mm		HIT-4438758	256.74
LOADER BOOM LH	9209137	010001-	P-UB-14	115 mm	170 mm		HIT-9180582	244.22
	9209137	010001-	Bushing	115 mm			HIT-4370337	66.38
	9209137	010001-	Wear Ring		170 mm		HIT-4370063	85.62
	9209137	010001-	Wear Ring		170 mm		HIT-4370064	36.15
LOADER BOOM RH	9209136	010001-	P-UB-14	115 mm	170 mm		HIT-9180582	244.22
	9209136	010001-	Bushing	115 mm			HIT-4370337	66.38
	9209136	010001-	Wear Ring		170 mm		HIT-4370064	36.15
	9209136	010001-	Wear Ring		170 mm		HIT-4370063	85.62
LOADER BUCKET LH	4219781	010001-	P-UB-10	115 mm	150 mm		HIT-4255532	242.90
	4219781	010001-	Bushing	115 mm			HIT-0352704	50.20
	4219781	010001-	Wear Ring		150 mm		HIT-0387305	18.08
	4219781	010001-	Wear Ring		150 mm		HIT-0237220	56.88
LOADER BUCKET RH	4219780	010001-	P-UB-10	115 mm	150 mm		HIT-4255532	242.90
	4219780	010001-	Bushing	115 mm			HIT-0352704	50.20
	4219780	010001-	Wear Ring		150 mm		HIT-0237220	56.88
	4219780	010001-	Wear Ring		150 mm		HIT-0387305	18.08
LOADER DUMP	4219782	010001-	P-UB-10	65 mm	100 mm		HIT-4255533	100.81
	4219782	010001-	Bushing	65 mm			HIT-0310604	21.71
	4219782	010001-	Wear Ring		100 mm		HIT-0254908	72.59
	4219782	010001-	Wear Ring		100 mm		HIT-0326005	11.88
LOADER LEVEL	4219779	010001-	P-UB-10	115 mm	170 mm		HIT-4438758	256.74
	4219779	010001-	P-UB-10	115 mm	170 mm		HIT-4255531	256.74
LOADING SHOVEL	4344048	010001-	P-UB-10	65 mm	100 mm		HIT-4255533	100.81

Hercules Sealing Products and original equipment Hitachi kits may not include the necessary wear rings for your cylinder rebuild.
Kits with an -EX suffix will include these wear rings.

Please ask your sales representative for a cross-reference if no -EX kit or complementary parts are listed.

HITACHI

Replacement Kits For

Excavators								
APPLICATION	CYL #	SERIAL #	CODE	ROD	BORE	Misc	KIT #	List \$
MODEL ZX450, ZX450LC, ZX450H, ZX450LCH, ZX460LCH, ZX480MT, ZX480MTH								
LOADING SHOVEL	4344048	010001-	Bushing	65 mm			HIT-0657704	22.57
	4344048	010001-	Wear Ring		130 mm		HIT-0657706	101.01
MODEL ZX450-3, ZX450LC-3								
ARM	4637753	020001-	P-UB-10	130 mm	190 mm		HIT-4653041	264.17
	4637753	020001-	P-UB-10	130 mm	190 mm		HIT-4653041-EX	447.70
	4637753	020001-	Bushing	130 mm			HIT-0353004	71.19
	4637753	020001-	Wear Ring		190 mm		HIT-0972305	38.95
	4637753	020001-	Wear Ring		190 mm		HIT-0242512	89.04
BOOM LH	4637752	020001-	P-UB-10	115 mm	170 mm		HIT-4653040	225.63
	4637752	020001-	P-UB-10	115 mm	170 mm		HIT-4653040-EX	373.03
	4637752	020001-	Bushing	115 mm			HIT-0352704	50.20
	4637752	020001-	Wear Ring		170 mm		HIT-0259307	85.62
	4637752	020001-	Wear Ring		170 mm		HIT-0972106	21.63
BOOM RH	4637751	020001-	P-UB-10	115 mm	170 mm		HIT-4653040	225.63
	4637751	020001-	P-UB-10	115 mm	170 mm		HIT-4653040-EX	373.03
	4637751	020001-	Bushing	115 mm			HIT-0352704	50.20
	4637751	020001-	Wear Ring		170 mm		HIT-0259307	85.62
	4637751	020001-	Wear Ring		170 mm		HIT-0972106	21.63
BUCKET	4637754	020001-	P-UB-10	120 mm	170 mm		HIT-4653042	119.53
	4637754	020001-	P-UB-10	120 mm	170 mm		HIT-4653042-EX	264.11
	4637754	020001-	Bushing	120 mm			HIT-0450506	48.63
	4637754	020001-	Wear Ring		170 mm		HIT-0972106	21.63
	4637754	020001-	Wear Ring		170 mm		HIT-0259307	85.62
MODEL ZX470H-3, ZX470LCH-3								
ARM	4637753	020001-	P-UB-10	130 mm	190 mm		HIT-4653041	264.17
	4637753	020001-	P-UB-10	130 mm	190 mm		HIT-4653041-EX	447.70
	4637753	020001-	Bushing	130 mm			HIT-0353004	71.19
	4637753	020001-	Wear Ring		190 mm		HIT-0972305	38.95
	4637753	020001-	Wear Ring		190 mm		HIT-0242512	89.04
BOOM LH	4637752	020001-	P-UB-10	115 mm	170 mm		HIT-4653040	225.63
	4637752	020001-	P-UB-10	115 mm	170 mm		HIT-4653040-EX	373.03
	4637752	020001-	Bushing	115 mm			HIT-0352704	50.20
	4637752	020001-	Wear Ring		170 mm		HIT-0972106	21.63
	4637752	020001-	Wear Ring		170 mm		HIT-0259307	85.62
BOOM RH	4637751	020001-	P-UB-10	115 mm	170 mm		HIT-4653040	225.63
	4637751	020001-	P-UB-10	115 mm	170 mm		HIT-4653040-EX	373.03
	4637751	020001-	Bushing	115 mm			HIT-0352704	50.20
	4637751	020001-	Wear Ring		170 mm		HIT-0972106	21.63
	4637751	020001-	Wear Ring		170 mm		HIT-0259307	85.62
BUCKET	4637754	020001-	P-UB-10	120 mm	170 mm		HIT-4653042	119.53
	4637754	020001-	P-UB-10	120 mm	170 mm		HIT-4653042-EX	264.11
	4637754	020001-	Bushing	120 mm			HIT-0450506	48.63
	4637754	020001-	Wear Ring		170 mm		HIT-0259307	85.62
	4637754	020001-	Wear Ring		170 mm		HIT-0972106	21.63
MODEL ZX470LC-5B								
ARM	4712920		P-UB-10	130 mm	190 mm		HIT-4S00960	347.12
	4712920		P-UB-10	130 mm	190 mm		HIT-4S00960-EX	546.95
	4712920		Wear Ring		190 mm		HIT-AT264245	46.06
	4712920		Wear Ring		190 mm		HIT-0972305	38.95
BOOM LH	4698939		P-UB-10	115 mm	170 mm		HIT-4S00961	225.63
	4698939			115 mm	170 mm		HIT-4S00961-EX	373.03
	4698939		Wear Ring		170 mm		HIT-AT264248	85.62
	4698939		Wear Ring		170 mm		HIT-4S00858	21.63
BOOM RH	4698938		P-UB-10	115 mm	170 mm		HIT-4686432	380.07

Hercules Sealing Products and original equipment Hitachi kits may not include the necessary wear rings for your cylinder rebuild.
Kits with an -EX suffix will include these wear rings.

Please ask your sales representative for a cross-reference if no -EX kit or complementary parts are listed.

Replacement Kits For

HITACHI

Excavators									
APPLICATION	CYL #	SERIAL #	CODE	ROD	BORE	Misc	KIT #	List \$	
MODEL ZX470LC-5B									
BUCKET	FYA000048 97			120 mm	170 mm		HIT-4S00959	119.53	
	FYA000048 97			120 mm	170 mm		HIT-4S00959-EX	264.11	
	FYA000048 97		Wear Ring		170 mm		HIT-4S00858	21.63	
	FYA000048 97		Wear Ring		170 mm		HIT-AT264248	85.62	
THUMB	AT383284		I-UB-14	3	5		HIT-AT383285	200.29	
MODEL ZX500LC-3									
ARM	4637753	020001-	P-UB-10	130 mm	190 mm		HIT-4653041	264.17	
	4637753	020001-	P-UB-10	130 mm	190 mm		HIT-4653041-EX	447.70	
	4637753	020001-	Bushing	130 mm			HIT-0353004	71.19	
	4637753	020001-	Wear Ring		190 mm		HIT-0242512	89.04	
	4637753	020001-	Wear Ring		190 mm		HIT-0972305	38.95	
BOOM LH	4637752	020001-	P-UB-10	115 mm	170 mm		HIT-4653040	225.63	
	4637752	020001-	P-UB-10	115 mm	170 mm		HIT-4653040-EX	373.03	
	4637752	020001-	Bushing	115 mm			HIT-0352704	50.20	
	4637752	020001-	Wear Ring		170 mm		HIT-0972106	21.63	
BOOM RH	4637752	020001-	Wear Ring		170 mm		HIT-0259307	85.62	
	4637751	020001-	P-UB-10	115 mm	170 mm		HIT-4653040	225.63	
	4637751	020001-	P-UB-10	115 mm	170 mm		HIT-4653040-EX	373.03	
	4637751	020001-	Bushing	115 mm			HIT-0352704	50.20	
BUCKET	4637751	020001-	Wear Ring		170 mm		HIT-0972106	21.63	
	4637751	020001-	Wear Ring		170 mm		HIT-0259307	85.62	
	4637754	020001-	P-UB-10	120 mm	170 mm		HIT-4653042	119.53	
	4637754	020001-	P-UB-10	120 mm	170 mm		HIT-4653042-EX	264.11	
BUCKET	4637754	020001-	Bushing	120 mm			HIT-0450506	48.63	
	4637754	020001-	Wear Ring		170 mm		HIT-0972106	21.63	
	4637754	020001-	Wear Ring		170 mm		HIT-0259307	85.62	
	MODEL ZX520LCH-3								
	ARM	4637753	020001-	P-UB-10	130 mm	190 mm		HIT-4653041	264.17
4637753		020001-	P-UB-10	130 mm	190 mm		HIT-4653041-EX	447.70	
4637753		020001-	Bushing	130 mm			HIT-0353004	71.19	
4637753		020001-	Wear Ring		190 mm		HIT-0972305	38.95	
4637753		020001-	Wear Ring		190 mm		HIT-0242512	89.04	
BOOM LH	4637752	020001-	P-UB-10	115 mm	170 mm		HIT-4653040	225.63	
	4637752	020001-	P-UB-10	115 mm	170 mm		HIT-4653040-EX	373.03	
	4637752	020001-	Bushing	115 mm			HIT-0352704	50.20	
	4637752	020001-	Wear Ring		170 mm		HIT-0259307	85.62	
BOOM RH	4637752	020001-	Wear Ring		170 mm		HIT-0972106	21.63	
	4637751	020001-	P-UB-10	115 mm	170 mm		HIT-4653040	225.63	
	4637751	020001-	P-UB-10	115 mm	170 mm		HIT-4653040-EX	373.03	
	4637751	020001-	Bushing	115 mm			HIT-0352704	50.20	
BUCKET	4637751	020001-	Wear Ring		170 mm		HIT-0259307	85.62	
	4637751	020001-	Wear Ring		170 mm		HIT-0972106	21.63	
	4637754	020001-	P-UB-10	120 mm	170 mm		HIT-4653042	119.53	
	4637754	020001-	P-UB-10	120 mm	170 mm		HIT-4653042-EX	264.11	
BUCKET	4637754	020001-	Bushing	120 mm			HIT-0450506	48.63	
	4637754	020001-	Wear Ring		170 mm		HIT-0259307	85.62	
	4637754	020001-	Wear Ring		170 mm		HIT-0972106	21.63	
	MODEL ZX800								
BACKHOE ARM	4331077	006001-	P-UB-10	150 mm	215 mm		HIT-4436496	318.31	
	4331077	006001-	P-UB-10	150 mm	215 mm		HIT-4436496-EX	631.11	
	4331077	006001-	Wear Ring		215 mm		HIT-0392306	94.69	
	4331077	006001-	Wear Ring		215 mm		HIT-0702704	21.49	

Hercules Sealing Products and original equipment Hitachi kits may not include the necessary wear rings for your cylinder rebuild.
Kits with an -EX suffix will include these wear rings.

Please ask your sales representative for a cross-reference if no -EX kit or complementary parts are listed.

Replacement Kits For

HITACHI

HITACHI

Excavators								
APPLICATION	CYL #	SERIAL #	CODE	ROD	BORE	Misc	KIT #	List \$
MODEL ZX800								
BACKHOE ARM	4456466	006001-	P-UB-10	160 mm	225 mm		HIT-4474521	245.47
	4456466	006001-	P-UB-10	160 mm	225 mm		HIT-4474521-EX	586.60
	4456466	006001-	Wear Ring		225 mm		HIT-0831308	22.53
	4456466	006001-	Wear Ring		225 mm		HIT-0242714	184.44
BACKHOE BOOM LH	4331076	006001-	P-UB-10	140 mm	200 mm		HIT-4438684	466.96
BACKHOE BOOM RH	4331075	006001-	P-UB-10	140 mm	200 mm		HIT-4438684	466.96
BACKHOE BUCKET	4360555	006001-	P-UB-10	150 mm	215 mm		HIT-4436496	318.31
	4360555	006001-	P-UB-10	150 mm	215 mm		HIT-4436496-EX	631.11
	4360555	006001-	Wear Ring		215 mm		HIT-0702704	21.49
	4360555	006001-	Wear Ring		215 mm		HIT-0392306	94.69
	4397518	006001-	P-UB-10	120 mm	180 mm		HIT-4437965	388.95
	4437039	006001-	P-UB-10	140 mm	190 mm		HIT-4438693	306.40
	4437039	006001-	P-UB-10	140 mm	190 mm		HIT-4438693-EX	439.25
	4437039	006001-	Wear Ring		190 mm		HIT-0420307	38.95
	4437039	006001-	Wear Ring		190 mm		HIT-0242512	89.04
BOOM LH	4331076	006001-	P-UB-10	140 mm	200 mm	Backhoe	HIT-4660036	466.96
BOOM RH	4331075	006001-	P-UB-10	140 mm	200 mm	Backhoe	HIT-4660036	466.96
C/W LIFTING	4392996	006001-	P-UB-10	120 mm	170 mm		HIT-4405053	221.60
	4392996	006001-	P-UB-10	120 mm	170 mm		HIT-4405053-EX	313.61
	4392996	006001-	Wear Ring		170 mm		HIT-0259307	85.62
	4392996	006001-	Wear Ring		170 mm		HIT-0420109	21.63
LOADER ARM	4328130	006001-	P-UB-10	140 mm	200 mm		HIT-4291362	210.65
	4328130	006001-	P-UB-10	140 mm	200 mm		HIT-4291362-EX	804.41
	4328130	006001-	Wear Ring		200 mm		HIT-4199817	87.44
	4328130	006001-	Wear Ring		200 mm		HIT-0340108	148.69
LOADER BUCKET LH	4328132	006001-	P-UB-10	130 mm	180 mm		HIT-4291368	288.61
	4328132	006001-	P-UB-10	130 mm	180 mm		HIT-4291368-EX	373.56
	4328132	006001-	Wear Ring		180 mm		HIT-0417609	31.63
	4328132	006001-	Wear Ring		180 mm		HIT-0332708	18.87
LOADER BUCKET RH	4328131	006001-	P-UB-10	130 mm	180 mm		HIT-4291368	288.61
	4328131	006001-	P-UB-10	130 mm	180 mm		HIT-4291368-EX	373.56
	4328131	006001-	Wear Ring		180 mm		HIT-0332708	18.87
	4328131	006001-	Wear Ring		180 mm		HIT-0417609	31.63
LOADER DUMP	4243502	006001-	P-UB-10	80 mm	130 mm		HIT-4314461	122.05
	4243502	006001-	P-UB-10	80 mm	130 mm		HIT-4314461-EX	217.40
	4243502	006001-	Wear Ring		130 mm		HIT-0399306	16.36
	4243502	006001-	Wear Ring		130 mm		HIT-0254309	49.93
LOADER LEVEL	4243498	006001-	P-UB-10	140 mm	200 mm		HIT-4291362	210.65
	4243498	006001-	P-UB-10	140 mm	200 mm		HIT-4291362-EX	804.41
	4243498	006001-	Wear Ring		200 mm		HIT-0340108	148.69
	4243498	006001-	Wear Ring		200 mm		HIT-4199817	87.44
MODEL ZX850H								
BACKHOE ARM	4331077	006001-	P-UB-10	150 mm	215 mm	STD Boom, BE Boom	HIT-4436496	318.31
	4331077	006001-	P-UB-10	150 mm	215 mm		HIT-4436496-EX	631.11
	4331077	006001-	Wear Ring		215 mm	STD Boom, BE Boom	HIT-0702704	21.49
	4331077	006001-	Wear Ring		215 mm	STD Boom, BE Boom	HIT-0392306	94.69
	4456466	006001-	P-UB-10	160 mm	225 mm	HD Boom	HIT-4474521	245.47
	4456466	006001-	P-UB-10	160 mm	225 mm		HIT-4474521-EX	586.60
	4456466	006001-	Wear Ring		225 mm	HD Boom	HIT-0831308	22.53
	4456466	006001-	Wear Ring		225 mm	HD Boom	HIT-0242714	184.44
BACKHOE BOOM LH	4331076	006001-	P-UB-10	140 mm	200 mm		HIT-4438684	466.96
	4331076	006001-	Wear Ring		200 mm		HIT-0645008	23.93

Hercules Sealing Products and original equipment Hitachi kits may not include the necessary wear rings for your cylinder rebuild.
Kits with an -EX suffix will include these wear rings.

Please ask your sales representative for a cross-reference if no -EX kit or complementary parts are listed.

Replacement Kits For

HITACHI

Excavators								
APPLICATION	CYL #	SERIAL #	CODE	ROD	BORE	Misc	KIT #	List \$
MODEL ZX850H								
BACKHOE BOOM LH	4331076	006001-	Wear Ring		200 mm		HIT-4199817	87.44
BACKHOE BOOM RH	4331075	006001-	P-UB-10	140 mm	200 mm		HIT-4438684	466.96
	4331075	006001-	Wear Ring		200 mm		HIT-0645008	23.93
	4331075	006001-	Wear Ring		200 mm		HIT-4199817	87.44
BACKHOE BUCKET	4360555	006001-	P-UB-10	150 mm	215 mm	BE Boom, BE Arm	HIT-4436496	318.31
	4360555	006001-	P-UB-10	150 mm	215 mm		HIT-4436496-EX	631.11
	4360555	006001-	Wear Ring		215 mm	BE Boom, BE Arm	HIT-0392306	94.69
	4360555	006001-	Wear Ring		215 mm	BE Boom, BE Arm	HIT-0702704	21.49
	4397518	006001-	P-UB-10	120 mm	180 mm	Long Arm	HIT-4660108	388.95
	4397518	006001-	P-UB-10	120 mm	180 mm		HIT-4437965	388.95
	4397518	006001-	Wear Ring		180 mm	Long Arm	HIT-0332708	18.87
	4397518	006001-	Wear Ring		180 mm	Long Arm	HIT-0643015	31.63
	4432009	006001-	P-UB-10	120 mm	180 mm	Long Arm	HIT-4692136	430.82
	4432009	006001-	Wear Ring		180 mm	Long Arm	HIT-0417609	31.63
	4432009	006001-	Wear Ring		180 mm	Long Arm	HIT-0332708	18.87
	4437039	006001-	P-UB-10	140 mm	190 mm	STD Boom, HD Boom, Semi-long Arm	HIT-4438693	306.40
	4437039	006001-	P-UB-10	140 mm	190 mm		HIT-4438693-EX	439.25
	4437039	006001-	Wear Ring		190 mm	STD Boom, HD Boom, Semi-long Arm	HIT-0420307	38.95
	4437039	006001-	Wear Ring		190 mm	STD Boom, HD Boom, Semi-long Arm	HIT-0242512	89.04
C/W LIFTING	4392996	006001-	P-UB-10	120 mm	170 mm		HIT-4405053	221.60
	4392996	006001-	P-UB-10	120 mm	170 mm		HIT-4405053-EX	313.61
	4392996	006001-	Wear Ring		170 mm		HIT-0420109	21.63
	4392996	006001-	Wear Ring		170 mm		HIT-0259307	85.62
LOADER ARM	4328130	006001-	P-UB-10	140 mm	200 mm		HIT-4291362	210.65
	4328130	006001-	P-UB-10	140 mm	200 mm		HIT-4291362-EX	804.41
	4328130	006001-	Wear Ring		200 mm		HIT-0340108	148.69
	4328130	006001-	Wear Ring		200 mm		HIT-4199817	87.44
LOADER BUCKET LH	4328132	006001-	P-UB-10	130 mm	180 mm		HIT-4291368	288.61
	4328132	006001-	P-UB-10	130 mm	180 mm		HIT-4291368-EX	373.56
	4328132	006001-	Wear Ring		180 mm		HIT-0417609	31.63
	4328132	006001-	Wear Ring		180 mm		HIT-0332708	18.87
LOADER BUCKET RH	4328131	006001-	P-UB-10	130 mm	180 mm		HIT-4291368	288.61
	4328131	006001-	P-UB-10	130 mm	180 mm		HIT-4291368-EX	373.56
	4328131	006001-	Wear Ring		180 mm		HIT-0417609	31.63
	4328131	006001-	Wear Ring		180 mm		HIT-0332708	18.87
LOADER DUMP	4243502	006001-	P-UB-10	80 mm	130 mm		HIT-4314461	122.05
	4243502	006001-	P-UB-10	80 mm	130 mm		HIT-4314461-EX	217.40
	4243502	006001-	Wear Ring		130 mm		HIT-0254309	49.93
	4243502	006001-	Wear Ring		130 mm		HIT-0399306	16.36
LOADER LEVEL	4243498	006001-	P-UB-10	140 mm	200 mm		HIT-4291362	210.65
	4243498	006001-	P-UB-10	140 mm	200 mm		HIT-4291362-EX	804.41
	4243498	006001-	Wear Ring		200 mm		HIT-4199817	87.44
	4243498	006001-	Wear Ring		200 mm		HIT-0340108	148.69
MODEL ZX870H-3								
ARM	4638083	020001-	P-UB-10	160 mm	225 mm		HIT-4653862	245.47
	4638083	020001-	P-UB-10	160 mm	225 mm		HIT-4653862-EX	586.60
	4638083	020001-	Wear Ring		225 mm		HIT-0242714	184.44
	4638083	020001-	Wear Ring		225 mm		HIT-0978308	22.53

Hercules Sealing Products and original equipment Hitachi kits may not include the necessary wear rings for your cylinder rebuild.
Kits with an -EX suffix will include these wear rings.

Please ask your sales representative for a cross-reference if no -EX kit or complementary parts are listed.

Replacement Kits For

HITACHI

Excavators								
APPLICATION	CYL #	SERIAL #	CODE	ROD	BORE	Misc	KIT #	List \$
MODEL ZX870H-3								
BOOM LH	4638081	020001-	P-UB-10	150 mm	215 mm		HIT-4653861	321.15
	4638081	020001-	P-UB-10	150 mm	215 mm		HIT-4653861-EX	633.95
	4638081	020001-	Wear Ring		215 mm		HIT-0392306	94.69
	4638081	020001-	Wear Ring		215 mm		HIT-0978106	21.49
BOOM RH	4638080	020001-	P-UB-10	150 mm	215 mm		HIT-4653861	321.15
	4638080	020001-	P-UB-10	150 mm	215 mm		HIT-4653861-EX	633.95
	4638080	020001-	Wear Ring		215 mm		HIT-0392306	94.69
	4638080	020001-	Wear Ring		215 mm		HIT-0978106	21.49
BUCKET	4638084	020001-	P-UB-10	140 mm	200 mm		HIT-4653863	210.65
	4638084	020001-	P-UB-10	140 mm	200 mm		HIT-4653863-EX	397.59
	4638084	020001-	Wear Ring		200 mm		HIT-4199817	87.44
	4638084	020001-	Wear Ring		200 mm		HIT-0977906	23.93
Excavators - Compact								
APPLICATION	CYL #	SERIAL #	CODE	ROD	BORE	Misc	KIT #	List \$
MODEL EX50U								
ARM	4403510	000101-	P-U-10	50 mm	80 mm		HIT-0656714	103.14
BLADE	4391327	000101-	P-U-10	60 mm	110 mm		HIT-0654715	57.82
BOOM(CAB)	4409057	000101-		55 mm	95 mm		HIT-0735309	47.88
BOOM(CANOPY)	4412158	000101-		55 mm	95 mm		HIT-0735309	47.88
BUCKET	4403511	000101-		45 mm	75 mm		HIT-0735609	24.58
SWING	4392050	000101-	P-U-10	50 mm	100 mm		HIT-0656604	33.43
MODEL EX50UNA								
ARM	4403510	240001-	P-U-10	50 mm	80 mm		HIT-0656714	103.14
BLADE	4391327	240001-	P-U-10	60 mm	110 mm		HIT-0654715	57.82
BOOM	4409057	240001-		55 mm	95 mm		HIT-0735309	47.88
BUCKET	4403511	240001-		45 mm	75 mm		HIT-0735609	24.58
SWING	4392050	240001-	P-U-10	50 mm	100 mm		HIT-0656604	33.43
MODEL EX50UR								
ARM	4245654	000101-		55 mm	90 mm		HIT-4265822	114.25
BLADE	4261898	000101-		60 mm	115 mm		HIT-4265824	113.86
BOOM	4245653	000101-	P-UB-10	65 mm	115 mm		HIT-4265821	105.80
BUCKET	4245655	000101-	P-UB-10	50 mm	80 mm		HIT-4265823	124.18
OFFSET	4245656	000101-	P-U-10	50 mm	90 mm		HIT-4269765	104.52
MODEL EX55UR								
ARM	4316317	000101-		55 mm	90 mm		HIT-4340250	37.76
BLADE	4316320	000101-	P-U-10	70 mm	110 mm		HIT-4340274	75.51
BOOM	4316316	000101-		60 mm	110 mm		HIT-4340243	78.86
BUCKET	4316318	000101-	P-U-10	50 mm	80 mm		HIT-4340253	44.05
OFFSET	4316319	000101-		50 mm	90 mm		HIT-4340256	32.64
MODEL EX55UR-3								
ARM	4418001	005001-		55 mm	85 mm		HIT-0732808	38.74
BLADE	4403515	005001-	P-U-10	65 mm	110 mm		HIT-0733106	41.49
BOOM	4413855	005001-	P-U-10	60 mm	105 mm		HIT-0732708	48.77
BUCKET	4403662	005001-	P-U-10	50 mm	80 mm		HIT-0732905	47.98
OFFSET	4403663	005001-		50 mm	90 mm		HIT-0733003	40.41
MODEL UH07-3								
ARM			P-UB-5	85 mm	125 mm		HIT-4094458	227.30
BOOM			P-UB-5	85 mm	125 mm		HIT-4094457	211.39
BUCKET			I-U-5	70 mm	125 mm		HIT-4071694	129.60
MODEL UH07-5								
ARM			P-UB-5	90 mm	130 mm		HIT-4104127	271.07
BOOM			P-UB-5	85 mm	125 mm		HIT-4117741	225.11
BUCKET			P-UB-5	75 mm	125 mm		HIT-4117743	236.28
MODEL UH07-7								
ARM			P-UB-10	100 mm	140 mm		HIT-4153211	251.99

Hercules Sealing Products and original equipment Hitachi kits may not include the necessary wear rings for your cylinder rebuild.
Kits with an -EX suffix will include these wear rings.

Please ask your sales representative for a cross-reference if no -EX kit or complementary parts are listed.

HITACHI

Replacement Kits For

Excavators - Compact								
APPLICATION	CYL #	SERIAL #	CODE	ROD	BORE	Misc	KIT #	List \$
MODEL UH07-7								
BOOM			P-UB-10	90 mm	130 mm		HIT-4153209	172.00
BUCKET			P-UB-10	80 mm	125 mm		HIT-4153213	223.05
MODEL UH009								
ARM			I-U-5	95 mm	150 mm		HIT-4064636	248.93
BOOM			I-U-5	90 mm	150 mm		HIT-4064635	159.71
BUCKET			I-U-5	90 mm	150 mm		HIT-4064635	159.71
MODEL UH010								
ARM			P-UB-5	105 mm	150 mm		HIT-4096959	368.41
BOOM			P-UB-5	95 mm	150 mm		HIT-4096957	233.25
BUCKET			P-UB-5	95 mm	150 mm		HIT-4096960	231.96
MODEL UH012								
ARM			P-U-5	110 mm	180 mm		HIT-4509364	457.60
BOOM			P-U-5	110 mm	180 mm		HIT-4509364	457.60
BUCKET			P-U-5	120 mm	180 mm		HIT-4509365	463.14
MODEL UH016								
ARM	3022991	005-009;053-069	P-UB-5	110 mm	170 mm		HIT-4153235	499.01
	3027628	001-165	P-UB-5	120 mm	190 mm		HIT-4162027	564.90
	3031888	166-	P-UB-10	120 mm	190 mm		HIT-4176980	337.27
	4167618	001-004;010-052;070-	P-UB-10	110 mm	170 mm		HIT-4167722	306.41
BOOM LH	3026175		P-UB-5	110 mm	170 mm	Old Style	HIT-4162026	529.62
	4167617		P-UB-10	110 mm	170 mm	New Style	HIT-4167721	312.33
BOOM RH	3026114		P-UB-5	110 mm	170 mm	Old Style	HIT-4162026	529.62
	4167616		P-UB-10	110 mm	170 mm	New Style	HIT-4167721	312.33
BUCKET	3026115	001-145	P-UB-5	110 mm	170 mm		HIT-4162028	528.67
	3027022	001-	P-UB-5	95 mm	150 mm		HIT-4150681	343.27
	3031889	146-	P-UB-10	110 mm	170 mm		HIT-4167721	312.33
DUMP	3024187	001-	P-UB-5	55 mm	100 mm		HIT-4144635	288.05
LEVEL	3025213	001-	P-UB-5	110 mm	170 mm		HIT-4153237	454.72
MODEL UH035								
ARM	4157138	002-	P-U-10	150 mm	225 mm		HIT-4163898	354.61
BOOM	4157139	002-	P-U-10	160 mm	240 mm		HIT-4163899	408.80
DUMP	4157143	002-	P-U-10	80 mm	140 mm		HIT-4163901	173.65
LEVEL	4157142	002-	P-U-10	160 mm	240 mm		HIT-4163899	408.80
TILT LH	4157141	002-	P-U-10	140 mm	190 mm		HIT-4163900	288.34
TILT RH	4157140	002-	P-U-10	140 mm	190 mm		HIT-4163900	288.34
MODEL UH045, UH061								
ARM			I-U-5	80 mm	130 mm		HIT-4101443	168.10
BOOM			I-U-5	70 mm	120 mm		HIT-4101442	127.43
BUCKET			I-U-5	70 mm	120 mm		HIT-4101442	127.43
MODEL ZX35U-2								
ARM	4632807	010001-	P-U-10	45 mm	75 mm		HIT-4634034	95.92
BLADE	4617784	010001-	P-U-14	45 mm	95 mm		HIT-4622066	140.44
BOOM	4632805	010001-	P-U-10	50 mm	85 mm		HIT-4634033	104.57
	4632806	010001-	P-U-10	50 mm	85 mm		HIT-4634033	104.57
BUCKET	4608466	010001-	P-U-10	40 mm	65 mm		HIT-4614058	123.26
SWING	4608470	010001-	P-U-10	45 mm	85 mm		HIT-4614059	124.10
MODEL ZX50U								
ANGLE	4428237	005001-007000	P-U-10	45 mm	80 mm		HIT-0797805	32.45
ARM	4468846	005001-	P-U-10	50 mm	80 mm		HIT-0843613	34.81
BLADE	4468880	005001-007000	P-U-10	55 mm	100 mm		HIT-0843907	92.32
	4618628	0070001-	P-U-14	50 mm	105 mm		HIT-4622067	123.20
BOOM(CAB)	4468845	005001-	P-U-10	55 mm	95 mm		HIT-0844807	47.49
BOOM(CANOPY)	4468844	005001-	P-U-10	55 mm	95 mm		HIT-0844807	47.49
BUCKET	4468847	005001-	P-U-10	45 mm	75 mm		HIT-0844705	67.79
SWING	4463353	005001-	P-U-10	50 mm	100 mm		HIT-0843808	74.61

Hercules Sealing Products and original equipment Hitachi kits may not include the necessary wear rings for your cylinder rebuild. Kits with an -EX suffix will include these wear rings.

Please ask your sales representative for a cross-reference if no -EX kit or complementary parts are listed.

HITACHI

Replacement Kits For

Excavators - Compact								
APPLICATION	CYL #	SERIAL #	CODE	ROD	BORE	Misc	KIT #	List \$
MODEL ZX50U								
TILT	4428236	005001-007000	P-U-10	65 mm	110 mm		HIT-0854418	60.27
MODEL ZX50U-2								
ARM	4632810	010001-	P-U-10	50 mm	80 mm		HIT-4634036	98.04
	4632813	010001-	P-U-10	50 mm	80 mm		HIT-4634036	98.04
BLADE	4618628	010001-	P-U-14	50 mm	105 mm		HIT-4622067	123.20
BOOM	4628947	010001-	P-U-10	45 mm	75 mm		HIT-4614069	80.79
BOOM(CAB)	4632809	010001-	P-UB-10	55 mm	90 mm		HIT-4634035	46.21
	4632812	010001-		55 mm	95 mm		HIT-4634038	57.13
BOOM(CANOPY)	4632808	010001-	P-UB-10	55 mm	90 mm		HIT-4634035	46.21
	4632811	010001-		55 mm	95 mm		HIT-4634038	57.13
BUCKET	4628945	010001-		40 mm	70 mm		HIT-4634037	38.15
	4628947	010001-	P-U-10	45 mm	75 mm		HIT-4614069	80.79
SWING	4616034	010001-		50 mm	90 mm		HIT-4635157	39.43
MODEL ZX50U-3								
ARM	4632813	020001-	P-U-10	50 mm	80 mm		HIT-4634036	98.04
ARM(ML)	4627233	020001-	P-U-10	50 mm	80 mm		HIT-4634036	98.04
BLADE	4618628	020001-	P-U-14	50 mm	105 mm		HIT-4622067	123.20
BOOM(CAB ML)	4655766	020001-		55 mm	95 mm		HIT-4634038	57.13
BOOM(CAB)	4655764	020001-		55 mm	95 mm		HIT-4634038	57.13
BOOM(CANOPY ML)	4655765	020001-		55 mm	95 mm		HIT-4634038	57.13
BOOM(CANOPY)	4655763	020001-		55 mm	95 mm		HIT-4634038	57.13
BUCKET(WITH COVER)	4667781	020001-	P-U-10	45 mm	75 mm		HIT-4614069	80.79
BUCKET(WITHOUT COVER)	4628947	020001-	P-U-10	45 mm	75 mm		HIT-4614069	80.79
SWING	4679054	020001-		50 mm	90 mm		HIT-4705345	114.06
MODEL ZX50U-3F								
ARM	4632813	020001-	P-U-10	50 mm	80 mm		HIT-4634036	98.04
ARM(ML)	4627233	020001-	P-U-10	50 mm	80 mm		HIT-4634036	98.04
BLADE	4618628	020001-	P-U-14	50 mm	105 mm		HIT-4622067	123.20
BOOM(CAB ML)	4655766	020001-		55 mm	95 mm		HIT-4634038	57.13
BOOM(CAB)	4655764	020001-		55 mm	95 mm		HIT-4634038	57.13
BOOM(CANOPY ML)	4655765	020001-		55 mm	95 mm		HIT-4634038	57.13
BOOM(CANOPY)	4655763	020001-		55 mm	95 mm		HIT-4634038	57.13
BUCKET(WITH COVER)	4667781	020001-	P-U-10	45 mm	75 mm		HIT-4614069	80.79
BUCKET(WITHOUT COVER)	4628947	020001-	P-U-10	45 mm	75 mm		HIT-4614069	80.79
SWING	4679054	020001-		50 mm	90 mm		HIT-4705345	114.06
MODEL ZX50U-3U								
ARM	4632813	020001-	P-U-10	50 mm	80 mm		HIT-4634036	98.04
ARM(ML)	4627233	020001-	P-U-10	50 mm	80 mm		HIT-4634036	98.04
BLADE	4618628	020001-	P-U-14	50 mm	105 mm		HIT-4622067	123.20
BOOM(CAB ML)	4655766	020001-		55 mm	95 mm		HIT-4634038	57.13
BOOM(CAB)	4655764	020001-		55 mm	95 mm		HIT-4634038	57.13
BOOM(CANOPY ML)	4655765	020001-		55 mm	95 mm		HIT-4634038	57.13
BOOM(CANOPY)	4655763	020001-		55 mm	95 mm		HIT-4634038	57.13
BUCKET(WITH COVER)	4667781	020001-	P-U-10	45 mm	75 mm		HIT-4614069	80.79
BUCKET(WITHOUT COVER)	4628947	020001-	P-U-10	45 mm	75 mm		HIT-4614069	80.79
SWING	4679054	020001-		50 mm	90 mm		HIT-4705345	114.06
MODEL ZX60								
ARM	4665900	00100001-	P-UB-10	55 mm	85 mm		HIT-4681368	96.71
BOOM	4665903	00100001-	P-UB-10	60 mm	105 mm		HIT-4681367	91.46
BUCKET	4665902	00100001-	P-UB-10	50 mm	80 mm		HIT-4681369	86.82
MODEL ZX70, ZX70LC								
ARM	4388224	060001-	P-UB-10	60 mm	95 mm	Offset Boom	HIT-4415584	126.21
	4388224	060001-	P-UB-10	60 mm	95 mm	Offset Boom	HIT-4415584-EX	177.27

Hercules Sealing Products and original equipment Hitachi kits may not include the necessary wear rings for your cylinder rebuild.
Kits with an -EX suffix will include these wear rings.

Please ask your sales representative for a cross-reference if no -EX kit or complementary parts are listed.

Replacement Kits For

HITACHI

Excavators - Compact								
APPLICATION	CYL #	SERIAL #	CODE	ROD	BORE	Misc	KIT #	List \$
MODEL ZX70, ZX70LC								
ARM	4388224	060001-	Wear Ring		95 mm	Offset Boom	HIT-0333007	20.08
	4446255	060001-	P-UB-10	60 mm	95 mm	Mono Boom, Swing Boom	HIT-4464985	105.31
	4446255	060001-	P-UB-10	60 mm	95 mm	Mono Boom, Swing Boom	HIT-4464985-EX	146.84
	4446255	060001-	Wear Ring		95 mm	Mono Boom, Swing Boom	HIT-0667108	14.84
	4458862	060001-	P-UB-10	60 mm	95 mm	Mono Boom, Swing Boom	HIT-4464985	105.31
	4458862	060001-	P-UB-10	60 mm	95 mm	Mono Boom, Swing Boom	HIT-4464985-EX	146.84
	4458862	060001-	Wear Ring		95 mm	Mono Boom, Swing Boom	HIT-0667108	14.84
BLADE	4452571	060001-	P-UB-10	70 mm	120 mm		HIT-4465736	117.57
	4452571	060001-	P-UB-10	70 mm	120 mm		HIT-4465736-EX	185.57
	4452571	060001-	Bushing	70 mm			HIT-0310304	24.51
	4452571	060001-	Wear Ring		120 mm		HIT-0667206	11.73
BOOM	4446254	060001-	P-UB-10	65 mm	115 mm	Mono Boom, Swing Boom	HIT-4464984	132.13
	4446254	060001-	P-UB-10	65 mm	115 mm	Mono Boom, Swing Boom	HIT-4464984-EX	164.88
	4446254	060001-	Bushing	65 mm		Mono Boom, Swing Boom	HIT-0310604	21.71
	4446254	060001-	Wear Ring		115 mm	Mono Boom, Swing Boom	HIT-0686405	10.89
	4612822	060001-	P-UB-10	65 mm	115 mm	Swing Boom	HIT-4464984	132.13
	4612822	060001-	P-UB-10	65 mm	115 mm	Swing Boom	HIT-4464984-EX	164.88
	4612822	060001-	Wear Ring		115 mm	Swing Boom	HIT-0686405	10.89
BUCKET	4446258	060001-	P-UB-10	55 mm	85 mm		HIT-4464986	100.77
	4446258	060001-	P-UB-10	55 mm	85 mm		HIT-4464986-EX	166.62
	4446258	060001-	Wear Ring		85 mm		HIT-0827011	28.75
MODEL ZX80, ZX80LCK, ZX80SB, ZX80SBLC								
ARM	4388224	060001-	P-UB-10	60 mm	95 mm	Offset Boom	HIT-4415584	126.21
	4388224	060001-	P-UB-10	60 mm	95 mm	Offset Boom	HIT-4415584-EX	177.27
	4388224	060001-	Wear Ring		95 mm	Offset Boom	HIT-0333007	20.08
	4446255	060001-	P-UB-10	60 mm	95 mm	Mono Boom, Swing Boom	HIT-4464985	105.31
	4446255	060001-	P-UB-10	60 mm	95 mm	Mono Boom, Swing Boom	HIT-4464985-EX	146.84
	4446255	060001-	Wear Ring		95 mm	Mono Boom, Swing Boom	HIT-0667108	14.84
	4458862	060001-	P-UB-10	60 mm	95 mm	Mono Boom, Swing Boom	HIT-4464985	105.31
	4458862	060001-	P-UB-10	60 mm	95 mm	Mono Boom, Swing Boom	HIT-4464985-EX	146.84
BLADE	4452571	060001-	P-UB-10	70 mm	120 mm		HIT-4465736	117.57
	4452571	060001-	P-UB-10	70 mm	120 mm		HIT-4465736-EX	185.57
	4452571	060001-	Bushing	70 mm			HIT-0310304	24.51
	4452571	060001-	Wear Ring		120 mm		HIT-0667206	11.73
BOOM	4446254	060001-	P-UB-10	65 mm	115 mm	Mono Boom, Swing Boom	HIT-4464984	132.13
	4446254	060001-	P-UB-10	65 mm	115 mm	Mono Boom, Swing Boom	HIT-4464984-EX	164.88
	4446254	060001-	Bushing	65 mm		Mono Boom, Swing Boom	HIT-0310604	21.71
	4446254	060001-	Wear Ring		115 mm	Mono Boom, Swing Boom	HIT-0686405	10.89

Hercules Sealing Products and original equipment Hitachi kits may not include the necessary wear rings for your cylinder rebuild.
Kits with an -EX suffix will include these wear rings.

Please ask your sales representative for a cross-reference if no -EX kit or complementary parts are listed.

Replacement Kits For

HITACHI

Excavators - Compact								
APPLICATION	CYL #	SERIAL #	CODE	ROD	BORE	Misc	KIT #	List \$
MODEL ZX80, ZX80LCK, ZX80SB, ZX80SBLC								
BOOM	4612822	060001-	P-UB-10	65 mm	115 mm	Swing Boom	HIT-4464984	132.13
	4612822	060001-	P-UB-10	65 mm	115 mm	Swing Boom	HIT-4464984-EX	164.88
	4612822	060001-	Wear Ring		115 mm	Swing Boom	HIT-0686405	10.89
BUCKET	4446258	060001-	P-UB-10	55 mm	85 mm		HIT-4464986	100.77
	4446258	060001-	P-UB-10	55 mm	85 mm		HIT-4464986-EX	166.62
	4446258	060001-	Wear Ring		85 mm		HIT-0827011	28.75
Loaders - Wheel								
APPLICATION	CYL #	SERIAL #	CODE	ROD	BORE	Misc	KIT #	List \$
MODEL LX100								
BOOM	AH143717		P-UB-1	63 mm			HIT-RE25151	108.90
	AH143717		N-N-14		125 mm		HIT-AH137208	130.69
BUCKET	AH136538		P-UB-1	63 mm			HIT-RE25151	108.90
	AH136538		N-N-14		140 mm		HIT-AH137209	144.45
Off-Highway Trucks								
APPLICATION	CYL #	SERIAL #	CODE	ROD	BORE	Misc	KIT #	List \$
MODEL EH1600								
HOIST				4, 7			VME-12619709	1168.84
SUSPENSION REAR			I-UB-11	6	8		EUC-E12631739	1192.00

HITACHI

Hercules Sealing Products and original equipment Hitachi kits may not include the necessary wear rings for your cylinder rebuild.
Kits with an -EX suffix will include these wear rings.

Please ask your sales representative for a cross-reference if no -EX kit or complementary parts are listed.

REPLACEMENT KITS FOR HITACHI

Part Number	Code (Pg. xviii)	Rod X Bore Size	List Price	Part Number	Code (Pg. xviii)	Rod X Bore Size	List Price
HIT-0654715	P-U-10	60 mm X 110 mm	\$ 57.82	HIT-4153213	P-UB-10	80 X 125	\$ 223.05
HIT-0656604	P-U-10	50 mm X 100 mm	33.43	HIT-4153235	P-UB-5	110 X 170	499.01
HIT-0656714		50 mm X 80 mm	103.14	HIT-4153236	P-UB-5	110 X 150	348.99
HIT-0732708		60 mm X 105 mm	48.77	HIT-4153237	P-UB-5	110 X 170	454.72
HIT-0732808		55 mm X 85 mm	38.74	HIT-4162026	P-UB-5	110 X 170	529.62
HIT-0732905	P-U-10	50 mm X 80 mm	47.98	HIT-4162027	P-UB-5	120 X 190	564.90
HIT-0733003		50 mm X 90 mm	40.41	HIT-4162028	P-UB-5	110 X 170	528.67
HIT-0733106	P-U-10	65 mm X 110 mm	41.49	HIT-4163569	P-UB-10	105 X 150	206.76
HIT-0735309	P-U-10	55 mm X 95 mm	47.88	HIT-4163573	P-UB-10	95 X 150	255.24
HIT-0735609	P-U-10	45 mm X 75 mm	24.58	HIT-4163898	P-U-10	150 X 225	354.61
HIT-0797805	P-U-10	45 mm X 80 mm	32.45	HIT-4163899	P-U-10	160 X 240	408.80
HIT-0843613	P-U-10	50 mm X 80 mm	34.81	HIT-4163900	P-U-10	140 X 190	288.34
HIT-0843808	P-U-10	50 X 100	74.61	HIT-4163901	P-U-10	80 X 140	173.65
HIT-0843907	P-U-10	55 X 100	92.32	HIT-4167721	P-UB-10	110 X 170	312.33
HIT-0844705	P-U-10	45 X 75	67.79	HIT-4167722	P-UB-10	110 X 170	306.41
HIT-0844807	P-U-10	55 mm X 95 mm	47.49	HIT-4167724	P-UB-10	110 X 140	302.70
HIT-0847204	P-U-10	40 X 75	82.66	HIT-4171990	P-UB-10	160 X 240	756.40
HIT-0850309	P-U-10	45 X 80	95.94	HIT-4171991	P-UB-10	150 X 225	653.18
HIT-0854418	P-U-10	65 mm X 110 mm	60.27	HIT-4171992	P-UB-10	140 X 190	447.87
HIT-1102306	P-UB-10	80 X 115	102.20	HIT-4171993	P-UB-10	80 X 140	321.46
HIT-4064635	I-U-5	90 X 150	159.71	HIT-4176980	P-UB-10	120 X 190	337.27
HIT-4064636	I-U-5	95 X 150	248.93	HIT-4179470	P-UB-10	95 X 150	255.66
HIT-4071694	I-U-5	70 X 125	129.60	HIT-4203830	P-UB-14	90 X 135	211.60
HIT-4094457	P-UB-5	85 X 125	211.39	HIT-4203831	P-UB-14	100 X 145	229.52
HIT-4094458	P-UB-5	85 X 125	227.30	HIT-4206018	P-UB-10	85 X 125	184.00
HIT-4094852	P-UB-5	110 X 170	489.04	HIT-4206019	P-UB-10	95 X 135	271.75
HIT-4096957	P-UB-5	95 X 150	233.25	HIT-4206020	P-UB-10	80 X 120	204.64
HIT-4096958	P-UB-5	105 X 150	326.05	HIT-4206340	P-UB-10	70 X 95	143.69
HIT-4096959	P-UB-5	105 X 150	368.41	HIT-4206340-EX	P-UB-10	70 mm X 95 mm	192.16
HIT-4096960	P-UB-5	95 X 150	231.96	HIT-4206343	P-UB-10	75 X 105	141.03
HIT-4101392	P-UB-5	120 X 190	514.11	HIT-4206343-EX	P-UB-10	75 mm X 105 mm	426.97
HIT-4101442	I-U-5	70 X 120	127.43	HIT-4206344	P-UB-10	80 X 115	150.81
HIT-4101443	I-U-5	80 X 130	168.10	HIT-4206345	P-UB-10	65 X 95	126.79
HIT-4104127	P-UB-5	90 X 130	271.07	HIT-4206345-EX	P-UB-10	65 mm X 95 mm	175.26
HIT-4117741	P-UB-5	85 X 125	225.11	HIT-4210676	P-UB-10	130 X 225	746.68
HIT-4117743	P-UB-5	75 X 125	236.28	HIT-4214722	P-UB-10	85 X 135	191.06
HIT-4117745	P-UB-5	95 X 150	277.99	HIT-4216264P	P-UB-10	85 X 120	234.03
HIT-4117746	P-UB-5	105 X 150	369.98	HIT-4221872	P-UB-10	110 X 190	516.94
HIT-4122039	P-UB-5	95 X 150	295.46	HIT-4223636	P-UB-10	35 X 65	113.69
HIT-4122040	P-UB-5	105 X 150	384.76	HIT-4236057	P-UB-10	115 X 170	323.03
HIT-4124367	P-UB-5	140 X 200	806.20	HIT-4236058	P-UB-10	130 X 190	349.66
HIT-4125182	P-UB-5	95 X 150	291.47	HIT-42464123	P-U-10	70 X 120	117.89
HIT-4125183	P-UB-5	105 X 150	509.98	HIT-4254041	P-UB-10	140 X 200	366.37
HIT-4144635	P-UB-5	55 X 100	288.05	HIT-4254042	P-UB-10	150 X 215	420.28
HIT-4150681	P-UB-5	95 X 150	343.27	HIT-4255531	P-UB-10	115 X 170	256.74
HIT-4153203	P-UB-5	85 X 125	317.13	HIT-4255532	P-UB-10	115 X 150	242.90
HIT-4153205	P-UB-5	100 X 140	267.02	HIT-4255533	P-UB-10	65 X 100	100.81
HIT-4153207	P-UB-5	80 X 125	238.90	HIT-4256119	P-UB-10	130 X 190	346.08
HIT-4153209	P-UB-10	90 X 130	172.00	HIT-4265821	P-UB-10	65 mm X 115 mm	105.80
HIT-4153211	P-UB-10	100 X 140	251.99	HIT-4265822		55 mm X 90 mm	114.25

HITACHI

REPLACEMENT KITS FOR HITACHI

Part Number	Code (Pg. xviii)	Rod X Bore Size	List Price	Part Number	Code (Pg. xviii)	Rod X Bore Size	List Price
HIT-4265823	P-UB-10	50 mm X 80 mm	\$ 124.18	HIT-4369890-EX	P-UB-10	75 X 110	\$ 298.77
HIT-4265824	-	60 mm X 115 mm	113.86	HIT-4369892	P-UB-10	80 X 110	115.19
HIT-4266596	P-UB-10	150 X 215	420.28	HIT-4369892-EX	P-UB-10	80 X 110	305.08
HIT-4269765	P-U-10	50 mm X 90 mm	104.52	HIT-4369893P	P-UB-10	80 X 115	189.14
HIT-4286459	P-UB-10	70 X 105	126.58	HIT-4369901	P-UB-10	85 X 120	196.06
HIT-4286459-EX	P-UB-10	70 mm X 105 mm	418.24	HIT-4369902	P-UB-10	85 X 125	313.26
HIT-4286463	P-UB-10	80 X 110	169.60	HIT-4369914	P-UB-10	95 X 130	250.83
HIT-4286739	P-UB-10	65 X 95	139.92	HIT-4369943	P-UB-10	105 X 145	272.83
HIT-4286739-EX	P-UB-10	65 mm X 95 mm	261.22	HIT-4369943-EX	P-UB-10	105 X 145	332.41
HIT-4286774	P-UB-10	85 X 120	202.10	HIT-4379260	P-UB-10	70 X 95	96.34
HIT-4286774-EX	P-UB-10	85 X 120	360.85	HIT-4379260-EX	P-UB-10	70 X 95	166.87
HIT-4286780	P-UB-10	95 X 130	209.11	HIT-4379261	P-UB-10	75 X 105	105.86
HIT-4286780-EX	P-UB-10	95 X 130	382.90	HIT-4379261-EX	P-UB-10	75 X 105	179.28
HIT-4286784	P-UB-10	75 X 110	152.67	HIT-4388027	P-UB-10	70 X 100	333.03
HIT-4286784-EX	P-UB-10	75 mm X 110 mm	361.48	HIT-4389719	P-UB-10	80 X 110	211.60
HIT-4291362	P-UB-10	140 X 200	210.65	HIT-4389720	P-UB-10	85 X 115	239.98
HIT-4291362-EX	P-UB-10	140 X 200	804.41	HIT-4389721	P-UB-10	75 X 105	155.96
HIT-4291368	P-UB-10	130 X 180	288.61	HIT-4405053	P-UB-10	120 X 170	221.60
HIT-4291368-EX	P-UB-10	130 X 180	373.56	HIT-4405053-EX	P-UB-10	120 X 170	313.61
HIT-4314461	P-UB-10	80 X 130	122.05	HIT-4415584	P-UB-10	60 X 95	126.21
HIT-4314461-EX	P-UB-10	80 X 130	217.40	HIT-4415584-EX	P-UB-10	60 X 95	177.27
HIT-4320954	P-UB-10	95 X 150	197.96	HIT-4436496	P-UB-10	150 X 215	318.31
HIT-4320990	P-UB-10	70 X 105	155.88	HIT-4436496-EX	P-UB-10	150 X 215	631.11
HIT-4320993	P-UB-10	80 X 110	115.19	HIT-4437965	P-UB-10	120 X 180	388.95
HIT-4320993-EX	P-UB-10	80 X 110	305.08	HIT-4438672	P-UB-10	115 X 170	372.00
HIT-4320994	P-UB-10	65 X 95	305.35	HIT-4438679	P-UB-10	130 X 190	314.64
HIT-4340243	P-U-10	60 mm X 110 mm	78.86	HIT-4438681	P-UB-10	120 X 170	232.96
HIT-4340250		55 mm X 90 mm	37.76	HIT-4438684	P-UB-10	140 X 200	466.96
HIT-4340253	P-U-10	50 mm X 80 mm	44.05	HIT-4438693	P-UB-10	140 X 190	306.40
HIT-4340256		50 mm X 90 mm	32.64	HIT-4438693-EX	P-UB-10	140 X 190	439.25
HIT-4340274	P-U-10	70 mm X 110 mm	75.51	HIT-4438758	P-UB-10	115 X 170	256.74
HIT-4340620	P-UB-10	115 X 170	425.12	HIT-4448395	P-UB-10	70 X 105	166.66
HIT-4340621	P-UB-10	130 X 190	490.16	HIT-4448395-EX	P-UB-10	70 X 105	361.69
HIT-4352346	P-U-10	40 mm X 75 mm	38.89	HIT-4448396	P-UB-10	80 X 115	201.08
HIT-4352354	P-U-10	45 mm X 85 mm	37.05	HIT-4448396-EX	P-UB-10	80 X 115	275.43
HIT-4352357	P-U-10	45 mm X 90 mm	38.45	HIT-4448397	P-UB-10	70 X 100	160.32
HIT-4363078	P-U-10	65 X 130	133.70	HIT-4448397-EX	P-UB-10	70 X 100	282.31
HIT-4364912	P-UB-10	70 X 105	101.28	HIT-4448398	P-UB-10	85 X 120	176.23
HIT-4364912-EX	P-UB-10	70 X 105	174.70	HIT-4448398-EX	P-UB-10	85 X 120	271.98
HIT-4364913	P-UB-10	80 X 110	121.34	HIT-4448399	P-UB-10	95 X 135	221.89
HIT-4364913-EX	P-UB-10	80 X 110	194.02	HIT-4448399-EX	P-UB-10	95 X 135	315.31
HIT-4364914	P-UB-10	65 X 95	305.35	HIT-4448400	P-UB-10	80 X 115	168.13
HIT-4364915	P-UB-10	85 X 120	204.72	HIT-4448400-EX	P-UB-10	80 X 115	292.84
HIT-4364915-EX	P-UB-10	85 X 120	289.01	HIT-4464984	P-UB-10	65 X 115	132.13
HIT-4364916	P-UB-10	95 X 130	258.35	HIT-4464984-EX	P-UB-10	65 X 115	164.88
HIT-4364916-EX	P-UB-10	95 X 130	349.15	HIT-4464985	P-UB-10	60 X 95	105.31
HIT-4369766	P-UB-10	65 X 95	114.28	HIT-4464985-EX	P-UB-10	60 X 95	146.84
HIT-4369766-EX	P-UB-10	65 X 95	181.53	HIT-4464986	P-UB-10	55 X 85	100.77
HIT-4369767	P-UB-10	65 X 100	120.06	HIT-4464986-EX	P-UB-10	55 X 85	166.62
HIT-4369890	P-UB-10	75 X 110	176.38	HIT-4465736	P-UB-10	70 X 120	117.57

REPLACEMENT KITS FOR HITACHI

Part Number	Code (Pg. xviii)	Rod X Bore Size	List Price	Part Number	Code (Pg. xviii)	Rod X Bore Size	List Price
HIT-4465736-EX	P-UB-10	70 X 120	\$ 185.57	HIT-4649050	P-UB-10	100 X 140	\$ 252.00
HIT-4467379	P-UB-10	80 X 110	219.60	HIT-4649050-EX	P-UB-10	100 X 140	350.11
HIT-4467380	P-UB-10	90 X 120	237.87	HIT-4649051	P-UB-10	115 X 170	210.51
HIT-4467381	P-UB-10	75 X 105	163.74	HIT-4649051-EX	P-UB-10	115 X 170	357.91
HIT-4474521	P-UB-10	160 X 225	245.47	HIT-4649053	P-UB-10	95 X 140	181.93
HIT-4474521-EX	P-UB-10	160 X 225	586.60	HIT-4649053-EX	P-UB-10	95 X 140	280.04
HIT-4477841	P-UB-10	100 X 135	293.03	HIT-4649745	P-UB-14	95 X 135	162.63
HIT-4477841-EX	P-UB-10	100 X 135	386.44	HIT-4649751	P-UB-14	90 X 135	165.93
HIT-4485612	P-UB-14	90 X 125	108.45	HIT-4649752	P-UB-14	105 X 150	227.63
HIT-4485612-EX	P-UB-14	90 X 125	275.78	HIT-4650419	P-UB-10	90 X 125	188.44
HIT-4485613	P-UB-14	105 X 140	155.44	HIT-4650419-EX	P-UB-10	90 X 125	294.71
HIT-4485613-EX	P-UB-14	105 X 140	267.81	HIT-4650433	P-UB-10	90 X 130	156.98
HIT-4485614	P-UB-14	90 X 130	122.18	HIT-4650433-EX	P-UB-10	90 X 130	250.12
HIT-4485614-EX	P-UB-14	90 X 130	252.62	HIT-4652138	P-U-10	35 mm X 55 mm	65.32
HIT-4485615	P-UB-14	95 X 135	145.27	HIT-4652139	P-U-10	40 mm X 75 mm	64.06
HIT-4485615-EX	P-UB-14	95 X 135	258.11	HIT-4652380	P-U-10	50 mm X 80 mm	86.94
HIT-4509364	P-U-5	110 X 180	457.60	HIT-4652380-EX	P-U-10	50 mm X 80 mm	110.79
HIT-4509365	P-U-5	120 X 180	463.14	HIT-4653040	P-UB-10	115 X 170	225.63
HIT-4614056	P-U-10	45 mm X 80 mm	40.66	HIT-4653040-EX	P-UB-10	115 X 170	373.03
HIT-4614058	P-U-10	40 X 65	123.26	HIT-4653041	P-UB-10	130 X 190	264.17
HIT-4614059	P-U-10	45 X 85	124.10	HIT-4653041-EX	P-UB-10	130 X 190	447.70
HIT-4614060	P-U-10	45 mm X 90 mm	48.11	HIT-4653042	P-UB-10	120 X 170	119.53
HIT-4614061	P-U-10	45 mm X 85 mm	70.44	HIT-4653042-EX	P-UB-10	120 X 170	264.11
HIT-4614062	P-U-10	40 mm X 70 mm	56.29	HIT-4653861	P-UB-10	150 X 215	321.15
HIT-4614069	P-U-10	45 X 75	80.79	HIT-4653861-EX	P-UB-10	150 X 215	633.95
HIT-4622066	P-U-14	45 X 95	140.44	HIT-4653862	P-UB-10	160 X 225	245.47
HIT-4622067	P-U-14	50 X 105	123.20	HIT-4653862-EX	P-UB-10	160 X 225	586.60
HIT-4624394	P-UB-10	90 X 125	188.44	HIT-4653863	P-UB-10	140 X 200	210.65
HIT-4624394-EX	P-UB-10	90 X 125	294.71	HIT-4653863-EX	P-UB-10	140 X 200	397.59
HIT-4627361	P-UB-10	90 X 130	79.35	HIT-4654421	P-UB-10	85 X 120	198.05
HIT-4627361-EX	P-UB-10	90 X 130	172.49	HIT-4654422	P-UB-10	95 X 135	221.89
HIT-4631062	P-UB-10	105 X 140	226.75	HIT-4654422-EX	P-UB-10	95 X 135	315.31
HIT-4631062-EX	P-UB-10	105 X 140	347.58	HIT-4656428	P-U-10	45 mm X 80 mm	61.53
HIT-4634033	P-U-10	50 X 85	104.57	HIT-4657449	P-UB-10	90 X 120	237.87
HIT-4634034	P-U-10	45 X 75	95.92	HIT-4657449-EX	P-UB-10	90 X 120	282.93
HIT-4634035	P-UB-14	55 mm X 90 mm	46.21	HIT-4660036	P-UB-10	140 X 200	466.96
HIT-4634036	P-U-10	50 X 80	98.04	HIT-4660108	P-UB-10	120 X 180	388.95
HIT-4634037		40 mm X 70 mm	38.15	HIT-4661485	P-UB-10	85 X 120	176.23
HIT-4634038		55 mm X 95 mm	57.13	HIT-4661485-EX	P-UB-10	85 X 120	292.84
HIT-4635157		50 mm X 90 mm	39.43	HIT-4662066-EX	P-UB-10	90 X 130	250.12
HIT-4639936	P-UB-10	95 X 135	246.95	HIT-4662069	P-UB-10	90 X 125	188.44
HIT-4639936-EX	P-UB-10	95 X 135	340.35	HIT-4662069-EX	P-UB-10	90 X 125	294.71
HIT-4639938	P-UB-10	100 X 145	238.14	HIT-4662888	P-UB-10	90 X 120	237.87
HIT-4639939	P-UB-10	90 X 135	284.62	HIT-4662888-EX	P-UB-10	90 X 120	282.93
HIT-4639939-EX	P-UB-10	90 X 135	319.37	HIT-4662891	P-UB-10	80 X 110	201.87
HIT-4640107	P-UB-14	105 X 150	514.81	HIT-4662891-EX	P-UB-10	80 X 110	264.19
HIT-4640108	P-UB-14	95 X 145	450.03	HIT-4662894	P-UB-10	65 X 95	79.97
HIT-4640118	P-UB-14	115 X 170	391.59	HIT-4662894-EX	P-UB-10	65 X 95	150.49
HIT-4649049	P-UB-10	100 X 145	204.28	HIT-4662895	P-UB-10	70 X 105	166.66
HIT-4649049-EX	P-UB-10	100 X 145	338.93	HIT-4662895-EX	P-UB-10	70 X 105	361.69

HITACHI

REPLACEMENT KITS FOR HITACHI

Part Number	Code (Pg. xviii)	Rod X Bore Size	List Price	Part Number	Code (Pg. xviii)	Rod X Bore Size	List Price
HIT-4663491	P-UB-10	65 mm X 115 mm	\$ 220.04	HIT-9178294	P-UB-14	85 X 125	150.37
HIT-4663491-EX	P-UB-10	65 mm X 115 mm	241.82	HIT-9180579	P-UB-14	100 X 145	204.29
HIT-4663493-EX	P-UB-10	75 X 105	204.67	HIT-9180579-EX	P-UB-14	100 X 145	321.35
HIT-4663496	P-UB-10	70 X 100	92.26	HIT-9180580	P-UB-14	90 X 135	164.31
HIT-4663496-EX	P-UB-10	70 X 100	175.80	HIT-9180580-EX	P-UB-14	90 X 135	277.12
HIT-4669905	P-UB-10	80 X 115	111.63	HIT-9180581	P-UB-14	105 X 150	279.79
HIT-4669905-EX	P-UB-10	80 X 115	155.42	HIT-9180581-EX	P-UB-14	105 X 150	404.29
HIT-4672004	P-UB-10	100 mm X 135 mm	126.43	HIT-9180582	P-UB-14	115 X 170	244.22
HIT-4681367	P-UB-10	60 X 105	91.46	HIT-9180582-EX	P-UB-14	115 X 170	419.40
HIT-4681368	P-UB-10	55 X 85	96.71	HIT-9180587	P-UB-14	95 X 135	180.01
HIT-4681369	P-UB-10	50 X 80	86.82	HIT-9207059	P-UB-14	105 X 140	155.44
HIT-4686432	P-UB-10	115 X 170	380.07	HIT-9207059-EX	P-UB-14	105 X 140	267.81
HIT-4687559	P-U-10	60 mm X 110 mm	177.19	HIT-AH137208	N-N-14	125 bore	130.69
HIT-4687559-EX	P-U-10	60 mm X 110 mm	198.97	HIT-AH137209	N-N-14	140 bore	144.45
HIT-4687560	P-U-10	55 mm X 90 mm	152.87	HIT-AH173451	P-UB-10	80 mm X 115 mm	310.18
HIT-4687560-EX	P-U-10	55 mm X 90 mm	161.13	HIT-AH225135	P-UB-10	95 mm X 135 mm	342.13
HIT-4687561	P-U-10	55 mm X 95 mm	133.41	HIT-AH225136	P-UB-10	85 X 120	198.05
HIT-4687561-EX	P-U-10	55 mm X 95 mm	163.10	HIT-AH225136-EX	P-UB-10	85 X 120	255.21
HIT-4692136	P-UB-10	120 X 180	430.82	HIT-AH225137	P-UB-10	80 mm X 115 mm	102.2
HIT-4704455	P-U-10	45 mm X 75 mm	62.42	HIT-AT196469	P-UB-10	65 X 95	305.35
HIT-4705345		50 mm X 90 mm	114.06	HIT-AT196470	P-UB-10	70 X 105	155.88
HIT-4S00715	P-UB-10	90 mm X 125 mm	117.02	HIT-AT383285	I-UB-14	3" X 5"	200.29
HIT-4S00783	P-UB-10	100 X 145	204.28	HIT-FXB00001834	P-UB-14	85 mm X 130 mm	177.97
HIT-4S00783-EX	P-UB-10	100 X 145	338.93	HIT-FYA00001393	P-UB-10	80 mm X 115 mm	79.56
HIT-4S00834	P-UB-10	80 mm X 115 mm	79.56	HIT-FYA00001398	P-UB-10	95 X 140	122.49
HIT-4S00849	P-UB-10	70 X 100	92.26	HIT-FYA00001398-EX	P-UB-10	95 X 140	227.74
HIT-4S00849-EX	P-UB-10	70 X 100	175.80	HIT-FYA00006591	P-UB-10	100 mm X 140 mm	133.94
HIT-4S00930-EX	P-UB-10	115 X 170	354.35	HIT-FYA00006596	P-UB-10	100 mm X 145 mm	121.53
HIT-4S00959	P-UB-10	120 X 170	119.53	HIT-FYA00008837	P-UB-10	115 mm X 170 mm	429.13
HIT-4S00959-EX	P-UB-10	120 X 170	264.11	HIT-FYA00008840	P-UB-10	100 mm X 145 mm	386.09
HIT-4S00960	P-UB-10	130 X 190	347.12	HIT-FYA00008843	P-UB-10	95 mm X 140 mm	361.32
HIT-4S00960-EX	P-UB-10	130 X 190	546.95	HIT-FYA00009240	P-UB-10	70 mm X 105 mm	71.34
HIT-4S00961	P-UB-10	115 X 170	225.63	HIT-FYA00012899	P-UB-10	70 mm X 105 mm	194.26
HIT-4S00961-EX	P-UB-10	115 X 170	373.03	HIT-FYA00012900	P-UB-10	70 mm X 100 mm	177.73
HIT-9078843	P-UB-14	95 X 145	225.76	HIT-FYA00012901	P-UB-10	80 mm X 115 mm	226.08
HIT-9078844	P-UB-14	105 X 150	337.89	HIT-FYA00012902	P-UB-10	80 mm X 110 mm	261.83
HIT-9078845	P-UB-14	100 X 145	229.52	HIT-FYA00012903	P-UB-10	90 mm X 120 mm	342.41
HIT-9078846	P-UB-14	110 X 165	331.61	HIT-FYA00012904	P-UB-10	75 mm X 105 mm	249.33
HIT-9103842	P-UB-10	90 X 125	187.80	HIT-FYD00000085	P-UB-10	60 mm X 110 mm	349.00
HIT-9103843	P-UB-14	100 X 135	246.02	HIT-FYD00000086	P-UB-10	55 mm X 90 mm	328.69
HIT-9103844	P-UB-10	85 X 125	189.43	HIT-FYD00000087	P-UB-10	50 mm X 80 mm	302.01
HIT-9123264	P-UB-14	110 X 165	184.74	HIT-RE25151	P-UB-1	63 rod	108.90
HIT-9123265	P-UB-14	95 X 145	146.70				
HIT-9156441	P-UB-14	100 X 135	163.58				
HIT-9175562	P-UB-14	100 X 145	196.15				
HIT-9175563	P-UB-14	110 X 165	238.66				
HIT-9175564	P-UB-14	95 X 145	165.86				
HIT-9175564-EX	P-UB-14	95 X 145	283.66				
HIT-9178283	P-UB-14	90 X 125	143.64				
HIT-9178284	P-UB-14	100 X 135	191.54				

REPLACEMENT PARTS FOR HITACHI

NOTE: Hitachi part numbers are used as a reference only. We do not imply that these kits are original REPLACEMENT PARTS.

BACK-UP RINGS

Part Number	Min Pkg Qty	List Price
HIT-0208306	1	\$ 13.43
HIT-0208606	1	11.54
HIT-0237419	1	11.54
HIT-0240912	1	9.56
HIT-0242505	1	24.15
HIT-0242507	1	8.41
HIT-0254905	1	2.75
HIT-0257005	1	18.93
HIT-0261310	1	1.59
HIT-0262403	1	14.39
HIT-0271310	1	9.56
HIT-0298904	1	1.31
HIT-0310506	1	2.94
HIT-0310904	1	1.55
HIT-0332704	1	4.24
HIT-0408809	1	9.80
HIT-0409008	1	10.30
HIT-0409906	1	1.22
HIT-0409911	1	12.59
HIT-0496605	1	11.43
HIT-0679904	1	1.81
HIT-0686706	1	9.16
HIT-0901704	1	3.69
HIT-0971209	1	35.12
HIT-0971212	1	2.80
HIT-0971220	1	2.25
HIT-0971309	1	37.81
HIT-0971410	1	33.76
HIT-133704	1	14.39
HIT-133707	1	14.12
HIT-136006	1	13.43
HIT-146416	1	13.66
HIT-150610	1	44.32
HIT-1660019	1	13.10
HIT-166009	1	13.10
HIT-167721	1	15.92
HIT-208306	1	11.54

BACK-UP RINGS

Part Number	Min Pkg Qty	List Price
HIT-208308	1	\$ 11.29
HIT-208508	1	12.58
HIT-208522	1	13.43
HIT-219405	1	14.29
HIT-223704	1	12.08
HIT-225612	1	9.56
HIT-236911	1	11.54
HIT-236919	1	11.54
HIT-237215	1	13.43
HIT-237217	1	13.66
HIT-237309	1	13.43
HIT-239506	1	44.32
HIT-240912	1	9.56
HIT-242307	1	42.38
HIT-242507	1	17.46
HIT-242708	1	48.53
HIT-257007	1	18.25
HIT-257510	1	44.17
HIT-261310	1	12.08
HIT-262403	1	14.39
HIT-271310	1	9.56
HIT-298904	1	11.85
HIT-309207	1	12.35
HIT-310506	1	11.59
HIT-310606	1	11.35
HIT-310904	1	1.55
HIT-317710	1	49.58
HIT-317718	1	15.92
HIT-336610	1	12.23
HIT-379908	1	47.78
HIT-386706	1	2.17
HIT-4007510	1	32.87
HIT-403347	1	35.12
HIT-4033747	1	11.54
HIT-4034645	1	13.66
HIT-4034646	1	14.41
HIT-4034647	1	30.26

BACK-UP RINGS

Part Number	Min Pkg Qty	List Price
HIT-4035029	1	\$ 11.82
HIT-4035030	1	11.82
HIT-4039658	1	14.41
HIT-4039660	1	32.87
HIT-4060391	1	10.98
HIT-4061803	1	43.15
HIT-4061827	1	14.41
HIT-4067085	1	39.43
HIT-4067140	1	12.35
HIT-4068627	1	11.29
HIT-4070047	1	16.50
HIT-4087862	1	13.10
HIT-409008	1	10.30
HIT-4094811	1	39.43
HIT-4094816	1	13.43
HIT-4094817	1	32.87
HIT-409709	1	11.43
HIT-409911	1	12.59
HIT-4103695	1	12.08
HIT-4103705	1	11.54
HIT-4104134	1	11.29
HIT-4113178	1	13.66
HIT-4113180	1	39.43
HIT-4170546	1	15.92
HIT-4170548	1	13.26
HIT-4505081	1	35.05
HIT-4505083	1	30.26
HIT-4505752	1	11.54
HIT-4509747	1	9.56
HIT-4510854	1	12.58
HIT-4510878	1	10.01
HIT-487862	1	13.10
HIT-4S00769	1	14.88
HIT-AT264243	1	8.41
HIT-AT264252	1	6.84
HIT-E4052580	1	7.87

HITACHI

REPLACEMENT PARTS FOR HITACHI

NOTE: Hitachi part numbers are used as a reference only. We do not imply that these kits are original REPLACEMENT PARTS.

BUFFER RINGS

Part Number	Rod Dia.	List Price
HIT-201003	55 mm	\$ 30.45
HIT-0826908	60 mm	26.37
HIT-187305	60 mm	59.40
HIT-0790008	65 mm	31.36
HIT-225613	65 mm	29.37
HIT-409104	65 mm	29.37
HIT-0408804	70 mm	34.23
HIT-0789310	70 mm	34.23
HIT-271311	70 mm	34.11
HIT-408804	70 mm	30.68
HIT-0409605	75 mm	62.76
HIT-158102	75 mm	36.40
HIT-240913	75 mm	36.40
HIT-409605	75 mm	36.40
HIT-0409004	80 mm	66.49
HIT-0789213	80 mm	38.54
HIT-174506	80 mm	39.22
HIT-309305	80 mm	38.54
HIT-409004	80 mm	39.22
HIT-0309005	85 mm	36.42
HIT-0788911	85 mm	41.35
HIT-128603	85 mm	26.45
HIT-157801	85 mm	38.73
HIT-409704	85 mm	38.73
HIT-0829304	90 mm	49.91
HIT-0971408	90 mm	49.91
HIT-4108704	90 mm	42.59
HIT-4253560	90 mm	42.59
HIT-4412693	90 mm	49.91
HIT-0971207	95 mm	52.69
HIT-127205	95 mm	43.96
HIT-127221	95 mm	43.96
HIT-151902	95 mm	43.96
HIT-309205	95 mm	43.96
HIT-409905	95 mm	43.96
HIT-4171486	95 mm	43.96
HIT-H227909	95 mm	52.69
HIT-208505	100 mm	44.66
HIT-4131728	100 mm	44.66
HIT-0971307	105 mm	56.18
HIT-127407	105 mm	50.81

BUFFER RINGS

Part Number	Rod Dia.	List Price
HIT-127419	105 mm	\$ 50.81
HIT-151703	105 mm	50.81
HIT-4171487	105 mm	50.81
HIT-4411655	105 mm	56.18
HIT-165702	110 mm	53.04
HIT-336805	110 mm	53.04
HIT-4094814	110 mm	53.04
HIT-0352705	115 mm	30.85
HIT-0972103	115 mm	30.85
HIT-0450518	120 mm	49.87
HIT-165903	120 mm	53.13
HIT-4094836	120 mm	53.13
HIT-0941506	130 mm	34.72
HIT-353005	130 mm	54.13
HIT-380004	130 mm	54.13
HIT-AT264251	130 mm	34.72
HIT-0417405	140 mm	51.69
HIT-187705	140 mm	51.68
HIT-379807	140 mm	51.68
HIT-0392303	150 mm	52.94
HIT-242705	150 mm	57.72
HIT-292303	150 mm	57.72
HIT-379906	150 mm	57.72
HIT-0400205	160 mm	57.46
HIT-336605	170 mm	73.03

CUSHION SEALS

Part Number	List Price
HIT-0408806	\$ 27.24
HIT-0409006	33.62
HIT-0409013	24.12
HIT-0420113	81.22
HIT-0420310	81.89
HIT-0666807	27.24
HIT-0667007	30.00
HIT-0667010	24.12
HIT-0667411	24.88
HIT-0675106	29.68
HIT-409707	36.94
HIT-409909	40.69
HIT-4S00940	81.89

O-RINGS

Part Number	Min Pkg Qty	List Price
HIT-0971233	5	\$ 7.09
HIT-127216	2	9.07
HIT-127218	3	2.83
HIT-127414	5	1.76
HIT-127417	2	5.89
HIT-128605	3	8.93
HIT-128609	3	2.71
HIT-128610	6	2.26
HIT-128612	3	11.10
HIT-136004	3	2.90
HIT-146423	10	0.67
HIT-148310	1	16.18
HIT-1486206	2	5.72
HIT-150609	1	14.39
HIT-166010	3	11.10
HIT-186206	2	5.72
HIT-208509	2	4.91
HIT-4007528	1	16.75
HIT-4007535	1	13.10
HIT-4025687	10	1.02
HIT-4031027	2	7.27
HIT-4033451	2	7.49

REPLACEMENT PARTS FOR HITACHI

NOTE: Hitachi part numbers are used as a reference only. We do not imply that these kits are original REPLACEMENT PARTS.

O-RINGS

Part Number	Min Pkg Qty	List Price
HIT-4033751	2	\$ 7.49
HIT-4034653	2	7.49
HIT-4034654	2	9.07
HIT-4034655	1	24.77
HIT-4034656	2	5.78
HIT-4034657	5	3.38
HIT-4034658	10	0.67
HIT-4035039	2	7.22
HIT-4037888	10	0.87
HIT-4038304	2	7.11
HIT-4039611	1	27.23
HIT-4039657	2	9.07
HIT-4039659	1	13.10
HIT-4039678	2	1.96
HIT-4039679	2	9.07
HIT-4040565	3	10.74
HIT-4046608	2	6.98
HIT-4049492	3	9.68
HIT-4049494	2	7.11
HIT-4049565	3	10.74
HIT-4049568	2	3.49
HIT-4068626	2	7.27
HIT-4068628	4	1.29
HIT-4068632	2	6.98
HIT-4068682	2	6.98
HIT-4070046	3	5.28
HIT-4070049	10	0.60
HIT-4083465	1	8.02
HIT-4087852	2	7.39
HIT-4094815	1	13.29
HIT-4094908	15	0.48
HIT-4095999	3	8.93
HIT-4101722	3	2.83
HIT-4103701	3	2.09
HIT-4104498	15	0.48
HIT-4105424	18	1.17
HIT-4113165	1	14.76
HIT-4123447	3	2.90
HIT-4138931	18	1.17
HIT-4140487	1	27.23

O-RINGS

Part Number	Min Pkg Qty	List Price
HIT-4140491	1	\$ 27.84
HIT-4253563	2	6.98
HIT-4504858	5	3.14
HIT-4505080	1	14.01
HIT-4505082	1	13.29
HIT-808509	1	4.91
HIT-939306	10	0.60
HIT-954488	3	5.00
HIT-955612	10	0.67
HIT-984614	10	0.60
HIT-985098	10	0.49
HIT-A810025	15	0.36
HIT-A810030	20	0.48
HIT-A810085	4	6.32
HIT-A810095	5	7.43
HIT-A810125	3	9.68
HIT-A810130	3	2.90
HIT-A810155	2	5.75
HIT-A810165	2	5.78
HIT-A810170	2	5.89
HIT-A811055	10	1.59
HIT-AB11110	5	2.69
HIT-AB11115	5	2.73
HIT-E4025715	1	8.01
HIT-Z984614	20	0.43
HIT-Z992446	5	3.12

O-RINGS 90 DUROMETER

Part Number	Min Pkg Qty	List Price
HIT-317406	1	\$ 27.17
HIT-317406	1	27.17
HIT-317717	1	11.69
HIT-317717	1	11.69
HIT-4007534	1	9.07
HIT-4007534	1	9.07
HIT-4061790	2	9.65
HIT-4104135	3	2.59
HIT-4104135	3	2.59

O-RINGS 90 DUROMETER

Part Number	Min Pkg Qty	List Price
HIT-4123441	1	\$ 64.67
HIT-4123441	1	64.67
HIT-4140490	1	28.18
HIT-4140492	1	40.34
HIT-4203611	3	3.01
HIT-4203611	3	3.01
HIT-4506405	30	0.11
HIT-4506405	30	0.11
HIT-4506408	25	0.25
HIT-4506408	25	0.25
HIT-4506424	1	0.72
HIT-4506424	1	0.72
HIT-4506428	12	1.00
HIT-4506428	12	1.00
HIT-4506430	12	1.20
HIT-4506430	12	1.20
HIT-A811025	1	0.40
HIT-A811025	1	0.40
HIT-A811030	12	0.54
HIT-A811030	12	0.54
HIT-A811035	10	0.66
HIT-A811035	10	0.66
HIT-A811040	10	0.72
HIT-A811040	10	0.72
HIT-A811045	10	1.45
HIT-A811045	10	1.45
HIT-A811050	8	1.53
HIT-A811050	8	1.53
HIT-A811070	5	1.84
HIT-A811070	5	1.84
HIT-A811075	4	7.09
HIT-A811075	4	7.09
HIT-A811080	4	2.23
HIT-A811080	4	2.23
HIT-A811085	3	2.30
HIT-A811090	3	2.32
HIT-A811095	5	2.38
HIT-A811100	3	2.59
HIT-A811105	3	2.65
HIT-A811110	3	2.69
HIT-A811115	3	2.73

REPLACEMENT PARTS FOR HITACHI

NOTE: Hitachi part numbers are used as a reference only. We do not imply that these kits are original REPLACEMENT PARTS.

O-RINGS 90 DUROMETER

Part Number	Min Pkg Qty	List Price
HIT-A811120	3	\$ 2.96
HIT-A811125	3	3.01
HIT-A811130	2	3.03
HIT-A811135	2	3.55
HIT-A811140	2	6.34
HIT-A811145	2	3.64
HIT-A811150	1	7.77
HIT-A811160	2	9.65
HIT-A811180	1	13.39
HIT-A811190	1	13.69
HIT-A811200	1	17.83
HIT-A811210	1	21.15
HIT-A811220	1	25.13
HIT-A811250	1	30.03
HIT-A812180	1	13.39
HIT-AT264241	1	13.39

PISTON RINGS

Part Number	Bore Diameter	List Price
HIT-E12617343	5-3/4	\$ 24.85
HIT-4016890	7	49.16
HIT-E4052468	7-3/4	42.24
HIT-4026780	9	98.78
HIT-E4051808	9.17	64.84
HIT-4026781	11	159.39
HIT-0961221	150 mm	48.09
HIT-0961424	170 mm	53.13
HIT-0961518	145 mm	45.61
HIT-4431271	130 mm	28.45
HIT-4431272	135 mm	58.26

PISTON SEALS

Part Number	Bore Diameter	List Price
HIT-310608	95 mm	\$ 44.21
HIT-201006	100 mm	44.11
HIT-0240807	100 mm	37.06
HIT-0310508	105 mm	41.10
HIT-0408807	105 mm	41.10
HIT-240915	110 mm	54.44
HIT-0240915	110 mm	54.44
HIT-0225614	115 mm	55.74
HIT-225614	115 mm	55.74
HIT-258203	120 mm	55.74
HIT-258205	120 mm	55.74
HIT-0258205	120 mm	55.74
HIT-128611	125 mm	55.55
HIT-223706	125 mm	55.74
HIT-4092193	125 mm	55.55
HIT-4124860	125 mm	81.86
HIT-0264305	130 mm	57.68
HIT-254305	130 mm	57.68
HIT-4085439	130 mm	55.55
HIT-0254305	130 mm	57.68
HIT-0971414	135 mm	94.12
HIT-309210	135 mm	65.14
HIT-133505	140 mm	64.05
HIT-0224106	140 mm	65.86
HIT-TH102795	140 mm	65.86
HIT-4185245	145 mm	100.90
HIT-0965404	150 mm	108.97
HIT-127210	150 mm	71.40
HIT-127412	150 mm	71.40
HIT-187405	150 mm	71.40
HIT-237218	150 mm	70.80
HIT-4128769	150 mm	71.40
HIT-4171492	150 mm	108.97
HIT-165703	170 mm	83.12
HIT-4094809	170 mm	83.12
HIT-4170547	170 mm	87.84
HIT-AT264253	170 mm	87.84
HIT-0332706	180 mm	95.98
HIT-0242510	190 mm	99.95
HIT-105707	190 mm	94.25
HIT-161603	190 mm	94.25

PISTON SEALS

Part Number	Bore Diameter	List Price
HIT-242510	190 mm	99.95
HIT-380006	190 mm	99.95
HIT-T201905	190 mm	99.95
HIT-379811	200 mm	102.96
HIT-0257010	200 mm	102.96
HIT-379911	215 mm	104.79
HIT-0392305	215 mm	104.79
HIT-242712	225 mm	115.02
HIT-0242712	225 mm	115.02
HIT-0400210	230 mm	363.49
HIT-0242310	240 mm	117.26
HIT-0400311	260 mm	508.85

PISTON U-SEALS

Part Number	Bore Diameter	List Price
HIT-Z951846	125 mm	\$ 55.55
HIT-Z996169	125 mm	55.55
HIT-Z966212	150 mm	71.40
HIT-Z966256	150 mm	71.40
HIT-4505069	180 mm	88.77
HIT-4505070	180 mm	88.77

ROD BUSHINGS

Part Number	Rod Diameter	List Price
HIT-1153502	40 mm	\$ 9.33
HIT-0652401	40 mm	9.33
HIT-0892005	40 mm	9.33
HIT-0891518	45 mm	11.07
HIT-0891605	45 mm	11.07
HIT-0920515	45 mm	12.81
HIT-0854104	50 mm	12.96
HIT-FYD00000053	50 mm	15.54
HIT-0948703	50 mm	12.96
HIT-1187203	55 mm	13.72
HIT-FYD00000040	55 mm	18.35

REPLACEMENT PARTS FOR HITACHI

NOTE: Hitachi part numbers are used as a reference only. We do not imply that these kits are original REPLACEMENT PARTS.

ROD BUSHINGS

Part Number	Rod Diameter	List Price
HIT-0826907	60 mm	\$ 18.65
HIT-0994204	60 mm	18.65
HIT-FYD00000021	60 mm	18.65
HIT-0310604	65 mm	21.71
HIT-0657704	65 mm	22.57
HIT-0790009	65 mm	18.42
HIT-0310304	70 mm	24.51
HIT-4633389	70 mm	22.55
HIT-0643402	70 mm	10.24
HIT-FXB00002262	70 mm	10.24
HIT-0271309	70 mm	20.92
HIT-0789311	70 mm	20.92
HIT-0310504	75 mm	27.12
HIT-310504	75 mm	27.12
HIT-FXB00002087	75 mm	27.12
HIT-0240911	75 mm	23.04
HIT-TH109311	75 mm	27.12
HIT-0309304	80 mm	31.26
HIT-FXB00002113	80 mm	31.26
HIT-0208605	80 mm	25.66
HIT-AT264314	80 mm	31.26
HIT-T108041	80 mm	31.26
HIT-0309004	85 mm	34.71
HIT-4272960	85 mm	34.71
HIT-FXB00001811	85 mm	37.06
HIT-0208305	85 mm	27.86
HIT-0788912	85 mm	27.86
HIT-T108019	85 mm	34.71
HIT-0325904	90 mm	33.48
HIT-4272961	90 mm	33.48
HIT-FXB00002051	90 mm	36.70
HIT-AT264321	90 mm	33.48
HIT-0309204	95 mm	37.71
HIT-309204	95 mm	37.71
HIT-4171488	95 mm	44.36
HIT-4272962	95 mm	37.71
HIT-4284535	95 mm	44.36
HIT-0971202	95 mm	37.71
HIT-T108050	95 mm	37.71
HIT-0836104	100 mm	51.68
HIT-4272963	100 mm	52.10

ROD BUSHINGS

Part Number	Rod Diameter	List Price
HIT-0373405	105 mm	\$ 44.45
HIT-4383093	105 mm	46.86
HIT-4432450	105 mm	44.45
HIT-336804	110 mm	84.51
HIT-4284534	110 mm	84.51
HIT-0352704	115 mm	50.20
HIT-4370337	115 mm	66.38
HIT-0961415	115 mm	61.48
HIT-1237306	115 mm	20.88
HIT-0450506	120 mm	48.63
HIT-0353004	130 mm	71.19
HIT-317404	130 mm	79.26

ROD U-SEALS

Part Number	Rod Dia.	List Price
HIT-4070021	100 mm	\$ 33.93
HIT-4168227	100 mm	21.60
HIT-0965402	105 mm	53.24
HIT-127408	105 mm	42.16
HIT-4069701	110 mm	47.25
HIT-4505060	110 mm	47.25
HIT-0352706	115 mm	45.87
HIT-0972104	115 mm	45.87
HIT-352706	115 mm	45.87
HIT-0972403	120 mm	55.88
HIT-4069711	120 mm	55.88
HIT-4505951	120 mm	55.88
HIT-0972303	130 mm	53.33
HIT-191405	130 mm	53.33
HIT-AT264242	130 mm	53.33
HIT-4094949	140 mm	65.52
HIT-4070027	150 mm	95.69
HIT-0978104	150 mm	95.69
HIT-4105385	160 mm	85.89
HIT-0978305	160 mm	85.89
HIT-4070039	55 mm	17.20
HIT-225611	65 mm	18.42
HIT-2711309	70 mm	20.92
HIT-271309	70 mm	20.92

ROD U-SEALS

Part Number	Rod Dia.	List Price
HIT-4508829	70 mm	\$ 25.13
HIT-127710	75 mm	25.33
HIT-240911	75 mm	23.04
HIT-0789214	80 mm	25.66
HIT-208605	80 mm	25.66
HIT-128606	85 mm	28.84
HIT-0105301	90 mm	29.65
HIT-4039668	90 mm	26.10
HIT-4094890	90 mm	26.10
HIT-4168226	90 mm	42.03
HIT-0971409	90 mm	47.67
HIT-0971208	95 mm	46.08
HIT-127207	95 mm	31.30
HIT-146407	95 mm	31.30
HIT-4034640	95 mm	31.30
HIT-4171484	95 mm	31.03

U-SEALS

Part Number	Rod Dia.	List Price
HIT-E4200159	4	\$ 17.41
HIT-12584908	8	42.11
HIT-E4012111	8-1/2	45.07
HIT-12584909	10	71.97

REPLACEMENT PARTS FOR HITACHI

NOTE: Hitachi part numbers are used as a reference only. We do not imply that these kits are original REPLACEMENT PARTS.

WEAR RINGS

Part Number	OD X Width	List Price
HIT-E4200162	4-1/2 X 1	\$ 7.30
HIT-E4012301	5-3/4 X 1	7.58
HIT-E4012107	6-3/4 X 1	10.44
HIT-E4017428	7-3/4 X 1	29.33
HIT-4200164	8-1/4 X 1	18.06
HIT-E4012110	8-3/4 X 1	34.73
HIT-E4012302	9-1/4 X 1	33.79
HIT-4026791	10-1/4 X 1	19.30
HIT-0387503	70 X 9.5 mm	24.45
HIT-0827011	85 X 6 mm	28.75
HIT-0891615	85 X 6 mm	28.75
HIT-0333007	95 X 14.8 mm	20.08
HIT-0310609	95 X 6 mm	10.66
HIT-0310610	95 X 6 mm	37.81
HIT-0667108	95 X 6.1 mm	14.84
HIT-0254908	100 X 5.9 mm	72.59
HIT-70183473	100 X 5.9 mm	18.60
HIT-0326005	100 X 6 mm	11.88
HIT-0686707	100 X 6 mm	15.37
HIT-0310510	105 X 6 mm	95.77
HIT-0666808	105 X 6 mm	34.46
HIT-0310509	105 X 6 mm	34.46
HIT-0298907	110 X 5.9 mm	79.26
HIT-4S00156	110 X 5.9 mm	79.26
HIT-0410005	110 X 7.9 mm	12.67
HIT-0667008	110 X 7.9 mm	10.89
HIT-0352708	115 X 14.8 mm	17.76
HIT-0310908	115 X 6 mm	40.55
HIT-0686405	115 X 7.9 mm	10.89
HIT-1102304	115 X 7.9 mm	10.89
HIT-0450508	120 X 14.8 mm	58.73
HIT-0460004	120 X 15 mm	42.70
HIT-0667206	120 X 7.9 mm	11.73
HIT-H227906	120 X 7.9 mm	13.29

WEAR RINGS

Part Number	OD X Width	List Price
HIT-0261308	120 X 8 mm	\$ 47.08
HIT-0998904	120 X 8 mm	47.08
HIT-AT264356	120 X 8 mm	28.15
HIT-0309009	125 X 7.9 mm	13.92
HIT-0309309	125 X 7.9 mm	13.29
HIT-0926604	125 X 7.9 mm	13.92
HIT-0223713	125 X 8 mm	49.06
HIT-4168234	125 X 9.7 mm	125.42
HIT-4253562	125 X 9.9 mm	14.83
HIT-4431329	130 X 10 mm	26.31
HIT-0657706	130 X 11.6 mm	101.01
HIT-0417605	130 X 14.8 mm	48.77
HIT-0409912	130 X 7.9 mm	16.36
HIT-0667409	130 X 7.9 mm	13.04
HIT-0932805	130 X 7.9 mm	16.36
HIT-0974906	130 X 7.9 mm	16.36
HIT-223707	130 X 7.9 mm	13.04
HIT-409912	130 X 7.9 mm	16.36
HIT-0223703	130 X 8 mm	49.93
HIT-0254309	130 X 8 mm	49.93
HIT-254309	130 X 8 mm	49.93
HIT-4185248	135 X 14.8 mm	16.16
HIT-0789110	135 X 7.9 mm	14.40
HIT-0962104	135 X 7.9 mm	14.40
HIT-309211	135 X 7.9 mm	14.40
HIT-0309212	135 X 8 mm	50.87
HIT-0971217	135 X 9.5 mm	20.15
HIT-0971218	135 X 9.7 mm	59.59
HIT-4185246	135 X 9.7 mm	59.59
HIT-4252191	135 X 9.8 mm	20.40
HIT-4414671	140 X 10 mm	18.90
HIT-224107	140 X 7.9 mm	14.95
HIT-0224108	140 X 8 mm	51.51
HIT-0937408	140 X 9.5 mm	17.94

WEAR RINGS

Part Number	OD X Width	List Price
HIT-0960302	140 X 9.5 mm	\$ 17.94
HIT-4168233	140 X 9.7 mm	61.56
HIT-4185249	145 X 14.8 mm	17.54
HIT-0373413	145 X 7.9 mm	81.03
HIT-0492209	145 X 9.5 mm	17.94
HIT-0962008	145 X 9.5 mm	17.94
HIT-4194621	145 X 9.5 mm	19.00
HIT-4S00803	145 X 9.5 mm	17.94
HIT-4185247	145 X 9.7 mm	65.19
HIT-4194622	150 X 14.8 mm	18.88
HIT-0237220	150 X 8 mm	56.88
HIT-0387305	150 X 9.5 mm	18.08
HIT-237219	150 X 9.5 mm	18.08
HIT-4171490	150 X 9.7 mm	68.31
HIT-0352712	160 X 9.5 mm	20.09
HIT-4194623	165 X 15 mm	27.81
HIT-4194624	165 X 9.7 mm	138.11
HIT-4370064	170 X 14.8 mm	36.15
HIT-0420109	170 X 9.5 mm	21.63
HIT-0972106	170 X 9.5 mm	21.63
HIT-0975411	170 X 9.5 mm	21.63
HIT-259306	170 X 9.5 mm	20.09
HIT-4S00797	170 X 9.5 mm	21.63
HIT-0259307	170 X 9.7 mm	85.62
HIT-4370063	170 X 9.7 mm	85.62
HIT-0420307	190 X 14.8 mm	38.95
HIT-0972305	190 X 14.8 mm	38.95
HIT-242511	190 X 15 mm	28.88
HIT-336808	190 X 15 mm	28.88
HIT-0242512	190 X 9.7 mm	89.04
HIT-4S00756	200 X 19.4 mm	23.93
HIT-4S00758	215 X 19.5 mm	21.49

HITACHI

REPLACEMENT PARTS FOR HITACHI

NOTE: Hitachi part numbers are used as a reference only. We do not imply that these kits are original REPLACEMENT PARTS.

WIPERS

Part Number	Rod Dia.	List Price
HIT-E9228981	4	\$ 4.09
HIT-E9230646	6-1/2	7.30
HIT-4094867	55 mm	27.00
HIT-225610	65 mm	31.03
HIT-0409117	65 mm	31.03
HIT-271308	70 mm	33.30
HIT-4036973	70 mm	9.19
HIT-0409503	70 mm	13.36
HIT-0666806	70 mm	35.28
HIT-4729045	70 mm	35.28
HIT-240910	72 mm	35.80
HIT-4103699	75 mm	35.80
HIT-0667504	75 mm	37.92
HIT-0667006	80 mm	44.73
HIT-208607	80 mm	42.22
HIT-409020	80 mm	44.73
HIT-0409019	80 mm	44.73
HIT-4729047	80 mm	44.73
HIT-0667204	85 mm	50.77
HIT-128607	85 mm	47.92

WIPERS

Part Number	Rod Dia.	List Price
HIT-208307	85 mm	\$ 47.92
HIT-0829305	90 mm	54.89
HIT-0971411	90 mm	54.89
HIT-4039669	90 mm	15.34
HIT-4094892	90 mm	51.80
HIT-4124849	90 mm	51.80
HIT-4348202	90 mm	54.89
HIT-0971210	95 mm	28.52
HIT-127208	95 mm	52.98
HIT-146409	95 mm	52.98
HIT-236920	95 mm	52.98
HIT-309206	95 mm	52.98
HIT-4039686	95 mm	21.04
HIT-4171482	95 mm	52.98
HIT-208507	100 mm	54.39
HIT-4074008	100 mm	35.86
HIT-4131730	100 mm	54.39
HIT-808507	100 mm	54.39
HIT-0971310	105 mm	55.68
HIT-127409	105 mm	52.56

WIPERS

Part Number	Rod Dia.	List Price
HIT-237216	105 mm	\$ 52.56
HIT-4171483	105 mm	52.56
HIT-4351498	105 mm	55.68
HIT-237310	110 mm	55.72
HIT-4505063	110 mm	55.72
HIT-0352709	115 mm	49.28
HIT-0972105	115 mm	25.70
HIT-352709	115 mm	49.28
HIT-0450519	120 mm	64.60
HIT-4505954	120 mm	60.97
HIT-0972304	130 mm	70.69
HIT-257006	130 mm	66.72
HIT-4S00952	130 mm	70.69
HIT-242506	140 mm	68.36
HIT-0977905	140 mm	72.43
HIT-242707	150 mm	71.68
HIT-4429148	150 mm	75.95
HIT-242306	160 mm	88.39
HIT-0978306	160 mm	93.66
HIT-4438827	160 mm	93.66

HUSKY BRUTE

Kit Number	Kit Reference Number	Code (Pg. xviii)	Rod X Bore Size	List Price
HB-790-030-004		P-V-8	2 X 4	\$ 62.57
HB-790-030-015		I-U-10, 12	2 X 5	58.25
HB-790-030-016		I-U-10, 12	2 X 5	81.80
HB-790-030-017		I-U-10, 12	2-1/2 X 6	77.95
HB-790-030-018		I-U-10, 12	2-1/2 X 6	111.66
HB-790-030-019		I-U-10, 12	3 X 6	113.59
HB-790-030-020		I-U-10, 12	2 X 5	100.22
HB-790-030-022		I-U-10, 12	3-1/2 X 7	133.55
HB-790-030-023		I-O-4	2-1/2 X 6	55.55
HB-790-030-024		5" Piston Kit		39.79
HB-790-035-501		P-OB-12	1-3/8 X 3-1/2	33.33
HB-790-035-502		5" Piston Kit		50.83
HB-790-035-504		P-OB-12	1-3/4 X 5	53.43
HB-790-035-507		I-U-5	3 X 6	90.42
HB-790-035-508		P-OB-12	2-1/2 X 6	96.53
HB-790-035-510		I-U-5	2-1/2 X 5	67.93
HB-790-035-519		I-V-9	2 X 4	83.76
HB-790-035-530		I-U-4	4 X 6-1/4	103.01
HB-790-035-531		I-U-5	4 X 7	135.48
HB-790-035-536		P-U-11	3-1/2 X 6	93.71
HB-790-120-019		I-U-5	4 X 7	113.59
HB-790-121-092		I-U-10, 12	2 X 5	81.80
HB-790-121-093		I-U-4	3-1/2 X 6	125.88
HB-790-121-097	790-121-097	I-U-4	4 X 7	97.95
HB-790-121-111		I-U-5	3 X 6	77.95
HB-790-122-302		6" Piston Kit		44.18
HB-790-200-011	790-200-011	I-U-5	2 X 3-1/2	50.46
HB-790-200-023		I-U-4	2-1/2 X 5	113.19
HBPMCK-D1192	790-035-50	P-OB-2,12	1-3/8 X 3-1/2	211.24
HBPMCK-F715	CYL. # F715	I-N-10,12	2 X 5	38.49
HBPMCK-F716	CYL. #716	I-U-10,12	2 X 5	81.80
HBPMCK-F717	790-030-018	I-N-10,12	2-1/2 X 6	77.76
HBPMCK-F718	CYL. #F718	I-U-10,12	2-1/2 X 6	110.38
HBPMCK-F721	790-030-019	I-U-10,12	3 X 6	113.59
HBPMCK-F726	CYL. #F726	I-U-10,12	2 X 5	100.76
HBPMCK-G968	790-030-022	I-U-10,12	3-1/2 X 7	137.44
HBPMCK-H163	CYL. #H163	I-N-4	2-1/2 X 6	66.26
HBPMCK-H182	790-030-024	I-N-4	2 X 5	53.69

HUSKY BRUTE

HYCO TELESCOPIC CYLINDERS

IMPORTANT NOTE

When ordering hyco telescopic parts it is helpful to provide a model number and serial number. The serial number is stamped into the base of the cylinder body or is just above the cylinder port. The serial number is the first four or five digits of the number. The last three or four digits indicate the date of manufacture.

EXAMPLE 12345 10 93
 SERIAL # MONTH YEAR

70,000 SERIES SINGLE ACTING

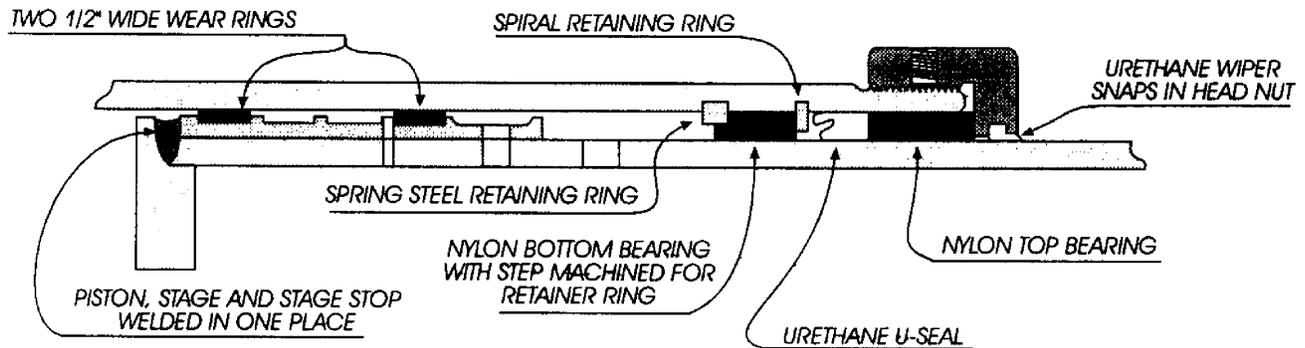

70,000 SERIES SINGLE ACTING

PACKING:	Normally uses urethane u-seals, but may be retrofitted with vee packing. All sizes 1/4" c.s.
WIPERS:	Urethane snap-in type.
BEARINGS:	Nylon bearings. Outer bearing is flat on the top and bottom. Inner bearing is "trapped" between two retainers. The bottom side of the inner bearing is "step-cut" on the o.d. to pilot over snap ring. c/s = .245"
PISTON:	Welded to stage. Uses 2 replaceable wear rings per stage.
STAGE O.D.'s:	3", 4", 5", 6", 7", 8-1/8", 9-3/8"
SPECIAL INFO.:	Spring steel type snap ring serves as internal stop. Uses a spiral retainer to "trap" lower bearing.
IDENTIFICATION:	Cylinder model number and serial number stamped on cylinder body near base of cylinder. Ex: 70000-815-180D

70,000 Series single action cylinders are manufactured to use urethane u-seals but may be retrofitted with a vee packing set if desired. We stock both types of packing for your convenience.

70,000 SERIES SINGLE ACTING PACKING SETS

Hercules® Sealing Products offers two types of packing for Hyco 70,000 series cylinders. Type 1 kits are identical to the original Hyco packing sets and utilize Parker u-seals. Type 2 kits contain a vee packing set retrofit for the original u-seal packing. The vee packing can be more effective in sealing an older cylinder with abrasive scoring or other surface blemishes.

HYCO TELESCOPIC CYLINDERS

70,000 SERIES CYLINDERS WITH K STYLE WIPER

Part Number	Description	List Price
TYPE 1: U-SEALS, WIPERS, NYLON BEARINGS AND RETAINER KITS		
HY-034-00070-300	3" Pack Kit	\$ 77.19
HY-034-00070-400	4" Pack Kit	99.72
HY-034-00070-500	5" Pack Kit	113.00
HY-034-00070-600	6" Pack Kit	128.06
HY-034-00070-700	7" Pack Kit	147.15
HY-034-00070-812	8-1/8" Pack Kit	252.04
HY-034-00070-938	9-3/8" Pack Kit	342.25
MULTIPLE STAGE KITS		
HY-034-00070-46	4 - 6"	\$ 340.25
HY-034-00070-47	4 - 7"	466.37
HY-034-00070-48-1/8	4 - 8-1/8"	710.38
HY-034-00070-49-3/8	4 - 9-3/8"	1064.92
HY-034-00070-57	5 - 7"	375.69
HY-034-00070-58-1/8	5 - 8-1/8"	616.55

Part Number	Description	List Price
TYPE 2: OPTIONAL VEE SETS, WIPERS, NYLON BEARINGS AND RETAINER KITS		
HY-034-00072-300	3" Pack Kit	\$ 66.54
HY-034-00072-400	4" Pack Kit	88.13
HY-034-00072-500	5" Pack Kit	104.70
HY-034-00072-600	6" Pack Kit	118.72
HY-034-00072-700	7" Pack Kit	133.73
HY-034-00072-812	8-1/8" Pack Kit	232.94
HY-034-00072-938	9-3/8" Pack Kit	300.33
MULTIPLE STAGE KITS		
HY-034-00072-46	4" - 6"	\$ 307.12
HY-034-00072-47	4" - 7"	439.12
HY-034-00072-48-1/8	4" - 8-1/8"	713.58
HY-034-00072-49-3/8	4" - 9-3/8"	1103.69
HY-034-00072-57	5" - 7"	355.53
HY-034-00072-58-1/8	5" - 8-1/8"	561.66

HYCO TELESCOPIC CYLINDERS

70,000 SERIES CYLINDERS

Part Number	Description	List Price
TYPE 1: U-SEALS, WIPERS, NYLON BEARINGS AND RETAINER KITS		
HY-B15252-300	3" Pack Kit	\$ 68.21
HY-B15252-400	4" Pack Kit	85.24
HY-B15252-600	6" Pack Kit	107.74
HY-B15252-700	7" Pack Kit	125.15
HY-B15252-812	8-1/8" Pack Kit	210.28
HY-B15252-938	9-3/8" Pack Kit	298.05
MULTIPLE STAGE KITS		
HY-B15252-46	4" - 6"	\$ 287.90
HY-B15252-47	4" - 7"	392.05
HY-B15252-48-1/8	4" - 8-1/8"	604.91
HY-B15252-49-3/8	4" - 9-3/8"	957.63
HY-B15252-500	5" Pack Kit	94.86
HY-B15252-57	5" - 7"	315.28
HY-B15252-58-1/8	5" - 8-1/8"	517.76

Part Number	Description	List Price
TYPE 2: OPTIONAL VEE SETS, WIPERS, NYLON BEARINGS AND RETAINER KITS		
HY-B15255-300	3" Pack Kit	\$ 57.54
HY-B15255-400	4" Pack Kit	74.22
HY-B15255-500	5" Pack Kit	86.57
HY-B15255-600	6" Pack Kit	98.42
HY-B15255-700	7" Pack Kit	111.77
HY-B15255-812	8-1/8" Pack Kit	191.95
HY-B15255-938	9-3/8" Pack Kit	251.53
MULTIPLE STAGE KITS		
HY-B15255-46	4" - 6"	\$ 254.74
HY-B15255-47	4" - 7"	364.79
HY-B15255-48-1/8	4" - 8-1/8"	607.01
HY-B15255-49-3/8	4" - 9-3/8"	814.44
HY-B15255-57	5" - 7"	295.08
HY-B15255-58-1/8	5" - 8-1/8"	470.27

HYCO

HYCO TELESCOPIC CYLINDERS

70,000 SERIES CYLINDERS

INDIVIDUAL PARTS

Part Number	Description	List Price
RETAINER RINGS		
HY-083-50002-00350	3" Retainer Ring	\$ 26.93
HY-083-50002-00450	4" Retainer Ring	26.93
HY-B9971-5.5	5" Retainer Ring	42.86
HY-B9971-6.5	6" Retainer Ring	43.00
HY-B9971-7.5	7" Retainer Ring	43.47
HY-B9971-988	9-3/8" Retainer Ring	151.88
PISTON WEAR RINGS		
HY-10764-300	3-1/2" Nylon Piston Wear Ring	\$ 4.57
HY-10764-400	4-1/2" Nylon Piston Wear Ring	4.89
HY-10764-500	5-1/2" Nylon Piston Wear Ring	4.89
HY-10764-600	6-1/2" Nylon Piston Wear Ring	6.41
HY-10764-700	7-1/2" Nylon Piston Wear Ring	6.41
HY-10764-812	8-5/8" Nylon Piston Wear Ring	11.51
HY-10764-938	9-7/8" Nylon Piston Wear Ring	21.63
MISCELLANEOUS PARTS		
HY-A20419	Set Screw for Headnut	\$ 1.29
HY-A20420	Nylon Slug for Headnut	0.66
HY-A2688	Manual Bleeder Valve (Min Pack 3)	5.36
INDIVIDUAL WIPERS		
HY-080-0005-300	3" Wiper	\$ 10.74
HY-080-0005-400	4" Wiper	16.60
HY-080-0005-500	5" Wiper	21.65
HY-080-0005-600	6" Wiper	24.20
HY-080-0005-700	7" Wiper	26.22
HY-080-0005-800	8" Wiper	57.58
HY-080-0005-812	8-1/8" Wiper	49.77
HY-080-0005-912	9-1/8" Wiper	86.73
HY-080-0005-938	9-3/8" Wiper	92.31
MULTIPLE STAGE WIPER KITS		
HY-080-0005-46	4" - 6"	\$ 54.11
HY-080-0005-47	4" - 7"	75.98
HY-080-0005-48-1/8	4" - 7" & 8-1/8"	117.58
HY-080-0005-49-1/8	4" - 8" & 9-1/8"	196.52
HY-080-0005-49-3/8	4" - 7", 8-1/8" & 9-3/8"	196.62
HY-080-0005-57	5" - 7"	62.15
HY-080-0005-58-1/8	5" - 7" & 8-1/8"	103.74

CAUTION:
Getting the correct Hyco headnut can be a problem. If you are unsure, call our sales department. Headnuts are measured at the I.D. of the wiper.

Part Number	Description	List Price
BEARINGS		
HY-B12075-3	3" Bearing	\$ 13.14
HY-B12075-4	4" Bearing	13.14
HY-B12075-5	5" Bearing	13.85
HY-B12075-6	6" Bearing	16.37
HY-B12075-7	7" Bearing	17.82
HY-B12075-8	8" Bearing	21.59
HY-B12075-8.12	8-1/8" Bearing	57.51
HY-B12075-9.12	9-1/8" Bearing	73.05
HY-B12075-9.38	9-3/8" Bearing	64.28
U-SEALS		
HY-085-00001-0300	3" U-SEAL	\$ 35.44
HY-085-00001-0400	4" U-SEAL	43.89
HY-085-00001-0500	5" U-SEAL	47.89
HY-085-00001-0600	6" U-SEAL	52.56
HY-085-00001-0700	7" U-SEAL	76.55
HY-085-00001-0812	8-1/8" U-SEAL	88.56
HY-085-00001-0938	9-3/8" U-SEAL	115.06
HEAD NUTS		
HY-011-49007W00125	4" Headnut, wiper included	\$ 84.28
HY-011-59006W00125	5" Headnut, wiper included	92.99
HY-011-69005W00125	6" Headnut, wiper included	103.25
HY-011-79007W00125	7" Headnut, wiper included	143.34
HY-011-93002W00125	8-1/8" Headnut, wiper included	210.35

HYCO

HYCO TELESCOPIC CYLINDERS

IMPORTANT NOTE

When ordering hyco telescopic parts it is helpful to provide a model number and serial number. The serial number is stamped into the base of the cylinder body or is just above the cylinder port. The serial number is the first four or five digits of the number. The last three or four digits indicate the date of manufacture.

EXAMPLE 12345 10 93
SERIAL # MONTH YEAR

30,000 SERIES SINGLE ACTING MANUFACTURED AFTER AUGUST 1, 1981

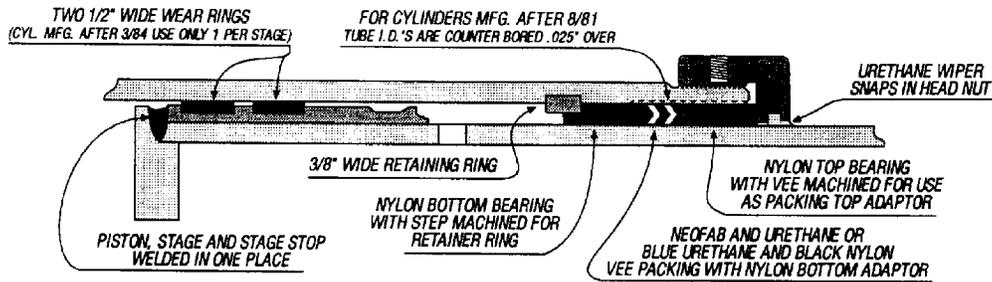

- PACKING:** Vee packing. Outer bearing serves as top adaptor for vee set. Note: Packing area is .025" over nominal bore. There is a "step" above the retainer ring groove where the bore dimension returns to nominal size.
- WIPERS:** Urethane snap-in type.
- BEARINGS:** Glass filled nylon. Outer bearing serves as top adaptor for vee set. Inner bearing is "step cut" on o.d. to pilot over snap ring.
- PISTON:** Welded to stage. Uses 1/2" wide replaceable wear rings as bearings. Cylinders manufactured 3/84 and before use 2 wear rings per stage. Cylinders manufactured after 3/84 use 1 per stage.
- STAGE O.D.'s:** 3", 4", 5", 6", 7", 8", 8-1/8", 8-1/4", 9-1/8", 9-3/8"
- SPECIAL INFO.:** Packing area bore diameter is .025" over nominal dimension. 3/8" thick spring steel snap ring serves as internal stop.
- IDENTIFICATION:** Cylinder model number and serial number stamped on cylinder body near base of cylinder.
Ex: 30001-85-220

The plungers and cylinder tube assembly have a "step" on the inside diameter above retaining ring groove. As a result packing surface is .025" over the plunger base I.D.. Pack sets contain wiper, vee packing, glass filled nylon top & bottom bearings, retainer rings are 3/8" wide, piston guide rings 1/2" wide, cylinders manufactured after 3/84 may only use one wear ring per stage.

Part Number	Description	List Price
VEE PACKING, AND WIPER KITS		
HY-14750-300VSW	3" Packing & Wiper Kit	\$ 20.82
HY-14750-400VSW	4" Packing & Wiper Kit	25.73
HY-14750-500VSW	5" Packing & Wiper Kit	29.17
HY-14750-600VSW	6" Packing & Wiper Kit	37.10
HY-14750-700VSW	7" Packing & Wiper Kit	50.33
HY-14750-800VSW	8" Packing & Wiper Kit	60.83
HY-14750-812VSW	8-1/8" Packing & Wiper Kit	96.88
HY-14750-912VSW	9-1/8" Packing & Wiper Kit	112.33

Part Number	Description	List Price
VEE PACKING, BUSHING AND WIPER KITS		
HY-14750-300	3" Pack Kit	\$ 47.52
HY-14750-400	4" Pack Kit	47.52
HY-14750-500	5" Pack Kit	48.60
HY-14750-600	6" Pack Kit	56.68
HY-14750-700	7" Pack Kit	94.21
HY-14750-800	8" Pack Kit	116.39
HY-14750-812	8-1/8" Pack Kit	153.84
HY-14750-825	8-1/4" Pack Kit	167.03
HY-14750-912	9-1/8" Pack Kit	151.37
HY-14750-938	9-3/8" Pack Kit	220.06

HYCO TELESCOPIC CYLINDERS

30,000 SERIES CYLINDERS

INDIVIDUAL PARTS

Part Number	Description	List Price
VEE PACKING, BUSHING AND WIPER KITS		
HY-14750-46	4 - 6" Pack Kit	\$ 152.79
HY-14750-47	4 - 7" Pack Kit	246.98
HY-14750-48	4 - 8" Pack Kit	279.55
HY-14750-482	4 - 8-1/4" Pack Kit	414.01
HY-14750-57	5 - 7" Pack Kit	199.47
HY-14750-58	5 - 8" Pack Kit	315.87
MAJOR REPAIR KITS		
Contain vee packing, bushings, wear rings, retainer rings and wipers.		
HY-MRK-14750-46	4" - 6"	\$ 334.80
HY-MRK-14750-47	4" - 7"	489.70
HY-MRK-14750-48	4" - 8"	677.38
RETAINER RINGS		
HY-B9971-3.5	3" Retainer Ring	\$ 60.78
HY-B9971-4.5	4" Retainer Ring	45.20
HY-B9971-5.5	5" Retainer Ring	42.86
HY-B9971-6.5	6" Retainer Ring	43.00
HY-B9971-7.5	7" Retainer Ring	43.47
HY-B9971-8.5	8" Retainer Ring	60.49
HY-B9971-900	8-1/4" Retainer Ring	184.00
HY-B9971-962	9-1/8" Retainer Ring	193.78
HY-B9971-988	9-3/8" Retainer Ring	151.88

PISTON WEAR RINGS		
HY-10764-300	3-1/2" Nylon Piston Wear Ring	\$ 4.57
HY-10764-400	4-1/2" Nylon Piston Wear Ring	4.89
HY-10764-500	5-1/2" Nylon Piston Wear Ring	4.89
HY-10764-600	6-1/2" Nylon Piston Wear Ring	6.41
HY-10764-700	7-1/2" Nylon Piston Wear Ring	6.41
HY-10764-800	8-1/2" Nylon Piston Wear Ring	7.73
HY-10764-812	8-5/8" Nylon Piston Wear Ring	11.51
HY-10764-825	9" Nylon Piston Wear Ring	12.36
HY-10764-900	9-3/4" Nylon Piston Wear Ring	13.20
HY-10764-938	9-7/8" Nylon Piston Wear Ring	21.63
PISTON WEAR RING KITS		
HY-10764-46	4-1/2" - 6-1/2" Kit (1 ea. size)	\$ 20.22
HY-10764-47	4-1/2" - 7-1/2" Kit (1 ea. size)	27.59
HY-10764-48	4-1/2" - 8-1/2" Kit (1 ea. size)	36.59
HY-10764-48.2	4-1/2" - 9" Kit (1 ea. size)	36.99
HY-10764-49	4-1/2" - 9-3/4" Kit (1 ea. size)	51.25
HY-10764-57	5-1/2" - 7-1/2" Kit (1 ea. size)	21.12
HY-10764-58	5-1/2" - 8-1/2" Kit (1 ea. size)	30.12

Part Number	Description	List Price
MISCELLANEOUS PARTS		
HY-ABV100	Automatic Bleeder Valve (For cylinders MFG prior to 1-1-88). Double seal set 3/4-16 UNF thread	\$ 370.21
HY-ABV103	Automatic Bleeder Valve with S.A.E. O-Ring Seals (For cylinders MFG after 1-1-88). SAE type seal 5/8-18 UNF thread	192.57
HY-A20419	Set Screw for Headnut	1.29
HY-A20420	Nylon Slug for Headnut	0.66
HY-A20866	Nylon Slug & Set Screw	2.59

HEADNUTS

CAUTION: Getting the correct Hyco headnut can be a problem. If you are unsure, call our sales department. Headnuts are measured at the I.D. of the wiper.

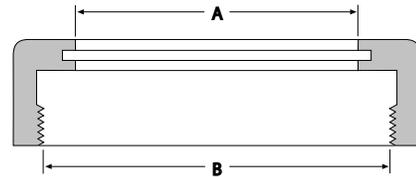

Part Number	"A" Wiper I.D.	"B" Thread I.D.	Threads/Inch	List Price
HY-A2527	3"	3.840"	12	\$ 81.75
HY-A2217	4"	4.840"	12	84.28
HY-A2216	5"	5.840"	12	85.75
HY-A2215	6"	6.840"	12	103.25
HY-A2406	7"	7.840"	12	143.34
HY-A3535	7" Headnut			214.20
HY-A20621	8"	9.020"	12	163.33
(For 30,000 Series prior to 9-1-87)				
HY-A22747	8"	8.990"	12	270.03
(For 30,000 Series after 9-1-87 and for threading on all 9-1/8" Stages)				
HY-A20558	8-1/8"	9.220"	12	238.30
HY-A3534	8-1/4" Headnut			627.29
(For 30,000 Series after 9/81)				
HY-A20599	9-3/8"	10.670"	12	298.22

NOTE:
REPLACEMENT STAGES AVAILABLE UPON REQUEST.
CYLINDER SERIAL NUMBER IS IMPORTANT

HYCO

HYCO TELESCOPIC CYLINDERS

30,000 SERIES SINGLE ACTING

MANUFACTURED BEFORE AUGUST 1, 1981

TWO 1/2" WIDE WEAR RINGS
(CYL. MFG. AFTER 3/84 USE ONLY 1 PER STAGE)

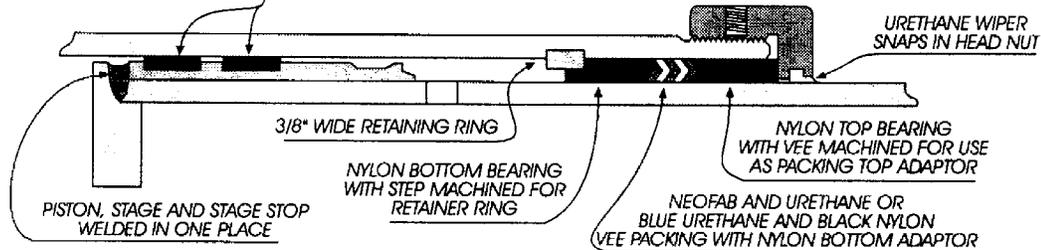

20,000 SERIES DOUBLE ACTING ALL

HYCO 30,000 SERIES

- PACKING:** Vee packing. Outer bearing serves as top adaptor for vee set. All packing is 1/4" cross section, except 9" stage has 3/8" c/s packing and 9-1/8" stage has 5/16" c/s packing.
- WIPERS:** Urethane snap-in type.
- BEARINGS:** Glass filled nylon. Outer bearing serves as top adaptor for vee set. Inner bearing is "step-cut" on o.d. to pilot over snap ring.
- PISTON:** Welded to stage. Uses 1/2" wide replaceable wear rings as bearings.
- STAGE O.D.'s:** 3", 4", 5", 6", 7", 8", 8-1/8", 8-1/4", 9", 9-1/8", 9-3/8"
- SPECIAL INFO.:** 3/8" spring steel snap ring serves as internal stop.
- IDENTIFICATION:** Cylinder model number and serial number stamped on cylinder body near base of cylinder. Ex: 30001-85-220

HYCO 20,000 SERIES DOUBLE ACTION

- PACKING:** Vee packing with bottom adaptor. 4" through 8" sizes 1/4" c.s.; 9" is 3/8" c.s.; 9-1/8" is 5/16".
- WIPERS:** Urethane snap-in type.
- BEARINGS:** Glass filled nylon. Top bearing serves as top adaptor for vee packing. Inner bearing is step-cut to pilot over snap ring.
- PISTON:** Welded to stage. Uses 1, 1/2" wide nylon wear ring and 2 iron piston rings in separate grooves.
- STAGE O.D.'s:** 3", 4", 5", 6", 7", 8", 9", 9-1/8"
- SPECIAL INFO.:** 3/8" spring steel snap ring serves as internal stop.
- IDENTIFICATION:** Cylinder model number and serial number stamped on cylinder body near base.

Part Number	Description	List Price
VEE PACKING, NYLON TOP & BOTTOM BEARINGS AND WIPER KITS		
HY-14411-300N	3" Pack Kit	\$ 42.08
HY-14411-400N	4" Pack Kit	42.08
HY-14411-500N	5" Pack Kit	58.44
HY-14411-600N	6" Pack Kit	61.35
HY-14411-700N	7" Pack Kit	79.64
HY-14411-800N	8" Pack Kit	120.61
HY-14411-812N	8-1/8" Pack Kit	167.84
HY-14411-825N	8-1/4" Pack Kit	227.11
HY-14411-900N	9" Pack Kit	259.24
HY-14411-912N	9-1/8" Pack Kit	233.31
HY-14411-938N	9-3/8" Pack Kit	222.79
MULTIPLE STAGE KITS		
HY-14411-46N	4" - 6" Pack Kit	\$ 161.89
HY-14411-47N	4" - 7" Pack Kit	241.50
HY-14411-48N	4" - 8" Pack Kit	278.56
HY-14411-491N	4" - 9-1/8" Pack Kit	595.38
HY-14411-49N	4" - 9" Pack Kit	621.32

Part Number	Description	List Price
VEE PACKING, BRONZE TOP BEARING, AND NYLON BOTTOM BEARING AND WIPER KITS		
HY-14411-300B	3" Pack Kit Hytrel & Fab Vees	\$ 54.22
HY-14411-400B	4" Pack Kit Hytrel & Fab Vees	80.77
HY-14411-500B	5" Pack Kit Hytrel & Fab Vees	91.37
HY-14411-600B	6" Pack Kit Hytrel & Fab Vees	105.32
HY-14411-700B	7" Pack Kit Hytrel & Fab Vees	119.40
HY-14411-800B	8" Pack Kit Hytrel & Fab Vees	130.45
HY-14411-812B	8-1/8" Pack Kit Hytrel & Fab Vees	176.62
HY-14411-825B	8-1/4" Pack Kit Hytrel & Fab Vees	227.70
HY-14411-912B	9-1/8" Pack Kit w/Nyl Top Bearing	240.35
HY-14411-938B	9-3/8" Pack Kit Hytrel & Fab Vees	231.33
Part Number	Stages	List Price
MAJOR REPAIR KITS - SINGLE ACTING		
Contains vee packing, bushings, wear rings, retainer rings and wipers.		
HY-MRK-14411-46	4" - 6"	\$ 321.97
HY-MRK-14411-47	4" - 7"	456.44
HY-MRK-14411-48	4" - 8"	639.26

HYCO TELESCOPIC CYLINDERS

30,000 SERIES CYLINDERS & 20,000 SERIES CYLINDERS

(MANUFACTURED BEFORE AUGUST 1, 1981)

(ALL)

Part Number	Description	List Price
RETAINER RINGS		
HY-B9971-3.5	3" Retainer Ring	\$ 60.78
HY-B9971-4.5	4" Retainer Ring	45.20
HY-B9971-5.5	5" Retainer Ring	42.86
HY-B9971-6.5	6" Retainer Ring	43.00
HY-B9971-7.5	7" Retainer Ring	43.47
HY-B9971-8.5	8" Retainer Ring	60.49
HY-B9971-900	8-1/4" Retainer Ring	184.00
HY-B9971-962	9-1/8" Retainer Ring	193.78
HY-B9971-988	9-3/8" Retainer Ring	151.88
PISTON WEAR RINGS		
HY-10764-300	3-1/2" Nylon Piston Wear Ring	\$ 4.57
HY-10764-400	4-1/2" Nylon Piston Wear Ring	4.89
HY-10764-500	5-1/2" Nylon Piston Wear Ring	4.89
HY-10764-600	6-1/2" Nylon Piston Wear Ring	6.41
HY-10764-700	7-1/2" Nylon Piston Wear Ring	6.41
HY-10764-800	8-1/2" Nylon Piston Wear Ring	7.73
HY-10764-812	8-5/8" Nylon Piston Wear Ring	11.51
HY-10764-825	9" Nylon Piston Wear Ring	12.36
HY-10764-900	9-3/4" Nylon Piston Wear Ring	13.20
HY-10764-938	9-7/8" Nylon Piston Wear Ring	21.63
PISTON WEAR RING KITS		
HY-10764-46	4-1/2" - 6-1/2" Kit (1 ea. size)	\$ 20.22
HY-10764-47	4-1/2" - 7-1/2" Kit (1 ea. size)	27.59
HY-10764-48	4-1/2" - 8-1/2" Kit (1 ea. size)	36.59
HY-10764-48.2	4-1/2" - 9" Kit (1 ea. size)	36.99
HY-10764-49	4-1/2" - 9-3/4" Kit (1 ea. size)	51.25
HY-10764-57	5-1/2" - 7-1/2" Kit (1 ea. size)	21.12
HY-10764-58	5-1/2" - 8-1/2" Kit (1 ea. size)	30.12
CAST IRON PISTON RINGS FOR DOUBLE ACTING CYLINDERS 1/2" WIDE		
HY-B12071-3	3-1/2 Cast Iron Piston Ring	\$ 46.96
HY-B12071-4	4-1/2 Cast Iron Piston Ring	26.20
HY-B12071-49	4-1/2-9-3/4 Cast Iron Piston Ring Kit	562.74
HY-B12071-5	5-1/2 Cast Iron Piston Ring	31.60
HY-B12071-6	6-1/2 Cast Iron Piston Ring	36.95
HY-B12071-7	7-1/2 Cast Iron Piston Ring	40.49
HY-B12071-8	8-1/2 Cast Iron Piston Ring	45.70
HY-B12071-812	8-5/8 Cast Iron Piston Ring	83.43
HY-B12071-9	9-3/4 Cast Iron Piston Ring	59.23
HY-B12071-938	9-7/8 Cast Iron Piston Ring	83.43

Part Number	Description	List Price
MISCELLANEOUS PARTS		
HY-A20419	Set Screw for Headnut	\$ 1.29
HY-A20420	Nylon Slug for Headnut	0.66
HY-A20866	Nylon Slug & Set Screw	2.59
HY-A2688	1/8" NPT Manual Bleeder Valve (Min Pack - 3)	5.36
HY-ABV100	Automatic Bleeder Valve	370.21

HEADNUTS

CAUTION:

Getting the correct Hyco headnut can be a problem. If you are unsure, call our sales department. Headnuts are measured at the I.D. of the wiper.

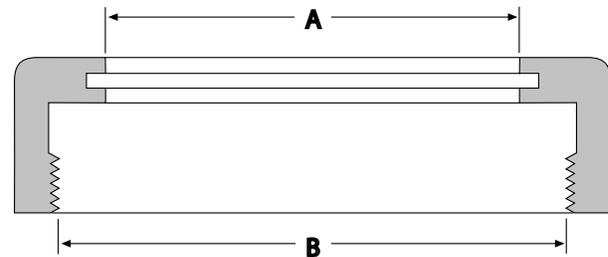

Part Number	"A" Wiper I.D.	"B" Thread I.D.	Threads/Inch	List Price
HY-A2527	3"	3.840"	12	\$ 81.75
HY-A2217	4" Headnut			84.28
HY-A2216	5"	5.840"	12	85.75
HY-A2215	6"	6.840"	12	103.25
HY-A2406	7"	7.840"	12	143.34
HY-A3535	7"	8.100"	12	214.20
	(For threading on 8-1/4" Stage)			
HY-A22747	8"	8.990"	12	270.03
	(For 30,000 Series after 9-1-87 and for threading on all 9-1/8" Stages)			
HY-A20621	8"	9.020"	12	163.33
	(For 30,000 Series prior to 9-1-87)			
HY-A3534	8-1/4"	9.780"	12	627.29
HY-A20558	8-1/8"	9.220"	12	238.30
	(For 30,000 Series after 9/81)			
HY-A20599	9-3/8"	10.670"	12	298.22

HYCO

HYCO TELESCOPIC CYLINDERS

20,000 SERIES CYLINDERS WITH K-STYLE WIPERS

Part Number	Description	List Price
MAJOR REPAIR KITS - SINGLE ACTING		
HY-MRK-034-00020-46	4" - 6" Pack Kit	\$ 374.56
HY-MRK-034-00020-47	4" - 7" Pack Kit	530.99
HY-MRK-034-00020-48	4" - 8" Pack Kit	745.55
VEE PACKING, BRONZE TOP & NYLON BOTTOM BEARINGS AND 2 WIPER KITS		
HY-034-00020-300B	3" Pack Kit	\$ 63.23
HY-034-00020-400B	4" Pack Kit	85.84
HY-034-00020-500B	5" Pack Kit	83.68
HY-034-00020-600B	6" Pack Kit	98.00
HY-034-00020-700B	7" Pack Kit	124.15
HY-034-00020-800B	8" Pack Kit	170.92
HY-034-00020-812B	8.12" Pack Kit	218.39
HY-034-00020-912B	9.12" Pack Kit	286.30
HY-034-00020-938B	9.38" Pack Kit	276.51

Part Number	Description	List Price
VEE PACKING, NYLON TOP & BOTTOM BEARINGS AND 2 WIPER KITS		
HY-034-00020-300N	3" Pack Kit	\$ 51.08
HY-034-00020-400N	4" Pack Kit	55.99
HY-034-00020-500N	5" Pack Kit	76.81
HY-034-00020-600N	6" Pack Kit	81.66
HY-034-00020-700N	7" Pack Kit	101.65
HY-034-00020-800N	8" Pack Kit	161.09
HY-034-00020-812N	8.12" Pack Kit	209.59
HY-034-00020-912N	9.12" Pack Kit	279.27
HY-034-00020-938N	9.38" Pack Kit	268.72
MULTIPLE STAGE KITS		
HY-034-00020-46N	4" - 6" Pack Kit	\$ 214.27
HY-034-00020-47N	4" - 7" Pack Kit	316.12
HY-034-00020-48N	4" - 8" Pack Kit	467.36
HY-034-00020-491N	4" - 9-1/8" Pack Kit	709.48

HYCO

HYCO TELESCOPIC CYLINDERS

10,000 SERIES CYLINDER CYLINDERS

MANUFACTURED FROM JULY, 1974 THROUGH AUGUST, 1976

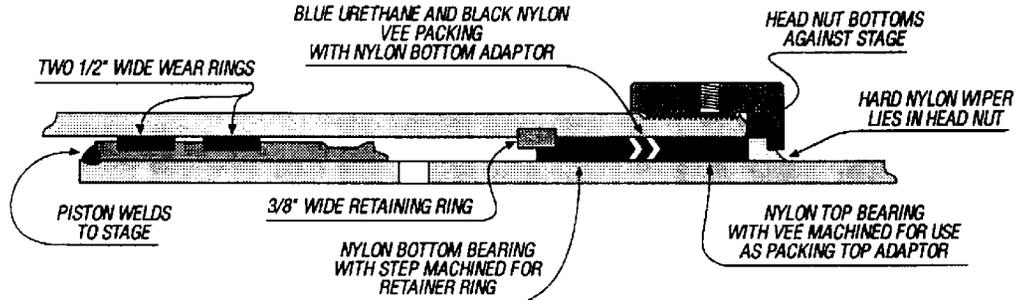

- PACKING: Vee packing. Outer bearing serves as top adapter for vee set.
- WIPERS: Hard black nylon. Does NOT snap into a groove. Wiper is "trapped" between head nut and top bearing.
- BEARINGS: Glass filled nylon. Outer bearing serves as top adapter for vee set. Inner bearing is "step-cut" to pilot over snap ring.
- PISTON: Welded to stage. Uses 2 replaceable 1/2" wide wear rings. Pistons are open through the bottom; they have no "plug", so a smaller stage will pass out through the bottom of the piston on a larger stage when the headnut is removed and the stages are removed from the cylinder body.
- STAGE O.D's: 3", 4", 5", 6", 7", 8", 8-1/4"
- SPECIAL INFO.: 3/8" spring steel snap ring serves as internal stop. Rod eye threads into stage.
- IDENTIFICATION: Cylinder model number and serial number stamped on cylinder body near base.

For all 10,000 Series Single Acting Cylinders manufactured from 7/74 through 8/76, kits include hard black wipers, vee sets and top and bottom bearings.

Part Number	Description	List Price
PISTON WEAR RINGS		
HY-10764-400	4-1/2" Nylon Piston Wear Ring	\$ 4.89
HY-10764-500	5-1/2" Nylon Piston Wear Ring	4.89
HY-10764-600	6-1/2" Nylon Piston Wear Ring	6.41
HY-10764-700	7-1/2" Nylon Piston Wear Ring	6.41
HY-10764-800	8-1/2" Nylon Piston Wear Ring	7.73
HY-10764-825	9" Nylon Piston Wear Ring	12.36
RETAINER RINGS		
HY-B9971-4.5	4" Retainer Ring	\$ 45.20
HY-B9971-5.5	5" Retainer Ring	42.86
HY-B9971-6.5	6" Retainer Ring	43.00
HY-B9971-7.5	7" Retainer Ring	43.47
HY-B9971-8.5	8" Retainer Ring	60.49
HY-B9971-900	8-1/4" Retainer Ring	184.00

Part Number	Description	List Price
VEE PACKING, NYLON TOP & BOTTOM BEARINGS AND WIPER KITS		
HY-11426-300	3" Pack Kit	\$ 61.78
HY-11426-400	4" Pack Kit	62.01
HY-11426-500	5" Pack Kit	75.44
HY-11426-600	6" Pack Kit	83.92
HY-11426-700	7" Pack Kit	107.85
HY-11426-800	8" Pack Kit	135.55
HY-11426-825	8-1/4" Pack Kit	266.90
MULTIPLE STAGE KITS		
HY-11426-48	4" - 8" Pack Kit	\$ 460.03

HYCO TELESCOPIC CYLINDERS

IMPORTANT NOTE:

WHEN ORDERING HYCO TELESCOPIC PARTS IT IS HELPFUL TO PROVIDE A MODEL NUMBER AND SERIAL NUMBER. THE SERIAL NUMBER IS STAMPED ONTO A METAL TAG APPLIED TO THE CYLINDER BODY. THE SERIAL NUMBER IS THE FIRST FOUR OR FIVE DIGITS OF THE NUMBER. THE LAST THREE OR FOUR DIGITS INDICATE THE DATE OF MANUFACTURE.

EXAMPLE 12345 10 93
SERIAL # MONTH YEAR

C900 - C2000 SERIES SINGLE ACTING

MANUFACTURED BEFORE JULY 10, 1974

C9000 SERIES DOUBLE ACTING ALL

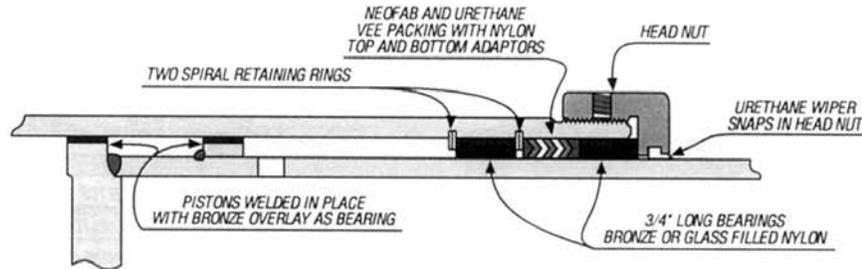

- PACKING:** Vee packing with nylon top and bottom adaptors 1/4" c.s. on 4" through 8".
WIPERS: Urethane snap-in type.
BEARINGS: 2 bearings, one above the vee packing and the other "trapped" between the two spiral retainers. Original bearings were bronze. Currently many replacements are glass filled or mineral filled nylon.
PISTON: Single acting cylinders have piston welded to stage. Piston bearings are bronze overlay on steel nylon. Double acting cylinders have steel piston which threads onto stage. Contains 2, 1/2" wide nylon wear rings and 2 cast iron piston rings in common groove.
STAGE O.D.'s: 3", 4", 5", 6", 7", 8", 8-1/4", 9", 9-3/4"
SPECIAL INFO.: 2 spiral retaining rings with bearings "trapped" between them serving as internal stop.
IDENTIFICATION: Cylinder model number and serial number stamped on metal tag applied to cylinder body.

For all C900 - C2000 Series single acting cylinders manufactured before 7/74 and all C9000 Series double acting telescopic cylinders, pack kits include only the wiper and vee packing. Nylon and bronze bearings are offered separately.

Part Number	Description	List Price
INDIVIDUAL STAGE VEE PACKING AND WIPER SETS		
HY-2VSW	2" Packing & Wiper	\$ 18.38
HY-3VSW	3" Packing & Wiper	18.80
HY-4VSW	4" Packing & Wiper	20.89
HY-5VSW	5" Packing & Wiper	24.05
HY-6VSW	6" Packing & Wiper	29.31
HY-7VSW	7" Packing & Wiper	34.23
HY-8VSW	8" Packing & Wiper	38.54
HY-8.12VSW	8-1/8" Packing & Wiper	80.10
HY-8.25VSW	8-1/4" Packing & Wiper	88.14
HY-9VSW	9" Packing & Wiper	100.15
HY-9.12VSW	9-1/8" Packing & Wiper	127.35
HY-9.37VSW	9-3/8" Packing & Wiper	120.41
HY-9.75VSW	9-3/4" Packing & Wiper	190.54

Part Number	Description	List Price
MULTIPLE STAGE VEE PACKING AND WIPER SETS		
HY-35	3" - 5" Pack Kit	\$ 68.94
HY-36	3" - 6" Pack Kit	105.22
HY-38	3" - 8" Pack Kit	194.69
HY-46	4" - 6" Pack Kit	86.07
HY-47	4" - 7" Pack Kit	128.01
HY-48	4" - 8" Pack Kit	134.79
HY-48-1/4	4" - 8-1/4" Pack Kit	236.83
HY-49	4" - 9" Pack Kit	298.94
HY-57	5" - 7" Pack Kit	107.57
HY-58	5" - 8" Pack Kit	154.98
HY-59-3/4	5" - 9-3/4" Pack Kit	386.59

HYCO TELESCOPIC CYLINDERS

C900 - C2000 SERIES SINGLE ACTING

MANUFACTURED BEFORE JULY10, 1974

AND

C9000 SERIES DOUBLE ACTING

ALL

Part Number	Description	List Price
NYLON BEARINGS		
HY-A2475N	3" Nylon Bearing	\$ 13.14
HY-A2227N	4" Nylon Bearing	13.14
HY-A2226N	5" Nylon Bearing	13.85
HY-A2225N	6" Nylon Bearing	16.37
HY-A2411N	7" Nylon Bearing	17.82
HY-A2447N	8" Nylon Bearing	21.59
HY-A3438N	8-1/4" Nylon Bearing	40.90
HY-A18415N	9" Nylon Bearing	75.93
NYLON BEARING KITS		
HY-NYB38	2 ea. 3" - 8" Nylon Bearings	\$ 187.36
HY-NYB46	2 ea. 4" - 6" Nylon Bearings	65.17
HY-NYB47	2 ea. 4" - 7" Nylon Bearings	119.54
HY-NYB48	2 ea. 4" - 8" Nylon Bearings	124.38
HY-NYB48-1/4	2 ea. 4" - 8-1/4" Nylon Bearings	199.33
HY-NYB49	2 ea. 4" - 9" Nylon Bearings	303.69
HY-NYB57	2 ea. 5" - 7" Nylon Bearings	93.79
HY-NYB58	2 ea. 5" - 8" Nylon Bearings	135.91
BRONZE BEARINGS		
HY-A2475B	3" Bronze Bearing	\$ 44.35
HY-A2227B	4" Bronze Bearing	85.57
HY-A2226B	5" Bronze Bearing	71.33
HY-A2225B	6" Bronze Bearing	81.71
HY-A2411B	7" Bronze Bearing	122.60
HY-A2447B	8" Bronze Bearing	127.98
HY-A3438B	8-1/4" Bronze Bearing	179.62
HY-A8258	9-3/4" Bottom Bronze Bearing	241.17
HY-A8308	9-3/4" Top Bronze Bearing	548.15
SPIRAL RETAINERS		
HY-A2477	3" Spiral Retainer	\$ 4.30
HY-A17794	4" Spiral Retainer	10.23
HY-A17793	5" Spiral Retainer	10.46
HY-A2228	6" Spiral Retainer	8.10
HY-A3012	7" Spiral Retainer	10.73
HY-A3013	8" Spiral Retainer	13.30
HY-A4616	8-1/4" Spiral Retainer	74.72
HY-A18387	9" Spiral Retainer	64.24
HY-A8246	9-3/4" Spiral Retainer	111.92
SPIRAL RETAINER KITS		
HY-SR48	2 ea. 4" - 8" Spiral Retainers	\$ 135.34
HY-SR49	2 ea. 4" - 9" Spiral Retainers	300.92
HY-SR58	2 ea. 5" - 8" Spiral Retainers	108.52

Part Number	Description	List Price
PISTON RINGS Double Acting Only		
HY-A18029	4-1/2" O.D. Cast Iron Piston Ring	\$ 12.30
HY-A18028	5-1/2" O.D. Cast Iron Piston Ring	16.88
HY-A18027	6-1/2" O.D. Cast Iron Piston Ring	20.26
HY-A18026	7-1/2" O.D. Cast Iron Piston Ring	30.71
HY-A18025	8-1/2" O.D. Cast Iron Piston Ring	42.99
HY-A18385	9-3/4" O.D. Cast Iron Piston Ring	68.32
PISTON RING KITS Double Acting Only		
HY-PR48	2 ea. 4-1/2"-8-1/2" Piston Rings	\$ 269.55
HY-PR49	2 ea. 4-1/2"-9-3/4" Piston Rings	391.29
PISTON WEAR RINGS Double Acting Only		
HY-10764-400	4-1/2" O.D. Piston Wear Ring	\$ 4.89
HY-10764-500	5-1/2" O.D. Piston Wear Ring	4.89
HY-10764-600	6-1/2" O.D. Piston Wear Ring	6.41
HY-10764-700	7-1/2" O.D. Piston Wear Ring	6.41
HY-10764-800	8-1/2" O.D. Piston Wear Ring	7.73
HY-10764-900	9-3/4" O.D. Piston Wear Ring	13.20
NYLON PISTON WEAR RING KITS Double Acting Only		
HY-NPB48	2 ea. 4-1/2"-8-1/2" Piston Wear Rings	\$ 68.48
HY-NPB49	2 ea. 4-1/2"-9-3/4" Piston Wear Rings	97.70
HEADNUTS		
Getting the correct Hyco headnut can be a problem. If you are unsure, call our sales department. Headnuts are measured at the I.D. of the wiper.		
HY-A2527	3" Headnut	\$ 81.75
HY-A2217	4" Headnut	84.28
HY-A2216	5" Headnut	85.75
HY-A2215	6" Headnut	103.25
HY-A2406	7" Headnut	143.34
HY-A3535	7" Headnut	214.20
HY-A2442	8" Headnut	218.86
HY-A3534	8-1/4" Headnut	627.29
HY-A18411	9" Headnut	217.87

HYCO

HYCO PISTON-ROD CYLINDERS

Kit Number	Cylinder Number	Code (Pg. xviii)	Rod X Bore Size	List Price
HY-A18881	C4979	I-V-12	2 X 4-1/2	\$ 63.26
HY-A22227	C6312	I-V-5	2 X 4	58.74
HY-A22228	C6404	I-N-4	2-1/2 X 3-1/2	21.45
HY-A22229	C6403	I-V-5	2-1/2 X 6	99.42
HY-A22230	C6443	I-V-5	2 X 5	74.86
HY-A22231	C6402	I-V-5	3 X 5	82.11
HY-A22286	C6304	I-U-5	3 X 5	79.83
HY-A22368	C5845	I-U-5	2-1/2 X 5	76.19
HY-A22891	C6591	I-U-5	3-1/2 X 4-1/2	76.19
HY-C2062K	C2062	I-V-9	2 X 6-1/2	95.63
HY-C2526K	C2526	I-V-7	2-1/2 X 5	91.41
HY-C2670K	C2670	I-V-5	2 X 3-1/4	73.94
HY-C2672K	C2672	I-V-5	2-1/2 X 5	108.45
HY-C2699K	C2699	I-V-5	2 X 4	83.56
HY-C3571K	C3571	I-V-9	1-1/2 X 3-1/2	79.59
HY-C3650K	C3650	I-V-5	3 X 6	82.60
HY-C3651K	C3651	I-V-5	3 X 7	121.61
HY-C4658K	C4658	I-V-5	3 X 7	96.17
HY-C4794K	C4794	I-V-5	3 X 7	125.02
HY-C4797K	C4797	I-V-9	3 X 7	218.23
HY-C6217K	C6217	I-V-9	2 X 6	148.36
HY-C6410K	C6410	I-U-5	2 X 4	60.17
HY-C6429K	C6429	I-V-5	3 X 7	133.32

REPLACEMENT KITS

Kit Number	Code (Pg. xviii)	Rod X Bore Size	List Price
HY-308-7244-0	I-U-10	1 X 2	\$ 16.25
HY-312-7753-0	I-U-5	2-1/2 X 3	42.07
HY-316-7754-0	I-U-5	3-1/2 X 4	65.98

HYDRO-AX

Kit Number	Code (Pg. xviii)	Rod X Bore Size	List Price
HA-2401-1046	P-V-12	2 X 3-1/2	\$ 66.45
HA-2401-1097	I-U-11	2 x 3-1/2	34.64
HA-2401-1100	I-U-11	1-1/4 X 3	28.37
HA-3002-1016	I-U-10	2 X 3-1/2	26.93
HA-3002-1031	I-U-10	1-1/2 X 3	23.08
HA-3002-1086	I-U-10	2-1/2 X 5-1/2	50.77
HA-3002-1092	P-U-10	1-1/4 X 2-1/2	20.08
HA-8711016	I-U-10	2 X 3-1/2	26.14
HA-8711031	I-U-10	1-1/2 X 3	21.93
HA-8711056	I-U-10	2-1/2 X 4-1/2	37.02
HA-8711086	I-U-10	2-1/2 X 5-1/2	50.38
HA-8711090	I-U-10	3 X 6	89.24
HA-8804019	I-U-11	2 X 3-1/2	44.60
HA-8804032	I-U-11	2-1/2 X 4	83.27
HA-8804048	I-U-13	1-1/2 X 3	37.51
HA-8804062	I-U-11	1-1/4 X 2-1/2	30.25
HA-8804076	I-U-13	2-1/2 X 4-1/2	66.24
HA-8804094	I-U-11	3 X 6	86.53
HA-8804105	I-U-13	2-1/2 X 5-1/2	85.38
HA-8804125	I-U-11	4-1/2 X 8	192.77
HA-8804138	I-U-11	4 X 7	125.06
HA-8804178	I-U-13	2-1/2 X 5	51.36
HA-8804197	I-U-11	4 X 6	86.53
HA-8804213	I-U-11	4-1/2 X 8	184.58
HA-8804214	I-U-11	4 X 7	125.06
HA-8804232	I-U-11	4 X 6	109.60

HYSTER

Kit Number	Code (Pg. xviii)	Rod X Bore Size	List Price	Kit Number	Code (Pg. xviii)	Rod X Bore Size	List Price
HYS-1332565	I-U-1	1-7/8 X 2-1/4	\$ 48.66	HYS-280182	I-O-10	1 X 2-1/4	\$ 15.55
HYS-1334570	I-U-4	3-1/2 X 4	70.49	HYS-280537	I-U-4	2-1/8 X 2-1/2	53.51
HYS-1334571	I-N-5	4 X 4-1/2	88.80	HYS-281474	P-U-10	1-1/2 X 3-1/2	41.95
HYS-133462	I-V-1	1-3/4" ROD	20.69	HYS-281815	I-U-10	1-3/4 X 3-1/2	21.49
HYS-1355337		GEAR KIT	25.30	HYS-281822	I-U-10	1-1/4 X 3	19.67
HYS-144267		O-RING KIT	12.50	HYS-281855	I-U-10, 12	1-3/4 X 3-1/2	44.43
HYS-148292	N-N-8	3-1/4" PISTON KIT	54.80	HYS-281859	I-U-10, 12	2-1/4 X 3-1/2	47.31
HYS-148414	I-V-1	1-3/4" ROD	22.55	HYS-281864	I-U-10	1-3/4 X 3-1/2	21.64
HYS-149193	N-N-P	2-1/2" BORE	20.20	HYS-314993		O-RING KIT	6.18
HYS-149194	P-V-1	1-3/4 X 2-1/2	27.71	HYS-318005	I-U-1	2-3/4, 3-3/4 Stages	70.56
HYS-149254	I-V-1	1-3/4" ROD	18.93	HYS-321758	I-U-10	2-1/4 X 4-1/2	31.86
HYS-149258	P-V-1	2" ROD	42.50	HYS-321909	I-U-5	3 X 4-3/4	117.07
HYS-149259	N-V-1	2-1/4" ROD	24.62	HYS-323645	I-U-8	1-3/4 X 4	58.30
HYS-149260	I-V-1	1-1/4" ROD	23.27	HYS-327393	I-U-4	2-1/8 X 2-1/2	39.14
HYS-149292		O-RING KIT	7.01	HYS-328074	I-U-10	1-1/4 X 2-3/4	23.56
HYS-1494726	P-U-10	1-3/4 X 4	33.41	HYS-328121	P-U-10	1-1/4 X 3	45.94
HYS-168801	N-U-12	1 X 3	60.75	HYS-328226	P-U-10	1-3/4 X 4-1/4	47.77
HYS-170881	P-V-8	1-1/4 X 3	40.75	HYS-333742	P-U-10	2-1/8 X 3	68.60
HYS-2026822	P-U-10	35 X 65 mm	82.97	HYS-334997	I-U-10	1-1/4 X 2-3/4	27.34
HYS-2085015	P-U-13	35 X 70 mm	65.39	HYS-337281	I-U-4	1-3/8 X 2	38.43
HYS-226074	I-U-8	1-1/2 X 3-1/2	51.97	HYS-339347	I-U-4	4, 5 Stages	162.38
HYS-2302714	I-U-11	28 mm X 2-1/2	20.22	HYS-340079	N-U-4	1-3/4 X 2-3/4	49.72
HYS-2303974	I-U-1	3 X 3-3/4	49.22	HYS-355695	P-U-10	1-3/8 X 3	40.89
HYS-250050	P-U-10	1-1/2 X 3-1/2	39.96	HYS-355909	I-U-5	1-1/2 X 4	58.49
HYS-250051	P-U-10	1-1/4 X 3	42.41	HYS-381762	I-U-10	2-7/8 X 4-1/2	64.50
HYS-250550	I-U-4	4-1/4 X 6	127.63	HYS-383991	P-U-10	1-1/4 X 3	39.14
HYS-250559	I-U-4	5-1/4 X 7-1/2	175.35	HYS-48628	I-U-4	3/4 X 1-5/8	19.65
HYS-250603	I-U-8	1 X 2-1/2	49.07	HYS-629326		HOSE REEL KIT	7.69
HYS-250937	I-U-8	1-1/2 X 3.525	117.13	HYS-639456	I-U-4	3 X 3-1/2	62.30
HYS-250943	I-U-1	3.70, 5.45 Stages	215.51	HYS-643280	I-U-4	3 X 3-1/2	65.87

Replacement Kits For

HYUNDAI

Excavators					
APPLICATION	CODE	ROD	BORE	KIT #	List \$
MODEL 130LC					
ARM	P-UB-10	80 mm	115 mm	HYU-91E6-2712	438.98
BOOM	P-UB-10	75 mm	105 mm	HYU-91E6-2711	143.91
BUCKET	P-UB-10	70 mm	100 mm	HYU-91E6-2713	156.40
MODEL R200LC, R210LC					
ARM	P-UB-14	95 mm	140 mm	HYU-91E1-2707	507.69
BOOM	P-UB-14	85 mm	125 mm	HYU-91E1-2706	388.78
BUCKET	P-UB-14	80 mm	120 mm	HYU-91E1-2708	414.47
MODEL R210LC-7					
ARM	P-UB-14	100 mm	140 mm	HYU-31Y1-15230N	252.42
ARM (LR)	P-UB-14	95 mm	140 mm	HYU-31Y1-06731N	254.91
BOOM	P-UB-14	85 mm	120 mm	HYU-31Y1-15880N	202.73
BUCKET	P-UB-14	85 mm	125 mm	HYU-31Y1-15700N	209.17
BUCKET (LR)	P-UB-14	70 mm	100 mm	HYU-31Y1-13800N	229.15
MODEL R280LC, R320LC-1					
ARM	P-UB-10	105 mm	150 mm	HYU-91E2-2708	449.07
BOOM	P-UB-10	95 mm	145 mm	HYU-91E2-2707	473.03
BUCKET	P-UB-10	95 mm	145 mm	HYU-91E2-2709	453.70
MODEL R420LC, R450LC					
ARM	P-UB-14	120 mm	185 mm	HYU-31E7-2712	679.98
BOOM	P-UB-14	110 mm	160 mm	HYU-31E7-2711	589.60
BUCKET	P-UB-14	110 mm	160 mm	HYU-31E7-2713	765.62

HYUNDAI

Kit Number	Code (Pg. xviii)	Rod X Bore Size	List Price
HYU-31E7-2711	P-UB-14	110 X 160 mm	\$ 589.60
HYU-31E7-2712	P-UB-14	120 X 185 mm	679.98
HYU-31E7-2713	P-UB-14	110 X 160 mm	765.62
HYU-31Y1-05260	P-UB-14	85 X 125 mm	286.19
HYU-31Y1-06731N	P-UB-14	95 X 140 mm	254.91
HYU-31Y1-13800N	P-UB-14	70 X 100 mm	229.15
HYU-31Y1-15230N	P-UB-14	100 X 140 mm	252.42
HYU-31Y1-15700N	P-UB-14	85 X 125 mm	209.17
HYU-31Y1-15880N	P-UB-14	85 X 120 mm	202.73
HYU-91E1-2706	P-UB-14	85 X 125 mm	388.78
HYU-91E1-2707	P-UB-14	95 X 140 mm	507.69

Kit Number	Code (Pg. xviii)	Rod X Bore Size	List Price
HYU-91E1-2708	P-UB-14	80 X 120 mm	\$ 414.47
HYU-91E2-2707	P-UB-10	95 X 145 mm	473.03
HYU-91E2-2708	P-UB-10	105 X 150 mm	449.07
HYU-91E2-2709	P-UB-10	95 X 145 mm	453.70
HYU-91E6-2711	P-UB-10	75 X 105 mm	143.91
HYU-91E6-2712	P-UB-10	80 X 115 mm	438.98
HYU-91E6-2713	P-UB-10	70 X 100 mm	156.40
HYU-91E8-2707	P-UB-14	100 X 140 mm	634.19
HYU-91E8-2708	P-UB-14	110 X 160 mm	812.04
HYU-91E8-2709	P-UB-14	100 X 140 mm	703.78

HYVA® TELESCOPICS

Hercules® Sealing Products provides repair kits for the popular front-end tipping cylinders with Outer Cover (FC) and with Rod Eye (FE) mount.

PACKING KIT
CONSISTS OF:

- 1 - Wiper
- 2 - Bearings
- 3 - U-seals

PACKING: Twin lip 92A urethane U-seals
 WIPERS: Dual lips snap-in 92A urethane
 BEARINGS: Polyacetal L-shaped bearing rings
 STAGES: 60, 78, 99, 120, 141, 162, 183 and 207

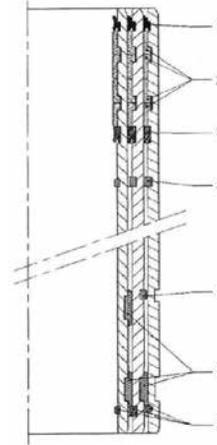

Kit Number	Description	List Price
Wiper, U-Seal and Bearing Kits		
HYVA-017-600-87K	60 mm Pack Kit	\$ 42.24
HYVA-017-600-75K	78 mm Pack Kit	52.68
HYVA-017-600-63K	99 mm Pack Kit	63.31
HYVA-017-600-51K	120 mm Pack Kit	71.33
HYVA-017-600-40K	141 mm Pack Kit	78.77
HYVA-017-600-38K	162 mm Pack Kit	93.80
HYVA-017-600-26K	183 mm Pack Kit	110.00
HYVA-017-600-14K	207 mm Pack Kit	147.55

Kit Number	Description	List Price
Multi-Stage Kits		
HYVA-120-3	78, 99 & 120 Kit	\$ 164.91
HYVA-141-4	78, 99, 120 & 141 Kit	247.01
HYVA-162-4	99, 120, 141 & 162 Kit	313.75
HYVA-183-5	99, 120, 141, 162 & 183 Kit	389.47
HYVA-207-5	120, 141, 162, 183 & 207 Kit	472.33

INGERSOLL-RAND

Kit Number	Code (Pg. xviii)	Rod X Bore Size	List Price	Kit Number	Code (Pg. xviii)	Rod X Bore Size	List Price
IR-50428648	I-U-10	3 X 5	\$ 36.04	IR-59484246	I-U-10	1-1/8 X 2-1/2	\$ 28.66
IR-50779636	P-U-10	3 X 6	56.84	IR-6589792	I-U-10	1-1/2 X 3-1/4	26.84
IR-51241909	PISTON SEAL	4-1/2	25.85	IR-6661441	P-O-1	1-1/8 Shaft Kit	5.18
IR-51293074	PISTON SEAL	6	42.63	IR-6803329	I-U-10	1-1/4 X 2	26.52
IR-51293082	WEAR RING	6 X 5/8	5.95	IR-6803472	I-U-10	1 X 2	20.62
IR-51293413	WIPER	1-1/2	13.05	IR-6804605	I-U-10	1-1/2 X 3-1/4	45.78
IR-51293421	PISTON SEAL	2-1/2	10.00	IR-70035308	I-V-5	70 X 100 mm	324.52
IR-51318095	O-RING KIT		10.35	IR-70035324	I-U-10	63 X 100 mm	74.49
IR-51324887	I-SPB-1	53,63 mm	202.80	IR-95086807	O-RING	Min.Pack 5	2.10
IR-52119906	VALVE KIT		15.97	IR-95086823	O-RING	Min.Pack 5	2.36
IR-52163987	P-U-10	3 X 4	86.17	IR-95295879	O-RING	Min. Pack 1	30.76
IR-58150798	I-U-5	1-1/2 X 3-1/2	41.97	IR-97114698	OIL SEAL		17.16

INTERNATIONAL HARVESTER

Kit Number	Code (Pg. xviii)	Rod X Bore Size	List Price	Kit Number	Code (Pg. xviii)	Rod X Bore Size	List Price
IH1124732C94	P-U-10	1-1/2 X 3	\$ 75.95	IH626230C3	P-U-10	1-3/4 X 3-1/2	\$ 32.53
IH1124738C91	P-U-10	1-1/2 X 4	42.83	IH626230C6	P-UB-10	1-3/4 X 3-1/2	80.18
IH-1279399H91	P-U-10	2 X 3-1/2	72.12	IH626232C2	P-U-10	2-1/4 X 3-1/2	36.47
IH-1434418H91	P-U-10	2 X 3-1/2	67.12	IH626233C2	P-U-10	2-1/2 X 4	38.55
IH1124745C91	P-U-10	2 X 4	66.11	IH626234C3	P-U-10	1-3/4 X 4	33.55
IH1124749C91	P-U-10	2-3/4 X 4-1/2	66.16	IH63577C91	P-U-10	2-1/4 X 4	57.32
IH1124749C93	P-U-10	2-3/4 X 4-1/2	66.16	IH63581C91	P-U-10	2-1/4 X 3-1/2	56.06
IH1124749C94	P-UB-10	2-3/4 X 4-1/2	89.87	IH636139C91	I-U-10	2-3/4 X 5	162.77
IH-1124749C93	P-UB-10	2-3/4 X 4-1/2	66.16	IH636144C91	P-U-10	2-1/2 X 5-1/2	74.38
IH-636139C91	I-U-10	2-3/4 X 5	162.77	IH636145C91	P-U-10	2-1/2 X 5-1/2	87.51
IH1124757C94	P-UB-10	2-3/4 X 5-1/2	287.18	IH636146C91	P-U-10	3 X 5-1/2	127.11
IH-1124760C94	P-UB-10	3-1/4 X 6	388.54	IH636147C91	P-U-10	3 X 5-1/2	81.81
IH1124774C93	P-UB-10	3-1/2 X 7	301.02	IH636149C91	P-U-10	2-1/2 X 6-1/2	162.73
IH1124867C91	P-U-10, 12	3-3/4, 5-3/4, 6-3/4 Stages	975.85	IH636229C91	P-U-10	2-3/4 X 6-1/2	162.11
IH1124857C94	P-UB-10	4-1/4 X 8-1/2	495.98	IH636230C91	P-U-10	3 X 7	114.11
IH1126587C91	P-U-10	2 X 3-1/2	51.63	IH63698C91	P-U-10	2 X 3	35.66
IH1126592C91	P-U-10	2-3/4 X 4-1/2	58.80	IH679325C91	P-U-10	2-1/4 X 4-1/2	59.50
IH1126614C91	P-U-10	2-1/2 X 6-1/2	80.92	IH679328C91	P-U-10	2-3/4 X 5	174.46
IH386693R92	P-OB-10	1-1/2 X 2-1/2	28.55	IH679330C91	P-U-10	2-3/4 X 6-1/2	105.93
IH471270R95	P-U-10, 12	1-1/2 X 2-1/2	49.39	IH679331C91	P-U-10	2-3/4 X 6-1/2	85.83
IH533625R93	P-U-10	2-1/2 X 4-1/2	53.55	IH679332C91	P-U-10	3 X 7	196.11
IH533626R93	P-U-10	2-1/2 X 4	53.32	IH-906000	TRACK ADJUSTER		20.29
IH545299R92	P-U-10	2-1/4 X 3-1/2	51.04	IH-906001	TRACK ADJUSTER		20.40
IH545300R93	P-U-10	2-1/4 X 4-1/2	56.79	IH-906004	TRACK ADJUSTER		40.24
IH545829R93	P-U-10	2 X 3-1/2	51.03	IH-933212C2	U-SEAL	3-1/4	23.56
IH545831R93	P-U-10	2-1/4 X 4	50.53	IH927444C91	O-Rings		6.89
IH546214R93	P-U-10	2 X 3-1/2	37.25	IH933310C91	P-U-10	4-1/2 X 9	232.67
IH609615C1	I-N-U	2-1/2 X 2-1/2	23.93	IH933419C91	P-U-10	2 X 4	57.92
IH622825C91	Track Adjuster for a TD8		19.11	IH935799C91	P-U-10	1-1/2 X 4	53.03
IH626199C1	P-U-10	1-1/2 X 3	28.57	IH943746C91	P-OB-10	1 X 3	23.83

REPLACEMENT PARTS FOR INTERNATIONAL HARVESTER

NOTE: International Harvester part numbers are used as a reference only. We do not imply that these kits are original REPLACEMENT PARTS.

BACK-UP RINGS

Part Number	Min. Pkgs.	List Price
IH-65985	10	\$ 1.29
IH-899129C2	1	34.03
IH-899130C2	2	10.44

BUFFER RINGS

Part Number	Rod Diameter	List Price
IH-1170748C1	3-1/4	\$ 40.70

PISTON SEALS

Part Number	Bore Diameter	List Price
IH-657862C1	6	\$ 52.42

U-SEALS

Part Number	Rod Diameter	List Price
IH-58614	2	\$ 10.81

WEAR RINGS

Part Number	O.D. X Width	List Price
IH-1170757C1	3-5/8 X 1-1/4	\$ 28.97
IH-140005	3-1/2 X 5/8	5.08
IH-933221C1	6 X 1-1/4	30.52

WIPERS

Part Number	Rod Diameter	List Price
IH-933207C1	3-1/4	\$ 19.97

REPLACEMENT PARTS FOR INTERNATIONAL HARVESTER

NOTE: International Harvester part numbers are used as a reference only. We do not imply that these kits are original REPLACEMENT PARTS.

O-RINGS

Part Number	Min. Pkgs.	List Price
IH-21003R1	20	\$ 0.50
IH-21056R1	20	0.39
IH-21295R1	5	2.28
IH-21480R1	20	0.30
IH-21597R1	20	0.59
IH-21923R1	10	1.29
IH-21924R1	20	0.32
IH-22204R1	5	2.28
IH-22272R1	20	0.23
IH-22277R1	20	0.22
IH-22278R1	20	0.27
IH-22287R1	10	1.15
IH-22288R1	20	0.32
IH-22289R1	10	1.29
IH-22290R1	10	1.06
IH-22291R1	10	1.29
IH-22292R1	5	1.64
IH-22408R1	20	0.47
IH-22409R1	20	0.53
IH-22410R1	20	0.56
IH-22411R1	10	0.85
IH-22412R1	10	1.18
IH-22414R1	10	1.25
IH-22458R1	20	0.20
IH-24595R1	20	0.36
IH-252483R1	50	0.20
IH-252707R1	50	0.09
IH-252738R1	50	0.07
IH-252739R1	50	0.07
IH-253070R1	50	0.12
IH-254091R1	20	0.53
IH-254688R1	10	1.18
IH-254691R1	50	0.12
IH-254693R1	10	1.44
IH-254954R1	50	0.19
IH-257642R1	10	0.88
IH-259246R1	20	0.72
IH-259771R1	20	0.42
IH-26969R1	5	2.68
IH-275611R1	20	0.23
IH-285723R1	20	0.62
IH-285724R1	20	0.65
IH-290987R1	20	0.54
IH-293726R1	20	0.42

O-RINGS

Part Number	Min. Pkgs.	List Price
IH-293739R1	20	\$ 0.22
IH-296867R1	5	1.64
IH-3040154R1	5	2.13
IH-3042933R1	5	2.47
IH-3042934R1	5	1.84
IH-3044436R1	20	0.72
IH-3044565R1	5	1.64
IH-3045524R1	20	0.29
IH-3046999R1	10	1.12
IH-3047879R1	10	1.18
IH-310959R1	50	0.20
IH-317923R1	20	0.69
IH-327085R1	20	0.23
IH-343903R1	20	0.26
IH-343912R1	5	1.84
IH-347070R1	50	0.19
IH-349900R1	50	0.12
IH-350057R1	20	0.56
IH-350429R1	50	0.09
IH-350667R1	50	0.09
IH-350684R1	50	0.10
IH-3508181R1	50	0.17
IH-352216R1	10	0.88
IH-352219R1	50	0.06
IH-352313R1	20	0.65
IH-352551R1	50	0.07
IH-354836R1	20	0.65
IH-355740R1	20	0.71
IH-355965R1	50	0.12
IH-355966R1	50	0.07
IH-355967R1	50	0.06
IH-356005R1	50	0.19
IH-359158R1	50	0.06
IH-360599R1	50	0.03
IH-360610R1	20	0.29
IH-361300R1	50	0.03
IH-362796R1	50	0.10
IH-363226R1	50	0.03
IH-364108R1	20	0.29
IH-364840R1	50	0.09
IH-364879R1	50	0.10
IH-368109R1	50	0.19
IH-369908R1	50	0.09
IH-370920R1	50	0.06

O-RINGS

Part Number	Min. Pkgs.	List Price
IH-370941R1	50	\$ 0.17
IH-370943R1	50	0.12
IH-370944R1	20	0.19
IH-371544R1	50	0.07
IH-372784R1	50	0.12
IH-372821R1	50	0.12
IH-375269R1	20	0.23
IH-375271R1	50	0.06
IH-376769R1	50	0.10
IH-377028R1	50	0.10
IH-378031R1	50	0.12
IH-379141R1	20	0.20
IH-379181R1	50	0.07
IH-379794R1	50	0.19
IH-381565R1	20	0.32
IH-382137R1	50	0.10
IH-382138R1	20	0.26
IH-382418R1	50	0.19
IH-382432R1	20	0.39
IH-382781R1	20	0.27
IH-383260R1	20	0.71
IH-3844498R1	20	0.29
IH-384578R1	50	0.10
IH-393120R1	10	0.98
IH-393349R1	50	0.10
IH-468335R1	10	1.06
IH-468339R1	10	0.79
IH-471140R1	10	0.88
IH-604844C1	20	0.29
IH-606921C1	5	2.10
IH-610411C1	20	0.69
IH-610412C1	10	1.15
IH-610414C1	20	0.50
IH-610415C1	5	1.76
IH-610416C1	5	2.16
IH-652226R1	10	0.85
IH-702283R1	20	0.47
IH-702981R1	10	0.98
IH-707220R1	20	0.59
IH-707253R1	20	0.26
IH-708560R1	50	0.20
IH-876092C1	1	9.77
IH-876101C1	1	25.65
IH-877690C1	1	7.76

REPLACEMENT SEAL KITS FOR JCB EQUIPMENT*

Replacement Seal Kits By Machine Type Table of Contents

Machine Type		Page
Backhoe Loaders	1CX, 2CX, 3C MIII, 3CX, 3CX SITEMASTER, 3D, 3D MKII, 3D MKIII, 4CN, 4C TURBO, 208S, 208SHF, 210S, 210SU, 214, 214E, 214SM-4, 215-4 CENTERMOUNT SERIES 3, 215S, 1400, 1400B, 1550, 1550B, 1700B, Midi CX, SITEMASTER	626 - 635
Excavators	JS200, JS210, JS240	635 - 636
Excavators - Compact	801, 803, 803 Magnum, 803 Plus, 803 Super, 804, 804 Plus, 804 Super, 8014, 8015, 8017, 8025ZTS, 8027Z, 8030ZTS, 8032Z, 8035ZTS, 8052, 8060, 8065RTS, 8080	636 - 640
Excavators - Tracked	JS130, JS160LC, JS200, JS200LC, JS220, JS260, JS260 AUTO, JS260 XD AUTO, JS330, JS330 Auto, JS330XD, JS330XD Auto, JZ140	640 - 645
Telehandlers	505-19 F.M, 505-22, 505-22 SWAY, 506B, 506C, 506C-HL, 508C, 520-50, 520-50LE, 525B-4HL, 527-55, 527-55S, 530B-4HL	645 - 649
Wheel Dozers/Loaders	426, 426B, 436, 436B, 456, 456B	649 - 651
Alpha-Numeric Kit Listing		652 - 653
JCB Individual Parts		654



*All manufacturer's names, part numbers and descriptions are used for reference purposes only. We do not imply that any part shown is the product of these manufacturers. We also do not imply that the list price shown is exactly that of the manufacturer.

Replacement Kits For

JCB

Backhoe Loaders							
APPLICATION	CYL #	SERIAL #	CODE	ROD	BORE	KIT #	List \$
MODEL 1CX							
BACKHOE BOOM		00807553-00808999; 01050000-01051999; 01298000-01299998; 00727000-00727999; 00751000-00751599	I-U-10	40 mm	70 mm	JCB-991-10152	76.33
BACKHOE BUCKET		00807553-00808999; 01050000-01051999; 01298000-01299998; 00727000-00727999; 00751000-00751599	I-U-10	40 mm	70 mm	JCB-991-10152	76.33
BACKHOE DIPPER		00807553-00808999; 01050000-01051999; 01298000-01299998; 00727000-00727999; 00751000-00751599	I-U-10	40 mm	70 mm	JCB-991-10152	76.33
CLAM SHOVEL		00807553-00808999; 01050000-01051999; 01298000-01299998; 00727000-00727999; 00751000-00751599; 00751600-00752999	I-U-10	25 mm	50 mm	JCB-991-00097	45.82
FRONT SHOVEL		00807553-00808999; 01050000-01051999; 01298000-01299998; 00727000-00727999; 00751000-00751599	I-U-10	30 mm	60 mm	JCB-991-00098	50.57
GRAB		00807553-00808999; 01050000-01051999; 01298000-01299998; 00727000-00727999; 00751000-00751599	I-U-10	25 mm	50 mm	JCB-991-00097	45.82
HIGH TIP		00807553-00808999; 01050000-01051999; 01298000-01299998; 00751600-00752999; 00806000-00807552	I-U-15	1-3/8"	2"	JCB-903-10301	41.02
LIFT		00807553-00808999; 01050000-01051999; 01298000-01299998; 00727000-00727999; 00751000-00751599	I-U-10	30 mm	60 mm	JCB-991-00098	50.57
SIDE TIP SHOVEL		00807553-00808999; 01050000-01051999; 01298000-01299998; 00751000-00751599; 00751600-00752999	I-U-15	1-1/2	2-1/2	JCB-997-00908	128.33
STABILIZER		00807553-00808999; 01050000-01051999; 01298000-01299998	I-U-10	30 mm	50 mm	JCB-991-10141	30.68
		00807553-00808999; 01050000-01051999; 01298000-01299998; 00727000-00727999; 00751000-00751599	I-U-10	30 mm	60 mm	JCB-991-00098	50.57
MODEL 2CX							
BACKHOE BOOM		00655030-00656999	I-U-10	40 mm	70 mm	JCB-991-00095	53.51
		00657000-00659598; 00489696-00499999; 00920001-00929999; 0069599-00659999; 00760001-00764999	I-U-10	50 mm	80 mm	JCB-991-00102	68.18
		00930001-00959999; 00960000-00989999; 01327000-01349999	I-U-10	50 mm	90 mm	JCB-991-00103	52.97
BACKHOE BUCKET		00655030-00656999	I-U-10	40 mm	70 mm	JCB-991-00095	53.51

JCB

JCB

Replacement Kits For

Backhoe Loaders							
APPLICATION	CYL #	SERIAL #	CODE	ROD	BORE	KIT #	List \$
MODEL 2CX							
BACKHOE BUCKET		00657000-00659598; 00489696-00499999; 00920001-00929999; 0069599-00659999; 00760001-00764999; 00960000-00989999; 01327000-01349999; 00930001-00959999	I-U-10	40 mm	70 mm	JCB-991-10152	76.33
BACKHOE DIPPER		00655030-00656999	I-U-10	40 mm	70 mm	JCB-991-00095	53.51
		00657000-00659598; 00489696-00499999; 00920001-00929999; 0069599-00659999; 00760001-00764999	I-U-10	50 mm	80 mm	JCB-991-00102	68.18
		00930001-00959999; 00960000-00989999; 01327000-01349999	I-U-10	50 mm	90 mm	JCB-991-00103	52.97
CLAM SHOVEL		00655030-00656999	I-U-10	30 mm	60 mm	JCB-991-00052	50.57
		00657000-00659598; 00489696-00499999; 00920001-00929999; 0069599-00659999; 00760001-00764999; 00930001-00959999; 00960000-00989999; 01327000-01349999; 00480600-00489695	I-U-10	30 mm	60 mm	JCB-991-00098	50.57
EXTENSION, EXTRADIG DIPPER		00657000-00659598; 00489696-00499999; 00920001-00929999; 0069599-00659999; 00760001-00764999; 00930001-00959999; 00960000-00989999; 01327000-01349999	I-U-10	30 mm	60 mm	JCB-991-00098	50.57
HYDRACLAMP		00655030-00656999	I-U-10	25 mm	50 mm	JCB-991-00054	56.07
		00655030-00656999	I-U-10	25 mm	50 mm	JCB-991-00097	45.82
LOADER LIFT		00655030-00656999	I-U-10	40 mm	70 mm	JCB-991-00095	53.51
		00657000-00659598; 00489696-00499999; 00920001-00929999; 0069599-00659999; 00760001-00764999; 00930001-00959999; 00960000-00989999; 01327000-01349999; 00480600-00489695	I-U-10	40 mm	70 mm	JCB-991-10152	76.33
QUICK HITCH		00655030-00656999; 00930001-00959999; 00960000-00989999; 01327000-01349999	I-U-15	1/2"	25 mm	JCB-548-12801	7.70
SHOVEL		00655030-00656999	I-U-10	40 mm	70 mm	JCB-991-00095	53.51
		00657000-00659598; 00489696-00499999; 00920001-00929999; 0069599-00659999; 00760001-00764999; 00930001-00959999; 00960000-00989999; 01327000-01349999; 00480600-00489695	I-U-10	40 mm	70 mm	JCB-991-10152	76.33
SLEW/SWING		00655030-00656999	I-U-10	40 mm	70 mm	JCB-991-00095	53.51

JCB

Replacement Kits For

JCB

Backhoe Loaders							
APPLICATION	CYL #	SERIAL #	CODE	ROD	BORE	KIT #	List \$
MODEL 2CX							
SLEW/SWING		00657000-00659598; 00489696-00499999; 00920001-00929999; 0069599-00659999; 00760001-00764999; 00930001-00959999	I-U-10	40 mm	70 mm	JCB-991-10152	76.33
		00960000-00989999; 01327000-01349999	I-U-10	40 mm	70 mm	JCB-991-10151	26.26
STABILIZER		00655030-00656999	I-U-10	40 mm	70 mm	JCB-991-00095	53.51
		00657000-00659598; 00489696-00499999; 00920001-00929999; 0069599-00659999; 00760001-00764999; 00930001-00959999	I-U-10	40 mm	70 mm	JCB-991-10152	76.33
		00930001-00959999; 00960000-00989999; 01327000-01349999	I-U-10	40 mm	60 mm	JCB-991-10081	37.26
STEERING		00655030-00656999	I-U-10	30 mm	60 mm	JCB-991-00052	50.57
		00657000-00659598; 00489696-00499999; 00920001-00929999; 0069599-00659999; 00760001-00764999; 00930001-00959999; 00960000-00989999; 01327000-01349999; 00480600-00489695	I-U-10	30 mm	60 mm	JCB-991-00098	50.57
TOW HITCH		00659599-00659598; 00760001-00764999	I-U-10	25 mm	50 mm	JCB-991-00097	45.82
MODEL 3C MIII							
BACKHOE BUCKET		M125001-M290000	I-SP-13	2	4	JCB-991-00003	58.20
BACKHOE DIPPER		M125001-M290000	I-SP-13	2	4	JCB-991-00003	58.20
BACKHOE GRAB		M125001-M290000	I-U-15	2-1/2	4-1/2	JCB-991-00008	111.95
DIPPER EXTENSION		M125001-M290000	I-U-15	2"	3-5/8"	JCB-991-00002	86.53
JAW BUCKET		M125001-M290000	I-SP-13	2	4	JCB-991-00003	58.20
LOADER BOOM		M125001-M290000	I-U-15	2	4-1/2	JCB-991-00004	82.94
LOADER LIFT		M125001-M290000	I-SP-13	2	4	JCB-991-00003	58.20
LOADER STABILIZER		M125001-M290000	I-U-15	2"	3-5/8"	JCB-991-00002	86.53
LOADER TILT		M125001-M290000	I-U-15	2"	3-5/8"	JCB-991-00002	86.53
POLE PLANTER RAM		M125001-M290000	I-SP-15	1-1/2"	2-3/4"	JCB-991-00001	63.15
STEERING		M125001-M290000	I-U-15	1"	2"	JCB-991-00009	40.25
MODEL 3CX							
BACKHOE BUCKET		-->M319999	I-U-15	50 mm	90 mm	JCB-991-00013	47.79
		M320000-UP	I-U-15	50 mm	90 mm	JCB-991-00096	107.84
BACKHOE BOOM & STICK		-->M319999	I-U-15	60 mm	100 mm	JCB-991-00012	52.59
		M320000-UP	I-U-15	60 mm	100 mm	JCB-991-00055	116.89
LOADER LIFT		-->M319999	I-U-15	50 mm	80 mm	JCB-991-00016	56.18
		M320000-UP	I-U-15	50 mm	80 mm	JCB-991-00061	108.69
LOADER TILT		-->M319999	I-U-15	40 mm	70 mm	JCB-991-00015	31.26
		M320000-UP	I-U-15	40 mm	70 mm	JCB-991-00122	51.17
STABILIZER - Heavy Duty		-->M319999	I-U-15	60 mm	100 mm	JCB-991-00012	52.59
		M320000-UP	I-U-15	60 mm	100 mm	JCB-991-00055	116.89
STABILIZER - Standard		-->M319999	I-U-15	40 mm	70 mm	JCB-991-00015	31.26
		M320000-UP	I-U-15	40 mm	70 mm	JCB-991-00122	51.17
STEERING-2WD		M290000-M300725	I-U-15	30 mm	60 mm	JCB-991-00017	54.77
		M300726-M337000	I-U-14	30 mm	60 mm	JCB-991-00021	43.75
		M337001-M356443	I-U-15	30 mm	70 mm	JCB-991-00036	46.76
STEERING-4WD		M290000-M297207	I-U-15	30 mm	60 mm	JCB-991-00017	54.77

JCB

Replacement Kits For

Backhoe Loaders							
APPLICATION	CYL #	SERIAL #	CODE	ROD	BORE	KIT #	List \$
MODEL 3CX							
STEERING-4WD		M297208-M319999	I-U-14	30 mm	60 mm	JCB-991-00020	26.98
		M320000-M337000	I-U-14	30 mm	60 mm	JCB-991-00021	43.75
STICK EXTENSION		-->M319999	I-U-15	40 mm	70 mm	JCB-991-00015	31.26
		M320000-UP	I-U-15	40 mm	70 mm	JCB-991-00122	51.17
SWING		-->M319999	I-U-15	60 mm	100 mm	JCB-991-00012	52.59
		M320000-UP	I-U-15	60 mm	100 mm	JCB-991-00055	116.89
	557-60018	M921696	I-U-10	50 mm	90 mm	JCB-991-00163	56.60
SWING w/ Side Shift		-->M319999	N-N-15		110 mm	JCB-991-00018	28.76
MODEL 3CX SITEMASTER							
BACHOE BOOM		M320000-UP	I-U-15	60 mm	110 mm	JCB-991-00058	73.27
BACKHOE BUCKET		M320000-UP	I-U-15	50 mm	90 mm	JCB-991-00096	107.84
LOADER LIFT		M320000-UP	I-U-15	50 mm	80 mm	JCB-991-00061	108.69
LOADER TILT		M320000-UP	I-U-15	40 mm	70 mm	JCB-991-00122	51.17
STABILIZER - Heavy Duty		M320000-UP	I-U-15	60 mm	100 mm	JCB-991-00055	116.89
STABILIZER - Standard		M320000-UP	I-U-15	40 mm	70 mm	JCB-991-00122	51.17
STEERING-2WD		M300726-M337000	I-U-14	30 mm	60 mm	JCB-991-00021	43.75
		M337001-M356443	I-U-15	30 mm	70 mm	JCB-991-00036	46.76
STEERING-4WD		M290000-M297206	I-U-15	30 mm	60 mm	JCB-991-00017	54.77
		M297207-M319999	I-U-14	30 mm	60 mm	JCB-991-00020	26.98
		M320000-M337000	I-U-14	30 mm	60 mm	JCB-991-00021	43.75
STICK		M320000-UP	I-U-15	60 mm	100 mm	JCB-991-00055	116.89
STICK EXTENSION		M320000-UP	I-U-15	40 mm	70 mm	JCB-991-00122	51.17
SWING		M320000-UP	I-U-15	60 mm	100 mm	JCB-991-00055	116.89
MODEL 3D							
ARM		M320000 UP	I-U-15	60 mm	100 mm	JCB-991-00130	116.89
		to M319999	I-U-15	60 mm	100 mm	JCB-991-00012	52.59
BOOM		M320000 UP	I-U-15	60 mm	110 mm	JCB-991-00131	73.27
		to M319999	I-U-15	60 mm	110 mm	JCB-991-00014	50.53
BUCKET		M320000 UP	I-U-15	50 mm	90 mm	JCB-991-00127	107.84
		to M319999	I-U-15	50 mm	90 mm	JCB-991-00013	47.79
EXTENSION		M320000 UP	I-U-15	40 mm	70 mm	JCB-991-00122	51.17
		to M319999	I-U-15	40 mm	70 mm	JCB-991-00015	31.26
JAW BUCKET		to M319999 - M320000 UP	I-SP-13	2	4	JCB-991-00003	58.20
LIFT		M320000 UP	I-U-15	50 mm	80 mm	JCB-991-00123	72.85
		to M319999	I-U-15	50 mm	80 mm	JCB-991-00016	56.18
SLEW CENTER MOUNT		to M319999	I-U-15	60 mm	100 mm	JCB-991-00012	52.59
SLEW SIDE SHIFT		to M319999	N-N-15		110 mm	JCB-991-00018	28.76
STABILIZER		M400000 UP	I-U-10	40 mm	70 mm	JCB-991-00095	53.51
STABILIZER 2WD		M356444 UP	I-U-10	30 mm	70 mm	JCB-991-00099	53.56
STABILIZER HD		M320000 UP	I-U-15	60 mm	100 mm	JCB-991-00130	116.89
		to M319999	I-U-15	60 mm	100 mm	JCB-991-00012	52.59
STABILIZER STD		M320000 UP	I-U-15	40 mm	70 mm	JCB-991-00122	51.17
		to M319999	I-U-15	40 mm	70 mm	JCB-991-00015	31.26
		M320000 UP	I-U-15	40 mm	70 mm	JCB-991-00122	51.17
TILT		M320000 UP	I-U-15	40 mm	70 mm	JCB-991-00122	51.17
		to M319999	I-U-15	40 mm	70 mm	JCB-991-00015	31.26
MODEL 3D MKII							
ARM			I-U-15	2-1/2	4-1/2	JCB-991-00008	111.95
BOOM			I-U-15	2-1/2	4-1/2	JCB-991-00008	111.95
BUCKET / JAW BUCKET			I-SP-13	2	4	JCB-991-00003	58.20
LIFT			I-U-15	2-1/2	4	JCB-991-00005	107.93
SLEW HD			N-N-13		5"	JCB-991-00010	59.79
SLEW STD			N-N-8		4-1/2"	JCB-991-00011	90.75
STABILIZER			I-U-15	2"	3-5/8"	JCB-991-00002	86.53
STEERING			I-U-15	1"	2"	JCB-991-00009	40.25

JCB

Replacement Kits For

JCB

Backhoe Loaders							
APPLICATION	CYL #	SERIAL #	CODE	ROD	BORE	KIT #	List \$
MODEL 3D MKII							
TILT			I-SP-13	2	4	JCB-991-00003	58.20
MODEL 3D MKIII							
ARM		M125001-M290000	I-U-15	2-1/2	4-1/2	JCB-991-00008	111.95
BUCKET		M125001-M290000	I-SP-13	2	4	JCB-991-00003	58.20
DIPPER		M125001-M290000	I-U-15	2-1/2	4-1/2	JCB-991-00008	111.95
EXTENSION		M125001-M290000	I-SP-15	1-1/2"	2-3/4"	JCB-991-00001	63.15
GRAB		M125001-M290000	I-U-15	2-1/2	4-1/2	JCB-991-00008	111.95
GRAB 6 IN 1		M125001-M290000	I-U-15	2"	3-5/8"	JCB-991-00002	86.53
JAW BUCKET		M125001-M290000	I-SP-13	2	4	JCB-991-00003	58.20
LOADER BOOM		M125001-M290000	I-U-15	2-1/2	4-1/2	JCB-991-00008	111.95
LOADER LIFT		M125001-M290000	I-U-15	2-1/2	4	JCB-991-00005	107.93
LOADER TILT		M125001-M290000	I-SP-13	2	4	JCB-991-00003	58.20
		M125986	I-U-15	63 mm	5"	JCB-991-00007	209.33
POLE PLANTER RAM		M125001-M290000	I-SP-15	1-1/2"	2-3/4"	JCB-991-00001	63.15
STABILIZER		M125001-M290000	I-U-15	2"	3-5/8"	JCB-991-00002	86.53
STEERING		M125001-M290000	I-U-15	1"	2"	JCB-991-00009	40.25
MODEL 4CN, 4C TURBO							
BACKHOE BOOM		-->M319999	I-U-15	60 mm	110 mm	JCB-991-00014	50.53
		M320000-UP	I-U-15	60 mm	110 mm	JCB-991-00058	73.27
BACKHOE BUCKET		-->M319999	I-U-15	50 mm	90 mm	JCB-991-00013	47.79
		M320000-UP	I-U-15	50 mm	90 mm	JCB-991-00096	107.84
LOADER LIFT		-->M319999	I-U-15	50 mm	80 mm	JCB-991-00016	56.18
		M320000-UP	I-U-15	50 mm	80 mm	JCB-991-00061	108.69
LOADER TILT		-->M319999	I-U-15	40 mm	70 mm	JCB-991-00015	31.26
		M320000-UP	I-U-15	40 mm	70 mm	JCB-991-00122	51.17
STABILIZER		-->M319999	I-U-15	60 mm	100 mm	JCB-991-00012	52.59
		M320000-UP	I-U-15	60 mm	100 mm	JCB-991-00055	116.89
STEERING-2WD		M290000-M300725	I-U-15	30 mm	60 mm	JCB-991-00017	54.77
		M300726-M337000	I-U-14	30 mm	60 mm	JCB-991-00021	43.75
STEERING-4WD		M290000-M297207	I-U-15	30 mm	60 mm	JCB-991-00017	54.77
		M297208-M319999	I-U-14	30 mm	60 mm	JCB-991-00020	26.98
		M320000-M337000	I-U-14	30 mm	60 mm	JCB-991-00021	43.75
		M337001-M356443	I-U-15	30 mm	70 mm	JCB-991-00036	46.76
STICK		-->M319999	I-U-15	60 mm	100 mm	JCB-991-00012	52.59
		M320000-UP	I-U-15	60 mm	100 mm	JCB-991-00055	116.89
STICK EXTENSION		-->M319999	I-U-15	40 mm	70 mm	JCB-991-00015	31.26
		M320000-UP	I-U-15	40 mm	70 mm	JCB-991-00122	51.17
SWING - Heavy Duty		-->M319999	I-U-15	60 mm	110 mm	JCB-991-00014	50.53
		M320000-UP	I-U-15	60 mm	110 mm	JCB-991-00058	73.27
SWING - Standard		-->M319999	I-U-15	60 mm	100 mm	JCB-991-00012	52.59
		M320000-UP	I-U-15	60 mm	100 mm	JCB-991-00055	116.89
MODEL 208S, 208S HF							
BOOM	556-60025	M751600-UP	I-U-10	40 mm	70 mm	JCB-991-00100	53.51
BUCKET 7' 3"	556-60026	M751600-UP	I-U-10	40 mm	70 mm	JCB-991-00100	53.51
BUCKET 8' 4"	556-60049	M751600-UP	I-U-10	40 mm	70 mm	JCB-991-00100	53.51
CLAMSHOVEL	551-60021	M751600-UP	I-U-10	25 mm	50 mm	JCB-991-00097	45.82
	980-38800	M751600-UP	I-U-10	25 mm	50 mm	JCB-991-00097	45.82
DIPPER	556-60027	M751600-UP	I-U-10	40 mm	70 mm	JCB-991-00100	53.51
HIGHTIP	997-07700	M751600-UP	I-U-15	1-3/8"	2"	JCB-903-10301	41.02
LIFT	553-60005	M751600-UP	I-U-10	30 mm	60 mm	JCB-991-00098	50.57
SHOVEL	553-60004	M751600-UP	I-U-10	30 mm	60 mm	JCB-991-00098	50.57
SIDETIP	997-0090	M751600-UP	I-U-15	1-1/2	2-1/2	JCB-997-00908	128.33
STABILIZER	553-60006	M751600-UP	I-U-10	30 mm	60 mm	JCB-991-00098	50.57
MODEL 210S, 210SU							
BUCKET	556-60000	M762248-M769999	I-U-10	40 mm	70 mm	JCB-991-00100	53.51

JCB

Replacement Kits For

JCB

Backhoe Loaders							
APPLICATION	CYL #	SERIAL #	CODE	ROD	BORE	KIT #	List \$
MODEL 210S, 210SU							
EXTENSION	553-60010	M762248-M769999	I-U-10	30 mm	60 mm	JCB-991-00098	50.57
	553-60022	M762248-M769999	I-U-10	30 mm	60 mm	JCB-991-00098	50.57
LIFT	556-60017	M762248-M769999	I-U-10	40 mm	70 mm	JCB-991-00100	53.51
LIFT LH	556-60023	M762248-M769999	I-U-10	40 mm	70 mm	JCB-991-00100	53.51
LIFT RH	556-60024	M762248-M769999	I-U-10	40 mm	70 mm	JCB-991-00100	53.51
SHOVEL	556-60084	M762248-M769999	I-U-10	40 mm	70 mm	JCB-991-00100	53.51
STABILIZER	556-60003	M762248-M769999	I-U-10	40 mm	70 mm	JCB-991-00100	53.51
	556-60093	M762248-M769999	I-U-10	40 mm	70 mm	JCB-991-00100	53.51
SWING	556-60010	M762248-M769999	I-U-10	40 mm	70 mm	JCB-991-00100	53.51
MODEL 214							
BOOM	561-39000	M400001-M430000	I-U-15	60 mm	110 mm	JCB-991-00131	73.27
	561-39100	M400001-M430000	I-U-15	60 mm	110 mm	JCB-991-00131	73.27
	561-60028	M400001-M430000	I-U-10	60 mm	110 mm	JCB-991-00110	88.90
	561-90011	M400001-M430000	I-U-10	60 mm	110 mm	JCB-991-00110	88.90
BUCKET	557-16000	M400001-M430000	I-U-15	50 mm	90 mm	JCB-991-00127	107.84
	557-16600	M400001-M430000	I-U-10	50 mm	90 mm	JCB-991-00103	52.97
	557-60006	M400001-M430000	I-U-15	50 mm	90 mm	JCB-991-00013	47.79
CLAMSHOVEL	556-31900	M400001-M430000	I-U-15	40 mm	70 mm	JCB-991-00122	51.17
	556-44000	M400001-M430000	I-U-10	40 mm	70 mm	JCB-991-00100	53.51
	556-60019	M400001-M430000	I-U-10	40 mm	70 mm	JCB-991-00100	53.51
DIPPER	559-50000	M400001-M430000	I-U-15	60 mm	100 mm	JCB-991-00055	116.89
	559-50100	M400001-M430000	I-U-15	60 mm	100 mm	JCB-991-00055	116.89
	559-60009	M400001-M430000	I-U-10	60 mm	100 mm	JCB-991-00145	70.20
	559-60019	M400001-M430000	I-U-10	60 mm	100 mm	JCB-991-00145	70.20
EXTENSION	556-31000	M400001-M430000	I-U-15	40 mm	70 mm	JCB-991-00122	51.17
	556-44500	M400001-M430000	I-U-10	40 mm	70 mm	JCB-991-00100	53.51
	556-45400	M400001-M430000	I-U-15	40 mm	70 mm	JCB-991-00122	51.17
	556-60057	M400001-M430000	I-U-10	40 mm	70 mm	JCB-991-00100	53.51
	JAW BUCKET	560-34300	M400001-M430000	I-SP-13	2	4	JCB-991-00003
LIFT	576-22100	M400001-M430000	I-U-15	50 mm	80 mm	JCB-991-00123	72.85
	576-60000	M400001-M430000	I-U-10	50 mm	80 mm	JCB-991-00102	68.18
SHOVEL	556-28900	M400001-M430000	I-U-15	40 mm	70 mm	JCB-991-00122	51.17
	556-44700	M400001-M430000	I-U-10	40 mm	70 mm	JCB-991-00095	53.51
STABILIZER	556-43700	M400001-M430000	I-U-10	40 mm	70 mm	JCB-991-00100	53.51
	559-53600	M400001-M430000	I-U-15	60 mm	100 mm	JCB-991-00055	116.89
	559-53700	M400001-M430000	I-U-15	60 mm	100 mm	JCB-991-00055	116.89
	559-60004	M400001-M430000	I-U-10	60 mm	100 mm	JCB-991-00145	70.20
	559-60005	M400001-M430000	I-U-10	60 mm	100 mm	JCB-991-00145	70.20
STEERING	556-33800	M400001-M430000	I-U-10	30 mm	70 mm	JCB-991-00099	53.56
	556-34000	M400001-M430000	I-U-10	30 mm	70 mm	JCB-991-00099	53.56
	556-46400	M400001-M430000	I-U-10	30 mm	70 mm	JCB-991-00099	53.56
	556-46500	M400001-M430000	I-U-10	30 mm	70 mm	JCB-991-00099	53.56
SWING	557-60074	M921696-	I-U-10	50 mm	90 mm	JCB-991-00163	56.60
	559-53400	M400001-M430000	I-U-15	60 mm	100 mm	JCB-991-00055	116.89
	559-53500	M400001-M430000	I-U-15	60 mm	100 mm	JCB-991-00055	116.89
MODEL 214E							
BOOM	561-60028	M430001-UP	I-U-10	60 mm	110 mm	JCB-991-00110	88.90
BUCKET	557-60006	M430001-UP	I-U-10	50 mm	90 mm	JCB-991-00103	52.97
DIPPER	559-60019	M430001-UP	I-U-10	60 mm	100 mm	JCB-991-00145	70.20
EXTENSION	556-60057	M430001-UP	I-U-10	40 mm	70 mm	JCB-991-00100	53.51
LIFT	576-60000	M430001-UP	I-U-10	50 mm	80 mm	JCB-991-00102	68.18
SHOVEL	556-44700	M430001-UP	I-U-10	40 mm	70 mm	JCB-991-00100	53.51
STABILIZER LH	559-60004	M430001-UP	I-U-10	60 mm	100 mm	JCB-991-00145	70.20
STABILIZER RH	559-60005	M430001-UP	I-U-10	60 mm	100 mm	JCB-991-00145	70.20
STEERING	556-46400	M430001-UP	I-U-10	30 mm	70 mm	JCB-991-00099	53.56

JCB

Replacement Kits For

JCB

Backhoe Loaders							
APPLICATION	CYL #	SERIAL #	CODE	ROD	BORE	KIT #	List \$
MODEL 214E							
STEERING	556-46500	M430001-UP	I-U-10	30 mm	70 mm	JCB-991-00099	53.56
SWING	559-53400	M430001-UP	I-U-15	60 mm	100 mm	JCB-991-00055	116.89
	559-53500	M430001-UP	I-U-15	60 mm	100 mm	JCB-991-00055	116.89
MODEL 214SM-4							
BOOM LIFT	563-60028	M460001-UP	I-U-10	65 mm	120 mm	JCB-991-00115	97.86
	563-60029	M460001-UP	I-U-10	65 mm	120 mm	JCB-991-00115	97.86
BUCKET	557-60006	M460001-UP	I-U-10	50 mm	90 mm	JCB-991-00103	52.97
	557-60016	M460001-UP	I-U-10	50 mm	90 mm	JCB-991-00103	52.97
	557-60030	M460001-UP	I-U-10	60 mm	90 mm	JCB-991-00147	90.65
CLAMSHOVEL	556-60077	M460001-UP	I-U-10	40 mm	70 mm	JCB-991-00100	53.51
DIPPER LIFT	561-60060	M460001-UP	I-U-10	60 mm	110 mm	JCB-991-00148	99.52
	561-60061	M460001-UP	I-U-10	60 mm	110 mm	JCB-991-00148	99.52
	561-60071	M460001-UP	I-U-10	60 mm	110 mm	JCB-991-00148	99.52
EXTENSION	556-60057	M460001-UP	I-U-10	40 mm	70 mm	JCB-991-00100	53.51
JAW BUCKET	560-34300	M460001-UP	I-SP-13	2	4	JCB-991-00003	58.20
LIFT	576-60000	M460001-UP	I-U-10	50 mm	80 mm	JCB-991-00102	68.18
SHOVEL	556-44700	M460001-UP	I-U-10	40 mm	70 mm	JCB-991-00100	53.51
STABILIZER	559-60063	M460001-UP	I-U-10	60 mm	100 mm	JCB-991-00145	70.20
	559-60069	M460001-UP	I-U-10	60 mm	100 mm	JCB-991-00152	67.33
STEERING	573-20001	M460001-UP	I-U-10	45 mm	75 mm	JCB-991-00156	86.00
SWING	559-60069	M460001-UP	I-U-10	60 mm	100 mm	JCB-991-00152	67.33
MODEL 215-4 CENTERMOUNT SERIES 3							
BOOM	556-60004	M460001-UP	I-U-10	75 mm	140 mm	JCB-991-00144	159.79
BUCKET	559-60024	M460001-UP	I-U-10	60 mm	100 mm	JCB-991-00145	70.20
	559-60074	M460001-UP	I-U-10	60 mm	100 mm	JCB-991-00145	70.20
CLAMSHOVEL	556-60077	M460001-UP	I-U-10	40 mm	70 mm	JCB-991-00100	53.51
DIPPER	561-60048	M460001-UP	I-U-10	65 mm	110 mm	JCB-991-00146	83.03
	561-60085	M460001-UP	I-U-10	65 mm	110 mm	JCB-991-00146	83.03
EXTENSION	556-60057	M460001-UP	I-U-10	40 mm	70 mm	JCB-991-00100	53.51
JAW BUCKET	560-34300	M460001-UP	I-SP-13	2	4	JCB-991-00003	58.20
LIFT	576-60000	M460001-UP	I-U-10	50 mm	80 mm	JCB-991-00102	68.18
SHOVEL	556-44700	M460001-UP	I-U-10	40 mm	70 mm	JCB-991-00100	53.51
SHOVEL C/W Reset Bracket	556-60022	M460001-UP	I-U-10	40 mm	70 mm	JCB-991-00100	53.51
STABILIZER	559-60063	M460001-UP	I-U-10	60 mm	100 mm	JCB-991-00145	70.20
STEERING	573-10001	M460001-UP	I-U-10	45 mm	75 mm	JCB-991-00156	86.00
SWING	559-60069	M460001-UP	I-U-10	60 mm	100 mm	JCB-991-00152	67.33
MODEL 215S							
BOOM	563-22600	M400001-M430000	I-U-15	65 mm	120 mm	JCB-991-00135	92.46
	563-60007	M400001-M430000	I-U-10	65 mm	120 mm	JCB-991-00115	97.86
	565-60004	M400001-M430000	I-U-10	70 mm	130 mm	JCB-991-00120	120.08
BUCKET	557-16000	M400001-M430000	I-U-15	50 mm	90 mm	JCB-991-00127	107.84
	557-16600	M400001-M430000	I-U-10	50 mm	90 mm	JCB-991-00103	52.97
CLAMSHOVEL	553-13800	M400001-M430000	I-U-15	40 mm	70 mm	JCB-991-00122	51.17
	556-44000	M400001-M430000	I-U-10	40 mm	70 mm	JCB-991-00095	53.51
	556-60019	M400001-M430000	I-U-10	40 mm	70 mm	JCB-991-00095	53.51
	556-60051	M400001-M430000	I-U-10	40 mm	70 mm	JCB-991-00095	53.51
DIPPER	559-50200	M400001-M430000	I-U-15	60 mm	100 mm	JCB-991-00130	116.89
	559-60013	M400001-M430000	I-U-10	60 mm	100 mm	JCB-991-00145	70.20
EXTENSION	556-31000	M400001-M430000	I-U-15	40 mm	70 mm	JCB-991-00122	51.17
	556-44500	M400001-M430000	I-U-10	40 mm	70 mm	JCB-991-00095	53.51
	556-45400	M400001-M430000	I-U-15	40 mm	70 mm	JCB-991-00122	51.17
JAW BUCKET	560-34300	M400001-M430000	I-SP-13	2	4	JCB-991-00003	58.20
LIFT	557-13100	M400001-M430000	I-U-15	50 mm	90 mm	JCB-991-00127	107.84
	557-16100	M400001-M430000	I-U-15	50 mm	90 mm	JCB-991-00127	107.84
	557-60000	M400001-M430000	I-U-10	50 mm	90 mm	JCB-991-00103	52.97

Replacement Kits For

JCB

Backhoe Loaders							
APPLICATION	CYL #	SERIAL #	CODE	ROD	BORE	KIT #	List \$
MODEL 215S							
LIFT	557-60004	M400001-M430000	I-U-10	50 mm	90 mm	JCB-991-00103	52.97
SHOVEL	556-28900	M400001-M430000	I-U-15	40 mm	70 mm	JCB-991-00122	51.17
	556-44700	M400001-M430000	I-U-10	40 mm	70 mm	JCB-991-00095	53.51
	556-60022	M400001-M430000	I-U-10	40 mm	70 mm	JCB-991-00095	53.51
STABILIZER	559-53600	M400001-M430000	I-U-15	60 mm	100 mm	JCB-991-00130	116.89
	559-53700	M400001-M430000	I-U-15	60 mm	100 mm	JCB-991-00130	116.89
	559-60004	M400001-M430000	I-U-10	60 mm	100 mm	JCB-991-00145	70.20
	559-60005	M400001-M430000	I-U-10	60 mm	100 mm	JCB-991-00145	70.20
STEERING LH - Front	553-09600	M400001-M430000	I-U-10	30 mm	60 mm	JCB-991-00098	50.57
	553-13400	M400001-M430000	I-U-10	30 mm	60 mm	JCB-991-00098	50.57
STEERING LH - Rear	553-09800	M400001-M430000	I-U-10	30 mm	60 mm	JCB-991-00098	50.57
	553-13800	M400001-M430000	I-U-10	30 mm	60 mm	JCB-991-00098	50.57
	553-14100	M400001-M430000	I-U-10	30 mm	60 mm	JCB-991-00098	50.57
STEERING RH - Front	553-09700	M400001-M430000	I-U-10	30 mm	60 mm	JCB-991-00098	50.57
	553-13600	M400001-M430000	I-U-10	30 mm	60 mm	JCB-991-00098	50.57
STEERING RH - Rear	553-09900	M400001-M430000	I-U-10	30 mm	60 mm	JCB-991-00098	50.57
	553-13800	M400001-M430000	I-U-10	30 mm	60 mm	JCB-991-00098	50.57
	553-14300	M400001-M430000	I-U-10	30 mm	60 mm	JCB-991-00098	50.57
SWING	559-52800	M400001-M430000	I-U-15	60 mm	100 mm	JCB-991-00130	116.89
	559-52900	M400001-M430000	I-U-15	60 mm	100 mm	JCB-991-00130	116.89
	559-53400	M400001-M430000	I-U-15	60 mm	100 mm	JCB-991-00130	116.89
	559-53500	M400001-M430000	I-U-15	60 mm	100 mm	JCB-991-00130	116.89
MODEL 1400, 1400B							
BOOM	561-31200	M337001-M399999	I-U-15	60 mm	110 mm	JCB-991-00131	73.27
	561-39000	M337001-M399999	I-U-15	60 mm	110 mm	JCB-991-00131	73.27
	561-60011	M337001-M399999	I-U-15	60 mm	110 mm	JCB-991-00131	73.27
CLAMSHOVEL	556-23700	TO M435696	I-U-15	40 mm	70 mm	JCB-991-00122	51.17
	556-31900	M337001-M399999	I-U-15	40 mm	70 mm	JCB-991-00122	51.17
DIPPER	557-12900	M337001-M399999	I-U-15	50 mm	90 mm	JCB-991-00127	107.84
	557-16600	M337001-M399999	I-U-15	50 mm	90 mm	JCB-991-00127	107.84
	559-44000	M337001-M399999	I-U-15	60 mm	100 mm	JCB-991-00130	116.89
	559-50000	M337001-M399999	I-U-15	60 mm	100 mm	JCB-991-00130	116.89
EXTENSION	556-23800	M337001-M399999	I-U-15	40 mm	70 mm	JCB-991-00122	51.17
	556-31000	M337001-M399999	I-U-15	40 mm	70 mm	JCB-991-00122	51.17
JAW BUCKET	560-34300	M337001-M399999	I-SP-13	2	4	JCB-991-00003	58.20
LIFT	576-14100	M337001-M399999	I-U-15	50 mm	80 mm	JCB-991-00123	72.85
SHOVEL	556-23900	M337001-M399999	I-U-15	40 mm	70 mm	JCB-991-00122	51.17
STABILIZER	556-23600	M337001-M399999	I-U-15	40 mm	70 mm	JCB-991-00122	51.17
STABILIZER LH	559-36300	M337001-M399999	I-U-15	60 mm	100 mm	JCB-991-00130	116.89
	559-53600	M337001-M399999	I-U-15	60 mm	100 mm	JCB-991-00130	116.89
	559-60004	M337001-M399999	I-U-15	60 mm	100 mm	JCB-991-00130	116.89
STABILIZER RH	559-36400	M337001-M399999	I-U-15	60 mm	100 mm	JCB-991-00130	116.89
	559-53700	M337001-M399999	I-U-15	60 mm	100 mm	JCB-991-00130	116.89
	559-60005	M337001-M399999	I-U-15	60 mm	100 mm	JCB-991-00130	116.89
	559-60005	M337001-M399999	I-U-15	60 mm	100 mm	JCB-991-00130	116.89
STEERING	556-27600	M337001-M399999	I-U-15	30 mm	70 mm	JCB-991-00036	46.76
	556-28700	M337001-M399999	I-U-15	30 mm	70 mm	JCB-991-00036	46.76
	556-46400	M337001-M399999	I-U-10	30 mm	70 mm	JCB-991-00099	53.56
	556-46500	M337001-M399999	I-U-10	30 mm	70 mm	JCB-991-00099	53.56
SWING LH	559-53400	M337001-M399999	I-U-15	60 mm	100 mm	JCB-991-00130	116.89
SWING RH	559-53500	M337001-M399999	I-U-15	60 mm	100 mm	JCB-991-00130	116.89
MODEL 1550, 1550B							
BOOM	563-15500	M337001-M399999	I-U-15	65 mm	120 mm	JCB-991-00135	92.46
BUCKET	557-12900	M337001-M399999	I-U-15	50 mm	90 mm	JCB-991-00127	107.84
	557-16000	M337001-M399999	I-U-15	50 mm	90 mm	JCB-991-00127	107.84
	557-16600	M337001-M399999	I-U-15	50 mm	90 mm	JCB-991-00127	107.84

JCB

Replacement Kits For

JCB

Backhoe Loaders							
APPLICATION	CYL #	SERIAL #	CODE	ROD	BORE	KIT #	List \$
MODEL 1550, 1550B							
CLAMSHOVEL	556-23700	M337001-M399999	I-U-15	40 mm	70 mm	JCB-991-00122	51.17
	556-31900	M337001-M399999	I-U-15	40 mm	70 mm	JCB-991-00122	51.17
	556-44000	M337001-M399999	I-U-15	40 mm	70 mm	JCB-991-00122	51.17
DIPPER	559-43200	M337001-M399999	I-U-15	60 mm	100 mm	JCB-991-00130	116.89
	559-50200	M337001-M399999	I-U-15	60 mm	100 mm	JCB-991-00130	116.89
EXTENSION - Long Type	556-23800	M337001-M399999	I-U-15	40 mm	70 mm	JCB-991-00122	51.17
	556-31000	M337001-M399999	I-U-15	40 mm	70 mm	JCB-991-00122	51.17
	556-44500	M337001-M399999	I-U-15	40 mm	70 mm	JCB-991-00122	51.17
JAW BUCKET	560-34300	M337001-M399999	I-SP-13	2	4	JCB-991-00003	58.20
LIFT	576-14100	M337001-M399999	I-U-15	50 mm	80 mm	JCB-991-00123	72.85
SHOVEL	556-23900	M337001-M399999	I-U-15	40 mm	70 mm	JCB-991-00122	51.17
STABILIZER	5568-36400	M337001-M399999	I-U-15	60 mm	100 mm	JCB-991-00130	116.89
	559-53700	M337001-M399999	I-U-15	60 mm	100 mm	JCB-991-00130	116.89
	559-60005	M337001-M399999	I-U-15	60 mm	100 mm	JCB-991-00130	116.89
STEERING	556-27600	M337001-M399999	I-U-15	30 mm	70 mm	JCB-991-00036	46.76
	556-28700	M337001-M399999	I-U-15	30 mm	70 mm	JCB-991-00036	46.76
	556-33800	M337001-M399999	I-U-15	30 mm	70 mm	JCB-991-00036	46.76
	556-33800	M337001-M399999	I-U-10	30 mm	70 mm	JCB-991-00099	53.56
	556-34000	M337001-M399999	I-U-15	30 mm	70 mm	JCB-991-00036	46.76
	556-34000	M337001-M399999	I-U-10	30 mm	70 mm	JCB-991-00099	53.56
	556-46400	M337001-M399999	I-U-10	30 mm	70 mm	JCB-991-00099	53.56
	556-46500	M337001-M399999	I-U-10	30 mm	70 mm	JCB-991-00099	53.56
SWING	559-53400	M337001-M399999	I-U-15	60 mm	100 mm	JCB-991-00130	116.89
MODEL 1700B							
BUCKET	557-12900	M337001-M399999	I-U-15	50 mm	90 mm	JCB-991-00127	107.84
	557-16000	M337001-M399999	I-U-15	50 mm	90 mm	JCB-991-00127	107.84
	557-16600	M337001-M399999	I-U-15	50 mm	90 mm	JCB-991-00127	107.84
	559-36100	M337001-M399999	I-U-15	60 mm	100 mm	JCB-991-00130	116.89
CLAMSHOVEL	556-23700	TO M345696	I-U-15	40 mm	70 mm	JCB-991-00122	51.17
	556-44000	M337001-M399999	I-U-15	40 mm	70 mm	JCB-991-00122	51.17
EXTENSION	556-23800	M337001-M399999	I-U-15	40 mm	70 mm	JCB-991-00122	51.17
	556-31000	M337001-M399999	I-U-15	40 mm	70 mm	JCB-991-00122	51.17
	556-44500	M337001-M399999	I-U-15	40 mm	70 mm	JCB-991-00122	51.17
JAW BUCKET	560-34300	M337001-M399999	I-SP-13	2	4	JCB-991-00003	58.20
LIFT	576-14100	M337001-M399999	I-U-15	50 mm	80 mm	JCB-991-00123	72.85
SHOVEL	576-14300	M337001-M399999	I-U-15	50 mm	80 mm	JCB-991-00123	72.85
	576-20200	M337001-M399999	I-U-15	50 mm	80 mm	JCB-991-00123	72.85
STABILIZER LH	559-36300	M337001-M399999	I-U-15	60 mm	100 mm	JCB-991-00130	116.89
	559-53600	M337001-M399999	I-U-15	60 mm	100 mm	JCB-991-00130	116.89
	559-60004	M337001-M399999	I-U-15	60 mm	100 mm	JCB-991-00130	116.89
STABILIZER RH	559-36400	M337001-M399999	I-U-15	60 mm	100 mm	JCB-991-00130	116.89
	559-53700	M337001-M399999	I-U-15	60 mm	100 mm	JCB-991-00130	116.89
	559-60005	M337001-M399999	I-U-15	60 mm	100 mm	JCB-991-00130	116.89
STEERING	556-27600	M337001-M399999	I-U-15	30 mm	70 mm	JCB-991-00036	46.76
	556-428700	M337001-M399999	I-U-15	30 mm	70 mm	JCB-991-00036	46.76
	556-46400	M337001-M399999	I-U-10	30 mm	70 mm	JCB-991-00099	53.56
	556-46500	M337001-M399999	I-U-10	30 mm	70 mm	JCB-991-00099	53.56
SWING LH	559-53400	M337001-M399999	I-U-15	60 mm	100 mm	JCB-991-00130	116.89
SWING RH	559-53500	M337001-M399999	I-U-15	60 mm	100 mm	JCB-991-00130	116.89
MODEL Midi CX							
BACKHOE BOOM		00972175-00989999; 01327000-01349999	I-U-10	45 mm	80 mm	JCB-991-10001	54.93
BACKHOE BUCKET		00972175-00989999; 01327000-01349999	I-U-10	35 mm	60 mm	JCB-991-00170	44.18

JCB

Replacement Kits For

JCB

Backhoe Loaders							
APPLICATION	CYL #	SERIAL #	CODE	ROD	BORE	KIT #	List \$
MODEL Midi CX							
BACKHOE BUCKET		00972175-00989999; 01327000-01349999	I-U-10	40 mm	60 mm	JCB-991-10081	37.26
BACKHOE DIPPER		00972175-00989999; 01327000-01349999	I-U-10	45 mm	80 mm	JCB-991-10001	54.93
KERB GRAB		00972175-00989999; 01327000-01349999	I-U-10	25 mm	50 mm	JCB-991-00097	45.82
LOADER LIFT		00972175-00989999; 01327000-01349999	I-U-10	35 mm	60 mm	JCB-991-00170	44.18
LOADER SHOVEL		00972175-00989999; 01327000-01349999	I-U-10	30 mm	60 mm	JCB-991-00098	50.57
SLEW/SWING		00972175-00989999; 01327000-01349999	I-U-10	40 mm	70 mm	JCB-991-10151	26.26
STABILIZER, CENTERMOUNT		00972175-00989999; 01327000-01349999	I-U-10	40 mm	70 mm	JCB-991-10152	76.33
STABILIZER, SIDESHIFT		00972175-00989999; 01327000-01349999	I-U-10	40 mm	60 mm	JCB-991-10081	37.26
MODEL SITEMASTER							
BACKHOE BOOM	561-31200	M337001-M399999	I-U-15	60 mm	110 mm	JCB-991-00131	73.27
	561-60011	M337001-M399999	I-U-15	60 mm	110 mm	JCB-991-00131	73.27
BACKHOE BUCKET	557-12900	M337001-M399999	I-U-15	50 mm	90 mm	JCB-991-00127	107.84
	557-16000	M337001-M399999	I-U-15	50 mm	90 mm	JCB-991-00127	107.84
	557-16600	M337001-M399999	I-U-15	50 mm	90 mm	JCB-991-00127	107.84
CLAMSHOVEL	556-23700	M337001-M399999	I-U-15	40 mm	70 mm	JCB-991-00122	51.17
	556-31900	M337001-M399999	I-U-15	40 mm	70 mm	JCB-991-00122	51.17
	556-44000	M337001-M399999	I-U-15	40 mm	70 mm	JCB-991-00122	51.17
DIPPER	559-44000	M337001-M399999	I-U-15	60 mm	100 mm	JCB-991-00130	116.89
	559-50000	M337001-M399999	I-U-15	60 mm	100 mm	JCB-991-00130	116.89
EXTENSION	556-23800	M337001-M399999	I-U-15	40 mm	70 mm	JCB-991-00122	51.17
	556-31000	M337001-M399999	I-U-15	40 mm	70 mm	JCB-991-00122	51.17
	556-44500	M337001-M399999	I-U-15	40 mm	70 mm	JCB-991-00122	51.17
JAW BUCKET	560-34300	M337001-M399999	I-SP-13	2	4	JCB-991-00003	58.20
LIFT	576-14100	M337001-M399999	I-U-15	50 mm	80 mm	JCB-991-00123	72.85
LOADER BOOM	561-39000	M337001-M399999	I-U-15	60 mm	110 mm	JCB-991-00131	73.27
SHOVEL	556-23900	M337001-M399999	I-U-15	40 mm	70 mm	JCB-991-00122	51.17
STABILIZER	559-36400	M337001-M399999	I-U-15	60 mm	100 mm	JCB-991-00130	116.89
STEERING	556-27600	M337001-M399999	I-U-15	30 mm	70 mm	JCB-991-00036	46.76
	556-28700	M337001-M399999	I-U-15	30 mm	70 mm	JCB-991-00036	46.76
	556-33800	M337001-M399999	I-U-15	30 mm	70 mm	JCB-991-00036	46.76
	556-34000	M337001-M399999	I-U-15	30 mm	70 mm	JCB-991-00036	46.76
	556-46400	M337001-M399999	I-U-10	30 mm	70 mm	JCB-991-00099	53.56
	556-46500	M337001-M399999	I-U-10	30 mm	70 mm	JCB-991-00099	53.56
SWING	559-53400	M337001-M399999	I-U-15	60 mm	100 mm	JCB-991-00130	116.89
Excavators							
APPLICATION	CYL #	SERIAL #	CODE	ROD	BORE	KIT #	List \$
MODEL JS200							
BOOM		01610000-01612499; 01613000-01613999	P-UB-14	85 mm	125 mm	JCB-332-G9282	160.37
BUCKET		01610000-01612499; 01613000-01613999	P-UB-14	85 mm	115 mm	JCB-332-C7368	118.45
DIPPER		01610000-01612499; 01613000-01613999	P-UB-14	95 mm	130 mm	JCB-332-G9281	167.34
MODEL JS210							
BOOM		00705001-00707999	P-UB-10	85 mm	125 mm	JCB-998-10020	148.97

JCB

Replacement Kits For

JCB

Excavators							
APPLICATION	CYL #	SERIAL #	CODE	ROD	BORE	KIT #	List \$
MODEL JS210							
BOOM		01018001-01020001; 01202500-01204022; 01503300-01504499; 01701500-01702499; 01610000-01612499; 01613000-01613999	P-UB-10	85 mm	125 mm	JCB-331-39036	110.55
BUCKET		01018001-01020001; 01202500-01204022; 01503300-01504499; 01701500-01702499; 01610000-01612499; 01613000-01613999	P-UB-10	85 mm	115 mm	JCB-331-39041	124.23
BUCKET, LONG REACH		00705001-00707999	P-UB-10	70 mm	95 mm	JCB-991-10129	109.12
CAB RAISE		01018001-01020001; 01202500-01204022; 01503300-01504499; 01701500-01702499; 01610000-01612499; 01613000-01613999	I-U-10	60 mm	90 mm	JCB-991-00147	90.65
DIPPER		01018001-01020001; 01202500-01204022; 01503300-01504499; 01701500-01702499; 01610000-01612499; 01613000-01613999	P-UB-10	95 mm	130 mm	JCB-331-39047	183.90
DIPPER, LONG REACH		00705001-00707999	P-UB-10	105 mm	150 mm	JCB-998-10022	271.17
MODEL JS240							
BOOM		00708501-00709199; 01040003-01041999	P-UB-10	90 mm	130 mm	JCB-998-10021	146.84
		01504700-01505099; 01040003-01041999	P-UB-14	90 mm	130 mm	JCB-903-21037	163.39
BUCKET		00708501-00709199	P-UB-10	90 mm	135 mm	JCB-998-10023	173.61
		01040003-01041999	P-UB-10	95 mm	130 mm	JCB-331-38788	194.18
		01504700-01505099; 01040003-01041999	P-UB-14	95 mm	130 mm	JCB-903-21049	113.44
DIPPER		00708501-00709199	P-UB-10	105 mm	150 mm	JCB-998-10022	271.17
		01040003-01041999	P-UB-10	100 mm	140 mm	JCB-991-10127	206.11
		01504700-01505099; 01040003-01041999	P-UB-14	100 mm	140 mm	JCB-903-21165	204.84
Excavators - Compact							
APPLICATION	CYL #	SERIAL #	CODE	ROD	BORE	KIT #	List \$
MODEL 801							
ARM		M645001-M645999 M648000-M649999	I-U-5	30 mm	50 mm	JCB-231-02906	36.21
		M648652-M649999	I-U-10	30 mm	50 mm	JCB-231-02909	106.44
BLADE		M645001-M645999 M648000-M648696	I-U-5	35 mm	70 mm	JCB-231-22506	90.58
		M648697-M649999	I-U-10	35 mm	70 mm	JCB-231-32807	83.93
BOOM		M645001-M645999 M648000-M649999	I-U-5	30 mm	50 mm	JCB-231-02906	36.21
BUCKET		M645001-M645999 M648000-M649999	I-U-5	30 mm	50 mm	JCB-231-02906	36.21
		M648652-M649999	I-U-10	30 mm	50 mm	JCB-231-02909	106.44
SWING		M645001-M645999 M648000-M648651	I-U-5	30 mm	50 mm	JCB-231-02906	36.21
		M648652-M649999	I-U-10	30 mm	50 mm	JCB-231-02909	106.44
MODEL 803							
ARM		M665001-M665736 M666001-M666935	I-U-10	40 mm	70 mm	JCB-232-02906	147.56
		M666936-M667435	I-U-10	40 mm	70 mm	JCB-232-56352	35.85

Replacement Kits For

JCB

Excavators - Compact							
APPLICATION	CYL #	SERIAL #	CODE	ROD	BORE	KIT #	List \$
MODEL 803							
BLADE		M665001-M665736 M666001-M666930	I-U-10	45 mm	90 mm	JCB-232-22510	178.19
		M666931-M667435	I-U-10	45 mm	90 mm	JCB-232-56754	132.72
BOOM		M665001-M665736 M666001-M666956	I-U-10	40 mm	80 mm	JCB-232-08512	189.41
		M666957-M667435	I-U-10	40 mm	80 mm	JCB-232-56152	129.30
BUCKET		M665001-M665736 M666001-M666956	I-UB-10	50 mm	75 mm	JCB-232-03407	96.71
		M666957-M667435	I-U-10	50 mm	75 mm	JCB-232-56507	142.27
SWING		M666001-M666333	I-U-10	40 mm	80 mm	JCB-232-08512	189.41
		M666334-M667435	I-U-10	50 mm	80 mm	JCB-232-56956	82.33
MODEL 803 Magnum, 803 Plus							
ARM		M765607-M765699	I-U-10	40 mm	70 mm	JCB-232-56352	35.85
		M765700-Sept 98	I-U-10	40 mm	70 mm	JCB-232-95956	52.77
		M827240-	P-U-10	40 mm	70 mm	JCB-991-10112	157.70
		Sept 98-M827239	P-U-10	40 mm	70 mm	JCB-991-10112	157.70
BLADE		M765607-M827239	I-U-10	45 mm	90 mm	JCB-232-56754	132.72
		M827240-	I-U-10	45 mm	90 mm	JCB-232-56754	132.72
BOOM		M765607-M827239	P-U-10	40 mm	80 mm	JCB-991-10111	155.46
		M765607-M827239	I-U-10	40 mm	80 mm	JCB-232-56152	129.30
		M827240-	P-U-10	40 mm	80 mm	JCB-991-10111	155.46
BUCKET		M765607-M827239	I-U-10	50 mm	75 mm	JCB-232-56507	142.27
		M827240-	P-U-10	50 mm	75 mm	JCB-991-10113	122.89
SWING		M765607-M827239	I-U-10	50 mm	80 mm	JCB-232-56956	82.33
		M827240-	I-U-10	40 mm	80 mm	JCB-991-00167	64.48
MODEL 803 Super							
ARM		M765607-M827239	P-U-10	40 mm	70 mm	JCB-991-10112	157.70
		M827240	I-U-10	40 mm	70 mm	JCB-232-56352	35.85
BLADE		M765607-M827239 M827240	I-U-10	45 mm	90 mm	JCB-232-56754	132.72
BOOM		M765607-M827239 M827240-	P-U-10	40 mm	80 mm	JCB-991-10111	155.46
BUCKET		M795607-M827239	P-U-10	50 mm	75 mm	JCB-991-10113	122.89
		M827240-	I-UB-10	50 mm	75 mm	JCB-232-03407	96.71
SWING		M765607-M827239 M827240	I-U-10	50 mm	80 mm	JCB-232-56956	82.33
MODEL 804							
ARM		M734001-M734401	I-U-10	45 mm	75 mm	JCB-232-51254	121.75
BLADE		M734001-M734135	I-U-10	45 mm	90 mm	JCB-232-22510	178.19
		M734136-M734401	I-U-10	45 mm	90 mm	JCB-232-56754	132.72
BOOM		M734001-M734401	I-U-10	45 mm	90 mm	JCB-232-51155	101.95
BUCKET		M734001-M734401	I-U-10	45 mm	75 mm	JCB-232-51254	121.75
SWING		M734001-M734135	I-U-10	40 mm	80 mm	JCB-232-08512	189.41
		M734136-M734401	I-U-10	45 mm	90 mm	JCB-232-56754	132.72
MODEL 804 Plus							
ARM			I-U-10	40 mm	70 mm	JCB-232-56352	35.85
		M734402-M734629	P-U-10	40 mm	70 mm	JCB-991-10112	157.70
BLADE		M734402-M734629	I-U-10	45 mm	90 mm	JCB-232-56754	132.72
BOOM		M734402-M734629	P-U-10	40 mm	80 mm	JCB-991-10111	155.46
BUCKET		M734402-M734629	P-U-10	50 mm	75 mm	JCB-991-10113	122.89
SWING		M734402-M734629	I-U-10	50 mm	80 mm	JCB-232-56956	82.33
MODEL 804 Super							
ARM		M34630-M734629 M734834-	I-U-10	45 mm	75 mm	JCB-991-00166	185.44
BLADE		M34630-M734629 M734834-	P-U-10	45 mm	90 mm	JCB-991-00165	139.94

Replacement Kits For

JCB

Excavators - Compact							
APPLICATION	CYL #	SERIAL #	CODE	ROD	BORE	KIT #	List \$
MODEL 804 Super							
BOOM		M34630-M734629 M734834-	I-U-10	45 mm	90 mm	JCB-991-00164	160.03
BUCKET		M34630-M734629 M734834-	I-U-10	50 mm	80 mm	JCB-991-00102	68.18
SWING		M34630-M734629 M734834-	I-U-10	40 mm	80 mm	JCB-991-00167	64.48
MODEL 8014							
BLADE			I-U-5	35 mm	70 mm	JCB-231-22506	90.58
		M791000-M795999	I-U-10	35 mm	70 mm	JCB-236-11516	71.97
BOOM		M791000-M791222	P-U-10	30 mm	50 mm	JCB-231-34316	142.19
		M791223-M795999	P-U-10	30 mm	55 mm	JCB-231-77408	131.13
SWING			P-U-10	30 mm	50 mm	JCB-991-10102	105.61
MODEL 8015							
BLADE		M730800-M731179 M820000-M821999 M894000-M895999	I-U-10	35 mm	70 mm	JCB-236-11516	71.97
BOOM		M730800-M731999	P-U-10	30 mm	50 mm	JCB-231-34316	142.19
		M820000-M821999	P-U-10	30 mm	55 mm	JCB-231-77408	131.13
BUCKET		M894878-M895999	I-U-10	30 mm	50 mm	JCB-231-35413	51.43
SWING		M894200-M895999	P-U-10	30 mm	50 mm	JCB-991-10102	105.61
MODEL 8017							
BLADE		M800000-M800999 M896000-M896999	I-U-10	35 mm	70 mm	JCB-231-22509	155.12
BOOM		M800000-M800999 M896000-M896999	P-U-10	30 mm	55 mm	JCB-231-77408	131.13
SWING		M800000-M800999 M896000-M896999	P-U-10	30 mm	50 mm	JCB-991-10102	105.61
MODEL 8025ZTS							
BOOM		01226500-01228500	P-U-10	40 mm	80 mm	JCB-991-10111	155.46
BUCKET		01226500-01228500	P-U-10	50 mm	75 mm	JCB-991-10113	122.89
DIPPER		01226500-01228500	P-U-10	40 mm	65 mm	JCB-983-11155	49.89
DOZER		01226500-01228500	P-U-10	45 mm	90 mm	JCB-903-20405	113.04
KERB GRAB		01226500-01228500	I-U-10	25 mm	50 mm	JCB-991-00097	45.82
SWING		01226500-01228500	P-U-10	40 mm	80 mm	JCB-903-20418	65.85
MODEL 8027Z							
BOOM		00898000-00898999	P-U-10	40 mm	80 mm	JCB-991-10111	155.46
		01226000-01776499	P-U-10	40 mm	80 mm	JCB-991-10111	155.46
BUCKET		00898000-00898999	P-U-10	50 mm	75 mm	JCB-991-10113	122.89
		01226000-01776499	P-U-10	50 mm	75 mm	JCB-991-10113	122.89
DIPPER		00898000-00898999	P-U-10	40 mm	65 mm	JCB-903-20434	70.12
		01226000-01776499	P-U-10	40 mm	65 mm	JCB-903-20434	70.12
DOZER		00898000-00898999	P-U-10	45 mm	90 mm	JCB-903-20405	113.04
		01226000-01776499	P-U-10	45 mm	90 mm	JCB-903-20405	113.04
SWING		00898000-00898999	P-U-10	40 mm	80 mm	JCB-903-20418	65.85
		01226000-01776499	P-U-10	40 mm	80 mm	JCB-903-20418	65.85
MODEL 8030ZTS							
BOOM		01228500-01230499	P-U-10	40 mm	80 mm	JCB-991-10111	155.46
BUCKET		01228500-01230499	I-U-10	50 mm	80 mm	JCB-991-00102	68.18
DIPPER		01228500-01230499	P-U-10	40 mm	65 mm	JCB-983-11155	49.89
DOZER		01228500-01230499	P-U-10	45 mm	90 mm	JCB-903-20405	113.04
KERB GRAB		01228500-01230499	I-U-10	25 mm	50 mm	JCB-991-00097	45.82
SWING		01228500-01230499	P-U-10	40 mm	80 mm	JCB-903-20418	65.85
MODEL 8032Z							
BOOM		00899000-00899999	P-U-10	40 mm	80 mm	JCB-991-10111	155.46
		01177000-01177999	P-U-10	40 mm	80 mm	JCB-991-10111	155.46
BUCKET		00899000-00899999	P-U-10	50 mm	75 mm	JCB-991-10113	122.89
		01177000-01177999	P-U-10	50 mm	75 mm	JCB-991-10113	122.89

Replacement Kits For

JCB

Excavators - Compact							
APPLICATION	CYL #	SERIAL #	CODE	ROD	BORE	KIT #	List \$
MODEL 803ZZ							
DIPPER		0089900-00899999	P-U-10	40 mm	65 mm	JCB-903-20434	70.12
		01177000-01177999	P-U-10	40 mm	65 mm	JCB-903-20434	70.12
DOZER		0089900-00899999	P-U-10	45 mm	90 mm	JCB-903-20405	113.04
		01177000-01177999	P-U-10	45 mm	90 mm	JCB-903-20405	113.04
SWING		0089900-00899999	P-U-10	40 mm	80 mm	JCB-903-20418	65.85
		01177000-01177999	P-U-10	40 mm	80 mm	JCB-903-20418	65.85
MODEL 8035ZTS							
BOOM		01230500-12314999	I-U-10	45 mm	90 mm	JCB-991-00164	160.03
DIPPER		01230500-12314999	I-U-10	45 mm	75 mm	JCB-991-00166	185.44
DOZER		01230500-12314999	P-U-10	45 mm	90 mm	JCB-903-20405	113.04
KERB GRAB		01230500-12314999	I-U-10	25 mm	50 mm	JCB-991-00097	45.82
SWING		01230500-12314999	P-U-10	40 mm	80 mm	JCB-903-20418	65.85
MODEL 8052							
ARM		M802000-	I-U-10	60 mm	90 mm	JCB-991-00147	90.65
BLADE		M802000-M802678	I-U-10	50 mm	80 mm	JCB-991-00102	68.18
		M802679-	I-U-10	60 mm	110 mm	JCB-991-00110	88.90
BOOM		M802000-	I-U-10	60 mm	100 mm	JCB-991-00145	70.20
BUCKET		M802000-	I-U-10	50 mm	80 mm	JCB-991-00102	68.18
SWING		M802000-	I-U-10	50 mm	90 mm	JCB-991-00103	52.97
MODEL 8060							
BOOM		00883000-00883829	I-U-10	60 mm	110 mm	JCB-991-10121	44.73
		00883830-00884999	I-U-10	60 mm	110 mm	JCB-991-10121	44.73
		01236000-01237999	I-U-10	60 mm	110 mm	JCB-991-10121	44.73
BUCKET		00883000-00883829	I-U-10	60 mm	90 mm	JCB-991-00147	90.65
		00883830-00884999	I-U-10	60 mm	90 mm	JCB-991-00147	90.65
		01236000-01237999	I-U-10	60 mm	90 mm	JCB-991-00147	90.65
DIPPER		00883000-00883829	I-U-10	60 mm	100 mm	JCB-991-00145	70.20
		00883830-00884999	I-U-10	60 mm	100 mm	JCB-991-00145	70.20
		01236000-01237999	I-U-10	60 mm	100 mm	JCB-991-00145	70.20
DOZER		00883000-00883829	I-U-10	60 mm	110 mm	JCB-991-00110	88.90
		00883830-00884999	I-U-10	60 mm	110 mm	JCB-991-00110	88.90
		01236000-01237999	I-U-10	60 mm	110 mm	JCB-991-00110	88.90
SWING		00883000-00883829	I-U-10	50 mm	90 mm	JCB-991-10122	84.66
		00883830-00884999	I-U-10	50 mm	90 mm	JCB-991-10122	84.66
		01236000-01237999	I-U-10	50 mm	90 mm	JCB-991-10122	84.66
MODEL 8065RTS							
BOOM		01536000-01537499	I-U-10	60 mm	110 mm	JCB-991-10121	44.73
BUCKET		01536000-01537499	I-U-10	50 mm	90 mm	JCB-991-00103	52.97
DIPPER		01536000-01537499	I-U-10	60 mm	100 mm	JCB-991-00145	70.20
DOZER		01536000-01537499	I-U-10	60 mm	110 mm	JCB-991-00110	88.90
SWING		01536000-01537499	I-U-10	50 mm	90 mm	JCB-991-00103	52.97
MODEL 8080							
BOOM		01024000-01025999	I-U-10	60 mm	100 mm	JCB-991-10138	68.66
		01024000-01025999	I-U-10	60 mm	110 mm	JCB-991-10144	75.29
		01442000-01443999	I-U-10	60 mm	110 mm	JCB-991-10144	75.29
		01442000-01443999	I-U-10	60 mm	100 mm	JCB-991-10138	68.66
BUCKET		01024000-01025999	I-U-10	50 mm	80 mm	JCB-991-00102	68.18
		01442000-01443999	I-U-10	50 mm	80 mm	JCB-991-00102	68.18
DIPPER		01024000-01025999	I-U-10	60 mm	90 mm	JCB-991-00147	90.65
		01442000-01443999	I-U-10	60 mm	90 mm	JCB-991-00147	90.65
DOZER		01024000-01025999	I-U-10	60 mm	110 mm	JCB-991-00110	88.90
		01442000-01443999	I-U-10	60 mm	110 mm	JCB-991-00110	88.90
KERB GRAB		01024000-01025999	I-U-10	25 mm	50 mm	JCB-991-00097	45.82
		01442000-01443999	I-U-10	25 mm	50 mm	JCB-991-00097	45.82
SWING		01024000-01025999	I-U-10	50 mm	90 mm	JCB-991-10122	84.66

JCB

Replacement Kits For

JCB

Excavators - Compact							
APPLICATION	CYL #	SERIAL #	CODE	ROD	BORE	KIT #	List \$
MODEL 8080							
SWING		01442000-01443999	I-U-10	50 mm	90 mm	JCB-991-10122	84.66
Excavators - Tracked							
APPLICATION	CYL #	SERIAL #	CODE	ROD	BORE	KIT #	List \$
MODEL JS130							
BOOM		00758001-00759999	P-UB-10	75 mm	100 mm	JCB-LQU0114	341.24
		00758001-00759999	P-UB-10	75 mm	100 mm	JCB-690-00693	298.31
		00890001-00890999	P-UB-10	75 mm	100 mm	JCB-LQU0114	341.24
		00890001-00890999	P-UB-10	75 mm	100 mm	JCB-690-00693	298.31
	33117713	01058001-01058049	P-UB-10	75 mm	100 mm	JCB-LQU0114	341.24
	90320240	01058001-01058049	P-UB-10	75 mm	100 mm	JCB-690-00693	298.31
	90320242	01058001-01058049	P-UB-10	75 mm	100 mm	JCB-690-00693	298.31
	LNU0155	00699002-00700999	P-UB-10	70 mm	110 mm	JCB-LQU0080	420.33
LQU116	01058001-01058049	P-UB-10	75 mm	100 mm	JCB-LQU0114	341.24	
BUCKET		00758001-00759999	P-UB-10	70 mm	95 mm	JCB-991-10129	109.12
		00758001-00759999	P-UB-10	70 mm	95 mm	JCB-LQU0126	261.69
		00890001-00890999	P-UB-10	70 mm	95 mm	JCB-LQU0126	261.69
		00890001-00890999	P-UB-10	70 mm	95 mm	JCB-991-10129	109.12
	33117714	01058001-01058049	P-UB-10	70 mm	95 mm	JCB-LQU0126	261.69
	90320252	01058001-01058049	P-UB-10	70 mm	95 mm	JCB-991-10129	109.12
	LNU01457	00699002-00700999	P-UB-10	65 mm	105 mm	JCB-LQU0082	197.28
	LQU0118	01058001-01058049	P-UB-10	70 mm	95 mm	JCB-LQU0126	261.69
DIPPER		00758001-00759443	P-UB-10	80 mm	115 mm	JCB-LQU0125	316.13
		00759444-00759999	P-UB-10	80 mm	115 mm	JCB-991-10139	432.69
		00890001-00890999	P-UB-10	80 mm	115 mm	JCB-991-10139	432.69
		00890001-00890999	P-UB-10	80 mm	115 mm	JCB-LQU0125	316.13
	99810686	01058001-01058049	P-UB-10	80 mm	115 mm	JCB-991-10139	432.69
	LNU0156	00699002-00700999	P-UB-10	80 mm	115 mm	JCB-LQU0081	371.83
LQU0117	01058001-01058049	P-UB-10	80 mm	115 mm	JCB-LQU0125	316.13	
DOZER		00758001-00759999	I-U-10	65 mm	120 mm	JCB-991-00115	97.86
	56370081RH	00890001-00890999	I-U-10	65 mm	120 mm	JCB-991-00115	97.86
	56370082LH	01058001-01058049	I-U-10	65 mm	120 mm	JCB-991-00115	97.86
MODEL JS160LC							
BOOM	99810693	00702971-00703849	P-UB-10	80 mm	115 mm	JCB-998-10040	343.72
	WHBCVLNU03 90		P-UB-10	80 mm	115 mm	JCB-998-10040	343.72
	WOHBCV33117 731	00702001-00702970	P-UB-10	80 mm	115 mm	JCB-LQU-0164	223.06
BUCKET	33117711	00702001-007002970	P-UB-10	75 mm	105 mm	JCB-LQU0166	227.02
	90320556	00702971-00703849	P-UB-10	75 mm	105 mm	JCB-903-20435	148.58
	LNU0395	00702001-007002970	P-UB-10	75 mm	105 mm	JCB-LQU0166	227.02
DIPPER	33117712	00702001-00702970	P-UB-10	90 mm	125 mm	JCB-LQU0165	252.53
	90320372	00702971-00703849	P-UB-10	85 mm	120 mm	JCB-903-20265	317.63
	LNU0392	00702001-00702970	P-UB-10	90 mm	125 mm	JCB-LQU0165	252.53
MODEL JS200							
BOOM	90320735	01018001-01020001	P-UB-10	85 mm	125 mm	JCB-331-39036	110.55
	90320735	01202500-01204022	P-UB-10	85 mm	125 mm	JCB-331-39036	110.55
	90320735	01503300-01504499	P-UB-10	85 mm	125 mm	JCB-331-39036	110.55
	90320735	01610000-01612499	P-UB-10	85 mm	125 mm	JCB-331-39036	110.55
	90320735	01613000-01613999	P-UB-10	85 mm	125 mm	JCB-331-39036	110.55
	90320735	01701500-01702499	P-UB-10	85 mm	125 mm	JCB-331-39036	110.55
	99810079	00705001-00705543	P-UB-10	85 mm	125 mm	JCB-998-10020	148.97
	99810079	00705544-00707999	P-UB-10	85 mm	125 mm	JCB-998-10020	148.97
	LQU0152	00705001-00705543	P-UB-10	85 mm	125 mm	JCB-998-10020	148.97
	LQU0152	00705544-00707999	P-UB-10	85 mm	125 mm	JCB-998-10020	148.97
BUCKET	33117714	00705001-00707999	P-UB-10	70 mm	95 mm	JCB-LQU0126	261.69

JCB

Replacement Kits For

Excavators - Tracked								
APPLICATION	CYL #	SERIAL #	CODE	ROD	BORE	KIT #	List \$	
MODEL JS200								
BUCKET	33139043	01018001-01020001	P-UB-10	85 mm	115 mm	JCB-331-39041	124.23	
	33139043	01202500-01204022	P-UB-10	85 mm	115 mm	JCB-331-39041	124.23	
	33139043	01503300-01504499	P-UB-10	85 mm	115 mm	JCB-331-39041	124.23	
	33139043	01610000-01612499	P-UB-10	85 mm	115 mm	JCB-331-39041	124.23	
	33139043	01613000-01613999	P-UB-10	85 mm	115 mm	JCB-331-39041	124.23	
	33139043	01701500-01702499	P-UB-10	85 mm	115 mm	JCB-331-39041	124.23	
	69000778	00705410-00707999	P-UB-10	80 mm	120 mm	JCB-690-00801	140.11	
	90320252	00705001-00707999	P-UB-10	70 mm	95 mm	JCB-991-10129	109.12	
	LQU0118	00705001-00707999	P-UB-10	70 mm	95 mm	JCB-LQU0126	261.69	
LQU0156	00705001-00705409	P-UB-10	80 mm	120 mm	JCB-LQU-0142	108.70		
CAB RAISE	5570109	01018001-01020001	I-U-10	60 mm	90 mm	JCB-991-00147	90.65	
	5570109	01203500-01204022	I-U-10	60 mm	90 mm	JCB-991-00147	90.65	
	5570109	01503300-01504499	I-U-10	60 mm	90 mm	JCB-991-00147	90.65	
	5570109	01701500-01702499	I-U-10	60 mm	90 mm	JCB-991-00147	90.65	
DIPPER	33139046	01018001-01020001	P-UB-10	95 mm	130 mm	JCB-331-39047	183.90	
	33139046	01202500-01204022	P-UB-10	95 mm	130 mm	JCB-331-39047	183.90	
	33139046	01503300-01504499	P-UB-10	95 mm	130 mm	JCB-331-39047	183.90	
	33139046	01610000-01612499	P-UB-10	95 mm	130 mm	JCB-331-39047	183.90	
	33139046	01613000-01613999	P-UB-10	95 mm	130 mm	JCB-331-39047	183.90	
	33139046	01701500-01702499	P-UB-10	95 mm	130 mm	JCB-331-39047	183.90	
	69000726	00705410-00707999	P-UB-10	100 mm	135 mm	JCB-690-00754	186.28	
	JBV0509	00705001-00707999	P-UB-10	105 mm	150 mm	JCB-998-10022	271.17	
	LQU0154	00705001-00705409	P-UB-10	100 mm	135 mm	JCB-LQU-0138	156.19	
MODEL JS200LC								
BOOM	LNU0158	00704002-00705000	P-UB-10	85 mm	125 mm	JCB-LQU0089	465.95	
	LNU0158	00704002-00705000	P-UB-10	85 mm	125 mm	JCB-LQU0036	465.95	
	LNU0158	00704075-00705000	P-UB-10	85 mm	125 mm	JCB-LQU0089	465.95	
BUCKET	LNU0157	00704002-00705000	P-UB-10	65 mm	105 mm	JCB-LQU0082	197.28	
	LNU0211	00704002-00705000	P-UB-10	80 mm	120 mm	JCB-LQU0046	430.30	
	LNU0211	00704002-00705000	P-UB-10	80 mm	120 mm	JCB-LQU0092	430.30	
DIPPER	LNU0160	00704002-00705000	P-UB-10	95 mm	140 mm	JCB-LQU0038	293.83	
	LNU0160	00704002-00705000	P-UB-10	95 mm	140 mm	JCB-LQU0091	293.83	
MODEL JS220								
BOOM	33117533	00705001-00706727	P-UB-10	95 mm	140 mm	JCB-LQU-0172	185.48	
	33149239	010180001-0120001	P-UB-14	95 mm	140 mm	JCB-903-21071	247.40	
	33149239	01053300-01504499	P-UB-14	95 mm	140 mm	JCB-903-21071	247.40	
	33149239	01202500-01204022	P-UB-14	95 mm	140 mm	JCB-903-21071	247.40	
	33149239	01701500-01702499	P-UB-14	95 mm	140 mm	JCB-903-21071	247.40	
	90320234	00705728-00707999	P-UB-10	95 mm	140 mm	JCB-903-20233	290.46	
	90320234	010180001-0120001	P-UB-10	95 mm	140 mm	JCB-903-20233	290.46	
	90320234	01053300-01504499	P-UB-10	95 mm	140 mm	JCB-903-20233	290.46	
	90320234	01202500-01204022	P-UB-10	95 mm	140 mm	JCB-903-20233	290.46	
	90320234	01701500-01702499	P-UB-10	95 mm	140 mm	JCB-903-20233	290.46	
	90320735	01018001-01020001	P-UB-10	85 mm	125 mm	JCB-331-39036	110.55	
	90320735	01202500-01204022	P-UB-10	85 mm	125 mm	JCB-331-39036	110.55	
	90320735	01503300-01504499	P-UB-10	85 mm	125 mm	JCB-331-39036	110.55	
	90320735	01610000-01612499	P-UB-10	85 mm	125 mm	JCB-331-39036	110.55	
	90320735	01613000-01613999	P-UB-10	85 mm	125 mm	JCB-331-39036	110.55	
	90320735	01701500-01702499	P-UB-10	85 mm	125 mm	JCB-331-39036	110.55	
	99810079	00705001-00705543	P-UB-10	85 mm	125 mm	JCB-998-10020	148.97	
	99810079	00705544-00707999	P-UB-10	85 mm	125 mm	JCB-998-10020	148.97	
	LNU0432	00705001-00706727	P-UB-10	95 mm	140 mm	JCB-LQU-0172	185.48	
	LQU0152	00705001-00705543	P-UB-10	85 mm	125 mm	JCB-998-10020	148.97	
	LQU0152	00705544-00707999	P-UB-10	85 mm	125 mm	JCB-998-10020	148.97	
	BUCKET		00705410-00707999	P-UB-10	80 mm	120 mm	JCB-690-00801	140.11

JCB

Replacement Kits For

JCB

Excavators - Tracked							
APPLICATION	CYL #	SERIAL #	CODE	ROD	BORE	KIT #	List \$
MODEL JS220							
BUCKET	33117714		P-UB-10	70 mm	95 mm	JCB-LQU0126	261.69
	33139043	01018001-01200001	P-UB-10	85 mm	115 mm	JCB-331-39041	124.23
	33139043	01202500-01204022	P-UB-10	85 mm	115 mm	JCB-331-39041	124.23
	33139043	01503300-01504499	P-UB-10	85 mm	115 mm	JCB-331-39041	124.23
	33139043	01610000-01612499	P-UB-10	85 mm	115 mm	JCB-331-39041	124.23
	33139043	01613000-01613999	P-UB-10	85 mm	115 mm	JCB-331-39041	124.23
	33139043	01701500-01702499	P-UB-10	85 mm	115 mm	JCB-331-39041	124.23
	69000778	00705001-00715409	P-UB-10	80 mm	120 mm	JCB-LQU-0142	108.70
	90320252		P-UB-10	70 mm	95 mm	JCB-991-10129	109.12
	99810076	00705001-00707999	P-UB-10	90 mm	135 mm	JCB-998-10023	173.61
	LQU0118		P-UB-10	70 mm	95 mm	JCB-LQU0126	261.69
	LQU0150	00705001-00707999	P-UB-10	90 mm	135 mm	JCB-998-10023	173.61
	LQU0156	00705001-00715409	P-UB-10	80 mm	120 mm	JCB-LQU-0142	108.70
CAB RAISE	55770109	01018001-01200001	I-U-10	60 mm	90 mm	JCB-991-00147	90.65
	55770109	01202500-01204022	I-U-10	60 mm	90 mm	JCB-991-00147	90.65
	55770109	01503300-01504499	I-U-10	60 mm	90 mm	JCB-991-00147	90.65
	55770109	01610000-01612499	I-U-10	60 mm	90 mm	JCB-991-00147	90.65
	55770109	01613000-01613999	I-U-10	60 mm	90 mm	JCB-991-00147	90.65
	55770109	01701500-01702499	I-U-10	60 mm	90 mm	JCB-991-00147	90.65
DIPPER	33139046	01018001-01200001	P-UB-10	95 mm	130 mm	JCB-331-39047	183.90
	33139046	01202500-01204022	P-UB-10	95 mm	130 mm	JCB-331-39047	183.90
	33139046	01503300-01504499	P-UB-10	95 mm	130 mm	JCB-331-39047	183.90
	33139046	01610000-01612499	P-UB-10	95 mm	130 mm	JCB-331-39047	183.90
	33139046	01613000-01613999	P-UB-10	95 mm	130 mm	JCB-331-39047	183.90
	33139046	01701500-01702499	P-UB-10	95 mm	130 mm	JCB-331-39047	183.90
	69000726	00705410-00707999	P-UB-10	100 mm	135 mm	JCB-LQU-0138	156.19
	JBV0509	00705001-00707999	P-UB-10	100 mm	135 mm	JCB-LQU-0138	156.19
LQU0154	00705001-00705409	P-UB-10	100 mm	135 mm	JCB-LQU-0138	156.19	
MODEL JS260							
BOOM		00708501-00709199	P-UB-10	90 mm	130 mm	JCB-998-10021	146.84
		01040003-01041999	P-UB-14	90 mm	130 mm	JCB-903-21037	163.39
		01040003-01041999	P-UB-10	90 mm	130 mm	JCB-998-10021	146.84
		01504700-01505099	P-UB-14	90 mm	130 mm	JCB-903-21037	163.39
	33142816	01504700-01505099	P-UB-14	90 mm	130 mm	JCB-903-21037	163.39
	99810078	00708501-00708625	P-UB-10	90 mm	130 mm	JCB-998-10021	146.84
	JBV0508	00708626-00709199	P-UB-10	90 mm	130 mm	JCB-998-10021	146.84
	LNU0196	00708501-00709199	P-UB-10	110 mm	160 mm	JCB-LQU0049	156.58
	LQU0146	00708501-00708625	P-UB-10	90 mm	130 mm	JCB-998-10021	146.84
BOOM POSITION, TAB		00708501-00709199	P-UB-10	110 mm	160 mm	JCB-LQU0049	156.58
		01040003-01041999	P-UB-10	110 mm	160 mm	JCB-LQU0049	156.58
BUCKET		00708501-00709199	P-UB-10	90 mm	135 mm	JCB-998-10023	173.61
		01040003-01041999	P-UB-14	95 mm	130 mm	JCB-903-21049	113.44
		01040003-01041999	P-UB-10	95 mm	130 mm	JCB-331-38788	194.18
		01054700-01505099	P-UB-14	95 mm	130 mm	JCB-903-21049	113.44
	33142817	01504700-01505099	P-UB-14	95 mm	130 mm	JCB-903-21049	113.44
	99810076	00708501-00708625	P-UB-10	90 mm	135 mm	JCB-998-10023	173.61
	JBV0510	00708626-00709199	P-UB-10	90 mm	135 mm	JCB-998-10023	173.61
	LQU0150	00708501-00708625	P-UB-10	90 mm	135 mm	JCB-998-10023	173.61
BUCKET, LONG REACH		01040003-01041999	P-UB-10	70 mm	95 mm	JCB-903-20839	280.58
DIPPER		00708501-00709199	P-UB-10	105 mm	150 mm	JCB-998-10022	271.17
		01040003-01041999	P-UB-14	100 mm	140 mm	JCB-903-21165	204.84
		01040003-01041999	P-UB-10	100 mm	140 mm	JCB-991-10127	206.11
		01504700-01505099	P-UB-14	100 mm	140 mm	JCB-903-21165	204.84
	33142815	01504700-01505099	P-UB-14	100 mm	140 mm	JCB-903-21165	204.84
	JBV0313	00708626-00709199	P-UB-10	105 mm	150 mm	JCB-998-10022	271.17

Replacement Kits For

JCB

Excavators - Tracked								
APPLICATION	CYL #	SERIAL #	CODE	ROD	BORE	KIT #	List \$	
MODEL JS260								
DIPPER	LQU0148	00708501-00708625	P-UB-10	105 mm	150 mm	JCB-998-10022	271.17	
MODEL JS260 AUTO								
BOOM		00708501-00709199	P-UB-10	90 mm	130 mm	JCB-998-10021	146.84	
		01040003-01041999	P-UB-10	90 mm	130 mm	JCB-998-10021	146.84	
		01040003-01041999	P-UB-14	90 mm	130 mm	JCB-903-21037	163.39	
		01504700-01505099	P-UB-14	90 mm	130 mm	JCB-903-21037	163.39	
BOOM POSITION, TAB		00708501-00709199	P-UB-10	110 mm	160 mm	JCB-LQU0049	156.58	
		01040003-01041999	P-UB-10	110 mm	160 mm	JCB-LQU0049	156.58	
BUCKET		00708501-00709199	P-UB-10	90 mm	135 mm	JCB-998-10023	173.61	
		01040003-01041999	P-UB-14	95 mm	130 mm	JCB-903-21049	113.44	
		01040003-01041999	P-UB-10	95 mm	130 mm	JCB-331-38788	194.18	
		01054700-01505099	P-UB-14	95 mm	130 mm	JCB-903-21049	113.44	
BUCKET, LONG REACH		01040003-01041999	P-UB-10	70 mm	95 mm	JCB-903-20839	280.58	
DIPPER		00708501-00709199	P-UB-10	105 mm	150 mm	JCB-998-10022	271.17	
		01040003-01041999	P-UB-14	100 mm	140 mm	JCB-903-21165	204.84	
		01040003-01041999	P-UB-10	100 mm	140 mm	JCB-991-10127	206.11	
		01504700-01505099	P-UB-14	100 mm	140 mm	JCB-903-21165	204.84	
MODEL JS260 XD AUTO								
BOOM		00708501-00709199	P-UB-10	90 mm	130 mm	JCB-998-10021	146.84	
		01040003-01041999	P-UB-10	90 mm	130 mm	JCB-998-10021	146.84	
		01040003-01041999	P-UB-14	90 mm	130 mm	JCB-903-21037	163.39	
		01504700-01505099	P-UB-14	90 mm	130 mm	JCB-903-21037	163.39	
BOOM POSITION, TAB		00708501-00709199	P-UB-10	110 mm	160 mm	JCB-LQU0049	156.58	
		01040003-01041999	P-UB-10	110 mm	160 mm	JCB-LQU0049	156.58	
BUCKET		00708501-00709199	P-UB-10	90 mm	135 mm	JCB-998-10023	173.61	
		01040003-01041999	P-UB-14	95 mm	130 mm	JCB-903-21049	113.44	
		01040003-01041999	P-UB-10	95 mm	130 mm	JCB-331-38788	194.18	
		01054700-01505099	P-UB-14	95 mm	130 mm	JCB-903-21049	113.44	
BUCKET, LONG REACH		01040003-01041999	P-UB-10	70 mm	95 mm	JCB-903-20839	280.58	
DIPPER		00708501-00709199	P-UB-10	105 mm	150 mm	JCB-998-10022	271.17	
		01040003-01041999	P-UB-10	100 mm	140 mm	JCB-991-10127	206.11	
		01040003-01041999	P-UB-14	100 mm	140 mm	JCB-903-21165	204.84	
		01504700-01505099	P-UB-14	100 mm	140 mm	JCB-903-21165	204.84	
MODEL JS330								
BOOM		00712501-00712778	P-UB-10	100 mm	140 mm	JCB-LQU-0072	213.60	
		00712779-00713999	P-UB-10	100 mm	140 mm	JCB-991-10127	206.11	
		00712952-00713999	P-UB-10	100 mm	140 mm	JCB-903-21024	154.67	
	33117531	00712501-00712778	P-UB-10	100 mm	140 mm	JCB-LQU-0072	213.60	
	33121129	00712952-00713999	P-UB-10	100 mm	140 mm	JCB-991-10127	206.11	
	33142426	00712952-00713999	P-UB-10	100 mm	140 mm	JCB-903-21024	154.67	
	90320207	00712779-00712951	P-UB-10	100 mm	140 mm	JCB-991-10127	206.11	
	90320207	00712952-00713999	P-UB-10	100 mm	140 mm	JCB-991-10127	206.11	
	LNU0210	00712501-00712778	P-UB-10	100 mm	140 mm	JCB-LQU-0072	213.60	
	BUCKET		00712501-00712770	P-UB-10	95 mm	140 mm	JCB-LQU-0172	185.48
		00712771-00713999	P-UB-10	95 mm	140 mm	JCB-903-20233	290.46	
		00712952-00713999	P-UB-14	95 mm	140 mm	JCB-903-21071	247.40	
33117533		00712501-00712770	P-UB-10	95 mm	140 mm	JCB-LQU-0172	185.48	
33121172		00712771-00712951	P-UB-10	95 mm	140 mm	JCB-903-20233	290.46	
33121172		00712952-00713999	P-UB-10	95 mm	140 mm	JCB-903-20233	290.46	
33142429		00712952-00713999	P-UB-14	95 mm	140 mm	JCB-903-21071	247.40	
90320234		00712771-00712951	P-UB-10	95 mm	140 mm	JCB-903-20233	290.46	
90320234		00712952-00713999	P-UB-10	95 mm	140 mm	JCB-903-20233	290.46	
90320556		00712952-00713999	P-UB-10	75 mm	105 mm	JCB-903-20435	148.58	
LNU0432		00712501-00712770	P-UB-10	95 mm	140 mm	JCB-LQU-0172	185.48	
DIPPER			00712501-00712779	P-UB-10	110 mm	160 mm	JCB-LQU-0074	327.12

JCB

Replacement Kits For

JCB

Excavators - Tracked							
APPLICATION	CYL #	SERIAL #	CODE	ROD	BORE	KIT #	List \$
MODEL JS330							
DIPPER		00712780-00713999	P-UB-10	110 mm	160 mm	JCB-903-20222	365.00
		00712952-00713999	P-UB-10	110 mm	160 mm	JCB-903-21061	218.25
	33114248	00712952-00713999	P-UB-10	110 mm	160 mm	JCB-903-21061	218.25
	33117532	00712501-00712779	P-UB-10	110 mm	160 mm	JCB-LQU-0074	327.12
	33121168	00712780-00712951	P-UB-10	110 mm	160 mm	JCB-903-20222	365.00
	33121168	00712952-00713999	P-UB-10	110 mm	160 mm	JCB-903-20222	365.00
	90320028	00712501-00712779	P-UB-10	110 mm	160 mm	JCB-LQU-0074	327.12
	90320223	00712780-00712951	P-UB-10	110 mm	160 mm	JCB-903-20222	365.00
	90320223	00712952-00713999	P-UB-10	110 mm	160 mm	JCB-903-20222	365.00
MODEL JS330 Auto							
BOOM		01224215-01224999	P-UB-14	95 mm	140 mm	JCB-903-21071	247.40
		01240500-01240999	P-UB-14	95 mm	140 mm	JCB-903-21071	247.40
BOOM, LONG REACH		01224215-01224999	P-UB-10	75 mm	105 mm	JCB-903-20435	148.58
		01240500-01240999	P-UB-10	75 mm	105 mm	JCB-903-20435	148.58
BUCKET		01224215-01224999	P-UB-10	100 mm	140 mm	JCB-903-21024	154.67
		01240500-01240999	P-UB-10	100 mm	140 mm	JCB-903-21024	154.67
DIPPER		01224215-01224999	P-UB-10	110 mm	160 mm	JCB-903-21061	218.25
		01240500-01240999	P-UB-10	110 mm	160 mm	JCB-903-21061	218.25
MODEL JS330XD							
BOOM		00712501-00712778	P-UB-10	100 mm	140 mm	JCB-LQU-0072	213.60
		00712779-00713999	P-UB-10	100 mm	140 mm	JCB-991-10127	206.11
		00712952-00713999	P-UB-10	100 mm	140 mm	JCB-903-21024	154.67
BUCKET		00712501-00712770	P-UB-10	95 mm	140 mm	JCB-LQU-0172	185.48
		00712771-00713999	P-UB-10	95 mm	140 mm	JCB-903-20233	290.46
		00712952-00713999	P-UB-14	95 mm	140 mm	JCB-903-21071	247.40
DIPPER		00712501-00712779	P-UB-10	110 mm	160 mm	JCB-LQU-0074	327.12
		00712780-00713999	P-UB-10	110 mm	160 mm	JCB-903-20222	365.00
		00712952-00713999	P-UB-10	110 mm	160 mm	JCB-903-21061	218.25
MODEL JS330XD Auto							
BOOM		01224215-01224999	P-UB-14	95 mm	140 mm	JCB-903-21071	247.40
		01240500-01240999	P-UB-14	95 mm	140 mm	JCB-903-21071	247.40
BOOM, LONG REACH		01224215-01224999	P-UB-10	75 mm	105 mm	JCB-903-20435	148.58
		01240500-01240999	P-UB-10	75 mm	105 mm	JCB-903-20435	148.58
BUCKET		01224215-01224999	P-UB-10	100 mm	140 mm	JCB-903-21024	154.67
		01240500-01240999	P-UB-10	100 mm	140 mm	JCB-903-21024	154.67
DIPPER		01224215-01224999	P-UB-10	110 mm	160 mm	JCB-903-21061	218.25
		01240500-01240999	P-UB-10	110 mm	160 mm	JCB-903-21061	218.25
MODEL JZ140							
BOOM	33144449	01137000-01137574	P-UB-10	75 mm	100 mm	JCB-903-20862	474.77
	33144455	01137583-01137999	P-UB-10	75 mm	100 mm	JCB-903-20862	474.77
	90320863		P-UB-10	75 mm	100 mm	JCB-903-20862	474.77
BUCKET		01137000-01137574	P-UB-10	70 mm	95 mm	JCB-903-20839	280.58
	90320840	01137583-01137999	P-UB-10	70 mm	95 mm	JCB-903-20839	280.58
DIPPER		01137000-01137574	P-UB-10	80 mm	115 mm	JCB-903-20856	362.04
	90320857	01137583-01137999	P-UB-10	80 mm	115 mm	JCB-903-20856	362.04
DOZER		01137000-01137154	I-U-10	65 mm	120 mm	JCB-991-00115	97.86
		01137155-01137574	I-U-10	65 mm	120 mm	JCB-991-00115	97.86
	56360081	01137583-01137999	I-U-10	65 mm	120 mm	JCB-991-00115	97.86
	56360082	01137583-01137999	I-U-10	65 mm	120 mm	JCB-991-00115	97.86
	56360106	01137583-01137999	I-U-10	65 mm	120 mm	JCB-991-00115	97.86
DOZER LH		01137575-01137582	I-U-10	65 mm	120 mm	JCB-991-00115	97.86
	56370106	01390000-01390499	I-U-10	65 mm	120 mm	JCB-991-00115	97.86
DOZER RH		01137575-01137582	I-U-10	65 mm	120 mm	JCB-991-00115	97.86
DOZER, RIGHT	56370107	01390000-01390499	I-U-10	65 mm	120 mm	JCB-991-00115	97.86

JCB

Replacement Kits For

JCB

Excavators - Tracked							
APPLICATION	CYL #	SERIAL #	CODE	ROD	BORE	KIT #	List \$
MODEL JZ140							
RAM POSITION		01137155-01137574	I-U-10	65 mm	120 mm	JCB-991-00115	97.86
	69000958	01137583-01137999	P-UB-10	75 mm	140 mm	JCB-690-00972	239.48
Telehandlers							
APPLICATION	CYL #	SERIAL #	CODE	ROD	BORE	KIT #	List \$
MODEL 505-19 F.M							
BOX TIPPER, STRIMECH	983-00130	M561011-M579360	I-U-15	50 mm	100 mm	JCB-983-00154	75.61
CARRIAGE - Sideshift	547-42101	M561011-M579360	I-U-4	7/8"	2"	JCB-547-42102	19.52
CLAMSHOVEL	556-44000	M561011-M579360	I-U-15	40 mm	70 mm	JCB-991-00122	51.17
	556-60019	M561011-M579360	I-U-10	40 mm	70 mm	JCB-991-00095	53.51
DISPLACEMENT	561-24200	M569247	I-U-15	50 mm	110 mm	JCB-991-00126	57.41
	561-60006	M561011-M579360	I-U-15	50 mm	110 mm	JCB-991-00126	57.41
	561-60019	M561011-M579360	I-U-10	50 mm	110 mm	JCB-991-00109	72.98
EXTENSION	553-13800	M561011-M579360	I-U-15	50 mm	70 mm	JCB-556-24900K	120.67
EXTENSION - Metric	556-60062	M561011-M579360	I-U-10	50 mm	70 mm	JCB-991-00105	80.91
LIFT	561-23600	M567495	I-U-15	60 mm	110 mm	JCB-991-00131	73.27
	561-42800	M569262	I-U-15	60 mm	110 mm	JCB-991-00131	73.27
	561-60005	M561011-M579360	I-U-15	60 mm	110 mm	JCB-991-00131	73.27
	561-60017	M561011-M579360	I-U-10	60 mm	110 mm	JCB-991-00110	88.90
LIFT - Float	561-60039	M561011-M579360	I-U-10	60 mm	110 mm	JCB-991-00110	88.90
LOG GRAB	545-45300	M561011-M579360	I-U-10	1-1/2"	2-3/8"	JCB-545-45307	42.96
MANURE FORK	980-35601	M561011-M579360	I-U-10	1-1/2"	3"	JCB-980-35603	60.06
STEERING - Front	551-06200	M561011-M579360	I-U-10	25 mm	50 mm	JCB-993-46200K	50.57
STEERING - Front & Rear	551-06400	M561011-M579360	I-U-10	25 mm	50 mm	JCB-991-00071	40.57
	551-08500	M568555	I-U-10	25 mm	50 mm	JCB-991-00054	56.07
	551-10100	M561011-M579360	I-U-10	25 mm	50 mm	JCB-991-00097	45.82
STEERING - Front, JCB Option	993-46200	M561011-M579360	I-U-10	25 mm	50 mm	JCB-993-46200K	50.57
STEERING - Rear	551-06300	M561011-M579360	I-U-10	25 mm	50 mm	JCB-993-46200K	50.57
STEERING - Rear, JCB Option	993-46400	M561011-M579360	I-U-10	25 mm	50 mm	JCB-993-46200K	50.57
TILT	553-02000	M561011-M579360	I-U-14	30 mm	60 mm	JCB-991-00021	43.75
	553-04300	M561011-M579360	I-U-14	30 mm	60 mm	JCB-991-00021	43.75
	561-23900	M561307	I-U-15	50 mm	110 mm	JCB-991-00126	57.41
	561-33500	M569262	I-U-15	50 mm	110 mm	JCB-991-00126	57.41
	561-60009	M561011-M579360	I-U-15	50 mm	110 mm	JCB-991-00126	57.41
	561-60020	M561011-M579360	I-U-10	50 mm	110 mm	JCB-991-00109	72.98
TILT - Boom Float	561-60038	M561011-M579360	I-U-10	50 mm	110 mm	JCB-991-00109	72.98
TOW HITCH	556-31100	M561011-M579360	I-U-10	30 mm	70 mm	JCB-991-00069	33.00
	556-42200	M568560	I-U-10	30 mm	70 mm	JCB-991-00099	53.56
	556-46700	M561011-M579360	I-U-10	30 mm	70 mm	JCB-991-00099	53.56
MODEL 505-22, 505-22 SWAY							
BOX TIPPER, STRIMECH	983-00130	M561011-M579360	I-U-15	50 mm	100 mm	JCB-983-00154	75.61
CARRIAGE - Sideshift	547-42101	M561011-M579360	I-U-4	7/8"	2"	JCB-547-42102	19.52
	993-34500	M561011-M579360	I-U-4	1"	2-1/2"	JCB-993-34509	21.05
CLAMSHOVEL	556-44000	M561011-M579360	I-U-15	40 mm	70 mm	JCB-991-00122	51.17
	556-60019	M561011-M579360	I-U-10	40 mm	70 mm	JCB-991-00095	53.51
DISPLACEMENT	561-32400	M569237	I-U-15	50 mm	110 mm	JCB-991-00126	57.41
	561-60008	M561011-M579360	I-U-15	50 mm	110 mm	JCB-991-00126	57.41
	561-60025	M561011-M579360	I-U-10	50 mm	110 mm	JCB-991-00109	72.98
EXTENSION	556-32700	M561011-M579360	I-U-15	50 mm	70 mm	JCB-556-24900K	120.67
	556-60050	M561011-M579360	I-U-10	50 mm	70 mm	JCB-991-00105	80.91
LIFT	561-24500	M567495	I-U-15	60 mm	110 mm	JCB-991-00131	73.27
	561-42700	M569149	I-U-15	60 mm	110 mm	JCB-991-00131	73.27
	561-60004	M561011-M579360	I-U-15	60 mm	110 mm	JCB-991-00131	73.27
	561-60015	M561011-M579360	I-U-10	60 mm	110 mm	JCB-991-00110	88.90
LOG GRAB	545-45300	M561011-M579360	I-U-10	1-1/2"	2-3/8"	JCB-545-45307	42.96
MANURE FORK	980-35601	M561011-M579360	I-U-10	1-1/2"	3"	JCB-980-35603	60.06

JCB

Replacement Kits For

JCB

Telehandlers							
APPLICATION	CYL #	SERIAL #	CODE	ROD	BORE	KIT #	List \$
MODEL 505-22, 505-22 SWAY							
STEERING - Front	551-06200	M561011-M579360	I-U-10	25 mm	50 mm	JCB-993-46200K	50.57
STEERING - Front & Rear	551-06400	M561011-M579360	I-U-10	25 mm	50 mm	JCB-991-00071	40.57
	551-08500	M568555	I-U-10	25 mm	50 mm	JCB-991-00054	56.07
	551-10100	M561011-M579360	I-U-10	25 mm	50 mm	JCB-991-00097	45.82
STEERING - Front, JCB Option	993-46200	M561011-M579360	I-U-10	25 mm	50 mm	JCB-993-46200K	50.57
STEERING - Rear	551-06300	M561011-M579360	I-U-10	25 mm	50 mm	JCB-993-46200K	50.57
STEERING - Rear, JCB Option	993-46400	M561011-M579360	I-U-10	25 mm	50 mm	JCB-993-46200K	50.57
SWAY	561-24800	M569212	I-U-15	50 mm	110 mm	JCB-991-00126	57.41
	561-60012	M561011-M579360	I-U-15	50 mm	110 mm	JCB-991-00126	57.41
	561-60023	M561011-M579360	I-U-10	50 mm	110 mm	JCB-991-00109	72.98
TILT	553-02000	M561011-M579360	I-U-14	30 mm	60 mm	JCB-991-00021	43.75
	553-04300	M561011-M579360	I-U-14	30 mm	60 mm	JCB-991-00021	43.75
	561-23900	M561307	I-U-15	50 mm	110 mm	JCB-991-00126	57.41
	561-33500	M569262	I-U-15	50 mm	110 mm	JCB-991-00126	57.41
	561-60009	M561011-M579360	I-U-15	50 mm	110 mm	JCB-991-00126	57.41
	561-60020	M561011-M579360	I-U-10	50 mm	110 mm	JCB-991-00109	72.98
TOW HITCH	556-31100	M561011-M579360	I-U-10	30 mm	70 mm	JCB-991-00069	33.00
	556-42200	M568560	I-U-10	30 mm	70 mm	JCB-991-00099	53.56
	556-46700	M561011-M579360	I-U-10	30 mm	70 mm	JCB-991-00099	53.56
MODEL 506B							
DISPLACEMENT	563-60012	M570000	I-U-10	65 mm	120 mm	JCB-991-00115	97.86
EXTENSION	903-05900	M570000	I-U-10	70 mm	110 mm	JCB-991-00112	103.04
	903-06100	M570000	I-U-10	70 mm	110 mm	JCB-991-00112	103.04
LIFT	561-60018	M570000	I-U-10	65 mm	110 mm	JCB-991-00111	99.92
STEERING - Front & Rear	551-10100	M570000	I-U-10	25 mm	50 mm	JCB-991-00097	45.82
SWAY	561-60012	M570000	I-U-15	50 mm	110 mm	JCB-991-00126	57.41
	561-60023	M570000	I-U-10	50 mm	110 mm	JCB-991-00109	72.98
TILT	563-60011	M570000	I-U-10	65 mm	120 mm	JCB-991-00115	97.86
MODEL 506C							
DISPLACEMENT	563-60012		I-U-10	65 mm	120 mm	JCB-991-00115	97.86
EXTENSION	561-60072		I-U-10	70 mm	110 mm	JCB-991-00112	103.04
	903-06100		I-U-10	70 mm	110 mm	JCB-991-00112	103.04
LIFT	561-60056		I-U-10	70 mm	110 mm	JCB-991-00112	103.04
STEERING	551-10100		I-U-10	25 mm	50 mm	JCB-991-00097	45.82
SWAY	561-60023		I-U-10	50 mm	110 mm	JCB-991-00109	72.98
	561-60127		I-U-10	50 mm	110 mm	JCB-991-00109	72.98
TILT	563-60011		I-U-10	65 mm	120 mm	JCB-991-00115	97.86
MODEL 506C-HL							
DISPLACEMENT	563-70012		I-U-10	65 mm	120 mm	JCB-991-00115	97.86
EXTENSION	561-60068		I-U-10	75 mm	110 mm	JCB-991-00161	88.22
LIFT	561-60120		I-U-10	70 mm	110 mm	JCB-991-00112	103.04
STEERING	553-13800		I-U-10	30 mm	60 mm	JCB-991-00098	50.57
	563-60012		I-U-10	30 mm	60 mm	JCB-991-00098	50.57
SWAY	561-60023		I-U-10	50 mm	110 mm	JCB-991-00109	72.98
	561-60127		I-U-10	50 mm	110 mm	JCB-991-00109	72.98
TILT	563-60011		I-U-10	65 mm	120 mm	JCB-991-00115	97.86
MODEL 508C							
DISPLACEMENT	563-60012		I-U-10	65 mm	120 mm	JCB-991-00115	97.86
EXTENSION	561-60068		I-U-10	75 mm	110 mm	JCB-991-00161	88.22
LIFT	563-60034		I-U-10	75 mm	120 mm	JCB-991-00160	96.08
	563-60041		I-U-10	75 mm	120 mm	JCB-991-00160	96.08
STEERING	551-13800		I-U-10	30 mm	60 mm	JCB-991-00098	50.57
	553-60143		I-U-10	30 mm	60 mm	JCB-991-00098	50.57
SWAY	561-60023		I-U-10	50 mm	110 mm	JCB-991-00109	72.98
	561-60127		I-U-10	50 mm	110 mm	JCB-991-00109	72.98

Replacement Kits For

JCB

Telehandlers							
APPLICATION	CYL #	SERIAL #	CODE	ROD	BORE	KIT #	List \$
MODEL 508C							
TILT	563-60033		I-U-10	65 mm	120 mm	JCB-991-00115	97.86
MODEL 520-50							
DISPLACEMENT		00754000-00754999; 00789001-00790999; 00881000-00882999; 01048000-01048999; 01411000-01411999	I-U-10	60 mm	110 mm	JCB-991-00110	88.90
EXTENSION		00754000-00754999; 00789001-00790999; 00881000-00882999; 01048000-01048999; 01411000-01411999	I-U-10	50 mm	70 mm	JCB-991-00105	80.91
LIFT		00754000-00754999; 00789001-00790999; 00881000-00882999; 01048000-01048999; 01411000-01411999	I-U-10	60 mm	110 mm	JCB-991-00110	88.90
LOG GRAB, MANURE SILAGE FORK		00754000-00754999; 00789001-00790999; 00881000-00882999; 01048000-01048999; 01411000-01411999	I-U-10	1-1/2"	2-3/8"	JCB-545-45307	42.96
MULTIBUCKET		00754000-00754999; 00789001-00790999; 00881000-00882999; 01048000-01048999; 01411000-01411999	I-U-10	1-1/2"	2-3/8"	JCB-545-45307	42.96
STEERING		00754000-00754999; 00789001-00790999; 00881000-00882999; 01048000-01048999; 01411000-01411999	I-U-10	30 mm	60 mm	JCB-991-00098	50.57
TILT		00754000-00754999; 00789001-00790999; 00881000-00882999; 01048000-01048999; 01411000-01411999	I-U-10	70 mm	120 mm	JCB-991-20027	33.21
TOW HITCH		00754000-00754999; 00789001-00790999; 00881000-00882999; 01048000-01048999; 01411000-01411999	I-U-10	25 mm	50 mm	JCB-991-00097	45.82
MODEL 520-50LE							
DISPLACEMENT		00754000-00754999; 00789001-00790999; 00881000-00882999; 01048000-01048999; 01411000-01411999	I-U-10	60 mm	110 mm	JCB-991-00110	88.90
EXTENSION		00754000-00754999; 00789001-00790999; 00881000-00882999; 01048000-01048999; 01411000-01411999	I-U-10	50 mm	70 mm	JCB-991-00105	80.91
LIFT		00754000-00754999; 00789001-00790999; 00881000-00882999; 01048000-01048999; 01411000-01411999	I-U-10	60 mm	110 mm	JCB-991-00110	88.90
LOG GRAB, MANURE SILAGE FORK		00754000-00754999; 00789001-00790999; 00881000-00882999; 01048000-01048999; 01411000-01411999	I-U-10	1-1/2"	2-3/8"	JCB-545-45307	42.96

JCB

Replacement Kits For

JCB

Telehandlers							
APPLICATION	CYL #	SERIAL #	CODE	ROD	BORE	KIT #	List \$
MODEL 520-50LE							
MULTIBUCKET		00754000-00754999; 00789001-00790999; 00881000-00882999; 01048000-01048999; 01411000-01411999	I-U-10	1-1/2"	2-3/8"	JCB-545-45307	42.96
STEERING		00754000-00754999; 00789001-00790999; 00881000-00882999; 01048000-01048999; 01411000-01411999	I-U-10	30 mm	60 mm	JCB-991-00098	50.57
TILT		00754000-00754999; 00789001-00790999; 00881000-00882999; 01048000-01048999; 01411000-01411999	I-U-10	70 mm	120 mm	JCB-991-20027	33.21
TOW HITCH		00754000-00754999; 00789001-00790999; 00881000-00882999; 01048000-01048999; 01411000-01411999	I-U-10	25 mm	50 mm	JCB-991-00097	45.82
MODEL 525B-4HL							
ATTACHMENT	545-45300	M272000-M276567	I-U-10	1-1/2"	2-3/8"	JCB-545-45307	42.96
DISPLACEMENT	561-09900	M272000-M276567	I-U-15	60 mm	110 mm	JCB-991-00058	73.27
EXTENSION	556-08300	M272050	I-SP-15	50 mm	70 mm	JCB-556-08300K	83.26
	556-12900	M272000-M276567	I-SP-15	50 mm	70 mm	JCB-556-08300K	83.26
EXTENSION w/ Check Valve	556-13400	M272000-M276567	I-SP-15	50 mm	70 mm	JCB-556-08300K	83.26
LIFT - 7' Mast - 1st Stage	547-41700	M272000-M276567	P-U-10	2"	2-1/2"	JCB-991-03900	40.69
LIFT - 7' Mast - 2nd Stage	547-41700	M272000-M276567	I-U-15	2-7/8"	3-1/2"	JCB-991-03800	58.30
TILT	561-29600	M272000-M276567	I-SP-15	60 mm	110 mm	JCB-561-10200K	111.88
TILT - Side	553-04300	M272000-M276567	I-U-14	30 mm	60 mm	JCB-991-00021	43.75
MODEL 527-55							
DISPLACEMENT		01014357-01014999	I-U-10	35 mm	70 mm	JCB-991-10041	36.54
		01014357-01014999; 01068000-01069999; 01069457-01069548; 01417000-01419999	I-U-10	40 mm	70 mm	JCB-991-10151	26.26
EXTENSION		01014357-01014999; 01068000-01069999; 01069457-01069548; 01417000-01419999	I-U-10	50 mm	70 mm	JCB-991-00105	80.91
LIFT		01014357-01014999; 01068000-01069999; 01069457-01069548; 01417000-01419999	I-U-10	65 mm	120 mm	JCB-991-00115	97.86
STEERING		01014357-01014999; 01068000-01069999; 01069457-01069548; 01417000-01419999	I-U-10	42 mm	75 mm	JCB-448-17201	33.30
TILT		01014357-01014999; 01068000-01069999; 01069457-01069548; 01417000-01419999	I-U-10	70 mm	120 mm	JCB-991-20027	33.21
TOW HITCH		01014357-01014999; 01068000-01069999; 01069457-01069548; 01417000-01419999	I-U-10	25 mm	50 mm	JCB-991-00097	45.82
MODEL 527-55S							
DISPLACEMENT		01014357-01014999	I-U-10	35 mm	70 mm	JCB-991-10041	36.54
		01014357-01014999; 01068000-01069999; 01069457-01069548; 01417000-01419999	I-U-10	40 mm	70 mm	JCB-991-10151	26.26

JCB

Replacement Kits For

JCB

Telehandlers							
APPLICATION	CYL #	SERIAL #	CODE	ROD	BORE	KIT #	List \$
MODEL 527-55S							
EXTENSION		01014357-01014999; 01068000-01069999; 01069457-01069548; 01417000-01419999	I-U-10	50 mm	70 mm	JCB-991-00105	80.91
LIFT		01014357-01014999; 01068000-01069999; 01069457-01069548; 01417000-01419999	I-U-10	65 mm	120 mm	JCB-991-00115	97.86
STEERING		01014357-01014999; 01068000-01069999; 01069457-01069548; 01417000-01419999	I-U-10	42 mm	75 mm	JCB-448-17201	33.30
TILT		01014357-01014999; 01068000-01069999; 01069457-01069548; 01417000-01419999	I-U-10	70 mm	120 mm	JCB-991-20027	33.21
TOW HITCH		01014357-01014999; 01068000-01069999; 01069457-01069548; 01417000-01419999	I-U-10	25 mm	50 mm	JCB-991-00097	45.82
MODEL 530B-4HL							
ATTACHMENT	545-45300	M580001-M584435	I-U-10	1-1/2"	2-3/8"	JCB-545-45307	42.96
BOOM LIFT	561-13800	M580970	I-U-15	60 mm	110 mm	JCB-991-00014	50.53
	561-22400	M580001-M584435	I-U-15	60 mm	110 mm	JCB-991-00029	73.27
CLAMSHOVEL	556-23700	M580001-M584435	I-U-15	40 mm	70 mm	JCB-991-00015	31.26
	556-31900	M580001-M584435	I-U-15	40 mm	70 mm	JCB-991-00122	51.17
DISPLACEMENT	563-05600	M580001-M584435	I-U-15	65 mm	120 mm	JCB-991-00030	92.46
EXTENSION - Inner	557-06700	M580001-M584435	I-SP-15	60 mm	90 mm	JCB-557-06700K	113.02
EXTENSION - Outer	561-17200	M581764	I-U-15	60 mm	110 mm	JCB-991-00014	50.53
	561-29500	M580001-M584435	I-U-15	60 mm	110 mm	JCB-991-00029	73.27
LIFT - 7' Mast - 1st Stage	547-41700	M580001-M584435	P-U-10	2"	2-1/2"	JCB-991-03900	40.69
LIFT - 7' Mast - 2nd Stage	547-41700	M580001-M584435	I-U-15	2-7/8"	3-1/2"	JCB-991-03800	58.30
STABILIZER	559-23100	M580810	I-U-15	60 mm	100 mm	JCB-991-00012	52.59
	559-32200	M580001-M584435	I-U-15	60 mm	100 mm	JCB-991-00028	116.89
TILT	563-23700	M580001-M584435	I-U-15	65 mm	120 mm	JCB-991-00030	92.46
TILT - Side	553-04300	M580001-M584435	I-U-14	30 mm	60 mm	JCB-991-00021	43.75
Wheel Dozers/Loaders							
APPLICATION	CYL #	SERIAL #	CODE	ROD	BORE	KIT #	List \$
MODEL 426, 426B							
LIFT		01231500-01232499; 01295000-01295999; 00531000-00531299; 00531300-00531800; 00532100-00532499; 00532500-00532999; 00533300-00533699; 01173000-01173999	I-U-10	60 mm	110 mm	JCB-991-00110	88.90
QUICK HITCH		00532500-00532999; 01173000-01173999	I-U-15	30 mm	60 mm	JCB-262-83024	13.81
		01231500-01232499; 01295000-01295999; 00531000-00531299; 00531300-00531800; 00533300-00533699;	I-U-10	25 mm	50 mm	JCB-991-00097	45.82
STEERING		01231500-01232499; 01295000-01295999; 00531000-00531299; 00531300-00531800; 00532100-00532499; 00532500-00532999; 00533300-00533699; 01173000-01173999	I-U-10	50 mm	80 mm	JCB-991-00102	68.18

JCB

Replacement Kits For

JCB

Wheel Dozers/Loaders							
APPLICATION	CYL #	SERIAL #	CODE	ROD	BORE	KIT #	List \$
MODEL 426, 426B							
TILT		01231500-01232499; 01295000-01295999; 00531000-00531299; 00531300-00531800; 00532100-00532499; 00532500-00532999; 00533300-00533699; 01173000-01173999	I-U-10	60 mm	100 mm	JCB-991-00145	70.20
TILT (Z-BAR)		00531000-00531299	P-UB-10	80 mm	160 mm	JCB-998-10374	158.68
		01231500-01232499; 01295000-01295999; 00531000-00531299; 00531300-00531800; 00532100-00532499; 00532500-00532999; 00533300-00533699; 01173000-01173999	I-U-10	70 mm	130 mm	JCB-991-00120	120.08
MODEL 436, 436B							
LIFT		01305000-01305999; 01410000-01410999; 00533000-00533299; 00533300-00533699; 00533700- 00534199;00534200- 00534999	I-U-10	70 mm	130 mm	JCB-991-00120	120.08
QUICK HITCH		01305000-01305999; 01410000-01410999; 00533000-00533299; 00534200-00534999; 00533300-00533699;	I-U-10	25 mm	50 mm	JCB-991-00097	45.82
STEERING		01305000-01305999; 01410000-01410999; 00533000-00533299; 00533300-00533699; 00533700-00534199; 00534200-00534999	I-U-10	50 mm	80 mm	JCB-991-00102	68.18
TILT	from: M533210	01305000-01305999; 01410000-01410999; 00533000-00533299; 00534200-00534999; 00533700-00534199;	I-U-10	65 mm	110 mm	JCB-991-00111	99.92
	to: M633209	00533000-00533299; 00533300-00533699;	I-U-10	60 mm	110 mm	JCB-991-00110	88.90
TILT (Z-BAR)		00533000-00533299; 00533300-00533699; 00533700-00534199	I-U-14	80 mm	160 mm	JCB-991-00149	346.96
	from: M1305060	01305000-01305999; 01410000-01410999	P-UB-14	90 mm	160 mm	JCB-991-10156	221.18
	to: M1305059	01305000-01305999; 00534200-00534999	P-UB-10	80 mm	160 mm	JCB-998-10374	158.68
MODEL 456, 456B							
LIFT		00539000-00539228	I-U-14	80 mm	160 mm	JCB-991-00149	346.96
		00539229-00539399	P-UB-10	80 mm	160 mm	JCB-998-10374	158.68
		00539400-00539807	P-UB-10	80 mm	160 mm	JCB-998-10374	158.68
	from: M1169139	1169001-1169999	P-UB-14	80 mm	160 mm	JCB-991-10154	221.40
	from: M1239002	01239000-01239499	P-UB-14	80 mm	160 mm	JCB-991-10154	221.40
	from: M539185	00539000-00539228	P-UB-10	80 mm	160 mm	JCB-998-10374	158.68
	to: M1169138	1169001-1169999	P-UB-10	80 mm	160 mm	JCB-998-10374	158.68
	to: M1239001	01239000-01239499	P-UB-10	80 mm	160 mm	JCB-998-10374	158.68
STEERING		00539229-00539399; 00539400-00539807; 00539000-00539228; 01239000-01239499	I-U-10	50 mm	90 mm	JCB-991-00103	52.97

JCB

Replacement Kits For

JCB

Wheel Dozers/Loaders							
APPLICATION	CYL #	SERIAL #	CODE	ROD	BORE	KIT #	List \$
MODEL 456, 456B							
TILT		00539229-00539399	P-UB-10	90 mm	180 mm	JCB-998-10375	205.90
		00539400-00539807	P-UB-10	90 mm	180 mm	JCB-998-10375	205.90
	from: M1169140	1169001-1169999	I-UB-14	90 mm	180 mm	JCB-991-10158	157.72
	from: M1239008	01239000-01239499	I-UB-14	90 mm	180 mm	JCB-991-10158	157.72
	from: M539185	00539000-00539228	P-UB-10	90 mm	180 mm	JCB-998-10375	205.90
	to: M1169139	1169001-1169999	P-UB-10	90 mm	180 mm	JCB-998-10375	205.90
	to: M1239007	01239000-01239499	P-UB-10	90 mm	180 mm	JCB-998-10375	205.90
TILT (Z-BAR)	from: M1169140	1169001-1169999	I-UB-14	90 mm	180 mm	JCB-991-10158	157.72
	from: M1239008	01239000-01239499	I-UB-14	90 mm	180 mm	JCB-991-10158	157.72

REPLACEMENT KITS FOR JCB

Kit Number	Rod X Bore Size	List Price	Kit Number	Rod X Bore Size	List Price
JCB-991-00097	25 X 50 mm	\$ 45.82	JCB-991-10127	100 X 140 mm	\$ 206.11
JCB-991-00098	30 X 60 mm	50.57	JCB-991-10129	70 X 95 mm	109.12
JCB-991-00099	30 X 70 mm	53.56	JCB-991-10138	60 X 100 mm	68.66
JCB-991-00100	40 X 70 mm	53.51	JCB-991-10139	80 X 115 mm	432.69
JCB-991-00102	50 X 80 mm	68.18	JCB-991-10141	30 X 50 mm	30.68
JCB-991-00103	50 X 90 mm	52.97	JCB-991-10142	60 X 100 mm	58.39
JCB-991-00105	50 X 70 mm	80.91	JCB-991-10144	60 X 110 mm	75.29
JCB-991-00109	50 X 110 mm	72.98	JCB-991-10151	40 X 70 mm	26.26
JCB-991-00110	60 X 110 mm	88.90	JCB-991-10154	80 X 160 mm	221.40
JCB-991-00111	65 X 110 mm	99.92	JCB-991-10156	90 X 160 mm	221.18
JCB-991-00112	70 X 110 mm	103.04	JCB-991-10158	90 X 180 mm	157.72
JCB-991-00115	65 X 120 mm	97.86	JCB-991-20027	70 X 120 mm	33.21
JCB-991-00116	70 X 120 mm	33.21	JCB-993-34509	1 X 2-1/2	21.05
JCB-991-00120	70 X 130 mm	120.08	JCB-993-46200K	25 X 50 mm	50.57
JCB-991-00122	40 X 70 mm	51.17	JCB-993-99610	O-ring Kit	3.76
JCB-991-00123	50 X 80 mm	72.85	JCB-997-00908	1-1/2 X 2-1/2	128.33
JCB-991-00126	50 X 110 mm	57.41	JCB-998-10020	85 X 125 mm	148.97
JCB-991-00127	50 X 90 mm	107.84	JCB-998-10021	90 X 130 mm	146.84
JCB-991-00130	60 X 100 mm	116.89	JCB-998-10022	105 X 150 mm	271.17
JCB-991-00131	60 X 110 mm	73.27	JCB-998-10023	90 X 135 mm	173.61
JCB-991-00135	65 X 120 mm	92.46	JCB-998-10040	80 X 115 mm	343.72
JCB-991-00144	75 X 140 mm	159.79	JCB-998-10200	O-ring Kit	38.35
JCB-991-00145	60 X 100 mm	70.20	JCB-998-10220	O-ring Kit	47.32
JCB-991-00146	65 X 110 mm	83.03	JCB-998-10242	O-ring Kit	32.04
JCB-991-00147	60 X 90 mm	90.65	JCB-998-10374	80 X 160 mm	158.68
JCB-991-00148	60 X 110 mm	99.52	JCB-998-10375	90 X 190 mm	205.90
JCB-991-00149	80 X 160 mm	346.96	JCB-LQU0036	85 X 125 mm	465.95
JCB-991-00152	60 X 100 mm	67.33	JCB-LQU0038	95 X 140 mm	293.83
JCB-991-00156	45 X 75 mm	86.00	JCB-LQU0045	95 X 140 mm	318.84
JCB-991-00160	75 X 120 mm	96.08	JCB-LQU0046	80 X 120 mm	430.30
JCB-991-00161	75 X 110 mm	88.22	JCB-LQU0049	110 X 160 mm	156.58
JCB-991-00163	50 X 90 mm	56.60	JCB-LQU0080	70 X 110 mm	420.33
JCB-991-00164	45 X 90 mm	160.03	JCB-LQU0081	80 X 120 mm	371.83
JCB-991-00165	45 X 90 mm	139.94	JCB-LQU0082	65 X 105 mm	197.28
JCB-991-00166	45 X 75 mm	185.44	JCB-LQU0089	85 X 125 mm	465.95
JCB-991-00167	40 X 80 mm	64.48	JCB-LQU0091	95 X 140 mm	293.83
JCB-991-00170	35 X 60 mm	44.18	JCB-LQU0092	80 X 120 mm	430.30
JCB-991-03800	2-7/8 X 3-1/2	58.30	JCB-LQU0096	55 X 85 mm	99.32
JCB-991-03900	2 X 2-1/2	40.69	JCB-LQU0114	75 X 100 mm	341.24
JCB-991-10001	45 X 80 mm	54.93	JCB-LQU0125	80 X 115 mm	316.13
JCB-991-10041	35 X 70 mm	36.54	JCB-LQU0126	70 X 95 mm	261.69
JCB-991-10081	40 X 60 mm	37.26	JCB-LQU-0138	100 X 135 mm	156.19
JCB-991-10102	30 X 50 mm	105.61	JCB-LQU-0142	80 X 120 mm	108.70
JCB-991-10111	40 X 80 mm	155.46	JCB-LQU-0164	80 X 115 mm	223.06
JCB-991-10112	40 X 70 mm	157.70	JCB-LQU0165	90 X 125 mm	252.53
JCB-991-10113	50 X 75 mm	122.89	JCB-LQU0166	75 X 105 mm	227.02
JCB-991-10121	60 X 110 mm	44.73	JCB-SKJ-CB7560	60 mm Rod Kit	14.56
JCB-991-10122	50 X 90 mm	84.66	JCB-SKJ-CB9035	35 X 90 mm	13.18

REPLACEMENT KITS FOR JCB

Kit Number	Rod X Bore Size	List Price
JCB-20-602005	Pump Kit	\$ 51.25
JCB-20-950206	O-ring Kit	18.77
JCB-231-02906	30 X 50 mm	36.21
JCB-231-02909	30 X 50 mm	106.44
JCB-231-22506	35 X 70 mm	90.58
JCB-231-22509	35 X 70 mm	155.12
JCB-231-32807	35 X 70 mm	83.93
JCB-231-34316	30 X 50 mm	142.19
JCB-231-35413	30 X 50 mm	51.43
JCB-231-77408	30 X 55 mm	131.13
JCB-232-02906	40 X 70 mm	147.56
JCB-232-03407	50 X 75 mm	96.71
JCB-232-08512	40 X 80 mm	189.41
JCB-232-22510	45 X 90 mm	178.19
JCB-232-51155	45 X 90 mm	101.95
JCB-232-51254	45 X 75 mm	121.75
JCB-232-56152	40 X 80 mm	129.30
JCB-232-56352	40 X 70 mm	35.85
JCB-232-56507	50 X 75 mm	142.27
JCB-232-56754	45 X 90 mm	132.72
JCB-232-56956	50 X 80 mm	82.33
JCB-232-95956	40 X 70 mm	52.77
JCB-236-11516	35 X 70 mm	71.97
JCB-25-221906	O-ring Kit	26.73
JCB-262-83024	30 X 60 mm	13.81
JCB-331-38788	95 X 130 mm	194.18
JCB-331-39036	85 X 125 mm	110.55
JCB-331-39041	85 X 115 mm	124.23
JCB-331-39047	95 X 130 mm	183.90
JCB-331-41835	85 mm Rotary	246.76
JCB-332-C7368	85 X 115 mm	118.45
JCB-332-G9281	95 X 130 mm	167.34
JCB-332-G9282	85 X 125 mm	160.37
JCB-448-17201	42 X 75 mm	33.30
JCB-545-45307	1-1/2 X 2-3/8	42.96
JCB-547-42102	7/8 X 2	19.52
JCB-548-12801	1/2 X 25 mm	7.70
JCB-556-08300K	50 X 70 mm	83.26
JCB-556-24900K	50 X 70 mm	120.67
JCB-557-06700K	60 X 90 mm	113.02
JCB-561-10200K	60 X 110 mm	111.88
JCB-690-00693	75 X 100 mm	298.31
JCB-690-00754	100 X 135 mm	186.28
JCB-690-00801	80 X 120 mm	140.11
JCB-690-00972	75 X 140 mm	647.53
JCB-903-10301	1-3/8 X 2	41.02
JCB-903-20265	85 X 120 mm	317.63
JCB-903-20405	45 X 90 mm	113.04

Kit Number	Rod X Bore Size	List Price
JCB-903-20418	40 X 80 mm	\$ 65.85
JCB-903-20434	40 X 65 mm	70.12
JCB-903-20839	70 X 95 mm	280.58
JCB-903-20856	80 X 115 mm	362.04
JCB-903-20862	75 X 100 mm	474.77
JCB-903-20903	80 X 115 mm	273.24
JCB-903-20910	75 X 105 mm	339.73
JCB-903-20916	85 X 120 mm	326.17
JCB-903-21037	90 X 130 mm	163.39
JCB-903-21049	95 X 130 mm	113.44
JCB-903-21165	100 X 140 mm	204.84
JCB-904-20156	O-ring Kit	25.59
JCB-980-35603	1-1/2 X 3	60.06
JCB-983-00154	50 X 100 mm	75.61
JCB-983-11155	40 X 65 mm	49.89
JCB-991-00001	1-1/2 X 2-3/4	63.15
JCB-991-00002	2 X 3-5/8	86.53
JCB-991-00003	2 X 4	58.20
JCB-991-00004	2 X 4-1/2	82.94
JCB-991-00005	2-1/2 X 4	107.93
JCB-991-00007	63 X 5 mm	209.33
JCB-991-00008	2-1/2 X 4-1/2	111.95
JCB-991-00009	1 X 2	40.25
JCB-991-00010	5 Piston Kit	59.79
JCB-991-00011	4-1/2 Piston Kit	90.75
JCB-991-00012	60 X 100 mm	52.59
JCB-991-00013	50 X 90 mm	47.79
JCB-991-00014	60 X 110 mm	50.53
JCB-991-00015	40 X 70 mm	31.26
JCB-991-00016	50 X 80 mm	56.18
JCB-991-00017	30 X 60 mm	54.77
JCB-991-00018	110 mm Piston Kit	28.76
JCB-991-00020	30X 60 mm	26.98
JCB-991-00021	30 X 60 mm	43.75
JCB-991-00026	50 x 80 mm	108.69
JCB-991-00027	50 x 90 mm	107.84
JCB-991-00028	60 X 100 mm	116.89
JCB-991-00029	60 X 110 mm	73.27
JCB-991-00030	65 X 120 mm	92.46
JCB-991-00036	30 X 70 mm	46.76
JCB-991-00054	25 X 50 mm	56.07
JCB-991-00055	60 X 100 mm	116.89
JCB-991-00058	60 X 110 mm	73.27
JCB-991-00061	50 X 80 mm	108.69
JCB-991-00069	30 X 70 mm	33.00
JCB-991-00071	25 X 50 mm	40.57
JCB-991-00095	40 X 70 mm	53.51
JCB-991-00096	50 X 90 mm	107.84

REPLACEMENT PARTS FOR JCB

NOTE: JCB part numbers are used as a reference only. We do not imply that these kits are original REPLACEMENT PARTS.

O-RINGS

Part Number	Min. Pkg Qty	List Price
JCB-LBQ0953	5	\$ 9.26
JCB-LBQ1453	1	7.66



Replacement Kits For

Telehandlers							
APPLICATION	CYL #	Misc-Parts, Instructions, etc.	CODE	ROD	BORE	KIT #	List \$
MODEL G9-43A							
BOOM LIFT							
016003316-0160070675,Including 0160032951,Excluding 0160040468							
91513274			P-UB-14	3-3/4	7	JLG-70022061	205.69
0160040675-,Including 0160040468,0160078671-,Excluding 0160048773							
1001108380			P-UB-14	3-3/4	7	JLG-70022061	205.69
0193001-0193007,0160000008-0160007141,0160007176-0160007822,0160008020-0160033297,Excluding 0160032951							
91513039			P-UB-14	3-3/4	7	JLG-91514020	220.51
COMPENSATING							
0160007176-0160007822,0160007869-0160007970,0160008020-0160033297							
91513226			P-UB-14	2-1/2	5-1/2	JLG-91514285	184.11
0160033316-,0160078671-,Excluding 0160048773							
91513272			P-UB-14	2-1/2	5-1/2	JLG-70024012	168.96
0193001-0193007,0160000008-0160007141							
91513040			P-UB-14	2-1/2	4-3/4	JLG-91514050	197.08
CROWD							
0160033222-							
91513276			P-UB-14	3	4	JLG-70022858	88.67
Before 0160033222							
91513002			P-UB-14	3	4	JLG-91514036	133.90
EXTEND/RETRACT							
0160078671-,Excluding 0160048773							
91513276			P-UB-14	3	4	JLG-70022858	88.67
FRAME LEVEL							
0160078671-,Excluding 0160048773							
91513273			P-UB-14	2	4	JLG-70022864	113.90
GRAPPLE BUCKET							
0193001-0193007,0160000008-,0160078671-,Excluding 0160048773							
70021393			I-U-10	1-1/4	2-1/2	JLG-70021452	9.48
OUTRIGGER							
0160039840-							
1001001211			I-U-10	2-1/2	5	JLG-70023899	71.99
Before 0160039840							
1001001211			P-UB-10	2-1/2	5	JLG-70024217	52.59
SIDE SHIFT CARRIAGE							
0160078671-,Excluding 0160048773							
70224539			I-U-13	25 mm	63 mm	JLG-70024549	57.72
SIDE TILT CARRIAGE							
0193001-0193007,0160000008-,0160078671-,Excluding 0160048773							
1001090134			I-U-10	1-3/4	3-1/2	JLG-70022041	22.58
SWAY							
0160033222-							
91513273			P-UB-14	2	4	JLG-70022864	113.90
0193001-0193007;0160000008-0160033206							
91513038			P-UB-14	2	4	JLG-91514063	153.00
SWING CARRIAGE							
0193001-0193007,0160000008-,0160078671-,Excluding 0160048773							
1001103182			I-U-10	1-1/2	3-1/2	JLG-2915023	32.78
TILT							
0160007142-0160033297							
91513225			P-UB-14	2-1/2	5-1/2	JLG-91514281	165.25



Replacement Kits For

Telehandlers							
APPLICATION	CYL #	Misc-Parts, Instructions, etc.	CODE	ROD	BORE	KIT #	List \$
MODEL G9-43A							
TILT							
0160033316-							
91513275			P-UB-14	2-1/2	5-1/2	JLG-70024013	154.59
0160078671-, Excluding 0160048773							
91513275			P-UB-14	2-1/2	5-1/2	JLG-91514281	165.25
0193001-0193007, 0160000008-0160007414							
91513027			P-UB-14	2-1/2	4-3/4	JLG-91514050	197.08
MODEL SKYTRAK 6036							
ATTACHMENT TILT							
0160045066-, Including 42742, 42747, 42755							
2716614			I-U-10, 14	2	5	JLG-8035720	152.12
-14833							
2711703			I-U-10, 14	2	5	JLG-8035720	152.12
14834-19988, 0160002345-0160044900							
2716614			I-U-10, 14	2	5	JLG-8035720	152.12
BOOM EXTEND							
0160045066-, Including 42742, 42747, 42755							
2717008			I-UB-10	3	4-1/2	JLG-8036502	73.58
-14833							
2711693	TJB Stamping		I-UB-10	3	4-1/2	JLG-8036294	96.68
2711693	BHE Stamping		P-U-10	3	4-1/2	JLG-8205667	31.18
15223-19988, 0160002345-							
2716571			I-UB-10	3	4-1/2	JLG-8036294	96.68
BOOM LIFT							
0160004110-0160015020, Including 0160003491, 3492							
2717257			I-U-14	2-3/4	5	JLG-8036782	130.48
0160015052-							
1684464			I-U-14	2-3/4	5	JLG-8036782	130.48
0160045066-, Including 42742, 42747, 42755							
1684464			I-U-14	2-3/4	5	JLG-8036782	130.48
-14833							
2711543	BHE Stamping		P-U-10	3	5-1/2	JLG-8205668	46.65
2713793	TJB Stamping		I-U-10	3	5-1/2	JLG-8032718	32.00
7129252	TJB Stamping		I-U-10	3	5-1/2	JLG-8032718	32.00
14834-19297							
2716616			I-U-14	2-3/4	5	JLG-8036132	162.65
19298-19988, 0160002345-0160004091, Excluding 0160003491, 3492							
2717196			I-U-14	2-3/4	5	JLG-8036782	130.48
FRAME LEVEL							
0160045066-, Including 42742, 42747, 42755							
1001091901			I-U-14	2-1/4	4-1/2	JLG-8035326	174.55
FRAME SWAY							
0160005638-							
2716563			I-U-14	2-1/4	4-1/2	JLG-8035326	174.55
14384-19988, 0160002345-0160004091, Excluding 0160003491, 3492							
2716563			I-U-14	2-1/4	4-1/2	JLG-8035326	174.55
FRAME TILT							
-14833							
2711673			I-U-10	2	115 mm	JLG-8032730	21.55
GRAPPLE BUCKET							
0160045066-, Including 42742, 42747, 42755							
70021393			I-U-10	1-1/4	2-1/2	JLG-70021452	9.48

JLG®

Replacement Kits For

JLG®

Telehandlers							
APPLICATION	CYL #	Misc-Parts, Instructions, etc.	CODE	ROD	BORE	KIT #	List \$
MODEL SKYTRAK 6036							
SIDE SHIFT CARRIAGE							
0160045066-,Including 42742,42747,42755							
70024539			I-U-13	25 mm	63 mm	JLG-70024549	57.72
SIDE TILT CARRIAGE							
0160045066-,Including 42742,42747,42755							
1001090134			I-U-10	1-3/4	3-1/2	JLG-70022041	22.58
-14833							
2711613			I-U-10,14	1-3/4	4	JLG-8035831	87.85
SLAVE							
0160004110-,Including 0160003491,3492							
2717260			I-U-14	1-1/2	3-3/4	JLG-7028739	62.28
-14833							
2716193			I-U-10,14	2	5	JLG-8035720	152.12
14834-19297							
2716615			I-U-14	1-1/2	3-3/4	JLG-8036131	109.69
19298-19988,0160002345-0160004088,Excluding 0160003491,3492							
2717197			I-U-14	1-1/2	3-3/4	JLG-7028739	62.28
STABIL-TRAK							
0160045066-,Including 42742,42747,42755							
2717198			I-U-14	2-1/4	4-1/2	JLG-8036747	121.35
STEERING							
-0160038390,Including 38848,38853,38855; Axle -829693							
1321149			I-U-10	50 mm	100 mm	JLG-8035981	132.50
-0160038390,Including 38848,38853,38855; Axle 829694-							
70021617			I-U-10	50 mm	100 mm	JLG-70021495	134.64
0160038391-,Excluding 38848,38853,38855							
70022173			I-U-10	50 mm	100 mm	JLG-70022178	109.92
0160045066-,Including 42742,42747,42755							
70022173			I-U-10	50 mm	100 mm	JLG-70022178	109.92
-3101							
8032963	Right Front, Left Rear		I-U-10	1-1/8	2-1/4	JLG-8033489	44.37
8032964	Left Front, Right Rear		I-U-10	1-1/8	2-1/4	JLG-8033489	44.37
3102-							
8034685	Right Front, Left Rear		P-U-10	1-1/8	2-1/4	JLG-8034690	50.47
8034686	Left Front, Right Rear		P-U-10	1-1/8	2-1/4	JLG-8034690	50.47
SWING CARRIAGE							
0160045066-,Including 42742,42747,42755							
1001103182			I-U-10	1-1/2	3-1/2	JLG-2915023	32.78
-14833							
2713363			I-U-10,14	1-3/4	4	JLG-8035831	87.85
TILT COMPENSATING (SLAVE)							
0160045066-,Including 42742,42747,42755							
2717260			I-U-14	1-1/2	3-3/4	JLG-7028739	62.28
MODEL SKYTRAK 6042							
ATTACHMENT TILT							
0160045066-,Including 42742,42747,42755							
2716614			I-U-10,14	2	5	JLG-8035720	152.12
17019-19897,0160002408-45063,Excluding 42742,42747,42755							
2716614			I-U-10,14	2	5	JLG-8035720	152.12
BOOM EXTEND							
0160045066-,Including 42742,42747,42755							
2717008			I-UB-10	3	4-1/2	JLG-8036502	73.58

JLG®

Replacement Kits For

JLG®

Telehandlers							
APPLICATION	CYL #	Misc-Parts, Instructions, etc.	CODE	ROD	BORE	KIT #	List \$
MODEL SKYTRAK 6042							
BOOM EXTEND							
17019-19897,0160002408-45063,Excluding 42742,42747,42755							
2717008			I-UB-10	3	4-1/2	JLG-8036502	73.58
BOOM LIFT							
0160003879-15022							
2717262			I-U-14	2-3/4	5	JLG-8036132	162.65
0160013567-27650							
1684455			I-U-14	2-3/4	5	JLG-8036132	162.65
0160027677-							
1684537			I-U-14	2-3/4	5	JLG-8036132	162.65
0160045066-,Including 42742,42747,42755							
1684537			I-U-14	2-3/4	5	JLG-8036132	162.65
17019-19897,0160002408-3867							
2717007			I-U-14	2-3/4	5	JLG-8036132	162.65
FRAME LEVEL							
0160045066-,Including 42742,42747,42755							
2716563			I-U-14	2-1/4	4-1/2	JLG-8035326	174.55
FRAME SWAY							
0160005696-							
2716563			I-U-14	2-1/4	4-1/2	JLG-8035326	174.55
17019-19897,0160002408-3867							
2716563			I-U-14	2-1/4	4-1/2	JLG-8035326	174.55
GRAPPLE BUCKET							
0160045066-,Including 42742,42747,42755							
70021393			I-U-10	1-1/4	2-1/2	JLG-70021452	9.48
17019-19897,0160002408-45063,Excluding 42742,42747,42755							
70021393			I-U-10	1-1/4	2-1/2	JLG-70021452	9.48
SIDE SHIFT CARRIAGE							
0160045066-,Including 42742,42747,42755							
70024539			I-U-13	25 mm	63 mm	JLG-70024549	57.72
SIDE TILT CARRIAGE							
0160045066-,Including 42742,42747,42755							
1001090134			I-U-10	1-3/4	3-1/2	JLG-70022041	22.58
17019-19897,0160002408-45063,Excluding 42742,42747,42755							
1001090134			I-U-10	1-3/4	3-1/2	JLG-70022041	22.58
SLAVE							
0160003879-							
2717260			I-U-14	1-1/2	3-3/4	JLG-7028739	62.28
17019-19299							
2716615			I-U-14	1-1/2	3-3/4	JLG-8036131	109.69
19300-19897,0160002408-3867							
2717197			I-U-14	1-1/2	3-3/4	JLG-7028739	62.28
STABIL-TRAK							
0160045066-,Including 42742,42747,42755							
2717198			I-U-14	2-1/4	4-1/2	JLG-8036747	121.35
17019-19299							
2716564			I-U-14	2-1/4	4-1/2	JLG-8035326	174.55
19300-19897,0160002408-							
2717198			I-U-14	2-1/4	4-1/2	JLG-8036747	121.35

JLG®

Replacement Kits For



Telehandlers							
APPLICATION	CYL #	Misc-Parts, Instructions, etc.	CODE	ROD	BORE	KIT #	List \$
MODEL SKYTRAK 6042							
STEERING FRONT							
-0160038918, Excluding 0160033533; AXLE -829693							
1321149			I-U-10	50 mm	100 mm	JLG-8035981	132.50
-0160038918, Excluding 0160033533; AXLE 829694-							
70021617			I-U-10	50 mm	100 mm	JLG-70021495	134.64
0160038919-, Including 33533							
70022173			I-U-10	50 mm	100 mm	JLG-70022178	109.92
SWING CARRIAGE							
0160045066-, Including 42742, 42747, 42755							
1001103182			I-U-10	1-1/2	3-1/2	JLG-2915023	32.78
17019-19897, 0160002408-45063, Excluding 42742, 42747, 42755							
1001103182			I-U-10	1-1/2	3-1/2	JLG-2915023	32.78
TILT COMPENSATING (SLAVE)							
0160045066-, Including 42742, 42747, 42755							
2717260			I-U-14	1-1/2	3-3/4	JLG-7028739	62.28
MODEL SKYTRAK 8042							
ATTACHMENT TILT							
0160045250-, Including 42754, 42762, 42877, 42911, 43185, 43220, 43244, Excluding 45255							
2716618			I-U-4, 14	2-1/2	6	JLG-8035780	200.19
-13197							
2712973			I-U-4, 14	2-1/2	6	JLG-8035780	200.19
13198-19791							
2716618			I-U-4, 14	2-1/2	6	JLG-8035780	200.19
19792-19987, 0160002332-4653							
2717203			I-U-14	2-1/2	6	JLG-8036786	126.17
BOOM EXTEND							
0160045250-, Including 42754, 42762, 42877, 42911, 43185, 43220, 43244, Excluding 45255							
2716173			I-UB-10, 14	3	5	JLG-8036295	177.46
-13197							
2716173			I-UB-10, 14	3	5	JLG-8036295	177.46
13198-19987, 0160002332-							
2716173			I-UB-10, 14	3	5	JLG-8036295	177.46
BOOM LIFT							
0160004670-14285							
2717259			I-U-14	3	6	JLG-8036746	143.81
0160015042-30716							
1684448			I-U-14	3	6	JLG-8036746	143.81
0160030721-							
2716617			I-U-10, 14	3	6	JLG-8035386	180.63
0160045250-, Including 42754, 42762, 42877, 42911, 43185, 43220, 43244, Excluding 45255							
2716617			I-U-10, 14	3	6	JLG-8035386	180.63
-13197							
2714993			I-U-10	3	6	JLG-8033731	34.96
13198-19145							
2716617			I-U-10, 14	3	6	JLG-8035386	180.63
19146-19987, 0160002332-4653							
2717199			I-U-14	3	6	JLG-8036746	143.81
FRAME LEVEL							
0160045250-, Including 42754, 42762, 42877, 42911, 43185, 43220, 43244, Excluding 45255							
2716563			I-U-14	2-1/4	4-1/2	JLG-8035326	174.55

Replacement Kits For

JLG®

Telehandlers							
APPLICATION	CYL #	Misc-Parts, Instructions, etc.	CODE	ROD	BORE	KIT #	List \$
MODEL SKYTRAK 8042							
FRAME SWAY							
0160005695-							
2716563			I-U-14	2-1/4	4-1/2	JLG-8035326	174.55
13198-19987,0160002332-4653							
2716563			I-U-14	2-1/4	4-1/2	JLG-8035326	174.55
FRAME TILT							
-0266							
7115662			I-U-10	2	4-1/2	JLG-8033747	25.16
0267-13197							
2713853			I-U-10	2	4-1/2	JLG-8033747	25.16
GRAPPLE BUCKET							
0160045250-,Including 42754,42762,42877,42911,43185,43220,43244,Excluding 45255							
70021393			I-U-10	1-1/4	2-1/2	JLG-70021452	9.48
13198-19987,0160002332-45249 Including 45255,Excluding 42754,42762,42877,42911,43185,43220,43244							
70021393			I-U-10	1-1/4	2-1/2	JLG-70021452	9.48
OUTRIGGER							
0160002940-							
2717201			I-U-14	3	5	JLG-8036784	131.23
0160045250-,Including 42754,42762,42877,42911,43185,43220,43244,Excluding 45255							
2717201			I-U-14	3	5	JLG-8036784	131.23
-13197							
2716163			I-U-10,14	3	5	JLG-8035519	176.43
13198-19987,0160002332-2914							
2716163			I-U-10,14	3	5	JLG-8035519	176.43
SIDE SHIFT CARRIAGE							
0160045250-,Including 42754,42762,42877,42911,43185,43220,43244,Excluding 45255							
70024539			I-U-13	25 mm	63 mm	JLG-70024549	57.72
SIDE TILT CARRIAGE							
0160045250-,Including 42754,42762,42877,42911,43185,43220,43244,Excluding 45255							
1001090134			I-U-10	1-3/4	3-1/2	JLG-70022041	22.58
-13197							
2711613			I-U-10,14	1-3/4	4	JLG-8035831	87.85
13198-19987,0160002332-45249 Including 45255,Excluding 42754,42762,42877,42911,43185,43220,43244							
1001090134			I-U-10	1-3/4	3-1/2	JLG-70022041	22.58
SLAVE							
0160004670-							
2714973			I-U-5,14	1-3/4	4-1/4	JLG-8034695	134.31
-13197							
2714973			I-U-5,14	1-3/4	4-1/4	JLG-8034695	134.31
13198-19987,0160002332-3866							
2714973			I-U-5,14	1-3/4	4-1/4	JLG-8034695	134.31
STABILIZER							
-13197							
2713333			I-U-10	2	4-1/2	JLG-8033747	25.16
STABIL-TRAK							
0160045250-,Including 42754,42762,42877,42911,43185,43220,43244,Excluding 45255							
2717198			I-U-14	2-1/4	4-1/2	JLG-8036747	121.35
13198-19145							
2716564			I-U-14	2-1/4	4-1/2	JLG-8035326	174.55
19146-19987,0160002332-							
2717198			I-U-14	2-1/4	4-1/2	JLG-8036747	121.35

JLG®



Replacement Kits For

Telehandlers							
APPLICATION	CYL #	Misc-Parts, Instructions, etc.	CODE	ROD	BORE	KIT #	List \$
MODEL SKYTRAK 8042							
STEERING							
0160038967-,Excluding 38971,38984; 0160045250-,Including 42754,42762,42877,42911,43185,43220,43244,Excluding 45255							
70022173			I-U-10	50 mm	100 mm	JLG-70022178	109.92
-1167							
		Cyl No not avail	I-U-10	1-1/8	2-1/2	JLG-8033801	55.72
1168-							
8034684			P-U-10	1	2-1/2	JLG-8034691	57.38
STEERING FRONT							
-0160038966,Including 38971,38984; AXLE -828784							
1321149			I-U-10	50 mm	100 mm	JLG-8035981	132.50
-0160038966,Including 38971,38984; AXLE 828785-							
70021617			I-U-10	50 mm	100 mm	JLG-70021495	134.64
STEERING REAR							
-0160038966,Including 38971,38984; AXLE -955402							
1321149			I-U-10	50 mm	100 mm	JLG-8035981	132.50
-0160038966,Including 38971,38984; AXLE 955403-							
70021617			I-U-10	50 mm	100 mm	JLG-70021495	134.64
SWING CARRIAGE							
0160045250-,Including 42754,42762,42877,42911,43185,43220,43244,Excluding 45255							
1001103182			I-U-10	1-1/2	3-1/2	JLG-2915023	32.78
-13197							
2713363			I-U-10	1-1/2	3-1/2	JLG-8035830	39.67
13198-19987,0160002332-45249 Including 45255,Excluding 42754,42762,42877,42911,43185,43220,43244							
1001103182			I-U-10	1-1/2	3-1/2	JLG-2915023	32.78
TILT COMPENSATION							
0160045250-,Including 42754,42762,42877,42911,43185,43220,43244,Excluding 45255							
2714973			I-U-5,14	1-3/4	4-1/4	JLG-8034695	134.31
MODEL SKYTRAK 10042							
ATTACHMENT TILT							
0160004673-							
2716618			I-U-4,14	2-1/2	6	JLG-8035780	200.19
0160045250-,Including 42754,42762,42877,42911,43185,43220,43244,Excluding 45255							
2716618			I-U-4,14	2-1/2	6	JLG-8035780	200.19
-13197							
2712973			I-U-4,14	2-1/2	6	JLG-8035780	200.19
13198-19788							
2716618			I-U-4,14	2-1/2	6	JLG-8035780	200.19
19789-19987,0160002332-4558							
2717203			I-U-14	2-1/2	6	JLG-8036786	126.17
BOOM EXTEND							
0160045250-,Including 42754,42762,42877,42911,43185,43220,43244,Excluding 45255							
2717052			I-UB-10,14	3	5	JLG-8036295	177.46
-13197							
2716173			I-UB-10,14	3	5	JLG-8036295	177.46
13198-18397							
2716173			I-UB-10,14	3	5	JLG-8036295	177.46
18398-19987,0160002332-							
2716173			I-UB-10,14	3	5	JLG-8036295	177.46
BOOM LIFT							
0160004673-15021							
2717259			I-U-14	3	6	JLG-8036746	143.81

Replacement Kits For

JLG®

Telehandlers							
APPLICATION	CYL #	Misc-Parts, Instructions, etc.	CODE	ROD	BORE	KIT #	List \$
MODEL SKYTRAK 10042							
BOOM LIFT							
0160015195-30708							
1684448			I-U-14	3	6	JLG-8036746	143.81
0160030767-							
2716617			I-U-10,14	3	6	JLG-8035386	180.63
0160045250-,Including 42754,42762,42877,42911,43185,43220,43244,Excluding 45255							
2716617			I-U-10,14	3	6	JLG-8035386	180.63
-13197							
2714993			I-U-10	3	6	JLG-8033731	34.96
13198-19241							
2716617			I-U-10,14	3	6	JLG-8035386	180.63
19242-19987,0160002332-4259							
2717199			I-U-14	3	6	JLG-8036746	143.81
FRAME LEVEL							
0160045250-,Including 42754,42762,42877,42911,43185,43220,43244,Excluding 45255							
2716563			I-U-14	2-1/4	4-1/2	JLG-8035326	174.55
FRAME SWAY							
0160005669-							
2716563			I-U-14	2-1/4	4-1/2	JLG-8035326	174.55
13198-19987,0160002332-4558							
2716563			I-U-14	2-1/4	4-1/2	JLG-8035326	174.55
FRAME TILT							
-0266							
7115662			I-U-10	2	4-1/2	JLG-8033747	25.16
0267-13197							
2713853			I-U-10	2	4-1/2	JLG-8033747	25.16
GRAPPLE BUCKET							
0160045250-,Including 42754,42762,42877,42911,43185,43220,43244,Excluding 45255							
70021393			I-U-10	1-1/4	2-1/2	JLG-70021452	9.48
13198-19987,0160002332-45249 Including 45255,Excluding 42754,42762,42877,42911,43185,43220,43244							
70021393			I-U-10	1-1/4	2-1/2	JLG-70021452	9.48
OUTRIGGER							
0160002940-							
2717201			I-U-14	3	5	JLG-8036784	131.23
0160045250-,Including 42754,42762,42877,42911,43185,43220,43244,Excluding 45255							
2717201			I-U-14	3	5	JLG-8036784	131.23
-13197							
2716163			I-U-10,14	3	5	JLG-8035519	176.43
13198-19987,0160002332-2914							
2716163			I-U-10,14	3	5	JLG-8035519	176.43
SIDE SHIFT CARRIAGE							
0160045250-,Including 42754,42762,42877,42911,43185,43220,43244,Excluding 45255							
70024539			I-U-13	25 mm	63 mm	JLG-70024549	57.72
SIDE TILT CARRIAGE							
0160045250-,Including 42754,42762,42877,42911,43185,43220,43244,Excluding 45255							
1001090134			I-U-10	1-3/4	3-1/2	JLG-70022041	22.58
-13197							
2711613			I-U-10,14	1-3/4	4	JLG-8035831	87.85
13198-19987,0160002332-45249 Including 45255,Excluding 42754,42762,42877,42911,43185,43220,43244							
1001090134			I-U-10	1-3/4	3-1/2	JLG-70022041	22.58

JLG®

Replacement Kits For

JLG®

Telehandlers								
APPLICATION	CYL #	Misc-Parts, Instructions, etc.	CODE	ROD	BORE	KIT #	List \$	
MODEL SKYTRAK 10042								
SLAVE								
0160004673-								
	2714973		I-U-5,14	1-3/4	4-1/4	JLG-8034695	134.31	
-13197								
	2714973		I-U-5,14	1-3/4	4-1/4	JLG-8034695	134.31	
13198-19987,0160002332-3858								
	2714973		I-U-5,14	1-3/4	4-1/4	JLG-8034695	134.31	
STABILIZER								
-13197								
	2713333		I-U-10	2	4-1/2	JLG-8033747	25.16	
STABIL-TRAK								
0160045250-,Including 42754,42762,42877,42911,43185,43220,43244,Excluding 45255								
	2717198		I-U-14	2-1/4	4-1/2	JLG-8036747	121.35	
13198-19241								
	2716564		I-U-14	2-1/4	4-1/2	JLG-8035326	174.55	
19242-19987,0160002332-								
	2717198		I-U-14	2-1/4	4-1/2	JLG-8036747	121.35	
STEERING								
0160038967-,Excluding 38971,38984; 0160045250-,Including 42754,42762,42877,42911,43185,43220,43244,Excluding 45255								
	70022173		I-U-10	50 mm	100 mm	JLG-70022178	109.92	
-1167								
		Cyl No not avail	I-U-10	1-1/8	2-1/2	JLG-8033801	55.72	
1168-								
	8034684		P-U-10	1	2-1/2	JLG-8034691	57.38	
STEERING FRONT								
-0160038966,Including 38971,38984; AXLE -1285171								
	1321149		I-U-10	50 mm	100 mm	JLG-8035981	132.50	
-0160038966,Including 38971,38984; AXLE 1285172-								
	70021617		I-U-10	50 mm	100 mm	JLG-70021495	134.64	
STEERING REAR								
-0160038966,Including 38971,38984; AXLE -949493								
	1321149		I-U-10	50 mm	100 mm	JLG-8035981	132.50	
-0160038966,Including 38971,38984; AXLE 949494-								
	70021617		I-U-10	50 mm	100 mm	JLG-70021495	134.64	
SWING CARRIAGE								
0160045250-,Including 42754,42762,42877,42911,43185,43220,43244,Excluding 45255								
	1001103182		I-U-10	1-1/2	3-1/2	JLG-2915023	32.78	
-13197								
	2713363		I-U-10	1-1/2	3-1/2	JLG-8035830	39.67	
13198-19987,0160002332-45249 Including 45255,Excluding 42754,42762,42877,42911,43185,43220,43244								
	1001103182		I-U-10	1-1/2	3-1/2	JLG-2915023	32.78	
TILT COMPENSATION								
0160045250-,Including 42754,42762,42877,42911,43185,43220,43244,Excluding 45255								
	2714973		I-U-5,14	1-3/4	4-1/4	JLG-8034695	134.31	
MODEL SKYTRAK 10054								
ATTACHMENT TILT								
0160006120-								
	2716618		I-U-4,14	2-1/2	6	JLG-8035780	200.19	
0160045250-,Including 42754,42762,42877,42911,43185,43220,43244,Excluding 45255								
	2716618		I-U-4,14	2-1/2	6	JLG-8035780	200.19	
-13197								
	2712973		I-U-4,14	2-1/2	6	JLG-8035780	200.19	

JLG®

Replacement Kits For

JLG®

Telehandlers							
APPLICATION	CYL #	Misc-Parts, Instructions, etc.	CODE	ROD	BORE	KIT #	List \$
MODEL SKYTRAK 10054							
ATTACHMENT TILT							
13198-19745							
	2716618		I-U-4,14	2-1/2	6	JLG-8035780	200.19
19746-19987,0160002332-6099							
	2717203		I-U-14	2-1/2	6	JLG-8036786	126.17
BOOM EXTEND							
0160045250-,Including 42754,42762,42877,42911,43185,43220,43244,Excluding 45255							
	2716173		I-UB-10,14	3	5	JLG-8036295	177.46
-13197							
	2716173		I-UB-10,14	3	5	JLG-8036295	177.46
13198-19987,0160002332-							
	2716173		I-UB-10,14	3	5	JLG-8036295	177.46
BOOM LIFT							
0160004667-15024							
	2717259		I-U-14	3	6	JLG-8036746	143.81
0160015044-30712							
	1684448		I-U-14	3	6	JLG-8036746	143.81
0160030719-							
	2716617		I-U-10,14	3	6	JLG-8035386	180.63
0160045250-,Including 42754,42762,42877,42911,43185,43220,43244,Excluding 45255							
	2716617		I-U-10,14	3	6	JLG-8035386	180.63
-13197							
	2714993		I-U-10	3	6	JLG-8033731	34.96
13198-19113							
	2716617		I-U-10,14	3	6	JLG-8035386	180.63
19114-19987,0160002332-4654							
	2717199		I-U-14	3	6	JLG-8036746	143.81
FRAME LEVEL							
0160045250-,Including 42754,42762,42877,42911,43185,43220,43244,Excluding 45255							
	2716563		I-U-14	2-1/4	4-1/2	JLG-8035326	174.55
FRAME SWAY							
0160005697-							
	2716563		I-U-14	2-1/4	4-1/2	JLG-8035326	174.55
13198-19987,0160002332-4654							
	2716563		I-U-14	2-1/4	4-1/2	JLG-8035326	174.55
FRAME TILT							
-0266							
	7115662		I-U-10	2	4-1/2	JLG-8033747	25.16
0267-13197							
	2713853		I-U-10	2	4-1/2	JLG-8033747	25.16
GRAPPLE BUCKET							
0160045250-,Including 42754,42762,42877,42911,43185,43220,43244,Excluding 45255							
	70021393		I-U-10	1-1/4	2-1/2	JLG-70021452	9.48
13198-19987,0160002332-45249 Including 45255,Excluding 42754,42762,42877,42911,43185,43220,43244							
	70021393		I-U-10	1-1/4	2-1/2	JLG-70021452	9.48
OUTRIGGER							
0160002940-							
	2717201		I-U-14	3	5	JLG-8036784	131.23
0160045250-,Including 42754,42762,42877,42911,43185,43220,43244,Excluding 45255							
	2717201		I-U-14	3	5	JLG-8036784	131.23
-13197							
	2716163		I-U-10,14	3	5	JLG-8035519	176.43

JLG®

Replacement Kits For

JLG®

Telehandlers							
APPLICATION	CYL #	Misc-Parts, Instructions, etc.	CODE	ROD	BORE	KIT #	List \$
MODEL SKYTRAK 10054							
OUTRIGGER							
13198-19987,0160002332-2914							
2716163			I-U-10,14	3	5	JLG-8035519	176.43
SIDE SHIFT CARRIAGE							
0160045250-,Including 42754,42762,42877,42911,43185,43220,43244,Excluding 45255							
70024539			I-U-13	25 mm	63 mm	JLG-70024549	57.72
SIDE TILT CARRIAGE							
0160045250-,Including 42754,42762,42877,42911,43185,43220,43244,Excluding 45255							
1001090134			I-U-10	1-3/4	3-1/2	JLG-70022041	22.58
-13197							
2711613			I-U-10,14	1-3/4	4	JLG-8035831	87.85
13198-19987,0160002332-45249 Including 45255,Excluding 42754,42762,42877,42911,43185,43220,43244							
1001090134			I-U-10	1-3/4	3-1/2	JLG-70022041	22.58
SLAVE							
0160004676-							
2714973			I-U-5,14	1-3/4	4-1/4	JLG-8034695	134.31
-13197							
2714973			I-U-5,14	1-3/4	4-1/4	JLG-8034695	134.31
13198-19987,0160002332-3864							
2714973			I-U-5,14	1-3/4	4-1/4	JLG-8034695	134.31
STABILIZER							
-13197							
2713333			I-U-10	2	4-1/2	JLG-8033747	25.16
STABIL-TRAK							
0160045250-,Including 42754,42762,42877,42911,43185,43220,43244,Excluding 45255							
2717198			I-U-14	2-1/4	4-1/2	JLG-8036747	121.35
13198-19113							
2716564			I-U-14	2-1/4	4-1/2	JLG-8035326	174.55
19114-19987,0160002332-							
2717198			I-U-14	2-1/4	4-1/2	JLG-8036747	121.35
STEERING							
0160038967-,Excluding 38971,38984; 0160045250-,Including 42754,42762,42877,42911,43185,43220,43244,Excluding 45255							
70022173			I-U-10	50 mm	100 mm	JLG-70022178	109.92
-1167							
	Cyl No not avail		I-U-10	1-1/8	2-1/2	JLG-8033801	55.72
1168-							
8034684			P-U-10	1	2-1/2	JLG-8034691	57.38
STEERING FRONT							
-0160038966,Including 38971,38984; AXLE -1285171							
1321149			I-U-10	50 mm	100 mm	JLG-8035981	132.50
-0160038966,Including 38971,38984; AXLE 1285172-							
70021617			I-U-10	50 mm	100 mm	JLG-70021495	134.64
STEERING REAR							
-0160038966,Including 38971,38984; AXLE -949493							
1321149			I-U-10	50 mm	100 mm	JLG-8035981	132.50
-0160038966,Including 38971,38984; AXLE 949494-							
70021617			I-U-10	50 mm	100 mm	JLG-70021495	134.64
SWING CARRIAGE							
0160045250-,Including 42754,42762,42877,42911,43185,43220,43244,Excluding 45255							
1001103182			I-U-10	1-1/2	3-1/2	JLG-2915023	32.78

JLG®

Replacement Kits For

JLG®

Telehandlers							
APPLICATION	CYL #	Misc-Parts, Instructions, etc.	CODE	ROD	BORE	KIT #	List \$
MODEL SKYTRAK 10054							
SWING CARRIAGE							
-13197							
	2713363		I-U-10	1-1/2	3-1/2	JLG-8035830	39.67
13198-19987,0160002332-45249 Including 45255,Excluding 42754,42762,42877,42911,43185,43220,43244							
	1001103182		I-U-10	1-1/2	3-1/2	JLG-2915023	32.78
TILT COMPENSATION							
0160045250-.Including 42754,42762,42877,42911,43185,43220,43244,Excluding 45255							
	2714973		I-U-5,14	1-3/4	4-1/4	JLG-8034695	134.31

REPLACEMENT KITS FOR JLG® INDUSTRIES

Kit Number	Code (Pg. xviii)	Rod X Bore Size	List Price	Kit Number	Code (Pg. xviii)	Rod X Bore Size	List Price
JLG-2900003	N-N-11	5" SWIVEL KIT	\$ 205.22	JLG-2900295	I-U-10	1-1/4 X 3	\$ 30.80
JLG-2900005	P-V-1	2 X 3	49.94	JLG-2900338	P-U-1	3-1/2 X 8	245.16
JLG-2900006	P-V-11	2 X 5	57.11	JLG-2900344	P-U-10	1 X 2 DOUBLE ROD	79.18
JLG-2900007	I-U, V-11	1 X 3	43.26	JLG-2900347	P-U-1	2 X 3	113.62
JLG-2900008	P-V-11	1 X 3	36.19	JLG-2900347	P-U-1	2 X 3	113.62
JLG-2900009	P-V-11	2 X 4	55.44	JLG-2900348	P-U-10	1-1/4 X 3	88.54
JLG-2900010	P-V-11	2-1/2 X 6	85.81	JLG-2900350	P-U-11	2 X 3	47.44
JLG-2900088	P-U-8	3 X 7	376.47	JLG-2900351	I-U-10	1-1/2 X 3	61.61
JLG-2900094	P-U-10	2 X 3	82.50	JLG-2900352	P-U-10	1-1/4 X 2-1/2	73.59
JLG-2900095	P-U-10	1-1/4 X 2-1/2	64.00	JLG-2900357	P-U-10	2 X 3	70.25
JLG-2900099	I-U-11	1-1/4 X 2-1/4	24.30	JLG-2900364	P-U-10	1-1/4 X 3	45.65
JLG-2900100	I-U-10, 12	2 X 6	110.96	JLG-2900367	P-U-11	1-1/4 X 3	64.03
JLG-2900101	P-V-11	1 X 2	33.18	JLG-2900368	P-U-11	2 X 3	150.09
JLG-2900102	P-V-11	2 X 3	41.98	JLG-2900381	P-U-11	1-1/4 X 2-1/2	34.91
JLG-2900103	P-V-11	1-1/4 X 3	37.87	JLG-2900398	P-U-11	1-1/2 X 2-1/2	88.31
JLG-2900104	I-U-11	1 X 3	19.45	JLG-2900400	O-RING KIT		3.62
JLG-2900107	P-V-11	1-1/2 X 4	49.34	JLG-2900408	I-U-11	1 X 2	20.30
JLG-2900108	I-U-10, 12	3-1/2 X 8	143.24	JLG-2900409	2-1/2, 3-1/2 STAGES		30.85
JLG-2900109	P-U-11	1 X 3	25.25	JLG-2900412	2-1/2, 3-1/2, 4-5/8 STAGES		59.33
JLG-2900109M	P-U-13	1 X 3	27.01	JLG-2900426	P-U-11	1-1/4 X 3	41.98
JLG-2900110	P-U-11	1-1/2 X 4	33.89	JLG-2900427	1-5/8" SWIVEL KIT		14.84
JLG-2900111	P-U-11	1-1/4 X 3	27.07	JLG-2900429	P-U-11	1-1/2 X 2-1/2	32.72
JLG-2900111M	P-U-13	1-1/4 X 3	27.49	JLG-2900431	P-U-11	2 X 4	37.13
JLG-2900112	I-U-10, 12	2 X 5	83.34	JLG-2900432	P-U-11	2 X 3	46.70
JLG-2900113	I-U-10, 12	3-1/2 X 9	176.57	JLG-2900432M	P-U-13	2 X 3	39.80
JLG-2900114	P-V-1	3-1/2 X 8	73.45	JLG-2900454	P-U-11	1-1/2 X 4	33.85
JLG-2900119	I,P,U-11	1-1/4 X 3	33.66	JLG-2900469	P-U-11	2 X 5	54.08
JLG-2900120	PUMP SEAL KIT		181.30	JLG-2900473	I-U-10, 12	4 X 5-1/2	112.99
JLG-2900123	P-U-11	2 X 4	50.91	JLG-2900485	P-U-10	3/4 X 2	30.99
JLG-2900124	I-U-11	1 X 2	16.74	JLG-2900499	2-1/2, 3-1/2, 4-5/8 STAGES		90.94
JLG-2900125	I-U-11	2 X 3	23.98	JLG-2900511	2-1/2, 3-1/2 STAGES		53.91
JLG-2900126	P-U-11	1-1/4 X 3	27.14	JLG-2900578	I-U-11	1-1/4 X 2	25.32
JLG-2900127	N-N-11	5-7/8" SWIVEL KIT	221.12	JLG-2900579	P-U-9	2-1/2 X 5	221.63
JLG-2900142	P-U-11	2-1/2 X 6	70.33	JLG-2900683	O-RING KIT		5.04
JLG-2900156	I-U-11	1 X 2	16.74	JLG-2900700	P-OB-3	1-1/8 X 2	11.99
JLG-2900157	I-U-11	2-1/2 X 4	43.26	JLG-2900701	N-OB-13	1 X 1-1/2	10.92
JLG-2900158	VALVE KIT		37.18	JLG-2901007	I-U-10	2 X 3-1/2	29.74
JLG-2900166	P-U-11	1-1/4 X 2	23.04	JLG-2901009	O-RING KIT		7.66
JLG-2900168	MOTOR KIT		26.19	JLG-2901034	I-OB-3	1-1/2 X 3-1/2	10.98
JLG-2900173	P-U-11	2 X 4	47.88	JLG-2901103	P-U-11	1-1/2 X 4	141.09
JLG-2900175	I-OB-2	1/2 X 1	19.30	JLG-2901105	P-U-11	2-1/2 X 6	75.00
JLG-2900184	N-U-10, 12	2 X 3	40.81	JLG-2901115	P-U-10	3 X 5	69.24
JLG-2900188	P-O-11	3/4 X 2	17.95	JLG-2901119	P-U-11	1-1/4 X 2-1/2	31.54
JLG-2900197	P-U-11	2 X 3	42.02	JLG-2901127	P-U-13	1 X 3	27.01
JLG-2900203	I-U-11	3 X 4	39.34	JLG-2901133	P-U-13	1-1/4 X 3	27.49
JLG-2900208	I-U-11	2 X 3	33.04	JLG-2901138	P-U-13	1-1/2 X 4	33.32
JLG-2900209	I-U-11	2 X 5	54.17	JLG-2901146	5" SWIVEL KIT		147.01
JLG-2900242	P-O-11	3/4 X 2	25.32	JLG-2901147	P-U-11	1 X 2	46.72
JLG-2900292	P-U-11	2-1/2 X 6	66.03	JLG-2901180	P-U-9	2-3/4 X 3-1/2	206.35
JLG-2900293	I-U-11	3 X 5	64.67	JLG-2915023	I-U-10	1-1/2 X 3-1/2	32.78

REPLACEMENT KITS FOR JLG® INDUSTRIES

Kit Number	Code (Pg. xviii)	Rod X Bore Size	List Price
JLG-7000312	1-1/2" PISTON KIT		\$ 21.10
JLG-70021452	I-U-10	1-1/4 X 2-1/2	9.48
JLG-70021495	I-U-10	50 mm X 100 mm	134.64
JLG-70022041	I-U-10	1-3/4 X 3-1/2	22.58
JLG-70022061	P-UB-14	3-3/4 X 7	205.69
JLG-70022178	I-U-10	50 mm X 100 mm	109.92
JLG-70022858	P-UB-14	3 X 4	88.67
JLG-70022864	P-UB-14	2 X 4	113.90
JLG-70023899	I-U-10	2-1/2 X 5	71.99
JLG-70024012	P-UB-14	2-1/2 X 5-1/2	168.96
JLG-70024013	P-UB-14	2-1/2 X 5-1/2	154.59
JLG-70024217	P-UB-10	2-1/2 X 5	52.59
JLG-70024549	I-U-13	25 mm X 63 mm	57.72
JLG-7028739	I-U-14	1-1/2 X 3-3/4	62.28
JLG-8032718	I-U-10	3 X 5-1/2	32.00
JLG-8032730	I-U-10	2 X 115 mm	21.55
JLG-8033489	I-U-10	1-1/8 X 2-1/4	44.37
JLG-8033731	I-U-10	3 X 6	34.96
JLG-8033747	I-U-10	2 X 4-1/2	25.16
JLG-8033801	I-U-10	1-1/8 X 2-1/2	55.72
JLG-8034690	P-U-10	1-1/8 X 2-1/4	50.47
JLG-8034691	P-U-10	1 X 2-1/2	57.38
JLG-8034695	I-U-5,14	1-3/4 X 4-1/4	134.31
JLG-8035326	I-U-14	2-1/4 X 4-1/2	174.55
JLG-8035386	I-U-10,14	3 X 6	180.63
JLG-8035519	I-U-10,14	3 X 5	176.43

Kit Number	Code (Pg. xviii)	Rod X Bore Size	List Price
JLG-8035720	I-U-15,10,10	2 X 5	\$ 152.12
JLG-8035732	I-U-15	3 X 5	166.52
JLG-8035780	I-U-4,14	2-1/2 X 6	200.19
JLG-8035830	I-U-10	1-1/2 X 3-1/2	39.67
JLG-8035831	I-U-10,14	1-3/4 X 4	87.85
JLG-8035981	I-U-10	50 mm X 100 mm	132.50
JLG-8036131	I-U-14	1-1/2 X 3-3/4	109.69
JLG-8036132	I-U-14	2-3/4 X 5	162.65
JLG-8036294	I-UB-10	3 X 4-1/2	96.68
JLG-8036295	I-UB-10,14	3 X 5	177.46
JLG-8036502	I-UB-10	3 X 4-1/2	73.58
JLG-8036746	I-U-14	3 X 6	143.81
JLG-8036747	I-U-14	2-1/4 X 4-1/2	121.35
JLG-8036782	I-U-14	2-3/4 X 5	130.48
JLG-8036784	I-U-14	3 X 5	131.23
JLG-8036786	I-U-14	2-1/2 X 6	126.17
JLG-8205667	P-U-10	3 X 4-1/2	31.18
JLG-8205668	P-U-10	3 X 5-1/2	46.65
JLG-91144003	P-UB-10	2-3/4 X 4-1/4	91.25
JLG-91514020	P-UB-14	3-3/4 X 7	220.51
JLG-91514036	P-UB-14	3 X 4	133.90
JLG-91514050	P-UB-14	2-1/2 X 4-3/4	197.08
JLG-91514063	P-UB-14	2 X 4	153.00
JLG-91514281	P-UB-14	2-1/2 X 5-1/2	165.25
JLG-91514285	P-UB-14	2-1/2 X 5-1/2	184.11

JLG®

REPLACEMENT SEAL KITS FOR JOHN DEERE EQUIPMENT*

Replacement Seal Kits By Machine Type

Table of Contents

Machine Type		Page
Backhoe Loaders	210C, 300B, 302A, 310, 310A, 310B, 310C, 310D, 310E, 310G, 310J, 310K, 310K EP, 310SE, 310SG, 310SJ, 310SK, 310SK TC, 315SE, 401C, 401D, 410, 410B, 410C, 410D, 410E, 410G, 410J, 410K, 410K TC, 415B, 500A, 500B, 500C, 510, 510B, 510C, 510D, 515B, 610B, 610C, 710B, 710C, 710D, 710G, 710J, 710K	666 - 685
Compactors	646, 646B, 646C	685 - 686
Crawler Dozers/ Loaders	350, 350B, 350C, 350D, 355D, 450, 450B, 450C, 450D, 450E, 450G, 450H, 450J, 455D, 455E, 455G, 550, 550A, 550B, 550G, 550H, 550J, 550K, 555, 555A, 555B, 555G, 650G, 650H, 650J, 650K, 655, 655B, 700H, 700J, 700K, 750B, 750C, 750C-II, 750J, 750K, 850, 850B, 850C, 850C-II, 850J, 850K	686 - 698
Excavators	70, 70D, 80, 85D, 110, 120, 120C, 135C, 135D, 160 LC, 160C LC, 160D LC, 160GLC, 190E, 200 LC, 200C LC, 200D LC, 210GLC, 225C LC, 230 LC, 230C LC, 240D LC, 250GLC, 270C LC, 270D LC, 290D, 330 LC, 330C LC, 350D LC, 350GLC, 370, 370C, 450 LC, 450C LC, 450D LC, 470GLC, 490D, 490E, 495D, 590D, 690, 690A, 690B, 690C, 690CR, 690D, 690E, 690E LC, 790, 790D, 790E LC, 792, 792D, 792D LC, 890, 890A, 892D, 892D LC, 892E, 892E LC, 990, 992D, 992D LC, 992E, 992E LC	698 - 713
Excavators - Compact	27 ZTS, 27C ZTS, 27D, 35 ZTS, 35C ZTS, 35D, 50 ZTS, 50C ZTS, 50D, 60D, 75C, 75D, 80C	713 - 716
Forestry - Feller Bunchers	493D, 653E, 693B, 693C, 693D, 743, 743A Tree Harvesters, 793D, 853	716 - 717
Loaders - Skid Steer	240, 250, 260, 270, 280, 317, 318D, 320, 320D, 323D, 325, 326D, 328, 328D, 329D, 332, 332D, 333D, CT322, CT332	717 - 720
Loaders - Wheel	244J, 300, 344E, 400, 401A, 444, 444C, 444CH, 444D, 444E, 444H, 444H LL, 444J, 444K, 524K, 544, 544A, 544B, 544C, 544D, 544E, 544E LL, 544E TC, 544G, 544H, 544H LL, 544J, 544K, 624E, 624G, 624H, 624J, 624K, 624KR, 644, 644A, 644B, 644C, 644D, 644E, 644ER, 644G, 644H, 644J, 644K, 724J, 744E, 744H, 744J, 824J, 844, TC44H, TC54H	720 - 731
Motor Graders	570, 570A, 570B, 670, 670A, 670B, 672A, 672B, 770, 770A, 770B, 772A, 772B	731 - 732
Scrapers	760, 760A, 762, 762A, 762B, 860, 860A, 860B, 862, 862B, 1312C, 1510C, 1512C, 1810C, 1812C, 1814C, 2112C, 5010	732 - 734
Skidders	340D, 440, 440A, 440B, 440C Skidders/Grapple Skidders, 440D, 448 Skidders/Grapple Skidders, 540, 540A, 540B, 540D, 548D Grapple Skidders, 640 Skidders/Grapple Skidders, 640D, 648D Grapple Skidders, 740, 740A, 3605 Grapple Skidders	734 - 736
Alpha-Numeric Kit Listing		737 - 742
John Deere Individual Parts		743 - 748

All manufacturer's names, part numbers and descriptions are used for reference purposes only. We do not imply that any part shown is the product of these manufacturers. We also do not imply that the list price shown is exactly that of the manufacturer.

Replacement Kits For

JOHN DEERE

Backhoe Loaders								
APPLICATION	CYL #	SERIAL #	Misc	CODE	ROD	BORE	KIT #	List \$
MODEL 210C								
BACKHOE BOOM	RE27508	-742688		P-UB-1	50 mm		JD-RE20595	50.84
	RE27508	-742688		N-N-14		100 mm	JD-AH212101	80.14
	RE32890	742689-		P-UB-1	50 mm		JD-RE20595	50.84
	RE32890	742689-		N-N-14		100 mm	JD-AH212101	80.14
BACKHOE BUCKET				P-UB-1	45 mm		JD-RE20434	57.55
				N-N-14		80 mm	JD-AH212091	84.66
BOOM LIFT	AH154790			I,P-UB-1	45 mm		JD-AH149813	59.46
	AH154790			N-N-14		70 mm	JD-AH212089	37.37
CROWD				P-UB-1	45 mm		JD-RE20434	57.55
				N-N-14		90 mm	JD-AH212096	66.72
EXT CROWD				I-U-4	1-1/4	2-1/2	JD-AT101377	77.24
LOADER BOOM				P-UB-1	45 mm		JD-RE20434	57.55
				N-N-14		70 mm	JD-AH212089	37.37
LOADER BUCKET				P-UB-1	40 mm		JD-RE20433	57.19
				N-N-14		70 mm	JD-RE20428	42.40
STABILIZER	RE20440			P-UB-1	45 mm		JD-RE20434	57.55
	RE20440			N-N-14		90 mm	JD-AH212096	66.72
SWING				P-UB-1	45 mm		JD-RE20434	57.55
				N-N-14		80 mm	JD-AH212091	84.66
MODEL 300B								
Backhoe Arrangement			9250, 9250A					
BACKHOE BOOM		All		P-V-8	2	4	JD-RE18732	46.38
BACKHOE BUCKET		All		P-V-8	1-3/4	3	JD-RE18751	36.62
BACKHOE CROWD		All		P-V-8	1-3/4	3-1/2	JD-RE18755	46.21
BACKHOE STABILIZER		All		P-V-8	1-3/4	3-1/2	JD-RE18754	57.33
BACKHOE SWING		All	9250	P-V-8	2	4	JD-RE18732	46.38
		39797-	9250A	P-U-10	1-3/4	3-1/2	JD-RE18756	48.49
LOADER BOOM LIFT		All		P-V-8	1-3/4	2-3/4	JD-RE19220	38.76
LOADER BUCKET TILT		All		P-V-8	1-1/2	2-1/2	JD-RE19217	30.13
MODEL 302A								
Backhoe Arrangement			9250, 9250A					
BACKHOE BOOM		All		P-V-8	2	4	JD-RE18732	46.38
BACKHOE BUCKET		All		P-V-8	1-3/4	3	JD-RE18751	36.62
BACKHOE CROWD		All		P-V-8	1-3/4	3-1/2	JD-RE18755	46.21
BACKHOE STABILIZER		All		P-V-8	1-3/4	3-1/2	JD-RE18754	57.33
BACKHOE SWING		All	9250	P-V-8	2	4	JD-RE18732	46.38
		39797-	9250A	P-U-10	1-3/4	3-1/2	JD-RE18756	48.49
MODEL 310								
Backhoe Arrangement			9450, 9500					
BACKHOE BOOM		All		P-V-8	2-1/4	4-1/2	JD-AR105355	83.97
BACKHOE BUCKET		All		P-V-8	2-1/4	3-1/2	JD-RE18757	61.75
BACKHOE CROWD		All		P-V-8	2	4	JD-AR105387	44.97
BACKHOE STABILIZER		All	9500	P-V-8	1-3/4	3	JD-RE18751	36.62
		All	9405	P-V-8	1-3/4	3-1/2	JD-RE18754	57.33
	AT45903	All		P-V-8	1-3/4	3-1/2	JD-AR96518	57.33
BACKHOE SWING		All	9405	P-V-8	1-3/4	4	JD-RE18730	46.17
		Field Replacement	9405	P-V-8	2	4	JD-AR105387	44.97
	AT36160	All		P-V-8	1-3/4	4	JD-AR96527	46.17
EXT CROWD	AT50186	All	Major Repair	I-U-12	1-1/4	2-1/2	JD-AT50214	131.91
	AT50186		Major Repair	I-U-12	1-1/4	2-1/2	JD-AT50214	131.91
	AT50186	All	Soft Seal Repair	I-U-1	1-1/4		JD-AT50213	38.41
	AT50186		Soft Seal Repair	I-U-1	1-1/4		JD-AT50213	38.41
LOADER BOOM LIFT		192004-		P-V-8	1-3/4	3	JD-RE18751	36.62
		-192003		P-V-8	1-3/4	2-3/4	JD-AR105403	42.99
LOADER BUCKET TILT		All		P-V-8	1-3/4	3	JD-RE18751	36.62

LA - Long Arm LGP - Low Ground Pressure LT - Long Track MFWD - Mechanical Front Wheel Drive MP - Multi-Purpose
 IDM - Inside Dozer Mount ODM - Outside Dozer Mount SLF - Super Long Front STD - Straight Dozer WT - Wide Track

Replacement Kits For

JOHN DEERE

Backhoe Loaders								
APPLICATION	CYL #	SERIAL #	Misc	CODE	ROD	BORE	KIT #	List \$
MODEL 310								
Backhoe Arrangement			9450, 9500					
STEERING		237996-		P-U-10	7/8	2	JD-RE18749	24.65
MODEL 310A, 310B								
Backhoe Arrangement			9450, 9500					
BACKHOE BOOM		-701219	9405, 9500	P-V-8	2-1/4	4-1/2	JD-AR105355	83.97
		701220-	9405	P-V-14	2-1/4	4-1/2	JD-RE18764	114.16
BACKHOE BUCKET		-701219	9405, 9500	P-V-8	2-1/4	3-1/2	JD-RE18757	61.75
		701220-	9405	P-V-14	2-1/4	3-1/2	JD-RE18758	100.05
BACKHOE CROWD		700423-		P-V-14	2	4	JD-RE18741	97.81
		-700422	9405, 9500	P-V-8	2	4	JD-AR105387	44.97
BACKHOE STABILIZER		700423-	9405	P-V-14	1-3/4	3-1/2	JD-RE12912	99.30
		All	9500	P-V-8	1-3/4	3	JD-RE18751	36.62
		-700422	9405	P-V-8	1-3/4	3-1/2	JD-RE18754	57.33
BACKHOE SWING		-346261	9405	P-V-8	1-3/4	4	JD-RE18730	46.17
		700423-	9405	P-V-14	2	4	JD-RE18741	97.81
		346262-700422	9405	P-V-8	2	4	JD-AR105387	44.97
LOADER BOOM LIFT		-291985		P-V-8	1-3/4	3	JD-RE18751	36.62
		291986-		P-V-8	1-3/4	3-1/4	JD-AR105402	39.78
LOADER BUCKET TILT		291986-		P-V-8	1-1/2	3-1/4	JD-AR105429	36.02
		-291985		P-V-8	1-3/4	3	JD-RE18751	36.62
STEERING		All		P-U-10	7/8	2	JD-RE18749	24.65
MODEL 310C								
Backhoe Arrangement			9450, 9500					
BACKHOE BOOM	AH150110			P-UB-1	56 mm		JD-AH149814	58.53
	AH150110			N-N-14		115 mm	JD-AH149846	118.74
	RE23999	-740892		P-UB-1	50 mm		JD-RE20595	50.84
	RE23999	-740892		N-N-14		115 mm	JD-AH149846	118.74
	RE31721	740893-		P-UB-1	56 mm		JD-RE31716	88.77
	RE31721	740893-		N-N-14		115 mm	JD-AH149846	118.74
BACKHOE BUCKET	AH147722			P-UB-1	50 mm		JD-AH148164	42.87
	AH147722			N-N-14		90 mm	JD-AH149843	66.72
	RE20829			P-UB-1	50 mm		JD-RE20595	50.84
	RE20829	-729080		N-N-14		90 mm	JD-AH149843	66.72
BACKHOE CROWD	AH138661	740539-		P-UB-1	56 mm		JD-RE31716	88.77
	AH138661	740539-		N-N-14		100 mm	JD-AH149844	84.21
	AH150119			P-UB-1	56 mm		JD-AH149814	58.53
	AH150119			N-N-14		100 mm	JD-AH149844	84.21
BACKHOE STABILIZER	AH150103			I,P-UB-1	45 mm		JD-AH149813	59.46
	AH150103			N-N-14		90 mm	JD-AH149843	66.72
	AH150392			P-UB-1	50 mm		JD-AH148164	42.87
	AH150392			N-N-14		100 mm	JD-AH149844	84.21
	RE20830	-727315		P-UB-1	45 mm		JD-RE20434	57.55
	RE20830	-727315		N-N-14		90 mm	JD-AH149843	66.72
	RE26578	761935-		P-UB-1	50 mm		JD-RE20595	50.84
	RE26578	761935-		N-N-14		100 mm	JD-AH149844	84.21
	RE26990	727316-761934		P-UB-1	45 mm		JD-RE20434	57.55
	RE26990	727316-761934		N-N-14		90 mm	JD-AH149843	66.72
BACKHOE SWING	AH148696			P-UB-1	50 mm		JD-AH148164	42.87
	AH148696			N-N-14		100 mm	JD-AH149844	84.21
	RE20831			P-UB-1	50 mm		JD-RE20595	50.84
	RE20831			N-N-14		100 mm	JD-AH149844	84.21
	Replacement			P-UB-1	50 mm		JD-RE20595	50.84
	Replacement			N-N-14		100 mm	JD-AH137687	70.51
BUCKET (MP)	AT142578			P-U-10	2	3	JD-AT142582	48.49
EXT DIPPERSTICK	AH144391			P-UB-1	45 mm		JD-RE20434	57.55

LA - Long Arm LGP - Low Ground Pressure LT - Long Track MFWD - Mechanical Front Wheel Drive MP - Multi-Purpose
 IDM - Inside Dozer Mount ODM - Outside Dozer Mount SLF - Super Long Front STD - Straight Dozer WT - Wide Track

Replacement Kits For

JOHN DEERE

Backhoe Loaders								
APPLICATION	CYL #	SERIAL #	Misc	CODE	ROD	BORE	KIT #	List \$
MODEL 310C								
Backhoe Arrangement			9450, 9500					
EXT DIPPERSTICK	AH144391			N-N-10		80 mm	JD-RE37003	15.03
	AH154784			I,P-UB-1	45 mm		JD-AH149813	59.46
	AH154784			N-N-10		80 mm	JD-RE37003	15.03
	AT101011			I-U-4	1-1/4	2-1/2	JD-AT101377	77.24
LOADER BOOM	AH138930	774762-		P-UB-1	45 mm		JD-RE20434	57.55
	AH138930	774762-		N-N-14		80 mm	JD-AH149842	67.24
	AH154778			I,P-UB-1	45 mm		JD-AH149813	59.46
	AH154778			N-N-14		80 mm	JD-AH149842	67.24
	RE20825	-774761		P-UB-1	45 mm		JD-RE20434	57.55
	RE20825	-774761		N-N-14		80 mm	JD-AH149842	67.24
LOADER BUCKET	AH154793			I,P-UB-1	45 mm		JD-AH149813	59.46
	AH154793			N-N-14		90 mm	JD-AH149843	66.72
	RE20826			P-UB-1	45 mm		JD-RE20434	57.55
	RE20826			N-N-14		90 mm	JD-AH149843	66.72
STEERING				I-U-10	32 mm	60 mm	JD-AT108329	43.56
STEERING (Hydrostatic)	AT76043			I-U-10	25 mm	50 mm	JD-AT78498	55.07
STEERING (Power)	AH139130			P-UB-1	25 mm		JD-RE21875	50.17
	AH139130			N-N-10		2	JD-AH137789	6.12
	AH154780			P-UB-1	25 mm		JD-AU149810	48.92
	AH154780			N-N-10		2	JD-AH137789	6.12
	RE18712	-726006		P-U-1	1		JD-RE14552	13.29
	RE18712	-726006		N-N-10		2	JD-RE14551	11.45
	RE21961	726007-746966		P-UB-1	25 mm		JD-RE21875	50.17
	RE21961	726007-746966		N-N-14		50 mm	JD-RE21874	48.93
	RE33800	746967-		P-UB-1	25 mm		JD-RE21875	50.17
	RE33800	746967-		N-N-14		50 mm	JD-RE33803	53.31
MODEL 310D								
BACKHOE ARM				P-UB-1	56 mm		JD-RE31716	88.77
				N-N-14		100 mm	JD-AH149844	84.21
BACKHOE BOOM				N-N-14		115 mm	JD-AH149846	118.74
	RE31721	740893-		P-UB-1	56 mm		JD-RE31716	88.77
BACKHOE BUCKET		817498-		P-UB-1	50 mm		JD-AH148164	42.87
				N-N-14		90 mm	JD-AH149843	66.72
	AH211073	-817497		P-UB-1	50 mm		JD-RE20595	50.84
	AH211073	817498-		N-N-14		90 mm	JD-AH212096	66.72
	AH211073	-817497		N-N-14		90 mm	JD-AH212096	66.72
BACKHOE STABILIZER				P-UB-1	50 mm		JD-AH148164	42.87
				N-N-14		100 mm	JD-AH137687	70.51
				N-N-14		100 mm	JD-AH149844	84.21
CROWD	AH154776			P-UB-1	56 mm		JD-RE31716	88.77
	AH154776			N-N-14		100 mm	JD-AH212101	80.14
EXT DIPPERSTICK	AH154784	787834-		P-UB-1	45 mm		JD-RE20434	57.55
	AH154784	787834-		N-N-10		80 mm	JD-AH212092	36.62
LOADER BOOM				P-UB-1	45 mm		JD-RE20434	57.55
				N-N-14		80 mm	JD-AH149842	67.24
	AH154778			I,P-UB-1	45 mm		JD-AH149813	59.46
	AH154778			N-N-14		80 mm	JD-AH212091	84.66
LOADER BUCKET				P-UB-1	45 mm		JD-RE20434	57.55
				N-N-14		90 mm	JD-AH149843	66.72
	AH154793			I,P-UB-1	45 mm		JD-AH149813	59.46
	AH154793			N-N-14		90 mm	JD-AH212096	66.72
STABILIZER	AH135635	-817458		P-UB-1	50 mm		JD-RE20595	50.84
	AH135635	-817458		N-N-14		100 mm	JD-AH212101	80.14
	AH135636	-817458		P-UB-1	50 mm		JD-RE20595	50.84

LA - Long Arm LGP - Low Ground Pressure LT - Long Track MFWD - Mechanical Front Wheel Drive MP - Multi-Purpose
 IDM - Inside Dozer Mount ODM - Outside Dozer Mount SLF - Super Long Front STD - Straight Dozer WT - Wide Track

Replacement Kits For

JOHN DEERE

Backhoe Loaders								
APPLICATION	CYL #	SERIAL #	Misc	CODE	ROD	BORE	KIT #	List \$
MODEL 310D								
STABILIZER	AH135636	-817458		N-N-14		100 mm	JD-AH212101	80.14
	AH143513	-817458		P-UB-1	50 mm		JD-RE20595	50.84
	AH143513	-817458		N-N-14		100 mm	JD-AH212101	80.14
	AH143514	-817458		P-UB-1	50 mm		JD-RE20595	50.84
	AH143514	-817458		N-N-14		100 mm	JD-AH212101	80.14
SWING				P-UB-1	50 mm		JD-AH148164	42.87
				N-N-14		100 mm	JD-AH149844	84.21
	AH136574	-817517		P-UB-1	50 mm		JD-RE20595	50.84
AH145619	-817517		N-N-14		100 mm	JD-AH212101	80.14	
MODEL 310E								
BACKHOE BOOM				P-UB-1	56 mm		JD-AH149814	58.53
				N-N-14		110 mm	JD-AH212585	89.20
BACKHOE BUCKET				P-UB-1	50 mm		JD-AH210484	41.20
				N-N-14		80 mm	JD-AH212091	84.66
BACKHOE CROWD		-837443		P-UB-1	56 mm		JD-AH149814	58.53
		837444-		P-UB-1	63 mm		JD-AH149815	59.57
		-837443		N-N-14		110 mm	JD-AH212585	89.20
		837444-		N-N-14		110 mm	JD-AH212585	89.20
BACKHOE STABILIZER LH	AH149971			P-UB-1	50 mm		JD-AH210484	41.20
	AH149971			N-N-14		80 mm	JD-AH212091	84.66
	AH176122			P-UB-1	50 mm		JD-AH210484	41.20
	AH176122			N-N-10		80 mm	JD-AH212092	36.62
	AH219499			P-UB-1	50 mm		JD-AH210484	41.20
	AH219499			N-N-10		80 mm	JD-AH212092	36.62
BACKHOE STABILIZER RH	AH149972			P-UB-1	50 mm		JD-AH210484	41.20
	AH149972			N-N-14		80 mm	JD-AH212091	84.66
	AH173202			P-UB-1	50 mm		JD-AH210484	41.20
	AH173202			N-N-10		80 mm	JD-AH212092	36.62
	AH219500			P-UB-1	50 mm		JD-AH210484	41.20
	AH219500			N-N-10		80 mm	JD-AH212092	36.62
BUCKET (MP)				I-U-10	2	3	JD-AT190898	82.34
LOADER BOOM				P-UB-1	50 mm		JD-AH210484	41.20
				N-N-14		80 mm	JD-AH212091	84.66
LOADER BUCKET				P-UB-1	45 mm		JD-AH147868	32.41
				N-N-14		80 mm	JD-AH212091	84.66
MODEL 310G								
BACKHOE BOOM	AH146874	-926493		P-UB-1	50 mm		JD-AH210484	41.20
	AH146874	-926493		N-N-14		80 mm	JD-AH212091	84.66
	AH211131	926130-		P-UB-1	56 mm		JD-AH149814	58.53
	AH211131	-926129		P-UB-1	56 mm		JD-AH149814	58.53
	AH211131	-926129 ; 926130-		N-N-14		110 mm	JD-AH149845	106.21
BACKHOE BUCKET	AH209080	910901-925926 ; 925927-		P-UB-1	50 mm		JD-AH210484	41.20
	AH209080	910900		P-UB-1	50 mm		JD-AH210484	41.20
	AH209080	910900		N-N-14		80 mm	JD-AH212091	84.66
	AH209080	910901-925926 ; 925927-		N-N-10		80 mm	JD-AH212092	36.62
BACKHOE CROWD	AH157980			P-UB-1	63 mm		JD-AH149815	59.57
	AH157980			N-N-14		110 mm	JD-AH149845	106.21
BACKHOE STABILIZER	AH219499	925947-951996		P-UB-1	50 mm		JD-AH210484	41.20
	AH219499	925947-951996		N-N-10		80 mm	JD-AH212092	36.62
	AH219500	-925946		N-N-14		80 mm	JD-AH212091	84.66
BACKHOE SWING	AH220099	-957128 ; 957129-		I,P-UB-1	45 mm		JD-AH149813	59.46
	AH220099	957129-		N-N-14		80 mm	JD-AH212091	84.66
	AH220099	-957128		N-N-14		80 mm	JD-AH149842	67.24

LA - Long Arm LGP - Low Ground Pressure LT - Long Track MFWD - Mechanical Front Wheel Drive MP - Multi-Purpose
 IDM - Inside Dozer Mount ODM - Outside Dozer Mount SLF - Super Long Front STD - Straight Dozer WT - Wide Track

Replacement Kits For

JOHN DEERE

Backhoe Loaders								
APPLICATION	CYL #	SERIAL #	Misc	CODE	ROD	BORE	KIT #	List \$
MODEL 310G								
BUCKET (MP)				I-U-10	2	3	JD-AT190898	82.34
EXT DIPPERSTICK	AH218606	953471-		I-U-1	32 mm		JD-AH148823	41.35
	AH218606	953471-		N-N-10		2-1/2	JD-AH212088	13.29
LOADER BUCKET	AH216338	-941225 ; 941226-		P-UB-1	50 mm		JD-AH210484	41.20
	AH216338	-941225 ; 941226-		N-N-14		90 mm	JD-AH212096	66.72
MODEL 310J								
BACKHOE BOOM	AH219632			P-UB-1	56 mm		JD-AH149814	58.53
	AH219632			N-N-14		110 mm	JD-AH149845	106.21
BACKHOE BUCKET	AH219631			P-UB-1	50 mm		JD-AH210484	41.20
	AH219631			N-N-10		80 mm	JD-AH212092	36.62
BACKHOE CROWD	AH219633			P-UB-1	63 mm		JD-AH149815	59.57
	AH219633			N-N-14		110 mm	JD-AH212585	89.20
BACKHOE STABILIZER	AH219499			P-UB-1	50 mm		JD-AH210484	41.20
	AH219499			N-N-10		80 mm	JD-AH212092	36.62
	AH219500			P-UB-1	50 mm		JD-AH210484	41.20
	AH219500			N-N-10		80 mm	JD-AH212092	36.62
BACKHOE SWING	AH220099			I,P-UB-1	45 mm		JD-AH149813	59.46
	AH220099			N-N-14		80 mm	JD-AH212091	84.66
BACKHOE THUMB	AH233825			P-UB-1	50 mm		JD-AH210484	41.20
	AH233825			N-N-10		90 mm	JD-AH212097	15.75
EXT DIPPERSTICK	AH218606			I-U-1	32 mm		JD-AH148823	41.35
	AH218606			N-N-10		2-1/2	JD-AH212088	13.29
LOADER BOOM LIFT	AH211203			P-UB-1	50 mm		JD-AH210484	41.20
	AH211203			N-N-10		80 mm	JD-AH212092	36.62
LOADER BUCKET	AH219634			P-UB-1	50 mm		JD-AH210484	41.20
	AH219634			N-N-10		90 mm	JD-AH212097	15.75
STEERING	AT326542			I-U-10	40 mm	65 mm	JD-T218502	113.90
MODEL 310K								
BACKHOE BUCKET	AHC11124	208446-		P-UB-1	50 mm		JD-AHC11573	110.02
	AHC11124	208446-		N-N-10		80 mm	JD-AH212092	36.62
BACKHOE STABILIZER (LH)	AHC11111	208446-		N-N-10		80 mm	JD-AH212092	36.62
	AHC11111	208446-		P-UB-1	50 mm		JD-AHC11573	110.02
BACKHOE STABILIZER (RH)	AHC11112	208446-		N-N-10		80 mm	JD-AH212092	36.62
	AHC11112	208446-		P-UB-1	50 mm		JD-AHC11573	110.02
BACKHOE THUMB	AHC11115	207436-		P-UB-1	50 mm		JD-AHC11573	110.02
	AHC11115	207436-		N-N-10		90 mm	JD-AH212097	15.75
BOOM LIFT	AHC11108			P-UB-1	50 mm		JD-AHC11573	110.02
	AHC11108			N-N-10		80 mm	JD-AH212092	36.62
FRONT COUPLER	AH217348			I-U-10	25 mm	40 mm	JD-AH176272	26.81
LOADER BUCKET	AHC11107	202928-		P-UB-1	50 mm		JD-AHC11573	110.02
	AHC11107	202928-		N-N-10		90 mm	JD-AH212097	15.75
SWING	AHC11319	203194-		I,P-UB-1	45 mm		JD-AHC11572	84.26
	AHC11319	203194-		N-N-14		80 mm	JD-AH212091	84.66
MODEL 310K EP								
BACKHOE BUCKET	AHC11124	208446-		P-UB-1	50 mm		JD-AHC11573	110.02
	AHC11124	208446-		N-N-10		80 mm	JD-AH212092	36.62
BACKHOE STABILIZER (LH)	AHC11111	208446-		N-N-10		80 mm	JD-AH212092	36.62
	AHC11111	208446-		P-UB-1	50 mm		JD-AHC11573	110.02
BACKHOE STABILIZER (RH)	AHC11112	208446-		N-N-10		80 mm	JD-AH212092	36.62
	AHC11112	208446-		P-UB-1	50 mm		JD-AHC11573	110.02
BACKHOE THUMB	AHC11115	207436-		P-UB-1	50 mm		JD-AHC11573	110.02
	AHC11115	207436-		N-N-10		90 mm	JD-AH212097	15.75

LA - Long Arm LGP - Low Ground Pressure LT - Long Track MFWD - Mechanical Front Wheel Drive MP - Multi-Purpose
 IDM - Inside Dozer Mount ODM - Outside Dozer Mount SLF - Super Long Front STD - Straight Dozer WT - Wide Track

Replacement Kits For

JOHN DEERE

Backhoe Loaders								
APPLICATION	CYL #	SERIAL #	Misc	CODE	ROD	BORE	KIT #	List \$
MODEL 310K EP								
BOOM LIFT	AHC11108			N-N-10		80 mm	JD-AH212092	36.62
	AHC11573			P-UB-1	50 mm		JD-AHC11573	110.02
EXT DIPPERSTICK	AH234004			I-U-1	32 mm		JD-AH148823	41.35
	AH234004			N-N-10		2-1/2	JD-AH212088	13.29
FRONT COUPLER	AH217348			I-U-10	25 mm	40 mm	JD-AH176272	26.81
LOADER BUCKET	AHC11107	202928-		P-UB-1	50 mm		JD-AHC11573	110.02
	AHC11107	202928-		N-N-10		90 mm	JD-AH212097	15.75
STEERING (MFWD)	AT326542			I-U-10	40 mm	65 mm	JD-T218502	113.90
SWING	AHC11319	203194-		I,P-UB-1	45 mm		JD-AHC11572	84.26
	AHC11319	203194-		N-N-14		80 mm	JD-AH212091	84.66
MODEL 310SE								
BACKHOE BOOM	AH211132			P-UB-1	56 mm		JD-AH149814	58.53
	AH211132			N-N-14		120 mm	JD-AH149847	128.03
BACKHOE CROWD	AH164137	837258-873598		P-UB-1	63 mm		JD-AH149815	59.57
	AH164137	837258-873598		N-N-14		115 mm	JD-AH212103	118.74
BACKHOE STABILIZER LH	AH207327			P-UB-1	50 mm		JD-AH210484	41.20
	AH207327			N-N-14		90 mm	JD-AH212096	66.72
	AH210901			P-UB-1	50 mm		JD-AH210484	41.20
	AH210901			N-N-10		90 mm	JD-AH212097	15.75
	AH219537			P-UB-1	50 mm		JD-AH210484	41.20
	AH219537			N-N-10		90 mm	JD-AH212097	15.75
	AH219537			P-UB-1	50 mm		JD-AH210484	41.20
BACKHOE STABILIZER RH	AH207328			P-UB-1	50 mm		JD-AH210484	41.20
	AH207328			N-N-14		90 mm	JD-AH212096	66.72
	AH210902			P-UB-1	50 mm		JD-AH210484	41.20
	AH210902			N-N-10		90 mm	JD-AH212097	15.75
	AH219538			P-UB-1	50 mm		JD-AH210484	41.20
	AH219538			N-N-10		90 mm	JD-AH212097	15.75
	AH219538			P-UB-1	50 mm		JD-AH210484	41.20
EXT ARM	AH211361			I,P-UB-1	45 mm		JD-AH149813	59.46
	AH211361			N-N-14		70 mm	JD-AH212089	37.37
EXT DIPPERSTICK	AH211361			I,P-UB-1	45 mm		JD-AH149813	59.46
	AH211361			N-N-14		70 mm	JD-AH212089	37.37
LOADER BOOM	AH146874			P-UB-1	50 mm		JD-AH210484	41.20
	AH146874			N-N-14		80 mm	JD-AH212091	84.66
LOADER BOOM LIFT	AH211206			P-UB-1	50 mm		JD-AH210484	41.20
	AH211206			N-N-10		80 mm	JD-AH212092	36.62
LOADER BUCKET	AH146873	-881677		P-UB-1	45 mm		JD-AH147868	32.41
	AH146873	-881677		N-N-14		80 mm	JD-AH212091	84.66
	AH216338	881678-		P-UB-1	50 mm		JD-AH210484	41.20
	AH216338	881678-		N-N-14		90 mm	JD-AH212096	66.72
SWING	AH147888			P-UB-1	50 mm		JD-AH210484	41.20
	AH147888			N-N-14		90 mm	JD-AH212096	66.72
MODEL 310SG								
BACKHOE BUCKET	AH149791	-926788		P-UB-1	63 mm		JD-AH149815	59.57
	AH149791	-926788		N-N-14		100 mm	JD-AH212101	80.14
	AH208379	-926129		P-UB-1	56 mm		JD-AH149814	58.53
	AH208379	926130-		P-UB-1	56 mm		JD-AH149814	58.53
	AH208379	-926129		N-N-14		90 mm	JD-AH212096	66.72
	AH208379	926130-		N-N-14		90 mm	JD-AH212096	66.72
	AH220526	926789-		P-UB-1	63 mm		JD-AH149815	59.57
	AH220526	926789-		N-N-14		100 mm	JD-AH212101	80.14
BACKHOE CROWD	AH164137			P-UB-1	63 mm		JD-AH149815	59.57
	AH164137			N-N-14		115 mm	JD-AH212103	118.74
BACKHOE STABILIZER	AH210901	-926206		P-UB-1	50 mm		JD-AH210484	41.20
	AH210901	-926206		N-N-14		90 mm	JD-AH212096	66.72
	AH219537	926207-952148		P-UB-1	50 mm		JD-AH210484	41.20

LA - Long Arm LGP - Low Ground Pressure LT - Long Track MFWD - Mechanical Front Wheel Drive MP - Multi-Purpose
 IDM - Inside Dozer Mount ODM - Outside Dozer Mount SLF - Super Long Front STD - Straight Dozer WT - Wide Track

Replacement Kits For

JOHN DEERE

Backhoe Loaders								
APPLICATION	CYL #	SERIAL #	Misc	CODE	ROD	BORE	KIT #	List \$
MODEL 310SG								
BACKHOE STABILIZER	AH219537	926207-952148		N-N-10		90 mm	JD-AH212097	15.75
EXT BACKHOE STABILIZER	AH212541	-925993		P-UB-1	50 mm		JD-AH210484	41.20
	AH212541	-925993		N-N-14		100 mm	JD-AH212101	80.14
EXT DIPPERSTICK	AH211361	-910900		I,P-UB-1	45 mm		JD-AH149813	59.46
	AH211361	910901-926427		I,P-UB-1	45 mm		JD-AH149813	59.46
	AH211361	-910900		N-N-14		70 mm	JD-AH212089	37.37
	AH211361	-910900		N-N-14		70 mm	JD-RE20428	42.40
	AH211361	910901-926427		N-N-10		70 mm	JD-AH212090	12.43
LOADER BOOM	AH211206	-910491		P-UB-1	50 mm		JD-AH210484	41.20
	AH211206	926249-		P-UB-1	50 mm		JD-AH210484	41.20
	AH211206	910492-926248		P-UB-1	50 mm		JD-AH210484	41.20
	AH211206	-910491		N-N-14		80 mm	JD-AH212091	84.66
	AH211206	926249-		N-N-10		80 mm	JD-AH212092	36.62
	AH211206	910492-926248		N-N-10		80 mm	JD-AH212092	36.62
LOADER BUCKET	AH216338	-941225		P-UB-1	50 mm		JD-AH210484	41.20
	AH216338	941226-		P-UB-1	50 mm		JD-AH210484	41.20
	AH216338	-941225		N-N-14		90 mm	JD-AH212096	66.72
	AH216338	941226-		N-N-14		90 mm	JD-AH212096	66.72
SWING	AH220108	-957114		P-UB-1	50 mm		JD-AH210484	41.20
	AH220108	957115-		P-UB-1	50 mm		JD-AH210484	41.20
	AH220108	-957114		N-N-14		90 mm	JD-AH212096	66.72
	AH220108	957115-		N-N-14		90 mm	JD-AH212096	66.72
MODEL 310SJ								
BACKHOE BOOM	AH217444			P-UB-1	56 mm		JD-AH149814	58.53
	AH217444			N-N-14		120 mm	JD-AH149847	128.03
BACKHOE BUCKET	AH219636			P-UB-1	56 mm		JD-AH149814	58.53
	AH219636			N-N-14		90 mm	JD-AH212096	66.72
	AH219638			P-UB-1	63 mm		JD-AH149815	59.57
	AH219638			N-N-14		100 mm	JD-AH212101	80.14
BACKHOE CROWD	AH219637			P-UB-1	63 mm		JD-AH149815	59.57
	AH219637			N-N-14		115 mm	JD-AH212103	118.74
BACKHOE STABILIZER	AH219537			P-UB-1	50 mm		JD-AH210484	41.20
	AH219537			N-N-10		90 mm	JD-AH212097	15.75
	AH219538			P-UB-1	50 mm		JD-AH210484	41.20
	AH219538			N-N-10		90 mm	JD-AH212097	15.75
	AH219541			P-UB-1	50 mm		JD-AH210484	41.20
	AH219541			N-N-10		100 mm	JD-AH212102	50.15
	AH219542			P-UB-1	50 mm		JD-AH210484	41.20
	AH219542			N-N-10		100 mm	JD-AH212102	50.15
BACKHOE SWING	AH220108			P-UB-1	50 mm		JD-AH210484	41.20
	AH220108			N-N-14		90 mm	JD-AH212096	66.72
EXT DIPPERSTICK	AH211361			I,P-UB-1	40 mm		JD-AH149194	49.62
	AH211361			N-N-10		70 mm	JD-AH212090	12.43
LOADER BOOM LIFT	AH211206			P-UB-1	50 mm		JD-AH210484	41.20
	AH211206			N-N-10		80 mm	JD-AH212092	36.62
LOADER BUCKET	AH219634			P-UB-1	50 mm		JD-AH210484	41.20
	AH219634			N-N-10		90 mm	JD-AH212097	15.75
STEERING	AT326542			I-U-10	40 mm	65 mm	JD-T218502	113.90
MODEL 310SK								
BACKHOE BUCKET	AH219636			P-UB-1	56 mm		JD-AH149814	58.53
	AH219636			N-N-14		90 mm	JD-AH212096	66.72
	AH219638			P-UB-1	63 mm		JD-AH149815	59.57
	AH219638			N-N-14		100 mm	JD-AH212101	80.14

LA - Long Arm LGP - Low Ground Pressure LT - Long Track MFWD - Mechanical Front Wheel Drive MP - Multi-Purpose
 IDM - Inside Dozer Mount ODM - Outside Dozer Mount SLF - Super Long Front STD - Straight Dozer WT - Wide Track

Replacement Kits For

JOHN DEERE

Backhoe Loaders								
APPLICATION	CYL #	SERIAL #	Misc	CODE	ROD	BORE	KIT #	List \$
MODEL 310SK								
BACKHOE STABILIZER (LH)	AHC11115	208446-		P-UB-1	50 mm		JD-AHC11573	110.02
	AHC11115	208446-		N-N-10		90 mm	JD-AH212097	15.75
	AHC11117	208446-		P-UB-1	50 mm		JD-AHC11573	110.02
	AHC11117	208446-		N-N-10		100 mm	JD-AH212102	50.15
BACKHOE STABILIZER (RH)	AHC11116	208446-		P-UB-1	50 mm		JD-AHC11573	110.02
	AHC11116	208446-		N-N-10		90 mm	JD-AH212097	15.75
	AHC11118	208446-		P-UB-1	50 mm		JD-AHC11573	110.02
	AHC11118	208446-		N-N-10		100 mm	JD-AH212102	50.15
BACKHOE THUMB	AHC11115	207436-		P-UB-1	50 mm		JD-AHC11573	110.02
	AHC11115	207436-		N-N-10		90 mm	JD-AH212097	15.75
BOOM LIFT	AHC11110			P-UB-1	50 mm		JD-AHC11573	110.02
	AHC11110			N-N-10		80 mm	JD-AH212092	36.62
CROWD	AH219637			P-UB-1	63 mm		JD-AH149815	59.57
	AH219637			N-N-14		115 mm	JD-AH212103	118.74
FRONT COUPLER	AH217348			I-U-10	25 mm	40 mm	JD-AH176272	26.81
LOADER BUCKET	AHC11107	202928-		P-UB-1	50 mm		JD-AHC11573	110.02
	AHC11107	202928-		N-N-10		90 mm	JD-AH212097	15.75
STEERING (MFWD)	AT326542			I-U-10	40 mm	65 mm	JD-T218502	113.90
SWING	AHC11321	203180-		P-UB-1	50 mm		JD-AHC11573	110.02
	AHC11321	203180-		N-N-14		90 mm	JD-AH212096	66.72
MODEL 310SK TC								
BACKHOE BUCKET	AH219638			P-UB-1	63 mm		JD-AH149815	59.57
	AH219638			N-N-14		100 mm	JD-AH212101	80.14
BACKHOE STABILIZER (LH)	AHC11117	208446-		P-UB-1	50 mm		JD-AHC11573	110.02
	AHC11117	208446-		N-N-10		100 mm	JD-AH212102	50.15
BACKHOE STABILIZER (RH)	AHC11118	208446-		P-UB-1	50 mm		JD-AHC11573	110.02
	AHC11118	208446-		N-N-10		100 mm	JD-AH212102	50.15
BACKHOE THUMB	AHC11115	207436-		P-UB-1	50 mm		JD-AHC11573	110.02
	AHC11115	207436-		N-N-10		90 mm	JD-AH212097	15.75
BOOM LIFT	AH216775			P-UB-1	56 mm		JD-AH149814	58.53
	AH216775			N-N-14		90 mm	JD-AH212096	66.72
FRONT COUPLER	AH217348			I-U-10	25 mm	40 mm	JD-AH176272	26.81
LOADER BUCKET	AH233998			P-UB-1	56 mm		JD-AH149814	58.53
	AH233998			N-N-14		100 mm	JD-AH212101	80.14
STEERING (MFWD)	AT326542			I-U-10	40 mm	65 mm	JD-T218502	113.90
SWING	AHC11321	203180-		P-UB-1	50 mm		JD-AHC11573	110.02
	AHC11321	203180-		N-N-14		90 mm	JD-AH212096	66.72
MODEL 315SE								
BACKHOE BOOM	AH211132			P-UB-1	56 mm		JD-AH149814	58.53
	AH211132			N-N-14		120 mm	JD-AH149847	128.03
BACKHOE CROWD	AH164137	870159-872967		P-UB-1	63 mm		JD-AH149815	59.57
	AH164137	870159-872967		N-N-14		115 mm	JD-AH212103	118.74
BACKHOE STABILIZER	AH154788			P-UB-1	45 mm		JD-RE20434	57.55
	AH154788			N-N-14		70 mm	JD-AH212089	37.37
	AH211348			I,P-UB-1	45 mm		JD-AH149813	59.46
	AH211348			N-N-14		70 mm	JD-AH212089	37.37
	RE32168			P-UB-1	45 mm		JD-RE20434	57.55
	RE32168			N-N-14		70 mm	JD-AH212089	37.37
EXT ARM	AH211361			I,P-UB-1	45 mm		JD-AH149813	59.46
	AH211361			N-N-14		70 mm	JD-AH212089	37.37
EXT DIPPERSTICK	AH211361			I,P-UB-1	45 mm		JD-AH149813	59.46
	AH211361			N-N-14		70 mm	JD-AH212089	37.37

LA - Long Arm LGP - Low Ground Pressure LT - Long Track MFWD - Mechanical Front Wheel Drive MP - Multi-Purpose
 IDM - Inside Dozer Mount ODM - Outside Dozer Mount SLF - Super Long Front STD - Straight Dozer WT - Wide Track

Replacement Kits For

JOHN DEERE

Backhoe Loaders								
APPLICATION	CYL #	SERIAL #	Misc	CODE	ROD	BORE	KIT #	List \$
MODEL 315SE								
LOADER BOOM	AH146874			P-UB-1	50 mm		JD-AH210484	41.20
	AH146874			N-N-14		80 mm	JD-AH212091	84.66
LOADER BOOM LIFT	AH211206			P-UB-1	50 mm		JD-AH210484	41.20
	AH211206			N-N-10		80 mm	JD-AH212092	36.62
LOADER BUCKET	AH146873	-881677		P-UB-1	45 mm		JD-AH147868	32.41
	AH146873	-881677		N-N-14		80 mm	JD-AH212091	84.66
	AH216338	881678-		P-UB-1	50 mm		JD-AH210484	41.20
	AH216338	881678-		N-N-14		90 mm	JD-AH212096	66.72
SWING	AH147888			P-UB-1	50 mm		JD-AH210484	41.20
	AH147888			N-N-14		90 mm	JD-AH212096	66.72
MODEL 401C								
Backhoe Arrangement			9250, 9250A					
BACKHOE BOOM		All		P-V-8	2	4	JD-RE18732	46.38
BACKHOE BUCKET		All		P-V-8	1-3/4	3	JD-RE18751	36.62
BACKHOE CROWD		All		P-V-8	1-3/4	3-1/2	JD-RE18755	46.21
BACKHOE STABILIZER		All		P-V-8	1-3/4	3-1/2	JD-RE18754	57.33
BACKHOE SWING		All	9250	P-V-8	2	4	JD-RE18732	46.38
		39797-	9250A	P-U-10	1-3/4	3-1/2	JD-RE18756	48.49
LOADER BOOM LIFT		All		P-V-8	1-3/4	2-3/4	JD-RE19220	38.76
LOADER BUCKET TILT		All		P-V-8	1-1/4	2-1/2	JD-AR105453	35.68
MODEL 401D								
Backhoe Arrangement			9250B					
BACKHOE BOOM		All		P-V-1	2		JD-RE16119	26.51
		All		N-N-14		4	JD-RE16118	79.05
BACKHOE BUCKET		All		P-V-8	1-3/4	3	JD-RE18751	36.62
BACKHOE CROWD		All		P-V-8	1-3/4	3-1/2	JD-RE18755	46.21
BACKHOE STABILIZER		All		P-V-8	1-3/4	3-1/2	JD-RE18754	57.33
BACKHOE SWING		All		P-U-10	1-3/4	3-1/2	JD-RE18756	48.49
LOADER BOOM LIFT		Non-Self Lvl Bucket		P-V-8	1-3/4	2-3/4	JD-RE19220	38.76
		Self Lvl Bucket		P-V-1	1-3/4		JD-RE16209	31.04
		Self Lvl Bucket		N-N-14		3-1/4	JD-RE30816	65.31
LOADER BUCKET TILT		Non-Self Lvl Bucket		P-V-8	1-1/2	2-1/2	JD-RE19217	30.13
		Self Lvl Bucket		P-V-8	1-1/4	2-1/2	JD-AR105453	35.68
STEERING		All		P-U-10	7/8	2	JD-RE18749	24.65
MODEL 410								
Backhoe Arrangement			9410, 9500					
BACKHOE BOOM		Field Replacement		P-V-14	2-1/4	4-1/2	JD-RE18764	114.16
		All		P-V-8	2-1/4	4-1/2	JD-AR105355	83.97
BACKHOE BUCKET		All		P-V-8	2-1/4	3-1/2	JD-RE18757	61.75
		Field Replacement		P-V-14	2-1/4	3-1/2	JD-RE18758	100.05
BACKHOE CROWD		All	9410	P-V-8	2-1/4	4-1/2	JD-AR105355	83.97
		All	9500	P-V-8	2	4	JD-AR105387	44.97
		Field Replacement	9410	P-V-14	2-1/4	4-1/2	JD-RE18764	114.16
BACKHOE STABILIZER		All	9410	P-V-8	1-3/4	3-1/2	JD-RE18754	57.33
		Field Replacement	9410	P-V-14	1-3/4	3-1/2	JD-RE12912	99.30
		All	9500	P-V-8	1-3/4	3	JD-RE18751	36.62
BACKHOE SWING		303203-	9410	P-V-8	2	4	JD-AR105387	44.97
		303203-	9410	P-V-14	2	4	JD-RE18741	97.81
		-303202	9410	P-V-8	1-3/4	4	JD-RE18730	46.17
LOADER BOOM LIFT		All		P-V-8	1-3/4	3-1/4	JD-AR105402	39.78
LOADER BUCKET TILT		All		P-V-8	1-1/2	3-1/4	JD-AR105429	36.02
MODEL 410B								
BACKHOE BOOM		All		P-V-1	2-1/4		JD-RE14208	37.91
		All		N-N-14		4-1/2	JD-RE14523	82.00
BACKHOE BUCKET		711907-		P-V-1	2-1/4		JD-RE14538	28.42

LA - Long Arm LGP - Low Ground Pressure LT - Long Track MFWD - Mechanical Front Wheel Drive MP - Multi-Purpose
 IDM - Inside Dozer Mount ODM - Outside Dozer Mount SLF - Super Long Front STD - Straight Dozer WT - Wide Track

Replacement Kits For

JOHN DEERE

Backhoe Loaders								
APPLICATION	CYL #	SERIAL #	Misc	CODE	ROD	BORE	KIT #	List \$
MODEL 410B								
BACKHOE BUCKET		-711906		P-U-1	2-1/2		JD-RE14516	38.13
		711907-		N-N-14		3-1/2	JD-RE16076	76.63
		-711906		N-N-14		3-1/2	JD-RE16076	76.63
BACKHOE CROWD		All		P-V-1	2		JD-RE16119	26.51
		All		N-N-14		4	JD-RE16118	79.05
BACKHOE STABILIZER		-719446		P-V-1	2		JD-RE16119	26.51
		719447-		P-UB-1	50 mm		JD-RE20595	50.84
		-719446		N-N-14		4	JD-RE16118	79.05
		719447-		N-N-14		100 mm	JD-RE31139	93.80
BACKHOE SWING		All		P-V-1	2		JD-RE16119	26.51
		All		N-N-14		4	JD-RE16118	79.05
LOADER BOOM LIFT		All		P-V-1	1-3/4		JD-RE16209	31.04
		All		N-N-14		3-1/4	JD-RE30816	65.31
LOADER BUCKET TILT		All		P-V-1	1-3/4		JD-RE30874	28.88
		All		N-N-14		3-1/2	JD-RE14517	75.78
		All		P-V-1	1		JD-RE14552	13.29
STEERING		All		P-U-1	1		JD-RE14551	11.45
		All		N-N-10		2	JD-RE14551	11.45
MODEL 410C								
BACKHOE BOOM	AH135265	All		P-UB-1	63 mm		JD-RE25151	108.90
	AH135265	All		N-N-14		115 mm	JD-RE31140	116.75
	RE21962	All		P-UB-1	63 mm		JD-RE25151	108.90
	RE21962	All		N-N-14		115 mm	JD-RE31140	116.75
BACKHOE BUCKET	AH147722			P-UB-1	50 mm		JD-AH210484	41.20
	AH147722			N-N-14		90 mm	JD-AH212096	66.72
	AH211073			P-UB-1	50 mm		JD-AH210484	41.20
	AH211073			N-N-14		90 mm	JD-AH212096	66.72
	RE25622	All		P-UB-1	50 mm		JD-RE20595	50.84
	RE25622	All		N-N-14		90 mm	JD-AH212096	66.72
BACKHOE CROWD	AH138661	740539-		P-UB-1	56 mm		JD-RE31716	88.77
	AH138661	740539-		N-N-14		100 mm	JD-AH137687	70.51
BACKHOE STABILIZER	RE26578	All		P-UB-1	50 mm		JD-RE20595	50.84
	RE26578	All		N-N-14		100 mm	JD-AH137687	70.51
BACKHOE SWING	RE15638	-737926		P-V-1	2		JD-RE16119	26.51
	RE15638	-737926		N-N-14		4	JD-RE16118	79.05
	RE33472	737927-		P-UB-1	50 mm		JD-RE20595	50.84
	RE33472	737927-		N-N-14		100 mm	JD-AH137687	70.51
BUCKET (MP)				I-U-10	2	3	JD-AT190898	82.34
DIPPER EXTENSION	AT101063	All		I-U-5	1-1/2	3	JD-AT79722	46.59
LOADER BOOM LIFT	AH138930	All		P-UB-1	45 mm		JD-RE20434	57.55
	AH138930	All		N-N-14		80 mm	JD-RE31138	53.16
	RE20825	All		P-UB-1	45 mm		JD-RE20434	57.55
	RE20825	All		N-N-14		80 mm	JD-RE31138	53.16
LOADER BUCKET TILT	RE20826	All		P-UB-1	45 mm		JD-RE20434	57.55
	RE20826	All		N-N-14		90 mm	JD-RE20430	48.01
	RE38227	All		P-UB-1	45 mm		JD-RE20434	57.55
	RE38227	All		N-N-14		90 mm	JD-RE20430	48.01
LOADER CLAM	AT142578	769393-		P-U-10	2	3	JD-AT142582	48.49
STEERING (Hydrostatic)	AT108335	749406-		I-U-10	32 mm	60 mm	JD-AT108329	43.56
	AT76403	-749405		I-U-10	25 mm	50 mm	JD-AT78498	55.07
STEERING (Power)	AH139130			P-UB-1	25 mm		JD-RE21875	50.17
	AH139130			N-N-10		2	JD-AH137789	6.12
	RE18712		Flame Cut Head	P-U-1	1		JD-RE14552	13.29
	RE18712		Flame Cut Head	N-N-10		2	JD-RE14551	11.45
	RE21961	-746966	Forged Head	P-UB-1	25 mm		JD-RE21875	50.17
	RE21961	-746966	Forged Head	N-N-14		50 mm	JD-RE21874	48.93

LA - Long Arm LGP - Low Ground Pressure LT - Long Track MFWD - Mechanical Front Wheel Drive MP - Multi-Purpose
 IDM - Inside Dozer Mount ODM - Outside Dozer Mount SLF - Super Long Front STD - Straight Dozer WT - Wide Track

Replacement Kits For

JOHN DEERE

Backhoe Loaders								
APPLICATION	CYL #	SERIAL #	Misc	CODE	ROD	BORE	KIT #	List \$
MODEL 410C								
STEERING (Power)	RE33803	746967-XXXX		P-UB-1	25 mm		JD-RE21875	50.17
	RE33803	746967-XXXX		N-N-14		50 mm	JD-RE33803	53.31
MODEL 410D								
BACKHOE BOOM	AH135265	All	Std Boom	P-UB-1	63 mm		JD-RE25151	108.90
	AH135265	All	Std Boom	N-N-14		115 mm	JD-RE31140	116.75
	RE15647	All	Hvy Lift Boom	P-V-1	2-1/2		JD-RE14745	43.47
	RE15647	All	Hvy Lift Boom	N-N-14		5	JD-RE14744	101.24
BACKHOE BUCKET	RE25622	All		P-UB-1	50 mm		JD-RE20595	50.84
	RE25622	All		N-N-14		90 mm	JD-RE20430	48.01
BACKHOE CROWD	AH135266	All	Hvy Lift Boom	P-UB-1	63 mm		JD-RE25151	108.90
	AH135266	All	Hvy Lift Boom	N-N-14		115 mm	JD-RE31140	116.75
	AH138661	All	Std Boom	P-UB-1	56 mm		JD-RE31716	88.77
	AH138661	All	Std Boom	N-N-14		100 mm	JD-AH137687	70.51
BACKHOE STABILIZER	AH135635	All		P-UB-1	50 mm		JD-RE20595	50.84
	AH135636	All		N-N-14		100 mm	JD-AH137687	70.51
BACKHOE SWING	RE33472	All		P-UB-1	50 mm		JD-RE20595	50.84
	RE33472	All		N-N-14		100 mm	JD-AH137687	70.51
DIPPER EXT (1.2M)	AH141377			P-UB-1	45 mm		JD-RE20434	57.55
	AH141377			N-N-10		80 mm	JD-RE37003	15.03
	AT10163			I-U-5	1-1/2	3	JD-AT79722	46.59
DIPPER EXT (1.5M)	AH141378			P-UB-1	45 mm		JD-RE20434	57.55
	AH141378			N-N-10		80 mm	JD-RE37003	15.03
	AT84174			I-U-5	1-1/2	3	JD-AT79722	46.59
LOADER BOOM LIFT	AH138931	All		P-UB-1	45 mm		JD-RE20434	57.55
	AH138931	All		N-N-14		90 mm	JD-RE20430	48.01
LOADER BUCKET TILT	RE38227	All		P-UB-1	45 mm		JD-RE20434	57.55
	RE38227	All		N-N-14		90 mm	JD-RE20430	48.01
LOADER CLAM	AT142578	All		P-U-10	2	3	JD-AT142582	48.49
STEERING	AT195570			I-U-10	36 mm	65 mm	JD-T153744	97.82
STEERING (Power)	AH134479	780659-		P-UB-1	25 mm		JD-RE21875	50.17
	AH134479	780659-		N-N-10		2-1/4	JD-RE30100	6.51
	AH13930	-780658		P-UB-1	25 mm		JD-RE21875	50.17
	AH13930	-780658		N-N-10		2	JD-AH137789	6.12
MODEL 410E								
BACKHOE BOOM	AH175366			P-UB-1	63 mm		JD-AH149815	59.57
	AH175366			N-N-14		125 mm	JD-AH149848	167.29
BACKHOE BUCKET	AH220526			P-UB-1	63 mm		JD-AH149815	59.57
	AH220526			N-N-14		100 mm	JD-AH212101	80.14
BACKHOE CROWD	AH164138	837229-873597		P-UB-1	63 mm		JD-AH149815	59.57
	AH164138	873598-		P-UB-1	63 mm		JD-AH149815	59.57
	AH164138	-837228		P-UB-1	63 mm		JD-AH149815	59.57
	AH164138	-837228		N-N-14		115 mm	JD-AH212103	118.74
	AH164138	837229-873597		N-N-14		115 mm	JD-AH212103	118.74
	AH164138	873598-		N-N-14		115 mm	JD-AH212103	118.74
BACKHOE DIPPER STICK	AH209719			N-N-14		70 mm	JD-AH212089	37.37
BACKHOE STABILIZER	AH219541			P-UB-1	50 mm		JD-AH210484	41.20
	AH219541			N-N-14		100 mm	JD-AH212101	80.14
BACKHOE SWING	AH147888			P-UB-1	50 mm		JD-AH210484	41.20
	AH147888			N-N-14		90 mm	JD-AH212096	66.72
LOADER BOOM	AH211206			P-UB-1	50 mm		JD-AH210484	41.20
	AH211206			N-N-10		80 mm	JD-AH212092	36.62
	AH211206			N-N-14		80 mm	JD-AH212091	84.66
LOADER BUCKET	AH146873	-88167		P-UB-1	45 mm		JD-AH147868	32.41
	AH146873	-88167		N-N-14		80 mm	JD-AH212091	84.66
	AH216338	881678-		N-N-14		90 mm	JD-AH212096	66.72

LA - Long Arm LGP - Low Ground Pressure LT - Long Track MFWD - Mechanical Front Wheel Drive MP - Multi-Purpose
 IDM - Inside Dozer Mount ODM - Outside Dozer Mount SLF - Super Long Front STD - Straight Dozer WT - Wide Track

Replacement Kits For

JOHN DEERE

Backhoe Loaders								
APPLICATION	CYL #	SERIAL #	Misc	CODE	ROD	BORE	KIT #	List \$
MODEL 410G								
BACKHOE BOOM		-945072		P-UB-1	63 mm		JD-AH149815	59.57
		-945072		N-N-14		125 mm	JD-AH149848	167.29
	AH175366	945073-		P-UB-1	63 mm		JD-AH149815	59.57
	AH175366	945073-		N-N-14		125 mm	JD-AH149848	167.29
BACKHOE BUCKET	AH149791	-926799		P-UB-1	63 mm		JD-AH149815	59.57
	AH149791	-926799		N-N-14		100 mm	JD-AH212101	80.14
	AH220526	926800-		P-UB-1	63 mm		JD-AH149815	59.57
	AH220526	926800-		N-N-14		100 mm	JD-AH212101	80.14
BACKHOE STABILIZER		925994-952006		P-UB-1	50 mm		JD-AH210484	41.20
		-925993		P-UB-1	50 mm		JD-AH210484	41.20
		925994-952006		N-N-10		100 mm	JD-AH212102	50.15
		-925993		N-N-14		100 mm	JD-AH212101	80.14
	AH219541	952007-		P-UB-1	50 mm		JD-AH210484	41.20
	AH219541	952007-		N-N-10		100 mm	JD-AH212102	50.15
	AH219542	952007-		P-UB-1	50 mm		JD-AH210484	41.20
	AH219542	952007-		N-N-10		100 mm	JD-AH212102	50.15
BACKHOE SWING		-957114		P-UB-1	50 mm		JD-AH210484	41.20
		-957114		N-N-14		90 mm	JD-AH212096	66.72
	AH220108	957115-		P-UB-1	50 mm		JD-AH210484	41.20
	AH220108	957115-		N-N-14		90 mm	JD-AH212096	66.72
BOOM	AH211206	926301-		P-UB-1	50 mm		JD-AH210484	41.20
	AH211206	926301-		N-N-10		80 mm	JD-AH212092	36.62
BOOM LIFT	AH211206	-910494		P-UB-1	50 mm		JD-AH210484	41.20
	AH211206	810495-926300		P-UB-1	50 mm		JD-AH210484	41.20
	AH211206	-910494		N-N-14		80 mm	JD-AH212091	84.66
	AH211206	810495-926300		N-N-10		80 mm	JD-AH212092	36.62
BUCKET (MP)		-925076		I-U-10	2	3	JD-AT190898	82.34
CROWD	AH164138			P-UB-1	63 mm		JD-AH149815	59.57
	AH164138			N-N-14		115 mm	JD-AH212103	118.74
EXT CROWD		-911725		I,P-UB-1	45 mm		JD-AH149813	59.46
		911726-927725		I,P-UB-1	45 mm		JD-AH149813	59.46
		-911725		N-N-14		70 mm	JD-AH212089	37.37
		911726-927725		N-N-10		70 mm	JD-AH212090	12.43
	AH209719	927726-		I,P-UB-1	40 mm		JD-AH149194	49.62
	AH209719	927726-		N-N-10		70 mm	JD-AH212090	12.43
LOADER BUCKET	AH216338	-941225		P-UB-1	50 mm		JD-AH210484	41.20
	AH216338	941226-		P-UB-1	50 mm		JD-AH210484	41.20
	AH216338	941226-		N-N-14		90 mm	JD-AH212096	66.72
	AH216338	-941225		N-N-14		90 mm	JD-AH212096	66.72
STEERING (MFWD)	AT195570	-911131		I-U-10	36 mm	65 mm	JD-T153744	97.82
STEERING (Power)				P-UB-1	25 mm		JD-AH149810	48.92
			w/o MFWD	N-N-10		2-1/4	JD-RE30100	6.51
MODEL 410J								
BACKHOE BOOM	AH219639			P-UB-1	63 mm		JD-AH149815	59.57
	AH219639			N-N-14		125 mm	JD-AH149848	167.29
BACKHOE BUCKET	AH219638			P-UB-1	63 mm		JD-AH149815	59.57
	AH219638			N-N-14		100 mm	JD-AH212101	80.14
BACKHOE THUMB	AH233825			P-UB-1	50 mm		JD-AH210484	41.20
	AH233825			N-N-10		90 mm	JD-AH212097	15.75
BOOM LIFT	AH211206			P-UB-1	50 mm		JD-AH210484	41.20
	AH211206			N-N-10		80 mm	JD-AH212092	36.62
BUCKET (MP)	AH210737			I-U-14	50 mm	3	JD-AH209022	77.65
CROWD	AH219640			P-UB-1	63 mm		JD-AH149815	59.57
	AH219640			N-N-14		115 mm	JD-AH212103	118.74
EXT DIPPERSTICK	AH209719			I,P-UB-1	40 mm		JD-AH149194	49.62

LA - Long Arm LGP - Low Ground Pressure LT - Long Track MFWD - Mechanical Front Wheel Drive MP - Multi-Purpose
 IDM - Inside Dozer Mount ODM - Outside Dozer Mount SLF - Super Long Front STD - Straight Dozer WT - Wide Track

Replacement Kits For

JOHN DEERE

Backhoe Loaders								
APPLICATION	CYL #	SERIAL #	Misc	CODE	ROD	BORE	KIT #	List \$
MODEL 410J								
EXT DIPPERSTICK	AH209719			N-N-10		70 mm	JD-AH212090	12.43
LOADER BOOM	AH211206			P-UB-1	50 mm		JD-AH210484	41.20
	AH211206			N-N-10		80 mm	JD-AH212092	36.62
LOADER BUCKET	AH219634			P-UB-1	50 mm		JD-AH210484	41.20
	AH219634			N-N-10		90 mm	JD-AH212097	15.75
STABILIZER	AH219541			P-UB-1	50 mm		JD-AH210484	41.20
	AH219541			N-N-10		100 mm	JD-AH212102	50.15
	AH219542			P-UB-1	50 mm		JD-AH210484	41.20
	AH219542			N-N-10		100 mm	JD-AH212102	50.15
STEERING	AT326542			I-U-10	40 mm	65 mm	JD-T218502	113.90
SWING	AH220108			P-UB-1	50 mm		JD-AH210484	41.20
	AH220108			N-N-14		90 mm	JD-AH212096	66.72
NEW MODEL 410K								
BACKHOE BUCKET	AH219638			P-UB-1	63 mm		JD-AH149815	59.57
	AH219638			N-N-14		100 mm	JD-AH212101	80.14
BACKHOE STABILIZER (LH)	AHC11115	208446-		P-UB-1	50 mm		JD-AHC11573	110.02
	AHC11115	208446-		N-N-10		90 mm	JD-AH212097	15.75
	AHC11117	208446-		P-UB-1	50 mm		JD-AHC11573	110.02
	AHC11117	208446-		N-N-10		100 mm	JD-AH212102	50.15
BACKHOE STABILIZER (RH)	AHC11116	208446-		P-UB-1	50 mm		JD-AHC11573	110.02
	AHC11116	208446-		N-N-10		90 mm	JD-AH212097	15.75
	AHC11118	208446-		P-UB-1	50 mm		JD-AHC11573	110.02
	AHC11118	208446-		N-N-10		100 mm	JD-AH212102	50.15
BACKHOE THUMB	AHC11115	207436-		P-UB-1	50 mm		JD-AHC11573	110.02
	AHC11115	207436-		N-N-10		90 mm	JD-AH212097	15.75
BOOM LIFT	AHC11110			P-UB-1	50 mm		JD-AHC11573	110.02
	AHC11110			N-N-10		80 mm	JD-AH212092	36.62
FRONT COUPLER	AH217348			I-U-10	25 mm	40 mm	JD-AH176272	26.81
LOADER BUCKET	AHC11107	202928-		P-UB-1	50 mm		JD-AHC11573	110.02
	AHC11107	202928-		N-N-10		90 mm	JD-AH212097	15.75
STEERING (MFWD)	AT326542			I-U-10	40 mm	65 mm	JD-T218502	113.90
SWING	AHC11321	203180-		P-UB-1	50 mm		JD-AHC11573	110.02
	AHC11321	203180-		N-N-14		90 mm	JD-AH212096	66.72
NEW MODEL 410K TC								
BACKHOE BUCKET	AH219638			P-UB-1	63 mm		JD-AH149815	59.57
	AH219638			N-N-14		100 mm	JD-AH212101	80.14
BACKHOE STABILIZER (LH)	AHC11117	208446-		P-UB-1	50 mm		JD-AHC11573	110.02
	AHC11117	208446-		N-N-10		100 mm	JD-AH212102	50.15
	AHC11118	208446-		P-UB-1	50 mm		JD-AHC11573	110.02
	AHC11118	208446-		N-N-10		100 mm	JD-AH212102	50.15
BACKHOE THUMB	AHC11115	207436-		P-UB-1	50 mm		JD-AHC11573	110.02
	AHC11115	207436-		N-N-10		90 mm	JD-AH212097	15.75
BOOM LIFT	AH216775			P-UB-1	56 mm		JD-AH149814	58.53
	AH216775			N-N-14		90 mm	JD-AH212096	66.72
FRONT COUPLER	AH217348			I-U-10	25 mm	40 mm	JD-AH176272	26.81
LOADER BUCKET	AH233998			P-UB-1	56 mm		JD-AH149814	58.53
	AH233998			N-N-14		100 mm	JD-AH212101	80.14
STEERING (MFWD)	AT326542			I-U-10	40 mm	65 mm	JD-T218502	113.90
SWING	AHC11323	206264-		P-UB-1	50 mm		JD-AHC11573	110.02
	AHC11323	206264-		N-N-14		90 mm	JD-AH212096	66.72
MODEL 415B								
BACKHOE BOOM		All		P-V-1	2-1/4		JD-RE14208	37.91
		All		N-N-14		4-1/2	JD-RE14523	82.00

LA - Long Arm LGP - Low Ground Pressure LT - Long Track MFWD - Mechanical Front Wheel Drive MP - Multi-Purpose
 IDM - Inside Dozer Mount ODM - Outside Dozer Mount SLF - Super Long Front STD - Straight Dozer WT - Wide Track

Replacement Kits For

JOHN DEERE

JOHN DEERE

Backhoe Loaders								
APPLICATION	CYL #	SERIAL #	Misc	CODE	ROD	BORE	KIT #	List \$
MODEL 415B								
BACKHOE BUCKET		All		P-U-1	2-1/2		JD-RE14516	38.13
		All		N-N-14		3-1/2	JD-RE16076	76.63
BACKHOE CROWD		All		P-V-1	2		JD-RE16119	26.51
		All		N-N-14		4	JD-RE16118	79.05
BACKHOE STABILIZER		All		N-N-14		3	JD-RE14082	70.14
BACKHOE SWING		All		P-U-1	2		JD-RE14556	25.19
		All		N-N-10		4	JD-RE14555	76.25
LOADER BOOM LIFT		All		P-V-1	1-3/4		JD-RE16209	31.04
		All		N-N-14		3-1/4	JD-RE30816	65.31
LOADER BUCKET TILT		All		P-V-1	1-3/4		JD-RE30874	28.88
		All		N-N-14		3-1/2	JD-RE14517	75.78
STEERING		All		P-U-1	1		JD-RE14552	13.29
		All		N-N-10		2	JD-RE14551	11.45
MODEL 500A								
		Backhoe Arrangement		95, 97, 9700				
BACKHOE BOOM		All		P-V-8	2-1/4	4-1/2	JD-RE10640	62.91
BACKHOE BUCKET		All		P-V-8	2-1/4	3-1/2	JD-RE18757	61.75
BACKHOE CROWD		All		P-V-8	2	4	JD-AR105387	44.97
BACKHOE STABILIZER		All	97, 9700	P-V-8	1-3/4	3-1/2	JD-RE18754	57.33
		All	95	P-V-8	1-3/4	3	JD-RE18751	36.62
BACKHOE SWING		All	9700	P-V-8	1-3/4	4	JD-RE18730	46.17
LOADER BOOM LIFT		All		P-V-8	1-1/2	2-3/4	JD-AR105430	33.37
LOADER BUCKET TILT		All		P-V-8	1-1/2	2-3/4	JD-AR105430	33.37
MODEL 500B								
		Backhoe Arrangement		9900				
BACKHOE BOOM		All others		P-U-8	2-1/2	5-1/2	JD-AR105281	99.11
		AT37797	All	P-V-8	2-1/2	5-1/2	JD-RE13277	103.64
		AU43137	All	P-V-8	2-1/2	5-1/2	JD-AR105443	106.75
BACKHOE BUCKET		All		P-V-8	2-1/2	4	JD-AR96526	70.57
BACKHOE CROWD		AT35944		P-V-8	2-1/2	5-1/2	JD-AR105443	106.75
		AT38002	All	P-V-8	2-1/2	5-1/2	JD-RE18734	96.75
		AU42875	All	P-V-8	2-1/2	5-1/2	JD-AR105443	106.75
BACKHOE STABILIZER		All		P-V-8	2-1/2	4-1/2	JD-AR105441	74.60
BACKHOE SWING		All		P-V-8	2	4-1/2	JD-AR105384	61.37
LOADER BOOM LIFT		All		P-V-8	2	3-1/2	JD-AR105392	39.37
LOADER BUCKET TILT		All		P-V-8	1-3/4	3	JD-RE18751	36.62
MODEL 500C								
		Backhoe Arrangement		9500, 9705				
BACKHOE BOOM		-700717	9500, 9705	P-V-8	2-1/4	4-1/2	JD-AR105355	83.97
		700718-	9705	P-V-14	2-1/4	4-1/2	JD-RE18764	114.16
BACKHOE BUCKET		-700717	9500, 9705	P-V-8	2-1/4	3-1/2	JD-RE18757	61.75
		700718-	9705	P-V-14	2-1/4	3-1/2	JD-RE18758	100.05
BACKHOE CROWD		-700717	9705	P-V-8	2-1/4	4-1/2	JD-AR105355	83.97
		700718-	9705	P-V-14	2-1/4	4-1/2	JD-RE18764	114.16
		All	9500	P-V-8	2	4	JD-AR105387	44.97
BACKHOE STABILIZER		-700717	9705	P-V-8	1-3/4	3-1/2	JD-RE18754	57.33
		All	9500	P-V-8	1-3/4	3	JD-RE18751	36.62
		700718-	9705	P-V-14	1-3/4	3-1/2	JD-RE12912	99.30
BACKHOE SWING		-303508	9705	P-V-8	1-3/4	4	JD-RE18730	46.17
		700718	9705	P-V-14	2	4	JD-RE18741	97.81
		303509-700717	9705	P-V-8	2	4	JD-AR105387	44.97
LOADER BOOM LIFT		All		P-V-8	1-3/4	3-1/4	JD-AR105402	39.78
LOADER BUCKET TILT		All		P-V-8	1-1/2	3-1/4	JD-AR105429	36.02

LA - Long Arm LGP - Low Ground Pressure LT - Long Track MFWD - Mechanical Front Wheel Drive MP - Multi-Purpose
 IDM - Inside Dozer Mount ODM - Outside Dozer Mount SLF - Super Long Front STD - Straight Dozer WT - Wide Track

Replacement Kits For

JOHN DEERE

Backhoe Loaders								
APPLICATION	CYL #	SERIAL #	Misc	CODE	ROD	BORE	KIT #	List \$
MODEL 510								
		Backhoe Arrangement		9900				
BACKHOE BOOM		-155578	9900	P-V-8	2-1/2	5-1/2	JD-AR105443	106.75
		155579-249770	9900	P-V-8	2-1/2	5-1/2	JD-RE13277	103.64
		249771-700717	9900	P-U-8	2-1/2	5-1/2	JD-AR105281	99.11
		700718-	9900	P-U-14	2-1/2	5-1/2	JD-RE18745	108.69
BACKHOE BUCKET		-700717	9900	P-V-8	2-1/2	4	JD-AR96526	70.57
		700718-	9900	P-V-14	2-1/2	4	JD-RE18735	113.77
BACKHOE CROWD		-155578	9900	P-V-8	2-1/2	5-1/2	JD-AR105443	106.75
		155579-700717	9900	P-V-8	2-1/2	5-1/2	JD-RE18734	96.75
		700718-		P-V-14	2-1/2	5-1/2	JD-RE18740	165.52
BACKHOE STABILIZER		-700717	9900	P-V-8	2-1/2	4-1/2	JD-AR105441	74.60
		700718-	9900	P-V-1	2-1/2		JD-RE17345	46.46
		700718-	9900	N-N-14		4-1/2	JD-RE14094	82.00
BACKHOE SWING		700718-	9900	P-V-14	2	4-1/2	JD-RE19225	106.34
		-700717	9900	P-V-8	2	4-1/2	JD-AR105384	61.37
LOADER BOOM LIFT		All		P-V-8	2	3-3/4	JD-AR105381	43.43
LOADER BUCKET TILT		All		P-V-8	2	3-1/2	JD-AR105392	39.37
LOADER CLAM		All		P-U-9	2	4	JIC-G32299	53.72
MODEL 510B								
BACKHOE BOOM		All		P-V-1	2-1/2		JD-RE14745	43.47
		All		N-N-14		5	JD-RE14744	101.24
BACKHOE BUCKET		All		P-V-1	2-1/4		JD-RE14538	28.42
		All		N-N-14		3-1/2	JD-RE16076	76.63
BACKHOE CROWD		All		P-V-1	2-1/4		JD-RE14208	37.91
		All		N-N-14		4-1/2	JD-RE14094	82.00
BACKHOE STABILIZER		719456-		P-UB-1	50 mm		JD-RE20595	50.84
		-719455		P-V-1	2		JD-RE16119	26.51
		-719455		N-N-14		4	JD-RE16118	79.05
		719456-		N-N-14		100 mm	JD-RE31139	93.80
BACKHOE SWING		All		P-V-1	2		JD-RE16119	26.51
		All		N-N-14		4	JD-RE16118	79.05
LOADER BOOM LIFT		All		P-V-1	1-3/4		JD-RE16209	31.04
		All		N-N-14		3-1/2	JD-RE14517	75.78
LOADER BUCKET TILT		All		P-V-1	2		JD-RE16119	26.51
		All		N-N-14		4	JD-RE14567	81.27
STEERING		All		P-U-1	1		JD-RE14552	13.29
		All		N-N-10		2	JD-RE14551	11.45
MODEL 510C								
BACKHOE BOOM	RE15647	All		P-V-1	2-1/2		JD-RE14745	43.47
	RE15647	All		N-N-14		5	JD-RE14744	101.24
BACKHOE BUCKET	AH147722			P-UB-1	50 mm		JD-AH210484	41.20
	AH147722			N-N-14		90 mm	JD-AH212096	66.72
	AH211073			P-UB-1	50 mm		JD-AH210484	41.20
	AH211073			N-N-14		90 mm	JD-AH212096	66.72
	RE25622	All		P-UB-1	50 mm		JD-RE20595	50.84
	RE25622	All		N-N-14		90 mm	JD-AH212096	66.72
BACKHOE CROWD	AH135266	-762814		P-UB-1	63 mm		JD-RE25151	108.90
	AH135266	-762814		N-N-14		115 mm	JD-RE31140	116.75
	AH142934	762815-		P-UB-1	63 mm		JD-RE25151	108.90
	AH142934	762815-		N-N-14		115 mm	JD-AH149846	118.74
	RE21965	-762814		P-UB-1	63 mm		JD-RE25151	108.90
	RE21965	-762814		N-N-14		115 mm	JD-RE31140	116.75
BACKHOE STABILIZER	RE26578	All		P-UB-1	50 mm		JD-RE20595	50.84
	RE26578	All		N-N-14		100 mm	JD-AH137687	70.51
BACKHOE SWING	RE15638	-737926		P-V-1	2		JD-RE16119	26.51

LA - Long Arm LGP - Low Ground Pressure LT - Long Track MFWD - Mechanical Front Wheel Drive MP - Multi-Purpose
 IDM - Inside Dozer Mount ODM - Outside Dozer Mount SLF - Super Long Front STD - Straight Dozer WT - Wide Track

Replacement Kits For

JOHN DEERE

Backhoe Loaders								
APPLICATION	CYL #	SERIAL #	Misc	CODE	ROD	BORE	KIT #	List \$
MODEL 510C								
BACKHOE SWING	RE15638	-737926		N-N-14		4	JD-RE16118	79.05
	RE33472	737927-		P-UB-1	50 mm		JD-RE20595	50.84
	RE33472	737927-		N-N-14		100 mm	JD-AH137687	70.51
BUCKET (MP)				I-U-10	2	3	JD-AT190898	82.34
DIPPER EXTENSION	AT84174	All		I-U-5	1-1/2	3	JD-AT79722	46.59
LOADER BOOM LIFT	AH138931	All		P-UB-1	45 mm		JD-RE20434	57.55
	AH138931			N-N-14		90 mm	JD-RE20430	48.01
	RE21959	All		P-UB-1	45 mm		JD-RE20434	57.55
	RE21959	All		N-N-14		90 mm	JD-RE20430	48.01
LOADER BUCKET TILT	RE21966	All		P-UB-1	50 mm		JD-RE20595	50.84
	RE38230	All		N-N-14		100 mm	JD-AH137687	70.51
LOADER CLAM	AT142578	769393-		P-U-10	2	3	JD-AT142582	48.49
STEERING (Hydrostatic)	AT108335	749406-		I-U-10	32 mm	60 mm	JD-AT108329	43.56
	AT76403	-749405		I-U-10	25 mm	50 mm	JD-AT78498	55.07
STEERING (Power)	AH139130			P-UB-1	25 mm		JD-RE21875	50.17
	AH139130			N-N-10		2	JD-AH137789	6.12
	RE18712		Flame Cut Head	P-U-1	1		JD-RE14552	13.29
	RE18712		Flame Cut Head	N-N-10		2	JD-RE14551	11.45
	RE21961	-746966	Forged Head	P-UB-1	25 mm		JD-RE21875	50.17
	RE21961	-746966	Forged Head	N-N-14		50 mm	JD-RE21874	48.93
	RE33803	746967-		P-UB-1	25 mm		JD-RE21875	50.17
	RE33803	746967-		N-N-14		50 mm	JD-RE33803	53.31
	MODEL 510D							
BACKHOE BOOM	RE15647	All		P-V-1	2-1/2		JD-RE14745	43.47
	RE15647	All		N-N-14		5	JD-RE14744	101.24
BACKHOE BUCKET	RE25622	All		P-UB-1	45 mm		JD-RE20434	57.55
	RE25622	All		N-N-14		90 mm	JD-RE20430	48.01
BACKHOE CROWD	AH135266	All		P-UB-1	63 mm		JD-RE25151	108.90
	AH135266	All		N-N-14		115 mm	JD-RE31140	116.75
BACKHOE STABILIZER	AH135635	All		P-UB-1	50 mm		JD-RE20595	50.84
	AH135635	All		N-N-14		100 mm	JD-AH137687	70.51
	AH135636			P-UB-1	50 mm		JD-RE20595	50.84
	AH135636			N-N-14		100 mm	JD-AH137687	70.51
BACKHOE SWING	RE33472	All		P-UB-1	50 mm		JD-RE20595	50.84
	RE33472	All		N-N-14		100 mm	JD-AH137687	70.51
DIPPER EXTENSION	AH141378			P-UB-1	45 mm		JD-RE20434	57.55
	AH141378			N-N-10		80 mm	JD-RE37003	15.03
	AT84174			I-U-5	1-1/2	3	JD-AT79722	46.59
LOADER BOOM LIFT	AH138931	All		P-UB-1	45 mm		JD-RE20434	57.55
	AH138931	All		N-N-14		90 mm	JD-RE20430	48.01
LOADER BUCKET TILT	RE38230	All		P-UB-1	50 mm		JD-RE20595	50.84
	RE38230	All		N-N-14		100 mm	JD-AH137687	70.51
LOADER CLAM	AT142578	All		P-U-10	2	3	JD-AT142582	48.49
STEERING	AT195570			I-U-10	36 mm	65 mm	JD-T153744	97.82
STEERING (Power)	AH134479	780659-		P-UB-1	25 mm		JD-RE21875	50.17
	AH134479	780659-		N-N-10		2-1/4	JD-RE30100	6.51
	AH139130	-780658		P-UB-1	25 mm		JD-RE21875	50.17
	AH139130	-780658		N-N-10		2	JD-AH137789	6.12
MODEL 515B								
BACKHOE BOOM		All		P-V-1	2-1/4		JD-RE14208	37.91
		All		N-N-14		4-1/2	JD-RE14523	82.00
BACKHOE BUCKET		All		P-V-1	2-1/4		JD-RE14538	28.42
		All		N-N-14		3-1/2	JD-RE16076	76.63
BACKHOE CROWD		All		P-U-1	2-1/4		JD-AH139417	39.76
		All		N-N-14		4-1/2	JD-RE14523	82.00

LA - Long Arm LGP - Low Ground Pressure LT - Long Track MFWD - Mechanical Front Wheel Drive MP - Multi-Purpose
 IDM - Inside Dozer Mount ODM - Outside Dozer Mount SLF - Super Long Front STD - Straight Dozer WT - Wide Track

Replacement Kits For

JOHN DEERE

Backhoe Loaders								
APPLICATION	CYL #	SERIAL #	Misc	CODE	ROD	BORE	KIT #	List \$
MODEL 515B								
BACKHOE STABILIZER		All		N-N-14		3	JD-RE14082	70.14
BACKHOE SWING		All		P-U-1	2		JD-RE14556	25.19
		All		N-N-10		4	JD-RE14555	76.25
LOADER BOOM LIFT		All		P-V-1	1-3/4		JD-RE16209	31.04
		All		N-N-14		3-1/2	JD-RE14517	75.78
LOADER BUCKET TILT		All		P-V-1	2		JD-RE16119	26.51
		All		N-N-14		4	JD-RE14567	81.27
STEERING		All		P-U-1	1		JD-RE14552	13.29
		All		N-N-10		2	JD-RE14551	11.45
MODEL 610B								
BACKHOE BOOM		All		P-V-1	2-1/2		JD-RE14745	43.47
		All		N-N-14		5	JD-RE14744	101.24
BACKHOE BUCKET		All		P-V-1	2-1/4		JD-RE14538	28.42
		All		N-N-14		3-1/2	JD-RE16076	76.63
BACKHOE CROWD		All		P-V-1	2-1/4		JD-RE14208	37.91
		All		N-N-14		4-1/2	JD-RE14094	82.00
BACKHOE STABILIZER		-719557		P-V-1	2		JD-RE16119	26.51
		719558-		P-UB-1	50 mm		JD-RE20595	50.84
		-719557		N-N-14		4	JD-RE16118	79.05
		719558-		N-N-14		100 mm	JD-RE31139	93.80
BACKHOE SWING		All		P-V-1	2		JD-RE16119	26.51
		All		N-N-14		4	JD-RE16118	79.05
LOADER BOOM LIFT		All		P-V-1	1-3/4		JD-RE16209	31.04
		All		N-N-14		3-1/2	JD-RE14517	75.78
LOADER BUCKET TILT		All		P-V-1	2		JD-RE16119	26.51
		All		N-N-14		4	JD-RE14567	81.27
STEERING		All		P-U-1	1		JD-RE14552	13.29
		All		N-N-10		2	JD-RE14551	11.45
MODEL 610C								
BACKHOE BOOM	RE15647	All		P-V-1	2-1/2		JD-RE14745	43.47
	RE15647	All		N-N-14		5	JD-RE14744	101.24
BACKHOE BUCKET	AH147722			P-UB-1	50 mm		JD-AH210484	41.20
	AH147722			N-N-14		90 mm	JD-AH212096	66.72
	AH211073			P-UB-1	50 mm		JD-AH210484	41.20
	AH211073			N-N-14		90 mm	JD-AH212096	66.72
	RE25622	All		P-UB-1	50 mm		JD-RE20595	50.84
	RE25622	All		N-N-14		90 mm	JD-AH212096	66.72
BACKHOE CROWD	AH135266			P-UB-1	63 mm		JD-RE25151	108.90
	AH135266			N-N-14		115 mm	JD-RE31140	116.75
	AH142934	762815-		P-UB-1	63 mm		JD-RE25151	108.90
	AH142934	762815-		N-N-14		115 mm	JD-AH149846	118.74
	RE21965	-762814		P-UB-1	63 mm		JD-RE25151	108.90
	RE21965	-762814		N-N-14		115 mm	JD-RE31140	116.75
BACKHOE STABILIZER	RE26578	All		P-UB-1	50 mm		JD-RE20595	50.84
	RE26578	All		N-N-14		100 mm	JD-AH137687	70.51
BACKHOE SWING	RE15638	-737926		P-V-1	2		JD-RE16119	26.51
	RE15638	-737926		N-N-14		4	JD-RE16118	79.05
	RE33472	737927		P-UB-1	50 mm		JD-RE20595	50.84
	RE33472	737927		N-N-14		100 mm	JD-AH137687	70.51
BUCKET (MP)				I-U-10	2	3	JD-AT190898	82.34
DIPPER EXTENSION	AT84174	All		I-U-5	1-1/2	3	JD-AT79722	46.59
LOADER BOOM LIFT	AH138931	All		P-UB-1	45 mm		JD-RE20434	57.55
	AH138931	All		N-N-14		90 mm	JD-RE20430	48.01
	RE21959	All		P-UB-1	45 mm		JD-RE20434	57.55
	RE21959	All		N-N-14		90 mm	JD-RE20430	48.01

LA - Long Arm LGP - Low Ground Pressure LT - Long Track MFWD - Mechanical Front Wheel Drive MP - Multi-Purpose
 IDM - Inside Dozer Mount ODM - Outside Dozer Mount SLF - Super Long Front STD - Straight Dozer WT - Wide Track

Replacement Kits For

JOHN DEERE

Backhoe Loaders								
APPLICATION	CYL #	SERIAL #	Misc	CODE	ROD	BORE	KIT #	List \$
MODEL 610C								
LOADER BUCKET TILT	RE21966	All		P-UB-1	50 mm		JD-RE20595	50.84
	RE21966	All		N-N-14		100 mm	JD-AH137687	70.51
	RE38230	All		P-UB-1	50 mm		JD-RE20595	50.84
	RE38230	All		N-N-14		100 mm	JD-AH137687	70.51
LOADER CLAM	AT142578	769393-		P-U-10	2	3	JD-AT142582	48.49
STEERING (Hydrostatic)	AT108335	749406-		I-U-10	32 mm	60 mm	JD-AT108329	43.56
	AT76403	-749405		I-U-10	25 mm	50 mm	JD-AT78498	55.07
STEERING (Power)	AH139130			P-UB-1	25 mm		JD-RE21875	50.17
	AH139130			N-N-10		2	JD-AH137789	6.12
	RE18712		Flame Cut Head	P-U-1	1		JD-RE14552	13.29
	RE18712		Flame Cut Head	N-N-10		2	JD-RE14551	11.45
	RE21961	-746966	Forged Head	P-UB-1	25 mm		JD-RE21875	50.17
	RE21961	-746966	Forged Head	N-N-14		50 mm	JD-RE21874	48.93
	RE33803	746967-		P-UB-1	25 mm		JD-RE21875	50.17
	RE33803	746967-		N-N-14		50 mm	JD-RE33803	53.31
MODEL 710B								
BACKHOE BOOM		All		P-U-1	2-3/4		JD-RE14880	44.31
		All		N-N-14		6	JD-RE14879	126.33
BACKHOE BUCKET		All		P-U-1	2-1/2		JD-RE14516	38.13
		All		N-N-14		4	JD-RE14567	81.27
BACKHOE CROWD		All		P-V-1	2-3/4		JD-RE14878	48.57
		All		N-N-14		5-1/2	JD-RE14877	123.45
BACKHOE STABILIZER		All		P-V-1	2-1/2		JD-RE14745	43.47
		All		N-N-14		4-1/2	JD-RE14094	82.00
BACKHOE SWING		All		P-U-1	2-1/4		JD-AH139417	39.76
		All		N-N-14		4-1/2	JD-RE14523	82.00
LOADER BOOM LIFT		All		P-V-1	2		JD-RE30817	32.31
		All		N-N-14		3-3/4	JD-RE14771	64.29
LOADER BUCKET TILT		All		P-V-1	2		JD-RE16119	26.51
		All		N-N-14		4-1/2	JD-RE14523	82.00
STEERING		All		P-U-1	1-1/4		JD-RE14773	23.31
		All		N-N-10		2-3/4	JD-RE14772	17.88
MODEL 710C								
BACKHOE BOOM	AH136547			P-UB-1	80 mm		JD-RE25152	159.41
	AH136547			N-N-14		160 mm	JD-AH137210	125.91
	AH142928			P-UB-1	80 mm		JD-RE25152	159.41
	AH142928			N-N-14		160 mm	JD-AH137210	125.91
BACKHOE BUCKET	AH140866			P-UB-1	63 mm		JD-AH134477	103.17
	AH140866			N-N-14		100 mm	JD-AH149844	84.21
	AH142927			P-UB-1	63 mm		JD-RE25151	108.90
	AH142927			N-N-14		100 mm	JD-AH149844	84.21
BACKHOE CROWD	AH136539			P-UB-1	70 mm		JD-RE37462	171.38
	AH136539			N-N-14		140 mm	JD-AH137209	144.45
BACKHOE STABILIZER	AH154791			P-UB-1	63 mm		JD-AH149815	59.57
	AH154791			N-N-14		115 mm	JD-AH149846	118.74
	RE36942			P-UB-1	63 mm		JD-RE28899	103.89
	RE36942			N-N-14		115 mm	JD-AH149846	118.74
BACKHOE SWING	AH139415			P-U-1	2-1/4		JD-AH139417	39.76
	AH139415			N-N-14		4-1/2	JD-RE14523	82.00
	AH141405			P-UB-1	56 mm		JD-RE31716	88.77
	AH141405			N-N-14		115 mm	JD-AH149846	118.74
	AH154781			P-UB-1	56 mm		JD-AH149814	58.53
	AH154781			N-N-14		115 mm	JD-AH149846	118.74
	AR104407	-704673		P-U-1	2-1/4		JD-AH139417	39.76
	AR104407	-704673		N-N-14		4-1/2	JD-RE14523	82.00

LA - Long Arm LGP - Low Ground Pressure LT - Long Track MFWD - Mechanical Front Wheel Drive MP - Multi-Purpose
 IDM - Inside Dozer Mount ODM - Outside Dozer Mount SLF - Super Long Front STD - Straight Dozer WT - Wide Track

Replacement Kits For

JOHN DEERE

Backhoe Loaders								
APPLICATION	CYL #	SERIAL #	Misc	CODE	ROD	BORE	KIT #	List \$
MODEL 710C								
BACKHOE SWING	RE15499	-704673		P-U-1	2-1/4		JD-AH139417	39.76
	RE15499	-704673		N-N-14		4-1/2	JD-RE14523	82.00
EXT DIPPERSTICK	AH155668			I,P-UB-1	45 mm		JD-AH149813	59.46
	AH155668			N-N-10		80 mm	JD-RE37003	15.03
LOADER BOOM	AH154789			P-UB-1	56 mm		JD-AH149814	58.53
	AH154789			N-N-14		100 mm	JD-AH137687	70.51
	RE32557			P-UB-1	56 mm		JD-RE31716	88.77
	RE32557			N-N-14		100 mm	JD-AH137687	70.51
LOADER BUCKET	AH154792			P-UB-1	56 mm		JD-AH149814	58.53
	AH154792			N-N-14		115 mm	JD-AH149846	118.74
	RE37702			P-UB-1	56 mm		JD-RE31716	88.77
	RE37702			N-N-14		115 mm	JD-AH149846	118.74
MULTI-PURPOSE	AT142582	768252-		P-U-10	2	3	JD-AT142582	48.49
STEERING (Power)	AH154794			I-U-1	32 mm		JD-AH148823	41.35
	AH154794			N-N-14		70 mm	JD-RE20428	42.40
	RE38529			P-UB-1	32 mm		JD-RE21873	48.97
	RE38529			N-N-14		70 mm	JD-RE20428	42.40
MODEL 710D								
BACKHOE BOOM	AH142928			P-UB-1	80 mm		JD-RE25152	159.41
	AH142928			N-N-14		160 mm	JD-AH137210	125.91
BACKHOE BUCKET	AH142927			P-UB-1	63 mm		JD-RE25151	108.90
	AH142927			N-N-14		100 mm	JD-AH149844	84.21
BACKHOE CROWD	AH142926			P-UB-1	70 mm		JD-AH142089	188.73
	AH142926			N-N-14		140 mm	JD-AH137209	144.45
BACKHOE STABILIZER	AH154791	831990-		P-UB-1	63 mm		JD-AH149815	59.57
	AH154791	831990-		N-N-14		115 mm	JD-AH149846	118.74
	RE36942			P-UB-1	63 mm		JD-RE28899	103.89
	RE36942	-831989		N-N-14		115 mm	JD-AH149846	118.74
BACKHOE SWING	AH141405			P-UB-1	56 mm		JD-RE31716	88.77
	AH141405			N-N-14		115 mm	JD-AH149846	118.74
	AH154781			P-UB-1	56 mm		JD-AH149814	58.53
	AH154781			N-N-14		115 mm	JD-AH149846	118.74
EXT DIPPERSTICK	AH146325			P-UB-1	45 mm		JD-RE20434	57.55
	AH146325			N-N-10		80 mm	JD-RE37003	15.03
	AH155668			I,P-UB-1	45 mm		JD-AH149813	59.46
	AH155668			N-N-10		80 mm	JD-RE37003	15.03
LOADER BOOM	AH154789			P-UB-1	56 mm		JD-AH149814	58.53
	AH154789			N-N-14		100 mm	JD-AH149844	84.21
	RE32557			P-UB-1	56 mm		JD-RE31716	88.77
	RE32557			N-N-14		100 mm	JD-AH149844	84.21
LOADER BUCKET	AH154792			P-UB-1	56 mm		JD-AH149814	58.53
	AH154792			N-N-14		115 mm	JD-AH149846	118.74
	RE37702			P-UB-1	56 mm		JD-RE31716	88.77
	RE37702			N-N-14		115 mm	JD-AH149846	118.74
MULTI-PURPOSE	AT142578			P-U-10	2	3	JD-AT142582	48.49
STEERING (Power)	AH154794			I-U-1	32 mm		JD-AH148823	41.35
	AH154794			N-N-14		70 mm	JD-RE20428	42.40
	RE38529			P-UB-1	32 mm		JD-RE21873	48.97
	RE38529			N-N-14		70 mm	JD-RE20428	42.40
MODEL 710G								
BOOM				P-UB-1	95 mm		JD-AH159192	158.28
				N-N-14		160 mm	JD-AH137210	125.91
BOOM LIFT		-943817		P-UB-1	56 mm		JD-AH149814	58.53
		-943817		N-N-14		100 mm	JD-AH212101	80.14
	AH211105	943818-		P-UB-1	56 mm		JD-AH149814	58.53

LA - Long Arm LGP - Low Ground Pressure LT - Long Track MFWD - Mechanical Front Wheel Drive MP - Multi-Purpose
 IDM - Inside Dozer Mount ODM - Outside Dozer Mount SLF - Super Long Front STD - Straight Dozer WT - Wide Track

Replacement Kits For

JOHN DEERE

Backhoe Loaders								
APPLICATION	CYL #	SERIAL #	Misc	CODE	ROD	BORE	KIT #	List \$
MODEL 710G								
BOOM LIFT	AH211105	943818-		N-N-14		100 mm	JD-AH212101	80.14
BUCKET				P-UB-1	70 mm		JD-AH156466	53.69
				N-N-14		110 mm	JD-AH149845	106.21
BUCKET (MP)	AT190880	-925076		I-U-10	2	3	JD-AT190898	82.34
CROWD				N-N-14		140 mm	JD-AH216299	148.76
EXTENSION		-945479		I,P-UB-1	45 mm		JD-AH149813	59.46
		-945479		N-N-10		80 mm	JD-AH212092	36.62
	AH216318	945480-		I,P-UB-1	45 mm		JD-AH149813	59.46
	AH216318	945480-		N-N-10		80 mm	JD-AH212092	36.62
LOADER BUCKET				P-UB-1	56 mm		JD-AH149814	58.53
				N-N-14		110 mm	JD-AH212585	89.20
STABILIZER		932173-952813		P-UB-1	63 mm		JD-AH149815	59.57
		-932172		P-UB-1	63 mm		JD-AH149815	59.57
		-932172		N-N-14		115 mm	JD-AH212103	118.74
		932173-952813		N-N-14		115 mm	JD-AH212103	118.74
	AH218930	952814-		P-UB-1	63 mm		JD-AH149815	59.57
	AH218930	952814-		N-N-14		115 mm	JD-AH212103	118.74
SWING		-957322		P-UB-1	56 mm		JD-AH149814	58.53
		-957322		N-N-14		110 mm	JD-AH210287	89.20
	AH223267	957323-		P-UB-1	56 mm		JD-AH149814	58.53
	AH223267	957323-		N-N-14		110 mm	JD-AH212585	89.20
MODEL 710J								
BOOM	AH225720			P-UB-1	95 mm		JD-AH159192	158.28
	AH225720			N-N-14		160 mm	JD-AH137210	125.91
BOOM LIFT	AH211105			P-UB-1	56 mm		JD-AH149814	58.53
	AH211105			N-N-14		100 mm	JD-AH212101	80.14
BUCKET	AH220411			P-UB-1	70 mm		JD-AH156466	53.69
	AH220411			N-N-14		110 mm	JD-AH149845	106.21
CROWD	AH225656			P-UB-1	85 mm		JD-AH207190	102.90
	AH225656			N-N-14		140 mm	JD-AH216299	148.76
LOADER BUCKET	AH220446			P-UB-1	56 mm		JD-AH149814	58.53
	AH220446			N-N-14		110 mm	JD-AH212585	89.20
STABILIZER	AH218930			P-UB-1	63 mm		JD-AH149815	59.57
	AH218930			N-N-14		115 mm	JD-AH212103	118.74
SWING	AH223267			P-UB-1	56 mm		JD-AH149814	58.53
	AH223267			N-N-14		110 mm	JD-AH212585	89.20
MODEL 710K								
EXT DIPPERSTICK	AH216318			I,P-UB-1	45 mm		JD-AH149813	59.46
	AH216318			N-N-10		80 mm	JD-AH212092	36.62
LOADER BOOM	AHC11173			P-UB-1	56 mm		JD-AH149814	58.53
	AHC11173			N-N-14		100 mm	JD-AH212101	80.14
	AHC11426			P-UB-1	56 mm		JD-AH149814	58.53
	AHC11426			N-N-14		110 mm	JD-AH212585	89.20
LOADER BUCKET	AHC11426			P-UB-1	56 mm		JD-AH149814	58.53
	AHC11426			N-N-14		110 mm	JD-AH212585	89.20
LOADER COUPLER	AH234870			I-U-10	28 mm	45 mm	JD-AH176273	27.07
STEERING (MFWD)	AT191187			I-U-14	50 mm	75 mm	JD-AT301907	130.44
SWING	AH234290	169173-		P-UB-1	56 mm		JD-AH149814	58.53
	AH234290	169173-		N-N-14		110 mm	JD-AH212585	89.20
Compactors								
APPLICATION	CYL #	SERIAL #	Misc	CODE	ROD	BORE	KIT #	List \$
MODEL 646, 646B								
BOOM LIFT		All		P-V-8	2-3/4	6-1/4	JD-RE18744	141.21
BUCKET TILT		223645-		P-V-8	2-3/4	6-1/4	JD-RE18744	141.21
		-223644		P-V-8	2-1/4	4-1/2	JD-AR105355	83.97

LA - Long Arm LGP - Low Ground Pressure LT - Long Track MFWD - Mechanical Front Wheel Drive MP - Multi-Purpose
 IDM - Inside Dozer Mount ODM - Outside Dozer Mount SLF - Super Long Front STD - Straight Dozer WT - Wide Track

Replacement Kits For

JOHN DEERE

Compactors								
APPLICATION	CYL #	SERIAL #	Misc	CODE	ROD	BORE	KIT #	List \$
MODEL 646, 646B								
CLAM (MP)		223645-		P-V-8	2	4	JD-AR105387	44.97
		-223644		P-U-9	2	4	JIC-G32299	53.72
STEERING		247907-		I-U-10	3-3/4	4	JD-AT34932	42.64
STEERING LH		-247906		I-U-1	3-3/4		JD-AT34933	39.24
STEERING RH		-247906		I-U-10	3-3/4	4	JD-AT34932	42.64
MODEL 646C								
BOOM LIFT		505144-		P-V-1	2-3/4		JD-RE16991	83.60
		505144-		N-N-14		6-1/4	JD-RE14022	133.75
BUCKET TILT		505144-		P-V-1	3		JD-RE16992	63.53
		505144-		N-N-14		6-1/4	JD-RE14022	133.75
CLAM (MP)		All		P-V-8	2	4	JD-AR105387	44.97
STEERING		-505143		P-U-10	1-3/4	3-3/4	JD-AR105320	40.13
		505144-		P-V-1	1-3/4		JD-RE16209	31.04
		505144-		N-N-10		3-3/4	JD-RE17099	15.78
Crawler Dozers/Loaders								
APPLICATION	CYL #	SERIAL #	Misc	CODE	ROD	BORE	KIT #	List \$
MODEL 350, 350B								
		Bulldozer Arrangement	6300, 6305, 6310					
		Ripper Arrangement	3100, 3110					
		Backhoe Arrangement	93, 93A, 95, 95A, 9250, 9300, 9550					
		Log Loader Arrangement	7702					
3 POINT HITCH		All		P-V-8	1-1/4	2-1/2	JD-AR105453	35.68
BACKHOE BOOM		-8249	9250	P-V-8	2	4	JD-AR105387	44.97
		8250-	9250, 9550	P-V-8	2	4	JD-RE18732	46.38
		700718-	9300	P-V-14	2-1/4	4-1/2	JD-RE18764	114.16
		-700717	9300	P-V-8	2-1/4	4-1/2	JD-AR105355	83.97
		All	93, 93A, 95, 95A	P-V-8	2-1/4	4-1/2	JD-RE10640	62.91
BACKHOE BUCKET		All	9250, 9550	P-V-8	1-3/4	3	JD-RE18751	36.62
		700718-	9300	P-V-14	2-1/4	3-1/2	JD-RE18758	100.05
		-700717	93, 93A, 95, 95A, 9300	P-V-8	2-1/4	3-1/2	JD-RE18757	61.75
BACKHOE CROWD		All	9250, 9550	P-V-8	1-3/4	3-1/2	JD-RE18755	46.21
		700718-		P-V-14	2	4	JD-RE18741	97.81
		-700717	93, 93A, 95, 95A, 9300	P-V-8	2	4	JD-AR105387	44.97
BACKHOE STABILIZER		All	9300	P-V-8	2	4	JD-AR105387	44.97
		All	93, 93A, 9250, 9550	P-V-8	1-3/4	3-1/2	JD-RE18754	57.33
BACKHOE SWING		-8249	9250	P-V-8	2	4	JD-AR105393	56.83
		39797-	9550	P-U-10	1-3/4	3-1/2	JD-RE18756	48.49
		8250-	9250	P-V-8	2	4	JD-RE18732	46.38
	T60873 piston	-39796	9550	P-U-10	1-3/4	3-1/2	JD-RE18756	48.49
DOZER ANGLE		Yr 1968-	6305	P-V-8	1-1/4	3	JD-AR105454	38.30
DOZER LIFT		Yr 1968-		P-V-8	1-1/4	3	JD-AR105454	38.30
DOZER TILT		59100-	6305	P-V-8	1-1/4	2-1/2	JD-AR105453	35.68
GRAPPLE		59100-		P-V-8	1-1/2	2-1/2	JD-RE19217	30.13
LOADER BOOM LIFT		All	350B	P-V-8	2	3-3/4	JD-AR105381	43.43
		All	350	P-V-8	2	4	JD-AR105387	44.97
LOADER BUCKET TILT		All	350	P-V-8	1-1/2	2-3/4	JD-AR105430	33.37
		All	350B	P-V-8	1-1/2	2-3/4	JD-RE19222	35.83
MULTI-PURPOSE		All		P-V-8	1-3/4	3	JD-RE18751	36.62
RIPPER		59100-		P-V-8	1-1/4	2-1/2	JD-AR105453	35.68

LA - Long Arm LGP - Low Ground Pressure LT - Long Track MFWD - Mechanical Front Wheel Drive MP - Multi-Purpose
 IDM - Inside Dozer Mount ODM - Outside Dozer Mount SLF - Super Long Front STD - Straight Dozer WT - Wide Track

Replacement Kits For

JOHN DEERE

Crawler Dozers/Loaders								
APPLICATION	CYL #	SERIAL #	Misc	CODE	ROD	BORE	KIT #	List \$
MODEL 350C								
		Bulldozer Arrangement	6300, 6305, 6310					
		Ripper Arrangement	3110					
		Backhoe Arrangement	93, 93A, 9250, 9300, 9550					
		Log Loader Arrangement	7702					
3 POINT HITCH		All		P-V-8	1-1/4	2-1/2	JD-AR105453	35.68
BACKHOE BOOM			9250, 9550	P-V-8	2	4	JD-RE18732	46.38
			93, 93A	P-V-8	2-1/4	4-1/2	JD-RE10640	62.91
		700423-	9300	P-V-14	2-1/4	4-1/2	JD-RE18764	114.16
		-700422	9300	P-V-8	2-1/4	4-1/2	JD-AR105355	83.97
BACKHOE BUCKET		-700422	93, 93A, 9300	P-V-8	2-1/4	3-1/2	JD-RE18757	61.75
		700423-	9300	P-V-14	2-1/4	3-1/2	JD-RE18758	100.05
		All	9250, 9550	P-V-8	1-3/4	3	JD-RE18751	36.62
BACKHOE CROWD		-700422	93, 93A, 9300	P-V-8	2	4	JD-AR105387	44.97
		700423-	9300	P-V-14	2	4	JD-RE18741	97.81
		All	9250, 9550	P-V-8	1-3/4	3-1/2	JD-RE18755	46.21
BACKHOE STABILIZER		All	93, 93A, 9250, 9550	P-V-8	1-3/4	3-1/2	JD-RE18754	57.33
		All	9300	P-V-8	2	4	JD-AR105387	44.97
BACKHOE SWING		39797-		P-U-10	1-3/4	3-1/2	JD-RE18756	48.49
		All	9250	P-V-8	2	4	JD-RE18732	46.38
		T60873 piston	-39796	9550	P-U-10	1-3/4	3-1/2	JD-RE18756
DOZER ANGLE		All	6305	P-V-8	1-1/4	3	JD-AR105454	38.30
DOZER LIFT		All		P-V-8	1-1/4	3	JD-AR105454	38.30
DOZER TILT		All	6305	P-V-8	1-1/4	2-1/2	JD-AR105453	35.68
GRAPPLE		All		P-V-8	1-1/2	2-1/2	JD-RE19217	30.13
LOADER BOOM LIFT		All		P-V-8	2	3-3/4	JD-AR105381	43.43
LOADER BUCKET TILT		All		P-V-8	1-1/2	2-3/4	JD-RE19222	35.83
MULTI-PURPOSE		All		P-V-8	1-3/4	3	JD-RE18751	36.62
RIPPER		All		P-V-8	1-1/4	2-1/2	JD-AR105453	35.68
MODEL 350D								
3 POINT HITCH		All		P-V-8	1-1/4	2-1/2	JD-AR105453	35.68
BACKHOE BOOM		All	9550	P-V-8	2	4	JD-RE18732	46.38
		700718-	9300	P-V-14	2-1/4	4-1/2	JD-RE18764	114.16
		-700717	9300	P-V-8	2-1/4	4-1/2	JD-AR105355	83.97
BACKHOE BUCKET		-700717	9300	P-V-8	2-1/4	3-1/2	JD-RE18757	61.75
		700718-	9300	P-V-14	2-1/4	3-1/2	JD-RE18758	100.05
		All	9550	P-V-8	1-3/4	3	JD-RE18751	36.62
BACKHOE CROWD		700718-	9300	P-V-14	2	4	JD-RE18741	97.81
		-700717	9300	P-V-8	2	4	JD-AR105387	44.97
		All		P-V-8	1-3/4	3-1/2	JD-RE18755	46.21
BACKHOE STABILIZER		All	9550	P-V-8	1-3/4	3-1/2	JD-RE18754	57.33
		All	9300	P-V-8	2	4	JD-AR105387	44.97
BACKHOE SWING		All	9550	P-U-10	1-3/4	3-1/2	JD-RE18756	48.49
DOZER ANGLE		All	6305	P-V-8	1-1/4	3	JD-AR105454	38.30
DOZER LIFT		All		P-V-8	1-1/4	3	JD-AR105454	38.30
DOZER TILT		All	6305	P-V-8	1-1/4	2-1/2	JD-AR105453	35.68
MODEL 355D								
3 POINT HITCH		All		P-V-8	1-1/4	2-1/2	JD-AR105453	35.68
BACKHOE BOOM		All	9550	P-V-8	2	4	JD-RE18732	46.38
		700718-	9300	P-V-14	2-1/4	4-1/2	JD-RE18764	114.16
		-700717	9300	P-V-8	2-1/4	4-1/2	JD-AR105355	83.97
BACKHOE BUCKET		All	9550	P-V-8	1-3/4	3	JD-RE18751	36.62
		700718-	9300	P-V-14	2-1/4	3-1/2	JD-RE18758	100.05
		-700717	9300	P-V-8	2-1/4	3-1/2	JD-RE18757	61.75
BACKHOE CROWD		All		P-V-8	1-3/4	3-1/2	JD-RE18755	46.21

LA - Long Arm LGP - Low Ground Pressure LT - Long Track MFWD - Mechanical Front Wheel Drive MP - Multi-Purpose
 IDM - Inside Dozer Mount ODM - Outside Dozer Mount SLF - Super Long Front STD - Straight Dozer WT - Wide Track

Replacement Kits For

JOHN DEERE

Crawler Dozers/Loaders								
APPLICATION	CYL #	SERIAL #	Misc	CODE	ROD	BORE	KIT #	List \$
MODEL 355D								
BACKHOE CROWD		700718-	9300	P-V-14	2	4	JD-RE18741	97.81
		-700717	9300	P-V-8	2	4	JD-AR105387	44.97
BACKHOE STABILIZER		All	9300	P-V-8	2	4	JD-AR105387	44.97
		All	9550	P-V-8	1-3/4	3-1/2	JD-RE18754	57.33
BACKHOE SWING		All	9550	P-U-10	1-3/4	3-1/2	JD-RE18756	48.49
LOADER BOOM LIFT		All		P-V-8	2	3-3/4	JD-AR105381	43.43
LOADER BUCKET TILT		All		P-V-8	1-1/2	2-3/4	JD-RE19222	35.83
MULTI-PURPOSE		All		P-V-8	1-3/4	3	JD-RE18751	36.62
MODEL 450, 450B								
		Bulldozer Arrangement	6400, 6405, 6410, 6415					
		Ripper Arrangement	3100, 3110					
		Backhoe Arrangement	93, 93A, 95, 95A, 9250, 9300, 9550					
		Log Loader Arrangement	7712					
BACKHOE BOOM		-8249	9250	P-V-8	2	4	JD-AR105387	44.97
		8250-	9250, 9550	P-V-8	2	4	JD-RE18732	46.38
		700718-	9300	P-V-14	2-1/4	4-1/2	JD-RE18764	114.16
		-700717	9300	P-V-8	2-1/4	4-1/2	JD-AR105355	83.97
		All	93, 93A, 95, 95A	P-V-8	2-1/4	4-1/2	JD-RE10640	62.91
BACKHOE BUCKET		-700717	93, 93A, 95, 95A, 9300	P-V-8	2-1/4	3-1/2	JD-RE18757	61.75
		700718-	9300	P-V-14	2-1/4	3-1/2	JD-RE18758	100.05
		All	9250, 9550	P-V-8	1-3/4	3	JD-RE18751	36.62
BACKHOE CROWD		All	9250, 9550	P-V-8	1-3/4	3-1/2	JD-RE18755	46.21
		700718-	9300	P-V-14	2	4	JD-RE18741	97.81
		-700717	93, 93A, 95, 95A, 9300	P-V-8	2	4	JD-AR105387	44.97
BACKHOE STABILIZER		All	9300	P-V-8	2	4	JD-AR105387	44.97
		All	93, 93A, 9250, 9550	P-V-8	1-3/4	3-1/2	JD-RE18754	57.33
		All	95, 95A	P-V-8	1-3/4	3	JD-RE18751	36.62
BACKHOE SWING		-8249	9250	P-V-8	2	4	JD-AR105393	56.83
		8250-	9250	P-V-8	2	4	JD-RE18732	46.38
		39797-	9550	P-U-10	1-3/4	3-1/2	JD-RE18756	48.49
		T60873 piston	-39796	9550	P-U-10	1-3/4	3-1/2	JD-RE18756
DOZER ANGLE		All	6405	P-V-8	1-1/2	3-1/2	JD-AR105432	44.84
DOZER LIFT		All		P-V-8	1-1/2	3-1/2	JD-AR105432	44.84
DOZER TILT			6415	P-V-8	2-1/4	4-1/2	JD-AR105355	83.97
			6405	P-V-8	1-1/2	3-1/2	JD-AR105432	44.84
		4pc Piston Seal	6415	P-V-1	2-1/4		JD-RE14208	37.91
		4pc Piston Seal	6415	N-N-14		4-1/2	JD-RE14094	82.00
GRAPPLE		All		P-V-8	1-3/4	3-1/2	JD-RE18754	57.33
GRAPPLE CLAMP		All		P-V-8	2-1/4	5-1/4	JD-AR105346	71.15
LOADER BOOM LIFT		All	450B	P-V-8	2-1/4	4-1/4	JD-RE18739	57.78
		All	450	P-V-8	2-1/4	4-1/2	JD-RE10640	62.91
LOADER BUCKET TILT		All	450B	P-V-8	2	3-1/2	JD-RE18748	55.25
		All	450	P-V-8	2	3-1/2	JD-AR105392	39.37
MULTI-PURPOSE		All		P-V-8	2	4	JD-AR105387	44.97
RIPPER		59100-		P-V-8	1-1/4	2-1/2	JD-AR105453	35.68
MODEL 450C								
		Bulldozer Arrangement	6400, 6405, 6410, 6415					
		Ripper Arrangement	3110					
		Backhoe Arrangement	93, 93A, 95, 95A, 9250, 9300, 9550					
		Log Loader Arrangement	7712					
BACKHOE BOOM		All	93, 93A, 95, 95A	P-V-8	2-1/4	4-1/2	JD-RE10640	62.91
		All	9250, 9550	P-V-8	2	4	JD-RE18732	46.38

LA - Long Arm LGP - Low Ground Pressure LT - Long Track MFWD - Mechanical Front Wheel Drive MP - Multi-Purpose
 IDM - Inside Dozer Mount ODM - Outside Dozer Mount SLF - Super Long Front STD - Straight Dozer WT - Wide Track

Replacement Kits For

JOHN DEERE

Crawler Dozers/Loaders								
APPLICATION	CYL #	SERIAL #	Misc	CODE	ROD	BORE	KIT #	List \$
MODEL 450C								
		Bulldozer Arrangement	6400, 6405, 6410, 6415					
		Ripper Arrangement	3110					
		Backhoe Arrangement	93, 93A, 95, 95A, 9250, 9300, 9550					
		Log Loader Arrangement	7712					
BACKHOE BOOM		-700385	9300	P-V-8	2-1/4	4-1/2	JD-AR105355	83.97
		700386-	9300	P-V-14	2-1/4	4-1/2	JD-RE18764	114.16
BACKHOE BUCKET		All	9250, 9550	P-V-8	1-3/4	3	JD-RE18751	36.62
		-700385	93, 93A, 95, 95A, 9300	P-V-8	2-1/4	3-1/2	JD-RE18757	61.75
		700386-	9300	P-V-14	2-1/4	3-1/2	JD-RE18758	100.05
BACKHOE CROWD		700386-	9300	P-V-14	2	4	JD-RE18741	97.81
		All		P-V-8	1-3/4	3-1/2	JD-RE18755	46.21
		-700385	93, 93A, 95, 95A, 9300	P-V-8	2	4	JD-AR105387	44.97
BACKHOE STABILIZER		All	93, 93A, 9250, 9550	P-V-8	1-3/4	3-1/2	JD-RE18754	57.33
		All	95, 95A	P-V-8	1-3/4	3	JD-RE18751	36.62
		All	9300	P-V-8	2	4	JD-AR105387	44.97
BACKHOE SWING		39797-	9550	P-U-10	1-3/4	3-1/2	JD-RE18756	48.49
		All	9250	P-V-8	2	4	JD-RE18732	46.38
	T60873 piston	-39796	9550	P-U-10	1-3/4	3-1/2	JD-RE18756	48.49
DOZER ANGLE		All	6405	P-V-8	1-1/2	3-1/2	JD-AR105432	44.84
DOZER LIFT		All		P-V-8	1-1/2	3-1/2	JD-AR105432	44.84
DOZER TILT		All	6415	P-V-8	2-1/4	4-1/2	JD-AR105355	83.97
		All	6405	P-V-8	1-1/2	3-1/2	JD-AR105432	44.84
		Field Replacement	6415	P-V-1	2-1/4		JD-RE14208	37.91
		Field Replacement	6415	N-N-14		4-1/2	JD-RE14094	82.00
GRAPPLE		All		P-V-8	1-3/4	3-1/2	JD-RE18754	57.33
GRAPPLE CLAMP		All		P-V-8	2-1/4	5-1/4	JD-AR105346	71.15
LOADER BOOM LIFT		All		P-V-8	2-1/4	4-1/4	JD-RE18739	57.78
LOADER BUCKET TILT		-205020		P-V-8	2	3-1/2	JD-RE18748	55.25
		205021-		P-V-8	1-3/4	3-1/2	JD-RE18754	57.33
MULTI-PURPOSE		All		P-V-8	2	4	JD-AR105387	44.97
RIPPER		All		P-V-8	1-1/4	2-1/2	JD-AR105453	35.68
MODEL 450D, 450E								
BACKHOE BOOM		All	9550	P-V-8	2	4	JD-RE18732	46.38
		700718-	9300	P-V-14	2-1/4	4-1/2	JD-RE18764	114.16
		-700717	9300	P-V-8	2-1/4	4-1/2	JD-AR105355	83.97
BACKHOE BUCKET		-700717	9300	P-V-8	2-1/4	3-1/2	JD-RE18757	61.75
		700718-	9300	P-V-14	2-1/4	3-1/2	JD-RE18758	100.05
		All	9550	P-V-8	1-3/4	3	JD-RE18751	36.62
BACKHOE CROWD		All	9550	P-V-8	1-3/4	3-1/2	JD-RE18755	46.21
		700718-	9300	P-V-14	2	4	JD-RE18741	97.81
		-700717	9300	P-V-8	2	4	JD-AR105387	44.97
BACKHOE STABILIZER		All	9300	P-V-8	2	4	JD-AR105387	44.97
		All	9550	P-V-8	1-3/4	3-1/2	JD-RE18754	57.33
BACKHOE SWING		All	9550	P-U-10	1-3/4	3-1/2	JD-RE18756	48.49
DOZER ANGLE		All	6405	P-V-8	1-1/2	3-1/2	JD-AR105432	44.84
DOZER LIFT		All		P-V-8	1-1/2	3-1/2	JD-AR105432	44.84
DOZER TILT		All	6405	P-V-8	1-1/2	3-1/2	JD-AR105432	44.84
		-712333	6415	P-V-8	2-1/4	4-1/2	JD-AR105355	83.97
		712334-	6415	P-V-1	2-1/4		JD-RE14208	37.91
		712334-	6415	N-N-14		4-1/2	JD-RE14094	82.00
MODEL 450G								
DOZER ANGLE	AH137775	-822210		P-UB-1	40 mm		JD-RE20433	57.19

JOHN DEERE

LA - Long Arm LGP - Low Ground Pressure LT - Long Track MFWD - Mechanical Front Wheel Drive MP - Multi-Purpose
 IDM - Inside Dozer Mount ODM - Outside Dozer Mount SLF - Super Long Front STD - Straight Dozer WT - Wide Track

Replacement Kits For

JOHN DEERE

Crawler Dozers/Loaders									
APPLICATION	CYL #	SERIAL #	Misc	CODE	ROD	BORE	KIT #	List \$	
MODEL 450G									
DOZER ANGLE	AH137775	-822210		N-N-14		70 mm	JD-RE20428	42.40	
	AH149949	-846913		I,P-UB-1	40 mm		JD-AH149194	49.62	
	AH149949	-846913		N-N-14		70 mm	JD-RE20428	42.40	
	AH161764	All		I,P-UB-1	40 mm		JD-AH149194	49.62	
	AH161764	All		N-N-10		70 mm	JD-RE37004	10.55	
DOZER ANGLE (WT)	AH137776	All		P-UB-1	45 mm		JD-RE20434	57.55	
	AH137776	All		N-N-14		80 mm	JD-AH149842	67.24	
	AH149950	-846912		I,P-UB-1	45 mm		JD-AH149813	59.46	
	AH149950	-846912		N-N-14		80 mm	JD-AH149842	67.24	
	AH161770	846913-		I,P-UB-1	45 mm		JD-AH149813	59.46	
	AH161770	846913-		N-N-10		80 mm	JD-RE37003	15.03	
DOZER LIFT	AH150067	-822042		P-UB-1	40 mm		JD-RE20433	57.19	
	AH150067	-822042		N-N-14		80 mm	JD-AH212091	84.66	
	AH161767	847000-		I,P-UB-1	40 mm		JD-AH149194	49.62	
	AH161767	822043-846999		I,P-UB-1	40 mm		JD-AH149194	49.62	
	AH161767	847000-		N-N-10		80 mm	JD-AH212092	36.62	
	AH161767	822043-846999		N-N-14		80 mm	JD-AH212091	84.66	
	RE28350	-822042		P-UB-1	40 mm		JD-RE20433	57.19	
	RE28350	-822042		N-N-14		80 mm	JD-AH149842	67.24	
DOZER LIFT (WT) (LGP)	AH143026	790251-822042		P-UB-1	40 mm		JD-RE20433	57.19	
	AH143026	790251-822042		N-N-14		80 mm	JD-AH149842	67.24	
	AH150066	790251-822042		P-UB-1	40 mm		JD-RE20433	57.19	
	AH150066	790251-822042		N-N-14		80 mm	JD-AH212091	84.66	
	AH161762	822043-846842		I,P-UB-1	40 mm		JD-AH149194	49.62	
	AH161762	846843-		I,P-UB-1	40 mm		JD-AH149194	49.62	
	AH161762	822043-846842		N-N-14		80 mm	JD-AH212091	84.66	
	AH161762	846843-		N-N-10		80 mm	JD-AH212092	36.62	
RIPPER	AU41772	59100-		P-V-8	1-1/4	2-1/2	JD-AR105453	35.68	
TILT	AH151379	822043-846913		I,P-UB-1	45 mm		JD-AH149813	59.46	
	AH151379	822043-846913		N-N-14		90 mm	JD-AH149843	66.72	
	AH161772	846914-		I,P-UB-1	45 mm		JD-AH149813	59.46	
	AH161772	846914-		N-N-10		90 mm	JD-AH134955	14.00	
	RE35814	-822042		P-UB-1	45 mm		JD-RE20434	57.55	
	RE35814	-822042		N-N-14		90 mm	JD-AH149843	66.72	
MODEL 450H									
BLADE ANGLE	AH216716			P-UB-14	40 mm	63 mm	JD-AH153497	128.99	
	AH216716			N-N-10		2-1/2	JD-AH212088	13.29	
BLADE LIFT	AH150349	-925555		I,P-UB-1	40 mm		JD-AH149194	49.62	
	AH150349	-925555		N-N-10		80 mm	JD-RE37003	15.03	
	AH210530	925556-		I,P-UB-1	40 mm		JD-AH149194	49.62	
	AH210530	925556-		N-N-10		80 mm	JD-AH212092	36.62	
BLADE TILT	AH150351	-925555		I,P-UB-1	45 mm		JD-AH149813	59.46	
	AH150351	-925555		N-N-10		90 mm	JD-AH212097	15.75	
	AH211381	925556-		I,P-UB-1	45 mm		JD-AH149813	59.46	
	AH211381	925556-		N-N-10		90 mm	JD-AH212097	15.75	
MODEL 450J									
BLADE ANGLE		102818-XXXXXX		P-UB-14	40 mm	63 mm	JD-AH153497	128.99	
		-102817		P-UB-14	40 mm	63 mm	JD-AH153497	128.99	
		102818-XXXXXX		N-N-10		2-1/2	JD-AH212088	13.29	
		-102817		N-N-10		2-1/2	JD-AH212088	13.29	
		AH216716	XXXXXX-		P-UB-14	40 mm	63 mm	JD-AH153497	128.99
		AH216716	XXXXXX-		N-N-10		2-1/2	JD-AH212088	13.29
		ALL			P-UB-14	40 mm	63 mm	JD-AH153497	128.99
BLADE LIFT	AH211370			I,P-UB-1	40 mm		JD-AH149194	49.62	
	AH211370			N-N-10		80 mm	JD-AH212092	36.62	

LA - Long Arm LGP - Low Ground Pressure LT - Long Track MFWD - Mechanical Front Wheel Drive MP - Multi-Purpose
 IDM - Inside Dozer Mount ODM - Outside Dozer Mount SLF - Super Long Front STD - Straight Dozer WT - Wide Track

Replacement Kits For

JOHN DEERE

Crawler Dozers/Loaders								
APPLICATION	CYL #	SERIAL #	Misc	CODE	ROD	BORE	KIT #	List \$
MODEL 450J								
BLADE TILT	AH211381			I,P-UB-1	45 mm		JD-AH149813	59.46
	AH211381			N-N-10		90 mm	JD-AH212097	15.75
MODEL 455D, 455E								
BACKHOE BOOM		All	9550	P-V-8	2	4	JD-RE18732	46.38
		-700717	9300	P-V-8	2-1/4	4-1/2	JD-AR105355	83.97
		700718-	9300	P-V-14	2-1/4	4-1/2	JD-RE18764	114.16
BACKHOE BUCKET		-700717	9300	P-V-8	2-1/4	3-1/2	JD-RE18757	61.75
		700718-	9300	P-V-14	2-1/4	3-1/2	JD-RE18758	100.05
		All	9550	P-V-8	1-3/4	3	JD-RE18751	36.62
BACKHOE CROWD		700718-	9300	P-V-14	2	4	JD-RE18741	97.81
		All	9550	P-V-8	1-3/4	3-1/2	JD-RE18755	46.21
		-700717	9300	P-V-8	2	4	JD-AR105387	44.97
BACKHOE STABILIZER		All	9300	P-V-8	2	4	JD-AR105387	44.97
		All	9550	P-V-8	1-3/4	3-1/2	JD-RE18754	57.33
BACKHOE SWING		All	9550	P-U-10	1-3/4	3-1/2	JD-RE18756	48.49
GRAPPLE CLAMP		All		P-V-8	2-1/4	5-1/4	JD-AR105346	71.15
LOADER BOOM LIFT		All		P-V-8	2-1/4	4-1/4	JD-RE18739	57.78
LOADER BUCKET TILT		All		P-V-8	1-3/4	3-1/2	JD-RE18754	57.33
MULTI-PURPOSE		All		P-V-8	2	4	JD-AR105387	44.97
MODEL 455G								
BUCKET CLAM	AH148714	All		P-UB-1	50 mm		JD-AH148164	42.87
	AH148714	All		N-N-14		100 mm	JD-AH149844	84.21
	RE25702	-822210		P-UB-1	50 mm		JD-RE20595	50.84
	RE25702	-822210		N-N-14		100 mm	JD-AH149844	84.21
LOADER BOOM	AH134483	-760572		P-UB-1	50 mm		JD-RE20595	50.84
	AH134483	760573-823917		P-UB-1	56 mm		JD-RE31716	88.77
	AH134483	-823917		N-N-14		100 mm	JD-AH149844	84.21
	AH150117	All		P-UB-1	56 mm		JD-AH149814	58.53
	AH150117	All		N-N-14		100 mm	JD-AH149844	84.21
LOADER BUCKET	AH148736	All		P-UB-1	50 mm		JD-AH148164	42.87
	AH148736	All		N-N-14		90 mm	JD-AH149843	66.72
	RE28353	-802210		P-UB-1	50 mm		JD-RE20595	50.84
	RE28353	-802210		N-N-14		90 mm	JD-AH149843	66.72
MULTI-PURPOSE	AH148736	All		P-UB-1	50 mm		JD-AH148164	42.87
	AH148736	All		N-N-14		90 mm	JD-AH149843	66.72
	RE28353	-802210		P-UB-1	50 mm		JD-RE20595	50.84
	RE28353	-802210		N-N-14		90 mm	JD-AH149843	66.72
RIPPER	AU41772	59100-		P-V-8	1-1/4	2-1/2	JD-AR105453	35.68
MODEL 550								
BACKHOE BOOM		All	9550	P-V-8	2	4	JD-RE18732	46.38
		-700717	9300	P-V-8	2-1/4	4-1/2	JD-AR105355	83.97
		700718-	9300	P-V-14	2-1/4	4-1/2	JD-RE18764	114.16
BACKHOE BUCKET		700718-	9300	P-V-14	2-1/4	3-1/2	JD-RE18758	100.05
		All	9550	P-V-8	1-3/4	3	JD-RE18751	36.62
		-700717	9300	P-V-8	2-1/4	3-1/2	JD-RE18757	61.75
BACKHOE CROWD		All	9550	P-V-8	1-3/4	3-1/2	JD-RE18755	46.21
		-700717	9300	P-V-8	2	4	JD-AR105387	44.97
BACKHOE STABILIZER		All	9300	P-V-8	2	4	JD-AR105387	44.97
		All	9550	P-V-8	1-3/4	3-1/2	JD-RE18754	57.33
BACKHOE SWING		39797-	9550	P-U-10	1-3/4	3-1/2	JD-RE18756	48.49
		T60873 piston -39796	9550	P-U-10	1-3/4	3-1/2	JD-RE18756	48.49
DOZER ANGLE		All	6405	P-V-8	1-1/2	3-1/2	JD-AR105432	44.84
DOZER LIFT		All		P-V-8	1-1/2	3-1/2	JD-AR105432	44.84
DOZER TILT		All	6405	P-V-8	1-1/2	3-1/2	JD-AR105432	44.84
		All	6415	P-V-8	2-1/4	4-1/2	JD-AR105355	83.97

LA - Long Arm LGP - Low Ground Pressure LT - Long Track MFWD - Mechanical Front Wheel Drive MP - Multi-Purpose
 IDM - Inside Dozer Mount ODM - Outside Dozer Mount SLF - Super Long Front STD - Straight Dozer WT - Wide Track

Replacement Kits For

JOHN DEERE

Crawler Dozers/Loaders								
APPLICATION	CYL #	SERIAL #	Misc	CODE	ROD	BORE	KIT #	List \$
MODEL 550								
DOZER TILT		Field Replacement	6415	P-V-1	2-1/4		JD-RE14208	37.91
		Field Replacement	6415	N-N-14		4-1/2	JD-RE14094	82.00
RIPPER		All		P-V-8	1-1/4	2-1/2	JD-AR105453	35.68
MODEL 550A, 550B								
BACKHOE BOOM		All	9550	P-V-8	2	4	JD-RE18732	46.38
		700718-	9300	P-V-14	2-1/4	4-1/2	JD-RE18764	114.16
		-700717	9300	P-V-8	2-1/4	4-1/2	JD-AR105355	83.97
BACKHOE BUCKET		All	9550	P-V-8	1-3/4	3	JD-RE18751	36.62
		700718-	9300	P-V-14	2-1/4	3-1/2	JD-RE18758	100.05
		-700717	9300	P-V-8	2-1/4	3-1/2	JD-RE18757	61.75
BACKHOE CROWD		All		P-V-8	1-3/4	3-1/2	JD-RE18755	46.21
		700718-	9300	P-V-14	2	4	JD-RE18741	97.81
		-700717	9300	P-V-8	2	4	JD-AR105387	44.97
BACKHOE STABILIZER		All	9550	P-V-8	1-3/4	3-1/2	JD-RE18754	57.33
		All	9300	P-V-8	2	4	JD-AR105387	44.97
BACKHOE SWING		All	9550	P-U-10	1-3/4	3-1/2	JD-RE18756	48.49
DOZER ANGLE		All	6405	P-V-8	1-1/2	3-1/2	JD-AR105432	44.84
DOZER LIFT		All		P-V-8	1-1/2	3-1/2	JD-AR105432	44.84
DOZER TILT		-712333	6415	P-V-8	2-1/4	4-1/2	JD-AR105355	83.97
		All	6405	P-V-8	1-1/2	3-1/2	JD-AR105432	44.84
		712334-	6415	P-V-1	2-1/4		JD-RE14208	37.91
		712334-	6415	N-N-14		4-1/2	JD-RE14094	82.00
MODEL 550G								
DOZER ANGLE	AH137776	All		P-UB-1	45 mm		JD-RE20434	57.55
	AH137776	All		N-N-14		80 mm	JD-AH149842	67.24
	AH149950	-846912		I,P-UB-1	45 mm		JD-AH149813	59.46
	AH149950	-846912		N-N-14		80 mm	JD-AH149842	67.24
	AH161770	846913-		I,P-UB-1	45 mm		JD-AH149813	59.46
	AH161770	846913-		N-N-10		80 mm	JD-RE37003	15.03
DOZER LIFT	AH150066	790251-822042		P-UB-1	40 mm		JD-RE20433	57.19
	AH150066	790251-822042		N-N-14		80 mm	JD-AH212091	84.66
	AH150067	-822042		P-UB-1	40 mm		JD-RE20433	57.19
	AH150067	-822042		N-N-14		80 mm	JD-AH212091	84.66
	AH161762	846843-		I,P-UB-1	40 mm		JD-AH149194	49.62
	AH161762	822043-846842		I,P-UB-1	40 mm		JD-AH149194	49.62
	AH161762	846843-		N-N-10		80 mm	JD-AH212092	36.62
	AH161762	822043-846842		N-N-14		80 mm	JD-AH212091	84.66
	AH161767	847000-		I,P-UB-1	40 mm		JD-AH149194	49.62
	AH161767	822043-846999		I,P-UB-1	40 mm		JD-AH149194	49.62
	AH161767	822043-846999		N-N-14		80 mm	JD-AH212091	84.66
	AH161767	847000-		N-N-10		80 mm	JD-AH212092	36.62
TILT	AH151379	All		I,P-UB-1	45 mm		JD-AH149813	59.46
	AH151379	All		N-N-14		90 mm	JD-AH149843	66.72
	AH161772	846914-		I,P-UB-1	45 mm		JD-AH149813	59.46
	AH161772	846914-		N-N-10		90 mm	JD-AH134955	14.00
	RE35814	-822042		P-UB-1	45 mm		JD-RE20434	57.55
	RE35814	-822042		N-N-14		90 mm	JD-AH149843	66.72
MODEL 550H								
BLADE ANGLE	AH165689	-925555		I,P-UB-1	45 mm		JD-AH149813	59.46
	AH165689	-925555		N-N-10		70 mm	JD-AH212090	12.43
	AH211365	925556-		I,P-UB-1	45 mm		JD-AH149813	59.46
	AH211851	925556-		N-N-10		70 mm	JD-AH212090	12.43
BLADE LIFT	AH163865	-925555		I,P-UB-1	40 mm		JD-AH149194	49.62
	AH163865	-925555		N-N-10		80 mm	JD-RE37003	15.03
	AH211370	925556-		I,P-UB-1	40 mm		JD-AH149194	49.62

LA - Long Arm LGP - Low Ground Pressure LT - Long Track MFWD - Mechanical Front Wheel Drive MP - Multi-Purpose
 IDM - Inside Dozer Mount ODM - Outside Dozer Mount SLF - Super Long Front STD - Straight Dozer WT - Wide Track

Replacement Kits For

JOHN DEERE

Crawler Dozers/Loaders								
APPLICATION	CYL #	SERIAL #	Misc	CODE	ROD	BORE	KIT #	List \$
MODEL 550H								
BLADE LIFT	AH211370	925556-		N-N-10		80 mm	JD-AH212092	36.62
BLADE TILT	AH158633	-925555		I,P-UB-1	45 mm		JD-AH149813	59.46
	AH158633	-925555		N-N-10		90 mm	JD-AH212097	15.75
	AH211381	925556-		I,P-UB-1	45 mm		JD-AH149813	59.46
	AH211381	925556-		N-N-10		90 mm	JD-AH212097	15.75
MODEL 550J								
BLADE ANGLE	AH211851			I,P-UB-1	45 mm		JD-AH149813	59.46
	AH211851			N-N-10		70 mm	JD-AH212090	12.43
BLADE LIFT	AH211370			I,P-UB-1	40 mm		JD-AH149194	49.62
	AH211370			N-N-10		80 mm	JD-AH212092	36.62
BLADE TILT	AH211381			I,P-UB-1	45 mm		JD-AH149813	59.46
	AH211381			N-N-10		90 mm	JD-AH212097	15.75
MODEL 550K								
DOZER ANGLE	AHC10698			I,P-UB-1	45 mm		JD-AH149813	59.46
	AHC10698			N-N-10		70 mm	JD-AH212090	12.43
DOZER LIFT	AHC10695			I,P-UB-1	40 mm		JD-AH149194	49.62
	AHC10695			N-N-10		80 mm	JD-AH212092	36.62
DOZER TILT	AHC10699			P-UB-1	50 mm		JD-AH210484	41.20
	AHC10699			N-N-10		100 mm	JD-AH212102	50.15
RIPPER	AH212646			P-UB-1	63 mm		JD-AH149815	59.57
	AH212646			N-N-10		125 mm	JD-AH167596	30.88
MODEL 555								
BACKHOE BOOM		-700717	9300	P-V-8	2-1/4	4-1/2	JD-AR105355	83.97
		700718-	9300	P-V-14	2-1/4	4-1/2	JD-RE18764	114.16
BACKHOE BUCKET		700718-	9300	P-V-14	2-1/4	3-1/2	JD-RE18758	100.05
		-700717	9300	P-V-8	2-1/4	3-1/2	JD-RE18757	61.75
BACKHOE CROWD		-700717	9300	P-V-8	2	4	JD-AR105387	44.97
		700718-	9300	P-V-14	2	4	JD-RE18741	97.81
BACKHOE STABILIZER		All		P-V-8	2	4	JD-AR105387	44.97
GRAPPLE		All		P-V-8	1-3/4	3-1/2	JD-RE18754	57.33
GRAPPLE CLAMP		All		P-V-8	2-1/4	5-1/4	JD-AR105346	71.15
LOADER BOOM LIFT		294038-		P-V-8	2-1/4	4-1/4	JD-RE18739	57.78
		-294037		I-U-8	2-1/4	4-1/4	JD-AH139418	51.36
LOADER BUCKET TILT		All		P-V-8	1-3/4	3-1/2	JD-RE18754	57.33
MULTI-PURPOSE		All		P-V-8	2	4	JD-AR105387	44.97
RIPPER		All		P-V-8	1-1/4	2-1/2	JD-AR105453	35.68
MODEL 555A, 555B								
BACKHOE BOOM		-700717	9300	P-V-8	2-1/4	4-1/2	JD-AR105355	83.97
		700718-	9300	P-V-14	2-1/4	4-1/2	JD-RE18764	114.16
BACKHOE BUCKET		700718-	9300	P-V-14	2-1/4	3-1/2	JD-RE18758	100.05
		-700717	9300	P-V-8	2-1/4	3-1/2	JD-RE18757	61.75
BACKHOE CROWD		700718-	9300	P-V-14	2	4	JD-RE18741	97.81
		-700717	9300	P-V-8	2	4	JD-AR105387	44.97
BACKHOE STABILIZER		All		P-V-8	2	4	JD-AR105387	44.97
GRAPPLE CLAMP		All		P-V-8	2-1/4	5-1/4	JD-AR105346	71.15
LOADER BOOM LIFT		All		P-V-8	2-1/4	4-1/4	JD-RE18739	57.78
LOADER BUCKET TILT		All		P-V-8	1-3/4	3-1/2	JD-RE18754	57.33
MULTI-PURPOSE		All		P-V-8	2	4	JD-AR105387	44.97
MODEL 555G								
BUCKET CLAM	AH148714	All		P-UB-1	50 mm		JD-AH148164	42.87
	AH148714	All		N-N-14		100 mm	JD-AH149844	84.21
	RE25702	-822210		P-UB-1	50 mm		JD-RE20595	50.84
	RE25702	-822210		N-N-14		100 mm	JD-AH149844	84.21
LOADER BOOM	AH150111	All		P-UB-1	63 mm		JD-AH149815	59.57
	AH150111	All		N-N-14		115 mm	JD-AH149846	118.74

LA - Long Arm LGP - Low Ground Pressure LT - Long Track MFWD - Mechanical Front Wheel Drive MP - Multi-Purpose
 IDM - Inside Dozer Mount ODM - Outside Dozer Mount SLF - Super Long Front STD - Straight Dozer WT - Wide Track

Replacement Kits For

JOHN DEERE

Crawler Dozers/Loaders								
APPLICATION	CYL #	SERIAL #	Misc	CODE	ROD	BORE	KIT #	List \$
MODEL 555G								
LOADER BOOM	RE26632	-823917		P-UB-1	63 mm		JD-RE28899	103.89
	RE26632	-823917		N-N-14		115 mm	JD-AH149846	118.74
LOADER BUCKET	AH148715	All		P-UB-1	50 mm		JD-AH148164	42.87
	AH148715	All		N-N-14		100 mm	JD-AH149844	84.21
	RE26633	-818179		P-UB-1	50 mm		JD-AH148164	42.87
	RE26633	-818179		N-N-14		100 mm	JD-AH149844	84.21
MODEL 650G								
DOZER ANGLE				N-N-14		80 mm	JD-RE31138	53.16
	AH137776	-822211		P-UB-1	45 mm		JD-RE20434	57.55
	AH137776	-822211		N-N-14		80 mm	JD-AH149842	67.24
	AH149950	-846912		I,P-UB-1	45 mm		JD-AH149813	59.46
	AH149950	-846912		N-N-14		80 mm	JD-AH149842	67.24
	AH161770	846913-		I,P-UB-1	45 mm		JD-AH149813	59.46
DOZER LIFT	AH161770	846913-		N-N-10		80 mm	JD-RE37003	15.03
				P-UB-1	40 mm		JD-RE20433	57.19
				N-N-14		80 mm	JD-RE31138	53.16
	AH143026	790251-822042		P-UB-1	40 mm		JD-RE20433	57.19
	AH143026	790251-822042		N-N-14		80 mm	JD-AH149842	67.24
	AH150066	790251-822042		P-UB-1	40 mm		JD-RE20433	57.19
	AH150066	790251-822042		N-N-14		80 mm	JD-AH212091	84.66
	AH150067	-822042		P-UB-1	40 mm		JD-RE20433	57.19
	AH150067	-822042		N-N-14		80 mm	JD-AH212091	84.66
	AH161762	822043-846842		I,P-UB-1	40 mm		JD-AH149194	49.62
	AH161762	846843-		I,P-UB-1	40 mm		JD-AH149194	49.62
	AH161762	846843-		N-N-10		80 mm	JD-AH212092	36.62
	AH161762	822043-846842		N-N-14		80 mm	JD-AH212091	84.66
	AH161767	822043-846999		I,P-UB-1	40 mm		JD-AH149194	49.62
	AH161767	847000-		I,P-UB-1	40 mm		JD-AH149194	49.62
	AH161767	822043-846999		N-N-14		80 mm	JD-AH212091	84.66
	AH161767	847000-		N-N-10		80 mm	JD-AH212092	36.62
	RE28350	-790250		P-UB-1	40 mm		JD-RE20433	57.19
	RE28350	-790250		N-N-14		80 mm	JD-AH149842	67.24
	LIFT	RE28350	-790250		P-UB-1	40 mm		JD-RE20433
RE28350		-790250		N-N-14		80 mm	JD-AH212091	84.66
TILT				N-N-14		100 mm	JD-RE31139	93.80
	AH149951	All		P-UB-1	50 mm		JD-RE20595	50.84
	AH149951	-822042		P-UB-1	50 mm		JD-RE20595	50.84
	AH149951	-822042		N-N-14		100 mm	JD-AH212101	80.14
	AH149951	All		N-N-14		100 mm	JD-AH137687	70.51
	AH161766	All		P-UB-1	50 mm		JD-AH148164	42.87
	AH161766	All		N-N-10		100 mm	JD-AH161781	23.31
	RE35808	-822042		P-UB-1	50 mm		JD-RE20595	50.84
	RE35808	-822042		N-N-14		100 mm	JD-AH149844	84.21
	MODEL 650H							
BLADE ANGLE	AH165689	-925555		I,P-UB-1	45 mm		JD-AH149813	59.46
	AH165689	-925555		N-N-10		70 mm	JD-AH212090	12.43
	AH211365	925556-		I,P-UB-1	45 mm		JD-AH149813	59.46
	AH211851	925556-		N-N-10		70 mm	JD-AH212090	12.43
BLADE LIFT	AH163865	-925555		I,P-UB-1	40 mm		JD-AH149194	49.62
	AH163865	-925555		N-N-10		80 mm	JD-RE37003	15.03
	AH211370	925556-		I,P-UB-1	40 mm		JD-AH149194	49.62
	AH211370	925556-		N-N-10		80 mm	JD-AH212092	36.62
BLADE TILT	AH158633	-925555		P-UB-1	50 mm		JD-AH210484	41.20
	AH158633	-925555		N-N-10		100 mm	JD-AH212102	50.15
	AH212097	925556-		P-UB-1	50 mm		JD-AH210484	41.20

LA - Long Arm LGP - Low Ground Pressure LT - Long Track MFWD - Mechanical Front Wheel Drive MP - Multi-Purpose
 IDM - Inside Dozer Mount ODM - Outside Dozer Mount SLF - Super Long Front STD - Straight Dozer WT - Wide Track

Replacement Kits For

JOHN DEERE

Crawler Dozers/Loaders								
APPLICATION	CYL #	SERIAL #	Misc	CODE	ROD	BORE	KIT #	List \$
MODEL 650H								
BLADE TILT	AH212097	925556-		N-N-10		100 mm	JD-AH212102	50.15
MODEL 650J								
BLADE ANGLE	AH211851			I,P-UB-1	45 mm		JD-AH149813	59.46
	AH211851			N-N-10		70 mm	JD-AH212090	12.43
BLADE LIFT	AH211370			I,P-UB-1	40 mm		JD-AH149194	49.62
	AH211370			N-N-10		80 mm	JD-AH212092	36.62
BLADE TILT	AH210979			P-UB-1	50 mm		JD-AH210484	41.20
	AH210979			N-N-10		100 mm	JD-AH212102	50.15
MODEL 650K								
DOZER ANGLE	AHC10698			I,P-UB-1	45 mm		JD-AH149813	59.46
	AHC10698			N-N-10		70 mm	JD-AH212090	12.43
DOZER LIFT	AHC10695			I,P-UB-1	40 mm		JD-AH149194	49.62
	AHC10695			N-N-10		80 mm	JD-AH212092	36.62
DOZER TILT	AHC10699			P-UB-1	50 mm		JD-AH210484	41.20
	AHC10699			N-N-10		100 mm	JD-AH212102	50.15
RIPPER	AH212646			P-UB-1	63 mm		JD-AH149815	59.57
	AH212646			N-N-10		125 mm	JD-AH167596	30.88
MODEL 655								
LOADER BOOM LIFT		All		P-U-8	3-3/4	5-1/2	JD-RE18763	108.08
LOADER BUCKET TILT		All		P-V-8	2-1/4	4-1/2	JD-AR105355	83.97
		Field Replacement		P-V-1	2-1/4		JD-RE14208	37.91
		Field Replacement		N-N-14		4-1/2	JD-RE14094	82.00
MULTI-PURPOSE		All		P-V-8	2	4	JD-AR105387	44.97
				P-V-1	2-1/2		JD-RE17345	46.46
	RE22315	All		N-N-14		5-1/2	JD-RE14102	123.45
TRACK ADJUSTER		All		I-U-4	3-3/4	3	JD-905001	56.36
MODEL 655B								
LOADER BOOM LIFT		All		P-U-1	3-3/4		JD-RE31528	73.09
		All		N-N-14		5-1/2	JD-RE15907	123.45
LOADER BUCKET TILT		All		P-V-1	2-1/4		JD-RE14208	37.91
		All		N-N-14		4-1/2	JD-RE14094	82.00
MULTI-PURPOSE		All		P-V-1	2-1/2		JD-RE17345	46.46
		All		N-N-14		5-1/2	JD-RE14102	123.45
TRACK ADJUSTER		All		I-U-4	3-3/4	3	JD-905001	56.36
MODEL 700H								
DOZER ANGLE		-925555		P-UB-1	56 mm		JD-AH149814	58.53
		-925555		N-N-10		90 mm	JD-AH212097	15.75
	AH211335	925556-		P-UB-1	56 mm		JD-AH149814	58.53
	AH211335	925556-		N-N-10		90 mm	JD-AH212097	15.75
DOZER LIFT	AH160177	-942019		P-UB-1	50 mm		JD-AH210484	41.20
	AH160177	-942019		N-N-10		100 mm	JD-AH212102	50.15
	AH215878	942020-		P-UB-1	50 mm		JD-AH210484	41.20
DOZER TILT		-942019		P-UB-1	50 mm		JD-AH210484	41.20
		-942019		N-N-10		100 mm	JD-AH212102	50.15
	AH216998	942020-		P-UB-1	50 mm		JD-AH210484	41.20
MODEL 700J								
DOZER ANGLE	AH211335	139436-		P-UB-1	56 mm		JD-AH149814	58.53
	AH211335	-139435		P-UB-1	56 mm		JD-AH149814	58.53
	AH211335	139436-		N-N-10		90 mm	JD-AH212097	15.75
	AH211335	-139435		N-N-10		90 mm	JD-AH212097	15.75
DOZER LIFT	AH215878	-139435		P-UB-1	50 mm		JD-AH210484	41.20
	AH215878	139436-		P-UB-1	50 mm		JD-AH210484	41.20
DOZER TILT	AH216998	-139435		P-UB-1	50 mm		JD-AH210484	41.20
	AH216998	139436-		P-UB-1	50 mm		JD-AH210484	41.20

JOHN DEERE

LA - Long Arm LGP - Low Ground Pressure LT - Long Track MFWD - Mechanical Front Wheel Drive MP - Multi-Purpose
 IDM - Inside Dozer Mount ODM - Outside Dozer Mount SLF - Super Long Front STD - Straight Dozer WT - Wide Track

Replacement Kits For

JOHN DEERE

Crawler Dozers/Loaders								
APPLICATION	CYL #	SERIAL #	Misc	CODE	ROD	BORE	KIT #	List \$
MODEL 700K								
DOZER ANGLE	AHC12643			P-UB-1	56 mm		JD-AH149814	58.53
	AHC12643			N-N-10		90 mm	JD-AH212097	15.75
DOZER LIFT	AHC10693			P-UB-1	50 mm		JD-AH210484	41.20
	AHC10693			N-N-10		100 mm	JD-AH212102	50.15
DOZER TILT	AHC10694			P-UB-1	50 mm		JD-AH210484	41.20
	AHC10694			N-N-10		100 mm	JD-AH212102	50.15
RIPPER	AH215878			P-UB-1	50 mm		JD-AH210484	41.20
	AH215878			N-N-10		100 mm	JD-AH212102	50.15
MODEL 750B								
ANGLE (Inside Dozer)	RE17343	-743282		P-V-1	2-3/4		JD-RE17342	63.27
	RE17343	-743282		N-N-14		6-1/4	JD-RE14022	133.75
DOZER LIFT	AH150118	779602-		P-UB-1	56 mm		JD-AH149814	58.53
	AH150118	779602-		N-N-14		100 mm	JD-AH149844	84.21
	AT101434	779602-		P-UB-1	56 mm		JD-RE31716	88.77
	AT101434	779602-		N-N-14		100 mm	JD-AH137687	70.51
	RE17453	-779601		N-N-14		4-1/4	JD-RE17458	83.60
	RE17459	-743282		N-N-14		4-1/4	JD-RE17458	83.60
	RE17462	All		N-N-14		4-1/4	JD-RE17458	83.60
	RE35226	743283-		N-N-14		4-1/4	JD-RE17458	83.60
TILT	AH145297			P-V-1	2-1/2		JD-RE17345	46.46
	AH145297			P-UB-1	80 mm		JD-RE25152	159.41
	AH145297			N-N-14		5-1/2	JD-RE14102	123.45
	AH145297			N-N-14		160 mm	JD-AH137210	125.91
	RE17344			P-V-1	2-1/2		JD-RE17345	46.46
	RE17344			N-N-14		5-1/2	JD-RE14102	123.45
TILT (Angle Dozer)	RE17350		6520	P-V-1	2-1/2		JD-RE17345	46.46
	RE17350		6520	N-N-14		5-1/2	JD-RE17351	123.45
TILT (Insider Dozer)	RE17341	-743282		P-V-1	2-3/4		JD-RE17342	63.27
	RE17341	-743282		N-N-14		6-1/4	JD-RE14022	133.75
MODEL 750C								
LIFT	AH141866	-823539		P-UB-1	56 mm		JD-RE31716	88.77
	AH141866	-823539		N-N-14		100 mm	JD-AH212101	80.14
TILT	AH160105	871488-		P-UB-1	80 mm		JD-AH156874	115.28
	AH160105	-871487		P-UB-1	80 mm		JD-RE25152	159.41
	AH160105	871488-		N-N-14		160 mm	JD-AH137210	125.91
	AH160105	-871487		N-N-14		160 mm	JD-AH137210	125.91
TILT ANGLE	RE17350			P-V-1	2-1/2		JD-RE17345	46.46
	RE17350			N-N-14		5-1/2	JD-RE17351	123.45
MODEL 750C-II								
ANGLE	RE17350			P-V-1	2-1/2		JD-RE17345	46.46
	RE17350			N-N-14		5-1/2	JD-RE17351	123.45
LIFT	AH150120	-943853		P-UB-1	56 mm		JD-AH149814	58.53
	AH150120	-943853		N-N-14		100 mm	JD-AH212101	80.14
	AH216805	943854-		P-UB-1	56 mm		JD-AH149814	58.53
	AH216805	943854-		N-N-14		100 mm	JD-AH212101	80.14
TILT	AH160105			P-UB-1	80 mm		JD-AH156874	115.28
	AH160105			N-N-14		160 mm	JD-AH137210	125.91
	AH175471	904887-		P-UB-1	63 mm		JD-AH149815	59.57
	AH175471	904887-		N-N-14		140 mm	JD-AH216299	148.76
MODEL 750J								
DOZER ANGLE	AH217118	-141343, 141344-	(IDM)	P-UB-1	70 mm		JD-AH156466	53.69
	AH217118	-141343, 141344-	(IDM)	N-N-14		110 mm	JD-AH212585	89.20
DOZER LIFT	AH208632	-141343, 141344-	(IDM)	P-UB-1	56 mm		JD-AH149814	58.53
	AH208632	-141343, 141344-	(IDM)	N-N-10		100 mm	JD-AH212102	50.15
	AH221187	-141343, 141344-	(ODM)	P-UB-1	56 mm		JD-AH149814	58.53

LA - Long Arm LGP - Low Ground Pressure LT - Long Track MFWD - Mechanical Front Wheel Drive MP - Multi-Purpose
 IDM - Inside Dozer Mount ODM - Outside Dozer Mount SLF - Super Long Front STD - Straight Dozer WT - Wide Track

Replacement Kits For

JOHN DEERE

Crawler Dozers/Loaders								
APPLICATION	CYL #	SERIAL #	Misc	CODE	ROD	BORE	KIT #	List \$
MODEL 750J								
DOZER LIFT	AH221187	-141343, 141344-	(ODM)	N-N-14		90 mm	JD-AH212096	66.72
DOZER TILT	AH208633	-141343, 141344-	(IDM)	P-UB-1	63 mm		JD-AH149815	59.57
	AH208633	-141343, 141344-	(IDM)	N-N-14		125 mm	JD-AH149848	167.29
	AH208635	-141343, 141344-	(ODM)	P-UB-1	63 mm		JD-AH149815	59.57
	AH208635	-141343, 141344-	(ODM)	N-N-14		125 mm	JD-AH149848	167.29
MODEL 750K								
CAB TILT	AH216188			I-U-1	32 mm		JD-AH149817	23.91
	AH216188			N-N-10		2-1/2	JD-AH212088	13.29
DOZER ANGLE (LGP) (LT)	AHC10544			P-UB-1	70 mm		JD-AH156466	53.69
	AHC10544			N-N-14		110 mm	JD-AH212585	89.20
DOZER LIFT (LGP) (LT)	AHC12220			P-UB-1	56 mm		JD-AH149814	58.53
	AHC12220			N-N-10		100 mm	JD-AH212102	50.15
DOZER TILT	AHC10536			P-UB-1	56 mm		JD-AH149814	58.53
	AHC10536			N-N-14		90 mm	JD-AH212096	66.72
DOZER TILT (LGP) (LT)	AHC10543			P-UB-1	63 mm		JD-AH149815	59.57
	AHC10543			N-N-14		125 mm	JD-AH149848	167.29
RIPPER	AH215949			P-UB-1	50 mm		JD-AH210484	41.20
	AH215949			N-N-10		90 mm	JD-AH212097	15.75
MODEL 850								
Bulldozer Arrangement			6540, 6545					
DOZER LIFT	AR105285	All	6540	P-U-10	2-1/2	4-1/4	JD-RE18731	82.85
	AT52374	-307525	6545	P-U-10	2-1/2	4-1/4	JD-RE18731	82.85
DOZER LIFT (LGP)	RE17462	All	6540, 6545	P-V-1	2-1/2		JD-AH142440	46.94
	RE17462	All		N-N-14		4-1/4	JD-RE17458	83.60
DOZER TILT	AR105289	All	6540	P-U-10	2-1/2	5-1/2	JD-AR105275	51.38
	RE17350	All	6540	P-V-1	2-1/2		JD-RE17345	46.46
	RE17350	All	6540	N-N-14		5-1/2	JD-RE17351	123.45
DOZER TILT (LGP) (LT)	AR89587	-705569	6545	P-V-8	2-3/4	6-1/4	JD-RE18744	141.21
	AT52367	-318357	6545	P-V-8	2-3/4	6-1/4	JD-RE18744	141.21
	RE16538	All	6545	P-V-8	2-3/4	6-1/4	JD-RE18744	141.21
	RE17349	All	6545	P-V-1	2-3/4		JD-RE17342	63.27
	RE17349	All	6545	N-N-14		6-1/4	JD-RE14104	127.07
MODEL 850B								
Bulldozer Arrangement			6540, 6545					
DOZER LIFT	RE17459	All	6540, 6545	P-V-1	2-1/2		JD-AH142440	46.94
	RE17459	All	6540, 6545	N-N-14		4-1/4	JD-RE17458	83.60
DOZER LIFT (LGP) (LT)	RE17462	All		P-V-1	2-1/2		JD-AH142440	46.94
	RE17462	-747861		N-N-14		4-1/4	JD-RE17458	83.60
	RE35226	747862-		P-V-1	2-1/2		JD-AH142440	46.94
	RE35226	747862-		N-N-14		4-1/4	JD-RE17458	83.60
DOZER LIFT (LT)	AH136158	779602-		P-UB-1	56 mm		JD-RE31716	88.77
	AH136158	779602-		N-N-14		100 mm	JD-AH137687	70.51
DOZER TILT	AH145297	All		P-UB-1	80 mm		JD-RE25152	159.41
	AH145297	All		N-N-14		180 mm	JD-AH137211	128.10
	RE17350	All	6540	P-V-1	2-1/2		JD-RE17345	46.46
	RE17350	All	6540	N-N-14		5-1/2	JD-RE17351	123.45
DOZER TILT (STD) (LGP) (LT)	RE17349	All	6545	P-V-1	2-3/4		JD-RE17342	63.27
	RE17349	All	6545	N-N-14		6-1/4	JD-RE14104	127.07
MODEL 850C								
LIFT	AH216805			P-UB-1	56 mm		JD-AH149814	58.53
	AH216805			N-N-14		100 mm	JD-AH212101	80.14
TILT		-848638		P-UB-1	80 mm		JD-RE25152	159.41
		-848638		N-N-14		180 mm	JD-AH137211	128.10
	AH159739	848639-		P-UB-1	80 mm		JD-AH156874	115.28

LA - Long Arm LGP - Low Ground Pressure LT - Long Track MFWD - Mechanical Front Wheel Drive MP - Multi-Purpose
 IDM - Inside Dozer Mount ODM - Outside Dozer Mount SLF - Super Long Front STD - Straight Dozer WT - Wide Track

Replacement Kits For

JOHN DEERE

Crawler Dozers/Loaders								
APPLICATION	CYL #	SERIAL #	Misc	CODE	ROD	BORE	KIT #	List \$
MODEL 850C								
TILT	AH159739	848639-		N-N-14		180 mm	JD-AH137211	128.10
TILT ANGLE	RE17350			P-V-1	2-1/2		JD-RE17345	46.46
	RE17350			N-N-14		5-1/2	JD-RE17351	123.45
MODEL 850C-II								
LIFT	AH150120	-943853		P-UB-1	56 mm		JD-AH149814	58.53
	AH150120	-943853		N-N-14		100 mm	JD-AH212101	80.14
	AH216805	943854-		P-UB-1	56 mm		JD-AH149814	58.53
	AH216805	943854-		N-N-14		100 mm	JD-AH212101	80.14
LIFT (LGP)	AH150121	-943853		P-UB-1	56 mm		JD-AH149814	58.53
	AH150121	-943853		N-N-14		100 mm	JD-AH212101	80.14
TILT	AH159739			P-UB-1	80 mm		JD-AH156874	115.28
	AH159739			N-N-14		180 mm	JD-AH137211	128.10
	AH175471	904887-		P-UB-1	63 mm		JD-AH149815	59.57
	AH175471	904887-		N-N-14		140 mm	JD-AH216299	148.76
TILT ANGLE	RE17350			P-V-1	2-1/2		JD-RE17345	46.46
	RE17350			N-N-14		5-1/2	JD-RE17351	123.45
MODEL 850J								
DOZER ANGLE	AH208628		(IDM)	P-UB-1	70 mm		JD-AH156466	53.69
	AH208628		(IDM)	N-N-14		115 mm	JD-AH212103	118.74
DOZER LIFT	AH208630		(IDM)	P-UB-1	63 mm		JD-AH149815	59.57
	AH208630		(IDM)	N-N-14		115 mm	JD-AH212103	118.74
	AH221183		(ODM)	P-UB-1	56 mm		JD-AH149814	58.53
	AH221183		(ODM)	N-N-14		90 mm	JD-AH212096	66.72
DOZER TILT	AH208631		(ODM)	P-UB-1	70 mm		JD-AH156466	53.69
	AH208631		(ODM)	N-N-10		6	JD-AH167533	60.46
	AH210140		(IDM)	P-UB-1	63 mm		JD-AH149815	59.57
	AH210140		(IDM)	N-N-14		125 mm	JD-AH149848	167.29
MODEL 850K								
CAB TILT	AH216188			I-U-1	32 mm		JD-AH149817	23.91
	AH216188			N-N-10		2-1/2	JD-AH212088	13.29
DOZER ANGLE (LGP) (WT)	AHC10408			P-UB-1	70 mm		JD-AH156466	53.69
	AHC10408			N-N-14		115 mm	JD-AH212103	118.74
DOZER LIFT (LGP)	AHC10169			P-UB-1	56 mm		JD-AH149814	58.53
	AHC10169			N-N-14		90 mm	JD-AH212096	66.72
DOZER LIFT (LGP) (WT)	AHC10406			P-UB-1	63 mm		JD-AH149815	59.57
	AHC10406			N-N-14		115 mm	JD-AH212103	118.74
DOZER LIFT (STD) (WT)	AHC10168			P-UB-1	56 mm		JD-AH149814	58.53
	AHC10168			N-N-14		90 mm	JD-AH212096	66.72
DOZER TILT	AH208631			P-UB-1	70 mm		JD-AH156466	53.69
	AH208631			N-N-10		6	JD-AH167533	60.46
DOZER TILT (LGP) (WT)	AHC10407			P-UB-1	63 mm		JD-AH149815	59.57
	AHC10407			N-N-14		125 mm	JD-AH149848	167.29
RIPPER	AH215949			P-UB-1	50 mm		JD-AH210484	41.20
	AH215949			N-N-10		90 mm	JD-AH212097	15.75
Excavators								
APPLICATION	CYL #	SERIAL #	Misc	CODE	ROD	BORE	KIT #	List \$
MODEL 70								
ARM	TH105922			P-UB-10	60 mm	100 mm	JD-TH106099	178.97
	TH105922			Bushing	60 mm		JD-TH106301	24.20
ARM/OFFSET BOOM	TH105901			P-UB-10	60 mm	100 mm	JD-TH106099	178.97
	TH106735			P-UB-10	60 mm	100 mm	JD-TH106099	178.97
BLADE	TH105913			P-UB-10	55 mm	90 mm	JD-TH110663	104.60
	TH105913			Bushing	55 mm		JD-TH106899	18.35
	TH105913			Wear Ring		90 mm	JD-TH105795	128.45

LA - Long Arm LGP - Low Ground Pressure LT - Long Track MFWD - Mechanical Front Wheel Drive MP - Multi-Purpose
 IDM - Inside Dozer Mount ODM - Outside Dozer Mount SLF - Super Long Front STD - Straight Dozer WT - Wide Track

Replacement Kits For

JOHN DEERE

Excavators								
APPLICATION	CYL #	SERIAL #	Misc	CODE	ROD	BORE	KIT #	List \$
MODEL 70								
BOOM	TH105921			P-UB-10	65 mm	115 mm	JD-TH111701	173.04
BUCKET	TH105901			P-UB-10	55 mm	90 mm	JD-TH106853	237.89
	TH105901			Bushing	55 mm		JD-TH106899	18.35
OFFSET BOOM	TH106736			P-UB-10	60 mm	110 mm	JD-TH106874	119.92
	TH106736			Bushing	60 mm		JD-TH106301	24.20
	TH106736			Wear Ring		110 mm	JD-TH106873	141.93
MODEL 70D								
ARM	TH110528	All		P-UB-10	60 mm	100 mm	JD-TH110662	93.92
	TH110528	All		Bushing	60 mm		JD-TH110296	20.61
	TH110528	All		Wear Ring		100 mm	JD-TH105781	140.78
	TH110645	All		P-UB-10	60 mm	100 mm	JD-TH110662	93.92
ARM OFFSET	TH110645	All		P-UB-10	60 mm	100 mm	JD-TH110662	93.92
	TH110645	All		Bushing	60 mm		JD-TH110296	20.61
	TH110645	All		Wear Ring		100 mm	JD-TH105781	140.78
BLADE	TH110626	All		P-UB-10	55 mm	90 mm	JD-TH110663	104.60
	TH110626	All		Bushing	55 mm		JD-TH106899	18.35
	TH110626	All		Wear Ring		90 mm	JD-TH105795	128.45
BOOM	TH110527	All		P-UB-10	65 mm	115 mm	JD-TH110661	150.20
BUCKET	TH110529	All		P-UB-10	55 mm	90 mm	JD-TH110663	104.60
	TH110529	All		Bushing	55 mm		JD-TH106899	18.35
	TH110529	All		Wear Ring		90 mm	JD-TH105795	128.45
OFFSET CYL	TH110644	All		P-UB-10	60 mm	110 mm	JD-TH106874	119.92
	TH110644	All		Bushing	60 mm		JD-TH106301	24.20
	TH110644	All		Wear Ring		110 mm	JD-TH106873	141.93
MODEL 80								
ARM	AP36041	All		P-UB-10	60 mm	95 mm	JD-AT200549	150.13
BOOM	AP36040	All		P-UB-10	65 mm	115 mm	JD-AT200548	199.06
BUCKET	AT250786	All		P-UB-10	55 mm	85 mm	JD-AT200550	158.28
MODEL 85D								
ARM	9197150G			P-UB-10	60 mm	95 mm	JD-4464985	105.31
	9197150G			P-UB-10	60 mm	95 mm	JD-4464985-EX	146.84
	9197150G			Bushing	60 mm		JD-0826907	18.65
	9197150G			Wear Ring		95 mm	JD-H158170	14.84
BLADE	9246135			P-U-10	70 mm	120 mm	JD-4632462	227.49
	9246135			Bushing	70 mm		JD-4633389	22.55
BOOM	9197149G			P-UB-10	65 mm	115 mm	JD-4663491	220.04
	9197149G			P-UB-10	65 mm	115 mm	JD-4663491-EX	241.82
	9197149G			Bushing	65 mm		JD-AT264389	21.71
	9197149G			Wear Ring		115 mm	JD-H163432	10.89
BUCKET	9197151G			P-UB-10	55 mm	85 mm	JD-4464986	100.77
	9197151G			Bushing	55 mm		JD-TH0827007	13.72
SWING	9280680			P-U-10	60 mm	110 mm	JD-4696459	74.30
	9280680			Bushing	60 mm		JD-0826907	18.65
MODEL 110								
BUCKET	AH148041	All		P-UB-10	65 mm	95 mm	JD-AH150595	209.08
MODEL 120								
ARM	AH149792	All		P-UB-10	80 mm	110 mm	JD-AH149796	373.39
BOOM (LH)	AH153169	All		P-UB-10	70 mm	105 mm	JD-AH151107	308.36
BOOM (RH)	AH153168	All		P-UB-10	70 mm	105 mm	JD-AH151107	308.36
BUCKET	AH148041	All		P-UB-10	65 mm	95 mm	JD-AH150595	209.08
MODEL 120C								
ARM	9183013J			P-UB-10	80 mm	115 mm	JD-4448396	201.08
BLADE (LH)				P-UB-10	70 mm	100 mm	JD-4388027	333.03
	9187647	Field Replacement		P-UB-10	70 mm	100 mm	JD-4388027	333.03
BLADE (RH)				P-UB-10	70 mm	100 mm	JD-4388027	333.03

LA - Long Arm LGP - Low Ground Pressure LT - Long Track MFWD - Mechanical Front Wheel Drive MP - Multi-Purpose
 IDM - Inside Dozer Mount ODM - Outside Dozer Mount SLF - Super Long Front STD - Straight Dozer WT - Wide Track

Replacement Kits For

JOHN DEERE

Excavators								
APPLICATION	CYL #	SERIAL #	Misc	CODE	ROD	BORE	KIT #	List \$
MODEL 120C								
BLADE (RH)	9187648	Field Replacement		P-UB-10	70 mm	100 mm	JD-4388027	333.03
BOOM (LH)	4428437Y			P-UB-10	70 mm	105 mm	JD-4662895	166.66
BOOM (RH)	4428436Y			P-UB-10	70 mm	105 mm	JD-4662895	166.66
BUCKET	9183014J			P-UB-10	70 mm	100 mm	JD-4448397	160.32
MODEL 135C								
ARM	9197519			P-UB-10	80 mm	115 mm	JD-4448396	201.08
BLADE	4472591			P-U-10	50 mm	95 mm	JD-0745308	115.61
BLADE (LH)	9187647			P-UB-10	70 mm	100 mm	JD-4388027	333.03
BLADE (RH)	9187648			P-UB-10	70 mm	100 mm	JD-4388027	333.03
BOOM (LH)	9197517			P-UB-10	70 mm	105 mm	JD-4662895	166.66
BOOM (RH)	9197518			P-UB-10	70 mm	105 mm	JD-4662895	166.66
BUCKET	9183014J			P-UB-10	70 mm	100 mm	JD-4448397	160.32
MODEL 135D								
ARM	9288686G			P-UB-10	80 mm	115 mm	JD-4S00847	79.75
	9288686G			P-UB-10	80 mm	115 mm	JD-4S00847-EX	185.46
	9288686G			Bushing	80 mm		JD-AT264314	31.26
	9288686G			Wear Ring		115 mm	JD-TH109357	40.55
	9288686G			Wear Ring		115 mm	JD-H227907	10.89
BLADE (LH)	9187647			P-UB-10	70 mm	100 mm	JD-4388027	333.03
	9187647			Bushing	70 mm		JD-0643402	10.24
BLADE (RH)	9187648			P-UB-10	70 mm	100 mm	JD-4388027	333.03
	9187648			Bushing	70 mm		JD-0643402	10.24
BOOM (LH)	9258475G			P-UB-10	70 mm	105 mm	JD-4662895	166.66
	9258475G			P-UB-10	70 mm	105 mm	JD-4662895-EX	361.69
	9258475G			Bushing	70 mm		JD-0310304	24.51
	9258475G			Wear Ring		105 mm	JD-AT264388	23.12
	9258475G			Wear Ring		105 mm	JD-0907801	11.26
BOOM (RH)	9258474G			P-UB-10	70 mm	105 mm	JD-4662895	166.66
	9258474G			P-UB-10	70 mm	105 mm	JD-4662895-EX	361.69
	9258474G			Bushing	70 mm		JD-0310304	24.51
	9258474G			Wear Ring		105 mm	JD-AT264388	23.12
	9258474G			Wear Ring		105 mm	JD-0907801	11.26
BUCKET	9257711G			P-UB-10	70 mm	100 mm	JD-4S00849	69.66
	9257711G			P-UB-10	70 mm	100 mm	JD-4S00849-EX	175.80
	9257711G			Bushing	70 mm		JD-0310304	24.51
	9257711G			Wear Ring		100 mm	JD-4S00840	72.59
	9257711G			Wear Ring		100 mm	JD-4S00839	11.88
THUMB	AT383236		From JUNE 2010	I-UB-14	2-1/2	4	JD-AT383237	440.42
MODEL 160 LC								
ARM	AH155022	All		P-UB-10	85 mm	115 mm	JD-AH155025	315.17
BOOM (LH)	AH155042	All		P-UB-10	80 mm	110 mm	JD-AH155045	342.96
BOOM (RH)	AH155051	All		P-UB-10	80 mm	110 mm	JD-AH155045	342.96
BUCKET	AH155037	All		P-UB-10	75 mm	105 mm	JD-AH155040	461.55
MODEL 160C LC								
ARM	9206378J			P-UB-10	90 mm	120 mm	JD-4467380	237.87
BOOM (LH)	9206377J			P-UB-10	80 mm	110 mm	JD-4467379	219.60
BOOM (RH)	9206376J			P-UB-10	80 mm	110 mm	JD-4467379	219.60
BUCKET	9206379J			P-UB-10	75 mm	105 mm	JD-4467381	163.74
MODEL 160D LC								
ARM				P-UB-10	90 mm	120 mm	JD-4657449	237.87
				P-UB-10	90 mm	120 mm	JD-4657449-EX	282.93
BOOM (LH)				P-UB-10	80 mm	110 mm	JD-4662891	201.87
				P-UB-10	80 mm	110 mm	JD-4662891-EX	264.19
BOOM (RH)				P-UB-10	80 mm	110 mm	JD-4662891	201.87
				P-UB-10	80 mm	110 mm	JD-4662891-EX	264.19

LA - Long Arm LGP - Low Ground Pressure LT - Long Track MFWD - Mechanical Front Wheel Drive MP - Multi-Purpose
 IDM - Inside Dozer Mount ODM - Outside Dozer Mount SLF - Super Long Front STD - Straight Dozer WT - Wide Track

Replacement Kits For

JOHN DEERE

Excavators								
APPLICATION	CYL #	SERIAL #	Misc	CODE	ROD	BORE	KIT #	List \$
MODEL 160D LC								
BUCKET				P-UB-10	75 mm	105 mm	JD-4663493	163.74
				P-UB-10	75 mm	105 mm	JD-4663493-EX	204.67
MODEL 160GLC								
ARM	9257020G	-55199		P-UB-10	90 mm	120 mm	JD-4657449	237.87
	9257020G	-55199		P-UB-10	90 mm	120 mm	JD-4657449-EX	282.93
	9257020G	-55199		Bushing	90 mm		JD-AT264321	33.48
	9257020G	-55199		Wear Ring		120 mm	JD-H227906	13.29
	9257020G	-55199		Wear Ring			JD-AT264356	28.15
	9323703	055200-		P-UB-10	90 mm	120 mm	JD-FYA00012903	342.41
	9323703	055200-		Bushing	90 mm		JD-FXB00002051	36.70
BOOM LH	9257019G	-55193		P-UB-10	80 mm	110 mm	JD-4662891	201.87
	9257019G	-55193		P-UB-10	80 mm	110 mm	JD-4662891-EX	264.19
	9257019G	-55193		Bushing	80 mm		JD-AT264314	31.26
	9257019G	-55193		Wear Ring		110 mm	JD-1119106	10.89
	9257019G	-55193		Wear Ring		110 mm	JD-4S00156	79.26
	9323702	055194-		P-UB-10	80 mm	110 mm	JD-FYA00012902	261.83
	9323702	055194-		Bushing	80 mm		JD-FXB00002113	31.26
BOOM RH	9257018G	-55193		P-UB-10	80 mm	110 mm	JD-4662891	201.87
	9257018G	-55193		P-UB-10	80 mm	110 mm	JD-4662891-EX	264.19
	9257018G	-55193		Bushing	80 mm		JD-AT264314	31.26
	9257018G	-55193		Wear Ring		110 mm	JD-1119106	10.89
	9257018G	-55193		Wear Ring		110 mm	JD-4S00156	79.26
	9323701	055194-		P-UB-10	80 mm	110 mm	JD-FYA00012902	261.83
	9323701	055194-		Bushing	80 mm		JD-FXB00002113	31.26
BUCKET	9257021G	-55223		P-UB-10	75 mm	105 mm	JD-4663493	163.74
	9257021G	-55223		P-UB-10	75 mm	105 mm	JD-4663493-EX	204.67
	9257021G	-55223		Bushing	75 mm		JD-TH109311	27.12
	9257021G	-55223		Wear Ring		105 mm	JD-0907801	11.26
	9257021G	-55223		Wear Ring		105 mm	JD-AT264388	23.12
	9323704	055224-		P-UB-10	75 mm	105 mm	JD-FYA00012904	249.33
	9323704	055224-		Bushing	75 mm		JD-FXB00002087	27.12
THUMB	AT383236		06/28/2010-	I-UB-14	2-1/2	4	JD-AT383237	440.42
MODEL 190E								
ARM	AT200453			P-UB-10	60 mm	95 mm	JD-AT200549	150.13
BLADE	AT200491			P-UB-10	50 mm	80 mm	JD-AT200574	142.10
BOOM	AT200452			P-UB-10	65 mm	115 mm	JD-AT200548	199.06
BUCKET	AT182460			P-UB-10	55 mm	85 mm	JD-AT200550	158.28
OFFSET BOOM ARM	AT200518			P-UB-10	60 mm	95 mm	JD-AT200549	150.13
OFFSET BOOM CYL	AT200507			P-UB-10	60 mm	105 mm	JD-AT200573	151.02
MODEL 200 LC								
ARM		051019-		P-UB-14	100 mm	145 mm	JD-AT264438	361.43
	AH148451	All		P-UB-10	95 mm	130 mm	JD-AH148453	349.64
BOOM (LH)	AH148792	All		P-UB-10	85 mm	120 mm	JD-AH148785	290.86
BOOM (RH)	AH148782	All		P-UB-10	85 mm	120 mm	JD-AH148785	290.86
BUCKET	AH148761	All		P-UB-10	75 mm	110 mm	JD-AH148776	314.21
MODEL 200C LC								
ARM	9169805Y			P-UB-10	95 mm	135 mm	JD-AH173444	221.49
BOOM (LH)	9175423Y			P-UB-10	85 mm	120 mm	JD-AH173457	290.86
BOOM (LH) (SLF)	AH165673			P-UB-10	85 mm	120 mm	JD-AH173457	290.86

LA - Long Arm LGP - Low Ground Pressure LT - Long Track MFWD - Mechanical Front Wheel Drive MP - Multi-Purpose
 IDM - Inside Dozer Mount ODM - Outside Dozer Mount SLF - Super Long Front STD - Straight Dozer WT - Wide Track

Replacement Kits For

JOHN DEERE

Excavators								
APPLICATION	CYL #	SERIAL #	Misc	CODE	ROD	BORE	KIT #	List \$
MODEL 200C LC								
BOOM (RH)	9175422Y			P-UB-10	85 mm	120 mm	JD-AH173457	290.86
BOOM (RH) (SLF)	AH148786			P-UB-10	85 mm	120 mm	JD-AH173457	290.86
BUCKET		-503594 ; 503595-		P-UB-10	80 mm	115 mm	JD-AH173451	310.18
BUCKET (SLF)				P-UB-10	65 mm	95 mm	JD-AT196469	305.35
MODEL 200D LC								
ARM				P-UB-10	95 mm	135 mm	JD-AH225135	342.13
BUCKET				P-UB-10	80 mm	115 mm	JD-AH225137	102.20
BUCKET (SLF)	4379259			P-UB-10	65 mm	95 mm	JD-AT196469	305.35
LEFT BOOM	9286529			P-UB-10	85 mm	120 mm	JD-AH225136	176.23
	9286529			P-UB-10	85 mm	120 mm	JD-AH225136-EX	255.21
RIGHT BOOM	9286528			P-UB-10	85 mm	120 mm	JD-AH225136	176.23
	9286528			P-UB-10	85 mm	120 mm	JD-AH225136-EX	255.21
MODEL 210GLC								
ARM	9234748G			P-UB-10	95 mm	135 mm	JD-AH225135	342.13
ARM (SLF)	1112701G			P-UB-10	100 mm	135 mm	JD-4672004	126.43
	1112701G			P-UB-10	100 mm	135 mm	JD-4672004-EX	193.47
	1112701G			Bushing	100 mm		JD-0836104	51.68
	1112701G			Wear Ring		135 mm	JD-H178696	50.87
	1112701G			Wear Ring		135 mm	JD-H227905	14.40
BOOM LH	9286529G			P-UB-10	85 mm	120 mm	JD-AH225136	176.23
	9286529G			P-UB-10	85 mm	120 mm	JD-AH225136-EX	255.21
	9286529G			Bushing	85 mm		JD-T108019	34.71
	9286529G			Wear Ring		120 mm	JD-H227906	13.29
	9286529G			Wear Ring		120 mm	JD-TH104923	47.08
BOOM RH	9286528G			P-UB-10	85 mm	120 mm	JD-AH225136	176.23
	9286528G			P-UB-10	85 mm	120 mm	JD-AH225136-EX	255.21
	9286528G			Bushing	85 mm		JD-T108019	34.71
	9286528G			Wear Ring		120 mm	JD-TH104923	47.08
	9286528G			Wear Ring		120 mm	JD-H227906	13.29
BUCKET	9248307G			P-UB-10	80 mm	115 mm	JD-AH225137	102.20
BUCKET (SLF)	4379259			P-UB-10	65 mm	95 mm	JD-AT196469	305.35
	4379259			Bushing	65 mm		JD-AT264389	21.71
THUMB	AT383236			I-UB-14	2-1/2	4	JD-AT383237	440.42
MODEL 225C LC								
ARM	9169805			P-UB-10	95 mm	135 mm	JD-4661594	221.89
BOOM (LH)	9196649			P-UB-10	85 mm	120 mm	JD-AH225136	176.23
BOOM (RH)	9196650			P-UB-10	85 mm	120 mm	JD-AH225136	176.23
BUCKET	DH900365J			P-UB-10	80 mm	115 mm	JD-AH173451	310.18
MODEL 230 LC								
ARM	AT154865	All		P-UB-14	100 mm	135 mm	JD-AT183658	182.24
	AT154865	All		Bushing	100 mm		JD-AT131414	52.10
	AT154865	All		Wear Ring		135 mm	JD-AT154718	20.40
	AT154865	All		Wear Ring		135 mm	JD-TH110033	59.59
BOOM (LH)	AT154864	All		P-UB-14	90 mm	125 mm	JD-AT154867	198.30
	AT154864	All		Bushing	90 mm		JD-AT154779	33.48
	AT154864	All		Wear Ring		125 mm	JD-AT154700	125.42
	AT154864	All		Wear Ring		125 mm	JD-AT154735	14.83
BOOM (RH)	AT154864	All		P-UB-14	90 mm	125 mm	JD-AT154867	198.30
	AT154864	All		Bushing	90 mm		JD-AT154779	33.48
	AT154864	All		Wear Ring		125 mm	JD-AT154700	125.42
	AT154864	All		Wear Ring		125 mm	JD-AT154735	14.83
BUCKET	AT182459	All		P-UB-14	85 mm	125 mm	JD-AT181250	139.70

LA - Long Arm LGP - Low Ground Pressure LT - Long Track MFWD - Mechanical Front Wheel Drive MP - Multi-Purpose
 IDM - Inside Dozer Mount ODM - Outside Dozer Mount SLF - Super Long Front STD - Straight Dozer WT - Wide Track

Replacement Kits For

JOHN DEERE

Excavators								
APPLICATION	CYL #	SERIAL #	Misc	CODE	ROD	BORE	KIT #	List \$
MODEL 230 LC								
BUCKET	AT182459	All		Bushing	85 mm		JD-AT154778	34.71
	AT182459	All		Wear Ring		125 mm	JD-AT154735	14.83
	AT182459	All		Wear Ring		125 mm	JD-AT154700	125.42
MODEL 230C LC								
ARM		-603582		P-UB-14	105 mm	140 mm	JD-9207059	155.44
	9234731J	603583-		P-UB-10	105 mm	140 mm	JD-4631062	226.75
ARM (SLF)				P-UB-10	105 mm	145 mm	JD-4369943	272.83
BOOM (LH)		603538-603552 ; 603514		P-UB-14	90 mm	125 mm	JD-4485612	108.45
	9234729J	603515-603552 ; 603553-		P-UB-10	90 mm	125 mm	JD-4662069	188.44
BOOM (RH)		603538-603552 ; 603514		P-UB-14	90 mm	125 mm	JD-4485612	108.45
	9234729J	603515-603537 ; 603533-		P-UB-10	90 mm	125 mm	JD-4662069	188.44
BUCKET		-603533		P-UB-14	90 mm	130 mm	JD-4485614	122.18
BUCKET (SLF)				P-UB-10	65 mm	95 mm	JD-AT196469	305.35
MODEL 240D LC								
ARM	PG200017G			P-UB-10	100 mm	140 mm	JD-4649050	252.00
	PG200017G			P-UB-10	100 mm	140 mm	JD-4649050-EX	350.11
ARM (SLF)	4388916			P-UB-10	105 mm	145 mm	JD-4369943	272.83
	4388916			P-UB-10	105 mm	145 mm	JD-4369943-EX	332.41
BOOM (LH)				P-UB-10	90 mm	125 mm	JD-4662069	188.44
BOOM (RH)				P-UB-10	90 mm	125 mm	JD-4662069	188.44
BUCKET				P-UB-10	90 mm	130 mm	JD-4662066	156.98
				P-UB-10	90 mm	130 mm	JD-4662066-EX	250.12
BUCKET (SLF)	4379259			P-UB-10	65 mm	95 mm	JD-AT196469	305.35
THUMB	AT383236			I-UB-14	3	5	JD-AT383285	200.29
MODEL 250GLC								
ARM	9246750G			P-UB-10	100 mm	140 mm	JD-FYA00006591	133.94
	9246750G			P-UB-10	100 mm	140 mm	JD-FYA00006591-EX	205.19
	9246750G			Bushing	100 mm		JD-0836104	51.68
	9246750G			Wear Ring			JD-4S00705	17.94
	9246750G			Wear Ring		140 mm	JD-TH102797	51.51
ARM (SLF)	4388916			P-UB-10	105 mm	145 mm	JD-4369943	272.83
	4388916			P-UB-10	105 mm	145 mm	JD-4369943-EX	332.41
	4388916			Bushing	105 mm		JD-0373405	44.45
	4388916			Wear Ring		145 mm	JD-0492209	17.94
	4388916			Wear Ring		145 mm	JD-4S00804	81.03
BOOM LH	9261586G			P-UB-10	90 mm	125 mm	JD-4662069	188.44
	9261586G			P-UB-10	90 mm	125 mm	JD-4662069-EX	211.45
	9261586G			Bushing	90 mm		JD-AT264321	33.48
	9261586G			Wear Ring		125 mm	JD-AT264362	9.08
	9261586G			Wear Ring			JD-4S00708	13.92
BOOM RH	9261586G			P-UB-10	90 mm	125 mm	JD-4S00715	117.02
	9261586G			P-UB-10	90 mm	125 mm	JD-4S00715-EX	140.01
	9261586G			Bushing	90 mm		JD-AT264321	33.48
	9261586G			Wear Ring			JD-4S00708	13.92
	9261586G			Wear Ring		125 mm	JD-AT264362	9.08
BUCKET	9282252G			P-UB-10	90 mm	130 mm	JD-4662066	156.98
	9282252G			P-UB-10	90 mm	130 mm	JD-4662066-EX	250.12
	9282252G			Bushing	90 mm		JD-AT264321	33.48
	9282252G			Wear Ring		130 mm	JD-H155318	49.93

LA - Long Arm LGP - Low Ground Pressure LT - Long Track MFWD - Mechanical Front Wheel Drive MP - Multi-Purpose
 IDM - Inside Dozer Mount ODM - Outside Dozer Mount SLF - Super Long Front STD - Straight Dozer WT - Wide Track

Replacement Kits For

JOHN DEERE

Excavators								
APPLICATION	CYL #	SERIAL #	Misc	CODE	ROD	BORE	KIT #	List \$
MODEL 250GLC								
BUCKET	9282252G			Wear Ring			JD-4S00712	16.36
BUCKET (SLF)	4379259			P-UB-10	65 mm	95 mm	JD-AT196469	305.35
	4379259			Bushing	65 mm		JD-AT264389	21.71
THUMB	AT383284			I-UB-14	3	5	JD-AT383285	200.29
MODEL 270C LC								
ARM			Aug 2004 -	P-UB-10	100 mm	145 mm	JD-4639938	238.14
			- Aug 2004	P-UB-14	100 mm	145 mm	JD-AT264438	361.43
ARM (SLF)				P-UB-10	105 mm	145 mm	JD-4369943	272.83
BOOM (LH)			Aug 2004 -	P-UB-10	95 mm	135 mm	JD-4639936	246.95
	9245979J		- Aug 2004	P-UB-14	95 mm	135 mm	JD-4485615	145.27
BOOM (RH)			Aug 2004 -	P-UB-10	95 mm	135 mm	JD-4639936	246.95
	9245978J		- Aug 2004	P-UB-14	95 mm	135 mm	JD-4485615	145.27
BUCKET			Aug 2004 -	P-UB-10	90 mm	135 mm	JD-4639939	284.62
			- Aug 2004	P-UB-14	90 mm	135 mm	JD-AT264439	332.38
BUCKET (SLF)				P-UB-10	65 mm	95 mm	JD-AT196469	305.35
MODEL 270D LC								
ARM				P-UB-14	105 mm	150 mm	JD-4649752	227.63
ARM (SLF)	4388916			P-UB-10	105 mm	145 mm	JD-4369943	272.83
	4388916			P-UB-10	105 mm	145 mm	JD-4369943-EX	332.41
BOOM (LH)				P-UB-14	95 mm	135 mm	JD-4649745	162.63
BOOM (RH)				P-UB-14	95 mm	135 mm	JD-4649745	162.63
BUCKET				P-UB-14	90 mm	135 mm	JD-4649751	165.93
BUCKET (SLF)	4379259			P-UB-10	65 mm	95 mm	JD-AT196469	305.35
THUMB	AT383236			I-UB-14	3	5	JD-AT383285	200.29
MODEL 290D								
ARM	AT130515	All		P-UB-10	70 mm	105 mm	JD-AT130601	171.69
BOOM	AT130512	All		P-UB-10	65 mm	95 mm	JD-AT130600	138.13
	AT130513	All		P-UB-10	65 mm	95 mm	JD-AT130600	138.13
	AT182454	All		P-UB-10	60 mm	95 mm	JD-AT130602	117.98
BUCKET	AT182454	All		Bushing	60 mm		JD-TH110296	20.61
MODEL 330 LC								
BOOM (Log Loader) (LH)		051012-		P-UB-14	115 mm	170 mm	JD-AT264441	359.21
BOOM (Log Loader) (RH)		051012-		P-UB-14	115 mm	170 mm	JD-AT264441	359.21
BUCKET	AT250263	All		P-UB-14	95 mm	145 mm	JD-AT181792	157.81
	AT250263	All		Bushing	95 mm		JD-AT131420	44.36
	AT250263	All		Wear Ring		145 mm	JD-TH110062	65.19
	AT250263	All		Wear Ring		145 mm	JD-TH110063	23.64
MODEL 330C LC								
ARM	0961401JEX		Aug 2004 -	P-UB-14	115 mm	170 mm	JD-4640118	391.59
	TH9206360		- Aug 2004	P-UB-14	115 mm	170 mm	JD-AT264441	359.21
BOOM (LH)	0961201JEX	804316-		P-UB-14	105 mm	150 mm	JD-4640107	514.81
	TH9206359	-804315		P-UB-14	105 mm	150 mm	JD-AT264440	354.06
BOOM (RH)	0961201JEX	804316-		P-UB-14	105 mm	150 mm	JD-4640107	514.81
	TH9206359	-804315		P-UB-14	105 mm	150 mm	JD-AT264440	354.06
BUCKET	0961501JEX		Aug 2004 -	P-UB-14	95 mm	145 mm	JD-4640108	450.03
	TH9206361		- Aug 2004	P-UB-14	95 mm	145 mm	JD-AT264430	324.88
MODEL 350D LC								
ARM				P-UB-10	115 mm	170 mm	JD-4S00930	222.48
				P-UB-10	115 mm	170 mm	JD-4S00930-EX	354.35
ARM (SLF)				P-UB-14	115 mm	170 mm	JD-4640118	391.59
BOOM (LH)				P-UB-10	100 mm	145 mm	JD-4S00783	204.28
				P-UB-10	100 mm	145 mm	JD-4S00783-EX	338.93
BOOM (RH)				P-UB-10	100 mm	145 mm	JD-4S00783	204.28
				P-UB-10	100 mm	145 mm	JD-4S00783-EX	338.93
BUCKET				P-UB-10	95 mm	140 mm	JD-4S07784	181.93

LA - Long Arm LGP - Low Ground Pressure LT - Long Track MFWD - Mechanical Front Wheel Drive MP - Multi-Purpose
 IDM - Inside Dozer Mount ODM - Outside Dozer Mount SLF - Super Long Front STD - Straight Dozer WT - Wide Track

Replacement Kits For

JOHN DEERE

Excavators								
APPLICATION	CYL #	SERIAL #	Misc	CODE	ROD	BORE	KIT #	List \$
MODEL 350D LC								
BUCKET				P-UB-10	95 mm	140 mm	JD-4S07784-EX	280.04
BUCKET (18m SLF)	4370785			P-UB-10	75 mm	105 mm	JD-AH155040	461.55
BUCKET (22m SLF)	4379259			P-UB-10	65 mm	95 mm	JD-AT196469	305.35
THUMB	AT383236			I-UB-14	3	5	JD-AT383285	200.29
MODEL 350GLC								
ARM	9303616	-808223		P-UB-10	115 mm	170 mm	JD-4S00930	222.48
	9303616	-808223		P-UB-10	115 mm	170 mm	JD-4S00930-EX	354.35
	9303616	-808223		Bushing	115 mm		JD-0352704	50.20
	9303616	-808223		Wear Ring		170 mm	JD-AT264248	23.10
	9303616	-808223		Wear Ring		170 mm	JD-4S00858	21.63
	9303616G	808224-		P-UB-10	115 mm	170 mm	JD-FYA00008837	429.13
	9303616G	808224-		Bushing	115 mm		JD-1237306	20.88
ARM (SLF)	4611472			P-UB-14	115 mm	170 mm	JD-4640118	391.59
	4611472			Bushing	115 mm		JD-0961415	61.48
BOOM LH	9261587G	-808213		P-UB-10	100 mm	145 mm	JD-FYA00006596	121.53
	9261587G	-808213		P-UB-10	100 mm	145 mm	JD-FYA00006596-EX	223.33
	9261587G	-808213		Bushing	100 mm		JD-0836104	51.68
	9261587G	-808213		Wear Ring		145 mm	JD-4S00804	81.03
	9261587G	-808213		Wear Ring		145 mm	JD-4S00803	17.94
	9303615	808214-		P-UB-10	100 mm	145 mm	JD-FYA00008840	386.09
	9303615	808214-		Bushing	100 mm		JD-1237106	41.68
BOOM RH	9261587G	-808213		P-UB-10	100 mm	145 mm	JD-FYA00006596	121.53
	9261587G	-808213		P-UB-10	100 mm	145 mm	JD-FYA00006596-EX	223.33
	9261587G	-808213		Bushing	100 mm		JD-0836104	51.68
	9261587G	-808213		Wear Ring		145 mm	JD-4S00804	81.03
	9261587G	-808213		Wear Ring		145 mm	JD-4S00803	17.94
	9303614	808214-		P-UB-10	100 mm	145 mm	JD-FYA00008840	386.09
	9303614	808214-		Bushing	100 mm		JD-1237106	41.68
BUCKET	9303617	-808228		p-ub-10	95 mm	140 mm	JD-FYA00001398	122.49
	9303617	-808228		P-UB-10	95 mm	140 mm	JD-FYA00001398-EX	193.74
	9303617	-808228		Bushing	95 mm		JD-T108050	37.71
	9303617	-808228		Wear Ring		140 mm	JD-TH102797	51.51
	9303617	-808228		Wear Ring			JD-4S00705	17.94
	9303617G	808229-		P-UB-10	95 mm	140 mm	JD-FYA00008843	361.32
	9303617G	808229-		Bushing	95 mm		JD-0971202	37.71
BUCKET (SLF)	4370785JEX		18m	P-UB-10	75 mm	105 mm	JD-AH155040	461.55
	4370785JEX		18m	Bushing	75 mm		JD-TH109311	27.12
	4379259			P-UB-10	65 mm	95 mm	JD-AT196469	305.35
	4379259			Bushing	65 mm		JD-AT264389	21.71
THUMB	AT383284		06/28/2010-	I-UB-14	3	5	JD-AT383285	200.29
MODEL 370								
BOOM (Log Loader) (LH)		051005-		P-UB-14	115 mm	170 mm	JD-AT264441	359.21
BOOM (Log Loader) (RH)		051005-		P-UB-14	115 mm	170 mm	JD-AT264441	359.21
BUCKET	AT250263	All		P-UB-14	95 mm	145 mm	JD-AT181792	157.81
	AT250263	All		Bushing	95 mm		JD-AT131420	44.36

LA - Long Arm LGP - Low Ground Pressure LT - Long Track MFWD - Mechanical Front Wheel Drive MP - Multi-Purpose
 IDM - Inside Dozer Mount ODM - Outside Dozer Mount SLF - Super Long Front STD - Straight Dozer WT - Wide Track

Replacement Kits For

JOHN DEERE

Excavators								
APPLICATION	CYL #	SERIAL #	Misc	CODE	ROD	BORE	KIT #	List \$
MODEL 370								
BUCKET	AT250263	All		Wear Ring		145 mm	JD-TH110062	65.19
	AT250263	All		Wear Ring		145 mm	JD-TH110063	23.64
MODEL 370C								
ARM	0961401JEX		Aug 2004 -	P-UB-14	115 mm	170 mm	JD-4640118	391.59
	TH9206360		- Aug 2004	P-UB-14	115 mm	170 mm	JD-AT264441	359.21
BOOM (LH)	0961201JEX	083163-		P-UB-14	105 mm	150 mm	JD-4640107	514.81
	TH9206359	-083162		P-UB-14	105 mm	150 mm	JD-AT264440	354.06
BOOM (RH)	0961201JEX	083163-		P-UB-14	105 mm	150 mm	JD-4640107	514.81
	TH9206359	-083162		P-UB-14	105 mm	150 mm	JD-AT264440	354.06
BUCKET	0961501JEX		Aug 2004 -	P-UB-14	95 mm	145 mm	JD-4640108	450.03
	TH9206361		- Aug 2004	P-UB-14	95 mm	145 mm	JD-AT264430	324.88
MODEL 450 LC								
BUCKET LONG ARM	AT182461	803513-		P-UB-14	95 mm	145 mm	JD-AT181792	157.81
	AT182461	-803512		P-UB-14	95 mm	145 mm	JD-AT201185	274.94
	AT182461	All		Bushing	95 mm		JD-AT131420	44.36
	AT182461	All		Wear Ring		145 mm	JD-TH110062	65.19
	AT182461	All		Wear Ring		145 mm	JD-TH110063	23.64
MODEL 450C LC								
ARM				P-UB-10	130 mm	190 mm	JD-AT302758	396.99
BOOM (LH)		-091286		P-UB-14	115 mm	170 mm	JD-9180582	244.22
		091287-		P-UB-10	115 mm	170 mm	JD-AT196471	371.61
BOOM (RH)		-091286		P-UB-14	115 mm	170 mm	JD-9180582	244.22
		091287-		P-UB-10	115 mm	170 mm	JD-AT196471	371.61
BUCKET (LA)			- Dec 2005	P-UB-14	95 mm	145 mm	JD-AT264430	324.88
MODEL 450D LC								
ARM	4653044G			P-UB-10	130 mm	190 mm	JD-4653041	264.17
	4653044G			P-UB-10	130 mm	190 mm	JD-4653041-EX	447.70
BOOM (LH)	4653043G			P-UB-10	115 mm	170 mm	JD-4S00961	225.63
	4653043G			P-UB-10	115 mm	170 mm	JD-4S00961-EX	373.03
BOOM (RH)				P-UB-10	115 mm	170 mm	JD-4653040	225.63
				P-UB-10	115 mm	170 mm	JD-4653040-EX	373.03
BUCKET				P-UB-10	120 mm	170 mm	JD-4S00959	119.53
				P-UB-10	120 mm	170 mm	JD-4S00959-EX	264.11
BUCKET (LA)	4658553G			P-UB-10	95 mm	145 mm	JD-4660570	186.12
THUMB	AT383236			I-UB-14	3	5	JD-AT383285	200.29
MODEL 470GLC								
ARM	4712920			P-UB-10	130 mm	190 mm	JD-4S00960	347.12
	4712920			P-UB-10	130 mm	190 mm	JD-4S00960-EX	432.12
	4712920			Wear Ring		130 mm	JD-AT264250	71.19
	4712920			Wear Ring		190 mm	JD-AT264245	46.06
	4712920			Wear Ring		190 mm	JD-0972305	38.95
BOOM LH	4698939			P-UB-10	115 mm	170 mm	JD-4S00961	225.63
	4698939			P-UB-10	115 mm	170 mm	JD-4S00961-EX	373.03
	4698939			Bushing	115 mm		JD-0352704	50.20
	4698939			Wear Ring		170 mm	JD-AT264248	23.10
	4698939			Wear Ring		170 mm	JD-4S00858	21.63
BOOM RH	4698938			P-UB-10	115 mm	170 mm	JD-4686432	380.07
	4698938			Bushing	115 mm		JD-0352704	50.20
BUCKET	FYA00004897			P-UB-10	120 mm	170 mm	JD-4S00959	119.53
	FYA00004897			P-UB-10	120 mm	170 mm	JD-4S00959-EX	264.11
	FYA00004897			Bushing	120 mm		JD-AT264291	48.63
	FYA00004897			Wear Ring		170 mm	JD-4S00858	21.63
	FYA00004897			Wear Ring		170 mm	JD-AT264248	23.10
COUNTERWEIGHT	4723756			P-UB-10	85 mm	130 mm	JD-FXB00001834	177.97

LA - Long Arm LGP - Low Ground Pressure LT - Long Track MFWD - Mechanical Front Wheel Drive MP - Multi-Purpose
 IDM - Inside Dozer Mount ODM - Outside Dozer Mount SLF - Super Long Front STD - Straight Dozer WT - Wide Track

Replacement Kits For

JOHN DEERE

Excavators								
APPLICATION	CYL #	SERIAL #	Misc	CODE	ROD	BORE	KIT #	List \$
MODEL 470GLC								
COUNTERWEIGHT	4723756			Bushing	85 mm		JD-FXB00001811	37.06
THUMB	AT383284		06/28/2010-	I-UB-14	3	5	JD-AT383285	200.29
MODEL 490D								
ARM				P-UB-10	80 mm	115 mm	JD-AT194335	254.14
	TH109346	All		P-UB-10	80 mm	115 mm	JD-TH109366	139.80
	TH109346	All		Bushing	80 mm		JD-T108041	31.26
	TH109346	All		Wear Ring		115 mm	JD-TH109356	12.84
	TH109346	All		Wear Ring		115 mm	JD-TH109357	40.55
BOOM	TH109307	All		P-UB-10	75 mm	105 mm	JD-TH109339	122.15
	TH109307	All		Bushing	75 mm		JD-TH109311	27.12
	TH109307	All		Wear Ring		105 mm	JD-TH109323	34.46
	TH109307	All		Wear Ring		105 mm	JD-TH109324	95.77
BOOM LH	AT264206			P-UB-10	75 mm	105 mm	JD-AT192095	118.02
	AT264206			P-UB-10	75 mm	105 mm	JD-AT192095-EX	173.65
	AT264206			Bushing	75 mm		JD-TH109311	27.12
	AT264206			Wear Ring		105 mm	JD-AT309607	33.29
	AT264206			Wear Ring		105 mm	JD-AT264388	23.12
BOOM RH				P-UB-10	75 mm	105 mm	JD-AT192095	118.02
				P-UB-10	75 mm	105 mm	JD-AT192095-EX	173.65
				Bushing	75 mm		JD-TH109311	27.12
				Wear Ring		105 mm	JD-AT264388	23.12
				Wear Ring		105 mm	JD-AT309607	33.29
BUCKET	AT1842468			P-UB-10	65 mm	95 mm	JD-AT264445	79.57
	TH109368	All		P-UB-10	65 mm	95 mm	JD-TH109390	126.79
	TH109368	All		Bushing	65 mm		JD-TH109372	21.71
	TH109368	All		Wear Ring		95 mm	JD-TH109378	37.81
	TH109368	All		Wear Ring		95 mm	JD-TH109377	10.66
MODEL 490E								
ARM	AT154402	All		P-UB-10	80 mm	110 mm	JD-AT177556	235.79
	AT154402	All		Bushing	80 mm		JD-T108041	31.26
	AT154402	All		Wear Ring		110 mm	JD-AT153936	12.67
	AT154402	All		Wear Ring		110 mm	JD-AT153830	79.26
BOOM (LH)	AT154399	All		P-UB-10	70 mm	105 mm	JD-AT176822	169.68
	AT154399	All		Bushing	70 mm		JD-AT133645	24.51
	AT154399	All		Wear Ring		105 mm	JD-TH109323	34.46
	AT154399	All		Wear Ring		105 mm	JD-TH109324	95.77
BOOM (RH)	AT154396	All		P-UB-10	70 mm	105 mm	JD-AT176822	169.68
	AT154396	All		Bushing	70 mm		JD-AT133645	24.51
	AT154396	All		Wear Ring		105 mm	JD-TH109323	34.46
	AT154396	All		Wear Ring		105 mm	JD-TH109324	95.77
BUCKET	AT154407	All		P-UB-10	65 mm	95 mm	JD-AT176737	182.24
	AT154407	All		Bushing	65 mm		JD-TH109372	21.71
	AT154407	All		Wear Ring		95 mm	JD-TH109378	37.81
	AT154407	All		Wear Ring		95 mm	JD-TH109377	10.66
MODEL 495D								
ARM	AT127253	All		P-UB-10	75 mm	105 mm	JD-TH109339	122.15
	AT127253	All		Bushing	75 mm		JD-TH109311	27.12
	AT127253	All		Wear Ring		105 mm	JD-TH109324	95.77
	AT127253	All		Wear Ring		105 mm	JD-TH109323	34.46
BUCKET	AT182453	All		P-UB-10	65 mm	95 mm	JD-TH109390	126.79
	AT182453	All		Bushing	65 mm		JD-TH109372	21.71
	AT182453	All		Wear Ring		95 mm	JD-TH109378	37.81
	AT182453	All		Wear Ring		95 mm	JD-TH109377	10.66

JOHN DEERE

LA - Long Arm LGP - Low Ground Pressure LT - Long Track MFWD - Mechanical Front Wheel Drive MP - Multi-Purpose
 IDM - Inside Dozer Mount ODM - Outside Dozer Mount SLF - Super Long Front STD - Straight Dozer WT - Wide Track

Replacement Kits For

JOHN DEERE

Excavators								
APPLICATION	CYL #	SERIAL #	Misc	CODE	ROD	BORE	KIT #	List \$
MODEL 590D								
ARM	AT127249	All		P-UB-10	85 mm	120 mm	JD-AT192075	121.43
	AT127249	All		Bushing	85 mm		JD-T108019	34.71
	AT127249	All		Wear Ring		120 mm	JD-T108046	11.73
	AT127249	All		Wear Ring		120 mm	JD-TH104923	47.08
BOOM (LH)	AT127250	All		P-UB-10	80 mm	115 mm	JD-AT194335	254.14
	AT127250	All		Bushing	80 mm		JD-T108041	31.26
	AT127250	All		Wear Ring		115 mm	JD-TH109356	12.84
	AT127250	All		Wear Ring		115 mm	JD-TH109357	40.55
BOOM (RH)	AT127251	All		P-UB-10	80 mm	115 mm	JD-AT194335	254.14
	AT127251	All		Bushing	80 mm		JD-T108041	31.26
	AT127251	All		Wear Ring		115 mm	JD-TH109356	12.84
	AT127251	All		Wear Ring		115 mm	JD-TH109357	40.55
BUCKET	AT127248	All		P-UB-10	80 mm	115 mm	JD-AT194335	254.14
	AT127248	All		Bushing	80 mm		JD-T108041	31.26
	AT127248	All		Wear Ring		115 mm	JD-TH109357	40.55
	AT127248	All		Wear Ring		115 mm	JD-TH109356	12.84
	AT182452	All		P-UB-10	80 mm	115 mm	JD-AT194335	254.14
	AT182452	All		Bushing	80 mm		JD-T108041	31.26
	AT182452	All		Wear Ring		115 mm	JD-TH109356	12.84
AT182452	All		Wear Ring		115 mm	JD-TH109357	40.55	
MODEL 690, 690A								
BOOM		000750-001662		P-V-8	2-3/4	5	JD-AR105309	85.70
	AR89435	001663-		P-V-8	2-3/4	5	JD-AR105309	85.70
	RE21394	All		P-UB-1	2-3/4		JD-RE21395	127.07
	RE21394	All		N-N-14		5	JD-RE15905	101.24
BUCKET		All		P-V-8	3-1/4	5-1/2	JD-AR105312	90.49
CROWD (Arm)		Field Replacement		P-V-1	3-1/4		JD-RE15906	45.03
		Field Replacement		N-N-14		5-1/2	JD-RE15907	123.45
	AT32257	All		P-V-8	3-1/4	5-1/2	JD-AR105312	90.49
	AT41907	All		P-V-8	3-1/4	5-1/2	JD-AR105313	88.02
	AU43243	All		P-V-8	3-1/4	5-1/2	JD-AR105312	90.49
MODEL 690B								
BOOM	AR89435	-501306		P-V-8	2-3/4	5	JD-AR105309	85.70
	RE12257	501307-		P-V-1	2-3/4		JD-RE17342	63.27
	RE12257	501307-		N-N-14		5	JD-RE15905	101.24
	RE21394	All		P-UB-1	2-3/4		JD-RE21395	127.07
	RE21394	All		N-N-14		5	JD-RE15905	101.24
BUCKET	RE11341	-501306		P-V-8	3-1/4	5-1/2	JD-AR105312	90.49
	RE21400	All		P-UB-1	3-1/4		JD-RE21401	87.13
	RE21400	501307-		P-V-1	3-1/4		JD-RE15906	45.03
	RE21400	501307-		N-N-14		5-1/2	JD-RE14102	123.45
	RE21400	All		N-N-14		5-1/2	JD-RE14102	123.45
CROWD (Arm)		501307-		P-V-1	3-1/4		JD-RE15906	45.03
	AT41907	-501306		P-V-8	3-1/4	5-1/2	JD-AR105313	88.02
	RE21406	501307-		P-UB-1	3-1/4		JD-RE21401	87.13
	RE21406	501307-		N-N-14		5-1/2	JD-RE15907	123.45
MODEL 690C								
BOOM	RE18949	-509184		P-V-1	2-3/4		JD-RE17342	63.27
	RE18949	-509184		N-N-14		5	JD-RE15905	101.24
	RE21394	509185-		P-UB-1	2-3/4		JD-RE21395	127.07
	RE21394	509185-		N-N-14		5	JD-RE15905	101.24
BUCKET	RE18950	-509184		P-V-1	3-1/4		JD-RE15906	45.03
	RE18950	-509184		N-N-14		5-1/2	JD-RE14102	123.45
	RE21400	509185-		P-UB-1	3-1/4		JD-RE21401	87.13
	RE21400	509185-		N-N-14		5-1/2	JD-RE14102	123.45

LA - Long Arm LGP - Low Ground Pressure LT - Long Track MFWD - Mechanical Front Wheel Drive MP - Multi-Purpose
 IDM - Inside Dozer Mount ODM - Outside Dozer Mount SLF - Super Long Front STD - Straight Dozer WT - Wide Track

Replacement Kits For

JOHN DEERE

Excavators								
APPLICATION	CYL #	SERIAL #	Misc	CODE	ROD	BORE	KIT #	List \$
MODEL 690C								
CROWD (Arm)	RE18951	-509184		P-V-1	3-1/4		JD-RE15906	45.03
	RE18951	-509184		N-N-14		5-1/2	JD-RE15907	123.45
	RE21406	509185-		P-UB-1	3-1/4		JD-RE21401	87.13
	RE21406	509185-		N-N-14		5-1/2	JD-RE15907	123.45
MODEL 690CR								
ANGLING	AU13861	All		P-V-8	1-1/2	3-1/2	JD-AR105432	44.84
ARM	RE21406	All		P-UB-1	3-1/4		JD-RE21401	87.13
	RE21406	All		N-N-14		5-1/2	JD-RE15907	123.45
BOOM	RE18949	-509184		P-V-1	2-3/4		JD-RE17342	63.27
	RE18949	-509184		N-N-14		5	JD-RE15905	101.24
	RE21394	509185-		P-UB-1	2-3/4		JD-RE21395	127.07
	RE21394	509185-		N-N-14		5	JD-RE15905	101.24
BUCKET	RE21400	All		P-UB-1	3-1/4		JD-RE21401	87.13
	RE21400	All		N-N-14		5-1/2	JD-RE14102	123.45
LIFT	AU13861	All		P-V-8	1-1/2	3-1/2	JD-AR105432	44.84
TILT	AU13847	All		P-V-8	1-1/2	3-1/2	JD-AR105432	44.84
MODEL 690D								
ARM	AT114837	All		P-UB-10	95 mm	135 mm	JD-AT114831	186.02
	AT114837	All		Bushing	95 mm		JD-T108052	12.98
	AT114837	All		Bushing	95 mm		JD-T108050	37.71
	AT114837	All		Wear Ring		135 mm	JD-T108059	50.87
	AT114837	All		Wear Ring		135 mm	JD-T108058	14.40
BOOM	AT112705	All		P-UB-10	85 mm	125 mm	JD-AT114822	155.01
	AT112705	All		Bushing	85 mm		JD-T108019	34.71
	AT112705	All		Wear Ring		125 mm	JD-T108024	13.92
	AT112705	All		Wear Ring		125 mm	JD-TH104949	49.06
BUCKET	AT114838	All		P-UB-10	80 mm	120 mm	JD-AT114836	153.84
	AT182451	All		P-UB-10	80 mm	120 mm	JD-AT114836	153.84
	AT182451	All		Bushing	80 mm		JD-T108041	31.26
	AT182451	All		Wear Ring		120 mm	JD-T108046	11.73
	AT182451	All		Wear Ring		120 mm	JD-TH104923	47.08
MODEL 690E								
ARM	AH144677			P-UB-14	95 mm	130 mm	JD-AH144595	290.62
BOOM	AH140588			P-UB-14	85 mm	120 mm	JD-AH144594	348.12
	AH144671			P-UB-14	85 mm	120 mm	JD-AH144594	348.12
	AH144674			P-UB-14	85 mm	120 mm	JD-AH144594	348.12
BUCKET	AH140587			P-UB-14	75 mm	110 mm	JD-AH144593	325.01
	AH142409			P-UB-14	75 mm	110 mm	JD-AH144593	325.01
MODEL 690E LC								
ARM	AH140590	-544625		P-UB-14	95 mm	130 mm	JD-AH144595	290.62
	AH140590	-544625		Bushing	95 mm		JD-H146481	37.71
	AH144677	544626-		P-UB-14	95 mm	130 mm	JD-AH144595	290.62
	AH144677	544626-		Bushing	95 mm		JD-H146481	37.71
BOOM (LH)	AH140588	-544743		P-UB-14	85 mm	120 mm	JD-AH144594	348.12
	AH140588	-544743		Bushing	85 mm		JD-H146480	34.71
	AH144671	544744-		P-UB-14	85 mm	120 mm	JD-AH144594	348.12
	AH144671	544744-		Bushing	85 mm		JD-H146480	34.71
BOOM (RH)	AH140589	-544743		P-UB-14	85 mm	120 mm	JD-AH144594	348.12
	AH140589	-544743		Bushing	85 mm		JD-H146480	34.71
	AH144674	544744-		P-UB-14	85 mm	120 mm	JD-AH144594	348.12
	AH144674	544744-		Bushing	85 mm		JD-H146480	34.71
BUCKET	AH142409	538667-544273		P-UB-14	75 mm	110 mm	JD-AH144593	325.01
	AH142409	-538666		P-UB-14	75 mm	110 mm	JD-AH144593	325.01
	AH142409	-538666		Bushing	75 mm		JD-H146479	27.12
	AH142409	538667-544273		Bushing	75 mm		JD-H146479	27.12

LA - Long Arm LGP - Low Ground Pressure LT - Long Track MFWD - Mechanical Front Wheel Drive MP - Multi-Purpose
 IDM - Inside Dozer Mount ODM - Outside Dozer Mount SLF - Super Long Front STD - Straight Dozer WT - Wide Track

Replacement Kits For

JOHN DEERE

Excavators								
APPLICATION	CYL #	SERIAL #	Misc	CODE	ROD	BORE	KIT #	List \$
MODEL 690E LC								
BUCKET	AH144595	544274-544696		Bushing	75 mm		JD-H146479	27.12
	AH162295	544697-		P-UB-14	75 mm	110 mm	JD-AH144593	325.01
	AH162295	544274-544696		P-UB-14	75 mm	110 mm	JD-AH144593	325.01
	AH162295	544697-		Bushing	75 mm		JD-H146479	27.12
BUCKET (SLF)	AT159611	All		P-UB-10	65 mm	95 mm	JD-AT176737	182.24
	AT159611	All		Bushing	65 mm		JD-TH109372	21.71
	AT159611	All		Wear Ring		95 mm	JD-TH109378	37.81
	AT159611	All		Wear Ring		95 mm	JD-TH109377	10.66
MODEL 790								
ARM	TH106316	All		P-UB-14	105 mm	150 mm	JD-TH102827	203.78
	TH106316	All		Wear Ring		150 mm	JD-TH102825	18.08
	TH106316	All		Wear Ring		150 mm	JD-TH102826	56.88
BOOM	TH102467	All		P-UB-14	95 mm	140 mm	JD-TH102798	210.89
	TH106315	All		P-UB-14	95 mm	140 mm	JD-TH102798	210.89
	TH106315	All		Bushing	95 mm		JD-TH102765	47.74
	TH106315	All		Wear Ring		140 mm	JD-TH102797	51.51
	TH106315	All		Wear Ring		140 mm	JD-TH102796	17.94
BUCKET	AT182467	All		P-UB-10	90 mm	140 mm	JD-TH102845	185.59
	AT182467	All		Wear Ring		140 mm	JD-TH102797	51.51
	AT182467	All		Wear Ring		140 mm	JD-TH102796	17.94
	TH106317	All		P-UB-10	90 mm	140 mm	JD-TH102845	185.59
MODEL 790D								
ARM	AT131428	007004-		P-UB-14	100 mm	145 mm	JD-TH110064	205.47
	AT131428	007004-		Wear Ring		145 mm	JD-TH110062	65.19
	AT131428	007004-		Wear Ring		145 mm	JD-TH110063	23.64
	TH110043	-007003		P-UB-14	100 mm	145 mm	JD-TH110064	205.47
	TH110043	-007003		Wear Ring		145 mm	JD-TH110063	23.64
	TH110043	-007003		Wear Ring		145 mm	JD-TH110062	65.19
ARM (SLF)	AT114837	All		P-UB-10	95 mm	135 mm	JD-AT114831	186.02
	AT114837	All		Bushing	95 mm		JD-T108050	37.71
	AT114837	All		Wear Ring		135 mm	JD-T108058	14.40
	AT114837	All		Bushing	95 mm		JD-T108052	12.98
	AT114837	All		Wear Ring		135 mm	JD-T108059	50.87
BOOM	AT131425	All		P-UB-14	90 mm	135 mm	JD-TH110035	191.71
	AT131425	All		Bushing	90 mm		JD-AT131422	42.75
	AT131425	All		Wear Ring		135 mm	JD-TH110034	16.16
	AT131425	All		Wear Ring		135 mm	JD-TH110033	59.59
BUCKET	AT131430	All		P-UB-14	90 mm	135 mm	JD-TH110035	191.71
	AT131430	All		Bushing	90 mm		JD-AT131422	42.75
	AT131430	All		Wear Ring		135 mm	JD-TH110033	59.59
	AT131430	All		Wear Ring		135 mm	JD-TH110034	16.16
MODEL 790E LC								
ARM	AT154865	-HJ900100		P-UB-14	100 mm	135 mm	JD-AT154868	173.47
	AT154865	HJ900101-		P-UB-14	100 mm	135 mm	JD-AT183658	182.24
	AT154865	-HJ900100		Bushing	100 mm		JD-AT131414	52.10
	AT154865	HJ900101-		Bushing	100 mm		JD-AT131414	52.10
	AT154865	-HJ900100		Wear Ring		135 mm	JD-AT154718	20.40
	AT154865	HJ900101-		Wear Ring		135 mm	JD-AT154718	20.40
	AT154865	HJ900101-		Wear Ring		135 mm	JD-TH110033	59.59
	AT154865	-HJ900100		Wear Ring		135 mm	JD-TH110033	59.59
ARM (SLF)	AT161589	All		P-UB-14	105 mm	145 mm	JD-AT176734	269.02
	AT161589	All		Bushing	105 mm		JD-AT161596	44.45
	AT161589	All		Wear Ring		145 mm	JD-AT161607	17.94
	AT161589	All		Wear Ring		145 mm	JD-AT161608	81.03
BOOM (LH)	AT154864	All		P-UB-14	90 mm	125 mm	JD-AT154867	198.30

LA - Long Arm LGP - Low Ground Pressure LT - Long Track MFWD - Mechanical Front Wheel Drive MP - Multi-Purpose
 IDM - Inside Dozer Mount ODM - Outside Dozer Mount SLF - Super Long Front STD - Straight Dozer WT - Wide Track

Replacement Kits For

JOHN DEERE

Excavators								
APPLICATION	CYL #	SERIAL #	Misc	CODE	ROD	BORE	KIT #	List \$
MODEL 790E LC								
BOOM (LH)	AT154864	All		Bushing	90 mm		JD-AT154779	33.48
	AT154864	All		Wear Ring		125 mm	JD-AT154735	14.83
	AT154864	All		Wear Ring		125 mm	JD-AT154700	125.42
BOOM (RH)	AT154864	All		P-UB-14	90 mm	125 mm	JD-AT154867	198.30
	AT154864	All		Bushing	90 mm		JD-AT154779	33.48
	AT154864	All		Wear Ring		125 mm	JD-AT154735	14.83
BUCKET	AT182459	All		P-UB-14	85 mm	125 mm	JD-AT181250	139.70
	AT182459	All		Bushing	85 mm		JD-AT154778	34.71
	AT182459	All		Wear Ring		125 mm	JD-AT154700	125.42
BUCKET (SLF)	AT159611	All		P-UB-10	65 mm	95 mm	JD-AT176737	182.24
	AT159611	All		Bushing	65 mm		JD-TH109372	21.71
	AT159611	All		Wear Ring		95 mm	JD-TH109378	37.81
	AT159611	All		Wear Ring		95 mm	JD-TH109377	10.66
MODEL 792								
ARM	TH106313	All		P-UB-10	110 mm	160 mm	JD-TH103347	233.03
	TH106313	All		Bushing	110 mm		JD-TH103332	84.51
	TH106313	All		Wear Ring		160 mm	JD-TH103346	69.91
	TH106313	All		Wear Ring		160 mm	JD-TH103345	19.60
BOOM	TH102340	All		P-UB-10	100 mm	150 mm	JD-AT194457	204.17
	TH106312	All		P-UB-10	100 mm	150 mm	JD-AT194457	204.17
	TH106312	All		P-UB-10	110 mm	160 mm	JD-TH103324	182.87
	TH106312	All		Bushing	100 mm		JD-TH103307	59.52
BUCKET	TH106312	All		Wear Ring		150 mm	JD-TH102826	56.88
	AT182466	All		P-UB-10	95 mm	150 mm	JD-TH103357	204.62
	AT182466	All		Bushing	95 mm		JD-TH102765	47.74
	AT182466	All		Wear Ring		150 mm	JD-TH102825	18.08
	AT182466	All		Wear Ring		150 mm	JD-TH102826	56.88
	TH106314	All		P-UB-10	95 mm	150 mm	JD-TH103357	204.62
MODEL 792D, 792D LC								
ARM	AT205924	All		P-UB-14	105 mm	150 mm	JD-TH111854	271.70
	AT205924	All		Wear Ring		150 mm	JD-TH111846	24.42
	AT205924	All		Wear Ring		150 mm	JD-TH111845	68.31
BOOM	AT205923	All		P-UB-14	95 mm	145 mm	JD-TH111625	255.82
	AT205923	All		Bushing	95 mm		JD-AT131420	44.36
	AT205923	All		Wear Ring		145 mm	JD-TH110062	65.19
BUCKET	AT205923	All		Wear Ring		145 mm	JD-AT159585	19.00
	AT205925	-803512		P-UB-14	95 mm	145 mm	JD-TH111625	255.82
	AT205925	803513-		P-UB-14	95 mm	145 mm	JD-AT181792	157.81
	AT205925	All		Bushing	95 mm		JD-AT131420	44.36
	AT205925	All		Wear Ring		145 mm	JD-TH110062	65.19
	AT205925	All		Wear Ring		145 mm	JD-AT159585	19.00
MODEL 890								
BOOM	RE11569	All	Capseal Style	N-N-14		7-1/2	JD-RE14033	163.67
	RE21201	All	Re-Capseal Style	P-UB-1	3-3/4		JD-RE21202	180.48
	RE21201	All	Re-Capseal Style	N-N-14		7-1/2	JD-RE14033	163.67
BUCKET	RE11571	All	Capseal Style	N-N-14		7-1/2	JD-RE14033	163.67
CROWD	RE11568	All	Capseal Style	N-N-14		7-1/2	JD-RE14033	163.67
	RE21195	All	Replacement	N-N-14		7-1/2	JD-RE14033	163.67
MODEL 890A								
BOOM	RE21210	All	Replacement	P-UB-1	3-3/4		JD-RE21202	180.48
MODEL 892D, 892D LC								
ARM	AT131416	703550-		P-UB-14	110 mm	165 mm	JD-AT181799	227.07
	AT131416	-703549		P-UB-14	110 mm	165 mm	JD-TH111627	302.63

LA - Long Arm LGP - Low Ground Pressure LT - Long Track MFWD - Mechanical Front Wheel Drive MP - Multi-Purpose
 IDM - Inside Dozer Mount ODM - Outside Dozer Mount SLF - Super Long Front STD - Straight Dozer WT - Wide Track

Replacement Kits For

JOHN DEERE

Excavators								
APPLICATION	CYL #	SERIAL #	Misc	CODE	ROD	BORE	KIT #	List \$
MODEL 892D, 892D LC								
ARM	AT131416	All		Bushing	110 mm		JD-AT131417	84.51
	AT131416	All		Wear Ring		165 mm	JD-TH111273	27.81
	AT131416	All		Wear Ring		165 mm	JD-TH111274	138.11
	TH111616	703550-		P-UB-14	110 mm	165 mm	JD-AT181799	227.07
	TH111616	-703549		P-UB-14	110 mm	165 mm	JD-TH111627	302.63
	TH111616	All		Bushing	110 mm		JD-AT131417	84.51
	TH111616	All		Wear Ring		165 mm	JD-TH111274	138.11
ARM (SLF)	TH111616	All		Wear Ring		165 mm	JD-TH111273	27.81
	AT130835	All		P-UB-14	105 mm	150 mm	JD-TH111854	271.70
	AT130835	All		Wear Ring		150 mm	JD-TH111846	24.42
BOOM (LH)	AT130835	All		Wear Ring		150 mm	JD-TH111845	68.31
	AT131413	-603426		P-UB-14	100 mm	145 mm	JD-TH111626	257.92
	AT131413	603427-		P-UB-14	100 mm	145 mm	JD-AT181794	186.63
	AT131413	All		Bushing	100 mm		JD-AT131414	52.10
BOOM (RH)	AT131413	All		Wear Ring		145 mm	JD-TH110063	23.64
	AT131413	All		Wear Ring		145 mm	JD-TH110062	65.19
	AT131413	503425-		P-UB-14	100 mm	145 mm	JD-AT181794	186.63
	AT131413	-503424		P-UB-14	100 mm	145 mm	JD-TH111626	257.92
BUCKET	AT131413	All		Bushing	100 mm		JD-AT131414	52.10
	AT131413	All		Wear Ring		145 mm	JD-TH110063	23.64
	AT131413	All		Wear Ring		145 mm	JD-TH110062	65.19
	AT182455	803513-		P-UB-14	95 mm	145 mm	JD-AT181792	157.81
	AT182455	-803512		P-UB-14	95 mm	145 mm	JD-TH111625	255.82
BUCKET (SLF)	AT182455	All		Bushing	95 mm		JD-AT131420	44.36
	AT182455	All		Wear Ring		145 mm	JD-TH110063	23.64
BUCKET (SLF)	AT182455	All		Wear Ring		145 mm	JD-TH110062	65.19
	AT86766	All		Wear Ring		100 mm	JD-TH111727	11.88
AT86766	All		Wear Ring		100 mm	JD-TH111728	72.59	
MODEL 892E, 892E LC								
ARM			892E LC	P-UB-14	110 mm	165 mm	JD-AT196472	292.14
	AT201181	-703549		P-UB-14	110 mm	165 mm	JD-AT201184	283.95
	AT201181	703550-		P-UB-14	110 mm	165 mm	JD-AT181799	227.07
	AT201181	All		Bushing	110 mm		JD-AT131417	84.51
	AT201181	All		Wear Ring		165 mm	JD-TH111274	138.11
	AT201181	All		Wear Ring		165 mm	JD-TH111273	27.81
BOOM (LH)			892E LC	P-UB-14	100 mm	145 mm	JD-AT196475	247.37
	AT201180	603427-		P-UB-14	100 mm	145 mm	JD-AT181794	186.63
	AT201180	-603426		P-UB-14	100 mm	145 mm	JD-TH111626	257.92
	AT201180	All		Bushing	100 mm		JD-AT131414	52.10
	AT201180	All		Wear Ring		145 mm	JD-TH110063	23.64
	AT201180	All		Wear Ring		145 mm	JD-TH110062	65.19
BOOM (RH)			892E LC	P-UB-14	100 mm	145 mm	JD-AT196475	247.37
	AT201180	-503424		P-UB-14	100 mm	145 mm	JD-TH111626	257.92
	AT201180	503425-		P-UB-14	100 mm	145 mm	JD-AT181794	186.63
	AT201180	All		Bushing	100 mm		JD-AT131414	52.10
	AT201180	All		Wear Ring		145 mm	JD-TH110062	65.19
	AT201180	All		Wear Ring		145 mm	JD-TH110063	23.64
BUCKET			892E LC	P-UB-14	95 mm	145 mm	JD-AT264430	324.88
		-803512	Incl Bushing & Wear Rings	P-UB-14	95 mm	145 mm	JD-AT196473	260.50
	AT182461	803513-		P-UB-14	95 mm	145 mm	JD-AT181792	157.81
	AT182461	-803512		P-UB-14	95 mm	145 mm	JD-AT201185	274.94
	AT182461	All		Bushing	95 mm		JD-AT131420	44.36
	AT182461	All		Wear Ring		145 mm	JD-TH110062	65.19
	AT182461	All		Wear Ring		145 mm	JD-TH110063	23.64

LA - Long Arm LGP - Low Ground Pressure LT - Long Track MFWD - Mechanical Front Wheel Drive MP - Multi-Purpose
 IDM - Inside Dozer Mount ODM - Outside Dozer Mount SLF - Super Long Front STD - Straight Dozer WT - Wide Track

Replacement Kits For

JOHN DEERE

Excavators								
APPLICATION	CYL #	SERIAL #	Misc	CODE	ROD	BORE	KIT #	List \$
MODEL 892E, 892E LC								
BUCKET	AT201182	-803512		P-UB-14	95 mm	145 mm	JD-AT201185	274.94
	AT201182	803513-		P-UB-14	95 mm	145 mm	JD-AT181792	157.81
	AT201182	All		Bushing	95 mm		JD-AT131420	44.36
	AT201182	All		Wear Ring		145 mm	JD-TH110063	23.64
	AT201182	All		Wear Ring		145 mm	JD-TH110062	65.19
BUCKET (SLF)	AT168750	011000-		P-UB-10	65 mm	100 mm	JD-AT168764	161.03
	AT168750	011000-		Bushing	65 mm		JD-TH109372	21.71
	AT168750	011000-		Wear Ring		100 mm	JD-TH111727	11.88
	AT168750	011000-		Wear Ring		100 mm	JD-TH111728	72.59
MODEL 990								
BOOM				N-N-14		7-1/2	JD-RE14033	163.67
	RE11569	510036-		N-N-14		7-1/2	JD-RE14033	163.67
	RE21201	All	Replacement	P-UB-1	3-3/4		JD-RE21202	180.48
	RE21201	All	Replacement	N-N-14		7-1/2	JD-RE14033	163.67
BUCKET	RE11570	-510035		N-N-14		7-1/2	JD-RE14033	163.67
	RE21207	510036-		N-N-14		7-1/2	JD-RE14033	163.67
CROWD	RE11568	-510035		N-N-14		7-1/2	JD-RE14033	163.67
	RE21195	510036-		N-N-14		7-1/2	JD-RE14033	163.67
MODEL 992D, 992D LC								
ARM	AT131955	All		P-UB-10	130 mm	190 mm	JD-AT132412	313.49
	AT131955	All		Wear Ring		190 mm	JD-AT132170	89.04
	AT131955	All		Wear Ring		190 mm	JD-AT132186	28.88
	AT132310			P-UB-10	130 mm	190 mm	JD-AT132412	313.49
BOOM	AT131954	All		P-UB-10	115 mm	170 mm	JD-AT132411	292.71
	AT131954	All		Bushing	115 mm		JD-AT132287	17.76
	AT131954	All		Wear Ring		170 mm	JD-AT132291	20.09
	AT131954	All		Wear Ring		170 mm	JD-AT132175	85.62
	AT132280	5222		P-UB-10	115 mm	170 mm	JD-AT132411	292.71
BUCKET 2.9M, 3.9M ARM	AT132280	5222		P-UB-10	115 mm	170 mm	JD-AT132411	292.71
	AT182457	All		P-UB-10	115 mm	170 mm	JD-AT132411	292.71
	AT182457	All		Bushing	115 mm		JD-AT132287	17.76
	AT182457	All		Wear Ring		170 mm	JD-AT132175	85.62
	AT182457	All		Wear Ring		170 mm	JD-AT132291	20.09
BUCKET 4.9M ARM	AT182455	All		P-UB-14	95 mm	145 mm	JD-TH111625	255.82
	AT182455	All		P-UB-14	95 mm	145 mm	JD-AT181792	157.81
	AT182455	All		Bushing	95 mm		JD-AT131420	44.36
	AT182455	All		Wear Ring		145 mm	JD-TH110063	23.64
	AT182455	All		Wear Ring		145 mm	JD-TH110062	65.19
MODEL 992E, 992E LC								
BUCKET 4.9M ARM	AT182461	803513-		P-UB-14	95 mm	145 mm	JD-AT181792	157.81
	AT182461	-803512		P-UB-14	95 mm	145 mm	JD-AT201185	274.94
	AT182461	All		Bushing	95 mm		JD-AT131420	44.36
	AT182461	All		Wear Ring		145 mm	JD-TH110063	23.64
	AT182461	All		Wear Ring		145 mm	JD-TH110062	65.19
Excavators - Compact								
APPLICATION	CYL #	SERIAL #	Misc	CODE	ROD	BORE	KIT #	List \$
MODEL 27 ZTS								
ARM				P-U-10	40 mm	70 mm	JD-TH0744010	51.38
BLADE				P-U-10	45 mm	85 mm	JD-TH0729006	76.97
BUCKET				P-U-10	35 mm	60 mm	JD-0744105	74.59
BUCKET CLAMP	AH216639			P-U-10	1	2	JD-AT191403	109.43
MODEL 27C ZTS								
ARM	4472578			P-U-10	40 mm	70 mm	JD-TH0744010	51.38
BLADE	4472581			P-U-10	45 mm	85 mm	JD-TH0729006	76.97
BOOM	4472577			P-U-10	40 mm	75 mm	JD-TH0743805	83.37

JOHN DEERE

LA - Long Arm LGP - Low Ground Pressure LT - Long Track MFWD - Mechanical Front Wheel Drive MP - Multi-Purpose
 IDM - Inside Dozer Mount ODM - Outside Dozer Mount SLF - Super Long Front STD - Straight Dozer WT - Wide Track

Replacement Kits For

JOHN DEERE

Excavators - Compact								
APPLICATION	CYL #	SERIAL #	Misc	CODE	ROD	BORE	KIT #	List \$
MODEL 27C ZTS								
BUCKET	4472579			P-U-10	35 mm	60 mm	JD-0744105	74.59
BUCKET CLAMP	AH216639			P-U-10	1	2	JD-AT191403	109.43
SWING	4472580			P-U-10	40 mm	75 mm	JD-0847204	82.66
MODEL 27D								
ARM	4643502G			P-U-10	40 mm	65 mm	JD-4652137	56.66
BLADE	0988301	-224003		P-U-14	45 mm	80 mm	JD-4652458	46.97
	4655418	224004-		P-U-10	45 mm	80 mm	JD-4656428	62.21
	4655418			P-U-10	45 mm	80 mm	JD-4656428	62.21
BOOM	4643500G			P-U-10	45 mm	75 mm	JD-4634034	95.92
	4643501G			P-U-10	45 mm	75 mm	JD-4634034	95.92
BUCKET	4643503G			P-U-10	35 mm	55 mm	JD-4652138	65.71
BUCKET CLAMP	AH216639			I-U-10	25 mm	50 mm	JD-AH158827	34.29
	AH216639			N-N-10		2	JD-AH167552	6.67
SWING	4643504			P-U-10	40 mm	75 mm	JD-4652139	64.66
MODEL 35 ZTS								
ARM	9184958			P-U-10	45 mm	75 mm	JD-0744408	172.43
BLADE LIFT	9184976			P-U-10	50 mm	95 mm	JD-0745308	115.61
BOOM	9184960			P-U-10	50 mm	80 mm	JD-0656714	123.31
BUCKET	9178101			P-U-10	40 mm	65 mm	JD-0744707	129.99
BUCKET CLAMP	AH216639			P-U-10	1	2	JD-AT191403	109.43
SWING	9179219			P-U-10	45 mm	85 mm	JD-0744808	112.95
MODEL 35C ZTS								
ARM	4472590			P-U-10	45 mm	75 mm	JD-0849304	91.13
BLADE LIFT	4472591			P-U-10	50 mm	95 mm	JD-0745308	115.61
BOOM	4467672			P-U-10	45 mm	80 mm	JD-0850309	95.94
BUCKET	4472585			P-U-10	40 mm	60 mm	JD-0849503	76.49
BUCKET CLAMP	AH216639			P-U-10	1	2	JD-AT191403	109.43
SWING	4472586			P-U-10	45 mm	85 mm	JD-TH0729006	76.97
MODEL 35D								
ARM	4632807G			P-U-10	45 mm	75 mm	JD-4634034	95.92
BLADE	4617784			P-U-14	45 mm	95 mm	JD-4622066	140.44
BOOM	4632806G			P-U-10	50 mm	85 mm	JD-4634033	104.57
BUCKET	4608466G			P-U-10	40 mm	65 mm	JD-4614058	123.26
SWING	4608470			P-U-10	45 mm	85 mm	JD-4614059	124.10
MODEL 50 ZTS								
ARM	4468846			P-U-10	50 mm	80 mm	JD-0843613	107.57
	9171446, AT251618			P-U-10	50 mm	80 mm	JD-0656714	123.31
BLADE TILT	AT191390			P-V-10	1-1/2	3	JD-AT191391	87.20
BOOM	9171448			P-U-10	55 mm	95 mm	JD-0735309	126.29
BUCKET	9171447			P-U-10	45 mm	75 mm	JD-0735609	153.21
BUCKET CLAMP	AH216808			P-UB-10	1-1/4	2	JD-AT260416	129.36
SWING	4463353			P-U-10	50 mm	100 mm	JD-0656604	215.99
MODEL 50C ZTS								
ARM	4468846			P-U-10	50 mm	80 mm	JD-0843613	107.57
BLADE LIFT	4468880			P-U-10	55 mm	100 mm	JD-0843907	92.32
BLADE TILT	AT191390			P-V-10	1-1/2	3	JD-AT191391	87.20
BOOM				P-U-10	55 mm	95 mm	JD-0844807	115.15
BUCKET	4468847			P-U-10	45 mm	75 mm	JD-0844705	67.79
BUCKET CLAMP	AH216808			P-UB-10	1-1/4	2	JD-AT260416	129.36
SWING	4463353			P-U-10	50 mm	100 mm	JD-0843808	74.61
MODEL 50D								
ARM	4632813G			P-U-10	50 mm	80 mm	JD-4634036	98.04
	4632813G	- 275292		P-U-10	50 mm	80 mm	JD-4634036	98.04
BLADE	4618628			P-U-14	50 mm	105 mm	JD-4622067	123.20

LA - Long Arm LGP - Low Ground Pressure LT - Long Track MFWD - Mechanical Front Wheel Drive MP - Multi-Purpose
 IDM - Inside Dozer Mount ODM - Outside Dozer Mount SLF - Super Long Front STD - Straight Dozer WT - Wide Track

Replacement Kits For

JOHN DEERE

Excavators - Compact								
APPLICATION	CYL #	SERIAL #	Misc	CODE	ROD	BORE	KIT #	List \$
MODEL 50D								
BLADE	4618628	- 275344		P-U-14	50 mm	105 mm	JD-4622067	123.20
	4718115	275344 - 275860		P-U-10	50 mm	105 mm	JD-FYD00000075	56.63
BOOM				P-UB-10	55 mm	95 mm	JD-FYD00000071	65.53
				P-U-10	55 mm	95 mm	JD-4634038	48.90
		275297 -		P-UB-10	55 mm	95 mm	JD-FYD00000071	65.53
	4655763G			P-U-10	55 mm	95 mm	JD-4634038	48.90
BOOM SWING	4679054	- 275356		P-U-14	50 mm	90 mm	JD-4705345	61.70
	4705267	- 275356		P-U-14	50 mm	90 mm	JD-4705345	61.70
BUCKET	4628947G			P-U-10	45 mm	75 mm	JD-4614069	80.79
	4628947G	- 275287		P-U-10	45 mm	75 mm	JD-4614069	80.79
	4718113G	275288 -		P-U-10	45 mm	75 mm	JD-FYD00000073	70.82
BUCKET CLAMP				P-UB-10	1-1/4	2	JD-AT260416	129.36
	AH216808			P-UB-10	1-1/4	2	JD-AT260416	129.36
SWING	4679054	- 275356		P-U-14	50 mm	90 mm	JD-4705345	61.70
	4705267	- 275356		P-U-14	50 mm	90 mm	JD-4705345	61.70
MODEL 60D								
ARM		280348-		P-UB-10	55 mm	90 mm	JD-FYD00000086	328.69
		280348-		Bushing	55 mm		JD-FYD00000040	18.35
	4671379	-280347		P-U-10	55 mm	90 mm	JD-4687560	152.87
	4671379	-280347		P-U-10	55 mm	90 mm	JD-4687560-EX	161.13
	4671379	-280347		Bushing	55 mm		JD-1187203	13.72
	4671379	-280347		Wear Ring		90 mm	JD-1187206	4.13
BLADE	4679703			P-U-14	70 mm	120 mm	JD-4687562	220.97
	4679703			Bushing	70 mm		JD-4633389	22.55
BLADE ANGLE	FYD00002783			P-U-10	40 mm	70 mm	JD-4614062	56.29
	FYD00002783			Bushing	40 mm		JD-1153502	9.33
BOOM		280348-		P-UB-10	60 mm	110 mm	JD-FYD00000085	349.00
		280348-		Bushing	60 mm		JD-FYD00000021	18.65
	4671378G	-280347		P-U-10	60 mm	110 mm	JD-4687559	177.19
	4671378G	-280347		P-U-10	60 mm	110 mm	JD-4687559-EX	198.97
	4671378G	-280347		Bushing	60 mm		JD-0994204	18.65
	4671378G	-280347		Wear Ring		110 mm	JD-1119106	10.89
BOOM SWING	4679702			P-U-10	55 mm	95 mm	JD-4687561	133.41
	4679702			P-U-10	55 mm	95 mm	JD-4687561-EX	163.10
	4679702			Bushing	55 mm		JD-0894204	13.72
	4679702			Wear Ring		95 mm	JD-1183502	14.84
BUCKET	4671380G	-280347		P-U-10	50 mm	80 mm	JD-4652380	86.94
	4671380G	-280347		P-U-10	50 mm	80 mm	JD-4652380-EX	110.79
	4671380G	-280347		Bushing	50 mm		JD-0854104	12.96
	4671380G	-280347		Wear Ring		80 mm	JD-1187301	11.92
	4713135	280348-		P-UB-10	50 mm	80 mm	JD-FYD00000087	302.01
	4713135	280348-		Bushing	50 mm		JD-FYD00000053	15.54
BUCKET CLAMP	AH216808			I-U-10	32 mm	2	JD-AH215765	42.44
MODEL 75C								
ARM	9197150			P-UB-10	60 mm	95 mm	JD-4464985	105.31
BOOM	9211074J			P-UB-10	65 mm	115 mm	JD-4464984	132.13
BUCKET	9197151			P-UB-10	55 mm	85 mm	JD-4464986	100.77

LA - Long Arm LGP - Low Ground Pressure LT - Long Track MFWD - Mechanical Front Wheel Drive MP - Multi-Purpose
 IDM - Inside Dozer Mount ODM - Outside Dozer Mount SLF - Super Long Front STD - Straight Dozer WT - Wide Track

Replacement Kits For

JOHN DEERE

Excavators - Compact									
APPLICATION	CYL #	SERIAL #	Misc	CODE	ROD	BORE	KIT #	List \$	
MODEL 75D									
ARM	9197150G			P-UB-10	60 mm	95 mm	JD-4464985	105.31	
	9197150G			P-UB-10	60 mm	95 mm	JD-4464985-EX	146.84	
	9197150G			Bushing	60 mm		JD-0826907	18.65	
	9197150G			Wear Ring		95 mm	JD-H158170	14.84	
BLADE	9246135			P-U-10	70 mm	120 mm	JD-4632462	227.49	
	9246135			Bushing	70 mm		JD-4633389	22.55	
BOOM	9197149G			P-UB-10	65 mm	115 mm	JD-4663491	220.04	
	9197149G			P-UB-10	65 mm	115 mm	JD-4663491-EX	241.82	
	9197149G			Bushing	65 mm		JD-AT264389	21.71	
	9197149G			Wear Ring		115 mm	JD-H163432	10.89	
BUCKET	9197151G			P-UB-10	55 mm	85 mm	JD-4464986	100.77	
	9197151G			P-UB-10	55 mm	85 mm	JD-4464986-EX	166.62	
	9197151G			Bushing	55 mm		JD-TH0827007	13.72	
	9197151G			Wear Ring		85 mm	JD-0891615	28.75	
MODEL 80C									
ARM	9163825			P-UB-10	60 mm	95 mm	JD-4415584	126.21	
	9197150			P-UB-10	60 mm	95 mm	JD-4464985	105.31	
BLADE	9201173			P-UB-10	70 mm	120 mm	JD-4465736	117.57	
BOOM	9197149			P-UB-10	65 mm	115 mm	JD-4464984	132.13	
BUCKET	9197151			P-UB-10	55 mm	85 mm	JD-4464986	100.77	
Forestry - Feller Bunchers									
APPLICATION	CYL #	SERIAL #	Misc	CODE	ROD	BORE	KIT #	List \$	
MODEL 493D									
ARM	TH109346	All		P-UB-10	80 mm	115 mm	JD-TH109366	139.80	
BOOM	TH109307	All		P-UB-10	75 mm	105 mm	JD-TH109339	122.15	
BUCKET	TH109368	All		P-UB-10	65 mm	95 mm	JD-TH109390	126.79	
MODEL 653E									
ARM	AH142919			P-UB-14	85 mm	120 mm	JD-AH144594	348.12	
BOOM	AH142577			P-UB-14	85 mm	120 mm	JD-AH144594	348.12	
HEAD TILT	AH144660			P-UB-14	75 mm	110 mm	JD-AH144593	325.01	
MODEL 693B									
BOOM		-501444		P-V-8	2-3/4	5	JD-AR105309	85.70	
		501445-		P-V-1	2-3/4		JD-RE17342	63.27	
		501445-		N-N-14		5	JD-RE15905	101.24	
		RE21394	501445-		P-UB-1	2-3/4		JD-RE21395	127.07
		RE21394	501445-		N-N-14		5	JD-RE15905	101.24
CROWD		-501444		P-V-8	3-1/4	5-1/2	JD-AR105313	88.02	
		501445-		P-V-1	3-1/4		JD-RE15906	45.03	
		501445-		N-N-14		5-1/2	JD-RE15907	123.45	
MULTI-STEM		All		P-U-10	1-3/4	4	JD-AT55695	27.26	
SHEAR		All		P-U-12	2-1/2	6-1/2	JD-AR105280	144.28	
SHEAR TILT		All		P-V-8	2-1/4	4-1/2	JD-AR105355	83.97	
TILT		-501444		P-V-8	3-1/4	5-1/2	JD-AR105312	90.49	
		501445-		P-V-1	3-1/4		JD-RE15906	45.03	
		501445-		N-N-14		5-1/2	JD-RE14102	123.45	
		RE21400	501307-		P-UB-1	3-1/4		JD-RE21401	87.13
		RE21400	501307-		N-N-14		5-1/2	JD-RE14102	123.45
MODEL 693C									
BOOM		509185-		P-UB-1	2-3/4		JD-RE21395	127.07	
		-509184		P-V-1	2-3/4		JD-RE17342	63.27	
		509185-		N-N-14		5	JD-RE15905	101.24	
		-509184		N-N-14		5	JD-RE15905	101.24	
HEAD TILT		509185-		P-UB-1	3-1/4		JD-RE21401	87.13	
		-509184		P-V-1	3-1/4		JD-RE15906	45.03	
		509185-		N-N-14		5-1/2	JD-RE14102	123.45	

LA - Long Arm LGP - Low Ground Pressure LT - Long Track MFWD - Mechanical Front Wheel Drive MP - Multi-Purpose
 IDM - Inside Dozer Mount ODM - Outside Dozer Mount SLF - Super Long Front STD - Straight Dozer WT - Wide Track

Replacement Kits For

JOHN DEERE

Forestry - Feller Bunchers								
APPLICATION	CYL #	SERIAL #	Misc	CODE	ROD	BORE	KIT #	List \$
MODEL 693C								
HEAD TILT		-509184		N-N-14		5-1/2	JD-RE14102	123.45
MODEL 693D								
ARM	AT112705	All		P-UB-10	85 mm	125 mm	JD-AT114822	155.01
	AT112705	All		Bushing	85 mm		JD-T108019	34.71
	AT112705	All		Wear Ring		125 mm	JD-T108024	13.92
	AT112705	All		Wear Ring		125 mm	JD-TH104949	49.06
BOOM	AT112705	All		P-UB-10	85 mm	125 mm	JD-AT114822	155.01
	AT112705	All		Bushing	85 mm		JD-T108019	34.71
	AT112705	All		Wear Ring		125 mm	JD-TH104949	49.06
	AT112705	All		Wear Ring		125 mm	JD-T108024	13.92
BUCKET	AT114838	All		P-UB-10	80 mm	120 mm	JD-AT114836	153.84
	AT182451	All		P-UB-10	80 mm	120 mm	JD-AT114836	153.84
	AT182451	All		Bushing	80 mm		JD-T108041	31.26
	AT182451	All		Wear Ring		120 mm	JD-T108046	11.73
	AT182451	All		Wear Ring		120 mm	JD-TH104923	47.08
MODEL 743,743A Tree Harvesters								
AXLE STABILIZER		All		P-U-5	2	4-1/2	JD-AR105515	93.52
DOZER LIFT		All		P-V-8	2	5	JD-RE18743	54.34
		Field Replacement		P-V-1	2		JD-RE30817	32.31
		Field Replacement		N-N-14		5	JD-RE15905	101.24
FEED ROLL		All		P-V-8	1-1/4	2-1/2	JD-AR105453	35.68
GRAPPLE		All		P-U-10	1-3/4	4	JD-AT55695	27.26
LOG ACCUMULATOR		All		P-V-8	1-3/4	3	JD-RE18751	36.62
MAIN LIFT		All		P-V-8	3-1/4	6-1/4	JD-RE18762	138.02
SECONDARY LIFT		All		P-V-8	2-1/2	4-1/2	JD-RE18760	65.48
SHEAR		All		P-U-12	2-1/2	6-1/2	JD-AR105280	144.28
STEERING		All		I-U-10	4-1/4	4.40	JD-RE19224	47.95
TILT		All		P-V-8	2-1/4	4-1/2	JD-AR105355	83.97
MODEL 793D								
ARM	AT131425	All		P-UB-14	90 mm	135 mm	JD-TH110035	191.71
	AT131425	All		Bushing	90 mm		JD-AT131422	42.75
	AT131425	All		Wear Ring		135 mm	JD-TH110033	59.59
	AT131425	All		Wear Ring		135 mm	JD-TH110034	16.16
BOOM	AT131425	All		P-UB-14	90 mm	135 mm	JD-TH110035	191.71
	AT131425	All		Bushing	90 mm		JD-AT131422	42.75
	AT131425	All		Wear Ring		135 mm	JD-TH110034	16.16
	AT131425	All		Wear Ring		135 mm	JD-TH110033	59.59
BUCKET	AT131430	All		P-UB-14	90 mm	135 mm	JD-TH110035	191.71
	AT131430	All		Bushing	90 mm		JD-AT131422	42.75
	AT131430	All		Wear Ring		135 mm	JD-TH110033	59.59
	AT131430	All		Wear Ring		135 mm	JD-TH110034	16.16
MODEL 853								
				P-UB-14	75 mm	110 mm	JD-AH144593	325.01
				P-UB-14	85 mm	120 mm	JD-AH144594	348.12
Loaders - Skid Steer								
APPLICATION	CYL #	SERIAL #	Misc	CODE	ROD	BORE	KIT #	List \$
MODEL 240								
BOOM (LH)	AH210318	925239-		I-U-10	40 mm	2-1/4	JD-AH160844	47.92
BOOM (RH)	AH210319	925239-		I-U-10	36 mm	2-1/4	JD-AH168977	53.16
BUCKET	AH212126	-925238		I-U-10	32 mm	2-1/4	JD-AH160843	50.28
BUCKET (LH)	AH211533	925239-		I-U-10	32 mm	2-1/4	JD-AH160843	50.28
	AH218165	925239-		I-U-10	32 mm	2-1/4	JD-AH160843	50.28
BUCKET (RH)	AH210320	925239-		I-U-10	32 mm	2-1/4	JD-AH160843	50.28
	AH218164	925239-		I-U-10	32 mm	2-1/4	JD-AH160843	50.28

LA - Long Arm LGP - Low Ground Pressure LT - Long Track MFWD - Mechanical Front Wheel Drive MP - Multi-Purpose
 IDM - Inside Dozer Mount ODM - Outside Dozer Mount SLF - Super Long Front STD - Straight Dozer WT - Wide Track

Replacement Kits For

JOHN DEERE

Loaders - Skid Steer								
APPLICATION	CYL #	SERIAL #	Misc	CODE	ROD	BORE	KIT #	List \$
MODEL 250								
BOOM		251874-		I-U-10	36 mm	2-1/4	JD-AH168977	53.16
		-925238		I-U-10	40 mm	2-1/4	JD-AH160844	47.92
BOOM (LH)	AH210318	925239-		I-U-10	40 mm	2-1/4	JD-AH160844	47.92
BOOM (RH)	AH210319	925239-		I-U-10	36 mm	2-1/4	JD-AH168977	53.16
BUCKET	AH212126	-925238		I-U-10	32 mm	2-1/4	JD-AH160843	50.28
BUCKET (LH)	AH211533	925239-		I-U-10	32 mm	2-1/4	JD-AH160843	50.28
	AH218165							
BUCKET (RH)	AH210320	925239-		I-U-10	32 mm	2-1/4	JD-AH160843	50.28
	AH218164	925239-		I-U-10	32 mm	2-1/4	JD-AH160843	50.28
MODEL 260								
BOOM	AH163702	-369999		I-U-10	45 mm	2-1/2	JD-AH160846	46.44
	AH163703	-369999		I-U-10	45 mm	2-1/2	JD-AH160846	46.44
	AH210322	925240-		I-U-10	45 mm	2-1/2	JD-AH160846	46.44
	AH210322	370000-925239		I-U-10	45 mm	2-1/2	JD-AH160846	46.44
BUCKET	AH158440	-160844		I-U-10	40 mm	2-1/2	JD-AH160845	47.64
	AH166137	160845-369999		I-U-10	36 mm	2-1/2	JD-AH166140	68.49
	AH210323	925240-		I-U-10	36 mm	2-1/2	JD-AH166140	68.49
	AH210323	370000-925239		I-U-10	36 mm	2-1/2	JD-AH166140	68.49
	AH210324	370000-925239		I-U-10	36 mm	2-1/2	JD-AH166140	68.49
	AH210324	925240-		I-U-10	36 mm	2-1/2	JD-AH166140	68.49
MODEL 270								
BOOM	AH163702	-379999		I-U-10	45 mm	2-1/2	JD-AH160846	46.44
	AH163703	-379999		I-U-10	45 mm	2-1/2	JD-AH160846	46.44
	AH210322	380000-925239		I-U-10	45 mm	2-1/2	JD-AH160846	46.44
	AH210322	925240-		I-U-10	45 mm	2-1/2	JD-AH160846	46.44
BUCKET	AH158440	-170702		I-U-10	40 mm	2-1/2	JD-AH160845	47.64
	AH166137	170703-370249		I-U-10	36 mm	2-1/2	JD-AH166140	68.49
	AH210325	925240-		I-U-10	36 mm	2-3/4	JD-AH174553	68.46
	AH210630	370250-379999		I-U-10	36 mm	2-3/4	JD-AH174553	68.46
	AH210630	380000-925239		I-U-10	36 mm	2-3/4	JD-AH174553	68.46
	AH211460	925240-		I-U-10	36 mm	2-3/4	JD-AH174553	68.46
MODEL 280								
BOOM	AH174080			N-N-10		70 mm	JD-AH212090	12.43
	AH174080			I,P-UB-1	45 mm		JD-AH149813	59.46
	AH210326			N-N-10		70 mm	JD-AH212090	12.43
	AH210326			I,P-UB-1	45 mm		JD-AH149813	59.46
BUCKET	AH210329	925240-		N-N-10		80 mm	JD-AH212092	36.62
	AH210329	925240-		I,P-UB-1	45 mm		JD-AH149813	59.46
	AH210329	-925239		I,P-UB-1	45 mm		JD-AH149813	59.46
	AH210329	-925239		N-N-10		80 mm	JD-AH212092	36.62
	AH211461	925240-		I,P-UB-1	45 mm		JD-AH149813	59.46
	AH211461	925240-		N-N-10		80 mm	JD-AH212092	36.62
	AH211461	-925239		I,P-UB-1	45 mm		JD-AH149813	59.46
	AH211461	-925239		N-N-10		80 mm	JD-AH212092	36.62
MODEL 317								
BOOM	AH212292	-111419		I-U-10	36 mm	2-1/4	JD-AH168977	53.16
	AH212293	-111419		I-U-10	36 mm	2-1/4	JD-AH168977	53.16
	AH218239	111420-		I-U-10	40 mm	2-1/4	JD-AH231937	42.82
	AH218240	111420-		I-U-10	40 mm	2-1/4	JD-AH231937	42.82
BUCKET	AH210320	-114864		I-U-10	32 mm	2-1/4	JD-AH231936	46.88
	AH211533	-114864		I-U-10	32 mm	2-1/4	JD-AH231936	46.88
	AH218164	114865-		I-U-10	32 mm	2-1/4	JD-AH231936	46.88
	AH218165	114865-		I-U-10	32 mm	2-1/4	JD-AH231936	46.88
QUIK-TATCH	AH216525	104831-		I-U-10	20 mm	32 mm	JD-AH174428	103.98

LA - Long Arm LGP - Low Ground Pressure LT - Long Track MFWD - Mechanical Front Wheel Drive MP - Multi-Purpose
 IDM - Inside Dozer Mount ODM - Outside Dozer Mount SLF - Super Long Front STD - Straight Dozer WT - Wide Track

Replacement Kits For

JOHN DEERE

Loaders - Skid Steer								
APPLICATION	CYL #	SERIAL #	Misc	CODE	ROD	BORE	KIT #	List \$
MODEL 317								
QUIK-TATCH	AH216525	-104830		I-U-10	20 mm	32 mm	JD-AH174428	103.98
MODEL 318D								
BOOM (LH)	AH218242	-179866		I-U-10	40 mm	2-1/4	JD-AH231937	42.82
	AHC10896	185695-		I-U-10	40 mm	2-1/4	JD-AH231937	42.82
	AHC10896	185695-		N-N-10		2-1/4	JD-AH164325	20.88
BOOM (RH)	AH218242	-179866		I-U-10	40 mm	2-1/4	JD-AH231937	42.82
	AHC10895	185695-		N-N-10		2-1/4	JD-AH164325	20.88
	AHC10895			I-U-10	40 mm	2-1/4	JD-AH231937	42.82
BUCKET (LH)	AHC10392			I-U-10	36 mm	2-1/2	JD-AH166140	68.49
BUCKET (RH)	AHC10391			I-U-10	36 mm	2-1/2	JD-AH166140	68.49
MODEL 320								
BOOM	AH212292	-111419		I-U-10	36 mm	2-1/4	JD-AH168977	53.16
	AH212293	-111419		I-U-10	36 mm	2-1/4	JD-AH168977	53.16
	AH218239	111420-		I-U-10	40 mm	2-1/4	JD-AH231937	42.82
	AH218240	111420-		I-U-10	40 mm	2-1/4	JD-AH231937	42.82
BUCKET	AH210320	-114864		I-U-10	32 mm	2-1/4	JD-AH231936	46.88
	AH211533	-114864		I-U-10	32 mm	2-1/4	JD-AH231936	46.88
	AH218164	114865-		I-U-10	32 mm	2-1/4	JD-AH231936	46.88
	AH218165	114865-		I-U-10	32 mm	2-1/4	JD-AH231936	46.88
QUIK-TATCH	AH216525	104831-		I-U-10	20 mm	32 mm	JD-AH174428	103.98
	AH216525	-104830		I-U-10	20 mm	32 mm	JD-AH174428	103.98
MODEL 320D								
BOOM (LH)	AH218242	-179866		I-U-10	40 mm	2-1/4	JD-AH231937	42.82
	AHC10896	185695-		N-N-10		2-1/4	JD-AH164325	20.88
	AHC10896	185695-		I-U-10	40 mm	2-1/4	JD-AH231937	42.82
BOOM (RH)	AH218241	-179866		I-U-10	40 mm	2-1/4	JD-AH231937	42.82
	AHC10895	185695-		I-U-10	40 mm	2-1/4	JD-AH231937	42.82
BUCKET (LH)	AHC10392			I-U-10	36 mm	2-1/2	JD-AH166140	68.49
BUCKET (RH)	AHC10391			I-U-10	36 mm	2-1/2	JD-AH166140	68.49
MODEL 323D								
BOOM (LH)	AH218242	-179866		I-U-10	40 mm	2-1/4	JD-AH231937	42.82
	AHC10764	179866-185694		N-N-10		2-1/4	JD-AH164325	20.88
	AHC10764	179866-185694		I,P-UB-1	40 mm		JD-AH149194	49.62
	AHC10896	185695-		N-N-10		2-1/4	JD-AH164325	20.88
	AHC10896	185695-		I-U-10	40 mm	2-1/4	JD-AH231937	42.82
BOOM (RH)	AHC10895	185695-		I-U-10	40 mm	2-1/4	JD-AH231937	42.82
	AHC10895	179867-185694		N-N-10		2-1/4	JD-AH164325	20.88
	AHC10895	179867-185694		I,P-UB-1	40 mm		JD-AH149194	49.62
	AHC10895	185695-		N-N-10		2-1/4	JD-AH164325	20.88
BUCKET (LH)	AH232322			I-U-10	36 mm	2-1/2	JD-AH166140	68.49
BUCKET (RH)	AH232321			I-U-10	36 mm	2-1/2	JD-AH166140	68.49
MODEL 325								
BOOM	AH210322			I-U-10	45 mm	2-1/2	JD-AH160846	46.44
BUCKET	AH210323			I-U-10	36 mm	2-1/2	JD-AH166140	68.49
	AH210324			I-U-10	36 mm	2-1/2	JD-AH166140	68.49
QUIK-TATCH	AH216525	-131897		I-U-10	20 mm	32 mm	JD-AH174428	103.98
MODEL 326D								
BOOM	AH210322			I-U-10	45 mm	2-1/2	JD-AH160846	46.44
BUCKET (LH)	AH232324			I-U-10	36 mm	2-3/4	JD-AH174553	68.46
BUCKET (RH)	AH232323			I-U-10	36 mm	2-3/4	JD-AH174553	68.46
MODEL 328								
BOOM	AH210322			I-U-10	45 mm	2-1/2	JD-AH160846	46.44
BUCKET	AH210325			I-U-10	36 mm	2-3/4	JD-AH174553	68.46
	AH211460			I-U-10	36 mm	2-3/4	JD-AH174553	68.46
QUIK-TATCH	AH216525	-131897		I-U-10	20 mm	32 mm	JD-AH174428	103.98

JOHN DEERE

LA - Long Arm LGP - Low Ground Pressure LT - Long Track MFWD - Mechanical Front Wheel Drive MP - Multi-Purpose
 IDM - Inside Dozer Mount ODM - Outside Dozer Mount SLF - Super Long Front STD - Straight Dozer WT - Wide Track

Replacement Kits For

JOHN DEERE

Loaders - Skid Steer								
APPLICATION	CYL #	SERIAL #	Misc	CODE	ROD	BORE	KIT #	List \$
MODEL 328D								
BOOM	AH210322			I-U-10	45 mm	2-1/2	JD-AH160846	46.44
BUCKET (LH)	AH232326			I,P-UB-1	40 mm		JD-AH149194	49.62
	AH232326			N-N-10		80 mm	JD-AH212092	36.62
BUCKET (RH)	AH232325			I,P-UB-1	40 mm		JD-AH149194	49.62
	AH232325			N-N-10		80 mm	JD-AH212092	36.62
MODEL 329D								
BOOM	AH210322			I-U-10	45 mm	2-1/2	JD-AH160846	46.44
BUCKET (LH)	AH232328			I,P-UB-1	45 mm		JD-AH149813	59.46
	AH232328			N-N-10		90 mm	JD-AH212097	15.75
BUCKET (RH)	AH232327			I,P-UB-1	45 mm		JD-AH149813	59.46
	AH232327			N-N-10		90 mm	JD-AH212097	15.75
MODEL 332								
BOOM	AH174080	-103752		N-N-10		70 mm	JD-AH212090	12.43
	AH174080	-103752		I,P-UB-1	45 mm		JD-AH149813	59.46
	AH210326	103753-		I,P-UB-1	45 mm		JD-AH149813	59.46
	AH210326	103753-		N-N-10		70 mm	JD-AH212090	12.43
BUCKET	AH210329			I,P-UB-1	45 mm		JD-AH149813	59.46
	AH210329			N-N-10		80 mm	JD-AH212092	36.62
	AH211461			I,P-UB-1	45 mm		JD-AH149813	59.46
	AH211461			N-N-10		80 mm	JD-AH212092	36.62
QUIK-TATCH	AH216525	-104830		I-U-10	20 mm	32 mm	JD-AH174428	103.98
	AH216525	104831-		I-U-10	20 mm	32 mm	JD-AH174428	103.98
MODEL 332D								
BOOM	AH232740			I,P-UB-1	45 mm		JD-AH149813	59.46
	AH232740			N-N-10		70 mm	JD-AH212090	12.43
BUCKET (LH)	AH232328			I,P-UB-1	45 mm		JD-AH149813	59.46
	AH232328			N-N-10		90 mm	JD-AH212097	15.75
BUCKET (RH)	AH232327			I,P-UB-1	45 mm		JD-AH149813	59.46
	AH232327			N-N-10		90 mm	JD-AH212097	15.75
MODEL 333D								
BOOM	AH232740			I,P-UB-1	45 mm		JD-AH149813	59.46
	AH232740			N-N-10		70 mm	JD-AH212090	12.43
BUCKET (LH)	AH232328			I,P-UB-1	45 mm		JD-AH149813	59.46
	AH232328			N-N-10		90 mm	JD-AH212097	15.75
BUCKET (RH)	AH232327			I,P-UB-1	45 mm		JD-AH149813	59.46
	AH232327			N-N-10		90 mm	JD-AH212097	15.75
MODEL CT322								
BOOM	AH218241			I-U-10	40 mm	2-1/4	JD-AH231937	42.82
	AH218242			I-U-10	40 mm	2-1/4	JD-AH231937	42.82
BUCKET	AH218164			I-U-10	32 mm	2-1/4	JD-AH231936	46.88
	AH218165			I-U-10	32 mm	2-1/4	JD-AH231936	46.88
QUIK-TATCH	AH216525			I-U-10	20 mm	32 mm	JD-AH174428	103.98
MODEL CT332								
BOOM	AH210326			I,P-UB-1	45 mm		JD-AH149813	59.46
	AH210326			N-N-10		70 mm	JD-AH212090	12.43
BUCKET	AH210329			N-N-10		80 mm	JD-AH212092	36.62
	AH210329			I,P-UB-1	45 mm		JD-AH149813	59.46
	AH211461			N-N-10		80 mm	JD-AH212092	36.62
	AH211461			I,P-UB-1	45 mm		JD-AH149813	59.46
QUIK-TATCH	AH216525			I-U-10	20 mm	32 mm	JD-AH174428	103.98
Loaders - Wheel								
APPLICATION	CYL #	SERIAL #	Misc	CODE	ROD	BORE	KIT #	List \$
MODEL 244J								
BOOM LIFT	AT310186	-20477		N-N-10		80 mm	JD-AT313779	22.61
	LW8924653	20478-		I-BB-10	40 mm	80 mm	JD-LW10450034	133.85

LA - Long Arm LGP - Low Ground Pressure LT - Long Track MFWD - Mechanical Front Wheel Drive MP - Multi-Purpose
 IDM - Inside Dozer Mount ODM - Outside Dozer Mount SLF - Super Long Front STD - Straight Dozer WT - Wide Track

Replacement Kits For

JOHN DEERE

Loaders - Wheel								
APPLICATION	CYL #	SERIAL #	Misc	CODE	ROD	BORE	KIT #	List \$
MODEL 244J								
BUCKET TILT	LW8924656	20737-		I-BB-10	40 mm	80 mm	JD-LW10450034	133.85
	LW8924656	-20736		I-BB-1	40 mm		JD-AT313782	226.48
STEERING	AT310407	-20606		I-BB-1	30 mm		JD-AT313783	51.40
	AT310407	-20606		N-N-10		70 mm	JD-AT313773	19.73
	LW8924660	20607-		I-BB-10	30 mm	70 mm	JD-LW10450066	97.61
WORKSITE PRO QUICK-TATCH	AH216525			I-U-10	20 mm	32 mm	JD-AH174428	103.98
MODEL 300								
Loader Arrangement			7300, 7320					
Backhoe Arrangement			92, 9250					
BACKHOE BOOM	All			P-V-8	1-3/4	3-1/2	JD-RE18754	57.33
	-8249	9250		P-V-8	2	4	JD-AR105387	44.97
	8250-	9250		P-V-8	2	4	JD-RE18732	46.38
BACKHOE BUCKET	All			P-V-8	1-3/4	3	JD-RE18751	36.62
BACKHOE CROWD	All	9250		P-V-8	1-3/4	3-1/2	JD-RE18755	46.21
	All			P-V-8	1-3/4	3-1/2	JD-RE18754	57.33
BACKHOE STABILIZER	All			P-V-8	1-3/4	3-1/2	JD-RE18754	57.33
BACKHOE SWING	-8249	9250		P-V-8	2	4	JD-AR105393	56.83
	8250-	9250		P-V-8	2	4	JD-RE18732	46.38
	All			P-V-8	1-3/4	3-1/2	JD-AR105412	74.43
LOADER BOOM LIFT	All	7320		P-V-8	1-1/2	2-1/2	JD-RE19217	30.13
	Yr 1969-	7300		P-U-8	1-1/2	2-1/4	JD-AR96532	24.59
LOADER BUCKET TILT	Yr 1967-	7300		P-V-8	1-1/4	2-1/2	JD-AR105453	35.68
	All	7320		P-V-8	1-1/2	2-1/2	JD-RE19217	30.13
MODEL 344E								
BOOM	AT122273	All		P-UB-10	60 mm	110 mm	JD-AT122564	126.51
BUCKET	AT122274	All		P-UB-10	60 mm	110 mm	JD-AT122564	126.51
STEERING	AT122275	All		P-UB-10	35 mm	60 mm	JD-AT122580	90.18
MODEL 400, 401A								
Loader Arrangement			7300, 7320					
Backhoe Arrangement			92, 9250					
BACKHOE BOOM	8250-	9250		P-V-8	2	4	JD-RE18732	46.38
	-8249	9250		P-V-8	2	4	JD-AR105387	44.97
	All	92		P-V-8	1-3/4	3-1/2	JD-RE18754	57.33
	All	94, 95, 95A, 9400		P-V-8	2-1/4	4-1/2	JD-RE10640	62.91
BACKHOE BUCKET	All	92, 9250		P-V-8	1-3/4	3	JD-RE18751	36.62
	All	94, 95, 95A, 9400		P-V-8	2-1/4	3-1/2	JD-RE18757	61.75
BACKHOE CROWD	All	9250		P-V-8	1-3/4	3-1/2	JD-RE18755	46.21
	All	94, 95, 95A, 9400		P-V-8	2	4	JD-AR105387	44.97
	All	92		P-V-8	1-3/4	3-1/2	JD-RE18754	57.33
BACKHOE STABILIZER	All	95, 95A		P-V-8	1-3/4	3	JD-RE18751	36.62
	All	92, 94, 9250, 9400		P-V-8	1-3/4	3-1/2	JD-RE18754	57.33
BACKHOE SWING	-8249	9250		P-V-8	2	4	JD-AR105393	56.83
	8250-	9250		P-V-8	2	4	JD-RE18732	46.38
	All	9400		P-V-8	1-3/4	4	JD-RE18730	46.17
	All	92		P-V-8	1-3/4	3-1/2	JD-AR105412	74.43
LOADER BOOM LIFT	Yr 1967, S/N 4600			P-V-8	1-1/2	2-1/2	JD-RE19217	30.13
	4601-			P-V-8	1-3/4	2-3/4	JD-RE19220	38.76
LOADER BUCKET TILT	All			P-V-8	1-1/4	2-1/2	JD-AR105453	35.68
MODEL 444, 444C, 444CH								
Backhoe Arrangement			9450					
BACKHOE BOOM		All		P-V-8	2	4	JD-RE18732	46.38
BACKHOE BUCKET		All		P-V-8	1-3/4	3	JD-RE18751	36.62
BACKHOE CROWD		All		P-V-8	1-3/4	3-1/2	JD-RE18755	46.21

JOHN DEERE

LA - Long Arm LGP - Low Ground Pressure LT - Long Track MFWD - Mechanical Front Wheel Drive MP - Multi-Purpose
 IDM - Inside Dozer Mount ODM - Outside Dozer Mount SLF - Super Long Front STD - Straight Dozer WT - Wide Track

Replacement Kits For

JOHN DEERE

JOHN DEERE

Loaders - Wheel								
APPLICATION	CYL #	SERIAL #	Misc	CODE	ROD	BORE	KIT #	List \$
MODEL 444, 444C, 444CH								
Backhoe Arrangement			9450					
BACKHOE STABILIZER		All		P-V-8	1-3/4	3-1/2	JD-RE18754	57.33
BACKHOE SWING		39797-	9450	P-U-10	1-3/4	3-1/2	JD-RE18756	48.49
		-39796	9450	P-U-10	1-3/4	3-1/2	JD-RE18756	48.49
LOADER BOOM LIFT		-503064		P-V-8	2-1/4	5-1/4	JD-AR105346	71.15
		503065-		P-V-1	2-1/4		JD-RE14208	37.91
		503065-		N-N-14		5-1/4	JD-RE14100	107.02
LOADER BUCKET TILT		-503064		P-V-8	2-1/4	5-1/4	JD-AR105356	66.46
		503065-		P-V-1	2-1/4		JD-RE14454	36.78
		503065-		N-N-14		5-1/4	JD-RE14100	107.02
LUMBER CLAMP		All		P-V-8	2	4	JD-AR105387	44.97
MULTI-PURPOSE		All		P-V-8	2	4	JD-AR105387	44.97
STEERING		All	444	I-U-10	3-3/8	3-5/8	JD-RE19227	42.71
		-505310	444, 444CH	P-U-10	1-1/2	3	JD-AR105272	24.91
		505311-	444C, 444CH	P-V-1	1-1/2		JD-RE18203	27.50
		505311-	444C, 444CH	N-N-10		3	JD-RE18202	10.05
MODEL 444D								
LOADER BOOM LIFT		All		P-V-1	2-1/4		JD-RE14208	37.91
		All		N-N-14		5-1/4	JD-RE14100	107.02
LOADER BUCKET TILT		All		P-V-1	2-1/4		JD-RE14454	36.78
		All		N-N-14		5-1/4	JD-RE14100	107.02
LUMBER FORK		All		P-V-8	2	4	JD-AR105387	44.97
MULTI-PURPOSE		All		P-V-8	2	4	JD-AR105387	44.97
STEERING		All		P-V-1	1-1/2		JD-RE18203	27.50
		All		N-N-10		3	JD-RE18202	10.05
MODEL 444E								
BOOM	AT121333	All		P-UB-10	60 mm	110 mm	JD-AT121500	144.53
BUCKET	AT121334	All		P-UB-10	65 mm	120 mm	JD-AT121501	146.77
STEERING	AT121335	All		P-UB-10	35 mm	65 mm	JD-AT121499	113.69
MODEL 444H								
BOOM	AH152902	-570411		P-UB-1	56 mm		JD-AH149814	58.53
	AH152902	-570411		N-N-14		100 mm	JD-AH212101	80.14
	AH216284	Field Replacement		P-UB-1	56 mm		JD-AH149814	58.53
	AH216284	570412-		P-UB-1	56 mm		JD-AH149814	58.53
	AH216284	570412-		N-N-14		100 mm	JD-AH212101	80.14
	AH216284	Field Replacement		N-N-14		100 mm	JD-AH212101	80.14
BUCKET	AH174752	-577511 : 577512-		P-UB-1	63 mm		JD-AH149815	59.57
	AH174752	-577511 : 577512-		N-N-14		115 mm	JD-AH212103	118.74
STEERING	AH147585	-568518		I-UB-14	32 mm	56 mm	JD-AH153496	74.82
	AH205056	568519-		P-UB-1	32 mm		JD-AH161589	47.09
	AH205056	568519-		N-N-14		56 mm	JD-AH161591	64.27
MODEL 444H LL								
BOOM	AH149101	-570613		P-UB-1	63 mm		JD-AH149815	59.57
	AH149101	-570613		N-N-14		110 mm	JD-AH163670	76.52
	AT152715	570614-		P-UB-1	63 mm		JD-AH149815	59.57
	AT152715	570614-		N-N-14		110 mm	JD-AH163670	76.52
BUCKET	AH152715			P-UB-1	63 mm		JD-AH149815	59.57
	AH152715			N-N-14		100 mm	JD-AH212101	80.14
STEERING	AH147585			I-UB-14	32 mm	56 mm	JD-AH153496	74.82
	AH205056			P-UB-1	32 mm		JD-AH161589	47.09
	AH205056			N-N-14		56 mm	JD-AH161591	64.27
MODEL 444J								
BOOM (Powerllel™)	AH209498	611275-		P-UB-1	56 mm		JD-AH149814	58.53
	AH209498	-611274		P-UB-1	56 mm		JD-AH149814	58.53
	AH209498	-611274		N-N-14		100 mm	JD-AH212101	80.14

LA - Long Arm LGP - Low Ground Pressure LT - Long Track MFWD - Mechanical Front Wheel Drive MP - Multi-Purpose
 IDM - Inside Dozer Mount ODM - Outside Dozer Mount SLF - Super Long Front STD - Straight Dozer WT - Wide Track

Replacement Kits For

JOHN DEERE

Loaders - Wheel								
APPLICATION	CYL #	SERIAL #	Misc	CODE	ROD	BORE	KIT #	List \$
MODEL 444J								
BOOM (Powerllel™)	AH209498	611275-		N-N-14		100 mm	JD-AH212101	80.14
BOOM (Tool Carrier)	AH163628	-611274		P-UB-1	63 mm		JD-AH149815	59.57
	AH163628	-611274		N-N-14		110 mm	JD-AH163670	76.52
BOOM (Z-Bar)	AH163627	-595722		P-UB-1	56 mm		JD-AH149814	58.53
	AH163627	-595722		N-N-14		100 mm	JD-AH212101	80.14
	AH216284	595723-		P-UB-1	56 mm		JD-AH149814	58.53
	AH216284	611275-		P-UB-1	56 mm		JD-AH149814	58.53
	AH216284	611275-		N-N-14		100 mm	JD-AH212101	80.14
	AH216284	595723-		N-N-14		100 mm	JD-AH212101	80.14
BUCKET	AH174752	611275-		P-UB-1	63 mm		JD-AH149815	59.57
	AH174752	-611274		P-UB-1	63 mm		JD-AH149815	59.57
	AH174752	611275-		N-N-14		115 mm	JD-AH212103	118.74
	AH174752	-611274		N-N-14		115 mm	JD-AH212103	118.74
BUCKET (Powerllel™)	AH154570	611275-		P-UB-1	75 mm		JD-AH154570	67.80
	AH154570	611275-		N-N-14		125 mm	JD-AH149848	167.29
	AH208164	-611274		P-UB-1	75 mm		JD-AH154570	67.80
	AH208164	-611274		N-N-14		125 mm	JD-AH149848	167.29
STEERING	AH205056	-611274		P-UB-1	32 mm		JD-AH161589	47.09
	AH205056	611275-		P-UB-1	32 mm		JD-AH161589	47.09
	AH205056	-611274		N-N-14		56 mm	JD-AH161591	64.27
	AH205056	611275-		N-N-14		56 mm	JD-AH161591	64.27
TILT (Tool Carrier)	AH152715	-611274		P-UB-1	63 mm		JD-AH149815	59.57
	AH152715	-611274		N-N-14		100 mm	JD-AH149844	84.21
MODEL 444K								
BOOM (Powerllel™)	AH209498	-642100		P-UB-1	56 mm		JD-AH149814	58.53
	AH209498			P-UB-1	56 mm		JD-AH149814	58.53
	AH209498	642101-		P-UB-1	56 mm		JD-AH149814	58.53
	AH209498			N-N-14		100 mm	JD-AH212101	80.14
	AH209498	642101-		N-N-14		100 mm	JD-AH212101	80.14
	AH209498	-642100		N-N-14		100 mm	JD-AH212101	80.14
BOOM (Z-Bar)	AH209498			P-UB-1	56 mm		JD-AH149814	58.53
	AH209498	-642100		P-UB-1	56 mm		JD-AH149814	58.53
	AH209498	642101-		P-UB-1	56 mm		JD-AH149814	58.53
	AH209498			N-N-14		100 mm	JD-AH212101	80.14
	AH209498	-642100		N-N-14		100 mm	JD-AH212101	80.14
	AH209498	642101-		N-N-14		100 mm	JD-AH212101	80.14
BUCKET (Powerllel™)	AH208164			P-UB-1	75 mm		JD-AH154570	67.80
	AH208164	642101-		P-UB-1	75 mm		JD-AH154570	67.80
	AH208164	-642100		P-UB-1	75 mm		JD-AH154570	67.80
	AH208164	-642100		N-N-14		125 mm	JD-AH149848	167.29
	AH208164	642101-		N-N-14		125 mm	JD-AH149848	167.29
	AH208164			N-N-14		125 mm	JD-AH149848	167.29
BUCKET (Z-Bar)	AH174752	642101-		P-UB-1	63 mm		JD-AH149815	59.57
	AH174752			P-UB-1	63 mm		JD-AH149815	59.57
	AH174752	-642100		P-UB-1	63 mm		JD-AH149815	59.57
	AH174752			N-N-14		115 mm	JD-AH212103	118.74
	AH174752	-642100		N-N-14		115 mm	JD-AH212103	118.74
	AH174752	642101-		N-N-14		115 mm	JD-AH212103	118.74
STEERING	AHC10900			P-UB-1	32 mm		JD-AH161589	47.09
	AHC10900	-642100		P-UB-1	32 mm		JD-AH161589	47.09
	AHC10900	642101-		P-UB-1	32 mm		JD-AH161589	47.09
	AHC10900			N-N-14		56 mm	JD-AH161591	64.27
	AHC10900	-642100		N-N-14		56 mm	JD-AH161591	64.27
	AHC10900	642101-		N-N-14		56 mm	JD-AH161591	64.27

JOHN DEERE

LA - Long Arm LGP - Low Ground Pressure LT - Long Track MFWD - Mechanical Front Wheel Drive MP - Multi-Purpose
 IDM - Inside Dozer Mount ODM - Outside Dozer Mount SLF - Super Long Front STD - Straight Dozer WT - Wide Track

Replacement Kits For

JOHN DEERE

Loaders - Wheel								
APPLICATION	CYL #	SERIAL #	Misc	CODE	ROD	BORE	KIT #	List \$
MODEL 524K								
BOOM	AH227328	-642245		P-UB-1	63 mm		JD-AH149815	59.57
	AH227328	-642245		N-N-14		115 mm	JD-AH163671	106.86
BOOM (Z-Bar)	AH227921			P-UB-1	63 mm		JD-AH149815	59.57
	AH227921			N-N-14		120 mm	JD-AH149847	128.03
BUCKET	AH227329	-642245		P-UB-1	63 mm		JD-AH149815	59.57
	AH227329	-642245		N-N-14		115 mm	JD-AH212103	118.74
BUCKET (Z-Bar)	AH227921			P-UB-1	75 mm		JD-AH154570	67.80
	AH227921			N-N-14		125 mm	JD-AH149848	167.29
STEERING	AH227102	-642245		I,P-UB-1	40 mm		JD-AH149194	49.62
	AH227102			I,P-UB-1	40 mm		JD-AH149194	49.62
	AH227102	-642245		N-N-14		63 mm	JD-AH212087	91.14
	AH227102			N-N-14		63 mm	JD-AH212087	91.14
MODEL 544, 544A								
Backhoe Arrangement			93, 93A, 9305					
BACKHOE BOOM		-701219	9305	P-V-8	2-1/4	4-1/2	JD-AR105355	83.97
		701220-	9305	P-V-14	2-1/4	4-1/2	JD-RE18764	114.16
		All	93, 93A	P-V-8	2-1/4	4-1/2	JD-RE10640	62.91
BACKHOE BUCKET		-701219	93, 93A, 9305	P-V-8	2-1/4	3-1/2	JD-RE18757	61.75
		701220-	9305	P-V-14	2-1/4	3-1/2	JD-RE18758	100.05
BACKHOE CROWD		701220-		P-V-14	2	4	JD-RE18741	97.81
		-701219	93, 93A, 9305	P-V-8	2	4	JD-AR105387	44.97
BACKHOE STABILIZER		All	93, 93A	P-V-8	1-3/4	3-1/2	JD-RE18754	57.33
		All	9305	P-V-8	2	4	JD-AR105387	44.97
GRAPPLE		All		P-V-8	1-3/4	3-1/2	JD-RE18754	57.33
LOADER BOOM LIFT		All		P-V-8	2-1/4	5-1/4	JD-AR105346	71.15
LOADER BUCKET TILT		All		P-V-8	2	3-1/2	JD-RE18748	55.25
LUMBER CLAMP		All		P-V-8	2-1/4	5-1/4	JD-AR105346	71.15
STEERING		All		I-U-1	3-3/8	3-5/8	JD-RE19226	45.33
		All		I-U-10	3-3/8	3-5/8	JD-RE19227	42.71
MODEL 544B								
Backhoe Arrangement			9305					
BACKHOE BOOM		-01219	9305	P-V-8	2-1/4	4-1/2	JD-AR105355	83.97
		701220-	9305	P-V-14	2-1/4	4-1/2	JD-RE18764	114.16
BACKHOE BUCKET		-701219	9305	P-V-8	2-1/4	3-1/2	JD-RE18757	61.75
		701220-	9305	P-V-14	2-1/4	3-1/2	JD-RE18758	100.05
BACKHOE CROWD		701220-	9305	P-V-14	2	4	JD-RE18741	97.81
		-701219	9305	P-V-8	2	4	JD-AR105387	44.97
BACKHOE STABILIZER		All		P-V-8	2	4	JD-AR105387	44.97
GRAPPLE		All		P-V-8	1-3/4	3-1/2	JD-RE18754	57.33
LOADER BOOM LIFT		All		P-V-8	2-1/4	5-1/4	JD-AR105346	71.15
LOADER BUCKET TILT		All		P-V-8	2-1/4	5-1/4	JD-AR105356	66.46
LUMBER CLAMP		-226223		P-V-8	2-1/4	5-1/4	JD-AR105346	71.15
		226224-		P-V-8	2	4	JD-AR105387	44.97
MULTI-PURPOSE		All		P-V-8	2	4	JD-AR105387	44.97
STEERING		-247599		I-U-1	3-3/8	3-5/8	JD-RE19226	45.33
		247600-		I-U-10	3-3/8	3-5/8	JD-RE19227	42.71
		All		I-U-10	3-3/8	3-5/8	JD-RE19227	42.71
MODEL 544C								
Backhoe Arrangement			9450					
BACKHOE BOOM		All		P-V-8	2	4	JD-RE18732	46.38
BACKHOE BUCKET		All		P-V-8	1-3/4	3	JD-RE18751	36.62
BACKHOE CROWD		All		P-V-8	1-3/4	3-1/2	JD-RE18755	46.21
BACKHOE STABILIZER		All		P-V-8	1-3/4	3-1/2	JD-RE18754	57.33
BACKHOE SWING		All		P-U-10	1-3/4	3-1/2	JD-RE18756	48.49
LOADER BOOM LIFT		504463-		P-V-1	2-1/2		JD-RE13745	36.96

LA - Long Arm LGP - Low Ground Pressure LT - Long Track MFWD - Mechanical Front Wheel Drive MP - Multi-Purpose
 IDM - Inside Dozer Mount ODM - Outside Dozer Mount SLF - Super Long Front STD - Straight Dozer WT - Wide Track

Replacement Kits For

JOHN DEERE

Loaders - Wheel								
APPLICATION	CYL #	SERIAL #	Misc	CODE	ROD	BORE	KIT #	List \$
MODEL 544C								
Backhoe Arrangement			9450					
LOADER BOOM LIFT		504463-		N-N-14		5-1/2	JD-RE14910	123.45
LOADER BUCKET TILT		504664-		N-N-14		5-1/2	JD-RE14910	123.45
LUMBER FORK		All		P-V-8	2	4	JD-AR105387	44.97
MULTI-PURPOSE		All		P-V-8	2	4	JD-AR105387	44.97
STEERING		-505253		P-U-10	1-1/2	3	JD-AR105272	24.91
		505254-		P-V-1	1-1/2		JD-RE18203	27.50
		505254-		N-N-10		3	JD-RE18202	10.05
MODEL 544D								
LOADER BOOM LIFT		All		P-V-1	2-1/2		JD-RE13745	36.96
		All		N-N-14		5-1/2	JD-RE14910	123.45
LOADER BUCKET		All		N-N-14		5-1/2	JD-RE14910	123.45
LUMBER FORK		All		P-V-8	2	4	JD-RE18733	37.92
MULTI-PURPOSE		All		P-V-8	2	4	JD-AR105387	44.97
STEERING		All		P-V-1	1-1/2		JD-RE18203	27.50
		All		N-N-10		3	JD-RE18202	10.05
MODEL 544E, 544E LL, 544E TC								
BOOM	AH136532	All		P-UB-1	63 mm		JD-RE25151	108.90
	AH136532	All		N-N-14		125 mm	JD-AH137208	130.69
	AH136534			P-UB-1	63 mm		JD-RE25151	108.90
	AH136534			N-N-14		125 mm	JD-AH137208	130.69
BUCKET	AH136537	All		P-UB-1	63 mm		JD-RE25151	108.90
	AH136537	All		N-N-14		140 mm	JD-AH137209	144.45
	AH136544	All		P-UB-1	80 mm		JD-RE25152	159.41
	AH136544	All		N-N-14		160 mm	JD-AH137210	125.91
	AH139262			P-UB-1	63 mm		JD-RE25151	108.90
	AH139262			N-N-14		140 mm	JD-AH137209	144.45
STEERING	RE27701	All		P-UB-1	40 mm		JD-RE20433	57.19
	RE27701	All		N-N-14		70 mm	JD-RE20428	42.40
MODEL 544G								
BOOM				P-UB-1	63 mm		JD-RE25151	108.90
				N-N-14		125 mm	JD-AH137208	130.69
BUCKET				P-UB-1	63 mm		JD-RE25151	108.90
				N-N-14		140 mm	JD-AH137209	144.45
STEERING				P-UB-1	40 mm		JD-RE20433	57.19
				N-N-14		70 mm	JD-RE20428	42.40
MODEL 544H								
BOOM	AH147533	-570068		P-UB-1	63 mm		JD-AH149815	59.57
	AH147533	-570068		N-N-14		115 mm	JD-AH163671	106.86
	AH163629	570069-		P-UB-1	63 mm		JD-AH149815	59.57
	AH163629	570069-		N-N-14		115 mm	JD-AH163671	106.86
BUCKET	AH152676	-579834		P-UB-1	75 mm		JD-AH154570	67.80
	AH152676	-579834		N-N-14		125 mm	JD-AH149848	167.29
	AH172986	579835-		P-UB-1	75 mm		JD-AH154570	67.80
	AH172986	579835-		N-N-14		125 mm	JD-AH149848	167.29
STEERING	AH147586	-568522		P-UB-14	40 mm	63 mm	JD-AH153497	128.99
	AH160118	568523-589817		I,P-UB-1	40 mm		JD-AH149194	49.62
	AH160118	568523-589817		N-N-14		63 mm	JD-AH212087	91.14
	AH211379	589818-		I,P-UB-1	40 mm		JD-AH149194	49.62
	AH211379	589818-		N-N-14		63 mm	JD-AH212087	91.14
MODEL 544H LL								
BOOM	AH147533	-570068		P-UB-1	63 mm		JD-AH149815	59.57
	AH147533	-570068		N-N-14		115 mm	JD-AH163671	106.86
	AH163629	570069-		P-UB-1	63 mm		JD-AH149815	59.57
	AH163629	570069-		N-N-14		115 mm	JD-AH163671	106.86

JOHN DEERE

LA - Long Arm LGP - Low Ground Pressure LT - Long Track MFWD - Mechanical Front Wheel Drive MP - Multi-Purpose
 IDM - Inside Dozer Mount ODM - Outside Dozer Mount SLF - Super Long Front STD - Straight Dozer WT - Wide Track

Replacement Kits For

JOHN DEERE

Loaders - Wheel								
APPLICATION	CYL #	SERIAL #	Misc	CODE	ROD	BORE	KIT #	List \$
MODEL 544H LL								
BUCKET	AH153921	All		P-UB-1	70 mm		JD-AH156466	53.69
	AH153921	All		N-N-14		110 mm	JD-AH149845	106.21
STEERING	AH147586	-568522		P-UB-14	40 mm	63 mm	JD-AH153497	128.99
	AH160118	568523-589817		I,P-UB-1	40 mm		JD-AH149194	49.62
	AH160118	568523-589817		N-N-14		63 mm	JD-AH212087	91.14
	AH211379	589818-		I,P-UB-1	40 mm		JD-AH149194	49.62
AH211379	589818-		N-N-14		63 mm	JD-AH212087	91.14	
MODEL 544J								
BOOM	AH206281	-611799 ; 611800-		P-UB-1	63 mm		JD-AH149815	59.57
	AH206281	-611799 ; 611800-		N-N-14		120 mm	JD-AH149847	128.03
BOOM (Powerllel™)	AH208215	-611799 ; 611800-		P-UB-1	63 mm		JD-AH149815	59.57
	AH208215	-611799 ; 611800-		N-N-14		115 mm	JD-AH163671	106.86
BOOM (Tool Carrier)	AH163629	-611799		P-UB-1	63 mm		JD-AH149815	59.57
	AH163629	-611799		N-N-14		115 mm	JD-AH163671	106.86
BUCKET	AH172986	-611799 ; 611800-		P-UB-1	75 mm		JD-AH154570	67.80
	AH172986	-611799 ; 611800-		N-N-14		125 mm	JD-AH149848	167.29
BUCKET (Powerllel™)	AH225345	-611799 ; 611800-		P-UB-1	80 mm		JD-AH156874	115.28
	AH225345	-611799 ; 611800-		N-N-14		140 mm	JD-AH216299	148.76
STEERING	AH211379	-611799 ; 611800-		I,P-UB-1	40 mm		JD-AH149194	49.62
	AH211379	-611799 ; 611800-		N-N-14		63 mm	JD-AH212087	91.14
MODEL 544K								
BOOM	AH208215			P-UB-1	63 mm		JD-AH149815	59.57
	AH208215			N-N-14		115 mm	JD-AH163671	106.86
	AH227921			P-UB-1	63 mm		JD-AH149815	59.57
	AH227921			N-N-14		120 mm	JD-AH149847	128.03
BUCKET	AH225345	-637006		P-UB-1	80 mm		JD-AH156874	115.28
	AH225345	-637006		N-N-14		140 mm	JD-AH216299	148.76
	AH227099			P-UB-1	75 mm		JD-AH154570	67.80
	AH227099			N-N-14		125 mm	JD-AH149848	167.29
	AHC10102	637007-		P-UB-1	80 mm		JD-AH156874	115.28
	AHC10102	637007-		N-N-14		140 mm	JD-AH216299	148.76
HI-VIS COUPLER	AH222122			I-U-1	32 mm		JD-AH148823	41.35
	AH222122			N-N-10		2-1/2	JD-AH212088	13.29
STEERING	AH227102			I,P-UB-1	40 mm		JD-AH149194	49.62
	AH227102			N-N-14		63 mm	JD-AH212087	91.14
MODEL 624E, 624G								
BOOM	AH136535	All		P-UB-1	63 mm		JD-RE25151	108.90
	AH136535	All		N-N-14		140 mm	JD-AH137209	144.45
BUCKET	AH136542	All		P-UB-1	80 mm		JD-RE25152	159.41
	AH136542	All		N-N-14		160 mm	JD-AH137210	125.91
STEERING	RE36926	All		P-UB-1	45 mm		JD-RE20434	57.55
	RE36926	All		N-N-14		80 mm	JD-RE31138	53.16
MODEL 624H								
BOOM	AH156875	-570361		N-N-14		125 mm	JD-AH163672	114.11
	AH163630	570362-		N-N-14		125 mm	JD-AH163672	114.11
	AT311670			P-UB-1	63 mm		JD-AH149815	59.57
	AT311670			N-N-14		125 mm	JD-AH163672	114.11
BOOM (Tool Carrier & Log Loader)	AH154122	-570463		N-N-14		125 mm	JD-AH163672	114.11
	AH163631	570464-		N-N-14		125 mm	JD-AH163672	114.11
BUCKET				P-UB-1	80 mm		JD-AH156874	115.28
		-582050		N-N-14		140 mm	JD-AH137209	144.45
		582051-		N-N-14		140 mm	JD-AH216299	148.76
	AH210133			P-UB-1	80 mm		JD-AH156874	115.28
	AH210133			N-N-14		140 mm	JD-AH137209	144.45

LA - Long Arm LGP - Low Ground Pressure LT - Long Track MFWD - Mechanical Front Wheel Drive MP - Multi-Purpose
 IDM - Inside Dozer Mount ODM - Outside Dozer Mount SLF - Super Long Front STD - Straight Dozer WT - Wide Track

Replacement Kits For

JOHN DEERE

Loaders - Wheel								
APPLICATION	CYL #	SERIAL #	Misc	CODE	ROD	BORE	KIT #	List \$
MODEL 624H								
BUCKET	AT311652	-582050		P-UB-1	80 mm		JD-AH156874	115.28
	AT311652	-582050		N-N-14		140 mm	JD-AH137209	144.45
STEERING	AH212033			I,P-UB-1	40 mm		JD-AH149194	49.62
	AH212033			N-N-14		70 mm	JD-AH212089	37.37
MODEL 624J								
BOOM	AH163630	611797-		P-UB-1	63 mm		JD-AH149815	59.57
	AH163630	-611796		P-UB-1	63 mm		JD-AH149815	59.57
	AH163630	611797-		N-N-14		125 mm	JD-AH163672	114.11
	AH163630	-611796		N-N-14		125 mm	JD-AH163672	114.11
BOOM (Powerllel™)	AH163631	-611796		P-UB-1	63 mm		JD-AH149815	59.57
	AH208687	-611796		P-UB-1	63 mm		JD-AH149815	59.57
	AH208687	611797-		P-UB-1	63 mm		JD-AH149815	59.57
	AH208687	-611796		N-N-14		125 mm	JD-AH149848	167.29
BOOM (Tool Carrier)	AH208687	611797-		N-N-14		125 mm	JD-AH149848	167.29
	AH163631	-611796		P-UB-1	63 mm		JD-AH149815	59.57
BUCKET	AH163631	-611796		N-N-14		125 mm	JD-AH163672	114.11
	AH225343	-611796		P-UB-1	80 mm		JD-AH156874	115.28
BUCKET (Powerllel™)	AH225343	611797-		P-UB-1	80 mm		JD-AH156874	115.28
	AH225343	611797-		N-N-14		140 mm	JD-AH216299	148.76
	AH225717	-611796		P-UB-1	95 mm		JD-AH159192	158.28
STEERING	AH225717	611797-		P-UB-1	95 mm		JD-AH159192	158.28
	AH225717	-611796		N-N-14		160 mm	JD-AH137210	125.91
	AH225717	611797-		N-N-14		160 mm	JD-AH137210	125.91
	AH212033	611797-		I,P-UB-1	40 mm		JD-AH149194	49.62
TILT	AH212033	-611796		I,P-UB-1	40 mm		JD-AH149194	49.62
	AH212033	-611796		N-N-14		70 mm	JD-AH212089	37.37
	AH212033	611797-		N-N-14		70 mm	JD-AH212089	37.37
TILT (Tool Carrier)	AH154123	-611796		P-UB-1	70 mm		JD-AH156466	53.69
	AH154123	-611796		N-N-14		115 mm	JD-AH212103	118.74
MODEL 624K	AH154123	-611796		P-UB-1	70 mm		JD-AH156466	53.69
	AH154123	-611796		N-N-14		115 mm	JD-AH212103	118.74
MODEL 624K								
BOOM (Powerllel™)	AH227925			P-UB-1	63 mm		JD-AH149815	59.57
	AH227925			N-N-14		125 mm	JD-AH163672	114.11
BOOM (Tool Carrier)	AHC10215			P-UB-1	63 mm		JD-AH149815	59.57
	AHC10215			N-N-14		125 mm	JD-AH163672	114.11
BUCKET (Powerllel™)	AH227925			P-UB-1	63 mm		JD-AH149815	59.57
	AH227925			N-N-14		125 mm	JD-AH163672	114.11
BUCKET (Tool Carrier)	AHC10103	637330-		P-UB-1	95 mm		JD-AH159192	158.28
	AHC10103	637330-		N-N-14		160 mm	JD-AH234795	86.32
BUCKET (Z-Bar)	AHC10214			P-UB-1	70 mm		JD-AH156466	53.69
	AHC10214			N-N-14		115 mm	JD-AH212103	118.74
STEERING	AHC10101	637110-		P-UB-1	80 mm		JD-AH156874	115.28
	AHC10101	637110-		N-N-14		140 mm	JD-AH216299	148.76
STEERING	AH227114			I,P-UB-1	40 mm		JD-AH149194	49.62
	AH227114			N-N-14		70 mm	JD-AH212089	37.37
MODEL 624KR								
BOOM	AH163631			P-UB-1	63 mm		JD-AH149815	59.57
	AH163631			N-N-14		125 mm	JD-AH163672	114.11
BUCKET	AH154123			P-UB-1	70 mm		JD-AH156466	53.69
	AH154123			N-N-14		115 mm	JD-AH212103	118.74
STEERING	AH227114			I,P-UB-1	40 mm		JD-AH149194	49.62
	AH227114			N-N-14		70 mm	JD-AH212089	37.37

JOHN DEERE

LA - Long Arm LGP - Low Ground Pressure LT - Long Track MFWD - Mechanical Front Wheel Drive MP - Multi-Purpose
 IDM - Inside Dozer Mount ODM - Outside Dozer Mount SLF - Super Long Front STD - Straight Dozer WT - Wide Track

Replacement Kits For

JOHN DEERE

Loaders - Wheel								
APPLICATION	CYL #	SERIAL #	Misc	CODE	ROD	BORE	KIT #	List \$
MODEL 644, 644A								
Backhoe Arrangement			93, 93A, 9305					
BACKHOE BOOM		-701219	9305	P-V-8	2-1/4	4-1/2	JD-AR105355	83.97
		701220-	9305	P-V-14	2-1/4	4-1/2	JD-RE18764	114.16
		All	93, 93A	P-V-8	2-1/4	4-1/2	JD-RE10640	62.91
BACKHOE BUCKET		-701219	93, 93A, 9305	P-V-8	2-1/4	3-1/2	JD-RE18757	61.75
		701220-	9305	P-V-14	2-1/4	3-1/2	JD-RE18758	100.05
BACKHOE CROWD		-701219	93, 93A, 9305	P-V-8	2	4	JD-AR105387	44.97
		701220-	9305	P-V-14	2	4	JD-RE18741	97.81
BACKHOE STABILIZER			9305	P-V-8	2	4	JD-AR105387	44.97
		All	93, 93A	P-V-8	1-3/4	3-1/2	JD-RE18754	57.33
LOADER BOOM LIFT		All		P-V-8	2-3/4	6-1/4	JD-RE18744	141.21
LOADER BUCKET TILT		All		P-V-8	2-1/4	4-1/2	JD-AR105355	83.97
LOADER CLAM		303-		P-U-9	2	4	JIC-G32299	53.72
LUMBER CLAMP		All		P-V-8	2-1/4	5-1/4	JD-AR105346	71.15
STEERING LH				I-U-1	3-3/4		JD-AT34933	39.24
STEERING RH		All		I-U-10	3-3/4	4	JD-AT34932	42.64
MODEL 644B								
LOADER BOOM LIFT		All		P-V-8	2-3/4	6-1/4	JD-RE18744	141.21
LOADER BUCKET TILT		All		P-V-8	2-3/4	6-1/4	JD-RE18744	141.21
LUMBER CLAMP		All		P-V-8	2	4	JD-AR105387	44.97
		All		P-V-8	2-1/4	5-1/4	JD-AR105346	71.15
MULTI-PURPOSE		All		P-V-8	2	4	JD-AR105387	44.97
STEERING		247613-		I-U-10	3-3/4	4	JD-AT34932	42.64
		All		I-U-10	3-3/4	4	JD-AT34932	42.64
		-247612		I-U-1	3-3/4		JD-AT34933	39.24
MODEL 644C								
LOADER BOOM LIFT		505377-		P-V-1	2-3/4		JD-RE16991	83.60
		505377-		N-N-14		6-1/4	JD-RE14022	133.75
LOADER BUCKET TILT		505377-		P-V-1	3		JD-RE16992	63.53
		505377-		N-N-14		6-1/4	JD-RE14022	133.75
LUMBER FORK		All		P-V-8	2	4	JD-AR105387	44.97
MULTI-PURPOSE		All		P-V-8	2	4	JD-AR105387	44.97
STEERING		All		P-V-1	1-3/4		JD-RE30874	28.88
		All		N-N-10		3-1/2	JD-RE17097	13.10
MODEL 644D								
LOADER BOOM LIFT		All		P-V-1	2-3/4		JD-RE16991	83.60
		All		N-N-14		6-1/4	JD-RE14022	133.75
LOADER BUCKET TILT		All		P-V-1	3		JD-RE16992	63.53
		All		N-N-14		6-1/4	JD-RE14022	133.75
LUMBER FORK		All		P-V-8	2	4	JD-RE18733	37.92
MULTI-PURPOSE		All		P-V-8	2	4	JD-AR105387	44.97
STEERING		All		P-UB-1	45 mm		JD-RE20434	57.55
		All		N-N-14		90 mm	JD-RE20430	48.01
MODEL 644E, 644ER								
LOADER BOOM LIFT	AH136545	All		P-UB-1	80 mm		JD-RE25152	159.41
	AH136545	All		N-N-14		160 mm	JD-AH137210	125.91
	AH136546	All		P-UB-1	80 mm		JD-RE25152	159.41
	AH136546	All		N-N-14		160 mm	JD-AH137210	125.91
LOADER BUCKET TILT	AH136549	All		P-UB-1	80 mm		JD-RE25152	159.41
	AH136549	All		N-N-14		180 mm	JD-AH137211	128.10
	AH136551	All		P-UB-1	80 mm		JD-RE25152	159.41
	AH136551	All		N-N-14		180 mm	JD-AH137211	128.10
STEERING	RE24865	All		P-UB-1	45 mm		JD-RE20434	57.55
	RE24865	All		N-N-14		90 mm	JD-RE20430	48.01

LA - Long Arm LGP - Low Ground Pressure LT - Long Track MFWD - Mechanical Front Wheel Drive MP - Multi-Purpose
 IDM - Inside Dozer Mount ODM - Outside Dozer Mount SLF - Super Long Front STD - Straight Dozer WT - Wide Track

Replacement Kits For

JOHN DEERE

Loaders - Wheel								
APPLICATION	CYL #	SERIAL #	Misc	CODE	ROD	BORE	KIT #	List \$
MODEL 644G								
BOOM	AH139265			P-UB-1	80 mm		JD-RE25152	159.41
	AH139265			N-N-14		160 mm	JD-AH137210	125.91
BUCKET	AH139266			P-UB-1	80 mm		JD-RE25152	159.41
	AH139266			N-N-14		180 mm	JD-AH137211	128.10
LOADER BOOM LIFT	AH139265	All		P-UB-1	80 mm		JD-RE25152	159.41
	AH139265	All		N-N-14		160 mm	JD-AH137210	125.91
LOADER BUCKET TILT	AH139266	All		P-UB-1	80 mm		JD-RE25152	159.41
	AH139266	All		N-N-14		180 mm	JD-AH137211	128.10
STEERING	AH150098	All		I,P-UB-1	45 mm		JD-AH149813	59.46
	AH150098	All		N-N-14		90 mm	JD-AH149843	66.72
	RE24865	All		P-UB-1	45 mm		JD-RE20434	57.55
	RE24865	All		N-N-14		90 mm	JD-AH149843	66.72
MODEL 644H								
BOOM	AH225288			P-UB-1	70 mm		JD-AH156466	53.69
	AH225288	589875-		P-UB-1	70 mm		JD-AH156466	53.69
	AH225288	570487-589874		P-UB-1	70 mm		JD-AH156466	53.69
	AH225288	-570486		P-UB-1	70 mm		JD-AH156466	53.69
	AH225288	589875-		N-N-14		140 mm	JD-AH163673	131.91
	AH225288			N-N-14		140 mm	JD-AH163673	131.91
	AH225288	-570486		N-N-14		140 mm	JD-AH163673	131.91
	AH225288	570487-589874		N-N-14		140 mm	JD-AH163673	131.91
	AT311653	-570486		P-UB-1	70 mm		JD-AH156466	53.69
	AT311653	570487-589874		P-UB-1	70 mm		JD-AH156466	53.69
	AT311653	589875-		P-UB-1	70 mm		JD-AH156466	53.69
	AT311653	570487-589874		N-N-14		140 mm	JD-AH163673	131.91
	AT311653	-570486		N-N-14		140 mm	JD-AH163673	131.91
	AT311653	589875-		N-N-14		140 mm	JD-AH163673	131.91
BUCKET	AH225288	-589893		P-UB-1	95 mm		JD-AH159192	158.28
	AH225288	-589893		N-N-14		160 mm	JD-AH137210	125.91
	AH225719	589894-		P-UB-1	95 mm		JD-AH159192	158.28
	AH225719			N-N-14		160 mm	JD-AH137210	125.91
	AH225719	589894-		N-N-14		160 mm	JD-AH137210	125.91
	AT311654			P-UB-1	95 mm		JD-AH159192	158.28
	AT311654			N-N-14		160 mm	JD-AH137210	125.91
STEERING	AH150468			N-N-14		80 mm	JD-AH212091	84.66
	AH211112			I,P-UB-1	45 mm		JD-AH149813	59.46
MODEL 644J								
LOADER BOOM	AH225288	-611231		P-UB-1	70 mm		JD-AH156466	53.69
	AH225288	-611231		N-N-14		140 mm	JD-AH163673	131.91
LOADER BUCKET	AH225719	611232-		P-UB-1	95 mm		JD-AH159192	158.28
	AH225719	-611231		N-N-14		160 mm	JD-AH137210	125.91
	AH225719	611232-		N-N-14		160 mm	JD-AH137210	125.91
STEERING	AH211112	611232-		I,P-UB-1	45 mm		JD-AH149813	59.46
	AH211112	-611231		I,P-UB-1	45 mm		JD-AH149813	59.46
	AH211112	611232-		N-N-14		80 mm	JD-AH212091	84.66
	AH211112	-611231		N-N-14		80 mm	JD-AH212091	84.66
MODEL 644K								
BOOM (PowerlleTM)		-625967		P-UB-1	70 mm		JD-AH156466	53.69
		-625967		N-N-14		140 mm	JD-AH163673	131.91
	AH230320	625968-		P-UB-1	70 mm		JD-AH156466	53.69
	AH230320	625968-		N-N-14		140 mm	JD-AH234770	121.49
BOOM (Z-Bar)		-625967		P-UB-1	70 mm		JD-AH156466	53.69
		-625967		N-N-14		140 mm	JD-AH163673	131.91
	AH230320	625968-		P-UB-1	70 mm		JD-AH156466	53.69
	AH230320	625968-		N-N-14		140 mm	JD-AH234770	121.49

JOHN DEERE

LA - Long Arm LGP - Low Ground Pressure LT - Long Track MFWD - Mechanical Front Wheel Drive MP - Multi-Purpose
 IDM - Inside Dozer Mount ODM - Outside Dozer Mount SLF - Super Long Front STD - Straight Dozer WT - Wide Track

Replacement Kits For

JOHN DEERE

Loaders - Wheel									
APPLICATION	CYL #	SERIAL #	Misc	CODE	ROD	BORE	KIT #	List \$	
MODEL 644K									
BUCKET (Powerllel™)	AH226721			P-UB-1	95 mm		JD-AH159192	158.28	
	AH226721			N-N-14		180 mm	JD-AH137211	128.10	
BUCKET (Z-Bar)	AHC10205	-627885		P-UB-1	95 mm		JD-AH159192	158.28	
	AHC10205	627886-		P-UB-1	95 mm		JD-AH159192	158.28	
	AHC10205	627886-		N-N-14		160 mm	JD-AH234795	86.32	
	AHC10205	-627885		N-N-14		160 mm	JD-AH137210	125.91	
STEERING	AH227132	-632197		I,P-UB-1	45 mm		JD-AH149813	59.46	
	AH227132	-632197		N-N-14		80 mm	JD-AH212091	84.66	
	AHC10913	632198-		I,P-UB-1	45 mm		JD-AHC11572	84.26	
	AHC10913	632198-		N-N-14		80 mm	JD-AH212091	84.66	
MODEL 724J									
BOOM	AH227117	611219-		P-UB-1	70 mm		JD-AH156466	53.69	
	AH227117	-611218		P-UB-1	70 mm		JD-AH156466	53.69	
	AH227117	-618145		P-UB-1	70 mm		JD-AH156466	53.69	
	AH227117	618146-		P-UB-1	70 mm		JD-AH156466	53.69	
	AH227117	-611218		N-N-14		140 mm	JD-AH163673	131.91	
	AH227117	-618145		N-N-14		140 mm	JD-AH163673	131.91	
	AH227117	618146-		N-N-14		140 mm	JD-AH163673	131.91	
BUCKET	AH227117	611219-		N-N-14		140 mm	JD-AH163673	131.91	
	BUCKET	AH210183			P-UB-1	95 mm		JD-AH159192	158.28
		AH210183			N-N-14		160 mm	JD-AH137210	125.91
		AHC10205	-618145		P-UB-1	95 mm		JD-AH159192	158.28
		AHC10205	618146-		P-UB-1	95 mm		JD-AH159192	158.28
		AHC10205	-618145		N-N-14		160 mm	JD-AH137210	125.91
AHC10205		618146-		N-N-14		160 mm	JD-AH137210	125.91	
STEERING	AH150468			I,P-UB-1	45 mm		JD-AH149813	59.46	
	AH150468			N-N-14		80 mm	JD-AH212091	84.66	
	AH227132	-618145		N-N-14		80 mm	JD-AH212091	84.66	
	AH227132	618146-		I,P-UB-1	45 mm		JD-AH149813	59.46	
	AH227132	618146-		N-N-14		80 mm	JD-AH212091	84.66	
MODEL 744E									
LOADER BOOM LIFT	AT137814	All		P-UB-10	95 mm	170 mm	JD-AT138138	277.55	
	AT161735	All		P-UB-10	95 mm	170 mm	JD-AT138138	277.55	
LOADER BUCKET TILT	AT137796	All		P-UB-10	100 mm	200 mm	JD-AT138137	350.94	
STEERING	AT137406	All		P-UB-10	50 mm	100 mm	JD-AT138119	161.71	
	AT158546	All		P-UB-10	50 mm	100 mm	JD-AT138119	161.71	
MODEL 744H									
BOOM	AH153813	-582317		P-UB-1	95 mm		JD-AH151382	139.73	
	AH153813	-582317		N-N-14		180 mm	JD-AH137211	128.10	
	AH175186	582318-		P-UB-1	95 mm		JD-AH159192	158.28	
	AH175186	582318-		N-N-14		180 mm	JD-AH137211	128.10	
	AT311655			P-UB-1	95 mm		JD-AH159192	158.28	
	AT311655			N-N-14		180 mm	JD-AH137211	128.10	
BUCKET	AT311656	575056-		P-UB-1	100 mm		JD-AH151321	171.47	
	AT311656			P-UB-1	115 mm		JD-AH207243	164.88	
	AT311656	575056-		N-N-14		200 mm	JD-AH151320	184.68	
	AT311656			N-N-14		200 mm	JD-AH151320	184.68	
	AT311657			P-UB-1	115 mm		JD-AH207243	164.88	
	AT311657			N-N-14		200 mm	JD-AH151320	184.68	
STEERING	AH148443			I,P-UB-1	45 mm		JD-AH149813	59.46	
	AH148443			N-N-14		90 mm	JD-AH212096	66.72	
MODEL 744J									
BOOM	AH222725	XXXXX-612699		P-UB-1	95 mm		JD-AH159192	158.28	
	AH222725	-590125		P-UB-1	95 mm		JD-AH159192	158.28	
	AH222725	612700-		P-UB-1	95 mm		JD-AH159192	158.28	

LA - Long Arm LGP - Low Ground Pressure LT - Long Track MFWD - Mechanical Front Wheel Drive MP - Multi-Purpose
 IDM - Inside Dozer Mount ODM - Outside Dozer Mount SLF - Super Long Front STD - Straight Dozer WT - Wide Track

Replacement Kits For

JOHN DEERE

Loaders - Wheel								
APPLICATION	CYL #	SERIAL #	Misc	CODE	ROD	BORE	KIT #	List \$
MODEL 744J								
BOOM	AH222725	612700-		N-N-14		180 mm	JD-AH137211	128.10
	AH222725	-590125		N-N-14		180 mm	JD-AH137211	128.10
	AH222725	XXXXX-612699		N-N-14		180 mm	JD-AH137211	128.10
BUCKET	AH222726	595693-612700		P-UB-1	115 mm		JD-AH207243	164.88
	AH222726	595693-612700		N-N-14		200 mm	JD-AH151320	184.68
STEERING	AH222727	-612699		I,P-UB-1	45 mm		JD-AH149813	59.46
	AH222727	612700-		I,P-UB-1	45 mm		JD-AH149813	59.46
	AH222727	-612699		N-N-14		90 mm	JD-AH212096	66.72
	AH222727	612700-		N-N-14		90 mm	JD-AH212096	66.72
MODEL 824J								
BOOM	AH222725	612711-		P-UB-1	95 mm		JD-AH159192	158.28
	AH222725			P-UB-1	95 mm		JD-AH159192	158.28
	AH222725	XXXXXX-612710		P-UB-1	95 mm		JD-AH159192	158.28
	AH222725			N-N-14		180 mm	JD-AH137211	128.10
	AH222725	612711-		N-N-14		180 mm	JD-AH137211	128.10
	AH222725	XXXXXX-612710		N-N-14		180 mm	JD-AH137211	128.10
STEERING		-612710		I,P-UB-1	45 mm		JD-AH149813	59.46
		-612710		N-N-14		90 mm	JD-AH212096	66.72
	AH222727	612711-		I,P-UB-1	45 mm		JD-AH149813	59.46
	AH222727	612711-		N-N-14		90 mm	JD-AH212096	66.72
MODEL 844								
BOOM		507993-510358		P-V-1	3-3/4		JD-RE15708	103.64
		510359-		P-UB-1	3-3/4		JD-RE21202	180.48
		510359-		N-N-14		7-1/2	JD-RE14033	163.67
		507993-510358		N-N-14		7-1/2	JD-RE14033	163.67
BUCKET		508226-510358		P-V-1	3-3/4		JD-RE15708	103.64
		510359-		P-UB-1	3-3/4		JD-RE21202	180.48
		510359-		N-N-14		7-1/2	JD-RE14033	163.67
		508226-510358		N-N-14		7-1/2	JD-RE14033	163.67
STEERING		All		P-V-8	2	3-3/4	JD-AR105381	43.43
MODEL TC44H								
BOOM	AH149101	-570613		P-UB-1	63 mm		JD-AH149815	59.57
	AH149101	-570613		N-N-14		110 mm	JD-AH163670	76.52
	AT152715	570614-		P-UB-1	63 mm		JD-AH149815	59.57
	AT152715	570614-		N-N-14		110 mm	JD-AH163670	76.52
BUCKET	AH152715			P-UB-1	63 mm		JD-AH149815	59.57
	AH152715			N-N-14		100 mm	JD-AH212101	80.14
STEERING	AH147585			I-UB-14	32 mm	56 mm	JD-AH153496	74.82
	AH205056			P-UB-1	32 mm		JD-AH161589	47.09
	AH205056			N-N-14		56 mm	JD-AH161591	64.27
MODEL TC54H								
BOOM	AH147533	-570068		P-UB-1	63 mm		JD-AH149815	59.57
	AH147533	-570068		N-N-14		115 mm	JD-AH163671	106.86
	AH163629	570069-		P-UB-1	63 mm		JD-AH149815	59.57
	AH163629	570069-		N-N-14		115 mm	JD-AH163671	106.86
BUCKET	AH153921	All		P-UB-1	70 mm		JD-AH156466	53.69
	AH153921	All		N-N-14		110 mm	JD-AH149845	106.21
STEERING	AH147586	-568522		P-UB-14	40 mm	63 mm	JD-AH153497	128.99
	AH160118	568523-589817		I,P-UB-1	40 mm		JD-AH149194	49.62
	AH160118	568523-589817		N-N-14		63 mm	JD-AH212087	91.14
	AH211379	589818-		I,P-UB-1	40 mm		JD-AH149194	49.62
	AH211379	589818-		N-N-14		63 mm	JD-AH212087	91.14

JOHN DEERE

LA - Long Arm LGP - Low Ground Pressure LT - Long Track MFWD - Mechanical Front Wheel Drive MP - Multi-Purpose
 IDM - Inside Dozer Mount ODM - Outside Dozer Mount SLF - Super Long Front STD - Straight Dozer WT - Wide Track

Replacement Kits For

JOHN DEERE

Motor Graders								
APPLICATION	CYL #	SERIAL #	Misc	CODE	ROD	BORE	KIT #	List \$
MODEL 570, 570A, 570B								
BLADE LIFT		All		P-V-8	1-3/4	3	JD-RE18751	36.62
BLADE PITCH		All		P-V-8	1-1/4	2-1/2	JD-AR105453	35.68
BLADE SIDESHIFT		All		P-V-8	1-1/2	2-1/2	JD-RE19217	30.13
CIRCLE SIDESHIFT		All		P-V-8	1-3/4	3	JD-RE18751	36.62
SCARIFIER & SNOW PLOW LIFT		All		P-V-8	1-3/4	4	JD-RE10223	39.89
STEERING (Rear)		All		P-V-8	1-1/4	3	JD-AR105454	38.30
WHEEL LEAN		All		P-V-8	1-1/4	3	JD-AR105454	38.30
MODEL 670, 670A, 670B, 672A, 672B								
BLADE LIFT		All		P-V-8	2	3-1/4	JD-RE18747	43.70
BLADE SIDESHIFT		All		P-V-10	1-1/2	3-1/2	JD-RE18742	57.60
BLADE TILT		All		P-V-8	1-3/4	4	JD-RE18736	42.41
CIRCLE SIDESHIFT		All		P-V-8	2	3-1/4	JD-RE18747	43.70
FRONT MOUNTED EQ		All		P-V-8	2	5	JD-RE18743	54.34
RIPPER		All		P-V-8	2-1/4	5-1/4	JD-AR105346	71.15
SCARIFIER		All		P-V-8	2	5	JD-RE18743	54.34
STEERING (Front)		All		P-U-8	1-1/4	3	JD-RE18750	30.04
STEERING (Rear)		All	670, 670A, 672A	P-V-8	1-3/4	3-1/2	JD-RE18754	57.33
		All	670B, 672B	P-UB-1	45 mm		JD-RE20434	57.55
		All	670B, 672B	N-N-14		90 mm	JD-RE20430	48.01
WHEEL LEAN		All		P-V-8	2	4	JD-RE18733	37.92
MODEL 770, 770A, 770B, 772A, 772B								
BLADE LIFT		All		P-V-8	2	3-1/2	JD-RE18748	55.25
BLADE SIDESHIFT		All		P-V-10	1-1/2	3-1/2	JD-RE18742	57.60
BLADE TILT		All		P-V-8	1-3/4	4	JD-RE18736	42.41
CIRCLE SIDESHIFT		All		P-V-8	1-3/4	3-1/2	JD-RE18754	57.33
FRONT MOUNTED EQ		All		P-V-8	2	5	JD-RE18743	54.34
RIPPER		All		P-V-8	2-1/4	5-1/4	JD-AR105346	71.15
SCARIFIER		All		P-V-8	2	5	JD-RE18743	54.34
STEERING (Front)		All		P-U-8	1-1/4	3	JD-RE18750	30.04
STEERING (Rear)		All		P-V-8	2	4	JD-RE18733	37.92
WHEEL LEAN		All		P-V-8	2	4	JD-RE18733	37.92
Scrapers								
APPLICATION	CYL #	SERIAL #	Misc	CODE	ROD	BORE	KIT #	List \$
MODEL 760								
BOWL LIFT		All		P-V-8	2	4	JD-AR105387	44.97
SCARIFIER		All		P-V-8	1-1/2	3	JD-AR105722	39.76
SLIDING FLOOR		1001-		P-V-8	2-1/4	4-1/2	JD-AR105351	69.33
		-1000		P-V-8	2-1/4	4-1/2	JD-AR105355	83.97
MODEL 760A								
BOWL LIFT		All		P-V-8	2	4	JD-AR105387	44.97
EJECTOR GATE	RE19217			P-V-8	1-1/2	2-1/2	JD-RE19217	30.13
SCARIFIER		All		P-V-8	1-1/2	3	JD-AR105722	39.76
SLIDING FLOOR		-2505		P-V-8	2-1/4	4-1/2	JD-AR105351	69.33
		2506-		P-V-8	2-1/4	5	JD-RE18759	91.20
MODEL 762, 762A, 762B								
BOWL LIFT		All		P-V-8	2	4-1/2	JD-RE18737	56.56
EJECTOR GATE		All		P-V-8	1-1/2	2-1/2	JD-RE19217	30.13
SLIDING FLOOR		All		P-V-8	2-1/4	5-1/4	JD-AR105346	71.15
STEERING		All		P-V-10,12	2	3-1/2	JD-RE18765	50.01
STEERING (Follow-Up)		All	762, 762A	N-OB-10	1/2	1	JD-AH65915	9.86
MODEL 860, 860A, 860B								
BOWL LIFT		All		P-V-8	2	5	JD-RE18743	54.34
EJECTOR GATE		All		P-V-8	1-3/4	3	JD-RE18752	37.89
SLIDING FLOOR		All		P-V-8	2-1/2	5-1/4	JD-RE18746	68.20

LA - Long Arm LGP - Low Ground Pressure LT - Long Track MFWD - Mechanical Front Wheel Drive MP - Multi-Purpose
 IDM - Inside Dozer Mount ODM - Outside Dozer Mount SLF - Super Long Front STD - Straight Dozer WT - Wide Track

Replacement Kits For

JOHN DEERE

Scrapers								
APPLICATION	CYL #	SERIAL #	Misc	CODE	ROD	BORE	KIT #	List \$
MODEL 860,860A,860B								
STEERING		All		P-V-10	2	4	JD-RE18738	31.89
MODEL 862								
AXLE SUSPENSION				P-V-1	2		JD-RE16119	26.51
				N-N-14		4	JD-RE16118	79.05
BOWL LIFT				P-V-8	2	5	JD-RE18743	54.34
EJECTOR GATE		4283-781780		P-U-8	2	3	JD-RE19218	44.01
		-4283		P-V-8	1-3/4	3	JD-RE18752	37.89
SLIDING FLOOR				P-V-8	2-1/2	5-1/4	JD-RE18746	68.20
STEERING				P-V-10	2	4	JD-RE18738	31.89
STEERING (Follow-Up)				N-OB-10	1/2	1	JD-AH65915	9.86
MODEL 862B								
BOWL LIFT		781781-		P-UB-1	63 mm		JD-RE25151	108.90
		781781-		N-N-14		140 mm	JD-AH137209	144.45
EJECTOR GATE		4283-781780		P-U-8	2	3	JD-RE19218	44.01
		781781-		P-UB-1	50 mm		JD-RE20595	50.84
		781781-		N-N-14		80 mm	JD-RE31138	53.16
STEERING				P-V-10	2	4	JD-RE18738	31.89
	RE18738	781781-		P-UB-1	50 mm		JD-RE20595	50.84
	RE18738	781781-		N-N-14		100 mm	JD-AH137687	70.51
MODEL 1312C								
BUCKET	AH163552		-2003	I,P-UB-1	45 mm		JD-AH149813	59.46
	AH163552		-2003	N-N-10		90 mm	JD-AH202290	15.75
GATE & WHEEL FRAME	AH166738		-2003	P-UB-1	63 mm		JD-AH149815	59.57
	AH166738		-2003	N-N-10		6	JD-AH167533	60.46
MODEL 1510C								
BUCKET	AH163552		-2003	I,P-UB-1	45 mm		JD-AH149813	59.46
	AH163552	-050001	2004-	I,P-UB-1	45 mm		JD-AH149813	59.46
	AH163552		-2003	N-N-10		90 mm	JD-AH202290	15.75
	AH163552	-050001	2004-	N-N-10		90 mm	JD-AH202290	15.75
	AH216652	050002-	2004-	I,P-UB-1	45 mm		JD-AH149813	59.46
	AH216652	050002-	2004-	N-N-10		90 mm	JD-AH212097	15.75
GATE & WHEEL FRAME	AH166738		-2003	P-UB-1	63 mm		JD-AH149815	59.57
	AH166738	-050004	2004-	P-UB-1	63 mm		JD-AH149815	59.57
	AH166738		-2003	N-N-10		6	JD-AH167533	60.46
	AH166738	-050004	2004-	N-N-10		6	JD-AH167533	60.46
	AH216715	050005-	2004-	P-UB-1	63 mm		JD-AH149815	59.57
	AH216715	050005-	2004-	N-N-10		6	JD-AH167533	60.46
MODEL 1512C								
BUCKET	AH163552	-050001	2004-	I,P-UB-1	45 mm		JD-AH149813	59.46
	AH163552	-050001	2004-	N-N-10		90 mm	JD-AH202290	15.75
	AH216652	050002-	2004-	I,P-UB-1	45 mm		JD-AH149813	59.46
	AH216652	050002-	2004-	N-N-10		90 mm	JD-AH212097	15.75
GATE & WHEEL FRAME	AH166738	-050004	2004-	P-UB-1	63 mm		JD-AH149815	59.57
	AH166738	-050004	2004-	N-N-10		6	JD-AH167533	60.46
	AH216715	050005-	2004-	P-UB-1	63 mm		JD-AH149815	59.57
	AH216715	050005-	2004-	N-N-10		6	JD-AH167533	60.46
MODEL 1810C								
BUCKET		060201-	Mfg 2006	P-UB-1	56 mm		JD-AH149814	58.53
		060201-	Mfg 2006	N-N-10		100 mm	JD-AH212102	50.15
LIFT GATE	AH149815	060201-		P-UB-1	63 mm		JD-AH149815	59.57
	AH149815	060201-		N-N-10		6	JD-AH167533	60.46
MODEL 1812C								
BUCKET	AH163552		-2003	I,P-UB-1	45 mm		JD-AH149813	59.46
	AH163552	-050001	2004-	I,P-UB-1	45 mm		JD-AH149813	59.46
	AH163552		-2003	N-N-10		90 mm	JD-AH202290	15.75

JOHN DEERE

LA - Long Arm LGP - Low Ground Pressure LT - Long Track MFWD - Mechanical Front Wheel Drive MP - Multi-Purpose
 IDM - Inside Dozer Mount ODM - Outside Dozer Mount SLF - Super Long Front STD - Straight Dozer WT - Wide Track

Replacement Kits For

JOHN DEERE

Scrapers								
APPLICATION	CYL #	SERIAL #	Misc	CODE	ROD	BORE	KIT #	List \$
MODEL 1812C								
BUCKET	AH163552	-050001	2004-	N-N-10		90 mm	JD-AH202290	15.75
	AH216652	050002-	2004-	I,P-UB-1	45 mm		JD-AH149813	59.46
	AH216652	050002-	2004-	N-N-10		90 mm	JD-AH212097	15.75
GATE & WHEEL FRAME	AH166738	-050004	2004-	P-UB-1	63 mm		JD-AH149815	59.57
	AH166738		-2003	P-UB-1	63 mm		JD-AH149815	59.57
	AH166738		-2003	N-N-10		6	JD-AH167533	60.46
	AH166738	-050004	2004-	N-N-10		6	JD-AH167533	60.46
	AH216715	050005-	2004-	P-UB-1	63 mm		JD-AH149815	59.57
	AH216715	050005-	2004-	N-N-10		6	JD-AH167533	60.46
MODEL 1814C								
BUCKET	AH163552		-2003	I,P-UB-1	45 mm		JD-AH149813	59.46
	AH163552	-050001	2004-	I,P-UB-1	45 mm		JD-AH149813	59.46
	AH163552		-2003	N-N-10		90 mm	JD-AH202290	15.75
	AH163552	-050001	2004-	N-N-10		90 mm	JD-AH202290	15.75
	AH216652	050002-	2004-	I,P-UB-1	45 mm		JD-AH149813	59.46
	AH216652	050002-	2004-	N-N-10		90 mm	JD-AH212097	15.75
GATE & WHEEL FRAME	AH166738		-2003	P-UB-1	63 mm		JD-AH149815	59.57
	AH166738	-050004	2004-	P-UB-1	63 mm		JD-AH149815	59.57
	AH166738		-2003	N-N-10		6	JD-AH167533	60.46
	AH166738	-050004	2004-	N-N-10		6	JD-AH167533	60.46
	AH216715	050005-	2004-	P-UB-1	63 mm		JD-AH149815	59.57
	AH216715	050005-	2004-	N-N-10		6	JD-AH167533	60.46
MODEL 2112C								
BUCKET		060201-	Mfg 2006	P-UB-1	56 mm		JD-AH149814	58.53
		060201-	Mfg 2006	N-N-10		100 mm	JD-AH212102	50.15
LIFT GATE	AH149815	060201-		P-UB-1	63 mm		JD-AH149815	59.57
	AH149815	060201-		N-N-10		6	JD-AH167533	60.46
MODEL 5010								
BOWL LIFT		All		P-V-8	2	4	JD-AR105387	44.97
EJECTOR GATE		All		P-OB-8	1-1/2	2-1/2	JD-AR99785	20.79
		All		P-V-8	1-1/2	2-1/2	JD-RE19217	30.13
SCARIFIER		All		P-V-8	1-1/2	3	JD-AR105722	39.76
SLIDING FLOOR		All		P-V-8	2	4-1/2	JD-AR105384	61.37
Skidders								
APPLICATION	CYL #	SERIAL #	Misc	CODE	ROD	BORE	KIT #	List \$
MODEL 340D								
BLADE LIFT		All		P-V-1	1-1/2		JD-RE14088	25.36
		All		N-N-14		3-1/2	JD-RE16076	76.63
STEERING		All		P-V-10	1-3/4	2-3/4	JD-AR105537	42.81
MODEL 440, 440A, 440B								
		Backhoe Arrangement		93, 93A, 95, 95A				
BACKHOE BOOM		All		P-V-8	2-1/4	4-1/2	JD-RE10640	62.91
BACKHOE BUCKET		All		P-V-8	2-1/4	3-1/2	JD-RE18757	61.75
BACKHOE CROWD		All		P-V-8	2	4	JD-AR105387	44.97
BACKHOE STABILIZER		All	93, 93A	P-V-8	1-3/4	3-1/2	JD-RE18754	57.33
		All	95, 95A	P-V-8	1-3/4	3	JD-RE18751	36.62
FRONT BLADE		All		P-V-8	1-1/2	3	JD-AR105722	39.76
STEERING		All		P-U-10	2-5/8	3	JD-AT38068	41.32
		All		P-U-1	2-5/8	3	JD-AT39022	20.88
MODEL 440C Skidders/Grapple Skidders								
BLADE LIFT		-282545		P-V-8	1-1/2	3	JD-AR105722	39.76
		282546-		P-V-1	1-1/2		JD-RE14088	25.36
		282546-		N-N-14		3	JD-RE14082	70.14
BOOM		All		P-V-8	2	4	JD-AR105387	44.97
		All		P-V-1	2		JD-RE16119	26.51

LA - Long Arm LGP - Low Ground Pressure LT - Long Track MFWD - Mechanical Front Wheel Drive MP - Multi-Purpose
 IDM - Inside Dozer Mount ODM - Outside Dozer Mount SLF - Super Long Front STD - Straight Dozer WT - Wide Track

Replacement Kits For

JOHN DEERE

Skidders								
APPLICATION	CYL #	SERIAL #	Misc	CODE	ROD	BORE	KIT #	List \$
MODEL 440C Skidders/Grapple Skidders								
BOOM		All		N-N-14		4	JD-RE16118	79.05
GRAPPLE		-405023		P-V-8	2-1/4	5-1/4	JD-AR105346	71.15
		405024-		P-V-1	2-1/4		JD-RE14208	37.91
		405024-		N-N-14		5-1/4	JD-RE14100	107.02
STEERING		-400823		P-U-10	3	3-1/4	JD-RE19216	43.43
		400824-		P-V-10	1-3/4	2-3/4	JD-AR105537	42.81
MODEL 440D, 448 Skidders/Grapple Skidders								
ARCH & BOOM		All	448D	P-V-1	2		JD-RE16119	26.51
		All	448D	N-N-14		4	JD-RE16118	79.05
BLADE LIFT		All		P-V-1	1-1/2		JD-RE14088	25.36
		All		N-N-14		3-1/2	JD-RE16076	76.63
GRAPPLE		-501505	448D	P-V-8	2-1/4	5-1/4	JD-AR105346	71.15
		501506-	448D	P-V-1	2-1/4		JD-RE14208	37.91
		501506-	448D	N-N-14		5-1/4	JD-RE14100	107.02
STEERING		All		P-V-10	1-3/4	2-3/4	JD-AR105537	42.81
MODEL 540, 540A								
FRONT BLADE		-119500, -40399		P-V-8	1-1/2	3	JD-AR105722	39.76
		119501-, 40400-		P-V-8	1-1/2	3-1/2	JD-AR105432	44.84
STEERING		All		P-UB-1	3	3-1/4	JD-AT39023	46.46
		All		P-U-10	3	3-1/4	JD-AT35142	65.03
MODEL 540B								
BLADE LIFT		-500808		P-V-8	1-1/2	3-1/2	JD-AR105432	44.84
		500809-		P-V-1	1-1/2		JD-RE14088	25.36
		500809-		N-N-14		3-1/2	JD-RE16076	76.63
BOOM		-500808		P-V-8	2	4	JD-AR105387	44.97
		500809-		P-V-1	2		JD-RE16119	26.51
		500809-		N-N-14		4	JD-RE16118	79.05
GRAPPLE		-501541		P-V-8	2-1/4	5-1/4	JD-AR105346	71.15
		501542-		P-V-1	2-1/4		JD-RE14208	37.91
		501542-		N-N-14		5-1/4	JD-RE14100	107.02
STEERING		-400571		P-U-10	3	3-1/4	JD-RE19216	43.43
		400572-		P-V-10	1-3/4	2-3/4	JD-AR105537	42.81
MODEL 540D, 548D Grapple Skidders								
BLADE LIFT		All		P-V-1	1-1/2		JD-RE14088	25.36
		All		N-N-14		3-1/2	JD-RE16076	76.63
BOOM		All	548D	P-V-1	2		JD-RE16119	26.51
		All	548D	N-N-14		4	JD-RE16118	79.05
GRAPPLE		All	548D	P-V-1	2-1/4		JD-RE14208	37.91
		All	548D	N-N-14		5-1/4	JD-RE14100	107.02
STEERING		All		P-V-10	1-3/4	2-3/4	JD-AR105537	42.81
MODEL 640 Skidders/Grapple Skidders								
ARCH & BOOM		-500986		P-V-8	2	4	JD-AR105387	44.97
		500987-		P-V-1	2		JD-RE16119	26.51
		500987-		N-N-14		4	JD-RE16118	79.05
BLADE LIFT		-500986		P-V-8	1-3/4	4	JD-RE10223	39.89
		500987-		P-V-1	1-3/4		JD-RE30874	28.88
		500987-		N-N-14		4	JD-RE16118	79.05
BOOM (Single Function)		All		P-V-1	2		JD-RE16119	26.51
		All		N-N-14		4	JD-RE14567	81.27
GRAPPLE		-502132		P-V-8	2-1/2	5-1/2	JD-RE10224	96.19
		502133-		P-V-1	2-1/2		JD-RE17345	46.46
		502133-		N-N-14		5-1/2	JD-RE14102	123.45
STEERING		All		I-U-10	3-3/8	3-5/8	JD-RE19227	42.71
TILT		-503561		P-V-8	2-1/4	4-1/2	JD-AR105355	83.97
		503562-		P-V-1	2-1/4		JD-RE14208	37.91

LA - Long Arm LGP - Low Ground Pressure LT - Long Track MFWD - Mechanical Front Wheel Drive MP - Multi-Purpose
 IDM - Inside Dozer Mount ODM - Outside Dozer Mount SLF - Super Long Front STD - Straight Dozer WT - Wide Track

Replacement Kits For

JOHN DEERE

Skidders								
APPLICATION	CYL #	SERIAL #	Misc	CODE	ROD	BORE	KIT #	List \$
MODEL 640 Skidders/Grapple Skidders								
TILT		503562-		N-N-14		4-1/2	JD-RE14094	82.00
MODEL 640D, 648D Grapple Skidders								
ARCH & BOOM		All	648D	P-V-1	2		JD-RE16119	26.51
		All	648D	N-N-14		4	JD-RE16118	79.05
BLADE LIFT		All		P-V-1	1-3/4		JD-RE30874	28.88
		All		N-N-14		4	JD-RE16118	79.05
BOOM (Single Function)		All	648D	P-V-1	2		JD-RE16119	26.51
		All	648D	N-N-14		4	JD-RE14567	81.27
GRAPPLE		All	648D	P-V-1	2-1/2		JD-RE17345	46.46
		All	648D	N-N-14		5-1/2	JD-RE14102	123.45
STEERING		All		P-V-1	1-3/4		JD-RE16209	31.04
		All		N-N-14		3	JD-RE16208	69.20
TILT		All		P-V-1	2-1/4		JD-RE14208	37.91
		All		N-N-14		4-1/2	JD-RE14094	82.00
MODEL 740, 740A								
ARCH & BOOM		-708051		P-V-8	2	4-1/4	JD-AR105391	48.32
		708052-	740A	P-V-1	2		JD-RE30817	32.31
		708052-	740A	N-N-14		4-1/4	JD-RE17458	83.60
GRAPPLE		-708051		P-V-8	2-3/4	6-1/4	JD-RE18744	141.21
		708052-	740A	P-V-1	2-3/4		JD-RE17342	63.27
		708052-	740A	N-N-14		6-1/4	JD-RE14104	127.07
LIFT		-708051		P-V-8	2	5	JD-RE18743	54.34
		708052-	740A	P-V-1	2		JD-RE30817	32.31
		708052-	740A	N-N-14		5	JD-RE15905	101.24
STEERING		All		I-U-10	4-1/4	4.40	JD-RE19224	47.95
TILT		-708051		P-V-8	2-1/4	4-1/2	JD-AR105355	83.97
		708052-	740A	P-V-1	2-1/4		JD-RE14208	37.91
		708052-	740A	N-N-14		4-1/2	JD-RE14094	82.00
MODEL 3605 Grapple Skidders								
BOOM		10201-		P-V-8	1-3/4	3-1/2	JD-RE18754	57.33
GRAPPLE		10201-		P-V-8	1-3/4	3-1/2	JD-RE18754	57.33

JOHN DEERE

LA - Long Arm LGP - Low Ground Pressure LT - Long Track MFWD - Mechanical Front Wheel Drive MP - Multi-Purpose
 IDM - Inside Dozer Mount ODM - Outside Dozer Mount SLF - Super Long Front STD - Straight Dozer WT - Wide Track

REPLACEMENT KITS FOR JOHN DEERE

IMPORTANT - PLEASE READ

If a kit part number is unknown, the machine model number, serial number, and cylinder application will help identify the repair kit you need.

Example: Model Number **580C**
 Serial Number **5411021**
 Cylinder Application **Backhoe Swing**

If none of the above information is known, size and description of the parts needed will almost always be sufficient.

Kit Number	Code (Pg. xviii)	Rod X Bore Size	List Price
JD-0656604	P-U-10	50 X 100 mm	\$ 215.99
JD-0656714	P-U-10	50 X 80 mm	123.31
JD-0735309	P-U-10	55 X 95 mm	126.29
JD-0735609	P-U-10	45 X 75 mm	153.21
JD-0744105	P-U-10	35 X 60 mm	74.59
JD-0744408	P-U-10	45 X 75 mm	172.43
JD-0744707	P-U-10	40 X 65 mm	129.99
JD-0744808	P-U-10	45 X 85 mm	112.95
JD-0745308	P-U-10	50 X 95 mm	115.61
JD-0843613	P-U-10	50 X 80 mm	107.57
JD-0843808	P-U-10	50 X 100 mm	74.61
JD-0843907	P-U-10	55 X 100 mm	92.32
JD-0844705	P-U-10	45 X 75 mm	67.79
JD-0844807	P-U-10	55 X 95 mm	115.15
JD-0847204	P-U-10	40 X 75 mm	82.66
JD-0849304	P-U-10	45 X 75 mm	91.13
JD-0849503	P-U-10	40 X 60 mm	76.49
JD-0850309	P-U-10	45 X 80 mm	95.94
JD-411077	P-U-1	2-3/8	24.78
JD-4369943	P-UB-10	105 X 145 mm	272.83
JD-4388027	P-UB-10	70 X 100 mm	333.03
JD-4415584	P-UB-10	60 X 95 mm	126.21
JD-4448396	P-UB-10	80 X 115 mm	201.08
JD-4448397	P-UB-10	70 X 100 mm	160.32
JD-4448398	P-UB-10	85 X 120 mm	176.23
JD-4448399	P-UB-10	95 X 135 mm	221.89
JD-4464984	P-UB-10	65 X 115 mm	132.13
JD-4464985	P-UB-10	60 X 95 mm	105.31
JD-4464985-EX	P-UB-10	60 mm X 95 mm	146.84
JD-4464986	P-UB-10	55 X 85 mm	100.77
JD-4464986-EX	P-UB-10	55 mm X 85 mm	166.62
JD-4465736	P-UB-10	70 X 120 mm	117.57
JD-4467379	P-UB-10	80 X 110 mm	219.60
JD-4467380	P-UB-10	90 X 120 mm	237.87
JD-4467381	P-UB-10	75 X 105 mm	163.74
JD-4485612	P-UB-14	90 X 125 mm	108.45
JD-4485614	P-UB-14	90 X 130 mm	122.18
JD-4485615	P-UB-14	95 X 135 mm	145.27
JD-4614058	P-U-10	40 X 65 mm	123.26
JD-4614059	P-U-10	45 X 85 mm	124.10
JD-4614062	P-U-10	40 mm X 70 mm	56.29
JD-4614069	P-U-10	45 X 75 mm	80.79
JD-4622066	P-U-14	45 X 95 mm	140.44
JD-4622067	P-U-14	50 X 105 mm	123.20
JD-4631062	P-UB-10	105 X 140 mm	226.75
JD-4632462	P-U-10	70 mm X 120 mm	227.49

Kit Number	Code (Pg. xviii)	Rod X Bore Size	List Price
JD-4634033	P-U-10	50 X 85 mm	\$ 104.57
JD-4634034	P-U-10	45 X 75 mm	95.92
JD-4634036	P-U-10	50 X 80 mm	98.04
JD-4639936	P-UB-10	95 X 135 mm	246.95
JD-4639938	P-UB-10	100 X 145 mm	238.14
JD-4639939	P-UB-10	90 X 135 mm	284.62
JD-4640107	P-UB-14	105 X 150 mm	514.81
JD-4640108	P-UB-14	95 X 145 mm	450.03
JD-4640118	P-UB-14	115 X 170 mm	391.59
JD-4649050	P-UB-10	100 X 140 mm	252.00
JD-4649745	P-UB-14	95 X 135 mm	162.63
JD-4649751	P-UB-14	90 X 135 mm	165.93
JD-4649752	P-UB-14	105 X 150 mm	227.63
JD-4652380	P-U-10	50 mm X 80 mm	86.94
JD-4652380-EX	P-U-10	50 mm X 80 mm	110.79
JD-4653040	P-UB-10	115 X 170 mm	225.63
JD-4653041	P-UB-10	130 X 190 mm	264.17
JD-4657449	P-UB-10	90 X 120 mm	237.87
JD-4660570	P-UB-10	95 X 145 mm	186.12
JD-4661594	P-UB-10	95 X 135 mm	221.89
JD-4662066	P-UB-10	90 X 130 mm	156.98
JD-4662069	P-UB-10	90 X 125 mm	188.44
JD-4662069-EX	P-UB-10	90 mm X 125 mm	211.45
JD-4662891	P-UB-10	80 X 110 mm	201.87
JD-4662895	P-UB-10	70 X 105 mm	166.66
JD-4662895-EX	P-UB-10	70 mm X 105 mm	361.69
JD-4663491	P-UB-10	65 mm X 115 mm	220.04
JD-4663491-EX	P-UB-10	65 mm X 115 mm	241.82
JD-4663493	P-UB-10	75 X 105 mm	163.74
JD-4672004	P-UB-10	100 mm X 135 mm	126.43
JD-4672004-EX	P-UB-10	100 mm X 135 mm	193.47
JD-4686432	P-UB-10	115 mm X 170 mm	380.07
JD-4687559	P-U-10	60 mm X 110 mm	177.19
JD-4687559-EX	P-U-10	60 mm X 110 mm	198.97
JD-4687560	P-U-10	55 mm X 90 mm	152.87
JD-4687560-EX	P-U-10	55 mm X 90 mm	161.13
JD-4687561	P-U-10	55 mm X 95 mm	133.41
JD-4687561-EX	P-U-10	55 mm X 95 mm	163.10
JD-4687562	P-U-14	70 mm X 120 mm	220.97
JD-4696459	P-UB-10	60 mm X 110 mm	74.30
JD-4S00715	P-UB-10	90 mm X 125 mm	117.02
JD-4S00715-EX	P-UB-10	90 mm X 125 mm	140.01
JD-4S00783	P-UB-10	100 X 145 mm	204.28
JD-4S00784	P-UB-10	95 X 140 mm	181.93
JD-4S00834	P-UB-10	80 mm X 115 mm	79.56
JD-4S00847	P-UB-10	80 mm X 115 mm	79.75

REPLACEMENT KITS FOR JOHN DEERE

Kit Number	Code (Pg. xviii)	Rod X Bore Size	List Price
JD-4S00847-EX	P-UB-10	80 mm X 115 mm	\$ 185.46
JD-4S00849	P-UB-10	70 mm X 100 mm	69.66
JD-4S00849-EX	P-UB-10	70 mm X 100 mm	175.80
JD-4S00930	P-UB-10	115 X 170 mm	222.48
JD-4S00959	P-UB-10	120 X 170 mm	119.53
JD-4S00960	P-UB-10	130 mm X 190 mm	347.12
JD-4S00960-EX	P-UB-10	130 mm X 190 mm	432.12
JD-4S00961	P-UB-10	115 X 170 mm	225.63
JD-4S07784	P-UB-10	95 X 140 mm	181.93
JD-905000	Track Adjuster Kit		21.79
JD-905001	Track Adjuster Kit		56.36
JD-905002	Track Adjuster Kit		23.73
JD-905003	Track Adjuster Kit		37.62
JD-9180582	P-UB-14	115 X 170 mm	244.22
JD-9207059	P-UB-14	105 X 150 mm	155.44
JD-AA15296	P-N-1	2-1/4	20.07
JD-AH134477	P-UB-1	63 mm Rod Kit	103.17
JD-AH134955	N-N-10	90 mm Piston Kit	14.00
JD-AH137208	N-N-14	125 mm Piston Kit	130.69
JD-AH137209	N-N-14	140 mm Piston Kit	144.45
JD-AH137210	N-N-14	160 mm Piston Kit	125.91
JD-AH137211	N-N-14	180 mm Piston Kit	128.10
JD-AH137687	N-N-14	100 mm Piston Kit	70.51
JD-AH137789	N-N-10	2" Piston Kit	6.12
JD-AH139417	P-U-1	2-1/4 Rod Kit	39.76
JD-AH139418	I-U-8	2-1/4 X 4-1/4	51.36
JD-AH142089	P-UB-1	70 mm Rod Kit	188.73
JD-AH142440	P-V-1	2-1/2 Rod Kit	46.94
JD-AH144593	P-UB-14	75 X 110 mm	325.01
JD-AH144594	P-UB-14	85 X 120 mm	348.12
JD-AH144595	P-UB-14	95 X 130 mm	290.62
JD-AH147868	P-UB-1	45 mm Rod Kit	32.41
JD-AH148164	P-UB-1	50 mm Rod Kit	42.87
JD-AH148453	P-UB-10	95 X 130 mm	349.64
JD-AH148776	P-UB-10	75 X 110 mm	314.21
JD-AH148785	P-UB-10	85 X 120 mm	290.86
JD-AH148823	I-U-1	32 mm Rod Kit	41.35
JD-AH149194	I,P-UB-1	40 mm Rod Kit	49.62
JD-AH149796	P-UB-10	80 X 110 mm	373.39
JD-AH149810	P-UB-1	25mm Rod Kit	48.92
JD-AH149813	I,P-UB-1	45 mm Rod Kit	59.46
JD-AH149814	P-UB-1	56 mm Rod Kit	58.53
JD-AH149815	P-UB-1	63 mm Rod Kit	59.57
JD-AH149817	I-U-10	32 mm X -1 mm	23.91
JD-AH149842	N-N-14	80 mm Piston Kit	67.24
JD-AH149843	N-N-14	90 mm Piston Kit	66.72
JD-AH149844	N-N-14	100 mm Piston Kit	84.21
JD-AH149845	N-N-14	110 mm Piston Kit	106.21
JD-AH149846	N-N-14	115 mm Piston Kit	118.74
JD-AH149847	N-N-14	102 mm Piston Kit	128.03
JD-AH149848	N-N-14	125 mm Piston Kit	167.29
JD-AH150595	P-UB-10	65 X 95 mm	209.08
JD-AH151107	P-UB-10	70 X 105 mm	308.36
JD-AH151320	N-N-14	200 mm Piston Kit	184.68

Kit Number	Code (Pg. xviii)	Rod X Bore Size	List Price
JD-AH151321	P-UB-1	100 mm Rod Kit	\$ 171.47
JD-AH151382	P-UB-1	95 mm Rod Kit	139.73
JD-AH153496	I-UB-14	32 X 56 mm	74.82
JD-AH153497	P-UB-14	40 X 63 mm	128.99
JD-AH154570	P-UB-1	75 mm Rod Kit	67.80
JD-AH155025	P-UB-10	85 X 115 mm	315.17
JD-AH155040	P-UB-10	75 X 105 mm	461.55
JD-AH155045	P-UB-10	80 X 110 mm	342.96
JD-AH156466	P-UB-1	70 mm Rod Kit	53.69
JD-AH156874	P-UB-1	80 mm Rod Kit	115.28
JD-AH159192	P-UB-1	95 mm Rod Kit	158.28
JD-AH160843	I-U-10	32 mm X 2-1/4	50.28
JD-AH160844	I-U-10	40 mm X 2-1/4	47.92
JD-AH161589	P-UB-1	32 mm Rod Kit	47.09
JD-AH161590	N-N-14	63 mm Piston Kit	91.14
JD-AH161591	N-N-14	56 mm Piston Kit	64.27
JD-AH161781	N-N-10	100 mm Piston Kit	23.31
JD-AH163670	N-N-14	110 mm Piston Kit	76.52
JD-AH163671	N-N-14	115 mm Piston Kit	106.86
JD-AH163672	N-N-14	125 mm Piston Kit	114.11
JD-AH163673	N-N-14	140 mm Piston Kit	131.91
JD-AH164325	N-N-10	2-1/4	20.88
JD-AH167533	N-N-10	6 Piston Kit	60.46
JD-AH167552	N-N-10	2 Piston Kit	6.67
JD-AH167596	N-N-10	125 mm	30.88
JD-AH168977	I-U-10	36 mm X 2-1/4	53.16
JD-AH173444	P-UB-10	95 X 135 mm	221.49
JD-AH173451	P-UB-10	80 X 115 mm	310.18
JD-AH173457	P-UB-10	85 X 120 mm	290.86
JD-AH176272	I-U-10	25 mm X 40 mm	26.81
JD-AH176273	I-U-10	28 mm X 45 mm	27.07
JD-AH202290	N-N-10	90 mm Piston Kit	15.75
JD-AH207190	P-UB-1	85 mm Rod Kit	102.90
JD-AH207243	P-UB-1	115 mm Rod Kit	164.88
JD-AH209022	I-U-14	50 mm X 3	77.65
JD-AH210287	N-N-14	110 mm Piston Kit	89.20
JD-AH210484	P-UB-1	50 mm Rod Kit	41.20
JD-AH212087	N-N-14	63 mm Piston Kit	91.14
JD-AH212088	N-N-10	2-1/2" Piston Kit	13.29
JD-AH212089	N-N-14	70 mm Piston Kit	37.37
JD-AH212090	N-N-10	70 mm Piston Kit	12.43
JD-AH212091	N-N-14	80 mm Piston Kit	84.66
JD-AH212092	N-N-10	80 mm Piston Kit	36.62
JD-AH212096	N-N-14	90 mm Piston Kit	66.72
JD-AH212097	N-N-10	90 mm Piston Kit	15.75
JD-AH212101	N-N-14	100 mm Piston Kit	80.14
JD-AH212102	N-N-10	100 mm Piston Kit	50.15
JD-AH212103	N-N-14	115 mm Piston Kit	118.74
JD-AH212585	N-N-14	110 mm Piston Kit	89.20
JD-AH215765	I-U-10	32 mm X 2	42.44
JD-AH216299	N-N-14	140 mm Piston Kit	148.76
JD-AH225136	P-UB-10	85 X 120 mm	176.23
JD-AH225137	P-UB-10	80 X 115 mm	102.20
JD-AH234770	N-N-14	140 mm	121.49

REPLACEMENT KITS FOR JOHN DEERE

Kit Number	Code (Pg. xviii)	Rod X Bore Size	List Price	Kit Number	Code (Pg. xviii)	Rod X Bore Size	List Price
JD-AH234795	N-N-14	160 mm	\$ 86.32	JD-AT101377	I-U-4	1-1/4 X 2-1/2	\$ 77.24
JD-AH65915	N-OB-10	1/2 X 1	9.86	JD-AT108329	I-U-10	32 X 60 mm	43.56
JD-AH78774	P-N-1	1-3/4	19.02	JD-AT114822	P-UB-10	85 X 125 mm	155.01
JD-AH78775	P-N-1	2	19.24	JD-AT114831	P-UB-10	95 X 135 mm	186.02
JD-AHC11572	I,P-UB-1	45 mm	84.26	JD-AT114836	P-UB-10	80 X 120 mm	153.84
JD-AHC11573	P-UB-1	50 mm	110.02	JD-AT119302	P-UB-1	2-1/2" Rod Kit	32.94
JD-AR105272	P-U-10	1-1/2 X 3	24.91	JD-AT119306	N-N-10	3	27.41
JD-AR105273	P-U-5	2-1/2 X 5-1/2	108.78	JD-AT119307	N-N-10	4" Piston Kit	29.25
JD-AR105275	P-U-10	2-1/2 X 5-1/2	51.38	JD-AT120007	N-N-10	7" Piston Kit	130.51
JD-AR105280	P-U-12	2-1/2 X 6-1/2	144.28	JD-AT120008	P-UB-1	4" Rod Kit	77.91
JD-AR105281	P-U-8	2-1/2 X 5-1/2	99.11	JD-AT121499	P-UB-10	35 X 65 mm	113.69
JD-AR105309	P-V-8	2-3/4 X 5	85.70	JD-AT121500	P-UB-10	60 X 110 mm	144.53
JD-AR105312	P-V-8	3-1/4 X 5-1/2	90.49	JD-AT121501	P-UB-10	65 X 120 mm	146.77
JD-AR105313	P-V-8	3-1/4 X 5-1/2	88.02	JD-AT122564	P-UB-10	60 X 110 mm	126.51
JD-AR105320	P-U-10	1-3/4 X 3-3/4	40.13	JD-AT122580	P-UB-10	35 X 60 mm	90.18
JD-AR105346	P-V-8	2-1/4 X 5-1/4	71.15	JD-AT130600	P-UB-10	65 X 95 mm	138.13
JD-AR105350	USE JD-RE18759			JD-AT130601	P-UB-10	70 X 105 mm	171.69
JD-AR105351	P-V-8	2-1/4 X 4-1/2	69.33	JD-AT130602	P-UB-10	60 X 95 mm	117.98
JD-AR105352	USE JD-RE10640			JD-AT132411	P-UB-10	115 X 170 mm	292.71
JD-AR105353	USE JD-AR105355			JD-AT132412	P-UB-10	130 X 190 mm	313.49
JD-AR105354	USE JD-RE18757			JD-AT138119	P-UB-10	50 X 100 mm	161.71
JD-AR105355	P-V-8	2-1/4 X 4-1/2	83.97	JD-AT138137	P-UB-10	100 X 200 mm	350.94
JD-AR105356	P-V-8	2-1/4 X 5-1/4	66.46	JD-AT138138	P-UB-10	95 X 170 mm	277.55
JD-AR105381	P-V-8	2 X 3-3/4	43.43	JD-AT142582	P-U-10	2 X 3	48.49
JD-AR105384	P-V-8	2 X 4-1/2	61.37	JD-AT154867	P-UB-14	90 X 125 mm	198.30
JD-AR105387	P-V-8	2 X 4	44.97	JD-AT154868	P-UB-14	100 X 135 mm	173.47
JD-AR105391	P-V-8	2 X 4-1/4	48.32	JD-AT161017	P-U-10	4 X 7	127.58
JD-AR105392	P-V-8	2 X 3-1/2	39.37	JD-AT168764	P-UB-10	65 X 100 mm	161.03
JD-AR105393	P-V-8	2 X 4	56.83	JD-AT176734	P-UB-10	105 X 145 mm	269.02
JD-AR105402	P-V-8	1-3/4 X 3-1/4	39.78	JD-AT176737	P-UB-10	65 X 95 mm	182.24
JD-AR105403	P-V-8	1-3/4 X 2-3/4	42.99	JD-AT176822	P-UB-10	70 X 105 mm	169.68
JD-AR105404	USE JD-RE19220			JD-AT177556	P-UB-10	80 X 110 mm	235.79
JD-AR105407	USE JD-RE18754			JD-AT180161	3-5/8 Swivel Kit		136.07
JD-AR105408	P-V-8	1-3/4 X 4	46.17	JD-AT181250	P-UB-14	85 X 125 mm	139.70
JD-AR105410	USE JD-RE10223			JD-AT181792	P-UB-14	95 X 145 mm	157.81
JD-AR105412	P-V-8	1-3/4 X 3-1/2	74.43	JD-AT181794	P-UB-14	100 X 145 mm	186.63
JD-AR105429	P-V-8	1-1/2 X 3-1/4	36.02	JD-AT181799	P-UB-14	110 X 165 mm	227.07
JD-AR105430	P-V-8	1-1/2 X 2-3/4	33.37	JD-AT183658	P-UB-14	100 X 135 mm	182.24
JD-AR105432	P-V-8	1-1/2 X 3-1/2	44.84	JD-AT190877	P-V-14	2-1/2 X 5-1/2	97.31
JD-AR105441	P-V-8	2-1/2 X 4-1/2	74.60	JD-AT190898	I-U-10	2 X 3	82.34
JD-AR105443	P-V-8	2-1/2 X 5-1/2	106.75	JD-AT191391	P-V-10	1-1/2 X 3	87.20
JD-AR105453	P-V-8	1-1/4 X 2-1/2	35.68	JD-AT191403	P-U-10	1 X 2	109.43
JD-AR105454	P-V-8	1-1/4 X 3	38.30	JD-AT192075	P-UB-10	85 X 120 mm	121.43
JD-AR105515	P-U-5	2 X 4-1/2	93.52	JD-AT192095	P-UB-10	75 mm X 105 mm	118.02
JD-AR105537	P-V-10	1-3/4 X 2-3/4	42.81	JD-AT192095-EX	P-UB-10	75 mm X 105 mm	173.65
JD-AR105722	P-V-8	1-1/2 X 3	39.76	JD-AT194335	P-U-10	80 X 115 mm	254.14
JD-AR105932	P-V-8	2 X 3-1/2	39.37	JD-AT194457	P-UB-10	100 X 150 mm	204.17
JD-AR96518	P-V-8	1-3/4 X 3-1/2	57.33	JD-AT196469	P-UB-10	65 X 95 mm	305.35
JD-AR96526	P-V-8	2-1/2 X 4	70.57	JD-AT196471	P-UB-10	115 X 170 mm	371.61
JD-AR96527	P-V-8	1-3/4 X 4	46.17	JD-AT196472	P-UB-14	110 X 165 mm	292.14
JD-AR96532	P-U-8	1-1/2 X 2-1/4	24.59	JD-AT196473	P-UB-14	95 X 145 mm	260.50
JD-AR98255	P-U-5	2-5/8 X 5-1/2	111.68	JD-AT196475	P-UB-14	100 X 145 mm	247.37
JD-AR99785	P-OB-8	1-1/2 X 2-1/2	20.79	JD-AT200548	P-UB-10	65 X 115 mm	199.06
JD-AT101337	I-U-4	1-1/4 X 2-1/2	61.2	JD-AT200549	P-UB-10	60 X 95 mm	150.13

REPLACEMENT KITS FOR JOHN DEERE

Kit Number	Code (Pg. xviii)	Rod X Bore Size	List Price
JD-AT200550	P-UB-10	55 X 85 mm	\$ 158.28
JD-AT200573	P-UB-10	60 X 105 mm	151.02
JD-AT200574	P-UB-10	50 X 80 mm	142.10
JD-AT201184	P-UB-14	110 X 165 mm	283.95
JD-AT201185	P-UB-14	95 X 145 mm	274.94
JD-AT205923	P-UB-14	95 X 145 mm	248.09
JD-AT217906	P-UB-14	100 X 135 mm	197.93
JD-AT251859	P-U-10	50 X 100 mm	215.99
JD-AT251867	P-U-10	50 X 80 mm	123.31
JD-AT251952	P-U-10	55 X 95 mm	126.29
JD-AT251964	P-U-10	45 X 75 mm	153.21
JD-AT260416	P-UB-10	1-1/4 X 2	129.36
JD-AT264430	P-UB-14	95 X 135 mm	324.88
JD-AT264438	P-UB-14	100 X 145 mm	361.43
JD-AT264439	P-UB-14	90 X 135 mm	332.38
JD-AT264440	P-UB-14	105 X 150 mm	354.06
JD-AT264441	P-UB-14	115 X 170 mm	359.21
JD-AT264445	P-UB-10		79.57
JD-AT302758	P-UB-10	130 X 190 mm	396.99
JD-AT304940	3-5/8 Swivel Kit		136.07
JD-AT314427	P-UB-14	120 X 170 mm	528.43
JD-AT33350	USE JD-AR105402		
JD-AT33351	USE JD-AR105429		
JD-AT34930	USE JD-RE18744		
JD-AT34932	I-U-10	3-3/4 X 4	42.64
JD-AT34933	I-U-1	3-3/4 Rod Kit	39.24
JD-AT35142	P-U-10	3 X 3-1/4	65.03
JD-AT35678	USE JD-AR105381		
JD-AT35775	USE JD-RE18759		
JD-AT35932	USE JD-AR105430		
JD-AT35934	USE JD-RE19217		
JD-AT35935	USE JD-AR105453		
JD-AT35939	USE JD-RE18739		
JD-AT35940	USE JD-RE19222		
JD-AT36404	USE JD-AR105384		
JD-AT36452	USE JD-AR105441		
JD-AT36453	USE JD-AR96526		
JD-AT36454	USE JD-AR105443		
JD-AT36829	USE JD-RE18751		
JD-AT36830	USE JD-RE18755		
JD-AT36831	USE JD-AR105355		
JD-AT36833	USE JD-RE18757		
JD-AT36835	USE JD-RE18730		
JD-AT36908	USE JD-RE18746		
JD-AT36910	USE JD-RE18738		
JD-AT36911	USE JD-RE18752		
JD-AT37322	USE JD-AR105312		
JD-AT37323	USE JD-AR105309		
JD-AT37347	USE JD-AR96532		
JD-AT38068	P-U-10	2-5/8 X 3	41.32
JD-AT383237	I-UB-14	2-1/2 X 4	440.42
JD-AT38582	USE JD-RE18732		
JD-AT38583	USE JD-RE13277		
JD-AT39022	P-U-1	2-5/8 X 3	20.88

Kit Number	Code (Pg. xviii)	Rod X Bore Size	List Price
JD-AT39023	P-UB-1	3 X 3-1/4	\$ 46.46
JD-AT41687	P-U-8	1-1/4 X 2-1/4	33.38
JD-AT41688	P-U-8	1-1/2 X 2-1/4	30.92
JD-AT42765	USE JD-AR105454		
JD-AT43470	USE JD-AR105313		
JD-AT49348	USE JD-AR105356		
JD-AT50213	I-U-1	1-1/4 Soft Seal Rod Kit	38.41
JD-AT50214	I-U-12	1-1/4 X 2-1/2 Major Kit	131.91
JD-AT52702	USE JD-RE18748		
JD-AT52703	USE JD-RE18754		
JD-AT52704	USE JD-RE18750		
JD-AT52705	USE JD-RE18736		
JD-AT52706	USE JD-RE18742		
JD-AT52707	USE JD-AR105346		
JD-AT52708	USE JD-RE18743		
JD-AT52709	USE JD-RE18747		
JD-AT52710	USE JD-AR105387		
JD-AT52712	USE JD-RE18737		
JD-AT55691	USE JD-AR105355		
JD-AT55692	USE JD-RE18731		
JD-AT55695	P-U-10	1-3/4 X 4	27.26
JD-AT56582	USE JD-AR105281		
JD-AT78498	I-U-10	25 X 50 mm	55.07
JD-AT79722	I-U-5	1-1/2 X 3	46.59
JD-AT85197	O-RING KIT	24.97	
JD-AU149810	P-UB-1	25 mm Rod Kit	48.92
JD-AU41182	USE JD-AR105351		
JD-AU41735	USE JD-AR105432		
JD-AU42199	USE JD-RE19226		
JD-AU42200	USE JD-RE19227		
JD-AU43986	USE JD-AR105392		
JD-F435828	P-UB-10	3-1/2 X 7	135.42
JD-FXB00001834	P-UB-14	85 mm X 130 mm	177.97
JD-FYA00001393	P-UB-10	80 mm X 115 mm	79.56
JD-FYA00001398	P-UB-10	95 mm X 140 mm	122.49
JD-FYA00001398-EX	P-UB-10	95 mm X 140 mm	193.74
JD-FYA00006591	P-UB-10	100 mm X 140 mm	133.94
JD-FYA00006591-EX	P-UB-10	100 mm X 140 mm	205.19
JD-FYA00006596	P-UB-10	100 mm X 145 mm	121.53
JD-FYA00006596-EX	P-UB-10	100 mm X 145 mm	223.33
JD-FYA00008837	P-UB-10	115 mm X 170 mm	429.13
JD-FYA00008840	P-UB-10	100 mm X 145 mm	386.09
JD-FYA00008843	P-UB-10	95 mm X 140 mm	361.32
JD-FYA00009240	P-UB-10	70 mm X 105 mm	71.34
JD-FYA00012899	P-UB-10	70 mm X 105 mm	194.26
JD-FYA00012900	P-UB-10	70 mm X 100 mm	177.73
JD-FYA00012901	P-UB-10	80 mm X 115 mm	226.08
JD-FYA00012902	P-UB-10	80 mm X 110 mm	261.83
JD-FYA00012903	P-UB-10	90 mm X 120 mm	342.41
JD-FYA00012904	P-UB-10	75 mm X 105 mm	249.33
JD-FYD00000085	P-UB-10	60 mm X 110 mm	349.00
JD-FYD00000086	P-UB-10	55 mm X 90 mm	328.69
JD-FYD00000087	P-UB-10	50 mm X 80 mm	302.01
JD-RE10223	P-V-8	1-3/4 X 4	39.89

REPLACEMENT KITS FOR JOHN DEERE

Kit Number	Code (Pg. xviii)	Rod X Bore Size	List Price	Kit Number	Code (Pg. xviii)	Rod X Bore Size	List Price
JD-RE10224	P-V-8	2-1/2 X 5-1/2	\$ 96.19	JD-RE18708	N-N-14	3-1/2 Piston Kit	\$ 75.78
JD-RE10640	P-V-8	2-1/4 X 4-1/2	62.91	JD-RE18730	P-V-8	1-3/4 X 4	46.17
JD-RE12912	P-V-14	1-3/4 X 3-1/2	99.30	JD-RE18731	P-U-10	2-1/2 X 4-1/4	82.85
JD-RE13277	P-V-8	2-1/2 X 5-1/2	103.64	JD-RE18732	P-V-8	2 X 4	46.38
JD-RE13745	P-V-1	2-1/2 Rod Kit	36.96	JD-RE18733	P-V-8	2 X 4	37.92
JD-RE14022	N-N-14	6-1/4 Piston Kit	133.75	JD-RE18734	P-V-8	2-1/2 X 5-1/2	96.75
JD-RE14033	N-N-14	7-1/2 Piston Kit	163.67	JD-RE18735	P-V-14	2-1/2 X 4	113.77
JD-RE14082	N-N-14	3 Piston Kit	70.14	JD-RE18736	P-V-8	1-3/4 X 4	42.41
JD-RE14088	P-V-1	1-1/2 Rod Kit	25.36	JD-RE18737	P-V-8	2 X 4-1/2	56.56
JD-RE14094	N-N-14	4-1/2 Piston Kit	82.00	JD-RE18738	P-V-10	2 X 4	31.89
JD-RE14100	N-N-14	5-1/4 Piston Kit	107.02	JD-RE18739	P-V-8	2-1/4 X 4-1/4	57.78
JD-RE14102	N-N-14	5-1/2 Piston Kit	123.45	JD-RE18740	P-V-14	2-1/2 X 5-1/2	165.52
JD-RE14104	N-N-14	6-1/4 Piston Kit	127.07	JD-RE18741	P-V-14	2 X 4	97.81
JD-RE14208	P-V-1	2-1/4 Rod Kit	37.91	JD-RE18742	P-V-10	1-1/2 X 3-1/2	57.60
JD-RE14454	P-V-1	2-1/4 Rod Kit	36.78	JD-RE18743	P-V-8	2 X 5	54.34
JD-RE14516	P-U-1	2-1/2 Rod Kit	38.13	JD-RE18744	P-V-8	2-3/4 X 6-1/4	141.21
JD-RE14517	N-N-14	3-1/2 Piston Kit	75.78	JD-RE18745	P-U-14	2-1/2 X 5-1/2	108.69
JD-RE14523	N-N-14	4-1/2 Piston Kit	82.00	JD-RE18746	P-V-8	2-1/2 X 5-1/4	68.20
JD-RE14538	P-V-1	2-1/4 Rod Kit	28.42	JD-RE18747	P-V-8	2 X 3-1/4	43.70
JD-RE14551	N-N-10	2 Piston Kit	11.45	JD-RE18748	P-V-8	2 X 3-1/2	55.25
JD-RE14552	P-U-1	1 Rod Kit	13.29	JD-RE18749	P-U-10	7/8 X 2	24.65
JD-RE14555	N-N-14	4 Piston Kit	76.25	JD-RE18750	P-U-8	1-1/4 X 3	30.04
JD-RE14556	P-U-1	2 Rod Kit	25.19	JD-RE18751	P-V-8	1-3/4 X 3	36.62
JD-RE14563	N-N-10	4-1/4 Piston Kit	32.25	JD-RE18752	P-V-8	1-3/4 X 3	37.89
JD-RE14567	N-N-14	4 Piston Kit	81.27	JD-RE18754	P-V-8	1-3/4 X 3-1/2	57.33
JD-RE14744	N-N-14	5 Piston Kit	101.24	JD-RE18755	P-V-8	1-3/4 X 3-1/2	46.21
JD-RE14745	P-V-1	2-1/2 Rod Kit	43.47	JD-RE18756	P-U-10	1-3/4 X 3-1/2	48.49
JD-RE14771	N-N-14	3-3/4 Piston Kit	64.29	JD-RE18757	P-V-8	2-1/4 X 3-1/2	61.75
JD-RE14772	N-N-10	2-3/4 Piston Kit	17.88	JD-RE18758	P-V-14	2-1/4 X 3-1/2	100.05
JD-RE14773	P-U-1	1-1/4 Rod Kit	23.31	JD-RE18759	P-V-8	2-1/4 X 5	91.20
JD-RE14877	N-N-14	5-1/2 Piston Kit	123.45	JD-RE18760	P-V-8	2-1/2 X 4-1/2	65.48
JD-RE14878	P-V-1	2-3/4 Rod Kit	48.57	JD-RE18762	P-V-8	3-1/4 X 6-1/4	138.02
JD-RE14879	N-N-14	6 Piston Kit	126.33	JD-RE18763	P-U-8	3-3/4 X 5-1/2	108.08
JD-RE14880	P-U-1	2-3/4 Rod Kit	44.31	JD-RE18764	P-V-14	2-1/4 X 4-1/2	114.16
JD-RE14910	N-N-14	5-1/2 Piston Kit	123.45	JD-RE18765	P-V-10,12	2 X 3-1/2	50.01
JD-RE15708	P-V-1	3-3/4 Rod Kit	103.64	JD-RE19216	P-U-10	3 X 3-1/4	43.43
JD-RE15905	N-N-14	5 Piston Kit	101.24	JD-RE19217	P-V-8	1-1/2 X 2-1/2	30.13
JD-RE15906	P-V-1	3-1/4 Rod Kit	45.03	JD-RE19218	P-U-8	2 X 3	44.01
JD-RE15907	N-N-14	5-1/2 Piston Kit	123.45	JD-RE19220	P-V-8	1-3/4 X 2-3/4	38.76
JD-RE16076	N-N-14	3-1/2 Piston Kit	76.63	JD-RE19222	P-V-8	1-1/2 X 2-3/4	35.83
JD-RE16118	N-N-14	4 Piston Kit	79.05	JD-RE19224	I-U-10	4-1/4 X 4.40	47.95
JD-RE16119	P-V-1	2 Rod Kit	26.51	JD-RE19225	P-V-14	2 X 4-1/2	106.34
JD-RE16208	N-N-14	3 Piston Kit	69.20	JD-RE19226	I-U-1	3-3/8 X 3-5/8	45.33
JD-RE16209	P-V-1	1-3/4 Rod Kit	31.04	JD-RE19227	I-U-10	3-3/8 X 3-5/8	42.71
JD-RE16991	P-V-1	2-3/4 Rod Kit	83.60	JD-RE20323	P-V-1	4 Rod Kit	81.77
JD-RE16992	P-V-1	3 Rod Kit	63.53	JD-RE20329	P-V-1	3-3/4 Rod Kit	76.07
JD-RE17097	N-N-10	3-1/2 Piston Kit	13.10	JD-RE20351	P-V-1	2-1/2 Rod Kit	41.70
JD-RE17099	N-N-10	3-3/4 Piston Kit	15.78	JD-RE20428	N-N-14	70 mm Piston Kit	42.40
JD-RE17342	P-V-1	2-3/4 Rod Kit	63.27	JD-RE20430	N-N-14	90 mm Piston Kit	48.01
JD-RE17345	P-V-1	2-1/2 Rod Kit	46.46	JD-RE20433	P-UB-1	40 mm Rod Kit	57.19
JD-RE17351	N-N-14	5-1/2 Piston Kit	123.45	JD-RE20434	P-UB-1	45 mm Rod Kit	57.55
JD-RE17458	N-N-14	4-1/4 Piston Kit	83.60	JD-RE20595	P-UB-1	50 mm Rod Kit	50.84
JD-RE18202	N-N-10	3 Piston Kit	10.05	JD-RE20874	P-V-1	1-3/4 Rod Kit	35.00
JD-RE18203	P-V-1	1-1/2 Rod Kit	27.50	JD-RE21202	P-UB-1	3-3/4 Rod Kit	180.48

REPLACEMENT KITS FOR JOHN DEERE

Kit Number	Code (Pg. xviii)	Rod X Bore Size	List Price
JD-RE21395	P-UB-1	2-3/4 Rod Kit	\$ 127.07
JD-RE21401	P-UB-1	3-1/4 Rod Kit	87.13
JD-RE21873	P-UB-1	32 mm Rod Kit	48.97
JD-RE21874	N-N-14	50 mm Piston Kit	48.93
JD-RE21875	P-UB-1	25 mm Rod Kit	50.17
JD-RE25151	P-UB-1	63 mm Rod Kit	108.9
JD-RE25152	P-UB-1	80 mm Rod Kit	159.41
JD-RE28899	P-UB-1	63 mm Rod Kit	103.89
JD-RE29103	P-UB-1	70 mm	188.73
JD-RE30100	N-N-10	2-1/4 Piston Kit	6.51
JD-RE30816	N-N-14	3-1/4 Piston Kit	65.31
JD-RE30817	P-V-1	2 Rod Kit	32.31
JD-RE30874	P-V-1	1-3/4 Rod Kit	28.88
JD-RE31138	N-N-14	80 mm Piston Kit	53.16
JD-RE31139	N-N-14	100 mm Piston Kit	93.80
JD-RE31140	N-N-14	115 mm Piston Kit	116.75
JD-RE31528	P-U-1	3-3/4 Rod Kit	73.09
JD-RE31716	P-UB-1	56 mm Rod Kit	88.77
JD-RE33803	N-N-14	50 mm Piston Kit	53.31
JD-RE37003	N-N-10	80 mm Piston Kit	15.03
JD-RE37004	N-N-10	70 mm Piston Kit	10.55
JD-RE37462	P-UB-1	70 mm Piston Kit	171.38
JD-T153744	I-U-10	36 X 65 mm	97.82
JD-T213801	I-U-10	38 mm X 65 mm	109.45
JD-T218502	I-U-10	40 X 65 mm	113.90
JD-TH0729006	P-U-10	45 X 85 mm	76.97
JD-TH0743805	P-U-10	40 X 75 mm	83.37
JD-TH0744010	P-U-10	40 X 70 mm	51.38

Kit Number	Code (Pg. xviii)	Rod X Bore Size	List Price
JD-TH0744408	P-U-10	45 X 75 mm	\$ 172.43
JD-TH0744707	P-U-10	40 X 65 mm	129.99
JD-TH0744808	P-U-10	45 X 85 mm	112.95
JD-TH0745308	P-U-10	50 X 95 mm	115.61
JD-TH102798	P-UB-10	95 X 140 mm	210.89
JD-TH102827	P-UB-10	105 X 150 mm	203.78
JD-TH102845	P-UB-10	90 X 140 mm	185.59
JD-TH103324	P-UB-10	110 X 160 mm	182.87
JD-TH103347	P-UB-10	110 X 160 mm	233.03
JD-TH103357	P-UB-10	95 X 150 mm	204.62
JD-TH106099	P-UB-10	60 X 100 mm	178.97
JD-TH106853	P-UB-10	55 X 90 mm	237.89
JD-TH106874	P-UB-10	60 X 110 mm	119.92
JD-TH109339	P-UB-10	75 X 105 mm	122.15
JD-TH109366	P-UB-10	80 X 115 mm	139.80
JD-TH109390	P-UB-10	65 X 95 mm	126.79
JD-TH110035	P-UB-14	90 X 135 mm	191.71
JD-TH110064	P-UB-14	100 X 145 mm	205.47
JD-TH110661	P-UB-10	65 X 115 mm	150.20
JD-TH110662	P-UB-10	60 X 100 mm	93.92
JD-TH110663	P-UB-10	55 X 90 mm	104.60
JD-TH111625	P-UB-14	95 X 145 mm	255.82
JD-TH111626	P-UB-14	100 X 145 mm	257.92
JD-TH111626	P-UB-14	100 X 145 mm	257.92
JD-TH111627	P-UB-14	110 X 165 mm	302.63
JD-TH111701	P-UB-10	65 X 115 mm	173.04
JD-TH111854	P-UB-14	105 X 150 mm	271.70
JD-TY7188	P-U-1	1-1/16	8.66

JOHN DEERE

JOHN DEERE WEAR RINGS

Original equipment John Deere metric kits do not include the wear rings required to rebuild a cylinder. The John Deere metric kits listed in this catalog reflect this design. However, we do offer the necessary wear rings required to rebuild John Deere cylinders. The cross reference chart below lists the wear rings needed to accompany the packing kits. If you have any questions, please contact one of our sales engineers.

Kit Number	Wear Ring Part Number	QTY	List Price	Kit Number	Wear Ring Part Number	QTY	List Price	Kit Number	Wear Ring Part Number	QTY	List Price
JD-TH102798	TH102796	2	\$ 17.94	JD-TH111625	TH110062	2	\$ 65.19	JD-AT176737	TH109377	2	\$ 10.66
	TH102797	2	51.51		AT159585	2	19.00		TH109378	2	37.81
JD-TH102827	TH102825	2	18.08	JD-TH111626	TH110062	2	65.19	JD-AT201184	TH111273	2	27.81
	TH102826	2	56.88		TH110063	2	23.64		TH111274	2	138.11
JD-TH102845	TH102796	2	17.94	JD-TH111627	TH111273	2	27.81	JD-AT201185	TH110062	2	65.19
	TH102797	2	51.51		TH111274	2	138.11		TH110063	2	23.64
JD-TH103347	TH103345	2	19.60	JD-TH111854	TH111845	2	68.31				
	TH103346	2	69.91		TH111846	2	24.42				
JD-TH103357	TH102825	2	18.08	JD-AT132412	AT132186	2	28.88				
	TH102826	2	56.88		AT132170	2	89.04				

REPLACEMENT PARTS FOR JOHN DEERE

NOTE: John Deere part numbers are used as a reference only. We do not imply that these kits are original REPLACEMENT PARTS.

BACK-UP RINGS

Part Number	Min. Pkg. Qty	List Price
JD-0257005	1	\$ 18.93
JD-0653302	1	1.65
JD-0826909	1	1.71
JD-0836107	1	13.43
JD-0892105	1	2.35
JD-0894404	1	1.59
JD-0901704	1	3.69
JD-0971321	1	2.35
JD-1148814	1	40.66
JD-1237120	1	2.54
JD-1237318	1	32.53
JD-4633512	1	12.08
JD-4694682	1	12.08
JD-4S00769	1	14.88
JD-4S00778	1	12.59
JD-4S00802	1	14.88
JD-AT133634	1	9.56
JD-AT153829	1	1.31
JD-AT153919	1	9.80
JD-AT153935	1	10.30
JD-AT153951	1	9.16
JD-AT174374	1	1.59
JD-AT264243	1	8.41
JD-AT264257	1	9.56
JD-AT264259	1	1.31
JD-AT264351	1	11.54
JD-AT264358	1	11.54
JD-FXB00001809	1	56.26
JD-FXB00001813	1	12.23
JD-FXB00001819	1	5.34
JD-FXB00002055	1	11.54

BACK-UP RINGS

Part Number	Min. Pkg. Qty	List Price
JD-FXB00002065	1	\$ 1.77
JD-FXB00002091	1	9.56
JD-FXB00002093	1	2.94
JD-H155310	1	11.54
JD-H155316	1	12.59
JD-H155916	1	11.43
JD-H178691	1	12.40
JD-L2309CU	5	1.86
JD-R34966	1	6.07
JD-R35473	5	4.13
JD-R35474	1	5.69
JD-R42926	25	0.38
JD-R43689	3	5.49
JD-R56753	10	0.94
JD-R69480	10	1.26
JD-R69481	5	1.42
JD-R78388	9	0.89
JD-R78806	5	1.73
JD-R78807	2	5.13
JD-R78993	10	1.29
JD-R78994	3	2.50
JD-R79001	5	2.27
JD-R81194	10	1.04
JD-R82728	5	2.31
JD-TH104926	1	11.54
JD-TH104929	1	1.59
JD-TH104953	1	11.54
JD-TH109315	1	9.56
JD-TH110055	1	13.10
JD-U10748	5	2.29

BUFFER RINGS

Part Number	Rod Diameter	List Price
JD-AH146560	45 mm	\$ 9.57
JD-RE20491	45 mm	22.41
JD-AH146561	50 mm	26.85
JD-FYD00001146	50 mm	18.46
JD-RE20757	50 mm	30.38
JD-FYD00001136	55 mm	18.57
JD-AH146562	56 mm	31.92
JD-0826908	60 mm	26.37
JD-FYD00001124	60 mm	26.37
JD-0790008	65 mm	31.36
JD-AT153914	70 mm	59.06
JD-AH144606	75 mm	62.76
JD-AH148777	75 mm	62.76
JD-H227913	80 mm	38.54
JD-AT153931	80 mm	66.49
JD-T108042	80 mm	38.54
JD-FXB00001810	85 mm	41.35
JD-AH144607	85 mm	36.42
JD-AH148786	85 mm	70.18
JD-4S00706	90 mm	49.91
JD-H227909	95 mm	52.69
JD-AH144608	95 mm	77.51
JD-AH148454	95 mm	77.51
JD-H179694	95 mm	52.69
JD-TH111217	95 mm	52.69
JD-4S00703	100 mm	54.21
JD-AT181790	100 mm	54.21
JD-AT201004	110 mm	58.49
JD-1237308	115 mm	112.12
JD-AT264292	120 mm	63.50
JD-AT264251	130 mm	34.72

REPLACEMENT PARTS FOR JOHN DEERE

NOTE: John Deere part numbers are used as a reference only. We do not imply that these kits are original REPLACEMENT PARTS.

BUSHINGS

Part Number	Rod Diameter	List Price
JD-AT264250	40 mm	\$ 71.19
JD-0658604	40 mm	10.92
JD-0479002	45 mm	12.81
JD-0735604	45 mm	12.81
JD-AT251961	45 mm	12.81
JD-0994204	50 mm	18.65
JD-0478703	50 mm	15.54
JD-AT251760	50 mm	15.54
JD-1153502	55 mm	9.33
JD-AT264291	55 mm	48.63
JD-0479203	55 mm	18.35
JD-AT251769	55 mm	18.35
JD-TH106899	55 mm	18.35
JD-0971202	60 mm	37.71
JD-4633389	60 mm	22.55
JD-TH106301	60 mm	24.20
JD-TH110296	60 mm	20.61
JD-FXB00002113	65 mm	31.26
JD-TH109372	65 mm	21.71
JD-0310304	70 mm	24.51
JD-0643402	70 mm	10.24
JD-0826907	70 mm	18.65
JD-0961415	70 mm	61.48
JD-AT264321	70 mm	33.48
JD-AT133645	70 mm	24.51
JD-FYD00000053	75 mm	15.54
JD-H146479	75 mm	27.12
JD-TH109311	75 mm	27.12
JD-FXB00002051	80 mm	36.70
JD-TH0827007	80 mm	13.72
JD-T108041	80 mm	31.26
JD-FYD00000021	85 mm	18.65
JD-AT154778	85 mm	34.71
JD-H146480	85 mm	34.71
JD-T108019	85 mm	34.71
JD-FXB00002087	90 mm	27.12
JD-FYD00000040	90 mm	18.35
JD-AT154779	90 mm	33.48
JD-AT131422	90 mm	42.75
JD-1237106	95 mm	41.68
JD-AT131420	95 mm	44.36
JD-H146481	95 mm	37.71
JD-T108050	95 mm	37.71
JD-TH102765	95 mm	47.74
JD-AT264314	100 mm	31.26
JD-0836104	100 mm	51.68
JD-AT131414	100 mm	52.10
JD-TH103307	100 mm	59.52

BUSHINGS

Part Number	Rod Diameter	List Price
JD-0373405	105 mm	\$ 44.45
JD-0894204	105 mm	13.72
JD-4432450	105 mm	44.45
JD-AT161596	105 mm	44.45
JD-AT131417	110 mm	84.51
JD-TH103332	110 mm	84.51
JD-0352704	115 mm	50.20
JD-0854104	115 mm	12.96
JD-1187203	115 mm	13.72
JD-FXB00001811	120 mm	37.06
JD-AT264389	130 mm	21.71

ROD BUSHINGS

Part Number	Rod Diameter	List Price
JD-FXB00002262	70 mm	\$ 10.24
JD-1237306	115 mm	20.88

CUSHION SEALS

Part Number	List Price
JD-0956612	\$ 20.63
JD-4469113	27.24
JD-4S00770	46.85
JD-4S00800	20.63
JD-4S00940	81.89
JD-4S01123	24.12
JD-H155320	31.34
JD-H155322	24.88

FACE SEALS

Part Number	List Price
JD-R35827	\$ 2.57

GLAND REMOVAL TOOLS

Part Number	Bore Diameter	List Price
JD-6.00X0.40-IT	6"	\$ 24.13
JD-70MM-IT	70 mm	8.34
JD-80MM-IT	80 mm	8.92
JD-90MM-IT	90 mm	9.81
JD-100MM-IT	100 mm	11.31

LINK PIN SEALS

Part Number	ID	List Price
JD-FYD00001153	45 mm	\$ 10.15
JD-FYD00001152	50 mm	11.20
JD-FYD00001132	60 mm	13.44
JD-TH104472	71 mm	27.16
JD-H149662	75 mm	28.96
JD-H149663	85 mm	29.30

O-RINGS

Part Number	Min. Pkg. Qty	List Price
JD-1224409	5	1.29
JD-32238	50	0.1
JD-32240	50	0.10
JD-4089028	1	23.68
JD-4276696	1	29.78
JD-82762R	50	0.10
JD-A34444R	10	0.85
JD-A3606R	50	0.17
JD-A3917R	50	0.06
JD-A4365R	50	0.06
JD-A4444R	10	0.85
JD-A4494R	10	0.79
JD-A4540R	20	0.32
JD-A4728R	20	0.72
JD-A5595R	10	1.12
JD-A5598R	10	1.15
JD-B14427	10	0.98
JD-B15646	50	0.12
JD-B30430	20	0.36
JD-B3685R	20	0.32
JD-B3690R	20	0.32

REPLACEMENT PARTS FOR JOHN DEERE

NOTE: John Deere part numbers are used as a reference only. We do not imply that these kits are original REPLACEMENT PARTS.

O-RINGS

Part Number	Min. Pkg. Qty	List Price
JD-C11884	10	\$ 1.18
JD-CH13522	5	2.71
JD-CH17212	5	1.83
JD-CH17447	5	7.43
JD-F1056R	20	0.47
JD-F1430R	10	0.88
JD-F1649R	20	0.47
JD-F1870R	20	0.39
JD-F2573R	10	1.15
JD-F2576R	10	1.18
JD-F3353R	50	0.07
JD-F3450R	20	0.71
JD-F950R	10	1.06
JD-H144918	10	0.88
JD-H144919	10	1.12
JD-H158942	2	10.69
JD-H21957	50	0.12
JD-H35244	20	0.20
JD-H35256	20	0.20
JD-H63858	50	0.19
JD-H64810	20	0.69
JD-H85996	5	1.64
JD-L2027CU	20	0.50
JD-L2104N	20	0.53
JD-L2301CU	20	0.67
JD-M4125T	50	0.19
JD-M4236T	20	0.62
JD-M4237T	20	0.59
JD-M44162	20	0.36
JD-N31773	20	0.23
JD-P42061	50	0.10
JD-P45750	50	0.12
JD-P46051	50	0.07
JD-P46129	20	0.72
JD-P46765	10	1.24
JD-P47889	50	0.09
JD-P47908	50	0.10
JD-P48347	50	0.09
JD-P48403	20	0.65
JD-P50631	20	0.39
JD-P50635	20	0.27
JD-P50883	50	0.09
JD-P51079	50	0.12

O-RINGS

Part Number	Min. Pkg. Qty	List Price
JD-P51212	50	\$ 0.06
JD-R10093	50	0.06
JD-R104556	100	0.11
JD-R104557	100	0.11
JD-R104558	100	0.11
JD-R105415	20	0.29
JD-R105416	50	0.23
JD-R106663	50	0.17
JD-R109982	20	0.26
JD-R111006	1	2.94
JD-R111120	10	0.85
JD-R11138R	20	0.22
JD-R120199	50	0.23
JD-R120233	20	0.72
JD-R1225R	50	0.20
JD-R126014	50	0.07
JD-R132237	20	0.42
JD-R151701	50	0.10
JD-R151990	50	0.07
JD-R26282	20	0.39
JD-R26543	10	0.88
JD-R26621	20	0.69
JD-R26863	20	0.59
JD-R26976	50	0.03
JD-R27149	50	0.12
JD-R27166	50	0.07
JD-R27490	50	0.03
JD-R27564	50	0.09
JD-R27796	5	1.96
JD-R27928	50	0.10
JD-R29463	50	0.19
JD-R30063	20	0.29
JD-R30063R	20	0.29
JD-R30200	20	0.29
JD-R30319	20	0.23
JD-R31378	20	0.54
JD-R31673	50	0.12
JD-R31674	50	0.1
JD-R33259	50	0.07
JD-R34404	50	0.09
JD-R34802	50	0.03
JD-R34812	50	0.03
JD-R36424	10	0.98

O-RINGS

Part Number	Min. Pkg. Qty	List Price
JD-R375R	50	\$ 0.09
JD-R394R	50	0.07
JD-R4172	10	1.06
JD-R41721	10	1.06
JD-R41987	10	0.79
JD-R459R	50	0.07
JD-R460R	50	0.19
JD-R495R	50	0.12
JD-R59422	1	4.24
JD-R59532	5	2.10
JD-R61467	20	0.47
JD-R6976	50	0.03
JD-R76030	10	1.18
JD-R82238	5	1.76
JD-R89332	5	2.21
JD-R90840	20	0.47
JD-T110443	5	1.78
JD-T11220	20	0.29
JD-T12275	10	1.25
JD-T13119	50	0.09
JD-T159344	2	6.29
JD-T159362	1	31.15
JD-T159472	1	23.76
JD-T16318	20	0.27
JD-T18440	50	0.07
JD-T19687	20	0.29
JD-T210833	10	1.38
JD-T218785	1	11.95
JD-T22827	50	0.19
JD-T22828	20	0.26
JD-T25335	20	0.29
JD-T26236	20	0.23
JD-T31029	20	0.23
JD-T34248	20	0.32
JD-T46620	1	3.21
JD-T56238	5	1.76
JD-TH111204	10	1.29
JD-U10063UR	20	0.65
JD-U10289	20	0.25
JD-U10746	10	0.85
JD-U10776	20	0.63
JD-U11017	20	0.42
JD-U11326	50	0.12

REPLACEMENT PARTS FOR JOHN DEERE

NOTE: John Deere part numbers are used as a reference only. We do not imply that these kits are original REPLACEMENT PARTS.

O-RINGS

Part Number	Min. Pkg. Qty	List Price
JD-U11343	50	\$ 0.10
JD-U11646	50	0.07
JD-U12037	50	0.20
JD-U12198	20	0.50
JD-U12331	20	0.53
JD-U12547	50	0.12
JD-U15149	50	0.17
JD-U15415	20	0.19
JD-U15973	20	0.23
JD-U15980	50	0.10
JD-U41966	20	0.22
JD-U42111	20	0.30

O-RINGS 90 DUROMETER

Part Number	Min. Pkg. Qty	List Price
JD-0658607	5	\$ 1.84
JD-0971348	5	2.30
JD-1237111	2	6.34
JD-1237119	5	2.32
JD-1237312	5	3.61
JD-1237317	5	2.65
JD-4069900	5	1.65
JD-4113162	2	4.28
JD-4513526	2	6.62
JD-4622346	20	0.57
JD-4633513	5	2.73
JD-4S00734	20	0.77
JD-970860	20	0.53
JD-A4730R	50	0.30
JD-A811070	5	1.84
JD-A811135	2	3.55
JD-A811140	2	6.34
JD-A811170	1	11.79
JD-AT121852	5	2.65
JD-AT200001	5	3.01
JD-AT264223	5	2.65
JD-AT264224	5	3.03
JD-AT264241	1	13.39
JD-AT264318	5	2.38
JD-AT264319	5	2.59
JD-AT264320	5	2.69
JD-AT264324	20	0.66
JD-AT264339	5	2.96
JD-AT264342	5	2.73

O-RINGS 90 DUROMETER

Part Number	Min. Pkg. Qty	List Price
JD-AT264348	10	\$ 1.32
JD-B2762R	50	0.27
JD-CH17160	5	2.23
JD-CH17854	5	2.30
JD-CH17886	50	0.30
JD-CH18696	5	2.32
JD-F3171R	50	0.32
JD-FXB00001812	5	3.01
JD-FXB00001814	5	3.03
JD-FXB00001818	5	1.83
JD-FXB00001825	50	0.27
JD-FXB00002018	5	2.73
JD-FXB00002020	5	2.96
JD-FXB00002098	10	1.59
JD-FXB00002119	5	2.65
JD-FXB00002121	5	2.69
JD-FXB00002127	5	1.83
JD-FYD00001131	50	0.30
JD-H1144920	5	2.40
JD-H178690	5	3.03
JD-N131838	20	0.53
JD-R135333	50	0.14
JD-R26286	50	0.22
JD-R26287	50	0.16
JD-R26288	50	0.22
JD-R26375	50	0.25
JD-R26906	50	0.26
JD-R28782	50	0.22
JD-R29936	20	0.42
JD-R30903	50	0.16
JD-R30916R	10	0.93
JD-R80615	2	5.57
JD-T110447	5	2.59
JD-T152396	5	2.38
JD-T76938	25	0.26
JD-T77613	34	0.10
JD-T77814	34	0.10
JD-T77857	34	0.11
JD-T77858	25	0.16
JD-T77932	29	0.14
JD-T78313	20	0.43
JD-T78612	20	0.29
JD-T78784	20	0.36
JD-TH100125	5	2.73
JD-TH101926	1	2.86
JD-TH104589	2	3.64
JD-TH105684	5	7.09
JD-TH110052	2	7.26
JD-U13639	20	0.53

O-RINGS 90 DUROMETER

Part Number	Min. Pkg. Qty	List Price
JD-U17409	20	\$ 0.38
JD-U40745	50	0.14

PISTON SEALS

Part Number	Bore Diameter	List Price
JD-RE11905	4-1/2	\$ 100.49
JD-RE11920	5-1/2	140.99
JD-4177837	70 mm	49.18
JD-RE20342	70 mm	48.85
JD-0495007	70 mm	35.86
JD-0380915	80 mm	36.54
JD-FYD00001149	80 mm	48.76
JD-4137866	85 mm	57.49
JD-RE20344	90 mm	79.99
JD-0243803	90 mm	39.69
JD-AT264392	95 mm	44.21
JD-RE20343	100 mm	66.38
JD-TH109322	105 mm	41.10
JD-4633518	105 mm	73.63
JD-FXB00002095	105 mm	41.10
JD-FXB00001816	107 mm	88.46
JD-AH138032	110 mm	70.65
JD-AH138082	110 mm	70.65
JD-TH166872	110 mm	54.44
JD-AT264386	110 mm	54.44
JD-FXB00002124	110 mm	54.44
JD-FYD00001128	110 mm	35.69
JD-RE20809	115 mm	78.06
JD-TH105767	115 mm	55.74
JD-AH138083	120 mm	103.69
JD-FXB00002023	120 mm	55.74
JD-AT264361	125 mm	55.74
JD-4431271	130 mm	28.45
JD-AH138084	130 mm	88.46
JD-4431272	130 mm	58.26
JD-AH173446	135 mm	65.14
JD-RE25146	137 mm	123.77
JD-RE25102	140 mm	100.17
JD-FYA00008845	140 mm	65.86
JD-TH102795	140 mm	65.86
JD-TH110065	145 mm	100.90
JD-4S00801	145 mm	67.63
JD-FYA00008842	145 mm	67.63
JD-TH111272	165 mm	136.86
JD-0961424	170 mm	53.13

REPLACEMENT PARTS FOR JOHN DEERE

NOTE: John Deere part numbers are used as a reference only. We do not imply that these kits are original REPLACEMENT PARTS.

PISTON SEALS

Part Number	Bore Diameter	List Price
JD-FYA00008839	170 mm	\$ 87.84
JD-T201905	190 mm	99.95

ROD U-SEALS

Part Number	Rod Diameter	List Price
JD-H172764	28 mm	\$ 6.97
JD-H154514	32 mm	6.50
JD-H161729	32 mm	6.97
JD-0481202	40 mm	15.83
JD-R81856	45 mm	13.15
JD-4135545	50 mm	17.05
JD-H152203	50 mm	9.63
JD-TH4070039	55 mm	17.20
JD-H152204	56 mm	14.65
JD-R92309	56 mm	14.65
JD-4154178	60 mm	18.74
JD-AT264378	60 mm	17.54
JD-H152205	63 mm	22.75
JD-0790009	65 mm	18.42
JD-AT133633	70 mm	20.92
JD-4633514	70 mm	19.27
JD-TH109314	75 mm	23.04
JD-TH104925	80 mm	25.66
JD-H227914	80 mm	25.66
JD-RE25149	80 mm	32.35
JD-TH104952	85 mm	27.86
JD-4S00707	90 mm	29.65
JD-FXB00002054	90 mm	47.67
JD-AH140482	95 mm	31.03
JD-H155308	95 mm	31.03
JD-H227910	95 mm	31.03
JD-0971208	95 mm	46.08
JD-AT333702	105 mm	39.98
JD-1237309	115 mm	100.34
JD-AT264242	130 mm	53.33

U-SEALS

Part Number	Rod Diameter	List Price
JD-AH209762	1-3/4	\$ 14.95
JD-AT124099	2-3/8	45.20
JD-R35680	2-3/8	3.66
JD-FYD00001144	50 mm	4.32
JD-FYD00001134	55 mm	4.55
JD-FYD00001122	60 mm	4.91

VEE SETS

Part Number	O.D.	List Price
JD-U12964	1-1/2	\$ 9.17
JD-U41824	1-1/2 X 1	12.95
JD-R76802	1-3/4	10.40
JD-U41825	1-3/4 X 1	5.90
JD-T35831	2-3/4	12.92
JD-T36998	2-1/4	10.40
JD-T54815	2-1/2	10.33
JD-C14517	2-1/2	14.26
JD-R76790	2-3/4	12.92
JD-T35851	2-3/4	12.92
JD-T38194	3	40.33
JD-T38193	3-1/2	40.82
JD-R76810	3-1/4	14.66
JD-R78605	3-3/4	41.74
JD-T37381	4	19.61
JD-R72828	4-1/2	43.55
JD-T37379	4-1/2	43.55
JD-U12974	4-1/2	43.55
JD-T37380	5	49.75
JD-W37380	5	19.67
JD-U42717	5-1/4	26.15
JD-T52425	5-1/2	50.47

WEAR RINGS

Part Number	O.D. X Width	List Price
JD-U41824	1-1/2 X 1	\$ 12.95
JD-U41825	1-3/4 X 1	5.90
JD-T51865	1-7/8 X 1-1/2	20.70
JD-T39981	2 X 3/16	4.52
JD-T48209	2 X 3/16	4.52
JD-U41823	2 X 1	6.25
JD-U42668	2-1/4 X 5/16	4.15
JD-C19240	2-1/4 X 5/8	4.35
JD-U17335	2-1/2 X 5/16	3.89
JD-U16379	2-1/2 X 1/2	4.31
JD-T40855	2-1/2 X 1	5.68
JD-U42716	2-1/2 X 1-35/64	9.77
JD-W20503	2-3/4 X 5/16	4.35
JD-U17336	2-3/4 X 5/8	4.68
JD-T58314	2-3/4 X 1	5.62
JD-T36524	3 X .212	3.45
JD-H139507	3 X 3/8	4.42
JD-T40416	3 X 1/2	4.42
JD-R82412	3 X 1.192	37.83
JD-R80337	3 X 1.382	33.54
JD-T36525	3-1/4 X .212	2.88
JD-R92819	3-1/4 X 1/4	4.28
JD-A29497	3-1/4 X 3/8	4.54
JD-T47976	3-1/4 X 3/4	5.08
JD-U42862	3-1/4 X 1	5.45
JD-R70098	3-1/4 X 1-9/16	22.00
JD-R77807	3-1/2 X 3/8	4.57
JD-U16397	3-1/2 X 1/2	4.57
JD-U43261	3-1/2 X 1/2	4.57
JD-U17217	3-1/2 X 5/8	5.08
JD-U42863	3-1/2 X 5/8	4.99
JD-U42704	3-1/2 X 3/4	5.10
JD-T36526	3.605 X .212	8.68
JD-U46592	3-3/4 X 5/8	5.24
JD-T36527	3.939 X .212	3.58
JD-R77825	4 X 3/8	5.80
JD-U16387	4 X 5/8	5.45
JD-U17337	4 X 5/8	5.45
JD-U43367	4 X 5/8	5.45
JD-U43356	4 X 3/4	9.58
JD-R83321	4 X 1.378	56.84
JD-U46747	4-1/4 X 5/8	5.45
JD-T39138	4-1/2 X 5/8	5.45
JD-U17225	4-1/2 X 5/8	5.45
JD-U44508	5 X 5/8	5.45
JD-U42719	5-1/4 X 5/8	5.45

REPLACEMENT PARTS FOR JOHN DEERE

NOTE: John Deere part numbers are used as a reference only. We do not imply that these kits are original REPLACEMENT PARTS.

WEAR RINGS

Part Number	O.D. X Width	List Price
JD-R80526	5-1/2 X 1/2	\$ 4.89
JD-U45180	5-1/2 X 5/8	5.78
JD-T42985	5-1/2 X 1	7.44
JD-U42985	5-1/2 X 1	7.44
JD-R77837	6 X 1	7.58
JD-R78603	6-1/4 X 5/8	5.99
JD-U43397	6-1/4 X 1	7.67
JD-T52419	6-1/2 X 1	8.18
JD-R76907	7 X 1	10.92
JD-R77642	7-1/2 X 1	16.86
JD-H156058	35 X 16 mm	5.34
JD-R81780	46 X 20 mm	11.26
JD-R82569	50 X 5 mm	8.80
JD-R81779	51 X 22.5 mm	16.25
JD-R81975	56 X 25 mm	13.12
JD-R92310	62 X 25 mm	13.60
JD-0652205	65 X 9.5 mm	45.36
JD-R81774	70 X 10 mm	4.57
JD-TH109743	70 X 14.5 mm	16.57
JD-1102802	70 X 6.2 mm	10.34
JD-0479010	75 X 11.8 mm	98.46
JD-R81777	80 X 10 mm	4.60
JD-0380914	80 X 11.8 mm	113.59
JD-FYD00001150	80 X 15 mm	8.05
JD-FYD00001148	80 X 6 mm	63.29
JD-1187301	80 X 6.2 mm	11.92
JD-TH111224	85 X 14.5 mm	19.38
JD-AT264287	85 X 15 mm	4.86
JD-0891615	85 X 6 mm	28.75
JD-R85230	86 X 40 mm	31.50
JD-TH105795	90 X 14.8 mm	128.45
JD-R81776	90 X 15 mm	5.56
JD-FYD00001140	90 X 20 mm	6.66
JD-1187206	90 X 6 mm	4.13
JD-FYD00001138	90 X 6 mm	36.31
JD-AT264229	95 X 14.8 mm	20.08
JD-AT264394	95 X 5.9 mm	7.65
JD-TH109377	95 X 6 mm	10.66
JD-H158170	95 X 6.1 mm	14.84
JD-1183502	95 X 6.2 mm	14.84
JD-TH109378	95 X 8 mm	37.81
JD-4S00154	100 X 14.8 mm	140.78
JD-TH105781	100 X 14.8 mm	140.78
JD-R81775	100 X 15 mm	14.71
JD-4S00840	100 X 5.9 mm	72.59
JD-4S00839	100 X 6 mm	11.88

WEAR RINGS

Part Number	O.D. X Width	List Price
JD-0686707	100 X 6 mm	\$ 15.37
JD-TH111727	100 X 6 mm	11.88
JD-TH111728	100 X 6 mm	72.59
JD-T108052	100 X 9.5 mm	12.98
JD-0907801	105 X 6 mm	11.26
JD-H158459	105 X 6 mm	34.46
JD-TH109323	105 X 6 mm	34.46
JD-TH109324	105 X 6 mm	95.77
JD-AT309607	105 X 6 mm	33.29
JD-TH106873	110 X 14.8 mm	141.93
JD-FYD00001129	110 X 25 mm	25.04
JD-4S00156	110 X 5.9 mm	79.26
JD-AT153830	110 X 5.9 mm	79.26
JD-FXB00002126	110 X 5.9 mm	79.26
JD-FYD00001127	110 X 5.9 mm	79.26
JD-AT264263	110 X 7.6 mm	42.72
JD-1119106	110 X 7.9 mm	10.89
JD-AT153936	110 X 7.9 mm	12.67
JD-H155873	110 X 7.9 mm	10.89
JD-H144225	110 X 9.5 mm	13.60
JD-FXB00002125	110 X 9.5 mm	13.60
JD-R82095	115 X 15 mm	13.57
JD-TH109357	115 X 6 mm	40.55
JD-H163432	115 X 7.9 mm	10.89
JD-H227907	115 X 7.9 mm	10.89
JD-TH2109356	115 X 7.9 mm	12.84
JD-AT132287	120 X 14.8 mm	17.76
JD-4633519	120 X 14.8 mm	17.94
JD-H155917	120 X 7.9 mm	11.73
JD-T108046	120 X 7.9 mm	11.73
JD-H227906	120 X 8 mm	13.29
JD-TH104923	120 X 8 mm	47.08
JD-H144226	120 X 9.4 mm	14.83
JD-R90653	125 X 20 mm	19.23
JD-4S00708	125 X 7.9 mm	13.92
JD-T108024	125 X 7.9 mm	13.92
JD-TH104949	125 X 8 mm	49.06
JD-AT264362	125 X 8.1 mm	9.08
JD-AT154700	125 X 9.7 mm	125.42
JD-AT154735	125 X 9.9 mm	14.83
JD-FXB00001817	130 X 14.8 mm	22.24
JD-H144230	130 X 4.75 mm	83.24
JD-4S00712	130 X 7.9 mm	16.36
JD-H155317	130 X 7.9 mm	13.04
JD-H155318	130 X 8 mm	49.93
JD-H144227	130 X 9.5 mm	18.40

WEAR RINGS

Part Number	O.D. X Width	List Price
JD-TH110034	135 X 14.8 mm	\$ 16.16
JD-4S00160	135 X 7.75 mm	37.33
JD-H178695	135 X 7.9 mm	14.40
JD-H227905	135 X 7.9 mm	14.40
JD-T108058	135 X 7.9 mm	14.40
JD-H178696	135 X 8 mm	50.87
JD-T108059	135 X 8 mm	50.87
JD-TH110033	135 X 9.7 mm	59.59
JD-AT154718	135 X 9.8 mm	20.40
JD-4414671	140 X 10 mm	18.90
JD-H170140	140 X 10 mm	13.51
JD-R85192	140 X 20 mm	21.06
JD-TH102797	140 X 8 mm	51.51
JD-4S00705	140 X 9.5 mm	17.94
JD-TH102796	140 X 9.5 mm	17.94
JD-TH110063	145 X 14.8 mm	23.64
JD-4S00804	145 X 7.9 mm	81.03
JD-AT161608	145 X 7.9 mm	81.03
JD-0492209	145 X 9.5 mm	17.94
JD-4S00803	145 X 9.5 mm	17.94
JD-AT159585	145 X 9.5 mm	19.00
JD-AT161607	145 X 9.5 mm	17.94
JD-TH110062	145 X 9.7 mm	65.19
JD-TH111846	150 X 14.8 mm	24.42
JD-TH102826	150 X 8 mm	56.88
JD-TH102825	150 X 9.5 mm	18.08
JD-TH111845	150 X 9.7 mm	68.31
JD-R85228	160 X 20 mm	19.16
JD-TH103345	160 X 9.5 mm	19.60
JD-TH103346	160 X 9.7 mm	69.91
JD-TH111273	165 X 14.8 mm	27.81
JD-TH111274	165 X 9.7 mm	138.11
JD-0961423	170 X 20 mm	87.59
JD-4S00797	170 X 9.5 mm	21.63
JD-AT132291	170 X 9.5 mm	20.09
JD-AT132175	170 X 9.7 mm	85.62
JD-4S00855	180 X 14.7 mm	31.63
JD-R85229	180 X 20 mm	20.72
JD-0972305	190 X 14.8 mm	38.95
JD-AT132186	190 X 15 mm	28.88
JD-AT264245	190 X 9.5 mm	46.06
JD-AT132170	190 X 9.7 mm	89.04

REPLACEMENT PARTS FOR JOHN DEERE

NOTE: John Deere part numbers are used as a reference only. We do not imply that these kits are original REPLACEMENT PARTS.

WIPERS

Part Number	Rod Diameter	List Price
JD-T51863	1-1/4	\$ 1.30
JD-T63053	1-3/4	14.10
JD-U11019	1-3/4	5.41
JD-U16406	1-3/4	5.27
JD-U11022	2-1/4	6.58
JD-AT124100	2-3/8	13.42
JD-T60752	3	20.63
JD-T47532	5	42.78
JD-AH151380	25 mm	19.55
JD-H158164	65 mm	32.87
JD-TH100374	65 mm	43.28
JD-H158453	70 mm	35.28
JD-H155867	75 mm	37.92
JD-4264035	80 mm	\$ 6.20
JD-AH152445	80 mm	43.15
JD-H157235	80 mm	44.73
JD-H159361	80 mm	43.15
JD-H159631	80 mm	43.15
JD-TH102446	80 mm	31.21

WIPERS

Part Number	Rod Diameter	List Price
JD-H155911	85 mm	\$ 50.77
JD-TH102445	90 mm	50.25
JD-AT217969	95 mm	28.52
JD-H155311	95 mm	28.52
JD-TH111215	95 mm	35.07
JD-AT181247	100 mm	57.63
JD-TH102411	100 mm	35.86
JD-TH110048	100 mm	18.60
JD-AT131682	110 mm	56.72
JD-AT181797	110 mm	59.03
JD-H156586	32 mm	17.65
JD-0658606	40 mm	21.86
JD-AH146556	45 mm	22.91
JD-AH146557	50 mm	21.77
JD-AT251898	50 mm	24.03
JD-FYD00001143	50 mm	24.03
JD-AT264381	55 mm	28.61
JD-AH146558	56 mm	33.55
JD-AT264377	60 mm	31.01

WIPERS

Part Number	Rod Diameter	List Price
JD-FYD00001121	60 mm	\$ 31.01
JD-TH105777	60 mm	31.01
JD-AH146559	63 mm	25.78
JD-4630847	70 mm	35.28
JD-4729045	70 mm	35.28
JD-FXB00002092	75 mm	37.92
JD-4729047	80 mm	44.73
JD-FXB00002118	80 mm	44.73
JD-FXB00001806	85 mm	50.77
JD-4428492	90 mm	54.89
JD-FXB00002056	90 mm	54.89
JD-1224407	95 mm	28.52
JD-1237110	100 mm	57.63
JD-4S00772	100 mm	57.63
JD-1237311	115 mm	25.70
JD-0239504	120 mm	60.97
JD-AT264283	120 mm	64.60
JD-4S00952	130 mm	70.69
JD-0978105	150 mm	75.95

REPLACEMENT PARTS FOR JOHN DEERE - UNITIZED PISTONS

NOTE: John Deere part numbers are used as a reference only. We do not imply that these kits are original REPLACEMENT PARTS.

Part Number	Bore Diameter	Hole Diameter	Piston Width	List Price	Part Number	Bore Diameter	Hole Diameter	Piston Width	List Price
JD-AH138200	50	16.56	31.24	\$ 106.19	JD-RE34085	80	27.58	40.74	\$ 128.59
JD-AH174930	50	20.55	31.24	108.05	JD-AH136453	90	27.58	45.75	223.56
JD-AH233516	50	16.56	31.24	106.19	JD-AH141183	90	30.58	45.75	198.70
JD-AH135785	56	16.59	31.24	139.73	JD-AH169436	90	30.58	45.75	288.75
JD-AH137177	63	22.58	31.24	134.14	JD-AH169827	90	26.09	45.75	214.25
JD-AH142159	63	20.57	31.24	104.98	JD-AH205060	90	30.58	45.75	198.70
JD-AH160647	63	22.58	31.24	134.14	JD-AHC11073	90	30.58	40.13	204.88
JD-AH166138	63	22.58	31.24	130.41	JD-AH205062	100	30.58	45.75	330.47
JD-AH228448	63	24.56	31.24	79.81	JD-AH159034	100	30.58	45.75	330.47
JD-RE29383	63	22.2	31.24	136.00	JD-AH164620	100	33.83	45.75	260.81
JD-AH158623	70	24.56	36.25	108.05	JD-AH166637	100	33.63	45.75	353.97
JD-AH165962	70	27.58	36.25	195.62	JD-AH169826	100	26.09	45.75	344.64
JD-AH172352	70	22.58	36.25	137.85	JD-AHC10806	100	30.58	40.13	258.75
JD-AH227867	70	27.58	36.25	108.05	JD-AH168884	115	36.63	45.75	288.75
JD-RE34084	70	24.56	36.25	195.62	JD-AHC10777	115	30.58	40.13	310.50
JD-AH139078	80	24.56	29.08	173.81	JD-AH167446	125	36.63	55.25	419.16
JD-AH165826	80	27.58	40.74	128.59	JD-AH166793	152	42.52	63.53	573.05
JD-AH173410	80	30.58	40.74	162.07	JD-AH173851	152	42.52	63.53	573.05
JD-RE33968	80	27.58	40.74	251.49					

JOHNSON

Part Number	Description	List Price
JO-225VPW	2-1/4" VEE SET & WIPER	\$ 18.23
JO-325VPW	3-1/4" VEE SET & WIPER	19.15
JO-425VPW	4-1/4" VEE SET & WIPER	26.34
JO-525VPW	5-1/4" VEE SET & WIPER	27.51
JO-625NVPW	6-1/4" VEE SET & WIPER	48.95
JO-750NVPW	7-1/2" VEE SET & WIPER	70.97
JO-875NVPW	8-3/4" VEE SET & WIPER	99.93
JO-RB392	3-3/4" BORE SNAP RING	23.52
JO-RC495	4-3/4" BORE SNAP RING	27.54
JO-RD595	5-3/4" BORE SNAP RING	49.95
JO-RE724	6-7/8" BORE SNAP RING	69.54
JO-RF849	8-1/8" BORE SNAP RING	92.74

KALMAR

Kit Number	Code (Pg. xviii)	Rod X Bore Size	List Price
KAL-920670.0003	P-U-13	32 X 63 mm	\$ 110.64
KAL-920673.0005	P-U-15	80 X 125 mm	146.80
KAL-920744.0001	P-U-13	32 X 63 mm	105.15
KAL-920744.0002	I-U-13	40 X 80 mm	145.89
KAL-920744.0003	P-U-10	60 X 80 mm	153.73
KAL-920744.0005	P-U-10	70 X 125 mm	176.42
KAL-920744.0006	P-U-15	70 X 160 mm	108.86
KAL-920744.0013	P-U-15	90 X 180 mm	126.45
KAL-921307.0001	P-U-10	50 X 100 mm	172.04

REPLACEMENT PARTS FOR KALMAR

NOTE: Kalmar part numbers are used as a reference only. We do not imply that these kits are original REPLACEMENT PARTS.

O-RINGS

Part Number	Min. Pkg Qty	List Price
KAL-0922571	50	\$ 0.07
KAL-0923376	50	0.07
KAL-0923379	50	0.09
KAL-0923558	50	0.06
KAL-0923560	50	0.06
KAL-0923561	50	0.07
KAL-0923562	50	0.10
KAL-0923563	50	0.12
KAL-0923564	50	0.19
KAL-0923565	50	0.07
KAL-0923566	50	0.10
KAL-0923567	50	0.10
KAL-0923568	50	0.12
KAL-0923569	20	0.20
KAL-0923570	20	0.23
KAL-0923571	20	0.27
KAL-0923572	20	0.29
KAL-0923573	20	0.29
KAL-0923574	50	0.10
KAL-0923575	50	0.17
KAL-0923576	20	0.29
KAL-0923577	20	0.54
KAL-0923578	20	0.32
KAL-0923579	20	0.39
KAL-0923580	20	0.39
KAL-0923582	20	0.53
KAL-0923584	20	0.59
KAL-0923585	20	0.62
KAL-0923586	20	0.69
KAL-0923587	20	0.72
KAL-0923591	10	0.79
KAL-0923598	10	0.88
KAL-0923599	10	1.06
KAL-0923644	50	0.17
KAL-0923645	50	0.09
KAL-0923646	20	0.26
KAL-0923648	50	0.19
KAL-0923649	50	0.20
KAL-0923650	20	0.32
KAL-0923651	20	0.56
KAL-0923663	50	0.07

O-RINGS

Part Number	Min. Pkg Qty	List Price
KAL-0923664	20	\$ 0.26
KAL-0923702	20	0.47
KAL-0923718	50	0.20
KAL-0923719	50	0.09
KAL-0923810	50	0.12
KAL-0923811	50	0.19
KAL-0923812	50	0.20
KAL-0923813	20	0.22
KAL-0923814	20	0.42
KAL-0923815	20	0.50
KAL-0923816	20	0.65
KAL-0923817	20	0.71
KAL-0923826	20	0.32
KAL-0923827	20	0.65
KAL-0923828	20	0.71
KAL-0923829	20	0.72
KAL-0923831	10	1.15
KAL-0923832	10	1.18
KAL-0923833	10	1.18
KAL-0923843	50	0.03
KAL-0923845	50	0.06
KAL-0923847	50	0.09
KAL-0923848	50	0.10
KAL-0923849	50	0.09
KAL-0923850	20	0.23
KAL-0923851	50	0.12
KAL-0923852	20	0.47
KAL-0923855	10	0.98
KAL-0923856	20	0.50
KAL-0923865	20	0.27
KAL-0923896	20	0.23
KAL-0923922	20	0.59
KAL-0923934	50	0.12
KAL-0923935	20	0.65
KAL-0923936	10	0.85
KAL-0923944	50	0.03
KAL-0923945	50	0.09
KAL-0923947	50	0.12
KAL-0923948	50	0.19
KAL-0923949	20	0.42
KAL-0923988	50	0.10

O-RINGS

Part Number	Min. Pkg Qty	List Price
KAL-0923989	50	\$ 0.12
KAL-0924003	50	0.07
KAL-0924038	20	0.29
KAL-0924137	20	0.19
KAL-0924158	20	0.80
KAL-0924187	20	0.65
KAL-0924416	50	0.12
KAL-0924686	10	1.02
KAL-0924859	20	0.20
KAL-0927902	50	0.03
KAL-0930897	50	0.10
KAL-231416	50	0.10
KAL-4255395	50	0.14
KAL-4910140	50	0.07
KAL-4910366	20	0.26
KAL-4910375	50	0.22
KAL-4910378	10	1.41
KAL-4910379	20	0.50
KAL-70923812	50	0.20
KAL-70923829	20	0.72
KAL-70924003	50	0.07
KAL-70926560	5	1.29
KAL-8653584	20	0.59

BACK-UP RINGS

Part Number	Min. Pkg Qty	List Price
KAL-0926644	10	\$ 1.29
KAL-0930280	5	1.93
KAL-4741128	10	1.09
KAL-8653585	10	1.29
KAL-8653594	1	2.89
KAL-931868-4	10	1.16

KALMAR

REPLACEMENT PARTS FOR KALMAR

NOTE: Kalmar part numbers are used as a reference only. We do not imply that these kits are original REPLACEMENT PARTS.

RETAINER RINGS

Part Number	List Price
KAL-231423	\$ 4.97
KAL-4255082	5.00
KAL-4910370	3.08
KAL-4910376	10.58
KAL-4910377	4.35
KAL-927822	11.24

PISTON SEALS

Part Number	Bore Dia.	List Price
KAL-4909279	2-1/2	\$ 8.50

WEAR RINGS

Part Number	OD X W	List Price
KAL-4910372	2-1/2 X 3/8	\$ 4.28
KAL-4850622-4	2-3/4 X 1	5.62
KAL-4910373	4 X 1/2	4.65
KAL-74844040	5-1/2 X 1	7.44

WIPERS

Part Number	Rod Dia.	List Price
KAL-4908498	1	\$ 1.20
KAL-74857829	1-1/4	5.41
KAL-4911395	2	2.06
KAL-4910380	2-1/2	2.47
KAL-74820557	2-5/8	8.90
KAL-8653582	2-3/4	2.61
KAL-74845370	3	20.63
KAL-8653591	4-1/2	4.43

PISTON U-SEALS

Part Number	Bore Dia.	List Price
KAL-4910347	4	\$ 21.11

U-SEALS

Part Number	Rod Dia.	List Price
KAL-78630662	1-1/2	\$ 13.33
KAL-4850624-0	2-1/2	11.10
KAL-74820556	2-5/8	11.59
KAL-8653586	2-3/4	12.14
KAL-8653592	4-1/2	28.10
KAL-8653595	4-1/2	20.65
KAL-74843499	5	27.25

NYLON PLUGS

Part Number	Rod Dia.	List Price
KAL-74816749	1/8 x 5/32	\$ 0.66

Replacement Kits For

KATO

Excavators						
APPLICATION	SERIAL #:	CODE	ROD	BORE	KIT #	List \$
MODEL HD-700SEV, HD-700II, HD-720VII						
ARM	329-1719-0	P-UB-10	95 mm	135 mm	KATO-329-1719000	470.97
BOOM	329-1169-0	P-UB-10	85 mm	125 mm	KATO-329-1169000	472.56
BUCKET	329-2389-0	P-UB-10	80 mm	120 mm	KATO-329-2389000	372.50
MODEL HD-770SEII						
ARM	309-754-1	P-UB-10	90 mm	130 mm	KATO-309-7540000	412.44
BOOM	309-960-2	P-UB-10	85 mm	130 mm	KATO-309-9600000	370.30
BUCKET	309-785-1	P-UB-10	85 mm	130 mm	KATO-309-7850000	370.30
MODEL HD-800SEV, HD-880SEII						
ARM	309-755-1	P-UB-10	100 mm	140 mm	KATO-309-7550000	476.52
BOOM	309-967-2	P-UB-10	85 mm	130 mm	KATO-309-9670000	427.59
BUCKET	309-786-1	P-UB-10	85 mm	125 mm	KATO-309-7860000	363.79
MODEL HD-800VII						
ARM	329-1729-0	P-UB-10	105 mm	150 mm	KATO-329-1729000	490.03
BOOM	329-1399-0	P-UB-10	85 mm	140 mm	KATO-329-1399000	431.17
BUCKET	309-7869-10	P-UB-10	85 mm	130 mm	KATO-309-7869001	410.81
MODEL HD-900SEV						
ARM	329-172-1	P-UB-10	105 mm	150 mm	KATO-329-1720000	490.03
BOOM	309-967-11	P-UB-10	85 mm	140 mm	KATO-309-9670001	431.17
BUCKET	309-786-11	P-UB-10	85 mm	130 mm	KATO-309-7860001	410.81
MODEL HD-1250SEV						
ARM	329-175-3	P-UB-10	110 mm	160 mm	KATO-329-1750000	495.96
BOOM	329-121-2	P-UB-10	100 mm	150 mm	KATO-329-1210000	468.98
BUCKET	329-241-2	P-UB-10	100 mm	150 mm	KATO-329-2410000	468.98
MODEL HD-1250VII						
ARM	329-1759-0	P-UB-10	110 mm	160 mm	KATO-329-1759000	495.96
BOOM	329-2419-2	P-UB-10	100 mm	150 mm	KATO-329-2419000	468.98
BUCKET	329-2419-2	P-UB-10	100 mm	150 mm	KATO-329-2419000	468.98

KATO

KATO EXCAVATORS

Part Number	Code (Pg. xviii)	Rod X Bore Size	List Price
KATO-309-13790020	P-U-5	90 X 150 mm	\$ 322.01
KATO-309-75400001	P-UB-10	90 X 130 mm	412.44
KATO-309-75500001	P-UB-10	100 X 140 mm	476.52
KATO-309-75590000	P-UB-10	100 X 140 mm	455.81
KATO-309-78500001	P-UB-10	85 X 130 mm	370.30
KATO-309-78590010	P-UB-10	85 X 125 mm	478.74
KATO-309-78600001	P-UB-10	85 X 125 mm	363.79
KATO-309-78600011	P-UB-10	85 X 130 mm	410.81
KATO-309-78690010	P-UB-10	85 X 130 mm	410.81
KATO-309-96000002	P-UB-10	85 X 130 mm	370.30
KATO-309-96090010	P-UB-10	85 X 130 mm	498.03
KATO-309-96700002	P-UB-10	85 X 130 mm	427.59
KATO-309-96700011	P-UB-10	85 X 140 mm	431.17
KATO-329-11690000	P-UB-10	85 X 125 mm	472.56

Part Number	Code (Pg. xviii)	Rod X Bore Size	List Price
KATO-329-12090000	P-UB-10	100 X 150 mm	\$ 497.79
KATO-329-12100002	P-UB-10	100 X 150 mm	468.98
KATO-329-13990000	P-UB-10	85 X 140 mm	431.17
KATO-329-17190000	P-UB-10	95 X 135 mm	470.97
KATO-329-17200001	P-UB-10	105 X 150 mm	490.03
KATO-329-17290000	P-UB-10	105 X 150 mm	490.03
KATO-329-17500003	P-UB-10	110 X 160 mm	495.96
KATO-329-17590000	P-UB-10	110 X 160 mm	495.96
KATO-329-23790000	P-UB-10	65 X 95 mm	337.04
KATO-329-23890000	P-UB-10	80 X 120 mm	372.50
KATO-329-23890001	P-UB-10	80 X 120 mm	426.71
KATO-329-24100002	P-UB-10	100 X 150 mm	468.98
KATO-329-24190002	P-UB-10	100 X 150 mm	468.98
KATO-75590020	P-U-10	100 X 140 mm	529.74

REPLACEMENT SEAL KITS FOR KOBELCO® EQUIPMENT*

Replacement Seal Kits By Machine Type

Table of Contents

▶ NEW MODELS

Machine Type	Page
Excavators K903II, K904III, K905II, K907D, K907II, K909A, K909II, K912II, K916II, SK60, SK70SR, SK70SR-1E, SK70SR-1ES, SK80CS, SK80CS-1E, SK80MSR, SK80MSR-1E, SK80MSR-1ES, SK100, SK115DZ IV, SK115SRDZ, SK115SRDZ-1E, SK120, SK120LC, SK135SR, SK135SR-1E, SK135SRL, SK135SRL-1E, SK135SRLC, SK135SRLC-1E, SK150, SK150LC, SK150LC III, SK150LC IV, SK160LC, SK160LC IV, SK160LC-6E, SK200, SK200 III, SK200 IV, SK200 V, SK200-6, SK200-6ES, SK200-8, SK200LC, SK200LC III, SK200LC IV, SK200LC V, SK200LC-6, SK210 IV, SK210LC, SK210LC-6E, SK210LC-8, SK220 III, SK220LC III, SK220 IV, SK220LC IV, SK230-6E, SK235SR, SK235SR-1E, SK235SR-1ES, SK235SR-2, SK235SRLC, SK235SRLC-1E, SK235SRLC-1ES, SK235SRLC-2, SK250 IV, SK250-8, SK250LC, SK250LC IV, SK250LC-6E, SK250NLC IV, SK260, SK260LC-8, SK290LC, SK290LC-6E, SK300 III, SK300 IV, SK300LC III, SK300LC IV, SK310 III, SK310LC III, SK320 III, SK320LC III, SK330 IV, SK330-6E, SK330-8, SK330LC, SK330LC IV, SK330LC-6E, SK350-8, SK350LC-8, SK400LC III, SK400LC IV	792 - 845
Excavators - Compact SK25SR-2, SK35SR-2, SK35SR-3	845 - 846
Alpha-Numeric Kit Listing	847 - 849
Kobelco® Individual Parts	850 - 853

KOBELCO®

All manufacturer's names, part numbers and descriptions are used for reference purposes only. We do not imply that any part shown is the product of these manufacturers. We also do not imply that the list price shown is exactly that of the manufacturer.

Replacement Kits For

KOBELCO®

Excavators							
APPLICATION	CYL #	SERIAL #	CODE	ROD	BORE	KIT #	List \$
MODEL K903II							
ARM			P-UB-1	65 mm		KOB-2438U1097R100	124.99
			N-N-10		110 mm	KOB-2438U716R140	158.73
BOOM			P-UB-1	70 mm		KOB-2438U721R100	186.84
			N-N-10		125 mm	KOB-2438U1094R140	213.85
BUCKET			P-UB-1	60 mm		KOB-2438U1096R100	138.74
			N-N-10		95 mm	KOB-2438U1096R200	161.95
MODEL K904II							
ARM			P-UB-1	75 mm		KOB-2438U991R100	141.76
			N-N-10		115 mm	KOB-2438U991R200	268.34
BOOM			P-UB-1	70 mm		KOB-2438U989R100	142.94
			N-N-10		100 mm	KOB-2438U989R200	195.69
BUCKET			P-UB-1	65 mm		KOB-2438U992R100	119.75
			N-N-10		95 mm	KOB-2438U992R200	193.77
MODEL K904III							
ARM			P-UB-1	75 mm		KOB-2438U1098R100	131.91
			N-N-10		115 mm	KOB-2438U1098R200	266.61
BOOM			P-UB-1	70 mm		KOB-2438U1099R100	141.49
			N-N-10		100 mm	KOB-2438U1123R200	195.69
BUCKET			P-UB-1	65 mm		KOB-2438U1097R100	124.99
			N-N-10		95 mm	KOB-2438U1097R200	193.57
MODEL K905II							
ARM	2438U973F1		P-UB-1	80 mm		KOB-2438U973R100	166.35
	2438U973F1		N-N-10		120 mm	KOB-2438U973R200	277.27
BOOM	2438U971F2, 972FS		P-UB-1	70 mm		KOB-2438U971R100	147.26
	2438U971F2, 972FS		N-N-10		105 mm	KOB-2438U971R200	197.34
BUCKET	2438U974F1		P-UB-1	65 mm		KOB-2438U974R100	126.54
	2438U974F1		N-N-10		100 mm	KOB-2438U974R200	204.05
MODEL K907D							
ARM	2438U921F1, F2		P-UB-1	95 mm		KOB-2438U921R100	132.10
	2438U921F1, F2		N-N-10		145 mm	KOB-2438U921R110	253.84
BOOM	2438U914D1F1, D2F1		P-UB-1	85 mm		KOB-2438U914R100	141.31
	2438U914D1F1, D2F1		N-N-10		125 mm	KOB-2438U914R200	207.38
BUCKET	2438U915F1		P-UB-1	75 mm		KOB-2438U915R100	106.77
	2438U915F1		N-N-10		120 mm	KOB-2438U915R110	202.38
MODEL K907II							
ARM	2438U941F1		P-UB-1	100 mm		KOB-2438U941R100	184.09
	2438U941F1		N-N-14		145 mm	KOB-2438U941R200	336.84
BOOM	2438U996F1, 997F1		P-UB-1	85 mm		KOB-2438U996R100	162.18
	2438U996F1, 997F1		N-N-14		125 mm	KOB-2438U996R200	341.19
BUCKET	2438U995F1		P-UB-1	80 mm		KOB-2438U995R100	118.55
	2438U995F1		N-N-14		120 mm	KOB-2438U995R200	311.58
MODEL K909A							
ARM			P-UB-1	100 mm		KOB-2438U588R110	180.50
			N-N-10		150 mm	KOB-2438U588R120	256.20
BOOM			P-UB-1	90 mm		KOB-2438U587R100	166.70
			N-N-10		140 mm	KOB-2438U587R110	250.97
BUCKET			P-UB-1	90 mm		KOB-2438U568R100	167.11
			N-N-10		130 mm	KOB-2438U568R110	236.23
MODEL K909II							
ARM	2438U953F1		P-UB-1	105 mm		KOB-2438U953R100	240.04
	2438U953F1		N-N-10		150 mm	KOB-2438U953R200	438.43
BOOM	2438U999F1, 1000F1		P-UB-1	90 mm		KOB-2438U999R100	155.75
	2438U999F1, 1000F1		N-N-10		140 mm	KOB-2438U999R200	299.97
BUCKET	2438U959F1		P-UB-1	85 mm		KOB-2438U959R100	125.96

KOBELCO®

Replacement Kits For

Excavators							
APPLICATION	CYL #	SERIAL #	CODE	ROD	BORE	KIT #	List \$
MODEL K909II							
BUCKET	2438U959F1		N-N-10		130 mm	KOB-2438U959R200	282.03
MODEL K912II							
ARM	2438U1323F1		P-UB-1	110 mm		KOB-2438U1323R100	209.29
	2438U1323F1		N-N-10		160 mm	KOB-2438U1323R110	385.48
BOOM	2438U776F1		P-UB-1	95 mm		KOB-2438U776R100	192.33
	2438U776F1		N-N-10		150 mm	KOB-2438U776R110	311.21
BUCKET	2438U1324F1		P-UB-1	100 mm		KOB-2438U1324R100	148.73
	2438U1324F1		N-N-10		150 mm	KOB-2438U1324R110	192.97
MODEL K916II							
ARM	2438U1029F1		P-UB-1	130 mm		KOB-2438U1029R100	310.04
	2438U1029F1		N-N-14		180 mm	KOB-2438U1029R200	449.39
BOOM	2438U1028D1F1, D2F1		P-UB-1	110 mm		KOB-2438U1028R100	178.83
	2438U1028D1F1, D2F1		N-N-14		170 mm	KOB-2438U1028R200	428.13
BUCKET	2438U1030F1		P-UB-1	120 mm		KOB-2438U1030R100	222.97
	2438U1030F1		N-N-14		170 mm	KOB-2438U1030R200	428.13
MODEL SK60							
ARM			P-UB-1	65 mm		KOB-2438U1097R100	124.99
			N-N-10		110 mm	KOB-2438U716R140	158.73
BOOM			P-UB-1	70 mm		KOB-2438U721R100	186.84
			N-N-10		125 mm	KOB-2438U1094R140	213.85
BUCKET			P-UB-1	60 mm		KOB-2438U1096R100	138.74
			N-N-10		95 mm	KOB-2438U1096R200	161.95
MODEL SK70SR							
ARM	YT01V00002F1	YT01-00101-	N-N-10		95 mm	KOB-2438U1096R200	161.95
BOOM	YT01V00001F1	YT01-00101-	N-N-10		110 mm	KOB-2438U716R140	158.73
MODEL SK70SR-1E							
ARM	YT01V00002F1	YT02-04001-YT02-05431	N-N-10		95 mm	KOB-2438U1096R200	161.95
	YT01V00002F1	YT03-05432-	N-N-10		95 mm	KOB-2438U1096R200	161.95
	YT01V00002F1	YT04-07001-	N-N-10		95 mm	KOB-2438U1096R200	161.95
BOOM	YT01V00004F1	YT04-07001-	N-N-10		110 mm	KOB-2438U716R140	158.73
	YT01V00004F2	YT04-07001-	N-N-10		110 mm	KOB-2438U716R140	158.73
BOOM Straight Boom	YT01V00004F1	YT02-04001-YT02-05431	N-N-10		110 mm	KOB-2438U716R140	158.73
	YT01V00004F1	YT03-05432-	N-N-10		110 mm	KOB-2438U716R140	158.73
	YT01V00004F2	YT02-04001-YT02-05431	N-N-10		110 mm	KOB-2438U716R140	158.73
	YT01V00004F2	YT03-05432-	N-N-10		110 mm	KOB-2438U716R140	158.73
MODEL SK70SR-1ES							
ARM	YT01V00002F1	YT04-07001-	N-N-10		95 mm	KOB-2438U1096R200	161.95
BOOM	YT01V00004F1	YT04-07001-	N-N-10		110 mm	KOB-2438U716R140	158.73
	YT01V00004F2	YT04-07001-	N-N-10		110 mm	KOB-2438U716R140	158.73
MODEL SK80CS							
ARM	YT01V00002F1	LF01-00501-LF01-00861	N-N-10		95 mm	KOB-2438U1096R200	161.95
BOOM	LF01V00003F1	LF01-00501-LF01-00861	N-N-10		110 mm	KOB-2438U716R140	158.73
MODEL SK80CS-1E							
ARM	YT01V00002F1	LF02-01001-LF02-01279	N-N-10		95 mm	KOB-2438U1096R200	161.95
	YT01V00002F1	LF03-01280-	N-N-10		95 mm	KOB-2438U1096R200	161.95
	YT01V00002F1	LF04-02001-	N-N-10		95 mm	KOB-2438U1096R200	161.95
MODEL SK80MSR							
ARM	YT01V00002F1	LF01-00501-LF01-00861	N-N-10		95 mm	KOB-2438U1096R200	161.95
BOOM	LF01V00003F1	LF01-00501-LF01-00861	N-N-10		110 mm	KOB-2438U716R140	158.73
MODEL SK80MSR-1E							
ARM	YT01V00002F1	LF01-01001-LF02-01001-01279	N-N-10		95 mm	KOB-2438U1096R200	161.95
	YT01V00002F1	LF02-01001-	N-N-10		95 mm	KOB-2438U1096R200	161.95
	YT01V00002F1	LF03-01280-	N-N-10		95 mm	KOB-2438U1096R200	161.95
	YT01V00002F1	LF04-02001-	N-N-10		95 mm	KOB-2438U1096R200	161.95

KOBELCO®

Replacement Kits For

Excavators							
APPLICATION	CYL #	SERIAL #	CODE	ROD	BORE	KIT #	List \$
MODEL SK80MSR-1ES							
ARM	YT01V00002F1	LF04-02001-	N-N-10		95 mm	KOB-2438U1096R200	161.95
MODEL SK100							
ARM			P-UB-1	75 mm		KOB-2438U1098R100	131.91
			N-N-10		115 mm	KOB-2438U1098R200	266.61
BOOM			P-UB-1	70 mm		KOB-2438U1099R100	141.49
			N-N-10		100 mm	KOB-2438U1123R200	195.69
BUCKET			P-UB-1	65 mm		KOB-2438U1097R100	124.99
			N-N-10		95 mm	KOB-2438U1097R200	193.57
MODEL SK115DZ IV							
ARM	2438U1132F1	LPU5001-	P-UB-10	80 mm	120 mm	KOB-2438U1132R300	432.64
	2438U1132F1	LPU5001-	P-UB-1	80 mm		KOB-2438U1132R100	155.62
	2438U1132F1	LPU5001-	N-N-10		120 mm	KOB-2438U1132R200	277.02
BOOM LH	2438U1134F1	LPU5001-	P-UB-10	70 mm	105 mm	KOB-2438U1133R300	320.09
	2438U1134F1	LPU5001-	P-UB-1	70 mm		KOB-2438U1133R100	139.58
	2438U1134F1	LPU5001-	N-N-10		105 mm	KOB-2438U1133R200	197.36
BOOM RH	2438U1133F1	LPU5001-	P-UB-10	70 mm	105 mm	KOB-2438U1133R300	320.09
	2438U1133F1	LPU5001-	P-UB-1	70 mm		KOB-2438U1133R100	139.58
	2438U1133F1	LPU5001-	N-N-10		105 mm	KOB-2438U1133R200	197.36
BUCKET	2438U1131F1	LPU5001-	P-UB-10	65 mm	100 mm	KOB-2438U1131R300	310.23
	2438U1131F1	LPU5001-	P-UB-1	65 mm		KOB-2438U1131R100	124.99
	2438U1131F1	LPU5001-	N-N-10		100 mm	KOB-2438U1131R200	201.60
DOZER	2438U738F1	LPU5001-	P-UB-10	65 mm	100 mm	KOB-2438U738R400	119.40
	2438U738F1	LPU5001-	P-UB-1	65 mm		KOB-2438U738R100	70.81
	2438U738F1	LPU5001-	N-N-10		100 mm	KOB-2438U738R200	48.58
	2438U738F2	LPU5001-	P-UB-10	65 mm	100 mm	KOB-2438U738R400	119.40
	2438U738F2	LPU5001-	P-UB-1	65 mm		KOB-2438U738R300	70.81
	2438U738F2	LPU5001-	N-N-10		100 mm	KOB-2438U738R200	48.58
MODEL SK115SRDZ							
ARM	YY01V00003F1	YY00101-	P-UB-14	80 mm	115 mm	KOB-YY01V00003R300	234.21
	YY01V00003F1	YY00101-	P-UB-1	80 mm		KOB-YY01V00003R100	86.24
	YY01V00003F1	YY00101-	N-N-14		115 mm	KOB-YY01V00003R200	147.97
	YY01V00003F1	YY02-03001-	P-UB-14	80 mm	115 mm	KOB-YY01V00003R300	234.21
	YY01V00003F1	YY02-03001-	P-UB-1	80 mm		KOB-YY01V00003R100	86.24
	YY01V00003F1	YY02-03001-	N-N-14		115 mm	KOB-YY01V00003R200	147.97
	YY01V00003F2	YY00101-	P-UB-14	80 mm	115 mm	KOB-YY01V00003R300	234.21
	YY01V00003F2	YY00101-	P-UB-1	80 mm		KOB-YY01V00003R100	86.24
	YY01V00003F2	YY00101-	N-N-14		115 mm	KOB-YY01V00003R200	147.97
	YY01V00003F2	YY02-03001-	P-UB-14	80 mm	115 mm	KOB-YY01V00003R300	234.21
	YY01V00003F2	YY02-03001-	P-UB-1	80 mm		KOB-YY01V00003R100	86.24
	YY01V00003F2	YY02-03001-	N-N-14		115 mm	KOB-YY01V00003R200	147.97
	YY01V00009F1	YY02-03001-	P-UB-14	80 mm	115 mm	KOB-YY01V00009R300	234.21
	YY01V00009F1	YY02-03001-	P-UB-1	80 mm		KOB-YY01V00009R100	86.24
	YY01V00009F1	YY02-03001-	N-N-14		115 mm	KOB-YY01V00009R200	147.97
ARM Telescopic	LP01V00010F1	YY02-03001-	P-UB-14	50 mm	70 mm	KOB-LP01V00004R300	252.91
	LP01V00010F1	YY02-03001-	P-UB-1	50 mm		KOB-LP01V00004R100	86.61
	LP01V00010F1	YY02-03001-	N-N-14		70 mm	KOB-LP01V00004R200	166.30
BOOM LH	YY01V00001F1	YY00101-	P-UB-14	70 mm	100 mm	KOB-YY01V00001R300	255.95
	YY01V00001F1	YY00101-	P-UB-1	70 mm		KOB-YY01V00001R100	77.73
	YY01V00001F1	YY00101-	N-N-14		100 mm	KOB-YY01V00001R200	178.24
	YY01V00001F1	YY02-03001-	P-UB-14	70 mm	100 mm	KOB-YY01V00001R300	255.95
	YY01V00001F1	YY02-03001-	P-UB-1	70 mm		KOB-YY01V00001R100	77.73
	YY01V00001F1	YY02-03001-	N-N-14		100 mm	KOB-YY01V00001R200	178.24
BOOM RH	YY01V00002F1	YY00101-	P-UB-14	70 mm	100 mm	KOB-YY01V00001R300	255.95
	YY01V00002F1	YY00101-	P-UB-1	70 mm		KOB-YY01V00001R100	77.73
	YY01V00002F1	YY00101-	N-N-14		100 mm	KOB-YY01V00001R200	178.24

Replacement Kits For

KOBELCO®

Excavators							
APPLICATION	CYL #	SERIAL #	CODE	ROD	BORE	KIT #	List \$
MODEL SK115SRDZ							
BOOM RH	YY01V00002F1	YY02-03001-	P-UB-14	70 mm	100 mm	KOB-YY01V00001R300	255.95
	YY01V00002F1	YY02-03001-	P-UB-1	70 mm		KOB-YY01V00001R100	77.73
	YY01V00002F1	YY02-03001-	N-N-14		100 mm	KOB-YY01V00001R200	178.24
BUCKET	YX01V00005F1	YY00101-	P-UB-14	65 mm	95 mm	KOB-YX01V00005R300	100.16
	YX01V00005F1	YY00101-	P-UB-1	65 mm		KOB-YX01V00005R100	72.49
	YX01V00005F1	YY00101-	N-N-14		95 mm	KOB-YX01V00005R200	83.31
	YX01V00005F1	YY02-03001-	P-UB-14	65 mm	95 mm	KOB-YX01V00005R300	100.16
	YX01V00005F1	YY02-03001-	P-UB-1	65 mm		KOB-YX01V00005R100	72.49
	YX01V00005F1	YY02-03001-	N-N-14		95 mm	KOB-YX01V00005R200	83.31
	YX01V00005F2	YY02-03001-	P-UB-14	65 mm	95 mm	KOB-YX01V00005R300	100.16
	YX01V00005F2	YY02-03001-	P-UB-1	65 mm		KOB-YX01V00005R100	72.49
	YX01V00005F2	YY02-03001-	N-N-14		95 mm	KOB-YX01V00005R200	83.31
	YX01V00005F3	YY02-03001-	P-UB-14	65 mm	95 mm	KOB-YX01V00005R300	100.16
	YX01V00005F3	YY02-03001-	P-UB-1	65 mm		KOB-YX01V00005R100	72.49
	YX01V00005F3	YY02-03001-	N-N-14		95 mm	KOB-YX01V00005R200	83.31
	YX01V00005F4	YY02-03001-	P-UB-14	65 mm	95 mm	KOB-YX01V00005R300	100.16
	YX01V00005F4	YY02-03001-	P-UB-1	65 mm		KOB-YX01V00005R100	72.49
	YX01V00005F4	YY02-03001-	N-N-14		95 mm	KOB-YX01V00005R200	83.31
DOZER LH	YX01V00006F1	YY00101-	P-UB-10	65 mm	110 mm	KOB-YX01V00006R300	180.14
	YX01V00006F1	YY00101-	P-UB-1	65 mm		KOB-YX01V00006R100	93.06
	YX01V00006F1	YY00101-	N-N-10		110 mm	KOB-YX01V00006R200	87.07
	YX01V00006F1	YY02-03001-	P-UB-10	65 mm	110 mm	KOB-YX01V00006R300	180.14
	YX01V00006F1	YY02-03001-	P-UB-1	65 mm		KOB-YX01V00006R100	93.06
	YX01V00006F1	YY02-03001-	N-N-10		110 mm	KOB-YX01V00006R200	87.07
DOZER RH	YX01V00007F1	YY00101-	P-UB-10	65 mm	110 mm	KOB-YX01V00006R300	180.14
	YX01V00007F1	YY00101-	P-UB-1	65 mm		KOB-YX01V00006R100	93.06
	YX01V00007F1	YY00101-	N-N-10		110 mm	KOB-YX01V00006R200	87.07
	YX01V00007F1	YY02-03001-	P-UB-10	65 mm	110 mm	KOB-YX01V00006R300	180.14
	YX01V00007F1	YY02-03001-	P-UB-1	65 mm		KOB-YX01V00006R100	93.06
	YX01V00007F1	YY02-03001-	N-N-10		110 mm	KOB-YX01V00006R200	87.07
OFFSET	YX01V00008F1	YY02-03001-	P-UB-14	70 mm	105 mm	KOB-YX01V00008R300	151.04
	YX01V00008F1	YY02-03001-	P-UB-1	70 mm		KOB-YX01V00008R100	52.14
	YX01V00008F1	YY02-03001-	N-N-14		105 mm	KOB-YX01V00008R200	98.89
MODEL SK115SRDZ-1E							
ARM	YY01V00003F1	YY03-04555-YY03-05770	P-UB-14	80 mm	115 mm	KOB-YY01V00003R300	234.21
	YY01V00003F1	YY03-04555-YY03-05770	P-UB-1	80 mm		KOB-YY01V00003R100	86.24
	YY01V00003F1	YY03-04555-YY03-05770	N-N-14		115 mm	KOB-YY01V00003R200	147.97
	YY01V00003F1	YY04-06001-	P-UB-14	80 mm	115 mm	KOB-YY01V00003R300	234.21
	YY01V00003F1	YY04-06001-	P-UB-1	80 mm		KOB-YY01V00003R100	86.24
	YY01V00003F1	YY04-06001-	N-N-14		115 mm	KOB-YY01V00003R200	147.97
	YY01V00003F2	YY03-04555-YY03-05770	P-UB-14	80 mm	115 mm	KOB-YY01V00003R300	234.21
	YY01V00003F2	YY03-04555-YY03-05770	P-UB-1	80 mm		KOB-YY01V00003R100	86.24
	YY01V00003F2	YY03-04555-YY03-05770	N-N-14		115 mm	KOB-YY01V00003R200	147.97
	YY01V00003F2	YY04-06001-	P-UB-14	80 mm	115 mm	KOB-YY01V00003R300	234.21
	YY01V00003F2	YY04-06001-	P-UB-1	80 mm		KOB-YY01V00003R100	86.24
	YY01V00003F2	YY04-06001-	N-N-14		115 mm	KOB-YY01V00003R200	147.97
	YY01V00003F3	YY04-06001-	P-UB-14	80 mm	115 mm	KOB-YY01V00003R300	234.21
	YY01V00003F3	YY04-06001-	P-UB-1	80 mm		KOB-YY01V00003R100	86.24
	YY01V00003F3	YY04-06001-	N-N-14		115 mm	KOB-YY01V00003R200	147.97
	YY01V00003F4	YY04-06001-	P-UB-14	80 mm	115 mm	KOB-YY01V00004R910	234.97
	YY01V00003F4	YY04-06001-	P-UB-1	80 mm		KOB-YY01V00004R900	86.98
	YY01V00003F4	YY04-06001-	N-N-14		115 mm	KOB-YY01V00003R200	147.97
	YY01V00003F5	YY04-06001-	P-UB-14	80 mm	115 mm	KOB-YY01V00004R910	234.97
	YY01V00003F5	YY04-06001-	P-UB-1	80 mm		KOB-YY01V00004R900	86.98
	YY01V00003F5	YY04-06001-	N-N-14		115 mm	KOB-YY01V00003R200	147.97

KOBELCO®

Replacement Kits For

KOBELCO®

Excavators							
APPLICATION	CYL #	SERIAL #	CODE	ROD	BORE	KIT #	List \$
MODEL SK115SRDZ-1E							
ARM	YY01V00009F1	YY03-04555-YY03-05770	P-UB-14	80 mm	115 mm	KOB-YY01V00009R300	234.21
	YY01V00009F1	YY03-04555-YY03-05770	P-UB-1	80 mm		KOB-YY01V00009R100	86.24
	YY01V00009F1	YY03-04555-YY03-05770	N-N-14		115 mm	KOB-YY01V00009R200	147.97
	YY01V00009F1	YY04-06001-	P-UB-14	80 mm	115 mm	KOB-YY01V00003R300	234.21
	YY01V00009F1	YY04-06001-	P-UB-1	80 mm		KOB-YY01V00003R100	86.24
	YY01V00009F1	YY04-06001-	N-N-14		115 mm	KOB-YY01V00003R200	147.97
	YY01V00009F2	YY04-06001-	P-UB-14	80 mm	115 mm	KOB-YY01V00004R910	234.97
	YY01V00009F2	YY04-06001-	P-UB-1	80 mm		KOB-YY01V00004R600	86.98
YY01V00009F2	YY04-06001-	N-N-14		115 mm	KOB-YY01V00003R200	147.97	
ARM Telescopic	LP01V00010F1	YY03-04555-YY03-05770	P-UB-14	50 mm	70 mm	KOB-LP01V00004R300	252.91
	LP01V00010F1	YY03-04555-YY03-05770	P-UB-1	50 mm		KOB-LP01V00004R100	86.61
	LP01V00010F1	YY03-04555-YY03-05770	N-N-14		70 mm	KOB-LP01V00004R200	166.30
BOOM LH	YY01V00001F1	YY03-04555-YY03-05770	P-UB-14	70 mm	100 mm	KOB-YY01V00001R300	255.95
	YY01V00001F1	YY03-04555-YY03-05770	P-UB-1	70 mm		KOB-YY01V00001R100	77.73
	YY01V00001F1	YY03-04555-YY03-05770	N-N-14		100 mm	KOB-YY01V00001R200	178.24
	YY01V00001F1	YY04-06001-	P-UB-14	70 mm	100 mm	KOB-YY01V00001R300	255.95
	YY01V00001F1	YY04-06001-	P-UB-1	70 mm		KOB-YY01V00001R100	77.73
	YY01V00001F1	YY04-06001-	N-N-14		100 mm	KOB-YY01V00001R200	178.24
	YY01V00001F2	YY04-06001-	P-UB-14	70 mm	100 mm	KOB-YY01V00045R700	279.72
	YY01V00001F2	YY04-06001-	P-UB-1	70 mm		KOB-YY01V00045R600	101.49
YY01V00001F2	YY04-06001-	N-N-14		100 mm	KOB-YY01V00001R200	178.24	
BOOM RH	YY01V00002F1	YY03-04555-YY03-05770	P-UB-14	70 mm	100 mm	KOB-YY01V00001R300	255.95
	YY01V00002F1	YY03-04555-YY03-05770	P-UB-1	70 mm		KOB-YY01V00001R100	77.73
	YY01V00002F1	YY03-04555-YY03-05770	N-N-14		100 mm	KOB-YY01V00001R200	178.24
	YY01V00002F1	YY04-06001-	P-UB-14	70 mm	100 mm	KOB-YY01V00001R300	255.95
	YY01V00002F1	YY04-06001-	P-UB-1	70 mm		KOB-YY01V00001R100	77.73
	YY01V00002F1	YY04-06001-	N-N-14		100 mm	KOB-YY01V00001R200	178.24
	YY01V00002F2	YY04-06001-	P-UB-14	70 mm	100 mm	KOB-YY01V00045R700	279.72
	YY01V00002F2	YY04-06001-	P-UB-1	70 mm		KOB-YY01V00045R600	101.49
YY01V00002F2	YY04-06001-	N-N-14		100 mm	KOB-YY01V00001R200	178.24	
BUCKET	YX01V00005F1	YY03-04555-YY03-05770	P-UB-14	65 mm	95 mm	KOB-YX01V00005R300	100.16
	YX01V00005F1	YY03-04555-YY03-05770	P-UB-1	65 mm		KOB-YX01V00005R100	72.49
	YX01V00005F1	YY03-04555-YY03-05770	N-N-14		95 mm	KOB-YX01V00005R200	83.31
	YX01V00005F1	YY04-06001-	P-UB-14	65 mm	95 mm	KOB-YX01V00005R300	100.16
	YX01V00005F1	YY04-06001-	P-UB-1	65 mm		KOB-YX01V00005R100	72.49
	YX01V00005F1	YY04-06001-	N-N-14		95 mm	KOB-YX01V00005R200	83.31
	YX01V00005F2	YY03-04555-YY03-05770	P-UB-14	65 mm	95 mm	KOB-YX01V00005R300	100.16
	YX01V00005F2	YY03-04555-YY03-05770	P-UB-1	65 mm		KOB-YX01V00005R100	72.49
	YX01V00005F2	YY03-04555-YY03-05770	N-N-14		95 mm	KOB-YX01V00005R200	83.31
	YX01V00005F2	YY04-06001-	P-UB-14	65 mm	95 mm	KOB-YX01V00005R300	100.16
	YX01V00005F2	YY04-06001-	P-UB-1	65 mm		KOB-YX01V00005R100	72.49
	YX01V00005F2	YY04-06001-	N-N-14		95 mm	KOB-YX01V00005R200	83.31
	YX01V00005F3	YY03-04555-YY03-05770	P-UB-14	65 mm	95 mm	KOB-YX01V00005R300	100.16
	YX01V00005F3	YY03-04555-YY03-05770	P-UB-1	65 mm		KOB-YX01V00005R100	72.49
	YX01V00005F3	YY03-04555-YY03-05770	N-N-14		95 mm	KOB-YX01V00005R200	83.31
	YX01V00005F3	YY04-06001-	P-UB-14	65 mm	95 mm	KOB-YX01V00005R300	100.16
	YX01V00005F3	YY04-06001-	P-UB-1	65 mm		KOB-YX01V00005R100	72.49
	YX01V00005F3	YY04-06001-	N-N-14		95 mm	KOB-YX01V00005R200	83.31
	YX01V00005F4	YY03-04555-YY03-05770	P-UB-14	65 mm	95 mm	KOB-YX01V00005R300	100.16
	YX01V00005F4	YY03-04555-YY03-05770	P-UB-1	65 mm		KOB-YX01V00005R100	72.49
	YX01V00005F4	YY03-04555-YY03-05770	N-N-14		95 mm	KOB-YX01V00005R200	83.31
	YX01V00005F4	YY04-06001-	P-UB-14	65 mm	95 mm	KOB-YX01V00005R300	100.16
	YX01V00005F4	YY04-06001-	P-UB-1	65 mm		KOB-YX01V00005R100	72.49
	YX01V00005F4	YY04-06001-	N-N-14		95 mm	KOB-YX01V00005R200	83.31
YX01V00005F5	YY03-04555-YY03-05770	P-UB-14	65 mm	95 mm	KOB-YX01V00005R300	100.16	

KOBELCO®

KOBELCO®

Replacement Kits For

Excavators							
APPLICATION	CYL #	SERIAL #	CODE	ROD	BORE	KIT #	List \$
MODEL SK115SRDZ-1E							
BUCKET	YX01V00005F5	YY03-04555-YY03-05770	P-UB-1	65 mm		KOB-YX01V00005R100	72.49
	YX01V00005F5	YY03-04555-YY03-05770	N-N-14		95 mm	KOB-YX01V00005R200	83.31
	YX01V00005F5	YY04-06001-	P-UB-14	65 mm	95 mm	KOB-YX01V00005R300	100.16
	YX01V00005F5	YY04-06001-	P-UB-1	65 mm		KOB-YX01V00005R100	72.49
	YX01V00005F5	YY04-06001-	N-N-14		95 mm	KOB-YX01V00005R200	83.31
	YX01V00005F6	YY04-06001-	P-UB-14	65 mm	95 mm	KOB-YY01V00005R700	108.10
	YX01V00005F6	YY04-06001-	P-UB-1	65 mm		KOB-YY01V00005R600	84.83
	YX01V00005F6	YY04-06001-	N-N-14		95 mm	KOB-YX01V00005R200	83.31
	YX01V00005F7	YY04-06001-	P-UB-14	65 mm	95 mm	KOB-YY01V00005R700	108.10
	YX01V00005F7	YY04-06001-	P-UB-1	65 mm		KOB-YY01V00005R600	84.83
	YX01V00005F7	YY04-06001-	N-N-14		95 mm	KOB-YX01V00005R200	83.31
	YX01V00005F8	YY04-06001-	P-UB-14	65 mm	95 mm	KOB-YY01V00005R700	108.10
	YX01V00005F8	YY04-06001-	P-UB-1	65 mm		KOB-YY01V00005R600	84.83
	YX01V00005F8	YY04-06001-	N-N-14		95 mm	KOB-YX01V00005R200	83.31
DOZER LH	YX01V00006F1	YY03-04555-YY03-05770	P-UB-10	65 mm	110 mm	KOB-YX01V00006R300	180.14
	YX01V00006F1	YY03-04555-YY03-05770	P-UB-1	65 mm		KOB-YX01V00006R100	93.06
	YX01V00006F1	YY03-04555-YY03-05770	N-N-10		110 mm	KOB-YX01V00006R200	87.07
	YX01V00006F1	YY04-06001-	P-UB-10	65 mm	110 mm	KOB-YX01V00006R300	180.14
	YX01V00006F1	YY04-06001-	P-UB-1	65 mm		KOB-YX01V00006R100	93.06
	YX01V00006F1	YY04-06001-	N-N-10		110 mm	KOB-YX01V00006R200	87.07
	YX01V00007F1	YY04-06001-	P-UB-10	65 mm	110 mm	KOB-YX01V00006R300	180.14
	YX01V00007F1	YY04-06001-	P-UB-1	65 mm		KOB-YX01V00006R100	93.06
DOZER RH	YX01V00007F1	YY03-04555-YY03-05770	P-UB-10	65 mm	110 mm	KOB-YX01V00006R300	180.14
	YX01V00007F1	YY03-04555-YY03-05770	P-UB-1	65 mm		KOB-YX01V00006R100	93.06
OFFSET	YX01V00008F1	YY03-04555-YY03-05770	N-N-10		110 mm	KOB-YX01V00006R200	87.07
	YX01V00008F1	YY03-04555-YY03-05770	P-UB-14	70 mm	105 mm	KOB-YX01V00008R300	151.04
	YX01V00008F1	YY03-04555-YY03-05770	P-UB-1	70 mm		KOB-YX01V00008R100	52.14
	YX01V00008F1	YY03-04555-YY03-05770	N-N-14		105 mm	KOB-YX01V00008R200	98.89
	YX01V00008F1	YY04-06001-	P-UB-14	70 mm	105 mm	KOB-YX01V00008R300	151.04
	YX01V00008F1	YY04-06001-	P-UB-1	70 mm		KOB-YX01V00008R100	52.14
	YX01V00008F1	YY04-06001-	N-N-14		105 mm	KOB-YX01V00008R200	98.89
	YX01V00008F2	YY04-06001-	P-UB-14	70 mm	105 mm	KOB-YX01V00008R700	200.40
MODEL SK120	YX01V00008F2	YY04-06001-	P-UB-1	70 mm		KOB-YY01V000045R600	101.49
	YX01V00008F2	YY04-06001-	N-N-14		105 mm	KOB-YX01V00008R200	98.89
ARM	2438U1132F1	LPU1001-	P-UB-10	80 mm	120 mm	KOB-2438U1132R300	432.64
	2438U1132F1	LPU1001-	P-UB-1	80 mm		KOB-2438U1132R100	155.62
	2438U1132F1	LPU1001-	N-N-10		120 mm	KOB-2438U1132R200	277.02
BOOM LH	2438U1134F1	LPU1001-	P-UB-10	70 mm	105 mm	KOB-2438U1133R300	320.09
	2438U1134F1	LPU1001-	P-UB-1	70 mm		KOB-2438U1133R100	139.58
	2438U1134F1	LPU1001-	N-N-10		105 mm	KOB-2438U1133R200	197.36
BOOM RH	2438U1133F1	LPU1001-	P-UB-10	70 mm	105 mm	KOB-2438U1133R300	320.09
	2438U1133F1	LPU1001-	P-UB-1	70 mm		KOB-2438U1133R100	139.58
	2438U1133F1	LPU1001-	N-N-10		105 mm	KOB-2438U1133R200	197.36
BUCKET	2438U1131F1	LPU1001-	P-UB-10	65 mm	100 mm	KOB-2438U1131R300	310.23
	2438U1131F1	LPU1001-	P-UB-1	65 mm		KOB-2438U1131R100	124.99
	2438U1131F1	LPU1001-	N-N-10		100 mm	KOB-2438U1131R200	201.60
MODEL SK120LC							
ARM	2438U1132F1	YPU1001-	P-UB-10	80 mm	120 mm	KOB-2438U1132R300	432.64
	2438U1132F1	YPU1001-	P-UB-1	80 mm		KOB-2438U1132R100	155.62
	2438U1132F1	YPU1001-	N-N-10		120 mm	KOB-2438U1132R200	277.02
BOOM LH	2438U1134F1	YPU1001-	P-UB-10	70 mm	105 mm	KOB-2438U1133R300	320.09
	2438U1134F1	YPU1001-	P-UB-1	70 mm		KOB-2438U1133R100	139.58
	2438U1134F1	YPU1001-	N-N-10		105 mm	KOB-2438U1133R200	197.36

KOBELCO®

Replacement Kits For

KOBELCO®

Excavators							
APPLICATION	CYL #	SERIAL #	CODE	ROD	BORE	KIT #	List \$
MODEL SK120LC							
BOOM RH	2438U1133F1	YPU1001-	P-UB-10	70 mm	105 mm	KOB-2438U1133R300	320.09
	2438U1133F1	YPU1001-	P-UB-1	70 mm		KOB-2438U1133R100	139.58
	2438U1133F1	YPU1001-	N-N-10		105 mm	KOB-2438U1133R200	197.36
BUCKET	2438U1131F1	YPU1001-	P-UB-10	65 mm	100 mm	KOB-2438U1131R300	310.23
	2438U1131F1	YPU1001-	P-UB-1	65 mm		KOB-2438U1131R100	124.99
	2438U1131F1	YPU1001-	N-N-10		100 mm	KOB-2438U1131R200	201.60
MODEL SK135SR							
ARM	YY01V00003F1	YY02-03001-	P-UB-14	80 mm	115 mm	KOB-YY01V00003R300	234.21
	YY01V00003F1	YY02-03001-	P-UB-1	80 mm		KOB-YY01V00003R100	86.24
	YY01V00003F2	YY02-03001-	P-UB-14	80 mm	115 mm	KOB-YY01V00003R300	234.21
	YY01V00003F2	YY02-03001-	P-UB-1	80 mm		KOB-YY01V00003R100	86.24
	YY01V00003F2	YY02-03001-	N-N-14		115 mm	KOB-YY01V00003R200	147.97
	YY01V00009F1	YY02-03001-	P-UB-14	80 mm	115 mm	KOB-YY01V00009R300	234.21
	YY01V00009F1	YY02-03001-	P-UB-1	80 mm		KOB-YY01V00009R100	86.24
	YY01V00009F1	YY02-03001-	N-N-14		115 mm	KOB-YY01V00009R200	147.97
ARM Telescopic	LP01V00010F1	YY02-03001-	P-UB-14	50 mm	70 mm	KOB-LP01V00004R300	252.91
	LP01V00010F1	YY02-03001-	P-UB-1	50 mm		KOB-LP01V00004R100	86.61
	LP01V00010F1	YY02-03001-	N-N-14		70 mm	KOB-LP01V00004R200	166.30
BOOM LH	YY01V00001F1	YY02-03001-	P-UB-14	70 mm	100 mm	KOB-YY01V00001R300	255.95
	YY01V00001F1	YY02-03001-	P-UB-1	70 mm		KOB-YY01V00001R100	77.73
	YY01V00001F1	YY02-03001-	N-N-14		100 mm	KOB-YY01V00001R200	178.24
BOOM RH	YY01V00002F1	YY02-03001-	P-UB-14	70 mm	100 mm	KOB-YY01V00001R300	255.95
	YY01V00002F1	YY02-03001-	P-UB-1	70 mm		KOB-YY01V00001R100	77.73
	YY01V00002F1	YY02-03001-	N-N-14		100 mm	KOB-YY01V00001R200	178.24
BUCKET	YX01V00005F1	YY02-03001-	P-UB-14	65 mm	95 mm	KOB-YX01V00005R300	100.16
	YX01V00005F1	YY02-03001-	P-UB-1	65 mm		KOB-YX01V00005R100	72.49
	YX01V00005F1	YY02-03001-	N-N-14		95 mm	KOB-YX01V00005R200	83.31
	YX01V00005F2	YY02-03001-	P-UB-14	65 mm	95 mm	KOB-YX01V00005R300	100.16
	YX01V00005F2	YY02-03001-	P-UB-1	65 mm		KOB-YX01V00005R100	72.49
	YX01V00005F2	YY02-03001-	N-N-14		95 mm	KOB-YX01V00005R200	83.31
	YX01V00005F3	YY02-03001-	P-UB-14	65 mm	95 mm	KOB-YX01V00005R300	100.16
	YX01V00005F3	YY02-03001-	P-UB-1	65 mm		KOB-YX01V00005R100	72.49
	YX01V00005F3	YY02-03001-	N-N-14		95 mm	KOB-YX01V00005R200	83.31
	YX01V00005F4	YY02-03001-	P-UB-14	65 mm	95 mm	KOB-YX01V00005R300	100.16
	YX01V00005F4	YY02-03001-	P-UB-1	65 mm		KOB-YX01V00005R100	72.49
	YX01V00005F4	YY02-03001-	N-N-14		95 mm	KOB-YX01V00005R200	83.31
	DOZER LH	YX01V00006F1	YY02-03001-	P-UB-10	65 mm	110 mm	KOB-YX01V00006R300
YX01V00006F1		YY02-03001-	P-UB-1	65 mm		KOB-YX01V00006R100	93.06
YX01V00006F1		YY02-03001-	N-N-10		110 mm	KOB-YX01V00006R200	87.07
DOZER RH	YX01V00007F1	YY02-03001-	P-UB-10	65 mm	110 mm	KOB-YX01V00006R300	180.14
	YX01V00007F1	YY02-03001-	P-UB-1	65 mm		KOB-YX01V00006R100	93.06
	YX01V00007F1	YY02-03001-	N-N-10		110 mm	KOB-YX01V00006R200	87.07
OFFSET	YX01V00008F1	YY02-03001-	P-UB-14	70 mm	105 mm	KOB-YX01V00008R300	151.04
	YX01V00008F1	YY02-03001-	P-UB-1	70 mm		KOB-YX01V00008R100	52.14
	YX01V00008F1	YY02-03001-	N-N-14		105 mm	KOB-YX01V00008R200	98.89
MODEL SK135SR-1E							
ARM	YY01V00003F1	YY03-04555-	P-UB-14	80 mm	115 mm	KOB-YY01V00003R300	234.21
	YY01V00003F1	YY03-04555-	P-UB-1	80 mm		KOB-YY01V00003R100	86.24
	YY01V00003F1	YY03-04555-	N-N-14		115 mm	KOB-YY01V00003R200	147.97
	YY01V00003F2	YY03-04555-	P-UB-14	80 mm	115 mm	KOB-YY01V00003R300	234.21
	YY01V00003F2	YY03-04555-	P-UB-1	80 mm		KOB-YY01V00003R100	86.24
	YY01V00003F2	YY03-04555-	N-N-14		115 mm	KOB-YY01V00003R200	147.97
ARM Offset Boom	YY01V00009F1	YY03-04555-	P-UB-14	80 mm	115 mm	KOB-YY01V00009R300	234.21
	YY01V00009F1	YY03-04555-	P-UB-1	80 mm		KOB-YY01V00009R100	86.24

Replacement Kits For

KOBELCO®

Excavators							
APPLICATION	CYL #	SERIAL #	CODE	ROD	BORE	KIT #	List \$
MODEL SK135SR-1E							
ARM Offset Boom	YY01V00009F1	YY03-04555-	N-N-14		115 mm	KOB-YY01V00009R200	147.97
ARM Telescopic	LP01V00010F1	YY03-04555-	P-UB-14	50 mm	70 mm	KOB-LP01V00004R300	252.91
	LP01V00010F1	YY03-04555-	P-UB-1	50 mm		KOB-LP01V00004R100	86.61
	LP01V00010F1	YY03-04555-	N-N-14		70 mm	KOB-LP01V00004R200	166.30
BOOM LH	YY01V00001F1	YY03-04555-	P-UB-14	70 mm	100 mm	KOB-YY01V00001R300	255.95
	YY01V00001F1	YY03-04555-	P-UB-1	70 mm		KOB-YY01V00001R100	77.73
	YY01V00001F1	YY03-04555-	N-N-14		100 mm	KOB-YY01V00001R200	178.24
BOOM RH	YY01V00002F1	YY03-04555-	P-UB-14	70 mm	100 mm	KOB-YY01V00001R300	255.95
	YY01V00002F1	YY03-04555-	P-UB-1	70 mm		KOB-YY01V00001R100	77.73
	YY01V00002F1	YY03-04555-	N-N-14		100 mm	KOB-YY01V00001R200	178.24
BUCKET	YX01V00005F1	YY03-04555-	P-UB-14	65 mm	95 mm	KOB-YX01V00005R300	100.16
	YX01V00005F1	YY03-04555-	P-UB-1	65 mm		KOB-YX01V00005R100	72.49
	YX01V00005F1	YY03-04555-	N-N-14		95 mm	KOB-YX01V00005R200	83.31
	YX01V00005F2	YY03-04555-	P-UB-14	65 mm	95 mm	KOB-YX01V00005R300	100.16
	YX01V00005F2	YY03-04555-	P-UB-1	65 mm		KOB-YX01V00005R100	72.49
	YX01V00005F2	YY03-04555-	N-N-14		95 mm	KOB-YX01V00005R200	83.31
	YX01V00005F3	YY03-04555-	P-UB-14	65 mm	95 mm	KOB-YX01V00005R300	100.16
	YX01V00005F3	YY03-04555-	P-UB-1	65 mm		KOB-YX01V00005R100	72.49
	YX01V00005F3	YY03-04555-	N-N-14		95 mm	KOB-YX01V00005R200	83.31
	YX01V00005F4	YY03-04555-	P-UB-14	65 mm	95 mm	KOB-YX01V00005R300	100.16
	YX01V00005F4	YY03-04555-	P-UB-1	65 mm		KOB-YX01V00005R100	72.49
	YX01V00005F4	YY03-04555-	N-N-14		95 mm	KOB-YX01V00005R200	83.31
	YX01V00005F5	YY03-04555-YY03-05770	P-UB-14	65 mm	95 mm	KOB-YX01V00005R300	100.16
	YX01V00005F5	YY03-04555-YY03-05770	P-UB-1	65 mm		KOB-YX01V00005R100	72.49
	YX01V00005F5	YY03-04555-YY03-05770	N-N-14		95 mm	KOB-YX01V00005R200	83.31
DOZER LH	YX01V00006F1	YY03-04555-	P-UB-10	65 mm	110 mm	KOB-YX01V00006R300	180.14
	YX01V00006F1	YY03-04555-	P-UB-1	65 mm		KOB-YX01V00006R100	93.06
	YX01V00006F1	YY03-04555-	N-N-10		110 mm	KOB-YX01V00006R200	87.07
DOZER RH	YX01V00007F1	YY03-04555-	P-UB-10	65 mm	110 mm	KOB-YX01V00006R300	180.14
	YX01V00007F1	YY03-04555-	P-UB-1	65 mm		KOB-YX01V00006R100	93.06
	YX01V00007F1	YY03-04555-	N-N-10		110 mm	KOB-YX01V00006R200	87.07
OFFSET	YX01V00008F1	YY03-04555-	P-UB-14	70 mm	105 mm	KOB-YX01V00008R300	151.04
	YX01V00008F1	YY03-04555-	P-UB-1	70 mm		KOB-YX01V00008R100	52.14
	YX01V00008F1	YY03-04555-	N-N-14		105 mm	KOB-YX01V00008R200	98.89
MODEL SK135SRL							
ARM	YY01V00003F1	LK01-01001-	P-UB-14	80 mm	115 mm	KOB-YY01V00003R300	234.21
	YY01V00003F1	LK01-01001-	P-UB-1	80 mm		KOB-YY01V00003R100	86.24
	YY01V00003F1	LK01-01001-	N-N-14		115 mm	KOB-YY01V00003R200	147.97
	YY01V00003F2	LK01-01001-	P-UB-14	80 mm	115 mm	KOB-YY01V00003R300	234.21
	YY01V00003F2	LK01-01001-	P-UB-1	80 mm		KOB-YY01V00003R100	86.24
	YY01V00003F2	LK01-01001-	N-N-14		115 mm	KOB-YY01V00003R200	147.97
BOOM LH	YY01V00001F1	LK01-01001-	P-UB-14	70 mm	100 mm	KOB-YY01V00001R300	255.95
	YY01V00001F1	LK01-01001-	P-UB-1	70 mm		KOB-YY01V00001R100	77.73
	YY01V00001F1	LK01-01001-	N-N-14		100 mm	KOB-YY01V00001R200	178.24
BOOM RH	YY01V00002F1	LK01-01001-	P-UB-14	70 mm	100 mm	KOB-YY01V00001R300	255.95
	YY01V00002F1	LK01-01001-	P-UB-1	70 mm		KOB-YY01V00001R100	77.73
	YY01V00002F1	LK01-01001-	N-N-14		100 mm	KOB-YY01V00001R200	178.24
BUCKET	YX01V00005F1	LK01-01001-	P-UB-14	65 mm	95 mm	KOB-YX01V00005R300	100.16
	YX01V00005F1	LK01-01001-	P-UB-1	65 mm		KOB-YX01V00005R100	72.49
	YX01V00005F1	LK01-01001-	N-N-14		95 mm	KOB-YX01V00005R200	83.31
	YX01V00005F2	LK01-01001-	P-UB-14	65 mm	95 mm	KOB-YX01V00005R300	100.16
	YX01V00005F2	LK01-01001-	P-UB-1	65 mm		KOB-YX01V00005R100	72.49
	YX01V00005F2	LK01-01001-	N-N-14		95 mm	KOB-YX01V00005R200	83.31
YX01V00005F3	LK01-01001-	P-UB-14	65 mm	95 mm	KOB-YX01V00005R300	100.16	

Replacement Kits For

KOBELCO®

Excavators							
APPLICATION	CYL #	SERIAL #	CODE	ROD	BORE	KIT #	List \$
MODEL SK135SRL							
BUCKET	YX01V00005F3	LK01-01001-	P-UB-1	65 mm		KOB-YX01V00005R100	72.49
	YX01V00005F3	LK01-01001-	N-N-14		95 mm	KOB-YX01V00005R200	83.31
DOZER LH	YX01V00006F1	LK01-01001-	P-UB-10	65 mm	110 mm	KOB-YX01V00006R300	180.14
	YX01V00006F1	LK01-01001-	P-UB-1	65 mm		KOB-YX01V00006R100	93.06
	YX01V00006F1	LK01-01001-	N-N-10		110 mm	KOB-YX01V00006R200	87.07
DOZER RH	YX01V00007F1	LK01-01001-	P-UB-10	65 mm	110 mm	KOB-YX01V00007R300	180.14
	YX01V00007F1	LK01-01001-	P-UB-1	65 mm		KOB-YX01V00007R100	93.06
	YX01V00007F1	LK01-01001-	N-N-10		110 mm	KOB-YX01V00007R200	87.07
OFFSET	YX01V00008F1	LK01-01001-	P-UB-14	70 mm	105 mm	KOB-YX01V00008R300	151.04
	YX01V00008F1	LK01-01001-	P-UB-1	70 mm		KOB-YX01V00008R100	52.14
	YX01V00008F1	LK01-01001-	N-N-14		105 mm	KOB-YX01V00008R200	98.89
MODEL SK135SRL-1E							
ARM	YY01V00003F1	LK03-01107-	P-UB-14	80 mm	115 mm	KOB-YY01V00003R300	234.21
	YY01V00003F1	LK03-01107-	P-UB-1	80 mm		KOB-YY01V00003R100	86.24
	YY01V00003F1	LK03-01107-	N-N-14		115 mm	KOB-YY01V00003R200	147.97
	YY01V00003F2	LK03-01107-	P-UB-14	80 mm	115 mm	KOB-YY01V00003R300	234.21
	YY01V00003F2	LK03-01107-	P-UB-1	80 mm		KOB-YY01V00003R100	86.24
	YY01V00003F2	LK03-01107-	N-N-14		115 mm	KOB-YY01V00003R200	147.97
ARM Offset Boom	YY01V00009F1	LK03-01107-	P-UB-14	80 mm	115 mm	KOB-YY01V00009R300	234.21
	YY01V00009F1	LK03-01107-	P-UB-1	80 mm		KOB-YY01V00009R100	86.24
	YY01V00009F1	LK03-01107-	N-N-14		115 mm	KOB-YY01V00009R200	147.97
ARM Telescopic	LP01V00010F1	LK03-01107-	P-UB-14	50 mm	70 mm	KOB-LP01V00004R300	252.91
	LP01V00010F1	LK03-01107-	P-UB-1	50 mm		KOB-LP01V00004R100	86.61
	LP01V00010F1	LK03-01107-	N-N-14		70 mm	KOB-LP01V00004R200	166.30
BOOM LH	YY01V00001F1	LK03-01107-	P-UB-14	70 mm	100 mm	KOB-YY01V00001R300	255.95
	YY01V00001F1	LK03-01107-	P-UB-1	70 mm		KOB-YY01V00001R100	77.73
	YY01V00001F1	LK03-01107-	N-N-14		100 mm	KOB-YY01V00001R200	178.24
BOOM RH	YY01V00002F1	LK03-01107-	P-UB-14	70 mm	100 mm	KOB-YY01V00002R300	255.95
	YY01V00002F1	LK03-01107-	P-UB-1	70 mm		KOB-YY01V00002R100	77.73
	YY01V00002F1	LK03-01107-	N-N-14		100 mm	KOB-YY01V00002R200	178.24
BUCKET	YX01V00005F1	LK03-01107-	P-UB-14	65 mm	95 mm	KOB-YX01V00005R300	100.16
	YX01V00005F1	LK03-01107-	P-UB-1	65 mm		KOB-YX01V00005R100	72.49
	YX01V00005F1	LK03-01107-	N-N-14		95 mm	KOB-YX01V00005R200	83.31
	YX01V00005F2	LK03-01107-	P-UB-14	65 mm	95 mm	KOB-YX01V00005R300	100.16
	YX01V00005F2	LK03-01107-	P-UB-1	65 mm		KOB-YX01V00005R100	72.49
	YX01V00005F2	LK03-01107-	N-N-14		95 mm	KOB-YX01V00005R200	83.31
	YX01V00005F3	LK03-01107-	P-UB-14	65 mm	95 mm	KOB-YX01V00005R300	100.16
	YX01V00005F3	LK03-01107-	P-UB-1	65 mm		KOB-YX01V00005R100	72.49
	YX01V00005F3	LK03-01107-	N-N-14		95 mm	KOB-YX01V00005R200	83.31
	YX01V00005F4	LK03-01107-	P-UB-14	65 mm	95 mm	KOB-YX01V00005R300	100.16
	YX01V00005F4	LK03-01107-	P-UB-1	65 mm		KOB-YX01V00005R100	72.49
	YX01V00005F4	LK03-01107-	N-N-14		95 mm	KOB-YX01V00005R200	83.31
	YX01V00005F5	LK03-01107-LK03-01109	P-UB-14	65 mm	95 mm	KOB-YX01V00005R300	100.16
	YX01V00005F5	LK03-01107-LK03-01109	P-UB-1	65 mm		KOB-YX01V00005R100	72.49
	YX01V00005F5	LK03-01107-LK03-01109	N-N-14		95 mm	KOB-YX01V00005R200	83.31
DOZER LH	YX01V00006F1	LK03-01107-	P-UB-10	65 mm	110 mm	KOB-YX01V00006R300	180.14
	YX01V00006F1	LK03-01107-	P-UB-1	65 mm		KOB-YX01V00006R100	93.06
	YX01V00006F1	LK03-01107-	N-N-10		110 mm	KOB-YX01V00006R200	87.07
DOZER RH	YX01V00007F1	LK03-01107-	P-UB-10	65 mm	110 mm	KOB-YX01V00007R300	180.14
	YX01V00007F1	LK03-01107-	P-UB-1	65 mm		KOB-YX01V00007R100	93.06
	YX01V00007F1	LK03-01107-	N-N-10		110 mm	KOB-YX01V00007R200	87.07
OFFSET	YX01V00008F1	LK03-01107-	P-UB-14	70 mm	105 mm	KOB-YX01V00008R300	151.04
	YX01V00008F1	LK03-01107-	P-UB-1	70 mm		KOB-YX01V00008R100	52.14
	YX01V00008F1	LK03-01107-	N-N-14		105 mm	KOB-YX01V00008R200	98.89

KOBELCO®

Replacement Kits For

KOBELCO®

Excavators							
APPLICATION	CYL #	SERIAL #	CODE	ROD	BORE	KIT #	List \$
MODEL SK135SRLC							
ARM	YY01V00003F1	YH01-00101-	P-UB-14	80 mm	115 mm	KOB-YY01V00003R300	234.21
	YY01V00003F1	YH01-00101-	P-UB-1	80 mm		KOB-YY01V00003R100	86.24
	YY01V00003F1	YH01-00101-	N-N-14		115 mm	KOB-YY01V00003R200	147.97
	YY01V00003F1	YH02-01301-	P-UB-14	80 mm	115 mm	KOB-YY01V00003R300	234.21
	YY01V00003F1	YH02-01301-	P-UB-1	80 mm		KOB-YY01V00003R100	86.24
	YY01V00003F1	YH02-01301-	N-N-14		115 mm	KOB-YY01V00003R200	147.97
	YY01V00003F2	YH01-00101-	P-UB-14	80 mm	115 mm	KOB-YY01V00003R300	234.21
	YY01V00003F2	YH01-00101-	P-UB-1	80 mm		KOB-YY01V00003R100	86.24
	YY01V00003F2	YH01-00101-	N-N-14		115 mm	KOB-YY01V00003R200	147.97
	YY01V00003F2	YH02-01301-	P-UB-14	80 mm	115 mm	KOB-YY01V00003R300	234.21
	YY01V00003F2	YH02-01301-	P-UB-1	80 mm		KOB-YY01V00003R100	86.24
	YY01V00003F2	YH02-01301-	N-N-14		115 mm	KOB-YY01V00003R200	147.97
	YY01V00009F1	YH02-01301-	P-UB-14	80 mm	115 mm	KOB-YY01V00009R300	234.21
	YY01V00009F1	YH02-01301-	P-UB-1	80 mm		KOB-YY01V00009R100	86.24
YY01V00009F1	YH02-01301-	N-N-14		115 mm	KOB-YY01V00009R200	147.97	
ARM Telescopic	LP01V00010F1	YH02-01301-	P-UB-14	50 mm	70 mm	KOB-LP01V00004R300	252.91
	LP01V00010F1	YH02-01301-	P-UB-1	50 mm		KOB-LP01V00004R100	86.61
	LP01V00010F1	YH02-01301-	N-N-14		70 mm	KOB-LP01V00004R200	166.30
BOOM LH	YY01V00001F1	YH01-00101-	P-UB-14	70 mm	100 mm	KOB-YY01V00001R300	255.95
	YY01V00001F1	YH01-00101-	P-UB-1	70 mm		KOB-YY01V00001R100	77.73
	YY01V00001F1	YH01-00101-	N-N-14		100 mm	KOB-YY01V00001R200	178.24
	YY01V00001F1	YH02-01301-	P-UB-14	70 mm	100 mm	KOB-YY01V00001R300	255.95
	YY01V00001F1	YH02-01301-	P-UB-1	70 mm		KOB-YY01V00001R100	77.73
	YY01V00001F1	YH02-01301-	N-N-14		100 mm	KOB-YY01V00001R200	178.24
BOOM RH	YY01V00002F1	YH01-00101-	P-UB-14	70 mm	100 mm	KOB-YY01V00001R300	255.95
	YY01V00002F1	YH01-00101-	P-UB-1	70 mm		KOB-YY01V00001R100	77.73
	YY01V00002F1	YH01-00101-	N-N-14		100 mm	KOB-YY01V00001R200	178.24
	YY01V00002F1	YH02-01301-	P-UB-14	70 mm	100 mm	KOB-YY01V00001R300	255.95
	YY01V00002F1	YH02-01301-	P-UB-1	70 mm		KOB-YY01V00001R100	77.73
	YY01V00002F1	YH02-01301-	N-N-14		100 mm	KOB-YY01V00001R200	178.24
BUCKET	YX01V00005F1	YH01-00101-	P-UB-14	65 mm	95 mm	KOB-YX01V00005R300	100.16
	YX01V00005F1	YH01-00101-	P-UB-1	65 mm		KOB-YX01V00005R100	72.49
	YX01V00005F1	YH01-00101-	N-N-14		95 mm	KOB-YX01V00005R200	83.31
	YX01V00005F1	YH02-01301-	P-UB-14	65 mm	95 mm	KOB-YX01V00005R300	100.16
	YX01V00005F1	YH02-01301-	P-UB-1	65 mm		KOB-YX01V00005R100	72.49
	YX01V00005F1	YH02-01301-	N-N-14		95 mm	KOB-YX01V00005R200	83.31
	YX01V00005F2	YH01-00101-	P-UB-14	65 mm	95 mm	KOB-YX01V00005R300	100.16
	YX01V00005F2	YH01-00101-	P-UB-1	65 mm		KOB-YX01V00005R100	72.49
	YX01V00005F2	YH01-00101-	N-N-14		95 mm	KOB-YX01V00005R200	83.31
	YX01V00005F2	YH02-01301-	P-UB-14	65 mm	95 mm	KOB-YX01V00005R300	100.16
	YX01V00005F2	YH02-01301-	P-UB-1	65 mm		KOB-YX01V00005R100	72.49
	YX01V00005F2	YH02-01301-	N-N-14		95 mm	KOB-YX01V00005R200	83.31
	YX01V00005F3	YH01-00101-	P-UB-14	65 mm	95 mm	KOB-YX01V00005R300	100.16
	YX01V00005F3	YH01-00101-	P-UB-1	65 mm		KOB-YX01V00005R100	72.49
	YX01V00005F3	YH01-00101-	N-N-14		95 mm	KOB-YX01V00005R200	83.31
	YX01V00005F3	YH02-01301-	P-UB-14	65 mm	95 mm	KOB-YX01V00005R300	100.16
	YX01V00005F3	YH02-01301-	P-UB-1	65 mm		KOB-YX01V00005R100	72.49
	YX01V00005F3	YH02-01301-	N-N-14		95 mm	KOB-YX01V00005R200	83.31
	YX01V00005F4	YH02-01301-	P-UB-14	65 mm	95 mm	KOB-YX01V00005R300	100.16
	YX01V00005F4	YH02-01301-	P-UB-1	65 mm		KOB-YX01V00005R100	72.49
	YX01V00005F4	YH02-01301-	N-N-14		95 mm	KOB-YX01V00005R200	83.31
DOZER LH	YX01V00006F1	YH02-01301-	P-UB-10	65 mm	110 mm	KOB-YX01V00006R300	180.14
	YX01V00006F1	YH02-01301-	P-UB-1	65 mm		KOB-YX01V00006R100	93.06
	YX01V00006F1	YH02-01301-	N-N-10		110 mm	KOB-YX01V00006R200	87.07
	YX01V00006R1	YH01-00101-	P-UB-10	65 mm	110 mm	KOB-YX01V00006R300	180.14

Replacement Kits For

KOBELCO®

Excavators								
APPLICATION	CYL #	SERIAL #	CODE	ROD	BORE	KIT #	List \$	
MODEL SK135SRLC								
DOZER LH	YX01V00006R1	YH01-00101-	P-UB-1	65 mm		KOB-YX01V00006R100	93.06	
	YX01V00006R1	YH01-00101-	N-N-10		110 mm	KOB-YX01V00006R200	87.07	
DOZER RH	YX01V00007F1	YH02-01301-	P-UB-10	65 mm	110 mm	KOB-YX01V00006R300	180.14	
	YX01V00007F1	YH02-01301-	P-UB-1	65 mm		KOB-YX01V00006R100	93.06	
	YX01V00007F1	YH02-01301-	N-N-10		110 mm	KOB-YX01V00006R200	87.07	
	YX01V00007R1	YH01-00101-	P-UB-10	65 mm	110 mm	KOB-YX01V00006R300	180.14	
	YX01V00007R1	YH01-00101-	P-UB-1	65 mm		KOB-YX01V00006R100	93.06	
	YX01V00007R1	YH01-00101-	N-N-10		110 mm	KOB-YX01V00006R200	87.07	
OFFSET	YX01V00008F1	YH01-00101-	P-UB-14	70 mm	105 mm	KOB-YX01V00008R300	151.04	
	YX01V00008F1	YH01-00101-	P-UB-1	70 mm		KOB-YX01V00008R100	52.14	
	YX01V00008F1	YH01-00101-	N-N-14		105 mm	KOB-YX01V00008R200	98.89	
	YX01V00008F1	YH02-01301-	P-UB-14	70 mm	105 mm	KOB-YX01V00008R300	151.04	
	YX01V00008F1	YH02-01301-	P-UB-1	70 mm		KOB-YX01V00008R100	52.14	
	YX01V00008F1	YH02-01301-	N-N-14		105 mm	KOB-YX01V00008R200	98.89	
MODEL SK135SRLC-1E								
ARM	YY01V00003F1	YH03-02097-	P-UB-14	80 mm	115 mm	KOB-YY01V00003R300	234.21	
	YY01V00003F1	YH03-02097-	P-UB-1	80 mm		KOB-YY01V00003R100	86.24	
	YY01V00003F1	YH03-02097-	N-N-14		115 mm	KOB-YY01V00003R200	147.97	
	YY01V00003F1	YH04-03001-	P-UB-14	80 mm	115 mm	KOB-YY01V00003R300	234.21	
	YY01V00003F1	YH04-03001-	P-UB-1	80 mm		KOB-YY01V00003R100	86.24	
	YY01V00003F1	YH04-03001-	N-N-14		115 mm	KOB-YY01V00003R200	147.97	
	YY01V00003F1	YY04-03001-	P-UB-14	80 mm	115 mm	KOB-YY01V00003R300	234.21	
	YY01V00003F1	YY04-03001-	P-UB-1	80 mm		KOB-YY01V00003R100	86.24	
	YY01V00003F1	YY04-03001-	N-N-14		115 mm	KOB-YY01V00003R200	147.97	
	YY01V00003F2	YH03-02097-	P-UB-14	80 mm	115 mm	KOB-YY01V00003R300	234.21	
	YY01V00003F2	YH03-02097-	P-UB-1	80 mm		KOB-YY01V00003R100	86.24	
	YY01V00003F2	YH03-02097-	N-N-14		115 mm	KOB-YY01V00003R200	147.97	
	YY01V00003F2	YH04-03001-	P-UB-14	80 mm	115 mm	KOB-YY01V00003R300	234.21	
	YY01V00003F2	YH04-03001-	P-UB-1	80 mm		KOB-YY01V00003R100	86.24	
	YY01V00003F2	YH04-03001-	N-N-14		115 mm	KOB-YY01V00003R200	147.97	
	YY01V00003F2	YY04-03001-	P-UB-14	80 mm	115 mm	KOB-YY01V00003R300	234.21	
	YY01V00003F2	YY04-03001-	P-UB-1	80 mm		KOB-YY01V00003R100	86.24	
	YY01V00003F2	YY04-03001-	N-N-14		115 mm	KOB-YY01V00003R200	147.97	
	YY01V00003F3	YH04-03001-	P-UB-14	80 mm	115 mm	KOB-YY01V00003R300	234.21	
	YY01V00003F3	YH04-03001-	P-UB-1	80 mm		KOB-YY01V00003R100	86.24	
	YY01V00003F3	YH04-03001-	N-N-14		115 mm	KOB-YY01V00003R200	147.97	
	YY01V00003F4	YH04-03001-	P-UB-14	80 mm	115 mm	KOB-YY01V00004R910	234.97	
	YY01V00003F4	YH04-03001-	P-UB-1	80 mm		KOB-YY01V00004R900	86.98	
	YY01V00003F4	YH04-03001-	N-N-14		115 mm	KOB-YY01V00003R200	147.97	
	YY01V00003F5	YH04-03001-	P-UB-14	80 mm	115 mm	KOB-YY01V00004R910	234.97	
	YY01V00003F5	YH04-03001-	P-UB-1	80 mm		KOB-YY01V00004R900	86.98	
	YY01V00003F5	YH04-03001-	N-N-14		115 mm	KOB-YY01V00003R200	147.97	
	YY01V00009F1	YH04-03001-	P-UB-14	80 mm	115 mm	KOB-YY01V00003R300	234.21	
	YY01V00009F1	YH04-03001-	P-UB-1	80 mm		KOB-YY01V00003R100	86.24	
	YY01V00009F1	YH04-03001-	N-N-14		115 mm	KOB-YY01V00003R200	147.97	
	YY01V00009F1	YY04-03001-	P-UB-14	80 mm	115 mm	KOB-YY01V00009R300	234.21	
	YY01V00009F1	YY04-03001-	P-UB-1	80 mm		KOB-YY01V00009R100	86.24	
	YY01V00009F1	YY04-03001-	N-N-14		115 mm	KOB-YY01V00009R200	147.97	
	YY01V00009F2	YH04-03001-	P-UB-14	80 mm	115 mm	KOB-YY01V00004R910	234.97	
	YY01V00009F2	YH04-03001-	P-UB-1	80 mm		KOB-YY01V00004R900	86.98	
	YY01V00009F2	YH04-03001-	N-N-14		115 mm	KOB-YY01V00003R200	147.97	
	ARM Offset Boom	YY01V00009F1	YH03-02097-	P-UB-14	80 mm	115 mm	KOB-YY01V00009R300	234.21
		YY01V00009F1	YH03-02097-	P-UB-1	80 mm		KOB-YY01V00009R100	86.24
		YY01V00009F1	YH03-02097-	N-N-14		115 mm	KOB-YY01V00009R200	147.97

KOBELCO®

Replacement Kits For

KOBELCO®

Excavators							
APPLICATION	CYL #	SERIAL #	CODE	ROD	BORE	KIT #	List \$
MODEL SK135SRLC-1E							
ARM Telescopic	LP01V00010F1	YH03-02097-	P-UB-14	50 mm	70 mm	KOB-LP01V00004R300	252.91
	LP01V00010F1	YH03-02097-	P-UB-1	50 mm		KOB-LP01V00004R100	86.61
	LP01V00010F1	YH03-02097-	N-N-14		70 mm	KOB-LP01V00004R200	166.30
BOOM LH	YY01V00001F1	YH03-02097-	P-UB-14	70 mm	100 mm	KOB-YY01V00001R300	255.95
	YY01V00001F1	YH03-02097-	P-UB-1	70 mm		KOB-YY01V00001R100	77.73
	YY01V00001F1	YH03-02097-	N-N-14		100 mm	KOB-YY01V00001R200	178.24
	YY01V00001F1	YH04-03001-	P-UB-14	70 mm	100 mm	KOB-YY01V00001R300	255.95
	YY01V00001F1	YH04-03001-	P-UB-1	70 mm		KOB-YY01V00001R100	77.73
	YY01V00001F1	YH04-03001-	N-N-14		100 mm	KOB-YY01V00001R200	178.24
	YY01V00001F1	YY04-03001-	P-UB-14	70 mm	100 mm	KOB-YY01V00001R300	255.95
	YY01V00001F1	YY04-03001-	P-UB-1	70 mm		KOB-YY01V00001R100	77.73
	YY01V00001F1	YY04-03001-	N-N-14		100 mm	KOB-YY01V00001R200	178.24
	YY01V00001F2	YH04-03001-	P-UB-14	70 mm	100 mm	KOB-YY01V00045R700	279.72
	YY01V00001F2	YH04-03001-	P-UB-1	70 mm		KOB-YY01V00045R600	101.49
	YY01V00001F2	YH04-03001-	N-N-14		100 mm	KOB-YY01V00001R200	178.24
	BOOM RH	YY01V00002F1	YH03-02097-	P-UB-14	70 mm	100 mm	KOB-YY01V00001R300
YY01V00002F1		YH03-02097-	P-UB-1	70 mm		KOB-YY01V00001R100	77.73
YY01V00002F1		YH03-02097-	N-N-14		100 mm	KOB-YY01V00001R200	178.24
YY01V00002F1		YH04-03001-	P-UB-14	70 mm	100 mm	KOB-YY01V00001R300	255.95
YY01V00002F1		YH04-03001-	P-UB-1	70 mm		KOB-YY01V00001R100	77.73
YY01V00002F1		YH04-03001-	N-N-14		100 mm	KOB-YY01V00001R200	178.24
YY01V00002F1		YY04-03001-	P-UB-14	70 mm	100 mm	KOB-YY01V00001R300	255.95
YY01V00002F1		YY04-03001-	P-UB-1	70 mm		KOB-YY01V00001R100	77.73
YY01V00002F1		YY04-03001-	N-N-14		100 mm	KOB-YY01V00001R200	178.24
YY01V00002F2		YH04-03001-	P-UB-14	70 mm	100 mm	KOB-YY01V00045R700	279.72
YY01V00002F2		YH04-03001-	P-UB-1	70 mm		KOB-YY01V00045R600	101.49
YY01V00002F2		YH04-03001-	N-N-14		100 mm	KOB-YY01V00001R200	178.24
BUCKET		YX01V00005F1	YH03-02097-	P-UB-14	65 mm	95 mm	KOB-YX01V00005R300
	YX01V00005F1	YH03-02097-	P-UB-1	65 mm		KOB-YX01V00005R100	72.49
	YX01V00005F1	YH03-02097-	N-N-14		95 mm	KOB-YX01V00005R200	83.31
	YX01V00005F1	YH04-03001-	P-UB-14	65 mm	95 mm	KOB-YX01V00005R300	100.16
	YX01V00005F1	YH04-03001-	P-UB-1	65 mm		KOB-YX01V00005R100	72.49
	YX01V00005F1	YH04-03001-	N-N-14		95 mm	KOB-YX01V00005R200	83.31
	YX01V00005F1	YY04-03001-	P-UB-14	65 mm	95 mm	KOB-YX01V00005R300	100.16
	YX01V00005F1	YY04-03001-	P-UB-1	65 mm		KOB-YX01V00005R100	72.49
	YX01V00005F1	YY04-03001-	N-N-14		95 mm	KOB-YX01V00005R200	83.31
	YX01V00005F2	YH03-02097-	P-UB-14	65 mm	95 mm	KOB-YX01V00005R300	100.16
	YX01V00005F2	YH03-02097-	P-UB-1	65 mm		KOB-YX01V00005R100	72.49
	YX01V00005F2	YH03-02097-	N-N-14		95 mm	KOB-YX01V00005R200	83.31
	YX01V00005F2	YH04-03001-	P-UB-14	65 mm	95 mm	KOB-YX01V00005R300	100.16
	YX01V00005F2	YH04-03001-	P-UB-1	65 mm		KOB-YX01V00005R100	72.49
	YX01V00005F2	YH04-03001-	N-N-14		95 mm	KOB-YX01V00005R200	83.31
	YX01V00005F2	YY04-03001-	P-UB-14	65 mm	95 mm	KOB-YX01V00005R300	100.16
	YX01V00005F2	YY04-03001-	P-UB-1	65 mm		KOB-YX01V00005R100	72.49
	YX01V00005F2	YY04-03001-	N-N-14		95 mm	KOB-YX01V00005R200	83.31
	YX01V00005F3	YH03-02097-	P-UB-14	65 mm	95 mm	KOB-YX01V00005R300	100.16
	YX01V00005F3	YH03-02097-	P-UB-1	65 mm		KOB-YX01V00005R100	72.49
	YX01V00005F3	YH03-02097-	N-N-14		95 mm	KOB-YX01V00005R200	83.31
	YX01V00005F3	YH04-03001-	P-UB-14	65 mm	95 mm	KOB-YX01V00005R300	100.16
	YX01V00005F3	YH04-03001-	P-UB-1	65 mm		KOB-YX01V00005R100	72.49
	YX01V00005F3	YH04-03001-	N-N-14		95 mm	KOB-YX01V00005R200	83.31
	YX01V00005F3	YY04-03001-	P-UB-14	65 mm	95 mm	KOB-YX01V00005R300	100.16
	YX01V00005F3	YY04-03001-	P-UB-1	65 mm		KOB-YX01V00005R100	72.49
	YX01V00005F3	YY04-03001-	N-N-14		95 mm	KOB-YX01V00005R200	83.31
	YX01V00005F4	YH03-02097-	P-UB-14	65 mm	95 mm	KOB-YX01V00005R300	100.16

KOBELCO®

Replacement Kits For

KOBELCO®

Excavators								
APPLICATION	CYL #	SERIAL #	CODE	ROD	BORE	KIT #	List \$	
MODEL SK135SRLC-1E								
BUCKET	YX01V00005F4	YH03-02097-	P-UB-1	65 mm		KOB-YX01V00005R100	72.49	
	YX01V00005F4	YH03-02097-	N-N-14		95 mm	KOB-YX01V00005R200	83.31	
	YX01V00005F4	YH04-03001-	P-UB-14	65 mm	95 mm	KOB-YX01V00005R300	100.16	
	YX01V00005F4	YH04-03001-	P-UB-1	65 mm		KOB-YX01V00005R100	72.49	
	YX01V00005F4	YH04-03001-	N-N-14		95 mm	KOB-YX01V00005R200	83.31	
	YX01V00005F4	YY04-03001-	P-UB-14	65 mm	95 mm	KOB-YX01V00005R300	100.16	
	YX01V00005F4	YY04-03001-	P-UB-1	65 mm		KOB-YX01V00005R100	72.49	
	YX01V00005F4	YY04-03001-	N-N-14		95 mm	KOB-YX01V00005R200	83.31	
	YX01V00005F5	YH03-02097-YH03-02716	P-UB-14	65 mm	95 mm	KOB-YX01V00005R300	100.16	
	YX01V00005F5	YH03-02097-YH03-02716	P-UB-1	65 mm		KOB-YX01V00005R100	72.49	
	YX01V00005F5	YH03-02097-YH03-02716	N-N-14		95 mm	KOB-YX01V00005R200	83.31	
	YX01V00005F5	YH04-03001-	P-UB-14	65 mm	95 mm	KOB-YX01V00005R300	100.16	
	YX01V00005F5	YH04-03001-	P-UB-1	65 mm		KOB-YX01V00005R100	72.49	
	YX01V00005F5	YH04-03001-	N-N-14		95 mm	KOB-YX01V00005R200	83.31	
	YX01V00005F5	YY04-03001-	P-UB-14	65 mm	95 mm	KOB-YX01V00005R300	100.16	
	YX01V00005F5	YY04-03001-	P-UB-1	65 mm		KOB-YX01V00005R100	72.49	
	YX01V00005F5	YY04-03001-	N-N-14		95 mm	KOB-YX01V00005R200	83.31	
	YX01V00005F6	YH04-03001-	P-UB-14	65 mm	95 mm	KOB-YY01V00005R700	108.10	
	YX01V00005F6	YH04-03001-	P-UB-1	65 mm		KOB-YY01V00005R600	84.83	
	YX01V00005F6	YH04-03001-	N-N-14		95 mm	KOB-YY01V00005R200	83.31	
	YX01V00005F7	YH04-03001-	P-UB-14	65 mm	95 mm	KOB-YY01V00005R700	108.10	
	YX01V00005F7	YH04-03001-	P-UB-1	65 mm		KOB-YY01V00005R600	84.83	
	YX01V00005F7	YH04-03001-	N-N-14		95 mm	KOB-YY01V00005R200	83.31	
	YX01V00005F8	YH04-03001-	P-UB-14	65 mm	95 mm	KOB-YY01V00005R700	108.10	
	YX01V00005F8	YH04-03001-	P-UB-1	65 mm		KOB-YY01V00005R600	84.83	
	YX01V00005F8	YH04-03001-	N-N-14		95 mm	KOB-YY01V00005R200	83.31	
	DOZER LH	YX01V00006F1	YH03-02097-	P-UB-10	65 mm	110 mm	KOB-YX01V00006R300	180.14
		YX01V00006F1	YH03-02097-	P-UB-1	65 mm		KOB-YX01V00006R100	93.06
YX01V00006F1		YH03-02097-	N-N-10		110 mm	KOB-YX01V00006R200	87.07	
YX01V00006F1		YH04-03001-	P-UB-10	65 mm	110 mm	KOB-YX01V00006R300	180.14	
YX01V00006F1		YH04-03001-	P-UB-1	65 mm		KOB-YX01V00006R100	93.06	
YX01V00006F1		YH04-03001-	N-N-10		110 mm	KOB-YX01V00006R200	87.07	
YX01V00006F1		YY04-03001-	P-UB-10	65 mm	110 mm	KOB-YX01V00006R300	180.14	
YX01V00006F1		YY04-03001-	P-UB-1	65 mm		KOB-YX01V00006R100	93.06	
DOZER RH	YX01V00007F1	YH03-02097-	P-UB-10	65 mm	110 mm	KOB-YX01V00006R300	180.14	
	YX01V00007F1	YH03-02097-	P-UB-1	65 mm		KOB-YX01V00006R100	93.06	
	YX01V00007F1	YH03-02097-	N-N-10		110 mm	KOB-YX01V00006R200	87.07	
	YX01V00007F1	YH04-03001-	P-UB-10	65 mm	110 mm	KOB-YX01V00006R300	180.14	
	YX01V00007F1	YH04-03001-	P-UB-1	65 mm		KOB-YX01V00006R100	93.06	
	YX01V00007F1	YH04-03001-	N-N-10		110 mm	KOB-YX01V00006R200	87.07	
	YX01V00007F1	YY04-03001-	P-UB-10	65 mm	110 mm	KOB-YX01V00006R300	180.14	
	YX01V00007F1	YY04-03001-	P-UB-1	65 mm		KOB-YX01V00006R100	93.06	
OFFSET	YX01V00008F1	YH03-02097-	P-UB-14	70 mm	105 mm	KOB-YX01V00008R300	151.04	
	YX01V00008F1	YH03-02097-	P-UB-1	70 mm		KOB-YX01V00008R100	52.14	
	YX01V00008F1	YH03-02097-	N-N-14		105 mm	KOB-YX01V00008R200	98.89	
	YX01V00008F1	YH04-03001-	P-UB-14	70 mm	105 mm	KOB-YX01V00008R300	151.04	
	YX01V00008F1	YH04-03001-	P-UB-1	70 mm		KOB-YX01V00008R100	52.14	
	YX01V00008F1	YH04-03001-	N-N-14		105 mm	KOB-YX01V00008R200	98.89	
	YX01V00008F1	YY04-03001-	P-UB-14	70 mm	105 mm	KOB-YX01V00008R300	151.04	
	YX01V00008F1	YY04-03001-	P-UB-1	70 mm		KOB-YX01V00008R100	52.14	
	YX01V00008F1	YY04-03001-	N-N-14		105 mm	KOB-YX01V00008R200	98.89	
	YX01V00008F2	YH04-03001-	P-UB-14	70 mm	105 mm	KOB-YX01V00008R700	200.40	
YX01V00008F2	YH04-03001-	P-UB-1	70 mm		KOB-YY01V000045R600	101.49		

Replacement Kits For

KOBELCO®

Excavators							
APPLICATION	CYL #	SERIAL #	CODE	ROD	BORE	KIT #	List \$
MODEL SK135SRLC-1E							
OFFSET	YX01V00008F2	YH04-03001-	N-N-14		105 mm	KOB-YX01V00008R200	98.89
MODEL SK150, SK150LC							
ARM	2438U1948F1	YMU1001-	P-UB-10	90 mm	130 mm	KOB-2438U1948R500	422.29
	2438U1948F1	YMU1001-	P-UB-1	90 mm		KOB-2438U1948R400	152.07
	2438U1948F1	YMU1001-	N-N-10		130 mm	KOB-2438U1948R200	270.23
BOOM LH	2438U1947F1	YMU1001-	P-UB-10	80 mm	120 mm	KOB-2438U1946R300	291.84
	2438U1947F1	YMU1001-	P-UB-1	80 mm		KOB-2438U1105R400	112.01
	2438U1947F1	YMU1001-	N-N-10		120 mm	KOB-2438U1946R200	196.40
BOOM RH	2438U1946F1	YMU1001-	P-UB-10	80 mm	120 mm	KOB-2438U1946R300	291.84
	2438U1946F1	YMU1001-	P-UB-1	80 mm		KOB-2438U1105R400	112.01
	2438U1946F1	YMU1001-	N-N-10		120 mm	KOB-2438U1946R200	196.40
BUCKET	2438U1949F1	YMU1001-	P-UB-10	75 mm	110 mm	KOB-2438U1949R500	308.06
	2438U1949F1	YMU1001-	P-UB-1	75 mm		KOB-2438U1949R400	108.84
	2438U1949F1	YMU1001-	N-N-10		110 mm	KOB-2438U1949R200	242.14
MODEL SK150LC III							
ARM	2438U1948F1	YM000101-	P-UB-10	90 mm	130 mm	KOB-2438U1948R500	422.29
	2438U1948F1	YM000101-	P-UB-1	90 mm		KOB-2438U1948R400	152.07
	2438U1948F1	YM000101-	N-N-10		130 mm	KOB-2438U1948R200	270.23
BOOM LH	2438U1947F1	YM000101-	P-UB-10	80 mm	120 mm	KOB-2438U1946R300	291.84
	2438U1947F1	YM000101-	P-UB-1	80 mm		KOB-2438U1105R400	112.01
	2438U1947F1	YM000101-	N-N-10		120 mm	KOB-2438U1946R200	196.40
BOOM RH	2438U1946F1	YM000101-	P-UB-10	80 mm	120 mm	KOB-2438U1946R300	291.84
	2438U1946F1	YM000101-	P-UB-1	80 mm		KOB-2438U1105R400	112.01
	2438U1946F1	YM000101-	N-N-10		120 mm	KOB-2438U1946R200	196.40
BUCKET	2438U1949F1	YM000101-	P-UB-10	75 mm	110 mm	KOB-2438U1949R300	219.11
	2438U1949F1	YM000101-	P-UB-10	75 mm	110 mm	KOB-2438U1949R500	308.06
	2438U1949F1	YM000101-	P-UB-1	75 mm		KOB-2438U1949R400	108.84
	2438U1949F1	YM000101-	N-N-10		110 mm	KOB-2438U1949R200	242.14
MODEL SK150LC IV							
ARM	2438U1948F1	YMU1001-YMU1500	P-UB-10	90 mm	130 mm	KOB-2438U1948R300	422.29
	2438U1948F1	YMU1001-YMU1500	P-UB-1	90 mm		KOB-2438U1948R100	152.07
	2438U1948F1	YMU1001-YMU1500	N-N-10		130 mm	KOB-2438U1948R200	270.23
	2438U1948F1	YMU1501-	P-UB-10	90 mm	130 mm	KOB-2438U1948R300	422.29
	2438U1948F1	YMU1501-	P-UB-1	90 mm		KOB-2438U1948R100	152.07
	2438U1948F1	YMU1501-	N-N-10		130 mm	KOB-2438U1948R200	270.23
BOOM LH	2438U1947F1	YMU1001-YMU1500	P-UB-10	80 mm	120 mm	KOB-2438U1946R300	291.84
	2438U1947F1	YMU1001-YMU1500	P-UB-1	80 mm		KOB-2438U1105R400	112.01
	2438U1947F1	YMU1001-YMU1500	N-N-10		120 mm	KOB-2438U1946R200	196.40
	2438U1947F1	YMU1501-	P-UB-10	80 mm	120 mm	KOB-2438U1946R300	291.84
	2438U1947F1	YMU1501-	P-UB-1	80 mm		KOB-2438U1105R400	112.01
	2438U1947F1	YMU1501-	N-N-10		120 mm	KOB-2438U1946R200	196.40
BOOM RH	2438U1946F1	YMU1001-YMU1500	P-UB-10	80 mm	120 mm	KOB-2438U1946R300	291.84
	2438U1946F1	YMU1001-YMU1500	P-UB-1	80 mm		KOB-2438U1105R400	112.01
	2438U1946F1	YMU1001-YMU1500	N-N-10		120 mm	KOB-2438U1946R200	196.40
	2438U1967F1	YMU1501-	P-UB-10	80 mm	120 mm	KOB-2438U1946R300	291.84
	2438U1967F1	YMU1501-	P-UB-1	80 mm		KOB-2438U1105R400	112.01
	2438U1967F1	YMU1501-	N-N-10		120 mm	KOB-2438U1946R200	196.40
BUCKET	2438U1949F1	YMU1001-YMU1500	P-UB-10	75 mm	110 mm	KOB-2438U1949R300	219.11
	2438U1949F1	YMU1001-YMU1500	P-UB-1	75 mm		KOB-2438U1949R400	108.84
	2438U1949F1	YMU1001-YMU1500	N-N-10		110 mm	KOB-2438U1949R200	242.14
	2438U1949F1	YMU1501-	P-UB-10	75 mm	110 mm	KOB-2438U1949R300	219.11
	2438U1949F1	YMU1501-	P-UB-1	75 mm		KOB-2438U1949R400	108.84
	2438U1949F1	YMU1501-	N-N-10		110 mm	KOB-2438U1949R200	242.14
MODEL SK160LC							
ARM	YM01V00008F1	YM02U0101-	P-UB-10	90 mm	125 mm	KOB-YM01V00008R300	306.46

Replacement Kits For

KOBELCO®

Excavators							
APPLICATION	CYL #	SERIAL #	CODE	ROD	BORE	KIT #	List \$
MODEL SK160LC							
ARM	YM01V00008F1	YM02U0101-	P-UB-1	90 mm		KOB-YM01V00008R100	96.21
	YM01V00008F1	YM02U0101-	N-N-10		125 mm	KOB-YM01V00008R200	168.82
BOOM LH	YM01V00007F1	YM02U0101-	P-UB-10	80 mm	110 mm	KOB-YM01V00006R300	231.79
	YM01V00007F1	YM02U0101-	P-UB-1	80 mm		KOB-YM01V00006R100	100.96
	YM01V00007F1	YM02U0101-	N-N-10		110 mm	KOB-YM01V00006R200	130.82
BOOM RH	YM01V00006F1	YM02U0101-	P-UB-10	80 mm	110 mm	KOB-YM01V00006R300	231.79
	YM01V00006F1	YM02U0101-	P-UB-1	80 mm		KOB-YM01V00006R100	100.96
	YM01V00006F1	YM02U0101-	N-N-10		110 mm	KOB-YM01V00006R200	130.82
BUCKET	YM01V00009F1	YM02U0101-	P-UB-10	75 mm	105 mm	KOB-YM01V00009R300	271.79
	YM01V00009F1	YM02U0101-	P-UB-1	75 mm		KOB-YM01V00009R100	90.82
	YM01V00009F1	YM02U0101-	N-N-10		105 mm	KOB-YM01V00009R200	180.97
MODEL SK160LC IV							
ARM	2438U1948F1	YM02U10101-	P-UB-10	90 mm	130 mm	KOB-2438U1948R300	422.29
	2438U1948F1	YM02U10101-	P-UB-1	90 mm		KOB-2438U1948R100	152.07
	2438U1948F1	YM02U10101-	N-N-10		130 mm	KOB-2438U1948R200	270.23
BOOM LH	2438U1947F1	YM02U10101-	P-UB-10	80 mm	120 mm	KOB-2438U1946R300	291.84
	2438U1947F1	YM02U10101-	P-UB-1	80 mm		KOB-2438U1105R400	112.01
	2438U1947F1	YM02U10101-	N-N-10		120 mm	KOB-2438U1946R200	196.40
BOOM RH	2438U1946F1	YM02U10101-	P-UB-10	80 mm	120 mm	KOB-2438U1946R300	291.84
	2438U1946F1	YM02U10101-	P-UB-1	80 mm		KOB-2438U1105R400	112.01
	2438U1946F1	YM02U10101-	N-N-10		120 mm	KOB-2438U1946R200	196.40
BUCKET	2438U1949F1	YM02U10101-	P-UB-10	75 mm	110 mm	KOB-2438U1949R300	219.11
	2438U1949F1	YM02U10101-	P-UB-1	75 mm		KOB-2438U1949R400	108.84
	2438U1949F1	YM02U10101-	N-N-10		110 mm	KOB-2438U1949R200	242.14
MODEL SK160LC-6E							
ARM	YM01V00008F3	YM03U0523-	P-UB-10	90 mm	125 mm	KOB-YM01V00008R300	306.46
	YM01V00008F3	YM03U0523-	P-UB-1	90 mm		KOB-YM01V00008R100	96.21
	YM01V00008F3	YM03U0523-	N-N-10		125 mm	KOB-YM01V00008R200	168.82
BOOM LH	YM01V00007F3	YM03U0523-	P-UB-10	80 mm	110 mm	KOB-YM01V00006R300	231.79
	YM01V00007F3	YM03U0523-	P-UB-1	80 mm		KOB-YM01V00006R100	100.96
	YM01V00007F3	YM03U0523-	N-N-10		110 mm	KOB-YM01V00006R200	130.82
BOOM RH	YM01V00006F3	YM03U0523-	P-UB-10	80 mm	110 mm	KOB-YM01V00006R300	231.79
	YM01V00006F3	YM03U0523-	P-UB-1	80 mm		KOB-YM01V00006R100	100.96
	YM01V00006F3	YM03U0523-	N-N-10		110 mm	KOB-YM01V00006R200	130.82
BUCKET	YM01V00009F4	YM03U0523-	P-UB-10	75 mm	105 mm	KOB-YM01V00009R300	271.79
	YM01V00009F4	YM03U0523-	P-UB-1	75 mm		KOB-YM01V00009R100	90.82
	YM01V00009F4	YM03U0523-	N-N-10		105 mm	KOB-YM01V00009R200	180.97
MODEL SK200							
ARM	2438U1104F1	YNU0001-	P-UB-10	100 mm	145 mm	KOB-2438U1104R500	447.45
	2438U1104F1	YNU0001-	P-UB-1	100 mm		KOB-2438U1104R400	138.04
	2438U1104F1	YNU0001-	N-N-10		145 mm	KOB-2438U1104R200	309.41
	2438U1108F1	YNU0001-	P-UB-14	100 mm	145 mm	KOB-2438U1108R300	387.74
	2438U1108F1	YNU0001-	P-UB-1	100 mm		KOB-2438U1108R100	171.04
	2438U1108F1	YNU0001-	N-N-14		145 mm	KOB-2438U1108R200	196.56
BOOM LH	2438U1103F1	YNU0001-	P-UB-10	85 mm	125 mm	KOB-2438U1102R500	328.12
	2438U1103F1	YNU0001-	P-UB-1	85 mm		KOB-2438U1102R600	118.89
	2438U1103F1	YNU0001-	N-N-10		125 mm	KOB-2438U1102R200	209.25
	2438U1107F1	YNU0001-	P-UB-10	85 mm	125 mm	KOB-2438U1106R300	423.76
	2438U1107F1	YNU0001-	P-UB-1	85 mm		KOB-2438U1106R100	156.79
	2438U1107F1	YNU0001-	N-N-10		125 mm	KOB-2438U1106R200	266.95
BOOM RH	2438U1102F1	YNU0001-	P-UB-10	85 mm	125 mm	KOB-2438U1102R500	328.12
	2438U1102F1	YNU0001-	P-UB-1	85 mm		KOB-2438U1102R600	118.89
	2438U1102F1	YNU0001-	N-N-10		125 mm	KOB-2438U1102R200	209.25
	2438U1106F1	YNU0001-	P-UB-10	85 mm	125 mm	KOB-2438U1106R300	423.76
2438U1106F1	YNU0001-	P-UB-1	85 mm		KOB-2438U1106R100	156.79	

Replacement Kits For

KOBELCO®

Excavators							
APPLICATION	CYL #	SERIAL #	CODE	ROD	BORE	KIT #	List \$
MODEL SK200							
BOOM RH	2438U1106F1	YNU0001-	N-N-10		125 mm	KOB-2438U1106R200	266.95
BUCKET	2438U1105F1	YNU0001-	P-UB-10	80 mm	120 mm	KOB-2438U1105R500	242.52
	2438U1105F1	YNU0001-	P-UB-1	80 mm		KOB-2438U1105R400	112.01
	2438U1105F1	YNU0001-	N-N-10		120 mm	KOB-2438U1105R200	147.14
	2438U1109F1	YNU0001-	P-UB-10	80 mm	120 mm	KOB-2438U1109R300	310.95
	2438U1109F1	YNU0001-	P-UB-1	80 mm		KOB-2438U1109R200	153.22
	2438U1109F1	YNU0001-	N-N-10		120 mm	KOB-2438U1109R100	159.10
MODEL SK200 III							
ARM	2438U1104F1		P-UB-10	100 mm	145 mm	KOB-2438U1104R300	409.89
	2438U1104F1		P-UB-1	100 mm		KOB-2438U1104R400	138.04
	2438U1104F1		N-N-10		145 mm	KOB-2438U1104R200	309.41
	2438U1104F1		Bushing	100 mm		KOB-2438U1104S4	51.68
	2438U1108F1		P-UB-14	100 mm	145 mm	KOB-2438U1108R300	387.74
	2438U1108F1		P-UB-1	100 mm		KOB-2438U1108R100	171.04
	2438U1108F1		N-N-14		145 mm	KOB-2438U1108R200	196.56
	2438U1129F1		P-UB-10	120 mm	180 mm	KOB-2438U1129R300	442.79
	2438U1129F1		P-UB-1	120 mm		KOB-2438U1129R100	161.01
BOOM LH	2438U1103F1		P-UB-10	85 mm	125 mm	KOB-2438U1102R300	328.12
	2438U1103F1		P-UB-1	85 mm		KOB-2438U1102R600	118.89
	2438U1103F1		N-N-10		125 mm	KOB-2438U1102R200	209.25
	2438U1107F1		P-UB-10	85 mm	125 mm	KOB-2438U1106R300	423.76
	2438U1107F1		P-UB-1	85 mm		KOB-2438U1106R100	156.79
	2438U1107F1		N-N-10		125 mm	KOB-2438U1106R200	266.95
BOOM RH	2438U1102F1		P-UB-10	85 mm	125 mm	KOB-2438U1102R300	328.12
	2438U1102F1		P-UB-1	85 mm		KOB-2438U1102R600	118.89
	2438U1102F1		N-N-10		125 mm	KOB-2438U1102R200	209.25
	2438U1106F1		P-UB-10	85 mm	125 mm	KOB-2438U1106R300	423.76
	2438U1106F1		P-UB-1	85 mm		KOB-2438U1106R100	156.79
	2438U1106F1		N-N-10		125 mm	KOB-2438U1106R200	266.95
BUCKET	2438U1097F1		P-UB-10	65 mm	95 mm	KOB-2438U1097R300	318.55
	2438U1097F1		P-UB-1	65 mm		KOB-2438U1097R100	124.99
	2438U1097F1		N-N-10		95 mm	KOB-2438U1097R200	193.57
	2438U1097F2		P-UB-10	65 mm	95 mm	KOB-2438U1097R300	318.55
	2438U1097F2		P-UB-1	65 mm		KOB-2438U1097R100	124.99
	2438U1097F2		N-N-10		95 mm	KOB-2438U1097R200	193.57
	2438U1105F1		P-UB-1	80 mm		KOB-2438U1105R400	112.01
	2438U1105F1		N-N-10		120 mm	KOB-2438U1105R200	147.14
	2438U1109F1		P-UB-10	80 mm	120 mm	KOB-2438U1109R300	310.95
	2438U1109F1		N-N-10		120 mm	KOB-2438U1109R100	159.10
	2438U1109F1		P-UB-1	80 mm		KOB-2438U1109R200	153.22
TELESCOPIC	2438U1130F1		P-UB-1	60 mm		KOB-2438U705R100	89.59
	2438U1130F2		P-UB-1	60 mm		KOB-2438U705R100	89.59
MODEL SK200 IV							
ARM	2438U1104F1	YNU0201-YNU0500	P-UB-10	100 mm	145 mm	KOB-2438U1104R300	409.89
	2438U1104F1	YNU0201-YNU0500	P-UB-1	100 mm		KOB-2438U1104R400	138.04
	2438U1104F1	YNU0201-YNU0500	N-N-10		145 mm	KOB-2438U1104R200	309.41
	2438U1104F1	YNU0201-YNU0500	Bushing	100 mm		KOB-2438U1104S4	51.68
	2438U1104F1	YNU0501-	P-UB-10	100 mm	145 mm	KOB-2438U1104R500	447.45
	2438U1104F1	YNU0501-	P-UB-1	100 mm		KOB-2438U1104R400	138.04
	2438U1104F1	YNU0501-	N-N-10		145 mm	KOB-2438U1104R200	309.41
	2438U1104F1	YNU0501-	Bushing	100 mm		KOB-2438U1104S4	51.68
	BOOM LH	2438U1103F1	YNU0201-YNU0500	P-UB-10	85 mm	125 mm	KOB-2438U1102R300
2438U1103F1		YNU0201-YNU0500	P-UB-1	85 mm		KOB-2438U1102R600	118.89
2438U1103F1		YNU0201-YNU0500	N-N-10		125 mm	KOB-2438U1102R200	209.25

Replacement Kits For

KOBELCO®

Excavators								
APPLICATION	CYL #	SERIAL #	CODE	ROD	BORE	KIT #	List \$	
MODEL SK200 IV								
BOOM LH	2438U1103F1	YNU0501-	P-UB-10	85 mm	125 mm	KOB-2438U1102R500	328.12	
	2438U1103F1	YNU0501-	P-UB-1	85 mm		KOB-2438U1102R600	118.89	
	2438U1103F1	YNU0501-	N-N-10		125 mm	KOB-2438U1102R200	209.25	
BOOM RH	2438U1102F1	YNU0201-YNU0500	P-UB-10	85 mm	125 mm	KOB-2438U1102R300	328.12	
	2438U1102F1	YNU0201-YNU0500	P-UB-1	85 mm		KOB-2438U1102R600	118.89	
	2438U1102F1	YNU0201-YNU0500	N-N-10		125 mm	KOB-2438U1102R200	209.25	
	2438U1102F1	YNU0501-	P-UB-10	85 mm	125 mm	KOB-2438U1102R500	328.12	
	2438U1102F1	YNU0501-	P-UB-1	85 mm		KOB-2438U1102R600	118.89	
	2438U1102F1	YNU0501-	N-N-10		125 mm	KOB-2438U1102R200	209.25	
BUCKET	2438U1097F2	YNU0501-	P-UB-1	65 mm		KOB-2438U1097R100	124.99	
	2438U1097F2	YNU0501-	N-N-10		95 mm	KOB-2438U1097R200	193.57	
	2438U1105F1	YNU0201-YNU0500	P-UB-1	80 mm		KOB-2438U1105R400	112.01	
	2438U1105F1	YNU0201-YNU0500	N-N-10		120 mm	KOB-2438U1105R200	147.14	
	2438U1105F1	YNU0501-	P-UB-10	80 mm	120 mm	KOB-2438U1105R500	242.52	
	2438U1105F1	YNU0501-	P-UB-1	80 mm		KOB-2438U1105R400	112.01	
	2438U1105F1	YNU0501-	N-N-10		120 mm	KOB-2438U1105R200	147.14	
MODEL SK200 V								
ARM	YN01V00003F1	YN018001-YN022848	P-UB-14	95 mm	135 mm	KOB-YN01V00003R300	302.48	
	YN01V00003F1	YN018001-YN022848	P-UB-1	95 mm		KOB-YN01V00003R100	60.53	
	YN01V00003F1	YN018001-YN022848	N-N-14		135 mm	KOB-YN01V00019R100	241.95	
	YN01V00003F1	YQ02801-	P-UB-14	95 mm	135 mm	KOB-YN01V00003R300	302.48	
	YN01V00003F1	YQ02801-	P-UB-1	95 mm		KOB-YN01V00003R100	60.53	
	YN01V00003F1	YQ02801-	N-N-14		135 mm	KOB-YN01V00019R100	241.95	
	YN01V00003F3	YN018001-YN022848	P-UB-14	95 mm	135 mm	KOB-YN01V00003R300	302.48	
	YN01V00003F3	YN018001-YN022848	P-UB-1	95 mm		KOB-YN01V00003R100	60.53	
	YN01V00003F3	YN018001-YN022848	N-N-14		135 mm	KOB-YN01V00019R100	241.95	
	YN01V00003F3	YQ02801-	P-UB-14	95 mm	135 mm	KOB-YN01V00003R300	302.48	
	YN01V00003F3	YQ02801-	P-UB-1	95 mm		KOB-YN01V00003R100	60.53	
	YN01V00003F3	YQ02801-	N-N-14		135 mm	KOB-YN01V00019R100	241.95	
	YN01V00019F1	YNT00001-	P-UB-14	95 mm	135 mm	KOB-YN01V00019R200	302.48	
	YN01V00019F1	YNT00001-	P-UB-1	95 mm		KOB-YN01V00003R100	60.53	
	YN01V00019F1	YNT00001-	N-N-14		135 mm	KOB-YN01V00019R100	241.95	
	YN01V00019F1	YQ02801-	P-UB-14	95 mm	135 mm	KOB-YN01V00019R200	302.48	
	YN01V00019F1	YQ02801-	P-UB-1	95 mm		KOB-YN01V00003R100	60.53	
	YN01V00019F1	YQ02801-	N-N-14		135 mm	KOB-YN01V00019R100	241.95	
	YN01V00019F2	YNT00001-	P-UB-14	95 mm	135 mm	KOB-YN01V00019R200	302.48	
	YN01V00019F2	YNT00001-	P-UB-1	95 mm		KOB-YN01V00003R100	60.53	
	YN01V00019F2	YNT00001-	N-N-14		135 mm	KOB-YN01V00019R100	241.95	
	YN01V00019F2	YQ02801-	P-UB-14	95 mm	135 mm	KOB-YN01V00019R200	302.48	
	YN01V00019F2	YQ02801-	P-UB-1	95 mm		KOB-YN01V00003R100	60.53	
	YN01V00019F2	YQ02801-	N-N-14		135 mm	KOB-YN01V00019R100	241.95	
	BOOM	YN01V0001F1	YNT00001-	P-UB-14	80 mm	120 mm	KOB-YN01V00001R300	189.32
		YN01V0001F1	YNT00001-	P-UB-1	80 mm		KOB-YN01V00001R100	90.11
		YN01V0001F1	YNT00001-	N-N-14		120 mm	KOB-YN01V00001R200	99.20
YN01V0001F2		YNT00001-	P-UB-14	80 mm	120 mm	KOB-YN01V00001R300	189.32	
YN01V0001F2		YNT00001-	P-UB-1	80 mm		KOB-YN01V00001R100	90.11	
YN01V0001F2		YNT00001-	N-N-14		120 mm	KOB-YN01V00001R200	99.20	
BOOM LH	YN01V00002F1	YN018001-YN022848	P-UB-14	80 mm	120 mm	KOB-YN01V00001R300	189.32	
	YN01V00002F1	YN018001-YN022848	P-UB-1	80 mm		KOB-YN01V00001R100	90.11	
	YN01V00002F1	YN018001-YN022848	N-N-14		120 mm	KOB-YN01V00001R200	99.20	
	YN01V00002F1	YQ02801-	P-UB-14	80 mm	120 mm	KOB-YN01V00001R300	189.32	
	YN01V00002F1	YQ02801-	P-UB-1	80 mm		KOB-YN01V00001R100	90.11	
	YN01V00002F1	YQ02801-	N-N-14		120 mm	KOB-YN01V00001R200	99.20	
	YN01V00002F2	YN018001-YN022848	P-UB-14	80 mm	120 mm	KOB-YN01V00001R300	189.32	
	YN01V00002F2	YN018001-YN022848	P-UB-1	80 mm		KOB-YN01V00001R100	90.11	

KOBELCO®

Replacement Kits For

KOBELCO®

Excavators								
APPLICATION	CYL #	SERIAL #	CODE	ROD	BORE	KIT #	List \$	
MODEL SK200 V								
BOOM LH	YN01V00002F2	YN018001-YN022848	N-N-14		120 mm	KOB-YN01V00001R200	99.20	
	YN01V00002F2	YQ02801-	P-UB-14	80 mm	120 mm	KOB-YN01V00001R300	189.32	
	YN01V00002F2	YQ02801-	P-UB-1	80 mm		KOB-YN01V00001R100	90.11	
	YN01V00002F2	YQ02801-	N-N-14		120 mm	KOB-YN01V00001R200	99.20	
BOOM RH	YN01V00001F1	YN018001-YN022848	P-UB-14	80 mm	120 mm	KOB-YN01V00001R300	189.32	
	YN01V00001F1	YN018001-YN022848	P-UB-1	80 mm		KOB-YN01V00001R100	90.11	
	YN01V00001F1	YN018001-YN022848	N-N-14		120 mm	KOB-YN01V00001R200	99.20	
	YN01V00001F1	YQ02801-	P-UB-14	80 mm	120 mm	KOB-YN01V00001R300	189.32	
	YN01V00001F1	YQ02801-	P-UB-1	80 mm		KOB-YN01V00001R100	90.11	
	YN01V00001F1	YQ02801-	N-N-14		120 mm	KOB-YN01V00001R200	99.20	
	YN01V00001F2	YN018001-YN022848	P-UB-14	80 mm	120 mm	KOB-YN01V00001R300	189.32	
	YN01V00001F2	YN018001-YN022848	P-UB-1	80 mm		KOB-YN01V00001R100	90.11	
	YN01V00001F2	YN018001-YN022848	N-N-14		120 mm	KOB-YN01V00001R200	99.20	
	YN01V00001F2	YQ02801-	P-UB-14	80 mm	120 mm	KOB-YN01V00001R300	189.32	
	YN01V00001F2	YQ02801-	P-UB-1	80 mm		KOB-YN01V00001R100	90.11	
	YN01V00001F2	YQ02801-	N-N-14		120 mm	KOB-YN01V00001R200	99.20	
	YN01V00001F2	YQ02801-	P-UB-14	80 mm	120 mm	KOB-YN01V00001R300	189.32	
	YN01V00001F2	YQ02801-	P-UB-1	80 mm		KOB-YN01V00001R100	90.11	
BUCKET	LP01V00005F1	YNT00001-	N-N-14		95 mm	KOB-YW01V00003R200	83.31	
	LP01V00005F2	YNT00001-	N-N-14		95 mm	KOB-YW01V00003R200	83.31	
	LP01V00005F3	YNT00001-	N-N-14		95 mm	KOB-YW01V00003R200	83.31	
	YN01V00004F1	YN018001-YN022848	P-UB-14	75 mm	115 mm	KOB-YN01V00004R300	145.53	
	YN01V00004F1	YN018001-YN022848	P-UB-1	75 mm		KOB-YN01V00004R100	57.05	
	YN01V00004F1	YN018001-YN022848	N-N-14		115 mm	KOB-YN01V00004R200	88.48	
	YN01V00004F1	YNT00001-	P-UB-14	75 mm	115 mm	KOB-YN01V00004R300	145.53	
	YN01V00004F1	YNT00001-	P-UB-1	75 mm		KOB-YN01V00004R100	57.05	
	YN01V00004F1	YNT00001-	N-N-14		115 mm	KOB-YN01V00004R200	88.48	
	YN01V00004F1	YQ02801-	P-UB-14	75 mm	115 mm	KOB-YN01V00004R300	145.53	
	YN01V00004F1	YQ02801-	P-UB-1	75 mm		KOB-YN01V00004R100	57.05	
	YN01V00004F1	YQ02801-	N-N-14		115 mm	KOB-YN01V00004R200	88.48	
	YN01V00004F2	YN018001-YN022848	P-UB-14	75 mm	115 mm	KOB-YN01V00004R300	145.53	
	YN01V00004F2	YN018001-YN022848	P-UB-1	75 mm		KOB-YN01V00004R100	57.05	
	YN01V00004F2	YN018001-YN022848	N-N-14		115 mm	KOB-YN01V00004R200	88.48	
	YN01V00004F2	YNT00001-	P-UB-14	75 mm	115 mm	KOB-YN01V00004R300	145.53	
	YN01V00004F2	YNT00001-	P-UB-1	75 mm		KOB-YN01V00004R100	57.05	
	YN01V00004F2	YNT00001-	N-N-14		115 mm	KOB-YN01V00004R200	88.48	
	YN01V00004F2	YQ02801-	P-UB-14	75 mm	115 mm	KOB-YN01V00004R300	145.53	
	YN01V00004F2	YQ02801-	P-UB-1	75 mm		KOB-YN01V00004R100	57.05	
	YN01V00004F2	YQ02801-	N-N-14		115 mm	KOB-YN01V00004R200	88.48	
	BUCKET Long Range	LP01V00005F1	YN018001-YN022848	N-N-14		95 mm	KOB-YW01V00003R200	83.31
		LP01V00005F1	YNT00001-	N-N-14		95 mm	KOB-YW01V00003R200	83.31
		LP01V00005F1	YQ02801-	N-N-14		95 mm	KOB-YW01V00003R200	83.31
LP01V00005F2		YN018001-YN022848	N-N-14		95 mm	KOB-YW01V00003R200	83.31	
LP01V00005F2		YNT00001-	N-N-14		95 mm	KOB-YW01V00003R200	83.31	
LP01V00005F2		YQ02801-	N-N-14		95 mm	KOB-YW01V00003R200	83.31	
LP01V00005F3		YN018001-YN022848	N-N-14		95 mm	KOB-YW01V00003R200	83.31	
LP01V00005F3		YNT00001-	N-N-14		95 mm	KOB-YW01V00003R200	83.31	
LP01V00005F3		YQ02801-	N-N-14		95 mm	KOB-YW01V00003R200	83.31	
YW01V00003F1		YN018001-YN022848	N-N-14		95 mm	KOB-YW01V00003R200	83.31	
MODEL SK200-6								
ARM	YN01V00039F1	YN30001-	P-UB-14	95 mm	135 mm	KOB-YN01V00039R300	246.98	
	YN01V00039F1	YN30001-	P-UB-1	95 mm		KOB-YN01V00039R100	60.53	
	YN01V00039F1	YN30001-	N-N-14		135 mm	KOB-YN01V00039R200	186.46	
ARM HD, Dismantle	YN01V00078F1	YN30001-	P-UB-14	95 mm	135 mm	KOB-YN01V00078R300	246.98	
	YN01V00078F1	YN30001-	P-UB-1	95 mm		KOB-YN01V00078R100	60.53	

Replacement Kits For

KOBELCO®

Excavators							
APPLICATION	CYL #	SERIAL #	CODE	ROD	BORE	KIT #	List \$
MODEL SK200-6							
ARM HD, Dismantle	YN01V00078F1	YN30001-	N-N-14		135 mm	KOB-YN01V00039R200	186.46
BOOM LH	YN01V00038F1	YN30001-	P-UB-14	85 mm	125 mm	KOB-YN01V00052R300	202.64
	YN01V00038F1	YN30001-	P-UB-1	85 mm		KOB-YN01V00052R100	57.05
	YN01V00038F1	YN30001-	N-N-14		125 mm	KOB-YN01V00052R200	145.60
BOOM RH	YN01V00037F1	YN30001-	P-UB-14	85 mm	125 mm	KOB-YN01V00052R300	202.64
	YN01V00037F1	YN30001-	P-UB-1	85 mm		KOB-YN01V00052R100	57.05
	YN01V00037F1	YN30001-	N-N-14		125 mm	KOB-YN01V00052R200	145.60
BUCKET	YN01V00068F1	YN30001-	P-UB-14	80 mm	115 mm	KOB-YN01V00068R300	118.26
	YN01V00068F1	YN30001-	P-UB-1	80 mm		KOB-YN01V00068R100	57.23
	YN01V00068F1	YN30001-	N-N-14		115 mm	KOB-YN01V00068R200	61.03
BUCKET HD, Dismantle	YN01V00077F1	YN30001-	P-UB-14	80 mm	115 mm	KOB-YN01V00077R300	118.26
	YN01V00077F1	YN30001-	P-UB-1	80 mm		KOB-YN01V00068R100	57.23
	YN01V00077F1	YN30001-	N-N-14		115 mm	KOB-YN01V00068R200	61.03
MODEL SK200-6ES							
ARM	YN01V00118F1	YN10-38001-YN10-41732	P-UB-1	95 mm		KOB-YN01V00105R100	138.45
	YN01V00118F2	YN10-38001-YN10-41732	P-UB-1	95 mm		KOB-YN01V00105R100	138.45
	YN01V00132F1	YN10-38001-YN10-41732	P-UB-10	95 mm	135 mm	KOB-YN01V00105R900	382.74
	YN01V00132F1	YN10-38001-YN10-41732	P-UB-1	95 mm		KOB-YN01V00105R100	138.45
	YN01V00132F1	YN10-38001-YN10-41732	N-N-10		135 mm	KOB-YN01V00105R800	244.29
	YN01V00132F2	YN10-38001-YN10-41732	P-UB-10	95 mm	135 mm	KOB-YN01V00105R900	382.74
	YN01V00132F2	YN10-38001-YN10-41732	P-UB-1	95 mm		KOB-YN01V00105R100	138.45
	YN01V00132F2	YN10-38001-YN10-41732	N-N-10		135 mm	KOB-YN01V00105R800	244.29
	YN01V00132F3	YN10-38001-YN10-41732	P-UB-10	95 mm	135 mm	KOB-YN01V00105R900	382.74
	YN01V00132F3	YN10-38001-YN10-41732	P-UB-1	95 mm		KOB-YN01V00105R100	138.45
	YN01V00132F3	YN10-38001-YN10-41732	N-N-10		135 mm	KOB-YN01V00105R800	244.29
	YN01V00132F4	YN10-38001-YN10-41732	P-UB-10	95 mm	135 mm	KOB-YN01V00105R900	382.74
	YN01V00132F4	YN10-38001-YN10-41732	P-UB-1	95 mm		KOB-YN01V00105R100	138.45
	YN01V00132F4	YN10-38001-YN10-41732	N-N-10		135 mm	KOB-YN01V00105R800	244.29
	YN01V00132F5	YN10-38001-YN10-41732	P-UB-10	95 mm	135 mm	KOB-YN01V00105R900	382.74
	YN01V00132F5	YN10-38001-YN10-41732	P-UB-1	95 mm		KOB-YN01V00105R100	138.45
	YN01V00132F5	YN10-38001-YN10-41732	N-N-10		135 mm	KOB-YN01V00105R800	244.29
BOOM LH	YN01V00104F1	YN10-38001-YN10-41732	P-UB-10	85 mm	125 mm	KOB-YN01V00103R900	308.86
	YN01V00104F1	YN10-38001-YN10-41732	P-UB-1	85 mm		KOB-YN01V00103R100	118.57
	YN01V00104F1	YN10-38001-YN10-41732	N-N-10		125 mm	KOB-YN01V00103R800	190.31
	YN01V00104F2	YN10-38001-YN10-41732	P-UB-10	85 mm	125 mm	KOB-YN01V00103R900	308.86
	YN01V00104F2	YN10-38001-YN10-41732	P-UB-1	85 mm		KOB-YN01V00103R100	118.57
	YN01V00104F2	YN10-38001-YN10-41732	N-N-10		125 mm	KOB-YN01V00103R800	190.31
	YN01V00104F3	YN10-38001-YN10-41732	P-UB-10	85 mm	125 mm	KOB-YN01V00103R900	308.86
	YN01V00104F3	YN10-38001-YN10-41732	P-UB-1	85 mm		KOB-YN01V00103R100	118.57
BOOM RH	YN01V00103F1	YN10-38001-YN10-41732	P-UB-10	85 mm	125 mm	KOB-YN01V00103R900	308.86
	YN01V00103F1	YN10-38001-YN10-41732	P-UB-1	85 mm		KOB-YN01V00103R100	118.57
	YN01V00103F1	YN10-38001-YN10-41732	N-N-10		125 mm	KOB-YN01V00103R800	190.31
	YN01V00103F2	YN10-38001-YN10-41732	P-UB-10	85 mm	125 mm	KOB-YN01V00103R900	308.86
	YN01V00103F2	YN10-38001-YN10-41732	P-UB-1	85 mm		KOB-YN01V00103R100	118.57
	YN01V00103F2	YN10-38001-YN10-41732	N-N-10		125 mm	KOB-YN01V00103R800	190.31
	YN01V00103F3	YN10-38001-YN10-41732	P-UB-10	85 mm	125 mm	KOB-YN01V00103R900	308.86
	YN01V00103F3	YN10-38001-YN10-41732	P-UB-1	85 mm		KOB-YN01V00103R100	118.57
BUCKET	YN01V00112F1	YN10-38001-YN10-41732	P-UB-10	80 mm	120 mm	KOB-YN01V00112R900	379.21
	YN01V00112F1	YN10-38001-YN10-41732	P-UB-1	80 mm		KOB-YN01V00112R100	138.93
	YN01V00112F1	YN10-38001-YN10-41732	N-N-10		120 mm	KOB-YN01V00112R800	236.82
	YN01V00112F2	YN10-38001-YN10-41732	P-UB-10	80 mm	120 mm	KOB-YN01V00112R900	379.21

KOBELCO®

KOBELCO®

Replacement Kits For

Excavators							
APPLICATION	CYL #	SERIAL #	CODE	ROD	BORE	KIT #	List \$
MODEL SK200-6ES							
BUCKET	YN01V00112F2	YN10-38001-YN10-41732	P-UB-1	80 mm		KOB-YN01V00112R100	138.93
	YN01V00112F2	YN10-38001-YN10-41732	N-N-10		120 mm	KOB-YN01V00112R800	236.82
	YN01V00112F4	YN10-38001-YN10-41732	P-UB-10	80 mm	120 mm	KOB-YN01V00112R900	379.21
	YN01V00112F4	YN10-38001-YN10-41732	P-UB-1	80 mm		KOB-YN01V00112R100	138.93
	YN01V00112F4	YN10-38001-YN10-41732	N-N-10		120 mm	KOB-YN01V00112R800	236.82
	YN01V00112F5	YN10-38001-YN10-41732	P-UB-10	80 mm	120 mm	KOB-YN01V00112R900	379.21
	YN01V00112F5	YN10-38001-YN10-41732	P-UB-1	80 mm		KOB-YN01V00112R100	138.93
	YN01V00112F5	YN10-38001-YN10-41732	N-N-10		120 mm	KOB-YN01V00112R800	236.82
	YN01V00119F1	YN10-38001-YN10-41732	P-UB-1	80 mm		KOB-YN01V00112R100	138.93
	YN01V00119F2	YN10-38001-YN10-41732	P-UB-1	80 mm		KOB-YN01V00112R100	138.93
YN01V00119F3	YN10-38001-YN10-41732	P-UB-1	80 mm		KOB-YN01V00112R100	138.93	
MODEL SK200-8							
ARM	YN01V00175F1	YN11-45001-	P-UB-10	95 mm	135 mm	KOB-YN01V00175R300	395.31
	YN01V00175F1	YN11-45001-	P-UB-1	95 mm		KOB-YN01V00175R100	118.51
	YN01V00175F1	YN11-45001-	N-N-10		135 mm	KOB-YN01V00175R200	268.31
	YN01V00175F2	YN11-45001-	P-UB-10	95 mm	135 mm	KOB-YN01V00175R300	395.31
	YN01V00175F2	YN11-45001-	P-UB-1	95 mm		KOB-YN01V00175R100	118.51
	YN01V00175F2	YN11-45001-	N-N-10		135 mm	KOB-YN01V00175R200	268.31
	YN02B00486F1	YN12-56001-	P-UB-10	95 mm	135 mm	KOB-YN01V00175R300	395.31
	YN02B00486F1	YN12-56001-	P-UB-1	95 mm		KOB-YN01V00175R100	118.51
YN02B00486F1	YN12-56001-	N-N-10		135 mm	KOB-YN01V00175R200	268.31	
BOOM	YN01V00151F1	YN11-45001-	P-UB-10	85 mm	120 mm	KOB-YN01V00151R300	431.35
	YN01V00151F1	YN11-45001-	P-UB-1	85 mm		KOB-YN01V00151R100	115.54
	YN01V00151F1	YN11-45001-	N-N-10		120 mm	KOB-YN01V00151R200	117.93
	YN02B00405F1	YN12-56001-	P-UB-10	85 mm	120 mm	KOB-YN01V00151R700	310.42
	YN02B00405F1	YN12-56001-	P-UB-1	85 mm		KOB-YN01V00151R100	115.54
	YN02B00405F1	YN12-56001-	N-N-10		120 mm	KOB-YN01V00151R600	119.11
BUCKET	YN01V00153F1	YN11-45001-	P-UB-10	80 mm	120 mm	KOB-YN01V00153R300	437.05
	YN01V00153F1	YN11-45001-	P-UB-1	80 mm		KOB-YN01V00153R100	119.97
	YN01V00153F1	YN11-45001-	N-N-10		120 mm	KOB-YN01V00151R200	117.93
	YN01V00153F2	YN11-45001-	P-UB-10	80 mm	120 mm	KOB-YN01V00153R300	437.05
	YN01V00153F2	YN11-45001-	P-UB-1	80 mm		KOB-YN01V00153R100	119.97
	YN01V00153F2	YN11-45001-	N-N-10		120 mm	KOB-YN01V00151R200	117.93
	YN12B00969F1	YN12-56001-	P-UB-10	80 mm	120 mm	KOB-YN01V00153R300	437.05
	YN12B00969F1	YN12-56001-	P-UB-1	80 mm		KOB-YN01V00153R100	119.97
	YN12B00969F1	YN12-56001-	N-N-10		120 mm	KOB-YN01V00151R200	117.93
	MODEL SK200LC						
ARM	2438U1104F1	YQU0701-	P-UB-10	100 mm	145 mm	KOB-2438U1104R500	447.45
	2438U1104F1	YQU0701-	P-UB-1	100 mm		KOB-2438U1104R400	138.04
	2438U1104F1	YQU0701-	N-N-10		145 mm	KOB-2438U1104R200	309.41
	2438U1108F1	YQU0701-	P-UB-14	100 mm	145 mm	KOB-2438U1108R300	387.74
	2438U1108F1	YQU0701-	P-UB-1	100 mm		KOB-2438U1108R100	171.04
	2438U1108F1	YQU0701-	N-N-14		145 mm	KOB-2438U1108R200	196.56
BOOM LH	2438U1103F1	YQU0701-	P-UB-10	85 mm	125 mm	KOB-2438U1102R500	328.12
	2438U1103F1	YQU0701-	P-UB-1	85 mm		KOB-2438U1102R600	118.89
	2438U1103F1	YQU0701-	N-N-10		125 mm	KOB-2438U1102R200	209.25
	2438U1107F1	YQU0701-	P-UB-10	85 mm	125 mm	KOB-2438U1106R300	423.76
	2438U1107F1	YQU0701-	P-UB-1	85 mm		KOB-2438U1106R100	156.79
	2438U1107F1	YQU0701-	N-N-10		125 mm	KOB-2438U1106R200	266.95
BOOM RH	2438U1102F1	YQU0701-	P-UB-10	85 mm	125 mm	KOB-2438U1102R500	328.12
	2438U1102F1	YQU0701-	P-UB-1	85 mm		KOB-2438U1102R600	118.89
	2438U1102F1	YQU0701-	N-N-10		125 mm	KOB-2438U1102R200	209.25
	2438U1106F1	YQU0701-	P-UB-10	85 mm	125 mm	KOB-2438U1106R300	423.76
	2438U1106F1	YQU0701-	P-UB-1	85 mm		KOB-2438U1106R100	156.79
	2438U1106F1	YQU0701-	N-N-10		125 mm	KOB-2438U1106R200	266.95

KOBELCO®

Replacement Kits For

KOBELCO®

Excavators							
APPLICATION	CYL #	SERIAL #	CODE	ROD	BORE	KIT #	List \$
MODEL SK200LC							
BUCKET	2438U1105F1	YQU0701-	P-UB-10	80 mm	120 mm	KOB-2438U1105R500	242.52
	2438U1105F1	YQU0701-	P-UB-1	80 mm		KOB-2438U1105R400	112.01
	2438U1105F1	YQU0701-	N-N-10		120 mm	KOB-2438U1105R200	147.14
	2438U1109F1	YQU0701-	P-UB-10	80 mm	120 mm	KOB-2438U1109R300	310.95
	2438U1109F1	YQU0701-	P-UB-1	80 mm		KOB-2438U1109R200	153.22
	2438U1109F1	YQU0701-	N-N-10		120 mm	KOB-2438U1109R100	159.10
MODEL SK200LC III							
ARM	2438U1104F1		P-UB-10	100 mm	145 mm	KOB-2438U1104R300	409.89
	2438U1104F1		P-UB-1	100 mm		KOB-2438U1104R400	138.04
	2438U1104F1		N-N-10		145 mm	KOB-2438U1104R200	309.41
	2438U1104F1		Bushing	100 mm		KOB-2438U1104S4	51.68
	2438U1108F1		P-UB-14	100 mm	145 mm	KOB-2438U1108R300	387.74
	2438U1108F1		P-UB-1	100 mm		KOB-2438U1108R100	171.04
	2438U1108F1		N-N-14		145 mm	KOB-2438U1108R200	196.56
	2438U1129F1		P-UB-10	120 mm	180 mm	KOB-2438U1129R300	442.79
	2438U1129F1		P-UB-1	120 mm		KOB-2438U1129R100	161.01
	2438U1129F1		N-N-10		180 mm	KOB-2445R174R200	281.76
BOOM LH	2438U1103F1		P-UB-10	85 mm	125 mm	KOB-2438U1102R300	328.12
	2438U1103F1		P-UB-1	85 mm		KOB-2438U1102R600	118.89
	2438U1103F1		N-N-10		125 mm	KOB-2438U1102R200	209.25
	2438U1107F1		P-UB-10	85 mm	125 mm	KOB-2438U1106R300	423.76
	2438U1107F1		P-UB-1	85 mm		KOB-2438U1106R100	156.79
	2438U1107F1		N-N-10		125 mm	KOB-2438U1106R200	266.95
BOOM RH	2438U1102F1		P-UB-10	85 mm	125 mm	KOB-2438U1102R300	328.12
	2438U1102F1		P-UB-1	85 mm		KOB-2438U1102R600	118.89
	2438U1102F1		N-N-10		125 mm	KOB-2438U1102R200	209.25
	2438U1106F1		P-UB-10	85 mm	125 mm	KOB-2438U1106R300	423.76
	2438U1106F1		P-UB-1	85 mm		KOB-2438U1106R100	156.79
	2438U1106F1		N-N-10		125 mm	KOB-2438U1106R200	266.95
BUCKET	2438U1097F1		P-UB-10	65 mm	95 mm	KOB-2438U1097R300	318.55
	2438U1097F1		P-UB-1	65 mm		KOB-2438U1097R100	124.99
	2438U1097F1		N-N-10		95 mm	KOB-2438U1097R200	193.57
	2438U1097F2		P-UB-10	65 mm	95 mm	KOB-2438U1097R300	318.55
	2438U1097F2		P-UB-1	65 mm		KOB-2438U1097R100	124.99
	2438U1097F2		N-N-10		95 mm	KOB-2438U1097R200	193.57
	2438U1105F1		P-UB-1	80 mm		KOB-2438U1105R400	112.01
	2438U1105F1		N-N-10		120 mm	KOB-2438U1105R200	147.14
	2438U1109F1		P-UB-10	80 mm	120 mm	KOB-2438U1109R300	310.95
	2438U1109F1		N-N-10		120 mm	KOB-2438U1109R100	159.10
TELESCOPIC	2438U1130F1		P-UB-1	60 mm		KOB-2438U705R100	89.59
	2438U1130F2		P-UB-1	60 mm		KOB-2438U705R100	89.59
MODEL SK200LC IV							
ARM	2438U1104F1	YQU2001-YQU3000	P-UB-10	100 mm	145 mm	KOB-2438U1104R300	409.89
	2438U1104F1	YQU2001-YQU3000	P-UB-1	100 mm		KOB-2438U1104R400	138.04
	2438U1104F1	YQU2001-YQU3000	N-N-10		145 mm	KOB-2438U1104R200	309.41
	2438U1104F1	YQU2001-YQU3000	Bushing	100 mm		KOB-2438U1104S4	51.68
	2438U1104F1	YQU3101-	P-UB-10	100 mm	145 mm	KOB-2438U1104R500	447.45
	2438U1104F1	YQU3101-	P-UB-1	100 mm		KOB-2438U1104R400	138.04
	2438U1104F1	YQU3101-	N-N-10		145 mm	KOB-2438U1104R200	309.41
	2438U1104F1	YQU3101-	Bushing	100 mm		KOB-2438U1104S4	51.68
BOOM LH	2438U1103F1	YQU2001-YQU3000	P-UB-10	85 mm	125 mm	KOB-2438U1102R300	328.12
	2438U1103F1	YQU2001-YQU3000	P-UB-1	85 mm		KOB-2438U1102R600	118.89
	2438U1103F1	YQU2001-YQU3000	N-N-10		125 mm	KOB-2438U1102R200	209.25
	2438U1103F1	YQU3101-	P-UB-10	85 mm	125 mm	KOB-2438U1102R500	328.12

Replacement Kits For

KOBELCO®

Excavators								
APPLICATION	CYL #	SERIAL #	CODE	ROD	BORE	KIT #	List \$	
MODEL SK200LC IV								
BOOM LH	2438U1103F1	YQU3101-	P-UB-1	85 mm		KOB-2438U1102R600	118.89	
	2438U1103F1	YQU3101-	N-N-10		125 mm	KOB-2438U1102R200	209.25	
BOOM RH	2438U1102F1	YQU2001-YQU3000	P-UB-10	85 mm	125 mm	KOB-2438U1102R300	328.12	
	2438U1102F1	YQU2001-YQU3000	P-UB-1	85 mm		KOB-2438U1102R600	118.89	
	2438U1102F1	YQU2001-YQU3000	N-N-10		125 mm	KOB-2438U1102R200	209.25	
	2438U1102F1	YQU3101-	P-UB-10	85 mm	125 mm	KOB-2438U1102R300	328.12	
	2438U1102F1	YQU3101-	P-UB-1	85 mm		KOB-2438U1102R600	118.89	
	2438U1102F1	YQU3101-	N-N-10		125 mm	KOB-2438U1102R200	209.25	
BUCKET	2438U1105F1	YQU3101-	P-UB-10	80 mm	120 mm	KOB-2438U1105R500	242.52	
	2438U1105F1	YQU3101-	P-UB-1	80 mm		KOB-2438U1105R400	112.01	
	2438U1105F1	YQU3101-	N-N-10		120 mm	KOB-2438U1105R200	147.14	
BUCKET Long Reach	2438U1097F2	YQU3101-	P-UB-1	65 mm		KOB-2438U1097R100	124.99	
	2438U1097F2	YQU3101-	N-N-10		95 mm	KOB-2438U1097R200	193.57	
MODEL SK200LC V								
ARM	YN01V00003F1	YQ002301-YQ002645	P-UB-14	95 mm	135 mm	KOB-YN01V00003R300	302.48	
	YN01V00003F1	YQ002301-YQ002645	P-UB-1	95 mm		KOB-YN01V00003R100	60.53	
	YN01V00003F1	YQ002301-YQ002645	N-N-14		135 mm	KOB-YN01V00019R100	241.95	
	YN01V00003F1	YQ02801-	P-UB-14	95 mm	135 mm	KOB-YN01V00003R300	302.48	
	YN01V00003F1	YQ02801-	P-UB-1	95 mm		KOB-YN01V00003R100	60.53	
	YN01V00003F1	YQ02801-	N-N-14		135 mm	KOB-YN01V00019R100	241.95	
	YN01V00003F3	YQ002301-YQ002645	P-UB-14	95 mm	135 mm	KOB-YN01V00003R300	302.48	
	YN01V00003F3	YQ002301-YQ002645	P-UB-1	95 mm		KOB-YN01V00003R100	60.53	
	YN01V00003F3	YQ002301-YQ002645	N-N-14		135 mm	KOB-YN01V00019R100	241.95	
	YN01V00003F3	YQ02801-	P-UB-14	95 mm	135 mm	KOB-YN01V00003R300	302.48	
	YN01V00003F3	YQ02801-	P-UB-1	95 mm		KOB-YN01V00003R100	60.53	
	YN01V00003F3	YQ02801-	N-N-14		135 mm	KOB-YN01V00019R100	241.95	
	YN01V00019F1	YQ02801-	P-UB-14	95 mm	135 mm	KOB-YN01V00019R200	302.48	
	YN01V00019F1	YQ02801-	P-UB-1	95 mm		KOB-YN01V00003R100	60.53	
	YN01V00019F1	YQ02801-	N-N-14		135 mm	KOB-YN01V00019R100	241.95	
	YN01V00019F1	YQT00001-	P-UB-14	95 mm	135 mm	KOB-YN01V00019R200	302.48	
	YN01V00019F1	YQT00001-	P-UB-1	95 mm		KOB-YN01V00003R100	60.53	
	YN01V00019F1	YQT00001-	N-N-14		135 mm	KOB-YN01V00019R100	241.95	
	YN01V00019F2	YQ02801-	P-UB-14	95 mm	135 mm	KOB-YN01V00019R200	302.48	
	YN01V00019F2	YQ02801-	P-UB-1	95 mm		KOB-YN01V00003R100	60.53	
	YN01V00019F2	YQ02801-	N-N-14		135 mm	KOB-YN01V00019R100	241.95	
	YN01V00019F2	YQT00001-	P-UB-14	95 mm	135 mm	KOB-YN01V00019R200	302.48	
	YN01V00019F2	YQT00001-	P-UB-1	95 mm		KOB-YN01V00003R100	60.53	
	YN01V00019F2	YQT00001-	N-N-14		135 mm	KOB-YN01V00019R100	241.95	
	BOOM LH	YN01V00002F1	YQ002301-YQ002645	P-UB-14	80 mm	120 mm	KOB-YN01V00001R300	189.32
		YN01V00002F1	YQ002301-YQ002645	P-UB-1	80 mm		KOB-YN01V00001R100	90.11
		YN01V00002F1	YQ002301-YQ002645	N-N-14		120 mm	KOB-YN01V00001R200	99.20
		YN01V00002F1	YQ02801-	P-UB-14	80 mm	120 mm	KOB-YN01V00001R300	189.32
		YN01V00002F1	YQ02801-	P-UB-1	80 mm		KOB-YN01V00001R100	90.11
		YN01V00002F1	YQ02801-	N-N-14		120 mm	KOB-YN01V00001R200	99.20
		YN01V00002F1	YQT00001-	P-UB-14	80 mm	120 mm	KOB-YN01V00001R300	189.32
		YN01V00002F1	YQT00001-	P-UB-1	80 mm		KOB-YN01V00001R100	90.11
YN01V00002F1		YQT00001-	N-N-14		120 mm	KOB-YN01V00001R200	99.20	
YN01V00002F2		YQ002301-YQ002645	P-UB-14	80 mm	120 mm	KOB-YN01V00001R300	189.32	
YN01V00002F2		YQ002301-YQ002645	P-UB-1	80 mm		KOB-YN01V00001R100	90.11	
YN01V00002F2		YQ002301-YQ002645	N-N-14		120 mm	KOB-YN01V00001R200	99.20	
YN01V00002F2		YQ02801-	P-UB-14	80 mm	120 mm	KOB-YN01V00001R300	189.32	
YN01V00002F2		YQ02801-	P-UB-1	80 mm		KOB-YN01V00001R100	90.11	
YN01V00002F2		YQ02801-	N-N-14		120 mm	KOB-YN01V00001R200	99.20	
YN01V00002F2		YQT00001-	P-UB-14	80 mm	120 mm	KOB-YN01V00001R300	189.32	

Replacement Kits For

KOBELCO®

Excavators							
APPLICATION	CYL #	SERIAL #	CODE	ROD	BORE	KIT #	List \$
MODEL SK200LC V							
BOOM LH	YN01V00002F2	YQT00001-	P-UB-1	80 mm		KOB-YN01V00001R100	90.11
	YN01V00002F2	YQT00001-	N-N-14		120 mm	KOB-YN01V00001R200	99.20
BOOM RH	YN01V00001F1	YQ002301-YQ002645	P-UB-14	80 mm	120 mm	KOB-YN01V00001R300	189.32
	YN01V00001F1	YQ002301-YQ002645	P-UB-1	80 mm		KOB-YN01V00001R100	90.11
	YN01V00001F1	YQ002301-YQ002645	N-N-14		120 mm	KOB-YN01V00001R200	99.20
	YN01V00001F1	YQ02801-	P-UB-14	80 mm	120 mm	KOB-YN01V00001R300	189.32
	YN01V00001F1	YQ02801-	P-UB-1	80 mm		KOB-YN01V00001R100	90.11
	YN01V00001F1	YQ02801-	N-N-14		120 mm	KOB-YN01V00001R200	99.20
	YN01V00001F1	YQT00001-	P-UB-14	80 mm	120 mm	KOB-YN01V00001R300	189.32
	YN01V00001F1	YQT00001-	P-UB-1	80 mm		KOB-YN01V00001R100	90.11
	YN01V00001F1	YQT00001-	N-N-14		120 mm	KOB-YN01V00001R200	99.20
	YN01V00001F2	YQ002301-YQ002645	P-UB-14	80 mm	120 mm	KOB-YN01V00001R300	189.32
	YN01V00001F2	YQ002301-YQ002645	P-UB-1	80 mm		KOB-YN01V00001R100	90.11
	YN01V00001F2	YQ002301-YQ002645	N-N-14		120 mm	KOB-YN01V00001R200	99.20
	YN01V00001F2	YQ02801-	P-UB-14	80 mm	120 mm	KOB-YN01V00001R300	189.32
	YN01V00001F2	YQ02801-	P-UB-1	80 mm		KOB-YN01V00001R100	90.11
	YN01V00001F2	YQ02801-	N-N-14		120 mm	KOB-YN01V00001R200	99.20
	BUCKET	YN01V00004F1	YQ002301-YQ002645	P-UB-14	75 mm	115 mm	KOB-YN01V00004R300
YN01V00004F1		YQ002301-YQ002645	P-UB-1	75 mm		KOB-YN01V00004R100	57.05
YN01V00004F1		YQ002301-YQ002645	N-N-14		115 mm	KOB-YN01V00004R200	88.48
YN01V00004F1		YQ02801-	P-UB-14	75 mm	115 mm	KOB-YN01V00004R300	145.53
YN01V00004F1		YQ02801-	P-UB-1	75 mm		KOB-YN01V00004R100	57.05
YN01V00004F1		YQ02801-	N-N-14		115 mm	KOB-YN01V00004R200	88.48
YN01V00004F1		YQT00001-	P-UB-14	75 mm	115 mm	KOB-YN01V00004R300	145.53
YN01V00004F1		YQT00001-	P-UB-1	75 mm		KOB-YN01V00004R100	57.05
YN01V00004F1		YQT00001-	N-N-14		115 mm	KOB-YN01V00004R200	88.48
YN01V00004F2		YQ02801-	P-UB-14	75 mm	115 mm	KOB-YN01V00004R300	145.53
YN01V00004F2		YQ02801-	P-UB-1	75 mm		KOB-YN01V00004R100	57.05
YN01V00004F2		YQ02801-	N-N-14		115 mm	KOB-YN01V00004R200	88.48
YN01V00004F2		YQT00001-	P-UB-14	75 mm	115 mm	KOB-YN01V00004R300	145.53
YN01V00004F2		YQT00001-	P-UB-1	75 mm		KOB-YN01V00004R100	57.05
YN01V00004F2		YQT00001-	N-N-14		115 mm	KOB-YN01V00004R200	88.48
BUCKET Long Range		LP01V00005F1	YQ002301-YQ002645	N-N-14		95 mm	KOB-YW01V00003R200
	LP01V00005F1	YQ02801-	N-N-14		95 mm	KOB-YW01V00003R200	83.31
	LP01V00005F1	YQT00001-	N-N-14		95 mm	KOB-YW01V00003R200	83.31
	LP01V00005F2	YQ002301-YQ002645	N-N-14		95 mm	KOB-YW01V00003R200	83.31
	LP01V00005F2	YQ02801-	N-N-14		95 mm	KOB-YW01V00003R200	83.31
	LP01V00005F2	YQT00001-	N-N-14		95 mm	KOB-YW01V00003R200	83.31
	LP01V00005F3	YQ002301-YQ002645	N-N-14		95 mm	KOB-YW01V00003R200	83.31
	LP01V00005F3	YQ02801-	N-N-14		95 mm	KOB-YW01V00003R200	83.31
	LP01V00005F3	YQT00001-	N-N-14		95 mm	KOB-YW01V00003R200	83.31
	YW01V00003F1	YQ002301-YQ002645	N-N-14		95 mm	KOB-YW01V00003R200	83.31
MODEL SK200LC-6							
ARM	YN01V00039F1	YQ03501-	P-UB-14	95 mm	135 mm	KOB-YN01V00039R300	246.98
	YN01V00039F1	YQ03501-	P-UB-1	95 mm		KOB-YN01V00039R100	60.53
	YN01V00039F1	YQ03501-	N-N-14		135 mm	KOB-YN01V00039R200	186.46
ARM HD, Dismantle	YN01V00078F1	YQ03501-	P-UB-14	95 mm	135 mm	KOB-YN01V00078R300	246.98
	YN01V00078F1	YQ03501-	P-UB-1	95 mm		KOB-YN01V00078R100	60.53
	YN01V00078F1	YQ03501-	N-N-14		135 mm	KOB-YN01V00078R200	186.46
BOOM LH	YN01V00038F1	YQ03501-	P-UB-14	85 mm	125 mm	KOB-YN01V00052R300	202.64

KOBELCO®

KOBELCO®

Replacement Kits For

Excavators							
APPLICATION	CYL #	SERIAL #	CODE	ROD	BORE	KIT #	List \$
MODEL SK200LC-6							
BOOM LH	YN01V00038F1	YQ03501-	P-UB-1	85 mm		KOB-YN01V00052R100	57.05
	YN01V00038F1	YQ03501-	N-N-14		125 mm	KOB-YN01V00052R200	145.60
BOOM RH	YN01V00037F1	YQ03501-	P-UB-14	85 mm	125 mm	KOB-YN01V00052R300	202.64
	YN01V00037F1	YQ03501-	P-UB-1	85 mm		KOB-YN01V00052R100	57.05
	YN01V00037F1	YQ03501-	N-N-14		125 mm	KOB-YN01V00052R200	145.60
BUCKET	YN01V00068F1	YQ03501-	P-UB-14	80 mm	115 mm	KOB-YN01V00068R300	118.26
	YN01V00068F1	YQ03501-	P-UB-1	80 mm		KOB-YN01V00068R100	57.23
	YN01V00068F1	YQ03501-	N-N-14		115 mm	KOB-YN01V00068R200	61.03
BUCKET HD, Dismantle	YN01V00077F1	YQ03501-	P-UB-14	80 mm	115 mm	KOB-YN01V00077R300	118.26
	YN01V00077F1	YQ03501-	P-UB-1	80 mm		KOB-YN01V00068R100	57.23
	YN01V00077F1	YQ03501-	N-N-14		115 mm	KOB-YN01V00068R200	61.03
MODEL SK210 IV							
ARM	2438U1104F1	YNU0501-	P-UB-10	100 mm	145 mm	KOB-2438U1104R500	447.45
	2438U1104F1	YNU0501-	P-UB-1	100 mm		KOB-2438U1104R400	138.04
	2438U1104F1	YNU0501-	N-N-10		145 mm	KOB-2438U1104R200	309.41
	2438U1104F1	YNU0501-	Bushing	100 mm		KOB-2438U1104S4	51.68
BOOM LH	2438U1103F1	YNU0501-	P-UB-10	85 mm	125 mm	KOB-2438U1102R500	328.12
	2438U1103F1	YNU0501-	P-UB-1	85 mm		KOB-2438U1102R600	118.89
	2438U1103F1	YNU0501-	N-N-10		125 mm	KOB-2438U1102R200	209.25
BOOM RH	2438U1102F1	YNU0501-	P-UB-10	85 mm	125 mm	KOB-2438U1102R300	328.12
	2438U1102F1	YNU0501-	P-UB-1	85 mm		KOB-2438U1102R600	118.89
	2438U1102F1	YNU0501-	N-N-10		125 mm	KOB-2438U1102R200	209.25
BUCKET	2438U1105F1	YNU0501-	P-UB-10	80 mm	120 mm	KOB-2438U1105R500	242.52
	2438U1105F1	YNU0501-	P-UB-1	80 mm		KOB-2438U1105R400	112.01
	2438U1105F1	YNU0501-	N-N-10		120 mm	KOB-2438U1105R200	147.14
BUCKET Long Reach	2438U1097F2	YNU0501-	P-UB-1	65 mm		KOB-2438U1097R100	124.99
	2438U1097F2	YNU0501-	N-N-10		95 mm	KOB-2438U1097R200	193.57
MODEL SK210LC							
ARM	2438U1104F1	YQU3101-	P-UB-10	100 mm	145 mm	KOB-2438U1104R500	447.45
	2438U1104F1	YQU3101-	P-UB-1	100 mm		KOB-2438U1104R400	138.04
	2438U1104F1	YQU3101-	N-N-10		145 mm	KOB-2438U1104R200	309.41
	2438U1104F1	YQU3101-	Bushing	100 mm		KOB-2438U1104S4	51.68
	YN01V00039F1	YQ07U0101-	P-UB-14	95 mm	135 mm	KOB-YN01V00039R300	246.98
	YN01V00039F1	YQ07U0101-	P-UB-1	95 mm		KOB-YN01V00003R100	60.53
	YN01V00039F1	YQ07U0101-	N-N-14		135 mm	KOB-YN01V00039R200	186.46
BOOM LH	2438U1103F1	YQU3101-	P-UB-10	85 mm	125 mm	KOB-2438U1102R500	328.12
	2438U1103F1	YQU3101-	P-UB-1	85 mm		KOB-2438U1102R600	118.89
	2438U1103F1	YQU3101-	N-N-10		125 mm	KOB-2438U1102R200	209.25
	YN01V00038F1	YQ07U0101-	P-UB-14	85 mm	125 mm	KOB-YN01V00052R300	202.64
	YN01V00038F1	YQ07U0101-	P-UB-1	85 mm		KOB-YN01V00052R100	57.05
	YN01V00038F1	YQ07U0101-	N-N-14		125 mm	KOB-YN01V00052R200	145.60
BOOM RH	2438U1102F1	YQU3101-	P-UB-10	85 mm	125 mm	KOB-2438U1102R300	328.12
	2438U1102F1	YQU3101-	P-UB-1	85 mm		KOB-2438U1102R600	118.89
	2438U1102F1	YQU3101-	N-N-10		125 mm	KOB-2438U1102R200	209.25
	YN01V00037F1	YQ07U0101-	P-UB-14	85 mm	125 mm	KOB-YN01V00052R300	202.64
	YN01V00037F1	YQ07U0101-	P-UB-1	85 mm		KOB-YN01V00052R100	57.05
	YN01V00037F1	YQ07U0101-	N-N-14		125 mm	KOB-YN01V00052R200	145.60
BUCKET	2438U1105F1	YQU3101-	P-UB-10	80 mm	120 mm	KOB-2438U1105R500	242.52
	2438U1105F1	YQU3101-	P-UB-1	80 mm		KOB-2438U1105R400	112.01
	2438U1105F1	YQU3101-	N-N-10		120 mm	KOB-2438U1105R200	147.14
	YN01V00068F1	YQ07U0101-	P-UB-14	80 mm	115 mm	KOB-YN01V00068R300	118.26
	YN01V00068F1	YQ07U0101-	P-UB-1	80 mm		KOB-YN01V00068R100	57.23
	YN01V00068F1	YQ07U0101-	N-N-14		115 mm	KOB-YN01V00068R200	61.03

Replacement Kits For

KOBELCO®

Excavators							
APPLICATION	CYL #	SERIAL #	CODE	ROD	BORE	KIT #	List \$
MODEL SK210LC							
BUCKET	YX01V00005F2	YQ07U0101-	P-UB-14	65 mm	95 mm	KOB-YX01V00005R300	100.16
	YX01V00005F2	YQ07U0101-	P-UB-1	65 mm		KOB-YX01V00005R100	72.49
	YX01V00005F2	YQ07U0101-	N-N-14		95 mm	KOB-YX01V00005R200	83.31
BUCKET Long Reach	2438U1097F2	YQU3101-	P-UB-1	65 mm		KOB-2438U1097R100	124.99
	2438U1097F2	YQU3101-	N-N-10		95 mm	KOB-2438U1097R200	193.57
MODEL SK210LC-6E							
ARM	YN01V00105F2	YQ08U0969-	P-UB-10	95 mm	135 mm	KOB-YN01V00105R900	382.74
	YN01V00105F2	YQ08U0969-	P-UB-1	95 mm		KOB-YN01V00105R100	138.45
	YN01V00105F2	YQ08U0969-	N-N-10		135 mm	KOB-YN01V00105R800	244.29
	YN01V00132F1	YQ08U0969-	P-UB-10	95 mm	135 mm	KOB-YN01V00105R900	382.74
	YN01V00132F1	YQ08U0969-	P-UB-1	95 mm		KOB-YN01V00105R100	138.45
	YN01V00132F1	YQ08U0969-	N-N-10		135 mm	KOB-YN01V00105R800	244.29
	YN01V00132F4	YQ08U0969-	P-UB-10	95 mm	135 mm	KOB-YN01V00105R900	382.74
	YN01V00132F4	YQ08U0969-	P-UB-1	95 mm		KOB-YN01V00105R100	138.45
BOOM LH	YN01V00104F2	YQ08U0969-	P-UB-10	85 mm	125 mm	KOB-YN01V00103R300	308.86
	YN01V00104F2	YQ08U0969-	P-UB-1	85 mm		KOB-YN01V00103R100	118.57
	YN01V00104F2	YQ08U0969-	N-N-10		125 mm	KOB-YN01V00103R200	190.31
BOOM RH	YN01V00103F2	YQ08U0969-	P-UB-10	85 mm	125 mm	KOB-YN01V00103R300	308.86
	YN01V00103F2	YQ08U0969-	P-UB-1	85 mm		KOB-YN01V00103R100	118.57
	YN01V00103F2	YQ08U0969-	N-N-10		125 mm	KOB-YN01V00103R200	190.31
BUCKET	YN01V00112F5	YQ08U0969-	P-UB-10	80 mm	120 mm	KOB-YN01V00112R900	379.21
	YN01V00112F5	YQ08U0969-	P-UB-1	80 mm		KOB-YN01V00112R100	138.93
	YN01V00112F5	YQ08U0969-	N-N-10		120 mm	KOB-YN01V00112R800	236.82
BUCKET Long Range	YX01V00005F4	YQ08U0969-	P-UB-14	65 mm	95 mm	KOB-YX01V00005R300	100.16
	YX01V00005F4	YQ08U0969-	P-UB-1	65 mm		KOB-YX01V00005R100	72.49
	YX01V00005F4	YQ08U0969-	N-N-14		95 mm	KOB-YX01V00005R200	83.31
MODEL SK210LC-8							
ARM	YN01V00172F1	YQ09U3301-	P-UB-10	95 mm	135 mm	KOB-YN01V00175R300	395.31
	YN01V00172F1	YQ09U3301-	P-UB-1	95 mm		KOB-YN01V00175R100	118.51
	YN01V00172F1	YQ09U3301-	N-N-10		135 mm	KOB-YN01V00175R200	268.31
	YN01V00175F1	YQ09U3301-	P-UB-10	95 mm	135 mm	KOB-YN01V00175R300	395.31
	YN01V00175F1	YQ09U3301-	P-UB-1	95 mm		KOB-YN01V00175R100	118.51
	YN01V00175F1	YQ09U3301-	N-N-10		135 mm	KOB-YN01V00175R200	268.31
	YN01V00175F1	YQ11-C6001-	P-UB-10	95 mm	135 mm	KOB-YN01V00175R300	395.31
	YN01V00175F1	YQ11-C6001-	P-UB-1	95 mm		KOB-YN01V00175R100	118.51
	YN01V00175F1	YQ11-C6001-	N-N-10		135 mm	KOB-YN01V00175R200	268.31
	YN01V00175F2	YQ11-C6001-	P-UB-10	95 mm	135 mm	KOB-YN01V00175R300	395.31
	YN01V00175F2	YQ11-C6001-	P-UB-1	95 mm		KOB-YN01V00175R100	118.51
	YN01V00175F2	YQ11-C6001-	N-N-10		135 mm	KOB-YN01V00175R200	268.31
	YN02B00486F1	YQ12-08001-	P-UB-10	95 mm	135 mm	KOB-YN01V00175R300	395.31
	YN02B00486F1	YQ12-08001-	P-UB-1	95 mm		KOB-YN01V00175R100	118.51
	YN02B00486F1	YQ12-08001-	N-N-10		135 mm	KOB-YN01V00175R200	268.31
	BOOM	YN01V00151F1	YQ09U3301-	P-UB-10	85 mm	120 mm	KOB-YN01V00151R300
YN01V00151F1		YQ09U3301-	P-UB-1	85 mm		KOB-YN01V00151R100	115.54
YN01V00151F1		YQ09U3301-	N-N-10		120 mm	KOB-YN01V00151R600	119.11
YN01V00151F1		YQ11-C6001-	P-UB-10	85 mm	120 mm	KOB-YN01V00151R300	431.35
YN01V00151F1		YQ11-C6001-	P-UB-1	85 mm		KOB-YN01V00151R100	115.54
YN01V00151F1		YQ11-C6001-	N-N-10		120 mm	KOB-YN01V00151R200	117.93
YN02B00405F1		YQ12-08001-	P-UB-10	85 mm	120 mm	KOB-YN01V00151R700	310.42
YN02B00405F1		YQ12-08001-	P-UB-1	85 mm		KOB-YN01V00151R100	115.54
YN02B00405F1		YQ12-08001-	N-N-10		120 mm	KOB-YN01V00151R600	119.11
BUCKET		YN01V00153F1	YQ09U3301-	P-UB-10	80 mm	120 mm	KOB-YN01V00153R300

KOBELCO®

Replacement Kits For

KOBELCO®

Excavators							
APPLICATION	CYL #	SERIAL #	CODE	ROD	BORE	KIT #	List \$
MODEL SK210LC-8							
BUCKET	YN01V00153F1	YQ09U3301-	P-UB-1	80 mm		KOB-YN01V00153R100	119.97
	YN01V00153F1	YQ09U3301-	N-N-10		120 mm	KOB-YN01V00151R600	119.11
	YN01V00153F1	YQ11-C6001-	P-UB-10	80 mm	120 mm	KOB-YN01V00153R300	437.05
	YN01V00153F1	YQ11-C6001-	P-UB-1	80 mm		KOB-YN01V00153R100	119.97
	YN01V00153F1	YQ11-C6001-	N-N-10		120 mm	KOB-YN01V00151R200	117.93
	YN01V00153F2	YQ11-C6001-	P-UB-10	80 mm	120 mm	KOB-YN01V00153R300	437.05
	YN01V00153F2	YQ11-C6001-	P-UB-1	80 mm		KOB-YN01V00153R100	119.97
	YN01V00153F2	YQ11-C6001-	N-N-10		120 mm	KOB-YN01V00151R200	117.93
	YN12B00969F1	YQ12-08001-	P-UB-10	80 mm	120 mm	KOB-YN01V00153R300	437.05
	YN12B00969F1	YQ12-08001-	P-UB-1	80 mm		KOB-YN01V00153R100	119.97
YN12B00969F1	YQ12-08001-	N-N-10		120 mm	KOB-YN01V00151R200	117.93	
BUCKET Long Reach	YX01V00005F6	YQ09U3301-	P-UB-14	65 mm	95 mm	KOB-YY01V00005R700	108.10
	YX01V00005F6	YQ09U3301-	P-UB-1	65 mm		KOB-YY01V00005R600	84.83
	YX01V00005F6	YQ09U3301-	N-N-14		95 mm	KOB-YY01V00005R200	83.31
MODEL SK220 III, SK220LC III, SK220 IV, SK220LC IV							
ARM	2438U1137F1	LQU0001-, LLU0601-	P-UB-1	105 mm		KOB-2438U953R100	240.04
	2438U1137F1	LQU0001-, LLU0601-	N-N-10		150 mm	KOB-2438U953R200	438.43
BOOM LH	2438U1136F1	LQU0001-, LLU0601-	P-UB-10	90 mm	140 mm	KOB-2438U1135R300	338.38
	2438U1136F1	LQU0001-, LLU0601-	P-UB-1	90 mm		KOB-2438U999R100	155.75
	2438U1136F1	LQU0001-, LLU0601-	N-N-10		140 mm	KOB-2438U999R200	299.97
BOOM RH	2438U1135F1	LQU0001-, LLU0601-	P-UB-10	90 mm	140 mm	KOB-2438U1135R300	338.38
	2438U1135F1	LQU0001-, LLU0601-	P-UB-1	90 mm		KOB-2438U999R100	155.75
	2438U1135F1	LQU0001-, LLU0601-	N-N-10		140 mm	KOB-2438U999R200	299.97
BUCKET	2438U1097F1.F2	LQU0001-, LLU0601-	P-UB-10	65 mm	95 mm	KOB-2438U1097R300	318.55
	2438U1097F1.F2	LQU0001-, LLU0601-	P-UB-1	65 mm		KOB-2438U1097R100	124.99
	2438U1097F1.F2	LQU0001-, LLU0601-	N-N-10		95 mm	KOB-2438U1097R200	193.57
	2438U1138F1	LQU0001-, LLU0601-	P-UB-1	85 mm		KOB-2438U959R100	125.96
	2438U1138F1	LQU0001-, LLU0601-	N-N-10		130 mm	KOB-2438U959R200	282.03
MODEL SK230-6E							
ARM	LQ01V00012F1	LQC-02001-	P-UB-10	100 mm	140 mm	KOB-LQ01V00007R300	260.50
	LQ01V00012F1	LQC-02001-	P-UB-1	100 mm		KOB-LQ01V00007R100	106.16
	LQ01V00012F1	LQC-02001-	N-N-10		140 mm	KOB-LQ01V00007R200	166.12
	LQ01V00012F2	LQC-02001-	P-UB-10	100 mm	140 mm	KOB-LQ01V00007R300	260.50
	LQ01V00012F2	LQC-02001-	P-UB-1	100 mm		KOB-LQ01V00007R100	106.16
	LQ01V00012F2	LQC-02001-	N-N-10		140 mm	KOB-LQ01V00007R200	166.12
	LQ01V00012F3	LQC-02001-	P-UB-10	100 mm	140 mm	KOB-LQ01V00007R300	260.50
	LQ01V00012F3	LQC-02001-	P-UB-1	100 mm		KOB-LQ01V00007R100	106.16
	LQ01V00012F3	LQC-02001-	N-N-10		140 mm	KOB-LQ01V00007R200	166.12
	LQ01V00012F4	LQC-02001-	P-UB-10	100 mm	140 mm	KOB-LQ01V00007R300	260.50
	LQ01V00012F4	LQC-02001-	P-UB-1	100 mm		KOB-LQ01V00007R100	106.16
	LQ01V00012F4	LQC-02001-	N-N-10		140 mm	KOB-LQ01V00007R200	166.12
	LQ01V00012F5	LQC-02001-	P-UB-10	100 mm	140 mm	KOB-LQ01V00007R300	260.50
	LQ01V00012F5	LQC-02001-	P-UB-1	100 mm		KOB-LQ01V00007R100	106.16
	LQ01V00012F5	LQC-02001-	N-N-10		140 mm	KOB-LQ01V00007R200	166.12
BOOM LH	LQ01V00011F1	LQC-02001-	P-UB-10	90 mm	135 mm	KOB-LQ01V00005R300	291.92
	LQ01V00011F1	LQC-02001-	P-UB-1	90 mm		KOB-LQ01V00001R400	96.04
	LQ01V00011F1	LQC-02001-	N-N-10		135 mm	KOB-LQ01V00001R200	195.88
	LQ01V00011F2	LQC-02001-	P-UB-10	90 mm	135 mm	KOB-LQ01V00005R300	291.92
	LQ01V00011F2	LQC-02001-	P-UB-1	90 mm		KOB-LQ01V00001R400	96.04
	LQ01V00011F2	LQC-02001-	N-N-10		135 mm	KOB-LQ01V00001R200	195.88
BOOM RH	LQ01V00010F1	LQC-02001-	P-UB-10	90 mm	135 mm	KOB-LQ01V00005R300	291.92
	LQ01V00010F1	LQC-02001-	P-UB-1	90 mm		KOB-LQ01V00001R400	96.04
	LQ01V00010F1	LQC-02001-	N-N-10		135 mm	KOB-LQ01V00001R200	195.88
	LQ01V00010F2	LQC-02001-	P-UB-10	90 mm	135 mm	KOB-LQ01V00005R300	291.92

Replacement Kits For

KOBELCO®

Excavators							
APPLICATION	CYL #	SERIAL #	CODE	ROD	BORE	KIT #	List \$
MODEL SK230-6E							
BOOM RH	LQ01V00010F2	LQC-02001-	P-UB-1	90 mm		KOB-LQ01V00001R400	96.04
	LQ01V00010F2	LQC-02001-	N-N-10		135 mm	KOB-LQ01V00001R200	195.88
BUCKET	LQ01V00013F1	LQC-02001-	P-UB-10	90 mm	125 mm	KOB-YB01V00010R300	274.12
	LQ01V00013F1	LQC-02001-	P-UB-1	90 mm		KOB-YB01V00010R100	105.30
	LQ01V00013F1	LQC-02001-	N-N-10		125 mm	KOB-YM01V00008R200	168.82
	LQ01V00013F2	LQC-02001-	P-UB-10	90 mm	125 mm	KOB-YB01V00010R300	274.12
	LQ01V00013F2	LQC-02001-	P-UB-1	90 mm		KOB-YB01V00010R100	105.30
	LQ01V00013F2	LQC-02001-	N-N-10		125 mm	KOB-YM01V00008R200	168.82
	LQ01V00013F3	LQC-02001-	P-UB-10	90 mm	125 mm	KOB-YB01V00010R300	274.12
	LQ01V00013F3	LQC-02001-	P-UB-1	90 mm		KOB-YB01V00010R100	105.30
	LQ01V00013F3	LQC-02001-	N-N-10		125 mm	KOB-YM01V00008R200	168.82
	LQ01V00013F4	LQC-02001-	P-UB-10	90 mm	125 mm	KOB-YB01V00010R300	274.12
	LQ01V00013F4	LQC-02001-	P-UB-1	90 mm		KOB-YB01V00010R100	105.30
	LQ01V00013F4	LQC-02001-	N-N-10		125 mm	KOB-YM01V00008R200	168.82
	LQ01V00013F5	LQC-02001-	P-UB-10	90 mm	125 mm	KOB-YB01V00010R300	274.12
	LQ01V00013F5	LQC-02001-	P-UB-1	90 mm		KOB-YB01V00010R100	105.30
	LQ01V00013F5	LQC-02001-	N-N-10		125 mm	KOB-YM01V00008R200	168.82
MODEL SK235SR							
ARM	YN01V00039F1	YF01-00101-	P-UB-14	95 mm	135 mm	KOB-YN01V00039R300	246.98
	YN01V00039F1	YF01-00101-	P-UB-1	95 mm		KOB-YN01V00003R100	60.53
	YN01V00039F1	YF01-00101-	N-N-14		135 mm	KOB-YN01V00039R200	186.46
	YN01V00105F1	YF01-00101-	P-UB-10	95 mm	135 mm	KOB-YN01V00105R300	382.74
	YN01V00105F1	YF01-00101-	P-UB-1	95 mm		KOB-YN01V00105R100	138.45
	YN01V00105F1	YF01-00101-	N-N-10		135 mm	KOB-YN01V00105R200	244.29
	YN01V00105F2	YF01-00101-	P-UB-10	95 mm	135 mm	KOB-YN01V00105R300	382.74
	YN01V00105F2	YF01-00101-	P-UB-1	95 mm		KOB-YN01V00105R100	138.45
	YN01V00105F2	YF01-00101-	N-N-10		135 mm	KOB-YN01V00105R200	244.29
	YN01V00105F3	YF01-00101-	P-UB-10	95 mm	135 mm	KOB-YN01V00105R300	382.74
	YN01V00105F3	YF01-00101-	P-UB-1	95 mm		KOB-YN01V00105R100	138.45
	YN01V00105F3	YF01-00101-	N-N-10		135 mm	KOB-YN01V00105R200	244.29
ARM HD, Dismantle	YN01V00078F1	YF01-00101-	P-UB-14	95 mm	135 mm	KOB-YN01V00039R300	246.98
	YN01V00078F1	YF01-00101-	P-UB-1	95 mm		KOB-YN01V00003R100	60.53
	YN01V00078F1	YF01-00101-	N-N-14		135 mm	KOB-YN01V00039R200	186.46
BOOM LH	YN01V00053F1	YF01-00101-	P-UB-14	85 mm	125 mm	KOB-YN01V00052R300	202.64
	YN01V00053F1	YF01-00101-	P-UB-1	85 mm		KOB-YN01V00052R100	57.05
	YN01V00053F1	YF01-00101-	N-N-14		125 mm	KOB-YN01V00052R200	145.60
	YN01V00053F2	YF01-00101-	P-UB-14	85 mm	125 mm	KOB-YN01V00052R300	202.64
	YN01V00053F2	YF01-00101-	P-UB-1	85 mm		KOB-YN01V00052R100	57.05
	YN01V00053F2	YF01-00101-	N-N-14		125 mm	KOB-YN01V00052R200	145.60
	YN01V00108F1	YF01-00101-	P-UB-10	85 mm	125 mm	KOB-YN01V00103R300	308.86
	YN01V00108F1	YF01-00101-	P-UB-1	85 mm		KOB-YN01V00103R100	118.57
	YN01V00108F1	YF01-00101-	N-N-10		125 mm	KOB-YN01V00103R200	190.31
BOOM RH	YN01V00052F1	YF01-00101-	P-UB-14	85 mm	125 mm	KOB-YN01V00052R300	202.64
	YN01V00052F1	YF01-00101-	P-UB-1	85 mm		KOB-YN01V00052R100	57.05
	YN01V00052F1	YF01-00101-	N-N-14		125 mm	KOB-YN01V00052R200	145.60
	YN01V00052F2	YF01-00101-	P-UB-14	85 mm	125 mm	KOB-YN01V00052R300	202.64
	YN01V00052F2	YF01-00101-	P-UB-1	85 mm		KOB-YN01V00052R100	57.05
	YN01V00052F2	YF01-00101-	N-N-14		125 mm	KOB-YN01V00052R200	145.60
	YN01V00107F1	YF01-00101-	P-UB-10	85 mm	125 mm	KOB-YN01V00103R300	308.86
	YN01V00107F1	YF01-00101-	P-UB-1	85 mm		KOB-YN01V00103R100	118.57
	YN01V00107F1	YF01-00101-	N-N-10		125 mm	KOB-YN01V00103R200	190.31
BUCKET	YN01V00068F1	YF01-00101-	P-UB-14	80 mm	115 mm	KOB-YN01V00068R300	118.26
	YN01V00068F1	YF01-00101-	P-UB-1	80 mm		KOB-YN01V00068R100	57.23
	YN01V00068F1	YF01-00101-	N-N-14		115 mm	KOB-YN01V00068R200	61.03

KOBELCO®

Replacement Kits For

KOBELCO®

Excavators							
APPLICATION	CYL #	SERIAL #	CODE	ROD	BORE	KIT #	List \$
MODEL SK235SR							
BUCKET	YN01V00106F1	YF01-00101-	P-UB-10	80 mm	115 mm	KOB-YN01V00106R300	272.99
	YN01V00106F1	YF01-00101-	P-UB-1	80 mm		KOB-YN01V00106R100	116.11
	YN01V00106F1	YF01-00101-	N-N-10		115 mm	KOB-YN01V00106R200	156.90
	YX01V00005F1	YF01-00101-	P-UB-14	65 mm	95 mm	KOB-YX01V00005R300	100.16
	YX01V00005F1	YF01-00101-	P-UB-1	65 mm		KOB-YX01V00005R100	72.49
	YX01V00005F1	YF01-00101-	N-N-14		95 mm	KOB-YX01V00005R200	83.31
	YX01V00005F2	YF01-00101-	P-UB-14	65 mm	95 mm	KOB-YX01V00005R300	100.16
	YX01V00005F2	YF01-00101-	P-UB-1	65 mm		KOB-YX01V00005R100	72.49
	YX01V00005F2	YF01-00101-	N-N-14		95 mm	KOB-YX01V00005R200	83.31
	YX01V00005F3	YF01-00101-	P-UB-14	65 mm	95 mm	KOB-YX01V00005R300	100.16
	YX01V00005F3	YF01-00101-	P-UB-1	65 mm		KOB-YX01V00005R100	72.49
	YX01V00005F3	YF01-00101-	N-N-14		95 mm	KOB-YX01V00005R200	83.31
	YX01V00005F4	YF01-00101-	P-UB-14	65 mm	95 mm	KOB-YX01V00005R300	100.16
	YX01V00005F4	YF01-00101-	P-UB-1	65 mm		KOB-YX01V00005R100	72.49
YX01V00005F4	YF01-00101-	N-N-14		95 mm	KOB-YX01V00005R200	83.31	
MODEL SK235SR-1E							
ARM	YN01V00105F1	YF02-01201-YF02-01299	P-UB-10	95 mm	135 mm	KOB-YN01V00105R900	382.74
	YN01V00105F1	YF02-01201-YF02-01299	P-UB-1	95 mm		KOB-YN01V00105R100	138.45
	YN01V00105F1	YF02-01201-YF02-01299	N-N-10		135 mm	KOB-YN01V00105R800	244.29
	YN01V00105F1	YF03-01300-YF03-01421	P-UB-10	95 mm	135 mm	KOB-YN01V00105R900	382.74
	YN01V00105F1	YF03-01300-YF03-01421	P-UB-1	95 mm		KOB-YN01V00105R100	138.45
	YN01V00105F1	YF03-01300-YF03-01421	N-N-10		135 mm	KOB-YN01V00105R800	244.29
	YN01V00105F2	YF02-01201-YF02-01299	P-UB-10	95 mm	135 mm	KOB-YN01V00105R900	382.74
	YN01V00105F2	YF02-01201-YF02-01299	P-UB-1	95 mm		KOB-YN01V00105R100	138.45
	YN01V00105F2	YF02-01201-YF02-01299	N-N-10		135 mm	KOB-YN01V00105R800	244.29
	YN01V00105F2	YF03-01300-YF03-01421	P-UB-10	95 mm	135 mm	KOB-YN01V00105R900	382.74
	YN01V00105F2	YF03-01300-YF03-01421	P-UB-1	95 mm		KOB-YN01V00105R100	138.45
	YN01V00105F2	YF03-01300-YF03-01421	N-N-10		135 mm	KOB-YN01V00105R800	244.29
	YN01V00105F3	YF02-01201-YF02-01299	P-UB-10	95 mm	135 mm	KOB-YN01V00105R900	382.74
	YN01V00105F3	YF02-01201-YF02-01299	P-UB-1	95 mm		KOB-YN01V00105R100	138.45
	YN01V00105F3	YF02-01201-YF02-01299	N-N-10		135 mm	KOB-YN01V00105R800	244.29
	YN01V00105F3	YF03-01300-YF03-01421	P-UB-10	95 mm	135 mm	KOB-YN01V00105R900	382.74
	YN01V00105F3	YF03-01300-YF03-01421	P-UB-1	95 mm		KOB-YN01V00105R100	138.45
	YN01V00105F3	YF03-01300-YF03-01421	N-N-10		135 mm	KOB-YN01V00105R800	244.29
	YN01V00105F4	YF02-01201-YF02-01299	P-UB-10	95 mm	135 mm	KOB-YN01V00105R900	382.74
	YN01V00105F4	YF02-01201-YF02-01299	P-UB-1	95 mm		KOB-YN01V00105R100	138.45
	YN01V00105F4	YF02-01201-YF02-01299	N-N-10		135 mm	KOB-YN01V00105R800	244.29
	YN01V00105F4	YF03-01300-YF03-01421	P-UB-10	95 mm	135 mm	KOB-YN01V00105R900	382.74
	YN01V00105F4	YF03-01300-YF03-01421	P-UB-1	95 mm		KOB-YN01V00105R100	138.45
	YN01V00105F4	YF03-01300-YF03-01421	N-N-10		135 mm	KOB-YN01V00105R800	244.29
	YN01V00105F5	YF02-01201-YF02-01299	P-UB-10	95 mm	135 mm	KOB-YN01V00105R900	382.74
	YN01V00105F5	YF02-01201-YF02-01299	P-UB-1	95 mm		KOB-YN01V00105R100	138.45
	YN01V00105F5	YF02-01201-YF02-01299	N-N-10		135 mm	KOB-YN01V00105R800	244.29
	YN01V00105F5	YF03-01300-YF03-01421	P-UB-10	95 mm	135 mm	KOB-YN01V00105R900	382.74
	YN01V00105F5	YF03-01300-YF03-01421	P-UB-1	95 mm		KOB-YN01V00105R100	138.45
	YN01V00105F5	YF03-01300-YF03-01421	N-N-10		135 mm	KOB-YN01V00105R800	244.29
	YN01V00105F6	YF02-01201-YF02-01299	P-UB-10	95 mm	135 mm	KOB-YN01V00105R900	382.74
	YN01V00105F6	YF02-01201-YF02-01299	P-UB-1	95 mm		KOB-YN01V00105R100	138.45
	YN01V00105F6	YF02-01201-YF02-01299	N-N-10		135 mm	KOB-YN01V00105R800	244.29
	YN01V00105F6	YF03-01300-YF03-01421	P-UB-10	95 mm	135 mm	KOB-YN01V00105R900	382.74
	YN01V00105F6	YF03-01300-YF03-01421	P-UB-1	95 mm		KOB-YN01V00105R100	138.45
	YN01V00105F6	YF03-01300-YF03-01421	N-N-10		135 mm	KOB-YN01V00105R800	244.29
	YN01V00132F1	YF02-01201-YF02-01299	P-UB-10	95 mm	135 mm	KOB-YN01V00105R900	382.74
	YN01V00132F1	YF02-01201-YF02-01299	P-UB-1	95 mm		KOB-YN01V00105R100	138.45
	YN01V00132F1	YF02-01201-YF02-01299	N-N-10		135 mm	KOB-YN01V00105R800	244.29

KOBELCO®

Replacement Kits For

KOBELCO®

Excavators							
APPLICATION	CYL #	SERIAL #	CODE	ROD	BORE	KIT #	List \$
MODEL SK235SR-1E							
ARM	YN01V00132F1	YF03-01300-YF03-01421	P-UB-10	95 mm	135 mm	KOB-YN01V00105R900	382.74
	YN01V00132F1	YF03-01300-YF03-01421	P-UB-1	95 mm		KOB-YN01V00105R100	138.45
	YN01V00132F1	YF03-01300-YF03-01421	N-N-10		135 mm	KOB-YN01V00105R800	244.29
	YN01V00132F1	YF04-01501-	P-UB-10	95 mm	135 mm	KOB-YN01V00105R900	382.74
	YN01V00132F1	YF04-01501-	P-UB-1	95 mm		KOB-YN01V00105R100	138.45
	YN01V00132F1	YF04-01501-	N-N-10		135 mm	KOB-YN01V00105R800	244.29
	YN01V00132F2	YF02-01201-YF02-01299	P-UB-10	95 mm	135 mm	KOB-YN01V00105R900	382.74
	YN01V00132F2	YF02-01201-YF02-01299	P-UB-1	95 mm		KOB-YN01V00105R100	138.45
	YN01V00132F2	YF02-01201-YF02-01299	N-N-10		135 mm	KOB-YN01V00105R800	244.29
	YN01V00132F2	YF03-01300-YF03-01421	P-UB-10	95 mm	135 mm	KOB-YN01V00105R900	382.74
	YN01V00132F2	YF03-01300-YF03-01421	P-UB-1	95 mm		KOB-YN01V00105R100	138.45
	YN01V00132F2	YF03-01300-YF03-01421	N-N-10		135 mm	KOB-YN01V00105R800	244.29
	YN01V00132F2	YF04-01501-	P-UB-10	95 mm	135 mm	KOB-YN01V00105R900	382.74
	YN01V00132F2	YF04-01501-	P-UB-1	95 mm		KOB-YN01V00105R100	138.45
	YN01V00132F2	YF04-01501-	N-N-10		135 mm	KOB-YN01V00105R800	244.29
	YN01V00132F3	YF02-01201-YF02-01299	P-UB-10	95 mm	135 mm	KOB-YN01V00105R900	382.74
	YN01V00132F3	YF02-01201-YF02-01299	P-UB-1	95 mm		KOB-YN01V00105R100	138.45
	YN01V00132F3	YF02-01201-YF02-01299	N-N-10		135 mm	KOB-YN01V00105R800	244.29
	YN01V00132F3	YF03-01300-YF03-01421	P-UB-10	95 mm	135 mm	KOB-YN01V00105R900	382.74
	YN01V00132F3	YF03-01300-YF03-01421	P-UB-1	95 mm		KOB-YN01V00105R100	138.45
	YN01V00132F3	YF03-01300-YF03-01421	N-N-10		135 mm	KOB-YN01V00105R800	244.29
	YN01V00132F3	YF04-01501-	P-UB-10	95 mm	135 mm	KOB-YN01V00105R900	382.74
	YN01V00132F3	YF04-01501-	P-UB-1	95 mm		KOB-YN01V00105R100	138.45
	YN01V00132F3	YF04-01501-	N-N-10		135 mm	KOB-YN01V00105R800	244.29
	YN01V00132F4	YF02-01201-YF02-01299	P-UB-10	95 mm	135 mm	KOB-YN01V00105R900	382.74
	YN01V00132F4	YF02-01201-YF02-01299	P-UB-1	95 mm		KOB-YN01V00105R100	138.45
	YN01V00132F4	YF02-01201-YF02-01299	N-N-10		135 mm	KOB-YN01V00105R800	244.29
	YN01V00132F4	YF03-01300-YF03-01421	P-UB-10	95 mm	135 mm	KOB-YN01V00105R900	382.74
	YN01V00132F4	YF03-01300-YF03-01421	P-UB-1	95 mm		KOB-YN01V00105R100	138.45
	YN01V00132F4	YF03-01300-YF03-01421	N-N-10		135 mm	KOB-YN01V00105R800	244.29
	YN01V00132F4	YF04-01501-	P-UB-10	95 mm	135 mm	KOB-YN01V00105R900	382.74
	YN01V00132F4	YF04-01501-	P-UB-1	95 mm		KOB-YN01V00105R100	138.45
	YN01V00132F4	YF04-01501-	N-N-10		135 mm	KOB-YN01V00105R800	244.29
	YN01V00132F5	YF02-01201-YF02-01299	P-UB-10	95 mm	135 mm	KOB-YN01V00105R900	382.74
	YN01V00132F5	YF02-01201-YF02-01299	P-UB-1	95 mm		KOB-YN01V00105R100	138.45
	YN01V00132F5	YF02-01201-YF02-01299	N-N-10		135 mm	KOB-YN01V00105R800	244.29
	YN01V00132F5	YF03-01300-YF03-01421	P-UB-10	95 mm	135 mm	KOB-YN01V00105R900	382.74
	YN01V00132F5	YF03-01300-YF03-01421	P-UB-1	95 mm		KOB-YN01V00105R100	138.45
	YN01V00132F5	YF03-01300-YF03-01421	N-N-10		135 mm	KOB-YN01V00105R800	244.29
	YN01V00132F5	YF04-01501-	P-UB-10	95 mm	135 mm	KOB-YN01V00105R900	382.74
YN01V00132F5	YF04-01501-	P-UB-1	95 mm		KOB-YN01V00105R100	138.45	
YN01V00132F5	YF04-01501-	N-N-10		135 mm	KOB-YN01V00105R800	244.29	
BOOM LH	YN01V00108F1	YF02-01201-YF02-01299	P-UB-10	85 mm	125 mm	KOB-YN01V00103R900	308.86
	YN01V00108F1	YF02-01201-YF02-01299	P-UB-1	85 mm		KOB-YN01V00103R100	118.57
	YN01V00108F1	YF02-01201-YF02-01299	N-N-10		125 mm	KOB-YN01V00103R800	190.31
	YN01V00108F1	YF03-01300-YF03-01421	P-UB-10	85 mm	125 mm	KOB-YN01V00103R900	308.86
	YN01V00108F1	YF03-01300-YF03-01421	P-UB-1	85 mm		KOB-YN01V00103R100	118.57
	YN01V00108F1	YF03-01300-YF03-01421	N-N-10		125 mm	KOB-YN01V00103R800	190.31
	YN01V00108F1	YF04-01501-	P-UB-10	85 mm	125 mm	KOB-YN01V00103R900	308.86
	YN01V00108F1	YF04-01501-	P-UB-1	85 mm		KOB-YN01V00103R100	118.57
	YN01V00108F1	YF04-01501-	N-N-10		125 mm	KOB-YN01V00103R800	190.31
	YN01V00108F2	YF02-01201-YF02-01299	P-UB-10	85 mm	125 mm	KOB-YN01V00103R900	308.86
	YN01V00108F2	YF02-01201-YF02-01299	P-UB-1	85 mm		KOB-YN01V00103R100	118.57
	YN01V00108F2	YF02-01201-YF02-01299	N-N-10		125 mm	KOB-YN01V00103R800	190.31
	YN01V00108F2	YF03-01300-YF03-01421	P-UB-10	85 mm	125 mm	KOB-YN01V00103R900	308.86

Replacement Kits For

KOBELCO®

Excavators								
APPLICATION	CYL #	SERIAL #	CODE	ROD	BORE	KIT #	List \$	
MODEL SK235SR-1E								
BOOM LH	YN01V00108F2	YF03-01300-YF03-01421	P-UB-1	85 mm		KOB-YN01V00103R100	118.57	
	YN01V00108F2	YF03-01300-YF03-01421	N-N-10		125 mm	KOB-YN01V00103R800	190.31	
	YN01V00108F2	YF04-01501-	P-UB-10	85 mm	125 mm	KOB-YN01V00103R900	308.86	
	YN01V00108F2	YF04-01501-	P-UB-1	85 mm		KOB-YN01V00103R100	118.57	
	YN01V00108F2	YF04-01501-	N-N-10		125 mm	KOB-YN01V00103R800	190.31	
	YN01V00108F3	YF02-01201-YF02-01299	P-UB-10	85 mm	125 mm	KOB-YN01V00103R900	308.86	
	YN01V00108F3	YF02-01201-YF02-01299	P-UB-1	85 mm		KOB-YN01V00103R100	118.57	
	YN01V00108F3	YF02-01201-YF02-01299	N-N-10		125 mm	KOB-YN01V00103R800	190.31	
	YN01V00108F3	YF03-01300-YF03-01421	P-UB-10	85 mm	125 mm	KOB-YN01V00103R900	308.86	
	YN01V00108F3	YF03-01300-YF03-01421	P-UB-1	85 mm		KOB-YN01V00103R100	118.57	
	YN01V00108F3	YF03-01300-YF03-01421	N-N-10		125 mm	KOB-YN01V00103R800	190.31	
	YN01V00108F3	YF04-01501-	P-UB-10	85 mm	125 mm	KOB-YN01V00103R900	308.86	
	YN01V00108F3	YF04-01501-	P-UB-1	85 mm		KOB-YN01V00103R100	118.57	
YN01V00108F3	YF04-01501-	N-N-10		125 mm	KOB-YN01V00103R800	190.31		
BOOM RH	YN01V00107F1	YF02-01201-YF02-01299	P-UB-10	85 mm	125 mm	KOB-YN01V00103R900	308.86	
	YN01V00107F1	YF02-01201-YF02-01299	P-UB-1	85 mm		KOB-YN01V00103R100	118.57	
	YN01V00107F1	YF02-01201-YF02-01299	N-N-10		125 mm	KOB-YN01V00103R800	190.31	
	YN01V00107F1	YF03-01300-YF03-01421	P-UB-10	85 mm	125 mm	KOB-YN01V00103R900	308.86	
	YN01V00107F1	YF03-01300-YF03-01421	P-UB-1	85 mm		KOB-YN01V00103R100	118.57	
	YN01V00107F1	YF03-01300-YF03-01421	N-N-10		125 mm	KOB-YN01V00103R800	190.31	
	YN01V00107F1	YF04-01501-	P-UB-10	85 mm	125 mm	KOB-YN01V00103R900	308.86	
	YN01V00107F1	YF04-01501-	P-UB-1	85 mm		KOB-YN01V00103R100	118.57	
	YN01V00107F1	YF04-01501-	N-N-10		125 mm	KOB-YN01V00103R800	190.31	
	YN01V00107F2	YF02-01201-YF02-01299	P-UB-10	85 mm	125 mm	KOB-YN01V00103R900	308.86	
	YN01V00107F2	YF02-01201-YF02-01299	P-UB-1	85 mm		KOB-YN01V00103R100	118.57	
	YN01V00107F2	YF02-01201-YF02-01299	N-N-10		125 mm	KOB-YN01V00103R800	190.31	
	YN01V00107F2	YF03-01300-YF03-01421	P-UB-10	85 mm	125 mm	KOB-YN01V00103R900	308.86	
	YN01V00107F2	YF03-01300-YF03-01421	P-UB-1	85 mm		KOB-YN01V00103R100	118.57	
	YN01V00107F2	YF03-01300-YF03-01421	N-N-10		125 mm	KOB-YN01V00103R800	190.31	
	YN01V00107F2	YF04-01501-	P-UB-10	85 mm	125 mm	KOB-YN01V00103R900	308.86	
	YN01V00107F2	YF04-01501-	P-UB-1	85 mm		KOB-YN01V00103R100	118.57	
	YN01V00107F2	YF04-01501-	N-N-10		125 mm	KOB-YN01V00103R800	190.31	
	YN01V00107F3	YF02-01201-YF02-01299	P-UB-10	85 mm	125 mm	KOB-YN01V00103R900	308.86	
	YN01V00107F3	YF02-01201-YF02-01299	P-UB-1	85 mm		KOB-YN01V00103R100	118.57	
	YN01V00107F3	YF02-01201-YF02-01299	N-N-10		125 mm	KOB-YN01V00103R800	190.31	
	YN01V00107F3	YF03-01300-YF03-01421	P-UB-10	85 mm	125 mm	KOB-YN01V00103R900	308.86	
	YN01V00107F3	YF03-01300-YF03-01421	P-UB-1	85 mm		KOB-YN01V00103R100	118.57	
	YN01V00107F3	YF03-01300-YF03-01421	N-N-10		125 mm	KOB-YN01V00103R800	190.31	
	YN01V00107F3	YF04-01501-	P-UB-10	85 mm	125 mm	KOB-YN01V00103R900	308.86	
	YN01V00107F3	YF04-01501-	P-UB-1	85 mm		KOB-YN01V00103R100	118.57	
	YN01V00107F3	YF04-01501-	N-N-10		125 mm	KOB-YN01V00103R800	190.31	
	BUCKET	YN01V00112F1	YF02-01201-YF02-01299	P-UB-10	80 mm	120 mm	KOB-YN01V00112R900	379.21
		YN01V00112F1	YF02-01201-YF02-01299	P-UB-1	80 mm		KOB-YN01V00112R100	138.93
		YN01V00112F1	YF02-01201-YF02-01299	N-N-10		120 mm	KOB-YN01V00112R800	236.82
		YN01V00112F1	YF03-01300-YF03-01421	P-UB-10	80 mm	120 mm	KOB-YN01V00112R900	379.21
		YN01V00112F1	YF03-01300-YF03-01421	P-UB-1	80 mm		KOB-YN01V00112R100	138.93
		YN01V00112F1	YF03-01300-YF03-01421	N-N-10		120 mm	KOB-YN01V00112R800	236.82
YN01V00112F1		YF04-01501-	P-UB-10	80 mm	120 mm	KOB-YN01V00112R900	379.21	
YN01V00112F1		YF04-01501-	P-UB-1	80 mm		KOB-YN01V00112R100	138.93	
YN01V00112F1		YF04-01501-	N-N-10		120 mm	KOB-YN01V00112R800	236.82	
YN01V00112F2		YF02-01201-YF02-01299	P-UB-10	80 mm	120 mm	KOB-YN01V00112R900	379.21	
YN01V00112F2		YF02-01201-YF02-01299	P-UB-1	80 mm		KOB-YN01V00112R100	138.93	
YN01V00112F2		YF02-01201-YF02-01299	N-N-10		120 mm	KOB-YN01V00112R800	236.82	
YN01V00112F2		YF03-01300-YF03-01421	P-UB-10	80 mm	120 mm	KOB-YN01V00112R900	379.21	
YN01V00112F2		YF03-01300-YF03-01421	P-UB-1	80 mm		KOB-YN01V00112R100	138.93	

Replacement Kits For

KOBELCO®

Excavators							
APPLICATION	CYL #	SERIAL #	CODE	ROD	BORE	KIT #	List \$
MODEL SK235SR-1E							
BUCKET	YN01V00112F2	YF03-01300-YF03-01421	N-N-10		120 mm	KOB-YN01V00112R800	236.82
	YN01V00112F2	YF04-01501-	P-UB-10	80 mm	120 mm	KOB-YN01V00112R900	379.21
	YN01V00112F2	YF04-01501-	P-UB-1	80 mm		KOB-YN01V00112R100	138.93
	YN01V00112F2	YF04-01501-	N-N-10		120 mm	KOB-YN01V00112R800	236.82
	YN01V00112F3	YF02-01201-YF02-01299	P-UB-10	80 mm	120 mm	KOB-YN01V00112R900	379.21
	YN01V00112F3	YF02-01201-YF02-01299	P-UB-1	80 mm		KOB-YN01V00112R100	138.93
	YN01V00112F3	YF02-01201-YF02-01299	N-N-10		120 mm	KOB-YN01V00112R800	236.82
	YN01V00112F3	YF03-01300-YF03-01421	P-UB-10	80 mm	120 mm	KOB-YN01V00112R900	379.21
	YN01V00112F3	YF03-01300-YF03-01421	P-UB-1	80 mm		KOB-YN01V00112R100	138.93
	YN01V00112F3	YF03-01300-YF03-01421	N-N-10		120 mm	KOB-YN01V00112R800	236.82
	YN01V00112F3	YF04-01501-	P-UB-10	80 mm	120 mm	KOB-YN01V00112R900	379.21
	YN01V00112F3	YF04-01501-	P-UB-1	80 mm		KOB-YN01V00112R100	138.93
	YN01V00112F3	YF04-01501-	N-N-10		120 mm	KOB-YN01V00112R800	236.82
	YN01V00112F4	YF02-01201-YF02-01299	P-UB-10	80 mm	120 mm	KOB-YN01V00112R900	379.21
	YN01V00112F4	YF02-01201-YF02-01299	P-UB-1	80 mm		KOB-YN01V00112R100	138.93
	YN01V00112F4	YF02-01201-YF02-01299	N-N-10		120 mm	KOB-YN01V00112R800	236.82
	YN01V00112F4	YF03-01300-YF03-01421	P-UB-10	80 mm	120 mm	KOB-YN01V00112R900	379.21
	YN01V00112F4	YF03-01300-YF03-01421	P-UB-1	80 mm		KOB-YN01V00112R100	138.93
	YN01V00112F4	YF03-01300-YF03-01421	N-N-10		120 mm	KOB-YN01V00112R800	236.82
	YN01V00112F4	YF04-01501-	P-UB-10	80 mm	120 mm	KOB-YN01V00112R900	379.21
YN01V00112F4	YF04-01501-	P-UB-1	80 mm		KOB-YN01V00112R100	138.93	
YN01V00112F4	YF04-01501-	N-N-10		120 mm	KOB-YN01V00112R800	236.82	
YN01V00112F5	YF04-01501-	P-UB-10	80 mm	120 mm	KOB-YN01V00112R900	379.21	
YN01V00112F5	YF04-01501-	P-UB-1	80 mm		KOB-YN01V00112R100	138.93	
YN01V00112F5	YF04-01501-	N-N-10		120 mm	KOB-YN01V00112R800	236.82	
MODEL SK235SR-1ES							
ARM	YN01V00132F1	YF04-01501-	P-UB-10	95 mm	135 mm	KOB-YN01V00105R900	382.74
	YN01V00132F1	YF04-01501-	P-UB-1	95 mm		KOB-YN01V00105R100	138.45
	YN01V00132F1	YF04-01501-	N-N-10		135 mm	KOB-YN01V00105R800	244.29
	YN01V00132F2	YF04-01501-	P-UB-10	95 mm	135 mm	KOB-YN01V00105R900	382.74
	YN01V00132F2	YF04-01501-	P-UB-1	95 mm		KOB-YN01V00105R100	138.45
	YN01V00132F2	YF04-01501-	N-N-10		135 mm	KOB-YN01V00105R800	244.29
	YN01V00132F3	YF04-01501-	P-UB-10	95 mm	135 mm	KOB-YN01V00105R900	382.74
	YN01V00132F3	YF04-01501-	P-UB-1	95 mm		KOB-YN01V00105R100	138.45
	YN01V00132F3	YF04-01501-	N-N-10		135 mm	KOB-YN01V00105R800	244.29
	YN01V00132F4	YF04-01501-	P-UB-10	95 mm	135 mm	KOB-YN01V00105R900	382.74
	YN01V00132F4	YF04-01501-	P-UB-1	95 mm		KOB-YN01V00105R100	138.45
	YN01V00132F4	YF04-01501-	N-N-10		135 mm	KOB-YN01V00105R800	244.29
	YN01V00132F5	YF04-01501-	P-UB-10	95 mm	135 mm	KOB-YN01V00105R900	382.74
	YN01V00132F5	YF04-01501-	P-UB-1	95 mm		KOB-YN01V00105R100	138.45
	YN01V00132F5	YF04-01501-	N-N-10		135 mm	KOB-YN01V00105R800	244.29
BOOM LH	YN01V00108F1	YF04-01501-	P-UB-10	85 mm	125 mm	KOB-YN01V00103R900	308.86
	YN01V00108F1	YF04-01501-	P-UB-1	85 mm		KOB-YN01V00103R100	118.57
	YN01V00108F1	YF04-01501-	N-N-10		125 mm	KOB-YN01V00103R800	190.31
	YN01V00108F2	YF04-01501-	P-UB-10	85 mm	125 mm	KOB-YN01V00103R900	308.86
	YN01V00108F2	YF04-01501-	P-UB-1	85 mm		KOB-YN01V00103R100	118.57
	YN01V00108F2	YF04-01501-	N-N-10		125 mm	KOB-YN01V00103R800	190.31
	YN01V00108F3	YF04-01501-	P-UB-10	85 mm	125 mm	KOB-YN01V00103R900	308.86
	YN01V00108F3	YF04-01501-	P-UB-1	85 mm		KOB-YN01V00103R100	118.57
	YN01V00108F3	YF04-01501-	N-N-10		125 mm	KOB-YN01V00103R800	190.31
BOOM RH	YN01V00107F1	YF04-01501-	P-UB-10	85 mm	125 mm	KOB-YN01V00103R900	308.86
	YN01V00107F1	YF04-01501-	P-UB-1	85 mm		KOB-YN01V00103R100	118.57
	YN01V00107F1	YF04-01501-	N-N-10		125 mm	KOB-YN01V00103R800	190.31
	YN01V00107F2	YF04-01501-	P-UB-10	85 mm	125 mm	KOB-YN01V00103R900	308.86
	YN01V00107F2	YF04-01501-	P-UB-1	85 mm		KOB-YN01V00103R100	118.57

Replacement Kits For

KOBELCO®

Excavators							
APPLICATION	CYL #	SERIAL #	CODE	ROD	BORE	KIT #	List \$
MODEL SK235SR-1ES							
BOOM RH	YN01V00107F2	YF04-01501-	N-N-10		125 mm	KOB-YN01V00103R800	190.31
	YN01V00107F3	YF04-01501-	P-UB-10	85 mm	125 mm	KOB-YN01V00103R900	308.86
	YN01V00107F3	YF04-01501-	P-UB-1	85 mm		KOB-YN01V00103R100	118.57
	YN01V00107F3	YF04-01501-	N-N-10		125 mm	KOB-YN01V00103R800	190.31
BUCKET	YN01V00112F1	YF04-01501-	P-UB-10	80 mm	120 mm	KOB-YN01V00112R900	379.21
	YN01V00112F1	YF04-01501-	P-UB-1	80 mm		KOB-YN01V00112R100	138.93
	YN01V00112F1	YF04-01501-	N-N-10		120 mm	KOB-YN01V00112R800	236.82
	YN01V00112F2	YF04-01501-	P-UB-10	80 mm	120 mm	KOB-YN01V00112R900	379.21
	YN01V00112F2	YF04-01501-	P-UB-1	80 mm		KOB-YN01V00112R100	138.93
	YN01V00112F2	YF04-01501-	N-N-10		120 mm	KOB-YN01V00112R800	236.82
	YN01V00112F3	YF04-01501-	P-UB-10	80 mm	120 mm	KOB-YN01V00112R900	379.21
	YN01V00112F3	YF04-01501-	P-UB-1	80 mm		KOB-YN01V00112R100	138.93
	YN01V00112F3	YF04-01501-	N-N-10		120 mm	KOB-YN01V00112R800	236.82
	YN01V00112F4	YF04-01501-	P-UB-10	80 mm	120 mm	KOB-YN01V00112R900	379.21
	YN01V00112F4	YF04-01501-	P-UB-1	80 mm		KOB-YN01V00112R100	138.93
	YN01V00112F4	YF04-01501-	N-N-10		120 mm	KOB-YN01V00112R800	236.82
	YN01V00112F5	YF04-01501-	P-UB-10	80 mm	120 mm	KOB-YN01V00112R900	379.21
	YN01V00112F5	YF04-01501-	P-UB-1	80 mm		KOB-YN01V00112R100	138.93
	YN01V00112F5	YF04-01501-	N-N-10		120 mm	KOB-YN01V00112R800	236.82
	MODEL SK235SR-2						
ARM	YN01V00175F1	YF05-02001-	P-UB-10	95 mm	135 mm	KOB-YN01V00175R300	395.31
	YN01V00175F1	YF05-02001-	P-UB-1	95 mm		KOB-YN01V00175R100	118.51
	YN01V00175F1	YF05-02001-	N-N-10		135 mm	KOB-YN01V00175R200	268.31
	YN01V00175F2	YF05-02001-	P-UB-10	95 mm	135 mm	KOB-YN01V00175R300	395.31
	YN01V00175F2	YF05-02001-	P-UB-1	95 mm		KOB-YN01V00175R100	118.51
BOOM	YN01V00175F2	YF05-02001-	N-N-10		135 mm	KOB-YN01V00175R200	268.31
	YF01V00001F1	YF05-02001-	P-UB-10	85 mm	125 mm	KOB-YF01V00001R300	323.48
	YF01V00001F1	YF05-02001-	P-UB-1	85 mm		KOB-LQ01V00003R100	96.67
BUCKET	YF01V00001F1	YF05-02001-	N-N-10		125 mm	KOB-YF01V00001R200	226.81
	YN01V00153F1	YF05-02001-	P-UB-10	80 mm	120 mm	KOB-YN01V00153R300	437.05
	YN01V00153F1	YF05-02001-	P-UB-1	80 mm		KOB-YN01V00153R100	119.97
	YN01V00153F1	YF05-02001-	N-N-10		120 mm	KOB-YN01V00151R600	119.11
	YN01V00153F2	YF05-02001-	P-UB-10	80 mm	120 mm	KOB-YN01V00153R300	437.05
	YN01V00153F2	YF05-02001-	P-UB-1	80 mm		KOB-YN01V00153R100	119.97
YN01V00153F2	YF05-02001-	N-N-10		120 mm	KOB-YN01V00151R600	119.11	
MODEL SK235SR-LC							
ARM	YN01V00039F1	YU01-00101-	P-UB-14	95 mm	135 mm	KOB-YN01V00039R300	246.98
	YN01V00039F1	YU01-00101-	P-UB-1	95 mm		KOB-YN01V00003R100	60.53
	YN01V00039F1	YU01-00101-	N-N-14		135 mm	KOB-YN01V00039R200	186.46
	YN01V00078F1	YU01-00101-	P-UB-14	95 mm	135 mm	KOB-YN01V00039R300	246.98
	YN01V00078F1	YU01-00101-	P-UB-1	95 mm		KOB-YN01V00003R100	60.53
	YN01V00078F1	YU01-00101-	N-N-14		135 mm	KOB-YN01V00039R200	186.46
	YN01V00105F1	YU01-00101-	P-UB-10	95 mm	135 mm	KOB-YN01V00105R300	382.74
	YN01V00105F1	YU01-00101-	P-UB-1	95 mm		KOB-YN01V00105R100	138.45
	YN01V00105F1	YU01-00101-	N-N-10		135 mm	KOB-YN01V00105R200	244.29
	YN01V00105F2	YU01-00101-	P-UB-10	95 mm	135 mm	KOB-YN01V00105R300	382.74
	YN01V00105F2	YU01-00101-	P-UB-1	95 mm		KOB-YN01V00105R100	138.45
	YN01V00105F2	YU01-00101-	N-N-10		135 mm	KOB-YN01V00105R200	244.29
	YN01V00105F3	YU01-00101-	P-UB-10	95 mm	135 mm	KOB-YN01V00105R300	382.74
	YN01V00105F3	YU01-00101-	P-UB-1	95 mm		KOB-YN01V00105R100	138.45
	YN01V00105F3	YU01-00101-	N-N-10		135 mm	KOB-YN01V00105R200	244.29
	BOOM LH	YN01V00053F1	YU01-00101-	P-UB-14	85 mm	125 mm	KOB-YN01V00052R300
YN01V00053F1		YU01-00101-	P-UB-1	85 mm		KOB-YN01V00052R100	57.05
YN01V00053F1		YU01-00101-	N-N-14		125 mm	KOB-YN01V00052R200	145.60
YN01V00053F2		YU01-00101-	P-UB-14	85 mm	125 mm	KOB-YN01V00052R300	202.64

KOBELCO®

Replacement Kits For

KOBELCO®

Excavators								
APPLICATION	CYL #	SERIAL #	CODE	ROD	BORE	KIT #	List \$	
MODEL SK235SRLC								
BOOM LH	YN01V00053F2	YU01-00101-	P-UB-1	85 mm		KOB-YN01V00052R100	57.05	
	YN01V00053F2	YU01-00101-	N-N-14		125 mm	KOB-YN01V00052R200	145.60	
	YN01V00108F1	YU01-00101-	P-UB-10	85 mm	125 mm	KOB-YN01V00103R300	308.86	
	YN01V00108F1	YU01-00101-	P-UB-1	85 mm		KOB-YN01V00103R100	118.57	
	YN01V00108F1	YU01-00101-	N-N-10		125 mm	KOB-YN01V00103R200	190.31	
BOOM RH	YN01V00052F1	YU01-00101-	P-UB-14	85 mm	125 mm	KOB-YN01V00052R300	202.64	
	YN01V00052F1	YU01-00101-	P-UB-1	85 mm		KOB-YN01V00052R100	57.05	
	YN01V00052F1	YU01-00101-	N-N-14		125 mm	KOB-YN01V00052R200	145.60	
	YN01V00052F2	YU01-00101-	P-UB-14	85 mm	125 mm	KOB-YN01V00052R300	202.64	
	YN01V00052F2	YU01-00101-	P-UB-1	85 mm		KOB-YN01V00052R100	57.05	
	YN01V00052F2	YU01-00101-	N-N-14		125 mm	KOB-YN01V00052R200	145.60	
	YN01V00107F1	YU01-00101-	P-UB-10	85 mm	125 mm	KOB-YN01V00103R300	308.86	
	YN01V00107F1	YU01-00101-	P-UB-1	85 mm		KOB-YN01V00103R100	118.57	
	YN01V00107F1	YU01-00101-	N-N-10		125 mm	KOB-YN01V00103R200	190.31	
	BUCKET	YN01V00068F1	YU01-00101-	P-UB-14	80 mm	115 mm	KOB-YN01V00068R300	118.26
		YN01V00068F1	YU01-00101-	P-UB-1	80 mm		KOB-YN01V00068R100	57.23
		YN01V00068F1	YU01-00101-	N-N-14		115 mm	KOB-YN01V00068R200	61.03
YN01V00106F1		YU01-00101-	P-UB-10	80 mm	115 mm	KOB-YN01V00106R300	272.99	
YN01V00106F1		YU01-00101-	P-UB-1	80 mm		KOB-YN01V00106R100	116.11	
YN01V00106F1		YU01-00101-	N-N-10		115 mm	KOB-YN01V00106R200	156.90	
YX01V00005F1		YU01-00101-	P-UB-14	65 mm	95 mm	KOB-YX01V00005R300	100.16	
YX01V00005F1		YU01-00101-	P-UB-1	65 mm		KOB-YX01V00005R100	72.49	
YX01V00005F1		YU01-00101-	N-N-14		95 mm	KOB-YX01V00005R200	83.31	
YX01V00005F2		YU01-00101-	P-UB-14	65 mm	95 mm	KOB-YX01V00005R300	100.16	
YX01V00005F2		YU01-00101-	P-UB-1	65 mm		KOB-YX01V00005R100	72.49	
YX01V00005F2		YU01-00101-	N-N-14		95 mm	KOB-YX01V00005R200	83.31	
YX01V00005F3		YU01-00101-	P-UB-14	65 mm	95 mm	KOB-YX01V00005R300	100.16	
YX01V00005F3		YU01-00101-	P-UB-1	65 mm		KOB-YX01V00005R100	72.49	
YX01V00005F3		YU01-00101-	N-N-14		95 mm	KOB-YX01V00005R200	83.31	
YX01V00005F4		YU01-00101-	P-UB-14	65 mm	95 mm	KOB-YX01V00005R300	100.16	
YX01V00005F4		YU01-00101-	P-UB-1	65 mm		KOB-YX01V00005R100	72.49	
YX01V00005F4		YU01-00101-	N-N-14		95 mm	KOB-YX01V00005R200	83.31	
MODEL SK235SRLC-1E								
ARM		YN01V00105F1	YU02-00501-YU02-00647	P-UB-10	95 mm	135 mm	KOB-YN01V00105R900	382.74
	YN01V00105F1	YU02-00501-YU02-00647	P-UB-1	95 mm		KOB-YN01V00105R100	138.45	
	YN01V00105F1	YU02-00501-YU02-00647	N-N-10		135 mm	KOB-YN01V00105R800	244.29	
	YN01V00105F1	YU03-00648-YU03-00770	P-UB-10	95 mm	135 mm	KOB-YN01V00105R900	382.74	
	YN01V00105F1	YU03-00648-YU03-00770	P-UB-1	95 mm		KOB-YN01V00105R100	138.45	
	YN01V00105F1	YU03-00648-YU03-00770	N-N-10		135 mm	KOB-YN01V00105R800	244.29	
	YN01V00105F2	YU02-00501-YU02-00647	P-UB-10	95 mm	135 mm	KOB-YN01V00105R900	382.74	
	YN01V00105F2	YU02-00501-YU02-00647	P-UB-1	95 mm		KOB-YN01V00105R100	138.45	
	YN01V00105F2	YU02-00501-YU02-00647	N-N-10		135 mm	KOB-YN01V00105R800	244.29	
	YN01V00105F2	YU03-00648-YU03-00770	P-UB-10	95 mm	135 mm	KOB-YN01V00105R900	382.74	
	YN01V00105F2	YU03-00648-YU03-00770	P-UB-1	95 mm		KOB-YN01V00105R100	138.45	
	YN01V00105F2	YU03-00648-YU03-00770	N-N-10		135 mm	KOB-YN01V00105R800	244.29	
	YN01V00105F3	YU02-00501-YU02-00647	P-UB-10	95 mm	135 mm	KOB-YN01V00105R900	382.74	
	YN01V00105F3	YU02-00501-YU02-00647	P-UB-1	95 mm		KOB-YN01V00105R100	138.45	
	YN01V00105F3	YU02-00501-YU02-00647	N-N-10		135 mm	KOB-YN01V00105R800	244.29	
	YN01V00105F3	YU03-00648-YU03-00770	P-UB-10	95 mm	135 mm	KOB-YN01V00105R900	382.74	
	YN01V00105F3	YU03-00648-YU03-00770	P-UB-1	95 mm		KOB-YN01V00105R100	138.45	
	YN01V00105F3	YU03-00648-YU03-00770	N-N-10		135 mm	KOB-YN01V00105R800	244.29	
	YN01V00105F4	YU02-00501-YU02-00647	P-UB-10	95 mm	135 mm	KOB-YN01V00105R900	382.74	
	YN01V00105F4	YU02-00501-YU02-00647	P-UB-1	95 mm		KOB-YN01V00105R100	138.45	
	YN01V00105F4	YU02-00501-YU02-00647	N-N-10		135 mm	KOB-YN01V00105R800	244.29	
	YN01V00105F4	YU03-00648-YU03-00770	P-UB-10	95 mm	135 mm	KOB-YN01V00105R900	382.74	

Replacement Kits For

KOBELCO®

Excavators							
APPLICATION	CYL #	SERIAL #	CODE	ROD	BORE	KIT #	List \$
MODEL SK235SRLC-1E							
ARM	YN01V00105F4	YU03-00648-YU03-00770	P-UB-1	95 mm		KOB-YN01V00105R100	138.45
	YN01V00105F4	YU03-00648-YU03-00770	N-N-10		135 mm	KOB-YN01V00105R800	244.29
	YN01V00105F5	YU02-00501-YU02-00647	P-UB-10	95 mm	135 mm	KOB-YN01V00105R900	382.74
	YN01V00105F5	YU02-00501-YU02-00647	P-UB-1	95 mm		KOB-YN01V00105R100	138.45
	YN01V00105F5	YU02-00501-YU02-00647	N-N-10		135 mm	KOB-YN01V00105R800	244.29
	YN01V00105F5	YU03-00648-YU03-00770	P-UB-10	95 mm	135 mm	KOB-YN01V00105R900	382.74
	YN01V00105F5	YU03-00648-YU03-00770	P-UB-1	95 mm		KOB-YN01V00105R100	138.45
	YN01V00105F5	YU03-00648-YU03-00770	N-N-10		135 mm	KOB-YN01V00105R800	244.29
	YN01V00105F6	YU02-00501-YU02-00647	P-UB-10	95 mm	135 mm	KOB-YN01V00105R900	382.74
	YN01V00105F6	YU02-00501-YU02-00647	P-UB-1	95 mm		KOB-YN01V00105R100	138.45
	YN01V00105F6	YU02-00501-YU02-00647	N-N-10		135 mm	KOB-YN01V00105R800	244.29
	YN01V00105F6	YU03-00648-YU03-00770	P-UB-10	95 mm	135 mm	KOB-YN01V00105R900	382.74
	YN01V00105F6	YU03-00648-YU03-00770	P-UB-1	95 mm		KOB-YN01V00105R100	138.45
	YN01V00105F6	YU03-00648-YU03-00770	N-N-10		135 mm	KOB-YN01V00105R800	244.29
	YN01V00132F1	YU02-00501-YU02-00647	P-UB-10	95 mm	135 mm	KOB-YN01V00105R900	382.74
	YN01V00132F1	YU02-00501-YU02-00647	P-UB-1	95 mm		KOB-YN01V00105R100	138.45
	YN01V00132F1	YU02-00501-YU02-00647	N-N-10		135 mm	KOB-YN01V00105R800	244.29
	YN01V00132F1	YU03-00648-YU03-00770	P-UB-10	95 mm	135 mm	KOB-YN01V00105R900	382.74
	YN01V00132F1	YU03-00648-YU03-00770	P-UB-1	95 mm		KOB-YN01V00105R100	138.45
	YN01V00132F1	YU03-00648-YU03-00770	N-N-10		135 mm	KOB-YN01V00105R800	244.29
	YN01V00132F1	YU04-00801-	P-UB-10	95 mm	135 mm	KOB-YN01V00105R900	382.74
	YN01V00132F1	YU04-00801-	P-UB-1	95 mm		KOB-YN01V00105R100	138.45
	YN01V00132F1	YU04-00801-	N-N-10		135 mm	KOB-YN01V00105R800	244.29
	YN01V00132F2	YU02-00501-YU02-00647	P-UB-10	95 mm	135 mm	KOB-YN01V00105R900	382.74
	YN01V00132F2	YU02-00501-YU02-00647	P-UB-1	95 mm		KOB-YN01V00105R100	138.45
	YN01V00132F2	YU02-00501-YU02-00647	N-N-10		135 mm	KOB-YN01V00105R800	244.29
	YN01V00132F2	YU03-00648-YU03-00770	P-UB-10	95 mm	135 mm	KOB-YN01V00105R900	382.74
	YN01V00132F2	YU03-00648-YU03-00770	P-UB-1	95 mm		KOB-YN01V00105R100	138.45
	YN01V00132F2	YU03-00648-YU03-00770	N-N-10		135 mm	KOB-YN01V00105R800	244.29
	YN01V00132F2	YU04-00801-	P-UB-10	95 mm	135 mm	KOB-YN01V00105R900	382.74
	YN01V00132F2	YU04-00801-	P-UB-1	95 mm		KOB-YN01V00105R100	138.45
	YN01V00132F2	YU04-00801-	N-N-10		135 mm	KOB-YN01V00105R800	244.29
	YN01V00132F3	YU02-00501-YU02-00647	P-UB-10	95 mm	135 mm	KOB-YN01V00105R900	382.74
	YN01V00132F3	YU02-00501-YU02-00647	P-UB-1	95 mm		KOB-YN01V00105R100	138.45
	YN01V00132F3	YU02-00501-YU02-00647	N-N-10		135 mm	KOB-YN01V00105R800	244.29
	YN01V00132F3	YU03-00648-YU03-00770	P-UB-10	95 mm	135 mm	KOB-YN01V00105R900	382.74
	YN01V00132F3	YU03-00648-YU03-00770	P-UB-1	95 mm		KOB-YN01V00105R100	138.45
	YN01V00132F3	YU03-00648-YU03-00770	N-N-10		135 mm	KOB-YN01V00105R800	244.29
	YN01V00132F3	YU04-00801-	P-UB-10	95 mm	135 mm	KOB-YN01V00105R900	382.74
	YN01V00132F3	YU04-00801-	P-UB-1	95 mm		KOB-YN01V00105R100	138.45
	YN01V00132F3	YU04-00801-	N-N-10		135 mm	KOB-YN01V00105R800	244.29
	YN01V00132F4	YU02-00501-YU02-00647	P-UB-10	95 mm	135 mm	KOB-YN01V00105R900	382.74
	YN01V00132F4	YU02-00501-YU02-00647	P-UB-1	95 mm		KOB-YN01V00105R100	138.45
	YN01V00132F4	YU02-00501-YU02-00647	N-N-10		135 mm	KOB-YN01V00105R800	244.29
	YN01V00132F4	YU03-00648-YU03-00770	P-UB-10	95 mm	135 mm	KOB-YN01V00105R900	382.74
	YN01V00132F4	YU03-00648-YU03-00770	P-UB-1	95 mm		KOB-YN01V00105R100	138.45
	YN01V00132F4	YU03-00648-YU03-00770	N-N-10		135 mm	KOB-YN01V00105R800	244.29
	YN01V00132F4	YU04-00801-	P-UB-10	95 mm	135 mm	KOB-YN01V00105R900	382.74
	YN01V00132F4	YU04-00801-	P-UB-1	95 mm		KOB-YN01V00105R100	138.45
	YN01V00132F4	YU04-00801-	N-N-10		135 mm	KOB-YN01V00105R800	244.29
YN01V00132F5	YU02-00501-YU02-00647	P-UB-10	95 mm	135 mm	KOB-YN01V00105R900	382.74	
YN01V00132F5	YU02-00501-YU02-00647	P-UB-1	95 mm		KOB-YN01V00105R100	138.45	
YN01V00132F5	YU02-00501-YU02-00647	N-N-10		135 mm	KOB-YN01V00105R800	244.29	
YN01V00132F5	YU03-00648-YU03-00770	P-UB-10	95 mm	135 mm	KOB-YN01V00105R900	382.74	
YN01V00132F5	YU03-00648-YU03-00770	P-UB-1	95 mm		KOB-YN01V00105R100	138.45	

KOBELCO®

Replacement Kits For

KOBELCO®

Excavators								
APPLICATION	CYL #	SERIAL #	CODE	ROD	BORE	KIT #	List \$	
MODEL SK235SRLC-1E								
ARM	YN01V00132F5	YU03-00648-YU03-00770	N-N-10		135 mm	KOB-YN01V00105R800	244.29	
	YN01V00132F5	YU04-00801-	P-UB-10	95 mm	135 mm	KOB-YN01V00105R900	382.74	
	YN01V00132F5	YU04-00801-	P-UB-1	95 mm		KOB-YN01V00105R100	138.45	
	YN01V00132F5	YU04-00801-	N-N-10		135 mm	KOB-YN01V00105R800	244.29	
BOOM LH	YN01V00108F1	YU02-00501-YU02-00647	P-UB-10	85 mm	125 mm	KOB-YN01V00103R900	308.86	
	YN01V00108F1	YU02-00501-YU02-00647	P-UB-1	85 mm		KOB-YN01V00103R100	118.57	
	YN01V00108F1	YU02-00501-YU02-00647	N-N-10		125 mm	KOB-YN01V00103R800	190.31	
	YN01V00108F1	YU03-00648-YU03-00770	P-UB-10	85 mm	125 mm	KOB-YN01V00103R900	308.86	
	YN01V00108F1	YU03-00648-YU03-00770	P-UB-1	85 mm		KOB-YN01V00103R100	118.57	
	YN01V00108F1	YU03-00648-YU03-00770	N-N-10		125 mm	KOB-YN01V00103R800	190.31	
	YN01V00108F1	YU04-00801-	P-UB-10	85 mm	125 mm	KOB-YN01V00103R900	308.86	
	YN01V00108F1	YU04-00801-	P-UB-1	85 mm		KOB-YN01V00103R100	118.57	
	YN01V00108F1	YU04-00801-	N-N-10		125 mm	KOB-YN01V00103R800	190.31	
	YN01V00108F2	YU02-00501-YU02-00647	P-UB-10	85 mm	125 mm	KOB-YN01V00103R900	308.86	
	YN01V00108F2	YU02-00501-YU02-00647	P-UB-1	85 mm		KOB-YN01V00103R100	118.57	
	YN01V00108F2	YU02-00501-YU02-00647	N-N-10		125 mm	KOB-YN01V00103R800	190.31	
	YN01V00108F2	YU03-00648-YU03-00770	P-UB-10	85 mm	125 mm	KOB-YN01V00103R900	308.86	
	YN01V00108F2	YU03-00648-YU03-00770	P-UB-1	85 mm		KOB-YN01V00103R100	118.57	
	YN01V00108F2	YU03-00648-YU03-00770	N-N-10		125 mm	KOB-YN01V00103R800	190.31	
	YN01V00108F2	YU04-00801-	P-UB-10	85 mm	125 mm	KOB-YN01V00103R900	308.86	
	YN01V00108F2	YU04-00801-	P-UB-1	85 mm		KOB-YN01V00103R100	118.57	
	YN01V00108F2	YU04-00801-	N-N-10		125 mm	KOB-YN01V00103R800	190.31	
	YN01V00108F3	YU02-00501-YU02-00647	P-UB-10	85 mm	125 mm	KOB-YN01V00103R900	308.86	
	YN01V00108F3	YU02-00501-YU02-00647	P-UB-1	85 mm		KOB-YN01V00103R100	118.57	
	YN01V00108F3	YU02-00501-YU02-00647	N-N-10		125 mm	KOB-YN01V00103R800	190.31	
	YN01V00108F3	YU03-00648-YU03-00770	P-UB-10	85 mm	125 mm	KOB-YN01V00103R900	308.86	
	YN01V00108F3	YU03-00648-YU03-00770	P-UB-1	85 mm		KOB-YN01V00103R100	118.57	
	YN01V00108F3	YU03-00648-YU03-00770	N-N-10		125 mm	KOB-YN01V00103R800	190.31	
	YN01V00108F3	YU04-00801-	P-UB-10	85 mm	125 mm	KOB-YN01V00103R900	308.86	
	YN01V00108F3	YU04-00801-	P-UB-1	85 mm		KOB-YN01V00103R100	118.57	
	YN01V00108F3	YU04-00801-	N-N-10		125 mm	KOB-YN01V00103R800	190.31	
	BOOM RH	YN01V00107F1	YU02-00501-YU02-00647	P-UB-10	85 mm	125 mm	KOB-YN01V00103R900	308.86
		YN01V00107F1	YU02-00501-YU02-00647	P-UB-1	85 mm		KOB-YN01V00103R100	118.57
		YN01V00107F1	YU02-00501-YU02-00647	N-N-10		125 mm	KOB-YN01V00103R800	190.31
		YN01V00107F1	YU03-00648-YU03-00770	P-UB-10	85 mm	125 mm	KOB-YN01V00103R900	308.86
		YN01V00107F1	YU03-00648-YU03-00770	P-UB-1	85 mm		KOB-YN01V00103R100	118.57
YN01V00107F1		YU03-00648-YU03-00770	N-N-10		125 mm	KOB-YN01V00103R800	190.31	
YN01V00107F1		YU04-00801-	P-UB-10	85 mm	125 mm	KOB-YN01V00103R900	308.86	
YN01V00107F1		YU04-00801-	P-UB-1	85 mm		KOB-YN01V00103R100	118.57	
YN01V00107F1		YU04-00801-	N-N-10		125 mm	KOB-YN01V00103R800	190.31	
YN01V00107F2		YU02-00501-YU02-00647	P-UB-10	85 mm	125 mm	KOB-YN01V00103R900	308.86	
YN01V00107F2		YU02-00501-YU02-00647	P-UB-1	85 mm		KOB-YN01V00103R100	118.57	
YN01V00107F2		YU02-00501-YU02-00647	N-N-10		125 mm	KOB-YN01V00103R800	190.31	
YN01V00107F2		YU03-00648-YU03-00770	P-UB-10	85 mm	125 mm	KOB-YN01V00103R900	308.86	
YN01V00107F2		YU03-00648-YU03-00770	P-UB-1	85 mm		KOB-YN01V00103R100	118.57	
YN01V00107F2		YU03-00648-YU03-00770	N-N-10		125 mm	KOB-YN01V00103R800	190.31	
YN01V00107F2		YU04-00801-	P-UB-10	85 mm	125 mm	KOB-YN01V00103R900	308.86	
YN01V00107F2		YU04-00801-	P-UB-1	85 mm		KOB-YN01V00103R100	118.57	
YN01V00107F2		YU04-00801-	N-N-10		125 mm	KOB-YN01V00103R800	190.31	
YN01V00107F3		YU02-00501-YU02-00647	P-UB-10	85 mm	125 mm	KOB-YN01V00103R900	308.86	
YN01V00107F3		YU02-00501-YU02-00647	P-UB-1	85 mm		KOB-YN01V00103R100	118.57	
YN01V00107F3		YU02-00501-YU02-00647	N-N-10		125 mm	KOB-YN01V00103R800	190.31	
YN01V00107F3		YU03-00648-YU03-00770	P-UB-10	85 mm	125 mm	KOB-YN01V00103R900	308.86	
YN01V00107F3		YU03-00648-YU03-00770	P-UB-1	85 mm		KOB-YN01V00103R100	118.57	
YN01V00107F3		YU03-00648-YU03-00770	N-N-10		125 mm	KOB-YN01V00103R800	190.31	

KOBELCO®

Replacement Kits For

KOBELCO®

Excavators							
APPLICATION	CYL #	SERIAL #	CODE	ROD	BORE	KIT #	List \$
MODEL SK235SRLC-1E							
BOOM RH	YN01V00107F3	YU04-00801-	P-UB-10	85 mm	125 mm	KOB-YN01V00103R900	308.86
	YN01V00107F3	YU04-00801-	P-UB-1	85 mm		KOB-YN01V00103R100	118.57
	YN01V00107F3	YU04-00801-	N-N-10		125 mm	KOB-YN01V00103R800	190.31
BUCKET	YN01V00112F1	YU02-00501-YU02-00647	P-UB-10	80 mm	120 mm	KOB-YN01V00112R900	379.21
	YN01V00112F1	YU02-00501-YU02-00647	P-UB-1	80 mm		KOB-YN01V00112R100	138.93
	YN01V00112F1	YU02-00501-YU02-00647	N-N-10		120 mm	KOB-YN01V00112R800	236.82
	YN01V00112F1	YU03-00648-YU03-00770	P-UB-10	80 mm	120 mm	KOB-YN01V00112R900	379.21
	YN01V00112F1	YU03-00648-YU03-00770	P-UB-1	80 mm		KOB-YN01V00112R100	138.93
	YN01V00112F1	YU03-00648-YU03-00770	N-N-10		120 mm	KOB-YN01V00112R800	236.82
	YN01V00112F1	YU04-00801-	P-UB-10	80 mm	120 mm	KOB-YN01V00112R900	379.21
	YN01V00112F1	YU04-00801-	P-UB-1	80 mm		KOB-YN01V00112R100	138.93
	YN01V00112F1	YU04-00801-	N-N-10		120 mm	KOB-YN01V00112R800	236.82
	YN01V00112F2	YU02-00501-YU02-00647	P-UB-10	80 mm	120 mm	KOB-YN01V00112R900	379.21
	YN01V00112F2	YU02-00501-YU02-00647	P-UB-1	80 mm		KOB-YN01V00112R100	138.93
	YN01V00112F2	YU02-00501-YU02-00647	N-N-10		120 mm	KOB-YN01V00112R800	236.82
	YN01V00112F2	YU03-00648-YU03-00770	P-UB-10	80 mm	120 mm	KOB-YN01V00112R900	379.21
	YN01V00112F2	YU03-00648-YU03-00770	P-UB-1	80 mm		KOB-YN01V00112R100	138.93
	YN01V00112F2	YU03-00648-YU03-00770	N-N-10		120 mm	KOB-YN01V00112R800	236.82
	YN01V00112F2	YU04-00801-	P-UB-10	80 mm	120 mm	KOB-YN01V00112R900	379.21
	YN01V00112F2	YU04-00801-	P-UB-1	80 mm		KOB-YN01V00112R100	138.93
	YN01V00112F2	YU04-00801-	N-N-10		120 mm	KOB-YN01V00112R800	236.82
	YN01V00112F3	YU02-00501-YU02-00647	P-UB-10	80 mm	120 mm	KOB-YN01V00112R900	379.21
	YN01V00112F3	YU02-00501-YU02-00647	P-UB-1	80 mm		KOB-YN01V00112R100	138.93
	YN01V00112F3	YU02-00501-YU02-00647	N-N-10		120 mm	KOB-YN01V00112R800	236.82
	YN01V00112F3	YU03-00648-YU03-00770	P-UB-10	80 mm	120 mm	KOB-YN01V00112R900	379.21
	YN01V00112F3	YU03-00648-YU03-00770	P-UB-1	80 mm		KOB-YN01V00112R100	138.93
	YN01V00112F3	YU03-00648-YU03-00770	N-N-10		120 mm	KOB-YN01V00112R800	236.82
	YN01V00112F3	YU04-00801-	P-UB-10	80 mm	120 mm	KOB-YN01V00112R900	379.21
	YN01V00112F3	YU04-00801-	P-UB-1	80 mm		KOB-YN01V00112R100	138.93
	YN01V00112F3	YU04-00801-	N-N-10		120 mm	KOB-YN01V00112R800	236.82
	YN01V00112F4	YU02-00501-YU02-00647	P-UB-10	80 mm	120 mm	KOB-YN01V00112R900	379.21
	YN01V00112F4	YU02-00501-YU02-00647	P-UB-1	80 mm		KOB-YN01V00112R100	138.93
	YN01V00112F4	YU02-00501-YU02-00647	N-N-10		120 mm	KOB-YN01V00112R800	236.82
	YN01V00112F4	YU03-00648-YU03-00770	P-UB-10	80 mm	120 mm	KOB-YN01V00112R900	379.21
	YN01V00112F4	YU03-00648-YU03-00770	P-UB-1	80 mm		KOB-YN01V00112R100	138.93
	YN01V00112F4	YU03-00648-YU03-00770	N-N-10		120 mm	KOB-YN01V00112R800	236.82
YN01V00112F4	YU04-00801-	P-UB-10	80 mm	120 mm	KOB-YN01V00112R900	379.21	
YN01V00112F4	YU04-00801-	P-UB-1	80 mm		KOB-YN01V00112R100	138.93	
YN01V00112F4	YU04-00801-	N-N-10		120 mm	KOB-YN01V00112R800	236.82	
YN01V00112F5	YU04-00801-	P-UB-10	80 mm	120 mm	KOB-YN01V00112R900	379.21	
YN01V00112F5	YU04-00801-	P-UB-1	80 mm		KOB-YN01V00112R100	138.93	
YN01V00112F5	YU04-00801-	N-N-10		120 mm	KOB-YN01V00112R800	236.82	
MODEL SK235SRLC-1ES							
ARM	YN01V00132F1	YU04-00801-	P-UB-10	95 mm	135 mm	KOB-YN01V00105R900	382.74
	YN01V00132F1	YU04-00801-	P-UB-1	95 mm		KOB-YN01V00105R100	138.45
	YN01V00132F1	YU04-00801-	N-N-10		135 mm	KOB-YN01V00105R800	244.29
	YN01V00132F2	YU04-00801-	P-UB-10	95 mm	135 mm	KOB-YN01V00105R900	382.74
	YN01V00132F2	YU04-00801-	P-UB-1	95 mm		KOB-YN01V00105R100	138.45
	YN01V00132F2	YU04-00801-	N-N-10		135 mm	KOB-YN01V00105R800	244.29
	YN01V00132F3	YU04-00801-	P-UB-10	95 mm	135 mm	KOB-YN01V00105R900	382.74
	YN01V00132F3	YU04-00801-	P-UB-1	95 mm		KOB-YN01V00105R100	138.45
	YN01V00132F3	YU04-00801-	N-N-10		135 mm	KOB-YN01V00105R800	244.29
	YN01V00132F4	YU04-00801-	P-UB-10	95 mm	135 mm	KOB-YN01V00105R900	382.74
	YN01V00132F4	YU04-00801-	P-UB-1	95 mm		KOB-YN01V00105R100	138.45
	YN01V00132F4	YU04-00801-	N-N-10		135 mm	KOB-YN01V00105R800	244.29

KOBELCO®

Replacement Kits For

KOBELCO®

Excavators							
APPLICATION	CYL #	SERIAL #	CODE	ROD	BORE	KIT #	List \$
MODEL SK235SRLC-1ES							
ARM	YN01V00132F5	YU04-00801-	P-UB-10	95 mm	135 mm	KOB-YN01V00105R900	382.74
	YN01V00132F5	YU04-00801-	P-UB-1	95 mm		KOB-YN01V00105R100	138.45
	YN01V00132F5	YU04-00801-	N-N-10		135 mm	KOB-YN01V00105R800	244.29
BOOM LH	YN01V00108F1	YU04-00801-	P-UB-10	85 mm	125 mm	KOB-YN01V00103R900	308.86
	YN01V00108F1	YU04-00801-	P-UB-1	85 mm		KOB-YN01V00103R100	118.57
	YN01V00108F1	YU04-00801-	N-N-10		125 mm	KOB-YN01V00103R800	190.31
	YN01V00108F2	YU04-00801-	P-UB-10	85 mm	125 mm	KOB-YN01V00103R900	308.86
	YN01V00108F2	YU04-00801-	P-UB-1	85 mm		KOB-YN01V00103R100	118.57
	YN01V00108F2	YU04-00801-	N-N-10		125 mm	KOB-YN01V00103R800	190.31
	YN01V00108F3	YU04-00801-	P-UB-10	85 mm	125 mm	KOB-YN01V00103R900	308.86
	YN01V00108F3	YU04-00801-	P-UB-1	85 mm		KOB-YN01V00103R100	118.57
BOOM RH	YN01V00107F1	YU04-00801-	P-UB-10	85 mm	125 mm	KOB-YN01V00103R900	308.86
	YN01V00107F1	YU04-00801-	P-UB-1	85 mm		KOB-YN01V00103R100	118.57
	YN01V00107F1	YU04-00801-	N-N-10		125 mm	KOB-YN01V00103R800	190.31
	YN01V00107F2	YU04-00801-	P-UB-10	85 mm	125 mm	KOB-YN01V00103R900	308.86
	YN01V00107F2	YU04-00801-	P-UB-1	85 mm		KOB-YN01V00103R100	118.57
	YN01V00107F2	YU04-00801-	N-N-10		125 mm	KOB-YN01V00103R800	190.31
	YN01V00107F3	YU04-00801-	P-UB-10	85 mm	125 mm	KOB-YN01V00103R900	308.86
	YN01V00107F3	YU04-00801-	P-UB-1	85 mm		KOB-YN01V00103R100	118.57
BUCKET	YN01V00112F1	YU04-00801-	P-UB-10	80 mm	120 mm	KOB-YN01V00112R900	379.21
	YN01V00112F1	YU04-00801-	P-UB-1	80 mm		KOB-YN01V00112R100	138.93
	YN01V00112F1	YU04-00801-	N-N-10		120 mm	KOB-YN01V00112R800	236.82
	YN01V00112F2	YU04-00801-	P-UB-10	80 mm	120 mm	KOB-YN01V00112R900	379.21
	YN01V00112F2	YU04-00801-	P-UB-1	80 mm		KOB-YN01V00112R100	138.93
	YN01V00112F2	YU04-00801-	N-N-10		120 mm	KOB-YN01V00112R800	236.82
	YN01V00112F3	YU04-00801-	P-UB-10	80 mm	120 mm	KOB-YN01V00112R900	379.21
	YN01V00112F3	YU04-00801-	P-UB-1	80 mm		KOB-YN01V00112R100	138.93
	YN01V00112F3	YU04-00801-	N-N-10		120 mm	KOB-YN01V00112R800	236.82
	YN01V00112F4	YU04-00801-	P-UB-10	80 mm	120 mm	KOB-YN01V00112R900	379.21
	YN01V00112F4	YU04-00801-	P-UB-1	80 mm		KOB-YN01V00112R100	138.93
	YN01V00112F4	YU04-00801-	N-N-10		120 mm	KOB-YN01V00112R800	236.82
	YN01V00112F5	YU04-00801-	P-UB-10	80 mm	120 mm	KOB-YN01V00112R900	379.21
YN01V00112F5	YU04-00801-	P-UB-1	80 mm		KOB-YN01V00112R100	138.93	
YN01V00112F5	YU04-00801-	N-N-10		120 mm	KOB-YN01V00112R800	236.82	
MODEL SK235SRLC-2							
ARM	YN01V00175F1	YU05-02001-	P-UB-10	95 mm	135 mm	KOB-YN01V00175R300	395.31
	YN01V00175F1	YU05-02001-	P-UB-1	95 mm		KOB-YN01V00175R100	118.51
	YN01V00175F1	YU05-02001-	N-N-10		135 mm	KOB-YN01V00175R200	268.31
	YN01V00175F2	YU05-02001-	P-UB-10	95 mm	135 mm	KOB-YN01V00175R300	395.31
	YN01V00175F2	YU05-02001-	P-UB-1	95 mm		KOB-YN01V00175R100	118.51
	YN01V00175F2	YU05-02001-	N-N-10		135 mm	KOB-YN01V00175R200	268.31
BOOM	YF01V00001F1	YU05-02001-	P-UB-10	85 mm	125 mm	KOB-YF01V00001R300	323.48
	YF01V00001F1	YU05-02001-	P-UB-1	85 mm		KOB-LQ01V00030R100	96.67
	YF01V00001F1	YU05-02001-	N-N-10		125 mm	KOB-YF01V00001R200	226.81
BUCKET	YN01V00153F1	YU05-02001-	P-UB-10	80 mm	120 mm	KOB-YN01V00153R300	437.05
	YN01V00153F1	YU05-02001-	P-UB-1	80 mm		KOB-YN01V00153R100	119.97
	YN01V00153F1	YU05-02001-	N-N-10		120 mm	KOB-YN01V00151R600	119.11
	YN01V00153F2	YU05-02001-	P-UB-10	80 mm	120 mm	KOB-YN01V00153R300	437.05
	YN01V00153F2	YU05-02001-	P-UB-1	80 mm		KOB-YN01V00153R100	119.97
YN01V00153F2	YU05-02001-	N-N-10		120 mm	KOB-YN01V00151R600	119.11	
MODEL SK250 IV							
ARM	2438U1137F1	LQU0101-	P-UB-1	105 mm		KOB-2438U953R100	240.04
	2438U1137F1	LQU0101-	N-N-10		150 mm	KOB-2438U953R200	438.43

KOBELCO®

KOBELCO®

Replacement Kits For

Excavators								
APPLICATION	CYL #	SERIAL #	CODE	ROD	BORE	KIT #	List \$	
MODEL SK250 IV								
BOOM LH	2438U1136F1	LQU0101-	P-UB-10	90 mm	140 mm	KOB-2438U1135R300	338.38	
	2438U1136F1	LQU0101-	P-UB-1	90 mm		KOB-2438U999R100	155.75	
	2438U1136F1	LQU0101-	N-N-10		140 mm	KOB-2438U999R200	299.97	
BOOM RH	2438U1135F1	LQU0101-	P-UB-10	90 mm	140 mm	KOB-2438U1135R300	338.38	
	2438U1135F1	LQU0101-	P-UB-1	90 mm		KOB-2438U999R100	155.75	
	2438U1135F1	LQU0101-	N-N-10		140 mm	KOB-2438U999R200	299.97	
BUCKET	2438U1138F1	LQU0101-	P-UB-1	85 mm		KOB-2438U959R100	125.96	
	2438U1138F1	LQU0101-	N-N-10		130 mm	KOB-2438U959R200	282.03	
MODEL SK250-8								
ARM	LQ01V00038F1	LQ12-C5001-	P-UB-10	105 mm	145 mm	KOB-LQ01V00038R300	320.68	
	LQ01V00038F1	LQ12-C5001-	P-UB-1	105 mm		KOB-LQ01V00038R100	131.26	
	LQ01V00038F1	LQ12-C5001-	N-N-10		145 mm	KOB-LQ01V00038R200	194.33	
	LQ01V00038F2	LQ12-C5001-	P-UB-10	105 mm	145 mm	KOB-LQ01V00038R300	320.68	
	LQ01V00038F2	LQ12-C5001-	P-UB-1	105 mm		KOB-LQ01V00038R100	131.26	
	LQ01V00038F2	LQ12-C5001-	N-N-10		145 mm	KOB-LQ01V00038R200	194.33	
BOOM	LQ01V00028F1	LQ12-C5001-	P-UB-10	95 mm	135 mm	KOB-LQ01V00028R300	291.69	
	LQ01V00028F1	LQ12-C5001-	P-UB-1	95 mm		KOB-YN01V00175R100	118.51	
	LQ01V00028F1	LQ12-C5001-	N-N-10		135 mm	KOB-LQ01V00028R200	200.87	
BUCKET	LQ01V00030F1	LQ12-C5001-	P-UB-10	85 mm	125 mm	KOB-LQ01V00030R300	311.77	
	LQ01V00030F1	LQ12-C5001-	P-UB-1	85 mm		KOB-LQ01V00030R100	96.67	
	LQ01V00030F1	LQ12-C5001-	N-N-10		125 mm	KOB-LQ01V00030R200	164.84	
	LQ01V00030F2	LQ12-C5001-	P-UB-10	85 mm	125 mm	KOB-LQ01V00030R300	311.77	
	LQ01V00030F2	LQ12-C5001-	P-UB-1	85 mm		KOB-LQ01V00030R100	96.67	
	LQ01V00030F2	LQ12-C5001-	N-N-10		125 mm	KOB-LQ01V00030R200	164.84	
MODEL SK250LC								
ARM	LQ01V00007F1	LL08U0101-	P-UB-10	100 mm	140 mm	KOB-LQ01V00007R300	260.50	
	LQ01V00007F1	LL08U0101-	P-UB-1	100 mm		KOB-LQ01V00007R100	106.16	
	LQ01V00007F1	LL08U0101-	N-N-10		140 mm	KOB-LQ01V00007R200	166.12	
	LQ01V00007F1	LL08U0101-	Bushing	100 mm		KOB-2438U1104S4	51.68	
BOOM LH	LQ01V00006F1	LL08U0101-	P-UB-10	90 mm	135 mm	KOB-LQ01V00005R300	291.92	
	LQ01V00006F1	LL08U0101-	P-UB-1	90 mm		KOB-LQ01V00001R400	96.04	
	LQ01V00006F1	LL08U0101-	N-N-10		135 mm	KOB-LQ01V00001R200	195.88	
BOOM RH	LQ01V00005F1	LL08U0101-	P-UB-10	90 mm	135 mm	KOB-LQ01V00005R300	291.92	
	LQ01V00005F1	LL08U0101-	P-UB-1	90 mm		KOB-LQ01V00001R400	96.04	
	LQ01V00005F1	LL08U0101-	N-N-10		135 mm	KOB-LQ01V00001R200	195.88	
BUCKET Long Reach	YX01V00005F2	LL08U0101-	P-UB-14	65 mm	95 mm	KOB-YX01V00005R300	100.16	
	YX01V00005F2	LL08U0101-	P-UB-1	65 mm		KOB-YX01V00005R100	72.49	
	YX01V00005F2	LL08U0101-	N-N-14		95 mm	KOB-YX01V00005R200	83.31	
MODEL SK250LC IV								
ARM	2438U1137F1	LLU1201-	P-UB-1	105 mm		KOB-2438U953R100	240.04	
	2438U1137F1	LLU1201-	N-N-10		150 mm	KOB-2438U953R200	438.43	
	2438U1137F1	LLU1801-	P-UB-1	105 mm		KOB-2438U953R100	240.04	
	2438U1137F1	LLU1801-	N-N-10		150 mm	KOB-2438U953R200	438.43	
BOOM LH	2438U1136F1	LLU1201-	P-UB-10	90 mm	140 mm	KOB-2438U1135R300	338.38	
	2438U1136F1	LLU1201-	P-UB-1	90 mm		KOB-2438U999R100	155.75	
	2438U1136F1	LLU1201-	N-N-10		140 mm	KOB-2438U999R200	299.97	
	2438U1136F1	LLU1801-	P-UB-10	90 mm	140 mm	KOB-2438U1135R300	338.38	
	2438U1136F1	LLU1801-	P-UB-1	90 mm		KOB-2438U999R100	155.75	
	2438U1136F1	LLU1801-	N-N-10		140 mm	KOB-2438U999R200	299.97	
BOOM RH	2438U1135F1	LLU1201-	P-UB-10	90 mm	140 mm	KOB-2438U1135R300	338.38	
	2438U1135F1	LLU1201-	P-UB-1	90 mm		KOB-2438U999R100	155.75	
	2438U1135F1	LLU1201-	N-N-10		140 mm	KOB-2438U999R200	299.97	
	2438U1135F1	LLU1801-	P-UB-10	90 mm	140 mm	KOB-2438U1135R300	338.38	
	2438U1135F1	LLU1801-	P-UB-1	90 mm		KOB-2438U999R100	155.75	

Replacement Kits For

KOBELCO®

Excavators							
APPLICATION	CYL #	SERIAL #	CODE	ROD	BORE	KIT #	List \$
MODEL SK250LC IV							
BOOM RH	2438U1135F1	LLU1801-	N-N-10		140 mm	KOB-2438U999R200	299.97
BUCKET	2438U1138F1	LLU1201-	P-UB-1	85 mm		KOB-2438U959R100	125.96
	2438U1138F1	LLU1201-	N-N-10		130 mm	KOB-2438U959R200	282.03
	2438U1138F1	LLU1801-	P-UB-1	85 mm		KOB-2438U959R100	125.96
	2438U1138F1	LLU1801-	N-N-10		130 mm	KOB-2438U959R200	282.03
MODEL SK250LC-6E							
ARM	LQ01V00012F1	LLC-02001-	P-UB-10	100 mm	140 mm	KOB-LQ01V00007R300	260.50
	LQ01V00012F1	LLC-02001-	P-UB-1	100 mm		KOB-LQ01V00007R100	106.16
	LQ01V00012F1	LLC-02001-	N-N-10		140 mm	KOB-LQ01V00007R200	166.12
	LQ01V00012F2	LLC-02001-	P-UB-10	100 mm	140 mm	KOB-LQ01V00007R300	260.50
	LQ01V00012F2	LLC-02001-	P-UB-1	100 mm		KOB-LQ01V00007R100	106.16
	LQ01V00012F2	LLC-02001-	N-N-10		140 mm	KOB-LQ01V00007R200	166.12
	LQ01V00012F3	LLC-02001-	P-UB-10	100 mm	140 mm	KOB-LQ01V00007R300	260.50
	LQ01V00012F3	LLC-02001-	P-UB-1	100 mm		KOB-LQ01V00007R100	106.16
	LQ01V00012F3	LLC-02001-	N-N-10		140 mm	KOB-LQ01V00007R200	166.12
	LQ01V00012F4	LL09U607-	P-UB-10	100 mm	140 mm	KOB-LQ01V00007R300	260.50
	LQ01V00012F4	LL09U607-	P-UB-1	100 mm		KOB-LQ01V00007R100	106.16
	LQ01V00012F4	LL09U607-	N-N-10		140 mm	KOB-LQ01V00007R200	166.12
	LQ01V00012F4	LL09U607-	Bushing	100 mm		KOB-2438U1104S4	51.68
	LQ01V00012F4	LLC-02001-	P-UB-10	100 mm	140 mm	KOB-LQ01V00007R300	260.50
	LQ01V00012F4	LLC-02001-	P-UB-1	100 mm		KOB-LQ01V00007R100	106.16
	LQ01V00012F4	LLC-02001-	N-N-10		140 mm	KOB-LQ01V00007R200	166.12
	LQ01V00012F5	LLC-02001-	P-UB-10	100 mm	140 mm	KOB-LQ01V00007R300	260.50
	LQ01V00012F5	LLC-02001-	P-UB-1	100 mm		KOB-LQ01V00007R100	106.16
	LQ01V00012F5	LLC-02001-	N-N-10		140 mm	KOB-LQ01V00007R200	166.12
	BOOM LH	LQ01V00011F1	LLC-02001-	P-UB-10	90 mm	135 mm	KOB-LQ01V00005R300
LQ01V00011F1		LLC-02001-	P-UB-1	90 mm		KOB-LQ01V00001R400	96.04
LQ01V00011F1		LLC-02001-	N-N-10		135 mm	KOB-LQ01V00001R200	195.88
LQ01V00011F2		LL09U607-	P-UB-10	90 mm	135 mm	KOB-LQ01V00005R300	291.92
LQ01V00011F2		LL09U607-	P-UB-1	90 mm		KOB-LQ01V00001R400	96.04
LQ01V00011F2		LL09U607-	N-N-10		135 mm	KOB-LQ01V00001R200	195.88
LQ01V00011F2		LLC-02001-	P-UB-10	90 mm	135 mm	KOB-LQ01V00005R300	291.92
LQ01V00011F2		LLC-02001-	P-UB-1	90 mm		KOB-LQ01V00001R400	96.04
BOOM RH	LQ01V00010F1	LLC-02001-	N-N-10		135 mm	KOB-LQ01V00001R200	195.88
	LQ01V00010F1	LLC-02001-	P-UB-10	90 mm	135 mm	KOB-LQ01V00005R300	291.92
	LQ01V00010F1	LLC-02001-	P-UB-1	90 mm		KOB-LQ01V00001R400	96.04
	LQ01V00010F2	LL09U607-	P-UB-10	90 mm	135 mm	KOB-LQ01V00005R300	291.92
	LQ01V00010F2	LL09U607-	P-UB-1	90 mm		KOB-LQ01V00001R400	96.04
	LQ01V00010F2	LL09U607-	N-N-10		135 mm	KOB-LQ01V00001R200	195.88
	LQ01V00010F2	LLC-02001-	P-UB-10	90 mm	135 mm	KOB-LQ01V00005R300	291.92
	LQ01V00010F2	LLC-02001-	P-UB-1	90 mm		KOB-LQ01V00001R400	96.04
BUCKET	LQ01V00013F1	LLC-02001-	N-N-10		135 mm	KOB-LQ01V00001R200	195.88
	LQ01V00013F1	LLC-02001-	P-UB-10	90 mm	125 mm	KOB-LQ01V00005R300	291.92
	LQ01V00013F1	LLC-02001-	P-UB-1	90 mm		KOB-LQ01V00001R400	96.04
	LQ01V00013F2	LLC-02001-	N-N-10		125 mm	KOB-LQ01V00001R200	195.88
	LQ01V00013F2	LLC-02001-	P-UB-10	90 mm	125 mm	KOB-LQ01V00005R300	291.92
	LQ01V00013F2	LLC-02001-	P-UB-1	90 mm		KOB-LQ01V00001R400	96.04
	LQ01V00013F3	LLC-02001-	N-N-10		125 mm	KOB-LQ01V00001R200	195.88
	LQ01V00013F3	LLC-02001-	P-UB-10	90 mm	125 mm	KOB-LQ01V00005R300	291.92
	LQ01V00013F3	LLC-02001-	P-UB-1	90 mm		KOB-LQ01V00001R400	96.04
	LQ01V00013F4	LLC-02001-	N-N-10		125 mm	KOB-LQ01V00001R200	195.88
	LQ01V00013F4	LLC-02001-	P-UB-10	90 mm	125 mm	KOB-LQ01V00005R300	291.92
	LQ01V00013F4	LLC-02001-	P-UB-1	90 mm		KOB-LQ01V00001R400	96.04

KOBELCO®

Replacement Kits For

KOBELCO®

Excavators							
APPLICATION	CYL #	SERIAL #	CODE	ROD	BORE	KIT #	List \$
MODEL SK250LC-6E							
BUCKET	LQ01V00013F5	LL09U607-	P-UB-10	90 mm	125 mm	KOB-YB01V00010R300	274.12
	LQ01V00013F5	LL09U607-	P-UB-1	90 mm		KOB-YB01V00010R100	105.30
	LQ01V00013F5	LLC-02001-	P-UB-10	90 mm	125 mm	KOB-YB01V00010R300	274.12
	LQ01V00013F5	LLC-02001-	P-UB-1	90 mm		KOB-YB01V00010R100	105.30
	LQ01V00013F5	LLC-02001-	N-N-10		125 mm	KOB-YM01V00008R200	168.82
BUCKET Long Reach	YX01V00005F4	LL09U607-	P-UB-14	65 mm	95 mm	KOB-YX01V00005R300	100.16
	YX01V00005F4	LL09U607-	P-UB-1	65 mm		KOB-YX01V00005R100	72.49
	YX01V00005F4	LL09U607-	N-N-14		95 mm	KOB-YX01V00005R200	83.31
MODEL SK250NLC IV							
ARM	2438U1137F1	LLU5059-	P-UB-1	105 mm		KOB-2438U953R100	240.04
	2438U1137F1	LLU5059-	N-N-10		150 mm	KOB-2438U953R200	438.43
BOOM LH	2438U1136F1	LLU5059-	P-UB-10	90 mm	140 mm	KOB-2438U1135R300	338.38
	2438U1136F1	LLU5059-	P-UB-1	90 mm		KOB-2438U999R100	155.75
	2438U1136F1	LLU5059-	N-N-10		140 mm	KOB-2438U999R200	299.97
BOOM RH	2438U1135F1	LLU5059-	P-UB-10	90 mm	140 mm	KOB-2438U1135R300	338.38
	2438U1135F1	LLU5059-	P-UB-1	90 mm		KOB-2438U999R100	155.75
	2438U1135F1	LLU5059-	N-N-10		140 mm	KOB-2438U999R200	299.97
BUCKET	2438U1138F1	LLU5059-	P-UB-1	85 mm		KOB-2438U959R100	125.96
	2438U1138F1	LLU5059-	N-N-10		130 mm	KOB-2438U959R200	282.03
MODEL SK260							
ARM	LQ01V00012F4		P-UB-10	100 mm	140 mm	KOB-LQ01V00007R300	260.50
	LQ01V00012F4		P-UB-1	100 mm		KOB-LQ01V00007R100	106.16
	LQ01V00012F4		N-N-10		140 mm	KOB-LQ01V00007R200	166.12
	LQ01V00012F4		Bushing	100 mm		KOB-2438U1104S4	51.68
	LQ01V00038F1		P-UB-10	105 mm	145 mm	KOB-LQ01V00038R300	320.68
	LQ01V00038F1		P-UB-1	105 mm		KOB-LQ01V00038R100	131.26
	LQ01V00038F1		N-N-10		145 mm	KOB-LQ01V00038R200	194.33
	LQ01V00038F2		P-UB-10	105 mm	145 mm	KOB-LQ01V00038R300	320.68
	LQ01V00038F2		P-UB-1	105 mm		KOB-LQ01V00038R100	131.26
	LQ01V00038F2		N-N-10		145 mm	KOB-LQ01V00038R200	194.33
BOOM	LQ01V00028F1		P-UB-10	95 mm	135 mm	KOB-LQ01V00028R300	291.69
	LQ01V00028F1		P-UB-1	95 mm		KOB-YN01V00175R100	118.51
	LQ01V00028F1		N-N-10		135 mm	KOB-LQ01V00028R200	200.87
BUCKET	LQ01V00030F1		P-UB-10	85 mm	125 mm	KOB-LQ01V00030R300	311.77
	LQ01V00030F1		P-UB-1	85 mm		KOB-LQ01V00030R100	96.67
	LQ01V00030F1		N-N-10		125 mm	KOB-LQ01V00030R200	164.84
	LQ01V00030F2		P-UB-10	85 mm	125 mm	KOB-LQ01V00030R300	311.77
	LQ01V00030F2		P-UB-1	85 mm		KOB-LQ01V00030R100	96.67
	LQ01V00030F2		N-N-10		125 mm	KOB-LQ01V00030R200	164.84
MODEL SK260LC-8							
ARM	LQ01V00038F1	LL12-C5001-	P-UB-10	105 mm	145 mm	KOB-LQ01V00038R300	320.68
	LQ01V00038F1	LL12-C5001-	P-UB-1	105 mm		KOB-LQ01V00038R100	131.26
	LQ01V00038F1	LL12-C5001-	N-N-10		145 mm	KOB-LQ01V00038R200	194.33
	LQ01V00038F2	LL12-C5001-	P-UB-10	105 mm	145 mm	KOB-LQ01V00038R300	320.68
	LQ01V00038F2	LL12-C5001-	P-UB-1	105 mm		KOB-LQ01V00038R100	131.26
	LQ01V00038F2	LL12-C5001-	N-N-10		145 mm	KOB-LQ01V00038R200	194.33
BOOM	LQ01V00028F1	LL12-C5001-	P-UB-10	95 mm	135 mm	KOB-LQ01V00028R300	291.69
	LQ01V00028F1	LL12-C5001-	P-UB-1	95 mm		KOB-YN01V00175R100	118.51
	LQ01V00028F1	LL12-C5001-	N-N-10		135 mm	KOB-LQ01V00028R200	200.87
BUCKET	LQ01V00030F1	LL12-C5001-	P-UB-10	85 mm	125 mm	KOB-LQ01V00030R300	311.77
	LQ01V00030F1	LL12-C5001-	P-UB-1	85 mm		KOB-LQ01V00030R100	96.67
	LQ01V00030F1	LL12-C5001-	N-N-10		125 mm	KOB-LQ01V00030R200	164.84
	LQ01V00030F2	LL12-C5001-	P-UB-10	85 mm	125 mm	KOB-LQ01V00030R300	311.77
	LQ01V00030F2	LL12-C5001-	P-UB-1	85 mm		KOB-LQ01V00030R100	96.67

KOBELCO®

Replacement Kits For

KOBELCO®

Excavators								
APPLICATION	CYL #	SERIAL #	CODE	ROD	BORE	KIT #	List \$	
MODEL SK260LC-8								
BUCKET	LQ01V00030F2	LL12-C5001-	N-N-10		125 mm	KOB-LQ01V00030R200	164.84	
MODEL SK290LC								
BOOM LH	LB01V00002F1	LB03U0101-	P-UB-10	100 mm	140 mm	KOB-LC01V00001R300	290.03	
	LB01V00002F1	LB03U0101-	P-UB-1	100 mm		KOB-LQ01V00007R100	106.16	
	LB01V00002F1	LB03U0101-	N-N-10		140 mm	KOB-LC01V00001R200	204.39	
	LB01V00002F1	LB03U0101-	Bushing	100 mm		KOB-2438U1104S4	51.68	
BOOM RH	LB01V00001F1	LB03U0101-	P-UB-10	100 mm	140 mm	KOB-LC01V00001R300	290.03	
	LB01V00001F1	LB03U0101-	P-UB-1	100 mm		KOB-LQ01V00007R100	106.16	
	LB01V00001F1	LB03U0101-	N-N-10		140 mm	KOB-LC01V00001R200	204.39	
	LB01V00001F1	LB03U0101-	Bushing	100 mm		KOB-2438U1104S4	51.68	
MODEL SK290LC-6E								
BOOM LH	LB01V00005F1	LB04U02801-	P-UB-10	100 mm	140 mm	KOB-LC01V00001R300	290.03	
	LB01V00005F1	LB04U02801-	P-UB-1	100 mm		KOB-LQ01V00007R100	106.16	
	LB01V00005F1	LB04U02801-	N-N-10		140 mm	KOB-LC01V00001R200	204.39	
	LB01V00005F1	LB04U02801-	Bushing	100 mm		KOB-2438U1104S4	51.68	
	LB01V00005F1	LB04U0298-LB04U02800	P-UB-10	100 mm	140 mm	KOB-LC01V00001R300	290.03	
	LB01V00005F1	LB04U0298-LB04U02800	P-UB-1	100 mm		KOB-LQ01V00007R100	106.16	
	LB01V00005F1	LB04U0298-LB04U02800	N-N-10		140 mm	KOB-LC01V00001R200	204.39	
	LB01V00005F1	LB04U0298-LB04U02800	Bushing	100 mm		KOB-2438U1104S4	51.68	
	LB01V00005F2	LB04U02801-	P-UB-10	100 mm	140 mm	KOB-LC01V00001R300	290.03	
	LB01V00005F2	LB04U02801-	P-UB-1	100 mm		KOB-LQ01V00007R100	106.16	
	LB01V00005F2	LB04U02801-	N-N-10		140 mm	KOB-LC01V00001R200	204.39	
	LB01V00005F2	LB04U02801-	Bushing	100 mm		KOB-2438U1104S4	51.68	
	LB01V00005F2	LB04U0298-LB04U02800	P-UB-10	100 mm	140 mm	KOB-LC01V00001R300	290.03	
	LB01V00005F2	LB04U0298-LB04U02800	P-UB-1	100 mm		KOB-LQ01V00007R100	106.16	
	LB01V00005F2	LB04U0298-LB04U02800	N-N-10		140 mm	KOB-LC01V00001R200	204.39	
	LB01V00005F2	LB04U0298-LB04U02800	Bushing	100 mm		KOB-2438U1104S4	51.68	
	BOOM RH	LB01V00006F1	LB04U02801-	P-UB-10	100 mm	140 mm	KOB-LC01V00001R300	290.03
		LB01V00006F1	LB04U02801-	P-UB-1	100 mm		KOB-LQ01V00007R100	106.16
		LB01V00006F1	LB04U02801-	N-N-10		140 mm	KOB-LC01V00001R200	204.39
		LB01V00006F1	LB04U02801-	Bushing	100 mm		KOB-2438U1104S4	51.68
LB01V00006F1		LB04U0298-LB04U02800	P-UB-10	100 mm	140 mm	KOB-LC01V00001R300	290.03	
LB01V00006F1		LB04U0298-LB04U02800	P-UB-1	100 mm		KOB-LQ01V00007R100	106.16	
LB01V00006F1		LB04U0298-LB04U02800	N-N-10		140 mm	KOB-LC01V00001R200	204.39	
LB01V00006F1		LB04U0298-LB04U02800	Bushing	100 mm		KOB-2438U1104S4	51.68	
LB01V00006F2		LB04U02801-	P-UB-10	100 mm	140 mm	KOB-LC01V00001R300	290.03	
LB01V00006F2		LB04U02801-	P-UB-1	100 mm		KOB-LQ01V00007R100	106.16	
LB01V00006F2		LB04U02801-	N-N-10		140 mm	KOB-LC01V00001R200	204.39	
LB01V00006F2		LB04U02801-	Bushing	100 mm		KOB-2438U1104S4	51.68	
LB01V00006F2		LB04U0298-LB04U02800	P-UB-10	100 mm	140 mm	KOB-LC01V00001R300	290.03	
LB01V00006F2		LB04U0298-LB04U02800	P-UB-1	100 mm		KOB-LQ01V00007R100	106.16	
LB01V00006F2		LB04U0298-LB04U02800	N-N-10		140 mm	KOB-LC01V00001R200	204.39	
LB01V00006F2		LB04U0298-LB04U02800	Bushing	100 mm		KOB-2438U1104S4	51.68	
BUCKET Long Reach		YM01V00009F2	LB04U02801-	P-UB-10	75 mm	105 mm	KOB-YM01V00009R300	271.79
		YM01V00009F2	LB04U02801-	P-UB-1	75 mm		KOB-YM01V00009R100	90.82
		YM01V00009F2	LB04U02801-	N-N-10		105 mm	KOB-YM01V00009R200	180.97
		YM01V00009F2	LB04U0298-LB04U02800	P-UB-10	75 mm	105 mm	KOB-YM01V00009R300	271.79
	YM01V00009F2	LB04U0298-LB04U02800	P-UB-1	75 mm		KOB-YM01V00009R100	90.82	
	YM01V00009F2	LB04U0298-LB04U02800	N-N-10		105 mm	KOB-YM01V00009R200	180.97	
MODEL SK300 III								
ARM	2438U11071F1-F4	LCU0001-	P-UB-10	120 mm	170 mm	KOB-2438U1171R300	507.79	
	2438U11071F1-F4	LCU0001-	P-UB-1	120 mm		KOB-2438U1171R100	175.97	
	2438U11071F1-F4	LCU0001-	N-N-10		170 mm	KOB-2438U1171R200	331.82	
BOOM LH	2438U1177F1-F4	LCU0001-	P-UB-10	100 mm	150 mm	KOB-2438U1170R300	351.63	

Replacement Kits For

KOBELCO®

Excavators							
APPLICATION	CYL #	SERIAL #	CODE	ROD	BORE	KIT #	List \$
MODEL SK300 III							
BOOM LH	2438U1177F1-F4	LCU0001-	P-UB-1	100 mm		KOB-2438U1170R100	127.13
	2438U1177F1-F4	LCU0001-	N-N-10		150 mm	KOB-2438U1172R400	229.65
BOOM RH	2438U1170F1-F4	LCU0001-	P-UB-10	100 mm	150 mm	KOB-2438U1170R300	351.63
	2438U1170F1-F4	LCU0001-	P-UB-1	100 mm		KOB-2438U1170R100	127.13
	2438U1170F1-F4	LCU0001-	N-N-10		150 mm	KOB-2438U1172R400	229.65
BUCKET	2438U1172F1-F5	LCU0001-	P-UB-10	100 mm	150 mm	KOB-2438U1172R500	478.77
	2438U1172F1-F5	LCU0001-	N-N-10		150 mm	KOB-2438U1172R200	224.51
MODEL SK300 IV							
ARM	2438U11071F1-F4	LCU0101-	P-UB-10	120 mm	170 mm	KOB-2438U1171R300	507.79
	2438U11071F1-F4	LCU0101-	P-UB-1	120 mm		KOB-2438U1171R100	175.97
	2438U11071F1-F4	LCU0101-	N-N-10		170 mm	KOB-2438U1171R200	331.82
BOOM LH	2438U1177F1-F4	LCU0101-	P-UB-10	100 mm	150 mm	KOB-2438U1170R300	351.63
	2438U1177F1-F4	LCU0101-	P-UB-1	100 mm		KOB-2438U1170R100	127.13
	2438U1177F1-F4	LCU0101-	N-N-10		150 mm	KOB-2438U1172R400	229.65
BOOM RH	2438U1170F1-F4	LCU0101-	P-UB-10	100 mm	150 mm	KOB-2438U1170R300	351.63
	2438U1170F1-F4	LCU0101-	P-UB-1	100 mm		KOB-2438U1170R100	127.13
	2438U1170F1-F4	LCU0101-	N-N-10		150 mm	KOB-2438U1172R400	229.65
BUCKET	2438U1172F1-F5	LCU0101-	P-UB-10	100 mm	150 mm	KOB-2438U1172R500	478.77
	2438U1172F1-F5	LCU0101-	N-N-10		150 mm	KOB-2438U1172R200	224.51
MODEL SK300LC III							
ARM	2438U11071F1-F4	YCU0001-	P-UB-10	120 mm	170 mm	KOB-2438U1171R300	507.79
	2438U11071F1-F4	YCU0001-	P-UB-1	120 mm		KOB-2438U1171R100	175.97
	2438U11071F1-F4	YCU0001-	N-N-10		170 mm	KOB-2438U1171R200	331.82
BOOM LH	2438U1177F1-F4	YCU0001-	P-UB-10	100 mm	150 mm	KOB-2438U1170R300	351.63
	2438U1177F1-F4	YCU0001-	P-UB-1	100 mm		KOB-2438U1170R100	127.13
	2438U1177F1-F4	YCU0001-	N-N-10		150 mm	KOB-2438U1172R400	229.65
BOOM RH	2438U1170F1-F4	YCU0001-	P-UB-10	100 mm	150 mm	KOB-2438U1170R300	351.63
	2438U1170F1-F4	YCU0001-	P-UB-1	100 mm		KOB-2438U1170R100	127.13
	2438U1170F1-F4	YCU0001-	N-N-10		150 mm	KOB-2438U1172R400	229.65
BUCKET	2438U1172F1-F5	YCU0001-	P-UB-10	100 mm	150 mm	KOB-2438U1172R500	478.77
	2438U1172F1-F5	YCU0001-	N-N-10		150 mm	KOB-2438U1172R200	224.51
MODEL SK300LC IV							
ARM	2438U11071F1-F4	YCU0603, YCU0607, YCU0611-	P-UB-10	120 mm	170 mm	KOB-2438U1171R300	507.79
	2438U11071F1-F4	YCU0603, YCU0607, YCU0611-	P-UB-1	120 mm		KOB-2438U1171R100	175.97
	2438U11071F1-F4	YCU0603, YCU0607, YCU0611-	N-N-10		170 mm	KOB-2438U1171R200	331.82
BOOM LH	2438U1177F1-F4	YCU0603, YCU0607, YCU0611-	P-UB-10	100 mm	150 mm	KOB-2438U1170R300	351.63
	2438U1177F1-F4	YCU0603, YCU0607, YCU0611-	P-UB-1	100 mm		KOB-2438U1170R100	127.13
	2438U1177F1-F4	YCU0603, YCU0607, YCU0611-	N-N-10		150 mm	KOB-2438U1172R400	229.65
BOOM RH	2438U1170F1-F4	YCU0603, YCU0607, YCU0611-	P-UB-10	100 mm	150 mm	KOB-2438U1170R300	351.63
	2438U1170F1-F4	YCU0603, YCU0607, YCU0611-	P-UB-1	100 mm		KOB-2438U1170R100	127.13
	2438U1170F1-F4	YCU0603, YCU0607, YCU0611-	N-N-10		150 mm	KOB-2438U1172R400	229.65
BUCKET	2438U1172F1-F5	YCU0603, YCU0607, YCU0611-	P-UB-10	100 mm	150 mm	KOB-2438U1172R500	478.77
	2438U1172F1-F5	YCU0603, YCU0607, YCU0611-	N-N-10		150 mm	KOB-2438U1172R200	224.51
MODEL SK310 III							
ARM	2438U1129F1	LC04201-	P-UB-10	120 mm	180 mm	KOB-2438U1129R300	442.79
	2438U1129F1	LC04201-	P-UB-1	120 mm		KOB-2438U1129R100	161.01

Replacement Kits For

KOBELCO®

Excavators							
APPLICATION	CYL #	SERIAL #	CODE	ROD	BORE	KIT #	List \$
MODEL SK310 III							
ARM	2438U1129F1	LC04201-	N-N-10		180 mm	KOB-2445R174R200	281.76
	2438U1137F1	LC04201-	P-UB-10	105 mm	150 mm	KOB-2438U1137R200	347.33
	2438U1137F1	LC04201-	P-UB-1	105 mm		KOB-2438U1137R100	204.71
	2438U1137F1	LC04201-	N-N-10		150 mm	KOB-2438U953R200	438.43
	2438U1171F1	LC04201-	P-UB-10	120 mm	170 mm	KOB-2438U1171R300	507.79
	2438U1171F1	LC04201-	P-UB-1	120 mm		KOB-2438U1171R100	175.97
	2438U1171F1	LC04201-	N-N-10		170 mm	KOB-2438U1171R200	331.82
	2438U1171F2	LC04201-	P-UB-10	120 mm	170 mm	KOB-2438U1171R300	507.79
	2438U1171F2	LC04201-	P-UB-1	120 mm		KOB-2438U1171R100	175.97
	2438U1171F2	LC04201-	N-N-10		170 mm	KOB-2438U1171R200	331.82
	2438U1171F3	LC04201-	P-UB-10	120 mm	170 mm	KOB-2438U1171R300	507.79
	2438U1171F3	LC04201-	P-UB-1	120 mm		KOB-2438U1171R100	175.97
	2438U1171F3	LC04201-	N-N-10		170 mm	KOB-2438U1171R200	331.82
	2438U1171F4	LC04201-	P-UB-10	120 mm	170 mm	KOB-2438U1171R300	507.79
	2438U1171F4	LC04201-	P-UB-1	120 mm		KOB-2438U1171R100	175.97
	2438U1171F4	LC04201-	N-N-10		170 mm	KOB-2438U1171R200	331.82
BOOM LH	2438U1177F1	LC04201-	P-UB-10	100 mm	150 mm	KOB-2438U1170R300	351.63
	2438U1177F1	LC04201-	P-UB-1	100 mm		KOB-2438U1170R100	127.13
	2438U1177F1	LC04201-	N-N-10		150 mm	KOB-2438U1170R200	219.67
	2438U1177F2	LC04201-	P-UB-10	100 mm	150 mm	KOB-2438U1170R300	351.63
	2438U1177F2	LC04201-	P-UB-1	100 mm		KOB-2438U1170R100	127.13
	2438U1177F2	LC04201-	N-N-10		150 mm	KOB-2438U1170R200	219.67
	2438U1177F3	LC04201-	P-UB-10	100 mm	150 mm	KOB-2438U1170R300	351.63
	2438U1177F3	LC04201-	P-UB-1	100 mm		KOB-2438U1170R100	127.13
	2438U1177F3	LC04201-	N-N-10		150 mm	KOB-2438U1170R200	219.67
	2438U1177F4	LC04201-	P-UB-10	100 mm	150 mm	KOB-2438U1170R300	351.63
	2438U1177F4	LC04201-	P-UB-1	100 mm		KOB-2438U1170R100	127.13
	2438U1177F4	LC04201-	N-N-10		150 mm	KOB-2438U1170R200	219.67
BOOM RH	2438U1170F1	LC04201-	P-UB-10	100 mm	150 mm	KOB-2438U1170R300	351.63
	2438U1170F1	LC04201-	P-UB-1	100 mm		KOB-2438U1170R100	127.13
	2438U1170F1	LC04201-	N-N-10		150 mm	KOB-2438U1170R200	219.67
	2438U1170F2	LC04201-	P-UB-10	100 mm	150 mm	KOB-2438U1170R300	351.63
	2438U1170F2	LC04201-	P-UB-1	100 mm		KOB-2438U1170R100	127.13
	2438U1170F2	LC04201-	N-N-10		150 mm	KOB-2438U1170R200	219.67
	2438U1170F3	LC04201-	P-UB-10	100 mm	150 mm	KOB-2438U1170R300	351.63
	2438U1170F3	LC04201-	P-UB-1	100 mm		KOB-2438U1170R100	127.13
	2438U1170F3	LC04201-	N-N-10		150 mm	KOB-2438U1170R200	219.67
	2438U1170F4	LC04201-	P-UB-10	100 mm	150 mm	KOB-2438U1170R300	351.63
	2438U1170F4	LC04201-	P-UB-1	100 mm		KOB-2438U1170R100	127.13
	2438U1170F4	LC04201-	N-N-10		150 mm	KOB-2438U1170R200	219.67
BUCKET	2438U1105F1	LC04201-	P-UB-10	80 mm	120 mm	KOB-2438U1105R500	242.52
	2438U1105F1	LC04201-	P-UB-1	80 mm		KOB-2438U1105R400	112.01
	2438U1105F1	LC04201-	N-N-10		120 mm	KOB-2438U1105R200	147.14
	2438U1172F1	LC04201-	P-UB-10	100 mm	150 mm	KOB-2438U1172R300	398.90
	2438U1172F1	LC04201-	N-N-10		150 mm	KOB-2438U1172R200	224.51
	2438U1172F2	LC04201-	N-N-10		150 mm	KOB-2438U1172R400	229.65
	2438U1172F3	LC04201-	P-UB-10	100 mm	150 mm	KOB-2438U1172R500	478.77
	2438U1172F3	LC04201-	N-N-10		150 mm	KOB-2438U1172R400	229.65
	2438U1172F4	LC04201-	P-UB-10	100 mm	150 mm	KOB-2438U1172R500	478.77
	2438U1172F4	LC04201-	P-UB-1	100 mm		KOB-2438U1172R100	194.19
	2438U1172F4	LC04201-	N-N-10		150 mm	KOB-2438U1172R400	229.65
	2438U1172F5	LC04201-	P-UB-10	100 mm	150 mm	KOB-2438U1172R500	478.77
	2438U1172F5	LC04201-	P-UB-1	100 mm		KOB-2438U1172R100	194.19
	2438U1172F5	LC04201-	N-N-10		150 mm	KOB-2438U1172R400	229.65

KOBELCO®

Replacement Kits For

KOBELCO®

Excavators								
APPLICATION	CYL #	SERIAL #	CODE	ROD	BORE	KIT #	List \$	
MODEL SK310LC III								
ARM	2438U1129F1	YC01301-	P-UB-10	120 mm	180 mm	KOB-2438U1129R300	442.79	
	2438U1129F1	YC01301-	P-UB-1	120 mm		KOB-2438U1129R100	161.01	
	2438U1129F1	YC01301-	N-N-10		180 mm	KOB-2445R174R200	281.76	
	2438U1137F1	YC01301-	P-UB-10	105 mm	150 mm	KOB-2438U1137R200	347.33	
	2438U1137F1	YC01301-	P-UB-1	105 mm		KOB-2438U1137R100	204.71	
	2438U1137F1	YC01301-	N-N-10		150 mm	KOB-2438U953R200	438.43	
	2438U1171F1	YC01301-	P-UB-10	120 mm	170 mm	KOB-2438U1171R300	507.79	
	2438U1171F1	YC01301-	P-UB-1	120 mm		KOB-2438U1171R100	175.97	
	2438U1171F1	YC01301-	N-N-10		170 mm	KOB-2438U1171R200	331.82	
	2438U1171F2	YC01301-	P-UB-10	120 mm	170 mm	KOB-2438U1171R300	507.79	
	2438U1171F2	YC01301-	P-UB-1	120 mm		KOB-2438U1171R100	175.97	
	2438U1171F2	YC01301-	N-N-10		170 mm	KOB-2438U1171R200	331.82	
	2438U1171F3	YC01301-	P-UB-10	120 mm	170 mm	KOB-2438U1171R300	507.79	
	2438U1171F3	YC01301-	P-UB-1	120 mm		KOB-2438U1171R100	175.97	
	2438U1171F3	YC01301-	N-N-10		170 mm	KOB-2438U1171R200	331.82	
	2438U1171F4	YC01301-	P-UB-10	120 mm	170 mm	KOB-2438U1171R300	507.79	
	2438U1171F4	YC01301-	P-UB-1	120 mm		KOB-2438U1171R100	175.97	
	2438U1171F4	YC01301-	N-N-10		150 mm	KOB-2438U1170R200	219.67	
	BOOM LH	2438U1177F1	YC01301-	P-UB-10	100 mm	150 mm	KOB-2438U1170R300	351.63
		2438U1177F1	YC01301-	P-UB-1	100 mm		KOB-2438U1170R100	127.13
2438U1177F1		YC01301-	N-N-10		150 mm	KOB-2438U1170R200	219.67	
2438U1177F2		YC01301-	P-UB-10	100 mm	150 mm	KOB-2438U1170R300	351.63	
2438U1177F2		YC01301-	P-UB-1	100 mm		KOB-2438U1170R100	127.13	
2438U1177F2		YC01301-	N-N-10		150 mm	KOB-2438U1170R200	219.67	
2438U1177F3		YC01301-	P-UB-10	100 mm	150 mm	KOB-2438U1170R300	351.63	
2438U1177F3		YC01301-	P-UB-1	100 mm		KOB-2438U1170R100	127.13	
2438U1177F3		YC01301-	N-N-10		150 mm	KOB-2438U1170R200	219.67	
2438U1177F4		YC01301-	P-UB-10	100 mm	150 mm	KOB-2438U1170R300	351.63	
2438U1177F4		YC01301-	P-UB-1	100 mm		KOB-2438U1170R100	127.13	
2438U1177F4		YC01301-	N-N-10		150 mm	KOB-2438U1170R200	219.67	
BOOM RH		2438U1170F1	YC01301-	P-UB-10	100 mm	150 mm	KOB-2438U1170R300	351.63
		2438U1170F1	YC01301-	P-UB-1	100 mm		KOB-2438U1170R100	127.13
	2438U1170F1	YC01301-	N-N-10		150 mm	KOB-2438U1170R200	219.67	
	2438U1170F2	YC01301-	P-UB-10	100 mm	150 mm	KOB-2438U1170R300	351.63	
	2438U1170F2	YC01301-	P-UB-1	100 mm		KOB-2438U1170R100	127.13	
	2438U1170F2	YC01301-	N-N-10		150 mm	KOB-2438U1170R200	219.67	
	2438U1170F3	YC01301-	P-UB-10	100 mm	150 mm	KOB-2438U1170R300	351.63	
	2438U1170F3	YC01301-	P-UB-1	100 mm		KOB-2438U1170R100	127.13	
	2438U1170F3	YC01301-	N-N-10		150 mm	KOB-2438U1170R200	219.67	
	2438U1170F4	YC01301-	P-UB-10	100 mm	150 mm	KOB-2438U1170R300	351.63	
	2438U1170F4	YC01301-	P-UB-1	100 mm		KOB-2438U1170R100	127.13	
	2438U1170F4	YC01301-	N-N-10		150 mm	KOB-2438U1170R200	219.67	
	BUCKET	2438U1105F1	YC01301-	P-UB-10	80 mm	120 mm	KOB-2438U1105R500	242.52
		2438U1105F1	YC01301-	P-UB-1	80 mm		KOB-2438U1105R400	112.01
2438U1105F1		YC01301-	N-N-10		120 mm	KOB-2438U1105R200	147.14	
2438U1172F1		YC01301-	P-UB-10	100 mm	150 mm	KOB-2438U1172R300	398.90	
2438U1172F1		YC01301-	N-N-10		150 mm	KOB-2438U1172R200	224.51	
2438U1172F2		YC01301-	N-N-10		150 mm	KOB-2438U1172R400	229.65	
2438U1172F3		YC01301-	P-UB-10	100 mm	150 mm	KOB-2438U1172R500	478.77	
2438U1172F3		YC01301-	N-N-10		150 mm	KOB-2438U1172R400	229.65	
2438U1172F4		YC01301-	P-UB-10	100 mm	150 mm	KOB-2438U1172R500	478.77	
2438U1172F4		YC01301-	P-UB-1	100 mm		KOB-2438U1172R100	194.19	
2438U1172F4		YC01301-	N-N-10		150 mm	KOB-2438U1172R400	229.65	
2438U1172F5		YC01301-	P-UB-10	100 mm	150 mm	KOB-2438U1172R500	478.77	
2438U1172F5		YC01301-	P-UB-1	100 mm		KOB-2438U1172R100	194.19	

KOBELCO®

Replacement Kits For

KOBELCO®

Excavators							
APPLICATION	CYL #	SERIAL #	CODE	ROD	BORE	KIT #	List \$
MODEL SK310LC III							
BUCKET	2438U1172F5	YC01301-	N-N-10		150 mm	KOB-2438U1172R400	229.65
MODEL SK320 III							
ARM	2438U1129F1	LC04201-	P-UB-10	120 mm	180 mm	KOB-2438U1129R300	442.79
	2438U1129F1	LC04201-	P-UB-1	120 mm		KOB-2438U1129R100	161.01
	2438U1129F1	LC04201-	N-N-10		180 mm	KOB-2445R174R200	281.76
	2438U1137F1	LC04201-	P-UB-10	105 mm	150 mm	KOB-2438U1137R200	347.33
	2438U1137F1	LC04201-	P-UB-1	105 mm		KOB-2438U1137R100	204.71
	2438U1137F1	LC04201-	N-N-10		150 mm	KOB-2438U953R200	438.43
	2438U1171F1	LC04201-	P-UB-10	120 mm	170 mm	KOB-2438U1171R300	507.79
	2438U1171F1	LC04201-	P-UB-1	120 mm		KOB-2438U1171R100	175.97
	2438U1171F1	LC04201-	N-N-10		170 mm	KOB-2438U1171R200	331.82
	2438U1171F2	LC04201-	P-UB-10	120 mm	170 mm	KOB-2438U1171R300	507.79
	2438U1171F2	LC04201-	P-UB-1	120 mm		KOB-2438U1171R100	175.97
	2438U1171F2	LC04201-	N-N-10		170 mm	KOB-2438U1171R200	331.82
	2438U1171F3	LC04201-	P-UB-10	120 mm	170 mm	KOB-2438U1171R300	507.79
	2438U1171F3	LC04201-	P-UB-1	120 mm		KOB-2438U1171R100	175.97
	2438U1171F3	LC04201-	N-N-10		170 mm	KOB-2438U1171R200	331.82
	2438U1171F4	LC04201-	P-UB-10	120 mm	170 mm	KOB-2438U1171R300	507.79
2438U1171F4	LC04201-	P-UB-1	120 mm		KOB-2438U1171R100	175.97	
2438U1171F4	LC04201-	N-N-10		170 mm	KOB-2438U1171R200	331.82	
BOOM LH	2438U1177F1	LC04201-	P-UB-10	100 mm	150 mm	KOB-2438U1170R300	351.63
	2438U1177F1	LC04201-	P-UB-1	100 mm		KOB-2438U1170R100	127.13
	2438U1177F1	LC04201-	N-N-10		150 mm	KOB-2438U1170R200	219.67
	2438U1177F2	LC04201-	P-UB-10	100 mm	150 mm	KOB-2438U1170R300	351.63
	2438U1177F2	LC04201-	P-UB-1	100 mm		KOB-2438U1170R100	127.13
	2438U1177F2	LC04201-	N-N-10		150 mm	KOB-2438U1170R200	219.67
	2438U1177F3	LC04201-	P-UB-10	100 mm	150 mm	KOB-2438U1170R300	351.63
	2438U1177F3	LC04201-	P-UB-1	100 mm		KOB-2438U1170R100	127.13
	2438U1177F3	LC04201-	N-N-10		150 mm	KOB-2438U1170R200	219.67
	2438U1177F4	LC04201-	P-UB-10	100 mm	150 mm	KOB-2438U1170R300	351.63
	2438U1177F4	LC04201-	P-UB-1	100 mm		KOB-2438U1170R100	127.13
	2438U1177F4	LC04201-	N-N-10		150 mm	KOB-2438U1170R200	219.67
BOOM RH	2438U1170F1	LC04201-	P-UB-10	100 mm	150 mm	KOB-2438U1170R300	351.63
	2438U1170F1	LC04201-	P-UB-1	100 mm		KOB-2438U1170R100	127.13
	2438U1170F1	LC04201-	N-N-10		150 mm	KOB-2438U1170R200	219.67
	2438U1170F2	LC04201-	P-UB-10	100 mm	150 mm	KOB-2438U1170R300	351.63
	2438U1170F2	LC04201-	P-UB-1	100 mm		KOB-2438U1170R100	127.13
	2438U1170F2	LC04201-	N-N-10		150 mm	KOB-2438U1170R200	219.67
	2438U1170F3	LC04201-	P-UB-10	100 mm	150 mm	KOB-2438U1170R300	351.63
	2438U1170F3	LC04201-	P-UB-1	100 mm		KOB-2438U1170R100	127.13
	2438U1170F3	LC04201-	N-N-10		150 mm	KOB-2438U1170R200	219.67
	2438U1170F4	LC04201-	P-UB-10	100 mm	150 mm	KOB-2438U1170R300	351.63
	2438U1170F4	LC04201-	P-UB-1	100 mm		KOB-2438U1170R100	127.13
	2438U1170F4	LC04201-	N-N-10		150 mm	KOB-2438U1170R200	219.67
BUCKET	2438U1105F1	LC04201-	P-UB-10	80 mm	120 mm	KOB-2438U1105R500	242.52
	2438U1105F1	LC04201-	P-UB-1	80 mm		KOB-2438U1105R400	112.01
	2438U1105F1	LC04201-	N-N-10		120 mm	KOB-2438U1105R200	147.14
	2438U1172F1	LC04201-	P-UB-10	100 mm	150 mm	KOB-2438U1172R300	398.90
	2438U1172F1	LC04201-	N-N-10		150 mm	KOB-2438U1172R200	224.51
	2438U1172F2	LC04201-	N-N-10		150 mm	KOB-2438U1172R400	229.65
	2438U1172F3	LC04201-	P-UB-10	100 mm	150 mm	KOB-2438U1172R500	478.77
	2438U1172F3	LC04201-	N-N-10		150 mm	KOB-2438U1172R400	229.65
	2438U1172F4	LC04201-	P-UB-10	100 mm	150 mm	KOB-2438U1172R500	478.77
	2438U1172F4	LC04201-	P-UB-1	100 mm		KOB-2438U1172R100	194.19
	2438U1172F4	LC04201-	N-N-10		150 mm	KOB-2438U1172R400	229.65

KOBELCO®

Replacement Kits For

KOBELCO®

Excavators								
APPLICATION	CYL #	SERIAL #	CODE	ROD	BORE	KIT #	List \$	
MODEL SK320 III								
BUCKET	2438U1172F5	LC04201-	P-UB-10	100 mm	150 mm	KOB-2438U1172R500	478.77	
	2438U1172F5	LC04201-	P-UB-1	100 mm		KOB-2438U1172R100	194.19	
	2438U1172F5	LC04201-	N-N-10		150 mm	KOB-2438U1172R400	229.65	
MODEL SK320LC III								
ARM	2438U1129F1	YC01301-	P-UB-10	120 mm	180 mm	KOB-2438U1129R300	442.79	
	2438U1129F1	YC01301-	P-UB-1	120 mm		KOB-2438U1129R100	161.01	
	2438U1129F1	YC01301-	N-N-10		180 mm	KOB-2445R174R200	281.76	
	2438U1137F1	YC01301-	P-UB-10	105 mm	150 mm	KOB-2438U1137R200	347.33	
	2438U1137F1	YC01301-	P-UB-1	105 mm		KOB-2438U1137R100	204.71	
	2438U1137F1	YC01301-	N-N-10		150 mm	KOB-2438U953R200	438.43	
	2438U1171F1	YC01301-	P-UB-10	120 mm	170 mm	KOB-2438U1171R300	507.79	
	2438U1171F1	YC01301-	P-UB-1	120 mm		KOB-2438U1171R100	175.97	
	2438U1171F1	YC01301-	N-N-10		170 mm	KOB-2438U1171R200	331.82	
	2438U1171F2	YC01301-	P-UB-10	120 mm	170 mm	KOB-2438U1171R300	507.79	
	2438U1171F2	YC01301-	P-UB-1	120 mm		KOB-2438U1171R100	175.97	
	2438U1171F2	YC01301-	N-N-10		170 mm	KOB-2438U1171R200	331.82	
	2438U1171F3	YC01301-	P-UB-10	120 mm	170 mm	KOB-2438U1171R300	507.79	
	2438U1171F3	YC01301-	P-UB-1	120 mm		KOB-2438U1171R100	175.97	
	2438U1171F3	YC01301-	N-N-10		170 mm	KOB-2438U1171R200	331.82	
	2438U1171F4	YC01301-	P-UB-10	120 mm	170 mm	KOB-2438U1171R300	507.79	
	2438U1171F4	YC01301-	P-UB-1	120 mm		KOB-2438U1171R100	175.97	
	2438U1171F4	YC01301-	N-N-10		170 mm	KOB-2438U1171R200	331.82	
	BOOM LH	2438U1177F1	YC01301-	P-UB-10	100 mm	150 mm	KOB-2438U1170R300	351.63
		2438U1177F1	YC01301-	P-UB-1	100 mm		KOB-2438U1170R100	127.13
2438U1177F1		YC01301-	N-N-10		150 mm	KOB-2438U1170R200	219.67	
2438U1177F2		YC01301-	P-UB-10	100 mm	150 mm	KOB-2438U1170R300	351.63	
2438U1177F2		YC01301-	P-UB-1	100 mm		KOB-2438U1170R100	127.13	
2438U1177F2		YC01301-	N-N-10		150 mm	KOB-2438U1170R200	219.67	
2438U1177F3		YC01301-	P-UB-10	100 mm	150 mm	KOB-2438U1170R300	351.63	
2438U1177F3		YC01301-	P-UB-1	100 mm		KOB-2438U1170R100	127.13	
2438U1177F3		YC01301-	N-N-10		150 mm	KOB-2438U1170R200	219.67	
2438U1177F4		YC01301-	P-UB-10	100 mm	150 mm	KOB-2438U1170R300	351.63	
2438U1177F4		YC01301-	P-UB-1	100 mm		KOB-2438U1170R100	127.13	
2438U1177F4		YC01301-	N-N-10		150 mm	KOB-2438U1170R200	219.67	
BOOM RH	2438U1170F1	YC01301-	P-UB-10	100 mm	150 mm	KOB-2438U1170R300	351.63	
	2438U1170F1	YC01301-	P-UB-1	100 mm		KOB-2438U1170R100	127.13	
	2438U1170F1	YC01301-	N-N-10		150 mm	KOB-2438U1170R200	219.67	
	2438U1170F2	YC01301-	P-UB-10	100 mm	150 mm	KOB-2438U1170R300	351.63	
	2438U1170F2	YC01301-	P-UB-1	100 mm		KOB-2438U1170R100	127.13	
	2438U1170F2	YC01301-	N-N-10		150 mm	KOB-2438U1170R200	219.67	
	2438U1170F3	YC01301-	P-UB-10	100 mm	150 mm	KOB-2438U1170R300	351.63	
	2438U1170F3	YC01301-	P-UB-1	100 mm		KOB-2438U1170R100	127.13	
	2438U1170F3	YC01301-	N-N-10		150 mm	KOB-2438U1170R200	219.67	
	2438U1170F4	YC01301-	P-UB-10	100 mm	150 mm	KOB-2438U1170R300	351.63	
	2438U1170F4	YC01301-	P-UB-1	100 mm		KOB-2438U1170R100	127.13	
	2438U1170F4	YC01301-	N-N-10		150 mm	KOB-2438U1170R200	219.67	
BUCKET	2438U1105F1	YC01301-	P-UB-10	80 mm	120 mm	KOB-2438U1105R500	242.52	
	2438U1105F1	YC01301-	P-UB-1	80 mm		KOB-2438U1105R400	112.01	
	2438U1105F1	YC01301-	N-N-10		120 mm	KOB-2438U1105R200	147.14	
	2438U1172F1	YC01301-	P-UB-10	100 mm	150 mm	KOB-2438U1172R300	398.90	
	2438U1172F1	YC01301-	N-N-10		150 mm	KOB-2438U1172R200	224.51	
	2438U1172F2	YC01301-	N-N-10		150 mm	KOB-2438U1172R400	229.65	
	2438U1172F3	YC01301-	P-UB-10	100 mm	150 mm	KOB-2438U1172R500	478.77	
	2438U1172F3	YC01301-	N-N-10		150 mm	KOB-2438U1172R400	229.65	
	2438U1172F4	YC01301-	P-UB-10	100 mm	150 mm	KOB-2438U1172R500	478.77	

KOBELCO®

Replacement Kits For

Excavators							
APPLICATION	CYL #	SERIAL #	CODE	ROD	BORE	KIT #	List \$
MODEL SK320LC III							
BUCKET	2438U1172F4	YC01301-	P-UB-1	100 mm		KOB-2438U1172R100	194.19
	2438U1172F4	YC01301-	N-N-10		150 mm	KOB-2438U1172R400	229.65
	2438U1172F5	YC01301-	P-UB-10	100 mm	150 mm	KOB-2438U1172R500	478.77
	2438U1172F5	YC01301-	P-UB-1	100 mm		KOB-2438U1172R100	194.19
	2438U1172F5	YC01301-	N-N-10		150 mm	KOB-2438U1172R400	229.65
MODEL SK330 IV							
ARM	2438U1171F1	LCU0101-	N-N-10		170 mm	KOB-2438U1171R200	331.82
	2438U1171F2	LCU0101-	P-UB-10	120 mm	170 mm	KOB-2438U1171R300	507.79
	2438U1171F2	LCU0101-	P-UB-1	120 mm		KOB-2438U1171R100	175.97
	2438U1171F2	LCU0101-	N-N-10		170 mm	KOB-2438U1171R200	331.82
	2438U1171F3	LCU0101-	P-UB-10	120 mm	170 mm	KOB-2438U1171R300	507.79
	2438U1171F3	LCU0101-	P-UB-1	120 mm		KOB-2438U1171R100	175.97
	2438U1171F3	LCU0101-	N-N-10		170 mm	KOB-2438U1171R200	331.82
	2438U1171F4	LCU0101-	P-UB-10	120 mm	170 mm	KOB-2438U1171R300	507.79
	2438U1171F4	LCU0101-	P-UB-1	120 mm		KOB-2438U1171R100	175.97
	2438U1171F4	LCU0101-	N-N-10		170 mm	KOB-2438U1171R200	331.82
BOOM LH	2438U1177F1	LCU0101-	P-UB-10	100 mm	150 mm	KOB-2438U1170R300	351.63
	2438U1177F1	LCU0101-	Bushing	100 mm		KOB-2438U1104S4	51.68
	2438U1177F2	LCU0101-	P-UB-10	100 mm	150 mm	KOB-2438U1170R300	351.63
	2438U1177F2	LCU0101-	P-UB-1	100 mm		KOB-2438U1170R100	127.13
	2438U1177F2	LCU0101-	N-N-10		150 mm	KOB-2438U1172R400	229.65
	2438U1177F2	LCU0101-	Bushing	100 mm		KOB-2438U1104S4	51.68
	2438U1177F3	LCU0101-	P-UB-1	100 mm		KOB-2438U1170R100	127.13
	2438U1177F3	LCU0101-	N-N-10		150 mm	KOB-2438U1172R400	229.65
	2438U1177F3	LCU0101-	Bushing	100 mm		KOB-2438U1104S4	51.68
	2438U1177F4	LCU0101-	P-UB-10	100 mm	150 mm	KOB-2438U1170R300	351.63
	2438U1177F4	LCU0101-	P-UB-1	100 mm		KOB-2438U1170R100	127.13
	2438U1177F4	LCU0101-	N-N-10		150 mm	KOB-2438U1172R400	229.65
	2438U1177F4	LCU0101-	Bushing	100 mm		KOB-2438U1104S4	51.68
	BOOM RH	2438U1170F1	LCU0101-	P-UB-10	100 mm	150 mm	KOB-2438U1170R300
2438U1170F1		LCU0101-	P-UB-1	100 mm		KOB-2438U1170R100	127.13
2438U1170F1		LCU0101-	N-N-10		150 mm	KOB-2438U1172R400	229.65
2438U1170F1		LCU0101-	Bushing	100 mm		KOB-2438U1104S4	51.68
2438U1170F2		LCU0101-	P-UB-10	100 mm	150 mm	KOB-2438U1170R300	351.63
2438U1170F2		LCU0101-	P-UB-1	100 mm		KOB-2438U1170R100	127.13
2438U1170F2		LCU0101-	N-N-10		150 mm	KOB-2438U1172R400	229.65
2438U1170F2		LCU0101-	Bushing	100 mm		KOB-2438U1104S4	51.68
2438U1170F3		LCU0101-	P-UB-10	100 mm	150 mm	KOB-2438U1170R300	351.63
2438U1170F3		LCU0101-	P-UB-1	100 mm		KOB-2438U1170R100	127.13
2438U1170F3		LCU0101-	N-N-10		150 mm	KOB-2438U1172R400	229.65
2438U1170F3		LCU0101-	Bushing	100 mm		KOB-2438U1104S4	51.68
2438U1170F4		LCU0101-	P-UB-10	100 mm	150 mm	KOB-2438U1170R300	351.63
2438U1170F4		LCU0101-	P-UB-1	100 mm		KOB-2438U1170R100	127.13
2438U1170F4		LCU0101-	N-N-10		150 mm	KOB-2438U1172R400	229.65
2438U1170F4		LCU0101-	Bushing	100 mm		KOB-2438U1104S4	51.68
BUCKET	2438U1172F1	LCU0101-	P-UB-10	100 mm	150 mm	KOB-2438U1172R300	398.90
	2438U1172F1	LCU0101-	P-UB-1	100 mm		KOB-2438U1170R100	127.13
	2438U1172F1	LCU0101-	N-N-10		150 mm	KOB-2438U1172R400	229.65
	2438U1172F1	LCU0101-	Bushing	100 mm		KOB-2438U1104S4	51.68
	2438U1172F2	LCU0101-	P-UB-10	100 mm	150 mm	KOB-2438U1172R300	398.90
	2438U1172F2	LCU0101-	P-UB-1	100 mm		KOB-2438U1170R100	127.13
	2438U1172F2	LCU0101-	N-N-10		150 mm	KOB-2438U1172R400	229.65
	2438U1172F2	LCU0101-	Bushing	100 mm		KOB-2438U1104S4	51.68
	2438U1172F3	LCU0101-	P-UB-10	100 mm	150 mm	KOB-2438U1172R500	478.77
	2438U1172F3	LCU0101-	P-UB-1	100 mm		KOB-2438U1170R100	127.13

KOBELCO®

Replacement Kits For

KOBELCO®

Excavators								
APPLICATION	CYL #	SERIAL #	CODE	ROD	BORE	KIT #	List \$	
MODEL SK330 IV								
BUCKET	2438U1172F3	LCU0101-	N-N-10		150 mm	KOB-2438U1172R400	229.65	
	2438U1172F3	LCU0101-	Bushing	100 mm		KOB-2438U1104S4	51.68	
	2438U1172F4	LCU0101-	P-UB-10	100 mm	150 mm	KOB-2438U1172R300	398.90	
	2438U1172F4	LCU0101-	P-UB-1	100 mm		KOB-2438U1172R100	194.19	
	2438U1172F4	LCU0101-	N-N-10		150 mm	KOB-2438U1172R400	229.65	
	2438U1172F4	LCU0101-	Bushing	100 mm		KOB-2438U1104S4	51.68	
	2438U1172F5	LCU0101-	P-UB-10	100 mm	150 mm	KOB-2438U1172R300	398.90	
	2438U1172F5	LCU0101-	P-UB-1	100 mm		KOB-2438U1172R100	194.19	
	2438U1172F5	LCU0101-	N-N-10		150 mm	KOB-2438U1172R400	229.65	
2438U1172F5	LCU0101-	Bushing	100 mm		KOB-2438U1104S4	51.68		
MODEL SK330-6E								
ARM	LC01V00005F1	LCC-02001-	P-UB-10	120 mm	170 mm	KOB-LC01V00005R300	573.73	
	LC01V00005F1	LCC-02001-	P-UB-1	120 mm		KOB-LC01V00005R100	175.97	
	LC01V00005F1	LCC-02001-	N-N-10		170 mm	KOB-LC01V00005R200	401.55	
BOOM LH	LC01V00002F1	LCC-02001-	P-UB-10	100 mm	140 mm	KOB-LC01V00001R300	290.03	
	LC01V00002F1	LCC-02001-	P-UB-1	100 mm		KOB-LQ01V00007R100	106.16	
	LC01V00002F1	LCC-02001-	N-N-10		140 mm	KOB-LC01V00001R200	204.39	
	LC01V00002F1	LCC-02001-	Bushing	100 mm		KOB-2438U1104S4	51.68	
BOOM RH	LC01V00001F1	LCC-02001-	P-UB-10	100 mm	140 mm	KOB-LC01V00001R300	290.03	
	LC01V00001F1	LCC-02001-	P-UB-1	100 mm		KOB-LQ01V00007R100	106.16	
	LC01V00001F1	LCC-02001-	N-N-10		140 mm	KOB-LC01V00001R200	204.39	
	LC01V00001F1	LCC-02001-	Bushing	100 mm		KOB-2438U1104S4	51.68	
BUCKET	LC01V00006F1	LCC-02001-	P-UB-10	100 mm	150 mm	KOB-LC01V00006R300	355.17	
	LC01V00006F1	LCC-02001-	P-UB-1	100 mm		KOB-LC01V00006R100	112.12	
	LC01V00006F1	LCC-02001-	N-N-10		150 mm	KOB-LC01V00006R200	243.06	
	LC01V00006F1	LCC-02001-	Bushing	100 mm		KOB-2438U1104S4	51.68	
MODEL SK330-8								
ARM	LC01V00054F1	LC10-07001-	P-UB-10	120 mm	170 mm	KOB-LC01V00054R300	782.95	
	LC01V00054F1	LC10-07001-	P-UB-1	120 mm		KOB-LC01V00054R100	165.41	
	LC01V00054F1	LC10-07001-	N-N-10		170 mm	KOB-LC01V00054R200	641.83	
	LC01V00054F1	LC10-C5001-	P-UB-10	120 mm	170 mm	KOB-LC01V00054R300	782.95	
	LC01V00054F1	LC10-C5001-	P-UB-1	120 mm		KOB-LC01V00054R100	165.41	
	LC01V00054F1	LC10-C5001-	N-N-10		170 mm	KOB-LC01V00054R200	641.83	
	LC01V00054F2	LC10-07001-	P-UB-10	120 mm	170 mm	KOB-LC01V00054R300	782.95	
	LC01V00054F2	LC10-07001-	P-UB-1	120 mm		KOB-LC01V00054R100	165.41	
	LC01V00054F2	LC10-07001-	N-N-10		170 mm	KOB-LC01V00054R200	641.83	
	LC01V00054F2	LC10-C5001-	P-UB-10	120 mm	170 mm	KOB-LC01V00054R300	782.95	
	LC01V00054F2	LC10-C5001-	P-UB-1	120 mm		KOB-LC01V00054R100	165.41	
	LC01V00054F2	LC10-C5001-	N-N-10		170 mm	KOB-LC01V00054R200	641.83	
	BOOM	LC01V00044F1	LC10-07001-	P-UB-10	100 mm	140 mm	KOB-LC01V00044R300	378.45
		LC01V00044F1	LC10-07001-	P-UB-1	100 mm		KOB-LC01V00044R100	111.74
LC01V00044F1		LC10-07001-	N-N-10		140 mm	KOB-LC01V00044R200	266.70	
LC01V00044F1		LC10-07001-	Bushing	100 mm		KOB-2438U1104S4	51.68	
LC01V00044F1		LC10-C5001-	P-UB-10	100 mm	140 mm	KOB-LC01V00044R300	378.45	
LC01V00044F1		LC10-C5001-	P-UB-1	100 mm		KOB-LC01V00044R100	111.74	
LC01V00044F1		LC10-C5001-	N-N-10		140 mm	KOB-LC01V00044R200	266.70	
LC01V00044F1		LC10-C5001-	Bushing	100 mm		KOB-2438U1104S4	51.68	
BUCKET		LC01V00055F1	LC10-07001-	P-UB-10	100 mm	150 mm	KOB-LC01V00055R300	449.86
	LC01V00055F1	LC10-07001-	P-UB-1	100 mm		KOB-LC01V00055R100	112.12	
	LC01V00055F1	LC10-07001-	N-N-10		150 mm	KOB-LC01V00055R200	337.74	
	LC01V00055F1	LC10-07001-	Bushing	100 mm		KOB-2438U1104S4	51.68	
	LC01V00055F1	LC10-C5001-	P-UB-10	100 mm	150 mm	KOB-LC01V00055R300	449.86	
	LC01V00055F1	LC10-C5001-	P-UB-1	100 mm		KOB-LC01V00055R100	112.12	
	LC01V00055F1	LC10-C5001-	N-N-10		150 mm	KOB-LC01V00055R200	337.74	
	LC01V00055F1	LC10-C5001-	Bushing	100 mm		KOB-2438U1104S4	51.68	
	LC01V00055F1	LC10-C5001-	Bushing	100 mm		KOB-2438U1104S4	51.68	

KOBELCO®

Replacement Kits For

KOBELCO®

Excavators							
APPLICATION	CYL #	SERIAL #	CODE	ROD	BORE	KIT #	List \$
MODEL SK330-8							
BUCKET	LC01V00055F2	LC10-07001-	P-UB-10	100 mm	150 mm	KOB-LC01V00055R300	449.86
	LC01V00055F2	LC10-07001-	P-UB-1	100 mm		KOB-LC01V00055R100	112.12
	LC01V00055F2	LC10-07001-	N-N-10		150 mm	KOB-LC01V00055R200	337.74
	LC01V00055F2	LC10-07001-	Bushing	100 mm		KOB-2438U1104S4	51.68
	LC01V00055F2	LC10-C5001-	P-UB-10	100 mm	150 mm	KOB-LC01V00055R300	449.86
	LC01V00055F2	LC10-C5001-	P-UB-1	100 mm		KOB-LC01V00055R100	112.12
	LC01V00055F2	LC10-C5001-	N-N-10		150 mm	KOB-LC01V00055R200	337.74
	LC01V00055F2	LC10-C5001-	Bushing	100 mm		KOB-2438U1104S4	51.68
MODEL SK330LC							
ARM	LC01V00005F1	YC06U0101-	P-UB-10	120 mm	170 mm	KOB-LC01V00005R300	573.73
	LC01V00005F1	YC06U0101-	P-UB-1	120 mm		KOB-LC01V00005R100	175.97
	LC01V00005F1	YC06U0101-	N-N-10		170 mm	KOB-LC01V00005R200	401.55
BOOM LH	LC01V00002F1	YC06U0101-	P-UB-10	100 mm	140 mm	KOB-LC01V00001R300	290.03
	LC01V00002F1	YC06U0101-	P-UB-1	100 mm		KOB-LQ01V00007R100	106.16
	LC01V00002F1	YC06U0101-	N-N-10		140 mm	KOB-LC01V00001R200	204.39
	LC01V00002F1	YC06U0101-	Bushing	100 mm		KOB-2438U1104S4	51.68
BOOM RH	LC01V00001F1	YC06U0101-	P-UB-10	100 mm	140 mm	KOB-LC01V00001R300	290.03
	LC01V00001F1	YC06U0101-	P-UB-1	100 mm		KOB-LQ01V00007R100	106.16
	LC01V00001F1	YC06U0101-	N-N-10		140 mm	KOB-LC01V00001R200	204.39
	LC01V00001F1	YC06U0101-	Bushing	100 mm		KOB-2438U1104S4	51.68
BUCKET	LC01V00006F1	YC06U0101-	P-UB-10	100 mm	150 mm	KOB-LC01V00006R300	355.17
	LC01V00006F1	YC06U0101-	P-UB-1	100 mm		KOB-LC01V00006R100	112.12
	LC01V00006F1	YC06U0101-	N-N-10		150 mm	KOB-LC01V00006R200	243.06
	LC01V00006F1	YC06U0101-	Bushing	100 mm		KOB-2438U1104S4	51.68
MODEL SK330LC IV							
ARM	2438U1171F2	YCU0603, YCU0611-	P-UB-10	120 mm	170 mm	KOB-2438U1171R300	507.79
	2438U1171F2	YCU0603, YCU0611-	P-UB-1	120 mm		KOB-2438U1171R100	175.97
	2438U1171F2	YCU0603, YCU0611-	N-N-10		170 mm	KOB-2438U1171R200	331.82
	2438U1171F3	YCU0603, YCU0611-	P-UB-10	120 mm	170 mm	KOB-2438U1171R300	507.79
	2438U1171F3	YCU0603, YCU0611-	P-UB-1	120 mm		KOB-2438U1171R100	175.97
	2438U1171F3	YCU0603, YCU0611-	N-N-10		170 mm	KOB-2438U1171R200	331.82
	2438U1171F4	YCU0603, YCU0611-	P-UB-10	120 mm	170 mm	KOB-2438U1171R300	507.79
	2438U1171F4	YCU0603, YCU0611-	P-UB-1	120 mm		KOB-2438U1171R100	175.97
	2438U1171F4	YCU0603, YCU0611-	N-N-10		170 mm	KOB-2438U1171R200	331.82
	BOOM LH	2438U1177F1	YCU0603, YCU0611-	P-UB-10	100 mm	150 mm	KOB-2438U1170R300
2438U1177F1		YCU0603, YCU0611-	N-N-10		150 mm	KOB-2438U1172R400	229.65
2438U1177F1		YCU0603, YCU0611-	Bushing	100 mm		KOB-2438U1104S4	51.68
2438U1177F2		YCU0603, YCU0611-	P-UB-10	100 mm	150 mm	KOB-2438U1170R300	351.63
2438U1177F2		YCU0603, YCU0611-	P-UB-1	100 mm		KOB-2438U1170R100	127.13
2438U1177F2		YCU0603, YCU0611-	N-N-10		150 mm	KOB-2438U1172R400	229.65
2438U1177F2		YCU0603, YCU0611-	Bushing	100 mm		KOB-2438U1104S4	51.68
2438U1177F3		YCU0603, YCU0611-	P-UB-1	100 mm		KOB-2438U1170R100	127.13
2438U1177F3		YCU0603, YCU0611-	N-N-10		150 mm	KOB-2438U1172R400	229.65
2438U1177F3		YCU0603, YCU0611-	Bushing	100 mm		KOB-2438U1104S4	51.68
2438U1177F4		YCU0603, YCU0611-	P-UB-10	100 mm	150 mm	KOB-2438U1170R300	351.63
2438U1177F4		YCU0603, YCU0611-	P-UB-1	100 mm		KOB-2438U1170R100	127.13
2438U1177F4		YCU0603, YCU0611-	N-N-10		150 mm	KOB-2438U1172R400	229.65
2438U1177F4		YCU0603, YCU0611-	Bushing	100 mm		KOB-2438U1104S4	51.68
BOOM RH	2438U1170F1	YCU0603, YCU0611-	P-UB-10	100 mm	150 mm	KOB-2438U1172R300	398.90
	2438U1170F1	YCU0603, YCU0611-	P-UB-1	100 mm		KOB-2438U1172R100	194.19
	2438U1170F1	YCU0603, YCU0611-	N-N-10		150 mm	KOB-2438U1172R400	229.65
	2438U1170F1	YCU0603, YCU0611-	Bushing	100 mm		KOB-2438U1104S4	51.68
	2438U1170F2	YCU0603, YCU0611-	P-UB-10	100 mm	150 mm	KOB-2438U1170R300	351.63
	2438U1170F2	YCU0603, YCU0611-	P-UB-1	100 mm		KOB-2438U1170R100	127.13
	2438U1170F2	YCU0603, YCU0611-	N-N-10		150 mm	KOB-2438U1172R400	229.65

KOBELCO®

Replacement Kits For

KOBELCO®

Excavators							
APPLICATION	CYL #	SERIAL #	CODE	ROD	BORE	KIT #	List \$
MODEL SK330LC IV							
BOOM RH	2438U1170F2	YCU0603, YCU0611-	Bushing	100 mm		KOB-2438U1104S4	51.68
	2438U1170F3	YCU0603, YCU0611-	P-UB-10	100 mm	150 mm	KOB-2438U1170R300	351.63
	2438U1170F3	YCU0603, YCU0611-	P-UB-1	100 mm		KOB-2438U1170R100	127.13
	2438U1170F3	YCU0603, YCU0611-	N-N-10		150 mm	KOB-2438U1172R400	229.65
	2438U1170F3	YCU0603, YCU0611-	Bushing	100 mm		KOB-2438U1104S4	51.68
	2438U1170F4	YCU0603, YCU0611-	P-UB-10	100 mm	150 mm	KOB-2438U1170R300	351.63
	2438U1170F4	YCU0603, YCU0611-	P-UB-1	100 mm		KOB-2438U1170R100	127.13
	2438U1170F4	YCU0603, YCU0611-	N-N-10		150 mm	KOB-2438U1172R400	229.65
BUCKET	2438U1172F1	YCU0603, YCU0611-	P-UB-10	100 mm	150 mm	KOB-2438U1172R300	398.90
	2438U1172F1	YCU0603, YCU0611-	P-UB-1	100 mm		KOB-2438U1170R100	127.13
	2438U1172F1	YCU0603, YCU0611-	N-N-10		150 mm	KOB-2438U1172R400	229.65
	2438U1172F1	YCU0603, YCU0611-	Bushing	100 mm		KOB-2438U1104S4	51.68
	2438U1172F2	YCU0603, YCU0611-	P-UB-10	100 mm	150 mm	KOB-2438U1172R300	398.90
	2438U1172F2	YCU0603, YCU0611-	N-N-10		150 mm	KOB-2438U1172R400	229.65
	2438U1172F2	YCU0603, YCU0611-	P-UB-1	100 mm		KOB-2438U1170R100	127.13
	2438U1172F2	YCU0603, YCU0611-	Bushing	100 mm		KOB-2438U1104S4	51.68
	2438U1172F3	YCU0603, YCU0611-	P-UB-10	100 mm	150 mm	KOB-2438U1172R500	478.77
	2438U1172F3	YCU0603, YCU0611-	P-UB-1	100 mm		KOB-2438U1170R100	127.13
	2438U1172F3	YCU0603, YCU0611-	N-N-10		150 mm	KOB-2438U1172R400	229.65
	2438U1172F3	YCU0603, YCU0611-	Bushing	100 mm		KOB-2438U1104S4	51.68
	2438U1172F4	YCU0603, YCU0611-	P-UB-10	100 mm	150 mm	KOB-2438U1172R500	478.77
	2438U1172F4	YCU0603, YCU0611-	P-UB-1	100 mm		KOB-2438U1170R100	127.13
	2438U1172F4	YCU0603, YCU0611-	N-N-10		150 mm	KOB-2438U1172R400	229.65
	2438U1172F4	YCU0603, YCU0611-	Bushing	100 mm		KOB-2438U1104S4	51.68
	2438U1172F5	YCU0603, YCU0611-	P-UB-10	100 mm	150 mm	KOB-2438U1172R500	478.77
	2438U1172F5	YCU0603, YCU0611-	P-UB-1	100 mm		KOB-2438U1170R100	127.13
	2438U1172F5	YCU0603, YCU0611-	N-N-10		150 mm	KOB-2438U1172R400	229.65
	2438U1172F5	YCU0603, YCU0611-	Bushing	100 mm		KOB-2438U1104S4	51.68
MODEL SK330LC-6E							
ARM	LC01V00005F2	YC07U0623-	P-UB-10	120 mm	170 mm	KOB-LC01V00005R300	573.73
	LC01V00005F2	YC07U0623-	P-UB-1	120 mm		KOB-LC01V00005R100	175.97
	LC01V00005F2	YC07U0623-	N-N-10		170 mm	KOB-LC01V00005R200	401.55
BOOM LH	LC01V00002F3	YC07U0623-	P-UB-10	100 mm	140 mm	KOB-LC01V00001R300	290.03
	LC01V00002F3	YC07U0623-	P-UB-1	100 mm		KOB-LQ01V00007R100	106.16
	LC01V00002F3	YC07U0623-	N-N-10		140 mm	KOB-LC01V00001R200	204.39
	LC01V00002F3	YC07U0623-	Bushing	100 mm		KOB-2438U1104S4	51.68
BOOM RH	LC01V00001F3	YC07U0623-	P-UB-10	100 mm	140 mm	KOB-LC01V00001R300	290.03
	LC01V00001F3	YC07U0623-	P-UB-1	100 mm		KOB-LQ01V00007R100	106.16
	LC01V00001F3	YC07U0623-	N-N-10		140 mm	KOB-LC01V00001R200	204.39
	LC01V00001F3	YC07U0623-	Bushing	100 mm		KOB-2438U1104S4	51.68
BUCKET	LC01V00006F3	YC07U0623-	P-UB-10	100 mm	150 mm	KOB-LC01V00006R300	355.17
	LC01V00006F3	YC07U0623-	P-UB-1	100 mm		KOB-LC01V00006R100	112.12
	LC01V00006F3	YC07U0623-	N-N-10		150 mm	KOB-LC01V00006R200	243.06
	LC01V00006F3	YC07U0623-	Bushing	100 mm		KOB-2438U1104S4	51.68
MODEL SK350-8							
ARM	LC01V00054F1		P-UB-10	120 mm	170 mm	KOB-LC01V00054R300	782.95
	LC01V00054F1		P-UB-1	120 mm		KOB-LC01V00054R100	165.41
	LC01V00054F1		N-N-10		170 mm	KOB-LC01V00054R200	641.83
	LC01V00054F2		P-UB-10	120 mm	170 mm	KOB-LC01V00054R300	782.95
	LC01V00054F2		P-UB-1	120 mm		KOB-LC01V00054R100	165.41
	LC01V00054F2		N-N-10		170 mm	KOB-LC01V00054R200	641.83
BOOM	LC01V00044F1		P-UB-10	100 mm	140 mm	KOB-LC01V00044R300	378.45
	LC01V00044F1		P-UB-1	100 mm		KOB-LC01V00044R100	111.74
	LC01V00044F1		N-N-10		140 mm	KOB-LC01V00044R200	266.70

KOBELCO®

Replacement Kits For

KOBELCO®

Excavators								
APPLICATION	CYL #	SERIAL #	CODE	ROD	BORE	KIT #	List \$	
MODEL SK350-8								
BOOM	LC01V00044F1		Bushing	100 mm		KOB-2438U1104S4	51.68	
BUCKET	LC01V00055F1		P-UB-10	100 mm	150 mm	KOB-LC01V00055R300	449.86	
	LC01V00055F1		P-UB-1	100 mm		KOB-LC01V00055R100	112.12	
	LC01V00055F1		N-N-10		150 mm	KOB-LC01V00055R200	337.74	
	LC01V00055F1		Bushing	100 mm		KOB-2438U1104S4	51.68	
	LC01V00055F2		P-UB-10	100 mm	150 mm	KOB-LC01V00055R300	449.86	
	LC01V00055F2		P-UB-1	100 mm		KOB-LC01V00055R100	112.12	
	LC01V00055F2		N-N-10		150 mm	KOB-LC01V00055R200	337.74	
	LC01V00055F2		Bushing	100 mm		KOB-2438U1104S4	51.68	
MODEL SK350LC-8								
ARM	LC01V00054F1	YC10-03501-	P-UB-10	120 mm	170 mm	KOB-LC01V00054R300	782.95	
	LC01V00054F1	YC10-03501-	P-UB-1	120 mm		KOB-LC01V00054R100	165.41	
	LC01V00054F1	YC10-03501-	N-N-10		170 mm	KOB-LC01V00054R200	641.83	
	LC01V00054F1	YC10-C5001-	P-UB-10	120 mm	170 mm	KOB-LC01V00054R300	782.95	
	LC01V00054F1	YC10-C5001-	P-UB-1	120 mm		KOB-LC01V00054R100	165.41	
	LC01V00054F1	YC10-C5001-	N-N-10		170 mm	KOB-LC01V00054R200	641.83	
	LC01V00054F2	YC10-03501-	P-UB-10	120 mm	170 mm	KOB-LC01V00054R300	782.95	
	LC01V00054F2	YC10-03501-	P-UB-1	120 mm		KOB-LC01V00054R100	165.41	
	LC01V00054F2	YC10-03501-	N-N-10		170 mm	KOB-LC01V00054R200	641.83	
	LC01V00054F2	YC10-C5001-	P-UB-10	120 mm	170 mm	KOB-LC01V00054R300	782.95	
	LC01V00054F2	YC10-C5001-	P-UB-1	120 mm		KOB-LC01V00054R100	165.41	
	LC01V00054F2	YC10-C5001-	N-N-10		170 mm	KOB-LC01V00054R200	641.83	
	BOOM	LC01V00044F1	YC10-03501-	P-UB-10	100 mm	140 mm	KOB-LC01V00044R300	378.45
LC01V00044F1		YC10-03501-	P-UB-1	100 mm		KOB-LC01V00044R100	111.74	
LC01V00044F1		YC10-03501-	N-N-10		140 mm	KOB-LC01V00044R200	266.70	
LC01V00044F1		YC10-03501-	Bushing	100 mm		KOB-2438U1104S4	51.68	
LC01V00044F1		YC10-C5001-	P-UB-10	100 mm	140 mm	KOB-LC01V00044R300	378.45	
LC01V00044F1		YC10-C5001-	P-UB-1	100 mm		KOB-LC01V00044R100	111.74	
LC01V00044F1		YC10-C5001-	N-N-10		140 mm	KOB-LC01V00044R200	266.70	
LC01V00044F1		YC10-C5001-	Bushing	100 mm		KOB-2438U1104S4	51.68	
BUCKET	LC01V00055F1	YC10-03501-	P-UB-10	100 mm	150 mm	KOB-LC01V00055R300	449.86	
	LC01V00055F1	YC10-03501-	P-UB-1	100 mm		KOB-LC01V00055R100	112.12	
	LC01V00055F1	YC10-03501-	N-N-10		150 mm	KOB-LC01V00055R200	337.74	
	LC01V00055F1	YC10-03501-	Bushing	100 mm		KOB-2438U1104S4	51.68	
	LC01V00055F1	YC10-C5001-	P-UB-10	100 mm	150 mm	KOB-LC01V00055R300	449.86	
	LC01V00055F1	YC10-C5001-	P-UB-1	100 mm		KOB-LC01V00055R100	112.12	
	LC01V00055F1	YC10-C5001-	N-N-10		150 mm	KOB-LC01V00055R200	337.74	
	LC01V00055F2	YC10-03501-	P-UB-10	100 mm	150 mm	KOB-LC01V00055R300	449.86	
	LC01V00055F2	YC10-03501-	P-UB-1	100 mm		KOB-LC01V00055R100	112.12	
	LC01V00055F2	YC10-03501-	N-N-10		150 mm	KOB-LC01V00055R200	337.74	
	LC01V00055F2	YC10-03501-	Bushing	100 mm		KOB-2438U1104S4	51.68	
	LC01V00055F2	YC10-C5001-	P-UB-10	100 mm	150 mm	KOB-LC01V00055R300	449.86	
	LC01V00055F2	YC10-C5001-	P-UB-1	100 mm		KOB-LC01V00055R100	112.12	
	LC01V00055F2	YC10-C5001-	N-N-10		150 mm	KOB-LC01V00055R200	337.74	
	LC01V00055F2	YC10-C5001-	Bushing	100 mm		KOB-2438U1104S4	51.68	
	MODEL SK400LC III							
	ARM	2438U1174F1	YS00547-	P-UB-14	130 mm	190 mm	KOB-2438U1174R300	816.71
2438U1174F1		YS00547-	P-UB-1	130 mm		KOB-2438U1174R100	335.75	
2438U1174F1		YS00547-	N-N-14		190 mm	KOB-2438U1174R200	480.94	
2438U1174F1		YSU0001-	P-UB-14	130 mm	190 mm	KOB-2438U1174R300	816.71	
2438U1174F1		YSU0001-	P-UB-1	130 mm		KOB-2438U1174R100	335.75	
2438U1174F1		YSU0001-	N-N-14		190 mm	KOB-2438U1174R200	480.94	
2438U1174F2		YS00547-	P-UB-14	130 mm	190 mm	KOB-2438U1174R300	816.71	
2438U1174F2		YS00547-	P-UB-1	130 mm		KOB-2438U1174R100	335.75	
2438U1174F2		YS00547-	N-N-14		190 mm	KOB-2438U1174R200	480.94	

Replacement Kits For

KOBELCO®

Excavators							
APPLICATION	CYL #	SERIAL #	CODE	ROD	BORE	KIT #	List \$
MODEL SK400LC III							
ARM	2438U1174F2	YSU0001-	P-UB-14	130 mm	190 mm	KOB-2438U1174R300	816.71
	2438U1174F2	YSU0001-	P-UB-1	130 mm		KOB-2438U1174R100	335.75
	2438U1174F2	YSU0001-	N-N-14		190 mm	KOB-2438U1174R200	480.94
BOOM LH	2438U1176F1	YS00547-	P-UB-14	115 mm	170 mm	KOB-2438U1173R300	573.71
	2438U1176F1	YS00547-	P-UB-1	115 mm		KOB-2438U1173R100	229.21
	2438U1176F1	YS00547-	N-N-14		170 mm	KOB-2438U1173R200	344.49
	2438U1176F1	YSU0001-	P-UB-14	115 mm	170 mm	KOB-2438U1173R300	573.71
	2438U1176F1	YSU0001-	P-UB-1	115 mm		KOB-2438U1173R100	229.21
	2438U1176F1	YSU0001-	N-N-14		170 mm	KOB-2438U1173R200	344.49
	2438U1176F2	YS00547-	P-UB-14	115 mm	170 mm	KOB-2438U1173R300	573.71
	2438U1176F2	YS00547-	P-UB-1	115 mm		KOB-2438U1173R100	229.21
	2438U1176F2	YS00547-	N-N-14		170 mm	KOB-2438U1173R200	344.49
	2438U1176F2	YSU0001-	P-UB-14	115 mm	170 mm	KOB-2438U1173R300	573.71
	2438U1176F2	YSU0001-	P-UB-1	115 mm		KOB-2438U1173R100	229.21
	2438U1176F2	YSU0001-	N-N-14		170 mm	KOB-2438U1173R200	344.49
BOOM RH	2438U1173F1	YS00547-	P-UB-14	115 mm	170 mm	KOB-2438U1173R300	573.71
	2438U1173F1	YS00547-	P-UB-1	115 mm		KOB-2438U1173R100	229.21
	2438U1173F1	YS00547-	N-N-14		170 mm	KOB-2438U1173R200	344.49
	2438U1173F1	YSU0001-	P-UB-14	115 mm	170 mm	KOB-2438U1173R300	573.71
	2438U1173F1	YSU0001-	P-UB-1	115 mm		KOB-2438U1173R100	229.21
	2438U1173F1	YSU0001-	N-N-14		170 mm	KOB-2438U1173R200	344.49
	2438U1173F2	YS00547-	P-UB-14	115 mm	170 mm	KOB-2438U1173R300	573.71
	2438U1173F2	YS00547-	P-UB-1	115 mm		KOB-2438U1173R100	229.21
	2438U1173F2	YS00547-	N-N-14		170 mm	KOB-2438U1173R200	344.49
	2438U1173F2	YSU0001-	P-UB-14	115 mm	170 mm	KOB-2438U1173R300	573.71
	2438U1173F2	YSU0001-	P-UB-1	115 mm		KOB-2438U1173R100	229.21
	2438U1173F2	YSU0001-	N-N-14		170 mm	KOB-2438U1173R200	344.49
BUCKET	2438U1175F1	YS00547-	P-UB-14	110 mm	160 mm	KOB-2438U1175R300	414.46
	2438U1175F1	YS00547-	P-UB-1	110 mm		KOB-2438U1175R100	176.08
	2438U1175F1	YS00547-	N-N-14		160 mm	KOB-2438U1175R200	277.77
	2438U1175F1	YSU0001-	P-UB-14	110 mm	160 mm	KOB-2438U1175R300	414.46
	2438U1175F1	YSU0001-	P-UB-1	110 mm		KOB-2438U1175R100	176.08
	2438U1175F1	YSU0001-	N-N-14		160 mm	KOB-2438U1175R200	277.77
	2438U1175F2	YS00547-	P-UB-14	110 mm	160 mm	KOB-2438U1175R300	414.46
	2438U1175F2	YS00547-	P-UB-1	110 mm		KOB-2438U1175R100	176.08
	2438U1175F2	YS00547-	N-N-14		160 mm	KOB-2438U1175R200	277.77
	2438U1175F2	YSU0001-	P-UB-14	110 mm	160 mm	KOB-2438U1175R300	414.46
	2438U1175F2	YSU0001-	P-UB-1	110 mm		KOB-2438U1175R100	176.08
	2438U1175F2	YSU0001-	N-N-14		160 mm	KOB-2438U1175R200	277.77
MODEL SK400LC IV							
ARM	2438U1174F1	YSJ00002-	P-UB-14	130 mm	190 mm	KOB-2438U1174R300	816.71
	2438U1174F1	YSJ00002-	P-UB-1	130 mm		KOB-2438U1174R100	335.75
	2438U1174F1	YSJ00002-	N-N-14		190 mm	KOB-2438U1174R200	480.94
	2438U1174F1	YSU0200-	P-UB-14	130 mm	190 mm	KOB-2438U1174R300	816.71
	2438U1174F1	YSU0200-	P-UB-1	130 mm		KOB-2438U1174R100	335.75
	2438U1174F1	YSU0200-	N-N-14		190 mm	KOB-2438U1174R200	480.94
	2438U1174F2	YSJ00002-	P-UB-14	130 mm	190 mm	KOB-2438U1174R300	816.71
	2438U1174F2	YSJ00002-	P-UB-1	130 mm		KOB-2438U1174R100	335.75
	2438U1174F2	YSJ00002-	N-N-14		190 mm	KOB-2438U1174R200	480.94
	2438U1174F2	YSU0200-	P-UB-14	130 mm	190 mm	KOB-2438U1174R300	816.71
	2438U1174F2	YSU0200-	P-UB-1	130 mm		KOB-2438U1174R100	335.75
	2438U1174F2	YSU0200-	N-N-14		190 mm	KOB-2438U1174R200	480.94
	2438U1174F3	YSU0200-	P-UB-14	130 mm	190 mm	KOB-2438U1174R300	816.71
	2438U1174F3	YSU0200-	P-UB-1	130 mm		KOB-2438U1174R100	335.75
	2438U1174F3	YSU0200-	N-N-14		190 mm	KOB-2438U1174R200	480.94

KOBELCO®

Replacement Kits For

KOBELCO®

Excavators								
APPLICATION	CYL #	SERIAL #	CODE	ROD	BORE	KIT #	List \$	
MODEL SK400LC IV								
BOOM LH	2438U1176F1	YSJ00002-	P-UB-14	115 mm	170 mm	KOB-2438U1173R300	573.71	
	2438U1176F1	YSJ00002-	P-UB-1	115 mm		KOB-2438U1173R100	229.21	
	2438U1176F1	YSJ00002-	N-N-14		170 mm	KOB-2438U1173R200	344.49	
	2438U1176F1	YSU0200-	P-UB-14	115 mm	170 mm	KOB-2438U1173R300	573.71	
	2438U1176F1	YSU0200-	P-UB-1	115 mm		KOB-2438U1173R100	229.21	
	2438U1176F1	YSU0200-	N-N-14		170 mm	KOB-2438U1173R200	344.49	
	2438U1176F2	YSJ00002-	P-UB-14	115 mm	170 mm	KOB-2438U1173R300	573.71	
	2438U1176F2	YSJ00002-	P-UB-1	115 mm		KOB-2438U1173R100	229.21	
	2438U1176F2	YSJ00002-	N-N-14		170 mm	KOB-2438U1173R200	344.49	
	2438U1176F2	YSU0200-	P-UB-14	115 mm	170 mm	KOB-2438U1173R300	573.71	
	2438U1176F2	YSU0200-	P-UB-1	115 mm		KOB-2438U1173R100	229.21	
	2438U1176F2	YSU0200-	N-N-14		170 mm	KOB-2438U1173R200	344.49	
	2438U1176F3	YSJ00002-	P-UB-14	115 mm	170 mm	KOB-2438U1173R300	573.71	
	2438U1176F3	YSJ00002-	P-UB-1	115 mm		KOB-2438U1173R100	229.21	
	2438U1176F3	YSJ00002-	N-N-14		170 mm	KOB-2438U1173R200	344.49	
	2438U1176F3	YSU0200-	P-UB-14	115 mm	170 mm	KOB-2438U1173R300	573.71	
	2438U1176F3	YSU0200-	P-UB-1	115 mm		KOB-2438U1173R100	229.21	
	2438U1176F3	YSU0200-	N-N-14		170 mm	KOB-2438U1173R200	344.49	
	2438U1176F4	YSU0200-	P-UB-14	115 mm	170 mm	KOB-2438U1173R300	573.71	
	2438U1176F4	YSU0200-	P-UB-1	115 mm		KOB-2438U1173R100	229.21	
	2438U1176F4	YSU0200-	N-N-14		170 mm	KOB-2438U1173R200	344.49	
	BOOM RH	2438U1173F1	YSJ00002-	P-UB-14	115 mm	170 mm	KOB-2438U1173R300	573.71
		2438U1173F1	YSJ00002-	P-UB-1	115 mm		KOB-2438U1173R100	229.21
		2438U1173F1	YSJ00002-	N-N-14		170 mm	KOB-2438U1173R200	344.49
2438U1173F1		YSU0200-	P-UB-14	115 mm	170 mm	KOB-2438U1173R300	573.71	
2438U1173F1		YSU0200-	P-UB-1	115 mm		KOB-2438U1173R100	229.21	
2438U1173F1		YSU0200-	N-N-14		170 mm	KOB-2438U1173R200	344.49	
2438U1173F2		YSJ00002-	P-UB-14	115 mm	170 mm	KOB-2438U1173R300	573.71	
2438U1173F2		YSJ00002-	P-UB-1	115 mm		KOB-2438U1173R100	229.21	
2438U1173F2		YSJ00002-	N-N-14		170 mm	KOB-2438U1173R200	344.49	
2438U1173F2		YSU0200-	P-UB-14	115 mm	170 mm	KOB-2438U1173R300	573.71	
2438U1173F2		YSU0200-	P-UB-1	115 mm		KOB-2438U1173R100	229.21	
2438U1173F2		YSU0200-	N-N-14		170 mm	KOB-2438U1173R200	344.49	
2438U1173F3		YSJ00002-	P-UB-14	115 mm	170 mm	KOB-2438U1173R300	573.71	
2438U1173F3		YSJ00002-	P-UB-1	115 mm		KOB-2438U1173R100	229.21	
2438U1173F3		YSJ00002-	N-N-14		170 mm	KOB-2438U1173R200	344.49	
2438U1173F3		YSU0200-	P-UB-14	115 mm	170 mm	KOB-2438U1173R300	573.71	
2438U1173F3		YSU0200-	P-UB-1	115 mm		KOB-2438U1173R100	229.21	
2438U1173F3		YSU0200-	N-N-14		170 mm	KOB-2438U1173R200	344.49	
2438U1173F4		YSU0200-	P-UB-14	115 mm	170 mm	KOB-2438U1173R300	573.71	
2438U1173F4		YSU0200-	P-UB-1	115 mm		KOB-2438U1173R100	229.21	
2438U1173F4		YSU0200-	N-N-14		170 mm	KOB-2438U1173R200	344.49	
BUCKET		2438U1175F1	YSJ00002-	P-UB-14	110 mm	160 mm	KOB-2438U1175R300	414.46
		2438U1175F1	YSJ00002-	P-UB-1	110 mm		KOB-2438U1175R100	176.08
		2438U1175F1	YSJ00002-	N-N-14		160 mm	KOB-2438U1175R200	277.77
	2438U1175F1	YSU0200-	P-UB-14	110 mm	160 mm	KOB-2438U1175R300	414.46	
	2438U1175F1	YSU0200-	P-UB-1	110 mm		KOB-2438U1175R100	176.08	
	2438U1175F1	YSU0200-	N-N-14		160 mm	KOB-2438U1175R200	277.77	
	2438U1175F2	YSJ00002-	P-UB-14	110 mm	160 mm	KOB-2438U1175R300	414.46	
	2438U1175F2	YSJ00002-	P-UB-1	110 mm		KOB-2438U1175R100	176.08	
	2438U1175F2	YSJ00002-	N-N-14		160 mm	KOB-2438U1175R200	277.77	
	2438U1175F2	YSU0200-	P-UB-14	110 mm	160 mm	KOB-2438U1175R300	414.46	
	2438U1175F2	YSU0200-	P-UB-1	110 mm		KOB-2438U1175R100	176.08	
	2438U1175F2	YSU0200-	N-N-14		160 mm	KOB-2438U1175R200	277.77	
	2438U1175F3	YSJ00002-	P-UB-14	110 mm	160 mm	KOB-2438U1175R300	414.46	

KOBELCO®

Replacement Kits For

KOBELCO®

Excavators							
APPLICATION	CYL #	SERIAL #	CODE	ROD	BORE	KIT #	List \$
MODEL SK400LC IV							
BUCKET	2438U1175F3	YSJ00002-	P-UB-1	110 mm		KOB-2438U1175R100	176.08
	2438U1175F3	YSJ00002-	N-N-14		160 mm	KOB-2438U1175R200	277.77
	2438U1175F3	YSU0200-	P-UB-14	110 mm	160 mm	KOB-2438U1175R300	414.46
	2438U1175F3	YSU0200-	P-UB-1	110 mm		KOB-2438U1175R100	176.08
	2438U1175F3	YSU0200-	N-N-14		160 mm	KOB-2438U1175R200	277.77
Excavators - Compact							
APPLICATION	CYL #	SERIAL #	CODE	ROD	BORE	KIT #	List \$
MODEL SK25SR-2							
ARM	PV01V00037F1	PV09-22001-PV09-22780	P-U-10	40 mm	70 mm	KOB-PV01V00037R300	178.67
BOOM Cab	PV01V00040F1	PV09-22001-PV09-22780	P-U-10	40 mm	70 mm	KOB-PV01V00039R300	178.67
BOOM Canopy	PV01V00039F1	PV09-22001-PV09-22780	P-U-10	40 mm	70 mm	KOB-PV01V00039R300	178.67
BUCKET	PM01V00043F1	PV09-22001-PV09-22780	P-U-10	30 mm	55 mm	KOB-PM01V00043R300	50.51
	PM01V00043F2	PV09-22001-PV09-22780	P-U-10	30 mm	55 mm	KOB-PM01V00043R300	50.51
	PM01V00043F3	PV09-22001-PV09-22780	P-U-10	30 mm	55 mm	KOB-PM01V00043R300	50.51
	PM01V00043F4	PV09-22001-PV09-22780	P-U-10	30 mm	55 mm	KOB-PM01V00043R300	50.51
	PM01V00043F5	PV09-22001-PV09-22780	P-U-10	30 mm	55 mm	KOB-PM01V00043R300	50.51
DOZER	PV01V00038F1	PV09-22001-PV09-22780	P-U-10	45 mm	80 mm	KOB-PV01V00038R300	85.62
SWING	PM01V00044F1	PV09-22001-PV09-22780	P-U-10	40 mm	75 mm	KOB-PM01V00044R300	109.51
MODEL SK35SR-2							
ARM	PW01V00045F1	PX09-08001-	P-U-10	45 mm	75 mm	KOB-PW01V00045R300	68.74
	PW01V00051F1	PX09-08001-	P-U-10	45 mm	75 mm	KOB-PW01V00051R300	62.77
	PW01V00051F1	PX11-08901-	P-U-10	45 mm	75 mm	KOB-PW01V00051R300	62.77
	PW01V00051F2	PX09-08001-	P-U-10	45 mm	75 mm	KOB-PW01V00051R300	62.77
	PW01V00051F2	PX11-08901-	P-U-10	45 mm	75 mm	KOB-PW01V00051R300	62.77
	PX01V00032F1	PX09-08001-	P-U-10	45 mm	80 mm	KOB-PW01V00043R300	65.49
	PX01V00035F1	PX09-08001-	P-U-10	45 mm	80 mm	KOB-PW01V00035R300	58.37
	PX01V00035F1	PX11-08901-	P-U-10	45 mm	80 mm	KOB-PW01V00048R300	58.37
	PX01V00035F2	PX09-08001-	P-U-10	45 mm	80 mm	KOB-PW01V00035R300	58.37
BOOM Cab	PW01V00044F1	PX09-08001-	P-U-10	45 mm	80 mm	KOB-PW01V00043R300	65.49
	PW01V00044F1	PX11-08901-	P-U-10	45 mm	80 mm	KOB-PW01V00043R300	65.49
	PW01V00044F2	PX09-08001-	P-U-10	45 mm	80 mm	KOB-PW01V00043R300	65.49
	PW01V00044F2	PX11-08901-	P-U-10	45 mm	80 mm	KOB-PW01V00043R300	65.49
	PX01V00031F1	PX09-08001-	P-U-10	50 mm	85 mm	KOB-PX01V00030R300	82.05
	PX01V00031F1	PX11-08901-	P-U-10	50 mm	85 mm	KOB-PX01V00030R300	82.05
	PX01V00031F2	PX09-08001-	P-U-10	50 mm	85 mm	KOB-PX01V00030R300	82.05
BOOM Canopy	PW01V00043F1	PX09-08001-	P-U-10	45 mm	80 mm	KOB-PW01V00043R300	65.49
	PW01V00043F1	PX11-08901-	P-U-10	45 mm	80 mm	KOB-PW01V00043R300	65.49
	PW01V00043F2	PX09-08001-	P-U-10	45 mm	80 mm	KOB-PW01V00043R300	65.49
	PW01V00043F2	PX11-08901-	P-U-10	45 mm	80 mm	KOB-PW01V00043R300	65.49
	PX01V00030F1	PX09-08001-	P-U-10	50 mm	85 mm	KOB-PX01V00030R300	82.05
	PX01V00030F2	PX11-08901-	P-U-10	50 mm	85 mm	KOB-PX01V00030R300	82.05
	BUCKET	PW01V00046F1	PX09-08001-	P-U-10	35 mm	65 mm	KOB-PW01V00046R300
PW01V00046F1		PX11-08901-	P-U-10	40 mm	65 mm	KOB-PX01V00041R300	74.20
PW01V00046F2		PX11-08901-	P-U-10	40 mm	65 mm	KOB-PX01V00041R300	74.20
DOZER	PW01V00033F1	PX09-08001-	P-U-10	45 mm	90 mm	KOB-PX01V00033R300	71.79
	PW01V00048F1	PX09-08001-	P-U-10	45 mm	80 mm	KOB-PX01V00048R300	72.20
	PW01V00048F1	PX11-08901-	P-U-10	45 mm	80 mm	KOB-PW01V00048R300	58.37
	PW01V00048F2	PX11-08901-	P-U-10	45 mm	80 mm	KOB-PW01V00048R300	58.37
SWING	PW01V00050F1	PX11-08901-	P-U-10	45 mm	80 mm	KOB-PW01V00043R300	65.49
	PW01V00050F2	PX11-08901-	P-U-10	45 mm	80 mm	KOB-PW01V00043R300	65.49
	PX01V00050F1	PX09-08001-	P-U-10	50 mm	100 mm	KOB-PX01V00043R300	65.29
MODEL SK35SR-3							
ANGLE DOZER	PW51B00065F1	PX15-21105	P-U-10	45 mm	80 mm	KOB-PX01V00048R300	72.20

KOBELCO®

Replacement Kits For

KOBELCO®

Excavators - Compact							
APPLICATION	CYL #	SERIAL #	CODE	ROD	BORE	KIT #	List \$
MODEL SK35SR-3							
ARM	PX01V00048F1	PX12-11001-PX12-12803	P-U-10	45 mm	80 mm	KOB-PX01V00042R300	70.95
	PX01V00048F2	PX12-11001-PX12-12803	P-U-10	45 mm	80 mm	KOB-PX01V00042R300	70.95
	PX01V00063F1	PV11-30001-PV11-30393	P-U-10	45 mm	80 mm	KOB-PX01V00042R300	70.95
	PX01V00063F1	PX13-15001-PX13-15682	P-U-10	45 mm	80 mm	KOB-PX01V00042R300	70.95
	PX01V00063F1	PX14-17001-PX14-17514	P-U-10	45 mm	80 mm	KOB-PX01V00042R300	70.95
	PX01V00063F1	PX15-21105	P-U-10	45 mm	80 mm	KOB-PX01V00042R300	70.95
BOOM Cab	PX01V00053F1	PX12-11001-PX12-12803	P-U-10	45 mm	80 mm	KOB-PX01V00045R300	65.49
	PX01V00053F2	PX12-11001-PX12-12803	P-U-10	45 mm	80 mm	KOB-PX01V00045R300	65.49
	PX01V00065F1	PV11-30001-PV11-30393	P-U-10	45 mm	80 mm	KOB-PX01V00045R300	65.49
	PX01V00065F1	PX13-15001-PX13-15682	P-U-10	45 mm	80 mm	KOB-PX01V00045R300	65.49
	PX01V00065F1	PX14-17001-PX14-17514	P-U-10	45 mm	80 mm	KOB-PX01V00045R300	65.49
	PX01V00066F1	PX15-21105	P-U-10	45 mm	80 mm	KOB-PX01V00045R300	65.49
BOOM Canopy	PX01V00052F1	PX12-11001-PX12-12803	P-U-10	45 mm	80 mm	KOB-PX01V00045R300	65.49
	PX01V00052F2	PX12-11001-PX12-12803	P-U-10	45 mm	80 mm	KOB-PX01V00045R300	65.49
	PX01V00062F1	PV11-30001-PV11-30393	P-U-10	45 mm	80 mm	KOB-PX01V00045R300	65.49
	PX01V00062F1	PX13-15001-PX13-15682	P-U-10	45 mm	80 mm	KOB-PX01V00045R300	65.49
	PX01V00062F1	PX14-17001-PX14-17514	P-U-10	45 mm	80 mm	KOB-PX01V00045R300	65.49
	PX01V00062F1	PX15-21105	P-U-10	45 mm	80 mm	KOB-PX01V00045R300	65.49
BUCKET	PX01V00041F1	PX12-11001-PX12-12803	P-U-10	40 mm	65 mm	KOB-PX01V00041R300	74.20
	PX01V00041F2	PX12-11001-PX12-12803	P-U-10	40 mm	65 mm	KOB-PX01V00041R300	74.20
	PX01V00064F1	PV11-30001-PV11-30393	P-U-10	40 mm	65 mm	KOB-PX01V00041R300	74.20
	PX01V00064F1	PX13-15001-PX13-15682	P-U-10	40 mm	65 mm	KOB-PX01V00041R300	74.20
	PX01V00064F1	PX14-17001-PX14-17514	P-U-10	40 mm	65 mm	KOB-PX01V00041R300	74.20
	PX01V00064F1	PX15-21105	P-U-10	40 mm	65 mm	KOB-PX01V00041R300	74.20
DOZER	PX01V00043F1	PV11-30001-PV11-30393	P-U-10	50 mm	100 mm	KOB-PX01V00043R300	65.29
	PX01V00043F1	PX12-11001-PX12-12803	P-U-10	50 mm	100 mm	KOB-PX01V00043R300	65.29
	PX01V00043F1	PX13-15001-PX13-15682	P-U-10	50 mm	100 mm	KOB-PX01V00043R300	65.29
	PX01V00043F1	PX14-17001-PX14-17514	P-U-10	50 mm	100 mm	KOB-PX01V00043R300	65.29
	PX01V00043F2	PV11-30001-PV11-30393	P-U-10	50 mm	100 mm	KOB-PX01V00043R300	65.29
	PX01V00043F2	PX12-11001-PX12-12803	P-U-10	50 mm	100 mm	KOB-PX01V00043R300	65.29
	PX01V00043F2	PX13-15001-PX13-15682	P-U-10	50 mm	100 mm	KOB-PX01V00043R300	65.29
	PX01V00043F2	PX14-17001-PX14-17514	P-U-10	50 mm	100 mm	KOB-PX01V00043R300	65.29
	PX01V00043F2	PX15-21105	P-U-10	50 mm	100 mm	KOB-PX01V00043R300	65.29
SWING	PX01V00042F1	PV11-30001-PV11-30393	P-U-10	45 mm	80 mm	KOB-PX01V00042R300	70.95
	PX01V00042F1	PX12-11001-PX12-12803	P-U-10	45 mm	80 mm	KOB-PX01V00042R300	70.95
	PX01V00042F1	PX13-15001-PX13-15682	P-U-10	45 mm	80 mm	KOB-PX01V00042R300	70.95
	PX01V00042F1	PX14-17001-PX14-17514	P-U-10	45 mm	80 mm	KOB-PX01V00042R300	70.95
	PX01V00042F2	PV11-30001-PV11-30393	P-U-10	45 mm	80 mm	KOB-PX01V00042R300	70.95
	PX01V00042F2	PX13-15001-PX13-15682	P-U-10	45 mm	80 mm	KOB-PX01V00042R300	70.95
	PX01V00042F2	PX14-17001-PX14-17514	P-U-10	45 mm	80 mm	KOB-PX01V00042R300	70.95
	PX01V00042F2	PX15-21105	P-U-10	45 mm	80 mm	KOB-PX01V00042R300	70.95
	PX01V00042F2	PX15-21105	P-U-10	45 mm	80 mm	KOB-PX01V00042R300	70.95

REPLACEMENT KITS FOR KOBELCO®

Kit Number	Code (Pg. xviii)	Rod X Bore Size	List Price	Kit Number	Code (Pg. xviii)	Rod X Bore Size	List Price
KOB-24038R42F1	N-N-14	120 mm Piston Kit	\$ 217.32	KOB-2438U1094R140	N-N-10	125 mm Piston Kit	\$ 213.85
KOB-24381104R400	P-UB-10	75 mm	108.84	KOB-2438U1096R100	P-UB-1	60 mm Rod Kit	138.74
KOB-2438U1028R100	P-UB-1	110 mm Rod Kit	178.83	KOB-2438U1096R200	N-N-10	95 mm Piston Kit	161.95
KOB-2438U1028R200	N-N-14	170 mm Piston Kit	428.13	KOB-2438U1097R100	P-UB-1	65 mm Rod Kit	124.99
KOB-2438U1029R100	P-UB-1	130 mm Rod Kit	310.04	KOB-2438U1097R200	N-N-10	95 mm Piston Kit	193.57
KOB-2438U1029R200	N-N-14	180 mm Piston Kit	449.39	KOB-2438U1097R300	P-UB-10	65 X 95 mm	318.55
KOB-2438U1030R100	P-UB-1	120 mm Rod Kit	222.97	KOB-2438U1098R100	P-UB-1	75 mm Rod Kit	131.91
KOB-2438U1030R200	N-N-14	170 mm Piston Kit	428.13	KOB-2438U1098R200	N-N-10	115 mm Piston Kit	266.61

REPLACEMENT KITS FOR KOBELCO®

Kit Number	Code (Pg. xviii)	Rod X Bore Size	List Price
KOB-2438U1099R100	P-UB-1	70 mm Rod Kit	\$ 141.49
KOB-2438U1102R200	N-N-10	125 mm Piston Kit	209.25
KOB-2438U1102R300	P-UB-10	85 X 125 mm	328.12
KOB-2438U1102R500	P-UB-10	85 X 125 mm	328.12
KOB-2438U1102R600	P-UB-1	85 mm Rod Kit	118.89
KOB-2438U1104R200	N-N-10	145 mm Piston Kit	309.41
KOB-2438U1104R300	P-UB-10	100 X 145 mm	409.89
KOB-2438U1104R400	P-UB-1	100 mm Rod Kit	138.04
KOB-2438U1104R500	P-UB-10	100 X 145 mm	447.45
KOB-2438U1105R200	N-N-10	120 mm Piston Kit	147.14
KOB-2438U1105R400	P-UB-1	80 mm Rod Kit	112.01
KOB-2438U1105R500	P-UB-10	80 X 120 mm	242.52
KOB-2438U1106R100	P-UB-1	85 mm Rod Kit	156.79
KOB-2438U1106R200	N-N-10	125 mm Piston Kit	266.95
KOB-2438U1106R300	P-UB-10	85 X 125 mm	423.76
KOB-2438U1108R100	P-UB-1	100 mm Rod Kit	171.04
KOB-2438U1108R200	N-N-14	145 mm Piston Kit	196.56
KOB-2438U1108R300	P-UB-14	100 X 145 mm	387.74
KOB-2438U1109R100	N-N-10	120 mm Piston Kit	159.10
KOB-2438U1109R200	P-UB-1	80 mm Rod Kit	153.22
KOB-2438U1109R300	P-UB-10	80 X 120 mm	310.95
KOB-2438U1123R200	N-N-10	100 mm Piston Kit	195.69
KOB-2438U1129R100	P-UB-1	120 mm	161.01
KOB-2438U1129R300	P-UB-10	120 X 180 mm	442.79
KOB-2438U1131R100	P-UB-1	65mm Rod Kit	124.99
KOB-2438U1131R200	N-N-10	100mm Piston Kit	201.60
KOB-2438U1131R300	P-UB-10	65 X 100 mm	310.23
KOB-2438U1132R100	P-UB-1	80 mm Rod Kit	155.62
KOB-2438U1132R200	N-N-10	120 mm Piston Kit	277.02
KOB-2438U1132R300	P-UB-10	80 X 120 mm	432.64
KOB-2438U1133R100	P-UB-1	70 mm Rod Kit	139.58
KOB-2438U1133R200	N-N-10	105 mm Piston Kit	197.36
KOB-2438U1133R300	P-UB-10	70 X 105 mm	320.09
KOB-2438U1135R300	P-UB-10	90 X 140 mm	338.38
KOB-2438U1137R100	P-UB-1	105 mm	204.71
KOB-2438U1137R200	P-UB-10	105 X 150 mm	347.33
KOB-2438U1170R100	P-UB-1	100 Rod Kit	127.13
KOB-2438U1170R200	N-N-10	150 mm	219.67
KOB-2438U1170R300	P-UB-10	100 X 150mm	351.63
KOB-2438U1171R100	P-UB-1	120 Rod Kit	175.97
KOB-2438U1171R200	N-N-10	170 mm Piston Kit	331.82
KOB-2438U1171R300	P-UB-10	120 X 170 mm	507.79
KOB-2438U1172R100	P-UB-1	100 mm	194.19
KOB-2438U1172R200	N-N-10	150 Piston Kit	224.51
KOB-2438U1172R300	P-UB-10	100 X 150 mm	398.90

Kit Number	Code (Pg. xviii)	Rod X Bore Size	List Price
KOB-2438U1172R400	N-N-10	150 mm	\$ 229.65
KOB-2438U1172R500	P-UB-10	100 X 150 mm	478.77
KOB-2438U1173R100	P-UB-1	115 mm	229.21
KOB-2438U1173R200	N-N-14	170 mm	344.49
KOB-2438U1173R300	P-UB-14	115 X 170 mm	573.71
KOB-2438U1174R100	P-UB-1	130 mm	335.75
KOB-2438U1174R200	N-N-14	190 mm	480.94
KOB-2438U1174R300	P-UB-14	130 X 190 mm	816.71
KOB-2438U1175R100	P-UB-1	110 mm	176.08
KOB-2438U1175R200	N-N-14	160 mm	277.77
KOB-2438U1175R300	P-UB-14	110 X 160 mm	414.46
KOB-2438U1323R100	P-UB-1	110 mm Rod Kit	209.29
KOB-2438U1323R110	N-N-10	160 mm Piston Kit	385.48
KOB-2438U1324R100	P-UB-1	100 mm Rod Kit	148.73
KOB-2438U1324R110	N-N-10	150 mm Piston Kit	192.97
KOB-2438U1343R120	P-U-1	130 mm Rod Kit	262.55
KOB-2438U1946R200	N-N-10	120 mm Piston Kit	196.40
KOB-2438U1946R300	P-UB-10	80 X 120 mm	291.84
KOB-2438U1948R100	P-UB-1	90 mm	152.07
KOB-2438U1948R200	N-N-10	130 mm Piston Kit	270.23
KOB-2438U1948R300	P-UB-10	90 X 130 mm	422.29
KOB-2438U1948R400	P-UB-1	90 mm Rod Kit	152.07
KOB-2438U1948R500	P-UB-10	90 X 130 mm	422.29
KOB-2438U1949R200	N-N-10	110 mm Piston Kit	242.14
KOB-2438U1949R300	P-UB-10	75 X 110 mm	219.11
KOB-2438U1949R400	P-UB-1	75 mm Rod Kit	108.84
KOB-2438U1949R500	P-UB-10	75 X 110 mm	308.06
KOB-2438U553R100	P-U-1	75 mm Rod Kit	147.43
KOB-2438U568R100	P-UB-1	90 mm Rod Kit	167.11
KOB-2438U568R110	N-N-10	130 mm Piston Kit	236.23
KOB-2438U587R100	N-N-10	90 mm Rod Kit	166.70
KOB-2438U587R110	N-N-10	140 mm Piston Kit	250.97
KOB-2438U588R110	P-UB-1	100 mm Rod Kit	180.50
KOB-2438U588R120	N-N-10	150 mm Piston Kit	256.20
KOB-2438U705R100	P-UB-1	60 mm	89.59
KOB-2438U716R140	N-N-10	110 mm Piston Kit	158.73
KOB-2438U721R100	P-UB-1	70 mm Rod Kit	186.84
KOB-2438U738R100	P-UB-1	65 mm	70.81
KOB-2438U738R200	N-N-10	100 mm	48.58
KOB-2438U738R300	P-UB-1	65 mm	70.81
KOB-2438U738R400	P-UB-10	65 X 100 mm	119.40
KOB-2438U776R100	P-UB-1	95 mm Rod Kit	192.33
KOB-2438U776R110	N-N-10	150 mm Piston Kit	311.21
KOB-2438U914R100	P-UB-1	85 mm Rod Kit	141.31
KOB-2438U914R200	N-N-10	125 mm Piston Kit	207.38

KOBELCO®

REPLACEMENT KITS FOR KOBELCO®

Kit Number	Code (Pg. xviii)	Rod X Bore Size	List Price	Kit Number	Code (Pg. xviii)	Rod X Bore Size	List Price
KOB-2438U915R100	P-UB-1	75 mm Rod Kit	\$ 106.77	KOB-LC01V00054R300	P-UB-10	120 X 170 mm	\$ 782.95
KOB-2438U915R110	N-N-10	120 mm Piston Kit	202.38	KOB-LC01V00055R100	P-UB-1	100 mm	112.12
KOB-2438U921R100	P-UB-1	95 mm Rod Kit	132.10	KOB-LC01V00055R200	N-N-10	150 mm	337.74
KOB-2438U921R110	N-N-10	145 mm Piston Kit	253.84	KOB-LC01V00055R300	P-UB-10	100 X 150 mm	449.86
KOB-2438U941R100	P-UB-1	100 mm Rod Kit	184.09	KOB-LP01V00001R100	P-UB-1	70 mm	77.73
KOB-2438U941R200	N-N-14	145 mm Piston Kit	336.84	KOB-LP01V00001R200	N-N-14	100 mm	178.24
KOB-2438U953R100	P-UB-1	105 mm Rod Kit	240.04	KOB-LP01V00001R300	P-UB-14	70 X 100 mm	255.95
KOB-2438U953R200	N-N-10	150 mm Piston Kit	438.43	KOB-LP01V00002R100	P-UB-1	80 mm	86.24
KOB-2438U959R100	P-UB-1	85 mm Rod Kit	125.96	KOB-LP01V00004R100	P-UB-1	50 mm	86.61
KOB-2438U959R200	N-N-10	130 mm Piston Kit	282.03	KOB-LP01V00004R200	N-N-14	70 mm	166.30
KOB-2438U971R100	P-UB-1	70 mm Rod Kit	147.26	KOB-LP01V00004R300	P-UB-14	50 X 70 mm	252.91
KOB-2438U971R200	N-N-10	105 mm Piston Kit	197.34	KOB-LQ01V00001R200	N-N-10	135 mm	195.88
KOB-2438U973R100	P-UB-1	80 mm Rod Kit	166.35	KOB-LQ01V00001R400	P-UB-1	90 mm	96.04
KOB-2438U973R200	N-N-10	120 mm Piston Kit	277.27	KOB-LQ01V00005R300	P-UB-10	90 X 135 mm	291.92
KOB-2438U974R100	P-UB-1	65 mm Rod Kit	126.54	KOB-LQ01V00007R100	P-UB-1	100 mm	106.16
KOB-2438U974R200	N-N-10	100 mm Piston Kit	204.05	KOB-LQ01V00007R200	N-N-10	140 mm	166.12
KOB-2438U985R300	N-N-14	180 mm Piston Kit	358.32	KOB-LQ01V00007R300	P-UB-10	100 X 140 mm	260.50
KOB-2438U989R100	P-UB-1	70 mm Rod Kit	142.94	KOB-LQ01V000028R200	N-N-10	135 mm	200.87
KOB-2438U989R200	N-N-10	100 mm Piston Kit	195.69	KOB-LQ01V000028R300	P-UB-10	95 X 135 mm	291.69
KOB-2438U991R100	P-UB-1	75 mm Rod Kit	141.76	KOB-LQ01V000030R100	P-UB-1	85 mm	96.67
KOB-2438U991R200	N-N-10	115 mm Piston Kit	268.34	KOB-LQ01V000030R200	N-N-10	125 mm	164.84
KOB-2438U992R100	P-UB-1	65 mm Rod Kit	119.75	KOB-LQ01V000030R300	P-UB-10	85 X 125 mm	311.77
KOB-2438U992R200	N-N-10	95 mm Piston Kit	193.77	KOB-LQ01V000038R100	P-UB-1	105 mm	131.26
KOB-2438U995R100	P-UB-1	80 mm Rod Kit	118.55	KOB-LQ01V000038R200	N-N-10	145 mm	194.33
KOB-2438U995R200	N-N-14	120 mm Piston Kit	311.58	KOB-LQ01V000038R300	P-UB-10	105 X 145 mm	320.68
KOB-2438U996R100	P-UB-1	85 mm Rod Kit	162.18	KOB-LQ01V00005R300	P-UB-10	90 X 135 mm	357.55
KOB-2438U996R200	N-N-14	125 mm Piston Kit	341.19	KOB-PM01V000043R300	P-U-10	30 X 55 mm	50.51
KOB-2438U999R100	P-UB-1	90 mm Rod Kit	155.75	KOB-PM01V000044R300	P-U-10	40 X 75 mm	109.51
KOB-2438U999R200	N-N-10	140 mm Piston Kit	299.97	KOB-PV01V000037R300	P-U-10	40 X 70 mm	178.67
KOB-2445R174R200	N-N-10	180 mm	281.76	KOB-PV01V000038R300		45 X 80 mm	85.62
KOB-2445Z-921F1	N-N-10	100 mm Piston Kit	118.29	KOB-PV01V000039R300	P-U-10	40 X 70 mm	178.67
KOB-2445Z-922F1	P-UB-1	50 mm Rod Kit	104.65	KOB-PW01V000035R300	P-U-10	45 X 80 mm	58.37
KOB-LC01V00001R200	N-N-10	140 mm	204.39	KOB-PW01V000043R300	P-U-10	45 X 80 mm	65.49
KOB-LC01V00001R300	P-UB-10	140 mm	290.03	KOB-PW01V000045R300	P-U-10	45 X 75 mm	68.74
KOB-LC01V00005R100	P-UB-1	120 mm	175.97	KOB-PW01V000046R300	P-U-10	35 X 65 mm	62.98
KOB-LC01V00005R200	N-N-10	170 mm	401.55	KOB-PW01V000048R300	P-U-10	45 X 80 mm	58.37
KOB-LC01V00005R300	P-UB-10	120 X 170 mm	573.73	KOB-PW01V000051R300	P-U-10	45 X 75 mm	62.77
KOB-LC01V00006R100	P-UB-1	100 mm	112.12	KOB-PX01V000030R300	P-U-10	50 X 85 mm	82.05
KOB-LC01V00006R200	N-N-10	150 mm	243.06	KOB-PX01V000033R300	P-U-10	45 X 90 mm	71.79
KOB-LC01V00006R300	P-UB-10	100 X 150 mm	355.17	KOB-PX01V000041R300	P-U-10	40 X 65 mm	74.20
KOB-LC01V000044R100	P-UB-1	100 mm	111.74	KOB-PX01V000042R300	P-U-10	45 X 80 mm	70.95
KOB-LC01V000044R200	N-N-10	140 mm	266.70	KOB-PX01V000043R300	P-U-10	50 X 100 mm	65.29
KOB-LC01V000044R300	P-UB-10	100 X 140 mm	378.45	KOB-PX01V000045R300	P-U-10	45 X 80 mm	65.49
KOB-LC01V000054R100	P-UB-1	120 mm	165.41	KOB-PX01V000048R300	P-U-10	45 X 80 mm	72.20
KOB-LC01V000054R200	N-N-10	170 mm	641.83	KOB-YB01V00010R100	P-UB-1	90 mm	105.30

KOBELCO®

REPLACEMENT KITS FOR KOBELCO®

Kit Number	Code (Pg. xviii)	Rod X Bore Size	List Price	Kit Number	Code (Pg. xviii)	Rod X Bore Size	List Price
KOB-YB01V00010R300	P-UB-10	90 X 125 mm	\$ 274.12	KOB-YN01V00106R100	P-UB-1	80 mm	\$ 116.11
KOB-YB01V00011R100	P-UB-1	75 mm	90.82	KOB-YN01V00106R200	N-N-10	115 mm	156.90
KOB-YB01V00011R300	P-UB-10	75 X 105 mm	271.79	KOB-YN01V00106R300	P-UB-10	80 X 115 mm	272.99
KOB-YF01V00001R200	N-N-10	125 mm	226.81	KOB-YN01V00106R700	P-UB-10	80 X 115 mm	272.99
KOB-YF01V00001R300	P-UB-10	85 X 125 mm	323.48	KOB-YN01V00112R100	P-UB-1	80 mm	138.93
KOB-YM01V00006R100	P-UB-1	80 mm	100.96	KOB-YN01V00112R800	N-N-10	120 mm	236.82
KOB-YM01V00006R200	N-N-10	110 mm	130.82	KOB-YN01V00112R900	P-UB-10	80 X 120 mm	379.21
KOB-YM01V00006R300	P-UB-10	80 X 110 mm	231.79	KOB-YN01V00151R100	P-UB-1	85 mm	115.54
KOB-YM01V00008R100	P-UB-1	90 mm	96.21	KOB-YN01V00151R200	N-N-10	120 mm	117.93
KOB-YM01V00008R200	N-N-10	125 mm	168.82	KOB-YN01V00151R300	P-UB-10	85 X 120 mm	431.35
KOB-YM01V00008R300	P-UB-10	90 X 125 mm	306.46	KOB-YN01V00151R600	N-N-10	120 mm	119.11
KOB-YM01V00009R100	P-UB-1	75 mm	90.82	KOB-YN01V00151R700	P-UB-10	85 X 120 mm	310.42
KOB-YM01V00009R200	N-N-10	105 mm	180.97	KOB-YN01V00153R100	P-UB-1	80 mm	119.97
KOB-YM01V00009R300	P-UB-10	75 X 105 mm	271.79	KOB-YN01V00153R300	P-UB-10	80 X 120 mm	437.05
KOB-YN01V00001R100	P-UB-1	80 mm	90.11	KOB-YN01V00175R100	P-UB-1	95 mm	118.51
KOB-YN01V00001R200	N-N-14	120 mm	99.20	KOB-YN01V00175R200	N-N-10	135 mm	268.31
KOB-YN01V00001R300	P-UB-14	80 X 120 mm	189.32	KOB-YN01V00175R300	P-UB-10	95 X 135 mm	395.31
KOB-YN01V00003R100	P-UB-1	95 mm	60.53	KOB-YW01V00003R200	N-N-14	95 mm	83.31
KOB-YN01V00003R200	N-N-14	135 mm	241.95	KOB-YX01V00004R600	P-UB-1	80 mm	86.98
KOB-YN01V00003R300	P-UB-14	95 X 135 mm	302.48	KOB-YX01V00005R100	P-UB-1	65 mm	72.49
KOB-YN01V00004R100	P-UB-1	75 mm	57.05	KOB-YX01V00005R200	N-N-14	95 mm	83.31
KOB-YN01V00004R200	N-N-14	115 mm	88.48	KOB-YX01V00005R300	P-UB-14	65 X 95 mm	100.16
KOB-YN01V00004R300	P-UB-14	75 X 115 mm	145.53	KOB-YX01V00006R100	P-UB-1	65 mm	93.06
KOB-YN01V00019R100	N-N-14	135 mm	241.95	KOB-YX01V00006R200	N-N-10	110 mm	87.07
KOB-YN01V00019R200	P-UB-14	95 X 135 mm	302.48	KOB-YX01V00006R300	P-UB-10	65 X 110 mm	180.14
KOB-YN01V00039R200	N-N-14	135 mm	186.46	KOB-YX01V00008R100	P-UB-1	70 mm	52.14
KOB-YN01V00039R300	P-UB-14	95 X 135 mm	246.98	KOB-YX01V00008R200	N-N-14	105 mm	98.89
KOB-YN01V00052R100	P-UB-1	85 mm	57.05	KOB-YX01V00008R300	P-UB-14	70 X 105 mm	151.04
KOB-YN01V00052R200	N-N-14	125 mm	145.60	KOB-YX01V00008R700	P-UB-14	70 X 105 mm	200.40
KOB-YN01V00052R300	P-UB-14	85 X 125 mm	202.64	KOB-YY01V00001R100	P-UB-1	70 mm	77.73
KOB-YN01V00068R100	P-UB-1	80 mm	57.23	KOB-YY01V00001R200	N-N-14	100 mm	178.24
KOB-YN01V00068R200	N-N-14	115 mm	61.03	KOB-YY01V00001R300	P-UB-14	70 X 100 mm	255.95
KOB-YN01V00068R300	P-UB-14	80 X 115 mm	118.26	KOB-YY01V00003R100	P-UB-1	80 mm	86.24
KOB-YN01V00077R300	P-UB-14	80 X 115 mm	118.26	KOB-YY01V00003R200	N-N-14	115 mm	147.97
KOB-YN01V00078R300	P-UB-14	95 X 135 mm	246.98	KOB-YY01V00003R300	P-UB-14	80 X 115 mm	234.21
KOB-YN01V00103R100	P-UB-1	85 mm	118.57	KOB-YY01V00004R900	P-UB-1	80 mm	86.98
KOB-YN01V00103R200	N-N-10	125 mm	190.31	KOB-YY01V00004R910	P-UB-14	80 X 115 mm	234.97
KOB-YN01V00103R300	P-UB-10	85 X 125 mm	308.86	KOB-YY01V00005R600	P-UB-1	65 mm	84.83
KOB-YN01V00103R800	N-N-10	125 mm	190.31	KOB-YY01V00005R700	P-UB-14	65 X 95 mm	108.10
KOB-YN01V00103R900	P-UB-10	85 X 125 mm	308.86	KOB-YY01V00009R100	P-UB-1	80 mm	86.24
KOB-YN01V00105R100	P-UB-1	95 mm	138.45	KOB-YY01V00009R200	N-N-14	115 mm	147.97
KOB-YN01V00105R200	N-N-10	135 mm	244.29	KOB-YY01V00009R300	P-UB-14	80 X 115 mm	234.21
KOB-YN01V00105R300	P-UB-10	95 X 135 mm	382.74	KOB-YY01V00045R600	P-UB-1	70 mm	101.49
KOB-YN01V00105R800	N-N-10	135 mm	244.29	KOB-YY01V00045R700	P-UB-14	70 X 100 mm	279.72
KOB-YN01V00105R900	P-UB-10	95 X 135 mm	382.74				

REPLACEMENT PARTS FOR KOBELCO®

NOTE: Kobelco part numbers are used as a reference only. We do not imply that these kits are original REPLACEMENT PARTS.

BACK-UP RINGS

Part Number	Min. Pkg Qty	List Price
KOB-2429U71S18	1	\$ 10.98
KOB-2438U1029S20	1	16.19
KOB-2438U1102S12	1	12.08
KOB-2438U1105S12	1	12.08
KOB-2438U1105S8	1	11.54
KOB-2438U1170S11	1	14.56
KOB-2438U1170S17	1	16.01
KOB-2438U1171S11	1	6.84
KOB-2438U1171S17	1	18.30
KOB-2438U1171S8	1	14.39
KOB-2438U1173S20	1	15.92
KOB-2438U1173S31	1	15.92
KOB-2438U1174S33	1	17.46
KOB-2438U1175S18	1	14.41
KOB-2438U1175S29	1	14.41
KOB-2438U1323S11	1	14.41
KOB-2438U1323S8	1	41.90
KOB-2438U1324S11	1	13.66
KOB-2438U1324S8	1	36.51
KOB-2438U1333S16	1	10.01
KOB-2438U1753S16	1	13.26
KOB-2438U1949S12	1	11.85
KOB-2438U515S26	1	3.65
KOB-2438U554S20	1	10.01
KOB-2438U738S26	1	6.07
KOB-2438U776S11	1	13.66
KOB-2438U776S8	1	11.54
KOB-2438U814S32	1	9.56
KOB-2438U897S13	1	16.50
KOB-2438U914S27	1	11.29
KOB-2438U915S13	1	10.98
KOB-2438U921S16	1	13.10
KOB-2438U921S33	1	13.10
KOB-2438U922S17	1	9.75
KOB-2438U953S8	1	37.81
KOB-2438U959S12	1	11.82
KOB-2438U959S8	1	11.54
KOB-2438U999S12	1	12.58
KOB-2438U999S8	1	11.54

BACK-UP RINGS

Part Number	Min. Pkg Qty	List Price
KOB-2445R216D22	1	\$ 15.92
KOB-2445R216D28	1	10.01
KOB-LB01V00007S008	1	13.43
KOB-LP01V00001S009	10	1.02
KOB-LP01V00001S020	1	2.75
KOB-LP01V00002S007	2	6.91
KOB-LP01V00004S007	1	1.79
KOB-LP01V00004S017	1	19.06
KOB-LP01V00004S025	1	3.65
KOB-LQ01V00001S011	1	12.40
KOB-LQ01V00001S017	1	13.72
KOB-LQ01V00003S017	1	14.88
KOB-LQ01V00004S017	1	11.43
KOB-LQ01V00007S008	1	13.43
KOB-LQ01V00038S017	1	14.88
KOB-LS01V00020S008	1	13.43
KOB-PZ01V00003S008	1	11.59
KOB-YM01V00006S017	1	10.30
KOB-YM01V00008S017	1	12.59
KOB-YM01V00009S017	1	9.80
KOB-YN01V00001S009	1	5.34
KOB-YN01V00001S020	1	12.08
KOB-YN01V00003S007	1	8.39
KOB-YN01V00003S018	1	12.40
KOB-YN01V00004S007	1	6.17
KOB-YN01V00004S018	1	11.85
KOB-YN01V00052S020	1	12.08
KOB-YN01V00105S008	1	11.54
KOB-YN01V00106S017	1	11.43
KOB-YR01V00001S011	1	11.85
KOB-YX01V00002S018	1	2.94
KOB-YX01V00006S016	1	10.98
KOB-YY01V00004S038	1	33.48
KOB-YY01V00045S033	1	22.31
KOB-ZD75G06500	1	3.65
KOB-ZD75G07500	1	11.02
KOB-ZD75G08000	1	11.18
KOB-ZD75G09000	1	11.35

BACK-UP RINGS

Part Number	Min. Pkg Qty	List Price
KOB-ZD75G09500	1	\$ 11.35
KOB-ZD75G10000	1	11.59
KOB-ZD75G10500	1	11.85
KOB-ZD75G11500	1	12.08
KOB-ZD85G18000	1	17.46
KOB-ZD85P11000	1	10.98

BUFFER RINGS

Part Number	Rod Dia.	List Price
KOB-LP01V00004S021	50 mm	\$18.46
KOB-LP01V00001S022	70 mm	34.23
KOB-YY01V00045S031	70 mm	34.23
KOB-YN01V00001S022	80 mm	38.54
KOB-YN01V00106S006	80 mm	66.49
KOB-YN01V00153S006	80 mm	38.54
KOB-YY01V00004S036	80 mm	38.54
KOB-LQ01V00004S006	85 mm	70.18
KOB-YN01V00052S022	85 mm	41.35
KOB-YN01V00103S035	85 mm	70.18
KOB-YN01V00151S006	85 mm	41.35
KOB-YN01V00003S020	95 mm	52.69
KOB-YN01V00175S006	95 mm	52.69
KOB-2438U1170S6	100 mm	44.66
KOB-2438U1324S25	100 mm	44.66
KOB-LC01V00044S006	100 mm	54.21
KOB-LQ01V00038S006	105 mm	56.18
KOB-2438U1171S6	120 mm	53.13

BUFFER SEALS

Part Number	Rod Dia.	List Price
KOB-2438U504S18	60 mm	\$ 26.38
KOB-R45P0050D6	65 mm	29.37
KOB-R45P0050D1	70 mm	34.11
KOB-R45P0050D2	75 mm	36.40

KOBELCO®

REPLACEMENT PARTS FOR KOBELCO®

NOTE: Kobelco part numbers are used as a reference only. We do not imply that these kits are original REPLACEMENT PARTS.

BUFFER SEALS

Part Number	Rod Dia.	List Price
KOB-YM01V00009S031	75 mm	36.39
KOB-YN01V00004S020	75 mm	36.39
KOB-R45P0050D9	80 mm	39.22
KOB-YM01V00006S006	80 mm	38.54
KOB-2438U278S25	85 mm	38.73
KOB-2438U959S6	85 mm	38.73
KOB-YM01V00008S006	90 mm	49.91
KOB-2438U999S6	90 mm	38.34
KOB-YM01V00008S034	90 mm	49.91
KOB-2438U720S19	95 mm	43.96
KOB-2438U776S6	95 mm	43.96
KOB-LC01V00006S032	100 mm	54.21
KOB-2438U1324S6	100 mm	44.66
KOB-R45P0050D11	100 mm	44.66
KOB-2438U953S6	105 mm	50.81
KOB-2438U1323S6	110 mm	53.04
KOB-R45P0050D12	110 mm	53.04
KOB-R45P0050D4	120 mm	53.13
KOB-LC01V00054S006	120 mm	63.50
KOB-R45P0050D13	130 mm	54.13

CUSHION SEALS

Part Number	List Price
KOB-2438U1104S15	\$ 44.74
KOB-2438U1104S24	24.19
KOB-2438U1135S15	23.55
KOB-LC01V00005S014	68.81
KOB-LC01V00005S025	46.85
KOB-LC01V00054S014	68.81
KOB-LQ01V00007S014	20.63
KOB-LQ01V00007S025	24.88
KOB-LQ01V00007S034	20.63
KOB-YM01V00006S014	30.00
KOB-YN01V00103S014	30.18
KOB-YN01V00105S014	31.34
KOB-YN01V00175S014	31.34

O-RINGS

Part Number	Min. Pkg Qty	List Price
KOB-2429U71S19	10	1.09
KOB-2438U1173S23	5	1.51
KOB-2438U1174S19	5	3.96
KOB-2438U1323S10	2	9.07
KOB-2438U1324S10	2	7.49
KOB-2438U504S19	20	0.72
KOB-2438U504S8	5	3.71
KOB-2438U720S16	5	2.02
KOB-2438U776S10	2	7.49
KOB-2438U911S12	5	1.96
KOB-2438U914D1S14	10	1.12
KOB-45Z91D125	5	1.76
KOB-45Z91D16	10	0.79
KOB-45Z91D249	5	1.96
KOB-LP01V00001S008	20	0.77
KOB-LP01V00002S006	20	0.88
KOB-R45P0051D13	5	3.93
KOB-R45P0051D16	10	0.79
KOB-R45P0051D27	5	1.96
KOB-R45P0051D28	10	1.44
KOB-YN01V00004S006	20	0.42
KOB-ZD11P11000	3	6.86
KOB-ZD12G03500	20	0.66
KOB-ZD12G06000	5	1.83
KOB-ZD12G06500	5	1.22
KOB-ZD12G07500	5	1.76
KOB-ZD12G08000	5	1.78
KOB-ZD12G09000	4	1.83
KOB-ZD12G09500	4	7.43
KOB-ZD12G10000	4	2.06
KOB-ZD12G10500	3	2.09
KOB-ZD12G11000	3	8.93
KOB-ZD12G11500	3	2.71
KOB-ZD12G12000	3	2.83
KOB-ZD12G13000	5	3.03
KOB-ZD12G13500	2	3.55
KOB-ZD12G14000	2	6.34
KOB-ZD12G14500	2	3.64
KOB-ZD12G15000	2	7.77
KOB-ZD12G16000	2	5.72

O-RINGS

Part Number	Min. Pkg Qty	List Price
KOB-ZD12G17000	2	5.89
KOB-ZD12G18000	1	13.39
KOB-ZD12P07500	2	4.61
KOB-ZD12P09000	3	5.00
KOB-ZD12P09500	3	5.18
KOB-ZD12P10000	2	6.62
KOB-ZD12P11000	3	6.86
KOB-ZD12P11500	2	6.98
KOB-ZD12P12000	2	7.11
KOB-ZD12P13000	2	7.27
KOB-ZD12P13500	2	7.39
KOB-ZD12P14000	2	7.49

2 PIECE PISTON SEALS

Part Number	Bore Dia.	List Price
KOB-2438U504S7	100 mm	\$ 50.70
KOB-2438U807S4	105 mm	49.86
KOB-2438U676S21	105 mm	41.10
KOB-2438U716S23	110 mm	54.44
KOB-LE01V00006S014	115 mm	55.74
KOB-2438U695S6	120 mm	55.74
KOB-2438U1105S16	120 mm	31.93
KOB-2438U675US20	125 mm	55.74
KOB-2438U1382S15	130 mm	57.68
KOB-LQ01V00001S016	135 mm	65.14
KOB-2438U999S16	140 mm	65.86
KOB-2438U706S6	145 mm	67.63
KOB-2438U1324S15	150 mm	70.80
KOB-2438U776S15	150 mm	70.80
KOB-2438U1323S15	160 mm	77.30
KOB-2438U1171S16	170 mm	87.84

REPLACEMENT PARTS FOR KOBELCO®

NOTE: Kobelco part numbers are used as a reference only. We do not imply that these kits are original REPLACEMENT PARTS.

PISTON SEALS

Part Number	Bore Dia.	List Price
KOB-LP01V00004S008	70 mm	\$ 50.17
KOB-YX01V00002S009	105 mm	69.39
KOB-EY01V00003S006	115 mm	78.06
KOB-YN01V00004S029	115 mm	78.06
KOB-2438U995S8	120 mm	73.63
KOB-YN01V00001S031	120 mm	73.63
KOB-2438U675S20	125 mm	55.74
KOB-YN01V00052S010	125 mm	81.86
KOB-2438U980S8	125 mm	81.86
KOB-YN01V00003S034	135 mm	94.12
KOB-2438U1104S18	145 mm	67.63
KOB-2438U982S6	145 mm	100.90
KOB-2438U1175S8	160 mm	123.77
KOB-2438U984S10	170 mm	140.25
KOB-2438U985S8	180 mm	129.73
KOB-2438U1174S8	190 mm	163.73

ROD BUSHING

Part Number	Rod Dia.	List Price
KOB-2438U1104S4	100 mm	\$ 51.68
KOB-2438U1324S4	100 mm	59.52

U-SEALS

Part Number	Rod Dia.	List Price
KOB-24838U42S10	60 mm	\$ 13.13
KOB-2438U286S31	65 mm	14.87
KOB-2438U897S18	65 mm	18.42
KOB-2438U561S11	70 mm	20.92
KOB-YY01V00045S032	70 mm	20.53
KOB-2438U309S35	75 mm	23.04
KOB-2438U814S31	75 mm	23.04
KOB-2418U130D34	80 mm	25.66
KOB-2438U1105S7	80 mm	25.66
KOB-YN01V00153S007	80 mm	25.66
KOB-YY01V00004S037	80 mm	33.26
KOB-2438U914D1S21	85 mm	27.86
KOB-2438U959S7	85 mm	32.74
KOB-2438U307S35	85 mm	27.86
KOB-YN01V00151S007	85 mm	27.86
KOB-2438U999S7	90 mm	29.33
KOB-2438U720S21	95 mm	31.03
KOB-2438U776S7	95 mm	31.30
KOB-YN01V00105S007	95 mm	31.03
KOB-YN01V00175S007	95 mm	31.03
KOB-2438U1324S7	100 mm	33.93
KOB-24838U17-18	100 mm	44.37
KOB-LQ01V00007S007	100 mm	21.60
KOB-2438U953S7	105 mm	42.16
KOB-LQ01V00038S007	105 mm	38.07
KOB-2418U130D23	110 mm	43.12
KOB-2438U1323S7	110 mm	47.25
KOB-2438U1173S24	115 mm	47.13
KOB-2438U352S10	120 mm	48.24
KOB-LC01V00054R007	120 mm	48.24
KOB-2438U1171S7	120 mm	55.88

WEAR RINGS

Part Number	OD x Width	List Price
KOB-R45T0098D1	100 X 14.8 mm	\$ 15.90
KOB-2438U814S23	105 x 6 mm	95.77
KOB-YM01V00009S018	105 x 6 mm	11.26
KOB-2438U1949S17	110 x 6 mm	39.87
KOB-2438U1949S16	110 x 7.8 mm	12.67
KOB-YN01V00106S018	115 x 7.8 mm	12.84
KOB-YN01V00001S012	120 x 6 mm	36.19
KOB-2438U1109S9	120 x 9.4 mm	14.83
KOB-LQ01V00030S017	125 x 7.9 mm	12.10
KOB-YM01V00008S018	125 X 7.9 mm	13.92
KOB-2438U675S28	125 X 8 mm	49.06
KOB-LQ01V00001S018	135 X 7.9 mm	15.63
KOB-YN01V00105S050	135 X 7.9 mm	15.63
KOB-YN01V00175S018	135 X 7.9 mm	14.40
KOB-LQ01V00001S019	135 X 8 mm	50.87
KOB-YN01V00003S009	135 X 9.5 mm	20.15
KOB-YN01V00019S037	135 X 9.5 mm	20.15
KOB-YN01V00049S009	135 X 9.5 mm	20.15
KOB-2438U999S18	140 X 8 mm	51.51
KOB-LQ01V00003S018	140 X 9.5 mm	17.94
KOB-2438U999S17	140 X 9.5 mm	17.94
KOB-LC01V00044S018	140 X 9.5 mm	17.94
KOB-2438U1104S20	145 X 7.9 mm	81.03
KOB-LQ01V00038S018	145 X 9.5 mm	17.94
KOB-2438U1324S17	150 X 8 mm	56.88
KOB-LC01V00006S017	150 x 9.3 mm	18.08
KOB-LC01V00055S017	150 x 9.5 mm	15.01
KOB-2438U953S17	150 X 9.5 mm	18.08
KOB-2438U1175S10	160 X 9.7 mm	69.91
KOB-2438U1028D1S11	170 X 14.8 mm	25.04
KOB-2438U1171S18	170 x 9.5 mm	21.63
KOB-2438U1171S19	170 x 9.7 mm	85.62
KOB-2438U1028D1S12	170 X 9.7 mm	85.62
KOB-2438U1174S9	190 X 15 mm	28.88
KOB-2438U507S41	190 X 9.7 mm	89.04

REPLACEMENT PARTS FOR KOBELCO®

NOTE: Kobelco part numbers are used as a reference only. We do not imply that these kits are original REPLACEMENT PARTS.

WIPERS

Part Number	Rod Dia.	List Price
KOB-2438U692S20	50 mm	\$ 24.03
KOB-2438U724S17	60 mm	31.01
KOB-2438U908S27	65 mm	31.03
KOB-2438U922S25	70 mm	33.30
KOB-2438U922S31	70 mm	33.30
KOB-YY01V00045S034	70 mm	35.28
KOB-2438U915S26	75 mm	14.17
KOB-LP01V00007S009	75 mm	37.92
KOB-2438U928S24	80 mm	42.22
KOB-2438U928S33	80 mm	42.22
KOB-2438U1105S35	80 mm	44.73

WIPERS

Part Number	Rod Dia.	List Price
KOB-YY01V00004S039	80 mm	\$ 44.73
KOB-2438U914D1S22	85 mm	47.92
KOB-2438U914S28	85 mm	47.92
KOB-2438U914D1S28	85 mm	14.53
KOB-LP01V00008S009	85 mm	50.77
KOB-2438U999S10	90 mm	51.80
KOB-2438U1135S35	90 mm	54.89
KOB-2438U1135S33	90 mm	54.89
KOB-2438U776S9	95 mm	28.52
KOB-2438U921S34	95 mm	52.98
KOB-YN01V00105S009	95 mm	28.52

WIPERS

Part Number	Rod Dia.	List Price
KOB-2438U1324S9	100 mm	\$ 54.39
KOB-2438U588S38	100 mm	54.39
KOB-2438U1172S37	100 mm	57.63
KOB-2438U953S10	105 mm	52.56
KOB-YN01V00020S009	105 mm	55.68
KOB-2438U1323S9	110 mm	55.72
KOB-2438U510S29	110 mm	55.72
KOB-2438U1173S25	115 mm	49.28
KOB-2438U1171S34	120 mm	64.60
KOB-2438U1343S28	130 mm	66.72

KOEHRING

Kit Number	Code (Pg. xviii)	Rod X Bore Size	List Price
KR-203088	O-RING KIT		\$ 6.87
KR-204650	P-U-10	3-1/4 X 4-3/4	67.42
KR-207889	I-U-10	5-1/2 X 11	222.76
KR-24589	I-U-10	3-1/2 X 6-1/2	56.73
KR-28054	P-U-10	2-1/2 X 4	50.80
KR-29760	I-U-10	2-1/2 X 4	21.09
KR-603E2503	I-U-12	1-3/4 X 3-1/2	61.19
KR-6620BC	P-U-14	80 X 120 mm	197.63
KR-7004208	P-U-9	2 X 4	105.28
KR-8030236	P-U-10	1 X 2-3/4	17.21
KR-8032707	I-U-10	2 X 5	57.95
KR-8032718	I-U-10	3 X 5-1/2	47.48
KR-8032957	O-RING KIT		9.82
KR-8033253	I-U-10	1-1/8 X 2-1/4	31.87
KR-8033489	I-U-13	1-1/2 X 2-1/4	31.87
KR-8205601	I-V-1	3-1/2" ROD	27.53

Kit Number	Code (Pg. xviii)	Rod X Bore Size	List Price
KR-8205602	P-V-9	3 X 4	\$ 60.05
KR-8205603	I-V-9	2 X 4	47.67
KR-8205604	I-V-9	1-1/2 X 4	43.83
KR-8205629	P-OB-10	7/8 X 2-1/4	19.82
KR-8205635	I-U-9	2 X 4	40.82
KR-8205639	I-U-5	2-1/2 X 6	92.58
KR-8205640	I-U-5	1-3/4 X 4-1/4	57.62
KR-8205641	I-U-5	2 X 5	69.07
KR-8205642	I-U-9	3 X 4	50.21
KR-8205642-1	I-U-10	3 X 4-1/2	35.83
KR-8205643	I-U-5	1-1/2 X 3	41.16
KR-8205646	I-U-10	3 X 4-1/2	36.15
KR-8205648	I-U-10	1-1/4 X 2-1/2	19.65
KR-8205668	P-U-10	3 X 5-1/2	62.77
KR-A24589	I-U-10	3-1/2 X 6-1/2	52.04

REPLACEMENT SEAL KITS FOR KOMATSU® EQUIPMENT*

Replacement Seal Kits By Machine Type

▶ **NEW MODELS**

Machine Type	Table of Contents	Page
Backhoe Loaders	WB140-2, WB140-2N, WB140PS-2, WB140PS-2N, WB146-5, WB146PS-5, WB150-2, WB150-2N, WB150AWS-2, WB150AWS-2N, WB150PS-2, WB150PS-2N	856 - 860
Crawler Dozers	D20A-5, D20A-6, D20A-7, D21A-7, D20P-5, D20P-5A, D20P-6, D20P-6A, D20P-7A, D21P-7A, D20PL-5, D20PLL-6, D20Q-5, D20Q-6, D20S-5, D20S-6, D21A-5, D21A-6, D21A-8, D21P-8, D21E-6, D21P-5, D21P-5A, D21P-6, D21P-6A, D21P-6B, D21PL-5, D21Q-5, D21Q-6, D21S-5, D21S-6, D31A-17, D31E-18, D31E-20, D31EX-21, D31PX-21, D31EX-21A, D31PX-21A, D31EX-22, D31P-17, D31P-17A, D31P-17B, D31P-18, D31PL-18, D31PLL-18, D31P-18A, D31P-20, D31PL-17, D31PLL-17, D31PX-22, D31Q-17, D31Q-18, D31Q-20, D31S-17, D31S-18, D31S-20, D37E-1, D37P-1, D37E-2, D37P-2, D37E-5, D37P-5, D37EX-21, D37PX-21, D37EX-21A, D37PX-21A, D37EX-22, D37PX-22, D39EX-21, D39PX-21, D39EX-21A, D39PX-21A, D39EX-22, D39PX-22, D40A-1, D40P-1, D40A-3, D40F-3, D40P-3, D40PL-3, D40PLL-3, D40PL-1, D41A-3, D41A-6, D41E-3, D41E-6, D41P-6, D41P-3, D41Q-3, D41S-3, D45A-1, D45E-1, D45P-1, D45S-1, D50-17, D50A-16, D50A-17, D50P-16, D50P-17, D50PL-17, D50S-16, D51EX-22, D51PX-22, D53-17, D53A-16, D53A-17, D53P-16, D53P-17, D53S-16, D53S-17, D57S-1, D57S-1B, D58E-1, D58E-1B, D58P-1, D60A-7, D60E-7, D60A-8, D60E-8, D60P-7, D60P-8, D60PL-7, D60P-8, D60PL-8, D60S-7, D60S-8, D61EX-12, D61PX-12, D61EX-15, D61PX-15, D63E-1, D65A-6, D65A-7, D65E-7, D65A-8, D65E-8, D65E-12, D65EX-12, D65EX-15, D65EX-15E0, D65EX-16, D65P-6, D65P-7, D65P-8, D65P-12, D65PX-12, D65PX-15, D65PX-15E0, D65PX-16, D65S-7, D65S-8, D66S-1, D68E-1, D68P-1, D75A-1, D75S-3, D75S-5, D80A-18, D80E-18, D83E-1, D83P-1, D85A-18, D85A-21, D85A-21, D85E-21, D85E-18, D85E-21, D85E-SS-2A, D85P-21, D95S-2, D135A-1, D135A-2, D155A-1, D155A-2, D155A-3, D155AX-3, D155AX-5, D155AX-6, D275A-2, D275A-5, D355A-3, D355A-5, D375A-1, D375A-2, D375A-3 , D375A-5 , D375A-6 , D475A-1, D475A-2, D475A-3, D475A-3 SD, D475A-5 , D475A-5E0 , D475ASD-5E0	860 - 885
Dump Trucks - Articulated	HM300-1 , HM300-1L , HM300-2 , HM300-3 , HM400-1 , HM400-1L , HM400-2, HM400-3	885 - 888
Excavators	PC05-5, PC05-6, PC10-5, PC10-6, PC10-7, PC12R-8, PC12UU-1, PC15-1, PC15-2, PC15-3, PC15R-8, PC20-5, PC20-6, PC20-7, PC20MRX-1, PC20R-8, PC25-1, PC25R-8, PC27MR-2, PC27MRX-1, PC27R-8, PC28UU-1, PC30-5, PC30-6, PC30-7, PC30MRX-1, PC35MR-2, PC35MRX-1A, PC35R-8, PC38UU-1, PC40-5, PC40-6, PC40-7, PC40MR-1, PC40MRX-1, PC40R-8, PC45-1, PC45MR-3, PC45MRX-1, PC45R-8, PC50MR-2, PC50UU-1, PC50UU-2, PC60-5, PC60-6, PC60-7, PC60L-5, PC60L-6, PC60U-5, PC75UU-1, PC75UU-2, PC75UU-3, PC78MR-6, PC78US-5, PC78US-6, PC80-3, PC80LC-3, PC90-1, PC95R-2, PC100-1, PC100-2, PC100-3, PC100-5, PC100-6, PC100-7, PC100L-3, PC100L-5, PC100U-3, PC120-3, PC120-5, PC120-6, PC128U-2, PC128UU, PC128UU-2, PC130-6, PC130-7K, PC138USLC-2, PC138USLC-8, PC150-1, PC150-3 , PC150-5, PC150-6K, PC150LC-6K, PC150LC-3, PC160-6K, PC160LC-7, PC160LC-7E0, PC160LC-7K, PC160LC-7K-KA, PC160LC-8 , PC180LC-6K, PC180LC-7K, PC180NLC-6K, PC180NLC-7K, PC200-1, PC200-2, PC200-3, PC200LC-3, PC200-5, PC200LC-5, PC200-6, PC200-6S, PC200LC-6S, PC200-7, PC200LC-7, PC200LC-6, PC200LC-6LE, PC200LC-7L, PC200LC-7US, PC200LC-8, PC200LC-8E0, PC210-3, PC210LC-3, PC210-6, PC210-6K, PC210-7K, PC210LC-6, PC210LC-6K, PC210LC-7K, PC210LC-8K, PC210NLC-7K, PC220, PC220LC, PC220-2, PC220LC-2, PC220-3, PC220LC-3, PC220-5, PC220LC-5, PC220-6, PC220LC-6, PC220LC-6LC, PC220LC-6LE , PC220LC-7 , PC220LC-7L , PC220LC-8 , PC228USLC-1 , PC228USLC-2 , PC228USLC-3 , PC228USLC-3E0 , PC228USLC-3S , PC228USLC-8 , PC230-6, PC240-6K, PC240LC-6K, PC240LC-7K, PC240NLC-6K, PC240NLC-7K, PC250LC-6, PC270-8, PC270LC-7L, PC270LC-8, PC270LL-7L, PC280LC-3, PC290LC-6K, PC290LC-7K, PC290NLC-6K, PC290NLC-7K, PC300-3, PC300LC-3, PC300-5, PC300LC-5, PC300-6, PC300-7, PC300HD-7E0, PC300HD-7L, PC300HD-8, PC300LC-7, PC300LC-7E0, PC300LC-7K, PC300LC-8, PC300LL-7E0, PC300LL-7L, PC308USLC-3, PC308USLC-3E0-W1, PC340-6K, PC340LC-6K, PC340LC-7K, PC340NLC-6K, PC340NLC-7K, PC350-6, PC360LC-3, PC400-3, PC400LC-3, PC400-5 L/S, PC400-5, PC400LC-5, PC400-6, PC400-7, PC400LC-7, PC400-7E0, PC400LC-7E0, PC400LC-7L, PC400LC-8, PC450-6, PC450-6K, PC450-7K, PC450LC-6K, PC450LC-7K, PC600-6, PC600LC-6, PC600LC-6A, PC600LC-6K, PC600LC-7, PC600LC-8, PC650-1, PC650-3, PC650-5, PC710-5, PC750-6, PC750SE-6, PC800-6, PC800-7, PC800SE-6, PC1000-1, PC1000SE-1, PC1000SP-1, PC1100-6 , PC1250-7 , PC1250-8 , PC1250LC-7 , PC1250LC-8 , PC1250SP-7 , PC1250SP-8 , PC1800-6 , PC2000-8	888 - 922
Excavators - Compact	PC27MR-3, PC28UU-2 , PC28UU-3 , PC35MR-3, PC78US-8	923 - 925
Excavators - Wheel	PW05-1, PW20-1, PW30-1, PW60, N-1, PW60-3, PW100-1, PW100-3, PW100N-3, PW150-1, PW210-1	925 - 927
Loaders - Skid Steer	SK815-5, SK815-5N, SK1020-5, SK1020-5N, SK1020-5NA	927
Loaders - Wheel	WA20-1, WA30-1, WA30-2, WA40-1, WA50-3, WA65-3, WA65-5, WA70-1, WA100-1, WA120-1, WA120-3, WA150-1, WA180-1, WA180-3, WA200-1, WA200-5L, WA200L-5, WA250-1, WA250-3, WA250-5, WA250-5L, WA250-6, WA250L-5, WA250PT-5, WA250PT-5L, WA250PTL-5, WA250PZ-6, WA300-1, WA320-1, WA320-3, WA320-3L, WA320-5L, WA320-6, WA320-6L, WA320PT-5L, WA320PZ-6, WA380-1, WA380-3, WA380-5L, WA380-6, WA380-7, WA400-1, WA420-1, WA420-3, WA430-6, WA450-1, WA450-2, WA450-3, WA450-5L, WA450-6, WA470-1, WA470-3, WA470-5, WA500-1, WA500-3, WA500-3LE, WA500-6, WA500-7 , WA600-1 , WA600-3, WA600-3L, WA600-6, WA700-1, WA700-3, WA800-1, WA800-2, WA800-3, WA900-1, WA900-3, WA900-3E0 , WA900-3LC , WA900L-3	927 - 941
Motor Graders	GD200A-1, GD300A-1, GD313A-1, GD405A-1, GD461A-1, GD500R-2, GD505A-2, GD505R-2, GD510R-1, GD511A-1, GD513A-1, GD513R-1, GD515A-1, GD521A-1, GD521R-1, GD523A-1, GD523R-1, GD525A-1, GD600R-3, GD605A-3, GD611A-1, GD611R-1, GD613A-1, GD613R-1, GD615A-1, GD621A-1, GD621R-1, GD623A-1, GD623R-1, GD623R-1, GD663A-1, GD625A-1, GD663A-1, GD705A-3, GD705A-4, GD725A-1, GD825A-1, GD825A-2	941 - 945
Off-Highway Trucks	830, 830E, 930, 930E-4, HD205-3, HD325-3, HD325-5, HD465-3, HD785-3, HD785-5, HD985-3, HD1200M-1	945
Wheel Dozers	WD600-3	945 - 946
Alpha-Numeric Kit Listing		947 - 955
Komatsu® Lift Trucks		956
Komatsu® Individual Parts		957 - 965

All manufacturer's names, part numbers and descriptions are used for reference purposes only. We do not imply that any part shown is the product of these manufacturers. We also do not imply that the list price shown is exactly that of the manufacturer.

Replacement Kits For

KOMATSU®

Backhoe Loaders

APPLICATION	CYL #	SERIAL #	Misc	CODE	ROD	BORE	KIT #	List \$
MODEL WB140-2								
B/H ARM	395002005	140F10001-		P-UB-14	60 mm	110 mm	KOM-878000490	108.11
B/H BOOM	395001007	140F10001- 140F10943		P-UB-14	60 mm	120 mm	KOM-878000489	106.95
	395001009	140F11531-		P-UB-14	60 mm	120 mm	KOM-878000489	106.95
B/H BOOM SWING LH	395005010	140F10001- 140F11408		P-UB-14	50 mm	115 mm	KOM-878000542	83.28
	395005018	140F11409-		P-UB-14	50 mm	115 mm	KOM-878000542	83.28
	707-02-11510	30026-		P-U-14	50 mm	115 mm	KOM-707-98-33500	88.08
	707-02-11510	30026-		Bushing	50 mm		KOM-07177-05030	15.54
B/H BOOM SWING RH	395005009	140F10001- 140F11408		P-UB-14	50 mm	115 mm	KOM-878000542	83.28
	395005017	140F11409-		P-UB-14	50 mm	115 mm	KOM-878000542	83.28
	707-02-11520	30026-		P-U-14	50 mm	115 mm	KOM-707-98-33500	88.08
	707-02-11520	30026-		Bushing	50 mm		KOM-07177-05030	15.54
B/H BUCKET	395003003	140F10001- 140F11530		P-UB-14	60 mm	95 mm	KOM-878000492	98.45
	395003005	140F11531-		P-UB-14	60 mm	95 mm	KOM-878000492	98.45
B/H OUTRIGGER LH	395011005	140F10001- 140F10792		P-UB-14	55 mm	110 mm	KOM-878000494	71.26
	395011008	140F10793-		P-UB-14	55 mm	110 mm	KOM-878000494	71.26
B/H OUTRIGGER RH	395011006	140F10001- 140F10792		P-UB-14	55 mm	110 mm	KOM-878000494	71.26
	395011007	140F10793-		P-UB-14	55 mm	110 mm	KOM-878000494	71.26
B/H TELESCOPIC ARM	395009001	140F10001- 140F11530		P-UB-10	40 mm	70 mm	KOM-878000388	67.10
	395009006	140F11531-		P-UB-10	40 mm	70 mm	KOM-878000388	67.10
L/S BOOM	395012014	140F10001-		P-UB-14	50 mm	85 mm	KOM-878000486	82.91
	707-00-80C10	30026-		P-U-14	50 mm	80 mm	KOM-707-98-25090	81.96
	707-00-80C10	30026-		Bushing	50 mm		KOM-07177-05030	15.54
L/S BUCKET	395013017	140F10001- 140F11450		P-UB-14	50 mm	80 mm	KOM-878000487	74.80
	707-00-85080	30026-		P-U-14	50 mm	85 mm	KOM-707-98-25830	105.94
	707-00-85080	30026-		Bushing	50 mm		KOM-07177-05030	15.54
L/S BUCKET LH	395013017	140F11451-		P-UB-14	50 mm	80 mm	KOM-878000487	74.80
L/S BUCKET MP	312230674	140F10001-		I-U-15	45 mm	80 mm	KOM-827020113	29.60
L/S BUCKET QC	200060282	140F10001-		I-SP-10	18 mm	30 mm	KOM-42N-879-1980	44.73
L/S BUCKET RH	395013019	140F11451-		P-UB-14	50 mm	80 mm	KOM-878000487	74.80
OUTRIGGER LH	721-00-11540	30026-		P-U-14	55 mm	110 mm	KOM-707-98-34460	81.01
	721-00-11540	30026-		Bushing	55 mm		KOM-07177-05530	18.35
OUTRIGGER RH	721-00-11550	30026-		P-U-14	55 mm	110 mm	KOM-707-98-34460	81.01
	721-00-11550	30026-		Bushing	55 mm		KOM-07177-05530	18.35
MODEL WB140-2N								
B/H ARM	2938-856-730	A20814-		P-UB-14	60 mm	110 mm	KOM-878000490	108.11
	395002005	A20001-A20813		P-UB-14	60 mm	110 mm	KOM-878000490	108.11
B/H BOOM	395001007	A20637-		P-UB-14	60 mm	120 mm	KOM-878000489	106.95
	395001009	A20001-A20636		P-UB-14	60 mm	120 mm	KOM-878000489	106.95
B/H BOOM SWING LH	395005018	A20001-A20636		P-UB-14	50 mm	115 mm	KOM-878000542	83.28
	395005022	A20637-		P-UB-14	50 mm	115 mm	KOM-878000542	83.28
B/H BOOM SWING RH	395005017	A20001-A20636		P-UB-14	50 mm	115 mm	KOM-878000542	83.28
	395005021	A20637-		P-UB-14	50 mm	115 mm	KOM-878000542	83.28
B/H BUCKET	395003005	A20001-		P-UB-14	60 mm	95 mm	KOM-878000492	98.45
B/H OUTRIGGER	395011007	A20637-		P-UB-14	55 mm	110 mm	KOM-878000494	71.26
B/H OUTRIGGER LH	395011008	A20001-A20636		P-UB-14	55 mm	110 mm	KOM-878000494	71.26
B/H OUTRIGGER RH	395011007	A20001-A20636		P-UB-14	55 mm	110 mm	KOM-878000494	71.26
B/H TELESCOPIC ARM	395009005	A20637-		P-UB-10	40 mm	70 mm	KOM-878000388	67.10
	395009006	A20001-A20636		P-UB-10	40 mm	70 mm	KOM-878000388	67.10

LT - Large size tire L/S - Loading Shovel SLF - Super Long Front B/H - Backhoe HD - Heavy Duty L BUCKET - Large Bucket
 K-LINK - K-type Linkage Blade LB HI-LIFT - High Lift Arm w Large Bucket HI-LIFT - High Lift Arm S HI-LIFT - Super High Lift Arm
 SU - Semi-U Dozer PAT - Power Angle Power Tilt MP - Mult-Purpose

Replacement Kits For

KOMATSU®

Backhoe Loaders								
APPLICATION	CYL #	SERIAL #	Misc	CODE	ROD	BORE	KIT #	List \$
MODEL WB140-2N								
L/S BOOM	2938-62-1290	A20814-		P-UB-14	50 mm	85 mm	KOM-878000486	82.91
	395012014	A20001-A20813		P-UB-14	50 mm	85 mm	KOM-878000486	82.91
L/S BUCKET	395013017	A20001-A20636		P-UB-14	50 mm	80 mm	KOM-878000487	74.80
L/S BUCKET LH	395013017	A20637-A20813		P-UB-14	50 mm	80 mm	KOM-878000487	74.80
L/S BUCKET MP	312230674	A20001-		I-U-15	45 mm	80 mm	KOM-827020113	29.60
L/S BUCKET QC	200060282	A20001-A20636		I-SP-10	18 mm	30 mm	KOM-42N-879-1980	44.73
L/S BUCKET RH	395013019	A20637-A20813		P-UB-14	50 mm	80 mm	KOM-878000487	74.80
	395013022	A20814-		P-UB-14	50 mm	80 mm	KOM-878000487	74.80
MODEL WB140PS-2								
B/H ARM	395002005	140F50001-		P-UB-14	60 mm	110 mm	KOM-878000490	108.11
B/H BOOM	395001007	140F50001- 140F50091		P-UB-14	60 mm	120 mm	KOM-878000489	106.95
	395001009	140F50092-		P-UB-14	60 mm	120 mm	KOM-878000489	106.95
B/H BOOM SWING LH	395005010	140F50001-		P-UB-14	50 mm	115 mm	KOM-878000542	83.28
	395005018	140F50092-		P-UB-14	50 mm	115 mm	KOM-878000542	83.28
B/H BOOM SWING RH	395005009	140F50001-		P-UB-14	50 mm	115 mm	KOM-878000542	83.28
	395005017	140F50092-		P-UB-14	50 mm	115 mm	KOM-878000542	83.28
B/H BUCKET	395003003	140F50001- 140F50091		P-UB-14	60 mm	95 mm	KOM-878000492	98.45
	395003005	140F50092-		P-UB-14	60 mm	95 mm	KOM-878000492	98.45
B/H OUTRIGGER LH	395011008	140F50001-		P-UB-14	55 mm	110 mm	KOM-878000494	71.26
B/H OUTRIGGER RH	395011007	140F50001-		P-UB-14	55 mm	110 mm	KOM-878000494	71.26
B/H TELESCOPIC ARM	395009001	140F50001- 140F50091		P-UB-10	40 mm	70 mm	KOM-878000388	67.10
	395009006	140F50092-		P-UB-10	40 mm	70 mm	KOM-878000388	67.10
L/S BOOM	395012014	140F50001-		P-UB-14	50 mm	85 mm	KOM-878000486	82.91
L/S BUCKET	395013017	140F5001- 140F50091		P-UB-14	50 mm	80 mm	KOM-878000487	74.80
L/S BUCKET LH	395013017	140F50092-		P-UB-14	50 mm	80 mm	KOM-878000487	74.80
L/S BUCKET MP	312230674	140F50001-		I-U-15	45 mm	80 mm	KOM-827020113	29.60
L/S BUCKET QC	200060282	140F50001-		I-SP-10	18 mm	30 mm	KOM-42N-879-1980	44.73
L/S BUCKET RH	395013019	140F50092-		P-UB-14	50 mm	80 mm	KOM-878000487	74.80
MODEL WB140PS-2N								
B/H ARM	2938-856-730	A40043-		P-UB-14	60 mm	110 mm	KOM-878000490	108.11
	395002005	A40034-A40042		P-UB-14	60 mm	110 mm	KOM-878000490	108.11
	395002006	A40001-A40033		P-UB-14	60 mm	115 mm	KOM-878000491	113.20
B/H BOOM	395001007	A40034-		P-UB-14	60 mm	120 mm	KOM-878000489	106.95
	395001010	A40001-A40033		P-UB-14	60 mm	125 mm	KOM-878000541	142.03
B/H BOOM SWING LH	395005018	A40001-A40033		P-UB-14	50 mm	115 mm	KOM-878000542	83.28
	395005022	A40034-		P-UB-14	50 mm	115 mm	KOM-878000542	83.28
B/H BOOM SWING RH	395005017	A40001-A40033		P-UB-14	50 mm	115 mm	KOM-878000542	83.28
	395005021	A40034-		P-UB-14	50 mm	115 mm	KOM-878000542	83.28
B/H BUCKET	395003005	A40001-		P-UB-14	60 mm	95 mm	KOM-878000492	98.45
B/H OUTRIGGER	395011007	A40034-		P-UB-14	55 mm	110 mm	KOM-878000494	71.26
	395011008	A40001-A40033		P-UB-14	55 mm	110 mm	KOM-878000494	71.26
B/H TELESCOPIC ARM	395009005	A40034-		P-UB-10	40 mm	70 mm	KOM-878000388	67.10
	395009006	A40001-A40033		P-UB-10	40 mm	70 mm	KOM-878000388	67.10
L/S BOOM	2938-62-1290	A40043-		P-UB-14	50 mm	85 mm	KOM-878000486	82.91
	395012014	A40001-A40042		P-UB-14	50 mm	85 mm	KOM-878000486	82.91
L/S BUCKET LH	395013017	A40001-		P-UB-14	50 mm	80 mm	KOM-878000487	74.80
L/S BUCKET MP	312230674	A40001-		I-U-15	45 mm	80 mm	KOM-827020113	29.60
L/S BUCKET QC	200060282	A40001-A40033		I-SP-10	18 mm	30 mm	KOM-42N-879-1980	44.73
L/S BUCKET RH	395013019	A40001-A40042		P-UB-14	50 mm	80 mm	KOM-878000487	74.80
	395013022	A40043-		P-UB-14	50 mm	80 mm	KOM-878000487	74.80
MODEL WB146-5								
B/H ARM	707-00-0Y873	A23001-		P-UB-14	60 mm	115 mm	KOM-707-99-35590	86.43

LT - Large size tire L/S - Loading Shovel SLF - Super Long Front B/H - Backhoe HD - Heavy Duty L BUCKET - Large Bucket

K-LINK - K-type Linkage Blade LB HI-LIFT - High Lift Arm w Large Bucket HI-LIFT - High Lift Arm S HI-LIFT - Super High Lift Arm

SU - Semi-U Dozer PAT - Power Angle Power Tilt MP - Mulit-Purpose

Replacement Kits For

KOMATSU®

Backhoe Loaders								
APPLICATION	CYL #	SERIAL #	Misc	CODE	ROD	BORE	KIT #	List \$
MODEL WB146-5								
B/H BOOM	707-00-0Y942	A23001-		P-UB-14	60 mm	120 mm	KOM-707-99-41270	119.43
B/H BUCKET	707-00-0Y902	A23001-		P-UB-14	55 mm	90 mm	KOM-707-99-26530	107.55
B/H OUTRIGGER LH	707-00-0Y830	A23001-		P-UB-14	50 mm	100 mm	KOM-707-99-32190	96.65
B/H OUTRIGGER RH	707-00-0Y840	A23001-		P-UB-14	50 mm	100 mm	KOM-707-99-32190	96.65
B/H SWING	707-02-07731	A23001-		P-UB-14	50 mm	100 mm	KOM-707-99-32070	138.17
B/H TELESCOPIC ARM	42N-6C-13301	A23001-		P-UB-10	40 mm	70 mm	KOM-42N-6C-13330	54.17
L/S BOOM	42N-6C-A1500	A23001-		P-UB-14	50 mm	90 mm	KOM-2938-6C-1290	95.84
L/S BUCKET LH	42N-6C-A1700	A23001-		P-UB-14	45 mm	70 mm	KOM-2938-6C-1480	79.08
L/S BUCKET MP	42N-6C-12800	A23001-		P-UB-14	40 mm	70 mm	KOM-42N-6C-13340	73.93
L/S BUCKET RH	42N-6C-A1800	A23001-		P-UB-14	45 mm	70 mm	KOM-2938-6C-1480	79.08
MODEL WB146PS-5								
B/H ARM	707-00-0Y873	A43001-		P-UB-14	60 mm	115 mm	KOM-707-99-35590	86.43
B/H BOOM	707-00-0Y942	A43001-		P-UB-14	60 mm	120 mm	KOM-707-99-41270	119.43
B/H BUCKET	707-00-0Y902	A43001-		P-UB-14	55 mm	90 mm	KOM-707-99-26530	107.55
B/H OUTRIGGER LH	707-00-0Y830	A43001-		P-UB-14	50 mm	100 mm	KOM-707-99-32190	96.65
B/H OUTRIGGER RH	707-00-0Y840	A43001-		P-UB-14	50 mm	100 mm	KOM-707-99-32190	96.65
B/H SWING	707-02-07731	A43001-		P-UB-14	50 mm	100 mm	KOM-707-99-32070	138.17
B/H TELESCOPIC ARM	42N-6C-13301	A43001-		P-UB-10	40 mm	70 mm	KOM-42N-6C-13330	54.17
L/S BOOM	42N-6C-A1500	A43001-		P-UB-14	50 mm	90 mm	KOM-2938-6C-1290	95.84
L/S BUCKET LH	42N-6C-A1700	A43001-		P-UB-14	45 mm	70 mm	KOM-2938-6C-1480	79.08
L/S BUCKET MP	42N-6C-12800	A43001-		P-UB-14	40 mm	70 mm	KOM-42N-6C-13340	73.93
L/S BUCKET RH	42N-6C-A1800	A43001-		P-UB-14	45 mm	70 mm	KOM-2938-6C-1480	79.08
MODEL WB150-2								
B/H ARM	395002006	150F10001-		P-UB-14	60 mm	115 mm	KOM-878000491	113.20
B/H BOOM	395001008	150F10001- 150F10164		P-UB-14	60 mm	125 mm	KOM-878000541	142.03
	395001010	150F10165-		P-UB-14	60 mm	125 mm	KOM-878000541	142.03
B/H BUCKET	395003003	150F10001-		P-UB-14	60 mm	95 mm	KOM-878000492	98.45
	395003005	150F10293-		P-UB-14	60 mm	95 mm	KOM-878000492	98.45
B/H OUTRIGGER LH	395011005	150F10001- 150F10124		P-UB-14	55 mm	110 mm	KOM-878000494	71.26
	395011008	150F10125-		P-UB-14	55 mm	110 mm	KOM-878000494	71.26
B/H OUTRIGGER RH	395011006	150F10001- 150F10124		P-UB-14	55 mm	110 mm	KOM-878000494	71.26
	395011007	150F10125-		P-UB-14	55 mm	110 mm	KOM-878000494	71.26
B/H SWING LH	395005010	150F10001- 150F10277		P-UB-14	50 mm	115 mm	KOM-878000542	83.28
	395005018	150F10278-		P-UB-14	50 mm	115 mm	KOM-878000542	83.28
B/H SWING RH	395005009	150F10001- 150F10277		P-UB-14	50 mm	115 mm	KOM-878000542	83.28
	395005017	150F10278-		P-UB-14	50 mm	115 mm	KOM-878000542	83.28
B/H TELESCOPIC ARM	395009001	150F10001-		P-UB-10	40 mm	70 mm	KOM-878000388	67.10
	395009006	150F10293-		P-UB-10	40 mm	70 mm	KOM-878000388	67.10
L/S BOOM	395012014	150F10001-		P-UB-14	50 mm	85 mm	KOM-878000486	82.91
L/S BUCKET	395013017	150F10001-		P-UB-14	50 mm	80 mm	KOM-878000487	74.80
L/S BUCKET LH	395013017	150F10293-		P-UB-14	50 mm	80 mm	KOM-878000487	74.80
L/S BUCKET MP	312230674	150F10001-		I-U-15	45 mm	80 mm	KOM-827020113	29.60
L/S BUCKET QC	200060282	150F10001-		I-SP-10	18 mm	30 mm	KOM-42N-879-1980	44.73
L/S BUCKET RH	395013019	150F10293-		P-UB-14	50 mm	80 mm	KOM-878000487	74.80
MODEL WB150-2N								
B/H ARM	2938-856-730	A60049-		P-UB-14	60 mm	110 mm	KOM-878000490	108.11
	395002005	A60029-A60048		P-UB-14	60 mm	110 mm	KOM-878000490	108.11
	395002006	A60001-A60028		P-UB-14	60 mm	115 mm	KOM-878000491	113.20
B/H BOOM	395001007	A60029-		P-UB-14	60 mm	120 mm	KOM-878000489	106.95
	395001010	A60001-A60028		P-UB-14	60 mm	125 mm	KOM-878000541	142.03
B/H BUCKET	395003005	A60001-		P-UB-14	60 mm	95 mm	KOM-878000492	98.45

LT - Large size tire L/S - Loading Shovel SLF - Super Long Front B/H - Backhoe HD - Heavy Duty L BUCKET - Large Bucket
 K-LINK - K-type Linkage Blade LB HI-LIFT - High Lift Arm w Large Bucket HI-LIFT - High Lift Arm S HI-LIFT - Super High Lift Arm
 SU - Semi-U Dozer PAT - Power Angle Power Tilt MP - Multi-Purpose

Replacement Kits For

KOMATSU®

Backhoe Loaders									
APPLICATION	CYL #	SERIAL #	Misc	CODE	ROD	BORE	KIT #	List \$	
MODEL WB150-2N									
B/H OUTRIGGER	395011007	A60029-		P-UB-14	55 mm	110 mm	KOM-878000494	71.26	
B/H OUTRIGGER LH	395011008	A60001-A60028		P-UB-14	55 mm	110 mm	KOM-878000494	71.26	
B/H OUTRIGGER RH	395011007	A60001-A60028		P-UB-14	55 mm	110 mm	KOM-878000494	71.26	
B/H SWING LH	395005018	A60001-A60028		P-UB-14	50 mm	115 mm	KOM-878000542	83.28	
	395005022	A60029-		P-UB-14	50 mm	115 mm	KOM-878000542	83.28	
B/H SWING RH	395005017	A60001-A60028		P-UB-14	50 mm	115 mm	KOM-878000542	83.28	
	395005021	A60029-		P-UB-14	50 mm	115 mm	KOM-878000542	83.28	
B/H TELESCOPIC ARM	395009005	A60029-		P-UB-10	40 mm	70 mm	KOM-878000388	67.10	
	395009006	A60001-A60028		P-UB-10	40 mm	70 mm	KOM-878000388	67.10	
L/S BOOM	2938-62-1290	A60049-		P-UB-14	50 mm	85 mm	KOM-878000486	82.91	
	395012014	A60001-A60048		P-UB-14	50 mm	85 mm	KOM-878000486	82.91	
L/S BUCKET LH	395013017	A60001-		P-UB-14	50 mm	80 mm	KOM-878000487	74.80	
L/S BUCKET MP	312230674	A60001-		I-U-15	45 mm	80 mm	KOM-827020113	29.60	
L/S BUCKET QC	200060282	A60001-A60028		I-SP-10	18 mm	30 mm	KOM-42N-879-1980	44.73	
L/S BUCKET RH	395013019	A60001-A60048		P-UB-14	50 mm	80 mm	KOM-878000487	74.80	
	395013022	A60049-		P-UB-14	50 mm	80 mm	KOM-878000487	74.80	
MODEL WB150AWS-2									
B/H ARM	395002006	150F80001-		P-UB-14	60 mm	115 mm	KOM-878000491	113.20	
B/H BOOM	395001010	150F80001-		P-UB-14	60 mm	125 mm	KOM-878000541	142.03	
B/H BUCKET	395003005	150F80001-		P-UB-14	60 mm	95 mm	KOM-878000492	98.45	
B/H OUTRIGGER LH	395011008	150F80001-		P-UB-14	55 mm	110 mm	KOM-878000494	71.26	
B/H OUTRIGGER RH	395011007	150F80001-		P-UB-14	55 mm	110 mm	KOM-878000494	71.26	
B/H SWING LH	395005018	150F80001-		P-UB-14	50 mm	115 mm	KOM-878000542	83.28	
B/H SWING RH	395005017	150F80001-		P-UB-14	50 mm	115 mm	KOM-878000542	83.28	
B/H TELESCOPIC ARM	395009006	150F80001-		P-UB-10	40 mm	70 mm	KOM-878000388	67.10	
L/S BOOM	395012014	150F80001-		P-UB-14	50 mm	85 mm	KOM-878000486	82.91	
L/S BUCKET LH	395013017	150F80001-		P-UB-14	50 mm	80 mm	KOM-878000487	74.80	
L/S BUCKET MP	312230674	150F80001-		I-U-15	45 mm	80 mm	KOM-827020113	29.60	
L/S BUCKET QC	200060282	150F80001-		I-SP-10	18 mm	30 mm	KOM-42N-879-1980	44.73	
L/S BUCKET RH	395013019	150F80001-		P-UB-14	50 mm	80 mm	KOM-878000487	74.80	
MODEL WB150AWS-2N									
B/H ARM	2938-856-730	A90002-		P-UB-14	60 mm	110 mm	KOM-878000490	108.11	
	2938-856-740	A90002-		P-UB-14	60 mm	115 mm	KOM-878000491	113.20	
	395002005	A90002-		P-UB-14	60 mm	110 mm	KOM-878000490	108.11	
	395002006	A90001		P-UB-14	60 mm	115 mm	KOM-878000491	113.20	
B/H ARM OFFSET	395006003	A90020-A90025		P-UB-14	60 mm	110 mm	KOM-878000490	108.11	
B/H BOOM	395001007	A90002-		P-UB-14	60 mm	120 mm	KOM-878000489	106.95	
	395001010	A90001		P-UB-14	60 mm	125 mm	KOM-878000541	142.03	
B/H BOOM (Long Arm)	395001008	A90002-A90019		P-UB-14	60 mm	125 mm	KOM-878000541	142.03	
B/H BOOM (Offset Arm)	395001009	A90020-A90025		P-UB-14	60 mm	120 mm	KOM-878000489	106.95	
B/H BUCKET	395003005	A90001-		P-UB-14	60 mm	95 mm	KOM-878000492	98.45	
B/H OFFSET ARM	200063140	A90020-A90025		I-SP-15	45 mm	85 mm	KOM-855660112	89.80	
B/H OUTRIGGER	395011007	A90002-		P-UB-14	55 mm	110 mm	KOM-878000494	71.26	
B/H OUTRIGGER LH	395011008	A90001-		P-UB-14	55 mm	110 mm	KOM-878000494	71.26	
B/H OUTRIGGER RH	395011007	A90001-		P-UB-14	55 mm	110 mm	KOM-878000494	71.26	
B/H SWING LH	395005018	A90001		P-UB-14	50 mm	115 mm	KOM-878000542	83.28	
	395005022	A90002-		P-UB-14	50 mm	115 mm	KOM-878000542	83.28	
B/H SWING RH	395005017	A90001		P-UB-14	50 mm	115 mm	KOM-878000542	83.28	
	395005021	A90002-		P-UB-14	50 mm	115 mm	KOM-878000542	83.28	
B/H TELESCOPIC ARM	395009005	A90002-		P-UB-10	40 mm	70 mm	KOM-878000388	67.10	
	395009006	A90001-		P-UB-10	40 mm	70 mm	KOM-878000388	67.10	
L/S BOOM	2938-62-1290	A90009-		P-UB-14	50 mm	85 mm	KOM-878000486	82.91	
	395012014	A90001-, A90002-A90008		P-UB-14	50 mm	85 mm	KOM-878000486	82.91	
L/S BUCKET LH	395013017	A90001-		P-UB-14	50 mm	80 mm	KOM-878000487	74.80	

LT - Large size tire L/S - Loading Shovel SLF - Super Long Front B/H - Backhoe HD - Heavy Duty L BUCKET - Large Bucket
 K-LINK - K-type Linkage Blade LB HI-LIFT - High Lift Arm w Large Bucket HI-LIFT - High Lift Arm S HI-LIFT - Super High Lift Arm
 SU - Semi-U Dozer PAT - Power Angle Power Tilt MP - Mult-Purpose

Replacement Kits For

KOMATSU®

Backhoe Loaders								
APPLICATION	CYL #	SERIAL #	Misc	CODE	ROD	BORE	KIT #	List \$
MODEL WB150AWS-2N								
L/S BUCKET MP	312230674	A90001-		I-U-15	45 mm	80 mm	KOM-827020113	29.60
L/S BUCKET RH	395013019	A90001-A90008		P-UB-14	50 mm	80 mm	KOM-878000487	74.80
	395013022	A90009-		P-UB-14	50 mm	80 mm	KOM-878000487	74.80
MODEL WB150PS-2								
B/H ARM	395002006	150F50001-		P-UB-14	60 mm	115 mm	KOM-878000491	113.20
B/H BOOM	395001008	150F50001- 150F50019		P-UB-14	60 mm	125 mm	KOM-878000541	142.03
	395001010	150F50020-		P-UB-14	60 mm	125 mm	KOM-878000541	142.03
B/H BUCKET	395003003	150F50001-		P-UB-14	60 mm	95 mm	KOM-878000492	98.45
	395003005	150F50020-		P-UB-14	60 mm	95 mm	KOM-878000492	98.45
B/H OUTRIGGER LH	395011008	150F50001-		P-UB-14	55 mm	110 mm	KOM-878000494	71.26
B/H OUTRIGGER RH	395011007	150F50001-		P-UB-14	55 mm	110 mm	KOM-878000494	71.26
B/H SWING LH	395005010	150F50001- 150F50019		P-UB-14	50 mm	115 mm	KOM-878000542	83.28
	395005018	150F50020-		P-UB-14	50 mm	115 mm	KOM-878000542	83.28
B/H SWING RH	395005009	150F50001- 150F50019		P-UB-14	50 mm	115 mm	KOM-878000542	83.28
	395005017	150F50020-		P-UB-14	50 mm	115 mm	KOM-878000542	83.28
B/H TELESCOPIC ARM	395009001	150F50001-		P-UB-10	40 mm	70 mm	KOM-878000388	67.10
	395009006	150F50020-		P-UB-10	40 mm	70 mm	KOM-878000388	67.10
L/S BOOM	395012014	150F50001-		P-UB-14	50 mm	85 mm	KOM-878000486	82.91
L/S BUCKET	395013017	150F50001- 150F50019		P-UB-14	50 mm	80 mm	KOM-878000487	74.80
L/S BUCKET LH	395013017	150F50020-		P-UB-14	50 mm	80 mm	KOM-878000487	74.80
L/S BUCKET MP	312230674	150F50001-		I-U-15	45 mm	80 mm	KOM-827020113	29.60
L/S BUCKET QC	200060282	150F50001-		I-SP-10	18 mm	30 mm	KOM-42N-879-1980	44.73
L/S BUCKET RH	395013019	150F50020-		P-UB-14	50 mm	80 mm	KOM-878000487	74.80
MODEL WB150PS-2N								
B/H ARM	2938-856-730	A70014-		P-UB-14	60 mm	110 mm	KOM-878000490	108.11
	2938-856-740	A70014-		P-UB-14	60 mm	115 mm	KOM-878000491	113.20
	395002005	A70010-A70013		P-UB-14	60 mm	110 mm	KOM-878000490	108.11
	395002006	A70001-A70009		P-UB-14	60 mm	115 mm	KOM-878000491	113.20
B/H BOOM	395001007	A70010-		P-UB-14	60 mm	120 mm	KOM-878000489	106.95
	395001010	A70001-A70009		P-UB-14	60 mm	125 mm	KOM-878000541	142.03
B/H BOOM (Long Arm)	395001008	A70010-		P-UB-14	60 mm	125 mm	KOM-878000541	142.03
B/H BUCKET	395003005	A70001-		P-UB-14	60 mm	95 mm	KOM-878000492	98.45
B/H OUTRIGGER	395011007	A70010-		P-UB-14	55 mm	110 mm	KOM-878000494	71.26
	395011008	A70001-A70009		P-UB-14	55 mm	110 mm	KOM-878000494	71.26
B/H SWING LH	395005018	A70001-A70009		P-UB-14	50 mm	115 mm	KOM-878000542	83.28
	395005022	A70010-		P-UB-14	50 mm	115 mm	KOM-878000542	83.28
B/H SWING RH	395005017	A70001-A70009		P-UB-14	50 mm	115 mm	KOM-878000542	83.28
	395005021	A70010-		P-UB-14	50 mm	115 mm	KOM-878000542	83.28
B/H TELESCOPIC ARM	395009005	A70010-		P-UB-10	40 mm	70 mm	KOM-878000388	67.10
	395009006	A70001-A70009		P-UB-10	40 mm	70 mm	KOM-878000388	67.10
L/S BOOM	2938-62-1290	A70014-		P-UB-14	50 mm	85 mm	KOM-878000486	82.91
	395012014	A70001-A70013		P-UB-14	50 mm	85 mm	KOM-878000486	82.91
L/S BUCKET LH	395013017	A70001-		P-UB-14	50 mm	80 mm	KOM-878000487	74.80
L/S BUCKET MP	312230674	A70001-		I-U-15	45 mm	80 mm	KOM-827020113	29.60
L/S BUCKET QC	200060282	A70001-A70009		I-SP-10	18 mm	30 mm	KOM-42N-879-1980	44.73
L/S BUCKET RH	395013019	A70001-A70013		P-UB-14	50 mm	80 mm	KOM-878000487	74.80
	395013022	A70014-		P-UB-14	50 mm	80 mm	KOM-878000487	74.80
Crawler Dozers								
APPLICATION	CYL #	SERIAL #	Misc	CODE	ROD	BORE	KIT #	List \$
MODEL D20A-5								
PAT ANGLE	101-63-55100	45001-53337		P-U-5	35 mm	70 mm	KOM-707-99-13410	131.33
	101-63-55101	53338-		P-U-5	35 mm	70 mm	KOM-707-99-13410	131.33

LT - Large size tire L/S - Loading Shovel SLF - Super Long Front B/H - Backhoe HD - Heavy Duty L BUCKET - Large Bucket
 K-LINK - K-type Linkage Blade LB HI-LIFT - High Lift Arm w Large Bucket HI-LIFT - High Lift Arm S HI-LIFT - Super High Lift Arm
 SU - Semi-U Dozer PAT - Power Angle Power Tilt MP - Mult-Purpose

Replacement Kits For

KOMATSU®

Crawler Dozers								
APPLICATION	CYL #	SERIAL #	Misc	CODE	ROD	BORE	KIT #	List \$
MODEL D20A-5								
PAT LIFT	101-63-13100	45001-53337		P-U-5	35 mm	70 mm	KOM-707-99-13410	131.33
	101-63-13101	53338-		P-U-5	35 mm	70 mm	KOM-707-99-13410	131.33
	101-63-13200	45001-53337		P-U-5	35 mm	70 mm	KOM-707-99-13410	131.33
	101-63-13201	53338-		P-U-5	35 mm	70 mm	KOM-707-99-13410	131.33
PAT TILT	101-63-54100	45001-53337		P-U-5	40 mm	80 mm	KOM-707-99-23010	121.28
	101-63-54101	53338-		P-U-5	40 mm	80 mm	KOM-707-99-23010	121.28
TRIMMING	101-63-79300	45001-		P-U-14	35 mm	70 mm	KOM-707-98-12440	83.38
	101-63-79400	45001-		P-U-14	35 mm	70 mm	KOM-707-98-12440	83.38
TRIMMING LIFT	101-63-69300	45001-		P-U-5	35 mm	70 mm	KOM-707-99-13410	131.33
	101-63-69400	45001-		P-U-5	35 mm	70 mm	KOM-707-99-13410	131.33
MODEL D20A-6								
3-POINT HITCH	101-63-02130	60001-		P-U-10	35 mm	70 mm	KOM-707-98-12450	108.77
	101-63-02140	60001-		P-U-10	35 mm	70 mm	KOM-707-98-12450	108.77
ANGLE LIFT	10G-63-02010	60001-		P-U-10	35 mm	50 mm	KOM-707-98-05420	83.07
	10G-63-02020	60001-		P-U-10	35 mm	50 mm	KOM-707-98-05420	83.07
PAT ANGLE	101-63-02030	60001-		P-U-10	35 mm	70 mm	KOM-707-98-12490	111.49
PAT LIFT	101-63-02010	60001-		P-U-10	35 mm	70 mm	KOM-707-98-12510	122.13
PAT TILT	101-63-02040	60001-		P-U-10	40 mm	80 mm	KOM-707-98-23030	76.37
TRIMMING	101-63-02060	60001-		P-U-10	35 mm	70 mm	KOM-707-98-12450	108.77
	101-63-02070	60001-		P-U-10	35 mm	70 mm	KOM-707-98-12450	108.77
TRIMMING LIFT	101-63-02080	60001-		P-U-10	45 mm	70 mm	KOM-707-98-15410	96.42
	101-63-02090	60001-		P-U-10	45 mm	70 mm	KOM-707-98-15410	96.42
MODEL D20A-7, D21A-7								
3-POINT HITCH LH	101-63-02130	75001-		P-U-14	35 mm	70 mm	KOM-101-63-02130K	44.33
	101-63-02130	75001-		Bushing	35 mm		KOM-07177-03525	8.22
	101-63-02130	78604-		P-U-14	35 mm	70 mm	KOM-101-63-02130K	44.33
	101-63-02130	78604-		Bushing	35 mm		KOM-07177-03525	8.22
3-POINT HITCH RH	101-63-02140	75001-		P-U-14	35 mm	70 mm	KOM-101-63-02140K	44.33
	101-63-02140	75001-		Bushing	35 mm		KOM-07177-03525	8.22
	101-63-02140	78604-		P-U-14	35 mm	70 mm	KOM-101-63-02140K	44.33
	101-63-02140	78604-		Bushing	35 mm		KOM-07177-03525	8.22
ANGLE (PAT)	101-63-02030	75001-78603		P-U-14	35 mm	70 mm	KOM-101-63-02030K	37.92
	101-63-02030	75001-78603		Bushing	35 mm		KOM-07177-03525	8.22
	101-63-02031	78604-		P-U-14	35 mm	70 mm	KOM-707-98-13420	36.95
	101-63-02031	78604-		Bushing	35 mm		KOM-07177-03525	8.22
BLADE LIFT LH	10G-63-02010	78604-		P-U-10	35 mm	50 mm	KOM-10G-63-02010K	72.68
	10G-63-02010	78604-		Bushing	35 mm		KOM-07177-03525	8.22
BLADE LIFT LH (PAT)	101-63-02011	78604-		P-U-14	35 mm	70 mm	KOM-707-98-13420	36.95
	101-63-02011	78604-		Bushing	35 mm		KOM-07177-03525	8.22
BLADE LIFT RH	10G-63-02020	78604-		P-U-10	35 mm	50 mm	KOM-10G-63-02020K	72.68
	10G-63-02020	78604-		Bushing	35 mm		KOM-07177-03525	8.22
BLADE LIFT RH (PAT)	101-63-02021	78604-		P-U-14	35 mm	70 mm	KOM-707-98-13420	36.95
	101-63-02021	78604-		Bushing	35 mm		KOM-07177-03525	8.22
GUIDE PLATE (PAT)	21S-63-02050	78604-	D20A-7	P-U-10	25 mm	50 mm	KOM-21S-63-02050K	76.27
	21S-63-02050	78604-		Bushing	25 mm		KOM-07177-02525	5.46
LIFT (PAT)	101-63-02010	75001-78603		P-U-14	35 mm	70 mm	KOM-101-63-02010K	37.92
	101-63-02010	75001-78603		Bushing	35 mm		KOM-07177-03525	8.22
LIFT LH	10G-63-02010	75001-		P-U-10	35 mm	50 mm	KOM-10G-63-02010K	72.68
	10G-63-02010	75001-		Bushing	35 mm		KOM-07177-03525	8.22
LIFT LH (PAT)	101-63-02011	78604-		P-U-14	35 mm	70 mm	KOM-707-98-13420	36.95
	101-63-02011	78604-		Bushing	35 mm		KOM-07177-03525	8.22
LIFT RH	10G-63-02020	75001-		P-U-10	35 mm	50 mm	KOM-10G-63-02020K	72.68
	10G-63-02020	75001-		Bushing	35 mm		KOM-07177-03525	8.22
LIFT RH (PAT)	101-63-02021	78604-		P-U-14	35 mm	70 mm	KOM-707-98-13420	36.95
	101-63-02021	78604-		Bushing	35 mm		KOM-07177-03525	8.22

LT - Large size tire L/S - Loading Shovel SLF - Super Long Front B/H - Backhoe HD - Heavy Duty L BUCKET - Large Bucket
 K-LINK - K-type Linkage Blade LB HI-LIFT - High Lift Arm w Large Bucket HI-LIFT - High Lift Arm S HI-LIFT - Super High Lift Arm
 SU - Semi-U Dozer PAT - Power Angle Power Tilt MP - Mult-Purpose

Replacement Kits For

KOMATSU®

Crawler Dozers									
APPLICATION	CYL #	SERIAL #	Misc	CODE	ROD	BORE	KIT #	List \$	
MODEL D20A-7, D21A-7									
TILT (PAT)	101-63-02040	75001-78603		P-U-10	40 mm	80 mm	KOM-101-63-02040K	42.34	
	101-63-02040	75001-78603		Bushing	40 mm		KOM-07177-04025	9.33	
	101-63-02041	78604-		P-U-10	40 mm	80 mm	KOM-707-98-23070	49.38	
	101-63-02041	78604-		Bushing	40 mm		KOM-07177-04025	9.33	
MODEL D20P-5									
LIFT	10G-63-13100	45003-53245		P-U-5	35 mm	70 mm	KOM-707-99-13410	131.33	
	10G-63-13101	53246-		P-U-5	35 mm	70 mm	KOM-707-99-13410	131.33	
	10G-63-13200	45003-53245		P-U-5	35 mm	70 mm	KOM-707-99-13410	131.33	
	10G-63-13201	53246-		P-U-5	35 mm	70 mm	KOM-707-99-13410	131.33	
TILT	101-63-52100	45003-53245		P-U-14	40 mm	80 mm	KOM-707-99-22010	117.80	
	101-63-52101	53246-		P-U-14	40 mm	80 mm	KOM-707-99-22010	117.80	
TRIMMING	101-63-79300	45003-		P-U-14	35 mm	70 mm	KOM-707-98-12440	83.38	
	101-63-79400	45003-		P-U-14	35 mm	70 mm	KOM-707-98-12440	83.38	
TRIMMING LIFT	101-63-69300	45003-		P-U-5	35 mm	70 mm	KOM-707-99-13410	131.33	
	101-63-69400	45003-		P-U-5	35 mm	70 mm	KOM-707-99-13410	131.33	
MODEL D20P-5A									
PAT ANGLE	101-63-55100	45003-		P-U-5	35 mm	70 mm	KOM-707-99-13410	131.33	
PAT LIFT	101-63-13100	45003-		P-U-5	35 mm	70 mm	KOM-707-99-13410	131.33	
PAT TILT	101-63-54100	45003-		P-U-5	40 mm	80 mm	KOM-707-99-23010	121.28	
MODEL D20P-6									
3-POINT HITCH	101-63-02130	60001-		P-U-10	35 mm	70 mm	KOM-707-98-12450	108.77	
	101-63-02140	60001-		P-U-10	35 mm	70 mm	KOM-707-98-12450	108.77	
LIFT	10G-63-02010	60001-		P-U-10	35 mm	50 mm	KOM-707-98-05420	83.07	
TILT	101-63-02050	60001-		P-U-10	40 mm	80 mm	KOM-707-98-23030	76.37	
TRIMMING	101-63-02060	60001-		P-U-10	35 mm	70 mm	KOM-707-98-12450	108.77	
	101-63-02070	60001-		P-U-10	35 mm	70 mm	KOM-707-98-12450	108.77	
TRIMMING LIFT	101-63-02080	60001-		P-U-10	45 mm	70 mm	KOM-707-98-15410	96.42	
	101-63-02090	60001-		P-U-10	45 mm	70 mm	KOM-707-98-15410	96.42	
MODEL D20P-6A									
3-POINT HITCH	101-63-02130	60001-		P-U-10	35 mm	70 mm	KOM-707-98-12450	108.77	
	101-63-02140	60001-		P-U-10	35 mm	70 mm	KOM-707-98-12450	108.77	
PAT ANGLE	101-63-02030	60001-		P-U-10	35 mm	70 mm	KOM-707-98-12490	111.49	
PAT LIFT	101-63-02010	60001-		P-U-10	35 mm	70 mm	KOM-707-98-12510	122.13	
PAT TILT	101-63-02040	60001-		P-U-10	40 mm	80 mm	KOM-707-98-23030	76.37	
MODEL D20P-7A, D21P-7A									
3-POINT HITCH LH	101-63-02130	75001-		P-U-14	35 mm	70 mm	KOM-101-63-02130K	44.33	
	101-63-02130	75001-		Bushing	35 mm		KOM-07177-03525	8.22	
	101-63-02130	78604-		P-U-14	35 mm	70 mm	KOM-101-63-02130K	44.33	
	101-63-02130	78604-		Bushing	35 mm		KOM-07177-03525	8.22	
3-POINT HITCH RH	101-63-02140	75001-		P-U-14	35 mm	70 mm	KOM-101-63-02140K	44.33	
	101-63-02140	75001-		Bushing	35 mm		KOM-07177-03525	8.22	
	101-63-02140	78604-		P-U-14	35 mm	70 mm	KOM-101-63-02140K	44.33	
	101-63-02140	78604-		Bushing	35 mm		KOM-07177-03525	8.22	
ANGLE	101-63-02030	75001-78603		P-U-14	35 mm	70 mm	KOM-101-63-02030K	37.92	
	101-63-02030	75001-78603		Bushing	35 mm		KOM-07177-03525	8.22	
	101-63-02031	78604-		P-U-14	35 mm	70 mm	KOM-707-98-13420	36.95	
	101-63-02031	78604-		Bushing	35 mm		KOM-07177-03525	8.22	
BLADE LIFT LH	101-63-02011	78604-		P-U-14	35 mm	70 mm	KOM-707-98-13420	36.95	
	101-63-02011	78604-		Bushing	35 mm		KOM-07177-03525	8.22	
BLADE LIFT RH	101-63-02021	78604-		P-U-14	35 mm	70 mm	KOM-707-98-13420	36.95	
	101-63-02021	78604-		Bushing	35 mm		KOM-07177-03525	8.22	
LIFT	101-63-02010	75001-78603		P-U-14	35 mm	70 mm	KOM-101-63-02010K	37.92	
	101-63-02010	75001-78603		Bushing	35 mm		KOM-07177-03525	8.22	
LIFT LH	101-63-02011	78604-		P-U-14	35 mm	70 mm	KOM-707-98-13420	36.95	
	101-63-02011	78604-		Bushing	35 mm		KOM-07177-03525	8.22	

LT - Large size tire L/S - Loading Shovel SLF - Super Long Front B/H - Backhoe HD - Heavy Duty L BUCKET - Large Bucket
 K-LINK - K-type Linkage Blade LB HI-LIFT - High Lift Arm w Large Bucket HI-LIFT - High Lift Arm S HI-LIFT - Super High Lift Arm
 SU - Semi-U Dozer PAT - Power Angle Power Tilt MP - Mult-Purpose

Replacement Kits For

KOMATSU®

Crawler Dozers								
APPLICATION	CYL #	SERIAL #	Misc	CODE	ROD	BORE	KIT #	List \$
MODEL D20P-7A, D21P-7A								
LIFT RH	101-63-02021	78604-		P-U-14	35 mm	70 mm	KOM-707-98-13420	36.95
	101-63-02021	78604-		Bushing	35 mm		KOM-07177-03525	8.22
TILT	101-63-02040	75001-78603		P-U-10	40 mm	80 mm	KOM-101-63-02040K	42.34
	101-63-02040	75001-78603		Bushing	40 mm		KOM-07177-04025	9.33
	101-63-02041	78604-		P-U-10	40 mm	80 mm	KOM-707-98-23070	49.38
	101-63-02041	78604-		Bushing	40 mm		KOM-07177-04025	9.33
MODEL D20PL-5								
LIFT	10G-63-13100	45001-50601		P-U-5	35 mm	70 mm	KOM-707-99-13410	131.33
	10G-63-13101	50602-		P-U-5	35 mm	70 mm	KOM-707-99-13410	131.33
	10G-63-13200	45001-50601		P-U-5	35 mm	70 mm	KOM-707-99-13410	131.33
	10G-63-13201	50602-		P-U-5	35 mm	70 mm	KOM-707-99-13410	131.33
TILT	101-63-52100	45001-50601		P-U-14	40 mm	80 mm	KOM-707-99-22010	117.80
	101-63-52101	50602-		P-U-14	40 mm	80 mm	KOM-707-99-22010	117.80
MODEL D20PLL-6								
3-POINT HITCH	101-63-02130	60001-		P-U-10	35 mm	70 mm	KOM-707-98-12450	108.77
	101-63-02140	60001-		P-U-10	35 mm	70 mm	KOM-707-98-12450	108.77
LIFT	10G-63-02030	60001-60204		P-U-10	35 mm	50 mm	KOM-707-98-05420	83.07
	10G-63-02040	60001-60204		P-U-10	35 mm	50 mm	KOM-707-98-05420	83.07
	10G-63-02111	60205-		P-U-10	35 mm	50 mm	KOM-707-98-05420	83.07
	10G-63-02121	60205-		P-U-10	35 mm	50 mm	KOM-707-98-05420	83.07
TILT	101-63-02050	60001-		P-U-10	40 mm	80 mm	KOM-707-98-23030	76.37
MODEL D20Q-5								
LIFT	103-63-22100	45368-51505		P-U-5	45 mm	80 mm	KOM-707-98-24050	120.71
	103-63-22101	51506-		P-U-5	45 mm	80 mm	KOM-707-98-24050	120.71
	103-63-22200	45368-51505		P-U-5	45 mm	80 mm	KOM-707-98-24050	120.71
	103-63-22201	51506-		P-U-5	45 mm	80 mm	KOM-707-98-24050	120.71
MODEL D20Q-6								
3-POINT HITCH	101-33-02130	60001-		P-U-10	35 mm	70 mm	KOM-707-98-12450	108.77
	101-63-02140	60001-		P-U-10	35 mm	70 mm	KOM-707-98-12450	108.77
DUMP	103-63-02030	60001-		P-U-10	35 mm	60 mm	KOM-707-98-12130	100.70
	103-63-02040	60001-		P-U-10	35 mm	60 mm	KOM-707-98-12130	100.70
LIFT	103-63-02010	60001-		P-U-10	45 mm	80 mm	KOM-707-98-24070	49.54
MODEL D20S-5								
LIFT	103-63-22100	45001-51497		P-U-5	45 mm	80 mm	KOM-707-98-24050	120.71
	103-63-22101	51498-		P-U-5	45 mm	80 mm	KOM-707-98-24050	120.71
	103-63-22200	45001-51497		P-U-5	45 mm	80 mm	KOM-707-98-24050	120.71
	103-63-22201	51498-		P-U-5	45 mm	80 mm	KOM-707-98-24050	120.71
MODEL D20S-6								
3-POINT HITCH	101-33-02130	60001-		P-U-10	35 mm	70 mm	KOM-707-98-12450	108.77
	101-63-02140	60001-		P-U-10	35 mm	70 mm	KOM-707-98-12450	108.77
DUMP	103-63-02030	60001-		P-U-10	35 mm	60 mm	KOM-707-98-12130	100.70
	103-63-02040	60001-		P-U-10	35 mm	60 mm	KOM-707-98-12130	100.70
LIFT	103-63-02010	60001-		P-U-10	45 mm	80 mm	KOM-707-98-24070	49.54
MODEL D21A-5								
PAT ANGLE	101-63-55100	45001-53276		P-U-5	35 mm	70 mm	KOM-707-99-13410	131.33
	101-63-55101	53277-		P-U-5	35 mm	70 mm	KOM-707-99-13410	131.33
PAT LIFT	101-63-13100	45001-53276		P-U-5	35 mm	70 mm	KOM-707-99-13410	131.33
	101-63-13101	53277-		P-U-5	35 mm	70 mm	KOM-707-99-13410	131.33
	101-63-13200	45001-53276		P-U-5	35 mm	70 mm	KOM-707-99-13410	131.33
	101-63-13201	53277		P-U-5	35 mm	70 mm	KOM-707-99-13410	131.33
PAT TILT	101-63-54100	45001-53276		P-U-5	40 mm	80 mm	KOM-707-99-23010	121.28
	101-63-54101	53277-		P-U-5	40 mm	80 mm	KOM-707-99-23010	121.28
MODEL D21A-6								
3-POINT HITCH	101-63-02130	60001-		P-U-10	35 mm	70 mm	KOM-707-98-12450	108.77
	101-63-02140	60001-		P-U-10	35 mm	70 mm	KOM-707-98-12450	108.77
ANGLE LIFT	10G-63-02010	60001-		P-U-10	35 mm	50 mm	KOM-707-98-05420	83.07

LT - Large size tire L/S - Loading Shovel SLF - Super Long Front B/H - Backhoe HD - Heavy Duty L BUCKET - Large Bucket

K-LINK - K-type Linkage Blade LB HI-LIFT - High Lift Arm w Large Bucket HI-LIFT - High Lift Arm S HI-LIFT - Super High Lift Arm

SU - Semi-U Dozer PAT - Power Angle Power Tilt MP - Mult-Purpose

KOMATSU®

Replacement Kits For

KOMATSU®

Crawler Dozers								
APPLICATION	CYL #	SERIAL #	Misc	CODE	ROD	BORE	KIT #	List \$
MODEL D21A-6								
ANGLE LIFT	10G-63-02020	60001-		P-U-10	35 mm	50 mm	KOM-707-98-05420	83.07
PAT ANGLE	101-63-02030	60001-		P-U-10	35 mm	70 mm	KOM-707-98-12490	111.49
PAT LIFT	101-63-02030	60001-		P-U-10	35 mm	70 mm	KOM-707-98-12510	122.13
PAT TILT	101-63-02040	60001-		P-U-10	40 mm	80 mm	KOM-707-98-23030	76.37
TRIMMING	101-63-02060	60001-		P-U-10	35 mm	70 mm	KOM-707-98-12450	108.77
	101-63-02070	60001-		P-U-10	35 mm	70 mm	KOM-707-98-12450	108.77
TRIMMING LIFT	101-63-02080	60001-		P-U-10	45 mm	70 mm	KOM-707-98-15410	96.42
	101-63-02090	60001-		P-U-10	45 mm	70 mm	KOM-707-98-15410	96.42
MODEL D21A-8, D21P-8								
3-POINT HITCH LH	707-00-0E980	83001-		P-U-14	35 mm	70 mm	KOM-707-98-12760	44.16
	707-00-0E980	83001-		Bushing	35 mm		KOM-07177-03525	8.22
3-POINT HITCH RH	707-00-0E990	83001-		P-U-14	35 mm	70 mm	KOM-707-98-12760	44.16
	707-00-0E990	83001-		Bushing	35 mm		KOM-07177-03525	8.22
BLADE ANGLE	707-00-0E920	83001-		P-U-14	35 mm	70 mm	KOM-707-98-12750	37.91
	707-00-0E920	83001-		Bushing	35 mm		KOM-07177-03525	8.22
BLADE LIFT LH	707-00-0E870	83001-		P-U-14	35 mm	70 mm	KOM-707-98-12740	45.19
	707-00-0E870	83001-		Bushing	35 mm		KOM-07177-03525	8.22
	707-00-0E930	83001-	D21A-8	P-U-10	35 mm	50 mm	KOM-707-98-05460	71.77
	707-00-0E930	83001-		Bushing	35 mm		KOM-07177-03525	8.22
BLADE LIFT RH	707-00-0E880	83001-		P-U-14	35 mm	70 mm	KOM-707-98-12740	45.19
	707-00-0E880	83001-		Bushing	35 mm		KOM-07177-03525	8.22
	707-00-0E940	83001-	D21A-8	P-U-10	35 mm	50 mm	KOM-707-98-05460	71.77
	707-00-0E940	83001-		Bushing	35 mm		KOM-07177-03525	8.22
BLADE TILT	707-00-0E910	83001-		P-U-10	40 mm	80 mm	KOM-707-98-22290	49.38
	707-00-0E910	83001-		Bushing	40 mm		KOM-07177-04025	9.33
MODEL D21E-6								
3-POINT HITCH	101-63-02130	60001-		P-U-10	35 mm	70 mm	KOM-707-98-12450	108.77
	101-63-02140	60001-		P-U-10	35 mm	70 mm	KOM-707-98-12450	108.77
PAT ANGLE	101-63-02030	60001-		P-U-10	35 mm	70 mm	KOM-707-98-12490	111.49
PAT LIFT	101-63-02010	60001-		P-U-10	35 mm	70 mm	KOM-707-98-12510	122.13
PAT TILT	101-63-02040	60001-		P-U-10	40 mm	80 mm	KOM-707-98-23030	76.37
MODEL D21P-5								
LIFT	10G-63-13100	45007-53306		P-U-5	35 mm	70 mm	KOM-707-99-13410	131.33
	10G-63-13101	53307-		P-U-5	35 mm	70 mm	KOM-707-99-13410	131.33
	10G-63-13200	45007-53306		P-U-5	35 mm	70 mm	KOM-707-99-13410	131.33
	10G-63-13201	53307-		P-U-5	35 mm	70 mm	KOM-707-99-13410	131.33
TILT	101-63-52100	45007-53306		P-U-14	40 mm	80 mm	KOM-707-99-22010	117.80
	101-63-52101	53307-		P-U-14	40 mm	80 mm	KOM-707-99-22010	117.80
MODEL D21P-5A								
PAT ANGLE	101-63-55100	45007-		P-U-5	35 mm	70 mm	KOM-707-99-13410	131.33
PAT LIFT	101-63-13100	45007-		P-U-5	35 mm	70 mm	KOM-707-99-13410	131.33
PAT TILT	101-63-54100	45007-		P-U-5	40 mm	80 mm	KOM-707-99-23010	121.28
MODEL D21P-6								
3-POINT HITCH	101-63-02130	60001-		P-U-10	35 mm	70 mm	KOM-707-98-12450	108.77
	101-63-02140	60001-		P-U-10	35 mm	70 mm	KOM-707-98-12450	108.77
LIFT	10G-63-02010	60001-		P-U-10	35 mm	50 mm	KOM-707-98-05420	83.07
TILT	101-63-02050	60001-		P-U-10	40 mm	80 mm	KOM-707-98-23030	76.37
TRIMMING	101-63-02060	60001-		P-U-10	35 mm	70 mm	KOM-707-98-12450	108.77
	101-63-02070	60001-		P-U-10	35 mm	70 mm	KOM-707-98-12450	108.77
TRIMMING LIFT	101-63-02080	60001-		P-U-10	45 mm	70 mm	KOM-707-98-15410	96.42
	101-63-02090	60001-		P-U-10	45 mm	70 mm	KOM-707-98-15410	96.42
MODEL D21P-6A, D21P-6B								
3-POINT HITCH	101-63-02130	60001-		P-U-10	35 mm	70 mm	KOM-707-98-12450	108.77
	101-63-02140	60001-		P-U-10	35 mm	70 mm	KOM-707-98-12450	108.77
PAT ANGLE	101-63-02030	60001-		P-U-10	35 mm	70 mm	KOM-707-98-12490	111.49

LT - Large size tire L/S - Loading Shovel SLF - Super Long Front B/H - Backhoe HD - Heavy Duty L BUCKET - Large Bucket
 K-LINK - K-type Linkage Blade LB HI-LIFT - High Lift Arm w Large Bucket HI-LIFT - High Lift Arm S HI-LIFT - Super High Lift Arm
 SU - Semi-U Dozer PAT - Power Angle Power Tilt MP - Mult-Purpose

KOMATSU®

Replacement Kits For

Crawler Dozers								
APPLICATION	CYL #	SERIAL #	Misc	CODE	ROD	BORE	KIT #	List \$
MODEL D21P-6A, D21P-6B								
PAT LIFT	101-63-02010	60001-		P-U-10	35 mm	70 mm	KOM-707-98-12510	122.13
PAT TILT	101-63-02040	60001-		P-U-10	40 mm	80 mm	KOM-707-98-23030	76.37
MODEL D21PL-5								
LIFT	10G-63-13100	45013-50606		P-U-5	35 mm	70 mm	KOM-707-99-13410	131.33
	10G-63-13101	50607-		P-U-5	35 mm	70 mm	KOM-707-99-13410	131.33
	10G-63-13200	45013-50606		P-U-5	35 mm	70 mm	KOM-707-99-13410	131.33
	10G-63-13201	50607-		P-U-5	35 mm	70 mm	KOM-707-99-13410	131.33
TILT	101-63-52100	45013-50606		P-U-14	40 mm	80 mm	KOM-707-99-22010	117.80
	101-63-52101	50607-		P-U-14	40 mm	80 mm	KOM-707-99-22010	117.80
MODEL D21Q-5								
LIFT	103-63-22100	45094-51497		P-U-5	45 mm	80 mm	KOM-707-98-24050	120.71
	103-63-22101	51493-		P-U-5	45 mm	80 mm	KOM-707-98-24050	120.71
	103-63-22200	45094-51497		P-U-5	45 mm	80 mm	KOM-707-98-24050	120.71
	103-63-22201	51493-		P-U-5	45 mm	80 mm	KOM-707-98-24050	120.71
MODEL D21Q-6								
3-POINT HITCH	101-33-02130	60001-		P-U-10	35 mm	70 mm	KOM-707-98-12450	108.77
	101-63-02140	60001-		P-U-10	35 mm	70 mm	KOM-707-98-12450	108.77
DUMP	103-63-02030	60001-		P-U-10	35 mm	60 mm	KOM-707-98-12130	100.70
	103-63-02040	60001-		P-U-10	35 mm	60 mm	KOM-707-98-12130	100.70
LIFT	103-63-02010	60001-		P-U-10	45 mm	80 mm	KOM-707-98-24070	49.54
MODEL D21S-5								
LIFT	103-63-22100	45003-51526		P-U-5	45 mm	80 mm	KOM-707-98-24050	120.71
	103-63-22101	51527-		P-U-5	45 mm	80 mm	KOM-707-98-24050	120.71
	103-63-22200	45003-51526		P-U-5	45 mm	80 mm	KOM-707-98-24050	120.71
	103-63-22201	51527-		P-U-5	45 mm	80 mm	KOM-707-98-24050	120.71
MODEL D21S-6								
3-POINT HITCH	101-33-02130	60001-		P-U-10	35 mm	70 mm	KOM-707-98-12450	108.77
	101-63-02140	60001-		P-U-10	35 mm	70 mm	KOM-707-98-12450	108.77
DUMP	103-63-02030	60001-		P-U-10	35 mm	60 mm	KOM-707-98-12130	100.70
	103-63-02040	60001-		P-U-10	35 mm	60 mm	KOM-707-98-12130	100.70
LIFT	103-63-02010	60001-		P-U-10	45 mm	80 mm	KOM-707-98-24070	49.54
MODEL D31A-17								
PAT ANGLE	114-63-55500	32001-		P-U-14	40 mm	90 mm	KOM-114-63-05030	104.49
PAT LIFT	114-63-12500	32001-		P-U-14	40 mm	90 mm	KOM-114-63-05030	104.49
	114-63-12600	32001-		P-U-14	40 mm	90 mm	KOM-114-63-05030	104.49
PAT TILT	114-63-54501	32001-		P-U-14	40 mm	90 mm	KOM-114-63-05030	104.49
RIPPER	113-63-42501	32001-		P-U-14	40 mm	90 mm	KOM-707-98-22500	111.91
TRIMMING	114-63-79500	32001-		P-U-14	40 mm	90 mm	KOM-707-98-22500	111.91
	114-63-79600	32001-		P-U-14	40 mm	90 mm	KOM-707-98-22500	111.91
TRIMMING LIFT	114-63-69500	32001-		P-U-14	40 mm	90 mm	KOM-707-98-22500	111.91
	114-63-69600	32001-		P-U-14	40 mm	90 mm	KOM-707-98-22500	111.91
MODEL D31E-18								
3-POINT HITCH	113-63-49500	40001-		P-U-14	45 mm	80 mm	KOM-707-98-24150	122.51
	113-63-49600	40001-		P-U-14	45 mm	80 mm	KOM-707-98-24150	122.51
ANGLE LIFT	11G-63-02011	40001-		P-U-14	45 mm	70 mm	KOM-707-98-15610	90.33
	11G-63-02021	40001-		P-U-14	45 mm	70 mm	KOM-707-98-15610	90.33
PAT ANGLE	114-63-02031	40001-		P-U-10	40 mm	90 mm	KOM-707-98-22420	109.51
PAT LIFT	114-63-02011	40001-		P-U-10	40 mm	90 mm	KOM-707-98-22420	109.51
PAT TILT	114-63-02041	40001-		P-U-10	40 mm	90 mm	KOM-707-98-22420	109.51
RIPPER	113-63-42501	40001-		P-U-14	40 mm	90 mm	KOM-707-98-22500	111.91
TRIMMING	114-63-02050	40001-		P-U-10	40 mm	90 mm	KOM-707-98-22410	109.51
TRIMMING LIFT	114-63-02070	40001-		P-U-10	40 mm	90 mm	KOM-707-98-22410	109.51
MODEL D31E-20								
ANGLE	114-63-02031	42001-		P-U-10	40 mm	90 mm	KOM-707-98-22410	109.51
	114-63-02031	42001-		Bushing	40 mm		KOM-07177-04025	9.33

LT - Large size tire L/S - Loading Shovel SLF - Super Long Front B/H - Backhoe HD - Heavy Duty L BUCKET - Large Bucket
 K-LINK - K-type Linkage Blade LB HI-LIFT - High Lift Arm w Large Bucket HI-LIFT - High Lift Arm S HI-LIFT - Super High Lift Arm
 SU - Semi-U Dozer PAT - Power Angle Power Tilt MP - Mult-Purpose

Replacement Kits For

KOMATSU®

Crawler Dozers								
APPLICATION	CYL #	SERIAL #	Misc	CODE	ROD	BORE	KIT #	List \$
MODEL D31E-20								
LIFT	11G-63-02011	42001-		P-U-14	45 mm	70 mm	KOM-707-98-15610	90.33
	11G-63-02011	42001-		Bushing	45 mm		KOM-07177-04530	12.81
	11G-63-02021	42001-		P-U-14	45 mm	70 mm	KOM-707-98-15610	90.33
	11G-63-02021	42001-		Bushing	45 mm		KOM-07177-04530	12.81
TILT	114-63-02041	42001-		P-U-10	40 mm	90 mm	KOM-707-98-22410	109.51
	114-63-02041	42001-		Bushing	40 mm		KOM-07177-04025	9.33
MODEL D31EX-21, D31PX-21								
ANGLE	707-00-0A031	50001-		P-U-14	40 mm	75 mm	KOM-707-98-22850	44.70
	707-00-0A031	50001-		Bushing	40 mm		KOM-707-52-10410	10.92
LIFT LH	707-00-0A011	50001-		P-U-14	40 mm	85 mm	KOM-707-98-22910	77.85
	707-00-0A011	50001-		Bushing	40 mm		KOM-07177-04025	9.33
LIFT RH	707-00-0A021	50001-		P-U-14	40 mm	85 mm	KOM-707-98-22910	77.85
	707-00-0A021	50001-		Bushing	40 mm		KOM-07177-04025	9.33
RIPPER	707-00-0C050	50001-	D31EX-21	P-U-14	45 mm	90 mm	KOM-707-98-24720	43.69
	707-00-0C050	50001-		Bushing	45 mm		KOM-07177-04530	12.81
TILT	707-00-0A041	50001-		P-U-14	45 mm	90 mm	KOM-707-98-24710	41.99
	707-00-0A041	50001-		Bushing	45 mm		KOM-07177-04530	12.81
MODEL D31EX-21A, D31PX-21A								
ANGLE	707-00-0A032	50501-50683	D31EX-21A	P-UB-14	40 mm	75 mm	KOM-707-99-14930	104.17
	707-00-0A032	50501-50683		Bushing	40 mm		KOM-707-52-90150	9.33
	707-00-0A032	50501-50897	D31PX-21A	P-UB-14	40 mm	75 mm	KOM-707-99-14930	104.17
	707-00-0A032	50501-50897		Bushing	40 mm		KOM-707-52-90150	9.33
	707-00-0A033	50684-	D31EX-21A	P-UB-14	40 mm	75 mm	KOM-707-99-14930	104.17
	707-00-0A033	50684-		Bushing	40 mm		KOM-707-52-90150	9.33
	707-00-0A033	50898-	D31PX-21A	P-UB-14	40 mm	75 mm	KOM-707-99-14930	104.17
	707-00-0A033	50898-		Bushing	40 mm		KOM-707-52-90150	9.33
LIFT LH	707-00-0A012	50501-		P-UB-14	40 mm	85 mm	KOM-707-99-23910	137.33
	707-00-0A012	50501-		Bushing	40 mm		KOM-707-52-90150	9.33
LIFT RH	707-00-0A022	50501-		P-UB-14	40 mm	85 mm	KOM-707-99-23910	137.33
	707-00-0A022	50501-		Bushing	40 mm		KOM-707-52-90150	9.33
RIPPER	707-00-0C051	50501-	D31EX-21A	P-UB-14	45 mm	90 mm	KOM-707-99-24660	126.80
	707-00-0C051	50501-		Bushing	45 mm		KOM-707-52-90220	9.33
TILT	707-00-0A042	50501-		P-UB-14	45 mm	90 mm	KOM-707-99-24670	125.10
	707-00-0A042	50501-		Bushing	45 mm		KOM-707-52-90220	9.33
MODEL D31EX-22								
BLADE ANGLE	707-00-0H610	60001-		P-UB-14	40 mm	80 mm	KOM-707-99-23040	118.43
	707-00-0H610	60001-		Bushing	40 mm		KOM-707-52-90150	9.33
BLADE LIFT	707-00-0H860	60001-		P-UB-14	40 mm	75 mm	KOM-707-99-14960	144.21
	707-00-0H860	60001-		Bushing	40 mm		KOM-707-52-90150	9.33
BLADE TILT	707-00-0H600	60001-		P-UB-14	45 mm	90 mm	KOM-707-99-24650	125.03
	707-00-0H600	60001-		Bushing	45 mm		KOM-707-52-90220	9.33
RIPPER	707-00-0H920	60001-		P-U-14	55 mm	105 mm	KOM-707-99-34240	128.50
	707-00-0H920	60001-		Bushing	55 mm		KOM-707-52-90300	18.49
MODEL D31P-17								
LIFT	11G-63-13500	32001-		P-U-14	40 mm	90 mm	KOM-114-63-05030	104.49
	11G-63-13600	32001-		P-U-14	40 mm	90 mm	KOM-114-63-05030	104.49
TILT	11G-63-52500	32001-		P-U-14	40 mm	90 mm	KOM-707-98-22500	111.91
TRIMMING	114-63-79500	32001-		P-U-14	40 mm	90 mm	KOM-707-98-22500	111.91
	114-63-79600	32001-		P-U-14	40 mm	90 mm	KOM-707-98-22500	111.91
TRIMMING LIFT	114-63-69500	32001-		P-U-14	40 mm	90 mm	KOM-707-98-22500	111.91
	114-63-69600	32001-		P-U-14	40 mm	90 mm	KOM-707-98-22500	111.91
MODEL D31P-17A, D31P-17B								
3-POINT HITCH	113-63-49500	32001-		P-U-14	45 mm	80 mm	KOM-707-98-24150	122.51
	113-63-49600	32001-		P-U-14	45 mm	80 mm	KOM-707-98-24150	122.51
PAT ANGLE	114-63-55500	32001-		P-U-14	40 mm	90 mm	KOM-114-63-05030	104.49

LT - Large size tire L/S - Loading Shovel SLF - Super Long Front B/H - Backhoe HD - Heavy Duty L BUCKET - Large Bucket
 K-LINK - K-type Linkage Blade LB HI-LIFT - High Lift Arm w Large Bucket HI-LIFT - High Lift Arm S HI-LIFT - Super High Lift Arm
 SU - Semi-U Dozer PAT - Power Angle Power Tilt MP - Mult-Purpose

KOMATSU®

Replacement Kits For

Crawler Dozers								
APPLICATION	CYL #	SERIAL #	Misc	CODE	ROD	BORE	KIT #	List \$
MODEL D31P-17A, D31P-17B								
PAT LIFT	114-63-12500	32001-		P-U-14	40 mm	90 mm	KOM-114-63-05030	104.49
	114-63-12600	32001-		P-U-14	40 mm	90 mm	KOM-114-63-05030	104.49
PAT TILT	114-63-54501	32001-		P-U-14	40 mm	90 mm	KOM-114-63-05030	104.49
MODEL D31P-18, D31PL-18, D31PLL-18								
3-POINT HITCH	113-63-49500	40001-		P-U-14	45 mm	80 mm	KOM-707-98-24150	122.51
	113-63-49600	40001-		P-U-14	45 mm	80 mm	KOM-707-98-24150	122.51
LIFT	11G-63-02011	40001-		P-U-14	45 mm	70 mm	KOM-707-98-15610	90.33
	11G-63-02021	40001-		P-U-14	45 mm	70 mm	KOM-707-98-15610	90.33
TILT	11G-63-02051	40001-		P-U-10	40 mm	90 mm	KOM-707-98-22410	109.51
MODEL D31P-18A								
3-POINT HITCH	113-63-49500	40001-		P-U-14	45 mm	80 mm	KOM-707-98-24150	122.51
	113-63-49600	40001-		P-U-14	45 mm	80 mm	KOM-707-98-24150	122.51
PAT ANGLE	114-63-02031	40001-		P-U-10	40 mm	90 mm	KOM-707-98-22410	109.51
PAT LIFT	114-63-02011	40001-		P-U-10	40 mm	90 mm	KOM-707-98-22410	109.51
PAT TILT	114-63-02041	40001-		P-U-10	40 mm	90 mm	KOM-707-98-22410	109.51
MODEL D31P-20								
ANGLE	114-63-02031	45001-		P-U-10	40 mm	90 mm	KOM-707-98-22410	109.51
LIFT	114-63-02011	45001-		P-U-10	40 mm	90 mm	KOM-707-98-22410	109.51
TILT	114-63-02041	45001-		P-U-10	40 mm	90 mm	KOM-707-98-22410	109.51
MODEL D31PL-17, D31PLL-17								
LIFT	11G-63-13500	32001-		P-U-14	40 mm	90 mm	KOM-114-63-05030	104.49
	11G-63-13600	32001-		P-U-14	40 mm	90 mm	KOM-114-63-05030	104.49
TILT	11G-63-52500	32001-		P-U-14	40 mm	90 mm	KOM-707-98-22500	111.91
MODEL D31PX-22								
BLADE ANGLE	707-00-0H610	60001-		P-UB-14	40 mm	80 mm	KOM-707-99-23040	118.43
	707-00-0H610	60001-		Bushing	40 mm		KOM-707-52-90150	9.33
BLADE LIFT	707-00-0H860	60001-		P-UB-14	40 mm	75 mm	KOM-707-99-14960	144.21
	707-00-0H860	60001-		Bushing	40 mm		KOM-707-52-90150	9.33
	707-E0-00190	60001-		P-UB-14	40 mm	75 mm	KOM-707-99-14970	115.64
	707-E0-00190	60001-		Bushing	40 mm		KOM-707-52-90151	9.33
BLADE TILT	707-00-0H600	60001-		P-UB-14	45 mm	90 mm	KOM-707-99-24650	125.03
	707-00-0H600	60001-		Bushing	45 mm		KOM-707-52-90220	9.33
REAR GUARD	707-E0-00200	60001-		P-U-14	30 mm	50 mm	KOM-707-98-04590	81.79
	707-E0-00200	60001-		Bushing	30 mm		KOM-707-52-15050	7.41
TRIMMING	707-E0-00180	60001-		P-UB-14	40 mm	75 mm	KOM-707-99-14980	132.26
	707-E0-00180	60001-		Bushing	40 mm		KOM-707-52-90151	9.33
MODEL D31Q-17								
DUMP	113-63-32500	32001-		P-U-14	45 mm	80 mm	KOM-707-98-24150	122.51
	113-63-32600	32001-		P-U-14	45 mm	80 mm	KOM-707-98-24150	122.51
LIFT	113-63-22500	32001-		P-U-14	50 mm	100 mm	KOM-707-99-32010	156.65
	113-63-22600	32001-		P-U-14	50 mm	100 mm	KOM-707-99-32010	156.65
MODEL D31Q-18								
3-POINT HITCH	113-63-49500	40001-		P-U-14	45 mm	80 mm	KOM-707-98-24150	122.51
	113-63-49600	40001-		P-U-14	45 mm	80 mm	KOM-707-98-24150	122.51
LIFT	113-63-02011	40001-		P-U-14	50 mm	100 mm	KOM-707-98-32050	146.96
	113-63-02021	40001-		P-U-14	50 mm	100 mm	KOM-707-98-32050	146.96
MODEL D31Q-20								
LIFT	113-63-02011	42001-		P-U-14	50 mm	100 mm	KOM-707-98-32050	146.96
	113-63-02021	42001-		P-U-14	50 mm	100 mm	KOM-707-98-32050	146.96
MODEL D31S-17								
BUCKET CLAM (MP)	113-63-59500	32001-		P-U-14	45 mm	80 mm	KOM-707-98-24150	122.51
DUMP	113-63-32500	32001-		P-U-14	45 mm	80 mm	KOM-707-98-24150	122.51
	113-63-32600	32001-		P-U-14	45 mm	80 mm	KOM-707-98-24150	122.51
LIFT	113-63-22500	32001-		P-U-14	50 mm	100 mm	KOM-707-99-32010	156.65
	113-63-22600	32001-		P-U-14	50 mm	100 mm	KOM-707-99-32010	156.65

LT - Large size tire L/S - Loading Shovel SLF - Super Long Front B/H - Backhoe HD - Heavy Duty L BUCKET - Large Bucket
 K-LINK - K-type Linkage Blade LB HI-LIFT - High Lift Arm w Large Bucket HI-LIFT - High Lift Arm S HI-LIFT - Super High Lift Arm
 SU - Semi-U Dozer PAT - Power Angle Power Tilt MP - Mult-Purpose

Replacement Kits For

KOMATSU®

Crawler Dozers								
APPLICATION	CYL #	SERIAL #	Misc	CODE	ROD	BORE	KIT #	List \$
MODEL D31S-18								
3-POINT HITCH	113-63-49500	40001-		P-U-14	45 mm	80 mm	KOM-707-98-24150	122.51
	113-63-49600	40001-		P-U-14	45 mm	80 mm	KOM-707-98-24150	122.51
BUCKET CLAM (MP)	113-63-59500	40001-		P-U-14	45 mm	80 mm	KOM-707-98-24150	122.51
LIFT	113-63-02011	40001-		P-U-14	50 mm	100 mm	KOM-707-98-32050	146.96
	113-63-02021	40001-		P-U-14	50 mm	100 mm	KOM-707-98-32050	146.96
RIPPER	113-63-42501	40001-		P-U-14	40 mm	90 mm	KOM-707-98-22500	111.91
MODEL D31S-20								
LIFT	113-63-02011	42001-		P-U-14	50 mm	100 mm	KOM-707-98-32050	146.96
	113-63-02021	42001-		P-U-14	50 mm	100 mm	KOM-707-98-32050	146.96
MODEL D37E-1, D37P-1								
3-POINT HITCH	113-63-49500	1001-		P-U-14	45 mm	80 mm	KOM-707-98-24150	122.51
	113-63-49600	1001-		P-U-14	45 mm	80 mm	KOM-707-98-24150	122.51
ANGLE LIFT	11G-63-13500	1001-		P-U-14	40 mm	90 mm	KOM-114-63-05030	104.49
	11G-63-13600	1001-		P-U-14	40 mm	90 mm	KOM-114-63-05030	104.49
PAT ANGLE	114-63-55500	1001-		P-U-14	40 mm	90 mm	KOM-114-63-05030	104.49
PAT LIFT	114-63-12500	1001-		P-U-14	40 mm	90 mm	KOM-114-63-05030	104.49
	114-63-12600	1001-		P-U-14	40 mm	90 mm	KOM-114-63-05030	104.49
PAT TILT	114-63-54501	1001-		P-U-14	40 mm	90 mm	KOM-114-63-05030	104.49
RIPPER	113-63-42501	1001-	D37E-1	P-U-14	40 mm	90 mm	KOM-707-98-22500	111.91
MODEL D37E-2, D37P-2								
3-POINT HITCH	113-63-49500	2001-		P-U-14	45 mm	80 mm	KOM-707-98-24150	122.51
	113-63-49600	2001-		P-U-14	45 mm	80 mm	KOM-707-98-24150	122.51
PAT ANGLE	114-63-02031	2001-		P-U-10	40 mm	90 mm	KOM-707-98-22420	109.51
PAT LIFT	114-63-02011	2001-		P-U-10	40 mm	90 mm	KOM-707-98-22420	109.51
PAT TILT	114-63-02041	2001-		P-U-10	40 mm	90 mm	KOM-707-98-22420	109.51
RIPPER	113-63-42501	2001-	D37E-2	P-U-14	40 mm	90 mm	KOM-707-98-22500	111.91
MODEL D37E-5, D37P-5								
ANGLE	114-63-02031	3001-		P-U-10	40 mm	90 mm	KOM-707-98-22410	109.51
	114-63-02031	3001-		Bushing	40 mm		KOM-07177-04025	9.33
LIFT	114-63-02011	3001-		P-U-10	40 mm	90 mm	KOM-707-98-22410	109.51
	114-63-02011	3001-		Bushing	40 mm		KOM-07177-04025	9.33
TILT	114-63-02011	3001-		P-U-10	40 mm	90 mm	KOM-707-98-22410	109.51
	114-63-02011	3001-		Bushing	40 mm		KOM-07177-04025	9.33
MODEL D37EX-21, D37PX-21								
ANGLE	707-00-0A031	5001-		P-U-14	40 mm	75 mm	KOM-707-98-22850	44.70
	707-00-0A031	5001-		Bushing	40 mm		KOM-707-52-10410	10.92
LIFT LH	707-00-0A011	5001-		P-U-14	40 mm	85 mm	KOM-707-98-22910	77.85
	707-00-0A011	5001-		Bushing	40 mm		KOM-07177-04025	9.33
LIFT RH	707-00-0A021	5001-		P-U-14	40 mm	85 mm	KOM-707-98-22910	77.85
	707-00-0A021	5001-		Bushing	40 mm		KOM-07177-04025	9.33
RIPPER	707-00-0C050	5001-	D37EX-21	P-U-14	45 mm	90 mm	KOM-707-98-24720	43.69
	707-00-0C050	5001-		Bushing	45 mm		KOM-07177-04530	12.81
TILT	707-00-0A041	5001-		P-U-14	45 mm	90 mm	KOM-707-98-24710	41.99
	707-00-0A041	5001-		Bushing	45 mm		KOM-07177-04530	12.81
MODEL D37EX-21A, D37PX-21A								
ANGLE	707-00-0A032	5501-5681	D37PX-21A	P-UB-14	40 mm	75 mm	KOM-707-99-14930	104.17
	707-00-0A032	5501-5736	D37EX-21A	P-UB-14	40 mm	75 mm	KOM-707-99-14930	104.17
	707-00-0A033	5682-	D37PX-21A	P-UB-14	40 mm	75 mm	KOM-707-99-14930	104.17
	707-00-0A033	5737-	D37EX-21A	P-UB-14	40 mm	75 mm	KOM-707-99-14930	104.17
LIFT LH	707-00-0A012	5501-		P-UB-14	40 mm	85 mm	KOM-707-99-23910	137.33
LIFT RH	707-00-0A022	5501-		P-UB-14	40 mm	85 mm	KOM-707-99-23910	137.33
RIPPER	707-00-0C051	5501-	D37EX-21A	P-UB-14	45 mm	90 mm	KOM-707-99-24660	126.80
TILT	707-00-0A042	5501-		P-UB-14	45 mm	90 mm	KOM-707-99-24670	125.10
MODEL D37EX-22								
BLADE ANGLE	707-00-0H610	60001-		P-UB-14	40 mm	80 mm	KOM-707-99-23040	118.43

LT - Large size tire L/S - Loading Shovel SLF - Super Long Front B/H - Backhoe HD - Heavy Duty L BUCKET - Large Bucket
 K-LINK - K-type Linkage Blade LB HI-LIFT - High Lift Arm w Large Bucket HI-LIFT - High Lift Arm S HI-LIFT - Super High Lift Arm
 SU - Semi-U Dozer PAT - Power Angle Power Tilt MP - Multi-Purpose

Replacement Kits For

KOMATSU®

KOMATSU®

Crawler Dozers								
APPLICATION	CYL #	SERIAL #	Misc	CODE	ROD	BORE	KIT #	List \$
MODEL D37EX-22								
BLADE ANGLE	707-00-0H610	60001-		Bushing	40 mm		KOM-707-52-90150	9.33
BLADE LIFT	707-00-0H860	60001-		P-UB-14	40 mm	75 mm	KOM-707-99-14960	144.21
	707-00-0H860	60001-		Bushing	40 mm		KOM-707-52-90150	9.33
BLADE TILT	707-00-0H600	60001-		P-UB-14	45 mm	90 mm	KOM-707-99-24650	125.03
	707-00-0H600	60001-		Bushing	45 mm		KOM-707-52-90220	9.33
RIPPER	707-00-0H920	60001-		P-U-14	55 mm	105 mm	KOM-707-99-34240	128.50
	707-00-0H920	60001-		Bushing	55 mm		KOM-707-52-90300	18.49
MODEL D37PX-22								
BLADE ANGLE	707-00-0H610	60001-		P-UB-14	40 mm	80 mm	KOM-707-99-23040	118.43
	707-00-0H610	60001-		Bushing	40 mm		KOM-707-52-90150	9.33
BLADE LIFT	707-00-0H860	60001-		P-UB-14	40 mm	75 mm	KOM-707-99-14960	144.21
	707-00-0H860	60001-		Bushing	40 mm		KOM-707-52-90150	9.33
BLADE TILT	707-00-0H600	60001-		P-UB-14	45 mm	90 mm	KOM-707-99-24650	125.03
	707-00-0H600	60001-		Bushing	45 mm		KOM-707-52-90220	9.33
MODEL D39EX-21, D39PX-21								
ANGLE	707-00-0A300	1001-		P-U-14	45 mm	85 mm	KOM-707-98-24910	70.52
	707-00-0A300	1001-		Bushing	45 mm		KOM-07177-04530	12.81
LIFT LH	707-00-0A280	1001-		P-U-14	45 mm	90 mm	KOM-707-98-24700	51.65
	707-00-0A280	1001-		Bushing	45 mm		KOM-07177-04530	12.81
LIFT RH	707-00-0A290	1001-		P-U-14	45 mm	90 mm	KOM-707-98-24700	51.65
	707-00-0A290	1001-		Bushing	45 mm		KOM-07177-04530	12.81
RIPPER	707-00-0C050	1001-	D39EX-21	P-U-14	45 mm	90 mm	KOM-707-98-24720	43.69
	707-00-0C050	1001-		Bushing	45 mm		KOM-07177-04530	12.81
TILT	707-00-0A310	1001-		P-U-14	45 mm	90 mm	KOM-707-98-24710	41.99
	707-00-0A310	1001-		Bushing	45 mm		KOM-07177-04530	12.81
MODEL D39EX-21A, D39PX-21A								
ANGLE	707-00-0A301	1501-1806	D39EX-21A	P-UB-14	45 mm	85 mm	KOM-707-99-24930	153.70
	707-00-0A301	1501-1870	D39PX-21A	P-UB-14	45 mm	85 mm	KOM-707-99-24930	153.70
	707-00-0A302	1807-	D39EX-21A	P-UB-14	45 mm	85 mm	KOM-707-99-24930	153.70
	707-00-0A302	1871-	D39PX-21A	P-UB-14	45 mm	85 mm	KOM-707-99-24930	153.70
LIFT LH	707-00-0E680	1501-		P-UB-14	45 mm	90 mm	KOM-707-99-24640	134.84
LIFT RH	707-00-0E690	1501-		P-UB-14	45 mm	90 mm	KOM-707-99-24640	134.84
RIPPER	707-00-0C051	1501-		P-UB-14	45 mm	90 mm	KOM-707-99-24660	126.80
TILT	707-00-0A311	1501-		P-UB-14	45 mm	90 mm	KOM-707-99-24650	125.03
MODEL D39EX-22								
BLADE ANGLE	707-00-0H610	3001-		P-UB-14	40 mm	80 mm	KOM-707-99-23040	118.43
	707-00-0H610	3001-		Bushing	40 mm		KOM-707-52-90150	9.33
BLADE LIFT	707-00-0H620	3001-		P-UB-14	40 mm	75 mm	KOM-707-99-14960	144.21
	707-00-0H620	3001-		Bushing	40 mm		KOM-707-52-90150	9.33
BLADE TILT	707-00-0H600	3001-		P-UB-14	45 mm	90 mm	KOM-707-99-24650	125.03
	707-00-0H600	3001-		Bushing	45 mm		KOM-707-52-90220	9.33
RIPPER	707-00-0H920	3001-		P-U-14	55 mm	105 mm	KOM-707-99-34240	128.50
	707-00-0H920	3001-		Bushing	55 mm		KOM-707-52-90300	18.49
MODEL D39PX-22								
BLADE ANGLE	707-00-0H610	3001-		P-UB-14	40 mm	80 mm	KOM-707-99-23040	118.43
	707-00-0H610	3001-		Bushing	40 mm		KOM-707-52-90150	9.33
BLADE LIFT	707-00-0H620	3001-		P-UB-14	40 mm	75 mm	KOM-707-99-14960	144.21
	707-00-0H620	3001-		Bushing	40 mm		KOM-707-52-90150	9.33
BLADE TILT	707-00-0H600	3001-		P-UB-14	45 mm	90 mm	KOM-707-99-24650	125.03
	707-00-0H600	3001-		Bushing	45 mm		KOM-707-52-90220	9.33
MODEL D40A-1, D40P-1								
LIFT	12F-63-13100	1501-2200		P-U-5	50 mm	80 mm	KOM-707-98-25050	126.46
	12F-63-13103	2201-		P-U-5	50 mm	80 mm	KOM-707-98-25050	126.46
	12F-63-13200	1501-2200		P-U-5	50 mm	80 mm	KOM-707-98-25050	126.46
	12F-63-13203	2201-		P-U-5	50 mm	80 mm	KOM-707-98-25050	126.46

LT - Large size tire L/S - Loading Shovel SLF - Super Long Front B/H - Backhoe HD - Heavy Duty L BUCKET - Large Bucket
 K-LINK - K-type Linkage Blade LB HI-LIFT - High Lift Arm w Large Bucket HI-LIFT - High Lift Arm S HI-LIFT - Super High Lift Arm
 SU - Semi-U Dozer PAT - Power Angle Power Tilt MP - Multi-Purpose

Replacement Kits For

KOMATSU®

Crawler Dozers								
APPLICATION	CYL #	SERIAL #	Misc	CODE	ROD	BORE	KIT #	List \$
MODEL D40A-3								
LIFT	12F-63-13701	6001-		P-U-14	45 mm	70 mm	KOM-12F-63-05020	97.20
	12F-63-13801	6001-		P-U-14	45 mm	70 mm	KOM-12F-63-05020	97.20
RIPPER	125-63-42300	6001-		P-U-14	60 mm	120 mm	KOM-707-98-41130	233.06
TRIMMING	124-63-79500	6001-		P-U-14	45 mm	90 mm	KOM-707-98-24530	167.87
	124-63-79600	6001-		P-U-14	45 mm	90 mm	KOM-707-98-24530	167.87
TRIMMING LIFT	124-63-69500	6001-		P-U-14	45 mm	70 mm	KOM-707-98-15650	97.40
	124-63-69600	6001-		P-U-14	45 mm	70 mm	KOM-707-98-15650	97.40
MODEL D40F-3								
TOOL BAR	120-63-48100	6221-		P-U-14	70 mm	140 mm	KOM-707-98-52100	289.38
	120-63-48200	6221-		P-U-14	70 mm	140 mm	KOM-707-98-52100	289.38
MODEL D40P-3, D40PL-3, D40PLL-3								
LIFT	12F-63-13701	6001-		P-U-14	45 mm	70 mm	KOM-12F-63-05020	97.20
	12F-63-13801	6001-		P-U-14	45 mm	70 mm	KOM-12F-63-05020	97.20
TILT	12F-63-52500	6001-		P-U-14	50 mm	100 mm	KOM-12F-63-05060	161.85
MODEL D40PL-1								
LIFT	12F-63-13100	1925-2200		P-U-5	50 mm	80 mm	KOM-707-98-25050	126.46
	12F-63-13103	2201-		P-U-5	50 mm	80 mm	KOM-707-98-25050	126.46
	12F-63-13200	1925-2200		P-U-5	50 mm	80 mm	KOM-707-98-25050	126.46
	12F-63-13203	2201-		P-U-5	50 mm	80 mm	KOM-707-98-25050	126.46
MODEL D41A-3								
LIFT	12F-63-13701	6001-		P-U-14	45 mm	70 mm	KOM-12F-63-05020	97.20
	12F-63-13801	6001-		P-U-14	45 mm	70 mm	KOM-12F-63-05020	97.20
RIPPER	125-63-42300	6001-		P-U-14	60 mm	120 mm	KOM-707-98-41130	233.06
TRIMMING	124-63-79500	6001-		P-U-14	45 mm	90 mm	KOM-707-98-24530	167.87
	124-63-79600	6001-		P-U-14	45 mm	90 mm	KOM-707-98-24530	167.87
TRIMMING LIFT	124-63-69500	6001-		P-U-14	45 mm	70 mm	KOM-707-98-15650	97.40
	124-63-69600	6001-		P-U-14	45 mm	70 mm	KOM-707-98-15650	97.40
MODEL D41A-6								
BLADE ANGLE	124-63-02210	B20001-		P-U-10	65 mm	130 mm	KOM-707-98-42420	104.71
BLADE LIFT	124-63-02201	B20001-		P-U-14	50 mm	105 mm	KOM-707-98-32820	232.86
BLADE TILT	124-63-02222	B20001-		P-U-14	55 mm	110 mm	KOM-707-98-34590	205.38
MODEL D41E-3								
LIFT	12F-63-13701	6001-		P-U-14	45 mm	70 mm	KOM-12F-63-05020	97.20
	12F-63-13801	6001-		P-U-14	45 mm	70 mm	KOM-12F-63-05020	97.20
PAT ANGLE	124-63-55500	6001-		P-U-14	65 mm	100 mm	KOM-707-98-36180	165.86
	124-63-55600	6001-		P-U-14	65 mm	100 mm	KOM-707-98-36180	165.86
PAT TILT	124-63-54500	6001-		P-U-14	60 mm	120 mm	KOM-707-98-41120	129.10
TILT	12F-63-52500	6001-		P-U-14	50 mm	100 mm	KOM-12F-63-05060	161.85
MODEL D41E-6, D41P-6								
ANGLE	124-63-02210	B20001-		P-U-10	65 mm	130 mm	KOM-707-98-42420	104.71
	124-63-02210	B20001-		Bushing	65 mm		KOM-707-52-10660	22.57
BLADE LIFT	124-63-02201	B20001-		P-U-14	50 mm	105 mm	KOM-707-98-32820	232.86
LIFT	124-63-02201	B20001-		P-U-14	50 mm	105 mm	KOM-707-98-32820	232.86
	124-63-02201	B20001-		Bushing	50 mm		KOM-07177-05030	15.54
RIPPER	125-63-42300	B20001-		P-U-14	60 mm	120 mm	KOM-707-98-41130	233.06
	125-63-42300	B20001-		Bushing	60 mm		KOM-07177-06030	18.65
TILT	124-63-02221	B20001-		P-U-10	65 mm	130 mm	KOM-707-98-42420	104.71
	124-63-02221	B20001-		Bushing	55 mm		KOM-07177-05530	18.35
	124-63-02222	B20001-		P-U-14	55 mm	110 mm	KOM-707-98-34590	205.38
MODEL D41P-3								
LIFT	12F-63-13701	6001-		P-U-14	45 mm	70 mm	KOM-12F-63-05020	97.20
	12F-63-13801	6001-		P-U-14	45 mm	70 mm	KOM-12F-63-05020	97.20
TILT	12F-63-52500	6001-		P-U-14	50 mm	100 mm	KOM-12F-63-05060	161.85
MODEL D41Q-3, D41S-3								
BUCKET CLAM (MP)	125-63-59500	6001-		P-U-14	50 mm	90 mm	KOM-707-98-25510	180.96
LIFT	125-63-22701	6001-		P-U-14	60 mm	110 mm	KOM-707-98-35510	193.10

LT - Large size tire L/S - Loading Shovel SLF - Super Long Front B/H - Backhoe HD - Heavy Duty L BUCKET - Large Bucket

K-LINK - K-type Linkage Blade LB HI-LIFT - High Lift Arm w Large Bucket HI-LIFT - High Lift Arm S HI-LIFT - Super High Lift Arm

SU - Semi-U Dozer PAT - Power Angle Power Tilt MP - Multit-Purpose

Replacement Kits For

KOMATSU®

Crawler Dozers								
APPLICATION	CYL #	SERIAL #	Misc	CODE	ROD	BORE	KIT #	List \$
MODEL D41Q-3, D41S-3								
LIFT	125-63-22801	6001-		P-U-14	60 mm	110 mm	KOM-707-98-35510	193.10
SIDE DUMP	125-63-97500	6001-		P-U-14	50 mm	80 mm	KOM-707-98-25170	183.18
MODEL D45A-1								
LIFT	12F-63-13100	1501-1800		P-U-5	50 mm	80 mm	KOM-707-98-25050	126.46
	12F-63-13103	1801-		P-U-5	50 mm	80 mm	KOM-707-98-25050	126.46
	12F-63-13200	1501-1800		P-U-5	50 mm	80 mm	KOM-707-98-25050	126.46
	12F-63-13203	1801-		P-U-5	50 mm	80 mm	KOM-707-98-25050	126.46
MODEL D45E-1								
LIFT	12F-63-13103	1803-		P-U-5	50 mm	80 mm	KOM-707-98-25050	126.46
	12F-63-13203	1803-		P-U-5	50 mm	80 mm	KOM-707-98-25050	126.46
MODEL D45P-1								
LIFT	12F-63-13103	1801-		P-U-5	50 mm	80 mm	KOM-707-98-25050	126.46
	12F-63-13203	1801-		P-U-5	50 mm	80 mm	KOM-707-98-25050	126.46
MODEL D45S-1								
DUMP	125-63-32100	1501-		P-U-5	65 mm	120 mm	KOM-707-99-42020	211.17
	125-63-32200	1501-		P-U-5	65 mm	120 mm	KOM-707-99-42020	211.17
LIFT	125-63-22100	1501-		P-U-5	60 mm	130 mm	KOM-707-99-41420	111.60
	125-63-22200	1501-		P-U-5	60 mm	130 mm	KOM-707-99-41420	111.60
MODEL D50-17								
BLADE LIFT (A)	130-63-12300	80001-		P-U-5	55 mm	90 mm	KOM-707-98-26540	97.03
	130-63-12400	80001-		P-U-5	55 mm	90 mm	KOM-707-98-26540	97.03
BLADE LIFT (P)	13F-63-14300	80001-		P-U-5	55 mm	90 mm	KOM-707-98-26540	97.03
	13F-63-14400	80001-		P-U-5	55 mm	90 mm	KOM-707-98-26540	97.03
BLADE TILT	130-63-52500	80001-		P-U-14	70 mm	160 mm	KOM-707-98-60120	186.17
MODEL D50A-16								
LIFT	130-63-12005	65001-		P-U-5	55 mm	90 mm	KOM-707-99-26410	134.93
	130-63-12105	65001-		P-U-5	55 mm	90 mm	KOM-707-99-26410	134.93
MODEL D50A-17								
LIFT	130-63-12006	80001-		P-U-5	55 mm	90 mm	KOM-707-98-26540	97.03
	130-63-12106	80001-		P-U-5	55 mm	90 mm	KOM-707-98-26540	97.03
MAP TILT	144-63-53300	80001-		P-U-14	70 mm	160 mm	KOM-707-98-60110	184.27
	144-63-53400	80001-		P-U-14	70 mm	160 mm	KOM-707-98-60110	184.27
TRIMMING LIFT	130-63-69100	80001-		P-U-5	55 mm	90 mm	KOM-707-98-26540	97.03
	130-63-69200	80001-		P-U-5	55 mm	90 mm	KOM-707-98-26540	97.03
MODEL D50P-16								
LIFT	13F-63-13100	65001-65007		P-U-5	55 mm	90 mm	KOM-130-63-05020	134.93
	13F-63-13101	65008-		P-U-5	55 mm	90 mm	KOM-130-63-05020	134.93
	13F-63-13200	65001-65007		P-U-5	55 mm	90 mm	KOM-130-63-05020	134.93
	13F-63-13201	65008-		P-U-5	55 mm	90 mm	KOM-130-63-05020	134.93
MODEL D50P-17, D50PL-17								
LIFT	13F-63-13102	80001-		P-U-5	55 mm	90 mm	KOM-707-98-26540	97.03
	13F-63-13202	80001-		P-U-5	55 mm	90 mm	KOM-707-98-26540	97.03
TILT	130-63-52500	80001-		P-U-14	70 mm	160 mm	KOM-707-98-60120	186.17
MODEL D50S-16								
DUMP	131-63-32002	65001-		P-U-5	65 mm	130 mm	KOM-131-63-05020	225.13
	131-63-32102	65001-		P-U-5	65 mm	130 mm	KOM-131-63-05020	225.13
LIFT	131-63-22003	65001-		P-U-5	65 mm	140 mm	KOM-131-63-05040	219.55
	131-63-22103	65001-		P-U-5	65 mm	140 mm	KOM-131-63-05040	219.55
MODEL D51EX-22								
ANGLE	707-00-0G851	B10001-		P-UB-14	50 mm	90 mm	KOM-707-99-25730	155.57
	707-00-0G851	B10001-		Bushing	50 mm		KOM-707-52-90260	12.96
LIFT	707-00-0G820	B10001-		P-UB-14	50 mm	90 mm	KOM-707-99-25720	82.80
	707-00-0G820	B10001-		Bushing	50 mm		KOM-707-52-90250	15.54
	707-00-0G830	B10001-		P-UB-14	50 mm	90 mm	KOM-707-99-25720	82.80
	707-00-0G830	B10001-		Bushing	50 mm		KOM-707-52-90250	15.54
RIPPER	707-00-XG860	B10001-		P-UB-14	60 mm	110 mm	KOM-707-99-35720	190.94

LT - Large size tire L/S - Loading Shovel SLF - Super Long Front B/H - Backhoe HD - Heavy Duty L BUCKET - Large Bucket
 K-LINK - K-type Linkage Blade LB HI-LIFT - High Lift Arm w Large Bucket HI-LIFT - High Lift Arm S HI-LIFT - Super High Lift Arm
 SU - Semi-U Dozer PAT - Power Angle Power Tilt MP - Mult-Purpose

Replacement Kits For

KOMATSU®

Crawler Dozers								
APPLICATION	CYL #	SERIAL #	Misc	CODE	ROD	BORE	KIT #	List \$
MODEL D51EX-22								
RIPPER	707-00-XG860	B10001-		Bushing	60 mm		KOM-707-52-90350	18.65
TILT	707-00-0G840	B10001-		P-UB-14	55 mm	100 mm	KOM-707-99-34300	161.07
	707-00-0G840	B10001-		Bushing	55 mm		KOM-707-52-90300	18.49
MODEL D51PX-22								
ANGLE	707-00-0G851	B10001-		P-UB-14	50 mm	90 mm	KOM-707-99-25730	155.57
	707-00-0G851	B10001-		Bushing	50 mm		KOM-707-52-90260	12.96
LIFT	707-00-0G820	B10001-		P-UB-14	50 mm	90 mm	KOM-707-99-25720	82.80
	707-00-0G820	B10001-		Bushing	50 mm		KOM-707-52-90250	15.54
	707-00-0G830	B10001-		P-UB-14	50 mm	90 mm	KOM-707-99-25720	82.80
	707-00-0G830	B10001-		Bushing	50 mm		KOM-707-52-90250	15.54
RIPPER	707-00-XG860	B10001-		P-UB-14	60 mm	110 mm	KOM-707-99-35720	190.94
	707-00-XG860	B10001-		Bushing	60 mm		KOM-707-52-90350	18.65
TILT	707-00-0G840	B10001-		P-UB-14	55 mm	100 mm	KOM-707-99-34300	161.07
	707-00-0G840	B10001-		Bushing	55 mm		KOM-707-52-90300	18.49
MODEL D53-17								
BLADE LIFT (A)	130-63-12300	80001-		P-U-5	55 mm	90 mm	KOM-707-98-26540	97.03
	130-63-12400	80001-		P-U-5	55 mm	90 mm	KOM-707-98-26540	97.03
BLADE LIFT (P)	13F-63-14300	80001-		P-U-5	55 mm	90 mm	KOM-707-98-26540	97.03
	13F-63-14400	80001-		P-U-5	55 mm	90 mm	KOM-707-98-26540	97.03
BLADE TILT	130-63-52500	80001-		P-U-14	70 mm	160 mm	KOM-707-98-60120	186.17
MODEL D53A-16								
LIFT	130-63-12005	65001-		P-U-5	55 mm	90 mm	KOM-707-99-26410	134.93
	130-63-12105	65001-		P-U-5	55 mm	90 mm	KOM-707-99-26410	134.93
MODEL D53A-17								
LIFT	130-63-12006	80001-		P-U-5	55 mm	90 mm	KOM-707-98-26540	97.03
	130-63-12106	80001-		P-U-5	55 mm	90 mm	KOM-707-98-26540	97.03
MAP TILT	144-63-53300	80001-		P-U-14	70 mm	160 mm	KOM-707-98-60110	184.27
	144-63-53400	80001-		P-U-14	70 mm	160 mm	KOM-707-98-60110	184.27
TRIMMING LIFT	130-63-69100	80001-		P-U-5	55 mm	90 mm	KOM-707-98-26540	97.03
	130-63-69200	80001-		P-U-5	55 mm	90 mm	KOM-707-98-26540	97.03
MODEL D53P-16								
LIFT	13F-63-13100	65280-		P-U-5	55 mm	90 mm	KOM-130-63-05020	134.93
	13F-63-13200	65280-		P-U-5	55 mm	90 mm	KOM-130-63-05020	134.93
MODEL D53P-17								
LIFT	13F-63-13102	80001-		P-U-5	55 mm	90 mm	KOM-707-98-26540	97.03
	13F-63-13202	80001-		P-U-5	55 mm	90 mm	KOM-707-98-26540	97.03
TILT	130-63-52500	80001-		P-U-14	70 mm	160 mm	KOM-707-98-60120	186.17
MODEL D53S-16								
DUMP	131-63-32002	65001-		P-U-5	65 mm	130 mm	KOM-131-63-05020	225.13
	131-63-32102	65001-		P-U-5	65 mm	130 mm	KOM-131-63-05020	225.13
LIFT	131-63-22003	65001-		P-U-5	65 mm	140 mm	KOM-131-63-05040	219.55
	131-63-22103	65001-		P-U-5	65 mm	140 mm	KOM-131-63-05040	219.55
MODEL D53S-17								
DUMP	131-63-32004	80001-		P-U-14	65 mm	130 mm	KOM-707-98-42410	271.46
	131-63-32104	80001-		P-U-14	65 mm	130 mm	KOM-707-98-42410	271.46
LIFT	131-63-22005	80001-		P-U-14	65 mm	140 mm	KOM-707-98-51100	237.94
	131-63-22105	80001-		P-U-14	65 mm	140 mm	KOM-707-98-51100	237.94
MODEL D57S-1								
BOTH-SIDE DUMP	135-63-93100	-9000		P-U-5	55 mm	100 mm	KOM-707-99-34030	137.72
DUMP	135-63-32305	6501-9000		P-U-5	65 mm	140 mm	KOM-707-98-51110	229.32
	135-63-32306	9001-		P-U-14	65 mm	140 mm	KOM-707-98-51100	237.94
	135-63-32406	6501-9000		P-U-5	65 mm	140 mm	KOM-707-98-51110	229.32
	135-63-32407	9001-		P-U-14	65 mm	140 mm	KOM-707-98-51100	237.94
LIFT	135-63-22304	6501-9000		P-U-5	70 mm	150 mm	KOM-707-98-52420	268.87
	135-63-22305	9001-		P-U-14	70 mm	150 mm	KOM-707-98-52430	210.80
	135-63-22404	6501-9000		P-U-5	70 mm	150 mm	KOM-707-98-52420	268.87

LT - Large size tire L/S - Loading Shovel SLF - Super Long Front B/H - Backhoe HD - Heavy Duty L BUCKET - Large Bucket
 K-LINK - K-type Linkage Blade LB HI-LIFT - High Lift Arm w Large Bucket HI-LIFT - High Lift Arm S HI-LIFT - Super High Lift Arm
 SU - Semi-U Dozer PAT - Power Angle Power Tilt MP - Mult-Purpose

KOMATSU®

Replacement Kits For

Crawler Dozers								
APPLICATION	CYL #	SERIAL #	Misc	CODE	ROD	BORE	KIT #	List \$
MODEL D57S-1								
LIFT	135-63-22405	9001-		P-U-14	70 mm	150 mm	KOM-707-98-52430	210.80
MODEL D57S-1B								
DUMP	135-63-32306	20001-		P-U-14	65 mm	140 mm	KOM-135-63-05020	291.80
	135-63-32407	20001-		P-U-14	65 mm	140 mm	KOM-135-63-05020	291.80
LIFT	135-63-22305	20001-		P-U-14	70 mm	150 mm	KOM-135-63-05060	200.05
	135-63-22405	20001-		P-U-14	70 mm	150 mm	KOM-135-63-05060	200.05
MODEL D58E-1								
LIFT	130-63-12006	80888-		P-U-5	55 mm	90 mm	KOM-707-98-26540	97.03
	130-63-12106	80888-		P-U-5	55 mm	90 mm	KOM-707-98-26540	97.03
MAP TILT	144-63-53300	80888-		P-U-14	70 mm	160 mm	KOM-707-98-60110	184.27
	144-63-53400	80888-		P-U-14	70 mm	160 mm	KOM-707-98-60110	184.27
TILT	130-63-52500	80888-		P-U-14	70 mm	160 mm	KOM-707-98-60120	186.17
MODEL D58E-1B								
PAT ANGLE	13F-63-02110	81285-		P-U-10	60 mm	120 mm	KOM-707-98-41020	103.71
PAT TILT	13F-63-02080	81285-		P-U-14	75 mm	150 mm	KOM-707-98-53410	242.10
MODEL D58P-1								
LIFT	13F-63-13102	80588-		P-U-5	55 mm	90 mm	KOM-707-98-26540	97.03
	13F-63-13202	80588-		P-U-5	55 mm	90 mm	KOM-707-98-26540	97.03
TILT	130-63-52500	80588-		P-U-14	70 mm	160 mm	KOM-707-98-60120	186.17
MODEL D60A-7, D60E-7								
LIFT	144-63-12601	40001-		P-U-14	65 mm	110 mm	KOM-707-99-36420	189.57
MODEL D60A-8								
LIFT	144-63-12502	45001-		P-U-14	65 mm	110 mm	KOM-144-63-05050	200.57
	144-63-12602	45001-		P-U-14	65 mm	110 mm	KOM-144-63-05050	200.57
MAP TILT	144-63-53300	45001-		P-U-14	70 mm	160 mm	KOM-707-98-60110	184.27
	144-63-53400	45001-		P-U-14	70 mm	160 mm	KOM-707-98-60110	184.27
RIPPER	144-63-42100	45001-		P-U-14	75 mm	160 mm	KOM-707-98-61100	237.12
TRIMMING	144-63-97300	45001-		P-U-14	55 mm	120 mm	KOM-707-99-40040	215.90
	144-63-97400	45001-		P-U-14	55 mm	120 mm	KOM-707-99-40040	215.90
TRIMMING LIFT	144-63-69500	45001-		P-U-14	65 mm	110 mm	KOM-707-99-36420	189.57
	144-63-69600	45001-		P-U-14	65 mm	110 mm	KOM-707-99-36420	189.57
MODEL D60A-8, D65A-8								
LIFT (FOR EC)	144-63-02011	45001-		P-U-10	65 mm	110 mm	KOM-707-98-36411	140.24
	144-63-02021	45001-		P-U-10	65 mm	110 mm	KOM-707-98-36411	140.24
MODEL D60E-8								
LIFT	144-63-13502	45001-		P-N-14	65 mm	110 mm	KOM-144-63-05020	150.77
	144-63-13602	45001-		P-N-14	65 mm	110 mm	KOM-144-63-05020	150.77
RIPPER	144-63-42100	45001-		P-U-14	75 mm	160 mm	KOM-707-98-61100	237.12
TILT	144-63-52200	45001-		P-U-14	70 mm	160 mm	KOM-144-63-05080	184.47
MODEL D60P-7, D60PL-7								
LIFT	144-63-13502	40001-		P-N-14	65 mm	110 mm	KOM-144-63-05020	150.77
	144-63-13602	40001-		P-N-14	65 mm	110 mm	KOM-144-63-05020	150.77
TILT	144-63-52200	40001-		P-U-14	70 mm	160 mm	KOM-144-63-05080	184.47
MODEL D60P-8, D60PL-8								
LIFT	144-63-13503	45001-		P-U-14	65 mm	110 mm	KOM-144-63-05050	200.57
	144-63-13603	45001-		P-U-14	65 mm	110 mm	KOM-144-63-05050	200.57
TILT	144-63-52200	45001-		P-U-14	70 mm	160 mm	KOM-144-63-05080	184.47
MODEL D60S-7								
DUMP	141-63-32300	40001-		P-U-14	60 mm	140 mm	KOM-141-63-05010	211.90
	141-63-32400	40001-		P-U-14	60 mm	140 mm	KOM-141-63-05010	211.90
DUMP (HI-LIFT)	141-63-33100	40001-		P-U-14	60 mm	140 mm	KOM-707-98-50100	211.90
	141-63-33200	40001-		P-U-14	60 mm	140 mm	KOM-707-98-50100	211.90
LIFT	141-63-22300	40001-		P-U-14	75 mm	160 mm	KOM-141-63-05050	240.42
	141-63-22400	40001-		P-U-14	75 mm	160 mm	KOM-141-63-05050	240.42
MODEL D60S-8								
DUMP	141-63-32300	45001-		P-U-14	60 mm	140 mm	KOM-141-63-05010	211.90

LT - Large size tire L/S - Loading Shovel SLF - Super Long Front B/H - Backhoe HD - Heavy Duty L BUCKET - Large Bucket
 K-LINK - K-type Linkage Blade LB HI-LIFT - High Lift Arm w Large Bucket HI-LIFT - High Lift Arm S HI-LIFT - Super High Lift Arm
 SU - Semi-U Dozer PAT - Power Angle Power Tilt MP - Mult-Purpose

Replacement Kits For

KOMATSU®

Crawler Dozers								
APPLICATION	CYL #	SERIAL #	Misc	CODE	ROD	BORE	KIT #	List \$
MODEL D60S-8								
DUMP	141-63-32400	45001-		P-U-14	60 mm	140 mm	KOM-141-63-05010	211.90
DUMP (HI-LIFT)	141-63-33100	45001-		P-U-14	60 mm	140 mm	KOM-707-98-50100	211.90
	141-63-33200	45001-		P-U-14	60 mm	140 mm	KOM-707-98-50100	211.90
LIFT	141-63-22300	45001-		P-U-14	75 mm	160 mm	KOM-141-63-05050	240.42
	141-63-22400	45001-		P-U-14	75 mm	160 mm	KOM-141-63-05050	240.42
MODEL D61EX-12, D61PX-12								
ANGLE (PAT)	134-63-01070	1001-1181, B3001-		I-UB-14	60 mm	100 mm	KOM-707-99-35160	171.90
	134-63-01071	1182-		P-UB-14	60 mm	100 mm	KOM-707-99-35170	58.51
LIFT (PAT)	134-63-01012	1001-1181, B3001-		I-U-14	55 mm	110 mm	KOM-707-98-34580	162.26
	134-63-01013	1182-		P-UB-14	55 mm	110 mm	KOM-707-99-34600	99.71
LIFT (SU, STT)	134-63-01060	1001-, B3001-		P-U-14	55 mm	110 mm	KOM-707-98-34640	98.08
RIPPER	14X-63-01052	1001-, B3001-	D61EX-12	P-U-14	70 mm	140 mm	KOM-707-98-52130	245.92
TILT (PAT)	134-63-01031	1001-1181, B3001-		I-U-14	70 mm	130 mm	KOM-707-98-43620	222.58
	134-63-01032	1182-		P-UB-14	70 mm	130 mm	KOM-707-99-43680	82.19
TILT (SU, STT)	134-63-01041	1001-, B3001-		P-U-14	70 mm	140 mm	KOM-707-98-52140	203.85
MODEL D61EX-15, D61PX-15								
ANGLE (PAT)	707-00-0C691	B40001-, B45001-		P-UB-14	65 mm	110 mm	KOM-707-99-36550	78.15
	707-00-0C691	B40001-, B45001-		Bushing	65 mm		KOM-707-52-90400	21.71
LIFT	707-00-0C671	B40001-, B45001-		P-UB-14	55 mm	110 mm	KOM-707-99-34620	109.31
LIFT (PAT)	707-00-0C681	B40001-, B45001-		P-UB-14	55 mm	110 mm	KOM-707-99-34630	102.27
RIPPER	707-01-0C851	B40001-, B45001-	D61EX-15	P-UB-14	70 mm	140 mm	KOM-707-99-52170	100.98
TILT	707-01-0C521	B40001-, B45001-		P-UB-14	70 mm	140 mm	KOM-707-99-52160	94.02
TILT (PAT)	707-00-0C821	B40001-, B45001-		P-UB-14	70 mm	130 mm	KOM-707-99-43690	84.31
MODEL D63E-1								
LIFT	130-63-12006	1001-		P-U-5	55 mm	90 mm	KOM-707-98-26540	97.03
	130-63-12106	1001-		P-U-5	55 mm	90 mm	KOM-707-98-26540	97.03
MAP TILT	144-63-53300	1001-		P-U-14	70 mm	160 mm	KOM-707-98-60110	184.27
	144-63-53400	1001-		P-U-14	70 mm	160 mm	KOM-707-98-60110	184.27
TILT	130-63-52500	1001-		P-U-14	70 mm	160 mm	KOM-707-98-60120	186.17
MODEL D65A-6								
LIFT	144-60-00040	20006-20021		P-U-10	65 mm	110 mm	KOM-144-60-00050K	170.39
	144-60-00041	20024-		P-U-10	65 mm	110 mm	KOM-144-60-00050K	170.39
	144-60-00050	20006-20021		P-U-10	65 mm	110 mm	KOM-144-60-00050K	170.39
	144-60-00051	20024-		P-U-10	65 mm	110 mm	KOM-144-60-00050K	170.39
	144-60-15004	-28883		P-U-10	65 mm	110 mm	KOM-144-60-00050K	170.39
	144-60-15104	-28883		P-U-10	65 mm	110 mm	KOM-144-60-00050K	170.39
	144-63-12100	28884-		P-U-5	65 mm	110 mm	KOM-144-63-12200K	247.21
	144-63-12200	28884-		P-U-5	65 mm	110 mm	KOM-144-63-12200K	247.21
MODEL D65A-7, D65E-7								
LIFT	144-63-12501	40001-		P-U-14	65 mm	110 mm	KOM-707-99-36420	189.57
MODEL D65A-8								
LIFT	144-63-12602	45001-		P-U-14	65 mm	110 mm	KOM-144-63-05050	200.57
	144-63-69600	45001-		P-U-14	65 mm	110 mm	KOM-144-63-05050	200.57
MAP TILT	144-63-53300	45001-		P-U-14	70 mm	160 mm	KOM-707-98-60110	184.27
	144-63-53400	45001-		P-U-14	70 mm	160 mm	KOM-707-98-60110	184.27
RIPPER	144-63-42100	45001-		P-U-14	75 mm	160 mm	KOM-707-98-61100	237.12
TRIMMING	144-63-97300	45001-		P-U-14	55 mm	120 mm	KOM-707-99-40040	215.90
	144-63-97400	45001-		P-U-14	55 mm	120 mm	KOM-707-99-40040	215.90
TRIMMING LIFT	144-63-69500	45001-		P-U-14	65 mm	110 mm	KOM-707-99-36420	189.57
	144-63-69600			P-U-14	65 mm	110 mm	KOM-707-99-36420	189.57
MODEL D65E-8								
LIFT	144-63-12502	45001-		P-U-14	65 mm	110 mm	KOM-144-63-05050	200.57
	144-63-12602	45001-		P-U-14	65 mm	110 mm	KOM-144-63-05050	200.57

LT - Large size tire L/S - Loading Shovel SLF - Super Long Front B/H - Backhoe HD - Heavy Duty L BUCKET - Large Bucket
 K-LINK - K-type Linkage Blade LB HI-LIFT - High Lift Arm w Large Bucket HI-LIFT - High Lift Arm S HI-LIFT - Super High Lift Arm
 SU - Semi-U Dozer PAT - Power Angle Power Tilt MP - Mult-Purpose

Replacement Kits For

KOMATSU®

Crawler Dozers								
APPLICATION	CYL #	SERIAL #	Misc	CODE	ROD	BORE	KIT #	List \$
MODEL D65E-8								
LIFT (FOR EC)	144-63-02011	45001-		P-U-10	65 mm	110 mm	KOM-707-98-36411	140.24
	144-63-02021	45001-		P-U-10	65 mm	110 mm	KOM-707-98-36411	140.24
RIPPER	144-63-42100	45001-		P-U-14	75 mm	160 mm	KOM-707-98-61100	237.12
TILT	144-63-52200	45001-		P-U-14	70 mm	160 mm	KOM-144-63-05080	184.47
MODEL D65E-12								
LIFT	14X-63-01063	60942-		P-U-14	65 mm	95 mm	KOM-707-98-28600	209.95
	14X-63-01063	60942-		Bushing	65 mm		KOM-707-52-10660	22.57
LIFT (TRIMMING)	14X-63-07011	60942-60993		P-U-14	65 mm	95 mm	KOM-707-98-28600	209.95
	14X-63-07011	60942-60993		Bushing	65 mm		KOM-707-52-10660	22.57
	14X-63-07012	60994-		P-U-14	65 mm	95 mm	KOM-707-98-28600	209.95
	14X-63-07012	60994-		Bushing	65 mm		KOM-707-52-10660	22.57
RIPPER	14X-63-01052	60942-		P-U-14	70 mm	140 mm	KOM-707-98-52130	245.92
	14X-63-01052	60942-		Bushing	70 mm		KOM-707-52-10700	22.55
TILT	14Y-63-01032	61027-65558		P-U-14	70 mm	140 mm	KOM-707-98-52140	203.85
	14Y-63-01033	60942-61026		P-U-14	70 mm	140 mm	KOM-707-98-52140	203.85
	707-01-0C300	6559-65582		P-U-14	70 mm	140 mm	KOM-707-98-52210	92.68
	707-01-0C301	65583-		P-UB-14	70 mm	140 mm	KOM-707-99-52160	94.02
TRIMMING LH	14X-63-07030	60942-		P-U-14	55 mm	120 mm	KOM-707-98-40020	242.47
	14X-63-07030	60942-		Bushing	55 mm		KOM-07177-05530	18.35
TRIMMING RH	14X-63-07040	60942-		P-U-14	55 mm	120 mm	KOM-707-98-40020	242.47
	14X-63-07040	60942-		Bushing	55 mm		KOM-07177-05530	18.35
MODEL D65EX-12								
LIFT	14X-63-01062	60001-60475		P-U-14	65 mm	95 mm	KOM-707-98-28600	209.95
	14X-63-01062	60001-60475		Bushing	65 mm		KOM-707-52-10660	22.57
	14X-63-01063	60476-		P-U-14	65 mm	95 mm	KOM-707-98-28600	209.95
	14X-63-01063	60476-		Bushing	65 mm		KOM-707-52-10660	22.57
	14Y-63-01014	60942-		P-U-14	65 mm	95 mm	KOM-707-98-28600	209.95
	14Y-63-01014	60942-		Bushing	65 mm		KOM-707-52-10660	22.57
LIFT (TRIMMING)	14X-63-07010	60001-60542		P-U-14	65 mm	95 mm	KOM-707-98-28600	209.95
	14X-63-07010	60001-60542		Bushing	65 mm		KOM-707-52-10660	22.57
	14X-63-07011	60543-60993		P-U-14	65 mm	95 mm	KOM-707-98-28600	209.95
	14X-63-07011	60543-60993		Bushing	65 mm		KOM-707-52-10660	22.57
	14X-63-07012	60994-		P-U-14	65 mm	95 mm	KOM-707-98-28600	209.95
	14X-63-07012	60994-		Bushing	65 mm		KOM-707-52-10660	22.57
RIPPER	14X-63-01052	60001-		P-U-14	70 mm	140 mm	KOM-707-98-52130	245.92
	14X-63-01052	60001-		Bushing	70 mm		KOM-707-52-10700	22.55
TILT	14Y-63-52142	61027-65558		P-U-14	70 mm	140 mm	KOM-707-98-52140	203.85
	14Y-63-52142	61027-65558		Bushing	70 mm		KOM-707-52-10700	22.55
	14Y-63-52143	60942-61026		P-U-14	70 mm	140 mm	KOM-707-98-52140	203.85
	14Y-63-52143	60942-61026		Bushing	70 mm		KOM-707-52-10700	22.55
	707-01-0C300	65559-65582		P-U-14	70 mm	140 mm	KOM-707-98-52210	92.68
	707-01-0C301	65583-		P-UB-14	70 mm	140 mm	KOM-707-99-52160	94.02
TILT/PITCH	14Y-63-01032	60476-		P-U-14	70 mm	140 mm	KOM-707-98-52140	203.85
	14Y-63-01032	60476-		Bushing	70 mm		KOM-707-52-10700	22.55
	14Y-63-01033	60001-60475		P-U-14	70 mm	140 mm	KOM-707-98-52140	203.85
	14Y-63-01033	60001-60475		Bushing	70 mm		KOM-707-52-10700	22.55
TRIMMING LH	14X-63-07030	60001-		P-U-14	55 mm	120 mm	KOM-707-98-40020	242.47
	14X-63-07030	60001-		Bushing	55 mm		KOM-07177-05530	18.35
TRIMMING RH	14X-63-07040	60001-		P-U-14	55 mm	120 mm	KOM-707-98-40020	242.47
	14X-63-07040	60001-		Bushing	55 mm		KOM-07177-05530	18.35
MODEL D65EX-15								
LIFT	707-02-00270	67001-67430		P-U-14	65 mm	95 mm	KOM-707-98-28640	127.31
	707-02-00270	67001-67430		Bushing	65 mm		KOM-707-52-10660	22.57
	707-02-00271	67431-, 69001-		P-UB-14	65 mm	95 mm	KOM-707-99-25880	140.49
	707-02-00271	67431-, 69001-		Bushing	65 mm		KOM-707-52-90400	21.71

LT - Large size tire L/S - Loading Shovel SLF - Super Long Front B/H - Backhoe HD - Heavy Duty L BUCKET - Large Bucket
 K-LINK - K-type Linkage Blade LB HI-LIFT - High Lift Arm w Large Bucket HI-LIFT - High Lift Arm S HI-LIFT - Super High Lift Arm
 SU - Semi-U Dozer PAT - Power Angle Power Tilt MP - Multi-Purpose

Replacement Kits For

KOMATSU®

Crawler Dozers								
APPLICATION	CYL #	SERIAL #	Misc	CODE	ROD	BORE	KIT #	List \$
MODEL D65EX-15								
LIFT (LONG TRACK)	707-02-00220	67001-67430		P-U-14	65 mm	95 mm	KOM-707-98-28640	127.31
	707-02-00220	67001-67430		Bushing	65 mm		KOM-707-52-10660	22.57
	707-02-0380	67431-, 69001-		P-UB-14	65 mm	95 mm	KOM-707-99-25880	140.49
	707-02-0380	67431-, 69001-		Bushing	65 mm		KOM-707-52-90400	21.71
RIPPER	707-01-0C850	67001-67319		P-U-14	70 mm	140 mm	KOM-707-98-52220	99.68
	707-01-0C850	67001-67319		Bushing	70 mm		KOM-707-52-10700	22.55
	707-01-0C851	67320-, 69001-		P-UB-14	70 mm	140 mm	KOM-707-99-52170	100.98
TILT/PITCH	707-01-0C300	67001-67430		P-U-14	70 mm	140 mm	KOM-707-98-52210	92.68
	707-01-0C301	67431-, 69001-		P-UB-14	70 mm	140 mm	KOM-707-99-52160	94.02
TRIMMING LH	707-63-0F230	67001-, 69001-		P-UB-14	55 mm	120 mm	KOM-707-99-40120	116.45
TRIMMING RH	707-63-0F240	67001-, 69001-		P-UB-14	55 mm	120 mm	KOM-707-99-40120	116.45
MODEL D65EX-15E0								
LIFT	707-02-00271	69001-		P-UB-14	65 mm	95 mm	KOM-707-99-25880	140.49
	707-02-00271	69001-		Bushing	65 mm		KOM-707-52-90400	21.71
LIFT (LONG TRACK)	707-02-00380	69001-		P-UB-14	65 mm	95 mm	KOM-707-99-25880	140.49
	707-02-00380	69001-		Bushing	65 mm		KOM-707-52-90400	21.71
LIFT (TRIMMING)	707-02-00400	69001-		P-UB-14	65 mm	95 mm	KOM-707-99-25880	140.49
	707-02-00400	69001-		Bushing	65 mm		KOM-707-52-90400	21.71
	707-02-00410	69001-		P-UB-14	65 mm	95 mm	KOM-707-99-25880	140.49
	707-02-00410	69001-		Bushing	65 mm		KOM-707-52-90400	21.71
RIPPER	707-01-0C851	69001-		P-UB-14	70 mm	140 mm	KOM-707-99-52170	100.98
	707-01-0C851	69001-		Bushing	70 mm		KOM-707-52-90470	10.24
TILT/PITCH	707-01-0C301	69001-		P-UB-14	70 mm	140 mm	KOM-707-99-52160	94.02
	707-01-0C301	69001-		Bushing	70 mm		KOM-707-52-90470	10.24
TRIMMING	707-63-0F230	69001-		P-UB-14	55 mm	120 mm	KOM-707-99-40120	116.45
	707-63-0F230	69001-		Bushing	55 mm		KOM-707-52-90300	18.49
	707-63-0F240	69001-		P-UB-14	55 mm	120 mm	KOM-707-99-40120	116.45
	707-63-0F240	69001-		Bushing	55 mm		KOM-707-52-90300	18.49
MODEL D65EX-16								
BLADE ANGLE	707-00-0J361	80001-80742		P-UB-14	65 mm	110 mm	KOM-707-99-36680	161.99
	707-00-0J361	80001-80742		Bushing	65 mm		KOM-707-52-90401	21.71
	707-E0-00041	80743-		P-UB-14	65 mm	110 mm	KOM-707-99-36720	166.24
	707-E0-00041	80743-		Bushing	65 mm		KOM-707-52-90401	21.71
BLADE LIFT LH	707-02-00930	80001-80928		P-UB-14	60 mm	85 mm	KOM-707-99-27110	155.60
	707-02-00930	80001-80928		Bushing	60 mm		KOM-707-52-90351	18.65
	707-02-00970	80001-80928		P-UB-14	60 mm	90 mm	KOM-707-99-27530	150.60
	707-02-00970	80001-80928		Bushing	60 mm		KOM-707-52-90351	18.65
	707-E2-00050	80929-		P-UB-14	60 mm	85 mm	KOM-707-99-27310	152.78
	707-E2-00050	80929-		Bushing	60 mm		KOM-707-52-90351	18.65
	707-E2-00090	80929-		P-UB-14	60 mm	90 mm	KOM-707-99-26730	145.87
	707-E2-00090	80929-		Bushing	60 mm		KOM-707-52-90351	18.65
BLADE LIFT RH	707-02-00940	80001-80928		P-UB-14	60 mm	85 mm	KOM-707-99-27110	155.60
	707-02-00940	80001-80928		Bushing	60 mm		KOM-707-52-90351	18.65
	707-02-00980	80001-80928		P-UB-14	60 mm	90 mm	KOM-707-99-27530	150.60
	707-02-00980	80001-80928		Bushing	60 mm		KOM-707-52-90351	18.65
	707-E2-00060	80929-		P-UB-14	60 mm	85 mm	KOM-707-99-27310	152.78
	707-E2-00060	80929-		Bushing	60 mm		KOM-707-52-90351	18.65
	707-E2-00100	80929-		P-UB-14	60 mm	90 mm	KOM-707-99-26730	145.87
	707-E2-00100	80929-		Bushing	60 mm		KOM-707-52-90351	18.65
BLADE TILT	707-00-0H990	80001-80928		P-UB-14	70 mm	130 mm	KOM-707-99-43730	183.88
	707-00-0H990	80001-80928		Bushing	70 mm		KOM-707-52-90461	10.24
	707-04-00270	80001-80928		P-UB-14	70 mm	125 mm	KOM-707-99-43320	166.35
	707-04-00270	80001-80928		Bushing	70 mm		KOM-707-52-90451	24.51

LT - Large size tire L/S - Loading Shovel SLF - Super Long Front B/H - Backhoe HD - Heavy Duty L BUCKET - Large Bucket
 K-LINK - K-type Linkage Blade LB HI-LIFT - High Lift Arm w Large Bucket HI-LIFT - High Lift Arm S HI-LIFT - Super High Lift Arm
 SU - Semi-U Dozer PAT - Power Angle Power Tilt MP - Mult-Purpose

Replacement Kits For

KOMATSU®

Crawler Dozers								
APPLICATION	CYL #	SERIAL #	Misc	CODE	ROD	BORE	KIT #	List \$
MODEL D65EX-16								
BLADE TILT	707-E0-00030	80929-		P-UB-14	70 mm	130 mm	KOM-707-99-43740	195.50
	707-E0-00030	80929-		Bushing	70 mm		KOM-707-52-90461	10.24
	707-E4-00020	80929-		P-UB-14	70 mm	125 mm	KOM-707-99-43390	193.46
	707-E4-00020	80929-		Bushing	70 mm		KOM-707-52-90451	24.51
	707-E4-00120	80001-		Bushing	60 mm		KOM-707-52-90351	18.65
PITCH	707-04-00270	80001-80928		P-UB-14	70 mm	125 mm	KOM-707-99-43320	166.35
	707-04-00270	80001-80928		Bushing	70 mm		KOM-707-52-90451	24.51
	707-E4-00020	80929-		P-UB-14	70 mm	125 mm	KOM-707-99-43390	193.46
	707-E4-00020	80929-		Bushing	70 mm		KOM-707-52-90451	24.51
RIPPER	707-00-0J370	80001-80928		P-UB-14	70 mm	125 mm	KOM-707-99-43310	202.27
	707-00-0J370	80001-80928		Bushing	70 mm		KOM-707-52-90451	24.51
	707-E0-00050	80001-		P-UB-14	70 mm	125 mm	KOM-707-99-42300	214.95
	707-E0-00050	80001-		Bushing	70 mm		KOM-707-52-90451	24.51
	707-E0-00050	80929-		P-UB-14	70 mm	125 mm	KOM-707-99-42300	214.95
	707-E0-00050	80929-		Bushing	70 mm		KOM-707-52-90451	24.51
	707-E0-00400	80001-		P-UB-14	70 mm	125 mm	KOM-707-99-42310	281.07
	707-E0-00400	80001-		Bushing	70 mm		KOM-707-52-90451	24.51
MODEL D65P-6								
LIFT	144-63-13100	30001-32000		P-U-5	65 mm	110 mm	KOM-144-63-12200K	247.21
	144-63-13200	30001-32000		P-U-5	65 mm	110 mm	KOM-144-63-12200K	247.21
	144-63-13300	30001-		P-U-5	65 mm	110 mm	KOM-144-63-12200K	247.21
	144-63-13400	30001-		P-U-5	65 mm	110 mm	KOM-144-63-12200K	247.21
TILT	144-63-52100	30001-31000		P-U-5	70 mm	160 mm	KOM-144-63-52100K	347.12
	144-63-52101	31001-		P-U-5	70 mm	160 mm	KOM-144-63-52100K	347.12
MODEL D65P-7								
LIFT	144-63-13502	40001-		P-N-14	65 mm	110 mm	KOM-144-63-05020	150.77
	144-63-13602	40001-		P-N-14	65 mm	110 mm	KOM-144-63-05020	150.77
TILT	144-63-52200	40001-		P-U-14	70 mm	160 mm	KOM-144-63-05080	184.47
MODEL D65P-8								
LIFT	144-63-13503	45001-		P-U-14	65 mm	110 mm	KOM-144-63-05050	200.57
	144-63-13603	45001-		P-U-14	65 mm	110 mm	KOM-144-63-05050	200.57
LIFT (FOR EC)	14F-63-02012	45001-		P-U-10	65 mm	110 mm	KOM-707-98-36411	140.24
	14F-63-02022	45001-		P-U-10	65 mm	110 mm	KOM-707-98-36411	140.24
TILT	144-63-52200	45001-		P-U-14	70 mm	160 mm	KOM-144-63-05080	184.47
MODEL D65P-12								
LIFT	14X-63-01013	60001-		P-U-14	65 mm	95 mm	KOM-707-98-28600	209.95
TILT	14X-63-01032	60001-		P-U-14	70 mm	140 mm	KOM-707-98-52140	203.85
MODEL D65PX-12								
LIFT	14Y-63-01013	60001-60508		P-U-14	65 mm	95 mm	KOM-707-98-28600	209.95
	14Y-63-01013	60001-60508		Bushing	65 mm		KOM-707-52-10660	22.57
	14Y-63-01014	60509-		P-U-14	65 mm	95 mm	KOM-707-98-28600	209.95
	14Y-63-01014	60509-		Bushing	65 mm		KOM-707-52-10660	22.57
PITCH	707-01-0C301	65582-		P-UB-14	70 mm	140 mm	KOM-707-99-52160	94.02
TILT	707-01-0C300	65582-65590		P-U-14	70 mm	140 mm	KOM-707-98-52210	92.68
	707-01-0C301	65591-		P-UB-14	70 mm	140 mm	KOM-707-99-52160	94.02
TILT/PITCH	14Y-63-01032	60476-65581		P-U-14	70 mm	140 mm	KOM-707-98-52140	203.85
	14Y-63-01032	60476-65581		Bushing	70 mm		KOM-707-52-10700	22.55
	14Y-63-01033	60001-60475		P-U-14	70 mm	140 mm	KOM-707-98-52140	203.85
	14Y-63-01033	60001-60475		Bushing	70 mm		KOM-707-52-10700	22.55
MODEL D65PX-15								
LIFT	707-02-00220	67001-67401		P-U-14	65 mm	95 mm	KOM-707-98-28640	127.31
	707-02-00220	67001-67401		Bushing	65 mm		KOM-707-52-10660	22.57
	707-02-00380	67402-, 69001-		P-UB-14	65 mm	95 mm	KOM-707-99-25880	140.49
	707-02-00380	67402-, 69001-		Bushing	65 mm		KOM-707-52-90400	21.71
TILT/PITCH	707-01-0C300	67001-67401		P-U-14	70 mm	140 mm	KOM-707-98-52210	92.68

LT - Large size tire L/S - Loading Shovel SLF - Super Long Front B/H - Backhoe HD - Heavy Duty L BUCKET - Large Bucket
 K-LINK - K-type Linkage Blade LB HI-LIFT - High Lift Arm w Large Bucket HI-LIFT - High Lift Arm S HI-LIFT - Super High Lift Arm
 SU - Semi-U Dozer PAT - Power Angle Power Tilt MP - Mult-Purpose

Replacement Kits For

KOMATSU®

Crawler Dozers								
APPLICATION	CYL #	SERIAL #	Misc	CODE	ROD	BORE	KIT #	List \$
MODEL D65PX-15								
TILT/PITCH	707-01-0C301	67402-, 69001-		P-UB-14	70 mm	140 mm	KOM-707-99-52160	94.02
MODEL D65PX-15E0								
LIFT	707-02-X0380	69001-		P-UB-14	65 mm	95 mm	KOM-707-99-25880	140.49
	707-02-X0380	69001-		Bushing	65 mm		KOM-707-52-90400	21.71
	707-02-X0390	69001-		P-UB-14	65 mm	95 mm	KOM-707-99-25880	140.49
	707-02-X0390	69001-		Bushing	65 mm		KOM-707-52-90400	21.71
TILT/PITCH	707-01-0C301	69001-		P-UB-14	70 mm	140 mm	KOM-707-99-52160	94.02
	707-01-0C301	69001-		Bushing	70 mm		KOM-707-52-90470	10.24
MODEL D65PX-16								
BLADE ANGLE	707-00-0J361	80001-		Bushing	65 mm		KOM-707-52-90401	21.71
	707-00-0J361	80001-80742		P-UB-14	65 mm	110 mm	KOM-707-99-36680	161.99
	707-E0-00041	80001-		Bushing	65 mm		KOM-707-52-90401	21.71
	707-E0-00041	80743-		P-UB-14	65 mm	110 mm	KOM-707-99-36720	166.24
BLADE LIFT LH	707-02-00950	80001-		P-UB-14	60 mm	85 mm	KOM-707-99-27120	188.21
	707-02-00950	80001-		Bushing	60 mm		KOM-707-52-90351	18.65
	707-02-00970	80001-		Bushing	60 mm		KOM-707-52-90351	18.65
	707-02-00970	80001-80928		P-UB-14	60 mm	90 mm	KOM-707-99-27530	150.60
	707-E2-00090	80001-		Bushing	60 mm		KOM-707-52-90351	18.65
	707-E2-00090	80929-		P-UB-14	60 mm	90 mm	KOM-707-99-26730	145.87
BLADE LIFT RH	707-02-00960	80001-		P-UB-14	60 mm	85 mm	KOM-707-99-27120	188.21
	707-02-00960	80001-		Bushing	60 mm		KOM-707-52-90351	18.65
	707-02-00980	80001-		Bushing	60 mm		KOM-707-52-90351	18.65
	707-02-00980	80001-80928		P-UB-14	60 mm	90 mm	KOM-707-99-27530	150.60
	707-E2-00100	80001-		Bushing	60 mm		KOM-707-52-90351	18.65
	707-E2-00100	80929-		P-UB-14	60 mm	90 mm	KOM-707-99-26730	145.87
BLADE TILT	707-00-0H990	80001-		Bushing	70 mm		KOM-707-52-90461	10.24
	707-00-0H990	80001-80928		P-UB-14	70 mm	130 mm	KOM-707-99-43730	183.88
	707-04-00270	80001-		Bushing	70 mm		KOM-707-52-90451	24.51
	707-04-00270	80001-80928		P-UB-14	70 mm	125 mm	KOM-707-99-43320	166.35
	707-E0-00030	80001-		Bushing	70 mm		KOM-707-52-90461	10.24
	707-E0-00030	80929-		P-UB-14	70 mm	130 mm	KOM-707-99-43740	195.50
	707-E4-00020	80001-		Bushing	70 mm		KOM-707-52-90451	24.51
	707-E4-00020	80929-		P-UB-14	70 mm	125 mm	KOM-707-99-43390	193.46
PITCH	707-04-00270	80001-80928		P-UB-14	70 mm	125 mm	KOM-707-99-43320	166.35
	707-04-00270	80001-80928		Bushing	70 mm		KOM-707-52-90451	24.51
	707-E4-00020	80001-		Bushing	70 mm		KOM-707-52-90451	24.51
	707-E4-00020	80929-		P-UB-14	70 mm	125 mm	KOM-707-99-43390	193.46
MODEL D65S-7								
DUMP	141-63-32300	40001-		P-U-14	60 mm	140 mm	KOM-141-63-05010	211.90
	141-63-32400	40001-		P-U-14	60 mm	140 mm	KOM-141-63-05010	211.90
DUMP (HI-LIFT)	141-63-33100	40001-		P-U-14	60 mm	140 mm	KOM-707-98-50100	211.90
	141-63-33200	40001-		P-U-14	60 mm	140 mm	KOM-707-98-50100	211.90
LIFT	141-63-22300	40001-		P-U-14	75 mm	160 mm	KOM-141-63-05050	240.42
	141-63-22400	40001-		P-U-14	75 mm	160 mm	KOM-141-63-05050	240.42
MODEL D65S-8								
DUMP	141-63-32300	45001-		P-U-14	60 mm	140 mm	KOM-141-63-05010	211.90
	141-63-32400	45001-		P-U-14	60 mm	140 mm	KOM-141-63-05010	211.90
DUMP (HI-LIFT)	141-63-33100	45001-		P-U-14	60 mm	140 mm	KOM-707-98-50100	211.90
	141-63-33200	45001-		P-U-14	60 mm	140 mm	KOM-707-98-50100	211.90
LIFT	141-63-22300	45001-		P-U-14	75 mm	160 mm	KOM-141-63-05050	240.42
	141-63-22400	45001-		P-U-14	75 mm	160 mm	KOM-141-63-05050	240.42
MODEL D66S-1								
BOTH-SIDE DUMP	142-63-99101	1001-		P-U-14	60 mm	120 mm	KOM-707-98-41140	241.42
BUCKET CLAM (MP)	142-63-59101	1001-		P-U-14	60 mm	120 mm	KOM-707-98-41130	233.06
	142-63-59201	1001-		P-U-14	60 mm	120 mm	KOM-707-98-41130	233.06

LT - Large size tire L/S - Loading Shovel SLF - Super Long Front B/H - Backhoe HD - Heavy Duty L BUCKET - Large Bucket
 K-LINK - K-type Linkage Blade LB HI-LIFT - High Lift Arm w Large Bucket HI-LIFT - High Lift Arm S HI-LIFT - Super High Lift Arm
 SU - Semi-U Dozer PAT - Power Angle Power Tilt MP - Mult-Purpose

Replacement Kits For

KOMATSU®

Crawler Dozers								
APPLICATION	CYL #	SERIAL #	Misc	CODE	ROD	BORE	KIT #	List \$
MODEL D66S-1								
DUMP	142-63-32300	1001-		P-U-14	100 mm	180 mm	KOM-707-98-66410	415.19
LIFT	142-63-22200	1001-		P-U-14	80 mm	150 mm	KOM-707-98-54510	230.23
MODEL D68E-1								
LIFT	144-63-16100	1001-		P-U-14	65 mm	110 mm	KOM-144-63-05050	200.57
	144-63-16200	1001-		P-U-14	65 mm	110 mm	KOM-144-63-05050	200.57
MODEL D68P-1								
LIFT	144-63-13503	45590-		P-U-14	65 mm	110 mm	KOM-144-63-05050	200.57
	144-63-13603	45590-		P-U-14	65 mm	110 mm	KOM-144-63-05050	200.57
RIPPER				P-U-14	75 mm	160 mm	KOM-707-98-61100	237.12
TILT	144-63-52200	45590-		P-U-14	70 mm	160 mm	KOM-144-63-05080	184.47
MODEL D75A-1								
ANGLE LIFT	144-63-12502	50001-		P-U-14	65 mm	110 mm	KOM-144-63-05050	200.57
	144-63-12602	50001-		P-U-14	65 mm	110 mm	KOM-144-63-05050	200.57
BLADE TILT (STT)	14F-63-03030	50281-		P-U-14	70 mm	160 mm	KOM-707-98-60100	358.40
RIPPER	144-63-42100	50001-		P-U-14	75 mm	160 mm	KOM-707-98-61100	237.12
STT LIFT	144-63-16100	50001-		P-U-14	65 mm	110 mm	KOM-144-63-05050	200.57
	144-63-16200	50001-		P-U-14	65 mm	110 mm	KOM-144-63-05050	200.57
TILT	144-63-52200	50001-		P-U-14	70 mm	160 mm	KOM-144-63-05080	184.47
MODEL D75S-3								
DUMP	145-63-32601	7001-10000		P-U-5	70 mm	150 mm	KOM-707-98-52420	268.87
	145-63-32602	10001-		P-U-14	70 mm	150 mm	KOM-707-98-52410	232.91
	145-63-32701	7001-10000		P-U-5	70 mm	150 mm	KOM-707-98-52420	268.87
	145-63-32702	10001-		P-U-14	70 mm	150 mm	KOM-707-98-52410	232.91
LIFT	145-63-23300	7001-10000		P-U-14	90 mm	180 mm	KOM-707-98-64450	207.89
	145-63-23301	10001-		P-U-14	90 mm	180 mm	KOM-707-98-64420	217.97
	145-63-23400	7001-10000		P-U-14	90 mm	180 mm	KOM-707-98-64450	207.89
	145-63-23401	10001-		P-U-14	90 mm	180 mm	KOM-707-98-64420	217.97
MODEL D75S-5								
BUCKET CLAM (MP)	145-63-59100	15001-		P-U-14	60 mm	140 mm	KOM-707-98-50100	211.90
	145-63-59200	15001-		P-U-14	60 mm	140 mm	KOM-707-98-50100	211.90
DUMP	145-63-32602	15001-		P-U-14	70 mm	150 mm	KOM-707-98-52410	232.91
	145-63-32702	15001-		P-U-14	70 mm	150 mm	KOM-707-98-52410	232.91
DUMP (SCORIA)	145-63-33600	15001-		P-U-5	70 mm	150 mm	KOM-707-98-52420	268.87
	145-63-33700	15001-		P-U-5	70 mm	150 mm	KOM-707-98-52420	268.87
LIFT	145-63-23301	15001-		P-U-14	90 mm	180 mm	KOM-707-98-64420	217.97
	145-63-23401	15001-		P-U-14	90 mm	180 mm	KOM-707-98-64420	217.97
LIFT (SCORIA)	145-63-23800	15001-		P-U-14	90 mm	180 mm	KOM-707-98-64450	207.89
	145-63-23900	15001-		P-U-14	90 mm	180 mm	KOM-707-98-64450	207.89
SIDE DUMP	145-63-97101	15001-		P-U-5	60 mm	110 mm	KOM-707-99-36410	168.95
MODEL D80A-18								
LIFT	154-63-12604	25001-		P-U-5	70 mm	120 mm	KOM-707-99-43010	192.79
	154-63-12704	25001-		P-U-5	70 mm	120 mm	KOM-707-99-43010	192.79
MAP TILT	154-63-52500	25001-		P-U-14	70 mm	160 mm	KOM-707-98-60121	184.40
	154-63-52600	25001-		P-U-14	70 mm	160 mm	KOM-707-98-60120	186.17
RIPPER	154-63-42503	25001-		P-U-14	70 mm	150 mm	KOM-707-98-52410	232.91
	154-63-42603	25001-		P-U-14	70 mm	150 mm	KOM-707-98-52410	232.91
TILT	154-63-52402	25001-26042		P-U-14	90 mm	200 mm	KOM-707-99-71100	257.43
TRIMMING	154-63-79400	25001-		P-U-14	70 mm	150 mm	KOM-707-98-52410	232.91
MODEL D80E-18								
RIPPER	154-63-42503	25001-		P-U-14	70 mm	150 mm	KOM-707-98-52410	232.91
	154-63-42603	25001-		P-U-14	70 mm	150 mm	KOM-707-98-52410	232.91
TILT	154-63-52402	25001-26042		P-U-14	90 mm	200 mm	KOM-707-99-71100	257.43
MODEL D83E-1								
LIFT	14F-63-02012	1001-		P-U-10	65 mm	110 mm	KOM-707-98-36411	140.24
	14F-63-02022	1001-		P-U-10	65 mm	110 mm	KOM-707-98-36411	140.24

LT - Large size tire L/S - Loading Shovel SLF - Super Long Front B/H - Backhoe HD - Heavy Duty L BUCKET - Large Bucket
 K-LINK - K-type Linkage Blade LB HI-LIFT - High Lift Arm w Large Bucket HI-LIFT - High Lift Arm S HI-LIFT - Super High Lift Arm
 SU - Semi-U Dozer PAT - Power Angle Power Tilt MP - Mult-Purpose

Replacement Kits For

KOMATSU®

Crawler Dozers								
APPLICATION	CYL #	SERIAL #	Misc	CODE	ROD	BORE	KIT #	List \$
MODEL D83E-1								
MAP TILT	154-63-52500	1001-		P-U-14	70 mm	160 mm	KOM-707-98-60121	184.40
	154-63-52600	1001-		P-U-14	70 mm	160 mm	KOM-707-98-60120	186.17
RIPPER	144-63-42100	1001-		P-U-14	75 mm	160 mm	KOM-707-98-61100	237.12
TILT	144-63-52200	1001-		P-U-14	70 mm	160 mm	KOM-144-63-05080	184.47
MODEL D83P-1								
LIFT	14F-63-02012	1001-		P-U-10	65 mm	110 mm	KOM-707-98-36411	140.24
	14F-63-02022	1001-		P-U-10	65 mm	110 mm	KOM-707-98-36411	140.24
TILT	144-63-52200	1001-		P-U-14	70 mm	160 mm	KOM-144-63-05080	184.47
MODEL D85A-18								
LIFT	154-63-12604	25001-		P-U-5	70 mm	120 mm	KOM-707-99-43010	192.79
	154-63-12704	25001-		P-U-5	70 mm	120 mm	KOM-707-99-43010	192.79
MAP TILT	154-63-52500	25001-		P-U-14	70 mm	160 mm	KOM-707-98-60121	184.40
	154-63-52600	25001-		P-U-14	70 mm	160 mm	KOM-707-98-60120	186.17
RIPPER	154-63-42503	25001-		P-U-14	70 mm	150 mm	KOM-707-98-52410	232.91
	154-63-42603	25001-		P-U-14	70 mm	150 mm	KOM-707-98-52410	232.91
TILT	154-63-52402	25001-28323		P-U-14	90 mm	200 mm	KOM-707-99-71100	257.43
TRIMMING	154-63-79400	25001-		P-U-14	70 mm	150 mm	KOM-707-98-52410	232.91
MODEL D85A-21								
BLADE LIFT	154-63-02010	36534-		P-U-14	70 mm	110 mm	KOM-707-98-37580	69.78
	154-63-02010	36534-		Bushing	70 mm		KOM-07177-07030	24.51
BLADE LIFT (A)	154-63-02010	35001-		P-U-14	70 mm	110 mm	KOM-707-98-37580	69.78
BLADE LIFT (E)	154-63-02050	35001-		P-U-14	70 mm	110 mm	KOM-707-98-37580	69.78
MODEL D85A-21, D85E-21								
LIFT	154-63-02010	35001-		P-U-14	70 mm	110 mm	KOM-707-98-37580	69.78
MAP TILT	154-63-02120	35001-		P-U-14	70 mm	140 mm	KOM-707-98-52110	276.87
	154-63-02130	35001-		P-U-14	70 mm	140 mm	KOM-707-98-52110	276.87
RIPPER	154-63-02081	35001-		P-U-14	70 mm	140 mm	KOM-707-98-52110	276.87
TILT	154-63-02070	35001-		P-U-14	80 mm	160 mm	KOM-707-98-62120	212.99
MODEL D85E-18								
RIPPER	154-63-42503	25001-		P-U-14	70 mm	150 mm	KOM-707-98-52410	232.91
	154-63-42603	25001-		P-U-14	70 mm	150 mm	KOM-707-98-52410	232.91
TILT	154-63-52402	25001-28323		P-U-14	90 mm	200 mm	KOM-707-99-71100	257.43
MODEL D85E-21								
BLADE LIFT (A)	154-63-02010	35001-		P-U-14	70 mm	110 mm	KOM-707-98-37580	69.78
BLADE LIFT (E)	154-63-02050	35001-		P-U-14	70 mm	110 mm	KOM-707-98-37580	69.78
MODEL D85E-SS-2A								
BLADE LIFT	14Y-63-01013	3001-		P-U-14	65 mm	95 mm	KOM-707-98-28600	209.95
BLADE TILT	14Y-63-01032	3001-		P-U-14	70 mm	140 mm	KOM-707-98-52140	203.85
RIPPER	14X-63-01052	3001-		P-U-14	70 mm	140 mm	KOM-707-98-52130	245.92
MODEL D85P-21								
TILT	154-63-02070	3001-		P-U-14	80 mm	160 mm	KOM-707-98-62120	212.99
MODEL D95S-2								
DUMP	155-63-32104	2001-2129		P-U-5	75 mm	160 mm	KOM-707-98-61110	285.86
	155-63-32204	2001-2129		P-U-5	75 mm	160 mm	KOM-707-98-61110	285.86
LIFT	155-63-22501	2112-		P-U-14	90 mm	180 mm	KOM-707-98-64450	207.89
	155-63-22601	2112-		P-U-14	90 mm	180 mm	KOM-707-98-64450	207.89
MODEL D135A-1								
LIFT	15A-63-02010	10001-		P-U-14	80 mm	130 mm	KOM-707-98-45610	253.04
PIN PULLER	15A-63-02080	10001-		P-U-10	30 mm	60 mm	KOM-707-98-11020	62.04
RIPPER LIFT	15A-63-02140	10001-		P-U-14	80 mm	160 mm	KOM-707-98-62100	177.35
	15A-63-02150	10001-		P-U-14	80 mm	160 mm	KOM-707-98-62100	177.35
RIPPER TILT	15A-63-02160	10001-		P-U-14	80 mm	150 mm	KOM-707-98-54500	177.07
	15A-63-02170	10001-		P-U-14	80 mm	150 mm	KOM-707-98-54500	177.07
TILT	15A-63-02130	10001-		P-U-14	90 mm	180 mm	KOM-707-98-64410	215.51
MODEL D135A-2								
LIFT	15A-63-02010	10301-		P-U-14	80 mm	130 mm	KOM-707-98-45610	253.04

LT - Large size tire L/S - Loading Shovel SLF - Super Long Front B/H - Backhoe HD - Heavy Duty L BUCKET - Large Bucket

K-LINK - K-type Linkage Blade LB HI-LIFT - High Lift Arm w Large Bucket HI-LIFT - High Lift Arm S HI-LIFT - Super High Lift Arm

SU - Semi-U Dozer PAT - Power Angle Power Tilt MP - Mult-Purpose

Replacement Kits For

KOMATSU®

Crawler Dozers								
APPLICATION	CYL #	SERIAL #	Misc	CODE	ROD	BORE	KIT #	List \$
MODEL D135A-2								
PIN PULLER	15A-63-02080	10301-		P-U-10	30 mm	60 mm	KOM-707-98-11020	62.04
RIPPER LIFT	15A-63-02140	10301-		P-U-14	80 mm	160 mm	KOM-707-98-62100	177.35
	15A-63-02150	10301-		P-U-14	80 mm	160 mm	KOM-707-98-62100	177.35
RIPPER TILT	15A-63-02160	10301-		P-U-14	80 mm	150 mm	KOM-707-98-54500	177.07
	15A-63-02170	10301-		P-U-14	80 mm	150 mm	KOM-707-98-54500	177.07
TILT	15A-63-02130	10301-		P-U-14	90 mm	180 mm	KOM-707-98-64410	215.51
MODEL D155A-1								
PIN PULLER	175-63-49102	15001-		P-U-5	35 mm	70 mm	KOM-707-99-12420	120.25
RIPPER LIFT	175-63-42700	17001-		P-U-14	90 mm	225 mm	KOM-707-99-71420	307.90
	175-63-42800	17001-		P-U-14	90 mm	225 mm	KOM-707-99-71420	307.90
RIPPER TILT	175-63-43700	17001-		P-U-14	90 mm	225 mm	KOM-707-99-71420	307.90
	175-63-43800	17001-		P-U-14	90 mm	225 mm	KOM-707-99-71420	307.90
TILT	175-63-52700	20004-		P-U-14	90 mm	225 mm	KOM-175-63-05140	366.22
MODEL D155A-2								
LIFT	175-63-02111	50001-		P-U-14	75 mm	140 mm	KOM-707-98-53100	278.90
	175-63-02111	50001-		Bushing	75 mm		KOM-07177-07530	27.12
PIN PULLER	175-63-49102	50001-		P-U-5	35 mm	70 mm	KOM-707-99-12420	120.25
RIPPER LIFT	175-63-42701	50001-		P-U-14	90 mm	225 mm	KOM-707-99-71420	307.90
	175-63-42701	50001-		Bushing	90 mm		KOM-07177-09035	39.34
	175-63-42801	50001-		P-U-14	90 mm	225 mm	KOM-707-99-71420	307.90
	175-63-42801	50001-		Bushing	90 mm		KOM-07177-09035	39.34
RIPPER TILT	175-63-43700	50001-		P-U-14	90 mm	225 mm	KOM-707-99-71420	307.90
	175-63-43700	50001-		Bushing	90 mm		KOM-07177-09035	39.34
	175-63-43800	50001-		P-U-14	90 mm	225 mm	KOM-707-99-71420	307.90
	175-63-43800	50001-		Bushing	90 mm		KOM-07177-09035	39.34
TILT	175-63-52700	50001-		P-U-14	90 mm	225 mm	KOM-175-63-05140	366.22
	175-63-52700	50001-		Bushing	90 mm		KOM-07177-09035	39.34
MODEL D155A-3, D155AX-3								
DUAL TILT	17A-63-02190	60001-		P-U-14	90 mm	200 mm	KOM-707-98-71020	365.34
	17A-63-02190	60001-		Bushing	90 mm		KOM-707-52-10910	44.52
LIFT	17A-63-01210	60001-		P-U-14	75 mm	120 mm	KOM-707-98-44200	380.40
	17A-63-01210	60001-		Bushing	75 mm		KOM-707-52-10750	30.98
RIPPER LIFT	17A-63-02140	60001-		P-U-14	80 mm	160 mm	KOM-707-98-62131	499.04
RIPPER TILT	17A-63-02160	60001-		P-U-14	80 mm	160 mm	KOM-707-98-62131	499.04
TILT	17A-63-02130	60001-		P-U-14	90 mm	180 mm	KOM-707-98-64410	215.51
	17A-63-02130	60001-		Bushing	90 mm		KOM-707-52-10910	44.52
MODEL D155AX-5								
DUAL TILT	17A-63-02190	70001-		P-U-14	90 mm	200 mm	KOM-707-98-71020	365.34
	17A-63-02190	70001-		Bushing	90 mm		KOM-707-52-10910	44.52
LIFT	17A-63-02110	70001-		P-U-14	75 mm	120 mm	KOM-707-98-44200	380.40
	17A-63-02110	70001-		Bushing	75 mm		KOM-707-52-10750	30.98
PIN PULLER	15A-63-02080	70001-		P-U-10	30 mm	60 mm	KOM-707-98-11070	89.00
RIPPER LIFT	17A-63-02140	70001-		P-U-14	80 mm	160 mm	KOM-707-98-62131	499.04
RIPPER TILT	17A-63-02160	70001-		P-U-14	80 mm	160 mm	KOM-707-98-62131	499.04
TILT	17A-63-02110	70001-		P-U-14	90 mm	180 mm	KOM-707-98-64410	215.51
MODEL D155AX-6								
BLADE LIFT LH	707-02-00660	80001-		P-UB-14	75 mm	110 mm	KOM-707-99-38740	76.35
	707-02-00660	80001-		Bushing	75 mm		KOM-707-52-90500	27.12
BLADE LIFT RH	707-02-00670	80001-		P-UB-14	75 mm	110 mm	KOM-707-99-38740	76.35
	707-02-00670	80001-		Bushing	75 mm		KOM-707-52-90500	27.12
BLADE TILT	707-04-00190	80001-		P-UB-14	90 mm	160 mm	KOM-707-99-64230	151.95
	707-04-00200	80001-		P-UB-14	90 mm	160 mm	KOM-707-99-64230	151.95
	707-04-00220	80001-		P-UB-14	90 mm	160 mm	KOM-707-99-64230	151.95
	707-04-00240	80001-		P-UB-14	90 mm	160 mm	KOM-707-99-64250	151.95
PIN PULLER	707-04-00210	80001-		P-U-3	30 mm	60 mm	KOM-707-98-11350	62.83

LT - Large size tire L/S - Loading Shovel SLF - Super Long Front B/H - Backhoe HD - Heavy Duty L BUCKET - Large Bucket
 K-LINK - K-type Linkage Blade LB HI-LIFT - High Lift Arm w Large Bucket HI-LIFT - High Lift Arm S HI-LIFT - Super High Lift Arm
 SU - Semi-U Dozer PAT - Power Angle Power Tilt MP - Mult-Purpose

Replacement Kits For

KOMATSU®

Crawler Dozers								
APPLICATION	CYL #	SERIAL #	Misc	CODE	ROD	BORE	KIT #	List \$
MODEL D155AX-6								
PIN PULLER	707-04-00210	80001-		Bushing	30 mm		KOM-07177-03025	7.41
RIPPER LIFT	707-01-0K410	80001-		P-UB-14	100 mm	180 mm	KOM-707-99-66660	151.03
RIPPER TILT	707-01-0K420	80001-		P-UB-14	110 mm	200 mm	KOM-707-99-74200	252.35
MODEL D275A-2								
BLADE LIFT	17M-63-01011	10001-		P-U-14	80 mm	130 mm	KOM-707-98-45620	293.07
BLADE TILT	17M-63-01031	10001-		P-U-14	100 mm	200 mm	KOM-707-98-73020	290.03
DUAL TILT	17M-63-01081	10001-		P-U-14	100 mm	200 mm	KOM-707-98-73020	290.03
	17M-63-01091	10001-		P-U-14	100 mm	225 mm	KOM-707-98-73400	321.84
PIN PULLER	175-63-02080	10001-		P-U-10	30 mm	60 mm	KOM-707-98-11020	62.04
RIPPER LIFT	17M-63-01041	10001-		P-U-14	100 mm	200 mm	KOM-707-98-73010	316.74
RIPPER TILT	17M-63-01061	10001-		P-U-14	90 mm	180 mm	KOM-707-98-64400	121.33
MODEL D275A-5								
BLADE LIFT	707-02-00200	25001-		P-UB-14	80 mm	120 mm	KOM-707-99-45310	120.00
BLADE TILT	707-01-0C160	25001-		P-UB-14	100 mm	180 mm	KOM-707-99-66600	166.55
RIPPER LIFT	707-01-0C170	25001-		P-UB-14	100 mm	180 mm	KOM-707-99-66610	147.98
	707-01-0C180	25001-		P-UB-14	100 mm	180 mm	KOM-707-99-66610	147.98
RIPPER TILT	707-01-0C190	25001-		P-UB-14	90 mm	160 mm	KOM-707-99-64200	162.47
	707-01-0C200	25001-		P-UB-14	90 mm	160 mm	KOM-707-99-64200	162.47
MODEL D355A-3								
LIFT	195-63-13700	4001-		P-U-5,14	90 mm	160 mm	KOM-195-63-05120	286.57
	195-63-13800	4001-		P-U-5,14	90 mm	160 mm	KOM-195-63-05120	286.57
PIN PULLER	175-63-49101	1632-		P-U-5	35 mm	70 mm	KOM-707-99-12420	120.25
TILT	195-63-52500	3301-		P-U-5	90 mm	160 mm	KOM-195-63-05130	242.90
MODEL D355A-5								
LIFT	195-63-01110	12959		P-U-5,14	90 mm	160 mm	KOM-195-63-05120	286.57
	195-63-01120	12959		P-U-5,14	90 mm	160 mm	KOM-195-63-05120	286.57
	195-63-13700	12622-12958		P-U-5,14	90 mm	160 mm	KOM-195-63-05120	286.57
	195-63-13800	12622-12958		P-U-5,14	90 mm	160 mm	KOM-195-63-05120	286.57
PIN PULLER	175-63-49102	12622-		P-U-5	35 mm	70 mm	KOM-707-99-12420	120.25
TILT	195-63-01130	12959-		P-U-5	90 mm	160 mm	KOM-195-63-05130	242.90
	195-63-52500	12622-12958		P-U-5	90 mm	160 mm	KOM-195-63-05130	242.90
MODEL D375A-1								
LIFT	195-63-01101	15001-		P-U-14	90 mm	150 mm	KOM-707-98-56600	210.49
	195-63-01201	15001-		P-U-14	90 mm	150 mm	KOM-707-98-56600	210.49
	195-63-01410	16001-		P-U-14	90 mm	150 mm	KOM-707-98-56610	225.53
PIN PULLER	195-63-49200	15001-		P-U-10	30 mm	60 mm	KOM-707-98-11020	62.04
RIPPER LIFT	195-63-01301	15001-		P-U-14	110 mm	225 mm	KOM-707-98-74400	590.54
	195-63-01401	15001-		P-U-14	110 mm	225 mm	KOM-707-98-74400	590.54
RIPPER TILT	195-63-01501	15001-		P-U-14	110 mm	200 mm	KOM-707-98-74100	427.91
	195-63-01601	15001-		P-U-14	110 mm	200 mm	KOM-707-98-74100	427.91
TILT	195-63-53200	15001-15413		P-U-14	110 mm	225 mm	KOM-707-98-74410	417.26
	195-63-53200	15417-15422		P-U-14	110 mm	225 mm	KOM-707-98-74410	417.26
	195-63-53400	15414-15416		P-U-14	110 mm	225 mm	KOM-707-98-74420	352.04
	195-63-53400	15423-		P-U-14	110 mm	225 mm	KOM-707-98-74420	352.04
MODEL D375A-2								
LIFT	195-63-01420	16001-		P-U-14	90 mm	150 mm	KOM-707-98-56610	225.53
PIN PULLER	175-63-02080	16001-		P-U-10	30 mm	60 mm	KOM-707-98-11020	62.04
RIPPER LIFT	195-63-01440	16001-		P-U-14	110 mm	225 mm	KOM-707-98-74400	590.54
	195-63-01450	16001-		P-U-14	110 mm	225 mm	KOM-707-98-74400	590.54
RIPPER TILT	195-63-01501	16001-		P-U-14	110 mm	200 mm	KOM-707-98-74100	427.91
	195-63-01601	16001-		P-U-14	110 mm	200 mm	KOM-707-98-74100	427.91
MODEL D375A-3								
LIFT	195-63-01410	17001-17607		P-U-14	90 mm	150 mm	KOM-707-98-56610	225.53
	195-63-01410	17001-17607		Bushing	90 mm		KOM-07177-09035	39.34
	195-63-01413	17608-		P-UB-14	90 mm	150 mm	KOM-707-99-56510	156.00

LT - Large size tire L/S - Loading Shovel SLF - Super Long Front B/H - Backhoe HD - Heavy Duty L BUCKET - Large Bucket
 K-LINK - K-type Linkage Blade LB HI-LIFT - High Lift Arm w Large Bucket HI-LIFT - High Lift Arm S HI-LIFT - Super High Lift Arm
 SU - Semi-U Dozer PAT - Power Angle Power Tilt MP - Multi-Purpose

Replacement Kits For

KOMATSU®

KOMATSU®

Crawler Dozers								
APPLICATION	CYL #	SERIAL #	Misc	CODE	ROD	BORE	KIT #	List \$
MODEL D375A-3								
LIFT	195-63-01413	17608-		Bushing	90 mm		KOM-707-52-90650	42.75
	195-63-01420	17001-		P-U-14	90 mm	150 mm	KOM-707-98-56610	225.53
	195-63-01420	17001-		Bushing	90 mm		KOM-07177-09035	39.34
PIN PULLER	175-63-02080	17001-		P-U-10	30 mm	60 mm	KOM-707-98-11020	62.04
	175-63-02080	17001-		Bushing	30 mm		KOM-707-52-15050	7.41
RIPPER LIFT LH	195-63-01440	17001-17607		P-U-14	110 mm	225 mm	KOM-707-98-74400	590.54
	195-63-01440	17001-17607		Bushing	110 mm		KOM-07177-01135	45.85
	195-63-01441	17608-		P-UB-14	110 mm	225 mm	KOM-707-99-74440	306.59
	195-63-01441	17608-		Bushing	110 mm		KOM-707-52-90850	45.85
RIPPER LIFT RH	195-63-01450	17001-17607		P-U-14	110 mm	225 mm	KOM-707-98-74400	590.54
	195-63-01450	17001-17607		Bushing	110 mm		KOM-07177-01135	45.85
	195-63-01451	17608-		P-UB-14	110 mm	225 mm	KOM-707-99-74440	306.59
	195-63-01451	17608-		Bushing	110 mm		KOM-707-52-90850	45.85
RIPPER TILT LH	195-63-01501	17001-17607		P-U-14	110 mm	200 mm	KOM-707-98-74100	427.91
	195-63-01501	17001-17607		Bushing	110 mm		KOM-07177-01135	45.85
	195-63-45502	17608-		P-UB-14	110 mm	200 mm	KOM-707-99-74020	281.15
	195-63-45502	17608-		Bushing	110 mm		KOM-707-52-90850	45.85
RIPPER TILT RH	195-63-01601	17001-17607		P-U-14	110 mm	200 mm	KOM-707-98-74100	427.91
	195-63-01601	17001-17607		Bushing	110 mm		KOM-07177-01135	45.85
	195-63-45602	17608-		P-UB-14	110 mm	200 mm	KOM-707-99-74020	281.15
	195-63-45602	17608-		Bushing	110 mm		KOM-707-52-90850	45.85
TILT	195-63-53401	17001-17607		P-U-14	110 mm	225 mm	KOM-707-98-74410	417.26
	195-63-53401	17001-17607		Bushing	110 mm		KOM-07177-01135	45.85
	195-63-53402	17608-17695		P-UB-14	110 mm	225 mm	KOM-707-99-74450	270.33
	195-63-53402	17608-17695		Bushing	110 mm		KOM-707-52-90850	45.85
	707-01-0Z390	17696-		P-UB-14	110 mm	225 mm	KOM-707-99-74450	270.33
	707-01-0Z390	17696-		Bushing	110 mm		KOM-707-52-90850	45.85
TILT (LH Pitch)	195-63-01311	17001-17607		P-U-14	110 mm	225 mm	KOM-707-98-74410	417.26
	195-63-01311	17001-17607		Bushing	110 mm		KOM-707-52-11110	87.94
	195-63-01312	17608-17703		P-UB-14	110 mm	225 mm	KOM-707-99-74450	270.33
	195-63-01312	17608-17703		Bushing	110 mm		KOM-707-52-90850	45.85
	707-01-0Z410	17704-		P-UB-14	110 mm	225 mm	KOM-707-99-74450	270.33
	707-01-0Z410	17704-		Bushing	110 mm		KOM-707-52-90850	45.85
TILT (RH Pitch)	195-63-01321	17001-17607		P-U-14	110 mm	250 mm	KOM-707-98-81010	436.87
	195-63-01321	17001-17607		Bushing	110 mm		KOM-707-52-11110	87.94
	195-63-01322	17608-17703		P-UB-14	110 mm	250 mm	KOM-707-99-81010	354.94
	195-63-01322	17608-17703		Bushing	110 mm		KOM-707-52-90850	45.85
	707-01-0Z420	17704-		P-UB-14	110 mm	250 mm	KOM-707-99-81010	354.94
	707-01-0Z420	17704-		Bushing	110 mm		KOM-707-52-90850	45.85
MODEL D375A-5								
BLADE LIFT	195-63-01413	18001-		P-UB-14	90 mm	150 mm	KOM-707-99-56510	156.00
	195-63-01413	18001-		Bushing	90 mm		KOM-707-52-90650	42.75
BLADE TILT	195-63-53402	18001-		P-UB-14	110 mm	225 mm	KOM-707-99-74450	270.33
	707-01-0Z390	18001-		P-UB-14	110 mm	225 mm	KOM-707-99-74450	270.33
BLADE TILT (LH Pitch)	195-63-01312	18001-		P-UB-14	110 mm	225 mm	KOM-707-99-74450	270.33
	707-01-0Z410	18001-		P-UB-14	110 mm	225 mm	KOM-707-99-74450	270.33
BLADE TILT (RH Pitch)	195-63-01322	18001-		P-UB-14	110 mm	250 mm	KOM-707-99-81010	354.94
	707-01-0Z420	18001-		P-UB-14	110 mm	250 mm	KOM-707-99-81010	354.94
PIN PULLER	175-63-02080	18001-		P-U-10	30 mm	60 mm	KOM-707-98-11020	62.04
	175-63-02080	18001-		Bushing	30 mm		KOM-07177-03025	7.41
RIPPER LIFT LH	195-63-01441	18001-18151		P-UB-14	110 mm	225 mm	KOM-707-99-74440	306.59
	195-63-01443	18152-		P-UB-14	110 mm	225 mm	KOM-707-99-74440	306.59
RIPPER LIFT RH	195-63-01451	18001-18151		P-UB-14	110 mm	225 mm	KOM-707-99-74440	306.59
	195-63-01453	18152-		P-UB-14	110 mm	225 mm	KOM-707-99-74440	306.59
RIPPER TILT LH	195-63-45502	18001-18151		P-UB-14	110 mm	200 mm	KOM-707-99-74020	281.15

LT - Large size tire L/S - Loading Shovel SLF - Super Long Front B/H - Backhoe HD - Heavy Duty L BUCKET - Large Bucket
 K-LINK - K-type Linkage Blade LB HI-LIFT - High Lift Arm w Large Bucket HI-LIFT - High Lift Arm S HI-LIFT - Super High Lift Arm
 SU - Semi-U Dozer PAT - Power Angle Power Tilt MP - Mult-Purpose

Replacement Kits For

KOMATSU®

Crawler Dozers								
APPLICATION	CYL #	SERIAL #	Misc	CODE	ROD	BORE	KIT #	List \$
MODEL D375A-5								
RIPPER TILT LH	195-63-45503	18152-		P-UB-14	110 mm	200 mm	KOM-707-99-74020	281.15
RIPPER TILT RH	195-63-45602	18001-18151		P-UB-14	110 mm	200 mm	KOM-707-99-74020	281.15
	195-63-45603	18152-		P-UB-14	110 mm	200 mm	KOM-707-99-74020	281.15
MODEL D375A-6								
DOZER BLADE LIFT LH	707-03-00340	60001-		P-UB-14	90 mm	140 mm	KOM-707-99-56240	160.70
	707-03-00340	60001-		Bushing	90 mm		KOM-707-52-90651	42.75
DOZER BLADE LIFT RH	707-03-00350	60001-		P-UB-14	90 mm	140 mm	KOM-707-99-56240	160.70
	707-03-00350	60001-		Bushing	90 mm		KOM-707-52-90651	42.75
DOZER BLADE TILT	707-01-0AY40	60001-		P-UB-14	110 mm	200 mm	KOM-707-99-74230	280.15
	707-01-0AY40	60001-		Bushing	110 mm		KOM-707-52-90851	45.85
	707-01-0AY50	60001-		P-UB-14	110 mm	200 mm	KOM-707-99-74230	280.15
PIN PULLER	707-01-0AY50	60001-		Bushing	110 mm		KOM-707-52-90851	45.85
	707-04-07200	60014-		P-U-3	30 mm	60 mm	KOM-707-98-11350	62.83
	707-04-07200	60014-		Bushing	30 mm		KOM-707-52-15050	7.41
RIPPER LIFT LH	707-04-X0070	60001-		P-U-3	30 mm	60 mm	KOM-707-98-11350	62.83
	707-04-X0070	60001-		Bushing	30 mm		KOM-707-52-15050	7.41
RIPPER LIFT RH	707-01-0AY20	60001-		P-UB-14	110 mm	200 mm	KOM-707-99-74240	311.41
	707-01-0AY20	60001-		Bushing	110 mm		KOM-707-52-90851	45.85
RIPPER TILT LH	707-01-0AY30	60001-		P-UB-14	110 mm	200 mm	KOM-707-99-74240	311.41
	707-01-0AY30	60001-		Bushing	110 mm		KOM-707-52-90851	45.85
RIPPER TILT RH	707-01-0AY60	60001-		P-UB-14	110 mm	180 mm	KOM-707-99-67700	264.02
RIPPER TILT RH	707-01-0AY70	60001-		P-UB-14	110 mm	180 mm	KOM-707-99-67700	264.02
MODEL D475A-1								
TILT (K Link)	198-63-02130	10001-		P-U-14	140 mm	250 mm	KOM-707-98-84011	594.92
MODEL D475A-2								
TILT	198-63-02130	10201-		P-U-14	140 mm	250 mm	KOM-707-98-84011	594.92
MODEL D475A-3								
BLADE TILT	198-63-02131	10601-		P-U-14	140 mm	250 mm	KOM-707-98-84011	594.92
DUAL TILT	198-63-02131	10601-		P-U-14	140 mm	250 mm	KOM-707-98-84011	594.92
MODEL D475A-3 SD								
BLADE TILT	198-63-02230	10601-		P-U-14	140 mm	250 mm	KOM-707-98-84011	594.92
DUAL TILT	198-63-02230	10601-		P-U-14	140 mm	250 mm	KOM-707-98-84011	594.92
MODEL D475A-5								
BLADE LIFT	707-03-00150	20001-20120		P-UB-14	110 mm	180 mm	KOM-707-99-67640	252.56
	707-03-00150	20001-20120		Bushing	110 mm		KOM-707-52-90850	45.85
	707-03-00152	20121-		P-UB-14	110 mm	180 mm	KOM-707-99-67640	252.56
BLADE TILT	707-01-0X760	20001-		P-UB-14	140 mm	250 mm	KOM-707-99-84200	367.58
	707-01-0X990	20001-		P-UB-14	140 mm	250 mm	KOM-707-99-84200	367.58
PIN PULLER	707-04-00070	20001-		P-U-3	30 mm	60 mm	KOM-707-98-11350	62.83
	707-04-00070	20001-		Bushing	30 mm		KOM-07177-03025	7.41
RIPPER LIFT	707-01-0F540	20001-20121		P-UB-14	120 mm	225 mm	KOM-707-99-75600	270.18
	707-01-0F540	20001-20121		Bushing	120 mm		KOM-707-52-90980	69.96
	707-01-0F541	20122-		P-UB-14	120 mm	225 mm	KOM-707-99-75600	270.18
	707-01-0F541	20122-		Bushing	120 mm		KOM-707-52-90980	69.96
RIPPER TILT	707-01-0F560	20001-		P-UB-14	140 mm	225 mm	KOM-707-99-77620	293.02
MODEL D475A-5E0								
BLADE LIFT	707-03-00152	30001-30146		P-UB-14	110 mm	180 mm	KOM-707-99-67640	252.56
	707-03-00152	30147-		P-UB-14	110 mm	180 mm	KOM-707-99-67640	252.56
BLADE TILT	707-01-0X760	30001-30146		P-UB-14	140 mm	250 mm	KOM-707-99-84200	367.58
	707-01-0X760	30147-		P-UB-14	140 mm	250 mm	KOM-707-99-84200	367.58
PIN PULLER	707-04-00070	30001-		P-U-3	30 mm	60 mm	KOM-707-98-11350	62.83
	707-04-00070	30001-		Bushing	30 mm		KOM-707-52-15050	7.41
	707-04-07200	30150-		P-U-3	30 mm	60 mm	KOM-707-98-11350	62.83
	707-04-07200	30150-		Bushing	30 mm		KOM-707-52-15050	7.41
	707-04-X0070	30147-		P-U-3	30 mm	60 mm	KOM-707-98-11350	62.83

LT - Large size tire L/S - Loading Shovel SLF - Super Long Front B/H - Backhoe HD - Heavy Duty L BUCKET - Large Bucket
 K-LINK - K-type Linkage Blade LB HI-LIFT - High Lift Arm w Large Bucket HI-LIFT - High Lift Arm S HI-LIFT - Super High Lift Arm
 SU - Semi-U Dozer PAT - Power Angle Power Tilt MP - Mult-Purpose

Replacement Kits For

KOMATSU®

KOMATSU®

Crawler Dozers								
APPLICATION	CYL #	SERIAL #	Misc	CODE	ROD	BORE	KIT #	List \$
NEW MODEL D475A-5E0								
PIN PULLER	707-04-X0070	30147-		Bushing	30 mm		KOM-707-52-15050	7.41
RIPPER LIFT	707-01-0F541	30001-30146		P-UB-14	120 mm	225 mm	KOM-707-99-75600	270.18
	707-01-0F541	30001-30146		Bushing	120 mm		KOM-707-52-90980	69.96
	707-01-0F541	30147-		P-UB-14	120 mm	225 mm	KOM-707-99-75600	270.18
	707-01-0F541	30147-		Bushing	120 mm		KOM-707-52-90981	69.96
RIPPER TILT	707-01-0F560	30001-30146		P-UB-14	140 mm	225 mm	KOM-707-99-77620	293.02
	707-01-0F560	30147-		P-UB-14	140 mm	225 mm	KOM-707-99-77620	293.02
NEW MODEL D475ASD-5E0								
BLADE LIFT	707-03-00152	30001-		P-UB-14	110 mm	180 mm	KOM-707-99-67640	252.56
BLADE TILT	707-01-0X990	30001-		P-UB-14	140 mm	250 mm	KOM-707-99-84200	367.58
PIN PULLER	707-04-00070	30001-		P-U-3	30 mm	60 mm	KOM-707-98-11350	62.83
	707-04-00070	30001-		Bushing	30 mm		KOM-707-52-15050	7.41
RIPPER LIFT	707-01-0F541	30001-		P-UB-14	120 mm	225 mm	KOM-707-99-75600	270.18
	707-01-0F541	30001-		Bushing	120 mm		KOM-707-52-90980	69.96
RIPPER TILT	707-01-0F560	30001-		P-UB-14	140 mm	225 mm	KOM-707-99-77620	293.02
Dump Trucks - Articulated								
APPLICATION	CYL #	SERIAL #	Misc	CODE	ROD	BORE	KIT #	List \$
NEW MODEL HM300-1								
HOIST	707-09-00030	1001-		P-U-14	80,120 mm	100,140 mm	KOM-707-99-54140	144.12
	707-09-00030	1001-		Bushing	80 mm		KOM-07177-08035	29.06
	707-09-00030	1001-		Bushing	120 mm		KOM-07177-01235	48.63
STEERING	707-00-0C781	1001-		P-U-14	70 mm	110 mm	KOM-707-98-37680	135.09
	707-00-0C781	1001-		Bushing	70 mm		KOM-707-52-10700	22.55
SUSPENSION FRONT	56D-50-13100	1001-1188		P-U-1	110 mm	150 mm	KOM-56D-50-13100K	98.63
	56D-50-13100	1001-1188		Bushing	110 mm		KOM-07177-01135	45.85
	56D-50-13101	1189-1484		P-UB-1	110 mm	150 mm	KOM-56D-50-13101K	103.69
	56D-50-13101	1189-1484		Bushing	110 mm		KOM-07177-01135	45.85
	56D-50-13102	1485-1584		P-UB-1	110 mm	150 mm	KOM-56D-50-13102K	242.03
	56D-50-13102	1485-1584		Bushing	110 mm		KOM-07177-01135	45.85
	56D-50-13103	1585-		P-UB-1	110 mm	150 mm	KOM-56D-50-13103K	242.03
SUSPENSION REAR	56D-50-14100	1001-1188		P-U-1	110 mm	150 mm	KOM-56D-50-14100K	98.63
	56D-50-14100	1001-1188		Bushing	110 mm		KOM-07177-01135	45.85
	56D-50-14101	1189-1484		P-UB-1	110 mm	150 mm	KOM-56D-50-14101K	103.69
	56D-50-14101	1189-1484		Bushing	110 mm		KOM-07177-01135	45.85
	56D-50-14102	1485-1584		P-UB-1	110 mm	150 mm	KOM-56D-50-14102K	242.03
	56D-50-14102	1485-1584		Bushing	110 mm		KOM-07177-01135	45.85
	56D-50-14103	1585-		P-UB-1	110 mm	150 mm	KOM-56D-50-14103K	242.03
NEW MODEL HM300-1L								
HOIST	707-09-07041	A10001-		P-U-14	80,120 mm	100,140 mm	KOM-707-99-54140	144.12
	707-09-07041	A10001-		Bushing	120 mm		KOM-07177-01235	48.63
	707-09-07041	A10001-		Bushing	80 mm		KOM-07177-08035	29.06
STEERING	707-00-0C782	A10001-		P-U-14	70 mm	110 mm	KOM-707-99-37620	146.93
	707-00-0C782	A10001-		Bushing	70 mm		KOM-707-52-10700	22.55
SUSPENSION FRONT	56D-50-13100	A10001-		P-U-1	110 mm	150 mm	KOM-56D-50-13100K	98.63
	56D-50-13100	A10001-		Bushing	110 mm		KOM-07177-01135	45.85
SUSPENSION REAR	56D-50-14100	A10001-A10019		P-U-1	110 mm	150 mm	KOM-56D-50-14100K	98.63
	56D-50-14100	A10001-A10019		Bushing	110 mm		KOM-07177-01135	45.85
	56D-50-14101	A10020-		P-UB-1	110 mm	150 mm	KOM-56D-50-14101K	103.69
	56D-50-14101	A10020-		Bushing	110 mm		KOM-07177-01135	45.85
NEW MODEL HM300-2								
HOIST	707-09-00031	2001-2784		P-U-14	80,120 mm	100,140 mm	KOM-707-99-54150	220.52
	707-09-00031	2001-2784		Bushing	120 mm		KOM-07177-01235	48.63
	707-09-00031	2001-2784		Bushing	80 mm		KOM-07177-08035	29.06

LT - Large size tire L/S - Loading Shovel SLF - Super Long Front B/H - Backhoe HD - Heavy Duty L BUCKET - Large Bucket
 K-LINK - K-type Linkage Blade LB HI-LIFT - High Lift Arm w Large Bucket HI-LIFT - High Lift Arm S HI-LIFT - Super High Lift Arm
 SU - Semi-U Dozer PAT - Power Angle Power Tilt MP - Mult-Purpose

Replacement Kits For

KOMATSU®

Dump Trucks - Articulated

APPLICATION	CYL #	SERIAL #	Misc	CODE	ROD	BORE	KIT #	List \$
MODEL HM300-2								
NEW HOIST	707-09-00031	2785-		P-U-14	80,120 mm	100,140 mm	KOM-707-99-54150	220.52
	707-09-00031	2785-		Bushing	120 mm		KOM-07177-01235	48.63
	707-09-00031	2785-		Bushing	80 mm		KOM-07177-08035	29.06
	707-09-00031	A11001-		P-U-14	80,120 mm	100,140 mm	KOM-707-99-54150	220.52
	707-09-00031	A11001-		Bushing	80 mm		KOM-07177-08035	29.06
	707-09-00031	A11001-		Bushing	120 mm		KOM-07177-01235	48.63
STEERING	707-00-0C782	2001-2784		P-U-14	70 mm	110 mm	KOM-707-99-37620	146.93
	707-00-0C782	2001-2784		Bushing	70 mm		KOM-707-52-10700	22.55
	707-00-0C782	2785-		P-U-14	70 mm	110 mm	KOM-707-99-37620	146.93
	707-00-0C782	2785-		Bushing	70 mm		KOM-707-52-10701	22.55
	707-00-0C782	A11001-		P-U-14	70 mm	110 mm	KOM-707-99-37620	146.93
	707-00-0C782	A11001-		Bushing	70 mm		KOM-707-52-10701	22.55
SUSPENSION FRONT	56D-50-13102	2001-2588		P-UB-1	110 mm	150 mm	KOM-56D-50-13102K	242.03
	56D-50-13102	2001-2588		Bushing	110 mm		KOM-07177-01135	45.85
	56D-50-13103	2589-2784		P-UB-1	110 mm	150 mm	KOM-56D-50-13103K	242.03
	56D-50-13103	2785-		P-UB-1	110 mm	150 mm	KOM-56D-50-13103K	242.03
	56D-50-13103	A11001-		P-UB-1	110 mm	150 mm	KOM-56D-50-13103K	242.03
	56D-50-26100	2589-2784		P-UB-1	110 mm	150 mm	KOM-56D-50-26100K	242.03
	56D-50-26100	2785-		P-UB-1	110 mm	150 mm	KOM-56D-50-26100K	242.03
	56D-50-26100	2785-		P-UB-1	110 mm	150 mm	KOM-56D-50-26100K	242.03
SUSPENSION REAR	56D-50-14102	2001-2588		P-UB-1	110 mm	150 mm	KOM-56D-50-14102K	242.03
	56D-50-14102	2001-2588		Bushing	110 mm		KOM-07177-01135	45.85
	56D-50-14103	2589-2784		P-UB-1	110 mm	150 mm	KOM-56D-50-14103K	242.03
	56D-50-14103	2785-		P-UB-1	110 mm	150 mm	KOM-56D-50-14103K	242.03
	56D-50-14103	A11001-		P-UB-1	110 mm	150 mm	KOM-56D-50-14103K	242.03
	56D-50-26200	2589-2784		P-UB-1	110 mm	150 mm	KOM-56D-50-26200K	242.03
	56D-50-26200	2785-		P-UB-1	110 mm	150 mm	KOM-56D-50-26200K	242.03
	56D-50-26200	2785-		P-UB-1	110 mm	150 mm	KOM-56D-50-26200K	242.03
MODEL HM300-3								
NEW HOIST LH	707-E0-00130	3001-		P-U-14	80 mm	110 mm	KOM-707-98-39700	158.51
	707-E0-00130	3001-		Bushing	80 mm		KOM-707-52-15540	29.06
HOIST RH	707-E0-00140	3001-		P-U-14	80 mm	110 mm	KOM-707-98-39700	158.51
	707-E0-00140	3001-		Bushing	80 mm		KOM-707-52-15540	29.06
STEERING	707-E0-00120	3001-		P-U-14	70 mm	105 mm	KOM-707-98-37300	151.92
SUSPENSION FRONT LH	56D-50-33000	3001-		P-UB-1	110 mm	150 mm	KOM-56D-50-33000K	242.03
SUSPENSION FRONT RH	56D-50-35000	3001-		P-UB-1	110 mm	150 mm	KOM-56D-50-35000K	242.03
SUSPENSION REAR	56D-50-34000	3001-		P-UB-1	110 mm	150 mm	KOM-56D-50-34000K	242.03
MODEL HM400-1								
NEW HOIST	707-09-07074	1350-		P-U-14	90, 140	120 mm	KOM-707-99-64152	360.09
	707-09-07074	1350-		Bushing	90 mm		KOM-07177-09040	42.75
	707-09-07074	1350-		Bushing	140 mm		KOM-07177-01435	102.72
	707-09-16022	1001-1079		P-U-14	90,140	120,160	KOM-707-99-64150	248.77
	707-09-16022	1001-1079		Bushing	140 mm		KOM-07177-01435	102.72
	707-09-16022	1001-1079		Bushing	90 mm		KOM-07177-09040	42.75
	707-09-16024	1080-1349		P-U-14	90, 140	120 mm	KOM-707-99-64152	360.09
	707-09-16024	1080-1349		Bushing	140 mm		KOM-07177-01435	102.72
	707-09-16024	1080-1349		Bushing	90 mm		KOM-07177-09040	42.75
	STEERING LH	707-00-07E60	1005-1456		P-U-14	70 mm	120 mm	KOM-707-98-43260
707-00-07E60		1005-1456		Bushing	70 mm		KOM-707-52-10700	22.55
707-00-0G620		1457-		P-U-14	70 mm	120 mm	KOM-707-99-43170	191.26
707-00-0G620		1457-		Bushing	70 mm		KOM-707-52-10700	22.55
721-00-12053		1001-1004		P-U-14	70 mm	120 mm	KOM-707-98-43260	148.47
721-00-12053		1001-1004		Bushing	70 mm		KOM-707-52-10700	22.55
STEERING RH	707-00-07E70	1005-1456		P-U-14	70 mm	120 mm	KOM-707-98-43260	148.47
	707-00-07E70	1005-1456		Bushing	70 mm		KOM-707-52-10700	22.55

LT - Large size tire L/S - Loading Shovel SLF - Super Long Front B/H - Backhoe HD - Heavy Duty L BUCKET - Large Bucket

K-LINK - K-type Linkage Blade LB HI-LIFT - High Lift Arm w Large Bucket HI-LIFT - High Lift Arm S HI-LIFT - Super High Lift Arm

SU - Semi-U Dozer PAT - Power Angle Power Tilt MP - Mult-Purpose

Replacement Kits For

KOMATSU®

KOMATSU®

Dump Trucks - Articulated									
APPLICATION	CYL #	SERIAL #	Misc	CODE	ROD	BORE	KIT #	List \$	
NEW MODEL HM400-1									
STEERING RH	707-00-0G630	1457-		P-U-14	70 mm	120 mm	KOM-707-99-43170	191.26	
	707-00-0G630	1457-		Bushing	70 mm		KOM-707-52-10700	22.55	
	721-00-12063	1001-1004		P-U-14	70 mm	120 mm	KOM-707-98-43260	148.47	
	721-00-12063	1001-1004		Bushing	70 mm		KOM-707-52-10700	22.55	
SUSPENSION FRONT	56B-50-13002	1001-1243		P-U-1	140 mm	180 mm	KOM-56B-50-13002K	276.53	
	56B-50-13002	1001-1243		Bushing	140 mm		KOM-07177-01440	100.02	
	56B-50-13003	1244-1447		P-UB-1	140 mm	180 mm	KOM-56B-50-13003K	419.83	
	56B-50-13003	1244-1447		Bushing	140 mm		KOM-07177-01440	100.02	
	56B-50-13004	1448-1743		P-UB-1	140 mm	180 mm	KOM-56B-50-13004K	419.83	
	56B-50-13004	1448-1743		Bushing	140 mm		KOM-07177-01440	100.02	
	56B-50-13005	1744-		P-UB-1	140 mm	180 mm	KOM-56B-50-13005K	419.83	
	56B-50-16100	1110-1243		P-U-1	140 mm	180 mm	KOM-56B-50-16100K	276.53	
	56B-50-16100	1110-1243		Bushing	140 mm		KOM-07177-01440	100.02	
	56B-50-16101	1244-1447		P-UB-1	140 mm	180 mm	KOM-56B-50-16101K	419.83	
	56B-50-16101	1244-1447		Bushing	140 mm		KOM-07177-01440	100.02	
	56B-50-16102	1448-1743		P-UB-1	140 mm	180 mm	KOM-56B-50-16102K	419.83	
	56B-50-16102	1448-1743		Bushing	140 mm		KOM-07177-01440	100.02	
	56B-50-16103	1744-		P-UB-1	140 mm	180 mm	KOM-56B-50-16103K	419.83	
SUSPENSION REAR	56B-50-14000	1001-1243		P-U-1	140 mm	180 mm	KOM-56B-50-14000K	276.53	
	56B-50-14000	1001-1243		Bushing	140 mm		KOM-07177-01440	100.02	
	56B-50-14001	1244-1447		P-UB-1	140 mm	180 mm	KOM-56B-50-14001K	419.83	
	56B-50-14001	1244-1447		Bushing	140 mm		KOM-07177-01440	100.02	
	56B-50-14002	1448-1743		P-UB-1	140 mm	180 mm	KOM-56B-50-14002K	419.83	
	56B-50-14002	1448-1743		Bushing	140 mm		KOM-07177-01440	100.02	
	56B-50-14003	1744-		P-UB-1	140 mm	180 mm	KOM-56B-50-14003K	419.83	
	56B-50-16201	1244-1447		P-UB-1	140 mm	180 mm	KOM-56B-50-16201K	419.83	
	56B-50-16201	1244-1447		Bushing	140 mm		KOM-07177-01440	100.02	
	56B-50-16202	1448-1743		P-UB-1	140 mm	180 mm	KOM-56B-50-16202K	419.83	
	56B-50-16202	1448-1743		Bushing	140 mm		KOM-07177-01440	100.02	
	56B-50-16203	1744-		P-UB-1	140 mm	180 mm	KOM-56B-50-16203K	419.83	
	NEW MODEL HM400-1L								
	HOIST	707-09-16024	A10001-		P-U-14	90,140	120,160	KOM-707-99-64150	248.77
707-09-16024		A10001-		Bushing	140 mm		KOM-07177-01435	102.72	
707-09-16024		A10001-		Bushing	90 mm		KOM-07177-09040	42.75	
STEERING LH	707-00-07E60	A10001-		P-U-14	70 mm	120 mm	KOM-707-98-43260	148.47	
	707-00-07E60	A10001-		Bushing	70 mm		KOM-707-52-10700	22.55	
STEERING RH	707-00-07E70	A10001-		P-U-14	70 mm	120 mm	KOM-707-98-43260	148.47	
	707-00-07E70	A10001-		Bushing	70 mm		KOM-707-52-10700	22.55	
SUSPENSION FRONT	56B-50-13002	A10001-		P-U-1	140 mm	180 mm	KOM-56B-50-13002K	276.53	
	56B-50-13002	A10001-		Bushing	140 mm		KOM-07177-01440	100.02	
SUSPENSION REAR	56B-50-14001	A10001-		P-UB-1	140 mm	180 mm	KOM-56B-50-14001K	419.83	
	56B-50-14001	A10001-		Bushing	140 mm		KOM-07177-01440	100.02	
MODEL HM400-2									
HOIST	707-09-00080	2448-		P-U-14	90, 140	120 mm	KOM-707-99-64180	366.06	
	707-09-07074	2001-2447		P-U-14	90, 140	120 mm	KOM-707-99-64152	360.09	
	707-09-07100	2448-		P-U-14	90, 140	120 mm	KOM-707-99-64180	366.06	
	707-09-16024	2001-2447		P-U-14	90, 140	120 mm	KOM-707-99-64152	360.09	
STEERING LH	707-00-0X420	2001-		P-U-14	70 mm	120 mm	KOM-707-99-43170	191.26	
	721-00-0G620	2001-		P-U-14	70 mm	120 mm	KOM-707-99-43170	191.26	
STEERING RH	707-00-0X430	2001-		P-U-14	70 mm	120 mm	KOM-707-99-43170	191.26	
	721-00-0G630	2001-		P-U-14	70 mm	120 mm	KOM-707-99-43170	191.26	
NEW MODEL HM400-3									
CAB TILT	707-E0-00110	3001-		P-U-10	25 mm	45 mm	KOM-707-98-02420	91.36	
HOIST LH	707-E0-00160	3001-		P-U-14	95 mm	135 mm	KOM-707-98-48700	257.62	
	707-E0-00160	3001-		Bushing	95 mm		KOM-707-52-10951	44.36	

LT - Large size tire L/S - Loading Shovel SLF - Super Long Front B/H - Backhoe HD - Heavy Duty L BUCKET - Large Bucket
 K-LINK - K-type Linkage Blade LB HI-LIFT - High Lift Arm w Large Bucket HI-LIFT - High Lift Arm S HI-LIFT - Super High Lift Arm
 SU - Semi-U Dozer PAT - Power Angle Power Tilt MP - Mult-Purpose

KOMATSU®

Replacement Kits For

Dump Trucks - Articulated								
APPLICATION	CYL #	SERIAL #	Misc	CODE	ROD	BORE	KIT #	List \$
MODEL HM400-3								
HOIST RH	707-E0-00170	3001-		P-U-14	95 mm	135 mm	KOM-707-98-48700	257.62
	707-E0-00170	3001-		Bushing	95 mm		KOM-707-52-10951	44.36
STEERING LH	707-E0-00230	3001-		P-UB-14	70 mm	120 mm	KOM-707-99-42170	205.85
	707-E0-00230	3001-		Bushing	70 mm		KOM-707-52-90461	10.24
STEERING RH	707-E0-00240	3001-		P-UB-14	70 mm	120 mm	KOM-707-99-42170	205.85
	707-E0-00240	3001-		Bushing	70 mm		KOM-707-52-90461	10.24
SUSPENSION REAR	56B-50-34000	3001-		P-UB-1	110 mm	150 mm	KOM-56B-50-34000K	247.07
Excavators								
APPLICATION	CYL #	SERIAL #	Misc	CODE	ROD	BORE	KIT #	List \$
MODEL PC05-5								
BLADE	707-00-60340	10401-		P-U-10	30 mm	60 mm	KOM-707-98-11090	97.88
MODEL PC05-6								
BLADE	707-00-60390	11701-		P-U-10	30 mm	60 mm	KOM-707-98-11090	97.88
BOOM	707-00-50660	11701-		P-U-10	30 mm	50 mm	KOM-707-98-04500	100.57
MODEL PC10-5								
ARM	20N-63-66701	10201-		P-U-10	35 mm	70 mm	KOM-707-98-12450	108.77
BLADE	20N-63-96300	10201-		P-U-10	35 mm	70 mm	KOM-707-98-12450	108.77
BOOM	20N-63-56700	10201-		P-U-10	35 mm	70 mm	KOM-707-98-12530	107.41
BOOM SWING	20N-63-86701	10201-		P-U-10	35 mm	70 mm	KOM-707-98-12520	108.17
BUCKET	20N-63-76500	10201-		P-U-10	35 mm	60 mm	KOM-707-98-12150	101.90
MODEL PC10-6								
BLADE	20N-63-02060	10501-10554		P-U-14	35 mm	70 mm	KOM-707-98-12410	67.75
BUCKET	20N-63-02040	10501-		P-U-10	35 mm	60 mm	KOM-707-98-12020	85.96
MODEL PC10-7								
ARM	20N-63-02222	25001-		P-U-14	40 mm	70 mm	KOM-707-98-14610	67.75
BLADE LIFT	20C-63-02050	25001-25857		P-U-10	35 mm	70 mm	KOM-707-98-12700	102.21
	20P-63-02140	25858-		P-U-14	35 mm	70 mm	KOM-707-98-12410	67.75
MODEL PC12R-8								
ARM	20M-63-02121	10001-		P-U-14	30 mm	50 mm	KOM-707-98-04640	85.32
BOOM SWING	20M-63-02140	10001-		P-U-14	30 mm	60 mm	KOM-707-98-11310	47.16
BUCKET	20M-63-02130	10001-		P-U-14	30 mm	50 mm	KOM-707-98-04640	85.32
MODEL PC12UU-1								
ARM	20C-63-02020	1001-		P-U-10	40 mm	70 mm	KOM-707-98-14710	115.41
BLADE	20C-63-02050	1001-		P-U-10	35 mm	70 mm	KOM-707-98-12700	102.21
BUCKET	20C-63-02030	1001-		P-U-10	35 mm	60 mm	KOM-707-98-12160	107.41
OFF-SET	20C-63-02040	1001-		P-U-14	35 mm	70 mm	KOM-707-98-12410	67.75
MODEL PC15-1								
ARM	20P-63-02020	1001-		P-U-10	40 mm	70 mm	KOM-707-98-14410	125.75
BLADE	20N-63-96300	1001-		P-U-10	35 mm	70 mm	KOM-707-98-12450	108.77
BOOM	20P-63-02010	1001-		P-U-10	40 mm	70 mm	KOM-707-99-14410	116.45
BOOM SWING	20P-63-02040	1001-		P-U-10	35 mm	70 mm	KOM-707-98-12520	108.17
BUCKET	20P-63-02030	1001-		P-U-10	35 mm	60 mm	KOM-707-98-12150	101.90
MODEL PC15-2								
ARM	20P-63-02070	2001-		P-U-10	40 mm	70 mm	KOM-707-98-14410	125.75
BLADE	20C-63-02050	2001-		P-U-10	35 mm	70 mm	KOM-707-98-12700	102.21
BOOM (Cab)	20P-63-02060	2001-		P-U-10	40 mm	70 mm	KOM-707-99-14410	116.45
BOOM (Canopy)	20P-63-02050	2001-		P-U-10	40 mm	70 mm	KOM-707-99-14410	116.45
BUCKET	20P-63-02040	2001-		P-U-10	35 mm	70 mm	KOM-707-98-12520	108.17
MODEL PC15-3								
BLADE LIFT	20P-63-02251	5001-		P-U-14	35 mm	70 mm	KOM-707-98-12410	67.75
MODEL PC15R-8								
ARM	20W-63-02121	10001-		P-U-14	35 mm	55 mm	KOM-707-98-13960	33.16
BLADE	20W-63-02150	10001-		P-U-14	35 mm	70 mm	KOM-707-98-12660	68.06
BOOM (Cab)	20W-63-02160	10001-		P-U-14	35 mm	60 mm	KOM-707-98-12330	66.29
BOOM (Canopy)	20W-63-02111	10001-		P-U-14	35 mm	60 mm	KOM-707-98-12330	66.29
BOOM (Swing)	20M-63-02140	10001-		P-U-14	30 mm	60 mm	KOM-707-98-11310	47.16

LT - Large size tire L/S - Loading Shovel SLF - Super Long Front B/H - Backhoe HD - Heavy Duty L BUCKET - Large Bucket

K-LINK - K-type Linkage Blade LB HI-LIFT - High Lift Arm w Large Bucket HI-LIFT - High Lift Arm S HI-LIFT - Super High Lift Arm

SU - Semi-U Dozer PAT - Power Angle Power Tilt MP - Multi-Purpose

KOMATSU®

Replacement Kits For

Excavators								
APPLICATION	CYL #	SERIAL #	Misc	CODE	ROD	BORE	KIT #	List \$
MODEL PC15R-8								
BUCKET	20M-63-02130	10001-		P-U-14	30 mm	50 mm	KOM-707-98-04640	85.32
MODEL PC20-5								
ARM	20R-63-66300	18001-		P-U-14	40 mm	80 mm	KOM-707-98-22120	125.74
BLADE	20S-63-96300	18001-		P-U-14	45 mm	90 mm	KOM-707-98-24600	170.85
BOOM	20R-63-56500	18001-		P-U-14	40 mm	80 mm	KOM-707-98-22030	136.42
BOOM SWING	20S-63-86301	18001-		P-U-14	35 mm	70 mm	KOM-707-98-12440	83.38
BUCKET	20R-63-76301	18001-		P-U-14	35 mm	70 mm	KOM-707-98-12440	83.38
MODEL PC20-6								
ARM	20R-63-02030	24001-		P-U-14	40 mm	75 mm	KOM-707-98-22200	142.72
BLADE	20S-63-02062	24001-		P-U-14	45 mm	90 mm	KOM-707-98-24520	115.38
BOOM (Cab)	20R-63-02011	24001-		P-U-14	45 mm	80 mm	KOM-707-99-24200	124.53
BOOM (Canopy)	20R-63-02021	24001-		P-U-14	45 mm	80 mm	KOM-707-99-24200	124.53
BOOM SWING	20S-63-02050	24001-		P-U-14	45 mm	85 mm	KOM-707-98-24510	128.85
BUCKET	20R-63-02040	24001-		P-U-14	35 mm	65 mm	KOM-707-98-12211	140.22
MODEL PC20-7								
ARM	20N-63-02222	35001-37000		P-U-14	40 mm	70 mm	KOM-707-98-14610	67.75
BLADE LIFT	20N-63-02251	35001-		P-U-14	35 mm	70 mm	KOM-707-98-12410	67.75
BUCKET	20P-63-02130	42355-		P-U-14	35 mm	60 mm	KOM-707-98-12310	66.29
	20P-63-02131	35001-		P-U-14	35 mm	60 mm	KOM-707-98-12310	66.29
MODEL PC20MRX-1								
ARM	22K-63-02131	10001-		P-U-14	40 mm	70 mm	KOM-707-98-14610	67.75
MODEL PC20R-8								
ARM	20N-63-02523	10001-		P-U-14	40 mm	65 mm	KOM-707-98-14830	48.29
BLADE LIFT (MAPI)	20N-63-02011	10001-		P-U-14	35 mm	70 mm	KOM-707-98-12410	67.75
MODEL PC25-1								
ARM	20R-63-02212	1001-		P-U-14	40 mm	75 mm	KOM-707-98-22200	142.72
BLADE LIFT	20S-63-02260	1001-		P-U-14	45 mm	95 mm	KOM-707-98-24610	59.78
BLADE TILT	20U-63-02090	1001-		P-U-14	45 mm	90 mm	KOM-707-98-24550	74.22
BOOM SWING	20S-63-02240	1001-		P-U-14	45 mm	85 mm	KOM-707-98-24510	128.85
BUCKET	20R-63-02222	1001-		P-U-14	40 mm	65 mm	KOM-707-98-14830	48.29
MODEL PC25R-8								
ARM	20P-63-02522	10001-		P-U-14	40 mm	70 mm	KOM-707-98-14610	67.75
BLADE	20P-63-02451	10001-		P-U-14	40 mm	70 mm	KOM-707-98-12670	67.75
BLADE LIFT	20N-63-02271	10001-		P-U-14	35 mm	70 mm	KOM-707-98-12410	67.75
BOOM (Cab)	20P-63-02512	10001-		P-U-14	45 mm	75 mm	KOM-707-98-24890	172.10
BOOM (Canopy)	20P-63-02502	10001-		P-U-14	45 mm	75 mm	KOM-707-98-24890	172.10
BOOM SWING	20P-63-02541	10001-		P-U-14	40 mm	80 mm	KOM-707-98-23130	102.43
MODEL PC27MR-2								
ARM	707-00-0F460	15001-		P-U-14	40 mm	65 mm	KOM-707-98-14910	48.34
BLADE LIFT	707-00-0E550	15001-		P-U-14	45 mm	85 mm	KOM-707-98-24930	79.13
BOOM	707-00-0F450	15001-		P-U-14	45 mm	75 mm	KOM-707-98-23890	63.38
BOOM SWING	707-00-0F480	15001-		P-U-14	40 mm	75 mm	KOM-707-98-22890	62.83
BUCKET	707-00-0F470	15001-		P-U-14	35 mm	55 mm	KOM-707-98-13990	93.22
MODEL PC27MRX-1								
ARM	22L-63-02230	10001-10878		P-U-14	40 mm	70 mm	KOM-707-98-14610	67.75
	22L-63-02231	10879-		P-U-14	40 mm	70 mm	KOM-707-98-14610	67.75
BLADE	21U-63-02451	10001-		P-U-14	40 mm	80 mm	KOM-707-98-22180	62.33
BOOM	22L-63-02112	10001-		P-U-14	45 mm	75 mm	KOM-707-98-24890	172.10
	22L-63-02113	10001-		P-U-14	45 mm	75 mm	KOM-707-98-24890	172.10
	22L-63-02122	10001-		P-U-14	45 mm	75 mm	KOM-707-98-24890	172.10
	22L-63-02123	10001-		P-U-14	45 mm	75 mm	KOM-707-98-24890	172.10
BOOM (Cab)	707-00-75330	10001-		P-U-14	45 mm	75 mm	KOM-707-98-24890	172.10
	707-00-75331	10001-		P-U-14	45 mm	75 mm	KOM-707-98-24890	172.10
BOOM SWING	721-00-80500	10001-		P-U-14	40 mm	80 mm	KOM-707-98-23130	102.43
BOOM SWING (Cab)	22L-63-86242	10001-		P-U-14	40 mm	80 mm	KOM-707-98-23130	102.43

LT - Large size tire L/S - Loading Shovel SLF - Super Long Front B/H - Backhoe HD - Heavy Duty L BUCKET - Large Bucket
 K-LINK - K-type Linkage Blade LB HI-LIFT - High Lift Arm w Large Bucket HI-LIFT - High Lift Arm S HI-LIFT - Super High Lift Arm
 SU - Semi-U Dozer PAT - Power Angle Power Tilt MP - Multi-Purpose

Replacement Kits For

KOMATSU®

Excavators								
APPLICATION	CYL #	SERIAL #	Misc	CODE	ROD	BORE	KIT #	List \$
MODEL PC27MRX-1								
BOOM SWING (Canopy)	22L-63-86142	10001-		P-U-14	40 mm	80 mm	KOM-707-98-23130	102.43
BUCKET	21U-63-02480	10001-		P-U-14	40 mm	70 mm	KOM-707-98-14610	67.75
	22L-63-02240	10001-		P-U-14	35 mm	60 mm	KOM-707-98-12310	66.29
MODEL PC27R-8								
ARM	20P-63-02522	10001-		P-U-14	40 mm	70 mm	KOM-707-98-14610	67.75
BLADE	20P-63-02552	10001-		P-U-14	40 mm	70 mm	KOM-707-98-12670	67.75
BLADE LIFT	20P-63-02140	10001-		P-U-14	35 mm	70 mm	KOM-707-98-12410	67.75
BOOM (Cab)	20P-63-02512	10001-		P-U-14	45 mm	75 mm	KOM-707-98-24890	172.10
BOOM (Canopy)	20P-63-02502	10001-		P-U-14	45 mm	75 mm	KOM-707-98-24890	172.10
BOOM (Swing)	20P-63-02541	10001-		P-U-14	40 mm	80 mm	KOM-707-98-23130	102.43
BUCKET	20P-63-02531	10001-		P-U-14	35 mm	60 mm	KOM-707-98-12310	66.29
MODEL PC28UU-1								
ARM	21U-63-02020	1001-		P-U-10	40 mm	80 mm	KOM-707-98-22080	129.50
BLADE	21U-63-02050	1001-3652		P-U-10	40 mm	80 mm	KOM-707-98-22060	104.54
	21U-63-02060	3653-		P-U-10	40 mm	80 mm	KOM-707-98-22060	104.54
BOOM	21U-63-02011	1001-		P-U-10	45 mm	80 mm	KOM-707-98-24060	121.97
BUCKET	21U-63-02030	1001-1825		P-U-14	35 mm	70 mm	KOM-707-98-12410	67.75
	21U-63-02031	1826-		P-U-14	35 mm	70 mm	KOM-707-98-12410	67.75
OFF-SET	21U-63-02041	1001-1825		P-U-14	35 mm	70 mm	KOM-707-98-12410	67.75
	21U-63-02042	1826-		P-U-14	35 mm	70 mm	KOM-707-98-12410	67.75
MODEL PC30-5								
ARM	20S-63-66300	6001-		P-U-14	40 mm	80 mm	KOM-707-98-22120	125.74
BLADE	20S-63-96300	6001-		P-U-14	45 mm	90 mm	KOM-707-98-24600	170.85
BOOM	20S-63-56500	6001-		P-U-14	40 mm	80 mm	KOM-707-98-22030	136.42
BOOM SWING	20S-63-86300	6001-		P-U-14	35 mm	70 mm	KOM-707-98-12440	83.38
BUCKET	20S-63-76102	6001-		P-U-14	40 mm	70 mm	KOM-707-98-14430	97.88
MODEL PC30-6								
ARM	20S-63-02030	10001-		P-U-14	40 mm	75 mm	KOM-707-98-22200	142.72
BLADE	20S-63-02062	10001-		P-U-14	45 mm	90 mm	KOM-707-98-24520	115.38
BLADE TILT	20U-63-02090	10001-		P-U-14	45 mm	90 mm	KOM-707-98-24550	74.22
BOOM (Cab)	20S-63-02021	10001-		P-U-14	45 mm	80 mm	KOM-707-99-24200	124.53
BOOM (Canopy)	20S-63-02011	10001-		P-U-14	45 mm	80 mm	KOM-707-99-24200	124.53
BOOM SWING	20S-63-02050	10001-		P-U-14	45 mm	85 mm	KOM-707-98-24510	128.85
BUCKET	20S-63-02040	10001-		P-U-14	40 mm	70 mm	KOM-707-98-14610	67.75
MODEL PC30-7								
ARM	20S-63-02202	18001-		P-U-14	45 mm	75 mm	KOM-707-98-24820	66.74
BLADE LIFT	20S-63-02260	18001-		P-U-14	45 mm	95 mm	KOM-707-98-24610	59.78
BLADE TILT	20U-63-02090	18001-		P-U-14	45 mm	90 mm	KOM-707-98-24550	74.22
BOOM	20S-63-02231	18001-		P-U-14	45 mm	85 mm	KOM-707-98-24920	130.41
BOOM SWING	20S-63-02240	18001-		P-U-14	45 mm	85 mm	KOM-707-98-24510	128.85
BUCKET	20S-63-02212	18001-		P-U-14	40 mm	70 mm	KOM-707-98-14610	67.75
MODEL PC30MRX-1								
BLADE	20U-63-02451	10001-		P-U-14	40 mm	80 mm	KOM-707-98-22180	62.33
BOOM (Cab)	707-00-75330	10001-		P-U-14	45 mm	75 mm	KOM-707-98-24890	172.10
BOOM (Canopy)	707-00-75320	10001-		P-U-14	45 mm	75 mm	KOM-707-98-24890	172.10
BOOM SWING (Cab)	721-00-80500	10001-		P-U-14	40 mm	80 mm	KOM-707-98-23130	102.43
BOOM SWING (Canopy)	721-00-80400	10001-		P-U-14	40 mm	80 mm	KOM-707-98-23130	102.43
BUCKET	20U-63-02432	10001-		P-U-14	40 mm	65 mm	KOM-707-98-14830	48.29
MODEL PC35MR-2								
ARM	707-00-0E570	5001-		P-U-14	45 mm	75 mm	KOM-707-98-23870	68.89
BLADE ANGLE	707-00-0G340	5001-		P-U-14	35 mm	60 mm	KOM-707-98-13220	49.56
BLADE LIFT	707-00-0E590	5001-		P-U-14	45 mm	95 mm	KOM-707-98-24770	59.84
	707-00-0F370	5001-		P-U-14	45 mm	95 mm	KOM-707-98-24770	59.84
BOOM	707-00-0E560	5001-		P-U-14	45 mm	80 mm	KOM-707-98-24330	73.00
BOOM SWING	707-00-0E580	5001-		P-U-14	50 mm	95 mm	KOM-707-98-29630	98.71

LT - Large size tire L/S - Loading Shovel SLF - Super Long Front B/H - Backhoe HD - Heavy Duty L BUCKET - Large Bucket
 K-LINK - K-type Linkage Blade LB HI-LIFT - High Lift Arm w Large Bucket HI-LIFT - High Lift Arm S HI-LIFT - Super High Lift Arm
 SU - Semi-U Dozer PAT - Power Angle Power Tilt MP - Multi-Purpose

Replacement Kits For

KOMATSU®

Excavators									
APPLICATION	CYL #	SERIAL #	Misc	CODE	ROD	BORE	KIT #	List \$	
MODEL PC35MR-2									
BUCKET	707-00-0E530	5001-		P-U-14	40 mm	65 mm	KOM-707-98-14930	100.37	
MODEL PC35MRX-1A									
ARM	22F-63-02121	1001-		P-U-14	45 mm	75 mm	KOM-707-98-23810	68.82	
BLADE	22F-63-02152	1001-		P-U-14	45 mm	95 mm	KOM-707-98-24610	59.78	
BOOM	22F-63-02112	3930-		P-U-14	45 mm	80 mm	KOM-707-98-24281	68.47	
BOOM SWING	22F-63-02142	1001-1008		P-U-14	50 mm	95 mm	KOM-707-98-29661	86.65	
	22F-63-02143	1009-		P-U-14	50 mm	95 mm	KOM-707-98-29661	86.65	
BUCKET	20S-63-02423	3930-		P-U-14	40 mm	65 mm	KOM-707-98-14830	48.29	
MODEL PC35R-8									
ARM	20S-63-02414	35001-		P-U-14	45 mm	75 mm	KOM-707-98-23810	68.82	
BUCKET	20S-63-02423	35001-		P-U-14	40 mm	65 mm	KOM-707-98-14830	48.29	
MODEL PC38UU-1									
BLADE	21X-63-02050	1001-		P-U-14	50 mm	95 mm	KOM-707-98-25610	135.85	
BOOM	21X-63-02010	1001-		P-U-14	50 mm	90 mm	KOM-707-98-25600	136.27	
BUCKET	21X-63-02030	1001-		P-U-14	40 mm	70 mm	KOM-707-98-14610	67.75	
OFF-SET	21X-63-02040	1001-		P-U-14	45 mm	85 mm	KOM-707-98-24510	128.85	
MODEL PC40-5									
ARM	20T-63-02021	8501-		P-U-14	55 mm	80 mm	KOM-707-98-26100	100.88	
BLADE	20S-63-96300	8501-		P-U-14	45 mm	90 mm	KOM-707-98-24600	170.85	
BOOM	20T-63-02011	8501-		P-U-14	55 mm	90 mm	KOM-707-98-26570	96.66	
BUCKET	20T-63-02031	8501-		P-U-14	55 mm	80 mm	KOM-707-98-26100	100.88	
SWING	20T-63-02040	8501-		P-U-14	50 mm	90 mm	KOM-707-98-25500	163.18	
MODEL PC40-6									
ARM	20T-63-02070	10001-		P-UB-14	50 mm	80 mm	KOM-707-98-25110	180.13	
BLADE	20T-63-02091	10001-13021		P-U-14	60 mm	100 mm	KOM-707-98-35100	114.96	
	20U-63-02080	13022-		P-U-14	60 mm	100 mm	KOM-707-98-35100	114.96	
BOOM (Cab)	20T-63-02050	10001-		P-U-14	55 mm	90 mm	KOM-707-98-26550	97.68	
BOOM (Canopy)	20T-63-02060	10001-		P-U-14	55 mm	90 mm	KOM-707-98-26550	97.68	
BUCKET	20T-63-02080	10001-		P-U-14	50 mm	80 mm	KOM-707-98-25110	180.13	
SWING	20T-63-02140	10001-		P-U-14	50 mm	90 mm	KOM-707-98-25510	180.96	
TILT	20U-63-02090	11899-		P-U-14	45 mm	90 mm	KOM-707-98-24550	74.22	
MODEL PC40-7									
ARM	20T-63-02201	18001-		P-UB-14	50 mm	80 mm	KOM-707-98-25110	180.13	
	20T-63-02201	18001-		Bushing	50 mm		KOM-07177-05030	15.54	
BLADE	20T-63-02231	18001-		P-U-14	50 mm	100 mm	KOM-707-98-32120	177.73	
BLADE LIFT	20T-63-02260	18001-		P-UB-14	50 mm	105 mm	KOM-707-98-32810	211.12	
BLADE TILT	20U-63-02090	18001-		P-U-14	45 mm	90 mm	KOM-707-98-24550	74.22	
	20U-63-02090	18001-		Bushing	45 mm		KOM-07177-04530	12.81	
BOOM	20T-63-02241	18001-		P-U-14	55 mm	90 mm	KOM-707-98-26560	169.58	
	20T-63-02241	18001-		Bushing	55 mm		KOM-07177-05530	18.35	
BOOM SWING	20T-63-02221	18001-		P-UB-14	50 mm	90 mm	KOM-707-98-25520	171.17	
BUCKET	20T-63-02211	18001-		P-UB-14	45 mm	75 mm	KOM-707-98-24210	187.46	
MODEL PC40MR-1, PC40MRX-1									
ARM	22M-63-02122	1001-5500		P-U-14	50 mm	80 mm	KOM-707-98-25250	90.60	
	707-00-0C460	5501-		P-U-14	50 mm	80 mm	KOM-707-98-25350	90.71	
BLADE	22N-63-02153	1001-5500		P-UB-14	50 mm	105 mm	KOM-707-98-32810	211.12	
	707-00-0C500	5501-		P-U-14	50 mm	105 mm	KOM-707-98-32900	96.30	
BOOM (Cab)	22N-63-02112	1001-5500		P-U-14	50 mm	90 mm	KOM-707-98-25560	82.99	
	707-00-0C450	5501-		P-U-14	50 mm	90 mm	KOM-707-98-25700	83.07	
BOOM (Canopy)	22N-63-02102	1001-5500	PC40MR-1	P-U-14	50 mm	90 mm	KOM-707-98-25560	82.99	
	707-00-0C440	5501-	PC40MR-1	P-U-14	50 mm	90 mm	KOM-707-98-25700	83.07	
BOOM SWING	22M-63-02142	1001-5500		P-UB-14	50 mm	90 mm	KOM-707-98-25520	171.17	
	707-00-0C490	5501-		P-U-14	50 mm	90 mm	KOM-707-98-25710	78.49	
BUCKET	20T-63-02425	1001-5500		P-U-14	45 mm	70 mm	KOM-707-98-15690	49.81	
	20T-63-02524	1001-5500		P-U-14	50 mm	75 mm	KOM-707-98-25910	81.41	

LT - Large size tire L/S - Loading Shovel SLF - Super Long Front B/H - Backhoe HD - Heavy Duty L BUCKET - Large Bucket
 K-LINK - K-type Linkage Blade LB HI-LIFT - High Lift Arm w Large Bucket HI-LIFT - High Lift Arm S HI-LIFT - Super High Lift Arm
 SU - Semi-U Dozer PAT - Power Angle Power Tilt MP - Mult-Purpose

Replacement Kits For

KOMATSU®

Excavators								
APPLICATION	CYL #	SERIAL #	Misc	CODE	ROD	BORE	KIT #	List \$
MODEL PC40MR-1, PC40MRX-1								
BUCKET	707-00-0C470	5501-		P-U-14	45 mm	70 mm	KOM-707-98-15740	49.95
	707-00-0C480	5501-		P-U-14	50 mm	75 mm	KOM-707-98-25970	81.56
MODEL PC40MR-2								
ARM	707-00-0E650	8001-		P-U-14	50 mm	80 mm	KOM-707-98-25350	90.71
BLADE	707-00-0E640	8001-		P-U-14	50 mm	110 mm	KOM-707-98-32550	88.92
BLADE (PAT)	707-00-0F400	8001-		P-U-14	55 mm	115 mm	KOM-707-98-34670	99.27
BOOM	707-00-0E600	8001-		P-U-14	50 mm	90 mm	KOM-707-98-29500	128.74
BOOM SWING	707-00-0E630	8001-		P-U-14	50 mm	90 mm	KOM-707-98-29510	90.48
BUCKET	707-00-0E610	8001-		P-U-14	45 mm	70 mm	KOM-707-98-15760	54.39
MODEL PC40R-8								
ARM	20T-63-02414	30001-		P-U-14	50 mm	80 mm	KOM-707-98-25250	90.60
BLADE	20T-63-02441	30001-		P-U-14	50 mm	100 mm	KOM-707-98-32120	177.73
BOOM	20T-63-02402	30001-		P-U-14	50 mm	90 mm	KOM-707-98-25560	82.99
BOOM SWING	20T-63-02433	30001-		P-UB-14	50 mm	90 mm	KOM-707-98-25520	171.17
BUCKET	20T-63-02425	30001-		P-U-14	45 mm	70 mm	KOM-707-98-15690	49.81
MODEL PC45-1								
ARM	20T-63-02310	1001-		P-U-14	50 mm	85 mm	KOM-707-98-25820	106.06
BLADE	20T-63-02231	1001-		P-U-14	50 mm	100 mm	KOM-707-98-32120	177.73
BLADE LIFT	20T-63-02260	1001-		P-UB-14	50 mm	105 mm	KOM-707-98-32810	211.12
BLADE TILT	20U-63-02090	1001-		P-U-14	45 mm	90 mm	KOM-707-98-24550	74.22
BOOM	20T-63-02300	1001-		P-U-14	55 mm	95 mm	KOM-707-98-34140	92.89
BOOM SWING	20T-63-02330	1001-		P-U-14	50 mm	95 mm	KOM-707-98-25620	86.58
BUCKET	20T-63-02320	1001-		P-UB-14	50 mm	80 mm	KOM-707-98-25110	180.13
MODEL PC45MR-3								
ARM	707-00-0H710	5001-		P-U-14	45 mm	70 mm	KOM-707-98-15770	54.39
BLADE	707-00-0H720	5001-		P-U-14	50 mm	110 mm	KOM-707-98-32570	88.92
BLADE (PAT)	707-00-0F400	5001-		P-U-14	55 mm	115 mm	KOM-707-98-34670	99.27
BLADE TILT	707-00-0G490	5001-		P-U-14	40 mm	70 mm	KOM-707-98-14770	46.43
BOOM	707-00-0H690	5001-		P-U-14	50 mm	90 mm	KOM-707-98-25750	83.08
	707-00-0H700	5001-		P-U-14	50 mm	80 mm	KOM-707-98-26300	90.61
BOOM SWING	707-00-0H660	5001-		P-U-14	50 mm	90 mm	KOM-707-98-25760	90.48
MODEL PC45MRX-1								
ARM	22N-63-02121	1001-3000		P-U-14	50 mm	85 mm	KOM-707-98-25830	105.94
	707-00-0C540	3001-		P-U-14	50 mm	85 mm	KOM-707-98-25870	170.06
BLADE	22N-63-02153	1001-3000		P-UB-14	50 mm	105 mm	KOM-707-98-32810	211.12
	707-00-0C500	3001-		P-U-14	50 mm	105 mm	KOM-707-98-32900	96.30
BOOM SWING	22N-63-02142	1001-3000		P-U-14	50 mm	95 mm	KOM-707-98-29661	86.65
	707-00-0C570	3001-		P-U-14	50 mm	95 mm	KOM-707-98-29620	86.75
BUCKET	20T-63-02524	1001-3000		P-U-14	50 mm	75 mm	KOM-707-98-25910	81.41
	707-00-0C480	3001-		P-U-14	50 mm	75 mm	KOM-707-98-25970	81.56
SLIDE	707-00-0C580	2240-		P-U-14	45 mm	75 mm	KOM-707-98-23860	66.02
MODEL PC45R-8								
ARM	20T-63-02514	5001-		P-U-14	50 mm	85 mm	KOM-707-98-25830	105.94
BOOM	20T-63-02402	5001-		P-U-14	50 mm	90 mm	KOM-707-98-25560	82.99
MODEL PC50MR-2								
ANGLE	707-00-0G490	5001-		P-U-14	40 mm	70 mm	KOM-707-98-14770	46.43
ARM	707-00-0E620	5001-		P-U-14	50 mm	85 mm	KOM-707-98-25870	170.06
BLADE	707-00-0E640	5001-		P-U-14	50 mm	110 mm	KOM-707-98-32550	88.92
	707-00-0F400	5001-		P-U-14	55 mm	115 mm	KOM-707-98-34670	99.27
BOOM	707-00-0E600	5001-		P-U-14	50 mm	90 mm	KOM-707-98-29500	128.74
BOOM SWING	707-00-0E670	5001-		P-U-14	50 mm	95 mm	KOM-707-98-29640	98.71
BUCKET	707-00-0E660	5001-		P-U-14	50 mm	75 mm	KOM-707-98-25980	86.00
MODEL PC50UU-1								
ARM	201-63-02030	4335-		P-U-14	55 mm	90 mm	KOM-707-98-26520	101.66
	20U-63-02020	1001-1566		P-U-14	55 mm	80 mm	KOM-707-98-26110	109.72

LT - Large size tire L/S - Loading Shovel SLF - Super Long Front B/H - Backhoe HD - Heavy Duty L BUCKET - Large Bucket
 K-LINK - K-type Linkage Blade LB HI-LIFT - High Lift Arm w Large Bucket HI-LIFT - High Lift Arm S HI-LIFT - Super High Lift Arm
 SU - Semi-U Dozer PAT - Power Angle Power Tilt MP - Multi-Purpose

Replacement Kits For

KOMATSU®

Excavators								
APPLICATION	CYL #	SERIAL #	Misc	CODE	ROD	BORE	KIT #	List \$
MODEL PC50UU-1								
ARM	20U-63-02021	1567-		P-U-14	55 mm	80 mm	KOM-707-98-26110	109.72
BLADE	20U-63-02050	1001-1767		P-U-14	60 mm	100 mm	KOM-20U-63-02050K	66.05
	20U-63-02051	1768-3400		P-U-14	60 mm	100 mm	KOM-20U-63-02051K	66.05
	20U-63-02080	3401-		P-U-14	60 mm	100 mm	KOM-707-98-35100	114.96
BOOM	20U-63-02060	1001-3400		P-U-14	55 mm	100 mm	KOM-707-98-34120	117.80
	20U-63-02062	3401-		P-U-14	55 mm	100 mm	KOM-707-98-34120	117.80
	20U-63-02160	4335-		P-U-14	55 mm	100 mm	KOM-707-98-34120	117.80
BOOM OFFSET	20U-63-02040	1001-		P-U-14	55 mm	100 mm	KOM-707-98-34160	83.41
BUCKET	20U-63-02030	1001-		P-U-14	55 mm	80 mm	KOM-707-98-26120	111.20
TILT	20U-63-02090	3401-		P-U-14	45 mm	90 mm	KOM-707-98-24550	74.22
MODEL PC50UU-2								
ARM	20U-63-02312	10835-12761	EU	P-U-14	55 mm	90 mm	KOM-707-98-26620	85.88
	20U-63-02312	8001-12771		P-U-14	55 mm	90 mm	KOM-707-98-26620	85.88
	20U-63-02313	12762-12799	EU	P-U-14	55 mm	90 mm	KOM-707-98-26620	85.88
	20U-63-02313	12772-14992		P-U-14	55 mm	90 mm	KOM-707-98-26620	85.88
	20U-63-02314	12800-	EU	P-U-14	55 mm	90 mm	KOM-707-98-26620	85.88
	20U-63-02314	14993-		P-U-14	55 mm	90 mm	KOM-707-98-26620	85.88
ARM (Mono Boom)	20T-63-02310	8001-14992		P-U-14	50 mm	85 mm	KOM-707-98-25820	106.06
	20U-63-02460	14993-		P-U-14	50 mm	85 mm	KOM-707-98-25820	106.06
BLADE	20U-63-02250	10835-12799	EU	P-U-14	50 mm	100 mm	KOM-707-98-32120	177.73
	20U-63-02250	8001-14992		P-U-14	50 mm	100 mm	KOM-707-98-32120	177.73
	20U-63-02251	12800-	EU	P-U-14	50 mm	100 mm	KOM-707-98-32120	177.73
	20U-63-02251	14993-18000		P-U-14	50 mm	100 mm	KOM-707-98-32120	177.73
	20U-63-02270	10835-12799	EU	P-UB-14	50 mm	105 mm	KOM-707-98-32810	211.12
	20U-63-02270	8001-14992		P-UB-14	50 mm	105 mm	KOM-707-98-32810	211.12
	20U-63-02271	12800-	EU	P-UB-14	50 mm	105 mm	KOM-707-98-32810	211.12
	20U-63-02271	14993-18000		P-UB-14	50 mm	105 mm	KOM-707-98-32810	211.12
	20U-63-02380	8001-14992		P-U-14	60 mm	110 mm	KOM-707-98-35520	70.05
	20U-63-02381	14993-		P-U-14	60 mm	110 mm	KOM-707-98-35520	70.05
	20U-63-02650	18001-		P-U-14	50 mm	100 mm	KOM-707-98-32120	177.73
	20U-63-02660	18001-		P-UB-14	50 mm	105 mm	KOM-707-98-32810	211.12
	BOOM	20U-63-02201	10835-12761	EU	P-U-14	55 mm	100 mm	KOM-707-98-34120
20U-63-02201		8001-12771		P-U-14	55 mm	100 mm	KOM-707-98-34120	117.80
20U-63-02202		12762-12799	EU	P-U-14	55 mm	100 mm	KOM-707-98-34180	81.72
20U-63-02202		12772-14992		P-U-14	55 mm	100 mm	KOM-707-98-34180	81.72
20U-63-02203		12800-	EU	P-U-14	55 mm	100 mm	KOM-707-98-34180	81.72
20U-63-02203		14993-		P-U-14	55 mm	100 mm	KOM-707-98-34180	81.72
BOOM (Mono Boom)	20U-63-02300	8001-14992		P-U-14	55 mm	100 mm	KOM-707-98-34120	117.80
	20U-63-02301	14993-		P-U-14	55 mm	100 mm	KOM-707-98-34120	117.80
BUCKET	20U-63-02221	10835-12799	EU	P-UB-14	50 mm	80 mm	KOM-707-98-25110	180.13
	20U-63-02221	8001-14992		P-UB-14	50 mm	80 mm	KOM-707-98-25110	180.13
	20U-63-02222	12800-	EU	P-UB-14	50 mm	80 mm	KOM-707-98-25110	180.13
	20U-63-02222	14993-		P-UB-14	50 mm	80 mm	KOM-707-98-25110	180.13
	20U-63-02281	12800-	EU	P-UB-14	50 mm	80 mm	KOM-707-98-25110	180.13
	20U-63-02281	14993-		P-UB-14	50 mm	80 mm	KOM-707-98-25110	180.13
	20U-63-02320	10835-12799	EU	P-UB-14	50 mm	80 mm	KOM-707-98-25110	180.13
	20U-63-02320	8001-14992		P-UB-14	50 mm	80 mm	KOM-707-98-25110	180.13
	20U-63-02470	16328-		P-UB-14	50 mm	80 mm	KOM-707-98-25110	180.13
OFFSET	20U-63-02230	10835-12799	EU	P-UB-14	50 mm	90 mm	KOM-707-98-25520	171.17
	20U-63-02230	8001-14992		P-UB-14	50 mm	90 mm	KOM-707-98-25520	171.17
	20U-63-02231	12800-	EU	P-UB-14	50 mm	90 mm	KOM-707-98-25520	171.17
	20U-63-02231	14993-		P-UB-14	50 mm	90 mm	KOM-707-98-25520	171.17
SLIDE	20T-63-02290	8617-		P-U-14	45 mm	75 mm	KOM-707-98-24820	66.74
SLIDE ARM	20U-63-02392	10835-12761	EU	P-U-14	35 mm	60 mm	KOM-707-98-12320	45.56
	20U-63-02392	8001-12771		P-U-14	35 mm	60 mm	KOM-707-98-12320	45.56

LT - Large size tire L/S - Loading Shovel SLF - Super Long Front B/H - Backhoe HD - Heavy Duty L BUCKET - Large Bucket

K-LINK - K-type Linkage Blade LB HI-LIFT - High Lift Arm w Large Bucket HI-LIFT - High Lift Arm S HI-LIFT - Super High Lift Arm

SU - Semi-U Dozer PAT - Power Angle Power Tilt MP - Mult-Purpose

Replacement Kits For

KOMATSU®

Excavators								
APPLICATION	CYL #	SERIAL #	Misc	CODE	ROD	BORE	KIT #	List \$
MODEL PC50UU-2								
SLIDE ARM	20U-63-02393	12762-12799	EU	P-U-14	35 mm	60 mm	KOM-707-98-12320	45.56
	20U-63-02393	12772-14992		P-U-14	35 mm	60 mm	KOM-707-98-12320	45.56
	20U-63-02394	12800-	EU	P-U-14	35 mm	60 mm	KOM-707-98-12320	45.56
	20U-63-02394	14993-		P-U-14	35 mm	60 mm	KOM-707-98-12320	45.56
TILT	20U-63-02090	8001-14992		P-U-14	45 mm	90 mm	KOM-707-98-24550	74.22
	20U-63-02091	14993-18000		P-U-14	45 mm	90 mm	KOM-707-98-24550	74.22
	20U-63-02670	18001-		P-U-14	45 mm	90 mm	KOM-707-98-24550	74.22
MODEL PC60-5								
ARM	201-63-02020	20501-		P-U-14	60 mm	90 mm	KOM-707-98-27500	175.66
BLADE	201-63-02070	20501-		P-U-14	60 mm	100 mm	KOM-707-98-35130	199.21
	201-63-02080	20501-		P-U-14	60 mm	100 mm	KOM-707-98-35130	199.21
BOOM	201-63-02010	20501-		P-U-14	65 mm	100 mm	KOM-707-99-36260	203.29
BUCKET	201-63-02030	20501-		P-U-14	55 mm	90 mm	KOM-707-98-26520	101.66
MODEL PC60-6								
ARM	201-63-02210	28001-		P-U-14	60 mm	90 mm	KOM-707-99-27600	234.48
BLADE	201-63-02220	28001-		P-U-14	70 mm	130 mm	KOM-707-98-43530	235.96
BOOM	201-63-02200	28001-		P-UB-14	65 mm	100 mm	KOM-707-99-36220	277.75
BUCKET	20X-63-02220	28001-		P-U-14	55 mm	90 mm	KOM-707-99-26620	254.69
MODEL PC60-7								
ARM	201-63-02312	45001-52273		P-UB-14	60 mm	100 mm	KOM-707-99-35230	263.46
BOOM	201-63-02302	45001-52273		P-UB-14	65 mm	115 mm	KOM-707-99-36630	311.33
BUCKET	201-63-02322	45001-52273		P-UB-14	55 mm	90 mm	KOM-707-99-26640	295.34
MODEL PC60L-5								
ARM	201-63-02020	7501-		P-U-14	60 mm	90 mm	KOM-707-98-27500	175.66
BOOM	201-63-02010	7501-		P-U-14	65 mm	100 mm	KOM-707-99-36260	203.29
BUCKET	201-63-02030	7501-		P-U-14	55 mm	90 mm	KOM-707-98-26520	101.66
MODEL PC60L-6								
ARM	201-63-02210	28001-		P-U-14	60 mm	90 mm	KOM-707-99-27600	234.48
BOOM	201-63-02200	28001-		P-UB-14	65 mm	100 mm	KOM-707-99-36220	277.75
BUCKET	20X-63-02220	28001-		P-U-14	55 mm	90 mm	KOM-707-99-26620	254.69
MODEL PC60U-5								
ARM	201-63-02050	4501-		P-U-14	60 mm	90 mm	KOM-707-98-27500	175.66
BLADE	201-63-02070	4501-		P-U-14	60 mm	100 mm	KOM-707-98-35130	199.21
	201-63-02080	4501-		P-U-14	60 mm	100 mm	KOM-707-98-35130	199.21
BOOM	201-63-02040	4501-		P-U-14	65 mm	100 mm	KOM-707-99-36260	203.29
BUCKET	201-63-02030	4501-		P-U-14	55 mm	90 mm	KOM-707-98-26520	101.66
MODEL PC75UU-1								
ARM	21W-63-02021	1001-		P-U-14	60 mm	90 mm	KOM-707-98-27500	175.66
	21W-63-02090	2655-		P-U-14	60 mm	90 mm	KOM-707-98-27500	175.66
BLADE	21W-63-02051	1001-		P-U-14	70 mm	130 mm	KOM-707-98-43510	287.25
	21W-63-02011	1001-1679		P-U-14	70 mm	110 mm	KOM-707-98-37600	83.78
BOOM	21W-63-02012	1680-		P-U-14	70 mm	110 mm	KOM-707-98-37600	83.78
	21W-63-02080	2655-		P-U-14	70 mm	110 mm	KOM-707-98-37600	83.78
BOOM OFFSET	21W-63-02041	1001-		P-U-14	55 mm	110 mm	KOM-707-98-34520	91.43
BUCKET	201-63-02030	1001-		P-U-14	55 mm	90 mm	KOM-707-98-26520	101.66
	21W-63-02030	1001-		P-U-14	55 mm	90 mm	KOM-707-98-26520	101.66
MODEL PC75UU-2								
ARM	21W-63-02141	5001-		P-U-14	65 mm	110 mm	KOM-707-98-36600	82.17
	21W-63-02220	7075-7345		P-U-14	60 mm	100 mm	KOM-21W-63-02220K	68.37
	21W-63-02221	7346-		P-U-14	60 mm	100 mm	KOM-21W-63-02221K	68.37
BLADE	21W-63-02051	5001-		P-U-14	70 mm	130 mm	KOM-707-98-43510	287.25
BOOM	21W-63-02131	5001-10370		P-U-14	70 mm	120 mm	KOM-707-98-43200	97.51
	21W-63-02310	10371-		P-U-14	70 mm	120 mm	KOM-707-98-43210	87.03
BOOM (Mono Boom)	21W-63-02210	7075-		P-U-14	70 mm	120 mm	KOM-707-98-43200	97.51
BUCKET	21W-63-02151	5001-		P-UB-14	55 mm	90 mm	KOM-707-98-26580	175.77

LT - Large size tire L/S - Loading Shovel SLF - Super Long Front B/H - Backhoe HD - Heavy Duty L BUCKET - Large Bucket
 K-LINK - K-type Linkage Blade LB HI-LIFT - High Lift Arm w Large Bucket HI-LIFT - High Lift Arm S HI-LIFT - Super High Lift Arm
 SU - Semi-U Dozer PAT - Power Angle Power Tilt MP - Multi-Purpose

Replacement Kits For

KOMATSU®

Excavators								
APPLICATION	CYL #	SERIAL #	Misc	CODE	ROD	BORE	KIT #	List \$
MODEL PC75UU-2								
BUCKET (Mono Boom)	20X-63-02220	7075-		P-U-14	55 mm	90 mm	KOM-707-99-26620	254.69
BUCKET (Slide Arm)	21W-63-02290	5001-		P-UB-14	55 mm	90 mm	KOM-707-98-26580	175.77
OFFSET	21W-63-02161	5001-		P-U-14	55 mm	110 mm	KOM-707-98-34560	89.02
SLIDE ARM	21W-63-02280	5001-10370		P-U-14	45 mm	75 mm	KOM-707-98-24830	58.29
	21W-63-02281	10371-		P-U-14	45 mm	75 mm	KOM-707-98-24830	58.29
MODEL PC75UU-3								
ARM	21W-63-02322	15001-		P-U-14	65 mm	110 mm	KOM-707-98-36630	74.92
BLADE	21W-63-02051	15001-19000		P-U-14	70 mm	130 mm	KOM-707-98-43510	287.25
	21W-63-02052	19001-		P-U-14	70 mm	130 mm	KOM-707-98-43510	287.25
BOOM	21W-63-02360	15001-		P-U-14	70 mm	120 mm	KOM-707-98-43210	87.03
BOOM OFFSET	21W-63-02161	15001-		P-U-14	55 mm	110 mm	KOM-707-98-34560	89.02
BUCKET	21W-63-02330	15001-		P-UB-14	55 mm	90 mm	KOM-707-98-26580	175.77
	21W-63-02690	16142-		P-UB-14	55 mm	90 mm	KOM-707-98-26580	175.77
TILT	21W-63-07110	15001-		P-U-10	40 mm	90 mm	KOM-707-98-22410	109.51
MODEL PC78MR-6								
ARM	707-00-0A640	1001-3460		P-U-14	60 mm	100 mm	KOM-707-98-35310	71.70
	707-00-0A641	3461-		P-U-14	60 mm	100 mm	KOM-707-98-35310	71.70
BLADE	707-00-0A660	1001-3034		P-U-14	65 mm	130 mm	KOM-707-98-42700	95.26
	707-00-0A661	3035-		P-U-14	65 mm	130 mm	KOM-707-98-42700	95.26
BOOM	707-00-0E250	1001-3460		P-U-14	65 mm	115 mm	KOM-707-98-36700	93.45
	707-00-0E251	3461-		P-U-14	65 mm	115 mm	KOM-707-98-36700	93.45
BOOM SWING	707-00-0E260	1001-3034		P-U-14	60 mm	120 mm	KOM-707-98-41330	86.93
	707-00-0E261	3035-		P-U-14	60 mm	120 mm	KOM-707-98-41330	86.93
BUCKET	707-00-0A650	1001-3460		P-U-14	55 mm	90 mm	KOM-707-98-26720	86.87
	707-00-0A651	3461-		P-U-14	55 mm	90 mm	KOM-707-98-26720	86.87
MODEL PC78US-5								
ARM	201-63-02511	1001-		P-U-14	60 mm	100 mm	KOM-707-98-35181	241.23
BLADE	21W-63-02052	1001-		P-U-14	70 mm	130 mm	KOM-707-98-43510	287.25
BOOM	21W-63-02574	1001-		P-U-14	70 mm	120 mm	KOM-707-98-43200	97.51
BUCKET	201-63-02520	1001-		P-UB-14	55 mm	90 mm	KOM-707-98-26580	175.77
MODEL PC78US-6								
ARM	707-00-0A640	4001-12048		P-U-14	60 mm	100 mm	KOM-707-98-35310	71.70
	707-00-0A641	12049-		P-U-14	60 mm	100 mm	KOM-707-98-35310	71.70
BLADE	707-00-0A660	4001-10418		P-U-14	65 mm	130 mm	KOM-707-98-42700	95.26
	707-00-0A661	10419-		P-U-14	65 mm	130 mm	KOM-707-98-42700	95.26
BOOM	707-00-0A630	4001-12048		P-U-14	65 mm	115 mm	KOM-707-98-36700	93.45
	707-00-0A631	12049-		P-U-14	65 mm	115 mm	KOM-707-98-36700	93.45
BUCKET	707-00-0A650	4001-12048		P-U-14	55 mm	90 mm	KOM-707-98-26720	86.87
	707-00-0A651	12049-		P-U-14	55 mm	90 mm	KOM-707-98-26720	86.87
MODEL PC80-3,PC80LC-3								
ARM	20X-63-02020	2001-		P-U-14	65 mm	100 mm	KOM-707-99-36270	203.09
BOOM	20X-63-02010	2001-		P-U-14	70 mm	110 mm	KOM-707-98-37600	83.78
BUCKET	20X-63-02030	2001-		P-U-14	55 mm	90 mm	KOM-707-98-26520	101.66
MODEL PC90-1								
ARM	20X-63-02210	1001-		P-U-14	65 mm	105 mm	KOM-707-99-36620	334.22
BOOM	20X-63-02200	1001-		P-UB-14	70 mm	110 mm	KOM-707-99-37610	354.92
BUCKET	20X-63-02220	1001-		P-U-14	55 mm	90 mm	KOM-707-99-26620	254.69
MODEL PC95R-2								
ARM	226-61-11400	21D5220114-21D5220430		P-UB-14	60 mm	100 mm	KOM-878000425	211.07
	707-01-0S650	21D5220431-		P-UB-14	60 mm	100 mm	KOM-707-99-35310	385.47
ARM (2pc Boom)	21D-61-12300	21D5220114-21D5220430		P-UB-14	60 mm	100 mm	KOM-878000425	211.07
	707-01-0S650	21D5220431-		P-UB-14	60 mm	100 mm	KOM-707-99-35310	385.47
BLADE	226-61-11600	21D5220114-21D5220430		P-UB-14	60 mm	120 mm	KOM-878000365	267.61

LT - Large size tire L/S - Loading Shovel SLF - Super Long Front B/H - Backhoe HD - Heavy Duty L BUCKET - Large Bucket
 K-LINK - K-type Linkage Blade LB HI-LIFT - High Lift Arm w Large Bucket HI-LIFT - High Lift Arm S HI-LIFT - Super High Lift Arm
 SU - Semi-U Dozer PAT - Power Angle Power Tilt MP - Mult-Purpose

Replacement Kits For

KOMATSU®

Excavators								
APPLICATION	CYL #	SERIAL #	Misc	CODE	ROD	BORE	KIT #	List \$
MODEL PC95R-2								
BLADE	707-01-0S620	21D5220431-		P-UB-14	60 mm	120 mm	KOM-707-99-41300	330.80
BOOM	226-31-11200	21D5220114- 21D5220430		P-UB-14	70 mm	120 mm	KOM-878000607	237.68
	707-01-0S640	21D5220431-		P-UB-14	70 mm	120 mm	KOM-707-99-43300	432.60
BOOM LH	226-61-11340	21D5220114- 21D5220430		P-UB-14	50 mm	90 mm	KOM-878000608	155.64
	707-01-0S670	21D5220431-		P-UB-14	50 mm	90 mm	KOM-707-99-25700	305.31
BOOM RH	226-61-11300	21D5220114- 21D5220430		P-UB-14	50 mm	90 mm	KOM-878000608	155.64
	707-01-0S670	21D5220431-		P-UB-14	50 mm	90 mm	KOM-707-99-25700	305.31
BOOM SWING	226-61-11100	21D5220114- 21D5220430		P-UB-14	60 mm	100 mm	KOM-21D-61-14140	257.40
	707-01-0S610	21D5220431-		P-UB-14	60 mm	100 mm	KOM-707-99-35300	363.05
BUCKET	226-61-11500	21D5220114- 21D5220430		P-UB-14	60 mm	90 mm	KOM-21D-61-13160	194.97
	707-01-0S690	21D5220431-		P-UB-14	60 mm	90 mm	KOM-707-99-27650	269.50
MODEL PC100-1, PC100-2								
ARM	202-63-62140			P-U-14	70 mm	120 mm	KOM-707-99-43100	202.80
MODEL PC100-3								
ARM	202-63-62500	10001-19852		P-U-14	75 mm	110 mm	KOM-707-98-38600	200.89
	202-63-69300	19853-		P-U-14	75 mm	110 mm	KOM-707-98-38600	200.89
BOOM	202-63-52500	18001-22872		P-UB-14	65 mm	100 mm	KOM-707-98-36100	170.56
	202-63-52600	18001-22872		P-UB-14	65 mm	100 mm	KOM-707-98-36100	170.56
	202-63-59300	22873-		P-UB-14	65 mm	100 mm	KOM-707-99-36200	246.73
	202-63-59400	22873-		P-UB-14	65 mm	100 mm	KOM-707-99-36200	246.73
BUCKET	203-63-72500	10001-19852		P-UB-14	65 mm	100 mm	KOM-707-98-36110	127.62
	203-63-79300	19853-		P-UB-14	65 mm	100 mm	KOM-707-99-36210	203.69
MODEL PC100-5								
ARM	202-63-02120	28001-		P-UB-14	75 mm	115 mm	KOM-707-99-44200	167.03
BOOM	202-63-02100	28001-		P-UB-14	65 mm	95 mm	KOM-707-98-36200	303.08
BUCKET	202-63-02130	28001-		P-UB-14	60 mm	90 mm	KOM-707-98-27600	243.86
MODEL PC100-6								
ARM	202-63-02322	40001-44999		P-UB-14	75 mm	115 mm	KOM-707-99-44200	167.03
	202-63-07720	45000-		P-UB-14	75 mm	115 mm	KOM-707-99-44220	125.19
BOOM	202-63-02303	40001-44999		P-UB-14	65 mm	95 mm	KOM-707-98-36200	303.08
BUCKET	202-63-02332	40001-44999		P-UB-14	60 mm	90 mm	KOM-707-98-27600	243.86
	202-63-07730	45000-		P-UB-14	60 mm	90 mm	KOM-707-98-27620	167.31
MODEL PC100L-3								
ARM	202-63-62500	12001-12137		P-U-14	75 mm	110 mm	KOM-707-98-38600	200.89
	202-63-69300	12138-		P-U-14	75 mm	110 mm	KOM-707-98-38600	200.89
BOOM	202-63-52500	12001-12367		P-UB-14	65 mm	100 mm	KOM-707-98-36100	170.56
	202-63-52600	12001-12367		P-UB-14	65 mm	100 mm	KOM-707-98-36100	170.56
	202-63-59300	12368-		P-UB-14	65 mm	100 mm	KOM-707-99-36200	246.73
	202-63-59400	12368-		P-UB-14	65 mm	100 mm	KOM-707-99-36200	246.73
BUCKET	203-63-72500	12001-12137		P-UB-14	65 mm	100 mm	KOM-707-98-36110	127.62
	203-63-79300	12138-		P-UB-14	65 mm	95 mm	KOM-707-98-36210	259.56
MODEL PC100L-5								
ARM	202-63-02120	14001-		P-UB-14	75 mm	115 mm	KOM-707-99-44200	167.03
BOOM	202-63-02100	14001-		P-UB-14	65 mm	95 mm	KOM-707-98-36200	303.08
BUCKET	202-63-02130	14001-		P-UB-14	60 mm	90 mm	KOM-707-98-27600	243.86
MODEL PC100U-3								
ARM	202-63-62500	12001-12019		P-U-14	75 mm	110 mm	KOM-707-98-38600	200.89
	202-63-62502	12020-		P-U-14	75 mm	110 mm	KOM-707-98-38600	200.89
	203-63-62340			P-U-14	80 mm	130 mm	KOM-707-98-45700	299.98
BOOM	202-63-53500	12001-		P-UB-14	65 mm	100 mm	KOM-707-98-36100	170.56
	202-63-53600	12001-		P-UB-14	65 mm	100 mm	KOM-707-98-36100	170.56

LT - Large size tire L/S - Loading Shovel SLF - Super Long Front B/H - Backhoe HD - Heavy Duty L BUCKET - Large Bucket
 K-LINK - K-type Linkage Blade LB HI-LIFT - High Lift Arm w Large Bucket HI-LIFT - High Lift Arm S HI-LIFT - Super High Lift Arm
 SU - Semi-U Dozer PAT - Power Angle Power Tilt MP - Multi-Purpose

Replacement Kits For

KOMATSU®

Excavators								
APPLICATION	CYL #	SERIAL #	Misc	CODE	ROD	BORE	KIT #	List \$
MODEL PC100U-3								
BOOM	203-63-52340			P-U-14	70 mm	120 mm	KOM-707-99-43100	202.80
BOOM SWING	202-63-13501	12001-		P-U-14	75 mm	120 mm	KOM-707-98-44120	255.34
BUCKET	202-63-72500	12001-12019		P-UB-14	65 mm	100 mm	KOM-707-98-36110	127.62
	203-63-72340			P-U-14	70 mm	120 mm	KOM-707-99-43100	202.80
	203-63-72501	12020-		P-UB-14	65 mm	100 mm	KOM-707-98-36110	127.62
MODEL PC120-3								
ARM	203-63-62500	18001-20335		P-U-14	75 mm	110 mm	KOM-707-98-38600	200.89
	203-63-62502	20336-24709		P-U-14	75 mm	110 mm	KOM-707-98-38600	200.89
	203-63-69300	24710-		P-U-14	75 mm	110 mm	KOM-707-98-38600	200.89
BOOM	203-63-52500	18001-24709		P-U-14	70 mm	110 mm	KOM-707-98-37500	185.78
	203-63-52600	18001-24709		P-U-14	70 mm	110 mm	KOM-707-98-37500	185.78
	203-63-59300	24710-		P-UB-14	70 mm	110 mm	KOM-707-99-37600	222.12
	203-63-59400	24710-		P-UB-14	70 mm	110 mm	KOM-707-99-37600	222.12
BUCKET	203-63-72500	18001-20335		P-UB-14	65 mm	100 mm	KOM-707-98-36110	127.62
	203-63-79300	20336-		P-UB-14	65 mm	100 mm	KOM-707-99-36210	203.69
MODEL PC120-5								
ARM	203-63-02120	30001-		P-UB-14	75 mm	115 mm	KOM-707-99-44200	167.03
BOOM	203-63-02100	30001-		P-UB-14	70 mm	105 mm	KOM-707-98-37620	183.24
BUCKET	203-63-02130	30001-		P-UB-14	65 mm	95 mm	KOM-707-98-36210	259.56
MODEL PC120-6								
ARM	203-63-02322	45001-56999		P-UB-14	75 mm	115 mm	KOM-707-99-44200	167.03
	203-63-02322	45001-56999		Bushing	75 mm		KOM-707-52-90500	27.12
BOOM	203-63-02303	45001-56999		P-UB-14	70 mm	105 mm	KOM-707-98-37620	183.24
	203-63-02303	45001-56999		Bushing	70 mm		KOM-707-52-90450	24.51
BUCKET	203-63-02332	45001-56999		P-UB-14	65 mm	95 mm	KOM-707-98-36210	259.56
	203-63-02332	45001-56999		Bushing	65 mm		KOM-707-52-90400	21.71
MODEL PC128US-2								
ARM	203-63-02721	5001-		P-UB-14	75 mm	115 mm	KOM-707-99-44220	125.19
	203-63-02722	5001-		P-UB-14	75 mm	115 mm	KOM-707-98-44310	123.49
BLADE LH	22B-63-02450	5001-		P-UB-14	75 mm	115 mm	KOM-707-99-44270	114.79
BLADE RH	22B-63-02460	5001-		P-UB-14	75 mm	115 mm	KOM-707-99-44270	114.79
BOOM	22B-63-02500	5001-		P-UB-14	70 mm	105 mm	KOM-707-99-37230	148.51
BOOM LH	22B-63-02400	5001-		P-UB-14	70 mm	105 mm	KOM-707-99-37230	148.51
BOOM RH	22B-63-02410	5001-		P-UB-14	70 mm	105 mm	KOM-707-99-37230	148.51
BUCKET	203-63-02731	5001-		P-UB-14	65 mm	95 mm	KOM-707-98-36240	166.81
MODEL PC128UU								
ARM	21Y-53-02121	1001-		P-UB-14	75 mm	115 mm	KOM-707-99-44310	262.64
BOOM	21Y-63-02101	1001-		P-UB-14	70 mm	105 mm	KOM-707-98-37620	183.24
BUCKET	21Y-63-02131	1001-		P-UB-14	60 mm	90 mm	KOM-707-98-27600	243.86
MODEL PC128UU-2								
ARM	21Y-63-02720	5001-		P-UB-14	75 mm	115 mm	KOM-707-99-44280	118.44
BOOM	21Y-63-02700	5001-		P-UB-14	70 mm	105 mm	KOM-707-98-37670	141.22
BUCKET	21Y-63-02730	5001-		P-UB-14	60 mm	90 mm	KOM-707-98-27620	167.31
OFFSET	21Y-63-09140	5001-		P-U-14	70 mm	130 mm	KOM-707-98-43530	235.96
MODEL PC130-6								
ARM	203-63-02321	45001-47712		P-UB-14	75 mm	115 mm	KOM-707-99-44200	167.03
	203-63-02321	45001-47712		Bushing	75 mm		KOM-707-52-90500	27.12
	203-63-02322	47713-50999		P-UB-14	75 mm	115 mm	KOM-707-99-44200	167.03
	203-63-02322	47713-50999		Bushing	75 mm		KOM-707-52-90500	27.12
	203-63-02721	51000-51134		P-UB-14	75 mm	115 mm	KOM-707-99-44220	125.19
	203-63-02722	51135-		P-UB-14	75 mm	115 mm	KOM-707-99-44230	125.19
	203-63-07720	51000-51134		P-UB-14	75 mm	115 mm	KOM-707-99-44220	125.19
	203-63-07721	51135-		P-UB-14	75 mm	115 mm	KOM-707-99-44230	125.19
BOOM	203-63-02302	45001-47712		P-UB-14	70 mm	105 mm	KOM-707-98-37620	183.24
	203-63-02302	45001-47712		Bushing	70 mm		KOM-707-52-90450	24.51

LT - Large size tire L/S - Loading Shovel SLF - Super Long Front B/H - Backhoe HD - Heavy Duty L BUCKET - Large Bucket
 K-LINK - K-type Linkage Blade LB HI-LIFT - High Lift Arm w Large Bucket HI-LIFT - High Lift Arm S HI-LIFT - Super High Lift Arm
 SU - Semi-U Dozer PAT - Power Angle Power Tilt MP - Multi-Purpose

Replacement Kits For

KOMATSU®

Excavators								
APPLICATION	CYL #	SERIAL #	Misc	CODE	ROD	BORE	KIT #	List \$
MODEL PC130-6								
BOOM	203-63-02303	47713-50999		P-UB-14	70 mm	105 mm	KOM-707-98-37620	183.24
	203-63-02303	47713-50999		Bushing	70 mm		KOM-707-52-90450	24.51
	203-63-02701	51000-		P-UB-14	70 mm	105 mm	KOM-707-98-37670	141.22
	203-63-02900	51000-		P-UB-14	70 mm	105 mm	KOM-707-99-37230	148.51
BUCKET	203-63-02331	45001-47712		P-UB-14	65 mm	95 mm	KOM-707-98-36210	259.56
	203-63-02331	45001-47712		Bushing	65 mm		KOM-707-52-90400	21.71
	203-63-02332	47713-50999		P-UB-14	65 mm	95 mm	KOM-707-98-36210	259.56
	203-63-02332	47713-50999		Bushing	65 mm		KOM-707-52-90400	21.71
	203-63-02731	51000-		P-UB-14	65 mm	95 mm	KOM-707-98-36240	166.81
	203-63-07730	51000-		P-UB-14	65 mm	95 mm	KOM-707-98-36240	166.81
MODEL PC130-7K								
ARM	707-01-0F030	70001-		P-UB-14	75 mm	115 mm	KOM-707-99-44340	127.95
BLADE LH	22B-63-02450	70001-		P-UB-14	75 mm	115 mm	KOM-707-99-44270	114.79
BLADE RH	22B-63-02460	70001-		P-UB-14	75 mm	115 mm	KOM-707-99-44270	114.79
BOOM	707-01-0G070	70001-		P-UB-14	70 mm	105 mm	KOM-707-99-37310	119.89
	707-01-0G230	70001-		P-UB-14	70 mm	105 mm	KOM-707-99-37300	112.59
BOOM ADJUST	20E-63-K2500	70001-		P-UB-14	70 mm	140 mm	KOM-20E-63-K2500K	113.56
BOOM LIFT	20E-63-03240	70001-		P-UB-14	70 mm	105 mm	KOM-20E-63-03240K	142.28
BUCKET	707-01-0F040	70001-		P-UB-14	65 mm	95 mm	KOM-707-99-25870	166.33
MODEL PC138USLC-2								
ARM	203-63-02722	1001-		P-UB-14	75 mm	115 mm	KOM-707-98-44310	123.49
	707-01-0G140	1501-		P-UB-14	75 mm	115 mm	KOM-707-99-44380	119.94
BLADE LH	22B-63-02450	1029-		P-UB-14	75 mm	115 mm	KOM-707-99-44270	114.79
	707-01-0G160	1501-		P-UB-14	75 mm	115 mm	KOM-707-99-44290	109.50
BLADE RH	22B-63-02460	1029-		P-UB-14	75 mm	115 mm	KOM-707-99-44270	114.79
	707-01-0G170	1501-		P-UB-14	75 mm	115 mm	KOM-707-99-44290	109.50
BOOM	22B-63-02500	1001-		P-UB-14	70 mm	105 mm	KOM-707-99-37230	148.51
	707-01-0G120	1501-		P-UB-14	70 mm	105 mm	KOM-707-99-37340	120.41
BUCKET	22B-63-02240	1001-		P-UB-14	65 mm	100 mm	KOM-707-99-36300	159.41
	707-01-0G150	1501-		P-UB-14	65 mm	100 mm	KOM-707-99-36330	144.15
MODEL PC138USLC-8								
ARM	707-01-0L680	20001-24509		P-UB-14	75 mm	110 mm	KOM-707-99-38780	106.14
	707-01-0L680	20001-24509		Bushing	75 mm		KOM-707-52-90500	27.12
	707-01-0L680	24150-25966	4600m	P-UB-14	75 mm	110 mm	KOM-707-99-38780	106.14
	707-01-0L680	24150-25966	4600m	Bushing	75 mm		KOM-707-52-90501	10.98
	707-01-0L681	25967-	4600m	P-UB-14	75 mm	110 mm	KOM-707-99-38820	143.12
	707-01-0L681	25967-	4600m	Bushing	75 mm		KOM-707-52-90501	10.98
BLADE	707-01-XL700	20001-24509		P-UB-14	75 mm	110 mm	KOM-707-99-38790	99.28
	707-01-XL700	20001-24509		Bushing	75 mm		KOM-707-52-90500	27.12
BLADE LH	707-01-0L700	24510-		P-UB-14	75 mm	110 mm	KOM-707-99-38790	99.28
	707-01-0L700	24510-		Bushing	75 mm		KOM-707-52-90501	10.98
BLADE RH	707-01-0L710	24510-		P-UB-14	75 mm	110 mm	KOM-707-99-38790	99.28
	707-01-0L710	24510-		Bushing	75 mm		KOM-707-52-90501	10.98
BOOM	707-01-0L660	20001-24509		P-UB-14	70 mm	105 mm	KOM-707-99-37170	108.55
	707-01-0L660	20001-24509		Bushing	70 mm		KOM-707-52-90470	10.24
BOOM LH	707-01-0L660	24510-		P-UB-14	70 mm	105 mm	KOM-707-99-37170	108.55
	707-01-0L660	24510-		Bushing	70 mm		KOM-707-52-90471	10.24
BOOM RH	707-01-0L660	24510-		P-UB-14	70 mm	105 mm	KOM-707-99-37170	108.55
	707-01-0L660	24510-		Bushing	70 mm		KOM-707-52-90471	10.24
BUCKET	707-01-0L691	20001-24509		P-UB-14	65 mm	95 mm	KOM-707-99-27780	111.72
	707-01-0L691	20001-24509		Bushing	65 mm		KOM-707-52-90420	20.86
	707-01-0L691	24510-		P-UB-14	65 mm	95 mm	KOM-707-99-27780	111.72
	707-01-0L691	24510-		Bushing	65 mm		KOM-707-52-90421	20.86
MODEL PC150-1								
ARM	21K-63-66301	1001-		P-U-14	80 mm	120 mm	KOM-707-98-45100	85.72

LT - Large size tire L/S - Loading Shovel SLF - Super Long Front B/H - Backhoe HD - Heavy Duty L BUCKET - Large Bucket

K-LINK - K-type Linkage Blade LB HI-LIFT - High Lift Arm w Large Bucket HI-LIFT - High Lift Arm S HI-LIFT - Super High Lift Arm

SU - Semi-U Dozer PAT - Power Angle Power Tilt MP - Multi-Purpose

KOMATSU®

Replacement Kits For

Excavators								
APPLICATION	CYL #	SERIAL #	Misc	CODE	ROD	BORE	KIT #	List \$
MODEL PC150-1								
ARM	21K-63-66301	1001-		Bushing	80 mm		KOM-07177-08030	31.26
BOOM LH	21K-63-56301	1001-		P-U-14	75 mm	110 mm	KOM-707-98-38510	189.79
	21K-63-56301	1001-		Bushing	75 mm		KOM-07177-07530	27.12
BOOM RH	21K-63-56401	1001-		P-U-14	75 mm	110 mm	KOM-707-98-38510	189.79
	21K-63-56401	1001-		Bushing	75 mm		KOM-07177-07530	27.12
BUCKET	21K-63-76301	1001-		P-U-14	70 mm	110 mm	KOM-707-98-37510	112.01
	21K-63-76301	1001-		Bushing	70 mm		KOM-07177-07030	24.51
MODEL PC150-3								
ARM	21K-63-66500	3001-4369		P-U-14	80 mm	120 mm	KOM-707-98-45200	263.75
	21K-63-66501	4370-		P-U-14	80 mm	120 mm	KOM-707-98-45200	263.75
BOOM	21K-63-56500	3001-4207		P-U-14	75 mm	110 mm	KOM-707-98-38510	189.79
	21K-63-56501	4208-		P-U-14	75 mm	110 mm	KOM-707-98-38510	189.79
	21K-63-56600	3001-4207		P-U-14	75 mm	110 mm	KOM-707-98-38510	189.79
	21K-63-56601	4208-		P-U-14	75 mm	110 mm	KOM-707-98-38510	189.79
BUCKET	21K-63-76500	3001-3480		P-UB-14	70 mm	100 mm	KOM-707-98-37110	216.99
	21K-63-76501	3481-		P-UB-14	70 mm	100 mm	KOM-707-98-37130	177.86
MODEL PC150-5								
ARM	21K-63-02120	6001-		P-UB-14	85 mm	120 mm	KOM-707-99-46200	363.04
BOOM	21K-63-02100	6001-		P-UB-14	75 mm	110 mm	KOM-707-98-38520	337.22
BUCKET	21K-63-02130	6001-		P-UB-14	70 mm	100 mm	KOM-707-98-37110	216.99
MODEL PC150-6K, PC150LC-6K								
ARM	21P-63-03120	K30667-		P-UB-14	85 mm	120 mm	KOM-21P-63-03120K	147.04
	21P-63-K1711	K30001-K30666		P-UB-14	85 mm	120 mm	KOM-21P-63-K1711K	202.14
ARM (2pc Boom)	21P-63-03120	K32001-		P-UB-14	85 mm	120 mm	KOM-21P-63-03120K	147.04
BOOM	21P-63-03200	K32001-		P-UB-14	75 mm	110 mm	KOM-21P-63-03200K	95.80
	21P-63-K1611	K30001-K31999		P-UB-14	75 mm	110 mm	KOM-21P-63-K1611K	91.81
BOOM (2pc - 1st Cyl)	20G-63-03240	K32001-		P-UB-14	85 mm	120 mm	KOM-20G-63-03240K	146.24
BOOM (2pc - 2nd Cyl)	20G-63-K1110	K32001-		P-UB-14	100 mm	160 mm	KOM-20G-63-K1110K	345.81
BUCKET	21P-63-03130	K30667-	LC-6K	P-UB-14	70 mm	105 mm	KOM-21P-63-03130K	141.29
	21P-63-K1821	K30001-	PC150-6K	P-UB-14	75 mm	110 mm	KOM-21P-63-K1821K	127.44
	21P-63-K3600	K30001-K30666	LC-6K	P-UB-12	70 mm	105 mm	KOM-21P-63-K3600K	172.06
MODEL PC150LC-3								
ARM	21K-63-66500	3001-4384		P-U-14	80 mm	120 mm	KOM-707-98-45200	263.75
	21K-63-66501	4385-		P-U-14	80 mm	120 mm	KOM-707-98-45200	263.75
BOOM	21K-63-56500	3001-4207		P-U-14	75 mm	110 mm	KOM-707-98-38510	189.79
	21K-63-56501	4208-		P-U-14	75 mm	110 mm	KOM-707-98-38510	189.79
	21K-63-56600	3001-4207		P-U-14	75 mm	110 mm	KOM-707-98-38510	189.79
	21K-63-56601	4208-		P-U-14	75 mm	110 mm	KOM-707-98-38510	189.79
BUCKET	21K-63-76500	3001-3493		P-UB-14	70 mm	100 mm	KOM-707-98-37110	216.99
	21K-63-76501	3494-		P-UB-14	70 mm	100 mm	KOM-707-98-37130	177.86
MODEL PC160-6K								
ARM (1 & 2pc Boom)	21P-63-K1711	K30001-K30197		P-UB-14	85 mm	120 mm	KOM-21P-63-K1711K	202.14
ARM (2pc Boom)	21P-63-03120	K30198-		P-UB-14	85 mm	120 mm	KOM-21P-63-03120K	147.04
BOOM	21P-63-03200	K32001-		P-UB-14	75 mm	110 mm	KOM-21P-63-03200K	95.80
	21P-63-K1611	K30001-K31999		P-UB-14	75 mm	110 mm	KOM-21P-63-K1611K	91.81
BOOM (2pc - 1st Cyl)	20G-63-03240	K32001-		P-UB-14	85 mm	120 mm	KOM-20G-63-03240K	146.24
	20G-63-K1410	K30001-K31999		P-UB-14	85 mm	120 mm	KOM-20G-63-K1410K	139.51
BOOM (2pc - 2nd Cyl)	20G-63-K1110	K30001-		P-UB-14	100 mm	160 mm	KOM-20G-63-K1110K	345.81
BUCKET	21P-63-03130	K30198-		P-UB-14	70 mm	105 mm	KOM-21P-63-03130K	141.29
	21P-63-K3600	K30001-K30197		P-UB-12	70 mm	105 mm	KOM-21P-63-K3600K	172.06
MODEL PC160LC-7								
ARM	707-01-0E510	10001-, K40001-		P-UB-14	85 mm	120 mm	KOM-707-99-46320	401.08
BOOM	707-01-0E490	10001-, K40001-		P-UB-14	75 mm	110 mm	KOM-707-99-38720	341.69
BUCKET	707-01-0E520	10001-10408, K40001-		P-UB-14	70 mm	105 mm	KOM-707-99-37290	333.39

LT - Large size tire L/S - Loading Shovel SLF - Super Long Front B/H - Backhoe HD - Heavy Duty L BUCKET - Large Bucket
 K-LINK - K-type Linkage Blade LB HI-LIFT - High Lift Arm w Large Bucket HI-LIFT - High Lift Arm S HI-LIFT - Super High Lift Arm
 SU - Semi-U Dozer PAT - Power Angle Power Tilt MP - Multi-Purpose

Replacement Kits For

KOMATSU®

Excavators								
APPLICATION	CYL #	SERIAL #	Misc	CODE	ROD	BORE	KIT #	List \$
MODEL PC160LC-7								
BUCKET	707-01-0H390	10409-		P-UB-14	70 mm	105 mm	KOM-707-99-37290	333.39
MODEL PC160LC-7-E0								
ARM	707-01-0L120	K45001-		P-UB-14	85 mm	120 mm	KOM-707-99-46420	147.73
BOOM	707-01-0L100	20001-, K45001-		P-UB-14	75 mm	110 mm	KOM-707-99-38760	125.78
BUCKET	707-01-0L130	20001-		P-UB-14	70 mm	105 mm	KOM-707-99-37150	164.77
	707-01-0L500	20001-, K45001-		P-UB-14	70 mm	105 mm	KOM-707-99-37150	164.77
MODEL PC160LC-7K								
ARM	707-01-0E510	K40001-		P-UB-14	85 mm	120 mm	KOM-707-99-46320	401.08
BOOM	707-01-0E490	K40001-		P-UB-14	75 mm	110 mm	KOM-707-99-38720	341.69
BUCKET	707-01-0E520	K40001-		P-UB-14	70 mm	105 mm	KOM-707-99-37290	333.39
MODEL PC160LC-7K-KA								
ARM	707-01-0E510	K40001-		P-UB-14	85 mm	120 mm	KOM-707-99-46320	401.08
	707-01-0E510	K40001-		Bushing	85 mm		KOM-707-52-90610	34.71
BOOM	707-01-0E490	K40001-		P-UB-14	75 mm	110 mm	KOM-707-99-38720	341.69
	707-01-0E490	K40001-		Bushing	75 mm		KOM-707-52-90500	27.12
BUCKET	707-01-0E520	K40001-		P-UB-14	70 mm	105 mm	KOM-707-99-37290	333.39
	707-01-0E520	K40001-		Bushing	70 mm		KOM-707-52-90470	10.24
MODEL PC160LC-8								
ARM	707-01-0L120	25001-		P-UB-14	85 mm	120 mm	KOM-707-99-46420	147.73
	707-01-0L120	25001-		Bushing	85 mm		KOM-707-52-90610	34.71
	707-01-0L120	C20001-		P-UB-14	85 mm	120 mm	KOM-707-99-46420	147.73
	707-01-0L120	C20001-		Bushing	85 mm		KOM-707-52-90610	34.71
	707-01-XYK30	B30001-		P-UB-14	85 mm	120 mm	KOM-707-99-46420	147.73
	707-01-XYK30	B30001-		Bushing	85 mm		KOM-707-52-90610	34.71
BOOM LH	707-01-0L100	25001-		P-UB-14	75 mm	110 mm	KOM-707-99-38760	125.78
	707-01-0L100	25001-		Bushing	75 mm		KOM-707-52-90500	27.12
	707-01-0L100	C20001-		P-UB-14	75 mm	110 mm	KOM-707-99-38760	125.78
	707-01-0L100	C20001-		Bushing	75 mm		KOM-707-52-90500	27.12
	707-01-XYK40	B30001-		P-UB-14	75 mm	110 mm	KOM-707-99-38760	125.78
	707-01-XYK40	B30001-		Bushing	75 mm		KOM-707-52-90500	27.12
BOOM RH	707-01-0L100	25001-		P-UB-14	75 mm	110 mm	KOM-707-99-38760	125.78
	707-01-0L100	25001-		Bushing	75 mm		KOM-707-52-90500	27.12
	707-01-0L100	C20001-		P-UB-14	75 mm	110 mm	KOM-707-99-38760	125.78
	707-01-0L100	C20001-		Bushing	75 mm		KOM-707-52-90500	27.12
	707-01-XYK20	B30001-		P-UB-14	75 mm	110 mm	KOM-707-99-38760	125.78
	707-01-XYK20	B30001-		Bushing	75 mm		KOM-707-52-90500	27.12
BUCKET	707-01-0L500	25001-	2.25m to 2.9m Arm	P-UB-14	70 mm	105 mm	KOM-707-99-37150	164.77
	707-01-0L500	25001-	2.25m to 2.9m Arm	Bushing	70 mm		KOM-707-52-90471	10.24
	707-01-0L500	C20001-	Arm, 2.6m	P-UB-14	70 mm	105 mm	KOM-707-99-37150	164.77
	707-01-0L500	C20001-	Arm, 2.6m	Bushing	70 mm		KOM-707-52-90471	10.24
	707-01-XYK50	B30001-		P-UB-14	70 mm	105 mm	KOM-707-99-37150	164.77
MODEL PC180LC-6K								
ARM	21P-63-K1711	K30001-		P-UB-14	85 mm	120 mm	KOM-21P-63-K1711K	202.14
BOOM LH	21P-63-K1611	K30001-		P-UB-14	75 mm	110 mm	KOM-707-98-38520	337.22
BOOM RH	21P-63-K1611	K30001-		P-UB-14	75 mm	110 mm	KOM-707-98-38520	337.22
BUCKET	21P-63-K3600	K30001-		P-UB-14	70 mm	105 mm	KOM-707-98-37620	183.24
MODEL PC180LC-7K								
ARM	707-01-0E510	K40001-		P-UB-14	85 mm	120 mm	KOM-707-99-46320	401.08
BOOM	707-01-0E490	K40001-		P-UB-14	75 mm	110 mm	KOM-707-99-38720	341.69
BUCKET	707-01-0E520	K40001-		P-UB-14	70 mm	105 mm	KOM-707-99-37290	333.39
MODEL PC180NLC-6K								
ARM	21P-63-K1711	K30001-		P-UB-14	85 mm	120 mm	KOM-21P-63-K1711K	202.14
BOOM LH	21P-63-K1611	K30001-		P-UB-14	75 mm	110 mm	KOM-707-98-38520	337.22
BOOM RH	21P-63-K1611	K30001-		P-UB-14	75 mm	110 mm	KOM-707-98-38520	337.22

LT - Large size tire L/S - Loading Shovel SLF - Super Long Front B/H - Backhoe HD - Heavy Duty L BUCKET - Large Bucket

K-LINK - K-type Linkage Blade LB HI-LIFT - High Lift Arm w Large Bucket HI-LIFT - High Lift Arm S HI-LIFT - Super High Lift Arm

SU - Semi-U Dozer PAT - Power Angle Power Tilt MP - Multi-Purpose

KOMATSU®

Replacement Kits For

Excavators								
APPLICATION	CYL #	SERIAL #	Misc	CODE	ROD	BORE	KIT #	List \$
MODEL PC180NLC-6K								
BUCKET	21P-63-K3600	K30001-		P-UB-14	70 mm	105 mm	KOM-707-98-37620	183.24
MODEL PC180NLC-7K								
ARM	707-01-0E510	K40001-		P-UB-14	85 mm	120 mm	KOM-707-99-46320	401.08
BOOM	707-01-0E490	K40001-		P-UB-14	75 mm	110 mm	KOM-707-99-38720	341.69
BUCKET	707-01-0E520	K40001-		P-UB-14	70 mm	105 mm	KOM-707-99-37290	333.39
MODEL PC200-1								
BOOM	205-63-55141	10001-20000		P-U-14	90 mm	130 mm	KOM-707-98-47500	262.46
BUCKET	205-63-75141			P-U-14	80 mm	130 mm	KOM-707-98-45700	299.98
MODEL PC200-2								
BUCKET	206-63-75141			P-U-14	80 mm	130 mm	KOM-707-98-45700	299.98
MODEL PC200-3, PC200LC-3								
ARM	205-63-62101	20001-35302		P-U-14	95 mm	130 mm	KOM-707-98-48600	319.41
	205-63-69300	35303-		P-UB-14	95 mm	130 mm	KOM-707-99-48610	321.27
BOOM	205-63-52100	20001-35302		P-U-14	85 mm	120 mm	KOM-707-98-46200	275.14
	205-63-52200	20001-35302		P-U-14	85 mm	120 mm	KOM-707-98-46200	275.14
	205-63-59300	35303-45000		P-UB-14	85 mm	120 mm	KOM-707-98-46270	408.09
BOOM (SLF)	205-63-59400	35303-45000		P-UB-14	85 mm	120 mm	KOM-707-98-46270	408.09
	206-63-52100	20001-35302		P-U-14	90 mm	130 mm	KOM-707-98-47600	314.59
	206-63-52200	20001-35302		P-U-14	90 mm	130 mm	KOM-707-98-47600	314.59
BUCKET	206-63-59300	35303-		P-UB-14	90 mm	130 mm	KOM-707-98-47620	372.35
	206-63-59400	35303-		P-UB-14	90 mm	130 mm	KOM-707-98-47620	372.35
	205-63-72100	20001-35302		P-U-14	75 mm	110 mm	KOM-707-98-38500	180.18
BUCKET (1.8M Arm)	205-63-72301	20001-		P-U-14	85 mm	120 mm	KOM-707-98-46100	222.90
	205-63-79700			P-UB-14	85 mm	120 mm	KOM-707-99-46210	364.96
BUCKET (SLF)	203-63-72500	20001-		P-UB-14	65 mm	100 mm	KOM-707-98-36110	127.62
MODEL PC200-5, PC200LC-5								
ARM	205-63-02120	45001-		P-UB-14	95 mm	135 mm	KOM-707-99-57200	298.85
BOOM	205-63-02100	45001-		P-UB-14	85 mm	120 mm	KOM-707-99-46600	225.34
BOOM (SLF)	206-63-02100	45001-		P-UB-14	90 mm	130 mm	KOM-707-99-47600	245.30
BUCKET	205-63-02130	45001-		P-UB-14	80 mm	115 mm	KOM-707-98-45220	337.63
BUCKET (HD)	206-63-02130	45001-		P-UB-14	90 mm	130 mm	KOM-707-98-47620	372.35
BUCKET (SLF)	203-63-02130	45001-		P-UB-14	65 mm	95 mm	KOM-707-98-36210	259.56
MODEL PC200-6								
ARM	205-63-02521	80001-84384		P-UB-14	95 mm	135 mm	KOM-707-99-57200	298.85
	205-63-02521	80001-84384		Bushing	95 mm		KOM-707-52-90710	47.74
	205-63-02521	A80001-, A82001-		P-UB-14	95 mm	135 mm	KOM-707-99-57200	298.85
	205-63-02521	A80001-, A82001-		Bushing	95 mm		KOM-707-52-90710	47.74
	205-63-02522	84385-		P-UB-14	95 mm	135 mm	KOM-707-99-57200	298.85
BOOM	205-63-02522	84385-		Bushing	95 mm		KOM-707-52-90710	47.74
	205-63-02501	80001-84384		P-UB-14	85 mm	120 mm	KOM-707-99-46600	225.34
	205-63-02501	80001-84384		Bushing	85 mm		KOM-707-52-90600	37.06
	205-63-02502	84385-		P-UB-14	85 mm	120 mm	KOM-707-99-46600	225.34
	205-63-02502	84385-		Bushing	85 mm		KOM-707-52-90600	37.06
	206-63-02501	A80001-, A82001-		P-UB-14	90 mm	130 mm	KOM-707-99-47600	245.30
	206-63-02501	A80001-, A82001-		Bushing	90 mm		KOM-707-52-90650	42.75
20Y-63-03101	96514-		P-UB-14	85 mm	120 mm	KOM-707-99-46270	233.48	
BUCKET	205-63-02130	A80001-, A82001-		P-UB-14	80 mm	115 mm	KOM-707-98-45220	337.63
	205-63-02130	A80001-, A82001-		Bushing	80 mm		KOM-707-52-90550	33.98
	205-63-02131	80001-84384		P-UB-14	80 mm	115 mm	KOM-707-98-45220	337.63
	205-63-02131	80001-84384		Bushing	80 mm		KOM-707-52-90550	33.98
	205-63-02132	84385-		P-UB-14	80 mm	115 mm	KOM-707-98-45220	337.63
	205-63-02132	84385-		Bushing	80 mm		KOM-707-52-90550	33.98
	205-63-02140	A80001-, A82001-		P-UB-14	85 mm	125 mm	KOM-205-63-02140K	194.79
	205-63-02140	A80001-, A82001-		Bushing	85 mm		KOM-707-52-90600	37.06

LT - Large size tire L/S - Loading Shovel SLF - Super Long Front B/H - Backhoe HD - Heavy Duty L BUCKET - Large Bucket
 K-LINK - K-type Linkage Blade LB HI-LIFT - High Lift Arm w Large Bucket HI-LIFT - High Lift Arm S HI-LIFT - Super High Lift Arm
 SU - Semi-U Dozer PAT - Power Angle Power Tilt MP - Multit-Purpose

Replacement Kits For

KOMATSU®

Excavators								
APPLICATION	CYL #	SERIAL #	Misc	CODE	ROD	BORE	KIT #	List \$
MODEL PC200-6S, PC200LC-6S								
ARM	205-63-03122	C10001-		P-UB-14	95 mm	135 mm	KOM-707-99-57250	298.85
BOOM	205-63-03101	C10001-		P-UB-14	85 mm	120 mm	KOM-707-99-46270	233.48
	205-63-07240	C10001-		P-UB-14	85 mm	120 mm	KOM-707-99-46270	233.48
BOOM (2pc - 1st Cyl)	205-63-03300	C10001-		P-UB-14	85 mm	120 mm	KOM-707-99-46270	233.48
BOOM (2pc - 2nd Cyl)	205-63-02821	C10001-		P-UB-14	110 mm	160 mm	KOM-707-99-67610	339.29
BUCKET	205-63-03131	C10001-		P-UB-14	80 mm	100 mm	KOM-707-98-45250	259.10
	205-63-03140	C10001-		P-UB-14	85 mm	125 mm	KOM-707-99-46290	372.02
	205-63-07132	C10001-		P-UB-14	80 mm	115 mm	KOM-707-98-45240	148.24
	205-63-07230	C10001-		P-UB-14	80 mm	100 mm	KOM-707-98-45250	259.10
	205-63-07280	C10001-		P-UB-14	85 mm	125 mm	KOM-707-99-46290	372.02
	205-63-07290	C10001-		P-UB-14	80 mm	115 mm	KOM-707-98-45240	148.24
BUCKET (Demo Spec)	206-63-03130	C10001-		P-UB-14	90 mm	130 mm	KOM-707-99-47670	372.94
	206-63-07290	C10001-		P-UB-14	90 mm	130 mm	KOM-707-99-47670	372.94
MODEL PC200-7, PC200LC-7								
ARM	707-01-0A310	200001-202830		P-UB-14	95 mm	135 mm	KOM-707-99-57160	361.84
	707-01-0A310	C70001-		P-UB-14	95 mm	135 mm	KOM-707-99-57160	361.84
	707-01-0A311	202831-		P-UB-14	95 mm	135 mm	KOM-707-99-57160	361.84
	707-01-0A312	205865-		P-UB-14	95 mm	135 mm	KOM-707-99-57160	361.84
	707-01-0C420	200001-202830		P-UB-14	95 mm	135 mm	KOM-707-99-57160	361.84
	707-01-0C421	202831-		P-UB-14	95 mm	135 mm	KOM-707-99-57160	361.84
BOOM	707-01-0A290	200001-		P-UB-14	85 mm	120 mm	KOM-707-99-46130	372.77
	707-01-0A290	C70001-		P-UB-14	85 mm	120 mm	KOM-707-99-46130	372.77
	707-01-0C400	200001-		P-UB-14	85 mm	120 mm	KOM-707-99-46130	372.77
BOOM (Lrg Dia Type)		C70001-		P-UB-14	90 mm	130 mm	KOM-707-99-47790	218.42
	707-01-0A940	200001-	LC-7	P-UB-14	90 mm	130 mm	KOM-707-99-47790	218.42
BUCKET	707-01-0A320	200001-		P-UB-14	80 mm	115 mm	KOM-707-99-45230	196.31
	707-01-0A320	C70001-		P-UB-14	80 mm	115 mm	KOM-707-99-45230	196.31
	707-01-0A321	205831-		P-UB-14	80 mm	115 mm	KOM-707-99-45230	196.31
	707-01-0A321	250001-254768	LC-7	P-UB-14	80 mm	115 mm	KOM-707-99-45230	196.31
	707-01-0C430	200001-		P-UB-14	80 mm	115 mm	KOM-707-99-45230	196.31
	707-01-0C431	205381-		P-UB-14	80 mm	115 mm	KOM-707-99-45230	196.31
	707-01-0C431	254769-	LC-7	P-UB-14	80 mm	115 mm	KOM-707-99-45230	196.31
	707-01-0C880	200001-		P-UB-14	85 mm	125 mm	KOM-707-99-46120	209.65
	707-01-0E081	250001-		P-UB-14	85 mm	125 mm	KOM-707-99-46120	209.65
	707-01-0G710	205865-		P-UB-14	85 mm	125 mm	KOM-707-99-46120	209.65
	707-01-0G871	255788-		P-UB-14	80 mm	115 mm	KOM-707-99-45230	196.31
MODEL PC200LC-6								
ARM	205-63-02521	80001-84384		P-UB-14	95 mm	135 mm	KOM-707-99-57200	298.85
	205-63-02521	A80001-, A82001-		P-UB-14	95 mm	135 mm	KOM-707-99-57200	298.85
	205-63-02522	84385-96513		P-UB-14	95 mm	135 mm	KOM-707-99-57200	298.85
	205-63-03121	96514-99471		P-UB-14	95 mm	135 mm	KOM-707-99-57250	298.85
	205-63-03122	99472-110674		P-UB-14	95 mm	135 mm	KOM-707-99-57270	373.71
	707-01-0E570	110675-		P-UB-14	95 mm	135 mm	KOM-707-99-57270	373.71
BOOM	205-63-02501	80001-84384		P-UB-14	85 mm	120 mm	KOM-707-99-46600	225.34
	205-63-02502	84385-96513		P-UB-14	85 mm	120 mm	KOM-707-99-46600	225.34
	205-63-02801	80001-96513		P-UB-14	85 mm	120 mm	KOM-707-99-46600	225.34
	205-63-03101	96514-		P-UB-14	85 mm	120 mm	KOM-707-99-46270	233.48
	205-63-03150	101894-		P-UB-14	90 mm	130 mm	KOM-707-99-47740	244.02
	205-63-03300	96514-		P-UB-14	85 mm	120 mm	KOM-707-99-46270	233.48
	205-63-07140	80001-96513		P-UB-14	85 mm	120 mm	KOM-707-99-46600	225.34
	205-63-07240	96514-		P-UB-14	85 mm	120 mm	KOM-707-99-46270	233.48
	206-63-02501	A80001-, A82001-		P-UB-14	90 mm	130 mm	KOM-707-99-47600	245.30
BUCKET	205-63-02130	A80001-, A82001-		P-UB-14	80 mm	115 mm	KOM-707-98-45220	337.63
	205-63-02131	80001-84384		P-UB-14	80 mm	115 mm	KOM-707-98-45220	337.63
	205-63-02132	84385-96513		P-UB-14	80 mm	115 mm	KOM-707-98-45220	337.63

LT - Large size tire L/S - Loading Shovel SLF - Super Long Front B/H - Backhoe HD - Heavy Duty L BUCKET - Large Bucket

K-LINK - K-type Linkage Blade LB HI-LIFT - High Lift Arm w Large Bucket HI-LIFT - High Lift Arm S HI-LIFT - Super High Lift Arm

SU - Semi-U Dozer PAT - Power Angle Power Tilt MP - Multi-Purpose

Replacement Kits For

KOMATSU®

Excavators								
APPLICATION	CYL #	SERIAL #	Misc	CODE	ROD	BORE	KIT #	List \$
MODEL PC200LC-6								
BUCKET	205-63-02140	80001-96513		P-UB-14	85 mm	125 mm	KOM-205-63-02140K	194.79
	205-63-02140	A80001-, A82001-		P-UB-14	85 mm	125 mm	KOM-205-63-02140K	194.79
	205-63-03131	94999-, 96514-		P-UB-14	80 mm	100 mm	KOM-707-98-45250	259.10
	205-63-03140	96514-		P-UB-14	85 mm	125 mm	KOM-707-99-46290	372.02
	205-63-07132	80001-		P-UB-14	80 mm	115 mm	KOM-707-98-45240	148.24
	205-63-07230	94999-		P-UB-14	80 mm	100 mm	KOM-707-98-45250	259.10
	205-63-07280	94999-		P-UB-14	85 mm	125 mm	KOM-707-99-46290	372.02
BUCKET (Demo Spec)	206-63-02130	80001-96513		P-UB-14	90 mm	130 mm	KOM-707-98-47620	372.35
	206-63-03130	96514-		P-UB-14	90 mm	130 mm	KOM-707-99-47670	372.94
	206-63-07290	94999-		P-UB-14	90 mm	130 mm	KOM-707-99-47670	372.94
MODEL PC200LC-6LE								
ARM	205-63-03121	A83001-		P-UB-14	95 mm	135 mm	KOM-707-99-57250	298.85
BOOM LH	206-63-03200	A83001-		P-UB-14	90 mm	130 mm	KOM-707-99-47660	256.38
BOOM RH	206-63-03100	A83001-		P-UB-14	90 mm	130 mm	KOM-707-99-47660	256.38
BUCKET	205-63-03131	A83001-		P-UB-14	90 mm	130 mm	KOM-707-99-47670	372.94
	205-63-03140	A83001-		P-UB-14	85 mm	125 mm	KOM-707-99-46290	372.02
BUCKET (Demo Spec)	206-63-03130	A83001-		P-UB-14	90 mm	130 mm	KOM-707-99-47670	372.94
MODEL PC200LC-7L								
ARM	707-01-0A310	A86001-		P-UB-14	95 mm	135 mm	KOM-707-99-57160	361.84
BOOM (Lrg Dia Type)	707-01-0A940	A86001-		P-UB-14	90 mm	130 mm	KOM-707-99-47790	218.42
BUCKET	707-01-0A320	A86001-		P-UB-14	80 mm	115 mm	KOM-707-99-45230	196.31
MODEL PC200LC-7-US								
ARM	707-01-0A310	200001-, C50001-		P-UB-14	95 mm	135 mm	KOM-707-99-57160	361.84
	707-01-0Z840	C70001-		P-UB-14	95 mm	135 mm	KOM-707-99-57160	361.84
BOOM	707-01-0A290	C70001-		P-UB-14	85 mm	120 mm	KOM-707-99-46130	372.77
BOOM (Lrg Dia Type)	707-01-0A940	200001-, C50001-		P-UB-14	90 mm	130 mm	KOM-707-99-47790	218.42
BUCKET	707-01-0A320	200001-, C50001-		P-UB-14	80 mm	115 mm	KOM-707-99-45230	196.31
MODEL PC200LC-8								
ARM	707-01-0H600	300001-		P-UB-14	95 mm	135 mm	KOM-707-98-48610	259.51
	707-01-0H600	A88001-		P-UB-14	95 mm	135 mm	KOM-707-98-48610	259.51
	707-01-0H600	C60001-		P-UB-14	95 mm	135 mm	KOM-707-98-48610	259.51
BOOM LH	707-01-0H580	300001-		P-UB-14	85 mm	120 mm	KOM-707-98-46280	169.71
	707-01-0H580	C60001-		P-UB-14	85 mm	120 mm	KOM-707-98-46280	169.71
	707-01-0H650	300001-		P-UB-14	90 mm	130 mm	KOM-707-98-47710	198.48
	707-01-0H650	A88001-		P-UB-14	90 mm	130 mm	KOM-707-98-47710	198.48
	707-01-0H650	C60001-		P-UB-14	90 mm	130 mm	KOM-707-98-47710	198.48
BOOM LH (Lrg Dia Type)	707-01-0H650	A88001-		P-UB-14	90 mm	130 mm	KOM-707-98-47710	198.48
BOOM RH	707-01-0H580	300001-		P-UB-14	85 mm	120 mm	KOM-707-98-46280	169.71
	707-01-0H580	C60001-		P-UB-14	85 mm	120 mm	KOM-707-98-46280	169.71
	707-01-0H650	300001-		P-UB-14	90 mm	130 mm	KOM-707-98-47710	198.48
	707-01-0H650	A88001-		P-UB-14	90 mm	130 mm	KOM-707-98-47710	198.48
BOOM RH (Lrg Dia Type)	707-01-0H650	A88001-		P-UB-14	90 mm	130 mm	KOM-707-98-47710	198.48
	707-01-0H650	C60001-		P-UB-14	90 mm	130 mm	KOM-707-98-47710	198.48
BUCKET	707-01-0H740	300001-		P-UB-14	80 mm	115 mm	KOM-707-98-39610	196.31
	707-01-0H740	A88001-		P-UB-14	80 mm	115 mm	KOM-707-98-39610	196.31
	707-01-0H740	C60001-		P-UB-14	80 mm	115 mm	KOM-707-98-39610	196.31
	707-01-0J270	A88001-		P-UB-14	80 mm	115 mm	KOM-707-98-39610	196.31
MODEL PC200LC-8E0								
BOOM LH	707-01-0H650	1001-		P-UB-14	90 mm	130 mm	KOM-707-98-47710	198.48
	707-01-0H650	1001-		Bushing	90 mm		KOM-707-52-90681	36.70
BOOM RH	707-01-0H650	1001-		P-UB-14	90 mm	130 mm	KOM-707-98-47710	198.48
	707-01-0H650	1001-		Bushing	90 mm		KOM-707-52-90681	36.70
BUCKET	707-01-0H740	1001-		P-UB-14	80 mm	115 mm	KOM-707-98-39610	196.31
	707-01-0H740	1001-		Bushing	80 mm		KOM-707-52-90561	31.26

LT - Large size tire L/S - Loading Shovel SLF - Super Long Front B/H - Backhoe HD - Heavy Duty L BUCKET - Large Bucket
 K-LINK - K-type Linkage Blade LB HI-LIFT - High Lift Arm w Large Bucket HI-LIFT - High Lift Arm S HI-LIFT - Super High Lift Arm
 SU - Semi-U Dozer PAT - Power Angle Power Tilt MP - Multit-Purpose

Replacement Kits For

KOMATSU®

Excavators									
APPLICATION	CYL #	SERIAL #	Misc	CODE	ROD	BORE	KIT #	List \$	
MODEL PC210-3, PC210LC-3									
ARM	205-63-62101	10001-		P-U-14	95 mm	130 mm	KOM-707-98-48600	319.41	
BOOM LH	205-63-52100	10001-		P-U-14	85 mm	120 mm	KOM-707-98-46200	275.14	
BOOM RH	205-63-52200	10001-		P-U-14	85 mm	120 mm	KOM-707-98-46200	275.14	
BUCKET	205-63-72100	10001-		P-U-14	75 mm	110 mm	KOM-707-98-38500	180.18	
MODEL PC210-6									
ARM	205-63-02521	80001-84384		P-UB-14	95 mm	135 mm	KOM-707-99-57200	298.85	
	205-63-02521	80001-84384		Bushing	95 mm		KOM-707-52-90710	47.74	
	205-63-02522	34385-		P-UB-14	95 mm	135 mm	KOM-707-99-57200	298.85	
	205-63-02522	34385-		Bushing	95 mm		KOM-707-52-90710	47.74	
	205-63-63340	A82001-		P-UB-14	95 mm	135 mm	KOM-707-99-57200	298.85	
BOOM	205-63-02051	80001-84384		P-U-14	90 mm	130 mm	KOM-707-98-47600	314.59	
	205-63-02501	80001-84384		Bushing	85 mm		KOM-707-52-90600	37.06	
	205-63-02502	84385-		P-UB-14	85 mm	120 mm	KOM-707-99-46600	225.34	
	205-63-02502	84385-		Bushing	85 mm		KOM-707-52-90600	37.06	
	206-63-54141	A82001-		P-UB-14	90 mm	130 mm	KOM-707-99-47600	245.30	
	20Y-63-03101	96514-		P-UB-14	85 mm	120 mm	KOM-707-99-46270	233.48	
	205-63-02131	80001-84384		P-UB-14	80 mm	115 mm	KOM-707-98-45220	337.63	
BUCKET	205-63-02131	80001-84384		Bushing	80 mm		KOM-707-52-90550	33.98	
	205-63-02132	84385-		P-UB-14	80 mm	115 mm	KOM-707-98-45220	337.63	
	205-63-02132	84385-		Bushing	80 mm		KOM-707-52-90550	33.98	
	205-63-73340	A82001-		P-UB-14	80 mm	115 mm	KOM-707-98-45220	337.63	
	208-63-73340	A82001-		P-UB-14	80 mm	115 mm	KOM-707-98-45220	337.63	
	BUCKET (Demo Spec)	206-63-73340	A82001-		P-UB-14	90 mm	130 mm	KOM-707-98-47620	372.35
	206-63-73340	A82001-		P-UB-14	90 mm	130 mm	KOM-707-98-47620	372.35	
MODEL PC210-6K									
ARM	20Y-63-K1170	K30001-		P-UB-14	95 mm	135 mm	KOM-707-99-57200	298.85	
BOOM (2pc - 1st Cyl)	205-63-K1360	K30001-K30873		P-UB-14	85 mm	120 mm	KOM-707-99-46600	225.34	
	205-63-K1361	K30874-		P-UB-14	85 mm	120 mm	KOM-707-99-46600	225.34	
BOOM (2pc - 2nd Cyl)	205-63-K1370	K30001-		P-UB-14	110 mm	160 mm	KOM-205-63-K1370K	343.68	
BOOM LH	205-63-K1170	K30001-K30873		P-UB-14	85 mm	120 mm	KOM-707-99-46600	225.34	
	205-63-K1171	K30874-		P-UB-14	85 mm	120 mm	KOM-707-99-46600	225.34	
BOOM RH	205-63-K1180	K30001-K30873		P-UB-14	85 mm	120 mm	KOM-707-99-46600	225.34	
	205-63-K1181	K30874-		P-UB-14	85 mm	120 mm	KOM-707-99-46600	225.34	
BUCKET	20Y-63-K1180	K30001-		P-UB-14	85 mm	125 mm	KOM-707-99-46290	372.02	
MODEL PC210-7K									
ARM	707-01-0A310	K40001-		P-UB-14	95 mm	135 mm	KOM-707-99-57160	361.84	
BOOM	707-01-0A290	K40001-		P-UB-14	85 mm	120 mm	KOM-707-99-46130	372.77	
BUCKET	707-01-0A320	K40001-		P-UB-14	80 mm	115 mm	KOM-707-99-45230	196.31	
MODEL PC210LC-6									
ARM	205-63-02521	A80001-		P-UB-14	95 mm	135 mm	KOM-707-99-57200	298.85	
	205-63-63340	A82001-		P-UB-14	95 mm	135 mm	KOM-707-99-57200	298.85	
BOOM	206-63-02501	A80001-		P-UB-14	90 mm	130 mm	KOM-707-99-47600	245.30	
	206-63-54141	A82001-		P-UB-14	90 mm	130 mm	KOM-707-99-47600	245.30	
BUCKET	205-63-73340	A82001-		P-UB-14	80 mm	115 mm	KOM-707-98-45220	337.63	
	208-63-73340	A82001-		P-UB-14	80 mm	115 mm	KOM-707-98-45220	337.63	
BUCKET (2.9M Arm)	205-63-02130	A80001-		P-UB-14	80 mm	115 mm	KOM-707-98-45220	337.63	
	206-63-02130	A80001-	Demo Spec	P-UB-14	90 mm	130 mm	KOM-707-98-47620	372.35	
BUCKET (Demo Spec)	206-63-73340	A82001-		P-UB-14	90 mm	130 mm	KOM-707-98-47620	372.35	
MODEL PC210LC-6K									
ARM	20Y-63-K1170	K30001-		P-UB-14	95 mm	135 mm	KOM-707-99-57200	298.85	
BOOM (2pc - 1st Cyl)	205-63-K1360	K30001-K30873		P-UB-14	85 mm	120 mm	KOM-707-99-46600	225.34	
	205-63-K1361	K30874-		P-UB-14	85 mm	120 mm	KOM-707-99-46600	225.34	
BOOM (2pc - 2nd Cyl)	205-63-K1370	K30001-		P-UB-14	110 mm	160 mm	KOM-205-63-K1370K	343.68	
BOOM LH	205-63-K1170	K30001-K30873		P-UB-14	85 mm	120 mm	KOM-707-99-46600	225.34	
	205-63-K1171	K30874-		P-UB-14	85 mm	120 mm	KOM-707-99-46600	225.34	
BOOM RH	205-63-K1180	K30001-K30873		P-UB-14	85 mm	120 mm	KOM-707-99-46600	225.34	

LT - Large size tire L/S - Loading Shovel SLF - Super Long Front B/H - Backhoe HD - Heavy Duty L BUCKET - Large Bucket
 K-LINK - K-type Linkage Blade LB HI-LIFT - High Lift Arm w Large Bucket HI-LIFT - High Lift Arm S HI-LIFT - Super High Lift Arm
 SU - Semi-U Dozer PAT - Power Angle Power Tilt MP - Mult-Purpose

Replacement Kits For

KOMATSU®

KOMATSU®

Excavators								
APPLICATION	CYL #	SERIAL #	Misc	CODE	ROD	BORE	KIT #	List \$
MODEL PC210LC-6K								
BOOM RH	205-63-K1181	K30874-		P-UB-14	85 mm	120 mm	KOM-707-99-46600	225.34
BUCKET	20Y-63-K1180	K30001-		P-UB-14	85 mm	125 mm	KOM-707-99-46290	372.02
MODEL PC210LC-7K								
ARM	707-01-0A310	K40001-		P-UB-14	95 mm	135 mm	KOM-707-99-57160	361.84
BOOM	707-01-0A290	K40001-		P-UB-14	85 mm	120 mm	KOM-707-99-46130	372.77
BUCKET	707-01-0A320	K40001-		P-UB-14	80 mm	115 mm	KOM-707-99-45230	196.31
MODEL PC210LC-8K								
ARM	707-01-0H580	K50001-		P-UB-14	95 mm	135 mm	KOM-707-98-48610	259.51
	707-01-0H580	K50001-		Bushing	95 mm		KOM-707-52-90720	37.71
	707-01-0H600	K50001-	Burst Valve	P-UB-14	95 mm	135 mm	KOM-707-98-48610	259.51
	707-01-0H600	K50001-	Burst Valve	Bushing	95 mm		KOM-707-52-90720	37.71
	707-01-0H601	K53811-	Burst Valve	P-UB-14	95 mm	135 mm	KOM-707-99-50500	147.82
	707-01-0H601	K53811-	Burst Valve	Bushing	95 mm		KOM-707-52-90721	37.71
BOOM	707-01-0H600	K50001-	Two-Piece Boom	P-UB-14	100 mm	160 mm	KOM-707-99-66350	147.90
	707-01-0H600	K50001-	Two-Piece Boom	Bushing	100 mm		KOM-707-52-90780	41.68
BOOM LH	707-01-0K520	K50001-		P-UB-14	85 mm	120 mm	KOM-707-98-46280	169.71
	707-01-0K520	K50001-		Bushing	85 mm		KOM-707-52-90610	34.71
	707-01-0K540	K50001-	Two-Piece Boom	P-UB-14	85 mm	120 mm	KOM-707-99-46390	111.88
	707-01-0K540	K50001-	Two-Piece Boom	Bushing	100 mm		KOM-707-52-90780	41.68
BOOM RH	707-01-0H580	K50001-	Two-Piece Boom	P-UB-14	85 mm	120 mm	KOM-707-99-46390	111.88
	707-01-0H580	K50001-	Two-Piece Boom	Bushing	85 mm		KOM-707-52-90610	34.71
	707-01-0K520	K50001-		P-UB-14	85 mm	120 mm	KOM-707-98-46280	169.71
	707-01-0K520	K50001-		Bushing	85 mm		KOM-707-52-90610	34.71
BUCKET	707-01-0H740	K50001-	For 2.9m Arm	P-UB-14	80 mm	115 mm	KOM-707-98-39610	196.31
	707-01-0H740	K50001-	For 2.9m Arm	Bushing	80 mm		KOM-707-52-90560	31.26
	707-01-0J080	K50001-	For 1.8m and 2.4m Arm	P-UB-14	85 mm	125 mm	KOM-707-99-47130	160.79
	707-01-0J080	K50001-	For 1.8m and 2.4m Arm	Bushing	85 mm		KOM-707-52-90610	34.71
	707-F1-00080	K53751-	For 2.4m Arm	P-UB-14	85 mm	125 mm	KOM-707-99-47040	160.79
	707-F1-00080	K53751-	For 2.4m Arm	Bushing	85 mm		KOM-707-52-90610	34.71
	707-F1-00090	K53751-	For 2.9m Arm	P-UB-14	80 mm	115 mm	KOM-707-99-45040	127.92
	707-F1-00090	K53751-	For 2.9m Arm	Bushing	80 mm		KOM-707-52-90560	31.26
MODEL PC210NLC-7K								
ARM	707-01-0A310	K40001-		P-UB-14	95 mm	135 mm	KOM-707-99-57160	361.84
BOOM	707-01-0A290	K40001-		P-UB-14	85 mm	120 mm	KOM-707-99-46130	372.77
BUCKET	707-01-0A320	K40001-		P-UB-14	80 mm	115 mm	KOM-707-99-45230	196.31
MODEL PC220,PC220LC,PC220-2,PC220LC-2								
ARM	206-63-65101	11001-		P-U-14	100 mm	150 mm	KOM-PC-1	196.18
BOOM LH	206-63-55300	11001-		P-U-14	90 mm	140 mm	KOM-PC-2	177.67
BUCKET	205-63-75101	11001-		P-U-14	80 mm	140 mm	KOM-PC-3	222.65
MODEL PC220-3, PC220LC-3								
ARM	206-63-62101	20001-23737		P-U-14	95 mm	140 mm	KOM-707-98-57201	162.05
ARM (SLF)	205-63-62101	2001-23614		P-U-14	95 mm	130 mm	KOM-707-98-48600	319.41
	205-63-69300	23615-		P-UB-14	95 mm	130 mm	KOM-707-99-48610	321.27
BOOM	206-63-52100	20001-23737		P-U-14	90 mm	130 mm	KOM-707-98-47600	314.59
	206-63-52200	20001-23737		P-U-14	90 mm	130 mm	KOM-707-98-47600	314.59
	206-63-59300	23738-		P-UB-14	90 mm	130 mm	KOM-707-98-47620	372.35
	206-63-59400	23738-		P-UB-14	90 mm	130 mm	KOM-707-98-47620	372.35

LT - Large size tire L/S - Loading Shovel SLF - Super Long Front B/H - Backhoe HD - Heavy Duty L BUCKET - Large Bucket
 K-LINK - K-type Linkage Blade LB HI-LIFT - High Lift Arm w Large Bucket HI-LIFT - High Lift Arm S HI-LIFT - Super High Lift Arm
 SU - Semi-U Dozer PAT - Power Angle Power Tilt MP - Mulit-Purpose

Replacement Kits For

KOMATSU®

Excavators								
APPLICATION	CYL #	SERIAL #	Misc	CODE	ROD	BORE	KIT #	List \$
MODEL PC220-3, PC220LC-3								
BUCKET	206-63-72100	20001-23737		P-U-14	90 mm	130 mm	KOM-707-98-47500	262.46
	206-63-79300	23738-		P-UB-14	90 mm	130 mm	KOM-707-99-47610	372.87
BUCKET (2M Arm)	206-63-72300	20001-		P-U-14	100 mm	140 mm	KOM-707-98-58230	177.06
BUCKET (SLF)	203-63-72500	20001-		P-UB-14	65 mm	100 mm	KOM-707-98-36110	127.62
MODEL PC220-5, PC220LC-5								
ARM	206-63-02120	35001-		P-UB-14	100 mm	140 mm	KOM-707-99-58200	373.00
ARM (SLF)	205-63-02120	35001-		P-UB-14	95 mm	135 mm	KOM-707-99-57200	298.85
BOOM	206-63-02100	35001-		P-UB-14	90 mm	130 mm	KOM-707-99-47600	245.30
BUCKET	206-63-02130	35001-		P-UB-14	90 mm	130 mm	KOM-707-98-47620	372.35
BUCKET (SLF)	203-63-02130	35001-		P-UB-14	65 mm	95 mm	KOM-707-98-36210	259.56
MODEL PC220-6								
ARM	206-63-02521	40001-52851		P-UB-14	100 mm	140 mm	KOM-707-99-58200	373.00
	206-63-03120	52852-53173		P-UB-14	100 mm	140 mm	KOM-707-99-58300	180.66
	206-63-03121	53174-56420		P-UB-14	100 mm	140 mm	KOM-707-99-58350	281.41
	707-01-0E580	56421-		P-UB-14	100 mm	140 mm	KOM-707-99-58350	281.41
BOOM	206-63-02501	40001-52851		P-UB-14	90 mm	130 mm	KOM-707-99-47600	245.30
	206-63-03100	52852-		P-UB-14	90 mm	130 mm	KOM-707-99-47660	256.38
	206-63-07100	50001-52851		P-UB-14	90 mm	130 mm	KOM-707-99-47600	245.30
	206-63-07200	52852-		P-UB-14	90 mm	130 mm	KOM-707-99-47660	256.38
BOOM LIFT	206-63-02801	50001-52851		P-UB-14	100 mm	140 mm	KOM-707-99-58260	137.00
	206-63-03300	52852-		P-UB-14	100 mm	140 mm	KOM-707-99-58310	144.18
	206-63-07140	50001-52851		P-UB-14	100 mm	140 mm	KOM-707-99-58260	137.00
	206-63-07240	52852-		P-UB-14	100 mm	140 mm	KOM-707-99-58310	144.18
BUCKET	206-63-02130	40001-52851		P-UB-14	90 mm	130 mm	KOM-707-98-47620	372.35
	206-63-02140	40001-52851		P-UB-14	100 mm	140 mm	KOM-707-98-58240	204.88
	206-63-02140	50001-52851		P-UB-14	100 mm	140 mm	KOM-707-99-58240	476.62
	206-63-03130	52852-		P-UB-14	90 mm	130 mm	KOM-707-99-47670	372.94
	206-63-03140	52852-		P-UB-14	100 mm	140 mm	KOM-707-99-58320	239.94
	206-63-07030	50001-		P-UB-14	90 mm	130 mm	KOM-707-98-47620	372.35
MODEL PC220LC-6								
ARM	206-63-02521	50001-		Bushing	100 mm		KOM-707-52-90750	59.52
	206-63-02521	50001-52851		P-UB-14	100 mm	140 mm	KOM-707-99-58200	373.00
	206-63-02521	A80001-		Bushing	100 mm		KOM-707-52-90750	59.52
	206-63-02521	A80001-A82000		P-UB-14	100 mm	140 mm	KOM-707-99-58200	373.00
	206-63-03120	52852-53173		P-UB-14	100 mm	140 mm	KOM-707-99-58300	180.66
	206-63-03121	53174-56420		P-UB-14	100 mm	140 mm	KOM-707-99-58350	281.41
	707-01-0E580	56421-		P-UB-14	100 mm	140 mm	KOM-707-99-58350	281.41
BOOM	206-63-02501	50001-		Bushing	90 mm		KOM-707-52-90650	42.75
	206-63-02501	50001-52851		P-UB-14	90 mm	130 mm	KOM-707-99-47600	245.30
	206-63-02801	A80001-		Bushing	100 mm		KOM-707-52-90750	59.52
	206-63-02801	A80001-A82000		P-UB-14	100 mm	140 mm	KOM-707-99-58260	137.00
	206-63-03100	52852-		P-UB-14	90 mm	130 mm	KOM-707-99-47660	256.38
	206-63-07100	50001-52851		P-UB-14	90 mm	130 mm	KOM-707-99-47600	245.30
	206-63-07200	52852-		P-UB-14	90 mm	130 mm	KOM-707-99-47660	256.38
BOOM LIFT	206-63-02801	50001-52851		P-UB-14	100 mm	140 mm	KOM-707-99-58260	137.00
	206-63-03300	52852-		P-UB-14	100 mm	140 mm	KOM-707-99-58310	144.18
	206-63-07140	50001-52851		P-UB-14	100 mm	140 mm	KOM-707-99-58260	137.00
	206-63-07240	52852-		P-UB-14	100 mm	140 mm	KOM-707-99-58310	144.18
BUCKET	206-63-02130	50001-		Bushing	90 mm		KOM-707-52-90650	42.75
	206-63-02130	50001-52851		P-UB-14	90 mm	130 mm	KOM-707-98-47620	372.35
	206-63-02130	A80001-		Bushing	90 mm		KOM-707-52-90650	42.75
	206-63-02130	A80001-A82000		P-UB-14	90 mm	130 mm	KOM-707-98-47620	372.35
	206-63-02140	50001-52851		P-UB-14	100 mm	140 mm	KOM-707-99-58240	476.62
	206-63-02140	A80001-A82000		P-UB-14	100 mm	140 mm	KOM-707-99-58240	476.62
	206-63-03130	52852-		P-UB-14	90 mm	130 mm	KOM-707-99-47670	372.94

LT - Large size tire L/S - Loading Shovel SLF - Super Long Front B/H - Backhoe HD - Heavy Duty L BUCKET - Large Bucket
 K-LINK - K-type Linkage Blade LB HI-LIFT - High Lift Arm w Large Bucket HI-LIFT - High Lift Arm S HI-LIFT - Super High Lift Arm
 SU - Semi-U Dozer PAT - Power Angle Power Tilt MP - Multi-Purpose

Replacement Kits For

KOMATSU®

Excavators								
APPLICATION	CYL #	SERIAL #	Misc	CODE	ROD	BORE	KIT #	List \$
MODEL PC220LC-6								
BUCKET	206-63-03140	52852-		P-UB-14	100 mm	140 mm	KOM-707-99-58320	239.94
	206-63-07030	50001-		P-UB-14	90 mm	130 mm	KOM-707-98-47620	372.35
MODEL PC220LC-6LC								
ARM	206-63-02521	A82001-A83000		P-UB-14	100 mm	140 mm	KOM-707-99-58200	373.00
BOOM	206-63-02801	A82001-A83000		P-UB-14	100 mm	140 mm	KOM-707-99-58260	137.00
BUCKET	206-63-02130	A82001-A83000		P-UB-14	90 mm	130 mm	KOM-707-98-47620	372.35
	206-63-02140	A82001-A83000		P-UB-14	100 mm	140 mm	KOM-707-99-58240	476.62
MODEL PC220LC-6LE								
ARM	206-63-03120	A83001-A83986		P-UB-14	100 mm	140 mm	KOM-707-99-58350	281.41
	206-63-03121	A83987-		P-UB-14	100 mm	140 mm	KOM-707-99-58350	281.41
BOOM	206-63-02801	A83001-		P-UB-14	100 mm	140 mm	KOM-707-99-58260	137.00
	206-63-03300	A83001-		P-UB-14	100 mm	140 mm	KOM-707-99-58310	144.18
BUCKET	206-63-02140	A83001-		P-UB-14	100 mm	140 mm	KOM-707-99-58240	476.62
	206-63-03130	A83001-		P-UB-14	90 mm	130 mm	KOM-707-98-47670	340.70
	206-63-03140	A83001-		P-UB-14	100 mm	140 mm	KOM-707-99-58320	239.94
MODEL PC220LC-7								
ARM	707-01-0A370	60001-60273		P-UB-14	100 mm	140 mm	KOM-707-99-58070	205.90
	707-01-0A371	60274-		P-UB-14	100 mm	140 mm	KOM-707-99-58070	205.90
	707-01-0A372	60767-		P-UB-14	100 mm	140 mm	KOM-707-99-58070	205.90
	707-01-0C690	60001-60273		P-UB-14	100 mm	140 mm	KOM-707-99-58070	205.90
	707-01-0C691	60274-		P-UB-14	100 mm	140 mm	KOM-707-99-58070	205.90
ARM (SLF)	707-01-0A311	60001-65888		P-UB-14	95 mm	135 mm	KOM-707-99-57160	361.84
	707-01-0A312	65889-		P-UB-14	95 mm	135 mm	KOM-707-99-57160	361.84
BOOM	707-01-0A350	60001-		P-UB-14	90 mm	130 mm	KOM-707-99-47790	218.42
	707-01-0C670	60001-		P-UB-14	90 mm	130 mm	KOM-707-99-47790	218.42
BOOM (Lrg Dia Type)	707-01-0C040	60001-		P-UB-14	95 mm	135 mm	KOM-707-99-50620	319.24
BUCKET	707-01-0A240	60001-		P-UB-14	100 mm	140 mm	KOM-707-99-58060	411.74
	707-01-0A380	60001-		P-UB-14	90 mm	130 mm	KOM-707-99-47570	316.70
	707-01-0A381	60759-		P-UB-14	90 mm	130 mm	KOM-707-99-47570	316.70
	707-01-0A382	60767-		P-UB-14	90 mm	130 mm	KOM-707-99-47570	316.70
	707-01-0C700	60001-		P-UB-14	90 mm	130 mm	KOM-707-99-47570	316.70
	707-01-0C701	60759-		P-UB-14	90 mm	130 mm	KOM-707-99-47570	316.70
	707-01-0G492	65889-		P-UB-14	90 mm	130 mm	KOM-707-99-47570	316.70
	707-01-0G502	60767-		P-UB-14	100 mm	140 mm	KOM-707-99-58060	411.74
	707-01-0H430	65001-		P-UB-14	100 mm	140 mm	KOM-707-99-58060	411.74
	707-01-0H720	65889-		P-UB-14	90 mm	130 mm	KOM-707-99-47570	316.70
	707-13-13611	65001-		P-UB-14	90 mm	130 mm	KOM-707-99-47570	316.70
BUCKET (SLF)	707-01-0F040	65272-		P-UB-14	65 mm	95 mm	KOM-707-99-25870	166.33
MODEL PC220LC-7L								
ARM	707-01-0A371	A86001-		P-UB-14	100 mm	140 mm	KOM-707-99-58070	205.90
BOOM (Lrg Dia Type)	707-01-0C040	A86001-		P-UB-14	95 mm	135 mm	KOM-707-99-50620	319.24
BUCKET	707-01-0A380	A86001-		P-UB-14	90 mm	130 mm	KOM-707-99-47570	316.70
MODEL PC220LC-8								
ARM	707-01-0H700	70001-		P-UB-14	100 mm	140 mm	KOM-707-98-58240	204.88
	707-01-0H700	70001-		Bushing	100 mm		KOM-707-52-90780	41.68
	707-01-0H700	80001-		P-UB-14	100 mm	140 mm	KOM-707-98-58240	204.88
	707-01-0H700	80001-		Bushing	100 mm		KOM-707-52-90780	41.68
	707-01-0H700	A88001-	KLC Spec	P-UB-14	100 mm	140 mm	KOM-707-98-58240	204.88
	707-01-0H700	A88001-	KLC Spec	Bushing	100 mm		KOM-707-52-90781	41.68
	707-01-0H710	70001-		P-UB-14	90 mm	130 mm	KOM-707-01-0H710K	147.89
	707-01-0H710	70001-		Bushing	90 mm		KOM-707-52-90680	36.70
	707-01-0H920	70001-		P-UB-14	90 mm	130 mm	KOM-707-01-0H920K	147.89
	707-01-0H920	70001-		Bushing	90 mm		KOM-707-52-90680	36.70
	707-01-0J840	70001-		P-UB-14	100 mm	140 mm	KOM-707-98-58240	204.88
	707-01-0J840	70001-		Bushing	100 mm		KOM-707-52-90780	41.68

LT - Large size tire L/S - Loading Shovel SLF - Super Long Front B/H - Backhoe HD - Heavy Duty L BUCKET - Large Bucket
 K-LINK - K-type Linkage Blade LB HI-LIFT - High Lift Arm w Large Bucket HI-LIFT - High Lift Arm S HI-LIFT - Super High Lift Arm
 SU - Semi-U Dozer PAT - Power Angle Power Tilt MP - Multi-Purpose

Replacement Kits For

KOMATSU®

Excavators

APPLICATION	CYL #	SERIAL #	Misc	CODE	ROD	BORE	KIT #	List \$	
MODEL PC220LC-8									
ARM	707-01-0J840	80001-	Burst Valve	P-UB-14	100 mm	140 mm	KOM-707-98-58240	204.88	
	707-01-0J840	80001-	Burst Valve	Bushing	100 mm		KOM-707-52-90780	41.68	
BOOM	707-01-0H700	80001-	For Arm Crane, Burst Valve	P-UB-14	100 mm	140 mm	KOM-707-98-58240	204.88	
	707-01-0H700	80001-	For Arm Crane, Burst Valve	Bushing	100 mm		KOM-707-52-90780	41.68	
	707-01-0H850	70001-	Large Diameter Type	P-UB-14	95 mm	135 mm	KOM-707-99-50680	159.18	
	707-01-0H850	70001-	Large Diameter Type	Bushing	95 mm		KOM-707-52-90720	37.71	
	707-01-0H890	80001-	For Arm Crane, Burst Valve	P-UB-14	90 mm	130 mm	KOM-707-98-47730	218.55	
	707-01-0H890	80001-	For Arm Crane, Burst Valve	Bushing	90 mm		KOM-707-52-90680	36.70	
	707-01-0J790	80001-	Burst Valve	P-UB-14	90 mm	130 mm	KOM-707-98-47730	218.55	
	707-01-0J790	80001-	Burst Valve	Bushing	90 mm		KOM-707-52-90680	36.70	
BOOM LH	707-01-0H680	70001-		P-UB-14	90 mm	130 mm	KOM-707-98-47730	218.55	
	707-01-0H680	70001-		P-UB-14	90 mm	130 mm	KOM-707-01-0H680K	153.18	
	707-01-0H680	70001-		Bushing	90 mm		KOM-707-52-90680	36.70	
	707-01-0H680	80001-		P-UB-14	90 mm	130 mm	KOM-707-98-47730	218.55	
	707-01-0H680	80001-		Bushing	90 mm		KOM-707-52-90680	36.70	
	707-01-0H850	70001-		P-UB-14	95 mm	135 mm	KOM-707-01-0H850K	182.09	
	707-01-0H850	70001-		Bushing	95 mm		KOM-707-52-90721	37.71	
	707-01-0H850	80001-	Lift	P-UB-14	95 mm	135 mm	KOM-707-99-50680	159.18	
	707-01-0H850	80001-	Lift	Bushing	95 mm		KOM-707-52-90720	37.71	
	707-01-0H850	A88001-		P-UB-14	95 mm	135 mm	KOM-707-99-50680	159.18	
	707-01-0H850	A88001-		Bushing	95 mm		KOM-707-52-90721	37.71	
	707-01-0J790	80001-		P-UB-14	90 mm	130 mm	KOM-707-98-47730	218.55	
	707-01-0J790	80001-		Bushing	90 mm		KOM-707-52-90680	36.70	
	707-01-0J970	70001-		P-UB-14	90 mm	130 mm	KOM-707-98-47730	218.55	
	707-01-0J970	70001-		Bushing	90 mm		KOM-707-52-90680	36.70	
	BOOM RH	707-01-0H680	70001-		P-UB-14	90 mm	130 mm	KOM-707-98-47730	218.55
707-01-0H680		70001-		P-UB-14	90 mm	130 mm	KOM-707-01-0H680K	153.18	
707-01-0H680		70001-		Bushing	90 mm		KOM-707-52-90680	36.70	
707-01-0H680		80001-		P-UB-14	90 mm	130 mm	KOM-707-98-47730	218.55	
707-01-0H680		80001-		Bushing	90 mm		KOM-707-52-90680	36.70	
707-01-0H850		70001-		P-UB-14	95 mm	135 mm	KOM-707-01-0H850K	182.09	
707-01-0H850		70001-		Bushing	95 mm		KOM-707-52-90721	37.71	
707-01-0H850		A88001-		P-UB-14	95 mm	135 mm	KOM-707-99-50680	159.18	
707-01-0H850		A88001-		Bushing	95 mm		KOM-707-52-90721	37.71	
707-01-0J790		70001-		P-UB-14	90 mm	130 mm	KOM-707-98-47730	218.55	
707-01-0J790		70001-		Bushing	90 mm		KOM-707-52-90680	36.70	
707-01-0J790		80001-		P-UB-14	90 mm	130 mm	KOM-707-98-47730	218.55	
707-01-0J790		80001-		Bushing	90 mm		KOM-707-52-90680	36.70	
BUCKET		707-01-0H710	80001-		P-UB-14	90 mm	130 mm	KOM-707-98-47720	316.77
		707-01-0H710	80001-		Bushing	90 mm		KOM-707-52-90680	36.70
		707-01-0H920	70001-	KA Spec	P-UB-14	90 mm	130 mm	KOM-707-98-47720	316.77
	707-01-0H920	70001-	KA Spec	Bushing	90 mm		KOM-707-52-90680	36.70	
	707-01-0H920	80001-	3.0m Arm	P-UB-14	90 mm	130 mm	KOM-707-98-47720	316.77	
	707-01-0H920	80001-	3.0m Arm	Bushing	90 mm		KOM-707-52-90680	36.70	
	707-01-0H920	A88001-		P-UB-14	90 mm	130 mm	KOM-707-98-47720	316.77	

LT - Large size tire L/S - Loading Shovel SLF - Super Long Front B/H - Backhoe HD - Heavy Duty L BUCKET - Large Bucket
 K-LINK - K-type Linkage Blade LB HI-LIFT - High Lift Arm w Large Bucket HI-LIFT - High Lift Arm S HI-LIFT - Super High Lift Arm
 SU - Semi-U Dozer PAT - Power Angle Power Tilt MP - Multi-Purpose

Replacement Kits For

KOMATSU®

KOMATSU®

Excavators								
APPLICATION	CYL #	SERIAL #	Misc	CODE	ROD	BORE	KIT #	List \$
MODEL PC220LC-8								
BUCKET	707-01-0H920	A88001-		Bushing	90 mm		KOM-707-52-90681	36.70
	707-01-0J080	70001-	1.8m Arm	P-UB-14	85 mm	125 mm	KOM-707-99-47130	160.79
	707-01-0J080	70001-	1.8m Arm	Bushing	85 mm		KOM-707-52-90610	34.71
	707-01-0J080	80001-	1.8m Arm	P-UB-14	85 mm	125 mm	KOM-707-99-47130	160.79
	707-01-0J080	80001-	1.8m Arm	Bushing	85 mm		KOM-707-52-90610	34.71
	707-01-0J860	70001-		P-UB-14	90 mm	130 mm	KOM-707-98-47720	316.77
	707-01-0J860	70001-		Bushing	90 mm		KOM-707-52-90680	36.70
	707-01-0J860	80001-		P-UB-14	90 mm	130 mm	KOM-707-98-47720	316.77
	707-01-0J860	80001-		Bushing	90 mm		KOM-707-52-90680	36.70
	707-01-0J860	A88001-	KLC Spec	P-UB-14	90 mm	130 mm	KOM-707-98-47720	316.77
	707-01-0J860	A88001-	KLC Spec	Bushing	90 mm		KOM-707-52-90681	36.70
	707-01-0J870	70001-		P-UB-14	90 mm	130 mm	KOM-707-98-47720	316.77
	707-01-0J870	70001-		Bushing	90 mm		KOM-707-52-90680	36.70
	707-01-0J870	80001-		P-UB-14	90 mm	130 mm	KOM-707-98-47720	316.77
	707-01-0J870	80001-		Bushing	90 mm		KOM-707-52-90680	36.70
	707-01-0J900	70001-	2.0m Arm	P-UB-14	100 mm	140 mm	KOM-707-99-59020	388.96
	707-01-0J900	70001-	2.0m Arm	Bushing	100 mm		KOM-707-52-90780	41.68
	707-01-0J900	80001-	2.0m Arm	P-UB-14	100 mm	140 mm	KOM-707-99-59020	388.96
	707-01-0J900	80001-	2.0m Arm	Bushing	100 mm		KOM-707-52-90780	41.68
	707-01-0J910	70001-	2.0m Arm	P-UB-14	100 mm	140 mm	KOM-707-99-59020	388.96
707-01-0J910	70001-	2.0m Arm	Bushing	100 mm		KOM-707-52-90780	41.68	
707-01-0J910	80001-	2.0m Arm	P-UB-14	100 mm	140 mm	KOM-707-99-59020	388.96	
707-01-0J910	80001-	2.0m Arm	Bushing	100 mm		KOM-707-52-90780	41.68	
CLAMSHELL	205-63-94100	70001-		P-U-14	80 mm	130 mm	KOM-205-63-94100K	62.44
	205-63-94100	70001-		Bushing	80 mm		KOM-07177-08030	31.26
MODEL PC228USLC-1								
ARM	22U-63-02222	11001-		P-UB-14	95 mm	135 mm	KOM-707-99-57270	373.71
BOOM	22U-63-02203	11001-		P-UB-14	85 mm	120 mm	KOM-707-98-46220	129.83
BUCKET	22U-63-02240	11001-		P-UB-14	90 mm	130 mm	KOM-707-99-47670	372.94
MODEL PC228USLC-2								
ARM	205-63-03122	15001-15922		P-UB-14	95 mm	135 mm	KOM-707-99-57270	373.71
	707-01-0E570	15923-		P-UB-14	95 mm	135 mm	KOM-707-99-57270	373.71
BOOM	22U-63-02103	15001-		P-UB-14	90 mm	130 mm	KOM-707-99-47730	235.06
	22U-63-02450	15321-		P-UB-14	85 mm	120 mm	KOM-707-98-46220	129.83
BUCKET	205-63-03131	15001-		P-UB-14	80 mm	100 mm	KOM-707-98-45250	259.10
MODEL PC228USLC-3								
ARM	707-01-0A311	30001-		P-UB-14	95 mm	135 mm	KOM-707-99-57160	361.84
BLADE LH	22U-63-02550	30001-		P-UB-14	100 mm	140 mm	KOM-707-99-58390	143.99
BLADE RH	22U-63-02560	30001-		P-UB-14	100 mm	140 mm	KOM-707-99-58390	143.99
BOOM	707-01-0E770	30001-		P-UB-14	85 mm	120 mm	KOM-707-99-46130	372.77
	707-01-0F300	30001-		P-UB-14	85 mm	120 mm	KOM-707-99-46130	372.77
BOOM (Lrg Dia Type)	707-01-0E790	30001-		P-UB-14	90 mm	130 mm	KOM-707-99-47790	218.42
BOOM ADJUST	707-01-0E270	30001-		P-UB-14	120 mm	185 mm	KOM-707-99-68730	392.59
BUCKET	707-01-0A320	30001-		P-UB-14	80 mm	115 mm	KOM-707-99-45230	196.31
MODEL PC228USLC-3E0								
ARM	707-01-0H600	40001-		P-UB-14	95 mm	135 mm	KOM-707-98-48610	259.51
BOOM	707-01-0K860	40001-		P-UB-14	85 mm	120 mm	KOM-707-98-46300	134.54
BOOM (Lrg Dia Type)	707-01-0K880	40001-		P-UB-14	90 mm	130 mm	KOM-707-98-47740	176.74
BUCKET	707-01-0H740	40001-		P-UB-14	80 mm	115 mm	KOM-707-98-39610	196.31
MODEL PC228USLC-3S								
ARM	22U-63-02623	20001-21274		P-UB-14	95 mm	135 mm	KOM-707-99-57180	193.72
	707-01-0X430	21275-21502		P-UB-14	95 mm	135 mm	KOM-707-99-57160	361.84
	707-01-0X431	21503-		P-UB-14	95 mm	135 mm	KOM-707-99-57160	361.84
BOOM	22U-63-02651	20001-		P-UB-14	90 mm	130 mm	KOM-707-99-47780	227.05
BUCKET	22U-63-02633	20001-21221		P-UB-14	80 mm	115 mm	KOM-707-99-45220	167.42

LT - Large size tire L/S - Loading Shovel SLF - Super Long Front B/H - Backhoe HD - Heavy Duty L BUCKET - Large Bucket
 K-LINK - K-type Linkage Blade LB HI-LIFT - High Lift Arm w Large Bucket HI-LIFT - High Lift Arm S HI-LIFT - Super High Lift Arm
 SU - Semi-U Dozer PAT - Power Angle Power Tilt MP - Mulit-Purpose

Replacement Kits For

KOMATSU®

Excavators								
APPLICATION	CYL #	SERIAL #	Misc	CODE	ROD	BORE	KIT #	List \$
MODEL PC228USLC-3S								
BUCKET	707-01-0C890	21222-		P-UB-14	80 mm	115 mm	KOM-707-99-45230	196.31
MODEL PC228USLC-8								
ARM	707-01-0CE31	50001-	With and without Anti-drop valve	P-UB-14	95 mm	135 mm	KOM-707-99-50780	148.42
	707-01-0CE31	50001-	With and without Anti-drop valve	Bushing	95 mm		KOM-707-52-90721	37.71
BLADE LH	22U-63-02550	50001-		P-UB-14	100 mm	140 mm	KOM-707-99-59230	132.70
	22U-63-02550	50001-		Bushing	100 mm		KOM-707-52-90781	41.68
BLADE RH	22U-63-02550	50001-		P-UB-14	100 mm	140 mm	KOM-707-99-59230	132.70
	22U-63-02550	50001-		Bushing	100 mm		KOM-707-52-90781	41.68
BOOM LH	707-01-0CE10	50001-	With and without Anti-drop valve	P-UB-14	85 mm	120 mm	KOM-707-99-46470	105.59
	707-01-0CE10	50001-	With and without Anti-drop valve	Bushing	85 mm		KOM-707-52-90611	34.71
	707-01-0CE50	50001-	For a 5700mm Boom with anti-drop valve	P-UB-14	90 mm	130 mm	KOM-707-99-47880	124.72
	707-01-0CE50	50001-	For a 5700mm Boom with anti-drop valve	Bushing	90 mm		KOM-707-52-90681	36.70
BOOM RH	707-01-0CE10	50001-	With and without Anti-drop valve	P-UB-14	85 mm	120 mm	KOM-707-99-46470	105.59
	707-01-0CE10	50001-	With and without Anti-drop valve	Bushing	85 mm		KOM-707-52-90611	34.71
	707-01-0CE50	50001-	For a 5700mm Boom with anti-drop valve	P-UB-14	90 mm	130 mm	KOM-707-99-47880	124.72
	707-01-0CE50	50001-	For a 5700mm Boom with anti-drop valve	Bushing	90 mm		KOM-707-52-90681	36.70
BUCKET	707-01-0CH30	50001-	For 2400mm and 2900mm Arm	P-UB-14	80 mm	115 mm	KOM-707-99-45040	127.92
	707-01-0CH30	50001-	For 2400mm and 2900mm Arm	Bushing	80 mm		KOM-707-52-90561	31.26
MODEL PC230-6								
ARM	206-63-02521	40001-52851		P-UB-14	100 mm	140 mm	KOM-707-99-58200	373.00
	206-63-03121	52852-		P-UB-14	100 mm	140 mm	KOM-707-99-58350	281.41
BOOM	206-63-02501	40001-52851		P-UB-14	90 mm	130 mm	KOM-707-99-47600	245.30
	206-63-03100	52852-		P-UB-14	90 mm	130 mm	KOM-707-99-47660	256.38
BUCKET	206-63-02130	40001-52851		P-UB-14	90 mm	130 mm	KOM-707-98-47620	372.35
	206-63-02140	40001-52851		P-UB-14	100 mm	140 mm	KOM-707-98-58240	204.88
	206-63-03130	52852-		P-UB-14	90 mm	130 mm	KOM-707-98-47670	340.70
	206-63-03140	52852-		P-UB-14	100 mm	140 mm	KOM-707-99-58320	239.94

LT - Large size tire L/S - Loading Shovel SLF - Super Long Front B/H - Backhoe HD - Heavy Duty L BUCKET - Large Bucket
 K-LINK - K-type Linkage Blade LB HI-LIFT - High Lift Arm w Large Bucket HI-LIFT - High Lift Arm S HI-LIFT - Super High Lift Arm
 SU - Semi-U Dozer PAT - Power Angle Power Tilt MP - Multi-Purpose

KOMATSU®

Replacement Kits For

Excavators								
APPLICATION	CYL #	SERIAL #	Misc	CODE	ROD	BORE	KIT #	List \$
MODEL PC240-6K								
ARM	206-63-K1140	K30001-		P-UB-14	95 mm	135 mm	KOM-707-99-57200	298.85
BOOM	206-63-K2120	K30001-		P-UB-14	95 mm	135 mm	KOM-206-63-K2120K	197.74
	206-63-K2150	K30001-		P-UB-14	120 mm	185 mm	KOM-206-63-K2150K	420.69
BOOM LH	206-63-K1240	K30001-		P-UB-14	95 mm	135 mm	KOM-206-63-K1240K	201.08
BOOM RH	206-63-K1250	K30001-		P-UB-14	95 mm	135 mm	KOM-206-63-K1250K	201.08
BUCKET	206-63-K2110	K30001-		P-UB-14	100 mm	140 mm	KOM-707-99-58240	476.62
MODEL PC240LC-6K								
ARM	206-63-K1140	K30001-		P-UB-14	95 mm	135 mm	KOM-707-99-57200	298.85
BOOM	206-63-K2120	K30001-		P-UB-14	95 mm	135 mm	KOM-206-63-K2120K	197.74
	206-63-K2150	K30001-		P-UB-14	120 mm	185 mm	KOM-206-63-K2150K	420.69
BOOM LH	206-63-K1240	K30001-		P-UB-14	95 mm	135 mm	KOM-206-63-K1240K	201.08
BOOM RH	206-63-K1250	K30001-		P-UB-14	95 mm	135 mm	KOM-206-63-K1250K	201.08
BUCKET	206-63-K2110	K30001-		P-UB-14	100 mm	140 mm	KOM-707-99-58240	476.62
MODEL PC240LC-7K								
ARM	707-01-XC120	K40019-		P-UB-14	100 mm	140 mm	KOM-707-99-58070	205.90
ARM (w/ Burst Valve)	707-01-XE050	K40019-		P-UB-14	100 mm	140 mm	KOM-707-99-58070	205.90
BOOM	707-01-0C040	K40019-		P-UB-14	95 mm	135 mm	KOM-707-99-50620	319.24
BOOM LIFT (2pc Boom)	707-01-0F050	K40019-		P-UB-14	100 mm	140 mm	KOM-707-99-58050	239.81
BUCKET (2, 2.5M Arm)	707-01-0A420	K40019-		P-UB-14	100 mm	140 mm	KOM-707-99-58060	411.74
BUCKET (3, 3.5M Arm)	707-01-XC130	K40019-		P-UB-14	90 mm	130 mm	KOM-707-99-47570	316.70
MODEL PC240NLC-6K								
ARM	206-63-K1140	K30001-		P-UB-14	95 mm	135 mm	KOM-707-99-57200	298.85
BOOM	206-63-K2120	K30001-		P-UB-14	95 mm	135 mm	KOM-206-63-K2120K	197.74
	206-63-K2150	K30001-		P-UB-14	120 mm	185 mm	KOM-206-63-K2150K	420.69
BOOM LH	206-63-K1240	K30001-		P-UB-14	95 mm	135 mm	KOM-206-63-K1240K	201.08
BOOM RH	206-63-K1250	K30001-		P-UB-14	95 mm	135 mm	KOM-206-63-K1250K	201.08
BUCKET	206-63-K2110	K30001-		P-UB-14	100 mm	140 mm	KOM-707-99-58240	476.62
MODEL PC240NLC-7K								
ARM	707-01-XC120	K40019-		P-UB-14	100 mm	140 mm	KOM-707-99-58070	205.90
ARM (w/ Burst Valve)	707-01-XE050	K40019-		P-UB-14	100 mm	140 mm	KOM-707-99-58070	205.90
BOOM	707-01-0C040	K40019-		P-UB-14	95 mm	135 mm	KOM-707-99-50620	319.24
BOOM LIFT (2pc Boom)	707-01-0F050	K40019-		P-UB-14	100 mm	140 mm	KOM-707-99-58050	239.81
BUCKET (2, 2.5M Arm)	707-01-0A420	K40019-		P-UB-14	100 mm	140 mm	KOM-707-99-58060	411.74
BUCKET (3, 3.5M Arm)	707-01-XC130	K40019-		P-UB-14	90 mm	130 mm	KOM-707-99-47570	316.70
MODEL PC250LC-6								
ARM	206-63-03120	A83001-A83986		P-UB-14	100 mm	140 mm	KOM-707-99-58350	281.41
	206-63-03121	A83987-		P-UB-14	100 mm	140 mm	KOM-707-99-58350	281.41
	206-63-64740	A83001-A83986		P-UB-14	100 mm	140 mm	KOM-707-99-58350	281.41
	206-63-64741	A83987-		P-UB-14	100 mm	140 mm	KOM-707-99-58350	281.41
BUCKET (2M Arm)	206-63-02140	A83001-		P-UB-14	100 mm	140 mm	KOM-707-99-58240	476.62
	206-63-02140	A83001-		Bushing	100 mm		KOM-707-52-90750	59.52
BUCKET (3.05 HD Arm)	206-63-07030	A83001-		P-UB-14	90 mm	130 mm	KOM-707-98-47620	372.35
	206-63-07030	A83001-		Bushing	90 mm		KOM-707-52-90650	42.75
MODEL PC270-8								
ARM	707-01-0H950	20001-		P-UB-14	110 mm	150 mm	KOM-707-99-59740	510.56
	707-01-0K400	20001-		P-UB-14	110 mm	150 mm	KOM-707-99-59740	510.56
BOOM	707-01-0H930	20001-		P-UB-14	100 mm	140 mm	KOM-707-99-59320	307.81
	707-01-0K380	20001-		P-UB-14	100 mm	140 mm	KOM-707-99-59320	307.81
	707-01-0L941	25015-		P-UB-14	100 mm	140 mm	KOM-707-99-59320	307.81
BOOM LH	707-01-0H930	20001-		P-UB-14	100 mm	140 mm	KOM-707-99-59330	181.05
BOOM RH	707-01-0H930	20001-25014		P-UB-14	100 mm	140 mm	KOM-707-99-59330	181.05
	707-01-0H931	25015-		P-UB-14	100 mm	140 mm	KOM-707-99-59320	307.81
BUCKET	707-01-0H910	20001-		P-UB-14	100 mm	140 mm	KOM-707-99-59020	388.96
	707-01-0J900	20001-		P-UB-14	100 mm	140 mm	KOM-707-99-59020	388.96
	707-01-0J910	20001-		P-UB-14	100 mm	140 mm	KOM-707-99-59020	388.96

LT - Large size tire L/S - Loading Shovel SLF - Super Long Front B/H - Backhoe HD - Heavy Duty L BUCKET - Large Bucket
 K-LINK - K-type Linkage Blade LB HI-LIFT - High Lift Arm w Large Bucket HI-LIFT - High Lift Arm S HI-LIFT - Super High Lift Arm
 SU - Semi-U Dozer PAT - Power Angle Power Tilt MP - Mulit-Purpose

Replacement Kits For

KOMATSU®

Excavators								
APPLICATION	CYL #	SERIAL #	Misc	CODE	ROD	BORE	KIT #	List \$
MODEL PC270-8								
BUCKET	707-01-0J920	20001-		P-UB-14	90 mm	130 mm	KOM-707-98-47720	316.77
MODEL PC270LC-7L								
ARM	707-01-0Z941	A86001-A86168		P-UB-14	110 mm	150 mm	KOM-707-99-59620	514.93
	707-01-0Z942	A86169-		P-UB-14	110 mm	150 mm	KOM-707-99-59620	514.93
	707-13-15240	A86001-		P-UB-14	110 mm	150 mm	KOM-707-99-59620	514.93
BOOM (Lrg Dia Type)	707-01-0A390	A86001-		P-UB-14	100 mm	140 mm	KOM-707-99-58050	239.81
	707-13-14560	A86001-		P-UB-14	100 mm	140 mm	KOM-707-99-58050	239.81
BUCKET	707-01-0A420	A86001-		P-UB-14	100 mm	140 mm	KOM-707-99-58060	411.74
	707-13-13570	A86001-		P-UB-14	100 mm	140 mm	KOM-707-99-58060	411.74
MODEL PC270LC-8								
ARM	707-01-0S910	A87001-		P-UB-14	110 mm	150 mm	KOM-707-99-59740	510.56
	707-13-15280	A87001-		P-UB-14	110 mm	150 mm	KOM-707-99-59740	510.56
BOOM	707-01-0H930	A87001-		P-UB-14	100 mm	140 mm	KOM-707-99-59320	307.81
	707-13-14860	A87001-		P-UB-14	100 mm	140 mm	KOM-707-99-59320	307.81
BUCKET	707-01-0H910	A87001-		P-UB-14	100 mm	140 mm	KOM-707-99-59020	388.96
	707-13-14840	A87001-		P-UB-14	100 mm	140 mm	KOM-707-99-59020	388.96
MODEL PC270LL-7L								
ARM	707-01-0Z942	A86001-		P-UB-14	110 mm	150 mm	KOM-707-99-59620	514.93
BOOM (Lrg Dia Type)	707-01-0A390	A86001-		P-UB-14	100 mm	140 mm	KOM-707-99-58050	239.81
BUCKET	707-01-0A380	A86001-		P-UB-14	90 mm	130 mm	KOM-707-99-47570	316.70
MODEL PC280LC-3								
ARM	206-63-62101	10001-		P-U-14	95 mm	140 mm	KOM-707-98-57201	162.05
ARM (SLF)	205-63-62101	10001-		P-U-14	95 mm	130 mm	KOM-707-98-48600	319.41
BOOM	206-63-52100	10001-		P-U-14	90 mm	130 mm	KOM-707-98-47600	314.59
	206-63-52200	10001-		P-U-14	90 mm	130 mm	KOM-707-98-47600	314.59
BUCKET	206-63-72100	10001-		P-U-14	90 mm	130 mm	KOM-707-98-47500	262.46
BUCKET (2M Arm)	206-63-72300	10001-		P-U-14	100 mm	140 mm	KOM-707-98-58230	177.06
BUCKET (SLF)	203-63-72500	10001-		P-UB-14	65 mm	100 mm	KOM-707-98-36110	127.62
CLAMSHHELL	206-63-96101	10001-		P-U-14	90 mm	130 mm	KOM-707-98-47680	214.41
MODEL PC290LC-6K								
ARM	206-63-K1610	K30001-		P-UB-14	110 mm	150 mm	KOM-206-63-K1610K	241.13
BOOM	206-63-K1721	K30001-		P-UB-14	100 mm	140 mm	KOM-206-63-K1721K	191.32
BOOM (2pc)	206-63-K1980	K30001-		P-UB-14	100 mm	140 mm	KOM-206-63-K1980K	190.47
BUCKET	206-63-K1911	K30001-		P-UB-14	100 mm	140 mm	KOM-206-63-K1911K	294.22
MODEL PC290LC-7K								
ARM	707-01-0Z940	K40001-K40182		P-UB-14	110 mm	150 mm	KOM-707-99-59620	514.93
	707-01-0Z941	K40183-		P-UB-14	110 mm	150 mm	KOM-707-99-59620	514.93
BOOM	707-01-0A390	K40001-		P-UB-14	100 mm	140 mm	KOM-707-99-58050	239.81
BOOM LIFT	707-01-0F050	K40001-		P-UB-14	100 mm	140 mm	KOM-707-99-58050	239.81
BUCKET	707-01-0A420	K40001-		P-UB-14	100 mm	140 mm	KOM-707-99-58060	411.74
	707-01-0C860	K40001-		P-UB-14	90 mm	130 mm	KOM-707-99-47570	316.70
	707-01-0C870	K40001-		P-UB-14	100 mm	140 mm	KOM-707-99-58060	411.74
MODEL PC290NLC-6K								
ARM	206-63-K1610	K30001-		P-UB-14	110 mm	150 mm	KOM-206-63-K1610K	241.13
BOOM	206-63-K1721	K30001-		P-UB-14	100 mm	140 mm	KOM-206-63-K1721K	191.32
BOOM (2pc)	206-63-K1980	K30001-		P-UB-14	100 mm	140 mm	KOM-206-63-K1980K	190.47
BUCKET	206-63-K1911	K30001-		P-UB-14	100 mm	140 mm	KOM-206-63-K1911K	294.22
MODEL PC290NLC-7K								
ARM	707-01-0Z940	K40001-K40182		P-UB-14	110 mm	150 mm	KOM-707-99-59620	514.93
	707-01-0Z941	K40183-		P-UB-14	110 mm	150 mm	KOM-707-99-59620	514.93
BOOM	707-01-0A390	K40001-		P-UB-14	100 mm	140 mm	KOM-707-99-58050	239.81
BOOM LIFT	707-01-0F050	K40001-		P-UB-14	100 mm	140 mm	KOM-707-99-58050	239.81
BUCKET	707-01-0A420	K40001-		P-UB-14	100 mm	140 mm	KOM-707-99-58060	411.74
	707-01-0C860	K40001-		P-UB-14	90 mm	130 mm	KOM-707-99-47570	316.70
	707-01-0C870	K40001-		P-UB-14	100 mm	140 mm	KOM-707-99-58060	411.74

LT - Large size tire L/S - Loading Shovel SLF - Super Long Front B/H - Backhoe HD - Heavy Duty L BUCKET - Large Bucket
 K-LINK - K-type Linkage Blade LB HI-LIFT - High Lift Arm w Large Bucket HI-LIFT - High Lift Arm S HI-LIFT - Super High Lift Arm
 SU - Semi-U Dozer PAT - Power Angle Power Tilt MP - Mult-Purpose

Replacement Kits For

KOMATSU®

Excavators								
APPLICATION	CYL #	SERIAL #	Misc	CODE	ROD	BORE	KIT #	List \$
MODEL PC300-3, PC300LC-3								
ARM	207-63-62101	12001-		P-U-14	110 mm	160 mm	KOM-707-98-67100	247.50
BOOM	207-63-52100	12001-		P-U-14	100 mm	140 mm	KOM-707-98-58200	316.08
	207-63-52200	12001-		P-U-14	100 mm	140 mm	KOM-707-98-58200	316.08
BUCKET	207-63-72101	12001-		P-U-14	100 mm	140 mm	KOM-707-98-58210	257.86
CLAMSHELL	206-63-96101	12001-		P-U-14	90 mm	130 mm	KOM-707-98-47680	214.41
WEIGHT REMOVER	208-63-07011	12001-		P-U-14	85 mm	130 mm	KOM-707-98-46600	260.22
MODEL PC300-5, PC300LC-5								
ARM	207-63-02120	20001-		P-UB-14	110 mm	160 mm	KOM-707-99-67110	334.08
BOOM	207-63-02100	20001-		P-UB-14	100 mm	140 mm	KOM-707-99-58210	380.18
BUCKET	207-63-02130	20001-		P-UB-14	100 mm	140 mm	KOM-707-99-58110	348.91
MODEL PC300-6								
ARM	207-63-02120	80001-		P-UB-14	110 mm	160 mm	KOM-707-99-67110	334.08
	207-63-02120	80001-		Bushing	110 mm		KOM-707-52-90860	87.94
BOOM	207-63-02301	80001-		P-UB-14	100 mm	140 mm	KOM-707-99-58210	380.18
	207-63-02301	80001-		Bushing	100 mm		KOM-07177-01040	52.10
	207-63-02501	33001-		P-UB-14	100 mm	140 mm	KOM-707-99-58360	305.61
BUCKET	207-63-02130	80001-		P-UB-14	100 mm	140 mm	KOM-707-99-58110	348.91
	207-63-02130	80001-		Bushing	100 mm		KOM-707-52-90750	59.52
MODEL PC300-7								
ARM	707-01-0A450	J20001-		P-UB-14	110 mm	160 mm	KOM-707-99-67090	399.71
BOOM	707-01-0A430	J20001-		P-UB-14	100 mm	140 mm	KOM-707-99-58080	279.98
BUCKET	707-01-0A460	J20001-		P-UB-14	100 mm	140 mm	KOM-707-99-58090	377.25
	707-01-0A470	J20001-		P-UB-14	110 mm	150 mm	KOM-707-99-59610	386.16
MODEL PC300HD-7E0								
ARM	707-01-0A452	A86001-		P-UB-14	110 mm	160 mm	KOM-707-99-72300	246.00
BOOM	707-01-0A430	A86001-		P-UB-14	100 mm	140 mm	KOM-707-99-58080	279.98
BUCKET	707-01-0H770	A86001-		P-UB-14	100 mm	140 mm	KOM-707-99-58090	377.25
MODEL PC300HD-7L								
ARM	707-01-0A450	A85001-		P-UB-14	110 mm	160 mm	KOM-707-99-67090	399.71
BOOM	707-01-0A430	A85001-		P-UB-14	100 mm	140 mm	KOM-707-99-58080	279.98
BUCKET	707-01-0A461	A85001-		P-UB-14	100 mm	140 mm	KOM-707-99-58090	377.25
	707-01-0A471	A85001-		P-UB-14	110 mm	150 mm	KOM-707-99-59610	386.16
MODEL PC300HD-8								
ARM	707-01-0A452	A87001-		P-UB-14	110 mm	160 mm	KOM-707-99-72300	246.00
	707-01-0A452	A87001-		Bushing	110 mm		KOM-707-52-90850	45.85
BOOM	707-01-0A431	A87001-		P-UB-14	100 mm	140 mm	KOM-707-99-58080	279.98
	707-01-0A431	A87001-		Bushing	100 mm		KOM-707-52-90780	41.68
BUCKET	707-01-0H771	A87001-	For 3.2m and 4.0m Arm	P-UB-14	100 mm	140 mm	KOM-707-99-58090	377.25
	707-01-0H771	A87001-	For 3.2m and 4.0m Arm	Bushing	100 mm		KOM-707-52-90780	41.68
	707-01-0H781	A87001-	For 2.2m and 2.6m Arm	P-UB-14	110 mm	150 mm	KOM-707-99-59610	386.16
	707-01-0H781	A87001-	For 2.2m and 2.6m Arm	Bushing	110 mm		KOM-707-52-90850	45.85
MODEL PC300LC-7								
ARM	707-01-0A450	40001-		P-UB-14	110 mm	160 mm	KOM-707-99-67090	399.71
	707-01-0A451	41266-46350		P-UB-14	110 mm	160 mm	KOM-707-99-72300	246.00
	707-01-0A452	46351-		P-UB-14	110 mm	160 mm	KOM-707-99-72300	246.00
	707-01-0C600	40001-46350		P-UB-14	110 mm	160 mm	KOM-707-99-67090	399.71
	707-01-0C601	46351-		P-UB-14	110 mm	160 mm	KOM-707-99-72300	246.00
BOOM	707-01-0A430	40001-46350		P-UB-14	100 mm	140 mm	KOM-707-99-58080	279.98
	707-01-0A431	46351-		P-UB-14	100 mm	140 mm	KOM-707-99-58080	279.98

LT - Large size tire L/S - Loading Shovel SLF - Super Long Front B/H - Backhoe HD - Heavy Duty L BUCKET - Large Bucket
 K-LINK - K-type Linkage Blade LB HI-LIFT - High Lift Arm w Large Bucket HI-LIFT - High Lift Arm S HI-LIFT - Super High Lift Arm
 SU - Semi-U Dozer PAT - Power Angle Power Tilt MP - Mulit-Purpose

Replacement Kits For

KOMATSU®

Excavators								
APPLICATION	CYL #	SERIAL #	Misc	CODE	ROD	BORE	KIT #	List \$
MODEL PC300LC-7								
BOOM	707-01-0C580	40001-46350		P-UB-14	100 mm	140 mm	KOM-707-99-58080	279.98
	707-01-0C581	46351-		P-UB-14	100 mm	140 mm	KOM-707-99-58080	279.98
	707-01-0E230	40001-46350		P-UB-14	100 mm	140 mm	KOM-707-99-58030	218.99
	707-01-0E231	46351-		P-UB-14	100 mm	140 mm	KOM-707-99-58030	218.99
BUCKET	707-01-0A460	40001-40836		P-UB-14	100 mm	140 mm	KOM-707-99-58090	377.25
	707-01-0A461	40837-		P-UB-14	100 mm	140 mm	KOM-707-99-58090	377.25
	707-01-0A463	41266-46350		P-UB-14	100 mm	140 mm	KOM-707-99-58090	377.25
	707-01-0A464	46351-		P-UB-14	100 mm	140 mm	KOM-707-99-58090	377.25
	707-01-0A470	40001-40527		P-UB-14	110 mm	150 mm	KOM-707-99-59610	386.16
	707-01-0A471	40528-		P-UB-14	110 mm	150 mm	KOM-707-99-59610	386.16
	707-01-0A473	41266-46350		P-UB-14	110 mm	150 mm	KOM-707-99-59610	386.16
	707-01-0A474	46351-		P-UB-14	110 mm	150 mm	KOM-707-99-59610	386.16
	707-01-0C610	40001-40527		P-UB-14	100 mm	140 mm	KOM-707-99-58090	377.25
	707-01-0C611	40528-46350		P-UB-14	100 mm	140 mm	KOM-707-99-58090	377.25
	707-01-0C612	46351-		P-UB-14	100 mm	140 mm	KOM-707-99-58090	377.25
	707-01-0C620	40001-40527		P-UB-14	110 mm	150 mm	KOM-707-99-59610	386.16
	707-01-0C621	40528-46350		P-UB-14	110 mm	150 mm	KOM-707-99-59610	386.16
	707-01-0C622	46351-		P-UB-14	110 mm	150 mm	KOM-707-99-59610	386.16
707-01-0H780	41266-46350		P-UB-14	110 mm	150 mm	KOM-707-99-59610	386.16	
707-01-0H781	46351-		P-UB-14	110 mm	150 mm	KOM-707-99-59610	386.16	
MODEL PC300LC-7E0								
ARM	707-01-0A451	50001-55786		P-UB-14	110 mm	160 mm	KOM-707-99-72300	246.00
	707-01-0A452	55787-		P-UB-14	110 mm	160 mm	KOM-707-99-72300	246.00
	707-01-0A452	A88001-		P-UB-14	110 mm	160 mm	KOM-707-99-72300	246.00
	707-01-0C600	50001-55786		P-UB-14	110 mm	160 mm	KOM-707-99-67090	399.71
	707-01-0C601	55787-		P-UB-14	110 mm	160 mm	KOM-707-99-72300	246.00
BOOM	707-01-0A430	50001-55786		P-UB-14	100 mm	140 mm	KOM-707-99-58080	279.98
	707-01-0A431	55787-		P-UB-14	100 mm	140 mm	KOM-707-99-58080	279.98
	707-01-0A431	A88001-		P-UB-14	100 mm	140 mm	KOM-707-99-58080	279.98
	707-01-0C580	50001-55786		P-UB-14	100 mm	140 mm	KOM-707-99-58080	279.98
	707-01-0C581	55787-		P-UB-14	100 mm	140 mm	KOM-707-99-58080	279.98
BUCKET	707-01-0C611	50001-55786		P-UB-14	100 mm	140 mm	KOM-707-99-58090	377.25
	707-01-0C612	55787-		P-UB-14	100 mm	140 mm	KOM-707-99-58090	377.25
	707-01-0C621	50001-55786		P-UB-14	110 mm	150 mm	KOM-707-99-59610	386.16
	707-01-0C622	55787-		P-UB-14	110 mm	150 mm	KOM-707-99-59610	386.16
	707-01-0H770	50001-55786		P-UB-14	100 mm	140 mm	KOM-707-99-58090	377.25
	707-01-0H771	55787-		P-UB-14	100 mm	140 mm	KOM-707-99-58090	377.25
	707-01-0H771	A88001-		P-UB-14	100 mm	140 mm	KOM-707-99-58090	377.25
	707-01-0H780	50001-55786		P-UB-14	110 mm	150 mm	KOM-707-99-59610	386.16
	707-01-0H781	55787-		P-UB-14	110 mm	150 mm	KOM-707-99-59610	386.16
707-01-0H781	A88001-		P-UB-14	110 mm	150 mm	KOM-707-99-59610	386.16	
MODEL PC300LC-7L								
ARM	707-01-XA450	A85001-		P-UB-14	110 mm	160 mm	KOM-707-99-67090	399.71
BOOM	707-01-0A430	A85001-		P-UB-14	100 mm	140 mm	KOM-707-99-58080	279.98
BUCKET	707-01-0A461	A85001-		P-UB-14	100 mm	140 mm	KOM-707-99-58090	377.25
	707-01-0A471	A85001-		P-UB-14	110 mm	150 mm	KOM-707-99-59610	386.16
MODEL PC300LC-8								
ARM	707-01-0A452	A90001-		P-UB-14	110 mm	160 mm	KOM-707-99-72300	246.00
	707-01-0A452	A90001-		Bushing	110 mm		KOM-707-52-90850	45.85
BOOM	707-01-0A431	A90001-		P-UB-14	100 mm	140 mm	KOM-707-99-58080	279.98
	707-01-0A431	A90001-		Bushing	100 mm		KOM-707-52-90780	41.68
BUCKET	707-01-0H771	A90001-	For 3.2m and 4.0m Arm	P-UB-14	100 mm	140 mm	KOM-707-99-58090	377.25

LT - Large size tire L/S - Loading Shovel SLF - Super Long Front B/H - Backhoe HD - Heavy Duty L BUCKET - Large Bucket
 K-LINK - K-type Linkage Blade LB HI-LIFT - High Lift Arm w Large Bucket HI-LIFT - High Lift Arm S HI-LIFT - Super High Lift Arm
 SU - Semi-U Dozer PAT - Power Angle Power Tilt MP - Multi-Purpose

Replacement Kits For

KOMATSU®

KOMATSU®

Excavators								
APPLICATION	CYL #	SERIAL #	Misc	CODE	ROD	BORE	KIT #	List \$
MODEL PC300LC-8								
BUCKET	707-01-0H771	A90001-	For 3.2m and 4.0m Arm	Bushing	100 mm		KOM-707-52-90780	41.68
	707-01-0H781	A90001-	For 2.2m and 2.6m Arm	P-UB-14	110 mm	150 mm	KOM-707-99-59610	386.16
	707-01-0H781	A90001-	For 2.2m and 2.6m Arm	Bushing	110 mm		KOM-707-52-90850	45.85
MODEL PC300LL-7E0								
ARM	707-01-0A451	A86001-		P-UB-14	110 mm	160 mm	KOM-707-99-72300	246.00
	707-01-0L350	A86001-		P-UB-14	140 mm	200 mm	KOM-707-99-77140	359.12
BOOM	707-01-0A430	A86001-		P-UB-14	100 mm	140 mm	KOM-707-99-58080	279.98
BOOM LIFT	707-01-0L140	A86001-		P-UB-14	110 mm	160 mm	KOM-707-99-67870	275.80
BUCKET	707-01-0H770	A86001-		P-UB-14	100 mm	140 mm	KOM-707-99-58090	377.25
HEEL	707-01-0H821	A86001-		P-UB-14	100 mm	160 mm	KOM-707-99-66240	301.19
MODEL PC300LL-7L								
ARM	707-01-0A450	A85001-		P-UB-14	110 mm	160 mm	KOM-707-99-67090	399.71
BOOM	707-01-0A430	A85001-		P-UB-14	100 mm	140 mm	KOM-707-99-58080	279.98
BUCKET	707-01-0A460	A85001-		P-UB-14	100 mm	140 mm	KOM-707-99-58090	377.25
MODEL PC308USLC-3								
ARM	707-01-0Z941	20001-		P-UB-14	110 mm	150 mm	KOM-707-99-59620	514.93
BOOM	707-01-0A390	20001-		P-UB-14	100 mm	140 mm	KOM-707-99-58080	279.98
BUCKET	707-01-0A420	20001-		P-UB-14	100 mm	140 mm	KOM-707-99-58060	411.74
MODEL PC308USLC-3E0-W1								
ARM	707-01-0H950	30001-		P-UB-14	110 mm	150 mm	KOM-707-99-59740	510.56
BOOM	707-01-0H930	30001-		P-UB-14	100 mm	140 mm	KOM-707-99-59320	307.81
BUCKET	707-01-0H910	30001-		P-UB-14	100 mm	140 mm	KOM-707-99-59020	388.96
	707-01-0H960	30001-		P-UB-14	100 mm	140 mm	KOM-707-99-59020	388.96
	707-01-0J860	30001-		P-UB-14	90 mm	130 mm	KOM-707-98-47720	316.77
MODEL PC340-6K								
ARM	207-63-02120	K30001-		P-UB-14	110 mm	160 mm	KOM-707-99-67110	334.08
BOOM	207-63-K1230	K30001-		P-UB-14	100 mm	140 mm	KOM-207-63-K1230K	183.97
	207-63-K1230	K30188-		P-UB-14	100 mm	140 mm	KOM-207-63-K1230K	183.97
BUCKET	207-63-02130	K30001-		P-UB-14	100 mm	140 mm	KOM-707-99-58110	348.91
MODEL PC340LC-6K								
ARM	207-63-02120	K30001-		P-UB-14	110 mm	160 mm	KOM-707-99-67110	334.08
BOOM	207-63-K1230	K30001-		P-UB-14	100 mm	140 mm	KOM-207-63-K1230K	183.97
	207-63-K1230	K30188-		P-UB-14	100 mm	140 mm	KOM-207-63-K1230K	183.97
BUCKET	207-63-02130	K30001-		P-UB-14	100 mm	140 mm	KOM-707-99-58110	348.91
MODEL PC340LC-7K								
ARM	707-01-0A450	K40001-		P-UB-14	110 mm	160 mm	KOM-707-99-67090	399.71
ARM (w/ Burst Valve)	707-01-0A450	K40001-		P-UB-14	110 mm	160 mm	KOM-707-99-67090	399.71
BOOM	701-01-0A430	K40001-		P-UB-14	100 mm	140 mm	KOM-707-99-58080	279.98
BUCKET (2.2, 2.6M Arm)	707-01-0A470	K40001-		P-UB-14	110 mm	150 mm	KOM-707-99-59610	386.16
BUCKET (3.2, 4M Arm)	707-01-0A460	K40001-		P-UB-14	100 mm	140 mm	KOM-707-99-58090	377.25
MODEL PC340NLC-6K								
ARM	207-63-02120	K30001-		P-UB-14	110 mm	160 mm	KOM-707-99-67110	334.08
BOOM	207-63-K1230	K30001-		P-UB-14	100 mm	140 mm	KOM-207-63-K1230K	183.97
	207-63-K1230	K30188-		P-UB-14	100 mm	140 mm	KOM-207-63-K1230K	183.97
BUCKET	207-63-02130	K30001-		P-UB-14	100 mm	140 mm	KOM-707-99-58110	348.91
MODEL PC340NLC-7K								
ARM	707-01-0A450	K40001-		P-UB-14	110 mm	160 mm	KOM-707-99-67090	399.71
ARM (w/ Burst Valve)	707-01-0A450	K40001-		P-UB-14	110 mm	160 mm	KOM-707-99-67090	399.71
BOOM	701-01-0A430	K40001-		P-UB-14	100 mm	140 mm	KOM-707-99-58080	279.98
BUCKET (2.2, 2.6M Arm)	707-01-0A470	K40001-		P-UB-14	110 mm	150 mm	KOM-707-99-59610	386.16
BUCKET (3.2, 4M Arm)	707-01-0A460	K40001-		P-UB-14	100 mm	140 mm	KOM-707-99-58090	377.25

LT - Large size tire L/S - Loading Shovel SLF - Super Long Front B/H - Backhoe HD - Heavy Duty L BUCKET - Large Bucket
 K-LINK - K-type Linkage Blade LB HI-LIFT - High Lift Arm w Large Bucket HI-LIFT - High Lift Arm S HI-LIFT - Super High Lift Arm
 SU - Semi-U Dozer PAT - Power Angle Power Tilt MP - Multi-Purpose

KOMATSU®

Replacement Kits For

Excavators								
APPLICATION	CYL #	SERIAL #	Misc	CODE	ROD	BORE	KIT #	List \$
MODEL PC350-6								
ARM	207-63-02341	10001-11999		P-UB-14	110 mm	160 mm	KOM-707-99-67110	334.08
	207-63-02541	12001-		P-UB-14	110 mm	160 mm	KOM-707-99-67280	318.83
BOOM	207-63-02301	10001-11999		P-UB-14	100 mm	140 mm	KOM-707-99-58210	380.18
	207-63-02501	12001-		P-UB-14	100 mm	140 mm	KOM-707-99-58360	305.61
BUCKET	207-63-02130	10001-11999		P-UB-14	100 mm	140 mm	KOM-707-99-58110	348.91
	207-63-02531	12001-		P-UB-14	100 mm	140 mm	KOM-707-99-58370	399.18
MODEL PC360LC-3								
ARM	207-63-62101	10001-		P-U-14	110 mm	160 mm	KOM-707-98-67100	247.50
BOOM	207-63-52100	10001-		P-U-14	100 mm	140 mm	KOM-707-98-58200	316.08
	207-63-52200	10001-		P-U-14	100 mm	140 mm	KOM-707-98-58200	316.08
BUCKET	207-63-72101	10001-		P-U-14	100 mm	140 mm	KOM-707-98-58210	257.86
CLAMSHELL	206-63-96101	10001-		P-U-14	90 mm	130 mm	KOM-707-98-47680	214.41
WEIGHT REMOVER	208-63-07011	10001-		P-U-14	85 mm	130 mm	KOM-707-98-46600	260.22
MODEL PC400-3, PC400LC-3								
ARM (B/H)	208-63-62101	11001-		P-U-14	120 mm	180 mm	KOM-707-98-68500	295.39
ARM (L/S)	208-63-64101	11001-		P-U-14	120 mm	180 mm	KOM-707-98-68400	310.80
BOOM (B/H)	208-63-52101	11001-		P-U-14	110 mm	160 mm	KOM-707-98-67100	247.50
	208-63-52201	11001-		P-U-14	110 mm	160 mm	KOM-707-98-67100	247.50
BOOM (L/S)	208-63-54103	11001-		P-U-14	110 mm	160 mm	KOM-707-98-67110	302.88
	208-63-54203	11001-		P-U-14	110 mm	160 mm	KOM-707-98-67110	302.88
BOTTOM DUMP	208-63-94100	11001-		P-U-14	95 mm	130 mm	KOM-707-98-48500	307.08
	208-63-94200	11001-		P-U-14	95 mm	130 mm	KOM-707-98-48500	307.08
BUCKET (B/H)	208-63-72101	11001-		P-U-14	120 mm	180 mm	KOM-707-98-68500	295.39
BUCKET (L/S)	208-63-74100	11001-		P-U-14	95 mm	130 mm	KOM-707-98-48510	324.11
	208-63-74200	11001-		P-U-14	95 mm	130 mm	KOM-707-98-48510	324.11
CLAMSHELL	208-63-92100	11001-		P-U-14	100 mm	140 mm	KOM-707-98-58230	177.06
WEIGHT REMOVER	208-63-07011	11001-		P-U-14	85 mm	130 mm	KOM-707-98-46600	260.22
MODEL PC400-5 L/S								
ARM	208-63-03120	20001-		P-UB-14	120 mm	185 mm	KOM-707-99-68510	386.07
	208-63-03120	20001-		Bushing	120 mm		KOM-707-52-90950	82.86
BOOM	208-63-03100	20001-		P-UB-14	110 mm	160 mm	KOM-707-99-67121	239.19
	208-63-03100	20001-		Bushing	110 mm		KOM-707-52-90860	87.94
BOTTOM DUMP	208-63-03150	20001-		P-U-14	90 mm	130 mm	KOM-707-98-47600	314.59
BUCKET	208-63-03130	20001-		P-UB-14	95 mm	135 mm	KOM-707-99-57200	298.85
	208-63-03130	20001-		Bushing	95 mm		KOM-707-52-90710	47.74
MODEL PC400-5, PC400LC-5								
ARM	208-63-02120	20001-		P-UB-14	120 mm	185 mm	KOM-707-99-68510	386.07
BOOM	208-63-02100	20001-		P-UB-14	110 mm	160 mm	KOM-707-99-67120	352.81
	208-63-02100	20001-		Bushing	110 mm		KOM-707-52-90860	87.94
BUCKET	208-63-02130	20001-		P-UB-14	110 mm	160 mm	KOM-707-99-67010	407.69
MODEL PC400-6								
ARM (B/H)	208-63-02120	30001-31999		P-UB-14	120 mm	185 mm	KOM-707-99-68510	386.07
	208-63-02521	32001-		P-UB-14	120 mm	185 mm	KOM-707-99-68560	673.22
ARM (L/S)	208-63-03120	30001-		P-UB-14	120 mm	185 mm	KOM-707-99-68510	386.07
BOOM (B/H)	208-63-02301	30001-31999		P-UB-14	110 mm	160 mm	KOM-707-99-67120	352.81
	208-63-02501	32001-		P-UB-14	110 mm	160 mm	KOM-707-99-67300	431.76
BOTTOM DUMP (L/S)	208-63-03150			P-UB-14	90 mm	130 mm	KOM-707-99-47600	245.30
BUCKET (B/H)	207-63-02531	32001-		P-UB-14	110 mm	160 mm	KOM-707-99-67310	470.48
	208-63-02130	30001-31999		P-UB-14	110 mm	160 mm	KOM-707-99-67010	407.69
BUCKET (L/S)	208-63-03130	30001-		P-UB-14	95 mm	135 mm	KOM-707-99-57200	298.85
MODEL PC400-7, PC400LC-7								
ARM	707-01-0F690	50001-50146		P-UB-14	120 mm	185 mm	KOM-707-99-68780	413.95
	707-01-0F691	50147-		P-UB-14	120 mm	185 mm	KOM-707-99-68780	413.95
	707-01-0F710	50001-		P-UB-14	130 mm	185 mm	KOM-707-99-69710	457.24
	707-01-0F741	50001-		P-UB-14	120 mm	185 mm	KOM-707-99-68780	413.95

LT - Large size tire L/S - Loading Shovel SLF - Super Long Front B/H - Backhoe HD - Heavy Duty L BUCKET - Large Bucket
 K-LINK - K-type Linkage Blade LB HI-LIFT - High Lift Arm w Large Bucket HI-LIFT - High Lift Arm S HI-LIFT - Super High Lift Arm
 SU - Semi-U Dozer PAT - Power Angle Power Tilt MP - Multi-Purpose

Replacement Kits For

KOMATSU®

Excavators								
APPLICATION	CYL #	SERIAL #	Misc	CODE	ROD	BORE	KIT #	List \$
MODEL PC400-7, PC400LC-7								
ARM	707-01-0F810	50001-		P-UB-14	120 mm	185 mm	KOM-707-99-68780	413.95
	707-01-0F840	50001-		P-UB-14	120 mm	185 mm	KOM-707-99-68780	413.95
	707-01-0G370	50001-		P-UB-14	120 mm	185 mm	KOM-707-99-68780	413.95
	707-01-0G570	50197-	PC400-7	P-UB-14	130 mm	185 mm	KOM-707-99-69740	456.36
BOOM	707-01-0F670	50001-		P-UB-14	110 mm	160 mm	KOM-707-99-67870	275.80
	707-01-0F790	50001-		P-UB-14	110 mm	160 mm	KOM-707-99-67870	275.80
	707-01-0G350	50001-		P-UB-14	110 mm	160 mm	KOM-707-99-67090	399.71
	707-01-0G550	50197-	PC400-7	P-UB-14	110 mm	160 mm	KOM-707-99-67070	247.14
BOTTOM DUMP	707-01-0G400	50001-		P-UB-14	90 mm	130 mm	KOM-707-99-47800	178.68
BUCKET	707-01-0F700	50001-50419		P-UB-14	100 mm	160 mm	KOM-707-99-66240	301.19
	707-01-0F701	50420-50472		P-UB-14	100 mm	160 mm	KOM-707-99-66240	301.19
	707-01-0F702	50473-		P-UB-14	110 mm	160 mm	KOM-707-99-72240	375.51
	707-01-0F820	50001-50472		P-UB-14	100 mm	160 mm	KOM-707-99-66240	301.19
	707-01-0F821	50473-		P-UB-14	110 mm	160 mm	KOM-707-99-72240	375.51
	707-01-0G580	50197-50295	PC400-7	P-UB-14	110 mm	160 mm	KOM-707-99-72240	375.51
	707-01-0G581	50296-50472	PC400-7	P-UB-14	110 mm	160 mm	KOM-707-99-72240	375.51
	707-01-0G582	50473-	PC400-7	P-UB-14	110 mm	160 mm	KOM-707-99-72240	375.51
MODEL PC400-7E0, PC400LC-7E0								
ARM	707-01-0F691	60001-		P-UB-14	120 mm	185 mm	KOM-707-99-68780	413.95
	707-01-0F691	A87001-	LC-7E0	P-UB-14	120 mm	185 mm	KOM-707-99-68780	413.95
	707-01-0F711	60001-		P-UB-14	130 mm	185 mm	KOM-707-99-69710	457.24
	707-01-0F711	A87001-	LC-7E0	P-UB-14	130 mm	185 mm	KOM-707-99-69710	457.24
	707-01-0F741	60001-		P-UB-14	120 mm	185 mm	KOM-707-99-68780	413.95
	707-01-0F741	A87001-	LC-7E0	P-UB-14	120 mm	185 mm	KOM-707-99-68780	413.95
	707-01-0F810	60001-		P-UB-14	120 mm	185 mm	KOM-707-99-68780	413.95
	707-01-0G370	60001-		P-UB-14	120 mm	185 mm	KOM-707-99-68780	413.95
BOOM	707-01-0F670	60001-		P-UB-14	110 mm	160 mm	KOM-707-99-67870	275.80
	707-01-0F670	A87001-	LC-7E0	P-UB-14	110 mm	160 mm	KOM-707-99-67870	275.80
	707-01-0F790	60001-		P-UB-14	110 mm	160 mm	KOM-707-99-67870	275.80
	707-01-0G350	60001-		P-UB-14	110 mm	160 mm	KOM-707-99-67090	399.71
BOTTOM DUMP	707-01-0G400	60001-		P-UB-14	90 mm	130 mm	KOM-707-99-47800	178.68
BUCKET	707-01-0F702	60001-		P-UB-14	110 mm	160 mm	KOM-707-99-72240	375.51
	707-01-0F702	A87001-	LC-7E0	P-UB-14	110 mm	160 mm	KOM-707-99-72240	375.51
	707-01-0F821	60001-		P-UB-14	110 mm	160 mm	KOM-707-99-72240	375.51
	707-01-0G380	60001-		P-UB-14	95 mm	135 mm	KOM-707-99-50650	205.10
WEIGHT REMOVER	707-00-0F111	A87001-	LC-7E0	P-U-14	60 mm	120 mm	KOM-707-98-41170	86.85
MODEL PC400LC-7L								
ARM	707-01-0F690	A86001-		P-UB-14	120 mm	185 mm	KOM-707-99-68780	413.95
	707-01-0F710	A86001-		P-UB-14	130 mm	185 mm	KOM-707-99-69710	457.24
BOOM	707-01-0F670	A86001-		P-UB-14	110 mm	160 mm	KOM-707-99-67870	275.80
BUCKET	707-01-0F700	A86001-		P-UB-14	100 mm	160 mm	KOM-707-99-66240	301.19
MODEL PC400LC-8								
ARM	707-01-0F691	A88001-		P-UB-14	120 mm	185 mm	KOM-707-99-68780	413.95
	707-01-0F691	A88001-		Bushing	120 mm		KOM-707-52-90980	69.96
	707-01-0F711	A88001-		P-UB-14	130 mm	185 mm	KOM-707-99-69710	457.24
	707-01-0F711	A88001-		Bushing	130 mm		KOM-707-52-91070	76.95
	707-01-0F741	A88001-	2.4m Arm	P-UB-14	120 mm	185 mm	KOM-707-99-68780	413.95
	707-01-0F741	A88001-	2.4m Arm	Bushing	120 mm		KOM-707-52-90980	69.96
BOOM	707-01-0F670	A88001-		P-UB-14	110 mm	160 mm	KOM-707-99-67870	275.80
	707-01-0F670	A88001-		Bushing	110 mm		KOM-707-52-90850	45.85
BUCKET	707-01-0F702	A88001-		P-UB-14	110 mm	160 mm	KOM-707-99-72240	375.51
	707-01-0F702	A88001-		Bushing	110 mm		KOM-707-52-90850	45.85
MODEL PC450-6								
ARM	208-63-02341	10001-11999		P-UB-14	130 mm	185 mm	KOM-707-99-69500	460.94

KOMATSU®

LT - Large size tire L/S - Loading Shovel SLF - Super Long Front B/H - Backhoe HD - Heavy Duty L BUCKET - Large Bucket
 K-LINK - K-type Linkage Blade LB HI-LIFT - High Lift Arm w Large Bucket HI-LIFT - High Lift Arm S HI-LIFT - Super High Lift Arm
 SU - Semi-U Dozer PAT - Power Angle Power Tilt MP - Mulit-Purpose

Replacement Kits For

KOMATSU®

Excavators								
APPLICATION	CYL #	SERIAL #	Misc	CODE	ROD	BORE	KIT #	List \$
MODEL PC450-6K								
ARM	208-63-K2120	K30001-		P-UB-14	120 mm	185 mm	KOM-707-99-68510	386.07
BOOM	208-63-K2301	K30075-		P-UB-14	110 mm	160 mm	KOM-707-99-67120	352.81
	208-63-K2320	K30001-K30074		P-UB-14	110 mm	160 mm	KOM-707-99-67120	352.81
BUCKET	208-63-02130	K30001-		P-UB-14	110 mm	160 mm	KOM-707-99-67010	407.69
MODEL PC450-7K								
ARM	707-01-0F691	K40001-		P-UB-14	120 mm	185 mm	KOM-707-99-68780	413.95
ARM (2.4M Arm)	707-01-0F741	K40001-		P-UB-14	120 mm	185 mm	KOM-707-99-68780	413.95
ARM (w/ Burst Valve)	707-01-0F691	K40001-		P-UB-14	120 mm	185 mm	KOM-707-99-68780	413.95
BOOM	707-01-0F670	K40001-		P-UB-14	110 mm	160 mm	KOM-707-99-67870	275.80
BUCKET	707-01-0F700	K40001-		P-UB-14	100 mm	160 mm	KOM-707-99-66240	301.19
MODEL PC450LC-6K								
ARM	208-63-K2120	K30001-		P-UB-14	120 mm	185 mm	KOM-707-99-68510	386.07
BOOM	208-63-K2301	K30075-		P-UB-14	110 mm	160 mm	KOM-707-99-67120	352.81
	208-63-K2320	K30001-K30074		P-UB-14	110 mm	160 mm	KOM-707-99-67120	352.81
BUCKET	208-63-02130	K30001-		P-UB-14	110 mm	160 mm	KOM-707-99-67010	407.69
MODEL PC450LC-7K								
ARM	707-01-0F691	K40001-		P-UB-14	120 mm	185 mm	KOM-707-99-68780	413.95
ARM (2.4M Arm)	707-01-0F741	K40001-		P-UB-14	120 mm	185 mm	KOM-707-99-68780	413.95
ARM (w/ Burst Valve)	707-01-0F691	K40001-		P-UB-14	120 mm	185 mm	KOM-707-99-68780	413.95
BOOM	707-01-0F670	K40001-		P-UB-14	110 mm	160 mm	KOM-707-99-67870	275.80
BUCKET	707-01-0F700	K40001-		P-UB-14	100 mm	160 mm	KOM-707-99-66240	301.19
MODEL PC600-6, PC600LC-6								
ARM	21M-63-02121	10001-		P-UB-14	140 mm	200 mm	KOM-707-99-77140	359.12
BOOM	21M-63-02101	10001-		P-UB-14	120 mm	185 mm	KOM-707-99-68580	402.06
BUCKET	21M-63-02131	10001-		P-UB-14	120 mm	185 mm	KOM-707-99-68560	673.22
	21M-63-02140	10001-	LC-6	P-UB-14	120 mm	185 mm	KOM-707-99-68560	673.22
MODEL PC600LC-6A								
ARM	21M-63-02121	10001-		P-UB-14	140 mm	200 mm	KOM-707-99-77140	359.12
	707-01-0E890	11107-		P-UB-14	140 mm	200 mm	KOM-707-99-77160	339.13
BOOM	21M-63-02101	10001-		P-UB-14	120 mm	185 mm	KOM-707-99-68580	402.06
	707-01-0E870	11107-		P-UB-14	130 mm	185 mm	KOM-707-99-69700	440.71
BOTTOM DUMP	707-01-0C500	11107-		P-UB-14	90 mm	140 mm	KOM-707-99-56220	165.16
BUCKET	21M-63-02131	10001-		P-UB-14	120 mm	185 mm	KOM-707-99-68560	673.22
	21M-63-02140	10001-		P-UB-14	120 mm	185 mm	KOM-707-99-68560	673.22
	707-01-0E900	11107-		P-UB-14	110 mm	160 mm	KOM-707-99-67830	217.97
MODEL PC600LC-6K								
ARM	21M-63-02121	K30001-		P-UB-14	140 mm	200 mm	KOM-707-99-77140	359.12
BOOM	21M-63-02101	K30001-		P-UB-14	120 mm	185 mm	KOM-707-99-68580	402.06
BUCKET	21M-63-02131	K30001-		P-UB-14	120 mm	185 mm	KOM-707-99-68560	673.22
	21M-63-02140	K30001-		P-UB-14	120 mm	185 mm	KOM-707-99-68560	673.22
MODEL PC600LC-7								
ARM	21M-63-02121	20001-		P-UB-14	140 mm	200 mm	KOM-707-99-77140	359.12
BOOM	21M-63-02101	20001-		P-UB-14	120 mm	185 mm	KOM-707-99-68580	402.06
BUCKET	21M-63-02131	20001-		P-UB-14	120 mm	185 mm	KOM-707-99-68560	673.22
	21M-63-02140	20001-		P-UB-14	120 mm	185 mm	KOM-707-99-68560	673.22
WEIGHT REMOVER	209-63-07010	20032-		P-U-14	85 mm	130 mm	KOM-209-63-07010K	100.47
	707-01-0G420	20050-		P-UB-14	120 mm	185 mm	KOM-707-99-68780	413.95
MODEL PC600LC-8								
ARM	707-01-0J650	30001-		P-UB-14	140 mm	200 mm	KOM-707-99-76300	368.40
BUCKET	707-01-0J660	30001-		P-UB-14	130 mm	185 mm	KOM-707-99-69790	446.10
	707-01-0J670	30001-	SE Spec.	P-UB-14	130 mm	185 mm	KOM-707-99-69790	446.10
LOADER ARM	707-01-0E890	30001-		P-UB-14	140 mm	200 mm	KOM-707-99-77160	339.13
LOADER BOOM	707-01-0E870	30001-		P-UB-14	130 mm	185 mm	KOM-707-99-69700	440.71
LOADER BOTTOM DUMP	707-01-0C500	30001-		P-UB-14	90 mm	140 mm	KOM-707-99-56220	165.16
LOADER BUCKET	707-01-0E900	30001-		P-UB-14	110 mm	160 mm	KOM-707-99-67830	217.97

LT - Large size tire L/S - Loading Shovel SLF - Super Long Front B/H - Backhoe HD - Heavy Duty L BUCKET - Large Bucket
 K-LINK - K-type Linkage Blade LB HI-LIFT - High Lift Arm w Large Bucket HI-LIFT - High Lift Arm S HI-LIFT - Super High Lift Arm
 SU - Semi-U Dozer PAT - Power Angle Power Tilt MP - Multi-Purpose

Replacement Kits For

KOMATSU®

Excavators								
APPLICATION	CYL #	SERIAL #	Misc	CODE	ROD	BORE	KIT #	List \$
MODEL PC600LC-8								
WEIGHT REMOVER	707-00-0X500	30001-	Counter Weight 1	P-U-14	50 mm	95 mm	KOM-707-98-29650	108.49
	707-01-0K360	30001-	Counter Weight 2	P-UB-14	85 mm	120 mm	KOM-707-99-46030	143.95
MODEL PC650-1								
BOTTOM DUMP	209-63-96103	10007-		P-UB-14	130 mm	180 mm	KOM-707-99-69600	479.61
PCOMPENSATION	209-63-86302	10007-		P-U-14	120 mm	200 mm	KOM-707-98-75020	318.81
	209-63-86402	10007-		P-U-14	120 mm	200 mm	KOM-707-98-75020	318.81
MODEL PC650-3								
ARM (B/H)	209-63-02031	10501-		P-UB-14	140 mm	200 mm	KOM-707-99-77240	827.28
BOOM (B/H)	209-63-02011	10501-		P-UB-14	140 mm	200 mm	KOM-707-99-77240	827.28
BUCKET (B/H)	209-63-02040	10501-10632		P-UB-14	130 mm	180 mm	KOM-707-99-69600	479.61
	209-63-02042			P-UB-14	130 mm	180 mm	KOM-707-99-69600	479.61
BUCKET (L/S)	209-63-03041	10501-		P-UB-14	130 mm	180 mm	KOM-707-99-69600	479.61
MODEL PC650-5								
ARM (B/H)	209-63-02120	20169-		P-UB-14	140 mm	200 mm	KOM-707-99-77240	827.28
BOOM (B/H)	209-63-02100	20169-		P-UB-14	140 mm	200 mm	KOM-707-99-77220	264.24
BOOM (L/S)	209-63-03011	20164-		P-UB-14	120 mm	180 mm	KOM-707-99-68600	300.92
BOTTOM DUMP (L/S)	209-63-03061	20164-		P-UB-14	90 mm	140 mm	KOM-707-99-56300	177.67
BUCKET (B/H)	209-63-02130	20169-		P-UB-14	130 mm	180 mm	KOM-707-99-69600	479.61
BUCKET (L/S)	209-63-03041	20164-		P-UB-14	130 mm	180 mm	KOM-707-99-69600	479.61
MODEL PC710-5								
ARM	209-63-02120	11019-		P-UB-14	140 mm	200 mm	KOM-707-99-77240	827.28
BOOM	209-63-02100	11019-		P-UB-14	140 mm	200 mm	KOM-707-99-77240	827.28
BUCKET	209-63-02130	11019-		P-UB-14	130 mm	180 mm	KOM-707-99-69600	479.61
MODEL PC750-6								
ARM (B/H)	209-63-02381	10001-		P-UB-14	140 mm	200 mm	KOM-707-99-77380	277.05
BOOM (B/H)	209-63-02301	10001-		P-UB-14	140 mm	200 mm	KOM-707-99-77380	277.05
BOOM (L/S)	209-63-03311	10001-		P-UB-14	140 mm	200 mm	KOM-707-99-77380	277.05
BUCKET (B/H)	209-63-02372	10001-		P-UB-14	120 mm	185 mm	KOM-707-99-68510	386.07
MODEL PC750SE-6								
ARM	209-63-02351	10001-		P-UB-14	120 mm	185 mm	KOM-707-99-68510	386.07
BOOM	209-63-02301	10001-		P-UB-14	140 mm	200 mm	KOM-707-99-77380	277.05
MODEL PC800-6								
ARM	209-63-02351	30001-		P-UB-14	120 mm	185 mm	KOM-707-99-68510	386.07
BOOM	209-63-02301	30001-		P-UB-14	140 mm	200 mm	KOM-707-99-77380	277.05
BUCKET	209-63-02372	30001-		P-UB-14	120 mm	185 mm	KOM-707-99-68510	386.07
MODEL PC800-7								
ARM	707-01-0A531	40001-		P-UB-14	120 mm	185 mm	KOM-707-99-68660	395.70
BOOM	707-01-0A510	40001-		P-UB-14	140 mm	200 mm	KOM-707-99-77300	266.76
	707-01-0Y020	40001-		P-UB-14	140 mm	200 mm	KOM-707-99-77300	266.76
BUCKET	209-63-02540	40001-		P-UB-14	120 mm	185 mm	KOM-707-99-68560	673.22
MODEL PC800SE-6								
ARM	209-63-02351	30001-		P-UB-14	120 mm	185 mm	KOM-707-99-68510	386.07
BOOM	209-63-02301	30001-		P-UB-14	140 mm	200 mm	KOM-707-99-77380	277.05
MODEL PC1000-1								
ARM (B/H)	21N-63-02030	10001-		P-UB-14	170 mm	250 mm	KOM-707-99-89200	767.25
ARM (L/S)	21N-63-03030	10001-		P-UB-14	130 mm	180 mm	KOM-707-99-69620	507.17
BOOM (B/H)	21N-63-02010	10001-		P-UB-14	160 mm	225 mm	KOM-707-99-78620	1271.90
BOOM (L/S)	21N-63-03010	10001-		P-UB-14	160 mm	225 mm	KOM-707-99-78620	1271.90
BOTTOM DUMP	21N-63-03071	10001-		P-UB-14	90 mm	140 mm	KOM-707-99-56310	415.22
BUCKET (B/H)	21N-63-02040	10001-		P-UB-14	160 mm	225 mm	KOM-707-99-78630	1271.52
BUCKET (L/S)	21N-63-03050	10001-		P-UB-14	140 mm	200 mm	KOM-707-99-77250	750.43
MODEL PC1000SE-1, PC1000SP-1								
ARM	21N-63-02030	10001-	SE-1	P-UB-14	170 mm	250 mm	KOM-707-99-89200	767.25
	21N-63-02031	10001-		P-UB-14	170 mm	250 mm	KOM-707-99-89200	767.25

LT - Large size tire L/S - Loading Shovel SLF - Super Long Front B/H - Backhoe HD - Heavy Duty L BUCKET - Large Bucket
 K-LINK - K-type Linkage Blade LB HI-LIFT - High Lift Arm w Large Bucket HI-LIFT - High Lift Arm S HI-LIFT - Super High Lift Arm
 SU - Semi-U Dozer PAT - Power Angle Power Tilt MP - Multi-Purpose

Replacement Kits For

KOMATSU®

Excavators

APPLICATION	CYL #	SERIAL #	Misc	CODE	ROD	BORE	KIT #	List \$
MODEL PC1000SE-1, PC1000SP-1								
BOOM	21N-63-02010	10001-	SE-1	P-UB-14	160 mm	225 mm	KOM-707-99-78620	1271.90
	21N-63-02011	10001-		P-UB-14	160 mm	225 mm	KOM-707-99-78620	1271.90
BUCKET	21N-63-02060	10001-		P-UB-14	160 mm	225 mm	KOM-707-99-78630	1271.52
MODEL PC1100-6								
ARM (L/S)	21N-63-03120	10001-10109		P-UB-14	130 mm	185 mm	KOM-707-99-69670	378.80
	21N-63-03120	10001-10109		Bushing	130 mm		KOM-707-52-91070	76.95
	21N-63-03121	10110-		P-UB-14	130 mm	185 mm	KOM-707-99-69670	378.80
	21N-63-03121	10110-		Bushing	130 mm		KOM-707-52-91070	76.95
BOOM (B/H)	21N-63-02302	10001-10154		P-UB-14	160 mm	225 mm	KOM-707-99-78700	1145.98
	21N-63-02302	10001-10154		Bushing	160 mm		KOM-707-52-91350	120.17
	21N-63-02303	10155-		P-UB-14	160 mm	225 mm	KOM-707-99-78700	1145.98
	21N-63-02303	10155-		Bushing	160 mm		KOM-707-52-91350	120.17
BOOM (L/S)	21N-63-03100	10001-		P-UB-14	160 mm	225 mm	KOM-707-99-78700	1145.98
	21N-63-03100	10001-		Bushing	160 mm		KOM-707-52-91350	120.17
BOTTOM DUMP (L/S)	21N-63-03160	10001-		P-UB-14	90 mm	140 mm	KOM-707-98-56210	192.19
	21N-63-03160	10001-		Bushing	90 mm		KOM-707-52-90650	42.75
BUCKET (B/H)	21N-63-02332	10001-		P-UB-14	110 mm	160 mm	KOM-707-99-67290	263.21
	21N-63-02342	10001-		P-UB-14	110 mm	160 mm	KOM-707-99-67290	263.21
	21N-63-02370	10001-	5.7m Arm	P-UB-14	140 mm	200 mm	KOM-707-99-77120	664.90
	21N-63-02370	10001-	5.7m Arm	Bushing	140 mm		KOM-707-52-11410	117.97
BUCKET (L/S)	21N-63-03140	10001-		P-UB-14	140 mm	200 mm	KOM-707-98-77210	265.70
	21N-63-03140	10001-		Bushing	140 mm		KOM-707-52-91150	117.97
BUCKET LH (B/H)	21N-63-02332	10001-	3.4m, 4.5m Arm	P-UB-14	110 mm	160 mm	KOM-707-99-67290	263.21
	21N-63-02332	10001-	3.4m, 4.5m Arm	Bushing	110 mm		KOM-707-52-90860	87.94
BUCKET RH (B/H)	21N-63-02342	10001-	3.4m, 4.5m Arm	P-UB-14	110 mm	160 mm	KOM-707-99-67290	263.21
	21N-63-02342	10001-	3.4m, 4.5m Arm	Bushing	110 mm		KOM-707-52-90860	87.94
MODEL PC1250-7								
ARM (L/S)	21N-63-03121	20001-		P-UB-14	130 mm	185 mm	KOM-707-99-69670	378.80
	21N-63-03121	20001-		Bushing	130 mm		KOM-707-52-91070	76.95
BOOM (B/H)	21N-63-02303	20001-20083		P-UB-14	160 mm	225 mm	KOM-707-99-78700	1145.98
	21N-63-02303	20001-20083		Bushing	160 mm		KOM-707-52-91350	120.17
	21N-63-02304	20084-20449		P-UB-14	160 mm	225 mm	KOM-707-99-78740	1145.98
	21N-63-02304	20084-20449		Bushing	160 mm		KOM-707-52-91350	120.17
	21N-63-02304	20450-		P-UB-14	160 mm	225 mm	KOM-707-99-78740	1145.98
	21N-63-02304	20450-		Bushing	160 mm		KOM-707-52-91350	120.17
BOOM (L/S)	21N-63-03100	20001-		P-UB-14	160 mm	225 mm	KOM-707-99-78700	1145.98
	21N-63-03100	20001-		Bushing	160 mm		KOM-707-52-91350	120.17
BOTTOM DUMP (L/S)	707-01-0E940	20001-		P-UB-14	110 mm	160 mm	KOM-707-99-67090	399.71
	707-01-0E940	20001-		Bushing	110 mm		KOM-707-52-90850	45.85
BUCKET (B/H)	21N-63-02370	20001-20083	5.7m Arm	P-UB-14	140 mm	200 mm	KOM-707-99-77120	664.90
	21N-63-02370	20001-20083	5.7m Arm	Bushing	140 mm		KOM-707-52-11410	117.97
	21N-63-02371	20084-	5.7m Arm	P-UB-14	140 mm	200 mm	KOM-707-99-77190	685.93
	21N-63-02371	20084-	5.7m Arm	Bushing	140 mm		KOM-707-52-91150	117.97
BUCKET LH (B/H)	21N-63-02332	20001-20083	3.4m, 4.5m Arm	P-UB-14	110 mm	160 mm	KOM-707-99-67290	263.21
	21N-63-02332	20001-20083	3.4m, 4.5m Arm	Bushing	110 mm		KOM-707-52-90860	87.94
	21N-63-02333	20084-20406	3.4m, 4.5m Arm	P-UB-14	110 mm	160 mm	KOM-707-99-67840	262.70
	21N-63-02333	20084-20406	3.4m, 4.5m Arm	Bushing	110 mm		KOM-707-52-90860	87.94
BUCKET LH (L/S)	707-01-0E920	20001-		P-UB-14	140 mm	200 mm	KOM-707-99-77050	265.70
	707-01-0E920	20001-		Bushing	140 mm		KOM-707-52-91151	117.97

LT - Large size tire L/S - Loading Shovel SLF - Super Long Front B/H - Backhoe HD - Heavy Duty L BUCKET - Large Bucket

K-LINK - K-type Linkage Blade LB HI-LIFT - High Lift Arm w Large Bucket HI-LIFT - High Lift Arm S HI-LIFT - Super High Lift Arm

SU - Semi-U Dozer PAT - Power Angle Power Tilt MP - Mulit-Purpose

Replacement Kits For

KOMATSU®

Excavators									
APPLICATION	CYL #	SERIAL #	Misc	CODE	ROD	BORE	KIT #	List \$	
NEW MODEL PC1250-7									
BUCKET RH (B/H)	21N-63-02342	20001-20083	3.4m, 4.5m Arm	P-UB-14	110 mm	160 mm	KOM-707-99-67290	263.21	
	21N-63-02342	20001-20083	3.4m, 4.5m Arm	Bushing	110 mm		KOM-707-52-90860	87.94	
	21N-63-02343	20084-20406	3.4m, 4.5m Arm	P-UB-14	110 mm	160 mm	KOM-707-99-67840	262.70	
	21N-63-02343	20084-20406	3.4m, 4.5m Arm	Bushing	110 mm		KOM-707-52-90860	87.94	
BUCKET RH (L/S)	707-01-0E930	20001-		P-UB-14	140 mm	200 mm	KOM-707-99-77050	265.70	
	707-01-0E930	20001-		Bushing	140 mm		KOM-707-52-91151	117.97	
NEW MODEL PC1250-8									
ARM (L/S)	21N-63-03121	30001-		P-UB-14	130 mm	185 mm	KOM-707-99-69670	378.80	
	21N-63-03121	30001-		Bushing	130 mm		KOM-707-52-91070	76.95	
	21N-63-03121	30158-		P-UB-14	130 mm	185 mm	KOM-707-99-69670	378.80	
	21N-63-03121	30158-		Bushing	130 mm		KOM-707-52-91071	76.95	
BOOM (B/H)	21N-63-02304	30001-30014		P-UB-14	160 mm	225 mm	KOM-707-99-78740	1145.98	
	21N-63-02304	30001-30014		Bushing	160 mm		KOM-707-52-91350	120.17	
	21N-63-02304	30015-		P-UB-14	160 mm	225 mm	KOM-707-99-78740	1145.98	
	21N-63-02304	30015-		Bushing	160 mm		KOM-707-52-91350	120.17	
	21N-63-02304	30158-30246		P-UB-14	160 mm	225 mm	KOM-707-99-78740	1145.98	
	21N-63-02304	30158-30246		Bushing	160 mm		KOM-707-52-91351	120.17	
BOOM (L/S)	21N-63-03100	30001-		P-UB-14	160 mm	225 mm	KOM-707-99-78700	1145.98	
	21N-63-03100	30001-		Bushing	160 mm		KOM-707-52-91350	120.17	
	21N-63-03100	30158-		P-UB-14	160 mm	225 mm	KOM-707-99-78700	1145.98	
	21N-63-03100	30158-		Bushing	160 mm		KOM-707-52-91351	120.17	
BOTTOM DUMP (L/S)	707-01-0E940	30001-		P-UB-14	110 mm	160 mm	KOM-707-99-67090	399.71	
	707-01-0E940	30001-		Bushing	110 mm		KOM-707-52-90850	45.85	
	707-01-0E940	30158-		P-UB-14	110 mm	160 mm	KOM-707-99-67090	399.71	
	707-01-0E940	30158-		Bushing	110 mm		KOM-707-52-90851	45.85	
BUCKET (B/H)	21N-63-02371	30001-	5.7m Arm	P-UB-14	140 mm	200 mm	KOM-707-99-77190	685.93	
	21N-63-02371	30001-	5.7m Arm	Bushing	140 mm		KOM-707-52-91150	117.97	
	21N-63-02371	30158-30246		P-UB-14	140 mm	200 mm	KOM-707-99-77190	685.93	
	21N-63-02371	30158-30246		Bushing	140 mm		KOM-707-52-91151	117.97	
BUCKET LH (L/S)	707-01-0E920	30001-		P-UB-14	140 mm	200 mm	KOM-707-99-77050	265.70	
	707-01-0E920	30001-		Bushing	140 mm		KOM-707-52-91151	117.97	
	707-01-0E920	30158-		P-UB-14	140 mm	200 mm	KOM-707-99-77050	265.70	
	707-01-0E920	30158-		Bushing	140 mm		KOM-707-52-91151	117.97	
BUCKET RH (L/S)	707-01-0E930	30001-		P-UB-14	140 mm	200 mm	KOM-707-99-77050	265.70	
	707-01-0E930	30001-		Bushing	140 mm		KOM-707-52-91151	117.97	
	707-01-0E930	30158-		P-UB-14	140 mm	200 mm	KOM-707-99-77050	265.70	
	707-01-0E930	30158-		Bushing	140 mm		KOM-707-52-91151	117.97	
NEW MODEL PC1250LC-7									
BOOM (B/H)	21N-63-02303	20001-20083		P-UB-14	160 mm	225 mm	KOM-707-99-78700	1145.98	
	21N-63-02304	20084-20449		P-UB-14	160 mm	225 mm	KOM-707-99-78740	1145.98	
	21N-63-02304	20084-20449		Bushing	160 mm		KOM-707-52-91350	120.17	
	21N-63-02304	20450-		P-UB-14	160 mm	225 mm	KOM-707-99-78740	1145.98	
	21N-63-02304	20450-		Bushing	160 mm		KOM-707-52-91350	120.17	
BUCKET (B/H)	21N-63-02370	20001-20083	5.7m Arm	P-UB-14	140 mm	200 mm	KOM-707-99-77120	664.90	
	21N-63-02370	20001-20083	5.7m Arm	Bushing	140 mm		KOM-707-52-11410	117.97	
	21N-63-02371	20084-	5.7m Arm	P-UB-14	140 mm	200 mm	KOM-707-99-77190	685.93	
	21N-63-02371	20084-	5.7m Arm	Bushing	140 mm		KOM-707-52-91150	117.97	
BUCKET LH (B/H)	21N-63-02332	20001-20083	3.4m, 4.5m Arm	P-UB-14	110 mm	160 mm	KOM-707-99-67290	263.21	
	21N-63-02332	20001-20083	3.4m, 4.5m Arm	Bushing	110 mm		KOM-707-52-90860	87.94	

KOMATSU®

LT - Large size tire L/S - Loading Shovel SLF - Super Long Front B/H - Backhoe HD - Heavy Duty L BUCKET - Large Bucket
 K-LINK - K-type Linkage Blade LB HI-LIFT - High Lift Arm w Large Bucket HI-LIFT - High Lift Arm S HI-LIFT - Super High Lift Arm
 SU - Semi-U Dozer PAT - Power Angle Power Tilt MP - Multi-Purpose

Replacement Kits For

KOMATSU®

Excavators								
APPLICATION	CYL #	SERIAL #	Misc	CODE	ROD	BORE	KIT #	List \$
NEW MODEL PC1250LC-7								
BUCKET LH (B/H)	21N-63-02333	20084-20406	3.4m, 4.5m Arm	P-UB-14	110 mm	160 mm	KOM-707-99-67840	262.70
	21N-63-02333	20084-20406	3.4m, 4.5m Arm	Bushing	110 mm		KOM-707-52-90860	87.94
BUCKET RH (B/H)	21N-63-02342	20001-20083	3.4m, 4.5m Arm	P-UB-14	110 mm	160 mm	KOM-707-99-67290	263.21
	21N-63-02342	20001-20083	3.4m, 4.5m Arm	Bushing	110 mm		KOM-707-52-90860	87.94
	21N-63-02343	20084-20406	3.4m, 4.5m Arm	P-UB-14	110 mm	160 mm	KOM-707-99-67840	262.70
	21N-63-02343	20084-20406	3.4m, 4.5m Arm	Bushing	110 mm		KOM-707-52-90860	87.94
NEW MODEL PC1250LC-8								
BOOM (B/H)	21N-63-02304	30001-		P-UB-14	160 mm	225 mm	KOM-707-99-78740	1145.98
	21N-63-02304	30001-		Bushing	160 mm		KOM-707-52-91350	120.17
	21N-63-02304	30158-30246		P-UB-14	160 mm	225 mm	KOM-707-99-78740	1145.98
	21N-63-02304	30158-30246		Bushing	160 mm		KOM-707-52-91351	120.17
BUCKET (B/H)	21N-63-02371	30001-	5.7m Arm	P-UB-14	140 mm	200 mm	KOM-707-99-77190	685.93
	21N-63-02371	30001-	5.7m Arm	Bushing	140 mm		KOM-707-52-91150	117.97
	21N-63-02371	30158-30246	5.7m Arm	P-UB-14	140 mm	200 mm	KOM-707-99-77190	685.93
	21N-63-02371	30158-30246	5.7m Arm	Bushing	140 mm		KOM-707-52-91151	117.97
NEW MODEL PC1250SP-7								
BOOM (B/H)	21N-63-02303	20001-20083		P-UB-14	160 mm	225 mm	KOM-707-99-78700	1145.98
	21N-63-02303	20001-20083		Bushing	160 mm		KOM-707-52-91350	120.17
	21N-63-02304	20084-		P-UB-14	160 mm	225 mm	KOM-707-99-78740	1145.98
	21N-63-02304	20084-		Bushing	160 mm		KOM-707-52-91350	120.17
BUCKET LH (B/H)	21N-63-02351	20001-20083	3.4m Arm	P-UB-14	110 mm	160 mm	KOM-707-99-67290	263.21
	21N-63-02351	20001-20083	3.4m Arm	Bushing	110 mm		KOM-707-52-90860	87.94
	21N-63-02352	20084-20406	3.4m Arm	P-UB-14	110 mm	160 mm	KOM-707-99-67840	262.70
	21N-63-02352	20084-20406	3.4m Arm	Bushing	110 mm		KOM-707-52-90860	87.94
BUCKET RH (B/H)	21N-63-02361	20001-20083	3.4m Arm	P-UB-14	110 mm	160 mm	KOM-707-99-67290	263.21
	21N-63-02361	20001-20083	3.4m Arm	Bushing	110 mm		KOM-707-52-90860	87.94
	21N-63-02362	20084-20406	3.4m Arm	P-UB-14	110 mm	160 mm	KOM-707-99-67840	262.70
	21N-63-02362	20084-20406	3.4m Arm	Bushing	110 mm		KOM-707-52-90860	87.94
NEW MODEL PC1250SP-8								
BOOM (B/H)	21N-63-02304	30158-30246		P-UB-14	160 mm	225 mm	KOM-707-99-78740	1145.98
	21N-63-02304	30158-30246		Bushing	160 mm		KOM-707-52-91351	120.17
NEW MODEL PC1800-6								
ARM (B/H)	21T-63-02330	10001-		P-UB-14	160 mm	250 mm	KOM-707-99-85310	1562.05
	21T-63-02330	10001-		Bushing	160 mm		KOM-707-52-91350	120.17
BUCKET (B/H)	21T-63-02350	10001-		P-UB-14	140 mm	200 mm	KOM-707-99-77130	953.13
	21T-63-02350	10001-		Bushing	140 mm		KOM-707-52-91150	117.97
NEW MODEL PC2000-8								
ARM (B/H)	707-01-0K770	20001-		P-UB-14	160 mm	250 mm	KOM-707-99-85350	2723.82
BOOM (B/H)	707-01-0K750	20001-		P-UB-14	200 mm	300 mm	KOM-707-99-96140	3268.34
BOOM LH (B/H)	707-01-0K750	20001-		P-UB-14	200 mm	300 mm	KOM-707-99-96140	3268.34
BOOM RH (B/H)	707-01-0K760	20001-		P-UB-14	200 mm	300 mm	KOM-707-99-96140	3268.34
BUCKET (B/H)	707-01-0K790	20001-		P-UB-14	140 mm	200 mm	KOM-707-99-76260	1184.79
LADDER CYLINDER	707-00-0E670	20073-		P-U-14	50 mm	95 mm	KOM-707-98-29640	98.71
	707-00-0E670	20073-		Bushing	50 mm		KOM-07177-05030	15.54
SERVICE BOARD LIFT	707-00-0Y770	20150-		P-U-14	35 mm	65 mm	KOM-707-98-13890	38.81
	707-00-0Y770	20150-		Bushing	35 mm		KOM-07177-03525	8.22

LT - Large size tire L/S - Loading Shovel SLF - Super Long Front B/H - Backhoe HD - Heavy Duty L BUCKET - Large Bucket
 K-LINK - K-type Linkage Blade LB HI-LIFT - High Lift Arm w Large Bucket HI-LIFT - High Lift Arm S HI-LIFT - Super High Lift Arm
 SU - Semi-U Dozer PAT - Power Angle Power Tilt MP - Multi-Purpose

Replacement Kits For

KOMATSU®

Excavators - Compact								
APPLICATION	CYL #	SERIAL #	Misc	CODE	ROD	BORE	KIT #	List \$
MODEL PC27MR-3								
ARM	707-00-0F461	20509-	2180 mm Boom, Breaker	P-U-14	40 mm	65 mm	KOM-707-98-14910	48.34
	707-00-0F461	20509-	2180 mm Boom, Breaker	Bushing	40 mm		KOM-707-52-15130	9.33
ARM (Cab)	707-00-0F461	20002-20508		P-U-14	40 mm	65 mm	KOM-707-98-14910	48.34
	707-00-0F461	20002-20508		Bushing	40 mm		KOM-707-52-15130	9.33
ARM (Canopy)	707-00-0F461	20002-20508		P-U-14	40 mm	65 mm	KOM-707-98-14910	48.34
	707-00-0F461	20002-20508		Bushing	40 mm		KOM-707-52-15130	9.33
BLADE LIFT	707-00-0E551	20509-		P-U-14	45 mm	85 mm	KOM-707-98-24930	79.13
	707-00-0E551	20509-		Bushing	45 mm		KOM-707-52-15210	12.81
BLADE LIFT (Cab)	707-00-0E551	20002-20508		P-U-14	45 mm	85 mm	KOM-707-98-24930	79.13
	707-00-0E551	20002-20508		Bushing	45 mm		KOM-707-52-15210	12.81
BLADE LIFT (Canopy)	707-00-0E551	20002-20508		P-U-14	45 mm	85 mm	KOM-707-98-24930	79.13
	707-00-0E551	20002-20508		Bushing	45 mm		KOM-707-52-15210	12.81
BOOM	707-00-0H551	20509-		P-U-14	45 mm	75 mm	KOM-707-98-23890	63.38
BOOM (Cab)	707-00-0H551	20002-20508		P-U-14	45 mm	75 mm	KOM-707-98-23890	63.38
BOOM (Canopy)	707-00-0H551	20002-20508		P-U-14	45 mm	75 mm	KOM-707-98-23890	63.38
BOOM SWING	707-00-0H571	20509-		P-U-14	40 mm	75 mm	KOM-707-98-22890	62.83
	707-00-0H571	20509-		Bushing	40 mm		KOM-707-52-10411	10.92
BOOM SWING (Cab)	707-00-0H571	20002-20508		P-U-14	40 mm	75 mm	KOM-707-98-22890	62.83
	707-00-0H571	20002-20508		Bushing	40 mm		KOM-707-52-10411	10.92
BOOM SWING (Canopy)	707-00-0H571	20002-20508		P-U-14	40 mm	75 mm	KOM-707-98-22890	62.83
	707-00-0H571	20002-20508		Bushing	40 mm		KOM-707-52-10411	10.92
BUCKET	707-00-0H561	20509-	1370 mm Arm	P-U-14	35 mm	55 mm	KOM-707-98-13990	93.22
	707-00-0H561	20509-	1370 mm Arm	Bushing	35 mm		KOM-707-52-15110	8.22
BUCKET (Cab)	707-00-0H561	20002-20508		P-U-14	35 mm	55 mm	KOM-707-98-13990	93.22
	707-00-0H561	20002-20508		Bushing	35 mm		KOM-707-52-15110	8.22
BUCKET (Canopy)	707-00-0H561	20002-20508		P-U-14	35 mm	55 mm	KOM-707-98-13990	93.22
	707-00-0H561	20002-20508		Bushing	35 mm		KOM-707-52-15110	8.22
NEW MODEL PC28UU-2								
ARM	21U-63-02122	7001-10800		P-U-14	40 mm	80 mm	KOM-707-98-22150	64.35
	21U-63-02122	7001-10800		Bushing	40 mm		KOM-07177-04025	9.33
BLADE	21U-63-02151	7001-10800		P-U-14	40 mm	80 mm	KOM-707-98-22020	58.03
	21U-63-02151	7001-10800		Bushing	40 mm		KOM-07177-04025	9.33
	21U-63-02152	10801-		P-U-14	40 mm	80 mm	KOM-707-98-22020	58.03
	21U-63-02152	10801-		Bushing	40 mm		KOM-07177-04025	9.33
BLADE TILT	20P-63-02121	7001-10800		P-U-14	40 mm	80 mm	KOM-707-98-23100	50.69
	20P-63-02121	7001-10800		Bushing	40 mm		KOM-07177-04025	9.33
BOOM	21U-63-02111	10801-	Head 707-29-80070	P-U-14	45 mm	80 mm	KOM-707-98-24170	65.37
	21U-63-02111	7001-10800	Head 707-29-80231	P-U-14	45 mm	80 mm	KOM-707-98-24170	65.37
	21U-63-02111	7001-10800	Head 707-29-80231	Bushing	45 mm		KOM-07177-04530	12.81
BUCKET	21S-63-02131	7001-10800	Double Arm	P-U-10	25 mm	50 mm	KOM-21S-63-02131K	107.06
	21S-63-02131	7001-10800	Double Arm	Bushing	25 mm		KOM-07177-02525	5.46
	21U-63-02131	7001-10800		P-U-14	35 mm	65 mm	KOM-707-98-12211	140.22
	21U-63-02131	7001-10800		Bushing	35 mm		KOM-07177-03525	8.22
OFFSET	21U-63-02141	7001-10800		P-U-14	35 mm	70 mm	KOM-707-98-12410	67.75
	21U-63-02141	7001-10800		Bushing	35 mm		KOM-07177-03525	8.22
SLIDE ARM	21U-63-02161	7001-10800		P-U-14	30 mm	50 mm	KOM-707-98-04610	32.47
	21U-63-02161	7001-10800		Bushing	30 mm		KOM-07177-03025	7.41

KOMATSU®

LT - Large size tire L/S - Loading Shovel SLF - Super Long Front B/H - Backhoe HD - Heavy Duty L BUCKET - Large Bucket
 K-LINK - K-type Linkage Blade LB HI-LIFT - High Lift Arm w Large Bucket HI-LIFT - High Lift Arm S HI-LIFT - Super High Lift Arm
 SU - Semi-U Dozer PAT - Power Angle Power Tilt MP - Multi-Purpose

Replacement Kits For

KOMATSU®

Excavators - Compact

APPLICATION	CYL #	SERIAL #	Misc	CODE	ROD	BORE	KIT #	List \$
MODEL PC28UU-3								
ARM	21U-63-02422	30001-		P-U-14	40 mm	75 mm	KOM-707-98-22820	50.36
	21U-63-02422	30001-		Bushing	40 mm		KOM-707-52-10410	10.92
BLADE	21U-63-02451	30001-		P-U-14	40 mm	80 mm	KOM-707-98-22180	62.33
BOOM	21U-63-02413	30001-		P-U-14	45 mm	75 mm	KOM-707-98-24820	66.74
BUCKET	21U-63-02480	30001-		P-U-14	40 mm	70 mm	KOM-707-98-14610	67.75
	21U-63-02480	30001-		Bushing	40 mm		KOM-07177-04025	9.33
	21U-63-02530	30001-		P-U-14	35 mm	65 mm	KOM-707-98-13850	37.83
OFFSET	21U-63-02442	30001-		P-U-14	35 mm	65 mm	KOM-707-98-13850	37.83
MODEL PC35MR-3								
ARM	707-00-0H501	15001-16594		P-U-14	45 mm	75 mm	KOM-707-98-23870	68.89
	707-00-0H501	15001-16594		Bushing	45 mm		KOM-707-52-15210	12.81
	707-00-0H501	16595-	2540 mm Boom	P-U-14	45 mm	75 mm	KOM-707-98-23870	68.89
	707-00-0H501	16595-	2540 mm Boom	Bushing	45 mm		KOM-707-52-15210	12.81
ARM (Cab)	707-00-0H501	15001-16594		P-U-14	45 mm	75 mm	KOM-707-98-23870	68.89
	707-00-0H501	15001-16594		Bushing	45 mm		KOM-707-52-15210	12.81
ARM (Canopy)	707-00-0G340	15001-16594	PA Blade	P-U-14	35 mm	60 mm	KOM-707-98-13220	49.56
	707-00-0G340	15001-16594	PA Blade	Bushing	35 mm		KOM-707-52-15110	8.22
BLADE	707-00-0E591	16595-18585		P-U-14	45 mm	95 mm	KOM-707-98-24770	59.84
	707-00-0E591	16595-18585		Bushing	45 mm		KOM-707-52-15210	12.81
	707-00-0E592	18686-		P-U-14	45 mm	95 mm	KOM-707-98-30550	69.00
	707-00-0E592	18686-		Bushing	45 mm		KOM-707-52-15210	12.81
BLADE ANGLE	707-00-0G340	16595-	Power Angle Dozer	P-U-14	35 mm	60 mm	KOM-707-98-13220	49.56
	707-00-0G340	16595-		Bushing	35 mm		KOM-707-52-15110	8.22
BLADE ANGLE (Cab)	707-00-0G340	15001-16594	PA Blade	P-U-14	35 mm	60 mm	KOM-707-98-13220	49.56
	707-00-0G340	15001-16594	PA Blade	Bushing	35 mm		KOM-707-52-15110	8.22
BLADE ANGLE (Canopy)	707-00-0F370	15001-16594	PAT Blade	P-U-14	45 mm	95 mm	KOM-707-98-24770	59.84
	707-00-0F370	15001-16594	PAT Blade	Bushing	45 mm		KOM-707-52-15210	12.81
BLADE LIFT	707-00-0F370	16595-	Power Angle, Power Tilt Dozer	P-U-14	45 mm	95 mm	KOM-707-98-24770	59.84
	707-00-0F370	16595-	Power Angle, Power Tilt Dozer	Bushing	45 mm		KOM-707-52-15210	12.81
BLADE LIFT (Cab)	707-00-0E591	15001-16594		P-U-14	45 mm	95 mm	KOM-707-98-24770	59.84
	707-00-0E591	15001-16594		Bushing	45 mm		KOM-707-52-15210	12.81
	707-00-0F370	15001-16594	PAT Blade	P-U-14	45 mm	95 mm	KOM-707-98-24770	59.84
	707-00-0F370	15001-16594	PAT Blade	Bushing	45 mm		KOM-707-52-15210	12.81
BLADE LIFT (Canopy)	707-00-0E591	15001-16594		P-U-14	45 mm	95 mm	KOM-707-98-24770	59.84
	707-00-0E591	15001-16594		Bushing	45 mm		KOM-707-52-15210	12.81
BOOM	707-00-0H511	16595-18686	Swing	P-U-14	50 mm	95 mm	KOM-707-98-29670	72.49
	707-00-0H511	16595-18686	Swing	Bushing	50 mm		KOM-707-52-15230	15.54
	707-00-0H512	18687-	Swing	P-U-14	50 mm	95 mm	KOM-707-98-29720	81.77
	707-00-0H512	18687-	Swing	Bushing	50 mm		KOM-707-52-15230	15.54
	707-00-0H541	16595-18400	2540 mm Boom	P-U-14	45 mm	80 mm	KOM-707-98-24330	73.00
	707-00-0H541	18401-18686	2540 mm Boom	P-U-14	45 mm	80 mm	KOM-707-98-24330	73.00
	707-00-0H542	18687-	2540 mm Boom	P-U-14	45 mm	80 mm	KOM-707-98-26070	73.46
BOOM (Cab)	707-00-0H541	15001-16594		P-U-14	45 mm	80 mm	KOM-707-98-24330	73.00
BOOM (Canopy)	707-00-0H541	15001-16594		P-U-14	45 mm	80 mm	KOM-707-98-24330	73.00
BOOM SWING (Cab)	707-00-0H511	15001-16594		P-U-14	50 mm	95 mm	KOM-707-98-29670	72.49

LT - Large size tire L/S - Loading Shovel SLF - Super Long Front B/H - Backhoe HD - Heavy Duty L BUCKET - Large Bucket
 K-LINK - K-type Linkage Blade LB HI-LIFT - High Lift Arm w Large Bucket HI-LIFT - High Lift Arm S HI-LIFT - Super High Lift Arm
 SU - Semi-U Dozer PAT - Power Angle Power Tilt MP - Multi-Purpose

Replacement Kits For

KOMATSU®

KOMATSU®

Excavators - Compact								
APPLICATION	CYL #	SERIAL #	Misc	CODE	ROD	BORE	KIT #	List \$
MODEL PC35MR-3								
BOOM SWING (Cab)	707-00-0H511	15001-16594		Bushing	50 mm		KOM-707-52-15230	15.54
BOOM SWING (Canopy)	707-00-0H511	15001-16594		P-U-14	50 mm	95 mm	KOM-707-98-29670	72.49
	707-00-0H511	15001-16594		Bushing	50 mm		KOM-707-52-15230	15.54
BUCKET	707-00-0E532	16595-	1720 mm Arm	P-U-14	40 mm	65 mm	KOM-707-98-14930	100.37
	707-00-0E532	16595-	1720 mm Arm	Bushing	40 mm		KOM-707-52-15130	9.33
	707-00-0E532	16595-16599	1720 mm Arm	P-U-14	40 mm	65 mm	KOM-707-98-14930	100.37
	707-00-0E532	16595-16599	1720 mm Arm	Bushing	40 mm		KOM-707-52-15130	9.33
	707-00-0E532	16600-18639	1720 mm Arm	P-U-14	40 mm	65 mm	KOM-707-98-14930	100.37
	707-00-0E532	16600-18639	1720 mm Arm	Bushing	40 mm		KOM-707-52-15130	9.33
	707-00-0E533	18640-	1720 mm Arm	P-U-14	40 mm	65 mm	KOM-707-98-14350	78.56
BUCKET (Cab)	707-00-0E532	15001-16594		P-U-14	40 mm	65 mm	KOM-707-98-14930	100.37
	707-00-0E532	15001-16594		Bushing	40 mm		KOM-707-52-15130	9.33
BUCKET (Canopy)	707-00-0E532	15001-16594		P-U-14	40 mm	65 mm	KOM-707-98-14930	100.37
	707-00-0E532	15001-16594		Bushing	40 mm		KOM-707-52-15130	9.33
MODEL PC78US-8								
BLADE	707-00-0H752	15752-		P-U-14	65 mm	115 mm	KOM-707-98-36700	93.45
	707-00-0H752	15752-		Bushing	65 mm		KOM-707-52-15310	18.35
BLADE ANGLE	707-00-0H950	15001-		P-U-14	65 mm	130 mm	KOM-707-98-42700	95.26
	707-00-0H950	15001-		Bushing	65 mm		KOM-707-52-10660	22.57
BOOM	707-00-0H740	15001-	Without Anti-drop valve	P-U-14	60 mm	100 mm	KOM-707-98-35310	71.70
	707-00-0H740	15001-	Without Anti-drop valve	Bushing	60 mm		KOM-07177-06030	18.65
BUCKET	707-00-0H751	15001-15751		P-U-14	65 mm	115 mm	KOM-707-98-36700	93.45
	707-00-0H751	15001-15751		Bushing	65 mm		KOM-707-52-15310	18.35
	707-00-0H930	15001-		P-U-14	65 mm	115 mm	KOM-707-98-36700	93.45
	707-00-0H930	15001-		Bushing	65 mm		KOM-707-52-10660	22.57
Excavators - Wheel								
APPLICATION	CYL #	SERIAL #	Misc	CODE	ROD	BORE	KIT #	List \$
MODEL PW05-1								
BLADE	707-00-60340	1001-		P-U-10	30 mm	60 mm	KOM-707-98-11090	97.88
BOOM	707-00-50650	1001-		P-U-10	30 mm	50 mm	KOM-707-98-04500	100.57
STEERING	707-00-60350	1001-		P-U-10	30 mm	60 mm	KOM-707-98-11090	97.88
SUSPENSION LOCK	707-00-40020	1001-		P-U-1	40 mm		KOM-707-98-06010	29.96
MODEL PW20-1								
ARM	20R-63-66300	1001-		P-U-14	40 mm	80 mm	KOM-707-98-22040	125.74
BLADE	21E-63-02010	1001-		P-U-14	45 mm	90 mm	KOM-707-98-24430	154.95
BOOM	20R-63-56500	1001-		P-U-14	40 mm	80 mm	KOM-707-98-22110	119.55
BOOM SWING	20S-63-86301	1001-		P-U-14	35 mm	70 mm	KOM-707-98-12440	83.38
BUCKET	20R-63-76301	1001-		P-U-14	35 mm	70 mm	KOM-707-98-12440	83.38
STEERING	21E-63-02020	1001-		P-U-10	35 mm	70 mm	KOM-707-98-12450	108.77
MODEL PW30-1								
ARM	20R-63-66300	1001-		P-U-14	40 mm	80 mm	KOM-707-98-22040	125.74
BLADE	21E-63-02010	1001-		P-U-14	45 mm	90 mm	KOM-707-98-24430	154.95
BOOM	20R-63-56500	1001-		P-U-14	40 mm	80 mm	KOM-707-98-22110	119.55
BOOM SWING	20S-63-86301	1001-		P-U-14	35 mm	70 mm	KOM-707-98-12440	83.38
BUCKET	20S-63-76102	1001-		P-U-14	40 mm	70 mm	KOM-707-98-14600	97.79
STEERING	21E-63-02020	1001-		P-U-10	35 mm	70 mm	KOM-707-98-12450	108.77

LT - Large size tire L/S - Loading Shovel SLF - Super Long Front B/H - Backhoe HD - Heavy Duty L BUCKET - Large Bucket
 K-LINK - K-type Linkage Blade LB HI-LIFT - High Lift Arm w Large Bucket HI-LIFT - High Lift Arm S HI-LIFT - Super High Lift Arm
 SU - Semi-U Dozer PAT - Power Angle Power Tilt MP - Multi-Purpose

Replacement Kits For

KOMATSU®

Excavators - Wheel

APPLICATION	CYL #	SERIAL #	Misc	CODE	ROD	BORE	KIT #	List \$
MODEL PW60,N-1								
BUCKET	201-63-26301	1501-		P-U-5	55 mm	90 mm	KOM-707-99-26600	190.08
OUTRIGGER	20B-63-12102	1501-		P-U-5	55 mm	90 mm	KOM-707-99-26600	190.08
STEERING	20B-63-22101	1501-		P-U-10	25 mm	50 mm	KOM-707-99-03500	92.27
MODEL PW60-3								
BLADE	20B-63-02060	2001-		P-U-14	45 mm	70 mm	KOM-707-98-15720	143.45
BOOM	201-63-02010	2001-		P-U-14	65 mm	100 mm	KOM-707-99-36260	203.29
BUCKET	201-63-02030	2001-		P-U-14	55 mm	90 mm	KOM-707-98-26520	101.66
OUTRIGGER	20B-63-02020	2001-		P-U-14	45 mm	70 mm	KOM-707-98-15700	102.32
MODEL PW100-1								
ARM	202-63-62100	1003-		P-U-14	70 mm	120 mm	KOM-707-98-43100	252.04
BLADE	20D-63-96300	1003-		P-U-14	50 mm	90 mm	KOM-707-98-25510	180.96
	20D-63-96400	1003-		P-U-14	50 mm	90 mm	KOM-707-98-25510	180.96
BOOM	202-63-52100	1003-		P-U-14	65 mm	110 mm	KOM-707-98-36510	183.18
	202-63-52200	1003-		P-U-14	65 mm	110 mm	KOM-707-98-36510	183.18
BUCKET	202-63-72100	1003-		P-U-14	65 mm	110 mm	KOM-707-98-36520	135.63
OUTRIGGER	20D-63-12700	1003-		P-U-14	65 mm	110 mm	KOM-707-98-36500	159.26
	20D-63-12800	1003-		P-U-14	65 mm	110 mm	KOM-707-98-36500	159.26
STEERING	20D-63-22301	1003-		P-U-14	30 mm	60 mm	KOM-707-99-11030	85.07
MODEL PW100-3								
OUTRIGGER	20G-63-12101	1601-		P-U-14	70 mm	110 mm	KOM-707-98-37500	185.78
	20G-63-12201	1601-		P-U-14	70 mm	110 mm	KOM-707-98-37500	185.78
MODEL PW100N-3								
ARM	202-63-62500	1601-1667		P-U-14	75 mm	110 mm	KOM-707-98-38600	200.89
	202-63-62502	1668-2300		P-U-14	75 mm	110 mm	KOM-707-98-38600	200.89
	20D-63-02030	2301-		P-U-14	75 mm	110 mm	KOM-707-98-38600	200.89
BOOM	202-63-52500	1601-2300		P-UB-14	65 mm	100 mm	KOM-707-98-36100	170.56
	202-63-52600	1601-2300		P-UB-14	65 mm	100 mm	KOM-707-98-36100	170.56
	20D-63-02010	2301-		P-UB-14	65 mm	100 mm	KOM-707-98-36100	170.56
BUCKET	202-63-72500	1601-1667		P-UB-14	65 mm	100 mm	KOM-707-98-36110	127.62
	202-63-72501	1668-2300		P-UB-14	65 mm	100 mm	KOM-707-98-36110	127.62
	20D-63-02040	2301-		P-UB-14	65 mm	100 mm	KOM-707-98-36110	127.62
OUTRIGGER	20D-63-13100	1601-		P-U-14	65 mm	110 mm	KOM-707-98-36560	159.16
	20D-63-13200	1601-		P-U-14	65 mm	110 mm	KOM-707-98-36560	159.16
STEERING	20D-63-22502	1601-		P-U-14	35 mm	70 mm	KOM-707-98-12410	67.75
MODEL PW150-1								
ARM	20G-63-62100	1001-		P-U-14	90 mm	130 mm	KOM-707-98-47510	303.48
ARM (Lock Valve)	20G-63-62141	1001-		P-U-14	90 mm	130 mm	KOM-707-98-47510	303.48
BLADE	20G-63-92110	1001-		P-U-14	70 mm	110 mm	KOM-707-98-37500	185.78
BOOM	20G-63-52100	1001-1024		P-U-14	70 mm	110 mm	KOM-707-98-37600	83.78
	20G-63-52101	1025-1220		P-U-14	70 mm	110 mm	KOM-707-98-37600	83.78
	20G-63-52102	1221-		P-U-14	70 mm	110 mm	KOM-707-98-37600	83.78
BOOM (Lock Valve)	20G-63-52110	1001-		P-U-14	70 mm	110 mm	KOM-707-98-37600	83.78
BUCKET	20G-63-72100	1001-		P-U-14	70 mm	110 mm	KOM-707-98-37610	136.62
OUTRIGGER	20G-63-12100	1001-1283		P-U-14	70 mm	110 mm	KOM-707-98-37500	185.78
	20G-63-12101	1284-		P-U-14	70 mm	110 mm	KOM-707-98-37500	185.78
	20G-63-12200	1001-1283		P-U-14	70 mm	110 mm	KOM-707-98-37500	185.78
	20G-63-12201	1284-		P-U-14	70 mm	110 mm	KOM-707-98-37500	185.78
STEERING	20G-63-22100	1001-		P-U-10	40 mm	80 mm	KOM-707-98-22010	97.03
	20G-63-22100	1284-		P-U-10	40 mm	80 mm	KOM-707-98-22010	97.03
SUSPENSION LOCK	20G-63-32100	1001-		P-U-14	70 mm	110 mm	KOM-707-98-37500	185.78
MODEL PW210-1								
ARM	205-63-62101	10001-		P-U-14	95 mm	130 mm	KOM-707-98-48600	319.41
	205-63-69300	10035-		P-UB-14	75 mm	110 mm	KOM-707-98-38551	302.44
BOOM	205-63-52100	10001-		P-U-14	85 mm	120 mm	KOM-707-98-46200	275.14
	205-63-52200	10001-		P-U-14	85 mm	120 mm	KOM-707-98-46200	275.14

LT - Large size tire L/S - Loading Shovel SLF - Super Long Front B/H - Backhoe HD - Heavy Duty L BUCKET - Large Bucket
 K-LINK - K-type Linkage Blade LB HI-LIFT - High Lift Arm w Large Bucket HI-LIFT - High Lift Arm S HI-LIFT - Super High Lift Arm
 SU - Semi-U Dozer PAT - Power Angle Power Tilt MP - Mulit-Purpose

Replacement Kits For

KOMATSU®

Excavators - Wheel								
APPLICATION	CYL #	SERIAL #	Misc	CODE	ROD	BORE	KIT #	List \$
MODEL PW210-1								
BUCKET	205-63-72100	10001-		P-U-14	75 mm	110 mm	KOM-707-98-38500	180.18
	205-63-72100	10035-		P-UB-14	75 mm	110 mm	KOM-707-98-38551	302.44
BUCKET (1.8M)	205-63-72301	10001-		P-U-14	85 mm	120 mm	KOM-707-98-46100	222.90
OUTRIGGER	20K-63-02010	10001-		P-U-14	80 mm	130 mm	KOM-707-98-45700	299.98
STEERING	20K-63-02030	10001-		P-U-14	40 mm	90 mm	KOM-707-98-22430	112.61
SUSPENSION LOCK	20G-63-32100	10001-		P-U-14	70 mm	110 mm	KOM-707-98-37500	185.78
Loaders - Skid Steer								
APPLICATION	CYL #	SERIAL #	Misc	CODE	ROD	BORE	KIT #	List \$
MODEL SK815-5								
BUCKET LH	37A-6C-11201	37BTF00003-, 37BF00006-		P-U-14	30 mm	60 mm	KOM-878010240	68.71
BUCKET RH	37A-6C-11301	37BTF00003-, 37BF00006-		P-U-14	30 mm	60 mm	KOM-878010240	68.71
LIFT	37B-6C-11101	37BTF00003-, 37BF00006-		P-U-14	35 mm	55 mm	KOM-878010241	59.85
MODEL SK815-5N								
BUCKET LH	37A-6C-11201	A30001-		P-U-14	30 mm	60 mm	KOM-878010240	68.71
BUCKET RH	37A-6C-11301	A30001-		P-U-14	30 mm	60 mm	KOM-878010240	68.71
LIFT	37B-6C-11101	A30001-		P-U-14	35 mm	55 mm	KOM-878010241	59.85
MODEL SK1020-5								
BUCKET LH	37C-6C-11200	37CTF00003-, 37CF00004-		P-U-14	35 mm	65 mm	KOM-878010284	61.79
BUCKET RH	37C-6C-11300	37CTF00003-, 37CF00004-		P-U-14	35 mm	65 mm	KOM-878010284	61.79
LIFT	37C-6C-11100	37CTF00003-, 37CF00004-		P-U-14	40 mm	65 mm	KOM-878010285	62.35
MODEL SK1020-5N								
BUCKET LH	37C-6C-11200	A70001-		P-U-14	35 mm	65 mm	KOM-878010284	61.79
BUCKET RH	37C-6C-11300	A70001-		P-U-14	35 mm	65 mm	KOM-878010284	61.79
LIFT	37C-6C-11100	A70001-		P-U-14	40 mm	65 mm	KOM-878010285	62.35
MODEL SK1020-5NA								
BUCKET LH	37C-6C-11200	A60001-		P-U-14	35 mm	65 mm	KOM-878010284	61.79
BUCKET RH	37C-6C-11300	A60001-		P-U-14	35 mm	65 mm	KOM-878010284	61.79
LIFT	37C-6C-11100	A60001-		P-U-14	40 mm	65 mm	KOM-878010285	62.35
Loaders - Wheel								
APPLICATION	CYL #	SERIAL #	Misc	CODE	ROD	BORE	KIT #	List \$
MODEL WA20-1								
CLAM	361-63-59100	1001-		P-U-10	25 mm	50 mm	KOM-707-98-03530	88.33
DUMP	361-63-22100	1001-		P-U-10	35 mm	60 mm	KOM-707-98-12080	102.19
STEERING	361-63-52100	1001-		P-U-10	25 mm	50 mm	KOM-707-98-03530	88.33
MODEL WA30-1								
DUMP	362-63-22101	1001-		P-U-14	35 mm	60 mm	KOM-707-98-12110	87.57
LIFT	362-63-12100	1001-		P-U-14	35 mm	60 mm	KOM-707-98-12100	85.78
	362-63-12200	1001-		P-U-14	35 mm	60 mm	KOM-707-98-12100	85.78
STEERING	362-63-52101	1001-		P-U-14	30 mm	60 mm	KOM-707-99-11040	85.07
MODEL WA30-2								
DUMP	362-63-22101	3001-4101		P-U-14	35 mm	60 mm	KOM-707-98-12110	87.57
	362-63-22300	4102-		P-U-10	35 mm	60 mm	KOM-707-98-12080	102.19
GRAPPLE	362-63-97100	3001-		P-U-10	30 mm	50 mm	KOM-707-99-04410	105.79
LIFT	362-63-12100	3001-4101		P-U-14	35 mm	60 mm	KOM-707-98-12100	85.78
	362-63-12200	3001-4101		P-U-14	35 mm	60 mm	KOM-707-98-12100	85.78
	362-63-12300	4102-		P-U-10	35 mm	60 mm	KOM-707-98-12080	102.19
	362-63-12400	4102-		P-U-10	35 mm	60 mm	KOM-707-98-12080	102.19
STEERING	362-63-52101	3001-4101		P-U-14	30 mm	60 mm	KOM-707-99-11040	85.07
MODEL WA40-1								
CLAM	363-63-22200	1001-		P-U-10	30 mm	60 mm	KOM-707-98-11090	97.88
GRAPPLE	362-63-97100	1001-		P-U-10	30 mm	50 mm	KOM-707-99-04410	105.79

LT - Large size tire L/S - Loading Shovel SLF - Super Long Front B/H - Backhoe HD - Heavy Duty L BUCKET - Large Bucket

K-LINK - K-type Linkage Blade LB HI-LIFT - High Lift Arm w Large Bucket HI-LIFT - High Lift Arm S HI-LIFT - Super High Lift Arm

SU - Semi-U Dozer PAT - Power Angle Power Tilt MP - Multi-Purpose

Replacement Kits For

KOMATSU®

Loaders - Wheel								
APPLICATION	CYL #	SERIAL #	Misc	CODE	ROD	BORE	KIT #	List \$
MODEL WA40-1								
STEERING	363-63-52100	1001-		P-U-10	35 mm	70 mm	KOM-707-98-12450	108.77
MODEL WA50-3								
DUMP	42A-63-01020	20642-		P-U-14	45 mm	75 mm	KOM-707-98-24820	66.74
MODEL WA65-3								
DUMP	42T-63-13170	HA940549-771, H20761-		P-UB-10	45 mm	80 mm	KOM-42T-63-H0P01	115.50
LIFT	42T-63-12110	HA940549-771, H20761-		P-UB-14	50 mm	95 mm	KOM-42T-63-H0P18	128.92
STEERING	42U-63-11110	HA940549-771, H20761-		P-U-10	35 mm	70 mm	KOM-42U-63-H0P12	52.19
MODEL WA65-5								
DUMP	42T-63-23100	H50051-		P-U-10	50 mm	85 mm	KOM-42U-63-H0P43	188.44
	42T-63-23110	H50051-		P-U-10	50 mm	85 mm	KOM-42T-63-H0P70	122.31
LIFT	42T-63-22100	H50051-		P-U-10	50 mm	95 mm	KOM-42U-63-H0P56	96.66
	42T-63-22120	H50051-		P-U-10	50 mm	95 mm	KOM-42T-63-H0P61	140.47
STEERING	42T-63-21010	H50051-		P-U-10	35 mm	70 mm	KOM-42U-63-H0P67	54.98
	42T-63-21020	H50051-		P-U-10	35 mm	70 mm	KOM-42T-63-H0P52	109.41
MODEL WA70-1								
DUMP	707-00-01200	12001-		P-U-14	40 mm	80 mm	KOM-707-99-22100	169.57
	707-00-80041	10001-11999		P-U-14	40 mm	80 mm	KOM-707-99-22100	169.57
DUMP (HI-LIFT)	707-00-80540	10001-11999		P-U-14	40 mm	80 mm	KOM-707-99-22100	169.57
LIFT	707-00-01000	1200-		P-U-14	45 mm	80 mm	KOM-707-99-24100	140.08
	707-00-80033	10001-11999		P-U-14	45 mm	80 mm	KOM-707-99-24100	140.08
LIFT (HI-LIFT)	707-00-80530	10001-11999		P-U-14	45 mm	80 mm	KOM-707-99-24100	140.08
MODEL WA100-1								
CLAM	707-00-90010	10001-		P-U-14	50 mm	90 mm	KOM-707-99-25520	163.64
DUMP	707-00-10031	10001-		P-U-14	50 mm	100 mm	KOM-707-99-32100	133.67
DUMP (HI-LIFT)	707-00-10400	10001-		P-U-14	50 mm	100 mm	KOM-707-99-32100	133.67
DUMP (L BUCKET)	707-00-11210	10001-		P-U-14	55 mm	110 mm	KOM-707-99-34500	114.23
DUMP (LB HI-LIFT)	707-00-11220	10001-		P-U-14	55 mm	110 mm	KOM-707-99-34500	114.23
DUMP (S HI-LIFT)	707-00-11230	10001-		P-U-14	55 mm	110 mm	KOM-707-99-34500	114.23
GRAPPLE	707-00-80330	10001-		P-U-14	40 mm	80 mm	KOM-707-99-22100	169.57
LIFT	707-00-10011	10001-		P-U-14	55 mm	100 mm	KOM-707-99-34100	115.32
	707-00-10021	10001-		P-U-14	55 mm	100 mm	KOM-707-99-34100	115.32
STEERING	707-00-60011	10001-19999		P-U-14	40 mm	60 mm	KOM-707-99-14200	98.19
	707-00-60012	20001-		P-U-14	40 mm	60 mm	KOM-707-99-14200	98.19
	707-00-60021	10001-19999		P-U-14	40 mm	60 mm	KOM-707-99-14200	98.19
	707-00-60022	20001-		P-U-14	40 mm	60 mm	KOM-707-99-14200	98.19
MODEL WA120-1								
DUMP	707-00-12140	10001-		P-U-14	60 mm	120 mm	KOM-707-99-41100	167.66
LIFT	707-00-11320	10001-		P-U-14	70 mm	110 mm	KOM-707-99-37500	125.94
	707-00-11330	10001-		P-U-14	70 mm	110 mm	KOM-707-99-37500	125.94
STEERING	707-00-60012	10001-		P-U-14	40 mm	60 mm	KOM-707-99-14200	98.19
	707-00-60022	10001-		P-U-14	40 mm	60 mm	KOM-707-99-14200	98.19
MODEL WA120-3								
DUMP	707-00-03211	50001-		P-U-14	50 mm	100 mm	KOM-707-99-32110	111.82
STEERING	707-00-60012	50001-		P-U-14	40 mm	60 mm	KOM-707-99-14200	98.19
	707-00-60022	50001-		P-U-14	40 mm	60 mm	KOM-707-99-14200	98.19
MODEL WA150-1								
CLAM	707-0090010	10001-		P-U-14	50 mm	90 mm	KOM-707-99-25520	163.64
DUMP	707-00-12022	10001-		P-U-14	60 mm	120 mm	KOM-707-99-41100	167.66
DUMP (HI-LIFT)	707-00-12300	10001-		P-U-14	60 mm	120 mm	KOM-707-99-41100	167.66
GRAPPLE	707-00-80330	10001-		P-U-14	40 mm	80 mm	KOM-707-99-22100	169.57
LIFT	707-00-11031	10001-		P-U-14	70 mm	110 mm	KOM-707-99-37500	125.94
	707-00-11041	10001-		P-U-14	70 mm	110 mm	KOM-707-99-37500	125.94
STEERING	707-00-60011	10001-19999		P-U-14	40 mm	60 mm	KOM-707-99-14200	98.19

LT - Large size tire L/S - Loading Shovel SLF - Super Long Front B/H - Backhoe HD - Heavy Duty L BUCKET - Large Bucket
 K-LINK - K-type Linkage Blade LB HI-LIFT - High Lift Arm w Large Bucket HI-LIFT - High Lift Arm S HI-LIFT - Super High Lift Arm
 SU - Semi-U Dozer PAT - Power Angle Power Tilt MP - Mulit-Purpose

Replacement Kits For

KOMATSU®

Loaders - Wheel								
APPLICATION	CYL #	SERIAL #	Misc	CODE	ROD	BORE	KIT #	List \$
MODEL WA150-1								
STEERING	707-00-60012	20001-		P-U-14	40 mm	60 mm	KOM-707-99-14200	98.19
	707-00-60021	10001-19999		P-U-14	40 mm	60 mm	KOM-707-99-14200	98.19
	707-00-60022	20001-		P-U-14	40 mm	60 mm	KOM-707-99-14200	98.19
MODEL WA180-1								
CLAM	707-00-90010	10001-		P-U-14	50 mm	90 mm	KOM-707-99-25520	163.64
DUMP	707-01-13190	10001-		P-U-14	70 mm	130 mm	KOM-707-99-43500	207.21
	707-01-13510	10001-		P-U-14	70 mm	130 mm	KOM-707-99-43500	207.21
LIFT	707-00-12080	10001-10088		P-U-14	70 mm	120 mm	KOM-707-99-43100	202.80
	707-00-12081	10089-		P-U-14	70 mm	120 mm	KOM-707-99-43100	202.80
STEERING	707-00-70410	10001-		P-U-14	45 mm	70 mm	KOM-707-99-15600	143.03
	707-00-70420	10001-		P-U-14	45 mm	70 mm	KOM-707-99-15600	143.03
MODEL WA180-3								
DUMP	707-00-03231	53001-		P-U-14	60 mm	120 mm	KOM-707-99-41130	63.77
	707-00-03231	53001-		Bushing	60 mm		KOM-07177-06030	18.65
	707-01-02310	50001-		P-U-14	70 mm	130 mm	KOM-707-99-43520	299.25
LIFT	707-00-03030	50001-		P-U-14	70 mm	110 mm	KOM-707-99-37510	166.79
	707-00-06130	50001-		P-U-14	70 mm	110 mm	KOM-707-99-37510	166.79
STEERING	707-00-60012	50001-		P-U-14	40 mm	60 mm	KOM-707-99-14200	98.19
	707-00-60022	50001-		P-U-14	40 mm	60 mm	KOM-707-99-14200	98.19
MODEL WA200-1								
CLAM	707-00-10080	10001-		P-U-14	50 mm	100 mm	KOM-707-99-32100	133.67
DUMP	707-00-13011	10001-		P-U-14	70 mm	130 mm	KOM-707-99-43500	207.21
DUMP (HI-LIFT)	707-01-13020	10001-		P-U-14	70 mm	130 mm	KOM-707-99-43500	207.21
GRAPPLE	707-00-80330	10001-		P-U-14	40 mm	80 mm	KOM-707-99-22100	169.57
LIFT	707-00-12011	10001-29999		P-U-14	70 mm	120 mm	KOM-707-99-43100	202.80
STEERING	707-00-70131	10001-19999		P-U-14	40 mm	70 mm	KOM-707-99-14600	137.61
	707-00-70132	20001-29999		P-U-14	40 mm	70 mm	KOM-707-99-14600	137.61
MODEL WA200-5L								
BOOM LH	707-00-0E720	A82001-		P-U-14	65 mm	120 mm	KOM-707-98-42150	76.73
	707-00-0E720	A82001-		Bushing	65 mm		KOM-707-52-10660	22.57
BOOM RH	707-00-0E730	A82001-		P-U-14	65 mm	120 mm	KOM-707-98-42150	76.73
	707-00-0E730	A82001-		Bushing	65 mm		KOM-707-52-10660	22.57
BUCKET	707-00-0E740	A82001-		P-U-14	65 mm	130 mm	KOM-707-98-42540	106.40
	707-00-0E740	A82001-		Bushing	65 mm		KOM-707-52-10660	22.57
BUCKET (HI-LIFT)	707-00-0F220	A82001-		P-U-14	65 mm	130 mm	KOM-707-98-42540	106.40
	707-00-0F220	A82001-		Bushing	65 mm		KOM-707-52-10660	22.57
STEERING	707-00-0C190	A82001-		P-U-14	40 mm	70 mm	KOM-707-99-14760	148.58
	707-00-0C190	A82001-		Bushing	40 mm		KOM-07177-04025	9.33
MODEL WA200L-5								
BOOM LH	707-00-0E720	65001-68260		P-U-14	65 mm	120 mm	KOM-707-98-42150	76.73
	707-00-0E720	65001-68260		Bushing	65 mm		KOM-707-52-10660	22.57
	707-00-0E721	68261-		P-U-14	65 mm	120 mm	KOM-707-98-42150	76.73
	707-00-0E721	68261-		Bushing	65 mm		KOM-707-52-10660	22.57
BOOM RH	707-00-0E730	65001-68260		P-U-14	65 mm	120 mm	KOM-707-98-42150	76.73
	707-00-0E730	65001-68260		Bushing	65 mm		KOM-707-52-10660	22.57
	707-00-0E731	68261-		P-U-14	65 mm	120 mm	KOM-707-98-42150	76.73
	707-00-0E731	68261-		Bushing	65 mm		KOM-707-52-10660	22.57
BUCKET	707-00-0E740	65001-		P-U-14	65 mm	130 mm	KOM-707-98-42540	106.40
	707-00-0E740	65001-		Bushing	65 mm		KOM-707-52-10660	22.57
STEERING	707-00-0C190	65001-		P-U-14	40 mm	70 mm	KOM-707-99-14760	148.58
	707-00-0C190	65001-		Bushing	40 mm		KOM-07177-04025	9.33
MODEL WA250-1								
DUMP	707-01-15030	10001-		P-U-14	75 mm	150 mm	KOM-707-99-53500	232.68
LIFT	707-01-13520	10001-		P-U-14	70 mm	130 mm	KOM-707-99-43500	207.21
STEERING	707-00-01350	10629-		P-U-14	40 mm	70 mm	KOM-707-99-14610	82.48

LT - Large size tire L/S - Loading Shovel SLF - Super Long Front B/H - Backhoe HD - Heavy Duty L BUCKET - Large Bucket
 K-LINK - K-type Linkage Blade LB HI-LIFT - High Lift Arm w Large Bucket HI-LIFT - High Lift Arm S HI-LIFT - Super High Lift Arm
 SU - Semi-U Dozer PAT - Power Angle Power Tilt MP - Multi-Purpose

Replacement Kits For

KOMATSU®

Loaders - Wheel								
APPLICATION	CYL #	SERIAL #	Misc	CODE	ROD	BORE	KIT #	List \$
MODEL WA250-1								
STEERING	707-00-70131	10001-10628		P-U-14	40 mm	70 mm	KOM-707-99-14600	137.61
MODEL WA250-3								
LIFT	707-01-03151	50001-		P-U-14	70 mm	120 mm	KOM-707-99-43110	241.22
STEERING	707-00-01350-	50001-		P-U-14	40 mm	70 mm	KOM-707-99-14600	137.61
MODEL WA250-5								
BUCKET	418-63-33111	H50051-		P-U-14	75 mm	150 mm	KOM-418-63-05000	146.13
	418-63-33111	H50051-		Bushing	75 mm		KOM-707-52-10750	30.98
BUCKET (HI-LIFT)	418-850-3410	H50051-		P-U-14	75 mm	150 mm	KOM-418-63-05000	146.13
	418-850-3410	H50051-		Bushing	75 mm		KOM-707-52-10750	30.98
LIFT	418-63-32110	H50051-		P-U-14	70 mm	130 mm	KOM-418-62-05000	82.83
	418-63-32110	H50051-		Bushing	70 mm		KOM-707-52-10700	22.55
STEERING	419-63-H1120	H50051-		P-U-14	40 mm	70 mm	KOM-419-63-H0P12	148.58
MODEL WA250-5L								
BOOM	418-63-32110	A73001-		P-U-14	70 mm	130 mm	KOM-418-62-05000	82.83
	418-63-32110	A73001-		Bushing	70 mm		KOM-707-52-10700	22.55
BUCKET	418-63-33111	A73001-		P-U-14	75 mm	150 mm	KOM-418-63-05000	146.13
	418-63-33111	A73001-		Bushing	75 mm		KOM-707-52-10750	30.98
BUCKET (HI-LIFT)	418-850-3410	A73001-		P-U-14	75 mm	150 mm	KOM-418-63-05000	146.13
	418-850-3410	A73001-		Bushing	75 mm		KOM-707-52-10750	30.98
STEERING	707-00-0C190	A73001-		P-U-14	40 mm	70 mm	KOM-707-99-14760	148.58
	707-00-0C190	A73001-		Bushing	40 mm		KOM-07177-04025	9.33
MODEL WA250-6								
BOOM LIFT	418-63-32110	75001-	Z-BAR	P-U-14	70 mm	130 mm	KOM-418-62-05000	82.83
	418-63-32110	75001-	Z-BAR	Bushing	70 mm		KOM-707-52-10700	22.55
	418-63-32110	75053-		P-U-14	70 mm	130 mm	KOM-418-62-05000	82.83
	418-63-32110	75053-		Bushing	70 mm		KOM-707-52-10700	22.55
	418-63-32110	A76001-		P-U-14	70 mm	130 mm	KOM-418-62-05000	82.83
	418-63-32110	A76001-		Bushing	70 mm		KOM-707-52-10700	22.55
BUCKET	418-63-33111	75001-		P-U-14	75 mm	150 mm	KOM-418-63-05000	146.13
	418-63-33111	75001-		Bushing	75 mm		KOM-707-52-10750	30.98
	418-63-33111	75053-		P-U-14	70 mm	130 mm	KOM-418-62-05000	82.83
	418-63-33111	75053-		Bushing	75 mm		KOM-707-52-10750	30.98
	418-63-33111	A76001-		P-U-14	75 mm	150 mm	KOM-418-63-05000	146.13
	418-63-33111	A76001-		Bushing	75 mm		KOM-707-52-10750	30.98
	418-850-3410	75001-	High Lift	P-U-14	75 mm	150 mm	KOM-418-63-05000	146.13
	418-850-3410	75001-	High Lift	Bushing	75 mm		KOM-707-52-10750	30.98
	418-850-3410	75053-	High Lift	P-U-14	75 mm	150 mm	KOM-418-63-05000	146.13
	418-850-3410	75053-	High Lift	Bushing	75 mm		KOM-707-52-10750	30.98
	418-850-3410	A76001-	High Lift	P-U-14	75 mm	150 mm	KOM-418-63-05000	146.13
	418-850-3410	A76001-	High Lift	Bushing	75 mm		KOM-707-52-10750	30.98
STEERING LH	707-00-0H170	75001-		P-UB-14	40 mm	70 mm	KOM-707-99-14460	122.79
	707-00-0H170	75001-		Bushing	40 mm		KOM-07177-04025	9.33
	707-00-0H170	75053-		P-UB-14	40 mm	70 mm	KOM-707-99-14460	122.79
	707-00-0H170	75053-		Bushing	40 mm		KOM-707-52-15130	9.33
	707-00-0H170	A76001-		P-UB-14	40 mm	70 mm	KOM-707-99-14460	122.79
	707-00-0H170	A76001-		Bushing	40 mm		KOM-707-52-15130	9.33
STEERING RH	707-00-0H180	75001-		P-UB-14	40 mm	70 mm	KOM-707-99-14460	122.79
	707-00-0H180	75001-		Bushing	40 mm		KOM-07177-04025	9.33
	707-00-0H180	75053-		P-UB-14	40 mm	70 mm	KOM-707-99-14460	122.79
	707-00-0H180	75053-		Bushing	40 mm		KOM-707-52-15130	9.33
	707-00-0H180	A76001-		P-UB-14	40 mm	70 mm	KOM-707-99-14460	122.79
	707-00-0H180	A76001-		Bushing	40 mm		KOM-707-52-15130	9.33
MODEL WA250L-5								
BUCKET	418-63-33111	70001-		P-U-14	75 mm	150 mm	KOM-418-63-05000	146.13
	418-63-33111	70001-		Bushing	75 mm		KOM-707-52-10750	30.98

LT - Large size tire L/S - Loading Shovel SLF - Super Long Front B/H - Backhoe HD - Heavy Duty L BUCKET - Large Bucket
 K-LINK - K-type Linkage Blade LB HI-LIFT - High Lift Arm w Large Bucket HI-LIFT - High Lift Arm S HI-LIFT - Super High Lift Arm
 SU - Semi-U Dozer PAT - Power Angle Power Tilt MP - Mult-Purpose

Replacement Kits For

KOMATSU®

Loaders - Wheel									
APPLICATION	CYL #	SERIAL #	Misc	CODE	ROD	BORE	KIT #	List \$	
MODEL WA250L-5									
LIFT	418-63-32110	70001-		P-U-14	70 mm	130 mm	KOM-418-62-05000	82.83	
	418-63-32110	70001-		Bushing	70 mm		KOM-707-52-10700	22.55	
STEERING	707-00-0C190	70001-		P-U-14	40 mm	70 mm	KOM-707-99-14760	148.58	
	707-00-0C190	70001-		Bushing	40 mm		KOM-07177-04025	9.33	
MODEL WA250PT-5									
BUCKET	707-01-0F750	70001-		P-U-14	90 mm	180 mm	KOM-707-99-64450	258.22	
	707-01-0F750	70001-		Bushing	90 mm		KOM-707-52-10910	44.52	
LIFT	418-63-32110	70001-		P-U-14	70 mm	130 mm	KOM-418-62-05000	82.83	
	418-63-32110	70001-		Bushing	70 mm		KOM-707-52-10700	22.55	
STEERING	707-00-0C190	70001-		P-U-14	40 mm	70 mm	KOM-707-99-14760	148.58	
	707-00-0C190	70001-		Bushing	40 mm		KOM-07177-04025	9.33	
MODEL WA250PT-5L									
BOOM	418-63-32110	A79001-		P-U-14	70 mm	130 mm	KOM-418-62-05000	82.83	
	418-63-32110	A79001-		Bushing	70 mm		KOM-707-52-10700	22.55	
BUCKET	707-01-X7830	A79001-		P-U-14	90 mm	180 mm	KOM-707-99-64450	258.22	
	707-01-X7830	A79001-		Bushing	90 mm		KOM-707-52-10910	44.52	
COUPLER	707-00-02460	A79001-		P-U-10	20 mm	35 mm	KOM-707-00-02460K	50.48	
	707-00-02460	A79001-		Bushing	20 mm		KOM-707-52-10260	3.66	
STEERING	707-00-0C190	A79001-		P-U-14	40 mm	70 mm	KOM-707-99-14760	148.58	
	707-00-0C190	A79001-		Bushing	40 mm		KOM-07177-04025	9.33	
MODEL WA250PTL-5									
BUCKET	707-01-0E460	70001-		P-U-14	90 mm	180 mm	KOM-707-99-64450	258.22	
	707-01-0E460	70001-		Bushing	90 mm		KOM-707-52-10910	44.52	
LIFT	418-63-32110	70001-		P-U-14	70 mm	130 mm	KOM-418-62-05000	82.83	
	418-63-32110	70001-		Bushing	70 mm		KOM-707-52-10700	22.55	
MULTI-COUPLER	707-00-02460	70001-		P-U-10	20 mm	35 mm	KOM-707-00-02460K	50.48	
	707-00-02460	70001-		Bushing	20 mm		KOM-707-52-10260	3.66	
STEERING	707-00-0C190	70001-		P-U-14	40 mm	70 mm	KOM-707-99-14760	148.58	
	707-00-0C190	70001-		Bushing	40 mm		KOM-07177-04025	9.33	
MODEL WA250PZ-6									
BOOM LIFT	418-63-32110	75750-		P-U-14	70 mm	130 mm	KOM-418-62-05000	82.83	
	418-63-32110	75750-		Bushing	70 mm		KOM-707-52-10700	22.55	
BUCKET	707-01-0K592	75001-75749		P-U-14	100 mm	170 mm	KOM-707-99-65840	333.33	
	707-01-0K592	75001-75749		Bushing	100 mm		KOM-707-52-11010	59.52	
	707-01-0K592	75750-		P-U-14	100 mm	170 mm	KOM-707-99-65840	333.33	
	707-01-0K592	75750-		Bushing	100 mm		KOM-707-52-11011	59.52	
MULTI-COUPLER	707-00-02460	75750-75777		P-U-10	20 mm	35 mm	KOM-707-00-02460K	50.48	
	707-00-02460	75750-75777		Bushing	20 mm		KOM-707-52-10261	3.66	
STEERING LH	707-00-0H170	75001-75749		P-UB-14	40 mm	70 mm	KOM-707-99-14460	122.79	
	707-00-0H170	75001-75749		Bushing	40 mm		KOM-07177-04025	9.33	
	707-00-0H170	75750-75846	w/o auto-greasing	P-UB-14	40 mm	70 mm	KOM-707-99-14460	122.79	
	707-00-0H170	75750-75846	w/o auto-greasing	Bushing	40 mm		KOM-707-52-15130	9.33	
	707-00-0H170	75750-75864	w/ auto-greasing	P-UB-14	40 mm	70 mm	KOM-707-99-14460	122.79	
	707-00-0H170	75750-75864	w/ auto-greasing	Bushing	40 mm		KOM-707-52-15130	9.33	
	707-00-0H170	75847-	w/o auto-greasing	P-U-14	40 mm	70 mm	KOM-707-98-13700	122.82	
	707-00-0H170	75847-	w/o auto-greasing	Bushing	40 mm		KOM-707-52-15130	9.33	
	707-00-0H170	75865-	w/ auto-greasing	P-U-14	40 mm	70 mm	KOM-707-98-13700	122.82	
	707-00-0H170	75865-	w/ auto-greasing	Bushing	40 mm		KOM-707-52-15130	9.33	
STEERING RH	707-00-0H180	75001-75749		P-UB-14	40 mm	70 mm	KOM-707-99-14460	122.79	

LT - Large size tire L/S - Loading Shovel SLF - Super Long Front B/H - Backhoe HD - Heavy Duty L BUCKET - Large Bucket
 K-LINK - K-type Linkage Blade LB HI-LIFT - High Lift Arm w Large Bucket HI-LIFT - High Lift Arm S HI-LIFT - Super High Lift Arm
 SU - Semi-U Dozer PAT - Power Angle Power Tilt MP - Multit-Purpose

Replacement Kits For

KOMATSU®

Loaders - Wheel								
APPLICATION	CYL #	SERIAL #	Misc	CODE	ROD	BORE	KIT #	List \$
MODEL WA250PZ-6								
STEERING RH	707-00-0H180	75001-75749		Bushing	40 mm		KOM-07177-04025	9.33
	707-00-0H180	75750-	w/ auto-greasing	P-UB-14	40 mm	70 mm	KOM-707-99-14460	122.79
	707-00-0H180	75750-	w/ auto-greasing	Bushing	40 mm		KOM-707-52-15130	9.33
	707-00-0H180	75750-75846	w/o auto-greasing	P-UB-14	40 mm	70 mm	KOM-707-99-14460	122.79
	707-00-0H180	75750-75846	w/o auto-greasing	Bushing	40 mm		KOM-707-52-15130	9.33
	707-00-0H180	75847-	w/o auto-greasing	P-UB-14	40 mm	70 mm	KOM-707-99-14460	122.79
	707-00-0H180	75847-	w/o auto-greasing	Bushing	40 mm		KOM-707-52-15130	9.33
MODEL WA300-1								
CLAM	707-00-12040	10001-29999		P-U-14	60 mm	120 mm	KOM-707-99-41140	235.12
DUMP	707-01-16151	10001-29999		P-U-14	80 mm	160 mm	KOM-707-99-62010	212.99
GRAPPLE	707-00-10040	10001-29999		P-U-14	50 mm	100 mm	KOM-707-99-32100	133.67
LIFT	707-01-14131	10001-29999		P-U-14	80 mm	140 mm	KOM-707-99-54100	181.95
STEERING	707-00-70131	10001-29999		P-U-14	40 mm	70 mm	KOM-707-99-14600	137.61
MODEL WA320-1								
DUMP	707-01-03710	20001-29999		P-U-14	80 mm	160 mm	KOM-707-99-62020	202.70
	707-01-16151	10001-19999		P-U-14	80 mm	160 mm	KOM-707-99-62010	212.99
LIFT		20001-29999		P-U-14	75 mm	140 mm	KOM-707-99-53100	179.25
	707-01-03510	20001-29999		P-U-14	80 mm	140 mm	KOM-707-99-54100	181.95
	707-01-14131	10001-19999		P-U-14	80 mm	140 mm	KOM-707-99-54100	181.95
STEERING	707-00-01380	20001-29999		P-U-14	40 mm	70 mm	KOM-707-99-14610	82.48
	707-00-70131	10001-19999		P-U-14	40 mm	70 mm	KOM-707-99-14600	137.61
MODEL WA320-3								
DUMP		30001-		P-U-14	80 mm	160 mm	KOM-707-99-62020	202.70
		30001-		Bushing	80 mm		KOM-07177-08040	33.98
	707-01-02550	50001-, 53001-		P-U-14	80 mm	160 mm	KOM-707-99-62020	202.70
	707-01-03251	30001-		P-U-14	70 mm	130 mm	KOM-707-99-43520	299.25
GRAPPLE		30001-		P-U-14	50 mm	100 mm	KOM-707-99-32100	133.67
		30001-		Bushing	50 mm		KOM-07177-05030	15.54
LIFT		30001-		P-U-14	75 mm	140 mm	KOM-707-99-53100	179.25
	707-01-03510	50001-		P-U-14	80 mm	140 mm	KOM-707-99-54100	181.95
	707-01-03510	53001-53046		P-U-14	75 mm	140 mm	KOM-707-99-53100	179.25
	707-01-03510	53001-53046		Bushing	75 mm		KOM-707-52-10750	30.98
STEERING	707-00-01350	30001-, 53001-		P-U-14	40 mm	70 mm	KOM-707-99-14610	82.48
MODEL WA320-3L								
DUMP	707-01-03721	A30001-		P-U-14	80 mm	160 mm	KOM-707-99-62020	202.70
DUMP (HI-LIFT)	707-01-02440	A30001-		P-U-14	80 mm	160 mm	KOM-707-99-62020	202.70
LIFT	707-01-03511	A30001-		P-U-14	75 mm	140 mm	KOM-707-99-53100	179.25
STEERING	707-00-03310	A30001-		P-UB-14	40 mm	70 mm	KOM-707-99-14750	100.33
MODEL WA320-5L								
BOOM	707-01-0F060	A32001-		P-UB-14	75 mm	140 mm	KOM-707-99-53170	251.66
DUMP	707-01-0F080	A32001-		P-UB-14	80 mm	160 mm	KOM-707-99-62120	341.75
STEERING	707-00-0Z680	A32001-		P-UB-14	40 mm	70 mm	KOM-707-99-14770	153.53
MODEL WA320-6								
BOOM LIFT	707-01-0F060	70001-70290		P-UB-14	75 mm	140 mm	KOM-707-99-53170	251.66
	707-01-0F060	70001-70290		Bushing	75 mm		KOM-707-52-90520	26.10
	707-01-0F060	70291-		P-UB-14	75 mm	140 mm	KOM-707-99-53170	251.66
	707-01-0F060	70291-		Bushing	75 mm		KOM-707-52-90521	26.10
	707-01-0F060	A34001-		P-UB-14	75 mm	140 mm	KOM-707-99-53170	251.66
	707-01-0F060	A34001-		Bushing	75 mm		KOM-707-52-90521	26.10
	707-01-0F060	A35001-		P-UB-14	75 mm	140 mm	KOM-707-99-53170	251.66
	707-01-0F060	A35001-		Bushing	75 mm		KOM-707-52-90520	26.10

LT - Large size tire L/S - Loading Shovel SLF - Super Long Front B/H - Backhoe HD - Heavy Duty L BUCKET - Large Bucket

K-LINK - K-type Linkage Blade LB HI-LIFT - High Lift Arm w Large Bucket HI-LIFT - High Lift Arm S HI-LIFT - Super High Lift Arm

SU - Semi-U Dozer PAT - Power Angle Power Tilt MP - Mult-Purpose

KOMATSU®

Replacement Kits For

KOMATSU®

Loaders - Wheel								
APPLICATION	CYL #	SERIAL #	Misc	CODE	ROD	BORE	KIT #	List \$
MODEL WA320-6								
BUCKET	707-01-0F080	70001-70290		P-UB-14	80 mm	160 mm	KOM-707-99-62120	341.75
	707-01-0F080	70001-70290		Bushing	80 mm		KOM-707-52-90560	31.26
	707-01-0F080	70291-		P-UB-14	80 mm	160 mm	KOM-707-99-62120	341.75
	707-01-0F080	70291-		Bushing	80 mm		KOM-707-52-90561	31.26
	707-01-0F080	A34001-		P-UB-14	80 mm	160 mm	KOM-707-99-62120	341.75
	707-01-0F080	A34001-		Bushing	80 mm		KOM-707-52-90561	31.26
	707-01-0F080	A35001-		P-UB-14	80 mm	160 mm	KOM-707-99-62120	341.75
	707-01-0F080	A35001-		Bushing	80 mm		KOM-707-52-90560	31.26
	707-01-0F940	70001-70290	High Lift	P-UB-14	80 mm	160 mm	KOM-707-99-62120	341.75
	707-01-0F940	70001-70290	High Lift	Bushing	80 mm		KOM-707-52-90560	31.26
	707-01-0F940	70291-	High Lift	P-UB-14	80 mm	160 mm	KOM-707-99-62120	341.75
	707-01-0F940	70291-	High Lift	Bushing	80 mm		KOM-707-52-90561	31.26
	707-01-0F940	A34001-	High Lift	P-UB-14	80 mm	160 mm	KOM-707-99-62120	341.75
	707-01-0F940	A34001-	High Lift	Bushing	80 mm		KOM-707-52-90561	31.26
	707-01-0F940	A35001-	High Lift	P-UB-14	80 mm	160 mm	KOM-707-99-62120	341.75
	707-01-0F940	A35001-	High Lift	Bushing	80 mm		KOM-707-52-90560	31.26
707-01-0G220	70291-	Large Capacity	P-UB-14	90 mm	180 mm	KOM-707-99-64570	215.57	
707-01-0G220	70291-	Large Capacity	Bushing	90 mm		KOM-707-52-90681	36.70	
STEERING LH	707-00-0H470	70001-70290		P-UB-14	40 mm	70 mm	KOM-707-99-14790	164.82
	707-00-0H470	70001-70290		Bushing	40 mm		KOM-707-52-90150	9.33
	707-00-0H470	70291-		P-UB-14	40 mm	70 mm	KOM-707-99-14790	164.82
	707-00-0H470	70291-		Bushing	40 mm		KOM-707-52-90151	9.33
	707-00-0H470	A34001-		P-UB-14	40 mm	70 mm	KOM-707-99-14790	164.82
	707-00-0H470	A34001-		Bushing	40 mm		KOM-707-52-90150	9.33
	707-00-0H470	A35001-		P-UB-14	40 mm	70 mm	KOM-707-99-14790	164.82
	707-00-0H470	A35001-		Bushing	40 mm		KOM-707-52-90150	9.33
STEERING RH	707-00-0H480	70001-70290		P-UB-14	40 mm	70 mm	KOM-707-99-14790	164.82
	707-00-0H480	70001-70290		Bushing	40 mm		KOM-707-52-90150	9.33
	707-00-0H480	70291-		P-UB-14	40 mm	70 mm	KOM-707-99-14790	164.82
	707-00-0H480	70291-		Bushing	40 mm		KOM-707-52-90151	9.33
	707-00-0H480	A34001-		P-UB-14	40 mm	70 mm	KOM-707-99-14790	164.82
	707-00-0H480	A34001-		Bushing	40 mm		KOM-707-52-90150	9.33
	707-00-0H480	A35001-		P-UB-14	40 mm	70 mm	KOM-707-99-14790	164.82
	707-00-0H480	A35001-		Bushing	40 mm		KOM-707-52-90150	9.33
MODEL WA320PT-5L								
BOOM LIFT	707-01-0F060	A39001-		P-UB-14	75 mm	140 mm	KOM-707-99-53170	251.66
	707-01-0F060	A39001-		Bushing	75 mm		KOM-707-52-90520	26.10
BUCKET	707-01-0G890	A39001-		P-UB-14	100 mm	200 mm	KOM-707-99-73160	523.95
	707-01-0G890	A39001-		Bushing	100 mm		KOM-707-52-90760	41.00
MULTI-COUPLER LOCK	707-00-02460	A39001-		P-U-10	20 mm	35 mm	KOM-707-00-02460K	50.48
	707-00-02460	A39001-		Bushing	20 mm		KOM-707-52-10260	3.66
STEERING	707-00-0Z680	A39001-		P-UB-14	40 mm	70 mm	KOM-707-99-14770	153.53
	707-00-0Z680	A39001-		Bushing	40 mm		KOM-707-52-90150	9.33
MODEL WA320PZ-6								
BOOM LIFT	707-01-0AH40	70001-		P-U-14	75 mm	140 mm	KOM-707-99-53270	112.01
	707-01-0AH40	70001-		Bushing	75 mm		KOM-707-52-90520	26.10
	707-01-0AH40	70452-		P-U-14	75 mm	140 mm	KOM-707-99-53270	112.01
	707-01-0AH40	70452-		Bushing	75 mm		KOM-707-52-90521	26.10
BUCKET	707-01-0AH51	70001-		P-UB-14	110 mm	180 mm	KOM-707-99-67690	250.66
	707-01-0AH51	70001-		Bushing	110 mm		KOM-707-52-90850	45.85
	707-01-0AH51	70452-		P-UB-14	110 mm	180 mm	KOM-707-99-67690	250.66
	707-01-0AH51	70452-		Bushing	110 mm		KOM-707-52-90851	45.85
MULTI-COUPLER LOCK	707-00-02460	70452-		P-U-10	20 mm	35 mm	KOM-707-00-02460K	50.48

LT - Large size tire L/S - Loading Shovel SLF - Super Long Front B/H - Backhoe HD - Heavy Duty L BUCKET - Large Bucket
 K-LINK - K-type Linkage Blade LB HI-LIFT - High Lift Arm w Large Bucket HI-LIFT - High Lift Arm S HI-LIFT - Super High Lift Arm
 SU - Semi-U Dozer PAT - Power Angle Power Tilt MP - Mult-Purpose

Replacement Kits For

KOMATSU®

Loaders - Wheel								
APPLICATION	CYL #	SERIAL #	Misc	CODE	ROD	BORE	KIT #	List \$
MODEL WA320PZ-6								
MULTI-COUPLER LOCK	707-00-02460	70452-		Bushing	20 mm		KOM-707-52-10261	3.66
STEERING LH	707-00-0H470	70001-		P-UB-14	40 mm	70 mm	KOM-707-99-14790	164.82
	707-00-0H470	70001-		Bushing	40 mm		KOM-707-52-90150	9.33
	707-00-0H470	70452-		P-UB-14	40 mm	70 mm	KOM-707-99-14790	164.82
	707-00-0H470	70452-		Bushing	40 mm		KOM-707-52-90151	9.33
STEERING RH	707-00-0H480	70001-		P-UB-14	40 mm	70 mm	KOM-707-99-14790	164.82
	707-00-0H480	70001-		Bushing	40 mm		KOM-707-52-90150	9.33
	707-00-0H480	70452-		P-UB-14	40 mm	70 mm	KOM-707-99-14790	164.82
	707-00-0H480	70452-		Bushing	40 mm		KOM-707-52-90151	9.33
MODEL WA350-1								
CLAM	707-00-12030	10001-		P-U-14	60 mm	120 mm	KOM-707-99-41140	235.12
DUMP	707-01-03700	20001-		P-U-14	90 mm	180 mm	KOM-707-99-64410	216.03
	707-01-18081	10001-19999	HIGH LIFT	P-U-14	90 mm	180 mm	KOM-707-99-64400	314.07
	707-01-18081	10001-19999	HIGH LIFT	Bushing	90 mm		KOM-07177-09035	39.34
	707-01-18082	10001-11357		P-U-14	90 mm	180 mm	KOM-707-99-64400	314.07
	707-01-18082	10001-11357		Bushing	90 mm		KOM-07177-09035	39.34
	707-01-18083	11358-19999		P-U-14	90 mm	180 mm	KOM-707-99-64400	314.07
707-01-18083	11358-19999		Bushing	90 mm		KOM-07177-09035	39.34	
GRAPPLE	707-00-10040	10001-		P-U-14	50 mm	100 mm	KOM-707-99-32100	133.67
LIFT	707-01-03500	20001-		P-U-14	85 mm	150 mm	KOM-707-99-55500	194.01
	707-01-15071	10001-19999		P-U-14	90 mm	150 mm	KOM-707-99-56500	244.74
STEERING	707-00-01800	20001-		P-U-14	45 mm	80 mm	KOM-707-99-24120	116.62
	707-00-80021	10001-19999		P-U-14	45 mm	80 mm	KOM-707-99-24110	120.42
MODEL WA380-1								
DUMP	707-01-03700	20001-		P-U-14	90 mm	180 mm	KOM-707-99-64400	314.07
	707-01-18082	10001-19999		P-U-14	90 mm	180 mm	KOM-707-99-64400	314.07
	707-01-18082	10001-19999		Bushing	90 mm		KOM-07177-09035	39.34
LIFT	707-01-01080	20001-		P-U-14	90 mm	160 mm	KOM-707-99-64010	207.99
	707-01-16280	10001-19999		P-U-14	90 mm	160 mm	KOM-707-99-64010	207.99
STEERING	707-00-01800	20001-		P-U-14	45 mm	80 mm	KOM-707-99-24120	116.62
	707-00-80021	10001-19999		P-U-14	45 mm	80 mm	KOM-707-99-24110	120.42
MODEL WA380-3								
DUMP	707-01-03290	50001-		P-U-14	90 mm	180 mm	KOM-707-99-64410	216.03
	707-01-03290	50001-		Bushing	90 mm		KOM-707-52-10910	44.52
	707-01-03290	A50001-		P-U-14	90 mm	180 mm	KOM-707-99-64410	216.03
	707-01-03290	A50001-		Bushing	90 mm		KOM-707-52-10910	44.52
LIFT	707-01-01080	50001-		P-UB-14	90 mm	160 mm	KOM-707-99-64040	300.16
	707-01-01080	50001-		Bushing	90 mm		KOM-07177-09035	39.34
LIFT ARM	707-01-01080	A50001-		P-UB-14	90 mm	160 mm	KOM-707-99-64040	300.16
LIFT ARM (HI-LIFT)	707-01-02210	A50001-		P-UB-14	90 mm	160 mm	KOM-707-99-64040	300.16
STEERING	707-00-01800	50001-		P-U-14	45 mm	80 mm	KOM-707-99-24120	116.62
	707-00-01800	50001-		Bushing	45 mm		KOM-07177-04530	12.81
	707-00-01800	A50001-		P-U-14	45 mm	80 mm	KOM-707-99-24120	116.62
MODEL WA380-5L								
BOOM LH	707-01-0A790	A52001-		P-UB-14	90 mm	160 mm	KOM-707-99-64080	262.78
BOOM RH	707-01-0A800	A52001-		P-UB-14	90 mm	160 mm	KOM-707-99-64080	262.78
DUMP	707-01-0A810	A52001-		P-UB-14	90 mm	180 mm	KOM-707-99-64540	301.44
DUMP (HI-LIFT)	707-01-XC990	A52001-		P-UB-14	90 mm	180 mm	KOM-707-99-64540	301.44
DUMP (Logging)	707-01-XE090	A52001-		P-UB-14	100 mm	200 mm	KOM-707-99-73160	523.95
STEERING	707-00-07F80	A52001-		P-UB-14	45 mm	90 mm	KOM-707-99-24630	195.47
MODEL WA380-6								
BOOM LIFT LH	707-01-0K160	65001-65948		P-UB-14	90 mm	130 mm	KOM-707-99-48620	165.21
	707-01-0K160	65001-65948		Bushing	90 mm		KOM-707-52-90680	36.70
	707-01-0K160	65949-		P-UB-14	90 mm	130 mm	KOM-707-99-48620	165.21
	707-01-0K160	65949-		Bushing	90 mm		KOM-707-52-90681	36.70

LT - Large size tire L/S - Loading Shovel SLF - Super Long Front B/H - Backhoe HD - Heavy Duty L BUCKET - Large Bucket
 K-LINK - K-type Linkage Blade LB HI-LIFT - High Lift Arm w Large Bucket HI-LIFT - High Lift Arm S HI-LIFT - Super High Lift Arm
 SU - Semi-U Dozer PAT - Power Angle Power Tilt MP - Mult-Purpose

Replacement Kits For

KOMATSU®

Loaders - Wheel								
APPLICATION	CYL #	SERIAL #	Misc	CODE	ROD	BORE	KIT #	List \$
MODEL WA380-6								
BOOM LIFT LH	707-01-0K160	A53001-		P-UB-14	90 mm	130 mm	KOM-707-99-48620	165.21
	707-01-0K160	A53001-		Bushing	90 mm		KOM-707-52-90681	36.70
	707-01-0K160	A54001-		P-UB-14	90 mm	130 mm	KOM-707-99-48620	165.21
	707-01-0K160	A54001-		Bushing	90 mm		KOM-707-52-90681	36.70
BOOM LIFT RH	707-01-0K170	65001-65948		P-UB-14	90 mm	130 mm	KOM-707-99-48620	165.21
	707-01-0K170	65001-65948		Bushing	90 mm		KOM-707-52-90680	36.70
	707-01-0K170	65949-		P-UB-14	90 mm	130 mm	KOM-707-99-48620	165.21
	707-01-0K170	65949-		Bushing	90 mm		KOM-707-52-90681	36.70
	707-01-0K170	A53001-		P-UB-14	90 mm	130 mm	KOM-707-99-48620	165.21
	707-01-0K170	A53001-		Bushing	90 mm		KOM-707-52-90681	36.70
	707-01-0K170	A54001-		P-UB-14	90 mm	130 mm	KOM-707-99-48620	165.21
	707-01-0K170	A54001-		Bushing	90 mm		KOM-707-52-90681	36.70
BUCKET	707-01-0K180	65001-65948		P-UB-14	90 mm	150 mm	KOM-707-99-56620	303.61
	707-01-0K180	65001-65948		Bushing	90 mm		KOM-707-52-90680	36.70
	707-01-0K180	65949-		P-UB-14	90 mm	150 mm	KOM-707-99-56620	303.61
	707-01-0K180	65949-		Bushing	90 mm		KOM-707-52-90681	36.70
	707-01-0K180	A53001-		P-UB-14	90 mm	150 mm	KOM-707-99-56620	303.61
	707-01-0K180	A53001-		Bushing	90 mm		KOM-707-52-90681	36.70
	707-01-0K180	A54001-		P-UB-14	90 mm	150 mm	KOM-707-99-56620	303.61
	707-01-0K180	A54001-		Bushing	90 mm		KOM-707-52-90681	36.70
	707-01-0L400	65001-65948	Large Bucket	P-UB-14	100 mm	160 mm	KOM-707-99-66380	251.13
	707-01-0L400	65001-65948	Large Bucket	Bushing	100 mm		KOM-707-52-90780	41.68
	707-01-0L400	65949-	Large Bucket	P-UB-14	100 mm	160 mm	KOM-707-99-66380	251.13
	707-01-0L400	65949-	Large Bucket	Bushing	100 mm		KOM-707-52-90781	41.68
	707-01-0L400	A53001-	Large Bucket	P-UB-14	100 mm	160 mm	KOM-707-99-66380	251.13
	707-01-0L400	A53001-	Large Bucket	Bushing	100 mm		KOM-707-52-90781	41.68
	707-01-0L400	A54001-	Large Bucket	P-UB-14	100 mm	160 mm	KOM-707-99-66380	251.13
	707-01-0L400	A54001-	Large Bucket	Bushing	100 mm		KOM-707-52-90781	41.68
	707-01-0L840	65001-65948	High Lift	P-UB-14	90 mm	150 mm	KOM-707-99-56620	303.61
	707-01-0L840	65001-65948	High Lift	Bushing	90 mm		KOM-707-52-90680	36.70
	707-01-0L840	65949-	High Lift	P-UB-14	90 mm	150 mm	KOM-707-99-56620	303.61
	707-01-0L840	65949-	High Lift	Bushing	90 mm		KOM-707-52-90681	36.70
	707-01-0L840	A53001-	High Lift	P-UB-14	90 mm	150 mm	KOM-707-99-56620	303.61
	707-01-0L840	A53001-	High Lift	Bushing	90 mm		KOM-707-52-90681	36.70
	707-01-0L840	A54001-	High Lift	P-UB-14	90 mm	150 mm	KOM-707-99-56620	303.61
	707-01-0L840	A54001-	High Lift	Bushing	90 mm		KOM-707-52-90681	36.70
LOCK MULTI-COUPLER	707-04-50190	A54001-		P-U-10	25 mm	50 mm	KOM-707-99-03420	60.46
	707-04-50190	A54001-		Bushing	25 mm		KOM-07177-02525	5.46
STEERING	707-00-0F510	A53001-		P-UB-14	45 mm	75 mm	KOM-707-98-23880	165.04
	707-00-0F510	A53001-		Bushing	45 mm		KOM-707-52-90220	9.33
	707-00-0F510	A54001-		P-UB-14	45 mm	75 mm	KOM-707-98-23880	165.04
	707-00-0F510	A54001-		Bushing	45 mm		KOM-707-52-90220	9.33
	707-00-0G780	65056-65948		P-UB-14	45 mm	75 mm	KOM-707-99-15810	185.08
	707-00-0G780	65056-65948		Bushing	45 mm		KOM-707-52-90220	9.33
	707-00-0G780	65949-		P-UB-14	45 mm	75 mm	KOM-707-99-15810	185.08
	707-00-0G780	65949-		Bushing	45 mm		KOM-707-52-90221	9.33
	707-00-0Y200	65001-65055		P-UB-14	45 mm	75 mm	KOM-707-98-23880	165.04
	707-00-0Y200	65001-65055		Bushing	45 mm		KOM-707-52-90220	9.33
MODEL WA380-7								
BOOM LIFT LH	707-E1-00920	10001-		P-UB-14	90 mm	130 mm	KOM-707-99-48630	243.47
	707-E1-00920	10001-		Bushing	90 mm		KOM-707-52-90681	36.70
	707-E1-00920	A64001-		P-UB-14	90 mm	130 mm	KOM-707-99-48630	243.47
	707-E1-00920	A64001-		Bushing	90 mm		KOM-707-52-90681	36.70
BOOM LIFT RH	707-E1-00930	10001-		P-UB-14	90 mm	130 mm	KOM-707-99-48630	243.47
	707-E1-00930	10001-		Bushing	90 mm		KOM-707-52-90681	36.70

LT - Large size tire L/S - Loading Shovel SLF - Super Long Front B/H - Backhoe HD - Heavy Duty L BUCKET - Large Bucket
 K-LINK - K-type Linkage Blade LB HI-LIFT - High Lift Arm w Large Bucket HI-LIFT - High Lift Arm S HI-LIFT - Super High Lift Arm
 SU - Semi-U Dozer PAT - Power Angle Power Tilt MP - Multit-Purpose

Replacement Kits For

KOMATSU®

Loaders - Wheel								
APPLICATION	CYL #	SERIAL #	Misc	CODE	ROD	BORE	KIT #	List \$
MODEL WA380-7								
BOOM LIFT RH	707-E1-00930	A64001-		P-UB-14	90 mm	130 mm	KOM-707-99-48630	243.47
	707-E1-00930	A64001-		Bushing	90 mm		KOM-707-52-90681	36.70
BUCKET	707-E1-00950	10001-	Large Bucket	P-UB-14	90 mm	150 mm	KOM-707-99-56730	372.17
	707-E1-00950	10001-	Large Bucket	Bushing	90 mm		KOM-707-52-90681	36.70
	707-E1-00950	A64001-		P-UB-14	90 mm	150 mm	KOM-707-99-56730	372.17
	707-E1-00950	A64001-		Bushing	90 mm		KOM-707-52-90681	36.70
STEERING	707-E0-00220	10001-		P-UB-14	45 mm	75 mm	KOM-707-99-15760	153.98
	707-E0-00220	10001-		Bushing	45 mm		KOM-707-52-90221	9.33
	707-E0-00220	A64001-		P-UB-14	45 mm	75 mm	KOM-707-99-15760	153.98
	707-E0-00220	A64001-		Bushing	45 mm		KOM-707-52-90221	9.33
MODEL WA400-1								
DUMP	707-01-03271	20001-		P-U-14	100 mm	200 mm	KOM-707-99-73020	183.34
	707-01-20081	10001-19999		P-U-14	100 mm	200 mm	KOM-707-99-73010	199.50
LIFT	707-01-01070	20001-		P-U-14	90 mm	160 mm	KOM-707-99-64010	207.99
	707-01-16081	10001-19999		P-U-14	100 mm	160 mm	KOM-707-99-66010	146.93
LOG GRAPPLE	707-01-13260	10001-19999		P-U-14	70 mm	130 mm	KOM-707-99-43540	272.45
LUMBER GRAPPLE	707-00-10040	10001-19999		P-U-14	50 mm	100 mm	KOM-707-99-32100	133.67
STEERING	707-00-01820	20001-		P-U-14	45 mm	90 mm	KOM-707-99-24510	74.75
	707-00-90221	10001-19999		P-U-14	45 mm	90 mm	KOM-707-99-24500	129.55
MODEL WA420-1								
DUMP	707-01-01270	20001-		P-U-14	100 mm	200 mm	KOM-707-99-73010	199.50
	707-01-20083	10001-19999		P-U-14	100 mm	200 mm	KOM-707-99-73010	199.50
LIFT	707-01-01070	20001-		P-U-14	90 mm	160 mm	KOM-707-99-64010	207.99
	707-01-16081	10001-19999		P-U-14	100 mm	160 mm	KOM-707-99-66010	146.93
STEERING	707-00-01820	20001-		P-U-14	45 mm	90 mm	KOM-707-99-24510	74.75
	707-00-90221	10001-19999		P-U-14	45 mm	90 mm	KOM-707-99-24500	129.55
MODEL WA420-3								
DUMP	707-01-03272	30001-		P-U-14	100 mm	200 mm	KOM-707-99-73020	183.34
	707-01-03272	30001-		Bushing	100 mm		KOM-707-52-11010	59.52
LIFT	707-01-03081	30001-		P-U-14	90 mm	160 mm	KOM-707-99-64030	292.14
	707-01-03081	30001-		Bushing	90 mm		KOM-707-52-10910	44.52
STEERING	707-00-01820	30001-		P-U-14	45 mm	90 mm	KOM-707-99-24510	74.75
	707-00-01820	30001-		Bushing	45 mm		KOM-07177-04530	12.81
MODEL WA430-6								
BUCKET	707-01-0K830	65001-		P-UB-14	100 mm	160 mm	KOM-707-99-66380	251.13
	707-01-0K830	A14001-	Large Bucket	P-UB-14	100 mm	160 mm	KOM-707-99-66380	251.13
	707-01-0L840	65001-	Hi-Lift Bucket	P-UB-14	90 mm	150 mm	KOM-707-99-56620	303.61
	707-01-0L840	A14001-	Hi-Lift Bucket	P-UB-14	90 mm	150 mm	KOM-707-99-56620	303.61
LIFT LH	707-01-0AL40	65340-		P-UB-14	95 mm	135 mm	KOM-707-99-50740	205.60
	707-01-0AL40	A14001-		P-UB-14	95 mm	135 mm	KOM-707-99-50740	205.60
	707-01-0K810	65001-65339		P-UB-14	90 mm	130 mm	KOM-707-99-47860	186.82
LIFT RH	707-01-0AL50	65340-		P-UB-14	95 mm	135 mm	KOM-707-99-50740	205.60
	707-01-0AL50	A14001-		P-UB-14	95 mm	135 mm	KOM-707-99-50740	205.60
	707-01-0K820	65001-65339		P-UB-14	90 mm	130 mm	KOM-707-99-47860	186.82
STEERING	707-00-XX750	65001-		P-UB-14	45 mm	75 mm	KOM-707-99-15810	185.08
	707-00-XX750	A14001-		P-UB-14	45 mm	75 mm	KOM-707-99-15810	185.08
MODEL WA450-1								
DUMP	707-01-03250	20001-		P-U-14	100 mm	200 mm	KOM-707-99-73020	183.34
	707-01-20121	10001-19999		P-U-14	100 mm	200 mm	KOM-707-99-73010	199.50
LIFT	707-01-03050	20001-		P-U-14	95 mm	180 mm	KOM-707-99-65400	223.42
	707-01-18121	10001-19999		P-U-14	100 mm	180 mm	KOM-707-99-66400	290.10
STEERING	707-00-01840	20001-		P-U-14	50 mm	100 mm	KOM-707-99-32110	111.82
	707-00-01940	20001-		P-U-14	50 mm	100 mm	KOM-707-99-32110	111.82
	707-00-10211	10001-19999		P-U-14	50 mm	100 mm	KOM-707-99-32100	133.67
	707-00-10231	10001-19999		P-U-14	50 mm	100 mm	KOM-707-99-32100	133.67

LT - Large size tire L/S - Loading Shovel SLF - Super Long Front B/H - Backhoe HD - Heavy Duty L BUCKET - Large Bucket
 K-LINK - K-type Linkage Blade LB HI-LIFT - High Lift Arm w Large Bucket HI-LIFT - High Lift Arm S HI-LIFT - Super High Lift Arm
 SU - Semi-U Dozer PAT - Power Angle Power Tilt MP - Mult-Purpose

Replacement Kits For

KOMATSU®

Loaders - Wheel								
APPLICATION	CYL #	SERIAL #	Misc	CODE	ROD	BORE	KIT #	List \$
MODEL WA450-2								
DUMP	707-01-03250	A25001-		P-U-14	100 mm	200 mm	KOM-707-99-73020	183.34
	707-01-03250	A25001-		Bushing	100 mm		KOM-707-52-11010	59.52
LIFT	707-01-03050	A25001-		P-U-14	95 mm	180 mm	KOM-707-99-65400	223.42
STEERING LH	707-00-01840	A25001-		P-U-14	50 mm	100 mm	KOM-707-99-32110	111.82
	707-00-01840	A25001-		Bushing	50 mm		KOM-07177-05030	15.54
STEERING RH	707-00-01940	A25001-		P-U-14	50 mm	100 mm	KOM-707-99-32110	111.82
	707-00-01940	A25001-		Bushing	50 mm		KOM-07177-05030	15.54
MODEL WA450-3								
DUMP	707-01-03251	30001		P-U-14	100 mm	200 mm	KOM-707-99-73020	183.34
	707-01-03251	30001		Bushing	100 mm		KOM-707-52-11010	59.52
LIFT	707-01-03150	30001		P-U-14	95 mm	180 mm	KOM-707-99-65400	223.42
STEERING LH	707-00-01840	30001		P-U-14	50 mm	100 mm	KOM-707-99-32110	111.82
	707-00-01840	30001		Bushing	50 mm		KOM-07177-05030	15.54
STEERING RH	707-00-01940	30001		P-U-14	50 mm	100 mm	KOM-707-99-32110	111.82
	707-00-01940	30001		Bushing	50 mm		KOM-07177-05030	15.54
MODEL WA450-5L								
DUMP	707-01-0A270	A36001-		P-UB-14	100 mm	200 mm	KOM-707-99-73150	410.37
	707-13-20222	A36001-		P-UB-14	100 mm	200 mm	KOM-707-99-73150	410.37
DUMP (HI-LIFT)	707-01-0C390	A36001-		P-UB-14	100 mm	200 mm	KOM-707-99-73150	410.37
	707-13-20222	A36001-		P-UB-14	120 mm	225 mm	KOM-707-99-75490	708.37
DUMP (L BUCKET)	707-01-0A691	A36001-		P-UB-14	120 mm	225 mm	KOM-707-99-75490	708.37
	707-13-22070	A36001-		P-UB-14	120 mm	225 mm	KOM-707-99-75490	708.37
LIFT LH	707-01-0A250	A36001-		P-UB-14	95 mm	180 mm	KOM-707-99-65420	237.84
	707-13-18231	A36001-		P-UB-14	95 mm	180 mm	KOM-707-99-65420	237.84
LIFT RH	707-01-0A260	A36001-		P-UB-14	95 mm	180 mm	KOM-707-99-65420	237.84
	707-13-18241	A36001-		P-UB-14	95 mm	180 mm	KOM-707-99-65420	237.84
STEERING LH	707-00-07D90	A36001-		P-UB-14	50 mm	100 mm	KOM-707-99-32250	233.40
	707-11-10A81	A36001-		P-UB-14	50 mm	100 mm	KOM-707-99-32250	233.40
STEERING RH	707-00-07E00	A36001-		P-UB-14	50 mm	100 mm	KOM-707-99-32250	233.40
	707-11-10A91	A36001-		P-UB-14	50 mm	100 mm	KOM-707-99-32250	233.40
MODEL WA450-6								
BUCKET	707-01-0K630	66001-		P-UB-14	100 mm	160 mm	KOM-707-99-66360	526.87
DUMP	707-13-16190	66001-		P-UB-14	100 mm	160 mm	KOM-707-99-66360	526.87
LIFT LH	707-01-0K610	66001-		P-UB-14	95 mm	140 mm	KOM-707-99-57310	356.50
	707-13-14910	66001-		P-UB-14	95 mm	140 mm	KOM-707-99-57310	356.50
LIFT RH	707-01-0K620	66001-		P-UB-14	95 mm	140 mm	KOM-707-99-57310	356.50
	707-13-14920	66001-		P-UB-14	95 mm	140 mm	KOM-707-99-57310	356.50
STEERING LH	707-00-0G760	66001-		P-UB-14	50 mm	90 mm	KOM-707-99-25710	205.48
	721-11-90750	66001-		P-UB-14	50 mm	90 mm	KOM-707-99-25710	205.48
STEERING RH	707-00-0G770	66001-		P-UB-14	50 mm	90 mm	KOM-707-99-25710	205.48
	721-11-90760	66001-		P-UB-14	50 mm	90 mm	KOM-707-99-25710	205.48
MODEL WA470-1								
DUMP	707-01-03250	20001-		P-U-14	100 mm	200 mm	KOM-707-99-73020	183.34
	707-01-20121	10001-19999		P-U-14	100 mm	200 mm	KOM-707-99-73010	199.50
LIFT	707-01-03050	20001-		P-U-14	95 mm	180 mm	KOM-707-99-65400	223.42
	707-01-18121	10001-19999		P-U-14	100 mm	180 mm	KOM-707-99-66400	290.10
STEERING	707-00-01840	20001-		P-U-14	50 mm	100 mm	KOM-707-99-32110	111.82
	707-00-01940	20001-		P-U-14	50 mm	100 mm	KOM-707-99-32110	111.82
	707-00-10211	10001-19999		P-U-14	50 mm	100 mm	KOM-707-99-32100	133.67
	707-00-10231	10001-19999		P-U-14	50 mm	100 mm	KOM-707-99-32100	133.67
MODEL WA470-3								
DUMP	421-63-H3020	-H20942		P-UB-14	100 mm	200 mm	KOM-421-63-H0P05	518.74
	421-63-H3021	H20943-		P-UB-14	100 mm	200 mm	KOM-707-99-H0P03	518.74
	707-01-03251	50001-52999		P-U-14	100 mm	200 mm	KOM-707-99-73020	183.34
	707-01-08691	53001-		P-U-14	100 mm	200 mm	KOM-707-99-73020	183.34

LT - Large size tire L/S - Loading Shovel SLF - Super Long Front B/H - Backhoe HD - Heavy Duty L BUCKET - Large Bucket
 K-LINK - K-type Linkage Blade LB HI-LIFT - High Lift Arm w Large Bucket HI-LIFT - High Lift Arm S HI-LIFT - Super High Lift Arm
 SU - Semi-U Dozer PAT - Power Angle Power Tilt MP - Multit-Purpose

Replacement Kits For

KOMATSU®

Loaders - Wheel								
APPLICATION	CYL #	SERIAL #	Misc	CODE	ROD	BORE	KIT #	List \$
MODEL WA470-3								
DUMP (HI-LIFT)	421-V50-H021	H20942-		P-UB-14	100 mm	200 mm	KOM-707-99-H0P03	518.74
DUMP (MAGNUM)	421-V58-H021	H20942-		P-UB-14	100 mm	200 mm	KOM-707-99-H0P03	518.74
LIFT	421-63-H2020	-H20946		P-U-14	95 mm	180 mm	KOM-707-99-H0P01	458.41
	421-63-H2021	H20947-		P-UB-14	95 mm	180 mm	KOM-707-99-H0P10	497.93
	707-01-03150	50001-52999		P-U-14	95 mm	180 mm	KOM-707-99-65400	223.42
	707-01-08621	53001-		P-U-14	95 mm	180 mm	KOM-707-99-65400	223.42
STEERING	707-00-01840	50001-52999		P-U-14	50 mm	100 mm	KOM-707-99-32110	111.82
	707-00-01940	50001-52999		P-U-14	50 mm	100 mm	KOM-707-99-32110	111.82
	707-00-08741	53001-		P-U-14	50 mm	100 mm	KOM-707-99-32110	111.82
	707-00-08751	53001-		P-U-14	50 mm	100 mm	KOM-707-99-32110	111.82
STEERING LH	707-00-H1841	H20942-		P-UB-14	50 mm	100 mm	KOM-707-99-H0P11	202.43
STEERING RH	707-00-H1941	H20942-		P-UB-14	50 mm	100 mm	KOM-707-99-H0P11	202.43
MODEL WA470-5								
DUMP	707-01-0A270	70001-		P-UB-14	100 mm	200 mm	KOM-707-99-73150	410.37
DUMP (HI-LIFT)	707-01-0C390	70001-		P-UB-14	100 mm	200 mm	KOM-707-99-73150	410.37
DUMP (L BUCKET)	707-01-0A691	70001-		P-UB-14	120 mm	225 mm	KOM-707-99-75490	708.37
LIFT LH	707-01-0A250	70001-		P-UB-14	95 mm	180 mm	KOM-707-99-65420	237.84
LIFT RH	707-01-0A260	70001-		P-UB-14	95 mm	180 mm	KOM-707-99-65420	237.84
STEERING LH	707-00-0A500	70001-		P-UB-14	50 mm	100 mm	KOM-707-99-32250	233.40
STEERING RH	707-00-0A510	70001-		P-UB-14	50 mm	100 mm	KOM-707-99-32250	233.40
MODEL WA500-1								
DUMP	707-01-22014	10001-		P-U-14	120 mm	225 mm	KOM-707-99-75400	257.72
DUMP (L BUCKET)	707-01-25010	10001-		P-U-14	140 mm	250 mm	KOM-707-99-84010	472.12
GRAPPLE	707-01-14011	10001-		P-U-14	70 mm	140 mm	KOM-707-99-52100	234.72
LIFT	707-01-20012	10001-		P-U-14	110 mm	200 mm	KOM-707-99-74010	229.89
STEERING	707-00-11011	10001-		P-U-14	55 mm	110 mm	KOM-707-99-34500	114.23
	707-00-11021	10001-		P-U-14	55 mm	110 mm	KOM-707-99-34500	114.23
MODEL WA500-3								
BOOM	707-01-03041	A70001-		P-UB-14	110 mm	200 mm	KOM-707-99-74120	238.45
DUMP	707-01-03242	50001-		P-UB-14	120 mm	225 mm	KOM-707-99-75450	532.57
	707-01-03242	50001-		Bushing	120 mm		KOM-707-52-90950	82.86
	707-01-03242	A70001-		P-UB-14	120 mm	225 mm	KOM-707-99-75450	532.57
LIFT	707-01-03041	50001-		P-UB-14	110 mm	200 mm	KOM-707-99-74120	238.45
	707-01-03041	50001-		Bushing	110 mm		KOM-707-52-90860	87.94
STEERING	707-00-03852	50001-		P-UB-14	55 mm	110 mm	KOM-707-99-34550	176.13
	707-00-03952	50001-		P-UB-14	55 mm	110 mm	KOM-707-99-34550	176.13
STEERING LH	707-00-03852	A70001-		P-UB-14	55 mm	110 mm	KOM-707-99-34550	176.13
STEERING RH	707-00-03952	A70001-		P-UB-14	55 mm	110 mm	KOM-707-99-34550	176.13
MODEL WA500-3LE								
BOOM	707-01-03041	A70001-		P-UB-14	110 mm	200 mm	KOM-707-99-74120	238.45
DUMP	707-01-03242	A70001-		P-UB-14	120 mm	225 mm	KOM-707-99-75450	532.57
STEERING LH	707-00-03852	A70001-		P-UB-14	55 mm	110 mm	KOM-707-99-34550	176.13
STEERING RH	707-00-03952	A70001-		P-UB-14	55 mm	110 mm	KOM-707-99-34550	176.13
MODEL WA500-6								
DUMP	707-01-0J730	A92001-		P-UB-14	120 mm	185 mm	KOM-707-99-68430	736.62
	707-13-18970	A92001-		P-UB-14	120 mm	185 mm	KOM-707-99-68430	736.62
DUMP (HI-LIFT)	707-01-0J740	A92001-		P-UB-14	120 mm	185 mm	KOM-707-99-68430	736.62
	707-13-18970	A92001-		P-UB-14	120 mm	185 mm	KOM-707-99-68430	736.62
LIFT LH	707-01-0J710	A92001-		P-UB-14	120 mm	160 mm	KOM-707-99-68420	529.92
	721-13-16110	A92001-		P-UB-14	120 mm	160 mm	KOM-707-99-68420	529.92
LIFT RH	707-01-0J710	A92001-		P-UB-14	120 mm	160 mm	KOM-707-99-68420	529.92
	721-13-16110	A92001-		P-UB-14	120 mm	160 mm	KOM-707-99-68420	529.92
STEERING LH	707-00-0G640	A92001-		P-UB-14	60 mm	100 mm	KOM-707-99-35320	324.44
	707-11-10G80	A92001-		P-UB-14	60 mm	100 mm	KOM-707-99-35320	324.44
STEERING RH	707-00-0G640	A92001-		P-UB-14	60 mm	100 mm	KOM-707-99-35320	324.44

LT - Large size tire L/S - Loading Shovel SLF - Super Long Front B/H - Backhoe HD - Heavy Duty L BUCKET - Large Bucket
 K-LINK - K-type Linkage Blade LB HI-LIFT - High Lift Arm w Large Bucket HI-LIFT - High Lift Arm S HI-LIFT - Super High Lift Arm
 SU - Semi-U Dozer PAT - Power Angle Power Tilt MP - Mult-Purpose

Replacement Kits For

KOMATSU®

Loaders - Wheel								
APPLICATION	CYL #	SERIAL #	Misc	CODE	ROD	BORE	KIT #	List \$
MODEL WA500-6								
STEERING RH	707-11-10G80	A92001-		P-UB-14	60 mm	100 mm	KOM-707-99-35320	324.44
MODEL WA500-7								
BOOM LH	707-E1-01310	A94001-		P-UB-14	120 mm	160 mm	KOM-707-99-67760	586.27
BUCKET	707-E1-01330	10001-		P-UB-14	120 mm	185 mm	KOM-707-99-67770	733.55
	707-E1-01330	10001-		Bushing	120 mm		KOM-707-52-90981	69.96
	707-E1-01330	A94001-		P-UB-14	120 mm	185 mm	KOM-707-99-67770	733.55
	707-E1-01330	A94001-		Bushing	120 mm		KOM-707-52-90981	69.96
LIFT LH	707-E1-01310	10001-		P-UB-14	120 mm	160 mm	KOM-707-99-67760	586.27
LIFT RH	707-E1-01320	10001-		P-UB-14	120 mm	160 mm	KOM-707-99-67760	586.27
STEERING LH	707-E0-00430	10001-		P-UB-14	60 mm	100 mm	KOM-707-99-35180	183.36
	707-E0-00430	10001-		Bushing	60 mm		KOM-707-52-90351	18.65
	707-E0-00430	A94001-		P-UB-14	60 mm	100 mm	KOM-707-99-35180	183.36
	707-E0-00430	A94001-		Bushing	60 mm		KOM-707-52-90351	18.65
STEERING RH	707-E0-00440	10001-		P-UB-14	60 mm	100 mm	KOM-707-99-35180	183.36
	707-E0-00440	10001-		Bushing	60 mm		KOM-707-52-90351	18.65
	707-E0-00440	A94001-		P-UB-14	60 mm	100 mm	KOM-707-99-35180	183.36
	707-E0-00440	A94001-		Bushing	60 mm		KOM-707-52-90351	18.65
MODEL WA600-1								
DUMP	707-01-28014	10001-10234		P-U-14	140 mm	280 mm	KOM-707-99-84400	404.75
	707-01-28014	10001-10234		Bushing	140 mm		KOM-707-52-11410	117.97
	707-01-28015	10235-11463		P-U-14	140 mm	280 mm	KOM-707-99-84400	404.75
	707-01-28015	10235-11463		Bushing	140 mm		KOM-707-52-11410	117.97
	707-01-28016	11464-		P-UB-14	140 mm	280 mm	KOM-707-99-84440	473.80
	707-01-28016	11464-		Bushing	140 mm		KOM-707-52-91150	117.97
GRAPPLE	707-01-14011	10001-		P-U-14	70 mm	140 mm	KOM-707-99-52100	234.72
LIFT	707-01-22111	10001-		P-U-14	120 mm	225 mm	KOM-707-99-75410	254.73
	707-01-22112	11464-		P-UB-14	120 mm	225 mm	KOM-707-99-75440	327.82
STEERING	707-00-13082	11464-		P-UB-14	70 mm	130 mm	KOM-707-99-43570	278.77
	707-01-13071	10001-		P-U-14	70 mm	130 mm	KOM-707-99-43500	207.21
	707-01-13072	11464-		P-UB-14	70 mm	130 mm	KOM-707-99-43570	278.77
	707-01-13081	10001-		P-U-14	70 mm	130 mm	KOM-707-99-43500	207.21
MODEL WA600-3								
DUMP	707-01-03231	50001-		P-UB-14	140 mm	280 mm	KOM-707-99-84450	507.18
	707-01-03231	A52001-		P-UB-14	140 mm	280 mm	KOM-707-99-84450	507.18
LIFT	707-01-03030	50001-		P-UB-14	120 mm	225 mm	KOM-707-99-75450	532.57
	707-01-03030	A52001-		P-UB-14	120 mm	225 mm	KOM-707-99-75450	532.57
STEERING	707-00-03061	50001-		P-UB-14	70 mm	130 mm	KOM-707-99-43590	289.40
	707-00-03861	A52001-		P-UB-14	70 mm	130 mm	KOM-707-99-43590	289.40
MODEL WA600-3L								
DUMP	707-01-03231	A52001-		P-UB-14	140 mm	280 mm	KOM-707-99-84450	507.18
LIFT	707-01-03030	A52001-		P-UB-14	120 mm	225 mm	KOM-707-99-75450	532.57
STEERING	707-00-03861	A52001-		P-UB-14	70 mm	130 mm	KOM-707-99-43590	289.40
MODEL WA600-6								
DUMP 3850mm Link	707-01-0J620	60001-		P-UB-14	140 mm	225 mm	KOM-707-99-77630	585.71
DUMP 3990mm Link	707-01-0J020	60001-		P-UB-14	140 mm	225 mm	KOM-707-99-77630	585.71
LIFT LH	707-01-0H990	60001-		P-UB-14	140 mm	200 mm	KOM-707-99-77090	561.19
LIFT RH	707-01-0H990	60001-		P-UB-14	140 mm	200 mm	KOM-707-99-77090	561.19
STEERING LH	707-01-0J030	60001-		P-UB-14	75 mm	115 mm	KOM-707-99-44060	256.31
STEERING LH (LDT)	707-01-0J130	60001-		P-UB-14	90 mm	130 mm	KOM-707-99-47830	360.74
STEERING RH	707-01-0J040	60001-		P-UB-14	75 mm	115 mm	KOM-707-99-44060	256.31
STEERING RH (LDT)	707-01-0J140	60001-		P-UB-14	90 mm	130 mm	KOM-707-99-47830	360.74
MODEL WA700-1								
DUMP	707-01-01220	10001-		P-UB-14	170 mm	280 mm	KOM-707-99-86600	903.79
LIFT	707-01-01020	10001-		P-UB-14	140 mm	225 mm	KOM-707-99-77600	519.63
STEERING	707-01-01320	10001-		P-UB-14	85 mm	130 mm	KOM-707-99-46620	311.35

LT - Large size tire L/S - Loading Shovel SLF - Super Long Front B/H - Backhoe HD - Heavy Duty L BUCKET - Large Bucket
 K-LINK - K-type Linkage Blade LB HI-LIFT - High Lift Arm w Large Bucket HI-LIFT - High Lift Arm S HI-LIFT - Super High Lift Arm
 SU - Semi-U Dozer PAT - Power Angle Power Tilt MP - Mult-Purpose

KOMATSU®

Replacement Kits For

Loaders - Wheel								
APPLICATION	CYL #	SERIAL #	Misc	CODE	ROD	BORE	KIT #	List \$
MODEL WA700-1								
STEERING	707-01-01420	10001-		P-UB-14	85 mm	130 mm	KOM-707-99-46620	311.35
MODEL WA700-3								
DUMP	707-01-01220	50001-		P-UB-14	170 mm	280 mm	KOM-707-99-86600	903.79
LIFT	707-01-01020	50001-		P-UB-14	140 mm	225 mm	KOM-707-99-77600	519.63
STEERING	707-01-01320	50001-		P-UB-14	85 mm	130 mm	KOM-707-99-46620	311.35
	707-01-01420	50001-		P-UB-14	85 mm	130 mm	KOM-707-99-46620	311.35
MODEL WA800-1								
DUMP	707-01-01210	10001-		P-UB-14	180 mm	300 mm	KOM-707-99-96200	1613.07
DUMP (HI-LIFT)	707-01-02100	10001-		P-UB-14	180 mm	300 mm	KOM-707-99-96200	1613.07
LIFT	707-01-01010	10001-		P-UB-14	160 mm	260 mm	KOM-707-99-85900	1002.87
LIFT (HI-LIFT)	707-01-02090	10001-		P-UB-14	160 mm	260 mm	KOM-707-99-85900	1002.87
STEERING	707-01-16181	10001-		P-UB-14	100 mm	160 mm	KOM-707-99-66210	307.50
	707-01-16191	10001-		P-UB-14	100 mm	160 mm	KOM-707-99-66210	307.50
MODEL WA800-2								
DUMP	707-01-01210	10501-		P-UB-14	180 mm	300 mm	KOM-707-99-96200	1613.07
DUMP (HI-LIFT)	707-01-02100	10501-		P-UB-14	180 mm	300 mm	KOM-707-99-96200	1613.07
LIFT	707-01-01010	10501-		P-UB-14	160 mm	260 mm	KOM-707-99-85900	1002.87
LIFT (HI-LIFT)	707-01-02090	10501-		P-UB-14	160 mm	260 mm	KOM-707-99-85900	1002.87
STEERING	707-01-16181	10501-		P-UB-14	100 mm	160 mm	KOM-707-99-66210	307.50
	707-01-16191	10501-		P-UB-14	100 mm	160 mm	KOM-707-99-66210	307.50
MODEL WA800-3								
DUMP	707-01-03210	50001-		P-UB-14	180 mm	300 mm	KOM-707-99-96200	1613.07
LIFT	707-01-03011	50001-		P-UB-14	160 mm	260 mm	KOM-707-99-85900	1002.87
STEERING	707-01-16181	50001-		P-UB-14	100 mm	160 mm	KOM-707-99-66210	307.50
	707-01-16191	50001-		P-UB-14	100 mm	160 mm	KOM-707-99-66210	307.50
MODEL WA900-1								
DUMP	707-01-03210	10001-		P-UB-14	180 mm	300 mm	KOM-707-99-96200	1613.07
LIFT	707-01-01010	10001-		P-UB-14	160 mm	260 mm	KOM-707-99-85900	1002.87
STEERING	707-01-16181	10001-		P-UB-14	100 mm	160 mm	KOM-707-99-66210	307.50
	707-01-16191	10001-		P-UB-14	100 mm	160 mm	KOM-707-99-66210	307.50
MODEL WA900-3								
DUMP	707-01-03212	50001-		P-UB-14	180 mm	300 mm	KOM-707-99-96200	1613.07
LIFT	707-01-03011	50001-		P-UB-14	160 mm	260 mm	KOM-707-99-85900	1002.87
STEERING	707-01-16181	50001-		P-UB-14	100 mm	160 mm	KOM-707-99-66210	307.50
	707-01-16191	50001-		P-UB-14	100 mm	160 mm	KOM-707-99-66210	307.50
MODEL WA900-3E0								
DUMP	707-01-02492	60001-60077	High Lift	P-UB-14	180 mm	300 mm	KOM-707-99-96200	1613.07
	707-01-02492	60001-60077	High Lift	Bushing	180 mm		KOM-707-52-91550	158.88
	707-01-02492	60078-	High Lift	P-UB-14	180 mm	300 mm	KOM-707-99-96200	1613.07
	707-01-02492	60078-	High Lift	Bushing	180 mm		KOM-707-52-91551	158.88
	707-01-03212	60001-60077		P-UB-14	180 mm	300 mm	KOM-707-99-96200	1613.07
	707-01-03212	60001-60077		Bushing	180 mm		KOM-707-52-91550	158.88
	707-01-03212	60078-		P-UB-14	180 mm	300 mm	KOM-707-99-96200	1613.07
	707-01-03212	60078-		Bushing	180 mm		KOM-707-52-91551	158.88
LIFT	707-01-02091	60001-60077	High Lift	P-UB-14	160 mm	260 mm	KOM-707-99-85900	1002.87
	707-01-02091	60001-60077	High Lift	Bushing	160 mm		KOM-707-52-11610	120.17
	707-01-02091	60078-	High Lift	P-UB-14	160 mm	260 mm	KOM-707-99-85900	1002.87
	707-01-02091	60078-	High Lift	Bushing	160 mm		KOM-707-52-11611	120.17
	707-01-03011	60001-60077		P-UB-14	160 mm	260 mm	KOM-707-99-85900	1002.87
	707-01-03011	60001-60077		Bushing	160 mm		KOM-707-52-11610	120.17
	707-01-03011	60078-		P-UB-14	160 mm	260 mm	KOM-707-99-85900	1002.87
	707-01-03011	60078-		Bushing	160 mm		KOM-707-52-11611	120.17
STEERING LH	707-01-16181	60001-60077		P-UB-14	100 mm	160 mm	KOM-707-99-66210	307.50
	707-01-16181	60001-60077		Bushing	100 mm		KOM-707-52-11010	59.52
	707-01-16181	60078-		P-UB-14	100 mm	160 mm	KOM-707-99-66210	307.50

LT - Large size tire L/S - Loading Shovel SLF - Super Long Front B/H - Backhoe HD - Heavy Duty L BUCKET - Large Bucket
 K-LINK - K-type Linkage Blade LB HI-LIFT - High Lift Arm w Large Bucket HI-LIFT - High Lift Arm S HI-LIFT - Super High Lift Arm
 SU - Semi-U Dozer PAT - Power Angle Power Tilt MP - Mult-Purpose

KOMATSU®

Replacement Kits For

Loaders - Wheel								
APPLICATION	CYL #	SERIAL #	Misc	CODE	ROD	BORE	KIT #	List \$
NEW MODEL WA900-3E0								
STEERING LH	707-01-16181	60078-		Bushing	100 mm		KOM-707-52-11011	59.52
STEERING RH	707-01-16191	60001-60077		P-UB-14	100 mm	160 mm	KOM-707-99-66210	307.50
	707-01-16191	60001-60077		Bushing	100 mm		KOM-707-52-11010	59.52
	707-01-16191	60078-		P-UB-14	100 mm	160 mm	KOM-707-99-66210	307.50
	707-01-16191	60078-		Bushing	100 mm		KOM-707-52-11011	59.52
NEW MODEL WA900-3LC								
DUMP	707-01-02492	A50001-	High Lift	P-UB-14	180 mm	300 mm	KOM-707-99-96200	1613.07
	707-01-02492	A50001-	High Lift	Bushing	180 mm		KOM-707-52-91550	158.88
	707-01-03212	A50001-		P-UB-14	180 mm	300 mm	KOM-707-99-96200	1613.07
	707-01-03212	A50001-		Bushing	180 mm		KOM-707-52-91550	158.88
LIFT	707-01-02091	A50001-	High Lift	P-UB-14	160 mm	260 mm	KOM-707-99-85900	1002.87
	707-01-02091	A50001-	High Lift	Bushing	160 mm		KOM-707-52-11610	120.17
	707-01-03011	A50001-		P-UB-14	160 mm	260 mm	KOM-707-99-85900	1002.87
	707-01-03011	A50001-		Bushing	160 mm		KOM-707-52-11610	120.17
STEERING LH	707-01-16181	A50001-		P-UB-14	100 mm	160 mm	KOM-707-99-66210	307.50
	707-01-16181	A50001-		Bushing	100 mm		KOM-707-52-11010	59.52
STEERING RH	707-01-16191	A50001-		P-UB-14	100 mm	160 mm	KOM-707-99-66210	307.50
	707-01-16191	A50001-		Bushing	100 mm		KOM-707-52-11010	59.52
NEW MODEL WA900L-3								
DUMP	707-01-02492	52001-	High Lift	P-UB-14	180 mm	300 mm	KOM-707-99-96200	1613.07
	707-01-02492	52001-	High Lift	Bushing	180 mm		KOM-707-52-91550	158.88
	707-01-03212	52001-		P-UB-14	180 mm	300 mm	KOM-707-99-96200	1613.07
	707-01-03212	52001-		Bushing	180 mm		KOM-707-52-91550	158.88
LIFT	707-01-02091	52001-	High Lift	P-UB-14	160 mm	260 mm	KOM-707-99-85900	1002.87
	707-01-02091	52001-	High Lift	Bushing	160 mm		KOM-707-52-11610	120.17
	707-01-07580	52001-		P-UB-14	160 mm	260 mm	KOM-707-99-85900	1002.87
	707-01-07580	52001-		Bushing	160 mm		KOM-707-52-11610	120.17
STEERING LH	707-01-07610	52001-		P-UB-14	100 mm	160 mm	KOM-707-99-66210	307.50
	707-01-07610	52001-		Bushing	100 mm		KOM-707-52-11010	59.52
STEERING RH	707-01-07620	52001-		P-UB-14	100 mm	160 mm	KOM-707-99-66210	307.50
	707-01-07620	52001-		Bushing	100 mm		KOM-707-52-11010	59.52
Motor Graders								
APPLICATION	CYL #	SERIAL #	Misc	CODE	ROD	BORE	KIT #	List \$
MODEL GD200A-1								
SCARIFIER	237-63-32500	2001-		P-U-14	40 mm	80 mm	KOM-707-98-22120	125.74
MODEL GD300A-1								
ARTICULATE	237-63-62501	2001-		P-U-14	60 mm	120 mm	KOM-707-98-41030	147.52
BLADE LIFT	237-63-12500	2001-		P-U-14	35 mm	70 mm	KOM-707-98-12550	83.57
BLADE SHIFT	237-63-42500	2001-		P-U-14	40 mm	60 mm	KOM-707-98-14240	100.11
FRONT BLADE	237-63-32500	2001-		P-U-14	40 mm	80 mm	KOM-707-98-22120	125.74
SCARIFIER	237-63-32500	2001-		P-U-14	40 mm	80 mm	KOM-707-98-22120	125.74
MODEL GD313A-1								
ARTICULATE	23E-63-62101	30001-		P-U-10	40 mm	70 mm	KOM-707-98-14410	125.75
BLADE LIFT	23E-63-12101	30001-		P-U-10	35 mm	60 mm	KOM-707-98-12120	88.32
BLADE SHIFT	23E-63-42101	30001-		P-U-10	40 mm	60 mm	KOM-707-98-14040	117.46
STEERING	23E-63-72300	30001-		P-U-10	25 mm	60 mm	KOM-707-98-11380	79.83
MODEL GD405A-1								
ARTICULATE	233-63-62300	50002-50610		P-U-14	50 mm	90 mm	KOM-707-98-25500	163.18
	233-63-62500	50611-		P-U-14	50 mm	90 mm	KOM-707-98-25430	150.83
BLADE LIFT	233-63-12300	50002-50610		P-U-14	40 mm	70 mm	KOM-707-98-14700	97.79
BLADE SHIFT	233-63-42300	50002-50610		P-U-14	40 mm	70 mm	KOM-707-98-14600	97.79
DRAWBAR SHIFT	233-63-22300	50002-50610		P-U-14	40 mm	70 mm	KOM-707-98-14700	97.79
LEANING	233-63-52300	50002-50610		P-U-14	35 mm	70 mm	KOM-707-98-12600	83.69
POWER TILT	233-63-18300	50002-		P-U-14	40 mm	80 mm	KOM-707-98-22100	128.07
SCARIFIER	238-63-32100	50002-50610		P-U-14	50 mm	80 mm	KOM-707-98-25170	183.18

LT - Large size tire L/S - Loading Shovel SLF - Super Long Front B/H - Backhoe HD - Heavy Duty L BUCKET - Large Bucket
 K-LINK - K-type Linkage Blade LB HI-LIFT - High Lift Arm w Large Bucket HI-LIFT - High Lift Arm S HI-LIFT - Super High Lift Arm
 SU - Semi-U Dozer PAT - Power Angle Power Tilt MP - Mult-Purpose

Replacement Kits For

KOMATSU®

Motor Graders								
APPLICATION	CYL #	SERIAL #	Misc	CODE	ROD	BORE	KIT #	List \$
MODEL GD461A-1								
ARTICULATE	23E-63-62101	10001-		P-U-10	40 mm	70 mm	KOM-707-98-14410	125.75
BLADE SHIFT	23E-63-42101	10001-		P-U-10	40 mm	60 mm	KOM-707-98-14040	117.46
DRAWBAR SHIFT	23D-63-22300	10001-		P-U-10	35 mm	60 mm	KOM-707-98-12120	88.32
STEERING	23E-63-72300	10001-		P-U-10	25 mm	60 mm	KOM-707-98-11380	79.83
MODEL GD500R-2								
BLADE LIFT	238-63-12100	11002-		P-U-14	50 mm	80 mm	KOM-707-98-25070	136.14
BLADE SHIFT	238-63-42100	11002-		P-U-14	50 mm	80 mm	KOM-707-98-25170	183.18
DRAWBAR SHIFT	238-63-22100	11002-		P-U-14	50 mm	80 mm	KOM-707-98-25070	136.14
FRONT BLADE	232-63-33300	11002-		P-U-5	50 mm	80 mm	KOM-707-98-25060	177.67
LEANING	238-63-52100	11002-		P-U-14	35 mm	70 mm	KOM-707-98-12600	83.69
POWER TILT	238-63-18101	11002-		P-U-14	40 mm	80 mm	KOM-707-98-22100	128.07
SCARIFIER	238-63-32100	11002-		P-U-14	50 mm	80 mm	KOM-707-98-25170	183.18
MODEL GD505A-2								
ARTICULATE	233-63-62300	50003-		P-U-14	50 mm	90 mm	KOM-707-98-25500	163.18
BLADE LIFT	238-63-12100	50003-		P-U-14	50 mm	80 mm	KOM-707-98-25070	136.14
BLADE SHIFT	238-63-42100	50003-		P-U-14	50 mm	80 mm	KOM-707-98-25170	183.18
DRAWBAR SHIFT	238-63-22100	50003-		P-U-14	50 mm	80 mm	KOM-707-98-25070	136.14
FRONT BLADE	232-63-33300	50003-		P-U-5	50 mm	80 mm	KOM-707-98-25060	177.67
LEANING	238-63-52100	50003-		P-U-14	35 mm	70 mm	KOM-707-98-12600	83.69
POWER TILT	238-63-18101	50003-		P-U-14	40 mm	80 mm	KOM-707-98-22100	128.07
SCARIFIER	238-63-32100	50003-		P-U-14	50 mm	80 mm	KOM-707-98-25170	183.18
MODEL GD505R-2								
BLADE LIFT	238-63-12100	30002-		P-U-14	50 mm	80 mm	KOM-707-98-25070	136.14
BLADE SHIFT	238-63-42100	30002-		P-U-14	50 mm	80 mm	KOM-707-98-25170	183.18
DRAWBAR SHIFT	238-63-22100	30002-		P-U-14	50 mm	80 mm	KOM-707-98-25070	136.14
FRONT BLADE	232-63-33300	30002-		P-U-5	50 mm	80 mm	KOM-707-98-25060	177.67
LEANING	238-63-52100	30002-		P-U-14	35 mm	70 mm	KOM-707-98-12600	83.69
POWER TILT	238-63-18101	30002-		P-U-14	40 mm	80 mm	KOM-707-98-22100	128.07
SCARIFIER	238-63-32100	30002-		P-U-14	50 mm	80 mm	KOM-707-98-25170	183.18
MODEL GD510R-1								
LEANING	23A-63-52101	15001-		P-U-14	35 mm	70 mm	KOM-707-98-12470	89.30
MODEL GD511A-1								
LEANING	23A-63-52101	10001-		P-U-14	35 mm	70 mm	KOM-707-98-12470	89.30
MODEL GD513A-1								
LEANING	23A-63-52101	10001-		P-U-14	35 mm	70 mm	KOM-707-98-12470	89.30
MODEL GD513R-1								
LEANING	23A-63-52101	30001-		P-U-14	35 mm	70 mm	KOM-707-98-12470	89.30
MODEL GD515A-1								
LEANING	23A-63-52101	50001-		P-U-14	35 mm	70 mm	KOM-707-98-12470	89.30
POWER TILT	23B-63-18101	50001-		P-U-10	40 mm	80 mm	KOM-707-98-23030	76.37
STEERING	23B-63-72501	50001-		P-U-10	35 mm	50 mm	KOM-707-98-05410	92.57
MODEL GD521A-1, GD521R-1								
BLADE LIFT	238-63-12301	10001-		P-U-14	50 mm	80 mm	KOM-707-98-25030	133.63
BLADE SHIFT	23B-63-42300	10001-		P-U-14	50 mm	80 mm	KOM-707-98-25040	179.82
DRAWBAR SHIFT	23B-63-22102	10001-		P-U-14	45 mm	80 mm	KOM-707-98-24040	127.62
FRONT BLADE	232-63-38100	10001-		P-U-14	45 mm	90 mm	KOM-707-98-24430	154.95
LEANING	23A-63-52102	10001-		P-U-14	35 mm	70 mm	KOM-707-98-12470	89.30
MODEL GD523A-1, GD523R-1								
BLADE LIFT	238-63-12301	30001-		P-U-14	50 mm	80 mm	KOM-707-98-25030	133.63
BLADE SHIFT	23B-63-42300	30001-		P-U-14	50 mm	80 mm	KOM-707-98-25040	179.82
DRAWBAR SHIFT	23B-63-22102	30001-		P-U-14	45 mm	80 mm	KOM-707-98-24040	127.62
FRONT BLADE	232-63-38100	30001-		P-U-14	45 mm	90 mm	KOM-707-98-24430	154.95
LEANING	23A-63-52102	30001-		P-U-14	35 mm	70 mm	KOM-707-98-12470	89.30
STEERING	23B-63-72302	30001-		P-U-10	35 mm	50 mm	KOM-707-98-05410	92.57
MODEL GD525A-1								
BLADE LIFT	238-63-12301	50001-		P-U-14	50 mm	80 mm	KOM-707-98-25030	133.63

LT - Large size tire L/S - Loading Shovel SLF - Super Long Front B/H - Backhoe HD - Heavy Duty L BUCKET - Large Bucket

K-LINK - K-type Linkage Blade LB HI-LIFT - High Lift Arm w Large Bucket HI-LIFT - High Lift Arm S HI-LIFT - Super High Lift Arm

SU - Semi-U Dozer PAT - Power Angle Power Tilt MP - Mult-Purpose

KOMATSU®

Replacement Kits For

Motor Graders								
APPLICATION	CYL #	SERIAL #	Misc	CODE	ROD	BORE	KIT #	List \$
MODEL GD525A-1								
BLADE SHIFT	23B-63-42301	50001-		P-U-14	50 mm	80 mm	KOM-707-98-25040	179.82
DRAWBAR SHIFT	23B-63-22102	50001-		P-U-14	45 mm	80 mm	KOM-707-98-24040	127.62
LEANING	23A-63-52102	50001-		P-U-14	35 mm	70 mm	KOM-707-98-12470	89.30
POWER TILT	23B-63-18101	50001-		P-U-10	40 mm	80 mm	KOM-707-98-23030	76.37
STEERING	23B-63-72302	50001-		P-U-10	35 mm	50 mm	KOM-707-98-05410	92.57
MODEL GD600R-3								
BLADE LIFT	238-63-12100	14001-		P-U-14	50 mm	80 mm	KOM-707-98-25070	136.14
DRAWBAR SHIFT	238-63-22100	14001-		P-U-14	50 mm	80 mm	KOM-707-98-25070	136.14
FRONT BLADE	232-63-33300	14001-		P-U-5	50 mm	80 mm	KOM-707-98-25060	177.67
POWER TILT	238-63-18101	14001-		P-U-14	40 mm	80 mm	KOM-707-98-22100	128.07
RIPPER	232-63-25101	14001-		P-U-5	50 mm	120 mm	KOM-707-99-40100	201.73
STEERING	232-63-76101	14001-		P-U-14	35 mm	60 mm	KOM-707-98-12200	85.78
MODEL GD605A-3								
ARTICULATE	233-63-62300	54001-		P-U-14	50 mm	90 mm	KOM-707-98-25500	163.18
BLADE LIFT	238-63-12100	54001-		P-U-14	50 mm	80 mm	KOM-707-98-25070	136.14
DRAWBAR SHIFT	238-63-22100	54001-		P-U-14	50 mm	80 mm	KOM-707-98-25070	136.14
FRONT BLADE	232-63-33300	54001-		P-U-5	50 mm	80 mm	KOM-707-98-25060	177.67
POWER TILT	238-63-18101	54001-		P-U-14	40 mm	80 mm	KOM-707-98-22100	128.07
RIPPER	232-63-25101	54001-		P-U-5	50 mm	120 mm	KOM-707-99-40100	201.73
STEERING	232-63-76101	54001-		P-U-14	35 mm	60 mm	KOM-707-98-12200	85.78
MODEL GD611A-1, GD611R-1								
ARTICULATE	23B-63-62101	10001-	GD611A-1	P-U-14	50 mm	90 mm	KOM-707-98-25430	150.83
BLADE LIFT	238-63-12301	10001-		P-U-14	50 mm	80 mm	KOM-707-98-25030	133.63
DRAWBAR SHIFT	23B-63-22102	10001-		P-U-14	45 mm	80 mm	KOM-707-98-24040	127.62
FRONT BLADE	232-63-38100	10001-		P-U-14	45 mm	90 mm	KOM-707-98-24430	154.95
LEANING	23B-63-52102	10001-		P-U-10	40 mm	80 mm	KOM-707-98-22140	50.55
POWER TILT	23B-63-18101	10001-		P-U-10	40 mm	80 mm	KOM-707-98-23030	76.37
MODEL GD613A-1, GD613R-1								
ARTICULATE	23B-63-62101	30001-	GD613A-1	P-U-14	50 mm	90 mm	KOM-707-98-25430	150.83
BLADE LIFT	238-63-12301	30001-		P-U-14	50 mm	80 mm	KOM-707-98-25030	133.63
DRAWBAR SHIFT	23B-63-22100	30001-		P-U-14	45 mm	80 mm	KOM-707-98-24040	127.62
LEANING	23B-63-52101	30001-		P-U-10	40 mm	80 mm	KOM-707-98-22140	50.55
STEERING	23B-63-72302	30001-		P-U-10	35 mm	50 mm	KOM-707-98-05410	92.57
MODEL GD615A-1								
ARTICULATE	23B-63-62101	50001-		P-U-14	50 mm	90 mm	KOM-707-98-25430	150.83
BLADE LIFT	238-63-12301	50001-		P-U-14	50 mm	80 mm	KOM-707-98-25030	133.63
BLADE SHIFT	23B-63-42301	50001-		P-U-14	50 mm	80 mm	KOM-707-98-25040	179.82
DRAWBAR SHIFT	23B-63-22102	50001-		P-U-14	45 mm	80 mm	KOM-707-98-24040	127.62
LEANING	23B-63-52102	50001-		P-U-10	40 mm	80 mm	KOM-707-98-22140	50.55
POWER TILT	23B-63-18101	50001-		P-U-10	40 mm	80 mm	KOM-707-98-23030	76.37
STEERING	23B-63-72501	50001-		P-U-10	35 mm	50 mm	KOM-707-98-05410	92.57
MODEL GD621A-1, GD621R-1								
ARTICULATE	23B-63-62101	10001-	GD621A-1	P-U-14	50 mm	90 mm	KOM-707-98-25430	150.83
BLADE LIFT	238-63-12301	10001-		P-U-14	50 mm	80 mm	KOM-707-98-25030	133.63
BLADE SHIFT	23B-63-42300	10001-		P-U-14	50 mm	80 mm	KOM-707-98-25040	179.82
DRAWBAR SHIFT	23B-63-22102	10001-		P-U-14	45 mm	80 mm	KOM-707-98-24040	127.62
FRONT BLADE	232-63-38100	10001-		P-U-14	45 mm	90 mm	KOM-707-98-24430	154.95
LEANING	23B-63-52102	10001-		P-U-10	40 mm	80 mm	KOM-707-98-22140	50.55
POWER TILT	23B-63-18101	10001-		P-U-10	40 mm	80 mm	KOM-707-98-23030	76.37
MODEL GD623A-1								
ARTICULATE	23B-63-62101	30001-		P-U-14	50 mm	90 mm	KOM-707-98-25430	150.83
BLADE LIFT	238-63-12301	30001-		P-U-14	50 mm	80 mm	KOM-707-98-25030	133.63
DRAWBAR SHIFT	23B-63-22100	30001-		P-U-14	45 mm	80 mm	KOM-707-98-24040	127.62
FRONT BLADE	232-63-38100	30001-		P-U-14	45 mm	90 mm	KOM-707-98-24430	154.95
LEANING	23B-63-52102	30001-		P-U-10	40 mm	80 mm	KOM-707-98-22140	50.55

LT - Large size tire L/S - Loading Shovel SLF - Super Long Front B/H - Backhoe HD - Heavy Duty L BUCKET - Large Bucket
 K-LINK - K-type Linkage Blade LB HI-LIFT - High Lift Arm w Large Bucket HI-LIFT - High Lift Arm S HI-LIFT - Super High Lift Arm
 SU - Semi-U Dozer PAT - Power Angle Power Tilt MP - Multi-Purpose

KOMATSU®

Replacement Kits For

Motor Graders								
APPLICATION	CYL #	SERIAL #	Misc	CODE	ROD	BORE	KIT #	List \$
MODEL GD623A-1								
POWER TILT	23B-63-18101	30001-		P-U-10	40 mm	80 mm	KOM-707-98-23030	76.37
SCARIFIER	23B-63-32102	30001-		P-U-14	50 mm	90 mm	KOM-707-98-25430	150.83
STEERING	23B-63-72302	30001-		P-U-10	35 mm	50 mm	KOM-707-98-05410	92.57
MODEL GD623R-1								
STEERING	23B-63-72302	30001-		P-U-10	35 mm	50 mm	KOM-707-98-05410	92.57
MODEL GD623R-1, GD663A-1								
ARTICULATE	23B-63-62101	30001-	GD663A-1	P-U-14	50 mm	90 mm	KOM-707-98-25430	150.83
BLADE LIFT	238-63-12301	30001-		P-U-14	50 mm	80 mm	KOM-707-98-25030	133.63
DRAWBAR SHIFT	23B-63-22100	30001-		P-U-14	45 mm	80 mm	KOM-707-98-24040	127.62
LEANING	23B-63-52102	30001-		P-U-10	40 mm	80 mm	KOM-707-98-22140	50.55
MODEL GD625A-1								
ARTICULATE	23B-63-62101	50001-		P-U-14	50 mm	90 mm	KOM-707-98-25430	150.83
BLADE LIFT	23B-63-18101	50001-		P-U-10	40 mm	80 mm	KOM-707-98-23030	76.37
BLADE SHIFT	23B-63-42301	50001-		P-U-14	50 mm	80 mm	KOM-707-98-25040	179.82
DRAWBAR SHIFT	23B-63-22102	50001-		P-U-14	45 mm	80 mm	KOM-707-98-24040	127.62
LEANING	23B-63-52100	50001-		P-U-10	40 mm	80 mm	KOM-707-98-22140	50.55
	23B-63-52102	60001-		P-U-10	40 mm	80 mm	KOM-707-98-22140	50.55
	23B-63-52102	60001-		Bushing	40 mm		KOM-07177-04025	9.33
POWER TILT	23B-63-18101	50001-		P-U-10	40 mm	80 mm	KOM-707-98-23030	76.37
SCARIFIER	23B-63-32102	50001-		P-U-14	50 mm	90 mm	KOM-707-98-25430	150.83
STEERING	23B-63-72501	50001-		P-U-10	35 mm	50 mm	KOM-707-98-05410	92.57
MODEL GD663A-1								
STEERING	23B-63-72302	30001-		P-U-10	35 mm	50 mm	KOM-707-98-05410	92.57
MODEL GD705A-3								
BLADE LIFT	234-63-13001	10002-		P-U-14	55 mm	90 mm	KOM-707-98-26600	152.05
DRAWBAR SHIFT	234-63-23000	10002-		P-U-14	55 mm	90 mm	KOM-707-98-26600	152.05
LEANING	234-63-53002	10002-		P-U-14	45 mm	90 mm	KOM-707-98-24530	167.87
POWER TILT	234-63-28001	10002-		P-U-14	50 mm	100 mm	KOM-707-99-33010	137.83
RIPPER	234-63-25000	10002-		P-U-14	70 mm	140 mm	KOM-707-98-52100	289.38
MODEL GD705A-4								
BLADE LIFT	234-63-13001	31001-		P-U-14	55 mm	90 mm	KOM-707-98-26600	152.05
DRAWBAR SHIFT	234-63-23001	31001-		P-U-14	55 mm	90 mm	KOM-707-98-26600	152.05
LEANING	234-63-53002	31001-		P-U-14	45 mm	90 mm	KOM-707-98-24530	167.87
POWER TILT	234-63-28100	31001-		P-U-14	50 mm	100 mm	KOM-707-99-32010	156.65
RIPPER	234-63-25001	31001-		P-U-14	70 mm	140 mm	KOM-707-98-52100	289.38
MODEL GD725A-1								
ARTICULATE	23C-63-63101	50001-		P-U-10	55 mm	110 mm	KOM-707-98-34410	167.92
BLADE LIFT	23C-63-13101	50001-		P-U-10	55 mm	90 mm	KOM-707-98-26450	261.20
BLADE SHIFT	23C-63-43101	50001-		P-U-10	55 mm	90 mm	KOM-707-98-26441	122.56
DRAWBAR SHIFT	23C-63-23101	50001-		P-U-10	55 mm	90 mm	KOM-707-98-26450	261.20
POWER TILT	23C-63-28101	50001-		P-U-10	50 mm	100 mm	KOM-707-98-33010	57.53
STEERING	23C-63-72101	50001-		P-U-10	35 mm	50 mm	KOM-707-98-05410	92.57
MODEL GD825A-1								
ARTICULATE	235-63-63000	10002-		P-U-14	65 mm	120 mm	KOM-707-98-41110	236.81
BLADE LIFT	235-63-16100	10002-		P-U-14	65 mm	100 mm	KOM-707-98-36230	139.33
BLADE SHIFT	235-63-42000	10002-		P-U-14	65 mm	100 mm	KOM-707-98-36140	105.85
DRAWBAR SHIFT	235-63-22000	10002-		P-U-14	60 mm	100 mm	KOM-707-98-35110	142.93
LEANING	235-63-53100	10002-		P-U-14	45 mm	90 mm	KOM-707-98-24500	115.21
POWER TILT	235-63-28000	10002-		P-U-14	65 mm	120 mm	KOM-707-98-42100	180.87
RIPPER	235-63-25200	10002-		P-U-14	70 mm	140 mm	KOM-707-98-52100	289.38
STEERING	235-63-76301	10002-10043		P-U-14	40 mm	60 mm	KOM-707-98-14030	100.11
	235-63-76303	10044-		P-U-14	40 mm	60 mm	KOM-707-98-14030	100.11
MODEL GD825A-2								
ARTICULATE	235-63-63000	11001-		P-U-14	65 mm	120 mm	KOM-707-98-41110	236.81
BLADE SHIFT	235-63-16100	11001-		P-U-14	65 mm	100 mm	KOM-707-98-36230	139.33

LT - Large size tire L/S - Loading Shovel SLF - Super Long Front B/H - Backhoe HD - Heavy Duty L BUCKET - Large Bucket
 K-LINK - K-type Linkage Blade LB HI-LIFT - High Lift Arm w Large Bucket HI-LIFT - High Lift Arm S HI-LIFT - Super High Lift Arm
 SU - Semi-U Dozer PAT - Power Angle Power Tilt MP - Mult-Purpose

KOMATSU®

Replacement Kits For

Motor Graders								
APPLICATION	CYL #	SERIAL #	Misc	CODE	ROD	BORE	KIT #	List \$
MODEL GD825A-2								
BLADE SIDE SHIFT	235-63-42000	11001-		P-U-14	65 mm	100 mm	KOM-707-98-36140	105.85
DRAWBAR SHIFT	235-63-22000	11001-		P-U-14	60 mm	100 mm	KOM-707-98-35110	142.93
POWER TILT	235-63-28000	11001-		P-U-14	65 mm	120 mm	KOM-707-98-42100	180.87
RIPPER	235-63-25200	11001-		P-U-14	70 mm	140 mm	KOM-707-98-52100	289.38
STEERING	235-63-76400	11001-		P-U-14	40 mm	60 mm	KOM-707-98-14030	100.11
Off-Highway Trucks								
APPLICATION	CYL #	SERIAL #	Misc	CODE	ROD	BORE	KIT #	List \$
MODEL 830								
HOIST	EJ6695				7, 10-1/2, 13	9-1/2, 11-1/2, 14	KOM-AK4892	2760.80
STEERING				P-U-14	3	6	KOM-AK4370	367.81
SUSPENSION FRONT	EJ6895	AF050-BU		I-UB-1	14		KOM-AK4441	1896.19
SUSPENSION REAR	EH9424			I-UB-1	12		KOM-AK4446	1086.98
MODEL 830E								
STEERING	TY7272			P-U-10	3	6	KOM-AK7283	101.42
	TY9935			P-U-10	3	6	KOM-AK7283	101.42
MODEL 930								
SUSPENSION REAR	EH9424	AFE50-AN		I-UB-1	12		KOM-AK4446	1086.98
MODEL 930E-4								
HOIST		A30462-A30464; A30472; A30477- A30480; A30490- A30493; A30496		I-UB-10	7, 10-1/2, 13	9-1/2, 11-3/4, 14	KOM-AK4773	2816.31
STEERING		A30462-A30464; A30472; A30477- A30480; A30490- A30493; A30496		P-U-14	2-1/4	6-1/2	KOM-AK4307	471.14
SUSPENSION FRONT		A30462-A30464; A30472; A30477- A30480; A30490- A30493; A30496		I-UB-1	15-3/4		KOM-AK4308	2619.93
SUSPENSION REAR		A30462-A30464; A30472; A30477- A30480; A30490- A30493; A30496		I-UB-1	14		KOM-AK5239	1254.41
MODEL HD205-3								
STEERING	567-63-12600	1003-		P-U-14	40 mm	60 mm	KOM-707-98-14200	77.18
MODEL HD325-3								
STEERING	566-63-11500	1501-		P-U-14	60 mm	80 mm	KOM-707-98-27100	141.33
MODEL HD325-5								
STEERING	566-63-11500	2001-		P-U-14	60 mm	80 mm	KOM-707-98-27100	141.33
MODEL HD465-3								
STEERING	569-63-41203	2001-		P-U-14	60 mm	80 mm	KOM-707-98-27100	141.33
STEERING (LT)	569-63-41303	2001-		P-U-14	60 mm	80 mm	KOM-707-98-27100	141.33
MODEL HD785-3								
STEERING	561-63-61102	2001-		P-U-14	70 mm	110 mm	KOM-707-98-37570	173.48
MODEL HD785-5								
STEERING	561-63-61102	4001-		P-U-14	70 mm	110 mm	KOM-707-98-37570	173.48
MODEL HD985-3								
STEERING	585-63-11100	1001-		P-U-14	70 mm	110 mm	KOM-707-98-37570	173.48
	585-63-11100	1021-		P-U-14	70 mm	110 mm	KOM-707-98-37570	173.48
MODEL HD1200M-1								
TAILGATE	566-63-41001			P-U-14	75 mm	140 mm	KOM-707-98-53100	278.90
	568-63-12101			P-U-14	75 mm	140 mm	KOM-707-98-53100	278.90
Wheel Dozers								
APPLICATION	CYL #	SERIAL #	Misc	CODE	ROD	BORE	KIT #	List \$
MODEL WD600-3								
LIFT	707-01-02030	50001-		P-U-14	90 mm	160 mm	KOM-707-99-64050	146.47

LT - Large size tire L/S - Loading Shovel SLF - Super Long Front B/H - Backhoe HD - Heavy Duty L BUCKET - Large Bucket
 K-LINK - K-type Linkage Blade LB HI-LIFT - High Lift Arm w Large Bucket HI-LIFT - High Lift Arm S HI-LIFT - Super High Lift Arm
 SU - Semi-U Dozer PAT - Power Angle Power Tilt MP - Mult-Purpose

Replacement Kits For

KOMATSU®

Wheel Dozers								
APPLICATION	CYL #	SERIAL #	Misc	CODE	ROD	BORE	KIT #	List \$
MODEL WD600-3								
LIFT	707-01-02030	50001-		Bushing	90 mm		KOM-707-52-10910	44.52
	707-01-08240	50001-		P-U-14	90 mm	160 mm	KOM-707-99-64050	146.47
	707-01-08240	50001-		Bushing	90 mm		KOM-707-52-10910	44.52
STEERING	707-01-XE630	50001-		P-UB-14	75 mm	140 mm	KOM-707-99-53160	131.75
TILT AND PITCH	707-01-02760	50001-		P-UB-14	90 mm	180 mm	KOM-707-99-64520	172.32
	707-01-08310	50001-		P-UB-14	90 mm	180 mm	KOM-707-99-64520	172.32

LT - Large size tire L/S - Loading Shovel SLF - Super Long Front B/H - Backhoe HD - Heavy Duty L BUCKET - Large Bucket
 K-LINK - K-type Linkage Blade LB HI-LIFT - High Lift Arm w Large Bucket HI-LIFT - High Lift Arm S HI-LIFT - Super High Lift Arm
 SU - Semi-U Dozer PAT - Power Angle Power Tilt MP - Mult-Purpose

REPLACEMENT KITS FOR KOMATSU® CONSTRUCTION EQUIPMENT

Kit Number	Code (Pg. xviii)	Rod X Bore Size	List Price	Kit Number	Code (Pg. xviii)	Rod X Bore Size	List Price
KOM-101-63-02010K	P-U-14	35 X 70 mm	\$ 37.92	KOM-21P-63-03130K	P-UB-14	70 X 105 mm	\$ 141.29
KOM-101-63-02030K	P-U-14	35 X 70 mm	37.92	KOM-21P-63-03200K	P-UB-14	75 X 110 mm	95.80
KOM-101-63-02040K	P-U-10	40 X 80 mm	42.34	KOM-21P-63-K1611K	P-UB-14	75 X 110 mm	91.81
KOM-101-63-02130K	P-U-14	35 X 70 mm	44.33	KOM-21P-63-K1711K	P-UB-14	85 X 120 mm	202.14
KOM-101-63-02140K	P-U-14	35 X 70 mm	44.33	KOM-21P-63-K1821K	P-UB-14	75 X 110 mm	127.44
KOM-10G-63-02010K	P-U-10	35 X 50 mm	72.68	KOM-21P-63-K3600K	P-UB-12	70 X 105 mm	172.06
KOM-10G-63-02020K	P-U-10	35 X 50 mm	72.68	KOM-21S-63-02050K	P-U-10	25 X 50 mm	76.27
KOM-114-63-05030	P-U-14	40 X 90 mm	104.49	KOM-21S-63-02131K	P-U-10	25 X 50 mm	107.06
KOM-12F-63-05020	P-U-14	45 X 70 mm	97.20	KOM-21W-63-02220K	P-U-14	60 X 100 mm	68.37
KOM-12F-63-05060	P-U-14	50 X 100 mm	161.85	KOM-21W-63-02221K	P-U-14	60 X 100 mm	68.37
KOM-130-63-05020	P-U-5	55 X 90 mm	134.93	KOM-2938-6C-1290	P-UB-14	50 X 90 mm	95.84
KOM-131-63-05020	P-U-5	65 X 130 mm	225.13	KOM-2938-6C-1480	P-UB-14	45 X 70 mm	79.08
KOM-131-63-05040	P-U-5	65 X 140 mm	219.55	KOM-418-62-05000	P-U-14	70 X 130 mm	82.83
KOM-135-63-05020	P-U-14	65 X 140 mm	291.80	KOM-418-63-05000	P-U-14	75 X 150 mm	146.13
KOM-135-63-05060	P-U-14	70 X 150 mm	200.05	KOM-419-63-H0P12	P-U-14	40 X 70 mm	148.58
KOM-141-63-05010	P-U-14	60 X 140 mm	211.90	KOM-421-63-H0P05	P-UB-14	100 X 200 mm	518.74
KOM-141-63-05050	P-U-14	75 X 160 mm	240.42	KOM-423-63-H2P07	P-U-14	90 X 160 mm	122.13
KOM-144-60-00050K	P-U-10	65 X 110 mm	170.39	KOM-423-63-H3P07	P-U-14	90 X 180 mm	163.95
KOM-144-63-05020	P-N-14	65 X 110 mm	150.77	KOM-42N-6C-13330	P-UB-10	40 X 70 mm	54.17
KOM-144-63-05050	P-U-14	65 X 110 mm	200.57	KOM-42N-6C-13340	P-UB-14	40 X 70 mm	73.93
KOM-144-63-05080	P-U-14	70 X 160 mm	184.47	KOM-42N-879-1980	I-SP-10	18 X 30 mm	44.73
KOM-144-63-12200K	P-U-5	65 X 110 mm	247.21	KOM-42T-63-H0P01	P-UB-10	45 X 80 mm	115.50
KOM-144-63-52100K	P-U-5	70 X 160 mm	347.12	KOM-42T-63-H0P18	P-UB-14	50 X 95 mm	128.92
KOM-175-63-05140	P-U-14	90 X 225 mm	366.22	KOM-42T-63-H0P52	P-U-10	35 X 70 mm	109.41
KOM-195-63-05120	P-U-5,14	90 X 160 mm	286.57	KOM-42T-63-H0P61	P-U-10	50 X 95 mm	140.47
KOM-195-63-05130	P-U-5	90 X 160 mm	242.90	KOM-42T-63-H0P70	P-U-10	50 X 85 mm	122.31
KOM-205-63-02140K	P-UB-14	85 X 125 mm	194.79	KOM-42U-63-H0P12	P-U-10	35 X 70 mm	52.19
KOM-205-63-94100K	P-U-14	80 X 130 mm	62.44	KOM-42U-63-H0P43	P-U-10	50 X 85 mm	188.44
KOM-205-63-K1360K	P-UB-14	85 X 120 mm	214.72	KOM-42U-63-H0P56	P-U-10	50 X 95 mm	96.66
KOM-205-63-K1361K	P-UB-14	85 X 120 mm	214.72	KOM-42U-63-H0P67	P-U-10	35 X 70 mm	54.98
KOM-205-63-K1370K	P-UB-14	110 X 160 mm	343.68	KOM-56B-50-13002K	P-U-1	140 X 180 mm	276.53
KOM-206-63-K1240K	P-UB-14	95 X 135 mm	201.08	KOM-56B-50-13003K	P-UB-1	140 X 180 mm	419.83
KOM-206-63-K1250K	P-UB-14	95 X 135 mm	201.08	KOM-56B-50-13004K	P-UB-1	140 X 180 mm	419.83
KOM-206-63-K1610K	P-UB-14	110 X 150 mm	241.13	KOM-56B-50-13005K	P-UB-1	140 X 180 mm	419.83
KOM-206-63-K1721K	P-UB-14	100 X 140 mm	191.32	KOM-56B-50-14000K	P-U-1	140 X 180 mm	276.53
KOM-206-63-K1911K	P-UB-14	100 X 140 mm	294.22	KOM-56B-50-14001K	P-UB-1	140 X 180 mm	419.83
KOM-206-63-K1980K	P-UB-14	100 X 140 mm	190.47	KOM-56B-50-14002K	P-UB-1	140 X 180 mm	419.83
KOM-206-63-K2120K	P-UB-14	95 X 135 mm	197.74	KOM-56B-50-14003K	P-UB-1	140 X 180 mm	419.83
KOM-206-63-K2150K	P-UB-14	120 X 185 mm	420.69	KOM-56B-50-16100K	P-U-1	140 X 180 mm	276.53
KOM-207-63-K1230K	P-UB-14	100 X 140 mm	183.97	KOM-56B-50-16101K	P-UB-1	140 X 180 mm	419.83
KOM-209-63-07010K	P-U-14	85 X 130 mm	100.47	KOM-56B-50-16102K	P-UB-1	140 X 180 mm	419.83
KOM-209-63-07010K	P-U-14	85 X 130 mm	100.47	KOM-56B-50-16103K	P-UB-1	140 X 180 mm	419.83
KOM-20E-63-03240K	P-UB-14	70 X 105 mm	142.28	KOM-56B-50-16201K	P-UB-1	140 X 180 mm	419.83
KOM-20E-63-K2500K	P-UB-14	70 X 140 mm	113.56	KOM-56B-50-16202K	P-UB-1	140 X 180 mm	419.83
KOM-20G-63-03240K	P-UB-14	85 X 120 mm	146.24	KOM-56B-50-16203K	P-UB-1	140 X 180 mm	419.83
KOM-20G-63-K1110K	P-UB-14	100 X 160 mm	345.81	KOM-56B-50-34000K	P-UB-1	110 X 150 mm	247.07
KOM-20G-63-K1410K	P-UB-14	85 X 120 mm	139.51	KOM-56D-50-13100K	P-U-1	110 X 150 mm	98.63
KOM-20U-63-02050K	P-U-14	60 X 100 mm	66.05	KOM-56D-50-13101K	P-UB-1	110 X 150 mm	103.69
KOM-20U-63-02051K	P-U-14	60 X 100 mm	66.05	KOM-56D-50-13102K	P-UB-1	110 X 150 mm	242.03
KOM-21D-61-13160	P-UB-14	60 X 90 mm	194.97	KOM-56D-50-13103K	P-UB-1	110 X 150 mm	242.03
KOM-21D-61-14140	P-UB-14	60 X 100 mm	257.40	KOM-56D-50-14100K	P-U-1	110 X 150 mm	98.63
KOM-21P-63-03120K	P-UB-14	85 X 120 mm	147.04	KOM-56D-50-14101K	P-UB-1	110 X 150 mm	103.69

REPLACEMENT KITS FOR KOMATSU® CONSTRUCTION EQUIPMENT

Kit Number	Code (Pg. xviii)	Rod X Bore Size	List Price
KOM-56D-50-14102K	P-UB-1	110 X 150 mm	\$ 242.03
KOM-56D-50-14103K	P-UB-1	110 X 150 mm	242.03
KOM-56D-50-26100K	P-UB-1	110 X 150 mm	242.03
KOM-56D-50-26200K	P-UB-1	110 X 150 mm	242.03
KOM-56D-50-33000K	P-UB-1	110 X 150 mm	242.03
KOM-56D-50-34000K	P-UB-1	110 X 150 mm	242.03
KOM-56D-50-35000K	P-UB-1	110 X 150 mm	242.03
KOM-707-00-02460K	P-U-10	20 X 35 mm	50.48
KOM-707-01-02670K	P-UB-14	130 X 200 mm	319.24
KOM-707-01-0H680K	P-UB-14	90 X 130 mm	153.18
KOM-707-01-0H710K	P-UB-14	90 X 130 mm	147.89
KOM-707-01-0H850K	P-UB-14	95 X 135 mm	182.09
KOM-707-01-0H920K	P-UB-14	90 X 130 mm	147.89
KOM-707-98-02420	P-U-10	25 X 45 mm	91.36
KOM-707-98-03530	P-U-10	25 X 50 mm	88.33
KOM-707-98-04500	P-U-10	30 X 50 mm	100.57
KOM-707-98-04590	P-U-14	30 X 50 mm	81.79
KOM-707-98-04600	P-U-14	30 X 50 mm	85.32
KOM-707-98-04610	P-U-14	30 X 50 mm	32.47
KOM-707-98-04640	P-U-14	30 X 50 mm	85.32
KOM-707-98-04730	P-U-14	30 X 55 mm	73.92
KOM-707-98-05410	P-U-10	35 X 50 mm	92.57
KOM-707-98-05420	P-U-10	35 X 50 mm	83.07
KOM-707-98-05460	P-U-10	35 X 50 mm	71.77
KOM-707-98-05460	P-U-10	35 X 50 mm	71.77
KOM-707-98-06010	P-U-1	40 mm Rod Kit	29.96
KOM-707-98-11020	P-U-10	30 X 60 mm	62.04
KOM-707-98-11070	P-U-10	30 X 60 mm	89.00
KOM-707-98-11090	P-U-10	30 X 60 mm	97.88
KOM-707-98-11310	P-U-14	30 X 60 mm	47.16
KOM-707-98-11350	P-U-3	30 X 60 mm	62.83
KOM-707-98-11380	P-U-10	25 X 60 mm	79.83
KOM-707-98-12020	P-U-10	35 X 60 mm	85.96
KOM-707-98-12080	P-U-10	35 X 60 mm	102.19
KOM-707-98-12100	P-U-14	35 X 60 mm	85.78
KOM-707-98-12110	P-U-14	35 X 60 mm	87.57
KOM-707-98-12120	P-U-10	35 X 60 mm	88.32
KOM-707-98-12130	P-U-10	35 X 60 mm	100.70
KOM-707-98-12150	P-U-10	35 X 60 mm	101.90
KOM-707-98-12160	P-U-10	35 X 60 mm	107.41
KOM-707-98-12200	P-U-14	35 X 60 mm	85.78
KOM-707-98-12211	P-U-14	35 X 65 mm	140.22
KOM-707-98-12310	P-U-14	35 X 63 mm	66.29
KOM-707-98-12320	P-U-14	35 X 60 mm	45.56
KOM-707-98-12330	P-U-14	35 X 60 mm	66.29
KOM-707-98-12410	P-U-14	35 X 70 mm	67.75
KOM-707-98-12440	P-U-14	35 X 70 mm	83.38
KOM-707-98-12450	P-U-10	35 X 70 mm	108.77
KOM-707-98-12470	P-U-14	35 X 70 mm	89.30
KOM-707-98-12490	P-U-10	35 X 70 mm	111.49
KOM-707-98-12510	P-U-10	35 X 70 mm	122.13
KOM-707-98-12520	P-U-10	35 X 70 mm	108.17

Kit Number	Code (Pg. xviii)	Rod X Bore Size	List Price
KOM-707-98-12530	P-U-10	35 X 70 mm	\$ 107.41
KOM-707-98-12550	P-U-14	35 X 70 mm	83.57
KOM-707-98-12600	P-U-14	35 X 70 mm	83.69
KOM-707-98-12660	P-U-14	35 X 70 mm	68.06
KOM-707-98-12670	P-U-14	40 X 70 mm	67.75
KOM-707-98-12700	P-U-10	35 X 70 mm	102.21
KOM-707-98-12740	P-U-14	35 X 70 mm	45.19
KOM-707-98-12750	P-U-14	35 X 70 mm	37.91
KOM-707-98-12760	P-U-14	35 X 70 mm	44.16
KOM-707-98-13220	P-U-14	35 X 60 mm	49.56
KOM-707-98-13420	P-U-14	35 X 70 mm	36.95
KOM-707-98-13700	P-U-14	40 X 70 mm	122.82
KOM-707-98-13850	P-U-14	35 X 65 mm	37.83
KOM-707-98-13890	P-U-14	35 X 65 mm	38.81
KOM-707-98-13960	P-U-14	35 X 55 mm	33.16
KOM-707-98-13990	P-U-14	35 X 55 mm	93.22
KOM-707-98-14030	P-U-14	40 X 60 mm	100.11
KOM-707-98-14040	P-U-10	40 X 60 mm	117.46
KOM-707-98-14200	P-U-14	40 X 60 mm	77.18
KOM-707-98-14240	P-U-14	40 X 60 mm	100.11
KOM-707-98-14350	P-U-14	40 X 65 mm	78.56
KOM-707-98-14410	P-U-10	40 X 70 mm	125.75
KOM-707-98-14430	P-U-14	40 X 70 mm	97.88
KOM-707-98-14600	P-U-14	40 X 70 mm	97.79
KOM-707-98-14610	P-U-14	40 X 70 mm	67.75
KOM-707-98-14700	P-U-14	40 X 70 mm	97.79
KOM-707-98-14710	P-U-10	40 X 70 mm	115.41
KOM-707-98-14770	P-U-14	40 X 70 mm	46.43
KOM-707-98-14830	P-U-14	40 X 65 mm	48.29
KOM-707-98-14910	P-U-14	40 X 65 mm	48.34
KOM-707-98-14930	P-U-14	40 X 65 mm	100.37
KOM-707-98-15410	P-U-10	45 X 70 mm	96.42
KOM-707-98-15610	P-U-14	45 X 70 mm	90.33
KOM-707-98-15650	P-U-14	45 X 70 mm	97.40
KOM-707-98-15690	P-U-14	45 X 70 mm	49.81
KOM-707-98-15700	P-U-14	45 X 70 mm	102.32
KOM-707-98-15720	P-U-14	45 X 70 mm	143.45
KOM-707-98-15740	P-U-14	45 X 70 mm	49.95
KOM-707-98-15760	P-U-14	45 X 70 mm	54.39
KOM-707-98-15770	P-U-14	45 X 70 mm	54.39
KOM-707-98-22010	P-U-10	40 X 80 mm	97.03
KOM-707-98-22020	P-U-14	40 X 80 mm	58.03
KOM-707-98-22030	P-U-14	40 X 80 mm	136.42
KOM-707-98-22040	P-U-14	40 X 80 mm	125.74
KOM-707-98-22060	P-U-10	40 X 80 mm	104.54
KOM-707-98-22080	P-U-10	40 X 80 mm	129.50
KOM-707-98-22100	P-U-14	40 X 80 mm	128.07
KOM-707-98-22110	P-U-14	40 X 80 mm	119.55
KOM-707-98-22120	P-U-14	40 X 80 mm	125.74
KOM-707-98-22140	P-U-10	40 X 80 mm	50.55
KOM-707-98-22150	P-U-14	40 X 80 mm	64.35
KOM-707-98-22180	P-U-14	40 X 80 mm	62.33

KOMATSU®

REPLACEMENT KITS FOR KOMATSU® CONSTRUCTION EQUIPMENT

Kit Number	Code (Pg. xviii)	Rod X Bore Size	List Price
KOM-707-98-22200	P-U-14	40 X 75 mm	\$ 142.72
KOM-707-98-22290	P-U-10	40 X 80 mm	49.38
KOM-707-98-22410	P-U-10	40 X 90 mm	109.51
KOM-707-98-22420	P-U-10	40 X 90 mm	109.51
KOM-707-98-22430	P-U-14	40 X 90 mm	112.61
KOM-707-98-22500	P-U-14	40 X 90 mm	111.91
KOM-707-98-22820	P-U-14	40 X 75 mm	50.36
KOM-707-98-22850	P-U-14	40 X 75 mm	44.70
KOM-707-98-22890	P-U-14	40 X 75 mm	62.83
KOM-707-98-22910	P-U-14	40 X 85 mm	77.85
KOM-707-98-23030	P-U-10	40 X 80 mm	76.37
KOM-707-98-23070	P-U-10	40 X 80 mm	49.38
KOM-707-98-23100	P-U-14	40 X 80 mm	50.69
KOM-707-98-23130	P-U-14	40 X 80 mm	102.43
KOM-707-98-23810	P-U-14	45 X 75 mm	68.82
KOM-707-98-23860	P-U-14	45 X 75 mm	66.02
KOM-707-98-23870	P-U-14	45 X 75 mm	68.89
KOM-707-98-23880	P-UB-14	45 X 75 mm	165.04
KOM-707-98-23890	P-U-14	45 X 75 mm	63.38
KOM-707-98-24040	P-U-14	45 X 80 mm	127.62
KOM-707-98-24050	P-U-5	45 X 80 mm	120.71
KOM-707-98-24060	P-U-10	45 X 80 mm	121.97
KOM-707-98-24070	P-U-10	45 X 80 mm	49.54
KOM-707-98-24150	P-U-14	45 X 80 mm	122.51
KOM-707-98-24170	P-U-14	45 X 80 mm	65.37
KOM-707-98-24210	P-UB-14	45 X 75 mm	187.46
KOM-707-98-24281	P-U-14	45 X 80 mm	68.47
KOM-707-98-24330	P-U-14	45 X 80 mm	73.00
KOM-707-98-24430	P-U-14	45 X 90 mm	154.95
KOM-707-98-24500	P-U-14	45 X 90 mm	115.21
KOM-707-98-24510	P-U-14	45 X 85 mm	128.85
KOM-707-98-24520	P-U-14	45 X 90 mm	115.38
KOM-707-98-24530	P-U-14	45 X 90 mm	167.87
KOM-707-98-24550	P-U-14	45 X 90 mm	74.22
KOM-707-98-24600	P-U-14	45 X 90 mm	170.85
KOM-707-98-24610	P-U-14	45 X 95 mm	59.78
KOM-707-98-24700	P-U-14	45 X 90 mm	51.65
KOM-707-98-24710	P-U-14	45 X 90 mm	41.99
KOM-707-98-24720	P-U-14	45 X 90 mm	43.69
KOM-707-98-24770	P-U-14	45 X 95 mm	59.84
KOM-707-98-24820	P-U-14	45 X 75 mm	66.74
KOM-707-98-24830	P-U-14	45 X 75 mm	58.29
KOM-707-98-24890	P-U-14	45 X 75 mm	172.10
KOM-707-98-24910	P-U-14	45 X 85 mm	70.52
KOM-707-98-24920	P-U-14	45 X 85 mm	130.41
KOM-707-98-24930	P-U-14	45 X 85 mm	79.13
KOM-707-98-25030	P-U-14	50 X 80 mm	133.63
KOM-707-98-25040	P-U-14	50 X 80 mm	179.82
KOM-707-98-25050	P-U-5	50 X 80 mm	126.46
KOM-707-98-25060	P-U-5	50 X 80 mm	177.67
KOM-707-98-25070	P-U-14	50 X 80 mm	136.14
KOM-707-98-25090	P-U-14	50 X 80 mm	81.96

Kit Number	Code (Pg. xviii)	Rod X Bore Size	List Price
KOM-707-98-25110	P-UB-14	50 X 80 mm	\$ 180.13
KOM-707-98-25170	P-U-14	50 X 80 mm	183.18
KOM-707-98-25250	P-U-14	50 X 80 mm	90.60
KOM-707-98-25350	P-U-14	50 X 80 mm	90.71
KOM-707-98-25430	P-U-14	50 X 90 mm	150.83
KOM-707-98-25500	P-U-14	50 X 90 mm	163.18
KOM-707-98-25510	P-U-14	50 X 90 mm	180.96
KOM-707-98-25520	P-UB-14	50 X 90 mm	171.17
KOM-707-98-25560	P-U-14	50 X 90 mm	82.99
KOM-707-98-25600	P-U-14	50 X 90 mm	136.27
KOM-707-98-25610	P-U-14	50 X 95 mm	135.85
KOM-707-98-25620	P-U-14	50 X 90 mm	86.58
KOM-707-98-25700	P-U-14	50 X 90 mm	83.07
KOM-707-98-25710	P-U-14	50 X 90 mm	78.49
KOM-707-98-25750	P-U-14	50 X 90 mm	83.08
KOM-707-98-25760	P-U-14	50 X 90 mm	90.48
KOM-707-98-25820	P-U-14	50 X 85 mm	106.06
KOM-707-98-25830	P-U-14	50 X 85 mm	105.94
KOM-707-98-25870	P-U-14	50 X 85 mm	170.06
KOM-707-98-25910	P-U-14	50 X 75 mm	81.41
KOM-707-98-25920	P-U-14	50 X 75 mm	55.50
KOM-707-98-25970	P-U-14	50 X 75 mm	81.56
KOM-707-98-25980	P-U-14	50 X 75 mm	86.00
KOM-707-98-26070	P-U-14	45 X 80 mm	73.46
KOM-707-98-26100	P-U-14	55 X 80 mm	100.88
KOM-707-98-26110	P-U-14	55 X 80 mm	109.72
KOM-707-98-26120	P-U-14	55 X 80 mm	111.20
KOM-707-98-26300	P-U-14	50 X 80 mm	90.61
KOM-707-98-26441	P-U-10	55 X 90 mm	122.56
KOM-707-98-26450	P-U-10	55 X 90 mm	261.20
KOM-707-98-26520	P-U-14	55 X 90 mm	101.66
KOM-707-98-26540	P-U-5	55 X 90 mm	97.03
KOM-707-98-26550	P-U-14	55 X 90 mm	97.68
KOM-707-98-26560	P-U-14	55 X 90 mm	169.58
KOM-707-98-26570	P-U-14	55 X 90 mm	96.66
KOM-707-98-26580	P-UB-14	55 X 90 mm	175.77
KOM-707-98-26600	P-U-5	55 X 90 mm	152.05
KOM-707-98-26620	P-U-14	55 X 90 mm	85.88
KOM-707-98-26720	P-U-14	55 X 90 mm	86.87
KOM-707-98-26900	P-U-14	55 X 85 mm	72.69
KOM-707-98-26901	P-U-14	55 X 85 mm	72.90
KOM-707-98-27100	P-U-14	60 X 80 mm	141.33
KOM-707-98-27500	P-U-14	60 X 90 mm	175.66
KOM-707-98-27600	P-UB-14	60 X 90 mm	243.86
KOM-707-98-27620	P-UB-14	60 X 90 mm	167.31
KOM-707-98-28600	P-U-14	65 X 95 mm	209.95
KOM-707-98-28640	P-U-14	65 X 95 mm	127.31
KOM-707-98-29500	P-U-14	50 X 90 mm	128.74
KOM-707-98-29510	P-U-14	50 X 90 mm	90.48
KOM-707-98-29620	P-U-14	50 X 95 mm	86.75
KOM-707-98-29630	P-U-14	50 X 95 mm	98.71
KOM-707-98-29640	P-U-14	50 X 95 mm	98.71

KOMATSU®

REPLACEMENT KITS FOR KOMATSU® CONSTRUCTION EQUIPMENT

Kit Number	Code (Pg. xviii)	Rod X Bore Size	List Price
KOM-707-98-29650	P-U-14	50 X 95 mm	\$ 108.49
KOM-707-98-29661	P-U-14	50 X 95 mm	86.65
KOM-707-98-29670	P-U-14	50 X 95 mm	72.49
KOM-707-98-29720	P-U-14	50 X 95 mm	81.77
KOM-707-98-30550	P-U-14	45 X 95 mm	69.00
KOM-707-98-32050	P-U-14	50 X 100 mm	146.96
KOM-707-98-32120	P-U-14	50 X 100 mm	177.73
KOM-707-98-32550	P-U-14	50 X 110 mm	88.92
KOM-707-98-32570	P-U-14	50 X 110 mm	88.92
KOM-707-98-32810	P-UB-14	50 X 105 mm	211.12
KOM-707-98-32820	P-U-14	50 X 105 mm	232.86
KOM-707-98-32900	P-U-14	50 X 105 mm	96.30
KOM-707-98-33010	P-U-10	50 X 100 mm	57.53
KOM-707-98-33500	P-U-14	50 X 115 mm	88.08
KOM-707-98-34120	P-U-14	55 X 100 mm	117.80
KOM-707-98-34140	P-U-14	55 X 95 mm	92.89
KOM-707-98-34160	P-U-14	55 X 100 mm	83.41
KOM-707-98-34180	P-U-14	55 X 110 mm	81.72
KOM-707-98-34410	P-U-10	55 X 110 mm	167.92
KOM-707-98-34460	P-U-14	55 X 110 mm	81.01
KOM-707-98-34520	P-U-14	55 X 110 mm	91.43
KOM-707-98-34560	P-U-14	55 X 110 mm	89.02
KOM-707-98-34580	I-U-14	55 X 110 mm	162.26
KOM-707-98-34590	P-U-14	55 X 110 mm	205.38
KOM-707-98-34640	P-U-14	55 X 110 mm	98.08
KOM-707-98-34670	P-U-14	55 X 115 mm	99.27
KOM-707-98-35100	P-U-14	60 X 100 mm	114.96
KOM-707-98-35110	P-U-14	60 X 100 mm	142.93
KOM-707-98-35130	P-U-14	60 X 100 mm	199.21
KOM-707-98-35181	P-U-14	60 X 100 mm	241.23
KOM-707-98-35310	P-U-14	60 X 100 mm	71.70
KOM-707-98-35510	P-U-14	60 X 110 mm	193.10
KOM-707-98-35520	P-U-14	60 X 110 mm	70.05
KOM-707-98-36100	P-UB-14	65 X 100 mm	170.56
KOM-707-98-36110	P-UB-14	65 X 100 mm	127.62
KOM-707-98-36140	P-U-14	65 X 100 mm	105.85
KOM-707-98-36180	P-U-14	65 X 100 mm	165.86
KOM-707-98-36200	P-UB-14	65 X 95 mm	303.08
KOM-707-98-36210	P-U-14	65 X 95 mm	259.56
KOM-707-98-36230	P-U-14	65 X 100 mm	139.33
KOM-707-98-36240	P-UB-14	65 X 95 mm	166.81
KOM-707-98-36280	P-U-14	65 X 100 mm	72.10
KOM-707-98-36411	P-U-10	65 X 110 mm	140.24
KOM-707-98-36450	P-U-14	65 X 110 mm	191.94
KOM-707-98-36500	P-U-14	65 X 110 mm	159.26
KOM-707-98-36510	P-U-14	65 X 110 mm	183.18
KOM-707-98-36520	P-U-14	65 X 110 mm	135.63
KOM-707-98-36560	P-U-14	65 X 110 mm	159.16
KOM-707-98-36590	P-U-14	65 X 115 mm	92.64
KOM-707-98-36600	P-U-14	65 X 110 mm	82.17
KOM-707-98-36630	P-U-14	65 X 110 mm	74.92
KOM-707-98-36700	P-U-14	65 X 115 mm	93.45

Kit Number	Code (Pg. xviii)	Rod X Bore Size	List Price
KOM-707-98-37110	P-UB-14	70 X 100 mm	\$ 216.99
KOM-707-98-37130	P-UB-14	70 X 100 mm	177.86
KOM-707-98-37300	P-U-14	70 X 105 mm	151.92
KOM-707-98-37500	P-U-14	70 X 110 mm	185.78
KOM-707-98-37510	P-U-14	70 X 110 mm	112.01
KOM-707-98-37570	P-U-14	70 X 110 mm	173.48
KOM-707-98-37580	P-U-14	70 X 110 mm	69.78
KOM-707-98-37600	P-U-14	70 X 110 mm	83.78
KOM-707-98-37610	P-U-14	70 X 110 mm	136.62
KOM-707-98-37620	P-UB-14	70 X 105 mm	183.24
KOM-707-98-37670	P-UB-14	70 X 105 mm	141.22
KOM-707-98-37680	P-U-14	70 X 110 mm	135.09
KOM-707-98-37690	P-U-14	70 X 110 mm	55.81
KOM-707-98-38500	P-U-14	75 X 110 mm	180.18
KOM-707-98-38510	P-U-14	75 X 110 mm	189.79
KOM-707-98-38520	P-UB-14	75 X 110 mm	337.22
KOM-707-98-38551	P-UB-14	75 X 110 mm	302.44
KOM-707-98-38600	P-U-14	75 X 110 mm	200.89
KOM-707-98-39610	P-UB-14	80 X 115 mm	196.31
KOM-707-98-39700	P-U-14	80 X 110 mm	158.51
KOM-707-98-40020	P-U-14	55 X 120 mm	242.47
KOM-707-98-41020	P-U-10	60 X 120 mm	103.71
KOM-707-98-41030	P-U-14	60 X 120 mm	147.52
KOM-707-98-41110	P-U-14	65 X 120 mm	236.81
KOM-707-98-41120	P-U-14	60 X 120 mm	129.10
KOM-707-98-41130	P-U-14	60 X 120 mm	233.06
KOM-707-98-41140	P-U-14	60 X 120 mm	241.42
KOM-707-98-41170	P-U-14	60 X 120 mm	86.85
KOM-707-98-41330	P-U-14	60 X 120 mm	86.93
KOM-707-98-42100	P-U-14	65 X 120 mm	180.87
KOM-707-98-42150	P-U-14	65 X 120 mm	76.73
KOM-707-98-42410	P-U-14	65 X 130 mm	271.46
KOM-707-98-42420	P-U-10	65 X 130 mm	104.71
KOM-707-98-42540	P-U-14	65 X 130 mm	106.40
KOM-707-98-42700	P-U-14	65 x 130 mm	95.26
KOM-707-98-43100	P-U-14	70 X 120 mm	252.04
KOM-707-98-43130	P-U-14	70 X 120 mm	166.32
KOM-707-98-43200	P-U-14	70 X 120 mm	97.51
KOM-707-98-43210	P-U-14	70 X 120 mm	87.03
KOM-707-98-43260	P-U-14	70 X 120 mm	148.47
KOM-707-98-43510	P-U-14	70 X 130 mm	287.25
KOM-707-98-43530	P-U-14	70 X 130 mm	235.96
KOM-707-98-43620	I-U-14	70 X 130 mm	222.58
KOM-707-98-44120	P-U-14	75 X 120 mm	255.34
KOM-707-98-44200	P-U-14	75 X 120 mm	380.40
KOM-707-98-44310	P-UB-14	75 X 115 mm	123.49
KOM-707-98-45100	P-U-14	80 X 120 mm	85.72
KOM-707-98-45200	P-U-14	80 X 120 mm	263.75
KOM-707-98-45220	P-UB-14	80 X 115 mm	337.63
KOM-707-98-45240	P-UB-14	80 X 11 mm	148.24
KOM-707-98-45250	P-UB-14	80 X 100 mm	259.10
KOM-707-98-45610	P-U-14	80 X 130 mm	253.04

KOMATSU®

REPLACEMENT KITS FOR KOMATSU® CONSTRUCTION EQUIPMENT

Kit Number	Code (Pg. xviii)	Rod X Bore Size	List Price	Kit Number	Code (Pg. xviii)	Rod X Bore Size	List Price
KOM-707-98-45620	P-U-14	80 X 130 mm	\$ 293.07	KOM-707-98-61100	P-U-14	75 X 160 mm	\$ 237.12
KOM-707-98-45700	P-U-14	80 X 130 mm	299.98	KOM-707-98-61110	P-U-5	75 X 160 mm	285.86
KOM-707-98-46100	P-U-14	85 X 120 mm	222.90	KOM-707-98-62100	P-U-14	80 X 160 mm	177.35
KOM-707-98-46200	P-U-14	85 X 120 mm	275.14	KOM-707-98-62120	P-U-14	80 X 160 mm	212.99
KOM-707-98-46220	P-UB-14	85 X 120 mm	129.83	KOM-707-98-62131	P-U-14	80 X 160 mm	499.04
KOM-707-98-46270	P-UB-14	85 X 120 mm	408.09	KOM-707-98-64400	P-U-14	90X 180 mm	121.33
KOM-707-98-46280	P-UB-14	85 X 120 mm	169.71	KOM-707-98-64410	P-U-14	90 X 180 mm	215.51
KOM-707-98-46300	P-UB-14	85 X 120 mm	134.54	KOM-707-98-64420	P-U-14	90 X 180 mm	217.97
KOM-707-98-46600	P-U-14	85 X 130 mm	260.22	KOM-707-98-64450	P-U-14	90 X 180 mm	207.89
KOM-707-98-47500	P-U-14	90 X 130 mm	262.46	KOM-707-98-66410	P-U-14	100 X 180 mm	415.19
KOM-707-98-47510	P-U-14	90 X 130 mm	303.48	KOM-707-98-67100	P-U-14	110 X 160 mm	247.50
KOM-707-98-47600	P-U-14	90 X 130 mm	314.59	KOM-707-98-67110	P-U-14	110 X 160 mm	302.88
KOM-707-98-47620	P-UB-14	90 X 130 mm	372.35	KOM-707-98-68400	P-U-14	120 X 180 mm	310.80
KOM-707-98-47670	P-UB-14	90 X 130 mm	340.70	KOM-707-98-68500	P-U-14	120 X 180 mm	295.39
KOM-707-98-47680	P-U-14	90 X 130 mm	214.41	KOM-707-98-71020	P-U-14	90 X 200 mm	365.34
KOM-707-98-47710	P-UB-14	90 X 130 mm	198.48	KOM-707-98-73010	P-U-14	100 X 200 mm	316.74
KOM-707-98-47720	P-UB-14	90 X 130 mm	316.77	KOM-707-98-73020	P-U-14	100 X 200 mm	290.03
KOM-707-98-47730	P-UB-14	90 X 130 mm	218.55	KOM-707-98-73400	P-U-14	100 X 225 mm	321.84
KOM-707-98-47740	P-UB-14	90 X 130 mm	176.74	KOM-707-98-74100	P-U-14	110 X 200 mm	427.91
KOM-707-98-48500	P-U-14	95 X 130 mm	307.08	KOM-707-98-74400	P-U-14	110 X 225	590.54
KOM-707-98-48510	P-U-14	95 X 130 mm	324.11	KOM-707-98-74410	P-U-14	110 X 225 mm	417.26
KOM-707-98-48600	P-U-14	95 X 130 mm	319.41	KOM-707-98-74420	P-U-14	110 X 225 mm	352.04
KOM-707-98-48610	P-UB-14	95 X 135 mm	259.51	KOM-707-98-75020	P-U-14	120 X 200 mm	318.81
KOM-707-98-48700	P-U-14	95 X 135 mm	257.62	KOM-707-98-77210	P-UB-14	140 X 200 mm	265.70
KOM-707-98-50100	P-U-14	60 X 140 mm	211.90	KOM-707-98-81010	P-U-14	110 X 250 mm	436.87
KOM-707-98-51100	P-U-14	65 X 140 mm	237.94	KOM-707-98-84011	P-U-14	140 X 250 mm	594.92
KOM-707-98-51110	P-U-5	65 X 140 mm	229.32	KOM-707-99-03420	P-U-10	25 X 50 mm	60.46
KOM-707-98-52100	P-U-14	70 X 140 mm	289.38	KOM-707-99-03500	P-U-10	25 X 50 mm	92.27
KOM-707-98-52110	P-U-14	70 X 140 mm	276.87	KOM-707-99-04410	P-U-10	30 X 50 mm	105.79
KOM-707-98-52130	P-U-14	70 X 140 mm	245.92	KOM-707-99-11030	P-U-14	30 X 60 mm	85.07
KOM-707-98-52140	P-U-14	70 X 140 mm	203.85	KOM-707-99-11040	P-UB-14	30 X 60 mm	85.07
KOM-707-98-52210	P-U-14	70 X 140 mm	92.68	KOM-707-99-12420	P-U-5	35 X 70 mm	120.25
KOM-707-98-52220	P-U-14	70 X 140 mm	99.68	KOM-707-99-13410	P-U-5	35 X 70 mm	131.33
KOM-707-98-52410	P-U-14	70 X 150 mm	232.91	KOM-707-99-14200	P-U-14	40 X 60 mm	98.19
KOM-707-98-52420	P-U-14	70 X 150 mm	268.87	KOM-707-99-14410	P-U-10	40 X 70 mm	116.45
KOM-707-98-52430	P-U-14	70 X 150 mm	210.80	KOM-707-99-14460	P-U-14	40 X 70 mm	122.79
KOM-707-98-53100	P-U-14	75 X 140 mm	278.90	KOM-707-99-14600	P-U-14	40 X 70 mm	137.61
KOM-707-98-53410	P-U-14	75 X 150 mm	242.10	KOM-707-99-14610	P-U-14	40 X 70 mm	82.48
KOM-707-98-54500	P-U-14	80 X 150 mm	177.07	KOM-707-99-14750	P-UB-14	40 X 70 mm	100.33
KOM-707-98-54510	P-U-14	80 X 150 mm	230.23	KOM-707-99-14760	P-U-14	40 X 70 mm	148.58
KOM-707-98-56210	P-UB-14	90 X 140 mm	192.19	KOM-707-99-14770	P-UB-14	40 X 70 mm	153.53
KOM-707-98-56600	P-U-14	90 X 150 mm	210.49	KOM-707-99-14790	P-UB-14	40 X 70 mm	164.82
KOM-707-98-56610	P-U-14	90 X 150 mm	225.53	KOM-707-99-14930	P-UB-14	40 X 75 mm	104.17
KOM-707-98-57201	P-U-14	95 X 140 mm	162.05	KOM-707-99-14960	P-UB-14	40 X 75 mm	144.21
KOM-707-98-58200	P-U-14	100 X 140 mm	316.08	KOM-707-99-14970	P-UB-14	40 X 75 mm	115.64
KOM-707-98-58210	P-U-14	100 X 140 mm	257.86	KOM-707-99-14980	P-UB-14	40 X 75 mm	132.26
KOM-707-98-58230	P-U-14	100 X 140 mm	177.06	KOM-707-99-15600	P-U-14	45 X 70 mm	143.03
KOM-707-98-58240	P-UB-14	100 X 140 mm	204.88	KOM-707-99-15760	P-UB-14	45 X 75 mm	153.98
KOM-707-98-60100	P-U-14	70 X 160 mm	358.40	KOM-707-99-15810	P-UB-14	45 X 75 mm	185.08
KOM-707-98-60110	P-U-14	70 X 160 mm	184.27	KOM-707-99-22010	P-U-14	40 X 80 mm	117.80
KOM-707-98-60120	P-U-14	70 X 160 mm	186.17	KOM-707-99-22100	P-U-14	40 X 80 mm	169.57
KOM-707-98-60121	P-U-14	70 X 160 mm	184.40	KOM-707-99-23010	P-U-5	40 X 80 mm	121.28

REPLACEMENT KITS FOR KOMATSU® CONSTRUCTION EQUIPMENT

Kit Number	Code (Pg. xviii)	Rod X Bore Size	List Price	Kit Number	Code (Pg. xviii)	Rod X Bore Size	List Price
KOM-707-99-23040	P-UB-14	40 X 80 mm	\$ 118.43	KOM-707-99-35160	I-UB-14	60 X 100 mm	\$ 171.90
KOM-707-99-23910	P-UB-14	40 X 85 mm	137.33	KOM-707-99-35170	P-UB-14	60 X 100 mm	58.51
KOM-707-99-24100	P-U-14	45 X 80 mm	140.08	KOM-707-99-35180	P-UB-14	60 X 100 mm	183.36
KOM-707-99-24110	P-U-14	45 X 80 mm	120.42	KOM-707-99-35230	P-UB-14	60 X 100 mm	263.46
KOM-707-99-24120	P-U-14	45 X 80 mm	116.62	KOM-707-99-35300	P-UB-14	60 X 100 mm	363.05
KOM-707-99-24200	P-U-14	45 X 80 mm	124.53	KOM-707-99-35310	P-UB-14	60 X 100 mm	385.47
KOM-707-99-24500	P-U-14	45 X 90 mm	129.55	KOM-707-99-35320	P-UB-14	60 X 100 mm	324.44
KOM-707-99-24510	P-U-14	45 X 90 mm	74.75	KOM-707-99-35590	P-UB-14	60 X 115 mm	86.43
KOM-707-99-24630	P-UB-14	45 X 90 mm	195.47	KOM-707-99-35720	P-UB-14	60 X 110 mm	190.94
KOM-707-99-24640	P-UB-14	45 X 90 mm	134.84	KOM-707-99-36200	P-UB-14	65 X 100 mm	246.73
KOM-707-99-24650	P-UB-14	45 X 90 mm	125.03	KOM-707-99-36210	P-UB-14	65 X 100 mm	203.69
KOM-707-99-24660	P-UB-14	45 X 90 mm	126.80	KOM-707-99-36220	P-UB-14	65 X 100 mm	277.75
KOM-707-99-24670	P-UB-14	45 X 90 mm	125.10	KOM-707-99-36260	P-U-14	65 X 100 mm	203.29
KOM-707-99-24930	P-UB-14	45 X 85 mm	153.70	KOM-707-99-36270	P-U-14	65 X 100 mm	203.09
KOM-707-99-25520	P-U-14	50 X 90 mm	163.64	KOM-707-99-36300	P-UB-14	65 X 100 mm	159.41
KOM-707-99-25700	P-UB-14	50 X 90 mm	305.31	KOM-707-99-36330	P-UB-14	65 x 100 mm	144.15
KOM-707-99-25710	P-UB-14	50 X 90 mm	205.48	KOM-707-99-36410	P-U-5	60 X 110 mm	168.95
KOM-707-99-25720	P-UB-14	50 X 90 mm	82.80	KOM-707-99-36420	P-U-14	65 X 110 mm	189.57
KOM-707-99-25730	P-UB-14	50 X 90 mm	155.57	KOM-707-99-36550	P-UB-14	65 X 110 mm	78.15
KOM-707-99-25870	P-UB-14	65 X 95 mm	166.33	KOM-707-99-36620	P-UB-14	65 X 105 mm	334.22
KOM-707-99-25880	P-UB-14	65 X 95 mm	140.49	KOM-707-99-36630	P-UB-14	65 X 115 mm	311.33
KOM-707-99-26410	P-U-5	55 X 90 mm	134.93	KOM-707-99-36680	P-UB-14	65 X 110 mm	161.99
KOM-707-99-26530	P-UB-14	55 x 90 mm	107.55	KOM-707-99-36720	P-UB-14	65 X 110 mm	166.24
KOM-707-99-26600	P-U-5	55 X 90 mm	190.08	KOM-707-99-37150	P-UB-14	70 X 105 mm	164.77
KOM-707-99-26620	P-U-14	55 X 90 mm	254.69	KOM-707-99-37170	P-UB-14	70 X 105 mm	108.55
KOM-707-99-26640	P-UB-14	55 X 90 mm	295.34	KOM-707-99-37230	P-UB-14	70 X 105 mm	148.51
KOM-707-99-26730	P-UB-14	60 X 90 mm	145.87	KOM-707-99-37290	P-UB-14	70 X 105 mm	333.39
KOM-707-99-27110	P-UB-14	60 X 85 mm	155.60	KOM-707-99-37300	P-UB-14	70 X 105 mm	112.59
KOM-707-99-27120	P-UB-14	60 X 85 mm	188.21	KOM-707-99-37310	P-UB-14	70 X 105 mm	119.89
KOM-707-99-27310	P-UB-14	60 X 85 mm	152.78	KOM-707-99-37340	P-UB-14	70 X 105 mm	120.41
KOM-707-99-27530	P-UB-14	60 X 90 mm	150.60	KOM-707-99-37500	P-U-14	70 X 110 mm	125.94
KOM-707-99-27600	P-U-14	60 X 90 mm	234.48	KOM-707-99-37510	P-U-14	70 X 110 mm	166.79
KOM-707-99-27650	P-UB-14	60 X 90 mm	269.50	KOM-707-99-37590	P-U-14	70 X 110 mm	62.31
KOM-707-99-27780	P-UB-14	65 X 95 mm	111.72	KOM-707-99-37591	P-UB-14	70 X 110 mm	97.34
KOM-707-99-32010	P-U-14	50 X 100 mm	156.65	KOM-707-99-37600	P-UB-14	70 X 110 mm	222.12
KOM-707-99-32070	P-UB-14	50 X 100 mm	138.17	KOM-707-99-37610	P-UB-14	70 X 110 mm	354.92
KOM-707-99-32100	P-U-14	50 X 100 mm	133.67	KOM-707-99-37620	P-U-14	70 X 110 mm	146.93
KOM-707-99-32110	P-U-14	50 X 100 mm	111.82	KOM-707-99-38720	P-UB-14	75 X 110 mm	341.69
KOM-707-99-32140	P-UB-14	50 X 100 mm	75.66	KOM-707-99-38740	P-UB-14	75 X 110 mm	76.35
KOM-707-99-32190	P-UB-14	50 X 100 mm	96.65	KOM-707-99-38760	P-UB-14	75 X 110 mm	125.78
KOM-707-99-32250	P-UB-14	50 X 100 mm	233.40	KOM-707-99-38780	P-UB-14	75 X 110 mm	106.14
KOM-707-99-33010	P-U-14	50 X 100 mm	137.83	KOM-707-99-38790	P-UB-14	75 X 110 mm	99.28
KOM-707-99-34030	P-U-5	55 X 100 mm	137.72	KOM-707-99-38820	P-UB-14	75 X 110 mm	143.12
KOM-707-99-34100	P-U-14	55 X 100 mm	115.32	KOM-707-99-40040	P-U-14	55 X 120 mm	215.90
KOM-707-99-34240	P-U-14	55 X 105 mm	128.50	KOM-707-99-40100	P-U-5	50 X 120 mm	201.73
KOM-707-99-34300	P-UB-14	55 X 100 mm	161.07	KOM-707-99-40120	P-UB-14	55 X 120 mm	116.45
KOM-707-99-34500	P-U-14	55 X 110 mm	114.23	KOM-707-99-41100	P-U-14	60 X 120 mm	167.66
KOM-707-99-34510	P-U-14	55 X 110 mm	170.29	KOM-707-99-41130	P-U-14	60 X 120 mm	63.77
KOM-707-99-34550	P-UB-14	55 X 110 mm	176.13	KOM-707-99-41140	P-U-14	60 X 120 mm	235.12
KOM-707-99-34600	P-UB-14	55 X 110 mm	99.71	KOM-707-99-41270	P-UB-14	60 X 120 mm	119.43
KOM-707-99-34620	P-UB-14	55 X 110 mm	109.31	KOM-707-99-41300	P-UB-14	60 X 120 mm	330.80
KOM-707-99-34630	P-UB-14	55 X 110 mm	102.27	KOM-707-99-41420	P-U-5	60 X 130 mm	111.60

KOMATSU®

REPLACEMENT KITS FOR KOMATSU® CONSTRUCTION EQUIPMENT

Kit Number	Code (Pg. xviii)	Rod X Bore Size	List Price	Kit Number	Code (Pg. xviii)	Rod X Bore Size	List Price
KOM-707-99-42020	P-U-5	65 X 120 mm	\$ 211.17	KOM-707-99-47610	P-UB-14	90 X 130 mm	\$ 372.87
KOM-707-99-42170	P-UB-14	70 X 120 mm	205.85	KOM-707-99-47660	P-UB-14	90 X 130 mm	256.38
KOM-707-99-42300	P-UB-14	70 X 125 mm	214.95	KOM-707-99-47670	P-UB-14	90 X 130 mm	372.94
KOM-707-99-42310	P-UB-14	70 X 125 mm	281.07	KOM-707-99-47730	P-UB-14	90 X 130 mm	235.06
KOM-707-99-43010	P-U-5	70 X 120 mm	192.79	KOM-707-99-47740	P-UB-14	90 X 130 mm	244.02
KOM-707-99-43100	P-U-14	70 X 120 mm	202.80	KOM-707-99-47780	P-UB-14	90 X 130 mm	227.05
KOM-707-99-43110	P-U-14	70 X 120 mm	241.22	KOM-707-99-47790	P-UB-14	90 X 130 mm	218.42
KOM-707-99-43170	P-U-14	70 X 120 mm	191.26	KOM-707-99-47800	P-UB-14	90 X 130 mm	178.68
KOM-707-99-43300	P-UB-14	70 X 120 mm	432.60	KOM-707-99-47830	P-UB-14	90 X 130 mm	360.74
KOM-707-99-43310	P-UB-14	70 X 125 mm	202.27	KOM-707-99-47860	P-UB-14	90 X 130 mm	186.82
KOM-707-99-43320	P-UB-14	70 X 125 mm	166.35	KOM-707-99-47880	P-UB-14	90 X 130 mm	124.72
KOM-707-99-43390	P-UB-14	70 X 125 mm	193.46	KOM-707-99-48610	P-UB-14	95 X 130 mm	321.27
KOM-707-99-43500	P-U-14	70 X 130 mm	207.21	KOM-707-99-48620	P-UB-14	90 X 130 mm	165.21
KOM-707-99-43520	P-U-14	70 X 130 mm	299.25	KOM-707-99-48630	P-UB-14	90 X 130 mm	243.47
KOM-707-99-43540	P-U-14	70 X 130 mm	272.45	KOM-707-99-50500	P-UB-14	95 X 135 mm	147.82
KOM-707-99-43570	P-UB-14	70 X 130 mm	278.77	KOM-707-99-50620	P-UB-14	95 X 135 mm	319.24
KOM-707-99-43590	P-UB-14	70 X 130 mm	289.40	KOM-707-99-50650	P-UB-14	95 X 135 mm	205.10
KOM-707-99-43680	P-UB-14	70 X 130 mm	82.19	KOM-707-99-50680	P-UB-14	95 X 135 mm	159.18
KOM-707-99-43690	P-UB-14	70 X 130 mm	84.31	KOM-707-99-50740	P-UB-14	95 X 135 mm	205.60
KOM-707-99-43730	P-UB-14	70 X 130 mm	183.88	KOM-707-99-50780	P-UB-14	95 X 135 mm	148.42
KOM-707-99-43740	P-UB-14	70 X 130 mm	195.50	KOM-707-99-52100	P-U-14	70 X 140 mm	234.72
KOM-707-99-44060	P-UB-14	75 X 115 mm	256.31	KOM-707-99-52160	P-UB-14	70 X 140 mm	94.02
KOM-707-99-44200	P-UB-14	75 X 115 mm	167.03	KOM-707-99-52170	P-UB-14	70 X 140 mm	100.98
KOM-707-99-44220	P-UB-14	75 X 115 mm	125.19	KOM-707-99-53100	P-U-14	75 X 140 mm	179.25
KOM-707-99-44230	P-UB-14	75 X 115 mm	125.19	KOM-707-99-53160	P-UB-14	75 X 140 mm	131.75
KOM-707-99-44270	P-UB-14	75 X 115 mm	114.79	KOM-707-99-53170	P-UB-14	75 X 140 mm	251.66
KOM-707-99-44280	P-UB-14	75 X 115 mm	118.44	KOM-707-99-53270	P-U-14	75 X 140 mm	112.01
KOM-707-99-44290	P-UB-14	75 X 115 mm	109.50	KOM-707-99-53500	P-U-14	75 X 150 mm	232.68
KOM-707-99-44310	P-UB-14	75 X 115 mm	262.64	KOM-707-99-54100	P-U-14	80 X 140 mm	181.95
KOM-707-99-44340	P-UB-14	75 X 115 mm	127.95	KOM-707-99-54140	P-U-14	80,120 X 100,140 mm	144.12
KOM-707-99-44380	P-UB-14	75 X 115 mm	119.94	KOM-707-99-54150	P-U-14	80,120 X 100,140 mm	220.52
KOM-707-99-45040	P-UB-14	80 X 115 mm	127.92	KOM-707-99-55500	P-U-14	85 X 150 mm	194.01
KOM-707-99-45220	P-UB-14	80 X 115 mm	167.42	KOM-707-99-56220	P-UB-14	90 X 140 mm	165.16
KOM-707-99-45230	P-UB-14	80 X 115 mm	196.31	KOM-707-99-56240	P-UB-14	90 X 140 mm	160.70
KOM-707-99-45310	P-UB-14	80 X 120 mm	120.00	KOM-707-99-56300	P-UB-14	90 X 140 mm	177.67
KOM-707-99-46030	P-UB-14	85 X 120 mm	143.95	KOM-707-99-56310	P-U-14	90 X 140 mm	415.22
KOM-707-99-46120	P-UB-14	85 X 125 mm	209.65	KOM-707-99-56500	P-U-14	90 X 150 mm	244.74
KOM-707-99-46130	P-UB-14	85 X 120 mm	372.77	KOM-707-99-56510	P-UB-14	90 X 150 mm	156.00
KOM-707-99-46200	P-UB-14	85 X 120 mm	363.04	KOM-707-99-56620	P-UB-14	90 X 150 mm	303.61
KOM-707-99-46210	P-UB-14	85 X 120 mm	364.96	KOM-707-99-56730	P-UB-14	90 X 150 mm	372.17
KOM-707-99-46270	P-UB-14	85 X 120 mm	233.48	KOM-707-99-57160	P-UB-14	95 X 135 mm	361.84
KOM-707-99-46290	P-UB-14	85 X 125 mm	372.02	KOM-707-99-57180	P-UB-14	95 X 135 mm	193.72
KOM-707-99-46320	P-UB-14	85 X 120 mm	401.08	KOM-707-99-57200	P-UB-14	95 X 135 mm	298.85
KOM-707-99-46390	P-UB-14	85 X 120 mm	111.88	KOM-707-99-57250	P-UB-14	95 X 135 mm	298.85
KOM-707-99-46420	P-UB-14	85 X 120 mm	147.73	KOM-707-99-57270	P-UB-14	95 X 135 mm	373.71
KOM-707-99-46470	P-UB-14	85 X 120 mm	105.59	KOM-707-99-57310	P-UB-14	95 X 140 mm	356.50
KOM-707-99-46600	P-UB-14	85 X 120 mm	225.34	KOM-707-99-58030	P-UB-14	100 X 140 mm	218.99
KOM-707-99-46620	P-UB-14	85 X 130 mm	311.35	KOM-707-99-58050	P-UB-14	100 X 140 mm	239.81
KOM-707-99-47040	P-UB-14	85 X 125 mm	160.79	KOM-707-99-58060	P-UB-14	100 X 140 mm	411.74
KOM-707-99-47130	P-UB-14	85 X 125 mm	160.79	KOM-707-99-58070	P-UB-14	100 X 140 mm	205.90
KOM-707-99-47570	P-UB-14	90 X 130 mm	316.70				
KOM-707-99-47600	P-UB-14	90 X 130 mm	245.30				

REPLACEMENT KITS FOR KOMATSU® CONSTRUCTION EQUIPMENT

Kit Number	Code (Pg. xviii)	Rod X Bore Size	List Price
KOM-707-99-58080	P-UB-14	100 X 140 mm	\$ 279.98
KOM-707-99-58090	P-UB-14	100 X 140 mm	377.25
KOM-707-99-58110	P-UB-14	100 X 140 mm	348.91
KOM-707-99-58200	P-UB-14	100 X 140 mm	373.00
KOM-707-99-58210	P-UB-14	100 X 140 mm	380.18
KOM-707-99-58240	P-UB-14	100 X 140 mm	476.62
KOM-707-99-58260	P-UB-14	100 X 140 mm	594.15
KOM-707-99-58300	P-UB-14	100 X 140 mm	180.66
KOM-707-99-58310	P-UB-14	100 X 140 mm	144.18
KOM-707-99-58320	P-UB-14	100 X 140 mm	239.94
KOM-707-99-58350	P-UB-14	100 X 140 mm	281.41
KOM-707-99-58360	P-UB-14	100 X 140 mm	305.61
KOM-707-99-58370	P-UB-14	100 X 140 mm	399.18
KOM-707-99-58390	P-UB-14	100 X 140 mm	143.99
KOM-707-99-59020	P-UB-14	100 X 140 mm	388.96
KOM-707-99-59230	P-UB-14	100 X 140 mm	132.70
KOM-707-99-59320	P-UB-14	100 X 140 mm	307.81
KOM-707-99-59330	P-UB-14	100 X 140 mm	181.05
KOM-707-99-59600	P-UB-14	100 X 150 mm	227.50
KOM-707-99-59610	P-UB-14	110 X 150 mm	386.16
KOM-707-99-59620	P-UB-14	110 X 150 mm	514.93
KOM-707-99-59740	P-UB-14	110 X 150 mm	510.56
KOM-707-99-62010	P-U-14	80 X 160 mm	212.99
KOM-707-99-62020	P-U-14	80 X 160 mm	202.70
KOM-707-99-62120	P-UB-14	80 X 160 mm	341.75
KOM-707-99-64010	P-U-14	90 X 160 mm	207.99
KOM-707-99-64030	P-U-14	90 X 160 mm	292.14
KOM-707-99-64040	P-UB-14	90 X 160 mm	300.16
KOM-707-99-64050	P-U-14	90 X 160 mm	146.47
KOM-707-99-64080	P-UB-14	90 X 160 mm	262.78
KOM-707-99-64120	P-UB-14	90 X 160 mm	300.16
KOM-707-99-64150	P-U-14	90,140 X 120,160 mm	248.77
KOM-707-99-64152	P-U-14	90, 140 X 120 mm	360.09
KOM-707-99-64180	P-U-14	90, 140 X 120 mm	366.06
KOM-707-99-64200	P-UB-14	90 X 160 mm	162.47
KOM-707-99-64230	P-UB-14	90 X 160 mm	151.95
KOM-707-99-64250	P-UB-14	90 X 160 mm	151.95
KOM-707-99-64400	P-U-14	90 X 180 mm	314.07
KOM-707-99-64410	P-U-14	90 X 180 mm	216.03
KOM-707-99-64450	P-U-14	90 X 180 mm	258.22
KOM-707-99-64520	P-UB-14	90 X 180 mm	172.32
KOM-707-99-64540	P-UB-14	90 X 180 mm	301.44
KOM-707-99-64570	P-UB-14	90 X 180 mm	215.57
KOM-707-99-65400	P-U-14	95 X 180 mm	223.42
KOM-707-99-65420	P-UB-14	95 X 180 mm	237.84
KOM-707-99-65840	P-U-14	100 X 170 mm	333.33
KOM-707-99-66010	P-U-14	100 X 160 mm	146.93
KOM-707-99-66210	P-U-14	100 X 160 mm	307.50
KOM-707-99-66240	P-UB-14	100 X 160 mm	301.19

Kit Number	Code (Pg. xviii)	Rod X Bore Size	List Price
KOM-707-99-66350	P-UB-14	100 X 160 mm	\$ 147.90
KOM-707-99-66360	P-UB-14	100 X 160 mm	526.87
KOM-707-99-66380	P-UB-14	100 X 160 mm	251.13
KOM-707-99-66400	P-U-14	100 X 180 mm	290.10
KOM-707-99-66600	P-UB-14	100 X 180 mm	166.55
KOM-707-99-66610	P-UB-14	100 X 180 mm	147.98
KOM-707-99-66660	P-UB-14	100 X 180 mm	151.03
KOM-707-99-67010	P-UB-14	110 X 160 mm	407.69
KOM-707-99-67070	P-UB-14	110 X 160 mm	247.14
KOM-707-99-67090	P-UB-14	110 X 160 mm	399.71
KOM-707-99-67110	P-UB-14	110 X 160 mm	334.08
KOM-707-99-67120	P-UB-14	110 X 160 mm	352.81
KOM-707-99-67121	P-UB-14	110 X 160 mm	239.19
KOM-707-99-67280	P-UB-14	110 X 160 mm	318.83
KOM-707-99-67290	P-UB-14	110 X 160 mm	263.21
KOM-707-99-67300	P-UB-14	110 X 160 mm	431.76
KOM-707-99-67310	P-UB-14	110 X 160 mm	470.48
KOM-707-99-67610	P-UB-14	110 X 160 mm	339.29
KOM-707-99-67640	P-UB-14	110 X 180 mm	252.56
KOM-707-99-67690	P-UB-14	110 X 180 mm	250.66
KOM-707-99-67700	P-UB-14	110 X 180 mm	264.02
KOM-707-99-67760	P-UB-14	120 X 160 mm	586.27
KOM-707-99-67770	P-UB-14	120 X 185 mm	733.55
KOM-707-99-67830	P-UB-14	110 X 160 mm	217.97
KOM-707-99-67840	P-UB-14	110 X 160 mm	262.70
KOM-707-99-67870	P-UB-14	110 X 160 mm	275.80
KOM-707-99-68420	P-UB-14	120 X 160 mm	529.92
KOM-707-99-68430	P-UB-14	120 X 185 mm	736.62
KOM-707-99-68510	P-UB-14	120 X 185 mm	386.07
KOM-707-99-68560	P-UB-14	120 X 185 mm	673.22
KOM-707-99-68580	P-UB-14	120 X 185 mm	402.06
KOM-707-99-68600	P-UB-14	120 X 180 mm	300.92
KOM-707-99-68660	P-UB-14	120 X 185 mm	395.70
KOM-707-99-68730	P-UB-14	120 X 185 mm	392.59
KOM-707-99-68780	P-UB-14	120 X 185 mm	413.95
KOM-707-99-68910	P-UB-14	120 X 170 mm	360.90
KOM-707-99-69500	P-UB-14	130 X 185 mm	460.94
KOM-707-99-69600	P-U-14	130 X 180 mm	479.61
KOM-707-99-69620	P-U-14	130 X 180 mm	507.17
KOM-707-99-69670	P-UB-14	130 X 185 mm	378.80
KOM-707-99-69700	P-UB-14	130 X 185 mm	440.71
KOM-707-99-69710	P-UB-14	130 X 185 mm	457.24
KOM-707-99-69740	P-UB-14	130 X 185 mm	456.36
KOM-707-99-69790	P-UB-14	130 X 185 mm	446.10
KOM-707-99-71100	P-U-14	90 X 200 mm	257.43
KOM-707-99-71420	P-U-14	90 X 225 mm	307.90
KOM-707-99-72240	P-UB-14	110 X 160 mm	375.51
KOM-707-99-72300	P-UB-14	110 X 160 mm	246.00
KOM-707-99-73010	P-U-14	100 X 200 mm	199.50
KOM-707-99-73020	P-U-14	100 X 200 mm	183.34
KOM-707-99-73150	P-UB-14	100 X 200 mm	410.37
KOM-707-99-73160	P-UB-14	100 X 200 mm	523.95

KOMATSU®

REPLACEMENT KITS FOR KOMATSU® CONSTRUCTION EQUIPMENT

Kit Number	Code (Pg. xviii)	Rod X Bore Size	List Price	Kit Number	Code (Pg. xviii)	Rod X Bore Size	List Price
KOM-707-99-74010	P-U-14	110 X 200 mm	\$ 229.89	KOM-707-99-85350	P-UB-14	160 X 250 mm	\$ 2723.82
KOM-707-99-74020	P-UB-14	110 X 200 mm	281.15	KOM-707-99-85900	P-UB-14	160 X 260 mm	1002.87
KOM-707-99-74120	P-UB-14	110 X 200 mm	238.45	KOM-707-99-86600	P-UB-14	170 X 280 mm	903.79
KOM-707-99-74140	P-UB-14	110 X 200 mm	324.65	KOM-707-99-89200	P-U-14	170 X 250 mm	767.25
KOM-707-99-74200	P-UB-14	110 X 200 mm	252.35	KOM-707-99-96140	P-UB-14	200 X 300 mm	3268.34
KOM-707-99-74230	P-UB-14	110 X 200 mm	280.15	KOM-707-99-96200	P-UB-14	180 X 300 mm	1613.07
KOM-707-99-74240	P-UB-14	110 X 200 mm	311.41	KOM-707-99-H0P01	P-U-14	95 X 180 mm	458.41
KOM-707-99-74440	P-UB-14	110 X 225 mm	306.59	KOM-707-99-H0P03	P-UB-14	100 X 200 mm	518.74
KOM-707-99-74450	P-UB-14	110 X 225 mm	270.33	KOM-707-99-H0P10	P-UB-14	95 X 180 mm	497.93
KOM-707-99-75400	P-U-14	120 X 225 mm	257.72	KOM-707-99-H0P11	P-UB-14	50 X 100 mm	202.43
KOM-707-99-75410	P-U-14	120 X 225 mm	254.73	KOM-780-454-73	N-N-10	200 mm	232.74
KOM-707-99-75420	P-U-14	120 X 225 mm	273.06	KOM-827020113	I-U-15	45 X 80 mm	29.60
KOM-707-99-75440	P-UB-14	120 X 225 mm	327.82	KOM-855660112	I-SP-15	45 X 85 mm	89.80
KOM-707-99-75450	P-UB-14	120 X 225 mm	532.57	KOM-878000365	P-UB-14	60 X 120 mm	267.61
KOM-707-99-75470	P-UB-14	120 X 225 mm	248.48	KOM-878000388	P-UB-10	40 X 70 mm	67.10
KOM-707-99-75490	P-UB-14	120 X 225 mm	708.37	KOM-878000425	P-UB-14	60 X 100 mm	211.07
KOM-707-99-75600	P-UB-14	120 X 225 mm	270.18	KOM-878000486	P-UB-14	50 X 85 mm	82.91
KOM-707-99-76260	P-UB-14	140 X 200 mm	1184.79	KOM-878000487	P-UB-14	50 X 80 mm	74.80
KOM-707-99-76300	P-UB-14	140 X 200 mm	368.40	KOM-878000489	P-UB-14	60 X 120 mm	106.95
KOM-707-99-77050	P-UB-14	140 X 200 mm	265.70	KOM-878000490	P-UB-14	60 X 110 mm	108.11
KOM-707-99-77090	P-UB-14	140 X 200 mm	561.19	KOM-878000491	P-UB-14	60 X 115 mm	113.20
KOM-707-99-77120	P-UB-14	140 X 200 mm	664.90	KOM-878000492	P-UB-14	60 X 95 mm	98.45
KOM-707-99-77130	P-UB-14	140 X 200 mm	953.13	KOM-878000494	P-UB-14	55 X 110 mm	71.26
KOM-707-99-77140	P-UB-14	140 X 200 mm	359.12	KOM-878000541	P-UB-14	60 X 125 mm	142.03
KOM-707-99-77160	P-UB-14	140 X 200 mm	339.13	KOM-878000542	P-UB-14	50 X 115 mm	83.28
KOM-707-99-77190	P-UB-14	140 X 200 mm	685.93	KOM-878000607	P-UB-14	70 X 120 mm	237.68
KOM-707-99-77220	P-UB-14	140 X 200 mm	264.24	KOM-878000608	P-UB-14	50 X 90 mm	155.64
KOM-707-99-77240	P-U-14	140 X 200 mm	827.28	KOM-878000617	I-SP-10	18 X 30 mm	44.73
KOM-707-99-77250	P-U-14	140 X 200 mm	750.43	KOM-878010240	P-U-14	30 X 60 mm	68.71
KOM-707-99-77300	P-UB-14	140 X 200 mm	266.76	KOM-878010241	P-U-14	35 X 55 mm	59.85
KOM-707-99-77380	P-UB-14	140 X 200 mm	277.05	KOM-878010284	P-U-14	35 X 65 mm	61.79
KOM-707-99-77600	P-UB-14	140 X 225 mm	519.63	KOM-878010285	P-U-14	40 X 65 mm	62.35
KOM-707-99-77620	P-UB-14	140 X 225 mm	293.02	KOM-AK4307	P-U-14	2-1/4 X 6-1/2	471.14
KOM-707-99-77630	P-UB-14	140 X 225 mm	585.71	KOM-AK4308	I-UB-1	15-3/4	2619.93
KOM-707-99-78620	P-UB-14	160 X 225 mm	1271.90	KOM-AK4370	P-U-14	3 X 6	367.81
KOM-707-99-78630	P-UB-14	160 X 225 mm	1271.52	KOM-AK4441	I-UB-1	14" ROD KIT	1896.19
KOM-707-99-78680	P-UB-14	160 X 225 mm	1146.00	KOM-AK4446	I-UB-1	12" ROD KIT	1086.98
KOM-707-99-78700	P-UB-14	160 X 225 mm	1145.98	KOM-AK4773	I-UB-10	7,10-1/2,13	2816.31
KOM-707-99-78740	P-UB-14	160 X 225 mm	1145.98	KOM-AK4773	I-UB-10		2816.31
KOM-707-99-81010	P-UB-14	110 X 250 mm	354.94	KOM-AK4892	TELESCOPIC KIT		2760.80
KOM-707-99-84010	P-U-14	140 X 250 mm	472.12	KOM-AK5239	I-UB-1	14	1254.41
KOM-707-99-84200	P-UB-14	140 X 250 mm	367.58	KOM-AK7283	P-U-10	3 X 6	101.42
KOM-707-99-84400	P-U-14	140 X 280 mm	404.75	KOM-PC-1	P-U-14	100 X 150 mm	196.18
KOM-707-99-84440	P-UB-14	140 X 280 mm	473.80	KOM-PC-2	P-U-14	90 X 140 mm	177.67
KOM-707-99-84450	P-UB-14	140 X 280 mm	507.18	KOM-PC-3	P-U-14	80 X 140 mm	222.65
KOM-707-99-85310	P-UB-14	160 X 250 mm	1562.05	KOM-RK1887	SHOCK STRUT VALVE		135.71

KOMATSU®

REPLACEMENT KITS FOR KOMATSU® LIFT TRUCKS

NOTE: Komatsu part numbers are used as a reference only. We do not imply that these kits are original REPLACEMENT PARTS.

Kit Number	Code (Pg. xviii)	Rod X Bore Size	List Price
KOM-34A-63-05010	I-U-4,12	50 X 70 mm	\$ 131.94
KOM-34A-64-05010	I-U-1	30mm Rod Kit	24.64
KOM-34B-63-05011	I-U-4,10	55 X 80 mm	165.95
KOM-34B-63-05021	I-U-4,10	60 X 80 mm	158.55
KOM-34B-64-05010	I-U-1	35 X 50 mm	35.53
KOM-3EA-64-05020	I-U-1	25 X 60 mm	39.25
KOM-3EA-64-05030	I-U-1	35mm Rod Kit	42.63
KOM-3EA-64-05190	I-U-10	1 X 2-1/2	42.69
KOM-3EB-34-05010	O-Ring Kit		21.13
KOM-3EB-63-05010	P-U-4	40 X 50 mm	94.09
KOM-3EB-63-05020	P-U-4	45 X 55 mm	42.21
KOM-3EB-64-05010	I-U-1	25 X 50 mm	33.41
KOM-3EB-64-05020	I-U-1	25 X 50 mm	51.17

Kit Number	Code (Pg. xviii)	Rod X Bore Size	List Price
KOM-3EB-64-05020L	P-U-10	25 X 50mm	\$ 29.53
KOM-3EB-64-05050	I-U-1	30 X 70 mm	39.27
KOM-3EB-64-05050L	I-U-3	30 X 70 mm	35.55
KOM-3EB-64-05060	I-U-1	35 X 65 mm	34.71
KOM-3EB-64-05091	I-U-3	30 X 70 mm	28.88
KOM-3EB-64-05190	I-U-10	1-1/4 X 2-3/4	51.37
KOM-3EB-64-A2000	I-U-10	1-5/8 X 2-1/2	65.86
KOM-3EB-64-A5191	I-U-10	1-1/4 X 2-3/4	85.77
KOM-3EC-63-05020	P-U-4	50 X 70 mm	65.02
KOM-3EC-64-05010L	I-U-3	45 X 90 mm	40.78
KOM-3EC-64-05190	I-U-10	1-3/4 X 3-1/2	48.25
KOM-3EC-64-A2390	I-U-10	1 X 2	36.20
KOM-ON43001-07567	I-U-10	50 X 75 mm	107.26

KOMATSU® TRACK ADJUSTER KITS

Kit Number	Code (Pg. xviii)	Bore Size	List Price
KOM-1909018	P-N-4	60 mm	\$ 49.94
KOM-1909019	N-N-4	70 mm	25.98
KOM-1909020	N-N-4	70 mm	29.78
KOM-1909021	P-N-4	70 mm	27.33
KOM-1909022	P-N-4	90 mm	35.53

Kit Number	Code (Pg. xviii)	Bore Size	List Price
KOM-1909023	N-N-4	100 mm	\$ 28.87
KOM-1909025	P-N-4	100 mm	35.69
KOM-1909041	P-OB-1	40 mm Rod	7.14
KOM-1909043	N-N-4	40 mm	48.39

REPLACEMENT PARTS FOR KOMATSU® EQUIPMENT

NOTE: Komatsu part numbers are used as a reference only. We do not imply that these kits are original REPLACEMENT PARTS.

BACK-UP RINGS

Part Number	Min Pkg Qty	List Price
KOM-07001-02014	1	\$ 2.46
KOM-07001-02018	1	2.46
KOM-07001-02020	1	2.46
KOM-07001-02050	1	3.68
KOM-07001-02055	1	5.02
KOM-07001-02060	1	10.75
KOM-07001-02065	1	6.07
KOM-07001-02070	1	11.02
KOM-07001-02075	1	8.39
KOM-07001-02080	1	11.18
KOM-07001-02085	1	11.35
KOM-07001-02090	1	11.35
KOM-07001-02095	1	11.35
KOM-07001-03022	1	2.46
KOM-07001-03040	1	3.14
KOM-07001-03045	1	3.53
KOM-07001-03050	1	3.53
KOM-07001-05055	1	11.47
KOM-07001-05080	1	8.19
KOM-07001-05090	1	16.50
KOM-07001-05095	1	9.75
KOM-07001-05100	1	10.01
KOM-07001-05105	1	10.80
KOM-07001-05110	1	10.98
KOM-07001-05115	1	11.29
KOM-07001-05118	1	17.46
KOM-07001-05120	1	11.82
KOM-07001-05125	1	12.35
KOM-07001-05130	1	12.58
KOM-07001-05135	1	13.10
KOM-07001-05140	1	13.66
KOM-07001-05150	1	14.41
KOM-07001-05155	1	14.88
KOM-07001-05160	1	15.92
KOM-07001-05170	1	16.19
KOM-07001-05175	1	17.41
KOM-07001-05180	1	17.46
KOM-07001-05185	1	17.72
KOM-07001-05190	1	18.25
KOM-07001-05195	1	18.74
KOM-07001-05220	1	21.03
KOM-07001-05300	1	43.89
KOM-070-35-91370	1	12.35

BACK-UP RINGS

Part Number	Min Pkg Qty	List Price
KOM-07146-02006	1	\$ 11.35
KOM-07146-02051	1	3.68
KOM-07146-02056	1	7.46
KOM-07146-02066	1	6.07
KOM-07146-02076	1	11.02
KOM-07146-02085	1	11.35
KOM-07146-02086	1	11.35
KOM-07146-02096	1	11.35
KOM-07146-02106	1	11.85
KOM-07146-02116	1	12.08
KOM-07146-02126	1	12.23
KOM-07146-02128	1	12.40
KOM-07146-02136	1	13.26
KOM-07146-02146	1	14.56
KOM-07146-05152	1	14.41
KOM-07146-05172	1	16.19
KOM-07146-05192	1	18.25
KOM-07146-05242	1	23.10
KOM-101-63-81230	1	11.85
KOM-111-63-81230	1	12.23
KOM-178-63-22460	1	29.27
KOM-20D-63-32290	1	12.08
KOM-20R-30-21550	1	3.14
KOM-3EE-62-25560	1	12.08
KOM-423-63-H2P04	1	4.36
KOM-423-63-H3P04	1	11.84
KOM-424-63-H0P08	1	13.81
KOM-42T-63-H0P07	10	1.20
KOM-42U-63-H0P63	10	0.99
KOM-569-63-42190	1	17.72
KOM-56D-50-13180	1	13.43
KOM-707-35-10710	1	1.82
KOM-707-35-10810	1	2.19
KOM-707-35-10860	1	2.42
KOM-707-35-10960	1	5.80
KOM-707-35-11060	1	3.69
KOM-707-35-11210	1	3.47
KOM-707-35-11260	1	4.73
KOM-707-35-30700	1	6.75
KOM-707-35-30800	1	2.30
KOM-707-35-30850	1	7.09
KOM-707-35-30900	1	3.91
KOM-707-35-31100	1	38.72

BACK-UP RINGS

Part Number	Min Pkg Qty	List Price
KOM-707-35-31210	1	\$ 5.33
KOM-707-35-31260	1	4.73
KOM-707-35-31410	1	6.16
KOM-707-35-31510	1	18.65
KOM-707-35-31760	1	24.05
KOM-707-35-52360	1	11.59
KOM-707-35-52370	1	3.14
KOM-707-35-52510	1	3.53
KOM-707-35-52520	1	16.75
KOM-707-35-52660	1	10.75
KOM-707-35-52670	1	11.35
KOM-707-35-52690	1	11.35
KOM-707-35-52700	1	11.02
KOM-707-35-52740	1	8.20
KOM-707-35-52750	1	8.39
KOM-707-35-52760	1	11.02
KOM-707-35-52770	1	11.18
KOM-707-35-52780	1	11.35
KOM-707-35-52830	1	11.35
KOM-707-35-52860	1	12.08
KOM-707-35-52880	1	13.26
KOM-707-35-52900	1	10.75
KOM-707-35-52910	1	11.02
KOM-707-35-52911	1	14.41
KOM-707-35-52920	1	11.18
KOM-707-35-52930	1	11.35
KOM-707-35-52940	1	11.59
KOM-707-35-52950	1	11.85
KOM-707-35-52951	1	11.85
KOM-707-35-52991	1	14.41
KOM-707-35-90010	1	9.47
KOM-707-35-90030	1	10.01
KOM-707-35-90300	1	2.46
KOM-707-35-90730	1	6.28
KOM-707-35-90810	1	8.28
KOM-707-35-90920	1	5.64
KOM-707-35-90940	1	8.19
KOM-707-35-90960	1	8.40
KOM-707-35-90970	1	8.40
KOM-707-35-90980	1	8.19
KOM-707-35-91010	1	2.31
KOM-707-35-91020	1	42.03
KOM-707-35-91050	1	11.35

KOMATSU®

REPLACEMENT PARTS FOR KOMATSU® EQUIPMENT

NOTE: Komatsu part numbers are used as a reference only. We do not imply that these kits are original REPLACEMENT PARTS.

BACK-UP RINGS

Part Number	Min Pkg Qty	List Price
KOM-707-35-91060	1	\$ 9.75
KOM-707-35-91100	1	11.85
KOM-707-35-91130	1	10.01
KOM-707-35-91140	1	13.10
KOM-707-35-91200	1	12.08
KOM-707-35-91220	1	10.98
KOM-707-35-91250	1	11.29
KOM-707-35-91311	1	12.23
KOM-707-35-91320	1	11.82
KOM-707-35-91440	1	13.10
KOM-707-35-91550	1	14.12
KOM-707-35-91610	1	11.85
KOM-707-35-91630	1	11.85
KOM-707-35-91650	1	14.88
KOM-707-35-91660	1	13.66
KOM-707-35-91750	1	15.92
KOM-707-35-91840	1	17.41
KOM-707-35-91850	1	2.94
KOM-707-35-92020	1	18.25
KOM-707-35-92050	1	18.74
KOM-707-35-92300	1	21.03
KOM-707-35-92600	1	10.75
KOM-707-35-92900	1	3.53
KOM-707-35-93020	1	34.04
KOM-707-35-99500	1	2.81
KOM-707-35-99510	1	3.53
KOM-707-35-99600	1	30.26
KOM-WA1436	1	4.57
KOM-WA1456	1	7.75

BACK-UP RINGS

Part Number	Rod Diam.	List Price
KOM-PB9910	7	\$ 80.45
KOM-PB9911	10-1/2	127.88
KOM-PB9912	13	205.37
KOM-PC0470	16-1/2	598.46
KOM-707-51-40640	40 mm	45.67
KOM-707-51-40650	40 mm	45.67
KOM-707-51-45640	45 mm	49.87
KOM-707-51-45650	45 mm	49.87
KOM-707-51-50640	50 mm	18.46

BUFFER RINGS

Part Number	Rod Diam.	List Price
KOM-707-51-55630	55 mm	\$ 18.57
KOM-707-51-55640	55 mm	18.57
KOM-707-51-60640	60 mm	26.37
KOM-707-51-60650	60 mm	26.37
KOM-707-51-65630	65 mm	31.36
KOM-707-51-65640	65 mm	31.36
KOM-707-51-65650	65 mm	31.36
KOM-707-51-70630	70 mm	34.23
KOM-707-51-70650	70 mm	34.23
KOM-707-51-75630	75 mm	36.39
KOM-707-51-75640	75 mm	36.39
KOM-707-51-75650	75 mm	36.39
KOM-707-51-80630	80 mm	38.54
KOM-707-51-80640	80 mm	38.54
KOM-707-51-80650	80 mm	38.54
KOM-707-51-85630	85 mm	41.35
KOM-707-51-85640	85 mm	41.35
KOM-707-51-85650	85 mm	41.35
KOM-707-51-90630	90 mm	49.91
KOM-707-51-90640	90 mm	49.91
KOM-707-51-90650	90 mm	49.91
KOM-707-51-95630	95 mm	52.69
KOM-707-51-95640	95 mm	52.69
KOM-707-51-95650	95 mm	52.69
KOM-421-63-H0P12	95 mm	52.69
KOM-707-51-10630	100 mm	54.21
KOM-707-51-10640	100 mm	54.21
KOM-707-51-10650	100 mm	54.21
KOM-707-51-11630	110 mm	58.49
KOM-707-51-11640	110 mm	58.49
KOM-707-51-11650	110 mm	86.98
KOM-707-51-12630	120 mm	63.50
KOM-707-51-12640	120 mm	63.50
KOM-707-51-12650	120 mm	120.56
KOM-707-51-13630	130 mm	98.56
KOM-707-51-13640	130 mm	98.56
KOM-707-51-13650	130 mm	98.56
KOM-707-51-14630	140 mm	160.49
KOM-707-51-14640	140 mm	160.49
KOM-707-51-14850	140 mm	289.71
KOM-707-51-14650	140 mm	127.38
KOM-707-51-16630	160 mm	161.30
KOM-707-51-16640	160 mm	161.30
KOM-707-51-16850	160 mm	303.50

BUFFER RINGS

Part Number	Rod Diam.	List Price
KOM-707-51-17630	170 mm	\$ 227.44
KOM-707-51-17640	170 mm	227.44
KOM-707-51-18640	180 mm	317.41
KOM-707-51-19630	190 mm	178.97
KOM-707-51-20850	200 mm	331.11

CUSHION SEALS

Part Number	List Price
KOM-EK7088	\$ 218.84

DUST SEALS

Part Number	Rod Diam.	List Price
KOM-20A-70-12221	30 mm	\$ 8.83
KOM-22L-70-21550	35 mm	22.34
KOM-419-09-11120	40 mm	20.57
KOM-707-77-40020	40 mm	10.77
KOM-3EA-22-11210	42 mm	11.03
KOM-07145-00045	45 mm	5.12
KOM-20U-70-42530	45 mm	18.46
KOM-07145-00050	50 mm	5.81
KOM-707-77-50020	50 mm	13.25
KOM-07145-00055	55 mm	7.72
KOM-07145-00060	60 mm	8.14
KOM-21W-70-41440	60 mm	24.96
KOM-07145-00065	65 mm	9.45
KOM-417-09-11120	65 mm	20.41
KOM-707-77-65110	65 mm	18.12
KOM-22B-70-12170	65 mm	13.96
KOM-07145-00070	70 mm	10.29
KOM-07145-10075	75 mm	11.57
KOM-20Y-70-23230	80 mm	15.79

LOCK NUTS

Part Number	List Price
KOM-VL7694	\$ 57.00

REPLACEMENT PARTS FOR KOMATSU® EQUIPMENT

NOTE: Komatsu part numbers are used as a reference only. We do not imply that these kits are original REPLACEMENT PARTS.

NYLON PLUGS

Part Number	Size	List Price
KOM-42Y-63-H0P25	5/16 x 1/4	\$ 2.02

OIL SEALS

Part Number	List Price
KOM-20A-70-12211	\$ 11.94
KOM-707-77-18010	132.82

O-RINGS

Part Number	Min Pkg Qty	List Price
KOM-07000-01125	5	\$ 2.71
KOM-07000-02005	100	0.09
KOM-07000-02010	100	0.06
KOM-07000-02011	100	0.09
KOM-07000-02012	100	0.55
KOM-07000-02014	100	0.11
KOM-07000-02015	100	0.77
KOM-07000-02016	100	0.11
KOM-07000-02018	100	0.11
KOM-07000-02020	100	0.96
KOM-07000-02021	100	0.12
KOM-07000-02050	10	3.20
KOM-07000-02055	10	1.01
KOM-07000-02060	10	1.15
KOM-07000-02065	10	1.22
KOM-07000-02070	10	1.47
KOM-07000-02075	5	1.76
KOM-07000-02080	5	1.78
KOM-07000-02085	5	6.32
KOM-07000-02090	5	1.83
KOM-07000-02095	5	7.43
KOM-07000-02100	5	2.06
KOM-07000-02105	5	2.09
KOM-07000-02110	5	8.93
KOM-07000-02115	5	2.71
KOM-07000-02120	5	2.83
KOM-07000-02125	5	9.68
KOM-07000-02130	5	2.90
KOM-07000-02135	2	10.74
KOM-07000-02140	2	11.10
KOM-07000-02145	5	3.49

O-RINGS

Part Number	Min Pkg Qty	List Price
KOM-07000-03020	50	\$ 0.10
KOM-07000-03022	25	0.34
KOM-07000-03025	25	0.36
KOM-07000-03028	20	0.48
KOM-07000-03030	20	0.48
KOM-07000-03032	20	0.49
KOM-07000-03035	20	2.09
KOM-07000-03038	20	0.64
KOM-07000-03040	20	2.79
KOM-07000-03042	20	0.67
KOM-07000-03045	10	0.88
KOM-07000-03048	10	0.90
KOM-07000-03050	10	0.93
KOM-07000-03052	20	0.39
KOM-07000-03055	20	0.39
KOM-07000-03058	20	0.42
KOM-07000-03062	20	0.50
KOM-07000-03065	20	0.50
KOM-07000-03068	20	0.53
KOM-07000-03070	20	0.53
KOM-07000-03075	20	0.56
KOM-07000-03078	20	0.59
KOM-07000-03080	20	0.62
KOM-07000-03082	20	0.65
KOM-07000-03090	20	0.69
KOM-07000-03092	20	0.69
KOM-07000-03095	20	0.71
KOM-07000-03098	20	0.72
KOM-07000-03100	10	0.79
KOM-07000-03105	10	0.85
KOM-07000-03110	10	0.88
KOM-07000-03115	10	1.12
KOM-07000-03120	10	1.18
KOM-07000-03125	10	1.25
KOM-07000-03130	10	1.29
KOM-07000-03140	5	1.51
KOM-07000-05055	5	2.49
KOM-07000-05060	2	3.38
KOM-07000-05065	2	4.31
KOM-07000-05070	2	4.32
KOM-07000-05075	2	4.62
KOM-07000-05080	2	4.72
KOM-07000-05085	2	4.90
KOM-07000-05090	2	5.00
KOM-07000-05095	2	5.18
KOM-07000-05100	2	5.28

O-RINGS

Part Number	Min Pkg Qty	List Price
KOM-07000-05105	2	\$ 6.74
KOM-07000-05110	2	6.86
KOM-07000-05120	2	7.11
KOM-07000-05125	2	7.22
KOM-07000-05130	2	7.27
KOM-07000-05135	2	7.39
KOM-07000-05140	2	7.49
KOM-07000-05145	2	7.62
KOM-07000-05150	2	9.07
KOM-07000-05155	2	5.75
KOM-07000-05160	2	5.72
KOM-07000-05165	2	5.78
KOM-07000-05170	2	5.89
KOM-07000-05175	2	7.93
KOM-07000-05180	2	14.89
KOM-07000-05185	2	8.1
KOM-07000-05190	2	8.17
KOM-07000-05195	2	8.26
KOM-07000-05200	2	9.64
KOM-07000-05210	2	9.81
KOM-07000-05220	2	10.01
KOM-07000-05225	1	10.16
KOM-07000-05230	1	10.16
KOM-07000-05235	1	10.90
KOM-07000-05240	1	11.10
KOM-07000-05250	1	11.70
KOM-07000-05260	1	12.83
KOM-07000-05270	1	12.94
KOM-07000-05280	1	13.67
KOM-07000-05290	1	14.45
KOM-07000-05300	1	14.54
KOM-07000-05305	1	17.03
KOM-07000-05310	1	17.03
KOM-07000-05345	1	18.64
KOM-07000-05400	1	26.04
KOM-07000-05430	1	27.20
KOM-07000-05435	1	27.72
KOM-07000-05440	1	28.63
KOM-07000-05445	1	28.82
KOM-07000-05460	1	30.38
KOM-07000-05465	1	30.59
KOM-07000-05470	1	30.92
KOM-07000-05480	1	31.15
KOM-07000-05490	1	32.05
KOM-07000-05495	1	32.28
KOM-07000-05500	1	32.84

KOMATSU®

REPLACEMENT PARTS FOR KOMATSU® EQUIPMENT

NOTE: Komatsu part numbers are used as a reference only. We do not imply that these kits are original REPLACEMENT PARTS.

O-RINGS

Part Number	Min Pkg Qty	List Price
KOM-07000-22070	10	\$ 1.47
KOM-07000-32055	10	1.01
KOM-07000-33032	20	0.49
KOM-07000-62018	100	0.11
KOM-07000-62070	10	1.47
KOM-07000-62115	5	2.71
KOM-07000-62130	5	2.90
KOM-07000-63045	10	0.88
KOM-07000-65190	2	8.17
KOM-07002-00823	50	0.29
KOM-07002-01023	25	0.33
KOM-07002-01423	100	0.09
KOM-07002-01623	100	0.46
KOM-07002-01823	100	0.77
KOM-07002-02034	50	0.10
KOM-07002-02434	50	0.12
KOM-07002-03334	20	0.48
KOM-07002-03634	50	0.20
KOM-07002-11423	100	0.09
KOM-07002-11823	100	0.77
KOM-07002-12034	50	0.10
KOM-07002-13034	50	0.19
KOM-07002-13334	20	0.48
KOM-07002-13634	50	0.20
KOM-07002-94115	5	2.37
KOM-198-63-43430	5	1.96
KOM-21T-09-11430	25	2.76
KOM-21T-09-11450	20	3.11
KOM-21T-09-11460	2	3.11
KOM-21T-09-11470	2	3.33
KOM-3046999R1	10	1.12
KOM-42T-63-H0P04	10	1.30
KOM-42U-63-H0P05	10	1.14
KOM-707-34-18020	50	0.09
KOM-707-34-36000	25	0.19
KOM-707-34-50030	20	0.49
KOM-SL8048	5	2.13
KOM-WA0100	20	0.69
KOM-WA0180	1	7.85

O-RINGS 90 DUROMETER

Part Number	Min Pkg Qty	List Price
KOM-02896-11008	50	\$ 0.10
KOM-02896-11009	50	0.10
KOM-02896-11012	50	0.11
KOM-02896-11015	50	0.14
KOM-02896-11018	50	0.16
KOM-02896-51015	50	0.14
KOM-02896-61009	50	0.10
KOM-02896-61012	50	0.11
KOM-02896-61015	50	0.14
KOM-02896-61018	50	0.16
KOM-07000-11008	50	0.25
KOM-07000-11009	50	0.25
KOM-07000-12010	25	0.40
KOM-07000-12011	25	0.41
KOM-07000-12012	25	0.41
KOM-07000-12014	20	0.57
KOM-07000-12015	20	0.56
KOM-07000-12016	20	0.56
KOM-07000-12018	20	0.57
KOM-07000-12021	20	0.75
KOM-07000-12055	10	1.59
KOM-07000-12060	5	1.83
KOM-07000-12065	5	1.82
KOM-07000-12070	5	1.84
KOM-07000-12075	5	7.09
KOM-07000-12080	5	2.23
KOM-07000-12085	5	2.30
KOM-07000-12090	5	2.32
KOM-07000-12095	5	2.38
KOM-07000-12100	5	2.59
KOM-07000-12105	5	2.65
KOM-07000-12110	5	2.69
KOM-07000-12115	5	2.73
KOM-07000-12120	5	2.96
KOM-07000-12125	5	3.01
KOM-07000-12130	5	3.03
KOM-07000-12135	2	3.55
KOM-07000-12145	5	3.64
KOM-07000-13022	25	0.46
KOM-07000-13025	20	0.72
KOM-07000-13028	10	1.00
KOM-07000-13030	10	1.20
KOM-07000-13032	10	1.26
KOM-07000-13035	10	1.32
KOM-07000-13037	20	0.47
KOM-07000-13038	10	1.41

O-RINGS 90 DUROMETER

Part Number	Min Pkg Qty	List Price
KOM-07000-13040	10	\$ 1.43
KOM-07000-13042	10	1.50
KOM-07000-13045	5	1.62
KOM-07000-13048	5	2.10
KOM-07000-13050	5	2.17
KOM-07000-13065	20	0.92
KOM-07000-13090	8	1.29
KOM-07000-13098	10	1.41
KOM-07000-13110	2	6.88
KOM-07000-13140	3	3.05
KOM-07000-15058	2	3.37
KOM-07000-15070	2	4.46
KOM-07000-15080	2	4.78
KOM-07000-15085	2	4.89
KOM-07000-15090	2	5.55
KOM-07000-15095	2	6.48
KOM-07000-15100	2	6.62
KOM-07000-15105	2	6.75
KOM-07000-15110	2	6.88
KOM-07000-15115	2	7.03
KOM-07000-15120	2	7.16
KOM-07000-15125	2	7.16
KOM-07000-15130	2	7.16
KOM-07000-15135	2	7.26
KOM-07000-15140	2	7.32
KOM-07000-15145	2	7.46
KOM-07000-15150	2	7.77
KOM-07000-15160	2	9.65
KOM-07000-15165	1	11.69
KOM-07000-15170	1	11.79
KOM-07000-15175	1	12.00
KOM-07000-15180	1	13.39
KOM-07000-15185	1	13.55
KOM-07000-15190	1	13.69
KOM-07000-15195	1	13.86
KOM-07000-15200	1	17.83
KOM-07000-15220	1	25.13
KOM-07000-15230	1	26.04
KOM-07000-15240	1	27.66
KOM-07000-15250	1	30.03
KOM-07000-15260	1	32.27
KOM-07000-15270	1	32.51
KOM-07000-15275	1	32.54
KOM-07000-15280	1	34.18
KOM-07000-15290	1	40.33
KOM-07000-15300	1	40.74

KOMATSU®

REPLACEMENT PARTS FOR KOMATSU® EQUIPMENT

NOTE: Komatsu part numbers are used as a reference only. We do not imply that these kits are original REPLACEMENT PARTS.

O-RINGS 90 DUROMETER

Part Number	Min Pkg Qty	List Price
KOM-07000-16150	2	\$ 4.16
KOM-07000-52120	5	2.96
KOM-07000-52125	5	3.01
KOM-07000-72018	20	0.55
KOM-07000-B2055	10	1.59
KOM-07000-B2065	5	1.82
KOM-07000-B2070	5	1.84
KOM-07000-B2080	5	2.23
KOM-07000-B2085	5	2.30
KOM-07000-B2090	5	2.32
KOM-07000-B2095	5	2.38
KOM-07000-B2105	5	2.65
KOM-07000-B2120	5	2.96
KOM-07000-B2125	5	3.01
KOM-07000-B3035	10	1.32
KOM-07000-B5080	2	4.78
KOM-07000-B5090	2	5.55
KOM-07000-B5100	2	6.62
KOM-07000-B5110	2	6.88
KOM-07000-B5120	2	7.16
KOM-07000-B5130	2	7.16
KOM-07000-B5140	2	7.32
KOM-07000-B5150	2	7.77
KOM-07000-B5160	2	9.65
KOM-07000-B5175	1	12.00
KOM-07000-B5185	1	13.55
KOM-07000-F5140	1	6.06
KOM-07002-03034	20	0.34
KOM-07002-11023	25	0.33
KOM-07002-61023	25	0.33
KOM-21T-09-11410	5	2.30
KOM-21T-09-11420	5	4.03
KOM-21T-09-11440	5	2.76
KOM-21T-09-11480	5	3.33
KOM-21T-09-11490	5	3.56
KOM-21T-09-11510	5	3.80
KOM-423-63-H2P03	1	11.29
KOM-423-63-H3P03	1	11.06
KOM-424-63-H0P07	1	10.62
KOM-42T-63-H0P08	10	1.04
KOM-42T-63-H0P09	20	0.64
KOM-42U-09-H1550	20	0.88
KOM-707-34-10600	5	2.38
KOM-707-34-55020	2	3.37
KOM-707-34-60030	2	4.74
KOM-723-46-17530	50	0.22

O-RINGS 90 DUROMETER

Part Number	Min Pkg Qty	List Price
KOM-WA0436	1	\$ 4.16
KOM-WA0456	1	15.24
KOM-WA5668	1	9.34

PISTON SEALS

Part Number	Bore Diam.	List Price
KOM-PC0584	6-1/2	\$ 156.96
KOM-PB8615	9-1/2	209.52
KOM-PB8618	11-3/4	231.61
KOM-PB8908	14	264.90
KOM-707-44-45070	45 mm	17.81
KOM-707-44-50180	50 mm	100.85
KOM-707-44-55180	55 mm	45.05
KOM-707-44-55150	55 mm	45.05
KOM-707-44-60180	60 mm	50.17
KOM-707-44-65180	65 mm	30.05
KOM-707-44-70070	70 mm	50.17
KOM-707-44-70080	70 mm	50.17
KOM-707-44-70110	70 mm	50.17
KOM-707-44-70180	70 mm	50.17
KOM-42U-63-H0P65	70 mm	16.87
KOM-707-44-70150	70 mm	50.17
KOM-707-44-75150	75 mm	48.66
KOM-707-44-75180	75 mm	48.66
KOM-42T-63-H0P11	80 mm	35.27
KOM-707-44-80080	80 mm	54.54
KOM-707-44-80180	80 mm	54.54
KOM-707-44-85180	85 mm	62.70
KOM-707-44-10150	85 mm	101.92
KOM-707-44-85150	85 mm	62.70
KOM-707-44-90070	90 mm	61.45
KOM-707-44-90080	90 mm	61.45
KOM-707-44-90180	90 mm	61.45
KOM-707-44-90150	90 mm	61.45
KOM-707-44-95180	95 mm	62.70
KOM-707-44-95150	95 mm	62.70
KOM-707-44-10080	100 mm	66.38
KOM-707-44-10180	100 mm	66.38
KOM-707-44-10250	105 mm	69.39
KOM-707-44-10280	105 mm	69.39
KOM-707-44-10911	105 mm	27.82
KOM-707-44-11080	110 mm	70.65

PISTON SEALS

Part Number	Bore Diam.	List Price
KOM-707-44-11150	110 mm	\$ 70.65
KOM-707-44-11180	110 mm	70.65
KOM-707-44-11250	115 mm	78.06
KOM-707-44-11280	115 mm	78.06
KOM-707-44-11920	115 mm	51.43
KOM-707-44-12080	120 mm	73.63
KOM-707-44-12150	120 mm	73.63
KOM-707-44-12180	120 mm	73.63
KOM-707-44-12280	125 mm	81.86
KOM-707-44-12250	125 mm	81.86
KOM-707-42-13012	130 mm	23.62
KOM-707-44-13070	130 mm	80.19
KOM-707-44-13080	130 mm	88.46
KOM-707-44-13150	130 mm	88.46
KOM-707-44-13180	130 mm	88.46
KOM-707-44-13911	130 mm	58.26
KOM-707-44-13250	135 mm	94.12
KOM-707-44-13280	135 mm	94.12
KOM-707-44-13920	135 mm	35.73
KOM-707-44-14080	140 mm	100.17
KOM-707-44-14150	140 mm	100.17
KOM-707-44-14180	140 mm	100.17
KOM-707-44-14280	145 mm	100.90
KOM-707-44-15080	150 mm	108.97
KOM-707-44-15150	150 mm	108.97
KOM-707-44-15180	150 mm	108.97
KOM-707-44-15190	150 mm	108.97
KOM-707-44-15280	155 mm	84.38
KOM-423-63-H2P06	160 mm	123.77
KOM-707-44-16080	160 mm	123.77
KOM-707-44-16150	160 mm	123.77
KOM-707-44-16180	160 mm	123.77
KOM-707-44-16190	160 mm	123.77
KOM-707-44-16280	165 mm	136.86
KOM-707-44-17180	170 mm	140.25
KOM-423-63-H3P06	180 mm	129.73
KOM-707-44-18080	180 mm	129.73
KOM-707-44-18180	180 mm	129.73
KOM-707-44-18190	180 mm	129.73
KOM-707-44-18150	180 mm	129.73
KOM-707-44-18250	185 mm	135.63
KOM-707-44-18280	185 mm	135.63
KOM-707-44-18290	185 mm	135.63
KOM-424-63-H0P10	200 mm	153.19

KOMATSU®

REPLACEMENT PARTS FOR KOMATSU® EQUIPMENT

NOTE: Komatsu part numbers are used as a reference only. We do not imply that these kits are original REPLACEMENT PARTS.

PISTON SEALS

Part Number	Bore Diam.	List Price
KOM-707-44-20080	200 mm	\$ 153.19
KOM-707-44-20180	200 mm	153.19
KOM-707-44-20190	200 mm	153.19
KOM-707-44-20020	200 mm	420.75
KOM-707-44-20150	200 mm	153.19
KOM-707-44-25010	210 mm	702.20
KOM-707-44-22080	225 mm	195.08
KOM-707-44-22180	225 mm	195.08
KOM-707-44-22280	225 mm	195.08
KOM-707-44-22290	225 mm	195.08
KOM-707-44-25080	250 mm	208.38
KOM-707-44-25180	250 mm	208.38
KOM-707-44-25190	250 mm	208.38
KOM-707-44-26180	260 mm	208.38
KOM-707-44-28080	280 mm	233.66
KOM-707-44-28180	280 mm	233.66
KOM-707-44-30010	300 mm	844.54

RETAINER RINGS

Part Number	List Price
KOM-04064-02512	\$ 2.50
KOM-04064-03515	1.29
KOM-04064-04518	4.94
KOM-04064-06525	3.68
KOM-04064-07525	2.66
KOM-04065-05220	4.82
KOM-07179-12047	3.27
KOM-PC1050	72.16

ROD BUSHINGS

Part Number	Rod Diam.	List Price
KOM-707-52-10260	20 mm	\$ 3.66
KOM-707-52-10261	20 mm	3.66
KOM-07177-02525	25 mm	5.46
KOM-707-52-15050	30 mm	7.41
KOM-07177-03025	30 mm	7.41
KOM-707-52-15110	35 mm	8.22
KOM-07177-03525	35 mm	8.22
KOM-707-52-10411	40 mm	10.92
KOM-707-52-15130	40 mm	9.33

ROD BUSHINGS

Part Number	Rod Diam.	List Price
KOM-707-52-90150	40 mm	\$ 9.33
KOM-707-52-90151	40 mm	9.33
KOM-07177-04025	40 mm	9.33
KOM-707-52-10410	40 mm	10.92
KOM-707-52-15210	45 mm	12.81
KOM-707-52-90220	45 mm	9.33
KOM-707-52-90221	45 mm	9.33
KOM-07177-04530	45 mm	12.81
KOM-707-52-15230	50 mm	15.54
KOM-707-52-90250	50 mm	15.54
KOM-707-52-90251	50 mm	15.54
KOM-707-52-90260	50 mm	12.96
KOM-07177-05030	50 mm	15.54
KOM-707-52-15310	55 mm	18.35
KOM-707-52-90300	55 mm	18.49
KOM-707-52-90301	55 mm	18.49
KOM-07177-05530	55 mm	18.35
KOM-707-52-15330	60 mm	18.65
KOM-707-52-90351	60 mm	18.65
KOM-07177-06030	60 mm	18.65
KOM-707-52-10661	65 mm	22.57
KOM-707-52-90401	65 mm	21.71
KOM-707-52-90420	65 mm	20.86
KOM-707-52-90421	65 mm	20.86
KOM-07177-06515	65 mm	12.66
KOM-07177-06530	65 mm	21.71
KOM-707-52-10660	65 mm	22.57
KOM-707-52-90400	65 mm	21.71
KOM-707-52-10701	70 mm	22.55
KOM-707-52-90451	70 mm	24.51
KOM-707-52-90461	70 mm	10.24
KOM-707-52-90470	70 mm	10.24
KOM-707-52-90471	70 mm	10.24
KOM-07177-07015	70 mm	20.23
KOM-07177-07030	70 mm	24.51
KOM-707-52-10700	70 mm	22.55
KOM-707-52-90450	70 mm	24.51
KOM-707-52-90501	75 mm	10.98
KOM-707-52-90520	75 mm	26.10
KOM-707-52-90521	75 mm	26.10
KOM-07177-07530	75 mm	27.12
KOM-707-52-90500	75 mm	27.12
KOM-707-52-90560	80 mm	31.26
KOM-707-52-90561	80 mm	31.26
KOM-07177-08030	80 mm	31.26

ROD BUSHINGS

Part Number	Rod Diam.	List Price
KOM-07177-08040	80 mm	33.98
KOM-707-52-10750	80 mm	30.98
KOM-707-52-90550	80 mm	33.98
KOM-07177-08035	80 mm	29.06
KOM-707-52-15540	80 mm	29.06
KOM-707-52-90610	85 mm	34.71
KOM-707-52-90611	85 mm	34.71
KOM-707-52-10850	85 mm	37.06
KOM-707-52-90600	85 mm	37.06
KOM-707-52-90680	90 mm	36.70
KOM-707-52-90681	90 mm	36.70
KOM-07177-09020	90 mm	33.22
KOM-07177-09035	90 mm	39.34
KOM-07177-09040	90 mm	42.75
KOM-707-52-10910	90 mm	44.52
KOM-707-52-90650	90 mm	42.75
KOM-707-52-90651	90 mm	42.75
KOM-707-52-90720	95 mm	37.71
KOM-707-52-90721	95 mm	37.71
KOM-707-52-10950	95 mm	44.36
KOM-707-52-90710	95 mm	47.74
KOM-707-52-10951	95 mm	44.36
KOM-707-52-11011	100 mm	59.52
KOM-707-52-90760	100 mm	41.00
KOM-707-52-90780	100 mm	41.68
KOM-707-52-90781	100 mm	41.68
KOM-07177-01020	100 mm	29.07
KOM-07177-01035	100 mm	51.68
KOM-07177-01040	100 mm	52.10
KOM-707-52-11010	100 mm	59.52
KOM-707-52-90750	100 mm	59.52
KOM-707-52-90850	110 mm	45.85
KOM-707-52-90851	110 mm	45.85
KOM-707-52-90861	110 mm	87.94
KOM-07177-01135	110 mm	45.85
KOM-07177-01140	110 mm	52.68
KOM-707-52-11110	110 mm	87.94
KOM-707-52-90860	110 mm	87.94
KOM-707-52-90980	120 mm	69.96
KOM-707-52-90981	120 mm	69.96
KOM-07177-01220	120 mm	49.12
KOM-07177-01240	120 mm	65.01
KOM-707-52-11210	120 mm	82.86
KOM-707-52-90950	120 mm	82.86

REPLACEMENT PARTS FOR KOMATSU® EQUIPMENT

NOTE: Komatsu part numbers are used as a reference only. We do not imply that these kits are original REPLACEMENT PARTS.

ROD BUSHINGS

Part Number	Rod Diam.	List Price
KOM-07177-01235	120 mm	\$ 48.63
KOM-707-52-91070	130 mm	76.95
KOM-707-52-91071	130 mm	76.95
KOM-707-52-11410	140 mm	117.97
KOM-07177-01435	140 mm	102.72
KOM-07177-01440	140 mm	100.02
KOM-707-52-91150	140 mm	117.97
KOM-707-52-91151	140 mm	117.97
KOM-707-52-11610	160 mm	120.17
KOM-707-52-11611	160 mm	120.17
KOM-707-52-91350	160 mm	120.17
KOM-707-52-91351	160 mm	120.17
KOM-707-52-91550	180 mm	158.88
KOM-707-52-91551	180 mm	158.88

SCREWS

Part Number	List Price
KOM-C1611	\$ 1.12
KOM-VN6410	2.21

STEEL PLUGS

Part Number	List Price
KOM-TY8879	\$ 87.05
KOM-VM0314	22.94
KOM-VM2202	59.97

PISTON U-SEALS

Part Number	Bore Diam.	List Price
KOM-707-44-35010	35 mm	\$ 4.11
KOM-09370-00040	40 mm	8.28
KOM-09370-00050	50 mm	11.04
KOM-09370-00060	60 mm	20.05
KOM-09370-00090	90 mm	16.09
KOM-09370-00100	100 mm	20.42
KOM-110-61-14250	100 mm	35.70
KOM-707-42-12012	100 mm	64.98

ROD U-SEALS

Part Number	Rod Diam.	List Price
KOM-PB9800	7	\$ 281.61
KOM-PB9804	10-1/2	379.25
KOM-PC0469	15-3/4	833.75
KOM-707-51-20030	20 mm	44.17
KOM-707-51-20250	200 mm	203.22
KOM-707-51-20080	200 mm	201.90
KOM-707-51-25030	25 mm	18.09
KOM-707-51-25210	25 mm	6.84
KOM-707-51-30030	30 mm	25.52
KOM-707-51-30210	30 mm	9.11
KOM-707-51-35210	35 mm	7.56
KOM-42U-63-H0P04	35 mm	10.20
KOM-707-51-40110	40 mm	13.21
KOM-707-51-40030	40 mm	23.72
KOM-707-51-40210	40 mm	14.02
KOM-707-51-45860	45 mm	29.09
KOM-42T-63-H0P03	45 mm	15.75
KOM-707-51-45110	45 mm	16.65
KOM-707-51-45030	45 mm	44.93
KOM-707-51-45210	45 mm	11.99
KOM-707-51-50030	50 mm	37.74
KOM-707-51-50110	50 mm	20.16
KOM-707-51-50210	50 mm	16.76
KOM-707-51-50211	50 mm	30.35
KOM-130-63-12173	55 mm	19.27
KOM-707-51-55030	55 mm	42.75
KOM-707-51-55110	55 mm	19.27
KOM-707-51-55211	55 mm	35.29
KOM-707-51-60860	60 mm	40.29
KOM-707-51-60030	60 mm	36.09
KOM-707-51-60060	60 mm	30.77
KOM-707-51-60211	60 mm	30.77
KOM-707-51-60110	60 mm	21.67
KOM-707-51-65860	65 mm	43.21
KOM-707-51-65210	65 mm	19.60
KOM-707-51-65030	65 mm	36.78
KOM-707-51-65110	65 mm	21.66
KOM-707-51-65211	65 mm	31.32
KOM-707-51-70730	70 mm	43.07
KOM-707-51-70860	70 mm	46.17
KOM-154-63-42370	70 mm	25.13
KOM-154-63-42373	70 mm	25.13
KOM-707-51-70030	70 mm	38.55
KOM-707-51-70110	70 mm	25.13
KOM-707-51-70211	70 mm	32.81
KOM-707-51-75030	75 mm	41.65

ROD U-SEALS

Part Number	Rod Diam.	List Price
KOM-707-51-75110	75 mm	\$ 25.33
KOM-707-51-75211	78 mm	35.46
KOM-707-51-80030	80 mm	43.01
KOM-707-51-80110	80 mm	27.86
KOM-707-51-80211	80 mm	36.61
KOM-707-51-85130	85 mm	39.52
KOM-707-51-85030	85 mm	46.43
KOM-707-51-85211	85 mm	39.52
KOM-707-51-90860	90 mm	64.54
KOM-707-51-90130	90 mm	42.03
KOM-154-63-52171	90 mm	26.10
KOM-154-63-52173	90 mm	26.10
KOM-707-51-90030	90 mm	49.39
KOM-707-51-90110	90 mm	26.10
KOM-707-51-90211	90 mm	42.03
KOM-707-51-95030	95 mm	51.58
KOM-707-51-95211	95 mm	43.92
KOM-707-51-10030	100 mm	52.13
KOM-707-51-10110	100 mm	33.93
KOM-707-51-10130	100 mm	44.37
KOM-707-51-10211	100 mm	44.37
KOM-707-51-11030	110 mm	67.33
KOM-707-51-11110	110 mm	47.25
KOM-56D-50-13170	110 mm	47.25
KOM-56D-50-13171	110 mm	75.94
KOM-707-51-12030	120 mm	69.22
KOM-707-51-12860	120 mm	98.69
KOM-707-51-12110	120 mm	55.88
KOM-707-51-13030	130 mm	102.29
KOM-707-51-13130	130 mm	65.28
KOM-707-51-14030	140 mm	65.52
KOM-707-51-14080	140 mm	103.60
KOM-707-51-14110	140 mm	65.52
KOM-707-51-14130	140 mm	57.85
KOM-56B-50-13160	140 mm	156.30
KOM-56B-50-13161	140 mm	156.30
KOM-707-51-16030	160 mm	173.83
KOM-707-51-16130	160 mm	117.06
KOM-707-51-17130	170 mm	129.44
KOM-707-51-18030	180 mm	177.69
KOM-707-51-18130	180 mm	160.24

REPLACEMENT PARTS FOR KOMATSU® EQUIPMENT

NOTE: Komatsu part numbers are used as a reference only. We do not imply that these kits are original REPLACEMENT PARTS.

U-SEALS

Part Number	Rod Diam.	List Price
KOM-3EC-V1-A1820	2	\$ 9.01
KOM-3EC-V1-A1840	2	9.01
KOM-PB8239	3	21.36
KOM-PC0553	3-1/4	24.02
KOM-PB9800	7	281.61
KOM-PB9808	13	403.87
KOM-PC0625	14	463.46
KOM-232-63-12451	70 mm	10.6
KOM-707-42-10012	80 mm	10.86

WASHERS

Part Number	List Price
KOM-TY1503	\$ 35.65

WEAR RINGS

Part Number	OD X Width	List Price
KOM-PC0554	3-1/2 X 1-1/2	\$ 15.8
KOM-VZ1988	6-1/2 X 1.615	60.32
KOM-PB9802	7-1/4 X 2	125.12
KOM-PB6555	9-1/2 X 1-1/4	50.21
KOM-PB9806	10-1/2 X 2	148.46
KOM-PB7444	11-3/4 X 1-1/4	134.72
KOM-PB9810	13-1/4 X 2	156.51
KOM-PB6792	14 X 1-1/4	190.30
KOM-707-39-35010	35 X 9.85 mm	4.84
KOM-707-39-45010	45 X 9.9 mm	2.28
KOM-42T-63-H0P05	49 X 25 mm	8.45
KOM-10E-63-32390	50 X 10 mm	8.36
KOM-07155-00515	50 X 14.8 mm	17.66
KOM-707-39-55110	55 X 9.85 mm	7.51
KOM-07155-00615	60 X 14.5 mm	11.03
KOM-707-39-65190	65 X 10 mm	6.90
KOM-07155-00720	70 X 20 mm	10.03
KOM-42U-63-H0P64	70 X 9.5 mm	13.27
KOM-07156-00710	70 X 9.9 mm	5.42
KOM-707-39-75030	75 X 20 mm	13.92
KOM-42T-63-H0P10	80 X 10 mm	24.18
KOM-07155-00820	80 X 20 mm	24.72
KOM-707-39-90110	90 X 12.5 mm	28.13
KOM-07155-00925	90 X 25 mm	16.78

WEAR RINGS

Part Number	OD X Width	List Price
KOM-707-39-95120	95 X 12.5 mm	\$ 28.49
KOM-707-39-95030	95 X 9.85 mm	26.91
KOM-707-39-10100	100 X 12.3 mm	23.39
KOM-07156-01012	100 X 12.5 mm	13.92
KOM-07155-01025	100 X 25 mm	15.98
KOM-707-39-10010	100 X 30 mm	10.70
KOM-707-39-10020	100 X 9.8 mm	9.66
KOM-707-39-10520	105 X 12.5 mm	27.56
KOM-707-39-10510	105 X 12.5 mm	12.98
KOM-707-39-10550	105 X 9.8 mm	21.03
KOM-07156-01112	110 X 12.5 mm	14.02
KOM-707-39-11110	110 X 12.5 mm	39.46
KOM-07155-01125	110 X 25 mm	20.40
KOM-707-39-11150	110 X 9.8 mm	22.85
KOM-707-39-11530	115 X 10 mm	13.53
KOM-707-39-11520	115 X 15 mm	18.33
KOM-707-39-11510	115 X 15 mm	46.52
KOM-07156-01215	120 X 15 mm	31.88
KOM-707-39-12100	120 X 15 mm	31.88
KOM-707-39-12110	120 X 15 mm	49.28
KOM-07155-01230	120 X 30 mm	24.73
KOM-707-39-12140	120 X 9.8 mm	24.11
KOM-707-39-12520	125 X 14.8 mm	22.73
KOM-707-39-12530	125 X 14.85 mm	26.53
KOM-707-39-12560	125 X 9.8 mm	22.29
KOM-707-39-13150	130 X 10 mm	20.05
KOM-07156-01315	130 X 14.8 mm	22.24
KOM-707-39-13110	130 X 15 mm	49.78
KOM-07155-01330	130 X 30 mm	35.69
KOM-707-39-13530	135 X 10 mm	46.22
KOM-707-39-13510	135 X 15 mm	54.04
KOM-707-39-14110	140 X 12.5 mm	23.46
KOM-07156-01417	140 X 17.5 mm	21.97
KOM-707-39-14820	140 X 17.5 mm	64.12
KOM-707-39-14100	140 X 17.5 mm	21.97
KOM-07155-01435	140 X 35 mm	12.39
KOM-707-39-15110	150 X 12.2 mm	67.80
KOM-707-39-15820	150 X 17.5 mm	44.24
KOM-707-44-01580	150 X 17.5 mm	44.24
KOM-07155-01535	150 X 35 mm	55.50
KOM-56D-50-13221	150 X 49.9 mm	33.61
KOM-707-39-16120	160 X 14.8 mm	26.34
KOM-707-39-16100	160 X 20 mm	49.31
KOM-07156-01620	160 X 20 mm	49.31
KOM-707-39-16820	160 X 20 mm	71.46
KOM-07155-01640	160 X 40 mm	60.74

WEAR RINGS

Part Number	OD X Width	List Price
KOM-707-39-17020	170 X 20 mm	\$ 87.59
KOM-07156-01822	180 X 22.5 mm	72.03
KOM-07155-01845	180 X 45 mm	22.21
KOM-56A-50-11160	180 X 79.8 mm	63.39
KOM-707-39-18510	185 X 22.5 mm	80.86
KOM-707-39-18830	185 X 22.5 mm	80.86
KOM-07156-02022	200 X 22 mm	22.84
KOM-707-39-20820	200 X 22.5 mm	74.99
KOM-707-39-20020	200 X 22.5 mm	74.99
KOM-07155-02045	200 X 45 mm	46.62
KOM-707-39-22820	225 X 25 mm	95.05
KOM-07156-02225	225 X 25 mm	84.05
KOM-581-63-22581	225 X 50 mm	84.32
KOM-07155-02250	225 X 50 mm	84.32
KOM-707-39-25820	250 X 27.5 mm	103.41
KOM-707-39-25011	250 X 27.5 mm	103.41
KOM-07155-02555	250 X 55 mm	108.31
KOM-707-39-26820	260 X 27.5 mm	161.59
KOM-707-39-28820	280 X 30 mm	127.62
KOM-07155-02860	280 X 60 mm	149.60
KOM-707-39-30820	300 X 30 mm	204.92
KOM-707-39-30900	300 X 30 mm	204.92

WIPERS

Part Number	Rod Diam.	List Price
KOM-3EC-V1-A1830	2	\$ 2.06
KOM-PC0552	3-1/4	22.25
KOM-PC0471	15-3/4	609.16
KOM-707-56-20590	20 mm	5.36
KOM-581-63-92670	200 mm	123.72
KOM-07016-20256	25 mm	7.57
KOM-707-56-25510	25 mm	7.57
KOM-707-56-25740	25 mm	13.97
KOM-707-56-30510	30 mm	16.95
KOM-707-56-30740	30 mm	16.95
KOM-175-63-75190	35 mm	16.88
KOM-42U-63-H0P62	35 mm	21.92
KOM-707-56-35740	35 mm	17.88
KOM-07016-00407	40 mm	21.86
KOM-707-56-40580	40 mm	21.86
KOM-07016-20407	40 mm	20.63
KOM-198-63-75190	40 mm	20.63
KOM-707-56-45510	40 mm	21.86

REPLACEMENT PARTS FOR KOMATSU® EQUIPMENT

NOTE: Komatsu part numbers are used as a reference only. We do not imply that these kits are original REPLACEMENT PARTS.

WIPERS

Part Number	Rod Diam.	List Price
KOM-707-56-40740	40 mm	\$ 21.86
KOM-112-63-15370	45 mm	23.72
KOM-42T-63-H0P02	45 mm	3.47
KOM-707-56-45580	45 mm	23.72
KOM-07016-20457	45 mm	22.50
KOM-707-56-45740	45 mm	23.72
KOM-176-63-92240	50 mm	24.03
KOM-707-56-50540	50 mm	24.03
KOM-707-56-50740	50 mm	24.03
KOM-07016-20507	50 mm	23.63
KOM-113-30-24240	50 mm	23.63
KOM-130-09-12931	50 mm	22.57
KOM-707-56-55540	55 mm	28.61
KOM-07016-00558	55 mm	27.00
KOM-707-56-55510	55 mm	28.61
KOM-203-30-66330	60 mm	13.89
KOM-07016-20608	60 mm	31.01
KOM-141-63-93270	60 mm	29.26
KOM-707-56-60540	60 mm	31.01
KOM-707-56-60740	60 mm	31.01
KOM-707-56-65540	65 mm	32.87
KOM-07016-00658	65 mm	31.03
KOM-07016-20658	65 mm	32.87
KOM-144-63-92170	65 mm	32.87
KOM-707-56-65740	65 mm	32.87
KOM-206-30-55150	70 mm	13.36
KOM-20Y-70-23220	70 mm	26.48
KOM-21K-70-12180	70 mm	23.02

WIPERS

Part Number	Rod Diam.	List Price
KOM-707-56-70540	70 mm	\$ 35.28
KOM-07016-00708	70 mm	33.30
KOM-07016-20708	70 mm	33.30
KOM-144-63-95170	70 mm	35.28
KOM-707-56-70651	70 mm	34.09
KOM-707-56-70740	70 mm	35.28
KOM-707-56-70820	70 mm	35.28
KOM-07016-20758	75 mm	35.80
KOM-144-63-94170	75 mm	35.80
KOM-205-70-62140	80 mm	50.03
KOM-07016-20808	80 mm	42.22
KOM-195-63-92190	80 mm	44.73
KOM-707-56-80740	80 mm	44.73
KOM-707-56-80820	80 mm	26.23
KOM-07016-20858	85 mm	47.92
KOM-707-56-85510	85 mm	50.77
KOM-707-56-85740	85 mm	50.77
KOM-205-70-62180	90 mm	63.89
KOM-207-30-54160	90 mm	14.53
KOM-207-70-72120	90 mm	63.89
KOM-707-56-90740	90 mm	54.89
KOM-07016-00908	90 mm	51.80
KOM-195-63-74170	90 mm	51.80
KOM-195-63-94170	90 mm	54.89
KOM-07016-20958	95 mm	52.98
KOM-707-56-95510	95 mm	28.52
KOM-421-09-11310	95 mm	16.76
KOM-707-56-95740	95 mm	28.52

WIPERS

Part Number	Rod Diam.	List Price
KOM-707-56-95820	95 mm	\$ 36.78
KOM-208-30-54150	100 mm	18.60
KOM-07016-01008	100 mm	56.82
KOM-07016-21008	100 mm	54.39
KOM-176-63-56170	100 mm	57.63
KOM-208-70-12231	100 mm	35.86
KOM-168-63-94170	110 mm	59.03
KOM-421-09-11320	110 mm	55.55
KOM-07016-21109	110 mm	55.72
KOM-198-63-94170	110 mm	55.72
KOM-56D-50-13190	110 mm	22.58
KOM-707-56-11740	110 mm	93.33
KOM-421-09-11350	120 mm	70.96
KOM-07016-21209	120 mm	60.97
KOM-195-63-93170	120 mm	60.97
KOM-707-56-12740	120 mm	111.22
KOM-421-09-11330	125 mm	66.94
KOM-707-56-13520	130 mm	66.72
KOM-198-63-93170	140 mm	72.43
KOM-07016-21400	140 mm	68.36
KOM-198-50-11171	140 mm	17.09
KOM-56B-50-13170	140 mm	34.06
KOM-707-56-16510	160 mm	93.66
KOM-566-63-22241	160 mm	93.66
KOM-707-56-17580	170 mm	104.45
KOM-707-56-18520	180 mm	119.00
KOM-568-63-22620	190 mm	110.87

KOMATSU®

Replacement Kits For

KUBOTA®

Excavators - Compact

APPLICATION	CYL #	SERIAL #	CODE	ROD	BORE	KIT #	List \$
NEW MODEL KH-28L							
ARM	68271-67600		I-U-5	55 mm	90 mm	KUB-68271-99400	136.27
BOOM LH	68271-67510		I-U-5	50 mm	80 mm	KUB-68271-99300	126.52
BOOM RH	68271-67520		I-U-5	50 mm	80 mm	KUB-68271-99300	126.52
BUCKET	68271-67800		I-U-5	50 mm	80 mm	KUB-68271-99500	126.52
DOZER	68081-75100		I-U-5	45 mm	80 mm	KUB-68271-99800	125.13
SWING	68271-67400		I-U-5	55 mm	100 mm	KUB-68271-99600	143.18
NEW MODEL KH-41(H)							
ARM	68501-67600		I-U-10	30 mm	50 mm	KUB-68721-91130	48.23
	68511-67600		I-U-10	30 mm	55 mm	KUB-68511-91110	49.33
BOOM	68501-67503		P-U-10	30 mm	55 mm	KUB-68191-91020	63.00
	68511-67503		P-U-10	30 mm	55 mm	KUB-68191-91020	63.00
BUCKET	68501-67800		I-U-10	30 mm	50 mm	KUB-68721-91130	48.23
	68511-67800		I-U-10	30 mm	55 mm	KUB-68511-91110	49.33
DOZER	68501-75100		I-U-10	35 mm	65 mm	KUB-68721-91160	83.42
	68511-75102		I-UB-10	35 mm	70 mm	KUB-68511-91120	53.42
SWING	68513-67400		P-U-10	30 mm	55 mm	KUB-68511-91010	201.77
NEW MODEL KH-90(H)							
ARM	68761-67602		P-UB-10	45 mm	80 mm	KUB-68761-91130	262.16
BOOM	68761-67501		P-U-10	45 mm	90 mm	KUB-68761-91120	302.23
BUCKET	68761-67802		P-UB-10	45 mm	70 mm	KUB-68761-91040	116.46
DOZER	68761-75101		P-UB-10	45 mm	90 mm	KUB-68761-91150	296.26
SWING	68741-67401		P-UB-10	45 mm	70 mm	KUB-68741-91010	132.51
NEW MODEL KH-91(H)							
ARM	68571-67600		P-U-10	45 mm	80 mm	KUB-68581-91030	113.37
BOOM	68581-67500		P-U-10	45 mm	90 mm	KUB-68581-91020	110.29
BUCKET	68541-67800		P-U-10	40 mm	70 mm	KUB-68761-91060	56.78
DOZER	68581-75100		P-UB-10	45 mm	90 mm	KUB-68761-91050	137.85
SWING	68541-67400		P-UB-10	40 mm	80 mm	KUB-68541-91010	242.26
NEW MODEL KH-171L							
ARM	68271-67600		I-U-5	55 mm	90 mm	KUB-68271-99400	136.27
BOOM LH	68271-67510		I-U-5	50 mm	80 mm	KUB-68271-99300	126.52
BOOM RH	68271-67520		I-U-5	50 mm	80 mm	KUB-68271-99300	126.52
BUCKET	68271-67800		I-U-5	50 mm	80 mm	KUB-68271-99500	126.52
DOZER	68081-75100		I-U-5	45 mm	80 mm	KUB-68271-99800	125.13
SWING	68271-67400		I-U-5	55 mm	100 mm	KUB-68271-99600	143.18
NEW MODEL KH-191							
ARM	68493-67600		P-U-10	55 mm	90 mm	KUB-68493-91030	88.82
BOOM	68493-67502		P-U-10	65 mm	120 mm	KUB-68493-91020	154.18
BUCKET	68493-67800		P-U-10	50 mm	80 mm	KUB-68493-91040	76.82
DOZER	68493-75100		P-U-10	60 mm	110 mm	KUB-68493-91050	190.66
SWING	68499-67400		P-U-10	55 mm	100 mm	KUB-68499-91010	139.04
NEW MODEL KX41(H)							
ARM	RB208-67600		P-U-10	35 mm	60 mm	KUB-RB201-91050	85.48
BLADE	RB208-75100		P-U-10	35 mm	70 mm	KUB-RB201-91030	60.34
BOOM	RB208-67700		P-U-10	30 mm	55 mm	KUB-RB201-91010	60.34
BUCKET	RB108-67800	-11244	P-U-10	30 mm	55 mm	KUB-RB101-91020	85.29

Replacement Kits For

KUBOTA®

KUBOTA®

Excavators - Compact

APPLICATION	CYL #	SERIAL #	CODE	ROD	BORE	KIT #	List \$
MODEL KX41(H)							
BUCKET	RB208-67800	11245-	P-U-10	30 mm	55 mm	KUB-RB101-91020	85.29
SWING	RB108-67400		P-U-10	30 mm	55 mm	KUB-RB101-91020	85.29
MODEL KX61-2 ALPHA							
ARM	RG238-67600		I-U-10	40 mm	70 mm	KUB-69741-91110	20.96
BLADE	RG238-75100		I-U-10	45 mm	90 mm	KUB-69741-91120	29.87
BOOM	RG208-67500		P-U-10	40 mm	80 mm	KUB-RG208-94310	67.91
BUCKET	RG238-67800		P-U-10	45 mm	75 mm	KUB-69441-91110	96.41
SWING	RG238-67400		P-U-10	40 mm	80 mm	KUB-RG208-94410	23.27
MODEL KX71(H)							
ARM	68318-67600		P-U-10	40 mm	70 mm	KUB-68861-93300	56.78
BLADE	68318-75100		P-U-10	45 mm	90 mm	KUB-68301-91050	114.20
MODEL KX080-3							
ARM	RD809-67600	-10046	P-U-10	60 mm	100 mm	KUB-RD809-72090	37.93
	RD809-67602	10047-	P-U-10	60 mm	100 mm	KUB-RD809-72090	37.93
	RD809-67603	10682-	P-U-10	60 mm	100 mm	KUB-RD809-72090	37.93
BLADE	RD809-75100		P-U-10	65 mm	125 mm	KUB-RD809-72450	105.74
BOOM	RD809-67500	-10007	P-U-10	65 mm	115 mm	KUB-RD809-72050	69.89
	RD809-67502	10008-	P-U-10	65 mm	115 mm	KUB-RD809-72050	69.89
	RD809-67503	10047-	P-U-10	65 mm	115 mm	KUB-RD809-72050	69.89
BUCKET	RD809-67800		P-U-10	55 mm	90 mm	KUB-RD809-71870	48.62
SWING	RD809-67400	-10103	P-U-10	60 mm	110 mm	KUB-RD809-72380	170.61
	RD809-67402	10104-	P-U-10	60 mm	110 mm	KUB-RD809-72380	170.61
MODEL KX101(H)							
ARM	68658-67600		P-U-10	45 mm	80 mm	KUB-68651-91030	124.55
BLADE	68318-75100		P-U-10	45 mm	90 mm	KUB-68301-91050	114.20
BOOM	68658-67700		P-U-10	45 mm	90 mm	KUB-68651-91020	70.21
BUCKET	68396-67800		P-U-10	40 mm	70 mm	KUB-68861-93300	56.78
SWING	68316-67400		P-U-10	40 mm	80 mm	KUB-68311-91010	120.54
MODEL KX121-3							
ANGLE BLADE	RD118-74700		P-U-10	30 mm	55 mm	KUB-RD118-71350	64.55
ARM	RD118-67600	-20005	P-U-10	45 mm	75 mm	KUB-RD118-71640	105.95
	RD118-67602	20006-	P-U-10	45 mm	75 mm	KUB-RD118-71640	105.95
	RD118-67603	20748-	P-U-10	45 mm	75 mm	KUB-RD118-71640	105.95
BLADE	RD118-75100	-20747	P-U-10	55 mm	95 mm	KUB-RD118-71870	130.07
	RD118-75102	20748-	P-U-10	55 mm	95 mm	KUB-RD118-71870	130.07
BOOM	RD118-67500	-20747	P-U-10	50 mm	85 mm	KUB-RD118-71400	84.22
	RD118-67502	20748-	P-U-10	50 mm	85 mm	KUB-RD118-71400	84.22
BUCKET	RD118-67802		P-U-10	40 mm	70 mm	KUB-RD411-71820	101.70
SWING	RD118-67400	-20747	P-U-10	45 mm	80 mm	KUB-RD118-71270	106.16
	RD118-67402	20748-	P-U-10	45 mm	80 mm	KUB-RD118-71270	106.16
MODEL KX121-3S							
ANGLE BLADE	RD118-74702		P-U-10	30 mm	55 mm	KUB-RD118-71350	64.55
ARM	RD118-67603		P-U-10	45 mm	75 mm	KUB-RD118-71640	105.95
BLADE	RD118-75102		P-U-10	55 mm	95 mm	KUB-RD118-71870	130.07
BOOM	RD138-67500		P-U-10	50 mm	85 mm	KUB-RD118-71400	84.22
BUCKET	RD118-67802		P-U-10	40 mm	70 mm	KUB-RD411-71820	101.70

Replacement Kits For

KUBOTA®

Excavators - Compact

APPLICATION	CYL #	SERIAL #	CODE	ROD	BORE	KIT #	List \$
MODEL KX121-3S							
SWING	RD118-67402		P-U-10	45 mm	80 mm	KUB-RD118-71270	106.16
MODEL KX155-3SZ							
BLADE	RD511-75102		P-U-10	55 mm	105 mm	KUB-RD511-71870	158.11
BOOM	RD541-67500		P-U-10	55 mm	95 mm	KUB-RD511-71490	86.33
BUCKET	RD541-67800		P-U-10	45 mm	75 mm	KUB-RD511-71820	78.83
SWING	RD541-67400		P-U-10	50 mm	90 mm	KUB-RD511-71270	106.78
MODEL KX161-3							
ARM	RD518-67600	-20006	P-U-10	50 mm	85 mm	KUB-RD518-71640	80.13
	RD518-67602	20007-	P-U-10	50 mm	85 mm	KUB-RD518-71640	80.13
BLADE	RD518-75100	-20006	P-U-10	55 mm	105 mm	KUB-RD511-71870	158.11
	RD518-75102	20007-	P-U-10	55 mm	105 mm	KUB-RD511-71870	158.11
BOOM	RD518-67500	-20006	P-U-10	55 mm	95 mm	KUB-RD511-71490	86.33
	RD518-67502	20007-	P-U-10	55 mm	95 mm	KUB-RD511-71490	86.33
BUCKET	RD518-67800	-20006	P-U-10	45 mm	75 mm	KUB-RD511-71820	78.83
	RD518-67802	20007-	P-U-10	45 mm	75 mm	KUB-RD511-71820	78.83
SWING	RD518-67400	-20006	P-U-10	50 mm	90 mm	KUB-RD511-71270	106.78
	RD518-67402	20007-	P-U-10	50 mm	90 mm	KUB-RD511-71270	106.78
MODEL KX161-3S							
ARM	RD518-67602		P-U-10	50 mm	85 mm	KUB-RD518-71640	80.13
BLADE	RD518-75102		P-U-10	55 mm	105 mm	KUB-RD511-71870	158.11
BOOM	RD538-67500		P-U-10	55 mm	95 mm	KUB-RD511-71490	86.33
BUCKET	RD518-67802		P-U-10	45 mm	75 mm	KUB-RD511-71820	78.83
SWING	RD518-67402		P-U-10	50 mm	90 mm	KUB-RD511-71270	106.78
MODEL KX161-3SZ							
ARM	RD547-67600		P-U-10	50 mm	85 mm	KUB-RD518-71640	80.13
BLADE	RD548-75100		P-U-10	55 mm	105 mm	KUB-RD548-71330	200.54
BOOM	RD541-67500		P-U-10	55 mm	95 mm	KUB-RD511-71490	86.33
BUCKET	RD547-67800		P-U-10	45 mm	75 mm	KUB-RD511-71820	78.83
SWING	RD548-67400		P-U-10	50 mm	90 mm	KUB-RD548-71130	148.21

REPLACEMENT KITS FOR KUBOTA® EQUIPMENT

NOTE: Kubota part numbers are used as a reference only. We do not imply that these kits are original REPLACEMENT PARTS.

Kit Number	Code (Pg. xviii)	Rod X Bore Size	List Price
KUB-68191-91020	P-U-10	30 X 55 mm	\$ 63.00
KUB-68271-99300	I-U-5	50 X 80 mm	126.52
KUB-68271-99400	I-U-5	55 X 90 mm	136.27
KUB-68271-99500	I-U-5	50 X 80 mm	126.52
KUB-68271-99600	I-U-5	55 X 100 mm	143.18
KUB-68271-99800	I-U-5	45 X 80 mm	125.13
KUB-68301-91050	P-U-10	45 X 90 mm	114.20
KUB-68311-91010	P-U-10	40 X 80 mm	120.54
KUB-68493-91020	P-U-10	65 X 120 mm	154.18
KUB-68493-91030	P-U-10	55 X 90 mm	88.82
KUB-68493-91040	P-U-10	50 X 80 mm	76.82
KUB-68493-91050	P-U-10	60 X 110 mm	190.66
KUB-68499-91010	P-U-10	55 X 100 mm	139.04
KUB-68511-91010	P-U-10	30 X 55 mm	201.77
KUB-68511-91110	I-U-10	30 X 55 mm	49.33
KUB-68511-91120	I-U-10	35 X 70 mm	53.42
KUB-68541-91010	I-U-10	40 X 80 mm	242.26
KUB-68581-91020	P-U-10	45 X 90 mm	110.29
KUB-68581-91030	P-U-10	45 X 80 mm	113.37
KUB-68651-91020	P-U-10	45 X 90 mm	70.21
KUB-68651-91030	P-U-10	45 X 80 mm	124.55
KUB-68721-91110	I-U-5	30 X 50 mm	39.78
KUB-68721-91130	I-U-10	30 X 50 mm	48.23
KUB-68721-91160	I-U-10	35 X 65 mm	83.42
KUB-68741-91010	P-UB-10	45 X 70 mm	132.51
KUB-68741-91020	P-U-10	40 X 80 mm	66.74
KUB-68761-91040	P-UB-10	45 X 70 mm	116.46
KUB-68761-91050	P-UB-10	45 X 90 mm	137.85
KUB-68761-91060	P-U-10	40 X 70 mm	56.78
KUB-68761-91120	P-U-10	45 X 90 mm	302.23
KUB-68761-91130	P-UB-10	45 X 80 mm	262.16
KUB-68761-91150	P-UB-10	45 X 90 mm	296.26
KUB-68811-93070	P-UB-10	40 X 70 mm	141.08
KUB-68861-93300	P-U-10	40 X 70 mm	56.78
KUB-69441-91110	P-U-10	45 X 75 mm	96.41
KUB-69521-91110	P-U-10	30 X 55 mm	56.56

Kit Number	Code (Pg. xviii)	Rod X Bore Size	List Price
KUB-69521-91130	P-U-10	30 X 55 mm	\$ 56.90
KUB-69721-91110	I-U-10	30 X 55 mm	19.43
KUB-69741-91110	I-U-10	40 X 70 mm	20.96
KUB-69741-91120	I-U-10	45 X 90 mm	29.87
KUB-RB101-91020	P-U-10	30 X 55 mm	85.29
KUB-RB201-91010	P-U-10	30 X 55 mm	60.34
KUB-RB201-91030	P-U-10	35 X 70 mm	60.34
KUB-RB201-91050	P-U-10	35 X 60 mm	85.48
KUB-RD118-71270	P-U-10	45 X 80 mm	106.16
KUB-RD118-71270	P-U-10	45 X 80 mm	106.16
KUB-RD118-71350	P-U-10	30 X 55 mm	64.55
KUB-RD118-71350	P-U-10	30 X 55 mm	64.55
KUB-RD118-71400	P-U-10	50 X 85 mm	84.22
KUB-RD118-71400	P-U-10	50 X 85 mm	84.22
KUB-RD118-71640	P-U-10	45 X 75 mm	105.95
KUB-RD118-71640	P-U-10	45 X 75 mm	105.95
KUB-RD118-71640	P-U-10	45 X 75 mm	105.95
KUB-RD118-71870	P-U-10	55 X 95 mm	130.07
KUB-RD118-71870	P-U-10	55 X 95 mm	130.07
KUB-RD411-71820	P-U-10	40 X 70 mm	101.70
KUB-RD511-71270	P-U-10	50 X 90 mm	106.78
KUB-RD511-71270	P-U-10	50 X 90 mm	106.78
KUB-RD511-71490	P-U-10	55 X 95 mm	86.33
KUB-RD511-71820	P-U-10	45 X 75 mm	78.83
KUB-RD511-71870	P-U-10	55 X 105 mm	158.11
KUB-RD511-71870	P-U-10	55 X 105 mm	158.11
KUB-RD518-71640	P-U-10	50 X 85 mm	80.13
KUB-RD548-71130	P-U-10	50 X 90 mm	148.21
KUB-RD548-71330	P-U-10	55 X 105 mm	200.54
KUB-RD809-71870	P-U-10	55 X 90 mm	48.62
KUB-RD809-72050	P-U-10	65 X 115 mm	69.89
KUB-RD809-72090	P-U-10	60 X 100 mm	37.93
KUB-RD809-72380	P-U-10	60 X 110 mm	170.61
KUB-RD809-72450	P-U-10	65 X 125 mm	105.74
KUB-RG208-94310	P-U-10	40 X 80 mm	67.91
KUB-RG208-94410	P-U-10	40 X 80 mm	23.27

REPLACEMENT PARTS FOR KUBOTA® EQUIPMENT

NOTE: Kubota part numbers are used as a reference only. We do not imply that these kits are original REPLACEMENT PARTS.

BACK-UP RINGS

Part Number	Min Pkg Qty	List Price
KUB-04810-50900	1	\$ 1.01
KUB-68371-92171	1	0.99
KUB-68511-71461	1	0.64
KUB-68571-71541	1	8.20
KUB-68741-71821	1	9.56

BUFFER RINGS

Part Number	Rod Diam.	List Price
KUB-68761-71561	45 mm	\$ 13.13

O-RINGS

Part Number	Min Pkg Qty	List Price
KUB-04810-50750	2	\$ 4.61
KUB-04810-50850	5	6.32
KUB-04810-50950	5	7.43
KUB-04811-50550	10	1.01
KUB-04811-50900	5	1.83
KUB-04811-50950	5	7.43
KUB-68131-64291	2	5.55
KUB-68131-64471	2	4.78
KUB-68181-64471	2	4.78
KUB-68541-71541	5	1.82
KUB-68591-67861	5	1.84
KUB-68811-93351	10	1.45
KUB-68811-93371	10	1.53
KUB-68817-93441	5	1.78
KUB-68869-93441	5	1.76
KUB-69201-91281	5	1.83
KUB-69201-91371	5	1.82
KUB-95123-08000	5	2.23

PISTON SEALS

Part Number	Bore Diam.	List Price
KUB-68741-71841	75 mm	\$ 35.35
KUB-68741-71441	80 mm	36.54
KUB-68741-72111	90 mm	39.69
KUB-RD101-71381	95 mm	44.21

PISTON U-SEALS

Part Number	Bore Diam.	List Price
KUB-69201-91241	90 mm	\$ 44.11

U-SEALS

Part Number	Rod Diam.	List Price
KUB-68241-67831	50 mm	\$ 17.05
KUB-68271-67671	55 mm	17.20
KUB-68371-92141	45 mm	12.10
KUB-68741-71811	45 mm	16.65

WIPERS

Part Number	Rod Diam.	List Price
KUB-68511-71441	30 mm	\$ 16.00
KUB-68741-71211	40 mm	20.63
KUB-68171-75141	45 mm	5.61
KUB-68741-71791	45 mm	22.50
KUB-68741-71971	45 mm	22.50
KUB-68331-67581	50 mm	6.37
KUB-RD101-71351	50 mm	24.03
KUB-68271-67681	55 mm	11.39

WEAR RINGS

Part Number	OD X Width	List Price
KUB-68741-72121	90 X 14.8 mm	\$128.45

LEACH

Kit Number	Cylinder	Code (Pg. xviii)	Rod X Bore Size	List Price	Kit Number	Cylinder	Code (Pg. xviii)	Rod X Bore Size	List Price
LCH-10035		I-U-5	4 X 6	\$ 77.00	LCH-2R2008K	2R1008	I-V-7	4-1/2 X 6	\$107.42
LCH-101102	300600	P-U-5	2-1/4 X 4	55.33	LCH-2R2114	2R1006	I-V-7	4-1/2 X 6	124.68
LCH-101103	401054	I-U-10	3-1/2 X 5	60.57	LCH-2R2114A	2R1006A, 2R1008A	I-U-5	4-1/2 X 6	100.86
LCH-101238		I-N-4	1-3/4 X 6	76.12	LCH-2R2114AU	2R1006A, 2R1008A	I-U-5	4-1/2 X 6	81.55
LCH-102168	401207	I-U-5	2 X 4	39.61	LCH-30653	18974,18975,	I-U-5	2 X 4	42.29
LCH-102169		I-U-13	3-1/2 X 5	101.00	LCH-30654	17001	I-U-5	2 X 5	101.12
LCH-102559		I-U-4	2 X 5	56.38	LCH-33557		I-U-5	2-1/4 X 5	78.18
LCH-102565	2RII T.G. LIFT	I-U-4	2-1/4 X 4	40.41	LCH-33558	31778	P-U-5	2-1/4 X 4	68.74
LCH-102566	402161, 402162	P-N-4	2-1/4 X 4	41.99	LCH-36363	2-1/4 X 3-1/2	I-U-10		53.86
LCH-102567	402314, 402315	P-U-4	2-1/4 X 4	48.99	LCH-950051	4, 5, 6 - Wipers, U-seals, Bearings			299.21
LCH-103945	2-3/8, 2-7/8, 3-3/8, 3-7/8 Stages			76.49	LCH-P16-541	P16-273	P-V-7	2-1/4 X 4	89.99
LCH-15452	15026	P-U-5	2-1/4 X 6	100.19	LCH-P16-569	P16-204	P-N-6	2-1/4 X 3	39.70
LCH-15452U	15026	P-U-5	2-1/4 X 6	104.44	LCH-P16-570	P16-7	N-N-6	4" BORE	32.07
LCH-15453	15074	P-N-6	2-1/4 X 4	48.42	LCH-P25-29K	P25-29	I-U-5	3 X 6	80.99
LCH-15454	15049	I-U-4	2 X 5	63.10	LCH-PO-1567	PO-265	I-O-6	2-1/4 X 4	47.18
LCH-15454U	15049	I-U-4	2 X 5	81.28	LCH-SR7145	Valve Kit 2R1696			17.28
LCH-15468	15373	P-U-5	2-1/4 X 4	56.68	LCH-SR7158	SR6002	I-OB-7	2 X 5	79.15
LCH-15468U	15373	P-U-5	2-1/4 X 4	86.18	LCH-SR7162		P-V-7	2-1/4 X 6	141.35
LCH-2R1054	2R1054	I-U-5	4 X 6	76.20	LCH-SR9002	SR6021	P-V-7	2-1/4 X 6	132.71

NOTES

NOTES

REPLACEMENT SEAL KITS FOR LIEBHERR EQUIPMENT*

Replacement Seal Kits By Machine Type

Table of Contents

Machine Type	Page
Excavators <small>R900 C-LI, R900 C HD-S LI, R900 C HD-SL LI, R904 C-LI, R904 C HD-SL 2000 LI, R904 C-HD-SL 2250 LI, R912 HD-SL, R912 LC, R914 B, R914 B HD-S, R914 B HD-SL, R924 B HD-SL LI, R924 Compact, R932 EW, R932 HD-SL, R934 B, R934 C, R934 EW, R934 HD-SL, R934 C HD-S, R934 C HD-SL, R942 HD-SL, R944 B, R944 C, R944 HD-SL, R954 B, R954 C, R954 HD, R964 C</small>	974 - 980
Excavators - Wheel <small>A309 LI, A311 LI, A312 LI, A314 LI, A316 LI, A900 C-LI, A904 C-LI</small>	980 - 984
Loaders - Wheel <small>L506 Stereo, L507 Stereo, L508 Stereo, L509 Stereo, L538, L538 (Z-bar), L544, L556 2plus2, L556 2plus2 High Lift, L564, L566 2plus2, L566 2plus2 High Lift</small>	984 - 985
Off-Highway Trucks <small>KL2420</small>	985
Alpha-Numeric Kit Listing	986 - 987
Liebherr Individual Parts	987



All manufacturer's names, part numbers and descriptions are used for reference purposes only. We do not imply that any part shown is the product of these manufacturers. We also do not imply that the list price shown is exactly that of the manufacturer.

Replacement Kits For

LIEBHERR

Excavators						
APPLICATION	MISC:	CODE	ROD	BORE	KIT #	List \$
MODEL R900 C-LI, R900 C HD-S LI, R900 C HD-SL LI						
Boom Adj (Hyd Adj)		N-N-10		140 mm	LBH-9165363	349.56
Boom Lift (Hyd Adj & Std)		I-BB-1	70 mm		LBH-9172122	102.62
		N-N-10		120 mm	LBH-9172577	163.16
Boom Lift (Ind Boom)		I-BB-1	85 mm		LBH-9158175	143.99
		N-N-10		125 mm	LBH-9060977	163.08
Boom Offset	100mm Bore Cyl	I-BB-1	50 mm		LBH-9062932	54.91
	90mm Bore Cyl	I-BB-1	50 mm		LBH-9061030	101.29
	90mm Bore Cyl	N-N-10		90 mm	LBH-9061380	94.24
Bucket (2.05m, 2.45m, 2.65m, 3.05m Stick)		I-BB-1	70 mm		LBH-9951829	121.95
		N-N-10		105 mm	LBH-9951831	135.74
Bucket (2.25m Stick)		I-BB-1	70 mm		LBH-9951829	121.95
Bucket (2.25m, 2.45m, 2.65m Stick)		I-BB-1	70 mm		LBH-9172117	170.31
		N-N-10		100 mm	LBH-9174200	139.78
Bucket (5.2m Stick)		I-BB-1	60 mm		LBH-9061404	116.33
		N-N-10		90 mm	LBH-9061380	94.24
Bucket (Ditch Clean)	1600mm & 2000mm	I-BB-1	90 mm		LBH-9967796	185.42
Dozer Blade		I-BB-1	70 mm		LBH-9116590	67.81
		N-N-10		130 mm	LBH-9111341	179.11
Stick		N-N-10		130 mm	LBH-9171671	162.69
Swivel Rotary (C-LI)		I-BB-1	95 mm		LBH-9265132	2848.08
Swivel Rotary (HDS & HD-SL)		I-BB-1	95 mm		LBH-9144401	533.97
MODEL R904 C-LI, R904 C HD-SL 2000 LI, R904 C-HD-SL 2250 LI						
Boom Adj (Hyd Adj)		I-BB-1	80 mm		LBH-9063173	286.43
		N-N-10		140 mm	LBH-9165363	349.56
Boom Lift (Hyd Adj)		I-BB-1	85 mm		LBH-9060195	144.63
		N-N-10		130 mm	LBH-9171671	162.69
Boom Offset		I-BB-1	50 mm		LBH-9061030	101.29
		N-N-10		90 mm	LBH-9061380	94.24
Bucket		I-BB-1	80 mm		LBH-9172118	280.83
		N-N-10		120 mm	LBH-9172577	163.16
Bucket (Ditch Clean)	1600mm	I-BB-1	90 mm		LBH-9967796	185.42
	1700mm	I-BB-1	50 mm		LBH-9061030	101.29
	1700mm	N-N-10		90 mm	LBH-9061380	94.24
Stick (Hyd Adj Boom)		I-BB-1	85 mm		LBH-9060195	144.63
		N-N-10		130 mm	LBH-9171671	162.69
Stick (Ind Boom)		I-BB-1	80 mm		LBH-9172118	280.83
		N-N-10		120 mm	LBH-9172577	163.16
Stick (Lat Adj Boom)		I-BB-1	85 mm		LBH-9060195	144.63
		N-N-10		130 mm	LBH-9171671	162.69
Stick (Std Boom)		N-N-10		130 mm	LBH-9171671	162.69
Swivel Rotary		I-BB-1	95 mm		LBH-9144401	533.97
MODEL R912 HD-SL, R912 LC						
Boom Lift		I-BB-1	85 mm		LBH-9060195	144.63
		N-N-10		130 mm	LBH-9171671	162.69
Boom Lift (Hyd Adj)		I-BB-1	90 mm		LBH-9060196	213.30
		N-N-10		140 mm	LBH-9165363	349.56

LIEBHERR

Replacement Kits For

LIEBHERR

Excavators						
APPLICATION	MISC:	CODE	ROD	BORE	KIT #	List \$
MODEL R912 HD-SL, R912 LC						
Boom Lift (Std & Ind Boom)		I-BB-1	85 mm		LBH-9158175	143.99
		N-N-10		125 mm	LBH-9060977	163.08
Bucket (5.5m Stick)		I-BB-1	80 mm		LBH-9172118	280.83
		N-N-10		120 mm	LBH-9172577	163.16
Bucket (Std)		I-BB-1	85 mm		LBH-9158175	143.99
		N-N-10		125 mm	LBH-9060977	163.08
Stick (4.0m, 5.0m, 5.65m, 7.2m Std Boom)		I-BB-1	95 mm		LBH-9060197	178.06
		N-N-10		140 mm	LBH-9165363	349.56
Stick (6.8m Std Boom)		I-BB-1	85 mm		LBH-9158175	143.99
		N-N-10		125 mm	LBH-9060977	163.08
Stick (9.7m LR)		I-BB-1	85 mm		LBH-9158175	143.99
		N-N-10		125 mm	LBH-9060977	163.08
Swivel Rotary		I-BB-1	95 mm		LBH-9144401	533.97
MODEL R914 B, R914 B HD-S, R914 B HD-SL						
Boom Adj (Hyd Adj)		I-BB-1	95 mm		LBH-9063136	307.12
		N-N-10		160 mm	LBH-9154141	223.87
Boom Lift	130mm Bore Cyl	I-BB-1	85 mm		LBH-9060195	144.63
	130mm Bore Cyl	N-N-10		130 mm	LBH-9171671	162.69
	140mm Bore Cyl	I-BB-1	90 mm		LBH-9060196	213.30
	140mm Bore Cyl	N-N-10		140 mm	LBH-9165363	349.56
	150mm Bore Cyl	I-BB-1	95 mm		LBH-9062534	301.63
	150mm Bore Cyl	N-N-10		150 mm	LBH-9165440	375.12
Boom Offset		I-BB-1	50 mm		LBH-9061030	101.29
		N-N-10		90 mm	LBH-9061380	94.24
Bucket (1.8m, 2.4m, 2.7m, 3m, 3.7m, 5.0m, 5.2m Stick)		I-BB-1	85 mm		LBH-9060195	144.63
		N-N-10		130 mm	LBH-9171671	162.69
Bucket (2.1m, 2.4m, 2.7m, 3m, 3.7m Stick)		I-BB-1	85 mm		LBH-9158175	143.99
		N-N-10		125 mm	LBH-9060977	163.08
Bucket (5.0m Ind Stick)		I-BB-1	80 mm		LBH-9172118	280.83
		N-N-10		120 mm	LBH-9172577	163.16
Bucket (5.2m, 6.0m, 6.8m Stick)		I-BB-1	80 mm		LBH-9172118	280.83
		N-N-10		120 mm	LBH-9172577	163.16
Bucket (7.4m LR Stick)		I-BB-1	60 mm		LBH-9061404	116.33
		N-N-10		90 mm	LBH-9061380	94.24
Bucket (Ditch Clean)		I-BB-1	90 mm		LBH-9967796	185.42
Dozer Blade		I-BB-1	70 mm		LBH-9116590	67.81
		N-N-10		130 mm	LBH-9111341	179.11
Stick (4.0m Hyd Adj Boom)	140mm Bore Cyl	I-BB-1	95 mm		LBH-9060197	178.06
	140mm Bore Cyl	N-N-10		140 mm	LBH-9165363	349.56
	s/n -13609	I-BB-1	105 mm		LBH-9158311	221.06
	s/n -13609	N-N-10		150 mm	LBH-9165440	375.12
	s/n 13610-	I-BB-1	105 mm		LBH-9158311	221.06
	s/n 13610-	N-N-10		150 mm	LBH-9165440	375.12
Stick (5.0m, 5.5m Hyd Adj Boom)	140mm Bore Cyl	N-N-10		140 mm	LBH-9165363	349.56
	150mm Bore Cyl	I-BB-1	105 mm		LBH-9158311	221.06

LIEBHERR

Replacement Kits For

LIEBHERR

Excavators						
APPLICATION	MISC:	CODE	ROD	BORE	KIT #	List \$
MODEL R914 B, R914 B HD-S, R914 B HD-SL						
Stick (5.0m, 5.5m Hyd Adj Boom)	150mm Bore Cyl	N-N-10		150 mm	LBH-9165440	375.12
Stick (5.0m, 5.7m, 7.2m, 7.6m, 8.2m Std Boom)		N-N-10		140 mm	LBH-9165363	349.56
Stick (5.6m Ind Boom)		I-BB-1	80 mm		LBH-9172118	280.83
		N-N-10		120 mm	LBH-9172577	163.16
Stick (5.7m, 8.2m, 9.0m Std Boom)		I-BB-1	105 mm		LBH-9158311	221.06
		N-N-10		150 mm	LBH-9165440	375.12
Stick (6.0m Std Boom)	s/n -13679	N-N-10		140 mm	LBH-9165363	349.56
	s/n 13680-	I-BB-1	105 mm		LBH-9158311	221.06
	s/n 13680-	N-N-10		150 mm	LBH-9165440	375.12
Stick (6.5m, 6.8m Ind Boom)		I-BB-1	85 mm		LBH-9158175	143.99
		N-N-10		125 mm	LBH-9060977	163.08
Stick (Lat Adj Boom)		I-BB-1	95 mm		LBH-9060197	178.06
		N-N-10		140 mm	LBH-9165363	349.56
Swivel Rotary		I-BB-1	95 mm		LBH-9144401	533.97
MODEL R924 B HD-SL LI						
Boom Adj (Hyd Adj)		I-BB-1	95 mm		LBH-9063136	307.12
		N-N-10		160 mm	LBH-9154141	223.87
Boom Lift	130mm Bore Cyl	I-BB-1	85 mm		LBH-9060195	144.63
	130mm Bore Cyl	N-N-10		130 mm	LBH-9171671	162.69
	140mm Bore Cyl	I-BB-1	90 mm		LBH-9060196	213.30
	140mm Bore Cyl	N-N-10		140 mm	LBH-9165363	349.56
	150mm Bore Cyl	I-BB-1	95 mm		LBH-9062534	301.63
Bucket (3.2m Ind Stick)		I-BB-1	105 mm		LBH-9061003	202.52
		N-N-10		160 mm	LBH-9154141	223.87
Bucket (3.7m FS Stick)		I-BB-1	85 mm		LBH-9158175	143.99
		N-N-10		125 mm	LBH-9060977	163.08
Bucket (4.0m, 5.0m Ind Stick)		I-BB-1	80 mm		LBH-9172118	280.83
Bucket (7.4m LR Stick)		I-BB-1	60 mm		LBH-9061404	116.33
		N-N-10		90 mm	LBH-9061380	94.24
Bucket (Ditch Clean)		I-BB-1	90 mm		LBH-9967796	185.42
Clam 10B		I-BB-1	60 mm		LBH-9114673	87.72
		N-N-10		85 mm	LBH-9113351	102.56
Clam 70C		I-BB-1	50 mm		LBH-9155154	157.95
		N-N-10		70 mm	LBH-9063464	52.16
Stick (4.0m Hyd Adj Boom)	s/n -13609	I-BB-1	95 mm		LBH-9060197	178.06
	s/n -13609	N-N-10		140 mm	LBH-9165363	349.56
	s/n 13610-	I-BB-1	105 mm		LBH-9158311	221.06
	s/n 13610-	N-N-10		150 mm	LBH-9179503	178.14
Stick (5.0m, 5.5m Hyd Adj Boom)	140mm Bore Cyl	I-BB-1	95 mm		LBH-9060197	178.06
	140mm Bore Cyl	N-N-10		140 mm	LBH-9165363	349.56
	150mm Bore Cyl	I-BB-1	105 mm		LBH-9158311	221.06
	150mm Bore Cyl	N-N-10		150 mm	LBH-9179503	178.14
Stick (5.0m, 5.7m, 6.0m, 7.6m, 8.2m Std Boom)		I-BB-1	95 mm		LBH-9060197	178.06

LIEBHERR

LIEBHERR

Replacement Kits For



Excavators						
APPLICATION	MISC:	CODE	ROD	BORE	KIT #	List \$
MODEL R924 B HD-SL LI						
Stick (5.0m, 5.7m, 6.0m, 7.6m, 8.2m Std Boom)		N-N-10		140 mm	LBH-9165363	349.56
Stick (5.7m, 5.9m, 6.0m, 8.2m, 9.0m Std Boom)		I-BB-1	105 mm		LBH-9158311	221.06
		N-N-10		150 mm	LBH-9179503	178.14
Stick (Ind Boom)	6.8m & 7.8m Boom	I-BB-1	85 mm		LBH-9158175	143.99
	6.8m & 7.8m Boom	N-N-10		125 mm	LBH-9060977	163.08
Stick (LR)		I-BB-1	85 mm		LBH-9060195	144.63
		N-N-10		130 mm	LBH-9171671	162.69
Swivel Rotary		I-BB-1	95 mm		LBH-9144401	533.97
MODEL R924 Compact						
Boom Adj (Hyd Adj)		I-BB-1	95 mm		LBH-9063136	307.12
		N-N-10		160 mm	LBH-9154141	223.87
Boom Lift		I-BB-1	90 mm		LBH-9172119	176.99
		N-N-10		130 mm	LBH-9171671	162.69
Boom Offset		I-BB-1	50 mm		LBH-9061030	101.29
		N-N-10		90 mm	LBH-9061380	94.24
Bucket		I-BB-1	80 mm		LBH-9172118	280.83
		N-N-10		120 mm	LBH-9172577	163.16
Bucket (Ditch Clean)		I-BB-1	90 mm		LBH-9967796	185.42
Stick		I-BB-1	95 mm		LBH-9060197	178.06
		N-N-10		140 mm	LBH-9165363	349.56
Swivel Rotary	198 Litronic	I-BB-1	95 mm		LBH-9265132	2848.08
	911 Litronic	I-BB-1	95 mm		LBH-9144401	533.97
MODEL R932 EW, R932 HD-SL						
Boom Adj (Hyd Adj)	160mm Bore Cyl	I-BB-1	105 mm		LBH-9061003	202.52
	160mm Bore Cyl	N-N-10		160 mm	LBH-9154141	223.87
	180mm Bore Cyl	N-N-10		180 mm	LBH-9169654	492.32
Boom Lift		I-BB-1	95 mm		LBH-9060197	178.06
		N-N-10		140 mm	LBH-9165363	349.56
Bucket (1.9m Stick)		I-BB-1	95 mm		LBH-9060197	178.06
		N-N-10		140 mm	LBH-9165363	349.56
Stick (4.0m Hyd Adj Boom)		I-BB-1	105 mm		LBH-9158311	221.06
		N-N-10		150 mm	LBH-9156782	173.40
Swivel Rotary		I-BB-1	95 mm		LBH-9144401	533.97
MODEL R934 B, R934 C, R934 EW, R934 HD-SL						
Boom Lift		I-BB-1	95 mm		LBH-9062534	301.63
		N-N-10		150 mm	LBH-9165440	375.12
Boom Lift (Ind Boom)		I-BB-1	105 mm		LBH-9158311	221.06
		N-N-10		150 mm	LBH-9156782	173.40
Bucket (3.0m Stick)		I-BB-1	80 mm		LBH-9172118	280.83
		N-N-10		120 mm	LBH-9172577	163.16
Bucket (4.8m Ind Stick)		I-BB-1	70 mm		LBH-9062256	103.96
		N-N-10		125 mm	LBH-9060977	163.08
Bucket (5.2m Demolition)		I-BB-1	85 mm		LBH-9060195	144.63
		N-N-10		130 mm	LBH-9171671	162.69

Replacement Kits For

LIEBHERR

Excavators						
APPLICATION	MISC:	CODE	ROD	BORE	KIT #	List \$
MODEL R934 B, R934 C, R934 EW, R934 HD-SL						
Bucket (8.8m, 7.5m LR Stick)		I-BB-1	70 mm		LBH-9172117	170.31
		N-N-10		100 mm	LBH-9174200	139.78
Stick (10.0m LR)		I-BB-1	90 mm		LBH-9060196	213.30
		N-N-10		140 mm	LBH-9165363	349.56
Stick (11.5m LR)		I-BB-1	95 mm		LBH-9060197	178.06
		N-N-10		140 mm	LBH-9165363	349.56
Stick (4.0m, 5.2m, 6.2m Hyd Adj Boom)		I-BB-1	105 mm		LBH-9158311	221.06
		N-N-10		150 mm	LBH-9165440	375.12
Stick (7.0m Ind Boom)		I-BB-1	95 mm		LBH-9060197	178.06
		N-N-10		140 mm	LBH-9165363	349.56
Stick (Std Boom)		I-BB-1	105 mm		LBH-9158311	221.06
		N-N-10		150 mm	LBH-9165440	375.12
Swivel Rotary		I-BB-1	95 mm		LBH-9144401	533.97
MODEL R934 C HD-S, R934 C HD-SL						
Boom Adj (Hyd Adj)		I-BB-1	110 mm		LBH-9158144	422.48
		N-N-10		180 mm	LBH-9169654	492.32
Boom Lift		I-BB-1	95 mm		LBH-9062534	301.63
		N-N-10		150 mm	LBH-9165440	375.12
Boom Lift (Ind Boom)		I-BB-1	100 mm		LBH-9596597	250.29
		N-N-10		150 mm	LBH-9165440	375.12
Bucket (3.1m Stick)		I-BB-1	85 mm		LBH-9060195	144.63
		N-N-10		130 mm	LBH-9171671	162.69
Bucket (3.6m Ind Stick)		I-BB-1	110 mm		LBH-9158144	422.48
		N-N-10		170 mm	LBH-9062821	297.30
Bucket (4.8m Ind Stick)		I-BB-1	70 mm		LBH-9062256	103.96
		N-N-10		125 mm	LBH-9060977	163.08
Bucket (Ditch Clean)	2000mm; 2400mm 1.45M3 (2x50° Swiveling)	I-BB-1	100 mm		LBH-9581868	177.38
	2400mm 1.15M3 (2x45° Adj)	I-BB-1	50 mm		LBH-9155154	157.95
Clam 65		I-BB-1	50 mm		LBH-9155154	157.95
		N-N-10		70 mm	LBH-9063464	52.16
Stick (4.2m Hyd Adj Boom)		I-BB-1	105 mm		LBH-9061003	202.52
		N-N-10		160 mm	LBH-9154141	223.87
Stick (5.2m Hyd Adj Boom)		I-BB-1	105 mm		LBH-9158311	221.06
		N-N-10		150 mm	LBH-9179503	178.14
Stick (Ind Boom)		I-BB-1	95 mm		LBH-9060197	178.06
		N-N-10		140 mm	LBH-9165363	349.56
Stick (Std Boom)		I-BB-1	105 mm		LBH-9158311	221.06
		N-N-10		150 mm	LBH-9179503	178.14
Swivel Rotary		I-BB-1	95 mm		LBH-9144401	533.97
MODEL R942 HD-SL						
Boom Lift		I-BB-1	105 mm		LBH-9158311	221.06
		N-N-10		150 mm	LBH-9156782	173.40
Bucket (2.1m, 2.6m, 3.3m, 4.1m Stick)		I-BB-1	105 mm		LBH-9158311	221.06

Replacement Kits For

LIEBHERR

LIEBHERR

Excavators						
APPLICATION	MISC:	CODE	ROD	BORE	KIT #	List \$
MODEL R942 HD-SL						
Bucket (2.1m, 2.6m, 3.3m, 4.1m Stick)		N-N-10		150 mm	LBH-9156782	173.40
Bucket (4.8m Stick)		I-BB-1	95 mm		LBH-9060197	178.06
		N-N-10		140 mm	LBH-9165363	349.56
Stick (4.5m, 5.5m, 6.0m Stick)		N-N-10		160 mm	LBH-9154141	223.87
Stick (6.3m Std Boom)		I-BB-1	105 mm		LBH-9061003	202.52
		N-N-10		160 mm	LBH-9154141	223.87
Stick (7.7m, 9.0m, 10.5m Ind Boom)		I-BB-1	105 mm		LBH-9158311	221.06
		N-N-10		150 mm	LBH-9156782	173.40
Swivel Rotary		I-BB-1	95 mm		LBH-9144401	533.97
MODEL R944 B, R944 C, R944 HD-SL						
Boom Lift		I-BB-1	105 mm		LBH-9061003	202.52
		N-N-10		160 mm	LBH-9154141	223.87
Bucket (2.1m Stick)		I-BB-1	105 mm		LBH-9061003	202.52
		N-N-10		160 mm	LBH-9154141	223.87
Bucket (2.6m, 3.3m, 4.1m Stick)		I-BB-1	105 mm		LBH-9158311	221.06
		N-N-10		150 mm	LBH-9156782	173.40
Bucket (4.0m Stick)		I-BB-1	80 mm		LBH-9172118	280.83
		N-N-10		120 mm	LBH-9172577	163.16
Bucket (4.1m Curved Stick)		I-BB-1	105 mm		LBH-9158311	221.06
		N-N-10		150 mm	LBH-9156782	173.40
Bucket (4.1m Stick)		I-BB-1	105 mm		LBH-9061003	202.52
		N-N-10		160 mm	LBH-9154141	223.87
Bucket (5.5m Curved Stick)		I-BB-1	95 mm		LBH-9060197	178.06
		N-N-10		140 mm	LBH-9165363	349.56
Stick (6.3m, 7.5m, 10.4m Std Boom)		I-BB-1	110 mm		LBH-9063688	235.66
		N-N-10		160 mm	LBH-9154141	223.87
Swivel Rotary		I-BB-1	95 mm		LBH-9144401	533.97
MODEL R954 B, R954 C, R954 HD						
Boom Lift (FS Bucket)		I-BB-1	125 mm		LBH-9062985	313.64
		N-N-10		180 mm	LBH-9062632	211.21
Boom Lift (Std)		I-BB-1	110 mm		LBH-9158144	422.48
		N-N-10		180 mm	LBH-9062632	211.21
Bucket		I-BB-1	105 mm		LBH-9158311	221.06
Bucket (2.35m Stick)		I-BB-1	110 mm		LBH-9158144	422.48
		N-N-10		180 mm	LBH-9062632	211.21
Bucket (2.9m Stick)		I-BB-1	110 mm		LBH-9158144	422.48
		N-N-10		170 mm	LBH-9169653	435.76
Bucket (Demolition)		I-BB-1	95 mm		LBH-9060197	178.06
		N-N-10		140 mm	LBH-9165363	349.56
Stick (10.3m Stick)		N-N-10		170 mm	LBH-9062821	297.30
Stick (6.7m Std Boom)		I-BB-1	125 mm		LBH-9062985	313.64
		N-N-10		180 mm	LBH-9062632	211.21
Stick (7.0m Ind Boom)		I-BB-1	125 mm		LBH-9064091	250.17
Stick (8.8m, 11.3m Ind Boom)		I-BB-1	110 mm		LBH-9063688	235.66
		N-N-10		160 mm	LBH-9154141	223.87
Stick (Std Boom)		I-BB-1	125 mm		LBH-9062985	313.64

Replacement Kits For

LIEBHERR

Excavators						
APPLICATION	MISC:	CODE	ROD	BORE	KIT #	List \$
MODEL R954 B, R954 C, R954 HD						
Stick (Std Boom)		N-N-10		180 mm	LBH-9062632	211.21
Swivel Rotary		I-BB-1	130 mm		LBH-9265064	1171.54
MODEL R964 C						
Boom Lift		N-N-10		180 mm	LBH-9169654	492.32
	1x6.3mm & 1x8.1mm wide rod seals	I-BB-1	125 mm		LBH-9062985	313.64
	2x6.3mm wide rod seals	I-BB-1	125 mm		LBH-9158145	205.00
Bucket (2.6m Stick)		N-N-10		180 mm	LBH-9062632	211.21
	1x6.3mm & 1x8.1mm wide rod seals	I-BB-1	125 mm		LBH-9062985	313.64
	2x6.3mm wide rod seals	I-BB-1	125 mm		LBH-9158145	205.00
Bucket (3.4m Stick)		I-BB-1	110 mm		LBH-9158144	422.48
		N-N-10		180 mm	LBH-9062632	211.21
	2x6.3mm wide rod seals	I-BB-1	125 mm		LBH-9158145	205.00
Bucket (4.2m Stick)		I-BB-1	125 mm		LBH-9062985	313.64
		N-N-10		180 mm	LBH-9062632	211.21
Bucket (5.0m Stick)		I-BB-1	110 mm		LBH-9158144	422.48
		N-N-10		170 mm	LBH-9062821	297.30
Stick (7.0m, 8.2m, 10m Std Boom)		N-N-10		210 mm	LBH-9159705	309.96
	1x6.3mm & 1x8.1mm wide rod seals	I-BB-1	140 mm		LBH-9062984	342.45
	2x6.3mm wide rod seals	I-BB-1	140 mm		LBH-9061471	363.40
Swivel Rotary		I-BB-1	130 mm		LBH-9265064	1171.54
Excavators - Wheel						
APPLICATION	MISC:	CODE	ROD	BORE	KIT #	List \$
MODEL A309 LI						
Boom Adj (Hyd Adj)		I-BB-1	70 mm		LBH-9062256	103.96
		N-N-10		125 mm	LBH-9060977	163.08
Boom Lift		I-BB-1	70 mm		LBH-9583532	95.65
		N-N-10		115 mm	LBH-9113343	135.10
Bucket		I-BB-1	50 mm		LBH-9063554	101.91
		N-N-10		80 mm	LBH-9062172	95.89
Bucket (Ditch Clean)	1300mm	I-BB-1	36 mm		LBH-9063270	61.93
	1300mm	N-N-10		70 mm	LBH-9155949	51.73
	1500mm & 1700mm	I-BB-1	80 mm		LBH-9592551	63.74
Oscillating Axle Stabilizer		I-BB-1	85 mm		LBH-9158310	77.11
Stabilizers		I-BB-1	50 mm		LBH-9159738	104.34
		N-N-10		110 mm	LBH-9063452	72.03
Stick		I-BB-1	60 mm		LBH-9061404	116.33
		N-N-10		90 mm	LBH-9061380	94.24
Swivel Rotary		I-BB-1	95 mm		LBH-9265132	2848.08
MODEL A311 LI						
Boom Adj (Hyd Adj)		I-BB-1	70 mm		LBH-9062256	103.96
		N-N-10		125 mm	LBH-9060977	163.08
Boom Lift		I-BB-1	70 mm		LBH-9062256	103.96
		N-N-10		125 mm	LBH-9060977	163.08
Bucket		I-BB-1	60 mm		LBH-9061404	116.33

Replacement Kits For

LIEBHERR

Excavators - Wheel						
APPLICATION	MISC:	CODE	ROD	BORE	KIT #	List \$
MODEL A311 LI						
Bucket		N-N-10		90 mm	LBH-9061380	94.24
Bucket (Ditch Clean)	1200mm; 1500mm 0,36M3; 1700mm 0,41M3	I-BB-1	80 mm		LBH-9592551	63.74
	1500mm 0,33M3	I-BB-1	36 mm		LBH-9063270	61.93
	1500mm 0,33M3	N-N-10		70 mm	LBH-9155949	51.73
	1700mm 0,37M3	I-BB-1	50 mm		LBH-9155154	157.95
Dozer Blade	2550mm	I-BB-1	50 mm		LBH-9159738	104.34
	2550mm	N-N-10		110 mm	LBH-9063452	72.03
Oscillating Axle Stabilizer		I-BB-1	85 mm		LBH-9158310	77.11
Stabilizers		I-BB-1	50 mm		LBH-9159738	104.34
		N-N-10		110 mm	LBH-9063452	72.03
Stick		I-BB-1	70 mm		LBH-9172117	170.31
		N-N-10		100 mm	LBH-9174200	139.78
Swivel Rotary		I-BB-1	95 mm		LBH-9265132	2848.08
MODEL A312 LI						
Boom Adj (Hyd Adj)		I-BB-1	80 mm		LBH-9063173	286.43
		N-N-10		140 mm	LBH-9165363	349.56
Boom Lift		I-BB-1	70 mm		LBH-9172117	170.31
		N-N-10		100 mm	LBH-9174200	139.78
Bucket		I-BB-1	60 mm		LBH-9061404	116.33
		N-N-10		90 mm	LBH-9061380	94.24
Bucket (Ditch Clean)	1200mm	I-BB-1	80 mm		LBH-9592551	63.74
	1500mm; 1600mm; 2000mm	I-BB-1	90 mm		LBH-9967796	185.42
	110mm Bore Cyl	I-BB-1	60 mm		LBH-9063449	86.85
	110mm Bore Cyl	N-N-10		110 mm	LBH-9063452	72.03
Dozer Blade	90mm Bore Cyl	I-BB-1	50 mm		LBH-9061030	101.29
	90mm Bore Cyl	N-N-10		90 mm	LBH-9061380	94.24
Oscillating Axle Stabilizer		I-BB-1	85 mm		LBH-9158310	77.11
Stabilizers		I-BB-1	70 mm		LBH-9193515	141.74
		N-N-10		120 mm	LBH-9172577	163.16
Stick		I-BB-1	75 mm		LBH-9064496	146.98
		N-N-10		110 mm	LBH-9159131	130.79
Swing		I-BB-1	50 mm		LBH-9061030	101.29
		N-N-10		90 mm	LBH-9061380	94.24
Swivel Rotary		I-BB-1	95 mm		LBH-9265132	2848.08
MODEL A314 LI						
Boom Adj (Hyd Adj)		I-BB-1	80 mm		LBH-9063173	286.43
		N-N-10		140 mm	LBH-9165363	349.56
Boom Lift		I-BB-1	70 mm		LBH-9063172	150.94
		N-N-10		110 mm	LBH-9159131	130.79
Boom Offset		I-BB-1	50 mm		LBH-9061030	101.29
		N-N-10		90 mm	LBH-9061380	94.24
Bucket		I-BB-1	60 mm		LBH-9061404	116.33
		N-N-10		90 mm	LBH-9061380	94.24

Replacement Kits For

LIEBHERR

Excavators - Wheel						
APPLICATION	MISC:	CODE	ROD	BORE	KIT #	List \$
MODEL A314 LI						
Bucket (Ditch Clean)		I-BB-1	90 mm		LBH-9967796	185.42
Dozer Blade	110mm Bore Cyl	I-BB-1	60 mm		LBH-9063449	86.85
	110mm Bore Cyl	N-N-10		110 mm	LBH-9063452	72.03
	90mm Bore Cyl	I-BB-1	50 mm		LBH-9061030	101.29
	90mm Bore Cyl	N-N-10		90 mm	LBH-9061380	94.24
Oscillating Axle Stabilizer		I-BB-1	85 mm		LBH-9063709	146.87
Stabilizers		I-BB-1	70 mm		LBH-9193515	141.74
		N-N-10		120 mm	LBH-9172577	163.16
Stick		N-N-10		115 mm	LBH-9113343	135.10
Stick (3.2m Boom)	-1997	I-BB-1	70 mm		LBH-9063172	150.94
	-1997	N-N-10		110 mm	LBH-9159131	130.79
	2001-	N-N-10		115 mm	LBH-9113343	135.10
Stick (4.3m Std, Lat Adj Boom)	s/n -28989	N-N-10		115 mm	LBH-9113343	135.10
Stick (4.5m Std Boom)		I-BB-1	70 mm		LBH-9063172	150.94
		N-N-10		110 mm	LBH-9159131	130.79
	2001-	N-N-10		115 mm	LBH-9113343	135.10
Stick (4.9m Std Boom, Lat Adj)		N-N-10		115 mm	LBH-9113343	135.10
Stick (5.0m Std Boom)		N-N-10		115 mm	LBH-9113343	135.10
Swivel Bucket 1500mm		I-BB-1	90 mm		LBH-9967796	185.42
Swivel Rotary		I-BB-1	95 mm		LBH-9265132	2848.08
MODEL A316 LI						
Boom Adj (Hyd Adj)		I-BB-1	80 mm		LBH-9063173	286.43
		N-N-10		140 mm	LBH-9165363	349.56
Boom Lift		I-BB-1	70 mm		LBH-9172122	102.62
		N-N-10		120 mm	LBH-9172577	163.16
Boom Offset		I-BB-1	50 mm		LBH-9061030	101.29
		N-N-10		90 mm	LBH-9061380	94.24
Bucket		I-BB-1	70 mm		LBH-9172117	170.31
		N-N-10		100 mm	LBH-9174200	139.78
Bucket (Ditch Clean)		I-BB-1	90 mm		LBH-9967796	185.42
Cab Elevation		I-BB-1	50 mm		LBH-9063554	101.91
		N-N-10		80 mm	LBH-9061383	48.90
Dozer Blade	100mm Bore Cyl	I-BB-1	60 mm		LBH-9174143	83.26
	100mm Bore Cyl	N-N-10		100 mm	LBH-9174142	112.51
	110mm Bore Cyl	I-BB-1	60 mm		LBH-9063449	86.85
	110mm Bore Cyl	N-N-10		110 mm	LBH-9063452	72.03
	90mm Bore Cyl	I-BB-1	50 mm		LBH-9061030	101.29
	90mm Bore Cyl	N-N-10		90 mm	LBH-9061380	94.24
Oscillating Axle Stabilizer		I-BB-1	85 mm		LBH-9063709	146.87
Stabilizers		I-BB-1	70 mm		LBH-9193515	141.74
		N-N-10		120 mm	LBH-9172577	163.16
Stick		I-BB-1	80 mm		LBH-9172118	280.83
		N-N-10		120 mm	LBH-9172577	163.16
Stick (4.6m Ind Boom)		I-BB-1	70 mm		LBH-9063172	150.94
		N-N-10		110 mm	LBH-9159131	130.79
Swivel Rotary		I-BB-1	95 mm		LBH-9265132	2848.08

Replacement Kits For

LIEBHERR

LIEBHERR

Excavators - Wheel						
APPLICATION	MISC:	CODE	ROD	BORE	KIT #	List \$
MODEL A900 C-LI						
Boom Adj (Hyd Adj)		I-BB-1	80 mm		LBH-9063173	286.43
		N-N-10		140 mm	LBH-9165363	349.56
Boom Lift		I-BB-1	85 mm		LBH-9158175	143.99
		N-N-10		125 mm	LBH-9060977	163.08
Boom Offset	100mm Bore Cyl	I-BB-1	50 mm		LBH-9062932	54.91
	90mm Bore Cyl	I-BB-1	50 mm		LBH-9061030	101.29
	90mm Bore Cyl	N-N-10		90 mm	LBH-9061380	94.24
Bucket (2.05m, 2.25m, 2.45m, 2.65m, 3.05m, 3.65m S)		I-BB-1	70 mm		LBH-9951829	121.95
		N-N-10		105 mm	LBH-9951831	135.74
Bucket (2.65m, 3.05m Stick)		I-BB-1	70 mm		LBH-9172117	170.31
		N-N-10		100 mm	LBH-9174200	139.78
Bucket (5.2m Stick)		I-BB-1	60 mm		LBH-9061404	116.33
		N-N-10		90 mm	LBH-9061380	94.24
Bucket (Ditch Clean)		I-BB-1	90 mm		LBH-9967796	185.42
Dozer Blade		I-BB-1	50 mm		LBH-9061030	101.29
		N-N-10		90 mm	LBH-9061380	94.24
Oscillating Axle Stabilizer		I-BB-1	85 mm		LBH-9063709	146.87
Stabilizers		I-BB-1	70 mm		LBH-9193515	141.74
		N-N-10		120 mm	LBH-9172577	163.16
Stick		I-BB-1	85 mm		LBH-9060195	144.63
		N-N-10		130 mm	LBH-9171671	162.69
Swivel Bucket		I-BB-1	90 mm		LBH-9967796	185.42
Swivel Rotary		I-BB-1	95 mm		LBH-9265132	2848.08
MODEL A904 C-LI						
Boom Adj (Hyd Adj)		I-BB-1	80 mm		LBH-9063173	286.43
	for Deep Hole	I-BB-1	90 mm		LBH-9060196	213.30
	for Deep Hole	N-N-10		140 mm	LBH-9165363	349.56
Boom Lift (Hyd Adj)		I-BB-1	85 mm		LBH-9285625	206.60
		N-N-10		135 mm	LBH-9285577	191.29
Boom Lift (Ind Boom)		I-BB-1	85 mm		LBH-9060195	144.63
		N-N-10		130 mm	LBH-9171671	162.69
Boom Lift (Std Boom)		I-BB-1	85 mm		LBH-9285625	206.60
		N-N-10		135 mm	LBH-9285577	191.29
Bucket (2.25m, 2.45m, 2.65m, 3.05m, 4.25m Stick)		I-BB-1	80 mm		LBH-9172118	280.83
		N-N-10		120 mm	LBH-9172577	163.16
Bucket (3.5m, 4.5m Ind Stick)		I-BB-1	80 mm		LBH-9172118	280.83
		N-N-10		120 mm	LBH-9172577	163.16
Bucket (4.3m Ind Stick)		I-BB-1	70 mm		LBH-9062256	103.96
		N-N-10		125 mm	LBH-9060977	163.08
Bucket (4.6m LR Stick)		I-BB-1	60 mm		LBH-9061404	116.33
		N-N-10		90 mm	LBH-9061380	94.24
Bucket (5.0m Stick)		I-BB-1	60 mm		LBH-9061404	116.33
		N-N-10		90 mm	LBH-9061380	94.24
Bucket (Ditch Clean)		I-BB-1	90 mm		LBH-9967796	185.42

Replacement Kits For

LIEBHERR

Excavators - Wheel

APPLICATION	MISC:	CODE	ROD	BORE	KIT #	List \$
MODEL A904 C-LI						
Dozer Blade	Front Dual Cyl; Prop Up 2550mm, 2750mm	I-BB-1	50 mm		LBH-9158084	103.05
	Front Single Cyl	I-BB-1	60 mm		LBH-9174143	83.26
	Front Single Cyl	N-N-10		100 mm	LBH-9174142	112.51
	Prop Up 2550mm	I-BB-1	60 mm		LBH-9063449	86.85
	Prop Up 2550mm	N-N-10		110 mm	LBH-9063452	72.03
Oscillating Axle Stabilizer		I-BB-1	85 mm		LBH-9063709	146.87
Stabilizers		I-BB-1	70 mm		LBH-9193515	141.74
		N-N-10		120 mm	LBH-9172577	163.16
Stick		I-BB-1	85 mm		LBH-9060195	144.63
		N-N-10		130 mm	LBH-9171671	162.69
Stick (4.6m, 6.8m LR Stick)		I-BB-1	70 mm		LBH-9583532	95.65
		N-N-10		115 mm	LBH-9113343	135.10
Stick (5.2m Std Boom, Lat Adj)		I-BB-1	85 mm		LBH-9060195	144.63
		N-N-10		130 mm	LBH-9171671	162.69
Stick (5.3m, 7.4m, 5.6m Std Boom)		I-BB-1	85 mm		LBH-9060195	144.63
		N-N-10		130 mm	LBH-9171671	162.69
Stick (5.5m Boom Low-Curved)		I-BB-1	85 mm		LBH-9060195	144.63
		N-N-10		130 mm	LBH-9171671	162.69
Stick (6.0m Ind Boom-Angled)		I-BB-1	80 mm		LBH-9172118	280.83
		N-N-10		120 mm	LBH-9172577	163.16
Stick (6.1m, 6.6m, 7.0m, 7.1m Ind Boom)		I-BB-1	80 mm		LBH-9172118	280.83
		N-N-10		120 mm	LBH-9172577	163.16
Swing		I-BB-1	60 mm		LBH-9159680	138.42
		N-N-10		120 mm	LBH-9111605	183.62
Swivel Bucket		I-BB-1	90 mm		LBH-9967796	185.42
Swivel Rotary		I-BB-1	95 mm		LBH-9265132	2848.08

Loaders - Wheel

APPLICATION	MISC:	CODE	ROD	BORE	KIT #	List \$
MODEL L506 Stereo						
Loader Lift		I-BB-1	40 mm		LBH-9063465	48.90
		N-N-10		80 mm	LBH-9061383	48.90
Loader Tilt		I-BB-1	40 mm		LBH-9063465	48.90
		N-N-10		80 mm	LBH-9061383	48.90
Steering	s/n -99998	I-BB-1	30 mm		LBH-9063423	30.91
	s/n -99998	N-N-10		70 mm	LBH-9064914	34.08
MODEL L507 Stereo						
Loader Lift	s/n -99998	I-BB-1	40 mm		LBH-9063465	48.90
	s/n -99998	N-N-10		80 mm	LBH-9061383	48.90
Loader Tilt		I-BB-1	40 mm		LBH-9063465	48.90
		N-N-10		80 mm	LBH-9061383	48.90
Steering	s/n -99998	I-BB-1	30 mm		LBH-9063423	30.91
	s/n -99998	N-N-10		70 mm	LBH-9064914	34.08
MODEL L508 Stereo						
Loader Lift		I-BB-1	50 mm		LBH-9063162	101.91
Loader Tilt		I-BB-1	50 mm		LBH-9063162	101.91

Replacement Kits For

LIEBHERR

LIEBHERR

Loaders - Wheel						
APPLICATION	MISC:	CODE	ROD	BORE	KIT #	List \$
MODEL L508 Stereo						
Steering	s/n -99998	I-BB-1	30 mm		LBH-9063423	30.91
	s/n -99998	N-N-10		70 mm	LBH-9064914	34.08
MODEL L509 Stereo						
Loader Lift	s/n -99998	I-BB-1	50 mm		LBH-9063162	101.91
Loader Tilt	s/n -99998	I-BB-1	50 mm		LBH-9063162	101.91
Steering	s/n -99998	I-BB-1	30 mm		LBH-9063423	30.91
	s/n -99998	N-N-10		70 mm	LBH-9064914	34.08
MODEL L538, L538 (Z-bar)						
Loader Lift		I-BB-1	60 mm		LBH-9177617	94.87
		N-N-10		110 mm	LBH-9159131	130.79
Loader Tilt		I-BB-1	50 mm		LBH-9061030	101.29
		N-N-10		90 mm	LBH-9061380	94.24
Steering		I-BB-1	40 mm		LBH-9061381	66.12
		N-N-10		90 mm	LBH-9063712	57.58
MODEL L544						
Loader Lift		I-BB-1	80 mm		LBH-9063757	150.61
		N-N-10		130 mm	LBH-9111341	179.11
Loader Tilt		I-BB-1	80 mm		LBH-9063173	286.43
		N-N-10		150 mm	LBH-9113131	190.27
Steering		I-BB-1	40 mm		LBH-9063465	48.90
		N-N-10		80 mm	LBH-9061383	48.90
MODEL L556 2plus2, L556 2plus2 High Lift						
Loader Lift		I-BB-1	80 mm		LBH-9063757	150.61
		N-N-10		130 mm	LBH-9111341	179.11
Loader Tilt		I-BB-1	80 mm		LBH-9063173	286.43
		N-N-10		150 mm	LBH-9113131	190.27
Steering		I-BB-1	40 mm		LBH-9063465	48.90
		N-N-10		80 mm	LBH-9061383	48.90
MODEL L564						
Loader Lift		I-BB-1	80 mm		LBH-9196096	214.53
		N-N-10		150 mm	LBH-9113131	190.27
Loader Tilt		I-BB-1	90 mm		LBH-9158397	211.35
		N-N-10		170 mm	LBH-9062821	297.30
Steering		I-BB-1	40 mm		LBH-9061381	66.12
		N-N-10		90 mm	LBH-9063712	57.58
MODEL L566 2plus2, L566 2plus2 High Lift						
Loader Lift		I-BB-1	80 mm		LBH-9196096	214.53
		N-N-10		150 mm	LBH-9113131	190.27
Loader Tilt		I-BB-1	90 mm		LBH-9158397	211.35
		N-N-10		170 mm	LBH-9062821	297.30
Steering		I-BB-1	40 mm		LBH-9061381	66.12
		N-N-10		90 mm	LBH-9063712	57.58
Off-Highway Trucks						
APPLICATION	MISC:	CODE	ROD	BORE	KIT #	List \$
MODEL KL2420						
Steering	Cyl 13029-D	P-U-10	2-3/4	5-1/2	LBH-13029-C-1	74.36

LIEBHERR

Kit Number	Code (Pg. xviii)	Rod X Bore Size	List Price
LBH-13029-C-1	P-U-10	2-3/4 X 5-1/2	\$ 74.36
LBH-5708-876-08	N-N-15	160 mm Piston	212.20
LBH-9060195	I-SP-1	85 mm Rod Kit	144.63
LBH-9060196	I-SP-1	90 mm Rod Kit	213.30
LBH-9060197	I-BB-1	95 mm Rod Kit	178.06
LBH-9060977	N-N-10	125 mm Piston Kit	163.08
LBH-9061003	I-BB-1	105 mm Rod Kit	202.52
LBH-9061030	I-BB-1	50 mm Rod Kit	101.29
LBH-9061380	N-N-10	90 mm Piston Kit	94.24
LBH-9061381	I-BB-1	40 mm Rod Kit	66.12
LBH-9061383	N-N-10	80 mm Piston Kit	48.90
LBH-9061404	I-BB-1	60 mm Rod Kit	116.33
LBH-9061471	I-BB-1	Seal Kit	363.40
LBH-9062172	N-N-10	80 mm Piston Kit	95.89
LBH-9062256	I-BB-1	70 mm Rod Kit	103.96
LBH-9062534	I-BB-1	95 mm Rod Kit	301.63
LBH-9062632	N-N-10	180 mm Piston Kit	211.21
LBH-9062821	N-N-10	170 mm Piston Kit	297.30
LBH-9062932	I-BB-1	50 mm Rod Kit	54.91
LBH-9062984	I-BB-1	140 mm Rod Kit	342.45
LBH-9062985	I-BB-1	125 mm Rod Kit	313.64
LBH-9063136	I-BB-1	95 mm Rod Kit	307.12
LBH-9063162	I-BB-1	50 mm Rod Kit	101.91
LBH-9063172	I-BB-1	70 mm Rod Kit	150.94
LBH-9063173	I-BB-1	80 mm Rod Kit	286.43
LBH-9063270	I-BB-1	36 mm Rod Kit	61.93
LBH-9063423	I-BB-1	30 mm Rod Kit	30.91
LBH-9063449	I-BB-1	60 mm Rod Kit	86.85
LBH-9063452	N-N-10	110 mm Piston Kit	72.03
LBH-9063464	N-N-10	70 mm Piston Kit	52.16
LBH-9063465	I-BB-1	40 mm Rod Kit	48.90
LBH-9063554	I-BB-1	50 mm Rod Kit	101.91
LBH-9063688	I-BB-1	110 mm Rod Kit	235.66
LBH-9063709	I-BB-1	85 mm Rod Kit	146.87
LBH-9063712	N-N-10	90 mm Piston Kit	57.58
LBH-9063757	I-BB-1	80 mm Rod Kit	150.61
LBH-9064091	I-BB-1	125 mm Rod Kit	250.17
LBH-9064496	I-BB-1	75 mm Rod Kit	146.98
LBH-9064914	N-N-10	70 mm Piston Kit	34.08
LBH-9111341	N-N-10	130 mm Piston Kit	179.11
LBH-9111605	N-N-10	120 mm Piston Kit	183.62
LBH-9113131	N-N-10	150 mm Piston Kit	190.27
LBH-9113343	N-N-10	115 mm Piston Kit	135.10
LBH-9113351	N-N-10	85 mm Piston Kit	102.56
LBH-9114437	N-N-10	220 mm Piston Kit	350.68
LBH-9114673	I-BB-1	60 mm Rod Kit	87.72

Kit Number	Code (Pg. xviii)	Rod X Bore Size	List Price
LBH-9116590	I-BB-1	70 mm Rod Kit	\$ 67.81
LBH-9124375	N-N-10	85 mm Piston Kit	88.12
LBH-9124376	I-SP-1	50 mm Rod Kit	81.34
LBH-9144401	I-BB-1	95mm Rod Kit	533.97
LBH-9154141	N-N-10	160 mm Piston Kit	223.87
LBH-9154605	N-N-10	85 mm Piston Kit	102.43
LBH-9154606	I-SP-1	36 mm Rod Kit	46.47
LBH-9155083	I-SP-1	110 mm Rod Kit	262.30
LBH-9155154	I-BB-1	50 mm Rod Kit	157.95
LBH-9155949	N-N-10	70 mm Piston Kit	51.73
LBH-9156782	N-N-10	150 mm Piston Kit	173.40
LBH-9156961	N-N-10	230 mm Piston Kit	942.22
LBH-9156962	I-SP-1	170 mm Rod Kit	911.25
LBH-9158084	I-BB-1	50 mm Rod Kit	103.05
LBH-9158144	I-SP-1	110 mm Rod Kit	422.48
LBH-9158145	I-SP-1	125 mm Rod Kit	205.00
LBH-9158175	I-BB-1	85 mm Rod Kit	143.99
LBH-9158310	I-BB-1	85 mm Rod Kit	77.11
LBH-9158311	I-BB-1	105 mm Rod Kit	221.06
LBH-9158397	I-BB-1	90 mm Rod Kit	211.35
LBH-9158674	I-SP-1	100 mm Rod Kit	289.16
LBH-9159131	N-N-10	100 mm Piston Kit	130.79
LBH-9159132	I-SP-1	70 mm Rod Kit	144.59
LBH-9159680	I-BB-1	60mm Rod Kit	138.42
LBH-9159705	N-N-10	210 mm Piston Kit	309.96
LBH-9159738	I-BB-1	50mm Rod Kit	104.34
LBH-9159739	I-SP-1	150 mm Rod Kit	1240.38
LBH-9165363	N-N-10	140 mm Piston	349.56
LBH-9165440	N-N-10	150 mm Piston	375.12
LBH-9165441	I-BB-1	100 mm	218.82
LBH-9169653	N-N-10	170 mm Piston	435.76
LBH-9169654	N-N-10	180 mm Piston	492.32
LBH-9169656	I-SP-1	110 mm Rod Kit	315.19
LBH-9170257	N-N-10	200 mm Piston	512.15
LBH-9170258	I-SP-1	110 mm Rod Kit	466.89
LBH-9170276	P-SP-1	140 mm Rod Kit	391.92
LBH-9171670	I-SP-1	80 mm Rod Kit	254.09
LBH-9171671	N-N-10	130 mm Piston Kit	162.69
LBH-9172117	I-SP-1	70 mm Rod Kit	170.31
LBH-9172118	I-SP-1	80 mm Rod Kit	280.83
LBH-9172119	I-BB-1	90mm Rod Kit	176.99
LBH-9172122	I-SP-1	70 mm Rod Kit	102.62
LBH-9172123	I-SP-1	110 mm Rod Kit	314.39
LBH-9172577	N-N-10	120 mm Piston Kit	163.16
LBH-9174142	N-N-10	100 mm Piston Kit	112.51
LBH-9174143	I-BB-1	60 mm Rod Kit	83.26

LIEBHERR

Kit Number	Code (Pg. xviii)	Rod X Bore Size	List Price
LBH-9174200	N-N-10	100 mm Piston Kit	\$ 139.78
LBH-9174519	I-SP-1	70 mm Rod Kit	111.11
LBH-9174575	I-SP-1	80 mm Rod Kit	148.43
LBH-9177617	I-BB-1	60 mm Rod Kit	94.87
LBH-9179503	N-N-10	150 mm Piston Kit	178.14
LBH-9193515	I-BB-1	70 mm Rod Kit	141.74
LBH-9196096	I-BB-1	80 mm Rod Kit	214.53
LBH-9265064	I-BB-1	130mm Rod Kit	1171.54
LBH-9265132	I-BB-1	95 mm Rod Kit	2848.08
LBH-9285577	N-N-10	135 mm Piston Kit	191.29

Kit Number	Code (Pg. xviii)	Rod X Bore Size	List Price
LBH-9285625	I-BB-1	85 mm Rod Kit	\$ 206.60
LBH-9581868	I-BB-1	100 mm Rod Kit	177.38
LBH-9583532	I-BB-1	70 mm Rod Kit	95.65
LBH-9592551	I-BB-1	80 mm Rod Kit	63.74
LBH-9596597	I-BB-1	100 mm Rod Kit	250.29
LBH-9951829	I-BB-1	70 mm Rod Kit	121.95
LBH-9951831	N-N-10	105 mm Piston Kit	135.74
LBH-9967796	I-BB-1	90 mm Rod Kit	185.42

REPLACEMENT PARTS FOR LIEBHERR EQUIPMENT

NOTE: Liebherr part numbers are used as a reference only. We do not imply that these kits are original REPLACEMENT PARTS.

BACK-UP RINGS

Part Number	Min Pkg Qty	List Price
LBH-10406AN	1	\$ 7.75
LBH-10406BX	1	7.21

O-RINGS

Part Number	Min Pkg Qty	List Price
LBH-10406AM	1	\$ 7.85
LBH-10406BW	1	4.00

WIPERS

Part Number	Rod Diam.	List Price
LBH-13298-A	12	\$ 43.14

LIEBHERR

LINK BELT

Kit Number	Code (Pg. xviii)	Rod X Bore Size	List Price
LB-3J12501	I-UB-11	3-1/2 X 4-1/2	\$ 179.74
LB-3J16874	P-UB-11	4-1/4 X 5-1/2	311.96
LB-3J16875	P-UB-10	4 x 5-1/4	248.04
LB-3X-0082	I-U-10	1-1/2 X 2-1/2	23.44
LB-3X-0106	I-OB-3	3-1/2 X 4-1/2	21.03
LB-3X-0256	P-U-10	5-1/2 X 8	238.04
LB-3X-0264	I-U-10	1-1/8 X 3	22.25
LB-587V305	I-U14	4-1/2 X 7-1/2	290.50
LB-LQU-0008	P-UB-10	100 X 150 mm	436.91
LB-LQU-0009	P-UB-10	110 X 160 mm	476.89
LB-LQU-0010	P-UB-10	95 X 140 mm	307.71
LB-LQU-0011	P-UB-10	70 X 110 mm	293.06
LB-LQU-0012	P-UB-10	85 X 125 mm	341.89
LB-LQU-0015	P-UB-10	70 X 110 mm	265.71
LB-LQU-0017	P-UB-14	110 X 160 mm	442.93
LB-LQU-0020	P-UB-10	85 X 125 mm	328.91
LB-LQU-0021	P-UB-10	100 X 140 mm	412.85
LB-LQU-0022	P-UB-10	80 X 120 mm	352.47
LB-LQU-0028	P-UB-10	90 X 140 mm	385.09
LB-LQU-0029	P-UB-10	105 X 150 mm	442.02
LB-LQU-0030	P-UB-10	90 X 130 mm	342.40
LB-LQU-0037	P-UB-10	85 X 130 mm	321.45

REPLACEMENT PARTS FOR LINK BELT EQUIPMENT

NOTE: Link Belt part numbers are used as a reference only. We do not imply that these kits are original REPLACEMENT PARTS.

U-SEALS

Part Number	Rod Diam.	List Price
LB-47A2657	3-1/2	\$ 18.41

LIUGONG

Replacement Kits For

Loaders - Wheel						
APPLICATION	CYL #	CODE	ROD	BORE	KIT #	List \$
MODEL CLG835						
LIFT	10C0056X0	P-UB-10	70 mm	125 mm	LGG-SP100594	121.25
STEERING	10C0055	P-UB-10	45 mm	80 mm	LGG-SP100530	95.63
TILT	10C0071	P-UB-10	70 mm	140 mm	LGG-SP102917	172.20
MODEL CLG836						
LIFT	10K0001	I-UB-10	70 mm	125 mm	LGG-SP104036	110.76
STEERING	10K0027	I-UB-10	40 mm	70 mm	LGG-SP104034	70.52
TILT	10K0002	I-UB-10	70 mm	140 mm	LGG-SP104035	150.01
MODEL CLG842						
LIFT	11E0036X0	P-UB-10	80 mm	140 mm	LGG-SP102909	83.02
STEERING	10E0017	P-UB-10	45 mm	80 mm	LGG-SP102910	119.09
TILT	11E0037X0	P-UB-10	80 mm	160 mm	LGG-SP102913	81.55
MODEL CLG855						
LIFT	10C0207	P-UB-10	80 mm	160 mm	LGG-SP102915	103.96
STEERING	10C0125	I-UB-10	40 mm	80 mm	LGG-SP103797	85.77
TILT	10C0208	P-UB-10	100 mm	200 mm	LGG-SP102916	191.96
MODEL CLG856						
LIFT	10C0023	I-UB-10	80 mm	160 mm	LGG-SP102906	140.55
STEERING	10C0031	I-UB-10	50 mm	90 mm	LGG-SP102905	62.13
TILT	10C0024	I-UB-10	80 mm	180 mm	LGG-SP102907	177.61
MODEL CLG862						
LIFT	10C0091X0	P-UB-10	90 mm	180 mm	LGG-SP102911	152.87
STEERING	10C0031	I-UB-10	50 mm	90 mm	LGG-SP102905	62.13
TILT	10C0090	P-UB-10	100 mm	200 mm	LGG-SP102914	272.29
MODEL CLG888						
LIFT	10C0063	P-UB-10	80 mm	160 mm	LGG-SP103791	176.76
STEERING	10C0065	I-UB-10	60 mm	100 mm	LGG-SP103792	54.35
TILT	10C0062	P-UB-10	100 mm	200 mm	LGG-SP103790	210.54
MODEL ZL30E						
LIFT	10C0056X0	P-UB-10	70 mm	125 mm	LGG-SP100594	121.25
STEERING	10C0055	P-UB-10	45 mm	80 mm	LGG-SP100530	95.63
TILT	10C0056X0	P-UB-10	70 mm	140 mm	LGG-SP100595	162.09
MODEL ZL40B						
LIFT	10C0011X0	I-UB-10	75 mm	150 mm	LGG-SP100628	121.32
STEERING	10C0022	I-U-10	40 mm	90 mm	LGG-SP100600	88.00
TILT	10C0013X0	I-UB-10	75 mm	165 mm	LGG-SP102899	256.76
MODEL ZL50C						
LIFT	10C0007X0	P-UB-10	80 mm	160 mm	LGG-SP102901	235.90
STEERING	10C0005	I-U-10	45 mm	100 mm	LGG-SP102900	70.18
TILT	10C0009X0	P-UB-10	80 mm	200 mm	LGG-SP102902	248.86
MODEL ZL50E						
LIFT	10C0046X0	P-UB-10	80 mm	160 mm	LGG-SP102903	110.91
STEERING	10C0022	I-U-10	40 mm	90 mm	LGG-SP100600	88.00
TILT	10C0047X0	P-UB-10	80 mm	180 mm	LGG-SP102904	173.99

LIUGONG

Kit Number	Code (Pg. xviii)	Rod X Bore Size	List Price
LGG-SP100530	P-UB-10	45 X 80 mm	\$ 95.63
LGG-SP100594	P-UB-10	70 X 125 mm	121.25
LGG-SP100595	P-UB-10	70 X 140 mm	162.09
LGG-SP100600	I-U-10	40 X 90 mm	88.00
LGG-SP100628	I-UB-10	75 X 150 mm	121.32
LGG-SP102899	I-UB-10	75 X 165 mm	256.76
LGG-SP102900	I-U-10	45 X 100 mm	70.18
LGG-SP102901	P-UB-10	80 X 160 mm	235.90
LGG-SP102902	P-UB-10	80 X 200 mm	248.86
LGG-SP102903	P-UB-10	80 X 160 mm	110.91
LGG-SP102904	P-UB-10	80 X 180 mm	173.99
LGG-SP102905	I-UB-10	50 X 90 mm	62.13
LGG-SP102906	I-UB-10	80 X 160 mm	140.55
LGG-SP102907	I-UB-10	80 X 180 mm	177.61
LGG-SP102909	P-UB-10	80 X 140 mm	83.02

Kit Number	Code (Pg. xviii)	Rod X Bore Size	List Price
LGG-SP102910	P-UB-10	45 X 80 mm	\$ 119.09
LGG-SP102911	P-UB-10	90 X 180 mm	152.87
LGG-SP102913	P-UB-10	80 X 160 mm	81.55
LGG-SP102914	P-UB-10	100 X 200 mm	272.29
LGG-SP102915	P-UB-10	80 X 160 mm	103.96
LGG-SP102916	P-UB-10	100 X 200 mm	191.96
LGG-SP102917	P-UB-10	70 X 140 mm	172.20
LGG-SP103790	P-UB-10	100 X 200 mm	210.54
LGG-SP103791	P-UB-10	80 X 160 mm	176.76
LGG-SP103792	I-UB-10	60 X 100 mm	54.35
LGG-SP103797	I-UB-10	40 X 80 mm	85.77
LGG-SP104034	I-UB-10	40 X 70 mm	70.52
LGG-SP104035	I-UB-10	70 X 140 mm	150.01
LGG-SP104036	I-UB-10	70 X 125 mm	110.76

LIUGONG

LOADMASTER™

Kit Number	Code (Pg. xviii)	Rod X Bore Size	List Price
LM-150129	P-U-10	2-1/2 X 5-1/4	\$ 68.84
LM-157615	I-U-5	2-1/2 X 4-1/4	126.28
LM-15762	I-U-1	4-3/4 X 5-1/2	94.71
LM-157625	I-U-1	4-3/4 X 5-1/2	79.74
LM-15768	I-U-5	2-1/2 X 5-1/4	128.18
LM-157685	I-U-5	2-1/2 X 5-1/4	123.20
LM-157775	I-U-5	2-1/4 X 4-1/4	129.26
LM-157785	I-U-5	2-1/2 X 5-1/2	121.20
LM-157845	I-U-5	2-1/2 X 4-3/4	171.88
LM-158725	I-U-5	2-1/2 X 7-1/4	201.76
LM-20663	I-U-5	3-1/2 X 5-1/2	132.16
LM-24861	I-U-5	2-1/2 X 5-1/2	133.54
LM-24862	I-U-5	2-1/2 X 5-1/2	132.16
LM-750006K	I-U-1	4-3/4 X 5-1/2	49.36
LM-750008-10	I-U-5	2-1/2 X 4-1/4	60.13
LM-750008-K	I-U-5	2-1/2 X 4-1/4	57.84
LM-750010K	I-U-5	2-1/2 X 5-1/2	120.54
LM-750011-10	I-U-5	2-1/2 X 5-1/4	74.94
LM-750012K	I-U-5	2-1/2 X 7-1/4	126.77
LM-750013K	I-U-5	1-1/2 X 4-1/4	58.07
LM-750094K	I-U-5	2-1/2 X 4-3/4	129.56
LM-750182K	I-U-5	2-1/2 X 5-1/2	111.15

LOG HOG™

Kit Number	Code (Pg. xviii)	Rod X Bore Size	List Price
LGH-28-04-30	I-U-3	1-1/2 X 3	\$ 23.74
LGH-37-06-05	I-U-3	1-1/2 X 3-1/2	14.87
LGH-37-06-05-HD	I-U-3	1-1/2 X 3-1/2	17.70
LGH-37-06-06	I-N-4	1-3/4 X 5	23.88
LGH-37-06-06-HD	I-N-4	1-3/4 X 5	37.90
LGH-37-06-07	I-U-5	2 X 5	52.90
LGH-37-06-08	I-U-5	2-1/2 X 6	66.25
LGH-37-06-08-HD	I-U-5	2-1/2 X 6	123.17
LGH-37-07-13	I-U-5	3 X 6	76.56
LGH-37-07-13-HD	I-U-5	3 X 6	125.70
LGH-37-07-29	I-N-4	2-1/2 X 6	28.22
LGH-37-07-29-HD	I-N-4	2-1/2 X 6	54.10
LGH-37-12-54	I-U-5	1-1/2 X 3-1/2	30.36
LGH-37-12-54-HD	I-U-5	1-1/2 X 3-1/2	53.41
LGH-37-12-59	I-U-5	1-3/4 X 4	39.54
LGH-37-12-59-HD	I-U-5	1-3/4 X 4	65.04
LGH-37-14-47	I-U-5	2-1/2 X 5	55.92
LGH-37-14-47-HD	I-U-5	2-1/2 X 5	86.48
LGH-37-17-48	I-N-4	3 X 7	37.93
LGH-37-17-48-HD	I-N-4	3 X 7	79.50
LGH-37-17-49	I-U-5	3-1/2 X 7	95.28
LGH-37-17-49-HD	I-U-5	3-1/2 X 7	180.62
LGH-37-17-50	I-U-5	3 X 7	89.08
LGH-37-17-50-HD	I-U-5	3 X 7	174.46
LGH-37-21-05	P-N-4	1-3/4 X 5	30.66
LGH-37-21-05-HD	P-N-4	1-3/4 X 5	40.85
LGH-37-53-34	I-U-5	1-3/4 X 4	64.82
LGH-37-53-52	I-U-5	3-1/2 X 7	90.21
LGH-37-53-52-HD	I-U-5	3-1/2 X 7	181.65
LGH-37-53-53-HD	I-U-5	1-1/2 X 3-1/2	53.72
LGH-37-53-54	I-U-5	3 X 7	93.56
LGH-37-53-54-HD	I-U-5	3 X 7	179.01
LGH-37-53-88	I-U-5	3 X 6	80.61
LGH-37-53-88-HD	I-U-5	3 X 6	129.75
LGH-37-68-68	5" Swivel Kit		99.34
LGH-37-72-98	I-U-5	3 X 5	68.15
LGH-37-72-98-HD	I-U-5	3 X 5	91.93
LGH-37-73-06	I-U-5	3 X 6	68.41
LGH-37-73-06-HD	I-U-5	3 X 6	129.86
LGH-37-75-43-HD	I-U-5	3 X 6	135.32
LGH-37-75-47	I-U-5	4 X 7	161.84
LGH-37-75-47-HD	I-U-5	4 X 7	188.21
LGH-37-90-77-HD	P-U-10	3-1/2 X 7	110.64
LGH-37-90-79	P-U-10	3 X 6	67.58
LGH-37-90-79-HD	P-U-10	3 X 6	76.48
LGH-37-90-80-HD	I-U-10	2-1/2 X 5	51.07
LGH-37-97-15	6 -1/2" Swivel Kit		150.59
LGH-38-11-44	I-U-10	3 X 6	144.76

LORAIN

Kit Number	Code (Pg. xviii)	Rod X Bore Size	List Price
LOR-1103	I-N-10	4-1/4 X 6	\$ 51.65
LOR-1103U	I-U-10	4-1/4 X 6	70.94
LOR-1139	I-U-10	3/4 , 1-1/2 X 2-1/2	35.52
LOR-1179	I-U-10	1-1/2 X 2-1/2	19.09
LOR-1191	O-Ring Kit		9.96
LOR-201521	P-U-10	3-1/2 X 5	70.50
LOR-201778	P-U-10	4 X 6	72.21
LOR-23699	P-U-3	2 X 3-1/2	27.13
LOR-28687	I-N-10	4 X 5	37.98
LOR-28696	I-OB-10	1-1/2 X 2	11.83
LOR-80187	I-U-10	3 X 4	45.14
LOR-963A	I-U-12	7 X 8-1/8	277.97
LOR-983-C	I-U-10, 12	4-1/2 X 8-1/8	280.45

LUCKY LOADER

Kit Number	Code (Pg. xviii)	Rod X Bore Size	List Price
LK-GL400-1000-250A	I-U-5	2-1/2 X 4	\$ 74.31
LK-GL700-3000-400	I-U-5	4 X 7	81.53
LK-L400-800-200	I-U-5	2 X 4	55.09
LK-L700-3600-400-A3	I-U-5	4 X 7	212.38
LK-TL600-2087-250	I-U-5	2-1/2 X 6	57.73
LK-TL600-2087-300	I-U-5	3 X 6	77.25

LULL®

Kit Number	Code (Pg. xviii)	Rod X Bore Size	List Price
LULL-3586-34	I-U-10	1-1/8 X 3	\$ 30.64
LULL-P19382	I-U-10	1-1/8 X 2-1/2	17.91

MARION TELESCOPIC CYLINDERS

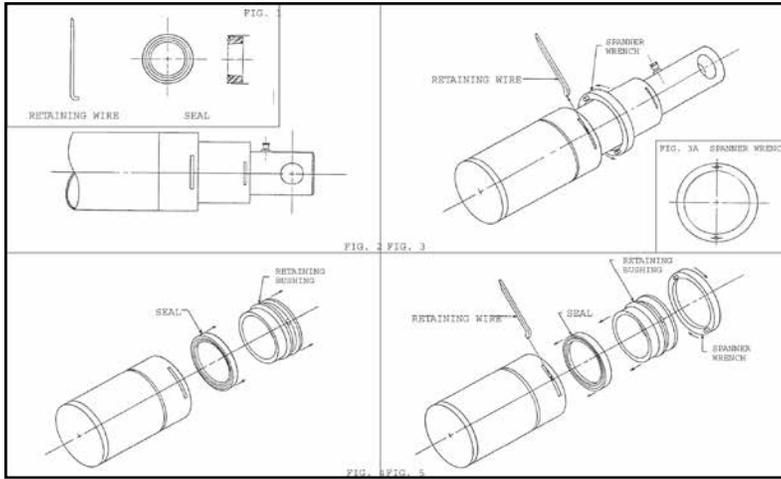

INSTRUCTIONS:

Remove cylinder and lie flat with sides parallel to ground. Drain oil from cylinder leaving stages slightly extended as shown in FIG. 2, exposing retaining wire slots. Using spanner wrench (FIG. 3A) or equivalent, remove retaining wire by turning retaining bushing counter-clockwise (FIG.3). After retaining wire is out, remove retaining bushing and seal, FIG. 4. Replace with seal provided in kit, FIG. 1. Retaining bushing (FIG. 5) and secure with retaining wire (FIG.1). Repeat steps for all other stages and other tubes.

Part Number	Stage Size	I.D.	O.D.	Height	List Price
STAGE BEARINGS					
MARION-35120	1-7/8	1-7/8	2-1/4	1	\$ 14.31
MARION-35130	2-3/4	2-3/4	3-1/4	1	18.56
MARION-35140	3-3/4	3-3/4	4-1/4	1	20.83
MARION-35150	4-3/4	4-3/4	5-1/4	1	21.31
MARION-35160	5-3/4	5-3/4	6-1/4	1	22.51
WIPERS					
MARION-35731	2-3/4	2-3/4	3.114	0.12	\$ 2.61
MARION-35741	3-3/4	3-3/4	3.996	0.11	7.73
MARION-35751	4-3/4	4-3/4	4.996	0.11	8.03
MARION-35761	5-3/4	5-3/4	5.996	0.11	23.03
MARION-35771	6-3/4	6-3/4	6.996	0.11	9.20
PISTON BEARINGS					
MARION-35420	1-7/8	2	2-1/4	1/2	\$ 4.31
MARION-35430	2-3/4	3	3-1/4	1/2	4.54
MARION-35440	3-3/4	4	4-1/4	1/2	4.78
MARION-35450	4-3/4	5	5-1/4	1/2	4.89
MARION-35460	5-3/4	6	6-1/4	1/2	6.41

Part Number	Stage Size	Length	Square C/S	List Price
RETAINING WIRE				
MARION-35240	2-3/4	10-1/4	1/8	\$ 12.67
MARION-35250	3-3/4	13-3/8	1/8	11.94
MARION-35260	4-3/4	16-3/8	1/8	12.16
MARION-35270	5-3/4	19-1/4	1/8	13.97
COMPLETE REPAIR KITS				
Part Number	Series	Stage Sizes	List Price	
Kits contain rod seals and retaining wire for each stage				
MARION-35704	32 series	1-7/8, 2-3/4	\$ 43.54	
MARION-35705	42 series	2-3/4, 3-3/4	54.40	
MARION-35706	43 series	1-7/8, 2-3/4, 3-3/4	72.35	
MARION-35707	53 series	2-3/4, 3-3/4, 4-3/4	91.27	
Kits contain rod seals, wipers and retaining wire for each stage				
MARION-35708	63 series	3-3/4, 4-3/4, 5-3/4	\$ 135.94	
MARION-35709	64 series	2-3/4, 3-3/4, 4-3/4, 5-3/4	159.89	
MARION-35715	62 series	4-3/4, 5-3/4	102.97	
MARION-35716	52 series	3-3/4, 4-3/4	81.41	

MARION

MARK HI-LIFT

Kit Number	Code (Pg. xviii)	Rod X Bore Size	List Price
ML-16963		Valve Kit	\$ 8.62
ML-20042	I-U-3	7/8 X 1-1/2	13.26
ML-20127	I-U-5	2-1/2 X 3-1/2	49.91
ML-20128	I-U-5	1-1/4 X 3-1/2	50.57
ML-244-A	I-OB-2	1 X 2	19.48
ML-3009A	I-OB-3	1-1/2 X 3-1/2	10.26
ML-3011-A	I-OB-3	1-1/2 X 3-1/2	10.67
ML-3012-1	I-OB-3	1-1/4 X 2	7.16
ML-3062-1	I-OB-3	3/4 X 1-1/2	10.99
ML-3065-A	I-N-3	1-1/2 X 4	8.47
ML-66017	I-U-5	2 X 4	77.81
ML-66041	I-U-10	1-1/2 X 3-1/2	27.69
ML-66043	I-U-5	3-1/2 X 6	75.58
ML-66044	I-U-5	1-3/8 X 2-1/2	35.25
ML-66045	I-U-5	2 X 3-1/2	47.34
ML-66165	I-U-5	2 X 5	83.27
ML-66226	I-U-10	1-1/2 X 3	22.98
ML-66227	I-U-10, 12	2-1/2 X 3-1/2	49.06
ML-66363	I-U-10, 12	2-3/4 X 3-3/4	65.65

Kit Number	Code (Pg. xviii)	Rod X Bore Size	List Price
ML-66502	I-U-10	2-1/2 X 5	\$ 84.40
ML-66548	I-U-3	1 X 2	19.13
ML-66563	I-U-3	1-1/4 X 3-1/2	30.46
ML-66651	I-U-3	1-3/8 X 2-1/2	14.66
ML-66657	I-U-1	4-1/2" ROD	38.06
ML-66721	I-U-10	3-1/2 X 6	106.79
ML-66806	Valve Kit		42.58
ML-66818	2 Stage	3-1/2, 4-1/2	55.57
ML-66895	I-U-10	2 X 4-1/2	88.83
ML-66971	Motor Kit		104.86
ML-67040	I-U-10	2 X 3-1/2	51.85
ML-67051	I-U-10	1-1/2 X 2-1/2	43.83
ML-67150	Valve Kit		23.19
ML-67842	I-U-10	1-1/2 X 2-1/2	24.60
ML-67843	I-U-13	1 X 2	18.66
ML-67845	I-U-1	3-1/2 X 4	35.91
ML-68518	P-O-1	7/16 SHAFT KIT	7.03
ML-68948	I-U-11	3/4 X 2	23.29

MASSEY FERGUSON

Replacement Kits For

Backhoe Loaders						
APPLICATION	CYL #	CODE	ROD	BORE	KIT #	List \$
MODEL 50H						
ARM	1605081M94	P-U-10	2	4-1/4	MF-1607730M91	208.30
BOOM	1605245M91	P-U-8	2	4-1/4	MF-1607427M91	224.81
BUCKET TILT	1605045M93	P-U-10	40 mm	2-1/2	MF-1606502M94	76.00
STABILIZER	1605174M92	P-U-10	2	3-1/2	MF-1607915M92	209.46
SWING	1605262M91	P-U-14	40 mm	75 mm	MF-3402545M91	125.59
Tractors						
APPLICATION	CYL #	CODE	ROD	BORE	KIT #	List \$
MODEL 250						
LIFT		P-U-10	45 mm	75 mm	MF-1606583M93	144.12
		P-U-10	40 mm	65 mm	MF-3443575M93	177.30

REPLACEMENT KITS FOR MASSEY FERGUSON EQUIPMENT

Kit Number	Code (Pg. xviii)	Rod X Bore Size	List Price
MF-1606487M93	I-U-10	2-1/4 x 3	\$ 37.29
MF-1606502M94	P-U-10	40 mm X 2-1/2"	76.00
MF-1606583M93	P-U-10	45 X 75 mm	144.12
MF-1606681M92	O-RING KIT		9.90
MF-1607427M91	P-U-8	2 X 4-1/4	224.81
MF-1607730M91	P-U-10	2 X 4-1/4	208.30
MF-1607915M92	P-U-10	2 X 3-1/2	209.46
MF-1609031M93	I-U-10	1-3/4 X 2-1/4	49.98
MF-3402545M91	P-U-14	40 X 75 mm	125.59

Kit Number	Code (Pg. xviii)	Rod X Bore Size	List Price
MF-3443575M93	P-U-10	40 X 65 mm	\$ 177.30
MF-3484947M93	P-U-10	35 X 65 mm	134.18
MF-3484955M92	P-U-10	50 X 70 mm	181.65
MF-3485221M93	P-U-10	40 X 75 mm	153.86
MF-3485304M92	P-U-10	35 X 70 mm	146.20
MF-3485427M92	P-U-10	45 X 80 mm	195.94
MF-704643M91	P-OB-3	1-1/4 X 2-1/2	28.67
MF-836994M91	P-U-10	2 X 4	95.65

REPLACEMENT PARTS FOR MASSEY FERGUSON EQUIPMENT

NOTE: Massey Ferguson part numbers are used as a reference only. We do not imply that these kits are original REPLACEMENT PARTS.

O-RINGS

Part Number	Min Pkg Qty	List Price
MF-1000546M1	50	\$ 0.19
MF-100054M1	50	0.10
MF-10006336M1	20	0.22
MF-10013774M1	20	0.23
MF-1001464M1	20	0.65
MF-1001484M1	50	0.20
MF-1001489M1	50	0.19
MF-1001833M1	50	0.06
MF-1004637M1	20	0.26
MF-1004648M1	50	0.03
MF-1004663M1	20	0.65
MF-100543M1	20	0.53
MF-100557M1	50	0.07
MF-1006240M1	50	0.03

O-RINGS

Part Number	Min Pkg Qty	List Price
MF-1006335M1	50	\$ 0.20
MF-1504788M1	20	0.32
MF-1506223M1	20	0.47
MF-195522M1	10	0.85
MF-195561M1	50	0.06
MF-195562M1	50	0.07
MF-195565M1	20	0.50
MF-195630M1	20	0.42
MF-195631M1	50	0.12
MF-195791M1	50	0.12
MF-196027M1	50	0.12
MF-196030M1	50	0.10
MF-25071761M1	50	0.03
MF-359001M1	50	0.09

O-RINGS

Part Number	Min Pkg Qty	List Price
MF-359002M1	50	\$ 0.09
MF-359230X1	20	0.59
MF-359231X1	20	0.71
MF-359287X1	50	0.03
MF-831196M1	50	0.20
MF-831533M1	50	0.06
MF-831535M1	50	0.07
MF-831617M1	50	0.10
MF-835126M1	20	0.56
MF-835130M1	20	0.42
MF-851145M1	50	0.17
MF-851147M1	20	0.32
MF-851258M1	50	0.09
MF-852140M1	20	0.47

Replacement Kits For

McNEILUS®

Refuse - Front Loaders							
APPLICATION	CYL #	SERIAL #	CODE	ROD	BORE	KIT #	List \$
MODEL 4020, 4320							
ARM	0619891	B5788	I-U-10/12	2-1/2	4-1/2	MTM-614472	70.43
	614366, D4496		I-U-10/12	2-1/2	4-1/2	MTM-614398	70.43
BODY LIFT	1000078, C4542		I-U-1	2-1/2	2-7/8	MTM-619976	36.49
FORK	0614333, DC33CC		I-U-10	2	3-1/2	MTM-614467	38.02
TAILGATE	0649881, C5219		I-U-1	2		MTM-619885	15.48
TOP DOOR	0614371, B4388		I-U-10	1-1/2	2	MTM-614384	20.88
MODEL 4022							
PACKER	D4210		I-U-10	4	6	MTM-614126	96.87
MODEL 4029, 4329							
ARM	0619891	B5788	I-U-10/12	2-1/2	4-1/2	MTM-614472	70.43
	0619891	B5788	I-U-10/12	2-1/2	4-1/2	MTM-614398	70.43
FORK	0614333, DC35CC-16-26		I-U-10	2	3-1/2	MTM-614467	38.02
TAILGATE	0619882, C5220		I-U-1	2		MTM-619978	16.21
TOP DOOR	0660778, B6151		I-U-10	1-1/2	2	MTM-123045	20.88
Refuse - Rear Loaders							
APPLICATION	CYL #	SERIAL #	CODE	ROD	BORE	KIT #	List \$
MODEL HD							
SLIDE	604146, D4265		I-U-10/12	4	5	MTM-604986	94.89
MODEL Metro-Pak							
SLIDE	0606960, C3850		I-U-10/12	2	4-1/2	MTM-606961	59.94
TAILGATE	0606953, B5347		I-U-10/12	2	4-1/2	MTM-606961	59.94
MODEL Tag Axle							
SLIDE	604976, D4541		I-U-10/12	4	5	MTM-379-6804-541	104.70
TAILGATE	0604136, D4190		I-U-1	3	3-1/2	MTM-602685	60.31
MODEL XC High Comp							
CONTAINER REEVING	0605700, B5473		I-U-10	3-1/2	5	MTM-605752	58.29
	0605702, B5806		I-U-10/12	1-3/4	3	MTM-375-1805-567	29.37
SLIDE	604135, D4171		I-U-10	4-1/2	5-1/2	MTM-602650	108.36
TAILGATE	0604136, D4190		I-U-1	3	3-1/2	MTM-602685	60.31
Refuse - Side Loaders							
APPLICATION	CYL #	SERIAL #	CODE	ROD	BORE	KIT #	List \$
MODEL Auto Reach							
ARM EXTEND	1132630, D20DD-3-67		I-U-10	1-1/4	2	MTM-1143852	27.57
ARM LIFT	643701, B5495		I-U-10,12	2	3-1/2	MTM-123016	64.58
ARM SWIVEL			I-U-10	1-1/4	2	MTM-379-6806-387	16.89
GRABBER	1132629, D20DD-4-6.25		P-U-10/12	1	2	MTM-644187	44.54
	643706, B5429		P-U-10/12	1	2	MTM-644187	44.54
PACKER			I-U-10/12	3	4-1/2	MTM-379-6806-231	90.33
PRE CRUSH	615860, C4539		I-U-10/12	2	3	MTM-630804	44.56
TAILGATE	D25LL-8-38		I-U-10	1-1/2	2-1/2	MTM-123060	23.12
MODEL Manual							
PACKER	630861, D4596		I-U-10/12	4	5	MTM-630862	106.19
	635876, B5489		I-U-10,12	4	5	MTM-635878	115.93
	663500, B6314		I-U-10,12	4	5	MTM-635878	115.93
PRE CRUSH	615860		I-U-10/12	2	3	MTM-630804	44.56
TAILGATE	0619882, C5220		I-U-1	2		MTM-619978	16.21

MCNEILUS® REFUSE TRUCKS

Kit Number	Code (Pg. xviii)	Rod X Bore Size	List Price
MTM-0601488	I-U-1	2-1/2 Rod Kit	\$ 32.64
MTM-0604136	I-U-1	3 X 3-1/2	60.31
MTM-0604146	I-U-10,12	4 X 5	94.89
MTM-0605700	I-U-10	3-1/2 X 5	58.29
MTM-0605702	I-U-10,12	1-3/4 X 3	29.37
MTM-0606953	I-U-1	2-1/2 X 3	19.64
MTM-0606960	I-U-10,12	2 X 4-1/2	59.94
MTM-0614333	I-U-10	2 X 3-1/2	38.02
MTM-0614371	I-U-10	1-1/2 X 2	20.88
MTM-0615860	I-U-10,12	2 X 3	44.56
MTM-0619881	I-U-1	2 Rod Kit	15.48
MTM-0619882	I-U-1	2 Rod Kit	16.21
MTM-0630861	I-U-10,12	4 X 5	106.19
MTM-0635878	I-U-10,12	4 X 5	115.93
MTM-0637010	I-U-10	1-1/2 X 2-1/2	23.12
MTM-0643701	I-U-10,12	2 X 3-1/2	64.58
MTM-0660778	I-U-10	1-1/2 X 2	20.88
MTM-1000078	I-U-1	2-1/2 X 2-7/8	36.49
MTM-1100031	I-U-10,12	3 X 4-1/2	90.33
MTM-1100106	I-U-10	1-1/4 X 2	16.89
MTM-1132629	P-U-10,12	1 X 2	44.54
MTM-1132630	I-U-10	1-1/4 X 2	27.57
MTM-1143852	I-U-10	1-1/4 X 2	27.57
MTM-123016	I-U-10,12	2 X 3-1/2	64.58
MTM-123045	I-U-10	1-1/2 X 2	20.88
MTM-123060	I-U-10	1-1/2 X 2-1/2	23.12

Kit Number	Code (Pg. xviii)	Rod X Bore Size	List Price
MTM-1234987	I-U-10	2 X 3-1/4	\$ 24.17
MTM-375-1805-567	I-U-10,12	1-3/4 X 3	29.37
MTM-379-6804-541	I-U-10,12	4 X 5	104.70
MTM-379-6806-231	I-U-10,12	3 X 4-1/2	90.33
MTM-379-6806-387	I-U-10	1-1/4 X 2	16.89
MTM-601488	I-U-1		32.64
MTM-602650	I-U-10	4-1/2 X 5-1/2	108.36
MTM-602685	I-U-1	3 X 3-1/2	60.31
MTM-604126	I-U-10	4 X 6	96.87
MTM-604986	I-U-10,12	4 X 5	94.89
MTM-605752	I-U-10	3-1/2 X 5	58.29
MTM-606961	I-U-10,12	2 X 4-1/2	59.94
MTM-614105		2-3/4,3-3/4,4-3/4	339.48
MTM-614126	I-U-10	4 X 6	96.87
MTM-614384	I-U-10	1-1/2 X 2	20.88
MTM-614398	I-U-10,12	2-1/2 X 4-1/2	70.43
MTM-614467	I-U-10	2 X 3-1/2	38.02
MTM-614472	I-U-10,12	2-1/2 X 4-1/2	70.43
MTM-619885	I-U-1	2 Rod Kit	15.48
MTM-619976	I-U-1	2-1/2 X 2-7/8	36.49
MTM-619978	I-U-1	2 Rod Kit	16.21
MTM-630804	I-U-10,12	2 X 3	44.56
MTM-630862	I-U-10,12	4 X 5	106.19
MTM-635878	I-U-10,12	4 X 5	115.93
MTM-644187	P-U-10,12	1 X 2	44.54
MTM-9570643701	I-U-10,12	2 X 3-1/2	64.58

MCNEILUS®

MEYER® PRODUCTS

Kit Number	Code (Pg. xviii)	Rod X Bore Size	List Price
MY-15254	P-O-6	1-1/8 X 1-3/4	\$ 16.29
MY-15456	P-OB-6	1-1/8 X 1-3/4	22.70

Kit Number	Code (Pg. xviii)	Rod X Bore Size	List Price
MY-15707	P-U-6	1-1/8 X 1-3/4	\$ 41.95
MY-7705	I-V-1	1-1/2" ROD	16.29

REPLACEMENT PARTS FOR MEYER® EQUIPMENT

NOTE: Meyer part numbers are used as a reference only. We do not imply that these kits are original REPLACEMENT PARTS.

O-RINGS

Part Number	Min Pkg Qty	List Price
MY-15122	50	\$ 0.06
MY-15123	50	0.06
MY-15125	50	0.06
MY-15126	50	0.07
MY-15131	20	0.65
MY-15163	20	0.61
MY-15198	2	5.59
MY-15687	10	1.18
MY-15693	20	0.41
MY-15701	50	0.22

PISTON CUPS

Part Number	Bore Dia.	List Price
MY-15691	1-3/4	\$ 10.42

WIPERS

Part Number	Rod Dia.	List Price
MY-05119	1-1/8	\$ 2.94

Replacement Kits For

MITSUBISHI

Excavators						
APPLICATION	CYL #	CODE	ROD	BORE	KIT #	List \$
MODEL MS-110-5, MS-110L-5, MS-110D-5, MS-110S-5						
ARM	C25320004	P-UB-15	80 mm	120 mm	MIT-C75300020	266.43
	C25320005	P-UB-15	80 mm	120 mm	MIT-C75300020	266.43
BOOM	C25300104	P-UB-15	70 mm	110 mm	MIT-C75300010	246.09
BUCKET	C25340004	P-UB-15	65 mm	110 mm	MIT-C75300030	243.20
	C25340005	P-UB-15	65 mm	110 mm	MIT-C75300030	243.20
MODEL MS-120-2, MS-120S-2, MS-120SS-2						
ARM	C65320002	P-UB-14	80 mm	120 mm	MIT-C65300022	312.19
	C65320003	P-UB-14	80 mm	120 mm	MIT-C65300022	312.19
	C65320004	P-UB-14	80 mm	120 mm	MIT-C65300022	312.19
BOOM	C65300102	P-UB-14	75 mm	110 mm	MIT-C65300012	342.30
	C65300103	P-UB-14	75 mm	110 mm	MIT-C65300012	342.30
	C65300104	P-UB-14	75 mm	110 mm	MIT-C65300012	342.30
BUCKET	C65340003	P-UB-14	70 mm	110 mm	MIT-C65300032	327.34
	C65340004	P-UB-14	70 mm	110 mm	MIT-C65300032	327.34
	C65340005	P-UB-14	70 mm	110 mm	MIT-C65300032	327.34
MODEL MS-180-3, MS-180S-3, MS-180LC-3						
ARM	E35300201	P-UB-5	90 mm	130 mm	MIT-E15300023	303.65
BOOM	E35300101	P-UB-5	85 mm	125 mm	MIT-E15300013	289.31
BUCKET	E35300301	P-UB-5	75 mm	120 mm	MIT-E15300033	256.36
MODEL MS-180-8						
ARM	E75300301	P-UB-10	100 mm	140 mm	MIT-E75300010	384.25
BOOM	E75300101	P-UB-10	85 mm	125 mm	MIT-E35300040	321.94
	E75300201	P-UB-10	85 mm	125 mm	MIT-E35300040	321.94
BUCKET	E75300401	P-UB-10	85 mm	125 mm	MIT-E35300040	321.94

REPLACEMENT KITS FOR MITSUBISHI EQUIPMENT

Kit Number	Code (Pg. xviii)	Rod X Bore Size	List Price
MIT-9185415310	I-U-10	25 X 55 mm	\$ 37.05
MIT-94504-02080	N-N-15	100 mm	21.94
MIT-C65300012	P-UB-14	75 X 110 mm	342.30
MIT-C65300022	P-UB-14	80 X 120 mm	312.19
MIT-C65300032	P-UB-14	70 X 110 mm	327.34
MIT-C75300010	P-UB-15	70 X 110 mm	246.09
MIT-C75300020	P-UB-15	80 X 120 mm	266.43
MIT-C75300030	P-UB-15	65 X 110 mm	243.20

Kit Number	Code (Pg. xviii)	Rod X Bore Size	List Price
MIT-E15300013	P-UB-5	85 X 125 mm	\$ 289.31
MIT-E15300023	P-UB-5	90 X 130 mm	303.65
MIT-E15300033	P-UB-5	75 X 120 mm	256.36
MIT-E25300061	P-UB-14	90 X 140 mm	423.09
MIT-E35300040	P-UB-10	85 X 125 mm	321.94
MIT-E75300010	P-UB-10	100 X 140 mm	384.25
MIT-F15300011	P-UB-14	100 X 150 mm	290.49

MITSUBISHI

REPLACEMENT PARTS FOR MITSUBISHI EQUIPMENT

NOTE: Mitsubishi part numbers are used as a reference only. We do not imply that these kits are original REPLACEMENT PARTS.

WIPERS

Part Number	Rod Dia.	List Price
MIT-91854-06400	25 mm	\$ 3.13
MIT-05566-13030	30 mm	16.00
MIT-05566-13530	35 mm	16.88
MIT-64374-79200	40 mm	21.56
MIT-A04500811	45 mm	23.72
MIT-A04500812	50 mm	24.03
MIT-A04501417	65 mm	31.03
MIT-A04500914	65 mm	32.87
MIT-A04500815	70 mm	35.28
MIT-A04500822	70 mm	35.28
MIT-A04501418	70 mm	33.30
MIT-A04500915	70 mm	35.28
MIT-C45300148	75 mm	35.80
MIT-E35300325	75 mm	35.80
MIT-A04500918	75 mm	37.92
MIT-1853252	80 mm	10.17
MIT-A04500817	80 mm	44.73
MIT-A04501420	80 mm	42.22
MIT-A04500917	80 mm	44.73
MIT-E15300392	85 mm	47.92
MIT-E35300127	85 mm	47.92
MIT-E353-00127	85 mm	47.92
MIT-1853094	90 mm	51.80
MIT-A04501422	90 mm	51.80
MIT-F25340118	90 mm	51.80
MIT-E85300320	95 mm	52.98
MIT-1853143	100 mm	54.39
MIT-A04501423	100 mm	54.39
MIT-F15302319	100 mm	21.04
MIT-F25340058	100 mm	54.39
MIT-A04903618	110 mm	55.72

ROD U-SEALS

Part Number	Rod Dia.	List Price
MIT-A04600911	45 mm	\$ 11.99
MIT-A04600912	50 mm	16.76
MIT-A04600914	65 mm	19.60
MIT-A04600915	70 mm	19.27
MIT-A04700415	70 mm	9.56
MIT-7953042	75 mm	25.33
MIT-A04600918	75 mm	23.45
MIT-C45300134	75 mm	9.56

ROD U-SEALS

Part Number	Rod Dia.	List Price
MIT-E35302115	75 mm	\$ 23.04
MIT-E35302116	75 mm	9.56
MIT-1853083	80 mm	27.86
MIT-A04600917	80 mm	25.66
MIT-A04700417	80 mm	11.54
MIT-48-7953142	85 mm	28.84
MIT-7953142	85 mm	28.84
MIT-E15301215	85 mm	11.54
MIT-E35301915	85 mm	27.86
MIT-E35301916	85 mm	11.54
MIT-1853057	90 mm	26.10
MIT-1853239	90 mm	26.10
MIT-A04600925	90 mm	29.65
MIT-A04700423	90 mm	11.54
MIT-E15301116	90 mm	11.54
MIT-E85300317	95 mm	31.30
MIT-E85300318	95 mm	11.54
MIT-1853136	100 mm	33.93
MIT-A04600926	100 mm	23.72
MIT-A04700424	100 mm	13.43
MIT-94319-02400	112 mm	35.70

PISTON U-SEALS

Part Number	Bore Dia.	List Price
MIT-05565-07010	70 mm	\$ 23.93
MIT-A04601211	70 mm	96.45
MIT-05565-08010	80 mm	27.11
MIT-A04601213	90 mm	112.54
MIT-A04601215	110 mm	144.65
MIT-A04601311	110 mm	70.65
MIT-E85300439	115 mm	55.74
MIT-A04601216	120 mm	144.65
MIT-A04601312	120 mm	73.63
MIT-C45300229	120 mm	51.20
MIT-E85300137	120 mm	55.74
MIT-E153-00386	125 mm	55.55
MIT-E35301920	125 mm	55.74
MIT-2153243	130 mm	55.55
MIT-E85300347	130 mm	57.68
MIT-4653414	140 mm	64.05
MIT-A04601314	140 mm	100.17
MIT-E75300322	140 mm	65.86

PISTON U-SEALS

Part Number	Bore Dia.	List Price
MIT-4653415	140 mm	\$ 64.05
MIT-1853063	150 mm	71.40
MIT-A04601315	150 mm	108.97
MIT-F15301123	150 mm	71.40
MIT-4653514	160 mm	76.97
MIT-A04601719	160 mm	123.77
MIT-F25340028	160 mm	76.97

PISTON SEALS

Part Number	Bore Dia.	List Price
MIT-91854-16300	55 mm	\$ 28.47

U-SEALS

Part Number	Rod Dia.	List Price
MIT-91854-06500	25 mm	\$ 3.05

BUFFER RINGS

Part Number	Rod Dia.	List Price
MIT-05566-03520	35 mm	\$ 4.30
MIT-A04600815	50 mm	9.90
MIT-A04600811	65 mm	12.11
MIT-A04601014	65 mm	31.36
MIT-A04600812	70 mm	13.09
MIT-A04601015	70 mm	34.23
MIT-A04601016	75 mm	36.39
MIT-E15302312	75 mm	36.40
MIT-E85300437	75 mm	32.61
MIT-A04600813	80 mm	14.56
MIT-A04601017	80 mm	38.54
MIT-E15300372	85 mm	38.73
MIT-E85300140	85 mm	36.42
MIT-A04601024	90 mm	42.59
MIT-E85300344	95 mm	40.29
MIT-A04601025	100 mm	44.66
MIT-F15302316	100 mm	44.66
MIT-A04601018	110 mm	58.49

REPLACEMENT PARTS FOR MITSUBISHI EQUIPMENT

NOTE: Mitsubishi part numbers are used as a reference only. We do not imply that these kits are original REPLACEMENT PARTS.

WEAR RINGS

Part Number	O.D. X Width	List Price
MIT-E85300345	100 X 9.7 mm	\$ 26.00
MIT-A04903612	110 X 6 mm	22.73
MIT-A04901911	110 X 30 mm	27.81
MIT-E85300420	115 X 6 mm	22.73
MIT-E85300440	115 X 7.9 mm	10.89
MIT-A04901912	120 X 6 mm	24.73
MIT-A04903613	120 X 7.9 mm	22.73
MIT-E85300136	120 X 8 mm	11.73
MIT-E85300120	120 X 30 mm	43.20
MIT-E35301921	125 X 8 mm	43.20
MIT-E85300326	130 X 7.9 mm	13.04
MIT-E85300438	130 X 8 mm	43.20
MIT-A04901915	140 X 8 mm	48.80
MIT-A04903616	140 X 8 mm	43.20
MIT-E75300323	140 X 40 mm	43.20
MIT-A04901916	150 X 8 mm	47.41
MIT-A04903617	150 X 40 mm	43.20

BACK-UP RINGS

Part Number	Min Pkg Qty	List Price
MIT-05568-90800	1	\$ 7.10
MIT-4653425	1	13.66
MIT-4653623	1	11.82
MIT-4753177	1	32.87
MIT-94153-07300	1	13.60
MIT-A04700312	1	10.01
MIT-A04700313	1	10.98
MIT-A04700314	1	6.13
MIT-A04700315	1	8.19
MIT-A04700324	1	13.66
MIT-A04700325	1	10.80
MIT-A04700416	1	9.56
MIT-E15301130	1	11.29
MIT-E15302093	1	11.85
MIT-E25310020	1	14.41

BACK-UP RINGS

Part Number	Min Pkg Qty	List Price
MIT-E35300217	1	\$ 11.82
MIT-E35300315	1	10.98
MIT-E35301917	1	12.08
MIT-E35302130	1	12.08
MIT-E75300317	1	36.51
MIT-E75300318	1	12.58
MIT-E85300321	1	12.23
MIT-E85300416	1	11.85
MIT-F15300921	1	13.66
MIT-F15301418	1	13.66

O-RINGS

Part Number	Min Pkg Qty	List Price
MIT-03158-08000	2	\$ 4.78
MIT-2153222	2	7.49
MIT-4753176	2	5.72
MIT-7953122	2	7.49
MIT-91254-06300	20	0.23
MIT-91254-09300	10	1.28
MIT-91254-13700	20	0.82
MIT-91254-15100	10	1.14
MIT-94004-00900	5	2.43
MIT-E35300316	10	0.79
MIT-F3150-04900	7	0.90
MIT-F3150-06000	5	3.38
MIT-F3150-07000	4	4.32
MIT-F3150-09000	2	5.00
MIT-F3153-04000	10	0.67
MIT-F3153-05000	10	3.20
MIT-F3157-05000	10	1.53
MIT-Z440101000	3	5.28
MIT-Z440101100	3	6.86
MIT-Z440200600	5	3.38
MIT-Z440201100	3	6.86
MIT-Z440201150	2	6.98
MIT-Z440201200	2	7.11

O-RINGS

Part Number	Min Pkg Qty	List Price
MIT-Z440201250	2	\$ 7.22
MIT-Z440201300	2	7.27
MIT-Z440201400	2	7.49
MIT-Z440201500	2	9.07
MIT-Z440201550	1	13.10
MIT-Z441101000	4	2.06
MIT-Z441101100	3	8.93
MIT-Z441101150	3	2.71
MIT-Z441101200	3	2.83
MIT-Z441101250	3	9.68
MIT-Z441101300	3	2.90
MIT-Z441101450	2	3.49
MIT-Z441101600	1	24.77

O-RINGS 90 DUROMETER

Part Number	Min Pkg Qty	List Price
MIT-Z440200800	3	\$ 4.78
MIT-Z441001150	3	2.73
MIT-Z441101050	3	2.65

MITSUBISHI

MITSUBISHI LIFT TRUCKS

Kit Number	Code (Pg. xviii)	Rod X Bore Size	List Price
MIT-91254-10330	P-U-10	22 X 45mm	\$ 46.22
MIT-91254-30330	P-U-10	22 X 45mm	40.73
MIT-91255-11120	I-U-10	22.4 X 45 mm	41.12
MIT-91273-30150	Valve Kit		5.85
MIT-91273-30220	Valve Kit		5.70
MIT-91854-15310	I-U-10	25 X 55 mm	37.05
MIT-91854-40230	P-U-10	25 X 55 mm	47.87
MIT-91872-22120	Valve Kit		8.50
MIT-93051-00028	I-U-4	2 in X 75 mm	118.63
MIT-93051-10068	I-U-4	40 X 50 mm	50.25
MIT-94004-00120	P-UB-1	30 mm Rod Kit	37.84
MIT-94004-00130	N-N-15	63 mm Piston Kit	56.49
MIT-94104-00110	N-N-13	70 mm Piston Kit	70.75
MIT-94104-00120	P-UB-1	35 mm Rod Kit for 70 mm Bore	39.71
MIT-94104-00170	I-U-10	30 X 63 mm	51.28
MIT-94114-00110	I-U-4	50 X 70 mm	82.32
MIT-94114-00210	I-U-4	60 X 70 mm	46.20
MIT-94119-00018	I-U-1	70 mm Rod Kit	45.30
MIT-94119-00048	I-U-1	50 mm Rod Kit	21.42
MIT-94119-00068	P-U-1	32 mm Rod Kit	39.17
MIT-94119-00088	P-U-1	32 mm	41.64
MIT-94133-00018	I-N-4	40 X 50 mm	64.99
MIT-94151-00018	P-U-1	70 mm Rod Kit	48.11
MIT-94151-00028	P-U-1	70 mm Rod Kit	51.79
MIT-94162-00018	P-U-4	35 X 45 mm	44.42
MIT-94204-10120	I-U-10	35 X 70 mm	24.96
MIT-94219-00018	P-U-1	35 mm Rod Kit	16.29
MIT-94219-00028	P-U-1	35 mm Rod Kit	26.36
MIT-94251-00018	I-U-1	75 mm Rod Kit	45.61
MIT-94251-00038	P-U-1	75 mm Rod Kit	62.78
MIT-94251-00058	P-U-1	75 mm Rod Kit	48.93
MIT-94262-00028	P-U-4	40 X 50 mm	84.59
MIT-94304-00110	N-N-13	80 mm Piston Kit	78.56
MIT-94304-00120	P-UB-1	35 mm Rod Kit for 80 mm Bore	44.76
MIT-94304-10140	I-U-10	35 X 80 mm	37.59
MIT-94314-00110	I-U-1	65 X 80 mm	46.28
MIT-94319-00018	I-U-1	60 mm Rod Kit	24.77
MIT-94319-00038	I-U-1	85 mm Rod Kit	43.24
MIT-94319-00068	P-U-1	40 mm Rod Kit	17.41
MIT-94319-00088	I-U-1	40 mm Rod Kit	55.50

MITSUBISHI LIFT TRUCKS

Kit Number	Code (Pg. xviii)	Rod X Bore Size	List Price
MIT-94351-00018	I-U-1	80 mm Rod Kit	\$ 32.98
MIT-94351-00028	P-U-1	45 X 55 mm	98.36
MIT-94351-00038	P-U-1	85 mm Rod Kit	66.30
MIT-94351-00068	P-U-1	85 mm Rod Kit	62.66
MIT-94362-00018	P-U-1	45 X 55 mm	98.36
MIT-94404-00120	P-UB-3	45 X 90 mm	59.34
MIT-94404-10140	I-U-10	40 X 80 mm	88.74
MIT-94404-10160	I-U-10	40 X 90 mm	73.83
MIT-94504-02090	P-U-1	40 X 100 mm	49.21

MOFFETT

Kit Number	Code (Pg. xviii)	Rod X Bore Size	List Price
MOFT-270021	I-V-15	40 X 75 mm	\$ 58.25
MOFT-270078	I-V-15	1-3/4 X 90 mm	56.79
MOFT-270711	I-U-15	1 X 2	23.19
MOFT-519-023-0000	I-U-15	25 X 50 mm	42.90

MONARCH ROAD MACHINERY

Kit Number	Code (Pg. xviii)	Rod X Bore Size	List Price
MRM-5117	I-V-1	1-1/2" ROD	\$ 15.36
MRM-5127	I-V-1	2" ROD	19.88
MRM-5137	I-V-1	2-1/2" ROD	23.09
MRM-5147	I-V-1	3" ROD	27.32
MRM-5157	I-V-1	3-1/2" ROD	34.85
MRM-5385	I-V-7	1-1/2 X 3	43.55
MRM-637405	P-OB-3	1-1/4 X 4	19.41

MORBARK

Kit Number	Code (Pg. xviii)	Rod X Bore Size	List Price
MB25180-210	I-U-5	2 X 4	\$ 52.90
MB26815-053	P-U-10	1-1/4 X 2-1/2	31.95
MB26815-054	I-U-10	1-1/2 X 3	24.67
MB26815-059	I-U-10	2-1/2 X 5	42.61
MB26815-060	I-U-10	2-1/2 X 5-1/2	52.68
MB26815-061-M	I-U-10	2 X 4	43.75
MB26815-071	I-U-10	3 X 6	85.07
MB26815-071-A	I-U-10	3 X 6	78.52

Replacement Kits For

NEW HOLLAND

Backhoe Loaders								
APPLICATION	CYL #	SERIAL #	Misc	CODE	ROD	BORE	KIT #	List \$
MODEL 555E								
LOADER BUCKET	85800500	1/96 -		P-UB-10	40 mm	80 mm	NH-85804740	53.98
LOADER LIFT	85800100	1/96 -		P-UB-10	50 mm	90 mm	NH-85802567	64.05
STABILIZER	85800600	1/96 -		P-UB-10	56 mm	100 mm	NH-85802571	48.97
SWING	85800300	1/96 -		P-UB-10	50 mm	110 mm	NH-85802570	73.96
	85800355	1/96 -		P-UB-10	2	110 mm	NH-87428631	73.10
MODEL B95								
BACKHOE BUCKET	87315527	1/06 -	Gland & Piston Not Included	P-UB-10	2-1/2	90 mm	NH-87428629	60.55
BACKHOE CROWD	87315531	1/06-2/13/08		P-UB-10	2-1/2	4-1/2	NH-87428632	86.59
	87315531	2/13/08 -		P-UB-10	2-1/2	4-1/2	NH-87633295	106.46
BACKHOE LIFT	87315532	1/06 -		P-UB-10	2-1/2	130 mm	NH-87428633	114.47
	87315535		Telescopic Dipper	P-UB-10,12	2-1/2	135 mm	NH-87428634	195.16
LOADER BUCKET	87315521	1/06 -		P-UB-10	1-5/8	80 mm	NH-87428627	40.12
	87573861	1/06 -		I-U-15	45 mm	80 mm	NH-87573868	61.97
LOADER LIFT	87315525	1/06 -		P-UB-10	2	90 mm	NH-87428628	64.58
STABILIZER	87315528	1/06 -	Center Pivot	P-UB-14	2-1/4	4	NH-84209920	83.70
STEERING	85805978			I-U-10	38 mm	63 mm	NH-85805990	62.72
SWING	87315529	1/06 -		P-UB-10	2	110 mm	NH-87428631	73.10
TELESCOPIC DIPPER - LONG	87315519			P-UB-10	2	2-3/4	NH-87428620	38.24
	87327259			P-UB-10	1-3/4	3	NH-87342131	39.98
TELESCOPIC DIPPER - SHORT	85800860			P-UB-10	2	2-3/4	NH-87428620	38.24
	87315517			P-UB-10	2	2-3/4	NH-87428620	38.24
	87327261	-031057763		P-UB-10	1-3/4	3	NH-87342131	39.98
	87327264	031057764-		P-UB-10	1-3/4	3	NH-87342131	39.98
MODEL B95B - TIER 3 (11/10-)								
BACKHOE BUCKET (4.42M ARM)	87499150			P-UB-10	2-1/2	3-1/2	NH-1542923C2	65.68
BOOM (4.42M ARM)	87487863			P-UB-10,12	2-1/2	5	NH-84154166	70.70
LOADER BUCKET	87315521			P-UB-10	1-5/8	80 mm	NH-87428627	40.12
LOADER BUCKET (4X1-6X1)	87573861			I-U-15	45 mm	80 mm	NH-87573868	61.97
LOADER LIFT	87315525			P-UB-10	2	90 mm	NH-87428628	64.58
STABILIZER (CENTER PIVOT)	84209918			P-UB-14	2-1/4	4	NH-84209920	83.70
SWING	87315529			P-UB-10	2	110 mm	NH-87428631	73.10
TELESCOPIC ARM (4.42M)	87327264			P-UB-10	1-3/4	3	NH-87342131	39.98
MODEL B95B - TIER 3 (2008)								
BACKHOE BUCKET	87382007	-N8GH22682		P-UB-10	2-1/2	3-1/2	NH-1542923C2	65.68
	87499150	N8GH22683-		P-UB-10	2-1/2	3-1/2	NH-1542923C2	65.68
BOOM	87487863			P-UB-10,12	2-1/2	5	NH-84154166	70.70

NEW HOLLAND

NEW

Replacement Kits For

NEW HOLLAND

Backhoe Loaders								
APPLICATION	CYL #	SERIAL #	Misc	CODE	ROD	BORE	KIT #	List \$
MODEL B95B - TIER 3 (2008)								
BOOM (TELESCOPIC ARM)	87499560	N8GH22725-	AFTER 3/2/2009	P-UB-10,12	2-1/2	5-1/4	NH-84155594	102.63
	87597583	-N8GH22724	BEFORE 3/2/2009	P-UB-10,12	2-1/2	5-1/4	NH-87654843	95.33
DITCHING (ARM)	87382083		AFTER 10/3/2008	P-UB-10	2-1/2	4-3/4	NH-84155586	58.24
	87382083		BEFORE 10/3/2008	P-UB-10	2-1/2	4-3/4	NH-87654844	56.73
	87594954			P-UB-10	2-1/2	5	NH-84154167	56.15
LOADER BUCKET	87315521			P-UB-10	1-5/8	80 mm	NH-87428627	40.12
	87573861			I-U-15	45 mm	80 mm	NH-87573868	61.97
LOADER LIFT	87315525			P-UB-10	2	90 mm	NH-87428628	64.58
STABILIZER	84209918	NAHH00547-		P-UB-14	2-1/4	4	NH-84209920	83.70
	87315528	-NAHH00547		P-UB-14	2-1/4	4	NH-84155591	83.70
SWING	874315529			P-UB-10	2	110 mm	NH-87428631	73.10
TELESCOPIC ARM (LONG)	87327259			P-UB-10	1-3/4	3	NH-87342131	39.98
TELESCOPIC ARM (SHORT)	87327264			P-UB-10	1-3/4	3	NH-87342131	39.98
MODEL LB75								
BACKHOE CROWD	85800940	9/00 -		P-UB-10	63 mm	4-1/2	NH-85819350	160.88
	87410343	9/00 -		P-UB-10	2-1/2	4-1/2	NH-87633295	106.46
	87410343	9/00-2/3/08		P-UB-10	2-1/2	4-1/2	NH-87428632	86.59
BACKHOE LIFT	87410346	9/00 -		P-UB-10	2-1/2	130 mm	NH-87428633	114.47
BUCKET	85800560	9/00 -		P-UB-10	1-5/8	80 mm	NH-87428627	40.12
	85800911	9/00 -		P-UB-10	2-1/2	90 mm	NH-87428629	60.55
LIFT	85800160	9/00 -		P-UB-10	2	90 mm	NH-87428628	64.58
	85800250	9/00 -		P-UB-10	2-1/2	130 mm	NH-87428633	114.47
	85800260	9/00 -		P-UB-10	2-1/2	130 mm	NH-87428633	114.47
LOADER BUCKET	85800500	6/99-8/00		P-UB-10	40 mm	80 mm	NH-85804740	53.98
	87410327	9/00 -		P-UB-10	1-5/8	80 mm	NH-87428627	40.12
	9968163	6/99-8/00		P-U-15	1-1/2	2-3/4	NH-9968164	25.14
LOADER LIFT	85800100	6/99-8/00		P-UB-10	50 mm	90 mm	NH-85802567	64.05
	87410330	9/00 -		P-UB-10	2	90 mm	NH-87428628	64.58
ROTATION PLATE	85800300	6/99-8/00		P-UB-10	50 mm	110 mm	NH-85802570	73.96
STABILIZER	85800660	9/00 -		P-UB-10	50 mm	110 mm	NH-85819356	40.29
	E7NNB580BB	6/99-8/00		P-UB-10	2	2-3/4	NH-87428620	38.24
SWING	85800355	6/99-8/00		P-UB-10	2	110 mm	NH-87428631	73.10
	85800360	9/00 -		P-UB-10	2	110 mm	NH-87428631	73.10
	85800360	9/00 -		P-UB-10	50 mm	110 mm	NH-85802570	73.96
	85800365	9/00 -		P-UB-10	2	110 mm	NH-87428631	73.10
	85824430	9/00 -		P-UB-10	2	110 mm	NH-87428631	73.10
MODEL LB75B								
BACKHOE ARM (DITCHING)	85800940	031044851-		P-UB-10	63 mm	4-1/2	NH-85819350	160.88
	87410343	031044851-		P-UB-10	2-1/2	4-1/2	NH-87633295	106.46

Replacement Kits For

NEW HOLLAND

Backhoe Loaders								
APPLICATION	CYL #	SERIAL #	Misc	CODE	ROD	BORE	KIT #	List \$
MODEL LB75B								
BACKHOE ARM (DITCHING)	87439682	031044851-		P-UB-10	63 mm	4-1/2	NH-85819350	160.88
BACKHOE BUCKET	87410333	031044851-		P-UB-10	2-1/2	90 mm	NH-87428629	60.55
BACKHOE LIFT	85800260	031044851-		P-UB-10	2-1/2	130 mm	NH-87428633	114.47
	87410346	031044851-		P-UB-10	2-1/2	130 mm	NH-87428633	114.47
LOADER BUCKET	85800560	031044851-		P-UB-10	1-5/8	80 mm	NH-87428627	40.12
	85820005	031044851-		I-U-15	45 mm	80 mm	NH-85824250	61.97
	87410327	031044851-		P-UB-10	1-5/8	80 mm	NH-87428627	40.12
LOADER LIFT	85800160	031044851-		P-UB-10	2	90 mm	NH-87428628	64.58
	87410330	031044851-		P-UB-10	2	90 mm	NH-87428628	64.58
STABILIZER	87410336	031044851-		P-UB-14	2-1/4	4	NH-84209920	83.70
STABILIZER (CENTER PIVOT)	85800660	031044851-		P-UB-10	50 mm	110 mm	NH-85819356	40.29
STEERING	85805978	031044851-		I-U-10	38 mm	63 mm	NH-85805990	62.72
SWING	85824430	-031053254		P-UB-10	2	110 mm	NH-87428631	73.10
	87450926	031053255-		P-UB-10	2	110 mm	NH-87428631	73.10
MODEL LB90								
ARM (DITCHING)	85800940			P-UB-10	63 mm	4-1/2	NH-85819350	160.88
	87410343		BEFORE 2/3/08	P-UB-10	2-1/2	4-1/2	NH-87428632	86.59
	87410343		AFTER 2/3/08	P-UB-10	2-1/2	4-1/2	NH-87633295	106.46
BACKHOE BUCKET	85800911			P-UB-10	2-1/2	90 mm	NH-85819358	60.55
BOOM	85800250		NOT PAINTED	P-UB-10,12	2-1/2	130 mm	NH-85819299	114.47
	85800260			P-UB-10,12	2-1/2	130 mm	NH-85819299	114.47
	87410346			P-UB-10	2-1/2	130 mm	NH-87428633	114.47
LOADER BUCKET	85800560			P-UB-10	1-5/8	80 mm	NH-85819355	40.12
	87410327			P-UB-10	1-5/8	80 mm	NH-87428627	40.12
LOADER LIFT	85800160			P-UB-10	2	90 mm	NH-85819352	64.58
	87410330			P-UB-10	2	90 mm	NH-87428628	64.58
STABILIZER (CENTER PIVOT)	85800660			P-UB-10	50 mm	110 mm	NH-85819356	40.29
	87410336			P-UB-14	2-1/4	4	NH-84155591	83.70
STABILIZER (SIDE SHIFT)	85800922			P-UB-10	2	2-3/4	NH-85819351	38.24
	87410324			P-UB-10	2	2-3/4	NH-87428620	38.24
SWING	85800360		BEFORE DATE CODE 0A26A2	P-UB-10	50 mm	110 mm	NH-85802570	73.96
	85800360		AFTER DATE CODE 0A26A2	P-UB-10	2	110 mm	NH-85819353	73.10
	85800365			P-UB-10	2	110 mm	NH-85819353	73.10
	85824430			P-UB-10	2	110 mm	NH-85819353	73.10
TELESCOPIC DIPPER - SHORT	85800860			P-UB-10	2	2-3/4	NH-85819357	38.24
	87411476			P-UB-10	2	2-3/4	NH-87428620	38.24

NEW HOLLAND

Replacement Kits For

NEW HOLLAND

Backhoe Loaders								
APPLICATION	CYL #	SERIAL #	Misc	CODE	ROD	BORE	KIT #	List \$
MODEL LB90B								
ARM (DITCHING)	85800940	031044887-		P-UB-10	63 mm	4-1/2	NH-85819350	160.88
	87410343	031044887-	BEFORE 2/3/08	P-UB-10	2-1/2	4-1/2	NH-87428632	86.59
	87410343	031044887-	AFTER 2/3/08	P-UB-10	2-1/2	4-1/2	NH-87633295	106.46
	87439682	031044887-		P-UB-10	63 mm	4-1/2	NH-85819350	160.88
BACKHOE BUCKET	87410333	031044887-		P-UB-10	2-1/2	90 mm	NH-87428629	60.55
BOOM	85800260	031044887-		P-UB-10,12	2-1/2	130 mm	NH-85819299	114.47
	87410346	031044887-		P-UB-10	2-1/2	130 mm	NH-87428633	114.47
LOADER BUCKET	85800560	031044887-		P-UB-10	1-5/8	80 mm	NH-85819355	40.12
	87410327	031044887-		P-UB-10	1-5/8	80 mm	NH-87428627	40.12
LOADER LIFT	85800160	031044887-		P-UB-10	2	90 mm	NH-85819352	64.58
	87410330	031044887-		P-UB-10	2	90 mm	NH-87428628	64.58
STABILIZER	85800660	031044887-		P-UB-10	50 mm	110 mm	NH-85819356	40.29
	87410336	031044887-		P-UB-14	2-1/4	4	NH-84155591	83.70
SWING	85824430	-031053254		P-UB-10	2	110 mm	NH-85819353	73.10
	87450926	031053255-		P-UB-10	2	110 mm	NH-87428631	73.10
TELESCOPIC DIPPER - SHORT	85800860	031044887-		P-UB-10	2	2-3/4	NH-85819357	38.24
	87411476	031044887-		P-UB-10	2	2-3/4	NH-87428620	38.24
MODEL LB110								
BACKHOE BOOM	85800830	09/00-		P-UB-10,12	2-1/2	135 mm	NH-87428634	195.16
	85800830	09/00-		P-UB-10	2-1/2	135 mm	NH-85819232	276.66
	87410321	09/00-		P-UB-10,12	2-1/2	135 mm	NH-87428634	195.16
BACKHOE BUCKET	85800911	09/00-		P-UB-10	2-1/2	90 mm	NH-87428629	60.55
BUCKET	85800911	09/00-		P-UB-10	2-1/2	90 mm	NH-87428629	60.55
BUCKET TILT	85800560	09/00-		P-UB-10	1-5/8	80 mm	NH-87428627	40.12
	87410327	09/00-		P-UB-10	1-5/8	80 mm	NH-87428627	40.12
CLAM 4X1-6X1	85820005	09/00-		I-U-15	45 mm	80 mm	NH-85824250	61.97
DIPPER	85800940	09/00-		P-UB-10	63 mm	4-1/2	NH-85819350	160.88
	87410343	09/00-	-02/03/2008	P-UB-10	2-1/2	4-1/2	NH-87428632	86.59
	87410343	09/00-	02/03/2008-	P-UB-10	2-1/2	4-1/2	NH-87633295	106.46
DIPPER EXTENSION	85800760	09/00-		P-UB-10	2	2-3/4	NH-87428620	38.24
	87411473	09/00-		P-UB-10	2	2-3/4	NH-87428620	38.24
LIFT	85800160	09/00-		P-UB-10	2	90 mm	NH-87428628	64.58
	87410330	09/00-		P-UB-10	2	90 mm	NH-87428628	64.58
LIFT CYL	85800160	09/00-		P-UB-10	2	90 mm	NH-87428628	64.58
	87410330	09/00-		P-UB-10	2	90 mm	NH-87428628	64.58
SLEW STAKED	85824430	31044515-		P-UB-10	2	110 mm	NH-87428631	73.10
SLEW THREADED	85800365	31024291-310		P-UB-10	2	110 mm	NH-87428631	73.10
SLEW WELDED	85800360	-31024290	0A26A2-	P-UB-10	2	110 mm	NH-87428631	73.10
	85800360	-31024290	-0A26A2	P-UB-10	50 mm	110 mm	NH-85802570	73.96
STABILISER, CENTRE PIVOT	85800660	09/00-		P-UB-10	50 mm	110 mm	NH-85819356	40.29
	87410336	09/00-		P-UB-14	2-1/4	4	NH-84209920	83.70

Replacement Kits For

NEW HOLLAND

Backhoe Loaders								
APPLICATION	CYL #	SERIAL #	Misc	CODE	ROD	BORE	KIT #	List \$
MODEL LB110								
STABILISER, SIDESHIFT	85800922	09/00-		P-UB-10	2	2-3/4	NH-87428620	38.24
	87410324	09/00-		P-UB-10	2	2-3/4	NH-87428620	38.24
STABILIZERS	85800660	09/00-		P-UB-10	50 mm	110 mm	NH-85819356	40.29
	85800922	09/00-		P-UB-10	2	2-3/4	NH-87428620	38.24
	87410324	09/00-		P-UB-10	2	2-3/4	NH-87428620	38.24
	87410336	09/00-		P-UB-14	2-1/4	4	NH-84209920	83.70
STEERING	85805978	09/00-		I-U-10	38 mm	63 mm	NH-85805990	62.72
SWING (STAKED)	85824430	31044515-		P-UB-10	2	110 mm	NH-87428631	73.10
SWING (THREADED)	85800365	31024291-310		P-UB-10	2	110 mm	NH-87428631	73.10
SWING (WELDED)	85800360	-31024290	-0A26A2	P-UB-10	50 mm	110 mm	NH-85802570	73.96
	85800360	-31024290	0A26A2-	P-UB-10	2	110 mm	NH-87428631	73.10
TILT	85800560	09/00-		P-UB-10	1-5/8	80 mm	NH-87428627	40.12
	87410327	09/00-		P-UB-10	1-5/8	80 mm	NH-87428627	40.12
MODEL LB110B								
BACKHOE BOOM	85800830	031044996-		P-UB-10	2-1/2	135 mm	NH-85819232	276.66
	85800830	31044793	LONG REACH	P-UB-10	2	90 mm	NH-87428628	64.58
	87410321	031044996-		P-UB-10,12	2-1/2	135 mm	NH-87428634	195.16
	87410321	31044793	LONG REACH	P-UB-10,12	2-1/2	135 mm	NH-87428634	195.16
BACKHOE BUCKET	87315527	01/05-		P-UB-10	2-1/2	90 mm	NH-87428629	60.55
	87410333	031044996-		P-UB-10	2-1/2	90 mm	NH-87428629	60.55
BOOM LIFT	87315535	01/05-		P-UB-10,12	2-1/2	135 mm	NH-87428634	195.16
BUCKET	87410333	31044793		P-UB-10	2-1/2	90 mm	NH-87428629	60.55
BUCKET 4X1-6X1	85820005	31044793		I-U-15	45 mm	80 mm	NH-85824250	61.97
CLAMSHELL	85820005	031044996-		I-U-15	45 mm	80 mm	NH-85824250	61.97
	87573861	01/05-		I-U-15	45 mm	80 mm	NH-87573868	61.97
DIPPER	85800940	031044996-		P-UB-10	63 mm	4-1/2	NH-85819350	160.88
	85800940	31044793		P-UB-10	63 mm	4-1/2	NH-85819350	160.88
	87315531	01/05-	-02/13/2008	P-UB-10	2-1/2	4-1/2	NH-87428632	86.59
	87315531	01/05-	02/13/2008-	P-UB-10	2-1/2	4-1/2	NH-87633295	106.46
	87410343	031044996-	02/03/2008-	P-UB-10	2-1/2	4-1/2	NH-87633295	106.46
	87410343	031044996-	-02/03/2008	P-UB-10	2-1/2	4-1/2	NH-87428632	86.59
	87410343	31044793	02/03/2008-	P-UB-10	2-1/2	4-1/2	NH-87633295	106.46
	87410343	31044793	-02/03/2008	P-UB-10	2-1/2	4-1/2	NH-87428632	86.59
	87439682	031044996-		P-UB-10	63 mm	4-1/2	NH-85819350	160.88
	87439682	31044793		P-UB-10	63 mm	4-1/2	NH-85819350	160.88
DIPPER EXTENSION	85800760	031044996-		P-UB-10	2	2-3/4	NH-87428620	38.24
	85800760	31044793	LONG REACH	P-UB-10	2	2-3/4	NH-87428620	38.24
	87315519	01/05-		P-UB-10	2	2-3/4	NH-87428620	38.24
	87327259	01/05-		P-UB-10	1-3/4	3	NH-87342131	39.98
	87411473	031044996-		P-UB-10	2	2-3/4	NH-87428620	38.24

NEW HOLLAND

Replacement Kits For

NEW HOLLAND

Backhoe Loaders								
APPLICATION	CYL #	SERIAL #	Misc	CODE	ROD	BORE	KIT #	List \$
MODEL LB110B								
DIPPER EXTENSION	87411473	31044793	LONG REACH	P-UB-10	2	2-3/4	NH-87428620	38.24
LIFT	85800160	031044996-		P-UB-10	2	90 mm	NH-87428628	64.58
	85800160	31044793	-04/03	P-UB-10	2	90 mm	NH-87428628	64.58
	87315525	01/05-		P-UB-10	2	90 mm	NH-87428628	64.58
	87410330	031044996-		P-UB-10	2	90 mm	NH-87428628	64.58
	87410330	31044793		P-UB-10	2	90 mm	NH-87428628	64.58
SLEW	85824430	-031053254		P-UB-10	2	110 mm	NH-87428631	73.10
	87450926	031053255-		P-UB-10	2	110 mm	NH-87428631	73.10
STABILIZER	85800660	031044996-		P-UB-10	50 mm	110 mm	NH-85819356	40.29
	85800922	031044996-		P-UB-10	2	2-3/4	NH-87428620	38.24
	87410336	031044996-		P-UB-14	2-1/4	4	NH-84209920	83.70
STABILIZER CENTRE PIVOT	87315528	01/05-		P-UB-14	2-1/4	4	NH-84209920	83.70
STABILIZER SIDE SHIFT	87315514	01/05-		P-UB-10	2	2-3/4	NH-87428620	38.24
	87574186	N7GH08034-		P-UB-10	2	2-3/4	NH-87608671	42.93
STABILIZERS	85800660	31044793		P-UB-10	50 mm	110 mm	NH-85819356	40.29
	85800922	31044793		P-UB-14	2-1/4	4	NH-84209920	83.70
	87410324	31044793		P-UB-10	2	2-3/4	NH-87428620	38.24
	87410336	31044793		P-UB-14	2-1/4	4	NH-84209920	83.70
SWING	85824430	-31053254	-31053254	P-UB-10	2	110 mm	NH-87428631	73.10
	87315529	01/05-		P-UB-10	2	110 mm	NH-87428631	73.10
	87450926	31053255-	31053255-	P-UB-10	2	110 mm	NH-87428631	73.10
TILT	85800560	031044996-		P-UB-10	1-5/8	80 mm	NH-87428627	40.12
	85800560	31044793		P-UB-10	1-5/8	80 mm	NH-87428627	40.12
	87315521	01/05-		P-UB-10	1-5/8	80 mm	NH-87428627	40.12
	87410327	031044996-		P-UB-10	1-5/8	80 mm	NH-87428627	40.12
	87410327	31044793		P-UB-10	1-5/8	80 mm	NH-87428627	40.12
Excavators - Compact								
APPLICATION	CYL #	SERIAL #	Misc	CODE	ROD	BORE	KIT #	List \$
MODEL E35B SR								
ARM	87571804	03/11-	BSN NBLN00650	P-U-10	45 mm	75 mm	NH-72280241	69.00
	PW01V00070F 2	03/11-	ASN NBLN00651	P-U-10	45 mm	75 mm	NH-72280241	69.00
BOOM	8756635	03/11-	BSN NBLN00650	P-U-10	45 mm	80 mm	NH-72280454	65.40
	PW01V00068F 1	03/11-	ASN NBLN00651	P-U-10	45 mm	80 mm	NH-72280454	65.40
	PW01V00071F 1	03/11-	BSN NBLN00650/A SN NBLN00651	P-U-10	45 mm	80 mm	NH-72280454	65.40

Replacement Kits For

NEW HOLLAND

Excavators - Compact								
APPLICATION	CYL #	SERIAL #	Misc	CODE	ROD	BORE	KIT #	List \$
MODEL E35B SR								
BUCKET	87573317	03/11-	BSN NBLN00650	P-U-10	40 mm	65 mm	NH-72280251	71.92
	PX01V00064F 1	03/11-		P-U-10	40 mm	65 mm	NH-72280251	71.92
DOZER	72286391	03/11-		P-U-10	50 mm	100 mm	NH-72280261	69.78
SWING	72286392	03/11-		P-U-10	45 mm	80 mm	NH-72280268	77.87
MODEL E35SR								
BOOM				P-U-10	50 mm	85 mm	NH- PX01V00030R 300	94.95
BUCKET				P-U-10	35 mm	65 mm	NH- PW01V00046 R300	66.75
DIPPER				P-U-10	45 mm	80 mm	NH- PW01V00048 R300	59.33
SWING				P-U-10	45 mm	80 mm	NH- PW01V00043 R300	65.40
MODEL E50B SR								
ARM	87345186	03/11-	BSN NBLN00652	P-U-10	50 mm	90 mm	NH-84365141	194.96
	PY01V00042F 3	03/11-	ASN NBLN00653	P-U-10	50 mm	90 mm	NH-84365141	194.96
BOOM	84537235	03/11-	ASN NBLB00653	P-U-10	55 mm	100 mm	NH- PY01V00043R 400	90.01
	87579029	03/11-	BSN NBLB00653	P-U-10	55 mm	100 mm	NH- PY01V00043R 400	90.01
	87579037	03/11-	BSN NBLB00652	P-U-10	55 mm	100 mm	NH- PY01V00043R 400	90.01
	PY01V00043F 2	03/11-	ASN NBLB00653	P-U-10	55 mm	100 mm	NH- PY01V00043R 400	90.01
BUCKET	87742171	03/11-	BSN NBLN00653	P-U-10	45 mm	75 mm	NH- PY01V00047R 400	86.30
	PY01V00047F 2	03/11-	BSN NBLN00652	P-U-10	45 mm	75 mm	NH- PY01V00047R 400	86.30
DOZER	72284279	03/11-		P-U-10	45 mm	75 mm	NH-72284189	89.11
SWING	72283413	03/11-		P-U-10	50 mm	90 mm	NH-84365143	194.96
Loaders - Skid Steer								
APPLICATION	CYL #	SERIAL #	Misc	CODE	ROD	BORE	KIT #	List \$
MODEL C175								
BOOM	87442336	N7M4666429-		P-U-11	3/4	1-1/2	NH-86627859	13.53
	87459207	N7M467969-	EUROPE	P-U-11	1-3/8	2-1/2	NH-86570922	32.82
	87675772	N7M4666429-		P-U-11	1-3/8	2-1/2	NH-86570922	32.82
	87675772	N7M467969-	EUROPE	P-U-11	1-3/8	2-1/2	NH-86570922	32.82
BOOM LH	87736740	N7M4666429-		P-UB-10	1-3/8	2-1/2	NH-87644127	43.59

NEW HOLLAND

Replacement Kits For

NEW HOLLAND

Loaders - Skid Steer								
APPLICATION	CYL #	SERIAL #	Misc	CODE	ROD	BORE	KIT #	List \$
MODEL C175								
BOOM LH	87736740	N7M467969-	EUROPE	P-UB-10	1-3/8	2-1/2	NH-87644127	43.59
BOOM RH	87736741	N7M4666429-		P-UB-10	1-3/8	2-1/2	NH-87644127	43.59
	87736741	N7M467969-	EUROPE	P-UB-10	1-3/8	2-1/2	NH-87644127	43.59
BUCKET	87038978	N7M4666429-		P-U-11	1-1/4	2-1/4	NH-86570919	41.73
	87038978	N7M467969-	EUROPE	P-U-11	1-1/4	2-1/4	NH-86570919	41.73
MOUNTING PLATE	87442336	N7M4666429-		P-U-11	3/4	1-1/2	NH-86627859	13.53
	87442336	N7M467969-	EUROPE	P-U-11	3/4	1-1/2	NH-86627859	13.53
MODEL C185								
BOOM	87038980	N8M472597-	EUROPE	P-U-11	1-1/2	2-1/2	NH-86570933	59.13
BOOM LH	87701859			P-UB-10	1-1/2	2-1/2	NH-87644128	50.44
BOOM RH	87701858			P-UB-10	1-1/2	2-1/2	NH-87644128	50.44
BUCKET	87038982	-N8M469897		P-U-11	1-1/4	2-1/2	NH-86570931	69.92
MOUNTING PLATE	87442336			P-U-11	3/4	1-1/2	NH-86627859	13.53
MODEL C190								
BOOM	87038985			P-U-11	1-3/4	2-3/4	NH-86536101	36.37
BOOM LH	87701861			P-UB-10	1-3/4	2-3/4	NH-87644129	35.90
BOOM RH	87701860			P-UB-10	1-3/4	2-3/4	NH-87644129	35.90
BUCKET	87038986			P-U-11	1-1/4	2-1/2	NH-86537054	83.89
MOUNTING PLATE	87442336			P-U-11	3/4	1-1/2	NH-86627859	13.53
MODEL L150								
BOOM	87038975	-N7M461810	EUROPE	P-U-11	1-3/8	2-1/2	NH-86570922	32.82
	87038975	-N7M466067		P-U-11	1-3/8	2-1/2	NH-86570922	32.82
	87038975	-N7M466068		P-U-11	1-3/8	2-1/2	NH-86570922	32.82
BOOM LH	87701855	-N7M461810	EUROPE	P-UB-10	1-3/8	2-1/2	NH-87644127	43.59
	87701855	-N7M466067		P-UB-10	1-3/8	2-1/2	NH-87644127	43.59
	87701855	-N7M466068		P-UB-10	1-3/8	2-1/2	NH-87644127	43.59
BOOM RH	87697439	-N7M461810	EUROPE	P-UB-10	1-3/8	2-1/2	NH-87644127	43.59
	87697439	-N7M466067		P-UB-10	1-3/8	2-1/2	NH-87644127	43.59
	87697439	-N7M466068		P-UB-10	1-3/8	2-1/2	NH-87644127	43.59
BUCKET	86631753	-N7M461810	EUROPE	P-U-11	1-1/8	1-7/8	NH-86570916	26.01
	86631753	-N7M466068		P-U-11	1-1/8	1-7/8	NH-86570916	26.01
	87038971	-N7M461810	EUROPE	P-U-11	1-1/8	1-7/8	NH-86570916	26.01
	87038971	-N7M466067		P-U-11	1-1/8	1-7/8	NH-86570916	26.01
	87038971	-N7M466068		P-U-11	1-1/8	1-7/8	NH-86570916	26.01
MODEL L160								
BOOM	86633432	-N7M448359		P-U-11	1-3/8	2-1/2	NH-86570922	32.82
	86633432	N7M448360-		P-U-11	1-3/8	2-1/2	NH-86570922	32.82
	87038977	-N7M448359		P-U-11	1-3/8	2-1/2	NH-86570922	32.82
	87038977	N7M448360-		P-U-11	1-3/8	2-1/2	NH-86570922	32.82
	87701856	-N7M448359		P-UB-10	1-3/8	2-1/2	NH-87644127	43.59
	87701856	N7M448360-		P-UB-10	1-3/8	2-1/2	NH-87644127	43.59
	87701857	-N7M448359		P-UB-10	1-3/8	2-1/2	NH-87644127	43.59
	87701857	N7M448360-		P-UB-10	1-3/8	2-1/2	NH-87644127	43.59
BUCKET	86633433	-N7M448359		P-U-11	1-1/4	2-1/4	NH-86570919	41.73
	87038978	-N7M448359		P-U-11	1-1/4	2-1/4	NH-86570919	41.73
	87038978	N7M448360-		P-U-11	1-1/4	2-1/4	NH-86570919	41.73

Replacement Kits For

NEW HOLLAND

Loaders - Skid Steer								
APPLICATION	CYL #	SERIAL #	Misc	CODE	ROD	BORE	KIT #	List \$
MODEL L160								
MOUNTING PLATE	87442336	-N7M448359		P-U-11	3/4	1-1/2	NH-86627859	13.53
	87442336	N7M448360-		P-U-11	3/4	1-1/2	NH-86627859	13.53
MODEL L170								
BOOM	86633432	- N7M456356		P-U-11	1-3/8	2-1/2	NH-86570922	32.82
	86633432	N7M456357 -		P-U-11	1-3/8	2-1/2	NH-86570922	32.82
	86633432	N7M468800 -	Europe	P-U-11	1-3/8	2-1/2	NH-86570922	32.82
	87038977	- N7M456356		P-U-11	1-3/8	2-1/2	NH-86570922	32.82
	87038977	N7M456357 -		P-U-11	1-3/8	2-1/2	NH-86570922	32.82
	87038977	N7M468800 -	Europe	P-U-11	1-3/8	2-1/2	NH-86570922	32.82
BOOM LH	87701857	- N7M456356		P-UB-10	1-3/8	2-1/2	NH-87644127	43.59
	87701857	N7M456357 -		P-UB-10	1-3/8	2-1/2	NH-87644127	43.59
	87701857	N7M468800 -	Europe	P-UB-10	1-3/8	2-1/2	NH-87644127	43.59
BOOM RH	87701856	- N7M456356		P-UB-10	1-3/8	2-1/2	NH-87644127	43.59
	87701856	N7M456357 -		P-UB-10	1-3/8	2-1/2	NH-87644127	43.59
	87701856	N7M468800 -	Europe	P-UB-10	1-3/8	2-1/2	NH-87644127	43.59
BUCKET	86633433	- N7M456356		P-U-11	1-1/4	2-1/4	NH-86570919	41.73
	87038978	- N7M456356		P-U-11	1-1/4	2-1/4	NH-86570919	41.73
	87038978	N7M456357 -		P-U-11	1-1/4	2-1/4	NH-86570919	41.73
	87038978	N7M468800 -	Europe	P-U-11	1-1/4	2-1/4	NH-86570919	41.73
MODEL L175								
BOOM	87459207	N7M470553-		P-U-11	1-3/8	2-1/2	NH-86570922	32.82
	87459207	N7M470572-		P-U-11	1-3/8	2-1/2	NH-86570922	32.82
	87460855	N7M470553-		P-U-11	1-3/8	2-1/2	NH-86570922	32.82
	87460855	N7M470572-		P-U-11	1-3/8	2-1/2	NH-86570922	32.82
	87675772	N7M470553-		P-U-11	1-3/8	2-1/2	NH-86570922	32.82
	87675772	N7M470572-		P-U-11	1-3/8	2-1/2	NH-86570922	32.82
	87736740	N7M470553-		P-UB-10	1-3/8	2-1/2	NH-87644127	43.59
	87736740	N7M470572-		P-UB-10	1-3/8	2-1/2	NH-87644127	43.59
	87736741	N7M470553-		P-UB-10	1-3/8	2-1/2	NH-87644127	43.59
	87736741	N7M470572-		P-UB-10	1-3/8	2-1/2	NH-87644127	43.59
	87736754	N7M470553-		P-UB-10	1-3/8	2-1/2	NH-87644127	43.59
BUCKET	87038978	N7M470553-		P-U-11	1-1/4	2-1/4	NH-86570919	41.73
	87038978	N7M470572-		P-U-11	1-1/4	2-1/4	NH-86570919	41.73
MOUNTING PLATE	87442336	-N7M468034		P-U-11	3/4	1-1/2	NH-86627859	13.53
	87442336	N7M470553-		P-U-11	3/4	1-1/2	NH-86627859	13.53
	87442336	N7M470572-		P-U-11	3/4	1-1/2	NH-86627859	13.53
MODEL L180								
BOOM	87038980	- N8M464425		P-U-11	1-1/2	2-1/2	NH-86570933	59.13
	87038980	N8M421368 -	Europe	P-U-11	1-1/2	2-1/2	NH-86570933	59.13
	87038980	N8M464426 -		P-U-11	1-1/2	2-1/2	NH-86570933	59.13
BOOM LH	87701859	- N8M464425		P-UB-10	1-1/2	2-1/2	NH-87644128	50.44
	87701859	N8M421368 -	Europe	P-UB-10	1-1/2	2-1/2	NH-87644128	50.44
	87701859	N8M464426 -		P-UB-10	1-1/2	2-1/2	NH-87644128	50.44
BOOM RH	87701858	- N8M464425		P-UB-10	1-1/2	2-1/2	NH-87644128	50.44
	87701858	N8M421368 -	Europe	P-UB-10	1-1/2	2-1/2	NH-87644128	50.44
	87701858	N8M464426 -		P-UB-10	1-1/2	2-1/2	NH-87644128	50.44

NEW HOLLAND

Replacement Kits For

NEW HOLLAND

Loaders - Skid Steer								
APPLICATION	CYL #	SERIAL #	Misc	CODE	ROD	BORE	KIT #	List \$
MODEL L180								
BUCKET	87038982	- N8M464425		P-U-11	1-1/4	2-1/2	NH-86570931	69.92
	87038982	N8M421368 -	Europe	P-U-11	1-1/4	2-1/2	NH-86570931	69.92
	87038982	N8M464426 -		P-U-11	1-1/4	2-1/2	NH-86570931	69.92
MODEL L185								
BOOM	87038980	- N8M465246		P-U-11	1-1/2	2-1/2	NH-86570933	59.13
	87038980	N8M465247 -		P-U-11	1-1/2	2-1/2	NH-86570933	59.13
	87038980	N8M467462 -	Europe	P-U-11	1-1/2	2-1/2	NH-86570933	59.13
BOOM LH	87701859	- N8M465246		P-UB-10	1-1/2	2-1/2	NH-87644128	50.44
	87701859	N8M465247 -		P-UB-10	1-1/2	2-1/2	NH-87644128	50.44
	87701859	N8M467462 -	Europe	P-UB-10	1-1/2	2-1/2	NH-87644128	50.44
BOOM RH	87701858	- N8M465246		P-UB-10	1-1/2	2-1/2	NH-87644128	50.44
	87701858	N8M465247 -		P-UB-10	1-1/2	2-1/2	NH-87644128	50.44
	87701858	N8M467462 -	Europe	P-UB-10	1-1/2	2-1/2	NH-87644128	50.44
BUCKET	87038982	- N8M465246		P-U-11	1-1/4	2-1/2	NH-86570931	69.92
MODEL L190								
BOOM	87038985	- N7M459486		P-U-11	1-3/4	2-3/4	NH-86536101	36.37
	87038985	N7M459487 -		P-U-11	1-3/4	2-3/4	NH-86536101	36.37
BOOM LH	87701861	- N7M459486		P-UB-10	1-3/4	2-3/4	NH-87644129	35.90
	87701861	N7M459487 -		P-UB-10	1-3/4	2-3/4	NH-87644129	35.90
BOOM RH	87701860	- N7M459486		P-UB-10	1-3/4	2-3/4	NH-87644129	35.90
	87701860	N7M459487 -		P-UB-10	1-3/4	2-3/4	NH-87644129	35.90
BUCKET	87038986	- N7M459486		P-U-11	1-1/4	2-1/2	NH-86537054	83.89
	87038986	N7M459487 -		P-U-11	1-1/4	2-1/2	NH-86537054	83.89
MODEL L454, L455								
BOOM	593204			I-U-10	1-1/4	1-1/2	NH-9610763	18.81
BUCKET	593390			P-U-10	1-1/2	3	NH-9610764	52.39
MODEL L553, L555								
BOOM	592567			I-U-10	1-1/2	1-7/8	NH-782679	37.43
BUCKET	593558			P-U-10	1-1/2	3	NH-9610764	52.39
MODEL L565, LX565, LX665								
BOOM (New)	86528677			P-U-10	1-3/8	2-1/2	NH-86527694	33.81
BOOM (Old)	9622429			P-U-10	1-3/8	2-1/2	NH-9801209	57.99
BUCKET(New)	86528678			P-U-11	1-1/4	2-1/4	NH-86570919	41.73
BUCKET(Old)	9622430			P-U-11	1-1/4	2-1/4	NH-86570919	41.73
GRAPPLE	9847007			P-U-10	1	1-1/2	NH-9600405	48.21
MODEL L781, L783, L785								
BOOM	86509051			I-U-10	1-1/2	2	NH-771707	40.64
BUCKET	771699			P-U-10	1-1/8	2-1/4	NH-771700	53.37
	86509051			P-U-10	1-1/8	2-1/4	NH-86509056	22.18
SELF LEVELING	264205			P-U-10	1-1/8	2-1/4	NH-219505	41.76
MODEL L865, LX865, L885, LX885								
BOOM	86528680			P-U-11	1-1/2	2-1/2	NH-86570933	59.13
	9845805			P-U-10	1-3/8	2-1/2	NH-9801209	57.99
BUCKET	86528679			P-U-10	1-1/4	2-1/2	NH-9843717	36.65
MODEL LS140								
BOOM	86590821	9/99 -		P-U-11	1-1/4	2-1/4	NH-86570919	41.73

Replacement Kits For

NEW HOLLAND

Loaders - Skid Steer								
APPLICATION	CYL #	SERIAL #	Misc	CODE	ROD	BORE	KIT #	List \$
MODEL LS140								
BOOM	87038973	9/99 -		P-U-11	1-1/4	2-1/4	NH-86570919	41.73
BUCKET	86631753	9/99 -		P-U-11	1-1/8	1-7/8	NH-86570916	26.01
	87038971	9/99 -		P-U-11	1-1/8	1-7/8	NH-86570916	26.01
MODEL LS150								
BOOM	86590848	9/99 -		P-U-11	1-3/8	2-1/2	NH-86570922	32.82
	87038975	9/99 -		P-U-11	1-3/8	2-1/2	NH-86570922	32.82
BUCKET	86631753	9/99 -		P-U-11	1-1/8	1-7/8	NH-86570916	26.01
	87038971	9/99 -		P-U-11	1-1/8	1-7/8	NH-86570916	26.01
MODEL LS160								
BOOM	86633432	9/99 -		P-U-11	1-3/8	2-1/2	NH-86570922	32.82
	87038977	9/99 -		P-U-11	1-3/8	2-1/2	NH-86570922	32.82
BUCKET	86633433	9/99 -		P-U-11	1-1/4	2-1/4	NH-86570919	41.73
	87038978	9/99 -		P-U-11	1-1/4	2-1/4	NH-86570919	41.73
MODEL LS170								
BOOM	86633432	9/99 -		P-U-11	1-3/8	2-1/2	NH-86570922	32.82
	87038977	9/99 -		P-U-11	1-3/8	2-1/2	NH-86570922	32.82
BUCKET	86633433	9/99 -		P-U-11	1-1/4	2-1/4	NH-86570919	41.73
	87038978	9/99 -		P-U-11	1-1/4	2-1/4	NH-86570919	41.73
MODEL LS180								
BOOM	86590828	9/99 -		P-U-11	1-1/2	2-1/2	NH-86570933	59.13
BUCKET	86590829	9/99 -		P-U-11	1-1/4	2-1/2	NH-86570931	69.92
MODEL LS180B								
BOOM	87038980	3/05 -		P-U-11	1-1/2	2-1/2	NH-86570933	59.13
BOOM LH	87701859	3/05 -		P-UB-10	1-1/2	2-1/2	NH-87644128	50.44
BOOM RH	87701858	3/05 -		P-UB-10	1-1/2	2-1/2	NH-87644128	50.44
BUCKET	87038982	3/05 -		P-U-11	1-1/4	2-1/2	NH-86570931	69.92
MODEL LS185B								
BOOM	87038980			P-U-11	1-1/2	2-1/2	NH-86570933	59.13
BOOM LH	87701859			P-UB-10	1-1/2	2-1/2	NH-87644128	50.44
BOOM RH	87701858			P-UB-10	1-1/2	2-1/2	NH-87644128	50.44
BUCKET	87038982			P-U-11	1-1/4	2-1/2	NH-86570931	69.92
MODEL LS190								
BOOM	86836659	9/99 -		P-U-11	1-3/4	2-3/4	NH-86536101	36.37
BUCKET	86537048	9/99 -		P-U-11	1-1/4	2-1/2	NH-86537054	83.89
MODEL LS190B								
BOOM	87038985			P-U-11	1-3/4	2-3/4	NH-86536101	36.37
BOOM LH	87701861			P-UB-10	1-3/4	2-3/4	NH-87644129	35.90
BOOM RH	87701860			P-UB-10	1-3/4	2-3/4	NH-87644129	35.90
BUCKET	87038986			P-U-11	1-1/4	2-1/2	NH-86537054	83.89
MODEL LX565								
BOOM	86528677	1/94-9/99		P-U-11	1-3/8	2-1/2	NH-86570922	32.82
	9622429	1/94-9/99		P-U-11	1-3/8	2-1/2	NH-86518276	60.28
BUCKET	86633433	1/94-9/99		P-U-11	1-1/4	2-1/4	NH-86570919	41.73
	9622430	1/94-9/99		P-U-11	1-1/4	2-1/4	NH-86570919	41.73
MODEL LX665								
BOOM	86528677	1/94-9/99		P-U-11	1-3/8	2-1/2	NH-86570922	32.82

NEW HOLLAND

Replacement Kits For

NEW HOLLAND

Loaders - Skid Steer								
APPLICATION	CYL #	SERIAL #	Misc	CODE	ROD	BORE	KIT #	List \$
MODEL LX665								
BOOM	9622429	1/94-9/99		P-U-11	1-3/8	2-1/2	NH-86518276	60.28
BUCKET	86633433	1/94-9/99		P-U-11	1-1/4	2-1/4	NH-86570919	41.73
	9622430	1/94-9/99		P-U-11	1-1/4	2-1/4	NH-86570919	41.73
MODEL LX865								
BOOM	86528680	11/94-9/99		P-U-11	1-1/2	2-1/2	NH-86570933	59.13
	86590828	11/94-9/99		P-U-11	1-1/2	2-1/2	NH-86570933	59.13
	9845805	11/94-9/99		P-U-11	1-3/8	2-1/2	NH-86518276	60.28
BUCKET	86570930	11/94-9/99		P-U-11	1-1/4	2-1/2	NH-86570931	69.92
	86590829	11/94-9/99		P-U-11	1-1/4	2-1/2	NH-86570931	69.92
MODEL LX885								
BOOM	86528680	11/94-9/99		P-U-11	1-1/2	2-1/2	NH-86570933	59.13
	86590828	11/94-9/99		P-U-11	1-1/2	2-1/2	NH-86570933	59.13
	9845805	11/94-9/99		P-U-11	1-3/8	2-1/2	NH-86518276	60.28
BUCKET	86570930	11/94-9/99		P-U-11	1-1/4	2-1/2	NH-86570931	69.92
	86590829	11/94-9/99		P-U-11	1-1/4	2-1/2	NH-86570931	69.92

REPLACEMENT PARTS FOR NEW HOLLAND - UNITIZED PISTONS

NOTE: New Holland part numbers are used as a reference only. We do not imply that these kits are original REPLACEMENT PARTS.

Part Number	Bore Diameter	Hole Diameter	Piston Width	List Price	Part Number	Bore Diameter	Hole Diameter	Piston Width	List Price
NH-81875232	110 mm	30.25	45.09	\$ 145.30	NH-85800982	100 mm	30.78	41.28	\$ 132.48
NH-83962807	80 mm	24.26	29.08	119.72	NH-85800983	115 mm	33.76	40.31	173.67
NH-85800981	90 mm	24.26	29.08	133.02	NH-87432513	80 mm	24.26	29.08	119.72

REPLACEMENT KITS FOR NEW HOLLAND EQUIPMENT

Kit Number	Code (Pg. xviii)	Rod X Bore Size	List Price
NH-1542923C2	P-UB-10	2-1/2 X 3-1/2	\$ 65.68
NH-219505	P-U-10	1-1/8 X 2-1/4	41.76
NH-72280241	P-U-10	45 X 75 mm	69.00
NH-72280251	P-U-10	40 X 65 mm	71.92
NH-72280261	P-U-10	50 X 100 mm	69.78
NH-72280268	P-U-10	45 X 80 mm	77.87
NH-72280454	P-U-10	45 X 80 mm	65.40
NH-72283999	P-U-10	50 X 90 mm	104.62
NH-72284189	P-U-10	45 X 75 mm	89.11
NH-771700	P-U-10	1-1/8 X 2-1/4	53.37
NH-771707	I-U-10	1-1/2 X 2	40.64
NH-782679	I-U-10	1-1/2 X 1-7/8	37.43
NH-83962835	I-U-10	1 X 50 mm	35.83
NH-84154166	P-UB-10,12	2-1/2 X 5	70.70
NH-84154167	P-UB-10	2-1/2 X 5	56.15
NH-84155586	P-UB-10	2-1/2 X 4-3/4	58.24
NH-84155591	P-UB-14	2-1/4 X 4	83.70
NH-84155594	P-UB-10,12	2-1/2 X 5-1/4	102.63
NH-84209920	P-UB-14	2-1/4 X 4	83.70
NH-84365141	P-U-10	50 X 90 mm	194.96
NH-84365143	P-U-10	50 X 90 mm	194.96
NH-85802567	P-UB-10	50 X 90 mm	64.05
NH-85802570	P-UB-10	50 X 110 mm	73.96
NH-85802571	P-UB-10	56 X 100 mm	48.97
NH-85804740	P-UB-10	40 X 80 mm	53.98
NH-85805990	I-U-10	38 X 63 mm	62.72
NH-85819232	P-UB-10	2-1/2 X 135 mm	276.66
NH-85819299	P-UB-10	2-1/2 X 130 mm	114.47
NH-85819350	P-UB-10	63 X 4-1/2	160.88
NH-85819351	P-UB-10	2 X 2-3/4	38.24
NH-85819352	P-UB-10	2 X 90 mm	64.58
NH-85819353	P-UB-10	2 X 110 mm	73.10
NH-85819355	P-UB-10	1-5/8 X 80 mm	40.12
NH-85819356	P-UB-10	50 X 110 mm	40.29
NH-85819357	P-UB-10	2 X 2-3/4	38.24
NH-85819358	P-UB-10	2-1/2 X 90 mm	60.55
NH-85824250	I-U-15	45 X 80 mm	61.97
NH-86509056	P-U-10	1-1/8 X 2-1/4	22.18
NH-86518276	P-U-11	1-3/8 X 2-1/2	60.28
NH-86527694	P-U-10	1-3/8 X 2-1/2	33.81
NH-86536101	P-U-11	1-3/4 X 2-3/4	36.37
NH-86537054	P-U-11	1-1/4 X 2-1/2	83.89
NH-86570916	P-U-11	1-1/8 X 1-7/8	26.01
NH-86570919	P-U-11	1-1/4 x 2-1/4	41.73
NH-86570922	P-U-11	1-3/8 X 2-1/2	32.82
NH-86570931	P-U-11	1-1/4 X 2-1/2	69.92
NH-86570933	P-U-11	1-1/2 X 2-1/2	59.13
NH-86627859	P-U-11	3/4 X 1-1/2	13.53
NH-86627859	P-U-11	3/4 X 1-1/2	13.53
NH-87312900	P-UB-10	2-1/2 X 5	80.09

Kit Number	Code (Pg. xviii)	Rod X Bore Size	List Price
NH-87342131	P-UB-10	1-3/4 X 3	\$ 39.98
NH-87414975	N-UB-1	2-1/4" Rod Kit	15.94
NH-87428620	P-UB-10	2 X 2-3/4	38.24
NH-87428627	P-UB-10	1-5/8 X 80 mm	40.12
NH-87428628	P-UB-10	2 X 90 mm	64.58
NH-87428629	P-UB-10	2-1/2 X 90 mm	60.55
NH-87428630	P-UB-2	2-1/4 X 4	46.06
NH-87428631	P-UB-10	2 X 110 mm	73.10
NH-87428632	P-UB-10	2-1/2 X 4-1/2	86.59
NH-87428633	P-UB-10	2-1/2 X 130 mm	114.47
NH-87428634	P-UB-10,12	2-1/2 X 135 mm	195.16
NH-87428866	P-UB-10	2 X 2-3/4	34.97
NH-87428869	P-UB-10	2-1/2 X 90 mm	62.94
NH-87428872	I,P-UB-10,12	2-1/2 X 4-1/2	91.01
NH-87428874	P-UB-10	2-1/2 X 135 mm	160.24
NH-87432407	P-UB-10	2 X 3-1/2	45.58
NH-87432412	P-UB-10	1-3/4 X 3-1/4	47.38
NH-87432515	P-UB-10	2 X 80 mm	41.64
NH-87445307-NP	P-UB-10	2 X 110 mm	64.38
NH-87529742	P-UB-10	4 X 6-1/2	115.62
NH-87573868	I-U-15	45 X 80 mm	61.97
NH-87608671	P-UB-10	2 X 2-3/4	42.93
NH-87633295	P-UB-10	2-1/2 X 4-1/2	106.46
NH-87644127	P-UB-10	1-3/8 X 2-1/2	43.59
NH-87644128	P-UB-10	1-1/2 X 2-1/2	50.44
NH-87644129	P-UB-10	1-3/4 X 2-3/4	35.90
NH-87651309	P-UB-10	2 X 3-3/4	53.53
NH-87653283	P-UB-10	2 X 3	35.16
NH-87654843	P-UB-10,12	2-1/2 X 5-1/4	95.33
NH-87654844	P-UB-10	2-1/2 X 4-3/4	56.73
NH-9600405	P-U-10	1 X 1-1/2	48.21
NH-9610763	I-U-10	1-1/4 X 1-1/2	18.81
NH-9610764	P-U-10	1-1/2 X 3	52.39
NH-9801209	P-U-10	1-3/8 X 2-1/2	57.99
NH-9843717	P-U-10	1-1/4 X 2-1/2	36.65
NH-9968164	P-U-15	1-1/2 X 2-3/4	25.14
NH-C5NN3N713A	Seal Kit	Seal Kit	48.24
NH-EHPN3A540AA	P-U-1	20mm Rod Kit	49.18
NH-PW01V00043R300	P-U-10	45 X 80 mm	65.40
NH-PW01V00046R300	P-U-10	35 X 65 mm	66.75
NH-PW01V00048R300	P-U-10	45 X 80 mm	59.33
NH-PX01V00030R300	P-U-10	50 X 85 mm	94.95
NH-PX01V00033R300	P-U-10	45 X 90 mm	84.39
NH-PX01V00045R300	P-U-10	45 X 80 mm	65.40
NH-PY01V00043R400	P-U-10	55 X 100 mm	90.01
NH-PY01V00047R400	P-U-10	45 X 75 mm	86.30

NEW HOLLAND

REPLACEMENT PARTS FOR NEW HOLLAND EQUIPMENT

NOTE: New Holland part numbers are used as a reference only. We do not imply that these kits are original REPLACEMENT PARTS.

BACK-UP RINGS

Part Number	Min Pkg Qty	List Price
NH-235784	10	\$ 1.29
NH-270103	10	0.67
NH-86502705	10	0.86
NH-86512008	10	0.96
NH-9603673	10	0.91

HEAD SEALS

Part Number	List Price
NH-87615485	\$ 18.90
NH-87615486	18.90

O-RINGS

Part Number	Min Pkg Qty	List Price
NH-216255	10	\$ 1.25
NH-235782	20	0.64
NH-510121	20	0.39
NH-510185	20	0.42
NH-510204	20	0.72
NH-9848676	20	0.47

PISTON SEALS

Part Number	Bore Dia.	List Price
NH-591983	2-1/2	\$ 9.13
NH-771702	2-1/4	7.66
NH-87402623	5-1/4	\$ 29.23

RETAINER RINGS

Part Number	List Price
NH-512015	\$ 22.71

U-SEALS

Part Number	Rod Dia.	List Price
NH-592955	1-1/2	\$ 13.17
NH-86513307	1-1/4	8.86
NH-9600664	1-3/8	9.70

WEAR RINGS

Part Number	O.D. X Width	List Price
NH-771701	2-1/4 X 3/8	\$ 4.15
NH-783874	2-1/2 X 3/8	4.28
NH-9842390	1.520 X 3/4	12.61
NH-9843627	1-3/8 X 1/2	9.54

WIPERS

Part Number	Rod Dia.	List Price
NH-128406	1-1/8	\$ 2.94
NH-46886	1-3/8	3.17
NH-511979	1-1/2	3.56
NH-529340	1-1/4	3.17

REPLACEMENT KITS FOR NISSAN LIFT TRUCKS

NOTE: A cylinder number will help in determining the proper kit part number. If no cylinder number is available, furnish rod and bore sizes and description of parts.

Kit Number	Code (Pg. xviii)	Rod X Bore Size	List Price
NN-49440-00H00	MOTOR KIT		\$ 8.85
NN-49510-L6025	P-U-10	25 X 55 mm	68.97
NN-49599-11H00	P-U-10	40 X 60 Double Rod	94.54
NN-49599-51K00	P-U-10	40 X 65 mm	94.47
NN-49599-FC000	I-U-10	40 mm X 2-3/8	77.63
NN-58099-00H00	P-U-4	35 X 45 mm	65.10
NN-58099-00H60	P-U-4	35 X 45 mm	46.20
NN-58099-0G211	I-U-4	2 in X 75 mm	33.12
NN-58099-0G511	I-U-4	2 in X 80 mm	110.80
NN-58099-10H00	P-U-5	40 X 50 mm	112.67
NN-58099-10H60	P-U-4	40 X 50 mm	43.00
NN-58099-20H12	P-U-4	45 X 60 mm	76.82
NN-58099-20H62	P-U-4	45 X 60 mm	39.86
NN-58099-23H00	P-U-1	45 X 55 mm	55.81
NN-58099-23H60	P-U-4	45 X 55 mm	48.98
NN-58099-31K11	I-U-4	2" X 2-3/4"	43.39
NN-58099-51H10	P-U-14	50 X 70 mm	87.99
NN-58099-51H60	P-U-4	50 X 65 mm	40.53
NN-58099-51H70	P-U-4	50 X 70 mm	66.42
NN-58099-L2600	P-U-4	40 X 50 mm	105.69
NN-58099-L4900	P-U-1	55 mm Rod Kit	57.39
NN-58099-L6000	P-U-4	50 X 70 mm	129.83
NN-58099-L6001	P-U-4	60 X 70 mm	138.57
NN-58099-L900	P-U-1	55 mm Rod Kit	57.39
NN-58099-L9010	P-U-4	60 X 80 mm	74.49
NN-58099-L9016	P-U-15	65 X 80 mm	76.91
NN-58199-L1100	I-U-4	50 X 70 mm	118.25
NN-58199-L1300	I-U-4	60 X 80 mm	129.35
NN-58199-L1400	I-U-4	45 X 65 mm	112.73
NN-58199-L1700	I-U-4	50 X 70 mm	118.25
NN-58199-L6000	I-U-4	65 X 90 mm	133.91
NN-58199-L6100	I-U-4	70 X 100 mm	138.69
NN-58299-01H00	P-U-1	32 mm Rod Kit	46.34
NN-58299-11H00	P-U-1	35 X 55 mm	51.40
NN-58299-L1100	I-U-1	60, 80, 112mm Stages	101.65

Kit Number	Code (Pg. xviii)	Rod X Bore Size	List Price
NN-58399-L1100	I-U-4	60 X 90 mm	\$132.51
NN-58499-02H10	P-U-1	70 mm Rod Kit	67.92
NN-58499-12H11	P-U-1	75 X 85 mm	88.09
NN-58499-22H10	P-U-1	90 mm Rod Kit	78.37
NN-58499-25H10	P-U-1	80 mm Rod Kit	88.61
NN-58499-6G500	I-U-4	2 in X 60 mm	119.72
NN-58499-L1100	I-U-1	80 mm Rod Kit	62.27
NN-58499-L1101	I-U-1	50 mm Rod Kit	39.66
NN-58499-L1102	I-U-1	50 mm Rod Kit	41.74
NN-58499-L1400	I-U-1	70 mm Rod Kit	53.16
NN-58499-L1401	I-U-1	45 mm Rod Kit	36.96
NN-58499-L1402	I-U-1	45 mm Rod Kit	38.93
NN-58499-L6000	I-U-4	70 X 100 mm	115.35
NN-58499-L6001	P-U-1	65mm Rod Kit	65.18
NN-58499-L7401	P-U-1	45 mm Rod Kit	31.84
NN-58699-00H00	P-U-1	25 X 65 mm	65.78
NN-58699-05H00	P-U-1	30 X 65 mm	60.87
NN-58699-10H00	P-U-3	30 X 70 mm	66.19
NN-58699-14H00	P-U-3	35 X 70 mm	68.41
NN-58699-20H00	P-U-1	35 X 80 mm	51.04
NN-58699-21H00	P-U-1	40 X 80 mm	61.69
NN-58699-51K00	P-U-3	30 X 60 mm	39.00
NN-58699-L1125	I-U-1	35 mm Rod Kit	43.45
NN-58699-L1126	I-U-1	35 mm Rod Kit	46.14
NN-58699-L1425	I-U-1	30 mm Rod Kit	46.14
NN-58699-L1426	I-U-1	30 mm Rod Kit	40.83
NN-58699-L6000	I-U-1	40 mm Rod Kit	46.69
NN-58699-L6011	I-U-1	40 mm Rod Kit	50.51
NN-58699-L6800	I-U-1	45 mm Rod Kit	52.42
NN-58699-L6811	I-U-1	45 mm Rod Kit	56.44
NN-58699-L8100	I-U-1	35 X 80 mm	32.36
NN-58699-L9000	I-U-1	50mm Rod Kit	53.83
NN-58699-L9010	I-U-1	50 X 100 mm	65.04
NN-69399-90H00		9/16" Valve Kit	7.30
NN-69399-L1202		9/16" Valve Kit	21.76

REPLACEMENT PARTS FOR NISSAN EQUIPMENT

NOTE: Nissan part numbers are used as a reference only. We do not imply that these kits are original REPLACEMENT PARTS.

O-RINGS

Part Number	Min Pkg Qty	List Price
NN-49516-L6004	10	\$ 0.88
NN-49526-L6004	10	3.20
NN-58117-L6000	20	0.72
NN-58122-L0700	2	4.32
NN-58123-L1100	5	1.82
NN-58123-L1300	5	1.76
NN-58123-L1400	10	1.15
NN-58124-L1300	5	6.32
NN-58124-L1400	10	1.47
NN-58124-L6100	5	2.09
NN-58142-L0800	5	2.49
NN-58185-48570	5	6.32
NN-58225-47600	2	3.39
NN-58245-47701	25	0.34
NN-58248-47230	2	5.55
NN-58251-48570	2	4.72
NN-58417-L1100	10	1.41
NN-58423-L1100	2	5.18
NN-58423-L1400	2	4.89
NN-58424-L1100	5	2.06
NN-58424-L1400	5	7.43
NN-58624-L3100	5	1.78
NN-58624-L6800	5	1.83
NN-58634-L3100	25	0.34
NN-69386-L1106	20	0.57
NN-69399-L2500	10	2.38
NN-85225-47600	2	3.39
NN-E8122-F8101	10	1.32
NN-G9386-L1106	20	0.57

PISTON U-SEALS

Part Number	Bore Dia.	List Price
NN-58140-L1401	65 mm	\$ 37.34
NN-58140-L1100	70 mm	37.34
NN-58140-L6000	90 mm	44.11
NN-58140-L6100	100 mm	44.11

U-SEALS

Part Number	Rod Dia.	List Price
NN-49522-L6004	25 mm	\$ 3.05
NN-58621-L1400	30 mm	7.14
NN-58621-L1100	35 mm	10.81
NN-58221-24H00	38 mm	12.50
NN-58621-L3100	40 mm	11.84
NN-58121-L1400	45 mm	13.97
NN-58242-L1400	65 mm	14.87
NN-30961-08012	80 mm	27.09

BUSHINGS

Part Number	Rod Dia.	List Price
NN-49521-FC000	60 mm	\$ 3.62

WIPERS

Part Number	Rod Dia.	List Price
NN-49524-L6004	25 mm	\$ 16.72
NN-58622-L1400	30 mm	7.54
NN-58222-01H01	32 mm	20.79
NN-58222-24H01	38 mm	28.39
NN-58622-L3100	40 mm	4.59
NN-58122-L1400	45 mm	5.61
NN-58017-L1300	50 mm	23.63
NN-58122-L1100	50 mm	6.37
NN-58017-L4900	55 mm	27.00
NN-58017-L6007	60 mm	29.26
NN-58122-L1300	60 mm	8.27
NN-58243-L1400	65 mm	8.81
NN-58453-L6000	65 mm	31.03
NN-58422-L1400	70 mm	9.19
NN-58243-L1100	80 mm	10.17

NISSAN

NPK

Kit Number	List Price
NPK-10X	\$ 360.94
NPK-10XB	332.78
NPK-20X	1001.17
NPK-4X	163.20
NPK-7XB	270.36
NPK-8XA	290.47
NPK-8XB	265.60

PANDROL-JACKSON

Kit Number	Code (Pg. xviii)	Rod X Bore Size	List Price
PJ-170217	I-U-4	3 X 6	\$ 78.07
PJ-170225	I-U-5	2 X 4	64.15
PJ-170225-1	I-U-5	2 X 4	64.15
PJ-170233-1	I-U-5	2-1/4 X 3-1/2	58.68
PJ-170452-1	P-U-10	2-1/2 X 3-1/2	80.16
PJ-240237-1	I-U-10	2-3/4 X 4	111.27
PJ-240266-1	P-U10	1 X 2	49.65
PJ-240268	P-U-10	1-1/2 X 2	46.56
PJ-240273-2	P-U-5	1-1/4 X 2-1/2	30.29
PJ-240312-1	P-U-5	1-1/2 X 3	49.56
PJ-240313	P-U-10	1-3/4 X 3-1/2	46.39
PJ-240316	I-U-5	1-1/2 X 2-1/2	27.88
PJ-240316-1	I-U-5	1-1/2 X 2-1/2	27.54
PJ-240370	P-U-5	1-3/4 X 3-1/2	54.67
PJ-240461	I-U-10	1-1/2 X 2-1/2	38.97

NPK - PANDROL-JACKSON

Replacement Kits For

PAK-MOR

Refuse - Front Loaders							
APPLICATION	CYL #:	MISC	CODE	ROD	BORE	KIT #	List \$
MODEL FHC 800, FHC 8338							
CONTAINER LEVELING	4148009AC		I-U-5	2	4	PKM-4148096	53.82
LIFT ARM	4149004AA		I-U-5	2	5	PKM-4148090	53.21
PACKER		Commercial Hyd. Cyl. w/ 3-3/4"-7.905" stages or Custom Hoist Cyl. w/ 4"-8" stages.				SEE NOTE	
REAR DOOR	4148048AD		I-U-5	1-1/2	3	PKM-4148097	41.29
TILT ARM	4148077AB		I-U-5	2	4	PKM-4148098	54.47
TOP DOOR	4148078AC		I-U-5	2	4	PKM-4148096	53.82
Refuse - Rear Loaders							
APPLICATION	CYL #:	MISC	CODE	ROD	BORE	KIT #	List \$
MODEL R100B							
EJECTOR	2000102	Telescopic Cylinder	I-V-12	4, 5	4-1/2, 5-1/2	PKM-2843163	438.23
	2001102	Telescopic Cylinder	I-V-12	4, 5	4-1/2, 5-1/2	PKM-2843163	438.23
	4148038AB	Piston Type Cylinder	I-U-5	2-1/2	5	PKM-4148092	74.40
	4148039AC	Piston Type Cylinder	I-U-5	4	5	PKM-4149001	82.38
	4148040AC	Piston Type Cylinder	I-U-5	4	5	PKM-4149001	82.38
	SD52DC-8-119	2 Stage Commercial Hyd. Cyl., 3-1/4" & 4-3/4" stages.				SEE NOTE	
	SD52DC-8-140	2 Stage Commercial Hyd. Cyl., 3-1/4" & 4-3/4" stages.				SEE NOTE	
PACKER	4148003		I-U-5	2-1/2	4	PKM-4148094	57.98
SWEEP	4148006AD		I-U-5	2-1/2	4	PKM-4148094	57.98
TAILGATE	4149039		I-U-4	2-1/2	3-1/2	PKM-4148093	37.73
WINCH	4148044AC		I-U-5	3	6	PKM-4148091	105.81
MODEL R200							
CONTAINER	466-01		I-OB-3	1-1/4	3-1/2	PKM-UD648-34	8.29
EJECTOR	2149-LM		I-U-5	2-1/2	5	PKM-2019-34	61.78
	2957-LM		I-U-5	2-1/2	5	PKM-2671-34	61.89
	2958-LM, 2959-L		I-U-5	4	5	PKM-1471-34	58.98
	D52CD-77-80	Single Stage Commercial Hyd. Cyl., 4-3/4" stage.				SEE NOTE	
	D52CD-77-86 1/2	Single Stage Commercial Hyd. Cyl., 4-3/4" stage.				SEE NOTE	
	SC52DC-8-140	2 Stage Commercial Hyd. Cyl., 3-3/4" & 4-3/4" stages.				SEE NOTE	
	SD52DC-8-119	2 Stage Commercial Hyd. Cyl., 3-3/4" & 4-3/4" stages.				SEE NOTE	
PACKER	3802-LM		I-U-5	2-1/2	5	PKM-1362-34	58.05
SWEEP	3809-LM		I-U-5	2-1/2	5	PKM-1362-34	58.05
TAILGATE	792-LM		I-U-5	2-1/2	3-1/2	PKM-UD2167-3	49.95
MODEL R200B							
EJECTOR	2000102	Telescopic Cylinder	I-V-12	4, 5	4-1/2, 5-1/2	PKM-2843163	438.23
	2001102	Telescopic Cylinder	I-V-12	4, 5	4-1/2, 5-1/2	PKM-2843163	438.23
	4148038AB	Piston Type Cylinder	I-U-5	2-1/2	5	PKM-4148092	74.40
	4148039AC	Piston Type Cylinder	I-U-5	4	5	PKM-4149001	82.38
	4148040AC	Piston Type Cylinder	I-U-5	4	5	PKM-4149001	82.38
	SD52DC-8-119	2 Stage Commercial Hyd. Cyl., 3-1/4" & 4-3/4" stages.				SEE NOTE	

Replacement Kits For

PAK-MOR

Refuse - Rear Loaders							
APPLICATION	CYL #:	MISC	CODE	ROD	BORE	KIT #	List \$
MODEL R200B							
EJECTOR	SD52DC-8-140	2 Stage Commercial Hyd. Cyl., 3-1/4" & 4-3/4" stages.				SEE NOTE	
PACKER	4148023		I-U-5	2-1/2	5	PKM-4148089	74.40
SWEEP	4148022		I-U-5	2-1/2	5	PKM-4148089	74.40
WINCH	4148044AC		I-U-5	3	6	PKM-4148091	105.81
MODEL R300B							
EJECTOR	2000102	Telescopic Cylinder	I-V-12	4, 5	4-1/2, 5-1/2	PKM-2843163	438.23
	2001102	Telescopic Cylinder	I-V-12	4, 5	4-1/2, 5-1/2	PKM-2843163	438.23
	4148038AB	Piston Type Cylinder	I-U-5	2-1/2	5	PKM-4148092	74.40
	4148039AC	Piston Type Cylinder	I-U-5	4	5	PKM-4149001	82.38
	4148040AC	Piston Type Cylinder	I-U-5	4	5	PKM-4149001	82.38
	SD52DC-8-119	2 Stage Commercial Hyd. Cyl., 3-1/4" & 4-3/4" stages.				SEE NOTE	
	SD52DC-8-140	2 Stage Commercial Hyd. Cyl., 3-1/4" & 4-3/4" stages.				SEE NOTE	
PACKER	4148037		I-U-5	3	6	PKM-4148091	105.81
SWEEP	4148000AC		I-U-5	3	6	PKM-4148091	105.81
TAILGATE	4148018AE		I-U-4	2-1/2	3-1/2	PKM-4148093	37.73
WINCH	4148044AC		I-U-5	3	6	PKM-4148091	105.81

For applications using Commercial Hydraulics telescopic cylinders, please see the Commercial Hydraulics section of this catalog for a listing of available replacement parts.

Kit Number	Code (Pg. xviii)	Rod X Bore Size	List Price	Kit Number	Code (Pg. xviii)	Rod X Bore Size	List Price
PKM-1101-34	I-U-5	1-1/2 X 3	\$ 33.18	PKM-4148091	I-U-5	3 X 6	\$105.81
PKM-1128-34	I-U-5	3 X 5	67.13	PKM-4148092	I-U-5	2-1/2 X 5	74.40
PKM-1362-34	I-U-5	2-1/2 X 5	58.05	PKM-4148093	I-U-4	2-1/2 X 3-1/2	37.73
PKM-1471-34	I-U-5	4 X 5	58.98	PKM-4148094	I-U-5	2-1/2 X 4	57.98
PKM-1963-34	I-OB-3	1-1/2 X 2-1/2	13.73	PKM-4148096	I-U-5	2 X 4	53.82
PKM-2019-34	I-U-5	2-1/2 X 5	61.78	PKM-4148097	I-U-5	1-1/2 X 3	41.29
PKM-2194LM	I-U-5	5 X 6	98.58	PKM-4148098	I-U-5	2 X 4	54.47
PKM-2302-34	I-OB-3	3/4 X 1-1/2	15.30	PKM-4149001	I-U-5	4 X 5	82.38
PKM-2608-34	I-OB-4	2-1/2 X 4	20.36	PKM-4149037	I-U-5	1-1/2 X 2-1/2	30.53
PKM-2671-34	I-U-5	2-1/2 X 5	61.89	PKM-4149048	I-U-5	1-1/2 X 3-1/3	27.38
PKM-2843115	I-U-5	1-1/2 X 3	27.26	PKM-4149051	I-U-5	2 X 4	57.26
PKM-2843129	I-OB-3	3/4 X 1-1/2	13.85	PKM-4149052	I-U-5	1-1/2 X 2-1/2	23.86
PKM-2843163	Repair kit for cyl 2000102, 2001102		438.23	PKM-4149066	I-U-5	2-1/2 X 3-1/2	45.86
PKM-2843164	Vee Sets & Wipers for above		61.30	PKM-4149107	I-U-5,12	1-1/2 X 2-1/2	87.82
PKM-2843168	Vee Sets, Wipers & Bushings for above		114.16	PKM-4149116	I-U-5,12	1-1/2 X 3	91.08
PKM-3016-34	I-U-10	2-1/2 X 3-1/2	23.06	PKM-4149118	I-U-5,12	1-1/4 X 2	53.24
PKM-4148024	I-U-5	2-1/2 X 4	53.30	PKM-4149124	I-U-5,12	1-1/2 X 3-1/2	101.41
PKM-4148027	I-U-5	1-1/2 X 2-1/2	36.05	PKM-625-34	I-U-5	2 X 4	41.80
PKM-4148032	I-U-4	2-1/2 X 3-1/2	34.31	PKM-646-34	I-OB-1	1-3/4 X 2-1/2	16.21
PKM-4148034	I-U-5	2-1/2 X 5	65.94	PKM-647-34	I-U-5	2 X 3	28.32
PKM-4148035	I-U-4	2-1/2 X 4	36.69	PKM-989-34	I-OB-3	1-1/2 X 2-1/2	16.43
PKM-4148036	I-U-5	3 X 6	84.83	PKM-UD1990-34	I-U-5	2-1/2 X 4	49.21
PKM-4148089	I-U-5	2-1/2 X 5	74.40	PKM-UD2167-34	I-U-5	2-1/2 X 3-1/2	49.95
PKM-4148090	I-U-5	2 X 5	53.21	PKM-UD648-34	I-OB-3	1-1/4 X 3-1/2	8.29

PAK-MOR

REPLACEMENT KITS FOR PEABODY GALION TELESCOPIC CYLINDER PARTS & KITS

PACKING: Vee packing - no top adaptor. .275" c.s.
WIPERS: Urethane; wiper does not snap into a groove, but is trapped between the head nut and top bearing.
BEARINGS: Castiloid (cast iron) outer bearing, grooved to serve as top adaptor for packing. Single action cylinders have inner bearing trapped between 2 spiral retainer rings. Double action cylinders (see below).
PISTON: Single action cylinder has 2 half-moon shaped castiloid bearings that fit into a groove at piston end of stage.
STAGE O.D.'s: 1.970; through 7.970; 9.125.
SPECIAL INFO. Stage diameters all .030" under nominal inch except 9.125. All stage bores .020 over nominal half-inch.
IDENTIFICATION: Model number stamped into "steadrest" area near gland collar on body.

DOUBLE ACTION SAME AS ABOVE EXCEPT:
BEARINGS: Has no inner bearing. Instead there is a steel spacer ring "trapped" between the two spiral retainers.
PISTON: Double action cylinder has bronze piston and threads onto stage. 2 or 3 "butt-cut" piston rings per stage in separate grooves.

PEABODY GALION

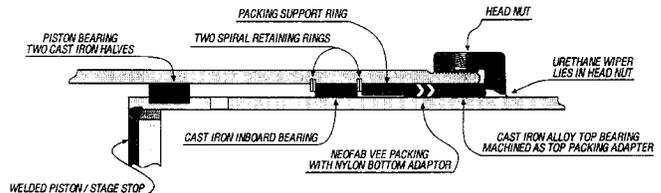

Part Number	Description	List Price
PACKINGS AND WIPERS		
PG-2VSW	1.970" Vee Set & Wiper	\$ 19.09
PG-3VSW	2.970" Vee Set & Wiper	21.17
PG-4VSW	3.970" Vee Set & Wiper	26.90
PG-5VSW	4.970" Vee Set & Wiper	34.97
PG-6VSW	5.970" Vee Set & Wiper	42.84
PG-7VSW	6.970" Vee Set & Wiper	38.87
PG-8VSW	7.970" Vee Set & Wiper	60.01
PG-9VSW	9.125" Vee Set & Wiper	74.28
PACKING & BEARING KITS		
PG-3PBK	2.970" Vee Set, Wiper & Top Bearing	\$ 45.18
PG-4PBK	3.970" Vee Set, Wiper & Top Bearing	51.92
PG-5PBK	4.970" Vee Set, Wiper & Top Bearing	65.47
PG-6PBK	5.970" Vee Set, Wiper & Top Bearing	83.16
PG-7PBK	6.970" Vee Set, Wiper & Top Bearing	99.92
PG-8PBK	7.970" Vee Set, Wiper & Top Bearing	132.21
RETAINER RINGS		
PG10-5304	2" SPIRAL RETAINER RING	\$ 4.97
PG10-25689	3" SPIRAL RETAINER RING	11.20
PG10-25688	4" SPIRAL RETAINER RING	10.23
PG10-25687	5" SPIRAL RETAINER RING	10.46
PG10-25686	6" SPIRAL RETAINER RING	8.10
PG10-25718	7" SPIRAL RETAINER RING	10.73
PG10-25729	8" SPIRAL RETAINER RING	22.28
PG10-26982	9-1/8" SPIRAL RETAINER RING	39.05
PISTON RINGS - DOUBLE ACTION ONLY		
PG10-25892	3-1/2" PISTON RING	\$ 11.91
PG10-25880	4-1/2" PISTON RING	12.14
PG10-28824	4.54" PISTON RING	12.27
PG10-30863	5.00" PISTON RING	12.66
PG10-28825	5.54" PISTON RING	20.43
PG10-25868	5-1/2" PISTON RING	17.11
PG10-25867	6-1/2" PISTON RING	39.63
PG10-25866	7-1/2" PISTON RING	50.48
PG10-25891	8-1/2" PISTON RING	55.32

Part Number	Description	List Price
STOP RINGS		
1 piece = 1/2 stop ring		
PG10-5224	4" Stop Ring	\$ 82.52
PG10-5299	7" Stop Ring	101.56
HEAD NUTS		
(MEASURED AT THREAD I.D.)		
PG10-25672	5" HEAD NUT	112.49
PG10-25670	7" HEAD NUT	147.60
PG10-25708	8" HEAD NUT	192.63
PG10-25709	9" HEAD NUT	212.31
MISCELLANEOUS PARTS		
PG10-11641	NYLON SLUG	\$ 0.66
PG10-25440	BLEEDER VALVE (MIN PACK - 3)	5.36
PG10-27728	SET SCREW	1.29
KITS		
PG-35PBK	3" - 5" Vee Set, Wiper & Top Bearing	\$ 162.57
PG-37PBK	3" - 7" Packing, Wiper, Top Bearing, Set Screws & Slugs	345.63
PG-38PBK	3" - 8" Packing, Wiper, Top Bearing, Set Screws & Slugs	477.83
PG-46PBK	4" - 6" Packing, Wiper, Top Bearing, Set Screws & Slugs	200.54
PG-47PBK	4" - 7" Packing, Wiper, Top Bearing, Set Screws & Slugs	300.47
PG-48PBK	4" - 8" Packing, Wiper, Top Bearing, Set Screws & Slugs	432.68
PG-49PBK	4" - 9" Vee Set, Wiper & Top Bearing	643.42
PG-57PBK	5" - 7" Packing, Wiper, Top Bearing, Set Screws & Slugs	248.59
PG-58PBK	5" - 8" Packing, Wiper, Top Bearing, Set Screws & Slugs	380.78
PG-67PBK	6" - 7" Packing, Wiper, Top Bearing, Set Screws & Slugs	183.09

REPLACEMENT KITS FOR PEABODY GALION TELESCOPIC CYLINDER PARTS & KITS

Part Number	Description	List Price
KITS		
PG-68PBK	6" - 8" Packing, Wiper, Top Bearing, Set Screws & Slugs	\$ 315.30
PG-3TA	2.970" TOP ADAPTOR	3.76
PG-4TA	3.970" TOP ADAPTOR	4.82
PG-5TA	4.970" TOP ADAPTOR	4.61
PG-6TA	5.970" TOP ADAPTOR	5.44
PG-7TA	6.970" TOP ADAPTOR	8.32
PG-8TA	7.970" TOP ADAPTOR	10.46
PG-10-40938	1-1/4" VEE SET	15.96
PG-10-12546	3.997" ID WIPER	4.09
PG-35	3" - 5" Packing, Wiper, Set Screw, Slug	99.00
PG-36	3" - 6" Packing, Wiper, Set Screw, Slug	150.06
PG-37	3" - 7" Packing, Wiper, Set Screw, Slug	214.06
PG-38	3" - 8" Packing, Wiper, Set Screw, Slug	285.61
PG-45	4" - 5" Vee Set & Wiper Set Screw, Slug	73.73
PG-46	4" - 6" Packing, Wiper, Set Screw, Slug	124.83
PG-47	4" - 7" Packing, Wiper, Set Screw, Slug	188.85
PG-48	4" - 8" Packing, Wiper, Set Screw, Slug	260.37
PG-49	4" - 9" Packing, Wiper, Set Screw, Slug	348.92

Part Number	Description	List Price
KITS		
PG-56	5" - 6" Vee Set & Wiper Set Screw, Slug	\$ 97.33
PG-57	5" - 7" Packing, Wiper, Set Screw, Slug	156.78
PG-58	5" - 8" Packing, Wiper, Set Screw, Slug	228.29
PG-67	6" - 7" Packing, Wiper, Set Screw, Slug	115.04
PG-68	6" - 8" Packing, Wiper, Set Screw, Slug	186.61
PG-SR38	3" - 8" Spiral Snap Ring Kit	161.28
PG-PR38	3-1/2" - 8-1/2" Piston Ring Kit	530.51
PG-PR48	4-1/2" - 8-1/2" Piston Ring Kit	401.02
PG91-04176	6" , 7-1/8", 8-3/8", 9-3/4" Vee Sets, Wipers and Piston Bearings	741.30
PARTS FOR 104176-ADA		
PG91-04176	6" , 7-1/8", 8-3/8", 9-3/4" Vee Sets, Wipers and Piston Bearings	\$ 741.30
PG10-51431	6" Cast Iron Bushing	178.90
PG10-51445	6-1/2" OD Cast Iron Piston Ring	32.33
PG10-51430	7-1/8" Cast Iron Bushing	218.08
PG10-17892	8 X .310 X .265/.295 Piston Ring	39.16
PG10-51429	8-3/8" Cast Iron Bushing	267.60
PG10-51428	9-3/4" Cast Iron Bushing	285.26

PEABODY GALION E-Z PACK GARBAGE TRUCK KITS

Kit Number	Cylinder	Code (Pg. xviii)	Rod X Bore Size	List Price
PG-2.5UW	2.470" ROD	U-SEAL & WIPER		\$ 21.40
PG-2101220	K4549-LDA	P-UB-12,14..2	X 4-1/2	189.32
PG-2115K	2115	I-V-1	2" ROD	26.64
PG-2534DAK	2534DA	I-U-5	1-3/4 X 2-1/2	28.28
PG-2UW	1.970" ROD	U-SEAL & WIPER		25.72
PG-3021CDAK	3021 CDA	I-U-5	2 X 3	52.71
PG-3027DAK	3027DA, 3032DA	I-U-5	2 X 3	81.31
PG-3032DAK	3032DA	I-U-5	2 X 3	81.31
PG-3120K	3120	I-V-1	3" ROD	26.24
PG-3128DAK	3128A	I-V-1	3" ROD	26.24
PG-3514DAK	3514DA	I-U-5	2-1/2 X 3-1/2	45.36
PG-3530ADAK	3530ADA	I-U-5	1-3/4 X 3-1/2	39.43
PG-3UW	2.970" ROD	U-SEAL & WIPER		28.89
PG-4021EDAK	4021EDA	I-U-5,12	2-1/2 X 4	91.25
PG-4027CDAK	4027CDA, 4032DA, 4037CDA	I-U-5	2-1/2 X 4	55.32
PG-4030DAK	4030DA	I-U-5	2 X 4	58.07
PG-4032DAK	4032DA	I-U-4	2-1/2 X 4	43.64
PG-4033BDAPR	4033BDA	I-U-12	2-1/2 X 4	60.03
PG-4042BDAK	4042BDA	I-U-10	2-1/4 X 4	47.62
PG-4042DAKPR	4042DA	I-U-12	2-1/2 X 4	60.03
PG-4046ADAK	4046ADA	I-V-1	3 X 4	25.88
PG-4128K	4128C	I-V-1	4" ROD	34.26
PG-4521DAK	4521DA	I-V-1	2 X 4-1/2	31.68
PG-4521DAKPR	4521DA	I-V-12	2 X 4-1/2	66.29
PG-4522DAK	4522DA	I-V-1	2 X 4-1/2	27.37

Kit Number	Cylinder	Code (Pg. xviii)	Rod X Bore Size	List Price
PG-4522DAKPR	4522DA	I-V-12	2 X 4-1/2	\$ 61.94
PG-4522EDAK	4522EDA	I-U-1	2 X 4-1/2	29.17
PG-4522EDAPR	4522EDA	I-U-12	2 X 4-1/2	69.84
PG-4522JDAK	D4522JDA	I-U-12	2 X 4-1/2	71.84
PG-4538BDAK	4538BDA	1-V-10,12	2 X 4-1/2	53.94
PG-4543DAKPR	4543DA	I-U-12	2 X 4-1/2	97.98
PG-4546DAPR	4546DA	I-U-12	2 X 4-1/2	93.10
PG-4552JDAK	4552JDA	I-U-12	2 X 4-1/4	71.84
PG-4UW	3.970" ROD	U-SEAL & WIPER		44.46
PG-5054ADAK	5054ADA	I-U-1	3 X 5	34.28
PG-5054ADAPR	5054ADA	I-U-12	3 X 5	148.49
PG-5055ADAK	5055ADA	I-U-1	4 X 5	55.86
PG-5055ADAPR	5055ADA	I-U-12	4 X 5	103.64
PG-5532DAKPR	5532DA	I-U-5,12	2-3/4 X 5-1/2	103.53
PG-5553DAK	5553DA	I-V-1	3 X 5-1/2	37.94
PG-5553DAKPR	5553	I-V-12	3 X 5-1/2	93.29
PG-5554DAK	5554DA	I-V-1	3 X 5-1/2	37.94
PG-5554DAKPR	5554DA	I-V-12	3 X 5-1/2	95.27
PG-5554EDAK	5554EDA	I-U-1	3 X 5-1/2	58.56
PG-5554EDAPR	5554 EDA	I-U-12	3 X 5-1/2	145.96
PG-5UW	4.970" ROD	U-SEAL & WIPER		40.40
PG-6054DAK	6054	I-V-1	3 X 6	36.81
PG-6540ADAK	6540ADA	I-V-5	4 X 6-1/2	144.88
PG-6540DAK	6540DA	I-V-12	4 X 6-1/2	296.70
PG-6553DAK	6553DA	I-V-1	3 X 6-1/2	41.60
PG-7078DAK	7078D	I-U-5	5 X 7	127.63

PEABODY GALION

E-Z PACK GARBAGE TRUCK KITS - FOR DANA BUILD CYLINDERS

Kit Number	Cylinder	Code (Pg. xviii)	Rod X Bore Size	List Price	Kit Number	Cylinder	Code (Pg. xviii)	Rod X Bore Size	List Price
PG59-01478	D63124FDA	I-V-1	4, 5, 6, Stages	\$ 202.34	PG59-05532	D5532DDA	I-U-10,12	2-3/4 X 5-1/2	\$ 121.93
PG59-01501	D74162ADA	I-V-1	4, 5, 6, 7 Stages	293.18	PG59-05554	D5554GDA	I-U-12	3 X 5-1/2	127.89
PG59-01504	D5391	I-V-1	3, 4, 5 Stages	168.17	PG59-06042	D6042BDA	I-U-10,12	2-3/4 X 6	97.52
PG59-01505	D4258	I-V-1	3, 4 Stages	75.41	PG59-4028GDA	D4028GDA	I-V-10	2-3/4 X 4	46.78
PG59-01507	D6292CDA	I-V-1	5, 6 Stages	123.29	PG59-46124		I-V-10	2 X 7	46.51
PG59-02563	D2534CDA, D2563BDA	I-U-10	1-3/4 X 2-1/2	48.52	PG59-46135	D5054CDA	I-U-12	3 X 5	135.91
PG59-03021	D3021GDA	I-U-10	2 X 3	30.10	PG59-46139	D6067ADA	I-V-10	5 X 6	195.09
PG59-03128	D3128C	I-V-1	3 X 3-1/2	33.10	PG59-46150	D3018DDA	I-U-10	2 X 3	26.69
PG59-03516	D3516CDA	I-U-10	1-3/4 X 3-1/2	24.75	PG59-46156		I-U-10,12	2-3/4 X 5-1/2	119.92
PG59-03526	D3526HDA	I-U-10	1-3/4 X 3-1/2	30.82	PG59-46167	D1510	I-OB-1	1 X 1-1/2	9.94
PG59-04028	D4028CDA,	I-U-10	2-3/4 X 4	35.90	PG59-46173		I-U-10	3 X 8	104.48
PG59-04030	D4030EDA	I-U-10	2 X 4	31.67	PG59-46818	D3549ADA	I-U-10,12	2 X 3-1/2	39.27
PG59-04035	D4035HDA	I-U-10	2-1/2 X 4	36.38	PG59-46819	D3016ADA	I-U-10	1-1/2 X 3	21.94
PG59-04526	D4548 DA	I-U-12	2 X 4-1/2	74.26	PG59-46823	D5067ADA	I-V-10	4 X 5	81.96
PG59-04548		I-U-12	2 X 4-1/2	112.72	PG59-47048	D3033ADA	I-U-10	1-3/4 X 3	34.90
PG59-04549	D4549BDA	I-U-10,12	2 X 4-1/2	52.54	PG59-48531		I-V-10	2 X 3-1/2	44.34
					PG59-49897		I-V-14	2-1/4 X 4	110.72

PEABODY GALION

E-Z PACK GARBAGE TRUCK KITS - FOR PEABODY GALION BUILD CYLINDERS

Kit Number	Cylinder	Code (Pg. xviii)	Rod X Bore Size	List Price	Kit Number	Cylinder	Code (Pg. xviii)	Rod X Bore Size	List Price
PG-2115045		I-V-10	2-3/4 X 4	\$ 37.06	PG91-04028	4028DA	I-U-4	2-3-4 X 4	\$ 41.72
PG-2115917		I-U-10	2 X 3	26.63	PG91-04035	4035CDA	I-U-5	2-1/2 X 4	45.82
PG-2116324		I-U-10	1-3/4 X 3	19.01	PG91-04526		I-U-12	2 X 4-1/2	87.07
PG-2116498		I-UB-10,12	2 X 4	53.28	PG91-04546	4548DA	I-U-12	2 X 4-1/2	93.10
PG-2117001		P-UB-10	2 X 4-1/2	72.57	PG91-05054		I-U-12	3 X 5	155.92
PG-2117025		I-V-10,12	2-1/2 X 5-1/2	72.94	PG91-06042	6042DA	I-U-5,12	2-3/4 X 6	106.49
PG-2118322		I-V-10,12	2 X 4-1/2	92.94	PG91-06067	6067ADA	I-U-10	5 X 6	106.49
PG-EZSK-6-84		I-U-10	5 X 6	62.91	PG91-13021	3021FDA	I-U-10	2 X 3	55.94
PG91-01530		P-U-4	2-1/2 X 5	48.73	PG91-13516	3516BDA	I-U-10	1-3/4 X 3-1/2	51.93
PG91-01533	5381B	I-V-1	3, 4, 5 Stages	89.39	PG91-13526		I-U-10	1-3/4 X 3-1/2	51.93
PG91-02534	2534BDA, 2563ADA	I-U-5	1-3/4 X 2-1/2	24.25	PG91-14028	4028BDA	I-U-10	2-3/4 X 4	53.62
PG91-03021	3021CDA	I-U-5	2 X 3	39.70	PG91-14030	4030DDA	I-U-10	2 X 4	61.18
PG91-03036		I-U-5	1-3/4 X 3-1/2	59.43	PG91-14035	4035EDA, 4035FDA	I-U-10	2-1/2 X 4	71.32
PG91-03516	3516CDA	I-U-4,10	1-3/4 X 3-1/2	59.16	PG91-14549	4549DA, 4549ADA	I-U-10,12	2 X 4-1/2	80.34
PG91-03530	3526CDA, 3526EDA	I-U-5	1-3/4 X 3-1/2	33.10	PG91-16042	6042ADA	I-U-10,12	2-3/4 X 6	102.31
PG91-04016		I-U-5	1-3/4 X 4	40.27	PG91-25554	5554FDA	I-U-12	3 X 5-1/2	158.85

PEABODY GALION

PEABODY GALION GALION-DAYBROOK LIFT GATE KITS

Part Number	Description	List Price
PG-10-40938	MODEL T1000, G10E	\$ 15.96
PG-20-33398	MODEL T8000E, T888R-CF, G8E, G8E-CG	50.55

PEABODY GALION GALION DUMP PUMP PARTS

Part Number	Description	List Price
PG10-147	BEARING - 1-1/2" O.D.	\$ 42.07
PG10-17635	PUMP HOUSING GASKET	1.01
PG10-17662	BEARING - 1-5/16" O.D.	19.26
PG-20-23878	13/16" VEE SET ONLY	6.81
PG-91-02101	13/16" COMPLETE SHAFT END COVER KIT	51.48

PEERLESS

Replacement Kits For

Forestry - Log Loaders

APPLICATION	CODE	ROD	BORE	KIT #	List \$
MODEL 2170B					
JIB BOOM	I-U-10	3	7	PRLS-842937500	68.15
MAIN BOOM	I-U-10	3	6	PRLS-842936800	84.53
STABILIZER	I-U-10	3	6	PRLS-842936800	84.53
MODEL 2770					
JIB BOOM	I-U-10	3-1/2	7	PRLS-842938200	98.61
MAIN BOOM	I-U-10	3	6	PRLS-842936800	84.53
STABILIZER	I-U-10	3	6	PRLS-842936800	84.53

PEERLESS

Kit Number	Code (Pg. xviii)	Rod X Bore Size	List Price
PRLS-300-4-446-4	I-U-13	3 X 6	\$ 91.42
PRLS-300-4-534-4	I-U-10	3 X 7	69.78
PRLS-300-5-510-4	I-U-10	3 X 7	67.56
PRLS-300-5-511-4	I-U-10	3 X 6	58.59

Kit Number	Code (Pg. xviii)	Rod X Bore Size	List Price
PRLS-842936800	I-U-10	3 X 6	\$ 84.53
PRLS-842937500	I-U-10	3 X 7	68.15
PRLS-842938200	I-U-10	3-1/2 X 7	98.61

PERFECTION - COBEY TELESCOPIC CYLINDER PARTS

- PACKING:** Vee packing with top and bottom adapters.
3, 4, & 5" stages have .265" CS.
6, 7, & 8 have 1/4" CS. 9" stage has 3/8" CS.
- WIPERS:** Urethane snap-in type.
- BEARINGS:** Original were bronze. Many replacements being offered in either glass-filled nylon or mineral filled nylon material. 3" through 6" stages have bearings above and below packing. 7" and 8" stages have bearing above packing only.
- PISTON:** Bronze bearing held in place by 2 spring steel snap rings.
- STAGE O.D.'s:** 2.580", 3.580", 4.580", 5.445", 6.445", 7.445", 8.445"
- SPECIAL INFO.** Internally threaded ring which serves as internal stop.
- IDENTIFICATION:** Model number and serial number stamped near base of cylinder.

PERFECTION

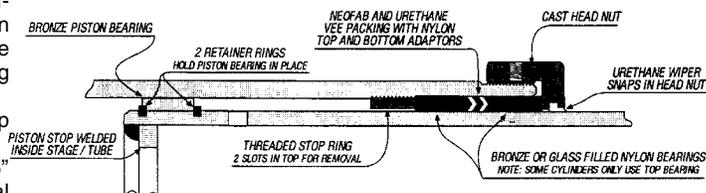

Kit Number	Stage O.D.	Description	List Price
PACKING & WIPERS			
PF-3VSW	2.580	Vee Set & Wiper	\$ 21.61
PF-4VSW	3.580	Vee Set & Wiper	37.89
PF-5VSW	4.580	Vee Set & Wiper	52.34
PF-6VSW	5.445	Vee Set & Wiper	45.81
PF-7VSW	6.445	Vee Set & Wiper	61.61
PF-8VSW	7.445	Vee Set & Wiper	69.35
PF-9VSW	8.445	Vee Set & Wiper	239.57
BEARINGS			
PF-4NB	3.580	Gland Bearing	\$ 25.54
PF-5NB	4.580	Gland Bearing	31.10
PF-6NB	5.445	Gland Bearing	33.70
PF-7NB	6.445	Gland Bearing	37.19
PF-8NB	7.445	Gland Bearing	39.61

Part Number	Description	List Price
KITS		
PF-35	3" - 5" Vee Set & Wiper	\$ 121.04
PF-46	4" - 6" Vee Set & Wiper	153.99
PF-47	4" - 7" Vee Set & Wiper	227.95
PF-48	4" - 8" Vee Set & Wiper	311.30
PF-49	4" - 9" Vee Set & Wiper	547.02
PF-57	5" - 7" Vee Set & Wiper	182.44
KITS		
PF-58	5" - 8" Vee Set & Wiper	\$ 265.79
PF-59	5" - 9" Vee Set & Wiper	477.66
PF-68	6" - 8" Vee Set & Wiper	212.32
MISCELLANEOUS PARTS		
PF-19120	Bleeder Valve (Min Pack - 3)	\$ 5.36

REPLACEMENT KITS FOR PERFECTION - COBEY

NOTE:
HEAD NUTS, END BEARINGS AND SNAP RINGS
ARE AVAILABLE. CALL FOR PRICE.

PERFECTION - COBEY SEAL KITS FOR TWIN TELESCOPICS

Kit Number	Cyl. Number	Stage Sizes	Description	List Price
PF-50493	475	3.220, 3.830	O-Rings, Back-Ups, Wipers	\$ 31.98
PF-50494	375	2.580, 3.220	O-Rings, Back-Ups, Wipers	23.34
PF-50530	495, 498	2.580, 3.220, 3.830	O-Rings, Back-Ups, Wipers	39.13
PF-88799	375	2.580, 3.220	U-Seals, O-Rings, Wipers	41.79
PF-88800	475	3.220, 3.830	U-Seals, O-Rings, Wipers	50.59
PF-88801	495, 498	2.580, 3.220, 3.830	U-Seals, O-Rings, Wipers	66.82

NOTE:
THE ABOVE CYLINDER ASSEMBLIES ARE AVAILABLE
FROM STOCK. CALL FOR PRICES.

PERFECTION - COBEY DUMP TRUCK PUMP PARTS

Part Number	Description	List Price
PF-75175	7/8" ID Vee Set	\$ 9.93
PF-75175 KIT	7/8" Vee Sets, O-Rings, Valve Gaskets	45.37
PF-78317+BU	7/8 " Shaft Seal & Back Up	12.9
PF-86081	3/4" ID Oil Seal	9.53
PF-86082	7/8 " ID Oil Seal	5.66
PF-86082 KIT	7/8" Shaft Pump Kit	21.75

PERFECTION - COBEY MISCELLANEOUS PERFECTION KITS & PARTS

Part Number	Description	List Price
PF-18273	2-3/4" Rod Vee Set	\$ 18.15
PF-18274	2" Rod Vee Set	7.60
PF-22001	2.58" Rod Dia.	3.71
PF-22002	3.22" Rod Dia.	4.16
PF-22003	3.83" Rod Dia.	4.52
PF-45007	1-1/4" ID Vee Set	8.75
PF-45030	2" ID Vee Set	12.80
PF-55152	2-1/2" ID Vee Set	16.94

Part Number	Description	List Price
PF-62463	2" ID Vee Set	\$ 12.80
PF-75175	7/8" I.D. Vee Set (each)	9.93
PF-81566	3/4" ID Vee Set	12.54
PF-84598K	P-U-52-1/2 X 4-1/2	79.26
PF-86081	3/4" I.D. Oil Seal	9.53
PF-86082	7/8 " ID Oil Seal	5.66

Replacement Kits For

PETTIBONE

Forklifts - Rough Terrain

APPLICATION	CYL #	CODE	ROD	BORE	KIT #	List \$
MODEL 636						
BOOM EXT.	AL-11621-10	P-U-5	2-1/4	4	PB-LL-6014-17	132.43
FORK/TILT	AL-10774	I-U-10	3	6	PB-LL-6018-16	75.65
LIFT	AL-10775	I-U-10	4	5	PB-LL-6016-31	106.40
REAR STAB.	AL-11263-1	I-U-10	2	3-1/2	PB-LL-6013-5	99.20
SIDE TILT/FORK 48"	AL-10089	P-V-10	1-1/4	2-1/4	PB-LL-6010-2	37.25
STEERING LH	LL-2989-315	P-U-10	1-1/8	2-1/4	PB-LL-2989-325	66.91
STEERING RH	LL-2989-316	P-U-10	1-1/8	2-1/4	PB-LL-2989-325	66.91
SWAY	AL11263	I-U-10	2	3-1/2	PB-LL-6013-5	99.20
MODEL B-66						
BOOM EXT.	AL-8935	P-U-5	2-1/4	4	PB-LL-4647-15	135.44
FORK	BL-9198	P-V-10, 12	2-1/2	6	PB-LL-4647-11	128.55
SWAY L	LL-218-2035	P-V-5	1-1/4	3	PB-LL-218-2037	45.46
SWAY R	LL-218-2036	P-V-5	1-1/4	3	PB-LL-218-2037	45.46
MODEL B-66B						
BOOM EXT.	AL-8935-H	P-U-5	2-1/4	4	PB-LL-4647-15	135.44
FORK/LIFT	AL-11091	P-U-10	2-1/2	6	PB-LL-6018-18	127.79
LIFT	AL-10156	P-V-10	4-1/4	5	PB-LL-218-2320	112.87
SWAY L	AL-10355	P-V-10	1-1/4	3	PB-LL-6012-2	30.73
SWAY R	AL-10356	P-V-10	1-1/4	3	PB-LL-6012-2	30.73
MODEL B-66C						
BOOM EXT.	AL-11621-8	P-U-5	2-1/4	4	PB-LL-6014-17	132.43
FORK/TILT	AL-11091	P-U-10	2-1/2	6	PB-LL-6018-18	127.79
LIFT	AL-10157-2	P-V-10	4-1/4	5	PB-LL-218-2320	112.87
SIDE TILT/FORK 48"	AL10089	P-V-10	1-1/4	2-1/4	PB-LL-6010-2	37.25
SIDE TILT/FORK 72"	AL-10397	P-V-10	1-1/4	2-1/4	PB-LL-6010-2	37.25
STEERING	LL-2989-	I-U-10	1-1/8	2-1/4	PB-LL-2989-104	35.05
SWAY	AL-11263	I-U-10	2	3-1/2	PB-LL-6013-5	99.20
MODEL C8042						
BOOM EXT.	SK-00052	I-U-10	3	5	PB-LL-6016-3	79.27
FORK/TILT	AL-10388	I-U-10	3	7	PB-LL-6019-2	83.84
LIFT	AL-10386	I-U-10	4	5	PB-LL-6016-31	106.40
STEERING LH - Front	AL-10319	P-V-10	1-1/4	2-1/2	PB-LL-6011-2	31.78
STEERING RH - Front	AL-10321	P-V-10	1-1/4	2-1/2	PB-LL-6011-2	31.78
SWAY	BL-9813	I-U-10	3	5	PB-LL-6016-28	57.71

PETTIBONE

PETTIBONE

Kit Number	Code (Pg. xviii)	Rod X Bore Size	List Price
PB-KM-3-62	I-U-5	1-1/4 X 3	\$ 41.74
PB-KM-3-63	I-V-11	1 X 2	30.59
PB-KM-3-64	I-U-1	3, 4, 5-1/2 Tele.	146.24
PB-KM-3-66	P-OB-3	1 X 2	14.92
PB-KMP-3404	3-3/8, 4-1/2, 5-1/4 UID		170.04
PB-L7595	P-V-5	3-1/2 X 6	182.86
PB-LA6414-1	I-U-4	3 X 4-1/2	67.08
PB-LL-218-1202	P-V-4	2-1/2 X 5	75.42
PB-LL-218-170	Wiper	2 Rod	5.76
PB-LL-218-179	P-V-7	2 X 3-1/2	74.32
PB-LL-218-190	P-V-7	1-1/4 X 3	60.04
PB-LL-218-195	P-V-7	1-3/8 X 3-1/2	63.95
PB-LL-218-2037	P-V-5	1-1/4 X 3	45.46
PB-LL-218-2090	1-1/4 X 2-1/2	P-V-10	49.06
PB-LL-218-2320	P-V-10	4-1/4 X 5	112.87
PB-LL-218-592	P-V-10,12	1 X 2	102.01
PB-LL-2580-4	Piston Ring	6 Piston Ring	17.28
PB-LL-2989-104	I-U-10	1-1/8 X 2-1/4	35.05
PB-LL-4647-11	P-V-10, 12	2-1/2 X 6	128.55
PB-LL-4647-15	P-U-5	2-1/4 X 4	135.44
PB-LL-576-16	Wiper	2-1/4 Rod	4.34
PB-LL-6010-2	P-V-10	1-1/4 X 2-1/4	37.25
PB-LL-6011-2	P-V-10	1-1/4 X 2-1/2	31.78
PB-LL-6012-2	P-V-10	1-1/4 X 3	30.73
PB-LL-6012-4	P-V-10	1-1/2 X 3	29.49
PB-LL-6012-6	P-V-10	1-1/4 X 3	26.55
PB-LL-6013-5	I-U-10	2 X 3-1/2	99.20
PB-LL-6014-10	I-V-7	2-1/4 X 4	73.17
PB-LL-6014-15	P-U-10	1-1/2 X 4	56.17
PB-LL-6014-17	P-U-5	2-1/4 X 4	132.43
PB-LL-6016-15	P-U-10	1-1/2 X 5	94.55
PB-LL-6016-28	I-U-10	3 X 5	57.71
PB-LL-6016-3	I-U-10	3 X 5	79.27
PB-LL-6016-31	I-U-10	4 X 5	106.40
PB-LL-6016-6	P-V-10	2-1/2 X 5	42.97
PB-LL-6018-13	P-U-10	3-1/2 X 6	121.57
PB-LL-6018-16	I-U-10	3 X 6	75.65
PB-LL-6018-18	P-U-10	2-1/2 X 6	127.79
PB-LL-6019-2	I-U-10	3 X 7	83.84
PB-LL-6290	I-V-10	2 X 4	51.98
PB-LL-731-3	Vee Set		30.96

P & H CRANE

Kit Number	Code (Pg. xviii)	Rod X Bore Size	List Price
PH-1045Z1795	I-U-10,12	5 X 6	\$ 190.14
PH-1045Z1925	P, I-OB-5	1-1/2 X 3-1/2	45.00
PH-1100P351F7	I-U-10	1-1/2 X 2-1/2	21.02
PH-1100P354F3	I-U-10	2 X 4	22.73
PH-1100P357F2	I-U-10	2 X 4-1/2	41.70
PH-1100P359F1	I-U-10	4 X 4-3/4	97.25
PH-1100P361F1	I-U-10,12	4-1/4 X 5	87.73
PH-1100P362F2	I-U-10, 12	4-1/4 X 5-1/4	97.32
PH-1100P366-2	I-U-4	4 X 6	116.68
PH-1100P366F1	I-U-10	4 X 6	63.11
PH-1100P369-1	I-U-10	4-1/4 X 6-1/2	185.61
PH-1100P372F1	I-U-10, 12	4-1/4 X 7	135.60
PH-1100P380F1	I-U-10, 12	4-1/4 X 9	375.64
PH-1100P381F1	I-U-10, 12	6-1/2 X 9	307.66
PH-1100P386F6	I-U-10, 12	7 X 10-1/2	582.69
PH-1100P419F2		7-3/4" Swivel	330.33

Replacement Kits For

PRENTICE®

Crane Loaders							
APPLICATION	CYL #	Misc - Serial #, Date, etc.	CODE	ROD	BORE	KIT #	List \$
MODEL 110 BC & SR							
FORK	110083		P-V-5	1-3/4	4	PR-147842	59.49
GRAPPLE	110087		P-V-5	1-1/2	3-1/2	PR-147819	46.26
	110266		I-U-5	1-1/2	3-1/2	PR-147753	39.63
MAIN BOOM	110260	STYLE III	I-V-5	4	6	PR-147858	86.54
	110274	STYLE III	I-V-5	4	6	PR-147858	86.54
	110295	STYLE III	I-V-5	4	6	PR-147858	86.54
	110312	STYLE III	I-U-5	4	6	PR-147734	91.71
STABILIZER	110102		P-V-5	1-3/4	4	PR-147830	59.49
	110262	STYLE III	I-U-5	2-1/2	4	PR-147751	49.96
	110294	STYLE II	P-V-5	2-1/2	4	PR-147857	63.55
STICK BOOM	110253	STYLE III	P-U-5	2	5	PR-147747	77.67
	110255		P-V-5	2	5	PR-147849	97.54
TELE STABILIZER	110297	STYLE III	I-U-5	2-1/2	4	PR-147751	49.96
MODEL 120							
GRAPPLE - 442	110415		I-U-11	2	3-1/2	PR-147770	68.01
GRAPPLE - 656	110435		I-U-11	2	3-1/2	PR-147770	68.01
MAIN BOOM	110407	STYLE IV	I-U-11	2-1/2	5	PR-10032269	91.77
	110407		I-U-11	2-1/2	5	PR-147780	66.00
STABILIZER	110448	STYLE IV	I-U-11	2	3-1/2	PR-10032265	54.29
	110448		I-U-11	2	3-1/2	PR-147770	68.01
STICK BOOM	110367		I-U-11	2-1/2	5	PR-147780	66.00
	110367	STYLE IV	I-U-11	2-1/2	5	PR-10032269	91.77
TELE STICK	110357	STYLE IV	I-U-11	2	3-1/2	PR-10032265	54.29
	110357		I-U-11	2	3-1/2	PR-147770	68.01
MODEL 150							
GRAPPLE	110360		I-U-11	1-1/2	3-1/2	PR-147788	53.75
	110376		I-U-11	2	3-1/2	PR-147770	68.01
MAIN BOOM	110359		I-U-11	4	6	PR-147781	83.67
	110359	STYLE IV	I-U-11	4	6	PR-10032275	109.48
STABILIZER	110375	STYLE IV	I-U-11	2-1/2	5	PR-10032269	91.77
	110375		I-U-11	2-1/2	5	PR-147780	66.00
STICK BOOM	110359		I-U-11	4	6	PR-147781	83.67
	110359	STYLE IV	I-U-11	4	6	PR-10032275	109.48
MODEL 180							
MAIN BOOM	110344	STYLE IV	I-U-11	4	7	PR-10032276	127.40
	110344		I-U-11	4	7	PR-147769	120.96
STABILIZER	110375		I-U-11	2-1/2	5	PR-147780	66.00
	110375	STYLE IV	I-U-11	2-1/2	5	PR-10032269	91.77
STICK BOOM	110322		I-U-11	3	6	PR-147786	100.33
	110322	STYLE IV	I-U-11	3	6	PR-10032274	100.95
MODEL 180B							
GRAPPLE	110415		I-U-11	2	3-1/2	PR-147770	68.01
MAIN BOOM	110344		I-U-11	4	7	PR-147769	120.96
STABILIZER	110375		I-U-11	2-1/2	5	PR-147780	66.00
STICK BOOM	110322		I-U-11	3	6	PR-147786	100.33

Replacement Kits For

PRENTICE®

Crane Loaders							
APPLICATION	CYL #	Misc - Serial #, Date, etc.	CODE	ROD	BORE	KIT #	List \$
MODEL 210							
MAIN BOOM	110272	STYLE III	I-U-5	4	6	PR-147734	91.71
STABILIZER	110252	STYLE III	I-U-5	2-1/2	5	PR-147746	80.52
	110273	STYLE III	P-V-5	2-1/2	5	PR-147731	64.90
STICK BOOM	110251	STYLE III	I-U-5	4	6	PR-147734	91.71
TELE STICK BOOM	110304	STYLE III	P-U-5	1-3/4	3-1/2	PR-147754	38.46
	110311	STYLE III	P-U-5	1-3/4	3-1/2	PR-147754	38.46
MODEL 210B							
MAIN BOOM	110351		I-U-11	4	6	PR-147781	83.67
STABILIZER	110350		I-U-11	3	6	PR-147786	100.33
STICK BOOM	110351		I-U-11	4	6	PR-147781	83.67
MODEL 210C							
HEEL	110524		I-U-11	4	6	PR-147111	83.67
MAIN BOOM	110464		I-U-11	4	6	PR-147781	83.67
STABILIZER	110350		I-U-11	3	6	PR-147786	100.33
STICK BOOM	110489		I-U-11	4	6	PR-147781	83.67
MODEL 210D							
JIB BOOM	110524		I-U-11	4	6	PR-147111	83.67
MAIN BOOM	110524		I-U-11	4	6	PR-147111	83.67
STABILIZER	110551		I-U-11	3	6	PR-147786	100.33
STICK BOOM	110524		I-U-11	4	6	PR-147111	83.67
MODEL 410							
BYPASS GRAPPLE	110267		P-U-5	1-3/4	3-1/2	PR-147754	38.46
	110276		P-V-5	1-3/4	3-1/2	PR-147736	46.60
GRAPPLE	110239	STYLE III	P-V-5	2	5	PR-147735	81.86
	110261	STYLE III	P-U-5	2	5	PR-147747	77.67
	110285		P-V-5	2	5	PR-147735	81.86
	110302		I-U-5	2-1/2	4	PR-147751	49.96
	110303		I-U-5	2-1/2	5	PR-147746	80.52
	110310		I-U-5	2-1/2	5	PR-147746	80.52
	110313		I-U-11	2-1/2	5	PR-147763	103.96
	110321		I-U-11	2-1/2	4	PR-147766	39.88
JIB BOOM	110251		I-U-5	4	6	PR-147734	91.71
	110272		I-U-5	4	6	PR-147734	91.71
MAIN BOOM	110258	STYLE III	I-U-5	4	6	PR-147734	91.71
	110291	STYLE III	I-U-5	4	6	PR-147734	91.71
STABILIZER	110257	STYLE III	I-U-5	4	6	PR-147734	91.71
	110290	STYLE III	I-V-5	4	6	PR-147732	96.62
STICK BOOM	110241		I-U-5	4	7	PR-147748	118.07
	110271	STYLE III	I-U-5	4	7	PR-147729	116.88
	110304		P-U-5	1-3/4	3-1/2	PR-147754	38.46
	110314		I-U-11	4	7	PR-147765	138.98
	110329		I-U-11	4	7	PR-147782	138.98
TELE STICK BOOM	110179	STYLE III	P-V-5	1-3/4	3-1/2	PR-147736	46.60
	110304	STYLE III	P-U-5	1-3/4	3-1/2	PR-147754	38.46
MODEL 410B							
BRAKE ACTIVATING	110345	STYLE IV	I-U-11	2-1/2	5	PR-10032269	91.77

Replacement Kits For

PRENTICE®

Crane Loaders							
APPLICATION	CYL #	Misc - Serial #, Date, etc.	CODE	ROD	BORE	KIT #	List \$
MODEL 410B							
JIB BOOM	110326	STYLE IV	I-U-11	4	6	PR-10032275	109.48
MAIN BOOM	110348	STYLE IV	I-U-11	4	6	PR-10032275	109.48
STABILIZER	110349	STYLE IV	I-U-11	4	6	PR-10032275	109.48
STEERING	110340	STYLE IV	I-U-11	2	3-1/2	PR-10032265	54.29
STICK BOOM	110323	STYLE IV	I-U-11	4	7	PR-10032276	127.40
TELE BOOM	110366	STYLE IV	I-U-11	2	3-1/2	PR-10032265	54.29
MODEL 410C							
JIB BOOM	110525	STYLE IV	I-U-11	4	6	PR-10032275	109.48
MAIN BOOM	110510	STYLE IV	I-U-11	4	6	PR-10032275	109.48
STABILIZER	110517	STYLE IV	I-U-11	4	6	PR-10032275	109.48
STICK BOOM	110513	STYLE IV	I-U-11	4	7	PR-10032276	127.40
TELE BOOM	110366	STYLE IV	I-U-11	2	3-1/2	PR-10032265	54.29
MODEL 410D							
CAB TILT	513714	S/N 27337 --> : STYLE I	P-N-2	1	2	PR-147618	10.96
JIB BOOM	110524	S/N 27337 -->	I-U-11	4	6	PR-147111	83.67
MAIN BOOM	110521	S/N 27337 -->	I-U-11	4	6	PR-147111	83.67
	110521	S/N 27337 --> : STYLE IV	I-U-11	4	6	PR-10032275	109.48
STABILIZER	110552	S/N 27337 --> : STYLE IV	I-U-11	4	6	PR-10032275	109.48
	110552	S/N 27337 -->	I-U-11	4	6	PR-147111	83.67
STEERING	110340	S/N 27337 --> : STYLE IV	I-U-11	2	3-1/2	PR-10032265	54.29
	110340	S/N 27337 -->	I-U-11	2	3-1/2	PR-147770	68.01
STICK BOOM	110513	S/N 27337 -->	I-U-11	4	7	PR-147794	120.96
TELE BOOM	110366	S/N 27337 --> : STYLE IV	I-U-11	2	3-1/2	PR-10032265	54.29
	110366	S/N 27337 -->	I-U-11	2	3-1/2	PR-147770	68.01
MODEL 410-DX							
CAB TILT	513714		P-N-2	1	2	PR-147618	10.96
STABILIZER	110552		I-U-11	4	6	PR-147111	83.67
STEERING	110340		I-U-11	4	6	PR-147111	83.67
STICK BOOM	10001524		I-U-11	4	6	PR-147111	83.67
MODEL 610							
GRAPPLE	110239		P-V-5	2	5	PR-147735	81.86
	110261		P-U-5	2	5	PR-147747	77.67
	110267		P-U-5	1-3/4	3-1/2	PR-147754	38.46
	110276		P-V-5	1-3/4	3-1/2	PR-147736	46.60
	110285		P-V-5	2	5	PR-147735	81.86
	110303		I-U-5	2-1/2	5	PR-147746	80.52
JIB BOOM	110259	STYLE III	I-U-5	4	6	PR-147734	91.71
	110372		I-U-11	4	6	PR-147781	83.67
	110372	STYLE IV	I-U-11	4	6	PR-10032275	109.48
MAIN BOOM	110254		I-U-5	4	7	PR-147748	118.07
	110316		I-U-11	4	7	PR-147765	138.98
	110331		I-U-11	4	7	PR-147769	120.96
	110331	STYLE IV	I-U-11	4	7	PR-10032276	127.40
	110370		I-U-11	4	7	PR-147769	120.96
	110370	STYLE IV	I-U-11	4	7	PR-10032276	127.40
STABILIZER	110242		I-U-5	4	7	PR-147748	118.07

Replacement Kits For

PRENTICE®

Crane Loaders							
APPLICATION	CYL #	Misc - Serial #, Date, etc.	CODE	ROD	BORE	KIT #	List \$
MODEL 610							
STABILIZER	110369	STYLE IV	I-U-11	4	7	PR-10032276	127.40
	110369		I-U-11	4	7	PR-147769	120.96
STEERING	110250	STYLE III	P-V-5	1-3/4	4	PR-147740	59.49
	110265	STYLE III	P-U-5	1-3/4	4	PR-147752	49.28
	110365	STYLE IV	I-U-11	2-1/2	4	PR-10032267	52.53
	110365		I-U-11	2-1/2	4	PR-147771	76.89
STICK BOOM	110258		I-U-5	4	6	PR-147734	91.71
	110348		I-U-11	4	6	PR-147781	83.67
MODEL RT-610							
GRAPPLE	110239		P-V-5	2	5	PR-147735	81.86
	110261		P-U-5	2	5	PR-147747	77.67
	110267		P-U-5	1-3/4	3-1/2	PR-147754	38.46
	110276		P-V-5	1-3/4	3-1/2	PR-147736	46.60
	110285		P-V-5	2	5	PR-147735	81.86
	110303		I-U-5	2-1/2	5	PR-147746	80.52
JIB BOOM	110259		I-U-5	4	6	PR-147734	91.71
	110372		I-U-11	4	6	PR-147781	83.67
MAIN BOOM	110254		I-U-5	4	7	PR-147748	118.07
	110316		I-U-11	4	7	PR-147765	138.98
	110331		I-U-11	4	7	PR-147769	120.96
	110370		I-U-11	4	7	PR-147769	120.96
STABILIZER	110242		I-U-5	4	7	PR-147748	118.07
	110369		I-U-11	4	7	PR-147769	120.96
STEERING	110250		P-V-5	1-3/4	4	PR-147740	59.49
	110265		P-U-5	1-3/4	4	PR-147752	49.28
	110365		I-U-11	2-1/2	4	PR-147771	76.89
STICK BOOM	110258		I-U-5	4	6	PR-147734	91.71
	110348		I-U-11	4	6	PR-147781	83.67
MODEL SERIES-3B3							
HOIST	110045	S/N Prior - 363	I-V-7	4-1/4	5	PR-147604	110.17
	110045	S/N 364 -->	I-V-5	4	5	PR-147809	84.53
	110045	S/N 364-->	I-V-1	4		PR-147504	25.77
MODEL SERIES-4B4							
STABILIZER-TYPE 1 (Bolt On Head)	110102	Cyls prior to 11/68	P-V-7	1-3/4	4	PR-147627	58.10
	110102	Cyls after 11/68	P-V-5	1-3/4	4	PR-147830	59.49
STICK BOOM	110214	S/N All	P-V-1	2		PR-147508	23.35
	110214	S/N Prior - 363	P-V-7	2	5	PR-147608	66.93
	110214	S/N 364 -->	P-V-5	2	5	PR-147811	75.71
MODEL SERIES-4BL							
HOIST	110044	S/N 364 -->	I-V-5	4	5	PR-147809	84.53
	110044	S/N All	I-V-1	4		PR-147504	25.77
	110044	S/N Prior - 363	I-V-7	4-1/4	5	PR-147604	110.17
MODEL SERIES-4L4							
HOIST	110044	S/N All	I-V-1	4		PR-147504	25.77
	110044	S/N Prior - 363	I-V-7	4-1/4	5	PR-147604	110.17
	110044	S/N 364 -->	I-V-5	4	5	PR-147809	84.53

Replacement Kits For

PRENTICE®

Crane Loaders							
APPLICATION	CYL #	Misc - Serial #, Date, etc.	CODE	ROD	BORE	KIT #	List \$
MODEL SERIES-4L4							
STABILIZER-TYPE 1 (Bolt On Head)	110102	Cyls after 11/68	P-V-5	1-3/4	4	PR-147830	59.49
	110102	Cyls prior to 11/68	P-V-7	1-3/4	4	PR-147627	58.10
MODEL SERIES-G							
MAIN BOOM	110036	S/N All	I-V-1	4		PR-147505	24.49
	110036	S/N 364 -->	I-V-5	4	6	PR-147800	80.08
STICK BOOM	110212	S/N All	P-V-1	2-1/2		PR-147513	22.87
	110212	S/N Prior - 363	P-V-7	2-1/2	5	PR-147613	65.99
	110212	S/N 364 -->	P-V-5	2-1/2	5	PR-147803	82.10
MODEL SERIES-GBL							
KNUCKLE (Bolt On Head)	110102	Cyls prior to 11/68	P-V-7	1-3/4	4	PR-147627	58.10
	110102	Cyls after 11/68	P-V-5	1-3/4	4	PR-147830	59.49
KNUCKLE (Snap Ring Head)	110012	Cyls prior to 11/68	P-O-7	1-3/4	4	PR-147602	42.44
	110012	Cyls after 11/68	P-O-5	1-3/4	4	PR-147807	42.03
MAIN BOOM	110036	S/N 364 -->	I-V-5	4	6	PR-147800	80.08
	110036	S/N All	I-V-1	4		PR-147505	24.49
STABILIZER-TYPE 1 (Snap Ring Head)	110013	Cyls after 11/68	P-O-5	1-3/4	4	PR-147807	42.03
	110013	Cyls prior to 11/68	P-O-7	1-3/4	4	PR-147602	42.44
STABILIZER-TYPE 2 (Bolt On Head)	110121	Cyls after 11/68	P-V-7	2-1/2	4-1/2	PR-147621	63.22
	110121	Cyls prior to 11/68	P-V-5	2-1/2	4-1/2	PR-147821	75.93
STABILIZER-TYPE 4 (Bolt On Head)	110042	Cyls after 8/23/68	P-V-5	2	5	PR-147811	75.71
	110042	Cyls prior to 8/23/68	P-V-7	2	5	PR-147608	66.93
STICK BOOM	110212	S/N All	P-V-1	2-1/2		PR-147513	22.87
	110212	S/N 364 -->	P-V-5	2-1/2	5	PR-147803	82.10
	110212	S/N Prior - 363	P-V-7	2-1/2	5	PR-147613	65.99
SWING (400° Swing)	204507	S/N Prior - 370; S/N 496 -->	I-N-9		5	PR-147629	100.19
	204507	S/N 371 - 495	I-N-5		5	PR-147817	87.87
MODEL SERIES-H							
MAIN BOOM	110037	S/N 373 -->	I-V-5	4	7	PR-147802	108.50
	110037	S/N Prior - 372	I-V-7	4	7	PR-147606	154.85
STABILIZER-TYPE 1 (Bolt On Head)	110158		P-V-5	2-1/2	4	PR-147814	59.49
STABILIZER-TYPE 1 (Screw On Head)	110067	Cyls prior to 11/68	P-V-7	2-1/2	4	PR-147612	58.30
	110067	Cyls after 11/68	P-V-5	2-1/2	4	PR-147814	59.49
STICK BOOM	110218	S/N All	P-V-5	2-1/2	6	PR-147801	84.45
	110218	S/N All	P-V-1	2-1/2	6	PR-147514	27.08
MODEL SERIES-HBL							
KNUCKLE (Bolt On Head)	110102	Cyls after 11/68	P-V-5	1-3/4	4	PR-147830	59.49
	110102	Cyls prior to 11/68	P-V-7	1-3/4	4	PR-147627	58.10
KNUCKLE (Snap Ring Head)	110012	Cyls after 11/68	P-O-5	1-3/4	4	PR-147807	42.03
	110012	Cyls prior to 11/68	P-O-7	1-3/4	4	PR-147602	42.44
STABILIZER-TYPE 1 (Snap Ring Head)	110013	Cyls prior to 11/68	P-O-7	1-3/4	4	PR-147602	42.44
	110013	Cyls after 11/68	P-O-5	1-3/4	4	PR-147807	42.03
STABILIZER-TYPE 2 (Bolt On Head)	110121	Cyls after 11/68	P-V-7	2-1/2	4-1/2	PR-147621	63.22
	110121	Cyls prior to 11/68	P-V-5	2-1/2	4-1/2	PR-147821	75.93
STABILIZER-TYPE 4 (Bolt On Head)	110042	Cyls after 8/23/68	P-V-5	2	5	PR-147811	75.71
	110042	Cyls prior to 8/23/68	P-V-7	2	5	PR-147608	66.93

Replacement Kits For

PRENTICE®

Crane Loaders							
APPLICATION	CYL #	Misc - Serial #, Date, etc.	CODE	ROD	BORE	KIT #	List \$
MODEL SERIES-HBL							
SWING (400° Swing)	204507	S/N Prior - 370; S/N 496 -->	I-N-9		5	PR-147629	100.19
	204507	S/N 371 - 495	I-N-5		5	PR-147817	87.87
Grapples & Attachments							
APPLICATION	CYL #	Misc - Serial #, Date, etc.	CODE	ROD	BORE	KIT #	List \$
MODEL ALL MODELS							
CLAM BKT CYL - 1041-5/8 YD	110137		P-V-5	1-3/4	4	PR-147830	59.49
	110137		P-U-5	1-3/4	4	PR-147752	49.28
	110379		I-U-11	2-1/2	4	PR-147771	76.89
FORK CYL - 1053	110342		I-U-11	2-1/2	4	PR-147771	76.89
GRAPPLE	110353	STYLE IV	I-U-11	2-1/2	4	PR-10032267	52.53
	110354	STYLE IV	I-U-11	2-1/2	4	PR-10032267	52.53
	110355	STYLE IV	I-U-11	2-1/2	5	PR-10032269	91.77
	110376	STYLE IV	I-U-11	2	3-1/2	PR-10032265	54.29
	110380	STYLE IV	I-U-11	2-1/2	4	PR-10032267	52.53
	110386	STYLE IV	I-U-11	2-1/2	5	PR-10032269	91.77
	110415	STYLE IV	I-U-11	2	3-1/2	PR-10032265	54.29
	110428	STYLE IV	I-U-11	2	3-1/2	PR-10032265	54.29
	110435	STYLE IV	I-U-11	2	3-1/2	PR-10032265	54.29
	110501	STYLE IV	I-U-11	2-1/2	4	PR-10032267	52.53
GRAPPLE - 1/2 Cord 270/CR, 848 Wedge 270/CR	110302		I-U-5	2-1/2	4	PR-147751	49.96
	110354		I-U-11	2-1/2	4	PR-147771	76.89
GRAPPLE - 1/2 Cord Slasher C/R	110321		I-U-11	2-1/2	4	PR-147766	39.88
	110353		I-U-11	2-1/2	4	PR-147771	76.89
GRAPPLE - 3/4 & 1 Cord 270/CR	110386		I-U-11	2-1/2	5	PR-147780	66.00
GRAPPLE - 3/4 & 1 Cord 270/CR & 955, 1060, 1066, &	110303		I-U-5	2-1/2	5	PR-147746	80.52
GRAPPLE - 310/410,342,351,CBP	110266		I-U-5	1-1/2	3-1/2	PR-147753	39.63
GRAPPLE - 315	110376		I-U-11	2	3-1/2	PR-147770	68.01
GRAPPLE - 442, AC442, TC442, & CX442	110415		I-U-11	2	3-1/2	PR-147770	68.01
GRAPPLE - 734	110428		I-U-11	2	3-1/2	PR-147770	68.01
GRAPPLE - 742 Wedge 270/CR	110267		P-U-5	1-3/4	3-1/2	PR-147754	38.46
	110358	STYLE IV	I-U-11	2	3-1/2	PR-10032265	54.29
	110358		I-U-11	2	3-1/2	PR-147770	68.01
GRAPPLE - 955, 1060, 1066, & 1372 Wedge 270/CR	110355		I-U-11	2-1/2	5	PR-147780	66.00
GRAPPLE - C554	110501		I-U-11	2-1/2	4	PR-147771	76.89
GRAPPLE - C656S, CX656S, C762S, CX762S	110435		I-U-11	2	3-1/2	PR-147770	68.01
GRAPPLE - C752S	110380		I-U-11	2-1/2	4	PR-147771	76.89
SLASHER - 752	110380		I-U-11	2-1/2	4	PR-147771	76.89
Knuckle Boom Loaders							
APPLICATION	CYL #	Misc - Serial #, Date, etc.	CODE	ROD	BORE	KIT #	List \$
MODEL 410C, SERIES F							
GRAPPLE	110087	S/N All	P-V-5	1-1/2	3-1/2	PR-147819	46.26

Replacement Kits For

PRENTICE®

Knuckle Boom Loaders							
APPLICATION	CYL #	Misc - Serial #, Date, etc.	CODE	ROD	BORE	KIT #	List \$
MODEL 410C, SERIES F							
GRAPPLE	110087	S/N All	P-V-1	1-1/2		PR-147515	31.15
	110134	S/N All	P-V-1	1-3/4		PR-147509	23.07
	110134	S/N All	P-V-5	1-3/4	4	PR-147812	47.12
SWING ASSY	110036	S/N 8200 - 10067	I-N-5		4	PR-147816	100.59
	110060	S/N 10068 -	I-N-9		4	PR-147628	146.25
MODEL 410C, SERIES G							
GRAPPLE	110087	S/N All	P-V-1	1-1/2		PR-147515	31.15
	110087	S/N All	P-V-5	1-1/2	3-1/2	PR-147819	46.26
	110134	S/N All	P-V-1	1-3/4		PR-147509	23.07
	110134	S/N All	P-V-5	1-3/4	4	PR-147812	47.12
H.D. STABILIZER	110042	S/N All	P-V-5	2	5	PR-147811	75.71
	110042	S/N All	P-V-1	2		PR-147508	23.35
MAIN BOOM	110036	S/N All	I-V-1	4		PR-147505	24.49
	110036	S/N All	I-V-5	4	6	PR-147800	80.08
STICK BOOM	110214	S/N All	P-V-5	2	5	PR-147811	75.71
	110214	S/N All	P-V-1	2		PR-147508	23.35
SWING ASSY	110036	S/N 8200 - 10067	I-N-5		4	PR-147816	100.59
	110060	S/N 10068 -	I-N-9		4	PR-147628	146.25
MODEL 410C, SERIES H							
GRAPPLE	110087	S/N All	P-V-1	1-1/2		PR-147515	31.15
	110087	S/N All	P-V-5	1-1/2	3-1/2	PR-147819	46.26
	110134	S/N All	P-V-5	1-3/4	4	PR-147812	47.12
	110134	S/N All	P-V-1	1-3/4		PR-147509	23.07
H.D. STABILIZER	110042	S/N All	P-V-1	2		PR-147508	23.35
	110042	S/N All	P-V-5	2	5	PR-147811	75.71
MAIN BOOM	110037	S/N All	I-V-5	4	7	PR-147802	108.50
	110037	S/N All	I-V-1	4		PR-147506	29.01
STICK BOOM	110216	S/N All	P-V-5	2-1/2	6	PR-147801	84.45
	110216	S/N All	P-V-1	2-1/2	6	PR-147514	27.08
SWING ASSY	111047	Cyls prior to 6/65	N-N-9		5	PR-147616	103.84
	111079	S/N 8200-HP7007, 11001 : 11/68 - 7/70	I-N-5		5	PR-147817	87.87
	111080	S/N 8200-HP7007, 11001 : 11/68 - 7/70	I-N-5		5	PR-147817	87.87
	111081	S/N 8200-HP7007, 11001 : 11/68 - 7/70	I-N-5		5	PR-147817	87.87
	204511	S/N 11002 -	I-N-9		5	PR-147629	100.19
	204512	S/N 11002 -	I-N-9		5	PR-147629	100.19

PRENTICE®

REPLACEMENT KITS FOR PRENTICE® EQUIPMENT

Kit Number	Code (Pg. xviii)	Rod X Bore Size	List Price
PR-10028680	I-U-11	2 x 3-1/2	\$ 33.87
PR-10032263	I-U-11	1-1/2 X 3	54.66
PR-10032264	I-U-11	1-1/2 X 3-1/2	47.61
PR-10032265	I-U-11	2 X 3-1/2	54.29
PR-10032266	I-U-11	2 X 4	63.03
PR-10032267	I-U-11	2-1/2 X 4	52.53
PR-10032268	I-U-11	2-1/2 X 4-1/2	77.72
PR-10032269	I-U-11	2-1/2 X 5	91.77
PR-10032270	I-U-11	3 X 5	97.16
PR-10032274	I-U-11	3 X 6	100.95
PR-10032275	I-U-11	4 X 6	109.48
PR-10032276	I-U-11	4 X 7	127.40
PR-10034620	I-U-11	2-1/2 X 4	52.53
PR-10034622	I-U-11	2-1/2 x 5	96.74
PR-10034624	I-U-11	3 X 6	100.95
PR-10034628	I-U-5	4 X 6	133.99
PR-10034629	I-U-11	4 X 6	147.81
PR-10034630	I-U-11	4 X 7	170.38
PR-147100	I-U-13	1-1/2 X 3	36.27
PR-147101	I-U-13	2-1/2 X 4-1/2	53.49
PR-147102	I-U-13	2-1/2 X 5-1/2	82.56
PR-147103	I-U-11	1-1/4 X 2-1/2	29.27
PR-147108	I-U-11	4-1/2 X 8	178.53
PR-147109	I-OB-1	3/4 Rod Kit	5.02
PR-147110	I-U-11	2-1/2 X 4	52.99
PR-147111	I-U-11	4 X 6	83.67
PR-147282	P-U-5	2 X 3-1/2	24.75
PR-147504	I-V-0	4" Rod Kit	25.77
PR-147505	I-V-1	4 X 6	24.49
PR-147506	I-V-0	4" Rod Kit	29.01
PR-147508	P-V-1	2" Rod Kit	23.35
PR-147509	P-V-1	1-3/4" Rod Kit	23.07
PR-147510	P-V-2	1-3/4 X 4-1/2	23.16
PR-147513	P-V-1	2-1/2 X 5	22.87
PR-147514	P-V-1	2-1/2 X 6	27.08
PR-147515	P-V-1	1-1/2 X 3-1/2	31.15
PR-147522	P-V-1	2-1/2" Rod Kit	24.27
PR-147530	P-V-1	1-3/4 X 4	27.25
PR-147532	I-U-1	4" Rod Kit	36.27
PR-147600	P-O-7	1-1/2 X 3-1/2	37.47
PR-147602	P-O-7	1-3/4 X 4	42.44
PR-147603	P-V-7	2 X 4-1/2	52.52
PR-147604	I-V-7	4-1/4 X 5	110.17
PR-147606	I-V-7	4 X 7	154.85
PR-147608	P-V-7	2 X 5	66.93
PR-147609	P-V-7	1-3/4 X 4	53.86
PR-147612	P-V-7	2-1/2 X 4	58.30
PR-147613	P-V-7	2-1/2 X 5	65.99
PR-147615	N-N-9	4" Piston Kit	54.32
PR-147616	N-N-9	5" Piston Kit	103.84

Kit Number	Code (Pg. xviii)	Rod X Bore Size	List Price
PR-147617	I-V-9	4 X 5	\$ 118.01
PR-147618	P-O-1	1" Rod Kit	10.96
PR-147619	P-V-7	1-1/2 X 3-1/2	47.22
PR-147621	P-V-7	2-1/2 X 4-1/2	63.22
PR-147627	P-V-7	1-3/4 X 4	58.10
PR-147628	I-N-9	4" Piston Kit	146.25
PR-147629	I-N-9	5" Piston Kit	100.19
PR-147703	Rotary Actuator		21.63
PR-147729	I-U-5	4 X 7	116.88
PR-147731	P-V-5	2-1/2 X 5	64.90
PR-147732	I-V-5	4 X 6	96.62
PR-147733	I-V-5	4 X 7	84.33
PR-147734	I-U-5	4 X 6	91.71
PR-147735	P-V-5	2 X 5	81.86
PR-147736	P-V-5	1-3/4 X 3-1/2	46.60
PR-147738	Rotary Actuator Kit	2 X 6-3/4	66.12
PR-147740	P-V-5	1-3/4 X 4	59.49
PR-147746	I-U-5	2-1/2 X 5	80.52
PR-147747	P-U-5	2 X 5	77.67
PR-147748	I-U-5	4 X 7	118.07
PR-147751	I-U-5	2-1/2 X 4	49.96
PR-147752	P-U-5	1-3/4 X 4	49.28
PR-147753	I-U-5	1-1/2 X 3-1/2	39.63
PR-147754	P-U-5	1-3/4 X 3-1/2	38.46
PR-147763	I-U-11	2-1/2 X 5	103.96
PR-147765	I-U-11	4 X 7	138.98
PR-147766	I-U-11	2-1/2 X 4	39.88
PR-147769	I-U-11	4 X 7	120.96
PR-147770	I-U-11	2 X 3-1/2	68.01
PR-147771	I-U-11	2-1/2 X 4	76.89
PR-147780	I-U-11	2-1/2 X 5	66.00
PR-147781	I-U-11	4 X 6	83.67
PR-147782	I-U-11	4 X 7	138.98
PR-147783	I-U-11	4-1/2 X 8	186.43
PR-147786	I-U-11	3 X 6	100.33
PR-147788	I-U-11	1-1/2 X 3-1/2	53.75
PR-147794	I-U-11	4 X 7	120.96
PR-147800	I-V-5	4 X 6	80.08
PR-147801	P-V-5	2-1/2 X 6	84.45
PR-147802	I-V-5	4 X 7	108.50
PR-147803	P-V-5	2-1/2 X 5	82.10
PR-147804	P-V-5	1-3/4 X 4-1/2	61.96
PR-147807	P-O-5	1-3/4 X 4	42.03
PR-147808	P-V-5	2 X 4-1/2	63.30
PR-147809	I-V-5	4 X 5	84.53
PR-147810	P-V-5	1-3/4 X 3-1/2	57.95
PR-147811	P-V-5	2 X 5	75.71
PR-147812	P-V-5	1-3/4 X 4	47.12
PR-147813	P-V-5	1-1/2 X 3-1/2	31.71
PR-147814	P-V-5	2-1/2 X 4	59.49

REPLACEMENT KITS FOR PRENTICE® EQUIPMENT

Kit Number	Code (Pg. xviii)	Rod X Bore Size	List Price
PR-147815	P-V-5	2-1/2 X 6	\$ 87.02
PR-147816	I-N-5	4" PISTON KIT	100.59
PR-147817	I-N-5	5" PISTON KIT	87.87
PR-147819	P-V-5	1-1/2 X 3-1/2	46.26
PR-147821	P-V-5	2-1/2 X 4-1/2	75.93
PR-147826	P-V-1	2-1/2 X 7	29.95
PR-147828	P-U-5	2 X 3-1/2	24.75
PR-147829	P-U-5	1-3/4 X 3	58.08
PR-147830	P-V-5	1-3/4 X 4	59.49
PR-147831	P-V-5	2-1/2 X 6	82.62
PR-147832	I-U-5	4 X 7	114.37
PR-147833	I-U-5	2-1/2 X 6	85.43
PR-147834	I-U-5	4 X 6	87.56
PR-147835	I-V-5	4 X 7	120.92
PR-147836	I-V-5	4 X 6	80.54

Kit Number	Code (Pg. xviii)	Rod X Bore Size	List Price
PR-147842	P-V-5	1-3/4 X 4	\$ 59.49
PR-147849	P-V-5	2 X 5	97.54
PR-147857	P-V-5	2-1/2 X 4	63.55
PR-147858	I-V-5	4 X 6	86.54
PR-30007033	P-U-14	2-1/2 X 5	204.18
PR-30007301	P-U-14	2-1/2 X 5	169.03
PR-563594	I-U-1	1" Rod Kit	40.80
PR-8804019	I-U-11	2 X 3-1/2	44.60
PR-8804048	I-U-11	1-1/2 X 3	37.51
PR-8804062	I-U-11	1-1/4 X 2-1/2	30.25
PR-8804076	I-U-10	2-1/2 X 4-1/2	66.24
PR-8804094	I-U-11	3 X 6	86.53
PR-8804105	I-U-10	2-1/2 X 5-1/2	85.38
PR-8804214	I-U-11	4 X 7	125.06

REPLACEMENT PARTS FOR PRENTICE® EQUIPMENT

NOTE: Prentice part numbers are used as a reference only. We do not imply that these kits are original REPLACEMENT PARTS.

U-SEALS

Part Number	Rod Dia.	List Price
PR-10032223	4	\$ 27.34

PRINCE

Kit Number	Code (Pg. xviii)	Rod X Bore Size	List Price
PC-10200	I-OB-5	1-1/4 X 2-3/8	\$ 29.16
PC-19700	I-U-10	1-3/8 X 3	19.84
PC-31841	I-U-10, 12	1-3/4 X 6	114.60
PC-31842	I-U-10, 12	2 X 6	114.09
PC-A807	P-V-9	2 X 5	76.09
PC-D1192	P-O-3, 12	1-3/8 X 3-1/4	35.06
PC-F-1121	I-OB-10	1-3/4 X 4	9.99
PC-F-1122	I-OB-10	1-3/4 X 3	13.07
PC-F237	I-OB-12	3 X 7	121.63
PC-G476	I-OB-3, 12	2 X 6	31.80
PC-H304	I-N-4	2-3/8, 3-3/8, 4-3/8 Stages	56.98
PC-H346	I-U-1	2-3/8, 3-3/8 Stages	36.94
PC-J1335	I-U-12	4-1/2 X 6	124.43
PC-J421	I-U-10, 12	1-1/2 X 3	53.47
PC-K1215	I-U-4	3, 4-1/2 Stages	107.63
PC-M387	I-U-3, 12	2-1/2 X 3-1/2	32.14
PMCK-10000	I-U-5	3 X 6	153.76
PMCK-19400	I-U-10	3/4 X 1-1/2	44.39
PMCK-19500	I-U-10	1-1/8 X 2	46.00
PMCK-19900	I-U-10	1-3/4 X 4	56.23
PMCK-21000	I-U-10	2-1/2 X 5	102.67
PMCK-22000	I-U-10	3 X 6	124.09
PMCK-35000	I, P-U-13	2 X 5	71.42
PMCK-42000	I-U-13	1-1/8 X 2	80.39
PMCK-43000	I-U-13	1-3/8 X 3	54.63
PMCK-43500	I-U-13	1-1/2 X 3-1/2	61.87
PMCK-44000	I-U-11	1-3/4 X 4	66.13

Kit Number	Code (Pg. xviii)	Rod X Bore Size	List Price
PMCK-5400	I-OB-3, 12	1-3/8 X 2-1/2	\$ 52.67
PMCK-5500	I-OB-3, 12	1-1/2 X 3-1/2	65.21
PMCK-5600	I-OB-3, 12	2 X 4	70.15
PMCK-7000	I-U-3	1-1/8 X 2-1/2	44.96
PMCK-7100	I-U-3	1-1/8 X 3	44.39
PMCK-8300	I-OB-3, 12	1-1/2 X 3	55.89
PMCK-8400	I-U-11	1 X 2	37.03
PMCK-9000	I-U-3	1-1/8 X 2	37.03
PMCK-9100	I-U-3	1-1/4 X 2-1/2	44.96
PMCK-9200	I-U-3	1-3/8 X 3	41.06
PMCK-9300	I-U-3	1-3/8 X 3-1/2	47.61
PMCK-9400	I-U-3	1-3/4 X 4	53.93
PMCK-9500	I-U-3	2 X 5	66.13
PMCK-9900	I-U-5	2-1/2 X 5	144.90
PMCK-AA-606	I-U-5	1-1/2 X 4	41.46
PMCK-AD414	I-U-13	2-1/2 X 4	32.94
PMCK-AE-343	I-U-2	3 X 8	41.24
PMCK-AF962	I-U-13	2-1/2 X 4	33.94
PMCK-AK-84	P-U-10	1-3/4 X 2-1/2	55.32
PMCK-AM-1139	P-U-10	1-3/4 X 2-1/2	54.23
PMCK-B200000	I-U-10	1-1/8 X 2	33.12
PMCK-B300000	P-U-10	1-3/8 X 3	39.67
PMCK-B400000	P-U-10	1-3/4 X 4	65.21
PMCK-B500000	P-U-10	2 X 5	59.52

PRINCE

We Also Carry the **PRINCE CYLINDER LINE**
in our **US Facility**

See the Complete Selection and
Place Your Order Online

RAYMOND LIFT TRUCKS

Kit Number	Code (Pg. xviii)	Rod X Bore Size	List Price
RAY-400-148-01	O-RING KIT		\$ 6.03
RAY-500-412-02	O-RING KIT		10.58
RAY-520-037-15	O-RING KIT		0.60
RAY-520-038-12	O-RING KIT		6.03
RAY-520-041-01	O-RING KIT		5.65
RAY-520-044-01	O-RING KIT		6.03
RAY-520047004	P-U-10	3/4 X 1-3/4	38.40
RAY-520-053-01	O-RING KIT		6.03
RAY-520-066-01	O-RING KIT		7.04
RAY-520-077-01	VALVE KIT		29.86
RAY-520-817-08	O-RING KIT		6.03
RAY-520-899-113	O-RING KIT		3.21
RAY-53072101	I-U-11	3/4 X 2-1/2	24.72
RAY-530-722-02	I-U-11	1 X 2-1/2	25.23
RAY-53072702	P-U-1	1-3/4	121.27
RAY-53073101	I-U-11	1-1/4 X 2-1/2	25.12
RAY-53073102	I-U-11	1-1/4 X 3	35.67
RAY-54004105	P-OB-10	3/4 X 1-3/4	46.75
RAY-540041105	P-OB-10	3/4 X 1-3/4	32.55
RAY-540-043-07	P-OB-10	3/4 X 1-3/4	41.96
RAY-540-046-05	P-OB-10	3/4 X 1-3/4	60.16
RAY-540-052-01	SEAL KIT		3.66
RAY-540-056-06	SEAL KIT		6.73
RAY-540067214	I-U-13	1-3/4 X 3-1/2	54.81
RAY-540113269	I-U-13	1-3/4 X 3-1/2	41.19
RAY-870-460-217	VALVE KIT		19.21
RAY-870-607-26	VALVE KIT		10.45

RED LION TIE-ROD CYLINDERS

Kit Number	Code (Pg. xviii)	Rod X Bore Size	List Price
RL-492901	P-OB-3	1-1/8 X 2	\$ 10.81
RL-492903	P-OB-3	1-1/8 X 2-1/2	11.49
RL-492907	P-OB-3	1-1/4 X 3	12.12
RL-492911	P-OB-3	1-1/4 X 3-1/2	12.78
RL-492915	P-OB-3	1-1/4 X 4	13.87
RL-RK-20TR-112	P-OB-3	1-1/8 X 2	15.55

REYNOLDS® SCRAPER

Kit Number	Code (Pg. xviii)	Rod X Bore Size	List Price
RE-1020306	I-U-10,12	2 X 6	\$105.77
RE-1020878	I-U-10,12	2 X 6	104.36
RE-1020879	I-U-10,12	2 X 3-1/2	42.74
RE-1023060	I-U-10,12	2-1/2 X 6	110.38

REYNOLDS® SCRAPER

Kit Number	Code (Pg. xviii)	Rod X Bore Size	List Price
RE-7040H012	I-U-10,12	1-1/2 X 3-1/2	\$ 40.44
RE-7040H012NPR	I-U-10	1-1/2 X 3-1/2	18.66
RE-7040H014	I-U-10,12	1-1/2 X 3	40.94
RE-7040H014NPR	I-U-10	1-1/2 X 3	18.00
RE-7040H017	I-U-10	2 X 3-1/2	39.45
RE-7040H017NPR	I-U-10	2 X 3-1/2	17.42
RE-7040H019	I-U-10,12	1-3/4 X 4	48.66
RE-7040H019NPR	I-U-10	1-3/4 X 4	20.81
RE-7040H022	I-U-10,12	1-1/2 X 4	32.15
RE-7040H022NPR	I-U-10	1-1/2 X 4	19.88
RE-7040H023	I-U-10,12	2 X 5	73.85
RE-7040H023NPR	I-U-10	2 X 5	25.25
RE-7040H026	I-U-10,12	1-1/2 X 2-1/2	39.31
RE-7040H026NPR	I-U-10	1-1/2 X 2	16.94

RONEN

Kit Number	Cylinder	Code (Pg. xviii)	Rod X Bore Size	List Price
RO-3.5K	GRAPPLE CYL.	P-U-10	2 X 3-1/2	\$ 50.90
RO-4.0K	SHEAR CYL.	I-U-5	2 X 4	51.34
RO-5.0K	BOOM CYL.	P-U-5	2-1/2 X 5	90.16
RO-6.0K	BOOM CYL.	P-U-5	2-1/2 X 6	102.96
RO-7.0K	BOOM CYL.	P-U-5	3 X 7	126.07
RO-PK-4		P-U-10	2 X 4	58.12
RO-PK-5		P-U-10	2-1/2 X 5	86.98
RO-PK-6		P-U-10	3 X 6	101.53
RO-PK-7		P-U-10	3-1/2 X 7	148.28

SAMSUNG

Kit Number	Code (Pg. xviii)	Rod X Bore Size	List Price
SAM-8048-00070	P-UB-14	80 X 120 mm	\$ 421.83
SAM-8048-00130	P-UB-14	105 X 160 mm	447.65
SAM-8048-00150	P-UB-14	105 X 150 mm	478.36
SAM-8130-00420	P-UB-14	95 X 140 mm	222.84

Replacement Kits For

SANDVIK

Loaders - Wheel						
APPLICATION	CYL #	CODE	ROD	BORE	KIT #	List \$
MODEL LH307						
DUMP		P-UB-10,12	110 mm	200 mm	SDK-56016048	441.17
LIFT		P-UB-10	90 mm	140 mm	SDK-56016093	128.51
STEERING		P-UB-10	50 mm	100 mm	SDK-56016050	72.05
MODEL LH410						
DUMP		P-UB-10,12	110 mm	200 mm	SDK-56002936	472.93
LIFT		P-UB-10,12	90 mm	160 mm	SDK-56019416	238.28
STEERING		P-UB-10	70 mm	125 mm	SDK-56019415	185.23
MODEL LH410M						
DUMP		P-UB-10,12	110 mm	200 mm	SDK-56002936	472.93
MODEL TORO 007						
DUMP		P-V-10,12	110 mm	200 mm	SDK-04001784	468.79
LIFT		P-V-10,12	90 mm	160 mm	SDK-04001785	239.64
STEERING		P-V-10	70 mm	125 mm	SDK-04001783	157.41
MODEL TORO 1250						
DUMP		I-V-9	140 mm	250 mm	SDK-04001773	538.84
LIFT		I-V-14	90 mm	180 mm	SDK-04001767	145.32
STEERING		P-V-10	70 mm	125 mm	SDK-04001783	157.41

SANDVIK

Kit Number	Code (Pg. xviii)	Rod X Bore Size	List Price	Kit Number	Code (Pg. xviii)	Rod X Bore Size	List Price
SDK-04001767	I-V-14	90 X 180 mm	\$ 145.32	SDK-56016048	P-UB-10,12	110 X 200 mm	\$ 441.17
SDK-04001773	I-V-9	140 X 250 mm	538.84	SDK-56016050	P-UB-10	50 X 100 mm	72.05
SDK-04001783	P-V-10	70 X 125 mm	157.41	SDK-56016093	P-UB-10	90 X 140 mm	128.51
SDK-04001784	P-V-10,12	110 X 200 mm	468.79	SDK-56019415	P-UB-10	70 X 125 mm	185.23
SDK-04001785	P-V-10,12	90 X 160 mm	239.64	SDK-56019416	P-UB-10,12	90 X 160 mm	238.28
SDK-56002936	P-UB-10,12	110 X 200 mm	472.93				

SANDVIK

SKYJACK

Kit Number	Code (Pg. xviii)	Rod X Bore Size	List Price
SKY-113443	I-U-4	7/8 X 2	\$ 21.51
SKY-105816	I-U-4	3/4 X 1-1/2	25.15
SKY-105888	I-U-2	3 X 3-1/2	62.90
SKY-113873	I-U-4	2-1/2 X 3-3/8	41.60

O-RINGS FOR SKYJACK EQUIPMENT

Part Number	Min Pkg Qty	List Price
SKY-103828	50	\$ 0.20
SKY-120436	20	0.23

SNORKEL

Kit Number	Code (Pg. xviii)	Rod X Bore Size	List Price
SN-007-2833	P-U-5	1-3/4 X 3-1/2	\$ 74.92
SN-015-0555	P-U-11	1 X 2-1/2	34.14
SN-015-0557	P, I-U-10	1 X 2	20.08
SN-2012	I-OB-10	1 X 1-1/2	8.41
SN-2030-2	I-U-4	2-1/8 X 4	34.60
SN-2123	I-OB-10	2 X 5	20.53
SN-300752	P-U-1	2-1/2 Rod Kit	24.02
SN-44000-4	I-V-1	1-1/4 Rod Kit	16.69
SN-45540-6		2-5/8 , 3-1/2 Stages	58.04
SN-45540-6N		1-3/4 X 3-1/2 2 Stage	55.29
SN-46102-6N		1-3/4 X 3-1/2 2 Stage	60.60
SN-467066	I-U-1	2 Stage 3, 3-1/2	92.52
SN-47514-4	I, P-OB-3	5/8 X 1-1/2	15.61
SN-4772866		3, 3-1/2 Stages	79.95
SN-48798-6		3 Stage 2-1/4, 3, 3-1/2	161.42
SN-48801-6		1-1/8, 2-5/8, 3-1/2 Stages	100.49
SN-55269-4	I-U-3	1 X 1-1/2	24.14
SN-56359-6	I-U-10, 12	1 X 2	42.49
SN-58400-6	I-U-4	2-1/4 X 4	45.93
SN-60549-6	I-U-11,12	2 X 3	57.44
SN-60556-6	I-U-10,12	1-1/2 X 2-1/2	43.17
SN-62167-6	I-U-10,12	1-3/4 X 3-1/2	47.87
SN-62197-6	I-U-12,12	1-3/4 X 3-1/2	44.19
SN-A007-1478-A	I-U-5	1-3/4 X 2-1/2	52.04
SN-A007-1479-B	I-U-5	1-1/2 X 3	43.39
SN-A007-3286	I-U-10, 12	2-1/2 X 3-1/2	43.51
SN-A007-3857	I-U-11, 12	2-1/2 X 5	124.62
SN-C007-1486	N-U-11	1-3/4 X 3-1/2	25.55

STEELMASTER

Kit Number	Cylinder	Code (Pg. xviii)	Rod X Bore Size	List Price
SM-TBN		I-U-5	3 X 6	\$ 70.85
SM-TFC	Telescopic Boom Fork Cyl.	I-U-5	1-1/4 X 4-1/2	45.90
SM-TTC	Telescopic Trolley Cyl.	I-U-5	2-1/2 X 3-1/2	44.12

SUMITOMO

Kit Number	Code (Pg. xviii)	Rod X Bore Size	List Price
SUMO-LZ00476	P-UB-10	105 X 150 mm	\$ 420.84
SUMO-LZ00477	P-UB-10	100 X 145 mm	309.67
SUMO-LZ006960	P-UB-14	125 X 180 mm	1058.56
SUMO-LZ006970	P-UB-14	130 X 190 mm	1048.77
SUMO-LZ006980	P-UB-14	140 X 200 mm	648.32
SUMO-LZ007310	P-UB-14	105 X 150 mm	343.56
SUMO-LZ007320	P-UB-10	120 X 170 mm	340.67
SUMO-LZ008050	P-UB-10	105 X 145 mm	319.45
SUMO-LZ008160	P-UB-10	90 X 130 mm	136.87
SUMO-LZ008380	P-UB-10	115 X 165 mm	395.11

TAMROCK

Kit Number	Code (Pg. xviii)	Rod X Bore Size	List Price
TAMR-85069909	P-U-14	25 X 40 mm	\$ 81.98
TAMR-85577709	P-U-15	50 X 125 mm	215.61
TAMR-85711149	O-RING KIT		3.71
TAMR-87285619	I-UB-10	50 X 70 mm	405.34

Replacement Kits For

TAKEUCHI®

Excavators							
APPLICATION	CYL #	SERIAL #	CODE	ROD	BORE	KIT #	List \$
MODEL TB015							
ARM	19000-61400	1153001-	P-U-10	30 mm	55 mm	TAK-19000-58099	80.97
BLADE	19000-59200	1153001-	P-U-10	35 mm	55 mm	TAK-19000-53499	88.25
BOOM	19000-61200	1153001-	P-U-10	30 mm	55 mm	TAK-19000-61299	75.03
BUCKET	19000-61500	1153001-	P-U-10	30 mm	50 mm	TAK-19000-61599	71.95
BUCKET TEL. A.	19000-62700	1153001-	P-U-10	30 mm	55 mm	TAK-19000-51999	75.15
SPANNER	19000-59300	1153001-	P-U-10	30 mm	55 mm	TAK-19000-51999	75.15
SWING	19000-57700	1153001-	P-U-10	35 mm	60 mm	TAK-19000-53399	83.46
TELESCOPIC	19000-62900	1153001-	P-U-13	25 mm	40 mm	TAK-19000-62699	80.64
MODEL TB025							
ARM	19000-52500	1255001-	I-U-14	40 mm	70 mm	TAK-19000-43999	100.19
BLADE	19000-52700	1255001-	I-U-14	45 mm	85 mm	TAK-19000-44299	118.78
BOOM	19000-52300	1255001-	P-U-14	40 mm	75 mm	TAK-19000-43899	109.47
BOOM CABIN	19000-52400	1255001-	P-U-14	40 mm	75 mm	TAK-19000-43899	109.47
	19000-69900	1255001-	P-U-14	40 mm	75 mm	TAK-19000-43899	109.47
BUCKET	19000-52600	1255001-	I-U-14	35 mm	60 mm	TAK-19000-44099	89.47
SWING	19000-51300	1255001-	I-U-14	40 mm	75 mm	TAK-19000-46199	137.19
MODEL TB035							
ARM	19000-56200	1355001-	P-U-10	45 mm	80 mm	TAK-19000-54999	77.18
BLADE	19000-55100	1355001-	P-U-10	55 mm	100 mm	TAK-19000-55199	113.29
BOOM	19000-54700	1355001-	P-U-10	45 mm	85 mm	TAK-19000-54799	82.05
BOOM CABIN	19000-54800	1355001-	P-U-10	45 mm	85 mm	TAK-19000-54799	82.05
	19000-70100	1355001-	P-U-10	45 mm	85 mm	TAK-19000-54799	82.05
BUCKET	19000-56300	1355001-	P-U-10	40 mm	70 mm	TAK-19000-52099	100.60
SWING	19000-56100	1355001-	P-U-10	45 mm	80 mm	TAK-19000-54199	88.25
TELESCOPIC	19000-62000	1355001-	P-U-10	40 mm	65 mm	TAK-19000-62099	78.01
MODEL TB036							
ARM	19000-11400	36003-.1140	P-U-5	45 mm	80 mm	TAK-19000-05099	115.04
ARM EXT. ARM	19000-16000	36003-.1140	P-U-5	45 mm	80 mm	TAK-19000-05099	115.04
BLADE	19000-12400	36003-.1140	P-U-5	40 mm	70 mm	TAK-19000-12299	62.16
	19000-12500	36003-.1140	P-U-5	40 mm	70 mm	TAK-19000-12299	62.16
BOOM LH - New	19000-32500	36003-.1140	P-U-5	40 mm	70 mm	TAK-19000-11299	88.72
BOOM LH - Old	19000-11300	36003-.1140	P-U-5	40 mm	70 mm	TAK-19000-11299	88.72
BOOM RH - New	19000-32400	36003-.1140	P-U-5	40 mm	70 mm	TAK-19000-11299	88.72
BOOM RH - Old	19000-11299	36003-.1140	P-U-5	40 mm	70 mm	TAK-19000-11299	88.72
BUCKET	19000-35400	36003-.1140	P-U-5	40 mm	70 mm	TAK-19000-05199	87.30
EXTENSION	19000-37700	36003-.1140	I-U-5	40 mm	60 mm	TAK-19000-37799	63.90
SWING	19000-25100	36003-.1140	P-U-5	50 mm	80 mm	TAK-19000-39199	144.89
MODEL TB068							
ARM	19000-19600	68003-68914&68233-68242	P-U-5	65 mm	105 mm	TAK-19000-19699	158.22
	19000-26400	68243- ,68195-68232	P-U-5	65 mm	105 mm	TAK-19000-19699	158.22
BLADE LH	19000-16500	68003-68914&68233-68242	P-U-5	60 mm	100 mm	TAK-19000-16499	146.67
	19000-25900	68195-68232&68243-	P-U-5	60 mm	100 mm	TAK-19000-16499	146.67
BLADE RH	19000-16600	68003-68914&68233-68242	P-U-5	60 mm	100 mm	TAK-19000-16499	146.67
	19000-25800	68195-68232&68243-	P-U-5	60 mm	100 mm	TAK-19000-16499	146.67
BOOM LH	19000-26100	68195-68232&68243-68295	P-U-5	55 mm	85 mm	TAK-19000-16199	125.36
	19000-32900	68296,68596-	P-U-5	55 mm	85 mm	TAK-19000-16199	125.36

Replacement Kits For

TAKEUCHI®

Excavators							
APPLICATION	CYL #	SERIAL #	CODE	ROD	BORE	KIT #	List \$
MODEL TB068							
BOOM RH	19000-26200	68195-68232&68243-68295	P-U-5	55 mm	85 mm	TAK-19000-16199	125.36
	19000-32800	68296, 68596-	P-U-5	55 mm	85 mm	TAK-19000-16199	125.36
BUCKET	19000-26000	68195-68232&68243-	P-U-5	55 mm	90 mm	TAK-19000-16399	128.82
SWING	19000-26300	63203-	P-U-5	60 mm	100 mm	TAK-19000-16499	146.67

REPLACEMENT KITS FOR TAKEUCHI® JAPANESE EXCAVATOR

Kit Number	Code (Pg. xviii)	Rod X Bore Size	List Price	Kit Number	Code (Pg. xviii)	Rod X Bore Size	List Price
TAK-03315-06199	P-08-1	35 mm Rod Kit	\$ 28.62	TAK-19000-47195	P-U-10	50 X 90 mm	\$ 77.75
TAK-03515-04299	P-08-1	40 mm Rod Kit	17.88	TAK-19000-47295	P-U-10	45 X 80 mm	73.85
TAK-03715-01599	P-08-1	45 mm Rod Kit	14.71	TAK-19000-47695	P-U-10	55 X 100 mm	88.82
TAK-03915-04199	P-08-1	50 mm Rod Kit	23.73	TAK-19000-51699	P-U-10	35 X 65mm	107.82
TAK-19000-00199	P-U-5	45 X 80 mm	69.70	TAK-19000-51899	P-U-10	35 X 63 mm	91.03
TAK-19000-00399	P-U-5	35 X 60 mm	49.71	TAK-19000-51999	P-U-10	30 X 55 mm	75.15
TAK-19000-00599	P-U-5	40 X 70 mm	49.54	TAK-19000-52099	P-U-10	40 X 70 mm	100.60
TAK-19000-02699	P-U-5	35 X 70 mm	60.94	TAK-19000-53399	P-U-10	35 X 60 mm	83.46
TAK-19000-04599	P-U-5	45 X 80 mm	93.79	TAK-19000-53499	P-U-10	30 X 55 mm	88.25
TAK-19000-04799	P-U-5	55 X 95 mm	85.36	TAK-19000-54199	P-U-10	45 X 80 mm	88.25
TAK-19000-04899	P-U-5	50 X 90 mm	96.31	TAK-19000-54399	P-U-10	40 X 75 mm	82.91
TAK-19000-04999	P-U-5	45 X 80 mm	82.45	TAK-19000-54499	P-U-10	35 X 65 mm	53.05
TAK-19000-05099	P-U-5	45 X 80 mm	115.04	TAK-19000-54799	P-U-10	45 X 85 mm	82.05
TAK-19000-05199	P-U-5	40 X 70 mm	87.30	TAK-19000-54999	P-U-10	45 X 80 mm	77.18
TAK-19000-09599	P-U-5	45 X 85 mm	84.01	TAK-19000-55099	P-U-10	40 X 70 mm	38.69
TAK-19000-09899	P-U-5	35 X 60 mm	70.15	TAK-19000-55199	P-U-10	55 X 100 mm	113.29
TAK-19000-09999	I,P-U-5	35 X 60 mm	76.99	TAK-19000-56999	P-U-10	25 X 50 mm	75.96
TAK-19000-10599	P-U-5	50 X 90 mm	79.46	TAK-19000-57199	P-U-10	25 X 50 mm	65.58
TAK-19000-11199	P-U-5	40 X 63 mm	88.65	TAK-19000-58099	P-U-10	30 X 55 mm	80.97
TAK-19000-11299	P-U-5	40 X 70 mm	88.72	TAK-19000-58199	P-U-10	40 X 65 mm	86.28
TAK-19000-11899	P-U-5	35 X 65 mm	89.37	TAK-19000-60699	I-U-14	35 X 60 mm	100.37
TAK-19000-12199	P-U-5	50 X 85 mm	103.48	TAK-19000-61299	P-U-10	30 X 55 mm	75.03
TAK-19000-12299	P-U-5	40 X 70 mm	62.16	TAK-19000-61599	P-U-10	30 X 50 mm	71.95
TAK-19000-13499	P-U-5	45 X 75 mm	147.83	TAK-19000-62099	P-U-10	40 X 65 mm	78.01
TAK-19000-16199	P-U-5	55 X 85 mm	125.36	TAK-19000-62699	P-U-13	25 X 40 mm	80.64
TAK-19000-16399	P-U-5	55 X 90 mm	128.82	TAK-19000-63499	P-UB-10	65 X 95 mm	173.49
TAK-19000-16499	P-U-5	60 X 100 mm	146.67	TAK-19000-63599	P-UB-10	55 X 85 mm	125.13
TAK-19000-19699	P-U-5	65 X 105 mm	158.22	TAK-19000-63699	P-UB-10	75 X 120 mm	207.40
TAK-19000-24599	P-U-5	40 X 70 mm	96.38	TAK-19000-63799	P-UB-10	60 X 100 mm	146.68
TAK-19000-27399	P-U-5	53 X 100 mm	216.47	TAK-19000-63999	P-U-1	60 X 110 mm	91.10
TAK-19000-30599	P-U-5	45 X 75 mm	103.60	TAK-19000-65199	P-UB-10	55 X 80 mm	146.47
TAK-19000-30699	P-U-5	45 X 75 mm	126.06	TAK-19000-70499	P-U-10	30 X 55 mm	61.07
TAK-19000-37799	I-U-5	40 X 60 mm	63.90	TAK-19000-70599	P-U-10	35 X 60 mm	90.90
TAK-19000-39199	P-U-5	50 X 80 mm	144.89	TAK-19000-72299	P-U-10	30 X 50 mm	67.14
TAK-19000-43899	P-U-14	40 X 75 mm	109.47	TAK-19000-75699	I-U-14	55 X 110 mm	155.50
TAK-19000-43999	I-U-14	40 X 70 mm	100.19	TAK-19000-75799	I-UB-14	50 X 90 mm	155.44
TAK-19000-44099	I-U-14	35 X 60 mm	89.47	TAK-19000-76399	P-UB-10	65 X 95 mm	129.77
TAK-19000-44299	I-U-14	45 X 85 mm	118.78	TAK-19000-77499	P-U-10	40 X 70 mm	54.78
TAK-19000-46199	I-U-14	40 X 75 mm	137.19	TAK-19000-77999	P-U-10	40 X 70 mm	46.58

TAKEUCHI®

REPLACEMENT KITS FOR TAKEUCHI® JAPANESE EXCAVATOR

Kit Number	Code (Pg. xviii)	Rod X Bore Size	List Price
TAK-19000-78299	P-U-10	45 X 85 mm	\$ 95.74
TAK-19000-78999	P-UB-10	55 X 80 mm	126.13
TAK-19000-79399	P-UB-10	75 X 120 mm	182.89
TAK-19000-79499	P-UB-10	60 X 100 mm	131.67
TAK-19000-81599	P-U-10	50 X 90 mm	93.97
TAK-19000-81899	P-U-10	40 X 65 mm	41.36
TAK-19000-87299	P-U-10	25 X 50 mm	25.67

Kit Number	Code (Pg. xviii)	Rod X Bore Size	List Price
TAK-19000-87499	P-U-10	30 X 55 mm	\$ 29.91
TAK-19000-87999	P-U-10	50 X 90 mm	56.84
TAK-19000-89599	P-UB-10	70 X 100 mm	101.43
TAK-19000-91499	P-U-10	45 X 80 mm	49.75
TAK-19017-30599		O-RING KIT	1.14
TAK-19029-03199		O-RING KIT	2.73

Replacement Kits For

TCM

Loaders - Wheel						
APPLICATION	CODE	ROD	BORE	Bearings Needed	KIT #	List \$
MODEL 720, 860						
BOOM	P-UB-10	75 mm	140 mm	MDU-75X80X30	TCM-26508-47011	278.34
BUCKET	P-UB-10	95 mm	190 mm	MDU-95X100X30	TCM-26608-57011	379.24
STEERING	P-UB-10	40 mm	80 mm		TCM-26604-57001	150.42
MODEL 870						
BUCKET	P-UB-10	95 mm	170 mm		TCM-26708-47001	541.48

REPLACEMENT KITS FOR TCM CONSTRUCTION EQUIPMENT

Kit Number	Code (Pg. xviii)	Rod X Bore Size	List Price
TCM-234A8-59801	P-U-10	30 X 70 mm	\$ 83.86
TCM-23918-59823	P-U-5	40 X 100 mm	162.95
TCM-24328-59815	P-U-5	50 X 100 mm	186.60
TCM-24358-59803	P-U-5	50 X 100 mm	186.99
TCM-25784-59803	P-U-10	30 X 70 mm	42.83

Kit Number	Code (Pg. xviii)	Rod X Bore Size	List Price
TCM-26438-57001	P-UB-10	70 X 130 mm	\$ 313.30
TCM-26508-47011	P-UB-10	75 X 140 mm	278.34
TCM-26604-57001	P-UB-10	40 X 80 mm	150.42
TCM-26608-57011	P-UB-10	95 X 190 mm	379.24
TCM-26708-47001	P-UB-10	95 X 170 mm	541.48

TCM

REPLACEMENT KITS FOR TCM LIFT TRUCKS

Kit Number	Code (Pg. xviii)	Rod X Bore Size	List Price
TCM-20804-59801	P-U-10	25 X 60 mm	\$ 57.83
TCM-210F0-89804	P-U-4	35 X 45 mm	106.07
TCM-210F8-49804	P-U-4	35 X 46 mm	73.67
TCM-214A0-59801	P-U-10	75 X 90 mm	123.38
TCM-214A0-59821	P-U-1	35 X 45 mm	64.94
TCM-214A0-89804	P-U-4	40 X 50 mm	74.23
TCM-214A4-59801	P-U-10	25 X 50 mm	54.68
TCM-214A8-49804	P-U-4	40 X 50 mm	86.00
TCM-214A8-49812	P-U-4	40 X 50 mm	90.06
TCM-214A8-59801	P-U-5	32 X 71 mm	153.29
TCM-214J0-59812	P-U-1	40 X 50 mm	86.99
TCM-214J8-49804	P-U-4	45 X 55 mm	86.81
TCM-214T0-89811	P-U-4	50 X 60 mm	113.06
TCM-214T8-49801	P-U-4	50 X 60 mm	108.32
TCM-22438-49811	P-N-4	60 X 90 mm	103.29
TCM-22438-49812	P-N-4	60 X 90 mm	49.88
TCM-22438-59804	P-U-5	40 X 90 mm	167.55
TCM-224T8-49803	P-U-1	50 X 65 mm	92.63
TCM-22578-49801	P-N-4	45 X 63 mm	104.78
TCM-22580-89801	P-N-4	45 X 70 mm	74.23
TCM-22678-59801	P-U-5	32 X 80 mm	88.12
TCM-228C0-59801	P-U-1	112 X 130 mm	357.36
TCM-23460-89801	P-N-4	50 X 90 mm	83.28
TCM-234A8-49803	P-U-4	40 X 50 mm	62.34
TCM-234A8-59805	P-U-5	30 X 71 mm	111.53
TCM-234F8-49801	P-U-4	45 X 55 mm	66.92
TCM-23650-59801	P-U-1	35 X 45 mm	76.98
TCM-23650-59802	P-U-1	35 X 45 mm	59.94
TCM-23650-89802	P-U-1	40 X 50 mm	74.51
TCM-23650-89803	P-N-4	40 X 50 mm	63.98
TCM-23650-89822	P-U-1	75 X 90 mm	116.06
TCM-23650-89841	P-U-1	40 mm	52.29
TCM-23654-52201	I-U-10	25 X 60 mm	46.31
TCM-23658-59811	P-U-5	32 X 70 mm	114.16

Kit Number	Code (Pg. xviii)	Rod X Bore Size	List Price
TCM-23658-59813	P-U-5	32 X 70 mm	\$ 114.16
TCM-23678-59801	P-U-5	32 X 71 mm	103.80
TCM-24239-49801	P-N-4	38 X 45 mm	80.84
TCM-24239-49804	P-U-1	35 X 45 mm	79.49
TCM-24240-89801	P-U-1	70 X 80 mm	67.10
TCM-24248-59802	P-U-5	30 X 63 mm	147.37
TCM-24248-59807	P-U-5	30 X 63 mm	101.54
TCM-24328-59804	P-U-5	50 X 100 mm	168.09
TCM-24450-89803	P-U-1	85 mm	75.57
TCM-24450-89823	P-N-4	45 X 55 mm	75.91
TCM-24458-59812	P-U-10	32 X 71 mm	162.05
TCM-24469-49803	P-U-4	45 X 55 mm	52.44
TCM-24600-89902	P-U-1	50 X 60 mm	149.00
TCM-24608-59803	P-U-10	50 X 90 mm	148.52
TCM-25594-59802	P-U-10	22 X 50 mm	63.84
TCM-25954-59802	P-U-10	25 X 60 mm	46.07
TCM-26094-17161	VALVE KIT		9.78
TCM-27248-49801	P-N-4	50 X 80 mm	95.73
TCM-27390-59801	P-U-10	70 X 80 mm	133.86
TCM-27390-59902	P-U-1	32 mm Rod Kit	107.60
TCM-27410-89811	P-U-1	75 mm	62.15
TCM-277H8-59802	P-U-5	30 X 63 mm	101.72
TCM-27830-89802	P-U-10	85 X 100 mm	164.06
TCM-510F0-59801	P-U-1	32 X 45 mm	92.12
TCM-510F2-40601	P-U-10	40 X 70 mm	239.11
TCM-514A2-40552	P-U-10	50 X 80 mm	250.40
TCM-514A2-40554	P-U-10	50 X 80 mm	196.85
TCM-514A2-42631	VALVE KIT		9.98
TCM-52486-09811	VALVE KIT		23.35

TCM

PISTON SEALS FOR TCM EQUIPMENT

Part Number	Bore Diam.	List Price
TCM-24458-50311	71 mm	\$ 27.45

Replacement Kits For

TEREX®

Backhoe Loaders

APPLICATION	CYL #	CODE	ROD	BORE	KIT #	List \$
MODEL TX760B						
SWING		P-UB-10	45 mm	90 mm	TX-3623368M91	174.44

Cranes

APPLICATION	CYL #	CODE	ROD	BORE	KIT #	List \$
MODEL AC160-2						
BOOM LIFT	26877012	I-N-10	300 mm	330 mm	TX-45285412	2784.52

Excavators

APPLICATION	CYL #	CODE	ROD	BORE	KIT #	List \$
MODEL RH90-C						
BH BUCKET	2160727	I-U-10	160 mm	220 mm	TX-2160727K	1840.61
BH STICK	2160796	I-UB-10	180 mm	250 mm	TX-2160796K	2385.26
FS BUCKET	2244809	I-UB-10	140 mm	180 mm	TX-2244809K	1298.03
FS CLAM	4525818	I-UB-10	80 mm	150 mm	TX-4525818	888.70
FS STICK	2160739	I-UB-10	150 mm	200 mm	TX-2160739K	1600.07
MODEL RH120-E						
BH BOOM	2766930	I-UB-10	200 mm	300 mm	TX-2766975	5865.68
BH BUCKET	3677250	I-UB-10	160 mm	220 mm	TX-2766978	4772.56
BH STICK	3650864	I-UB-10	200 mm	280 mm	TX-2766982	5556.14

Off-Highway Trucks

APPLICATION	CYL #	CODE	ROD	BORE	KIT #	List \$
MODEL 3305AA						
BODY	9019954				TX-15050416	217.71
MODEL 3305B						
BODY	15232133				TX-15050416	217.71
	9019954				TX-15050416	217.71
MODEL 3307						
BODY	15232133				TX-15050416	217.71
	9019954				TX-15050416	217.71
MODEL 3307D						
BODY	9019954				TX-15050416	217.71
MODEL 3308E						
BODY	15232133				TX-15050416	217.71
MODEL 3407						
BODY	9019954				TX-15050416	217.71
MODEL TR100						
FRONT RIDE	15250974	I-U-1	9		TX-9396484	1856.57
HOIST	15227019	I-U-12	5-1/2, 8-1/4	7-1/2, 9	TX-15265278	429.85
REAR RIDE	9079698	I-SP-1	10-1/2		TX-15050414	99.05
STEERING	15307881	P-U-10	50 mm	110 mm	TX-15274213	61.14
	15307881	P-U-10	50 mm	110 mm	TX-15274213	61.14
	15318033	P-U-10	50 mm	110 mm	TX-15500961	92.06

Scrapers

APPLICATION	CYL #	CODE	ROD	BORE	KIT #	List \$
MODEL S23E						
STEERING	9066953	P-V-12	2-1/2	5-1/2	TX-15050390	133.87
	9066954	P-V-12	2-1/2	5-1/2	TX-15050390	133.87

TEREX®

Replacement Kits For

TEREX®

Scrapers						
APPLICATION	CYL #	CODE	ROD	BORE	KIT #	List \$
MODEL S24						
APRON / EJECTOR	9217579	P-V-1	7-15/16	9-1/8	TX-15050409	347.69
BOWL	9217584	P-V-1	7-15/16	9-1/8	TX-15050409	347.69
STEERING	9062928	P-V-12	3	7	TX-15050396	158.97
MODEL S24B						
APRON	15014766	I-V-12	2-1/2	6-1/4	TX-15050394	97.24
	15016260	I-V-12	2-1/2	6-1/4	TX-15050394	97.24
BOWL	9272694	P-U-10	3-1/2	8	TX-15050399	201.73
EJECTOR	15015718	I-SP-12	4-1/2	7-1/2	TX-15050415	626.07
RIDE	9062425	I,P-U-12	7	8	TX-15050406	397.95
STEERING	15005121	P-V-12	3	7	TX-15050396	158.97
	15009641	P-V-12	3	7	TX-15050396	158.97
MODEL S24C						
APRON	15014766	I-V-12	2-1/2	6-1/4	TX-15050394	97.24
	15016260	I-V-12	2-1/2	6-1/4	TX-15050394	97.24
BOWL	9272694	P-U-10	3-1/2	8	TX-15050399	201.73
EJECTOR	15015718	I-SP-12	4-1/2	7-1/2	TX-15050415	626.07
STEERING	15005121	P-V-12	3	7	TX-15050396	158.97
	15009641	P-V-12	3	7	TX-15050396	158.97
MODEL TS14						
APRON / EJECTOR	9217579	P-V-1	7-15/16	9-1/8	TX-15050409	347.69
BOWL	9005146	P-V-1	7-15/16	9-1/8	TX-15050409	347.69
	9217584	P-V-1	7-15/16	9-1/8	TX-15050409	347.69
MODEL TS14B						
APRON / EJECTOR	9217579	P-V-1	7-15/16	9-1/8	TX-15050409	347.69
BOWL	9005146	P-V-1	7-15/16	9-1/8	TX-15050409	347.69
STEERING	9066951	P-V-12	2-1/2	5-1/2	TX-15050390	133.87
	9066952	P-V-12	2-1/2	5-1/2	TX-15050390	133.87
	9382500	P-U-12	2-1/2	5-1/2	TX-9397201	456.25
	9382501	P-U-12	2-1/2	5-1/2	TX-9397201	456.25
MODEL TS14C						
APRON / EJECTOR	9217579	P-V-1	7-15/16	9-1/8	TX-15050409	347.69
BOWL	15007421	P-U-10	3-1/2	8	TX-15050399	201.73
STEERING	9382500	P-U-12	2-1/2	5-1/2	TX-9397201	456.25
	9382501	P-U-12	2-1/2	5-1/2	TX-9397201	456.25
MODEL TS18A						
APRON	9217579	P-V-1	7-15/16	9-1/8	TX-15050409	347.69
MODEL TS24						
APRON / EJECTOR	9217579	P-V-1	7-15/16	9-1/8	TX-15050409	347.69
BOWL	9217584	P-V-1	7-15/16	9-1/8	TX-15050409	347.69
STEERING	15009641	P-V-12	3	7	TX-15050396	158.97
	9062928	P-V-12	3	7	TX-15050396	158.97
MODEL TS24A						
APRON	15014766	I-V-12	2-1/2	6-1/4	TX-15050394	97.24
	15016260	I-V-12	2-1/2	6-1/4	TX-15050394	97.24
	15016261	I-V-12	2-1/2	6-1/4	TX-15050394	97.24
STEERING	15005121	P-V-12	3	7	TX-15050396	158.97

TEREX®

Replacement Kits For

TEREX®

Scrapers						
APPLICATION	CYL #	CODE	ROD	BORE	KIT #	List \$
MODEL TS24A						
STEERING	15009641	P-V-12	3	7	TX-15050396	158.97
	9062928	P-V-12	3	7	TX-15050396	158.97
MODEL TS24B						
APRON	15014766	I-V-12	2-1/2	6-1/4	TX-15050394	97.24
	15016260	I-V-12	2-1/2	6-1/4	TX-15050394	97.24
BOWL	9272694	P-U-10	3-1/2	8	TX-15050399	201.73
EJECTOR	15015718	I-SP-12	4-1/2	7-1/2	TX-15050415	626.07
RIDE	9062425	I,P-U-12	7	8	TX-15050406	397.95
STEERING	15005121	P-V-12	3	7	TX-15050396	158.97
	15009641	P-V-12	3	7	TX-15050396	158.97
	9062928	P-V-12	3	7	TX-15050396	158.97
MODEL TS24C						
APRON	15014766	I-V-12	2-1/2	6-1/4	TX-15050394	97.24
	15016260	I-V-12	2-1/2	6-1/4	TX-15050394	97.24
BOWL	9272694	P-U-10	3-1/2	8	TX-15050399	201.73
EJECTOR	15015718	I-SP-12	4-1/2	7-1/2	TX-15050415	626.07
STEERING	15005121	P-V-12	3	7	TX-15050396	158.97
	15009641	P-V-12	3	7	TX-15050396	158.97

TEREX®

Kit Number	Code (Pg. xviii)	Rod X Bore Size	List Price	Kit Number	Code (Pg. xviii)	Rod X Bore Size	List Price
TX-15050390	P-V-12	2-1/2 X 5-1/2	\$ 133.87	TX-2160796K	I-UB-10	180 X 250 mm	\$ 2385.26
TX-15050394	I-V-12	2-1/2 X 6-1/4	97.24	TX-2244809K	I-UB-10	140 X 180 mm	1298.03
TX-15050396	P-V-12	3 X 7	158.97	TX-2766975	I-UB-10	200 X 300 mm	5865.68
TX-15050399	P-U-10	3-1/2 X 8	201.73	TX-2766978	I-UB-10	160 X 220 mm	4772.56
TX-15050406	I,P-U-12	7 X 8	397.95	TX-2766982	I-UB-10	200 X 280 mm	5556.14
TX-15050409	P-V-1	7.925 Rod Kit	347.69	TX-3307F	I-U-1	7" Rod Front Suspension	136.25
TX-15050414	I-SP-1	10-1/2	99.05	TX-3307R	I-U-1	8-1/4" Rod Rear Suspension	140.31
TX-15050415	I-SP-12	4-1/2, 6, 7-1/2 Stages	626.07	TX-3307SC	I-U-12	1-3/4 X 3-1/4	45.36
TX-15050416	I-U-12	5-1/4, 6-3/4 Stages	217.71	TX-3311HC	I-U-12	6-3/4 X 8-1/4	274.81
TX-15265278	I-U-12	5-1/2, 8-1/4	429.85	TX-4525776	I-UB-10	100 X 190 mm	1812.63
TX-3623368M91	P-UB-10	45 mm X 90 mm	174.44	TX-4525818	I-UB-10	80 X 150 mm	888.70
TX-15274213	P-U-10	50 X 110 mm	61.14	TX-4525978K	I-UB-10	170 X 230 mm	2791.44
TX-15500915	P-U-10	63 X 110 mm	58.08	TX-45285412	I-N-10	300 X 330 mm	2784.52
TX-15500926	P-U-10	80 X 125 mm	83.66	TX-607325	P-V-12	3 X 7	143.47
TX-15500961	P-U-10	50 X 110 mm	92.06	TX-9396483	I-U-1	10-1/2	819.01
TX-15921417	Valve Kit		15.81	TX-9396484	I-U-1	9	1856.57
TX-181976999248	I-U-10,12	50 X 70 mm	159.92	TX-9397201	P-U-12	2-1/2 X 5-1/2	456.25
TX-2160727K	I-U-10	160 X 220 mm	1840.61	TX-TS24EJ	I-V-1	4, 5-3/4, 7-1/2 Tele	354.95
TX-2160739K	I-UB-10	150 X 200 mm	1600.07				

REPLACEMENT PARTS FOR TEREX® EQUIPMENT

NOTE: Terex part numbers are used as a reference only. We do not imply that these kits are original REPLACEMENT PARTS.

BACK-UP RINGS

Part Number	Min Pkg Qty	List Price
TX-9006187	1	\$ 3.41
TX-9014362	1	2.31
TX-9014635	1	7.17
TX-9016784	1	7.44
TX-9036867	1	7.00
TX-9069472	1	11.53

LINK PIN BUSHINGS

Part Number	ID X OD	List Price
TX-9014649	3 x 3-3/4	\$266.11

O-RINGS

Part Number	Min Pkg Qty	List Price
TX-9014636	1	\$ 3.86
TX-9016783	1	5.10
TX-9141912	10	1.29

PISTON RINGS

Part Number	Bore Dia.	List Price
TX-9003456	5-1/2	\$ 17.10
TX-9014633	7-1/2	29.27
TX-9250452	8	34.65

PISTON SEALS

Part Number	Bore Dia.	List Price
TX-15232053	1-3/4	\$ 6.34

U-SEALS

Part Number	Rod Dia.	List Price
TX-9005427	2-1/2	\$ 12.96
TX-9381918	2-1/2	16.19
TX-15227032	5-1/2	27.12
TX-9270713	8-1/4	42.00
TX-15237500	10-1/2	259.44

WEAR RINGS

Part Number	Rod Dia.	List Price
TX-15227031	5-3/4 x 1	\$ 7.58
TX-6944596	8-1/2 x 1	22.66
TX-9014131	7-1/2 x 1	16.86
TX-9016788	11-3/4 x 7	219.60
TX-9018420	9 x 1	23.08

WIPERS

Part Number	Rod Dia.	List Price
TX-15050280	2-1/2	\$ 18.02
TX-15227030	5-1/2	15.06
TX-15021207	7	138.61
TX-9256608	8-1/4	25.46
TX-15050293	9	28.42
TX-9016787	10-1/2	36.56

TEREX®

Replacement Kits For

TIMBERJACK

Forestry - Log Loaders							
APPLICATION	CYL #	SERIAL #	CODE	ROD	BORE	KIT #	List \$
MODEL 330							
JIB BOOM			I-U-10	3	7	TBJ-842937500	61.71
MAIN BOOM			I-U-10	3	6	TBJ-842936800	78.43
STABILIZER			I-U-10	3	6	TBJ-842936800	78.43
MODEL 430							
JIB BOOM			I-U-10	3-1/2	7	TBJ-842938200	89.31
MAIN BOOM			I-U-10	3	6	TBJ-842936800	78.43
STABILIZER			I-U-10	3	6	TBJ-842936800	78.43
Skidders							
APPLICATION	CYL #	SERIAL #	CODE	ROD	BORE	KIT #	List \$
MODEL 240							
DOZER	8256787		I-U-10	1-3/4	4	TBJ-231384700	51.10
STEERING	2313806		I-U-10	2	4-1/2	TBJ-231383200	103.53
	2313816		I-U-10	1-3/4	4	TBJ-231384700	51.10
MODEL 240A							
ARCH-SINGLE	8259164		I-U-10	1-3/4	4	TBJ-231384700	51.10
	8268592		P-U-10	1-3/4	4	TBJ-845167600	81.45
DOZER	8260240		I-U-10	1-3/4	4	TBJ-231384700	51.10
GRAPPLE	8424465		I-U-5	2-1/2	4	TBJ-8429306	67.17
	8427905		I-U-5	2	4	TBJ-843010000	55.17
STEERING	2313806		I-U-10	2	4-1/2	TBJ-231383200	103.53
	8268602		P-U-10	2	4-1/2	TBJ-845167700	106.27
MODEL 240B							
ARCH-SINGLE	8268592		P-U-10	1-3/4	4	TBJ-845167600	81.45
DOZER	8268597		P-U-10	1-3/4	4	TBJ-845167600	81.45
GRAPPLE	8419398		I-U-5	2-1/2	4	TBJ-842249600	98.55
	8424465		I-U-5	2-1/2	4	TBJ-8429306	67.17
	8427905		I-U-5	2	4	TBJ-843010000	55.17
	F431703		P-UB-10	2	4	TBJ-F434195	117.00
	F431737		P-UB-10	2-1/2	4	TBJ-F434787	129.71
STEERING	8268602		P-U-10	2	4-1/2	TBJ-845167700	106.27
MODEL 360							
ARCH	F120710		I-UB-1	50 mm		TBJ-F432351	47.39
	F120710		N-N-14		100 mm	TBJ-842884100	77.52
CAB TILT	8119718		I-U-10	25 mm	2	TBJ-8431265	32.77
DOZER	F120975		N-N-14		90 mm	TBJ-F434056	63.66
	F120975		P-UB-1	45 mm		TBJ-F433400	66.38
GRAPPLE	F431737		P-UB-10	2-1/2	4	TBJ-F434787	129.71
	F431738		P-UB-10	2-1/2	4-1/2	TBJ-F434785	140.23
	F434169		P-UB-10	2	4	TBJ-F434195	117.00
	F434381		P-UB-10	2	4	TBJ-F434195	117.00
STEERING	F120975		N-N-14		90 mm	TBJ-F434056	63.66
	F120975		P-UB-1	45 mm		TBJ-F433400	66.38
MODEL 380, 380A, 380B							
ARCH	2315925		I-U-10	1-3/4	3-1/2	TBJ-845089800	91.32
ARCH LH	8216620		I-U-5	1-3/4	4-1/2	TBJ-8450282	93.61
ARCH RH	8216621		I-U-5	1-3/4	4-1/2	TBJ-8450282	93.61

Replacement Kits For

TIMBERJACK

Skidders							
APPLICATION	CYL #	SERIAL #	CODE	ROD	BORE	KIT #	List \$
MODEL 380, 380A, 380B							
ARCH-DUAL	2315925		I-U-10	1-3/4	3-1/2	TBJ-845089800	91.32
ARCH-SINGLE	8256796		I-U-10	1-3/4	4	TBJ-845109500	95.72
BOOM	2315925		I-U-10	1-3/4	3-1/2	TBJ-845089800	91.32
DOZER	8256792		I-U-10	1-3/4	3-1/2	TBJ-231385100	85.64
GRAPPLE	8245558		I-U-10	2-1/2	5-1/2	TBJ-845089900	122.37
	8414685		I-U-10	2-1/2	5	TBJ-841468700	42.92
	8417513		I-U-10	2-1/2	5	TBJ-8417516	82.51
	8417552		I-U-5	2-1/2	4	TBJ-842249600	98.55
	8419223		I-U-10	3-1/2	6-1/2	TBJ-841923200	68.18
	8419398		I-U-5	2-1/2	4	TBJ-842249600	98.55
	8419411		I-U-10	2-1/2	5	TBJ-8417516	82.51
8424465		I-U-5	2-1/2	4	TBJ-8429306	67.17	
STEERING	8256798		I-U-10	1-3/4	3-1/2	TBJ-231385100	85.64
UNSPECIFIED APPLICATION	2313814		I-U-10	1-3/4	3-1/2	TBJ-231385100	85.64
MODEL 380, 450C							
ARCH-DUAL	8268601		P-U-10	1-3/4	3-1/2	TBJ-845167400	83.15
ARCH-SINGLE	8268593		P-U-10	1-3/4	4	TBJ-845167600	81.45
BOOM	8268601		P-U-10	1-3/4	3-1/2	TBJ-845167400	83.15
DOZER	8268596		P-U-10	1-3/4	4	TBJ-845167600	81.45
	8268600		P-U-10	1-3/4	3-1/2	TBJ-845167400	83.15
GRAPPLE	8419411		I-U-10	2-1/2	5	TBJ-843009800	83.30
	8424465		I-U-5	2-1/2	4	TBJ-8429306	67.17
	8424465	10650-14999	I-U-5	2-1/2	4	TBJ-842249600	98.55
	8425715		I-U-5	2-1/2	4-1/2	TBJ-843011300	62.89
	8427905		I-U-5	2	4	TBJ-843010000	55.17
	8428962		I-U-10	2-1/2	5-1/2	TBJ-843009900	122.37
	F431703		P-UB-10	2	4	TBJ-F434195	117.00
	F431737		P-U-10	2-1/2	4	TBJ-843113700	106.27
	F431738		P-UB-10	2-1/2	4-1/2	TBJ-F434785	140.23
GRAPPLE T.J. 105"	8247956		I-U-10	2-1/2	5-1/2	TBJ-845089900	122.37
STEERING	8268599		P-U-10	1-3/4	3-1/2	TBJ-845167400	83.15
MODEL 450							
ARCH	2315925		I-U-10	1-3/4	3-1/2	TBJ-845089800	91.32
	8244039		I-U-10	1-3/4	4	TBJ-845109500	95.72
	8256796		I-U-10	1-3/4	4	TBJ-845109500	95.72
ARCH-DUAL	2315925		I-U-10	1-3/4	3-1/2	TBJ-845089800	91.32
ARCH-SINGLE	8256796		I-U-10	1-3/4	4	TBJ-845109500	95.72
BOOM	2315925		I-U-10	1-3/4	3-1/2	TBJ-845089800	91.32
	8244039		I-U-10	1-3/4	4	TBJ-845109500	95.72
	8256796		I-U-10	1-3/4	4	TBJ-845109500	95.72
DOZER	8256792		I-U-10	1-3/4	3-1/2	TBJ-231385100	85.64
GRAPPLE	8247955		I-U-10	1-3/4	4	TBJ-845109500	95.72
	8414685		I-U-10	2-1/2	5	TBJ-841468700	42.92
	8417513		I-U-10	2-1/2	5	TBJ-8417516	82.51
	8417552		I-U-5	2-1/2	4	TBJ-842249600	98.55
	8419223		I-U-10	3-1/2	6-1/2	TBJ-841923200	68.18

TIMBERJACK

Replacement Kits For

TIMBERJACK

Skidders							
APPLICATION	CYL #	SERIAL #	CODE	ROD	BORE	KIT #	List \$
MODEL 450							
GRAPPLE	8419224		I-U-10	3-1/2	6-1/2	TBJ-841923200	68.18
	8419398		I-U-5	2-1/2	4	TBJ-842249600	98.55
	8419411		I-U-10	2-1/2	5	TBJ-8417516	82.51
	8424465		I-U-5	2-1/2	4	TBJ-842249600	98.55
GRAPPLE T.J.105"	8247956		I-U-10	2-1/2	5-1/2	TBJ-845089900	122.37
STEERING	8256798		I-U-10	1-3/4	3-1/2	TBJ-231385100	85.64
UNSPECIFIED APPLICATION	2313814		I-U-10	1-3/4	3-1/2	TBJ-231385100	85.64
MODEL 460							
ARCH-DUAL	F120977		N-N-14		90 mm	TBJ-F434056	63.66
	F120977		P-UB-1	45 mm		TBJ-F433400	66.38
ARCH-SINGLE	F120710		N-N-14		100 mm	TBJ-842884100	77.52
	F120710		I-UB-1	50 mm		TBJ-F432351	47.39
BOOM	F122026		N-N-14		90 mm	TBJ-F434056	63.66
	F122026		I-UB-1	50 mm		TBJ-F432351	47.39
CAB TILT	8119718		I-U-10	25 mm	2	TBJ-8431265	32.77
	8119718		N-O-1			TBJ-F033365	4.54
DOZER	F120709		N-N-14		100 mm	TBJ-842884100	77.52
	F120709		I-UB-1	50 mm		TBJ-F432351	47.39
GRAPPLE	F431737		P-UB-10	2-1/2	4	TBJ-F434787	129.71
	F431738		P-UB-10	2-1/2	4-1/2	TBJ-F434785	140.23
	F433137		P-UB-10	2-1/2	5-1/2	TBJ-F433145	164.37
	F433146		P-UB-10	2-1/2	5-1/2	TBJ-F433145	164.37
	F434169		P-UB-10	2	4	TBJ-F434195	117.00
	F434381		P-UB-10	2	4	TBJ-F434195	117.00
STEERING	F120975		N-N-14		90 mm	TBJ-F434056	63.66
	F120975		P-UB-1	45 mm		TBJ-F433400	66.38
UNSPECIFIED APPLICATION	F122183		P-UB-10	63 mm		TBJ-F433415	55.95
	F122183		N-N-14		125 mm	TBJ-F434140	157.09

REPLACEMENT KITS FOR TIMBERJACK EQUIPMENT

Kit Number	Code (Pg. xviii)	Rod X Bore Size	List Price
TBJ-231383200	I-U-10	2 X 4-1/2	\$ 103.53
TBJ-231384700	I-U-10	1-3/4 X 4	51.10
TBJ-231385100	I-U-10	1-3/4 X 3-1/2	85.64
TBJ-41468700	I-U-10	2-1/2 X 5	33.62
TBJ-41477400	P-U-5	2 X 4	41.04
TBJ-41478200	I-U-5	1-1/2 X 3-1/2	28.22
TBJ-42289700	I-U-4	2-1/2 X 4	64.75
TBJ-450999	I-U-8	1 X 3-1/2	39.26
TBJ-700797300	P-UB-10	2 X 4	71.44
TBJ-700867900	P-UB-10	3 X 5	215.95

Kit Number	Code (Pg. xviii)	Rod X Bore Size	List Price
TBJ-700884400	P-UB-14	3 X 5	\$ 219.80
TBJ-841468700	I-U-10	2-1/2 X 5	42.92
TBJ-8417516	I-U-10	2-1/2 X 5	82.51
TBJ-841923200	I-U-10	3-1/2 X 6-1/2	68.18
TBJ-842249600	I-U-5	2-1/2 X 4	98.55
TBJ-842884100	N-N-14	100 mm	77.52
TBJ-8429306	I-U-5	2-1/2 X 4	67.17
TBJ-842936800	I-U-10	3 X 6	78.43
TBJ-842937500	I-U-10	3 X 7	61.71
TBJ-842938200	I-U-10	3-1/2 X 7	89.31

TIMBERJACK

Kit Number	Code (Pg. xviii)	Rod X Bore Size	List Price
TBJ-842961900	I-U-10	3-1/2 X 7	\$ 74.52
TBJ-843009800	I-U-10	2-1/2 X 5	83.30
TBJ-843009900	I-U-10	2-1/2 X 5-1/2	122.37
TBJ-843010000	1-U-5	2 X 4	55.17
TBJ-843011300	I-U-5	2-1/2 X 4-1/2	62.89
TBJ-843032500	I-U-10	3 X 7	63.20
TBJ-843032800	I-U-10	3 X 6	82.78
TBJ-843113700	P-U-10	2-1/2 X 4	106.27
TBJ-8431265	I-U-10	25 mm X 2 in	32.77
TBJ-8450282	I-U-5	1-3/4 X 4-1/2	93.61
TBJ-8450446	I-V-9	2 X 4-1/2	71.88
TBJ-8450702	I-U-5	1-3/4 X 4	68.01
TBJ-8450703	I-U-5	1-3/4 X 4-1/2	73.26
TBJ-8450704	I-U-5	2-1/2 X 6	103.86
TBJ-8450705	I-U-5	2-1/2 X 4-1/2	82.33
TBJ-8450706	I-U-4	1 X 3-1/2	22.61
TBJ-8450709	I-U-12	1-3/4 X 4	57.45
TBJ-8450710	I-U-5	1-3/4 X 3-1/2	53.29
TBJ-845089800	I-U-10	1-3/4 X 3-1/2	91.32
TBJ-845089900	I-U-10	2-1/2 X 5-1/2	122.37
TBJ-845109500	I-U-10	1-3/4 X 4	95.72
TBJ-845167400	P-U-10	1-3/4 X 3-1/2	83.15
TBJ-845167600	P-U-10	1-3/4 X 4	81.45
TBJ-845167700	P-U-10	2 X 4-1/2	106.27
TBJ-F033365	N-O-1	-	4.54
TBJ-F432351	I-UB-1	50 mm	47.39
TBJ-F433145	P-UB-10	2-1/2 X 5-1/2	164.37
TBJ-F433400	P-UB-1	45 mm	66.38
TBJ-F433415	P-UB-10	63 mm	55.95
TBJ-F434056	N-N-14	90 mm	63.66
TBJ-F434140	N-N-14	125 mm	157.09
TBJ-F434195	P-UB-10	2 X 4	117.00
TBJ-F434785	P-UB-10	2-1/2 X 4-1/2	140.23
TBJ-F434787	P-UB-10	2-1/2 X 4	129.71
TBJ-F436221	BORE SWIVEL KIT	6, 6-1/2	206.09

PISTON SEALS FOR TIMBERJACK EQUIPMENT

Part Number	Bore Diam.	List Price
TBJ-811035200	3-1/2	\$ 40.41

TOWMOTOR - CATERPILLAR® LIFT TRUCKS

FOR A LIST OF
TOWMOTOR / CATERPILLAR®
LIFT TRUCKS
SEE OUR LISTING OF KITS UNDER THE
CATERPILLAR® SECTION IN THIS CATALOG

TOYOTA LIFT TRUCKS

Kit Number	Code (Pg. xviii)	Rod X Bore Size	List Price
TOY-04431-30091-71	P-U-5	60 X 90 mm	\$ 234.62
TOY-04433-10010-71	P-U-10	40 X 60 mm	97.41
TOY-04433-10020-71	P-U-10	40 X 60 mm	61.02
TOY-04433-20011-71	I-U-10	50 X 75 mm	189.07
TOY-04433-20030-71	I-U-10	50 X 80 mm	162.10
TOY-04433-U1010-71	I-U-10	40 mm X 2-3/8 in	48.51
TOY-04433-U2040-71	I-U-10	50 mm X 3	46.07
TOY-04433-U2050-71	I-U-10	50 mm X 3-1/8 in	180.62
TOY-04433-U3010-71	I-U-10	50 mm X 3-1/8 in	180.62
TOY-04451-10070-71	P-V-12	22 X 40 mm	67.90
TOY-04451-10090-71	P-V-12	22 X 40 mm	75.13
TOY-04451-10120-71	P-U-12	22 X 45 mm	70.06
TOY-04451-20100-71	P-V-12	22 X 50 mm	75.41
TOY-04451-20101-71	P-U-12	22 X 50 mm	80.41
TOY-04451-20170-71	P-V-12	22 X 50 mm	76.27
TOY-04451-20171-71	P-U-12	22 X 50 mm	76.58
TOY-04455-U2010-71	OVERHAUL STEER KIT		72.35
TOY-04456-10020-71	P-U-10	22 X 50 mm	49.73
TOY-04456-10031-71	P-U-5	30 X 55 mm	148.51
TOY-04456-10050-71	P-U-12	22 X 45 mm	63.34
TOY-04456-20010-71	P-U-12	22 X 40 mm	72.47
TOY-04456-20020-71	P-U-12	22 X 40 mm	68.04
TOY-04456-20030-71	N-U-12	22 X 50 mm	57.55
TOY-04456-20060-71	I-U-12	22 X 50 mm	33.04
TOY-04456-30010-71	P-U-1	25 X 55 mm	53.26
TOY-04456-30011-71	P-U-12	25 X 55 mm	71.57
TOY-04651-10060-71	P-N-4	50 X 80 mm	65.49
TOY-04651-10132-71	P-U-5	30 X 80 mm	87.58
TOY-04651-10330-71	P-U-5	30 X 70 mm	69.01
TOY-04651-10333-71	P-U-5	30 X 70 mm	101.85
TOY-04651-10334-71	P-U-5	30 X 70 mm	101.85
TOY-04651-10652-71	P-U-4	50 X 65 mm	104.55
TOY-04651-10662-71	P-U-4	50 X 65 mm	104.55
TOY-04651-10671-71	P-U-1	70 mm Rod Kit	88.52
TOY-04651-10870-71	P-U-1	70 X 80 mm	100.92
TOY-04651-10871-71	P-U-1	70 mm Rod Kit	88.52
TOY-04651-10882-71	P-U-5	30 X 70 mm	101.85
TOY-04651-10892-71	P-U-5	30 X 70 mm	101.85
TOY-04651-11032-71	P-U-1	35 X 50 mm	61.99
TOY-04651-11061-71	P-U-4	40 X 50 mm	72.74
TOY-04651-11250-71	P-U-1	75 X 90 mm	149.65
TOY-04651-11261-71	P-U-1	35 X 50 mm	61.64
TOY-04651-11270-71	P-U-1	75 X 90 mm	151.12
TOY-04651-11271-71	P-U-1	75 mm Rod Kit	94.95
TOY-04651-11290-71	P-U-4	40 X 50 mm	72.34
TOY-04651-11291-71	P-U-4	40 X 50 mm	71.89
TOY-04651-11300-71	N-U-4	50 X 65 mm	77.65
TOY-04651-11390-71	P-U-4	40 X 50 mm	77.85
TOY-04651-20132-71	P-U-1	60 X 70 mm	109.43
TOY-04651-20133-71	P-U-4	60 X 70 mm	121.48
TOY-04651-20141-71	P-U-4	50 X 70 mm	89.37
TOY-04651-20142-71	P-U-4	50 X 70 mm	101.75
TOY-04651-20151-71	P-V-5	30 X 70 mm	160.52
TOY-04651-20182-71	P-U-4	60 X 75 mm	105.60
TOY-04651-20184-71	P-U-1	75 X 90 mm	108.70
TOY-04651-20185-71	P-U-1	75 X 90 mm	108.70
TOY-04651-20186-71	P-U-1	75 X 90 mm	151.12

Kit Number	Code (Pg. xviii)	Rod X Bore Size	List Price
TOY-04651-20260-71	P-U-1	50 X 70 mm	\$ 71.59
TOY-04651-20262-71	P-U-1	50 X 70 mm	90.45
TOY-04651-20262-71	P-U-1	50 X 70 mm	90.45
TOY-04651-20390-71	P-U-4	50 X 70 mm	107.62
TOY-04651-20400-71	P-U-4	60 X 70 mm	118.06
TOY-04651-20421-71	P-U-4	50 X 70 mm	102.93
TOY-04651-20441-71	P-U-5	30 X 70 mm	64.11
TOY-04651-20442-71	P-U-5	30 X 70 mm	101.85
TOY-04651-20841-71	P-U-1	75 X 90 mm	151.36
TOY-04651-20970-71	P-U-1	75 X 90 mm	151.12
TOY-04651-20971-71	P-U-1	75 mm Rod Kit	95.16
TOY-04651-20980-71	P-U-4	40 X 50 mm	59.19
TOY-04651-20992-71	P-U-1	35 X 50 mm	61.64
TOY-04651-21150-71	P-U-4	40 X 50 mm	59.64
TOY-04651-21151-71	P-U-4	40 X 50 mm	72.34
TOY-04651-21290-71	P-U-4	40 X 50 mm	59.64
TOY-04651-21310-71	P-U-1	35 X 50 mm	61.22
TOY-04651-21340-71	P-U-1	35 X 50 mm	61.64
TOY-04651-21350-71	P-U-4	40 X 50 mm	76.81
TOY-04651-30111-71	P-N-4	60 X 100 mm	83.09
TOY-04651-30170-71	P-U-5	40 X 100 mm	98.66
TOY-04651-30181-71	I-U-1	30 X 90 mm	93.87
TOY-04651-30211-71	P-N-4	60 X 80 mm	97.58
TOY-04651-30212-71	P-U-4	60 X 80 mm	101.85
TOY-04651-30561-71	P-U-4	60 X 80 mm	110.95
TOY-04651-30841-71	P-U-1	90 X 105 mm	136.41
TOY-04651-30842-71	P-U-1	90 X 105 mm	184.42
TOY-04651-30911-71	P-U-1	60 X 80 mm	97.37
TOY-04651-30920-71	P-U-4	60 X 80 mm	112.85
TOY-04651-30980-71	P-U-4	60 X 80 mm	78.29
TOY-04651-30991-71	P-U-5	40 X 100 mm	71.96
TOY-04651-31170-71	P-U-1	55 X 65 mm	86.27
TOY-04651-31180-71	P-U-4	50 X 65 mm	99.84
TOY-04651-31181-71	P-U-4	50 X 65 mm	91.09
TOY-04651-31210-71	P-U-1	90 X 105 mm	185.91
TOY-04651-31211-71	P-U-1	85 X 105 mm	223.60
TOY-04651-31220-71	P-U-1	40 X 60 mm	59.31
TOY-04651-31230-71	P-U-1	40 X 60 mm	59.73
TOY-04651-31240-71	P-U-1	55 X 65 mm	87.67
TOY-04651-31250-71	P-U-1	55 X 65 mm	88.09
TOY-04651-31280-71	P-U-4	50 X 65 mm	98.31
TOY-04651-31281-71	P-U-4	50 X 65 mm	89.59
TOY-04651-31282-71	P-U-4	50 X 65 mm	75.51
TOY-04651-31290-71	P-U-4	60 X 90 mm	110.72
TOY-04651-31302-71	P-U-1	95 mm Rod Kit	113.61
TOY-04651-31311-71	P-U-1	105 mm Rod Kit	114.87
TOY-04651-31410-71	P-U-1	45 X 65 mm	74.77
TOY-04651-31420-71	P-U-1	45 X 65 mm	76.27
TOY-04651-31430-71	P-U-1	55 X 65 mm	88.52
TOY-04651-31440-71	P-U-1	55 X 65 mm	85.21
TOY-04651-31450-71	P-U-4	70 X 90 mm	139.18
TOY-04651-31500-71	P-U-4	45 X 55 mm	76.91
TOY-04651-31510-71	P-U-4	45 X 55 mm	76.47
TOY-04651-31520-71	P-U-4	45 X 55 mm	77.97
TOY-04651-31530-71	P-U-4	45 X 55 mm	75.21
TOY-04651-31800-71	P-U-4	55 X 80 mm	90.08
TOY-04651-31810-71	P-U-4	55 X 80 mm	84.07

TOYOTA

TOYOTA LIFT TRUCKS

Kit Number	Code (Pg. xviii)	Rod X Bore Size	List Price
TOY-04651-31820-71	P-U-5	70 X 120 mm	221.90
TOY-04651-31830-71	P-U-5	70 X 110 mm	67.69
TOY-04652-10020-71	P-U-1	70 X 80 mm	142.06
TOY-04652-10030-71	P-U-1	70 X 80 mm	142.06
TOY-04652-10170-71	P-U-1	70 mm Rod Kit	73.81
TOY-04652-10191-71	P-U-1	70 X 85 mm	51.72
TOY-04652-10300-71	P-U-10	50 X 70 mm	94.76
TOY-04652-20031-71	P-U-1	75 X 90 mm	115.52
TOY-04652-20040-71	P-U-1	75 X 90 mm	107.86
TOY-04652-30010-71	P-U-1	90 X 105 mm	138.02
TOY-04652-30011-71	P-U-1	85 X 105 mm	135.23
TOY-04652-30020-71	P-U-1	40 X 60 mm	59.73
TOY-04652-30030-71	P-U-1	40 X 60 mm	59.31
TOY-04652-30040-71	P-U-1	50 X 70 mm	79.12
TOY-04652-30050-71	P-U-1	50 X 70 mm	80.66
TOY-04652-30131-71	P-U-1	85 X 105 mm	134.94
TOY-04652-30132-71	P-U-1	85 X 105 mm	78.25
TOY-04652-30150-71	P-U-1	85 X 105 mm	127.13
TOY-04652-U1020-71	I-U-4	2 X 2-3/4	128.39
TOY-04652-U2010-71	I-U-4	50 X 75 mm	113.43
TOY-04652-U2020-71	I-U-4	2" X 75 mm	99.43
TOY-04653-10020-71	P-U-4	35 X 45 mm	69.53
TOY-04653-10030-71	P-U-4	35 X 45 mm	68.78
TOY-04653-10040-71	P-U-4	35 X 45 mm	69.53
TOY-04653-10050-71	P-U-4	35 X 45 mm	69.11
TOY-04653-10060-71	P-U-1	35 X 50 mm	62.94
TOY-04653-10170-71	P-U-1	35 mm	36.43
TOY-04653-10500-71	P-U-1	35 X 45 mm	29.84
TOY-04653-10530-71	P-U-4	35 X 45 mm	26.64
TOY-04653-20071-71	P-U-4	40 X 50 mm	77.85
TOY-04653-20081-71	P-U-4	40 X 50 mm	78.38
TOY-04653-20090-71	P-U-1	35 X 50 mm	67.10
TOY-04653-20100-71	P-U-1	35 mm Rod Kit	58.33
TOY-04653-20110-71	P-U-1	35 X 50 mm	44.65
TOY-04653-20130-71	P-U-1	40 X 50 mm	60.01
TOY-04653-20230-71	P-U-4	50 X 63 mm	44.23
TOY-04653-30010-71	P-U-1	55 X 65 mm	86.71
TOY-04653-30020-71	P-U-1	55 X 65 mm	86.71
TOY-04653-30030-71	P-U-1	115 mm Rod Kit	171.04
TOY-04653-30050-71	P-U-5	45 X 55 mm	75.51
TOY-04653-30060-71	P-U-4	45 X 55 mm	77.53
TOY-04653-30111-71	P-U-1	90 mm	41.94
TOY-04653-30211-71	P-U-4	45 X 55 mm	74.88
TOY-04653-30221-71	P-U-4	45 X 55 mm	81.71
TOY-04653-30230-71	P-U-1	40 X 55 mm	75.21
TOY-04653-30240-71	P-U-1	40 X 55 mm	68.04
TOY-04653-30310-71	P-U-3	50 X 70 mm	39.86
TOY-04653-U1010-71	I-U-1	32 mm X 1-3/4	31.96
TOY-04653-U1011-71	I-U-1	32 mm X 1-3/4	75.92
TOY-04653-U2010-71	I-U-4	1-3/8 X 2	53.68
TOY-04653-U3010-71	I-U-1	40 mm X 2-1/8	31.96
TOY-04654-10020-71	P-U-4	35 X 45 mm	69.65
TOY-04654-10030-71	P-U-4	35 X 45 mm	69.11
TOY-04654-20020-71	P-U-1	40 X 50 mm	60.01
TOY-04654-30020-71	P-U-4	45 X 55 mm	108.44
TOY-04654-30030-71	P-U-4	45 X 55 mm	106.22
TOY-04654-U1010-70	I-U-4	1-3/8 X 1-3/4	33.85

Kit Number	Code (Pg. xviii)	Rod X Bore Size	List Price
TOY-04654-U1010-71	I-U-1	1-3/8 X 1-3/4	\$ 33.85
TOY-04654-U3010-71	I-U-4	45 X 55 mm	56.65
TOY-04655-20030-71	P-U-5	30 X 70 mm	91.41
TOY-04655-20080-71	P-U-5	30 X 70 mm	61.58
TOY-04655-20090-71	I-U-13	30 X 70 mm	194.58
TOY-04655-30040-71	P-U-5	40 X 90 mm	107.71
TOY-04655-30041-71	P-U-5	40 X 90 mm	116.57
TOY-04655-30300-71	P-U-5	45X100 in	81.38
TOY-04655-U1010-71	I-U-10	30 X 70 mm	157.10
TOY-04655-U2010-71	I-U-10	1-1/4 X 2-3/4	83.77
TOY-04655-U3010-71	I-U-10	1-1/4 X 3	94.17
TOY-04671-20380-71	VALVE KIT		20.84
TOY-04671-20390-71	VALVE KIT		48.49
TOY-04676-20370-71	VALVE KIT		18.88
TOY-04676-20380-71	VALVE KIT		22.68
TOY-04676-20421-71	VALVE KIT		14.09
TOY-04676-20431-71	VALVE KIT		16.02
TOY-04676-20441-71	VALVE KIT		15.57
TOY-04676-20491-71	VALVE KIT		13.39
TOY-04676-20501-71	VALVE KIT		14.09
TOY-04676-20511-71	VALVE KIT		14.91
TOY-04676-20521-71	VALVE KIT		16.20
TOY-04676-20560-71	VALVE KIT		15.36
TOY-04676-20570-71	VALVE KIT		30.00
TOY-04676-20580-71	VALVE KIT		14.91
TOY-04676-20590-71	VALVE KIT		13.09
TOY-04676-20600-71	VALVE KIT		17.88
TOY-04676-20680-71	VALVE KIT		11.08
TOY-04676-20690-71	VALVE KIT		17.92
TOY-04676-20700-71	VALVE KIT		16.01
TOY-04676-20722-71	VALVE KIT		13.26
TOY-04676-20742-71	O-RING KIT		16.55
TOY-04676-30312-71	VALVE KIT		13.09
TOY-04676-30313-71	VALVE KIT		10.99
TOY-04676-30331-71	VALVE KIT		16.20
TOY-04676-30332-71	VALVE KIT		13.28
TOY-04676-30341-71	VALVE KIT		43.68
TOY-04676-30342-71	VALVE KIT		19.85
TOY-04676-30620-71	VALVE KIT		15.35
TOY-04676-30920-71	VALVE KIT		15.07
TOY-04676-30930-71	VALVE KIT		13.95
TOY-04676-30940-71	VALVE KIT		18.89
TOY-04676-30950-71	VALVE KIT		18.97
TOY-04676-30970-71	VALVE KIT		12.25
TOY-04676-30980-71	VALVE KIT		10.11
TOY-04676-30990-71	VALVE KIT		24.24
TOY-04676-31000-71	VALVE KIT		13.80
TOY-04676-31010-71	VALVE KIT		16.05
TOY-04676-31020-71	VALVE KIT		21.63
TOY-04676-31161-71	VALVE KIT		9.77
TOY-04676-31171-71	O-RING KIT		13.26
TOY-04676-U2010-71	VALVE KIT		25.84
TOY-04676-30311-71	VALVE KIT		12.24

TOYOTA

REPLACEMENT PARTS FOR TOYOTA EQUIPMENT

NOTE: Toyota part numbers are used as a reference only. We do not imply that these kits are original REPLACEMENT PARTS.

O-RINGS

Part Number	Min Pkg Qty	List Price
TOY-65592-U2200-71	20	\$ 0.22

U-SEALS

Part Number	Rod Dia.	List Price
TOY-77167-20100-71	80 mm	\$ 31.31

WIPERS

Part Number	Rod Dia.	List Price
TOY-65575-31620-71	40 mm	\$ 21.56

PISTON BUSHINGS

Part Number	Bore Dia.	List Price
TOY-65254-14180-71	90 mm	\$ 99.42

TROJAN LOADER

Kit Number	Code (Pg. xviii)	Rod X Bore Size	List Price
TJN-2112888	P-U-10	2-3/4 X 6-1/4	\$ 78.77
TJN-2112889	P-U-10	4 X 9	179.44
TJN-2114241	P-U-10	3 X 7	90.65
TJN-3000SC	I-U-1	1-3/4 X 4	21.32
TJN-6755591	P-U-9	3 X 6-1/2	167.50

UPRIGHT

Kit Number	Code (Pg. xviii)	Rod X Bore Size	List Price
UPRT-060211-014	I-U-4	1 X 2	\$ 20.56
UPRT-063905-010	I-U-11	1-1/4 X 2-1/2	25.07
UPRT-101015-010	I-U-10	1 X 2-1/4	15.47
UPRT-63904-010	I-U-4	2-1/2 X 5	92.60
UPRT-64346-010	I-U-11	1-1/4 X 3	23.29
UPRT-65397-011	I-U-11	3/4 X 2-1/4	17.10
UPRT-65970-011	I-U-10	3/4 X 1-1/4	22.01
UPRT-68457-010	I-U-11	3/4 X 2-1/4	17.13

VANGUARD

Kit Number	Code (Pg. xviii)	Rod X Bore Size	List Price
VG-101422	I-U-3	2-1/2 X 4	\$ 53.93
VG-10756	I-U-10	1-1/2 X 3-1/2	17.31
VG-10758	I-U-11,12		50.77
VG-10759	I-U-12	2 X 4	80.76
VG-17579	P-OB-3	1-1/4 X 3	15.02
VG-25068	I-U-10	2-1/2 X 4	22.82
VG-47105	I-U-10	1-1/4 X 3	41.92
VG-47107	I-U-10,12	2-1/2 X 4	87.31
VG-47152	I-U-12	1-3/8 X 3-1/4	83.43
VG-47763	I-U-10	1-1/4 X 3	30.56
VG-53957	I-U-10	1-1/2 X 3	36.70
VG-A13215651	I-U-5	2-1/2 X 4	43.22

VENCO LIFTGATE

Kit Number	Code (Pg. xviii)	Rod X Bore Size	List Price
VE-13088	P-U-4	1-1/4 X 4	\$ 88.00
VE-13089	P-U-4	1-1/4 X 3-1/2	73.77
VE-13090	P-U-4	1-1/8 X 3	63.72

REPLACEMENT SEAL KITS FOR VOLVO EQUIPMENT*

Replacement Seal Kits By Machine Type

▶ **NEW MODELS**

Table of Contents

Machine Type		Page
Backhoe Loaders	BL60, BL61, BL61 Plus, BL70, VOLVO BL71, BL71 Plus	1060 - 1061
Dump Trucks - Articulated	5350B, A20, A25, A25B, A25C, A25D, A25E, A25F , A30, A30C, A30D, A30E, A30F , A35, A35C, A35D, A35E, A35F , A35F FS , A40, A40D, A40E, A40F , A40F FS	1061 - 1064
Excavators	EC140B LC, EC140B LCM, EC160B LC, EC160B NLC, EC160C L , EC160C NL , EC200B, EC210B, EC210C L, EC210C LR, EC210C N, EC210C NL, EC230B, EC240B, EC240B FX, EC240B LC, EC240B LR, EC240B NLC, EC240C L , EC240C LD , EC240C LR , EC240C NL , EC280, EC290B FX, EC290B LC, EC290B LR, EC290B NLC, EC290C L , EC290C LD , EC290C LR , EC290C NL , EC330B LC, EC330C L , EC330C LD , EC340, EC360, EC360B LC, EC360B LR, EC360B NLC, EC360C HR , EC360C L , EC360C LD , EC360C NL , EC460B LC, EC460B LR, EC460C HR , EC460C L , EC460C LD	1064 - 1079
Excavators - Compact	EC15 XR, EC15 XT, EC15 XTV, EC15B XR, EC15B XT, EC15B XTV, EC20 XT, EC20 XTV, EC20B XT, EC20B XTV, EC25, EC30, EC35, EC55, EC55B, ECR58, ECR88	1079 - 1085
Forestry - Log Skidders	662, 664, 664B, 664C, 664D, 666, 666B, 666C, 666D, 667C, 667D, 668, 668B, 668C, 668D, F65, F665, F666, F668	1085 - 1086
Loaders - Skid Steer	MC90, MC90B	1086
Loaders - Wheel	12B, 35A, 35AWS, 35B, 35C, 35R, 45A, 45B, 45FB, 45C, 55A, 55A-II, 55-III, 55-IIIA, 55-III B, 55B, 55C, 75A-II, 75B, LF75B, 75C, 75-III, 75-III A, 85A, 85A-II, 85A-III, 85-III A, 125A, 125A-II, 125-111A, 125B, 125C, 175A, 175A-II, 175B, 175C, 175-III, 175-III A, 275B, 275C, 275-III, 275-III A, 475B, 475C, 475CT, 475-III A, 675B, L20B, L25B, L30, L30B, L35B, L40B, L45B, L50, L50B, L50C, L50C OR, L50D, L60E, L60F, L70, L70B, L70C, L70C BM, L70D, L70E, L70F, L90, L90B, L90C, L90C BM, L90D, L90E, L90F, L110E, L110F, L120, L120B, L120C, L120C BM, L120D, L120E, L120F , L140, L150, L150C, L150C BM, L150D, L150E, L150F , L150G , L160, L180, L180C, L180C BM, L180D, L180D HL, L180E, L180E HL, L180F , L180F HL , L180G , L190, L220D, L220E, L220F , L220G , L250G , L270, L270B, L320, L330C, L330C BM, L330C LL, L330C LL BM, L330D, L330E, L350F , L480, L480B, L480T	1086 - 1118
Motor Graders	710-740A, 750A & 780A, G930	1118
Scrapers	T450D	1118
Wheel Dozers	180, 180-III, 280, 280B, 280C, 280-III, 280-III A, 380B, 380-III, 380-III A, W380	1118 - 1120
Alpha-Numeric Kit Listing		1121 - 1126
Volvo Individual Parts		1126 - 1130

VOLVO

All manufacturer's names, part numbers and descriptions are used for reference purposes only. We do not imply that any part shown is the product of these manufacturers. We also do not imply that the list price shown is exactly that of the manufacturer.

Replacement Kits For

VOLVO

Backhoe Loaders							
APPLICATION	CYL #	SERIAL #	CODE	ROD	BORE	KIT #	List \$
MODEL BL60							
BACKHOE LOCK		10001-11314	I-O-10	16 mm	40 mm	VME-11710606	18.44
BOOM		10001-	I-UB-10	65 mm	115 mm	VME-11712455	89.39
BUCKET		10001-11314	I-UB-10	55 mm	85 mm	VME-11712450	114.22
DIPPER		10001-	I-UB-10	60 mm	110 mm	VME-11709624	80.53
EXTENSION		10001-11315	I-UB-10	40 mm	70 mm	VME-11709538	52.97
LIFT		10001-11314	I-UB-10	50 mm	80 mm	VME-11712746	82.77
SLEW		10001-	I-UB-10	50 mm	95 mm	VME-11709677	104.76
STABILIZER	11885749	10001-11314	I-UB-10	50 mm	95 mm	VME-11710948	73.67
	11886367	10001-	I-UB-10	55 mm	95 mm	VME-11715295	103.12
STEERING	11880001	10939-	I-U-10	38 mm	63 mm	VME-11716720	37.95
	11891267	10001-	I-U-10	36 mm	63 mm	VME-11712523	75.57
	11891284- 11891387	10939-11314	I-U-10	38 mm	63 mm	VME-11709898	62.32
	11891360	10001-	I-U-10	36 mm	63 mm	VME-11712523	75.57
	11891386	10001-	I-U-10	36 mm	63 mm	VME-11712523	75.57
	11895045	10001-	I-U-10	36 mm	63 mm	VME-11712523	75.57
	11895046	10939-	I-U-10	38 mm	63 mm	VME-11716720	37.95
	1887360	10939-	I-U-10	38 mm	63 mm	VME-11716720	37.95
TILT		10001-	I-UB-10	60 mm	105 mm	VME-11712749	80.53
MODEL BL61							
BACKHOE LOCK		10001-11458	I-O-10	16 mm	40 mm	VME-11710606	18.44
BOOM		10001-11458	I-UB-10	65 mm	120 mm	VME-11709528	113.88
BUCKET		10001-11458	I-UB-10	55 mm	85 mm	VME-11712450	114.22
DIPPER		10001-11458	I-UB-10	60 mm	110 mm	VME-11709624	80.53
EXTENSION		10001-11458	I-UB-10	40 mm	70 mm	VME-11709538	52.97
LIFT		10001-11458	I-UB-10	50 mm	85 mm	VME-11709617	110.21
SLEW		10001-11458	I-UB-10	50 mm	95 mm	VME-11709677	104.76
STABILIZER		10001-11458	I-UB-10	50 mm	70 mm	VME-11709632	46.60
STEERING	11880004	10627-11458	I-U-10	38 mm	63 mm	VME-11716720	37.95
	11887362	11459-	I-U-10	36 mm	65 mm	VME-11716625	66.92
	11891305	10001-11458	I-U-10	38 mm	63 mm	VME-11709898	62.32
	11891306	10001-11458	I-U-10	36 mm	63 mm	VME-11712523	75.57
	11891496	10001-11458	I-U-10	36 mm	63 mm	VME-11712523	75.57
	11895045	11459-	I-U-10	36 mm	65 mm	VME-11716625	66.92
TILT		10001-11458	I-UB-10	60 mm	105 mm	VME-11712749	80.53
MODEL BL61 Plus							
BOOM		10001-	I-UB-10	65 mm	120 mm	VME-11709528	113.88
DIPPER		10001-	I-UB-10	60 mm	110 mm	VME-11709624	80.53
EXTENSION		10001-	I-UB-10	40 mm	70 mm	VME-11709538	52.97
LIFT		10001-	I-UB-10	50 mm	85 mm	VME-11709617	110.21
SLEW		10001-	I-UB-10	50 mm	95 mm	VME-11709677	104.76
STABILIZER		10001-	I-UB-10	50 mm	70 mm	VME-11709632	46.60
STEERING	11887361	10001-	I-U-10	38 mm	63 mm	VME-11716720	37.95
	11887362	10001-	I-U-10	36 mm	65 mm	VME-11716625	66.92
TILT		10001-	I-UB-10	60 mm	105 mm	VME-11712749	80.53
MODEL BL70							
BACKHOE LOCK		10001-11488	I-O-10	16 mm	40 mm	VME-11710606	18.44
BOOM		10001-	I-UB-10	65 mm	120 mm	VME-11709528	113.88
BUCKET		10001-11488	I-UB-10	60 mm	90 mm	VME-11709547	96.02
DIPPER		10001-	I-UB-10	60 mm	120 mm	VME-11709543	111.03
EXTENSION		10001-	I-UB-10	40 mm	70 mm	VME-11709538	52.97
LIFT		10001-11488	I-UB-10	50 mm	85 mm	VME-11709617	110.21
SLEW		10001-	I-UB-10	50 mm	95 mm	VME-11709677	104.76
STABILIZER	11885749	10001-11488	I-UB-10	50 mm	95 mm	VME-11710948	73.67
	11886367	10001-	I-UB-10	55 mm	95 mm	VME-11715295	103.12

LR - Long Reach

SLF - Super Long Front

QF - Quick Fit

FS - Front Shovel

MH - Material Handle

AS - Articulate Slope

VOLVO

Replacement Kits For

Backhoe Loaders							
APPLICATION	CYL #	SERIAL #	CODE	ROD	BORE	KIT #	List \$
MODEL BL70							
STEERING		10001-	I-U-10	36 mm	65 mm	VME-11716625	66.92
		10001-11488	I-U-10	38 mm	63 mm	VME-11709898	62.32
TILT		10001-	I-UB-10	60 mm	110 mm	VME-11709624	80.53
MODEL BL71							
BACKHOE LOCK		10021-16826	I-O-10	16 mm	40 mm	VME-11710606	18.44
BOOM		10021-	I-UB-10	65 mm	120 mm	VME-11709528	113.88
BUCKET		10021-16826	I-UB-10	60 mm	90 mm	VME-11709547	96.02
DIPPER		10021-	I-UB-10	60 mm	120 mm	VME-11709543	111.03
EXTENSION		10021-	I-UB-10	40 mm	70 mm	VME-11709538	52.97
LIFT		10021-16826	I-UB-10	50 mm	85 mm	VME-11709617	110.21
SLEW		10021-	I-UB-10	50 mm	95 mm	VME-11709677	104.76
STABILIZER		10021-	I-UB-10	50 mm	70 mm	VME-11709632	46.60
STEERING		10021-16826	I-U-10	38 mm	63 mm	VME-11709898	62.32
		10021-16826	I-U-10	36 mm	65 mm	VME-11716625	66.92
TILT		10021-	I-UB-10	60 mm	110 mm	VME-11709624	80.53
MODEL BL71 Plus							
BOOM		10001-	I-UB-10	65 mm	120 mm	VME-11709528	113.88
DIPPER		10001-10494	I-UB-10	60 mm	120 mm	VME-11709543	111.03
		10495-	I-UB-10	60 mm	110 mm	VME-11709624	80.53
EXTENSION		10001-	I-UB-10	40 mm	70 mm	VME-11709538	52.97
LIFT		10001-10494	I-UB-10	50 mm	85 mm	VME-11709617	110.21
SLEW		10001-	I-UB-10	50 mm	95 mm	VME-11709677	104.76
STABILIZER		10001-	I-UB-10	50 mm	70 mm	VME-11709632	46.60
STEERING		10001-	I-U-10	36 mm	65 mm	VME-11716625	66.92
TILT		10001-	I-UB-10	60 mm	110 mm	VME-11709624	80.53
Dump Trucks - Articulated							
APPLICATION	CYL #	SERIAL #	CODE	ROD	BORE	KIT #	List \$
MODEL 5350B							
STEERING	4782849-6	-2475	P-U-15	70 mm	100 mm	VME-6630443	68.41
	4833274-6	2746-	P-U-15	70 mm	100 mm	VME-6630443	68.41
TILT	11053261-1		6 stage	60-140		VME-6630839	316.22
	11053262-9		6 stage	75-160		VME-6630852	363.97
	4941338-8		6 stage	60-140		VME-6630839	316.22
	4941761-1		4 stage	70-140		VME-6213407	353.37
	4942058-1		6 stage	75-160		VME-6630852	363.97
MODEL A20							
STEERING	4833274-6		P-U-15	70 mm	100 mm	VME-6630443	68.41
TILT	11053261-1	1533-	6 stage	60-140		VME-6630839	316.22
	11053262-9	1127-1532	6 stage	75-160		VME-6630852	363.97
	4942058-1	-1126	6 stage	75-160		VME-6630852	363.97
MODEL A25							
STEERING	4833274-6		P-U-15	70 mm	100 mm	VME-6630443	68.41
TILT	11043078-2	4067-5598	3 stage	75-140		VME-11991589	238.60
	11053261-1	4092-5486	6 stage	60-140		VME-6630839	316.22
	11053262-9	-5486	6 stage	75-160		VME-6630852	363.97
	11061382-5	5487-	5 stage	75-140		VME-11993411	351.52
	11061383-3	5599-	3 stage	75-140		VME-11993103	197.50
	4941338-8	-4091	6 stage	60-140		VME-6630839	316.22
	4941761-1	-4066	4 stage	70-140		VME-6213407	353.37
MODEL A25B							
STEERING	4833274-6		P-U-15	70 mm	100 mm	VME-6630443	68.41
MODEL A25C							
STEERING	4833274-6	-10256;-60911	P-U-15	70 mm	100 mm	VME-6630443-7	68.56
TIPPING (4X4)	11088346-9	-10256;-60911	P-U-13	70 mm	125 mm	VME-11990351-6	228.33
TIPPING (6X6)	11005475-6	-10256;-60911	P-U-13	70 mm	125 mm	VME-11990351-6	228.33

LR - Long Reach

SLF - Super Long Front

QF - Quick Fit

FS - Front Shovel

MH - Material Handle

AS - Articulate Slope

Replacement Kits For

VOLVO

Dump Trucks - Articulated							
APPLICATION	CYL #	SERIAL #	CODE	ROD	BORE	KIT #	List \$
MODEL A25D							
HOIST	11190986	11001-12999;13001-20000;61001-61118;71001-71999;72001-	P-U-10,13	80 mm	125 mm	VME-11988209	224.06
	11190986	11001-12999;13001-20000;61001-61118;71001-71999;72001-	P-U-10,13	80 mm	125 mm	VME-11988209-EX	241.94
	11190986	11001-12999;13001-20000;61001-61118;71001-71999;72001-	Bushing	80 mm		VME-11088150	3.59
	11190986	11001-12999;13001-20000;61001-61118;71001-71999;72001-	Wear Ring		125 mm	VME-4833220	9.19
	11296003	11001-12999;61001-61118;71001-71999	P-U-10,13	80 mm	125 mm	VME-11988209	224.06
	11296003	11001-12999;61001-61118;71001-71999	P-U-10,13	80 mm	125 mm	VME-11988209-EX	241.94
	11296003	11001-12999;61001-61118;71001-71999	Bushing	80 mm		VME-11088150	3.59
	11296003	11001-12999;61001-61118;71001-71999	Wear Ring		125 mm	VME-4833220	9.19
	11296031	11001-12999;13001-20000;61001-61118;71001-71999;72001-	P-U-10,13	80 mm	125 mm	VME-11988209	224.06
	11296031	11001-12999;13001-20000;61001-61118;71001-71999;72001-	P-U-10,13	80 mm	125 mm	VME-11988209-EX	241.94
	11296031	11001-12999;13001-20000;61001-61118;71001-71999;72001-	Bushing	80 mm		VME-11088150	3.59
11296031	11001-12999;13001-20000;61001-61118;71001-71999;72001-	Wear Ring		125 mm	VME-4833220	9.19	
STEERING	11296025	11001-12999;61001-61118;71001-71999	P-U-10	60 mm	100 mm	VME-11709249	64.38
	11296025	11001-12999;61001-61118;71001-71999	P-U-10	60 mm	100 mm	VME-11709249-EX	74.44
	11296025	11001-12999;61001-61118;71001-71999	Bushing	60 mm		VME-11088053	2.73
	11296025	11001-12999;61001-61118;71001-71999	Wear Ring		100 mm	VME-11088148	4.71
	11296026	11001-12999;13001-20000;61001-61118;71001-71999	I-UB-10	60 mm	100 mm	VME-11712387	79.62
MODEL A25E							
HOIST	11190986	13001-;73001-	P-U-10,13	80 mm	125 mm	VME-11988209	224.06
	11190986	13001-;73001-	P-U-10,13	80 mm	125 mm	VME-11988209-EX	241.94
	11190986	13001-;73001-	Bushing	80 mm		VME-11088150	3.59
	11190986	13001-;73001-	Wear Ring		125 mm	VME-4833220	9.19
	11296031	13001-;73001-	P-U-10,13	80 mm	125 mm	VME-11988209	224.06
	11296031	13001-;73001-	P-U-10,13	80 mm	125 mm	VME-11988209-EX	241.94
	11296031	13001-;73001-	Bushing	80 mm		VME-11088150	3.59
	11296031	13001-;73001-	Wear Ring		125 mm	VME-4833220	9.19
STEERING	11296026	13001-;73001-	I-UB-10	60 mm	100 mm	VME-11712387	79.62
MODEL A25F							
HOIST	16217815	13001-, 53001-, 73401-	P-U-10,13	80 mm	125 mm	VME-11988209	224.06
	16217815	13001-, 53001-, 73401-	P-U-10,13	80 mm	125 mm	VME-11988209-EX	241.94
	16217815	13001-, 53001-, 73401-	Bushing	80 mm		VME-11088150	3.59
	16217815	13001-, 53001-, 73401-	Wear Ring		125 mm	VME-4833220	9.19
HYDRAULIC	11296026	13001-, 53001-, 73401-	I-UB-10	60 mm	100 mm	VME-11712387	79.62
MODEL A30							
STEERING	11005212-3		P-U-15	60 mm	100 mm	VME-6630843-8	70.71
	11088154-7		P-U-15	60 mm	100 mm	VME-6630843-8	70.71
TIPPING	11005120-8		P-U-15	80 mm	140 mm	VME-11990170-0	232.26
	11088306-3		P-U-15	80 mm	140 mm	VME-11990170-0	232.26
MODEL A30C							
HOIST	11088306-3	-2320;-2275	P-U-15	80 mm	140 mm	VME-11990170-0	232.26
	11088815-3	-2320;-2275	P-U-15	80 mm	140 mm	VME-11990170-0	232.26
STEERING	11088154-7	-2320;-2275	P-U-15	60 mm	100 mm	VME-6630843-8	70.71
MODEL A30D							
HOIST	11296003	10001-11999;60001-60093;70001-72999	P-U-10,13	80 mm	125 mm	VME-11988209	224.06
	11296003	10001-11999;60001-60093;70001-72999	P-U-10,13	80 mm	125 mm	VME-11988209-EX	241.94
	11296003	10001-11999;60001-60093;70001-72999	Bushing	80 mm		VME-11088150	3.59
	11296003	10001-11999;60001-60093;70001-72999	Wear Ring		125 mm	VME-4833220	9.19

LR - Long Reach

SLF - Super Long Front

QF - Quick Fit

FS - Front Shovel

MH - Material Handle

AS - Articulate Slope

VOLVO

Replacement Kits For

Dump Trucks - Articulated							
APPLICATION	CYL #	SERIAL #	CODE	ROD	BORE	KIT #	List \$
MODEL A30D							
HOIST	11296031	10001-11999;12001-20000;60001-60093;70001-72999;73000-80000	P-U-10,13	80 mm	125 mm	VME-11988209	224.06
	11296031	10001-11999;12001-20000;60001-60093;70001-72999;73000-80000	P-U-10,13	80 mm	125 mm	VME-11988209-EX	241.94
	11296031	10001-11999;12001-20000;60001-60093;70001-72999;73000-80000	Bushing	80 mm		VME-11088150	3.59
	11296031	10001-11999;12001-20000;60001-60093;70001-72999;73000-80000	Wear Ring		125 mm	VME-4833220	9.19
STEERING	11296025	10001-11999;60001-60093;70001-72999	P-U-10	60 mm	100 mm	VME-11709249	64.38
	11296025	10001-11999;60001-60093;70001-72999	P-U-10	60 mm	100 mm	VME-11709249-EX	74.44
	11296025	10001-11999;60001-60093;70001-72999	Bushing	60 mm		VME-11088053	2.73
	11296025	10001-11999;60001-60093;70001-72999	Wear Ring		100 mm	VME-11088148	4.71
	11296026	10001-11999;12001-20000;60001-60093;70001-72999;73000-80000	I-UB-10	60 mm	100 mm	VME-11712387	79.62
MODEL A30E							
HOIST	11296031	12001-;72001-	P-U-10,13	80 mm	125 mm	VME-11988209	224.06
	11296031	12001-;72001-	P-U-10,13	80 mm	125 mm	VME-11988209-EX	241.94
	11296031	12001-;72001-	Bushing	80 mm		VME-11088150	3.59
	11296031	12001-;72001-	Wear Ring		125 mm	VME-4833220	9.19
STEERING	11296026	72001-;12001-	I-UB-10	60 mm	100 mm	VME-11712387	79.62
MODEL A30F							
HOIST	16217815	12001-, 52001-, 72701-	P-U-10,13	80 mm	125 mm	VME-11988209	224.06
	16217815	12001-, 52001-, 72701-	P-U-10,13	80 mm	125 mm	VME-11988209-EX	241.94
	16217815	12001-, 52001-, 72701-	Bushing	80 mm		VME-11088150	3.59
	16217815	12001-, 52001-, 72701-	Wear Ring		125 mm	VME-4833220	9.19
HYDRAULIC	11296026	12001-, 52001-, 72701-	I-UB-10	60 mm	100 mm	VME-11712387	79.62
MODEL A35							
STEERING	11088155-4	1882-;1886(USA)-	P-U-15	70 mm	110 mm	VME-11990070	88.05
	4833125-0	-1881-;1885(USA)	P-U-15	70 mm	110 mm	VME-11990070	88.05
TILT	11043080-8	-1194-;1200(USA)	3 stage	75-140		VME-11991589	238.60
	11061384-1	1195-;1201(USA)-	3 stage	75-140		VME-11993103	197.50
MODEL A35C							
STEERING	11088751-0	-4260	P-U-15	70 mm	110 mm	VME-11701665-9	64.73
TILT	11061384-1	-4260	3 stage	75-140		VME-11993103-8	200.92
MODEL A35D							
HOIST	11149003	11001-60000;61001-70000;70001-99999	P-UB-10	90 mm	150 mm	VME-11708734	93.10
	11149003	11001-60000;61001-70000;70001-99999	P-UB-10	90 mm	150 mm	VME-11708734-EX	164.65
	11149003	11001-60000;61001-70000;70001-99999	Bushing	90 mm		VME-11088249	20.61
	11149003	11001-60000;61001-70000;70001-99999	Wear Ring		150 mm	VME-11088149	10.45
	11296032	11001-60000;70001-99999;61001-70000	P-U-10	90 mm	150 mm	VME-11711945	148.83
	11296032	11001-60000;70001-99999;61001-70000	P-U-10	90 mm	150 mm	VME-11711945-EX	209.36
	11296032	11001-60000;70001-99999;61001-70000	Bushing	90 mm		VME-11088249	20.61
	11296032	11001-60000;70001-99999;61001-70000	Wear Ring		150 mm	VME-11088149	10.45
STEERING	11149000	11001-60000;70001-99999;61001-70000	P-U-15	70 mm	120 mm	VME-11700151	89.97
	11149000	11001-60000;70001-99999;61001-70000	P-U-15	70 mm	120 mm	VME-11700151-EX	93.58
	11149000	11001-60000;70001-99999;61001-70000	Bushing	70 mm		VME-11088054	3.20
	11296028	11001-60000;70001-99999;61001-70000	I-UB-10	70 mm	120 mm	VME-11712388	110.23
MODEL A35E							
HOIST	11296034	10001-	P-U-10	90 mm	150 mm	VME-11711945	148.83
	11296034	10001-	P-U-10	90 mm	150 mm	VME-11711945-EX	209.36
	11296034	10001-	Bushing	90 mm		VME-11088249	20.61
	11296034	10001-	Wear Ring		150 mm	VME-11088149	10.45
STEERING	11296028	10001-	I-UB-10	70 mm	120 mm	VME-11712388	110.23
MODEL A35F							
HOIST	15146032	10001-, 50001-	P-UB-10	90 mm	150 mm	VME-15153996	176.81
HYDRAULIC	11296028	10001-, 50001-	I-UB-10	70 mm	120 mm	VME-11712388	110.23

LR - Long Reach

SLF - Super Long Front

QF - Quick Fit

FS - Front Shovel

MH - Material Handle

AS - Articulate Slope

Replacement Kits For

VOLVO

Dump Trucks - Articulated

APPLICATION	CYL #	SERIAL #	CODE	ROD	BORE	KIT #	List \$
MODEL A35F FS							
HOIST	15146032	10001-, 50001-	P-UB-10	90 mm	150 mm	VME-15153996	176.81
HYDRAULIC	11296028	10001-, 50001-	I-UB-10	70 mm	120 mm	VME-11712388	110.23
	17202131	10001-, 50001-	P-UB-10	90 mm	115 mm	VME-17207945	
MODEL A40							
HOIST	11088003	1001-1151;60001-60026;1001-1097;60101-70000;1201-10000	P-UB-13	90 mm	160 mm	VME-11700176	414.64
STEERING	11088298	1001-1151;60001-60026;1001-1097;60101-70000;1201-10000	P-U-15	70 mm	120 mm	VME-11700151	89.97
	11088298	1001-1151;60001-60026;1001-1097;60101-70000;1201-10000	P-U-15	70 mm	120 mm	VME-11700151-EX	93.58
	11088298	1001-1151;60001-60026;1001-1097;60101-70000;1201-10000	Bushing	70 mm		VME-11088054	3.20
MODEL A40D							
HOIST	11149003	10001-60000;60001-70000;70001-99999	P-UB-10	90 mm	150 mm	VME-11708734	93.10
	11149003	10001-60000;60001-70000;70001-99999	P-UB-10	90 mm	150 mm	VME-11708734-EX	164.65
	11149003	10001-60000;60001-70000;70001-99999	Bushing	90 mm		VME-11088249	20.61
	11149003	10001-60000;60001-70000;70001-99999	Wear Ring		150 mm	VME-11088149	10.45
	11296032	10001-60000;70001-99999;60001-70000	P-U-10	90 mm	150 mm	VME-11711945	148.83
	11296032	10001-60000;70001-99999;60001-70000	P-U-10	90 mm	150 mm	VME-11711945-EX	209.36
	11296032	10001-60000;70001-99999;60001-70000	Bushing	90 mm		VME-11088249	20.61
	11296032	10001-60000;70001-99999;60001-70000	Wear Ring		150 mm	VME-11088149	10.45
STEERING	11149000	10001-60000;70001-99999;60001-70000	P-U-15	70 mm	120 mm	VME-11700151	89.97
	11149000	10001-60000;70001-99999;60001-70000	P-U-15	70 mm	120 mm	VME-11700151-EX	93.58
	11149000	10001-60000;70001-99999;60001-70000	Bushing	70 mm		VME-11088054	3.20
	11296028	10001-60000;70001-99999;61001-70000	I-UB-10	70 mm	120 mm	VME-11712388	110.23
MODEL A40E							
HOIST	11296034	11001-	P-U-10	90 mm	150 mm	VME-11711945	148.83
	11296034	11001-	P-U-10	90 mm	150 mm	VME-11711945-EX	209.36
	11296034	11001-	Bushing	90 mm		VME-11088249	20.61
	11296034	11001-	Wear Ring		150 mm	VME-11088149	10.45
STEERING	11296028	11001-	I-UB-10	70 mm	120 mm	VME-11712388	110.23
MODEL A40F							
HOIST	15146032	11001-, 51001-	P-UB-10	90 mm	150 mm	VME-15153996	176.81
HYDRAULIC	11296028	11001-, 51001-	I-UB-10	70 mm	120 mm	VME-11712388	110.23
MODEL A40F FS							
HOIST	15146032	11001-, 51001-	P-UB-10	90 mm	150 mm	VME-15153996	176.81
HYDRAULIC	11296028	11001-, 51001-	I-UB-10	70 mm	120 mm	VME-11712388	110.23
	17202131	11001-, 51001-	P-UB-10	90 mm	115 mm	VME-17207945	
Excavators							
APPLICATION	CYL #	SERIAL #	CODE	ROD	BORE	KIT #	List \$
MODEL EC140B LC, EC140B LCM							
BOOM	14513832	10001-12687	P-UB-10	70 mm	105 mm	VME-14516932	171.45
	14513833	10001-12687	P-UB-10	70 mm	110 mm	VME-14516933	223.38
	14514845	10001-12687	P-UB-10	70 mm	105 mm	VME-14516932	171.45
	14514847	10001-12687	P-UB-10	70 mm	110 mm	VME-14516933	223.38
	14563313	12688-	P-UB-10	70 mm	105 mm	VME-14516932	171.45
	14564035	12688-	P-UB-10	70 mm	105 mm	VME-14516932	171.45
	14564141	12688-	P-UB-10	70 mm	110 mm	VME-14516933	223.38
	14564147	12688-	P-UB-10	70 mm	110 mm	VME-14516933	223.38
BOOM (Adj 2nd)	14513834	10001-12687	P-UB-10	90 mm	160 mm	VME-14516934	228.10
	14514848	10001-12687	P-UB-10	90 mm	160 mm	VME-14516934	228.10
	14564150	12688-	P-UB-10	90 mm	160 mm	VME-14516934	228.10
	14564156	12688-	P-UB-10	90 mm	160 mm	VME-14516934	228.10
BUCKET	14510883	10001-10835	P-UB-10	70 mm	100 mm	VME-14547310	210.37
	14514560	10001-10838	P-UB-10	70 mm	100 mm	VME-14547310	210.37
	14522846	10836-12687	P-UB-10	70 mm	100 mm	VME-14547310	210.37

LR - Long Reach

SLF - Super Long Front

QF - Quick Fit

FS - Front Shovel

MH - Material Handle

AS - Articulate Slope

VOLVO

Replacement Kits For

Excavators								
APPLICATION	CYL #	SERIAL #	CODE	ROD	BORE	KIT #	List \$	
MODEL EC140B LC, EC140B LCM								
BUCKET	14522900	10839-12687	P-UB-10	70 mm	100 mm	VME-14547310	210.37	
	14564132	12688-	P-UB-10	70 mm	100 mm	VME-14547310	210.37	
	14564139	12688-	P-UB-10	70 mm	100 mm	VME-14547310	210.37	
DIPPER ARM	14513836	10001-10786	P-UB-10	80 mm	120 mm	VME-14515053	234.44	
	14514846	10001-10892	P-UB-10	80 mm	120 mm	VME-14515053	234.44	
	14522843	10787-12687	P-UB-10	80 mm	120 mm	VME-14515053	234.44	
	14522844	10893-12687	P-UB-10	80 mm	120 mm	VME-14515053	234.44	
	14563395	12688-	P-UB-10	80 mm	120 mm	VME-14515053	234.44	
	14564129	12688-	P-UB-10	80 mm	120 mm	VME-14515053	234.44	
DOZER BLADE	14507885	10001-;20001-	P-UB-10	90 mm	130 mm	VME-14517001	175.00	
	14507886	10001-;20001-	P-UB-10	90 mm	130 mm	VME-14517001	175.00	
QUICK-FIT	1171-90610	10001-10943	P-U-10	25 mm	50 mm	VME-14510910	84.11	
	14522369	10944-	P-U-10	25 mm	50 mm	VME-14523116	68.20	
MODEL EC160B LC, EC160B NLC								
BOOM	14517998	10001-11551	P-UB-10	75 mm	115 mm	VME-14519503	184.88	
	14518003	10001-11551	P-UB-10	75 mm	115 mm	VME-14519503	184.88	
	14564001	11552-	P-UB-10	75 mm	115 mm	VME-14519503	184.88	
	14564007	11552-	P-UB-10	75 mm	115 mm	VME-14519503	184.88	
BOOM (Adj 2nd)	14518890	10086-11551	P-UB-10	90 mm	160 mm	VME-14516934	228.10	
	14521288	10086-11551	P-UB-10	90 mm	160 mm	VME-14516934	228.10	
	14556577	11552-	P-UB-10	90 mm	160 mm	VME-14516934	228.10	
	14564032	11552-	P-UB-10	90 mm	160 mm	VME-14516934	228.10	
BUCKET	14518000	10001-10153	P-UB-10	75 mm	105 mm	VME-14519504	224.74	
	14518290	10001-10153	P-UB-10	75 mm	105 mm	VME-14519504	224.74	
	14523674	10154-11551	P-UB-10	75 mm	105 mm	VME-14519504	224.74	
	14523675	10154-11551	P-UB-10	75 mm	105 mm	VME-14519504	224.74	
	14564024	11552-	P-UB-10	75 mm	105 mm	VME-14519504	224.74	
	14564030	11552-	P-UB-10	75 mm	105 mm	VME-14519504	224.74	
DIPPER ARM	14517999	10001-11551	P-UB-10	80 mm	120 mm	VME-14519505	262.64	
	14518289	10001-11551	P-UB-10	80 mm	120 mm	VME-14519505	262.64	
	14564010	11552-	P-UB-10	80 mm	120 mm	VME-14519505	262.64	
	14564016	11552-	P-UB-10	80 mm	120 mm	VME-14519505	262.64	
DOZER BLADE	14515318	10001-99999	P-UB-10	95 mm	140 mm	VME-14519624	226.82	
	14515319	10001-99999	P-UB-10	95 mm	140 mm	VME-14519624	226.82	
QUICK-FIT	1171-90610	10001-10223	P-U-10	25 mm	50 mm	VME-14510910	84.11	
	14522369	10224-	P-U-10	25 mm	50 mm	VME-14523116	68.20	
	14522370	10224-	P-U-10	32 mm	70 mm	VME-14523132	106.09	
NEW MODEL EC160C L								
BOOM	14538693	120001-139999, 140001-140192	P-UB-10	75 mm	115 mm	VME-14589127	137.33	
	14538693	120001-139999, 140001-140192	Bushing	75 mm		VME-9612-07540	30.16	
	14549083	120001-139999, 140001-140192	P-UB-10	90 mm	160 mm	VME-14589123	177.69	
	14549083	120001-139999, 140001-140192	Bushing	90 mm		VME-9612-09040	38.46	
	14554983	120001-139999, 140001-140192	P-UB-10	75 mm	115 mm	VME-14589127	137.33	
	14554983	120001-139999, 140001-140192	Bushing	75 mm		VME-9612-07540	30.16	
	14554986	120001-139999, 140001-140192	P-UB-10	90 mm	160 mm	VME-14589123	177.69	
	14554986	120001-139999, 140001-140192	Bushing	90 mm		VME-9612-09040	38.46	
BUCKET	14538695	120001-139999, 140001-140192	P-UB-10	75 mm	105 mm	VME-14589128	102.58	
	14538695	120001-139999, 140001-140192	Bushing	75 mm		VME-9612-07540	30.16	
	14554985	120001-139999, 140001-140192	P-UB-10	75 mm	105 mm	VME-14589128	102.58	
	14554985	120001-139999, 140001-140192	Bushing	75 mm		VME-9612-07540	30.16	
DIPPER ARM	14538694	120001-139999, 140001-140192	P-UB-10	80 mm	120 mm	VME-14589124	262.64	
	14554984	120001-139999, 140001-140192	P-UB-10	80 mm	120 mm	VME-14589124	262.64	
DOZER BLADE	14538697	120001-139999, 140001-140192	P-UB-10	95 mm	140 mm	VME-14589126	157.67	
	14538697	120001-139999, 140001-140192	Bushing	95 mm		VME-9612-09540	46.60	
	14538698	120001-139999, 140001-140192	P-UB-10	95 mm	140 mm	VME-14589126	157.67	

LR - Long Reach

SLF - Super Long Front

QF - Quick Fit

FS - Front Shovel

MH - Material Handle

AS - Articulate Slope

Replacement Kits For

VOLVO

Excavators							
APPLICATION	CYL #	SERIAL #	CODE	ROD	BORE	KIT #	List \$
MODEL EC160C L							
DOZER BLADE	14538698	120001-139999, 140001-140192	Bushing	95 mm		VME-9612-09540	46.60
QUICK-FIT	14522369	120001-139999, 140001-140192	P-U-10	25 mm	50 mm	VME-14523116	68.20
	14522370	120001-139999, 140001-140192	P-U-10	32 mm	70 mm	VME-14523132	106.09
MODEL EC160C NL							
BOOM	14538693	120001-139999, 140001-140192	P-UB-10	75 mm	115 mm	VME-14589127	137.33
	14538693	120001-139999, 140001-140192	Bushing	75 mm		VME-9612-07540	30.16
	14549083	120001-139999, 140001-140192	P-UB-10	90 mm	160 mm	VME-14589123	177.69
	14549083	120001-139999, 140001-140192	Bushing	90 mm		VME-9612-09040	38.46
	14554983	120001-139999, 140001-140192	P-UB-10	75 mm	115 mm	VME-14589127	137.33
	14554983	120001-139999, 140001-140192	Bushing	75 mm		VME-9612-07540	30.16
	14554986	120001-139999, 140001-140192	P-UB-10	90 mm	160 mm	VME-14589123	177.69
	14554986	120001-139999, 140001-140192	Bushing	90 mm		VME-9612-09040	38.46
BUCKET	14538695	120001-139999, 140001-140192	P-UB-10	75 mm	105 mm	VME-14589128	102.58
	14538695	120001-139999, 140001-140192	Bushing	75 mm		VME-9612-07540	30.16
	14554985	120001-139999, 140001-140192	P-UB-10	75 mm	105 mm	VME-14589128	102.58
	14554985	120001-139999, 140001-140192	Bushing	75 mm		VME-9612-07540	30.16
DIPPER ARM	14538694	120001-139999, 140001-140192	P-UB-10	80 mm	120 mm	VME-14589124	262.64
	14554984	120001-139999, 140001-140192	P-UB-10	80 mm	120 mm	VME-14589124	262.64
DOZER BLADE	14538697	120001-139999, 140001-140192	P-UB-10	95 mm	140 mm	VME-14589126	157.67
	14538697	120001-139999, 140001-140192	Bushing	95 mm		VME-9612-09540	46.60
	14538698	120001-139999, 140001-140192	P-UB-10	95 mm	140 mm	VME-14589126	157.67
	14538698	120001-139999, 140001-140192	Bushing	95 mm		VME-9612-09540	46.60
QUICK-FIT	14522369	120001-139999, 140001-140192	P-U-10	25 mm	50 mm	VME-14523116	68.20
	14522370	120001-139999, 140001-140192	P-U-10	32 mm	70 mm	VME-14523132	106.09
MODEL EC200B							
ARM			P-UB-10	95 mm	135 mm	VME-14589131	305.19
BOOM			P-UB-10	80 mm	125 mm	VME-14589129	282.53
BUCKET			P-UB-10	80 mm	120 mm	VME-14589132	198.79
MODEL EC210B							
ARM	14512429	10001-12065;30001-30156	P-UB-10	95 mm	135 mm	VME-14515052	252.51
	14522908	12066-14998;20001-20073;30157-30792	P-UB-10	95 mm	135 mm	VME-14515052	252.51
	14523658	10001-14998;20001-20073;30001-30792	P-UB-10	95 mm	135 mm	VME-14515052	252.51
	14534547	14999-;30793-;20074-	P-UB-10	95 mm	135 mm	VME-14515052	252.51
	14535513	14999-;30793-;20074-	P-UB-10	95 mm	135 mm	VME-14515052	252.51
ARM (SLF)	14512432		P-UB-10	95 mm	135 mm	VME-14515052	252.51
	14514852		P-UB-10	95 mm	135 mm	VME-14515052	252.51
BOOM	14512428		P-UB-10	80 mm	125 mm	VME-14515051	230.25
	14524660		P-UB-10	80 mm	125 mm	VME-14515051	230.25
BOOM (SLF)	14512431		P-UB-10	105 mm	160 mm	VME-14514456	394.86
	14514853		P-UB-10	105 mm	160 mm	VME-14514456	394.86
BUCKET	14512430	10001-12065;30001-30156	P-UB-10	80 mm	120 mm	VME-14515053	234.44
	14523659	12066-;30157-	P-UB-10	80 mm	120 mm	VME-14515053	234.44
	14523664	10001-12065;12066-;30001-30156;30157-	P-UB-10	80 mm	120 mm	VME-14515053	234.44
BUCKET (SLF)	14522846	12066-;30157-	P-UB-10	70 mm	100 mm	VME-14547310	210.37
	14522900	12066-;30157-	P-UB-10	70 mm	100 mm	VME-14547310	210.37
MODEL EC210C L							
BOOM	14534531	110001-119999, 120001-129999	P-UB-10	80 mm	125 mm	VME-14515051	230.25
	14550417	110001-119999, 120001-129999	P-UB-10	105 mm	160 mm	VME-14514456	394.86
	14554977	110001-119999, 120001-129999	P-UB-10	80 mm	125 mm	VME-14515051	230.25
	14554980	110001-119999, 120001-129999	P-UB-10	105 mm	160 mm	VME-14514456	394.86
BUCKET	14534533	110001-119999, 120001-129999	P-UB-10	80 mm	120 mm	VME-14515053	234.44
	14536165	110001-119999, 120001-129999	P-UB-10	90 mm	130 mm	VME-14514454	267.76
	14536959	110001-119999, 120001-129999	P-UB-10	70 mm	100 mm	VME-14551098	128.10
	14554979	110001-119999, 120001-129999	P-UB-10	80 mm	120 mm	VME-14515053	234.44
	14554982	110001-119999, 120001-129999	P-UB-10	70 mm	100 mm	VME-14551098	128.10

LR - Long Reach

SLF - Super Long Front

QF - Quick Fit

FS - Front Shovel

MH - Material Handle

AS - Articulate Slope

VOLVO

Replacement Kits For

Excavators								
APPLICATION	CYL #	SERIAL #	CODE	ROD	BORE	KIT #	List \$	
MODEL EC210C L								
BUCKET	14556575	110001-119999, 120001-129999	P-UB-10	90 mm	130 mm	VME-14514454	267.76	
DIPPER ARM	14534532	110001-119999, 120001-129999	P-UB-10	95 mm	135 mm	VME-14515052	252.51	
	14535789	110001-119999, 120001-129999	P-UB-10	95 mm	135 mm	VME-14515052	252.51	
	14554978	110001-119999, 120001-129999	P-UB-10	95 mm	135 mm	VME-14515052	252.51	
	14554981	110001-119999, 120001-129999	P-UB-10	95 mm	135 mm	VME-14515052	252.51	
MODEL EC210C LR								
BOOM	14534531	110001-119999, 120001-129999	P-UB-10	80 mm	125 mm	VME-14515051	230.25	
	14550417	110001-119999, 120001-129999	P-UB-10	105 mm	160 mm	VME-14514456	394.86	
	14554977	110001-119999, 120001-129999	P-UB-10	80 mm	125 mm	VME-14515051	230.25	
	14554980	110001-119999, 120001-129999	P-UB-10	105 mm	160 mm	VME-14514456	394.86	
MODEL EC210C N								
BOOM	14534531	110001-119999, 120001-129999	P-UB-10	80 mm	125 mm	VME-14515051	230.25	
	14550417	110001-119999, 120001-129999	P-UB-10	105 mm	160 mm	VME-14514456	394.86	
	14554977	110001-119999, 120001-129999	P-UB-10	80 mm	125 mm	VME-14515051	230.25	
	14554980	110001-119999, 120001-129999	P-UB-10	105 mm	160 mm	VME-14514456	394.86	
BUCKET	14534533	110001-119999, 120001-129999	P-UB-10	80 mm	120 mm	VME-14515053	234.44	
	14536165	110001-119999, 120001-129999	P-UB-10	90 mm	130 mm	VME-14514454	267.76	
	14536959	110001-119999, 120001-129999	P-UB-10	70 mm	100 mm	VME-14551098	128.10	
	14554979	110001-119999, 120001-129999	P-UB-10	80 mm	120 mm	VME-14515053	234.44	
	14554982	110001-119999, 120001-129999	P-UB-10	70 mm	100 mm	VME-14551098	128.10	
	14556575	110001-119999, 120001-129999	P-UB-10	90 mm	130 mm	VME-14514454	267.76	
	DIPPER ARM	14534532	110001-119999, 120001-129999	P-UB-10	95 mm	135 mm	VME-14515052	252.51
		14535789	110001-119999, 120001-129999	P-UB-10	95 mm	135 mm	VME-14515052	252.51
14554978		110001-119999, 120001-129999	P-UB-10	95 mm	135 mm	VME-14515052	252.51	
14554981		110001-119999, 120001-129999	P-UB-10	95 mm	135 mm	VME-14515052	252.51	
MODEL EC210C NL								
BOOM	14534531	110001-119999, 120001-129999	P-UB-10	80 mm	125 mm	VME-14515051	230.25	
	14554977	110001-119999, 120001-129999	P-UB-10	80 mm	125 mm	VME-14515051	230.25	
BUCKET	14534533	110001-119999, 120001-129999	P-UB-10	80 mm	120 mm	VME-14515053	234.44	
	14536165	110001-119999, 120001-129999	P-UB-10	90 mm	130 mm	VME-14514454	267.76	
	14536959	110001-119999, 120001-129999	P-UB-10	70 mm	100 mm	VME-14551098	128.10	
	14554979	110001-119999, 120001-129999	P-UB-10	80 mm	120 mm	VME-14515053	234.44	
	14554982	110001-119999, 120001-129999	P-UB-10	70 mm	100 mm	VME-14551098	128.10	
	14556575	110001-119999, 120001-129999	P-UB-10	90 mm	130 mm	VME-14514454	267.76	
DIPPER ARM	14534532	110001-119999, 120001-129999	P-UB-10	95 mm	135 mm	VME-14515052	252.51	
	14535789	110001-119999, 120001-129999	P-UB-10	95 mm	135 mm	VME-14515052	252.51	
	14554978	110001-119999, 120001-129999	P-UB-10	95 mm	135 mm	VME-14515052	252.51	
	14554981	110001-119999, 120001-129999	P-UB-10	95 mm	135 mm	VME-14515052	252.51	
MODEL EC230B								
BOOM (FS)	142508811	0-4655	P-UB-11	105 mm	160 mm	VME-11997089-5	709.53	
	142654656	4656-	P-UB-11	105 mm	160 mm	VME-11997089-5	709.53	
BOOM (MH)	142479005	0-4655	P-UB-11	105 mm	160 mm	VME-11997089-5	709.53	
	142654649	4656-	P-UB-11	105 mm	160 mm	VME-11997089-5	709.53	
BUCKET	142508902	0-4655	P-UB-14	90 mm	140 mm	VME-11997091-1	565.04	
	142654664	4656-	P-UB-14	90 mm	140 mm	VME-11997091-1	565.04	
BUCKET (AS)	142459759		P-U-14	50 mm	70 mm	VME-11997227	201.12	
BUCKET (QF)	142357003	0-4465	P-UB-10	32 mm	70 mm	VME-11999887	117.06	
	142616416	4466-	P-UB-10	32 mm	70 mm	VME-11999887	117.06	
DIPPER ARM	140533530		P-UB-14	105 mm	150 mm	VME-11997226	491.10	
KNUCKLE	142654680	ALL	P-UB-11	105 mm	160 mm	VME-11997089-5	709.53	
KNUCKLE (FS)	140533357		P-UB-15	80 mm	125 mm	VME-11997225	333.81	
MODEL EC240B								
ARM	14510809	10001-10841	P-UB-10	100 mm	140 mm	VME-14514457	360.50	
	14510810	10001-	P-UB-10	100 mm	140 mm	VME-14514457	360.50	
	14514829	10001-	P-UB-10	100 mm	140 mm	VME-14514457	360.50	

LR - Long Reach SLF - Super Long Front QF - Quick Fit FS - Front Shovel MH - Material Handle AS - Articulate Slope

VOLVO

Replacement Kits For

Excavators								
APPLICATION	CYL #	SERIAL #	CODE	ROD	BORE	KIT #	List \$	
MODEL EC240B								
ARM	14514837	10001-10841	P-UB-10	100 mm	140 mm	VME-14514457	360.50	
	14521659	10842-12112	P-UB-10	100 mm	140 mm	VME-14514457	360.50	
	14521758	10842-12112	P-UB-10	100 mm	140 mm	VME-14514457	360.50	
	14535044	12113-	P-UB-10	100 mm	140 mm	VME-14514457	360.50	
	14536159	12113-	P-UB-10	100 mm	140 mm	VME-14514457	360.50	
BOOM	14510808	10001-12641- INT;80001-EU,NA	P-UB-10	90 mm	135 mm	VME-14514455	387.10	
	14510811	10001-12641- INT;80001-EU,NA	P-UB-10	105 mm	160 mm	VME-14514456	394.86	
	14514827	10001-12641- INT;80001-EU,NA	P-UB-10	105 mm	160 mm	VME-14514456	394.86	
	14514840	10001-12641- INT;80001-EU,NA	P-UB-10	90 mm	135 mm	VME-14514455	387.10	
	14530665	10001-12641- INT;80001-EU,NA	P-UB-10	90 mm	135 mm	VME-14514455	387.10	
BUCKET	14514833	10001-12641- INT;80001-EU,NA	P-UB-10	90 mm	130 mm	VME-14514454	267.76	
	14523665	10001-12641- INT;80001-EU,NA	P-UB-10	90 mm	130 mm	VME-14514454	267.76	
14523666	10001-12641- INT;80001-EU,NA	P-UB-10	90 mm	130 mm	VME-14514454	267.76		
MODEL EC240B FX								
BOOM	14510808	10001-12786;30001-30243	P-UB-10	90 mm	135 mm	VME-14514455	387.10	
	14514840	10001-12786;30001-30243	P-UB-10	90 mm	135 mm	VME-14514455	387.10	
	14530665	12787-13234;30244-;80001-81034	P-UB-10	90 mm	135 mm	VME-14514455	387.10	
	14541247	12787-13234;30244-;80001-81034	P-UB-10	90 mm	135 mm	VME-14514455	387.10	
	14563900	13235-;81035-	P-UB-10	90 mm	135 mm	VME-14514455	387.10	
	14563929	13235-;81035-	P-UB-10	90 mm	135 mm	VME-14514455	387.10	
BOOM (Adj 2nd)	14510811	12641-13234;80001-81034	P-UB-10	105 mm	160 mm	VME-14514456	394.86	
	14514827	12641-13234;80001-81034	P-UB-10	105 mm	160 mm	VME-14514456	394.86	
	14563950	13235-;81035-	P-UB-10	105 mm	160 mm	VME-14514456	394.86	
	14563956	13235-;81035-	P-UB-10	105 mm	160 mm	VME-14514456	394.86	
BUCKET	14504187	10001-10973	P-UB-10	90 mm	130 mm	VME-14514454	267.76	
	14514833	10001-10973	P-UB-10	90 mm	130 mm	VME-14514454	267.76	
	14523665	10974-12768;30001-30243	P-UB-10	90 mm	130 mm	VME-14514454	267.76	
	14541237	12787-13234;80001-81034;30244-	P-UB-10	90 mm	130 mm	VME-14514454	267.76	
	14541267	10974-12729;12787-13234;30001-30243;30244-;80001-81034	P-UB-10	90 mm	130 mm	VME-14514454	267.76	
	14563959	13235-;81035-	P-UB-10	90 mm	130 mm	VME-14514454	267.76	
	14563965	13235-;81035-	P-UB-10	90 mm	130 mm	VME-14514454	267.76	
BUCKET (LR)	14510883	10001-10973	P-UB-10	70 mm	100 mm	VME-14547310	210.37	
	14514560	10001-10973	P-UB-10	70 mm	100 mm	VME-14547310	210.37	
	14522846	10974-13234;80001-81034;30001-	P-UB-10	70 mm	100 mm	VME-14547310	210.37	
	14522900	10974-13234;80001-81034;30001-	P-UB-10	70 mm	100 mm	VME-14547310	210.37	
	14564132	13235-;81035-	P-UB-10	70 mm	100 mm	VME-14547310	210.37	
	14564139	13235-;81035-	P-UB-10	70 mm	100 mm	VME-14547310	210.37	
DIPPER ARM	14510809	10001-10841	P-UB-10	100 mm	140 mm	VME-14514457	360.50	
	14510810	12641-13234;80001-81034	P-UB-10	100 mm	140 mm	VME-14514457	360.50	
	14514829	12641-13234;80001-81034	P-UB-10	100 mm	140 mm	VME-14514457	360.50	
	14514837	10001-10841	P-UB-10	100 mm	140 mm	VME-14514457	360.50	
	14521659	10842-12112	P-UB-10	100 mm	140 mm	VME-14514457	360.50	
	14521758	10842-12112	P-UB-10	100 mm	140 mm	VME-14514457	360.50	
	14535044	12113-13234;80001-81034	P-UB-10	100 mm	140 mm	VME-14514457	360.50	
	14536159	12113-13234;80001-81034	P-UB-10	100 mm	140 mm	VME-14514457	360.50	
	14563932	13235-;81035-	P-UB-10	100 mm	140 mm	VME-14514457	360.50	
	14563938	13235-;81035-	P-UB-10	100 mm	140 mm	VME-14514457	360.50	
	14563941	13235-;81035-	P-UB-10	100 mm	140 mm	VME-14514457	360.50	
	14563947	13235-;81035-	P-UB-10	100 mm	140 mm	VME-14514457	360.50	
	QUICK-FIT	14522370	11090-	P-U-10	32 mm	70 mm	VME-14523132	106.09
	MODEL EC240B LC							
BOOM	14510808	10001-12786;30001-30243	P-UB-10	90 mm	135 mm	VME-14514455	387.10	
	14514840	10001-12786;30001-30243	P-UB-10	90 mm	135 mm	VME-14514455	387.10	

LR - Long Reach

SLF - Super Long Front

QF - Quick Fit

FS - Front Shovel

MH - Material Handle

AS - Articulate Slope

Replacement Kits For

VOLVO

Excavators								
APPLICATION	CYL #	SERIAL #	CODE	ROD	BORE	KIT #	List \$	
MODEL EC240B LC								
BOOM	14530665	12787-13235;30244-;80001-81034	P-UB-10	90 mm	135 mm	VME-14514455	387.10	
	14541247	12787-13235;30244-;80001-81034	P-UB-10	90 mm	135 mm	VME-14514455	387.10	
	14563900	13235-;81035-	P-UB-10	90 mm	135 mm	VME-14514455	387.10	
	14563929	13235-;81035-	P-UB-10	90 mm	135 mm	VME-14514455	387.10	
BOOM (Adj 2nd)	14510811	10001-13234;30001-30258;80001-81034	P-UB-10	105 mm	160 mm	VME-14514456	394.86	
	14514827	10001-13234;30001-30258;80001-81034	P-UB-10	105 mm	160 mm	VME-14514456	394.86	
	14563950	13235-;81035-	P-UB-10	105 mm	160 mm	VME-14514456	394.86	
	14563956	13235-;81035-	P-UB-10	105 mm	160 mm	VME-14514456	394.86	
BUCKET	14504187	10001-10973	P-UB-10	90 mm	130 mm	VME-14514454	267.76	
	14514833	10001-10973	P-UB-10	90 mm	130 mm	VME-14514454	267.76	
	14523665	10974-12786;30001-30243	P-UB-10	90 mm	130 mm	VME-14514454	267.76	
	14541237	12787-13234;30244-;80001-81034	P-UB-10	90 mm	130 mm	VME-14514454	267.76	
	14541267	10974-12729;12787-13234;30001-30243;30244-;80001-81034	P-UB-10	90 mm	130 mm	VME-14514454	267.76	
	14563959	13235-;81035-	P-UB-10	90 mm	130 mm	VME-14514454	267.76	
	14563965	13235-;81035-	P-UB-10	90 mm	130 mm	VME-14514454	267.76	
	14510883	10001-10973	P-UB-10	70 mm	100 mm	VME-14547310	210.37	
BUCKET (LR)	14514560	10001-10973	P-UB-10	70 mm	100 mm	VME-14547310	210.37	
	14522846	10974-13234;30001-;80001-81034	P-UB-10	70 mm	100 mm	VME-14547310	210.37	
	14522900	10974-13234;30001-;80001-81034	P-UB-10	70 mm	100 mm	VME-14547310	210.37	
	14564132	13235-;81035-	P-UB-10	70 mm	100 mm	VME-14547310	210.37	
	14564139	13235-;81035-	P-UB-10	70 mm	100 mm	VME-14547310	210.37	
	14510809	10001-10841	P-UB-10	100 mm	140 mm	VME-14514457	360.50	
DIPPER ARM	14510810	10001-13234;30001-30258;80001-81034	P-UB-10	100 mm	140 mm	VME-14514457	360.50	
	14514829	10001-13234;30001-30258;80001-81034	P-UB-10	100 mm	140 mm	VME-14514457	360.50	
	14514837	10001-10841	P-UB-10	100 mm	140 mm	VME-14514457	360.50	
	14521659	10842-12112	P-UB-10	100 mm	140 mm	VME-14514457	360.50	
	14521758	10842-12112	P-UB-10	100 mm	140 mm	VME-14514457	360.50	
	14535044	12113-13234;80001-81034	P-UB-10	100 mm	140 mm	VME-14514457	360.50	
	14536159	12113-13234;80001-81034	P-UB-10	100 mm	140 mm	VME-14514457	360.50	
	14563932	13235-;81035-	P-UB-10	100 mm	140 mm	VME-14514457	360.50	
	14563938	13235-;81035-	P-UB-10	100 mm	140 mm	VME-14514457	360.50	
	14563941	13235-;81035-	P-UB-10	100 mm	140 mm	VME-14514457	360.50	
	14563947	13235-;81035-	P-UB-10	100 mm	140 mm	VME-14514457	360.50	
	QUICK-FIT	14522370	11090-	P-U-10	32 mm	70 mm	VME-14523132	106.09
	MODEL EC240B LR, EC240B NLC							
	BOOM	14510808	10001-12786;30001-30243	P-UB-10	90 mm	135 mm	VME-14514455	387.10
14514840		10001-12786;30001-30243	P-UB-10	90 mm	135 mm	VME-14514455	387.10	
14530665		12787-13234;30244-;80001-81034	P-UB-10	90 mm	135 mm	VME-14514455	387.10	
14541247		12787-13234;30244-;80001-81034	P-UB-10	90 mm	135 mm	VME-14514455	387.10	
14563900		13235-;81035-	P-UB-10	90 mm	135 mm	VME-14514455	387.10	
14563929		13235-;81035-	P-UB-10	90 mm	135 mm	VME-14514455	387.10	
BOOM (Adj 2nd)	14510811	10001-13234;30001-30258;80001-81034	P-UB-10	105 mm	160 mm	VME-14514456	394.86	
	14514827	10001-13234;30001-30258;80001-81034	P-UB-10	105 mm	160 mm	VME-14514456	394.86	
	14563950	13235-;81035-	P-UB-10	105 mm	160 mm	VME-14514456	394.86	
	14563956	13235-;81035-	P-UB-10	105 mm	160 mm	VME-14514456	394.86	
BUCKET	14504187	10001-10973	P-UB-10	90 mm	130 mm	VME-14514454	267.76	
	14514833	10001-10973	P-UB-10	90 mm	130 mm	VME-14514454	267.76	
	14523665	10974-12786;30001-30243	P-UB-10	90 mm	130 mm	VME-14514454	267.76	
	14541237	12787-13234;30244-;80001-81034	P-UB-10	90 mm	130 mm	VME-14514454	267.76	
	14541267	10974-12729;12787-13234;30001-30243;30244-;80001-81034	P-UB-10	90 mm	130 mm	VME-14514454	267.76	
	14563959	13235-;81035-	P-UB-10	90 mm	130 mm	VME-14514454	267.76	
	14563965	13235-;81035-	P-UB-10	90 mm	130 mm	VME-14514454	267.76	
	14510883	10001-10973	P-UB-10	70 mm	100 mm	VME-14547310	210.37	

LR - Long Reach

SLF - Super Long Front

QF - Quick Fit

FS - Front Shovel

MH - Material Handle

AS - Articulate Slope

Replacement Kits For

VOLVO

Excavators							
APPLICATION	CYL #	SERIAL #	CODE	ROD	BORE	KIT #	List \$
MODEL EC240B LR, EC240B NLC							
BUCKET (LR)	14514560	10001-10973	P-UB-10	70 mm	100 mm	VME-14547310	210.37
	14522846	10974-13234;30001-;80001-81034	P-UB-10	70 mm	100 mm	VME-14547310	210.37
	14522900	10974-13234;30001-;80001-81034	P-UB-10	70 mm	100 mm	VME-14547310	210.37
	14564132	13235-;81035-	P-UB-10	70 mm	100 mm	VME-14547310	210.37
	14564139	13235-;81035-	P-UB-10	70 mm	100 mm	VME-14547310	210.37
DIPPER ARM	14510809	10001-10841	P-UB-10	100 mm	140 mm	VME-14514457	360.50
	14510810	10001-13234;30001-30258;80001-81034	P-UB-10	100 mm	140 mm	VME-14514457	360.50
	14514829	10001-13234;30001-30258;80001-81034	P-UB-10	100 mm	140 mm	VME-14514457	360.50
	14514837	10001-10841	P-UB-10	100 mm	140 mm	VME-14514457	360.50
	14521659	10842-12112	P-UB-10	100 mm	140 mm	VME-14514457	360.50
	14521758	10842-12112	P-UB-10	100 mm	140 mm	VME-14514457	360.50
	14535044	12113-13234;80001-81034	P-UB-10	100 mm	140 mm	VME-14514457	360.50
	14536159	12113-13234;80001-81034	P-UB-10	100 mm	140 mm	VME-14514457	360.50
	14563932	13235-;81035-	P-UB-10	100 mm	140 mm	VME-14514457	360.50
	14563938	13235-;81035-	P-UB-10	100 mm	140 mm	VME-14514457	360.50
	14563941	13235-;81035-	P-UB-10	100 mm	140 mm	VME-14514457	360.50
	14563947	13235-;81035-	P-UB-10	100 mm	140 mm	VME-14514457	360.50
	QUICK-FIT	14522370	11090-	P-U-10	32 mm	70 mm	VME-14523132
MODEL EC240C L							
BOOM	14551710	110001-120001	P-UB-10	90 mm	135 mm	VME-14589134	357.10
	14551713	110001-120001	P-UB-10	105 mm	160 mm	VME-14589130	221.23
	14551713	110001-120001	Bushing	105 mm		VME-9612-10540	46.34
	14551715	110001-120001	P-UB-10	90 mm	135 mm	VME-14589134	357.10
	14551718	110001-120001	P-UB-10	105 mm	160 mm	VME-14589130	221.23
	14551718	110001-120001	Bushing	105 mm		VME-9612-10540	46.34
BUCKET	14550919	110001-120001	P-UB-10	70 mm	100 mm	VME-14589125	128.10
	14550919	110001-120001	Bushing	70 mm		VME-9612-07040	27.58
	14551353	110001-120001	P-UB-10	70 mm	100 mm	VME-14589125	128.10
	14551353	110001-120001	Bushing	70 mm		VME-9612-07040	27.58
	14551712	110001-120001	P-UB-10	90 mm	130 mm	VME-14589133	348.43
	14551712	110001-120001	Bushing	90 mm		VME-9612-09040	38.46
	14551717	110001-120001	P-UB-10	90 mm	130 mm	VME-14589133	348.43
	14551717	110001-120001	Bushing	90 mm		VME-9612-09040	38.46
DIPPER ARM	14551416	110001-120001	P-UB-10	100 mm	140 mm	VME-14589135	255.29
	14551416	110001-120001	Bushing	100 mm		VME-9612-10040	41.00
	14551711	110001-120001	P-UB-10	100 mm	140 mm	VME-14589135	255.29
	14551711	110001-120001	Bushing	100 mm		VME-9612-10040	41.00
	14551714	110001-120001	P-UB-10	100 mm	140 mm	VME-14589135	255.29
	14551714	110001-120001	Bushing	100 mm		VME-9612-10040	41.00
	14551719	110001-120001	P-UB-10	100 mm	140 mm	VME-14589135	255.29
	14551719	110001-120001	Bushing	100 mm		VME-9612-10040	41.00
QUICK-FIT	14522370	110001-120001	P-U-10	32 mm	70 mm	VME-14523132	106.09
MODEL EC240C LD							
BOOM	14551710	110001-120001	P-UB-10	90 mm	135 mm	VME-14589134	357.10
	14551713	110001-120001	P-UB-10	105 mm	160 mm	VME-14589130	221.23
	14551713	110001-120001	Bushing	105 mm		VME-9612-10540	46.34
	14551715	110001-120001	P-UB-10	90 mm	135 mm	VME-14589134	357.10
	14551718	110001-120001	P-UB-10	105 mm	160 mm	VME-14589130	221.23
	14551718	110001-120001	Bushing	105 mm		VME-9612-10540	46.34
BUCKET	14550919	110001-120001	P-UB-10	70 mm	100 mm	VME-14589125	128.10
	14550919	110001-120001	Bushing	70 mm		VME-9612-07040	27.58
	14551353	110001-120001	P-UB-10	70 mm	100 mm	VME-14589125	128.10
	14551353	110001-120001	Bushing	70 mm		VME-9612-07040	27.58
	14551712	110001-120001	P-UB-10	90 mm	130 mm	VME-14589133	348.43
	14551712	110001-120001	Bushing	90 mm		VME-9612-09040	38.46

LR - Long Reach

SLF - Super Long Front

QF - Quick Fit

FS - Front Shovel

MH - Material Handle

AS - Articulate Slope

VOLVO

Replacement Kits For

Excavators								
APPLICATION	CYL #	SERIAL #	CODE	ROD	BORE	KIT #	List \$	
NEW MODEL EC240C LD								
BUCKET	14551717	110001-120001	P-UB-10	90 mm	130 mm	VME-14589133	348.43	
	14551717	110001-120001	Bushing	90 mm		VME-9612-09040	38.46	
DIPPER ARM	14551416	110001-120001	P-UB-10	100 mm	140 mm	VME-14589135	255.29	
	14551416	110001-120001	Bushing	100 mm		VME-9612-10040	41.00	
	14551711	110001-120001	P-UB-10	100 mm	140 mm	VME-14589135	255.29	
	14551711	110001-120001	Bushing	100 mm		VME-9612-10040	41.00	
	14551714	110001-120001	P-UB-10	100 mm	140 mm	VME-14589135	255.29	
	14551714	110001-120001	Bushing	100 mm		VME-9612-10040	41.00	
	14551719	110001-120001	P-UB-10	100 mm	140 mm	VME-14589135	255.29	
	14551719	110001-120001	Bushing	100 mm		VME-9612-10040	41.00	
QUICK-FIT	14522370	110001-120001	P-U-10	32 mm	70 mm	VME-14523132	106.09	
NEW MODEL EC240C LR								
BOOM	14551710	110001-120001	P-UB-10	90 mm	135 mm	VME-14589134	357.10	
	14551715	110001-120001	P-UB-10	90 mm	135 mm	VME-14589134	357.10	
BUCKET	14550919	110001-120001	P-UB-10	70 mm	100 mm	VME-14589125	128.10	
	14550919	110001-120001	Bushing	70 mm		VME-9612-07040	27.58	
	14551353	110001-120001	P-UB-10	70 mm	100 mm	VME-14589125	128.10	
	14551353	110001-120001	Bushing	70 mm		VME-9612-07040	27.58	
	14551712	110001-120001	P-UB-10	90 mm	130 mm	VME-14589133	348.43	
	14551712	110001-120001	Bushing	90 mm		VME-9612-09040	38.46	
	14551717	110001-120001	P-UB-10	90 mm	130 mm	VME-14589133	348.43	
	14551717	110001-120001	Bushing	90 mm		VME-9612-09040	38.46	
DIPPER ARM	14551416	110001-120001	P-UB-10	100 mm	140 mm	VME-14589135	255.29	
	14551416	110001-120001	Bushing	100 mm		VME-9612-10040	41.00	
	14551711	110001-120001	P-UB-10	100 mm	140 mm	VME-14589135	255.29	
	14551711	110001-120001	Bushing	100 mm		VME-9612-10040	41.00	
	14551714	110001-120001	P-UB-10	100 mm	140 mm	VME-14589135	255.29	
	14551714	110001-120001	Bushing	100 mm		VME-9612-10040	41.00	
	14551719	110001-120001	P-UB-10	100 mm	140 mm	VME-14589135	255.29	
	14551719	110001-120001	Bushing	100 mm		VME-9612-10040	41.00	
QUICK-FIT	14522370	110001-120001	P-U-10	32 mm	70 mm	VME-14523132	106.09	
NEW MODEL EC240C NL								
BOOM	14551710	110001-120001	P-UB-10	90 mm	135 mm	VME-14589134	357.10	
	14551713	110001-120001	P-UB-10	105 mm	160 mm	VME-14589130	221.23	
	14551713	110001-120001	Bushing	105 mm		VME-9612-10540	46.34	
	14551715	110001-120001	P-UB-10	90 mm	135 mm	VME-14589134	357.10	
	14551718	110001-120001	P-UB-10	105 mm	160 mm	VME-14589130	221.23	
	14551718	110001-120001	Bushing	105 mm		VME-9612-10540	46.34	
BUCKET	14550919	110001-120001	P-UB-10	70 mm	100 mm	VME-14589125	128.10	
	14550919	110001-120001	Bushing	70 mm		VME-9612-07040	27.58	
	14551353	110001-120001	P-UB-10	70 mm	100 mm	VME-14589125	128.10	
	14551353	110001-120001	Bushing	70 mm		VME-9612-07040	27.58	
	14551712	110001-120001	P-UB-10	90 mm	130 mm	VME-14589133	348.43	
	14551712	110001-120001	Bushing	90 mm		VME-9612-09040	38.46	
	14551714	110001-120001	P-UB-10	100 mm	140 mm	VME-14589135	255.29	
	14551714	110001-120001	Bushing	100 mm		VME-9612-10040	41.00	
	14551717	110001-120001	P-UB-10	90 mm	130 mm	VME-14589133	348.43	
	14551717	110001-120001	Bushing	90 mm		VME-9612-09040	38.46	
	14551719	110001-120001	P-UB-10	100 mm	140 mm	VME-14589135	255.29	
14551719	110001-120001	Bushing	100 mm		VME-9612-10040	41.00		
DIPPER ARM	14551711	110001-120001	P-UB-10	100 mm	140 mm	VME-14589135	255.29	
	14551711	110001-120001	Bushing	100 mm		VME-9612-10040	41.00	
	14551714	110001-120001	P-UB-10	100 mm	140 mm	VME-14589135	255.29	
	14551714	110001-120001	Bushing	100 mm		VME-9612-10040	41.00	
	14551719	110001-120001	P-UB-10	100 mm	140 mm	VME-14589135	255.29	

LR - Long Reach

SLF - Super Long Front

QF - Quick Fit

FS - Front Shovel

MH - Material Handle

AS - Articulate Slope

VOLVO

Replacement Kits For

Excavators							
APPLICATION	CYL #	SERIAL #	CODE	ROD	BORE	KIT #	List \$
MODEL EC240C NL							
DIPPER ARM	14551719	110001-120001	Bushing	100 mm		VME-9612-10040	41.00
QUICK-FIT	14522370	110001-120001	P-U-10	32 mm	70 mm	VME-14523132	106.09
MODEL EC280							
ARM	143446169		P-UB-10	110 mm	160 mm	VME-11705818	513.94
BOOM	143446151		P-UB-10	100 mm	150 mm	VME-11703474	445.53
BUCKET	143446169		P-UB-10	110 mm	160 mm	VME-11705818	513.94
	143446177		P-UB-10	95 mm	140 mm	VME-11705814	398.64
QUICK FIT	143419398		P-UB-10	32 mm	70 mm	VME-11702311	89.46
MODEL EC290B FX							
BOOM	14510288	10001-13846;30001-30270	P-UB-10	95 mm	140 mm	VME-14513714	376.95
	14514556	10001-13846;30001-30270	P-UB-10	95 mm	140 mm	VME-14513714	376.95
	14530664	13847-14793;30271-;80001-81090	P-UB-10	95 mm	140 mm	VME-14541717	379.16
	14539227	13847-14793;30271-;80001-81090	P-UB-10	95 mm	140 mm	VME-14541717	379.16
	14563840	14794-;81091-	P-UB-10	95 mm	140 mm	VME-14541717	379.16
	14563846	14794-;81091-	P-UB-10	95 mm	140 mm	VME-14541717	379.16
BOOM (Adj 2nd)	14513283	10270-14793;80001-81090	P-UB-10	110 mm	170 mm	VME-14519359	299.59
	14516724	10270-14793;80001-81090	P-UB-10	110 mm	170 mm	VME-14519359	299.59
	14563883	14794-;81091-	P-UB-10	110 mm	170 mm	VME-14519359	299.59
	14563889	14794-;81091-	P-UB-10	110 mm	170 mm	VME-14519359	299.59
BUCKET	14510293	10001-11245;30001-30036	P-UB-10	95 mm	140 mm	VME-14513714	376.95
	14514558	10001-11245;30001-30036	P-UB-10	95 mm	140 mm	VME-14541717	379.16
	14522904	11246-13846;30037-30270;80001-80042	P-UB-10	95 mm	140 mm	VME-14513714	376.95
	14522906	11246-13846;30037-30270;80001-80042	P-UB-10	95 mm	140 mm	VME-14541717	379.16
	14533937	13847-14793;80043-81090;30271-	P-UB-10	95 mm	140 mm	VME-14513714	376.95
	14541245	13847-14793;80043-81090;30271-	P-UB-10	95 mm	140 mm	VME-14541717	379.16
	14563892	14794-;81091-	P-UB-10	95 mm	140 mm	VME-14513714	376.95
	14563898	14794-;81091-	P-UB-10	95 mm	140 mm	VME-14541717	379.16
BUCKET (LR)	14510883	10001-11206;30001-30018	P-UB-10	70 mm	100 mm	VME-14547310	210.37
	14514560	10001-11206;30001-30018	P-UB-10	70 mm	100 mm	VME-14547310	210.37
	14522846	11207-14793;80001-81090;30019-	P-UB-10	70 mm	100 mm	VME-14547310	210.37
	14522900	11207-;30019-	P-UB-10	70 mm	100 mm	VME-14547310	210.37
	14564132	14794-;81091-	P-UB-10	70 mm	100 mm	VME-14547310	210.37
	14564139	30290-;13562-;80001-	P-UB-10	70 mm	100 mm	VME-14547310	210.37
DIPPER ARM	14510443	10001-10951;30001-30006	P-UB-10	105 mm	150 mm	VME-14513715	401.47
	14510790	13562-14793;80001-81090	P-UB-10	105 mm	150 mm	VME-14513715	401.47
	14514557	10001-10951;30001-30006	P-UB-10	105 mm	150 mm	VME-14513715	401.47
	14514559	13562-14793;80001-81090	P-UB-10	105 mm	150 mm	VME-14513715	401.47
	14521658	10952-11245;30007-30036	P-UB-10	105 mm	150 mm	VME-14513715	401.47
	14521664	10952-11245;30007-30036	P-UB-10	105 mm	150 mm	VME-14513715	401.47
	14522902	11246-12927;30037-	P-UB-10	105 mm	150 mm	VME-14513715	401.47
	14522903	11246-12927;30037-	P-UB-10	105 mm	150 mm	VME-14513715	401.47
	14535421	12928-14793;80001-81090	P-UB-10	105 mm	150 mm	VME-14513715	401.47
	14536161	12928-14793;80001-81090	P-UB-10	105 mm	150 mm	VME-14513715	401.47
	14563849	14794-;81091-	P-UB-10	105 mm	150 mm	VME-14513715	401.47
	14563855	14794-;81091-	P-UB-10	105 mm	150 mm	VME-14513715	401.47
	14563858	14794-;81091-	P-UB-10	105 mm	150 mm	VME-14513715	401.47
	14563880	14794-;81091-	P-UB-10	105 mm	150 mm	VME-14513715	401.47
	QUICK-FIT	14522370	11436-	P-U-10	32 mm	70 mm	VME-14523132
MODEL EC290B LC, EC290B LR							
BOOM	14510288	10001-13846;30001-30270	P-UB-10	95 mm	140 mm	VME-14513714	376.95
	14514556	10001-13846;30001-30270	P-UB-10	95 mm	140 mm	VME-14513714	376.95
	14530664	13847-14793;30271-;80001-81090	P-UB-10	95 mm	140 mm	VME-14541717	379.16
	14539227	13847-14793;30271-;80001-81090	P-UB-10	95 mm	140 mm	VME-14541717	379.16
	14540644	13847-;30271-	P-UB-10	95 mm	140 mm	VME-14541717	379.16
	14563840	14794-;81091-	P-UB-10	95 mm	140 mm	VME-14541717	379.16

LR - Long Reach

SLF - Super Long Front

QF - Quick Fit

FS - Front Shovel

MH - Material Handle

AS - Articulate Slope

VOLVO

Replacement Kits For

Excavators									
APPLICATION	CYL #	SERIAL #	CODE	ROD	BORE	KIT #	List \$		
MODEL EC290B LC, EC290B LR									
BOOM	14563846	14794-;81091-	P-UB-10	95 mm	140 mm	VME-14541717	379.16		
BOOM (Adj 2nd)	14513283	10001-13561;30001-30289	P-UB-10	110 mm	170 mm	VME-14519359	299.59		
	14513283	10270-14793;80001-81090	P-UB-10	110 mm	170 mm	VME-14519359	299.59		
	14516724	10001-13561;30001-30289	P-UB-10	110 mm	170 mm	VME-14519359	299.59		
	14516724	10270-14793;80001-81090	P-UB-10	110 mm	170 mm	VME-14519359	299.59		
	14563883	14794-;81091-	P-UB-10	110 mm	170 mm	VME-14519359	299.59		
	14563889	14794-;81091-	P-UB-10	110 mm	170 mm	VME-14519359	299.59		
BUCKET	14510293	10001-11245;30001-30036	P-UB-10	95 mm	140 mm	VME-14513714	376.95		
	14514558	10001-11245;30001-30036	P-UB-10	95 mm	140 mm	VME-14541717	379.16		
	14522904	11246-13846;30037-30270;80001-80042	P-UB-10	95 mm	140 mm	VME-14513714	376.95		
	14522906	11246-13846;30037-30270	P-UB-10	95 mm	140 mm	VME-14541717	379.16		
	14522906	11246-13846;30037-30270;80001-80042	P-UB-10	95 mm	140 mm	VME-14541717	379.16		
	14533937	13847-;30271-	P-UB-10	95 mm	140 mm	VME-14513714	376.95		
	14533937	13847-14793;80043-81090;30271-	P-UB-10	95 mm	140 mm	VME-14513714	376.95		
	14541245	13847-14793;80043-81090;30271-	P-UB-10	95 mm	140 mm	VME-14541717	379.16		
	14563892	14794-;81091-	P-UB-10	95 mm	140 mm	VME-14513714	376.95		
	14563898	14794-;81091-	P-UB-10	95 mm	140 mm	VME-14541717	379.16		
	BUCKET (LR)	14510883	10001-11206;30001-30018	P-UB-10	70 mm	100 mm	VME-14547310	210.37	
		14514560	10001-11206;30001-30018	P-UB-10	70 mm	100 mm	VME-14547310	210.37	
14522846		11207-14793;30019-;80001-81090	P-UB-10	70 mm	100 mm	VME-14547310	210.37		
14522900		11207-;30019-	P-UB-10	70 mm	100 mm	VME-14547310	210.37		
14564132		14794-;81091-	P-UB-10	70 mm	100 mm	VME-14547310	210.37		
14564139		30290-;13562-;80001-	P-UB-10	70 mm	100 mm	VME-14547310	210.37		
DIPPER ARM	14510443	10001-10951;30001-30006	P-UB-10	105 mm	150 mm	VME-14513715	401.47		
	14510790	10001-14793;30001-30289;80001-81090	P-UB-10	105 mm	150 mm	VME-14513715	401.47		
	14514557	10001-10951;30001-30006	P-UB-10	105 mm	150 mm	VME-14513715	401.47		
	14514559	10001-14793;30001-30289;80001-81090	P-UB-10	105 mm	150 mm	VME-14513715	401.47		
	14521658	10952-11245;30007-30036	P-UB-10	105 mm	150 mm	VME-14513715	401.47		
	14521664	10952-11245;30007-30036	P-UB-10	105 mm	150 mm	VME-14513715	401.47		
	14522902	11246-12927;30037-	P-UB-10	105 mm	150 mm	VME-14513715	401.47		
	14522903	11246-12927;30037-	P-UB-10	105 mm	150 mm	VME-14513715	401.47		
	14535421	12928-14793;80001-81090	P-UB-10	105 mm	150 mm	VME-14513715	401.47		
	14536161	12928-14793;80001-81090	P-UB-10	105 mm	150 mm	VME-14513715	401.47		
	14563849	14794-;81091-	P-UB-10	105 mm	150 mm	VME-14513715	401.47		
	14563855	14794-;81091-	P-UB-10	105 mm	150 mm	VME-14513715	401.47		
	14563858	14794-;81091-	P-UB-10	105 mm	150 mm	VME-14513715	401.47		
	14563880	14794-;81091-	P-UB-10	105 mm	150 mm	VME-14513715	401.47		
	QUICK-FIT	14522370	11436-	P-U-10	32 mm	70 mm	VME-14523132	106.09	
MODEL EC290B NLC									
BOOM	14510288	10001-13846;30001-30270	P-UB-10	95 mm	140 mm	VME-14513714	376.95		
	14514556	10001-13846;30001-30270	P-UB-10	95 mm	140 mm	VME-14513714	376.95		
	14530664	13847-14793;30271-;80001-81090	P-UB-10	95 mm	140 mm	VME-14541717	379.16		
	14539227	13847-14793;30271-;80001-81090	P-UB-10	95 mm	140 mm	VME-14541717	379.16		
	14540644	13847-;30271-	P-UB-10	95 mm	140 mm	VME-14541717	379.16		
	14563840	14794-;81091-	P-UB-10	95 mm	140 mm	VME-14541717	379.16		
	14563846	14794-;81091-	P-UB-10	95 mm	140 mm	VME-14541717	379.16		
BOOM (Adj 2nd)	14513283	10001-13561;30001-30289	P-UB-10	110 mm	170 mm	VME-14519359	299.59		
	14513283	10270-14793;80001-81090	P-UB-10	110 mm	170 mm	VME-14519359	299.59		
	14516724	10001-13561;30001-30289	P-UB-10	110 mm	170 mm	VME-14519359	299.59		
	14516724	10270-14793;80001-81090	P-UB-10	110 mm	170 mm	VME-14519359	299.59		
	14563883	14794-;81091-	P-UB-10	110 mm	170 mm	VME-14519359	299.59		
	14563889	14794-;81091-	P-UB-10	110 mm	170 mm	VME-14519359	299.59		
BUCKET	14510293	10001-11245;30001-30036	P-UB-10	95 mm	140 mm	VME-14513714	376.95		
	14514558	10001-11245;30001-30036	P-UB-10	95 mm	140 mm	VME-14541717	379.16		
	14522904	11246-13846;30037-30270;80001-80042	P-UB-10	95 mm	140 mm	VME-14513714	376.95		

LR - Long Reach SLF - Super Long Front QF - Quick Fit FS - Front Shovel MH - Material Handle AS - Articulate Slope

Replacement Kits For

VOLVO

Excavators							
APPLICATION	CYL #	SERIAL #	CODE	ROD	BORE	KIT #	List \$
MODEL EC290B NLC							
BUCKET	14522906	11246-13846;30037-30270	P-UB-10	95 mm	140 mm	VME-14541717	379.16
	14522906	11246-13846;30037-30270;80001-80042	P-UB-10	95 mm	140 mm	VME-14541717	379.16
	14533937	13847-;30271-	P-UB-10	95 mm	140 mm	VME-14513714	376.95
	14533937	13847-14793;80043-81090;30271-	P-UB-10	95 mm	140 mm	VME-14513714	376.95
	14541245	13847-14793;30271-;80043-81090	P-UB-10	95 mm	140 mm	VME-14541717	379.16
	14563892	14794-;81091-	P-UB-10	95 mm	140 mm	VME-14513714	376.95
	14563898	14794-;81091-	P-UB-10	95 mm	140 mm	VME-14541717	379.16
BUCKET (LR)	14510883	10001-11206;30001-30018	P-UB-10	70 mm	100 mm	VME-14547310	210.37
	14514560	10001-11206;30001-30018	P-UB-10	70 mm	100 mm	VME-14547310	210.37
	14522846	11207-14793;30019-;80001-81090	P-UB-10	70 mm	100 mm	VME-14547310	210.37
	14522900	11207-;30019-	P-UB-10	70 mm	100 mm	VME-14547310	210.37
	14564132	14794-;81091-	P-UB-10	70 mm	100 mm	VME-14547310	210.37
	14564139	30290-;13562-;80001-	P-UB-10	70 mm	100 mm	VME-14547310	210.37
DIPPER ARM	14510443	10001-10951;30001-30006	P-UB-10	105 mm	150 mm	VME-14513715	401.47
	14510790	10001-14793;30001-30289;80001-81090	P-UB-10	105 mm	150 mm	VME-14513715	401.47
	14514557	10001-10951;30001-30006	P-UB-10	105 mm	150 mm	VME-14513715	401.47
	14514559	10001-14793;30001-30289;80001-81090	P-UB-10	105 mm	150 mm	VME-14513715	401.47
	14521658	10952-11245;30007-30036	P-UB-10	105 mm	150 mm	VME-14513715	401.47
	14521664	10952-11245;30007-30036	P-UB-10	105 mm	150 mm	VME-14513715	401.47
	14522902	11246-12927;30037-	P-UB-10	105 mm	150 mm	VME-14513715	401.47
	14522903	11246-12927;30037-	P-UB-10	105 mm	150 mm	VME-14513715	401.47
	14535421	12928-14793;80001-81090	P-UB-10	105 mm	150 mm	VME-14513715	401.47
	14536161	12928-14793;80001-81090	P-UB-10	105 mm	150 mm	VME-14513715	401.47
	14563849	14794-;81091-	P-UB-10	105 mm	150 mm	VME-14513715	401.47
	14563855	14794-;81091-	P-UB-10	105 mm	150 mm	VME-14513715	401.47
	14563858	14794-;81091-	P-UB-10	105 mm	150 mm	VME-14513715	401.47
	14563880	14794-;81091-	P-UB-10	105 mm	150 mm	VME-14513715	401.47
QUICK-FIT	14522370	11436-	P-U-10	32 mm	70 mm	VME-14523132	106.09
MODEL EC290C L							
BOOM	14550418	110001-	P-UB-10	95 mm	140 mm	VME-14589136	261.28
	14550427	110001-	P-UB-10	95 mm	140 mm	VME-14589136	261.28
	14550714	110001-	P-UB-10	110 mm	170 mm	VME-14589137	275.37
	14550714	110001-	Bushing	110 mm		VME-9612-11050	44.85
	14550715	110001-	P-UB-10	110 mm	170 mm	VME-14589137	275.37
	14550715	110001-	Bushing	110 mm		VME-9612-11050	44.85
BUCKET	14550435	110001-	P-UB-10	95 mm	140 mm	VME-14589136	261.28
	14550436	110001-	P-UB-10	95 mm	140 mm	VME-14589136	261.28
	14550919	110001-	P-UB-10	70 mm	100 mm	VME-14589125	128.10
	14550919	110001-	Bushing	70 mm		VME-9612-07040	27.58
	14551353	110001-	P-UB-10	70 mm	100 mm	VME-14589125	128.10
	14551353	110001-	Bushing	70 mm		VME-9612-07040	27.58
DIPPER ARM	14550433	110001-	P-UB-10	105 mm	150 mm	VME-14589138	322.43
	14550433	110001-	Bushing	105 mm		VME-9612-10540	46.34
	14550434	110001-	P-UB-10	105 mm	150 mm	VME-14589138	322.43
	14550434	110001-	Bushing	105 mm		VME-9612-10540	46.34
	14550712	110001-	P-UB-10	105 mm	150 mm	VME-14589138	322.43
	14550712	110001-	Bushing	105 mm		VME-9612-10540	46.34
	14550713	110001-	P-UB-10	105 mm	150 mm	VME-14589138	322.43
	14550713	110001-	Bushing	105 mm		VME-9612-10540	46.34
QUICK-FIT	14522370	110001-	P-U-10	32 mm	70 mm	VME-14523132	106.09
MODEL EC290C LD							
BOOM	14550418	110001-	P-UB-10	95 mm	140 mm	VME-14589136	261.28
	14550427	110001-	P-UB-10	95 mm	140 mm	VME-14589136	261.28
	14550714	110001-	P-UB-10	110 mm	170 mm	VME-14589137	275.37
	14550714	110001-	Bushing	110 mm		VME-9612-11050	44.85

LR - Long Reach

SLF - Super Long Front

QF - Quick Fit

FS - Front Shovel

MH - Material Handle

AS - Articulate Slope

VOLVO

Replacement Kits For

Excavators							
APPLICATION	CYL #	SERIAL #	CODE	ROD	BORE	KIT #	List \$
NEW MODEL EC290C LD							
BOOM	14550715	110001-	P-UB-10	110 mm	170 mm	VME-14589137	275.37
	14550715	110001-	Bushing	110 mm		VME-9612-11050	44.85
BUCKET	14550435	110001-	P-UB-10	95 mm	140 mm	VME-14589136	261.28
	14550436	110001-	P-UB-10	95 mm	140 mm	VME-14589136	261.28
	14550919	110001-	P-UB-10	70 mm	100 mm	VME-14589125	128.10
	14550919	110001-	Bushing	70 mm		VME-9612-07040	27.58
	14551353	110001-	P-UB-10	70 mm	100 mm	VME-14589125	128.10
	14551353	110001-	Bushing	70 mm		VME-9612-07040	27.58
DIPPER ARM	14550433	110001-	P-UB-10	105 mm	150 mm	VME-14589138	322.43
	14550433	110001-	Bushing	105 mm		VME-9612-10540	46.34
	14550434	110001-	P-UB-10	105 mm	150 mm	VME-14589138	322.43
	14550434	110001-	Bushing	105 mm		VME-9612-10540	46.34
	14550712	110001-	P-UB-10	105 mm	150 mm	VME-14589138	322.43
	14550712	110001-	Bushing	105 mm		VME-9612-10540	46.34
	14550713	110001-	P-UB-10	105 mm	150 mm	VME-14589138	322.43
	14550713	110001-	Bushing	105 mm		VME-9612-10540	46.34
QUICK-FIT	14522370	110001-	P-U-10	32 mm	70 mm	VME-14523132	106.09
NEW MODEL EC290C LR							
BOOM	14550418	110001-	P-UB-10	95 mm	140 mm	VME-14589136	261.28
	14550427	110001-	P-UB-10	95 mm	140 mm	VME-14589136	261.28
	14550714	110001-	P-UB-10	110 mm	170 mm	VME-14589137	275.37
	14550714	110001-	Bushing	110 mm		VME-9612-11050	44.85
	14550715	110001-	P-UB-10	110 mm	170 mm	VME-14589137	275.37
	14550715	110001-	Bushing	110 mm		VME-9612-11050	44.85
BUCKET	14550435	110001-	P-UB-10	95 mm	140 mm	VME-14589136	261.28
	14550436	110001-	P-UB-10	95 mm	140 mm	VME-14589136	261.28
	14550712	110001-	P-UB-10	105 mm	150 mm	VME-14589138	322.43
	14550712	110001-	Bushing	105 mm		VME-9612-10540	46.34
	14550713	110001-	P-UB-10	105 mm	150 mm	VME-14589138	322.43
	14550713	110001-	Bushing	105 mm		VME-9612-10540	46.34
	14550919	110001-	P-UB-10	70 mm	100 mm	VME-14589125	128.10
	14550919	110001-	Bushing	70 mm		VME-9612-07040	27.58
	14551353	110001-	P-UB-10	70 mm	100 mm	VME-14589125	128.10
	14551353	110001-	Bushing	70 mm		VME-9612-07040	27.58
DIPPER ARM	14550433	110001-	P-UB-10	105 mm	150 mm	VME-14589138	322.43
	14550433	110001-	Bushing	105 mm		VME-9612-10540	46.34
	14550434	110001-	P-UB-10	105 mm	150 mm	VME-14589138	322.43
	14550434	110001-	Bushing	105 mm		VME-9612-10540	46.34
	14550712	110001-	P-UB-10	105 mm	150 mm	VME-14589138	322.43
	14550712	110001-	Bushing	105 mm		VME-9612-10540	46.34
	14550713	110001-	P-UB-10	105 mm	150 mm	VME-14589138	322.43
	14550713	110001-	Bushing	105 mm		VME-9612-10540	46.34
	14550714	110001-	P-UB-10	110 mm	170 mm	VME-14589137	275.37
	14550714	110001-	Bushing	110 mm		VME-9612-11050	44.85
	14550715	110001-	P-UB-10	110 mm	170 mm	VME-14589137	275.37
	14550715	110001-	Bushing	110 mm		VME-9612-11050	44.85
QUICK-FIT	14522370	110001-	P-U-10	32 mm	70 mm	VME-14523132	106.09
NEW MODEL EC290C NL							
BOOM	14550418	110001-	P-UB-10	95 mm	140 mm	VME-14589136	261.28
	14550427	110001-	P-UB-10	95 mm	140 mm	VME-14589136	261.28
	14550714	110001-	P-UB-10	110 mm	170 mm	VME-14589137	275.37
	14550714	110001-	Bushing	110 mm		VME-9612-11050	44.85
	14550715	110001-	P-UB-10	110 mm	170 mm	VME-14589137	275.37
	14550715	110001-	Bushing	110 mm		VME-9612-11050	44.85
BUCKET	14550435	110001-	P-UB-10	95 mm	140 mm	VME-14589136	261.28

LR - Long Reach SLF - Super Long Front QF - Quick Fit FS - Front Shovel MH - Material Handle AS - Articulate Slope

Replacement Kits For

VOLVO

Excavators							
APPLICATION	CYL #	SERIAL #	CODE	ROD	BORE	KIT #	List \$
NEW MODEL EC290C NL							
BUCKET	14550436	110001-	P-UB-10	95 mm	140 mm	VME-14589136	261.28
	14550919	110001-	P-UB-10	70 mm	100 mm	VME-14589125	128.10
	14550919	110001-	Bushing	70 mm		VME-9612-07040	27.58
	14551353	110001-	P-UB-10	70 mm	100 mm	VME-14589125	128.10
	14551353	110001-	Bushing	70 mm		VME-9612-07040	27.58
DIPPER ARM	14550433	110001-	P-UB-10	105 mm	150 mm	VME-14589138	322.43
	14550433	110001-	Bushing	105 mm		VME-9612-10540	46.34
	14550434	110001-	P-UB-10	105 mm	150 mm	VME-14589138	322.43
	14550434	110001-	Bushing	105 mm		VME-9612-10540	46.34
	14550712	110001-	P-UB-10	105 mm	150 mm	VME-14589138	322.43
	14550712	110001-	Bushing	105 mm		VME-9612-10540	46.34
	14550713	110001-	P-UB-10	105 mm	150 mm	VME-14589138	322.43
	14550713	110001-	Bushing	105 mm		VME-9612-10540	46.34
QUICK-FIT	14522370	110001-	P-U-10	32 mm	70 mm	VME-14523132	106.09
MODEL EC330B LC							
BOOM	14503654	10001-10712	P-UB-10	105 mm	150 mm	VME-14512968	219.19
	14503654	80001-, 10713-	P-UB-10	105 mm	150 mm	VME-14512968	219.19
	14563836	80001-, 10713-	P-UB-10	105 mm	150 mm	VME-14512968	219.19
BUCKET	14501282	10001-10712	P-UB-10	100 mm	145 mm	VME-14512961	312.07
	14506018	10001-10712	P-UB-10	105 mm	160 mm	VME-14512955	287.71
	14506018	80001-, 10713-	P-UB-10	105 mm	160 mm	VME-14512955	287.71
	14523667	10001-10712	P-UB-10	100 mm	145 mm	VME-14512961	312.07
	14523667	80001-, 10713-	P-UB-10	100 mm	145 mm	VME-14512961	312.07
	14563823	80001-, 10713-	P-UB-10	100 mm	145 mm	VME-14512961	312.07
	14563830	80001-, 10713-	P-UB-10	105 mm	160 mm	VME-14512955	287.71
	14572517	80001-, 10713-	P-UB-10	100 mm	145 mm	VME-14512961	312.07
	14572519	80001-, 10713-	P-UB-10	105 mm	160 mm	VME-14512955	287.71
DIPPER ARM	14501281	10001-10712	P-UB-10	115 mm	175 mm	VME-14512950	684.94
	14521660	10001-10712	P-UB-10	115 mm	175 mm	VME-14512950	684.94
	14535416	80001-, 10713-	P-UB-10	115 mm	175 mm	VME-14512950	684.94
	14563816	80001-, 10713-	P-UB-10	115 mm	175 mm	VME-14512950	684.94
NEW MODEL EC330C L							
BOOM	14549596	110001-110152, 140001-140084	P-UB-10	105 mm	160 mm	VME-14589139	361.92
BUCKET	14572518	110001-110152, 140001-140084	P-UB-10	100 mm	145 mm	VME-14589141	297.28
	14572518	110001-110152, 140001-140084	Bushing	100 mm		VME-9612-10040	41.00
	14572520	110001-110152, 140001-140084	P-UB-10	105 mm	160 mm	VME-14589142	333.44
	14572520	110001-110152, 140001-140084	Bushing	105 mm		VME-9612-10540	46.34
DIPPER ARM	14549597	110001-110152, 140001-140084	P-UB-10	115 mm	175 mm	VME-14589140	532.45
	14549597	110001-110152, 140001-140084	Bushing	115 mm		VME-9612-11545	61.48
QUICK-FIT	14522371	110001-110152, 140001-140084	P-U-10	32 mm	90 mm	VME-14522992	91.77
NEW MODEL EC330C LD							
BOOM	14549596	110001-110152, 140001-140084	P-UB-10	105 mm	160 mm	VME-14589139	361.92
BUCKET	14572518	110001-110152, 140001-140084	P-UB-10	100 mm	145 mm	VME-14589141	297.28
	14572518	110001-110152, 140001-140084	Bushing	100 mm		VME-9612-10040	41.00
	14572520	110001-110152, 140001-140084	P-UB-10	105 mm	160 mm	VME-14589142	333.44
	14572520	110001-110152, 140001-140084	Bushing	105 mm		VME-9612-10540	46.34
DIPPER ARM	14549597	110001-110152, 140001-140084	P-UB-10	115 mm	175 mm	VME-14589140	532.45
	14549597	110001-110152, 140001-140084	Bushing	115 mm		VME-9612-11545	61.48
QUICK FIT	14522371	110001-110152, 140001-140084	P-U-10	32 mm	90 mm	VME-14522992	91.77
MODEL EC340							
ARM	14344619		P-UB-10	125 mm	170 mm	VME-11702757	602.54
BOOM	143446185		P-UB-10	105 mm	150 mm	VME-11702744	411.63
BUCKET	14344620	1227-	P-UB-10	105 mm	150 mm	VME-11705815	433.79
BUCKET (QF)	143419398		P-UB-10	32 mm	70 mm	VME-11702311	89.46

LR - Long Reach

SLF - Super Long Front

QF - Quick Fit

FS - Front Shovel

MH - Material Handle

AS - Articulate Slope

VOLVO

Replacement Kits For

Excavators							
APPLICATION	CYL #	SERIAL #	CODE	ROD	BORE	KIT #	List \$
MODEL EC360							
BOOM	114604980	Standard seal kit	P-UB-14	105 mm	160 mm	VME-814816020	504.01
	114607440	Tropical seal kit	P-UB-14	105 mm	160 mm	VME-814816130	504.01
BUCKET		Tropical seal kit	P-UB-14	105 mm	150 mm	VME-814816150	410.02
	114605000	Standard seal kit	P-UB-14	105 mm	150 mm	VME-814816030	401.97
DIPPER ARM	114604990	Standard seal kit	P-UB-14	115 mm	170 mm	VME-814816040	579.19
	114607450	Tropical seal kit	P-UB-14	115 mm	170 mm	VME-814816140	579.19
MODEL EC360B LC, EC360B LR							
BOOM	14508896	10001-12151;12152-12657;80001-80899	P-UB-10	105 mm	160 mm	VME-14512948	394.66
	14563810	12152-;80001-	P-UB-10	105 mm	160 mm	VME-14512948	394.66
BUCKET	14501282	10001-10692	P-UB-10	100 mm	145 mm	VME-14512961	312.07
	14506018	10001-12151;12152-12657;80001-80899	P-UB-10	105 mm	160 mm	VME-14512955	287.71
	14523667	10693-;12152-12657;80001-80899	P-UB-10	100 mm	145 mm	VME-14512961	312.07
	14563823	12658-12815;80900-80940	P-UB-10	100 mm	145 mm	VME-14512961	312.07
	14563830	12658-12815;80900-80940	P-UB-10	105 mm	160 mm	VME-14512955	287.71
	14572517	12152-;80001-	P-UB-10	100 mm	145 mm	VME-14512961	312.07
COUNTERWEIGHT	14572519	12816-;80941-	P-UB-10	105 mm	160 mm	VME-14512955	287.71
	14507604	10001-12151;12152-;80001-	P-UB-14	80 mm	160 mm	VME-14510588	202.79
DIPPER ARM	14501281	10001-10589	P-UB-10	115 mm	175 mm	VME-14512950	684.94
	14521660	10590-11505	P-UB-10	115 mm	175 mm	VME-14512950	684.94
	14535416	11506-;12152-12657;80001-80899	P-UB-10	115 mm	175 mm	VME-14512950	684.94
	14563816	12658-;80900-	P-UB-10	115 mm	175 mm	VME-14512950	684.94
QUICK-FIT	1171-90630	10001-12151	P-U-10	32 mm	90 mm	VME-14510912	98.38
	14522371	10001-12151;12152-;80001-	P-U-10	32 mm	90 mm	VME-14522992	91.77
MODEL EC360B NLC							
BOOM	14508896	10001-12657;80001-80899	P-UB-10	105 mm	160 mm	VME-14512948	394.66
	14563810	12152-;80001-	P-UB-10	105 mm	160 mm	VME-14512948	394.66
BUCKET	14501282	10001-10692	P-UB-10	100 mm	145 mm	VME-14512961	312.07
	14506018	10001-12657;80001-80899	P-UB-10	105 mm	160 mm	VME-14512955	287.71
	14523667	10693-;12152-12657;80001-80899	P-UB-10	100 mm	145 mm	VME-14512961	312.07
	14563823	12658-12815;80900-80940	P-UB-10	100 mm	145 mm	VME-14512961	312.07
	14563830	12658-12815;80900-80940	P-UB-10	105 mm	160 mm	VME-14512955	287.71
	14572517	12152-;80001-	P-UB-10	100 mm	145 mm	VME-14512961	312.07
COUNTERWEIGHT	14572519	12816-;80941-	P-UB-10	105 mm	160 mm	VME-14512955	287.71
	14507604	10001-12151;12152-;80001-	P-UB-14	80 mm	160 mm	VME-14510588	202.79
DIPPER ARM	14501281	10001-10589	P-UB-10	115 mm	175 mm	VME-14512950	684.94
	14521660	10590-11505	P-UB-10	115 mm	175 mm	VME-14512950	684.94
	14535416	11506-;12152-12657;12658-;80001-80899;80900-	P-UB-10	115 mm	175 mm	VME-14512950	684.94
QUICK-FIT	1171-90630	10001-12151	P-U-10	32 mm	90 mm	VME-14510912	98.38
	14522371	10001-12151;12152-;80001-	P-U-10	32 mm	90 mm	VME-14522992	91.77
MODEL EC360C HR							
BOOM	14549596	190001-	P-UB-10	105 mm	160 mm	VME-14589139	361.92
BUCKET	14572352	190001-	P-UB-10	90 mm	130 mm	VME-14589133	348.43
	14572352	190001-	Bushing	90 mm		VME-9612-09040	38.46
	14572518	190001-	P-UB-10	100 mm	145 mm	VME-14589141	297.28
	14572518	190001-	Bushing	100 mm		VME-9612-10040	41.00
CAB TILT	14586438	190001-	P-U-10	35 mm	65 mm	VME-14597349	73.56
	14586438	190001-	Bushing	35 mm		VME-14597338	24.97
DIPPER ARM	14549597	190001-	P-UB-10	115 mm	175 mm	VME-14589140	532.45
	14549597	190001-	Bushing	115 mm		VME-9612-11545	61.48
	14567071	190001-	P-UB-10	105 mm	150 mm	VME-14589138	322.43
	14567071	190001-	Bushing	105 mm		VME-9612-10540	46.34
QUICK-FIT	14522371	190001-	P-U-10	32 mm	90 mm	VME-14522992	91.77
MODEL EC360C L							
BOOM	14549596	110001-115000, 140001-145000	P-UB-10	105 mm	160 mm	VME-14589139	361.92

LR - Long Reach

SLF - Super Long Front

QF - Quick Fit

FS - Front Shovel

MH - Material Handle

AS - Articulate Slope

Replacement Kits For

VOLVO

Excavators								
APPLICATION	CYL #	SERIAL #	CODE	ROD	BORE	KIT #	List \$	
NEW MODEL EC360C L								
BUCKET	14549598	110001-115000, 140001-145000	P-UB-10	100 mm	145 mm	VME-14589141	297.28	
	14549598	110001-115000, 140001-145000	Bushing	100 mm		VME-9612-10040	41.00	
	14549599	110001-115000, 140001-145000	P-UB-10	105 mm	160 mm	VME-14589142	333.44	
	14549599	110001-115000, 140001-145000	Bushing	105 mm		VME-9612-10540	46.34	
	14572518	110168-	P-UB-10	100 mm	145 mm	VME-14512961	312.07	
	14572518	115001-, 145001-	P-UB-10	100 mm	145 mm	VME-14589141	297.28	
	14572518	115001-, 145001-	Bushing	100 mm		VME-9612-10040	41.00	
	14572520	110168-	P-UB-10	105 mm	160 mm	VME-14512955	287.71	
	14572520	115001-, 145001-	P-UB-10	105 mm	160 mm	VME-14589142	333.44	
14572520	115001-, 145001-	Bushing	105 mm		VME-9612-10540	46.34		
DIPPER ARM	14549597	110001-115000, 140001-145000	P-UB-10	115 mm	175 mm	VME-14589140	532.45	
	14549597	110001-115000, 140001-145000	Bushing	115 mm		VME-9612-11545	61.48	
QUICK-FIT	14522371	110001-115000, 140001-145000	P-U-10	32 mm	90 mm	VME-14522992	91.77	
NEW MODEL EC360C LD								
BOOM	14549596	115001-, 145001-	P-UB-10	105 mm	160 mm	VME-14589139	361.92	
BUCKET	14572518	115001-, 145001-	P-UB-10	100 mm	145 mm	VME-14589141	297.28	
	14572518	115001-, 145001-	Bushing	100 mm		VME-9612-10040	41.00	
	14572520	115001-, 145001-	P-UB-10	105 mm	160 mm	VME-14589142	333.44	
	14572520	115001-, 145001-	Bushing	105 mm		VME-9612-10540	46.34	
DIPPER ARM	14549597	115001-, 145001-	P-UB-10	115 mm	175 mm	VME-14589140	532.45	
	14549597	115001-, 145001-	Bushing	115 mm		VME-9612-11545	61.48	
QUICK-FIT	14522371	115001-, 145001-	P-U-10	32 mm	90 mm	VME-14522992	91.77	
NEW MODEL EC360C NL								
BOOM	14549596	110001-, 140001-	P-UB-10	105 mm	160 mm	VME-14589139	361.92	
	14549596	115001-, 145001-	P-UB-10	105 mm	160 mm	VME-14589139	361.92	
BUCKET	14549598	110001-, 140001-	P-UB-10	100 mm	145 mm	VME-14589141	297.28	
	14549598	110001-, 140001-	Bushing	100 mm		VME-9612-10040	41.00	
	14549599	110001-, 140001-	P-UB-10	105 mm	160 mm	VME-14589142	333.44	
	14549599	110001-, 140001-	Bushing	105 mm		VME-9612-10540	46.34	
	14572518	115001-, 145001-	P-UB-10	100 mm	145 mm	VME-14589141	297.28	
	14572518	115001-, 145001-	Bushing	100 mm		VME-9612-10040	41.00	
	14572520	115001-, 145001-	P-UB-10	105 mm	160 mm	VME-14589142	333.44	
	14572520	115001-, 145001-	Bushing	105 mm		VME-9612-10540	46.34	
DIPPER ARM	14549597	110001-, 140001-	P-UB-10	115 mm	175 mm	VME-14589140	532.45	
	14549597	110001-, 140001-	Bushing	115 mm		VME-9612-11545	61.48	
	14549597	115001-, 145001-	P-UB-10	115 mm	175 mm	VME-14589140	532.45	
	14549597	115001-, 145001-	Bushing	115 mm		VME-9612-11545	61.48	
QUICK-FIT	14522371	110001-, 140001-	P-U-10	32 mm	90 mm	VME-14522992	91.77	
	14522371	115001-, 145001-	P-U-10	32 mm	90 mm	VME-14522992	91.77	
MODEL EC460B LC, EC460B LR								
BOOM	14508475	10001-11514	P-UB-10	110 mm	165 mm	VME-14513726	467.54	
	14508475	11515-12094;80001-82626	P-UB-10	110 mm	165 mm	VME-14513726	467.54	
	14556580	12095-;82627-	P-UB-10	110 mm	165 mm	VME-14513726	467.54	
BUCKET	1146-07300	10001-10485	P-UB-10	110 mm	165 mm	VME-14513726	467.54	
	14505615	10001-12094;80001-80626	P-UB-10	115 mm	175 mm	VME-14512950	684.94	
	14523673	10486-;11515-12094;80001-80626	P-UB-10	110 mm	165 mm	VME-14513726	467.54	
	14559350	12095-12214;80627-80639	P-UB-10	110 mm	165 mm	VME-14513726	467.54	
	14561138	12095-12214;80627-80639	P-UB-10	115 mm	175 mm	VME-14512950	684.94	
	14572137	12215-;80640-	P-UB-10	110 mm	165 mm	VME-14513726	467.54	
	14572515	12215-;80640-	P-UB-10	115 mm	175 mm	VME-14512950	684.94	
COUNTERWEIGHT	14507604	10001-11514;11515-;80001-	P-UB-14	80 mm	160 mm	VME-14510588	202.79	
DIPPER ARM	1146-07290	10001-10485	P-UB-10	130 mm	190 mm	VME-14513727	441.57	
	14523672	10486-11124	P-UB-10	130 mm	190 mm	VME-14513727	441.57	
	14535510	11125-;11515-12094;80001-82626	P-UB-10	130 mm	190 mm	VME-14513727	441.57	
	14559322	12095-;82627-	P-UB-10	130 mm	190 mm	VME-14513727	441.57	

LR - Long Reach

SLF - Super Long Front

QF - Quick Fit

FS - Front Shovel

MH - Material Handle

AS - Articulate Slope

VOLVO

Replacement Kits For

Excavators							
APPLICATION	CYL #	SERIAL #	CODE	ROD	BORE	KIT #	List \$
MODEL EC460B LC, EC460B LR							
QUICK-FIT	1171-90630	10001-11514	P-U-10	32 mm	90 mm	VME-14510912	98.38
	14522371	10001-11514;11515-;80001-	P-U-10	32 mm	90 mm	VME-14522992	91.77
NEW MODEL EC460C HR							
BOOM	14574729	190001-	P-UB-10	115 mm	175 mm	VME-14589140	532.45
	14574729	190001-	Bushing	115 mm		VME-9612-11545	61.48
BUCKET	14570757	190001-	P-UB-10	110 mm	165 mm	VME-14589145	472.59
	14570757	190001-	Bushing	110 mm		VME-9612-11050	44.85
	14572352	190001-	P-UB-10	90 mm	130 mm	VME-14589133	348.43
	14572352	190001-	Bushing	90 mm		VME-9612-09040	38.46
CAB TILT	14586438	190001-	P-U-10	35 mm	65 mm	VME-14597349	73.56
	14586438	190001-	Bushing	35 mm		VME-14597338	24.97
DIPPER ARM	14549597	190001-	P-UB-10	115 mm	175 mm	VME-14589140	532.45
	14549597	190001-	Bushing	115 mm		VME-9612-11545	61.48
	14595215	190001-	P-UB-10	130 mm	190 mm	VME-14589144	434.75
	14595215	190001-	Bushing	130 mm		VME-9612-13050	51.64
QUICK-FIT	14522371	190001-	P-U-10	32 mm	90 mm	VME-14522992	91.77
NEW MODEL EC460C L							
BOOM	14548954	110001-110506	P-UB-10	110 mm	165 mm	VME-14589143	354.78
	14548954	115001-115434	P-UB-10	110 mm	165 mm	VME-14589143	354.78
BUCKET	14550055	110001-110103	P-UB-10	110 mm	165 mm	VME-14589143	354.78
	14550055	110104-110506	P-UB-10	110 mm	165 mm	VME-14589145	472.59
	14550055	110104-110506	Bushing	110 mm		VME-9612-11050	44.85
	14550055	115001-115434	P-UB-10	110 mm	165 mm	VME-14589145	472.59
	14550055	115001-115434	Bushing	110 mm		VME-9612-11050	44.85
	14550077	110001-110506	P-UB-10	115 mm	175 mm	VME-14589140	532.45
	14550077	110001-110506	Bushing	115 mm		VME-9612-11545	61.48
	14550077	115001-115434	P-UB-10	115 mm	175 mm	VME-14589140	532.45
	14550077	115001-115434	Bushing	115 mm		VME-9612-11545	61.48
	14570757	110104-	P-UB-10	110 mm	165 mm	VME-14573751	505.20
14572516	110104-	P-UB-10	115 mm	175 mm	VME-14512950	684.94	
DIPPER ARM	14550096	110001-110506	P-UB-10	130 mm	190 mm	VME-14589144	434.75
	14550096	110001-110506	Bushing	130 mm		VME-9612-13050	51.64
	14550096	115001-115434	P-UB-10	130 mm	190 mm	VME-14589144	434.75
	14550096	115001-115434	Bushing	130 mm		VME-9612-13050	51.64
HYDRAULIC	14563828	110001-110506	P-UB-14	80 mm	160 mm	VME-14589146	241.25
	14563828	110001-110506	Bushing	80 mm		VME-9611-08030	31.26
	14563828	115001-115434	P-UB-14	80 mm	160 mm	VME-14589146	241.25
	14563828	115001-115434	Bushing	80 mm		VME-9611-08030	31.26
QUICK-FIT	14522371	110001-110506	P-U-10	32 mm	90 mm	VME-14522992	91.77
	14522371	115001-115434	P-U-10	32 mm	90 mm	VME-14522992	91.77
NEW MODEL EC460C LD							
BOOM	14548954	115001-115434	P-UB-10	110 mm	165 mm	VME-14589143	354.78
BUCKET	14550055	115001-115434	P-UB-10	110 mm	165 mm	VME-14589145	472.59
	14550055	115001-115434	Bushing	110 mm		VME-9612-11050	44.85
	14550077	115001-115434	P-UB-10	115 mm	175 mm	VME-14589140	532.45
	14550077	115001-115434	Bushing	115 mm		VME-9612-11545	61.48
DIPPER ARM	14550096	115001-115434	P-UB-10	130 mm	190 mm	VME-14589144	434.75
	14550096	115001-115434	Bushing	130 mm		VME-9612-13050	51.64
HYDRAULIC	14563828	115001-115434	P-UB-14	80 mm	160 mm	VME-14589146	241.25
	14563828	115001-115434	Bushing	80 mm		VME-9611-08030	31.26
QUICK-FIT	14522371	115001-115434	P-U-10	32 mm	90 mm	VME-14522992	91.77
Excavators - Compact							
APPLICATION	CYL #	SERIAL #	CODE	ROD	BORE	KIT #	List \$
MODEL EC15 XR							
BOOM	11800597	10151-99999	P-U-10	35 mm	60 mm	VME-11988180	73.57

LR - Long Reach SLF - Super Long Front QF - Quick Fit FS - Front Shovel MH - Material Handle AS - Articulate Slope

Replacement Kits For

VOLVO

Excavators - Compact							
APPLICATION	CYL #	SERIAL #	CODE	ROD	BORE	KIT #	List \$
MODEL EC15 XR							
BOOM	5670789	10151-99999	P-U-15	35 mm	60 mm	VME-5960049	28.80
	5670789	10151-99999	P-U-10	35 mm	60 mm	VME-5960105	35.81
	5670853	10151-99999	P-U-15	35 mm	60 mm	VME-5960049	28.80
	5670853	10151-99999	P-U-10	35 mm	60 mm	VME-5960105	35.81
BOOM EXTENSION	5670508	10151-99999	P-UB-15	30 mm	60 mm	VME-7410836	17.46
BUCKET	11800599	10151-99999	P-U-10	35 mm	60 mm	VME-11988179	47.68
	5670821	10151-99999	P-U-10	35 mm	60 mm	VME-5960105	35.81
	5670821	10151-99999	P-U-15	35 mm	60 mm	VME-5960049	28.80
	5670859	10151-99999	P-U-10	35 mm	60 mm	VME-5960105	35.81
	5670859	10151-99999	P-U-15	35 mm	60 mm	VME-5960049	28.80
DIPPER	11800598	10151-99999	P-U-10	35 mm	60 mm	VME-11988179	47.68
	5670820	10151-99999	P-U-15	35 mm	60 mm	VME-5960049	28.80
	5670820	10151-99999	P-U-10	35 mm	60 mm	VME-5960105	35.81
	5670856	10151-99999	P-U-15	35 mm	60 mm	VME-5960049	28.80
	5670856	10151-99999	P-U-10	35 mm	60 mm	VME-5960105	35.81
DOZER BLADE	11800596	10151-99999	P-U-10	35 mm	63 mm	VME-11988181	50.70
	5670665	10151-99999	P-U-15	35 mm	60 mm	VME-5960049	28.80
	5670665	10151-99999	P-U-10	35 mm	60 mm	VME-5960105	35.81
	5670861	10151-99999	P-U-15	35 mm	60 mm	VME-5960049	28.80
	5670861	10151-99999	P-U-10	35 mm	60 mm	VME-5960105	35.81
SWING	11800600	10151-99999	P-U-10	35 mm	60 mm	VME-11988179	47.68
	5670829	10151-99999	P-U-15	35 mm	60 mm	VME-5960049	28.80
	5670829	10151-99999	P-U-10	35 mm	60 mm	VME-5960105	35.81
	5670864	10151-99999	P-U-10	35 mm	60 mm	VME-5960105	35.81
	5670864	10151-99999	P-U-15	35 mm	60 mm	VME-5960049	28.80
MODEL EC15 XT							
BOOM	11800597	10151-99999	P-U-10	35 mm	60 mm	VME-11988180	73.57
	5670789	10151-99999	P-U-10	35 mm	60 mm	VME-5960105	35.81
	5670789	10151-99999	P-U-15	35 mm	60 mm	VME-5960049	28.80
	5670853	10151-99999	P-U-15	35 mm	60 mm	VME-5960049	28.80
	5670853	10151-99999	P-U-10	35 mm	60 mm	VME-5960105	35.81
BOOM EXTENSION	5670508	10151-99999	P-UB-15	30 mm	60 mm	VME-7410836	17.46
BUCKET	11800599	10151-99999	P-U-10	35 mm	60 mm	VME-11988179	47.68
	5670821	10151-99999	P-U-10	35 mm	60 mm	VME-5960105	35.81
	5670821	10151-99999	P-U-15	35 mm	60 mm	VME-5960049	28.80
	5670859	10151-99999	P-U-15	35 mm	60 mm	VME-5960049	28.80
	5670859	10151-99999	P-U-10	35 mm	60 mm	VME-5960105	35.81
DIPPER	11800598	10151-99999	P-U-10	35 mm	60 mm	VME-11988179	47.68
	5670820	10151-99999	P-U-15	35 mm	60 mm	VME-5960049	28.80
	5670820	10151-99999	P-U-10	35 mm	60 mm	VME-5960105	35.81
	5670856	10151-99999	P-U-15	35 mm	60 mm	VME-5960049	28.80
	5670856	10151-99999	P-U-10	35 mm	60 mm	VME-5960105	35.81
DOZER BLADE	11800596	10151-99999	P-U-10	35 mm	63 mm	VME-11988181	50.70
	5670665	10151-99999	P-U-10	35 mm	60 mm	VME-5960105	35.81
	5670665	10151-99999	P-U-15	35 mm	60 mm	VME-5960049	28.80
	5670861	10151-99999	P-U-10	35 mm	60 mm	VME-5960105	35.81
	5670861	10151-99999	P-U-15	35 mm	60 mm	VME-5960049	28.80
DOZER BLADE, VARIABLE TRACK	11800605	10151-99999	P-U-10	40 mm	70 mm	VME-11988184	57.32
	5670677	10151-99999	P-U-10	40 mm	70 mm	VME-5960104	83.75
	5670862	10151-99999	P-U-10	40 mm	70 mm	VME-5960104	83.75
SWING	11800600	10151-99999	P-U-10	35 mm	60 mm	VME-11988179	47.68
	5670829	10151-99999	P-U-10	35 mm	60 mm	VME-5960105	35.81
	5670829	10151-99999	P-U-15	35 mm	60 mm	VME-5960049	28.80
	5670864	10151-99999	P-U-15	35 mm	60 mm	VME-5960049	28.80

LR - Long Reach

SLF - Super Long Front

QF - Quick Fit

FS - Front Shovel

MH - Material Handle

AS - Articulate Slope

Replacement Kits For

VOLVO

Excavators - Compact							
APPLICATION	CYL #	SERIAL #	CODE	ROD	BORE	KIT #	List \$
MODEL EC15 XT							
SWING	5670864	10151-99999	P-U-10	35 mm	60 mm	VME-5960105	35.81
MODEL EC15 XTV							
BOOM	11800597	10151-99999	P-U-10	35 mm	60 mm	VME-11988180	73.57
	5670789	10151-99999	P-U-15	35 mm	60 mm	VME-5960049	28.80
	5670789	10151-99999	P-U-10	35 mm	60 mm	VME-5960105	35.81
	5670853	10151-99999	P-U-15	35 mm	60 mm	VME-5960049	28.80
	5670853	10151-99999	P-U-10	35 mm	60 mm	VME-5960105	35.81
BOOM EXTENSION	5670508	10151-99999	P-UB-15	30 mm	60 mm	VME-7410836	17.46
BUCKET	11800599	10151-99999	P-U-10	35 mm	60 mm	VME-11988179	47.68
	5670821	10151-99999	P-U-10	35 mm	60 mm	VME-5960105	35.81
	5670821	10151-99999	P-U-15	35 mm	60 mm	VME-5960049	28.80
	5670859	10151-99999	P-U-15	35 mm	60 mm	VME-5960049	28.80
	5670859	10151-99999	P-U-10	35 mm	60 mm	VME-5960105	35.81
DIPPER	11800598	10151-99999	P-U-10	35 mm	60 mm	VME-11988179	47.68
	5670820	10151-99999	P-U-15	35 mm	60 mm	VME-5960049	28.80
	5670820	10151-99999	P-U-10	35 mm	60 mm	VME-5960105	35.81
	5670856	10151-99999	P-U-15	35 mm	60 mm	VME-5960049	28.80
	5670856	10151-99999	P-U-10	35 mm	60 mm	VME-5960105	35.81
DOZER BLADE	11800596	10151-99999	P-U-10	35 mm	63 mm	VME-11988181	50.70
	5670665	10151-99999	P-U-15	35 mm	60 mm	VME-5960049	28.80
	5670665	10151-99999	P-U-10	35 mm	60 mm	VME-5960105	35.81
	5670861	10151-99999	P-U-15	35 mm	60 mm	VME-5960049	28.80
	5670861	10151-99999	P-U-10	35 mm	60 mm	VME-5960105	35.81
DOZER BLADE, VARIABLE TRACK	11800605	10151-99999	P-U-10	40 mm	70 mm	VME-11988184	57.32
	5670677	10151-99999	P-U-10	40 mm	70 mm	VME-5960104	83.75
	5670862	10151-99999	P-U-10	40 mm	70 mm	VME-5960104	83.75
SWING	11800600	10151-99999	P-U-10	35 mm	60 mm	VME-11988179	47.68
	5670829	10151-99999	P-U-10	35 mm	60 mm	VME-5960105	35.81
	5670829	10151-99999	P-U-15	35 mm	60 mm	VME-5960049	28.80
	5670864	10151-99999	P-U-10	35 mm	60 mm	VME-5960105	35.81
	5670864	10151-99999	P-U-15	35 mm	60 mm	VME-5960049	28.80
MODEL EC15B XR							
BOOM	11800597	10151-10179	P-U-10	35 mm	60 mm	VME-11988180	73.57
	5670853	10180-UP	P-U-10	35 mm	60 mm	VME-5960105	35.81
BOOM EXTENSION	5670508	10151-99999	P-UB-15	30 mm	60 mm	VME-7410836	17.46
BUCKET	11800599	10151-10179	P-U-10	35 mm	60 mm	VME-11988179	47.68
	5670859	10180-UP	P-U-10	35 mm	60 mm	VME-5960105	35.81
DIPPER	11800598	10151-10179	P-U-10	35 mm	60 mm	VME-11988179	47.68
	5670856	10180-UP	P-U-10	35 mm	60 mm	VME-5960105	35.81
DOZER BLADE	11800596	10151-10179	P-U-10	35 mm	63 mm	VME-11988181	50.70
	5670861	10180-UP	P-U-10	35 mm	60 mm	VME-5960105	35.81
SWING	11800600	10151-10179	P-U-10	35 mm	60 mm	VME-11988179	47.68
	5670864	10180-UP	P-U-10	35 mm	60 mm	VME-5960105	35.81
MODEL EC15B XT							
BOOM	11800597	25151-40000	P-U-10	35 mm	60 mm	VME-11988180	73.57
	5670853	25151-40000	P-U-10	35 mm	60 mm	VME-5960105	35.81
BOOM EXTENSION	5670508	25151-40000	P-UB-15	30 mm	60 mm	VME-7410836	17.46
BUCKET	11800599	25151-40000	P-U-10	35 mm	60 mm	VME-11988179	47.68
	5670859	25151-40000	P-U-10	35 mm	60 mm	VME-5960105	35.81
DIPPER	11800598	25151-40000	P-U-10	35 mm	60 mm	VME-11988179	47.68
	5670856	25151-40000	P-U-10	35 mm	60 mm	VME-5960105	35.81
DOZER BLADE	11800596	25151-40000	P-U-10	35 mm	63 mm	VME-11988181	50.70
	5670861	25151-40000	P-U-10	35 mm	60 mm	VME-5960105	35.81
SWING	11800600	25151-40000	P-U-10	35 mm	60 mm	VME-11988179	47.68

LR - Long Reach SLF - Super Long Front QF - Quick Fit FS - Front Shovel MH - Material Handle AS - Articulate Slope

Replacement Kits For

VOLVO

Excavators - Compact							
APPLICATION	CYL #	SERIAL #	CODE	ROD	BORE	KIT #	List \$
MODEL EC15B XT							
SWING	5670864	25151-40000	P-U-10	35 mm	60 mm	VME-5960105	35.81
MODEL EC15B XTV							
BOOM	11800597	40151-99999	P-U-10	35 mm	60 mm	VME-11988180	73.57
	5670853	40151-99999	P-U-15	35 mm	60 mm	VME-5960049	28.80
	5670853	40151-99999	P-U-10	35 mm	60 mm	VME-5960105	35.81
BOOM EXTENSION	5670508	40151-99999	P-UB-15	30 mm	60 mm	VME-7410836	17.46
BUCKET	11800599	40151-99999	P-U-10	35 mm	60 mm	VME-11988179	47.68
	5670859	40151-99999	P-U-15	35 mm	60 mm	VME-5960049	28.80
	5670859	40151-99999	P-U-10	35 mm	60 mm	VME-5960105	35.81
DIPPER	11800598	40151-99999	P-U-10	35 mm	60 mm	VME-11988179	47.68
	5670856	40151-99999	P-U-10	35 mm	60 mm	VME-5960105	35.81
	5670856	40151-99999	P-U-15	35 mm	60 mm	VME-5960049	28.80
DOZER BLADE	11800596	40151-99999	P-U-10	35 mm	63 mm	VME-11988181	50.70
	5670861	40151-99999	P-U-10	35 mm	60 mm	VME-5960105	35.81
	5670861	40151-99999	P-U-15	35 mm	60 mm	VME-5960049	28.80
SWING	11800600	40151-99999	P-U-10	35 mm	60 mm	VME-11988179	47.68
	5670864	40151-99999	P-U-15	35 mm	60 mm	VME-5960049	28.80
	5670864	40151-99999	P-U-10	35 mm	60 mm	VME-5960105	35.81
MODEL EC20 XT							
BOOM	11800602	10151-99999	P-U-10	35 mm	63 mm	VME-11988183	79.52
	5670788	10151-99999	P-U-10	35 mm	63 mm	VME-5960102	43.69
	5670788	10151-99999	P-U-15	35 mm	63 mm	VME-5960050	31.63
	5670854	10151-99999	P-U-15	35 mm	63 mm	VME-5960050	31.63
	5670854	10151-99999	P-U-10	35 mm	63 mm	VME-5960102	43.69
BUCKET	11800601	10151-99999	P-U-10	35 mm	60 mm	VME-11988179	47.68
	5670822	10151-99999	P-U-15	35 mm	60 mm	VME-5960049	28.80
	5670822	10151-99999	P-U-10	35 mm	60 mm	VME-5960105	35.81
	5670860	10151-99999	P-U-10	35 mm	60 mm	VME-5960105	35.81
	5670860	10151-99999	P-U-15	35 mm	60 mm	VME-5960049	28.80
DIPPER		10151-99999	P-U-10	40 mm	63 mm	VME-15174598	58.63
		10151-99999	P-U-10	35 mm	60 mm	VME-5960105	35.81
	5670829	10151-99999	P-U-15	35 mm	60 mm	VME-5960049	28.80
	5670864	10151-99999	P-U-15	35 mm	60 mm	VME-5960049	28.80
DOZER BLADE	11800605	10151-99999	P-U-10	40 mm	70 mm	VME-11988184	57.32
	5670677	10151-99999	P-U-10	40 mm	70 mm	VME-5960104	83.75
	5670862	10151-99999	P-U-10	40 mm	70 mm	VME-5960104	83.75
SWING	11800600	10151-99999	P-U-10	35 mm	60 mm	VME-11988179	47.68
	5670829	10151-99999	P-U-15	35 mm	60 mm	VME-5960049	28.80
	5670829	10151-99999	P-U-10	35 mm	60 mm	VME-5960105	35.81
	5670864	10151-99999	P-U-15	35 mm	60 mm	VME-5960049	28.80
	5670864	10151-99999	P-U-10	35 mm	60 mm	VME-5960105	35.81
MODEL EC20 XTV							
BOOM	11800602	10151-99999	P-U-10	35 mm	63 mm	VME-11988183	79.52
	5670788	10151-99999	P-U-15	35 mm	63 mm	VME-5960050	31.63
	5670788	10151-99999	P-U-10	35 mm	63 mm	VME-5960102	43.69
	5670854	10151-99999	P-U-10	35 mm	63 mm	VME-5960102	43.69
	5670854	10151-99999	P-U-15	35 mm	63 mm	VME-5960050	31.63
BUCKET	11800601	10151-99999	P-U-10	35 mm	60 mm	VME-11988179	47.68
	5670822	10151-99999	P-U-15	35 mm	60 mm	VME-5960049	28.80
	5670822	10151-99999	P-U-10	35 mm	60 mm	VME-5960105	35.81
	5670860	10151-99999	P-U-15	35 mm	60 mm	VME-5960049	28.80
	5670860	10151-99999	P-U-10	35 mm	60 mm	VME-5960105	35.81
DIPPER		10151-99999	P-U-10	40 mm	63 mm	VME-15174598	58.63
	5670857	10151-99999	P-U-10	40 mm	60 mm	VME-5960103	59.46
	5670857	10151-99999	P-U-15	40 mm	63 mm	VME-5960051	50.89

LR - Long Reach

SLF - Super Long Front

QF - Quick Fit

FS - Front Shovel

MH - Material Handle

AS - Articulate Slope

VOLVO

Replacement Kits For

Excavators - Compact							
APPLICATION	CYL #	SERIAL #	CODE	ROD	BORE	KIT #	List \$
MODEL EC20 XTV							
DOZER BLADE	11800605	10151-99999	P-U-10	40 mm	70 mm	VME-11988184	57.32
	5670677	10151-99999	P-U-10	40 mm	70 mm	VME-5960104	83.75
	5670862	10151-99999	P-U-10	40 mm	70 mm	VME-5960104	83.75
SWING	11800600	10151-99999	P-U-10	35 mm	60 mm	VME-11988179	47.68
	5670829	10151-99999	P-U-15	35 mm	60 mm	VME-5960049	28.80
	5670829	10151-99999	P-U-10	35 mm	60 mm	VME-5960105	35.81
	5670864	10151-99999	P-U-10	35 mm	60 mm	VME-5960105	35.81
	5670864	10151-99999	P-U-15	35 mm	60 mm	VME-5960049	28.80
MODEL EC20B XT							
BOOM	11800602	60151-80000	P-U-10	35 mm	63 mm	VME-11988183	79.52
	5670854	60151-80000	P-U-10	35 mm	63 mm	VME-5960102	43.69
BUCKET	11800601	60151-80000	P-U-10	35 mm	60 mm	VME-11988179	47.68
	5670860	60151-80000	P-U-10	35 mm	60 mm	VME-5960105	35.81
DIPPER		60151-80000	P-U-10	40 mm	63 mm	VME-15174598	58.63
	5670857	60151-80000	P-U-10	40 mm	60 mm	VME-5960103	59.46
DOZER BLADE	11800605	60151-80000	P-U-10	40 mm	70 mm	VME-11988184	57.32
	5670862	60151-80000	P-U-10	40 mm	70 mm	VME-5960104	83.75
SWING	11800600	60151-80000	P-U-10	35 mm	60 mm	VME-11988179	47.68
	5670864	60151-80000	P-U-10	35 mm	60 mm	VME-5960105	35.81
MODEL EC20B XTV							
BOOM	11800602	80151-99999	P-U-10	35 mm	63 mm	VME-11988183	79.52
	5670854	80151-99999	P-U-10	35 mm	63 mm	VME-5960102	43.69
BUCKET	11800601	80151-99999	P-U-10	35 mm	60 mm	VME-11988179	47.68
	5670860	80151-99999	P-U-10	35 mm	60 mm	VME-5960105	35.81
DIPPER		80151-99999	P-U-10	40 mm	63 mm	VME-15174598	58.63
	5670857	80151-99999	P-U-10	40 mm	60 mm	VME-5960103	59.46
DOZER BLADE	11800605	80151-99999	P-U-10	40 mm	70 mm	VME-11988184	57.32
	5670862	80151-99999	P-U-10	40 mm	70 mm	VME-5960104	83.75
SWING	11800600	80151-99999	P-U-10	35 mm	60 mm	VME-11988179	47.68
	5670864	80151-99999	P-U-10	35 mm	60 mm	VME-5960105	35.81
MODEL EC25							
BOOM	11800606	10151-99999	P-U-10	45 mm	70 mm	VME-11988358	82.55
	5670880	10151-99999	P-U-10	45 mm	70 mm	VME-5960121	60.85
BUCKET		10151-99999	P-U-10	40 mm	63 mm	VME-15174598	58.63
	5670850	10151-99999	P-U-10	40 mm	60 mm	VME-5960103	59.46
DIPPER	11800607	10151-99999	P-U-10	45 mm	70 mm	VME-11988359	43.89
	5670851	10151-99999	P-U-10	45 mm	70 mm	VME-5960100	80.73
DOZER BLADE	11800609	10151-99999	P-U-10	50 mm	90 mm	VME-11988360	52.47
	5670882	10151-99999	P-U-10	50 mm	90 mm	VME-5960124	65.29
SWING	11800608	10151-99999	P-U-10	45 mm	70 mm	VME-11988359	43.89
	5670879	10151-99999	P-U-10	45 mm	70 mm	VME-5960100	80.73
MODEL EC30							
BOOM	11800610	10151-99999	P-U-10	45 mm	80 mm	VME-11988361	53.52
	5670877	10151-99999	P-U-10	45 mm	80 mm	VME-5960123	75.99
BUCKET		10151-99999	P-U-10	40 mm	63 mm	VME-15174598	58.63
	5670850	10151-99999	P-U-10	40 mm	60 mm	VME-5960103	59.46
DIPPER	11800611	10151-99999	P-U-10	45 mm	70 mm	VME-11988359	43.89
	5670878	10151-99999	P-U-10	45 mm	70 mm	VME-5960100	80.73
DOZER BLADE	11800609	10151-99999	P-U-10	50 mm	90 mm	VME-11988360	52.47
	5670882	10151-99999	P-U-10	50 mm	90 mm	VME-5960124	65.29
SWING	11800608	10151-99999	P-U-10	45 mm	70 mm	VME-11988359	43.89
	5670879	10151-99999	P-U-10	45 mm	70 mm	VME-5960100	80.73
MODEL EC35							
BOOM	11800615	28310151-28399999	P-U-10	50 mm	90 mm	VME-11988983	75.75
	PJ5670847	28310151-28399999	P-U-10	50 mm	90 mm	VME-5960122	68.42

LR - Long Reach

SLF - Super Long Front

QF - Quick Fit

FS - Front Shovel

MH - Material Handle

AS - Articulate Slope

Replacement Kits For

VOLVO

Excavators - Compact							
APPLICATION	CYL #	SERIAL #	CODE	ROD	BORE	KIT #	List \$
MODEL EC35							
BOOM OFFSET	11800614	28310151-28399999	P-U-10	45 mm	80 mm	VME-11988361	53.52
	PJ5670873	28310151-28399999	P-U-10	45 mm	80 mm	VME-5960123	75.99
BUCKET	11800612	28310151-28399999	P-U-10	45 mm	70 mm	VME-11988359	43.89
	PJ5670848	28310151-28399999	P-U-10	45 mm	70 mm	VME-5960100	80.73
DIPPER ARM	11800613	28310151-28399999	P-U-10	50 mm	80 mm	VME-11988963	72.72
	PJ5670849	28310151-28399999	P-U-10	50 mm	80 mm	VME-5960101	88.54
MODEL EC55							
BOOM	1146-06451	5001-7620	P-UB-14	60 mm	105 mm	VME-14589154	212.93
	1146-06461	5001-7620	P-UB-14	60 mm	105 mm	VME-14589154	212.93
	14501658	5001-7620	P-UB-14	60 mm	105 mm	VME-14589154	212.93
	14501659	5001-7620	P-UB-14	60 mm	105 mm	VME-14589154	212.93
	14507999	20001-21355	P-UB-14	60 mm	105 mm	VME-14589154	212.93
BUCKET	1146-01191	20001-21355	P-UB-14	50 mm	80 mm	VME-14589150	164.12
	1146-01191	5001-7620	P-UB-14	50 mm	80 mm	VME-14589150	164.12
DIPPER ARM	14503580	20001-21355	P-UB-14	55 mm	90 mm	VME-14589153	155.13
	14503580	5001-7620	P-UB-14	55 mm	90 mm	VME-14589153	155.13
	14508004	20001-21355	P-UB-14	55 mm	90 mm	VME-14589153	155.13
DOZER BLADE	1146-01201	20001-21355	P-UB-14	60 mm	105 mm	VME-8148-14041	161.73
	1146-01201	5001-7620	P-UB-14	60 mm	105 mm	VME-8148-14041	161.73
SWING	1146-01211	20001-21355	P-UB-14	45 mm	90 mm	VME-8148-14051	134.28
	1146-01211	5001-7620	P-UB-14	45 mm	90 mm	VME-8148-14051	134.28
MODEL EC55B							
BOOM	1146-06461	30001-31254	P-UB-14	60 mm	105 mm	VME-14589154	212.93
	14501658	30001-31254	P-UB-14	60 mm	105 mm	VME-14589154	212.93
	14501659	30001-31254	P-UB-14	60 mm	105 mm	VME-14589154	212.93
	14507999	30001-31254	P-UB-14	60 mm	105 mm	VME-14589154	212.93
	14524922	31255-	P-UB-14	60 mm	105 mm	VME-14589154	212.93
	14524923	31255-	P-UB-14	60 mm	105 mm	VME-14589154	212.93
	14524924	31255-50129	P-UB-14	60 mm	105 mm	VME-14589154	212.93
	14524925	31255-	P-UB-14	60 mm	105 mm	VME-14589154	212.93
	14533036	34476-	P-UB-10	60 mm	110 mm	VME-14589148	129.83
	14535784	34476-	P-UB-10	60 mm	110 mm	VME-14589148	129.83
	14535784	50130-	P-UB-10	60 mm	110 mm	VME-14589148	129.83
	14540392	34476-	P-UB-10	60 mm	110 mm	VME-14589148	129.83
	14540392	50130-	P-UB-10	60 mm	110 mm	VME-14589148	129.83
	BUCKET	1146-01191	30001-31254	P-UB-14	50 mm	80 mm	VME-14589150
14524787		31255	P-UB-14	50 mm	80 mm	VME-14589150	164.12
DIPPER ARM	14503580	30001-	P-UB-14	55 mm	90 mm	VME-14589153	155.13
	14503580	50001-	P-UB-14	55 mm	90 mm	VME-14589153	155.13
	14521124	30001-	P-UB-14	55 mm	90 mm	VME-14589153	155.13
	14521124	50001-	P-UB-14	55 mm	90 mm	VME-14589153	155.13
DOZER BLADE	14518032	30001-32308	P-UB-14	60 mm	105 mm	VME-14520420	159.06
	14518032	50001-50026	P-UB-14	60 mm	105 mm	VME-14520420	159.06
	14528340	32309-	P-UB-14	60 mm	105 mm	VME-14520420	159.06
	14528340	50027-	P-UB-14	60 mm	105 mm	VME-14520420	159.06
SWING	1146-01211	30001-	P-UB-14	45 mm	90 mm	VME-8148-14051	134.28
	1146-01211	50001-	P-UB-14	45 mm	90 mm	VME-8148-14051	134.28
MODEL ECR58							
BOOM	14519229	10001-	P-UB-10	55 mm	100 mm	VME-14524766	92.46
BOOM SWING	14519233	10001-	P-UB-10	45 mm	85 mm	VME-14524769	104.16
BUCKET	14519231	10001-10135	P-UB-10	50 mm	75 mm	VME-14524768	98.98
	14532855	10136-	P-UB-10	50 mm	75 mm	VME-14524768	98.98
DIPPER ARM	14519230	10001-	P-UB-10	55 mm	85 mm	VME-14524767	106.69
MODEL ECR88							
BOOM	14528551	10001-	P-UB-10	70 mm	105 mm	VME-14530833	161.56

LR - Long Reach

SLF - Super Long Front

QF - Quick Fit

FS - Front Shovel

MH - Material Handle

AS - Articulate Slope

VOLVO

Replacement Kits For

Excavators - Compact							
APPLICATION	CYL #	SERIAL #	CODE	ROD	BORE	KIT #	List \$
MODEL ECR88							
BOOM	14528552	10001-	P-UB-10	70 mm	105 mm	VME-14530833	161.56
BUCKET	14522092	10001-	P-UB-10	55 mm	80 mm	VME-14530719	187.08
	14522093	10001-	P-UB-10	55 mm	80 mm	VME-14530719	187.08
DIPPER ARM	14520122	10001-11285	P-UB-10	60 mm	90 mm	VME-14530716	186.92
	14521325	1001-11285	P-UB-10	60 mm	90 mm	VME-14530716	186.92
	14546791	11286-	P-UB-10	60 mm	90 mm	VME-14530716	186.92
	14549303	11286-	P-UB-10	60 mm	90 mm	VME-14530716	186.92
DOZER BLADE	14520124	10001-	P-UB-10	95 mm	130 mm	VME-14530717	166.17
SWING	14520125	10001-	P-UB-10	55 mm	100 mm	VME-14530718	134.82
Forestry - Log Skidders							
APPLICATION	CYL #	SERIAL #	CODE	ROD	BORE	KIT #	List \$
MODEL 662							
STEER & BLADE	1904666	501A;501B;502A;502B	P-U-10	1-3/4	3-1/2	VME-1991086	50.20
MODEL 664							
STEER & BLADE	1904674	C9014;C9024;C9034;C9044	P-U-10	1-3/4	3-1/2	VME-1991086	50.20
	1906258	C9014;C9024;C9034;C9044	P-U-10	1-3/4	3-1/2	VME-1991086	50.20
MODEL 664B							
ARCH	1906258	514E;514F;508A;508B;508C	P-U-10	1-3/4	3-1/2	VME-1991086	50.20
GRAPPLE	1916232	514E;514F;508A;508B;508C	P-TR-10	2-3/4	6	VME-1991089	113.12
STEER & BLADE	1906258	514E;514F;508A;508B;508C	P-U-10	1-3/4	3-1/2	VME-1991086	50.20
MODEL 664C							
ARCH	1904666	514H;508H;546H	P-U-10	1-3/4	3-1/2	VME-1991086	50.20
GRAPPLE	1916232	514H;508H;546H	P-TR-10	2-3/4	6	VME-1991089	113.12
STEER & BLADE	1904666	514H;508H;546H	P-U-10	1-3/4	3-1/2	VME-1991086	50.20
MODEL 664D							
ARCH	2552115	528A-528D;540A;529C;551D-551G	P-UB-10	2	4	VME-2551403	75.42
STEER & BLADE	2552115	528A-528D;540A;529C;551D-551G	P-UB-10	2	4	VME-2551403	75.42
MODEL 666							
STEER & BLADE	1904674	C9016;C9026;C9036;C9046	P-U-10	1-3/4	3-1/2	VME-1991086	50.20
	1906258	C9016;C9026;C9036;C9046	P-U-10	1-3/4	3-1/2	VME-1991086	50.20
MODEL 666B							
ARCH	1906258	513E-513G;515A;500D-500G;526A	P-U-10	1-3/4	3-1/2	VME-1991086	50.20
GRAPPLE	1916232	513E-513G;515A;500D-500G;526A	P-TR-10	2-3/4	6	VME-1991089	113.12
STEER & BLADE	1904674	513E-513G;515A;500D-500G;526A	P-U-10	1-3/4	3-1/2	VME-1991086	50.20
	1906258	513E-513G;515A;500D-500G;526A	P-U-10	1-3/4	3-1/2	VME-1991086	50.20
MODEL 666C							
ARCH	1904666	513H;500H;515H;542H;526H	P-U-10	1-3/4	3-1/2	VME-1991086	50.20
GRAPPLE	1916232	513H;500H;515H;542H;526H	P-TR-10	2-3/4	6	VME-1991089	113.12
	2552121	513H;500H;515H;542H;526H	P-UB-10	2	4	VME-2551403	75.42
STEER & BLADE	1904666	513H;500H;515H;542H;526H	P-U-10	1-3/4	3-1/2	VME-1991086	50.20
MODEL 666D							
ARCH	2552115	548A;549A;552A;555A;559A;564B	P-UB-10	2	4	VME-2551403	75.42
BOOM	2552115	548A;549A;552A;555A;559A;564B	P-UB-10	2	4	VME-2551403	75.42
GRAPPLE	2552115	548A;549A;552A;555A;559A;564B	P-UB-10	2	4	VME-2551403	75.42
	2552121	548A;549A;552A;555A;559A;564B	P-UB-10	2	4	VME-2551403	75.42
STEER & BLADE	2552361	548A;549A;552A;555A;559A;564B	P-UB-10	1-3/4	3-1/2	VME-2542570	81.20
MODEL 667C							
ARCH	1917220	503B;504B-C;509B;510B-C;534B-C;535A;536B-C;537A	P-U-10	1-3/4	3-1/2	VME-1991086	50.20
	2552115	503B;504B-C;509B;510B-C;534B-C;535A;536B-C;537A	P-UB-10	2	4	VME-2551403	75.42
BOOM	1919023	503B;504B-C;509B;510B-C;534B-C;535A;536B-C;537A	P-U-10	1-3/4	3-1/2	VME-1991086	50.20
GRAPPLE	1916232	503B;504B-C;509B;510B-C;534B-C;535A;536B-C;537A	P-TR-10	2-3/4	6	VME-1991089	113.12
STEER & BLADE	1917220	503B;504B-C;509B;510B-C;534B-C;535A;536B-C;537A	P-U-10	1-3/4	3-1/2	VME-1991086	50.20

LR - Long Reach SLF - Super Long Front QF - Quick Fit FS - Front Shovel MH - Material Handle AS - Articulate Slope

VOLVO

Replacement Kits For

Forestry - Log Skidders							
APPLICATION	CYL #	SERIAL #	CODE	ROD	BORE	KIT #	List \$
MODEL 667D							
ARCH	2552115	534D;534E;535D-G;536D-E;537D-G;556G;557G	P-UB-10	2	4	VME-2551403	75.42
BOOM	1919023	534D;534E;535D-G;536D-E;537D-G;556G;557G	P-U-10	1-3/4	3-1/2	VME-1991086	50.20
	2552115	534D;534E;535D-G;536D-E;537D-G;556G;557G	P-UB-10	2	4	VME-2551403	75.42
STEER & BLADE	2552361	534D;534E;535D-G;536D-E;537D-G;556G;557G	P-UB-10	1-3/4	3-1/2	VME-2542570	81.20
MODEL 668							
TILT	2518802	505A;507A	P-U-10	1-3/4	3-1/2	VME-2538177	66.15
MODEL 668B							
TILT	2518802	505B;507B	P-U-10	1-3/4	3-1/2	VME-2538177	66.15
MODEL 668C							
STEER & BLADE	2537607	505C;507C;532A;533A;538C;539C	P-U-10	2	4	VME-2530107	52.30
MODEL 668D							
STEER & BLADE	2552141	507D;507E;532D;532E;539D;539E	P-UB-10	2	4	VME-2551403	75.42
MODEL F65							
ARCH	2552115	553G;553GC;554G;554GC	P-UB-10	2	4	VME-2551403	75.42
GRAPPLE	2552121	553G;553GC;554G;554GC	P-UB-10	2	4	VME-2551403	75.42
STEER & BLADE	2552115	553G;553GC;554G;554GC	P-UB-10	2	4	VME-2551403	75.42
MODEL F665							
ARCH	2552115	553G;554G	P-UB-10	2	4	VME-2551403	75.42
GRAPPLE	2552121	553G;554G	P-UB-10	2	4	VME-2551403	75.42
STEER & BLADE	2552115	553G;554G	P-UB-10	2	4	VME-2551403	75.42
MODEL F666							
ARCH	2552115	559B;555B;564B	P-UB-10	2	4	VME-2551403	75.42
BOOM	2552115	559B;555B;564B	P-UB-10	2	4	VME-2551403	75.42
GRAPPLE	2552121	559B;555B;564B	P-UB-10	2	4	VME-2551403	75.42
STEER & BLADE	2552361	559B;555B;564B	P-UB-10	1-3/4	3-1/2	VME-2542570	81.20
MODEL F668							
STEER & BLADE	2552141	565A;566A	P-UB-10	2	4	VME-2551403	75.42
Loaders - Skid Steer							
APPLICATION	CYL #	SERIAL #	CODE	ROD	BORE	KIT #	List \$
MODEL MC90							
ARM	11841419	60000-61000	I-U-10	1-5/8	2-3/4	VME-11711929	26.87
TILT LH	11850382	60000-61000	I-U-10	1-1/2	3	VME-11711451	28.03
TILT RH	11850383	60000-61000	I-U-10	1-1/2	3	VME-11711451	28.03
MODEL MC90B							
ARM	11841419	61001-62000	I-U-10	1-5/8	2-3/4	VME-11711929	26.87
TILT LH	11851262	61001-62000	I-U-10	1-1/2	3	VME-11711451	28.03
TILT RH	11851263	61001-62000	I-U-10	1-1/2	3	VME-11711451	28.03
Loaders - Wheel							
APPLICATION	CYL #	SERIAL #	CODE	ROD	BORE	KIT #	List \$
MODEL 12B							
BUCKET	1503797		I-U-10	1-3/4	3-1/2	VME-2516072	44.73
MODEL 35A							
BOOM	1504471		P-V-10	2-3/4	6	VME-2516065	93.06
BUCKET	1504470		P-U-10	2	5	VME-2516059	78.00
CLAMP	2512955		P-V-10	1-3/4	3-1/2	VME-2516071	66.64
STEERING	1524562		I-U-10	1	2-1/2	VME-2516055	27.85
	1524563		I-U-10	1	2-1/2	VME-2516055	27.85
MODEL 35AWS							
BOOM	1504471	C5WG9-301-999;7WG101-;C3WA9-91-999	P-V-10	2-3/4	6	VME-2516065	93.06
BUCKET	1504470	C5WG9-301-999;7WG101-;C3WA9-91-999	P-U-10	2	5	VME-2516059	78.00
CLAMP	2512955		P-V-10	1-3/4	3-1/2	VME-2516071	66.64
STEERING	1524562	C5WG9-301-999;7WG101-;C3WA9-91-999	I-U-10	1	2-1/2	VME-2516055	27.85
	1524563	C5WG9-301-999;7WG101-;C3WA9-91-999	I-U-10	1	2-1/2	VME-2516055	27.85

LR - Long Reach

SLF - Super Long Front

QF - Quick Fit

FS - Front Shovel

MH - Material Handle

AS - Articulate Slope

VOLVO

Replacement Kits For

Loaders - Wheel								
APPLICATION	CYL #	SERIAL #	CODE	ROD	BORE	KIT #	List \$	
MODEL 35B								
CLAMP			P-V-10	1-3/4	3-1/2	VME-2516071	66.64	
STEERING	1524562		I-U-10	1	2-1/2	VME-2516055	27.85	
	1524563		I-U-10	1	2-1/2	VME-2516055	27.85	
MODEL 35C								
BOOM	2521773	458A101CB-116CB;472A101CB-255CB	P-U-10	2	4	VME-2530107	52.30	
	2521774	458A101CB-116CB;472A101CB-255CB	P-U-10	2	4	VME-2530107	52.30	
	2523265	458A117CB-;472A256CB-	P-U-10	2	4	VME-2530107	52.30	
	2523266	458A101CB-116CB;472A101CB-255CB	P-U-10	2	4	VME-2530107	52.30	
	2530960	472D9101-;807B9101-	P-UB-10	2	4-1/2	VME-2551398	79.20	
	2530961	472D9101-;807B9101-	P-UB-10	2	4-1/2	VME-2551398	79.20	
	2533144	472D101CB-;807B101CB-	P-UB-10	2	4	VME-2551403	75.42	
	2533145	472D101CB-;807B101CB-	P-UB-10	2	4	VME-2551403	75.42	
	2538680	472C220CB-	P-U-10	2	4	VME-2530107	52.30	
	2538682	472C220CB-	P-U-10	2	4	VME-2530107	52.30	
	2538691	472C9101-;807A9101-	P-U-10	2	4-1/2	VME-2538178	54.72	
	2538692	472C9101-;807A9101-	P-U-10	2	4-1/2	VME-2538178	54.72	
	BUCKET	2521041	458A101CB-116CB;472A101CB-255CB	P-U-10	1-3/4	3-1/2	VME-2538174	44.83
		2521043	458A101CB-116CB;472A101CB-255CB	P-U-10	1-3/4	3-1/2	VME-2538174	44.83
2523229		458A117CB-;472A256CB-327CB	P-U-10	1-3/4	3-1/2	VME-2538174	44.83	
2523230		458A117CB-;472A256CB-327CB	P-U-10	1-3/4	3-1/2	VME-2538174	44.83	
2526749		472A328CB-	P-U-10	1-3/4	3-1/2	VME-2538174	44.83	
2526750		472A328CB-	P-U-10	1-3/4	3-1/2	VME-2538174	44.83	
2533903		472D9101CB-;807B9101CB-	P-UB-10	1-3/4	3-1/2	VME-2542570	81.20	
2533904		472D101CB-;807B101CB-	P-UB-10	1-3/4	3-1/2	VME-2542570	81.20	
2533905		472D101CB-;807B101CB-	P-UB-10	1-3/4	3-1/2	VME-2542570	81.20	
2533906		472D101CB-;807B101CB-	P-UB-10	1-3/4	3-1/2	VME-2542570	81.20	
2538686		472C220CB-	P-U-10	1-3/4	3-1/2	VME-2538174	44.83	
2538687		472C220CB-	P-U-10	1-3/4	3-1/2	VME-2538174	44.83	
2538696		807A9101-	P-U-10	1-3/4	3-1/2	VME-2538174	44.83	
2538697		472C9101-	P-U-10	1-3/4	3-1/2	VME-2538174	44.83	
MODEL 35R								
BOOM			P-V-10	2-3/4	6	VME-2516065	93.06	
BUCKET			P-U-10	2	5	VME-2516059	78.00	
CLAMP			P-V-10	1-3/4	3-1/2	VME-2516071	66.64	
STEERING			I-U-10	1	2-1/2	VME-2516055	27.85	
MODEL 45A								
BOOM	1504472		P-U-10	2-3/4	7	VME-2516148	112.41	
BUCKET	1504470		P-U-10	2	5	VME-2516059	78.00	
STEERING	1524562		I-U-10	1	2-1/2	VME-2516055	27.85	
	1524563		I-U-10	1	2-1/2	VME-2516055	27.85	
MODEL 45B, 45FB								
BOOM	3980095		P-V-10	2	4-1/2	VME-2516271	59.45	
BUCKET	3980108		P-U-10	1-3/4	3-1/2	VME-2516270	63.20	
	3980125		P-U-10	1-3/4	3-1/2	VME-2516270	63.20	
CLAMP	1539308		P-V-10	1-3/4	3-1/2	VME-2516071	66.64	
GRAPPLE	1539308		P-V-10	1-3/4	3-1/2	VME-2516071	66.64	
STEERING	3980906		I-U-10	1-1/4	2-1/2	VME-2516272	50.92	
MODEL 45C								
BOOM	2521767	459A101CB-140CB;473A101CB-322CB	P-U-10	2	4-1/2	VME-2538178	54.72	
	2521768	459A101CB-140CB;473A101CB-322CB	P-U-10	2	4-1/2	VME-2538178	54.72	
	2522734	459A141CB-;473A323CB-	P-U-10	2	4-1/2	VME-2538178	54.72	
	2522735	459A141CB-;473A323CB-	P-U-10	2	4-1/2	VME-2538178	54.72	
	2530960	459E101CB-;473D101CB-;485B101CB-	P-UB-10	2	4-1/2	VME-2551398	79.20	
	2530961	459E101CB-;473D101CB-;485B101CB-	P-UB-10	2	4-1/2	VME-2551398	79.20	

LR - Long Reach SLF - Super Long Front QF - Quick Fit FS - Front Shovel MH - Material Handle AS - Articulate Slope

Replacement Kits For

VOLVO

Loaders - Wheel							
APPLICATION	CYL #	SERIAL #	CODE	ROD	BORE	KIT #	List \$
MODEL 45C							
BOOM	2531210	459C9501-;473C9501-;485A9501-;459E9101CB-;473D9101CB-;485B9101CB-	P-UB-10	2-1/4	5	VME-2542577	102.27
	2531211	459C9501-;473C9501-;485A9501-;459E9101CB-;473D9101CB-;485B9101CB-	P-UB-10	2-1/4	5	VME-2542577	102.27
	2538691	459A141CB-;473A323CB-	P-U-10	2	4-1/2	VME-2538178	54.72
	2538692	459D123CB-;473C	P-U-10	2	4-1/2	VME-2538178	54.72
BUCKET			P-UB-10	2	3-1/2	VME-2538184	80.11
	2521042	459A101CB-140CB;473A101CB-322CB	P-U-10	1-3/4	3-1/2	VME-2538174	44.83
	2521044	459A101CB-140CB;473A101CB-322CB	P-U-10	1-3/4	3-1/2	VME-2538174	44.83
	2522923	459A141CB-155CB;473A323CB-403CB	P-U-10	1-3/4	3-1/2	VME-2538174	44.83
	2522924	459A141CB-155CB;473A323CB-403CB	P-U-10	1-3/4	3-1/2	VME-2538174	44.83
	2526536	459A156CB-;473A404CB-	P-U-10	1-3/4	3-1/2	VME-2538174	44.83
	2526537	459A156CB-;473A404CB-	P-U-10	1-3/4	3-1/2	VME-2538174	44.83
	2531024	459C9501CB-;473C9501-;485A9501-	P-UB-10	2	4	VME-2551403	75.42
	2531025	459C9501CB-;473C9501-;485A9501-	P-UB-10	2	4	VME-2551403	75.42
	2533903	459E101CB-;473D101CB-;485B101CB-	P-UB-10	1-3/4	3-1/2	VME-2542570	81.20
	2533905	459E101CB-;473D101CB-;485B101CB-	P-UB-10	1-3/4	3-1/2	VME-2542570	81.20
	2538696	459D123CB-;473C	P-U-10	1-3/4	3-1/2	VME-2538174	44.83
	2538697	459D123CB-;473C	P-U-10	1-3/4	3-1/2	VME-2538174	44.83
MODEL 55A, 55A-II, 55-III, 55-III-A, 55-III-A GRR							
BOOM			P-UB-10	2-1/4	5	VME-2542577	102.27
			P-V-10	1-3/4	3-1/2	VME-2516071	66.64
			P-U-10	2-1/4	5	VME-2530108	62.40
	1507822	416A101-416A499;4160A101FSC-4160A499FSC	I-U-10	2-1/4	5	VME-2516060	53.58
	1507823	416A101-416A499;4160A101FSC-4160A499FSC	I-U-10	2-1/4	5	VME-2516060	53.58
	1508377	9BG101-;9BA101-	P-U-10	2	3-1/2	VME-2516073	55.80
	1546056	433A101-;416A500-;4160A500FSC-;4152A102FSC-	I-U-10	2-1/4	5	VME-2516060	53.58
	1546057	433A101-;416A500-;4160A500FSC-;4152A102FSC-	I-U-10	2-1/4	5	VME-2516060	53.58
	2514111	433B700CAC-;433B395FSC-;416C857CAC-;416C205FSC-	P-U-10	2-1/4	5	VME-2516058	60.94
	2514122	433B700CAC-;433B395FSC-;416C857CAC-;416C205FSC-	P-U-10	2-1/4	5	VME-2516058	60.94
BUCKET			P-UB-10	2	4	VME-2551403	75.42
			P-U-10	2	4	VME-2530107	52.30
	1507711	9BG101-;9BA101-	P-U-10	2	3-1/2	VME-2516073	55.80
	1539308		P-V-10	1-3/4	3-1/2	VME-2516071	66.64
	1545412	433A101-433A110;416A101-416A519;4160A500FSC-;4152A102FSC-	P-U-10	2	4	VME-2516090	50.30
	1549758	433A111-;416A520-	P-U-10	2	4	VME-2516090	50.30
CLAMP	1539308		P-V-10	1-3/4	3-1/2	VME-2516071	66.64
SIDE DUMP	1545577		P-U-10	2	3-1/2	VME-2516073	55.80
STEERING			P-U-10	1-3/4	3-1/2	VME-2538177	66.15
			P-UB-10	1-3/4	3-1/2	VME-2542570	81.20
	1503828	9BG101-;9BA101-	I-U-10	1	2-1/2	VME-2516055	27.85
	1508904	416C101FSC-273;4152101ENC-;4152C101FSC-	I-U-10	1-3/4	3-1/2	VME-2516072	44.73
	1508904	433B101C-;433B101ENC-;433B101FSC-631FSC;416C101C-	I-U-10	1-3/4	3-1/2	VME-2516072	44.73
MODEL 55B							
BOOM			P-U-10	2-1/4	5	VME-2530108	62.40
			P-U-10	2	3-1/2	VME-2516073	55.80
			I-U-10	2-1/4	5	VME-2516060	53.58
			P-V-10	1-3/4	3-1/2	VME-2516071	66.64
			P-UB-10	2-1/4	5	VME-2542577	102.27

LR - Long Reach

SLF - Super Long Front

QF - Quick Fit

FS - Front Shovel

MH - Material Handle

AS - Articulate Slope

VOLVO

Replacement Kits For

Loaders - Wheel							
APPLICATION	CYL #	SERIAL #	CODE	ROD	BORE	KIT #	List \$
MODEL 55B							
BOOM	2514111		P-U-10	2-1/4	5	VME-2516058	60.94
	2514122		P-U-10	2-1/4	5	VME-2516058	60.94
BUCKET			P-U-10	2	4	VME-2516090	50.30
			P-V-10	1-3/4	3-1/2	VME-2516071	66.64
			P-U-10	2	3-1/2	VME-2516073	55.80
			P-UB-10	2	4	VME-2551403	75.42
	2532635		P-U-10	2	4	VME-2530107	52.30
CLAMP	1539306		P-V-10	1-3/4	3-1/2	VME-2516071	66.64
SIDE DUMP	1545577		P-U-10	2	3-1/2	VME-2516073	55.80
STEERING			P-UB-10	1-3/4	3-1/2	VME-2542570	81.20
			I-U-10	1	2-1/2	VME-2516055	27.85
			I-U-10	1-3/4	3-1/2	VME-2516072	44.73
	2532705		P-U-10	1-3/4	3-1/2	VME-2538177	66.15
MODEL 55C							
BOOM	2523872	480A;480B101CB-152CB;481A;481B101CB-136CB	P-U-10	2-1/4	5	VME-2530108	62.40
	2523873	480A;480B101CB-152CB;481A;481B101CB-136CB	P-U-10	2-1/4	5	VME-2530108	62.40
	2531210		P-UB-10	2-1/4	5	VME-2542577	102.27
	2531211		P-UB-10	2-1/4	5	VME-2542577	102.27
	2538706	480B153CB-;481B137CB-	P-U-10	2-1/4	5	VME-2530108	62.40
	2538707	480B153CB-;481B137CB-	P-U-10	2-1/4	5	VME-2530108	62.40
BUCKET	2526667		P-U-10	2	4	VME-2530107	52.30
	2526668		P-U-10	2	4	VME-2530107	52.30
	2531024		P-UB-10	2	4	VME-2551403	75.42
	2531025		P-UB-10	2	4	VME-2551403	75.42
	2538701		P-U-10	2	4	VME-2530107	52.30
	2538702		P-U-10	2	4	VME-2530107	52.30
MODEL 75A-II							
BOOM			P-U-10	2-1/4	5	VME-2516061	74.97
			P-U-10	2	5	VME-2516059	78.00
			P-V-10	2-1/4	4-1/2	VME-2516070	77.73
BUCKET			P-U-10	2-1/4	4-1/2	VME-2516070	77.73
			P-U-10	2	4	VME-2516088	75.11
			P-U-10	2	5	VME-2516059	78.00
CLAMP			P-V-10	1-3/4	3-1/2	VME-2516071	66.64
SIDE DUMP			P-V-10	1-3/4	3-1/2	VME-2516071	66.64
STEERING			P-V-10	1-3/4	3-1/2	VME-2516071	66.64
	1503828		I-U-10	1	2-1/2	VME-2516055	27.85
MODEL 75B, LF75B							
BOOM	1518977		P-U-10	2-1/4	5	VME-2516058	60.94
	1518977		P-U-10	2-1/4	5	VME-2530108	62.40
	1518978		P-U-10	2-1/4	5	VME-2516058	60.94
	1518978		P-U-10	2-1/4	5	VME-2530108	62.40
	1546056		I-U-10	2-1/4	5	VME-2516060	53.58
	1546057		I-U-10	2-1/4	5	VME-2516060	53.58
	2514111		P-U-10	2-1/4	5	VME-2516058	60.94
	2514122		P-U-10	2-1/4	5	VME-2516058	60.94
	2518075		P-U-10	2-1/4	5	VME-2516058	60.94
	2518075		P-U-10	2-1/4	5	VME-2530108	62.40
	2518076		P-U-10	2-1/4	5	VME-2516058	60.94
	2518076		P-U-10	2-1/4	5	VME-2530108	62.40
	2527513		P-U-10	2-1/4	5	VME-2530108	62.40
	2527549		P-U-10	2-1/4	5	VME-2530108	62.40
	2528565		P-U-10	2-1/4	5	VME-2530108	62.40
	2528566		P-U-10	2-1/4	5	VME-2530108	62.40
	2541827		P-UB-10	2-1/4	5	VME-2542577	102.27

LR - Long Reach SLF - Super Long Front QF - Quick Fit FS - Front Shovel MH - Material Handle AS - Articulate Slope

VOLVO

Replacement Kits For

VOLVO

Loaders - Wheel							
APPLICATION	CYL #	SERIAL #	CODE	ROD	BORE	KIT #	List \$
MODEL 75B, LF75B							
BOOM	2541828		P-UB-10	2-1/4	5	VME-2542577	102.27
BUCKET			P-U-10	2-1/4	5	VME-2530108	62.40
	1511554		P-V-10	2-1/4	4-1/4	VME-2516054	53.45
	2518071		P-V-10	2-1/4	4-1/4	VME-2516054	53.45
	2520412		P-U-10	2-1/4	5	VME-2516058	60.94
	2532204		P-U-10	2-1/4	5	VME-2516058	60.94
	964581		P-UB-10	2-1/4	5	VME-2542577	102.27
CLAMP	1539308		P-V-10	1-3/4	3-1/2	VME-2516071	66.64
SIDE DUMP	1545577		P-U-10	2	3-1/2	VME-2516073	55.80
STEERING			P-U-10	1-3/4	3-1/2	VME-2538177	66.15
	1508904		I-U-10	1-3/4	3-1/2	VME-2516072	44.73
	2532706		P-UB-10	1-3/4	3-1/2	VME-2542570	81.20
MODEL 75C							
BOOM			P-U-10	2-1/4	5	VME-2530108	62.40
	2541827		P-UB-10	2-1/4	5	VME-2542577	102.27
	2541828		P-UB-10	2-1/4	5	VME-2542577	102.27
BUCKET			P-U-10	2-1/4	5	VME-2530108	62.40
			P-U-10	2-3/4	5	VME-2538187	61.76
			P-U-10	2-1/4	5	VME-2516058	60.94
	2532204		P-UB-10	2-1/4	5	VME-2542577	102.27
	2541652		P-UB-10	2-3/4	5	VME-2542569	92.00
	964581		P-UB-10	2-1/4	5	VME-2542577	102.27
	STEERING			P-U-10	1-3/4	3-1/2	VME-2538177
2529205			P-UB-10	1-3/4	3-1/2	VME-2542570	81.20
2532705			P-UB-10	1-3/4	3-1/2	VME-2542570	81.20
2541853			P-UB-10	1-3/4	3-1/2	VME-2542570	81.20
964667			P-UB-10	1-3/4	3-1/2	VME-2542570	81.20
964792			P-UB-10	1-3/4	3-1/2	VME-2542570	81.20
MODEL 75-III							
BOOM	1503887	10CG101-	P-V-10	2-1/4	4-1/2	VME-2516070	77.73
BUCKET	1503233	10CG101-	P-U-10	2	4	VME-2516088	75.11
	1507808	10CG101-	P-U-10	2	4	VME-2516088	75.11
STEERING	1503828	10CG101-	I-U-10	1	2-1/2	VME-2516055	27.85
MODEL 75-III A							
BOOM			P-U-10	2	5	VME-2516059	78.00
	1535946		P-U-10	2-1/4	5	VME-2516061	74.97
BUCKET			P-U-10	2	5	VME-2516059	78.00
	1509802		P-V-10	2-1/4	4-1/2	VME-2516070	77.73
	1536064		P-V-10	2-1/4	4-1/2	VME-2516070	77.73
CLAMP	1539308		P-V-10	1-3/4	3-1/2	VME-2516071	66.64
SIDE DUMP			P-V-10	1-3/4	3-1/2	VME-2516071	66.64
STEERING	1504836		P-V-10	1-3/4	3-1/2	VME-2516071	66.64
MODEL 85A, 85A-II							
STEERING	1503828		I-U-10	1	2-1/2	VME-2516055	27.85
	1503875		I-U-10	1	2-1/2	VME-2516055	27.85
MODEL 85A-II, 85-III, 85-III A							
BOOM			P-U-10	2	5	VME-2516059	78.00
	1502853		P-V-10	2-3/4	6	VME-2516065	93.06
	1502854		P-V-10	2-3/4	6	VME-2516065	93.06
	1503887		P-V-10	2-1/4	4-1/2	VME-2516070	77.73
BUCKET			P-V-10	2-3/4	6	VME-2516065	93.06
	1507808		P-U-10	2	4	VME-2516088	75.11
	1509813		P-V-10	2-1/4	4-1/2	VME-2516070	77.73
CLAMP			P-V-10	2-1/4	4-1/2	VME-2516070	77.73
SIDE DUMP			P-U-10	2	5	VME-2516059	78.00

LR - Long Reach

SLF - Super Long Front

QF - Quick Fit

FS - Front Shovel

MH - Material Handle

AS - Articulate Slope

VOLVO

Replacement Kits For

Loaders - Wheel								
APPLICATION	CYL #	SERIAL #	CODE	ROD	BORE	KIT #	List \$	
MODEL 85A-II, 85-III, 85-III A								
STEERING	1503875		I-U-10	1	2-1/2	VME-2516055	27.85	
	1531950		P-V-10	1-3/4	3-1/2	VME-2516071	66.64	
MODEL 125A, 125A-II, 125-111A								
BOOM	1503235	12AFC101-;12AFG101-	P-V-10	2-3/4	6	VME-2516065	93.06	
	1503236		P-U-10	2-3/4	7	VME-2516148	112.41	
BUCKET			P-U-10	2-3/4	7	VME-2516148	112.41	
	1503234	404A101-404A299;403A101-403A299	P-V-10	2-3/4	6	VME-2516065	93.06	
	1509846	12AFC101-;12AFG101-	P-V-10	2-1/4	4-1/2	VME-2516070	77.73	
	1543216	404A300-;403A300-	P-V-10	2-3/4	6	VME-2516065	93.06	
STEERING			P-V-10	1-3/4	3-1/2	VME-2516071	66.64	
MODEL 125B								
BOOM			P-U-10	2-3/4	6	VME-2538182	90.32	
			P-UB-10	2-3/4	6	VME-2542568	240.21	
	1519174		P-V-10	2-3/4	6	VME-2518493	102.58	
	1519175		P-V-10	2-3/4	6	VME-2518493	102.58	
	2517389		P-V-10	2-3/4	6	VME-2518493	102.58	
	2517390		P-V-10	2-3/4	6	VME-2518493	102.58	
BUCKET			P-U-10	2-3/4	5	VME-2538187	61.76	
			P-U-10	2-1/4	4-1/2	VME-2538179	58.55	
			P-UB-10	2-1/4	4-1/2	VME-2542576	85.26	
			P-UB-10	2-3/4	5	VME-2542569	92.00	
	1519173		P-V-10	2-1/4	4-1/2	VME-2516152	65.24	
	2517395		P-V-10	2-1/4	4-1/2	VME-2516152	65.24	
STEERING			P-U-10	1-3/4	3-1/2	VME-2538177	66.15	
			P-UB-10	1-3/4	3-1/2	VME-2542570	81.20	
	2501171		I-U-10	1-3/4	3-1/2	VME-2516072	44.73	
MODEL 125C								
BOOM	2528568		P-U-10	2-3/4	6	VME-2538182	90.32	
	2528570		P-U-10	2-3/4	6	VME-2538182	90.32	
	2528982		P-U-10	2-3/4	6	VME-2538182	90.32	
	2528983		P-U-10	2-3/4	6	VME-2538182	90.32	
	2541356	496A170CB-;497A171CB-;4244A157FSC-	P-UB-10	2-3/4	6	VME-2542568	240.21	
	2541357	496A170CB-;497A171CB-;4244A157FSC-	P-UB-10	2-3/4	6	VME-2542568	240.21	
	2554419		P-UB-10	2-3/4	6	VME-2542568	240.21	
	2561089		P-UB-10	2-3/4	6	VME-2542568	240.21	
	964597	496A101CB-130CB;497A101CB-146CB	P-UB-10	2-3/4	6	VME-2542568	240.21	
	964598	496A101CB-130CB;497A101CB-146CB	P-UB-10	2-3/4	6	VME-2542568	240.21	
	964793	496A131CB-169CB;497A147CB-170CB;4244101FSC-156FSC	P-UB-10	2-3/4	6	VME-2542568	240.21	
	964794	496A131CB-169CB;497A147CB-170CB;4244101FSC-156FSC	P-UB-10	2-3/4	6	VME-2542568	240.21	
	BUCKET	2532213		P-U-10	2-3/4	5	VME-2538187	61.76
		2541648	496A170CB-;497A191CB-;4244A169FSC-	P-UB-10	2-3/4	5	VME-2542569	92.00
2554081			P-UB-10	2-3/4	5	VME-2542569	92.00	
2561088			P-UB-10	2-3/4	5	VME-2542569	92.00	
964796		496A101CB-169CB;497A101CB-190CB;4244A101FSC-169FSC	P-UB-10	2-3/4	5	VME-2542569	92.00	
STEERING	2525743		P-U-10	1-3/4	3-1/2	VME-2538174	44.83	
	2541852	496A170CB-;497A191CB-;4244A160FSC-	P-UB-10	1-3/4	3-1/2	VME-2542570	81.20	
	964797	496A101CB-169CB;497A101CB-190CB;4244A101FSC-159FSC	P-UB-10	1-3/4	3-1/2	VME-2542570	81.20	
MODEL 175A								
STEERING	1503987		P-V-10	1-3/4	3-1/2	VME-2516071	66.64	
MODEL 175A-II								
STEERING	1503987		P-V-10	1-3/4	3-1/2	VME-2516071	66.64	
MODEL 175B								
BOOM			P-V-10	2-3/4	7	VME-2516155	161.59	

LR - Long Reach SLF - Super Long Front QF - Quick Fit FS - Front Shovel MH - Material Handle AS - Articulate Slope

VOLVO

Replacement Kits For

Loaders - Wheel							
APPLICATION	CYL #	SERIAL #	CODE	ROD	BORE	KIT #	List \$
MODEL 175B							
BOOM	1518400		P-V-10	2-3/4	7	VME-2518494	152.59
	2518119		P-V-10	2-3/4	7	VME-2518494	152.59
	2528567		P-UB-10	2-3/4	7	VME-2551397	167.25
	964596		P-U-10	2-3/4	7	VME-2538183	95.21
BUCKET			P-V-10	2-3/4	6	VME-2516065	93.06
	1511622		P-V-10	2-3/4	6	VME-2518493	102.58
	1517851		P-V-10	2-3/4	6	VME-2518493	102.58
	2518125		P-V-10	2-3/4	6	VME-2518493	102.58
	2524276		P-U-10	2-3/4	6	VME-2538182	90.32
	964798		P-UB-10	2-3/4	6	VME-2542568	240.21
STEERING	1511641		P-V-10	2	4-1/2	VME-2516151	51.08
	2518117		P-V-10	2	4-1/2	VME-2516151	51.08
	2532353		P-U-10	2	4-1/2	VME-2538178	54.72
	964586		P-UB-10	2	4-1/2	VME-2551398	79.20
MODEL 175C							
BOOM	2524467		P-U-10	3	7	VME-2541637	117.32
	2541825		P-UB-10	3	7	VME-2542571	202.44
	964789		P-UB-10	3	7	VME-2542571	202.44
BUCKET	2524276		P-U-10	2-3/4	6	VME-2538182	90.32
	2541789		P-UB-10	2-3/4	6	VME-2542568	240.21
	964796		P-UB-10	2-3/4	6	VME-2542568	240.21
STEERING	2528848		P-U-10	2-1/4	4-1/2	VME-2538179	58.55
	2541510		P-UB-10	2-1/4	4-1/2	VME-2542576	85.26
	964801		P-UB-10	2-1/4	4-1/2	VME-2542576	85.26
MODEL 175-III, 175-III A							
BOOM	1503236		P-U-10	2-3/4	7	VME-2516148	112.41
BUCKET	1503234		P-V-10	2-3/4	6	VME-2516065	93.06
	1543216		P-V-10	2-3/4	6	VME-2516065	93.06
MODEL 275B							
BOOM			P-UB-10	3-1/2	9	VME-2551396	274.53
			P-U-10	3-1/2	9	VME-2538180	187.66
	1511407		P-V-10	3-1/2	9	VME-2516242	164.05
	1511408		P-V-10	3-1/2	9	VME-2516242	164.05
	1518399		P-V-10	3-1/2	9	VME-2516242	164.05
	1537215		I-U-10	3-1/2	9	VME-2516228	143.64
	1537216		I-U-10	3-1/2	9	VME-2516228	143.64
	2504218		P-V-10	3-1/2	9	VME-2516242	164.05
	BUCKET			P-U-10	2-3/4	7	VME-2538183
			P-UB-10	2-3/4	7	VME-2551397	167.25
1511406			P-V-10	2-3/4	7	VME-2516155	161.59
1513815			P-V-10	2-3/4	7	VME-2518494	152.59
2516176			P-V-10	2-3/4	7	VME-2518494	152.59
947456			P-V-10	2-3/4	7	VME-2516155	161.59
STEERING			P-UB-10	2-1/4	5-1/4	VME-2551399	114.76
			P-U-10	2-1/4	5-1/4	VME-2538181	73.52
	1511749		P-V-10	2-1/4	5-1/4	VME-2516274	60.69
	1538181		I-U-10	2-1/4	5-1/4	VME-2516156	60.41
	2516160		P-V-10	2-1/4	5-1/4	VME-2516274	60.69
MODEL 275C							
BOOM	2525863		P-U-10	4	9	VME-2538193	199.84
	2541292	492A239C;243C-999C;492A201CAC-	P-UB-10	4	9	VME-2542574	363.82
	2554810		P-UB-10	4	9	VME-2542574	363.82
	964802	492A101C-238C;240C;241C;242C	P-UB-10	4	9	VME-2542574	363.82
BUCKET	2541297	492A226C-235C	P-U-10	2-3/4	7	VME-2551397	167.25
	964803	492A101C-225C	P-UB-10	2-3/4	7	VME-2551397	167.25
STEERING	2529566		P-U-10	2-1/4	4-1/2	VME-2538179	58.55

LR - Long Reach

SLF - Super Long Front

QF - Quick Fit

FS - Front Shovel

MH - Material Handle

AS - Articulate Slope

VOLVO

Replacement Kits For

Loaders - Wheel							
APPLICATION	CYL #	SERIAL #	CODE	ROD	BORE	KIT #	List \$
MODEL 275C							
STEERING	2541515	492A239C;243C-251C;253C;255C-999C;492A201CAC-	P-UB-10	2-1/4	4-1/2	VME-2542576	85.26
	964804	492A101C-238C;240C;241C;242C;252C;254C;255C	P-UB-10	2-1/4	4-1/2	VME-2542576	85.26
MODEL 275-III							
BUCKET	1503231		P-U-10	2-3/4	7	VME-2516148	112.41
	1543895		P-U-10	2-3/4	7	VME-2516148	112.41
MODEL 275-III A							
BUCKET	1503231		P-U-10	2-3/4	7	VME-2516148	112.41
	1543895		P-U-10	2-3/4	7	VME-2516148	112.41
STEERING	1503241		P-U-10	2-1/4	5-1/2	VME-2516094	73.58
	1515236		P-U-10	2-1/4	5-1/2	VME-2516094	73.58
MODEL 475B							
BUCKET	1513011		P-V-10	4-1/2	9	VME-2516230	181.74
	2514104		P-V-10	4-1/2	9	VME-2516230	181.74
STEERING			P-UB-10	2-3/4	7	VME-2551397	167.25
			P-U-10	2-3/4	7	VME-2526058	106.84
	1503659		P-U-10	2-3/4	7	VME-2516148	112.41
	2514101		P-V-10	2-3/4	7	VME-2518494	152.59
MODEL 475C, 475CT							
STEERING	2527900	483A;487A;488A	P-U-10	2-3/4	6	VME-2538182	90.32
	2541333	487C;487B;483B;483C	P-UB-10	2-3/4	6	VME-2542568	240.21
	964807	483A;487A;488A	P-UB-10	2-3/4	6	VME-2542568	240.21
MODEL 475-III A							
BUCKET	1513011		P-V-10	4-1/2	9	VME-2516230	181.74
STEERING	1503659	3AYC101-	P-U-10	2-3/4	7	VME-2516148	112.41
	2514101		P-V-10	2-3/4	7	VME-2518494	152.59
MODEL 675B							
STEERING	1512049	436A	P-U-10	3-1/2	8	VME-2516187	125.26
MODEL L20B							
LIFT	2812347	1700001-1700999	I-UB-10	50 mm	100 mm	VME-11370055	156.15
STEERING	2808059	1700001-1700999	P-U-10	32 mm	70 mm	VME-2906622	83.05
TILT	2812348	1700001-1700499	I-UB-10	50 mm	100 mm	VME-11370055	156.15
MODEL L25B							
LIFT	2812347	1750001-1759999	I-UB-10	50 mm	100 mm	VME-11370055	156.15
STEERING	2808059	1750001-1759999	P-U-10	32 mm	70 mm	VME-2906622	83.05
TILT	11308884	1752065-	I-UB-10	50 mm	100 mm	VME-11370055	156.15
	2812348	1750001-1752064	I-UB-10	50 mm	100 mm	VME-11370055	156.15
MODEL L30							
ATTACHMENT	11001980	70118-	P-U-1	20 mm		VME-11990060	53.74
	11005340	-70117	P-U-1	25 mm		VME-11990175	80.93
	4833424	-70117	P-U-1	20 mm		VME-11990060	53.74
LIFT	11001575	70118-	P-U-15	50 mm	100 mm	VME-6630564	91.07
	11005193	-70117	P-U-15	50 mm	100 mm	VME-6630513	77.15
STEERING	11001574	70118-	P-U-15	32 mm	63 mm	VME-6630661	98.24
	11005192	-70117	P-U-15	32 mm	63 mm	VME-6630661	98.24
TILT	11001576	70118-	P-U-15	40 mm	80 mm	VME-6630662	63.32
	11005194	-70117	P-U-15	40 mm	80 mm	VME-11990106	81.60
MODEL L30B							
LIFT	2808056	1802201-1802999;1812201-1812999;1822201-1822999;1823601-1823999	P-U-10	45 mm	80 mm	VME-2907081	107.93
	2808056	1832201-1832999;1833601-1833999;1852201-1852999;1853601-1853999	P-U-10	45 mm	80 mm	VME-2907081	107.93
STEERING	2808059	1802201-1802999;1812201-1812999;1822201-1822999;1823601-1823999	P-U-10	32 mm	70 mm	VME-2906622	83.05
	2808059	1832201-1832999;1833601-1833999;1852201-1852999;1853601-1853999	P-U-10	32 mm	70 mm	VME-2906622	83.05

LR - Long Reach

SLF - Super Long Front

QF - Quick Fit

FS - Front Shovel

MH - Material Handle

AS - Articulate Slope

Replacement Kits For

VOLVO

Loaders - Wheel							
APPLICATION	CYL #	SERIAL #	CODE	ROD	BORE	KIT #	List \$
MODEL L30B							
TILT	2808057	1802201-1802999;1812201-1812999; 1822201-1822999;1823601-1823999	P-U-10	50 mm	100 mm	VME-2907091	158.20
	2808057	1832201-1832999;1833601-1833999; 1852201-1852999;1853601-1853999	P-U-10	50 mm	100 mm	VME-2907091	158.20
MODEL L35B							
LIFT	2808049	1862201-1862999;1863601-1869999; 1872201-1872999;1873601-1879999	P-U-10	50 mm	85 mm	VME-2907070	128.56
	2808049	1882201-1882999;1883601-1889999; 1892201-1892999;1893601-1899999	P-U-10	50 mm	85 mm	VME-2907070	128.56
STEERING	2808059	1862201-1862999;1863601-1869999; 1872201-1872999;1873601-1879999	P-U-10	32 mm	70 mm	VME-2906622	83.05
	2808059	1882201-1882999;1883601-1889999; 1892201-1892999;1893601-1899999	P-U-10	32 mm	70 mm	VME-2906622	83.05
TILT	2808057	1862201-1862999;1863601-1869999; 1872201-1872999;1873601-1879999	P-U-10	50 mm	100 mm	VME-2907091	158.20
	2808057	1882201-1882999;1883601-1889999; 1892201-1892999;1893601-1899999	P-U-10	50 mm	100 mm	VME-2907091	158.20
MODEL L40B							
LIFT	11306083	1911001-1911499;1921001-1921499	P-U-10	50 mm	110 mm	VME-2907415	143.72
	11306297	1911001-1911499;1921001-1921499	P-U-10	50 mm	100 mm	VME-11370826	155.00
	11306961	1921500-1929999	P-U-10	50 mm	110 mm	VME-11370773	124.76
STEERING	2808059	1911001-1911499;1921001-1929999	P-U-10	32 mm	70 mm	VME-2906622	83.05
TILT	11306298	-1911117;-1921325	P-U-10	63 mm	125 mm	VME-2907389	170.85
	11306298	1911118;-1921326-	P-U-10	63 mm	125 mm	VME-2907389	170.85
	11306298	1921001-1921499;1911001-1911499	P-U-10	65 mm	125 mm	VME-11370750	132.40
	11306298	1921500-1929999	P-U-10	65 mm	125 mm	VME-11370750	132.40
MODEL L45B							
LIFT	11306083	1951001-1951499;1941001-1941499	P-U-10	50 mm	110 mm	VME-2907415	143.72
	11306961	1951500-1959999;1941500-1949999	P-U-10	50 mm	110 mm	VME-11370773	124.76
STEERING	2808059	1951001-1959999;1941001-1949999	P-U-10	32 mm	70 mm	VME-2906622	83.05
TILT	11306298	-1941180;-1951383	P-U-10	63 mm	125 mm	VME-2907389	170.85
	11306298	1941181;-1951384-	P-U-10	63 mm	125 mm	VME-2907389	170.85
	11306298	1951001-1951499;1941001-1941499	P-U-10	65 mm	125 mm	VME-11370750	132.40
	11306298	1951500-1959999;1941500-1949999	P-U-10	65 mm	125 mm	VME-11370750	132.40
MODEL L50							
ATTACHMENT	11005340	ALL	P-U-1	25 mm		VME-11990175	80.93
	4833424	ALL	P-U-1	20 mm		VME-11990060	53.74
LIFT	11005271	6401-;60301(USA)-	P-U-15	50 mm	90 mm	VME-11990244	70.74
	4782418	-6400-;60300(USA)	P-U-15	40 mm	80 mm	VME-6630560	103.44
	4784618	-6400-;60300(USA)	P-U-15	50 mm	100 mm	VME-6630513	77.15
STEERING	4784920	ALL	P-U-15	32 mm	63 mm	VME-6630661	98.24
TILT	110052630	6401-;60301(USA)-	P-U-15	45 mm	80 mm	VME-11990243	40.56
	4782424	-6400-;60300(USA)	P-U-15	50 mm	100 mm	VME-6630562	74.03
	4833111	-6400-;60300(USA)	P-U-15	50 mm	90 mm	VME-6630858	62.75
MODEL L50B							
LIFT	11088016	ALL	P-U-15	60 mm	90 mm	VME-11990438	105.66
	11088016	ALL	P-U-15	60 mm	90 mm	VME-11990438-EX	108.79
	11088016	ALL	Bushing	60 mm		VME-11088053	2.73
STEERING	11005137	ALL	P-U-15	40 mm	63 mm	VME-11990439	77.64
	11005137	ALL	P-U-15	40 mm	63 mm	VME-11990439-EX	79.20
	11005137	ALL	Bushing	40 mm		VME-11088081	1.82
	11088072	ALL	P-U-15	40 mm	63 mm	VME-11990439	77.64
	11088072	ALL	P-U-15	40 mm	63 mm	VME-11990439-EX	79.20
	11088072	ALL	Bushing	40 mm		VME-11088081	1.82
TILT	11088017	ALL	P-U-15	70 mm	125 mm	VME-11990437	161.18
	11088017	ALL	P-U-15	70 mm	125 mm	VME-11990437-EX	167.21
	11088017	ALL	Bushing	70 mm		VME-11088054	3.20

LR - Long Reach

SLF - Super Long Front

QF - Quick Fit

FS - Front Shovel

MH - Material Handle

AS - Articulate Slope

VOLVO

Replacement Kits For

Loaders - Wheel								
APPLICATION	CYL #	SERIAL #	CODE	ROD	BORE	KIT #	List \$	
MODEL L50C								
LIFT	11088016	9001-10005	P-U-15	60 mm	90 mm	VME-11990438	105.66	
	11088016	9001-10005	P-U-15	60 mm	90 mm	VME-11990438-EX	108.79	
	11088016	9001-10005	Bushing	60 mm		VME-11088053	2.73	
	11088559	10006-11954	P-UB-13	70 mm	100 mm	VME-11998810	232.66	
	11088559	10006-11954	P-UB-13	70 mm	100 mm	VME-11998810-EX	238.64	
	11088559	10006-11954	Bushing	70 mm		VME-11088054	3.20	
	11088559	10006-11954	Wear Ring		100 mm	VME-11088148	4.71	
	11088855	11955-13000	P-UB-13	70 mm	100 mm	VME-11998810	232.66	
	11088855	11955-13000	P-UB-13	70 mm	100 mm	VME-11998810-EX	238.64	
	11088855	11955-13000	Bushing	70 mm		VME-11088054	3.20	
STEERING	11005137	10006-13000	P-U-15	40 mm	63 mm	VME-11990439	77.64	
	11005137	10006-13000	P-U-15	40 mm	63 mm	VME-11990439-EX	79.20	
	11005137	10006-13000	Bushing	40 mm		VME-11088081	1.82	
	11088072	10006-13000	P-U-15	40 mm	63 mm	VME-11990439	77.64	
	11088072	10006-13000	P-U-15	40 mm	63 mm	VME-11990439-EX	79.20	
	11088072	10006-13000	Bushing	40 mm		VME-11088081	1.82	
TILT	11088017	-9441	P-U-15	70 mm	125 mm	VME-11990437	161.18	
	11088017	-9441	P-U-15	70 mm	125 mm	VME-11990437-EX	167.21	
	11088017	-9441	Bushing	70 mm		VME-11088054	3.20	
	11088445	9442-11954	P-U-15	70 mm	125 mm	VME-11990437	161.18	
	11088445	9442-11954	P-U-15	70 mm	125 mm	VME-11990437-EX	167.21	
	11088445	9442-11954	Bushing	70 mm		VME-11088054	3.20	
	11088854	11955-	P-U-15	70 mm	125 mm	VME-11990437	161.18	
	11088854	11955-	P-U-15	70 mm	125 mm	VME-11990437-EX	167.21	
	11088854	11955-	Bushing	70 mm		VME-11088054	3.20	
MODEL L50C OR								
LIFT	11088016	9001-10005	P-U-15	60 mm	90 mm	VME-11990438	105.66	
	11088016	9001-10005	P-U-15	60 mm	90 mm	VME-11990438-EX	108.79	
	11088016	9001-10005	Bushing	60 mm		VME-11088053	2.73	
	11088559	10006-11954	P-UB-13	70 mm	100 mm	VME-11998810	232.66	
	11088559	10006-11954	P-UB-13	70 mm	100 mm	VME-11998810-EX	238.64	
	11088559	10006-11954	Bushing	70 mm		VME-11088054	3.20	
	11088559	10006-11954	Wear Ring		100 mm	VME-11088148	4.71	
	11088855	11955-13000	P-UB-13	70 mm	100 mm	VME-11998810	232.66	
	11088855	11955-13000	P-UB-13	70 mm	100 mm	VME-11998810-EX	238.64	
	11088855	11955-13000	Bushing	70 mm		VME-11088054	3.20	
	11088855	11955-13000	Wear Ring		100 mm	VME-11088148	4.71	
	STEERING	11005137	10006-10966;35001-40000	P-U-15	40 mm	63 mm	VME-11990439	77.64
		11005137	10006-10966;35001-40000	P-U-15	40 mm	63 mm	VME-11990439-EX	79.20
11005137		10006-10966;35001-40000	Bushing	40 mm		VME-11088081	1.82	
11088072		10006-10966;35001-40000	P-U-15	40 mm	63 mm	VME-11990439	77.64	
11088072		10006-10966;35001-40000	P-U-15	40 mm	63 mm	VME-11990439-EX	79.20	
11088072		10006-10966;35001-40000	Bushing	40 mm		VME-11088081	1.82	
TILT	11088017	-9441	P-U-15	70 mm	125 mm	VME-11990437	161.18	
	11088017	-9441	P-U-15	70 mm	125 mm	VME-11990437-EX	167.21	
	11088017	-9441	Bushing	70 mm		VME-11088054	3.20	
	11088445	9442-11954	P-U-15	70 mm	125 mm	VME-11990437	161.18	
	11088445	9442-11954	P-U-15	70 mm	125 mm	VME-11990437-EX	167.21	
	11088445	9442-11954	Bushing	70 mm		VME-11088054	3.20	
	11088854	11955-	P-U-15	70 mm	125 mm	VME-11990437	161.18	
	11088854	11955-	P-U-15	70 mm	125 mm	VME-11990437-EX	167.21	
	11088854	11955-	Bushing	70 mm		VME-11088054	3.20	
MODEL L50D								
LIFT	11088855	70101-80000;13002-14100	P-UB-13	70 mm	100 mm	VME-11998810	232.66	

LR - Long Reach

SLF - Super Long Front

QF - Quick Fit

FS - Front Shovel

MH - Material Handle

AS - Articulate Slope

VOLVO

Replacement Kits For

Loaders - Wheel							
APPLICATION	CYL #	SERIAL #	CODE	ROD	BORE	KIT #	List \$
MODEL L50D							
LIFT	11088855	70101-80000;13002-14100	P-UB-13	70 mm	100 mm	VME-11998810-EX	238.64
	11088855	70101-80000;13002-14100	Bushing	70 mm		VME-11088054	3.20
	11088855	70101-80000;13002-14100	Wear Ring		100 mm	VME-11088148	4.71
STEERING	11005137	70101-80000;13002-14100	P-U-15	40 mm	63 mm	VME-11990439	77.64
	11005137	70101-80000;13002-14100	P-U-15	40 mm	63 mm	VME-11990439-EX	79.20
	11005137	70101-80000;13002-14100	Bushing	40 mm		VME-11088081	1.82
	11088072	70101-80000;13002-14100	P-U-15	40 mm	63 mm	VME-11990439	77.64
	11088072	70101-80000;13002-14100	P-U-15	40 mm	63 mm	VME-11990439-EX	79.20
	11088072	70101-80000;13002-14100	Bushing	40 mm		VME-11088081	1.82
TILT	11088854	70101-80000;13002-14100	P-U-15	70 mm	125 mm	VME-11990437	161.18
	11088854	70101-80000;13002-14100	P-U-15	70 mm	125 mm	VME-11990437-EX	167.21
	11088854	70101-80000;13002-14100	Bushing	70 mm		VME-11088054	3.20
MODEL L60E							
HYDRAULIC	11005402	1004-99999	P-U-15	60 mm	125 mm	VME-11000107	155.53
	11010770	1004-99999	P-U-1	25 mm		VME-11990175	80.93
	11045350	1004-99999	P-U-15	60 mm	125 mm	VME-11704247	126.26
	11045351	1004-99999	P-U-15	50 mm	100 mm	VME-11704251	55.03
	11045352	1004-99999	P-U-15	70 mm	140 mm	VME-11704250	144.96
	11045353	1004-99999	P-U-15	60 mm	110 mm	VME-11704249	117.82
	11045354	1004-99999	P-U-15	40 mm	80 mm	VME-11704253	61.03
	11045355	1004-99999	P-U-15	40 mm	80 mm	VME-11704253	61.03
	11045356	1004-99999	P-U-15	60 mm	125 mm	VME-11704247	126.26
	11045357	1004-99999	P-U-15	60 mm	110 mm	VME-11704249	117.82
	11045358	1004-99999	P-U-15	80 mm	150 mm	VME-11704689	168.90
	11045360	1004-99999	P-U-15	50 mm	110 mm	VME-11704252	82.80
	11045361	1004-99999	P-U-15	50 mm	110 mm	VME-11704252	82.80
	11045363	1004-99999	P-U-15	60 mm	110 mm	VME-11704249	117.82
	11045366	1004-99999	P-U-15	60 mm	125 mm	VME-11704248	108.31
	11082749	1004-99999	P-U-15	60 mm	125 mm	VME-11704247	126.26
	11088569	1004-99999	P-U-15	80 mm	150 mm	VME-11700187	108.18
	11107530	1004-99999	P-UB-15	45 mm	70 mm	VME-11709872	82.42
	11107764	1004-99999	P-UB-15	45 mm	70 mm	VME-11709872	82.42
	11107837	1004-99999	P-UB-15	45 mm	70 mm	VME-11709872	82.42
	11142677	1004-99999	P-U-15	40 mm	80 mm	VME-11704253	61.03
	11156699	1004-99999	I-UB-10	32 mm	50 mm	VME-11709821	84.03
	11156701	1004-99999	I-UB-10	32 mm	50 mm	VME-11709821	84.03
	11157999	1004-99999	P-U-15	40 mm	80 mm	VME-11704253	61.03
	11417176	1004-99999	P-U-15	60 mm	125 mm	VME-11704247	126.26
	4784150	1004-99999	P-U-15	40 mm	80 mm	VME-6630662	63.32
	4881335	1004-99999	P-U-15	25 mm	40 mm	VME-6630886	20.90
4881336	1004-99999	P-U-15	25 mm	40 mm	VME-6630886	20.90	
LIFT	11107849	1004-99999	P-UB-10	70 mm	110 mm	VME-11709998	161.37
TILT	11107474	1004-99999	P-UB-10	80 mm	150 mm	VME-11709868	214.78
	11107845	1004-99999	P-UB-10	80 mm	150 mm	VME-11709868	214.78
	11107850	1004-99999	P-UB-10	80 mm	150 mm	VME-11709868	214.78
MODEL L60F							
HYDRAULIC	11107837	4004-, 70601-, 61401-	P-UB-15	45 mm	70 mm	VME-11709872	82.42
LIFT	11107849	4004-, 70601-, 61401-	P-UB-10	70 mm	110 mm	VME-11709998	161.37
TILT	11107845	4004-, 70601-, 61401-	P-UB-10	80 mm	150 mm	VME-11709868	214.78
	11107850	4004-, 70601-, 61401-	P-UB-10	80 mm	150 mm	VME-11709868	214.78
MODEL L70							
ATTACHMENT	11005340	ALL	P-U-1	25 mm		VME-11990175	80.93
	4833424	ALL	P-U-1	20 mm		VME-11990060	53.74
LIFT	11005288	7401-;60501(USA)-	P-U-15	60 mm	100 mm	VME-11990181	64.23
	4833304	-7400-;60500(USA)	P-UB-15	60 mm	110 mm	VME-11990028	80.42

LR - Long Reach

SLF - Super Long Front

QF - Quick Fit

FS - Front Shovel

MH - Material Handle

AS - Articulate Slope

VOLVO

Replacement Kits For

Loaders - Wheel							
APPLICATION	CYL #	SERIAL #	CODE	ROD	BORE	KIT #	List \$
MODEL L70							
STEERING	11005388	ALL	P-U-15	36 mm	70 mm	VME-6630909	64.65
	4784940	ALL	P-U-15	36 mm	70 mm	VME-6630909	64.65
TILT	11005284	7401-;60501(USA)-	P-U-15	50 mm	100 mm	VME-11990180	77.30
	4833399	-7400;-60500(USA)	P-U-15	50 mm	100 mm	VME-6630513	77.15
MODEL L70B							
LIFT	11088340	ALL	P-UB-13	70 mm	100 mm	VME-11998810	232.66
	11088340	ALL	P-UB-13	70 mm	100 mm	VME-11998810-EX	238.64
	11088340	ALL	Bushing	70 mm		VME-11088054	3.20
	11088340	ALL	Wear Ring		100 mm	VME-11088148	4.71
STEERING	11088289	ALL	P-U-15	40 mm	63 mm	VME-11990439	77.64
	11088289	ALL	P-U-15	40 mm	63 mm	VME-11990439-EX	79.20
	11088289	ALL	Bushing	40 mm		VME-11088081	1.82
TILT	11088333	ALL	P-UB-14	80 mm	150 mm	VME-11998809	308.00
	11088333	ALL	P-UB-14	80 mm	150 mm	VME-11998809-EX	301.03
	11088333	ALL	Bushing	80 mm		VME-11088150	3.59
	11088333	ALL	Wear Ring		150 mm	VME-11088149	10.45
MODEL L70C							
LIFT	11088340	-15067	P-UB-13	70 mm	100 mm	VME-11998810	232.66
	11088340	-15067	P-UB-13	70 mm	100 mm	VME-11998810-EX	238.64
	11088340	-15067	Bushing	70 mm		VME-11088054	3.20
	11088340	-15067	Wear Ring		100 mm	VME-11088148	4.71
	11088857	15068-	P-UB-13	70 mm	100 mm	VME-11998810	232.66
	11088857	15068-	P-UB-13	70 mm	100 mm	VME-11998810-EX	238.64
	11088857	15068-	Bushing	70 mm		VME-11088054	3.20
QUICK-FIT	11082447	70007-70300;13116-16500	P-U-15	25 mm	45 mm	VME-11999362	73.28
	11142695	70007-70300;13116-16500	P-U-10	16 mm	32 mm	VME-11705087	122.90
	11142695	70007-70300;13116-16500	P-U-10	16 mm	32 mm	VME-11705087-EX	125.55
	11142695	70007-70300;13116-16500	Bushing	16 mm		VME-11708994	2.65
	11157123	70007-70300;13116-16500	P-U-10	16 mm	32 mm	VME-11709111	63.07
STEERING	11088289	70007-70300;13116-16500	P-U-15	40 mm	63 mm	VME-11990439	77.64
	11088289	70007-70300;13116-16500	P-U-15	40 mm	63 mm	VME-11990439-EX	79.20
	11088289	70007-70300;13116-16500	Bushing	40 mm		VME-11088081	1.82
TILT	11088500	-15067	P-UB-14	80 mm	150 mm	VME-11998809	308.00
	11088500	-15067	P-UB-14	80 mm	150 mm	VME-11998809-EX	301.03
	11088500	-15067	Bushing	80 mm		VME-11088150	3.59
	11088500	-15067	Wear Ring		150 mm	VME-11088149	10.45
	11088856	15068-	P-UB-14	80 mm	150 mm	VME-11998809	308.00
	11088856	15068-	P-UB-14	80 mm	150 mm	VME-11998809-EX	301.03
	11088856	15068-	Bushing	80 mm		VME-11088150	3.59
11088856	15068-	Wear Ring		150 mm	VME-11088149	10.45	
MODEL L70C BM							
LIFT	11088340	11246-13115	P-UB-13	70 mm	100 mm	VME-11998810	232.66
	11088340	11246-13115	P-UB-13	70 mm	100 mm	VME-11998810-EX	238.64
	11088340	11246-13115	Bushing	70 mm		VME-11088054	3.20
	11088340	11246-13115	Wear Ring		100 mm	VME-11088148	4.71
QUICK-FIT	11082447	11246-13115	P-U-15	25 mm	45 mm	VME-11999362	73.28
STEERING	11088289	11246-13115	P-U-15	40 mm	63 mm	VME-11990439	77.64
	11088289	11246-13115	P-U-15	40 mm	63 mm	VME-11990439-EX	79.20
	11088289	11246-13115	Bushing	40 mm		VME-11088081	1.82
TILT	11088333	-10161	P-UB-14	80 mm	150 mm	VME-11998809	308.00
	11088333	-10161	P-UB-14	80 mm	150 mm	VME-11998809-EX	301.03
	11088333	-10161	Bushing	80 mm		VME-11088150	3.59
	11088333	-10161	Wear Ring		150 mm	VME-11088149	10.45
	11088460	10162-10790	P-UB-14	80 mm	150 mm	VME-11998809	308.00

LR - Long Reach

SLF - Super Long Front

QF - Quick Fit

FS - Front Shovel

MH - Material Handle

AS - Articulate Slope

Replacement Kits For

VOLVO

Loaders - Wheel							
APPLICATION	CYL #	SERIAL #	CODE	ROD	BORE	KIT #	List \$
MODEL L70C BM							
TILT	11088460	10162-10790	P-UB-14	80 mm	150 mm	VME-11998809-EX	301.03
	11088460	10162-10790	Bushing	80 mm		VME-11088150	3.59
	11088460	10162-10790	Wear Ring		150 mm	VME-11088149	10.45
	11088500	10791-	P-UB-14	80 mm	150 mm	VME-11998809	308.00
	11088500	10791-	P-UB-14	80 mm	150 mm	VME-11998809-EX	301.03
	11088500	10791-	Bushing	80 mm		VME-11088150	3.59
11088500	10791-	Wear Ring		150 mm	VME-11088149	10.45	
MODEL L70D							
LIFT	11088857	17002-60000	P-UB-13	70 mm	100 mm	VME-11998810	232.66
	11088857	17002-60000	P-UB-13	70 mm	100 mm	VME-11998810-EX	238.64
	11088857	17002-60000	Bushing	70 mm		VME-11088054	3.20
	11088857	17002-60000	Wear Ring		100 mm	VME-11088148	4.71
QUICK-FIT	11142695	17002-60000	P-U-10	16 mm	32 mm	VME-11705087	122.90
	11142695	17002-60000	P-U-10	16 mm	32 mm	VME-11705087-EX	125.55
	11142695	17002-60000	Bushing	16 mm		VME-11708994	2.65
	11157123	17002-60000	P-U-10	16 mm	32 mm	VME-11709111	63.07
STEERING	11088289	17002-60000	P-U-15	40 mm	63 mm	VME-11990439	77.64
	11088289	17002-60000	P-U-15	40 mm	63 mm	VME-11990439-EX	79.20
	11088289	17002-60000	Bushing	40 mm		VME-11088081	1.82
TILT	11088856	17002-60000	P-UB-14	80 mm	150 mm	VME-11998809	308.00
	11088856	17002-60000	P-UB-14	80 mm	150 mm	VME-11998809-EX	301.03
	11088856	17002-60000	Bushing	80 mm		VME-11088150	3.59
	11088856	17002-60000	Wear Ring		150 mm	VME-11088149	10.45
MODEL L70E							
LIFT	11107644	-21028	P-UB-10	70 mm	110 mm	VME-11709998	161.37
	11107644	-21028	P-UB-10	70 mm	110 mm	VME-11709998-EX	173.19
	11107644	-21028	Bushing	70 mm		VME-11088054	3.20
	11107644	-21028	Wear Ring		110 mm	VME-11107528	4.52
	11107824	21001-22957;60001-;71001-	P-UB-10	70 mm	120 mm	VME-11715864	138.29
	11107824	21001-22957;60001-;71001-	P-UB-10	70 mm	120 mm	VME-11715864-EX	153.66
	11107824	21001-22957;60001-;71001-	Bushing	70 mm		VME-11088054	3.20
	11107824	21001-22957;60001-;71001-	Wear Ring		120 mm	VME-11107298	5.00
	11107851	21029-	P-UB-10	70 mm	110 mm	VME-11709998	161.37
	11107851	21029-	P-UB-10	70 mm	110 mm	VME-11709998-EX	173.19
	11107851	21029-	Bushing	70 mm		VME-11088054	3.20
	11107851	21029-	Wear Ring		110 mm	VME-11107528	4.52
	QUICK-FIT	11157123	21001-22957;60001-;71001-	P-U-10	16 mm	32 mm	VME-11709111
STEERING	11107530	21001-22957;60001-;71001-	P-UB-15	45 mm	70 mm	VME-11709872	82.42
	11107530	21001-22957;60001-;71001-	P-UB-15	45 mm	70 mm	VME-11709872-EX	83.75
	11107530	21001-22957;60001-;71001-	Bushing	45 mm		VME-11107549	3.14
	11107764	21001-22957;60001-;71001-	P-UB-15	45 mm	70 mm	VME-11709872	82.42
	11107764	21001-22957;60001-;71001-	P-UB-15	45 mm	70 mm	VME-11709872-EX	83.75
	11107764	21001-22957;60001-;71001-	Bushing	45 mm		VME-11107549	3.14
	11107837	21001-22957;60001-;71001-	P-UB-15	45 mm	70 mm	VME-11709872	82.42
	11107837	21001-22957;60001-;71001-	P-UB-15	45 mm	70 mm	VME-11709872-EX	83.75
	11107837	21001-22957;60001-;71001-	Bushing	45 mm		VME-11107549	3.14
TILT	11107846	21001-22957;60001-;71001-	P-UB-10	90 mm	160 mm	VME-11709965	373.62
	11107846	21001-22957;60001-;71001-	P-UB-10	90 mm	160 mm	VME-11709965-EX	401.12
	11107846	21001-22957;60001-;71001-	Bushing	90 mm		VME-11005427	6.80
	11107846	21001-22957;60001-;71001-	Wear Ring		160 mm	VME-11107223	11.16
	11107852	21001-22957;60001-;71001-	P-UB-10	90 mm	160 mm	VME-11709965	373.62
	11107852	21001-22957;60001-;71001-	P-UB-10	90 mm	160 mm	VME-11709965-EX	401.12
	11107852	21001-22957;60001-;71001-	Bushing	90 mm		VME-11005427	6.80
11107852	21001-22957;60001-;71001-	Wear Ring		160 mm	VME-11107223	11.16	

LR - Long Reach

SLF - Super Long Front

QF - Quick Fit

FS - Front Shovel

MH - Material Handle

AS - Articulate Slope

VOLVO

Replacement Kits For

Loaders - Wheel							
APPLICATION	CYL #	SERIAL #	CODE	ROD	BORE	KIT #	List \$
MODEL L70F							
HYDRAULIC	11107837	24004-, 71401-, 61801-	P-UB-15	45 mm	70 mm	VME-11709872	82.42
LIFT	11107824	24004-, 71401-, 61801-	P-UB-10	70 mm	120 mm	VME-11715864	138.29
	11107851	24004-, 71401-, 61801-	P-UB-10	70 mm	110 mm	VME-11709998	161.37
TILT	11107846	24004-, 71401-, 61801-	P-UB-10	90 mm	160 mm	VME-11709965	373.62
	11107852	24004-, 71401-, 61801-	P-UB-10	90 mm	160 mm	VME-11709965	373.62
MODEL L90							
ATTACHMENT	11005340	ALL	P-U-1	25 mm		VME-11990175	80.93
	4741301	ALL	P-U-1	20 mm		VME-6630475	46.30
	4833424	ALL	P-U-1	20 mm		VME-11990060	53.74
LIFT	11005000	ALL	P-U-15	60 mm	120 mm	VME-11990026	129.41
	11005178	ALL	P-U-15	60 mm	120 mm	VME-11990026	129.41
STEERING	4784553	ALL	P-U-15	50 mm	80 mm	VME-11990050	64.99
TILT	11088064	11016-	P-UB-15	60 mm	110 mm	VME-11990028	80.42
	4833225	-11015	P-UB-15	60 mm	110 mm	VME-11990028	80.42
MODEL L90B							
ATTACHMENT	11005340	ALL	P-U-1	25 mm		VME-11990175	80.93
LIFT	11088062	ALL	P-U-15	60 mm	120 mm	VME-11990026	129.41
STEERING	11088065	ALL	P-U-15	50 mm	80 mm	VME-11990050	64.99
TILT	11088064	ALL	P-UB-15	60 mm	110 mm	VME-11990028	80.42
MODEL L90C							
LIFT	11088764	14305-17000;62463-65000;70060-80000	P-UB-14	70 mm	130 mm	VME-11999895	250.13
	11088764	14305-17000;62463-65000;70060-80000	P-UB-14	70 mm	130 mm	VME-11999895-EX	235.46
	11088764	14305-17000;62463-65000;70060-80000	Bushing	70 mm		VME-11088054	3.20
	11088764	14305-17000;62463-65000;70060-80000	Wear Ring		130 mm	VME-11088609	8.54
	11107308	14305-17000;62463-65000;70060-80000	P-UB-10	70 mm	130 mm	VME-11707023	181.68
	11107308	14305-17000;62463-65000;70060-80000	P-UB-10	70 mm	130 mm	VME-11707023-EX	196.08
	11107308	14305-17000;62463-65000;70060-80000	Bushing	70 mm		VME-11088054	3.20
	11107308	14305-17000;62463-65000;70060-80000	Wear Ring		130 mm	VME-11088609	8.54
QUICK-FIT	11082447	14305-17000;62463-65000;70060-80000	P-U-15	25 mm	45 mm	VME-11999362	73.28
	11142695	14305-17000;62463-65000;70060-80000	P-U-10	16 mm	32 mm	VME-11705087	122.90
	11142695	14305-17000;62463-65000;70060-80000	P-U-10	16 mm	32 mm	VME-11705087-EX	125.55
	11142695	14305-17000;62463-65000;70060-80000	Bushing	16 mm		VME-11708994	2.65
	11157123	14305-17000;62463-65000;70060-80000	P-U-10	16 mm	32 mm	VME-11709111	63.07
STEERING	11088546	14305-17000;62463-65000;70060-80000	P-U-15	40 mm	70 mm	VME-11999907	53.65
	11088546	14305-17000;62463-65000;70060-80000	P-U-15	40 mm	70 mm	VME-11999907-EX	55.72
	11088546	14305-17000;62463-65000;70060-80000	Bushing	40 mm		VME-11088081	1.82
TILT	11088769	14305-17000;62463-65000;70060-80000	P-UB-14	90 mm	190 mm	VME-11999893	506.56
	11088769	14305-17000;62463-65000;70060-80000	P-UB-14	90 mm	190 mm	VME-11999893-EX	552.20
	11088769	14305-17000;62463-65000;70060-80000	Bushing	90 mm		VME-11088249	20.61
	11088769	14305-17000;62463-65000;70060-80000	Wear Ring		190 mm	VME-11088014	15.91
	11107306	14305-17000;62463-65000;70060-80000	P-UB-10	90 mm	190 mm	VME-11707028	400.14
	11107306	14305-17000;62463-65000;70060-80000	P-UB-10	90 mm	190 mm	VME-11707028-EX	456.69
	11107306	14305-17000;62463-65000;70060-80000	Bushing	90 mm		VME-11088249	20.61
	11107306	14305-17000;62463-65000;70060-80000	Wear Ring		190 mm	VME-11088014	15.91
MODEL L90C BM							
LIFT	11088635	-13784	P-UB-14	70 mm	130 mm	VME-11999895	250.13
	11088635	-13784	P-UB-14	70 mm	130 mm	VME-11999895-EX	235.46
	11088635	-13784	Bushing	70 mm		VME-11088054	3.20
	11088635	-13784	Wear Ring		130 mm	VME-11088609	8.54
	11088764	13785-	P-UB-14	70 mm	130 mm	VME-11999895	250.13
	11088764	13785-	P-UB-14	70 mm	130 mm	VME-11999895-EX	235.46
	11088764	13785-	Bushing	70 mm		VME-11088054	3.20
	11088764	13785-	Wear Ring		130 mm	VME-11088609	8.54
QUICK-FIT	11082447	13001-14304;61901-62462;70001-70052	P-U-15	25 mm	45 mm	VME-11999362	73.28
STEERING	11088546	13001-14304;61901-62462;70001-70052	P-U-15	40 mm	70 mm	VME-11999907	53.65

LR - Long Reach

SLF - Super Long Front

QF - Quick Fit

FS - Front Shovel

MH - Material Handle

AS - Articulate Slope

Replacement Kits For

VOLVO

Loaders - Wheel							
APPLICATION	CYL #	SERIAL #	CODE	ROD	BORE	KIT #	List \$
MODEL L90C BM							
STEERING	11088546	13001-14304;61901-62462;70001-70052	P-U-15	40 mm	70 mm	VME-11999907-EX	55.72
	11088546	13001-14304;61901-62462;70001-70052	Bushing	40 mm		VME-11088081	1.82
TILT	11088636	-13784	P-UB-14	90 mm	190 mm	VME-11999893	506.56
	11088636	-13784	P-UB-14	90 mm	190 mm	VME-11999893-EX	552.20
	11088636	-13784	Bushing	90 mm		VME-11088249	20.61
	11088636	-13784	Wear Ring		190 mm	VME-11088014	15.91
	11088769	13785-	P-UB-14	90 mm	190 mm	VME-11999893	506.56
	11088769	13785-	P-UB-14	90 mm	190 mm	VME-11999893-EX	552.20
	11088769	13785-	Bushing	90 mm		VME-11088249	20.61
	11088769	13785-	Wear Ring		190 mm	VME-11088014	15.91
MODEL L90D							
LIFT	11088764	-17003	P-UB-14	70 mm	130 mm	VME-11999895	250.13
	11088764	-17003	P-UB-14	70 mm	130 mm	VME-11999895-EX	235.46
	11088764	-17003	Bushing	70 mm		VME-11088054	3.20
	11088764	-17003	Wear Ring		130 mm	VME-11088609	8.54
	11107308	17004-;64001-;70501-	P-UB-10	70 mm	130 mm	VME-11707023	181.68
	11107308	17004-;64001-;70501-	P-UB-10	70 mm	130 mm	VME-11707023-EX	196.08
	11107308	17004-;64001-;70501-	Bushing	70 mm		VME-11088054	3.20
	11107308	17004-;64001-;70501-	Wear Ring		130 mm	VME-11088609	8.54
QUICK-FIT	11082447	17001-20000;64001-64937;70501-70800	P-U-15	25 mm	45 mm	VME-11999362	73.28
	11142695	17001-20000;64001-64937;70501-70800	P-U-10	16 mm	32 mm	VME-11705087	122.90
	11142695	17001-20000;64001-64937;70501-70800	P-U-10	16 mm	32 mm	VME-11705087-EX	125.55
	11142695	17001-20000;64001-64937;70501-70800	Bushing	16 mm		VME-11708994	2.65
	11157123	17001-20000;64001-64937;70501-70800	P-U-10	16 mm	32 mm	VME-11709111	63.07
STEERING	11088546	17001-20000;64001-64937;70501-70800	P-U-15	40 mm	70 mm	VME-11999907	53.65
	11088546	17001-20000;64001-64937;70501-70800	P-U-15	40 mm	70 mm	VME-11999907-EX	55.72
	11088546	17001-20000;64001-64937;70501-70800	Bushing	40 mm		VME-11088081	1.82
TILT	11088769	-17003	P-UB-14	90 mm	190 mm	VME-11999893	506.56
	11088769	-17003	P-UB-14	90 mm	190 mm	VME-11999893-EX	552.20
	11088769	-17003	Bushing	90 mm		VME-11088249	20.61
	11088769	-17003	Wear Ring		190 mm	VME-11088014	15.91
	11107306	17004-;64001-;70501-	P-UB-10	90 mm	190 mm	VME-11707028	400.14
	11107306	17004-;64001-;70501-	P-UB-10	90 mm	190 mm	VME-11707028-EX	456.69
	11107306	17004-;64001-;70501-	Bushing	90 mm		VME-11088249	20.61
	11107306	17004-;64001-;70501-	Wear Ring		190 mm	VME-11088014	15.91
MODEL L90E							
LIFT	11107844	20005-30000;66001-70000;70801-80000	P-UB-10	70 mm	125 mm	VME-11715865	142.71
	11107844	20005-30000;66001-70000;70801-80000	P-UB-10	70 mm	125 mm	VME-11715865-EX	167.33
	11107844	20005-30000;66001-70000;70801-80000	Bushing	70 mm		VME-11088054	3.20
	11107844	20005-30000;66001-70000;70801-80000	Wear Ring		125 mm	VME-4833220	9.19
	11107853	20005-30000;66001-70000;70801-80000	P-UB-10	70 mm	120 mm	VME-11709829	152.05
	11107853	20005-30000;66001-70000;70801-80000	P-UB-10	70 mm	120 mm	VME-11709829-EX	168.18
	11107853	20005-30000;66001-70000;70801-80000	Bushing	70 mm		VME-11088054	3.20
	11107853	20005-30000;66001-70000;70801-80000	Wear Ring		120 mm	VME-11107298	5.00
STEERING	11107525	-20837-;66464-;70887	P-UB-15	50 mm	80 mm	VME-11709817	76.97
	11107525	-20837-;66464-;70887	P-UB-15	50 mm	80 mm	VME-11709817-EX	79.33
	11107525	-20837-;66464-;70887	Bushing	50 mm		VME-11088052	2.03
	11107787	20838-;66465-;70888-	P-UB-15	50 mm	80 mm	VME-11709817	76.97
	11107787	20838-;66465-;70888-	P-UB-15	50 mm	80 mm	VME-11709817-EX	79.33
	11107787	20838-;66465-;70888-	Bushing	50 mm		VME-11088052	2.03
TILT	11107847	20005-30000;66001-70000;70801-80000	P-UB-10	90 mm	180 mm	VME-11709832	387.25
	11107847	20005-30000;66001-70000;70801-80000	P-UB-10	90 mm	180 mm	VME-11709832-EX	417.21
	11107847	20005-30000;66001-70000;70801-80000	Bushing	90 mm		VME-11005427	6.80
	11107847	20005-30000;66001-70000;70801-80000	Wear Ring		180 mm	VME-11107217	12.54
	11107854	20005-30000;66001-70000;70801-80000	P-UB-10	90 mm	180 mm	VME-11709832	387.25

LR - Long Reach

SLF - Super Long Front

QF - Quick Fit

FS - Front Shovel

MH - Material Handle

AS - Articulate Slope

VOLVO

Replacement Kits For

Loaders - Wheel								
APPLICATION	CYL #	SERIAL #	CODE	ROD	BORE	KIT #	List \$	
MODEL L90E								
TILT	11107854	20005-30000;66001-70000;70801-80000	P-UB-10	90 mm	180 mm	VME-11709832-EX	417.21	
	11107854	20005-30000;66001-70000;70801-80000	Bushing	90 mm		VME-11005427	6.80	
	11107854	20005-30000;66001-70000;70801-80000	Wear Ring		180 mm	VME-11107217	12.54	
MODEL L90F								
HYDRAULIC	11107769	25006-, 71501-, 68101-	P-UB-15	50 mm	80 mm	VME-11709817	76.97	
LIFT	11107844	25006-, 71501-, 68101-	P-UB-10	70 mm	125 mm	VME-11715865	142.71	
	11107853	25006-, 71501-, 68101-	P-UB-10	70 mm	120 mm	VME-11709829	152.05	
TILT	11107847	25006-, 71501-, 68101-	P-UB-10	90 mm	180 mm	VME-11709832	387.25	
	11107854	25006-, 71501-, 68101-	P-UB-10	90 mm	180 mm	VME-11709832	387.25	
MODEL L110E								
HYDRAULIC	11005402	2002-61000, 61001-70400, 70401-99999	P-U-15	60 mm	125 mm	VME-11000107	155.53	
	11010770	2002-61000, 61001-70400, 70401-99999	P-U-1	25 mm		VME-11990175	80.93	
	11045350	2002-61000, 61001-70400, 70401-99999	P-U-15	60 mm	125 mm	VME-11704247	126.26	
	11045351	2002-61000, 61001-70400, 70401-99999	P-U-15	50 mm	100 mm	VME-11704251	55.03	
	11045352	2002-61000, 61001-70400, 70401-99999	P-U-15	70 mm	140 mm	VME-11704250	144.96	
	11045353	2002-61000, 61001-70400, 70401-99999	P-U-15	60 mm	110 mm	VME-11704249	117.82	
	11045354	2002-61000, 61001-70400, 70401-99999	P-U-15	40 mm	80 mm	VME-11704253	61.03	
	11045355	2002-61000, 61001-70400, 70401-99999	P-U-15	40 mm	80 mm	VME-11704253	61.03	
	11045356	2002-61000, 61001-70400, 70401-99999	P-U-15	60 mm	125 mm	VME-11704247	126.26	
	11045357	2002-61000, 61001-70400, 70401-99999	P-U-15	60 mm	110 mm	VME-11704249	117.82	
	11045358	2002-61000, 61001-70400, 70401-99999	P-U-15	80 mm	150 mm	VME-11704689	168.90	
	11045360	2002-61000, 61001-70400, 70401-99999	P-U-15	50 mm	110 mm	VME-11704252	82.80	
	11045361	2002-61000, 61001-70400, 70401-99999	P-U-15	50 mm	110 mm	VME-11704252	82.80	
	11045363	2002-61000, 61001-70400, 70401-99999	P-U-15	60 mm	110 mm	VME-11704249	117.82	
	11045366	2002-61000, 61001-70400, 70401-99999	P-U-15	60 mm	125 mm	VME-11704248	108.31	
	11082749	2002-61000, 61001-70400, 70401-99999	P-U-15	60 mm	125 mm	VME-11704247	126.26	
	11088569	2002-61000, 61001-70400, 70401-99999	P-U-15	80 mm	150 mm	VME-11700187	108.18	
	11107516	1002-2165, 70201-70257, 60001-60631	P-UB-15	50 mm	80 mm	VME-11709817	76.97	
	11107790	1002-2165, 70201-70257, 60001-60631	P-UB-15	50 mm	80 mm	VME-11709817	76.97	
	11107790	2202-, 70401-70433, 61001-61289	P-UB-15	50 mm	80 mm	VME-11709817	76.97	
	11142677	2002-61000, 61001-70400, 70401-99999	P-U-15	40 mm	80 mm	VME-11704253	61.03	
	11156699	2002-61000, 61001-70400, 70401-99999	I-UB-10	32 mm	50 mm	VME-11709821	84.03	
	11156701	2002-61000, 61001-70400, 70401-99999	I-UB-10	32 mm	50 mm	VME-11709821	84.03	
	11157999	2002-61000, 61001-70400, 70401-99999	P-U-15	40 mm	80 mm	VME-11704253	61.03	
	11417176	2002-61000, 61001-70400, 70401-99999	P-U-15	60 mm	125 mm	VME-11704247	126.26	
	4784150	2002-61000, 61001-70400, 70401-99999	P-U-15	40 mm	80 mm	VME-6630662	63.32	
	4881335	2002-61000, 61001-70400, 70401-99999	P-U-15	25 mm	40 mm	VME-6630886	20.90	
	4881336	2002-61000, 61001-70400, 70401-99999	P-U-15	25 mm	40 mm	VME-6630886	20.90	
	LIFT	11107855	1002-2165, 70201-70257, 60001-60631	P-UB-10	80 mm	150 mm	VME-11708825	129.55
		11107855	2202-, 70401-70433, 61001-61289	P-UB-10	80 mm	150 mm	VME-11708825	129.55
TILT	11107848	1002-2165, 70201-70257, 60001-60631	P-UB-10	110 mm	220 mm	VME-11708833	265.37	
	11107848	2202-, 70401-70433, 61001-61289	P-UB-10	110 mm	220 mm	VME-11708833	265.37	
	11107856	1002-2165, 70201-70257, 60001-60631	P-UB-10	110 mm	220 mm	VME-11708833	265.37	
	11107856	2202-, 70401-70433, 61001-61289	P-UB-10	110 mm	220 mm	VME-11708833	265.37	
MODEL L110F								
HYDRAULIC	11107790	3503-, 70601-, 61501-	P-UB-15	50 mm	80 mm	VME-11709817	76.97	
TILT	11107848	3503-, 70601-, 61501-	P-UB-10	110 mm	220 mm	VME-11708833	265.37	
	11107856	3503-, 70601-, 61501-	P-UB-10	110 mm	220 mm	VME-11708833	265.37	
MODEL L120								
ATTACHMENT	11005340	ALL	P-U-1	25 mm		VME-11990175	80.93	
	4741301	ALL	P-U-1	20 mm		VME-6630475	46.30	
	4833424	ALL	P-U-1	20 mm		VME-11990060	53.74	
LIFT	4833249	ALL	P-U-15	70 mm	140 mm	VME-11990029	182.47	
STEERING	4833261	ALL	P-U-15	50 mm	80 mm	VME-11990050	64.99	
TILT	4833231	ALL	P-U-15	70 mm	125 mm	VME-11990027	112.35	

LR - Long Reach

SLF - Super Long Front

QF - Quick Fit

FS - Front Shovel

MH - Material Handle

AS - Articulate Slope

Replacement Kits For

VOLVO

Loaders - Wheel								
APPLICATION	CYL #	SERIAL #	CODE	ROD	BORE	KIT #	List \$	
MODEL L120B								
ATTACHMENT	11005340	ALL	P-U-1	25 mm		VME-11990175	80.93	
LIFT	11088048	ALL	P-U-15	70 mm	140 mm	VME-11990404	152.46	
STEERING	11088049	ALL	P-U-15	50 mm	80 mm	VME-11990050	64.99	
TILT	11088046	ALL	P-UB-15	60 mm	125 mm	VME-11990405	97.07	
MODEL L120C								
LIFT	11088637	11319-60000;70075-80000;61677-70000	P-UB-14	80 mm	160 mm	VME-11999894	306.41	
	11088637	11319-60000;70075-80000;61677-70000	P-UB-14	80 mm	160 mm	VME-11999894-EX	354.73	
	11088637	11319-60000;70075-80000;61677-70000	Bushing	80 mm		VME-11088150	3.59	
	11088637	11319-60000;70075-80000;61677-70000	Wear Ring		160 mm	VME-11088109	44.67	
	11088778	11319-60000;70075-80000;61677-70000	P-UB-14	90 mm	170 mm	VME-11990349	467.44	
	11088778	11319-60000;70075-80000;61677-70000	P-UB-14	90 mm	170 mm	VME-11990349-EX	512.26	
	11088778	11319-60000;70075-80000;61677-70000	Bushing	90 mm		VME-11088249	20.61	
	11088778	11319-60000;70075-80000;61677-70000	Wear Ring		170 mm	VME-11005323	14.23	
	11107316	11319-60000;70075-80000;61677-70000	P-UB-10	90 mm	170 mm	VME-11707447	532.08	
	11107316	11319-60000;70075-80000;61677-70000	P-UB-10	90 mm	170 mm	VME-11707447-EX	575.51	
QUICK-FIT	11107316	11319-60000;70075-80000;61677-70000	Bushing	90 mm		VME-11088249	20.61	
	11107316	11319-60000;70075-80000;61677-70000	Wear Ring		170 mm	VME-11005323	14.23	
	11082447	11319-60000;70075-80000;61677-70000	P-U-15	25 mm	45 mm	VME-11999362	73.28	
	11142695	11319-60000;70075-80000;61677-70000	P-U-10	16 mm	32 mm	VME-11705087	122.90	
	11142695	11319-60000;70075-80000;61677-70000	P-U-10	16 mm	32 mm	VME-11705087-EX	125.55	
STEERING	11142695	11319-60000;70075-80000;61677-70000	Bushing	16 mm		VME-11708994	2.65	
	11157123	11319-60000;70075-80000;61677-70000	P-U-10	16 mm	32 mm	VME-11709111	63.07	
	11088537	11319-60000;70075-80000;61677-70000	P-UB-15	50 mm	80 mm	VME-11999906	74.73	
	11088537	11319-60000;70075-80000;61677-70000	P-UB-15	50 mm	80 mm	VME-11999906-EX	77.14	
	11088537	11319-60000;70075-80000;61677-70000	Bushing	50 mm		VME-11088052	2.03	
TILT	11088773	11319-60000;70075-80000;61677-70000	P-UB-14	110 mm	230 mm	VME-11999892	465.83	
	11088773	11319-60000;70075-80000;61677-70000	P-UB-14	110 mm	230 mm	VME-11999892-EX	567.40	
	11088773	11319-60000;70075-80000;61677-70000	Bushing	110 mm		VME-11088324	27.39	
	11088773	11319-60000;70075-80000;61677-70000	Wear Ring		230 mm	VME-11088323	56.47	
	11088785	11319-60000;70075-80000;61677-70000	P-UB-14	110 mm	230 mm	VME-11999892	465.83	
	11088785	11319-60000;70075-80000;61677-70000	P-UB-14	110 mm	230 mm	VME-11999892-EX	567.40	
	11088785	11319-60000;70075-80000;61677-70000	Bushing	110 mm		VME-11088324	27.39	
	11088785	11319-60000;70075-80000;61677-70000	Wear Ring		230 mm	VME-11088323	56.47	
	11107105	11319-60000;70075-80000;61677-70000	P-UB-14	110 mm	230 mm	VME-11999892	465.83	
	11107105	11319-60000;70075-80000;61677-70000	P-UB-14	110 mm	230 mm	VME-11999892-EX	567.40	
MODEL L120C BM	11107105	11319-60000;70075-80000;61677-70000	Bushing	110 mm		VME-11088324	27.39	
	11107105	11319-60000;70075-80000;61677-70000	Wear Ring		230 mm	VME-11088323	56.47	
	LIFT	11088637	9901-11318;61301-61676	P-UB-14	80 mm	160 mm	VME-11999894	306.41
		11088637	9901-11318;61301-61676	P-UB-14	80 mm	160 mm	VME-11999894-EX	354.73
		11088637	9901-11318;61301-61676	Bushing	80 mm		VME-11088150	3.59
		11088637	9901-11318;61301-61676	Wear Ring		160 mm	VME-11088109	44.67
		11088778	9901-11318;61301-61676	P-UB-14	90 mm	170 mm	VME-11990349	467.44
		11088778	9901-11318;61301-61676	P-UB-14	90 mm	170 mm	VME-11990349-EX	512.26
		11088778	9901-11318;61301-61676	Bushing	90 mm		VME-11088249	20.61
		11088778	9901-11318;61301-61676	Wear Ring		170 mm	VME-11005323	14.23
STEERING	11088537	9901-11318;61301-61676	P-UB-15	50 mm	80 mm	VME-11999906	74.73	
	11088537	9901-11318;61301-61676	P-UB-15	50 mm	80 mm	VME-11999906-EX	77.14	
	11088537	9901-11318;61301-61676	Bushing	50 mm		VME-11088052	2.03	
TILT	11088638	-10639	P-UB-14	110 mm	230 mm	VME-11999892	465.83	
	11088638	-10639	P-UB-14	110 mm	230 mm	VME-11999892-EX	567.40	
	11088638	-10639	Bushing	110 mm		VME-11088324	27.39	
	11088638	-10639	Wear Ring		230 mm	VME-11088323	56.47	
	11088773	9901-11318;61301-61676	P-UB-14	110 mm	230 mm	VME-11999892	465.83	
	11088773	9901-11318;61301-61676	P-UB-14	110 mm	230 mm	VME-11999892-EX	567.40	

LR - Long Reach

SLF - Super Long Front

QF - Quick Fit

FS - Front Shovel

MH - Material Handle

AS - Articulate Slope

VOLVO

Replacement Kits For

Loaders - Wheel							
APPLICATION	CYL #	SERIAL #	CODE	ROD	BORE	KIT #	List \$
MODEL L120C BM							
TILT	11088773	9901-11318;61301-61676	Bushing	110 mm		VME-11088324	27.39
	11088773	9901-11318;61301-61676	Wear Ring		230 mm	VME-11088323	56.47
	11088785	10640-	P-UB-14	110 mm	230 mm	VME-11999892	465.83
	11088785	10640-	P-UB-14	110 mm	230 mm	VME-11999892-EX	567.40
	11088785	10640-	Bushing	110 mm		VME-11088324	27.39
	11088785	10640-	Wear Ring		230 mm	VME-11088323	56.47
MODEL L120D							
LIFT	11088637	-14003	P-UB-14	80 mm	160 mm	VME-11999894	306.41
	11088637	-14003	P-UB-14	80 mm	160 mm	VME-11999894-EX	354.73
	11088637	-14003	Bushing	80 mm		VME-11088150	3.59
	11088637	-14003	Wear Ring		160 mm	VME-11088109	44.67
	11107312	14004-;63001-;70501-	P-UB-10	80 mm	160 mm	VME-11707024	245.26
	11107312	14004-;63001-;70501-	P-UB-10	80 mm	160 mm	VME-11707024-EX	294.89
	11107312	14004-;63001-;70501-	Bushing	80 mm		VME-11088150	3.59
	11107312	14004-;63001-;70501-	Wear Ring		160 mm	VME-11088109	44.67
	11107316	14001-15418;70501-70615;63001-63291	P-UB-10	90 mm	170 mm	VME-11707447	532.08
	11107316	14001-15418;70501-70615;63001-63291	P-UB-10	90 mm	170 mm	VME-11707447-EX	575.51
	11107316	14001-15418;70501-70615;63001-63291	Bushing	90 mm		VME-11088249	20.61
11107316	14001-15418;70501-70615;63001-63291	Wear Ring		170 mm	VME-11005323	14.23	
QUICK-FIT	11142695	14001-15418;70501-70615;63001-63291	P-U-10	16 mm	32 mm	VME-11705087	122.90
	11142695	14001-15418;70501-70615;63001-63291	P-U-10	16 mm	32 mm	VME-11705087-EX	125.55
	11142695	14001-15418;70501-70615;63001-63291	Bushing	16 mm		VME-11708994	2.65
	11157123	14001-15418;70501-70615;63001-63291	P-U-10	16 mm	32 mm	VME-11709111	63.07
STEERING	11088537	14001-15418;70501-70615;63001-63291	P-UB-15	50 mm	80 mm	VME-11999906	74.73
	11088537	14001-15418;70501-70615;63001-63291	P-UB-15	50 mm	80 mm	VME-11999906-EX	77.14
	11088537	14001-15418;70501-70615;63001-63291	Bushing	50 mm		VME-11088052	2.03
TILT	11107105	-14003	P-UB-14	110 mm	230 mm	VME-11999892	465.83
	11107105	-14003	P-UB-14	110 mm	230 mm	VME-11999892-EX	567.40
	11107105	-14003	Bushing	110 mm		VME-11088324	27.39
	11107105	-14003	Wear Ring		230 mm	VME-11088323	56.47
	11107310	14004-;63001-;70501-	P-UB-10	110 mm	230 mm	VME-11707029	483.88
	11107310	14004-;63001-;70501-	P-UB-10	110 mm	230 mm	VME-11707029-EX	584.17
	11107310	14004-;63001-;70501-	Bushing	110 mm		VME-11088324	27.39
	11107310	14004-;63001-;70501-	Wear Ring		230 mm	VME-11088323	56.47
	11107314	14001-15418;70501-70615;63001-63291	P-UB-10	110 mm	230 mm	VME-11707029	483.88
	11107314	14001-15418;70501-70615;63001-63291	P-UB-10	110 mm	230 mm	VME-11707029-EX	584.17
	11107314	14001-15418;70501-70615;63001-63291	Bushing	110 mm		VME-11088324	27.39
	11107314	14001-15418;70501-70615;63001-63291	Wear Ring		230 mm	VME-11088323	56.47
	MODEL L120E						
LIFT	11107561	-16797-;64229-;70730	P-UB-10	80 mm	150 mm	VME-11708825	129.55
	11107561	-16797-;64229-;70730	P-UB-10	80 mm	150 mm	VME-11708825-EX	170.64
	11107561	-16797-;64229-;70730	Bushing	80 mm		VME-11088150	3.59
	11107561	-16797-;64229-;70730	Wear Ring		150 mm	VME-11107289	18.47
	11107855	16798-19668;19804-;64230-66000;66001-;70731-71400;71401-	P-UB-10	80 mm	150 mm	VME-11708825	129.55
	11107855	16798-19668;19804-;64230-66000;66001-;70731-71400;71401-	P-UB-10	80 mm	150 mm	VME-11708825-EX	170.64
	11107855	16798-19668;19804-;64230-66000;66001-;70731-71400;71401-	Bushing	80 mm		VME-11088150	3.59
	11107855	16798-19668;19804-;64230-66000;66001-;70731-71400;71401-	Wear Ring		150 mm	VME-11107289	18.47
	11107857	16001-19668;19804-;64001-66000;66001-;70701-71400;71401-	P-UB-10	90 mm	160 mm	VME-11709384	178.41
	11107857	16001-19668;19804-;64001-66000;66001-;70701-71400;71401-	P-UB-10	90 mm	160 mm	VME-11709384-EX	231.20

LR - Long Reach

SLF - Super Long Front

QF - Quick Fit

FS - Front Shovel

MH - Material Handle

AS - Articulate Slope

Replacement Kits For

VOLVO

Loaders - Wheel							
APPLICATION	CYL #	SERIAL #	CODE	ROD	BORE	KIT #	List \$
MODEL L120E							
LIFT	11107857	16001-19668;19804-;64001-66000;66001-;70701-71400;71401-	Bushing	90 mm		VME-11088249	20.61
	11107857	16001-19668;19804-;64001-66000;66001-;70701-71400;71401-	Wear Ring		160 mm	VME-11107223	11.16
QUICK-FIT	11157115	16001-19668;19804-;64001-66000;66001-;70701-71400;71401-	P-U-15	25 mm	45 mm	VME-11999362	73.28
	11157123	16001-19668;19804-;64001-66000;66001-;70701-71400;71401-	P-U-10	16 mm	32 mm	VME-11709111	63.07
STEERING	11107516	16001-19668;70701-71400;64001-66000	P-UB-15	50 mm	80 mm	VME-11709817	76.97
	11107516	16001-19668;70701-71400;64001-66000	P-UB-15	50 mm	80 mm	VME-11709817-EX	79.33
	11107516	16001-19668;70701-71400;64001-66000	Bushing	50 mm		VME-11088052	2.03
	11107790	16001-19668;19804-;64001-66000;66001-;70701-71400;71401-	P-UB-15	50 mm	80 mm	VME-11709817	76.97
	11107790	16001-19668;19804-;64001-66000;66001-;70701-71400;71401-	P-UB-15	50 mm	80 mm	VME-11709817-EX	79.33
	11107790	16001-19668;19804-;64001-66000;66001-;70701-71400;71401-	Bushing	50 mm		VME-11088052	2.03
TILT	11107244	16001-19668;70701-71400;64001-66000	P-UB-10	110 mm	220 mm	VME-11708833	265.37
	11107244	16001-19668;70701-71400;64001-66000	P-UB-10	110 mm	220 mm	VME-11708833-EX	366.16
	11107244	16001-19668;70701-71400;64001-66000	Bushing	110 mm		VME-11088324	27.39
	11107244	16001-19668;70701-71400;64001-66000	Wear Ring		220 mm	VME-11107254	40.58
	11107856	16001-19668;19804-;64001-66000;66001-;70701-71400;71401-	P-UB-10	110 mm	220 mm	VME-11708833	265.37
	11107856	16001-19668;19804-;64001-66000;66001-;70701-71400;71401-	P-UB-10	110 mm	220 mm	VME-11708833-EX	366.16
	11107856	16001-19668;19804-;64001-66000;66001-;70701-71400;71401-	Bushing	110 mm		VME-11088324	27.39
	11107856	16001-19668;19804-;64001-66000;66001-;70701-71400;71401-	Wear Ring		220 mm	VME-11107254	40.58
	11107858	16001-19668;19804-;64001-66000;66001-;70701-71400;71401-	P-UB-10	110 mm	220 mm	VME-11708833	265.37
	11107858	16001-19668;19804-;64001-66000;66001-;70701-71400;71401-	P-UB-10	110 mm	220 mm	VME-11708833-EX	366.16
	11107858	16001-19668;19804-;64001-66000;66001-;70701-71400;71401-	Bushing	110 mm		VME-11088324	27.39
	11107858	16001-19668;19804-;64001-66000;66001-;70701-71400;71401-	Wear Ring		220 mm	VME-11107254	40.58
	MODEL L120F						
HYDRAULIC	11045351	23004-, 66401-, 71701-	P-U-15	50 mm	100 mm	VME-11704251	55.03
	11045352	23004-, 66401-, 71701-	P-U-15	70 mm	140 mm	VME-11704250	144.96
	11045353	23004-, 66401-, 71701-	P-U-15	60 mm	110 mm	VME-11704249	117.82
	11045355	23004-, 66401-, 71701-	P-U-15	40 mm	80 mm	VME-11704253	61.03
	11045356	23004-, 66401-, 71701-	P-U-15	60 mm	125 mm	VME-11704247	126.26
	11045357	23004-, 66401-, 71701-	P-U-15	60 mm	110 mm	VME-11704249	117.82
	11045358	23004-, 66401-, 71701-	P-U-15	80 mm	150 mm	VME-11704689	168.90
	11045360	23004-, 66401-, 71701-	P-U-15	50 mm	110 mm	VME-11704252	82.80
	11045361	23004-, 66401-, 71701-	P-U-15	50 mm	110 mm	VME-11704252	82.80
	11045363	23004-, 66401-, 71701-	P-U-15	60 mm	110 mm	VME-11704249	117.82
	11045366	23004-, 66401-, 71701-	P-U-15	60 mm	125 mm	VME-11704248	108.31
	11107790	23004-, 66401-, 71701-	P-UB-15	50 mm	80 mm	VME-11709817	76.97
	11107790	23004-, 66401-, 71701-	P-UB-15	50 mm	80 mm	VME-11709817-EX	79.33
	11107790	23004-, 71701-, 66401-	P-UB-15	50 mm	80 mm	VME-11709817	76.97
	11107790	23004-, 71701-, 66401-	P-UB-15	50 mm	80 mm	VME-11709817-EX	79.33
	11156699	23004-, 66401-, 71701-	I-UB-10	32 mm	50 mm	VME-11709821	84.03
	11156701	23004-, 66401-, 71701-	I-UB-10	32 mm	50 mm	VME-11709821	84.03
	11157999	23004-, 66401-, 71701-	P-U-15	40 mm	80 mm	VME-11704253	61.03
	11417176	23004-, 66401-, 71701-	P-U-15	60 mm	125 mm	VME-11704247	126.26
	15155930	23004-, 66401-, 71701-	P-U-15	40 mm	80 mm	VME-11704253	61.03

LR - Long Reach

SLF - Super Long Front

QF - Quick Fit

FS - Front Shovel

MH - Material Handle

AS - Articulate Slope

VOLVO

Replacement Kits For

Loaders - Wheel							
APPLICATION	CYL #	SERIAL #	CODE	ROD	BORE	KIT #	List \$
MODEL L120F							
LIFT	11107855	23004-, 66401-, 71701-	P-UB-10	80 mm	150 mm	VME-11708825	129.55
	11107855	23004-, 66401-, 71701-	P-UB-10	80 mm	150 mm	VME-11708825-EX	170.64
	11107855	23004-, 71701-, 66401-	P-UB-10	80 mm	150 mm	VME-11708825	129.55
	11107855	23004-, 71701-, 66401-	P-UB-10	80 mm	150 mm	VME-11708825-EX	170.64
	11107857	23004-, 66401-, 71701-	P-UB-10	90 mm	160 mm	VME-11709384	178.41
	11107857	23004-, 66401-, 71701-	P-UB-10	90 mm	160 mm	VME-11709384-EX	231.20
	11107857	23004-, 71701-, 66401-	P-UB-10	90 mm	160 mm	VME-11709384	178.41
	11107857	23004-, 71701-, 66401-	P-UB-10	90 mm	160 mm	VME-11709384-EX	231.20
TILT	11107856	23004-, 71701-, 66401-	P-UB-10	110 mm	220 mm	VME-11708833	265.37
	11107856	23004-, 71701-, 66401-	P-UB-10	110 mm	220 mm	VME-11708833-EX	366.16
	11107858	23004-, 71701-, 66401-	P-UB-10	110 mm	220 mm	VME-11708833	265.37
	11107858	23004-, 71701-, 66401-	P-UB-10	110 mm	220 mm	VME-11708833-EX	366.16
	15148701	23004-, 66401-, 71701-	P-UB-10	110 mm	220 mm	VME-17253817	265.37
	15148701	23004-, 66401-, 71701-	P-UB-10	110 mm	220 mm	VME-17253817-EX	366.16
	15165423	23004-, 66401-, 71701-	P-UB-10	110 mm	220 mm	VME-17253817	265.37
	15165423	23004-, 66401-, 71701-	P-UB-10	110 mm	220 mm	VME-17253817-EX	366.16
MODEL L140							
LIFT	2561089	831A;831AC	P-UB-10	2-3/4	6	VME-2542568	240.21
TILT	2561088	831A;831AC	P-UB-10	2-3/4	5	VME-2542569	92.00
MODEL L150							
ATTACHMENT	11005392	ALL	P-U-15	32 mm	63 mm	VME-6630661	98.24
LIFT	11005470	-1233;-60096(USA)	P-UB-14	90 mm	170 mm	VME-11990349	467.44
	11005470	-1233;-60096(USA)	P-UB-14	90 mm	170 mm	VME-11990349-EX	512.26
	11005470	-1233;-60096(USA)	Bushing	90 mm		VME-11088249	20.61
	11005470	-1233;-60096(USA)	Wear Ring		170 mm	VME-11005323	14.23
	11088115	1234;-60097(USA)-	P-UB-14	90 mm	170 mm	VME-11990349	467.44
	11088115	1234;-60097(USA)-	P-UB-14	90 mm	170 mm	VME-11990349-EX	512.26
	11088115	1234;-60097(USA)-	Bushing	90 mm		VME-11088249	20.61
	11088115	1234;-60097(USA)-	Wear Ring		170 mm	VME-11005323	14.23
STEERING	11005294	ALL	P-U-15	50 mm	90 mm	VME-11990347	72.27
	11005294	ALL	P-U-15	50 mm	90 mm	VME-11990347-EX	74.74
	11005294	ALL	Bushing	50 mm		VME-11088052	2.03
TILT	11005462	ALL	P-UB-14	120 mm	250 mm	VME-11990348	692.36
	11005462	ALL	P-UB-14	120 mm	250 mm	VME-11990348-EX	759.53
	11005462	ALL	Bushing	120 mm		VME-11088879	13.36
	11005462	ALL	Wear Ring		250 mm	VME-11005324	41.30
MODEL L150C							
LIFT	11088807	2768-10000;60701-70000	P-UB-14	90 mm	170 mm	VME-11990349	467.44
	11088807	2768-10000;60701-70000	P-UB-14	90 mm	170 mm	VME-11990349-EX	512.26
	11088807	2768-10000;60701-70000	Bushing	90 mm		VME-11088249	20.61
	11088807	2768-10000;60701-70000	Wear Ring		170 mm	VME-11005323	14.23
QUICK-FIT	11005392	2768-10000;60701-70000	P-U-15	32 mm	63 mm	VME-6630661	98.24
	11045365	2768-10000;60701-70000	P-U-15	32 mm	63 mm	VME-11704254	53.82
STEERING	11088296	2768-10000;60701-70000	P-U-15	50 mm	90 mm	VME-11990347	72.27
	11088296	2768-10000;60701-70000	P-U-15	50 mm	90 mm	VME-11990347-EX	74.74
	11088296	2768-10000;60701-70000	Bushing	50 mm		VME-11088052	2.03
TILT	11088805	2768-10000;60701-70000	P-UB-14	120 mm	250 mm	VME-11990348	692.36
	11088805	2768-10000;60701-70000	P-UB-14	120 mm	250 mm	VME-11990348-EX	759.53
	11088805	2768-10000;60701-70000	Bushing	120 mm		VME-11088879	13.36
	11088805	2768-10000;60701-70000	Wear Ring		250 mm	VME-11005324	41.30
MODEL L150C BM							
LIFT	11005470	-1233;-60096	P-UB-14	90 mm	170 mm	VME-11990349	467.44
	11005470	-1233;-60096	P-UB-14	90 mm	170 mm	VME-11990349-EX	512.26
	11005470	-1233;-60096	Bushing	90 mm		VME-11088249	20.61
	11005470	-1233;-60096	Wear Ring		170 mm	VME-11005323	14.23

LR - Long Reach

SLF - Super Long Front

QF - Quick Fit

FS - Front Shovel

MH - Material Handle

AS - Articulate Slope

Replacement Kits For

VOLVO

Loaders - Wheel							
APPLICATION	CYL #	SERIAL #	CODE	ROD	BORE	KIT #	List \$
MODEL L150C BM							
LIFT	11088115	1234-1792;60097-60333	P-UB-14	90 mm	170 mm	VME-11990349	467.44
	11088115	1234-1792;60097-60333	P-UB-14	90 mm	170 mm	VME-11990349-EX	512.26
	11088115	1234-1792;60097-60333	Bushing	90 mm		VME-11088249	20.61
	11088115	1234-1792;60097-60333	Wear Ring		170 mm	VME-11005323	14.23
	11088497	1793-2697;60334-60710	P-UB-14	90 mm	170 mm	VME-11990349	467.44
	11088497	1793-2697;60334-60710	P-UB-14	90 mm	170 mm	VME-11990349-EX	512.26
	11088497	1793-2697;60334-60710	Bushing	90 mm		VME-11088249	20.61
	11088497	1793-2697;60334-60710	Wear Ring		170 mm	VME-11005323	14.23
	11088807	2698-;60711-	P-UB-14	90 mm	170 mm	VME-11990349	467.44
	11088807	2698-;60711-	P-UB-14	90 mm	170 mm	VME-11990349-EX	512.26
	11088807	2698-;60711-	Bushing	90 mm		VME-11088249	20.61
11088807	2698-;60711-	Wear Ring		170 mm	VME-11005323	14.23	
QUICK-FIT	11005392	2081-2767;60501-60708	P-U-15	32 mm	63 mm	VME-6630661	98.24
STEERING	11005294	-1662;-60267	P-U-15	50 mm	90 mm	VME-11990347	72.27
	11005294	-1662;-60267	P-U-15	50 mm	90 mm	VME-11990347-EX	74.74
	11005294	-1662;-60267	Bushing	50 mm		VME-11088052	2.03
	11088296	1663;-60268-	P-U-15	50 mm	90 mm	VME-11990347	72.27
	11088296	1663;-60268-	P-U-15	50 mm	90 mm	VME-11990347-EX	74.74
	11088296	1663;-60268-	Bushing	50 mm		VME-11088052	2.03
TILT	11005462	-2006;-60419	P-UB-14	120 mm	250 mm	VME-11990348	692.36
	11005462	-2006;-60419	P-UB-14	120 mm	250 mm	VME-11990348-EX	759.53
	11005462	-2006;-60419	Bushing	120 mm		VME-11088879	13.36
	11005462	-2006;-60419	Wear Ring		250 mm	VME-11005324	41.30
	11088474	2007-2693;60420-60710	P-UB-14	120 mm	250 mm	VME-11990348	692.36
	11088474	2007-2693;60420-60710	P-UB-14	120 mm	250 mm	VME-11990348-EX	759.53
	11088474	2007-2693;60420-60710	Bushing	120 mm		VME-11088879	13.36
	11088474	2007-2693;60420-60710	Wear Ring		250 mm	VME-11005324	41.30
	11088805	2694-;60711-	P-UB-14	120 mm	250 mm	VME-11990348	692.36
	11088805	2694-;60711-	P-UB-14	120 mm	250 mm	VME-11990348-EX	759.53
	11088805	2694-;60711-	Bushing	120 mm		VME-11088879	13.36
	11088805	2694-;60711-	Wear Ring		250 mm	VME-11005324	41.30
	MODEL L150D						
LIFT	11088807	-5004	P-UB-14	90 mm	170 mm	VME-11990349	467.44
	11088807	-5004	P-UB-14	90 mm	170 mm	VME-11990349-EX	512.26
	11088807	-5004	Bushing	90 mm		VME-11088249	20.61
	11088807	-5004	Wear Ring		170 mm	VME-11005323	14.23
	11107320	5005-;62501-62658	P-UB-10	90 mm	170 mm	VME-11707025	266.25
	11107320	5005-;62501-62658	P-UB-10	90 mm	170 mm	VME-11707025-EX	288.06
	11107320	5005-;62501-62658	Bushing	90 mm		VME-11005427	6.80
	11107320	5005-;62501-62658	Wear Ring		170 mm	VME-11005323	14.23
QUICK-FIT	11045365	62501-70000;5002-6000	P-U-15	32 mm	63 mm	VME-11704254	53.82
	11157116	62501-70000;5002-6000	P-U-15	32 mm	63 mm	VME-11704254	53.82
STEERING	11088296	62501-70000;5002-6000	P-U-15	50 mm	90 mm	VME-11990347	72.27
	11088296	62501-70000;5002-6000	P-U-15	50 mm	90 mm	VME-11990347-EX	74.74
	11088296	62501-70000;5002-6000	Bushing	50 mm		VME-11088052	2.03
TILT	11088805	-5004	P-UB-14	120 mm	250 mm	VME-11990348	692.36
	11088805	-5004	P-UB-14	120 mm	250 mm	VME-11990348-EX	759.53
	11088805	-5004	Bushing	120 mm		VME-11088879	13.36
	11088805	-5004	Wear Ring		250 mm	VME-11005324	41.30
	11107318	5005-;62501-62658	P-UB-10	120 mm	250 mm	VME-11707030	533.97
	11107318	5005-;62501-62658	P-UB-10	120 mm	250 mm	VME-11707030-EX	589.81
	11107318	5005-;62501-62658	Bushing	120 mm		VME-11088879	13.36
	11107318	5005-;62501-62658	Wear Ring		250 mm	VME-11005324	41.30
	11107322	62501-70000;5002-6000	P-UB-10	120 mm	230 mm	VME-11707450	467.64
	11107322	62501-70000;5002-6000	P-UB-10	120 mm	230 mm	VME-11707450-EX	539.50

LR - Long Reach

SLF - Super Long Front

QF - Quick Fit

FS - Front Shovel

MH - Material Handle

AS - Articulate Slope

VOLVO

Replacement Kits For

Loaders - Wheel								
APPLICATION	CYL #	SERIAL #	CODE	ROD	BORE	KIT #	List \$	
MODEL L150D								
TILT	11107322	62501-70000;5002-6000	Bushing	120 mm		VME-11088496	12.85	
	11107322	62501-70000;5002-6000	Wear Ring		230 mm	VME-11088323	56.47	
MODEL L150E								
LIFT	11107539	-6534	P-UB-10	90 mm	160 mm	VME-11709018	179.11	
	11107539	-6534	P-UB-10	90 mm	160 mm	VME-11709018-EX	204.51	
	11107539	-6534	Bushing	90 mm		VME-11005427	6.80	
	11107539	-6534	Wear Ring		160 mm	VME-11107223	11.16	
	11107714	6535-8721	P-UB-10	90 mm	160 mm	VME-11709018	179.11	
	11107714	6535-8721	P-UB-10	90 mm	160 mm	VME-11709018-EX	204.51	
	11107714	6535-8721	Bushing	90 mm		VME-11005427	6.80	
	11107714	6535-8721	Wear Ring		160 mm	VME-11107223	11.16	
	11107859	8722-10000;10002-63000	P-UB-10	90 mm	160 mm	VME-11709018	179.11	
	11107859	8722-10000;10002-63000	P-UB-10	90 mm	160 mm	VME-11709018-EX	204.51	
	11107859	8722-10000;10002-63000	Bushing	90 mm		VME-11005427	6.80	
	11107859	8722-10000;10002-63000	Wear Ring		160 mm	VME-11107223	11.16	
	QUICK-FIT	11157116	10002-63000	P-U-15	32 mm	63 mm	VME-11704254	53.82
	STEERING	11107333	6001-10000;10002-63000;63001-80000	P-UB-15	50 mm	90 mm	VME-11709029	73.41
11107333		6001-10000;10002-63000;63001-80000	P-UB-15	50 mm	90 mm	VME-11709029-EX	75.84	
11107333		6001-10000;10002-63000;63001-80000	Bushing	50 mm		VME-11088052	2.03	
TILT	11107256	63001-80000;6001-8721	P-UB-10	110 mm	230 mm	VME-11709026	273.79	
	11107256	63001-80000;6001-8721	P-UB-10	110 mm	230 mm	VME-11709026-EX	359.75	
	11107256	63001-80000;6001-8721	Bushing	110 mm		VME-11088324	27.39	
	11107256	63001-80000;6001-8721	Wear Ring		230 mm	VME-11107264	18.99	
	11107386	63001-80000;6001-8721	P-UB-10	110 mm	230 mm	VME-11709026	273.79	
	11107386	63001-80000;6001-8721	P-UB-10	110 mm	230 mm	VME-11709026-EX	359.75	
	11107386	63001-80000;6001-8721	Bushing	110 mm		VME-11088324	27.39	
	11107386	63001-80000;6001-8721	Wear Ring		230 mm	VME-11107264	18.99	
	11107860	8722-10000;10002-63000	P-UB-10	110 mm	230 mm	VME-11709026	273.79	
	11107860	8722-10000;10002-63000	P-UB-10	110 mm	230 mm	VME-11709026-EX	359.75	
	11107860	8722-10000;10002-63000	Bushing	110 mm		VME-11088324	27.39	
	11107860	8722-10000;10002-63000	Wear Ring		230 mm	VME-11107264	18.99	
	11107861	8722-10000;10002-63000	P-UB-10	110 mm	230 mm	VME-11709026	273.79	
	11107861	8722-10000;10002-63000	P-UB-10	110 mm	230 mm	VME-11709026-EX	359.75	
	11107861	8722-10000;10002-63000	Bushing	110 mm		VME-11088324	27.39	
	11107861	8722-10000;10002-63000	Wear Ring		230 mm	VME-11107264	18.99	
	MODEL L150F							
	HYDRAULIC	11045351	13003-	P-U-15	50 mm	100 mm	VME-11704251	55.03
11045352		13003-	P-U-15	70 mm	140 mm	VME-11704250	144.96	
11045353		13003-	P-U-15	60 mm	110 mm	VME-11704249	117.82	
11045355		13003-	P-U-15	40 mm	80 mm	VME-11704253	61.03	
11045356		13003-	P-U-15	60 mm	125 mm	VME-11704247	126.26	
11045357		13003-	P-U-15	60 mm	110 mm	VME-11704249	117.82	
11045358		13003-	P-U-15	80 mm	150 mm	VME-11704689	168.90	
11045360		13003-	P-U-15	50 mm	110 mm	VME-11704252	82.80	
11045361		13003-	P-U-15	50 mm	110 mm	VME-11704252	82.80	
11045363		13003-	P-U-15	60 mm	110 mm	VME-11704249	117.82	
11045366		13003-	P-U-15	60 mm	125 mm	VME-11704248	108.31	
11107333		13003-	P-UB-15	50 mm	90 mm	VME-11709029	73.41	
11107333		13003-	P-UB-15	50 mm	90 mm	VME-11709029-EX	75.84	
11107333		13003-17724	P-UB-15	50 mm	90 mm	VME-11709029	73.41	
11107333		13003-17724	P-UB-15	50 mm	90 mm	VME-11709029-EX	75.84	
11157116		13003-	P-U-15	32 mm	63 mm	VME-11704254	53.82	
11157116		13003-17724	P-U-15	32 mm	63 mm	VME-11704254	53.82	
11157999		13003-	P-U-15	40 mm	80 mm	VME-11704253	61.03	
11417176		13003-	P-U-15	60 mm	125 mm	VME-11704247	126.26	

VOLVO

NEW

LR - Long Reach SLF - Super Long Front QF - Quick Fit FS - Front Shovel MH - Material Handle AS - Articulate Slope

VOLVO

Replacement Kits For

Loaders - Wheel							
APPLICATION	CYL #	SERIAL #	CODE	ROD	BORE	KIT #	List \$
MODEL L150F							
HYDRAULIC	15155930	13003-	P-U-15	40 mm	80 mm	VME-11704253	61.03
LIFT	11107859	13003-	P-UB-10	90 mm	160 mm	VME-11709018	179.11
	11107859	13003-	P-UB-10	90 mm	160 mm	VME-11709018-EX	204.51
	11107859	13003-17724	P-UB-10	90 mm	160 mm	VME-11709018	179.11
	11107859	13003-17724	P-UB-10	90 mm	160 mm	VME-11709018-EX	204.51
TILT	11107860	13003-	P-UB-10	110 mm	230 mm	VME-11709026	273.79
	11107860	13003-	P-UB-10	110 mm	230 mm	VME-11709026-EX	359.75
	11107860	13003-17724	P-UB-10	110 mm	230 mm	VME-11709026	273.79
	11107860	13003-17724	P-UB-10	110 mm	230 mm	VME-11709026-EX	359.75
	11107861	13003-	P-UB-10	110 mm	230 mm	VME-11709026	273.79
	11107861	13003-	P-UB-10	110 mm	230 mm	VME-11709026-EX	359.75
	11107861	13003-17724	P-UB-10	110 mm	230 mm	VME-11709026	273.79
	11107861	13003-17724	P-UB-10	110 mm	230 mm	VME-11709026-EX	359.75
MODEL L150G							
HYDRAULIC	11045351	18501-, 22004-	P-U-15	50 mm	100 mm	VME-11704251	55.03
	11045352	18501-, 22004-	P-U-15	70 mm	140 mm	VME-11704250	144.96
	11045353	18501-, 22004-	P-U-15	60 mm	110 mm	VME-11704249	117.82
	11045355	18501-, 22004-	P-U-15	40 mm	80 mm	VME-11704253	61.03
	11045356	18501-, 22004-	P-U-15	60 mm	125 mm	VME-11704247	126.26
	11045357	18501-, 22004-	P-U-15	60 mm	110 mm	VME-11704249	117.82
	11045358	18501-, 22004-	P-U-15	80 mm	150 mm	VME-11704689	168.90
	11045360	18501-, 22004-	P-U-15	50 mm	110 mm	VME-11704252	82.80
	11045361	18501-, 22004-	P-U-15	50 mm	110 mm	VME-11704252	82.80
	11045363	18501-, 22004-	P-U-15	60 mm	110 mm	VME-11704249	117.82
	11045366	18501-, 22004-	P-U-15	60 mm	125 mm	VME-11704248	108.31
	11157999	18501-, 22004-	P-U-15	40 mm	80 mm	VME-11704253	61.03
	11417176	18501-, 22004-	P-U-15	60 mm	125 mm	VME-11704247	126.26
	15090184	18501-, 22004-	P-UB-10	60 mm	100 mm	VME-17254012	80.80
LIFT	15094209	18501-, 22004-	P-UB-10	90 mm	160 mm	VME-17264520	143.81
	17230567	18501-, 22004-	P-UB-10	90 mm	160 mm	VME-17264520	143.81
TILT	15086728	18501-, 22004-	P-UB-10	110 mm	220 mm	VME-17264860	277.46
	15129463	18501-, 22004-	P-UB-10	110 mm	220 mm	VME-17264860	277.46
	17230569	18501-, 22004-	P-UB-10	110 mm	220 mm	VME-17264860	277.46
	17230570	18501-, 22004-	P-UB-10	110 mm	220 mm	VME-17264860	277.46
MODEL L160							
ATTACHMENT	11005392	ALL	P-U-15	32 mm	63 mm	VME-6630661	98.24
	4782979	ALL	P-U-15	60 mm	125 mm	VME-11000107	155.53
	4782993	ALL	P-U-15	50 mm	100 mm	VME-6630513	77.15
	4784151	ALL	P-U-15	60 mm	125 mm	VME-11000107	155.53
	4784247	ALL	P-U-15	28 mm	63 mm	VME-6630749	49.12
	4833321	ALL	P-U-15	70 mm	140 mm	VME-6630650	119.31
LIFT	11005152	-2704;60117(USA)-	P-U-15	80 mm	170 mm	VME-6630510	219.40
	11005153	2705-2981	P-U-15	80 mm	170 mm	VME-6630510	219.40
	11005247	2982-;60208(USA)-	P-U-15	80 mm	160 mm	VME-11990158	200.40
	11005251	2982-	P-U-15	80 mm	160 mm	VME-11990158	200.40
	4833410	-2704;60117(USA)-	P-U-15	80 mm	170 mm	VME-6630510	219.40
	4833411	-2704	P-U-15	80 mm	170 mm	VME-6630510	219.40
STEERING	4782803	ALL	P-U-15	50 mm	110 mm	VME-6630511	78.69
TILT	4833412	ALL	P-U-15	70 mm	140 mm	VME-6630938	130.45
MODEL L180							
BRACKET	11005392	ALL	P-U-15	32 mm	63 mm	VME-6630661	98.24
LIFT	11088007	ALL	P-UB-14	90 mm	190 mm	VME-11990396	385.72
	11088007	ALL	P-UB-14	90 mm	190 mm	VME-11990396-EX	406.63
	11088007	ALL	Bushing	90 mm		VME-11005427	6.80
	11088007	ALL	Wear Ring		190 mm	VME-11088014	15.91

LR - Long Reach

SLF - Super Long Front

QF - Quick Fit

FS - Front Shovel

MH - Material Handle

AS - Articulate Slope

VOLVO

Replacement Kits For

Loaders - Wheel							
APPLICATION	CYL #	SERIAL #	CODE	ROD	BORE	KIT #	List \$
MODEL L180							
LIFT, HIGH	11088169	ALL	P-U-13	70 mm	140 mm	VME-11998574	289.93
	11088169	ALL	P-U-13	70 mm	140 mm	VME-11998574-EX	302.80
	11088169	ALL	Bushing	70 mm		VME-11088054	3.20
	11088169	ALL	Wear Ring		140 mm	VME-11088220	9.70
	11088171	ALL	P-U-13	100 mm	140 mm	VME-11998575	332.97
	11088171	ALL	P-U-13	100 mm	140 mm	VME-11998575-EX	359.33
	11088171	ALL	Bushing	100 mm		VME-11088222	6.04
	11088171	ALL	Wear Ring		140 mm	VME-11088220	9.70
	4782993	ALL	P-U-15	50 mm	100 mm	VME-6630513	77.15
4833321	ALL	P-U-15	70 mm	140 mm	VME-6630650	119.31	
STEERING	11005404	ALL	P-U-15	50 mm	100 mm	VME-11990398	67.03
	11005404	ALL	P-U-15	50 mm	100 mm	VME-11990398-EX	69.73
	11005404	ALL	Bushing	50 mm		VME-11088052	2.03
TILT	11088000	ALL	P-UB-14	120 mm	260 mm	VME-11990395	737.65
	11088000	ALL	P-UB-14	120 mm	260 mm	VME-11990395-EX	790.78
	11088000	ALL	Bushing	120 mm		VME-11088879	13.36
	11088000	ALL	Wear Ring		260 mm	VME-11088013	42.97
MODEL L180C							
LIFT	11088808	2533-4000;60465-70000	P-UB-14	90 mm	190 mm	VME-11990396	385.72
	11088808	2533-4000;60465-70000	P-UB-14	90 mm	190 mm	VME-11990396-EX	406.63
	11088808	2533-4000;60465-70000	Bushing	90 mm		VME-11005427	6.80
	11088808	2533-4000;60465-70000	Wear Ring		190 mm	VME-11088014	15.91
QUICK-FIT	11005392	2533-4000;60465-70000	P-U-15	32 mm	63 mm	VME-6630661	98.24
	11045365	2533-4000;60465-70000	P-U-15	32 mm	63 mm	VME-11704254	53.82
STEERING	11088297	2533-4000;60465-70000	P-U-15	50 mm	100 mm	VME-11990398	67.03
	11088297	2533-4000;60465-70000	P-U-15	50 mm	100 mm	VME-11990398-EX	69.73
	11088297	2533-4000;60465-70000	Bushing	50 mm		VME-11088052	2.03
TILT	11088806	2533-4000;60465-70000	P-UB-14	120 mm	260 mm	VME-11990395	737.65
	11088806	2533-4000;60465-70000	P-UB-14	120 mm	260 mm	VME-11990395-EX	790.78
	11088806	2533-4000;60465-70000	Bushing	120 mm		VME-11088879	13.36
	11088806	2533-4000;60465-70000	Wear Ring		260 mm	VME-11088013	42.97
	11088810	2533-4000;60465-70000	P-UB-14	120 mm	250 mm	VME-11701531	686.76
	11088810	2533-4000;60465-70000	P-UB-14	120 mm	250 mm	VME-11701531-EX	739.32
	11088810	2533-4000;60465-70000	Bushing	120 mm		VME-11088879	13.36
	11088810	2533-4000;60465-70000	Wear Ring		250 mm	VME-11005324	41.30
MODEL L180C BM							
LIFT	11088007	-1530;-60154	P-UB-14	90 mm	190 mm	VME-11990396	385.72
	11088007	-1530;-60154	P-UB-14	90 mm	190 mm	VME-11990396-EX	406.63
	11088007	-1530;-60154	Bushing	90 mm		VME-11005427	6.80
	11088007	-1530;-60154	Wear Ring		190 mm	VME-11088014	15.91
	11088498	1531-2473;60155-60476	P-UB-14	90 mm	190 mm	VME-11990396	385.72
	11088498	1531-2473;60155-60476	P-UB-14	90 mm	190 mm	VME-11990396-EX	406.63
	11088498	1531-2473;60155-60476	Bushing	90 mm		VME-11005427	6.80
	11088498	1531-2473;60155-60476	Wear Ring		190 mm	VME-11088014	15.91
	11088808	2474-;60477-	P-UB-14	90 mm	190 mm	VME-11990396	385.72
	11088808	2474-;60477-	P-UB-14	90 mm	190 mm	VME-11990396-EX	406.63
	11088808	2474-;60477-	Bushing	90 mm		VME-11005427	6.80
	11088808	2474-;60477-	Wear Ring		190 mm	VME-11088014	15.91
	QUICK-FIT	11005392	1836-2532;60301-60464	P-U-15	32 mm	63 mm	VME-6630661
STEERING	11005404	-1396;-60106	P-U-15	50 mm	100 mm	VME-11990398	67.03
	11005404	-1396;-60106	P-U-15	50 mm	100 mm	VME-11990398-EX	69.73
	11005404	-1396;-60106	Bushing	50 mm		VME-11088052	2.03
	11088297	1397-;60107-	P-U-15	50 mm	100 mm	VME-11990398	67.03
	11088297	1397-;60107-	P-U-15	50 mm	100 mm	VME-11990398-EX	69.73
	11088297	1397-;60107-	Bushing	50 mm		VME-11088052	2.03

LR - Long Reach

SLF - Super Long Front

QF - Quick Fit

FS - Front Shovel

MH - Material Handle

AS - Articulate Slope

Replacement Kits For

VOLVO

Loaders - Wheel							
APPLICATION	CYL #	SERIAL #	CODE	ROD	BORE	KIT #	List \$
MODEL L180C BM							
TILT	11088000	-1769;-60204	P-UB-14	120 mm	260 mm	VME-11990395	737.65
	11088000	-1769;-60204	P-UB-14	120 mm	260 mm	VME-11990395-EX	790.78
	11088000	-1769;-60204	Bushing	120 mm		VME-11088879	13.36
	11088000	-1769;-60204	Wear Ring		260 mm	VME-11088013	42.97
	11088475	1770-2470;60205-60477	P-UB-14	120 mm	260 mm	VME-11990395	737.65
	11088475	1770-2470;60205-60477	P-UB-14	120 mm	260 mm	VME-11990395-EX	790.78
	11088475	1770-2470;60205-60477	Bushing	120 mm		VME-11088879	13.36
	11088475	1770-2470;60205-60477	Wear Ring		260 mm	VME-11088013	42.97
	11088674	-2470;-60477	P-UB-14	120 mm	250 mm	VME-11701531	686.76
	11088674	-2470;-60477	P-UB-14	120 mm	250 mm	VME-11701531-EX	739.32
	11088674	-2470;-60477	Bushing	120 mm		VME-11088879	13.36
	11088674	-2470;-60477	Wear Ring		250 mm	VME-11005324	41.30
	11088806	2471;-60478-	P-UB-14	120 mm	260 mm	VME-11990395	737.65
	11088806	2471;-60478-	P-UB-14	120 mm	260 mm	VME-11990395-EX	790.78
	11088806	2471;-60478-	Bushing	120 mm		VME-11088879	13.36
	11088806	2471;-60478-	Wear Ring		260 mm	VME-11088013	42.97
	11088810	2471;-60478-	P-UB-14	120 mm	250 mm	VME-11701531	686.76
11088810	2471;-60478-	P-UB-14	120 mm	250 mm	VME-11701531-EX	739.32	
11088810	2471;-60478-	Bushing	120 mm		VME-11088879	13.36	
11088810	2471;-60478-	Wear Ring		250 mm	VME-11005324	41.30	
MODEL L180D							
LIFT	11088808	-4004	P-UB-14	90 mm	190 mm	VME-11990396	385.72
	11088808	-4004	P-UB-14	90 mm	190 mm	VME-11990396-EX	406.63
	11088808	-4004	Bushing	90 mm		VME-11005427	6.80
	11088808	-4004	Wear Ring		190 mm	VME-11088014	15.91
	11107229	4005;-62001-70000	P-UB-10	90 mm	190 mm	VME-11707026	284.90
	11107229	4005;-62001-70000	P-UB-10	90 mm	190 mm	VME-11707026-EX	305.81
	11107229	4005;-62001-70000	Bushing	90 mm		VME-11005427	6.80
11107229	4005;-62001-70000	Wear Ring		190 mm	VME-11088014	15.91	
QUICK-FIT	11045365	62001-70000;4002-5000	P-U-15	32 mm	63 mm	VME-11704254	53.82
	11157116	62001-70000;4002-5000	P-U-15	32 mm	63 mm	VME-11704254	53.82
STEERING	11088297	62001-70000;4002-5000	P-U-15	50 mm	100 mm	VME-11990398	67.03
	11088297	62001-70000;4002-5000	P-U-15	50 mm	100 mm	VME-11990398-EX	69.73
	11088297	62001-70000;4002-5000	Bushing	50 mm		VME-11088052	2.03
TILT	11088806	-4004	P-UB-14	120 mm	260 mm	VME-11990395	737.65
	11088806	-4004	P-UB-14	120 mm	260 mm	VME-11990395-EX	790.78
	11088806	-4004	Bushing	120 mm		VME-11088879	13.36
	11088806	-4004	Wear Ring		260 mm	VME-11088013	42.97
	11107324	4005;-62001-70000	P-UB-10	120 mm	260 mm	VME-11707031	602.67
	11107324	4005;-62001-70000	P-UB-10	120 mm	260 mm	VME-11707031-EX	658.71
	11107324	4005;-62001-70000	Bushing	120 mm		VME-11088879	13.36
	11107324	4005;-62001-70000	Wear Ring		260 mm	VME-11088013	42.97
	11107326	62001-70000;4002-5000	P-UB-10	120 mm	250 mm	VME-11707451	528.19
	11107326	62001-70000;4002-5000	P-UB-10	120 mm	250 mm	VME-11707451-EX	584.15
	11107326	62001-70000;4002-5000	Bushing	120 mm		VME-11088879	13.36
	11107326	62001-70000;4002-5000	Wear Ring		250 mm	VME-11005324	41.30
MODEL L180D HL							
LIFT	11088169	62001-70000;4002-5000	P-U-13	100 mm	140 mm	VME-11998575	332.97
	11088169	62001-70000;4002-5000	P-U-13	100 mm	140 mm	VME-11998575-EX	359.33
	11088169	62001-70000;4002-5000	Bushing	100 mm		VME-11088222	6.04
	11088169	62001-70000;4002-5000	Wear Ring		140 mm	VME-11088220	9.70
	11107595	62001-70000;4002-5000	P-U-13	100 mm	140 mm	VME-11998575	332.97
	11107595	62001-70000;4002-5000	P-U-13	100 mm	140 mm	VME-11998575-EX	359.33
	11107595	62001-70000;4002-5000	Bushing	100 mm		VME-11088222	6.04
11107595	62001-70000;4002-5000	Wear Ring		140 mm	VME-11088220	9.70	

LR - Long Reach

SLF - Super Long Front

QF - Quick Fit

FS - Front Shovel

MH - Material Handle

AS - Articulate Slope

Replacement Kits For

VOLVO

Loaders - Wheel							
APPLICATION	CYL #	SERIAL #	CODE	ROD	BORE	KIT #	List \$
MODEL L180D HL							
STEERING	11088297	62001-70000;4002-5000	P-U-15	50 mm	100 mm	VME-11990398	67.03
	11088297	62001-70000;4002-5000	P-U-15	50 mm	100 mm	VME-11990398-EX	69.73
	11088297	62001-70000;4002-5000	Bushing	50 mm		VME-11088052	2.03
TILT	11088171	62001-70000;4002-5000	P-U-13	70 mm	140 mm	VME-11998574	289.93
	11088171	62001-70000;4002-5000	P-U-13	70 mm	140 mm	VME-11998574-EX	302.80
	11088171	62001-70000;4002-5000	Bushing	70 mm		VME-11088054	3.20
	11088171	62001-70000;4002-5000	Wear Ring		140 mm	VME-11088220	9.70
	11107600	62001-70000;4002-5000	P-U-13	70 mm	140 mm	VME-11998574	289.93
	11107600	62001-70000;4002-5000	P-U-13	70 mm	140 mm	VME-11998574-EX	302.80
	11107600	62001-70000;4002-5000	Bushing	70 mm		VME-11088054	3.20
	11107600	62001-70000;4002-5000	Wear Ring		140 mm	VME-11088220	9.70
MODEL L180E							
LIFT	11107534	-5426	P-UB-10	90 mm	180 mm	VME-11709019	192.52
	11107534	-5426	P-UB-10	90 mm	180 mm	VME-11709019-EX	219.92
	11107534	-5426	Bushing	90 mm		VME-11005427	6.80
	11107534	-5426	Wear Ring		180 mm	VME-11107217	12.54
	11107862	5427-9999	P-UB-10	90 mm	180 mm	VME-11709019	192.52
	11107862	5427-9999	P-UB-10	90 mm	180 mm	VME-11709019-EX	219.92
	11107862	5427-9999	Bushing	90 mm		VME-11005427	6.80
	11107862	5427-9999	Wear Ring		180 mm	VME-11107217	12.54
QUICK-FIT	11157116	8001-9999	P-U-15	32 mm	63 mm	VME-11704254	53.82
STEERING	11107334	5001-9999;62501-69999	P-UB-15	50 mm	100 mm	VME-11709028	80.39
	11107334	5001-9999;62501-69999	P-UB-15	50 mm	100 mm	VME-11709028-EX	82.68
	11107334	5001-9999;62501-69999	Bushing	50 mm		VME-11088052	2.03
TILT	11107863	5001-9999;62501-69999	P-UB-10	120 mm	250 mm	VME-11709025	416.48
	11107863	5001-9999;62501-69999	P-UB-10	120 mm	250 mm	VME-11709025-EX	495.50
	11107863	5001-9999;62501-69999	Bushing	120 mm		VME-11088879	13.36
	11107863	5001-9999;62501-69999	Wear Ring		250 mm	VME-11107227	26.54
	11107864	5001-9999;62501-69999	P-UB-10	120 mm	250 mm	VME-11709025	416.48
	11107864	5001-9999;62501-69999	P-UB-10	120 mm	250 mm	VME-11709025-EX	495.50
	11107864	5001-9999;62501-69999	Bushing	120 mm		VME-11088879	13.36
	11107864	5001-9999;62501-69999	Wear Ring		250 mm	VME-11107227	26.54
MODEL L180E HL							
LIFT	11088169	5086-8000	P-U-13	100 mm	140 mm	VME-11998575	332.97
	11088169	5086-8000	P-U-13	100 mm	140 mm	VME-11998575-EX	359.33
	11088169	5086-8000	Bushing	100 mm		VME-11088222	6.04
	11088169	5086-8000	Wear Ring		140 mm	VME-11088220	9.70
	11107595	5086-9999	P-U-13	100 mm	140 mm	VME-11998575	332.97
	11107595	5086-9999	P-U-13	100 mm	140 mm	VME-11998575-EX	359.33
	11107595	5086-9999	Bushing	100 mm		VME-11088222	6.04
	11107595	5086-9999	Wear Ring		140 mm	VME-11088220	9.70
STEERING	11107334	5086-9999	P-UB-15	50 mm	100 mm	VME-11709028	80.39
	11107334	5086-9999	P-UB-15	50 mm	100 mm	VME-11709028-EX	82.68
	11107334	5086-9999	Bushing	50 mm		VME-11088052	2.03
TILT	11088171	5086-8000	P-U-13	70 mm	140 mm	VME-11998574	289.93
	11088171	5086-8000	P-U-13	70 mm	140 mm	VME-11998574-EX	302.80
	11088171	5086-8000	Bushing	70 mm		VME-11088054	3.20
	11088171	5086-8000	Wear Ring		140 mm	VME-11088220	9.70
	11107600	5086-9999	P-U-13	70 mm	140 mm	VME-11998574	289.93
	11107600	5086-9999	P-U-13	70 mm	140 mm	VME-11998574-EX	302.80
	11107600	5086-9999	Bushing	70 mm		VME-11088054	3.20
	11107600	5086-9999	Wear Ring		140 mm	VME-11088220	9.70
MODEL L180F							
HYDRAULIC	11045351	11004-	P-U-15	50 mm	100 mm	VME-11704251	55.03
	11045352	11004-	P-U-15	70 mm	140 mm	VME-11704250	144.96

LR - Long Reach

SLF - Super Long Front

QF - Quick Fit

FS - Front Shovel

MH - Material Handle

AS - Articulate Slope

VOLVO

Replacement Kits For

Loaders - Wheel								
APPLICATION	CYL #	SERIAL #	CODE	ROD	BORE	KIT #	List \$	
NEW MODEL L180F								
HYDRAULIC	11045355	11004-	P-U-15	40 mm	80 mm	VME-11704253	61.03	
	11045358	11004-	P-U-15	80 mm	150 mm	VME-11704689	168.90	
	11045360	11004-	P-U-15	50 mm	110 mm	VME-11704252	82.80	
	11045361	11004-	P-U-15	50 mm	110 mm	VME-11704252	82.80	
	11045366	11004-	P-U-15	60 mm	125 mm	VME-11704248	108.31	
	11107334	11004-	P-UB-15	50 mm	100 mm	VME-11709028	80.39	
	11107334	11004-	P-UB-15	50 mm	100 mm	VME-11709028-EX	82.68	
	11107334	11004-15577	P-UB-15	50 mm	100 mm	VME-11709028	80.39	
	11107334	11004-15577	P-UB-15	50 mm	100 mm	VME-11709028-EX	82.68	
	11156699	11004-	I-UB-10	32 mm	50 mm	VME-11709821	84.03	
	11156701	11004-	I-UB-10	32 mm	50 mm	VME-11709821	84.03	
	11157116	11004-	P-U-15	32 mm	63 mm	VME-11704254	53.82	
	11157116	11004-15577	P-U-15	32 mm	63 mm	VME-11704254	53.82	
	11157999	11004-	P-U-15	40 mm	80 mm	VME-11704253	61.03	
	11417176	11004-	P-U-15	60 mm	125 mm	VME-11704247	126.26	
	15155930	11004-	P-U-15	40 mm	80 mm	VME-11704253	61.03	
	LIFT	11107862	11004-	P-UB-10	90 mm	180 mm	VME-11709019	192.52
11107862		11004-	P-UB-10	90 mm	180 mm	VME-11709019-EX	219.92	
11107862		11004-15577	P-UB-10	90 mm	180 mm	VME-11709019	192.52	
11107862		11004-15577	P-UB-10	90 mm	180 mm	VME-11709019-EX	219.92	
TILT	11107863	11004-	P-UB-10	120 mm	250 mm	VME-11709025	416.48	
	11107863	11004-	P-UB-10	120 mm	250 mm	VME-11709025-EX	495.50	
	11107863	11004-15577	P-UB-10	120 mm	250 mm	VME-11709025	416.48	
	11107863	11004-15577	P-UB-10	120 mm	250 mm	VME-11709025-EX	495.50	
	11107864	11004-	P-UB-10	120 mm	250 mm	VME-11709025	416.48	
	11107864	11004-	P-UB-10	120 mm	250 mm	VME-11709025-EX	495.50	
	11107864	11004-15577	P-UB-10	120 mm	250 mm	VME-11709025	416.48	
	11107864	11004-15577	P-UB-10	120 mm	250 mm	VME-11709025-EX	495.50	
NEW MODEL L180F HL								
HYDRAULIC	11045351		P-U-15	50 mm	100 mm	VME-11704251	55.03	
	11045351	11004-15577	P-U-15	50 mm	100 mm	VME-11704251	55.03	
	11045352		P-U-15	70 mm	140 mm	VME-11704250	144.96	
	11045353		P-U-15	60 mm	110 mm	VME-11704249	117.82	
	11045355		P-U-15	40 mm	80 mm	VME-11704253	61.03	
	11045356		P-U-15	60 mm	125 mm	VME-11704247	126.26	
	11045357		P-U-15	60 mm	110 mm	VME-11704249	117.82	
	11045358		P-U-15	80 mm	150 mm	VME-11704689	168.90	
	11045360		P-U-15	50 mm	110 mm	VME-11704252	82.80	
	11045361		P-U-15	50 mm	110 mm	VME-11704252	82.80	
	11045363		P-U-15	60 mm	110 mm	VME-11704249	117.82	
	11045366		P-U-15	60 mm	125 mm	VME-11704248	108.31	
	11107334	11004-15577	P-UB-15	50 mm	100 mm	VME-11709028	80.39	
	11107334	11004-15577	P-UB-15	50 mm	100 mm	VME-11709028-EX	82.68	
	11156699		I-UB-10	32 mm	50 mm	VME-11709821	84.03	
	11156701		I-UB-10	32 mm	50 mm	VME-11709821	84.03	
	11157999		P-U-15	40 mm	80 mm	VME-11704253	61.03	
	11417176		P-U-15	60 mm	125 mm	VME-11704247	126.26	
	15155930		P-U-15	40 mm	80 mm	VME-11704253	61.03	
	LIFT	11107889	11004-15577	P-UB-10	110 mm	140 mm	VME-17253752	260.17
	TILT	11107906	11004-15577	P-UB-10	70 mm	140 mm	VME-17253805	171.09
	NEW MODEL L180G							
	HYDRAULIC	11045351	16001-, 19004-	P-U-15	50 mm	100 mm	VME-11704251	55.03
11045352		16001-, 19004-	P-U-15	70 mm	140 mm	VME-11704250	144.96	
11045353		16001-, 19004-	P-U-15	60 mm	110 mm	VME-11704249	117.82	
11045355		16001-, 19004-	P-U-15	40 mm	80 mm	VME-11704253	61.03	

LR - Long Reach

SLF - Super Long Front

QF - Quick Fit

FS - Front Shovel

MH - Material Handle

AS - Articulate Slope

VOLVO

Replacement Kits For

Loaders - Wheel							
APPLICATION	CYL #	SERIAL #	CODE	ROD	BORE	KIT #	List \$
MODEL L180G							
HYDRAULIC	11045356	16001-, 19004-	P-U-15	60 mm	125 mm	VME-11704247	126.26
	11045357	16001-, 19004-	P-U-15	60 mm	110 mm	VME-11704249	117.82
	11045358	16001-, 19004-	P-U-15	80 mm	150 mm	VME-11704689	168.90
	11045360	16001-, 19004-	P-U-15	50 mm	110 mm	VME-11704252	82.80
	11045361	16001-, 19004-	P-U-15	50 mm	110 mm	VME-11704252	82.80
	11045363	16001-, 19004-	P-U-15	60 mm	110 mm	VME-11704249	117.82
	11045366	16001-, 19004-	P-U-15	60 mm	125 mm	VME-11704248	108.31
	11157999	16001-, 19004-	P-U-15	40 mm	80 mm	VME-11704253	61.03
	11417176	16001-, 19004-	P-U-15	60 mm	125 mm	VME-11704247	126.26
15090184	16001-, 19004-	P-UB-10	60 mm	100 mm	VME-17254012	80.80	
LIFT	15094104	16001-, 19004-	P-UB-10	90 mm	180 mm	VME-17238417	157.59
TILT	15086745	16001-, 19004-	P-UB-10	120 mm	240 mm	VME-17238415	349.02
	15131243	16001-, 19004-	P-UB-10	120 mm	240 mm	VME-17238415	349.02
	17230577	16001-, 19004-	P-UB-10	120 mm	240 mm	VME-17238415	349.02
	17230578	16001-, 19004-	P-UB-10	120 mm	240 mm	VME-17238415	349.02
MODEL L190							
TILT	2562742	828A101-828A672;828AC673-828AC788	P-UB-10	2-3/4	6	VME-2542568	240.21
MODEL L220D							
LIFT	11107552	1001-10000	P-UB-10	90 mm	190 mm	VME-11705882	205.78
	11107552	1001-10000	P-UB-10	90 mm	190 mm	VME-11705882-EX	242.78
	11107552	1001-10000	Bushing	90 mm		VME-11005427	6.80
	11107552	1001-10000	Wear Ring		190 mm	VME-11107168	13.11
QUICK-FIT	11157116	1001-10000	P-U-15	32 mm	63 mm	VME-11704254	53.82
STEERING	11107057	1001-10000	P-U-10	50 mm	100 mm	VME-11703689	79.47
	11107057	1001-10000	P-U-10	50 mm	100 mm	VME-11703689-EX	86.58
	11107057	1001-10000	Bushing	50 mm		VME-11088052	2.03
	11107057	1001-10000	Wear Ring		100 mm	VME-11088148	4.71
TILT	11107050	1001-10000	P-UB-14	120 mm	260 mm	VME-11703860	655.07
	11107050	1001-10000	P-UB-14	120 mm	260 mm	VME-11703860-EX	733.91
	11107050	1001-10000	Bushing	120 mm		VME-11088496	12.85
	11107050	1001-10000	Wear Ring		260 mm	VME-11107041	55.29
	11107118	1001-10000	P-UB-14	120 mm	260 mm	VME-11703860	655.07
	11107118	1001-10000	P-UB-14	120 mm	260 mm	VME-11703860-EX	733.91
	11107118	1001-10000	Bushing	120 mm		VME-11088496	12.85
	11107118	1001-10000	Wear Ring		260 mm	VME-11107041	55.29
	11107328	1001-10000	P-UB-10	120 mm	260 mm	VME-11707027	579.70
	11107328	1001-10000	P-UB-10	120 mm	260 mm	VME-11707027-EX	660.14
	11107328	1001-10000	Bushing	120 mm		VME-11088496	12.85
	11107328	1001-10000	Wear Ring		260 mm	VME-11107332	27.63
	11107330	1001-10000	P-UB-10	120 mm	260 mm	VME-11707027	579.70
	11107330	1001-10000	P-UB-10	120 mm	260 mm	VME-11707027-EX	660.14
	11107330	1001-10000	Bushing	120 mm		VME-11088496	12.85
	11107330	1001-10000	Wear Ring		260 mm	VME-11107332	27.63
MODEL L220E							
LIFT	11107794	2005-3566;4003-9999	P-UB-10	90 mm	190 mm	VME-11705882	205.78
	11107794	2005-3566;4003-9999	P-UB-10	90 mm	190 mm	VME-11705882-EX	242.78
	11107794	2005-3566;4003-9999	Bushing	90 mm		VME-11005427	6.80
	11107794	2005-3566;4003-9999	Wear Ring		190 mm	VME-11107168	13.11
STEERING	11107793	2005-3566;4003-9999	P-UB-10	60 mm	100 mm	VME-11714561	110.71
	11107793	2005-3566;4003-9999	P-UB-10	60 mm	100 mm	VME-11714561-EX	116.52
	11107793	2005-3566;4003-9999	Bushing	60 mm		VME-11088053	2.73
	11107793	2005-3566;4003-9999	Wear Ring		100 mm	VME-11088148	4.71
TILT	11107795	2005-3566;4003-9999	P-UB-10	120 mm	260 mm	VME-11707027	579.70
	11107795	2005-3566;4003-9999	P-UB-10	120 mm	260 mm	VME-11707027-EX	660.14
	11107795	2005-3566;4003-9999	Bushing	120 mm		VME-11088496	12.85

LR - Long Reach

SLF - Super Long Front

QF - Quick Fit

FS - Front Shovel

MH - Material Handle

AS - Articulate Slope

VOLVO

Replacement Kits For

Loaders - Wheel							
APPLICATION	CYL #	SERIAL #	CODE	ROD	BORE	KIT #	List \$
MODEL L220E							
TILT	11107795	2005-3566;4003-9999	Wear Ring		260 mm	VME-11107332	27.63
	11107829	2005-3566;4003-9999	P-UB-10	120 mm	260 mm	VME-11707027	579.70
	11107829	2005-3566;4003-9999	P-UB-10	120 mm	260 mm	VME-11707027-EX	660.14
	11107829	2005-3566;4003-9999	Bushing	120 mm		VME-11088496	12.85
	11107829	2005-3566;4003-9999	Wear Ring		260 mm	VME-11107332	27.63
MODEL L220F							
HYDRAULIC	11045351	6005-	P-U-15	50 mm	100 mm	VME-11704251	55.03
	11045352	6005-	P-U-15	70 mm	140 mm	VME-11704250	144.96
	11045353	6005-	P-U-15	60 mm	110 mm	VME-11704249	117.82
	11045355	6005-	P-U-15	40 mm	80 mm	VME-11704253	61.03
	11045356	6005-	P-U-15	60 mm	125 mm	VME-11704247	126.26
	11045357	6005-	P-U-15	60 mm	110 mm	VME-11704249	117.82
	11045358	6005-	P-U-15	80 mm	150 mm	VME-11704689	168.90
	11045360	6005-	P-U-15	50 mm	110 mm	VME-11704252	82.80
	11045361	6005-	P-U-15	50 mm	110 mm	VME-11704252	82.80
	11045363	6005-	P-U-15	60 mm	110 mm	VME-11704249	117.82
	11045366	6005-	P-U-15	60 mm	125 mm	VME-11704248	108.31
	11107793	6005-	P-UB-10	60 mm	100 mm	VME-11714561	110.71
	11107793	6005-	P-UB-10	60 mm	100 mm	VME-11714561-EX	116.52
	11156699	6005-	I-UB-10	32 mm	50 mm	VME-11709821	84.03
	11156701	6005-	I-UB-10	32 mm	50 mm	VME-11709821	84.03
	11157999	6005-	P-U-15	40 mm	80 mm	VME-11704253	61.03
	11417176	6005-	P-U-15	60 mm	125 mm	VME-11704247	126.26
	15010209	6005-8485	P-UB-10	60 mm	100 mm	VME-11714561	110.71
	15010209	6005-8485	P-UB-10	60 mm	100 mm	VME-11714561-EX	116.52
	15155930	6005-	P-U-15	40 mm	80 mm	VME-11704253	61.03
LIFT	11107794	6005-	P-UB-10	90 mm	190 mm	VME-11705882	205.78
	11107794	6005-	P-UB-10	90 mm	190 mm	VME-11705882-EX	242.78
	11107794	6005-8485	P-UB-10	90 mm	190 mm	VME-11705882	205.78
	11107794	6005-8485	P-UB-10	90 mm	190 mm	VME-11705882-EX	242.78
TILT	11107795	6005-	P-UB-10	120 mm	260 mm	VME-11707027	579.70
	11107795	6005-	P-UB-10	120 mm	260 mm	VME-11707027-EX	660.14
	11107795	6005-8485	P-UB-10	120 mm	260 mm	VME-11707027	579.70
	11107795	6005-8485	P-UB-10	120 mm	260 mm	VME-11707027-EX	660.14
	11107829	6005-	P-UB-10	120 mm	260 mm	VME-11707027	579.70
	11107829	6005-	P-UB-10	120 mm	260 mm	VME-11707027-EX	660.14
	11107829	6005-8485	P-UB-10	120 mm	260 mm	VME-11707027	579.70
	11107829	6005-8485	P-UB-10	120 mm	260 mm	VME-11707027-EX	660.14
MODEL L220G							
HYDRAULIC	11045351	9001-, 12004-	P-U-15	50 mm	100 mm	VME-11704251	55.03
	11045352	9001-, 12004-	P-U-15	70 mm	140 mm	VME-11704250	144.96
	11045353	9001-, 12004-	P-U-15	60 mm	110 mm	VME-11704249	117.82
	11045355	9001-, 12004-	P-U-15	40 mm	80 mm	VME-11704253	61.03
	11045356	9001-, 12004-	P-U-15	60 mm	125 mm	VME-11704247	126.26
	11045357	9001-, 12004-	P-U-15	60 mm	110 mm	VME-11704249	117.82
	11045358	9001-, 12004-	P-U-15	80 mm	150 mm	VME-11704689	168.90
	11045360	9001-, 12004-	P-U-15	50 mm	110 mm	VME-11704252	82.80
	11045361	9001-, 12004-	P-U-15	50 mm	110 mm	VME-11704252	82.80
	11045363	9001-, 12004-	P-U-15	60 mm	110 mm	VME-11704249	117.82
	11045366	9001-, 12004-	P-U-15	60 mm	125 mm	VME-11704248	108.31
	11157999	9001-, 12004-	P-U-15	40 mm	80 mm	VME-11704253	61.03
	11417176	9001-, 12004-	P-U-15	60 mm	125 mm	VME-11704247	126.26
	15090184	9001-, 12004-	P-UB-10	60 mm	100 mm	VME-17254012	80.80
LIFT	15093342	9001-, 12004-	P-UB-10	90 mm	190 mm	VME-17238406	235.19
TILT	15086624	9001-, 12004-	P-UB-10	120 mm	250 mm	VME-17238353	490.09

LR - Long Reach

SLF - Super Long Front

QF - Quick Fit

FS - Front Shovel

MH - Material Handle

AS - Articulate Slope

VOLVO

Replacement Kits For

Loaders - Wheel							
APPLICATION	CYL #	SERIAL #	CODE	ROD	BORE	KIT #	List \$
MODEL L220G							
TILT	15128783	9001-, 12004-	P-UB-10	120 mm	250 mm	VME-17238353	490.09
MODEL L250G							
HYDRAULIC	11045351	1002-, 3004-	P-U-15	50 mm	100 mm	VME-11704251	55.03
	11045352	1002-, 3004-	P-U-15	70 mm	140 mm	VME-11704250	144.96
	11045353	1002-, 3004-	P-U-15	60 mm	110 mm	VME-11704249	117.82
	11045355	1002-, 3004-	P-U-15	40 mm	80 mm	VME-11704253	61.03
	11045356	1002-, 3004-	P-U-15	60 mm	125 mm	VME-11704247	126.26
	11045357	1002-, 3004-	P-U-15	60 mm	110 mm	VME-11704249	117.82
	11045358	1002-, 3004-	P-U-15	80 mm	150 mm	VME-11704689	168.90
	11045360	1002-, 3004-	P-U-15	50 mm	110 mm	VME-11704252	82.80
	11045361	1002-, 3004-	P-U-15	50 mm	110 mm	VME-11704252	82.80
	11045363	1002-, 3004-	P-U-15	60 mm	110 mm	VME-11704249	117.82
	11045366	1002-, 3004-	P-U-15	60 mm	125 mm	VME-11704248	108.31
	11157999	1002-, 3004-	P-U-15	40 mm	80 mm	VME-11704253	61.03
	11417176	1002-, 3004-	P-U-15	60 mm	125 mm	VME-11704247	126.26
	15090184	1002-, 3004-	P-UB-10	60 mm	100 mm	VME-17254012	80.80
LIFT	15176546	1002-, 3004-	P-UB-10	110 mm	190 mm	VME-17265005	306.75
TILT	15086562	1002-, 3004-	P-UB-10	120 mm	220 mm	VME-17265044	443.18
MODEL L270							
LIFT	2561435	827A101-	P-UB-10	4	9	VME-2542574	363.82
STEERING	12579007	827A101-	P-UB-10	2-3/4	5	VME-2562115	227.61
	2559738	827A101-	P-UB-10	2-3/4	5	VME-2562115	227.61
TILT	2561422	827A101-	P-UB-10	3-1/2	7-1/2	VME-2562116	236.74
MODEL L270B							
LIFT	2561435	827BC00501-	P-UB-10	4	9	VME-2542574	363.82
STEERING	12579007	827BC00501-	P-UB-10	2-3/4	5	VME-2562115	227.61
TILT	2561422	827BC00501-	P-UB-10	3-1/2	7-1/2	VME-2562116	236.74
MODEL L320							
LIFT	2558980	811A101-;811AC00651-	P-UB-10	4-1/2	9	VME-2562117	324.50
STEERING	12579807	811A101-;811AC00651-	P-UB-10	2-3/4	5	VME-2562115	227.61
TILT	2559495	811A101-;811AC00651-	P-UB-10	3-1/2	7-1/2	VME-2562116	236.74
MODEL L330C							
LIFT	11088626	60001-60086	P-UB-14	120 mm	230 mm	VME-11707904	655.78
	11088626	60001-60086	P-UB-14	120 mm	230 mm	VME-11707904-EX	932.28
	11088626	60001-60086	Bushing	120 mm		VME-11088496	12.85
	11088626	60001-60086	Wear Ring		230 mm	VME-11088323	56.47
	11088795	60001-61000	P-UB-14	120 mm	230 mm	VME-11707904	655.78
	11088795	60001-61000	P-UB-14	120 mm	230 mm	VME-11707904-EX	932.28
	11088795	60001-61000	Bushing	120 mm		VME-11088496	12.85
	11088795	60001-61000	Wear Ring		230 mm	VME-11088793	101.53
	11088795	60188-61000	P-UB-14	120 mm	230 mm	VME-11707904	655.78
	11088795	60188-61000	P-UB-14	120 mm	230 mm	VME-11707904-EX	932.28
	11088795	60188-61000	Bushing	120 mm		VME-11088496	12.85
	11088795	60188-61000	Wear Ring		230 mm	VME-11088793	101.53
STEERING	11107381	60188-61000	P-UB-15	70 mm	125 mm	VME-15012903	176.18
	11107381	60188-61000	P-UB-15	70 mm	125 mm	VME-15012903-EX	181.89
	11107381	60188-61000	Bushing	70 mm		VME-11088054	3.20
	11107382	60188-61000	P-UB-15	70 mm	125 mm	VME-15012903	176.18
	11107382	60188-61000	P-UB-15	70 mm	125 mm	VME-15012903-EX	181.89
	11107382	60188-61000	Bushing	70 mm		VME-11088054	3.20
STEERING LH	11088529	60001-61000	P-UB-15	70 mm	125 mm	VME-11707902	144.58
STEERING RH	11088531	60001-61000	P-UB-15	70 mm	125 mm	VME-11707902	144.58
TILT	11088625	60001-61000	P-UB-14	90 mm	190 mm	VME-11707903	405.80
	11088625	60001-61000	P-UB-14	90 mm	190 mm	VME-11707903-EX	453.62
	11088625	60001-61000	Bushing	90 mm		VME-11088249	20.61

LR - Long Reach SLF - Super Long Front QF - Quick Fit FS - Front Shovel MH - Material Handle AS - Articulate Slope

VOLVO

VOLVO

Replacement Kits For

Loaders - Wheel							
APPLICATION	CYL #	SERIAL #	CODE	ROD	BORE	KIT #	List \$
MODEL L330C							
TILT	11088625	60001-61000	Wear Ring		190 mm	VME-11088014	15.91
	11088625	60188-61000	P-UB-14	90 mm	190 mm	VME-11707903	405.80
	11088625	60188-61000	P-UB-14	90 mm	190 mm	VME-11707903-EX	453.62
	11088625	60188-61000	Bushing	90 mm		VME-11088249	20.61
	11088625	60188-61000	Wear Ring		190 mm	VME-11088014	15.91
MODEL L330C BM							
LIFT	11088626	-60086	P-UB-14	120 mm	230 mm	VME-11707904	655.78
	11088626	-60086	P-UB-14	120 mm	230 mm	VME-11707904-EX	932.28
	11088626	-60086	Bushing	120 mm		VME-11088496	12.85
	11088626	-60086	Wear Ring		230 mm	VME-11088323	56.47
	11088795	60087-	P-UB-14	120 mm	230 mm	VME-11707904	655.78
	11088795	60087-	P-UB-14	120 mm	230 mm	VME-11707904-EX	932.28
	11088795	60087-	Bushing	120 mm		VME-11088496	12.85
STEERING	11088795	60087-	Wear Ring		230 mm	VME-11088793	101.53
	11107381	60001-60187	P-UB-15	70 mm	125 mm	VME-15012903	176.18
	11107381	60001-60187	P-UB-15	70 mm	125 mm	VME-15012903-EX	181.89
	11107381	60001-60187	Bushing	70 mm		VME-11088054	3.20
	11107382	60001-60187	P-UB-15	70 mm	125 mm	VME-15012903	176.18
	11107382	60001-60187	P-UB-15	70 mm	125 mm	VME-15012903-EX	181.89
TILT	11107382	60001-60187	Bushing	70 mm		VME-11088054	3.20
	11088625	60001-60187	P-UB-14	90 mm	190 mm	VME-11707903	405.80
	11088625	60001-60187	P-UB-14	90 mm	190 mm	VME-11707903-EX	453.62
	11088625	60001-60187	Bushing	90 mm		VME-11088249	20.61
11088625	60001-60187	Wear Ring		190 mm	VME-11088014	15.91	
MODEL L330C LL							
LIFT	11088626	60001-60086	P-UB-14	120 mm	230 mm	VME-11707904	655.78
	11088626	60001-60086	P-UB-14	120 mm	230 mm	VME-11707904-EX	932.28
	11088626	60001-60086	Bushing	120 mm		VME-11088496	12.85
	11088626	60001-60086	Wear Ring		230 mm	VME-11088323	56.47
	11088795	60001-61000	P-UB-14	120 mm	230 mm	VME-11707904	655.78
	11088795	60001-61000	P-UB-14	120 mm	230 mm	VME-11707904-EX	932.28
	11088795	60001-61000	Bushing	120 mm		VME-11088496	12.85
	11088795	60001-61000	Wear Ring		230 mm	VME-11088793	101.53
	11088795	68052-70000	P-UB-14	120 mm	230 mm	VME-11707904	655.78
	11088795	68052-70000	P-UB-14	120 mm	230 mm	VME-11707904-EX	932.28
	11088795	68052-70000	Bushing	120 mm		VME-11088496	12.85
	11088795	68052-70000	Wear Ring		230 mm	VME-11088793	101.53
	STEERING	11107381	68052-70000	P-UB-15	70 mm	125 mm	VME-15012903
11107381		68052-70000	P-UB-15	70 mm	125 mm	VME-15012903-EX	181.89
11107381		68052-70000	Bushing	70 mm		VME-11088054	3.20
11107382		68052-70000	P-UB-15	70 mm	125 mm	VME-15012903	176.18
11107382		68052-70000	P-UB-15	70 mm	125 mm	VME-15012903-EX	181.89
11107382		68052-70000	Bushing	70 mm		VME-11088054	3.20
STEERING LH	11088529	60001-61000	P-UB-15	70 mm	125 mm	VME-11707902	144.58
STEERING RH	11088531	60001-61000	P-UB-15	70 mm	125 mm	VME-11707902	144.58
TILT	11088625	60001-61000	P-UB-14	90 mm	190 mm	VME-11707903	405.80
	11088625	60001-61000	P-UB-14	90 mm	190 mm	VME-11707903-EX	453.62
	11088625	60001-61000	Bushing	90 mm		VME-11088249	20.61
	11088625	60001-61000	Wear Ring		190 mm	VME-11088014	15.91
	11088625	68052-70000	P-UB-14	90 mm	190 mm	VME-11707903	405.80
	11088625	68052-70000	P-UB-14	90 mm	190 mm	VME-11707903-EX	453.62
	11088625	68052-70000	Bushing	90 mm		VME-11088249	20.61
	11088625	68052-70000	Wear Ring		190 mm	VME-11088014	15.91
MODEL L330C LL BM							
LIFT	11088626	-60086	P-UB-14	120 mm	230 mm	VME-11707904	655.78

LR - Long Reach

SLF - Super Long Front

QF - Quick Fit

FS - Front Shovel

MH - Material Handle

AS - Articulate Slope

VOLVO

Replacement Kits For

VOLVO

Loaders - Wheel							
APPLICATION	CYL #	SERIAL #	CODE	ROD	BORE	KIT #	List \$
MODEL L330C LL BM							
LIFT	11088626	-60086	P-UB-14	120 mm	230 mm	VME-11707904-EX	932.28
	11088626	-60086	Bushing	120 mm		VME-11088496	12.85
	11088626	-60086	Wear Ring		230 mm	VME-11088323	56.47
	11088795	60087-	P-UB-14	120 mm	230 mm	VME-11707904	655.78
	11088795	60087-	P-UB-14	120 mm	230 mm	VME-11707904-EX	932.28
	11088795	60087-	Bushing	120 mm		VME-11088496	12.85
STEERING	11107381	60001-60189	Wear Ring		230 mm	VME-11088793	101.53
	11107381	60001-60189	P-UB-15	70 mm	125 mm	VME-15012903	176.18
	11107381	60001-60189	P-UB-15	70 mm	125 mm	VME-15012903-EX	181.89
	11107381	60001-60189	Bushing	70 mm		VME-11088054	3.20
	11107382	60001-60189	P-UB-15	70 mm	125 mm	VME-15012903	176.18
	11107382	60001-60189	P-UB-15	70 mm	125 mm	VME-15012903-EX	181.89
TILT	11088625	60001-60189	Bushing	70 mm		VME-11088054	3.20
	11088625	60001-60189	P-UB-14	90 mm	190 mm	VME-11707903	405.80
	11088625	60001-60189	P-UB-14	90 mm	190 mm	VME-11707903-EX	453.62
	11088625	60001-60189	Bushing	90 mm		VME-11088249	20.61
	11088625	60001-60189	Wear Ring		190 mm	VME-11088014	15.91
MODEL L330D							
LIFT	11107383	61001-70000	P-UB-10	110 mm	200 mm	VME-11707905	766.59
STEERING	11107981	61001-70000	P-UB-15	70 mm	125 mm	VME-15012903	176.18
	11107981	61001-70000	P-UB-15	70 mm	125 mm	VME-15012903-EX	181.89
	11107981	61001-70000	Bushing	70 mm		VME-11088054	3.20
	11107982	61001-70000	P-UB-15	70 mm	125 mm	VME-15012903	176.18
	11107982	61001-70000	P-UB-15	70 mm	125 mm	VME-15012903-EX	181.89
	11107982	61001-70000	Bushing	70 mm		VME-11088054	3.20
TILT	11107148	-61084	P-UB-10	90 mm	170 mm	VME-11709226	320.76
	11107494	61085-62017	P-UB-10	90 mm	170 mm	VME-11709226	320.76
	11107505	62018-	P-UB-10	90 mm	170 mm	VME-11709226	320.76
MODEL L330E							
LIFT	11107579	-62117	P-UB-10	110 mm	200 mm	VME-11707905	766.59
	11107865	62118-	P-UB-10	110 mm	200 mm	VME-11707905	766.59
	11107867	62006-99999	P-UB-10	120 mm	230 mm	VME-11712156	596.42
STEERING	11107381	62006-99999	P-UB-15	70 mm	125 mm	VME-15012903	176.18
	11107381	62006-99999	P-UB-15	70 mm	125 mm	VME-15012903-EX	181.89
	11107381	62006-99999	Bushing	70 mm		VME-11088054	3.20
	11107382	62006-99999	P-UB-15	70 mm	125 mm	VME-15012903	176.18
	11107382	62006-99999	P-UB-15	70 mm	125 mm	VME-15012903-EX	181.89
	11107382	62006-99999	Bushing	70 mm		VME-11088054	3.20
	11107929	62006-99999	P-UB-15	70 mm	125 mm	VME-15012903	176.18
	11107929	62006-99999	P-UB-15	70 mm	125 mm	VME-15012903-EX	181.89
	11107929	62006-99999	Bushing	70 mm		VME-11088054	3.20
	11107930	62006-99999	P-UB-15	70 mm	125 mm	VME-15012903	176.18
	11107930	62006-99999	P-UB-15	70 mm	125 mm	VME-15012903-EX	181.89
	11107930	62006-99999	Bushing	70 mm		VME-11088054	3.20
	TILT	11088625	62006-99999	P-UB-14	90 mm	190 mm	VME-11707903
11088625		62006-99999	P-UB-14	90 mm	190 mm	VME-11707903-EX	453.62
11088625		62006-99999	Bushing	90 mm		VME-11088249	20.61
11088625		62006-99999	Wear Ring		190 mm	VME-11088014	15.91
11107866		62006-99999	P-UB-10	90 mm	170 mm	VME-11709226	320.76
MODEL L350F							
HYDRAULIC	11045351	1001-10000	P-U-15	50 mm	100 mm	VME-11704251	55.03
	11045352	1001-10000	P-U-15	70 mm	140 mm	VME-11704250	144.96
	11045353	1001-10000	P-U-15	60 mm	110 mm	VME-11704249	117.82
	11045355	1001-10000	P-U-15	40 mm	80 mm	VME-11704253	61.03
	11045356	1001-10000	P-U-15	60 mm	125 mm	VME-11704247	126.26

LR - Long Reach SLF - Super Long Front QF - Quick Fit FS - Front Shovel MH - Material Handle AS - Articulate Slope



Replacement Kits For

VOLVO

Loaders - Wheel

APPLICATION	CYL #	SERIAL #	CODE	ROD	BORE	KIT #	List \$
MODEL L350F							
HYDRAULIC	11045357	1001-10000	P-U-15	60 mm	110 mm	VME-11704249	117.82
	11045358	1001-10000	P-U-15	80 mm	150 mm	VME-11704689	168.90
	11045360	1001-10000	P-U-15	50 mm	110 mm	VME-11704252	82.80
	11045361	1001-10000	P-U-15	50 mm	110 mm	VME-11704252	82.80
	11045363	1001-10000	P-U-15	60 mm	110 mm	VME-11704249	117.82
	11045366	1001-10000	P-U-15	60 mm	125 mm	VME-11704248	108.31
	11107746	1001-10000	P-UB-10	70 mm	110 mm	VME-11716047	93.76
	11107746	1001-10000	P-UB-10	70 mm	110 mm	VME-11716047-EX	121.85
	11107746	1001-10000	Bushing	70 mm		VME-11088054	3.20
	11107746	1001-10000	Wear Ring		110 mm	VME-11107528	4.52
	11156699	1001-10000	I-UB-10	32 mm	50 mm	VME-11709821	84.03
	11156701	1001-10000	I-UB-10	32 mm	50 mm	VME-11709821	84.03
	11157999	1001-10000	P-U-15	40 mm	80 mm	VME-11704253	61.03
	11417176	1001-10000	P-U-15	60 mm	125 mm	VME-11704247	126.26
	15155930	1001-10000	P-U-15	40 mm	80 mm	VME-11704253	61.03
LIFT	11107772	1001-10000	P-UB-10	120 mm	230 mm	VME-15154575	436.01
	11107883	1001-10000	P-UB-10	110 mm	200 mm	VME-15010254	349.27
TILT	11107931	1001-10000	P-UB-10	120 mm	260 mm	VME-15011881	603.37
MODEL L480							
STEERING	2541333	830A101-	P-UB-10	2-3/4	6	VME-2542568	240.21
MODEL L480B							
STEERING	12584868	830BC00301-	P-UB-10	2-3/4	6	VME-2542568	240.21
MODEL L480T							
STEERING	2541333	829A201-	P-UB-10	2-3/4	6	VME-2542568	240.21
Motor Graders							
APPLICATION	CYL #	SERIAL #	CODE	ROD	BORE	KIT #	List \$
MODEL 710-740A							
CIRCLE SHIFT	89013	24736-;24483;24598;24599;24619;24620	I-U-5	2	4	VME-12724303	89.15
MODEL 750A & 780A							
CIRCLE TURN	89011	24736-;24483;24598;24599;24619;24620	I-U-5	1-3/8	3	VME-12724304	87.79
MODEL G930							
ARTICULATION	12744475	39300-99999;501000-	I-U-5	2	4-1/2	VME-12743310	79.11
Scrapers							
APPLICATION	CYL #	SERIAL #	CODE	ROD	BORE	KIT #	List \$
MODEL T450D							
STEERING	11296028	17001-99999	I-UB-10	70 mm	120 mm	VME-11712388	110.23
Wheel Dozers							
APPLICATION	CYL #	SERIAL #	CODE	ROD	BORE	KIT #	List \$
MODEL 180							
PITCH	1503598	2892-2942;2LC52-;2LG101-	P-V-10	2-3/4	6	VME-2516065	93.06
TILT	1503598	1896;1898-1902;2823-2891;1823-1895;1897;1903;1904	P-V-10	2-3/4	6	VME-2516065	93.06
	1503986	2892-2942;2LC52-;2LG101-	P-V-10	1-3/4	3-1/2	VME-2516071	66.64
MODEL 180-III							
LIFT	1503608	5LC101-;6LG101-;4035B101FSC-	P-U-10	2	5	VME-2516059	78.00
PITCH	1503598	5LC101-;6LG101-;4035B101FSC-	P-V-10	2-3/4	6	VME-2516065	93.06
STEERING	1503987	5LC101-;6LG101-;4035B101FSC-	P-V-10	1-3/4	3-1/2	VME-2516071	66.64
TILT	1503986	5LC101-;6LG101-;4035B101FSC-	P-V-10	1-3/4	3-1/2	VME-2516071	66.64
MODEL 280							
LIFT	1503604	32123-32999;1MC156-3MC999;1MG1-3MG999	P-V-10	2-3/4	6	VME-2516065	93.06
PITCH	1503607	32123-32999;1MC156-3MC999;1MG1-3MG999	P-V-10	2-3/4	6	VME-2516065	93.06
MODEL 280B							
LIFT	2522607	498A;499A	P-U-10	2-3/4	6	VME-2538182	90.32
	962698	498A;499A	P-UB-10	2-3/4	6	VME-2542568	240.21

LR - Long Reach

SLF - Super Long Front

QF - Quick Fit

FS - Front Shovel

MH - Material Handle

AS - Articulate Slope

Replacement Kits For

VOLVO

Wheel Dozers							
APPLICATION	CYL #	SERIAL #	CODE	ROD	BORE	KIT #	List \$
MODEL 280B							
PITCH	964665	498A;499A	P-UB-10	2	4-1/2	VME-2551398	79.20
STEERING	2528419	498A;499A	P-U-10	2-1/4	5-1/4	VME-2538181	73.52
	964663	498A;499A	P-UB-10	2-1/4	5-1/4	VME-2551399	114.76
TILT	2522880	498A;499A	P-U-10	2-1/4	5-1/4	VME-2538181	73.52
	964662	498A;499A	P-UB-10	2-1/4	5-1/4	VME-2551399	114.76
MODEL 280C							
LIFT	12565916	819A	P-U-10	2-3/4	6	VME-2538182	90.32
	2522607	819A	P-U-10	2-3/4	6	VME-2538182	90.32
	962698	819A	P-UB-10	2-3/4	6	VME-2542568	240.21
PITCH	964665	819A	P-UB-10	2	4-1/2	VME-2551398	79.20
STEERING	2528419	819A	P-U-10	2-1/4	5-1/4	VME-2538181	73.52
	964663	819A	P-UB-10	2-1/4	5-1/4	VME-2551399	114.76
TILT	2522880	819A	P-U-10	2-1/4	5-1/4	VME-2538181	73.52
	964662	819A	P-UB-10	2-1/4	5-1/4	VME-2551399	114.76
MODEL 280-III							
LIFT	1503604	4MC102-6MC999;4MG101-8MG999	P-V-10	2-3/4	6	VME-2516065	93.06
PITCH	1503607	4MC102-6MC999;4MG101-8MG999	P-V-10	2-3/4	6	VME-2516065	93.06
MODEL 280-III A							
LIFT	1503604	8AMC192-;9AMG425-;4047B101FSC;456B101-999;456C101-145C;460D101C-130C	P-V-10	2-3/4	6	VME-2516065	93.06
	1503605	8AMC101-8AMC192;9AMG125-9AMG424	P-U-10	2-1/4	5-1/2	VME-2516094	73.58
	2522607	456C146C-;460D131C-	P-U-10	2-3/4	6	VME-2538182	90.32
PITCH	964665	460D131C-	P-UB-10	2	4-1/2	VME-2551398	79.20
STEERING	1503241	8AMC101-8AMC217;9AMG125-9AMG469	P-U-10	2-1/4	5-1/2	VME-2516094	73.58
	1503606	456B101-999;456C101-145C	P-U-10	2-1/4	5-1/2	VME-2516094	73.58
	1515236	3AMC218-;9AMG470-;4047B101FSC-;456B101-999;456C101C-145C;460D101-130C	P-U-10	2-1/4	5-1/2	VME-2516094	73.58
	2522880	456C146C-	P-U-10	2-1/4	5-1/4	VME-2538181	73.52
	2522932	456C146C-;460D131C-	P-U-10	2-1/4	5-1/4	VME-2538181	73.52
	964584	456C146C-	P-UB-10	2-1/4	5-1/4	VME-2551399	114.76
TILT	1503606	8AMC101-9AMC999;9AMG122-9AMG124-;4047B101FSC-;460D101-130C	P-U-10	2-1/4	5-1/2	VME-2516094	73.58
	2522880	460D131C-	P-U-10	2-1/4	5-1/4	VME-2538181	73.52
	964662	460D131C-	P-UB-10	2-1/4	5-1/4	VME-2551399	114.76
MODEL 380B							
LIFT	12568715	813A;813B;813BC	P-UB-10	2-3/4	6	VME-2542568	240.21
	12572636	813A;813B;813BC	P-UB-10	2-3/4	6	VME-2542568	240.21
	1510225	418F101K-114K;484B101K-108K;434C101K-104K	P-V-10	2-3/4	6	VME-2516065	93.06
	2522115	418F115K-;484B109K-;434C105K-;484C101C-136C	P-U-10	2-3/4	6	VME-2538182	90.32
	2522115	808A101C-110C;810A101C-999C;434D101C-999C	P-U-10	2-3/4	6	VME-2538182	90.32
	2552344	418F;484B;434C;813A;813B;813BC	P-U-10	2-3/4	6	VME-2538182	90.32
	2556914	813A;813B;813BC	P-UB-10	2-3/4	6	VME-2542568	240.21
	962697	484C101C-136C;808A101C-110C;810A101C-999C;434D101C-999C	P-UB-10	2-3/4	6	VME-2542568	240.21
	964787	484C137C-999C;808A111C-999C;808A101CAC-;484C101CAC-;810A101CAC-	P-UB-10	2-3/4	6	VME-2542568	240.21
	PITCH	1505457	418F101K-114K;484B101K-108K;434C101K-104K	P-U-10	2-1/4	5-1/2	VME-2516094
2522411		418F115K-;484B109K-;434C105K-;484C;808A;434D;810A;813A;813B;813BC	P-U-10	2-1/4	5-1/4	VME-2538181	73.52
2556971		813A;813B;813BC	P-UB-10	2-1/4	5-1/4	VME-2551399	114.76

LR - Long Reach

SLF - Super Long Front

QF - Quick Fit

FS - Front Shovel

MH - Material Handle

AS - Articulate Slope

Replacement Kits For

VOLVO

Wheel Dozers							
APPLICATION	CYL #	SERIAL #	CODE	ROD	BORE	KIT #	List \$
MODEL 380B							
PITCH	964583	418F115K-;484B109K-;434C105K-;484C;808A;434D;810A;813A;813B;813BC	P-UB-10	2-1/4	5-1/4	VME-2551399	114.76
STEERING	2522598	418F115K-;484B109K-;434C105K-;484C;808A;434D;810A;813A;813B;813BC	P-UB-10	3-1/2	8	VME-2538186	188.48
TILT	2522120	418F115K-;484B109K-;434C105K-;484C;808A;434D;810A;813A;813B;813BC	P-U-10	2-3/4	6	VME-2538182	90.32
	964577	418F115K-;484B109K-;434C105K-;484C;808A;434D;810A;813A;813B;813BC	P-UB-10	2-3/4	6	VME-2542568	240.21
MODEL 380-III							
LIFT	1503610	5RG101-	P-U-10	2-3/4	7	VME-2516148	112.41
TILT	1503603	5RG101-	P-V-10	2-3/4	6	VME-2516065	93.06
MODEL 380-IIIA							
LIFT	1510225	418A406-;418D;484A;434A	P-V-10	2-3/4	6	VME-2516065	93.06
	1531615	418A101-418A405;434A	P-V-10	2-3/4	6	VME-2516065	93.06
PITCH	1505457	418A101-999;418D;484A;434A	P-U-10	2-1/4	5-1/2	VME-2516094	73.58
MODEL W380							
TILT	2561629		P-UB-10	2-3/4	6	VME-2542568	240.21

LR - Long Reach

SLF - Super Long Front

QF - Quick Fit

FS - Front Shovel

MH - Material Handle

AS - Articulate Slope

REPLACEMENT KITS FOR VOLVO EQUIPMENT

Kit Number	Code (Pg. xviii)	Rod X Bore Size	List Price
VME-11000107	P-U-15	60 X 125 mm	\$ 155.53
VME-11370055	I-UB-10	50 X 100 mm	156.15
VME-11370750	P-U-10	65 X 125 mm	132.40
VME-11370773	P-U-10	50 X 110 mm	124.76
VME-11370826	P-U-10	50 X 100 mm	155.00
VME-11700151	P-U-15	70 X 120 mm	89.97
VME-11700151-EX	P-U-15	70 X 120 mm	93.58
VME-11700176	P-UB-13	90 X 160 mm	414.64
VME-11700187	P-U-15	80 X 150 mm	108.18
VME-11701531	P-UB-14	120 X 250 mm	686.76
VME-11701531-EX	P-UB-14	120 X 250 mm	739.32
VME-11701665-9	P-U-15	70 X 110 mm	64.73
VME-11702311	P-U-10	32 X 70 mm	89.46
VME-11702744	P-UB-10	105 X 150 mm	411.63
VME-11702757	P-UB-10	125 X 170 mm	602.54
VME-11703474	P-UB-10	100 X 150 mm	445.53
VME-11703689	P-U-10	50 X 100 mm	79.47
VME-11703689-EX	P-U-10	50 X 100 mm	86.58
VME-11703860	P-UB-14	120 X 260 mm	655.07
VME-11703860-EX	P-UB-14	120 X 260 mm	733.91
VME-11704247	P-U-15	60 X 125 mm	126.26
VME-11704248	P-U-15	60 X 125 mm	108.31
VME-11704249	P-U-15	60 X 110 mm	117.82
VME-11704250	P-U-15	70 X 140 mm	144.96
VME-11704251	P-U-15	50 X 100 mm	55.03
VME-11704252	P-U-15	50 X 110 mm	82.80
VME-11704253	P-U-15	40 X 80 mm	61.03
VME-11704254	P-U-15	32 X 63 mm	53.82
VME-11704689	P-U-15	80 X 150 mm	168.90
VME-11705087	P-U-10	16 X 32 mm	122.90
VME-11705087-EX	P-U-10	16 X 32 mm	125.55
VME-11705101	O-rings		6.16
VME-11705109	O-rings		7.00
VME-11705814	P-UB-10	95 X 140 mm	398.64
VME-11705815	P-UB-10	105 X 150 mm	433.79
VME-11705818	P-UB-10	110 X 160 mm	513.94
VME-11705882	P-UB-10	90 X 190 mm	205.78
VME-11705882-EX	P-UB-10	90 X 190 mm	242.78
VME-11707023	P-UB-10	70 X 130 mm	181.68
VME-11707023-EX	P-UB-10	70 X 130 mm	196.08
VME-11707024	P-UB-10	80 X 180 mm	245.26
VME-11707024-EX	P-UB-10	80 X 180 mm	294.89
VME-11707025	P-UB-10	90 X 170 mm	266.25
VME-11707025-EX	P-UB-10	90 X 170 mm	288.06
VME-11707026	P-UB-10	90 X 190 mm	284.90

Kit Number	Code (Pg. xviii)	Rod X Bore Size	List Price
VME-11707026-EX	P-UB-10	90 X 190 mm	\$ 305.81
VME-11707027	P-UB-10	120 X 260 mm	579.70
VME-11707027-EX	P-UB-10	120 X 260 mm	660.14
VME-11707028	P-UB-10	90 X 190 mm	400.14
VME-11707028-EX	P-UB-10	90 X 190 mm	456.69
VME-11707029	P-UB-10	110 X 230 mm	483.88
VME-11707029-EX	P-UB-10	110 X 230 mm	584.17
VME-11707030	P-UB-10	120 X 250 mm	533.97
VME-11707030-EX	P-UB-10	120 X 250 mm	589.81
VME-11707031	P-UB-10	120 X 260 mm	602.67
VME-11707031-EX	P-UB-10	120 X 260 mm	658.71
VME-11707447	P-UB-10	90 X 170 mm	532.08
VME-11707447-EX	P-UB-10	90 X 170 mm	575.51
VME-11707450	P-UB-10	120 X 230 mm	467.64
VME-11707450-EX	P-UB-10	120 X 230 mm	539.50
VME-11707451	P-UB-10	120 X 250 mm	528.19
VME-11707451-EX	P-UB-10	120 X 250 mm	584.15
VME-11707902	P-UB-15	70 X 125 mm	144.58
VME-11707903	P-UB-14	90 X 190 mm	405.80
VME-11707903-EX	P-UB-14	90 X 190 mm	453.62
VME-11707904	P-UB-14	120 X 230 mm	655.78
VME-11707904-EX	P-UB-14	120 X 230 mm	932.28
VME-11707905	P-UB-10	110 X 200 mm	766.59
VME-11708734	P-UB-10	90 X 150 mm	93.10
VME-11708734-EX	P-UB-10	90 X 150 mm	164.65
VME-11708825	P-UB-10	80 X 150 mm	129.55
VME-11708825-EX	P-UB-10	80 X 150 mm	170.64
VME-11708833	P-UB-10	110 X 220 mm	265.37
VME-11708833-EX	P-UB-10	110 X 220 mm	366.16
VME-11709018	P-UB-10	90 X 160 mm	179.11
VME-11709018-EX	P-UB-10	90 X 160 mm	204.51
VME-11709019	P-UB-10	90 X 180 mm	192.52
VME-11709019-EX	P-UB-10	90 X 180 mm	219.92
VME-11709025	P-UB-10	120 X 250 mm	416.48
VME-11709025-EX	P-UB-10	120 X 250 mm	495.50
VME-11709026	P-UB-10	110 X 230 mm	273.79
VME-11709026-EX	P-UB-10	110 X 230 mm	359.75
VME-11709028	P-UB-15	50 X 100 mm	80.39
VME-11709028-EX	P-UB-15	50 X 100 mm	82.68
VME-11709029	P-UB-15	50 X 90 mm	73.41
VME-11709029-EX	P-UB-15	50 X 90 mm	75.84
VME-11709111	P-U-10	16 X 32 mm	63.07
VME-11709226	P-UB-10	90 X 170 mm	320.76
VME-11709249	P-U-10	60 X 100 mm	64.38
VME-11709249-EX	P-U-10	60 X 100 mm	74.44

VOLVO

REPLACEMENT KITS FOR VOLVO EQUIPMENT

Kit Number	Code (Pg. xviii)	Rod X Bore Size	List Price
VME-11709384	P-UB-10	90 X 160 mm	\$ 178.41
VME-11709384-EX	P-UB-10	90 X 160 mm	231.20
VME-11709528	I-UB-10	65 X 120 mm	113.88
VME-11709538	I-UB-10	40 X 70 mm	52.97
VME-11709543	I-UB-10	60 X 120 mm	111.03
VME-11709547	I-UB-10	60 X 90 mm	96.02
VME-11709617	I-UB-10	50 X 85 mm	110.21
VME-11709624	I-UB-10	60 X 110 mm	80.53
VME-11709632	I-UB-10	50 X 70 mm	46.60
VME-11709677	I-UB-10	50 X 95 mm	104.76
VME-11709817	P-UB-15	50 X 80 mm	76.97
VME-11709817-EX	P-UB-15	50 X 80 mm	79.33
VME-11709821	I-UB-10	32 X 50 mm	84.03
VME-11709829	P-UB-10	70 X 120 mm	152.05
VME-11709829-EX	P-UB-10	70 X 120 mm	168.18
VME-11709832	P-UB-10	90 X 180 mm	387.25
VME-11709832-EX	P-UB-10	90 X 180 mm	417.21
VME-11709868	P-UB-10	80 X 150 mm	214.78
VME-11709872	P-UB-15	45 X 70 mm	82.42
VME-11709872-EX	P-UB-15	45 X 70 mm	83.75
VME-11709898	I-U-10	38 X 63 mm	62.32
VME-11709965	P-UB-10	90 X 160 mm	373.62
VME-11709965-EX	P-UB-10	90 X 160 mm	401.12
VME-11709998	P-UB-10	70 X 110 mm	161.37
VME-11709998-EX	P-UB-10	70 X 110 mm	173.19
VME-11710606	I-O-10	16 X 40 mm	18.44
VME-11710948	I-UB-10	50 X 95 mm	73.67
VME-11711451	I-U-10	1-1/2 X 3	28.03
VME-11711929	I-U-10	1-5/8 X 2-3/4	26.87
VME-11711945	P-U-10	90 X 150 mm	148.83
VME-11711945-EX	P-U-10	90 X 150 mm	209.36
VME-11712156	P-UB-10	120 X 230 mm	596.42
VME-11712387	I-UB-10	60 X 100 mm	79.62
VME-11712388	I-UB-10	70 X 120 mm	110.23
VME-11712450	I-UB-10	55 X 85 mm	114.22
VME-11712455	I-UB-10	65 X 115 mm	89.39
VME-11712523	I-U-10	36 X 63 mm	75.57
VME-11712746	I-UB-10	50 X 80 mm	82.77
VME-11712749	I-UB-10	60 X 105 mm	80.53
VME-11714561	P-UB-10	60 X 100 mm	110.71
VME-11714561-EX	P-UB-10	60 X 100 mm	116.52
VME-11715295	I-UB-10	55 X 95 mm	103.12
VME-11715864	P-UB-10	70 X 120 mm	138.29
VME-11715864-EX	P-UB-10	70 X 120 mm	153.66
VME-11715865	P-UB-10	70 X 125 mm	142.71

Kit Number	Code (Pg. xviii)	Rod X Bore Size	List Price
VME-11715865-EX	P-UB-10	70 X 125 mm	\$ 167.33
VME-11716047	P-UB-10	70 X 110 mm	93.76
VME-11716047-EX	P-UB-10	70 X 110 mm	121.85
VME-11716625	I-U-10	36 X 65 mm	66.92
VME-11716720	I-U-10	38 X 63 mm	37.95
VME-11988179	P-U-10	35 X 60 mm	47.68
VME-11988180	P-U-10	35 X 60 mm	73.57
VME-11988181	P-U-10	35 X 63 mm	50.70
VME-11988183	P-U-10	35 X 63 mm	79.52
VME-11988184	P-U-10	40 X 70 mm	57.32
VME-11988209	P-U-10,13	80 X 125 mm	224.06
VME-11988209-EX	P-U-10,13	80 X 125 mm	241.94
VME-11988358	P-U-10	45 X 70 mm	82.55
VME-11988359	P-U-10	45 X 70 mm	43.89
VME-11988360	P-U-10	50 X 90 mm	52.47
VME-11988361	P-U-10	45 X 80 mm	53.52
VME-11988963	P-U-10	50 X 80 mm	72.72
VME-11988983	P-U-10	50 X 90 mm	75.75
VME-11990026	P-U-15	60 X 120 mm	129.41
VME-11990027	P-U-15	70 X 125 mm	112.35
VME-11990028	P-UB-15	60 X 110 mm	80.42
VME-11990029	P-U-15	70 X 140 mm	182.47
VME-11990050	P-U-15	50 X 80 mm	64.99
VME-11990060	P-U-1	20 mm Rod Kit	53.74
VME-11990070	P-U-15	70 X 110 mm	88.05
VME-11990106	P-U-15	40 X 80 mm	81.60
VME-11990106-4	P-U-15	40 X 80 mm	81.60
VME-11990158	P-U-15	80 X 160 mm	200.40
VME-11990170-0	P-U-15	80 X 140 mm	232.26
VME-11990175	P-U-1	25 mm Rod Kit	80.93
VME-11990180	P-U-15	50 X 100 mm	77.30
VME-11990181	P-U-15	60 X 100 mm	64.23
VME-11990243	P-U-15	45 X 80 mm	40.56
VME-11990243-5	P-U-15	45 X 80 mm	40.56
VME-11990244	P-U-15	50 X 90 mm	70.74
VME-11990244-3	P-U-15	50 X 90 mm	70.74
VME-11990347	P-U-15	50 X 90 mm	72.27
VME-11990347-EX	P-U-15	50 X 90 mm	74.74
VME-11990348	P-UB-14	120 X 250 mm	692.36
VME-11990348-EX	P-UB-14	120 X 250 mm	759.53
VME-11990349	P-UB-14	90 X 170 mm	467.44
VME-11990349-EX	P-UB-14	90 X 170 mm	512.26
VME-11990351-6	P-U-13	70 X 125 mm	228.33
VME-11990395	P-UB-14	120 X 260 mm	737.65
VME-11990395-EX	P-UB-14	120 X 260 mm	790.78

VOLVO

REPLACEMENT KITS FOR VOLVO EQUIPMENT

Kit Number	Code (Pg. xviii)	Rod X Bore Size	List Price	Kit Number	Code (Pg. xviii)	Rod X Bore Size	List Price
VME-11990396	P-UB-14	90 X 190 mm	\$ 385.72	VME-11999907	P-U-15	40 X 70 mm	\$ 53.65
VME-11990396-EX	P-UB-14	90 X 190 mm	406.63	VME-11999907-EX	P-U-15	40 X 70 mm	55.72
VME-11990398	P-U-15	50 X 100 mm	67.03	VME-12619709	I-UB-10	4,7	1168.84
VME-11990398-EX	P-U-15	50 X 100 mm	69.73	VME-12724303	I-U-5	2 X 4	89.15
VME-11990404	P-U-15	70 X 140 mm	152.46	VME-12724304	I-U-5	1-3/8 X 3	87.79
VME-11990405	P-UB-15	60 X 125 mm	97.07	VME-12724306	I-U-5	2 X 3-1/2	64.33
VME-11990437	P-U-15	70 X 125 mm	161.18	VME-12743310	I-U-5	2 X 4-1/2	79.11
VME-11990437-3	P-U-15	70 X 125 mm	161.18	VME-12969637	Valve Kit		29.36
VME-11990437-EX	P-U-15	70 X 125 mm	167.21	VME-14510588	P-UB-14	80 X 160 mm	202.79
VME-11990438	P-U-15	60 X 90 mm	105.66	VME-14510910	P-U-10	25 X 50 mm	84.11
VME-11990438-1	P-U-15	60 X 90 mm	105.66	VME-14510911	P-U-10	32 X 70 mm	87.45
VME-11990438-EX	P-U-15	60 X 90 mm	108.79	VME-14510912	P-U-10	32 X 90 mm	98.38
VME-11990439	P-U-15	40 X 63 mm	77.64	VME-14512948	P-UB-10	105 X 160 mm	394.66
VME-11990439-EX	P-U-15	40 X 63 mm	79.20	VME-14512950	P-UB-10	115 X 175 mm	684.94
VME-11991589	75,120,140 mm Tele.		238.60	VME-14512955	P-UB-10	105 X 160 mm	287.71
VME-11991589-0	75,120,140 mm Tele.		238.60	VME-14512961	P-UB-10	100 X 145 mm	312.07
VME-11993103	75,120,140 mm Tele.		197.50	VME-14512968	P-UB-10	105 X 150 mm	219.19
VME-11993103-8	75,120,140 mm Tele.		200.92	VME-14513714	P-UB-10	95 X 140 mm	376.95
VME-11993411	75,90,105,120,140 mm Tele.		351.52	VME-14513715	P-UB-10	105 X 150 mm	401.47
VME-11993411-5	75,90,105,120,140 mm Tele.		351.52	VME-14513726	P-UB-10	110 X 165 mm	467.54
VME-11997089-5	P-U-14	105 X 160 mm	709.53	VME-14513727	P-UB-10	130 X 190 mm	441.57
VME-11997091-1	P-UB-14	90 X 140 mm	565.04	VME-14514454	P-UB-10	90 X 130 mm	267.76
VME-11997225	P-U-15	80 X 125 mm	333.81	VME-14514455	P-UB-10	90 X 135 mm	387.10
VME-11997226	P-U-14	105 X 150 mm	491.10	VME-14514456	P-UB-10	105 X 160 mm	394.86
VME-11997227	P-U-14	50 X 70 mm	201.12	VME-14514457	P-UB-10	100 X 140 mm	360.50
VME-11998574	P-U-13	70 X 140 mm	289.93	VME-14515051	P-UB-10	80 X 125 mm	230.25
VME-11998574-EX	P-U-13	70 X 140 mm	302.80	VME-14515052	P-UB-10	95 X 135 mm	252.51
VME-11998575	P-U-13	100 X 140	332.97	VME-14515053	P-UB-10	80 X 120 mm	234.44
VME-11998575-EX	P-U-13	100 X 140	359.33	VME-14516932	P-UB-10	70 X 105 mm	171.45
VME-11998809	P-UB-14	80 X 150 mm	308.00	VME-14516933	P-UB-10	70 X 110 mm	223.38
VME-11998809-EX	P-UB-14	80 X 150 mm	301.03	VME-14516934	P-UB-10	90 X 160 mm	228.10
VME-11998810	P-UB-13	70 X 100 mm	232.66	VME-14517001	P-UB-10	90 X 130 mm	175.00
VME-11998810-EX	P-UB-13	70 X 100 mm	238.64	VME-14519359	P-UB-10	110 X 170 mm	299.59
VME-11999362	P-U-15	25 X 45 mm	73.28	VME-14519503	P-UB-10	75 X 115 mm	184.88
VME-11999887	P-UB-10	32 X 70 mm	117.06	VME-14519504	P-UB-10	75 X 105 mm	224.74
VME-11999892	P-UB-14	110 X 230 mm	465.83	VME-14519505	P-UB-10	80 X 120 mm	262.64
VME-11999892-EX	P-UB-14	110 X 230 mm	567.40	VME-14519624	P-UB-10	95 X 140 mm	226.82
VME-11999893	P-UB-14	90 X 190 mm	506.56	VME-14520420	P-UB-14	60 X 105 mm	159.06
VME-11999893-EX	P-UB-14	90 X 190 mm	552.20	VME-14522992	P-U-10	32 X 90 mm	91.77
VME-11999894	P-UB-14	80 X 160 mm	306.41	VME-14523116	P-U-10	25 X 50 mm	68.20
VME-11999894-EX	P-UB-14	80 X 160 mm	354.73	VME-14523132	P-U-10	32 X 70 mm	106.09
VME-11999895	P-UB-14	70 X 130 mm	250.13	VME-14524766	P-UB-10	55 X 100 mm	92.46
VME-11999895-EX	P-UB-14	70 X 130 mm	235.46	VME-14524767	P-UB-10	55 X 85 mm	106.69
VME-11999906	P-UB-15	50 X 80 mm	74.73	VME-14524768	P-UB-10	50 X 75 mm	98.98
VME-11999906-EX	P-UB-15	50 X 80 mm	77.14	VME-14524769	P-UB-10	45 X 85 mm	104.16

REPLACEMENT KITS FOR VOLVO EQUIPMENT

Kit Number	Code (Pg. xviii)	Rod X Bore Size	List Price
VME-14530716	P-UB-10	60 X 90 mm	\$ 186.92
VME-14530717	P-UB-10	95 X 130 mm	166.17
VME-14530718	P-UB-10	55 X 100 mm	134.82
VME-14530719	P-UB-10	55 X 80 mm	187.08
VME-14530833	P-UB-10	70 X 105 mm	161.56
VME-14541717	P-UB-10	95 X 140 mm	379.16
VME-14547310	P-UB-10	70 X 100 mm	210.37
VME-14551098	P-UB-10	70 X 100 mm	128.10
VME-14553242	P-UB-10	75 X 105 mm	186.70
VME-14573751	P-UB-10	110 X 165 mm	505.20
VME-14589123	P-UB-10	90 X 160 mm	177.69
VME-14589124	P-UB-10	80 X 120 mm	262.64
VME-14589125	P-UB-10	70 X 100 mm	128.10
VME-14589126	P-UB-10	95 X 140 mm	157.67
VME-14589127	P-UB-10	75 X 115 mm	137.33
VME-14589128	P-UB-10	75 X 105 mm	102.58
VME-14589129	P-UB-10	80 X 125 mm	282.53
VME-14589130	P-UB-10	105 X 160 mm	221.23
VME-14589131	P-UB-10	95 X 135 mm	305.19
VME-14589132	P-UB-10	80 X 120 mm	198.79
VME-14589133	P-UB-10	90 X 130 mm	348.43
VME-14589134	P-UB-10	90 X 135 mm	357.10
VME-14589135	P-UB-10	100 X 140 mm	255.29
VME-14589136	P-UB-10	95 X 140 mm	261.28
VME-14589137	P-UB-10	110 X 170 mm	275.37
VME-14589138	P-UB-10	105 X 150 mm	322.43
VME-14589139	P-UB-10	105 X 160 mm	361.92
VME-14589140	P-UB-10	115 X 175 mm	532.45
VME-14589141	P-UB-10	100 X 145 mm	297.28
VME-14589142	P-UB-10	105 X 160 mm	333.44
VME-14589143	P-UB-10	110 X 165 mm	354.78
VME-14589144	P-UB-10	130 X 190 mm	434.75
VME-14589145	P-UB-10	110 X 165 mm	472.59
VME-14589146	P-UB-14	80 X 160 mm	241.25
VME-14589148	P-UB-10	60 X 110 mm	129.83
VME-14589150	P-UB-14	50 X 80 mm	164.12
VME-14589153	P-UB-14	55 X 90 mm	155.13
VME-14589154	P-UB-14	60 X 105 mm	212.93
VME-14589159	P-UB-10	105 X 150 mm	219.19
VME-14589164	P-UB-10	50 X 75 mm	98.98
VME-14589199	P-UB-14	95 X 140 mm	110.49
VME-14597349	P-U-10	35 X 65 mm	73.56
VME-15010254	P-UB-10	110 X 200 mm	349.27
VME-15011881	P-UB-10	120 X 260 mm	603.37
VME-15012903	P-UB-15	70 X 125 mm	176.18

Kit Number	Code (Pg. xviii)	Rod X Bore Size	List Price
VME-15012903-EX	P-UB-15	70 X 125 mm	\$ 181.89
VME-15078352	P-U-10	50 X 90 mm	39.26
VME-15153996	P-UB-10	90 X 150 mm	176.81
VME-15154575	P-UB-10	120 X 230 mm	436.01
VME-15174598	P-U-10	40 X 63 mm	58.63
VME-1701665-9	P-U-15	70 X 110 mm	64.73
VME-17200208	P-U-15	40 X 80 mm	61.03
VME-17207945	P-UB-10	90 X 115 mm	250.00
VME-17238353	P-UB-10	120 X 250 mm	490.09
VME-17238406	P-UB-10	90 X 190 mm	235.19
VME-17238415	P-UB-10	120 X 240 mm	349.02
VME-17238417	P-UB-10	90 X 180 mm	157.59
VME-17253752	P-UB-10	110 X 140 mm	260.17
VME-17253805	P-UB-10	70 X 140 mm	171.09
VME-17253817	P-UB-10	110 X 220 mm	265.37
VME-17253817-EX	P-UB-10	110 X 220 mm	366.16
VME-17254012	P-UB-10	60 X 100 mm	80.80
VME-17264520	P-UB-10	90 X 160 mm	143.81
VME-17264860	P-UB-10	110 X 220 mm	277.46
VME-17265005	P-UB-10	110 X 190 mm	306.75
VME-17265044	P-UB-10	120 X 220 mm	443.18
VME-1990351-6	P-U-13	70 X 125 mm	228.33
VME-1991086	P-U-10	1-3/4 X 3-1/2	50.20
VME-1991089	P-TR-10	2-3/4 X 6	113.12
VME-2516054	P-V-10	2-1/4 X 4-1/4	53.45
VME-2516055	I-U-10	1 X 2-1/2	27.85
VME-2516058	P-U-10	2-1/4 X 5	60.94
VME-2516059	P-U-10	2 X 5	78.00
VME-2516060	I-U-10	2-1/4 X 5	53.58
VME-2516061	P-U-10	2-1/4 X 5	74.97
VME-2516065	P-V-10	2-3/4 X 6	93.06
VME-2516070	P-V-10	2-1/4 X 4-1/2	77.73
VME-2516071	P-V-10	1-3/4 X 3-1/2	66.64
VME-2516072	I-U-10	1-3/4 X 3-1/2	44.73
VME-2516073	P-U-10	2 X 3-1/2	55.80
VME-2516088	P-U-10	2 X 4	75.11
VME-2516090	P-U-10	2 X 4	50.30
VME-2516094	P-U-10	2-1/4 X 5-1/2	73.58
VME-2516148	P-U-10	2-3/4 X 7	112.41
VME-2516151	P-V-10	2 X 4-1/2	51.08
VME-2516152	P-V-10	2-1/4 X 4-1/2	65.24
VME-2516155	P-V-10	2-3/4 X 7	161.59
VME-2516156	I-U-10	2-1/4 X 5-1/4	60.41
VME-2516187	P-U-10	3-1/2 X 8	125.26
VME-2516228	I-U-10	3-1/2 X 9	143.64

VOLVO

REPLACEMENT KITS FOR VOLVO EQUIPMENT

Kit Number	Code (Pg. xviii)	Rod X Bore Size	List Price	Kit Number	Code (Pg. xviii)	Rod X Bore Size	List Price
VME-2516230	P-V-10	4-1/2 X 9	\$ 181.74	VME-2907389	P-U-10	63 X 125 mm	\$ 170.85
VME-2516242	P-V-10	3-1/2 X 9	164.05	VME-2907415	P-U-10	50 X 110 mm	143.72
VME-2516270	P-U-10	1-3/4 X 3-1/2	63.20	VME-5960049	P-U-15	35 X 60 mm	28.80
VME-2516271	P-V-10	2 X 4-1/2	59.45	VME-5960050	P-U-15	35 X 63 mm	31.63
VME-2516272	I-U-10	1-1/4 X 2-1/2	50.92	VME-5960051	P-U-15	40 X 63 mm	50.89
VME-2516274	P-V-10	2-1/4 X 5-1/4	60.69	VME-5960100	P-U-10	45 X 70 mm	80.73
VME-2518493	P-V-10	2-3/4 X 6	102.58	VME-5960101	P-U-10	50 X 80 mm	88.54
VME-2518494	P-V-10	2-3/4 X 7	152.59	VME-5960102	P-U-10	35 X 63 mm	43.69
VME-2526058	P-U-10	2-3/4 X 7	106.84	VME-5960103	P-U-10	40 X 60 mm	59.46
VME-2530107	P-U-10	2 X 4	52.30	VME-5960104	P-U-10	40 X 70 mm	83.75
VME-2530108	P-U-10	2-1/4 X 5	62.40	VME-5960105	P-U-10	35 X 60 mm	35.81
VME-2538174	P-U-10	1-3/4 X 3-1/2	44.83	VME-5960121	P-U-10	45 X 70 mm	60.85
VME-2538177	P-U-10	1-3/4 X 3-1/2	66.15	VME-5960122	P-U-10	50 X 90 mm	68.42
VME-2538178	P-U-10	2 X 4-1/2	54.72	VME-5960123	P-U-10	45 X 80 mm	75.99
VME-2538179	P-U-10	2-1/4 X 4-1/2	58.55	VME-5960124	P-U-10	50 X 90 mm	65.29
VME-2538180	P-U-10	3-1/2 X 9	187.66	VME-6213407	70,105,120,140 mm Tele.		353.37
VME-2538181	P-U-10	2-1/4 X 5-1/4	73.52	VME-6630100	75,90,105,120,140,160 mm Tele.		311.86
VME-2538182	P-U-10	2-3/4 X 6	90.32	VME-6630443	P-U-15	70 X 100 mm	68.41
VME-2538183	P-U-10	2-3/4 X 7	95.21	VME-6630443-7	P-U-15	70 X 100 mm	68.56
VME-2538184	P-UB-10	2 X 3-1/2	80.11	VME-6630475	P-U-1	20 mm Rod Kit	46.30
VME-2538186	P-UB-10	3-1/2 X 8	188.48	VME-6630498-1	P-U-15	70 X 140 mm	77.52
VME-2538187	P-U-10	2-3/4 X 5	61.76	VME-6630510	P-U-15	80 X 170 mm	219.40
VME-2538193	P-U-10	4 X 9	199.84	VME-6630511	P-U-15	50 X 110 mm	78.69
VME-2541637	P-U-10	3 X 7	117.32	VME-6630513	P-U-15	50 X 100 mm	77.15
VME-2542568	P-UB-10	2-3/4 X 6	240.21	VME-6630560	P-U-15	40 X 80 mm	103.44
VME-2542569	P-UB-10	2-3/4 X 5	92.00	VME-6630560-8	P-U-15	40 X 80 mm	103.44
VME-2542570	P-UB-10	1-3/4 X 3-1/2	81.20	VME-6630562	P-U-15	50 X 100 mm	74.03
VME-2542571	P-UB-10	3 X 7	202.44	VME-6630564	P-U-15	50 X 100 mm	91.07
VME-2542574	P-UB-10	4 X 9	363.82	VME-6630564-0	P-U-15	50 X 100 mm	91.07
VME-2542576	P-UB-10	2-1/4 X 4-1/2	85.26	VME-6630574	P-U-15	36 X 75 mm	54.87
VME-2542577	P-UB-10	2-1/4 X 5	102.27	VME-6630637-4	P-U-15	60 X 110 mm	181.40
VME-2551396	P-UB-10	3-1/2 X 9	274.53	VME-6630650	P-U-15	50 X 100 mm	119.31
VME-2551397	P-UB-10	2-3/4 X 7	167.25	VME-6630661	P-U-15	32 X 63 mm	98.24
VME-2551398	P-UB-10	2 X 4-1/2	79.20	VME-6630662	P-U-15	40 X 80 mm	63.32
VME-2551399	P-UB-10	2-1/4 X 5-1/4	114.76	VME-6630749	P-U-15	28 X 63 mm	49.12
VME-2551403	P-UB-10	2 X 4	75.42	VME-6630839	60,75,90,105,120,140 mm Tele.		316.22
VME-2562115	P-UB-10	2-3/4 X 5	227.61	VME-6630839-6	60,75,90,105,120,140 mm Tele.		316.22
VME-2562116	P-UB-10	3-1/2 X 7-1/2	236.74	VME-6630843-8	P-U-15	60 X 100 mm	70.71
VME-2562117	P-UB-10	4-1/2 X 9	324.50	VME-6630852	75,90,105,120,140,160 mm Tele.		363.97
VME-26408	I-U-5	1-3/8 X 3	47.55	VME-6630852-9	75,90,105,120,140,160 mm Tele.		363.97
VME-26409	I-U-5	2 X 4	68.58	VME-6630858	P-U-15	50 X 90 mm	62.75
VME-2906622	P-U-10	32 X 70 mm	83.05	VME-6630886	P-U-15	25 X 40 mm	20.90
VME-2907070	P-U-10	50 X 85 mm	128.56	VME-6630909	P-U-15	36 X 70 mm	64.65
VME-2907081	P-U-10	45 X 80 mm	107.93	VME-6630938	P-U-15	70 X 140 mm	130.45
VME-2907091	P-U-10	55 X 100 mm	158.20	VME-7410836	P-UB-15	30 X 60 mm	17.46

REPLACEMENT KITS FOR VOLVO EQUIPMENT

Kit Number	Code (Pg. xviii)	Rod X Bore Size	List Price	Kit Number	Code (Pg. xviii)	Rod X Bore Size	List Price
VME-814810131	P-UB-14	100 X 140 mm	\$ 195.27	VME-814816030	P-UB-14	105 X 150 mm	\$ 401.97
VME-814810151	P-UB-14	90 X 130 mm	233.21	VME-814816040	P-UB-14	115 X 170 mm	579.19
VME-8148-14041	P-UB-14	60 X 105 mm	161.73	VME-814816130	P-UB-14	105 X 160 mm	504.01
VME-8148-14051	P-UB-14	45 X 90 mm	134.28	VME-814816140	P-UB-14	115 X 170 mm	579.19
VME-814816020	P-UB-14	105 X 160 mm	504.01	VME-814816150	P-UB-14	105 X 150 mm	410.02

REPLACEMENT PARTS FOR VOLVO EQUIPMENT

NOTE: Volvo part numbers are used as a reference only. We do not imply that these kits are original REPLACEMENT PARTS.

BACK-UP RINGS

Part Number	Min Pkg Qty	List Price
VME-11005090	1	\$ 3.47
VME-11005097	1	3.42
VME-11005124	1	6.11
VME-11043006	1	2.17
VME-11088032	1	6.58
VME-11088040	1	4.24
VME-11088180	1	1.79
VME-11088320	1	4.71
VME-11088600	1	0.98
VME-11088601	1	0.94
VME-11088602	1	4.43
VME-11107089	1	4.74
VME-11107203	1	4.91
VME-11107255	1	7.89
VME-11149040	1	0.85
VME-11149375	1	2.00
VME-11704129	1	2.23
VME-11704148	1	1.31
VME-11704165	1	2.31
VME-11704205	1	0.89
VME-14597337	1	11.24
VME-14597340	1	5.34
VME-14880826	1	9.75
VME-14880846	1	9.47
VME-14880881	1	39.34
VME-15101592	1	8.49
VME-4040098	10	1.04
VME-4040145	10	0.98
VME-4040147	10	1.29

BACK-UP RINGS

Part Number	Min Pkg Qty	List Price
VME-4040151	5	\$ 1.50
VME-44266	5	1.80
VME-4786742	1	1.61
VME-4786743	1	2.23
VME-4786834	1	1.54
VME-4786962	1	2.31
VME-4880855	1	2.37
VME-4881099	1	1.10
VME-52020	10	1.29
VME-9566-10950	1	9.75
VME-9566-11050	1	10.80
VME-9566-11100	1	10.98
VME-9566-11150	1	11.29
VME-9566-11200	1	11.82
VME-9566-11250	1	12.35
VME-9566-11300	1	12.58
VME-9566-11400	1	13.66
VME-9566-11550	1	29.51
VME-9566-30380	1	2.94
VME-9566-30600	1	6.13
VME-9566-30750	1	8.19
VME-9566-30900	1	9.47
VME-9566-31000	1	10.01
VME-9566-31050	1	10.80
VME-9566-31100	1	10.98
VME-9566-31150	1	11.29
VME-9566-31200	1	11.82
VME-9566-31250	1	12.35
VME-9566-31300	1	12.58

BACK-UP RINGS

Part Number	Min Pkg Qty	List Price
VME-9566-31350	1	\$ 13.10
VME-9566-31400	1	13.66
VME-9566-31500	1	14.41
VME-9566-31501	1	28.71
VME-9566-31600	1	30.26
VME-9566-31750	1	34.25
VME-9566-40800	1	11.18
VME-9566-40900	1	11.35
VME-9566-40950	1	11.35
VME-9566-41000	1	11.59
VME-9566-41100	1	11.85
VME-9566-41500	1	14.41
VME-9567-20500	1	30.26
VME-9567-20551	1	38.27
VME-9567-20701	1	22.31
VME-9567-20751	1	39.34
VME-9567-20800	1	33.76
VME-9567-20801	1	33.48
VME-9567-20900	1	42.03
VME-9567-20950	1	11.54
VME-9567-21000	1	56.14
VME-9567-21050	1	37.81
VME-9567-21100	1	59.26
VME-9567-21301	1	46.62

VOLVO

REPLACEMENT PARTS FOR VOLVO EQUIPMENT

NOTE: Volvo part numbers are used as a reference only. We do not imply that these kits are original REPLACEMENT PARTS.

BUFFER RINGS

Part Number	Rod Dia.	List Price
VME-11107424	45 mm	\$ 18.26
VME-1146-08220	45 mm	18.26
VME-11088055	60 mm	30.45
VME-11202568	60 mm	26.37
VME-11088082	70 mm	34.11
VME-11107834	70 mm	32.68
VME-11202569	70 mm	34.23
VME-1146-08170	70 mm	34.23
VME-14502455	75 mm	36.39
VME-11088174	80 mm	39.22
VME-1146-07960	80 mm	38.54
VME-11107371	90 mm	56.65
VME-1146-08100	90 mm	49.91
VME-15124240	90 mm	42.59
VME-1146-07990	95 mm	52.69
VME-1146-08120	100 mm	54.21
VME-1146-08130	105 mm	56.18
VME-11088322	110 mm	53.04
VME-11107372	110 mm	70.54
VME-1146-08140	110 mm	58.49
VME-15124231	110 mm	53.04
VME-1146-08150	115 mm	32.26
VME-11107376	120 mm	70.67
VME-15124233	120 mm	53.13
VME-1146-08160	130 mm	98.56

LINK PIN SEALS

Part Number	ID	List Price
VME-14881296	40 mm	\$ 9.55
VME-11005017	90 mm	30.57
VME-11005099-4	100 mm	35.81
VME-11005019-2	120 mm	38.24

MODULAR BEARINGS

Part Number	ID	List Price
VME-59136	1-3/8	\$ 10.17
VME-59189	2	12.13

OIL SEALS

Part Number	Desc.	List Price
VME-11704551	25 mm	\$ 73.52

O-RINGS

Part Number	Min Pkg Qty	List Price
VME-1046-05730	1	\$ 25.62
VME-11107170	1	4.36
VME-11704124	5	4.18
VME-11704130	2	6.98
VME-11704134	5	1.99
VME-11704143	20	0.77
VME-11704146	5	1.78
VME-11704149	5	1.76
VME-11704161	5	2.09
VME-11704166	2	3.65
VME-11704206	10	1.26
VME-11704556	5	2.65
VME-13960175	20	0.66
VME-13960227	10	1.59
VME-13962503	1	27.23
VME-13962510	1	16.56
VME-13962511	1	37.16
VME-13962512	1	28.00
VME-15163649	1	3.56
VME-15163659	1	7.14
VME-4040071	20	0.69
VME-4040097	20	0.39
VME-4040103	20	0.62
VME-4040142	20	0.54
VME-4040257	20	0.59

O-RINGS

Part Number	Min Pkg Qty	List Price
VME-4040259	5	\$ 1.79
VME-44243	10	1.27
VME-44244	10	1.15
VME-925027	2	4.79
VME-925030	2	3.65
VME-925032	2	7.32
VME-925034	1	12.21
VME-925059	10	1.11
VME-925079	5	2.49
VME-925081	5	3.07
VME-925083	5	3.14
VME-925093	10	1.23
VME-925254	10	1.15
VME-925256	10	1.37
VME-925259	5	2.06
VME-925263	5	1.82
VME-949659	2	3.82
VME-9511-12038	10	1.41
VME-9511-12065	2	4.28
VME-9511-12075	2	4.78
VME-9511-12085	2	4.89
VME-9511-12090	2	5.55
VME-9511-12120	2	7.16
VME-9511-12130	2	7.16
VME-9511-12140	2	7.32
VME-9511-12150	2	9.13
VME-9511-12160	1	18.20
VME-9511-22075	5	7.09
VME-9511-22080	5	2.23
VME-9511-22085	5	2.32
VME-9511-22100	5	2.59
VME-9511-22150	2	7.77
VME-960226	5	2.26
VME-962501	1	13.29
VME-962508	1	14.76
VME-962509	1	18.13
VME-967343	1	6.41
VME-977016	10	1.15

REPLACEMENT PARTS FOR VOLVO EQUIPMENT

NOTE: Volvo part numbers are used as a reference only. We do not imply that these kits are original REPLACEMENT PARTS.

O-RINGS

Part Number	Min Pkg Qty	List Price
VME-990583	20	\$ 0.66
VME-990588	5	1.83
VME-990589	5	1.82
VME-990592	5	2.23
VME-990595	5	2.38
VME-990596	5	2.59
VME-990633	2	3.39
VME-990637	2	4.61
VME-990639	2	4.89
VME-990640	2	5.55
VME-990643	2	6.69
VME-990644	2	6.75
VME-990646	2	7.03
VME-990649	2	7.16
VME-990650	2	7.26
VME-990651	2	7.32
VME-990652	2	9.13
VME-990653	1	16.47
VME-990654	1	18.20
VME-990656	1	18.95

PISTON SEALS

Part Number	Bore Dia.	List Price
VME-6213080	40 mm	\$ 17.15
VME-14597343	65 mm	21.35
VME-4833022	70 mm	23.93
VME-14519361	75 mm	27.45
VME-11704211	80 mm	27.11
VME-14519360	85 mm	26.97
VME-6120053	90 mm	27.43
VME-11107066	100 mm	37.07
VME-11107804	100 mm	37.07
VME-14510892	100 mm	30.33
VME-14512067	105 mm	34.20
VME-11107805	110 mm	35.69
VME-14517562	115 mm	39.81

PISTON SEALS

Part Number	Bore Dia.	List Price
VME-4833448	120 mm	\$ 39.89
VME-11107807	125 mm	44.22
VME-11149365	125 mm	44.22
VME-11704135	125 mm	40.67
VME-14512071	125 mm	44.22
VME-14510828	130 mm	47.04
VME-14880749	137 mm	123.77
VME-9562-11600	137 mm	123.77
VME-9562-11400	140 mm	100.17
VME-11107809	140 mm	55.00
VME-11704172	140 mm	44.64
VME-14510425	140 mm	55.00
VME-14502440	145 mm	84.48
VME-11107810	150 mm	57.77
VME-14510456	150 mm	57.77
VME-15075435	150 mm	38.39
VME-11107811	160 mm	61.70
VME-14508903	160 mm	61.70
VME-14512072	165 mm	125.04
VME-14512073	170 mm	67.22
VME-11107813	180 mm	78.77
VME-11107814	190 mm	99.36
VME-14512074	190 mm	99.36
VME-11107815	200 mm	109.79
VME-11107817	220 mm	123.13
VME-11107818	230 mm	140.71
VME-15101298	240 mm	228.74
VME-11107820	250 mm	182.71
VME-11107821	260 mm	242.27

RETAINER RINGS

Part Number	List Price
VME-13949015	\$ 2.26
VME-947378	8.82

ROD BUSHINGS

Part Number	Rod Dia.	List Price
VME-11708994	16 mm	\$ 2.65
VME-14597338	35 mm	24.97
VME-9612-05535	55 mm	21.21
VME-9612-06035	60 mm	22.82
VME-9612-07040	70 mm	27.58
VME-9612-07540	75 mm	30.16
VME-9611-08030	80 mm	31.26
VME-9612-09030	90 mm	36.70
VME-9612-09040	90 mm	38.46
VME-9612-09540	95 mm	46.60
VME-9612-10040	100 mm	41.00
VME-9612-10540	105 mm	46.34
VME-9612-11050	110 mm	44.85
VME-9612-11545	115 mm	61.48
VME-9612-13050	130 mm	51.64

PISTON U-SEALS

Part Number	Bore Dia.	List Price
VME-12165	3	\$ 15.88
VME-12724821	4	19.29

U-SEALS

Part Number	Rod Dia.	List Price
VME-12724215	1-3/8	\$ 16.67
VME-12724223	2	22.13
VME-12584905	4	17.41
VME-12584906	6	29.93
VME-6213081	25 mm	8.47
VME-4784044-2	40 mm	15.91
VME-11704203	40 mm	15.91
VME-11005091	45 mm	15.75
VME-9563-20450	45 mm	18.79
VME-6120050	50 mm	55.49

REPLACEMENT PARTS FOR VOLVO EQUIPMENT

NOTE: Volvo part numbers are used as a reference only. We do not imply that these kits are original REPLACEMENT PARTS.

BUFFER RINGS

Part Number	Rod Dia.	List Price
VME-4941322-2	60 mm	\$ 19.36
VME-11202566	60 mm	13.12
VME-11704127	60 mm	21.67
VME-4784047	60 mm	21.67
VME-4833157-3	70 mm	17.50
VME-11107363	70 mm	17.50
VME-11202567	70 mm	17.50
VME-11704163	70 mm	17.50
VME-4784048	70 mm	27.12
VME-11005107	90 mm	16.49
VME-9563-20900	90 mm	29.65
VME-9563-20950	95 mm	31.03
VME-9563-21000	100 mm	23.72
VME-9563-21050	105 mm	40.80
VME-11088321	110 mm	45.35
VME-11107365	110 mm	45.35
VME-9563-21100	110 mm	43.89
VME-9563-21150	115 mm	47.13
VME-11005106	120 mm	55.22
VME-11107375	120 mm	55.22
VME-9563-21303	130 mm	65.03

WEAR RINGS

Part Number	O.D. X Width	List Price
VME-4200162	4-1/4 X 1	\$ 13.27
VME-11704218	36 x 20 mm	10.08
VME-2906616	37 x 9.9 mm	6.82
VME-11704202	44 X 20 mm	14.67
VME-11088081	45 x 13.9 mm	1.82
VME-2907076	49 x 25 mm	8.45
VME-11107549	50 x 27.9 mm	3.14
VME-11370064	55 x 14.6 mm	10.96
VME-6120051	55 X 14.7 mm	10.96
VME-11088052	55 x 15.9 mm	2.03
VME-2276780	55 x 29.4 mm	9.37

WEAR RINGS

Part Number	O.D. X Width	List Price
VME-11370063	55 x 9.4 mm	\$ 8.11
VME-11202574	65 X 15 mm	7.23
VME-11088053	65 x 17.9 mm	2.73
VME-11704125	66 X 29.7 mm	14.56
VME-2907391	68 x 24.7 mm	10.49
VME-2907399	68 x 9.5 mm	10.53
VME-2906621	70 x 10 mm	7.15
VME-11088054	75 x 17.9 mm	3.20
VME-9565-20750	75 X 20 mm	13.92
VME-9568-00750	75 X 6 mm	63.21
VME-11704162	76 X 39.7 mm	9.77
VME-6120058	80 X 9.7 mm	6.08
VME-2290213	80 x 9.8 mm	5.93
VME-11088150	85 x 17.9 mm	3.59
VME-9565-20850	85 X 25 mm	21.32
VME-9568-00850	85 X 6 mm	49.80
VME-2907068	85 x 9.9 mm	14.35
VME-11005427	96 x 25 mm	6.80
VME-11088249	96 x 28.9 mm	20.61
VME-11370065	100 x 14.6 mm	15.98
VME-11202576	100 X 14.7 mm	15.98
VME-9565-11000	100 X 14.8 mm	16.55
VME-11088148	100 x 16.9 mm	4.71
VME-14880809	100 X 25 mm	15.98
VME-2907089	100 x 9.3 mm	12.98
VME-9565-11050	105 X 15 mm	18.06
VME-9565-21050	105 X 24.5 mm	24.23
VME-14880896	105 X 6 mm	95.77
VME-11088222	108 x 17.9 mm	6.04
VME-11107528	110 x 13.9 mm	4.52
VME-9568-01100	110 X 6 mm	39.87
VME-2907421	110 x 9.5 mm	13.60
VME-9565-11150	115 X 15 mm	18.33
VME-9568-01150	115 X 6 mm	40.55
VME-11088324	118 x 29.9 mm	27.39
VME-11107298	120 x 13.9 mm	5.00
VME-11202577	120 X 14.8 mm	17.76
VME-9568-01200	120 X 6 mm	36.19

WEAR RINGS

Part Number	O.D. X Width	List Price
VME-9565-11250	125 X 14.8 mm	\$ 22.73
VME-4833220	125 x 16.7 mm	9.19
VME-9568-01250	125 X 6 mm	56.90
VME-2907417	125 x 7.8 mm	13.92
VME-11088496	128 x 29.9 mm	12.85
VME-11088879	128 x 34.7 mm	13.36
VME-9565-11300	130 X 14.8 mm	22.24
VME-11088609	130 x 23.9 mm	8.54
VME-11704174	140 X 12.7 mm	18.49
VME-9565-11400	140 X 20 mm	28.11
VME-11088220	140 x 24.9 mm	9.70
VME-14502441	145 X 20 mm	25.18
VME-14502442	145 X 6 mm	95.90
VME-9565-11500	150 X 20 mm	30.04
VME-11107289	150 x 21.88 mm	18.47
VME-11088149	150 x 24.9 mm	10.45
VME-9568-01500	150 X 6 mm	94.67
VME-9565-11600	160 X 20 mm	31.83
VME-11107223	160 x 24.9 mm	11.16
VME-11088109	160 x 29.9 mm	44.67
VME-14508905	160 X 6 mm	111.02
VME-9568-01600	160 X 6 mm	111.02
VME-9565-11651	165 X 30 mm	41.16
VME-9568-01650	165 X 6 mm	119.15
VME-11107156	170 x 19.9 mm	37.03
VME-9565-11700	170 X 25 mm	40.32
VME-11005323	170 x 29.9 mm	14.23
VME-9568-01705	170 X 6 mm	79.83
VME-14503567	175 X 25 mm	37.19
VME-14503568	175 X 6 mm	123.16
VME-11107217	180 x 24.9 mm	12.54
VME-11107168	190 x 24.9 mm	13.11
VME-9565-11900	190 X 25 mm	44.41
VME-11088014	190 x 29.9 mm	15.91
VME-9568-01900	190 X 8 mm	76.55
VME-11107159	200 x 24.9 mm	55.05
VME-11107254	220 x 23.95 mm	40.58
VME-15087850	220 X 33.9 mm	33.33

REPLACEMENT PARTS FOR VOLVO EQUIPMENT

NOTE: Volvo part numbers are used as a reference only. We do not imply that these kits are original REPLACEMENT PARTS.

WEAR RINGS

Part Number	O.D. X Width	List Price
VME-11107264	230 x 24.9 mm	\$ 18.99
VME-11088793	230 x 27.8 mm	101.53
VME-11088323	230 x 39.95 mm	56.47
VME-15100633	240 X 34 mm	35.22
VME-11107227	250 x 33.9 mm	26.54
VME-11005324	250 x 49.9 mm	41.30
VME-11107332	260 x 33.9 mm	27.63
VME-11088013	260 x 49.9 mm	42.97
VME-11107041	260 x 64.9 mm	55.29

WIPERS

Part Number	Rod Diam.	List Price
VME-12724216	1-3/8	\$ 4.42
VME-12724224	2	5.71
VME-2520124	3-1/2	28.51
VME-2541768	4-1/2	53.73
VME-2541770	5	58.17
VME-4782831	25 mm	2.50
VME-14597334	35 mm	17.88
VME-11005051-5	40 mm	22.35
VME-11704197	40 mm	22.35
VME-11005052	45 mm	22.89
VME-9567-20550	55 mm	28.61
VME-11005055	60 mm	25.41
VME-11202570	60 mm	10.07
VME-11704123	60 mm	25.41
VME-11005057	70 mm	26.39
VME-11202571	70 mm	14.34
VME-11704159	70 mm	26.39

WIPERS

Part Number	Rod Diam.	List Price
VME-9564-20700	70 mm	\$ 35.28
VME-9564-20750	75 mm	37.92
VME-11005059-8	80 mm	27.16
VME-11005015	80 mm	31.24
VME-11005059	80 mm	27.16
VME-11005061	90 mm	29.33
VME-9564-20900	90 mm	54.89
VME-9564-20950	95 mm	28.52
VME-9564-21000	100 mm	57.63
VME-9564-21050	105 mm	55.68
VME-11107246	110 mm	56.72
VME-9564-21100	110 mm	59.03
VME-9564-21150	115 mm	25.70
VME-11005067	120 mm	60.94
VME-11107224	120 mm	73.52
VME-9564-21300	130 mm	70.69

WABCO TRUCKS

Kit Number	Code (Pg. xviii)	Rod X Bore Size	List Price
WBC-587294	3 Stage Tele.	6-1/4, 8-1/8, 9-3/4	\$1112.20
WBC-AK0076	P-U-10	2-1/2 X 5	158.58
WBC-AK0700	3 Stage Tele	3-3/4, 5-1/4, 6-3/4	484.20
WBC-RK1655	3 Stage Tele.	3-3/4, 5-1/4, 6-3/4	588.49

WALTCO LIFT GATE

Kit Number	Code (Pg. xviii)	Rod X Bore Size	List Price
WC-1111-5	I-OB-10	1-1/4 X 4	\$ 13.87
WC-20280095	I-OB-10	1-3/4 X 4	15.78
WC-2500	I-OB-10	1-3/4 X 4	11.73
WC-70270081	I-OB-3	2 X 4-3/4	12.22
WC-70270091	N-OB-3	2 X 4-3/4	8.59
WC-70270681	I-U-4	2 X 4-3/4	32.84
WC-LD-81	I-OB-10	1-1/4 X 4	14.28

WARD TELESCOPIC CYLINDER PARTS

PACKING: Vee packing with top and bottom adapters. All .275 c.s.
WIPERS: Urethane snap-in type.
BEARINGS: Originally nylon, reinforced with metal. Outer bearing is flat on both sides. Inner bearing is step-cut on o.d. to pilot over snap ring.
PISTON: Steel, welded to stage. Double action has 3 replaceable nylon wear rings and 2 cast iron piston rings in separate grooves. Single action has 2 replaceable nylon wear rings.
STAGE O.D.'s: 3.950", 4.950", 5.950", 6.950", 7.950", 8.950"
SPECIAL INFO. 1/4" spring steel snap ring serves as internal stop. Gland collars are cast steel, have square reliefs in casting and "ears" on bottom of gland collar for set screw.

WARD CO

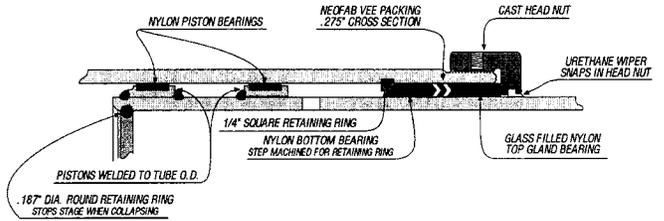

Part Number	Description	List Price
PACKING & WIPER		
WD-3VSW	2.950" I.D. Vee Set & Wiper	\$ 21.53
WD-4VSW	3.950" I.D. Vee Set & Wiper	26.20
WD-5VSW	4.950" I.D. Vee Set & Wiper	33.25
WD-6VSW	5.950" I.D. Vee Set & Wiper	42.03
WD-7VSW	6.950" I.D. Vee Set & Wiper	51.18
WD-8VSW	7.950" I.D. Vee Set & Wiper	61.53
WD-9VSW	8.950" I.D. Vee Set & Wiper	82.40
TOP BEARINGS		
WD-4NGTB	3.950" I.D. Top Bearing	\$ 52.30
WD-5NGTB	4.950" I.D. Top Bearing	59.20
WD-6NGTB	5.950" I.D. Top Bearing	61.93
WD-7NGTB	6.950" I.D. Top Bearing	85.62
WD-8NGTB	7.950" I.D. Top Bearing	107.17
WD-9NGTB	8.950" I.D. Top Bearing	108.64
BOTTOM BEARINGS		
WD-4NGBB	3.950" I.D. Bottom Bearing	\$ 52.30
WD-5NGBB	4.950" I.D. Bottom Bearing	59.20
WD-6NGBB	5.950" I.D. Bottom Bearing	84.98
WD-7NGBB	6.950" I.D. Bottom Bearing	85.62
WD-8NGBB	7.950" I.D. Bottom Bearing	107.17
PISTON WEAR RINGS		
WD310-737-40	4-1/2" O.D. Piston Wear Rings	\$ 4.89
WD310-737-50	5-1/2" O.D. Piston Wear Rings	4.89
WD310-764-60	6-1/2" O.D. Piston Wear Rings	6.41
WD310-764-70	7-1/2" O.D. Piston Wear Rings	10.42
WD310-764-80	8-1/2" O.D. Piston Wear Rings	11.01
WD310-764-90	9-1/2" O.D. Piston Wear Rings	13.09
PISTON RINGS - DOUBLE ACTION ONLY		
WD505-066-17	4-1/2" O.D. Piston Ring	\$ 12.27
WD505-066-24	5-1/2" O.D. Piston Ring	17.10
WD505-066-28	6-1/2" O.D. Piston Ring	19.78

Part Number	Description	List Price
WD505-066-35	7-1/2" O.D. Piston Ring	\$ 42.24
WD505-066-38	8-1/2" O.D. Piston Ring	47.10
WD505-066-40	9-1/2" O.D. Piston Ring	145.71
KITS		
WD-48	4" - 8" Vee Sets & Wipers	\$ 234.16
WD-49	4" - 9" Vee Sets & Wipers	324.22
WD-BNB48	4" - 8" Bottom Bearings	403.57
WD-PR48	4-1/2" - 8-1/2" Piston Rings	254.37
WD-PR49	4-1/2" - 9-1/2" Piston Rings	390.11
WD-TNB48	4" - 8" Top Bearings	379.57
WD-TNB49	4" - 9" Top Bearings	492.33
WD-WR48	4-1/2" - 8-1/2" Piston Wear Rings	103.62
WD-WR49	4-1/2" - 9-1/2" Piston Wear Rings	138.75

WHITE LIFT TRUCK

Kit Number	Code (Pg. xviii)	Rod X Bore Size	List Price
WLT-20-7300283	I-U-4	1-3/4 X 4	\$ 58.75
WLT-20-7302715	I-U-10	1-1/2 X 3-1/2	32.75
WLT-30-3305457	P-U-10	1-1/2 X 3-1/2	33.76

WHITEMAN / CONSPRAY

Kit Number	Code (Pg. xviii)	Rod X Bore Size	List Price
WCS-02KS-4963	I-U-11	3 X 4	\$ 40.28
WCS-02KS-4964	I-U-5	3-1/2 X 8	165.07
WCS-02KS-4966	I-U-10	5-1/2 X 6-1/2	156.55
WCS-02KS-85A		Pump Kit	15.01
WCS-02KS-954		6" Rod Kit	105.09
WCS-05KS-8451	I-U-10	1-3/4 X 3-1/4	61.98

WARD - WHITEMAN

YALE® LIFT TRUCKS

Kit Number	Code (Pg. xviii)	Rod X Bore Size	List Price
YA-066414600	4-1/16 Rod Wiper		\$ 17.42
YA-5001689-04	4-1/16 ID Vee Set		46.14
YA-502566003	I-N-8	2-1/2 X 3-1/2	116.32
YA-502566004	I-N-8	2 X 3-1/2	111.14
YA-503130000	P-V-4	2 X 3-1/4	56.39
YA-504236229	P-U-10	2-1/8 X 2-3/4	67.34
YA-504236245	P-U-10	1-3/8 X 3	36.39
YA-504853000	I-U-5	1-1/4 X 3	82.83
YA-504857000	I-N-8	2-1/4 X 4	49.40
YA-5048620	I-N-8	1-3/4 X 2-1/2	23.57
YA-505136003	I-N-8	2-1/2 X 3-1/2	47.73
YA-505136004	I-N-8	2 X 3-1/2	39.89
YA-505136007	I-U-1	1-5/8 X 2-1/4	18.82
YA-505136008	I-U-1	1-5/16 X 2-1/4	18.42
YA-505136009	I-U-1	3-1/4" Rod	28.09
YA-505136010	I-U-1	1-7/8 X 2-1/2	17.71
YA-505136012	I-U-11	1-7/8 X 2-1/4	55.41
YA-505136013	I-U-1	2-5/8 Rod Kit	20.20
YA-505136014	I-U-1	3-3/4 ROD	26.51
YA-505136015	I-U-10	2-5/8 X 3	84.35
YA-505136027	I-U-1	1-5/8 X 2	23.07
YA-505136028	i-u-4	1-3/8 x 2	75.67
YA-505136031	I-U-1	3 X 3-3/4	28.88
YA-505136035	I-U-4	1-3/8 X 2	47.22
YA-505136036	I-U-4	1-5/8 X 2	39.79
YA-505136037	I-U-12	1-3/8 X 2	49.01
YA-505136040	I-U-4	1-5/8 X 1-7/8	44.20
YA-505136059	I-U-1	1-1/4 X 1-3/4	23.03
YA-505142000	I-V-1	3-3/8, 4-1/16 Stages	93.75
YA-505143000	I-V-1	2-1/2, 3 Stages	66.99
YA-505163001	ROD KIT		14.76

Kit Number	Code (Pg. xviii)	Rod X Bore Size	List Price
YA-506785001	I-N-8	2-1/4 X 4	\$ 170.72
YA-506787001	I-N-8	2-3/4 X 4-1/2	181.75
YA-506788001	I-N-8	2-3/4 X 4-1/2	79.29
YA-507016002	I-V-5	1-1/2 x 4	65.99
YA-509753000	I-V-12	1 X 2	31.06
YA-510078000	I-U-5	1 X 2-1/2	41.09
YA-510398000	I-V-1	2-1/4, 3, 3-3/4 Stages	141.54
YA-510659001	I-V-2	1-1/4 X 3-1/2	37.18
YA-512944003	I-U-10	1 X 2	20.07
YA-513355800	O-RING KIT		3.93
YA-514527000	I-V-1	3, 3-3/4 Stages	87.65
YA-515229000	I-U-4	2-1/4 X 3-3/4	42.86
YA-516149002	I-U-11	1 X 2	27.05
YA-516149005	I-U-11	1 X 2	21.62
YA-516149006	I-U-11	1-1/8 X 2-1/2	26.70
YA-5178128-17	SHAFT KIT		1.81
YA-518617001	I-V-10	1-1/4 X 2-1/2	66.90
YA-519132600	I-U-5	1-3/4 X 3-1/2	46.89
YA-519675801	O-RING KIT		7.12
YA-580026957	P-U-10	2-1/8 X 2-3/4	32.57
YA-580060036	P-U-10	2-1/8 X 2-3/4	49.90
YA-900299851	65 mm, 80 mm 2 Stage		49.28
YA-900847850	P-U-10	25 X 60 mm	44.43
YA-900879850	I-U-3	35 X 80 mm	18.43
YA-901115850	P-U-1	32 mm Rod Kit	41.87
YA-9012238-07	P-U-10	40 X 70 mm	68.36
YA-9017888-10	P-U-10	35 X 70 mm	53.78
YA-9019058-52	P-U-10	35 X 65 mm	82.57
YA-9022018-50	SHAFT KIT		12.11

YALE®

REPLACEMENT PARTS FOR YALE® EQUIPMENT

NOTE: Kubota part numbers are used as a reference only. We do not imply that these kits are original REPLACEMENT PARTS.

VEE SETS

Part Number	ID	List Price
YA-5001689-19	2-1/4	\$ 34.80

O-RINGS

Part Number	Min Pkg Qty	List Price
YA-912452100	100	\$ 0.11

YANMAR EXCAVATORS

Kit Number	Code (Pg. xviii)	Rod X Bore Size	List Price
YAN-172147-99340	P-U-14	55 X 95 mm	\$ 141.96
YAN-172425-72500	P-U-1	55 mm Rod Kit	35.54
YAN-172425-72600	N-N-14	90 mm Piston Kit	36.86
YAN-933138-70699	P-U-5	40 X 88 mm	131.40
YAN-933711-33599	P-U-5	50 X 80 mm	65.37
YAN-933711-34799	P-U-5	40 X 75 mm	149.10

Replacement Kits For

YUTANI

Excavators						
APPLICATION	CYL #	CODE	ROD	BORE	KIT #	List \$
MODEL MD-120LC						
ARM	2438U983F1	P-UB-1	80 mm		YUT-2438U928R100	197.47
BOOM L	2438U923F1	P-UB-1	70 mm		YUT-2438U922R100	135.38
BOOM R	2438U922F1	P-UB-1	70 mm		YUT-2438U922R100	135.38
BUCKET	2438U897F1	P-UB-1	65 mm		YUT-2438U897R100	113.88
	2438U897F1	N-N-10		100 mm	YUT-2438U897R110	127.84
MODEL MD-140BLC						
ARM	2438U973F1	N-N-10		120 mm	YUT-2438U973R200	296.64
	2438U973F1	P-UB-1	80 mm		YUT-2438U973R100	222.91
BOOM L	2438U972F2	P-UB-1	70 mm		YUT-2438U971R100	139.75
	2438U972F2	N-N-10		105 mm	YUT-2438U971R200	211.14
BOOM R	2438U971F2	P-UB-1	70 mm		YUT-2438U971R100	139.75
	2438U971F2	N-N-10		105 mm	YUT-2438U971R200	211.14
BUCKET	2438U974F1	N-N-10		100 mm	YUT-2438U974R200	216.25
	2438U974F1	P-UB-1	65 mm	100 mm	YUT-2438U974R100	112.08
MODEL MD-180LC						
ARM	2438U921F1	P-UB-1	95 mm		YUT-2438U921R100	141.33
	2438U921F1	N-N-10		145 mm	YUT-2438U921R110	271.58
	2438U921F2	P-UB-1	95 mm		YUT-2438U921R100	141.33
	2438U921F2	N-N-10		145 mm	YUT-2438U921R110	271.58
	2438U982F1	P-UB-1	95 mm		YUT-2438U921R100	141.33
BOOM	2438U914D1F1	P-UB-1	85 mm		YUT-2438U914R100	151.18
	2438U914D2F1	P-UB-1	85 mm		YUT-2438U914R100	151.18
BOOM L	2438U981F1	P-UB-1	85 mm		YUT-2438U914R100	151.18
BOOM R	2438U980F1	P-UB-1	85 mm		YUT-2438U914R100	151.18
BUCKET	2438U915F1	P-UB-1	75 mm		YUT-2438U915R100	114.23
	2438U915F1	N-N-10		120 mm	YUT-2438U915R110	216.52
MODEL MD-200BLC						
ARM	2438U941F1	N-N-14		145 mm	YUT-2438U941R200	373.00
	2438U941F1	P-UB-1	100 mm		YUT-2438U941R100	343.20
BOOM L	2438U996F1	P-UB-1	85 mm		YUT-2438U996R100	173.53
	2438U996F1	N-N-14		125 mm	YUT-2438U996R200	341.19
BOOM R	2438U997F1	N-N-14		125 mm	YUT-2438U996R200	341.19
	2438U997F1	P-UB-1	85 mm		YUT-2438U996R100	173.53
BUCKET	2438U995F1	N-N-14		120 mm	YUT-2438U995R200	315.30
	2438U995F1	P-UB-1	80 mm		YUT-2438U995R100	170.86
MODEL MD-240BLC						
ARM	2438U953F1	N-N-10		150 mm	YUT-2438U953R200	310.97
	2438U953F1	P-UB-1	105 mm		YUT-2438U953R100	338.57
BOOM L	2438U1000F1	P-UB-1	90 mm		YUT-2438U999R100	166.62
	2438U1000F1	N-N-10		140 mm	YUT-2438U999R200	320.94
BOOM R	2438U999F1	P-UB-1	90 mm		YUT-2438U999R100	166.62
	2438U999F1	N-N-10		140 mm	YUT-2438U999R200	320.94
BUCKET	2438U959F1	N-N-10		130 mm	YUT-2438U959R200	239.29
	2438U959F1	P-UB-1	85 mm		YUT-2438U959R100	179.26
MODEL MD-300LC						
ARM	2438U1323F1	P-UB-1	110 mm		YUT-2438U1323R100	251.03

Replacement Kits For

YUTANI

Excavators						
APPLICATION	CYL #	CODE	ROD	BORE	KIT #	List \$
MODEL MD-300LC						
ARM	2438U1323F1	N-N-10		160 mm	YUT-2438U1323R110	426.87
BOOM	2438U776F1	P-UB-1	95 mm		YUT-2438U776R100	205.78
	2438U776F1	N-N-10		150 mm	YUT-2438U776R110	332.97
BUCKET	2438U1324F1	P-UB-1	100 mm		YUT-2438U1324R100	283.82
	2438U1324F1	N-N-10		150 mm	YUT-2438U1324R110	252.36
MODEL MD-450BLC						
ARM	2438U1029F1	N-N-14		180 mm	YUT-2438U1029R200	340.64
	2438U1029F1	P-UB-1	130 mm		YUT-2438U1029R100	308.65
BOOM	2438U1028D1F1	P-UB-1	110 mm		YUT-2438U1028R100	191.32
	2438U1028D1F1	N-N-14		170 mm	YUT-2438U1028R200	474.09
	2438U1028D2F1	P-UB-1	110 mm		YUT-2438U1028R100	191.32
	2438U1028D2F1	N-N-14		170 mm	YUT-2438U1028R200	474.09
BUCKET	2438U1030F1	N-N-14		170 mm	YUT-2438U1030R200	474.09
	2438U1030F1	P-UB-1	120 mm		YUT-2438U1030R100	238.55

REPLACEMENT KITS FOR YUTANI EQUIPMENT

Kit Number	Description	List Price
YUT-2438U1028R100	110 mm Rod Kit	\$ 191.32
YUT-2438U1028R200	170 mm Piston Kit	474.09
YUT-2438U1029R100	130 mm Rod Kit	308.65
YUT-2438U1029R200	180 mm Piston Kit	340.64
YUT-2438U1030R100	120 mm Rod Kit	238.55
YUT-2438U1030R200	170 mm Piston Kit	474.09
YUT-2438U1323R100	110 mm Rod Kit	251.03
YUT-2438U1323R110	160 mm Piston Kit	426.87
YUT-2438U1324R100	100 mm Rod Kit	283.82
YUT-2438U1324R110	150 mm Piston Kit	252.36
YUT-2438U776R100	95 mm Rod Kit	205.78
YUT-2438U776R110	150 mm Piston Kit	332.97
YUT-2438U897R100	65 mm Rod Kit	113.88
YUT-2438U897R110	100 mm Piston Kit	127.84
YUT-2438U914R100	85 mm Rod Kit	151.18
YUT-2438U915R100	75 mm Rod Kit	114.23
YUT-2438U915R110	120 mm Piston Kit	216.52
YUT-2438U921R100	95 mm Rod Kit	141.33
YUT-2438U921R110	145 mm Piston Kit	271.58
YUT-2438U922R100	70 mm Rod Kit	135.38

Kit Number	Description	List Price
YUT-2438U928R100	80 mm Rod Kit	\$ 197.47
YUT-2438U941R100	100 mm Rod Kit	343.20
YUT-2438U941R200	145 mm Piston Kit	373.00
YUT-2438U953R100	105 mm Rod Kit	338.57
YUT-2438U953R200	150 mm Piston Kit	310.97
YUT-2438U959R100	85 mm Rod Kit	179.26
YUT-2438U959R200	130 mm Piston Kit	239.29
YUT-2438U971R100	70 mm Rod Kit	139.75
YUT-2438U971R200	105 mm Piston Kit	211.14
YUT-2438U973R100	80 mm Rod Kit	222.91
YUT-2438U973R200	120 mm Piston Kit	296.64
YUT-2438U974R100	65 mm Rod Kit	112.08
YUT-2438U974R200	100 mm Piston Kit	216.25
YUT-2438U985R200	180 mm Piston Kit	371.22
YUT-2438U995R100	80 mm Rod Kit	170.86
YUT-2438U995R200	120 mm Piston Kit	315.30
YUT-2438U996R100	85 mm Rod Kit	173.53
YUT-2438U996R200	125 mm Piston Kit	341.19
YUT-2438U999R100	90 mm Rod Kit	166.62
YUT-2438U999R200	140 mm Piston Kit	320.94

YUTANI

NOTES

NOTES

Pumps, Motors and Valve Repair Kits

Contents	Page
Bosch Rexroth Pump Kits	1139 - 1140
Parker/Commercial Intertech Pump Repair Kits	1141 - 1158
Parker/Gresen Pump Repair Kits	1159 - 1164
Vickers® Pump Repair Kits	1165 - 1169
Char-Lynn® and White Motors Repair Kits	1171 - 1181
Parker/Commercial Intertech and Parker Gresen Valve Repair Kits	1183 - 1122

PUMP, MOTOR AND VALVE



**The 2015 New Products Catalog
and Calendar
are Now Available!**

**Order Online -
www.HerculesUS.com**

Bosch Rexroth Pump Repair Kits

Contents

Page

Bosch Rexroth Pump Kits

1140

PUMP REPAIR KITS

BOSCH REXROTH PUMP KITS



A10 NBR SERVICE KITS FOR SERIES 30 & 31

Kit Number	PUMP TECHNICAL DATA				Kit List Price
	Model Number	Size	Displacement in. ³ / (cm ³)	Flow Rate (GPM)	
BRR-R910937565	A10V(S)0	18	1.1 / (18)	15.7	\$ 47.83
BRR-R910915845	A10V(S)0	28	1.71 / (28)	22	53.56
BRR-R910915885	A10V(S)0	45	2.75 / (45)	31	57.57
BRR-R910915846	A10V(S)0	71	4.33 / (71)	41	68.82
BRR-R910915847	A10V(S)0	100	6.1 / (100)	53	62.84
BRR-R910941169	A10V(S)0	140	8.54 / (140)	67	88.61

Parker/Commercial Intertech Pump Repair Kits

Contents	Page
Identifying Pumps & Motors	1142
Pump/Motor Seal Kits	1143 - 1145
Repair Parts	1146
Parts Breakdown	
• C101/102 Parts Breakdown	1147
• G101/102 Parts Breakdown	1148
• P20 Parts Breakdown	1149
• P30 Parts Breakdown	1150
• P31 Parts Breakdown	1151
• P50 Parts Breakdown	1152
• P51 Parts Breakdown	1153
• P75 Parts Breakdown	1154
• P76 Parts Breakdown	1155
• P330 Parts Breakdown	1156
• P350 Parts Breakdown	1157
• P365 Parts Breakdown	1158

IDENTIFYING PUMPS & MOTORS



By the Shape and Size of the Port End Cover

1. Look at the Unit from the Port End, see which example it matches the closest. Include the Shape, Size, and most importantly the Bolt Pattern.
2. Measure the overall width of the Unit, then match the width to the chart beside the Port End you chose in step #1.
3. If there is not a "See Also" block on the chart you used, then you've identified the Unit. Otherwise move to step #4.
4. A Numbered Note marker will direct you to the next step or steps.

PORT END VIEW

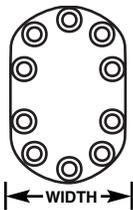

Series	"D"
Width	4.50

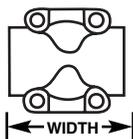

Series	315	330	350	365
Side Ported Width	4.25	6.68	7.12	7.38
Unported Width	4.00	4.81	5.75	6.25

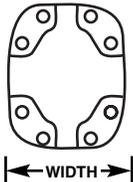

Series	37X	75/76	125
Width	5.12	6.13	7.00
See Also		②	

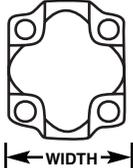

Series	15H	25X	20	30/31	50/51
Width	4.38	4.94	4.50	4.81	4.94
See Also		①		②	①②

1 - SHAFT END VIEW

Look at the Unit from the Shaft End, compare it to the views below. Select the Shaft type on your Unit.

SERIES 31/51



25X/37X



2 - DISASSEMBLE UNIT

This step requires the Port End Cover of the Unit to be removed & inspected for Dowel Pins. This is the only way to tell the difference between some Series.

Series 31/51/76: Assembled with Dowel Pins.

**Call Our Component Sales Team
If You Need More Assistance**

PUMP/MOTOR SEAL KITS



Identify kits by using model and shaft end cover numbers. Example:

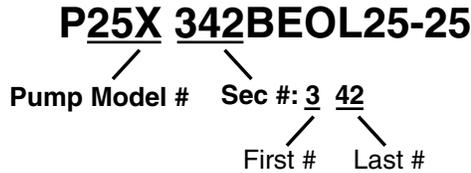

P20 SERIES

Kit Part #	Application	SEC First #	SEC Last #	Price
Pumps CM-P20SPSK		1, 2, 3, 4, 5, 6	05, 27, 42, 91, 92, 94, 96, 97	\$ 15.96
Motors CM-M20SPSK		8, 9, 19	05, 10, 42, 94, 97	22.07
Multiple Section Pumps & Motors CM-MP20MSSK Note: Use 1 Kit per section in a multi-section Pump or Motor				3.13

25X SERIES

Kit Part #	Application	SEC First #	SEC Last #	Price
Pumps CM-P25SBSKT1	Type I, Single Bearing	1, 2, 3	00, 01, 02, 03, 06, 40, 41, 42, 78, 79, 97, 98	\$ 19.19
CM-P25SBSKT2	Type II, Single Bearing	1, 2, 3	04, 05, 07	19.10
CM-P25DBSK	Type II, Double Bearing	6, 8	00, 42, 78, 97, 98	24.46
Motors CM-M25SBSKT1	Type I, Single Bearing	7, 9	00, 01, 02, 03, 06, 40, 41, 42, 78, 79, 95, 97, 98	\$ 27.80
CM-M25SBSKT3	Type II, Single Bearing	7, 9	04, 05, 07	30.92
CM-M25DBSK	Type II, Double Bearing	8	00, 42, 47, 78, 97, 98	26.36
Multiple Section Pumps & Motors CM-MP25MSSK Note: Use 1 Kit per section in a multi-section Pump or Motor				\$ 3.18

30 SERIES

Kit Part #	Application	SEC First #	SEC Last #	Price
Pumps CM-P30SPSK		1 - 6	05 - 97	\$ 13.02
Motors CM-M30SPSK	Type I, Single Bearing	8 - 9	05 - 94	34.48
Multiple Section Pumps & Motors CM-MP30MSSK Note: Use 1 Kit per section in a multi-section Pump or Motor				\$ 3.36

PUMP REPAIR KITS

REPAIR PARTS



Standard Series Pump Parts

PUMP REPAIR KITS

Description	Engineering #	Part #	Price
P20/30/31 SERIES			
Snap Ring	X134-206	CM-391-2686-063	\$ 3.26
Outboard Bearing	X69-40	CM-391-0381-040	33.14
Seal (pump)	X73-37-16	CM-391-2883-058	2.86
Check Assemblies	M1391K	CM-391-3681-001	2.48
Plug	T1391	CM-391-2286-004	3.60
Spacer	VB1669-2	CM-391-3383-069	39.02
Seal Retainer	AE1669	CM-391-3381-040	16.43
Hi Pressure Seal	X73-50-9	CM-391-2883-119	20.22
Ring Seals	LB1669-1	CM-391-2585-006	10.59
Roller Bearings	Y1032	CM-391-0381-906	22.75
Thrust Plates	AA1058	CM-391-2185-913	50.30
P50/51 SERIES			
Snap Ring	X134-283	CM-391-2686-063	\$ 3.26
Outboard Bearing	X69-58	CM-391-0381-040	33.14
Seal (pump)	X73-37-17	CM-391-2883-058	2.86
Check Assemblies	M1391K	CM-391-3681-001	2.48
Plug	T1391	CM-391-2286-004	3.60
Spacer	VB1669-1	CM-391-3383-069	39.02
Seal Retainer	AC1669	CM-391-3381-040	16.43
Hi Pressure Seal	X73-50-8	CM-391-2883-119	20.22
Ring Seals	NB1669-1	CM-391-2585-006	10.59
Roller Bearings	S1032	CM-391-0381-906	22.75
Thrust Plates	Y1058	CM-391-2185-913	50.30
P75/76 SERIES			
Snap Ring	X96-315	CM-391-2686-025	\$ 7.58
Outboard Bearing	X69-59	CM-391-0381-078	58.02
Spacer	VB1669	CM-391-3383-018	24.88
Seal Retainer	RA1072	CM-391-2584-051	41.38
O Ring	L3006-164	CM-391-2881-457	0.47
Seal (pump)	X73-37-10	CM-391-2883-052	9.16
(motor)	X73-50-1	CM-391-2883-094	32.42
Check Assemblies	M1391K	CM-391-3681-001	2.48

Description	Engineering #	Part #	Price
P75/76 SERIES			
Plug	T1391	CM-391-2286-004	\$ 3.60
Ring Seals	WB1669-1	CM-391-2585-011	15.39
Roller Bearings	R1032	CM-391-0381-904	49.70
Pocket Seals	BA3026-6	CM-391-2882-084	4.06
Thrust Plates	BA1058	CM-391-2185-920	125.70
P330 SERIES			
Snap Ring		300-206	\$ 3.26
Outboard Bearing	X69-40	CM-391-0381-040	33.14
Seal	X73-37-16	CM-391-2883-058	2.86
Bushings	(330) BUSHINGS	CM-391-0482-306	15.38
Channel Seal	P330 CHNL SEAL	CM-391-2885-065	7.61
Thrust Plates	P330 THRUST PLT	CM-391-2185-956	109.82
Gasket Seal	SOR-75NBR-4x1/8-C/S	580-242	0.87
Dowel Pins (Solid)	P31 DOWEL PINS	CM-391-2082-032	11.34
P350 SERIES			
Snap Ring		WHM-283	\$ 10.61
Outboard Bearing	X69-58	CM-391-0381-077	48.67
Seal	X73-37-16	CM-391-2883-103	2.86
Bushings	(330) BUSHINGS	CM-391-0482-308	27.33
Channel Seal	P330 CHNL SEAL	CM-391-2885-066	9.05
Thrust Plates	P330 THRUST PLT	CM-391-2185-957	66.34
Gasket Seal	SOR-75NBR-4.5x1/8-C/S	580-246	1.29
Dowel Pins (Solid)	P31 DOWEL PINS	CM-391-2082-032	11.34
P365 SERIES			
Snap Ring		300-315	\$ 9.05
Outboard Bearing	X69-59	CM-391-0381-078	58.02
Seal	X73-37-10	CM-391-2883-052	9.16
Bushings	BUSHING 365	CM-391-0482-307	40.05
Channel Seal	CHANNELSEAL	CM-391-2885-064	5.90
Thrust Plates	P365 THRUST PLT	CM-391-2185-055	81.88
Gasket Seal	SOR-75NBR-5x1/8-C/S	580-250	1.85
Dowel Pins (Solid)	PIN,DOWEL	CM-391-2082-062	2.37

C101/C102 PARTS BREAKDOWN



Seal Kit for C101 - CM-HC101
Seal Kit for C102 - CM-HC102

Typical Parts

Item	Description	Part #	Req	Price
A	Shaft End Cover	For reference only	1	N/A
B	Snap Ring	CM-391-2686-065	1	\$ 4.33
C	Seal Retainer	CM-391-3383-087	1	10.46
D	Lip Seal	CM-391-2883-115	1	39.73
E	Check Assembly	CM-391-3681-001	2	N/A
F	Ring Seal	CM-391-2585-009	2	11.53

Item	Description	Part #	Req	Price
G	Roller Bearing	CM-391-0381-905	4	\$ 34.61
H	Thrust Plate	CM-391-2185-912	2	50.80
J	Pocket Seal	CM-391-2882-050	12	0.75
M	Port End Cover	For reference only	1	N/A
N	Valve Spool	For reference only	1	N/A

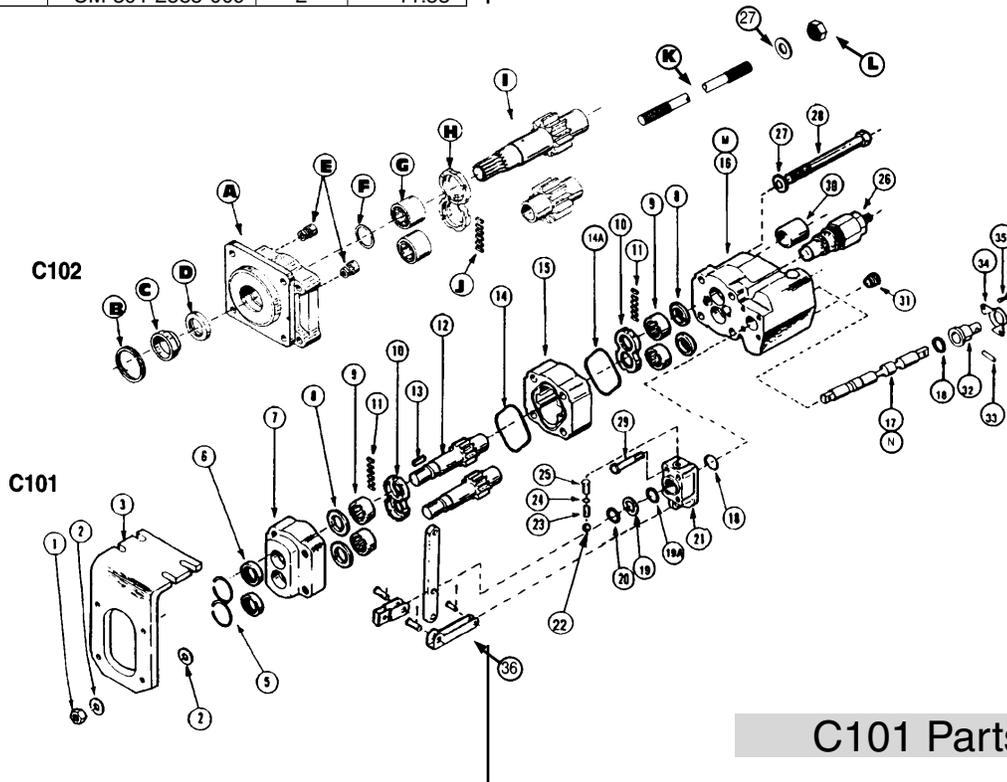

C101 Parts List

Item	Description	Part #	Req	Price
1	Hex Nut	For reference only	4	N/A
2	Washer	For reference only	8	N/A
3	Bracket (optional)	For reference only	1	N/A
5	Snap Ring	CM-391-2681-493	2	\$ 3.37
6	Lip Seal	CM-391-2883-096	2	31.53
7	Shaft End Cover	For reference only	1	N/A
8	Ring Seal	CM-391-2585-009	4	11.53
9	Roller Bearing	CM-391-0381-905	4	34.61
10	Thrust Plate	CM-391-2185-916	2	51.95
11	Pocket Seals	CM-391-2882-050	12	0.75
12	Gear Set 2"	For reference only	1	N/A
	2 1/2"	For reference only	1	N/A
13	Shaft Key	For reference only	1	N/A
14	Gasket Seal	For reference only	2	N/A
15	Gear 2"	For reference only	1	N/A
	Housing 2 1/2"	For reference only	1	N/A
16*	Port End Cover	For reference only	1	N/A
17*	Valve Spool	For reference only	1	N/A
18	"O" Ring	CM-391-2881-103	2	0.17
19A	Wiper Ring	CM-391-2883-147	1	2.99
19	Retainer Ring	CM-391-3782-126	1	4.21
20	Snap Ring	CM-391-2688-003	1	10.01

Item	Description	Part #	Req	Price
21	Detent Cap	For reference only	1	N/A
22	Detent Ball	For reference only	1	N/A
23	Detent Spring	For reference only	1	N/A
24	Lock Washer	For reference only	1	N/A
25	Detent Retainer	For reference only	1	N/A
26	Relief Valve	For reference only	1	N/A
27	Washer	For reference only	4	N/A
28	Cap Screw 2"	For reference only	4	N/A
	2 1/2"	For reference only	4	N/A
29	Cap Screw	For reference only	4	N/A
30	Sleeve (optional)	For reference only	1	N/A
31	Pipe Plug - 1" NPT	For reference only	1	N/A
32	Spool End Cap	For reference only	1	N/A
33	Spiral Pin	For reference only	1	N/A
34	Bracket	For reference only	1	N/A
35	Socket Hd.	For reference only	2	N/A
	Cap Screw	For reference only	1	N/A
36	Handle Ass'y (optional)	For reference only	1	N/A

*Items 16, 17 M and N are not serviceable parts.

PUMP REPAIR KITS

G101/G102 PARTS BREAKDOWN



Seal Kit for G101 - CM-HG101
Seal Kit for G102 - CM-HG102

Item	Description	Part #	Req	Price
B	Lip Seal	CM-391-2883-119	1	\$ 20.22
C	Seal Retainer	CM-391-3381-040	1	16.43
D	Spacer	CM-391-3383-069	1	39.02
E	Snap Ring	CM-391-2686-063	1	3.26
F	Checks	CM-391-3681-001	2	2.48

Item	Description	Part #	Req	Price
G	Ring Seal	CM-391-2585-006	2	\$ 10.59
H	Roller Bearing	CM-391-0381-906	4	22.75
I	Thrust Plate	CM-391-2185-913	2	50.30
J	Pocket Seal	568C-093	1ft	0.75

PUMP REPAIR KITS

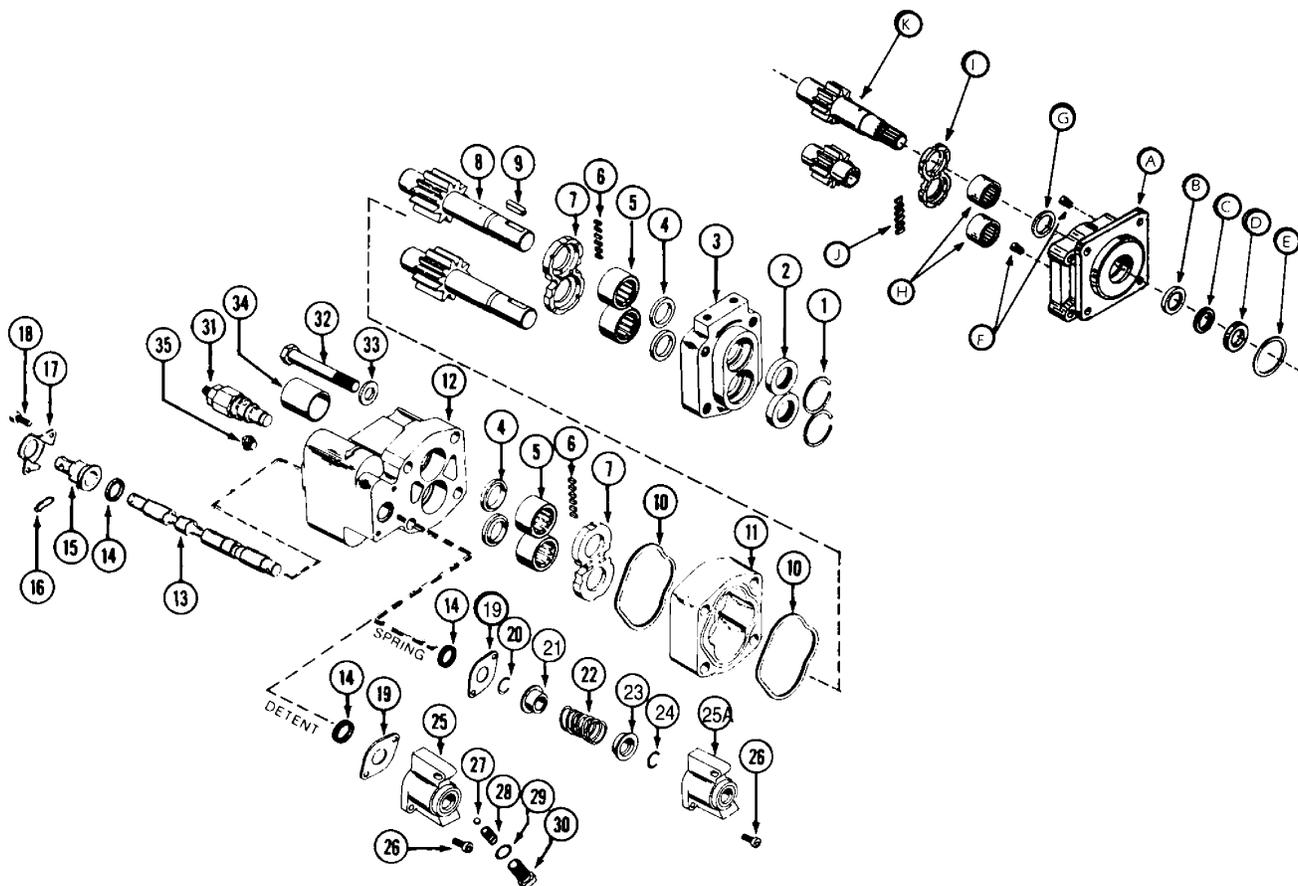

Item	Description	Part #	Req	Price
1	Snap Ring	CM-391-2681-487	2	\$ 3.04
2	Lip Seal	CM-391-2883-119	2	20.22
4	Ring Seal	CM-391-2585-006	4	10.59
5	Roller Bearing	CM-391-0381-906	4	22.75

Item	Description	Part #	Req	Price
6	Pocket Seal	568C-093	1ft	\$ 0.75
7	Thrust Plate	CM-391-2185-913	2	50.30
14	Quad Ring Seal	CM-391-1985-014	2	1.64

P20 PARTS BREAKDOWN



Note:

This page shows the typical arrangement of a 2-section unit. It may not be pictorially correct and is not to scale.

Plug 5 in position B gives clockwise rotation.

Plug 5 in position A gives counter-clockwise rotation.

Check valves in both positions give bi-directional rotation

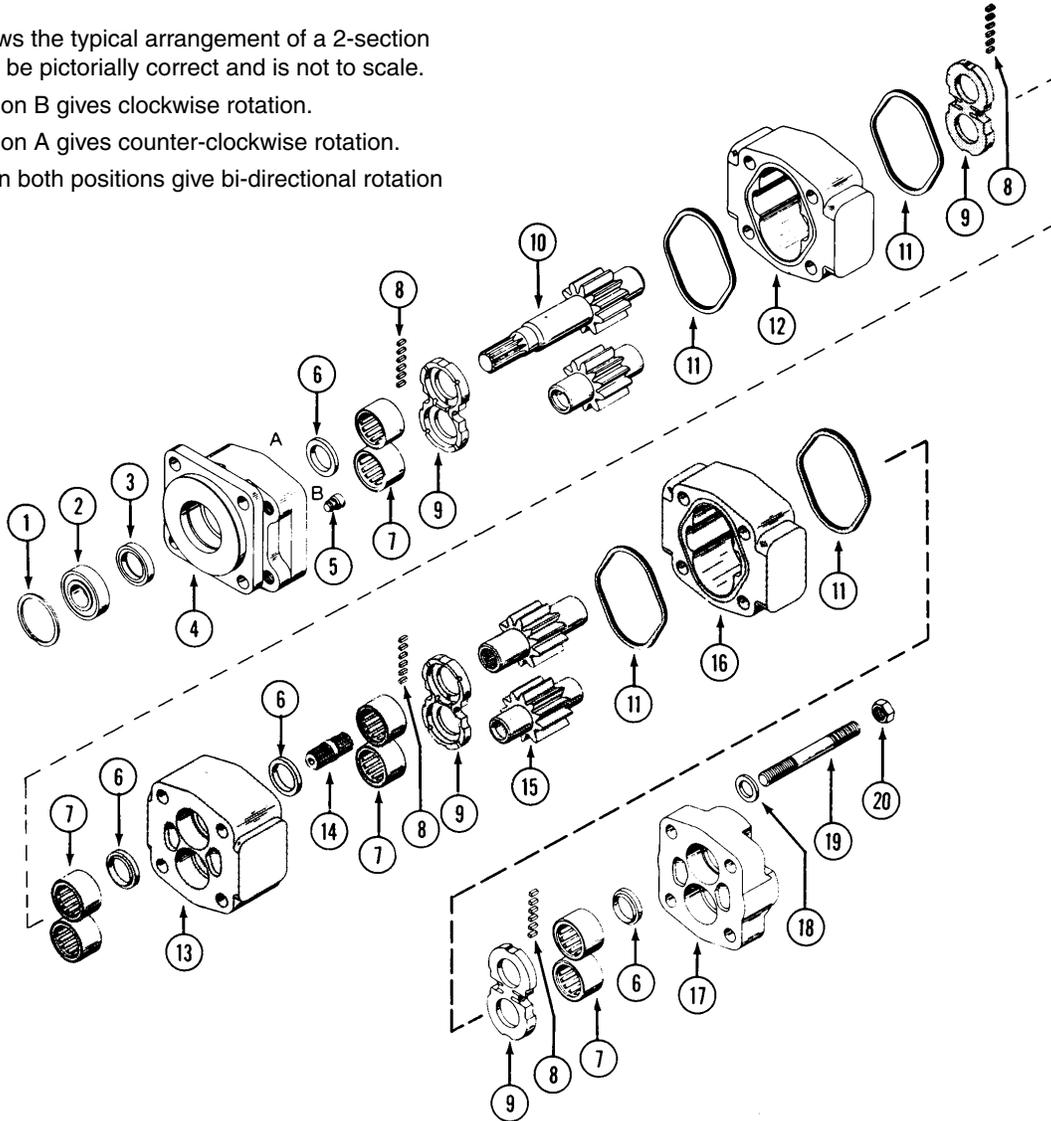

PUMP REPAIR KITS

Item	Description	Part #	Price
1	Snap Ring	CM-391-2686-063	\$ 3.26
2	Outboard Bearing	CM-391-0381-040	33.14
3	Seal	CM-391-2883-058	2.86
4	Shaft End Cover	For reference only	N/A
5	Check Assemblies or Plug	CM-391-3681-001	2.48
6	Ring Seals	CM-391-2585-006	10.59
7	Roller Bearings	CM-391-0381-906	22.75
8	Pocket Seals	568C-093	0.75
9	Thrust Plates	CM-391-2185-913	50.30
10	Integral Drive Shaft and Gear Set	For reference only	N/A

Item	Description	Part #	Price
11	Gasket Seals	580-239	\$ 0.85
12	Gear Housing	For reference only	N/A
13	Bearing Carrier	For reference only	N/A
14	Connecting Shaft	For reference only	N/A
15	Matched Gear Set	For reference only	N/A
16	Gear Housing	For reference only	N/A
17	Port End Cover	For reference only	N/A
18	Washers	For reference only	N/A
19	Studs or Cap Screws	For reference only	N/A
20	Nuts	For reference only	N/A

P30 PARTS BREAKDOWN



Note:

This page shows the typical arrangement of a 2-section unit. It may not be pictorially correct and is not to scale.

Plug 5 in position B gives clockwise rotation.

Plug 5 in position A gives counter-clockwise rotation.

Check valves in both positions give bi-directional rotation

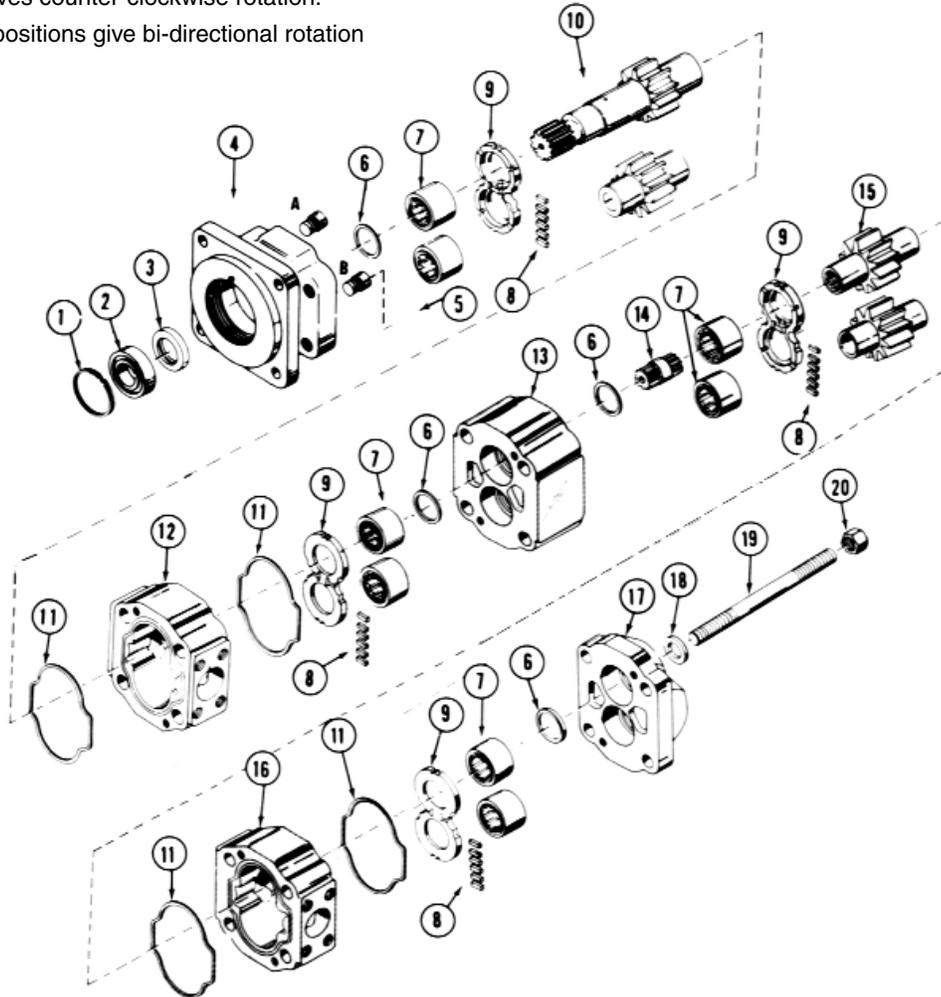

PUMP REPAIR KITS

Item	Description	Part #	Price
1	Snap Ring	CM-391-2686-063	\$ 3.26
2	Outboard Bearing	CM-391-0381-040	33.14
3	Seal (Pump)	CM-391-2883-058	2.86
4	Hi Pressure Seal (Motor)	CM-391-2883-119	20.22
5	Check Assemblies	CM-391-3681-001	2.48
	Plug	CM-391-2286-004	3.60
6	Ring Seals	CM-391-2585-006	10.59
7	Roller Bearings	CM-391-0381-906	22.75
8	Pocket Seals	568C-093	0.75
9	Thrust Plates	CM-391-2185-913	50.30
10	Integral Drive Shaft and Gear Set	For reference only	N/A

Item	Description	Part #	Price
11	Gasket Seals	CM-391-2884-050	\$ 0.87
12	Gear Housing	For reference only	N/A
13	Bearing Carrier	For reference only	N/A
14	Connecting Shaft	For reference only	N/A
15	Matched Gear Set	For reference only	N/A
16	Gear Housing	For reference only	N/A
17	Port End Cover	For reference only	N/A
18	Washers	For reference only	N/A
19	Studs or Cap Screws	For reference only	N/A
20	Nuts	For reference only	N/A

P31 PARTS BREAKDOWN



Note:

This page shows the typical arrangement of a 2-section unit. It may not be pictorially correct and is not to scale.

Plug 5 in position B gives clockwise rotation.

Plug 5 in position A gives counter-clockwise rotation.

Check valves in both positions give bi-directional rotation.

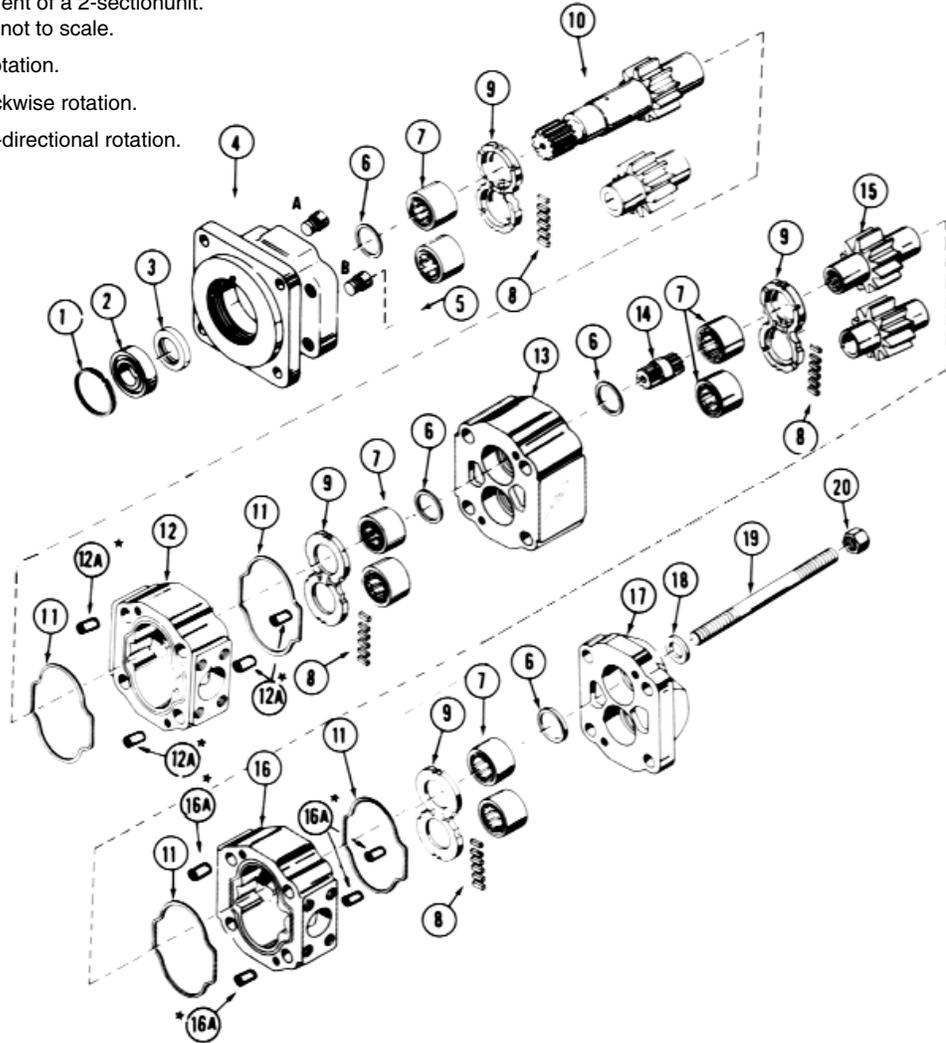

Item	Description	Part #	Price
1	Snap Ring	CM-391-2686-063	\$ 3.26
2	Outboard Bearing	CM-391-0381-040	33.14
3	Seal (Pump)	CM-391-2883-058	2.86
	Hi Pressure Seal (Motor)	CM-391-2883-119	20.22
4	Shaft End Cover	For reference only	N/A
5	Check Assemblies	CM-391-3681-001	2.48
	Plug	CM-391-2286-004	3.60
6	Ring Seals	CM-391-2585-006	10.59
7	Roller Bearings	CM-391-0381-906	22.75
8	Pocket Seals	568C-093	0.75
9	Thrust Plates	CM-391-2185-913	50.30
10	Integral Drive Shaft and Gear Set	For reference only	N/A

Item	Description	Part #	Price
11	Gasket Seals	CM-391-2884-050	\$ 0.87
12	Gear Housing	For reference only	N/A
12A	Dowel Pins	CM-391-2082-032	11.34
13	Bearing Carrier	For reference only	N/A
14	Connecting Shaft	For reference only	N/A
15	Matched Gear Set	For reference only	N/A
16	Gear Housing	For reference only	N/A
16A	Dowel Pins	CM-391-2082-032	11.34
17	Port End Cover	For reference only	N/A
18	Washers	For reference only	N/A
19	Studs or Cap Screws	For reference only	N/A
20	Nuts	For reference only	N/A

PUMP REPAIR KITS

P50 PARTS BREAKDOWN



Note:

This page shows the typical arrangement of a 2-section unit. It may not be pictorially correct and is not to scale.

Plug 5 in position B gives clockwise rotation.

Plug 5 in position A gives counter-clockwise rotation.

Check valves in both positions give bi-directional rotation.

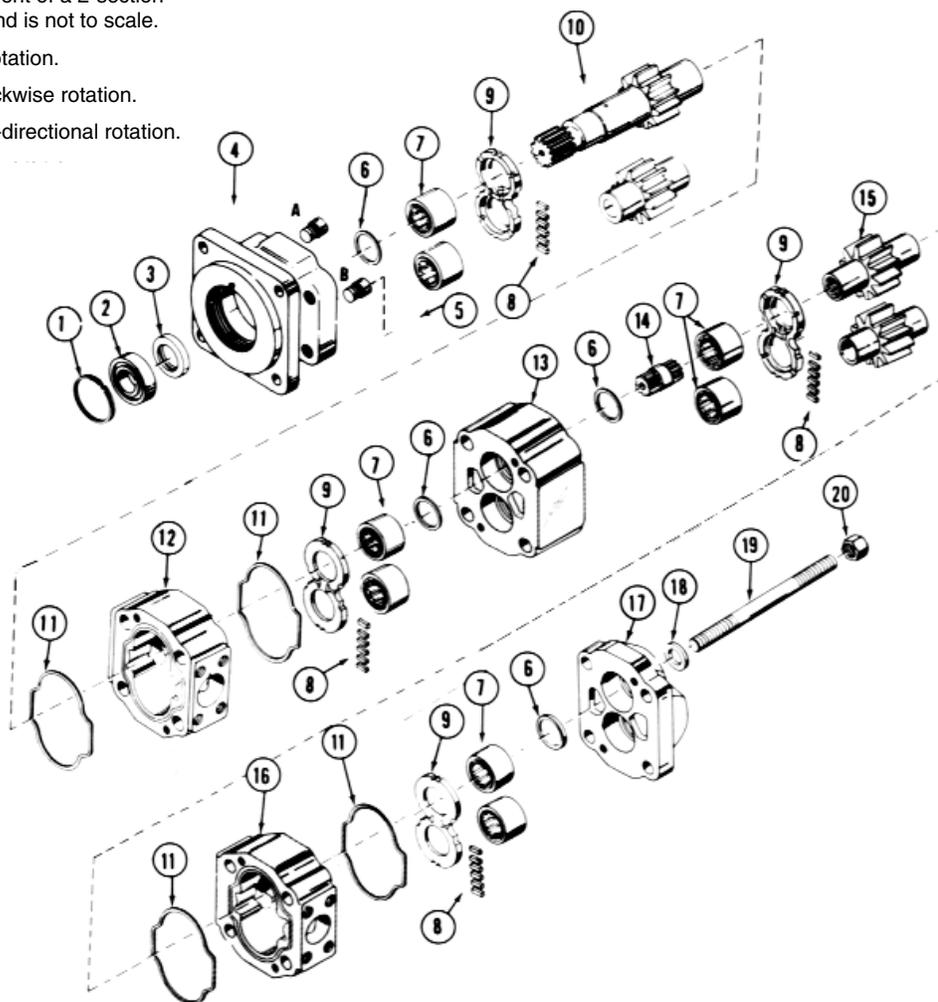

Item	Description	Part #	Price
1	Snap Ring	CM-391-2686-065	\$ 4.33
2	Outboard Bearing	CM-391-0381-077	48.67
3	Seal (Pump)	CM-391-2883-103	7.93
4	Hi Pressure Seal (Motor)	CM-391-2883-115	39.73
4	Shaft End Cover	For reference only	N/A
5	Check Assemblies	CM-391-3681-001	2.48
	Plug	CM-391-2286-004	3.60
6	Ring Seals	CM-391-2585-009	11.53
7	Roller Bearings	CM-391-0381-905	34.61
8	Pocket Seals	580C-093	0.84
9	Thrust Plates	CM-391-2185-912	50.80
10	Integral Drive Shaft and Gear Set	For reference only	N/A

Item	Description	Part #	Price
11	Gasket Seals	CM-391-2884-021	\$ 0.92
12	Gear Housing	For reference only	N/A
13	Bearing Carrier	For reference only	N/A
14	Connecting Shaft	For reference only	N/A
15	Matched Gear Set	For reference only	N/A
16	Gear Housing	For reference only	N/A
17	Port End Cover	For reference only	N/A
18	Washers	For reference only	N/A
19	Studs or Cap Screws	For reference only	N/A
20	Nuts	For reference only	N/A

P51 PARTS BREAKDOWN



Note:

This page shows the typical arrangement of a 2-section unit. It may not be pictorially correct and is not to scale.

Plug 5 in position B gives clockwise rotation.

Plug 5 in position A gives counter-clockwise rotation.

Check s in both positions give bi-directional rotation.

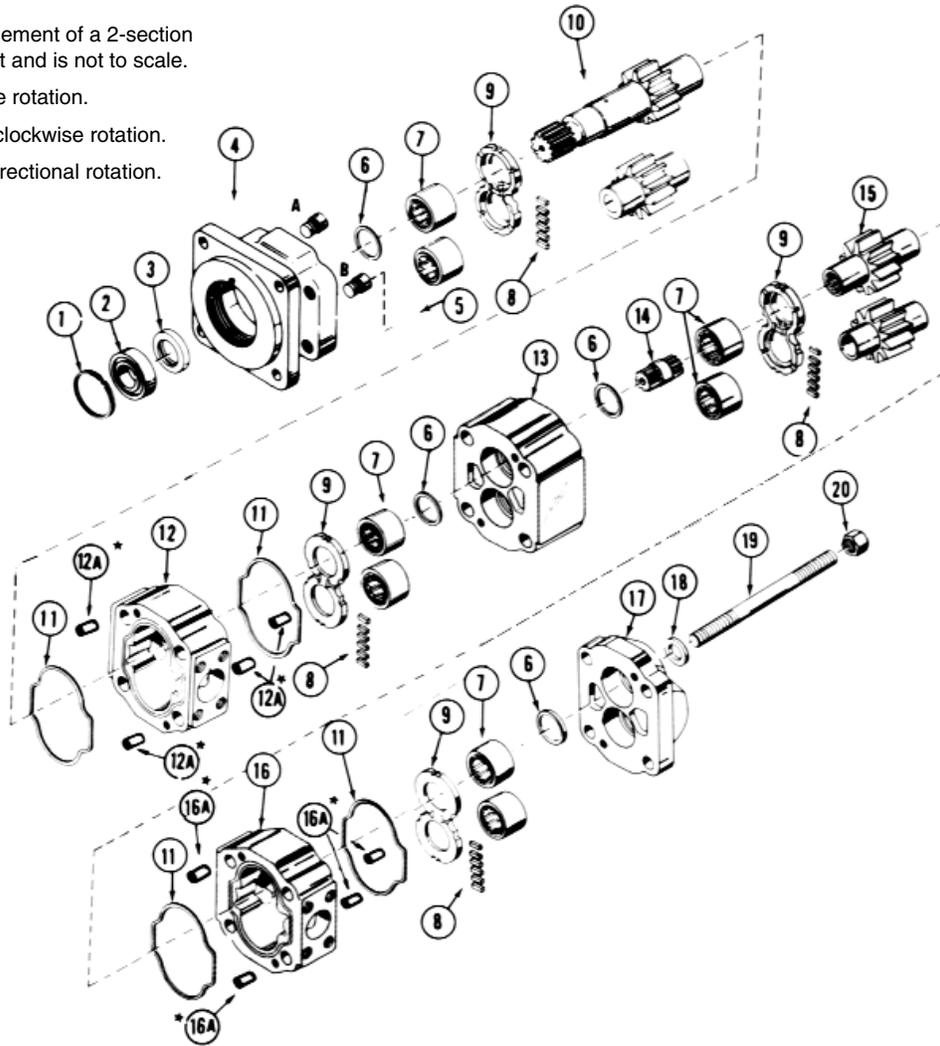

PUMP REPAIR KITS

Item	Description	Part #	Price
1	Snap Ring	CM-391-2686-065	\$ 4.33
2	Outboard Bearing	CM-391-0381-077	48.67
3	Seal	CM-391-2883-103	7.93
	Hi Pressure Seal (Motor)	CM-391-2883-115	39.73
4	Shaft End Cover	For reference only	N/A
5	Check Assemblies	CM-391-3681-001	2.48
	Plug	CM-391-2286-004	3.60
6	Ring Seals	CM-391-2585-009	11.53
7	Roller Bearings	CM-391-0381-905	34.61
8	Pocket Seals	580C-093	0.84
9	Thrust Plates	CM-391-2185-912	50.80
10	Integral Drive Shaft and Gear Set	For reference only	N/A

Item	Description	Part #	Price
11	Gasket Seals	CM-391-2884-021	\$ 0.92
12	Gear Housing	For reference only	N/A
12A	Dowel Pins	CM-391-2082-032	11.34
13	Bearing Carrier	For reference only	N/A
14	Connecting Shaft	For reference only	N/A
15	Matched Gear Set	For reference only	N/A
16	Gear Housing	For reference only	N/A
16A	Dowel Pins	CM-391-2082-032	11.34
17	Port End Cover	For reference only	N/A
18	Washers	For reference only	N/A
19	Studs or Cap Screws	For reference only	N/A
20	Nuts	For reference only	N/A

P75 PARTS BREAKDOWN



Note:

Plug 7 in position B gives clockwise rotation.
 Plug 7 in position A gives counter-clockwise rotation.
 Check valves in both positions
 give bi-directional rotation.

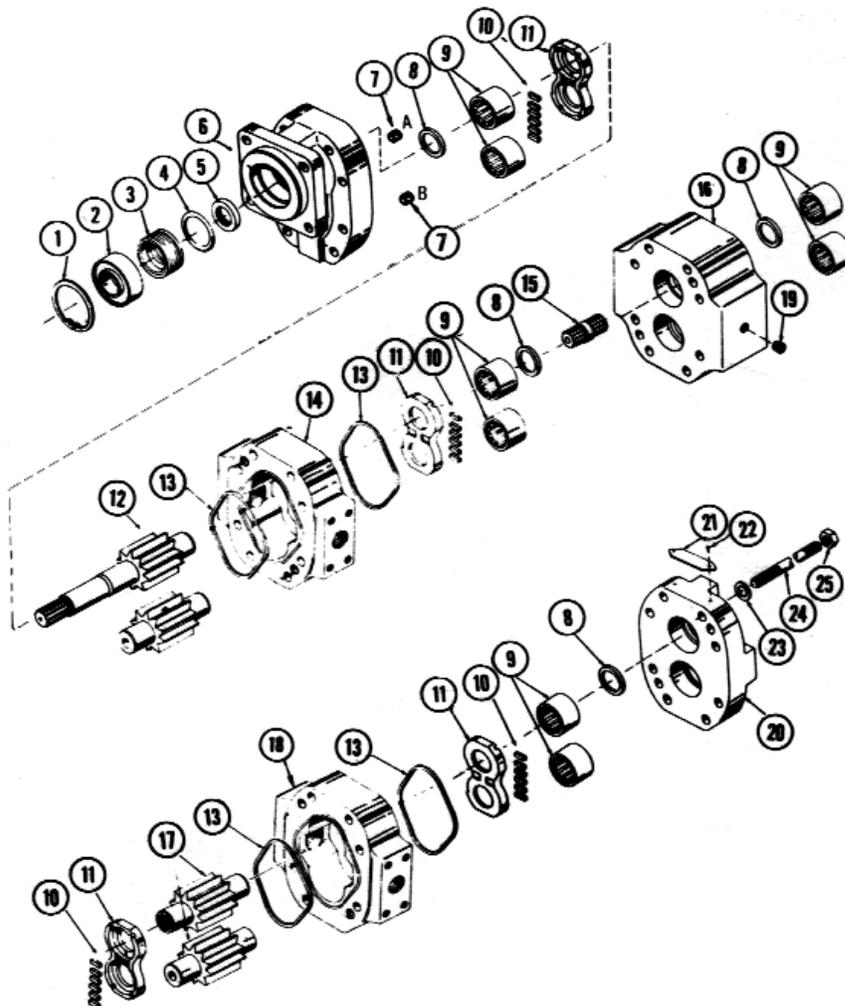

PUMP REPAIR KITS

Item	Description	Part #	Price
1	Snap Ring	CM-391-2686-025	\$ 7.58
2	Outboard Bearing	CM-391-0381-078	58.02
	Spacer	CM-391-3383-018	24.88
3	Seal Retainer	CM-391-2584-051	41.38
4	"O" Ring	CM-391-2881-457	0.47
5	Seal (Pump)	CM-391-2883-052	9.16
	Seal (Motor)	CM-391-2883-094	32.42
6	Shaft End Cover	For reference only	N/A
7	Check Assemblies	CM-391-3681-001	2.48
	Plug	CM-391-2286-004	3.60
8	Ring Seals	CM-391-2585-011	15.39
9	Roller Bearings	CM-391-0381-904	49.70
10	568C-125	CM-391-2282-084	0.77
11	Thrust Plates	CM-391-2185-920	125.70

Item	Description	Part #	Price
12	Integral Drive Shaft	For reference only	N/A
13	Gasket Seals	580-252	\$ 2.05
14	Gear Housing	For reference only	N/A
15	Connecting Shaft	For reference only	N/A
16	Bearing Carrier	For reference only	N/A
17	Matched Gear Set	For reference only	N/A
18	Gear Housing	For reference only	N/A
19	Plug	For reference only	N/A
20	Port End Cover	For reference only	N/A
21	Name Plate	For reference only	N/A
22	Drive Screws	For reference only	N/A
23	Washers	For reference only	N/A
24	Studs or Cap Screws	For reference only	N/A
25	Nuts	For reference only	N/A

P76 PARTS BREAKDOWN



Note:

This page shows the typical arrangement of a 2-section unit. It may not be pictorially correct and is not to scale.

Plug 7 in position B gives clockwise rotation.

Plug 7 in position A gives counter-clockwise rotation.

Check valves in both positions give bi-directional rotation.

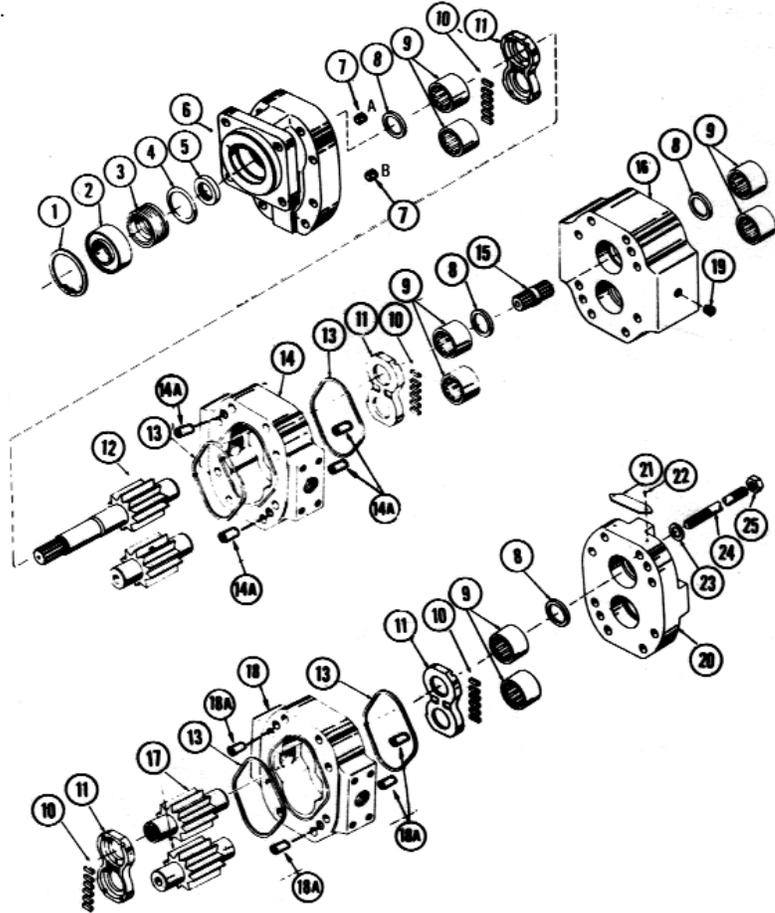

Item	Description	Part #	Price
1	Snap Ring	CM-391-2686-025	\$ 7.58
2	Outboard Bearing	CM-391-0381-078	58.02
3	Seal Retainer	CM-391-2584-051	41.38
4	"O" Ring	CM-391-2881-457	0.47
5	Seal (Pump)	CM-391-2883-052	9.16
	Seal (Motor)	CM-391-2883-094	32.42
6	Shaft End Cover	For reference only	N/A
7	Check Assemblies	CM-391-3681-001	2.48
	Plug	CM-391-2286-004	3.60
8	Ring Seals	CM-391-2585-011	15.39
9	Roller Bearings	CM-391-0381-904	49.70
10	Pocket Seals	568C-125	0.85
11	Thrust Plates	CM-391-2185-920	125.70
12	Integral Drive Shaft and Gear Set	For reference only	N/A
13	Gasket Seals	580-252	2.05

Item	Description	Part #	Price
14	Gear Housing	For reference only	N/A
14A	Dowel Pins	For reference only	N/A
15	Connecting Shaft	For reference only	N/A
16	Bearing Carrier	For reference only	N/A
17	Matched Gear Set	For reference only	N/A
18	Gear Housing	For reference only	N/A
18A	Dowel Pins	For reference only	N/A
19	Plug	For reference only	N/A
20	Port End Cover	For reference only	N/A
21	Name Plate	For reference only	N/A
22	Drive Screws	For reference only	N/A
23	Washers	For reference only	N/A
24	Studs or Cap Screws	For reference only	N/A
25	Nuts	For reference only	N/A

PUMP REPAIR KITS

P330 PARTS BREAKDOWN



Note:

Plug 5 required in position A and B.

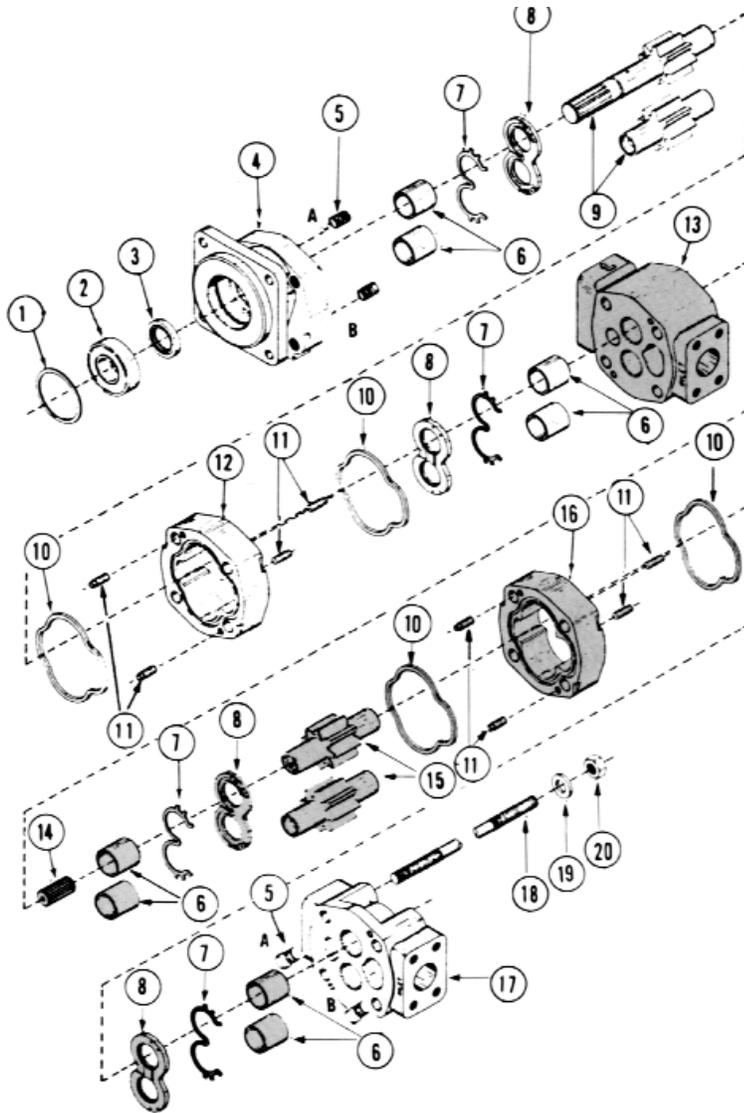

PUMP REPAIR KITS

Item	Description	Part #	Price
1	Snap Ring	300-206	\$ 3.26
2	Outboard Bearing	CM-391-0381-040	33.14
3	Seal	CM-391-2883-058	2.86
4	Shaft End Cover	For reference only	N/A
5	Plug	CM-391-2286-004	3.60
6	Bushings	CM-391-0482-306	15.38
7	Channel Seal	CM-391-2885-065	7.61
8	Thrust Plates	CM-391-2185-956	109.82
9	Integral Drive Shaft and Gear Set	For reference only	N/A
10	Gasket Seal	580-242	0.87

Item	Description	Part #	Price
11	Dowel Pins (Hollow)	CM-391-2082-032	\$ 11.34
12	Gear Housing	For reference only	N/A
13	Bearing Carrier	For reference only	N/A
14	Connection Shaft	For reference only	N/A
15	Matched Gear Set	For reference only	N/A
16	Gear Housing	For reference only	N/A
17	Port End Cover	For reference only	N/A
18	Studs or Cap Screws	For reference only	N/A
19	Washers	For reference only	N/A
20	Nuts	For reference only	N/A

P350 PARTS BREAKDOWN



Note:

Plug 5 in position B gives clockwise rotation.

Plug 5 in position A gives counter-clockwise rotation.

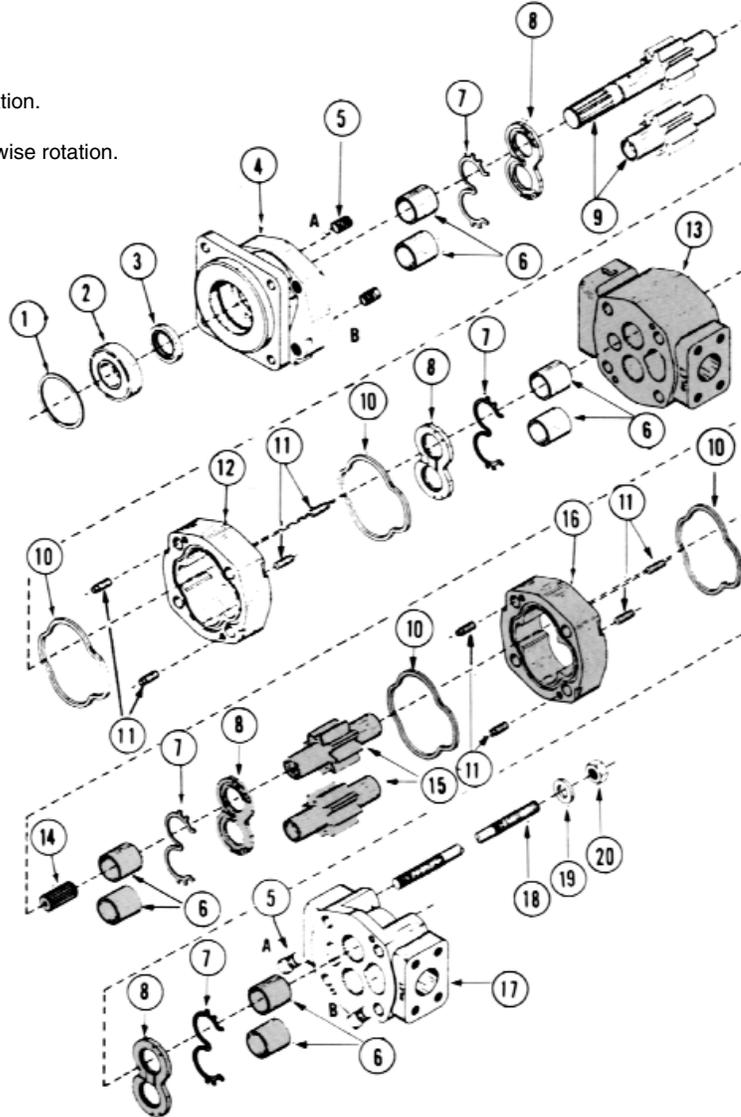

PUMP REPAIR KITS

Item	Description	Part #	Price
1	Snap Ring	WHM-283	\$ 10.61
2	Outboard Bearing	CM-391-0381-077	48.67
3	Seal	CM-391-2883-103	7.93
4	Shaft End Cover	For reference only	N/A
5	Plug	CM-391-2286-004	3.60
6	Bushings	CM-391-0482-308	27.33
7	Channel Seal	CM-391-2885-066	9.05
8	Thrust Plates	CM-391-2185-957	66.34
9	Integral Drive Shaft and Gear Set	For reference only	N/A
10	Gasket Seal	580-246	1.29

Item	Description	Part #	Price
11	Dowel Pins (Solid)	CM-391-2082-032	\$ 11.34
12	Gear Housing	For reference only	N/A
13	Bearing Carrier	For reference only	N/A
14	Connection Shaft	For reference only	N/A
15	Matched Gear Set	For reference only	N/A
16	Gear Housing	For reference only	N/A
17	Port End Cover	For reference only	N/A
18	Studs or Cap Screws	For reference only	N/A
19	Washers	For reference only	N/A
20	Nuts	For reference only	N/A

P365 PARTS BREAKDOWN



Note:

Plug 5 in position B gives clockwise rotation.
 Plug 5 in position A gives counter-clockwise rotation.

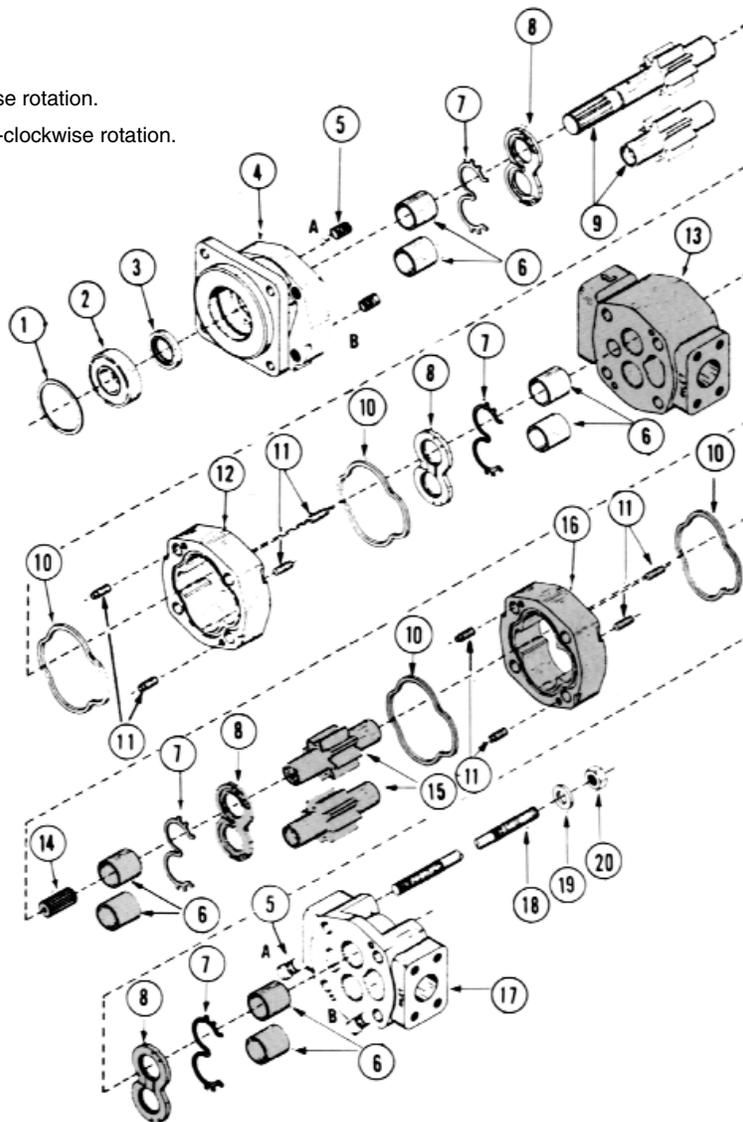

PUMP REPAIR KITS

Item	Description	Part #	Price
1	Snap Ring	300-315	\$ 9.05
2	Outboard Bearing	CM-391-0381-078	58.02
3	Seal	CM-391-2883-052	9.16
4	Shaft End Cover	For reference only	N/A
5	Plug	CM-391-2286-004	3.60
6	Bushings	CM-391-0482-307	40.05
7	Channel Seal	CM-391-2885-064	5.90
8	Thrust Plates	CM-391-2185-055	81.88
9	Integral Drive Shaft and Gear Set	For reference only	N/A
10	Gasket Seal	580-250	1.85

Item	Description	Part #	Price
11	Dowel Pins (Hollow)	CM-391-2082-032	\$ 11.34
12	Gear Housing	For reference only	N/A
13	Bearing Carrier	For reference only	N/A
14	Connection Shaft	For reference only	N/A
15	Matched Gear Set	For reference only	N/A
16	Gear Housing	For reference only	N/A
17	Port End Cover	For reference only	N/A
18	Studs or Cap Screws	For reference only	N/A
19	Washers	For reference only	N/A
20	Nuts	For reference only	N/A

Parker / Gresen Pump Repair Kits

Contents	Page
Gear Pump Parts	
• P16, TP16 - 2 Place, TP16 - 3 Place	1160
• PVP16, CP16, 20	1161
• R20, TP20 - 2 Place, TP20 - 3 Place	1162
• M20 Motor	1163
Assembly Torque Values	1164
Overhung Load Data	1164

P16 PUMP PARTS



Part #	Description	Pump Model	Price
TY-17098	Dowel pins	All	\$ 1.89
TY-15419	Service kit	All	107.33
TY-27163	Pressure plate	All	76.29
TY-14881	Shaft Seal	All	5.43

TP16 PUMP PARTS 2 PLACE



Part #	Description	Pump Model	Price
TY-17098	Dowel pins	All	\$ 1.89
TY-15623	Service kit	All	55.67
TY-27163	Pressure plate	All	76.29
TY-14881	Shaft Seal	All	5.43

TP16 PUMP PARTS 3 PLACE



Part #	Description	Pump Model	Price
TY-17098	Dowel pins	All	\$ 1.89
TY-15609	Service kit	All	82.22
TY-27163	Pressure plate	All	76.29
TY-14881	Shaft Seal	All	5.43

PVP16 PUMP PARTS



Part #	Description	Pump Model	Price
TY-17098	Dowel pins	All	\$ 1.89
TY-15419	Service kit	All	107.33
TY-27163	Pressure plate	All	76.29
TY-14881	Shaft Seal	All	5.43

CP16 PUMP PARTS



Part #	Description	Pump Model	Price
TY-17098	Dowel pins	All	\$ 1.89
TY-15419	Service kit	All	107.33
TY-27163	Pressure plate	All	76.29
TY-14881	Shaft Seal	All	5.43

SERIES 20 PUMP PARTS



Part #	Description	Pump Model	Price
TY-15629	Soft goods service kit - Shaft #4	All	\$ 58.61
TY-15630	Soft goods service kit - Shaft #1,2,3,5,6,7	All	138.73
TY-14145	Shaft seal - Shaft #1,2,3,5	All	14.18
TY-14416	Shaft seal - Shaft #4	All	15.65

R20 PUMP PARTS



Part #	Description	Pump Model	Price
TY-14662	Soft goods service kit - Shaft #1,2,3,5,6	All	\$ 174.96
TY-14305	Soft goods service kit - Shaft #4	All	77.42
TY-22792	Pressure Plate	All	70.44
TY-14145	Shaft seal - Shaft #1,2,3,5	All	14.18
TY-14416	Shaft seal - Shaft #4	All	15.65

TP20 PUMP PARTS 2 PLACE



Part #	Description	Pump Model	Price
TY-15672	Seal kit	All	\$ 88.33
TY-22195	Pressure plate	20200—20450	70.43
TY-14145	Shaft Seal	All	14.18

TP20 PUMP PARTS 3 PLACE



Part #	Description	Pump Model	Price
TY-15672	Seal kit	All	\$ 88.33
TY-22195	Pressure plate	20200—20450	70.43
TY-14145	Shaft Seal	All	14.18

M20 MOTOR PARTS

Parker / **GRESEN**



Part #	Description	Pump Model	Price
TY-14306	Soft goods service kit - Shaft #1,2,3,5,6	All	\$ 166.94
TY-15382	Soft goods service kit - Shaft #4	All	116.77
TY-15483	Shaft seal - Shaft #1,2,3,5	All	111.82

PUMP REPAIR KITS

ASSEMBLY TORQUE VALUES

Parker / **GRESEN** / **TYRONE**

Assembly Torque Values

NOTES:

All torque values are based on a lubricated condition. If capscrews and/or nuts are dirty, they must be washed, blown dry, and re-oiled prior to installation. All studs must be washed and blown dry—DO NOT re-oil.

The following torque values are to be used in the assembly of pumps and motors:

Series	Size	Torque (Ft.-Lbs)
P1	5/16 "	20-25
P12	M10	20-25
P14, FP14, TFP14, TP16	3/8 "	30-35
SSFP14	1/2 "	80-90
P2	3/8 "	30-35
P16, HP16, TP16	1/2 "	70-75
FPR16	1/2 "	80-90
FP16	5/8 "	160-175
TFP16	5/8 "	160-175
SSFP16	5/8 "	160-175
DP16	1/2 "	70-75
DP16 (valve)	3/8 "	30-35
FP17	5/16 "	18-20
20, M20, FP20	1/2 "	80-90
P6, FM6, TM6	1/2 "	80-90
25, M25, FP25	5/8 "	160-175
FP257, FPW257	5/8 "	160-175
HP7, HM7, FP7	3/4 "	240-250
SL7	5/8 "	160-175
HP8, HM8, FP8, SL8	3/4 "	240-250
PM23	5/8 "	180-190
DPH	5/8 "	180-190
HILLSDALE	3/8 "	40-45
HILLSDALE	7/16 "	50-55
T101/102	5/8 "	195-200
MGG/PGG (body)	5/16 "	21-24
MGG/PGG (flange)	#10	46-54 (in.-lb.)

NOTES:

For "Mixed" Series, ie: TP25450-20200-P14-45A, use torque values corresponding to each section: 25 Series for the 25450 (160-175), 20 Series for the 20200 (80-90), and P14 Series for the P14-45 (30-35). Verify stud/capscrew sizes.

Torque value should be divided into two or three equal values, and applied in stages. e.g. P16 should be first torqued to 35 ft. lbs. then torqued to the final value of 70-75 ft. lbs.

While torquing the pump please follow pattern as shown below:

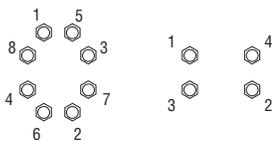

Overhung Load Data

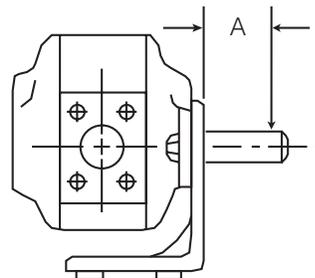

PUMP SIZE	Dim. "A"	Allowable Load "L"	Allowable Operating Pressure
P12-17	1.00 "	100 Lbs..	2000 PSI
-22	"	"	"
-28	"	"	"
-34	"	"	"
-40	"	"	"
-45	"	"	"
P14-42	1.00 "	200 Lbs..	2000 PSI
-59	"	"	"
-74	"	"	"
-91	"	"	"
-108	"	"	"
P16-45	1.00 "	390 Lbs..	2200 PSI
-65	"	"	2200 PSI
-85	"	"	2100 PSI
-100	"	"	2100 PSI
-115	"	"	2000 PSI
-150	"	"	1800 PSI
-180	"	"	1700 PSI
-200	"	"	1600 PSI
20150	1.50 "	1050 Lbs..	2000 PSI
20200	"	"	"
20250	"	"	"
20300	"	"	"
20350	"	"	"
20400	"	"	"
20450	"	"	"
25500	1.50 "	1050 Lbs..	1800 PSI
25550	"	"	1600 PSI
25600	"	"	1350 PSI
25770	"	"	1150 PSI
25950	"	"	900 PSI
HP7	1.50 "	1300 Lbs..	3000 PSI
HP8	1.50 "	1300 Lbs..	2800 PSI

Allowable Load "L" must not be exceeded.

When Belt Drive is used, "L" must include both belt pre-tension and torque load.

Vickers® Pump Repair Kits

Contents	Page
VQ Series and Catridge Kits	1166 - 1167
V & Motor Seal Kits	1168
Shaft Seals and Bearings	1169

VQ SEAL VQ SEAL KITS

VICKERS® PART #	DESCRIPTION	LIST PRICE
20 VQ		
VI-433762	20 Seal Pack (4 Req'd)	\$ 8.34
25 VQ		
VI-920021	Single VQ Seal Kit	\$ 59.54
VI-920023	Single VQ Seal Kit - Viton	92.88
VI-920022	Double VQ Seal Kit	66.68
VI-920024	Double VQ Seal Kit - Viton	108.36
VI-433764	Seal Pack (4 Req'd)	13.10
35 VQ		
VI-920015	Single VQ Seal Kit	\$ 61.92
VI-920029	Single VQ Seal Kit - Viton	100.03
VI-920016	Double VQ Seal Kit	67.87
VI-920030	Double VQ Seal Kit - Viton	114.32
VI-433766	Seal Pack (4 Req'd)	10.72
45 VQ		
VI-920025	Single VQ Seal Kit	\$ 65.49
VI-920027	Single VQ Seal Kit - Viton	109.55
VI-920026	Double VQ Seal Kit	70.33
VI-920028	Double VQ Seal Kit - Viton	116.70
VI-433768	Seal Pack (4 Req'd)	11.91
2520 VQ		
VI-920040	Single VQ Seal Kit	\$ 86.93
VI-920042	Single VQ Seal Kit - Viton	96.45
VI-920041	Double VQ Seal Kit	86.93
VI-920043	Double VQ Seal Kit - Viton	158.37

VICKERS® PART #	DESCRIPTION	LIST PRICE
3520 VQ		
VI-920048	Single VQ Seal Kit	\$ 90.50
VI-920050	Single VQ Seal Kit - Viton	195.33
VI-920049	Double VQ Seal Kit	98.84
VI-920051	Double VQ Seal Kit - Viton	158.37
3525 VQ		
VI-920056	Single VQ Seal Kit	\$ 90.50
VI-920058	Single VQ Seal Kit - Viton	152.42
VI-920057	Double VQ Seal Kit	98.84
VI-920059	Double VQ Seal Kit - Viton	176.24
4520 VQ		
VI-920060	Single VQ Seal Kit	\$ 96.45
VI-920062	Single VQ Seal Kit - Viton	163.14
VI-920061	Double VQ Seal Kit	103.60
VI-920063	Double VQ Seal Kit - Viton	179.81
4525 VQ		
VI-920068	Single VQ Seal Kit	\$ 100.03
VI-920070	Single VQ Seal Kit - Viton	175.05
VI-920069	Double VQ Seal Kit	108.36
VI-920071	Double VQ Seal Kit - Viton	190.53
4535 VQ		
VI-920072	Single VQ Seal Kit	\$ 100.03
VI-920074	Single VQ Seal Kit - Viton	182.19
VI-920073	Double VQ Seal Kit	108.36
VI-920075	Double VQ Seal Kit - Viton	194.10

VQ CARTRIDGE KITS 10 VANE VQ SERIES

VITON SEALS

GPM	VICKERS® PART #	LIST PRICE
20 VQ		
5	VI-421588	\$ 349.49
7	VI-421589	349.49
9	VI-423097	349.49
11	VI-421590	349.49
12	VI-421591	349.49
14	VI-421592	349.49
25 VQ		
12	VI-421570	\$ 339.11
14	VI-421571	339.11
17	VI-421572	339.11
19	VI-421573	339.11
21	VI-421574	339.11

GPM	VICKERS® PART #	LIST PRICE
35 VQ		
21	VI-421582	\$ 428.44
25	VI-421583	428.44
30	VI-421584	428.44
35	VI-421585	428.44
38	VI-421586	428.44
45 VQ		
42	VI-419511	\$ 498.50
47	VI-421954	498.50
50	VI-419510	498.50
67	VI-421955	498.50
60	VI-419509	498.50

All Cartridge Kits are 100% tested and are guaranteed to be free of defects in material and workmanship. Each Kit meets or exceeds flow and pressure specifications.

All Cartridge Kits will be clockwise rotation unless otherwise specified.

ORDER BY
THE VICKERS®
PART NUMBER!

Call Today!
1-800-777-5617

V & MOTOR SEAL KITS

VICKERS® PART #	DESCRIPTION	PRICE
25 V/30 V		
VI-922850	Seal Kit	\$ 28.58
VI-919656	Seal Kit - Viton	109.55
35 V		
VI-922851	Seal Kit	\$ 38.11
VI-919262	Seal Kit - Viton	140.51
45 V		
VI-919850	Seal Kit	\$ 35.72
VI-919632	Seal Kit - Viton	50.01
50 V		
VI-922853	Seal Kit	\$ 70.26
2520 V		
VI-922856	Seal Kit	46.44
VI-919303	Seal Kit - Viton	163.14
3520 V		
VI-922859	Seal Kit	50.01
VI-919304	Seal Kit - Viton	185.76
3525 V		
VI-922862	Seal Kit	50.01
VI-919305	Seal Kit - Viton	201.24
4520 V		
VI-922863	Seal Kit	50.01
VI-919616	Seal Kit - Viton	272.69
4525 V		
VI-922865	Seal Kit	51.20
VI-919345	Seal Kit - Viton	242.92

VICKERS® PART #	DESCRIPTION	PRICE
4535 V		
VI-922866	Seal Kit	\$ 57.16
VI-919346	Seal Kit - Viton	254.83
25 M		
VI-923157	Seal Kit	\$ 51.20
35 M		
VI-923163	Seal Kit	\$ 70.26
45 M		
VI-923106	Seal Kit	\$ 71.45
50 M		
VI-923096	Seal Kit	\$ 109.55
V 10		
VI-923548	Seal Kit	\$ 41.68
V 110		
VI-922793	Seal Kit	\$ 26.20
V 210		
VI-922732	Seal Kit	\$ 32.15
V 210/V 20		
VI-922733	Seal Kit	\$ 27.01
V 2010		
VI-923577	Seal Kit	\$ 40.49
V 2020		
VI-923174	Seal Kit	\$ 35.72

Equipment manufacturer's names, part numbers and descriptions are used for reference purposes only. We do not imply that any part shown is the product of these manufacturers.

SHAFT SEALS AND BEARINGS

SHAFT SEALS

VICKERS® PART #	DESCRIPTION	SERIES	PRICE
VI-229235	Primary	V20	\$ 16.67
VI-229236	Primary	V20	26.20
VI-394976	Primary	25130	13.10
VI-429286	Primary Viton	25130	20.24
VI-429283	Secondary	25130	19.05
VI-394973	Primary	35V	17.86
VI-429284	Primary Viton	35VV	17.93
VI-429281	Secondary	35V	21.43
VI-394974	Primary	45V	13.10
VI-429285	Primary Viton	45VV	20.24
VI-429282	Secondary	45VS	20.83

BEARINGS

VICKERS® PART #	DESCRIPTION	SERIES	PRICE
VI-98574	Standard	V20	\$ 8.95
VI-1705	Standard	25V	22.62
VI-232750	Heavy Duty	26131	78.59
VI-38441	Standard	35V	48.82
VI-131812	Standard	45V	39.30

**ORDER BY THE VICKERS®
PART NUMBER**

Our complete line of seals and bearings assures your repair is right the first time!

NOTES

NOTES



Char-Lynn® and White Motor Repair Kits

Contents

Char-Lynn® Seal Kits	1172
White RS Series	1173
• Motor Breakdown & Components	1173
White RE Series	1174
• Motor Breakdown & Components	1174
• 72 mm Bearing Motor Breakdown	1175
• 1.5" Bearing Motor Breakdown & Components	1176
• 1.5" Bearing Wheel Motor Breakdown & Components	1177
• 1.5" Bearing SAE "A" Style Flange Motor Breakdown & Components	1178
• 125 mm Bearing Motor Breakdown & Components	1179
• 12 Housing Brake Motor Breakdown & Components	1180
White DR Series	1181
• Motor Breakdown & Components	1181

CHAR-LYNN® SEAL KITS*

Char-lynn® Model Identification

XXX - XXX - XXX
 Product - Product - Engineering
 Line Identification Change Code

Kit Number	Series	Description	Model Number	List Price
CHR-6405	10,000 Note: The -002 and -003 bearingless motors use 4 seals while the -004 motor uses 3 seals. Note: This kit is not applicable to 10,000 series two speed motors.	Motor Seal Kit	119-XXXX-002;-003;-004 120-XXXX-002;-003;-004 121-XXXX-002;-003;-004	\$ 109.79
CHR-6406	10,000 Note: Applicable to 10,000 series two speed motors.	Shaft Seal Kit	119-XXXX-001;-002;-003;-004 120-XXXX-002;-003;-004	118.19
CHR-60023	H A	Buna N Seal Kit Buna N Seal Kit	101-XXXX-007 130-XXXX-001	81.67
CHR-60026	S	Buna N Seal Kit	103-XXXX-007	84.20
CHR-60036	H	Buna N Seal Kit	101-XXXX-005	64.00
CHR-60042	S	Buna N Seal Kit	103-XXXX-006	84.65
CHR-60533	S	Buna N Seal Kit	103-XXXX-008	78.59
CHR-60539	S	Buna N Seal Kit	103-XXXX-009;-010	99.52
CHR-60540	A H	Buna N Seal Kit Buna N Seal Kit	130-XXXX-002;-003 101-XXXX-008;-009	96.70
CHR-61104	6000	Shaft Seal Kit	112-XXXX-002;-003;-004 113-XXXX-002;-003;-004	164.85
CHR-61105	6000	Rear Motor Kit	112-XXXX-002;-003;-004 113-XXXX-002;-003;-004	60.32
CHR-61234	4000	Rear Motor Kit	109-XXXX-004; 110-XXXX-004	56.01
CHR-61236	4000	Shaft Seal Kit	109-XXXX-004; 110-XXXX-004	88.32
CHR-61237	6000	Shaft Seal Kit	112-XXXX-005; 113-XXXX-005	89.38
CHR-61238	6000	Rear Motor Kit	112-XXXX-005; 113-XXXX-005	80.42
CHR-61252	2000 Note: Not for 106- Bearingless motors.	Buna N Seal Kit	104-XXXX-003;-004;-005 105-XXXX-003;-004;-005	127.15
CHR-61258	2000	Buna N Seal Kit	104-XXXX-006; 105-XXXX-006	127.67
CHR-61259	2000 Note: Does not fit 106-XXXX-003;-004;-005 motors	Buna N Seal Kit	106-XXXX-006	61.96
CHR-64417	Steering unit with external shaft			49.34
CHR-64418	Steering unit with internal spline			84.92

*Original OEM Char-Lynn Kits

STANDARD RS SERIES MOTOR

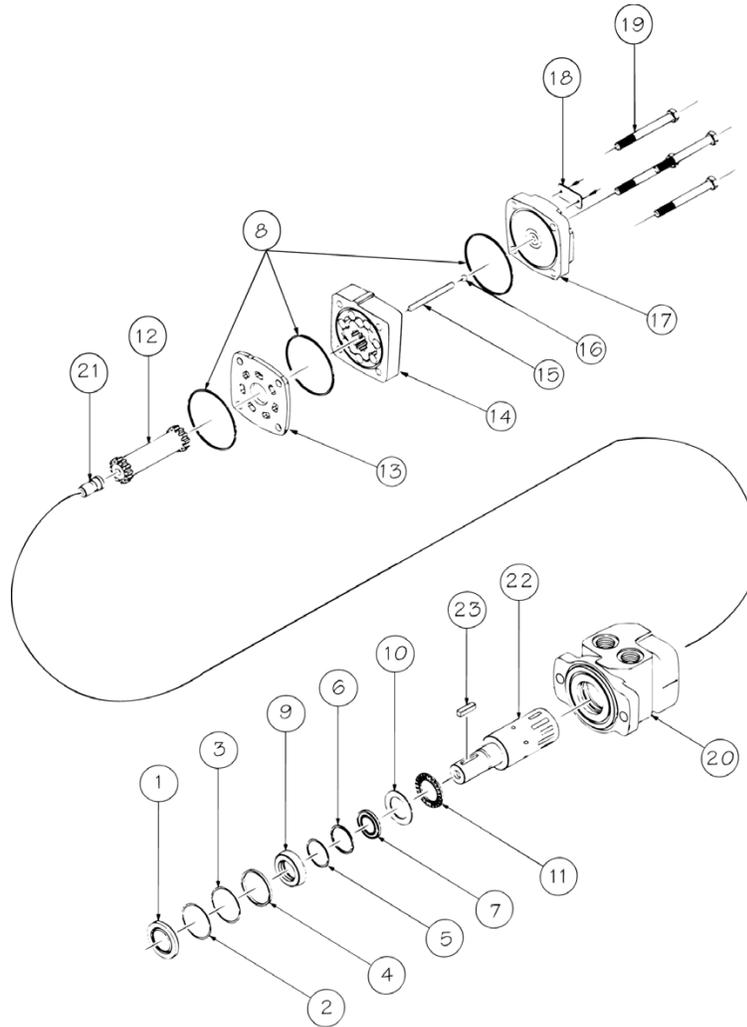

MOTOR REPAIR KITS

STANDARD SEAL KITS

KIT #	DESCRIPTION	ITEMS	PRICE
WTE-200222001	PS-222001	1 - 10	\$ 74.12
WTE-200222002	PS-222002	1 - 8	52.72
WTE-200222003	PS-222003	9 - 10	47.71

DESCRIPTION	EXPLODED VIEW ITEM #
DUST SEAL	1
SPLIT WIRE RING	2
METAL BACKUP SHIM	3
HIGH PRESSURE SEAL	4
METAL BACKUP SHIM	5
TEFLON BACKUP SHIM	6
SHAFT SEAL	7
BODY SEALS (3)	8
SEAL CARRIER	9
THRUST WASHER	10

HOUSING TYPES

DESCRIPTION
#01 4-HOLE W/ 1/2" NPT
#02 4-HOLE W/ 7/8" O-RING
#03 2-HOLE W/ 1/2" NPT
#04 2-HOLE W/ 7/8" O-RING
#05 4-HOLE W/ MANIFOLD PORTS
#06 2-HOLE W/ MANIFOLD PORTS
#07 2-HOLE W/ OFFSET 1/2" BSPF
#09 2-HOLE W/ OFFSET MNFLD. W/ 1/2" BSPF
#10 2-HOLE W/ALIGNED 1/2" BSPF
#11 6-HOLE W/ 7/8" O-RING
#12 4-HOLE W/ MILLED MANIFOLD
#13 2-HOLE W/ MILLED MANIFOLD
#14 6-HOLE W/ 1/2" NPT
#17 2-HOLE MLD. & SPTFCD. W/OFST. 1/2" BSPF

DESCRIPTION
#18 4-HOLE REAR MOUNT W/ 9/16 O-RING
#20 2-HOLE ALIGNED W/ 1/2" BSPF
#21 4-HOLE METRIC MOUNT W/ 1/2" BSPF
#25 4-HOLE METRIC MNT. W/ MANIFOLD PORTS
#26 2-HOLE METRIC MNT. W/ MANIFOLD PORTS
#27 2-HOLE W/OFFSET BSPF AND .200 PILOT
#29 2-HOLE W/OFFSET MNFLD. AND .200 PILOT
#30 2-HOLE W/OFFSET 7/8" O-RING & RLF. PORT
#32 4-HOLE W/OFFSET 7/8" O-RING & RLF. PORT
#34 2-HOLE W/ 7/8" O-RING
#37 2-HOLE W/ 1/2" BSPF W/ RLF PRT & .200 PLT.
#40 2-HOLE W/ALIGNED 1/2" BSPF & .200 PILOT
#46 2-HOLE W/METRIC MNFLD. MNT. & .200 PILOT

STANDARD RE SERIES MOTOR

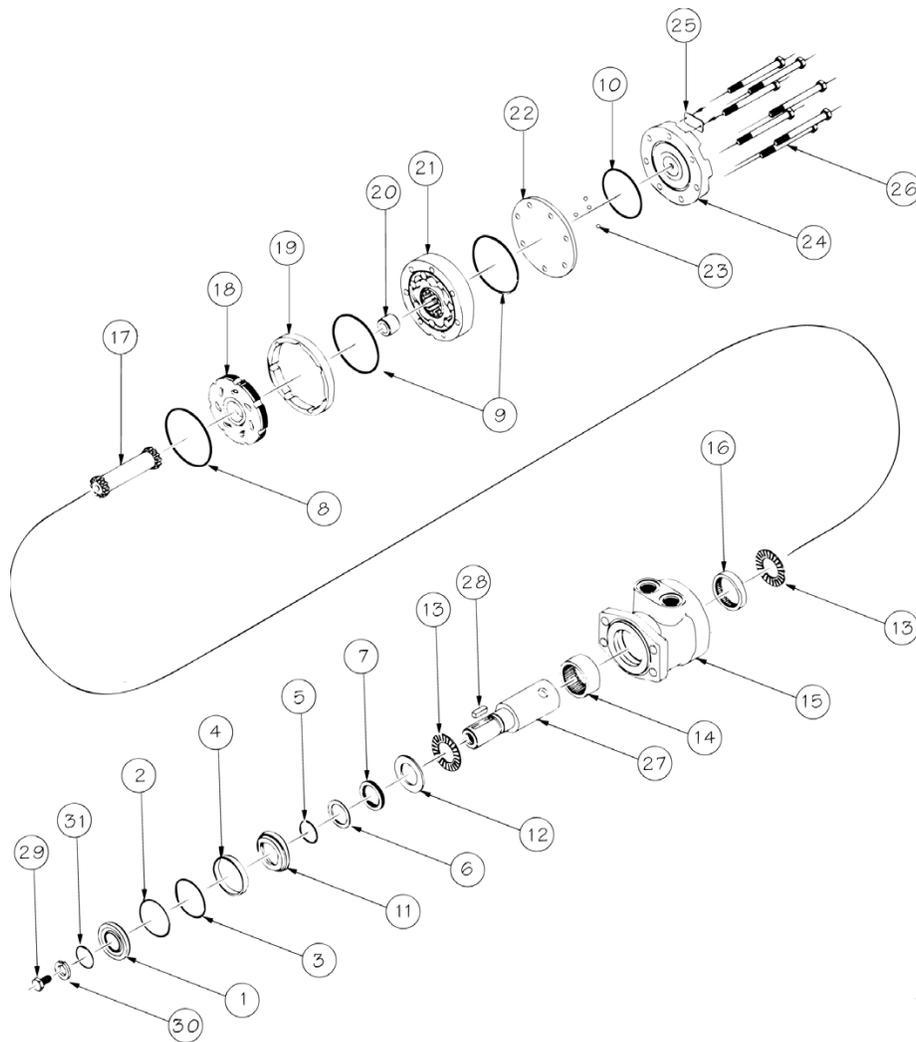

STANDARD SEAL KITS

KIT #	DESCRIPTION	ITEMS	PRICE
WTE-500444001	PE-444001	1 - 12	\$100.79
WTE-500444002	PE-444002	1 - 10	62.46
WTE-500444003	PE-444003	11 - 12	65.15

DESCRIPTION	EXPLODED VIEW ITEM #
DUST SEAL	1
SPLIT WIRE RING	2
METAL BACKUP SHIM	3
HIGH PRESSURE SEAL	4
METAL BACKUP SHIM	5
TEFLON BACKUP SHIM	6
SHAFT SEAL	7
REAR HOUSING SEAL	8
BODY SEALS (2)	9
ENDCOVER SEAL	10
SEAL CARRIER	11
THRUST WASHER	12

HOUSING TYPES

DESCRIPTION
#02 4-HOLE W/O PILOT & RS 4-HOLE BLT PTRN.
#05 SETBACK W/ 1/2" BSPF
#06 4-HOLE SAE "A" STYLE W/ 1/2" BSPF
#07 SETBACK W/ 7/8" O-RING
#08 4-HOLE SAE "A" STYLE W/ 7/8" O-RING
#11 SETBACK W/ BRAKE MOUNT W/ 7/8" O-RING
#16 2-HOLE SAE "A" STYLE W/ 7/8" O-RING
#17 2-HOLE SAE "A" STYLE W/ 1/2" BSPF

DESCRIPTION
#18 6-HOLE SAE "A" STYLE W/ 7/8" O-RING
#19 6-HOLE SAE "A" STYLE W/ 1/2" BSPF
#35 SETBACK W/RELIEF PRT W/ 1/2" BSPF
#36 4-HOLE SAE "A" W/RLF. PRT & 1/2" BSP.F
#37 SETBACK W/RLF. PORT & 7/8" O-RING
#38 4-HOLE SAE "A" W/RLF. PRT & 7/8" O-RING
#48 6-HOLE SAE "A" W/RLF. PRT & 7/8" O-RING
#49 6-HOLE SAE "A" W/RLF. PRT & 1/2" BSPF

MOTOR REPAIR KITS

RE 72 MM BEARING MOTOR

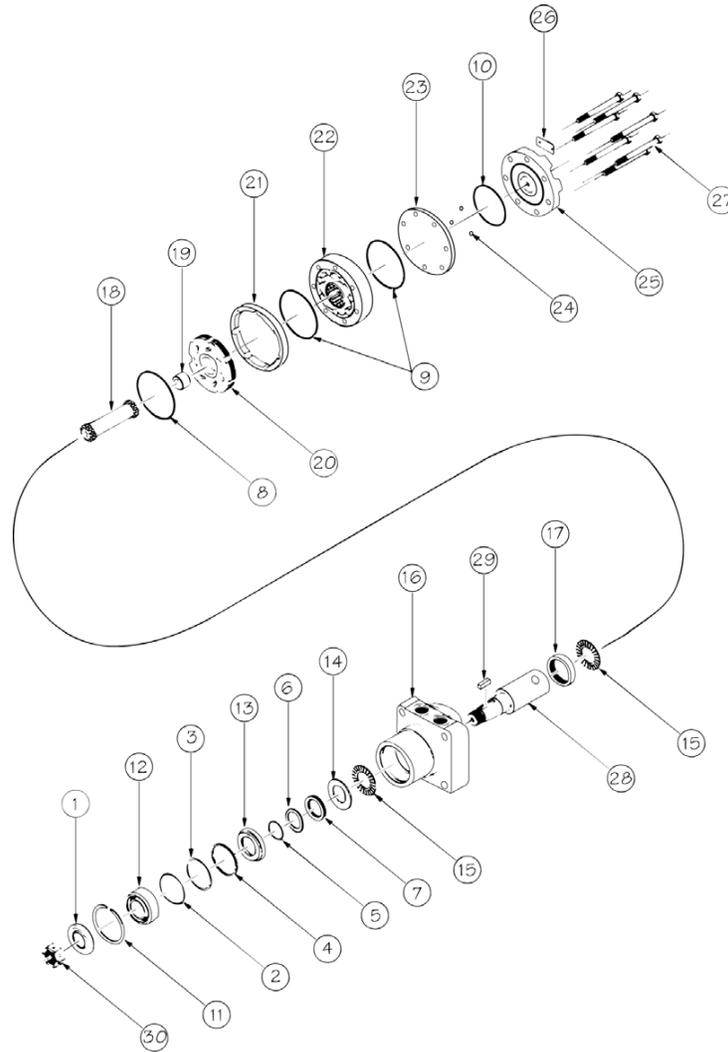

MOTOR REPAIR KITS

STANDARD SEAL KITS

KIT #	DESCRIPTION	ITEMS	PRICE
WTE-500444001	PE-444001	1 - 12	\$100.79
WTE-500444002	PE-444002	1 - 10	62.46
WTE-500444003	PE-444003	11 - 12	65.15

DESCRIPTION	EXPLODED VIEW ITEM #
DUST SEAL	1
SPLIT WIRE RING	2
METAL BACKUP SHIM	3
HIGH PRESSURE SEAL	4
METAL BACKUP SHIM	5
TEFLON BACKUP SHIM	6
SHAFT SEAL	7
REAR HOUSING SEAL	8
BODY SEALS (2)	9
ENDCOVER SEAL	10
SEAL CARRIER	11
THRUST WASHER	12

HOUSING TYPES

DESCRIPTION
#09 SETBACK W/ 7/8" O-RING
#14 SETBACK W/ 1/2" BSPF
#15 SETBACK W/TURNED PILOT W/ 7/8" O-RING
#22 SETBACK W/"C" FRONT MNT. W/ 7/8" O-RING
#24 SETBACK W/"C" FRONT MNT. W/ 1/2" BSP.F
#39 SETBACK W/RELIEF PORT W/ 7/8" O-RING
#44 SETBACK W/RELIEF PORT W/ 1/2" BSP.F

RE 1.5" BEARING MOTOR

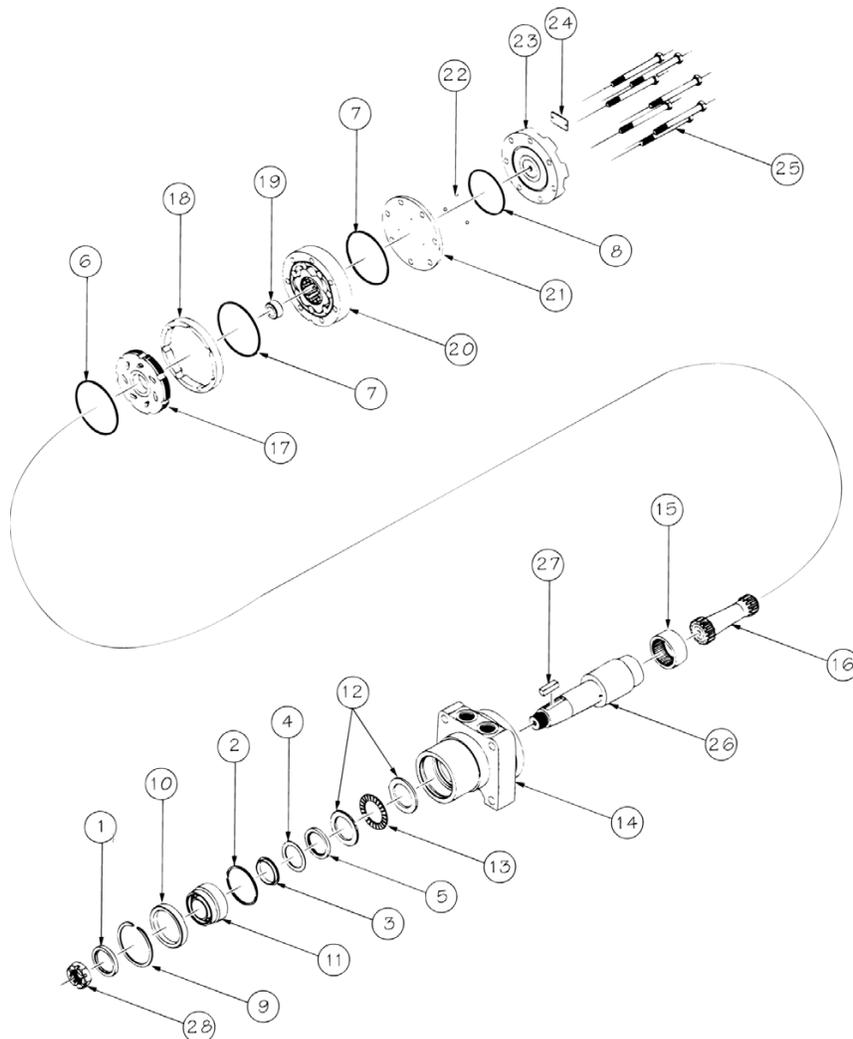

STANDARD SEAL KITS

KIT #	DESCRIPTION	ITEMS	PRICE
WTE-700666000	PT-666000	1 - 8	\$ 71.85

DESCRIPTION	EXPLODED VIEW ITEM #
DUST SEAL	1
HIGH PRESSURE SEAL	2
METAL BACKUP SHIM	3
TEFLON BACKUP SEAL	4
SHAFT SEAL	5
REAR HOUSING SEAL	6
BODY SEALS (2)	7
ENDCOVER SEAL	8

HOUSING TYPES

DESCRIPTION
#20 SETBACK W/ 7/8" O-RING
#21 SETBACK W/ 1/2" BSP.F
#23 SETBACK W/ SAE "C" FRONT MOUNT W/ 7/8" O-RING
#25 SETBACK W/ SAE "C" FRONT MOUNT W/ 1/2" BSP.F
#50 SETBACK W/ RELIEF PORT AND 7/8" O-RING
#53 SETBACK W/ SAE "C" FRONT MOUNT W/RELIEF PORT & 7/8" O-RING

MOTOR REPAIR KITS

RE 1.5" BEARING WHEEL MOTOR

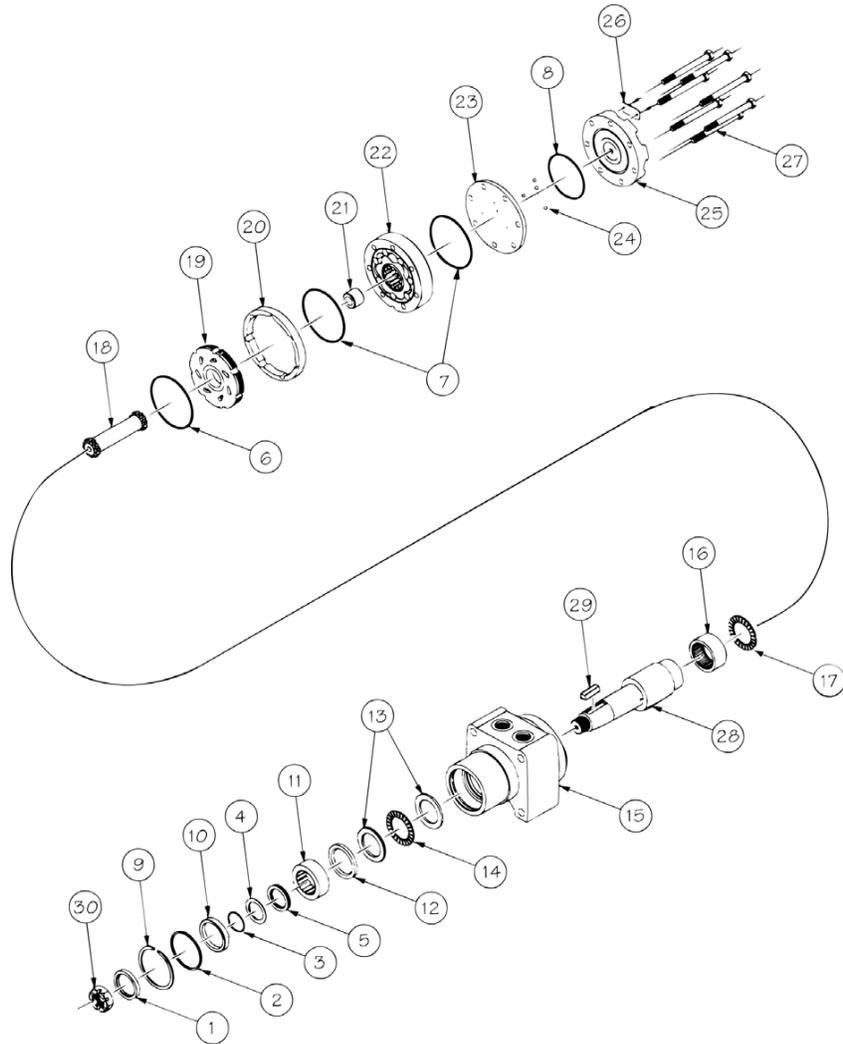

MOTOR REPAIR KITS

STANDARD SEAL KITS

KIT #	DESCRIPTION	ITEMS	PRICE
WTE-700666000	PT-666000	1 - 8	\$ 71.85

DESCRIPTION	EXPLODED VIEW ITEM #
DUST SEAL	1
HIGH PRESSURE SEAL	2
METAL BACKUP SHIM	3
TEFLON BACKUP SEAL	4
SHAFT SEAL	5
REAR HOUSING SEAL	6
BODY SEALS (2)	7
ENDCOVER SEAL	8

HOUSING TYPES

DESCRIPTION
#67 WHEEL MOTOR W/ 7/8" O-RING PORTS

RE 1.5" BEARING SAE "A" STYLE FLANGE MOTOR

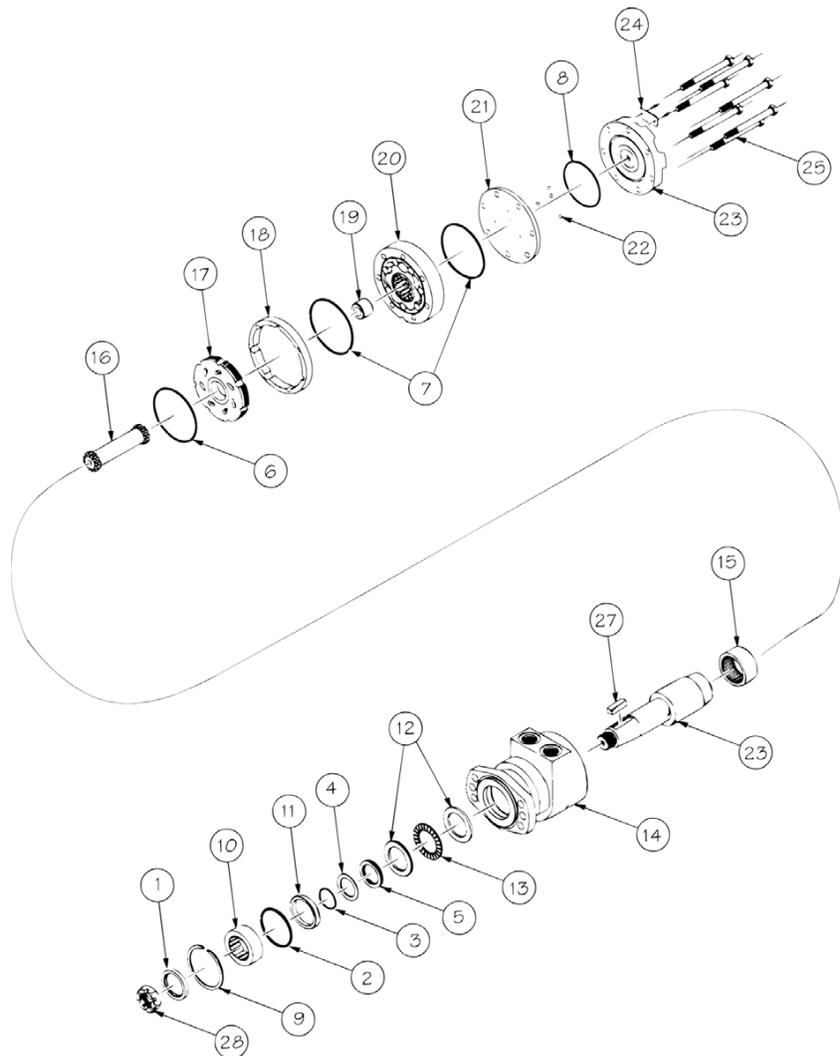

STANDARD SEAL KITS

KIT #	DESCRIPTION	ITEMS	PRICE
WTE-700666000	PT-666000	1 - 8	\$ 71.85

DESCRIPTION	EXPLODED VIEW ITEM #
DUST SEAL	1
HIGH PRESSURE SEAL	2
METAL BACKUP SHIM	3
TEFLON BACKUP SHIM	4
SHAFT SEAL	5
REAR HOUSING SEAL	6
BODY SEALS (2)	7
ENDCOVER SEAL	8

HOUSING TYPES

DESCRIPTION
#62 6-HOLE SAE "A" STYLE FLANGE W/ 7/8" O-RING
#66 6-HOLE SAE "A" STYLE FLANGE W/ 1/2" BSP.F
#68 6-HOLE SAE "A" STYLE FLANGE W/ MNFLD. PORTS
#92 6-HOLE SAE "A" STYLE FLANGE W/ 7/8" O-RING & RLF. PRT.
#96 6-HOLE SAE "A" STYLE FLANGE W/ 1/2" BSP.F & RLF. PRT.

MOTOR REPAIR KITS

RE 125 MM BEARING MOTOR

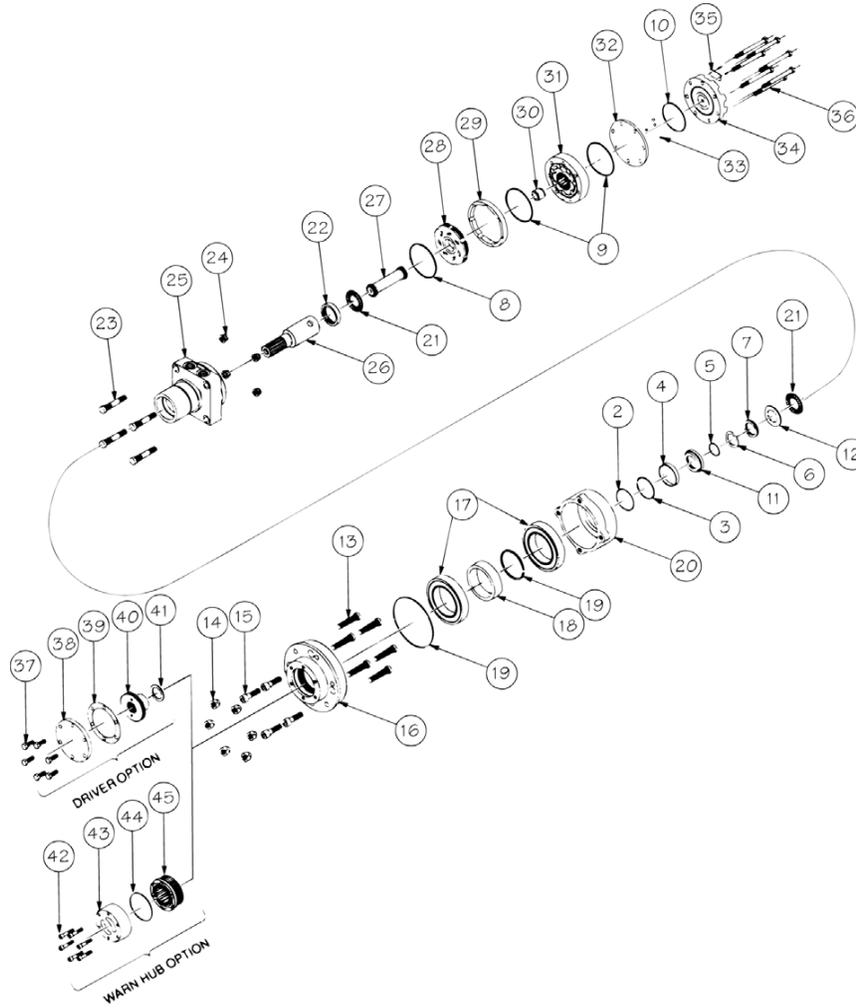

MOTOR REPAIR KITS

STANDARD SEAL KITS

KIT #	DESCRIPTION	ITEMS	PRICE
WTE-500444125	PE-444125	1 - 10, 39	\$ 87.98
WTE-500444003	PE-444003	11 - 12	65.15

DESCRIPTION	EXPLODED VIEW ITEM #
FLANGE SEAL	1
WIRE RING	2
METAL BACKUP SHIM	3
HIGH PRESSURE SEAL	4
METAL BACKUP SHIM	5
TEFLON BACKUP SEAL	6
SHAFT SEAL	7
REAR HOUSING SEAL	8
BODY SEAL	9
ENDCOVER SEAL	10
PAPER GASKET	39
SEAL CARRIER	11
THRUST WASHER	12

HOUSING TYPES

DESCRIPTION
#10 SETBACK W/ 7/8" O-RING

RE 12 HOUSING BRAKE MOTOR

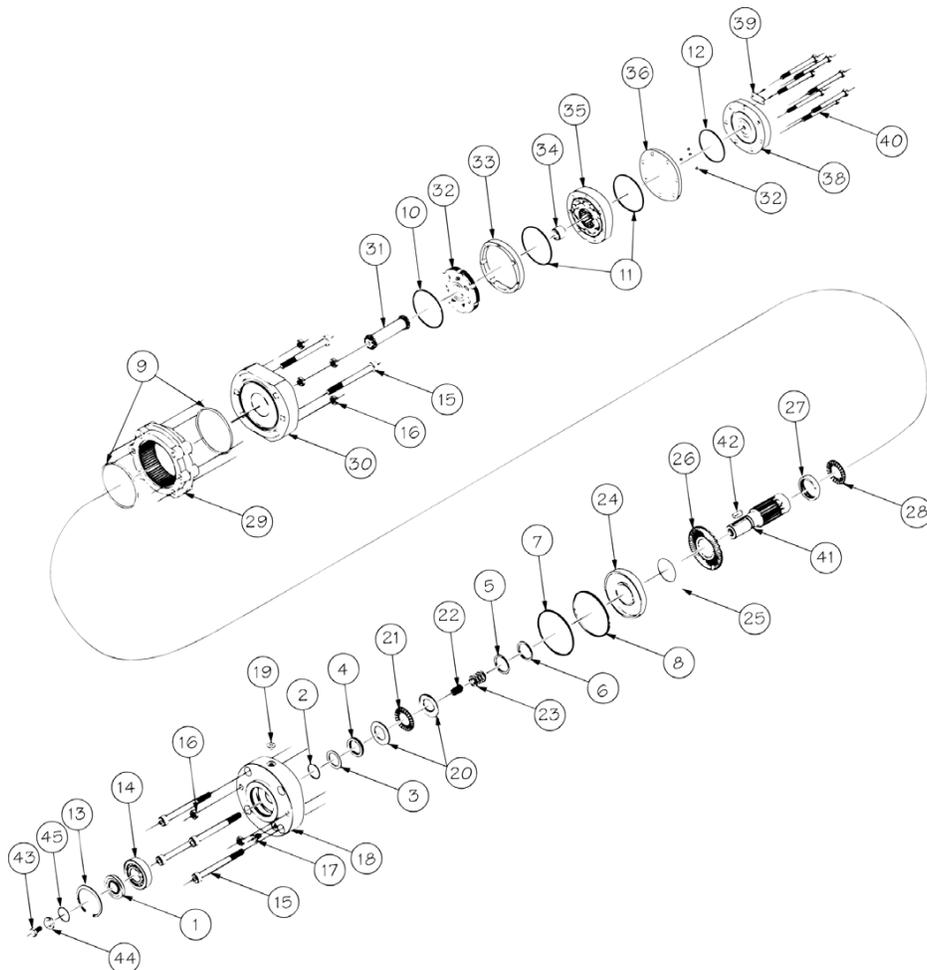

STANDARD SEAL KITS

KIT #	DESCRIPTION	ITEMS	PRICE
WTE-500444500	PE-444500	1 - 12	\$ 144.35

DESCRIPTION	EXPLODED VIEW ITEM #
DUST SEAL	1
METAL BACKUP SHIM	2
TEFLON BACKUP SEAL	3
SHAFT SEAL	4
SMALL O-RING PISTON SEAL	5
SMALL TEFLON PISTON SEAL	6
LARGE O-RING PISTON SEAL	7
LARGE TEFLON PISTON SEAL	8
HOUSING SEALS (2)	9
REAR HOUSING SEAL	10
BODY SEALS (2)	11
ENDCOVER SEAL	12

HOUSING TYPES

DESCRIPTION
FRONT HOUSING SECTION (INCLUDES ITEMS #1, 13, 14 & 18)
CENTER HOUSING SECTION
REAR HOUSING SECTION (INCLUDES ITEMS #27 & 30)

MOTOR REPAIR KITS

STANDARD DR SERIES MOTOR

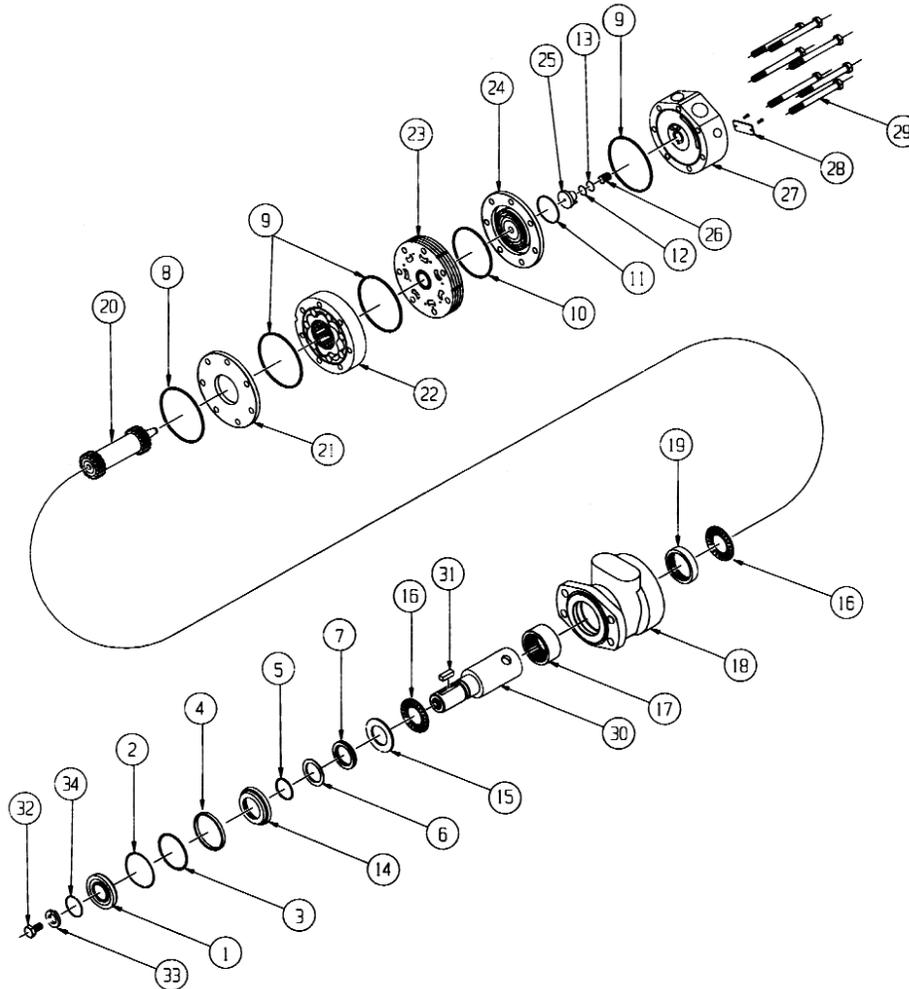

STANDARD SEAL KITS

KIT #	DESCRIPTION	ITEMS	PRICE
WTE-600555000	PR-555000	1 - 13	\$ 123.42
WTE-500444003	PE-444003	14 - 15	65.15

DESCRIPTION	EXPLODED VIEW ITEM #
DUST SEAL	1
SPLIT WEAR RING	2
METAL BACKUP SHIM	3
HIGH PRESSURE SEAL	4
METAL BACK UP SHIM	5
TEFLON BACKUP SEAL	6
SHAFT SEAL	7
REAR HOUSING SEAL	8
BODY SEALS (3)	9
MANIFOLD SEALS	10
COMMUTATOR SEAL	11
O-RING SEAL	12
TEFLON BACKUP SEAL	13
SEAL CARRIER	14
THRUST WASHER	15

HOUSING TYPES

DESCRIPTION
#07 SETBACK W/ 7/8" O-RING
#08-4-HOLES SAE "A" STYLE
#11-SETBACK W/BRAKE MOUNT
#16-2-HOLE SAE "A" STYLE
#18-6-HOLE SAE "A" STYLE

MOTOR REPAIR KITS

NOTES

NOTES

Parker / Commercial Intertech and Parker / Gresen Valve Repair Kits

Contents	Page
Parker / Commercial Valve Repair Kits	1184
Parker / Gresen Valve Repair Kits	1184
• 25P & V42	1184
• SP, SPK & SSK	1184
• 300 & 400	1184

PARKER / COMMERCIAL VALVE SERVICE KITS

VALVE SERVICE KITS		
CM-391-1803-030	Valve Series A20 Service Kit	\$ 6.73
CM-391-1803-201	Valve Series A35 Service Kit	32.95

PARKER / GRESEN VALVE SERVICE KITS

Part Number	Bill Material	Description	Price
25P & V42 CONTROL VALVES			
GR-K-7001	6432001	Seal Kit, One Section Only	\$ 163.60
GR-K-7004	6430001	Seal Kit, KC Main Relief	62.10
GR-K-7037	10825001	Seal Kit, RP51 Relief	10.51
SP, SPK & SSK VALVES			
GR-K-2001	6459001	Seal Kit-1 spool valve w/adjustment relief	\$ 30.67
GR-K-2002	6458001	Seal Kit-2 spool valve w/adjustable relief	188.44
GR-K-2003	6460001	Seal Kit-3 spool valve w/adjustable relief	40.00
GR-K-2029	12759001	Standard Relief Kit, SP	273.27
GR-K-2030	12758001	High Pressure Relief Kit, SP	410.17
300 & 400 CONTROL VALVES			
GR-K-3001	6467001	Spool Seals	\$ 6.44

PARKER / GRESEN VALVE REPAIR PARTS

Part Number	Description	Qty	Price
GR-401272	O-RINGS	50	\$ 0.06
GR-401273	O-RINGS	50	0.06
GR-404463	O-RINGS	50	0.06
GR-405393	O-RINGS	50	0.25
GR-405688	O-RINGS	50	0.26
GR-406093	O-RINGS	50	0.06
GR-406265	O-RINGS	50	0.03
GR-406270	O-RINGS	50	0.06
GR-406460	O-RINGS	50	0.07
GR-406484	O-RINGS	50	0.06
GR-406725	O-RINGS	50	0.26
GR-406814	O-RINGS	50	0.32
GR-407229	O-RINGS	50	0.16
GR-407328	O-RINGS	50	0.06
GR-407342	O-RINGS	50	0.09
GR-407347	O-RINGS	50	0.10
GR-408870	O-RINGS	50	0.07
GR-493127	O-RINGS	50	0.10

Appendix

Contents	Page
Metric / Inch Conversion Table	1186 - 1187
Common Telescopic Cylinders - Distinguishing Characteristics	1188 - 1197

Inches		Millimeter
Fractions	Decimals	
—	.0004	.01
—	.004	.10
—	.01	.25
1/64	.0156	.397
—	.0197	.50
—	.0295	.75
1/32	.03125	.794
—	.0394	1.0
3/64	.0469	1.191
—	.059	1.5
1/16	.062	1.588
5/64	.0781	1.984
—	.0787	2.0
3/32	.094	2.381
—	.0984	2.5
7/64	.109	2.778
—	.1181	3.0
1/8	.125	3.175
—	.1378	3.5
9/64	.141	3.572
5/32	.156	3.969
—	.1575	4.0
11/64	.172	4.366
—	.177	4.5
3/16	.1875	4.763
—	.1969	5.0
13/64	.203	5.159
—	.2165	5.5
7/32	.219	5.556
15/64	.234	5.953
—	.2362	6.0
1/4	.250	6.350
—	.2559	6.5
17/64	.2656	6.747
—	.2756	7.0
9/32	.281	7.144
—	.2953	7.5
19/64	.297	7.541
5/16	.312	7.938
—	.315	8.0
21/64	.328	8.334
—	.335	8.5
11/32	.344	8.731
—	.3543	9.0
23/64	.359	9.128

Inches		Millimeter
Fractions	Decimals	
—	.374	9.5
3/8	.375	9.525
25/64	.391	9.922
—	.3937	10.0
13/32	.406	10.319
—	.413	10.5
27/64	.422	10.716
—	.4331	11.0
7/16	.438	11.113
29/64	.453	11.509
15/32	.469	11.906
—	.4724	12.0
31/64	.484	12.303
—	.492	12.5
1/2	.500	12.700
—	.5118	13.0
33/64	.5156	13.097
17/32	.531	13.494
35/64	.547	13.891
—	.5512	14.0
9/16	.563	14.288
—	.571	14.5
37/64	.578	14.684
—	.5906	15.0
19/32	.594	15.081
39/64	.609	15.478
5/8	.625	15.875
—	.6299	16.0
41/64	.6406	16.272
—	.6496	16.5
21/32	.658	16.669
—	.6693	17.0
43/64	.672	17.066
11/16	.6875	17.463
45/64	.703	17.859
—	.7087	18.0
23/32	.719	18.256
—	.7283	18.5
47/64	.734	18.653
—	.7480	19.0
3/4	.750	19.050
49/64	.7656	19.447
25/32	.781	19.844
—	.7874	20.0
51/64	.797	20.241

Inches		Millimeter
Fractions	Decimals	
13/16	.8125	20.638
—	.8268	21.0
53/64	.828	21.034
27/32	.844	21.431
55/64	.859	21.828
—	.8661	22.0
7/8	.875	22.225
57/64	.8906	22.622
—	.9055	23.0
29/32	.9062	23.019
59/64	.922	23.416
15/16	.9375	23.813
—	.9449	24.0
61/64	.953	24.209
31/32	.969	24.606
—	.9843	25.0
63/64	.9844	25.003
1	1.000	25.400
—	1.0236	26.0
1-1/32	1.0312	26.194
1-1/16	1.062	26.988
—	1.063	27.0
1-3/32	1.094	27.781
—	1.1024	28.0
1-1/8	1.125	28.575
—	1.1417	29.0
1-5/32	1.156	29.369
—	1.1811	30.0
1-3/16	1.1875	30.163
1-7/32	1.219	30.956
—	1.2205	31.0
1-1/4	1.250	31.750
—	1.2598	32.0
1-9/32	1.281	32.544
—	1.2992	33.0
1-5/16	1.312	33.338
—	1.3386	34.0
1-11/32	1.344	34.131
1-3/8	1.375	34.925
—	1.3779	35.0
1-13/32	1.406	35.719
—	1.4173	36.0
1-7/16	1.438	36.513
—	1.4567	37.0
1-15/32	1.469	37.306

Inches		Millimeter
Fractions	Decimals	
—	1.4961	38.0
1-1/2	1.500	38.100
1-17/32	1.531	38.894
—	1.5354	39.0
1-9/16	1.562	39.688
—	1.5748	40.0
1-19/32	1.594	40.481
—	1.6142	41.0
1-5/8	1.625	41.275
—	1.6535	42.0
1-21/32	1.6562	42.069
1-11/16	1.6875	42.863
—	1.6929	43.0
1-23/32	1.719	43.656
—	1.7323	44.0
1-3/4	1.750	44.450
—	1.7717	45.0
1-25/32	1.781	45.244
—	1.8110	46.0
1-13/16	1.8125	46.038
1-27/32	1.844	46.831
—	1.8504	47.0
1-7/8	1.875	47.625
—	1.8898	48.0
1-29/32	1.9062	48.419
—	1.9291	49.0
1-15/16	1.9375	49.213
—	1.9685	50.0
1-31/32	1.969	50.006
2	2.000	50.800
—	2.0079	51.0
2-1/32	2.03125	51.594
—	2.0472	52.0
2-1/6	2.062	52.388
—	2.0866	53.0
2-3/32	2.094	53.181
2-1/8	2.125	53.975
—	2.126	54.0
2-5/32	2.156	54.769
—	2.165	55.0
2-3/16	2.1875	55.563
—	2.2047	56.0
2-7/32	2.219	56.356
—	2.244	57.0
2-1/4	2.250	57.150

Inches		Millimeter
Fractions	Decimals	
2-9/32	2.281	57.944
—	2.2835	58.0
2-5/16	2.312	58.738
—	2.3228	59.0
2-11/32	2.344	59.531
—	2.3622	60.0
2-3/8	2.375	60.325
—	2.4016	61.0
2-13/32	2.406	61.119
2-7/16	2.438	61.913
—	2.4409	62.0
2-15/32	2.469	62.706
—	2.4803	63.0
2-1/2	2.500	63.500
—	2.5197	64.0
2-17/32	2.531	64.294
—	2.559	65.0
2-9/16	2.562	65.088
2-19/32	2.594	65.881
—	2.5984	66.0
2-5/8	2.625	66.675
—	2.638	67.0
2-21/32	2.656	67.469
—	2.6772	68.0
2-11/16	2.6875	68.263
—	2.7165	69.0
2-23/32	2.719	69.056
2-3/4	2.750	69.850
—	2.7559	70.0
2-25/32	2.781	70.6439
—	2.7953	71.0
2-13/16	2.8125	71.4376
—	2.8346	72.0
2-27/32	2.844	72.2314
—	2.8740	73.0
2-7/8	2.875	73.025
2-29/32	2.9062	73.819
—	2.9134	74.0
2-15/16	2.9375	74.613
—	2.9527	75.0
2-31/32	2.969	75.406
—	2.9921	76.0
3	3.000	76.200
3-1/32	3.0312	76.994
—	3.0315	77.0

Inches		Millimeter
Fractions	Decimals	
3-1/16	3.062	77.788
—	3.0709	78.0
3-3/32	3.094	78.581
—	3.1102	79.0
3-1/8	3.125	79.581
—	3.1496	80.0
3-5/32	3.156	80.169
3-3/16	3.1875	80.963
—	3.1890	81.0
3-7/32	3.219	81.756
—	3.2283	82.0
3-1/4	3.250	82.550
—	3.2677	83.0
3-9/32	3.281	83.344
—	3.3071	84.0
3-5/16	3.312	84.1377
3-11/32	3.344	84.9314
—	3.3464	85.0
3-3/8	3.375	85.725
—	3.3858	86.0
3-13/32	3.406	86.519
—	3.4252	87.0
3-7/16	3.438	87.313
—	3.4648	88.0
3-15/32	3.469	88.108
3-1/2	3.500	88.900
—	3.5039	89.0
3-17/32	3.531	89.694
—	3.5433	90.0
3-9/16	3.562	90.4877
—	3.5827	91.0
3-19/32	3.594	91.281
—	3.622	92.0
3-5/8	3.625	92.075
3-21/32	3.656	92.869
—	3.6614	93.0
3-11/16	3.6875	93.663
—	3.7008	94.0
3-23/32	3.719	94.456
—	3.7401	95.0
3-3/4	3.750	95.250
—	3.7795	96.0
3-25/32	3.781	96.044
3-13/16	3.8125	96.838
—	3.8189	97.0

Inches		Millimeter
Fractions	Decimals	
3-27/32	3.844	97.631
—	3.8583	98.0
3-7/8	3.875	98.425
—	3.8976	99.0
3-29/32	3.9062	99.219
—	3.9370	100.0
3-15/16	3.9375	100.013
3-31/32	3.969	100.806
—	3.9764	101.0
4	4.000	101.600
4-1/16	4.062	103.188
4-1/8	4.125	104.775
—	4.1338	105.0
4-3/16	4.1875	106.363
4-1/4	4.250	107.950
4-5/16	4.312	109.538
—	4.3307	110.0
4-3/8	4.375	111.125
4-7/16	4.438	112.713
4-1/2	4.500	114.300
—	4.5275	115.0
4-9/16	4.562	115.888
4-5/8	4.625	117.475
4-11/16	4.6875	119.063
—	4.7244	120.0
4-3/4	4.750	120.650
4-13/16	4.8125	122.238
4-7/8	4.875	123.825
—	4.9212	125.0
4-15/16	4.9375	125.413
5	5.000	127.000
—	5.1181	130.0
5-1/4	5.250	133.350
5-1/2	5.500	139.700
—	5.5118	140.0
5-3/4	5.750	146.050
—	5.9055	150.0
6	6.000	152.400
6-1/4	6.250	158.750
—	6.2992	160.0
6-1/2	6.500	165.100
—	6.6929	170.0
6-3/4	6.750	171.450
7	7.000	177.800
—	7.0866	180.0

Inches		Millimeter
Fractions	Decimals	
—	7.4803	190.0
7-1/2	7.500	190.500
—	7.8740	200.0
8	8.000	203.200
—	8.2677	210.0
8-1/2	8.500	215.900
—	8.6614	220.0
9	9.000	228.600
—	9.0551	230.0
—	9.4488	240.0
9-1/2	9.500	241.300
—	9.8425	250.0
10	10.000	254.001
—	10.2362	260.0
—	10.6299	270.0
11	11.000	279.401
—	11.0236	280.0
—	11.4173	290.0
—	11.8110	300.0
12	12.000	304.801
13	13.000	330.201
—	13.7795	350.0
14	14.000	355.601
15	15.000	381.001
—	15.7480	400.0
16	16.000	406.401
17	17.000	431.801
—	17.7165	450.0
18	18.000	457.201
19	19.000	482.601
—	19.6850	500.0
20	20.000	508.001

ANTHONY

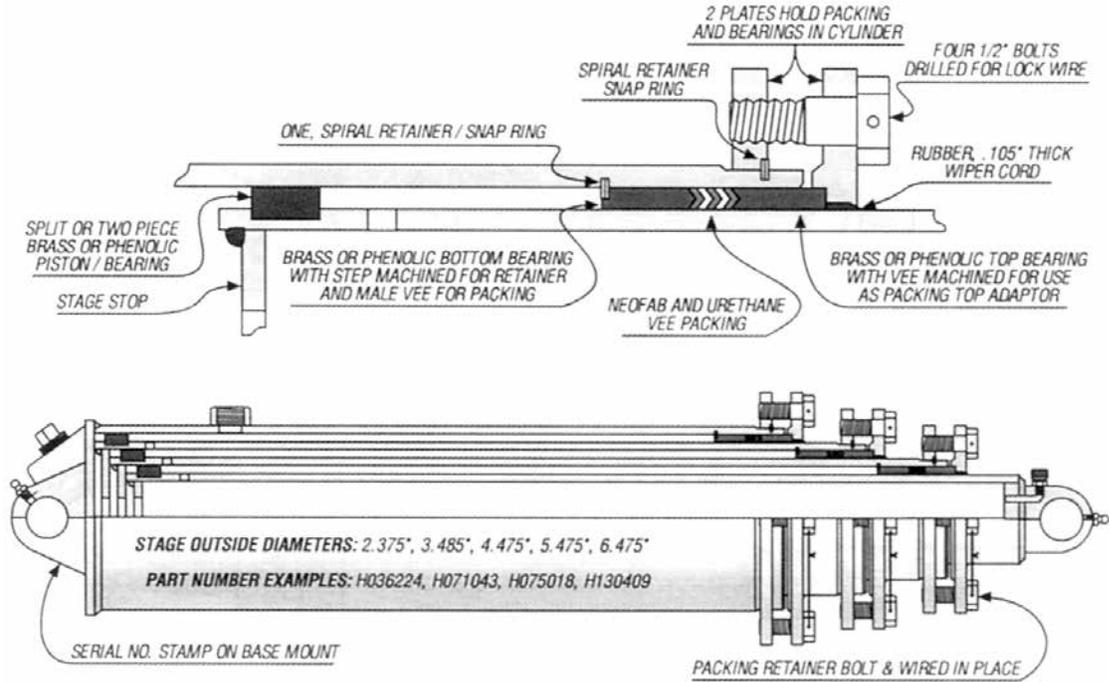

COMMERCIAL

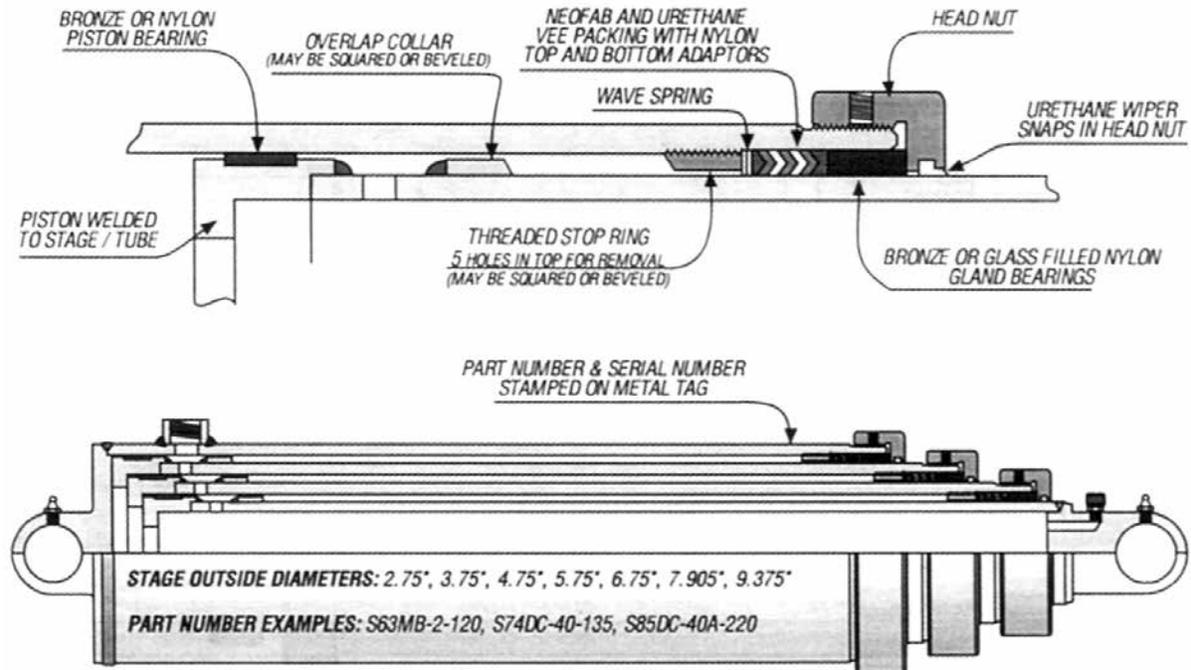

CUSTOM HOISTS® 400 SERIES

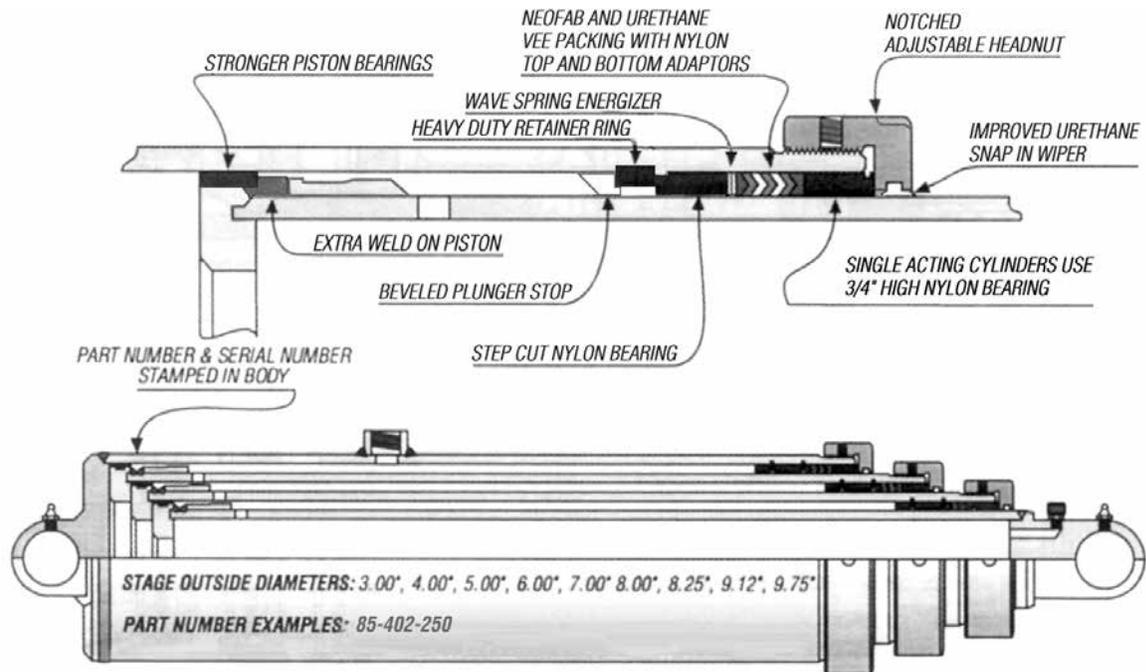

CUSTOM HOISTS® OLD SERIES

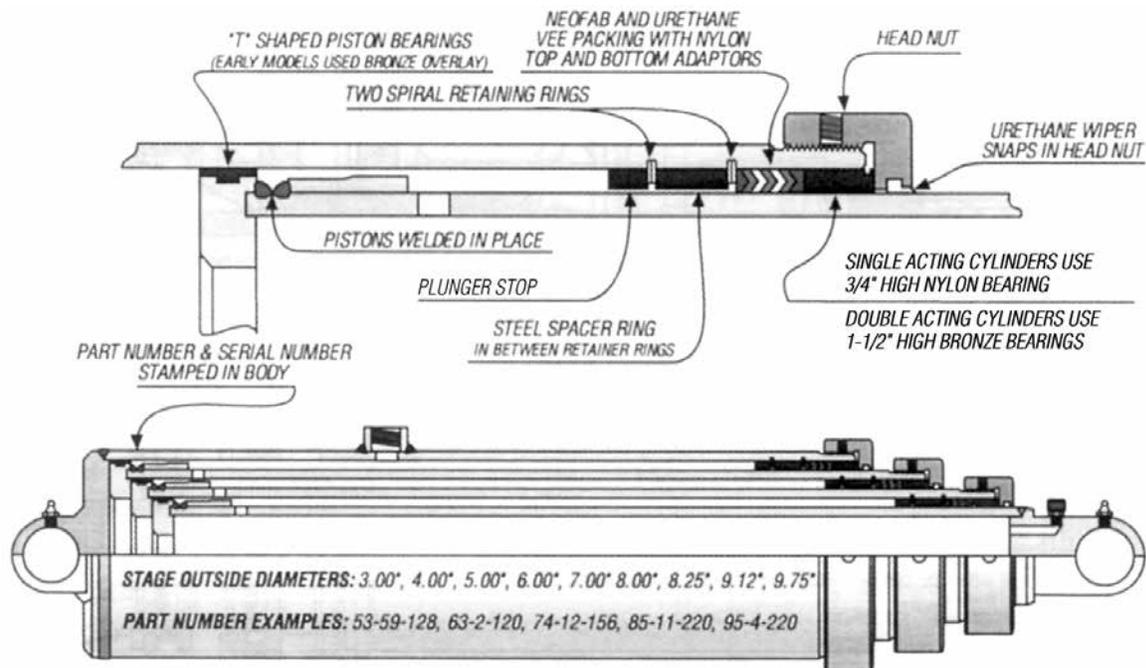

APPENDIX

FONTAINE®

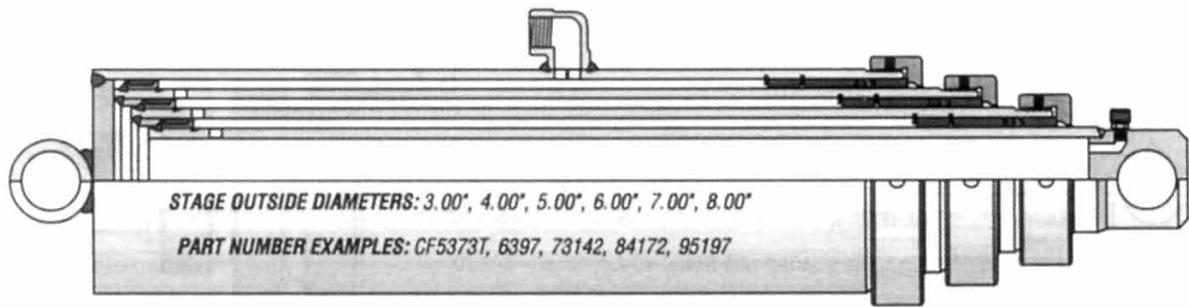
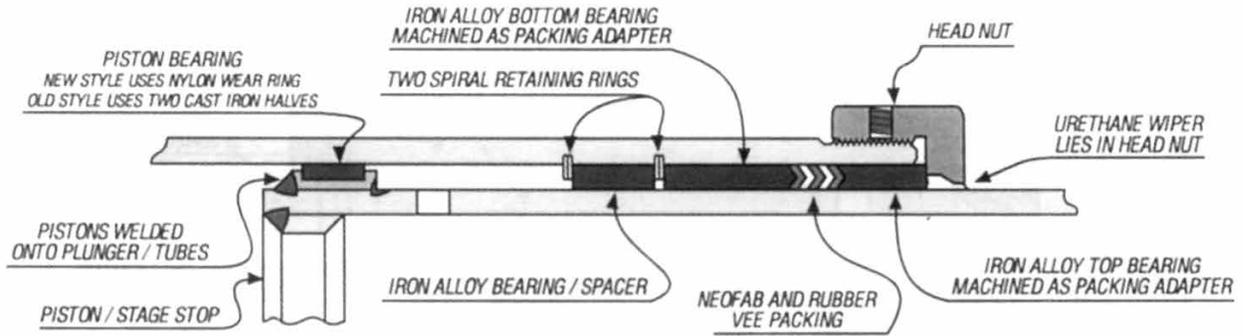

GLENCO / FARMHAND

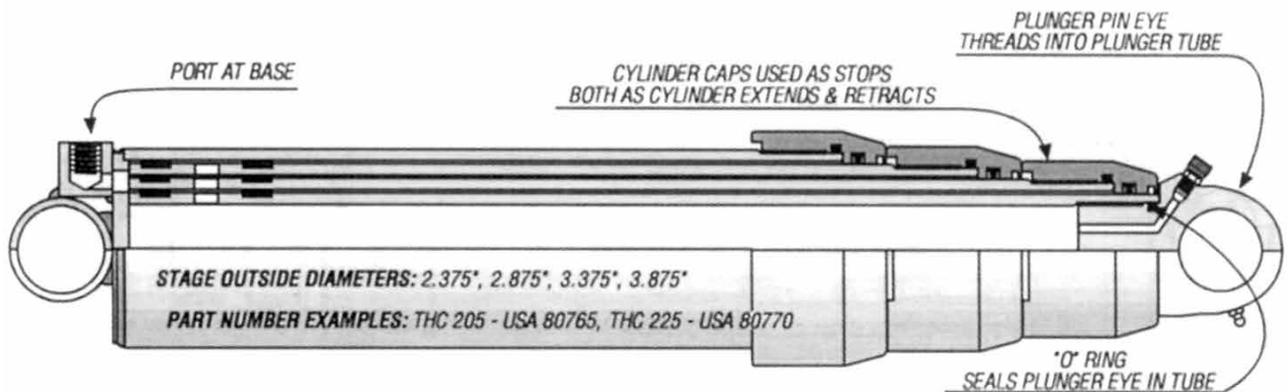
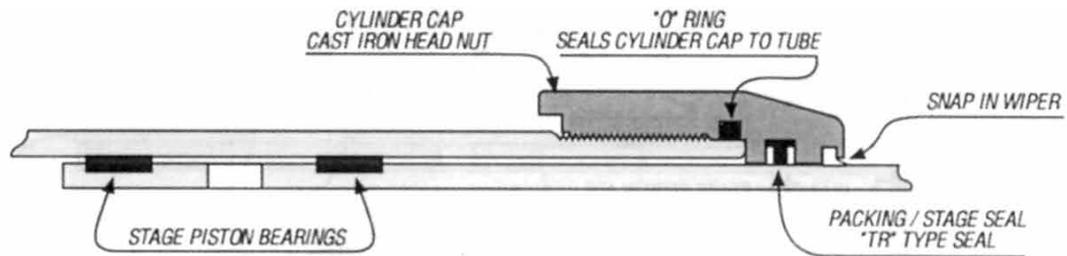

HEIL® “OLD STYLE” HPT SERIES

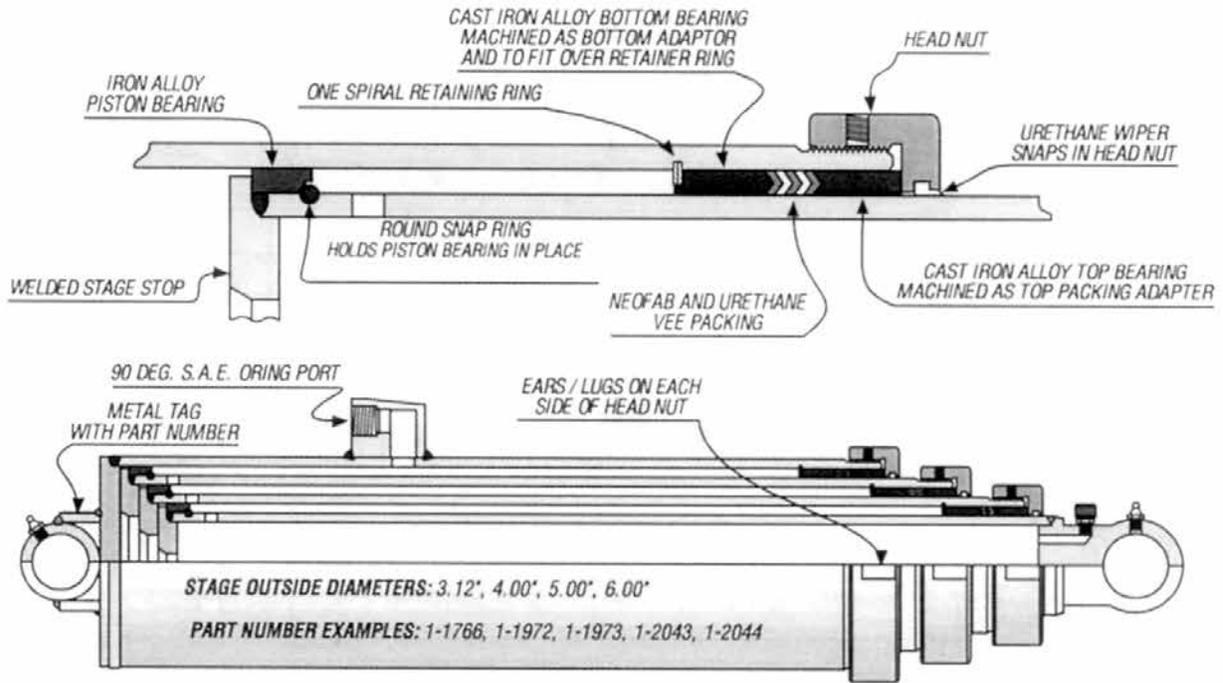

HEIL® “NEW STYLE” HPT SERIES

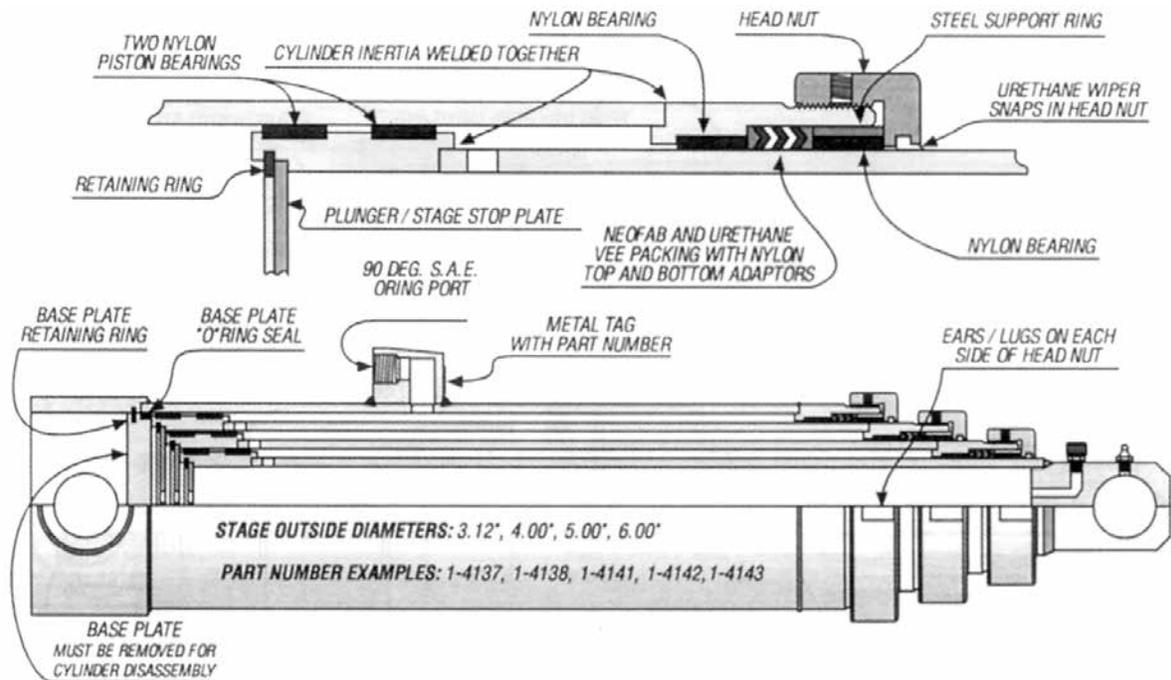

HEIL® "NEW STYLE" HPT SERIES

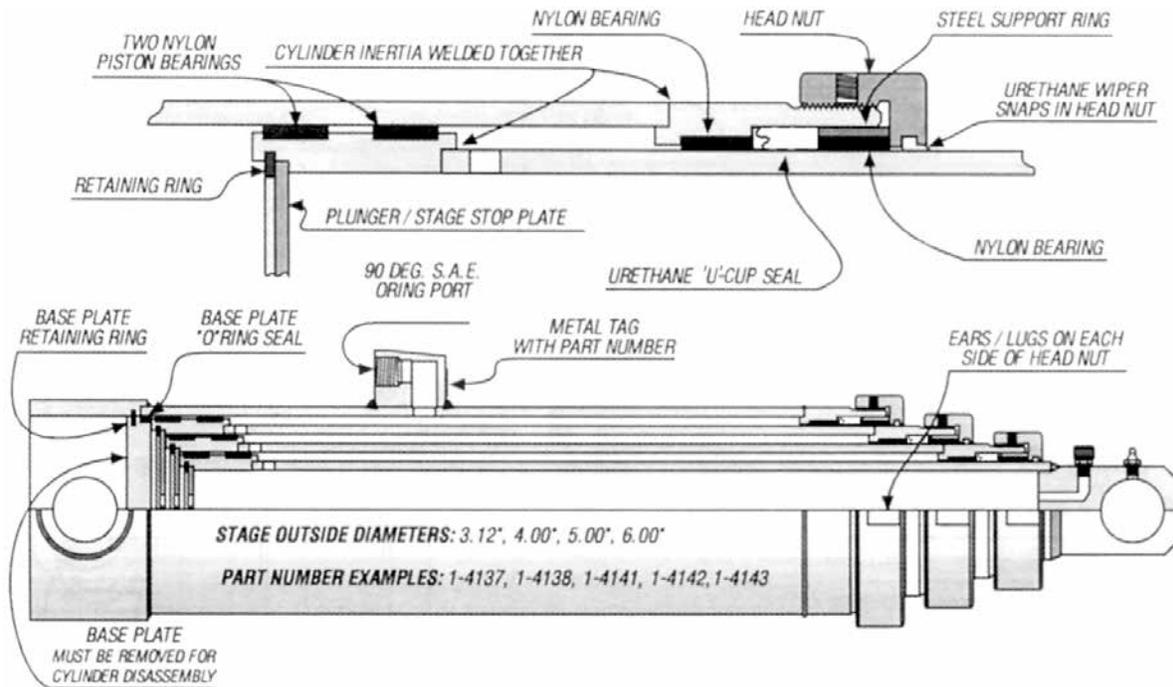

HYCO 900 - 2000 SERIES (MFG. PRIOR TO 6/74)

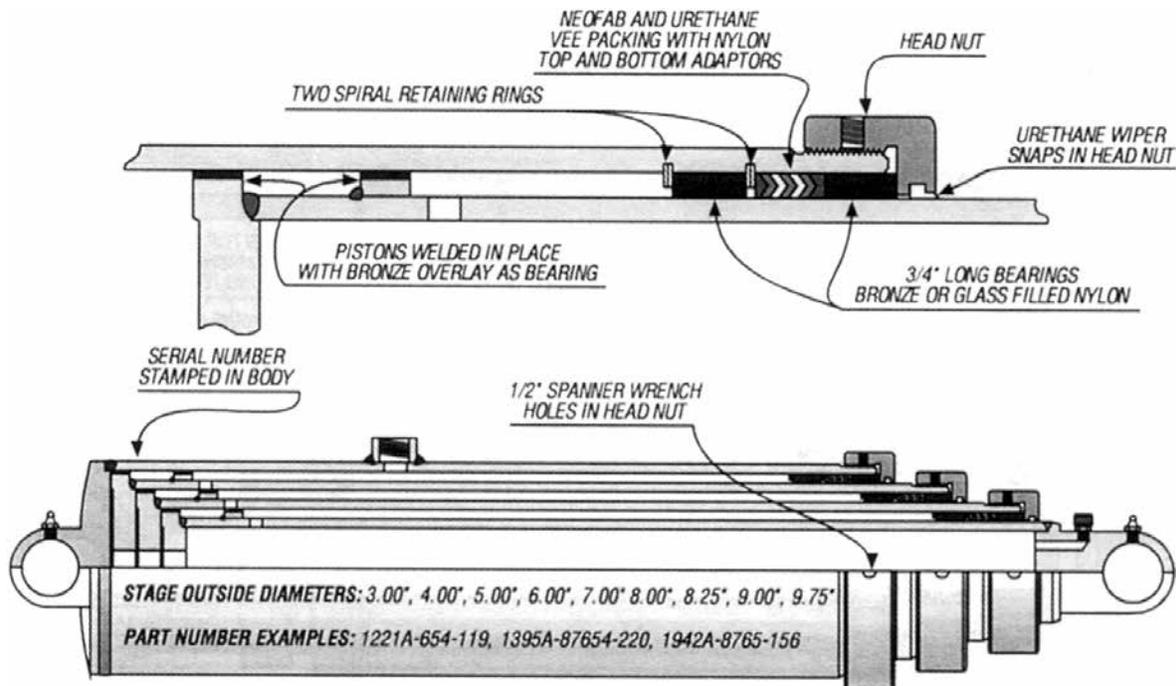

HYCO 10,000 SERIES

(MFG. PRIOR TO 7/74 TO 8/76)

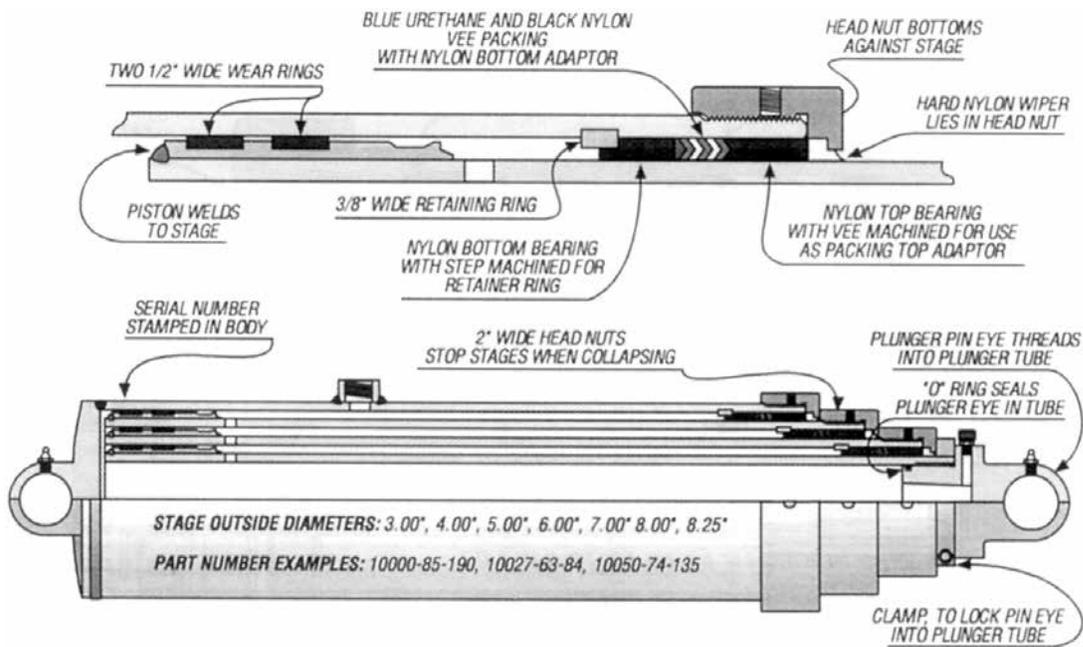

HYCO 30,000 SERIES

(OLD STYLE MFG. FROM 8/76 TO 7/81)
(NEW STYLE MFG. FROM 8/81 TO PRESENT)

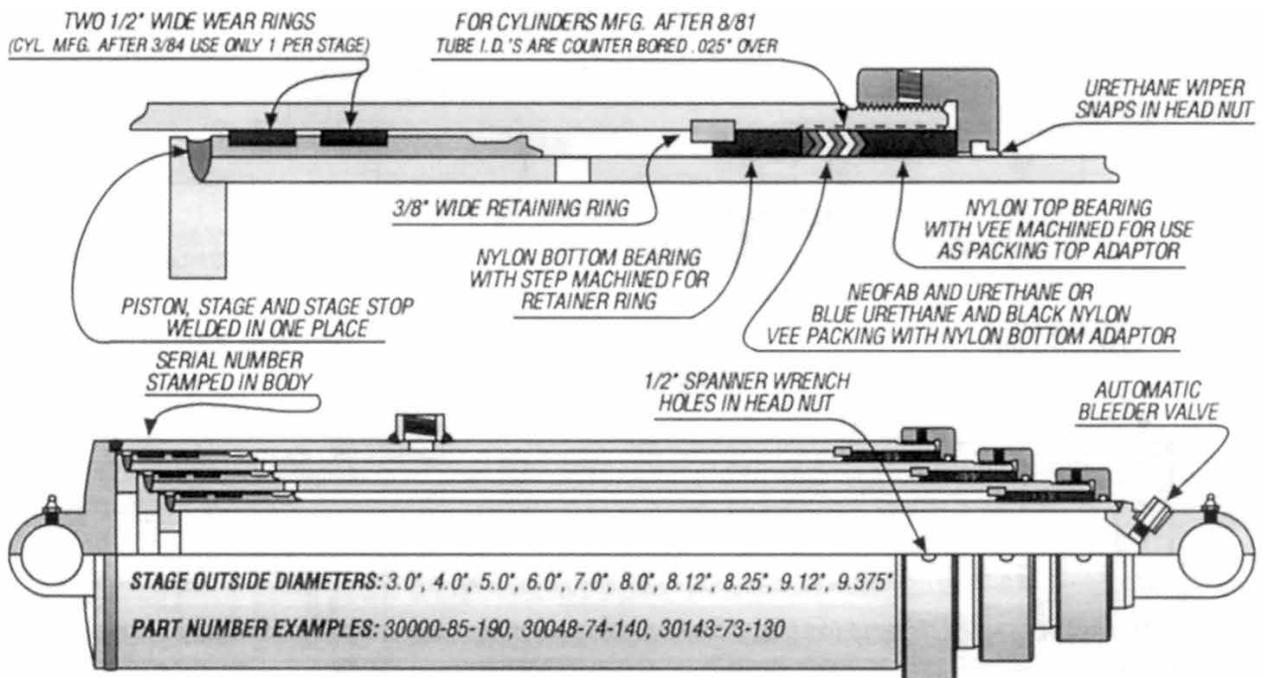

HYCO 30,000 SERIES

(NEW STYLE MFG. FROM 8/76 TO 7/81)

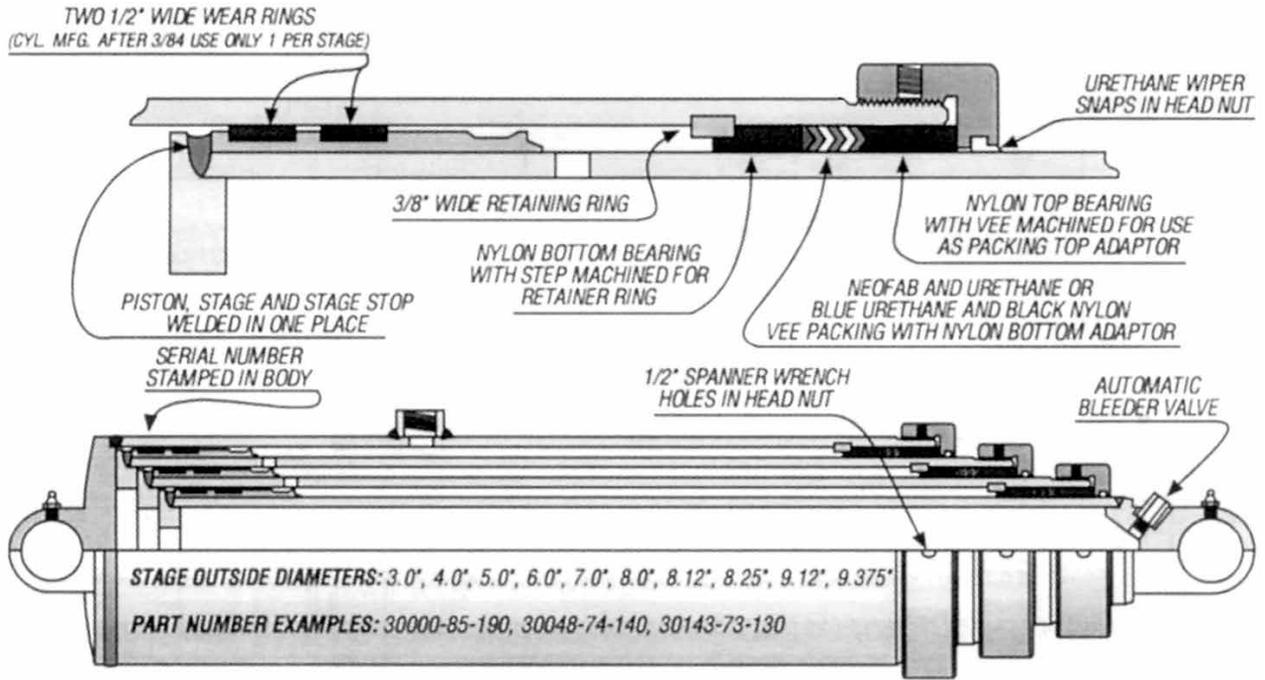

HYCO 70,000 SERIES

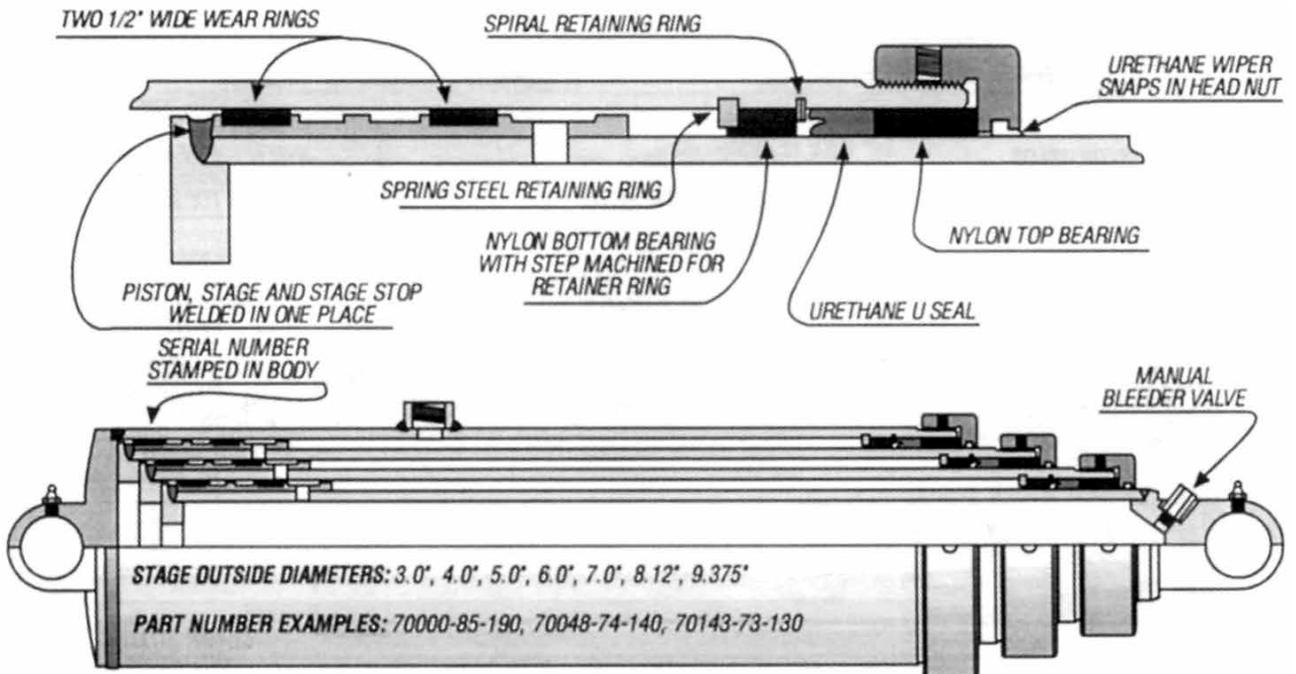

JOHNSON

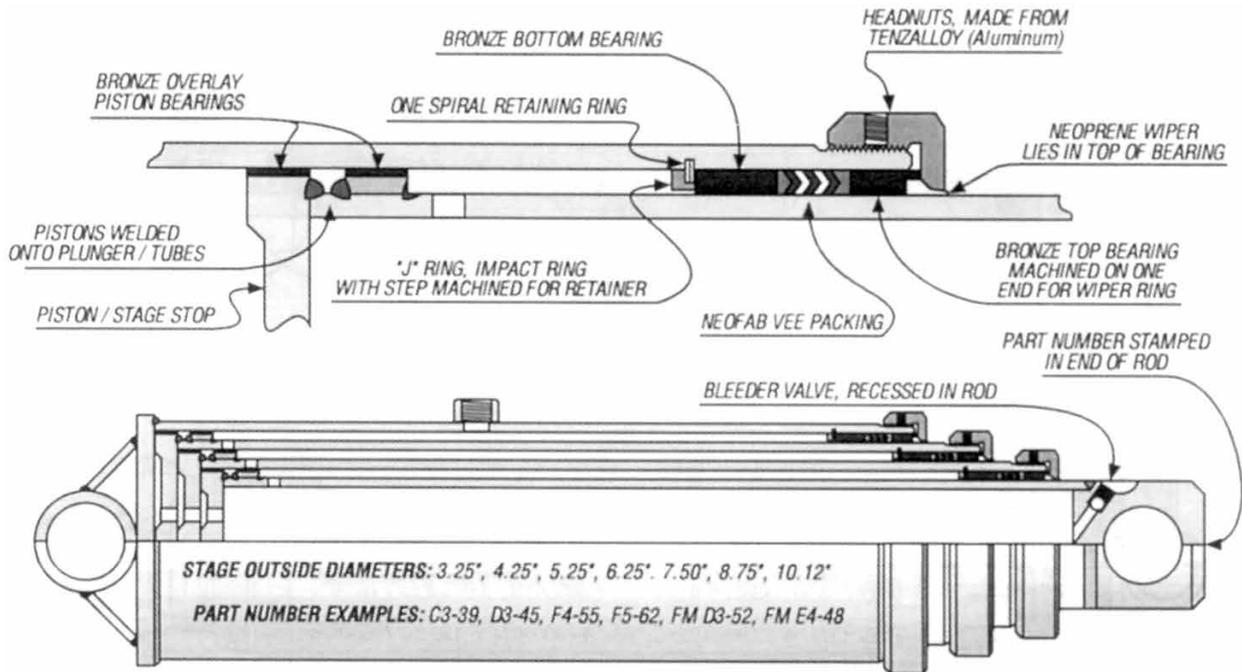

MARION MFG.

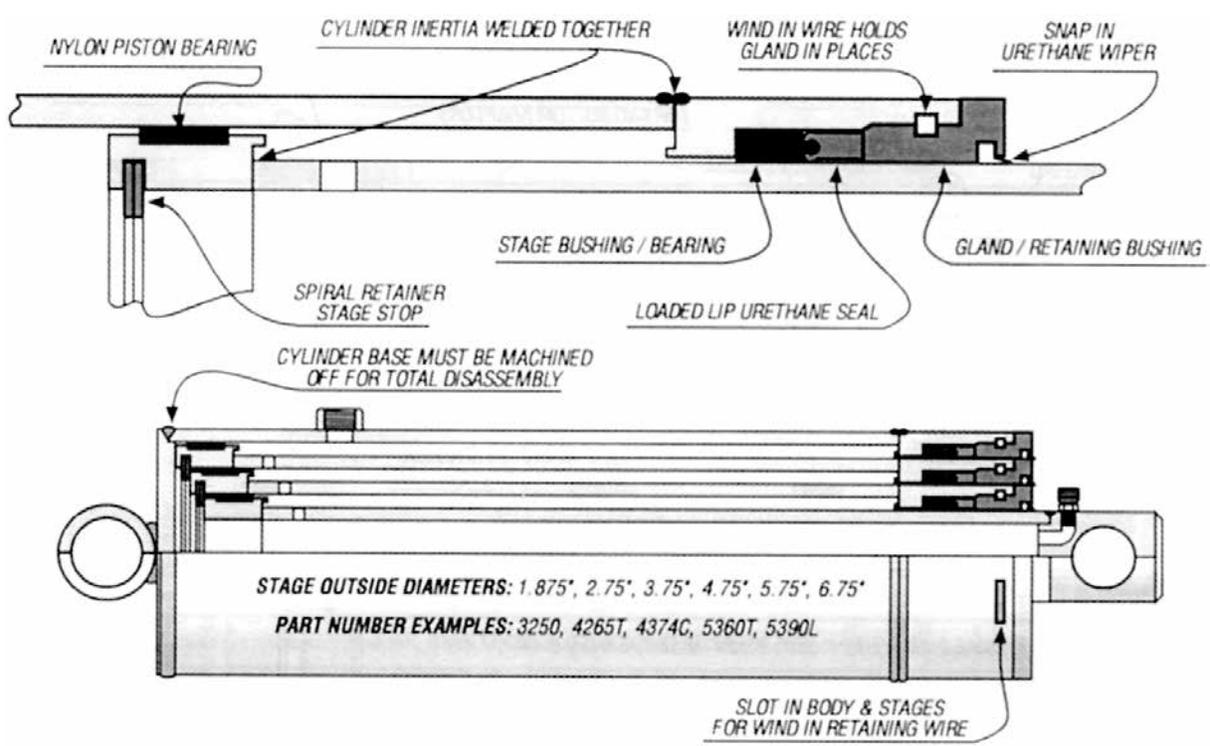

APPENDIX

PEABODY GALION

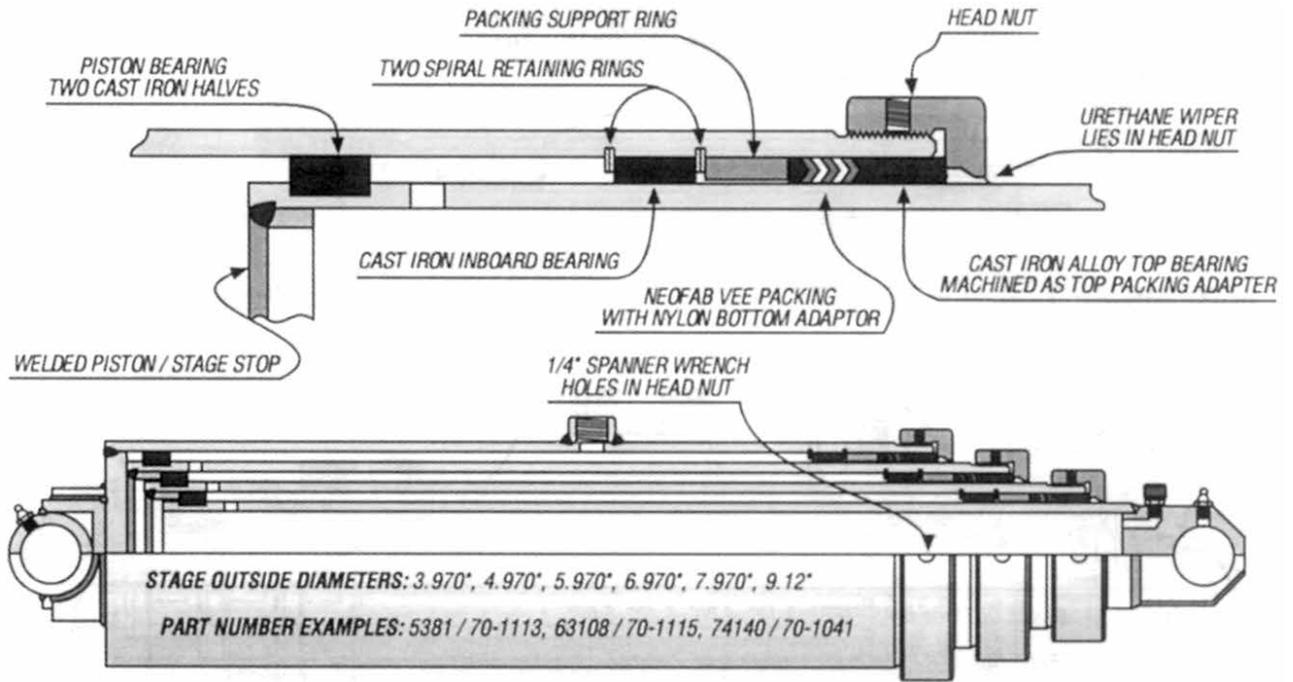

PERFECTION

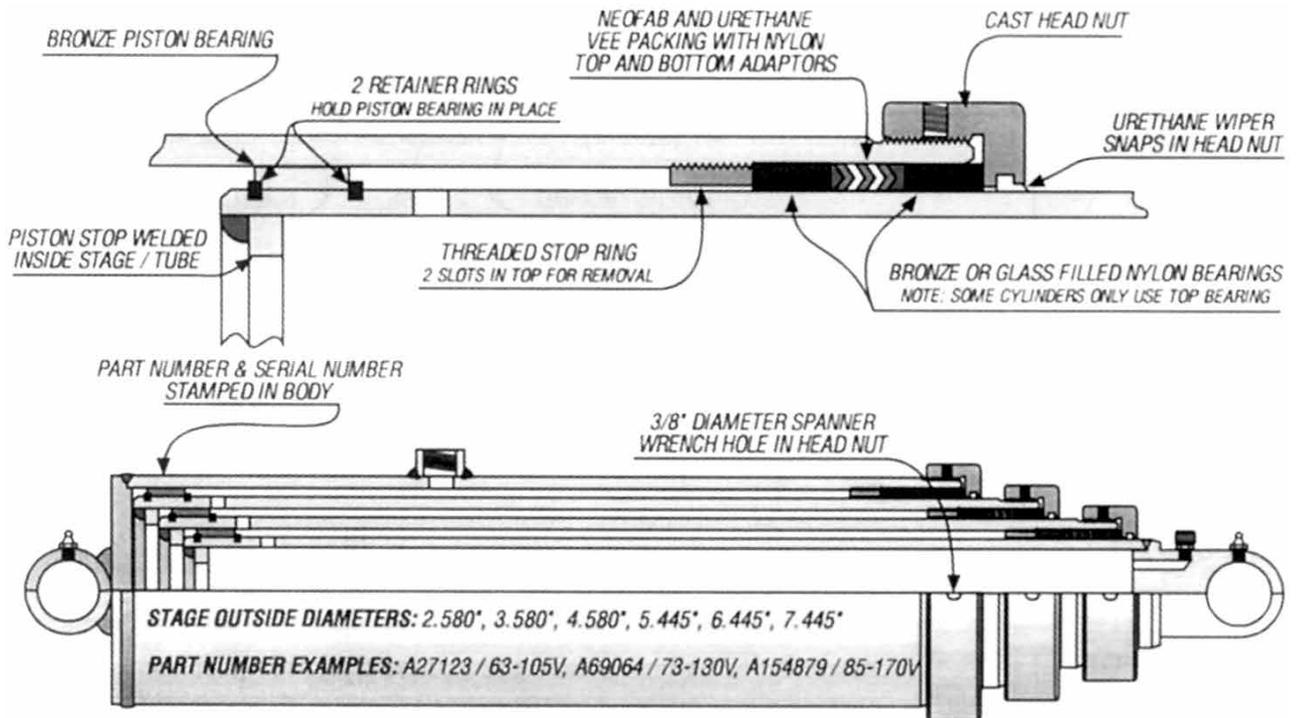

PERFECTION FARM HOISTS

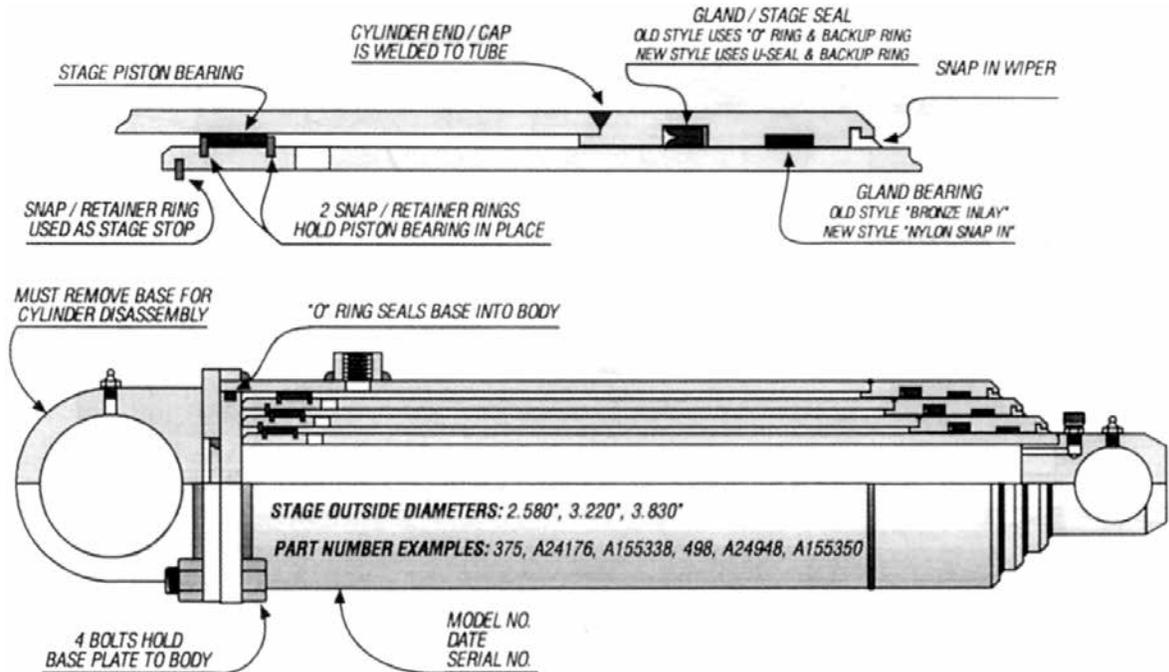

WARD CO.

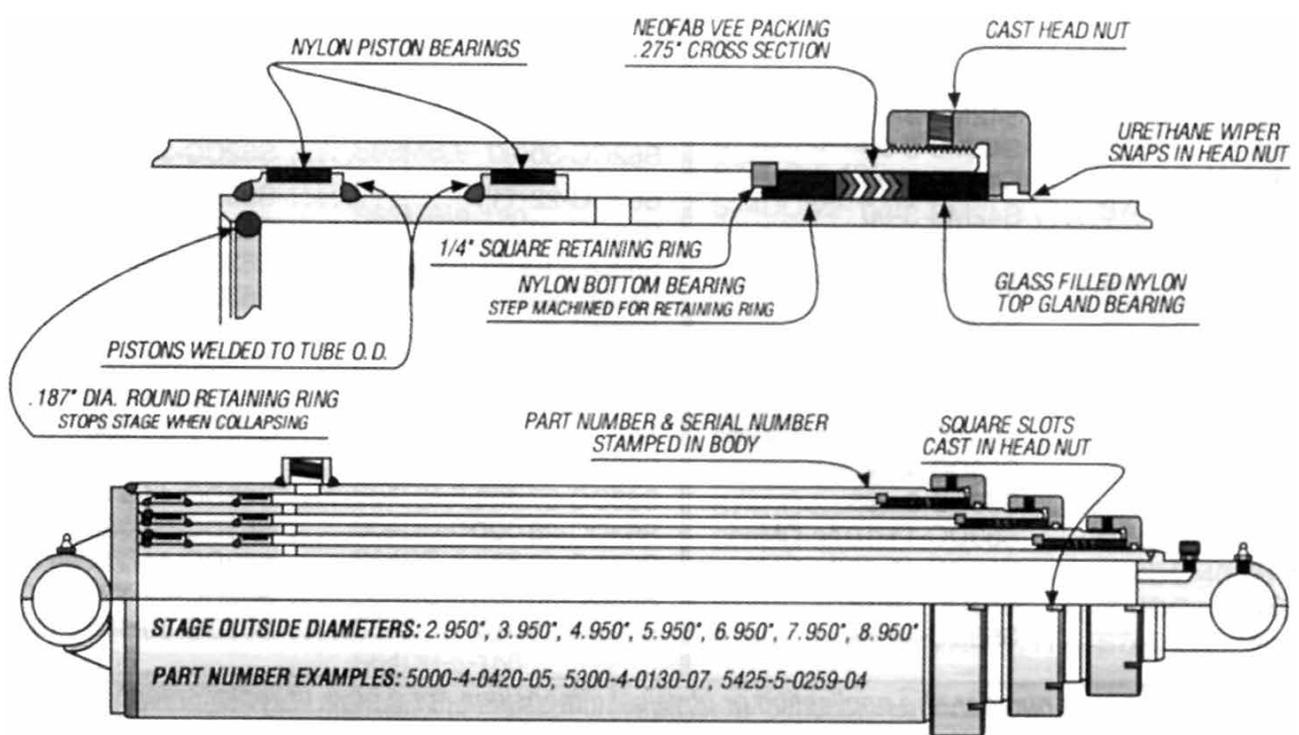

APPENDIX

