

# HANLEY CONTROLS CLONMEL LTD.

## Mechanical Sales Dept.

## Stock Book

### Issue 02



Hanley Controls Clonmel Ltd.  
Gortnafleur, Clonmel, Co. Tipperary, Ireland  
Tel: + 353 52 6122722,  
[mechanicalsales@hccl.ie](mailto:mechanicalsales@hccl.ie)  
[www.hccl.ie](http://www.hccl.ie)

# SS Tube, Clamps & Tooling

## INSTRUMENT TUBE

Schoeller Bleckmann Seamless SS316L Tube (ASTM A269)

Metric sizes: 6mm to 20mm

Imperial sizes: 1/8" to 1" OD



## TUBE CLAMPS

### Clamp Materials

Polypropylene, PA6, Aluminium

### Hardware

Galv or SS plates and bolts

### Type

Singles and Double Clamps

Mounting Rail available

### Sizes

OD & NB sizes from 6mm to 168.3mm  
(up to 50mm stocked in Clonmel)

## PARKER TUBE CUTTERS

Size Part No.  
1/8"-11/8" 218B-SS



Replacement wheel # 218B-WHEEL-SS

## PARKER DEBURRING TOOL

Size Part No.  
3/16"-11/2" PT-D

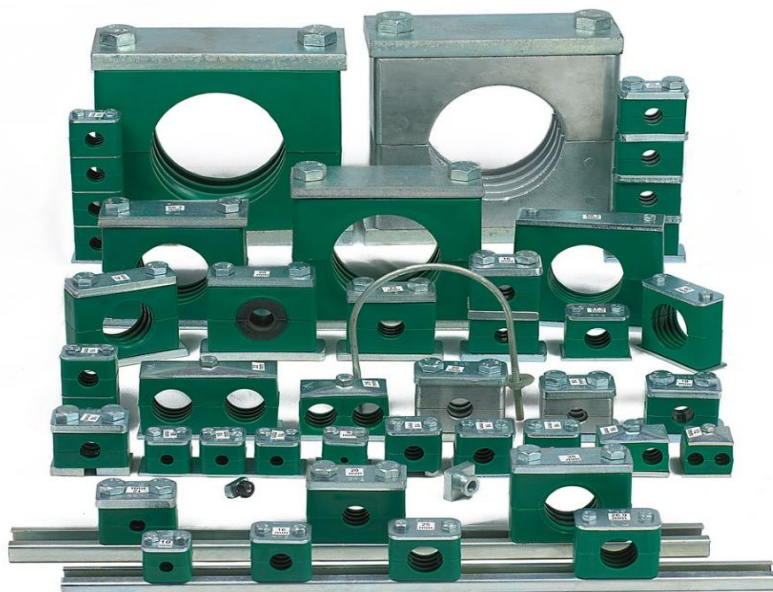

## PARKER/RIDGID TUBE BENDERS

Size	Part No.	Ridgid No.
1/4"	PTB-4T	38033
3/8"	PTB-6T	38043
1/2"	PTB-8T	38048
6mm	PTB-6M	38053
8mm (5/16")	PTB-8M	38038
10mm	PTB-10M	38058
12mm	PTB-12M	38063



## NEW - Unistrut Clamp

Use instead of weld plate

Part no. BA-A/B1-ZN

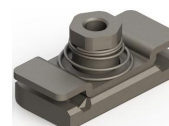

# Industrial Ball Valves

SS316 & Nickel Brass  
Larger sizes on request

## Red Bore 1 piece Ball Valve (1000psi) BSPP SS316



Part No.	Size
1/4BSP10-10	1/4"
3/8BSP10-10	3/8"
1/2BSP10-10	1/2"
3/4BSP10-10	3/4"
1BSP10-10	1"
1 1/4BSP10-10	1 1/4"
1 1/2BSP10-10	1 1/2"
2BSP10-10	2"

## Full Bore 2 piece Ball Valve (1000psi) SS316



Part No.	Size
1/4BSP20-10	1/4"
3/8BSP20-10	3/8"
1/2BSP20-10	1/2"
3/4BSP20-10	3/4"
1BSP20-10	1"
1 1/4BSP20-10	1 1/4"
1 1/2BSP20-10	1 1/2"
2BSP20-10	2"

## MARS Full Bore 2 piece Ball Valve (2000psi) BSPP SS316 DEGREASED



*Suitable for use with steam*

Part No.	Size
1/4BSP20-40	1/4"
3/8BSP20-40	3/8"
1/2BSP20-40	1/2"
3/4BSP20-40	3/4"
1BSP20-40	1"

## Full Bore 1 piece Ball Valve PN40 BSPP Brass DEGREASED



Part No.	Size
520002	1/4"
520003	3/8"
520004	1/2"
520005	3/4"
520006	1"
520007	1 1/4"
520008	1 1/2"
520009	2"

## ENOLGAS OMEGA Full Bore 2 piece Ball Valve - Gas BSPP Brass.



Part No.	Size
S0271N64	1/2"
S0271N65	3/4"
S0271N66	1"
S0271N68	1 1/2"
S0271N69	2"
S0271N69	2"

## Legris Economy Ball Valve PN30 BSPP Brass



Part No.	Size
4902 10 13	1/4"
4902 10 17	3/8"
4902 15 21	1/2"
4902 20 27	3/4"
4902 25 34	1"

## Globe Valve for STEAM, PN32, BSPP Bronze



Part No.	Size
GVBZ350-12	1/2"
GVBZ350-34	3/4"
GVBZ350-1	1"
GVBZ350-114	1 1/4"
GVBZ350-112	1 1/2"
GVBZ350-2	2"

## Legris 3/2 Vented Lockable Ball Valve PN40 BSPP Brass



Part No.	Size
0439 04 10	1/8"
0439 07 13	1/4"
0439 10 17	3/8"
0439 13 21	1/2"
0439 18 27	3/4"
0439 23 34	1"



See Page 6 for details of instrumentation valves available

# Instrument Air Manifolds

### Standard Features

- \* Lockable 1/4" SS316 Ball Valves
- \* Materials: SS316
- \* Inlet size: 3/4"
- \* Outlet Size: 1/4"
- \* Manufactured in Clonmel

### Application

Instrument Air / Hook Up

10 Way Manifold with lockable valves, clamps & isolating valve.  
 Ordering Code LFF1012-4BXV



### Options / Ordering Guide - L SERIES

1	2	3	4	—	5	6	7	8	9																																																										
<b>L</b>	FF	20	12		4	B	X	B	X																																																										
<div style="border: 1px solid black; background-color: #FFD700; padding: 2px; margin-bottom: 5px;">1. Series</div> <div style="border: 1px solid black; background-color: #FFD700; padding: 2px; margin-bottom: 5px;">2. Style (valve centres)</div> <table border="1" style="width: 100%; border-collapse: collapse; font-size: 8px;"> <tr> <td>Single Side (45mm)</td> <td style="text-align: center;">F</td> </tr> <tr> <td>Double Sided (45mm)</td> <td style="text-align: center;">FF</td> </tr> <tr> <td>Single Side (62mm)</td> <td style="text-align: center;">G</td> </tr> <tr> <td>Double Sided (62mm)</td> <td style="text-align: center;">GG</td> </tr> </table>	Single Side (45mm)	F	Double Sided (45mm)	FF	Single Side (62mm)	G	Double Sided (62mm)	GG	<div style="border: 1px solid black; background-color: #FFD700; padding: 2px; margin-bottom: 5px;">3. No. of valves</div> <div style="border: 1px solid black; background-color: #FFD700; padding: 2px; margin-bottom: 5px;">4. Main Inlet Thread</div> <table border="1" style="width: 100%; border-collapse: collapse; font-size: 8px;"> <tr> <td>3/4" BSP (std)</td> <td style="text-align: center;">12</td> </tr> <tr> <td>Special</td> <td style="text-align: center;">30</td> </tr> </table>	3/4" BSP (std)	12	Special	30	<div style="border: 1px solid black; background-color: #FFD700; padding: 2px; margin-bottom: 5px;">5. Dist. Threads</div> <table border="1" style="width: 100%; border-collapse: collapse; font-size: 8px;"> <tr> <td>1/4"</td> <td style="text-align: center;">4</td> </tr> </table> <p style="font-size: 8px; margin-top: 5px;">1/8" &amp; 1/2" on request</p> <div style="border: 1px solid black; background-color: #FFD700; padding: 2px; margin-bottom: 5px;">6. Connection on Distribution</div> <table border="1" style="width: 100%; border-collapse: collapse; font-size: 8px;"> <tr> <td>SS Ball Valve Lockable (Std)</td> <td style="text-align: center;">B</td> </tr> <tr> <td>SS Ball Valve Lockable Vented*</td> <td style="text-align: center;">V</td> </tr> <tr> <td>Brass Ball Valve Vented</td> <td style="text-align: center;">N</td> </tr> <tr> <td>Brass Self Sealing Stud</td> <td style="text-align: center;">R</td> </tr> <tr> <td>Special / Other</td> <td style="text-align: center;">S</td> </tr> </table> <p style="font-size: 8px; margin-top: 5px;">* G/GG Style only</p> <div style="border: 1px solid black; background-color: #FFD700; padding: 2px; margin-bottom: 5px;">7. Parker Connection Options</div> <table border="1" style="width: 100%; border-collapse: collapse; font-size: 8px;"> <tr> <td>None</td> <td style="text-align: center;">X</td> </tr> <tr> <td>Legris LF3000 Push-fit Stud (Brass/Plastic)</td> <td style="text-align: center;">1</td> </tr> <tr> <td>Legris LF3600 Push-fit Stud (All plated Brass)</td> <td style="text-align: center;">2</td> </tr> <tr> <td>Legris LF3800 Push-fit Stud (SS316/303)</td> <td style="text-align: center;">3</td> </tr> <tr> <td>Legris LF3900 Push-fit Stud (SS316)</td> <td style="text-align: center;">4</td> </tr> <tr> <td>ALOK Compression metric - 6mm (SS316)</td> <td style="text-align: center;">5</td> </tr> <tr> <td>ALOK Compression imperial - 1/4" (SS316)</td> <td style="text-align: center;">6</td> </tr> <tr> <td>Special*</td> <td style="text-align: center;">7</td> </tr> </table>	1/4"	4	SS Ball Valve Lockable (Std)	B	SS Ball Valve Lockable Vented*	V	Brass Ball Valve Vented	N	Brass Self Sealing Stud	R	Special / Other	S	None	X	Legris LF3000 Push-fit Stud (Brass/Plastic)	1	Legris LF3600 Push-fit Stud (All plated Brass)	2	Legris LF3800 Push-fit Stud (SS316/303)	3	Legris LF3900 Push-fit Stud (SS316)	4	ALOK Compression metric - 6mm (SS316)	5	ALOK Compression imperial - 1/4" (SS316)	6	Special*	7	<div style="border: 1px solid black; background-color: #FFD700; padding: 2px; margin-bottom: 5px;">8. Mounting Blocks</div> <table border="1" style="width: 100%; border-collapse: collapse; font-size: 8px;"> <tr> <td>PP Green Clamp Halves</td> <td style="text-align: center;">B</td> </tr> <tr> <td>add Galv plates &amp; bolts</td> <td style="text-align: center;">G</td> </tr> <tr> <td>add SS plates &amp; bolts</td> <td style="text-align: center;">S</td> </tr> </table> <div style="border: 1px solid black; background-color: #FFD700; padding: 2px; margin-bottom: 5px;">9. Options / Extras</div> <table border="1" style="width: 100%; border-collapse: collapse; font-size: 8px;"> <tr> <td>None</td> <td style="text-align: center;">X</td> </tr> <tr> <td>Test Cert</td> <td style="text-align: center;">T</td> </tr> <tr> <td>P32 Reg 1/2" w/gauge</td> <td style="text-align: center;">R</td> </tr> <tr> <td>P32 Filter Reg 1/2" w/gauge</td> <td style="text-align: center;">F</td> </tr> <tr> <td>Inlet Ball Valve 1/2"</td> <td style="text-align: center;">V</td> </tr> <tr> <td>P33 Reg 3/4" w/gauge</td> <td style="text-align: center;">L</td> </tr> <tr> <td>P33 Filter Reg 3/4" w/gauge</td> <td style="text-align: center;">M</td> </tr> <tr> <td>Inlet Ball Valve 3/4"</td> <td style="text-align: center;">N</td> </tr> <tr> <td>Special Order</td> <td style="text-align: center;">S</td> </tr> </table>	PP Green Clamp Halves	B	add Galv plates & bolts	G	add SS plates & bolts	S	None	X	Test Cert	T	P32 Reg 1/2" w/gauge	R	P32 Filter Reg 1/2" w/gauge	F	Inlet Ball Valve 1/2"	V	P33 Reg 3/4" w/gauge	L	P33 Filter Reg 3/4" w/gauge	M	Inlet Ball Valve 3/4"	N	Special Order	S
Single Side (45mm)	F																																																																		
Double Sided (45mm)	FF																																																																		
Single Side (62mm)	G																																																																		
Double Sided (62mm)	GG																																																																		
3/4" BSP (std)	12																																																																		
Special	30																																																																		
1/4"	4																																																																		
SS Ball Valve Lockable (Std)	B																																																																		
SS Ball Valve Lockable Vented*	V																																																																		
Brass Ball Valve Vented	N																																																																		
Brass Self Sealing Stud	R																																																																		
Special / Other	S																																																																		
None	X																																																																		
Legris LF3000 Push-fit Stud (Brass/Plastic)	1																																																																		
Legris LF3600 Push-fit Stud (All plated Brass)	2																																																																		
Legris LF3800 Push-fit Stud (SS316/303)	3																																																																		
Legris LF3900 Push-fit Stud (SS316)	4																																																																		
ALOK Compression metric - 6mm (SS316)	5																																																																		
ALOK Compression imperial - 1/4" (SS316)	6																																																																		
Special*	7																																																																		
PP Green Clamp Halves	B																																																																		
add Galv plates & bolts	G																																																																		
add SS plates & bolts	S																																																																		
None	X																																																																		
Test Cert	T																																																																		
P32 Reg 1/2" w/gauge	R																																																																		
P32 Filter Reg 1/2" w/gauge	F																																																																		
Inlet Ball Valve 1/2"	V																																																																		
P33 Reg 3/4" w/gauge	L																																																																		
P33 Filter Reg 3/4" w/gauge	M																																																																		
Inlet Ball Valve 3/4"	N																																																																		
Special Order	S																																																																		



**HANLEY CONTROLS**

CLONMEL

# SS316 BSP Fittings

Male threads BSPT, Female threads BSPP

150psi working pressure

Barrell Nipple	Size	Part No.
	1/8"	BN-2
	1/4"	BN-4
	3/8"	BN-6
	1/2"	BN-8
	3/4"	BN-12
	1"	BN-16
	1 1/4"	BN-20
	1 1/2"	BN-24
	2"	BN-32

Hex Nipple	Size	Part No.
	1/8"	HN-2
	1/4"	HN-4
	3/8"	HN-6
	1/2"	HN-8
	3/4"	HN-12
	1"	HN-16
	1 1/4"	HN-20
	1 1/2"	HN-24
	2"	HN-32

Female Tee	Size	Part No.
	1/8"	ST-2
	1/4"	ST-4
	3/8"	ST-6
	1/2"	ST-8
	3/4"	ST-12
	1"	ST-16
	1 1/4"	ST-20
	1 1/2"	ST-24
	2"	ST-32

M x F Elbow	Size	Part No.
	1/8"	SFME-2
	1/4"	SFME-4
	3/8"	SFME-6
	1/2"	SFME-8
	3/4"	SFME-12
	1"	SFME-16
	1 1/4"	SFME-20
	1 1/2"	SFME-24
	2"	SFME-32

90 deg Elbow	Size	Part No.
	1/8"	S90-2
	1/4"	S90-4
	3/8"	S90-6
	1/2"	S90-8
	3/4"	S90-12
	1"	S90-16
	1 1/4"	S90-20
	1 1/2"	S90-24
	2"	S90-32

45 deg Elbow	Size	Part No.
	1/8"	S45-2
	1/4"	S45-4
	3/8"	S45-6
	1/2"	S45-8
	3/4"	S45-12
	1"	S45-16
	1 1/4"	S45-20
	1 1/2"	S45-24
	2"	S45-32

2 pce Union	Size	Part No.
	1/8"	HU-18
	1/4"	HU-14
	3/8"	HU-38
	1/2"	HU-12
	3/4"	HU-34
	1"	HU-1
	1 1/4"	HU-11/4
	1 1/2"	HU-11/2
	2"	HU-2

Full Socket	Size	Part No.
	1/8"	SS-2
	1/4"	SS-4
	3/8"	SS-6
	1/2"	SS-8
	3/4"	SS-12
	1"	SS-16
	1 1/4"	SS-20
	1 1/2"	SS-24
	2"	SS-32

Hex Plug	Size	Part No.
	1/8"	HP-2
	1/4"	HP-4
	3/8"	HP-6
	1/2"	HP-8
	3/4"	HP-12
	1"	HP-16
	1 1/4"	HP-20
	1 1/2"	HP-24
	2"	HP-32

Red Nipple	Size M x F	Part No.
	1/4" x 1/8"	HRN-4-2
	3/8" x 1/4"	HRN-6-4
	1/2" x 1/4"	HRN-8-4
	1/2" x 3/8"	HRN-8-6
	3/4" x 1/4"	HRN-12-4
	3/4" x 3/8"	HRN-12-6
	3/4" x 1/2"	HRN-12-8
	1" x 3/4"	HRN-16-12
	1" x 1/2"	HRN-16-8
	1 1/4" x 1"	HRN-20-16
	1 1/2" x 1"	HRN-24-16
	2" x 1 1/2"	HRN-32-24

Red Bush	Size M x F	Part No.
	1/4" x 1/8"	HRB-4-2
	3/8" x 1/4"	HRB-6-4
	1/2" x 1/4"	HRB-8-4
	1/2" x 3/8"	HRB-8-6
	3/4" x 1/4"	HRB-12-4
	3/4" x 3/8"	HRB-12-6
	3/4" x 1/2"	HRB-12-8
	1" x 3/4"	HRB-16-12
	1" x 1/4"	HRB-16-4
	1" x 1/2"	HRB-16-8
	1 1/4" x 1"	HRB-20-16
	1 1/2" x 1"	HRB-24-16



## B SERIES BALL VALVE

B Series Ball Valves provide quick on-off control of fluids utilized in process and instrumentation applications. A broad selection of valve body, seat and seal materials provide a wide range of pressures and temperatures.



## C SERIES CHECK VALVE

Parker C Series Check Valves are designed for uni-directional flow control of fluids and gases in industries such as chemical processing, oil and gas production and transmission, pharmaceutical, pulp and paper, power and utilities.



## V SERIES NEEDLE VALVE

V Series Needle Valves are designed for positive leak tight shut-off and regulation of fluids in process, power, and instrumentation applications. Wide variety of port sizes and styles, temperature capabilities ranging from -54°C to 232°C and pressures to 5000 psig (345 bar),



## HNV SERIES NEEDLE VALVE

Globe style barstock needle valves are purpose designed valves for operation with any fluid up to 6,000 psig (414 barg) rating. Complete with standard PTFE gland packing and self centering non rotational tip.



## F SERIES INLINE FILTER

Parker F Series Inline Filters are designed for protection of instrumentation systems from undesirable materials. Component changes or repair and maintenance can admit dirt, chips, scale, or other contaminants to the small bore tubing.



## IR4000 SERIES REGULATOR

The IR4000 Series regulator offers high pressure capability with an inlet pressure up to 4,000 psig. The large convoluted Hastelloy C-22® diaphragm provides stable pressure control over the operational range of the regulator.



BSPT & BSPP threads also available

Imperial & Metric sizes available

## Union Elbow

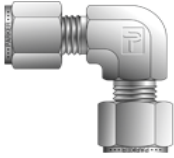

**Size**  
1/4"  
3/8"  
1/2"  
3/4"  
1"

**Part No.**  
4EE4-316  
6EE6-316  
8EE8-316  
12EE12-316  
16EE16-316

## Male Stud Elbow NPT

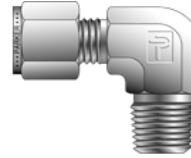

**Size**  
1/4" OD x 1/4"  
3/8" OD x 3/8"  
1/2" OD x 1/4"  
1/2" OD x 3/8"  
1/2" OD x 1/2"

**Part No.**  
4MSEL4N-316  
6MSEL6N-316  
8MSEL4N-316  
8MSEL6N-316  
8MSEL8N-316

## Union Tee



**Size**  
1/4"  
3/8"  
1/2"  
3/4"  
1"

**Part No.**  
4ET4-316  
6ET6-316  
8ET8-316  
12ET12-316  
16ET16-316

## Tube End Reducer

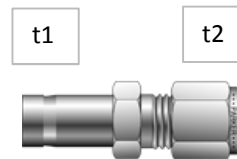

**Size t1 x t2**  
1/4" x 3/8"  
1/4" x 1/2"  
3/8" x 1/4"  
3/8" x 1/2"  
1/2" x 1/4"  
1/2" x 3/8"  
1/2" x 3/4"

**Part No.**  
4TUR6-316  
4TUR8-316  
6TUR4-316  
6TUR8-316  
8TUR4-316  
8TUR6-316  
8TUR12-316

## Union

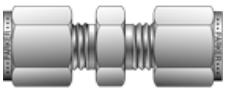

**Size**  
1/4"  
3/8"  
1/2"  
3/4"  
1"  
1/2" x 1/4"  
1/2" x 3/8"  
3/4" x 1/2"

**Part No.**  
4SC4-316  
6SC6-316  
8SC8-316  
12SC12-316  
16SC16-316  
8RU4-316  
8RU6-316  
12RU8-316

## Female Stud NPT

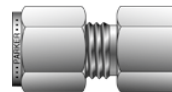

**Size**  
1/4" OD x 1/4"  
3/8" OD x 1/4"  
1/2" OD x 1/2"  
3/4" OD x 3/4"

**Part No.**  
4FSC4N-316  
6FSC4N-316  
8FSC8N-316  
12FSC12N-316

## Tube Cap

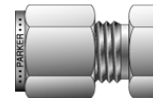

**Size**  
1/4"  
3/8"  
1/2"

**Part No.**  
4BLEN4-316  
6BLEN6-316  
8BLEN8-316

## Male Stud NPT



**Size (OD x NPT) Part No.**  
1/4" x 1/4" 4MSC4N-316  
1/4" x 1/2" 4MSC8N-316  
3/8" x 1/8" 6MSC2N-316  
3/8" x 1/4" 6MSC4N-316  
3/8" x 3/8" 6MSC6N-316  
3/8" x 1/2" 6MSC8N-316  
3/8" x 3/4" 6MSC12N-316  
1/2" x 1/4" 8MSC4N-316  
1/2" x 3/8" 8MSC6N-316  
1/2" x 1/2" 8MSC8N-316  
1/2" x 3/4" 8MSC12N-316  
3/4" x 1/2" 12MSC8N-316  
3/4" x 3/4" 12MSC12N-316  
1" x 1/2" 16MSC8N-316  
1" x 1" 16MSC16N-316

## Ferrule Sets



**Size Part No.**  
1/4" 4 ALOK-316-SET  
3/8" 6 ALOK-316-SET  
1/2" 8 ALOK-316-SET  
3/4" 12 ALOK-316-SET

## Compression Nut



**Size Part No.**  
1/4" 4NU4-316  
3/8" 6NU6-316  
1/2" 8NU8-316  
3/4" 12NU12-316  
1" 16NU16-316

## Bulkhead Union



**Size Part No.**  
1/4" 4BC4-316  
3/8" 6BC6-316  
1/2" 8BC8-316  
3/4" 12BC12-316  
1" 16BC16-316

## Alok Plug/Cap



**Size Part No.**  
1/4" 4BLP4-316  
3/8" 6BLP6-316  
1/2" 8BLP8-316  
3/4" 12BLP12-316  
1" 16BLP16-316

# Legris LF3000 Push-in Fittings

Nickel plated brass / Technical Polymer  
Vaccum to 20 Bar  
-20 / +80 deg C

## Male Stud Fitting BSPT



Size	Part No.	Size	Part No.	Size	Part No.
04mm x 1/8"	3175 04 10	08mm x 1/4"	3175 08 13	12mm x 3/8"	3175 12 17
04mm x 1/4"	3175 04 13	08mm x 3/8"	3175 08 17	12mm x 1/2"	3175 12 21
04mm x 3/8"	3175 04 17	08mm x 1/2"	3175 08 21	14mm x 3/8"	3175 14 17
06mm x 1/8"	3175 06 10	10mm x 1/8"	3175 10 10	14mm x 1/2"	3175 14 21
06mm x 1/4"	3175 06 13	10mm x 1/4"	3175 10 13	16mm x 3/8"	3175 16 17
06mm x 3/8"	3175 06 17	10mm x 3/8"	3175 10 17	16mm x 1/2"	3175 16 21
06mm x 1/2"	3175 06 21	10mm x 1/2"	3175 10 21		
08mm x 1/8"	3175 08 10	12mm x 1/4"	3175 12 13		

## Male Stud Elbow BSPT



Size	Part No.	Size	Part No.	Size	Part No.
04mm x 1/8"	3109 04 10	08mm x 1/4"	3109 08 13	12mm x 3/8"	3109 12 17
04mm x 1/4"	3109 04 13	08mm x 3/8"	3109 08 17	12mm x 1/2"	3109 12 21
04mm x 3/8"	3109 04 17	08mm x 1/2"	3109 08 21	14mm x 3/8"	3109 14 17
06mm x 1/8"	3109 06 10	10mm x 1/8"	3109 10 10	14mm x 1/2"	3109 14 21
06mm x 1/4"	3109 06 13	10mm x 1/4"	3109 10 13	16mm x 3/8"	3109 16 17
06mm x 3/8"	3109 06 17	10mm x 3/8"	3109 10 17	16mm x 1/2"	3109 16 21
06mm x 1/2"	3109 06 21	10mm x 1/2"	3109 10 21		
08mm x 1/8"	3109 08 10	12mm x 1/4"	3109 12 13		

## Extended Stud Elbow BSPT



Size	Part No.	Size	Part No.
06mm x 1/8"	3129 06 10	08mm x 3/8"	3129 08 17
06mm x 1/4"	3129 06 13	10mm x 1/4"	3129 10 13
08mm x 1/8"	3129 08 10	10mm x 3/8"	3129 10 17
08mm x 1/4"	3129 08 13	10mm x 1/2"	3129 10 21

## Female Stud BSPP & Metric Threads



Size	Part No.	Size	Part No.	Size	Part No.
04mm x M5	3114 04 19	08mm x 1/8"	3114 08 10	10mm x 1/2"	3114 10 21
04mm x 1/8"	3114 04 10	08mm x 1/4"	3114 08 13	12mm x 3/8"	3114 12 17
04mm x 1/4"	3114 04 13	08mm x 3/8"	3114 08 17	12mm x 1/2"	3114 12 21
06mm x 1/8"	3114 06 10	10mm x 1/4"	3114 10 13	14mm x 3/8"	3114 14 17
06mm x 1/4"	3114 06 13	10mm x 3/8"	3114 10 17	16mm x 1/2"	3114 16 21

## Male Stud Elbow BSPP & Metric



Size	Part No.
04mm x M5	3199 04 19
06mm x 1/4"	3199 06 13

## Stud Fitting, Male BSPP & Metric



Size	Part No.
04mm x M5	3101 04 19
06mm x M5	3101 06 19
10mm x 1/4"	3101 10 13
10mm x 3/8"	3101 10 17



# Legris LF3000 Push-in Fittings

Nickel plated brass / Technical Polymer  
Vaccum to 20 Bar  
-20 / +80 deg C

Equal Joiner	Size	Part No.
	04mm	3106 04 00
	06mm	3106 06 00
	08mm	3106 08 00
	10mm	3106 10 00
	12mm	3106 12 00
	14mm	3106 14 00
	16mm	3106 16 00

Equal Elbow	Size	Part No.
	04mm	3102 04 00
	06mm	3102 06 00
	08mm	3102 08 00
	10mm	3102 10 00
	12mm	3102 12 00
	14mm	3102 14 00
	16mm	3102 16 00

Tee	Size	Part No.
	04mm	3104 04 00
	06mm	3104 06 00
	08mm	3104 08 00
	10mm	3104 10 00
	12mm	3104 12 00
	14mm	3104 14 00
	16mm	3104 16 00

Cross	Size	Part No.
	04mm	3107 04 00
	06mm	3107 06 00
	08mm	3107 08 00

Bulkhead	Size	Part No.
	04mm	3116 04 00
	06mm	3116 06 00
	08mm	3116 08 00
	10mm	3116 10 00
	12mm	3116 12 00
	14mm	3116 14 00

Blanking Plug	Size	Part No.
	04mm	3126 04 00
	06mm	3126 06 00
	08mm	3126 08 00
	10mm	3126 10 00
	12mm	3126 12 00
	14mm	3126 14 00
	16mm	3126 16 00

Stud Standpipe Male BSPP Thread	Size	Part No.
	06mm x 1/8"	3131 06 10



Bulkhead Connector Fem BSPP	Size	Part No.	Size	Part No.	Size	Part No.
	04mm x 1/8"	3136 04 10	06mm x 3/8"	3136 06 17	12mm x 3/8"	3136 12 17
	04mm x 1/4"	3136 04 13	08mm x 1/8"	3136 08 10	12mm x 1/2"	3136 12 21
	06mm x 1/8"	3136 06 10	08mm x 1/4"	3136 08 13	16mm x 3/8"	3136 16 17
	06mm x 1/4"	3136 06 13	10mm x 3/8"	3136 10 17	16mm x 1/2"	3136 16 21

Increaser Push-In x Stem	Size	Part No.
	06 x 04mm	3168 06 04
	08 x 06mm	3168 08 06
	12 x 08mm	3168 12 08
	12 x 10mm	3168 12 10

End Cap	Size	Part No.
	06mm	3151 06 00
	08mm	3151 08 00
	10mm	3151 10 00
	12mm	3151 12 00

Push-in x Stub Reducer	Size	Part No.	Size	Part No.	Size	Part No.
	04 x 06mm	3166 04 06	06 x 12mm	3166 06 12	10 x 12mm	3166 10 12
	04 x 08mm	3166 04 08	06 x 14mm	3166 06 14	10 x 14mm	3166 10 14
	04 x 10mm	3166 04 10	08 x 10mm	3166 08 10	12 x 14mm	3166 12 14
	06 x 08mm	3166 06 08	08 x 12mm	3166 08 12		
	06 x 10mm	3166 06 10	08 x 14mm	3166 08 14		

# Legris LF3600 All Metal Fittings

Nickel plated brass (FDA approved materials 21CFR)

Vaccum to 30 Bar, -20 / +150 deg C

**LF3800/3900 SERIES STAINLESS PUSH-IN ALSO AVAILABLE ON REQUEST**

## Male Stud Fitting BSPT



Size	Part No.
04mm x 1/8"	3675 04 10
04mm x 1/4"	3675 04 13
06mm x 1/8"	3675 06 10
06mm x 1/4"	3675 06 13
08mm x 1/8"	3675 08 10
08mm x 3/8"	3675 08 17
10mm x 1/4"	3675 10 13
10mm x 3/8"	3675 10 17
10mm x 1/2"	3675 10 21
12mm x 1/4"	3675 12 13
12mm x 3/8"	3675 12 17
12mm x 1/2"	3675 12 21
14mm x 3/8"	3675 14 17
14mm x 1/2"	3675 14 21

## Male Stud Elbow BSPT



Size	Part No.
04mm x 1/8"	3609 04 10
04mm x 1/4"	3609 04 13
06mm x 1/8"	3609 06 10
06mm x 1/4"	3609 06 13
08mm x 1/8"	3609 08 10
08mm x 1/4"	3609 08 13
08mm x 3/8"	3609 08 17
10mm x 1/4"	3609 10 13
10mm x 3/8"	3609 10 17
12mm x 1/4"	3609 12 13
12mm x 3/8"	3609 12 17
12mm x 1/2"	3609 12 21
14mm x 3/8"	3609 14 17
14mm x 1/2"	3609 14 21

## Stud Fitting, Male BSPP & Metric



Size	Part No.
04mm x M5	3601 04 19
06mm x M5	3601 06 19

## Equal Tee



Size	Part No.
04mm	3604 04 00
06mm	3604 06 00
08mm	3604 08 00
10mm	3604 10 00
12mm	3604 12 00
14mm	3604 14 00

## Male Stud Elbow BSPP & Metric



Size	Part No.
04mm x M5	3699 04 19
06mm x 1/4"	3699 06 13

## Bulkhead



Size	Part No.
04mm	3616 04 00
06mm	3616 06 00
08mm	3616 08 00
10mm	3616 10 00
12mm	3616 12 00
14mm	3616 14 00

## Equal Tube Connector



Size	Part No.
04mm	3606 04 00
06mm	3606 06 00
08mm	3606 08 00
10mm	3606 10 00
12mm	3606 12 00
14mm	3606 14 00

## Push-in x Stub Reducer



Size	Part No.
04 x 06mm	3666 04 06
04 x 08mm	3666 04 08
06 x 08mm	3666 06 08
06 x 10mm	3666 06 10
08 x 10mm	3666 08 10
08 x 12mm	3666 08 12
10 x 12mm	3666 10 12
12 x 14mm	3666 12 14

## Equal Elbow



Size	Part No.
04mm	3602 04 00
06mm	3602 06 00
08mm	3602 08 00
10mm	3602 10 00
12mm	3602 12 00
14mm	3602 14 00

## Increaser Push-In x Stem



Size	Part No.
06 x 04mm	3668 06 04



**HANLEY CONTROLS**

CLONMEL

# Legris Function Fittings

**Compact Flow  
Regulator Exhaust,  
Male BSPP thread**



Size	Part No.
04mm x 1/8"	7060 04 10
06mm x 1/8"	7060 06 10
06mm x 1/4"	7060 06 13
08mm x 1/8"	7060 08 10
08mm x 1/4"	7060 08 13
08mm x 3/8"	7060 08 17
10mm x 1/4"	7060 10 13
10mm x 3/8"	7060 10 17
12mm x 3/8"	7060 12 17
12mm x 1/2"	7060 12 21

**In-line One-way Flow  
Regulator**



Size	Part No.
04mm	7770 04 00
06mm	7770 06 00
08mm	7770 08 00
10mm	7770 10 00
12mm	7770 12 00

**In-line Equal Non-  
Return Valve**



Size	Part No.
04mm	7996 04 00
06mm	7996 06 00
08mm	7996 08 00
10mm	7996 10 00
12mm	7996 12 00

**Metal Quick Exhaust  
Valve, BSPP**



Size	Part No.
1/8"	7970 10 10
1/4"	7970 13 13
3/8"	7970 17 17
1/2"	7970 21 21
3/4"	7970 27 27

**Soft Start Fitting for  
Isolating Valve, Male  
BSPP**



Size	Part No.
08mm x 1/4"	7860 08 13

**Polymer Silencer,  
Male BSPP & Metric**



Size	Part No.
M5	0674 00 19
1/8"	0674 00 10
1/4"	0674 00 13
3/8"	0674 00 17
1/2"	0674 00 21

**Flow Control Polymer  
Silencer, Male BSPP &  
Metric**



Size	Part No.
M5	0676 00 19
1/8"	0676 00 10
1/4"	0676 00 13
3/8"	0676 00 17
1/2"	0676 00 21

**Compact Silencer,  
Male BSPP & Metric**



Size	Part No.
M5	0673 00 19
1/8"	0673 00 10
1/4"	0673 00 13
3/8"	0673 00 17
1/2"	0673 00 21

**Threaded Silencer,  
Male BSPP & Metric**



Size	Part No.
M5	0675 00 19
1/8"	0675 00 10
1/4"	0675 00 13
3/8"	0675 00 17
1/2"	0675 00 21

**2/2 In-line Mini Ball  
Valve (push-in)**



Size	Part No.
04mm	7910 04 00
06mm	7910 06 00
08mm	7910 08 00
10mm	7910 10 00
12mm	7910 12 00
14mm	7910 14 00

**3/2 In-line Mini Ball  
Valve with Vent**



Size	Part No.
04mm	7913 04 00
06mm	7913 06 00
08mm	7913 08 00
10mm	7913 10 00
12mm	7913 12 00

# Legris Brass Adaptors

Nickel plated brass  
60 bar  
-10 / +80 deg C

## Reducing Nipple BSPT



Size	Part No.
1/8" x 1/8"	0900 00 10
1/8" x 1/4"	0900 10 13
1/8" x 3/8"	0900 10 17
1/4" x 1/4"	0900 00 13
1/4" x 3/8"	0900 13 17

Size	Part No.
1/4" x 1/2"	0900 13 21
3/8" x 3/8"	0900 00 17
3/8" x 1/2"	0900 17 21
1/2" x 1/2"	0900 00 21
1/2" x 3/4"	0900 21 27

Size	Part No.
3/4" x 3/4"	0900 00 27
3/4" x 1"	0900 27 34
1" x 1"	0900 00 34

## Reducer Male BSPT x Female BSPP



Size	Part No.
1/4" x 1/8"	0904 10 13
3/8" x 1/8"	0904 10 17
1/2" x 1/8"	0904 10 21
3/8" x 1/4"	0904 13 17

Size	Part No.
1/2" x 1/4"	0904 13 21
1/2" x 3/8"	0904 17 21
3/4" x 3/8"	0904 17 27
3/4" x 1/2"	0904 21 27

Size	Part No.
1" x 1/2"	0904 21 34
1" x 3/4"	0904 27 34

## Female Socket BSPP & Metric



Size	Part No.
M5 x M5	0902 00 19
M5 x 1/8"	0902 19 10
1/8" x 1/8"	0902 00 10
1/8" x 1/4"	0902 10 13
1/8" x 3/8"	0902 10 17

Size	Part No.
1/4" x 1/4"	0902 00 13
1/4" x 3/8"	0902 13 17
1/4" x 1/2"	0902 13 21
3/8" x 3/8"	0902 00 17
3/8" x 1/2"	0902 17 21

Size	Part No.
1/2" x 1/2"	0902 00 21
1/2" x 3/4"	0902 21 27
3/4" x 3/4"	0902 00 27

## Increaser Male Metric / BSPP x BSPP Female



Size	Part No.
M5 x 1/8"	0906 10 19
1/8" x 1/8"	0906 00 10
1/8" x 1/4"	0906 10 13
1/8" x 3/8"	0906 10 17

Size	Part No.
1/4" x 1/4"	0906 00 13
1/4" x 3/8"	0906 13 17
1/4" x 1/2"	0906 13 21
3/8" x 3/8"	0906 00 17

Size	Part No.
3/8" x 1/2"	0906 17 21
1/2" x 1/2"	0906 00 21

## Red Nipple BSPP & Metric



Size	Part No.
M5 x M5	0901 00 19
M5 x 1/8"	0901 19 10
1/4" x 1/4"	0901 00 13

Size	Part No.
1/4" x 3/8"	0901 13 17
3/8" x 3/8"	0901 00 17
1/2" x 1/2"	0901 00 21

## Reducer Male BSPP/ Female BSPP/Metric



Size	Part No.
1/2" x 1/4"	0905 13 21
3/4" x 1/4"	0905 13 27
1/2" x 3/8"	0905 17 21
1/8" x M5	0905 19 10
3/4" x 1/2"	0905 21 27

## Equal Cross



Size	Part No.
1/8"	0908 00 10
1/4"	0908 00 13
3/8"	0908 00 17
1/2"	0908 00 21

# Legris Brass Adaptors

Nickel plated brass  
60 bar  
-10 / +80 deg C

## Equal Female Y BSPP



**Size**  
1/8"  
1/4"  
3/8"  
1/2"

**Part No.**  
0910 00 10  
0910 00 13  
0910 00 17  
0910 00 21

## Equal Female Tee BSPP



**Size**  
1/8"  
1/4"  
3/8"  
1/2"  
3/4"  
1"

**Part No.**  
0915 00 10  
0915 00 13  
0915 00 17  
0915 00 21  
0915 00 27  
0915 00 34

## Equal Y Male BSPT x Female BSPP



**Size**  
1/8"  
1/4"  
3/8"  
1/2"

**Part No.**  
0911 00 10  
0911 00 13  
0911 00 17  
0911 00 21

## Equal Stud Branch Tee BSPT x BSPP



**Size**  
1/4"

**Part No.**  
0916 00 13

## Equal Female Elbow BSPP



**Size**  
1/8"  
1/4"  
3/8"  
1/2"  
3/4"  
1"

**Part No.**  
0912 00 10  
0912 00 13  
0912 00 17  
0912 00 21  
0912 00 27  
0912 00 34

## Internal Hex Head Plug BSPP



**Size**  
1/8"  
1/4"

**Part No.**  
0919 00 10  
0919 00 13

## Equal Male Stud Elbow BSPT x BSPP



**Size**  
1/8"  
1/4"  
3/8"  
1/2"  
3/4"  
1"

**Part No.**  
0913 00 10  
0913 00 13  
0913 00 17  
0913 00 21  
0913 00 27  
0913 00 34

## Bulkhead Female BSPP x Metric Male



**Size**  
1/4" x M20

**Part No.**  
0920 00 13

## Equal Stud Elbow Male BSPT thread



**Size**  
1/8"  
1/4"  
3/8"  
1/2"

**Part No.**  
0914 00 10  
0914 00 13  
0914 00 17  
0914 00 21

## Hex Head Plug BSPP & Metric



**Size**  
M5  
1/8"  
1/4"  
3/8"  
1/2"

**Part No.**  
0220 19 00  
0220 10 00  
0220 13 00  
0220 17 00  
0220 21 00

## SEMI RIGID PA (NYLON)

### 25m Tube pack

SIZE	Natural	Black	Blue	Grey
04 x 02mm	1025P04 00	1025P04 01	1025P04 04	
06 x 04mm	1025P06 00	1025P06 01	1025P06 04	1025P06 06
08 x 06mm	1025P08 00	1025P08 01	1025P08 04	
10 x 08mm	1025P10 00	1025P10 01	1025P10 04	1025P10 06
12 x 10mm	1025P12 00	1025P12 01	1025P12 04	
14 x 12mm	1025P14 00	1025P14 01	1025P14 04	
16 x 13mm		1025P16 01 13	1025P16 04 13	



### 100m Tube Pack

SIZE	Natural	Black	Blue	Grey	Red
04 x 02mm	1100P04 00	1100P04 01	1100P04 04		
06 x 04mm	1100P06 00	1100P06 01	1100P06 04	1100P06 06	1100P06 03
08 x 06mm	1100P08 00	1100P08 01			
10 x 08mm	1100P10 00	1100P10 01	1100P10 04		
12 x 10mm	1100P12 00				

### LARGE DRUMS 6MM

	Natural	Black	Blue	Grey	Red
500m Drum	2005P06 00	2005P06 01	2005P06 04	2005P06 06	2005P06 03
1000m Drum	2010P06 00	2010P06 01	2010P06 04	2010P06 06	2010P06 03

## POLYURETHANE (PU) ESTER

### 25m Tubepack

Size	Black	Blue	Red	Green
04 x 2.5mm	1025U04 01	1025U04 04	1025U04 03	1025U04 02
06 x 04mm	1025U06 01	1025U06 04	1025U06 03	1025U06 02
08 x 5.5mm	1025U08 01	1025U08 04	1025U08 03	1025U08 02
10 x 0.7mm	1025U10 01	1025U10 04	1025U10 03	1025U10 02
12 x 08mm	1025U12 01	1025U12 04	1025U12 03	1025U12 02



### 100m Tubepack

Size	Black	Blue	Red	Yellow
04 x 2.5mm		1100U04 04		
06 x 04mm	1100U06 01	1100U06 04	1100U06 03	
08 x 5.5mm	1100U08 01	1100U08 04		
10 x 0.7mm	1100U10 01	1100U10 04		
12 x 08mm		1100U12 04		1100U12 05



# Pneumatic Tube



## TECHNICAL/PROJECT AIRLINE - SPECIALS

### LDPE NATURAL INNER C/W PVC OUTER SHEATH (1MM)

Internal & External use, UV stable, -20/+60 deg C

Flexible, abrasion and crush resistant, self extinguishing PVC outer sheath

500m drum Shorter lengths available	<b>SIZE</b>	<b>Green</b>
	06 x 04mm	1001 Y00 00 42 alt reference P01L6X1STS/04



### ANTI-SPARK PU ETHER

Single layer, generally indoor applications, fireproof to UL94 V-0, -20/+70 deg C

Excellent flexibility & chemical resistance

100m coil	<b>SIZE</b>	<b>Black</b>	<b>Blue</b>	<b>Red</b>
	06 x 04mm	1100U06K01		
	08 x 5.5mm	1100U08K01	1100U08K04	1100U08K03
300m drum	12 x 08mm	1100U12K01	1100U12K04	1100U12K03
	06 x 04mm	2003U06K01	2003U06K04	2003U06K03
	08 x 5.5mm	2003U08K01	2003U08K04	2003U08K03



### ADVANCED PE

Internal & External use, UV stable, -40/+95 deg C, excellent chemical resistance

FDA approved material

75m coil	<b>SIZE</b>	<b>Natural</b>	<b>Black</b>	<b>Blue</b>
	12 x 9mm	1075Y12F00	1075Y12F01	1075Y12F04
300m coil	06 x 04mm	1030Y06F00	1030Y06F01	1030Y06F04
	06 x 04mm	1090Y06F00		



### PTFE

Excellent chemical resistance, useful in high temp applications -270/+260 deg C

Lowest coefficient of friction of all polymers

500m drum	<b>SIZE</b>	<b>Natural</b>
	06 x 04mm	A1AS001903/K450



# Safety Blow Gun & Recoil Hose



**Safety Blowgun, Lower Connection 1/4" BSPP female**

Part No. 0654 00 13



**Safety Angled Nozzle (short)**  
M12 x 1.25

Part No. 0690 06 00



**Progressive Control Blowgun, Lower Conn, Interchange Nozzle, 1/4" BSPP**

Part No. 0652 66 13



**Angled Nozzle (short)**  
M12 x 1.25

Part No. 0690 06 01



**Energy Saving Blowgun Kit, Angled Nozzle, Male 1/4" BSPT Thread**

Part No. 0631 00 23



**Safety Booster Nozzle w/Air Screen**  
M12 x 1.25

Part No. 0690 11 00



## PA RECOIL TUBE, MALE ENDS

Length	Size	Thread	Part no.
2m	06 x 04mm	1/4" BSPT	1470P06 04 13
2m	08 x 06mm	1/4" BSPT	1470P08 04 13
4m	06 x 04mm	1/4" BSPT	1471P06 04 13
4m	08 x 06mm	1/4" BSPT	1471P08 04 13
6m	06 x 04mm	1/4" BSPT	1472P06 04 13
6m	08 x 06mm	1/4" BSPT	1472P08 04 13

## PU ESTER RECOIL TUBE, MALE ENDS

Length	Size	Thread	Part no.
2m	04 x 2.5mm	1/8" BSPT	1470U04 04 10
2m	06 x 04mm	1/4" BSPT	1470U06 04 13
2m	08 x 05mm	1/4" BSPT	1470U08 04 13
2m	10 x 07mm	1/4" BSPT	1470U10 04 13
2m	12 x 08mm	3/8" BSPT	1470U12 04 17
4m	04 x 2.5mm	1/8" BSPT	1471U04 04 10
4m	06 x 04mm	1/4" BSPT	1471U06 04 13
4m	08 x 05mm	1/4" BSPT	1471U08 04 13
4m	10 x 07mm	1/4" BSPT	1471U10 04 13
4m	12 x 08mm	3/8" BSPT	1471U12 04 17
6m	08 x 05mm	1/4" BSPT	1472U08 04 13
6m	10 x 07mm	1/4" BSPT	1472U10 04 13
6m	12 x 08mm	3/8" BSPT	1472U12 04 17







**HANLEY CONTROLS**

CLONMEL

# Compressors



## TRADITIONAL SERIES

### Direct Drive Lubricated

	Tank	Volt	CFM	kW/HP	Bar/psi
S-SXDL504FPS504 (Model NDV/50CM3)	50	230	12.6	2.2/3	8/116



## TRADITIONAL SERIES

### Direct Drive Oil Free

	Tank	Volt	CFM	kW/HP	Bar/psi
S-A3CC404FPS501 (Model S02/24CM2)	24	230	8.1	1.5/2	8 / 116
S-A3DV404FPS536 (Model S02/50CM2)	50	230	8.1	1.5/2	8 / 116



## TRADITIONAL SERIES - 110V

### Direct Drive Oil Free

	Tank	Volt	CFM	kW/HP	Bar/psi
S-8213885FPS535*	6	110	7.1	1.1/1.5	8 / 116
S-A8CA3C4FPS541**	24	110	7.1	1.1/1.5	8 / 116

\* Model ROLL CAGE OM195/6-110V

\*\* Model OM197/24 TECH-110V



## TECH SERIES - PORTABLE

### Direct Drive Lubricated

	Tank	Volt	CFM	kW/HP	Bar/psi
S-6SCA404FPS506 (Model F1-241/24 TECH)	24	230	8.5	1.5/2	10 / 145



## TECH SERIES - PORTABLE

### Belt Drive Lubricated

	Tank	Volt	CFM	kW/HP	Bar/psi
S-28DA504FPS032*	50	230	12.5	2.2/3	10 / 145
S-28FA504FPS009**	100	230	12.5	2.2/3	10 / 145

(\*Model NB2800B/50/3M TECH)

(\*\*Model NB2800B/100/3M TECH)



## WORKSHOP SERIES - STATIONARY

### Belt Drive Lubricated

	Tank	Volt	CFM	kW/HP	Bar/psi
S-28FN504FPS040*	100	230	12.5	2.2/3	10 / 145
S-36LN504FPS014**	200	230	13.95	2.2/3	10 / 145

(\*Model NB28C/100 FM3)

(\*\*Model NB38C/200 FM3)



# SCREW COMPRESSOR SALES & SERVICE



**REGULATOR**  
P3LRA12BNGP

**Size**  
1/4"

**Type**  
Relieving

**Gauge**  
8 bar



**FILTER**  
P3LFA12EPSN

**Size**  
1/4"

**Type**  
5 micron

**Drain**  
Semi-auto



**COALESCING FILTER**  
P3LFA12CPPN

**Size**  
1/4"

**Type**  
0.01 micron

**Drain**  
Manual push



**FILTER REG**  
P3LEA12GPPBNNP  
P3LEA12EPPBNGP

**Size**  
1/4"  
1/4"

**Type**  
Relieving  
Relieving

**Drain**  
Manual push  
Manual push

**Gauge**  
none  
8 bar

**Filter**  
40 micron  
5 micron



**FRL COMBO**  
P3LCA12PEPNGLNW  
P3LCA12PESNGLNW

**Size**  
1/4"  
1/4"

**Type**  
Relieving  
Relieving

**Drain**  
Manual push  
Semi-auto

**Gauge**  
8 Bar  
8 Bar

**Filter**  
5 micron  
5 micron



**Angle Bracket**



**Part No.**  
P3LKA00MR

**Panel Nut**



**Part No.**  
P3LKA00MP

## Parker Pneumatic

## P3L - Lite Series Air Preparation System

- Compact body ported units
- Port size G<sup>1</sup>/<sub>4</sub>
- Unique deflector plate ensuring maximum water and particulate removal
- Solid control piston with lip seal for extended life.
- Proportional oil delivery over a wide range of air flows.



## ACCESSORIES

**REGULATOR**  
P31RB12BNTP      Size 1/4"      Type Relieving      Gauge 8 bar (square)



### Gauge



P3D-KAB1ANN

**FILTER**  
P31FB12EGMN      Size 1/4"      Type 5 micron      Drain Manual  
P31FB12EGBN      Size 1/4"      Type 5 micron      Drain Pulse



### Angle Bracket



P31KB00MR

**COALESCING FILTER**  
P31FB12DGMN      Size 1/4"      Type 0.01 micron      Drain Manual  
P31FB12DGBN      Size 1/4"      Type 0.01 micron      Drain Pulse



**FILTER REG**  
P31EB12EGMBNTP      Size 1/4"      Type Relieving      Drain Manual      Gauge 10 bar  
P31EB12EGBBNTP      Size 1/4"      Type Relieving      Drain Pulse      Gauge 10 bar

### O-ring Kit



P31KA00CY

**FRL COMBO**  
P31CA12GEMNTLNW      Size 1/4"      Type Relieving      Drain Pulse      Gauge 10 bar



### Key-lock Kit



P31KB00AL

**BALL/LOCKOUT VALVE**  
P31VB12LBNN      Size 1/4"



### Panel Nut (Alu)



P31KA00MM

**BODY CONNECTOR**  
P31KA00CB      Size 1/4"



## P31 Mini Series

40mm body width

1/4" Ported

Flows up to:	dm <sup>3</sup> /s	(SCFM)
Filter	12	(25)
Coalescer	2	(4.2)
Regulator	30	(64)
Filter/Regulator	14	(30)
Lubricator	13	(28)

Features:

- Space saving integral gauge
- Manifold style regulators available
- OSHA compliant shut-off valves
- Soft-Start & Quick Dump valves
- Electronic Proportional Regulator



<b>REGULATOR</b> P32RB14BNGP	Size 1/2"	Type Relieving	Gauge 8 bar		
<b>FILTER</b> P32FB14EGMN P32FB14EGAN	Size 1/2" 1/2"	Type 5 micron 5 micron	Drain Manual Auto		
<b>COALESCING FILTER</b> P32FB14DGMM P32FB14DGAN	Size 1/2" 1/2"	Type 0.01 micron 0.01 micron	Drain Manual Auto		
<b>FILTER REG</b> P32EB14EGMBNGP	Size 1/2"	Type Relieving	Drain Pulse	Gauge 8 bar	
<b>FRL COMBO</b> P32CA14GEMNGLNW	Size 1/2"	Type Relieving	Drain Manual	Gauge 8 bar	
<b>BALL/LOCKOUT VALVE</b> P32VB14LBNN	Size 1/2"				
<b>BODY CONNECTOR</b> P32KA00CB	Size 1/2"				



## ACCESSORIES

### Gauge



P6G-ERB2110



### Angle Bracket



P32KB00MR



### O-ring Kit



P32KA00CY



### Key-lock Kit



P32KB00AL



### Panel Nut (Alu)



P32KA00MM



## P32 Compact Series

60mm body width

1/4", 3/8", & 1/2" Ported

Flows up to: dm<sup>3</sup>/s (SCFM)

Filter	38	(80)
Coalescer	11	(23)
Regulator	67	(142)
Filter/Regulator	64	(136)
Lubricator	47	(100)

Features:

- Manifold style regulators available
- OSHA Compliant shut-off valves
- Soft-Start & Quick Dump valves
- Electronic Proportional Regulator



## REGULATOR

P3XRA14BNGN

Size  
1/2"

Type  
Relieving

Gauge  
8 bar

P3XRA16BNGN

Size  
3/4"

Type  
Relieving

Gauge  
8 bar



## ACCESSORIES

### Gauge



KG8012-00

## FILTER

P3XFA14EGCN

Size  
1/2"

Type  
5 micron

Drain  
Manual/semi-auto



### Wall Bracket



P3XKA00MW

## COALESCING FILTER

P3XFA14DGCN

Size  
1/2"

Type  
0.01 micron

Drain  
Manual/semi-auto

## FILTER REG

P3XEA14EGCBNGN

Size  
1/2"

Type  
Relieving

Drain  
Man/S.A.

Gauge  
8 bar

P3XEA16EGCBNGN

Size  
3/4"

Type  
Relieving

Drain  
Man/S.A.

Gauge  
8 bar



## Modular Connector



P3XKA00CB

## FRL COMBO

P3XCA14GEANGPNW

Size  
1/2"

Type  
Relieving

Drain  
Auto

Gauge  
8 Bar

P3XCA14GECNGPNW

Size  
1/2"

Type  
Relieving

Drain  
Man/S.A.

Gauge  
8 Bar



### O-ring Kit



P3XKA04CY

## FRL & SLIDE VALVE

P3XAA14GECNGPNW

Size  
1/2"

Type  
Relieving

Drain  
Man/S.A.

Gauge  
8 Bar



### Panel Nut



P3XKA00MM

### Key-lock Kit



P3XKA00AS

**For larger sizes, ask us about**

**P3Y Series  
Air Preparation**

3/4" & 1" Body Ported



**P3Z Series  
Air preparation**

1 1/2" & 2" Ported



**Parker Magnalift, 2/2 Brass  
all fluids.**

Zero Pressure Differential



Size	Voltage	Valve c/w Solenoid Coil	Valve body only
3/8"	230	221G13-2995-4818653D	221G13
1/2"	230	221G15-2995-4818653D	221G15
3/4"	230	221G16-2995-4818653D	221G16
1"	230	221G17-2995-4818653D	221G17

**REPLACEMENT COILS**

Part No.	Voltage		DIN Plug	Coil Nut*
481865C2	24vDC	0-6bar	3EV290V10	KIT 482995.50
481865A2	24vAC	0-16bar		
4818653D	230v	0-16bar		
481865A5	110v	0-16bar		

\*Coil nut kit to be ordered separately, not included with coils

**PA Series 2/2 NC stainless steel  
16 bar Ankle Seat Piston Valve**



SS316 body, SS304 actuator

Size	Part No.	Function
3/8"	PA10C1G3R032S	Flow Over Seat
3/8"	PA10C2G3R032S	Flow Under Seat, Anti water hammer
1/2"	PA15C1G4R032S	Flow Over Seat
1/2"	PA15C2G4R032S	Flow Under Seat, Anti water hammer
3/4"	PA20C1G5R032S	Flow Over Seat
3/4"	PA20C2G5R032S	Flow Under Seat, Anti water hammer
1"	PA25S1G6R063S	Flow Over Seat
1"	PA25SAG6R063S	Flow Under Seat, Anti water hammer
1 1/4"	PA32S1G7R063S	Flow Over Seat
1 1/4"	PA32SAG7R080S	Flow Under Seat, Anti water hammer

**Solenoid Banjo Valve to  
control PA Series valve**



Size	Part No.	Voltage	Function
1/8"	131B14-496131P9	230v	3 way Direct Acting Pilot
1/8"	131B14-496131C2	24vDC	3 way Direct Acting Pilot
1/4"	131B04-496131P9	230v	3 way Direct Acting Pilot
1/4"	131B04-496131C2	24vDC	3 way Direct Acting Pilot

**Namur Valve NC, pilot  
operated**

Anodized aluminium



Size	Part No.	Voltage	Function
1/4"	341N05-496131C2	24vDC	3/2 or 5/2
1/4"	341N05-496131P9	230v	3/2 or 5/2

# Parker Moduflex Valve Island

The Moduflex Valve System redefines flexibility for pneumatic users. Whether configured from basic components or ordered as a pre-assembled and tested valve manifold. Moduflex flexibility is unmatched in the market place. No other system can be adapted so simply; unique captive fitting release system, quick release electrical connectors and single mechanical screw connection between manifolds offers the ultimate capability for system changes.

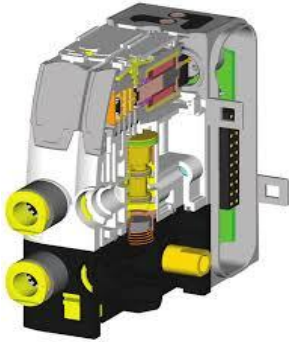

## MODUFLEX VALVE TECHNOLOGY

Two technology platforms enable the compact design and high performance of the Moduflex Valve System.

The compact dual 4/2 & 3/2 valves utilize well proven Parker seal technology. The standard 4/2 valves adopt the long life super durable ceramic switching technology.

Vacuum generator

Dual flow control module

Dual pilot operated check valve module

Pressure regulation module



### Fieldbus Options

DeviceNet  
Profibus  
CANopen  
AS-i  
Interbus-S

### Ports

Size 1: 4 & 6mm push-in  
Size 2: 6, 8, 10, & 12mm push-in

### Mountings

S Series: Individual subbase  
T Series: Manifold Mount with individual connectors  
V Series: Manifold mount with collective wiring or fieldbus

Valves	Type	Function	Size	Actuator	Return
P2M1T4ES2C	4/2		1	Solenoid	Spring
P2M1T4PS	4/2		1	Air pilot	Spring
P2M1TDEE2C	Dual 3/2	NC +NC	1	Solenoid	Spring
P2M1TDP	Dual 3/2	NC +NC	1	Air pilot	Spring

### Accessories

P2M2HXT01	Valve Island Head & Tail module set
FMD06-1	6mm push-in fittings (size 1)
MMDVA2	Silencer
P8LS08L226C	Flying lead with LED (2mts)

# Parker Pneumatic Cylinders



Parker P1D-S  
ISO 1552/VDMA Cylinders  
**MADE TO ORDER**  
in our Clonmel workshop

The innovative P1D is a future-proof generation of ISO cylinders. The cylinders are double-acting, with a unique design of air cushioning. The light, stiff body extrusion has sensor grooves for simple and protected sensor installation.

Installation dimensions according to international standards Complies with the ISO 6431, ISO 15552, VDMA 24562 and AFNOR installation dimension standards.

## ORDERING GUIDE / Part No. Structure

<b>P</b>	<b>1</b>	<b>D</b>	<b>-</b>	<b>S</b>	<b>0</b>	<b>3</b>	<b>2</b>	<b>M</b>	<b>S</b>	<b>-</b>	<b>0</b>	<b>1</b>	<b>0</b>	<b>0</b>
					Bore				Stroke					

### Bore

032 = 32mm  
040 = 40mm  
050 = 50mm  
063 = 63mm  
080 = 80mm  
100 = 100mm  
125 = 125mm

### Stroke

0100 = 100mm  
Custom strokes up to 2800mm available

## P1D-S ACCESSORIES



Size	Clevis Bracket MP2	Clevis Bracket MP4	Clevis	Swivel Rod Eye
32mm	P1C-4KMT	P1C-4KME	P1C-4KRC	P1C-4KRS
40mm	P1C-4LMT	P1C-4LME	P1C-4LRC	P1C-4LRS
50mm	P1C-4MMT	P1C-4MME	P1C-4MRC	P1C-4MRS
63mm	P1C-4NMT	P1C-4NME	P1C-4MRC	P1C-4MRS
80mm	P1C-4PMT	P1C-4PME	P1C-4PRC	P1C-4PRS
100mm	P1C-4QMT	P1C-4QME	P1C-4QRC	P1C-4QRS
125mm	P1C-4RMT	P1C-4RME	P1C-4RRC	P1C-4RRS



## P1D-S ACCESSORIES contd.



Size	Pivot Bracket	Foot Bracket MS1	Flange MF1/MF2	Mounting Kit
32mm	P1C-4KMD	P1C-4KMF	P1C-4KMB	P1E-6KB0
40mm	P1C-4LMD	P1C-4LMF	P1C-4LMB	P1E-6LB0
50mm	P1C-4MMD	P1C-4MMF	P1C-4MMB	P1E-6MB0
63mm	P1C-4NMD	P1C-4NMF	P1C-4NMB	P1E-6NB0
80mm	P1C-4PMD	P1C-4PMF	P1C-4PMB	P1E-6PB0
100mm	P1C-4QMD	P1C-4QMF	P1C-4QMB	P1E-6QB0
125mm	P1C-4RMD	P1C-4RMF	P1C-4RMB	

### P1A Mini Cylinder Double Acting - ISO 6432



Part No.	Bore	Stroke
P1A-S016DS-0025	16mm	25mm
P1A-S016DS-0050	16mm	50mm
P1A-S016DS-0080	16mm	80mm
P1A-S020DS-0025	20mm	25mm
P1A-S020DS-0050	20mm	50mm
P1A-S020DS-0080	20mm	80mm
P1A-S020DS-0100	20mm	100mm
P1A-S025DS-0025	25mm	25mm
P1A-S025DS-0050	25mm	50mm
P1A-S025DS-0080	25mm	80mm
P1A-S025DS-0100	25mm	100mm

### Clevis Bracket



Size	Part No.
16mm	P1A-4DMT
20/25mm	P1A-4HMT

### Foot MS8



Size	Part No.
16mm	P1A-4DMF
20/25mm	P1A-4HMF

### Clevis



Size	Part No.
16mm	P1A-4DRC
20mm	P1A-4HRC
25mm	P1A-4JRC

### P1A Mini Cylinder Spring Return - ISO 6432

Part No.	Bore	Stroke
P1A-S020SS-0025	20mm	25mm
P1A-S020SS-0050	20mm	50mm
P1A-S025SS-0025	25mm	25mm
P1A-S025SS-0050	25mm	50mm

### Swivel Rod Eye



Size	Part No.
16mm	P1A-4DRS
20mm	P1A-4HRS
25mm	P1A-4JRS

### Reed Switch 24-230V AC/DC Sensor Mount

Part No.
P8S-GRFLX2
P8S-TMC01

## High Performance... From Foundry to Clean Room

Our **ORIGA System Plus - Pneumatic (OSP-P)** rodless cylinder is designed for maximum strength and minimum weight

Offering complete flexibility for design engineers. The OSP-P cylinder's compact design combines actuation, guidance and control. And it includes modular accessories and components.

The OSP-P is available in pneumatic and electric drive types and offers:

- Stainless steel sealing band for ultra low-friction travel
- Low-profile piston with optimum guidance
- Single-end and multi-position air supply options
- Extended seal life for minimum of 8,000 km operation
- High direct-load carrying capacity
- Stroke lengths up to 6000 mm (longer on request)

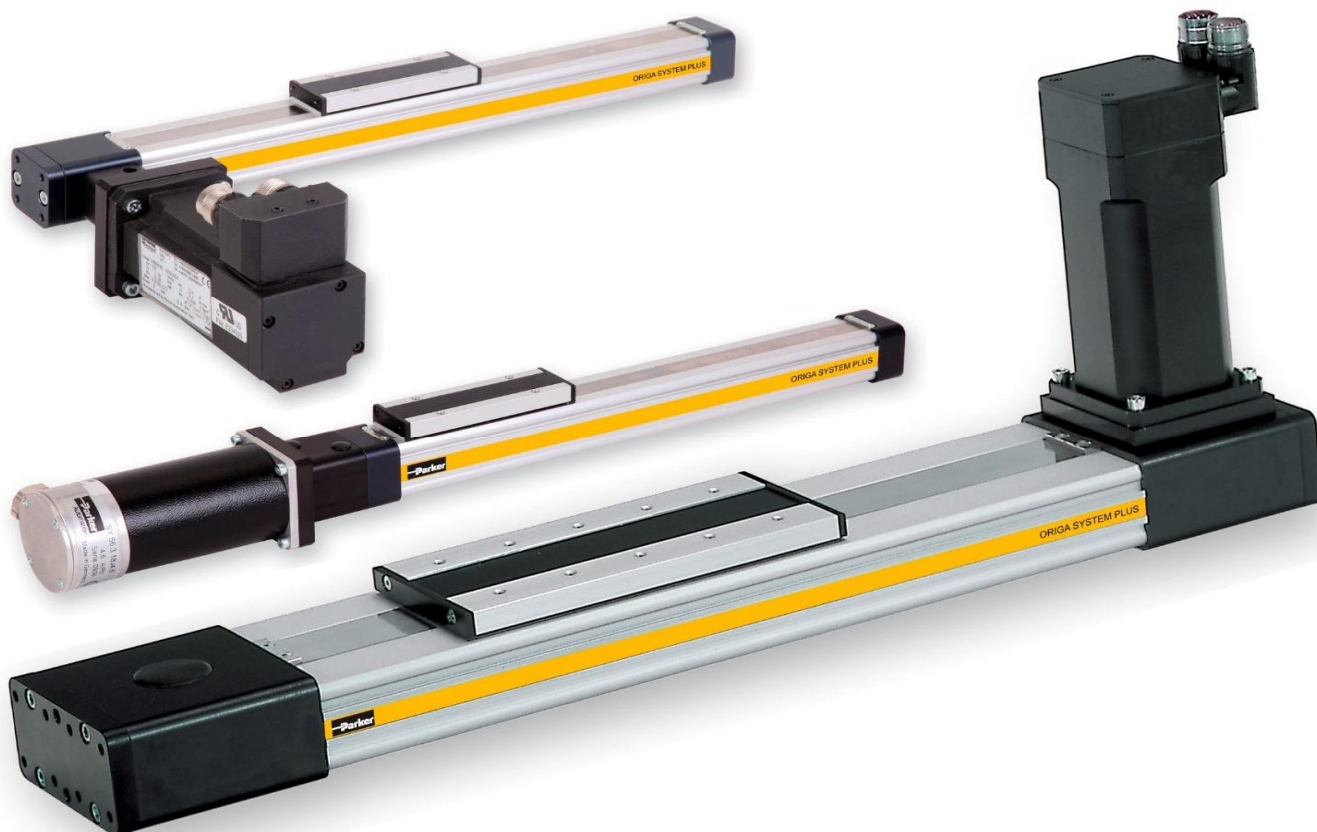

## Viking Lite Directional Control Valve



Part No.	Type	Size	Actuation	Return	Coil
P2LAZ311ESNDC	3/2	1/8"	Solenoid	Spring	
P2LBZ312ESNDC	3/2	1/4"	Solenoid	Spring	
P2LCZ313ESNDCB49	3/2	3/8"	Solenoid	Spring	24vDC



P2LAZ511EENDC	5/2	1/8"	Solenoid	Solenoid	
P2LBZ512EENDC	5/2	1/4"	Solenoid	Solenoid	
P2LCZ513EENDC	5/2	3/8"	Solenoid	Solenoid	



P2LAZ511ESNDC	5/2	1/8"	Solenoid	Spring	
P2LBZ512ESNDC	5/2	1/4"	Solenoid	Spring	
P2LCZ513ESNDC	5/2	3/8"	Solenoid	Spring	
P2LDX512ESNDD	5/2	1/2"	Solenoid	Spring	

## Flow Rate Qmax

P2LAZ 19.0l/s	(Closed)	P2LBZ612EENDCB49	5/3	1/4"	Solenoid	Solenoid	24vDC
P2LBZ 38.0l/s	(Pressurized)	P2LBZ712EENDCB49	5/3	1/4"	Solenoid	Solenoid	24vDC
P2LCZ 72.0l/s	(Vented)	P2LBZ812EENDCB49	5/3	1/4"	Solenoid	Solenoid	24vDC

**Valves without coils are available, omit B49 from the part no. when specifying**

## Manifold Bar P2LA for 5/2 valve



Part No.	No. Valves
9121658075	4
9121658076	6
9121658077	8
9121658063	Blanking Plate

## Manifold Bar P2LB for 5/2 valve



Part No.	No. Valves
9121594806X	4
9121594807X	6
9121594808X	8
9121594809X	Blanking Plate

## Solenid Coil 22mm



Part No.	Voltage
P2FCB440	12vAC
P2FCB442	24vAC
P2FCB445	12vDC
P2FCB449	24vDC
P2FCB451	48vDC
P2FCB453	120vAC
P2FCB457	230vAC

## Manifold Bar P2LA/B for 3/2 valve



Part No.	No. Valves
91213204SXZ	4
91213206SXZ	6
91213208SXZ	8
912132PBSXZ	Blanking Plate

**DIN Plug/Connector 22mm**  
w/o fly lead

**Part No.**  
3EV10V10

**Spare Solenoid Nut**  
Vented

**Part No.**  
P2FND



**Spare Solenoid Nut**  
Captured

**Part No.**  
P2FNP



**Isomax ISO 5599-1**  
**CNOMO operator with**  
**solenoid**



Part No.	Type	Size	Actuation	Return	Volt
DX1-621-BL49	5/2	1 (43mm)	Solenoid	Spring	24vDC
DX2-621-BL49	5/2	2 (56mm)	Solenoid	Spring	24vDC
DX1-606-BL49	5/2	1 (43mm)	Solenoid	Solenoid	24vDC
DX2-606-BL49	5/2	2 (56mm)	Solenoid	Solenoid	24vDC

**Single Subbase with side**  
**ports**



Part No.	Size	Port	Side ported Manifold	Size	Port
PL1-1/4-70	1	1/4" BSP	P2N-EM512MD	1	1/4"
PL1-3/8-70	1	3/8" BSP	P2N-EM513MD	2	3/8"
PL2-3/8-70	2	3/8" BSP			
P2N-HS514SS	2	1/2" BSP	<b>Connecting kit</b>	<b>Size</b>	<b>Port</b>
			P2N-EM513ES	1	1/4"
			P2N-EM514ES	2	3/8"

*Use suffix -80 for NPT threads*

**Solenoid Coil 30mm**



**Part No.**  
P2FCA445 24vAC  
P2FCA449 24vDC  
P2FCA453 120vAC  
P2FCA457 230vAC

**DIN Plug / Connector**  
**30mm**

w/o fly lead

**Part No.**  
3EV290V10



## Viking Extreme Pneumatic & Lever Valves



Part No.	Type	Size	Actuator	Return
P2LAX511VV	5/2	1/8"	Lever	Lever
P2LAX511VS	5/2	1/8"	Lever	Spring
P2LAX511PP	5/2	1/8"	Air	Air
P2LAX511PS	5/2	1/8"	Air	Spring
P2LBX312PP	3/2	1/4"	Air	Air
P2LBX312PS	3/2	1/4"	Air	Spring
P2LBX312VS	3/2	1/4"	Lever	Spring
P2LBX312VV	3/2	1/4"	Lever	Lever
P2LBX512PP	5/2	1/4"	Air	Air
P2LBX512PS	5/2	1/4"	Air	Spring
P2LBX512VS	5/2	1/4"	Lever	Spring
P2LBX512VV	5/2	1/4"	Lever	Lever

## B43 Series Midget Mech Operated Valves



Part No.	Type	Size	Actuation	Return
B43003CS	3/2	1/8"	Plunger	Spring
B43004CS	5/2	1/8"	Plunger	Spring
B43003RS	3/2	1/8"	Roller	Spring
B43004RS	5/2	1/8"	Roller	Spring
B43003RTS	3/2	1/8"	One way roller	Spring

## B53 Series Inter. Mech Operated Valves



Part No.	Type	Size	Actuation	Return
B53003CS	3/2	1/4"	Plunger	Spring
B53004CS	5/2	1/4"	Plunger	Spring
B53003RS	3/2	1/4"	Roller	Spring
B53004RS	5/2	1/4"	Roller	Spring

## B43/53 Series Midget Manually Op Valves



Part No.	Type	Size	Actuation	Return
B43003BXS	3/2	1/8"	Button	Spring
B43003HXS	3/2	1/8"	Button	Button
B43004BXS	5/2	1/8"	Button	Spring
B43004HXS	5/2	1/8"	Button	Button
B43003LS	3/2	1/8"	Lock down lever	Spring
B43004LS	5/2	1/8"	Lock down lever	Spring
B53003HXS	3/2	1/4"	Button	Spring
B53003HX	3/2	1/4"	Button	Button
B53004HXS	5/2	1/4"	Button	Spring
B53004HX	5/2	1/4"	Button	Button

Standard button colour is black, for green swap Z for X in part no.; for red swap Y for X



## PXB Mounting Block



Part No.  
ZB4-BZ09

## How to specify your pneumatic switch

1. Choose Mounting Block ZB4-BZ009
2. Select desired Valve/Electrical Contact
3. Choose your Pushbutton/Selector switch

## PXB 3/2 Switch Valves



Part No.	Type	Flow
PXB-B3911	NC Valve	60l/min
PXB-B3912	NO Valve	60l/min
PXB-B4931	NO/NC valve	240l/min
ZBE-101	NO electrical contact block	
ZBE-102	NC electrical contact block	

## Spring Return Push Button

Part No.	Color
ZB4-BA2	Black
ZB4-BA3	Green
ZB4-BA4	Red



## Mushroom Head 40mm

Part No.	Color
ZB4-BC2	Black
ZB4-BC3	Green
ZB4-BC4	Red



## Selector Switch

Part No.	Positions
ZB4-BD2	2 pos
ZB4-BD3	3 pos



## Visual Indicator

Part No.
PXV-F1314



## Pneumatic Time Delay Relays - 4mm swivel push-in connections

Part No.	Function	Range
PRT-E10	Output after	0.1 to 3 secs
PRT-B10	Output after	10 to 180 secs
PRT-F10	Output during	0.1 to 3 secs
PRT-C10	Output during	0.1 to 30 secs
PRT-D10	Output during	10 to 180 secs



## 3 Port Cascade Sub-base

Part No.
PZU-C12

## STEWART BUCHANAN GAUGES

Manufactured in Scotland, Stewarts offer a vast range of Premium Quality pressure and differential pressure gauges. For the optimal solution and the widest range of applications, there is a choice of measuring systems in bourdon tube, diaphragm element and capsule element technologies.



Stewarts have also developed a number of specialised gauges:

**VIBRAGAUGE®** – to alleviate problems caused by Vibration;

**SNUBBAGAUGE®** – to alleviate problems caused by Shock and Surge;

**NITELITEGAGE®** – for use in Dark Areas (Luminescent Dial & Reflective Pointers).

Model 732 (4" Dial)	Part No.	Range	Connection
Stainless Steel	732E76B	0-6 bar	1/2" BSPP
Bottom Connection	732E710B	0-10 bar	1/2" BSPP
Dual Scale psi/bar	732E716B	0-16 bar	1/2" BSPP
Accuracy 1%	732E720B	0-20 bar	1/2" BSPP
<b>Model 732 is a Vibragauge, no need to fill with glycerine</b>	732E86B	0-6 bar	1/2" NPT
	732E810B	0-10 bar	1/2" NPT
	732E816B	0-16 bar	1/2" NPT
	732E820B	0-20 bar	1/2" NPT
Model 632 (2.5" Dial)	Part No.	Range	Connection
Stainless Steel	632C34B	0-4 bar	1/4" BSPP
Bottom Connection	632C36B	0-6 bar	1/4" BSPP
Dual Scale psi/bar	632C310B	0-10 bar	1/4" BSPP
Accuracy 1%	632C316B	0-16 bar	1/4" BSPP
<b>Supplied as a dry gauge, can be glycerine filled</b>	632C44B	0-4 bar	1/4" NPT
	632C46B	0-6 bar	1/4" NPT
	632C410B	0-10 bar	1/4" NPT
	632C416B	0-16 bar	1/4" NPT



## New Calibration Service

We now offer a Calibration Service for gauges up to 20 bar at our workshop in Clonmel. Competitive rates and fast turnaround



## WIKA GAUGES



Part No.	Range	Connection
WG63-14B/-30HG	Vacuum -1 bar	1/4" BSPP bottom
WG63-14B-10G	0-10 bar	1/4" BSPP bottom
WG63-14R/-30HG	Vacuum -1 bar	1/4" BSPP back
WG63-14R-10G	0-10 bar	1/4" BSPP back



## ECONOMY GAUGES

Part No.	Range	Connection
G50-10T	0-10 bar	1/4" BST back
G50-10R	0-10 bar	1/8" BST back
G50-10C	0-10 bar	1/4" BST bottom
G50-06T	0-6 bar	1/4" BST back
G50-06C	0-6 bar	1/4" BST bottom
G50-04C	0-4 bar	1/4" BST bottom
G50-04B	0-4 bar	1/8" BST bottom



Dial size: 50mm

ABS case, brass connections

## PARKER 3 & 5 VALVE MANIFOLDS

Comprehensive range of two, three and five valve manifolds for pressure and flow measurement applications. Direct or remote mounting options. Process, instrument and vent connections can be provided in a variety of sizes and thread forms including NPT, BSPT and BSPP



## PARKER BLOCK & BLEED VALVES

This series of two-valve manifolds combine valves into one unitised block to perform isolation, bleed and calibration of pressure transmitters, gauges and switches. Process, instrument and vent connections can be provided in a variety of sizes and thread forms



**Braided Clear\* PVC Hose**  
30m coil



Part No.	ID
RPVC14	1/4"
RPVC38	3/8"
RPVC12	1/2"
RPVC34	3/4"
RPVC1	1"
RPVC114	1 1/4"
RPVC112	1 1/2"
RPVC2	2"

\*Other colours available  
\*15m & 100m coils also available

**Clear Wire reinforced PVC Hose**



Part No.	ID
FX050-30	1/2"
FX075-30	3/4"
FX100-30	1"
FX125-30	1 1/4"
FX150-30	1 1/2"
FX200-30	2"

10m coils also available

**Copper Tube**



Part No.	OD	Coil
MCT-6/30	6mm	30m
MCT-8/30	8mm	30m
MCT-10/30	10mm	30m
MCT-12	12mm	10m
MCT-12/30	12mm	30m
ICT-14/30	1/4"	30m
ICT-38/30	3/8"	30m

**PVC coated Copper Tube**



Part No.	OD	Coil
MSCT-6	6mm	30m
MSCT-8	8mm	30m
MSCT-10	10mm	30m
ISCT-14	1/4"	30m
ISCT-38	3/8"	30m

**Fluorocarbon Tube**



PFA Part No.	OD
TX1/4	1/4"
TX3/8	3/8"
TX1/2	1/2"
TX3/4	3/4"
TX1	1"
TX1 1/2	1 1/2"

PVDF & FEP also available

PTFE Part No.	OD	Coil
A1AS001903	6mm	(500m)
PTFE6-100	6mm	(100m)
PTFE4-50	4mm	(50m)
PTFE8-50	8mm	(50m)
PTFE10-50	10mm	(50m)
PTFE12-50	12mm	(50m)

Fittings to suit also available

**Soft unreinforced PVC (for DPT)**

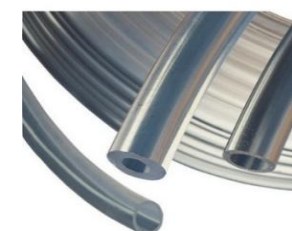

Part No.	OD
CPVC8/5-30m	8mm
CPVC8/5-100m	8mm
CPVC8/5-500m	8mm

# Hose Clamps & Clips

## Mikalor O-Clip, zinc plated 2 ear



Part No.	Min	Max	Part No.	Min	Max	Part No.	Min	Max
3012101	5	7	3012179	17	20	3012240	31	34
3012110	7	9	3012187	18	21	3012259	34	37
3012128	9	11	3012195	20	23	3012267	37	40
3012136	11	12	3012208	22	25	3012275	40	43
3012144	13	15	3012216	23	27	3012283	43	46
3012152	14	17	3012224	25	28			
3012160	15	18	3012232	28	31			

Page 1358 of the HCCL 2016/17 Catalogue. SS version also available

## Jubilee Clip, zinc plated



Part No.	Min	Max	Part No.	Min	Max	Part No.	Min	Max
OOO-MS	9.5	12	2A-MS	35	50	6X-MS	120	150
MOO-MS	11	16	2-MS	40	55	7-MS	135	165
OO-MS	13	20	2X-MS	45	60	7 1/2-MS	158	190
O-MS	16	22	3-MS	55	70	8 1/2-MS	184	216
OX-MS	18	25	3X-MS	60	80	9 1/2-MS	210	242
1A-MS	22	30	4-MS	70	90	10 1/2-MS	235	267
1-MS	25	35	4X-MS	85	100	11 1/2-MS	260	292
1X-MS	30	40	5-MS	90	120	12 1/2-MS	286	318
1M-MS	32	45	6-MS	110	140			

Page 1365 of the HCCL 2016/17 Catalogue. SS version also available

## Jubilee Superclamp, zinc plated



Part No.	Min	Max	Part No.	Min	Max	Part No.	Min	Max
JSC19	17	19	JSC59	56	59	JSC130	122	130
JSC22	20	22	JSC63	60	63	JSC139	131	139
JSC25	23	25	JSC67	64	67	JSC148	140	148
JSC28	26	28	JSC73	68	73	JSC161	149	161
JSC31	29	31	JSC79	74	79	JSC174	162	174
JSC35	32	35	JSC85	80	85	JSC187	175	187
JSC39	36	39	JSC91	86	91	JSC200	188	200
JSC43	40	43	JSC97	92	97	JSC213	201	213
JSC47	44	47	JSC103	98	103	JSC226	214	226
JSC51	48	51	JSC112	104	112	JSC239	227	239
JSC55	52	55	JSC121	113	121			

Page 1366 of the HCCL 2016/17 Catalogue. SS version also available

# Cam & Groove / Hosetails

**Available in Brass / Plastic / Aluminium / Stainless Steel**

Sizes: 1/2" - 2"



Brass



Brass



Brass



PVC-U



Nickel Brass



Aluminium



SS316



Nylon / PP

**Available in Stainless Steel / Brass / Polypropylene / Aluminium**

Sizes 1/2" - 6"

**Type A**



(Aluminium)

**Type B**



(Aluminium)

**Type C**



(Polypropylene)

**Type D**



(Polypropylene)

**Type E**



(Brass)

**Type F**



(Brass)

**Dust Plug**



(Stainless)

**Lever Stop**



(Stainless)

# Brass Compression Fittings

NPT or BSP threads available  
 Imperial sizes from 1/8" to 1" / Metric sizes from 4mm to 22mm  
 Manufacturers: Wade / Airpro

**Male Stud**



**Female Stud**



**Equal Joiner**



**Equal Elbow**



**Male Stud Elbow**



**Bulkhead**



**Ferrule**



**Tee**



**Tube Cap**



**Blanking Tube End**



**Standpipe**



**PC Nut**



## ASSOCIATED PRODUCTS

**Ball Valves**



**Y Strainer**



**Check Valves**



**Gate Valves**





# Hose Reels for Air & Water

## Transair Air Hose Reel (12 Bar)

PU Hose		L		Inlet	Outlet
180 deg Swivel	Part No.	mts	ID	BSPP	BSPP
Spring Return	6698 10 01	10	5/16"	1/4"	1/4"
Lightweight	6698 10 02	16	5/16"	1/4"	1/4"



## Air & Water Hose Reel (17 bar)

Reinforced PVC hose

180 deg Swivel		L		Inlet	Outlet
Spring Return	Part No.	mts	ID	BSPT	BSPT
Lightweight	ZA04-10B	10	3/8"	1/4"	1/4"
	ZA05-15B	15	3/8"	1/4"	1/4"
	ZA05-20B	20	3/8"	3/8"	3/8"



Hi-Vis versions available

## Air Hose Reel (20 & 28 Bar)

Rubber Hose		L		Inlet	Outlet
Spring Return	Part No.	mts	ID	BSPT	BSPT
Powder Coated	SAHR-15-38	15	3/8"	3/8"	3/8"
Steel	SAHR-15-12	15	1/2"	1/2"	1/2"



## Air & Water Hose Reel (20 Bar)

PU Hose

Spring Return		L		Inlet	Outlet
SS304 body	Part No.	mts	ID	BSPT	BSPT
	SSHR-15-38SHV06T	15	3/8"	3/8"	3/8"



**Pipe**  
6m lengths  
Plain ends



**Female Adaptor**  
Socket x Rp



**Elbow 90**  
BS Inch  
PN 15



**Adaptor**  
Spigot BS Inch x Rp



**Elbow 45**  
BS Inch  
PN 15



**Adaptor Bush**  
Socket BS Inch x R



**Equal Tee**  
BS Inch  
PN 15



**Adaptor Socket**  
BS Inch x Metric



**Barrell Nipple**  
BS Inch  
PN 15



**Adaptor Nipple**  
BS Inch Spigot x R



**Socket**  
BS Inch  
PN 15



**Flange Adaptor**  
Gaskets & Back Rings  
also available



**Cap**  
BS Inch  
PN 15



**Full Face Flange**  
Universal Fitting  
PN/ANSI/BS



**Reducing Bush**  
Spigot x Socket  
PN12



**Union**  
Socket x Socket



**Reducing Bush**  
Spigot x Rp



**Adaptor Socket Nipple**  
Spigot/Socket x R



## STOCKED IN CLONMEL

- ABS 1/2" to 6"
- PVC-U Metric
- Sch80 PVC-U
- Sch80 PVC-C

**Type 546 Ball Valve**  
BS Inch Sockets



**Type 561/562 Check Valve**  
BS Inch Sockets



### Tangit Glue

ABS 799298022  
PVC-U 799298003  
PVC-C 799298027



### Tangit Cleaner

799298010



## Parker FS Series (Ind)

Media: Non-Spill Double Shut Off. Flat face  
Interchangeability: Hydraulics / Fluid Transfer  
Materials: None  
SS316

### Coupler NPT Female thread



Size	Part No.
3/8"	FS-371-6FP
1/2"	FS-501-8FP
3/4"	FS-751-12FP
1"	FS-1001-16FP

### Nipple NPT Female thread



Size	Part No.
3/8"	FS-372-6FP
1/2"	FS-502-8FP
3/4"	FS-752-12FP
1"	FS-1002-16FP

## Parker 60 Series (Ind)

Media: Double Shut Off  
Interchangeability: Hydraulics / Fluid Transfer  
Materials: ISO 7241 series B  
Brass, Steel, SS303, SS316

### Coupler NPT female thread



Size	Brass Part No.	SS303 Part No.	SS316 Part No.
1/8"	BH1-60	SH1-62	SSH1-62Y
1/4"	BH2-60	SH2-62	SSH2-62Y
3/8"	BH3-60	SH3-62	SSH3-62Y
1/2"	BH4-60	SH4-62	SSH4-62Y
3/4"	BH6-60	SH6-62	SSH6-62Y
1"	BH8-60	SH8-62	SSH8-62Y

### Nipple NPT female thread



Size	Brass Part No.	SS303 Part No.	SS316 Part No.
1/8"	BH1-61	SH1-63	SSH1-63Y
1/4"	BH2-61	SH2-63	SSH2-63Y
3/8"	BH3-61	SH3-63	SSH3-63Y
1/2"	BH4-61	SH4-63	SSH4-63Y
3/4"	BH6-61	SH6-63	SSH6-63Y
1"	BH8-61	SH8-63	SSH8-63Y

**BSPP threads also available**



## Parker ST Series (Ind)

Media: Water / Fluids  
Interchangeability: None  
Materials: Brass, Steel, SS303, SS316.

### Coupler NPT female thread



Size	Brass Part No.	SS303 Part No.	SS316 Part No.
1/8"	BST-1	SST-1	SST-1Y
1/4"	BST-2	SST-2	SST-2Y
3/8"	BST-3	SST-3	SST-3Y
1/2"	BST-4	SST-4	
3/4"	BST-6	SST-6	
1"	BST-1	SST-8	

### Nipple NPT female thread



Size	Brass Part No.	SS303 Part No.	SS316 Part No.
1/8"	BST-N1	SST-N1	SST-N1Y
1/4"	BST-N2	SST-N2	SST-N2Y
3/8"	BST-N3	SST-N3	SST-N3Y
1/2"	BST-N4	SST-N4	
3/4"	BST-N6	SST-N6	
1"	BST-N1	SST-N8	

BSPT threads also available

## Parker CPI (Inst)

Media: Air/Gas/Liquids  
Interchangeability: Swagelok QC Series  
Materials: Stainless Steel

### CPI Coupler with Alok Comp End



Size	Part No.
1/4"	4A-Q4CY-SSP
3/8"	6A-Q6CY-SSP
1/2"	8A-Q8CY-SSP

### CPI Nipple with Alok Comp End



Size	Part No.
1/4"	4A-Q4VY-SS
3/8"	6A-Q6VY-SS
1/2"	8A-Q8VY-SS

### CPI Coupler NPT female



Size	Part No.
1/4"	4F-Q4CY-SSP
3/8"	6F-Q6CY-SSP
1/2"	8F-Q8CY-SSP

### CPI Nipple NPT female



Size	Part No.
1/4"	4F-Q4VY-SS
3/8"	6F-Q6VY-SS
1/2"	8F-Q8VY-SS

Keyed and coloured options available on request (MOQ 10 no. for keyed option)

## Rectus 86/87 (Mould)

Media: Coolant Lines & Injection Moulds. Straight-thru, single or double shut-off  
 Interchangeability: Water / Fluids  
 Materials: DME, Jiffy  
 Brass, brass nickel plated

### Coupler



Size	Male BSPT	Female BSPP	Hosetail
DN6	86KBAW13MVX	86KBIW13MVX	86KBTFO6MVX
DN9	87KBAW13MVX	87KBIW13MVX	87KBTFO9MVX

### Plug



Size	Male BSPT	Female BSPP	Hosetail
DN6	86SBAK13MXX	86SFIW13MXX	86SFTFO9MXX
DN9	87SFAK13MXX	87SFIW13MXX	87SFTF13MXX

## Rectus 10/11/12 (Mould)

Media: Coolant Lines & Injection Moulds. Straight-thru, single or double shut-off  
 Interchangeability: Water / Fluids  
 Materials: Hasco  
 Brass, brass nickel plated

### Coupler



Size	Male BSPT	Female BSPP	Hosetail
DN6	10KBAW13MVX	10KBIW13MVX	10KBTFO9MVX
DN9	11KBAW13MVX	11KBIW13MVX	11KBTF13MVX
DN13	12KBAW21MVX		

### Plug



Size	Male BSPT	Female BSPP	Hosetail
DN6	10SBAW13MXN	10SFIW13MXN	10SFTFO9MXX
DN9	11SFAW13MXN	11SFIW13MXN	11SFTFO9MXX
DN13	12SFAW21MXN		12SFTF13MXX

## Rectus 26KE (Pneu)

Media: SAFETY COUPLING - SELF VENTING  
 Interchangeability: Compressed Air  
 Materials: Cejn 320, Festo KD, Rectus 25/1600/1625, Tema 1600, JWL 520/530  
 Brass Nickel plated / Steel

### Coupler



Size	Male BSPP	Female BSPP
1/4"	26KEAW13MPN	26KEIW13MPN
3/8"	26KEAW17MPN	26KEIW17MPN
1/2"	26KEAW21MPN	26KEIW21MPN

### Plug



Size	Male BSPT	Female BSPP
1/4"	25SFAK13SXZ	25SFIW13SXZ
3/8"	25SFAK17SXZ	25SFIW17SXZ
1/2"	25SFAK21SXZ	25SFIW21SXZ

## Rectus 17KA (Pneu)

Media: Compressed Air  
Interchangeability: Schrader Series NW5, Twist-Lock  
Materials: Brass Nickel plated

### Coupler



#### Size

1/4"  
3/8"  
1/2"

#### Male BSPT

17KAAK13SPN  
17KAAK17SPN  
17KAAK21SPN

#### Female BSPP

17KAIW13SPN  
17KAIW17SPN  
17KAIW21SPN

#### Hosetail

17KATF06SPN  
17KATF10SPN  
17KATF13SPN

### Plug



#### Size

1/4"  
3/8"

#### Male BSPT

17SFAK13SXN

#### Female BSPP

17SFIW13SXN

#### Hosetail

17SFTF06SXN  
17SFTF10SXN

## Rectus 19KA (Pneu)

Media: Compressed Air  
Interchangeability: PCL Standard  
Materials: Brass Nickel plated

### Coupler



#### Size

1/4"  
3/8"  
1/2"

#### Male BSPT

19KAAK13MPN  
19KAAK17MPN  
19KAAK21MPN

#### Female BSPP

19KAIW13MPN  
19KAIW17MPN  
19KAIW21MPN

#### Hosetail

19KATF06MPN  
19KATF10MPN  
19KATF13MPN

### Plug



#### Size

1/4"  
3/8"

#### Male BSPT

19SFAK13SXN  
19SFAK17SXN

#### Female BSPP

19SFIW13SXN  
19SFIW17SXN

#### Hosetail

19SFTF06SXN  
19SFTF10SXN

## Rectus 21KA (Pneu)

Media: Compressed Air  
Interchangeability: Rectus 90, Camozzi, EWO  
Materials: Brass Nickel plated

### Coupler



#### Size

1/8"  
1/4"  
3/8"

#### Male BSPP

21KAAW10MPN  
21KAAW13MPN  
21KAAW17MPN

#### Female BSPP

21KAIW10MPN  
21KAIW13MPN  
21KAIW17MPN

#### Hosetail

21KATF06MPN  
21KATF10MPN

Plug	Size	Male BSPP	Female BSPP	Hosetail
	1/8"	21SFAW10MXN	21SFIW10MXN	
	1/4"	21SFAW13MXN	21SFIW13MXN	21SFTF06MXN
	3/8"	21SFAW17MXN	21SFIW17MXN	21SFTF10MXN

### Rectus 25KA (Pneu)

Media: Single Shut Off Compressed Air  
 Interchangeability: Cejn 320. Euro standard profile used on most air tools and compressors  
 Materials: Brass Nickel plated, Stainless Steel

Coupler	Size	Male BSPT	Female BSPP	Hosetail
	1/4"	25KAAK13MPN	25KAIW13MPN	25KATF06MPN
	3/8"	25KAAK17MPN	25KAIW17MPN	25KATF10MPN
	1/2"	25KAAK21MPN	25KAIW21MPN	25KATF13MPN

Plug	Size	Male BSPT	Female BSPP	Hosetail
	1/4"	25SFAK13SXZ	25SFIW13SXZ	25SFTF06SXZ
	3/8"	25SFAK17SXZ	25SFIW17SXZ	25SFTF10SXZ
	1/2"	25SFAK21SXZ	25SFIW21SXZ	25SFTF13SXZ

### Rectus 26KA (Pneu)

Media: Single Shut Off Compressed Air  
 Interchangeability: Cejn 320, Festo KD, Rectus 25/1600/1625, Tema 1600, JWL 520/530  
 Materials: Brass

Coupler	Size	Male BSPP	Female BSPP	Hosetail
	1/4"	26KAAW13MPX	26KAIW13MPX	26KATF06MPX
	3/8"	26KAAW17MPX	26KAIW17MPX	26KATF10MPX
	1/2"	26KAAW21MPX	26KAIW21MPX	26KATF13MPX

Plug	Size	Male BSPP	Female BSPP	Hosetail
	1/4"	26SFAW13MXX	26SF1W13MXX	26SFTF06MXX
	3/8"	26SFAW17MXX	26SF1W17MXX	26SFTF10MXX
	1/2"	26SFAW21MXX	26SF1W21MXX	26SFTF13MXX

## PCL Airflow (Pneu)

Media: Single Shut Off  
Compressed Air  
Interchangeability: Rectus 17KA  
Materials: Brass Nickel plated

### Coupler



Size	Male BSPT	Female BSPP	Hosetail
1/4"	AC21CM02	AC21CF02	AC21R02
3/8"	AC21EM02	AC21EF02	AC21S02
1/2"	AC21JM02	AC21JF02	AC21T02

### Plug



Size	Male BSPT	Female BSPP	Hosetail
1/4"	ACA2593	ACA2746	ACA1793
3/8"	ACA6509	ACA6582	ACA2487
1/2"	ACA6584	ACA6583	ACA2488

*PCL 60 Series and M100 Series available on request*

## Legris C9000 (Pneu)

Media: Quick-acting vent allows disconnecting to be carried out in total safety  
Compressed Air to 16 bar  
Interchangeability: European  
Materials: Polymer

### European Profile Coupler, Male BSPP



Size	Part No.
1/4"	9401E07 13
3/8"	9401E07 17
1/2"	9401E07 21

### European Profile Coupler, Female BSPT



Size	Part No.
1/4"	9414E07 13
3/8"	9414E07 17
1/2"	9414E07 21

### European Profile Unvalved Plug Male BSPP



Size	Part No.
1/4"	9087E07 13
3/8"	9087E07 17
1/2"	9087E07 21

### European Profile Unvalved Plug with Hosetail



Size	Part No.
08mm	9094E07 08
10mm	9094E07 10
13mm	9094E07 13

# Wash Down Equipment

## Pressure Lance Range 150deg / 280 bar

Pressure Lance, 900mm, 3/8" BSPP  
 Pressure Lance, 900mm with 15deg tip, 3/8" BSPP  
 Pressure Lance, 430mm, 3/8" BSPP  
 Adjustable Pressure Lance, 900mm, 3/8" BSPP

**Part No.**  
 PRESSURE-LANCE  
 PRESSURE-LANCE15  
 PRESSURE-LANCESH  
 CD-2502



## Lance Spares



**Lance Trigger**  
 Part no. ST900  
 1/4" BSPP Inlet

## Accessories to connect Lance to Hose



**Swivel Coupling**  
 Part no. 21-049  
 3/8" BSPP MxF



**Fixed Adaptor**  
 Part no. 1BPA0606  
 3/8" X 3/8"  
 Part no. 1BPA0406  
 1/4" X 3/8"

## Connect Wash Gun to Hose



**Swivel Coupling**  
 Part no. 21-052  
 1/2" BSPP MxF

## Wash Gun



Part no. WASH-GUN  
 Wash Gun, Blue, 1/2"  
 BSPP brass inlet

## Hygienic Wash Gun



Part no. HYGWASH-GUN  
 Wash Gun, White,  
 1/2" BSPP SS inlet

## SS Spare Nozzles



0 deg     2020-2982  
 15 deg    2020-3105  
 25 deg    2020-3147  
 40 deg    2020-3204

## Connection to Power Washer



**M22 Female x 1/4" Male**  
 Part no. PWAB-14M  
 M22 fem X 1/4" BSPP male

Other options available

## REPLACEMENT WASH DOWN HOSE

Plastic Wash Down Hose (6m) - c/w 1/4" BSPP swivel ends\*  
 Plastic Wash Down Hose (10m) - c/w 1/4" BSPP swivel ends\*  
 1-wire Rubber Wash Down Hose (6m) - c/w 1/4" BSPP swivel & M22x1.5 connection  
 1-wire Rubber Wash Down Hose (10m) - c/w 1/4" BSPP swivel & M22x1.5 connection

**Part no.**  
 HYD-ASSY-0000940  
 HYD-ASSY-0000941  
 HYD-ASSY-0000942  
 HYD-ASSY-0000178

\*Accessory PWAB-14M required



Full range of Wash Down in the HCCL Catalogue



**82 Series - Brass**



**82 Series - Stainless**



**Mould Coupler**

## WHY PUSH-LOK?

Parker's Push-Lok Plus multipurpose hose line features the widest fluid compatibility, application range and size range in the industry. It also incorporates the highest working pressure in all sizes, making it the most versatile general-purpose hose available.

### Easy Assembly and Organization

The Push-Lok system is easy to use. No clamps or special tools are required during installation. And with Parker's exclusive colorcode system, you can inventory, maintain and identify your hose needs easily and efficiently.

### Exceptional Value and Savings

Parker Push-Lok assemblies can be made in seconds, saving valuable time and cost.

And, Push-Lok 82 Series fittings are reusable. You can replace the hose at the job site without any special tools or clamps.

### Operational Integrity

Helping you maintain a clean work environment is another important reason to use Parker's Push-Lok system. Its unique seal ensures reliable, durable, leak-free service.

Outstanding quality, valuable efficiency and Parker's leak-free assurance are what you get with every Parker Push-Lok hose and fitting system. The industry's most complete line of low-pressure hose and fittings, Push-Lok offers the range and versatility to meet all your needs.

## PUSHLOK HOSE STOCKED

801PLUS-4	1/4"
801PLUS-6	3/8"
801PLUS-8	1/2"
801PLUS-12	3/4"
801PLUS-16	1"
830M-8	1/2"
830M-12	3/4"

Yellow,  
Blue,  
Red,  
Grey

## Assembly and Disassembly Steps

### Assembly is easy

1. Cut hose cleanly and squarely with a sharp knife or a Parker Push-Lok cut-off tool
2. Lubricate the Push-Lok fitting and/or Hose I.D. with a light oil or soapy water only. Do not use heavy oil or grease.
3. Insert fitting into hose until the barb is in the hose.
4. Place end fitting against a flat object (bench or wall). Grip hose approximately one inch from end and push with steady force until the end of the hose bottoms on the fitting and is covered by the yellow plastic cap.





# Donaldson®

*Filtration Solutions*

- Donaldson manufactures a complete line of refrigerated compressed air dryers, absorption and membrane dryers and complete range of filters
- Donaldson filter housings are used to purify air and technical gases. We offer both non-sanitary and sanitary 3-A filter housings, both T-type and in-line as well as high pressure housings to meet your specific air quality requirements and system solutions.
- The modularly designed processing ranges offer individual customer solutions, and therefore guarantee the highest efficiency.





The *original* and market leading modular piping system for compressed air, inert gas and vacuum.  
Manufactured to the highest quality standards in France

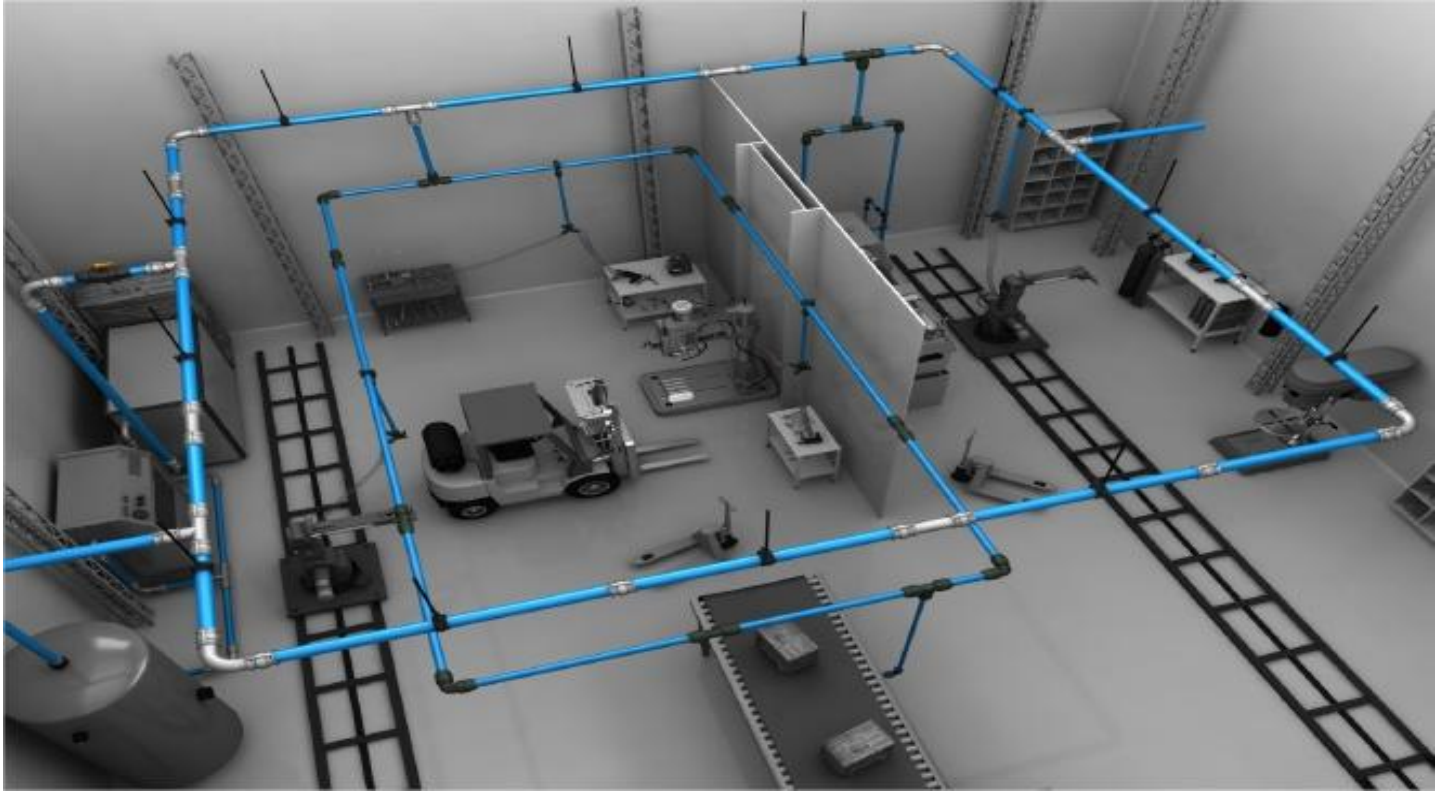

**Available Pipe Sizes 16.5/25/40/50/63/76/100/168mm**



## FEATURES & BENEFITS

High quality aluminium & SS pipe range. Low friction internal surface ensures optimal flow rates

Leak free connections (Push-in up to 40mm)

Modular and extremely adaptable

Suitable for aggressive environments

Colour coded - Blue, Green Grey as standard. Others on request

Up to 16 bar working pressure

Full range of fittings and accessories



## ON-SITE SERVICING / CALLOUT

We offer a scheduled maintenance programme for customer product including:

- All makes of Compressors
- Vacuum Pumps
- Nationwide Service
- 24 hour phone response



## REPAIRS WORKSHOP

We offer a repair service for customer product including:

- Pneumatic Cylinders (Piston)
- Pneumatic Cylinders (Rodless)
- Diaphragm Pumps
- Air Tools
- Compressors



## HOSE ASSEMBLIES

Hydraulic and industrial hoses assembled to your exact specification

Hygienic and Pharma hoses also available



## PANEL MANUFACTURE / ASSEMBLIES

We manufacture Solenoid Islands and bespoke Pneumatic Panels to your drawings

POU filter & regulator assemblies

Electrical JB enclosures

## What is VMI?

Vendor Managed Inventory (VMI) is a streamlined approach to inventory management and order fulfillment. VMI involves collaboration between a supplier and their customer which changes the traditional ordering process

Talk to us to see how we can help you by maintaining an agreed inventory of material in your **ENGINEERING STORES**

<b>Noel Walsh</b>	<b>086 8118435</b>
<b>Dwayne Dunphy</b>	<b>086 8533565</b>
<b>Sean Brennan</b>	<b>086 8098420</b>
<b>Martin Ralph</b>	<b>086 4669193</b>
<b>Padraig Lynch</b>	<b>086 4615560</b>
<b>Tom Egan</b>	<b>083 8589258</b>



## Red, Blue, Yellow, & Grey available

PART NO.	L mm	W mm	H mm
SB-1-RED	125	100	60
SB-1-BLUE	125	100	60
SB-1-YELLOW	125	100	60
SB-1-GREY	125	100	60
SB-2-RED	170	100	85
SB-2-BLUE	170	100	85
SB-2-YELLOW	170	100	85
SB-2-GREY	170	100	85
SB-3-RED	220	130	125
SB-3-BLUE	220	130	125
SB-3-YELLOW	220	130	125
SB-3-GREY	220	130	125
SB-4-RED	290	178	143
SB-4-BLUE	290	178	143
SB-4-YELLOW	290	178	143
SB-4-GREY	290	178	143
SB-5-RED	290	363	145
SB-5-BLUE	290	363	145
SB-5-YELLOW	290	363	145
SB-5-GREY	290	363	145
SB-6-RED	440	180	145
SB-6-BLUE	440	180	145
SB-6-YELLOW	440	180	145
SB-6-GREY	440	180	145
SB-7-RED	435	400	215
SB-7-BLUE	435	400	215
SB-7-GREY	435	400	215

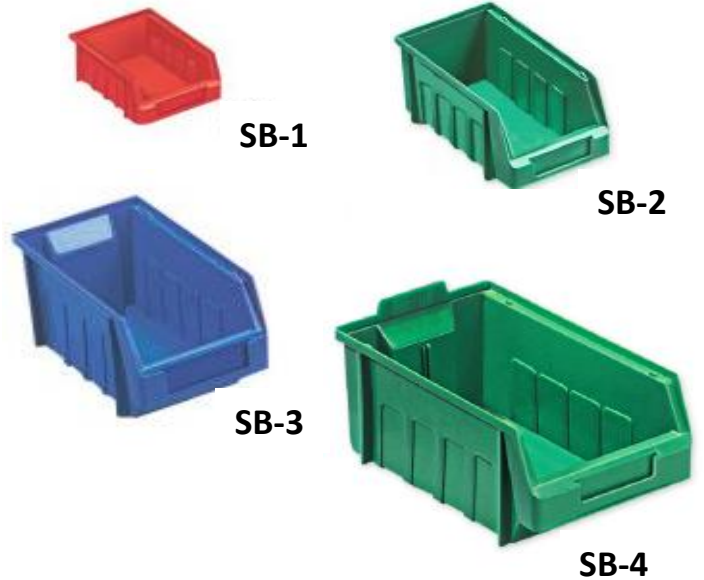

### Louvred Wall Panels

SB/LP1	457 x 457mm
SB/LP2	457 x 610mm
SB/LP3	457 x 915mm
SB/LP6	457 x 1830mm





# Technical Training



Enroll your Instrumentation Fitters, Technicians, & Maintenance Personnel on the Parker **SBEX** Training Programme to give them the hands-on training they need to help your organisation save time, reduce overheads and increase safety on your Small Bore Tube System.

### Course Goals

- Increasing understanding of small bore tubing systems and components
- Improving small bore tubing systems safety
- Enhancing small bore tubing systems integrity
- Reducing potential losses
- Augmenting skills and confidence whilst working on small bore tubing systems



Contact **NOEL WALSH** for more details @ 086 8118435 or email [noel.walsh@hccl.ie](mailto:noel.walsh@hccl.ie)



- GF Plastics Piping Systems affords high product safety by offering its customers professional training. The courses are clearly defined, structured and designed for the different levels of practical experience and application requirements of participants.
- Our experts are at your side wherever you are and conduct practical training in the various fusion and jointing methods on site. The training duration and program depends on the actual project and the system to be installed.
- Products: PVC/ABS/PP/PE/PVDF

Contact **DWAYNE DUNPHY** for more details @ 086 8533565 or email [dwayne.dunphy@hccl.ie](mailto:dwayne.dunphy@hccl.ie)



We offer different training options for individuals interested in gaining an advanced understanding of Transair products including:

- On site Installation Training Module for contractors
- On site Technical Module for engineers on the benefits of the Transair system

Contact **SEAN BRENNAN** for more details @ 086 8098420 or email [sean.brennan@hccl.ie](mailto:sean.brennan@hccl.ie)

## Type 13LAH Heavy Duty Clamp



Part No.	Size
13LAH-1/2-3/4-TL	1/2" & 3/4"
13LAH-1-11/2-TL	1" & 11/2"
13LAH-2-TL	2"
13LAH-21/2-TL	21/2"

Part No.	Size
13LAH-3-TL	3"
13LAH-4-TL	4"
13LAH-6-TL	6"

## Solid PTFE Gasket/ O ring



Part No.	Size
40MP-G-1/2	1/2"
40MP-G-3/4	3/4"
40MP-G-1	1"
40MP-G-11/2	11/2"
40MP-G-2	2"

Part No.	Size
40MP-G-21/2	21/2"
40MP-G-3	3"
40MP-G-4	4"
40MP-G-6	6"

## CLAMP GASKETS (1" O.D. TO 8" O.D.)(3A)

 <b>O-RING</b> 40MP-U BUNA 40MP-UW BUNA WHITE 40MP-X SILICONE 40MP-E EPDM 40MP-G PTFE 40MP-SFY FKM	 <b>FLANGED (TYPE 2)</b> 40MPF-U BUNA 40MPF-X SILICONE 40MPF-E EPDM 40MPF-SFY FKM	 <b>ENVELOPE (TYPE 3)</b> A40MP-GR PTFE  <b>ALSO AVAILABLE</b> BEVEL SEAT JOHN PERRY
---	--	--

## Solid Tri-clamp Blank



-BPE suffix denotes SFF1 polish finish

Part No.	Size
16AMP-1/2-3/4-BPE	1/2" & 3/4"
16AMP-1-11/2-BPE	1" & 11/2"
16AMP-2	2"
16AMP-21/2	21/2"

Part No.	Size
16AMP-3	3"
16AMP-4	4"
16AMP-6	6"

## Clamp x male adaptor (21MP)



Part No.	Size
38820505	1/2" x 1/2"
3221005	1 x 1/2"
328210	1 x 3/4"
328210A	1 x 1"

**Contact us for details of the full Topline range**

## Clamp x female adaptor (22MP)



Part No.	Size
38830505	1/2" x 1/2"
32831005	1 x 1/2"
328310	1 x 3/4"
328310A	1 x 1"



# Our Partners



# VISUAL INDEX



SS tube &  
Clamps  
Page 2



Ind Ball  
Valves  
Page 3



Inst Air  
Manifold  
Page 4



SS316  
15Opsi  
Page 5



Inst.  
Valves  
Page 6



Parker  
Alok  
Page 7



Plastic  
Push-in  
Page 8



Metal  
Push-in  
Page 10



Function  
Fitting  
Page 11



Brass  
Adaptors  
Page 12



Airline  
Page 14



Blow Gun &  
Recoil Hose  
Page 16



Nuair  
Compressor  
Page 17



Air Prep  
Page 18



Solenoid  
Air / Water  
Page 22



Moduflex  
Page 23



Pneu  
Cylinders  
Page 24



Pneu  
Valves  
Page 27



Gauges  
Page 32



Hoses  
Page 34



Hose  
Clamps  
Page 35



Hose Tail  
Fittings  
Page 36



Brass Comp  
Fittings  
Page 37



Hose Reel  
Page 38



+GF+  
Plastics  
Page 39



Quick  
Coupler  
Page 40



Wash-  
Down  
Page 46



Legris  
Transair  
Page 49



Storage  
Bins  
Page 52



Tri-clamp  
Fittings  
Page 54